

DRIVING A BULLET ON WHEELS



# POPULAR MECHANICS

## MAGAZINE

WRITTEN SO YOU CAN UNDERSTAND IT

REG. TRADE MARK GREAT BRITAIN NO. 40426

**SEPT.  
25 CENTS**



SEE PAGE 375

**PUSH-BUTTON RAILROADING**



**THIS CERTIFICATE and THIS CABLE**



**assure you of  
CERTIFIED RE-WIRING Service**

CERTIFIED RE-WIRING Service means that the wiring system of your car will be put in A-1 condition, to give you better performance, faster pick-up, more economy and greater safety. The Certified Re-Wiring Certificate assures you that the mechanic is *specially trained to do the job right*—and the purple-and-gold carton with the name PACKARD on it assures you that *highest quality Packard cable will be used for replacement*. When your car needs wiring attention, new battery cables or new spark plug cables, go to the service station that uses Packard cable and that can show you the mechanic's Certificate. You'll be better satisfied with the job.



Look for this sign. Hundreds of service stations are already displaying the Authorized CERTIFIED RE-WIRING Service sign. Look for it in your neighborhood. If there is none near you, ask to see the mechanic's Certificate—and demand Packard cable.

**Packard**  
REG. U. S. PAT. OFF.  
TRADE MARK

**THE STANDARD WIRING EQUIPMENT OF THE AUTOMOTIVE INDUSTRY**



# Popular Mechanics Magazine

H. H. WINDSOR, Founder

H. H. WINDSOR, Jr., Editor and Publisher

September, 1939

Vol. 72, No. 3

## IN THIS ISSUE

<u>The Future of Television</u>	321
<u>Push-Button Railroading</u>	328
<u>A Fortune on a Limb</u>	Coloroto
<u>Driving a Bullet on Wheels</u>	348
<u>On the Bridge of a Superliner</u>	354
<u>Science—the Maker of Champions</u>	360
<u>Riches of the Forgotten Mines</u>	366
<u>Taking America's Picture</u>	371
<u>16,000 Miles on \$4.20—Part II</u>	381
<u>Deathtrap Dramas of the Tar Pits</u>	386
<u>Models That Save Lives</u>	392
<u>They Fly without Wings</u>	402
<u>Battling the Green Horde</u>	407
<u>Mercy Flier of the Arctic</u>	412

(Continued on next page)

## Air-Crash Detectives

**F**LAMES burst through the cockpit floor and billow up around the helpless pilot. Out of control, the plane climbs steeply and then plummets into a ravine. After souvenir hunters have picked over the tangled, scorched wreckage, the air-crash detectives arrive. In the brush near by they find a wooden box lid, fire-scarred. This one clue tells them where the fire started, points the way to minor changes in aircraft design that make it impossible for such a tragedy to recur. An article in the October issue tells of these new "G" men, who make flying safer by analyzing accidents.

## Wonders of Ship Surgery

**H**ER side gashed, her plates crumpled by a collision at sea, a big freighter limps to the ship hospital in the nearest port. A tramp steamer goes to the doctor to have seventy tons of seaweed and barnacles shaved off. Ship surgeons "operate" to save a liner high ashore. Read the story of these dry-dock doctors which appears in next month's issue.

## Next Month

**W**HEN Marconi tapped out his first wireless message he didn't guess that doctors would soon be using radio waves to treat disease. Modern science has put strange new tools in the hands of surgeons and physicians. Helium for asthma, X-rays for cancer, infrared to produce artificial fever, sterilizing rays and sulfanilamide. An article in October, "New Weapons to Fight Disease," tells of the amazing progress medical science has made in recent years in its battle for health.

## Touchdown Machines

**B**EEF and brawn made the varsity football teams a generation ago. Today it is brains and speed. And instead of scrimmage, it is machines that train the team—charging machines that measure the lineman's push and prevent the injuries of scrimmaging against "live bait"; forward pass targets, mechanical exercisers, blocking bags—these are the tools of the 1939 varsity coach. Read "Touchdowns in the Making" in next month's issue.

## Ride 'em Cowboy!

**W**HEN you see the rodeo clown capering after a Brahma steer that has just shaken a cowboy into the dust, don't laugh. To the rodeo performers that clown is the official lifesaver of a very dangerous business. An article in October, illustrated by eight pages of Coloroto pictures, takes you out west where the roundups are still wild and the cowboys are still venturesome daredevils.





**CORROSION**  
**ENGINE VARNISH**  
**SLUDGE**  
**STUCK RINGS**  
**CARBON**

**5**

**ENGINE RISKS**

**THAT PYROIL DEFEATS**

Your car may have a world of power today. But every time it operates, its engine faces five serious risks: Carbon, corrosion, "engine varnish," sludge, and stuck rings.

Such creators of engine trouble work costly damage. But if you have safeguarded your car with Pyroil these risks are headed for defeat.

Pyroil is a pure oiliness lubrication product. It is different from your regular lubricant. Your service station or garage attendant adds merely a few ounces to the gasoline tank and the crankcase of your car. Quickly, a super protective film of Pyroil is spread to the internal parts of your engine. It is adsorbed on delicate, vital surfaces of rings, valves, pistons, cylinder walls, shafts and bearings. This unusual Pyroil film dissolves gum which builds up carbon deposits. Carbon is reduced. Corrosion (acid attack that removes metal) is prevented. Engine varnish that can "freeze" and damage a motor is combated. Dangerous, clogging sludge is harmlessly dispersed. Rings do not stick. Your engine operates efficiently.

Remember, Pyroil is a product which has earned world reputation. It is inexpensive. It can give you a better performing car. It may save you many dollars in avoided repairs. Ask to have a few ounces poured in your gasoline tank and crankcase today. Manufactured and Guaranteed by Pyroil Company, W. V. Kidder, Founder, 59 Pyroil Bldg., La Crosse, Wisconsin, U. S. A.



**SIMPLY  
ADD TO  
GAS & OIL**

**FREE!** An interesting and important booklet that every car owner should have, titled, "QUESTIONS AND ANSWERS." Also—an especially INTERESTING OFFER TO YOU if you have not previously used Pyroil. Mail coupon below for these today.

**DISTRIBUTORS:  
CHECK AND MAIL  
COUPON FOR FRAN-  
CHISE FACTS.**

PYROIL COMPANY, 59 Pyroil Bldg.,  
La Crosse, Wisconsin, U. S. A.

Please send me the Free Booklet, "Questions and Answers."  
Also, information about your special offer.

Send details of your plan for Distributors.

Name \_\_\_\_\_

Address \_\_\_\_\_

City \_\_\_\_\_ State \_\_\_\_\_

## (Contents—Continued)

### AUTOMOTIVE

Rotary gas engine has six moving parts.....	326
Auto spring of rubber and steel.....	327
Whistles gauge air volume in compression chamber.....	336
Diesel highway "liner" has Venetian blinds.....	353
Timer for auto ignition flashes neon light.....	358
Hill-hold for brake pedal for left foot.....	364
High-speed valve grinder reaches back to cowl.....	370
Motor bike pedals for telegraph messengers.....	374
Salmon ride in truck over Grand Coulee dam.....	374
Metal clacker warns of flat tire.....	376
Collision switch cuts off ignition.....	380
Seven-foot tire holds 100-pound tube.....	400
Pack animals ride truck to forest fires.....	401
"Liquid coal" runs auto engine.....	410
Five-car trailer train hauls cotton to gin.....	411

### AVIATION

Army plane hides in door of hangar.....	331
Army could fly to Europe fast.....	332
Seaplane beaching gear has its own brakes.....	332
All-weather lights for runways.....	368
Bouncing radio beam warns pilot of danger.....	369
Navy planes are cleaned with live steam.....	384
Chart aids pilot flying by instrument.....	385
Plane brake made of bike parts.....	390
Airplane gets a "shine" before first flight.....	400
Scout plane converted into a bomber.....	405

### BOATS AND BOATING

Paddle wheel raft is latest bathing fad.....	332
"Mother" barge escorts undersea explorers.....	333
Rubber lifeboat for bombers holds ten men.....	359
Aquatic mower cuts weeds in lagoon.....	369
Cement cover turns wrecked ship into pier.....	375

### CONSTRUCTION

Tile applied to wall without cement.....	384
Water helps preserve roof of cinder block house.....	396
Chimneys on truck test heights for draft.....	410

### FARMS

The all-electric farm.....	334
Pea weevil trap helps war on insects.....	353
Products of farm used 400 ways.....	378
Walking-type tractor pulls one-horse plow.....	384
Tree planting on farms doubled since 1935.....	385
Farmer kills weeds and insects with steam.....	401

### HOUSEHOLD

Non-skid cup for house pets.....	331
Clothes rod for shelf holds without screws.....	358
Food chopper with three cutting blades.....	374
Doorbell button says "wait".....	376
Modern house furniture does double duty.....	379
Clothes catcher on ironing board.....	406
Transparent plicofilm covers for furniture.....	416

### MODELS

Five-foot roller skates advertise derby.....	336
Streamline model plane engine has rotating piston.....	336
Tiny lifelike band does everything but play.....	396
Miniature wind tunnel tests model planes.....	411

### RADIO AND ELECTRICITY

Television transmitted on phone lines.....	353
Soundproof Diesel generator installed in truck.....	358
Lighting San Francisco-Oakland Bay bridge.....	377
"Third dimension" effect obtained from two sets.....	396
More wires packed in same size cable.....	400
Radio teaching aids for use in schools.....	455
How to build a two-tube "phantom" record player.....	456
Simplified mechanical push-button tuning.....	458
Practical radio hints.....	459
Noise filter for a.c. or d.c. supply lines.....	460
Portable radio power plant for amateur stations.....	460
Television receiver uses 9-in. cathode-ray tube.....	460
Ultra compact transmitter of advanced design.....	460

### SCIENCE AND INDUSTRY

Some birds can hear only high tones.....	364
Liquid-air demonstrations with egg and cigar.....	365
Diamond dent helps measure rate of wear.....	370



Photo of moon through 82-inch telescope.....	385
Iron "G-man" tracks down other metals.....	391
Luminous page shows sea life.....	415

## SPORTS

Pitchers test speed balls on photoelectric meter....	326
Stunt rider hurdles men and horses.....	368
Alpinists train indoors for scaling mountains.....	397
Paper golf tees carry advertising message.....	406

## TOOLS

Automatic tension wrench limits power of pull....	327
Tool restores threads on worn pipes.....	370
Fireman's metal-cutting torch worn in a vest.....	376
Electric spinner cleans paintbrush.....	378
Transparent plastic pump oiler.....	390
Pocket case packed with data for mechanic.....	391
Trip hammer saw setting tool.....	410

## MISCELLANEOUS

"Electric baton" controls saxophone volume.....	333
"Navigation" lights on bicycle protect rider at night.....	358
Hole in 200-inch mirror aids in focusing.....	359
Gas mask for baby used by mother.....	364
Apple bobbing contest in swimming pool.....	365
"Railbirds" roost on stools at California track.....	368
Robot information office speaks by phone.....	370
Paravane finds marine mines and cuts mooring.....	375
Automatic sight for rifle ends guesswork.....	376
"Filling station" for puppies feeds nine.....	378
Drag detector warns engineer of broken equipment.....	380
"Fish-eye view" of diver snapped from pool.....	380
Electric ironers restore damaged documents.....	390
The human glider.....	398
Megaphone 500 years old had two-mile range.....	405
Steam-operated ice cuber.....	406
Average man's right arm bigger than left.....	416

## (Craftsman and Shop Notes)

## AUTOMOTIVE

Characteristics of hot and cold spark plugs.....	478
Checking motor condition with tire pump.....	478
Repairing flickering headlights.....	478
Supporting fencer guides in vertical position.....	478
Carburetor needle valves dressed in drill press.....	479
Lowering carburetor float level improves mileage.....	479
Rope aids in washing top of car.....	479
Leveling solution in storage battery.....	480
Two-compartment sack for skid chains.....	480

## BOATS AND BOATING

Adjustable footrest for rowboat.....	424
Deadeyes for model ship from sheet rubber.....	439
Boat propeller-shaft bearing from rubber heels.....	443

## CAMPING, HUNTING, FISHING

Emergency fly vise.....	424
Fishhooks strung on safety pin.....	424
Inexpensive fly vise.....	426
Chalk mark repels ants.....	449
Small, folding crawfish nets.....	450
Weighted hook for casting with insect bait.....	450
Bucket float for carrying camp water.....	451
Rubber shield for fishing reel.....	451

## FARM

Large outdoor kettle supported on pipe standards.....	464
Chicken catcher has automatic jaws.....	465
Team hitch to move portable buildings.....	472
Lantern suspended safely on special hanger.....	474

## FURNITURE

Folding picnic table.....	420
Making a Cape Cod cricket chair.....	422
Three little footstools.....	435

## HAND TOOLS

Nail clipper pulls thumbtacks.....	424
Safety razor makes sander.....	424
Calking gun from hand sprayer.....	427
Wrench teeth sharpened with grinding compound.....	440

Center drill has adjustable core.....	464
Screwdriver guide to loosen tight screws.....	472
Turning chisels prevented from rolling.....	472
Gauge aids in filing saw.....	477

## HOME IMPROVEMENTS

Instantaneous water pump fitted with pressure tank.....	443
Sundial over door entrance is attractive.....	454
Working with wallboard.....	466

## HOUSEHOLD

Locating leak in bathroom float.....	420
Non-tipping frame for garbage can.....	424
Gravel-screen door mat catches dirt.....	440
Removing common stains from fabrics.....	441
Bobby-pin easels for photographs.....	449
Garbage-can lid removed easily with long handle.....	451
Solving home problems.....	452

## LAWN AND GARDEN

Lawn mower tires from garden hose.....	424
Trapeze on bird bath.....	424
Iron cover for outdoor fireplace.....	426
Paper tubes protect plants against cut worms.....	451

## OFFICE

Labels made with waterproof adhesive tape.....	420
Simple compass made from cheap ruler.....	424
Letterheads printed on wallpaper.....	450
Fresh mimeograph stencils give clear-cut copy.....	473

## POWER TOOLS

"Step-collet" chuck.....	461
Adjustable lathe jig shapes wood dowels.....	463
Turned parts from sturdy circle cutter.....	473
Pepping up "tired" magnets.....	475

## SPORTS

Wrist guard for archers.....	424
Shelter and table for the beach.....	427
Holder keeps ball and bat together.....	440

## STORE AND SHOP

Office stapling machine used to tack up signs.....	464
Padded clips protect push-truck loads.....	464
Care of hot bearings.....	465
Window signs have flypaper on backs.....	465
Clamp-on socket for shop light.....	474

## TOYS AND NOVELTIES

Savings bank filled by efficient "cashier".....	425
Toy merry-go-round is crank operated.....	439
Fun with toy machine gun.....	449

## MISCELLANEOUS

Sandcraft pictures on wood and glass.....	417
Applying glue uniformly to fretwork.....	421
Lathe-turned candy box has hinged cover.....	421
Shelf brackets anchored in cement block wall.....	426
The "Atlantic"—world's first mountain climber.....	428
Celluloid softened with acid for etching.....	440
Small animals mounted in lifelike poses.....	444
Metal silver-plated with hypo solution.....	450
Tubular rivet pushes needle in repairing harness.....	451
Photo laboratory truck has extension ladder.....	452
Door for beehives made of sawdust.....	454
H-Gauge helps fit floor bridging accurately.....	463
Duster sifts graphite on linotype machine.....	464
Magnet holds oil on machine.....	465
Signwriter's maulstick has level.....	472
Eave gutter provides shelves for small parts.....	474
Smokestack from old hot-water tanks.....	474
Fence posts capped with asphalt roofing.....	477
Repairing a cracked bearing.....	479

## IMPORTANT NOTICE

It is the intention of this magazine to provide its readers with information regarding the latest developments in the mechanical arts. We take no responsibility as to whether the disclosures contained in our articles are covered by patents and advise readers to investigate this subject before making, using, or selling any of the products, machines, or processes described, in order to avoid possible liability for patent infringement.



# How to Make YOUR Body Bring You

# FAME

## Instead of SHAME!

**Will You Let Me Prove I Can Make You a New Man?**

I KNOW what it means to have a body that people pity! I was once a skinny, 97-lb. weakling—such a poor specimen that I was constantly self-conscious, embarrassed. But later I discovered the secret that turned me into "The World's Most Perfectly Developed Man." I'd like to prove that the same system can make a NEW MAN of YOU!

### 7 DAY TRIAL OFFER

I don't say I can do all this for you in 7 days. But I DO want to prove I can show you enough results in even THAT short time to convince you that my system of "Dynamic Tension" will give you the kind of body you have always longed to have!

Do you want powerful shoulders—a fine, deep chest—biceps like iron—arms and legs rippling with strength—a stomach ridged with sinewy muscle—a build to be proud of? Then let me prove that "Dynamic Tension" is what you need.

**FREE BOOK** It costs only a stamp—or a postcard—to mail coupon below. I'll send my new, free book, "Everlasting Health and Strength." It tells about my Dynamic Tension method; shows, from actual photos, how I have developed my pupils—explains about my 7 DAY TRIAL OFFER.

Charles Atlas, Dept. 8J, 115 East 23rd St., New York, N. Y.

*Charles Atlas*

This actual snapshot taken at the beach, shows how I look today.

Mail Coupon Now for **FREE Book**

**CHARLES ATLAS, Dept 8J, 115 East 23rd Street, New York, N. Y.**

I want the proof that DYNAMIC TENSION will help make a new man of me—give me a healthy, husky body and big muscle development. Send me your free book, "Everlasting Health and Strength"—and full details of your 7-DAY Trial Offer.

Name..... (Please print or write plainly)

Address.....

City..... State.....

When writing please mention Popular Mechanics

# ELECTRICAL ENGINEERING

★ ONE YEAR Residence Course prepares you for technical positions

Thorough training in minimum time. Combines theory with practical work in well-equipped laboratories. Experienced faculty and complete facilities provide training essential for interesting technical careers.

Over 7000 Graduates

High employment record is industry's endorsement of Bliss training. Graduates hold responsible technical and engineering positions. Suburban campus; modern buildings; dormitory. Enjoyable student life. 47th year begins Sept. 27. CATALOG. Give age.

# BLISS

**ELECTRICAL SCHOOL**

119 Takoma Ave., Washington, D. C.



# AVIATION APPRENTICES



AIRMINDED YOUNG MEN INTERESTED IN TRAINING FOR ENTERING THE WELL PAID FIELD OF AVIATION AS APPRENTICES—Write immediately, enclosing stamp.

**MECHANIX UNIVERSAL AVIATION SERVICE CO.**

Wayne County Airport, Box 857, Dept. E, Detroit, Mich.



*Learn to Write*

Begin Today. Write for our Free Book, "How to Become a Good Penman." It contains specimens and tells how others learned to write in spare time. Your name elegantly written on a card if you enclose stamp for postage. Write today. The Tamblyn School of Penmanship, Dept. 8, Ridge Blvd., Kansas City, Mo.



## MECHANICAL DENTISTRY AT HOME!

To make Crowns, Plates, Bridgework, etc., for Dentists. Easy practical way to learn mechanical dentistry at home in spare time. FULL EQUIPMENT OF TOOLS AND MATERIALS INCLUDED WITH COURSE. Low tuition. Easy terms. Write for FREE BOOK about this money making profession that is not affected by machine age.

**McCARRIE SCHOOL OF MECHANICAL DENTISTRY**  
207 N. Broad St., Dept. 748, Philadelphia, Pa.



## SUCCEED IN LANDSCAPING

Send for FREE book with full details about landscape training. Study at home, earn while learning. Profitable, healthful career; interesting hobby; men, women. Give age, occupation.

**AMERICAN LANDSCAPE SCHOOL**  
6103 Grand Avenue, Des Moines, Iowa

# LEARN WATCH REPAIRING



AT HOME You can learn by our modern and original system of instruction every part of the Watch Repairing Trade at home. You can earn money while learning and prepare yourself for a well paying position or start in business after completing our course of instruction. Good watch repairers are in demand and generally earn very good salaries. For particulars apply to the Wisconsin School of Watch Repairing 524 E. Mason St., MILWAUKEE, WIS.



# He Climbed—Out of a Mine Shaft Into a Chief Executive's Chair!

THE AMAZING STORY OF A LASALLE STUDENT\*



Back in 1921 I was a laborer with nothing ahead of me, apparently, but the hard life of a laborer. Then I enrolled for LaSalle training in Accountancy. It wasn't easy to study, but discouraged, yet vaguely hopeful, I plugged away.



A year later I went to work in a copper mine, 3800 feet underground, still keeping up my study. If conditions were bad before—they were worse now! But something drove me on, and the encouraging letters from my instructors kept the light of hope burning.



When I was only half-way through I decided to go to Los Angeles and try to get a job. I had had no experience other than my training, which I found actual—not theoretical. Presenting my evidence of study and character, I was employed as assistant book-keeper.



Within the next two years I made rapid progress, and was promoted to the position of office manager, with consequent increases in salary. By this time I had completed my course—the foundation for my complete accountancy knowledge being this splendid LaSalle training.



I decided I would go further. I would be a Certified Public Accountant. I joined an accounting firm and took the LaSalle C. P. A. coaching course. Last May I took the State examination. I passed, I was finally a Certified Public Accountant! My goal had been reached!



I shall never be able to express my gratitude for the opportunity to fight my way from a laborer's job to a C. P. A.'s desk. To any man of intelligence who wants to get out of the rut and succeed, I recommend that he enroll with LaSalle.

## Spare-Time Training Promises Great Rewards Today

**T**HIS true story illustrates what a man can do, who is resolved to get out of a rut and is willing to invest his spare time now for the sake of tremendous dividends later.

Why not take unbiased stock of *your* capabilities? Have *you* the training and knowledge needed to carry you from your present job to a highly-paid future position? If not, you must first equip yourself—to meet fast-changing business conditions that are today rich with opportunity for advancement, greater security and increased income. Not until you can do some one particular thing and do it *well*, are these prizes for YOU.

LaSalle experts will show you how to get

\*Name gladly given on request.

# LASALLE EXTENSION UNIVERSITY

Dept. 964-R **A CORRESPONDENCE IN**

Kindly send me your free booklet on the business field I have checked—and

- |  |  |
|--|--|
| <input type="checkbox"/> Business Management | <input type="checkbox"/> Business Correspondence |
| <input type="checkbox"/> Law                 | <input type="checkbox"/> Commercial Law          |
| <input type="checkbox"/> Traffic Management  | <input type="checkbox"/> Accountancy             |

Name \_\_\_\_\_

Address \_\_\_\_\_

This One



AAYH-S7H-ZUTP



IF MEN WORE  
PRICE TAGS—



**WHAT** you make is an excellent barometer of your value! And a big factor in determining your value is—training!

For over 47 years the International Correspondence Schools have provided training for men who realized that lack of it was a handicap. The courses through which this training is acquired cost over \$5,000,000 to prepare. Written by leading authorities, texts are constantly revised as conditions change. Serious-minded men are invited to check the coupon on the opposite page and mail it—today!





**\$18**



**\$45**

# HOW WOULD YOU FEEL?

## INTERNATIONAL CORRESPONDENCE SCHOOLS

BOX 5554-J, SCRANTON, PENNA.



Without cost or obligation, please send me a copy of your booklet, "Who Wins and Why," and full particulars about the subject *before* which I have marked X:



### TECHNICAL AND INDUSTRIAL SUBJECTS

- |  |   |   |  |   |
|--|---|---|--|---|
| <input type="checkbox"/> Agriculture                     | <input type="checkbox"/> Air Brakes             | <input type="checkbox"/> Civil Engineering        | <input type="checkbox"/> Manufacture of Pulp Paper | <input type="checkbox"/> Sanitary Engineering       |
| <input type="checkbox"/> Air Conditioning and Cooling    | <input type="checkbox"/> Coal Mining            | <input type="checkbox"/> Contracting and Building | <input type="checkbox"/> Marine Engineering        | <input type="checkbox"/> Sheet Metal Work           |
| <input type="checkbox"/> Architectural Drafting          | <input type="checkbox"/> Cotton Manufacturing   | <input type="checkbox"/> Diesel Engineering       | <input type="checkbox"/> Mechanical Drafting       | <input type="checkbox"/> Steam Electric Engineering |
| <input type="checkbox"/> Architecture                    | <input type="checkbox"/> Electrical Engineering | <input type="checkbox"/> Electric Lighting        | <input type="checkbox"/> Mechanical Engineering    | <input type="checkbox"/> Steam Engineering          |
| <input type="checkbox"/> Auto Electric Technician        | <input type="checkbox"/> Fire Boilers           | <input type="checkbox"/> Fruit Growing            | <input type="checkbox"/> Mine Foreman              | <input type="checkbox"/> Steam Fitting              |
| <input type="checkbox"/> Auto Technician                 | <input type="checkbox"/> Heating                | <input type="checkbox"/> Heat Treatment of Metals | <input type="checkbox"/> Navigation                | <input type="checkbox"/> Structural Drafting        |
| <input type="checkbox"/> Aviation Engineering            | <input type="checkbox"/> Highway Engineering    | <input type="checkbox"/> House Planning           | <input type="checkbox"/> Patternmaking             | <input type="checkbox"/> Structural Engineering     |
| <input type="checkbox"/> Boilermaking                    | <input type="checkbox"/> Machinist              | <input type="checkbox"/> Management of Inventions | <input type="checkbox"/> Pharmacy                  | <input type="checkbox"/> Surveying and Mapping      |
| <input type="checkbox"/> Bridge and Building Foremanship | <input type="checkbox"/> R. R. Locomotives      |   | <input type="checkbox"/> Plumbing                  | <input type="checkbox"/> Telegraph Engineering      |
| <input type="checkbox"/> Bridge Engineering              | <input type="checkbox"/> R. R. Section Foreman  |   | <input type="checkbox"/> Radio                     | <input type="checkbox"/> Telephone Work             |
| <input type="checkbox"/> Building Estimating             | <input type="checkbox"/> R. R. Signalmen        |   | <input type="checkbox"/> Refrigeration             | <input type="checkbox"/> Toolmaking                 |
| <input type="checkbox"/> Chemistry                       |   |   |  | <input type="checkbox"/> Ventilation                |
|  |   |   |  | <input type="checkbox"/> Welding, Electric and Gas  |
|  |   |   |  | <input type="checkbox"/> Woolen Manufacturing       |

### BUSINESS SUBJECTS

- |  |  |  |  |   |                                  |
|--|--|--|--|---|----------------------------------|
| <input type="checkbox"/> Accounting              | <input type="checkbox"/> Advertising                 | <input type="checkbox"/> College Preparatory | <input type="checkbox"/> Grade School Subjects | <input type="checkbox"/> Railway Postal Clerk   | <input type="checkbox"/> Signs   |
| <input type="checkbox"/> Bookkeeping             | <input type="checkbox"/> Cost Accounting             | <input type="checkbox"/> C. P. Accounting    | <input type="checkbox"/> High School Subjects  | <input type="checkbox"/> Salesmanship           | <input type="checkbox"/> Spanish |
| <input type="checkbox"/> Business Correspondence | <input type="checkbox"/> First Year College Subjects | <input type="checkbox"/> Foremanship         | <input type="checkbox"/> Illustrating          | <input type="checkbox"/> Secretarial Work       |                                  |
| <input type="checkbox"/> Business Management     | <input type="checkbox"/> French                      |  | <input type="checkbox"/> Lettering Show Cards  | <input type="checkbox"/> Stenography and Typing |                                  |
| <input type="checkbox"/> Cartooning              | <input type="checkbox"/> Civil Service               |  | <input type="checkbox"/> Managing Men at Work  | <input type="checkbox"/> Traffic Management     |                                  |

### DOMESTIC SCIENCE SUBJECTS

- |   |   |  |
|---|---|--|
| <input type="checkbox"/> Advanced Dressmaking | <input type="checkbox"/> Home Dressmaking                       | <input type="checkbox"/> Tea Room and Cafeteria Management, Catering |
| <input type="checkbox"/> Foods and Cookery    | <input type="checkbox"/> Professional Dressmaking and Designing |  |

Name..... Age..... Address.....

City..... State..... Present Position.....

Canadian residents send coupon to International Correspondence Schools Canadian, Limited, Montreal, Canada  
 British residents send coupon to I. C. S., 71 Kingway, London, W. C. 2, England



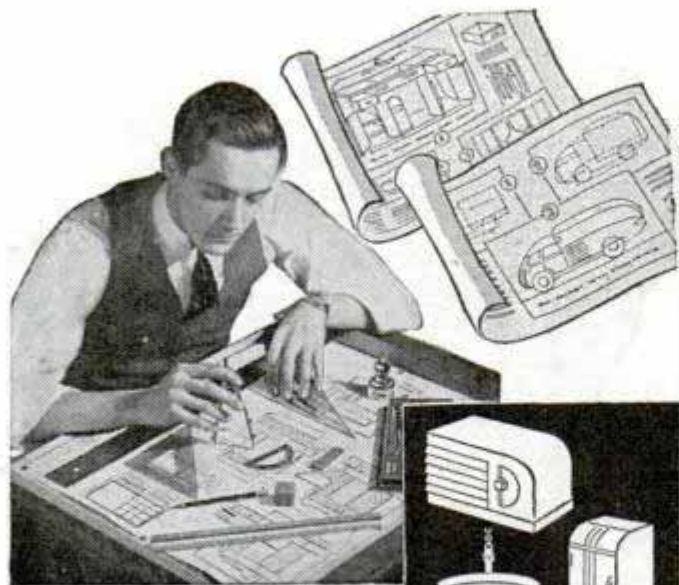

# GET INTO INDUSTRIAL DESIGNING and DRAFTING

Learn to make the drawings and blue prints with which all industry begins; learn also how to create **new designs and new products**. Learn how to improve and re-style old products so they have more "eye appeal," more selling power. Drafting is a very big field, but drafting with industrial designing is twice as big, a fast growing profession, rich in opportunities—if you have the right kind of training. Drafting and industrial designing are related—and you can learn **both** subjects right in your own home, in your spare time. Get your training from a practical engineer, who knows today's market demands, and who trains you quickly, easily, by his tested, practical "Easy Work" method.

## Manufacturers Want MEN

with ideas. Factories must **continuously** bring out new models, new products, and improved designs. Products must be re-styled and improved year after year, season after season, in order to keep up with competitors and demands of the public. Because this field is so large there is a scarcity of trained, skilled designers. The Dobe combination method is ideal for men going into drafting or designing. Extremely valuable for executives, too.

### I'LL TRAIN YOU AT HOME BY THE WORK-JOB METHOD



I can prepare you just as I have trained many hundred successful students from 16 to past 50. No previous experience or special inventive ability needed. High school education replaced by work experience. I'll train you **thoroughly** by applied instruction on actual work until you are competent . . . yes, until you are holding a good paying position. Complete working outfit furnished without extra charge.

### Send for FREE BOOK

"Industrial Designing and Drafting." Mail the coupon for FREE details as to how you can learn Industrial Designing and Drafting. Engineer Dobe, Libertyville, Illinois.

ENGINEER DOBE, Div. 3376, Libertyville, Ill.

Please send me FREE BOOK on "Industrial Designing and Drafting" also please explain how you assist your graduates to good positions in these fields.



Name.....  
 Address.....  
 Town..... State..... Age.....

When writing please mention Popular Mechanics

# GET IN THE SWING with Slingerland . . . DRUMS



GENE KRUPA — World's Greatest Swing Drummer uses Slingerland

tone, easy playing, rich power by musicians. Easy payments. 5-days free trial. See at your dealers.

Cut this ad out—good for \$1.00 credit. Free special information on how to organize drum and bugle corps. Free Catalog—mention instrument wanted.

# GUITARS MANDOLINS

## WONDERFUL VALUE EASY PAYMENTS

Compare the value—tone and power in Slingerland "Radio King" drums, banjos, guitars, mandolins, marimbas or bugles—before you buy. Guaranteed more for your money. Acclaimed the tops in smooth world's leading



**SLINGERLAND DRUM CO.**  
 1330 Belden Avenue Chicago, Illinois

# BE A PASSENGER Traffic Inspector

## Quality for a GOOD JOB in your Spare Time



Our simple, home-study course will train you an Railway and Bus Passenger Traffic Inspector in a few months. On completion we help place you at up to \$135 per month, plus expenses, to start, or refund tuition. Men—19 to 50—get interesting "Success Story." Write

**STANDARD BUSINESS TRAINING INSTITUTE**  
 Div. 209 Buffalo, N. Y.

# AUDELS Carpenters and Builders Guides 4 vols. \$6



Inside Trade Information for Carpenters, Builders, Joiners, Building Mechanics and all Woodworkers. These Guides give you the short-cut instructions that you want—including new methods, ideas, solutions, plans, systems and money saving suggestions. An easy progressive course for the apprentice and student. A practical daily helper and Quick Reference for the master worker. Carpenters everywhere are using these Guides as a Helping Hand to Easier Work, Better Work and Better Pay. To get this assistance for yourself, simply fill in and mail the FREE COUPON below.

### Inside Trade Information On:

How to use the steel square—How to file and set saws—How to build furniture—How to use a mitre box—How to use the chalk line—How to use rules and scales—How to make joints—Carpenters arithmetic—Solving mensuration problems—Estimating strength of timbers—How to set girders and sills—How to frame houses and roofs—How to estimate costs—How to build houses, barns, garages, bungalows, etc.—How to read and draw plans—Drawing up specifications—How to excavate—How to use settings 12, 13 and 17 on the steel square—How to build hoists and scaffolds—skylights—How to build stairs—How to put on interior trim—How to hang doors—How to lath-lay floors—How to paint.



### THEO. AUDEL & CO., 49 W. 23rd St., New York City

Mail Audels Carpenters and Builders Guides, 4 vols., on 7 days' free trial. If O.K. I will remit \$1 in 7 days, and \$1 monthly until \$6 is paid. Otherwise I will return them. No obligation unless I am satisfied.

Name.....  
 Address.....  
 Occupation.....  
 Reference..... P.M.





# Be a Radio Expert

Many make **\$30 \$40 \$50** a week

I will train you at home for many Good Spare Time and Full Time Radio Jobs

**J. E. SMITH, Pres., National Radio Institute**  
Established 25 years  
He has directed the training of more men for the Radio Industry than anyone else.



Broadcasting Stations

Employ managers, engineers, operators, installation and maintenance men for fascinating jobs and pay well for trained men.

**Set Servicing**

Fixing Radio sets in spare time pays many \$5, \$10, \$15 a week extra while learning. Full time repair work pays as much as \$30, \$40, \$50 a week.



**Loud Speaker Systems**

Building, installing, servicing and operating public address systems is another growing field for trained Radio men.



**HERE'S PROOF**



**\$50 Monthly in Spare Time**

"I work on Radio part time, still holding my regular job. Since enrolling seven years ago, I have averaged around \$50 every month." **JOHN B. MORISSETTE**, 809 Valley St., Manchester, N. H.

**Makes \$50 to \$60 a Week**

"I am making between \$50 and \$60 a week after all expenses are paid, and I am getting all the Radio work I can take care of, thanks to N. R. I." **H. W. SPANGLER**, 126 1/2 S. Gay St., Knoxville, Tenn.



**Operates Public Address System**

"I have a position with the Los Angeles Civil Service, operating the Public Address System in the City Hall Council. My salary is \$170 a month." **R. H. ROOD**, R. 136, City Hall, Los Angeles, Calif.



Radio offers you many opportunities for well-paying spare time and full time jobs. And you don't have to give up your job, leave home or spend a lot of money to train to get these jobs—to become a Radio Expert.

**Get Ready Now for Jobs Like These**

Radio broadcasting stations employ engineers, operators, station managers and pay well for trained men. Fixing Radio sets in spare time pays many \$200 to \$500 a year—full time jobs with Radio jobbers, manufacturers and dealers as much as \$30, \$40, \$50 a week. Many Radio Experts open full or part time Radio sales and repair businesses. Radio manufacturers and jobbers employ testers, inspectors, foremen, engineers, servicemen, in good-pay jobs with opportunities for advancement. Automobile, police, aviation, commercial Radio, loud speaker systems are newer fields offering good opportunities now and for the future. Television promises to open many good jobs soon. Men I trained have good jobs in these branches of Radio. Read how they got their jobs. Mail coupon.

**Why Many Radio Experts Make \$30, \$40, \$50 a Week**

Radio is young—yet it's one of our large industries. More than 28,000,000 homes have one or more Radios. There are more Radios than telephones. Every year millions of Radios get out of date and are replaced. Millions more need new tubes, repairs. Over \$50,000,000 are spent every year for Radio repairs alone. Over 5,000,000 auto Radios are in use; more are being sold every day, offering more profit-making opportunities for Radio experts. And RADIO IS STILL YOUNG, GROWING, expanding into new fields. The few hundred \$30, \$40, \$50 a week jobs of 20 years ago have grown to thousands. Yes, Radio offers opportunities—now and for the future!

**Many Make \$5, \$10, \$15 a Week Extra in Spare Time While Learning**

The day you enroll, in addition to our regular Course, I start sending Extra Money Job Sheets; show you how to do Radio repair jobs. Throughout your training I send plans and directions that made good spare time money—\$200 to \$500—for hundreds, while learning.

**Here's How You Get Practical Experience While Learning**

I send you special Radio equipment; show you how to conduct experiments, build circuits illustrating important principles used in modern Radio receivers, broadcast stations and loud-speaker installations. This 50-50 method of training—with printed instructions and working with Radio parts and circuits—makes learning at home interesting, fascinating, practical. I ALSO GIVE YOU A MODERN, PROFESSIONAL ALL-WAVE, ALL-PURPOSE RADIO SET SERVICING INSTRUMENT to help you make good money fixing Radios while learning and equip you with a professional instrument for full-time jobs after graduation.

**Money Back Agreement Protects You**

I am so sure I can train you to your satisfaction that I agree in writing to refund every penny you pay me, if you are not satisfied with my Lessons and Instruction Service when you finish. A copy of this agreement comes with my Free Book.

**Find Out What Radio Offers You**

Act Today. Mail the coupon now for "Rich Rewards in Radio." It points out Radio's spare time and full time opportunities and those coming in Television; tells about my training in Radio and Television; shows you letters from men I trained telling what they are doing and earning. Find out what Radio offers YOU! MAIL COUPON in an envelope, or paste on a postcard—NOW!

J. E. SMITH, President  
Dept. 9JP, National Radio Institute  
Washington, D. C.

**THIS FREE BOOK HAS HELPED HUNDREDS OF MEN MAKE MORE MONEY**



**This Coupon is Good For One FREE Copy of My Book**

J. E. SMITH, President, Dept. 9JP  
National Radio Institute, Washington, D. C.

Dear Mr. Smith: Without obligating me, send "Rich Rewards in Radio," which points out the spare time and full time opportunities in Radio and explains your 50-50 method of training men at home in spare time to become Radio Experts. (Please Write Plainly.)

NAME.....AGE.....  
ADDRESS.....  
CITY.....STATE.....



# 3 Grades of

## Each One Marking a

### Grade School Graduate



After I had completed the College Preparatory course with the American School I was admitted to Indiana University where I made a general average of 90. I was told by my professors that I had the "study habit" and was better able to carry college work than many graduates of resident high schools. The courses given by the American School were so thorough and complete that my foundation for advanced work was adequate and strong enough to stand the tests.—DELMORE LIGGETT, Rising Sun, Indiana.

The man with only grade school education starts at \$400 a year, averages only \$1,265 a year over a period of 40 working years. Today no ambitious man need be chained

down to low pay by grade school education. In your own home you can get expert help and complete your high school course or prepare for drafting, Diesel, air conditioning, etc., and get ready to earn more money.\*

### High School Graduate



I graduated from high school in June, 1936, and in October, 1937, enrolled in your Engineering Course just a little over a year ago; and I am writing you today telling you of the wonderful things which have happened to me since that day when I enrolled. I have studied hard and consistently and according to your instructors have earned good grades and have progressed rapidly. This rapid progress has been made possible by the methods "American School" uses and the splendid manner in which your instructors handle any special inquiries or problems which may confront the student.

Very recently I did the major part of the Designing, Drawing and Detailing of a device which has been patented by one of the world's leading automotive truck manufacturers. This device is being used now by the Motor Truck Corporation and they have made the statement that it saves them \$13 on every unit they produce. I will not be 21 years of age until next Spring and expect by that time to have completed my course and have my "American" diploma which I will be mighty proud of.—EDWARD H. McCLELLAND, Cleveland, Ohio.

High School graduate starts at \$900 a year, averages \$2,112 over a 40-year period. This means that *High School education to average persons is an actual cash earning of \$847 above earning of the average grade school graduate.* A High School graduate

not only has bigger jobs open to him, but he can go on to college, prepare for teaching or other professions, or for leadership in business or industry. High School education definitely increases your opportunities for advancement and your earning ability!\*

### College or Vocational Training



From a practical standpoint I can truthfully say that my study of the course accomplished for me all I ever hoped it could and even more. As evidence of this, I submit the fact that at 30, I am now employed as auditor and accountant in a position of trust at compensation more than double what I was receiving at the time of my enrollment.—L. V. PEART, Ogden, Utah.

The man with college education or some other form of specialized training starts at \$1,400 a year, is earning \$5,000 at the age

of 49—or an average of \$3,425 a year. He is a leader in his community, has a good car,

and a comfortable home. You can get ready for opportunities open to Architect, Business Manager, Mechanical Engineer, Professional Accountant, etc., through expert methods of preparation available in your own home, and get the knowledge that will open the way to the higher paid jobs!\*

\*Figures from Government report.

**Mail the Coupon for a Free Lesson**



# Applicants—

## Definite Promotion Step

### Step Up to a Better Job by Stepping Up Your Fitness for It

You think in words but you cannot think, write or speak in words you do not know.

How about your job? What you think and do is limited to things you know. Every new task or operation—every new job—is a new lesson to be learned, and your grading on that lesson definitely measures your efficiency. You should make it your first order of business to learn everything you possibly can about your present job. Do not be satisfied with just getting by. Become the best informed person on that kind of work in your office or plant.

Next consider the job ahead. Study up on the principles of the new work. Learn all you can about it so when there is an opening and you are offered the chance to step up you will be prepared to make good. All of us are on trial at all times.

#### Don't Be Handicapped

There are jobs and opportunities today in such active fields as Air Conditioning, Diesel, Drafting, Accounting, Merchandising, etc. *These jobs—these opportunities—are open only to trained men.* That's why thousands of ambitious men are taking American School's courses—are spending a few hours a week getting ready to earn more money.

American School graduates hold important positions as architects, engineers, accountants, superintendents,

draftsmen, foremen, managers, etc., or successfully operate their own business. Hundreds of our High School graduates have entered colleges, universities, normal schools, etc., have attained success in business and industry.

Without obligation send for a beginning lesson. Spend an evening reading it and you will be surprised at how much you can learn in only one hour. You will find out how other fellows are making good—earning promotion.



### Try a Lesson Yourself—No Obligation

**American School, Dept. G645, Drexel Ave. at 58th St., Chicago**

I have checked the line of work in which I would like a good job. Please send me without expense or obligation on my part a copy of your Bulletin and an early lesson in the field I have selected.

- |  |   |   |
|--|---|---|
| <input type="checkbox"/> Air Conditioning                | <input type="checkbox"/> Electrical Engineering         | <input type="checkbox"/> Law                    |
| <input type="checkbox"/> Architecture                    | <input type="checkbox"/> Diesel Engineering             | <input type="checkbox"/> Liberal Arts (College) |
| <input type="checkbox"/> Automotive Engineering          | <input type="checkbox"/> Drafting and Designing         | <input type="checkbox"/> Mechanical Engineering |
| <input type="checkbox"/> Automobile Repairing            | <input type="checkbox"/> Electric Refrigeration         | <input type="checkbox"/> Merchandising          |
| <input type="checkbox"/> Bookkeeping and Cost Accounting | <input type="checkbox"/> Heating, Ventilating, Plumbing | <input type="checkbox"/> Private Secretary      |
| <input type="checkbox"/> Business Management             | <input type="checkbox"/> Professional Accounting        | <input type="checkbox"/> Radio and Television   |
| <input type="checkbox"/> Civil Engineering               | <input type="checkbox"/> Incl. C. P. A. Coaching        | <input type="checkbox"/> Salesmanship           |
| <input type="checkbox"/> Aviation                        | <input type="checkbox"/> High School                    | <input type="checkbox"/> Shop Practice          |
| <input type="checkbox"/> Contracting, Building           | <input type="checkbox"/> Highway Engineering            | <input type="checkbox"/> Steam Engineering      |
|  |   | <input type="checkbox"/> Shop Management        |

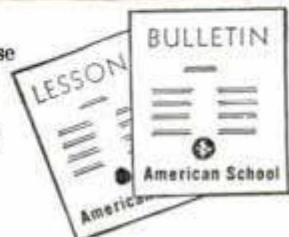

Name..... Age..... Occupation.....

Street..... City..... State.....



# TRAIN FOR ELECTRICITY IN 12 WEEKS

BY ACTUAL WORK ON MOTORS, GENERATORS, ENGINES Etc.

## PAY TUITION AFTER GRADUATION

*I'll Finance  
Your Training*  
IF YOU'RE SHORT OF MONEY



Mail coupon today for details of my "Pay after graduation plan" and famous Coyne "Learn by Doing" method of practical shop training for your start for success in this big-pay field. Age or lack of money need not hold you back . . . If you are short of money you can get training first—then pay for most of it in small monthly payments after you graduate.

### LEARN BY DOING IN 12 WEEKS IN COYNE SHOPS

Coyne Training is practical training, easy to grasp . . . you learn quickly by doing actual jobs on real electrical machinery in my shops. Not by books—not a correspondence or a home study course—you are trained right here in my big Chicago training shops. You don't need previous experience or a lot of book learning. Expert instructors guide you every step of the way. Start any time.



### EARN WHILE LEARNING Job Help After Graduation

Big things ahead in Electricity mean steady jobs, good pay, and a real future for many trained men in this fascinating "live" industry. Thousands of opportunities. Rush the coupon TODAY for Big Free Book with many photos of the great Coyne Shops in Chicago—Opportunities in Electricity—How we can train you for your start in this field and let you pay your tuition after graduation in easy monthly payments. If you need part time work to help with living expenses my employment department will help you. After graduation you will be given Free lifetime employment service.

### DIESEL, ELECTRIC REFRIGERATION AND AIR CONDITIONING TRAINING

Now included at no extra cost. Take advantage of this training to increase your earning capacity.

### GET MY STORY

I have a mighty interesting story to tell about my school that will interest any fellow who wants to get ahead . . . Fill in the coupon today and mail it to me and you'll get my big FREE Catalog and all the facts.



*H. C. Lewis*  
H. C. LEWIS, President,  
Coyne Electrical School,  
500 S. Paulina Street, Dept. 69-72C, Chicago, Ill.  
Send me, without cost or obligation, your Big Free Book and details of Pay-Tuition-After-Graduation-Offer.

NAME .....

ADDRESS .....

CITY .....

STATE .....

When writing please mention Popular Mechanics

## BOEING SCHOOL PREPARES FOR TOP JOBS

Boeing School training, in 11 thorough ground and flying courses, commands world-wide respect from air executives. Separate courses for college and high school graduates. Enter any quarter, limited enrollment, 30 full-time instructors, unexcelled equipment. 85% of graduates employed. Big demand for trained pilots and meteorologists. U. S. - approved school. Owned and operated by United Air Lines. Ask for Bulletin. 7099 Hangar 5, Airport, Oakland, California.



### SCHOOL OF AERONAUTICS

### ENGINEERING DEGREE IN TWO YEARS

B. S. Degree courses in engineering: Electrical, Civil, Chem., Mechanical, Radio and Television, or Aeronautical. 1 yr. Mech. Drafting. Intense, practical, thorough program. Large industrial center. Prep courses without extra charge. Earn board if desired. Low tuition and living costs. Enter September 5, December, March, June. Write for Catalog.

239-A E. Washington Blvd., Fort Wayne, Ind.

### INDIANA TECHNICAL COLLEGE

## LAW STUDY AT HOME

Legally trained men win higher positions and bigger success in business and public life. Greater opportunities now than ever before. Big corporations are headed by men with legal training.

More Ability: More Prestige: More Money

We guide you step by step. You can train at home during spare time. Degree of LL. B. Successful graduates in every section of the U. S. We furnish all text material, including 14-volume Law Library. Low cost, easy terms. Get our valuable 48-page "Law Training for Leadership" and "Evidence" books FREE. Send for them NOW.  
LaSalle Extension University, Dept. 964-L Chicago  
A Correspondence Institution



### Learn How to Write

Write for my Free Book, "HOW TO BECOME an EXPERT PENMAN," which shows how others became experts by my Method. Supplies furnished to students. Your name elegantly written on a card if you enclose stamp. Write Today. T. M. TEVIS, Box 25K, CHILLICOTHE, MO.

### Learn Public Speaking

At home—in spare time. Many overcome "stage-fright," gain self-confidence and increase earning power, this easy way. Write for free booklet, *How to Work Wonders With Words* and requirements.  
North American Institute, Dept. 1356  
3601 Michigan Ave., Chicago, Illinois



### CARTOONING

FREE TRIAL LESSON! Cash in on your sense of humor—AT HOME—BY MAIL. Have fun! Make money! No experience needed to start. Write today for FREE LESSON, mailed postpaid. No obligation.  
Moon Gag-Cartoon School, Dept. A, Fall Creek, Wis.

# Coffee Agents MAKE! MONEY!

Own a steady route; full or part time. Make money at once and all year 'round with Coffee, Teas, Spices and other home necessities—over 200 nationally known, guaranteed products. Complete Outfit, including large assortment of full size packages—FREE to reliable persons. Old-established company. Write quick for details of my Free Offer. E. J. Mills, 7844 Monmouth Ave., Cincinnati, Ohio.





**MEN** — If you are mechanically inclined and interested in

# DIESEL

**INVESTIGATE**

the Hemphill Diesel training programs, which have been developed over a period of years and represent the accumulated experience of many American and European Diesel engineers.

**PRACTICAL**

Diesel and Diesel-electric training. . . You may start the course at home, and complete it in any of the shops and laboratories operated by the Hemphill Schools—America's Original Exclusive Diesel Training Institution.

**INTERESTING**

You will find Hemphill Diesel training practical — absorbing — useable. Your training includes work on industrial, transport and marine engines—installation, repairs and operation. The "March of Diesel" describes the various courses.



## HEMPHILL DIESEL SCHOOLS

All communications concerning enrollment in any of the Hemphill Diesel Courses should be sent to one of the following addresses:

- NEW YORK . . . 31-26 Queens Blvd., L.I.C.
- CHICAGO . . . . . 2014 Larrabee Street
- MEMPHIS . . . . . 417 Monroe Avenue
- LOS ANGELES . . . 2120 San Fernando Rd.
- VANCOUVER, B.C. . . . 1363 Granville St.

Applications for enrollment will be accepted from English speaking students residing in foreign countries. Write for special terms.

**Hemphill Diesel Schools** (use nearest address)  
Please send data on your Diesel courses, also copy of the booklet "March of Diesel."

NAME \_\_\_\_\_ AGE \_\_\_\_\_  
STREET \_\_\_\_\_  
CITY \_\_\_\_\_ STATE \_\_\_\_\_





# DRAFTING

**BOOKS SENT FREE!**

**ON APPROVAL**  
**5 VOLUMES BRAND NEW EDITION**  
 Only 15 minutes a day with these WONDER BOOKS can prepare you for a good drafting job in less than a year. Mechanical and architectural drafting from simple straight lines to important complex plans. *A step at a time!* Built especially for beginners, for men with only grammar schooling. Drafting room practice, PLUS ENGINEERING, made easy and clear. Includes complete information on blue print reading for building and machine trades.

**Big Field Big Demand Big Pay**  
 Competent draftsmen are urgently needed right now in all building and manufacturing lines at \$30.00 to \$75.00 a week. That's just the beginning—FOR DRAFTSMEN HAVE THE BEST CHANCES FOR ADVANCEMENT. Pleasant, fascinating work, easy to learn and do. Learn quickly with these books—send coupon for a set and see for yourself.

*A year's consulting membership in the American Technical Society now given to all readers of this famous cyclopedia of drafting. Many say that it is worth more than the cost of the books.*

Complete set of drawing instruments if you send for these drafting books NOW. These instruments are made of the finest of German silver, are absolutely accurate and are packed in velvet lined leatherette pocket case. Real \$10 value, but included with these books.

**AMERICAN TECHNICAL SOCIETY**  
 Dept. D619, Drexel at 58th St., Chicago, Ill.

American Technical Society, Dept. D619, Drexel at 58th St., Chicago, Ill. Send for 10 days' trial New 5 volume set of drafting. I will pay the few cents delivery charges. If I wish, I may return books in 10 days and owe you nothing but if I decide to keep them, I will send \$2.00 after 10 days, then only \$3.00 a month until \$24.50, the advertising price, is paid. Send latest edition and include drawing instruments and Membership Certificate.

Name.....  
 Address.....  
 Attach letter stating age, occupation, employer's name and address and that of at least one business man as a reference.

## For Beginners or Experts

Written, so you can understand every word, by 22 well known engineers and architects. De-Luxe flexible binding, nearly 2,000 pages, 1546 blueprints, charts and diagrams; prepares you for a good drafting job in mechanical or architectural lines. Sent for 10 days' free use if you mail coupon immediately.

## These Instruments Included



# Learn this Profitable Profession



## in 90 Days at Home

Hundreds of men and women of all ages 18-50 make \$10.00 to \$20.00 in a single day giving scientific Swedish Massage and Hydro-Therapy treatments. There is a big demand from Hospitals, Sanitariums, Clubs, Doctors and private patients as well as opportunities for establishing your own office.

Learn this interesting money-making profession in your own home by mail, through our home study course. Same instructors as in our NATIONALLY KNOWN resident school. A diploma is awarded upon completion of the course. Course can be completed in 3 to 4 months. High School training is not necessary. Many earn big money while learning.

## Anatomy Charts & Booklet FREE

Enroll now and we will include uniform coat, medical dictionary, patented reducing roller and Hydro-Therapy supplies without extra cost. The reducing course alone may be worth many times the modest tuition fee.

Send coupon now for Anatomy Charts and booklet containing photographs and letters from successful graduates. These will all be sent postpaid—FREE.



THE College of Swedish Massage (Successor to National College of Massage) Dept. 664—30 E. Adams St., Chicago.

You may send me FREE and postpaid, Anatomy Charts, booklet containing photographs and letters from graduates, and complete details of your offer.

Name.....  
 Address.....  
 City..... State.....

# A GOOD LIVING FROM POULTRY



with a business of your own. How to start small way, spare time, grow from profits, or prepare for good job in large poultry plant. Harry M. Lamon, nationally known Poultry Expert, shows latest scientific methods, money making secrets in poultry raising. His system of home study training used by thousands. Endorsed by many colleges and leading Poultrymen. Established 20 years. Write today for his big FREE BOOK "How To Raise Poultry For Profit". Shows way to real business opportunity. Harry M. Lamon, Pres.

**NATIONAL POULTRY INSTITUTE**  
 DEPT. 50-A ADAMS CENTER, N. Y.

# TRI-STATE COLLEGE

**B. S. Degree in 2 Years**  
 World famous for technical 2-year courses in Civil, Electrical, Mechanical, Chemical, Radio, Aeronautical Engineering, Business Administration and Accounting. Special preparatory department for those who lack required high school work. Short diploma courses (36 weeks) in Surveying, Drafting. Low tuition. Low living costs. Students from every state and many foreign countries. 56th year. Graduates successful. Enter September, January, March, June. Write for catalog. 499 College Ave., ANGOLA, IND.

# EARN MONEY at Home

Make delicious, new "NON-GREASY" Potato Chips at low cost. We furnish equipment and instructions. Potatoes plentiful and cheap. Groceries, markets, restaurants, taverns do the retailing for you. Profit large—unusually so. You can start this money-making business on a "next to nothing" outlay of cash. Write for Potato Chip Booklet.  
**LONG-EAKINS CO., 928-S. High St., Springfield, O.**

# Get this NEW AUTO RACING BOOK

**BRAND NEW, 5th Edition.** Tells how to layout & build Engines, Frames & Bodies for fine dirt track cars. How to Rebuild cars & engines; Superchargers, etc., H.P. curves for Ford AB & V8. International formula—midget racing car plans & information worth 5 times cost of book. Get this great Book NOW—be up-to-date on all racing car information. \$1 Postpaid, or \$1.15 C.O.D.  
**RAY F. KUNS, Dept. B-3, Madisonville, Cincinnati, Ohio**

# Correspondence Courses in RADIO and ELECTRICAL ENGINEERING

**LOW AS \$25**  
**ELECTRICAL ENGINEERING.** Get good grasp of wide electrical field. Modern. Very understandable. Theory made easy.  
**RADIO ENGINEERING.** Extra fine course in radio, public address, photo-electric work. Trains you to be super-service man, real vacuum tube technician. Tuition ONLY \$25, either course. Deferred payment plan. Experiment kits furnished.  
**FREE LINCOLN ENGINEERING SCHOOL. Box 931-P9, Lincoln, Nebr.**

Greater opportunities now in advertising. Learn easily and quickly in spare time. Practical work. No text books. Old established school. Low tuition—Easy terms. Send for free booklet and requirements.  
**Page-Davis School of Advertising**  
 Dept. 1356, 3601 Mich. Av., Chicago

# RADIO ENGINEERING

broadcasting, aviation and police radio, servicing, marine and Morse telegraphy taught thoroughly. 48 weeks' engineering course equivalent to three years' college radio work. School established 1874. All expenses low. Catalog free.  
**Dodge's Institute, Ada St., Valparaiso, Ind.**

# STOP THAT SLAM!

**AMAZING INVENTION STOPS SLAMMING DOORS**  
**KANT-SLAM** closes heaviest doors silently, positively, automatically. Prevents slamming or leaving doors open. Hydraulic action. Lasts many years. Easily installed. **LOW PRICED.** Real Demonstrator Purchased. We supply actual KANT-SLAM on quick sales to stores, offices, carried miniature door. You make big money on building can use 1 to 20! Free Demonstrator to workers. Write! Get free details.  
**KANT-SLAM CO. Dept. N-53 Bloomfield, Ind.**



**PAYS BIG PROFITS DAILY!**





## Be Your Own MUSIC Teacher

**LEARN AT HOME** by wonderful improved method. Simple as A-B-C—a child can learn it. Your lessons consist of real selections, instead of tiresome exercises. Each of these delightfully easy lessons adds a new "piece" to your list. You read real notes, too—no "numbers" or trick music. Method is so thorough that many of our 700,000 students are band and orchestra LEADERS.

### Be Popular

Everything is in print and pictures. First you are told what to do. Then a picture shows you how. In a few short months you may become an excellent musician—the life of every party!

**Free Book and Demonstration Lesson** Write at once for our illustrated Free Book and Free Demonstration Lesson. Please mention your favorite instrument. No obligations. Instruments supplied when needed, cash or credit. (Fortieth Year—Est. 1898.)

### U. S. SCHOOL OF MUSIC

79 Brunswick Bldg., New York City, N. Y.

#### Pick Your Course

- |                          |                           |
|--------------------------|---------------------------|
| Piano                    | Guitar                    |
| Violin                   | Saxophone                 |
| Organ                    | Mandolin                  |
| Cornet                   | Ukulele                   |
| Trombone                 | Harp                      |
| Piccolo                  | Clarinet                  |
| Flute                    | Cello                     |
| Hawaiian Steel Guitar    | Trumpet                   |
| Piano Accordion          | Plain Accordion           |
| Voice and Speech Culture | Modern Elementary Harmony |
| Drums and Traps          |                           |

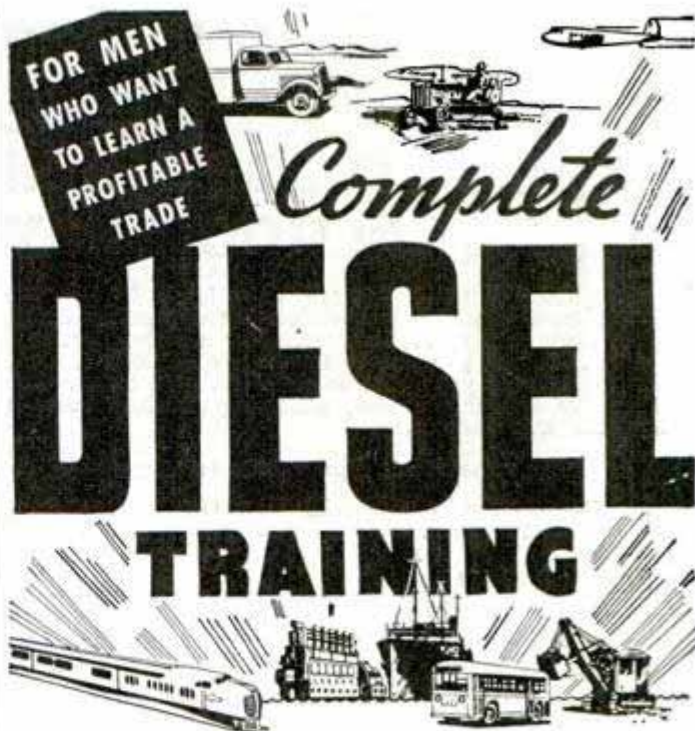

**NO MATTER WHERE YOU ARE OR WHAT YOU DO —we have a training plan for YOU!**

If you are sincerely ambitious and interested in making good in the Diesel field, be sure to immediately investigate our flexible training plan that will fit your circumstances. A Plan for every Man. A Plan for those seeking immediate shop training as well as for those who cannot give up their present employment and income. For 34 years National Schools, a recognized leader in the field of trade education, has helped wide-awake men to success. This million-dollar trade school will supply you with a sincere, honest statement of facts of what you should do to quickly get into the profitable Diesel Industry. No exaggerations—no misstatements; and a definite plan to fit you.

**Write Today for Full Details**

Mail the coupon below. Find out how you can get the finest in Diesel training without delay. See how this great trade school operates and makes its facilities available to every ambitious man. Actual work in modern training shops, a part of every man's instruction. Shop methods time-tested for 34 years. Fascinating, efficient preparation. Get the facts.

**WE ARE DEFINITELY INTERESTED IN HELPING MEN OF LIMITED INCOME AND "BLIND ALLEY" JOB HOLDERS.**

## Regain Perfect Speech, If You STAMMER

Send today for beautifully illustrated book entitled "DON'T STAMMER," which describes the Bogue Unit Method for the scientific correction of stammering and stuttering. Method successfully used at Bogue Institute for 38 years—since 1901. Endorsed by physicians. Full information concerning correction of stammering sent free. No obligation. Benjamin N. Bogue, Dept. 1306 Circle Tower, Indianapolis, Indiana.

## Learn PHOTOGRAPHY at Home

Splendid opportunities. Prepare in spare time. Easy plan. No previous experience needed, common school education sufficient. Send for free booklet "Opportunities in Photography", particulars and requirements.

**American School of Photography**  
3601 Michigan Ave., Dept. 1356, Chicago, Ill.

## CARTOONING PAYS WELL

Exclusive instruction by a famous cartoonist makes it easy to learn at home. Write for Free Booklet describing details of the course.

**NATIONAL SCHOOL OF CARTOONING**  
439 Penton Bldg. Cleveland, Ohio

## AN AVIATION CAREER OFFERS YOU GREAT FUTURE!



Demand for trained aircraftmen is increasing and already exceeds supply. Curtiss-Wright Tech, Aviation's foremost school, is located on Grand Central Air Terminal in heart of the aircraft industry and specializes in training MASTER MECHANICS and AERONAUTICAL ENGINEERS. (No flying involved.) Graduates are obtaining immediate employment. Write for details NOW. Dept. PM-9.

**CURTISS - WRIGHT TECHNICAL INSTITUTE**  
Glendale (Los Angeles) California

## NATIONAL SCHOOLS

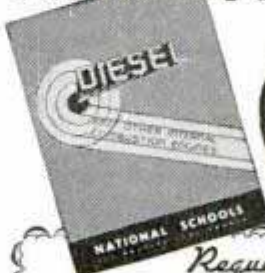

**FREE BOOK**

*Los Angeles*

### Request for Free Book

**NATIONAL SCHOOLS** (established 1905) Dept. 9-PMA  
4000 South Figueroa Street, Los Angeles

Please send me, without obligation, your **FREE BOOK** and information regarding Diesel Employment Opportunities and Requirements.

NAME \_\_\_\_\_ AGE \_\_\_\_\_

ADDRESS \_\_\_\_\_ CITY \_\_\_\_\_ STATE \_\_\_\_\_



# M ECHANICS-WELDERS - COLLISION MEN

## GOOD JOBS and Mighty GOOD PAY

Do you want to earn big money? If so let us know which of the following trades you prefer. You learn by doing. Practical work. Expert teachers. Low tuition. Personal attention. It will pay you to investigate AT ONCE. Just check the courses you'd like to take and mail today. You will receive full information, absolutely without cost or obligation. But don't delay.

**Check the Trade You'd Like to Learn**

- |   |   |
|---|---|
| <input type="checkbox"/> Complete Auto Mechanics (including Diesel) | <input type="checkbox"/> Electric Arc and Acetylene Welding |
| <input type="checkbox"/> Auto Collision                             | <input type="checkbox"/> Spray Painting                     |
| <input type="checkbox"/> Metal Finishing                            | <input type="checkbox"/> Body and Fender Bumping            |

Ask about our "Pay After Graduation Plan"

Name .....

Address .....

Mail the above at once to

**MICHIGAN TRADE SCHOOL** Write for FREE FOLDER  
3758 Woodward Ave. Detroit, Mich.

## This MACHINISTS' Home-Study Course helps men get ahead



Newly assembled—specially priced—these five recent books give you the practical facts on modern machines, up-to-date methods, you need to advance in machine shop work. Take advantage of the other man's experience as found in books, to solve your problems, increase your efficiency, with

### The NEW AMERICAN MACHINISTS' LIBRARY

5 volumes—2014 pages—1853 illustrations

(A combined home-study course and reference library)

This library of machine shop practice was written for practical men. It gives you the best methods for every kind of machine shop work. It fully explains lathes, drills, and other machine tools and their operation, automatic screw machines, speeds and feeds, gear design and production, punch and die work, metal surfacing, etc., etc. Plainly written—completely illustrated—the best kind of help to the machine shop man who wants to advance himself.

No money down—special price—easy payments.

#### EXAMINATION COUPON

McGraw-Hill Book Co., 330 W. 42nd St., New York

Send me for ten days' examination the new American Machinists' Library. If satisfactory I will send you \$1.50 in 10 days and \$3.00 monthly until the price of \$16.50 is paid. If not wanted, I will return the books postpaid. (To insure prompt shipment write plainly and fill in all lines.)

Name.....  
Home Address.....  
City and State.....  
Position.....  
Name of Company..... PM-9-39

## CLIMBING AHEAD

THESE DAYS IS *tough going...*

... BUT... consider the hundreds of men now in Aviation who started their careers with Aero I.T.I. training. You may be right where these men once were—wondering how to get ahead faster. If so, you owe it to yourself to find out about the training that has placed so many men in the rapidly expanding Aviation industry. During one 60 day period 126 Aero I.T.I. trained men were placed with one aircraft plant alone!

**Find Out** about Aero I.T.I. training. Choice of three courses in Aircraft Mechanics, two in Aeronautical Engineering. You can take full-time courses at the school, or start your training at home. For full details, write NOW

**AERO INDUSTRIES TECHNICAL INSTITUTE**  
5253 West San Fernando Road • Los Angeles, California

## Free • DRAFTING

More good jobs now in Drafting. Learn AT HOME in spare time (or at our Chicago School). Send postcard for FREE TRIAL LESSON and see how easy to learn and get a good job.

**CHICAGO TECHNICAL COLLEGE**  
M-200 Tech. Bldg., 118 E. 26th St., Chicago, Ill.

## Want a CAREER in Photography?

Let us train you to become an expert. Fascinating opportunities in Commercial, News, Portrait, Advertising, Natural Color and Motion Picture photography. Individual instruction by recognized authorities. Personal Attendance and Home Study courses. Free booklet.

**NEW YORK INSTITUTE OF PHOTOGRAPHY**  
10 West 33 St., Dept. 49, New York City

### Operator No. 38

### FOLLOW THIS MAN

Secret Service Operator No. 38 is on the job! Running down dangerous Counterfeit Gang. Tell-tale finger prints in murdered girl's room.

**Free** The Confidential Report Operator No. 38 made to his chief. Write for it.

**Earn a Regular Monthly Salary**

YOU can become a Finger Print Expert at home, in your spare time, at small cost. Write for confidential full report and details. Literature will be sent only to persons stating their age.

**INSTITUTE OF APPLIED SCIENCE**  
1920 Sunnyside Ave., Dept. 1356 Chicago, Ill.

## VOICE

100% Improvement Guaranteed

We build, strengthen the vocal organs—not with singing lessons—but by fundamentally sound and scientifically correct silent exercises... and absolutely guarantee to improve any singing or speaking voice at least 100%... Write for wonderful voice book—sent free. Learn WHY you can now have the voice you want. No literature sent to anyone under 17 years unless signed by parent.

**PERFECT VOICE INSTITUTE, Studio 1356**  
64 E. Lake St., Chicago

## JOBS in RADIO-TELEVISION

Extension and resident training in television, aviation and police radio. Let us tell you how we train men, fit them for good jobs, help them get jobs. Write for catalog. Affiliated with KMBC, major network station. Address **MIDLAND TELEVISION, Inc., 106-J Power & Light Bldg., Kansas City, Mo.**

## LEARN TOOL and DIE MAKING EARN BIGGER PAY THE ALLIED WAY!

Machinist Trade and Screw Machine Work in fully equipped State Certified shops. Practical Methods on actual work; jobs open for Trained Men. Employment help given. Enter now; Low Tuition. Illustrated Book FREE.

**ALLIED SCREW MACHINE CO., INC.**  
(School Div.) Dept. PM-9, 609-613 W. Lake St., Chicago, Ill.

## Earn Cash at Home!

**M.M. EARNED \$1174 at Home!**

We paid M. M. \$1174 for exceptional cellar crop Snow-King mushrooms! We furnish materials; buy all crops. Big FREE picture book tells if your cellar, shed, barn, suitable. Est. 1905. Write today.

**United Co., 3848 Lincoln Av., Dept. 304, Chicago**



# AVIATION WANTS MORE LINCOLN TRAINED MEN



Now is the time to get into Aviation! Airlines expanding; Factories flooded with orders for new airplanes; Employment opportunities for Graduates of this **Lincoln Government Approved School** are now better than ever. 53 Lincoln Trained Men recently

placed in good-pay positions. Opportunities for many more. We assist Graduates in locating positions. **BE A SKILLED WELL-PAID PILOT.** Your Training here is Government Approved every step of the way. 15 Training Planes; 5 types, give wide piloting experience; Training prepares you for any Pilot Rating up to and including Commercial, (Transport). **BE A SKILLED AVIATION MECHANIC.** Learn Airplane and Engine maintenance, overhaul, repair. Training prepares for immediate employment with Airline, Airport or Factory. Advanced Training prepares you for Government Mechanics Rating. **Train Now at this Lincoln Government Approved School.** We furnish part-time work for board and room while in training.



**MAIL COUPON TODAY for complete information.**  
**LINCOLN AIRPLANE & FLYING SCHOOL**  
 569 AIRCRAFT BLDG., LINCOLN, NEBRASKA

**LINCOLN AIRPLANE & FLYING SCHOOL**  
 569 Aircraft Bldg., Lincoln, Nebraska.

I want to get into Aviation. Please send me complete information about Lincoln Training.

Name.....Age.....  
 Address.....  
 City.....State.....

## Earn Money at Home



**BIG FREE** book in colors tells new easy way. You don't need experience. We show you how to decorate beautiful Art Novelties right in your own home by simple "3-step" method. No tedious study. Everything furnished including supply of Novelties for you to decorate and Homecrafters Outfit. Big profit per piece for decorating. Many sit at home, and make up to \$25 to \$50 a week—full time or spare time.

*First Lesson Now Free!*

Prizes, Toys, etc. More like fun than work and you earn as you learn. Hundreds making big money this fascinating way.

Just mail coupon and get first lesson *absolutely free*. Start right in decorating Gifts, Bridge



**MAIL THIS!**

**NO CANVASSING** You risk nothing in sending for Free Lesson. So sure are we of your satisfaction we give an absolute Warranty backed by \$1,000 Bond. Costs nothing to find out. Openings for new workers now in every locality. Mail coupon immediately for Free Book and Free Lesson. Get started making money at once.

**FIRESIDE INDUSTRIES**  
 Dept. 66-M, Adrian, Mich.

Please send big Free Book and FREE LESSON. This does not obligate me in any way.

Name.....  
 Address.....

**GIVEN YOU TO DECORATE**

**New York Electrical School** Established 1902  
 Ask for free illustrated booklet  
 44 West 17th St., N. Y. C.

**CARTOON YOUR WAY TO SUCCESS!**  
 DON'T COPY - LEARN TO ORIGINATE!

RAYE BURNS will teach you HOW to CREATE ORIGINAL CARTOONS at home that you can SELL! Course has 26 lessons and 600 illustrations. **\$2.85**  
 Send name and address for free details. Only....

RAYE BURNS SCHOOL, Dept. M-3, Box 2194, CLEVELAND, OHIO

Let me put my Finger on YOUR **Mistakes in English**

ARE you worried about making embarrassing errors in spelling, grammar, pronunciation? My patented 100% self-correcting device gives you a confident command of English, teaches you to speak and write forcefully, entertainingly. No tiresome rules to study. My method has shown over 100,000 people how to make good English a daily habit.

**FREE BOOK** Send for free book, "How You Can Master Good English in 15 Minutes a Day."

**SHERWIN CODY SCHOOL OF ENGLISH**  
 59 Searle Building Rochester, N. Y.



SHERWIN CODY

# TRAVEL-for 'UNCLE SAM'

**RAILWAY POSTAL CLERKS**  
 Men 18 to 35  
 \$1900 First year regular  
**MANY OTHER GOVERNMENT JOBS**  
 Grade School Education Usually Sufficient  
 \$1260 to \$2100 First Year  
 MEN—WOMEN  
 Mail Coupon immediately—today sure.

**GET A U. S. GOVERNMENT JOB**

**COUPON**

**FRANKLIN INST., Dept. N173, Rochester, N. Y.**

Gentlemen: Rush to me, without charge, 32 page book with list of U. S. Government big paid positions. Advise me also regarding salaries, hours, work, vacation, etc. Tell me how to qualify for a position.

Name.....  
 Address.....



# POPULAR



# INVENTIONS

**G**REATER protection from mosquitoes and other insects in the summer camp or cottage is provided in a netting support for cots. The device, patented recently, consists of pairs of upright bars having ends bent to form loops of a shape similar

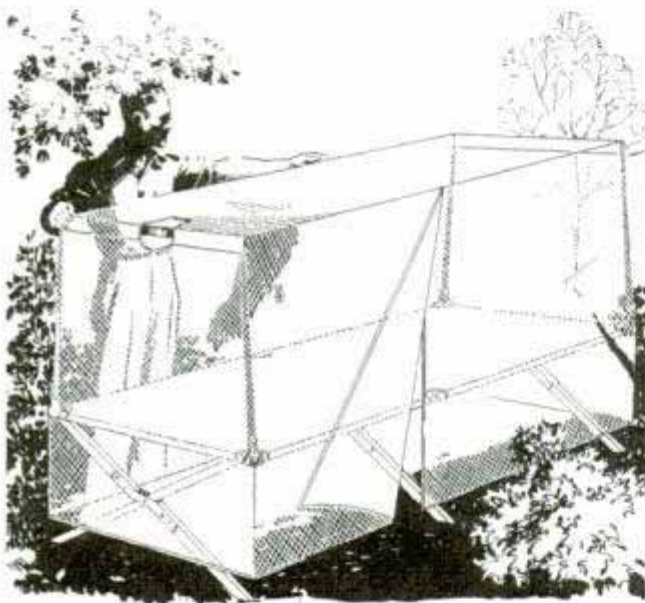

to the cross section of the cot's crossbars. These bars support the mosquito netting well above the occupant of the cot. The netting extends to the floor, thus eliminating the nuisance of insects coming in under the edge of the protective covering. An overlapping flap permits entry to the cot.

**W**HEN the marksman scores a hit on a new electric rifle range, a light



flashes on a photo cell and causes the target to return to its original position. The target, of the moving type, rises from the bottom of the target board and continues until a

hit is scored or until it disappears at the top. The rifle discharges a flash of light instead of a bullet, the beam actuating the photo cell and relay mechanism, thus making the range automatic in operation.

**F**ULL utilization of window space is the purpose of a combined sill and wall bracket patented recently. The part of the bracket resting on the window sill may be used for flowerpots and boxes, while the lower part incorporates a shelf for books or magazines. The bracket is easily attachable to the sill. A brace on the lower part rests against the wall, holding the bracket in proper position.



**P**OSSIBILITY that a rear-engine automobile may be offered on the market in the near future is the prospect held out by a recent patent. The engine is of the radial type, a four-cylinder job that might be mounted in the rear compartment of the

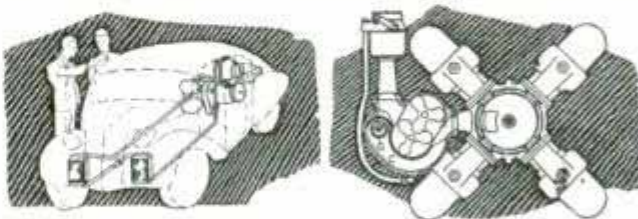

modern automobile without materially altering present design. The patent also covers a means of introducing air into the engine compartment for cooling purposes. Openings in the front fenders admit air which is conducted to the engine by means of ducts.

(Continued to page 24A)



# A Sensational New Business

## That May

# Sweep You to Riches

This is undoubtedly the most amazing money-making opportunity ever offered to the readers of this—or any other—magazine. It tells how any ambitious, level-headed man can quickly establish a remarkable new kind of business that may pay a steady net cash profit of \$40.00 a day—a business that offers unlimited opportunity, rapid expansion—a business in which you can employ others to work for you and run your daily profits up as high as you want them to go—a business that may make many men independently wealthy within the next few years.

HERE, briefly, are the "high-spots" of this thrilling new business that should create "fortunes" for those with the vision and foresight to get in on the ground floor now:

- 1 An utterly new product with a natural, staple demand and big repeat business, yet one that has all of the appeal of a novelty.
- 2 Requires no house-to-house canvassing or selling. You simply manufacture. Every store, tavern, club, or any establishment where any sort of food is handled are your immediate customers.
- 3 Starting with one unit alone you have a capacity to enable you to make \$42.00 profit a day selling at wholesale.
- 4 An amazing product that can be manufactured by special secret process by only one mill in the country. This mill, one of the largest of its kind, manufactures the product exclusively for us and our operators. No one else can make it or buy it. This means your protection from cut-throat price competition.
- 5 All year around business; no slack seasons.
- 6 Tremendous natural demand in every community, whether large or small.
- 7 Absolutely no experience needed to be successful.
- 8 No expensive equipment needed. Your whole investment will be less than your first week's potential income.

This is truth; not fiction—fact; not theory. To the best of our knowledge, no other business in America offers one-tenth the opportunity for profit and independence.

### *Vision Turned to Reality*

A short time ago, this amazing money-making product was nothing more than a dream—today it is a reality.

It is a practical, tried out, thoroughly tested business!

Every detail has been perfected—complete and tested plans of operation worked out—all necessary equipment ready to turn over to those who are prepared to develop this new "gold mine."

### *No Selling—No Canvassing*

Do not confuse this new product with anything you have ever heard of before. It is not a potato chip, not candy, not a cheese chip, not a paste preparation—but a natural product that comes from the sky, from the ground, and from the air. It is not like anything you ever saw or heard of, or imagined. The simple truth about it is stranger than your wildest dream. And you can be the first to supply this great demand.

### *\$100.00 a Week, Net, to Start*

According to accurate figures, the very minimum of the first operation should produce a net cash profit of at least \$100.00 a week. Since it is possible to make \$42.00 a day, you can see that it would take only two and a half days of full operation to make a profit of \$100.00. This, we figure to be a minimum. We would not be interested in appointing men who could not make at least that much every week. Then, as demand increases, other men can be put to work for you and you can double, triple or quadruple your weekly profit as steady repeat business develops.

### *No Expensive Equipment*

Ordinarily a proposition as big as this would require the purchase of expensive equipment with which to manufacture this remarkable new product. But in this case our manufacturing process has been so simplified that we can furnish you with everything you need to start off making a profit the very first day—all for an investment of \$150.00.

### *No Experience Needed*

Absolutely no experience is required to quickly become successful in this thrilling and fascinating new business. We tell you how to start—how to establish yourself quickly—how to operate the business the very day you are ready to go. We furnish all necessary plans, systems and equip-

ment. Any man with ordinary intelligence and a real desire to succeed is bound to make money.

### *Small Town or Big City*

Another feature that makes this business unlike any other is that it can be operated anywhere. No matter where you live—in the smallest town or the largest city—you can establish yourself practically overnight and start enjoying an independent income at once. From the foregoing facts, you can readily see that this is not a business for the timid operator who is satisfied to make a bare living, but for the wide-awake, aggressive go-getter who wants to see his energy and enthusiasm produce the greatest possible results in the shortest possible time.

### *Facts Sent Free*

To all such men, we request permission to mail an unusual and complete presentation. After you have read the amazing facts and figures in this presentation, then you can decide whether or not an initial investment of \$150.00 is too much to ask for a complete business that can bring back that investment in the first three days of operation, and then continue to pay as much as \$252.00 a week net profit for one man operation, and up to as high as a thousand a week net profit to those men who have the ability to organize and direct other men.

### *Act Quickly*

There is no time to lose. Today this proposition is new. Tomorrow it will be a little older—next week a little older still. So get the facts without a moment's delay. It's the newcomers in any enterprise of this sort—the "ground floor operators"—who always reap the richest rewards.

There is no coupon on this ad. We do not want to hear from coupon clippers. If you don't agree that this is worth a letter—or a telegram—you are not the man for the business.

So write or wire today—without the slightest cost or obligation—and get the information that can make you independent for life.

**KING K. CO. Dept. K-39**  
**620 N. Michigan Ave.**  
**CHICAGO ILLINOIS**





**Know Electricity as Experts Know It—and Get an Expert's Pay!**

What about your future? Who is safe today? Surely not the man who is contented to stand still! Know your job thoroughly—prepare yourself for jobs ahead. To do just this thousands of men have used

**The Croft Library of Practical Electricity**

The Croft Library is a complete electrical educator. It is founded on practice—on 20 years of shirt-sleeve experience—on work as it is actually done. It is jammed from cover to cover with the kind of hard-headed facts you want. Written so that the beginner can easily understand it, yet so sound, so thorough, that it is the daily guide of 59,000 highly paid electrical workers and engineers. Croft tells you the things you need to know about motors, generators, armatures, commutators, transformers, circuits, switchboards, distribution systems—electrical machinery of every type—illumination in its every phase—the most improved methods of lighting—lamps and lamp effects, etc.—how to do a complete job, from estimating it, to completion.

**6 volumes, 2155 pages—only \$16.50 No money down—Easy payments.**

Fill in and mail the coupon attached and we will send you the entire set of six volumes for ten days' Examination on approval. We take all the risk—you assume no obligation. If you decide to keep the books, send \$1.50 in ten days and the balance at the rate of \$3.00 a month. Send the coupon NOW and see the books for yourself.

**EXAMINATION COUPON**

McGRAW-HILL BOOK CO., 330 W. 42nd St., New York

Send me for ten days' examination on approval the Croft Library of Practical Electricity. If satisfactory I will send you \$1.50 in 10 days and \$3.00 monthly until the price of \$16.50 is paid. If not wanted, I will return the books postpaid. (To insure prompt shipment write plainly and fill in all lines.)

Name.....  
 Home Address.....  
 City and State.....  
 Position.....  
 Name of Company..... P.M. 9-39

**MECHANICS**

**KNOW YOUR CAR**

**You Need this Book**

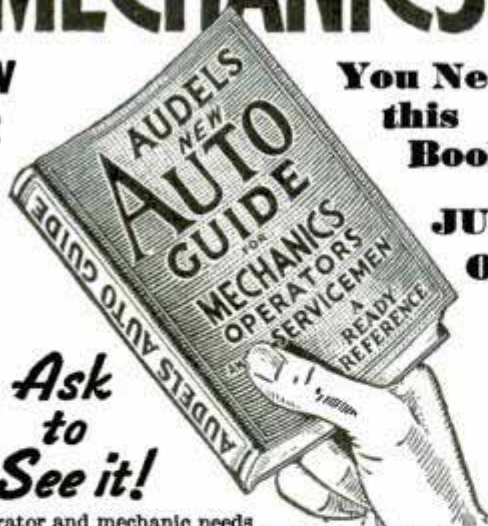

**JUST OUT!**

**Ask to See it!**

Every operator and mechanic needs AUDELS NEW AUTO GUIDE. This book saves time, money and worry. Highly endorsed. It presents the whole subject of auto mechanics: 1—Basic principles, 2—Construction, 3—Operation, 4—Service, 5—Repair. Easily understood. Over 1500 pages—1540 illustrations showing inside views of modern cars, trucks and buses with instructions for all service jobs. Diesel Engines fully treated, \$4 fully illustrated. To Get This Assistance for Yourself Simply **4** Fill in and Mail Coupon Today.

**COMPLETE • PAY ONLY \$1. A MONTH** ←  
**THEO. AUDEL & CO., 49 WEST 23rd STREET, NEW YORK**  
 Please send me postpaid AUDELS NEW AUTOMOBILE GUIDE (\$4) for free examination. If I decide to keep it, I will send you \$1 within 7 days; then remit \$1 monthly until purchase price of \$4 is paid. Otherwise, I will return it to you promptly.

Name.....  
 Address.....  
 Occupation.....  
 Reference..... P.M.

**It's Lots of Fun to PLAY the DRUMS**

...and EASY, too!



O'NEIL SPENCER

Step out in front! Be entertaining... popular... sought-after by friends. Start to play a **GRETSCH DRUM**. Begin a **BIG MONEY** career—be an ace drummer like O'Neil Spencer, with John Kirby's Band. O'Neil and thousands of others have won success on radio, stage and screen using **GRETSCH** equipment. **EASY TO PLAY**—no difficult lessons. Buy **GRETSCH DRUMS**, on **NEW EASY-PAYMENT** plan.

**EASY TO PLAY \* EASY TO PAY**

Send penny postcard for **FREE DRUM** catalogue and full information about **EASY-PAYMENT** plan and **FREE TRIAL** through your **GRETSCH** dealer. Address Dept. PM 90

**The FRED. GRETSCH MFG. CO.**  
 Musical Instrument Makers Since 1883  
**60 BROADWAY, BROOKLYN, N. Y.**

GRETSCH also offers **SUPER VALUES** in Guitars, Saxophones, Trumpets, Trombones, Accordions. Send for **FREE** catalogue. Mention instrument.

**You CAN GET IN AVIATION**

Like hundreds of successful graduates **SPARTAN** Training following standard College or University planned curriculum will give YOU Aviation training that will qualify for positions now open. Advantages: Factory affiliation building ALL-METAL Commercial and Military Airplanes. Unequaled year-round flying weather and country. **GOVERNMENT APPROVED**. All courses Mechanical and Flight. Write for Illustrated Catalog.

**HOME OF THE DAWN PATROL**  
 J. D. GREEN, Director, Dept. PM 23, TULSA, OKLAHOMA  
**SPARTAN SCHOOL OF AVIATION**

**MAKE MONEY**

with your **CAMERA**  
 Thousands of publications buy **MILLIONS** of photos yearly from amateurs. We show you what to photograph, how to do it, where to sell for biggest profits. Learn at home to become a journalistic or press photographer. Pay for course in easy installments. Use any camera. Write for **FREE BOOK**.  
**UNIVERSAL PHOTOGRAPHERS, Inc., Dept. 79, 10 W. 33rd St., N. Y. C.**

**Be a MONEY-MAKING RADIO EXPERT**  
 I'll train you for a good job in Radio, Television, or a business of your own. My new, personalized sparetime home-study Course fits you quickly, easily. You get real Radio Equipment. I show you how to earn while you learn.  
**FREE:** Write for complete details in new catalog "HOW TO MAKE MONEY IN RADIO" **Sprayberry Academy of Radio, 210-J University Place, N. W. Washington, D. C.**

**ARTISTS MAKE MONEY**

Find out your ability. Send name, age, occupation and address for Free Vocational Art Test.  
**Federal Schools, Inc., 9139 Federal Schools Bldg., Minneapolis, Minn.**

**FAILURE?**

Are you discouraged, bewildered, seeing others forge ahead to success, wealth, power while you remain in the ranks? Do you ever ask what it is that makes them successful where you fail, when they have no more intelligence than you? Don't give up... I can help you! Send your name and address to **H. C. McCulloch, Desk 69, Pershing Square Bldg., New Rochelle, N. Y.**

**PHOTO-ENGRAVING TASOPE' SINCE 1931**

**TASOPE'**, world's largest builders of complete Photo-Engraving Plants. We supply newspapers, printeries, studios, colleges, high schools and individuals with precision-built equipment, and give thorough training in Photo-Engraving and Photography, (home or residence)—all at one low cost! Cash in on popularity of pictures. Big money working full or part time for others, or open your own well-paying business. Amazingly small investment. Cash or terms. Catalogs free.  
**THE AURORA SCHOOL OF PHOTO-ENGRAVING**  
 Dept. PM-8 Tasope' Bldg. Aurora, Mo.

When writing please mention Popular Mechanics



for  
quick  
action

SEND  
TO-DAY

# MAIL COUPON NOW

for Free Book and Record of Invention Form

**CLARENCE A. O'BRIEN AND HYMAN BERMAN**  
703 Adams Building  
Washington, D. C.

Registered Patent Attorneys Before U. S. Patent Office  
Please send me at once your Big Free 48-Page Book "Patent Guide For the Inventor" and your Specially Prepared "Record of Invention" Form. This request does not obligate me.

NAME.....

ADDRESS.....

CITY.....

STATE.....

(Please write or print plainly)

## YOU CAN PATENT

### IMPROVEMENTS IN MACHINERY, ARTICLES, DESIGNS, FORMULAS, ETC., IF NEW

Every year thousands of Patents are granted. Very few, however, represent the discovery of entirely new principles. Most of them provide new methods of doing some every-day thing in a better way—changes for greater efficiency, usefulness, adaptability, or beauty in some previously Patented thing. These IMPROVEMENTS are patentable if new, and actually represent new invention. These improvement Patents offer large chances for profit if commercially useful. The business world wants improved products and services.

### MODELS AND FINISHED DRAWINGS UNNECESSARY

Our Big Book tells you how you can start immediately to apply for Patent Protection even if you haven't finished models or drawings available now. It will tell you how we can prepare the specifications and finished drawings necessary in the form prescribed by the Patent Office—so as to secure for you full Patent Protection. Mail Coupon for Our Big Book TODAY.

### OUR SERVICES TO YOU

We are Registered Patent and Trade-Mark Attorneys, serving Inventors all over the United States and abroad. Our Organization is complete. We have Draftsmen, experienced Searchers and Attorneys to serve your interests. We can act as your legal adviser in all Patent Matters. Our complete service is described in Our Big Book. Mail Coupon for it NOW.

### IN CASE YOU FEEL THAT YOU HAVE NOT SUFFICIENT FUNDS AVAILABLE FOR PATENT FEES

Our Big Book tells you how to legally assign an interest in your invention before filing application—to some friend willing to aid you. Better to do this than to delay indefinitely and see another inventor develop your invention and Patent it before you do. Send Coupon NOW.

### REASONABLE FEES—CONVENIENT TERMS

Don't worry about finances. Our fees are very reasonable—we can arrange convenient terms of payment. It is our custom to permit clients to pay for our services in installments as the application progresses in our office. See our Big Book for fees in obtaining Patent. It explains our arrangements clearly. Send for it NOW.



### REQUEST OUR BOOK —NOW!

Know exactly what you should do to secure a Patent—what must be done every step of the way—how the Patent Law protects you—what we, as Registered Patent Attorneys, can do for you. Mail the coupon NOW for our Big Booklet and "Record of Invention" Form.

## CLARENCE A. O'BRIEN & HYMAN BERMAN

703 Adams Building

Washington, D. C.

Registered Patent Attorneys Before U. S. Patent Office



Learn by pre-tested Training

# RADIO *plus* TELEVISION



**A flexible Training Plan to fit your immediate needs**

National Schools offer optional training planned to fit your present circumstances. You can master Radio, Television, Sound and allied trades by National's exclusive plan. Actual shop and studio training; also complete training if you cannot give up your present employment and income. A definite plan to fit your needs.

**FREE BOOK of details**

Explains National's pre-tested plan; how you can master Radio, all branches, Sound-Recording, Public Address & Communication Systems, Broadcasting, Television. This interesting Book will be sent post-paid, without obligation to you.

**NATIONAL SCHOOLS**  
Los Angeles (EST. 1905)

Request for **FREE BOOK of DETAILS**

NATIONAL SCHOOLS, Dept. 9-PMR  
4000 S. Figueroa St., Los Angeles, Calif.

NAME \_\_\_\_\_ Age \_\_\_\_\_

ADDRESS \_\_\_\_\_

CITY \_\_\_\_\_ STATE \_\_\_\_\_

# Diesel... *the NEW POWER*



The amazing performance of the Diesel powered Burlington Zephyr trains has opened a new era of power efficiency. Airplanes, automobiles, great industrial plants will soon be using these marvelously efficient engines. This means a new profession, a new trade for thousands of men. Learn Diesel operation, construction and repair NOW through our brand new quick reference cyclopedia, the only complete encyclopaedia on Diesel Engineering.

**6 Big Books Shipped FREE**

for examination. If you want to get into the most promising new field of the century, the liveliest, most up-to-date, most talked of profession, send for these books on our amazingly free shipment offer. Over 2500 pages profusely illustrated and right up to the minute. Examine these books, read them, test them and if not thoroughly satisfied return them at our expense and you won't owe us one cent.

**Brand New 1939 Edition**

This brand new 6 volume edition of Diesel Engineering is the last word in Diesel information. Brought right up-to-date by a group of prominent engineers, makes it the final authority for beginners and experts alike.

Six large volumes, handsome, durable binding, 2500 pages, covers Diesels from theory to design, electricity and its application through diesel power, in fact, all related subjects, to help you master this NEW, BIG PAY profession.

AMERICAN TECHNICAL SOCIETY,

Drexel at 58th Street, Dept. 0619, Chicago, Illinois.  
You may send me the new 6 volumes on Diesel Engineering for ten days free examination. I will pay the few cents express only. Will examine the books and return them in ten days unless I decide to keep them, in which case I agree to send you \$2.00 in ten days and \$3.00 a month until the total price of only \$24.80 is paid.  
Name \_\_\_\_\_  
Address \_\_\_\_\_  
City \_\_\_\_\_ State \_\_\_\_\_  
Please attach a letter giving age, occupation and the name and address of your employer and that of at least one business man as reference.

## NEW INVENTIONS

(Continued from page 20A)

**C**OOKE can in grocery stores would always appear to be full, and thus more inviting to the customer, if a new invention came into general use. It consists of a cookie can with simple mechanism which pushes each layer of cookies to the top of the can as the layer above is sold.

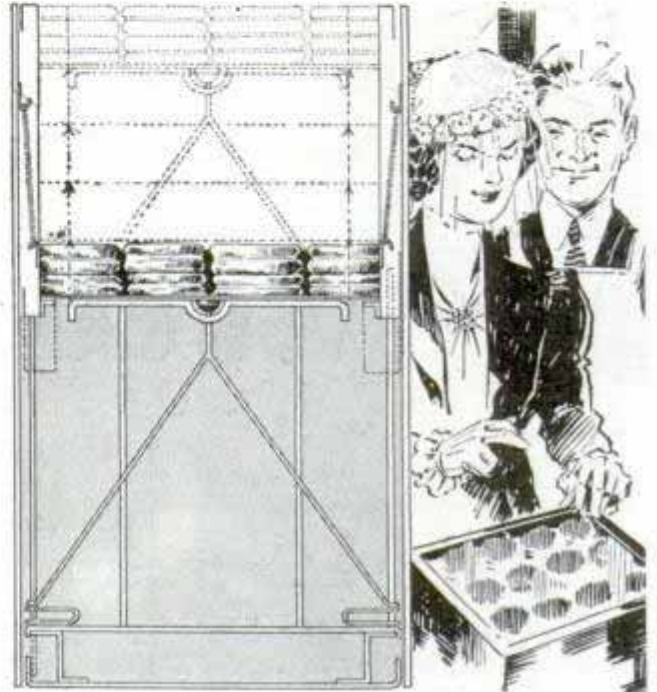

The mechanism, working on a spring principle, is operated by lightly pressing down the top of the can. Thus, to the eye of the customer, the last layer of cookies in the can will appear as attractive as the first and increased sales might be expected. The can is refillable.

**S**ERVING the purpose of a shutter and an awning, a new combination attachment for windows has been patented.

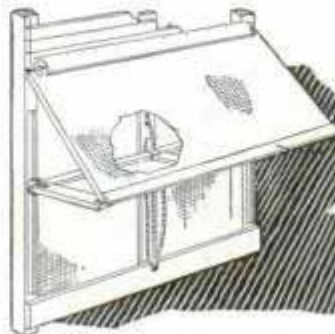

It consists of two sections of wood or fabric-covered metal frame, hinged together and operating on guides at either side of the window frame. Pushing the lower section upward causes the device to assume the form of an awning; pulling it down causes it to flatten against the window in the manner of a shutter.

(Continued to page 26A)





# Easy

YOU'LL advance faster with an easy playing Conn. Choice of world's greatest artists. Many exclusive features yet they cost no more. Home trial. Easy payments. See your dealer or write for free book. Mention instrument.

C. G. CONN, Ltd, 931 Conn Bldg. ELKHART, IND.



# CONN

BAND INSTRUMENTS

## EARN A DEGREE AT HOME

From A Chartered Institution Of Higher Learning Employers Now Demand College Graduates With Degrees

88 Degree Courses in Art; Sciences; Philosophy; Education; Psychology; Public Health; Sociology; Physics; Chemistry; Pol. Science; Theology; Law; Business Training; Accounting; Statistics; Adv.; Sales; Agriculture. Electrical, Mechanical, Civil, Structural, Diesel, Architectural, Mining, Drafting, Automotive, Aeronautical, Radio, Refrigeration, Highway, Marine, Air Conditioning, Geology, Petroleum, Industrial, Chemical Engineering. Founded 1908. 170 p. Catalog Free. McKinley-Roosevelt Graduate College, 4244 Clarendon Ave., Chicago

## LEARN CARTOONING

by the method that has developed hundreds successfully. Send name, address and age for free chart to test your ability.

THE LANDON SCHOOL, 1739 National Bldg., Cleveland, Ohio



**NEW YORK SCHOOL OF MECHANICAL DENTISTRY**

Learn how to make Crowns, Bridges, Plates in this OLDEST Laboratory Center. Practical training. Day, Eve. Easy terms. Ask for free Catalog P and tool offer. N. Y. SCHOOL of MECHANICAL DENTISTRY, 125 W. 31 St., N. Y. C.

**MAKE MONEY AT HOME!**

AT HOME you can make perfect flexible rubber molds, any object. Just paint plastic rubber over object. Let dry. Then cast imitation marble, etc. Write for free sample and free book "Making Money at Home."

SO-LO WORKS, Dept. F-825, Cincinnati, Ohio

*The World's Biggest*

Get Shop Notes for 1939! Only 50 cents. May easily be best investment of your entire lifetime. Contains 417 money-making, time-saving ideas, hints, short cuts for mechanics, farmers, home workshop fans, handymen—for everyone who uses tools. 224 pages, 417 articles, 806 illustrations. Get 1938 Shop Notes too. Only 50c.

**POPULAR MECHANICS PRESS**  
Room 939-C, 200 E. Ontario St., Chicago

**50¢ WORTH SHOP NOTES FOR 1939**

## GROW PLANTS WITHOUT SOIL

Startling New Development

Complete Directions for Small and Large Scale Growing

Get the new book "Soilless Growth of Plants" and learn this new technique which everyone is talking about. Three methods described—Water Culture, Sand Culture, Sub-Irrigation. Explains all operations. Tells how to make containers and nutrient solutions from raw materials at small cost—how to grow flowers, vegetables and fruits without soil. A fine hobby and a money-saving investment for city dwellers. A source of new business for gardeners, nurserymen, etc. Only book of its kind. Order today "Soilless Growth of Plants." Sent postpaid for \$2.75.

POPULAR MECHANICS PRESS Dept. 939 200 E. Ontario St., Chicago

## REAL JOBS OPEN FOR TRAINED AUTO MECHANICS



**LEARN QUICK!**  
**8 WEEKS**  
*practical* SHOP TRAINING!

## AUTO, DIESEL and AVIATION mechanics

I'll train you quickly, correctly for this fascinating work, paying up to \$60 a week! Based on 25 years' experience knowing how to train men well, in the 2 biggest, best schools of their kind in the world. You learn with real tools, on real equipment, a complete, practical course in Auto, Diesel and Aviation Mechanics, so you can step out of low-pay jobs into a career in the biggest field of opportunity in America today!

**SPECIAL LOW RATE**

### SPECIAL LOW TUITION RATE IF YOU ACT NOW!

Again McSweeney leads in real value. If you write at once we will reveal a special new low tuition rate that will amaze you, and on easy terms it makes it easy for you to train AT ONCE for a big-pay job! Write TODAY for details!

## McSWEENEY MEN MAKE GOOD!

25 years' success means something to you! Read how others have succeeded with McSweeney training: "Just got thru writing income tax check. Money spent at your school was best thing I ever did!"—Lee Grant, O.; J. W. Wiggins, Okla., says before we trained him he had no income, now has own business, money in bank and to spend! G. B. Park, Ind., says "Your training fitted me to handle any job in auto field." These men were trained in our fine big schools, best of their kind anywhere!

### TWO FINE BIG SCHOOLS



DETROIT



KANSAS CITY

**FREE BOOK!**

Send now for your copy of my big book giving all the facts and announcement of amazing new low tuition rate for short time only—but you must write at once!

Address nearest school:

**McSWEENEY TRADE SCHOOL**  
Dept. A-7, Detroit, Mich., or Kansas City, Mo.  
Without cost or obligation send me your big FREE book.

NAME.....  
STREET.....  
TOWN.....STATE.....AGE.....



# Be An ARTIST



**Trained Artists Are Capable of Earning \$35, \$50, \$75, Weekly**

**Learn at Home - In Your Spare Time**

New opportunities for trained Artists each year. Magazines, advertisers, newspapers, printing houses, etc., pay good money for art work. Our practical, proven method makes it fun to learn Commercial Art, Cartooning and Designing AT HOME, in spare time.

**Two Big Artist's Outfits Included**

Drawing board, paints, brushes and all materials you need come with very first lessons. The second outfit is given later in the course. Actual fun learning to draw this way.

**Write Today for FREE BOOK**

Our Free Book "Art for Pleasure and Profit" describes wonderful opportunities in this fascinating field and gives full details of our simple method of instruction. Tells all about our students—their successes—what they say—actual reproductions of their work—and how some earned money even while learning. Mail coupon below or paste on postcard today.

**\$40 Extra Per Month**  
In spare time, writes student R. G. Reid, Jr. of Oklahoma.

**Paid for Course**  
W. R. Kent of New Jersey earned more than twice the tuition while studying.

**\$25 for One Drawing**  
One small picture brings easy money to Mrs. G. A. Wemmer of Kansas.

**FREE BOOK gives details!**

Washington School of Art, Studio 129M  
1115—15th St., N. W., Washington, D. C.

Yes! I am interested in learning to draw. Please send me your Free Book, "Art for Pleasure and Profit."

Name ..... Age .....

Address .....

City ..... State .....



# AUTO

**BOOKS SENT FREE**

on approval. Just mail the coupon and we'll send you a set of these remarkable auto books, just off the press. Whether you are a mechanic or helper, expert or apprentice, auto owner or driver, if you're interested in knowing all about automobile mechanics, take advantage of this FREE OFFER.

**GET A BETTER JOB**

A better job—in the gigantic auto industry. BIGGER PAY—a chance to go into business for yourself and get a share of the huge profits, are waiting for any man who even half tries to improve himself. Learn auto engineering with these wonder books a new way—without studying or memorizing. Simply use the JIFFY INDEX to look up the answer to any auto problem. Built by eleven of America's greatest automobile engineers, and written in simple language so you can understand it. Very newest cars, all covered.

**FREE Privilege of consulting Automobile Engineers of American Technical Society for one year without cost if you mail coupon immediately**

Send promptly and we will include a Brand New EXTRA volume with over 300 pages including ALL 1939 cars with wiring diagrams and data sheets on each.



**CAN YOU FIX IT?**

These wonder books tell step by step HOW to take out "play" in differential — to kill the shimmy in steering—to set TIMING—how to put your finger instantly on engine trouble and then the quick expert way to FIX it. Newest improvements fully covered. Equal to a complete trade course at less than a fourth the cost.

**6 BIG VOLUMES**  
Brand New Edition  
2500 pages, 2000 illustrations, wiring diagrams, etc., including Marine Engines, Aviation Motors, Diesel engines, etc. De Luxe edition, gold-stamped flexible binding.

**AMERICAN TECHNICAL SOCIETY,**

Drexel Ave. & 58th St., Dept. AG19, Chicago, Ill.

I would like to see the new 6-volume edition of your AUTO BOOKS. I will pay the few cents delivery charges only, but if I choose to, I may return them express collect. If after 10 days use I prefer to keep them. I will send you \$2 and pay the balance at the rate of only \$3 a month, until \$24.80 is paid. Please include free membership and extra Volume No. 7, as per your offer above.

Name .....  
Address .....  
City ..... State .....

Attach letter stating age, occupation and name and address of employer and that of at least one business man as reference.

## NEW INVENTIONS

(Continued from page 24A)

**F**OR exterminating insects rapidly on a large scale, a device attachable to the front of automobile, truck or tractor has been patented. It consists of a frame with parallel wires, a transforming coil, vertical shafts which oscillate rods extending between the wires to clear the exterminator

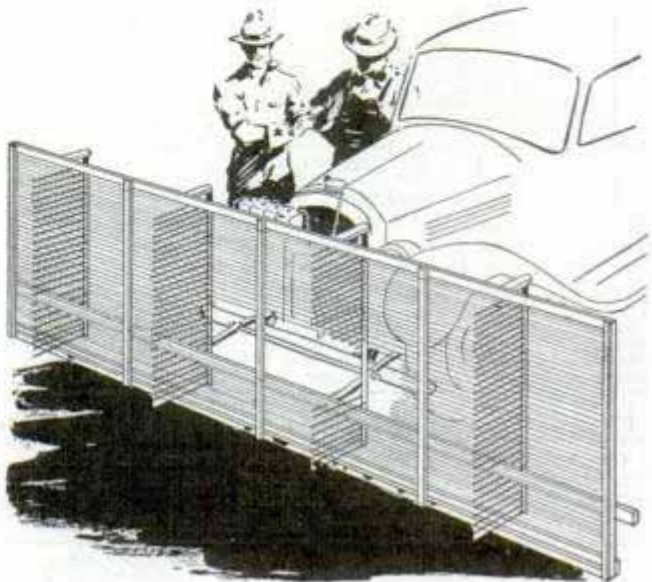

of insects, and means for connecting the device to a source of electrical power. Alternate wires in the frame are connected, forming a circuit and composing an "electric chair" for insects that touch the frame as the shocker moves across a field.

**S**OMETHING new in water-sports craft is promised in a hydro-safety boat patented recently. The craft has spaced parallel open side members with rotary pon-

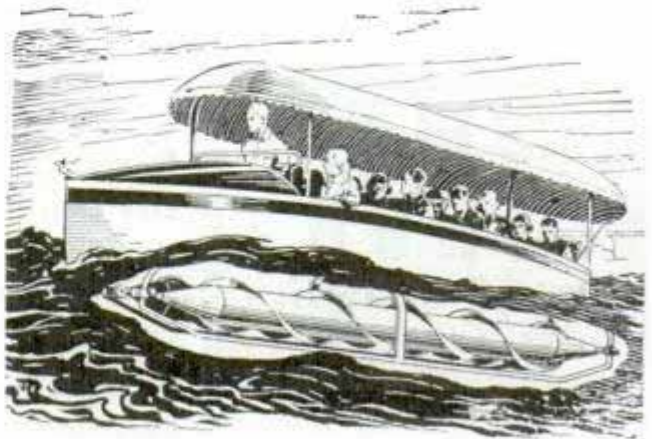

toons, on which are spiral blades, extending the full length of the hull. Rotation of the pontoons causes the craft to move forward through the water.

(Continued to page 28A)





**USERS THRILLED**  
by LACO'S HEATING,  
FUEL ECONOMY and **LOW COST!**

**Write for New Free Books!**

You simply can't appreciate, until you try them, how much heat is delivered from very little oil by these great new LACO Oil-Heaters and Oil-Burners! A thoroughly high quality burner—yet, sold at a price that saves you many dollars! Finest materials and workmanship . . . new improved features . . . backed by the guarantee of one of the industry's leading manufacturers . . . sold Direct-From-Factory-To-Dealer . . . at Very LOW PRICES—that's the reason LACO is so very popular. Write for new free books, and the low prices!

**LACO**

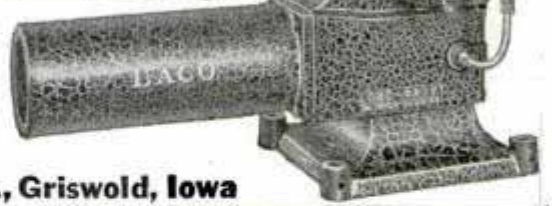

**LACO OIL BURNER CO., 199 Union Ave., Griswold, Iowa**

**BROOKLYN YMCA TRADE SCHOOL**



**Unlimited Instruction** until you have mastered every part of Course without additional charge.

**Full Shop Equipment**  
Unexcelled Instruction  
Fireproof Dormitories.

**Special Privileges. Check your interests** on coupon to receive free literature.

- Mechanical Pre-Engineering
- Diesel Engines
- Diesel Pre-Engineering
- Aeronautical Pre-Engineering
- Aviation Mechanic
- Auto Mechanic
- Refrigeration
- Television and Radio Mechanic
- Architectural-Mechanical Drafting
- Machinist
- Armature Winding
- Oil Burner
- Talking Pictures
- Air Conditioning
- Tool and Die Making
- Electrical

**MAIL COUPON**

1117 Bedford Ave., Dept. P.M.  
Brooklyn, New York City, N. Y.

Name.....

Address.....

**MYSTERIOUS DEVICE WELDS BRAZES AND SOLDERS ANYONE CAN OPERATE**



Now, an electric welding, brazing and soldering Torch, complete with power unit, goggles and supplies. Works INSTANTLY off any light socket. Does a thousand and one repair jobs at amazingly LOW COST on aluminum, iron, steel and other metals. Indispensable for Auto, Body and Fender Repairs, and home repairs—shop, factory, farm, engineer, janitor, sheet metal, radio and bicycle repairs. Anyone can handle without previous experience with our sim- **10-DAY HOME TRIAL**. Write at once for Special Introductory Low Price Offer. Try 3 in 1 Electric Torch for 10 days at our risk, or get one free by helping to introduce it. **ELECTRO-TORCH CO., 2613-EP Michigan Ave., Chicago**

**DIESEL**

Get BETTER training. Realize Adcox advantages. Located in Pacific Northwest, a Diesel center. Established 28 years. Modern equipment, expert instructors. Close cooperation for YOUR success. Earn room and board while learning. Send for free book, "What Every Man Should Know About Diesel". Dept. 18. Home study and resident courses.  
**L. L. ADCOX TRADE SCHOOL**  
Portland Oregon

**EARN THE DEGREE**

Doctor of Psychology (Ph.D.), Philosophy, Divinity. General Courses—Arts, Business, etc. A Correspondence Institution Chartered by State of Washington. Send for 32-page FREE Bulletin at once. No Obligation.  
**Temple Bar College, Dept. 2-R, 1629 Thirteenth Avenue Seattle, Washington, U.S.A.**

**TOOL & DIE MAKING DESIGNING**

Machinists Trade. Not a correspondence course. Practical shop training in the world's Industrial center. Write today for full information.  
**NATIONAL SCHOOL OF MECHANICAL TRADES**  
Dept. 110 628 W. Lake St. Chicago, Ill.

**THIS VALUABLE BOOK FREE**



**LEARN CARTOONING AT HOME IN SPARE TIME**

Send for this FREE book containing money-making tips, cartooning charts, idea creating methods, list of cartoon buyers, and other valuable information. Read about the money-making opportunities in one of the most fascinating of all professions—**CARTOONING**. With this booklet we will include a complete portfolio describing our easy Course in Cartooning and explaining our new Marionette Method of Instruction. We will also tell you how to get the Cartoonists' Exchange Laugh Finder FREE of extra cost. This amazing device actually helps create and originate humorous ideas. Send name at once and mention your age.

**CARTOONISTS' EXCHANGE**  
Dept. 99 Pleasant Hill, Ohio

**RADIO ENGINEERING**

RCA Institutes offer an intensive course of high standard embracing all phases of Radio and Television. Practical training with modern equipment at New York and Chicago schools. Also specialized courses and Home Study Courses under "No obligation" plan. Catalog Dept. PC-39.

**RCA INSTITUTES, Inc.**  
A Radio Corporation of America Service  
75 Varick St., New York 1154 Merchandise Mart, Chicago

★ **GET ON "UNCLE SAM'S" PAYROLL** ★

**Hundreds Appointments Each Year**

**\$1260 TO \$2100 FIRST YEAR**

Grade School Education  
Usually Sufficient  
Short Hours—Vacations With Pay  
**MEN—WOMEN**  
Mail Coupon immediately—  
today sure.

FRANKLIN INST., Dept. N195, Rochester, N. Y.  
Gentlemen: Rush to me, without charge, 32 page book with list of U. S. Government big paid positions. Advise me also regarding salaries, hours, work, vacation, etc. Tell me how to qualify for a position.  
Name.....  
Address.....

When writing to advertisers please mention Popular Mechanics



# TAKE YOUR PICK of these POSITIONS

**Commercial AVIATION ENGINEER**

**ARC WELDING ENGINEER**

**AIR CONDITIONING ENGINEER**

**Commercial ELECTRICAL ENGINEER**

**Commercial RADIO ENGINEER**

## Prepare in One Year!

Fast growing industries need men who can DO THINGS—and who KNOW WHY AND HOW to do things best. They need PRACTICAL, TRAINED MEN—and are willing to pay them well. We have been training men for good positions for 36 years. You can combine a college education with actual practice in our fully equipped shops and laboratories. Personal instruction given by experts—small classes—nominal fees. Student Guidance Service aids you in obtaining work while in school and on graduation. Investigate this specialized training program which will prepare you for a better position with better pay. Act now—new classes begin within a month. Send coupon TODAY!

### MILWAUKEE SCHOOL of ENGINEERING Institute of Electrotechnics

Dept. PM-939, Broadway and East State, Milwaukee, Wis. Without cost or obligation, please rush full details and tell me how to become in ONE YEAR—  
**COMMERCIAL** ( ) Aviation Engineer ( ) Welding Engineer ( ) Air Conditioning and Refrigeration Engineer ( ) Electrical Engineer ( ) Radio Engineer ( ) Electrical Engineer with B. S. Degree (4 yrs.) **VOCATIONAL COURSES** ( ) Welding Operator (3 mos.) ( ) Welding Technician (4 mos.) ( ) Air Conditioning and Refrigeration Technician (6 mos.) ( ) Radio Technician (6 mos.) ( ) Send details of Student Loan Plan ( ) Earn Part Expense Plan  
 Name..... Age.....  
 Address..... Education.....  
 City..... State.....

## Learn to MOUNT BIRDS

### Tan SKINS, Make Up FURS

Be a Taxidermist. We teach you at Home. Mount Birds, Animals, Pets, common specimens. Save your hunting trophies; decorate home and den. Make genuine KROME LEATHER, tan and make up furs for sparetime profit. **FREE BOOK** 48 pages—tells all about it. Hunters, get this wonderful book. It's Now Free. Send postal card Today—This Minute! State your AGE.  
 N. W. School of Taxidermy, 3376 Elwood Bldg., Omaha, Nebr.



## PARKS AIR COLLEGE

PARKS AIRPORT EAST ST. LOUIS, ILL.

### Offers YOU COLLEGE and PROFESSIONAL TRAINING Majoring in AVIATION

Accredited by the Illinois Superintendent of Public Instruction, U.S. approved as a Commercial Ground and Flying School and Mechanics' School. Open to high school graduates. **FOUR** courses lead to B.S. degrees in Professional Piloting, Aviation Operations, Maintenance Engineering, Aeronautical Engineering. **SIXTEEN TRAINING PLANES** are used in professional flight training which prepares graduates for airline flight operations. 74% of graduates enter air transportation in North and South America. 69,000 hours flight training given, 650 hours being flown monthly. **FACULTY** of 34 specialists in various fields of aviation. 1569 graduates. Enrollment limited to a total of 300. 100-acre airport, 14 buildings devoted to school purposes exclusively. Dormitories and dining hall at the College. Fall term October 2. Send postcard for new 60-page catalog. **12th YEAR Registrar, Dept. PM-9 PARKS AIR COLLEGE, East St. Louis, Ill.**

## NEW INVENTIONS

(Continued from page 26A)

**D**RINKING glasses can be made secure against oscillation and vibration in trailer, railroad dining car, airplane and elsewhere by using a holder patented recently in England. It consists of metal hub and a large rubber disk. When a glass is

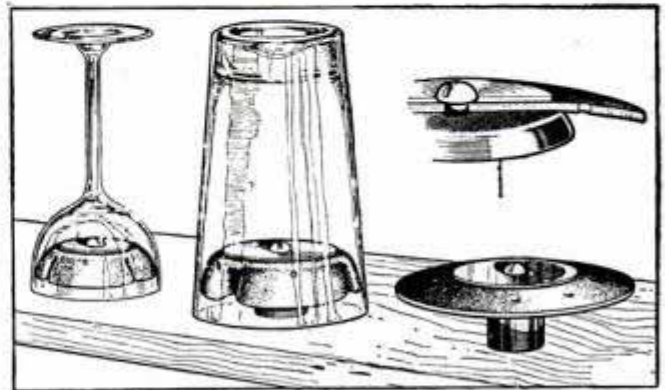

pushed firmly down over the disk, the rubber is compressed inside the glass, providing a firm anchorage. With the holder, glasses can be hung on the wall or even suspended from the roof. A glass will not fall off the holder if put on straight, but can be removed easily by tilting.

**P**UTTING a boat into drydock would be simplified greatly if a newly patented hydraulic device should come into general use. Installed at the bottom of whatever body of water it may be used in, the device consists of a plunger with gripping mechanism to hold the boat firmly. The plunger is forced upward, by hydraulic means, to engage the bottom of the craft and to lift it clear of the water to facilitate repairs or painting. Pipes leading from a fluid pressure tank to the cylinder in which the plunger moves up and down permit hydraulic operation.

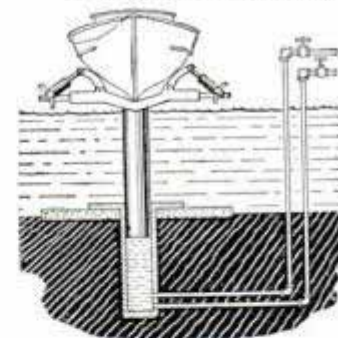

Due to the fact that many of the devices described in this department are still in the patent office stage and are not on the market, Popular Mechanics Magazine cannot undertake to supply further information regarding them.





# Calling All Cars

**A MYSTERIOUS DISCOVERY SAVES UP TO 30% on GASOLINE or Costs Nothing to Try**

Stop wasting Gas!—trim dollars off gas bills—get more power—quicker pickup—faster acceleration! **AUTO OWNERS everywhere praise VACU-MATIC!** Proven so efficient, it is guaranteed to satisfy, or the trial costs you nothing.

**Automatic Supercharge Principle**  
Vacu-matic is entirely different! It operates on the supercharge principle by automatically adding a charge of extra oxygen, drawn free from the outer air into the heart of the gas mixture. It is entirely automatic and allows the motor to "breathe" at the correct time, opening and closing as required. Saves up to 30% on gas costs, with better motor performance.

**FITS ALL CARS**  
Constructed of six parts fused into a single unit, adjusted and sealed at the factory. Easily and quickly installed by anyone in a few minutes.

**AGENTS Yours FREE**

**FOR INTRODUCING.** Here's a splendid opportunity for unusual sales and profits. Every car, truck, tractor owner a prospect. Send name and address now for big money making offer and how you can get yours Free. **The Vacu-matic Co., 7617- 467 W. State Street, Wauwatosa, Wis.**

# 68 Pages of facts for INVENTORS

These books were prepared for men of ideas—men who have an article in mind that will make money, save money, save labor or give pleasure. Leading thinkers agree that the world of a few years from now will be radically different because of the contributions to progress that inventors will make. Now is the time—if you have an idea—to see about protecting it.

## Many Little Ideas May Have Big Commercial Possibilities

Don't think that to be profitable an idea needs to be complicated. Simple articles—just a person's hunch—have often proved profitable. The crinkly hair pin, the metal tip for shoe laces, the paper clip are good examples. Also improvements on patented articles sometimes prove more profitable than the original article itself.

## Don't Delay—Send for These Free Books Now

Many a man has waited until too late to protect an idea by a United States Patent. Remember someone else may be thinking along the same lines that you are, and the Patent Laws favor the man who files his application for a patent first. Delays of even a few days can sometimes mean the loss of a patent. So learn the important facts about Patent Protection at once.

## 41 Years of Proven Service

For forty-one years this capable organization has served inventors from all over the country. Our large staff of patent specialists gives you expert and prompt service. Our fees are reasonable; we also help with deferred payments.



# VICTOR J. EVANS & Co.

**REGISTERED PATENT ATTORNEYS**  
MAIN OFFICE: 112-K, VICTOR BUILDING WASHINGTON, D. C.

**Pittsburgh Office: 514-N, Empire Building**

Send me **FREE** copies of your books, "Patent Protection" and "When and How to Sell an Invention."

Name.....  
Street and No.....  
City or Town..... State.....

MAIL COUPON TODAY FOR YOUR COPIES

# ENGINEERING

**DEGREE IN TWO YEARS**

**TECHNICAL AND APPLIED COURSES.** Nonesentials omitted. TIME AND MONEY SAVED, Degree 2 yrs., diploma 1 yr. Electrical, Mechanical, Architectural, Structural, Civil, Aeronautical, Highway. All courses include Air Conditioning, Electric Refrigeration and Diesel. Short intensive courses 3 and 4 months in Electricity, Power Plant, Diesel-Electric, Electric Refrigeration, Drafting. Extensive modern equipment. **LOW TUITION.** Part-time work for room and board. Thousands of successful graduates in U. S. and foreign lands. Approved by Industry, endorsed by educators, recommended by alumni. One and two-year courses start in Sept., short courses open year round. 40th YEAR. Residence courses. Catalog free.

**FINLAY ENGINEERING COLLEGE**  
1001 Indiana Avenue Kansas City, Mo.

# STUDY ENGINEERING AT HOME

**Earn a Degree at Home**  
**From A Chartered Institution Of Higher Learning**  
**Employers Demand Degree Men For Key Positions**

**53 Degree Courses** in Electrical, Mechanical, Civil, Structural, Diesel, Architectural, Drafting, Automotive, Aeronautical, Radio, Refrigeration, Air Conditioning, Highway, Mining, Geology, Petroleum, Marine, Industrial, Chemical Engineering, Arts, Sciences, Philosophy, Psychology; Chemistry; Education; Business Training; Law; etc.  
**McKinley-Roosevelt Graduate College, 4238 Clarendon Ave., Chicago**

*Learn to play...*

Easy lessons at home. Inexpensive. 132-page Music Dictionary **FREE** when you enroll. Stop lessons when you like. Money back guarantee. Write for free details. **Hamann Institute, 3016 N. 24th Place, Dept. H-9, Milwaukee, Wis.**

Hawaiian Steel Guitar  
Spanish Guitar  
Piano

# Government Jobs

Write for catalog No. 47. Valuable information free.  
**COLUMBIAN CORRESPONDENCE COLLEGE, Washington, D. C.**

# DIESEL

Maximum training minimum time; practical and theoretical. Modern equipment, experienced teachers. Personal instruction. 40th year. Catalog free. Residence course in three months.  
**FINLAY ENGINEERING COLLEGE, 10th & Indiana, Kansas City, Mo.**

# A FUTURE FOR YOU IN RADIO AND TELEVISION ENGINEERING

Complete **ONE YEAR** residence course begins Sept. 18 in the Nation's Capital. Qualifies you for job in professional field. 95 per cent of men in last 5 classes stepped into good jobs. Modern equipment in laboratories and shops; dormitories; outstanding faculty. Write for details in **FREE BOOKLET, CAPITOL RADIO ENGINEERING INSTITUTE, Dept. PO-9, 3224-16th St., N. W., Washington, D. C.**

**ATLAS STICK-ON LETTERS**  
Beautiful Gold Colored. New Styles. 5 Year Guarantee. Large Sizes—Penny Each. Tremendous Demand. Amazing Profits. Write for Samples and Starting Equipment. Hurry!  
**ATLAS Sign Works, 7943 Halsted, Chicago**



Always write your name and full address clearly when answering advertisements.



# PATENTS

**Booklet Free Highest References**  
**Promptness Assured Best Results**

Send drawing or model.

## ALL BUSINESS GIVEN PROMPT AND PROPER ATTENTION

Listed Patent Lawyer in the latest editions of the Rand-McNally Directory of Bankers and Bank-Recommended Attorneys, published by Rand-McNally & Co., Chicago, Ill.; The Baggott & Ryall Directory of Guaranteed Attorneys, published by Legal Directory Corporation, Boston, Mass.; American Lawyers Annual, Cleveland, Ohio; Bankers Service Legal Directory, published by Bankers Service Co., Boston, Mass.; Eyre's Law List, 9 Park Place, New York City; Snow-Church Directory Co. Lawyers List, published in New York City, and the Central Guarantee Co., Bankers and Lawyers Directories, 630 Fifth Avenue, New York City.

**WATSON E. COLEMAN,** Victor Building, 724 Ninth Street, N. W.  
**REGISTERED PATENT LAWYER** **WASHINGTON, D.C.**

### INVENTORS PATENT YOUR IDEAS SEND FOR FREE BOOK



#### HOW TO OBTAIN A PATENT

Written by a Former Member of the Examining Corps (1922-24) of the U.S. Patent Office. If you want to profit by your idea, you should take steps to apply for a U. S. Patent at once. Your first step is to get this Free Book. This interesting illustrated book contains valuable information you should have. It tells you fully how to obtain a patent on your idea in the quickest way. With this Free Book you will also receive a "Record of Invention" form on which you can easily record your idea. Personal and Confidential Service: Your case will be personally handled only by a Registered Patent Attorney who is also a Former Member of the Examining Corps of the U. S. Patent Office. All communications confidential.

MAIL COUPON TODAY for FREE PATENT BOOK and RECORD OF INVENTION Form.

**CARL MILLER**  
**REGISTERED PATENT ATTORNEY**  
**FORMER MEMBER EXAMINING CORPS U. S. PATENT OFFICE**

Woolworth Bldg., 35th Floor, Dept. 99A, New York City  
MILLER BUILDING, Dept 99A, WASHINGTON, D. C.

Please send me your Free Book, "How to Obtain a Patent," and your "Record of Invention" form.

NAME.....

ADDRESS.....

### New Ideas now Salable Before Patenting

Practical, useful inventions may now be safely marketed without patenting expense. Write for proof that we successfully sell both patented and unpatented inventions.

**Chartered Institute of American Inventors**  
Dept. 4, Barrister Building, Washington, D. C.

### PATENTS—TRADE MARKS

All cases submitted given personal attention  
Form "Evidence of Conception" with instructions  
for use and "Schedule of Government  
and Attorneys' Fees"—FREE!

**LANCASTER, ALLWINE & ROMMEL**  
Patent Law Offices

412 Bowen Bldg. Washington, D. C.

**ALBERT E. DIETERICH**  
**THEODORE H. RUTLEY**  
**REGISTERED PATENT LAWYERS**  
512 B Colorado Bldg. WASHINGTON, D. C.  
*Booklet on Patents sent free*

**INVENTORS** who derive largest profits know and heed certain simple but vital facts before applying for patents. Our book, Patent-Sense, gives those facts; sent free. Trade Marks—Copyrights.  
**LACEY & LACEY, Est. 1869, 635 F St., N. W., Dept. 5, WASHINGTON, D. C.**

## RUPTURED?

Get Relief This Proven Way

Why try to worry along with trusses that gouge your flesh—press heavily on hips and spine—enlarge opening—fail to hold rupture? You need the Cluthe. No leg-straps or cutting belts. Automatic adjustable pad holds at real opening—follows every body movement with instant increased support in case of strain. Cannot slip whether at work or play. Light. Waterproof. Can be worn in bath. Send for amazing FREE book, "Advice To Ruptured" and details of liberal truthful 60-day trial offer. Also endorsements from grateful users in your neighborhood. Write:

**Cluthe Sons Dept. 31 Bloomfield, New Jersey**



### BUCHSTEIN'S FIBRE LIMB

Correctly fitted. Strong, light, neat, cool, soothing. Braces for all deformities. On terms.

**D. BUCHSTEIN CO.**  
610 3rd Ave. South, Minneapolis, Minn.

### AGENTS 300% Profit SIGN LETTERS

For Store Fronts and Office Windows. Anyone can put them on. Free Samples. Liberal Offer to general agents.  
**METALLIC LETTER CO., 438 N. Clark St., Chicago**

### MONEY IN RABBITS—CAVIES

**WE BUY** and put you in touch with other markets. Catalog and copy of magazine 10c. Or send 25c for Book Catalog and Price List and Year's Subscription to the AMERICAN SMALL STOCK FARMER.  
**OUTDOOR ENTERPRISE CO., BOX 919, NEW CITY, N. Y.**

### Monuments \$9. Up

Best Quality Marble and Granite. Big Saving. Free Lettering. Guaranteed. Erected if desired. Write for Catalog and samples.  
**U. S. MARBLE & GRANITE CO., A-18, Oneo, Fla.**

## To PROTECT YOUR INVENTION—Use this coupon, NOW

Delays are dangerous and may be very costly. My personal service assures prompt action, strict confidence, and a minimum of expense. I suggest that you send me a model or drawing, or sketch and description of your invention, and \$5.00. I will make a search and report

promptly as to its patentability and send you a copy of my 72-page booklet. Or, if you prefer to read my booklet first, mail the attached coupon at once. I will also send my "Record of Invention" form. (Over 38 years experience as a Registered Patent Attorney.)

**L. F. Randolph,** 302-D Victor Bldg., Washington, D.C.

Please send me at once, free of charge, your 72 page booklet and "Record of Invention" form.

Name.....

Address.....

### A PERSONAL CONFIDENTIAL PATENT SERVICE



# NOW YOU CAN PRESERVE YOUR POPULAR MECHANICS

## In This Handsome PERMANENT ART BINDER



**Specially Designed and Made for Popular Mechanics Readers. Has Self-Binding Feature**

Your Popular Mechanics Magazine will be doubly interesting and doubly valuable when preserved in one of these handsome art binders, which holds six issues. Heavy leather-grained finish, embossed and stamped in antique gold style. Covers open flat. Patented fasteners hold magazines in place and any issue may be inserted or removed easily and quickly.

**Only \$1** *Postpaid*

(\$1.25 Foreign or Canada)

**ORDER ON COUPON BELOW!**

Will make a beautiful addition to your reading table or personal library. Size  $10\frac{3}{8} \times 7\frac{1}{8} \times 3\frac{1}{4}$  inches. Specify whether wanted for January to June or July to December issues. Use these binders for your collection of back issues.

**POPULAR MECHANICS PRESS, Dept. PMB, 200 East Ontario Street, Chicago.**

I enclose \$\_\_\_\_\_ for which you may send me \_\_\_\_\_ Art Binders for Popular Mechanics Magazine.

PLEASE CHECK  for January to June Issues.  for July to December Issues.

Name \_\_\_\_\_

Address \_\_\_\_\_

City \_\_\_\_\_ State \_\_\_\_\_

*When writing please mention Popular Mechanics*

**Inventors- FREE BOOKS**

Now Tell You How To PROTECT And To CAPITALIZE On Your Invention • Save Time, Money

● At last here are the patent facts you want. Competent advice on patent procedure is essential to good results. Our 63 years' experience enables us to clearly explain everything you need to know about protecting and commercializing your idea. You will find the answers in these free booklets that are yours for the asking. If you want prompt advice from reputable patent attorneys, tear out and mail the coupon below at once.

**C.A. SNOW & CO.** *Registered Patent Attorneys Since 1875*

**FREE FACTS FOR YOU**

**199 SNOW BUILDING, WASHINGTON, D. C.**

Gentlemen: Please send me—without cost or obligation—your FREE books, "Suggestions on How to Commercialize Your Invention" and "How We Protect You." Also Certification of Invention form.

Name \_\_\_\_\_

Street and No. \_\_\_\_\_

City or Town \_\_\_\_\_ State \_\_\_\_\_

## Learn To MOUNT BIRDS

**TAN SKINS—MAKE UP FURS**

Be a Taxidermist. We teach you at Home. Mount Birds, Animals, Pets, Heads, Fish. Save your hunting trophies. Decorate home and den. **Make Money. Mount and tan for others. Fun and Profit! Don't delay. WRITE TODAY—NOW—for FREE BOOK with 100 game pictures. Hunters, get your copy. It's Now Free. Send post card. State your AGE.**



N. W. SCHOOL OF TAXIDERMISTRY, Dept. 9376, Omaha, Nebr.

## Auto-Diesel

Master a real trade. Auto Mechanics, Diesel Mechanics, Arc Welding, Acetylene Welding, etc. Let us train you to be an expert Auto-Diesel Mechanic and help you get a good job. The cost to you is reasonable. Learn on modern equipment with tools under experienced instructors. Real shop work. Steam heated buildings. Room and board in our steam heated dormitory. We pay your fare to Nashville. For free catalog write

**Nashville Auto-Diesel School, Dept. 75, Nashville, Tenn.**

## How To Secure A Government Position

In the Classified Service! Railway Postal Clerk, \$1900 a year regular. Postal Clerk, City Mail Carrier, \$1700 regular. Other attractive positions paying \$1260 to \$2100 a year. Our tested method helps you pass examinations. Men—Women, age 18-50, send for FREE BOOK explaining requirements TODAY.

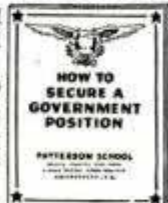

**PATTERSON SCHOOL, 2310 Mercantile Bldg., Rochester, N. Y.** Send without obligation, free book "How to Secure a Government Position."

Name \_\_\_\_\_ Age \_\_\_\_\_

Address \_\_\_\_\_



To Ambitious Bookkeepers and Junior Accountants—

# ARE YOU GETTING AHEAD THE SPEEDY WAY



## —OR THE SLOW WAY?



### Here's how you can find out! Answer these questions:

- Do you know *why* the management asks for each set of figures that you prepare?
- Do you see clearly *how* those figures will shape company policies?
- Do you daily *interpret* your books and your records in terms of profit and loss to your firm?
- In short, is your day-to-day work *full of meaning* to you or is it just humdrum routine?

**Y**OUR answers to those questions would give an experienced personnel man a picture of your entire future!

For only to the man or woman who "knows what it's all about" does speedy, worthwhile promotion come. The routine worker goes ahead at a snail's pace—if at all.

Yet knowing what it's all about in bookkeeping and accounting is within reach of almost *any* office worker—provided he has ambition enough to *train* earnestly.

The road is clearly marked and an average person—like you—can travel it if he really *wants* to!

Naturally, it takes real work—work that even LaSalle, after 30 years, can only cut down, not cut out entirely.

But LaSalle can, and does, make your study interesting—easy to understand—*useful right on your present job*—if you will do *your* part.

Of course, your time for the movies, the card-table, and the radio will be somewhat less than that of those who sit and merely *hope* for promotion, or *wish* for a raise. But the hours *you* sacrifice now earn hard cash profits for you in the future.

Hundreds, yes thousands, just like you have *proved* that LaSalle-trained accountants can earn —\$2,000, \$3,000, \$5,000 and even more. Their stories are so interesting—so full of encouragement—that we have published a whole book of them: "Success Reports."

This book is jam-packed with human interest experiences that show how bookkeepers and junior accountants who once were discouraged cogs in the business machine have today become important executives, auditors, comptrollers, and Certified Public Accountants—with good incomes and with all the prestige of real business success.

Over and over, you find such phrases as: "Then came my second raise"—"So then they made me manager"—"That first increase completely paid for my training the first two months."

To anyone interested—really ambitious—we will gladly send a copy of this book *absolutely free!* It has been a true inspiration to many, a real help to all who have read it.

Would you like a copy? Without the slightest obligation? Then mail the coupon and we will forward it by return mail. You'll be glad you read it!

## LaSalle Extension University A Correspondence Institution

Dept. 964-HR

Chicago, Illinois

Gentlemen:

As an ambitious (man) (woman) interested in a real future, I should like a FREE copy of "Success Reports" telling how others have built their futures through LaSalle Accountancy Training. Please send me a copy at once—without obligation on my part—also send your booklet, "Accountancy, the Profession That Pays."

Name.....Age.....

Position.....Firm.....

Address.....

When writing to advertisers please mention Popular Mechanics

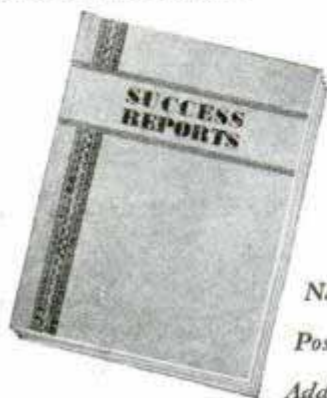





# CLASSIFIED

## Advertisements



Advertisements in this section, 35 cents per word, each insertion, minimum 10 words, payable in advance

To be inserted under proper classification in October issue, copy should be in our office August 8th

October issue on sale September 1st

Popular Mechanics Magazine, 200 East Ontario Street, Chicago, Illinois

## YOU'LL PROFIT

By reading and answering the classified ads in this section. Hundreds of opportunities to make and save money.

Popular Mechanics Magazine,  
200 East Ontario Street, Chicago, Illinois

Gentlemen: I'm through experimenting. For nearly four years I have had a 25-word ad in every issue of Popular Mechanics Magazine. During that period this same ad has appeared in more than 150 daily newspapers and magazines, the address keyed so that I could trace all replies to the publications producing results. After classifying these returns on a cost basis, I was not surprised to learn that Popular Mechanics landed four times the business credited to Popular Mechanics' nearest competitor. That's why I'm through experimenting.

(Original letter on file in our office)

Cordially,  
NORMAN P. HENDERSON.

### AUTOMOBILES—MIDGET CARS

**AUTOMOBILE** Mechanics who want business or earn extra money write for samples and details of nationally distributed Self-locking Triple-X Piston Rings. Eliminate re-boring. Guaranteed life of car. Franchise valuable. Some territories open. Triple-X Co., 3801 South Racine, Desk N, Chicago.

**MIDGETS**, Box 543-H, Zanesville, Ohio. Manufacture parts, kits. Planbook-catalog, 10c.

**TOURING** Mountains? Our new altimeters indicate height. \$3.95. Air Transport. Garden City, N. Y.

**MIDGETS!** Racecars, sportcars, motor-scooters. New bargain lists—over 130 used motors, midgets, parts—20c. Midgets, Box 543-H, Zanesville, Ohio.

**MIDGET** Cars. Parts. Plans 50c. Catalog 20c. Derby Midgets, Woodstock, Ill.

**MIDGET** Racers, two-passenger autos. Midget motorcycles, motorscooters, motors, wheels, parts, plans, handbook catalog, 58 illustrations, 20c. Midwest, Box 1959-J, Chicago.

**CHEVROLET** 1935-1938: Gasoline saving device. \$1. Walert Co., 3429 No. 10th St., Milwaukee, Wisconsin.

**GAS Saver**—Connects to wiper line. Postpaid 25c. Guaranteed. Motor Specialties, Wilkensburg, Penna.

**ALUMINUM** Alloy pistons, automotive, aviation, diesel, industrial, marine, midget, model, motorcycle, outboard. Finished or semi. Judson Mfg. Co., Hedge and Gillingham, Philadelphia, Penna.

**VAPOR-SCREEN** Gas saver, for all cars 50c. Accessory Annex, McKeesport, Penna.

### AUTO TRAILERS

**TRAILER** Instruction book containing 68 pages designs, plans, parts, illustrations, Mail 10c stamps today. A. J. Stephens, Kansas City, Mo.

**BUILD** The famous, low-cost Jim Dandy Cabin Trailer. Complete plans and instructions 50c. Plans to build the beautiful, streamlined Jim Dandy Cabin Cruiser, \$1.00. Trailer Builders Manual and catalog of trailer parts, supplies and equipment—over 100 interesting, illustrated pages, 25c. Order today. Satisfaction guaranteed. Trailer Supply Co., 411-A Jackson St., Wausau, Wisconsin.

**TOURISTS'** Cabins, attractive 10x12 ft., how to build and 359 other practical articles in Shop Notes, Vol. 32, only 50 cents postpaid. Popular Mechanics Press, Room (C39), 200 E. Ontario St., Chicago.

### AUTO SUPPLIES AND EQUIPMENT

**HIGH-PRESSURE** Nozzle—Combines air and water pressure for cleaning chassis and engines. Air controlled. Snap on-off air connector. Its efficiency will amaze you. \$5.75 postpaid U. S. and Canada. Details free. A. L. Hess, 1135 S. Atlanta St., Tulsa, Okla.

**POWERBALL** Your car. More dig. Saves gas. Removes flat spots. Turns 200,000 rpm. Write Powerball, 803 So. Gramercy Pl., Los Angeles.

**VALUABLE** Body and fender repair hints. 50c. Max, P.O. Box 131, W. Palm Beach, Florida.

**BARGAINS**—Compressors, welders, battery chargers, car washers, attractively priced. Terms, trial. Write for bargain list. Hobart Automotive Supply, Box M-985, Troy, Ohio.

**SAND** Blast spark plug cleaners, \$3.00 postpaid. Wen Co., Webster City, Iowa.

**GASOLINE** Substitutes, reduces operating costs to minimum. No dieselizing. 16 guaranteed formulas, \$1.00. Dieselo Company, P.O. Box 607, Albany, New York.

**FREE** Wholesale bargain catalogue auto supplies, equipment, tools. For dealers only. American, 1189 Bedford Ave., Brooklyn, N. Y.

**1939 PLYMOUTH** (Deluxe), Chrysler, DeSoto, Dodge cars shift much easier with rod added to lever. Send for free diagram. Dual-Eez-Rod, P.O. Box 267, Grand Central Annex, New York, N. Y.

**ELECTRIC** Tire regroover to regroove tread on smooth or worn tires. Guaranteed only \$5.00. Agents wanted. Lee Mfg. Co., 5405 Powell, Portland, Ore.

**TURN** Scrap into money. Convert old auto generators into A.C. generators for auto radio, camp and home lighting, power and other uses. Complete book \$1 postpaid. Popular Mechanics Press, Room (C39), 200 E. Ontario St., Chicago.

**MODERNIZE** Your gearshift! Make simple, neat, standard shift, dash control. Illustrated instructions. 30c. Shaffer, Litchfield, Nebraska.

**RE-REFINE** Crankcase drainings, request information. Zeiball, Mount Holly, N. J.

**ACETYLENE** Welding outfits, \$32.95; electric welders, \$74.95. Easy-payment plan. Box 331, Hamilton, Ohio.

**PLATING** Outfits for auto parts. Connect to a battery. No tanks used. Free particulars and proofs. Gunmetal Co., Ave. J, Decatur, Ill.

**CRANKCASE** Oil, refine it. Specifications, one dollar. Technical Laboratories, East Haven, Conn.

### MOTORCYCLES, BICYCLES, MOTOR SCOOTERS AND SUPPLIES

**SEND** 10c for 1939 Handbook of Information. New and used parts, accessories for Indian, Harley, Henderson, Excelsior. Valuable information on motorcycle rebuilding. Bootz, 622 East Grand, Des Moines, Iowa.

**BUILD** Power scooters, midget cars. We supply tires, wheels, motors. Lowest prices. Send 10c for plans, etc. Build-Your-Own Devices, 5238 Lake, Chicago.

**MOTORCYCLE** Parts and accessories, new and used, for all motorcycles. Write for prices. Henderson list 10c. Triangle, 1111 Washington, Chicago.

**MOTORSCOOTERS**, Midget cars! Easily built. Complete plans and literature on wheels, tires, motors, etc. 10c. Honsakers, Masontown, Penna.

**MOTORSCOOTERS!** Save 70% building own Comet scooter. We manufacture parts. Literature, drawing, 10c. Comet Cycle Company, Box 3032, Madison, Wisconsin.

**SEND** 10c in stamps for illustrated bulletin of cut-rate motorcycle supplies, new and used parts. Authorized Harley distributors. Tulsa Motor & Cycle Co., 917 E. 2nd, Tulsa, Oklahoma.

**MOTORSCOOTERS:** Save \$30-\$50 building latest, easiest built scooter. Steel kit, \$3.95, plans free. Complete illustrated catalog 20c. Midwest, Box 1959-K, Chicago.

**ALLOY** Pistons \$3.00—Harley, Indian, Henderson, Excelsior, Cleveland, Cylindar grinding, rings, bearings, gaskets, chains, sprockets, helmets, goggles, accessories, parts new and used for less. Catalogue and wings pin 10c. Ballak, 1115 Chestnut, St. Louis, Mo.

**YOUR** Money's worth at Knuth's. The best buys in reconditioned Harleys. Just think! Fully equipped police specials 37-80's only \$250.00. 36-80's for \$220.00. Many other bargains. Send 6c for bulletin. Knuth's, 2491 Fondulac, Milwaukee, Wis. "Everything for the motorcyclist."

**WRITE** Us for motorscooter, midget car, motorboat motors, Clear-Vue Co., Dayton, Ohio.

**HARLEY** And Indian pistons. Aluminum alloy, absolutely guaranteed, \$2.50. With pin and three rings, \$3.25. Frank Reed, 1806 Ave. B, Council Bluffs, Iowa.

**MOTORCYCLES**, Reconditioned. New, used, parts and accessories. All makes. Large stock. Bargains. Illustrated catalog, 15c. Indian Motorcycle Sales, Kansas City, Mo.

**MOTORCYCLE** Bargains, lowest prices, bargain sheets for stamp. Motorcycle accessories. Rochester Harley Davidson Corp., 129 W. Main St., Rochester, N. Y.



**MOTORCYCLE** Cylinder boring \$2.00. Aluminum pistons, stock or racing, all models, (dealers supplied). New and used Indian parts. Used motorcycles. Stamp brings list. Phila. Indian, 1635 Hunting Park, Philadelphia, Penna.

**INSIDE Dealer prices.** Overstocked, all models, Indians and Harleys. Rebuilt, guaranteed. Dime brings latest list. Crandall-Hicks, Boston, Mass.

**RECONDITIONED Motorcycles.** New—used parts for all makes. Authorized Harley-Davidson dealer. Whitman Motorcycle & Supply Co., 405-9 Southwest Blvd., Kansas City, Mo.

### AVIATION

**SNOWSLED Engines** \$95.00. Ford A, powerful, aircooled, propeller driven. Conversion only, \$29.95. Literature free. Heath Aviation Company, Dept. M-1, Benton Harbor, Michigan.

**PROPELLERS** For airplanes, sleds, boats. Catalog 10c. Banks Propellers, Love Field, Dallas, Texas.

**130 AIRPLANES** \$35 Up. Located everywhere. Complete catalogue 25c. Used Aircraft Directory, Athens, Ohio.

**AIRPLANES!** 10 Exclusive photographs \$1.00. Lynnpeltcher, 4772 Del Monte, San Diego, California.

**AVIATION Opportunity.** Short trade courses; master mechanic training. Write Registrar Missouri Aviation Institute, Municipal Air Terminal, Kansas City, Mo.

**AVIATION Apprentices** — Airminded young men interested in training for entering aviation as apprentices see ad on page 6A.

**LEARN To fly free.** Folder, dime. Ohmeyer, Box 391, Hempstead, N. Y.

**JUST Out.** Practical course in flying. 29 chapters, illustrated, complete. Only \$1.00. Aircraft Directory, Athens, Ohio.

**PROPELLERS** For airplanes, sleds. Iced-sled blueprints, supplies. Catalog dime. Lorenzen Propellers, Niles, Michigan.

**GET Into aviation.** Pilots earn up to \$6000 a year! Airplane mechanics and aeronautical engineers also get big pay! Prepare at this Lincoln government approved school. Write for complete information. Lincoln Airplane & Flying School, 2004 Aircraft Bldg., Lincoln, Nebraska.

**WRIGHT "Whirlwind"** engine, model lithographed in colors, size 13x22 in. Shows and names every part. Invaluable for aviation students. \$1 postpaid. Popular Mechanics Press, Room (C39), 200 E. Ontario St., Chicago.

### BATTERIES, GENERATORS, ETC.

**50-1/2 HORSE.** Repulsion induction, 110-220 volt, heavy duty motors, 3400 speed, \$9.75. Also generator bargains. Electrical Surplus Company, 1885 Milwaukee, Chicago.

**ELECTROPLATING**—Motor generators or belt drive, attractively priced. Easy terms, trial. Hobart Platers, Box M-992, Troy, Ohio.

**REBUILD Farm and auto batteries.** Convert old into cash. Send 25c for catalog and complete manufacturing course. Home Occupations, St. Paul, Minn.

**NEW 110 A.C.** auto fanbelt generators for movies, amplifier, neon signs, \$16.00 up. LeJay Manufacturing, 147 LeJay Building, Minneapolis.

**HOME Battery charger** works from house current. Plugs into automobile dash receptacle. Keeps battery fully charged. Pays for self. Rush name for complete facts. Choate Mfg. Co., 3466 Principio, Cincinnati, Ohio.

**EDISON Lifetime storage batteries** for light and power. Eliminates acid battery diseases. Long guarantee. All kinds rebuilt generating plants, motors, and miscellaneous articles at bargain prices. Free interesting literature. T. Hawley Smith Co., Croton Falls, N. Y.

**REWOUND Auto generators** give 110 volts a.c. for lighting outfit. Complete instructions in Shop Notes for 1937 only 50 cents postpaid. Popular Mechanics Press, Room (C39), 200 E. Ontario St., Chicago.

**EDISON Storage batteries** for light-power systems. Non-acid. Odorless, fifteen year life. Five year unconditional guarantee. Bargains in complete lighting systems. Low prices. Free illustrated literature. "See-Jay" Battery Co., 82 Sterling Ave., Yonkers, N. Y.

### ELECTRICAL SUPPLIES, EQUIPMENT

**FLUORESCENT Lighting.** New. Stamp appreciated. Balco, 1728 N. Wells, Chicago.

**BARGAINS**—Arc welders, also motor generator. Write for new bargain list telling needs. Hobart Bros., Box M-997, Troy, Ohio.

**ELECTRIC Engraver,** engraves all metals deeply, dollar. Hudson Bros., East Syracuse, N. Y.

**ELECTRO-SCRIBE:** Electric pencil. Writes, engraves all metals. \$1.00 postpaid. Details. Beyer Mfg. Co., 4515-K Cottage Grove, Chicago.

**MAGNET,** Alnico, new wonder alloy lifts 50 times own weight, \$1.00. Advance, 861-P10, Minneapolis, Minn.

**BUILD Electric plant** for your cabin. Operates from wind. Complete plans and valuable catalog 10c. LeJay Manufacturing, 447 LeJay Building, Minneapolis, Minn.

**80 PAGE Handbook.** Drawings, formulas, hookups. Electricians, winders, foremen, maintenance. \$3.00. Circular free. "Maintenance," Box 22, Fairview Station, Detroit, Mich.

**REPAIRING Electrical appliances** and 330 other money making shop kinks in Vol. 31, Shop Notes, only 50c postpaid. Popular Mechanics Press, 200 E. Ontario St., Chicago.

### WELDING AND SOLDERING

**GENUINE Arc-welding** from any 32 volt battery light system. Economical, easy to build. Plans \$1.00. Pulis & Johnson, Bairo, Okla.

**75-200 AMPERE Arc welders** from Dodge generators. Complete plans 35c. 100 other generator changes. LeJay Manufacturing, 347 LeJay Building, Minneapolis, Minn.

**LEARN Arc welding.** It's easy—get big pay jobs—complete individual instruction at bare cost of materials used. Write for details. The Arc Welding School, Box M-999, Troy, Ohio.

**REBUILT a.c. d.c. Arc welders,** all sizes; engine governors, idlers. Terms. Low prices. Guaranteed. Service Co., 3732 Cedar Ave., Cleveland, Ohio.

**DEMONSTRATORS.** Electric arc welders. Money-saving prices. Used by the government. Trial and terms guaranteed. Hobart Welders, M-993, Troy, Ohio.

**D.C. ARC-WELDER** Plans \$1.00 each or three for \$2.00. 25-200 amperes from 32 volt Delco light plant generator. 25-200 amperes from North-east Dodge automobile generators. 25-600 amperes from vehicle d.c. motors. Welders Club, AB-3432 M-Mart, Chicago. (Special: 44 Lessons in Arc-welding 50c, foreign 75c.) For sale: 20 Westinghouse d.c. vehicle motors.

**LOW-TEMP Brazing,** use gasoline blowtorch. Particulars. Schmidt, 3216 Olive, Chicago.

**GAS Soldering torch.** Works from any gas outlet. No oxygen—no compressed air—no blower. Instant heat. Any size flame. Make soldering easy. \$5.95 on money back guarantee, or free facts. Rush name. Choate Mfg. Co., 3467 Principio Ave., Cincinnati, Ohio.

**OXYACETYLENE Welding and cutting** and 359 other informative articles in Shop Notes, Vol. 32, only 50c postpaid. Popular Mechanics Press, Room (C39), 200 E. Ontario St., Chicago.

### ELECTRIC FENCING

**ELECTROFENCE AC controller,** blueprints \$1, blueprints and parts \$6.50. Assembled \$7.50. Electrofence, West Winfield, N. Y.

### ENGINES, MOTORS, DYNAMOS

**"PEPY" Governors** make automobile engines into power units. Most sensitive and accurate. Low price. \$9.50 postpaid. Get circular. Harris Machinery, Minneapolis, Minn.

**300 MOTOR Diagrams and tables** covering three phase; Star, Delta, nine lead, two and four speed; two phase; single phase; split phase, capacitor, repulsion induction, fan, armature windings, etc. Satisfaction guaranteed or money refunded. \$1.50 prepaid. Educational Advancement Company, Lakewood, New York.

**GOVERNORS.** Auto engine, guaranteed accurate. Wilhelm Eng Co., Webster City, Iowa.

**BARGAINS**—Plating generators, motor generator sets, also arc welders. New low prices for large and small shops. Trial—easy terms if desired. Hobart Bros., Box M-996, Troy, Ohio.

**ALTERNATING,** 1/2 Horse, 110 volt, induction motors. Rebuilt, guaranteed, \$7.25. Wilmot Auto Supply, 2247 St. Paul Ave., Chicago.

**ALTERNATING Current bargains.** Fans, grinders, drills, motors, clocks, shavers. Home workshop tools. New pricelist free. Mailorder Electric, 713 South Dearborn, Chicago.

**THREE To ten KVA alternating generators.** Motors, converters. State your needs. Queen City Electric, 519 South California, Chicago.

**MOTOR Winding data.** Introductory selection single and three phase, \$1.00. Motor Data Co., Box 7631, Kansas City, Mo.

**AIR Compressors,** new, 1 3/4 x 1 3/4, \$6.00; 2x2, \$7.00; 2 1/2 x 2, \$8.00. Guaranteed. Send check or money order. Free catalog. National, 1915 South State, Chicago, Ill.

**REFINE Used oil** without cost. Particulars. F. Gerwin, Fairview, Oklahoma.

**BARGAIN**—1/2 Hp. motors, 60 cycle, 1 phase, 110 volt, like new, guaranteed, \$7.40. Send check to Erie Electric Motor Co., 120 Church, Buffalo, N. Y.

**ARMATURE Winding.** New edition. Construction, winding, repairing a.c. and d.c. motors and generators. \$2.00. Popular Mechanics, 200 E. Ontario St., Chicago.

### MACHINERY, TOOLS AND SUPPLIES

**YOU'LL Be money ahead** if you buy Atlas equipment. Metal and wood lathes, drill presses, arbor presses, metal shaper, vises, motors, grinders, tools and attachments. Send for 1939 catalog. Atlas Press Co., 2943 N. Pitcher St., Kalamazoo, Mich.

**BARGAINS, Demonstrators,** electric arc welders, guaranteed, 30 days trial and terms. Write Hobart Welder Exchange, Box M-994, Troy, Ohio.

**DIAMOND Grinding wheel dresser** \$2. Collectors specimens \$1. Carmody, Box 202, East Orange, N. J.

**TREMENDOUS Surplus** of factory tools selling out. Drills, taps, files, hacksaws, etc. Send for free lists, include six cents postage. Travers Tool Co., 264 Jackson Ave., Long Island City, N. Y.

**FREE Catalog** of electric motors, grinders, drills, paint spray equipment, pumps, work shop machinery, blowers and exhaust fans. Sutton Electric Co., 767 Granby, Norfolk, Va.

**PLASTICS,** Brass, aluminum, Dowmetal, monel, stainless steel, gears, etc. Catalog 10c. Hobby Supply House, Box 2014, Pittsburgh, Penna.

**DRILL Grinding attachment** fits bench grinder, hand or power turned. Handles sizes 3/16 to 1 1/4". Price \$7.85. Descriptive literature on request. Tractor-Lite Co., Sidney, Iowa.

**14" x 6' GREAVES Klusman** cone head engine lathe, quick change. No. 0 Cincinnati miller, cheap. Write for particulars. Cincinnati Machinery & Supply Co., 221 E. Second St., Cincinnati, Ohio.

**HOMEMADE Band saw,** saw table, jointer, grinder and 350 other practical shop subjects in Shop Notes, Vol. 32, only 50c postpaid. Popular Mechanics Press, 200 E. Ontario St., Chicago.

### BOATS, OUTBOARD MOTORS, ETC.

**SAILKITS 100 Square feet** \$4.15. Other sizes, marine supplies reduced. Tents, sleeping bags 45% discount. Catalogue 5c. Alans, 98 Chambers, New York City.

**BUILD A boat** by the Welch System. It's inexpensive; interesting and profitable. Everything for building; equipping or repairing boats. Use Welch Ready Cut Parts. Send 10c for catalog showing boats of many types; boat hardware; propellers; marine paints; sails; boat finishing materials and Welch White Cap marine motors. Welch Boat Company, Station K-1, Milwaukee, Wisconsin.

**16 FOOT Plywood kayak.** Building plans in July Rudder 35c. Free catalog boat-building plans. Rudder, 15 Murray Street, New York.

**BUILD Electric outboard** from old automobile generator. Operates with car battery. Smooth—quiet. Plans 10c. LeJay Manufacturing, 547 LeJay Building, Minneapolis, Minn.



**EASY** Built Kayaks—outboards. Complete kits. Twenty models. Catalogue. Kayak Boat, 154 East 129th, New York.

**PADDLE-BOARD** Kits. 14 ft. complete, \$14.95 f.o.b. Box 2283, Laguna Beach, California.

**AMERICA'S** Biggest kayak values! 12' kit \$10.00 complete. Literature. Playaks, Dedham, Mass.

SEE Our ad on page 125A. Cleveland Boat Blueprint Co.

**PROPELLERS.** Gear pumps, stuffing boxes, bearings, etc. Wm. Baker, Pond St., Quincy, Mass.

**AIR-COOLED** Inboard motorboats. Complete \$75.00. Details. Clear-Vue Company, Dayton, Ohio.

**FORD-ZEPHYR** Marine conversions. Catalog 10c. Lehman Engineering Company, Dept. D, Newark, N. J.

**MARINE** Power—Easily convert any Ford motor (domestic and foreign) with Osco parts and kits. Complete catalogue 25c (coin). Osmithson, 3644 Lawrence St., Philadelphia, Penna.

**ASSEMBLE** Your own boat. Our finished knock-down frames and materials save you 2/3 builder's cost. All types and sizes. Send 25c for big catalog. Brooks Boat Co., Inc., D4, Saginaw, Mich.

**OUTBOARDS** — Save 1/2. Good used parts, all makes and models. Bargains rebuilt motors. Crandall Hicks Co., 959 Commonwealth, Boston, Mass.

**BOAT** Designers are highly paid professionals. Complete course by mail. Catalog. Westlawn, Montville, N. J.

**BUILD** Your own boat—New book gives plans, methods, etc. 312 pages \$3. Popular Mechanics Press, Room (C39), 200 E. Ontario St., Chicago.

#### SPORTING GOODS, GUNS, FISHING TACKLE, ARCHERY

**HUDSON** Bay blankets, complete camping, hunting, outdoor equipment. Catalog. Howe Fur Company, Coopers Mills, Maine.

**BUILD** 22 Cal. Olympic single target pistol. Special sights. Best game gun. Specifications, prints—\$2.00. Details—10c. Investigate. Box 186, Kenosha, Wis.

**TENNIS** Restrainers: Frames, gut, silk. Free catalogue. Tennis Supply Co., 437 Palace Bldg., Minneapolis, Minn.

**BARGAINS!** A-1 Gov't. Slings 50c, swivels 35c. Gun catalog 5c. J. Warshal Sons, First-Madison-PM, Seattle, Wash.

**GOLF** Clubs. Five club matched set \$2.50. Lincoln Surplus, 123 Galena, Freeport, Ill.

**BOWS,** Arrows, raw materials. Beautiful catalog (over 125 pictures) and "Essentials of Archery" a handbook on making bows and arrows 35c. Everyone intending to make their own should have this manual. Instruction folder and catalog 10c. L. E. Stemmler, Queens Village, N. Y.

**OUTDOOR** Sports for everyone—Enjoy them all your round with aid of book published by Popular Mechanics. Hundreds of ideas for new and popular sports for every season; complete instructions for making necessary equipment at small cost, 350 pages and 650 illustrations. \$2 postpaid. Popular Mechanics Press, Room (C39), 200 E. Ontario St., Chicago.

#### FIELD GLASSES, TELESCOPES AND MICROSCOPES

**TELESCOPES.** Microscopes, binoculars; 1939 bargain catalog free. Brownscope Co., 5 West 27th Street, New York.

#### ANTIQUES, RELICS, INDIAN GOODS

**ARROWHEADS!** Glacial boulder beauties. Rainbow variations. Don McKillop, Regina, Sask.

**INDIAN** Relics, coins, bills, gems, crystals, curios, etc. Illustrated catalog 5c. 100 ancient arrowheads \$3.00. H. Daniel, Hot Springs, Ark.

**SWORDS.** Rapiers, pistols, daggers, armor list 10c. Robert Abels, 860A Lexington Ave., New York.

**INDIAN** Relics, beadwork, coins, curios, minerals, old glass. Catalog 6c. Indian Museum, Northbranch, Kansas.

#### TAXIDERMY

**TAXIDERMY** Supplies—Quality artificial eyes, teeth, genuine Jonas head forms. Tools, materials, etc. Everything for the progressive taxidermist. Send 10c for big illustrated catalogue. Jonas Bros., 1049 Broadway, Denver, Colo.

#### DOGS, PETS, BIRDS

**PHEASANTS** — Common, ornamental, shooting, restocking, display. Send 5c stamp for pamphlet price list. Rainbow Farm Pheasantry, Barrington, Illinois.

**SPORTSMEN:** 200 Pointers, setters, straight cooners, combination hunters, rabbit and fox hounds. Reasonable. List free. Ramsey Creek Kennels, Ramsey, Illinois.

**BEAUTIFUL** Pure white police dogs. Ansonia Kennels, Mose, N. Dak.

#### POULTRY AND FARM SUPPLIES

**MAKE** Money with poultry. Read America's leading poultry magazine for latest information. Three years \$1.00; nine months 25c. Poultry Tribune, Dept. E-93, Mount Morris, Ill.

#### TREES, SHRUBS, ROOTS, HERBS

**JUST** Out! World's greatest "Herbalist Almanac." Beautifully illustrated in natural colors. Contains over 200 old-fashioned herb medicine recipes for home use. 10c postpaid. Worth dollars! Botanics, 145 W. 112th St., Chicago.

#### FARMS AND FARM LANDS

**ORCHARD** Farm, 800 poultry, cow, equipment, growing crops included: 22 acres on high ground near town; 150 apple, 180 pear, 40 other fruit trees; good 9-room house, bath, electricity, fireplaces, new barn, poultry houses; moneymaker and only \$4000, attractive terms; page 44 big free catalog. Strout Realty, 255-P 4th Ave., New York City.

**WRITE** American Investment Co., Oklahoma City, for plats of bargain farms selling on small payments.

**THE** Great Northern Railway serves an agricultural empire where rents, prices and operating costs are low in Minnesota, North Dakota, Montana, Idaho, Washington and Oregon. Write for free book. E. C. Leedy, Dept. 957, St. Paul, Minnesota.

**FLORIDA** Tax deed lands. Good fruit and farm lands. Ten acres \$70.00. \$5.00 down. \$5.00 month. Many others. Florida Tax Deed Service, 8007K Nebraska, Tampa, Florida.

**GOVERNMENT** Lands ten cents acre up. Information all states twenty-five cents. National Tax Service, 600A Majestic Bldg., Detroit, Mich.

**GOOD** Farms available. Washington Minnesota, Idaho, western Montana, Oregon. Dependable crops, favorable climate. Write for impartial advice, literature and list of typical bargains. Specify state. J. W. Haw, 119 Northern Pacific Ry., St. Paul, Minn.

#### FARM MACHINERY AND SUPPLIES

**FORDS** Portable Hammermill operators make regularly weekly net earnings, \$50, \$75, \$100 and more. Fords' exclusive molasses impregnator gives operators big competitive advantage. Equipment may be purchased 25% down, balance from earnings. Write for particulars about this safe, sure, profitable year-round business. Myers Sherman Company, 1428 12th, Streator, Illinois.

**GARDEN** And all purpose tractors at factory price. Shaw Du-All 2 to 8 horsepower, riding or walking types. Does plowing, discing, harrowing, cultivating; mows lawns, cuts weeds, does hauling; runs belt machinery. Air or steel tires. Thousands in use. 10 day trial. Write for free catalog. Shaw Mfg. Co., Dept. PM-8, Galesburg, Kansas.

#### PROFITABLE OCCUPATIONS

**HOW** To earn money at home! Big, free book tells inside story—how hundreds are earning cash raising mushrooms in cellars, sheds. Cash paid for all raised. Write today. United, 3848 Lincoln Ave., Dept. 67, Chicago.

**MAKE** Money raising mink. Write today to Skyline Minkery, Box 135, So. Sudbury, Mass.

**MAKE** Money making-selling archery—operating archery range. Complete construction book 50c. Catalogue materials free. Chester Brown, 617 South State, Chicago.

**BUSINESS** Proposition resilvering mirrors, autoparts, reflectors, making chipped glass signs. Write Sprinkle, Plater, 288, Marion, Indiana.

**NATIONAL** Baking Institute announces a new home study course covering all phases of commercial baking. Good field for ambitious men. Nearly a depression proof business. Common school education sufficient. Send for free booklet "Opportunities in the Baking Industry" and requirements. National Baking Institute, 3601 Michigan Avenue, Dept. 3436, Chicago, U.S.A.

**NEUFOND** Giant bullfrog breeders \$25 dozen. Peacock's Tropicarium, Fort Lauderdale, Florida.

**\$30** WEEKLY. Grow mushrooms. Cellar, shed. We buy 30c lb. Mr. B made \$270 spare time. World's largest company. 40 page book free. Mushrooms, Dept. 701, 2019 Second, Seattle, Wash.

**TRAINED** Mice—Fun and profit. Instructions \$1.00. "Circo," 3301 Second, Richmond, Va.

**MEN—**Women, operate "Specialty Candy Factory" home, all or spare time. Steady income. (Our 31st year.) Hillyer Ragsdale, Inc., Drawer 62, East Orange, N. J.

**MONEY** In rabbits and cavies. We buy and put you in touch with other markets. Catalog and copy of magazine 10c. Or send 25c for book catalog and price list and year's subscription to the American Small Stock Farmer. Stahl, Box 1, Holmes Park, Mo.

**SELL** By mail. Make own wonder product. Write Springer, 8723 Union, Chicago.

**STANDARD** Rabbit Journal, Milton, Penna., year 50c. Sample dime. Supplies.

**1001** WAYS to Use Concrete. Send for large free illustrated folder describing new Popular Mechanics book covering every known use of concrete for the home, farm, building, business and industry. Popular Mechanics Press, Room (C39), 200 E. Ontario St., Chicago.

#### BOOKS, PERIODICALS, PICTURES, POSTCARDS

**SEND** 10c For trial subscription, American Freeman, questions and answers magazine. Haldeman-Julius, Box 107, Girard, Kansas.

**BOOK—**Israel, Yesterday and Tomorrow. Prophecies of future of Jews and Jerusalem. 10 cents. Mrs. W. H. Merril, Bradenton, Fla.

**MAIL** Postcards from Washington in own handwriting. You address, then return here for mailing. 25c for two. 50c for six historical postcards. Mailing Service, Suite 1204, No. 1343 H Street Northwest, Washington, D. C.

**ANY** Book in print. Want list on request. Stenger, 652 Woodland Park, Chicago.

**BOY** Mechanic—Famous library of 3 volumes covers the building of almost everything a boy might want to make. Actually covers 3,000 different articles. Each volume 460 pages, fully illustrated. Cloth. Price \$2 each or set of 3 vols.—\$5 postpaid. Popular Mechanics Press, Room (C39), 200 E. Ontario St., Chicago.

#### GAMES—ENTERTAINMENT

**PLAYS,** Operettas, musical comedies, complete minstrel first-parts with song programs, blackface skits, vaudeville acts, monologs, dialogs, recitations, juvenile plays and songs, musical readings, entertainments, make-up goods. Catalog free. T. S. Denison & Co., 203 N. Wabash, Dept. 11, Chicago.

#### MAGIC TRICKS, PUZZLES, JOKER NOVELTIES

**ILLUSTRATED** Magic catalog 10c. Davis Co., 1618 St. Paul St., Philadelphia, Penna.

**HOUSE** Of 1000 mysteries! Professional magic! Pocket tricks! Jokes! Puzzles! Novelties! Two big surprise catalogs! Both illustrated! Both for 20c! Lawson Vick Co., Dept. P11, Queens Village, N. Y.

**BE** A magician. Large professional magic catalogue of latest tricks 25c. Cash paid for complete Tarbell magic courses. Write, Ireland, C-109 North Dearborn, Chicago.



**LARGE** Magic catalog 25c. Hundreds of tricks. Chicago Magic Company, 2300 N. Mason Avenue, Chicago.

**AMAZING!** New 100 page catalog 500 tricks 10c. Lyle Douglas, Station A-5, Dallas, Texas.

**EARN** Money in any crowd. Call names of strangers, tell unspoken questions. Professional course mind reading, spirit writing, etc., \$1. Henderson, Box 341, San Bernardino, Calif.

**WORLD'S** Largest magic shop professional catalog, 25c. Holden, 220 W. 42nd St., New York.

**LEARN** Ventriloquism, 3c stamp brings particulars. Smith, 125 N. Jefferson, Peoria, Illinois.

### STAMP COLLECTING

**GIANT** Packet 200 all different from Africa, South America, Asia, South Sea Islands, etc. Includes world's smallest stamp; triangle and diamond-shaped stamps; animal stamps. Nicaragua "Will Rogers" airmail; many others. Also packet 17 different United States (cataloging 50c) —all obsolete, including \$4 denomination, commemoratives, etc. Total catalogue price over \$5.00! Everything for only 5c to approval applicants! Mystic Stamp Company, Dept. 80-N, Camden, New York.

**WANTED.** U. S. postage, small discount. Langer, 761 Sixth Ave., New York.

**WELL** Filled stock book, 48 packets, worth 15c alone with 21 mint sets from 21 French colonies, 84 large stamps in all, new and old issues, 25c, approvals, French, 241 Euclid, Cleveland.

**GENUINE** Baden, Liberian Bongo, mystery British Colony triangle, Manchukuo, Caymans, \$5 U. S. Negri Sembilan, Mayotte Islands. Everything 3c with approvals. Viking, 1-Z Hanson Pl., Brooklyn, N. Y.

**500** WORLDWIDE Mission better stamps 45 cents. Eagle Stamps, Box 402, Glen Cove, N. Y.

**MIXED** U. S., good stamps, no damaged or straight edges, over 200 different, 1,000 —\$1.00; 8,000—\$5.00; 20,000—\$10.00. Richard Higgs, Charles Town, W. Va.

**PHILIPPINES** — Beautiful pictorials, commemoratives in packet, 50 different, only 75c. 100 different \$2.75. Philippine Education Co., Manila, Philippines.

**250** ALL Different stamps—10c plus 3c postage. No approvals. Elmsco, 76 Dorrance, Providence, R. I.

**\$1.00, \$5.00** POSTAGE Due stamp 6c. Frank Strosky, Box 53, Perth Amboy, New Jersey.

**BEAUTIFUL** Roumanian packet, 3c, approvals. Ward, Box 592, Vancouver, Wash.

**BRITISH** Colonies, 400 different \$3.00, Lecomte, Frere Orban, Jumet, Belgium.

**1000** WORLDWIDE Stamps mixture 25c. Monlar, 1542 Waverly, Cincinnati, Ohio.

**SIX** Dollars for 9c! 300 different stamps (cat. price \$6) only 9c with approval! Tatham Stamp Co., Springfield-30, Mass.

**FREE**—Any 10 stamps from one of our marvelous approval selections free. Give 2 stamp collector references please. Ranger Stamp Co., Houston, Texas.

**U. S. And** foreign penny approvals. Lenott Stamp Company, Oxford, Maryland.

**NEW** Slovakia. We offer 4 mint Father Hlinka with bargain packet including Will Rogers airmails, Hindenburg zeppelin, Ireland's U. S. Constitution, Albania, Kenya, \$1 Chinese, Syria, mosquito, coronations, etc. Absolutely nothing common. Only 5c to bargain approval applicants. Gladstone Stamps, 5800 Markham, Chicago.

**FREE**—25 Different stamps with complete Will Rogers set 10c. Schildhouse, Colonial Arcade, Cleveland, Ohio.

**SWELL** Penny approvals. Fine value. Thomas, 321 Willow, Mayfield, Ky.

**THREE** Sets for three cent stamp! Jack Reed, Houtzdale, Penna.

**No. 1** STAMPS Are usually hard to get, yet am offering 15 different to approval applicants inclosing 3c. M. Moulblow, Box 11, Rosebank, N. Y.

**100** DIFFERENT U. S. 25c. Karr Ross, DeRidder, Louisiana.

**BOLIVIA** Llamas set, Mexico mosquito stamp, 3c. Approvals. Big Chief Stamps, 1521 Marsac St., Bay City, Mich.

**200** MIXED U. S. stamps, about 150 varieties, 53 cents. Jungkind, Box 806-8, Little Rock, Ark.

**CANADIAN** Royal visit set to penny and up approval applicants. 3c postage. Leader, 1550 Seward, Detroit, Mich.

**FREE!** Three different triangles to approval applicants. Rozenber, Miller, Ind.

**UNPICKED** Mixture: 40c pound! 100 U. S. revenues—10c! (700—50c.) 500 different world; 30c! Vanvoorhis, Hyndman, Penna.

**25** UNITED States, including \$4 and \$5 stamps free to approval applicants. 3c postage. Brownie Stamp Shop, Flint, Mich.

**1000** DIFFERENT 75c; 600, 50c; 300, 20c. Fred Onken, 630 79th St., Brooklyn.

**FREE!** Two coronation sets, Postage 3c. Roberts, 312F Shearerblg, Bay City, Mich.

**FREE!** Ten military occupation and local stamps. Approvals. Barker, 714 Market, San Francisco.

**ALBANIA**—3 Mint sets only 5c to approval applicants. Nels Dolve, Box 406A, Minneapolis, Minnesota.

**PENNY** Approval fine selection. Sweeper, 101 Monmouth St., Newark, N. J.

**SEND** 5c For our big packet of 100 different and ask for approvals and we'll include free the only Mussolini stamp, National Co., Box 308, Red Lion, Penna.

**FREE!** 20 Different Canada to approval applicants. Hunziker, Box 225-SM, Minneapolis, Minn.

**WILL** Rogers stamp is included in our packet of twenty different airmails 5c to approval applicants. Barker, 714 Market, San Francisco.

**FREE**—From every continent, 155 different, airmails, triangle, commemoratives, pictorials, many U. S. and others, with 1c approvals. Send 5c for postage and handling. Ace Stamps, Euclid Arcade, Cleveland, Ohio.

**40,000** VARIETIES First quality stamps available on approvals 1/4c up. Representative selection on request. Adults only. PKEigwin Stamp Co., Vineland, N. J.

**\$1.00** PACKET Given! Inclose postage, request approvals. Secrist, Muscatine, Iowa.

**CANNON!** Set of stamps showing cannon, firing squad, cavalry charge and 200 other different stamps, only 10c to approval applicants. L. H. Reich Stamp Co., 4647 Kenmore, Chicago.

**FREE.** U. S. \$1, \$2, \$4 and \$5 stamps. Unbeatable U. S. approvals. Nelson, 369 1/2 Robert Street, St. Paul, Minn.

**UNITED** States—45 different, gauge, hinges, pricelist 10c. No approvals. Seidenberg, Baroda, Mich.

**150** GENUINE U. S. and foreign stamps, 5c. Stanton, Niantic, Conn.

**SENSATIONAL** Combination offer! Big packet 105 all different including Greenland (new country), Congo, Manchukuo, Costa Rica triangle, air-mails, commemoratives, giant diamond-shaped stamp, \$4 United States; complete set United States telegraphs, cataloging 20c, scarce set Siberia cataloging 50c. Packet British colonies including Gwalior, Hyderabad, Burma (new country), jubilee and coronations. Total catalog price over \$3.00! Everything for only 5c to approval applicants! World-Wide Stamp Company, Department 600, Camden, New York.

**QUEEREST** Stamp packet: Mozambique, Japan, China, Soruth, Albania, many others—5c to approval buyers. R. M. Stamp Co., Box 230P, Port Chester, N. Y.

**FREE!** 80-Page "United States & British North America" catalog. Nearly 1,000 illustrations! Lowest prices! Large catalog "foreign stamps" also included. Harris & Co., 137 Transit Building, Boston, Mass.

**WHOLESALE** Supplements to dealers for 10c postage. Hundreds of bargains. Grossman Stampco, 102 West 42nd, New York.

**50** DIFFERENT, Fine U. S. including perforation gauge, 10c with approvals. The Stamp Shop, 809 Holland Bldg., St. Louis, Mo.

**CANADA** Catalog, illustrated, 136 pages, \$1.00. Miniature sheet triangles (4 diff.) 10c approvals. Victoria Stamp Co., London 4, Canada.

**100** DIFFERENT Hungary 7c, approvals. Hazett, 701P Fourth Baycity, Mich.

**PENNY** Approvals, that satisfy. Neil Gronberg, Box 5441-P, Philadelphia, Penna.

**FREE,** 50 Stamps, Iraq, etc. Postage 1c. Album 3c. Bullard, 268 Northampton, Boston, Mass.

**AIRMAILS** And commemoratives, 25 different, including Columbians, Panama-Pacific, Edison, Zeppelin, etc., only 5c with exceptionally fine United States and foreign approvals. Marco Stamp Co., Box 888, San Francisco, Calif.

**UNITED** States illustrated looseleaf catalog, \$1.00. Send postage for free United States price list, precancel list. Stanley Gibbons, 38-P Park Row, New York.

**200** DIFFERENT 10c. Big 50% approvals. Covert Stamp, 39 State, Rochester, N. Y.

**BRAZIL,** 50 Different 10c with bargain approvals. Davis, Silver Lake, Ind.

**ASK** For our wonderful one cent approval. Prospect Stamp Co., 225 Broadview, Toronto, Canada.

**WHOLESALE** Catalog for dealers. Illustrated. Postage 5c. Frank Co., 4900 Chalmers, Baltimore, Md.

**WEEKLY** Stamp magazine, thirteen weeks, 10c. Stamp Journal, Kalamazoo, Mich.

**TRIANGLES!** Triangles! Triangles! Triangles! Count them. Four! With famous Rivera nude stamp. Only 3c to approval applicants. Cactus Junior, Tucson, Arizona.

**STAMP** Dealers, your ad here will bring wonderful returns. Ask me for proof. F. W. Johnson, Manager, Classified Advertising, Popular Mechanics Magazine, 200 E. Ontario St., Chicago.

### RARE COINS

**ENCYCLOPEDIA** Of rare coins, 36th edition. Revised and illustrated, 50c postpaid. Novelty book included. Lakeside Press, 330 Lakeview, Orlando, Florida.

**OLD** Money wanted. Will pay \$100.00 for 1894 dime, S. mint, \$50.00 for 1913 Liberty head nickel (not buffalo). Big premiums paid for all rare coins. Send 4c for large coin folder. May mean much profit to you. Numismatic Co., Dept. 20, Fort Worth, Texas.

**COIN** Collections. Gold coins, 55% premium. A. French, Rte. 1, Troy, N. Y.

**"VALUABLE** Current Coins" booklet prices paid, 5c. Numismatist, Lockhart, Texas.

**CERTAIN** Large cents worth \$750.00; small cents \$12.00; nickels \$250.00; dimes \$300.00. Send 15c for latest 1939 complete 36 page illustrated buying book. American Coin Co., Box 3507-A, Cleveland, Ohio.

**15** DIFFERENT Coins 25c. 60 different \$1.00. Otto Oddehon, Overland Station, St. Louis, Mo.

**FOUR** U. S. cents, list 15c. Paget, 546 Westfield, Rochester, New York.

**WILL** Pay \$10.00 each for certain Lincoln pennies; Indianheads \$100.00; dimes \$700.00. Catalogue 10c. Federal Coin Exchange, Columbus, Ohio.

**GET** Profit and pleasure in collecting old coins. Send 10c for 56-page illustrated coin catalog. You'll be delighted with it. Send for it now. B. Max Mehl, 370 Mehl Bldg., Fort Worth, Texas. Largest rare coin establishment in U. S. Established 38 years.

**BIG** Prices paid for certain wanted coins. 1909 cent \$10.00, some silver dollars \$4000, 1864-1865 Indian head cents \$100.00 each, dimes before 1895, \$600; liberty head nickels before 1914, \$500; encased postage stamps; some large pennies \$2000; half cents, \$275.00; paper money, gold dollars \$1500, foreign coins \$165, some worth \$6000 each. You may have coins for which we pay big premiums. Therefore send 15c today for 1939 big illustrated coin book for certain wanted coins. National Coin Corporation (80), Daytona Beach, Florida.

**COMMEMORATIVE** Half dollars, Lincoln, Stone Mountain, Oregon, Texas, Cleveland, Kentucky, San Diego, Long Island, \$1.50 each. Illustrated catalogue No. 14, 25c. Norman Shultz, Salt Lake, Utah.

**FREE!** Foreign coin, banknote, and large illustrated coin catalogue. Send 4c postage. Coin approvals sent. Tatham Coinco, Springfield-125, Mass.

**\$5** TO \$500 Each paid for hundreds of old or odd coins. Keep all until posted. Many very valuable. Send 10 cents for illustrated Coin Value Book, 4x6. Guaranteed buying and selling prices. 31 years in business. Coin Exchange, Box 5, Le Roy, N. Y.



## HOBBIES AND COLLECTIONS

**TOKENS.** Send only 50c during August and September for our complete collection of sales tax tokens containing over twenty metal tokens plus several tax stamps. Robert McClelland, 4000 Urbandale, Des Moines, Iowa.

**UNUSED Book match covers.** 100 all different. \$1.00. Free list, Charles Edelman, 1311C East 84, Cleveland, Ohio.

## PHOTO FINISHING

**BUY A dollar size package of sensational Transfoto.** Makes your own photo print or unlimited quantities direct from any negative onto anything at night, daytime, indoors or outdoors. Makes over 250 prints. All orders mailed C.O.D. Eldrick J. Thibault, Newton Falls, N. Y.

**SIXTEEN Prints from your roll 25c.** Photo Service, Meade, Kan.

**PHOTOGRAPHY** For pleasure and profit. Prepare for profitable business or fascinating hobby at home. Previous experience unnecessary. Common school education sufficient. Write for information and requirements. American School of Photography, 3601 Michigan Ave., Dept. 3456, Chicago.

**PERFECT Enlargements 5x7—10c; 8x10—20c.** Send negatives. Photo Print, Box 184-M, Duncan, Okla.

**NO Free offers, just better photo finishing.** Rolls developed eight prints 25c. 35mm. \$1.50. Rohs Supply, 8410 Drexel, Chicago.

**EIGHT Prints, two 5x7, 25c, 25 reprints 25c.** Sural Photo Company, AG-3306 Potomac, Chicago.

**IMMEDIATE Service!** Better pictures. Sixteen guaranteed prints from roll, 25c. One colored or two plain enlargements and 8 guaranteed prints, 25c coin. Special! Coupon for 8x10 enlargement given with every 25c worth Kodak finishing. Any 36 exposure, 35 mm. film fine-grain developed and each good negative enlarged to 3x4 prints for only \$1.00. 3x4 reprints, 4c each. One day service. Details and mailers free on request. American Studios, Dept. 22, LaCrosse, Wis.

**ROLL Developed and eight guaranteed professional prints including two enlargements that will not fade 25c (coin).** California Film Service, Box 379, Pasadena, California.

**PHOTO Mill.** Immediate service! No delay! Roll developed, carefully printed and choice of two beautiful 5x7 professional enlargements, one tinted enlargement, or eight reprints—for 25c coin. Reprints 2c each. The Photo Mill, Box 629-12, Minneapolis, Minnesota.

**FREE Album and negative file and 2 enlargement coupons with each roll developed, 8 guaranteed prints 25c.** Memrilane Studios, General P.O. Box 666, Dept. "K," New York.

**OIL Coloring photographs a fascinating hobby or profitable business.** Learn at home by easy simplified method. Previous experience unnecessary. Common school education sufficient. Send for free information and requirements. National Art School, 3601 Michigan Avenue, Dept. 3436, Chicago, Illinois.

**ROLLS Developed—16 prints, 2 enlargements 25c. 25 reprints 25c.** Trial, Filmcraft, River Grove, Illinois.

**PROFESSIONAL Doubleweight enlargements 11x14—50c; 8x10—35c, four \$1.00; 5x7—20c, six \$1.00.** Stewart, B-6852 Indiana, Chicago.

**FILMS Developed, three Lifetime prints each negative or 2 sparkling enlargements 16 prints—25c. Reprints 1c.** Trial, Filmcraft, G-58, Des Moines, Iowa.

**35MM. ROLLS Developed free!** Send for price lists on prints and free mailing bags. Minixip Laboratories, 100 North LaSalle St., Dept. 59, Chicago.

**ROLL Developed and printed 20c in coin, or 25c and two enlargements.** Reprints 3c each. The Photo Finisher, Station E, Box 42, Columbus, Ohio.

**HAVE You tried our service?** Roll developed 16 Velox prints or 8 prints, 2 enlargements 25c. Immediate delivery. Chicago Photo Lab., Box 3, So. Chicago, Ill.

**DEVELOP—Print your own photos.** Complete outfit \$1.95. Photographic Distributors, 27 West 24 Street, New York City.

**TWENTY Reprints 25c.** Roll developed and two prints each negative, 25c. Send for free mailing envelopes, price list. Star Photos, J-109 N. Dearborn, Chicago.

**BETTER Pictures** wants you to know of their quality, and complete service. Introductory offer—35mm, 36 exposures developed and enlarged 3 1/4 x 3 3/4"—\$1.00. All roll films developed and printed—2 rolls for 35c. Let's get acquainted! Mail your film to Better Pictures, 2143 Farragut Ave., Chicago.

**PROFESSIONAL, Overnight service.** Developed, printed, 2 enlargements, 25c. Fotoservice, 1942 Marlow, Toledo, Ohio.

**ROLL Developed—16 guaranteed prints, one enlargement, 25c.** Dick's Photo, Louisville, Kentucky.

**NOW! Quality finishing.** Instant service. Eight Velox prints, two enlargements, 25c coin. Snap Shop, 12, LaCrosse, Wis.

**35MM. ROLLS Fine grain, developed, each shot enlarged to 3 1/2 x 5—\$1.00.** 18 exposures 60c. Reprints 3c. Ideal Films, Birmingham, Alabama.

**SENSATIONALLY New.** Rolls finished in beautiful natural colors, or with eight cinema type enlargements, or sixteen prints—25c. Colorcraft, PM-2510, Hollywood, California.

**THE Modern Finishers, St. Paul, Minnesota,** are the outstanding finishers in America for low prices with quality pictures. Our modern methods give quick service and bright guaranteed neverfade pictures. Roll developed, 16 modern tone prints, 25c coin, 16 modern tone reprints, 25c. Enlargement coupons. Join our thousands of satisfied customers by sending us your next roll or reprint order. Modern Finishers, St. Paul, Minnesota.

**JOIN The thousands who are changing to Willard's Brilliantone prints—the style leaders of 1939.** Roll developed, two prints each negative, only 25c. Valuable enlargement coupon. Willard Studios, Box 3535-A, Cleveland, Ohio.

**OVERNIGHT! No waiting!** 25c brings either 16 sparkling Lifetime prints, one "Oilcolored" or 2 satin 5x7 enlargements and 8 prints each expertly finished roll! 20 glistening reprints 25c; 100—\$1.00. Beautiful quality. No waiting! Lifetone Studios, C-39, Des Moines, Iowa.

**OVERSIZE Electrogloss deckledged prints.** Rolls developed, 16 prints 25c, or 8 prints, two 5x7 electrogloss enlargements 25c. Reprints 3c. Artshop, Weatherford, Oklahoma.

**LARJARGRAPH Reprints: Five 5x7 enlargements 25c.** Cardinal Photos, Summit, N. J.

**TECHNIFINISH—35mm, 36 Exposure rolls perfectly enlarged to 2 5/8" x 3 3/4" glossy prints—75c.** Cartridge reload with Eastman Plus X—25c. Fast satisfactory service guaranteed. Write for postpaid mailing bags and information. Technifinish Laboratory, 110 Lexington, Rochester, N. Y.

**MINIATURE Film, fine grain development, 2 1/2 x 3 1/2 enlargements, 35mm. \$1.00, bantam 25c.** Film Capital Service, Box 504, Rochester, N. Y.

**ROLL Developed, 16 guaranteed prints, 25c.** Smart Photo, Winona, Minnesota.

**PROMPT Service—Guaranteed work.** Two beautiful portrait type doubleweight enlargements, eight neverfade gloss prints, each roll 25c. Dubuque Film Service, Dubuque, Iowa.

**MILLIONS Now know "Hollytints means better prints."** Trial roll printed including two beautiful enlargements—25c. Fascinating premium coupons. Hollytints, P-1350, Hollywood, California.

**EXPERT Finishing.** One day service. Rolls developed 16 Velox prints or 8 Velox prints, 2 enlargements 25c. Expert Studios, LaCrosse, Wisconsin.

**PROMPT Service—Quality work; 2 beautiful doubleweight gloss enlargements, 8 guaranteed neverfade prints each roll, 25c.** Excel Photos, Dubuque, Iowa.

**ROLL Developed, 16 prints 25c.** Wilkes-Barre Photo Service, Box 64, Wilkes-Barre, Penna.

**ONE 6 1/2 x 8 1/2 Wide border embossed enlargement or one 5x7 hand colored enlargement with each roll developed and 8 prints 25c.** 36 exposure roll developed and 36 3 1/4 x 4 1/2 enlargements \$1.35. 18 exposure roll 75c. Vidor, 321-P Hennepin, Minneapolis, Minn.

**ROLLS Developed, two prints each and two free enlargement coupons, 25c; reprints, 2c each; 100 or more, 1c.** Summers' Studio, Unionville, Mo.

**THREE Prints each good negative in roll 25c.** Reprints 3c. Fred D. Eastman, Bode, Iowa.

**IDEAL Photos.** Professional deckle-edge prints and free enlargement each roll only 25c. Illustrated price-list free. Write today. Ideal Photos, Box 2255, Paterson, N. J.

**SPECIALIZING 35mm.** Rolls fine-grain developed, 36 enlargements 3 1/2 x 5, \$1.00. Cartridge reload 35c. Photoshop, Linton, Indiana.

**FOR The discriminating amateur, roll developed and carefully printed 25c, reprints 3c.** Superior workmanship, same day service. Paramount Co., 327 E. 92nd St., New York.

**ROLL Developed and 8 beautiful Velox glossy prints 25c coin or stamps.** Reprints 3c each. Fotoprint Service, Roanoke, Va.

**8 PLEASING Velox prints, 2 enlargements 25c coin.** Please U Film Service, LaCrosse, Wis.

**20 REPRINTS 25c.** 100 Reprints, \$1.00. Films developed, 2 prints each negative, 25c. Mercury Studios, Box 822-B, Chicago.

**PROMPT Service! Rolls developed, two Velox prints each negative 25c.** Hensch Studios, Harrisburg, Penna.

**PHOTO Mill.** Immediate service! No delay! Roll developed, carefully printed and choice of two beautiful 5x7 professional enlargements, one tinted enlargement, or eight reprints—for 25c coin. Reprints 2c each. The Photo Mill, Box 629-12, Minneapolis, Minnesota.

**ROLL Developed, 8 brilliant fadeproof Velox prints and two professional enlargements 25c.** Overnight service. Young Photo Service, 405-C, Albany, N. Y.

**LIFE Photo finishing lasts a life time.** Roll developed, 8 prints, 2 enlargements 25c. Reprints 1 1/2c. Life Photos, Hutchinson, Kansas.

**TWO Glossy enlargements, 1 colored with roll 25c.** Arbor Service, 10, Joliet, Ill.

**CANDID Special.** 35mm. rolls enlarged to 3 1/4 x 4 1/2, \$1.00. 18mm. rolls 60c. 3 1/4 x 4 1/2 reprints 3c. Brown Photo Company, 1910-61 Emerson, Minneapolis, Minn.

**16 PRINTS With roll 25c.** 16 reprints 25c. Rex Photo, Ogden, Utah.

**GUARANTEED.** Roll developed, 16 prints 25c. 20 prints 25c. Quality Photo, Hutchinson, Kansas.

**QUICK Service—Rolls developed, 8 guaranteed prints; 2 enlargements; 25c coin.** OK Photo Service, Ottawa, Kansas.

**ROLL Developed, 2 prints each negative 25c.** Enlargement coupon. Arcraft Studios, Box 3580-A, Cleveland, Ohio.

## CAMERAS, PHOTO SUPPLIES

**NEW Free photography book now ready—lists and illustrates hundreds of sensational new and used bargains plus valuable information on modern photographic methods, high-speed miniature candid cameras, precision lenses, night equipment, enlargers, darkroom equipment, movie cameras, screens, etc. Money-back guarantee. Liberal trade-in allowance on your old equipment. Get free book today.** Write Central Camera Co., Dept. I16Z, 230 South Wabash Avenue, Chicago, Illinois.

**"PHOTOPASTE"—Mounts photos instantly without curling.** Large size, 25c. Bennett Laboratories, Box 202, Palms, California.

**45 GOOD Cameras, bargains, 35-70% off, for example:** Ica 3 1/4 x 4 3/4 for plates, film packs, Aplanat, groundglass focusing \$3.25. Voightlander "Vag" 3 1/4 x 4 3/4 (also 2 1/2 x 3 1/4) plates-film packs, Skopar lens 4.5, \$12.00. Rosenstock 9x12 cm. Anastigmat 4.5, new compur shutter, delayed action, double extension, complete, brand new, \$24.50. Voightlander Rolifilm camera, 2 1/4 x 3 1/4, Anastigmat 4.5. Ibsor 2 sizes, brand new, \$13.50 (reg. \$23.50). Leica, Contax, Dollina, Rolleiflex, enlargers, etc. Cheap. Money-back guarantee. Trade-in. Ask for booklet PM 1, free. Brenner Photo Co., 943 Penna. Ave., N. W., Washington, D. C.

**BASS Inventory clearance.** Profit by these unusual bargains. 35 mm. Candid Midget, F:4.5 lens, \$12.50. Used Foth Derby, F:3.5, \$15.75. 2 1/4 x 3 1/4 Agfa Film Pack and plate, with F:6.3 lens, auto shutter, film adapter and holder, \$11.95. Used Argus, F:4.5 lens, \$7.75. New Candid Midget, Xenon F:2 lens, Rapid Compur and case, \$84.75 value, at \$47.50. Hundreds of other bargains in the great Bass Bargaingram and special bulletins. Your money back is unsatisfactory after 14 days trial. Write Bass Camera Company, Dept. AG, 179 W. Madison St., Chicago, Illinois.



**CAMERAS.** Enlargers, on time. See advertisement under Motion Pictures. Moggull's.

**MAKE Money** in photography. Learn quickly at home. Spare or full time. Easy plan. Previous experience unnecessary. Common school education sufficient. Interesting booklet and requirements free. American School of Photography, 3601 Michigan Ave., Dept. 3431, Chicago.

**BUILD Your own printer.** Complete plans, details and specifications 15c. Photo Products, 607 Hill St., Ann Arbor, Mich.

**AMAZING Bargains** in used cameras. Free bulletin. 8x10 doubleweight enlargements—20c. Standard Camera Exchange, 509 Fifth Avenue, New York.

**SPEEDO Print dryer.** Low priced. Dries photographic prints in 15 minutes. Prevents warping, curling. Large capacity. Newest type Ferrotype Chrome Plate included free. Write General Devices, 3128 Lookout Circle, Dept. C-1, Cincinnati, O.

**ENLARGE Your own photos.** Make money doing work for others. Build your own enlarger. 4 complete plans 50c. Popular Mechanics Press, Dept. 939, 200 E. Ontario St., Chicago.

**CAMERA Repairing!** Bellows made to order—any size! Fit all standard cameras! All makes shutters repaired by experts! Lowest prices! For complete information write, United Camera Company, Inc., A-1515 Belmont, Chicago.

**FREE To camera owners:** Set of 3 filters for names and addresses of 3 camera owners. Photo-Craft, Dept. MC, Canton, Ohio.

**ENLARGER \$1.59.** Enlarges eight times size of small negatives. Fully guaranteed. Paramount Sales Company, 89 Dudley Street, Boston, Mass.

**CAMERAS Films,** paper 25% to 35% discount. Paramount Photo Division, 327 East 92nd St., New York.

**HAVE You a camera?** Send ten cents for recent number of our big magazine, showing how to make better pictures and earn money. American Photography, 116 Camera House, Boston, 17, Mass.

**MAKE Photography Pay.** New book. \$1.00. Popular Mechanics, 200 E. Ontario St., Chicago.

### MOTION PICTURES AND SOUND EQUIPMENT

**MOVIE Film.** New! Sensational! 200 ft. 8mm. notched in four 25 ft. scored double 8 rolls, daylight leaders between each load \$1.75; 400 ft. 16mm. measured, notched 100 ft. lengths \$4.00. Graphichrome, D188 Randolph St., Chicago.

**35MM.** Sound films rented, sold, exchanged. Oakley Films, Nelsonville, Ohio.

**SALE:** Erpi-Western Electric sound system sound film projector, new, 750-1000w, 15w output, 12" speaker, complete; regular \$410.00, special \$289.50. Synchronized flash cameras \$4.50, \$5.95 up. Standard \$89.50 projector, 750w, f:1.65 lens (new, 400' model) \$49.50. "Like new" specials: \$60.00 Reflecta \$29.50; Leica E f:3.5 \$44.75; RE Auto Graflex (less lens) \$39.00. Movie cameras: Bell 16mm, f:4.5 \$6.49; Univex 8mm, f:5.6 \$4.49. Trade-ins accepted. Monthly terms. Moggull's, 64 West 48th, New York City.

**50-16MM.** Sound projectors. Cheap. Roshon, State Theatre, Pittsburgh, Penna.

**SILENT 35MM.** films. Projectors. Cheap. Demsey, 1223 Berkley, Youngstown, Ohio.

**35MM.** Professional Bell & Howell single system sound recording camera, with silent check pawl ultra-speed movement, turret front, four lenses, complete with microphone, amplifier, 12 volt generator, cases, tripod, magazines, \$1,100.00. Bass Camera Company, 179 W. Madison St., Chicago, Illinois.

**8MM, 16MM.** Bargains. Free catalog. Movie Shop, 838 Broadway, Bayonne, N. J.

**1000 FEET 35MM.** 75c. Lists. Calderara, 5119 South St. Louis, Chicago.

**ROYAL Home movies—8mm.—16mm.** Cartoons, comedies, westerns, travelogs. Free list. Royal Home Movies, 425 Melrose St., Boston, Mass.

**8 AND 16MM.** film \$1.35 a roll and up. Processing included. Photoart, 28 Winchester St., Boston, Mass.

**8-16MM. FILMS:** Rentals, exchanges. Free catalogue (with sample art 10c). Garden Exchange, 317 West 50th, New York.

**BEADED Screens.** Make your own! Crystal beads to cover 20 square feet, \$1.00. Finer quality, \$1.25. Directions included. Gard, Box 418, Madison Square Station, New York.

**FILM,** Art sample, 10c. Others, lists free. Goodwill Company, Jackson, Tenn.

**8-16MM. FILMS,** 10% discount. Lists. Paragon, Box 453, Meriden, Conn.

**\$15.00 BOX Screen.** Special \$10.00. Others, Box 151, Union, N. J.

**LOOK!** "The world's greatest of all Passion Plays," 35mm, and 16mm. Sound or silent, rent or purchase. Hemenway Film Co., F 37 Church St., Boston, Mass.

**16MM. VELOTEX.** Perfect outdoor film, 100 ft. rolls \$1.95 including free processing. Sample free. Velotex Laboratories, 600-D, Gary, Indiana.

**100 FT. 16mm.** Outdoor film \$1.95. 25 ft. double 8mm., \$1.35, free processing. Free 8mm., 16mm. lists. Home Movies, Box 216, Easton, Penna.

**GUARANTEED 8MM.** 24-hour reversal processing. Double 8mm., 45c. Single, 25c. Univex 15c. Eso-S, 3945 Central, Kansas City, Missouri.

**MOVIE Film.** Develop yourself. Univex, Eastman, etc. Chemical samples 15c. Raw film wholesale. Lake Camera Exchange, Gary, Ind.

**HERE'S News from Bass!** Our 64-page Cine Bargaingram is ready! Free for the asking! 8 mm., 16 mm., and 35 mm. silent and sound equipment. Popeye, Betty Boop, and other films. Accessories to gladden the heart of amateur or professional. A few used bargains: Univex 8 camera, F:5.6 lens, each \$5.75. Univex, motor drive, 8 mm. projector, \$12.50. Bell & Howell model 57, 16 mm. projector, 200 watt, and case, \$32.50. New RCA 16 mm. sound on film camera, Newsreel model, \$250.00. Write today. The book will be mailed at once. Bass Camera Company, Dept. A, 179 West Madison St., Chicago, Illinois.

**15% TO 25% Discount** on still or movie cameras. Free circular. Paramount Co., 327 E. 92nd St., New York City.

**BARGAINS!** 8mm., 16mm., free literature. Elder, B-739 Boylston, Boston, Mass.

### RADIOS, SUPPLIES, INSTRUCTION

**RADIO Engineering,** broadcasting, aviation and police radio, servicing, marine and Morse telegraphy taught thoroughly. All expenses low. Catalog free. Dodge's Institute, Ames St., Valparaiso, Ind.

**SEND For free giant money saving radio and phonograph record catalogue.** United Radio Company, 1000-M, Newark, N. J.

**AERIAL Eliminators,** lightning proof, 59c postpaid. John Sing, Louisville, Tenn.

### MUSIC AND MUSICAL INSTRUMENTS

**SONG Poems wanted.** Free examination. Send poems to McNeil, Master of Music, 510-PM So. Alexandria, Los Angeles, Calif.

**SONGPOEMS Wanted.** Free melody. Publication. Placements. Songland, "D39PM9," Thomaston, Maine.

**LEARN Swing piano,** complete course, \$1.00. Kelly School of Music, 942 Market, San Francisco.

**SONGS.** Song poems, bought, published. Best offer. Free information, rhyming dictionary. Write immediately. Metro Melody Music Publishers, 1204 Sutter, San Francisco.

**SONGWRITERS!** Outstanding, amazing offer. Hibbeler, C-5, 2157 No. Avers, Chicago.

**JOIN Our Record Club.** Send for your copy of this big 500 page record catalog and encyclopedia. Contains lists of thousands of famous records and musical data on pronunciations and dates of composers; 25c plus 10c for mailing, (stamps or coin). It also enrolls you in our Record Club. We carry a large selection of records from 10c up. Write today. Modell's, Dept. 305, 58 Cortlandt St., New York City.

**SONGWRITERS — Agents,** new sales plan. National Music-D, 532 Sixteenth, Oakland, Calif.

**MUSIC Composed to words.** Rhyming pamphlet on request. Phonograph recording of completed songs. Send poem for consideration. Keenan's Studios, Dept. PM, Box 2140, Bridgeport, Conn.

**SONGS—Arranged,** revised by arranger "Linger Longer," "Gypsy Tearoom," others. Send for details. Harold Potter, 1619 Broadway (P), New York.

**SIMPLIFIED Swing courses!** Accordion, saxophone, clarinet, trumpet. Write Swingmaster, 1259-N Bender, East Cleveland, Ohio.

**SONG Poem writers wanted—Our guaranteed plan** has aided many songwriters. Burl Bogg's song won a nation wide contest. Other new writers have had their songs broadcast. We may be able to help you. Send poems or write for free booklet today. Indiana Song Bureau, Dept. 53, Salem, Indiana.

**MUSIC Composed to words.** Wonderful proposition. Bauer Bros., Oshkosh, Wis.

**WRITE Songs.** Big money and reputation. Write for information, J. Gordon Pub. Co., 201 N. Hoyne Ave., Chicago.

**WANTED! Lyrics, melodies for songs.** We arrange, publish, sell. Superior Song Studios, Passaic, N. J.

**SONGWRITERS:** Send your poem today for immediate consideration. Richard Brothers, 24 Woods Building, Chicago.

**SONG Writers.** Send for publishing agreement. McKinley Music Publishers, 1501 E. 55th St., Chicago.

**ORIGINAL Music** composed to your words, \$5. 200 printed copies \$10. Reginald Belcher, Chatham, New Jersey. 30 years church organist.

**PIANO, Self Instruction.** Play within an hour. \$1.00. Popular Mechanics, 200 E. Ontario St., Chicago.

### BUSINESS OPPORTUNITIES

**SELL Merchandise** but buy nothing. Start local business on other fellow's investment, in what he no longer wants. Works everywhere, makes big money, all of which you keep. Deal from depot, not street-selling. Learn about this modern opportunity now. Full information 25c—refunded if not delighted. National Advisory Service, Box A481, Manchester, N. H.

**AMBITIOUS Men** who want to build permanent respectable business in their own community write for agency proposition on new non-competitive household appliance. Every home, large and small, a prospect. Over 3000 sold in Los Angeles test campaign. Complete selling instructions and advertising help furnished. Ample profit margin. Write to J. G. Donaldson, 1225 Santa Monica Boulevard, Santa Monica, California.

**AMAZING Product** sweeps country. Make at home, spare time. Sell by mail. Big profits. Details free. Young, 3148 North, Chicago.

**YOUR Own highly profitable,** substantial business easily established anywhere, without capital. Everything furnished you. Business service, 888 Purchase, New Bedford, Mass.

**CALIFORNIA Progressive Monthly Magazine** for opportunities. Send 10c. Dellingers, 820 West 17th, Los Angeles.

**PROFIT With new products.** Make, sell, repeat. Analysis. Research. Guaranteed formulas. Biggest catalog free. Nominal prices. Gibson Laboratory, Chemists, BD-1142 Sunnyside, Chicago.

**START Your own business.** Make large profits. Sell auction—bankrupt clothing bargains and general merchandise. Experience unnecessary. Free wholesale catalog. Superior Jobbing, 1250-O Jefferson, Chicago.

**WE Can only handle south Texas.** Profit by our plans. Stamp appreciated. Specialty Service Co., Galveston, Texas.

**PLAQUES, Bookends, molds.** Stamp brings catalog. Colonial Arts, Derry, N. H.

**"RUBBER Molds."** Make them yourself. Formulas, instructions 25c. Ideal Service, 179-R9, Park Ridge, Ill.

**\$1,000,000 SALES** in this field last year! If you have elementary education and ambition you can have your share this dignified business. Be first in your community by writing for details today! National, Box 450, Green Bay, Wis.

**DON'T Sell!** Make people buy! Learn big companies' way. Expert's manual \$1.00. Money-back guarantee. Specialty Selling Council, 185 Madison Ave., New York.



**BELTS, Suspenders, make 'em and make money!** Sell year around. Materials supplied. Sample belt 25c. Artm Leather, 400 Joseph Ave., Rochester, N. Y.

**"RESILVERING Mirrors"** and 50 other money-makers 10c. Ideal Service, M509, Park Ridge, Ill.

**INVENTORS**—Small ideas may have large commercial possibilities. Write us for free book, "Patent Guide for the Inventor" and "Record of Invention" form. Delays are dangerous in patent matters. Free information on how to proceed. Clarence A. O'Brien & Hyman Berman, 58-X Adams Building, Washington, D. C.

**EARN Steady income** with "route" of peanut, gum and amusement machines. Small capital required. Robbins Co., 1141P DeKalb Avenue, Brooklyn, New York.

**BE Rich.** Make 900% profit bottle vanilla extract. Free labels. Tharp, 914 Lexington, Cumberland, Md.

**FORMULAS**—Fast selling products. Guaranteed. Laboratory tested. Lowest prices. Catalog free. Kemico, 50-8, Park Ridge, Ill.

**POPCORN Machines,** carmelcrisp, crispettes, cheese coat, potato chips. Long Eakins, 2035-J High St., Springfield, Ohio.

**SELL Drugless remedies.** All ailments. Wholesalers, Box 2695, Hollywood, Calif.

**SUCCESSFUL Business** easily started! Big profits! Formula catalog free. B. Kinford, Wayne, Penna.

**MANUFACTURE** From Phospholene. Cleaning fluid 1c gallon; bleach 2c gallon; hand soap 2c pound; and ten fast sellers. Sample 25c. Details free. Western, 401 Climax Bldg., Cleveland, O.

**NEW Framed feather pictures!** Retail 69c. Sample 20c stamps. Dozen \$1.80 postpaid. Marquez-PBL, Apartado 1176, Mexico City.

**M. M. Earned \$267** three weeks, raising mushrooms in cellar! Exceptional, but your cellar, shed perhaps suitable. We buy crops. Book free. United, 3848 Lincoln Ave., Dept. 65, Chicago.

**FOUND Your own business!** "120 Ways to Make Money," 120 pages, 6x9, \$1.00. R. Guy Smith's, 94 Carlos, Moss Beach, California.

**MAKE Money** in business of your own. 25c brings valuable booklet of opportunities. Circular for stamp. Otto, Box 864, Sequim, Wash.

**EARN Money** publishing. Copy and plan 10c. Blau, Mt. Vernon, Mo.

**ONE Hundred opportunities,** plans, quarter. Tyler's Agency, Pen Yan, N. Y.

**SELL Reconditioned typewriters,** wonderful proposition. Underwoods, Remingtons, Royals, wholesale \$29.00. Retail \$39.00. Catalogue, 10c. American Business Service, Shamokin, Pennsylvania.

**LEARN Account** collecting. Good income; quick results. Interesting folder free. National Collectors Association, Newark, Ohio.

**KNACK** Of making money is knowing how. Send 3c stamp. Money-Makers' Service, 126 Lexington Ave., New York.

**EARN \$25 Weekly** spare time. Free circular. Hammond, 120 W. Susquehanna, Philadelphia, Penna.

**\$50 WEEK** With a kodak. Booklet describing 100 magazine markets and information. 35c. Send for your copy today. A. Klassen, Box 71, Edgerton, Minn.

**YOU'LL Like** resilvering mirrors, auto-parts, reflectors, making chipped glass signs. Write Sprinkle, Plater, 127, Marion, Indiana.

**MAKE 900% Profit** selling folio by mail. Double knockout. Free circular. The Better Products Co., Box 167, Potsdam, N. Y.

**PROFITABLE Home** business. Complete instructions, sample, big mails, 10c. A. Riegel, Kintnersville, Penna.

**PROFITABLE Mail** order business. Small capital. 25c. Phelps, 1843-N Mannerling Road, Cleveland, Ohio.

**\$50.00 WEEKLY.** Men, women, selling new nautical jewelry. Dollar sample 25c. Sestero, 275 West 73, New York.

**26 YEAR** Old firm offers splendid profitable opportunity. Local or mail order. New Rotex Gold Writing Process beautifies greeting cards. Complete outfit, with sample box 21 fine Xmas cards, powerful sales folder, postpaid 50c (foreign countries 75c.) Uffert Card Co., 19 East 17th St., New York.

**HANDY Men**—Earn money home operating Community "Fix-It" Shop. Stafford, Makanda, Illinois.

**NEW Illustrated** catalog, Moldex and models. Send stamp. Pentucket Arts, Haverhill, Mass.

**UNIQUE Money-maker**—Traffic safety sales board. Samples, plans, instructions \$1.00. M. Summers, El Monte, Calif.

**MAKE Cuts** for printers, big profit. My instructions, 25c. L. A. Watson, 604 East 43rd St., Chicago, Ill.

**GIANT Mail**, opportunities, added income, ideas. 68 page magazine 10c. Katz, 4254 N. Kimball, Chicago.

**MAKE Artificial** marble, glazed tiles, uncanny. Tabletops, plaques, floors, hones, novelties. Hard, fireproof, inexpensive, cement secrets. Brilliant tile and liquid rubber samples 3c. John A. Payn, 945 Grande Vista Avenue, Los Angeles, Calif.

**\$30 WEEKLY.** Grow mushrooms. Cellar, shed. We buy 30c lb. Mr. B made \$270 spare time. World's largest company. 40 page book free. Mushrooms, Dept. 701, 2019 Second, Seattle, Wash.

**CHIPPING** Glass signs folder free. Beveridge, 160-22 Locust, Jamaica, New York.

**USED**—Rebuilt coin operated phonographs. Earn \$10 to \$50 weekly each. Year around. Legal. Get locations. \$75 to \$150 each. Square Deal Coin Machine Co., Box 263, Kankakee, Ill.

**"PROSPERITY** Pointers" sent for 10c. Business of your own. Get next to unique opportunities for wide-awakes. Lytle Supply Co., P.O. Box 35, Sta. E, Columbus, Ohio, Dept. 10PM.

**COLOR Concrete** with chemicals. Stucco-rock. Cement artistry. Washing-wells. Spin concrete pottery. Benches. Miniature castles, mills. Cold glaze, marbling, sample 10c. Hollywood CementCraft, 8527 Wonderland, Hollywood, California.

**MOLD Making,** plaster casting. Particulars free. Plastic Arts, 711 Neely, Muncie, Indiana.

**ADVERTISERS!** 1,600,000 Mail order circulation. Inch advertisement, \$15.40. "Get results," 20 newspapers, 18 words, \$6.50. Diener-Dorskind, 1474P Broadway, New York.

**PLASTEX Industries** offers industrious men an opportunity to start a business of their own, manufacturing art goods, novelties, souvenirs, etc., in Plastex and marble imitation. 5c material makes \$1 articles. Rubber moulds furnished for speed production. Small investment brings big returns. You are just in time for big wholesale season now starting. Write for interesting booklet mailed free. Plastex Industries, Dept. A, 1085 Washington Ave., New York.

**RESILVER Mirrors.** Let experienced man teach you. Big profits. Prospects everywhere. Joyce, 12461 Dresden, Detroit.

**"SCHEMER"** Magazine, Alliance, Ohio, (41st year) prints schemes, tips, opportunities, formulas; winners: \$10,000—\$25,000 reported. Year, \$1.00. Now get acquainted: trial six months only 30c.

**WHY Work** for others? Be your own boss. Sell products with your name on the labels. Cosmetics, household specialties, extracts, etc. Details free. Chemical Co., Box 5269, Richmond, Va.

**"SALTED** Peanuts in Shell." Patent and \$1.00 started originator toward eventually earning \$50,000. Sold huge amount without personally canvassing! Now retired. Work plan—home. Warning—act quick! Treatises-A, BX1240, San Bernardino, Calif.

**START Mail** order business. Make, sell amazing product spare time. Big profits. Write for free facts. Konis, 5645 Fullerton, Chicago.

**MAKE Money** by mail, the way we do. Free information. Maywood, P-1107 Broadway, New York.

**BUILD Neon** signs. A business for yourself. McMaster Sign Co., 730 State St., Bellingham, Washington.

**POPCORN Machines,** all types. Carmelcorn equipment. Northside Mfg. 1925-10th, Des Moines, Iowa.

**LIQUID Marble**—anyone can make! Colorful, glazed! Moulded, brushed, sprayed. Rubberlastic moulds. Composition flooring. Big money in these! Particulars free. Marbleizing Service, Edwardsville, Ill.

**SMALL Business** of Your Own. 1000 tried and proven methods. \$1.00. Popular Mechanics, 200 E. Ontario St., Chicago.

**WE Help** start you in business, furnishing outfits and instruction, operating "Specialty Candy Factory" home. Men and women, opportunity to earn \$20.00 to \$50.00 weekly, all or spare time. (Our 31st year.) Booklet free. W. Hillyer Ragsdale, Inc., Drawer 4, East Orange, N. J.

**HOW** And where to obtain capital fully explained, free particulars. Star Service, Wapakoneta, Ohio.

**YOUR Own** business! Selling by mail. Details free. Maples, 3418 South Marshfield, Chicago, Illinois.

**SUCCEED** With your products. Make-sell. Formulas. Accurate analyses. Catalog free. B. Thaxly Company, Washington, D. C.

**INVENTORS**—We successfully sell inventions, patented and unpatented. Write for proof, and tell us what you have for sale. Chartered Institute of American Inventors, Dept. 4-C, Washington, D. C.

**I WANT** To send you proof of the wonderful pulling power of Popular Mechanics Magazine's classified pages. What's your proposition? Write me today. F. W. Johnson, Manager Classified Advertising, 200 E. Ontario St., Chicago, Ill.

**DELAWARE Charters:** Complete service \$35. Submitted forms. Chas. G. Guyer, Inc., Wilmington, Del.

**107 WAYS** To make money, in home or office, business of your own. Full particulars free. Elite Co., 214 Grand St., New York.

**LOOKING** For business? 2c daily maintains dignified, individual branch office. Co-operative Offices, 126 Lexington Avenue, New York.

**SELL** By mail. Books, novelties. Bargains! Big profits! Particulars free. E. Elfco, 438 N. Wells, Chicago.

**ELITE** Collection of business plans, contains 107 tested plans and scores of formulas. Start own business; home, office. Particulars free. Elite Co., 214 Grand St., New York.

**CHARTERS:** Delaware; best, cheapest; free forms. Colonial Charter Co., Wilmington, Del.

**WHERE** To buy at lowest wholesale prices. Information free. Yorena, Box P-312, Bayonne, N. J.

**MAIL** Order business is your opportunity. Many began small, now earn thousands yearly. No personal contact. Boundless opportunities. Have had over 30 years experience; will help you succeed. Send 25c for valuable booklets, none free. B. Breniser, 257 S. 21st, Philadelphia.

**MAN** In each town to plate auto parts, reflectors, bicycles, fixtures, mirrors, by late method. Simple plan of manufacturing at home starts you in good paying business. Free particulars and proofs. Gunmetal Co., Ave. H, Decatur, Ill.

**FINANCIAL Independence** obtainable by placing coin operated merchandise vending machines, out on percentage basis, no experience required, little capital needed, write for free details. Torr, 2047 1/2 South 68th Street, Philadelphia, Pennsylvania.

#### MONEYMAKING OPPORTUNITIES

**TURN** Spare time to dollars, men and women, nothing to make, no canvassing, experience unnecessary. P.O. Box 777, Harrisburg, Penna.

**HOME** Work opportunities, plans, formulas. Monthly Mentor Magazine. Send dime. Glen Ferris, Box 767, Bremerton, Wash.

**EARN \$25 Weekly.** No capital required. Complete plan 50c. SFS, Box 525, Georgetown, Kentucky.

**GROW** Plants without soil. Folder free. Gordon Laboratories, 509-J Fifth Ave., New York.

**RURAL Mailings** give best results. Lists 3c per 1000. Particulars free. Saalfrank, Hampton, Virginia.

**EARN Extra** money writing for publication. Simple method. Demand inexhaustible. Details free. Dona Veretts, 17 Grotton, Lowell, Mass.

**YOU'LL Like** resilvering mirrors, auto-parts, reflectors, making chipped glass signs. Write Sprinkle, Plater, 287, Marion, Indiana.

**BE Independent.** Start mail order business. Over 100 ways. Particulars free. Campbell Service, 3231 Dupont North, Minneapolis, Minnesota.



**MECHANICAL Dentistry**—A lucrative uncrowded profession. Earn while you learn at home in your spare time. For particulars write Neville Precision System, Dept. B, 210 N. Kolin Ave., Chicago, Ill.

**SOME Good money-making plans and ideas.** Write postal. Spangler, 1724 Warwick, Baltimore, Md.

**START Profitable mailing business.** We trust you. Monthly payments. Particulars, copy 25c Opportunities Magazine 10c. Hunt Co., 49 Edgemere, Trenton, N. J.

**WONDERFUL 64 Page moneymaking opportunity magazine 10c.** Practical Sales, Allendale, South Carolina.

**MOULDS, Guaranteed,** for casting toy soldiers, Indians, trappers, warships, sinker moulds, 244 kinds. Send 5c for illustrated catalogue. Henry C. Schiercke, 645 Spencer, Ghent, N. Y.

**EARN While learning body, fender repairing.** Trial lesson now 50c. Hope Trade School, Dept. L, Burlington, Vermont.

**HOME Operated mail order business,** sparetime, pays permanent income. "Getting Right Start," new manual, by mail-sales expert tells how. Sent prepaid for quarter—send for it now; get extra, author's personal counsel. Sales Development, 1020 E. 4th, Duluth, Minn.

**BE A professional scrapbooker.** Big fees. Unlimited opportunities. No competition. No capital needed. Write Scrapbookers Guild, 59 Park Place, New York, N. Y.

**GOLDMINE! Barbecued frankfurters formula (dime).** Davis, Box 1484-M, Clarksburg, W. Va.

**SECRETS Of moneymaking in mailorder, sparetime and home work—newest easy and quick ways to biggest profits.** Details for stamp. Lewis Company, 828-G Carpenter, Oak Park, Ill.

**MANUFACTURE Your own vanilla, bleach, washing solution, furniture polish, wall paint soap, anti-freeze, windshield cleaner.** All fast sellers. Send 25c for mixing formulas and manufacturing course. Home Occupations, St. Paul, Minn.

**MAKE Money at home by mail.** Write G. Bond System, Box 1436, Long Beach, Calif.

**HUNDREDS Of money-making ideas.** Stamp please. Gifford, Dept. A, Aberdeen, South Dakota.

**MILLION Articles.** Buy wholesale. Valuable directory 10c (silver). Ideal Service, D-9, Park Ridge, Ill.

**MONEY-MAKING Projects.** Color-glazed concrete pottery, Gravestones, tiles, walls. Guaranteed basement waterproofing. Operators wanted. Booklet, details 10c. National Potteries, Minneapolis, Minnesota.

**BIG Mails of opportunities; imprints, new offers; mailorder propositions.** Six months 15c, sample free. Harvey Teeple, Decatur, Indiana.

**WONDERFUL Moneymaking opportunity magazine, 25c; full instructions \$1.00.** Haldean, Boulder, Colo.

**"SALTED Peanuts in Shell."** See advertisement under "Business Opportunities" classification.

**PROFITS, Day-night.** No selling. Operate "Silver King" vendors \$3.25 up. Free instructions. Automatic, 2427 Fullerton, Chicago.

**MAKE Household product of 100 uses.** Sell by mail or agents, spare time. Information free. Ribot, 620 East 62nd, Chicago.

**MAN In each town to plate auto parts, reflectors, bicycles, fixtures, mirrors, by late method.** Simple plan of manufacturing at home starts you in good paying business. Free particulars and proofs. Gunmetal Co., Ave. N, Decatur, Ill.

**RAISE Earthworms for profit.** Information free, stamp appreciated. Bureau Zoological Research, 106A Broadway, Peoria, Ill.

**BIG Money easily made; 107 test plans for your choice.** Home, office. Descriptive booklet free. Elite Co., 214 Grand St., New York.

**WHOLESALE Sources, 500,000 articles.** Free directory. Maywood, 1107 Broadway, New York.

**ACCOUNTANTS And bookkeepers.** Real profit from new type bookkeeping service. Write Asco, Box 1468, Springfield, Mass.

**1059 WAYS To start a profitable business.** Get Popular Mechanics book of modern formulas and methods for practical specialty manufacturing. Price only \$1.25 postpaid. Popular Mechanics Press, Room (C39), 200 E. Ontario St., Chicago.

## FORMULAS, PLANS, ETC.

**SELF Vulcanizing cement,** patch your tire, use at once. Typed formula 50 cents. Formula Agency, 274 Boston St., Lynn, Mass.

**ONE Ingredient formulas! Big profits!** Fast, repeat sellers. Catalog free. A. Kinford, Wayne, Penna.

**GUARANTEED Formulas—New fast sellers.** None better. Lowest prices. Catalog free. Kemico, 49N, Park Ridge, Ill.

**PENETRATING Oil.** Guaranteed formula \$1.00. Excellent for garages and homes. Roy H. Shaw, 200 Cayuga Ave., Warren, Penna.

**FREE! 1939 Illustrated book, 10,000 formulas, recipes, trade secrets.** 900 pages loaded with money making and saving opportunities. 3c stamp brings details this and 24 other equally profitable. Adams-Brown Company, Chestnut Hill, Mass.

**ANALYSIS.** Duplication guaranteed. Valuable formulas. Consultation. Associated Chemists, Indianapolis, Indiana.

**FORMULAS: 15 Proven moneymaking formulas \$1.00.** (Not stock-formula catalogue stuff), real unusual offers. List free. Marvel Laboratories, 6629 No. Maplewood, Chicago.

**WATERLESS Hand cleaner.** Sample; formula; \$1.00. C-Beach, 156, Groton, Conn.

**MAKE Paint 30 cts. gallon.** Details 10c. Box 688, Kellogg, Idaho.

**ANALYSIS.** Research. Newest guaranteed formulas. Biggest catalog free. Nominal prices. Gibson Laboratory, Chemists, BD-1142 Sunnyside, Chicago.

**10,000 FORMULAS—900 Page volume,** most amazing value in years. \$1.85 postpaid. Ideal Book Shop, 1799, Park Ridge, Ill.

**FORMULAS—All kinds.** Real moneymakers. Lowest prices. Catalog free. Clover Formulary, P-9, Niles Center, Ill.

**EXTRAORDINARY Success** always assured using Miller's Certified Formulas! (Based on analysis of America's exceedingly popular products.) Stamp brings latest Formula Messenger. Miller, Manufacturer's Chemist, Tampa, Florida.

**10 EXCEPTIONALLY Good formulas,** included free, humorous verse, entitled, Definition of a Woman. This choice collection, only \$1.00. Hamilton Products, 124 Andrews St., Massena, N. Y.

**THAXLY Formulas for perfect products.** Accurate analyses. Catalog free. B. Thaxly Company, Washington, D. C.

**REAL Manufacturing formulas.** Lists free. Cummings, Chemist, Gordon Avenue, Syracuse, N. Y.

**FORMULAS.** Latest money makers. Literature free. Belfort, 4042 N. Keeler, Chicago.

**ELITE Formulas and plans; make and sell your own products.** Descriptive booklet free. Elite Co., 214 Grand St., New York.

## CHEMISTRY

**SPECTROSCOPE** For quick chemical analysis \$2.50. Kutting Sons, Campbell, California.

**HANDBOOK** For chemical experimenters, hundreds of experiments, illustrated 50c. Experiment booklet 15c. Chemical catalogue 5c. Reading Scientific Company, Reading, Penna.

**FREE: 40 Page catalog of chemical and laboratory supplies for amateur chemists.** Wollensak microscopes and supplies, scientific books at big discount. JE-9 Winn, 124 West 23 Street, N. Y. C.

**JOIN American Amateur Chemists Society.** Journal, particulars 10c. Haslett, Mich.

**FREE Chemistry catalog.** Supplies at 5c! Equip complete laboratory. Send 3c for postage. Kemkit Scientific Corp., 397P Bridge St., Brooklyn, N. Y.

**CHEMICALS.** Laboratory, glassware, apparatus. Send 3c for catalog CP1. Biological Supply Company, 1176 Mt. Hope Avenue, Rochester, N. Y.

## HELP WANTED

**BIG Money taking orders; shirts, ties, hosiery, underwear, pants, jackets, raincoats, uniforms, etc.** Sales equipment free! Experience unnecessary. Nimrod, 4922-BG Lincoln, Chicago.

**M. M. Earned \$267, three weeks,** raising mushrooms in cellar! Exceptional, but your cellar, shed perhaps suitable. We buy crops. Book free. United, 3848 Lincoln Ave., Dept. 66, Chicago.

**ROUTE Men wanted.** Local grocery routes paying up to \$45 in a week. Automobile given producers as bonus. Zanol Products, 6043 Monmouth, Cincinnati, Ohio.

**\$30 WEEKLY.** Grow mushrooms. Cellar, shed. We buy 30c lb. Mr. B made \$270 spare time. World's largest company. 40 page book free. Mushrooms, Dept. 701, 2019 Second, Seattle, Wash.

**CREW Managers.** Men-women. \$15.00 daily. Unusual product. Sanigarb, Rochester, N. Y.

**LEARN Air conditioning—America's next big industry.** Thousands of opportunities. Get your start with complete book by E. W. Riesbeck. \$3.50 postpaid. Popular Mechanics Press, Room (C39), 200 E. Ontario St., Chicago.

## AGENTS WANTED

**BIG Profits showing outstanding Christmas card values.** 21-card "Blue Ribbon" assortment sells for \$1. Pays you 50c. Ten other popular assortments; personal Christmas cards, 50 for \$1, up. Experience unnecessary. Free sample offer. Chilton Greetings, 147 Essex, Dept. 2-H, Boston, Mass.

**NECESSITIES Are always in demand!** Experience unnecessary to earn steady income supplying tremendous demand for customized shirts factory to wearer. Gigantic variety; one year guarantee; nine sizes. Half price offer creates amazing values. Superior advantages eliminate competition. World's largest concern of its kind. Our sales force earns \$100,000.00 yearly. Get your share! Postcard brings you complete self-selling outfit free. Simply write orders. We deliver and collect. Write Dept. 404, Roseliff-Quaker, 1239 Broadway, New York.

**CHRISTMAS Card box assortments** selling like "wildfire." People who have never sold a thing in their lives are reaping harvests with our "New Champion" 21 folder assortment, including sensational "mystery card"—Biggest sales-puller of all time. Costs 50c—sell for \$1.00. Worth \$2.85. Also seven other bargain assortments, and personal imprinted cards. Write today. Samples on approval. Silver Swan Studios, 320 Fifth Ave., Dept. 74, New York.

**SELL 50 Personal Christmas cards—\$1.00.** Amazing bargain! 50 folders with customer's name imprinted. Sells fast. Pays big profit. Free samples. Also unqualified \$1 Christmas card assortments. General Card, 400 S. Peoria St., Dept. P-19, Chicago.

**YOU'LL Thank your lucky star** when you receive my amazing free offer for making up to \$45.00 in a week. No money risk. No experience needed. Write quick. Mills, 6049 Monmouth, Cincinnati, Ohio.

**LET Me send you \$6.00 worth actual sample food products and household necessities, free.** Finest quality. Look after coffee and tea route. No experience. No investment. Bright future. Blair, Dept. 31-M, Lynchburg, Virginia.

**SELL Bronko Tite-Splicer to farmers.** New invention. Has no competition. Amazing demonstration. Answers long felt need. Real money maker for workers. J. Gibbon, Primghar, Iowa.

**BUSINESS Proposition resilvering mirrors, autopaarts, reflectors, making chipped glass signs.** Write Sprinkle, Plater, 128, Marion, Indiana.

**SELL Season's Christmas card hit!** "America's Favorite" 21-card assortment, \$1. Profit 100%. Big selection assortments, personal Christmas cards low as 50 for \$1. Free samples. Wetmore & Sugden, 749 Monroe, Dept. 79, Rochester, N. Y.

**CHRISTMAS Card salespeople—Best selling line.** You make 50c on different 21-folder \$1 box. Christmas cards with name, 50 for \$1. Other novelties, everyday, gift wrappings. Experience unnecessary. Free samples. Schwer, Dept. M-4, Westfield, Mass.

**CHRISTMAS Cards.** Absolutely finest assortment. Big profits. Write for samples. Robinson Cards, 500 Orange, Clinton, Mass.



**SELL** Christmas cards with sender's signature in raised gold. 21 folders, retail \$1. You make 100%. Also name-imprinted Christmas cards, 50 for \$1. Other money-making assortments. Get samples. Friendship, 444 Adams, Elmira, N. Y.

**MERCHANTS** Wall signs. Cost 1c, sell 10c. Send 15c for samples. Richards, 221-M Indiana Ave., Indianapolis.

**AGENTS**—Amazing new glass cleaner sells fast, repeats. Demonstrations reap big profits. Needed everywhere. Write Universal Utility, Gloversville, N. Y.

**DON'T** Be a job hunter—Start your own business on our capital. No hard times; no lay-offs; always your own boss. Hundreds average \$3,000 to \$5,000 annual sales year after year. Sales way up this year. We supply stocks, equipment on credit. 200 home necessities. Selling experience unnecessary. Wonderful opportunity to own pleasant, dignified, profitable business backed by world-wide industry. Write Rawleighs, Dept. I-U-PPM, Freeport, Ill.

**CLERKS**, Factory, mill or office workers. Rare opportunity. Earn extra money. 70% commission selling metal social security, life-time plates and cases. Send 10c with your S. S. number. Wm. Hamant, 665 W. Lexington St., Baltimore, Maryland.

**YOUR** Hose free with outfit. Make up to \$32.50 in a week taking orders for amazing new hosiery. Replacement guaranteed against holes, snags, runs. Rush name, hose size. Wilknit, Desk K-37, Greenfield, Ohio.

**CHRISTMAS** Cards. Sell 50 assorted folders name imprinted \$1.00—cost you 50c. Samples free. Dunbar, New Brunswick, N. J.

**WORLD'S** Fastest money maker. Sell 50c packs of razor blades for 5c. Tharp, 914 Lexington, Cumberland, Md.

**BIG** Money taking orders; shirts, ties, hosiery, underwear, pants, jackets, rain-coats, uniforms, etc. Sales equipment free! Experience unnecessary. Nimrod, 4922-AN Lincoln, Chicago.

**SUCTION** Sponge cleans cars like magic. Banishes auto-washing drudgery. New! Hot seller! Samples sent on trial. Write "Inventor," 110 Kristee Bldg., Akron, Ohio.

**NEW** Invention, automatic gas station signal. Upkeep, installation, electricity not necessary. 100% profit. Knipp, 1915 Florida, Long Beach, California.

**BEAUTIFUL** Bird pictures handmade with genuine feathers. Sell on sight! Large profits! Free particulars. Samples 10c stamps. Marquez-PL, Apartado 1176, Mexico City.

**500% PROFIT** With new perfected (1939) quick-action, no flint, automatic gas lighter. Retail 25c. Sample 10c. New Method Co., Box PMH-80, Bradford, Penna.

**INCREASE** Your income handling subscriptions. All magazines. Pines, A-583 Monroe, Brooklyn, N. Y.

**COMIC** Postcards, jokes, booklets, photos, mirrors, fan dancers, naughty pigs, fun cards, greetings, birthdays, convalescent, congratulations, anniversary, Christmas, New Years—12 samples, pricelists, 10c stamps. Complete assortment—100 samples for \$1.00. Express paid. Artform Co., 1710 Undercliff Avenue, New York.

**MEN, Women**—Sell our patented household necessity at 50c. Big cash profit. Proven demand. Write quick. Fuller, Box 4534, Sta. C. Kansas City, Mo.

**HANDLE** Exclusive territory for unique business service. Long profit. Real cooperation. Box 5411, Philadelphia.

**MOSQUITO** Incense, new fast seller. Particulars free. Samples 10c. Mission, 2328W Pico, Los Angeles, Calif.

**OUR** Complete line necessities, household articles, sundries, tricks, snappy jokes, sell fast. Write La France, 55 Hanover Street, Boston, Mass.

**NOW**—Direct factory representatives wanted. New profit plan on nationally known, guaranteed electric refrigerators. Write today. Gennett and Sons, Dept. C, Richmond, Indiana.

**100% PROFIT** In new perfected (1939) quick-action self-starting cigar lighter. No flint or friction. No wind can blow it out. Retail 25c. Costs you \$1.75 dozen. Sample and can fluid 25c. New Method Co., Box PM-81, Bradford, Penna.

**LOOKING** For steady employment? Midwest, 137 East Spring, Columbus, Ohio.

**MAKE** Big profits selling famous Waltham Christmas cards. 21-card assortment sells for \$1, pays you 50c. Other popular assortments and personals. Free sample offer. Waltham Art Publishers, 160 N. Washington St., Dept. 238, Boston, Mass.

**SELL** Personal initial Christmas cards—21 for \$1. Earn up to \$3 hour. Novel gold, silver initials included. 100% profit. 50 name-imprinted Christmas cards, \$1. Many assortments. Get samples. Artistic, 845 Way, Elmira, New York.

**RARE** Opportunity selling new sensational necktie rack. Samples 25c. Jewell Novelty Co., Muskegon, Mich.

**SELL** Gas-Miser. New. Scientific. Improved automobile operation. Saves gasoline. Unconditional guarantee. Agents coining money. Write Malone & Moles, Sioux City, Ia.

**PROFIT** With new products. Make, sell, repeat. Analysis. Research. Guaranteed formulas. Biggest catalog free. Nominal prices. Gibson Laboratory, Chemists, BD-1142 Sunnyside, Chicago.

**EX-O-LENE!** Mile increasing, super power anti-knock compound. Needed by millions. Powerful, harmless, guaranteed. Distributors wanted. Big profits. Protected territory. Thermo Exolene, Peoria, Ill.

**AGENTS!** Men's suits \$1.53, pants 37c. Dresses 15c, ladies' coats \$1.10. Other big bargains. Catalog free. Roosevelt Mercantile, 566-AD Roosevelt Road, Chicago.

**BIG** Money selling guaranteed reconditioned Elgin, Waltham, Hamilton watches, \$3.75 up. No investment. Free catalog. Grossman Jewelry, 4666-R State, Chicago.

**YOUR** Own local shoe business. Free outfit starts you! Bonus shoes given. 200 styles. Big advance commissions. Experience unnecessary. Tanners Shoes, 442, Boston, Mass.

**RESURRECTION** Plant, unique novelty, miracle of nature. Costs below 2c, sells for 25c. C. E. Locke, 10 Rio St., Mesilla, New Mexico.

**CHRISTMAS** Cards. Earn \$2 an hour. Take orders galore from friends. 50 exquisite folders with name at \$1. Free album 32 designs. Fastest selling 21 folder box in America. Costs 50c. Sells \$1. Request samples. Sunshine Art, Dept. E, 154 Nassau, New York City.

**SELL** Famous Glas-Glo. Sample 3c. Glas-Glo, Phelps, N. Y.

**AGENTS**, Merchants specialty. Sample dime. Refunded. Lamont Company, Beacon, New York.

**500% PROFIT!** Transfer sign letters for windows, offices, trucks, signs. Colors: gold, silver, red, many combinations. Auto monograms. Easily applied. Neonite, Akron, Ohio.

**AGENTS:** Smash go prices! Santos coffee 12c lb. 4-oz. vanilla 8½c. Razor blades 10 for 8½c. 100 sticks chewing gum 12c. Christmas cards, 21 in box, 14c. 150 other bargains. Premiums. Experience unnecessary. Carnation Company, PO, St. Louis, Mo.

**AGENTS** Make big profits on food products, bargain deals. Low wholesale prices. Rush name for trial outfit offer. Ho-Ro-Co, 2810-S Dodier, St. Louis, Mo.

**AGENTS**—To mail our literature. Good profits. Home business. Maywood, 1105-1107 Broadway, New York.

**SUCCEED** With your products. Make-sell. Formulas. Accurate analyses. Catalog free. B. Thaxly Company, Washington, D. C.

**ATLAS** Window sign letters. Large sizes—penny each. Get beautiful samples. Atlas, 7941 Halsted, Chicago.

**ENGRAVED** Name plates, numbers, signs, etc., easily sold, profits large. Brett Bros., Winthrop, Mass.

**300% PROFIT** Selling gold leaf letters for store windows; high grade letters 1½c each. Free samples. Metallic Co., 438-B North Clark, Chicago.

**BIG** Money applying initials on automobiles. Easiest thing today. Free samples. Also, sideline salesmen for short order decalomania name plates. "Ralco," 1305 Washington, Boston, Mass.

**REVOLUTIONARY** Window cleaning tool. Good Housekeeping approval. Only ten \$2.25 sales daily to housewives, factories, schools, stores will make you \$350.00 monthly. Carter Products Corp., 900 Front Ave., Cleveland, Ohio.

**AGENTS**—Opportunity make money; book containing 107 successful business plans; home-office; send for free introductory booklet. Elite Co., 214 Grand St., New York.

**STARTLING** Invention—Pocket adding machine. Nationally advertised \$2.50. Whirlwind seller. Big profits. Baby Calculator Co., Box 1118, Chicago.

**BIG** Money applying initials on automobiles. Write for particulars and free samples. American Letter Company, Dept. 40, Dunellen, New Jersey.

**FREE** Sample—Amazing cleaner; sells homes, taverns, everywhere. Big profit—fast repeater. Betco, 5007 Irving Park, Chicago.

**MANUFACTURE** Specialties, hire agents yourself. Big money. Free literature. Gilbert Supply, 1107-P Broadway, New York.

**AGENTS:** Stamping names on pocket-key protectors. Sample check with your name, address, 25c. Stamping outfits, Emblem checks, check-fobs, name plates. Hart Mfg. Co., 303 Degraw St., Brooklyn, N. Y.

**DO** You want agents for your proposition? Your ad in this space will place your message before hundreds of men seeking fast-selling products. My folder "How to Secure Agents," is filled with proof. I'll gladly send you a copy free. F. W. Johnson, Manager Classified Advertising, Popular Mechanics Magazine, 200 E. Ontario St., Chicago.

### HIGH-GRADE SALESMEN

**\$193 WEEKLY** On \$15 deal. Successful, reputable, bonded, nationally known concern, offers remarkable opportunity for consistently large earnings to capable salesmen having successfully sold specialties or intangibles. Outstanding, essential, copyrighted credit control service for business and professional men, selling for only \$15. Guarantees \$200 minimum cash return to clients. Used and endorsed by foremost authorities. Depression proof. Large repeat business. Exclusive territory. Future and permanence. Write fully to President, Bureau of Credit Control, Rives Strong Bldg., Los Angeles, California.

**OPENINGS!** Call on all dealers with New Trade-Stimulator Plans. It's "hot." \$3 commission on each \$5 sale. Big repeat commissions. No investment. Sales kit free. Universal, 6227 Broadway, Dept. C59, Chicago.

**IF** You are now selling to manufacturers, wholesalers and retailers, and want to add another line write us. Dexter Manufacturing Co., 3225 Ravenswood, Chicago.

**SELL** Mexican novelties. Commission. Free samples. Marquez, Apartado 1176, Mexico City.

**SALESMEN** Sell calendars, book matches, fans, advertising novelties. Samples free. Fleming Calendar Co., 6543 Cottage Grove Ave., Chicago.

**HERE** Are extra \$\$\$ for you. Make money in your spare time. Turn odd moments into cash. Earn extra weekly income quickly, easily. Hundreds of different offers to choose from—all legitimate, well established companies. Regardless of where you live or what your interests are, there is something here for you. Big newsy monthly magazine tells how. Next 6 issues free as introductory offer to win new friends. No obligations now or later. Write today for this fascinating publication. A postcard will do. Address "What To Sell," Box M8, 168 N. Michigan Ave., Chicago, Ill.

**SELL** Xmas cards. 50 with name \$1, unequalled. Also America's finest box assortment. Costs 50c, sells \$1. Worth \$3. Sample on approval. National Greetings, Douglas Bldg., 3rd and Spring, Los Angeles, Calif.

**SELL** Printing at cut prices. 2,000 business cards \$1.50; 1,000 envelopes or statements, etc. \$1.75; 25 printed sales books \$1.50; 1,000 process embossed cards \$1.50; 2,000 two-color labels, free holder \$1.50; 2,500 printed handbills \$1.75; 500 book matches \$1.50. One-third comm. Free outfit. Bargain Prtg. Co., 189-F W. Madison, Chicago.

**SOXFORDS** Will boost you financially. Spare, full time. Results most gratifying. Shaw & Son, Box 282, Salem, Oregon.

**SALESMEN:** We pay \$5.00 commission, plus \$1.50 bonus to inspect and register filing stations, protect them against hold-ups and burglary. This is a sensation for live wires. \$26.00 daily average earnings. Write quick. National Anti-Crime Union, Inc., Dept. 501, Carthage, Missouri.



**YOUR Own suits and other gifts free as bonus, plus big cash profits for selling your friends fine quality, individually made to measure suits and overcoats. Popular new low price ranges help make sales easy. Exclusive sport and swing styles no extra charge. Elaborate selection new fall and winter materials and patterns. Satisfaction or money back guaranteed by reliable thirty year old tailoring firm. No experience needed. Sample outfit free. Jay Rose & Co., Dept. P-99, 330 South Wells, Chicago, Ill.**

**KLEEN-ALL Polish.** Modern as tomorrow. Proposition, trial 10c. Quarter-Line, Marathon, N. Y.

**BIG Commissions—selling to stores celulooid pricing tickets, metal shelf moulding. To restaurants, menu covers, signs. P. Pricing Press, 124 White St., New York.**

**EXTRA Money—Take orders for personal Christmas cards and stationery. Names inscribed. Also big-value 21-card assortment at \$1.00. Profit 50c. Experience unnecessary. Samples free. Wallace Brown, 225 Fifth Ave., Dept. F-34, New York City.**

**SELL Business stationery \$2.65 thousand, business cards, book matches, advertising gummed tape, restaurant necessities, salesbooks, office supplies, pricing sets, advertising specialties. 40% comm. Free premium deals. Sales portfolio free. David Lionel Press, 312 So. Hamilton, Dept. KJ, Chicago.**

**WORLD'S Largest "direct selling" book match factory offers liberal daily earnings calling on business places. Experience unnecessary—spare, full time. High quality, quick deliveries, low factory prices. Special features, are booming business. Repeats boost prices. Free kit—full instructions. Match Corp. of America, 3433 West 48th Pl., Dept. E-9, Chicago.**

**SELL Our new Kitchen Miller. Limitless, untouched market. Secure exclusive city, county or state distribution. Sample \$1.00 postpaid. Kut-Kwik Company, 5849 Ocean View Drive, Oakland, California.**

**SALESMEN, Distributors: 200 items, brushes, mops, Marvelous magnetic brush, excels vacuum cleaner. Neway Brush Co., Hartford, Conn.**

**EXCEPTIONAL Opportunity in open territories. Get paid for all business in your district as our factory representative calling on radio and auto trade with Dual Remote Controls. Write Dual Remote Control Co., Inc., 31776 W. Warren, Wayne, Mich.**

**BLADES. Finest quality. Factory prices, postpaid. Ace Blades, Buffalo, N. Y.**

**NEW Specialty—Sells every business and professional man. Four \$15 sales daily pay \$280 weekly. Farrell cleared over \$1,000.00 monthly. Write, F. E. Armstrong, President, Dept. PM, Mobile, Ala.**

**EXCELLENT Opportunity selling our complete line of brushes, largest commissions. Write for sales plan. Wire Grip Sanitary Brush Company, 2300 5th Ave., New York.**

**EARN Money in your spare time taking subscriptions to Popular Mechanics. Unlimited possibilities, every family a prospect. Easy to sell. Bonus paid in addition to liberal commission. Send postcard for further details today. Circulation Dept., Popular Mechanics Magazine, 200 E. Ontario St., Chicago.**

#### EDUCATIONAL AND INSTRUCTION

**DRAFTSMEN Get big pay. Learn now. Particulars free. Monroe Institute, Alton, Illinois.**

**BECOME Practical scientific investigator. Modern, illustrated course. Thorough training by former agent U. S. secret service. Particulars free. International Secret Service Institute, PM-99, Hoboken, N. J.**

**FOR An extremely profitable lifetime business, operate a collection-credit agency. Free folder. Cole Associates, Syracuse, N. Y.**

**GOOD Pay, steady job. Learn meat cutting easily—quickly. Essential business. People must eat. Openings for trained men everywhere. Intensive short course makes you fully qualified union meat cutter in six weeks. Free catalog. We have no salesmen. National School of Meat Cutting, Dept. U-2, Toledo, Ohio.**

**"SHORTHAND Simplified," \$1.00. Phonetic chart, 24x36, 25c. Simmons, Rocky Hill, Conn.**

**WATCH Repairing is steady profitable work. Experts always in demand. You can learn watchmaking trade at home, spare time. New original instruction system. Script engraving course included. Write for free details today! Nelson Co., J-2001 Manhattan Building, Chicago.**

**LEARN A trade in aviation—We offer courses in aircraft welding, aircraft sheet metal, airplane and engine mechanics. For complete details, write Aviation Industries Co., Box 1181, Wichita, Kansas.**

**BLUEPRINT Reading course, complete, \$1.00 postpaid. Details free. Shervin Publications, Box 116, Breathedsville, Maryland.**

**BE A detective. Big money, everywhere, travel. Complete course by mail. Costs amazingly little. Free information. Lee School of Detectives, 1523-A West Pico, Los Angeles.**

**PHOTO Engraving—Modern method, without expensive equipment. Imagic, Bristol, Tennessee.**

**ENROLL Now, decorating, paperhanging, graining, marbling, sign and pictorial painting. Catalogue free. Chicago Painting School, 102 W. Lake Street, Chicago.**

**LEARN Professional typing. Earn extra money! Best method. \$2, complete. Maurice Paschall, Azle, Texas.**

**LEARN Watchmaking. Complete instructions \$3.50. Work models 50c. Catalog wholesale tool, material, watches 5c. Stewart's, 721 Olive, St. Louis, Mo.**

**WRITE For newspapers—gain pleasure, good pay and perhaps fame. Full time or freelancing (part time). Hundreds of stories, articles, ideas, are needed in every issue. We successfully coach you by mail. 45 years newspaper experience—plenty of contacts for placing graduates. The Millers, Dept. 10, Carmel, California.**

**MASSAGE, Hydrotherapy, dietetics, drugless therapeutics, chiropody, taught by mail. Evans Correspondence School, Montgomery, Ala.**

**LEARN Auto mechanics, body, repairing, welding electricity, refrigeration. Diesel. Stevinson's, 2008A Main, Kansas City, Mo.**

**TELEGRAPHY Taught thoroughly. Railroad retirement act creating opportunities for new operators. Expenses low. Catalog free. Dodge's Institute, Hiatt Ave., Valparaiso, Ind.**

**GOVT Jobs start \$1260-\$2100 year. Men-women age 18-50. Former examiner's tested method helps qualify you. Particulars, list jobs free. Write today. Patterson School, 8C Mercantile Bldg., Rochester, N. Y.**

**SECRET Investigation. Experience unnecessary. Detective particulars free. George Wagner, M-2640 Broadway, N. Y.**

**DIESEL Instruction. Practical professional course. Simply written. Contains valuable information never before published. Sent postpaid anywhere in U. S. or Canada. \$7.50. J. C. Maloney, 56 W. Washington St., Chicago.**

#### PLAYS, STORIES, MANUSCRIPTS

**STORIES, Novels revised, typed for marketing. Welton Tinney, Winnsboro, Texas.**

**BEGINNERS! Make splendid income weekly writing. Details, stamp. Fame, Lathrop, Calif.**

#### CARTOONING, COMMERCIAL ART, SHOWCARD WRITING, SIGN PAINTING

**HAVE Your own money making business. Learn show card writing, sign painting. Write for details. Begley Specialty, 1472G Broadway, New York.**

**CASH For your cartoons when you learn by our method. National Cartoon Features, Box 1901, Dallas, Texas.**

**PEN And ink drawings. Let us draw your advertising and catalogue illustrations, from photos, copies or objects. Best work and fair prices. Heraldic Studios, 1914P Oakdale Avenue, Chicago, Ill.**

**AMATEUR Cartoonists wishing steady income copying and duplicating cartoons for advertisers, write Ad-Service, Argyle, Wisconsin.**

**MAKE Art Pay. Advanced art students. \$1.00. Popular Mechanics, 200 E. Ontario St., Chicago.**

#### ADVERTISING AGENCIES—LETTER WRITERS—FOR ADVERTISERS

**SALES Letters. \$2.50. Guaranteed. Hutzletter, 41-44 Davies Bldg., Dayton, Ohio.**

**ADVERTISE: 24 Words in 250 newspapers \$10. Lists free. Advertising Bureau, 4515-C Cottage Grove, Chicago.**

**INCH Display, 47 syndicates \$1.50. Del-lingers, 820 West 17th, Los Angeles.**

**1250 PICTURE Post cards reproduced from any size photo \$11.00. One inch advertisement on back free. 10c for samples and price list. Dexter, 16 Main Street, Pearl River, N. Y.**

**LEARN Advertising quickly at home. Easy practical plan. No text books. Common school education sufficient. Interesting booklet and requirements free. Page-Davis School of Advertising, 3601 Michigan Avenue, Dept. 343C, Chicago.**

**INCH Display advertisement 30 magazines, year \$24. Wood's Popular Services, Atlantic City, (N. J.)**

**SELL Your product through agents, mail order. Advertise newspapers, magazines. Publishers' rates. Snappy layout your inch advertisement \$1. Martin Advertising Agency, 171M Madison Avenue, New York.**

**SELL By mail? Want agents? Our "guide-book" packed with helpful advice, rates, publications, sent for stamp. Chicago Advertising Agency, 20PK West Jackson, Chicago.**

**DIRECT-MAIL Advertising services. Sales letters that sell. Mailing lists. Omaha List & Letter Co., Box 2172, South Omaha, Nebr.**

**ADVERTISING Placed all magazines, newspapers, radio. Lowest rates. Free service. 54 page rate book free. Baker Advertising Agency, A-189 West Madison, Chicago. Successors to Ankrum. Established 28 years.**

**FREE—New Advertisers Rate Guide, 44 pages. Includes everything. Lowest rates. E. H. Brown Advertising Agency, 140 S. Dearborn, Chicago.**

#### BUSINESS SERVICE

**LOS ANGELES Address. Forwarding service. Permanent, reliable, confidential. \$1 monthly. Box 9188-A, Los Angeles.**

**TURN Your old and bad accounts into cash. Free circular. Wright Service, Imbler, Penna.**

**150,000 AGENTS. Canvassers names, \$10.00 thousand, \$2.00 hundred. New York mail address. \$5.00 three months. Graubard, 1650 Broadway.**

**WASHINGTON, D. C., mail address and phone messages, individual secretarial service. Mailing Service, Suite 1204, No. 1343 H St. Northwest, Washington, D. C.**

**MAIL Postcards from Washington, D. C. Send 25c (coin) for three scenic postcards (ten 50c). Fill and return for mailing here. Rico, 1930 Calvert, Washington, D. C.**

**ADVISORY Engineering service. Mechanical, electrical, chemical and allied problems, by man professionally active in both practical and academic work. 1107 Times Star Tower, Cincinnati, Ohio.**

**LET Us merchandise your household ideas. Hoffman Lion Mills Co., Inc., Fall River, Mass.**

**CHICAGO Mail address \$1 monthly. Your personal, business mail forwarded daily. Established 1919. General, 56 West Washington.**

#### RUBBER STAMPS AND OFFICE SUPPLIES

**2 LINES 25c, 3—35c. Cushioned. Stamp Works, Centerport, N. Y.**

**CUSHION Mounted two lines 25c, each additional line 10c. Stamp Works, Hastings, Nebr.**

**TWO Lines 25c, 3 lines 35c. Newman, 4943 Leighton, Lincoln, Nebr.**

**NEW Movable indexing tab, 100 uses. 125. \$1. Adjustabs, Paterson, N. J.**

**ORIGINAL, Cushion mounted. One, two lines, 25c; three 35c; four 45c. Stamp Works, 814 Bradley, Peoria, Ill.**

**2 LINES 25c, 3 Lines 35c, Stamp Works, Auburn, Nebr.**

#### TYPEWRITERS, DUPLICATORS, OFFICE DEVICES

**SAVE On duplicating supplies. Buy stencils, inks, etc. Direct. Shattuck, 315 Third Avenue, Pittsburgh, Penna.**



**INCREASE** Business now. "Excelligraph" Rotary Stencil Printer reprints thousands everything you typewrite, hand-write, draw or trace. Colors. \$19.75 to \$44. Terms. Illustrated literature free to business or professional men. Pittsburgh Typewriter Supply, Department K-2, Pittsburgh, Penna.

**NEW \$3.75** Automatic adding machine. Fully guaranteed. Bassett, Box 302-K, Altadena, California.

**TYPEWRITERS.** Adder, mimeograph, multigraph, addressograph. Send for free lists of machines that will help you at half price. Pruitt, 28 Pruitt Bldg., Chicago.

#### PRINTING, MULTIGRAPHING, MIMEOGRAPHING, GUMMED LABELS

**8½x11 IMITATION** Typewritten letters, \$2.30; letterheads, envelopes, postcards, 6x9 circulars, \$1.89; envelope slips, 75c 1000—quantities. Samples. Goodprint, Harrisonburg, Va.

**1000 STICKERS.** Four lines 50c. Catalog labels. Cott's, Spickard, Missouri.

**PLATELESS** Engraved business cards; distinctive; send for samples. A. S. Georgia, 30 East 23rd Street, New York, N. Y.

**ENGRAVURE** Printing, lowest possible prices. Samples free. Sunco, Mohawk, N. Y.

**\$1.00 POSTPAID**—125 8½x11 20 Pound bond letterheads and 125 envelopes. Benneville, 907 West Roosevelt, Philadelphia.

**500 TWO-COLOR** Letterheads \$1.85. Samples free. Colorpress, Larned Bldg., Detroit.

**HAMMERMILL** Letterheads, any color paper and ink, 300 8½x11, \$1.48 postpaid. 30 type styles available. Free particulars. Woodruff's, 217A Lewis, Duluth, Minn.

**6x9 CIRCULARS.** Envelopes, \$2.30—1000 plus postage, quantities cheaper. Warrior Press, North Birmingham, Alabama.

**DE LUXE** Business cards—pro-embossed. Thinplate, 1000—\$1.99, postpaid. Shinn's Shop, Bellflower, California.

**MULTICOLOR** Printing, embossing, multigraphing. Inexpensive. Universal's, 203 Avon Ave., Newark, N. J.

**10,000—3x6 CIRCULARS** \$4.95. Handee labels, 5,000—\$1.95. Letterheads, envelopes, typewriter letters, cards, etc. Free samples. Okayprint, Martins Ferry, Ohio.

**1000 ENVELOPES.** 6¼, 6¾, \$1.85; 10" \$2.25. Allen, Fort Edward, N. Y.

**YOUR** Photo on your business card will make people remember you—help you get jobs! 25 glossy photographic cards, size 2x3¾" with your picture 1" square, and name, address, business, and phone set in type, only \$1. Mail photo (any size), name, etc. (please print), with remittance (no stamps). Studio Press, P.O. Box No. 355, Chicago.

**BOOK** Matches—Printed any wording. Carton, 50c postpaid. VanDorn's, Ottawa, Illinois.

**GOOD** Printing. Reasonable. State your wants. Hamilton Printers, 1314 So. Racine, Chicago, Ill.

**USE** Printed stationery. 200 8½x11 bond letterheads. 200 6¾ envelopes, both \$1.00, postpaid. Franklin Printery, 2932 Pershing, Chicago.

**1000 BUSINESS** Cards \$1.00 post paid. Superba Print, 912 Towne, Los Angeles, Calif.

**500 ¾x2¼** FOUR Line gummed stickers, 25c. Moritz Printery, Saginaw, Mich.

**NOTICE** Our adv. on page 137A. Book matches printed for you! Only \$1.00. Sanderson Match Company, Ottawa, Illinois.

#### PRINTING OUTFITS AND SUPPLIES

**PRINT** Your own cards, stationery, circulars, advertising. Save money. Easy rules furnished. Print for others, big profits. Junior outfits \$9.00, senior outfits \$17.00 up. Details free. Kelsey Presses, E-11, Meriden, Conn.

**MAKE** Photo-engraving outfit yourself! Particulars free. Nu-Ideas, Carrollton, Illinois.

**BARGAINS** — Presses, type, supplies. Send stamp. 159 Harvard, Cambridge, Mass.

**LONG** Established printers warehouse. Big lists 3c. Landis, Richland, Penna.

**HAND** Presses, type and complete printers' supplies. Send stamp for catalog and new price list. P. Peiffer & Co., Newark, N. J.

**BARGAINS.** Presses, type. List 3c. Exchange, E-15, 110 Dexter, Meriden, Conn.

#### PATENT ATTORNEYS

**INVENTORS**—Time counts—Don't risk delay in patenting your invention. Write for new 48-page free booklet, "Patent Guide for the Inventor." No charge for preliminary information. Clarence A. O'Brien and Hyman Berman, Registered Patent Attorneys, 58-X Adams Building, Washington, D. C.

**PATENTS.** Gerald P. Welch, Registered Patent Attorney, Plankinton Arcade, Milwaukee, Wisconsin.

**INVENTORS:** Send immediately for your copies of our new free books, "Patent Protection" and "Suggestions on Selling an Invention." Sixty-eight pages of interesting facts. They tell how Patent Laws protect you; kind of sketch or model needed; simple steps to take without cost; how successful inventors have secured financial assistance; show interesting inventions; illustrate important mechanical movements. With books we also send free Evidence of Invention form to help establish date of disclosure. Prompt service, reasonable fees, special deferred payment plan. Strictest secrecy. Forty-one years' experience. Highest references. Write us today. The facts in our books are worth money to the man with a good invention. Address: Victor J. Evans & Co., Registered Patent Attorneys, 113-K Victor Building, Washington, D. C.

**PATENTS** Obtained through associated patent attorney. Write for details. R. & S. Engineering Co., Dept. M91, 17 East 42nd Street, New York City.

**INVENTORS:** Get my new free book. Use my personal, confidential patent service. Send for free facts on patenting your invention. Also suggestions on financing a patent application. Reasonable fees. Deferred payments arranged. Write Hugh E. McMorrow, Registered Patent Attorney, Dept. 322-B, Barrister Building, Washington, D. C.

**PATENTS.** Protect your idea by securing free "Proof of Invention" folder. Exceptional personal service. Established 1906. E. E. Vrooman, 871 Woodard Bldg., Washington, D. C.

**"INVENTOR'S** Guide." 100 mechanical movements, free; advises on patenting, selling inventions. Frank Ledermann, Tribune Bldg., New York.

**L. P. RANDOLPH,** 302-B Victor Bldg., Washington, D. C. Low cost. Book and information free.

**PATENTS.** Booklet free. Highest references. Best results. Promptness assured. Watson E. Coleman, Patent Lawyer, 724 Ninth St., Washington, D. C.

**INVENTORS**—Send for free booklet "Patent-Sense." Information based on 64 years experience. Lacey & Lacey, Dept. 5A, 635 F St., Washington, D. C.

#### FOR INVENTORS

**INVENTORS**—Time counts—Don't risk delay in patenting your invention. Write for new 48-page free booklet, "Patent Guide for the Inventor." No charge for preliminary information. Clarence A. O'Brien and Hyman Berman, Registered Patent Attorneys, 58-X Adams Building, Washington, D. C.

**NOTICE**—Valuable information for inventors. Time and money saved, list of 1,000 picked patent buyers. Best method of presenting patents for sale. Also list of unpatented idea buyers. The way, and place to obtain financial assistance. All the above information for \$1.00. Royal Keystone Enterprise, Box 192, Berryville, Ark.

**INVENTION** Sales Bulletin describing over 500 inventions, showing how we sell inventions, patented or unpatented, with booklet and particulars free. Patentee System, 9443 Pleasant, Chicago.

**"1,300** PATENTED Invention drawings" \$1. Centofanti, 25 South Pearl, Youngstown, Ohio.

**INVENTING** Taught at your home by Trofimov School of Inventive Practice, Hanna Rd., Willoughby, Ohio.

**WE** Locate buyers meritorious patented, unpatented inventions. If will sell, reply immediately. Descriptive booklet free. Invention Reporter, 5A-11236 South Fairfield, Chicago.

**PROTECT** Your inventions from the hands of others at the cost of good necktie. Send dollar bill for full information. Absolutely guaranteed. Carlyle Oliver Co., Vermontville, Michigan.

**INVENTORS**—Send for 72-page book on patents. Reasonable terms. Conscientious treatment to inventors. L. F. Randolph, Registered Patent Attorney, 302-E Victor Bldg., Washington, D. C.

**HAVE** You a sound, practical invention for sale, patented or unpatented? If so, write Chartered Institute of American Inventors, Dept. 4-A, Washington, D. C.

**INVENTORS:** Profit by your invention. A practical talk to inventors by an experienced manufacturer. Our 68 page booklet "Mind vs. Matter" mailed upon receipt of 25c. Rex Engineering Co., Cincinnati, Ohio, Dept. D.

**INVENTORS:** "Making Inventions Pay," our 32-page illustrated book, mailed upon receipt of 3c postage. Crescent Tool Co., Dept. Z, Cincinnati, Ohio.

**I** SELL Patents. Established in 1900. Charles A. Scott, 773PM Garson Ave., Rochester, N. Y.

**INVENTORS**—Protect your invention for a few cents without immediate and expensive patenting. Details free. Lindleys, Box 588, Kokomo, Indiana.

#### INVENTIONS WANTED

**LET** Us market your inventions. Write for free bulletin. R. & S. Engineering Co., Dept. M92, 17 East 42nd Street, New York City.

**WANTED**—Meritorious patented, unpatented inventions. Booklet free. Invention Reporter, 5B-11236 So. Fairfield, Chicago.

**CASH** For inventions patented or unpatented. Stamp appreciated. Mr. Ball, 9441-A Pleasant, Chicago.

**SMALL** Inventions wanted by manufacturers. I'll help you sell your invention. Write for free circular. Stanley Hull, 7829-K Euclid Avenue, Cleveland, Ohio.

**SIMPLE.** Practical inventions wanted by manufacturers, patented or unpatented. For information write Chartered Institute of American Inventors, Dept. 4-D, Washington, D. C.

#### PATENTS FOR SALE

**TRIPLE** Purpose vacuum cleaner. Emil Settlage, C.C.C. Co. 554, Stanfield, Ore.

**PATENTS** For sale: To manufacturers only: New shell type electrical series multiple transformer unit, coil box and other inventions from electrician, Victor A. LaFave, Rantoul, Illinois.

**ROLLER** Skate brake patent, brakes sold separately. Box 163, Wayne, Penna.

**NEW** Trailer hitch. Unhook 10 seconds. Need manufacturer. Write Stanley Walker, Box 84, Route 3, Alma, Michigan.

**PATENTS.** American and Canadian. Pig weighing machines. Awarded silver medal Royal Lancashire show. Enquiries: Robinson Bros., Leeds, 4, England.

**MACHINE** For pulling lodged steel out of hardrock and new type transom opener. Hjalmar Sundquist, Box 1475, Juneau, Alaska.

**SCREWLESS** Attachment plug. Margaret Dudte, 2102 Colorado Ave., Colorado Springs, Colorado.

**TRIPLE** Duty household article of furniture—practical, unique, patented. Suitable for progressive furniture manufacturer. Atelier, 622 Elati, Denver, Colo.

**MANUFACTURERS:** For new products or profitable manufacturing opportunities, inquire. Invention Reporter, 5C-11236 So. Fairfield, Chicago.

**SNOW** Shield, for car rear window. Lewis Jones, 1604 St. Agnes Ave., Utica, N. Y.

**SELL** Your patent through a small classified ad in Popular Mechanics. Many inventors have found buyers in this way. Ask me for proof—I'll gladly send it to you. F. W. Johnson, Manager Classified Advertising, 200 E. Ontario St., Chicago.



### MANUFACTURING

**MANUFACTURING.** Dies, stampings, models, of meritorious products on liberal terms. Write Stanley L. Glamb, Dual Remote Control Co., Inc., 31776 W. Warren, Wayne, Mich.

**INVENTIONS** Manufactured by an experienced company, in any quantity at low cost. Metal specialties, novelties, stampings, dies, and models. Free estimates. Our booklet "Mind vs. Matter" sent upon receipt of 25c. Rex Engineering Co., Cincinnati, Ohio, Dept. C.

**INVENTIONS**—Manufactured in any quantity at low cost by old established company. Stampings, metal specialties, dies, models, etc. Free estimates. Send for catalog. Crescent Tool Co., Dept. X, Cincinnati, Ohio.

### MODELS AND MODEL SUPPLIES

**CATALOGUE** Of over 40 engines, castings, supplies, 25c. Refunded. Howardco, A-2417 North Ashland, Chicago.

**SPEED!** Model power boats! Racing hull construction kits. All classes. Engines, accessories. Cruiser kit. Free literature. St. Louis Model Boat Co., Clayton, St. Louis, Mo.

**FREE** Model airplane catalog, gas and rubber model supplies. Leader, 5130 So. Damen, Chicago, Dept. P5.

**WE** Build working models which will "put over" your ideas. We offer complete service from designing to marketing. Write for "4-Points of Service" bulletin. R. & S. Engineering Co., Dept. M93, 17 East 42nd Street, New York City.

**HAVE** Your models, insect specimens, micro slides photographed size 8x10. \$1.50. Write Wheeler, 2734 N. Western, Chicago.

**CARVED** Hull ship model kits. Ship and yacht model fittings; model yacht sails. Illustrated catalog 20c. A. J. Fisher, 1002-M Etowah Ave., Royal Oak, Mich.

**MODELS**—Your ideas developed into practical working models. 30 years successful experience; thousands of satisfied customers. Confidential service guaranteed. Bank references. Send 3c postage for our large booklet—"Making Inventions Pay." Crescent Tool Co., Dept. Y, Cincinnati, Ohio.

**MODELS**—Practical models put over your ideas. We develop models from the crude to perfect working devices. Your idea might have large commercial value. Services confidential. Bank references. Registered graduate engineers at your service. Send 25c for our 68 page booklet "Mind vs. Matter." Rex Engineering Co., Cincinnati, Ohio, Dept. B.

### BLUEPRINTS AND PLANS

**PURPLEMARTIN** Birdhouse blueprints \$1.00. Albert Publishers, Box 24, Des Plaines, Illinois.

### HOME CRAFTSMEN

**SPARROW** Trap plans, 25c. Frank Shilling, 1017-P Dueber, Canton, Ohio.

**LEATHERCRAFTSMEN**—Write for free instructions and price list of leather, tools, etc. Sample cards 5c. Wilder & Co., Dept. 8F, 1038 Crosby St., Chicago, Ill.

**22 LAWN** Ornament patterns 25c coin. Strother, Box 383-R, Belington, West Virginia.

**SCULPTOR** Model plaques, bookends, figures, to order, makes any wood carving. Box 451, Leominster, Mass.

**LET** Me do your wood-turning job. Free preliminary estimates. Romaine Harshman, Sullivan, Illinois.

**FORTY** Superb halftone illustrations new designs novelty furniture of plywood, with pattern price list and credit coupon. 10c. Wo-Met Mfg. Co., Ashburn, Georgia.

**MAKE** It Yourself—Hundreds of practical and useful devices described in our big book. Plain instructions and illustrations show you how. Save money on things for yourself or make profit selling to others. 900 articles. 480 pages. 823 illustrations. \$3 postpaid. Popular Mechanics Press, Room (C39), 200 E. Ontario St., Chicago.

**MEXICAN** Wood novelties easily made. Our 20 Mexican patterns and instructions 25c. Mexican Arts Crafts, Eagle Pass, Tex.

**NAUTICAL** Cigarette dispenser smacks of the sea. Blue print four inch all metal ships wheel. Fifty cents coin. Hebert, Box 62, Station "S," Brooklyn, N. Y.

**20 LAWN** Ornament patterns 30c. 20 novelty patterns 30c. 14 silhouette patterns 30c. 15 lawn ornament patterns different from those above 30c. All for \$1.00. Modern Woodcraft, Saginaw, Michigan.

### FOR THE HOME

**PATENTED** Plumbing flusher cleans clogged drains instantly. Uses water pressure from any faucet. Fits sink, bathtubs, toilets. Easy to use. Works wonders. \$1.00 prepaid. Boyce Company, Box 281, Venice, California.

**LARGE** Ships wheel ash tray \$1.25. Paper knife \$1.00. Both solid walnut, hand turned, inlaid with beautiful contrasting Minnesota hardwoods. Shattuck, Altura, Minn.

### OLD GOLD, WATCHES, JEWELRY, PRECIOUS STONES

**WATCH** Parts, tools, supplies. Write for price list 43. Dean Company, 87 Nassau Street, New York.

**AGATES,** Gems, minerals. Men's solid sterling silver agate rings \$4.50. 20 genuine rough gemstones and price list \$1.00. Hill, Route 7, Salem, Oregon.

**AUSTRALIA'S** Lovely opals. Illustrated catalogue free. Good selection \$5.00. Norman Seward, Melbourne, Australia.

**ELGIN,** Waltham, Hamilton watches. Make big money. \$3.95. Send for free jewelry catalog. Plymouth Jewelry Exchange, 163-B Canal St., New York.

**HIGHEST** Prices for old gold—Mail your teeth, watches, jewelry. 100% full cash value mailed day shipment received. Satisfaction guaranteed or articles cheerfully returned. Information free. Chicago Gold Smelting Company, 300-P Champlain Building, Chicago.

**5000** REBUILT Elgin, Waltham, Hamilton watches. Also ladies, gents wrist watches. Make big money! 12 size, 7 jewel, Elgin or Waltham, \$4.75; 16 size, 17 jewel, \$7.50. Send for free watch and diamond catalogue. The New York Jobbers, Dept. M. 74 Bowery, New York, N. Y.

**GOLD** \$35 Ounce. Ship old gold teeth, crowns, jewelry, watches—receive cash by return mail. Satisfaction guaranteed. Free information. Dr. Weisberg's Gold Refining Co., 1500-Q Hennepin, Minneapolis, Minn.

**WATCHMAKERS'** Supplies, tools, watches. Sold—purchased. Ben Segal Company, 5 So. Wabash, Chicago.

### TOBACCO

**GUARANTEED:** Cigarette, pipe or chewing, 5 lbs. \$1.00, ten \$1.75. Pay when received. Pipe and box cigars free. Rives Tobacco Co., Paducah, Ky.

**LOOK!** Try cheaper tobacco! Then taste our milder golden smoking or rich ripe chewing, four pounds, postpaid, \$1.00. Riverside Ranch, 201, Hazel, Kentucky.

### FOR SALE—MISCELLANEOUS

**SCOTCH** Tweeds, \$2 yard. Blankets \$6.95. Tailored topcoats \$19.95. Dime brings samples and "Consumers Digest" expose, "What's Wrong With Men's Clothing?" Bridge Mill, Galashiels, Scotland. Agents wanted.

### PERSONAL

**YOUR** Eyes trained to overcome weakness, astigmatism, nearsightedness without glasses. Complete guaranteed course \$1.00. Eyesight Improvement, Box 193, Hamilton, Ohio.

**ATHLETE'S** Foot cured quickly, easily, permanently. \$1. Box 9188-A, Station S, Los Angeles.

**HAY** Fever absolutely stopped with Clarke's Nasal Filter. Worn invisibly in the nose. Details 3c. 701 Ridge Ave., Pittsburgh.

**GETTING** Bald? Amazing European remedy. 30 day treatment. 50c. Bennett Laboratories, Box 202, Palms, California.

**WIN** Prize money: Booklet—"Successful Contesting"—shows how. 10c postpaid. Bulletin listing \$200,000.00 prizes included. World Publishers, 4515-B Cottage Grove, Chicago.

**NERVOUS?** Fears? Depressed? Afflicted? Free helpful information. Norman Ferngold, Psychologist, Office 15, 38 Shirley Street, Worcester, Mass.

**EVERYMAN'S** Legal Manual. Authoritative advice. \$1.00. Popular Mechanics, 200 E. Ontario St., Chicago.

### MISCELLANEOUS

**CIVIL** Service home study courses, preparing for examinations any or all sixteen government positions. 300 lessons with answers, explanations. Closing-out slightly imperfect sets \$13.50 complete—while they last. If not pleased, return within five days—money refunded. No COD. American Institute, Box 212, Denison, Texas.

**HAND-WOVEN** Ties \$1. Write for free sample of tie material and 32 colored pictures of patterns. Log Cabin Hand Weavers, 11 Post Road, Oregon City, Oregon.

**WHY** Be bothered by rats? My new non-poisonous exterminator drives them outside to die. Send 50c. Ferret, Box 151, Kansas City, Missouri.

**EMBOSSED** Signs for exclusive shops and manufacturers. Any color. Sample with your copy 25c prepaid. Signograf, 739 Cole, San Francisco, Calif.

**BE** A good conversationalist! Our practical course "How to Become a Good Conversationalist" teaches you how. Details free. Nankers Company, Box 884, Colorado Springs, Colorado.

**SWAPPERS!** Collectors! Join now. Get best swap offers in U. S. 3 months membership 25c. Send list your articles today. National Swappers Club, North Birmingham, Ala.

**POPE** Pius XI and XII, 9", artistically sculptured and beautifully finished. \$1.50 each. Free Photo, Box 451, Leominster, Mass.

**GOOD** Eyesight without glasses. No drugs. A. Jacobson, Upsala, Minnesota.

**CASH** For used microscopes, binoculars, slide rules, drawing sets, scientific instruments, cameras, shotguns, golf sets. Write details. Elman's 2302 Van Buren, Chicago.

**NATION'S** Capital souvenirs. Washington monument (marblite) 75c. capitol, Lincoln memorial, White House (white metal) \$1.00 each. Rico, 1930 Calvert, Washington, D. C.

**STANDARD** Electric lamp insect killer. \$2.00 up. Literature free. Sauer Bros., San Leandro, Calif.

**RATS**—Destroy these destroyers without traps or poison. My secret. Send dime. M. E. Palmer, Mullan, Idaho.

**AMATEUR** Tattooing outfits. Illustrated list free. Tatuco, 651 South State, Chicago.

**COATS** Of arms and crests, correctly painted in colors or black and white, from heraldic description or furnished copy. \$10.00 and up. Highest grade work. Heraldic Studios, 1914P Oakdale Avenue, Chicago, Ill.

**TATTOOING** Outfits, supplies, illustrated list free. Percy Waters, Anniston, Alabama.

**REFINE** Used oil without cost. Particulars. F. Gerwin, Fairview, Oklahoma.

**AMATEUR** Cartoonists wishing steady income copying and duplicating cartoons for advertisers, write Ad-Service, Argyle, Wisconsin.

**SWAPPER'S** Friend, R4, Saline, Michigan. Interests swappers, collectors. 50c year, sample 10c.

**10,000** MONEY-MAKING Formulas. Tells you how to make and sell almost everything under the sun; cosmetics, mucilage, anti-freeze solutions, battery solution, beverages, cheese, chewing gum, cleaning preparations, extracts, hair preparations, inks, bluing, leather polish, mirrors, perfumes, polishes, typewriter ribbons, carbon paper, washing powders, liquid soap, and hundreds of other profitable articles. \$4 postpaid. Popular Mechanics Press, Room (C39), 200 E. Ontario St., Chicago.



**SUPPRESSED  
KNOWLEDGE  
OF THE AGES**

What strange powers did the ancients possess? Where was the source of knowledge that made it possible for them to perform miracles? Were these profound secrets burned with ancient libraries, or are they buried beneath crumbling Temple walls? These wise men of the past knew the mysteries of life, and personal power. This wisdom is not lost—it is withheld from the mass. It is offered freely TO YOU if, with an open mind, you wish to step out of the rut of monotonous existence and MASTER YOUR LIFE.

**THIS FREE BOOK**

Man's intolerance has at times swept his achievements from the face of the earth, yet secret brotherhoods have preserved this sacred wisdom of the ages. The Rosicrucians, one of these ancient brotherhoods, INVITE YOU to write and secure a free copy of "The Secret Heritage." It will point out how you may receive age-old truths. You can learn to MAKE YOUR LIFE ANEW—the fulfillment of your ideals awaits you. Address:

Scribe L.N.T.

**The Rosicrucians**  
— AMORC —  
SAN JOSE, CALIFORNIA  
The Rosicrucians are NOT a religious organization

**HOW TO MODERNIZE  
YOUR OLD RADIO**

**MIDWEST FACTORY-TO-YOU  
20th ANNIVERSARY SPECIAL!**



**WITH TELEVISION  
ADAPTATION**

Here's today's biggest radio value — the 1940 TELEVISION-ADAPTED Midwest at sensationally low factory-to-you price. Now enjoy exciting world-wide reception. Absolute satisfaction guaranteed on money-back basis. Send 1c postcard for FREE 1940 Catalog. (User-agents make easy extra money!) UP TO \$40 TRADE-IN ALLOWANCE

**PUT THIS 1940  
14 TUBE  
CHASSIS IN YOUR  
PRESENT CABINET  
\$19.95  
COMPLETE CHASSIS  
WITH TUBES  
AND SPEAKER**

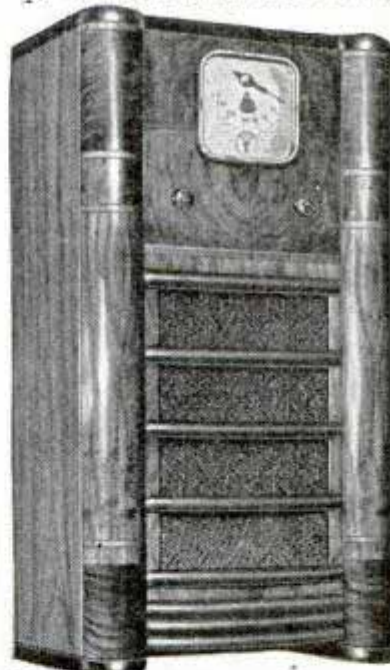

**SAVE UP TO 50%  
30 DAYS TRIAL  
EASY PAY PLAN**

**14-TUBE  
CONSOLE  
\$29.95  
COMPLETE**

**MIDWEST RADIO CORPORATION**  
Dept. 15-C Cincinnati, Ohio

PASTE COUPON ON 1c POSTCARD... OR WRITE TODAY!

MIDWEST RADIO CORPORATION  
Cincinnati, Ohio Name \_\_\_\_\_  
Dept. 15-C  
Send me your new FREE catalog, complete details of your liberal 30-day Trial offer, factory-to-you wholesale prices and big TRADE-IN offer. Address \_\_\_\_\_  
Town \_\_\_\_\_ State \_\_\_\_\_  
User-Agents Make Easy Extra Money. Check here [ ] for details.

**for MORE PAY learn From  
An ENGINEER**

**DRAFTING**  
GET READY FOR PROSPERITY PAY. I will train you at your home by mail on Practical Drafting until IN POSITION, or prepare you for BETTER PAY on the Job you have. All tools and drawing table sent at once if you enroll now. WRITE FOR FREE BOOK. Give your age.  
ENGINEER DOBE Div. 337A Libertyville, Ill.

**CANDID 8 BIG  
CAMERA GLOSSY PRINTS 25c  
FINISHING**

A sensational money saving offer for Candid Camera fans. Roll developed FINE GRAIN and 8 BIG 2 1/4 x 3 1/4 glossy prints for 25c postpaid. A specialized service for candid cameras including 35m Vest Pocket 127 roll and smaller. Send 25c (coin) for each set of 8 — Send Now! 18 EXP. 56c—36 EXP. \$1.12. PROMPT SERVICE!  
CANDID PICTURE SERVICE  
540-F Lake Shore Drive, Chicago, Illinois

**Only 16c A Day  
Puts This Arc Welder  
IN YOUR SHOP**



**WORKS ON 110-VOLT A. C.**

Now it is EASY for every inventor, laboratory, home workshop owner, garage, repair shop, and factory to afford a complete electric welding service. Remarkable New Commonwealth Arc Welder Model 75-UL—yours for only 16c a day. Instant-change heat selector. Six welding heats—including EXTRA LOW heat for welding fenders and light sheet metals. ALL coils insulated with amazing new FLEXIBLE GLASS—for CONTINUOUS-DUTY welding and complete protection against moisture, acid fumes, age or rot. ABSOLUTE GUARANTEE. USE IT ANYWHERE. Simply plug into 110-Volt socket. Cost only few cents an hour to operate. Easy to strike and hold arc. Sensational low price includes Helmet, Welding Cables, Electrode Holder, Welding Rods, easy instructions, etc. Nothing else to buy. Stop throwing away profits! Do your own welding. Get Complete free details. Commonwealth Manufacturing Corp., Dept. B-51, 4208 Davis Lane, Cincinnati, Ohio



Get this valuable **SLIDE RULE**

**EASY TO USE**  
Saves time and  
mental effort  
in solving  
mathematical  
problems

**FREE!**

by accepting this  
amazing offer now

Full Size  
10 ins. long

Directions for using

...at last  
practical  
**MATHEMATICS**  
made EASY and ENTERTAINING

ACCURATE—NICELY  
FINISHED

Has all the scales  
of

A \$1<sup>00</sup> RULE

**NEVER** before—and probably never again—a fine, full-size slide rule free! Genuine Manheim type in nicely finished wood with calibrations in contrasting black on white, accurate indicator with reading lens that magnifies. Has A, B, C, D, K, S, T, and L scales as on expensive slide rules costing \$1.00 or more, and in addition, an inch scale, millimeter scale and table of equivalents. This valuable slide rule, with directions for use, is yours free if you accept our offer on this marvelous new book, "Speed and Fun with Figures," that makes practical mathematics positively easy and entertaining.

602  
Pages

**Hundreds of Mathematical Short-Cuts**  
"Lightning Calculators" Secrets Revealed

Why waste time with roundabout laborious methods of calculation? Why scrawl endless figures on paper to get the answer, and then not be sure you are right? Learn the shortcuts! Make mathematics exhilarating, practical, useful in your daily work! Part 1 of this great book gives the proved methods used by lightning calculators to solve difficult problems *instantly*.

**3 BOOKS IN 1**  
Rapid  
Arithmetic  
Slide Rule  
Manual  
Recreations in  
Mathematics  
ILLUSTRATED  
Cloth Bound

**Marvelous Aid of Slide Rule Made Clear**

Multiplication and division are no trick at all, complicated roots and powers, trigonometric and reciprocal functions are easy—with the slide rule. Part 2 of this book shows you how simple it all is.

**Mathematics As Recreation—Puzzles, Tricks, Etc.**

"The Moon Hoax," the "School Girl Problem," "Cattle Problem of Archimedes" and hundreds of other mathematical tricks given in Part 3 afford endless amusement and education, too.

**EXAMINE FREE—Slide Rule Included If You Act Promptly**

"Speed and Fun with Figures" combines three books that sold for \$4.75 into one volume for only \$3.50. Send no money. Examine the book 5 days FREE. Then return it or send \$1.50 and \$1.00 a month for two months (\$3.50 in all). Slide rule included free if you act at once!

SEND NO MONEY—MAIL THIS COUPON—SLIDE RULE FREE

**SPEED  
AND  
FUN  
WITH  
FIGURES**

SAVE  
OVER  
**26%**  
by this special offer

**Mail Now—Slide Rule FREE**

D. Van Nostrand Company, Inc., 250 Fourth Ave., New York City

Send *Speed and Fun with Figures* postpaid on 5 DAYS FREE APPROVAL and include the Slide Rule FREE. At the end of 5 days I will return the shipment or send \$1.50 and \$1.00 a month for two months, \$3.50 in all. (5% discount for cash, same return privilege.) PM 9-39

Name.....

Address.....

City..... State.....

Reference.....

Address.....

FOR FREE CATALOG of best books of practical instruction and technical information, check here. If you do not want *Speed and Fun with Figures* cross out paragraph at left.

When writing to advertisers please mention *Popular Mechanics*



# Popular Mechanics Magazine

REGISTERED IN U. S. PATENT OFFICE AND CANADA

WRITTEN SO YOU CAN UNDERSTAND IT

Vol. 72

SEPTEMBER, 1939

No. 3

By David Sarnoff

President  
Radio Corporation of America

*2991*  
*Plaza New York City*  
*30 Rockefeller*  
LONG confined to the homes and workshops of its scientific guardians, television has just been graduated from this protective environment, and has been thrust out to make its way in the world. What will it offer to mankind, and what response will mankind make to it?

One by one the shackles that chained man to the limited sphere of his own mind and his immediate neighborhood have been struck from him. Today with the aid of modern means of transportation he can move his body about rapidly, easily and at will; he can enlarge the pow-

## The FUTURE of TELEVISION

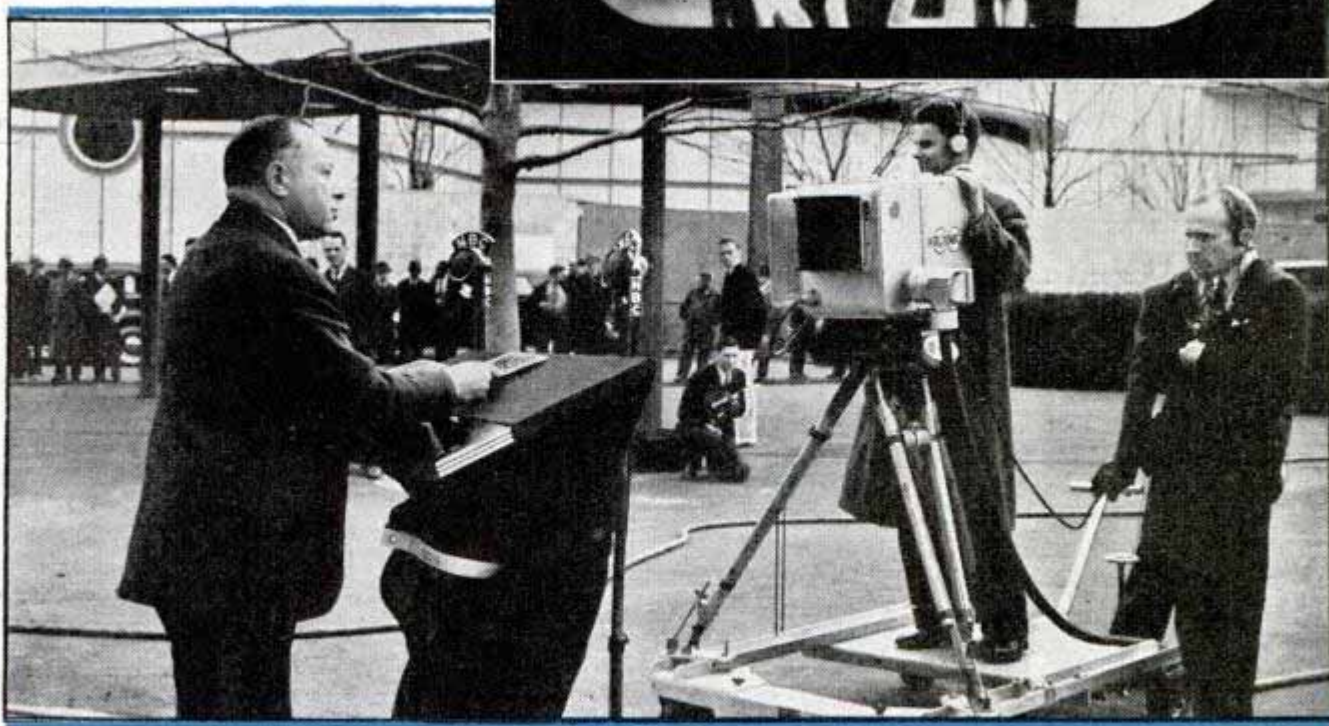

Bottom, David Sarnoff delivers speech at New York world's fair while television camera and sound instruments pick up scene. Above, the television image received eight miles away

*RCA's Herbert Huldner* 321





ers of his hands and arms thousands of times with the help of machines; he can extend his voice by radio to other men throughout the world, and hear them in return. Now the last shackle is being broken; through television his eyesight promises to become all-embracing and world-wide. And not only is he given the power to see at a distance those things which may be evident within the limited spectrum of the visible rays of light, but also those which heretofore have been invisible because they could only be perceived through the use of waves outside the visible region.

Television will finally bring to people in their homes, for the first time in history, a complete means of instantaneous participation in the sights and sounds of the entire outer world. It will be more realistic than a motion picture, because it

will project the present instead of the past. Aural radio already has demonstrated the greatly heightened psychological significance, to the listener, of feeling that he is present at the radio performance, as a member of an audience listening to living performers. The sensation that one is participating in an event actually taking place at the precise moment of hearing it is quite different and much more intense than the sensation one has in witnessing a sound picture or hearing a record of the same event, later on. With the advent of television, the combined emotional results of both seeing and hearing an event or a performance at the instant of its occurrence become new forces to be reckoned with, and they will be much greater forces than those aroused by audition only. The emotional appeal of pictures to the



*Top, watching television pictures on indirect viewing mirror under lid of receiver, which has twelve-inch kinescope and thirty-six tubes. Center, the kinescope receiving tube and iconoscope, "eye" of transmitter. Below, mobile television station which picks up image and sound in the field*



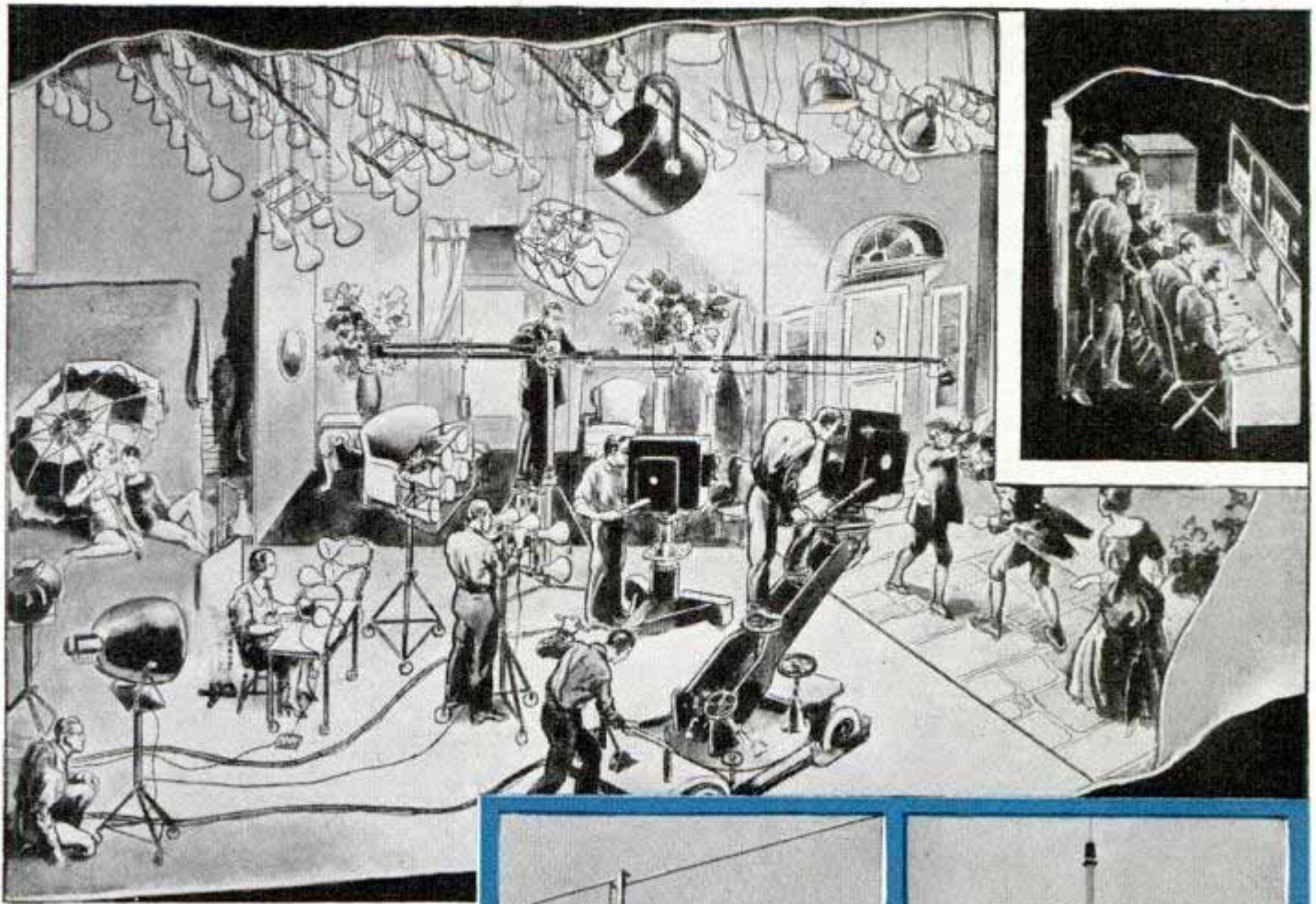

mass of people is everywhere apparent. We have only to regard the success of motion pictures, tabloid newspapers, and picture magazines, to be convinced of this.

Let us consider next what sort of program material television may present to its audience. Radio programs today cover almost every conceivable type of material that may be of value as entertainment, instruction and news. But while the scope of television programs will be equally broad, it is clear that the relative emphasis on the various types of subject matter can be changed to advantage. In aural radio we tend to emphasize program material that may be enjoyed without the use of vision; hence music forms a major part of aural radio programs. In television it will be natural to emphasize types of program material where the addition of visibility will

enhance the emotional effect—such as drama, news, or sporting events.

Radio already has made significant contributions to novel dramatic forms and materials. Experimentation is constantly going on, under the daily pressure of providing ever-changing programs. Famous dramatists, actors, and producers are turning in increasing numbers to radio as a new and important medium, and the intellectual standard of much radio drama is

Top, drawing of television studio. Upper right, control room where engineers monitor broadcasts. Below, receiving and transmitting antennas

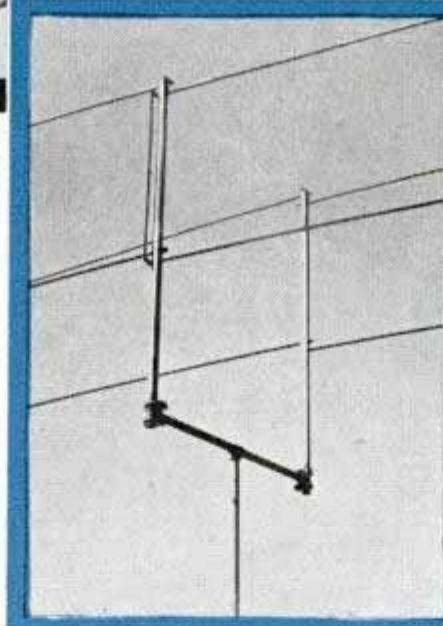



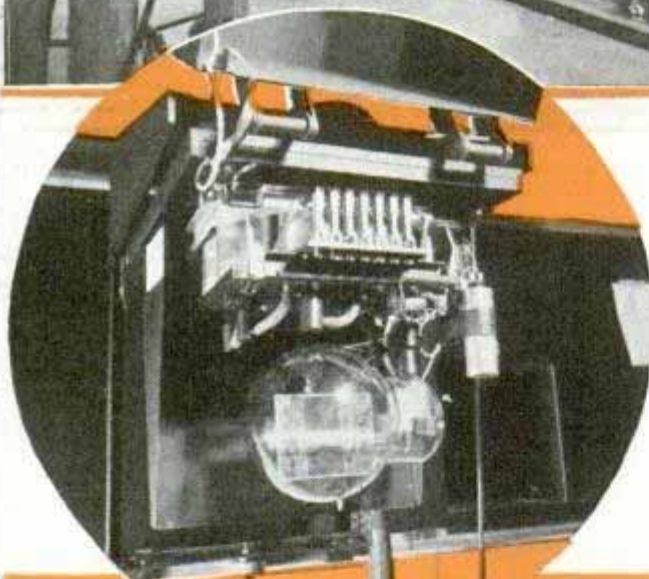

*Top, studio scene during actual television broadcast; notice twin cameras and "mike boom." Center, inside the iconoscope camera. Bottom, audio and video units in transmitting room*

in the best tradition of the legitimate theater. With the advent of television, a new impetus will be given to this form of art, and we may expect it gradually to replace some other types of programs which now occupy a large part of radio time.

While some television dramas may be recorded on film, for convenience or for network distribution, it is not certain that the standards, methods or artistic ideas of the present-day motion-picture industry will control the material presented. Radio has always been an independent force, and has broken new ground in what it has done. A first-class radio program is like no theatrical or motion-picture presentation that ever was. It is a new thing in the world. Similarly, it is quite likely that television drama will be a new development, using the best of the theater and motion pictures, and building a new art-form based upon these.

It is probable that television drama of high caliber and produced by first-rate artists, will materially raise the level of dramatic taste of the nation, just as aural broadcasting has raised the level of musical appreciation.



2791

Playton, S.C.  
High Point, N.C.

An outstanding contribution of television will be its ability to bring news and sporting events to the listener while they are occurring. The widespread public participation in events such as those which occurred during the European war crisis in the summer of 1938, and the intensity of the mass emotions aroused thereby, have given us a glimpse of the possibilities of this phase of radio. It readily may be imagined what will be the results when television adds to the effect of reality of projecting the vision as well as the hearing of the audience to the scene of action.

Educational institutions are gradually adopting mechanical inventions as aids to teaching, and radio receivers as well as phonographs are becoming increasingly familiar sights in schoolrooms. With television we may find the educational uses of radio increasing; for while children may be restless when merely listening to a speaker without seeing him, living pictures may capture and hold their interest.

There is another aspect of television which is important, and this is the nature and effects of its by-products. New instrumentalities have been developed, specifically for the purpose of transmitting visual intelligence by radio. These include iconoscopes, or devices for converting a light image into electric currents, amplifiers of wide frequency range, high-powered ultra-short wave transmitters and kinescopes which reproduce the original image by converting electric currents into light. All these devices are beginning to find applications in fields remote from television, and, as familiarity with them grows, their fields of application will be extended.

The whole subject of electron optics, or the control of electron beams by electric and magnetic fields, has received great attention because of its importance in television devices. This has led to a whole new range of possibilities in optical devices which heretofore have been limited because of their dependence on the wave lengths of light. With the wave length of electrons of moderate velocity thousands of times shorter than that of light, it is obvious that by the use of electrons and electron optics we can design magnifying devices of much finer resolution than heretofore; and this has already resulted in a

(Continued to page 142A)

## Paint Carried in 'Knapsack' Is Fed to Brush by Valve



Paint is fed smoothly to bristles under control of valve in handle, eliminating dipping of brush

To eliminate the dipping and dripping of paintbrushes, a painter invented a tank that is worn across the shoulders, feeding paint to the bristles under control of a valve in the brush handle. From the knapsack-style tank, the paint travels to a flexible leather pocket distributor which extends almost to the end of the bristles.

## Rake with a Roller on the Back Packs Down the Garden



Two garden tools in one is a rake with a detachable roller for use in finishing the surface of a garden or re-seeded lawn. In garden planting, the rake serves the

usual purpose in opening furrows and covering the seeded rows. Then the roller is attached for pressing down the soil upon the seeds to help germination. It is used on lawns in the same way when bare spots are re-seeded.

comb & Jones painter

asked in S.C.  
High Point, N.C.

harder, due, etc.



## Small Rotary Gas Engine Has Six Moving Parts

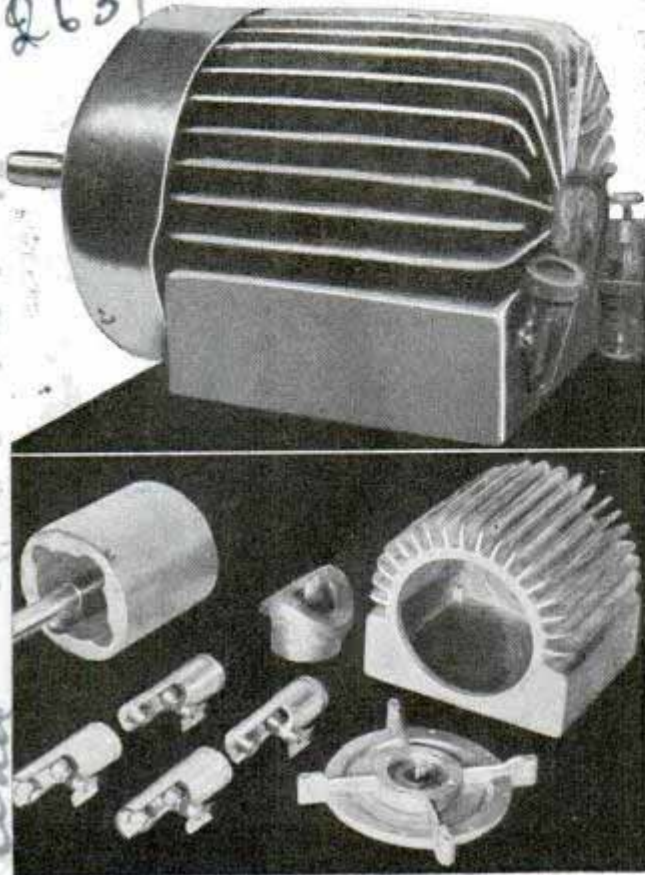

Small-size four-cylinder rotary engine (top) has only six moving parts (as shown below)

Claimed to be almost vibrationless, a small four-cylinder engine of the rotary type has been produced. One model, developing one-third horsepower and weighing only fifteen pounds, has a diameter of five inches and a length of seven inches. Basic design follows that of an electric motor. It has a rotor carrying all moving parts, a stator or shell which houses the rotor and a front bearing plate. There are only six moving parts in the four-cylinder job. The rotor is a cylindrical block mounted on a shaft, with the cylinders set parallel to the shaft and the pistons reciprocating by means of a special cam mounted on the bearing flange. The engine is designed so there are four power strokes per revolution instead of the two

power strokes of the ordinary four-cycle engine. The rotor revolves in the stator, which is designed with an oil sump in the base, from which the rapidly turning block picks up and forces under pressure a film of oil between the outer wall of the rotor and the inner wall of the stator. The oil film provides lubrication and also carries off heat quickly so that the cooling fins on the outer side of the stator can dissipate it. A tiny incandescent wire, heated with a low-tension magneto, furnishes the ignition without the aid of other parts. The engine is remarkable in that it has no valves, no gears, no flywheel, no ignition points and no oil pumps. Only one gasket is used. For use in automobiles, an eight-cylinder motor about fifteen inches in diameter and slightly longer would develop, theoretically, twice the power of the conventional engine of the same displacement.

## Speed of Baseball Is Measured by Electric "Clocking" Meter

Big league baseball pitchers are finding out exactly how fast their speed balls travel. A pitching speed meter just completed clocks the ball in the interval it passes between two photoelectric circuits set up in a twelve-foot trailer. The pitcher throws from a distance of twenty feet. As the ball reaches its target a bell rings and the speed of the ball, translated into feet per second, shows instantly on a dial. It is accurate within one and one-half per cent in thousandths of a second.

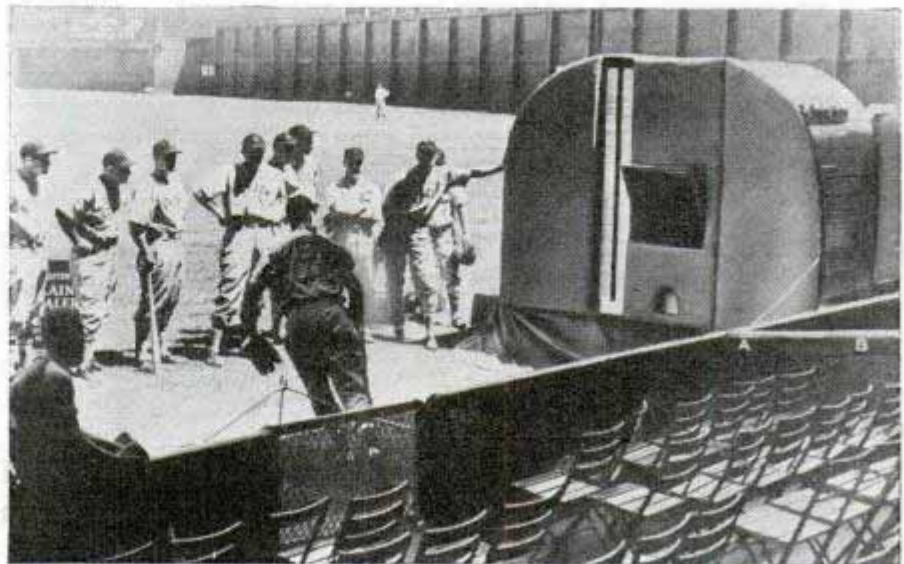

Boston Red Sox pitcher flings a fast one at the window and photoelectric "eyes" register speed of ball on dial visible at left

Pitching Speed Meter

Lester S. Myers  
 #16 W. 100th St. New York City  
 8/4/39



# Rubber Torsion Spring for Autos Stops Noise

Walter & Gorton 1032  
 71 Lehigh Ave. Akron  
 Since Service 5/25/35

Akron Ohio.

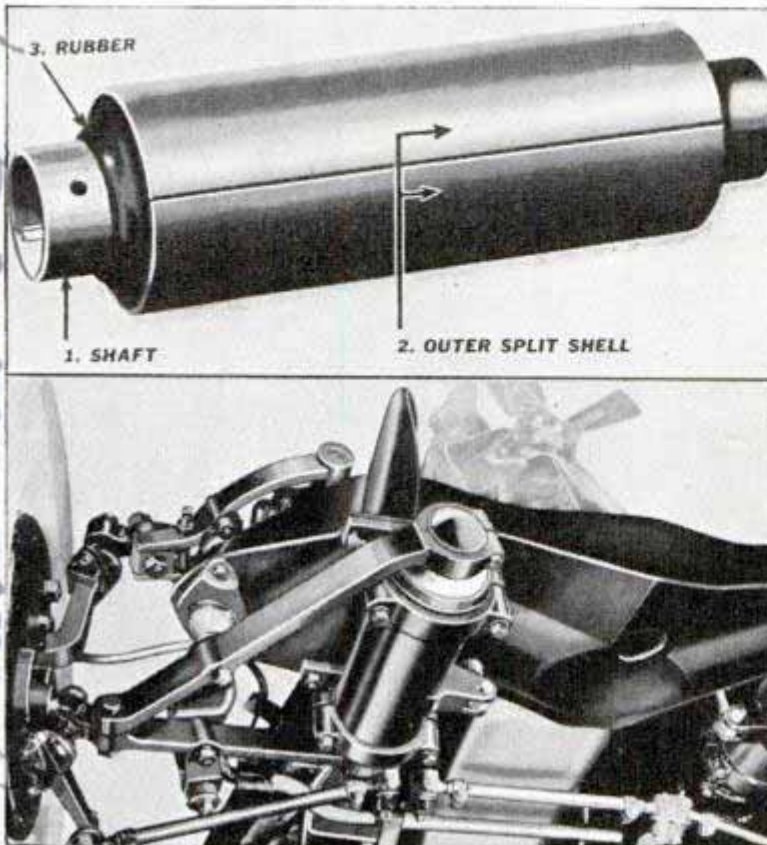

Above at left, "rolling-pin" spring showing rubber between steel layers. Below and right, views from beneath and front of car

Three pounds of rubber and seven pounds of steel make up a torsion spring developed to replace the conventional all-steel automobile spring. In 36,000 miles of rough test service over a period of two and one-half years the rubber spring required no adjustment. Built like a rolling pin, it consists of an inner metal shaft, an outer metal shell which is split to permit the rubber to be placed under compression in use, and a cylinder of rubber sandwiched

between and bonded to shaft and shell. As the automobile wheel moves up and down the rubber, acting in torsion, absorbs the shock and returns the wheel to its original position. The rubber not only softens the ride but reduces rattles and squeaks, eliminates the possibility of sudden breaks and needs no lubrication. The principle is adaptable to trains and other vehicles. One 1940 model automobile built in Europe has adopted springs of this type.

## Wrench Limits Power of Pull by Releasing Its Tension

It is impossible to tighten bolts beyond the desired limit of pressure if a wrench that may be pre-set is used. Where accurate tension of nuts is of vital importance, the new tool will automatically release when the correct tension is reached. The mechanic can feel, as well as see, the operation of the lever arm, but there is no dial to watch, and thus it can be applied in dark or hidden places. The setting scale reads in inch pounds.



Pivoted lever will let go when predetermined pressure is applied to wrench

Send return postage to our Bureau of Information to learn the name of the maker of any device described in this magazine.

7900 Manchester  
 St. Louis

Surber Products Co. St. Louis



2363

# PUSH-BUTTON

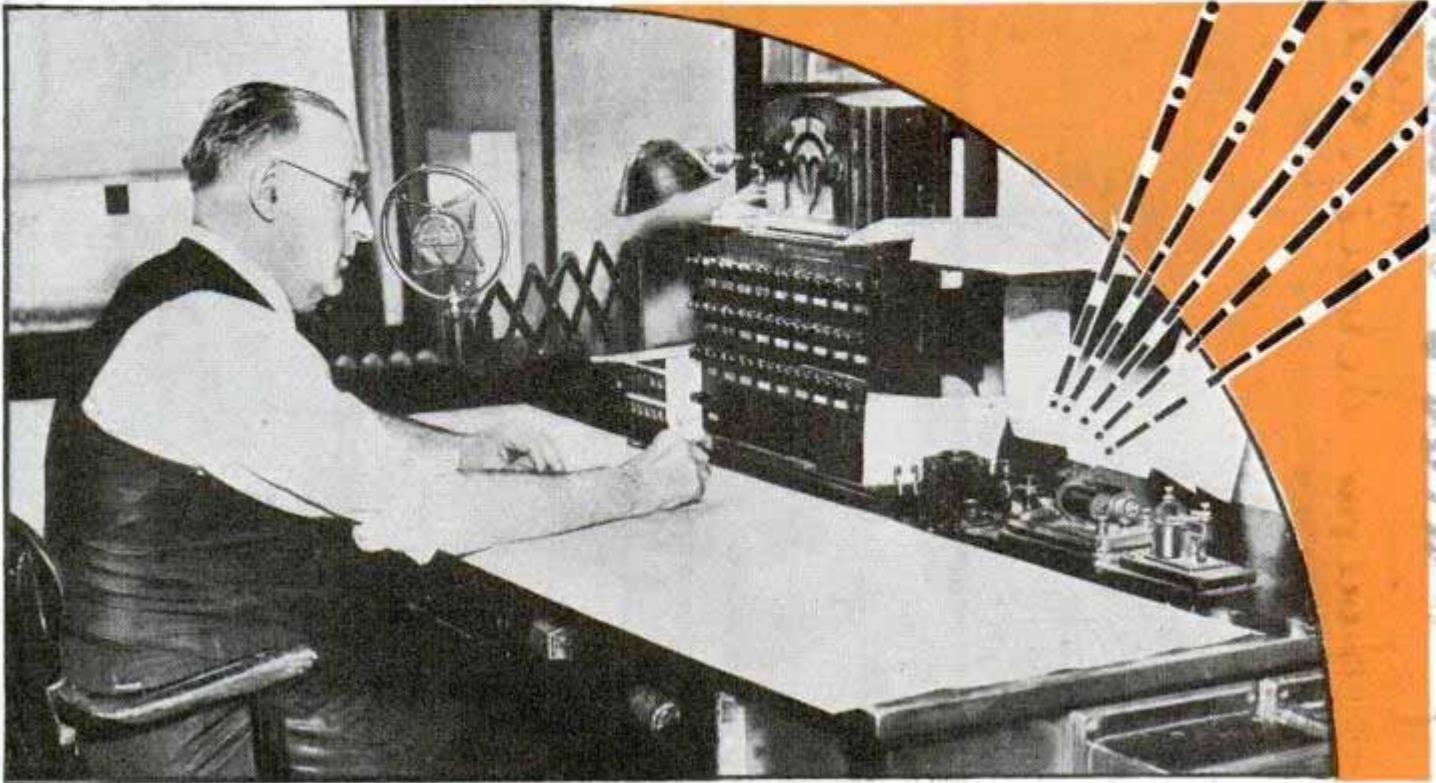

**H**HEAD-ON down the single track thunder

two fast passenger trains, their engineers alert but neither aware the other is close ahead. An unseen hand moves in a tower miles away; a switch clicks, a signal flashes. The eastbound express swerves into a siding, the limited roars through westward and almost as its last car clears the switch the express, without pausing, noses back into the main line. No time lost. A nonstop meet.

By Roderick M. Grant

A rock breaks from a bluff and falls across a railroad right of way, but it crushes a "detector" fence, and automatic signals turn red to stop trains short of disaster. Over in Pennsylvania an engineer hauling a string of gondolas chats through the rails with the caboose he has left on a spur track five miles back. A towerman presses two buttons and automatically switches and signals line up a route for an interurban train through the tangle of tracks ap-

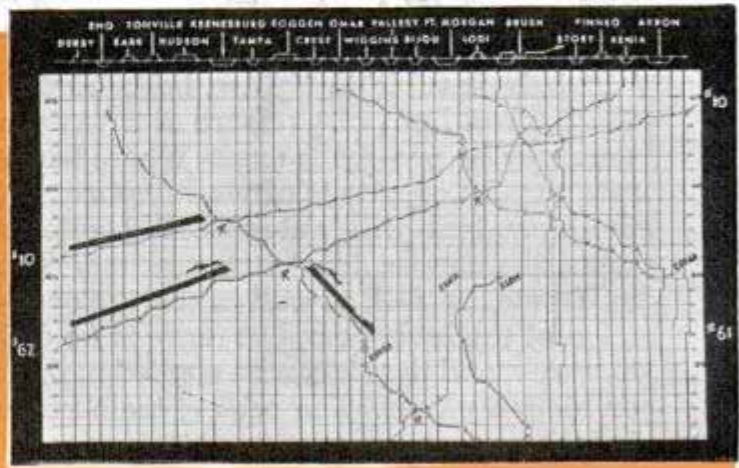

Dispatcher, top, talks to towerman by flicking switch; telegraph automatically reports passage of train. Below, Burlington operator at Brush, Colo., watching diagram showing train positions, controls 112 miles of line. Automatic log, right, records train movements, "R" indicating nonstop meet



2363

Union Switch and Signal Co  
Swissvale, Pa.

# RAILROADING

A.C. Jensen

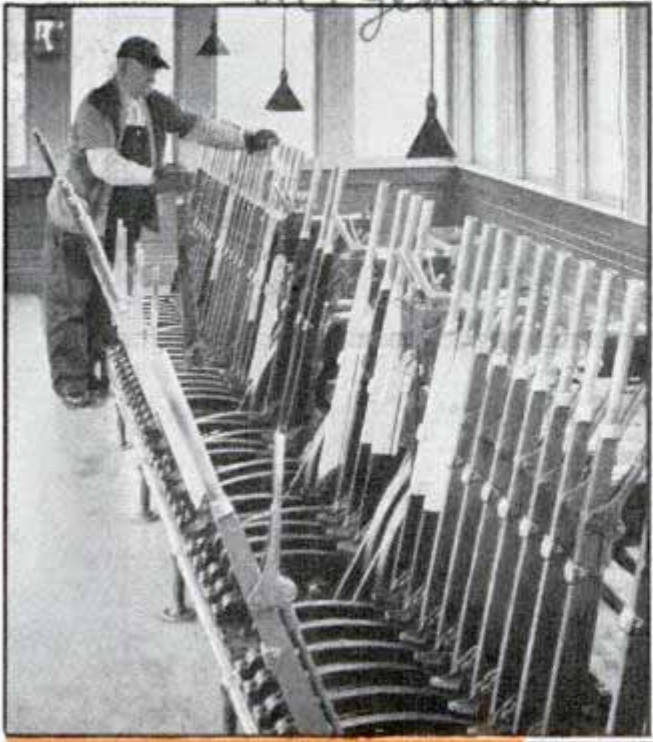

OLD

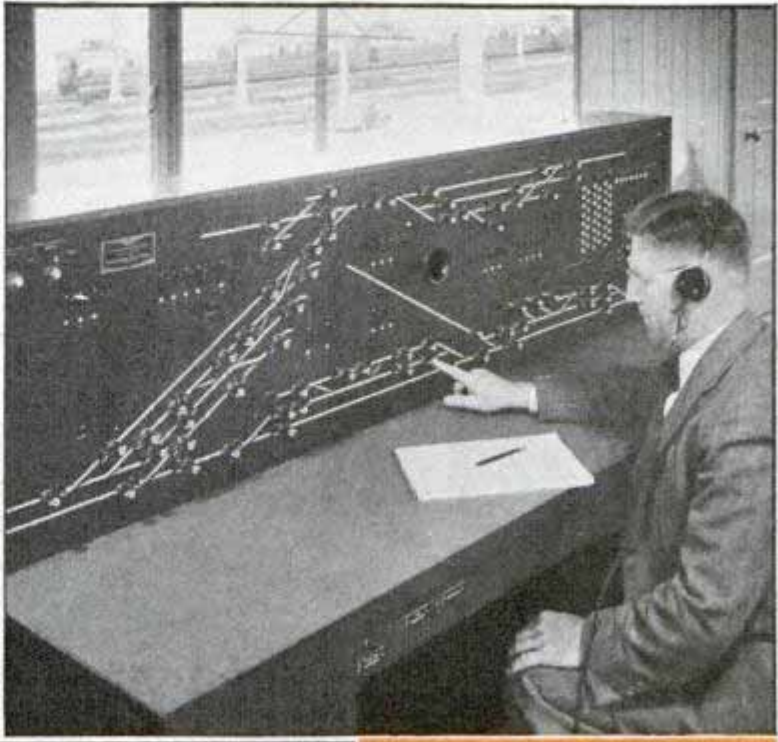

NEW

Top, old and new ways of switching; operator at right pushes two buttons lining up train route to San Francisco bay bridge. Center, governors on axle of bay bridge interurban hold train speed to limit shown on motorman's panel, below, according to track conditions ahead

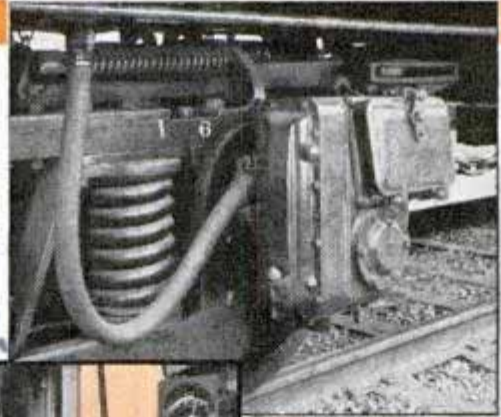

E.B. Smith

proaching the San Francisco bay bridge. The northbound mail train races past Galt station and in the dispatcher's office two counties distant an automatic telegraph key without a sending hand clicks the message in Morse: "North by Galt."

All this goes on behind the scenes on the railroads. Automatic signals keep trains moving without written orders, robots report train movements, electric detectors unnoticed by the passenger keep him out of danger.

American trains lead the world in speed—whether drawn by steam or Diesel or electric power. More than half the world's mile-a-minute passenger-train mileage is in the United States—48,287 miles of daily passenger runs scheduled at sixty miles an hour or better.

But it isn't streamlining that does it. Streamlining is just the billboard that sells tickets. It is engineering that gets you there on time—engineering marvels that the public seldom sees, such as push-button interlocking controls and cab-to-



Cont. Paul Conant 703 Santa



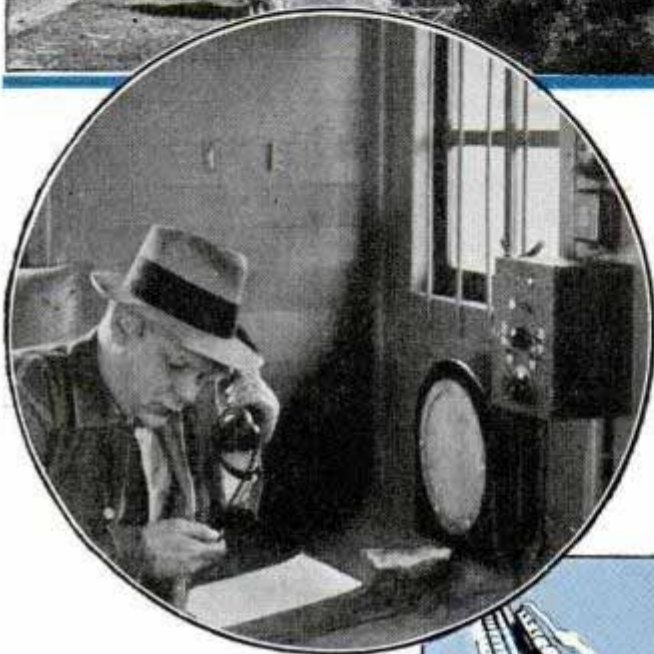
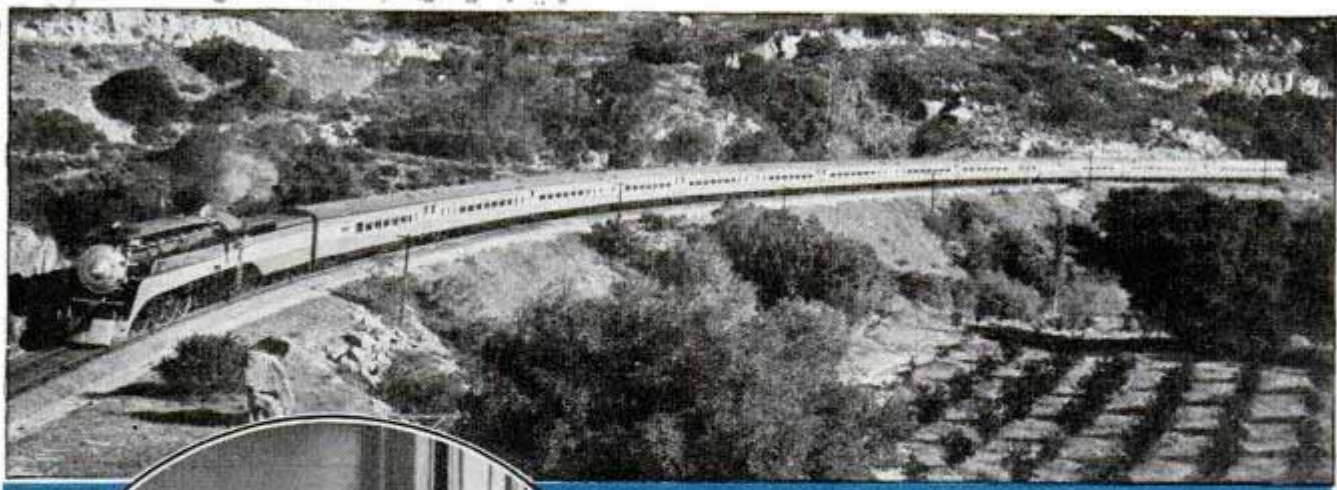

Top, streamline train on Southern Pacific. Below, conductor in caboose (circle) chats with engineer by telephone, message traveling through rails. By same method crews of trains and agents could converse

caboose signals and automatic train controls.

Time was, for example, when way freights and local passenger trains dozed on sidetracks waiting for the fast mail, long overdue. And all along the line the engineer would reach down for orders handed up by stationmasters on a hoop. Morse keys kept up a busy staccato reporting train movements and relaying orders from the dispatcher.

Now take a look at centralized traffic control as it clicks on a section of the Burlington line.

Downhill out of Denver and the Rockies streaks the silversided "Zephyr," heading into the night for Chicago, swiftly overtaking the manifest freight that started

down that single track forty-five minutes ahead.

Head-on in their path crawls the local freight, Denver-bound. One track, three trains—and one of them a Diesel-electric streamliner doing ninety miles in the first sixty minutes. Three engineers wonder where they'll meet, but there are no train orders to tell them. One man in a tower miles away at Brush, Colo., maneuvers those trains with his fingertips. Under his control is every locomotive, every switch, every signal in the 112-mile stretch between Akron, Colo., and the Denver terminal yards. Before him is an illuminated map on which the position of every train

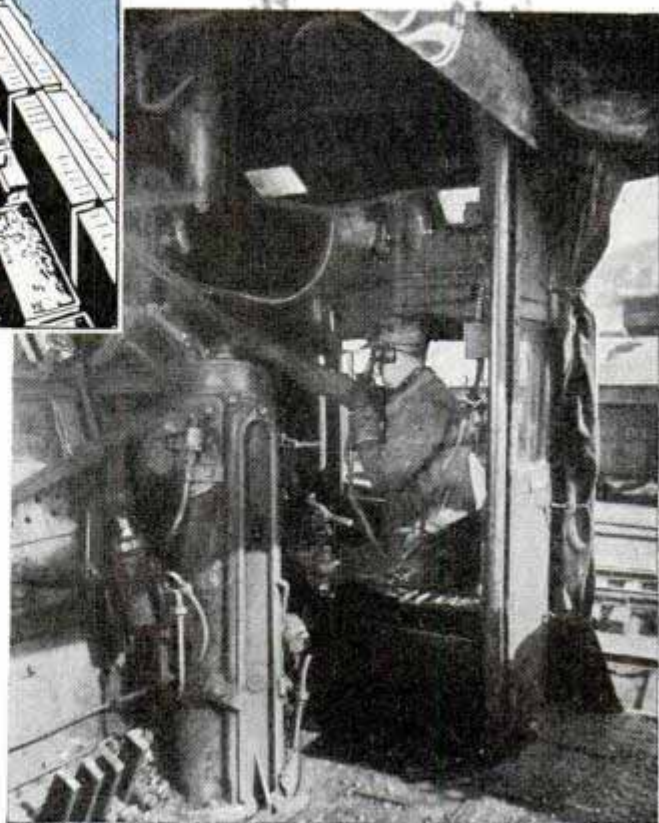
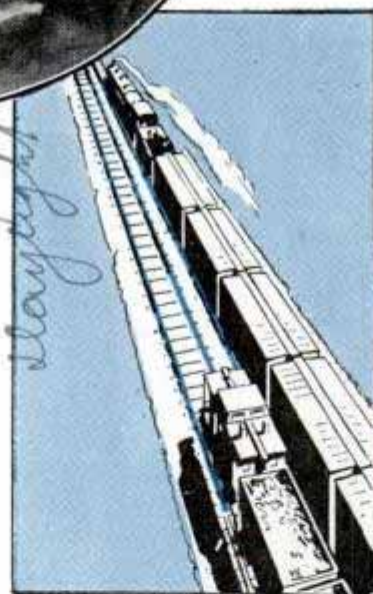



at every moment is represented by a moving dot of light. On the table at the base of the map is an automatic graph, moved by electric clockwork, with forty-five pens that log the arrival of trains at every siding in those 112 miles. Watching the lights moving across the map, the operator observes that the eastbound freight running ahead of the "Zephyr" has reached Tampa. He flicks a switch lever beneath the route map, moves a signal lever to conform with the switch, presses a button and forty-one miles away at Roggen a switch and signal snap into position. A few minutes later a tiny pen jogs on the graph; the westbound freight is sliding into the sidetrack at Roggen, the eastbound fast freight roars past on the main line, and without either train stopping they proceed their opposite ways. A nonstop meet. Forty minutes later the way freight ambles into the siding at Keenesburg, the "Zephyr" highballs past and again the freight takes the main line without a stop. Fifty minutes pass and the "Zephyr" overtakes the eastbound freight. Another of those forty-five pens on the graph jogs automatically and the dispatcher watching his lights knows the streamliner is breezing through while the freight, at slower pace, is moving through the siding at Brush, then following the "Zephyr's" clicking heels eastward.

One railroad that installed this centralized traffic-control system found it eliminated 46,355 train stops per year, and when you consider it takes not only time but extra coal and water to stop a heavy freight or a string of steel passenger cars, the saving by nonstop meets is amazingly large. Thirteen railroads operating single-track lines obtained in effect a double-track system by installing centralized traffic control and postponed building the extra track. The first remote-control switch in this country was installed near a tunnel in the mountains of the northwest to enable heavy freights to proceed without stopping on the upgrade to let the brakeman open the switch.

Electric sentinels stand guard over railway lines at innumerable danger spots to signal the engineer if something is wrong. Fire on a wooden trestle opens a circuit and sounds a warning in a yard four miles distant. Electric fences are laid along the

(Continued to page 128A)

## Non-Skid Cup for House Pet Holds Food and Water

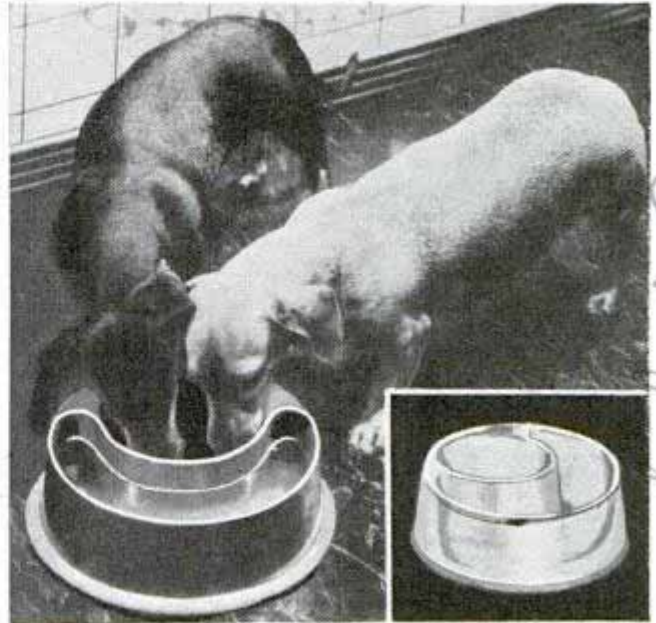

Dogs cannot upset their dish because its rubber base clings to floor. Inset shows dual containers

Floors are kept tidy by a non-spill combination food and drink bowl for dogs or cats that will not slip or tip on the smoothest waxed wood or linoleum. A patented rubber base holds it in place. Two compartments each hold a quart, and being made of molded Bakelite the dish has nothing to chip off.

## Army Plane Hides Like Ostrich in Door of Its Hangar

There's good reason for the big army bombers at Mitchell Field, L. I., to hide their heads. There isn't room in the hangar for the twin-engine ships, so the tails are left outside. Holes cut in the hangar doors fit closely around the tails.

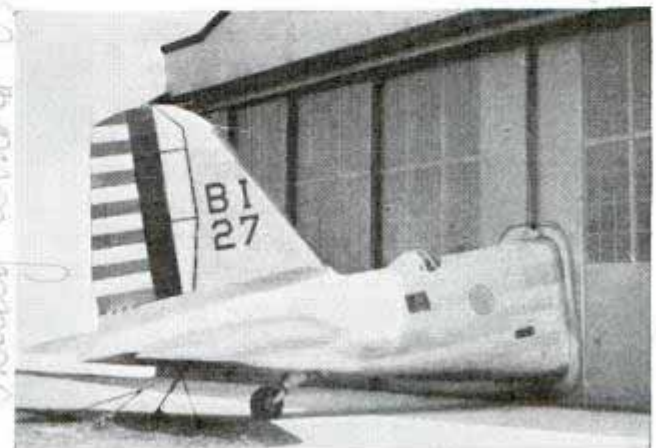

Bomber too big for hangar plays "ostrich" in door

Stafford - Shebert Co. 5710 N. 25th Milwaukee

2363

2639

Judy Arnold Photo



Karst Forest Park  
Hanover, Pa.

# Inflated Paddle-Wheel Rafts Offer New Sport to Bathers

Seayook



Bathers splash and paddle their way around the surf in two-passenger raft floating on a couple of air-filled rubber rings like inner tubes

Introduced at Miami as one of the latest bathing fads is a small inflated craft operated by paddle wheels. Bathers virtually are seated in the water as they crank their way across the surface. Two inflated tubes at the bow and stern keep the raft afloat.

## Army Could Reach Europe Faster by Air Than Water at the Same Cost

Flying clippers may replace troopships if there is ever again a mass movement of armies across the Atlantic. The big transatlantic planes that are now in regular passenger service could carry three soldiers for every two carried by ship in the same time and at the same cost in transport equipment. The S.S. "America,"

largest American-built steamer, now under construction, will have cost \$17,000,000 and could carry 4,000 soldiers across in two weeks. For the same sum, thirty-five flying boats like the "Atlantic Clipper" could be built, and in two weeks they could ferry 6,000 soldiers.

## Beaching Gear Has Water-Filled Tires

Large flying boats that have no wheels of their own to give them mobility on shore, depend on a special type of land gear which is attached while the plane rests on the water. Recently the wheels of this beaching gear have been equipped with brakes, and since they are operated independently of the seaplane, a mechanic must run beside each wheel to apply the brake. The wheels are submerged in attaching them to a plane, and the tires are partly filled with water so the gear will not be too buoyant.

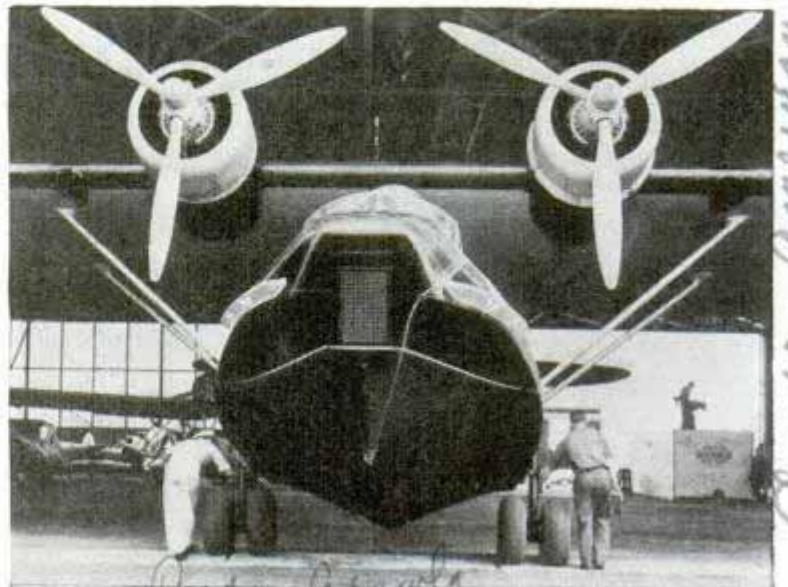

Men alongside wheels are ready to apply brakes if necessary. Water is placed in tires to help in attaching gear to plane

Consolidated Aircraft Corp.

Vertical handwritten notes on the left margin, including "Science Service" and "6/19/39".

Vertical handwritten notes on the right margin, including "New York" and "Carter - American".



*2692. a w. Chaddy Wagner  
% Midnight Sun Club  
1634 Broadway New York  
Duddy Wagner*

# 'Electric Baton' Controls Saxophone Volume

Full control of the volume of his saxophones is obtained by a band leader who has invented an "electric baton." The mouthpiece of the instrument is connected by an electric wire to an amplifier under the player's music stand. Near the leader is a control board which he manipulates to regulate the amplifier's volume.

*Clude Rogers Lennie Losen*



*at Midnight Sun Club*

Left, saxophone players with their instruments hooked up to amplifiers are under direct control of orchestra leader who regulates tone volume by turning dial as above

*Acme 2900*

# "Mother" Barge Escorts Divers Exploring Sea Bottom

J. E. Williamson, under-sea explorer, has a new "mother" ship, the forty-foot barge, "Jules Verne III," which will be used to examine the ocean floor around the Bahamas. In the bottom of the craft is a large well through which the flexible tube and "Photosphere" are lowered. Then, as the barge moves slowly along the surface, the observers and photographers in the undersea chamber are carried along in the tropical waters beneath. The latest equipment for color photography is carried.



"Photosphere" for undersea observers is lowered from well inside barge

*Ward Wollen  
Built at Symonette's Shipyards.*



# The ALL-ELECTRIC



That electricity can do a large proportion of the work on the modern farm is demonstrated at the New York world's fair in the electric utility industry's exhibit, an electrified farm in which more than 100 practical applications of rural power service are shown. Left, community storage and packing building with electrically operated machine for cleaning and grading apples and potatoes

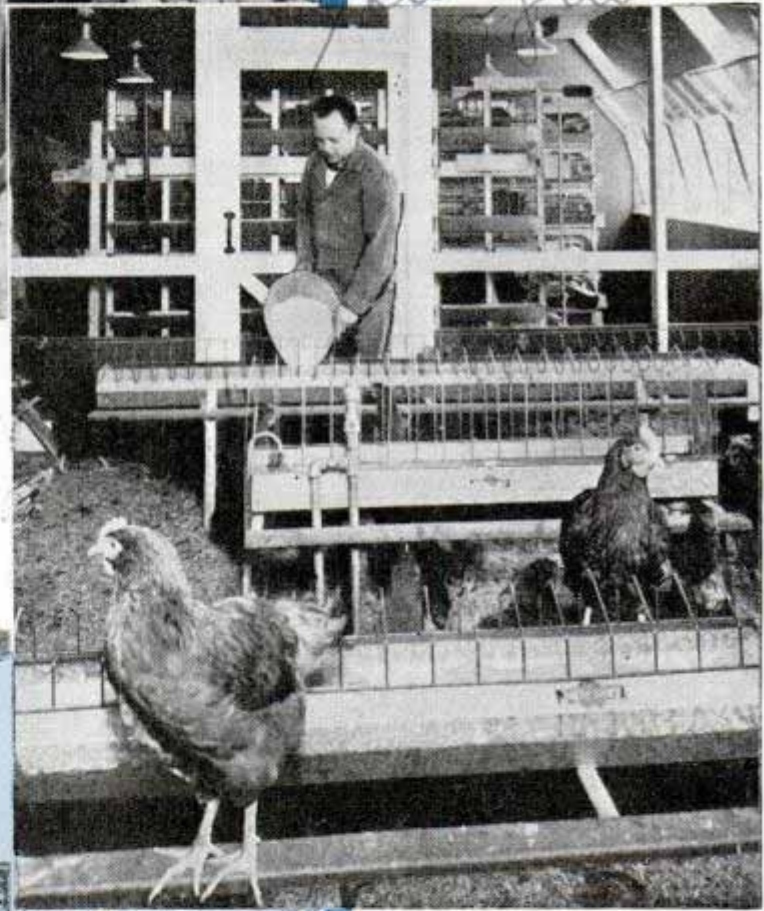

All common uses of electricity and many new, tested practices are on display on this farm. Right, poultry house with battery of pens in background. The science of killing chickens and then scalding and waxing them electrically for the market is demonstrated. The hens have a long day, because of the electric lighting in the poultry house. Other equipment includes egg cleaner and grader, latest type candler and ultraviolet illumination and modern ventilation devices to keep the flock healthy



Planned for assembly-line efficiency, the electric farm kitchen (left) is arranged in logical order, from dual-temperature refrigerator, which has zero-temperature section for storing frozen foods, right around to the range, work spaces and labor-saving appliances. Note the arrangement of windows to provide extra light

734  
 Electric Utilities exhibit  
 Corp Plaza of Leghills  
 World's Fair  
 New York

*Mural*



2734

# FARM

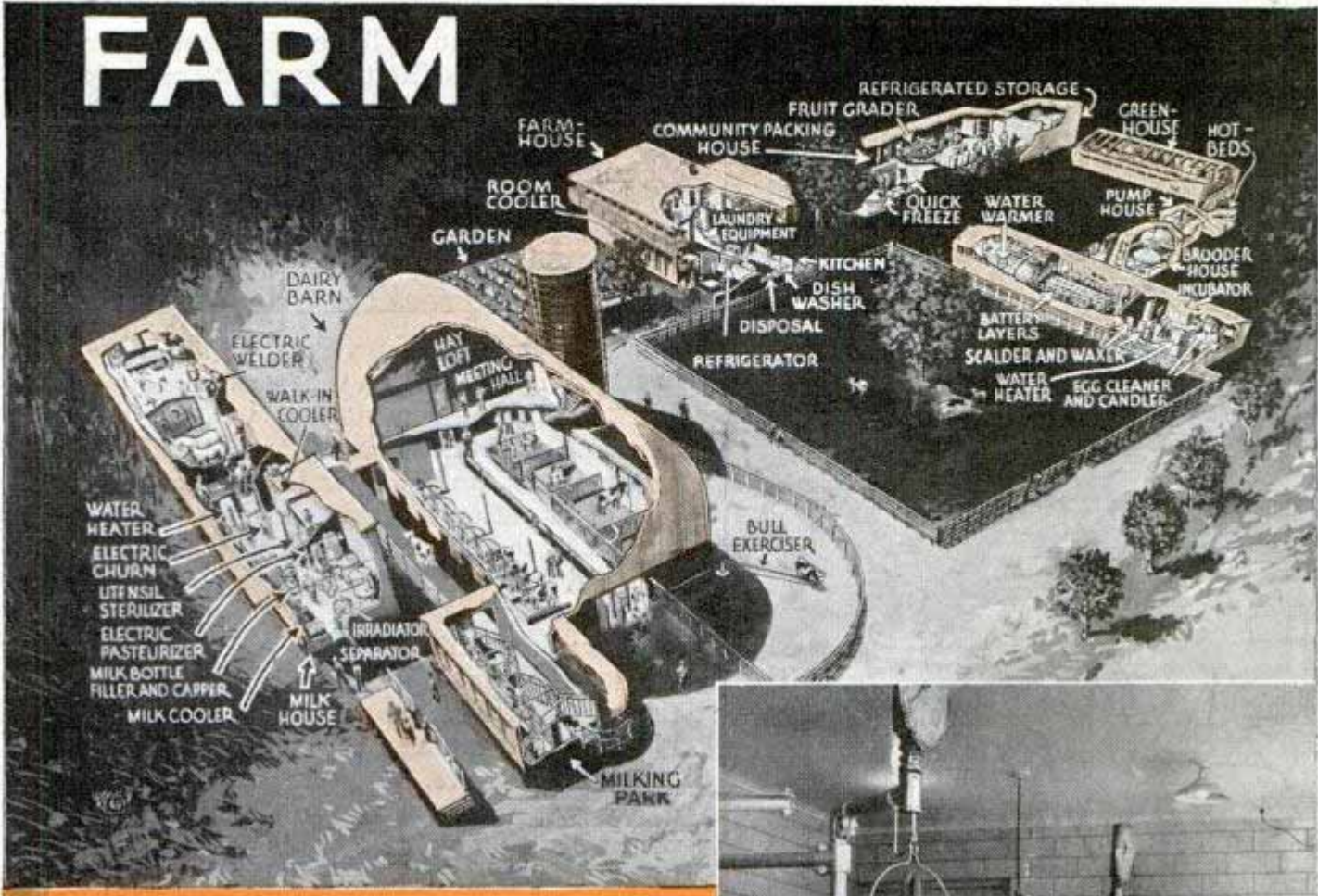

Above, sketch of all-electric farm. Note that barn contains a community meeting hall. The farm house contains ground-level laundry, with machine that automatically soaks, washes, rinses and rough-dries clothes. Next to the washer are electric ironer and electric sewing machine. At one side of the house is a vegetable and flower garden, with plants started in electric hotbeds. The barn has proper lighting and ventilation, drinking cups and machines for grinding and mixing feed. Stalls are covered with rubber mats which minimize danger of injury to animals

*Horstmann Laurus page Hill*

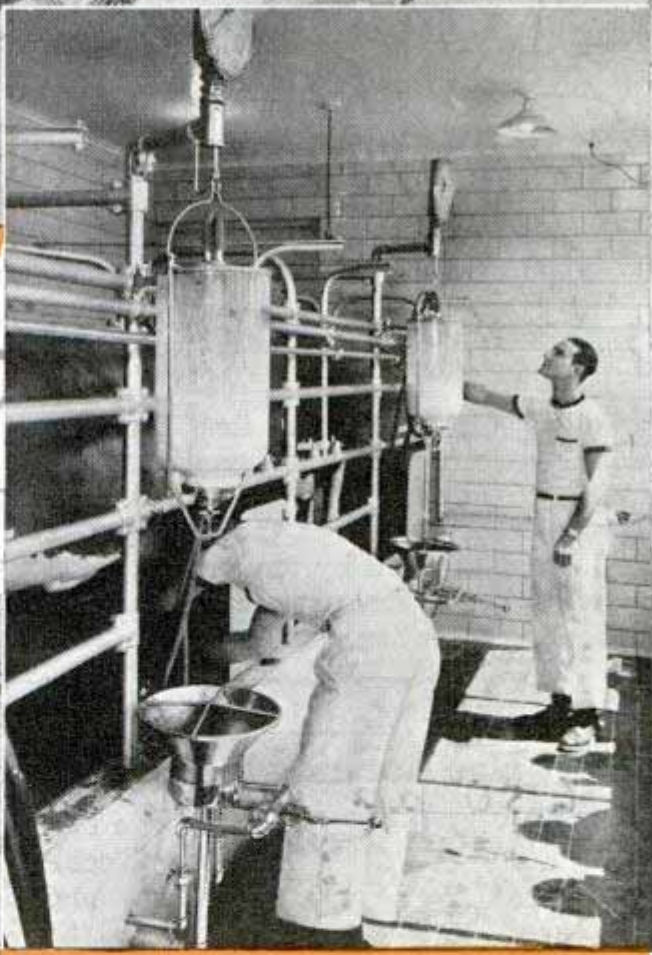

Above, milking time, with the modern magnetic combine milker drawing the milk into a glass container where it is weighed without exposure to the air. After weighing it is conducted by sanitary pipes to the dairy room. Utensils used throughout the milk-handling room are washed in hot water and sterilized by electricity. Left, attendants inspecting the dairy herd in the air-conditioned barn

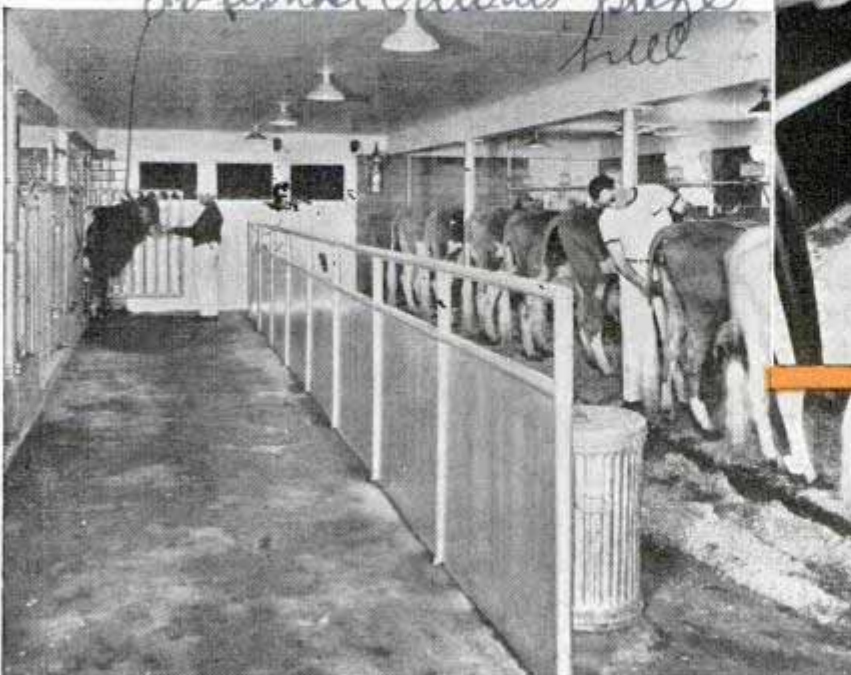

*L. S. Laurus page Hill* 335



# Roller Skates Five Feet Long Advertise National Derby



Youngster standing on five-foot roller skates gives an idea of their comparatively large size

Roller skates five feet long that never will be worn were displayed at Venice, Calif., to announce the national roller-skate derby. Although they are practical and could be used by anyone big enough to wear them, their service is limited to attracting attention.

## Streamline Model Plane Engine Has Rotating Piston

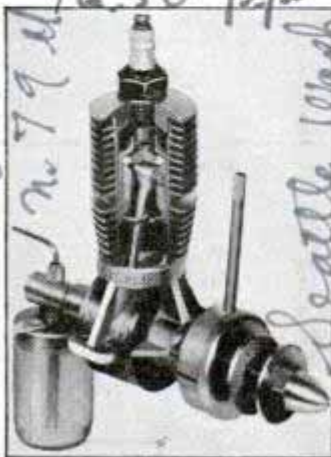

Designed with full-length cooling fins, a new engine for model airplanes has a rotating piston whose movement is intended to result in even wear of cylinder walls. The engine is streamline, having no excess metal

around the cylinder, a factor tending to allow piston and cylinder to expand or contract evenly. The transparent gas tank may be filled through a hole in the cap. The engine may be run either in an upright or inverted position.

## Whistles Gauge Air Volume in Compression Chamber

How to measure the volume of the compression space above the pistons of an internal combustion engine, without removing the cylinder head has been solved by the invention of a whistling gauge. The rate of vibration of the air inclosed in the cylinder head is compared with that of air inclosed in an adjustable and calibrated chamber of known volume by employing two identical whistles, one attached to one spark-plug port of the engine, the other to the adjustable chamber. The whistles are blown by air having a common supply and constant pressure. The pitch of the notes of the whistles on the two chambers depends upon the volume of air contained in them. Thus, when notes of the same pitch are produced, the volumes of the two chambers are equal.

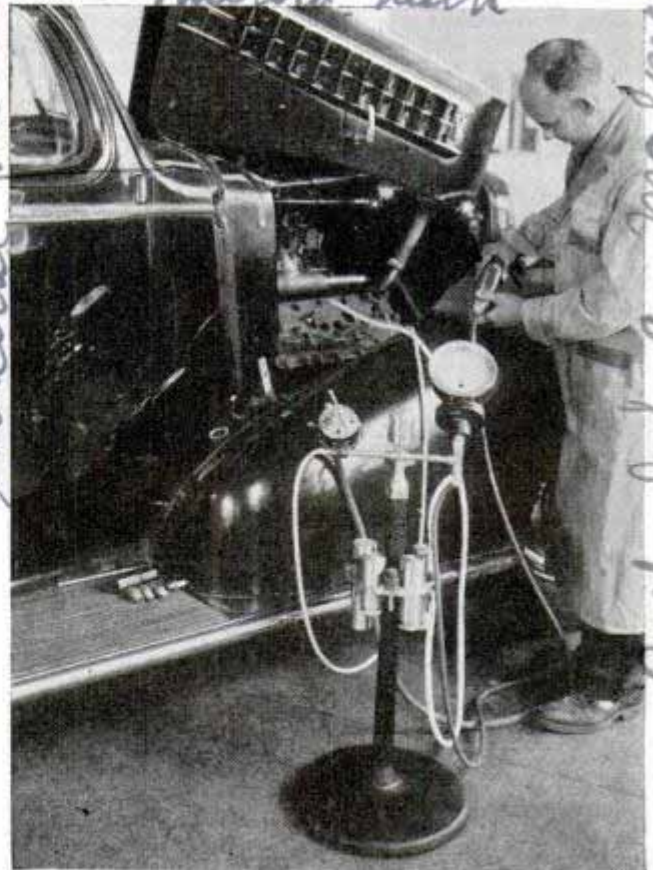

Measuring compression space volume with whistling device eliminates removal of head

Larry Sim

Schelman

General Motors Crumley

Mulford

Com. John A. Maloney

McClure & Co. Chicago

2701

16.50 per pair

Mr. Model Wheel Co. 325

Seattle Wash





# A FORTUNE *on a* LIMB

SCIENCE wages constant war on enemies of fruit trees. Above, light traps mounted in orchard by Purdue University experimenters to catch codling moths, parents of a worm which annually destroys apples worth a fortune.





*G. A. ...*



*Purchased from J. G. ...  
Markham, Kenia, ...*

*9292 Markham*

GUARDING the secret of a new peach is this cage (above). At left, spraying trees with latest type of automatic equipment drawn by a tractor.

*Hardie ... Hudson, Ind.*

same goes for the grape or berry with new features; an ornamental bush with special eye appeal, a quick-growing nut tree, or a rose that might cause garden club members to grope for superlatives.

One spring, Paul Stark, famed specialist in new fruits, was making routine tests of apples sent in to the Missouri nursery his family has operated for 123 years, when he came to a yellow one. One bite convinced him of its commercial possibilities. Because of a distinctive flavor and crisp juiciness rarely found in apples at the fag end of the season, he decided to make a trip to the West Virginia orchard the following fall to look at the parent tree.

When he arrived at the orchard, a careful check of the scrubby trees and wild seedlings failed to produce a single

**N**ATURE likes to play tricks on us, but if you can catch her in the act, there's a fortune awaiting you.

In reality, her pranks are new fruits or outstanding improvements in established varieties and if you are lucky enough to have one of either growing in your back yard, any progressive nurseryman will pay a fancy price for it. The

*Cent. James McCreery 471 W. 6th*

*33A*



2272  
 yellow apple. But when the plant explorer started back to the railroad station he noticed a tree laden with yellow apples growing on the side of a hill, some distance from the orchard. When he was certain its fruit bore the flavor that had occasioned the search, he dug a shallow ditch around the base of the trunk to study the root system. It was strong and vigorous and when the orchard owner, A. H. Mullins, returned home, Stark paid him \$5,000 for exclusive propagation rights.

Naturally, he couldn't dig the tree up and cart it home, so he

**LIFTER** for roots of tree (right) passes underneath the entire root system and lifts tree out of ground.

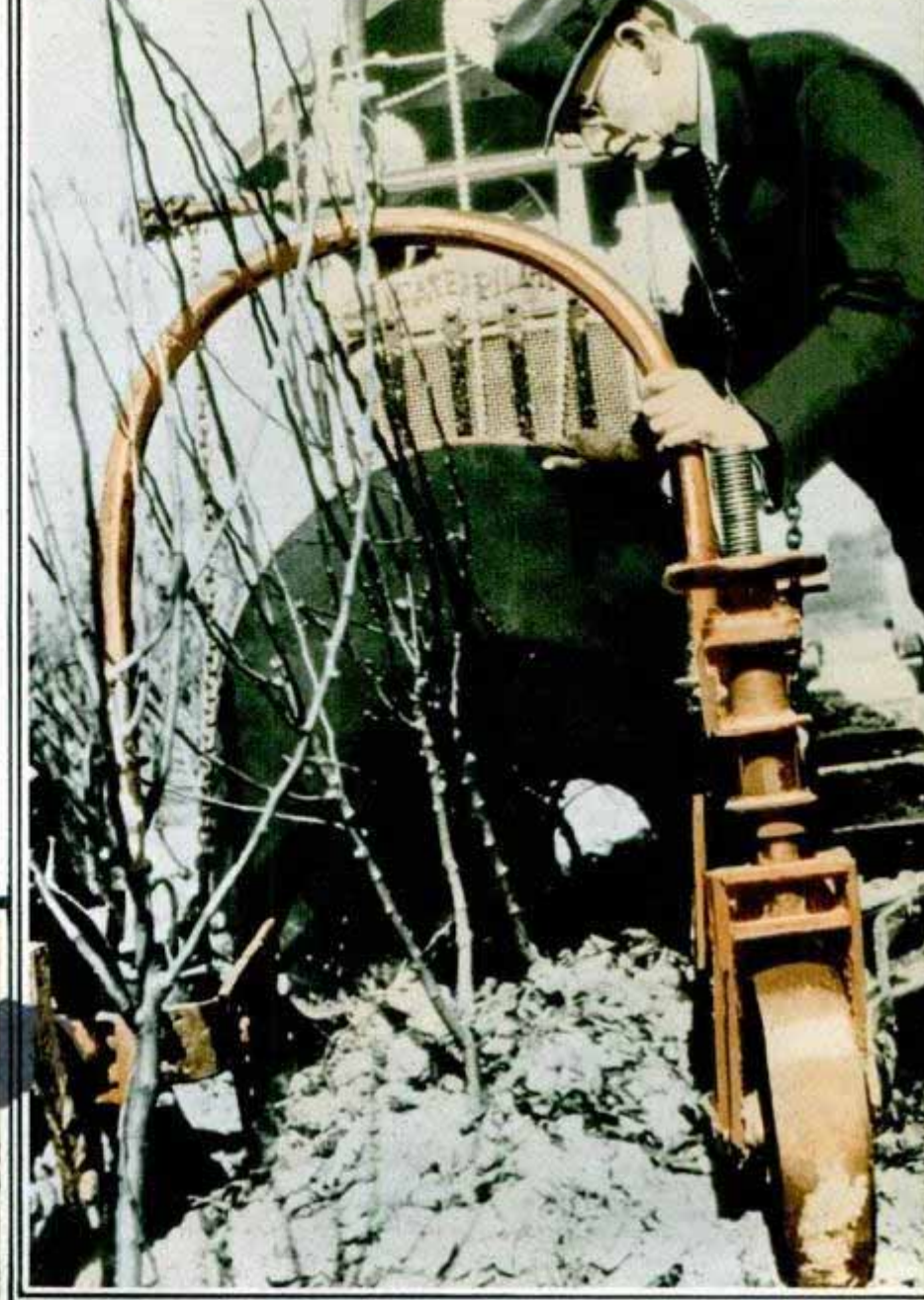

339  
**TOWERING** above fruit tree (left) the spray operator can reach every limb. The tower is pneumatic-powered.

did the next best thing, taking scions or shoots from it. These could be grafted on other stock already growing in the nursery and in this way, the new variety could be launched. And to prevent anyone else from doing the same thing, the tree was encased in a cage fitted with padlocks and a burglar alarm.

Christened Golden Delicious, the variety proved a stake winner and today millions of these trees are growing, all progeny of the tree in the cage in the West Virginia mountains.

Did you ever hear of a boy going through college on a tree limb? A New Jersey youth did

*and field paper  
 developed by Paul  
 Lowman*



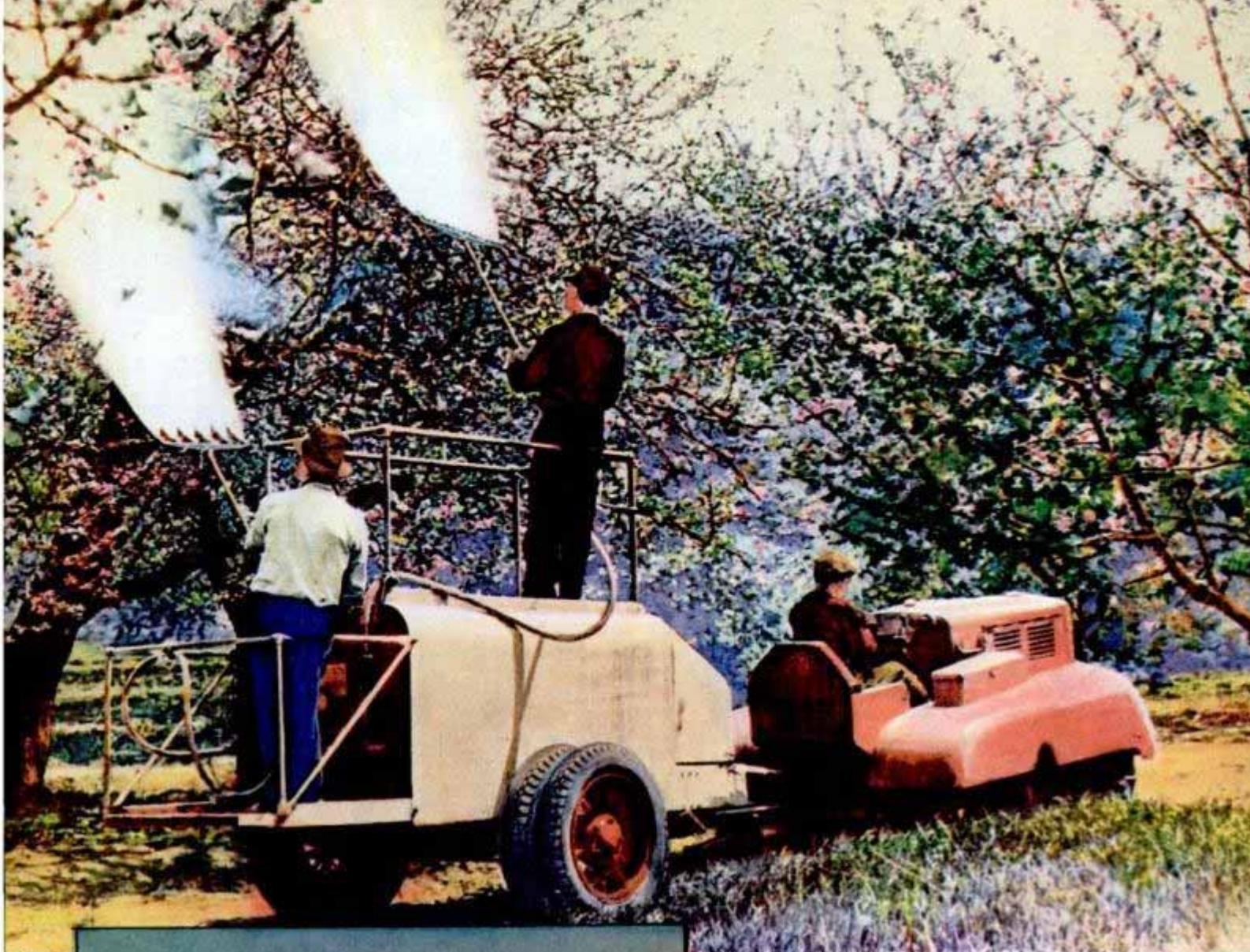

*Stark*

**FIGHTING** plant diseases (above) with special sprays. Left, gold plums, a variety from trees produced from an original that cost \$3,000.

*Stark* *Durbin*

after his father, Lewis Mood, noticed the apples growing on one bough of a Delicious tree were bright red in August while others on the same tree as well as the rest in the orchard were just beginning to blush. He wrote Stark about this phenomenon and on his next swing eastward, the fruit scout stopped there. He checked the limb carefully and then handed Mood a royalty contract amounting to \$6,000, which paid for the boy's college education.

That limb was the answer to an apple grower's prayer. When a customer steps up to a fruit stand to buy a big eating apple he wants a bright red one. Color's the thing and in an effort to sell their apples many growers allowed them to re-

340

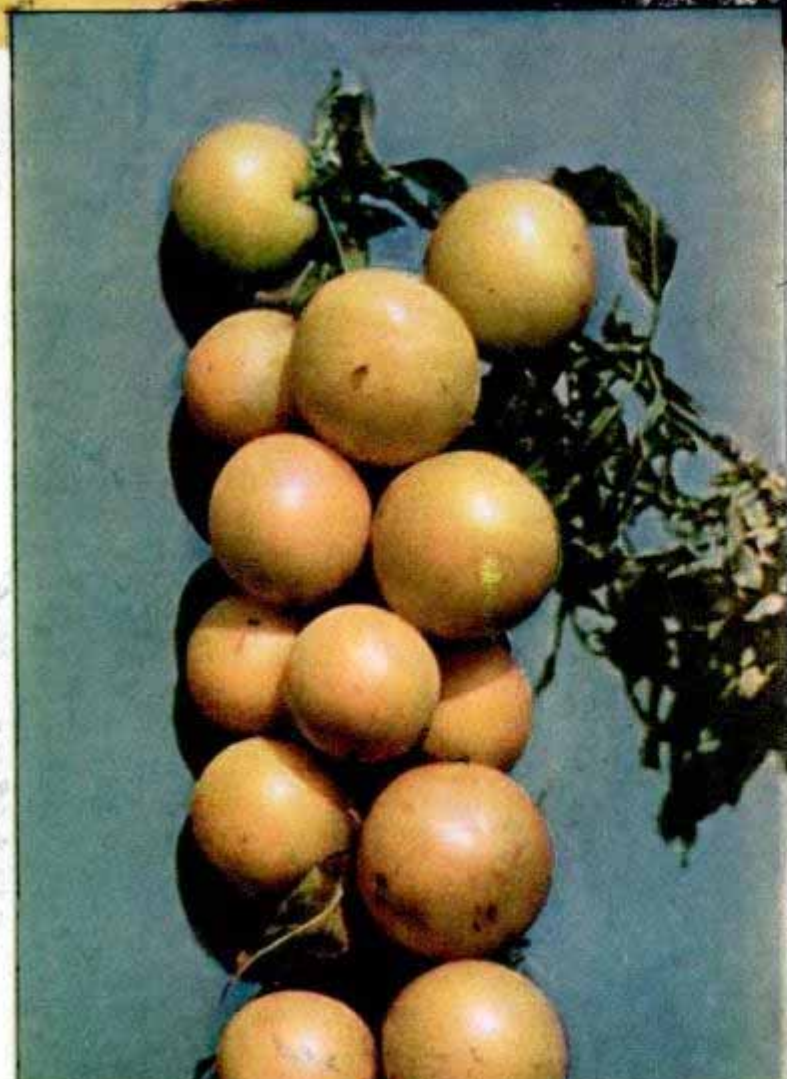





341

COLOR is highly important in sales of apples. Above, note the difference between the ordinary apples held by the young woman and the Double Red Delicious apples on the tree.

*Stark*

main on the trees until they were over-ripe. As a result, many became dry and mealy and would not stand up in storage. The bough found by the New Jersey orchardist, however, made possible a new strain, one that produces brightly colored apples that can be picked while still hard and crisp, capable of standing the rigors of shipping.

For years, this lack of color was a handicap to the Stayman Winesap in the market, particularly those grown in the northern part of the country. That's why J. H. Dickey knew he had something when a limb of one of his trees was ablaze with scarlet apples weeks ahead of the other Staymans in his Wenatchee orchard. He wired Stark to see if he might be interested. He was — paying the Washington orchardist \$1,000 a foot for the three-foot limb, which bore these highly colored Stayman Winesaps.

The technical term for nature's jokes is bud sport, which, according to the

fruit expert, is a spontaneous variation which remains constant and reproduces true to type. In other words, a branch offering a higher color, larger fruit, or some other specific improvement and having the ability to transmit this superior quality to its offspring can be classed as a bud sport.

Cherry growers have been benefited greatly by the discoveries of amateur and professional plant hunters. A former horticulturist of Michigan, L. R. Taft, has found two variations of the Montmorency cherry that have been a tonic to his bank account. One ripens two weeks before the regular variety, the other two weeks later, making it possible for the grower to stagger the picking season over six weeks instead of two. This adds to his profits as the extended season minimizes the need for extra pickers and equipment.

A bud sport that enhances the color of the Jonathan brought a Washington





2292  
 from Dept. of Agriculture  
**CONTROL** of spray used in fighting the peach borer in trunk and roots of tree is made possible by this special apparatus (above) developed by Oliver I. Snapp. The device reaches the pests working underground to increase effectiveness of spray.

342  
 grower \$2,000 and a similar price was paid for a giant grape developed in an Arkansas vineyard. A fifteen-year search for a mid-season giant peach ended in an Illinois orchard where Stark paid a record price for the tree. The originator of the thornless barberry bush was awarded a \$5,000 royalty contract.

Twice yearly, special competitions are held in effort to bring to light the latest in fruit styles. Of the 500 new varieties of fruits entered in the contest last fall, a specimen resembling a large red and gold peach on the outside and an apricot on the inside stood out prominently. A seventy-four-year-old retired butcher, J. C. Sparks, had cultivated it from a seedling in his Colorado garden and in its

seventh year the tree had produced more than three bushels of "peach apricots." For his trouble, he received \$300 first prize and an additional \$2,500 will be paid him when the new fruit emerges from the test orchards.

A few years ago, an orchardist found some apples on one of his trees were colored in alternate quarters of yellow and red. So perfect were the separations an artist could not have improved upon them. These he distributed among his friends, one being relayed to the plant explorer. He found it had good eating qualities and coupled with its incredible color scheme was a "natural" for a commercial grower. At the time, the orchard owner hadn't bothered to mark the limb

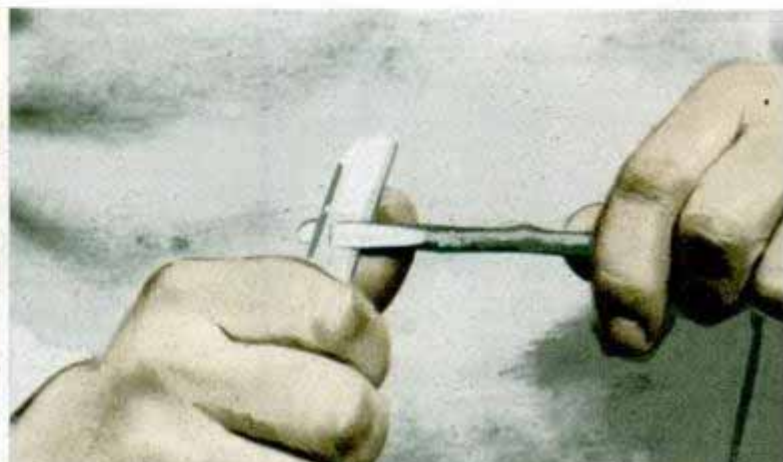
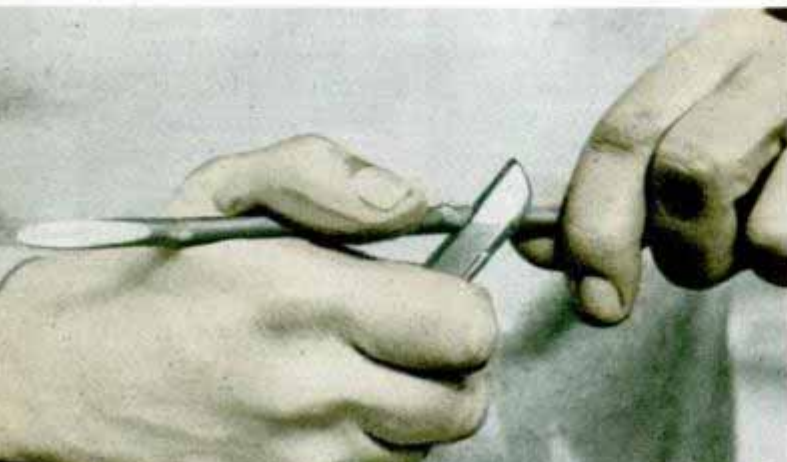



and evidently it was pruned off, as no more of them ever appeared. The industry lost a perfect trade-mark, the grower a bank roll.

Eccentric Johnny Appleseed, never known as Jonathan Chapman, roamed through the wilds of Western Pennsylvania and Ohio in the early eighties scattering apple-seeds wherever he went, but when James Stark, a contemporary of his, forded the Mississippi to set out an orchard in the Louisiana Purchase tract, he brought scions from his father's orchard, which he was able to graft on seedling trees.

Stark's method was the more scientific as apple seeds will grow and produce apples but these will not be the same kind as the fruit from which the seeds were taken, and, moreover, the apples will be of inferior quality. In order to produce the same variety, scions must be taken from the parent tree and grafted on other roots of seedlings.

During the last half century, the Starks have traveled all over the world in quest of new fruits and ornamentals. Several years ago, the late Clarence Stark heard about a young man who, with limited capital, was doing wonders with plums.

*Californian*  
**NUTTING** is easy with tower (right) which makes it less difficult for workers to reach all parts of tree. Strip at bottom of this page and page opposite (left to right): making sloping cut in twig; cutting tongue; making tongue in seedling tree, and fitting twig and seedling together, completing the graft.

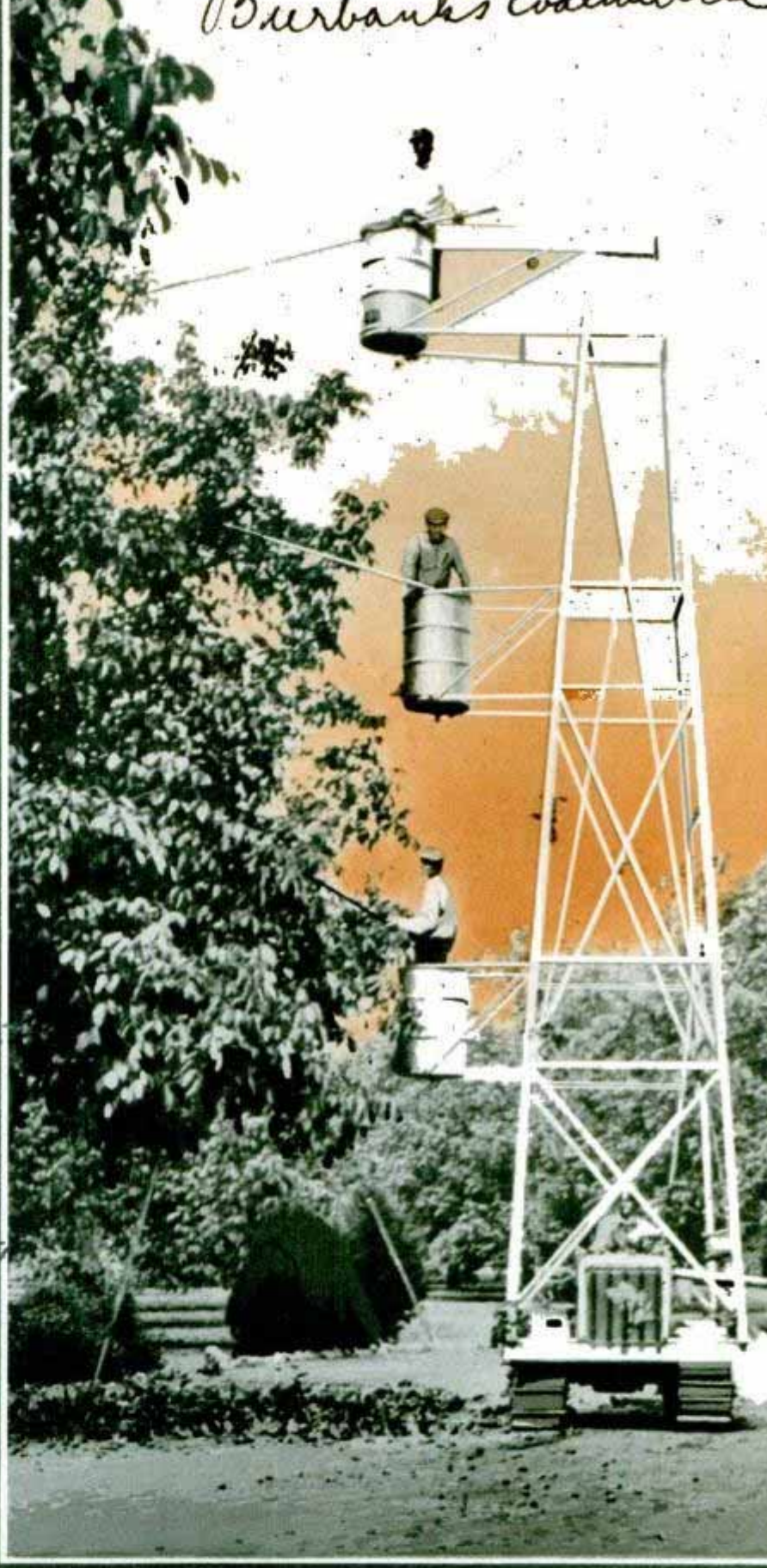





2092  
344  
*Hal Oberka*  
INVITING is this basket of peaches, just filled from the trees. Producing a fruit that can command a premium on the market is the ambition of the specialist and it's worth real money when he does it.

He decided to visit him at his experimental farm at Sebastopol, Calif., where thousands of experiments were being conducted. Before the visit was concluded, the Missourian bought a golden colored plum for \$3,000, two others for \$1,000 each.

The young man's name was Luther Burbank.

That was the first of a number of transactions between the plant wizard and the Louisiana, Mo., nursery. During the sunset years of his life, Burbank watched Paul Stark rise as a horticulturist and designated him as his successor. When Burbank died in 1926, his old trunk chock full of seeds and breeding secrets was turned over to the Stark organization.

Bugaboo of the apple branch of the billion-dollar fruit growing industry is the codling moth, parent of the "apple" worm, which annually destroys or renders unfit for marketing millions of dollars worth of fruit. Major combative

measures have been in the nature of scientific spraying techniques and light traps rather than in research on worm-proof strains. However, efforts still are being made to make the seedless apple commercially practicable. Having only stamens and a small quantity of pollen, the tree is blossomless. Inasmuch as the codling moth lays its eggs on the blossom, a wormless apple may not be outside the range of possibility.

A high quality pear tree capable of withstanding the Central West's blight would be a real gold mine. A peach tree that would thrive in the northern portion of the country would be worth its weight in gold.

A tree or plant that can be considered seriously, Stark points out, must be superior to those with which it must compete. If it offers a different color than those on the fruit stands, greater uniformity of size, an earlier or later ripening season, or other outstanding point, it has the makings of a gold mine.



## Window 'Greenhouse' Hangs on Outside Wall

You can have flowers blooming outside your window all year around by installing a greenhouse that hangs on the outer wall and covers the entire window. Consisting mostly of light steel frames and glass panels, the "garden" is delivered knocked-down, and all material necessary for its assembly is furnished. No puttying, flashing or extra construction is needed. Plants get heat from the house as well as from the sun in winter, and in summer the glass panes may be replaced by screens.



Plants bloom all year around in this window greenhouse

### Low-Cost Artificial Rubber Withstands Long Use

Artificial rubber that wears two to four times as long as ordinary Para rubber can be made from butane gas, a by-product of the oil industry. Development of an inexpensive method of manufacturing this synthetic rubber was announced recently by a Chicago oil products firm. It can be produced cheaply enough to compete with the natural rubber, and it withstands greater heat and is more resistant to acid.

### Speedy Boat with Twin Pontoons Is Driven by Air Screw



Driven by an "outrigger" engine with an air propeller, this Italian boat won race from Pavia to Venice. Driver sits in right of twin pontoons

Unusual in design and powered like an airplane, a new Italian built speedboat is capable of sustained fast travel. It recently won a 280-mile race from Pavia to Venice. The craft has two pontoonlike sections separated from each other by water. Extending upward from each section are substantial supports on which is mounted a powerful aviation-type engine which drives a large air screw, very similar to those used on airplanes.

Mineral Oil Products Co. Chicago  
 113 Michigan

Lord and Burnham Co.,  
 Livingston, N.Y.

2790  
 2794  
 T. J. ...  
 ...

...  
 ...



*Mr. Donald,  
1344 W Washington*

*San Angeles  
California*

### Machine for Dyeing Carpets Has Fluid Tank in Handle

*\$48.80 - \$165.70*

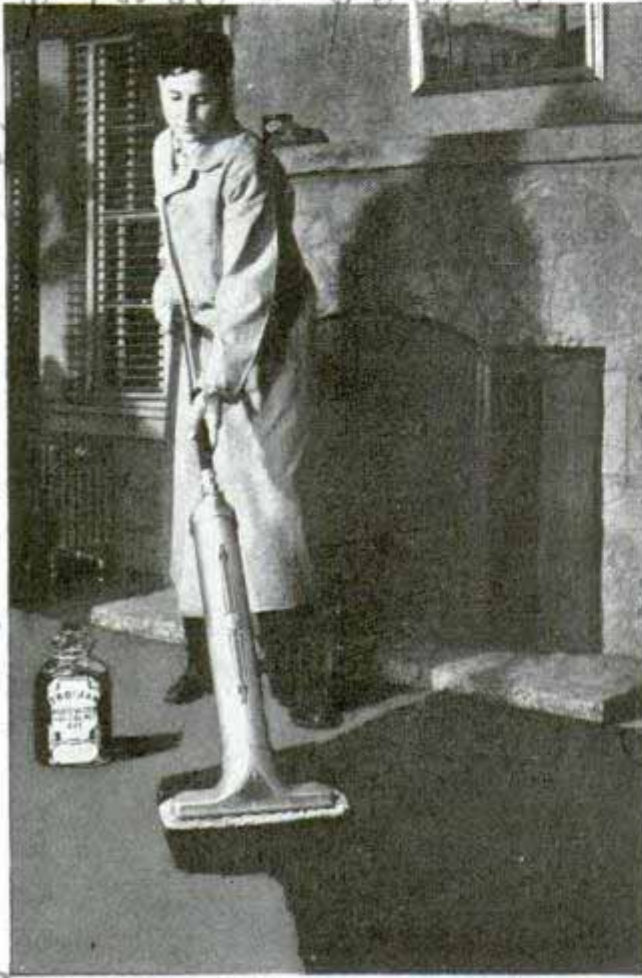

*Dyeing a rug with fluid fed from tank in lower part of handle. Rugs can be shampooed in similar manner*

Designed for cleaning and dyeing rugs and carpeting and for scrubbing and waxing floors, a new non-electrical machine has a fluid tank located on the lower part of the handle. The fluid is released by a trigger just above the tank. Shampooing is accomplished without removing rugs from the floor. In much the same manner, dye may be applied and spread rapidly.

material which has millions of tiny bubbles of nitrogen sealed into it during manufacture. This helps to cushion the foot.

### Disappearing Lavatory Mirror Hides Toothbrush Holders

At a glance you'd think it was just a bathroom mirror. Press the glass at one side and it turns on a swivel, the mirror disappearing into the wall while a bracket holding a drinking glass, soap dish and four toothbrushes emerges into view. The fixture is recessed into the lavatory wall.

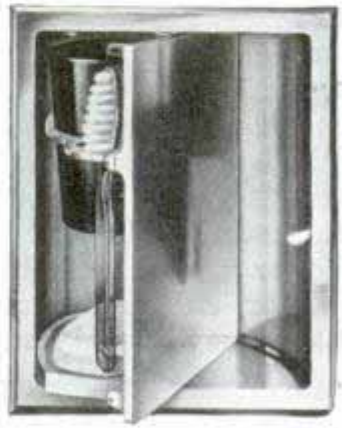

### Cast-Iron Spring Bends into "U" to Show Strength of Metal

As a demonstration of the strength and hardness of modern cast iron without brittleness, a manufacturer shaped a coil spring from the metal. Bent into a complete "U," the cast-iron coil sprung back to its original shape undamaged. From the same mix of cast iron a razor was made to give another demonstration of the fine grain and hardness of the metal.



*Coil spring of cast iron, bent "U"-shaped, returns to original shape without cracking or distortion*

### Extra Soles for Walking Shoes Let You Tread on Air

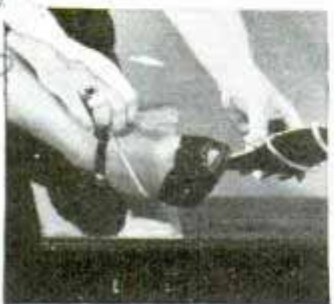

Literally you tread on air when you wear the extra soles that are being introduced for walking shoes. The soles are made of a new lightweight rubber

*Tropic Products Manufacturing Co.  
2130 S. Wabdash Chitney  
Greer S.C.  
Virginia Rubbers Co.  
2nd Montgomery St.*

*Pomona Pump Co*



2754. *Buffalo Evening News*  
**Twenty-Two Foot 'Queen Mary' Carries Two**

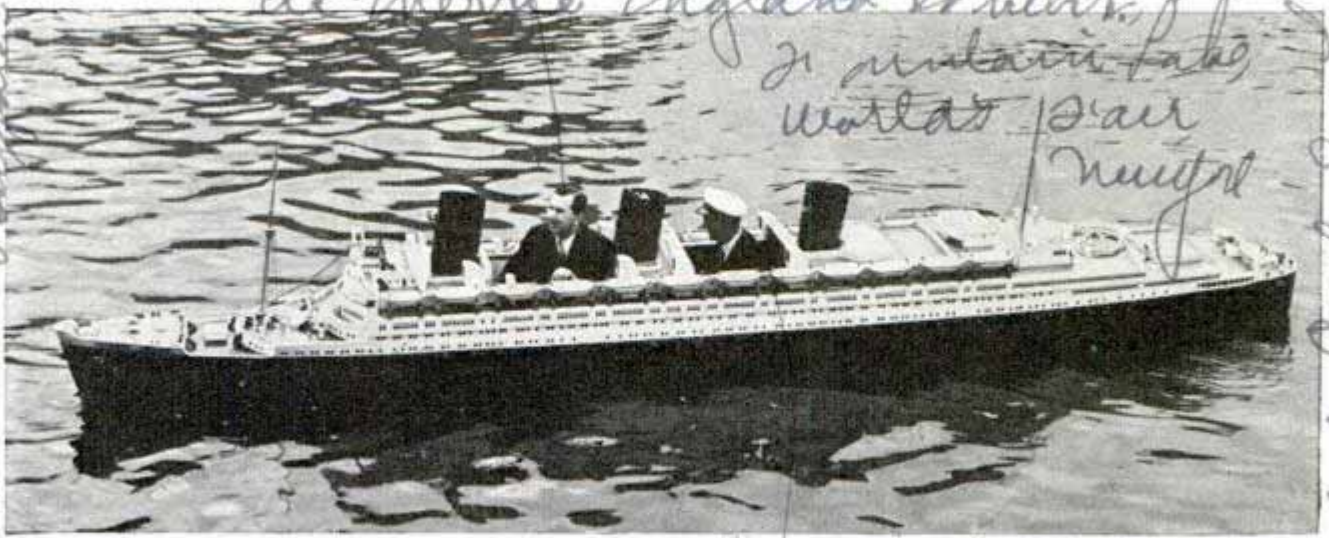

*Watchmaker built into this model of the famous "Queen Mary" all the skill and precision his trade had taught him. The craft easily holds its builder and an extra passenger*

*Conk mark Palmer 259 Delaware St. Buffalo, N.Y.*

Sailing under its own power and having a displacement sufficient to float with two passengers aboard, a twenty-two foot model of the ocean liner, "Queen Mary," has been constructed by a Toronto, Ont., watchmaker during a period of two and one-half years. Built with precision on a scale of one-quarter inch to the foot, the

craft draws nearly eighteen inches of water and has ridden out four-foot waves. In the hull are 1,630 portholes, and the boat contains 556 windows, 846 stanchions, 300 feet of cable railings, and twenty-four lifeboats equipped with propellers and canvas covers. There are 5,394 screws and 11,106 nails holding together 12,000 pieces of wood.

*Oscar H. Fletcher*  
**Sanding Block Bends Slotted Back to Fit Curved Surface**

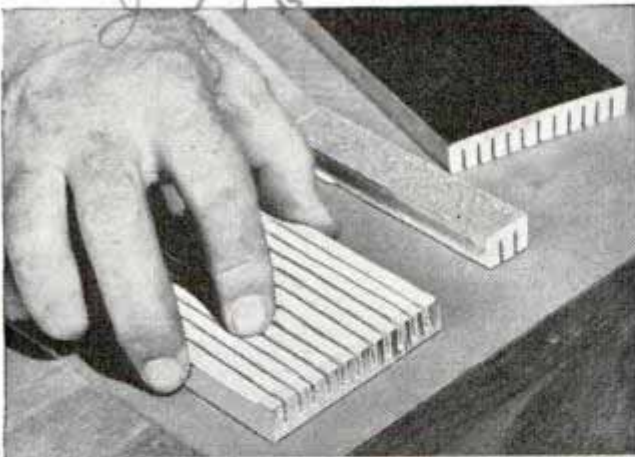

Made especially for sanding curved or angular surfaces, an abrasive block faced with sand or emery paper has a slotted back which permits flexibility. The wooden block is a half inch thick. It lies flat and rigid unless the paper top over the slotted side is cut, then the sanded side bends to fit convex, concave or angular surfaces.



*Slots in these sanding blocks permit bending them to fit a concave or convex surface*

*2746*  
**Squeegee for Vacuum Cleaner Sucks Up Dirty Water**

Instead of mopping up the dirty water after scrubbing the floor, a squeegee can be fastened to the vacuum cleaner to suck up the water. The squeegee attachment permits its use on home or factory vacuum cleaner. It has double blades of rubber.

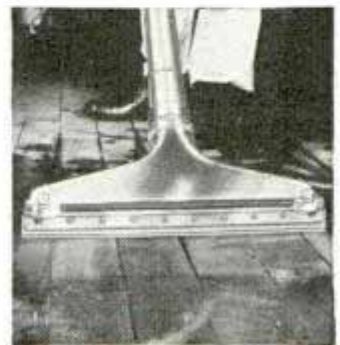

*Vanderwever and Held Floor Machine Co.*

*Conk mark Palmer 259 Delaware St. Buffalo, N.Y.*

*General agent: Carl M. Lewis 63 Erskine Ave. Toronto.*



70

551

Capt. George E. T. Eyston, 70 miles  
per hour  
American agent  
Joe

# DRIVING a

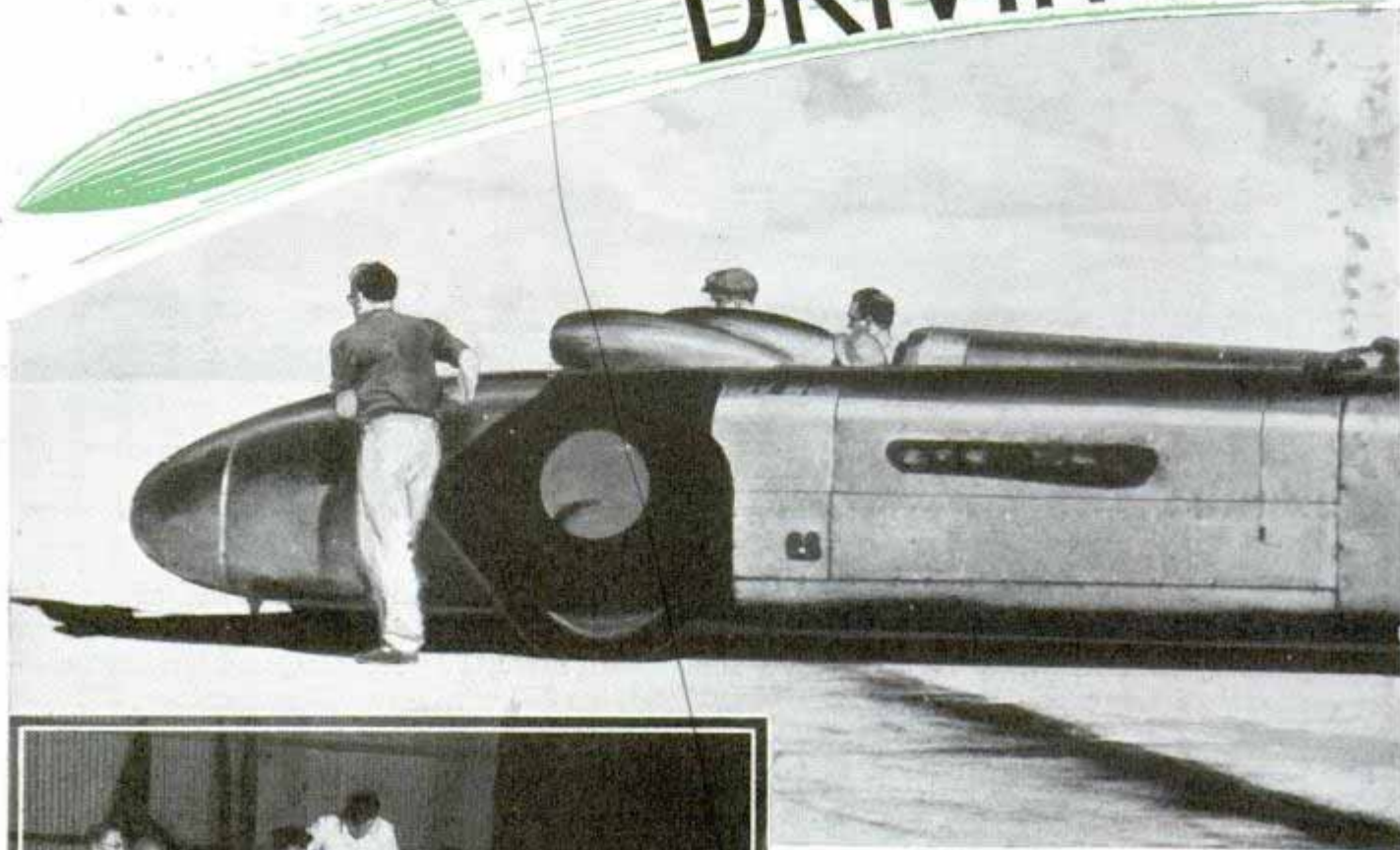

By  
 Capt. George E. T. Eyston

**I**F YOU have ever "let out" your car to ninety miles an hour you have just the ghost of an idea how it feels to grip the wheel of the "Thunderbolt" at four times that speed.

That's about the speed of a cannonball, you know. Shoot a field howitzer parallel to that black line across the Utah Salt Beds and, within the measured mile that marks my top speed, I could theoretically lean out and pluck the shell right out of the air. At 528 feet per second Thunderbolt would even make a pretty good race against a .45-service revolver bullet with its muzzle velocity of 750 feet per second.

Last year, after I established a world's land record of 357.5 miles an hour, I said man would probably never travel much faster on

Top, pushing "Thunderbolt" to starting line; below, Captain Eyston watches alterations in makeshift garage near Salt Beds



# BULLET on WHEELS

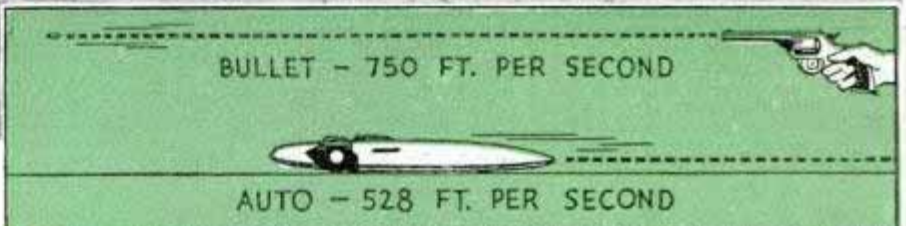

earth. I still believe that. Not that Thunderbolt has done her best yet; if my friend John Cobb is successful in attacking my record in Utah this year I am confident it will not be his for long. I am working on certain refinements of design, motors, brakes and tires that will produce an even faster Thunderbolt. What those changes are I am not ready to reveal. But even without this year's improvements my car has not reached the limit of its capabilities.

There is much more to superspeed driving than the designing of a powerful engine and stable vehicle. There is the human element. Nerves. Physical condition. Eyes that can sight along that guiding

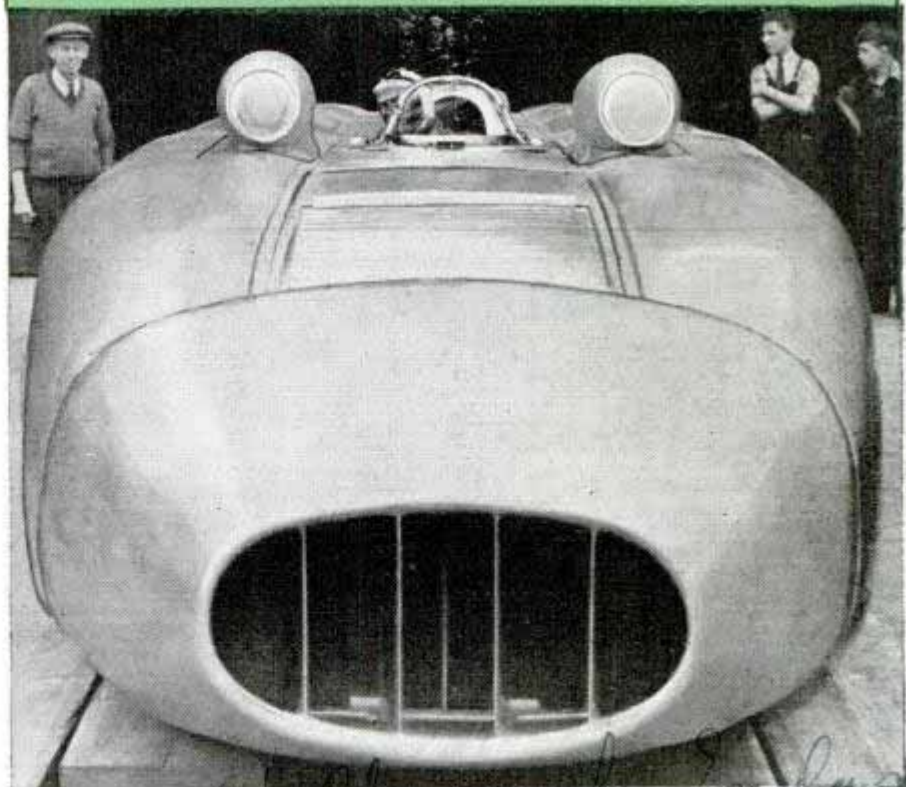

*at Chevrolet, England*  
 Head-on view of world's fastest automobile with Captain Eyston in cockpit. Drawing compares its speed with that of bullet from army pistol. Target was painted on side of car above front wheels to interrupt photoelectric beam on clocking device



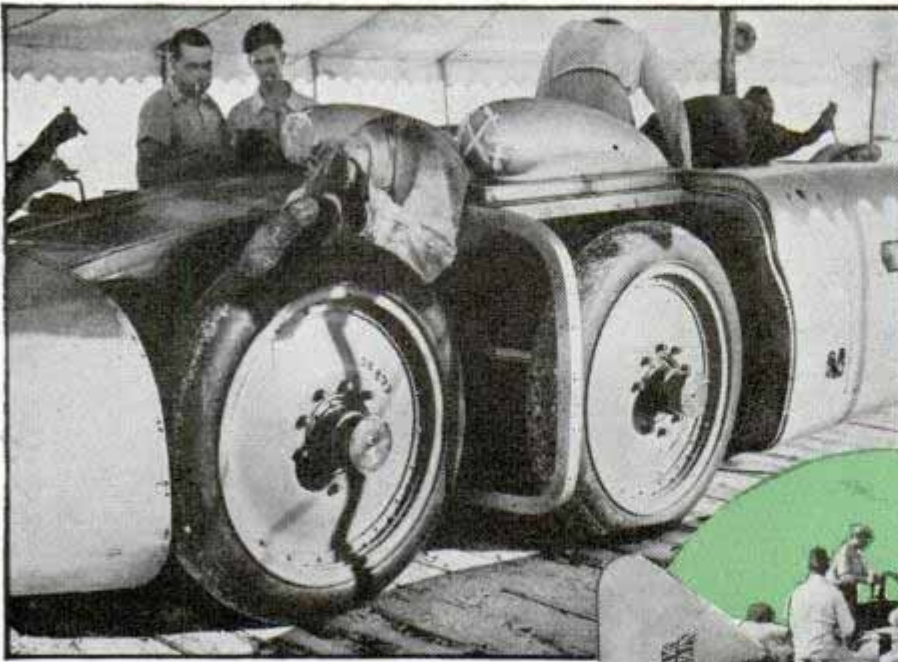

Above, mechanics check car under canopy before test run. Right, refueling between runs. Below, airplane view of record dash—notice tail fin was removed as unnecessary weight—and "pit" scene showing front wheel hubs

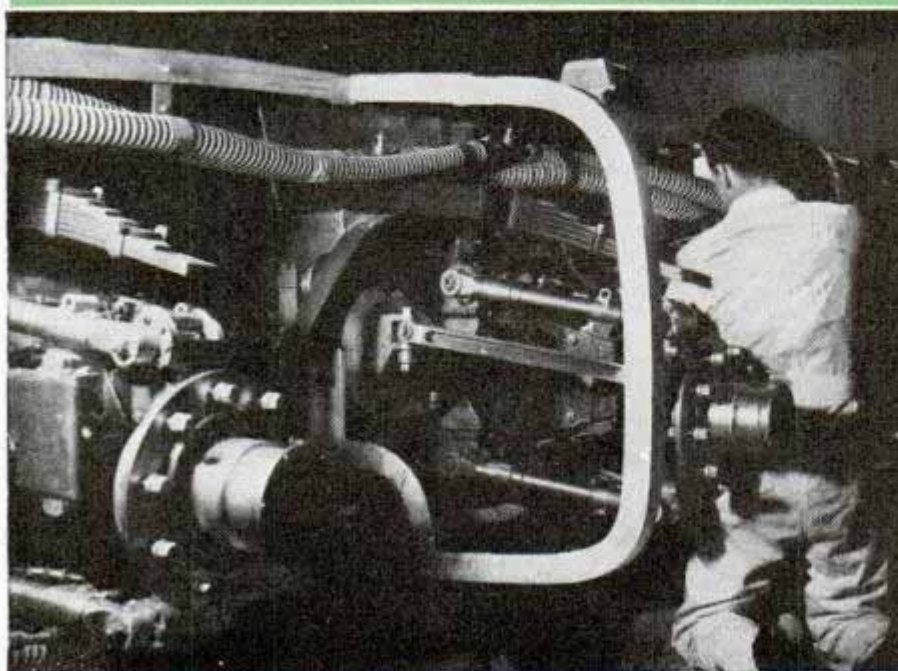
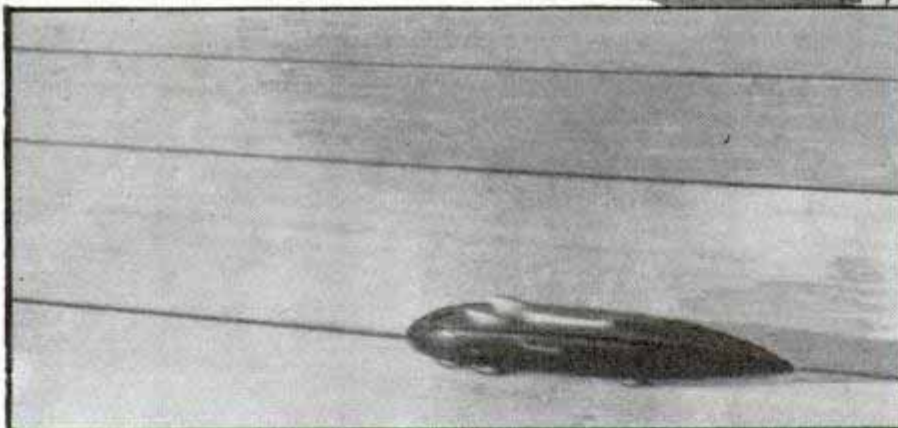
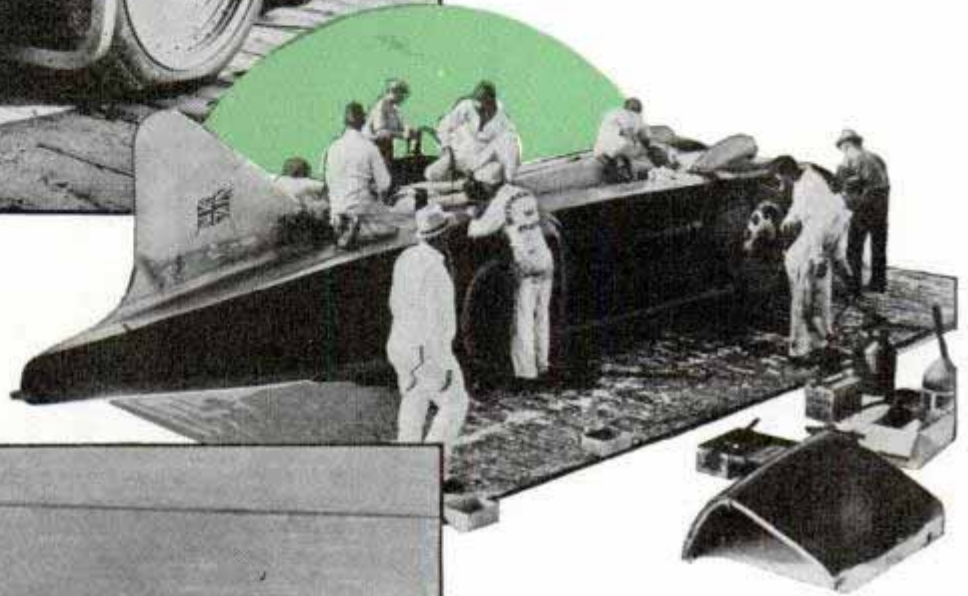

ribbon across the desert and still watch the measuring posts and the dials on the instrument board. Hands steady enough to hold the wheel true as a gunsight for thirteen miles, and a steady foot on the accelerator.

I scarcely need mention that you need a clear head for split-second decisions.

I should not be writing this had I not acted quickly in my last record dash. My dial showed I was doing 360 miles an hour as I was leaving the measured mile. I had but six miles to stop or hurtle over the railroad, and that would be disaster. Dozens of alternatives flashed through my mind. Decelerate too quickly and I would lose control; apply the brakes too heavily and I would go into a dangerous skid. The only safe alternative was to swing into a wide circle, let the power diminish gradually and start braking.

I knew Thunderbolt was sprung correctly; I knew her steering was properly alined; I knew



2 5 51

her tires were fit. I gripped the wheel tighter, pulled her around into a wide loop and completed ten circles before I could safely bring the car to a stop.

But there are other factors besides the human element, and chief among them is rubber. A car can go only as fast as its tires. You people who drive sixty miles an hour on the highways are always in mortal danger of a blowout that might send your automobile careening against another car or a culvert. Yours are four or six ply, low-pressure tires, heavy and well-made, but the danger is there. Then think of me, riding six times as fast on treadless tires less than a half inch thick, inflated to 120 pounds air pressure!

The amazing thing to me is that these tires last as long as they do. Much thinner than yours, they take a terrific pun-

(Continued to page 120A)

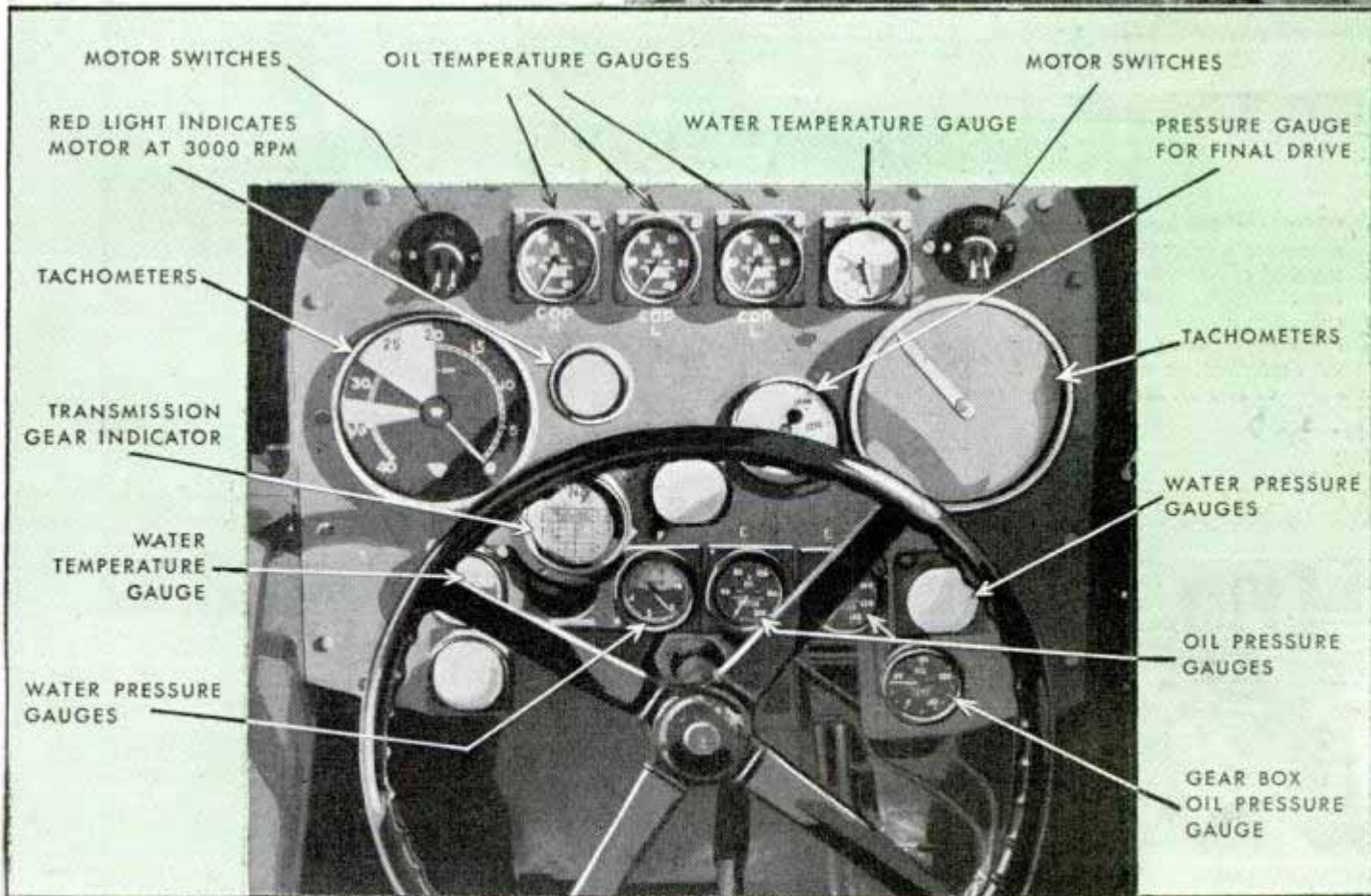
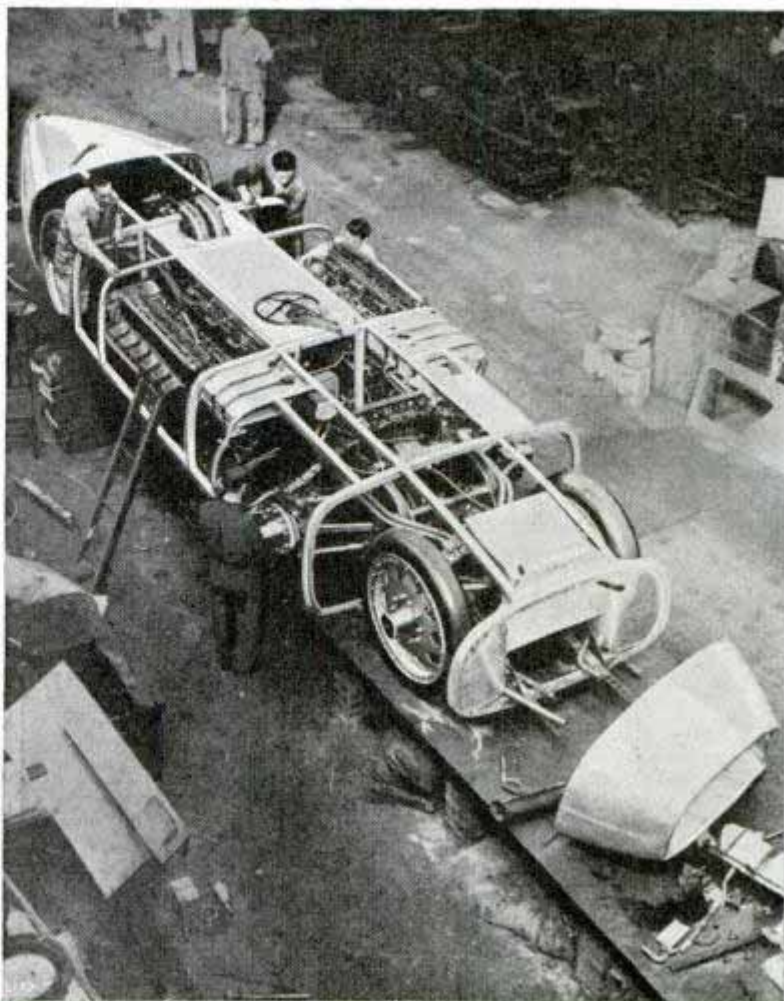

Top, assembling the twenty-four-cylinder giant. The engine is behind cockpit and there are four wheels forward and two at rear. Below is a view of instrument board from driver's seat



# 'Big Top' Is Air Conditioned for Any Weather

And now air conditioning has reached the "big top" of the traveling circus. The Ringling Brothers and Barnum & Bailey

show has a portable heating and cooling system that pipes comfortable air into the roof of the big tent in cool or hot weather.

Eight mobile units are posted close beside the main tent, and from each one two arms extend upward along the tent roof, then curve inside it where metal distributors spread the air. Ice is used for cooling, producing a temperature drop of six to eight degrees even when 12,000 patrons jam the tent. An oil heater is used on cold days. The cooling system sends 215,000 cubic feet of cool, washed air into the big top each minute while suction fans draw out the stale air.



"Big top" performer, above, cools off under breeze from vent of air-conditioning system. Right, two of the ducts delivering "perfect weather" from portable units to points of distribution on the roof of the circus tent.

# Melodies Played on Auto Horns by 'Wobble-Stick' Switch

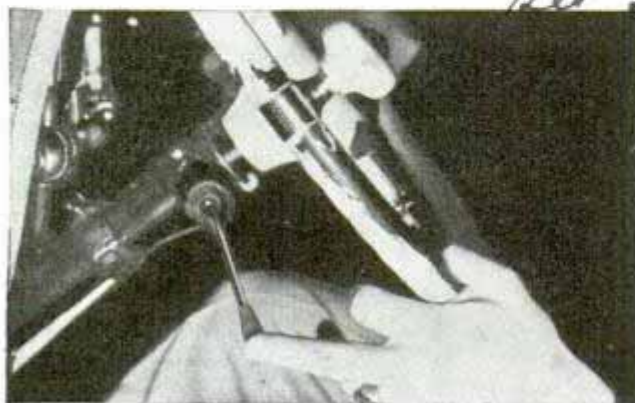

Switch lever is wiggled to produce melodious notes

Automobile drivers can play tunes on car horns by attaching to the steering column a "wobble-stick" switch that resembles a small gear-shift lever, to operate three differently toned electric horns. Three electric circuits are operated alternately by moving the switch lever, and each circuit is attached to a separate horn.

Send return postage to our Bureau of Information to learn the name of the maker of any device described in this magazine.

L.O. Sawyer, 542 N. Ryker Ave. Los Angeles, Calif.

Ringling Circus, 633 Plymouth Court Chicago

761.

503

see Sept. 1940. 396



Radio Corp. of America  
30 Rockefeller Plaza

### Television Rides on Phone Wires from Scene to Studios

Long considered to be impossible, the transmission of a high definition television picture over an ordinary telephone line was accomplished in New York recently by the National Broadcasting company. Engineers, however, were careful to explain that this did not warrant a prophecy of a nationwide network through telephone circuits, since the linking of several cities differs markedly from local pickups within the limits of one city. In the experiment an indoor scene was picked up by a television camera, and the picture monitored in the control room of the NBC mobile television station. From there the electrical impulses, representing the picture, were passed through telephone wires to the NBC broadcasting studios at Radio City.

### Diesel-Driven Highway Liner Has Venetian Window Blinds



Air conditioning under driver's control, Venetian blinds and adjustable seats are comforts of Diesel buses operating from Chicago to Pacific

Diesel-engined buses made their debut on transcontinental highways this summer when a fleet of twenty-five began operating between Chicago and San Francisco and Los Angeles. Seating twenty-eight passengers, the buses offer the comforts of air conditioning and roomy, adjustable seats. One row of four chairs provided for the long-legged patrons has thirteen extra inches of leg room. Humidity and temperature are automatically controlled, and 1,200 cubic feet of filtered air is circulated per minute. Venetian blinds at each window are individually controlled from the seats. The power unit is a six-cylinder, two-cycle Diesel engine.

### Pests Snared by Revolving Nets to Watch Their Activity

Efficiency in dusting fields to combat crop pests in eastern Oregon, Washington

and Idaho is increased by pea weevil and aphid traps that give accurate information of the intensity of insect flights during the day. Driven by a one-horsepower gasoline engine, two large nets revolving fifty times a minute sweep the insects from the air. Counts are made three times a day, and when flight increases are noted in any section the pea growers throughout the affected area are warned so a concerted warfare against the pests can be started on all fronts.

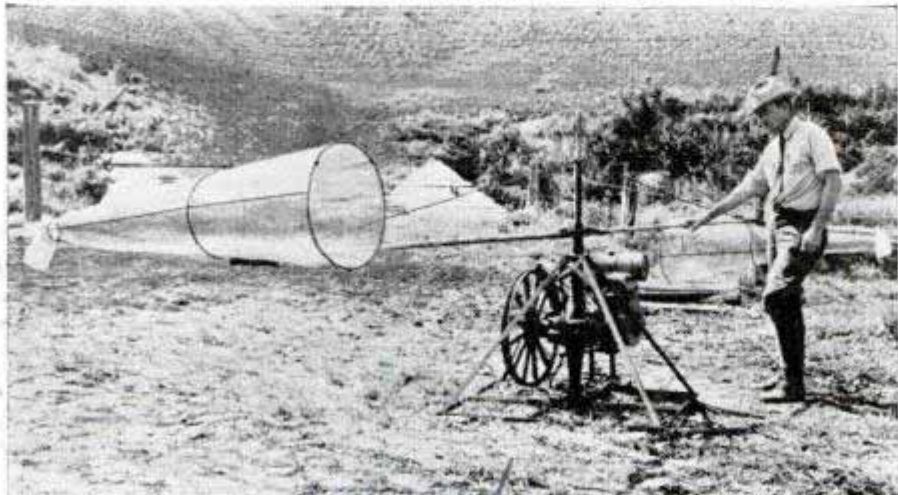

Insects trapped in sack at small end of net are counted thrice each day

Yellow Coach with Diesel engine  
motor car with Venetian blinds

cc  
Un  
er  
s.

cont. volan shift 1/2 East Oregonian



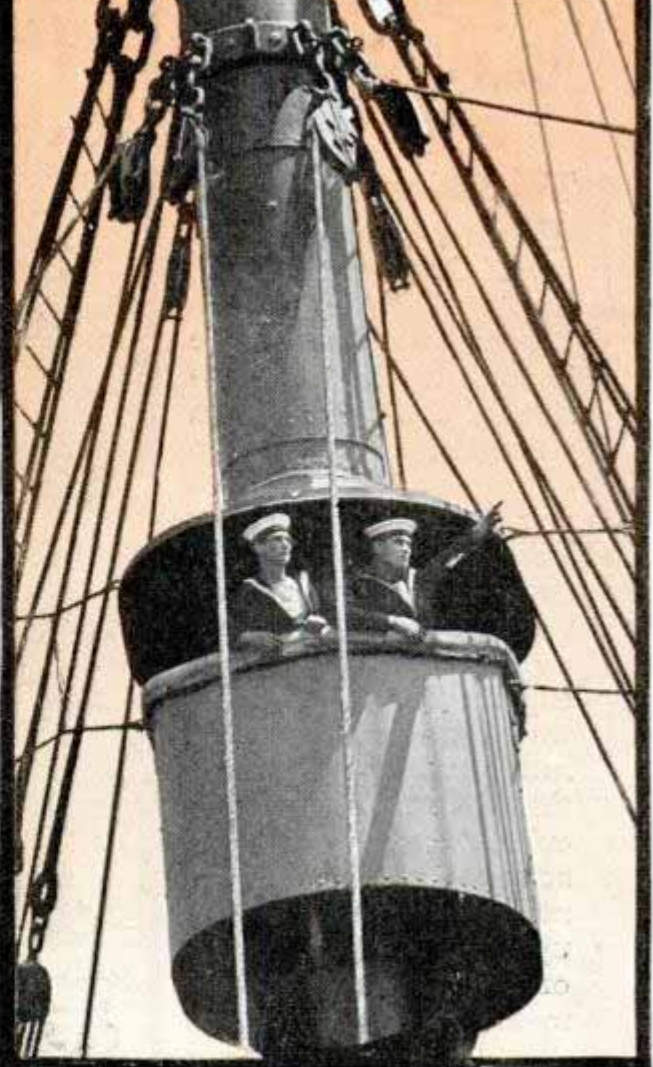
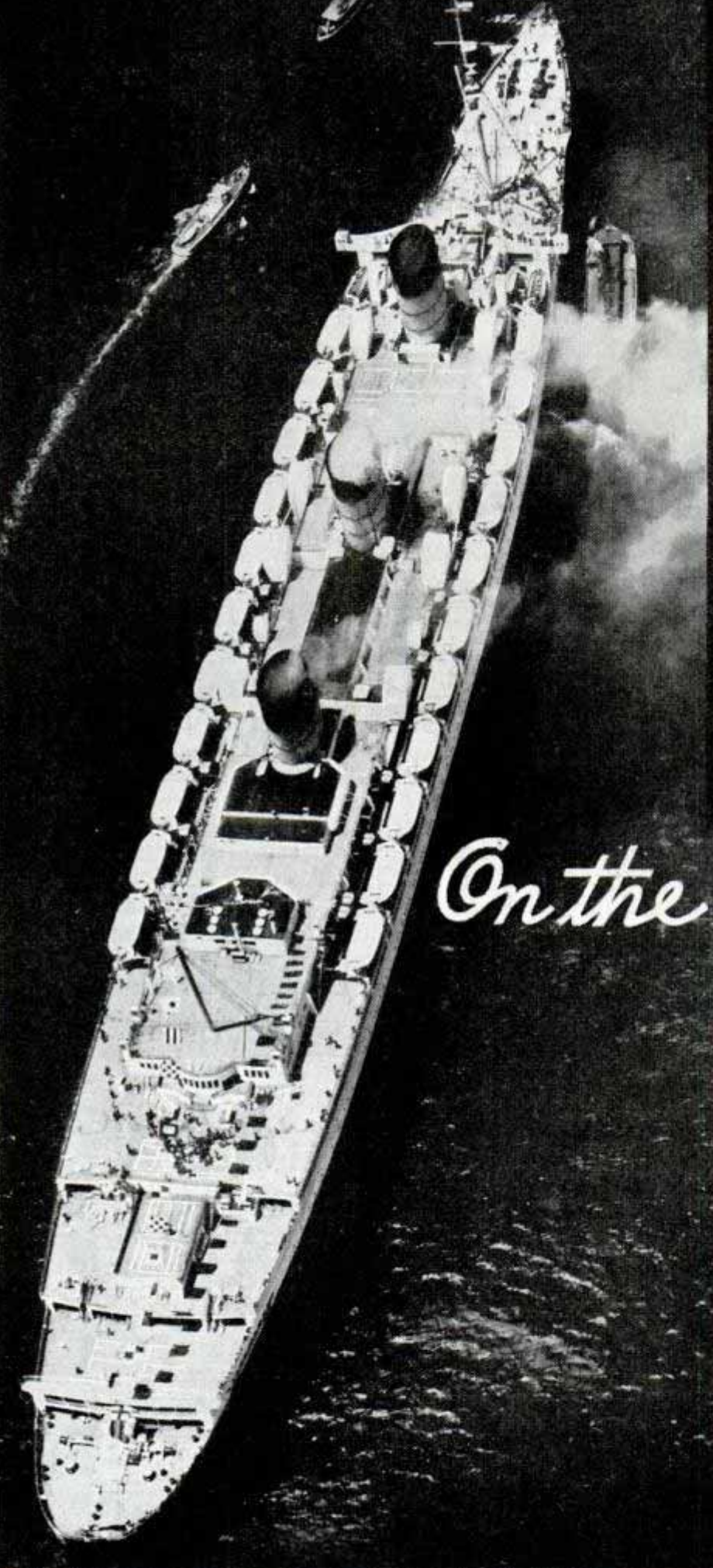

*On the*

# BRIDGE

2335

By

Commodore R. B. Irving  
of the R.M.S. "Queen Mary"

As Told to Julian P. Leggett

IT'S been a long time since I was in charge of a rowboat, but considering the vast difference in sizes, I believe that a superliner, such as the "Queen Mary," is about as easy to handle as a rowboat under good conditions.

Not so long ago, during a tugboat strike in New York harbor, we had the alternative of anchoring and waiting until the strike was settled or of docking without the help of tugs. Since the weather was perfect and we wished to avoid a long delay, we elected to try docking under our own power. It was high water and there was no wind. The "Queen Mary" answered her helm like a ferryboat, so that I was able to maneuver

*New York*

*Air view (left) shows many features of modern liner. Note lifeboats on either side. Right, the lookout in crow's-nest high above deck*

*Commodore White Star*



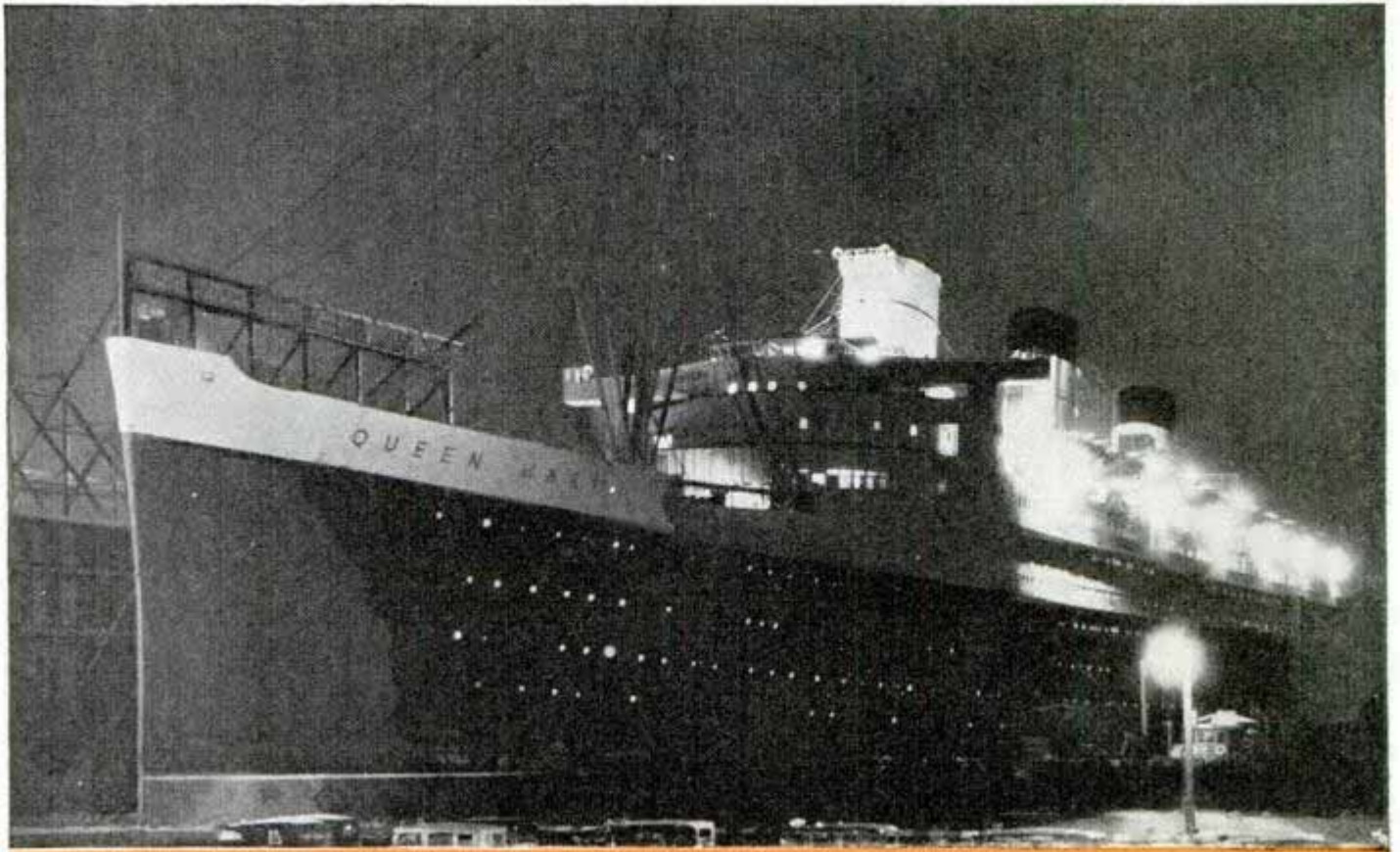

## of a SUPERLINER

her easily between the Cunard White Star pier and the Italian Line pier, which was unoccupied, fortunately. Then, with a small boat carrying a line ahead of us, we moved forward into our berth. We were off the end of the pier at 6:10 a.m. and at 6:44 the gangways were down, completing the job in exactly the same time as that required when tugs did the job. That was an emergency measure, however, and would never be employed when tugboat service is available.

Credit for such skillful maneuvering of any great liner should go, in large measure, to the well-trained crew—the men in the engine room as well as the officers on the bridge. All are at their stations, know just

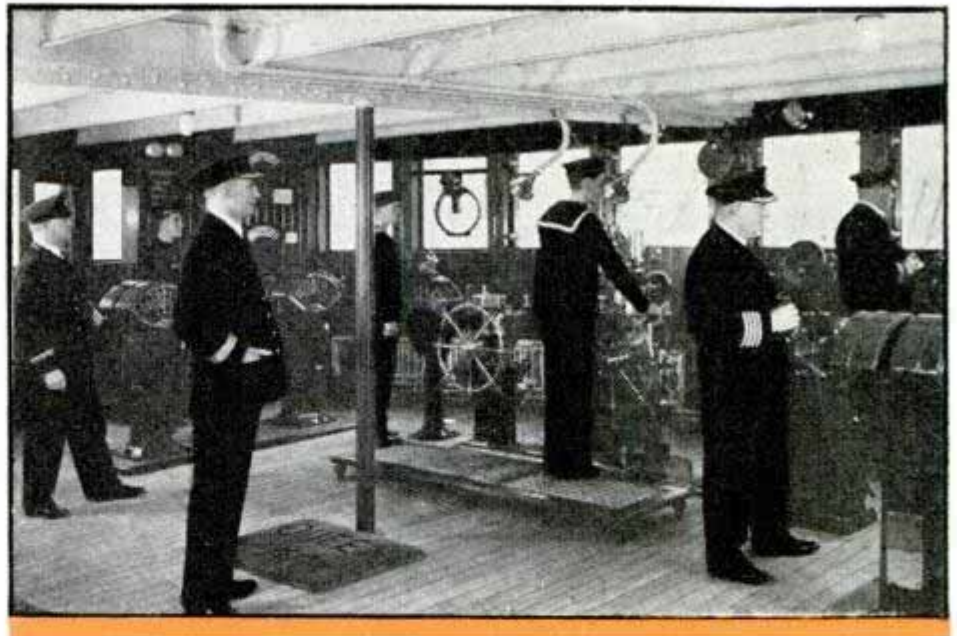

*Night view of brightly lighted liner at its New York pier. Below, on the bridge of the "Queen Mary." Commodore Irving is at left (foreground)*

what is expected of them and they perform it, as in any business. Cooperation, the giving and the obeying of orders at the proper time, plus the skill of officers, is the secret.

On the bridge I see that the men perform the duties expected of them. The bridge



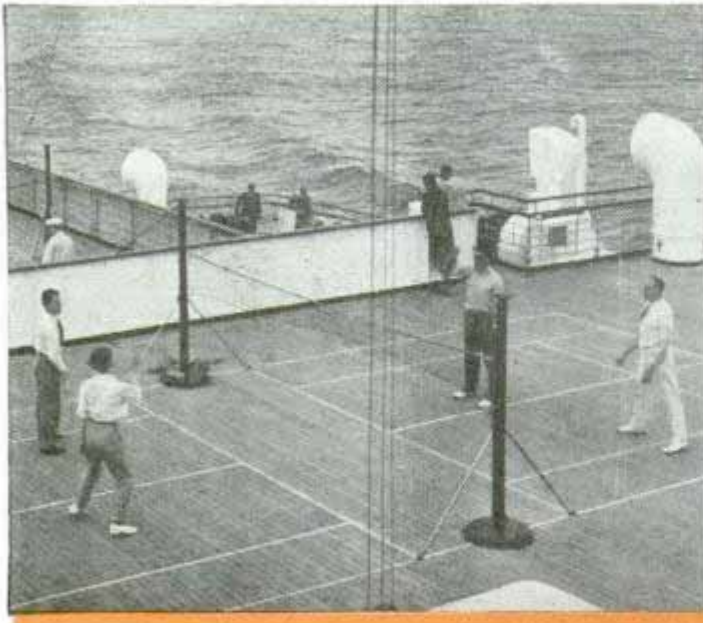

complement consists of seven officers, including myself, six quartermasters and four deck boys. The officers are responsible for the course we run and are constantly checking the instruments on the bridge for accuracy. The quartermasters handle the helm and the engine room telegraph. The deck boys run errands. There are about twelve instruments on the bridge, of which the Sperry gyrocompass is the most important, I would say. This compass is not affected by the earth's magnetism or metal parts of the vessel, and keeps the ship constantly on her course more accurately than any human being could. Even so, we cannot take any chances and consequently the compass is under constant supervision by one of my officers who checks it each hour for possible error by comparison with ordinary magnetic compasses and observation of the planets.

The engine room telegraph is the next instrument of importance on the bridge. It is controlled by one of the quartermasters who, at the direction of one of the officers, moves the indicator to whatever speed is required. In turn this change is automatically shown on the telegraph in the engine room where the engineers make the necessary adjustments in the ship's movements. These are

made at the engine room controls, which regulate the operation of the ship's powerful oil-burning engines, capable of approximately 200,000 horsepower. The power plant consists of a system of single reduction geared turbines, operating four propellers. The engines are "cushioned," similar to those in the modern automobile. Instead of being riveted directly to the bedplating, the foundations are "sprung," thus eliminating much vibration. Every one of the 257,000 blades for these turbines was tested and fitted by hand, to insure reliability. Each of four gear wheels meas-



Top, left, playing deck tennis. Right, example of luxury afforded cabin-class passengers aboard the modern liner. Bottom, partial view of starting platform, with engineer making out log. Dials show engine performance.



ures fourteen feet in diameter and together they weigh nearly 600 tons. The cutting of each wheel, calculated to a thousandth of an inch, occupied from two to three months. The five boiler rooms accommodate twenty-seven enormous boilers, having a total of nearly 160,000 tubes, and the boilers are fed oil from nearly fifty side bunkers. Six filling stations make it possible to fuel the ship in eight hours.

That great power plant is one of the factors in our record crossings of the Atlantic. In August, 1938, we sailed from Southampton with no intention of attempting a fast run. However, the weather was perfect throughout the voyage and we crossed from Bishop's Rock to Ambrose Channel light vessel in three days twenty-one hours and forty-eight minutes, the fastest westbound transatlantic crossing made by any passenger liner. On

(Continued to page 122A)

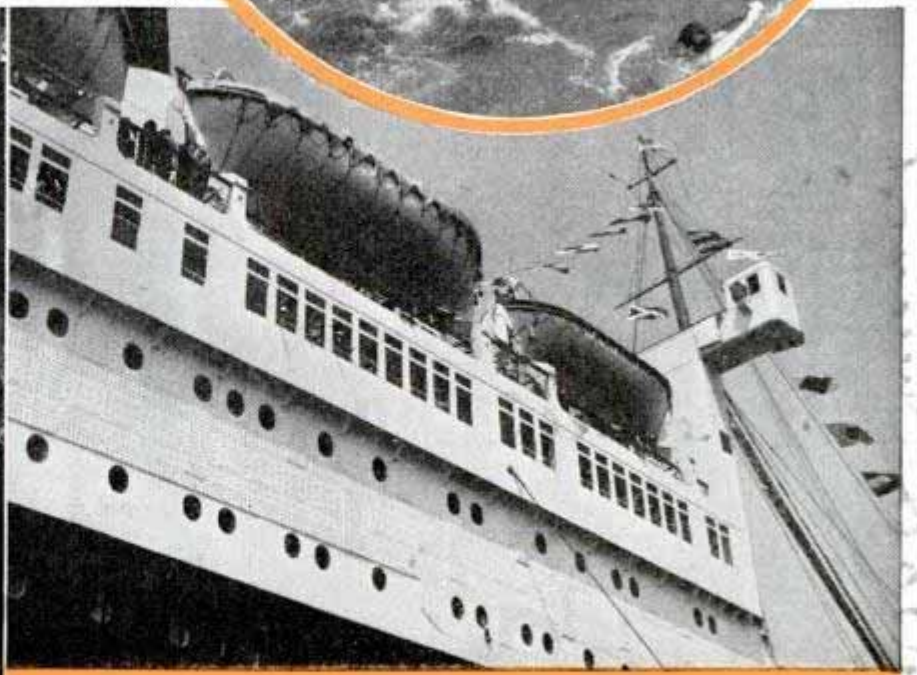
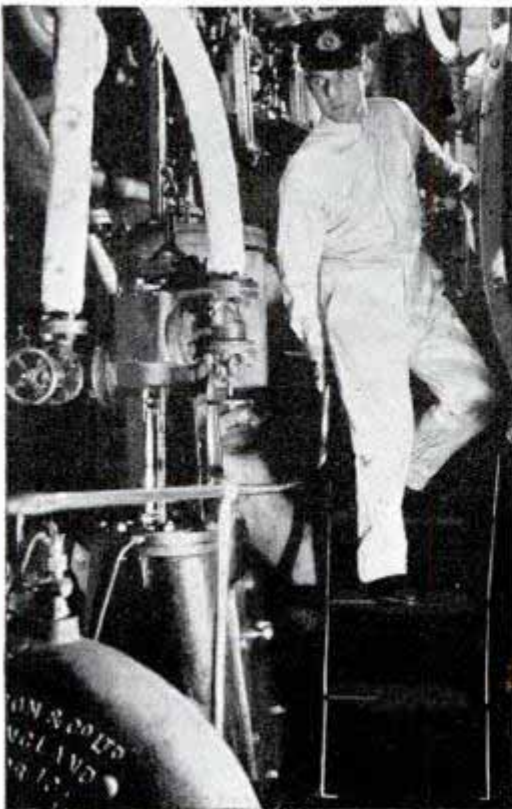
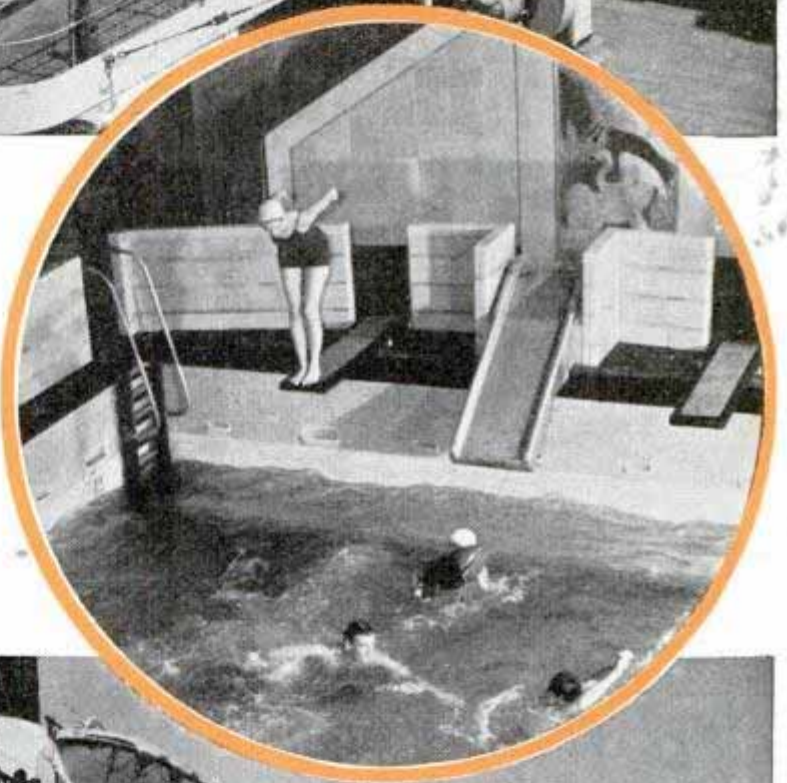

Top, officers of the watch on duty. Circle, swimming pool adds to passengers' enjoyment of voyage. Bottom, left, making routine inspection of auxiliary machinery. Right, view of boat deck, as photographed from U. S. coast guard cutter



2646

### Timer to Test Auto Ignition Flashes Neon Light

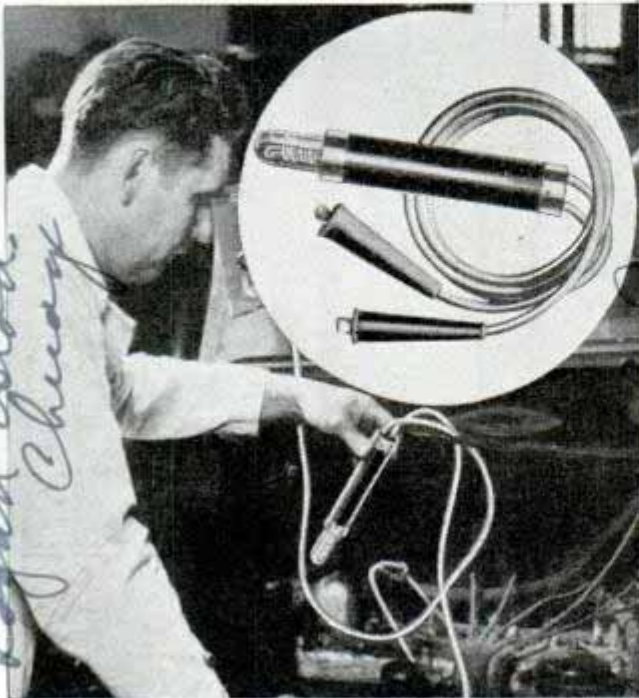

Inspecting ignition with neon-light tester. Inset shows the unit with its five feet of cord

Split-second timing of an automobile engine is accomplished by using a neon light tester that operates while the motor is running. With its aid ignition is timed, and the governor, spark plugs and ignition cables can be tested. The condition of worn distributor cams also is revealed as well as sprung distributor shaft or excessive play. A combination of silvering and saffron colored coating in the light dome concentrates the ray and triples its power.

### Clothes Rod Grips Edge of Shelf without Aid of Screws

Walls are saved from being marred by installing a clothes bar that hangs on a shelf without screws or nails to hold it. The notched ends grip the shelf, and put-

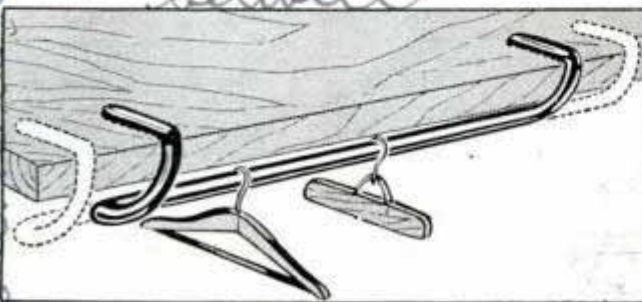

Self-supporting clothes rod gripping edge of shelf. Dotted outline indicates how bar may be extended

ting weight on the rod makes it take a tighter hold. It can be shifted from one closet to another and the ends telescope into the tube, making it adjustable in length from fifteen to twenty-four inches.

### "Navigation" Lights on Bicycle Protect Rider at Night

Red and green "navigation" lights attached to the front axle of a bicycle are proposed as a protection for "bike" riders at night. General use of these lights, low and close together, red on the left and green on the right as on ships at sea, would help identify the bicycle on the street. The lights have non-breakable lenses of transparent phenolic molded Bakelite, and operate on standard batteries in aluminum cases.



### Soundproof Diesel Generator Is Built in a Truck

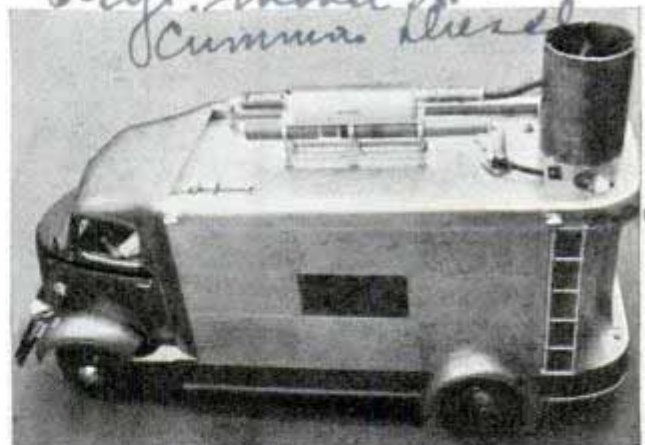

Cork and rubber walls absorb noise of Diesel generating plant on this truck, used on movie "locations"

What the movies needed was a portable electric generating plant that could deliver power for hours at a time "on location" and withstand the shock of sudden loads and variations in demand. So Paul Grosso built it, a Diesel generator in a duralumin truck, soundproofed so that it can operate within 200 feet of the sensitive sound microphones on the movie lot. Arrived on location, the truck driver pulls the steer-

E. Edelmann & Co. 2332 Logan Blvd. Chicago

Machie. Lovejoy Mfg. Co. 1706 W. 13th Chicago Ill

Delta Electric Co. Marion, Ind.

2673

2683

6-cyl. model 7 Cummins Diesel

Indianaapolis, Ind. Tower, Circle Research, Circle

Sedgwick International







g 50 G

Mr. Thomas G. Sumner, Jr.

10555 Hoffman Ave

Los Angeles

# SCIENCE-



IN 1908 a giant athlete put the sixteen-pound shot fifty-one feet for a record that most people thought would stand forever. But nineteen years later the mark was surpassed and you would have to put the shot more than fifty-seven feet one inch to be champion today. The record for the mile hadn't changed much in fifty years before Nurmi began his spectacular career. Now even Nurmi's speed has been beaten and the time for the mile today is about six seconds less than it was sixty years ago. In 1908 the farthest an athlete had ever thrown the javelin was 180 feet and since then some seventy-eight feet have been added to the distance.

Today man is running and swimming faster, jumping higher, and throwing things farther than ever before. Tradition to the contrary, he is better at feats of strength and agility than the best athletes of the past.

Why? Let's ask that question of Dean Cromwell, the "maker of champions" who



*Athlete practicing with discus (left); javelin thrower in action (right), and electrical pacing device that runs along track beside pool to train swimmers to maintain certain pace (circle)*

has been track and field coach at the University of Southern California for thirty years. Cromwell's students have a habit of creating new world records. A dozen of his athletes have been Olympic champions

Los Angeles, Calif



2-506

# the MAKER of CHAMPIONS



*Tumbler practicing by diving through hoop (top); high jumper "rolling" over bar (below), and football player training with aid of scientifically designed dummy (circle)*

and many others have record-breaking performances to their credit.

"Man is a superathlete today because science is providing him with better tools and is teaching him to use them better," Cromwell says. "A sprinter can run faster on pavement than he can in sand but he can run fastest on a scientifically designed

track that has just the right amount of resiliency. Pole vaulters are better than they used to be because we have thrown away the heavy poles they once used and provided light bamboo poles for them. The men have smaller loads to carry up into the air. Once javelins were so flexible that they vibrated in the air, cutting down their flight. Now we are using javelins of stiff birch that fly much farther.

"The fastest races are run on springy tracks that have surfaces firm enough to hold the spikes. A six-inch layer of wood



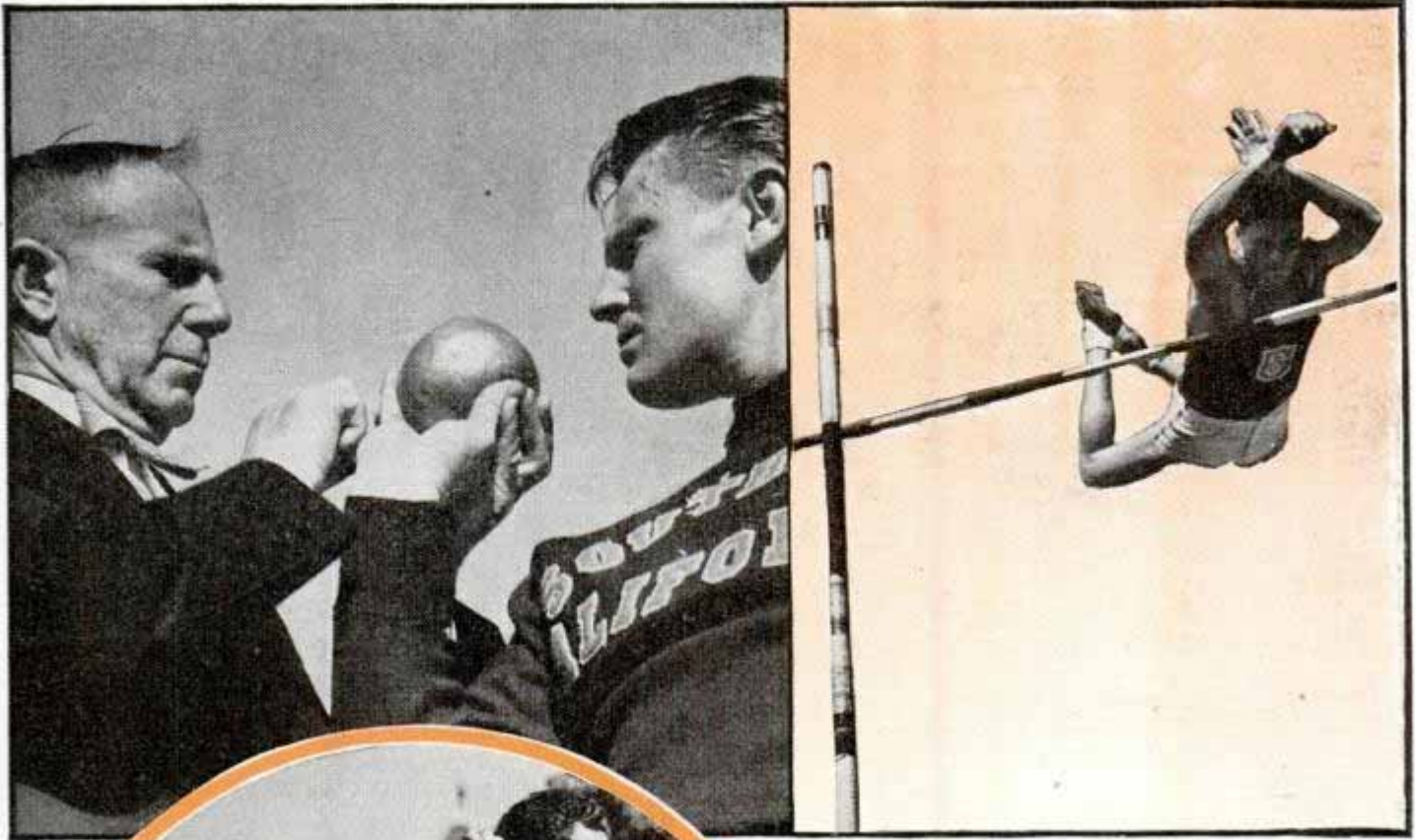

*Coach Cromwell corrects shot putter's style (left); holding body parallel with ground while going over bar helps set pole-vaulting records (right), and runner clearing high hurdle in race (circle)*

shavings rolled down to two inches, covered with well-packed soil, makes a fast track, as does a properly constructed cinder path having a base of large cinders with smaller ones above them and a final top dressing of fine material."

A mechanical freak among running tracks is the wooden indoor practice track at Dartmouth College. It is called the fast-

est track in the world. However, records made on it are unofficial because only outdoor performances count in the books. On this track Glenn Cunningham recently ran the mile in 4:04.4, faster by two seconds than it had ever been run before and possibly a couple of seconds slower than the time Cunningham might have made if he had been familiar with the track.

The course is fast because the builders worked out their own ideas instead of following the usual type of construction. The surface consists of one-and-a-half-inch solid spruce boards on a two by four framework. The planks run lengthwise along

the straightaways but are set across the course at the turns and the turns are banked thirty degrees instead of the usual twenty degrees. The wooden track is laid on an old indoor cinder track which partly accounts for its springiness.

Mere ability to run fast would never win a sprint today. Spiked shoes, starting blocks or holes, a crouching start, and a



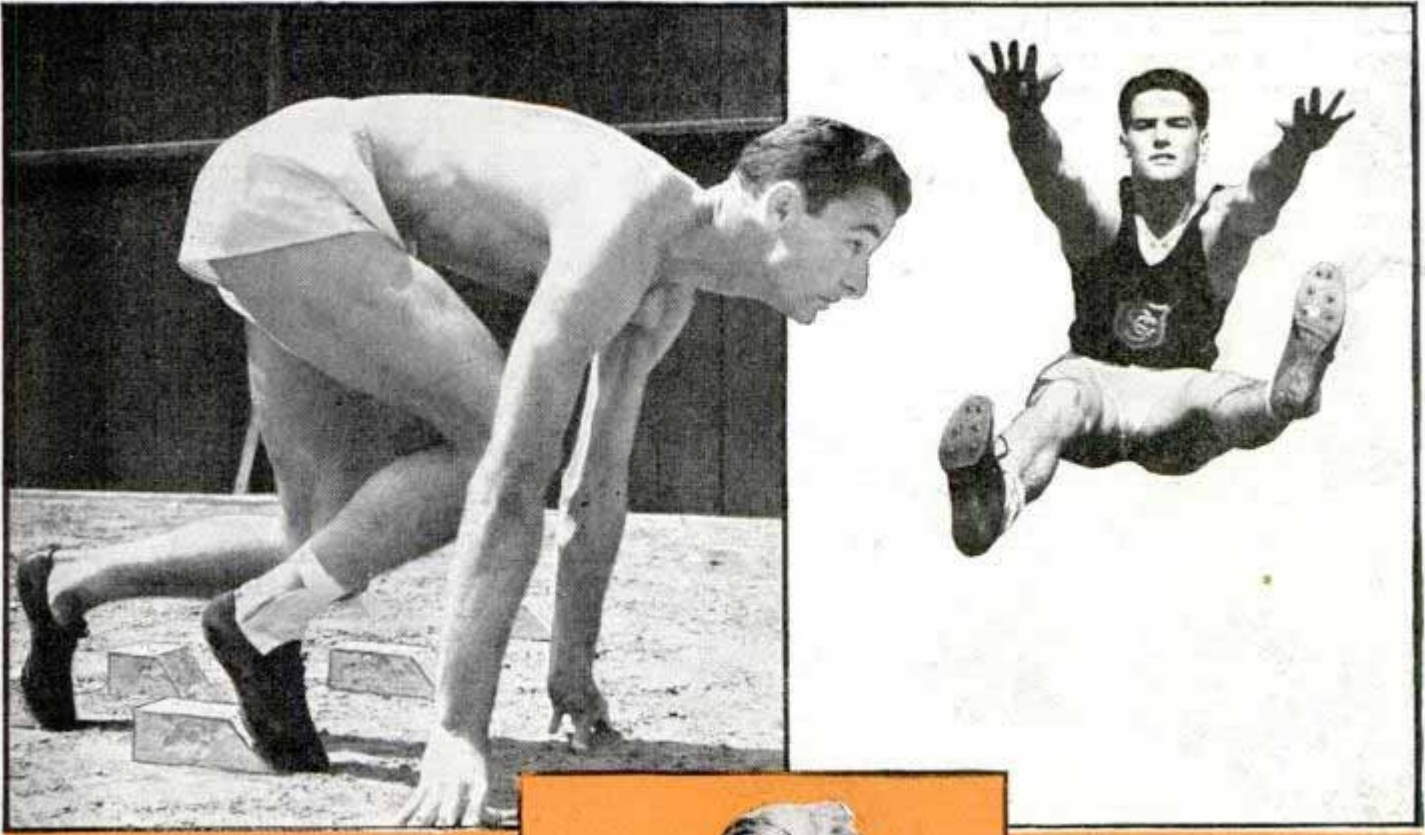

leap at the finish all contribute to reaching the finish line sooner. With training, a runner learns to get away simultaneously with the sound of the starting gun, seemingly reducing reaction time to nothing.

To avoid carrying an unnecessary load the weight of an athlete's shoes and clothes is reduced to a minimum. Sprint shoes have six long spikes in the soles to get a grip on the ground and the shoes used by broad jumpers and other field men also have two spikes in the heels. Athletes are still experimenting for the most satisfactory shoe, and one of the latest kinds used by field men is fitted with a large thin metal cleat shaped like a horseshoe.

Offhand you might think that if you threw the discus with a tail wind behind it you would get the best distance, but wind-tunnel tests have confirmed the fact that the opposite is true. An athlete may add as



*Sprinter braced against wooden blocks to get powerful start (top, left); broad jumper after the takeoff (right), and javelin thrower extending arm backward to get benefit of long pull (bottom)*

much as twenty feet to his normal toss by throwing it across wind or even directly into the wind. The spinning discus takes on some of the properties of an air-foil shape. Manufacturers once made the discus by shaping it out of a block of wood cut across the grain but now they cut the shape horizontally with the grain. It travels farther that way.

Natural ability rarely wins a championship any more. A good coach breaks an action down into its separate parts, studying each motion of a runner's stride or analyzing step by step the movements that comprise the broad jump. Any performance is reduced almost to a mathematical problem with the idea that when each separate motion can be made most efficiently the com-

(Continued to page 118A)



## Baby's Life Size Gas Mask Also Is Used by Its Mother



*Mother helps baby breathe by drawing air into inclosed chamber which is impervious to poison gas used in air raids*

Twofold protection is given by a gas mask recently tried in Paris, that supplies pure air to both a mother and her baby in case of war. The baby is encased in a gastight bag, and the breathing apparatus is so arranged that the mother draws air into the container for the baby as well as for herself. This helps the infant who could not breathe strongly enough to pull air through the valve.

## Some Birds Can't Hear Man in Ordinary Speech

Some birds cannot hear ordinary human voice tones, but only sounds two octaves and more higher than middle C on the piano, it was learned in tests at Cornell University. The tests were conducted in a cage in which the birds were able to get food only while standing on an electrical platform. A whistling sound warned them

that their claws would receive a slight electric shock if they remained on the platform. When the birds learned to hop off the platform to avoid the shock, the tone of the sound was varied to measure their range of hearing. Sparrows and starlings, it was found, paid no attention to the note when it dropped to about two octaves above middle C. The sparrows could not hear sounds below 675 cycles a second, and the starlings' hearing washed out at 700, a slightly higher note. Pigeons heard faintly down to 200, or nearly two octaves lower; but below 500 cycles they appeared rather insensitive to sound. At the upper end of the scale the birds did not quite match the best human ears, which are sensible to sounds to about 16,000 cycles.

## Hill-Hold for Brake Pedal Is Operated by Left Foot

Virtually giving the driver a third foot to hold his brake pedal while releasing the clutch on a hill and at the same time pressing the accelerator, a small bracket attached to the brake extends to a point near the clutch pedal. This extension arm holds the car motionless when depressed by the left foot while also holding the clutch, and the brake is released as the clutch is being engaged.

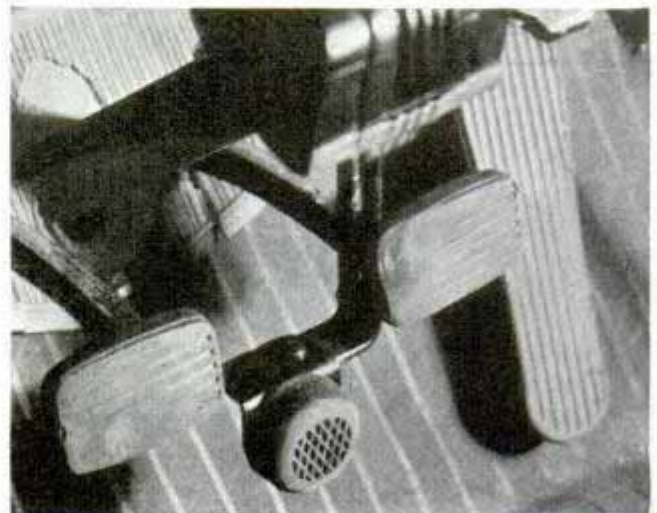

*Pressing clutch pedal and hill-hold bracket with left foot leaves right one free to operate accelerator*

2664

Althaca, NY

L. L. Esriver, 542  
Los Angeles



# Egg "Poached" in Liquid Air Is Hard as Stone

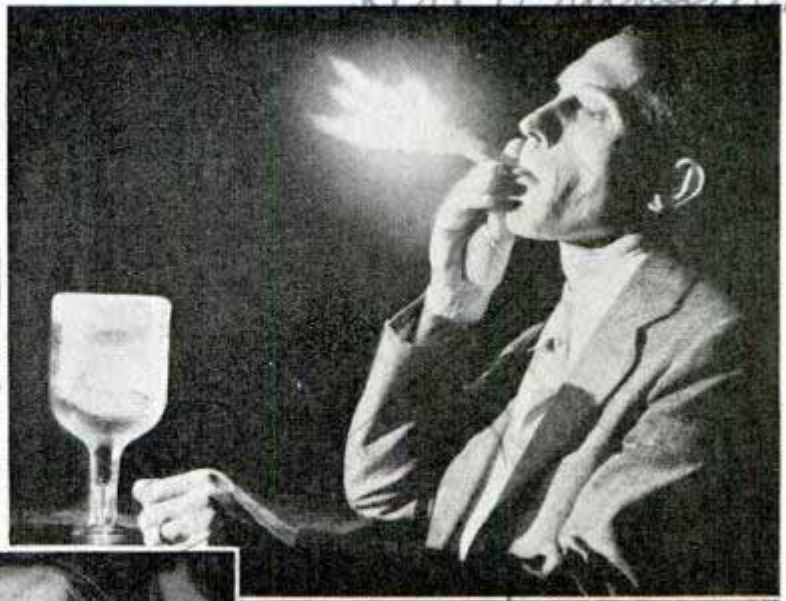

Top, left, breaking egg with chisel; right, cigar spouting flame. At bottom, vapor from liquid-air cocktail is exhaled

Cigars and eggs take on queer characteristics when immersed in liquid air, it was shown in demonstrations at the National Bureau of Standards. The cigar becomes saturated with excess oxygen, and when lighted spurts flame like a Roman candle. Subjected to the low temperature of liquid air, which is about 310 degrees below zero Fahrenheit, an egg comes out so hard that instead of a knife and a fork, a hammer and chisel are required to break it.

## Apple Bobbing on Grand Scale Held in Swimming Pool

Apple bobbing has grown into a major annual event at Seattle, Wash., where some 30,000 apples are dumped in an indoor swimming tank so youngsters may plunge in and try their skill. After the contest, apples that escape damage are given to charitable organizations. The state of Washington, called the nation's "apple basket," produces approximately 23,000,000 boxes of apples each year, and the large crop yield is feted during the autumn season.

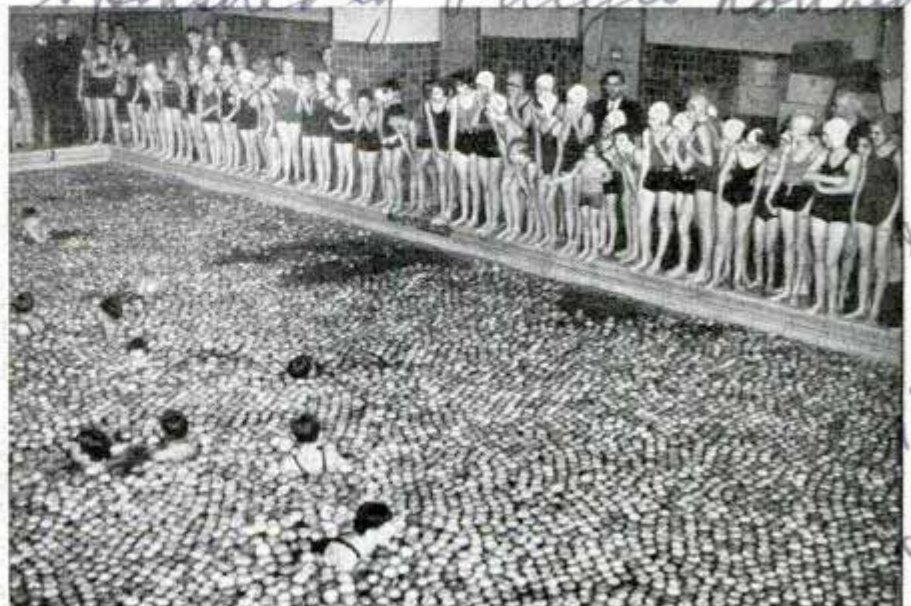

Children swimming among 30,000 apples in extraordinary bobbing contest conducted in large indoor pool to celebrate the annual fruit crop

Washington Athletic Club.

*J. W. Cox  
Washington  
2601 Constitution Ave  
Washington D.C.  
Dr. Francis Smith*

*Washington D.C.*

*Yakima Wash.*

*Grand  
Bridgeton Park Wash  
Blakely*



2597

Mr. Thomas G. Stinson, Jr.  
10555 Hollywood Ave  
Los Angeles Calif

# RICHES of the

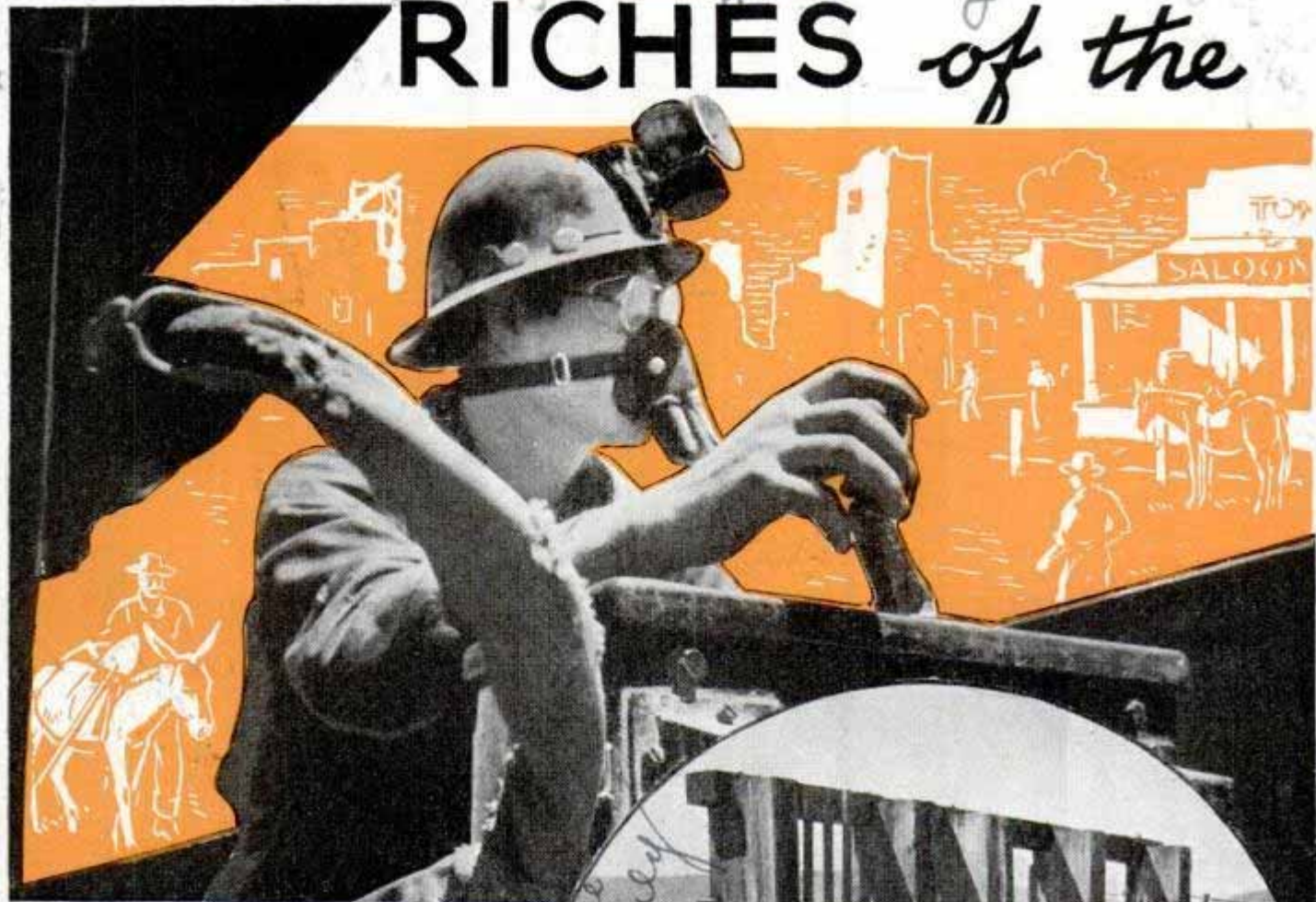

WITH few exceptions the dozen or so famous lost mines of the west remain as great mysteries today as when hordes of early prospectors first took up the search for them. The Lost Peg-Leg, and Lost Dutch Oven, the Mine with the Iron Door and other lost mines of tradi-

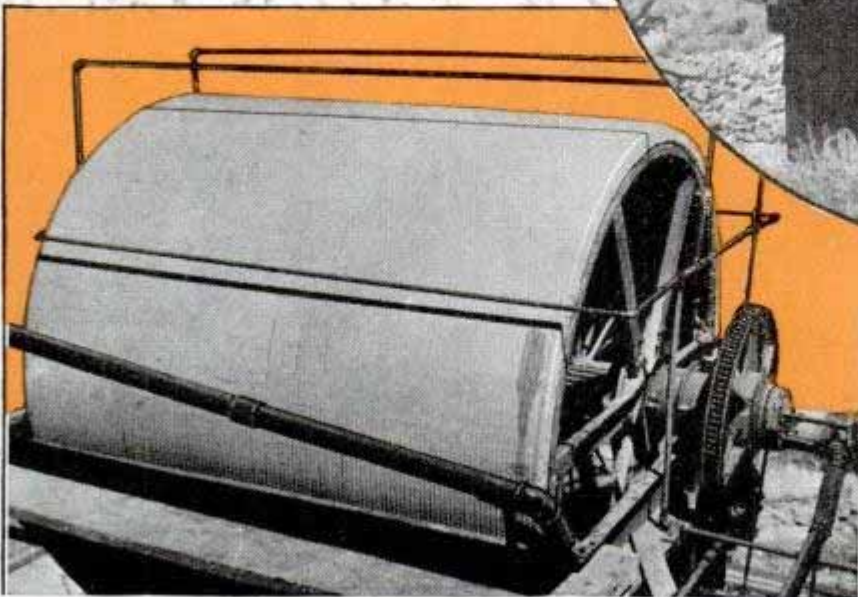
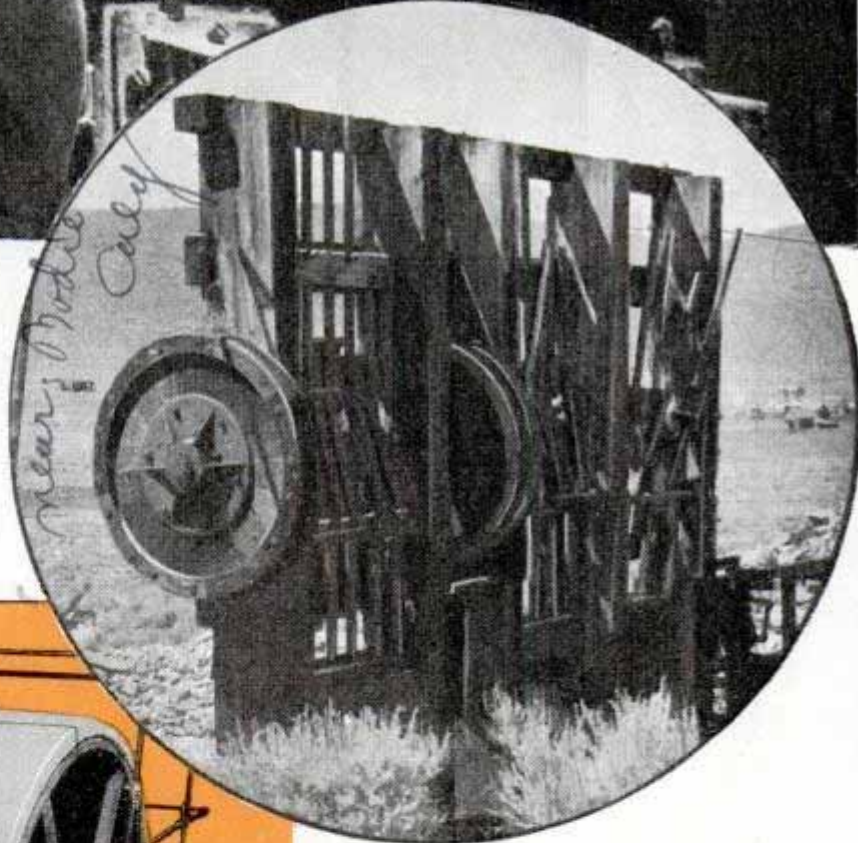

tion seem to have vanished into the haze above the mountains and desert hills.

Modern prospectors don't bother to hunt these will-o'-the-wisp promises of fortune because there are plenty of other mines that are easier to find. Picking his way along a creek bed this fall, a prospector may

Top, miner at controls of electric locomotive hauling ore from mine to mill. Circle, remains of old wooden stamp mill at early gold camp. Bottom, gold-refining equipment on Soledad Mountain, California



California Testing Laboratory, 2577  
1429 Santa Fe Ave Los Angeles

# FORGOTTEN MINES



spot a cluster of rocks piled in a heap on the hillside.

"Hm. Someone's claim monument," he muses. "Let's find out how old it is and what the ore looks like." If the location notice, usually scribbled on paper and protected in a tobacco

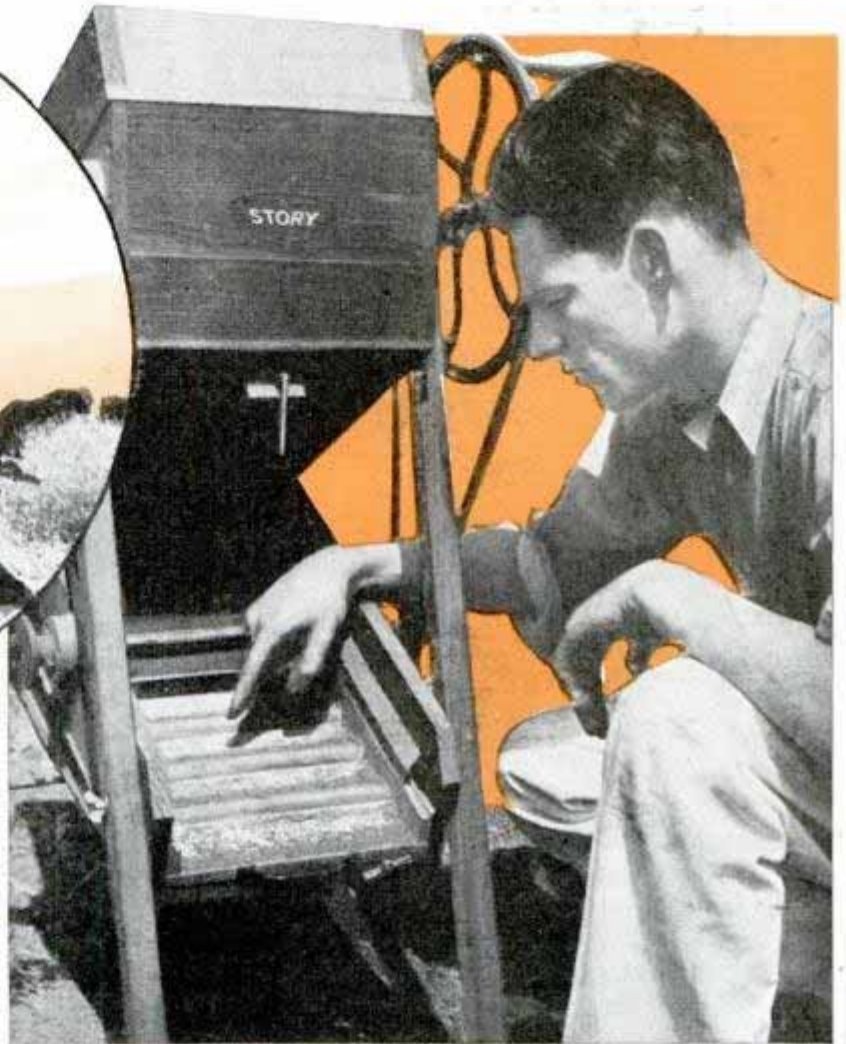

Top, resting place of early prospector; right, dry washer that separates gold dust from sand. Below, working sluice box in Mother Lode country

co can, reveals the claim is a recent one the prospector goes on his way, but if the claim is ten or twenty or fifty years old and no work has been done on it the prospector investigates further. Someone, he figures, found rock that looked valuable enough to spend half a day erecting monuments. Discovery rights have lapsed and now the ground can be relocated. Hundreds of early prospectors claimed ledges of rock that had possibilities and then never returned to develop them. Lost and abandoned claims and mines are scattered throughout the west and when you find one on public land you may claim it for your own. Perhaps it is worthless, but perhaps it may develop into something rich.

In many cases the piles of rock erected by the '49ers to mark their claims and the tunnels and dumps they created have vanished without a trace. Nature is constantly changing the scenery. Rocks tumble to the

(Continued to page 140A)



Science fiction  
6/1/39

# Stunt Rider Flies through Air over Two Men and Horses

2653

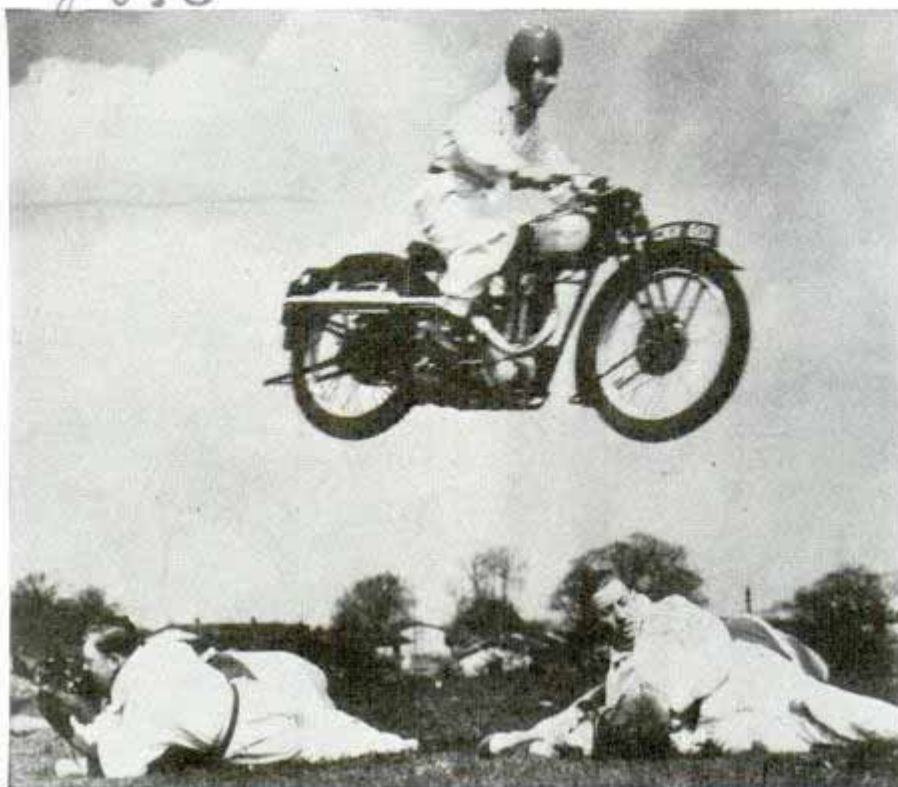

Two men lying on ground with their horses are probably more worried than army motorcyclist hurdling them in London stunt performance

It takes nerve to "fly" a motorcycle, but it also takes nerve to be the "ground crew" when the stunt rider is sailing overhead. A dispatch rider of the British army signal corps performed this spectacular leap at a London tournament, hurdling two men and two horses in his jump.

at Caterham Camp, England Hollywood Surf Club

## All-Weather Light System Helps Pilot Land in Fog

Air-line service in all kinds of weather is brought a step nearer by radically new runway lights that fog cannot hide from the pilot. The lighting system, which is being tested at the government experiment station in Indianapolis, involves a complicated lens arrangement making the lights visible for 500 feet almost regardless of the weather's thickness. Once radio has led the pilot to the runway's approach, he can follow the row of lamps to land safely. Four different colors are used—green to mark the approach, white the runway proper, and yellow

Civil Aeronautics Authority



Welded permanently into the pavement, these stools offer a bit of comfort to spectators at a California racetrack

clw. John O. Bartow

the end of the runway, while the backs of the lamps glow in red to warn the pilot if he heads in the wrong direction. One peculiar effect of the lenses is to make each lamp look just as bright to the on-course pilot whether he is 100 feet or 500 feet away from it, and yet the powerful light is so controlled that it does not become blinding. The secret lies in taking advantage of the changing angle between the moving plane and the lamps. The lights are spaced 200 feet apart.

## 2651 Stools for 'Railbirds' Welded in Sockets at Racetrack

"Railbirds" watching the races at the Inglewood, Calif., track no longer have to lean on the fence to rest. Three long rows of permanent stools have been provided for them, the pedestals being welded into sockets laid in the cement.



# Bouncing Radio Beam Warns Pilot of Danger

Mountain, tall building, aircraft—any solid object that looms in the path of a plane is detected instantly, miles away, on the voltmeter of a power beam transmitter demonstrated recently at Floyd Bennett

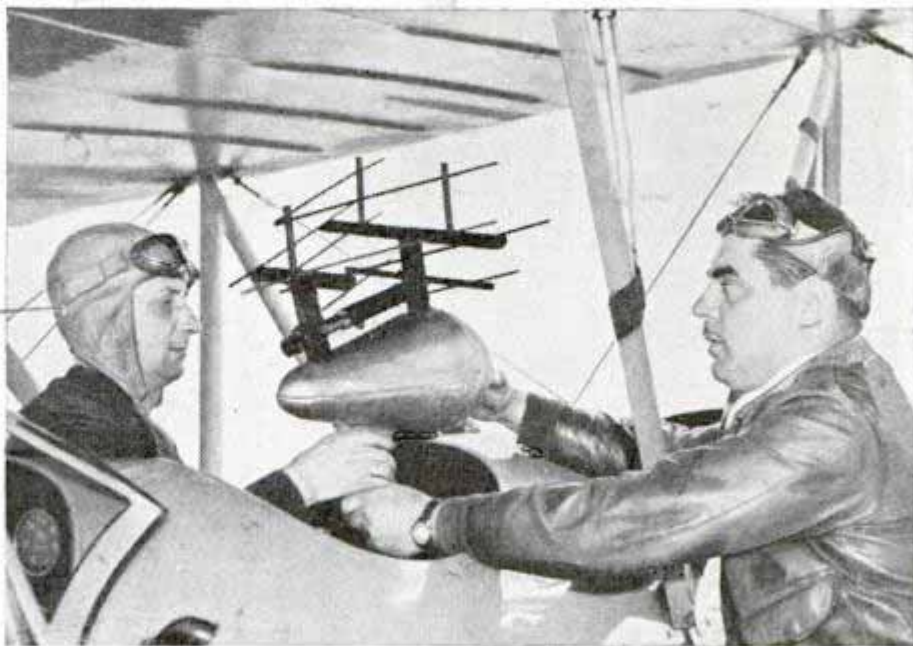

Using radio beam to detect hidden aircraft, left, and to indicate obstacle in path of plane, above

field in Brooklyn. The beam, reaching a circumference of 250 feet, is shot from a three-tube set in a "teardrop" aluminum housing that weighs altogether ten pounds and uses 180 volts from dry cells. When this beam strikes any object more than a yard in diameter it rebounds to its source, registering the obstruction on its voltmeter. So sensitive is it that a pilot flying 3,000 feet high was able to "pick up" the Tylon at the New York world's fair from fourteen miles away. Besides acting as a warning guide to pilots flying blind, it could be used aboard ship to detect icebergs, vessels or land hidden in fog; or by ground crews to spot lost aircraft.

# Water-Going Mowing Machine Cuts Weeds in Lagoon

When a growth of water plants choked a park lagoon at New Braunfels, Tex., a mechanic with an inventive turn of mind came to the rescue with his water-going mowing machine. Driven by a light automobile engine, an all-steel scow is equipped with powered cutting blades at the front. Controllable wings at the stern serve as rudders and shield the propeller.



Blades mounted at the bow sever weeds as mower moves through the water

D. Stahl Corp. • Christus

g. 67 ... saving success  
New York City  
Corp. 280 Broadway  
New York  
Almaguad



2667

# Robot Information Cabinet Answers Your Questions



Talking cabinet will tell you location of any place in city if you lift lever to its name shown on panel

Information about the location of prominent places in a city, such as theaters, parks, public institutions and hotels, is given by the electric "Informat" which telephones advice directly from a reproducer. To ask a question you take the receiver off the hook and raise a lever to the name of the place you desire information about. Then you listen to the voice of the machine. Five hundred places can be listed in a unit.

## "Chaser" Restores Worn Threads on One to Five-Inch Pipes



Damaged, battered and crossed threads of old pipes can be cleaned and restored for use by a tool recently announced. Fitting any size pipe from

one to five inches in diameter, the chaser is simple to use and can be adjusted to match any one of nine pitches, working with threads ranging from eight to twenty-four per inch. Besides pipe, it will handle axle housings, bearing cages and large shafts.

## Wear in Bearing Surface Shown by Measuring Indentations

To measure the amount of wear on the bearing surfaces of machinery, the Bureau of Standards has developed a method of marking the surface with minute indentations. This is done with a specially shaped diamond point. The dimensions of the indentations are taken before and after the bearing has been used, and the change of the dents during use makes possible a quick and accurate determination of the extent of wear.

## High-Speed Valve Tool Is Offset for Working Close to Cowl

Turning at a speed of 12,000 revolutions a minute, a powerful valve seat grinder provides fast cutting action with only slight pressure. Because of its offset design, the tool needs no extra attachments to reach valves back near the cowl. The manufacturer claims it will grind to an accuracy within .0001 inch.



Electric valve grinder works efficiently in close quarters and can be held securely with one hand

Informant Co. R. 1010 S. Michigan

Watson Tool Co. Watonia, Michigan

Clarinda, Inc.



# TAKING AMERICA'S PICTURE

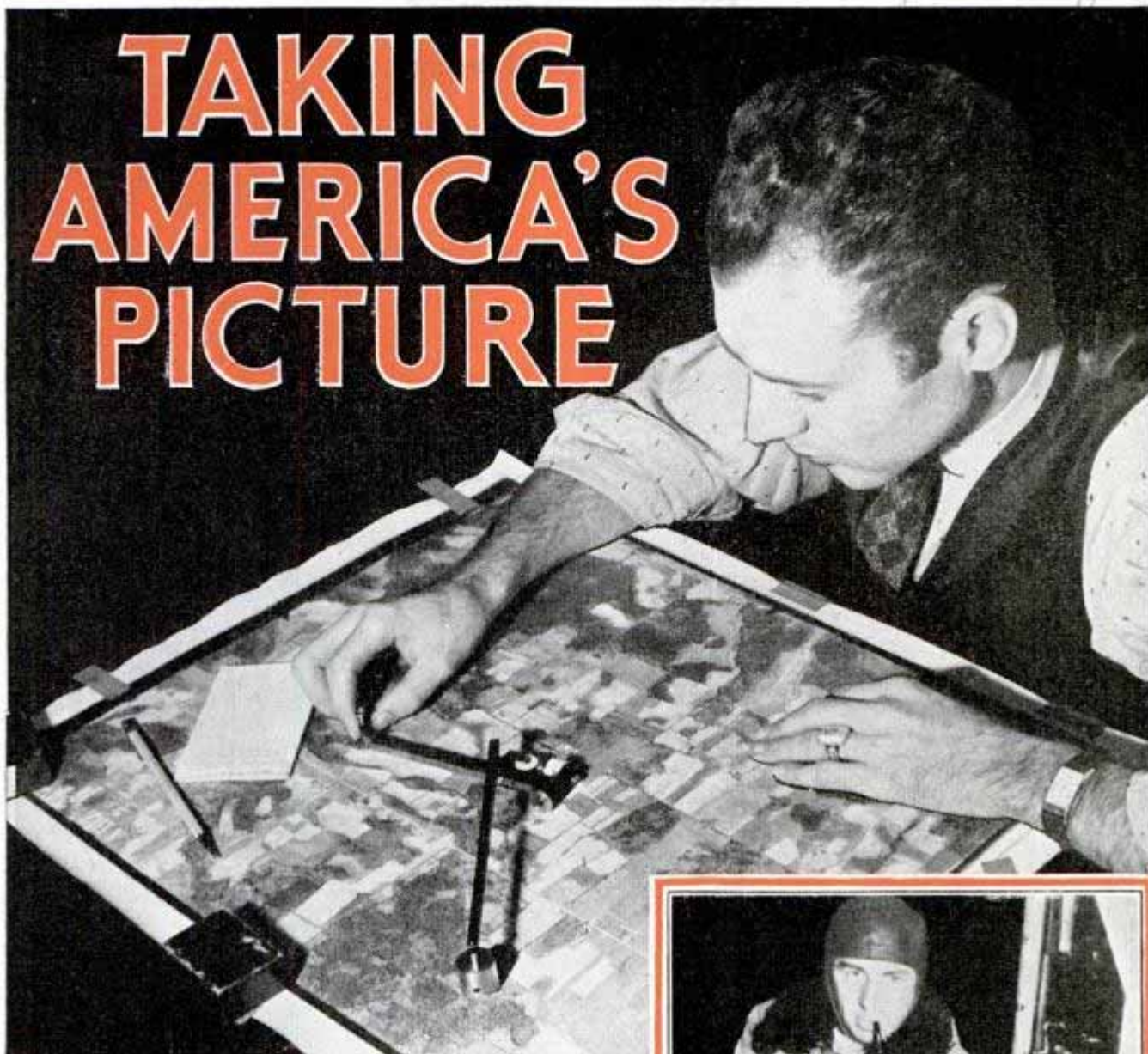

**I**N THE thin air 14,000 feet above Nebraska's farm lands a tiny speck shuttles back and forth in the cloudless sky. Simultaneously over the cattle country of Montana, the cotton lands of Mississippi, the forests of Oregon and the terrain of other states other little specks are flying back and forth, at the same distance above the ground.

These airplanes, almost fifty of them, are cabin jobs, scientific photographic studios of the air. Equipped with oxygen tanks for pilot and photographer, precise flying instruments, modern aerial cameras, film and filters, they are engaged in the gigantic task of taking America's picture, a job that involves more than 1,333,000 nine-by-nine inch photographs of some 3,000,000 square miles of land.

When the huge undertaking is finished some years hence, a detailed picture of the United States will show all of America's visible natural resources. It will show the extent of soil



*Aerial map in use (top) and flying photographer with oxygen tube in mouth*





*Top, indexing aerial photos composing map of county. Bottom, photo shows strip cropping to combat soil erosion*

erosion, the course of lakes and rivers and sites for future dams and irrigation projects. It will be an invaluable scientific aid to the United States Department of Agriculture, the Civilian Conservation Corps and other agencies which are already using completed sections of the pictorial map for flood-control work, checking crop control and for other constructive projects.

America's picture will cost approximately \$15,000,000, just a fraction of what it

would cost if land-bound surveyors attempted to do the same task and spent an inestimable amount of time conquering mountains, deserts and waterways in so doing.

The aerial photographers have their hazards too, but they have overcome the great majority of these with one exception—the weather.

"In taking America's picture the weather is a highly important and uncertain factor," says William H. Meyer, Jr., general manager of Fairchild Aerial Surveys.

"In and about New York City, for example, we can figure on one suitable photographic day in every seven, or about four and one-half a month. This average will vary for different sections of the country. The yearly average, based on the Weather Bureau data for the past thirty-seven years, broken down to a monthly average, gives Colorado approximately seven days per month, California in certain sections as high as fifteen days per month and Arizona eighteen days per month.

"One of the qualifications for this work is to be able to conquer the mental as well as physical hazards of the weather, to use every flying minute to the greatest advantage and outwit the 'jumps' and 'jitters' which are apt to creep up on a photographic crew if they can't maintain an even disposition while waiting for the right kind of weather. On one project in

Tennessee we had to wait sixty-seven days for a break in the weather. It must also be remembered that in photographing the United States, the government has specified that photography may be undertaken only when the sun is at an angle of twenty-five degrees above the horizon.

"Before a crew is sent out on an assignment flight maps are prepared, the camera is thoroughly tested and sufficient panchromatic supersensitive aerial film, usu-

*Charles County, Md*



ally in rolls 150 feet long and nine inches wide, to complete the assignment is taken along. From a roll of film approximately 185 individual nine-by-nine inch exposures are made.

"On a good day they may photograph as many as 500 square miles of terrain, the developed pictures showing every fence, house, and tree in the area. These individual exposures are taken with a Fairchild aerial camera equipped with an eight-and-one-quarter-inch lens."

Eighteen aerial survey companies, including Fairchild, are engaged in the job of taking the country's picture.

Photographing from the air calls for a high degree of specialized skill on the part of pilot and photographer alike.

"In addition to being expert aerial photographers," says Mr. Meyer, "they must have a thorough knowledge of the construction and maintenance of the cameras in order that necessary repairs may be made at the base of operations, rather than having to send the equipment back to the factory, thereby losing valuable time."

Photographic pilots too are chosen for

(Continued to page 135A)

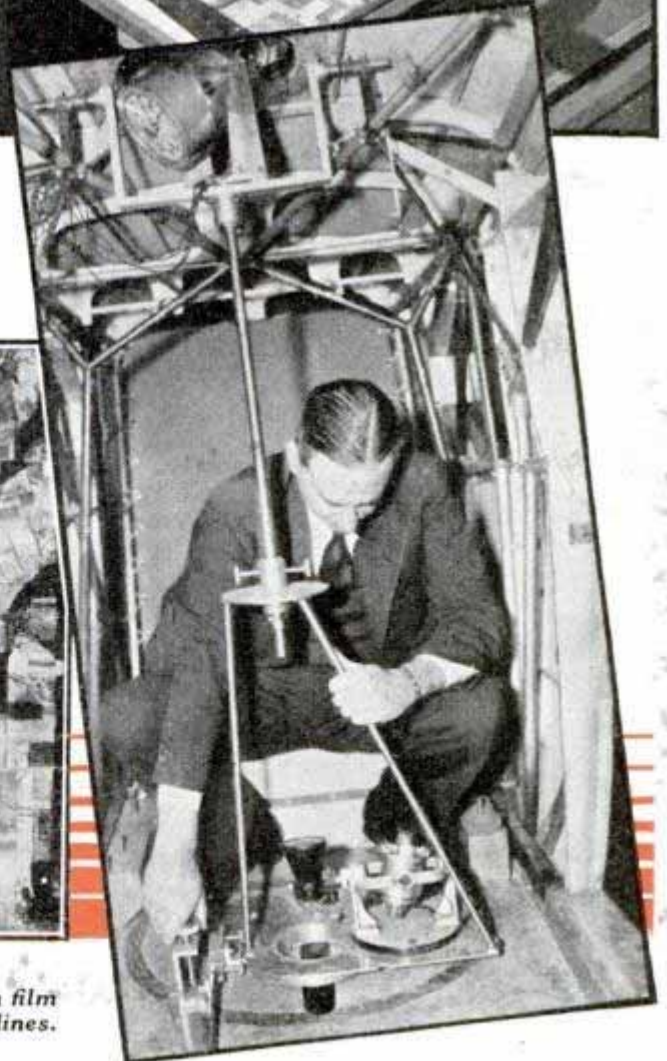

Top, enlarging camera for projecting aerial photos from film roll. Right, device which facilitates flight on parallel lines. Left, Floyd County, Ind., from the air



# Motor Bike without Pedals Speeds Delivery Service



Western Union messenger rides lightweight motor bicycle to save time and effort

Telegraph messengers in big cities are being equipped with "telemotors," motorized bicycles without pedals. Controlled entirely from the handlebars, the vehicle is intended to speed up service in less congested sections. It is faster and less fatiguing than a bicycle.

# Salmon Ride in Trucks over Dam on Way to Spawning Ground

Six trucks of radical design have been finished recently to transport salmon from the lower river to still water above Grand Coulee dam during the spawning season.

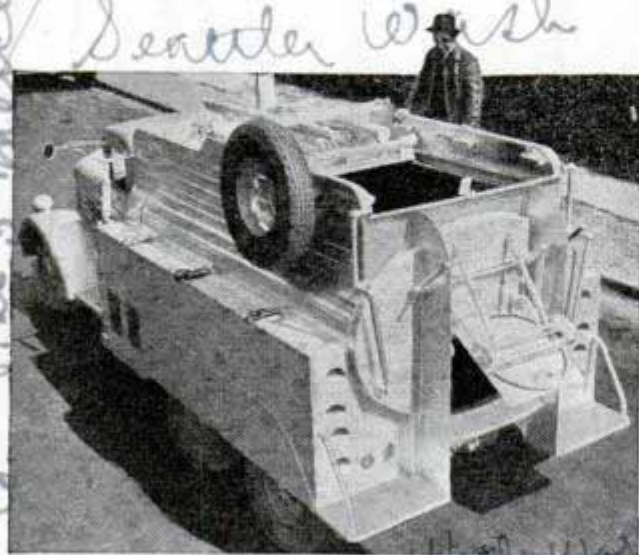

Salmon get lift in this truck over barrier erected by man between ocean and spawning ground of the fish

Each truck has a large tank at the back that holds about 500 gallons of water and can carry 400 or 500 fish. These are put in through the top of the tank, and to unload its burden the truck is backed onto a pier and a door at the back opened, pouring out fish and water together.

# Chopper for All Kinds of Food Has Three Cutting Blades

Cutting up food is speeded and the work lightened by a chopper with triple knives that has an easy spring action. Raw or cooked meats, vegetables or fruits can be



Cabbage is easily and quickly shredded. Inset shows chopper used in cubing and tenderizing steak

chopped for either fine salads or coarser dishes. The cutter also will shred cabbage, cube and tenderize steaks, dice potatoes and other vegetables, and cut potatoes for French fries.

Our Bureau of Information keeps on file the names and addresses of makers of, and dealers in, all devices described in the pages of Popular Mechanics Magazine. We are glad to furnish this information to our readers upon request, accompanied by stamped, self-addressed envelope.

Handwritten notes in the left margin include: '2697', 'Simplex Mfg Co', 'Southern Bldg', 'new York', 'Western Union', 'Telegraph', 'Union', '681', '2644', '75 cent', '2517', 'Seattle Wash', 'Renwood Motor', '1263 Meyer', 'Dolley Mfg Co, 9-11 main', 'H. E. Hume', 'H. E. Hume', 'H. E. Hume'.



# Cement Cover Turns Wrecked Ship into Pier

Conversion of the hull of a grounded mailboat into a substantial pier large enough for warships to use is the accomplishment of French engineers. The ship, "Fountainbleau," ran aground in Djibouti harbor after fire broke out, settling into mud at a point where the water was about twenty feet deep. This left the ship half submerged. Engineers, failing in their attempts to raise the craft, hit upon the idea of converting it into a pier and soon the hull was encased in layers of cement and stone. Now the concrete-covered ship is in use, French warships frequently mooring there.

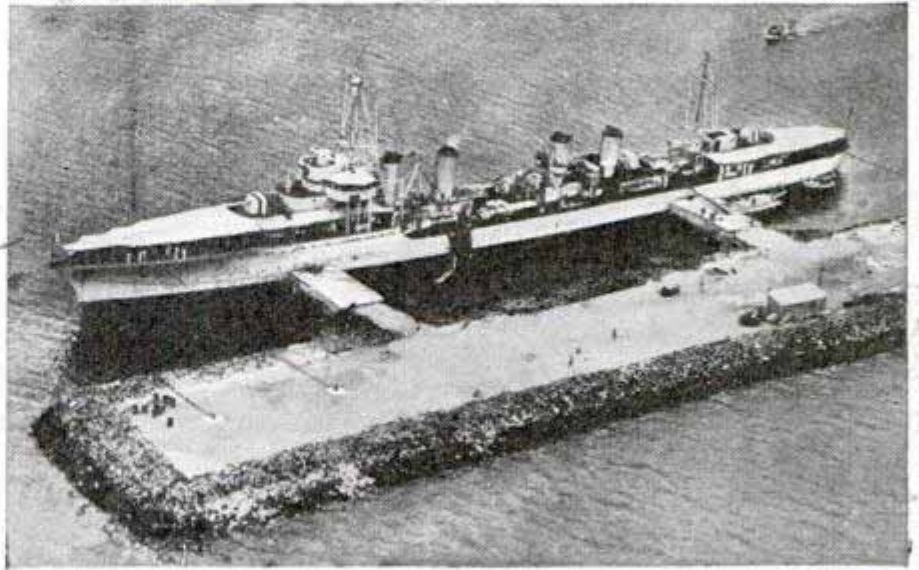

Top, mailboat covered with cement serves as pier for big ship. Bottom, same craft before conversion

# Paravane Finds Underwater Mines and Cuts Moorings

Latest in protective paravane equipment was inspected recently at a national defense conference at Massachusetts Institute of Technology. The paravane is a buoyant, torpedo-shaped instrument which

is towed from either side of a ship or between two ships, submerged at a definite depth. It is provided with cutters. As the tow cable contacts the mooring wire of a mine, it slides the wire along to the paravane where the cutters go into action, severing the mine from its mooring and causing it to rise to the surface. There, it may be destroyed easily by gun fire. Paravanes were used extensively during the World War. Another form of the paravane is a cigar-shaped, charged mine, submerged at the proper depth and towed from the side of a ship. The mine may be controlled from the ship or it may explode upon contact with a submarine. Vanes deflect it away from the ship as it is towed forward. Two paravanes may be used, one on each side of a ship.

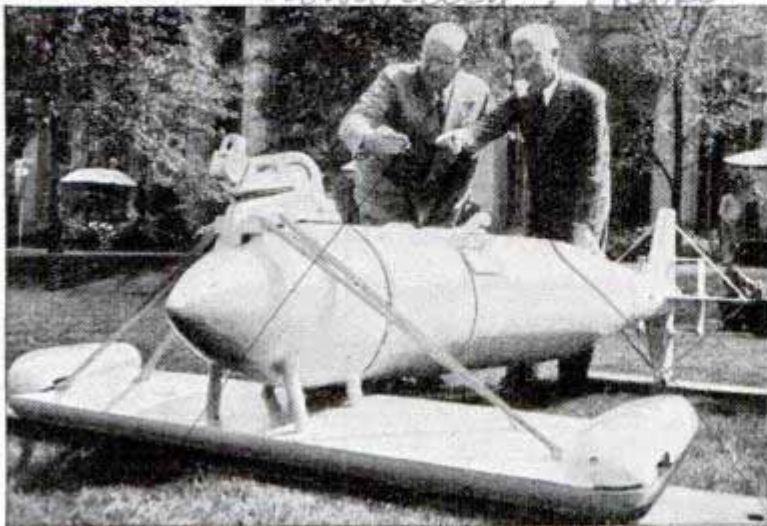

Examining details of latest paravane. Note wire cutter (at top) that severs mine mooring

Louis G. Johnson, Asst.

Rear Admiral



# Fireman's Portable Torch Worn in Adjustable Vest



Fireman cutting through hinges of steel door with torch, carrying oxygen and acetylene tanks on back

Carried in an adjustable canvas vest, a complete oxyacetylene flame cutter enables firemen to gain quick access to buildings by cutting through steel doors, barred windows or metal locks. The equipment, self-contained, weighs only forty-three pounds and with the vest arrangement the fireman can use his legs and arms on ladders and working in close quarters.

# Automatic Sight for Rifle Ends Guesswork

Accurate shooting, without guessing at the distance to the target, is made possible by an automatic sight for rifles. The gunner sights through it and makes an adjust-



Using rifle sight which automatically gives the proper elevation for the shot

ment, which results in the elevation being set automatically, whether the target or game is twenty-five or 200 yards away. If the gunner knows the distance, he sets the sight to the known yardage, thus automatically sighting the rifle properly.

# Metal Clacker Warns Motorist When Tire Goes Flat

Of particular value on trailer wheels, a metal clacker gives loud warning to the motorist when a tire goes flat. It is mounted on the rim, touching the tire, and as the tire is deflated it presses against the clacker and causes a distinctive sound at each revolution of the wheel.



# "Wait," Says Doorbell Button If You Are Busy

To the aid of the housewife, so often engaged in household tasks she cannot leave at the moment a doorbell rings, there

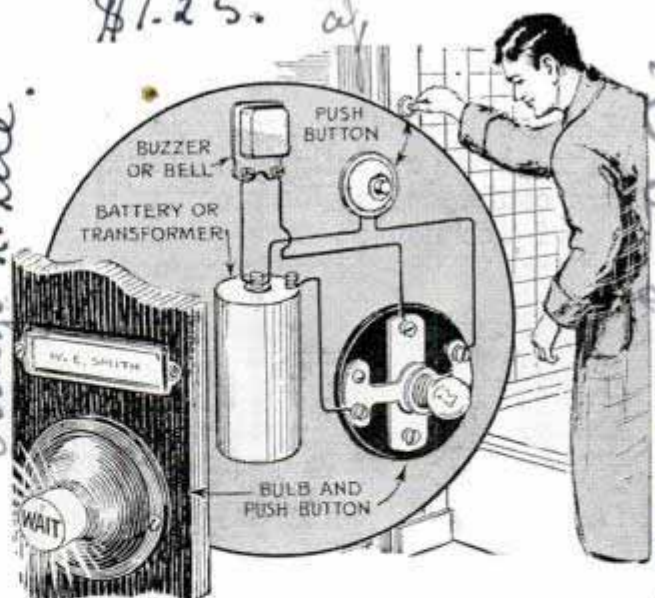

Pressing button inside the house turns on light at front door asking caller to wait

comes a push button that signals "Wait" to the caller. Pressed at some convenient place in the house, the button lights a small bulb at the front door on which is printed the message to wait. Only one wire need be added to the regular doorbell wiring.

*Vertical handwritten notes on the left margin:*  
Kerotest Mfg Co. 2525 Liberty Ave  
Pittsburgh Pa  
D. F. Mosberg + Son  
Che. New Haven Conn  
66  
pend  
48-95

*Handwritten notes at the top right:*  
230 N 11th  
Pocatello Idaho

*Vertical handwritten notes on the right margin:*  
Sh. P.abela  
Karo Hardware Co., 1836



# Dial Two Numbers and Bay Bridge Is Lighted

*California Toll Bridge Authority*

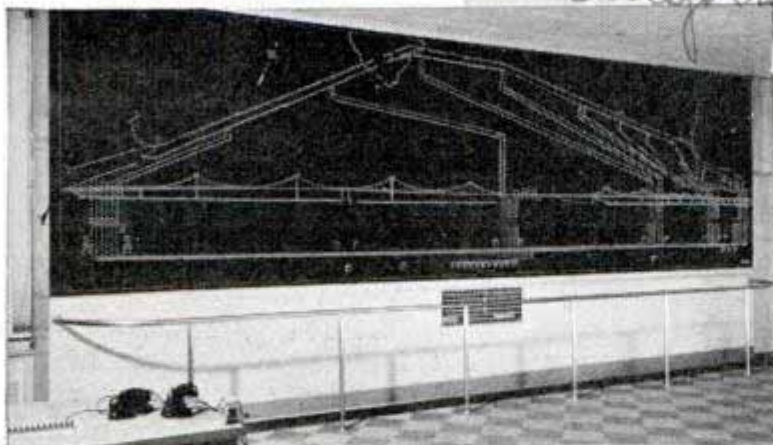

*Upper left, diagram of Bay Bridge with tiny lamp for every light on bridge; right, dialing a number to turn on a group of lights on bridge. Below at left, view of bridge showing part of 400,000-watt illumination system*

Twilight arrives over the San Francisco-Oakland Bay bridge. A girl steps to a "telephone" dial, gives it a couple of twirls, and a thousand lights are set aglow from shore to shore along the great span. That's all it takes to light the bridge. At first it was more complicated; there was a large panel of switches governing the numerous divisions of the 400,000-watt illumination system. But addition of other electrical facilities put too heavy a burden on those switches, and young as the bridge was, its lighting control board became obsolete. Now you dial two numbers, and eight miles of sodium-vapor lamps glow red, then orange-yellow. The same dial con-

trols navigation signals, red-flashing aerial beacons, fog bells and sirens along the bridge. Certain designated numbers on the dial turn on separate lighting circuits, and dialing the same numbers again turns them off. From the dial, electrical impulses flash over two wires the size of pencil leads, causing selector switches at substations to "step up" to the contacts corresponding to the numbers dialed. Thus electrical circuits are closed and any group or groups of lights selected are switched on. The two "master numbers" operate the entire system at once. On the wall of the control room is a twenty-six-foot illuminated board with tiny lights duplicating those of the bridge itself. If a fog bell is in trouble, a sodium-vapor lamp goes dark or an aviation beacon stops revolving, a light on the master board goes out too, indicating instantly the trouble spot. With this to guide him, a trouble shooter can go direct to the scene of the breakdown.

*Cont Paul Conant 703 Bay Bridge*



Science Service

Mrs Louise Schuetz, Escanaba, Mich.

### 'Filling Station' for Puppies Feeds Family of Nine



Puppies learning to use mechanical nursing system when large family was deserted by overtaxed mother

Like the old woman who lived in a shoe, one golden cocker spaniel had so many babies she didn't know what to do. Luckily for these nine puppies, their owner knew what to do when the mother could not feed them adequately. A mechanical feeder was prepared having nine nipples from infant nursing bottles, and the pups receive from it a mixture of warm milk and sugar. It causes no conflict even if all of them get hungry at the same time.

267

### Farm Products Have 400 Uses and Food Is but One

American farmers once were considered only as food producers, but that picture has been changed by industrial research, according to a list of non-food uses of agricultural products recently compiled by the United States department of agriculture. Even farmers will be surprised to learn that from eighty-six agricultural sources there come 133 raw materials used for purposes other than food, and these

raw materials are fashioned into 240 different manufactured products. In all there are more than 400 non-food uses for these farm crops. Cattle, in addition to meat, yield cattle grease which is the source of glycerol that may find its way into the family car as anti-freeze, or, by another process, may become a part of dynamite. Corn, in contrast, appears as the sizing on the backs of carpets, or as an adhesive, a rayon fiber, a tanning agent, as wallboard, or even a smoking pipe. Grapes have non-food uses, for their seeds contain an oil that goes into lubricants and soaps. Even bees play a double role. They furnish beeswax which appears in polishes, candles, cosmetics, and is used by lithographers in making colored pictures.

2496

### Spinner Cleans Paintbrush by Centrifugal Force

Centrifugal force is used for cleaning paintbrushes in an electric spinner just put on the market. The brush is placed in turpentine to soak overnight, then is attached to the spinner, inserted in a large can and the motor is turned on. The centrifugal throw at 2,000 revolutions per minute cleans the bristles quickly.

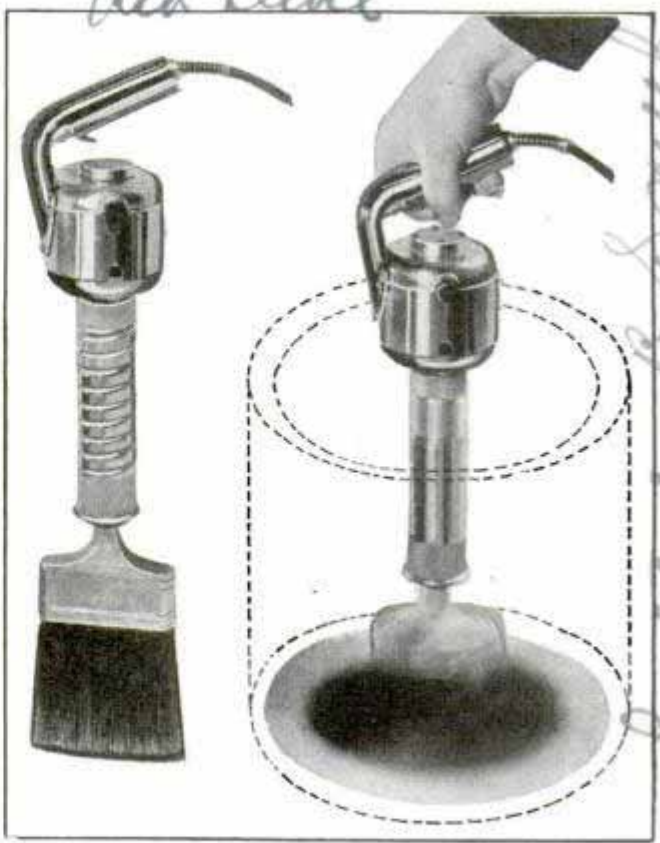

Spinning at high speed inside can, as at right, paintbrush is thoroughly cleaned by centrifugal force

Mrs. J. Simpson, N.Y. and Rand on



# Modern Home Furniture Does Double Duty

*Helen Magoon.*

*Marian Johnson.*



Wardrobe chest for the dressing room, above, has a sliding mirror that slips out of sight when not in use, disappearing into the back of the chest



Even when the chair above is upside down it is right side up. One seat is cloth-covered, the other is upholstered in leather. This not only should double its useful life but affords a seasonal change of styling



*Marian Johnson*



*Aven*

*All. Acme*

Furniture is leading a double life. Bookcases are beds and lounge chairs are radio cabinets. At left is a combination chest of drawers and dressing table with small compartments in lower corners for shoes, a storage drawer so roomy you could sleep guests in it, and a clock and jewelry compartments on top. Above, a secretary that hides a six-foot folding bed in its base



# Dive Is Caught By Camera from Ladder in Pool



Cameraman perches on stepladder in pool while helpers at left stand ready to rescue camera "in case"

To catch high-speed snapshots of a diving champion from an unusual angle, without involving himself and the camera in a ducking, a photographer worked out an elaborate setup. He posted himself on a stepladder in six feet of water at the middle of a San Francisco indoor pool. An assistant steadied the ladder. Still, it might tip over, so the camera was attached to a cord swung from a block and tackle high over the water. If the photographer toppled from his perch, an assistant on the sidelines pulled the cord to hoist the camera high and dry, then another aid with a long pole hauled it in.

# Collision Switch Cuts Off Ignition When Auto Is Hit or Upset



Shutting off the ignition immediately when the automobile is struck, whether it tips over or not, a collision switch that can be installed in any car

is always ready to act in the prevention of gasoline fires. Its operation is entirely mechanical and is so fast that the current is broken before the vehicle comes to rest after being hit. In case the car tips over the switch will go to work in the same way. It consists of silver-plated contacts held together by spring tension. If the auto is jolted severely or tipped over, a heavy conical weight is forced out of a cupped recess, thus breaking the connection, which can be reset only by lifting the top knob and placing the weight in the recess by hand. The switch can also be adapted to airplanes.

# Drag Detector Warns Engineer of Broken Brake Equipment

Broken brake beams dragging from a train could damage a railway bridge enough to tie up traffic for hours, but the Missouri Pacific railroad is posting automatic sentries near its single-track bridges to warn the engineer of dragging equipment. The detector units are breakable loops of cast iron, installed between the rails at rail level and extending eighteen inches outside the rails. A dragging beam or rod would shatter the loops and start a red light flashing against the train at the approach to the bridge.

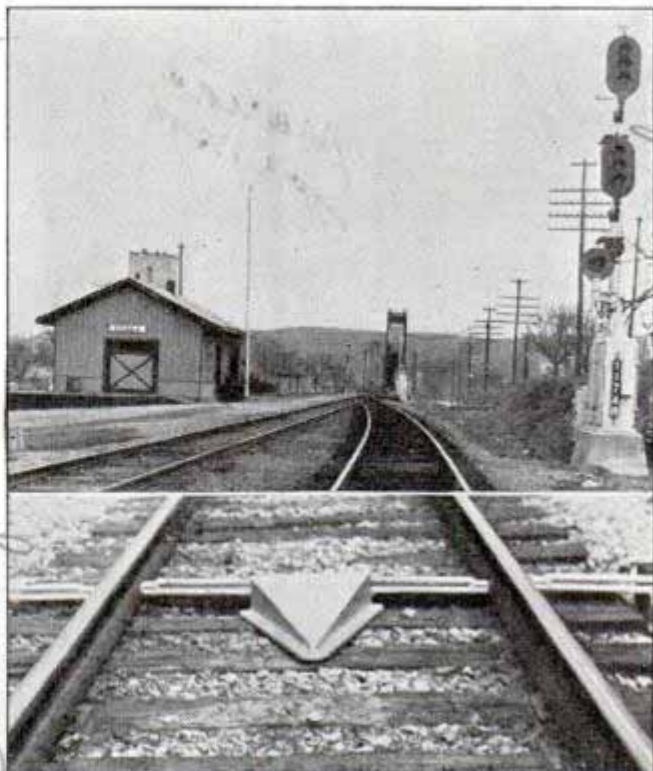

Dragging brake beams would break iron loops in track, below, and set signals at bridge against train

*Mary Jane Leesting*

*Army  
parade plunge*

*2684*

*2565*  
*M. P. R. Co.*  
*St. Louis*  
*W. H. R. Co.*  
*St. Louis*  
*W. H. R. Co.*  
*St. Louis*  
*W. H. R. Co.*  
*St. Louis*

*Albert Mfg. Co. Inc.*



J. 361

16,000  
MILES  
ON \$4.20

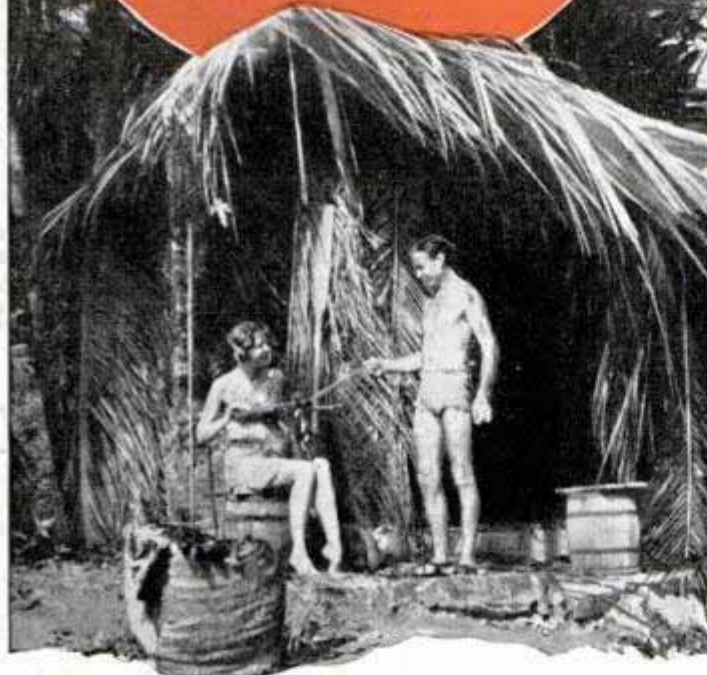

By Dana and Ginger Lamb

Pl-325  
PART II  
Santa Ana Calif

**G**INGER and I were marooned at last. As the little coast guard boat chugged noisily out to sea we faced the realization of childhood dreams and the stark reality, too, that we had just three weeks' food supply and the boat would not be back for eight months.

This adventure had begun as a test voyage to determine whether we were qualified for a life of exploration. We paddled and sailed our homemade "hybrid" sixteen-foot canoe down from California, along the west coast of Mexico and Central America, bound for Panama. We headed into the surf with 150 pounds of equipment and \$4.20 in cash. Instead of forming an elaborate and cum-

Top, the authors with lance, machete, pistols and knives for hunting. Left, their hut on Cocos Island. Below, wild pigs furnished food and leather

bersome expedition we meant to travel alone, forage in the jungle, take from the waters and the land the necessities of life.





*Above, starting campfire by old Indian bow-and-drill method. Left, homemade jigs and spoons were used for trolling, fish supplying both food and oil to make paints. Big fellow at left is a "wahoo," Pacific game fish*

We explored, we found adventure, we foraged and we liked it.

We got as far as Puntarenas, Costa Rica, and there discovered we were only 350 miles from Cocos—the desert island of our young dreams. Perhaps we were children of civilization, but so was Robinson Crusoe. If he could make a go of it, we could. So the government boat took us to the island and promised to return in eight months.

Paddling toward the palm and jungle-fringed shore of Wafer Bay we glanced back at the little "Santa Rosa," dwindling to a speck on the ocean as she headed back to the mainland. We wondered if we had

good sense. Three weeks' supply of food, a few seeds, meager camping equipment, and not a neighbor to borrow from on this isolated, uninhabited island.

Had our two years of travel along the coast of Mexico and Central America prepared us for this? We had dreamed about landing on this island for years, and there was no turning back now. The "Santa Rosa" was only a smudge on a cloudy horizon, as we grounded the canoe at the mouth of the little stream at the

head of Wafer Bay and surveyed our surroundings.

In the beautiful little coconut grove beside the stream was the worst mess we had ever seen. Surrounding the two dilapidated old treasure-hunters' shacks were piles of filth and refuse that clearly indicated why the existence of others before us on this tropic Paradise had been so miserable, and in some cases, tragic.

There was only one solution, and that was work, and plenty of it. As though to lend us a hand, rain descended in torrents as we set to work cleaning up the mess.

Camping on the clean white sand of the



beach, we put in long, hard days removing this blotch left by man, and relegated most of it to the briny deep. Then we set to work on our hut, with only a machete, hunting knife, and the small drill, for tools, using some material salvaged from the old huts, and the balance secured from the palm grove and jungle. Our hut was similar to those used by the natives along the coast on the mainland, and had a very steep thatched roof to shed the daily downpour of rain.

In the evenings by the light of the campfire we made crude tools, a wooden hoe, rake, and shovel for use in our little garden, planted close to the beach. We had been told that a garden could not be grown on Cocos—that all vegetables grew to tops due to the over-rich soil—but a little experimenting showed us that the mixture of soil and sand along the shore was just lean enough to produce good crops of corn, beans, chayotes, and the like.

(Continued to page 116A)

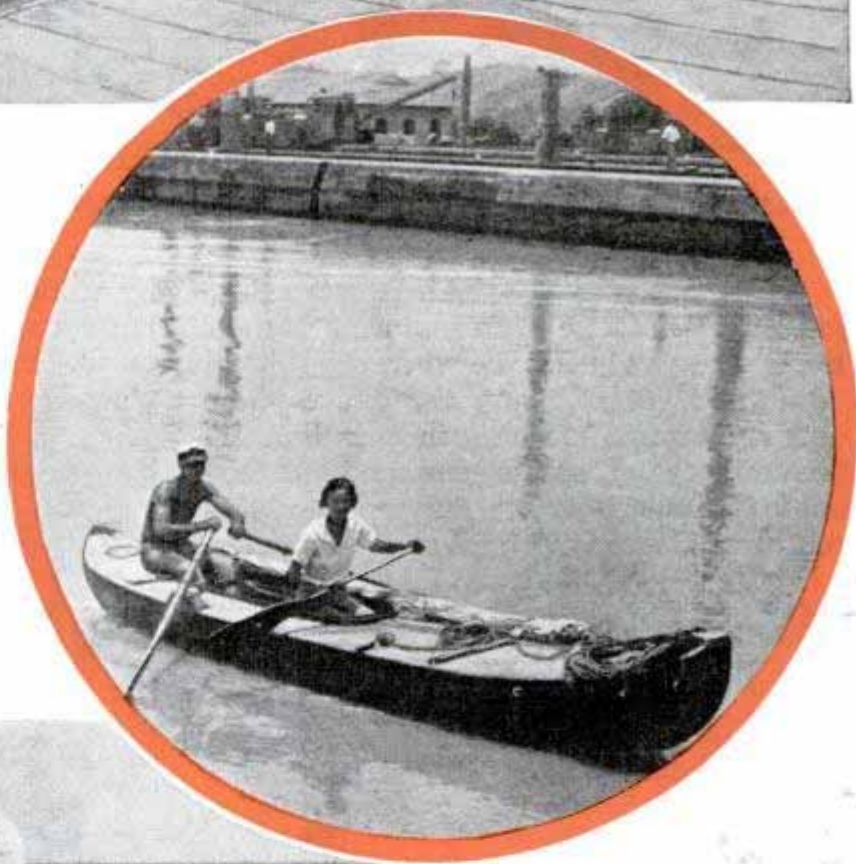
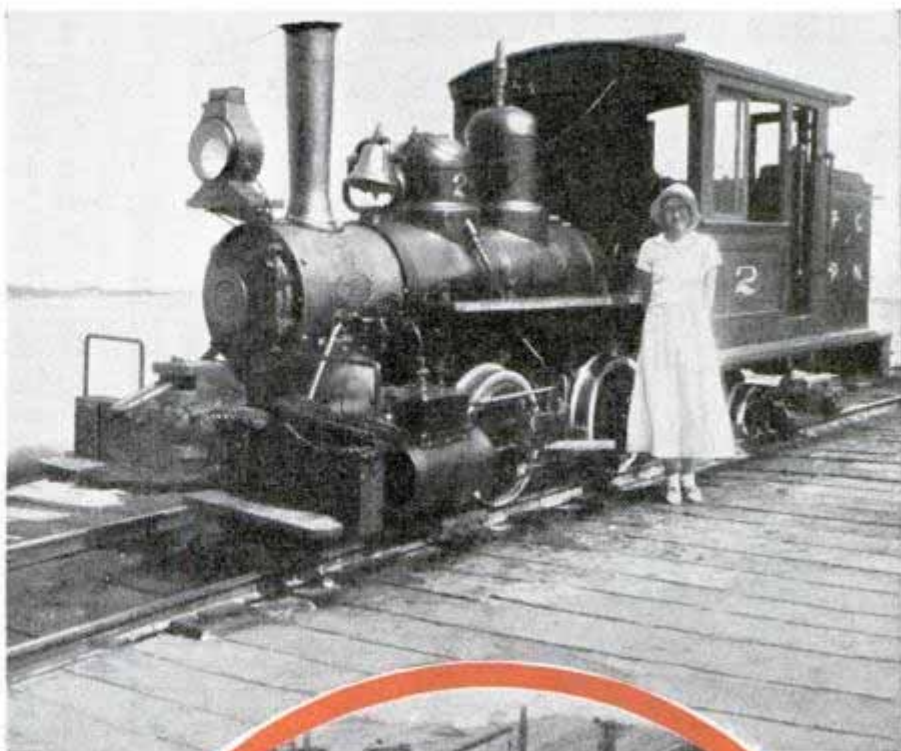

*Ginger poses beside "No. 2," picturesque old iron horse on the Nicaraguan railway, top. Look closely and you'll notice the engine carries a towrope, just "in case." Center, the crew of the "Vagabunda" reach the Panama Canal after three years voyaging down Pacific coast in their homemade craft. At left, safely beached as a storm strikes, the voyagers rush to cover equipment before blowing sand can do damage*



2611  
 2/10 Washington County, Tenn  
 W. B. Burkhardt, Td

## Planes Get "Turkish Bath" for Fast and Easy Clean-Up

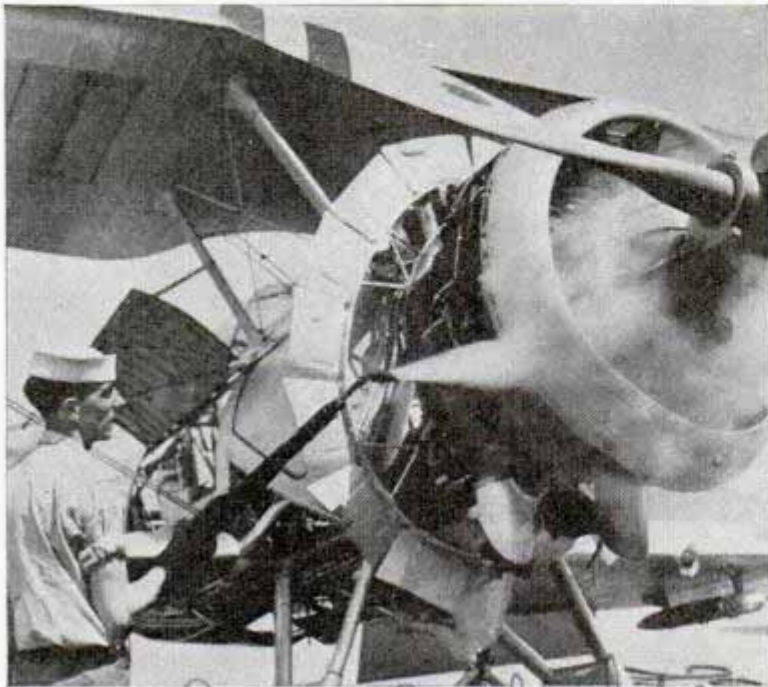

One of the navy's planes getting a steam bath to rid it quickly of briny dirt picked up in flight over ocean

Airplanes at the Naval Air Reserve Base at Floyd Bennett Field are given a bath of live steam to rid them of dirt, grease and ocean salt. In this way the entire plane gets a thorough cleaning in less than fifteen minutes. Steam is generated in a machine that mixes it with soapsuds, and this mixture is forced out of the hose nozzle.

## Homemade Walk-Type Tractor Pulls a One-Horse Plow

To cultivate and plow his small tract, one man built a walking-type tractor from

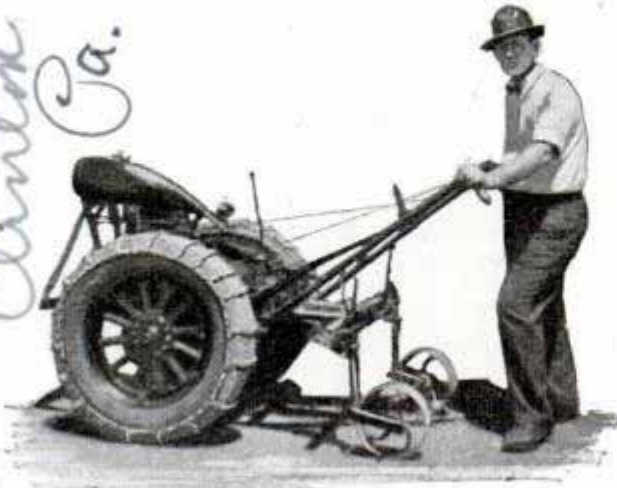

Operator walks behind tractor, guiding it and controlling the speed by levers mounted on the handle

parts of an automobile and motorcycle. For power, a single-cylinder motorcycle engine and fuel tank, together with other motorcycle parts, were mounted on a welded angle-iron frame made from discarded bed rails. To obtain a wide selection of speeds he mounted the gear box reclaimed from an old Dodge automobile at the rear of the motorcycle drive. Power is transmitted through the gear box to the large drive wheels taken from an old car. The handles were shaped from gas pipe and properly fitted. This tractor not only cultivates, but draws a conventional one-horse plow.

## Tile Held without Cement Reduces Weight of Wall

Clay tile can be installed in bathrooms and kitchens without the usual heavy coating of cement by using a special metal disk that holds the squares in place on a backing of plywood. In an old house the plywood is placed over the plaster wall and nailed into

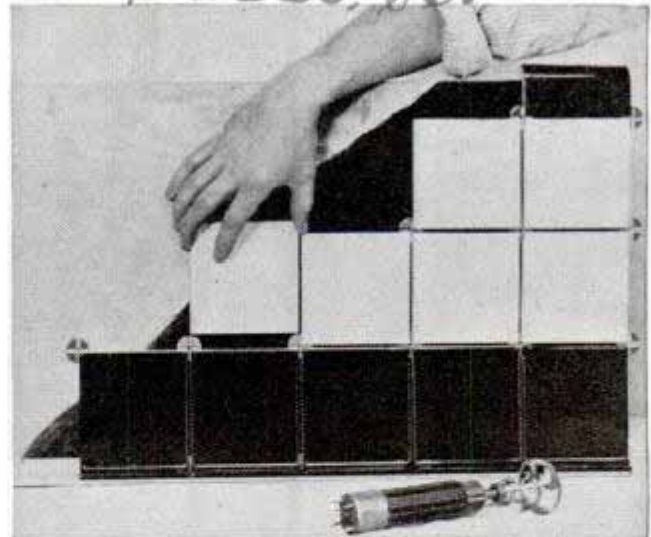

Tiles are slipped down on clips and held in place as shown. In foreground is tool for nailing clips

the studding, while on new work it is nailed to furring strips fastened across the studding. To this wood backing are nailed metal disks about the size of a quarter. The tiles are slotted at each corner where one-quarter of the disk fits snugly. After the tiles are in place, the joints are filled with cement or waterproof mastic.

Rev. R. C. Dettmer,  
 Clinton, Pa.  
 2665

Butler-Weiland



# Close-Up Picture of Moon 'Shot' with Big Eye

As telescopes become bigger, privacy for the "man in the moon" is fading away. Unusual detail can be seen in a recent photograph of the moon which was made with the aid of the eighty-two inch telescope at McDonald observatory in Texas.

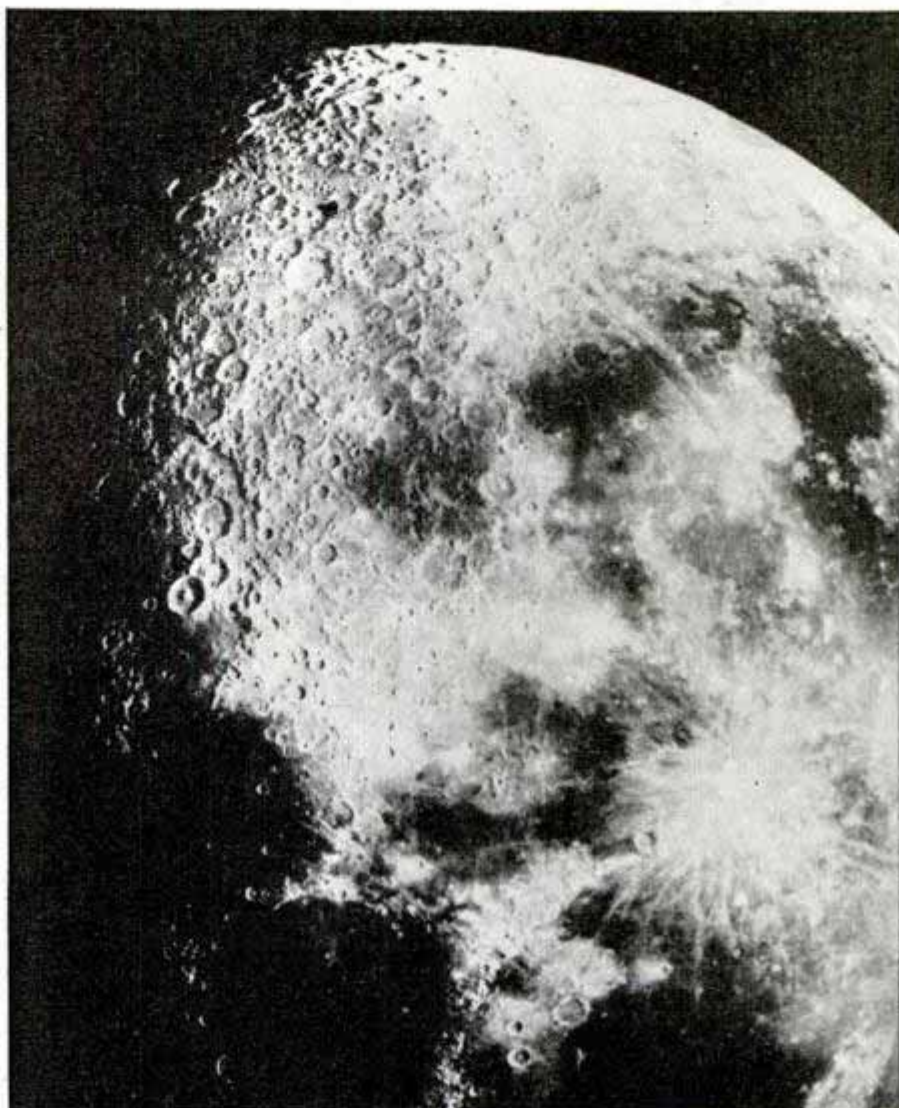

Craters are sharply defined in this photograph of the moon taken with the help of the giant Cassegrain telescope at McDonald observatory

9695

## Tree-Planting Work Doubled on Farms Since 1935

Tree-planting activities on American farms have doubled since 1935, the distribution of 55,359,728 trees to the farmers in 1938 comparing with 26,150,197 three years previous. The trees distributed under a cooperative program authorized by Congress are young seedlings and transplants. Georgia led the states by a wide margin in 1938 with the distribution of 7,036,000 forest seedlings. New York planted 5,610,000.

help of agriculturist

## Chart Aids Instrument Flying by Solving Pilot's Problems

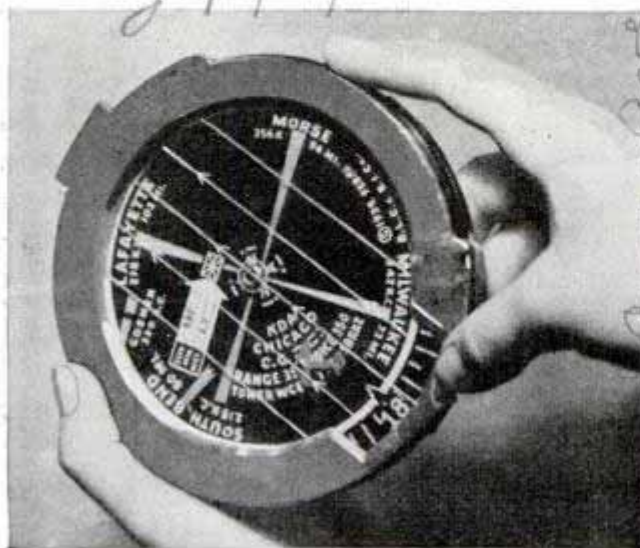

Notice miniature airplane, showing pilot's position on chart that works out navigation problems

Flying by instrument is made easier by a chart that works out mechanically for the pilot his course and bearing. The instrument houses a rotating compass rose to which is attached a circular chart showing radio beams radiating from various airports. Mounted on the instrument board, it can be operated with one hand. Problems of wind drift, bearing on range station and the like are solved, and a miniature airplane rotates with the chart to show the position and direction of the ship.

speed order

Crystal-clear clarinets, made entirely of the plastic "Lucite," except for keys and mouthpiece holder, have a different tone which some prefer to that of a metal instrument.

Do Line Course and Bedfer Co.



2578.

457

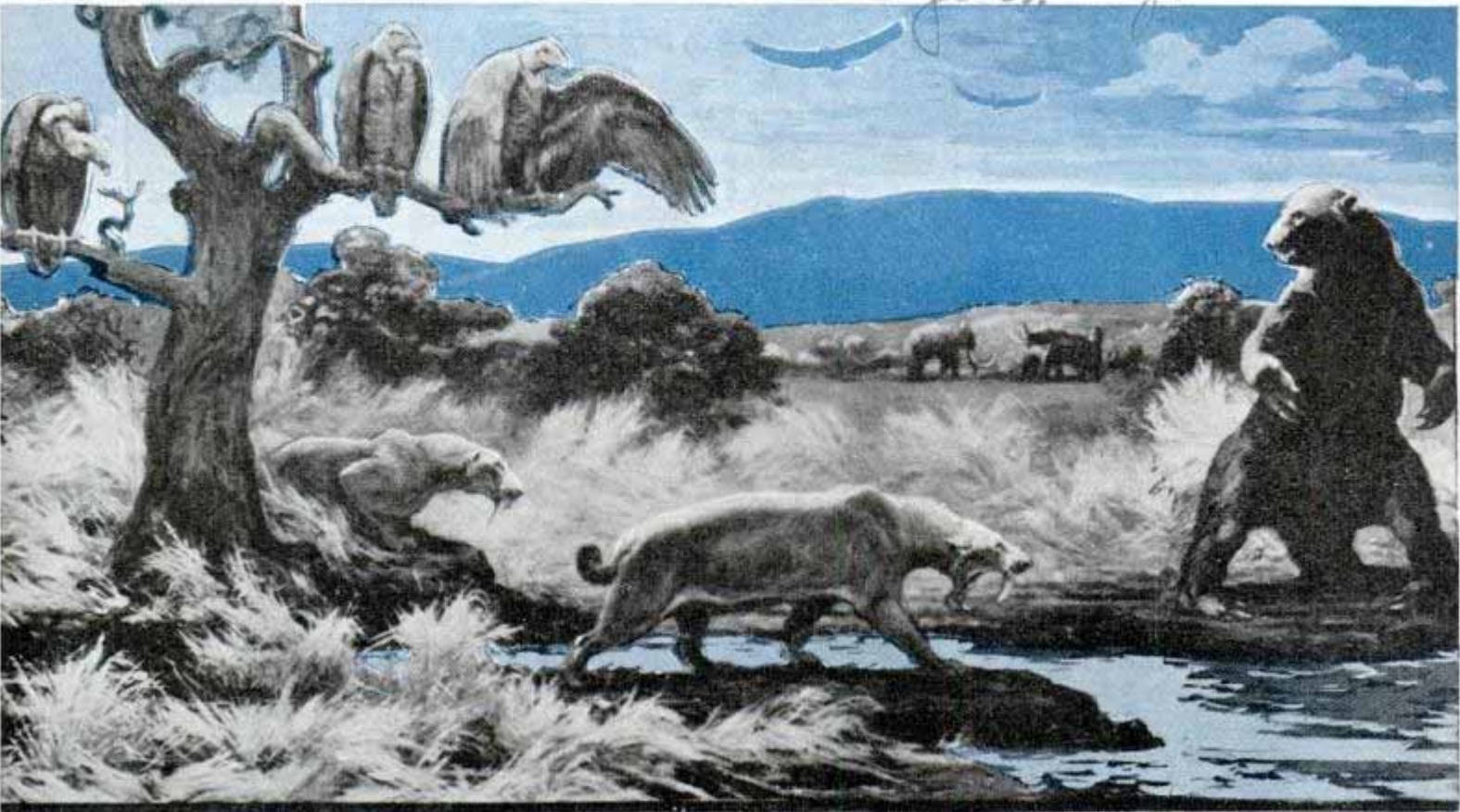
S. Serrano Co  
Los Angeles, Calif

# DEATHTRAP DRAMAS



Top (this and page opposite), mural of tar-pit drama. Bottom (this page), small tar pool in the Los Angeles deathtrap

**A**LTHOUGH the animal actors left the stage 500,000 years ago, science and art, with the aid of some first-rate detective work, have made prehistoric dramas live again.

The setting is the world's strangest deathtrap, the Los Angeles, Calif., tar pits. For half a million years these pits have sucked down struggling animals, thereby writing a unique record of the passing show of life. And now science has spread that pageant for the world to see.

Poised in the act of ripping open the throat of his opponent, a great sabertooth tiger is frozen forever with his murderous eighteen-inch tusk pointed to the sky. Brooding over a black pool is a gigantic bear. Once he sat there watching the beginning of the feud between the sabertooth tigers.

It started when a huge hairy elephant slipped from the pit bank and plunged one foot into the black tar. Struggling to free himself, the elephant had slipped deeper, another foot had become entangled. Frightened trumpeting had roared through the meadow. And suddenly that plain had



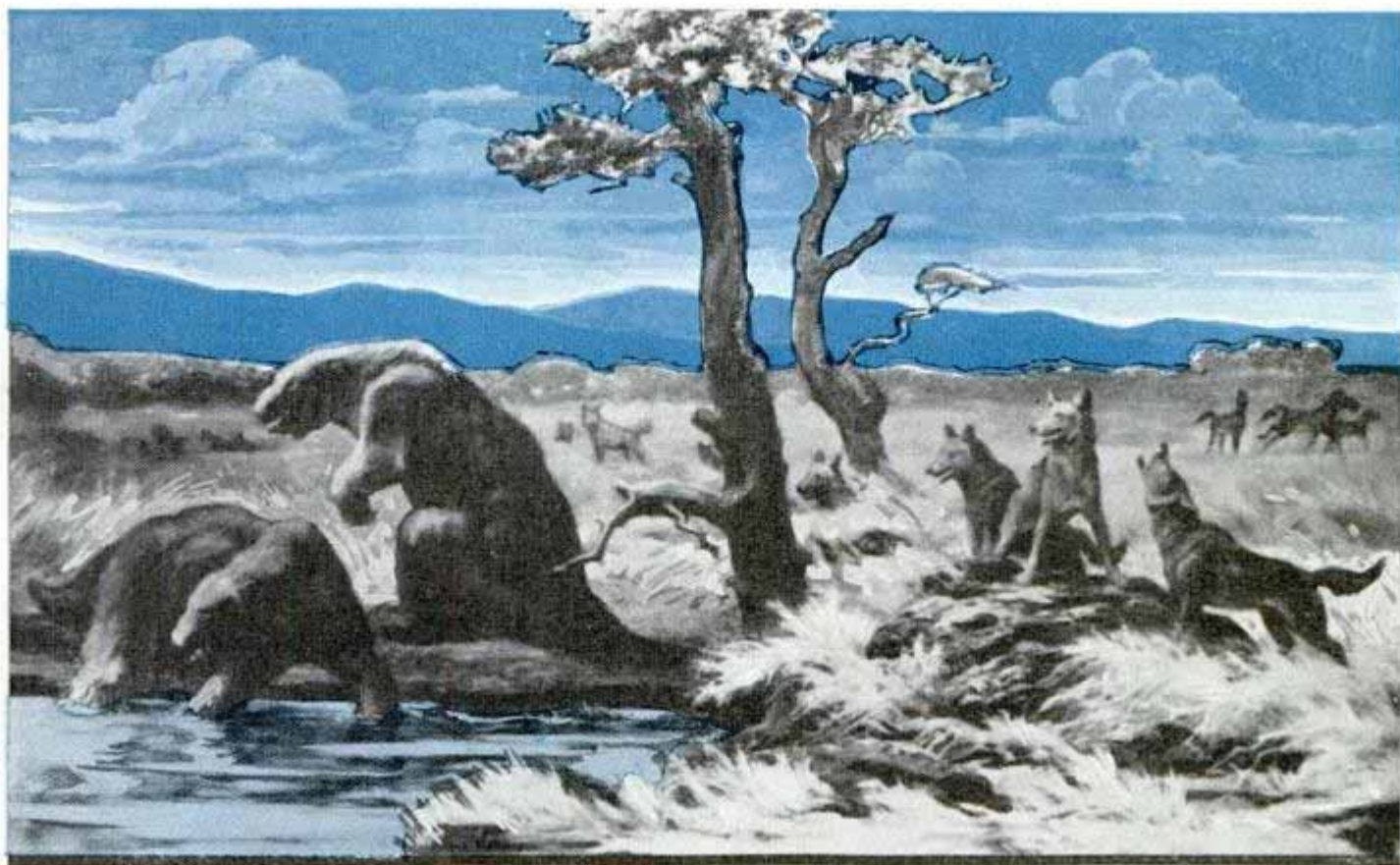

## of the TAR PITS

*Below, skeletons of sabertooth tiger, ground sloth, mammoth and giant prehistoric elephant. Some of these served as models for concrete figures*

Courtesy Los Angeles Museum of History, Science and Art

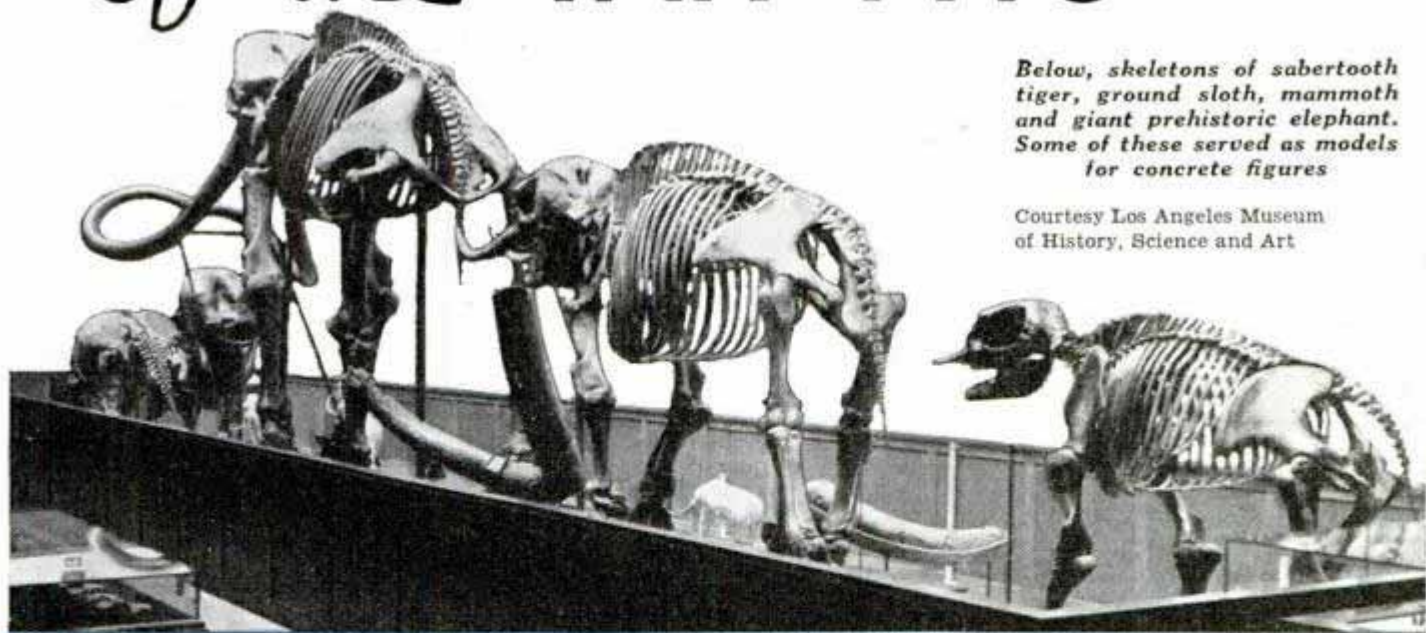

become filled with half-seen shapes moving through the tall grass toward the spot where the enormous animal struggled.

Just before dawn the first of the sabertooth tigers had struck, its tusk ripping open the elephant's shoulder. But the elephant, mired now to its belly, could still fight. A careless move by the tiger, and

one of the gigantic tusks had caught it, and flung it, writhing in death, far out into the clutching tar.

But there had been other tigers, and the great dire wolves had closed in. In the end, the elephant had ceased to struggle. Only the tar went on with its work, sucking at the great carcass, pulling it deep





nels in the earth, the pits have been proven to date from early Pleistocene times, or approximately 500,000 years. They are not permanent, but change occasionally as new tar springs open and old ones close. Gas which comes up from subterranean reservoirs causes the tar to form huge black bubbles, which rise slowly to form a dome, then break and sink lazily back.

The stickiness of the tar is almost unbelievable. Once part of a man or animal is caught, it is practically impossible for him to escape without outside help. Struggling only embeds him more deeply. Moreover, the tar itself has a sucking effect caused by movements in the subterranean reservoir.

So for half a million years this deathtrap has sucked down a vast assortment of creatures, ranging from minute insects to great shaggy mammoths and elephants

into the subterranean pit. It was when only part of the elephant's back was still visible that the two sabertooth tigers which the bear was watching had arrived. Instead of making the most of things before the elephant had completely disappeared, they had decided to fight among themselves. The fight had been going on for some time now, and the bear was considering whether it would be to his advantage to intervene. At that instant the clock stopped. It is still stopped. You can go any day and see for yourself.

For when the Los Angeles tar pits sucked down struggling prehistoric monsters, they wrote the record so clearly in tar and bones that scientists have been able to reconstruct almost exactly the circumstances of those tragedies.

Formed by tar coming through deep fun-

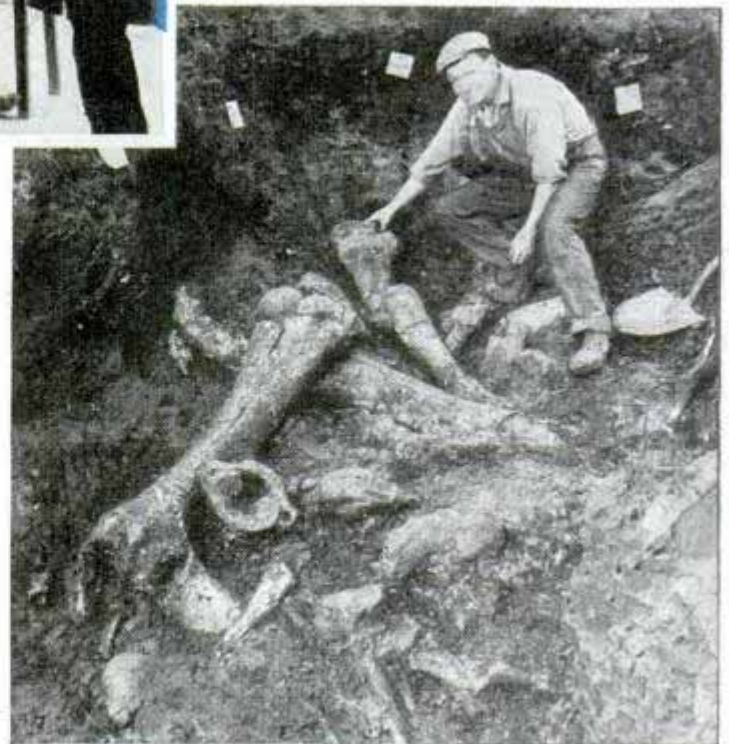

*Top, concrete lion and lioness in position in tar-pit region. Center, how the figures were made from models. Bottom, scientist recovering fossil bones from the deathtrap*



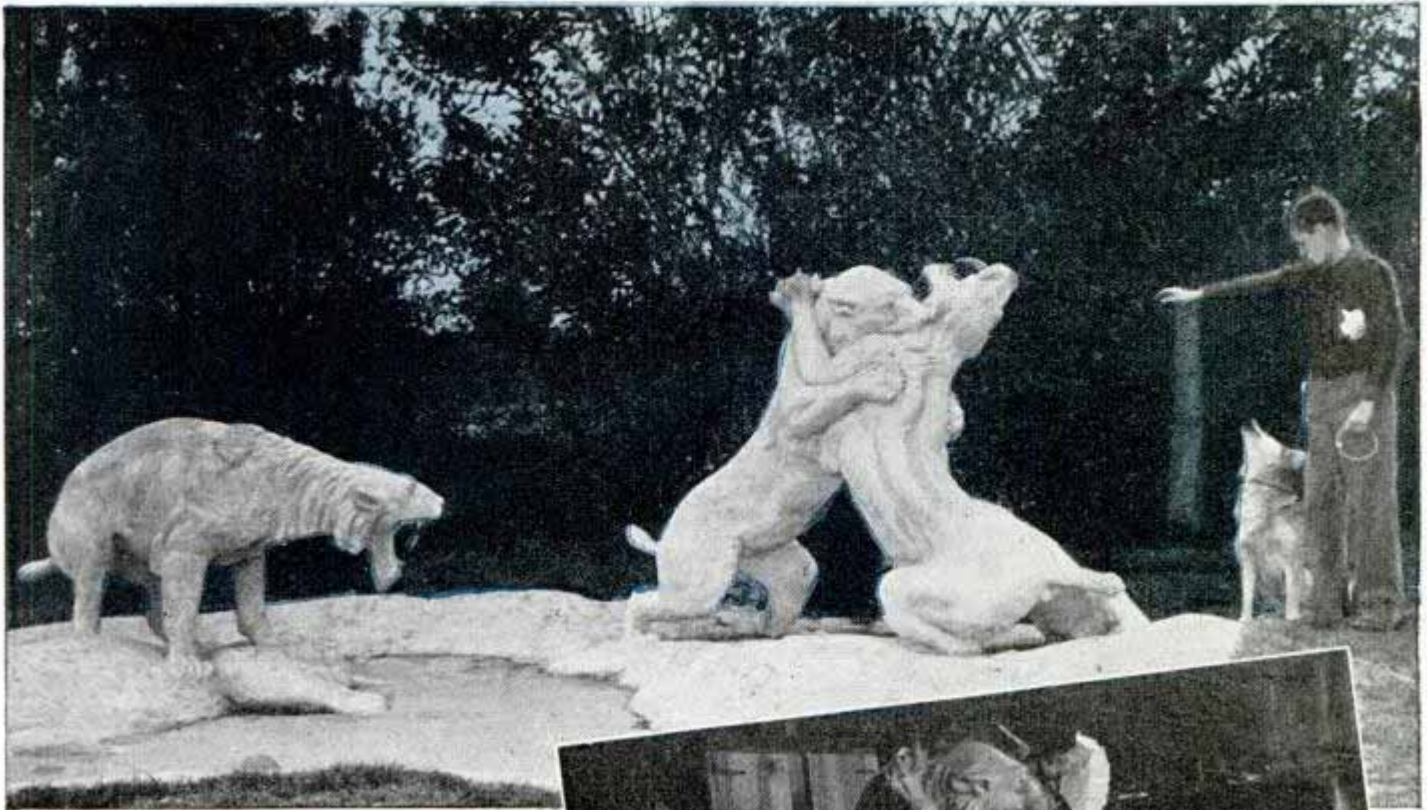

whose size exceeded that of any alive today. The tar kept bony structures in a state of perfect preservation.

Systematic removal of the bones was begun a few years ago. The skeletons were assembled in the Los Angeles Museum. Scientists from all parts of the world visited this unique collection.

Dr. William A. Bryan, director of the museum, conceived the idea out of which grew the world's strangest museum. He had sketches prepared showing how the ground sloths, mastadons, gigantic bears, and wolves looked and acted half a million years ago. Next he took these sketches to Herman T. Beck, noted sculptor.

"I want them life-sized and made to last forever," he declared.

With the aid of Los Angeles county, there began  
(Continued to page 138A)

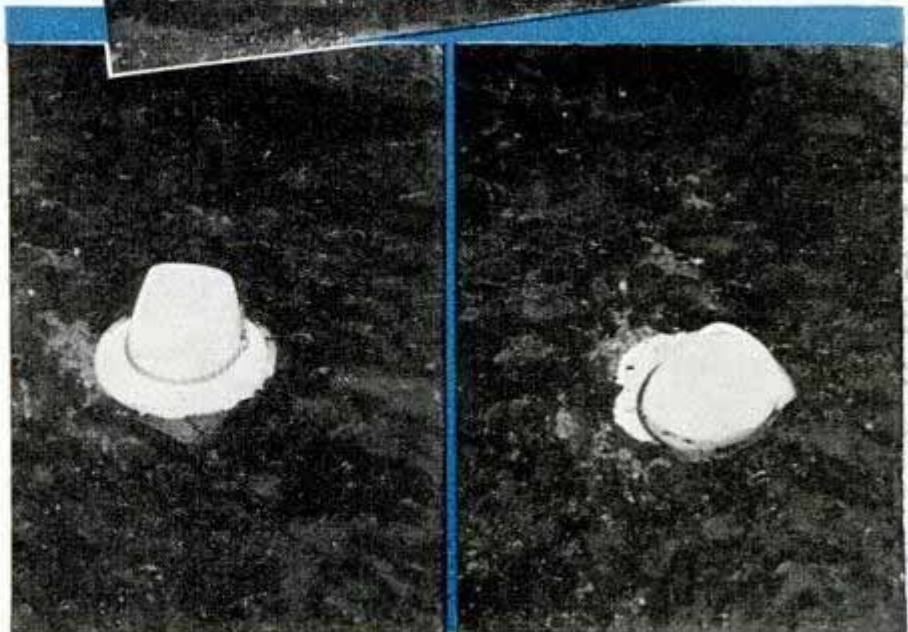

Top, two sabertooth tigers battling beside tar pits while a third looks on—the figures being concrete. Center, the figures were made by pouring concrete into plaster casts constructed from life-size clay figures. Bottom, hat blown into the tar (left) slowly disappears (right)



Waterbury, Conn.

2606

### Transparent Plastic Oiler Keeps Supply Visible

Clear view



Oil supply is always visible in this transparent pumper, which spouts oil at pressure of thumb

Pump oilers are now made of a transparent plastic so that the workman can see how much oil is left in the container. The amount of oil ejected is easily controlled by the pressure exerted on the thumb lever.

into the tail-wheel bearing, the device is a standard bicycle hand-brake attachment. It is operated from the cockpit by means of a lever attached to a thin tubing containing a choke wire, leading to the tail. Replacements can be made from any bicycle-parts store.

### Old Historical Papers Restored by Pressing with Ironer

Electric ironers are now in regular service at the National Archives in Washington, D. C., for rehabilitating historical documents, many of them being priceless, which have been damaged by water or have become faded and wrinkled with age. During the Ohio river valley flood in 1937, when many official records were left in a water-soaked condition, it was found that a household ironer, by applying heat and pressure at the same time, dries out the

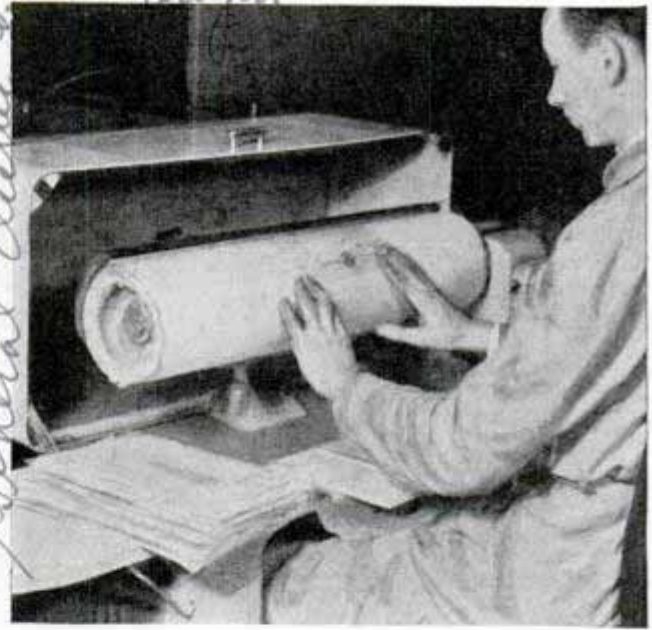

Ironing out wrinkles in historical records with a family-size electric machine

2603

### Plane Brake Made of Bike Parts Fits on Tail Wheel

Intended for airplanes weighing up to 4,000 pounds, an auxiliary tail-wheel brake introduced recently is made of bicycle parts. It brings a light plane to a stop, even with a thirty-mile wind behind the ship, without the hazard of the plane nosing over. The brake also is useful as a parking device, taking the place of chocks. Fitted



Pointing to small brake, made of bicycle parts, which is installed in tail wheel

paper, removes wrinkles, and often makes the writing or printing sharper and easier to read than it was before the damage. The success achieved in flooded areas brought the suggestion to use the machines in Washington, where fifty-eight rotary-type ironers are in daily operation.

Names and addresses of manufacturers and dealers in articles described in this magazine will be furnished by our Bureau of Information upon request accompanied by stamped, self-addressed envelope.

Mr. Archie J. Baxler, Island Beach, N.J.

Brooklyn, N.Y. Andy Arnold photo

570 Lexington Ave. General Electric Co.

2633

neutral



2514

# Iron "G-Man" Tracks Down Other Metals

*Dr. E. Bruce Ashcraft*

Iron made 99.99 per cent pure by new refining processes is so free from impurities that it is used as a detective in laboratories to aid in analyzing all metallic elements. When an electric arc is formed between two electrodes of pure iron, the metal gives off radiation which, when focused through the prism of a spectrograph, is recorded as a series of lines, or waves, on a photographic plate. In testing other metals, wave-length pictures of them are made in a similar manner. By comparing such a picture with the pure iron standard, the investigator is provided with a measurement of the wave length of all metallic elements in the test piece. The production of this spectrographically pure iron involves an electrolysis process developed by Westinghouse research laboratories, whereby iron molecules in a chemical solution are attracted to an electrode made of lead. After removal of the oxides from this porous iron, it is "cooked" in a high frequency furnace. Carbon and oxygen re-

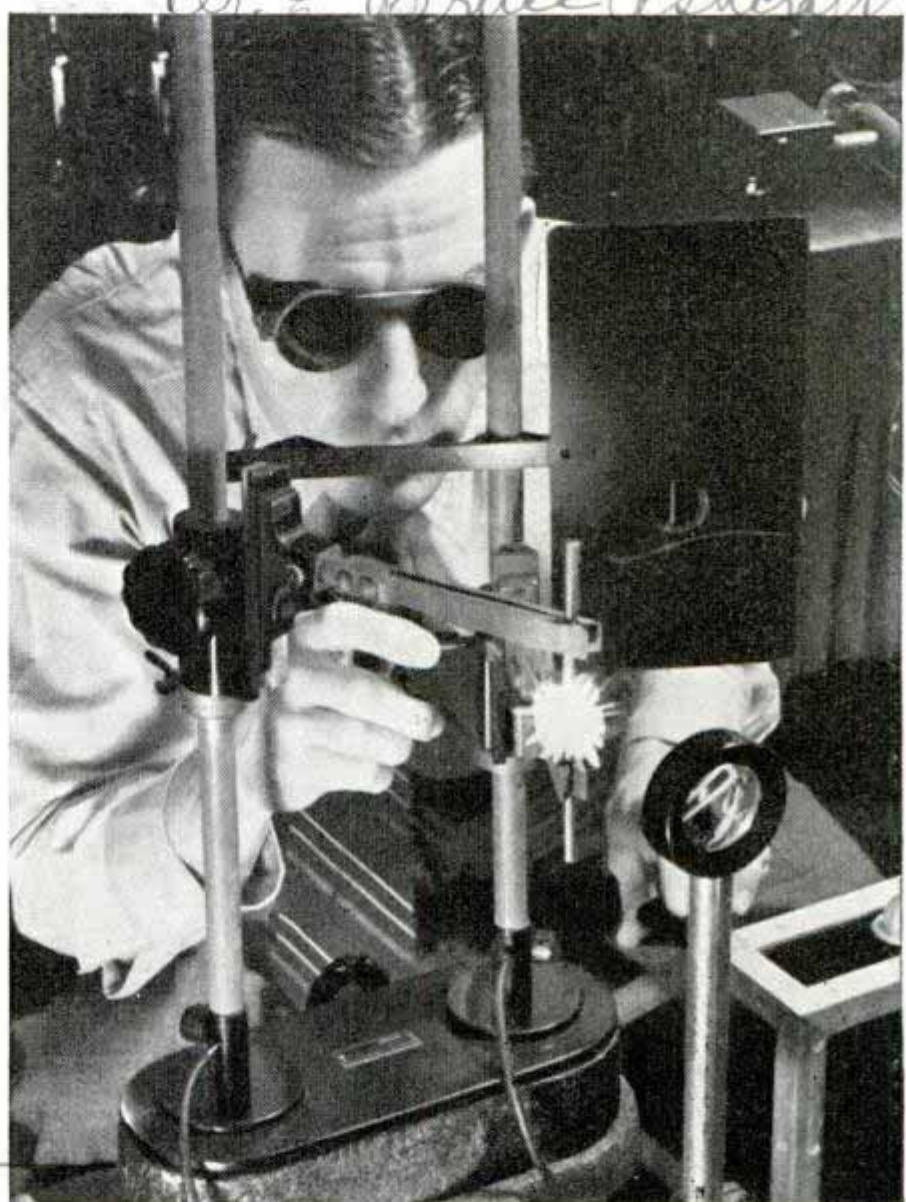

*Forming electric arc with pure iron in spectrograph, which focuses the radiation through prisms to record wave-length portrait of the metal*

maining in the metal combine during the heating and are drawn off by a vacuum system as carbon monoxide.

# Pocket Case Filled with Data for Mechanic or Draftsman

*2531  
\$1.00*

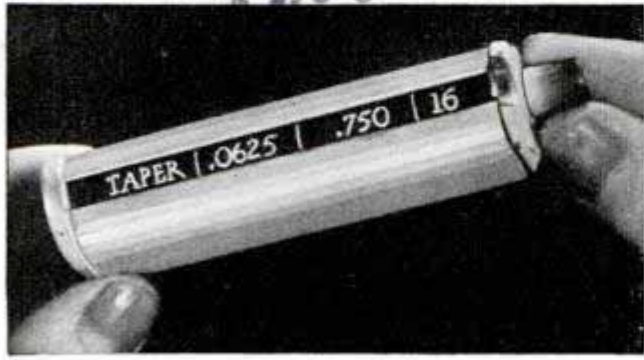

*This tiny encyclopedia of machinists' data gives quick answers at the turn of a knob*

In an aluminum case small enough to fit in your vest pocket is packed a volume of handy information for the machinist, draftsman or home workshop enthusiast. A twist of the knob brings into view in two windows various data on pipe threads and other standard threads per inch, tapers per foot and per inch, the sizes of round stock necessary to make hexagons and squares of various dimensions, and decimal equivalents of fourths, eighths, sixteenths, thirty-seconds and sixty-fourths.

*Latatule Co 502 Fiske Bldg*



G. 52  
457 S. Serrano Ave  
Los Angeles

# MODELS *that* SAVE

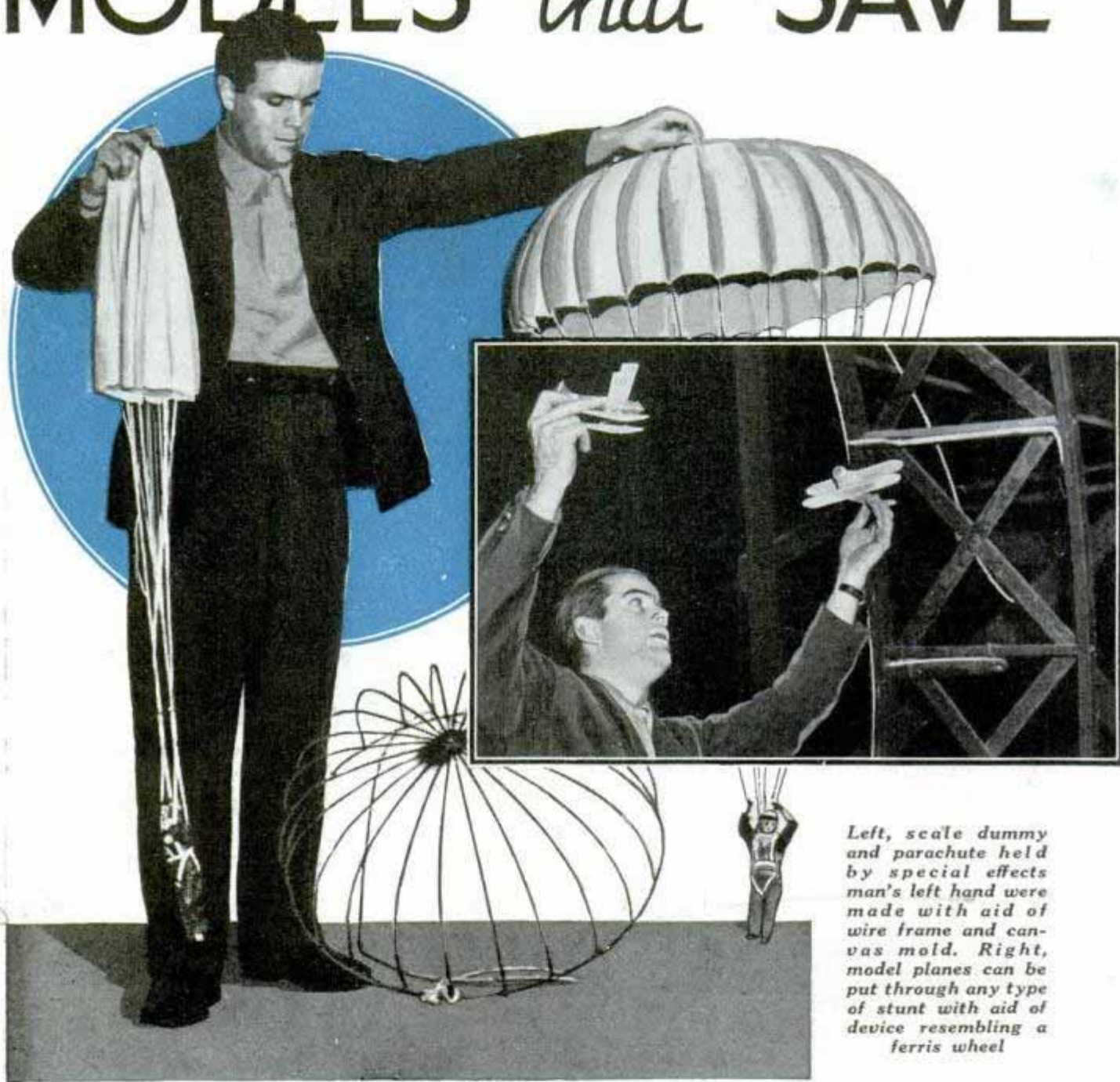

*Left, scale dummy and parachute held by special effects man's left hand were made with aid of wire frame and canvas mold. Right, model planes can be put through any type of stunt with aid of device resembling a ferris wheel*

*Hollywood Carley*  
**W**HEN a movie producer wanted a scene showing a man jumping out of a plane with a parachute and landing in a motorboat, he found no stunt man willing to try it. So he called in Fred Jackman of the Hollywood Special Effects company and explained the problem.

Jackman returned to his shop and issued this order:

"Rig up a dummy that will jump out of a plane with a chute and land in a motorboat. Use one of our stock planes and fill up the lake. Better get a north country background."

Instead of considering the job unusual, the shop workers thought they were rather lucky that the dummy didn't have to jump out of the motorboat into the moving plane.

Even that wouldn't be very unusual for this unique business—which resulted from crossing a hobby with a desire to save people's lives. For years Jackman's hobby was building miniatures, particularly animated ones. Then he began wondering if he could turn his hobby to some practical good. The result is a company specializing in preparing sets for movie scenes in which stunt men face too great a risk.



# LIVES

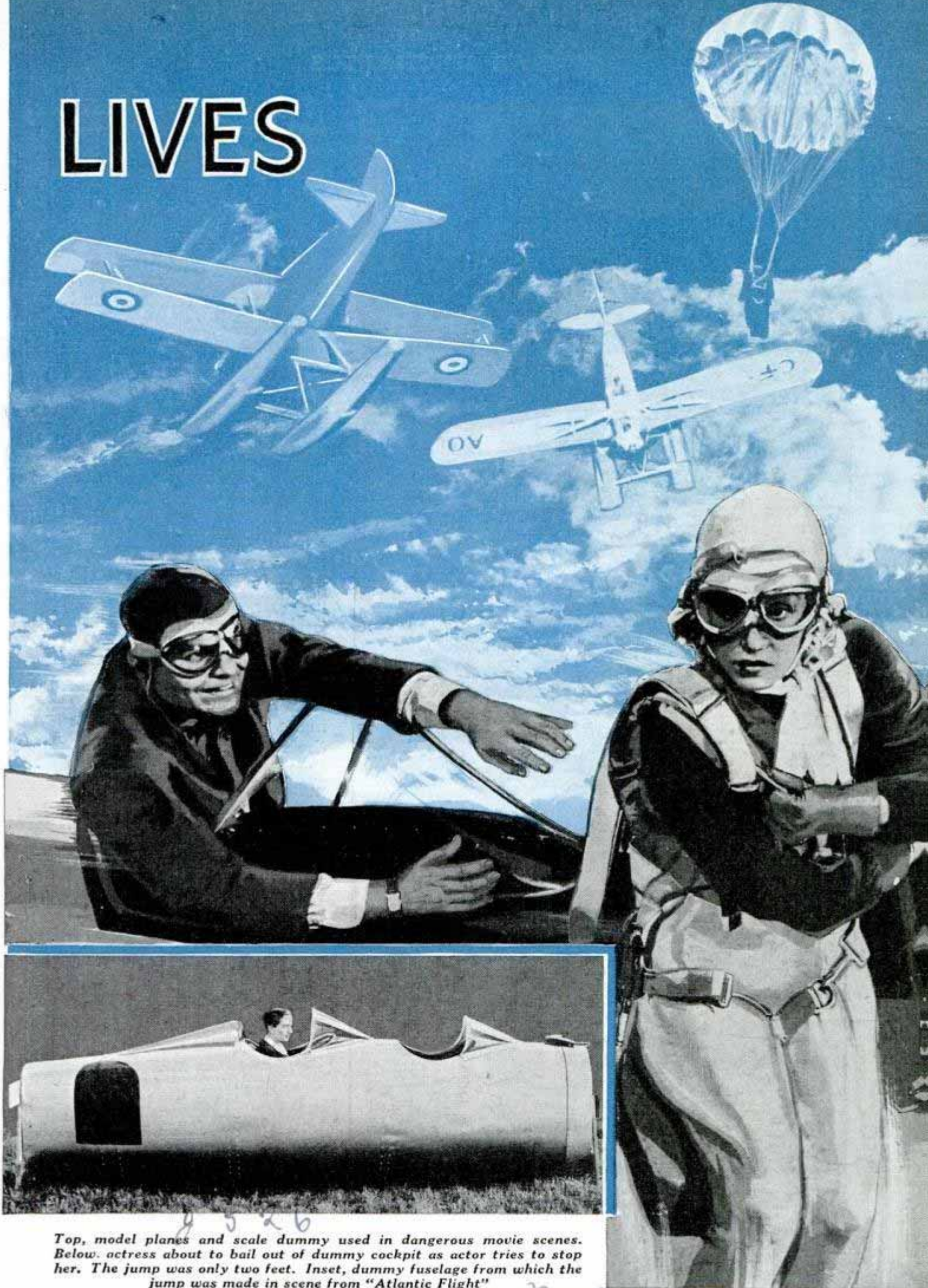

8 5 26  
Top, model planes and scale dummy used in dangerous movie scenes. Below, actress about to bail out of dummy cockpit as actor tries to stop her. The jump was only two feet. Inset, dummy fuselage from which the jump was made in scene from "Atlantic Flight"



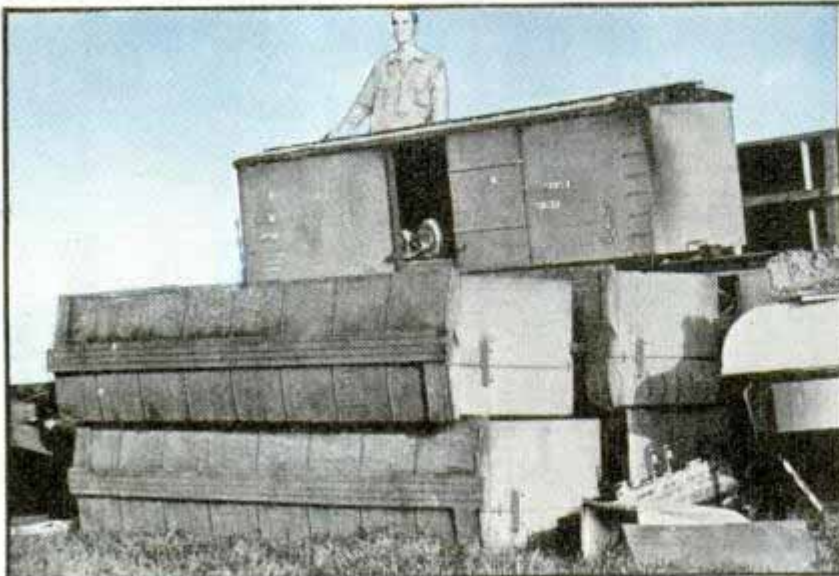
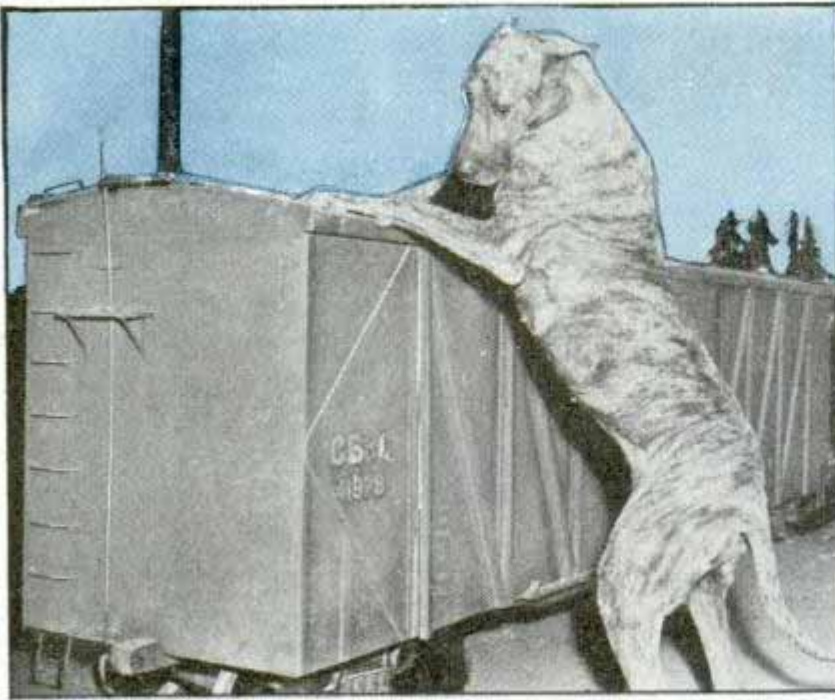

*Top, dog with model of freight train used in "Professor Beware." Cars of the train are shown piled up (photo at bottom) after scene had been taken. Center, model houses, car and dummy used to produce scenes in which stunt men would have faced real danger*

Here's how Jackman's men went about the job of making the dummy bail out of the plane and land in the speeding motorboat.

First, the trick effect experts got out the stock parachute and dummy. The parachute, when opened, is about three feet in diameter and made perfectly to scale, each shroud being an exact duplicate of that on a standard chute. The dummy is a doll stuffed with cotton and painted to resemble an aviator. A plane was chosen from the score kept on hand. The motorboat was also taken from the assortment of stock models. The "lake" is a cement pond forty by fifty feet, which tapers at one end to allow for the perspective of a camera lens. The north country background was a standard stage drop hung on the building behind the lake.

The problem was how to make the dummy jump from the flying plane and land in the motorboat. The plane was pulled on a concealed wire, and the motorboat ran by its own power on an underwater track. The dummy was dropped by a timing device which operated a given number of seconds after the plane started. The motorboat was started at the same instant as the plane and ran a shorter distance at a slower speed, which brought it slightly behind the plane at the instant the timing device released the dummy.

It sounds perfect in theory, but it didn't work out that easily. A wind came up and the dummy landed every place on the lot except in the boat.

After three days and over two hundred trials, Jackman was about ready to give up



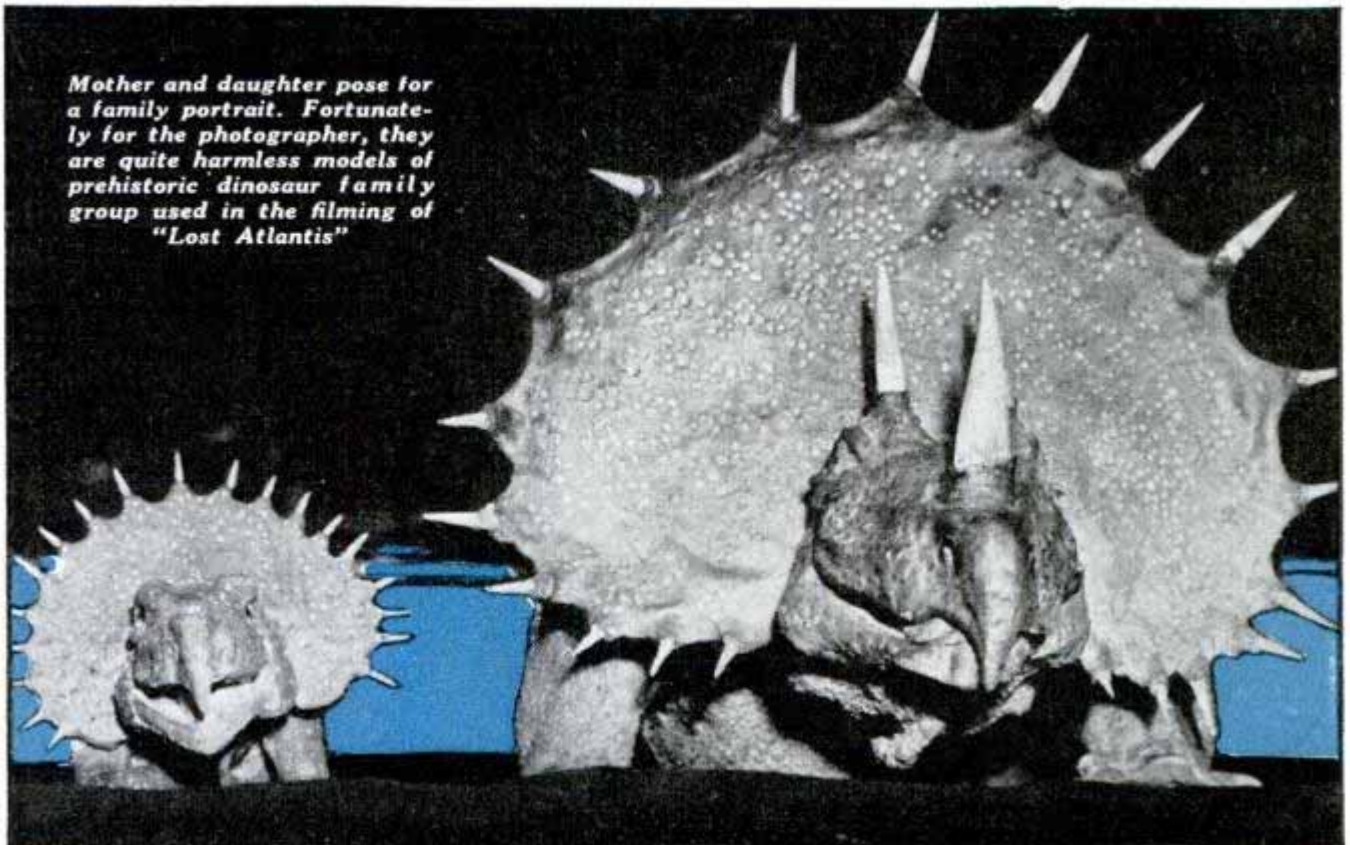

*Mother and daughter pose for a family portrait. Fortunately for the photographer, they are quite harmless models of prehistoric dinosaur family group used in the filming of "Lost Atlantis"*

when the dummy dropped again from the plane, the chute opened perfectly, and the figure settled into the motorboat. The cameramen said the take was good, and the developed film proved they were right.

Dinosaurs are stars of "Lost Atlantis," a new film. They range in size from four inches to two feet, and are made of a special sponge rubber molded over a flexible

wire frame. First stage of dinosaur creation is to secure the picture of a dinosaur skeleton from the local museum. Next the beast is modeled and remodeled in clay until it looks weird enough. Finally the framework is made, the sponge rubber molded around it, and the prehistoric figure painted. Two girls who worked over

(Continued to page 130A)

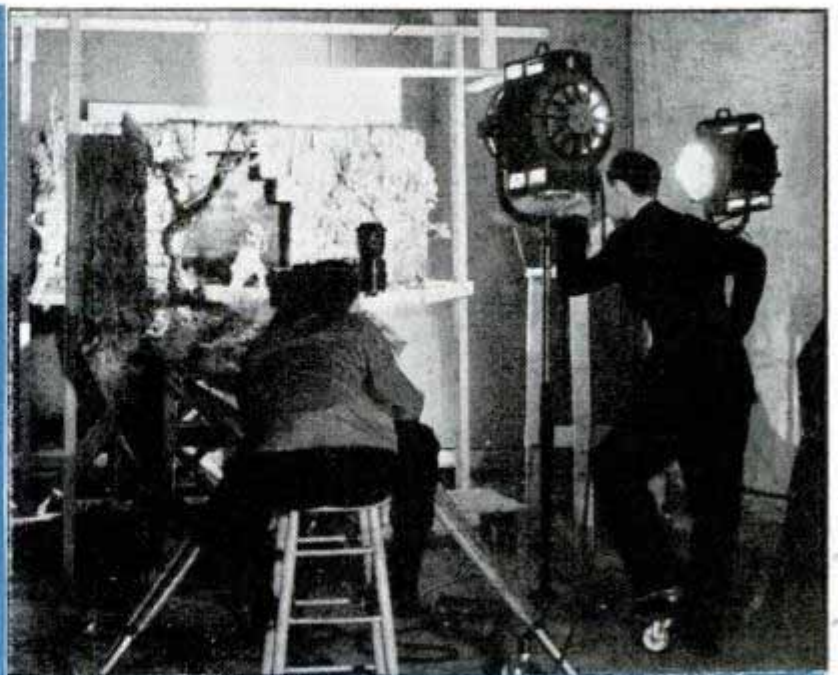

*Left, model of prehistoric monster. Right, how scene at left was filmed. Such shooting is really a series of stills, as the camera is stopped and the models moved after each frame*



g 629

Red Cross  
1931  
S. Carnai  
Philadelphia

# Tiny Lifelike Band Does Everything but Play



Mimicking movements of a real orchestra, toy musicians sway rhythmically with the music they seem to produce, but never a sound comes from their instruments. That is supplied by a phonograph hidden from view. The half-pint members of the band were made by an unemployed Philadelphia craftsman, who used bits of wire, wood, cloth and other scrap materials and doll heads. What once were dentists' drills and tin cans were converted into musical instruments by his skilled hands.

Like a serious, hard-working orchestra these midgets go through all the motions, synchronized with music coming from a concealed phonograph

Warren  
Millard

# Water Helps Preserve the Roof of Cinder Block House

Flooding the roof with water to preserve it seems paradoxical, yet that is the case at the cinder block house of a Knoxville, Tenn., resident. Water has a preservative effect on the volatiles in the roof, made up of pitch, felt and gravel. It also keeps the house cooler in summer by evaporation and by reflecting the sun's rays. An automatic valve keeps the water at a three-inch level. This plan is practical on a concrete structure where there is no wood to rot. Chemicals could be added to prevent freezing in a cold climate. This cinder house is unplastered, its walls being painted, and its floors are concrete tile squares.

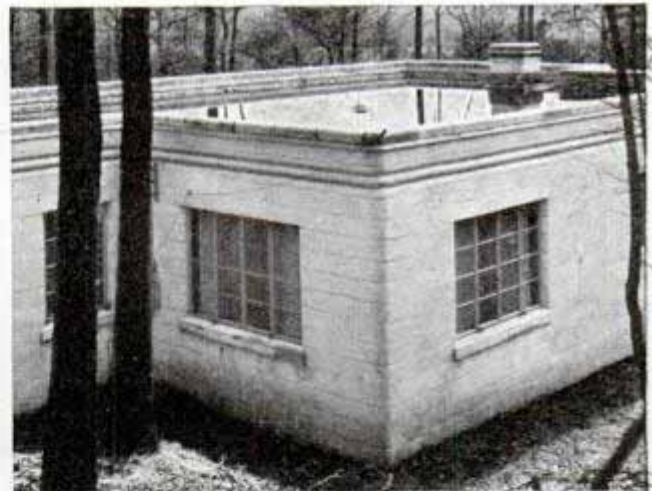

Automatic valve keeps roof flooded three inches deep to preserve volatiles in roofing materials

James  
Knoxville, Tenn.

# Wind Indicator in Pocket-Size Case Has Space to Store Valuables

Packed in a tiny Bakelite case handy for the yachtsman, fisherman and for outdoor

sports is a combination compass and wind instrument that gives instant indication of the speed and direction of the wind. It is less than four inches long and weighs under two ounces. Precision-built of non-magnetic, rustproof materials, it has a waterproof housing that contains a compartment for matches, money, licenses and the like. One model measures wind speeds from five to thirty miles an hour, another speeds from ten to sixty miles an hour.

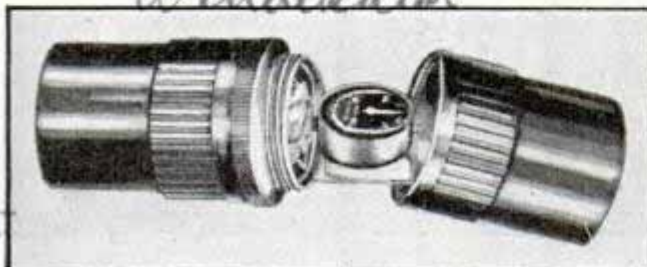

Tiny wind indicator for sportsmen has Bakelite case

4-95

Wendekalot

g 670 Ruth Peck MeLeod, 1902. Melrose

General Communication Co



# Alpinists Train Indoors for Scaling Mountains

Paul's Photos

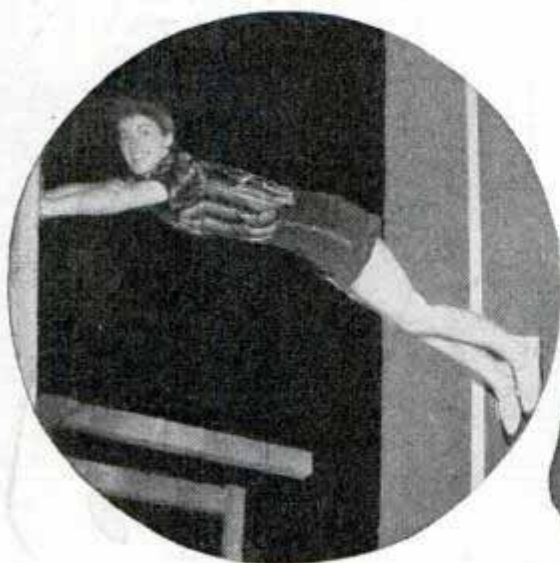

When Alpinist, above, is confronted by a narrow chasm in mountains it will only be necessary to remember the method in indoor school of descending parallel walls by hands and feet. Top, center, Alpine instructor demonstrates scaling technique

To train himself for endurance and for keeping balance with heavy equipment, mountaineer above practices carrying table with weights attached. Below, swaying platform teaches mountain climber to preserve equilibrium where footing is insecure, as on a slippery slope

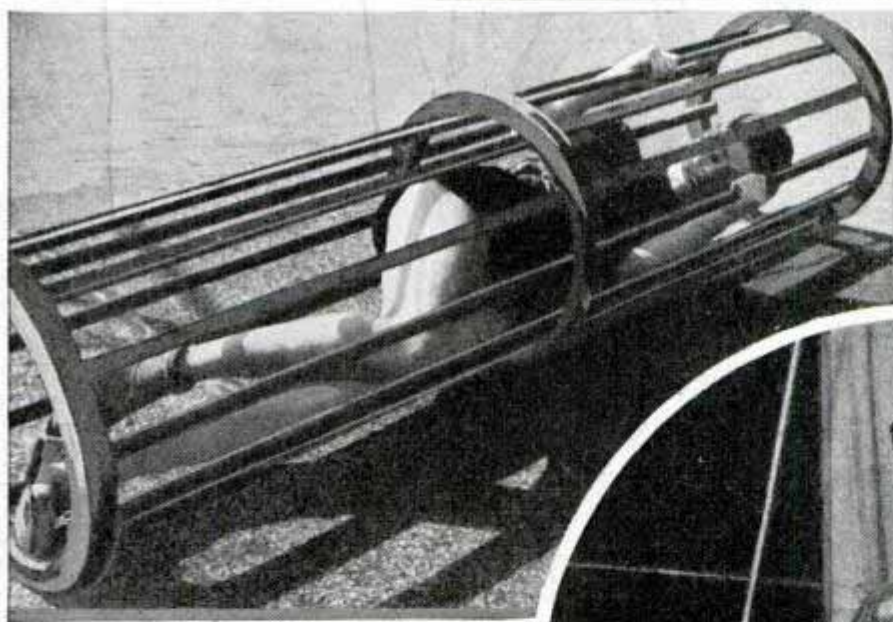

Far from the inspiring scenery of the mountains, aspiring Alpinists train indoors for the perils and labors of mountain climbing. Although lacking the scenery, they are not without the "props," for the Alpine club of Paris is equipped with many a "synthetic" hazard to harden muscles and steady nerves. The athlete above, for example, is not trying to escape from a medieval torture cage but is engaged in practice maneuvers in a rolling cylinder that gives special exercises for the ambitious mountaineer. After a rigorous course of training at Paris the novice is ready to try his skill and endurance on any snow-clad peak



of 50 ft. ...  
build, 50 5. 5 the  
never

# The HUMAN

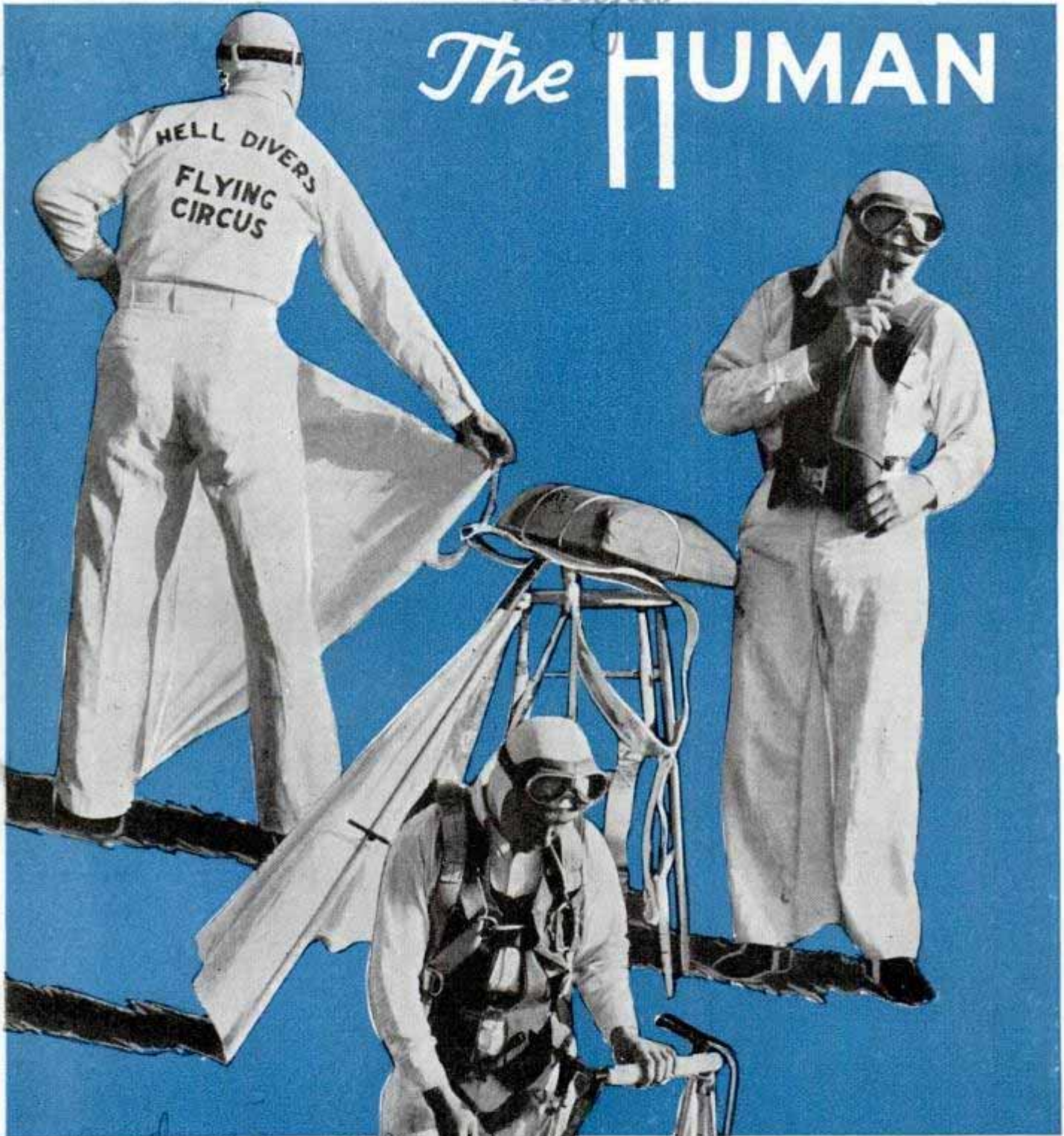

\* Huey Morgan

Here's how the daring batwing glider prepares for his leap from a plane and descent to the earth. Left, donning trousers with web between the legs and straps under the insteps to hold the web taut. This gives the glider longitudinal control, much the same as the stabilizer of a plane

Right, wearing flotation vest which is inflated rapidly by blowing into a valve. This would keep the human glider afloat if he fell into water. Bottom, preparing to attach the folding batlike wings which are hinged to a steel frame strapped to the man's chest. The fabric is airplane cloth.



2569

# GLIDER



*Above, the human glider in two positions simulating those in which he would appear shortly after leaping from the plane high in the air. Note the manner in which the wings are being used. The web between the legs aids in controlling the slow downward swoop. Left, at the moment of leaving the plane*

*Right, the human glider, getting close to earth, must open his parachute to avoid injury from a rough landing. Getting his head down, he drops the right wing and puts that hand on the ring of the rip cord. This position enables him to take the shock of the parachute's opening on his shoulders*

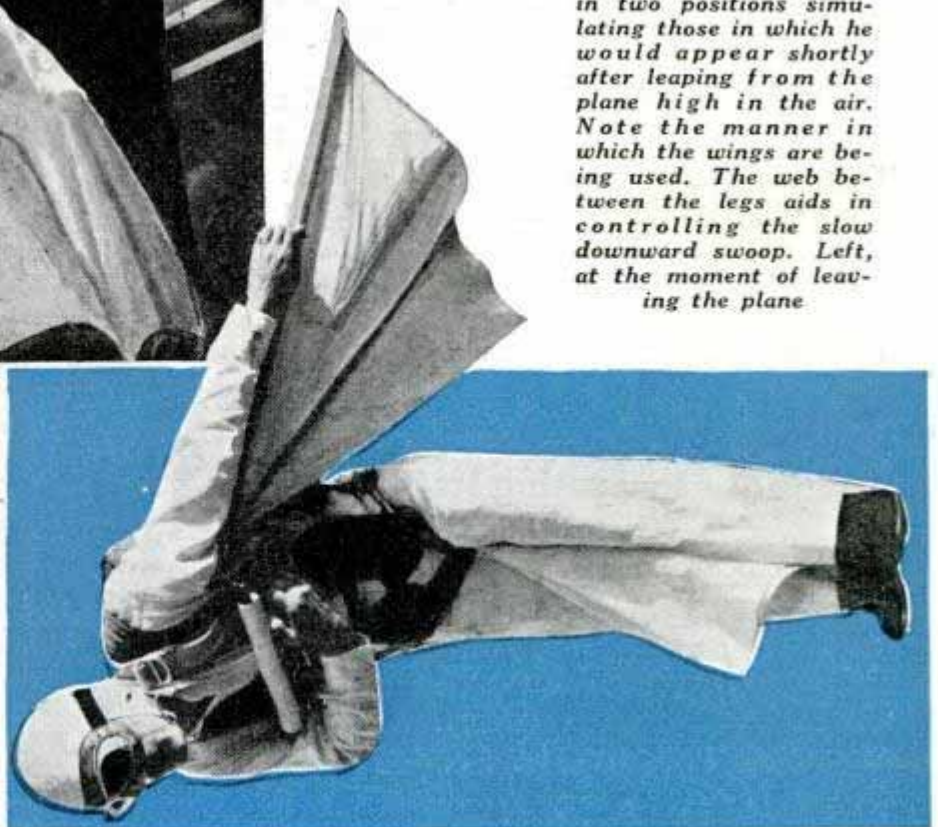



*Information manager  
Western Electric Co. N.Y.  
195 Broadway N.Y.*

# Plane Is Polished by 'Bootblacks' before Its Flying Debut

once are run through a bath of paper pulp. The pulp forms a thin coating on the copper, producing a covered wire with a diameter three thousandths of an inch less than the paper-wound wire and thus saving space in the standard cable for 606 additional wires.

## Seven-Foot Pneumatic Tire Encases 100-Pound Tube

How'd you like to drive a truck with seven-foot pneumatic tires and have one go flat? It takes three men and a specially designed derrick five hours to change one of these gargantuan tires. They were built by the U. S. Rubber company for giant earth-moving machines at work on the Hansen dam near San Fernando, Calif., machines capable of carrying thirty cubic yards of dirt at seventeen miles an hour. Each tire, of thirty-four ply construction, weighs about 1,500 pounds and has rubber tread more than three inches deep at its thickest. The tubes themselves weigh 100 pounds each. One of these tires, inflated, has a loading capacity of twelve and one-half tons.

*Special Service  
Em. Truck*



Here's how workmen shined up one big transport plane as it was being prepared for its first passenger-carrying flight

It's a big day in the life of a transport plane when, after passing all the government tests, it takes off with passengers for the first time. Like a youth being graduated, it must look its best and of course a "shine" is requisite. In one instance workmen polished the body by reciprocating a long fabric strip over it similar to the familiar shoe-shining process.

## 600 More Wires Packed in Cable without Increasing Its Size

Telephone engineers are now packing 4,242 separately insulated copper wires in one cable. The cable is the same size as before—two and five-eighths inches in diameter; the wires themselves are the same, yet there are 606 more wires in the cable than before. The secret lies in the insulation. Instead of wrapping each copper wire spirally in paper ribbon, sixty strands at



Inner tube of giant truck tire weighs 100 pounds, and the seven-foot tire itself weighs 1,500 pounds

*9507  
1790  
195 Broadway N.Y.  
New York City  
Souris pull*

*9696*



# Pack Animals Ride Fast Truck to Forest Fire

Within twenty minutes from the time an alarm goes out from a lookout station, a fast truck of the U. S. Forest Service is speeding to the scene of the latest forest fire. Instead of the familiar city fire-truck equipment, this vehicle carries nine mules and a saddle horse, all wearing masks to protect their eyes from wind. These ten animals make up a complete pack train, an important part of the fire-fighting equipment. The truck which carries the animals is a powerful, lightweight vehicle designed especially for the rapid transportation of animals and equipment. Its body is made of aluminum. Capable of a gross load of 32,000 pounds, the truck has a speed up to seventy miles an hour on the highway. A powerful engine enables it to maintain speeds of twenty-five to thirty miles per hour on the six-per-cent grades found on national forest roads. A roomy compartment, back of the cab is used to carry nine pack saddles, a riding saddle, two bales of hay, 100 pounds of oats and miscellaneous equipment. A bed is available for the pack rider when the truck is in transit. Loading and unloading is accomplished by a portable ramp.



Pack animals being carried to scene of forest fire (top and center). Bottom, loaded with supplies and on the trail to fire lines

## Farmer Scalds Soil with Steam to Rid It of Weed Seeds and Insects

To rid the earth of weed seeds as well as insect enemies of his crops, a farmer has invented a portable boiler that shoots superheated steam into the soil. The boiler is mounted in front of a disk harrow and

pulled by a tractor. As the disks open up the soil, pipes from the boiler send steam at 300 degrees into the furrows. Tests showed the steam-sterilized soil was freed of pests, and produced healthy crops.

New Century Magazine  
May 1931

2511  
Derby  
Motor Truck Corp.  
1263 Mercer  
Seattle, Wash.

Casey 1234 Oregon Portland Ore

Buss Elliott Yakima Wash



2592

Cont. Wallace H. Morris, 5702 Magnolia

# They FLY

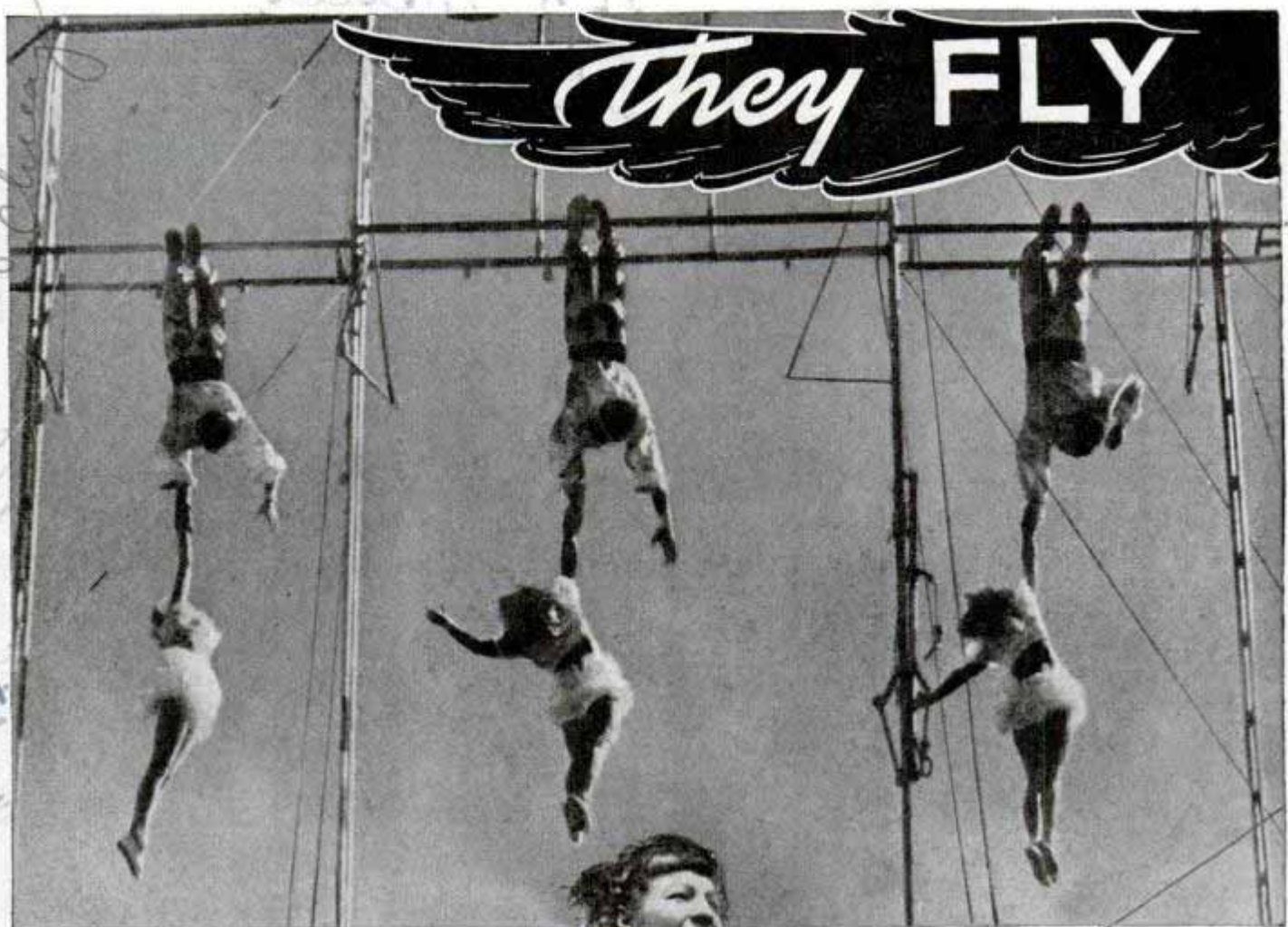
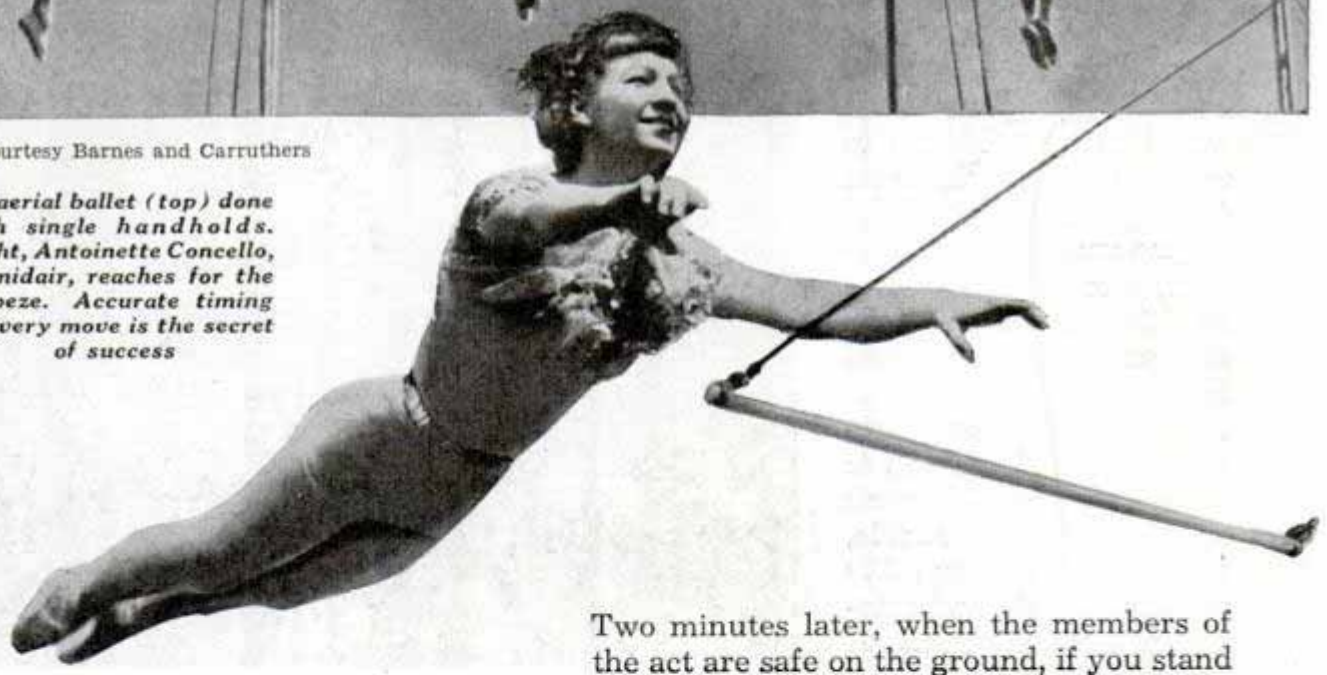

Photo courtesy Barnes and Carruthers

*An aerial ballet (top) done with single handholds. Right, Antoinette Concello, in midair, reaches for the trapeze. Accurate timing of every move is the secret of success*



Two minutes later, when the members of the act are safe on the ground, if you stand close enough you realize the perspiration was honest, for the man's face and the faces of his fellow actors are beaded. One gets that way, risking one's neck.

**F**FIFTY feet above the ground, three men and a girl in an ensemble balance themselves on a taut wire five-eighths of an inch in diameter. A circus act is under way. They have just passed the most dangerous point of their performance.

In the world of the circus, true aerial acts are of several varieties, but all are distinguished by the fact that they "hang from the ceiling," with no connection to the ground other than the ropes and guy-wires of their rigging. When they work outdoors, at fairs and similar attractions, metal framework is used to rear the acts

One of the men gingerly removes one hand from a long balancing pole and goes through the motions of wiping perspiration from his brow. A ripple of nervous laughter goes through the tense audience.



# Without WINGS

into the air. Besides the high-wire acts there are the "flying" or casting acts, double-trapeze acts, swinging-ladder acts, head-balancing trapeze acts, "iron-jaw" acts, "ceiling-walking" acts and one-arm acts. The latter calls for a deep reserve of strength, since such a performer will throw himself or herself in an aerial somersault one hundred or more times without stopping, while hanging high in the air, by one arm, at the end of a rope.

Among the aristocracy of circus performers are the "flying" or casting acts. Here a performer flies through the air from a swinging trapeze and is caught by another member of the troupe hanging by his knees from another trapeze at the opposite end of the rigging. This latter member is appropriately known as the catcher, who must time his own trapeze,

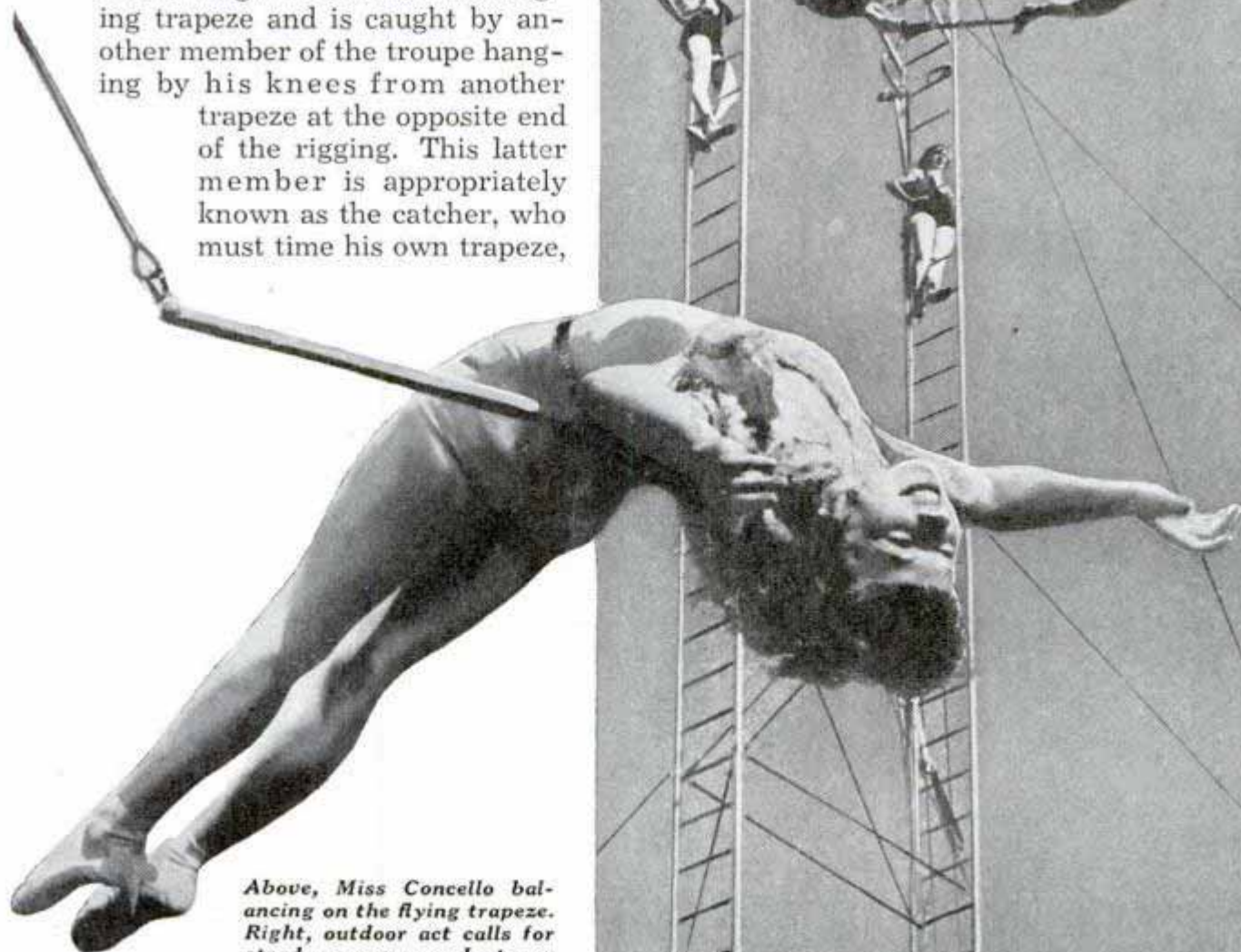

Above, Miss Concello balancing on the flying trapeze. Right, outdoor act calls for steady nerves and strong rigging



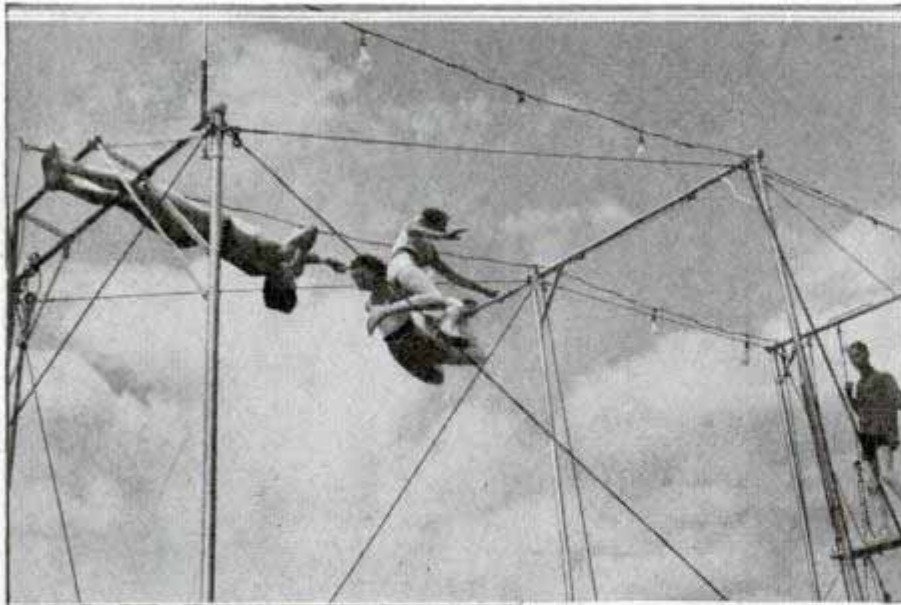

moving through the air to meet the oncoming flier, to a fraction of a second, and to a quarter of an inch in the arc he travels. His hands must meet the hands or ankles of the other, and their grip must be sure and of just the right tension.

Antoinette Concello is the only woman aerialist who today does either two and one-half or three somersaults in the air, between the time of leaving the flying trapeze and landing safely in the

hands of the catcher. She generally confines her somersaults to two and a half. If she does three of them, she says, there is a split second of unconsciousness during the last half turn, before her hands meet those of the catcher.

Not always is the timing perfect between the catcher and herself, and their hands miss. A fall to the protecting net below is the result. Aerialists take no unnecessary chances, but if an act is to remain a headliner, it must retain those chancy spots where a loss of balance, a slip or an error in judging time or distance may mean a broken limb, if not a broken neck. No flying act is done without a net. In the case of the high-wire walkers, a small

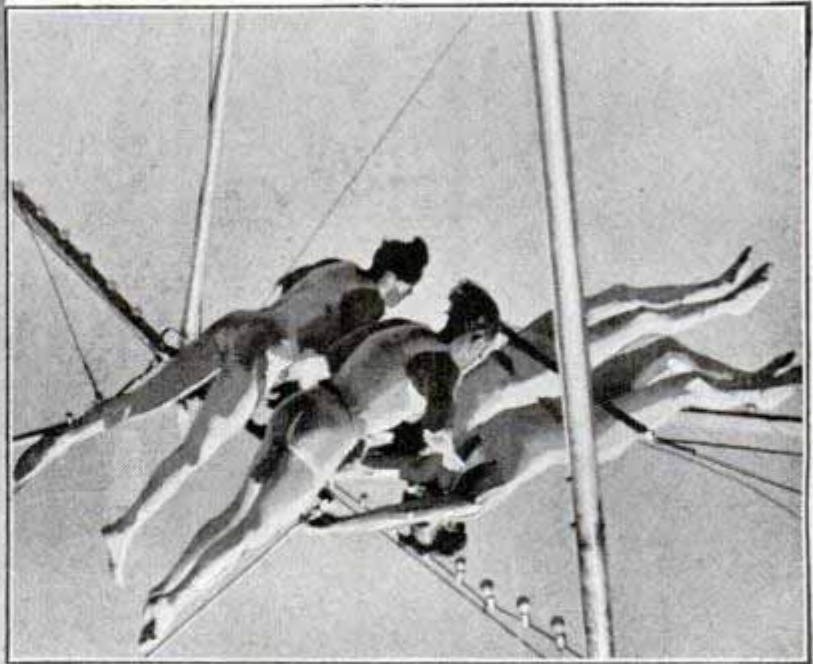

Photos courtesy Barnes and Carruthers

Two flying artists pass in midair (top), one leaving the catcher's hands as the other reaches for catcher. Left, strong-jaw act in which strong jaw muscles and sound teeth are essential. Right, a "double pass," two members of the act going in one direction, two in the other

*Flying Artists*



net is held by eight or ten workers on the ground below the act, at its most dangerous point. But such a net has little value as a lifesaving device in case of emergency. It is wholly psychological in its effect, and gives the members of the act a feeling of safety.

Trainers of aerial acts try to get hold of their new material while it is young, some as youthful as eight years of age. Around forty years of age is generally recognized as the time when an aerialist working in a dangerous act had better begin thinking about some less hazardous occupation.

The youngsters have muscles and bones that are capable of correct training. Virtually as soon as they are strong enough, especially in high-wire acts, they go into training. This is begun near the ground, until they acquire courage and the essential sense of balance. Gradually the wire is raised to fifteen feet, thirty feet, and on up to regular working height, from fifty to seventy-five feet.

Beginners in flying acts are generally started around the age of fourteen. Younger than that they are too small to reach from the pedestal and grasp the flying bar. The catcher must be mature. Fliers in their maturity weigh between 105 and 150 pounds, while catchers, who do the heavy work, run from 160 to 190 pounds.

Rigging for aerial acts is not made after a set pattern. Each act has its own needs and its own ideas. When a performer wants such equipment, he goes usually to a competent machine shop, and has his rigging made to order. He furnishes the specifications for size, weight or thickness of materials, the kind of wood, metal wire or rope he wants used, and the machinist, working with him, turns out the job accordingly.

Crystallization is the bogey of the aerialists. When a metal part crystallizes the results are apt to

(Continued to page 127A)

## Horn With Two-Mile Range Used to Direct Field Work

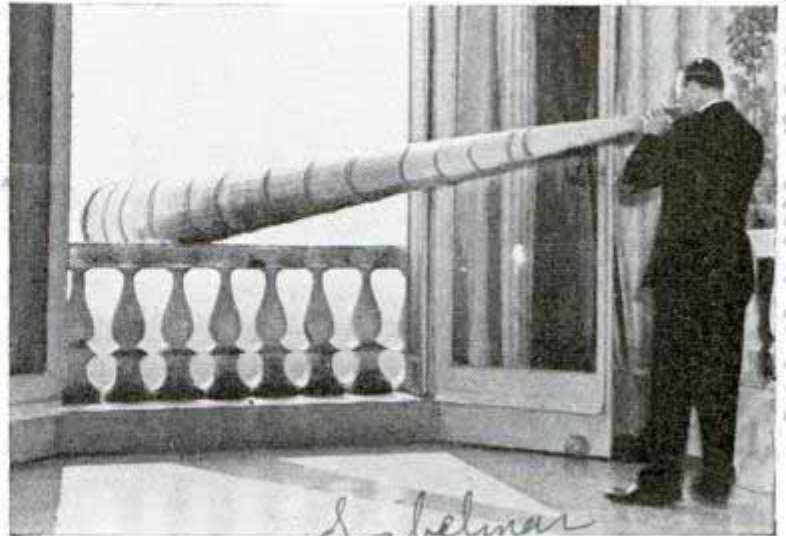

*S. Belman*  
Five hundred years ago this Italian megaphone was used to direct laborers in fields. It could be heard two miles away

*Venice*  
It was no simple task in the fifteenth century for one to make himself heard two miles away, but that was the range of an Italian "megafono" which served as the equivalent of a one-way telephone. When the master wanted to summon a servant from the fields, he hauled the megafono to the balcony and bellowed a command that would carry a great distance in favorable weather.

## Scout Plane Converted into a Bomber by Fitting Racks to Landing Gear

*9635*  
British scout planes with a top speed of more than 200 miles an hour can be converted quickly into bombers by attaching racks to the undercar-



*Westlander Lusander*  
*Central Features News*  
Fitted to the "trouser cuffs" of this fast British scout plane are racks to hold bombs for additional striking power

riage. The bomb carriers project outward horizontally from the landing gear and equip the fast planes for offensive striking power when it is needed.

*Bristol Perseus engines*



# Paper Golf Tees by the Strip Are Used and Discarded

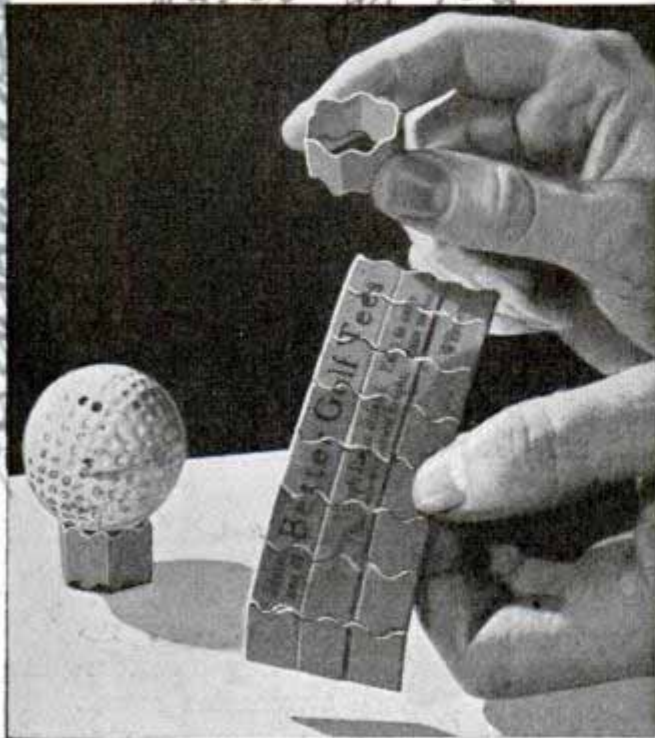

*Tee is torn off card along wavy line and squeezed into six-sided "seat" just the right height for ball*

Paper golf tees that resemble a tiny cardboard crown on which the ball is set have just been introduced. They are made in strips of ten, each tee being torn off along wavy lines when needed. An advertising message can be printed on the strips.

# Steam Slices Up Blocks of Ice into Convenient Cubes

Fed by gravity on a stainless-steel incline, big blocks of ice are sliced into small



*Large block of ice fed into steam cutter at right emerges at left as hundreds of small cubes*

cubes by a steam-operated machine just developed. A series of horizontal steam-filled tubes swiftly cut the block into slabs, which are moved by a lever-operated conveyor onto a horizontal double grid containing steam tubes at right angles to each other. These cut the slabs into cubes, which are released over a screening grill.

# 'Hammock' under Ironing Board Keeps Clothes Off Floor

Laundered clothes are kept from soiling through contact with the floor while being ironed, by a catcher attached to the board. It receives the long pieces as they hang over the edge. Two telescoping arms that hold a strip of heavy muslin to form a U-shaped shield will save steps for the housewife by serving as racks for hanging



*Laundered garments can be ironed without fear of soiling them if this clothes catcher is on the board*

garments. A flat metal plate, to which the arms are fastened, is screwed to the underside of the ironing board, and when not in use the "outrigger" frame can be folded out of the way. The clothes catcher, it is claimed, will not interfere with the folding features of any modern board.

☐Inquiries as to makers of articles described in Popular Mechanics, will be answered by our Bureau of Information upon receipt of return postage.

*9 450  
W. Dimette, et al.  
\$2.00 for 100  
C. P. Young, 3019  
Thermo-Cube Co., 3268 W. Grand, Chicago*

*2604  
Hammock' under Ironing Board  
Keeps Clothes Off Floor  
Every man Clothes Catcher Co. 133 2 1/2  
Kavanaugh City, Ind.  
10 roadways!*



2599 Cont. U.S. de A with Muller  
459 D. Serrano Ave  
Los Angeles



# Battling the GREEN HORDE

Photo U. S. Forest Service

SCOUTS warn that the enemy, five hundred million strong, is about to attack. At headquarters a tired man sits before a map. His finger draws an imaginary line.

"There," he says wearily, "we'll have to stop them, or give up. Are the flame throwers at work?"

A man answers:

"That job will be done by morning."

The chief turns to another lieutenant:

"How about the bacteria? Have you plenty on hand?"

"Not yet. But more are coming tonight."

The chief turns back to the map. Then a phone jangles:

"Smith reporting. We're making a last stand at the ridge. Get us more supplies.

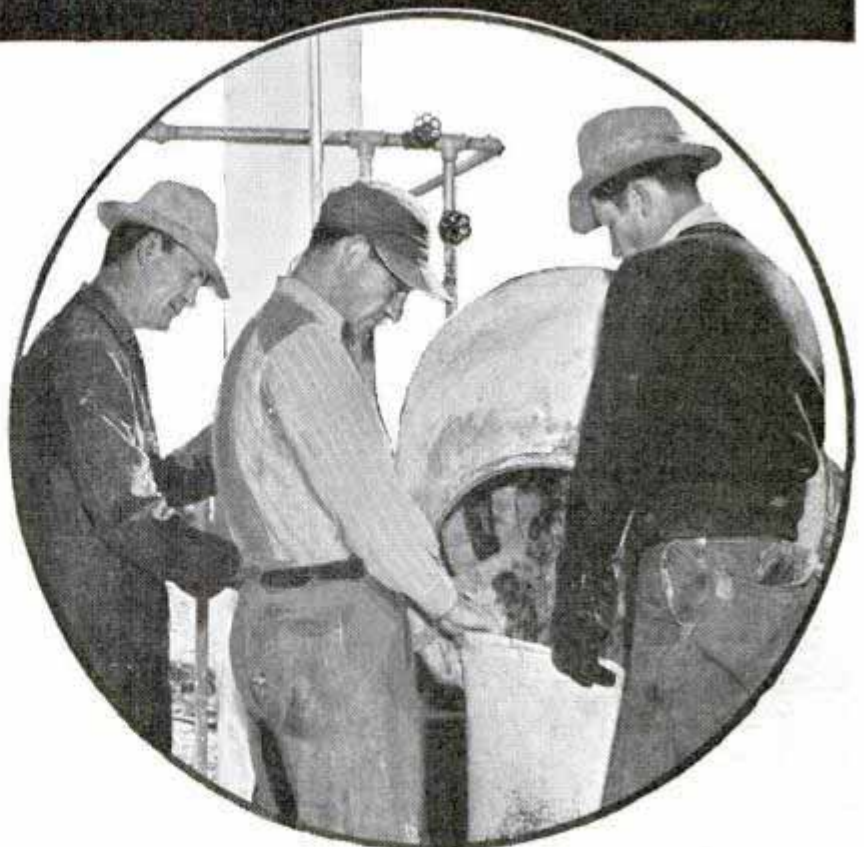

One of the green horde (inset). Last desperate measure is to burn the fields with aid of flame throwers (top). Poison bran mash being sacked to be rushed to front lines (bottom)



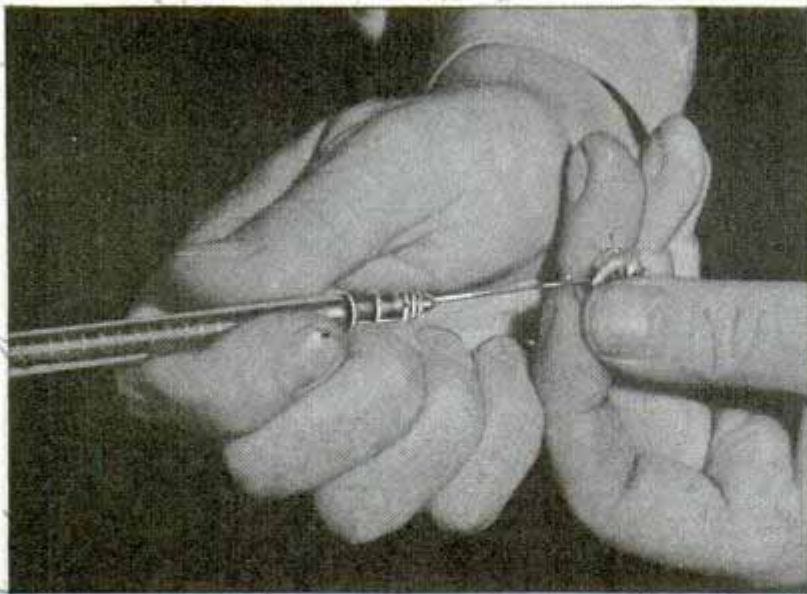

armies of them which can do a million dollars worth of damage in a night.

Scientific, coordinated action is slowly winning the war against the 'hopper, one of humanity's oldest enemies. It is a fight in which scientists, and officials of state and federal bureaus of agriculture play a leading part.

One of the most desperate fights in recent years was made in southern and central California in 1939, but before the invading army could be stopped, more than a million dollars worth of damage had been done. At one time the invading army reached the outskirts of the town of Coalinga, and began eating the paint off houses.

The standard ammunition in a grasshopper war is bran mash poisoned with sodium arsenate. This is churned in concrete mixers, loaded into trucks, and taken to the point where the chief of operations has decided to make a stand. Often valuable crops must be sacrificed to

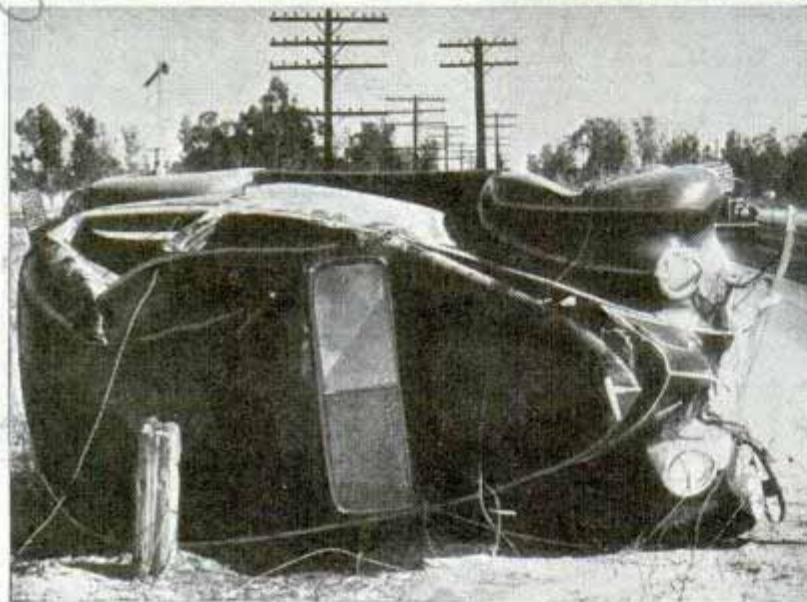

The enemy will start advancing in the morning."

"All right. I'll send more planes along to help out. We're planning to do some bombing along the ridge."

And at dawn the enemy marches on, leaving the ground seared and blasted. Not even a blade of grass or a scraggly weed remains.

You have seen members of this invading army often in the garden, hopping among the flowers. But you have probably never seen them when they cover the sky so that they create an artificial night. They are grasshoppers, not the few mild 'hoppers you're used to, but vast



*Top, one of the inoculations by which bacteria are brought to maximum deadliness. Center, car overturned after skidding on pavement made slippery by grasshopper horde. Bottom, "bombing" the enemy with poison mash*

near Coalinga Calif



straighten out the line of defense and so conserve men and supplies.

Spreading the poisoned bran is done with a two-wheeled machine having a hopper into which the bran is constantly fed. At the bottom of the hopper are whirling disks which toss the bran outward by centrifugal force. The machine is known as a "broadcaster." By trundling it across the fields behind a truck, and keeping it filled from a second truck, a large area can be covered quickly.

Sometimes, however, there isn't time to scatter the bran, or isolated fields must be blocked off with a strip of poison. Then the enemy must be "bombed." Low-flying planes drop the bran in a wide swath which effectively stops the advancing hordes. To insure accurate bombing, the plane must almost skim the ground.

When a great swarm of 'hoppers reaches a poisoned area, a miracle seems to occur. In a few hours the grasshoppers vanish. What actually happens is that the 'hoppers crawl under clods and stones to die.

(Continued to page 126A)

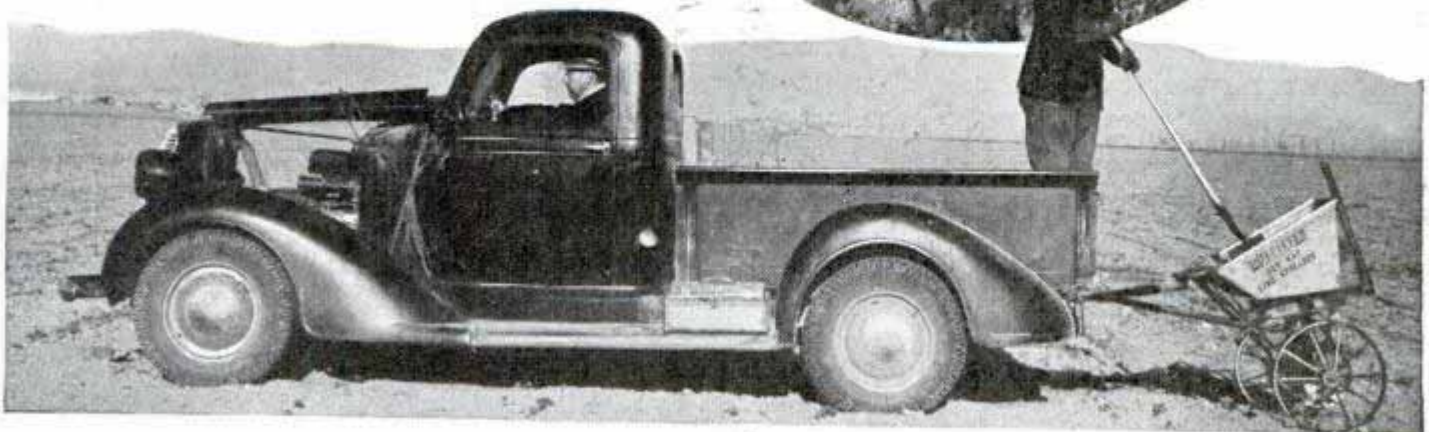
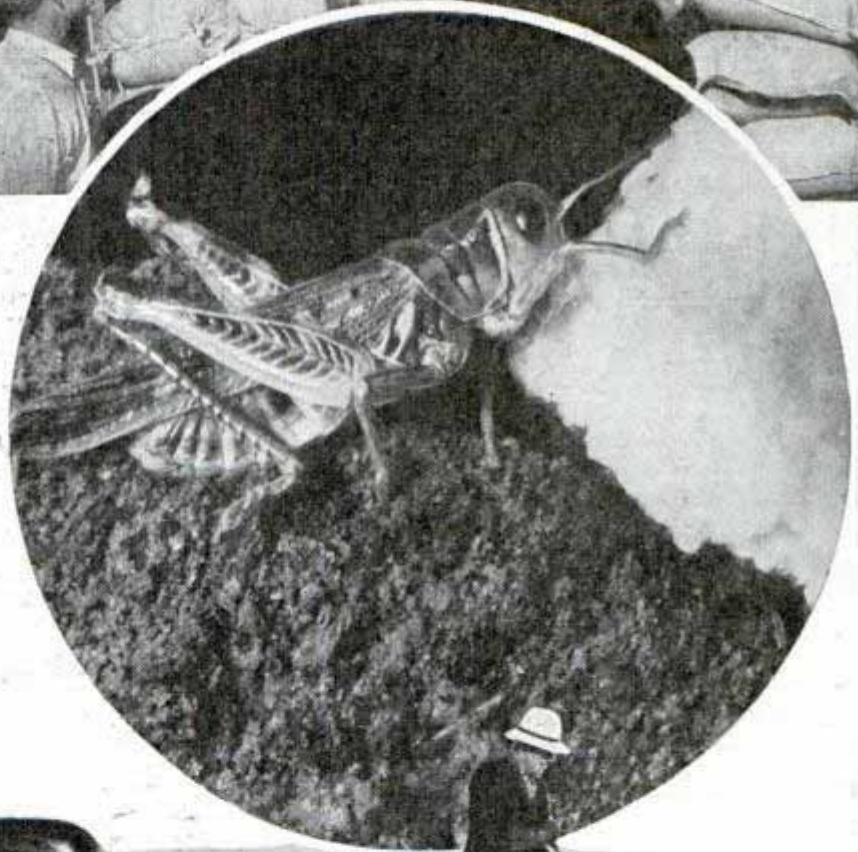

**Top, truckload of bran arrives at the battlefront. Circle, grasshopper eating its last meal—poison bran mash. Bottom, "broadcaster" being used to spread mash quickly across field in path of the green horde**



*Rodwin de viler  
Coal Research Div.  
Armour Institute, Chicago*

### Saw Teeth Set by Hammer Operated by Foot Pedal



*\$1.75 send*

Every step on the treadle releases uniform blow of trip hammer for setting teeth of saw

Fatiguing hand work in setting saws is eliminated by a pedal-operated tool now available. It is a trip hammer, delivering a stroke of uniform pressure at each step on the treadle. The tool is easily fastened to the workbench and is adjustable to various sizes and types of saws. There is no danger of getting the saw out of alignment.

### "Liquid Coal" at Dime a Gallon Runs Automobile Engine

Finely pulverized coal suspended in an oil "carrier" was used to drive a stock 1939 automobile in a recent demonstration. The car was started with gasoline, then "liquid coal" was fed to the motor from an auxiliary tank without changing the carburetor

*Trade Tool Co. 1090 4  
Madison Ave. Cleveland Ohio.*

*Scienc  
Expos  
June 1939*

or ignition system. This fuel could be marketed for about ten cents a gallon, and contains more energy than gasoline. Previous experiments with coal as fuel for an internal combustion engine have proved impractical because of the ash, and it has not been demonstrated whether the new fuel overcomes this handicap.

*J-566*

### Chimneys on a Railway Truck Show Best Height for Draft

In an effort to obtain accurate data concerning the optimum height for chimneys under various conditions, the Anthracite Industries Laboratory in Pennsylvania has begun a unique study on its roof. The plant chimney connection was cut off just above the roof, where a section of standard gauge railway track has been laid. On this track are three steel-frame cars supporting three brick chimneys of different heights. Thus the various chimneys can be tested by rolling them over the hole in the roof and cementing the joint. Complete accuracy is obtained by pre-heating the chimneys to identical temperatures before changing their positions. Thermocouples and draft tubes imbedded in each chimney show the operator what is taking place in the stack.

*Prima P.*

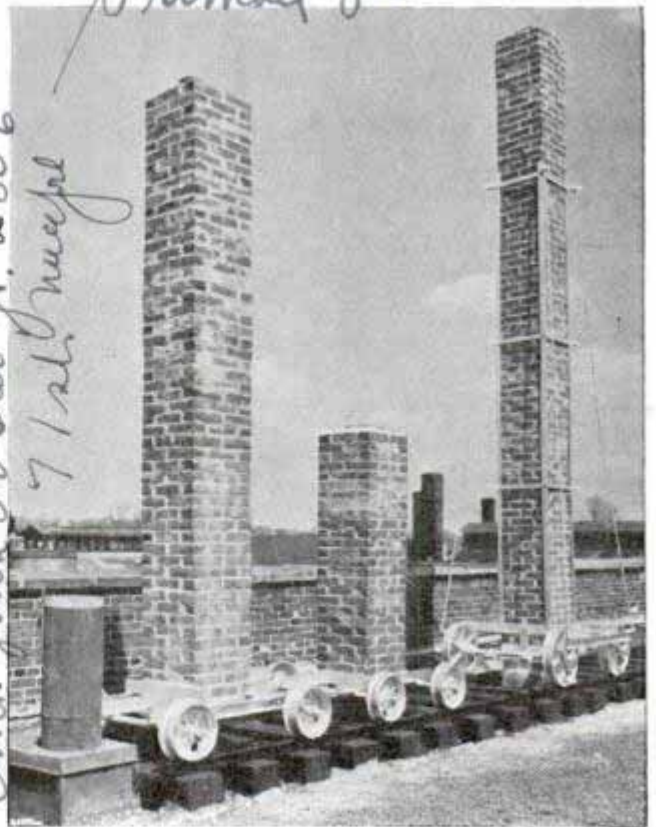

Test chimneys of various heights are mounted on wheeled trucks and rolled over hole in roof

*Cent. John Foster Jr. 230 E  
71st Street*



# Five-Car Trailer Train Hauls Cotton to Gin

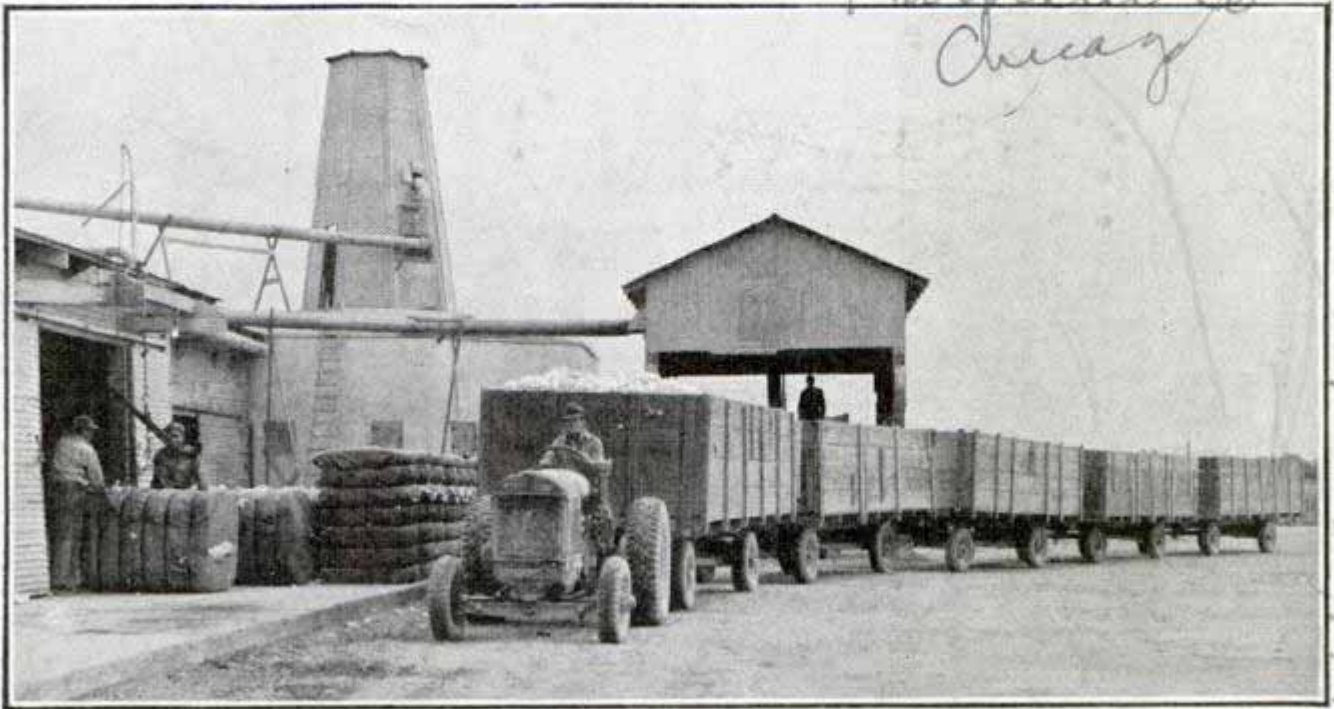

Here's a plantation train riding on rubber. The five trailers are loaded with cotton, arriving at the gin from the field where the Goodyear company raises its own cotton for use in tire and rubber fabrics

In cotton-picking time down on the Goodyear Tire and Rubber company farm a five-wagon trailer train shuttles back and forth between field and gin, bringing in

the white harvest. The company grows, cleans, gins and bales its own cotton for tires and rubberized fabrics, and this gin turns out as many as fifty bales a day.

## Miniature Wind Tunnel Tests Design of Model Planes

Two high-school boys at Eureka, Ill., built a miniature wind tunnel to test the streamlining of scale model airplanes,

boats, automobiles and buildings. At one end is a one-third horsepower electric motor driving a thirteen-inch propeller. Air

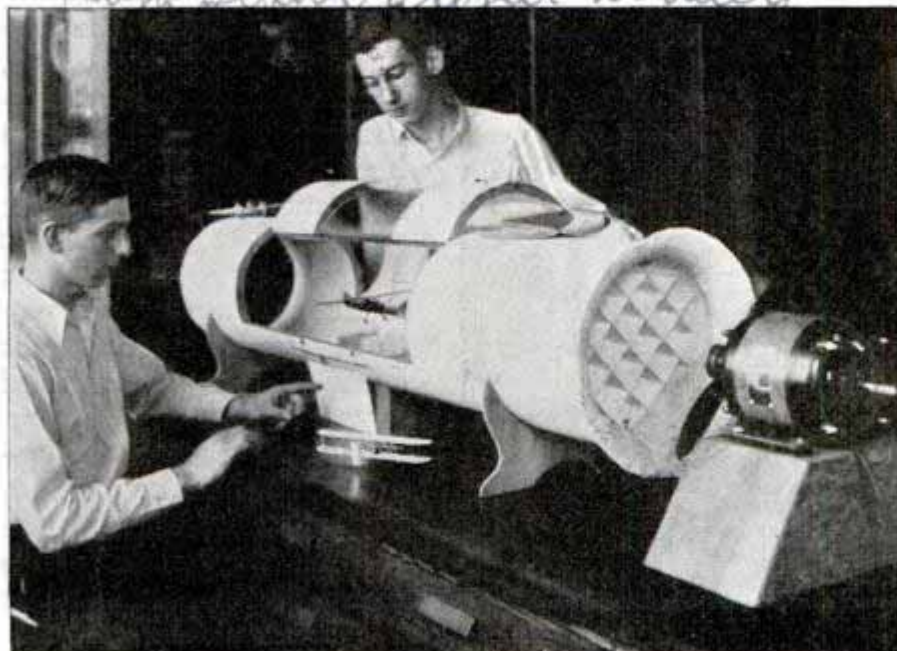

Notice the tiny airplane suspended at center of wind tunnel, which has a removable door with window for observing tests of model planes.

resistance is measured by the distance the model is pushed back by the air. A model of an early Wright biplane is blown back three times as far as a miniature modern plane. Cardboard squares straighten out the air blast. There is a large removable door in the top of the tunnel for placing and removing the models.

☐Inquiries as to makers of articles described in Popular Mechanics will be answered by our Bureau of Information upon receipt of a stamped, self-addressed envelope.

James Harnish and

Tractor uses Goodyear all weather tires  
Wagon  
Chicago  
Harvest Co  
International  
Farmall wagons

Industrial 10-20 model

J 55



2-25

# MERCY FLIER *of the*

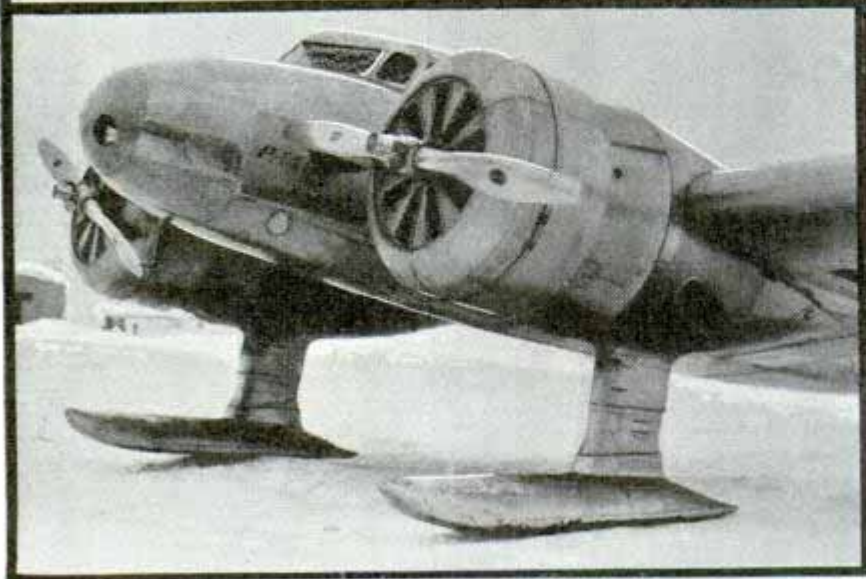
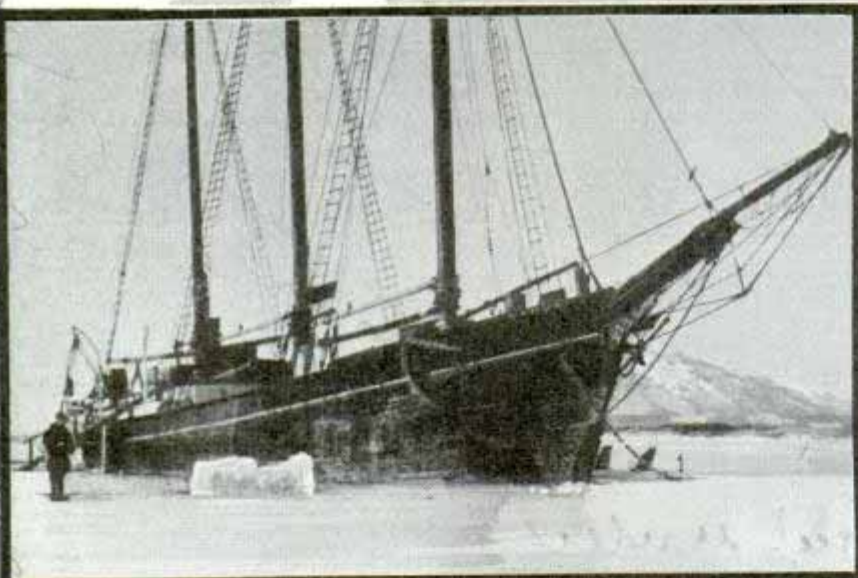
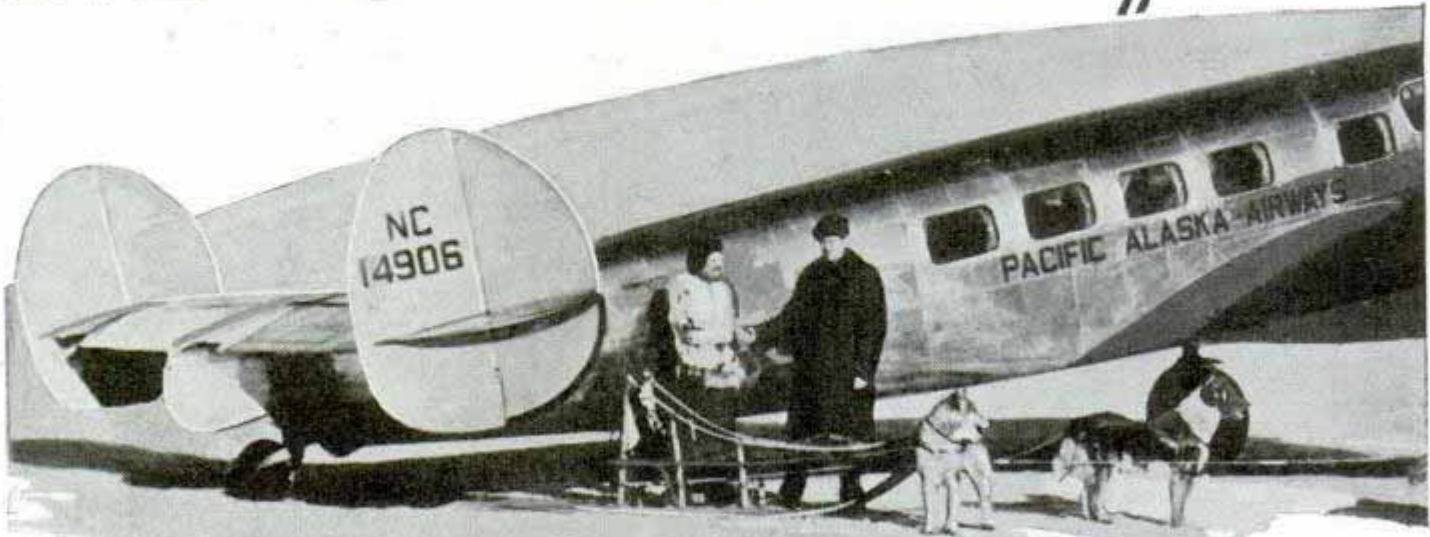

**H**ARDLY a person in Barrow held the faintest hope that the tiny settlement was not doomed to extinction. A diphtheria epidemic was ravaging the community of 300 Eskimos and a handful of whites living in the cluster of huts surrounding the United States Army Signal Corps radio station and the Presbyterian Mission on the northern tip of Alaska jutting into the Arctic ocean.

Huddled in huts of timbers and turf and stones built half underground for protection against chilling winds that sweep Point Barrow more than eight months each year, the natives were certain that death was only a matter of days.

Already they had appealed to their benefactor, Dr. Henry Griest, the medical-missionary head of the Presbyterian outpost. But the doctor could only ask the pleading natives to be patient. His small hospital

Old and the new in Alaskan transportation (top). Trading ship "Nanuk" near which Crosson based on one rescue mission (center). Skis enable plane to land on ice or snow (bottom)

Emb. Ross L. Cunningham 4516 w  
Crosby 118 1/2



Joe Crosson, manager, Pacific  
Alaska Airways, subsidiary  
Pan American Airways

# ARCTIC

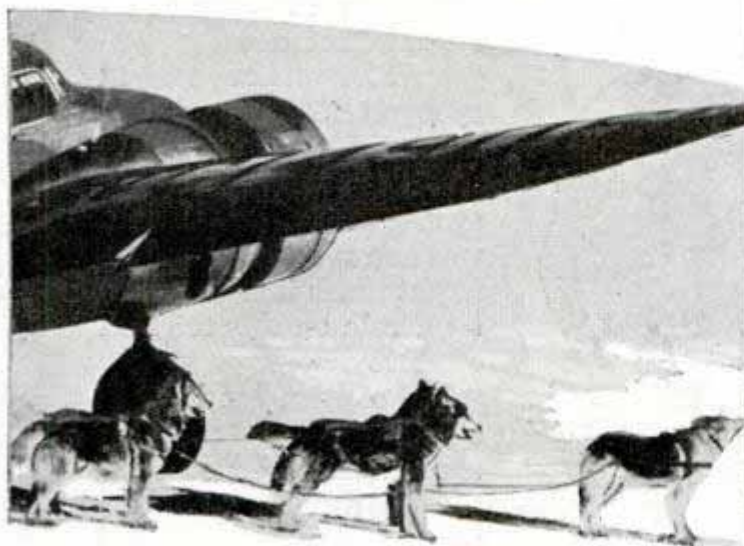

was filled and its staff was working the clock around. The lone hope, Dr. Griest explained, lay in obtaining a supply of antitoxin from Fairbanks or Nome, 500 miles to the south. These cities already had been notified by the radio of the signal corps station, operated by Sergeant Stanley Morgan.

But the possibility of a serum-carrying expedition penetrating to the com-

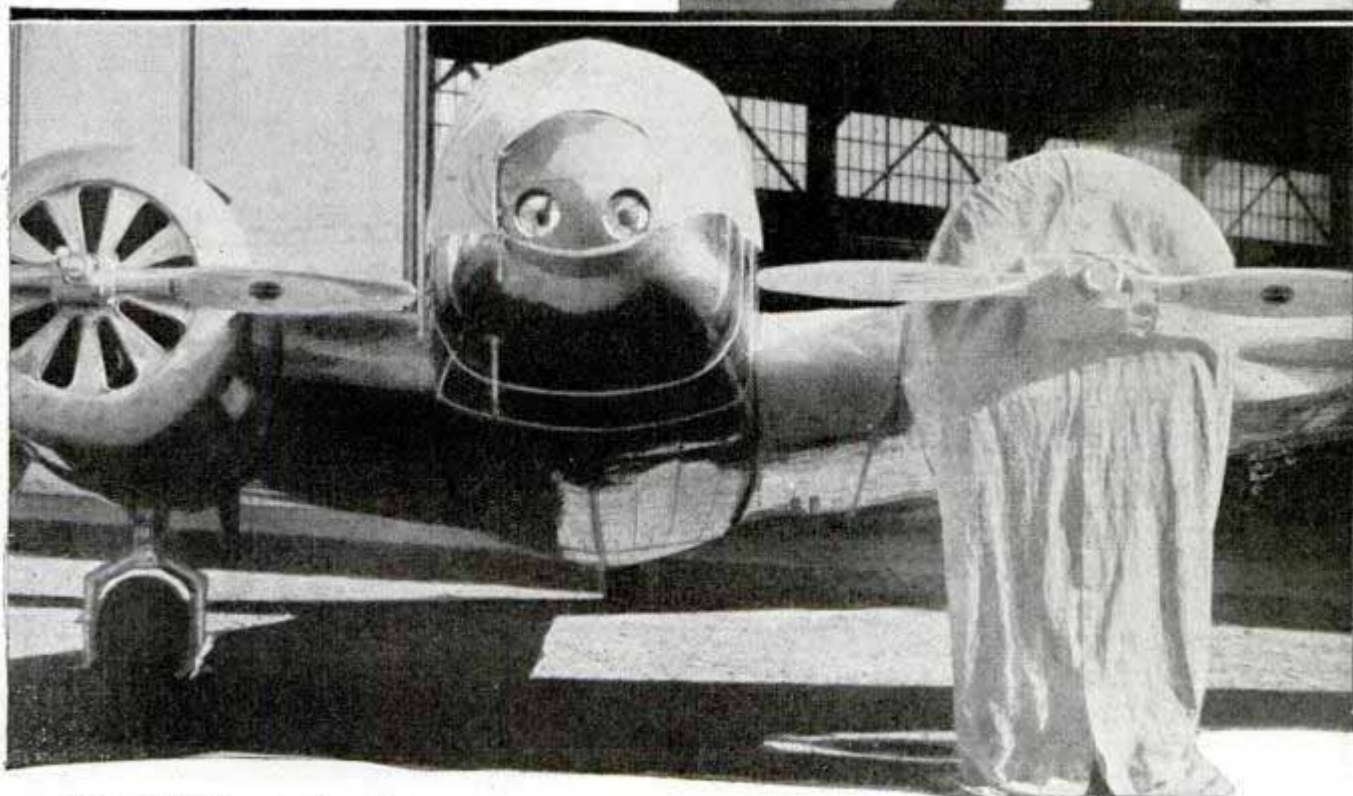

Photo courtesy Pan American Airways

**Right, Joe Crosson in parka used on Arctic flights. Bottom, Alaskan plane in "night gown" which protects it from cold. This equipment is carried by all planes for use where hangars are not available**





munity within weeks was remote. A freezing March wind whipped fog across the frozen Arctic and there was no hope that the ice would break up soon to allow vessels to reach Barrow on their annual voyages with medicines and supplies. The overland route to the south was barred by the ice and snow covered Anuktuvuk plateau for 200 miles, and by the Endicott mountain range with peaks towering 9,000 feet. Dog teams would require weeks to cover the distance from Fairbanks or

Nome. And, meanwhile, death was striking with increasing rapidity.

But the frantic radio appeal sent out by Sergeant Morgan had reached sympathetic and resourceful ears. Private and governmental forces swung into action. There was one solution—a plane might reach into the Arctic Circle on this mission of mercy.

Two hundred and eighty thousand units of serum, sufficient to curb the epidemic, were assembled at Fairbanks and Pilot Joseph E. Crosson was selected for the difficult job of flying the serum to Barrow, an errand not new to this flier whose exploits already had won him the title of the "Arctic Mercy Flier."

Crosson supervised the loading of the antitoxin and a supply of fresh vegetables—to enrich the diet of the diphtheria sufferers—and then roared



*Arctic "limousine" (top) used at Point Barrow to travel over ice and snow. Center, view of Endicott range over which Crosson flew on serum-carrying flight. Bottom, passenger-carrying ship of the far North*



away into the northern sky. Ahead of him lay 500 miles of perhaps the most dangerous flying country in the world.

With the directness of a homing pigeon, Crosson flew 200 miles north to Wiseman, where he landed for refueling. Then he was in the air again, flying blind through clouds and blizzards. Over the narrow passes of the Endicott mountain range he hurtled to win his way to a vast plateau of ice and snow which was the last leg of the hazardous mission. There was one remaining danger—of overshooting Barrow and flying out over the ocean in the gathering darkness with his rapidly diminishing fuel supply. To double-check his calculated position, Crosson watched cloud formations for that telltale darkening which polar fliers know marks a shoreline.

Before long he was able to make out the coastline and followed along to the north until the aerial masts of the Barrow radio station informed him his mission was at an end. The people of the settlement, having been informed by radio of his departure, were on the lookout for the plane and shouts of joy rang out when the plane zoomed low and landed on its skis on the improvised runway.

Ten minutes later Dr. Griest was administering the serum. The epidemic was stemmed within a few days. Joe Crosson had flown to another victory over Arctic death.

In the twelve years that Crosson has been flying over Alaska his fame has become that of a twentieth century knight errant whose great flying skill is readily available to those in need of it.

Today he may be called on for a flight to some isolated mining or fishing settlement where a victim of accident or disease requires immediate transportation to medical attention. Tomorrow it may be a summons to search for another airman or a party of travelers overdue in the Alaska wasteland, or to rush food to a starving village.

Joe Crosson takes these tasks in the stride of routine work, sandwiching them in between his duties as manager of the Pacific Alaska Airways, the Alaska subsidiary of the Pan American Airways, which operates scheduled mail and passenger service from Juneau to Nome, with

(Continued to page 114A)

## Luminous Page Shows Life as Seen from Diving Bell

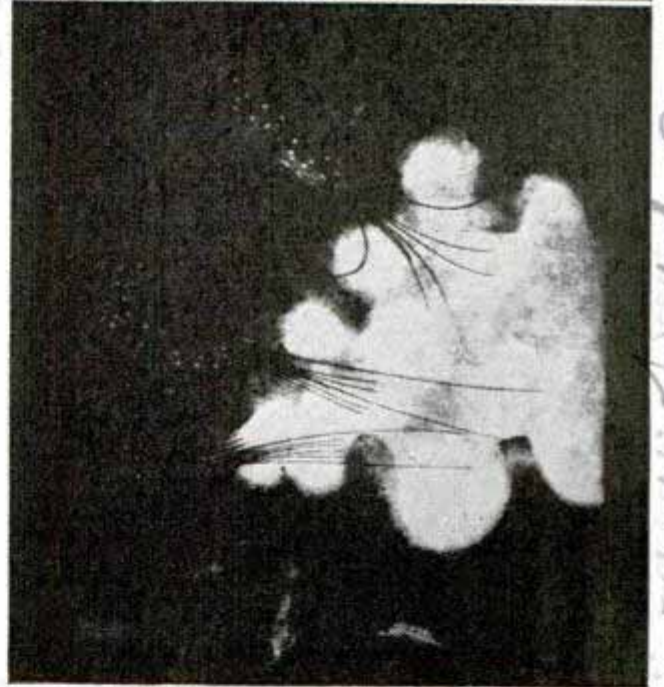

Top, energizing page of luminous book over light; below, same page emitting its luminous glow

One page in the "Smithsonian Scientific Series," recently published, cost \$10,000 and two years of research. It is a luminous page, glowing with its own light. Seen in ordinary light, it shows a group of North Atlantic red shrimp, crustaceans that can shoot a luminous cloud. When the page is held over an electric light for two minutes, and then is placed in the dark, it glows, appearing to the reader as a scene from a diving bell. The page keeps its brilliance for several minutes, and its latent luminosity is permanent. The printing of this luminous page is a unique achievement.

A. C. Wetzel, Miller

5:00 Fifth Avenue, New York



# Photo Laboratory Truck Has Extension Ladder



One feature of camera truck is this extension ladder for shots from above

Completely equipped for processing negatives and making prints, including enlargements up to thirty by forty inches, a photographic laboratory on wheels is being used to get pictures otherwise unobtainable. It is set on a 1939 truck chassis, has a floor area of sixty-five square feet, has running water, which may be electrically heated or cooled by ice refrigeration, and fans for conditioning the air. The roof has a non-skid rubber matting on which as many as six photographers may work at the same time. An extension ladder, which is useful in the taking of certain pictures, enables the photographer to reach a height

of thirty-five feet above the ground. It is sufficiently rigid for time exposures. When not in use, the ladder may be fitted into a recess in the roof. While the laboratory travels at speeds up to sixty miles an hour, film processing can be carried on.

## Right Arm Bigger Than the Left Is Heritage of Average Man

Most men grow up just a bit lopsided. Measuring a group of children and college men, Prof. Clarence R. Van Dusen of Michigan State college found the average person's right arm is bigger than his left; in the case of children, the right arm is more apt to be longer than the left. It may be that more use of the right arm develops it, but Professor Van Dusen thinks it probable that the tendency toward a mightier right is hereditary.

## Transparent Furniture Cover Protects Against Dirt

Protecting the fine fabric of furniture and mattresses from damage in showrooms and stores is one of the latest applications for Pliofilm, a transparent material derived from rubber. In homes it will keep furniture clean and fresh during long periods while it is out of use. The cover is non-inflammable, odorless, durable and washable. Its transparency is not lost by flattening the material down to conform to the shape of the piece of furniture.



Yes, you can sit on the furniture without damaging the transparent Pliofilm cover or soiling the piece

*Dodge Bros. Corp. 79 00 99  
Cameau de Detroit, Mich*

*259 -  
near Piches Blvd.  
Wilmington, 3843 Wisconsin  
Los Angeles*

*Iron Lab  
2648  
Deane Avenue 6267  
2479  
1546 - 10  
A. mechanical  
1442  
Dodge*





# CRAFTSMAN

## SANDCRAFT PICTURES *on wood and glass*

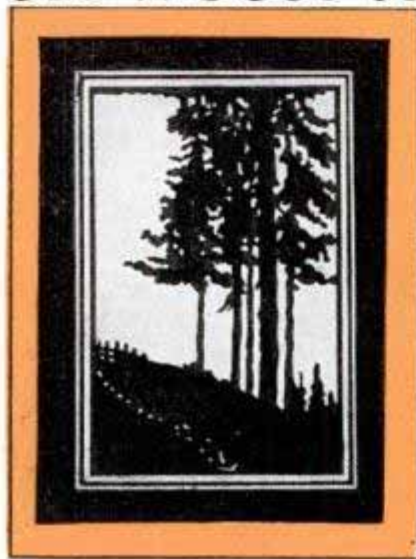

By L. REINKE

"CARVING" pictures with a sandblast on wood, glass, stone or metal—that's sandcrafting by this simple and novel process. Attractive scenes in silhouette form, line drawings that stand out in bold relief on panels, serving trays, bookends and other items are easily done with the simplest equipment. No artistic ability is required; you can transfer a clipping from a magazine or newspaper to blank white

*The ship plaque above is a typical sandcraft picture made on a panel of straight-grained yellow pine. Note unusual background effect*

SANDPAPER --- LIGHTLY WAX --- CARDBOARD DAM --- POUR COMPOSITION --- TRACE DESIGN

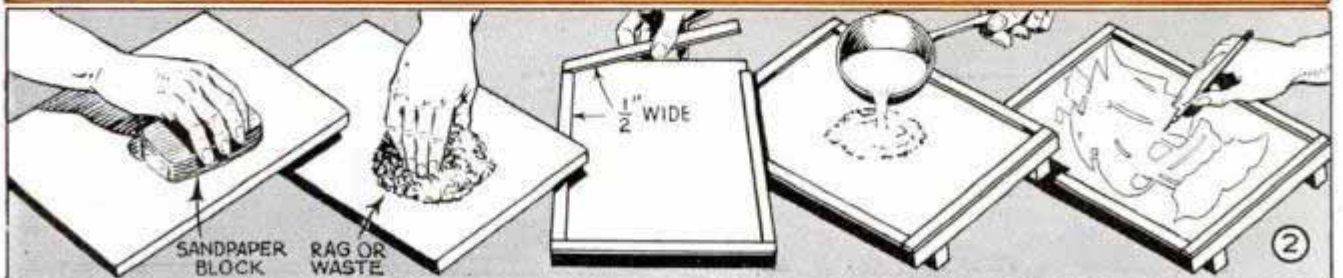



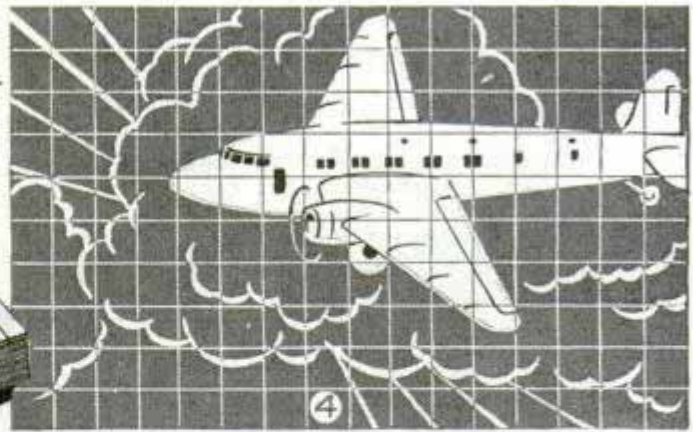

in cake form ready for use, or you can make it yourself. In a double boiler over low heat melt flake or powdered glue, 4 parts, in water, 1 part. Keep the contents of the boiler thoroughly stirred so that all particles of the glue dissolve. When melted the mixture should be about the consistency of cream. To this you add glycerin, 1 part, and mix thoroughly. Finally, add zinc oxide, one teaspoonful, to give a white color. Now cut four cardboard strips,  $\frac{1}{2}$  in. wide, coat the edges of the plaque with composition and press the strips in place, as shown, to form

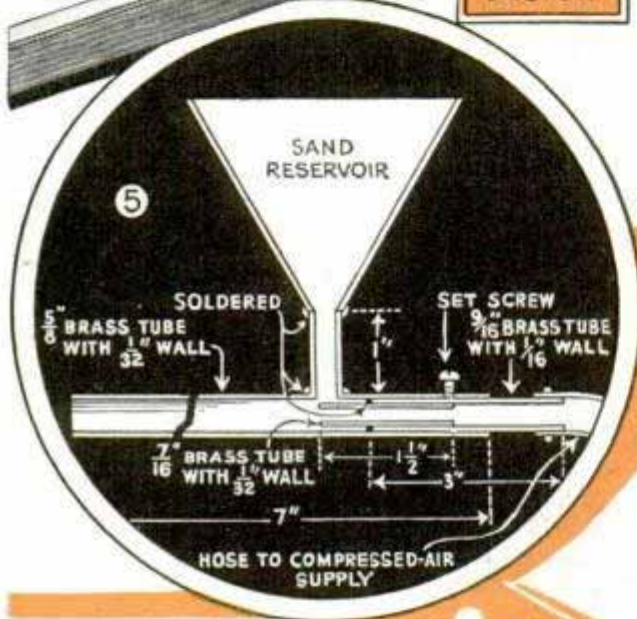

paper with a carbon sheet. Use a soft lead pencil in tracing the design.

The ship plaque directly below Fig.

1 is an example of the work as it is done on wood. Although practically any common woods can be used, fir, pine or similar softwoods will give a deep-cut background like that shown while the hardwoods will give a background less deeply relieved. To make this plaque, first you enlarge the design in Fig. 6 on white paper, using either the 1-in. squares as given, or  $\frac{1}{2}$ -in. squares if you wish the pattern to fit on a single board 10 or 12 in. wide. The panel must be sanded smooth with fine sandpaper, then lightly coated with liquid wax as shown in the first two steps in Fig. 2.

Now the waxed surface is coated with a composition material which you can get from monument dealers and stone cutters





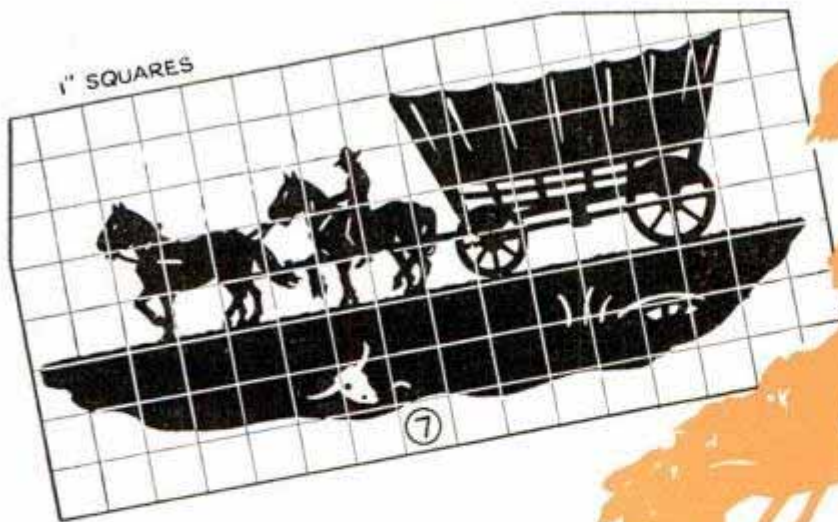

dams, preventing loss of the composition as it is poured over the surface, Fig. 2. In pouring, see that the mixture spreads to a uniform thickness equal to that of the cardboard. Let it harden 24 to 36 hrs., or until a test shows that it cuts easily with a sharp knife without dragging on the blade or spreading. This assured, you dampen the surface to make it slightly tacky, and locate the pattern over it face down. Press into uniform contact and re-



minutes and the cost is very reasonable. If you do the work yourself, protect your eyes with tight-fitting goggles.

After the work has been blasted to the proper depth, usually about  $\frac{1}{8}$  in., cover the composition on the design with a cloth saturated in hot water and allow to stand overnight. This will soften the coating so it can be removed. Smooth the surface with sandpaper and steel wool, stain the wood to the color or color combination you desire, and finish with shellac or varnish, as in Fig. 9. Other designs are shown in Figs. 4, 7, 8, and 10.

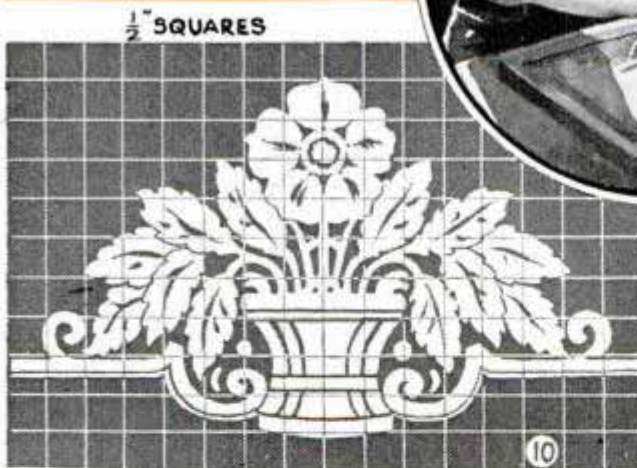

move. The pencil lines of the pattern will adhere to the composition. Then you simply cut away the latter to the bare wood over all the background, leaving the full pattern standing in relief, Fig. 3.

After this has been done, you're ready for the sandblasting. Fig. 5 details a simple "gun" which can be connected to an air compressor or a large inflated auto or truck tire. Or, if you prefer, a monument dealer is equipped to do the job in a few

On glass you use exactly the same procedure except, of course, that the surface of the glass need only be wiped dry before pouring the composition. No wax is necessary. In working on glass, the design is usually cut out and sandblasted, leaving the background clear. Then the whole panel is backed with black paper. However, striking effects can be achieved by blasting the background and backing the panel with black paper or colored enamel.



## Folding Picnic Table Carried in Car Has Pointed Legs to Push in Ground

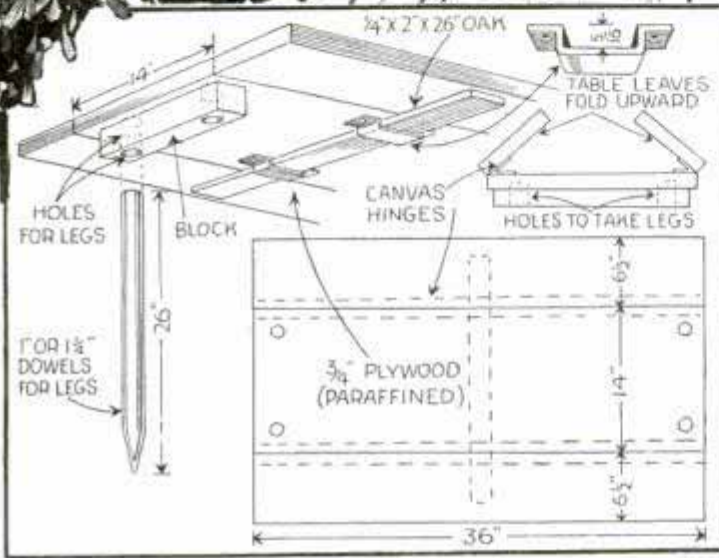

Here is a table large enough for the average picnic lunch, and it folds into a compact bundle, which may be carried under the arm or slipped into the car luggage compartment. For carrying, a large rubber band cut from an inner tube is slipped over the condensed unit, holding it together firmly. The four pointed legs and the oak battens are slipped under this band. Because picnic tables are sometimes unavoidably exposed to rain, it is a good idea to coat the table with hot paraffin and rub it briskly while still liquid. Take only a small section at a time.

—Dale R. Van Horn, Lincoln, Nebr.

## Locating Leaks in Bathroom Float

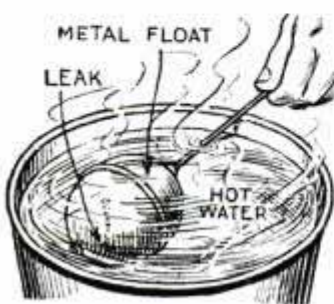

If your bathroom float becomes "water-logged" and it seems impossible to find the leak, just remove the float and submerge it in extremely hot water.

This will make the air inside expand, forcing it out through the leak and causing bubbles. If the float is partly or completely filled with liquid, the leak can be located by holding the float under a hot-water faucet rotating it slowly while the water runs over it. As soon as the water inside the float becomes heated, pressure will increase and a tiny stream will emit from the leak.

—Walker Kelly, Little Rock, Ark.

## Labels of Adhesive Tape Stick to Any Surface

Adhesive tape of the waterproof type makes excellent labels for almost any use, as it sticks to glass, wood, metal, and almost any other kind of surface. Several labels can be made at one time by using strips of the tape 2 or 3 ft. long. These are laid on a hard, flat surface, preferably glass, sticky side down. The top surface of the adhesive is washed thoroughly with denatured alcohol. When dry, the labels can be lettered with India ink and a ball-point pen. Washing the adhesive with denatured alcohol gives a good writing surface and its penetration of the tape provides greater adhesive qualities. When soiled, the labels can be cleaned by washing them with a piece of cotton dipped in denatured alcohol.

—C. N. Suffill, Lincoln, Nebr.





# Lathe-Turned Candy Box Has a Hinged Cover

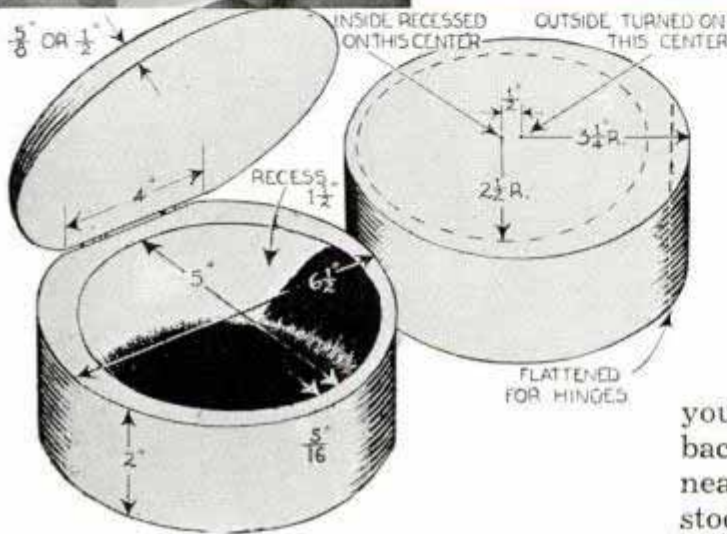
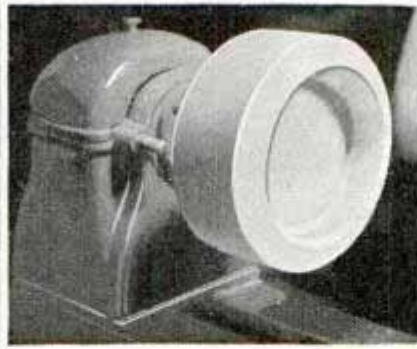
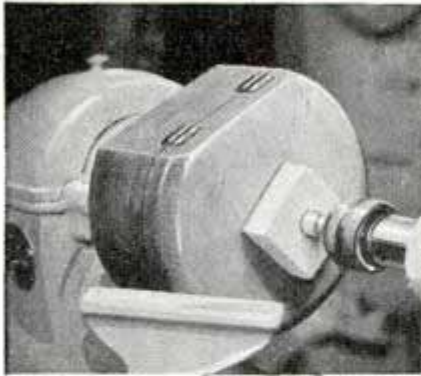

This turned box has an off center compartment or recess and a cover that is flush with the sides. You have two turning centers, one for the outside over-all and one for the inner recess. Turning the latter off center leaves sufficient stock so that

you can cut off a portion to provide a flat back in order to mount two small hinges neatly in line. Also, extra thickness of stock at this point permits use of screws of ample length. After this has been done the whole job is again mounted in the lathe for truing the cover flush with the side. This operation is shown in the upper-left photo. Any close-grained hardwood can be used for an enamel finish. For a natural finish use walnut, mahogany or maple.

## Uniform Coating of Glue Applied to One Side of Fretwork

Amateur craftsmen who have had the appearance of fretwork ruined by glue oozing from under it when attaching it to furniture and other plane surfaces, will find the following method of applying the glue the answer to their problem: Brush a thin coat of glue on a perfectly flat surface, press the fretwork firmly on the glue-coated surface, then lift it and apply it to the work. This method assures that a uniform coating of glue will adhere to the underside of the fretwork, yet there will not be any excess to ooze out.

☞ Grease poured into the sink is the cause of many clogged drains, which can be avoided by pouring your grease into a tin can, and discarding it when the fat hardens.

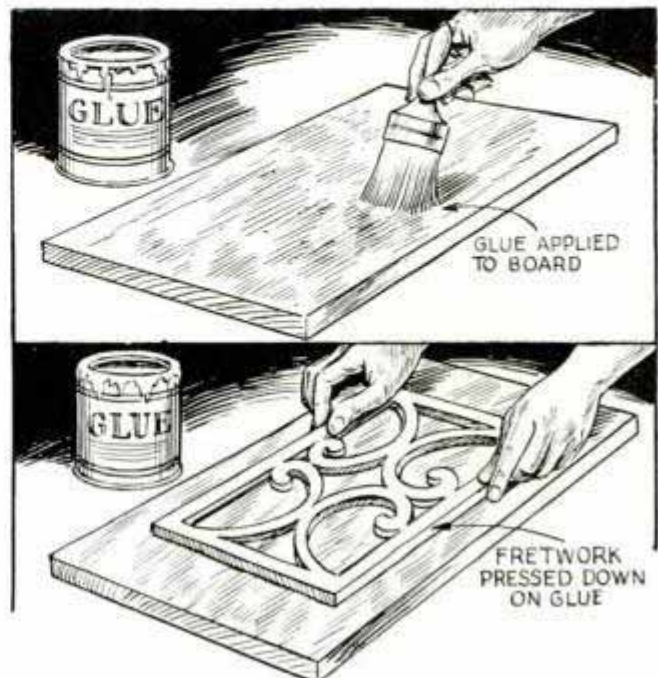







# CRICKET CHAIR

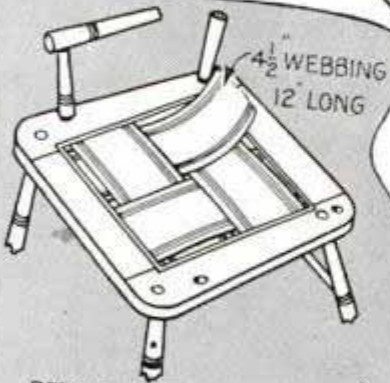

DETAILS OF SEAT WEBBING

### MATERIAL LIST

- 2 pcs. 1 5/8 x 1 5/8 x 25 in. maple— back posts
- 1 pc. 3/4 x 19 in. maple dowel— back cross rail
- 1 pc. 3/4 x 13 1/2 in. maple dowel— back cross rail
- 5 pcs. 1/2 x 18 in. maple dowel— spindles
- 2 pcs. 1 5/8 x 1 5/8 x 15 in. maple— arms
- 2 pcs. 1 5/8 x 1 5/8 x 12 in. maple— arm posts
- 2 pcs. 1 1/8 x 4 3/4 x 17 1/2 in. maple— seat
- 2 pcs. 1 1/8 x 4 x 9 1/2 in. maple— seat
- 4 pcs. 1 5/8 x 1 5/8 x 18 in. maple— legs
- 2 pcs. 1 1/4 x 1 1/4 x 17 in. maple— side rungs
- 1 pc. 3/4 x 14 in. maple dowel— back rung
- 1 pc. 3/4 x 18 in. maple dowel— stretcher

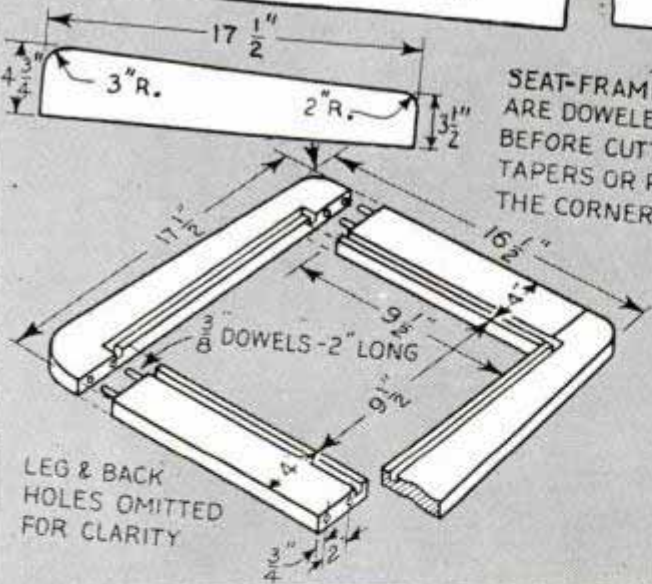

THE SEAT FRAME IS GLUED UP BEFORE SHAPING

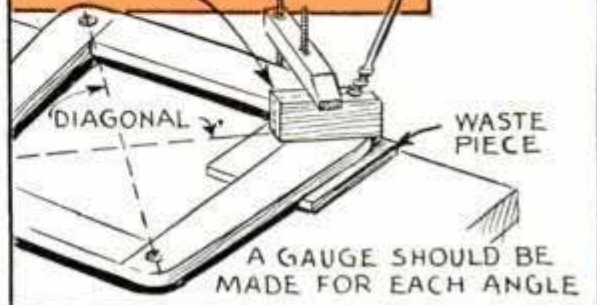
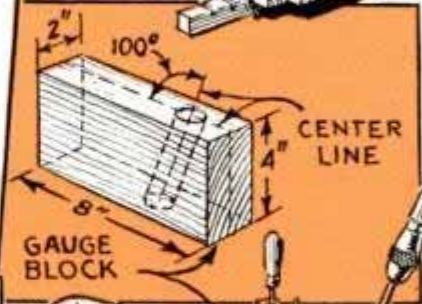
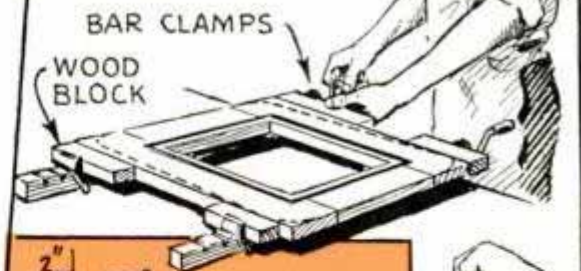

*This chair will just suit the craftsman who likes to build reproductions of colonial furniture. Separate cushions make it easy to keep clean. The woodwork is all solid maple, both for strength and authenticity. All angle dowel holes should be bored in the stock before turning, as in this way you can use a jig on the square surfaces. The strength and durability of the chair depend on the fit of the round tenons in the legs, arms and back posts*



## Compass Improvised from Ruler Gives Accurate Radii

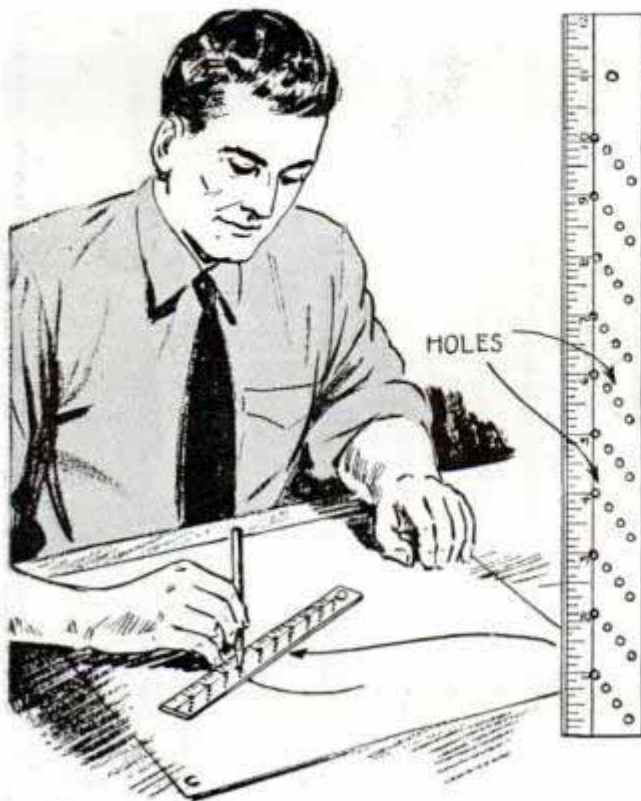

Here is a good compass that anybody can make from a five-cent ruler. Holes to take a lead pencil are drilled in the ruler at  $\frac{1}{4}$ -in. intervals, locating them at slight angles across the face of the ruler so that they will not break into each other. To get them exactly on line with the  $\frac{1}{4}$ -in. divisions, it is a good idea to lay them out with the aid of a small try square. A pivot hole must be drilled exactly on the center of an inch mark on the ruler.

## Avoiding Upset Garbage Can

Dogs will be unable to tip over your garbage can if you build a frame consisting of two iron bands held together by

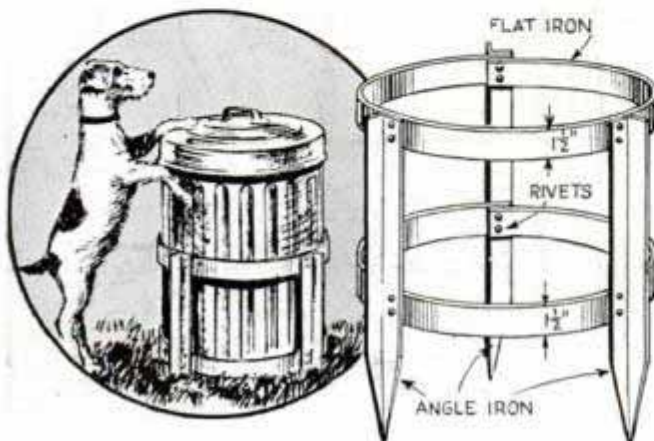

three angle-iron stakes. When the can is set in the frame and the cover fitted tightly, it will be impossible for small animals to tip it or remove the lid.

## Bird Bath Fitted with Trapeze Pleases Feathered Friends

If you have a bird bath in your garden, rig up a trapeze above it. The enjoyment that the birds will get from this will more than repay you for your time. Just bend a length of small brass rod to a U-shape and invert it above the water. From this, suspend a miniature swing made from fine brass wire.



## Emergency Vise for Tying Flies



When you are fishing and have to repair a fly, your pocketknife will make a good improvised vise for the purpose. Just stick the large blade into a log, bend the handle so that the point of

the hook may be inserted in the hinge and allow it to close gently. The hook will be held securely and will not be injured.

## Garden-Hose "Tires" on Mower

Your old lawn mower can be equipped with rubber tires at practically no cost, by using lengths of discarded garden hose, as shown. Two pieces should be cut long enough to go around the rims, wire being run through the hose and the ends twisted together to tighten the tire on the wheel. Four bands of wire around the hose and rim hold it in place.





# Savings Bank Filled by Efficient "Cashier"

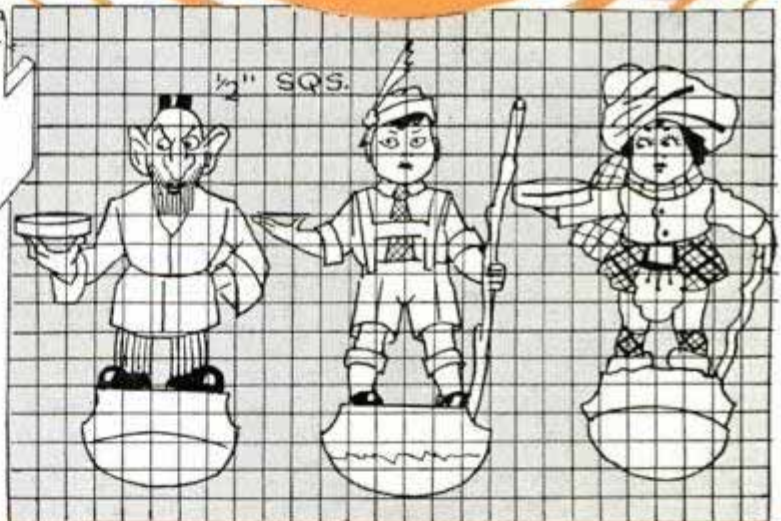
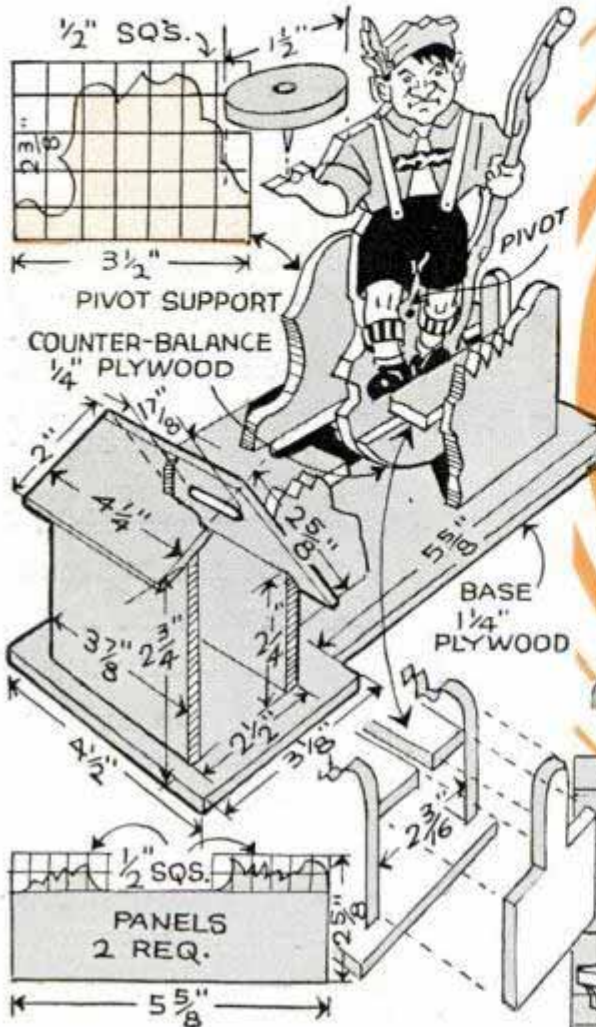

Any one of these fellows you choose will gladly receive your savings on a tray and deposit them regularly in the "bank." Of course, the figures are only plywood cut-outs painted to represent the different personalities you see pictured. Details above show how the device is assembled and how it works. When you drop a coin on the tray the pivoted figure tilts and the coin slides off the tray and through the slot in the roof of the bank. Small plywood weights attached to the lower end of the cutout provide a means of attaining the delicate balance necessary. Painting is done with showcard colors. Simply unscrew the bottom of the bank when you wish to withdraw the "account."



☛ Sprinkle the buds and leaves of house-grown hyacinths, tulips, etc., to prevent shriveling.



## Quick-Acting Fly Vise Holds Spool and Grips Loose End of Thread

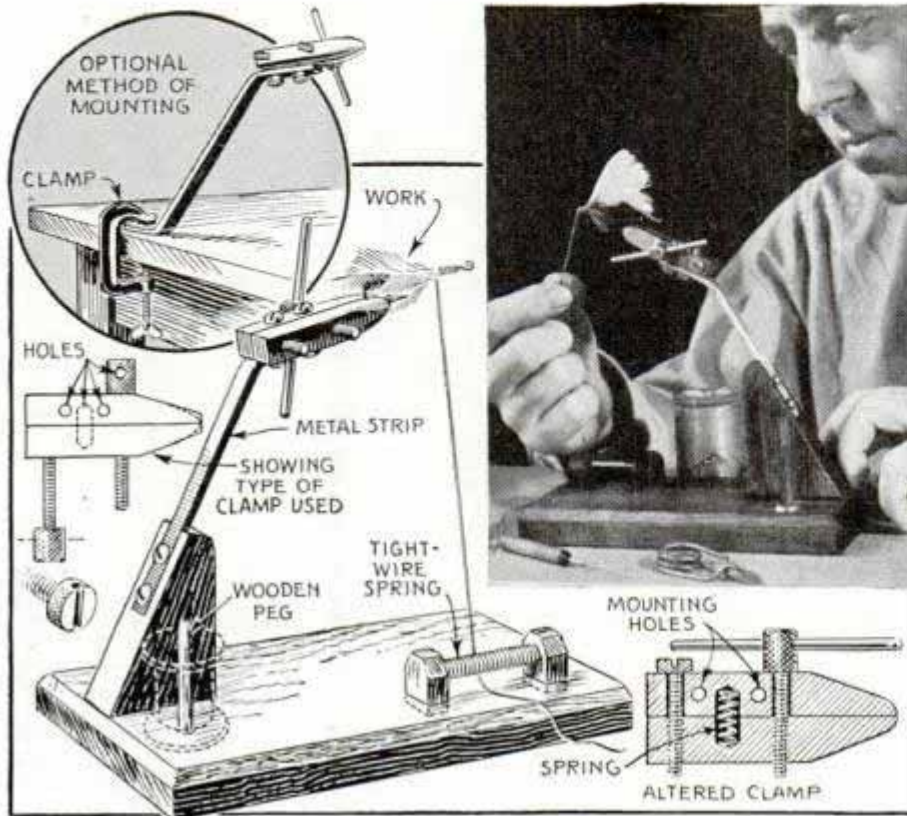

This inexpensive fly vise consists of a dime-store metal clamp mounted on a slanting arm, which is in turn screwed to a wood base. The jaws are rounded at the ends with a file and are drilled partly through from the inside surfaces to take a spring, which spreads them as the tightening screws are loosened. When purchased, the rear screw does not pass entirely through both jaws. This screw hole is drilled out so that both screws can be driven in from the same side. Also, two small holes must be drilled in one jaw to mount the clamp on the supporting arm. A wooden peg set in the base holds the thread spool, and a tightly coiled spring mounted between two wooden brackets on the base serves as a holder for the loose end of the thread.—Fred Howard, Chicago.

## Shelf Brackets in Fruit Cellar Anchored in Concrete Wall

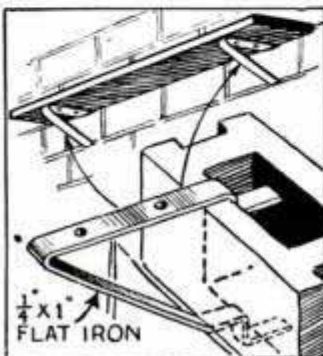

When laying a concrete foundation for his home, one workman installed brackets for the shelves in his fruit cellar as indicated. These were shaped from flat iron and were

put in place as the wall was laid, thus assuring that they would be anchored securely and permanently. The same idea can be adapted when laying up any wall of concrete blocks where shelves are likely to be desired on the inside. The brackets can be placed between every row of blocks if necessary, although every second row usually is better, as this gives a wider spacing of the shelves.

## Outdoor Fireplace Covered with Top of Old Stove

Before building your outdoor fireplace get the top from an old iron cookstove to use as a cover. Then put up the fireplace to fit it. With the stove top, the heat is even on all parts of the cooking surface, smoke goes up the chimney of the fireplace, and pots and pans are protected from soot and blaze of the fire. Cookstoves or their tops can be picked up in the country or in junk shops for almost nothing.—R. H. Moulton, Glencoe, Ill.





# Beach Tent and Table Roll Up into Bundle

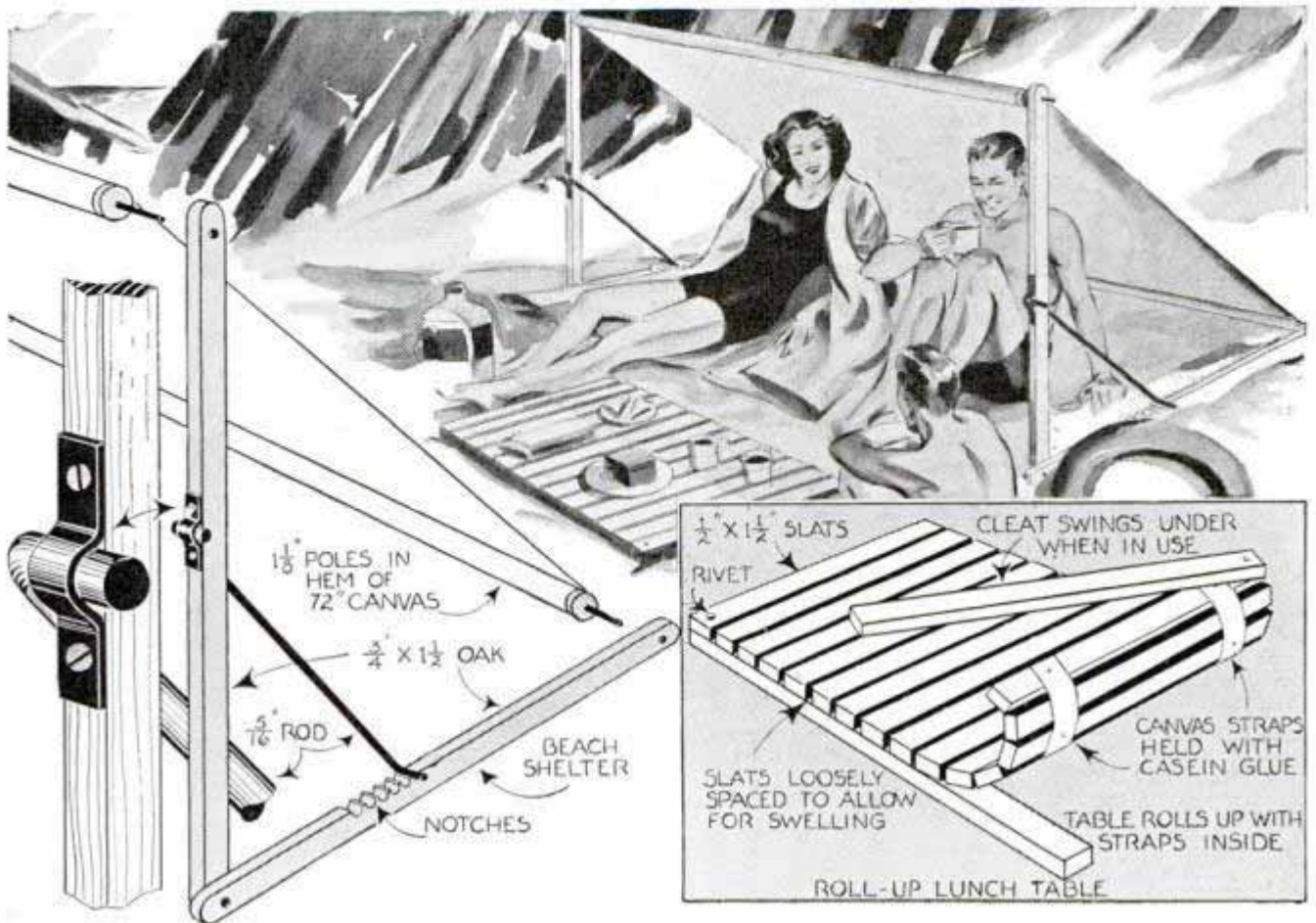

Lunch on a sandy beach is a pleasure with this roll-up table and folding shelter, which are fully portable for carrying in a car. The table provides a smooth surface on which to spread your lunch, and consists of a number of slats fastened together with webbing or canvas straps on the underside. Protection from the sun and

wind is provided by the shelter, which consists of canvas tacked to two poles, these being supported by side frames. The latter fold up when not in use, and have a pivoted brace to hold them open. The foot of the brace sets in one of several notches cut in the lower wood bar to permit adjustment to keep the canvas taut.

## Barrel of Small Insect Sprayer Provides Good Calking Gun

For an occasional calking job around the home, the barrel of an old insect sprayer makes a good gun. After removing the sprayer tank, the pointed end of the barrel will enable you to force the compound into cracks around windows, doors and other openings. If desired, a short piece of tubing threaded at one end can be soldered to the gun for attaching nozzles of various shapes.—A. H. Waychoff, Phoenix, Ariz.

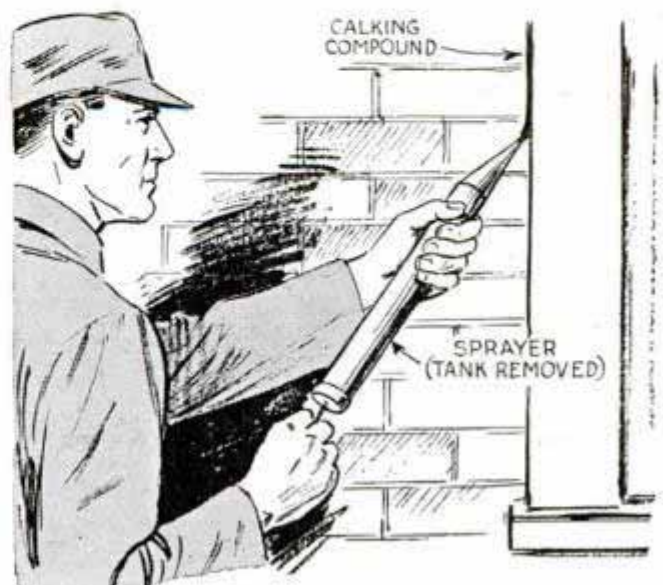

☛ To keep a pair of scissors from making holes in your workbag and, at the same time always have a thimble easy to find, fit the thimble over the small end of a cork, and stick the scissors in the large end.



# The "ATLANTIC"

This model, one-forty-eighth the size of its famous American prototype, fits standard-size model-railway track and actually runs under power of a tiny permanent-magnet motor, located in the boiler. Standard rod, wire, tubing and other materials are used and lathe work, which is usually the largest part of a model locomotive job, has been reduced to a minimum.

By ALEXANDER MAXWELL

IN 1832, a new locomotive, especially designed for mountain runs, had steam up at Baltimore. Behind it were several cars, loaded with fifty tons of freight. At 30 m.p.h. it rolled over the open road, then took the grade at 12 m.p.h. It strained and it snorted, but kept going, and with a triumphant blast of the whistle coasted to a stop at the very end of the line, high in the hills of Maryland. In 1898 the "Atlantic," and its companion, the "Jefferson," were retired from active service. Both are in running condition and now make the rounds of fairs and exhibitions. For this model, shown completed in Fig. 1, all measurements were taken from the original engine. It is slightly simplified to make use of existing parts and ma-

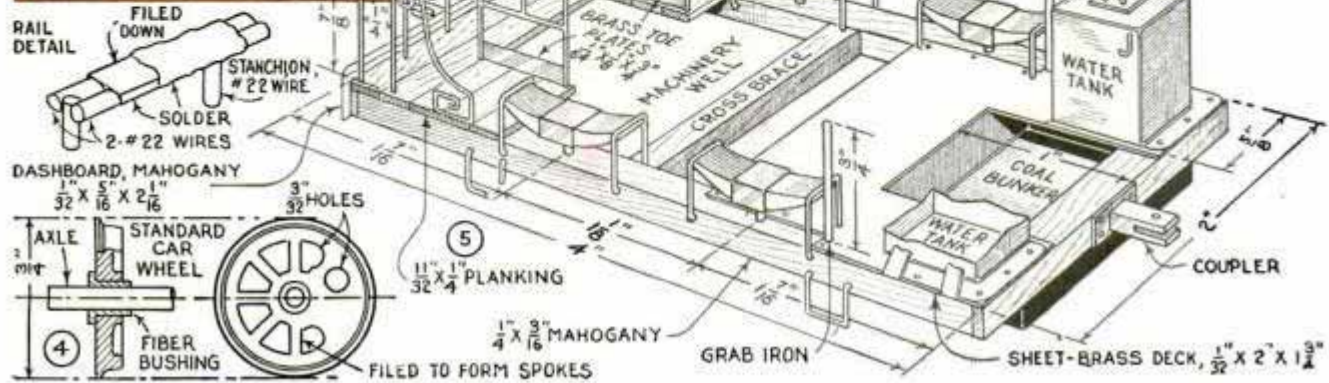
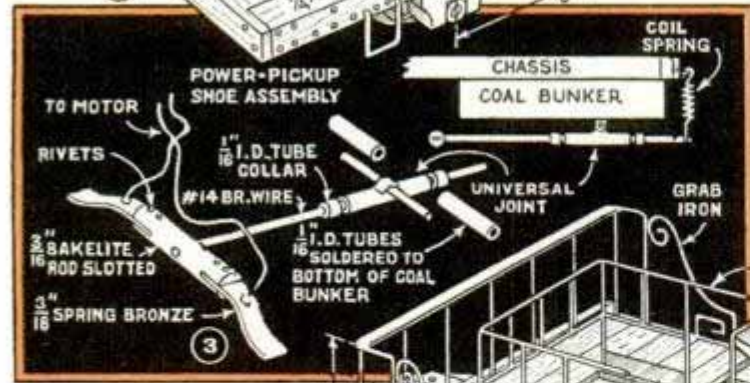
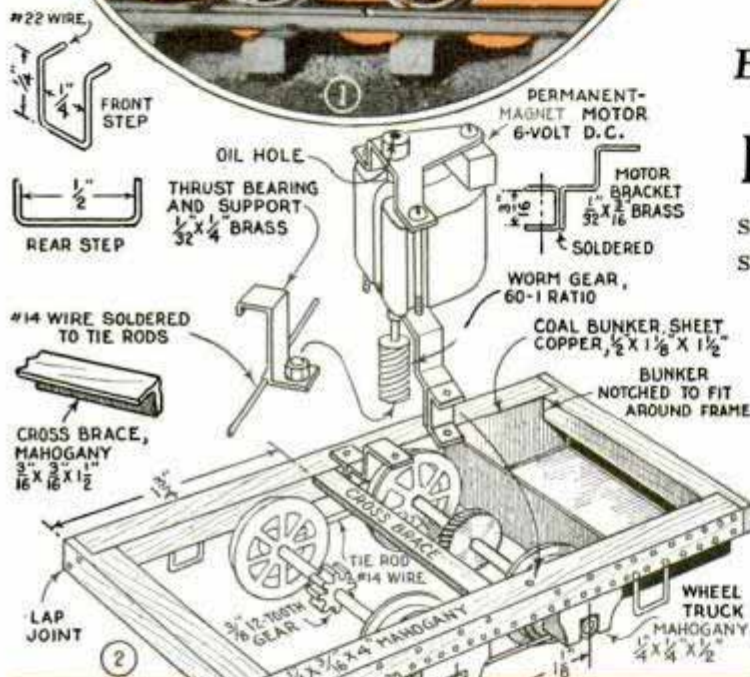
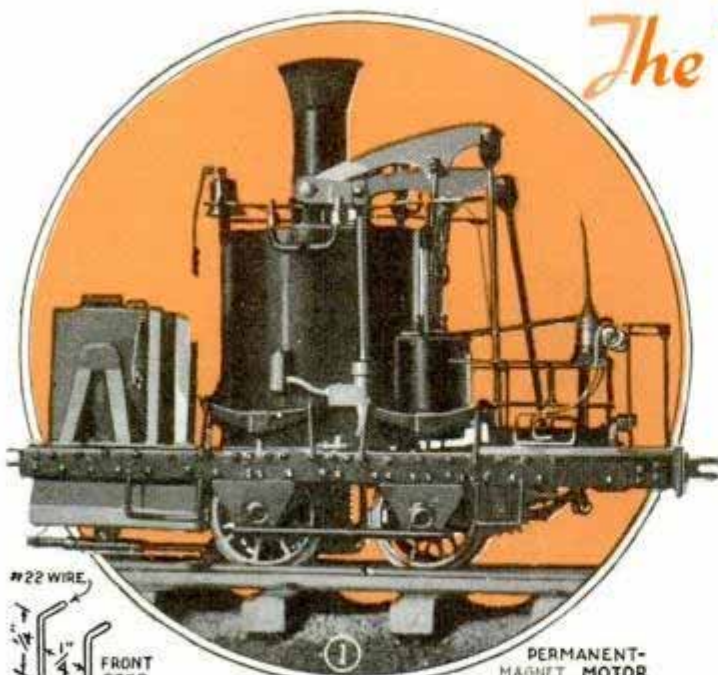



# --World's First Mountain Climber

1832 Locomotive, in miniature, runs on 0-gauge track

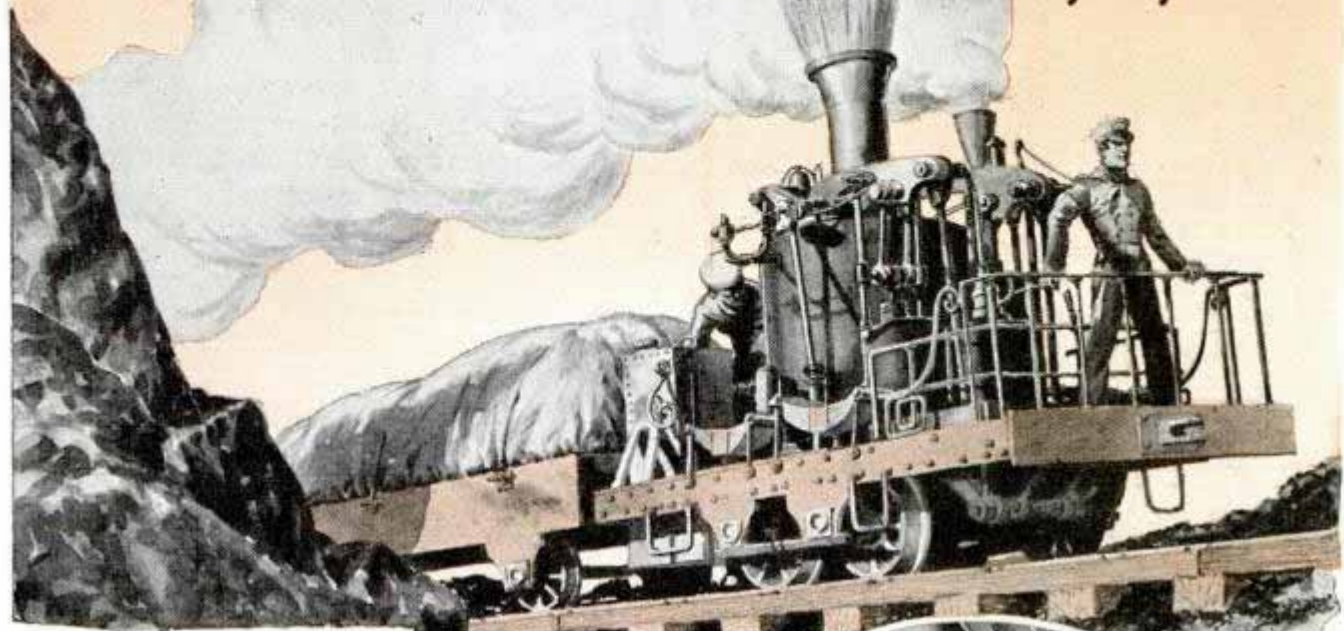

Although horses had been stationed along the track to pull the train in case of possible failure, the engine chugged along upgrade at 12 m.p.h., with several cars carrying 50 tons of freight

terial and is  $\frac{1}{48}$  actual size, which is "0" gauge. Two-rail track is the latest, so insulated wheels are specified. Several items are needed which are not commonly used by modelmakers. Clock wire, lengths of brass of sizes from No. 14 to No. 22; bronze bushings, which are already bored to size and come in 2-in. lengths; tiny Swiss files for delicate shaping of intricate parts. Your local jeweler knows where these can be obtained.

The bronze bushings are bored to fit standard drill rod. It is best to get the bushings first, then fit the rods to them. For the wheels, crankshaft and beams, the fit must be easy running; for the pistons and pump considerable slack is desirable as these parts are purely ornamental and should hang limp. Bronze bearings last for years if kept oiled. By the use of bushings and drill rod, lathe work on this model is kept down to a minimum.

The wooden chassis, Fig. 2, is held together with celluloid cement. After it has dried, bank pins may be driven for good

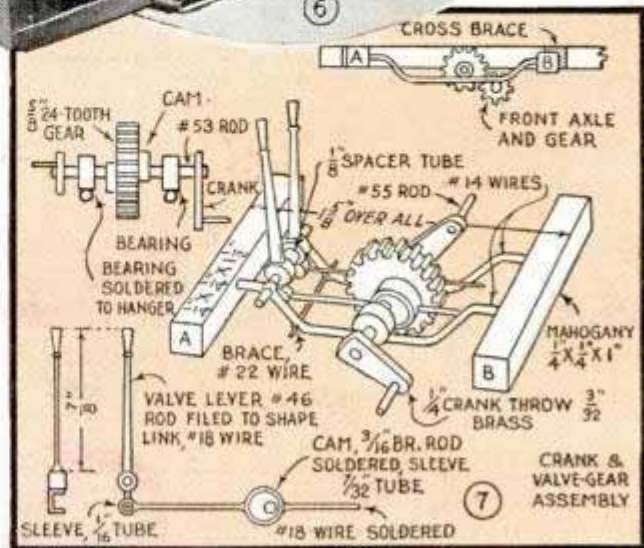
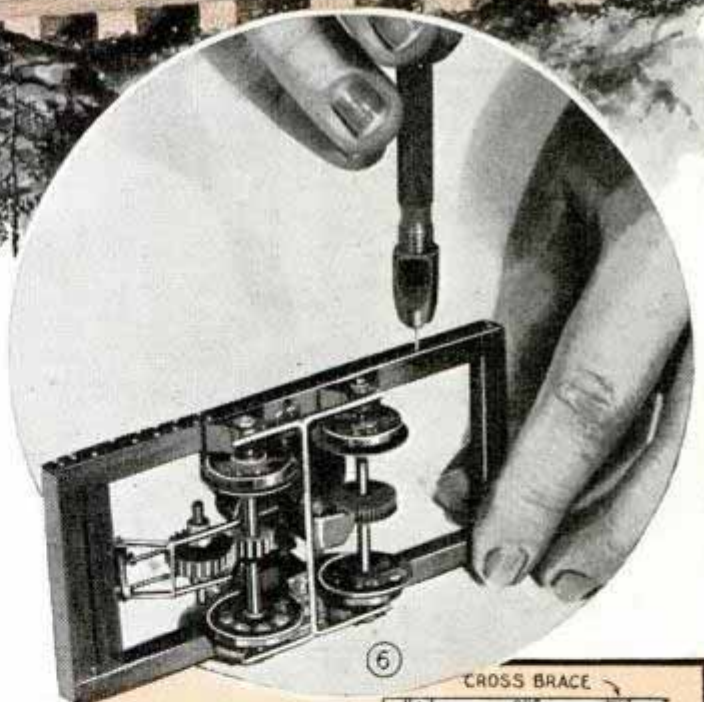











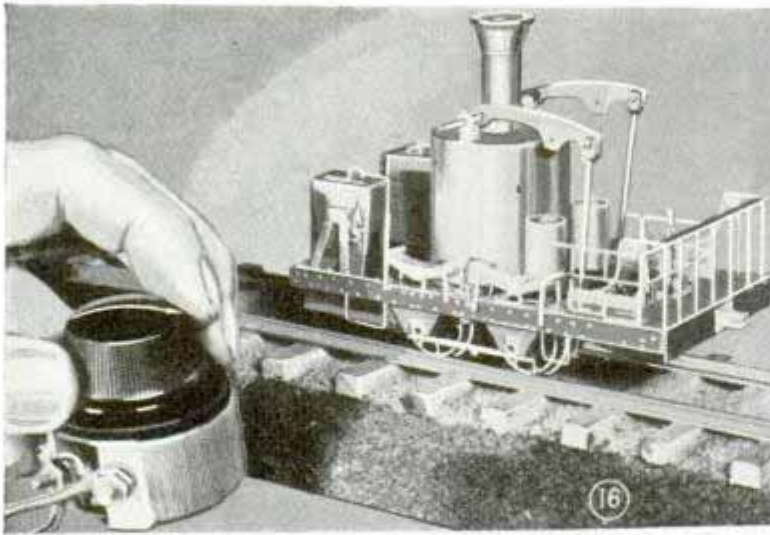

deck is tacked down with No. 24 escutcheon pins. The forward end is not fastened but rests against the chassis under the springs and is held down by the boiler. For rivets in the frame, use No. 24 pins, drilling a hole for each, Fig. 6, and placing them as in Fig. 2. Both sides are practically alike. The oilcan, poker and shovel, Fig. 14, are prominent fixtures. The shovel and poker hang from hooks on the water tanks. See Fig. 5.

The boiler shell, Fig. 11, goes directly over the motor as in Figs. 12 and 15. The two lugs go over the motor brackets slightly forward of the center line. Check the position carefully, getting the shell as far forward as possible, still clearing the motor. Mark where the lugs go, then solder them in place. The cylinders are first riveted to the boiler after which solder is run in around them. Locate the centerlines, Fig. 20, and put a rivet at top and bottom. Use No. 24 pins, bend them over and solder inside the boiler.

In this engine exhaust steam first turned the rotary blower, underneath the firebox,

then went up the pipe. This gracefully twines itself from behind the cylinder and up the side of the boiler, ending in a bell, Fig. 11. The three trycocks check the water level in the boiler, and the pump, Fig. 13, draws a constant supply from the tanks while the engine is moving. From the check valve, the pipe goes through the firebox for preheating, out the other side and up into the boiler.

The engine may be tried out on a length of track, to assure that each added part works without binding. Speed of the motor is

controlled with a radio rheostat as shown in Fig. 16. Use jigs freely, and hold the bearings rigid and parallel while being soldered. For example, when installing the axle on top of the boiler, Fig. 18, thrust it through the smokestack first, then slip a bearing on from either end. Downward pressure on the axle will hold these in place. Flow solder around them. The axle may now be withdrawn, as it must be, whenever the boiler is removed to get at the motor. Fig. 8 shows another jig; the four piston guides are set in holes drilled in wood, clamped in place against the cylinders and all are soldered at once.

The steam chest is made of lead, primarily because a traction weight is needed. Make a casting, Fig. 20, flow solder around it, and file to shape. For this use a very soft solder, which may be dressed down with a knife or sandpaper. The throttle, Fig. 21, fits on the center of the steam chest as in Fig. 18. When installing the piston rod and guide assembly, Fig. 18, the three rods are threaded on the pin, the two guides slipped in place and the whole low-

## MATERIAL LIST

1/4" brass rod (6 in.)  
No. 56 rod (1 ft.)  
1/16" tubing (4 in.)  
No. 53 rod (1 ft.)  
1/16" sheet brass (2 x 3")  
3/8" tubing (4")  
Lead weights (5 oz.)  
1/8" square brass rod (2")  
1/4" square brass rod (2")  
No. 16 wire 1 length  
No. 20 wire 1 length  
No. 14 wire 1 length  
No. 60 rod 1 length

No. 22 wire 5 lengths  
1/32" sheet brass (6 x 6 in.)  
1/64" sheet brass (1 x 3 in.)  
1/8" copper tubing (3 in.)  
1-5/16" brass tube (1-7/16")  
3/32" tubing (3 in.)  
3/32" brass rod (3 in.)  
3/16" brass rod (3 in.)  
No. 18 wire (1 length)  
3/32" beads (3)  
5/16" ship's bell (1)  
2/56" machine screws (4)  
7/32" tube (3 in.)

1/4 x 3/16" mahogany strip (1 ft.)  
3/16 x 3/16" mahogany strip (1 ft.)  
1/4 x 1/4 x 1/2" mahogany blocks (4)  
3/16" Bakelite rod (3")  
3/16" phosphor bronze strip (3 in.)  
No. 60 piano wire (spring) (15c roll)  
1 Knapp per-mag motor (\$3.50)  
1 60-1 worm gear for above  
1 5/8" 24-tooth gear No. 53 bore  
1 3/8" 12-tooth gear to fit on axle  
2 0-gauge axles and wheels (2 rail)  
1 1/8" ball bearing (thrust)  
No. 46 rod (1 ft.) No. 53 rod (1 ft.)

Bronze bushings to fit No. 53 rod, No. 56 rod axles



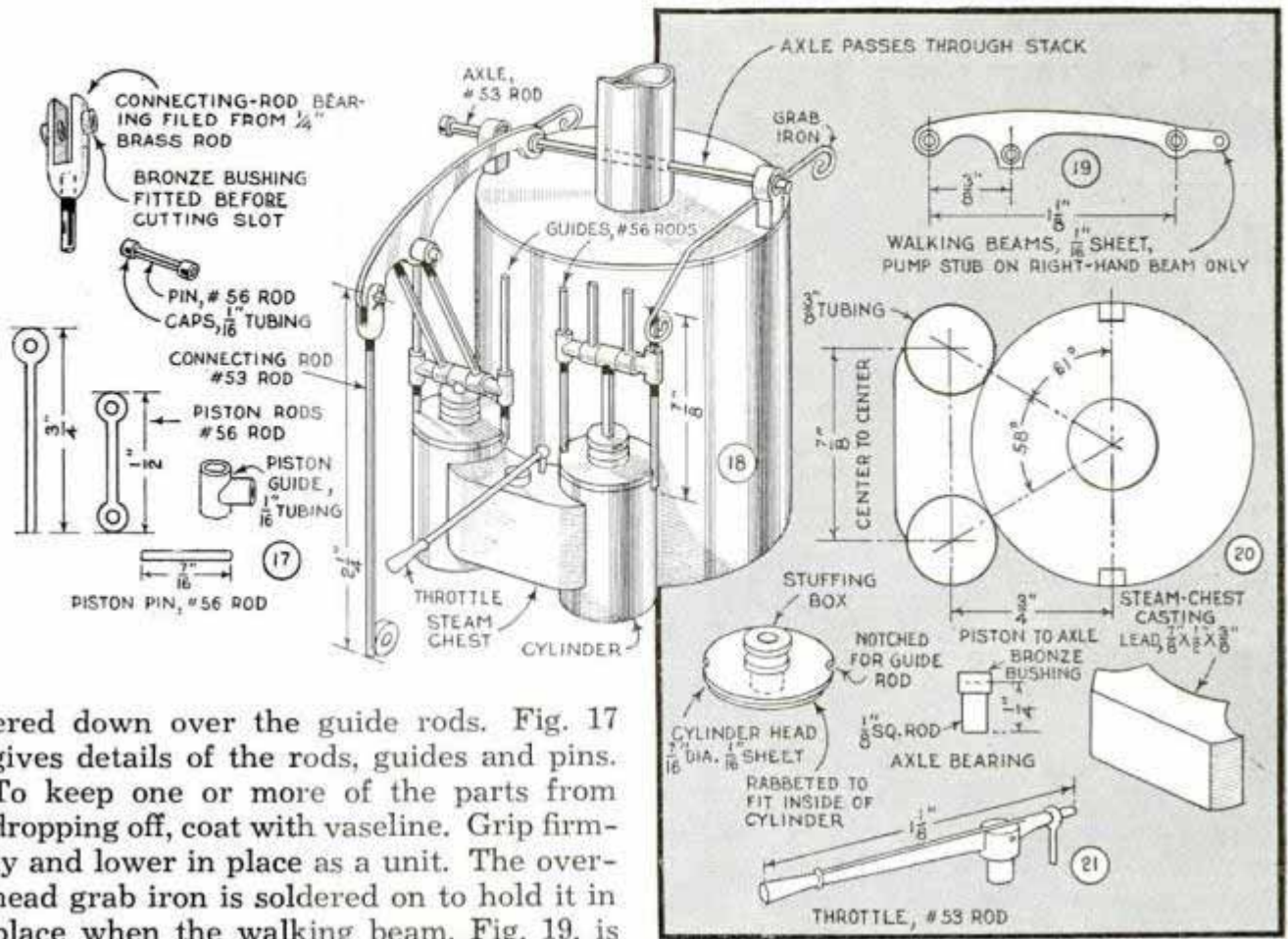

ered down over the guide rods. Fig. 17 gives details of the rods, guides and pins. To keep one or more of the parts from dropping off, coat with vaseline. Grip firmly and lower in place as a unit. The overhead grab iron is soldered on to hold it in place when the walking beam, Fig. 19, is removed. The pins between beam and connecting rod are permanent. Solder a cap to one end, install, then solder the cap to the other end. Those between the beam and pistons must be removable. The cap goes on one end, but a No. 76 hole is drilled in the other and a piece of radio coil wire is used as a cotter pin.

According to an early account the "Atlantic" was red, trimmed with gold, gray and green. Select a high-grade, dark-red automobile enamel, pour out some in a cup and mix with a few drops of turpentine and enough black coach color to lower the

shade to an ox blood. Apply three coats, a day apart, to the entire boiler, chassis sides and water tanks. The deck and coal-bunker sides are dark gray. Antique the deck with black to look like worn spots and weather stains. The walking beams, grabirons and railings are gold with a dash of copper green. The pipes are gold and gray, and the bearings are dark green. Use black on the springs, steps and journals. Make the spring bands and fire shovel dark green. The ball and whistle are left natural brass.

## Cutting Large Sheets of Paper Accurately on a Trimmer

Difficulty in trimming sheets of paper that require one or more strokes of the cutting blade to finish each edge can be overcome by using a thumbtack to keep the sheet from moving to one side or the other as it is moved forward for the second stroke of the cutter. The tack is pushed through the paper on the cutting line so that the projecting point will bear against one side of the lower cutting blade and serve as a guide.

—Leon Kubala, Seguin, Tex.





## Archers' Rubber Wrist Guard Cut Out of Inner Tube

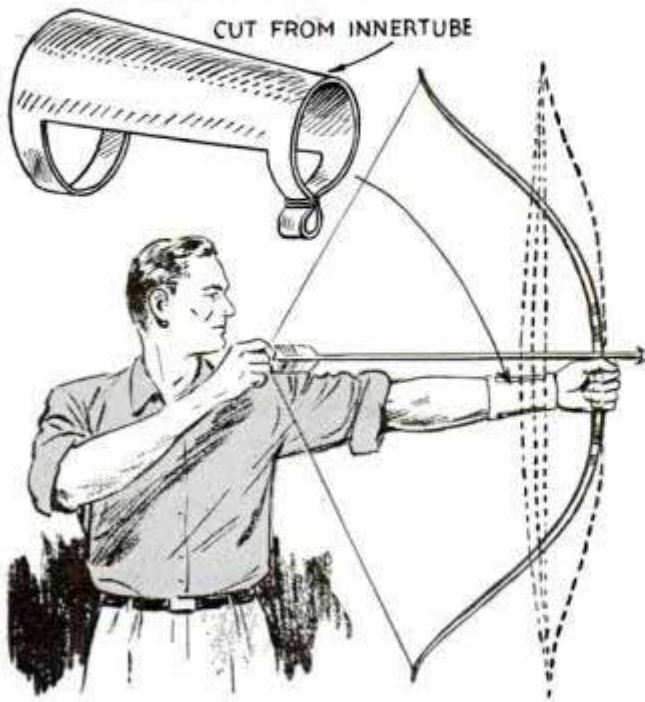

Essential to an archer in preventing the bowstring from chafing the wrist, a guard can be made from a piece of inner tube. To make the lower end fit the wrist snugly, a small loop is bound off with a stout cord as indicated.

## Footrest on Boat Is Adjustable to Suit Different People

To accommodate a rowboat to various people who rented it, the owner of a summer camp used this adjustable footrest. It

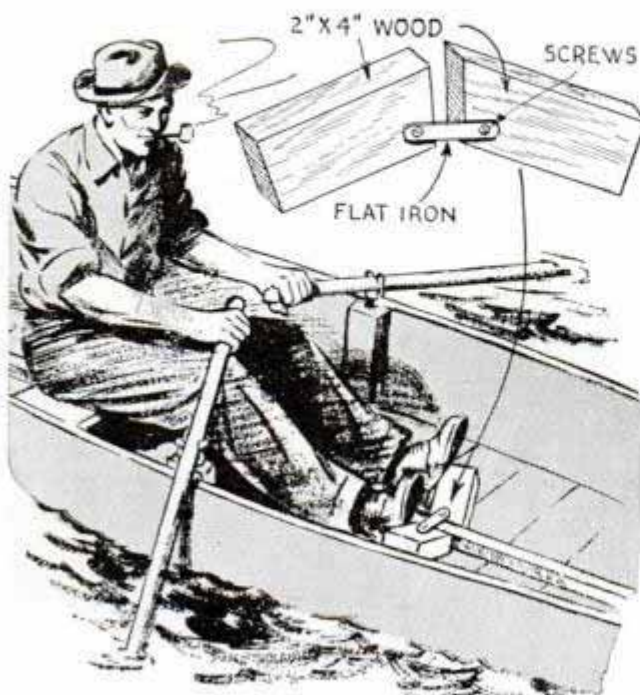

consists of two lengths of 2 by 4-in. wood, which are hinged together with a length of flat iron. The footrest straddles the center strip on the boat bottom, and pressure of the rower's feet against either block locks it in the desired position.

## Old Safety Razor Used as Sander on Delicate Work

For smoothing small pieces, or the inner surfaces of curved work, a simple little sander may be made in a jiffy by merely removing the blade from an old safety razor and slipping a piece of sandpaper over the end as indicated. When the handle is tightened, the comb guard grips the sandpaper.



## Nail Clipper Pulls Thumbtacks

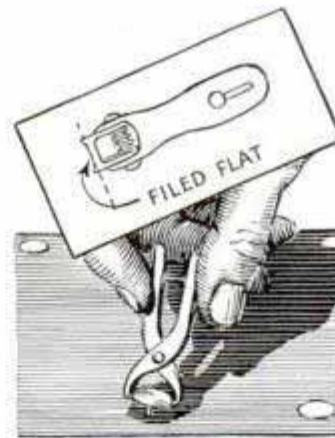

head of the tack and then tipped sideways to pull it out.—K. Fish, St. Cloud, Minn.

## Safety Pin Holds Fishhooks

Fishhooks can be kept from getting tangled and scattered around by just stringing them on a safety pin. Pins of various sizes may be used in proportion to the number and size of hooks carried, which can be taken off one at a time as they are needed.





# 3 Little FOOTSTOOLS

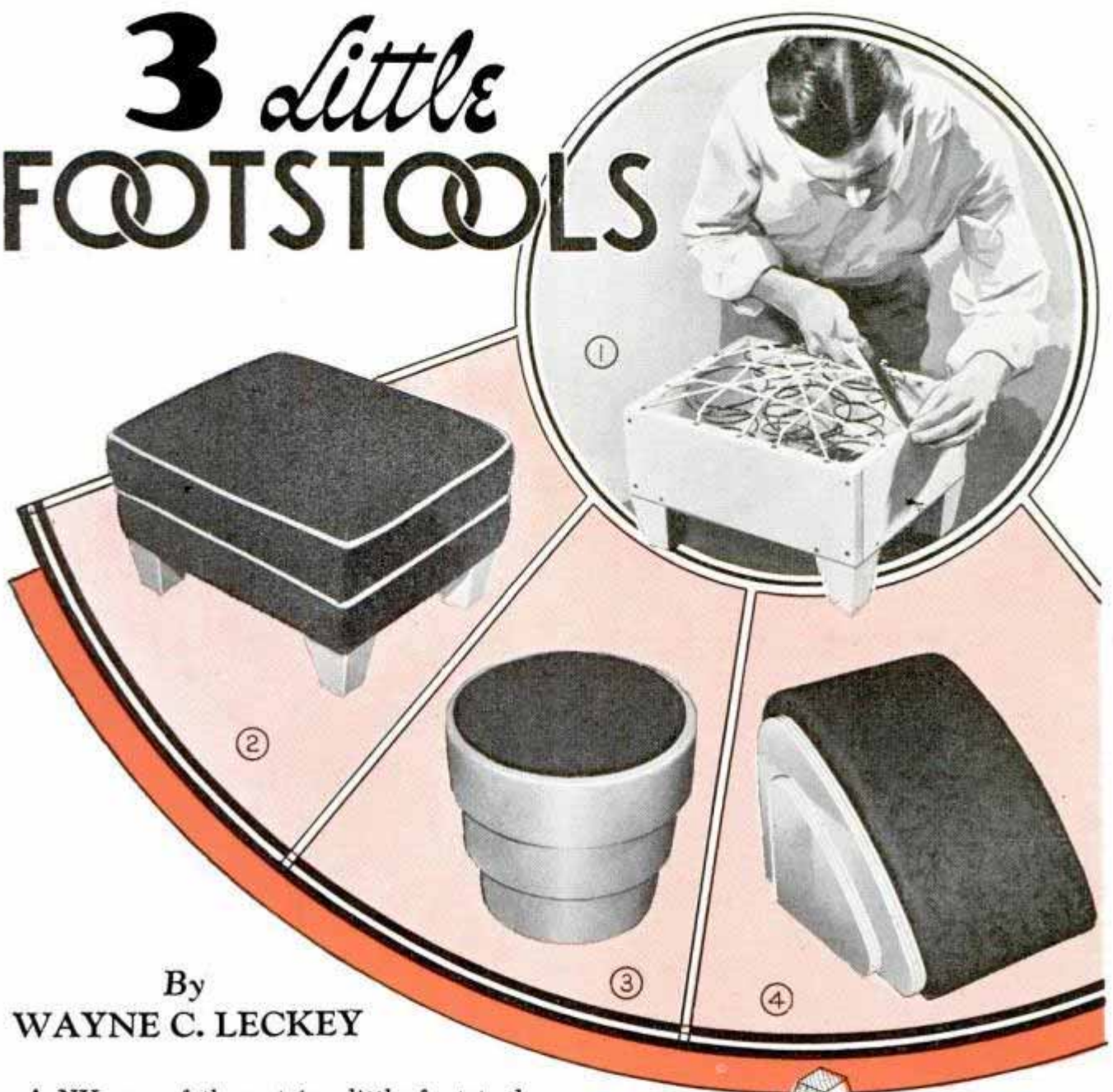

By  
WAYNE C. LECKEY

ANY one of these trim, little footstools, designed and tailored in the latest styling, will add an attractive touch to your home furnishings. They can be made and upholstered easily right in your own shop.

To make the spring-filled stool shown in Fig. 2, your first job is to make a rough, boxlike framework as detailed in Fig. 5. This should be made of hardwood, preferably birch, to hold tacks well. Plain, butt joints glued and screwed securely will do in assembling. The short, "stub" legs are cut from 2½-in. square stock and are tapered accurately by first drawing guide lines from the top corners. To make the dowel register in both leg and corner block, clamp the leg flush at the corner of the frame and bore down through both with a 1-in. bit from the inside.

The frame is now ready to upholster.

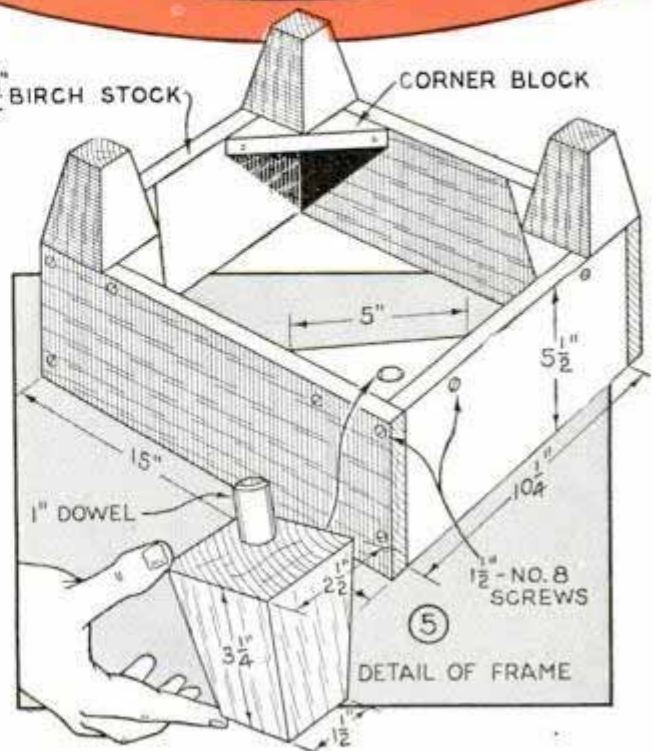



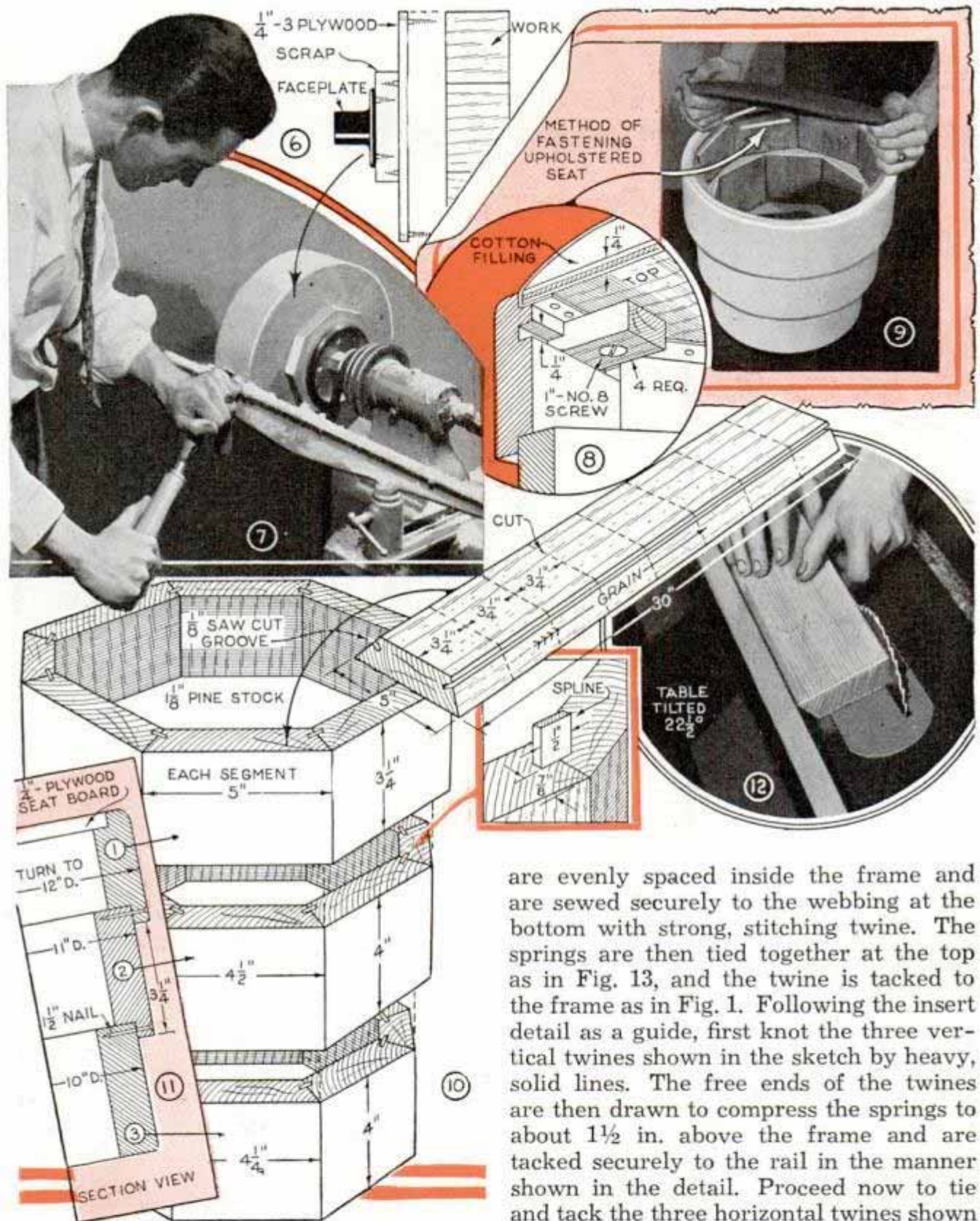

The bottom is first strung with webbing as in Fig. 14. This is easily stretched taut with a homemade tool as shown in Fig. 16. Nail points driven in at one end serve to grasp the webbing while prying downward. Interlace two strips each way, double tacking the ends with 10-oz. tacks.

Next, four No. 3 wide-center coil springs

are evenly spaced inside the frame and are sewed securely to the webbing at the bottom with strong, stitching twine. The springs are then tied together at the top as in Fig. 13, and the twine is tacked to the frame as in Fig. 1. Following the insert detail as a guide, first knot the three vertical twines shown in the sketch by heavy, solid lines. The free ends of the twines are then drawn to compress the springs to about  $1\frac{1}{2}$  in. above the frame and are tacked securely to the rail in the manner shown in the detail. Proceed now to tie and tack the three horizontal twines shown dotted in the sketch, knotting the twine at each point indicated. Finally, when the two diagonal twines are in place, you will have made 32 knots. Next, the springs are covered with a double thickness of 10-oz. burlap, drawing it firmly and tacking to the top edges of the frame. Follow this by tacking 5-in. strips along the four edges as shown in Fig. 17. To form the roll, place a



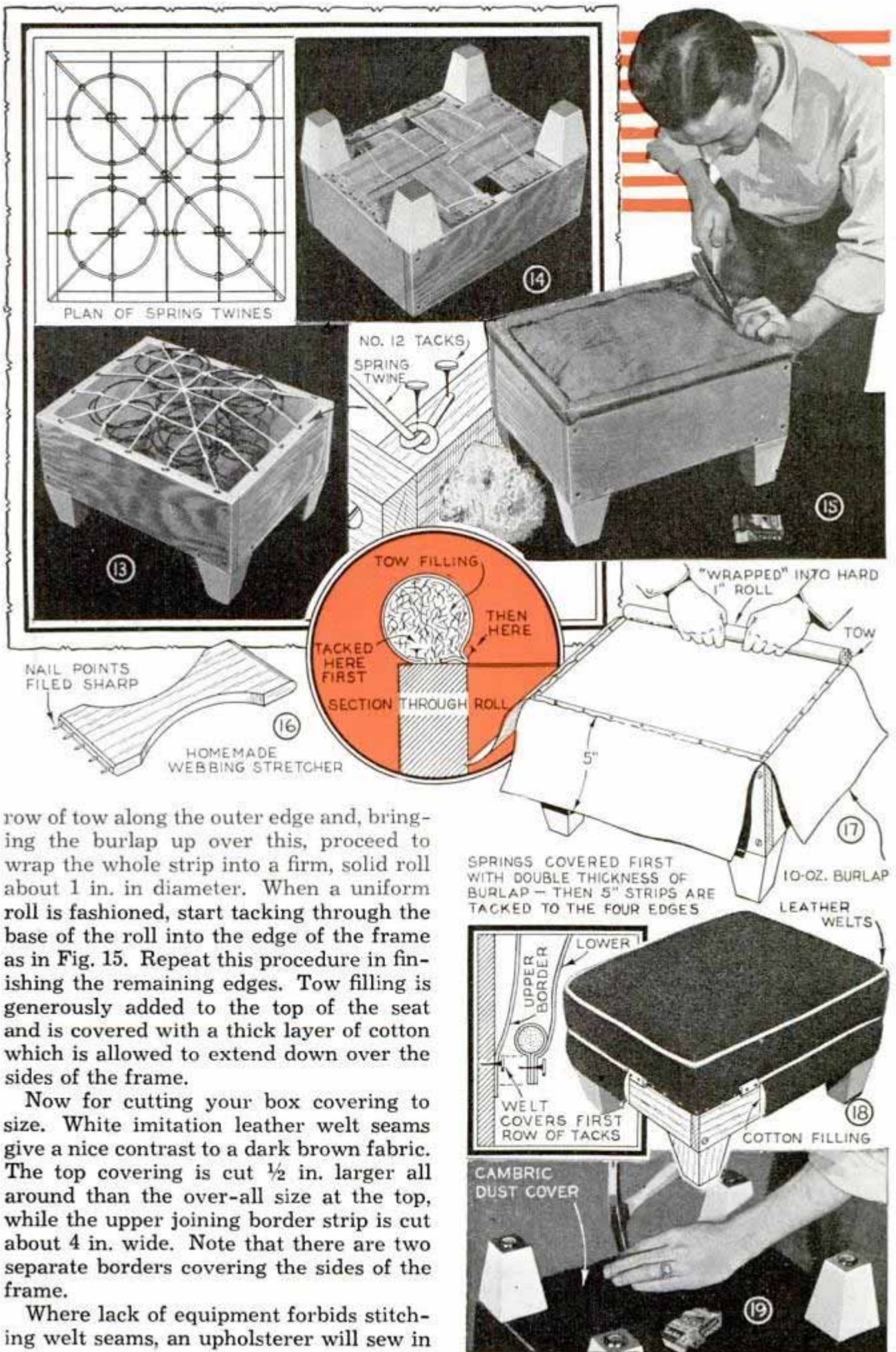

row of tow along the outer edge and, bringing the burlap up over this, proceed to wrap the whole strip into a firm, solid roll about 1 in. in diameter. When a uniform roll is fashioned, start tacking through the base of the roll into the edge of the frame as in Fig. 15. Repeat this procedure in finishing the remaining edges. Tow filling is generously added to the top of the seat and is covered with a thick layer of cotton which is allowed to extend down over the sides of the frame.

Now for cutting your box covering to size. White imitation leather welt seams give a nice contrast to a dark brown fabric. The top covering is cut 1/2 in. larger all around than the over-all size at the top, while the upper joining border strip is cut about 4 in. wide. Note that there are two separate borders covering the sides of the frame.

Where lack of equipment forbids stitching welt seams, an upholsterer will sew in

SPRINGS COVERED FIRST WITH DOUBLE THICKNESS OF BURLAP - THEN 5" STRIPS ARE TACKED TO THE FOUR EDGES

LEATHER WELTS  
COTTON FILLING

CAMBRIC DUST COVER



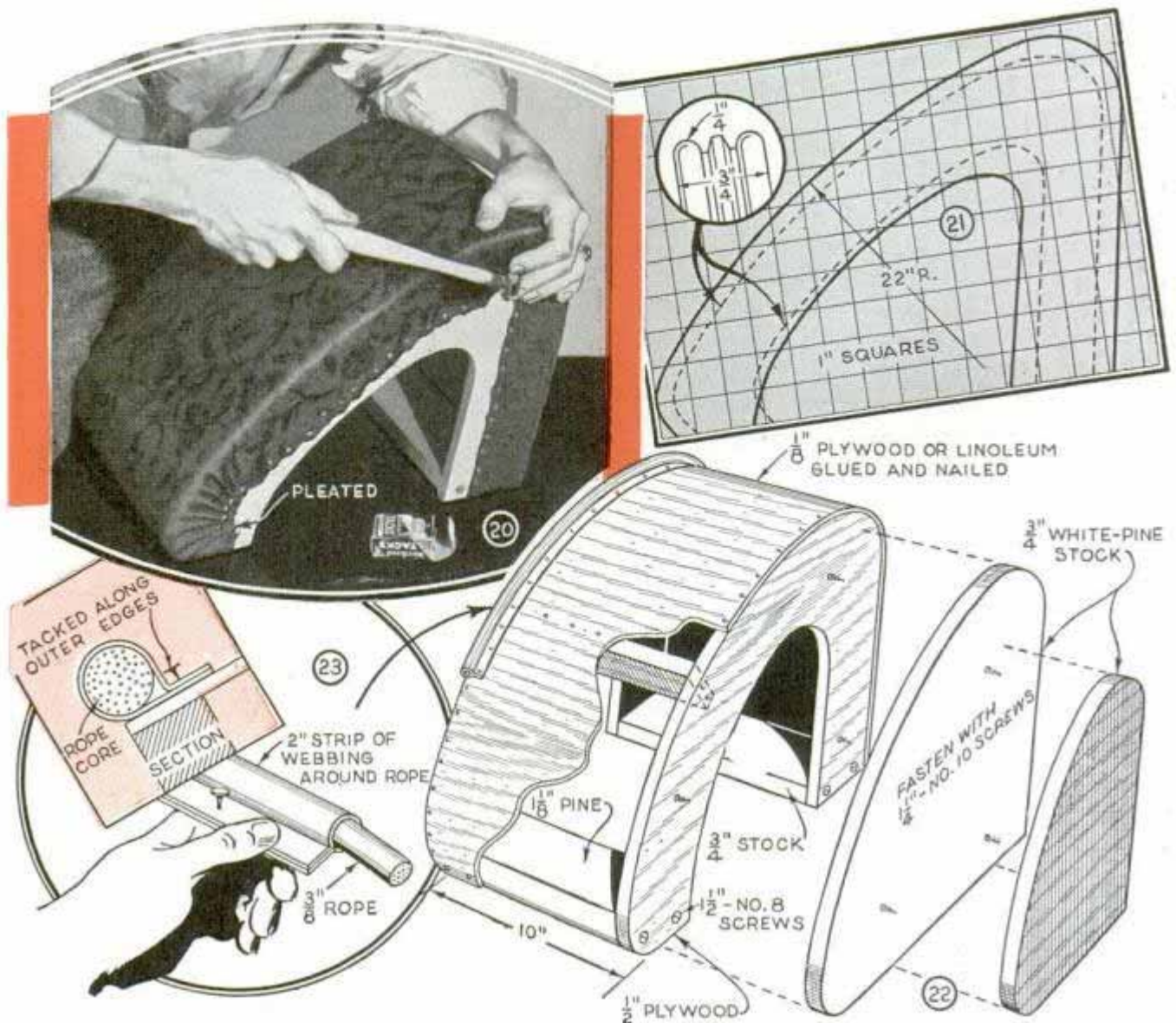

the welt once you have the pieces cut to size. With the top and upper border joined with a welt between, draw it on over the padding and tack the lower edge of the border evenly around the entire frame as in Fig. 18. Then the lower border is fitted by blind tacking through the welt mid point up on the frame, keeping the welt running evenly. Finally, when the lower border is brought down smoothly and tacked to the underside of the rails, you'll have a very neat job with no tack heads visible. Complete the stool by tacking a piece of black cambric over the webbing on the bottom as in Fig. 19.

For a smart antiqued finish of bone-white enamel, the turned stool shown in Fig. 3 can very well be made of inexpensive pine stock. Begin construction with the three hexagon-shape rims in Fig. 10. Stock,  $1\frac{1}{8}$  in. thick, from which the segments are cut, is first beveled and grooved on the saw as in Fig. 12 and then cross-cut

into eight equal lengths. Check the angle for an exact  $22\frac{1}{2}$  degrees by making a test cut on a scrap of wood first before cutting your stock. Then with splines cut to fit the grooves, glue the segments together on a flat surface. For a simple means of drawing the joints together temporarily while the glue is drying, a clamp fastener placed across each joint and driven just part way in to grip the stock, will pull the two together. Place these in both top and bottom edges.

To swing the diameters called for in Fig. 11, makes it necessary to turn the work on the outer end of the lathe as in Fig. 7. The work is mounted on the face plate by means of a  $\frac{1}{4}$ -in. disk which is screwed to the edge of the rim as in Figs. 6 and 7. Turn the largest rim first. This one requires a rabbet cut in both top and bottom edges. To cut these, first turn the rabbet in the bottom edge. Then by removing the work and turning down the plywood disk







## Bat and Ball Are Kept Together with Rubber Carrier

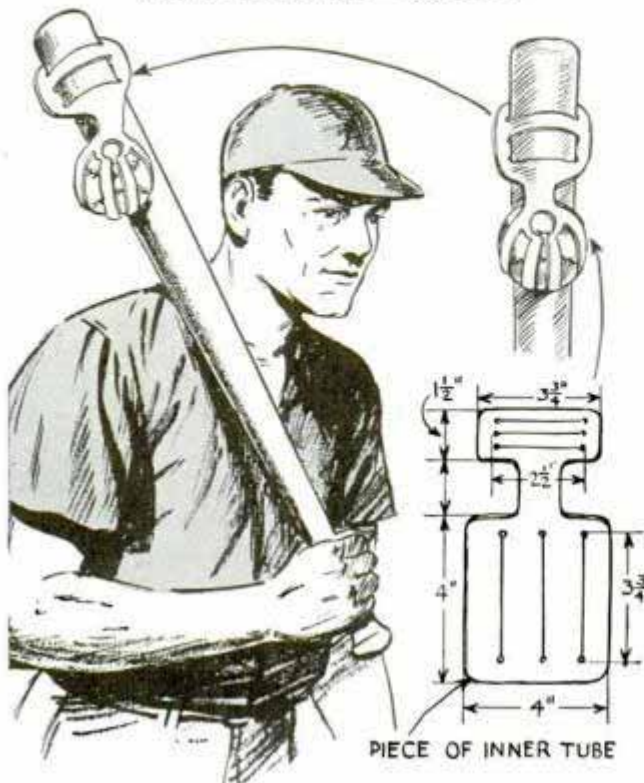

To assure that his bat and ball would always be together when wanted, one baseball player made up this simple ball holder, which slips over the bat. It is cut from a piece of inner tube to the size and shape indicated in the detail. The slits made in the rubber should terminate in round holes, otherwise the rubber is likely to tear out. When not in use, the holder is folded up and carried in the pocket.

—John R. Handley, Akron, Ohio.

## Tracking of Dirt Inside House Prevented by Screen Mat

Laid in front of an entrance door, this mat provides a good surface for scraping the shoe soles before entering the house.



It consists of a  $\frac{1}{2}$ -in. mesh gravel screen tacked to wood slats, which are spaced about 1 in. apart. Heavy rubber can be tacked around the edges of the mat to prevent catching your toe on it, or better still, the outer slats can be beveled to provide a sloping surface.

—J. H. Dunnewin, Grand Rapids, Mich.

## Acetic Acid Softens Celluloid to Etch It Easily

The next time you want to etch heavy sheet celluloid, coat it thoroughly with acetic acid before trying to cut it. The acid softens the celluloid so the etching tools can cut deeply and cleanly. After a few hours, the acid will evaporate and leave the celluloid in its original condition.



## Teeth of Pipe Wrench Sharpened with Valve-Grinding Compound



Teeth on the jaws of a pipe wrench often become flattened or nicked so that they do not grip securely. As the jaws of most pipe wrenches are so hard that a file will not cut them,

they can be sharpened by using valve-grinding compound. Apply the compound to a coarse three-cornered file and then rub it back and forth between the teeth. The compound will collect between the file teeth and slowly work out when pulling it back and forth over the pipe jaws.

☞ To keep artificial flowers in a permanently attractive position, place the stems in a mixture of hot paraffin and sand poured in the bottom of the vase.



# Removing Common Household STAINS from FABRICS

Tested methods anyone can use in applying various chemicals on clothes, upholstery, rugs, linens and other fabrics

**R**EMOVAL of various ordinary stains from silk, cotton, rayon, and other fabrics becomes an easy matter if you use the right chemicals and methods. First you make sure as to what sort of stain is present, as application of the wrong spot remover may fix the stain so that removal is almost impossible. It is equally important to know what the material is, as silk and wool will be damaged by many agents that are perfectly safe on cotton, and some solvents will dissolve or soften certain types of rayons. Dyes also must be considered, as many of the chemicals used will not only take away the spot but also the dye. Use of water must be undertaken with caution with delicate fabrics, as many fabrics will water-spot. Finally, it must be remembered that some spots are truly indelible, and it is sometimes better to leave a spot alone than to make it look worse by working on it. "Spotting" makes use of a number of types of agents, which include solvents, chemical agents, and absorbent powders. Stains are treated by three methods, namely solvent, chemical, and absorption. The chemicals needed can be obtained at most drug stores.

**Solvent Method:** With this method the idea is to wash the stain out of the fabric into a blotting pad underneath. The solvent remaining in the fabric then evaporates. This method is used to remove grease and oil stains. The best solvents are carbon tetrachloride, benzene, and cleaner's naphtha or Stoddard Solvent



*Grease*

Solvent method. Best solvents for grease and oil stains are carbon tetrachloride, benzene, cleaner's naphtha (see text for safety precautions) or Stoddard solvent. Also see text

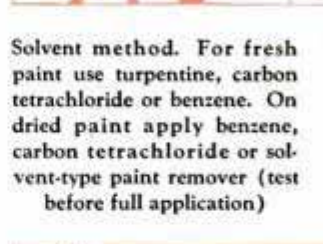

*Paint*

Solvent method. For fresh paint use turpentine, carbon tetrachloride or benzene. On dried paint apply benzene, carbon tetrachloride or solvent-type paint remover (test before full application)



*Tar*

Solvent method. On rugs and clothing tar spots can be removed usually by means of ethylene dichloride or benzene. (Former is unsafe on acetate rayons and some dyed goods)

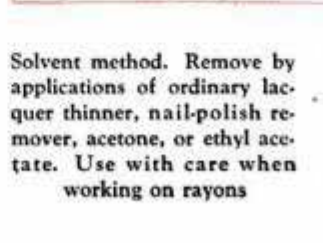

*Nail Polish and Lacquer*

Solvent method. Remove by applications of ordinary lacquer thinner, nail-polish remover, acetone, or ethyl acetate. Use with care when working on rayons



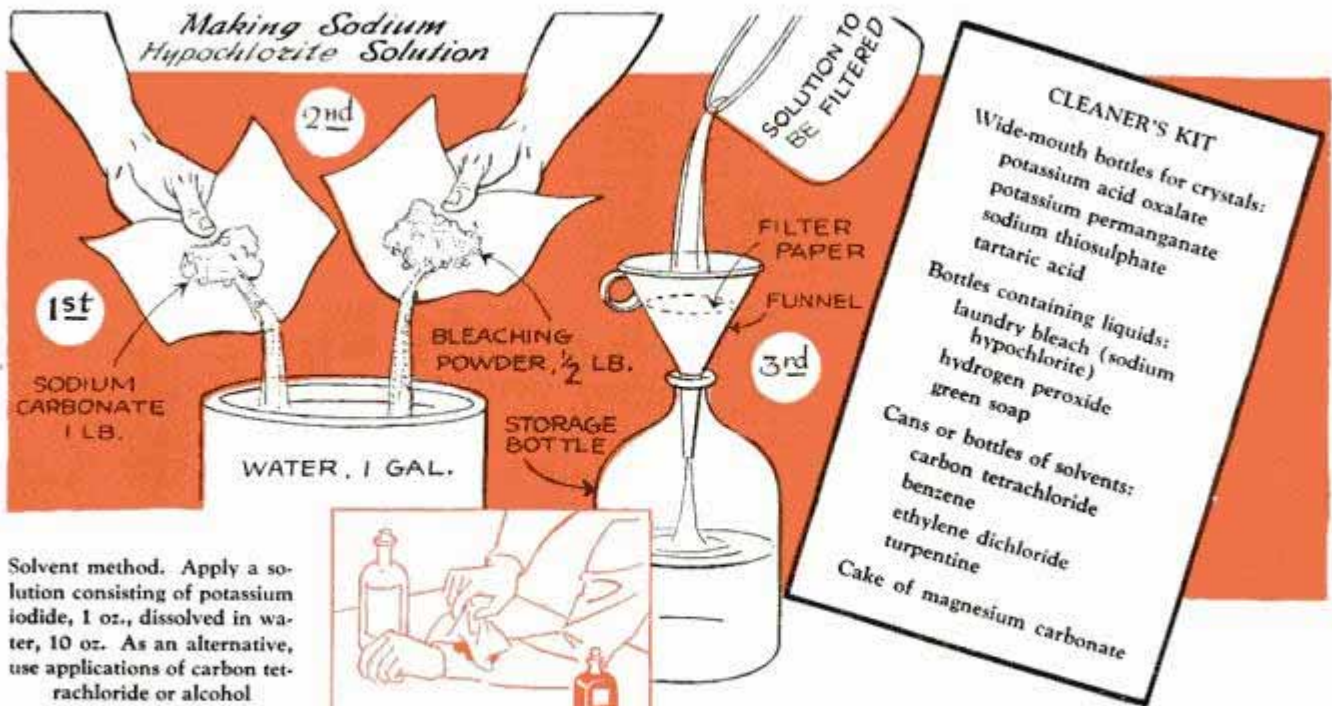

Solvent method. Apply a solution consisting of potassium iodide, 1 oz., dissolved in water, 10 oz. As an alternative, use applications of carbon tetrachloride or alcohol



Chemical method. Saturated solution of potassium acid oxalate in water. Do not use on some dyes or if fabric water-spots. Rinse with cold water after spot has been removed

Chemical method. Sodium hypochlorite on cotton, linen or rayon. If it affects dye, and on silk or wool, use cold water, then 3% hydrogen peroxide. Potassium permanganate, 1 oz., in water, 1 pt., can also be used



Chemical method. Sodium hypochlorite on cotton, linen or rayon. If this affects dye, and on silk or wool, use potassium acid oxalate. Brown or yellow stains from sodium hypochlorite are treated as rust stains

Chemical method. Sodium hypochlorite on linen, cotton or rayon. On silk or wool, use tartaric acid, 4 oz., dissolved in water, 1 pt. On silks use green soap



Chemical method. For stains caused by various kinds of fruits and also those caused by grass and leaves, apply the same treatments as advised for coffee, tea and mildew stains

(which is safer than naphtha). Carbon tetrachloride is recommended as it is non-inflammable. Your cleaner's kit should also contain ethylene dichloride, turpentine and "green soap"—an alcoholic solution of soap. Solvents always should be used where ventilation is good. With inflammable solvents, particularly naphtha, be very careful as the fumes are dangerous.

In applying a solvent, care must be taken to avoid spreading the spot, and also leaving a ring. The fabric should be laid on a flat surface, with a pad of clean cloth or blotting paper underneath. The solvent is applied sparingly so that it will not spread the stain. It is applied with a clean cloth, rubbing in one direction only. The solvent will carry the stain into the pad underneath. After the spot has been removed, a ring or clean spot often will be left. This can be eliminated only by skillfully blending it at the edges to make the change more gradual. The ten small illustrations with accompanying cleaning suggestions tell what solvents to use for various stains. Most of the solvents recommended do not affect dyes or fabrics.

**Chemical Method:** In using a chemical, the stain is not washed out directly but is, in a practical sense, "bleached" and the chemical that remains in the fabric must be removed by washing. When using chemical methods there is always the likelihood of damaging dyed or printed goods, and the chemical always should be tested on the selvage first. After applying a chem-



ical solution to a stain, and the stain has disappeared, rinse away the remaining chemical with water. In some cases the recommended chemicals are unsafe on delicate fabrics, on account of the dye or because of water-spotting. In such cases, about the only thing to do is to rinse with water, if that is safe, and in any case to try the use of green soap on the spot. After using the green soap, rinse with alcohol. The use of potassium permanganate may leave a dark stain, which can be removed from the cloth with a solution of sodium thiosulphate.

**Sodium-hypochlorite solution** is a useful and powerful spot remover for cotton, linen, and rayon, but affects many dyes and silk and wool. It can be made by dissolving sodium carbonate (washing soda), 1 lb., in water, 1 gal., and adding chlorinated lime, ½ lb. After being mixed well, the solids are allowed to settle to the bottom and the clear liquid poured off or filtered. If preferred, a chlorine-type laundry bleach labeled "sodium hypochlorite, 5%" can be used.

**Absorption Method:** This is usually applied only in the case of grease and oil stains. Magnesium carbonate, talc, whiting, and other fine-grained powders have the property of absorbing oils and greases. Of these, magnesium carbonate is the best, and is available in cake form from dry-goods stores. It can be rubbed on the spot, where it is left until the oil is absorbed, and is then brushed off. On stains that are not fresh, it is even better to powder some of the magnesium carbonate and mix it to a paste with benzene (benzol, from coal tar, not benzine, which is similar to gasoline). The paste is rubbed on the spot, allowed to dry, and brushed off. The benzene dissolves the grease or oil and the magnesium carbonate absorbs it. This is useful on heavy garments such as coats.

## Pressure Tank on Water Pump Gives Smooth Flow

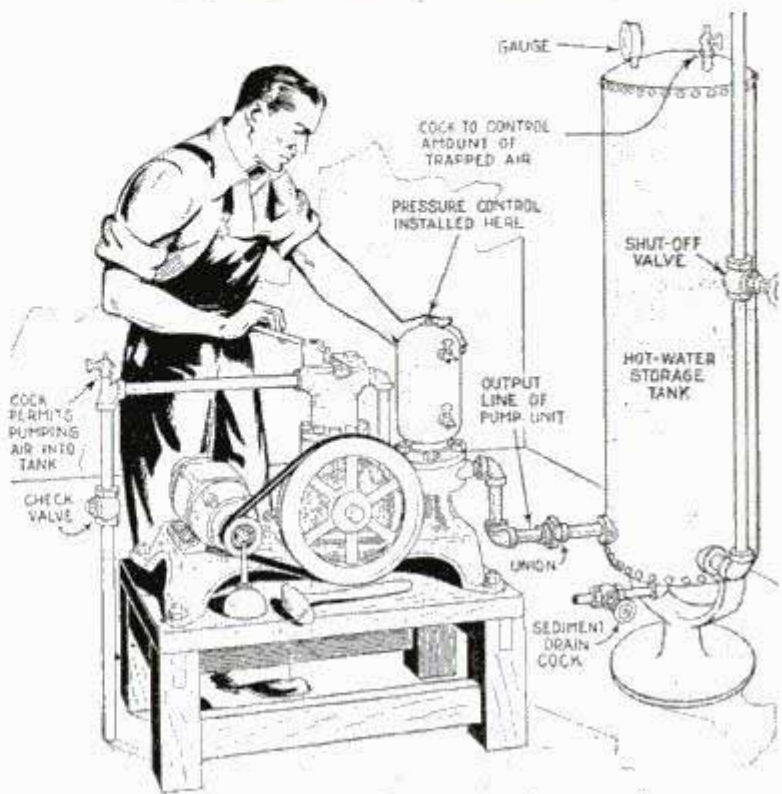

After leasing a home in which water pressure was provided by a small pump of the instantaneous type that started when a faucet was opened, and often forced the water out in spurts, one man fitted the pump with a small pressure tank. This was a used hot-water tank and smoothed out the pump impulses. The drawing shows how the installation was made.—John W. Schulz, Bay Shore, N. Y.

## Stern Bearing for Boat Propeller Shaft Made from Rubber Heels

Two large rubber heels provide a good substitute for a rubber-lined stern bearing for a boat propeller shaft. With a half-round chisel or gouge, make a hole through the center of each one to take the shaft tightly. Push the heels on the shaft, line it up with the engine inside the stuffing box and then screw the heels to the stern deadwood with the rear edge of one upward and the other with the rear edge down. Resiliency of the rubber allows for any slight misalignment, eases the strain on the engine and tends to produce a quiet-running bearing. As water lubricates rubber, your bearing will last indefinitely.

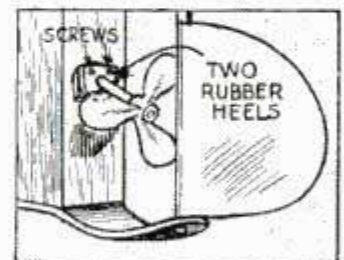



# SMALL ANIMALS

and study of the habits of the animal you are going to mount. If the individual is of a species very active in life, then the specimen should be mounted in such a way as to emphasize some characteristic pose or action.

For the first subject you might choose a squirrel. An animal of this size is easy to skin properly. Although the methods described refer directly to the mounting of a squirrel, any animal, except the larger ones, can be mounted in a like manner. Lay the squirrel on its back, the head pointing to your left and with a scalpel, or a sharp knife, make an incision from A to B as in Fig. 1. Work the skin down each side toward the back, being careful not to cut through the abdomen or

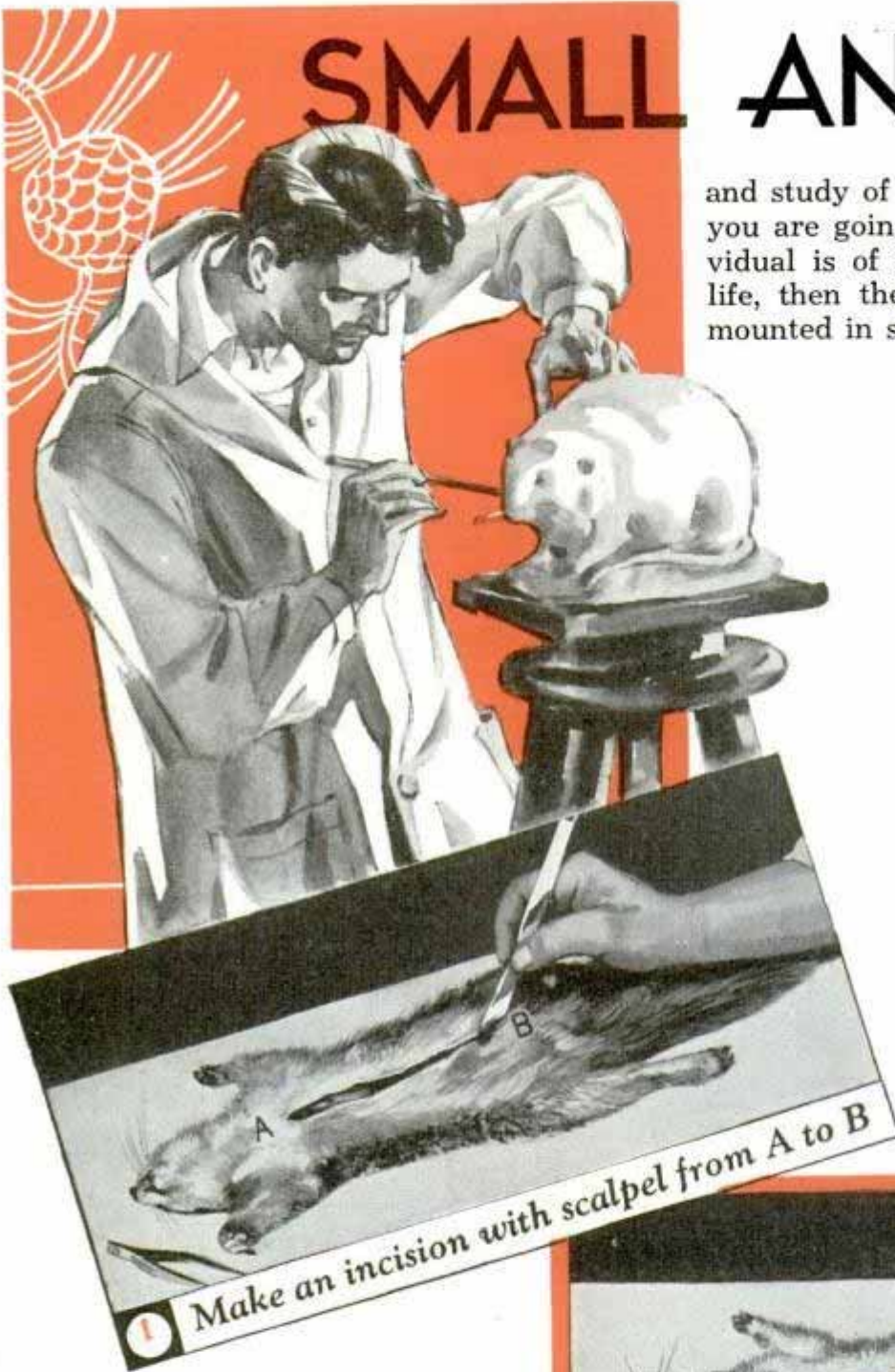

By  
**John William Moyer**

Staff Taxidermist  
Field Museum of Natural History



ONE of the first steps in mounting a small animal is to become thoroughly familiar with that particular species in life, that is the anatomy and characteristic poses so that these can be worked accurately and attractively into the mounted specimen. This means some observation

the skin. When you reach the back legs skin each leg down the inside of the foot, Fig. 2, A. When the foot is reached, skin down to the toes, and cut it from the leg but leave the entire foot attached to the skin, Fig. 2, B.

After both back legs have been skinned



# MOUNTED

*in life-like poses*

out, separate the skin from around the base of the tail and skin it a part of the way down. Now grasp the part of the tail that is skinned out and firmly but gently pull on the skin until the tail bone pulls loose, Fig. 3, A. It is most important that the entire tail bone be removed.

Skin the carcass down over the back toward the front legs. Do this by gently pulling the skin over the back, using the knife to separate it from the flesh, in much the same manner you would invert a glove in removing it from your hand. When the front legs are reached, skin them down the inside, as was done to the back legs, Fig. 4, A, and leave each foot attached to the skin, Fig. 4, B. Continue the skinning toward the head, being very careful in removing the skin around the ears and eyes that you do not cut through it. When the mouth is reached, continue skinning around the lips until the skin comes loose from the skull, Fig. 5, A. There is no need to remove the ear cartilage in the smaller animals. An important step at this time, is to make a small slit near the tip of the tail, so the preserving solutions can run through it. Wash the skin thor-

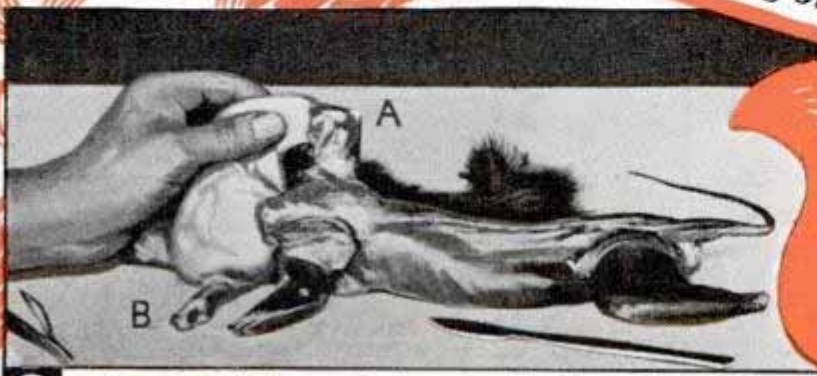
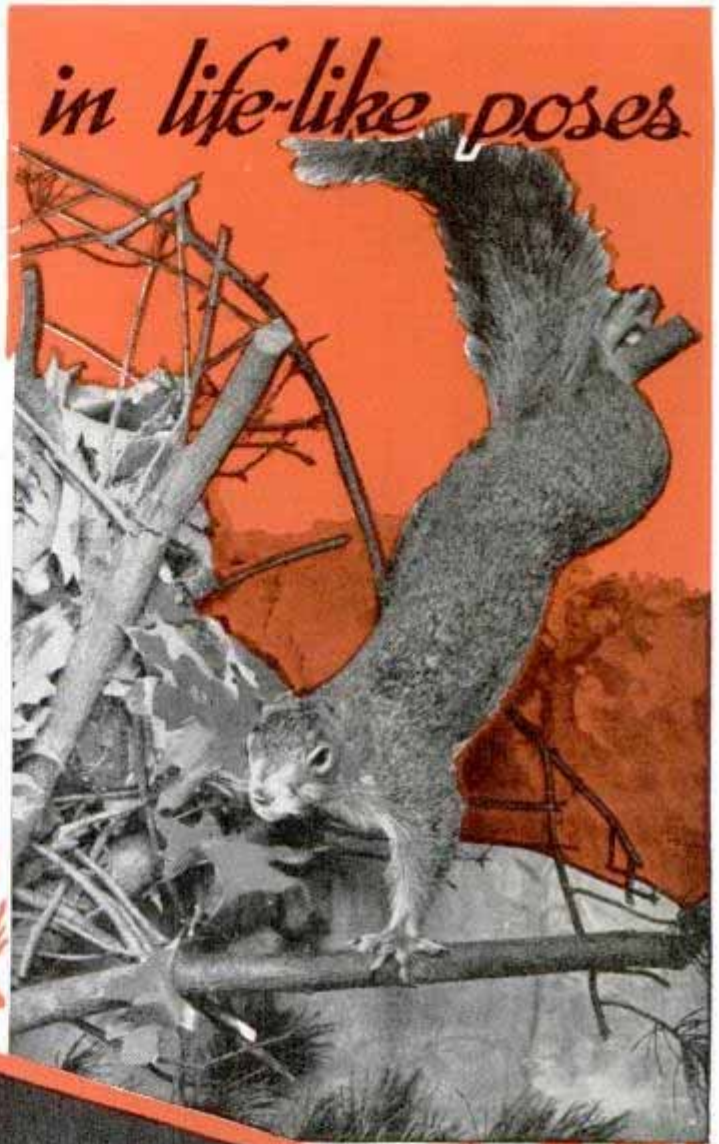



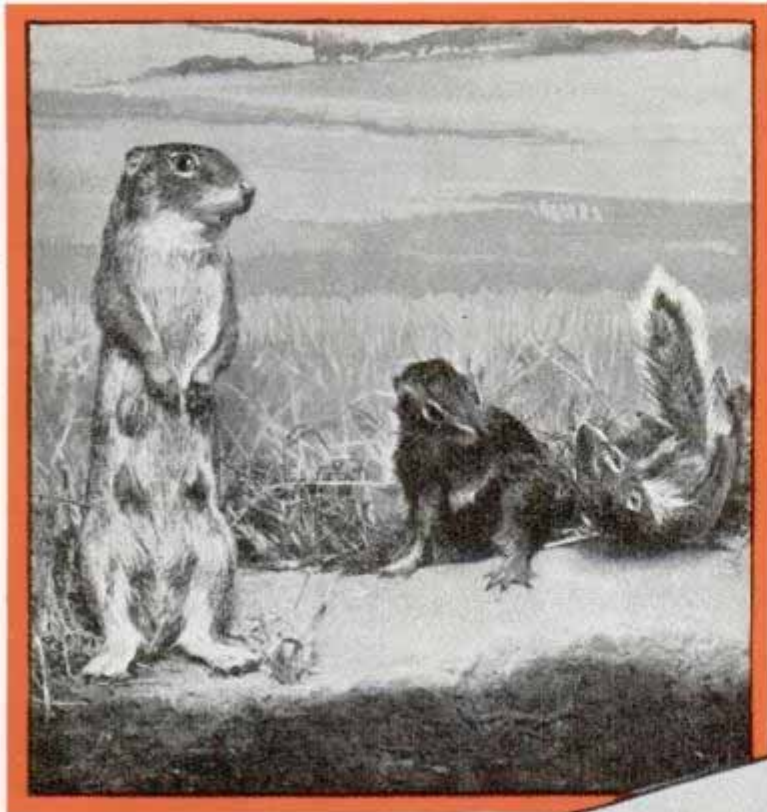

open the lips and nostrils, so they will not shrink in drying.

After the skin has been scraped, turn it right side out, put it back in the alcohol and leave for about two weeks. This tans the skin. When ready to put it on the modeled body, remove from the alcohol, allow to drain well and then immerse it in a saturate solution of borax-water. To make the borax water add carbolic acid, 1 teaspoonful, to water, 1 quart. Then after stirring thoroughly, add all the powdered borax the water will take up. This solution preserves the skin. Allow it to stay in the borax-water for about an hour, remove and hang up to drain.

In mounting by this method, the entire skeleton is used. As soon as the carcass is skinned, remove the intestines and cut away all flesh and muscles. Clean the head thoroughly by removing the brains through a small hole

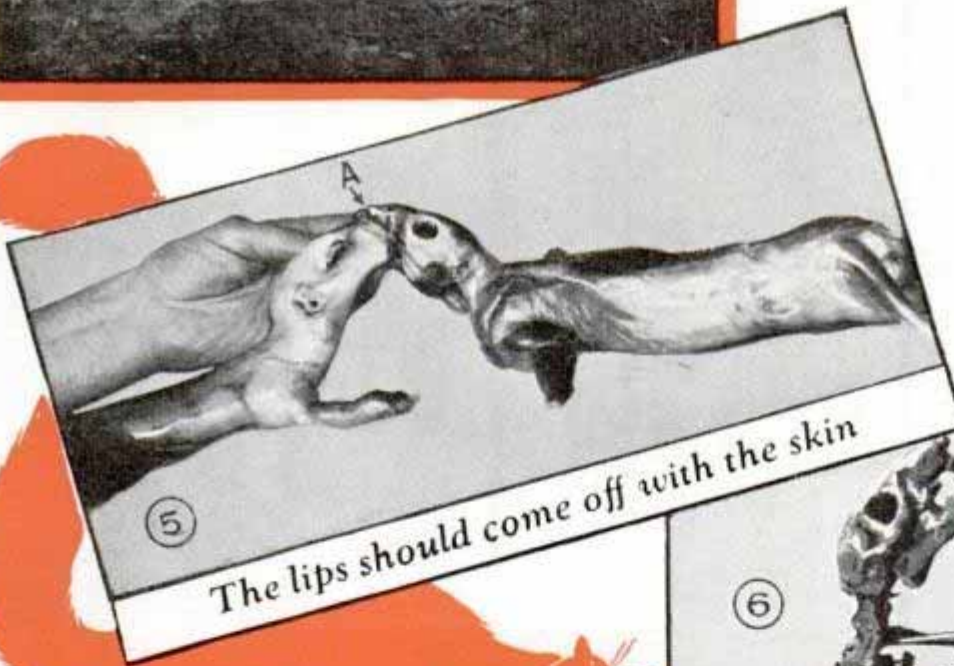

The lips should come off with the skin



The entire skeleton is used in mounting

oughly in cold, running water, allow it to drain, then immerse in commercial grain alcohol in a glass container, leaving it in the alcohol for a day. Then remove and with a small scraper, which can be made by filing a few coarse teeth in the blade of a dull knife, scrape off the inner layer of skin which is over the entire flesh side. Be sure to scrape the skin thoroughly so that one can get the proper amount of stretch when mounting. With a sharp knife, shave down the skin around the eyes and split



made in the roof of the mouth. Remove the eyes and cut away all the face muscles. The tail can be cut off and discarded after making a notation of the length. Although all the flesh is cut away, do not cut the cartilage and ligaments that hold the bones together, as no part of the skeleton must be separated. When you have the skeleton thoroughly cleaned, wash it in cold, running water. Better still, let it soak in water overnight, then remove and allow to partly dry.

When ready to mount the squir-

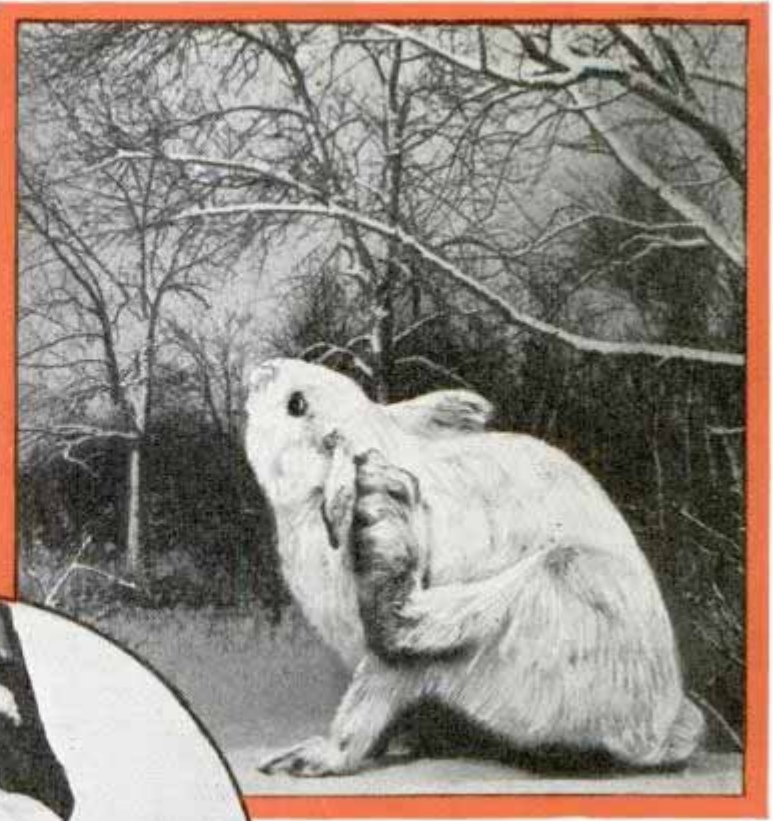

rel, cut the following wires: (larger, or smaller wires are used according to the size of the specimen) four No. 12-gauge wires, sharpened on one end for the legs, one No. 14-gauge wire, sharpened on each end for the head and neck, and one No. 18-gauge wire, tapered to a long point on one end and sharpened on the other. This is

the tail wire. Fit a block of balsa wood into the thorax Fig. 6, A. Make an artificial tail by wrapping very fine tow around the tail wire, starting about 3 in. from the tapered end.

Choose a suitable branch to mount the animal upon and decide now on the pose you want. Shellac the balsa-wood core and then wire the legs, the ends of each wire being forced into the wood core and wired to the leg bones; Fig. 6, B, B. The head and neck wire is worked through the top of the skull and fastened into the wood core. The tail is set into place but not fastened. Holes are drilled in the branch to receive the leg wires and the skeleton is shaped and allowed to dry, Fig. 6. While drying, brush it with formaldehyde. This will help to set the bones and will preserve the cartilage and ligaments.

Now, using papier-mache, model over



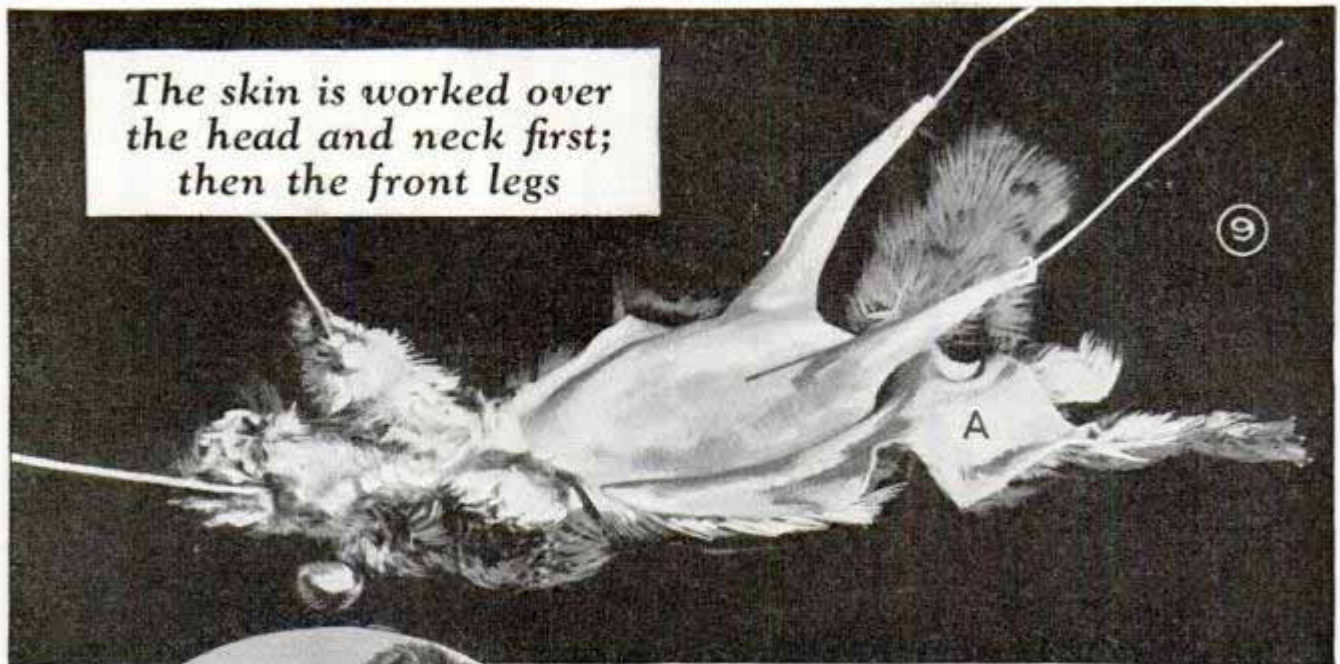

*The skin is worked over the head and neck first; then the front legs*



*Leg wires should be anchored securely*

the skeleton the flesh and muscles that were cut away. Try the skin on occasionally to be sure it fits and see that you are getting the correct contours to the body. Figs. 7 and 8 show the correct anatomy worked out in papier-mache, in the position chosen for the finished mount. Notice that the tail wire has been removed and that the eye sockets and the lip muscles are not as yet modeled in.

After the papier-mache has set, remove the body from the branch. Insert the tail wire into the tail skin and work it well down to the tip of the tail. Mix a small quantity of papier-mache for the eye sockets and lip muscles, but see that this is kept damp so it will not set. Put a small

lump of the mache into each foot and work it well down between the toes. The skin of the squirrel is now pulled over the body. Work the head skin down over the head and neck and the skin of each leg down over the leg. In some specimens the skin of the leg may have to be cut open to get it around the body, Fig. 9, A. Anchor the tail wire to the body and after adjusting the skin in position, begin between the front legs and sew up the incision.

Place the specimen back on the branch and anchor the leg wires in place, Fig. 10. Fit glass eyes, adjusting the eyelids around them. The lips and mouth are shaped and held in position until dry with pins. A small piece of cardboard will hold the ears up and the toes can be fastened to the branch with pins. Smooth the hair and see that no part of it is matted. Set the specimen away to dry for two or three weeks. After drying, the pins and cardboard can be removed. Comb out the hair and "fluff" it up. Brush out the tail, which should be full and bushy. The eyelids and lips can be touched up with black oil paints. In taking specimens for mounting, keep in mind that squirrels and other animals are protected by law in nearly all states. They can be taken legally only during open seasons.

☞ Warm, camphorated oil applied with a soft cloth to white rings on highly polished furniture will remove the stains easily. Rub furniture until dry and polish with another clean, soft cloth.



# Play Machine Gun Stutters Challenge to Foe

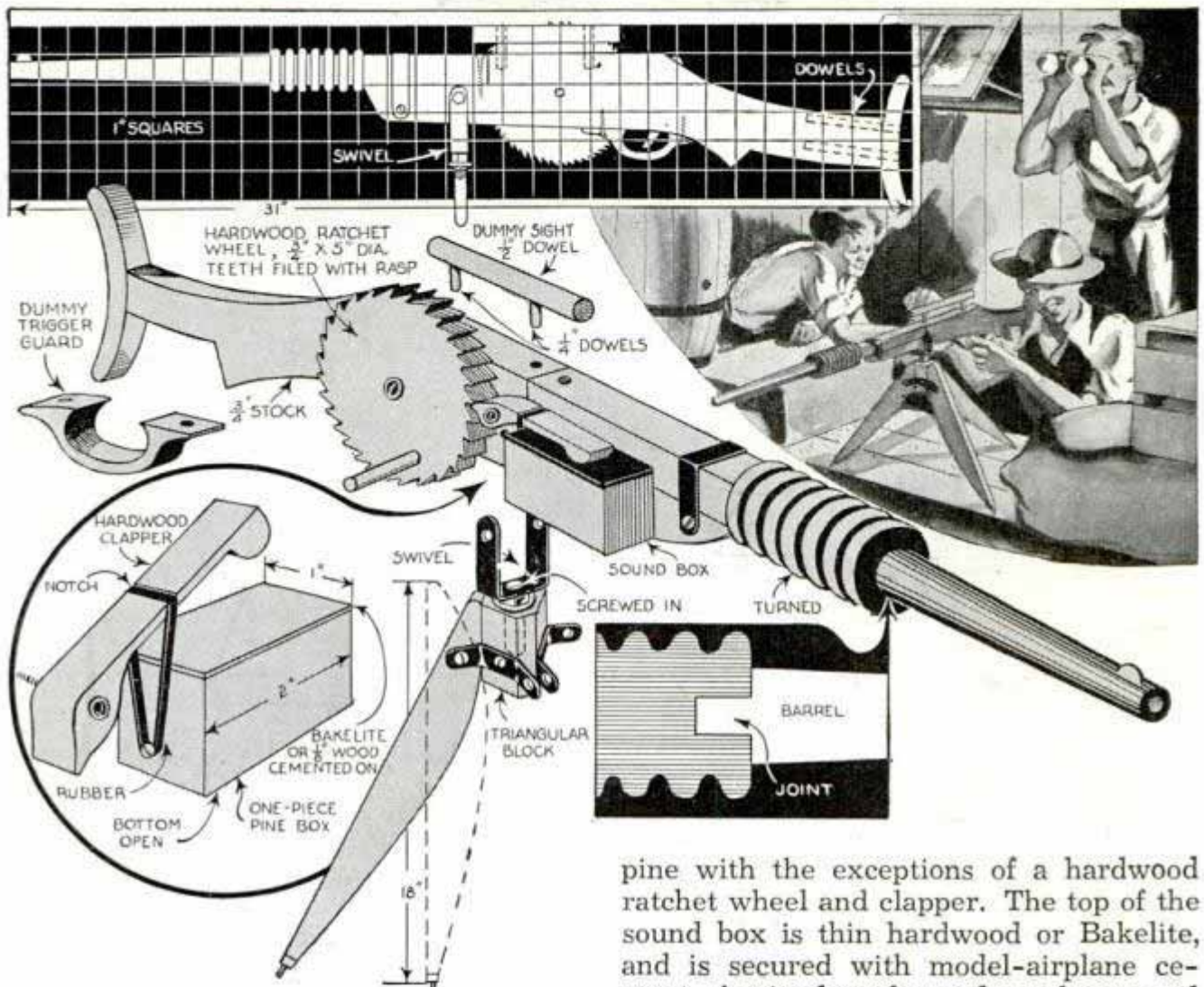

Boys will have a lot of fun staging sham battles with this machine gun, which is harmless as it uses no ammunition but produces a realistic sound. It is made of

pine with the exceptions of a hardwood ratchet wheel and clapper. The top of the sound box is thin hardwood or Bakelite, and is secured with model-airplane cement. A tripod can be made as shown, and adds much to the "front-line" effect. The outfit can be dismantled instantly and carried over no-man's land each time the battle line advances.

## Bobby Pins Form Handy Easels for Small Photographs

Instead of propping up photos on your dresser or mantel, simply bend a few bobby pins as indicated and use them as easels. These are not likely to scratch a table surface, and they permit the photographs to be set at any desired angle.

### Chalk Mark Repels Ants

A piece of soft white chalk carried along on picnics will solve the problem of keeping ants out of the food. Draw a heavy chalk mark around the outside edge of the picnic table and the ants crawling up the table legs will not cross the chalk line to get at the food.





## Small Folding Crawfish Nets Easy to Store and Carry

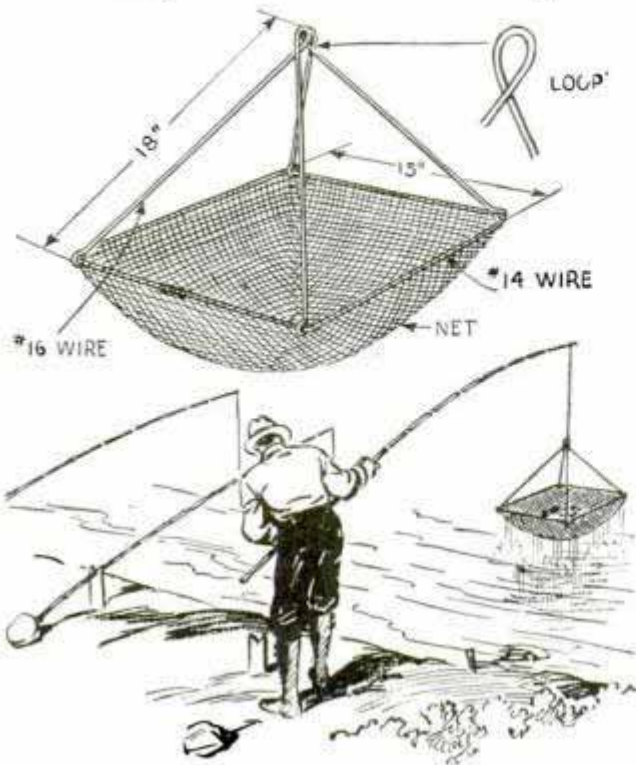

More crabs can be caught in a day with several small nets spaced some distance apart than in a single large net. Also, the little nets are easy to store and carry. Use No. 16-gauge galvanized iron wire and  $\frac{1}{2}$ -in. mesh net to make a pocket 8 in. deep. Tie the bait in the center with twine. Always carry your crawfish or crabs home in a sack or basket, because if confined in still water they will die almost at once. In air they will live several days.

## Hypo Silver Plates Metal



Acid hypo photo-fixing solutions that have become too exhausted for further photographic work contain silver dissolved from negatives and prints that can be deposited on brass and iron by simply immersing the work in it for several minutes. Of course, the deposit is very thin, but it will serve for many purposes. Ordinary acid hypo works better than non-acidified hypo. If no results are obtained, acetic acid should be added to the

solution drop by drop until the silver deposits. The metal to be plated should be cleaned thoroughly with soap and water, and then rinsed in acetic acid followed by a thorough rinsing in water. It is a good idea to coat the plated work with clear lacquer after washing and drying it.

## Weighted Hook for Casting with Insect Bait

Fishermen who have difficulty in casting a hook baited with a grasshopper or other light insect will find that a solder-weighted hook overcomes the trouble. If a U-shaped piece of small wire is cast in the solder, the projecting ends will serve as a clamp which can be bent around the insect.

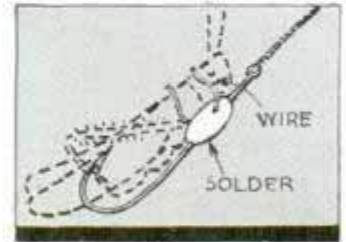

## Eye-Catching Letterheads Made from Wallpaper

Individuality is always appreciated, and if you select a wallpaper design suiting your personality and make it into letterheads your written messages will be

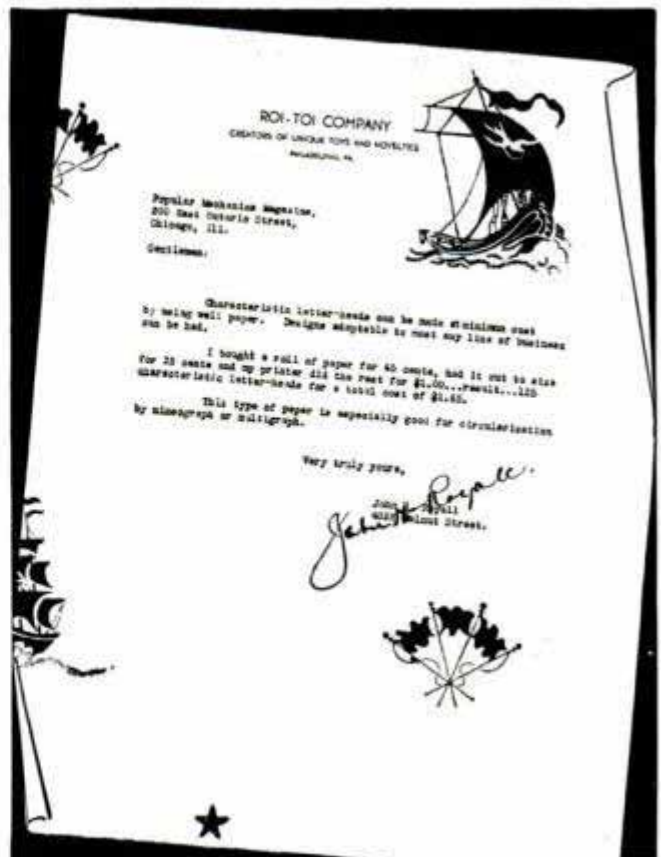



doubly effective. Have the roll cut into standard letter-sheet sizes, and your name and address printed at the top. Wallpaper takes mimeograph ink very well, and this type of appeal is colorful and attractive for advertising.

—John H. Royall, Philadelphia, Pa.

### Tubular Rivet Pushes Needle in Repairing Harness

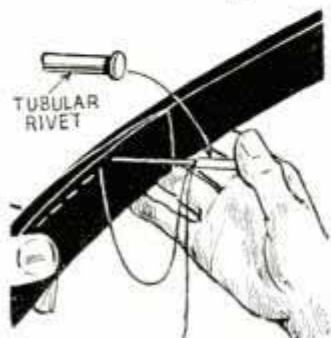

Difficulty in pushing a large needle through leather to make small harness repairs may be overcome by slipping a tubular rivet over the end of the needle as

shown. The rivet is not injurious to the thumb and pressure can be applied easily.

### Disk Float to Carry Water without Spilling

If you have to carry water in buckets from a spring at your camp, a disk float on the water when the bucket is filled will help prevent spilling. The float can be provided with a handle cut from a piece of heavy sheet metal and bent to the shape indicated in the drawing.



### Rubber Shield for Fishing Reel

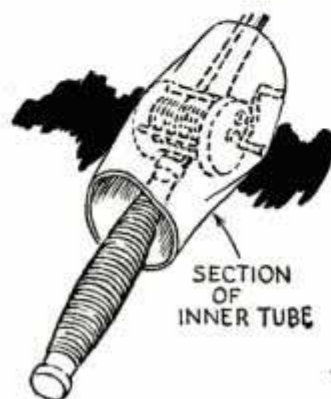

Fishermen who carry their reels and rods assembled in the car, will find this shield a handy protection for the reel. The shield is a section of old inner tube slipped into place as indicated.

### Extension Handle on Trash Can to Loosen Lid Easily



Fit your garbage-can lid with a handle as indicated and the women members of your family can remove it easily. The handle provides a strong leverage to pull the lid off the can and folds down flat when it is not being used.

### Plants Protected from Cut Worms by Paper Tubes

Young seedlings can be protected against the ravages of cut worms by slipping tubes of asphalt roofing paper around them as indicated. The tubes are made by cutting strips from the paper and fastening them together with glue, cement, pins, or wire. The tubes should extend 2 or 3 in. into the ground.

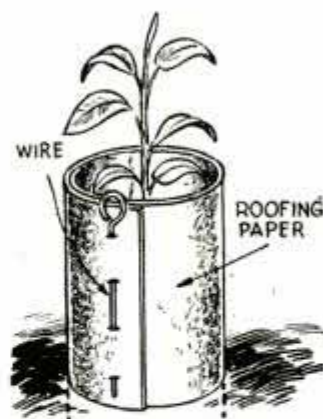

During the germinating period, seeds should be kept moist, but not wet, and the seed bed should never be allowed to dry out once the germ has broken the seed coat; if this happens, the tiny plant dies without ever getting above ground.



# Solving HOME



ELASTIC ①  
CELLOPHANE BAG

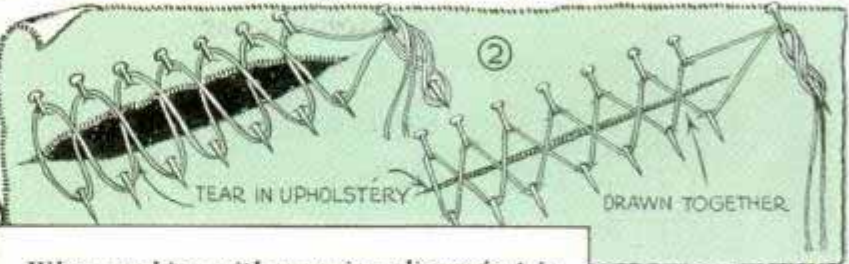

TEAR IN UPHOLSTERY

DRAWN TOGETHER

When working with an onion, discomfort to your eyes is avoided if you hold it inside a Cellophane bag as in 1, which will confine the fumes without obstructing vision. Stitching a tear in the fabric of upholstered furniture is simplified by pushing pins through adjacent edges of the tear and then lacing with a strong cord to bring the material together. Bobby pins are good substitutes for regular pins, as in 4, when fitting a dress that will show pinholes

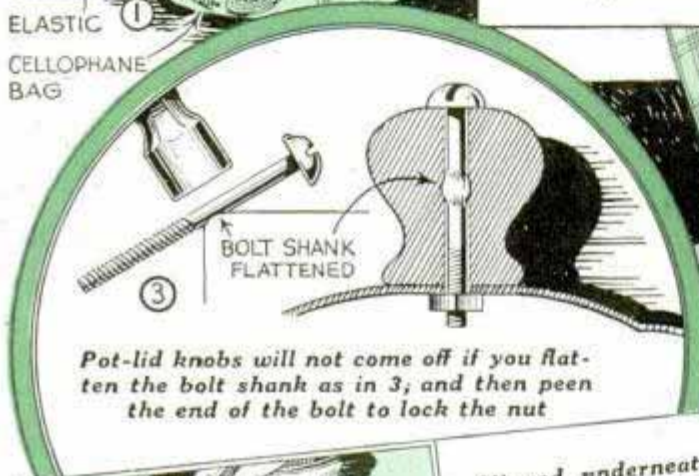

BOLT SHANK FLATTENED

Pot-lid knobs will not come off if you flatten the bolt shank as in 3; and then press the end of the bolt to lock the nut



BOBBY PINS

④

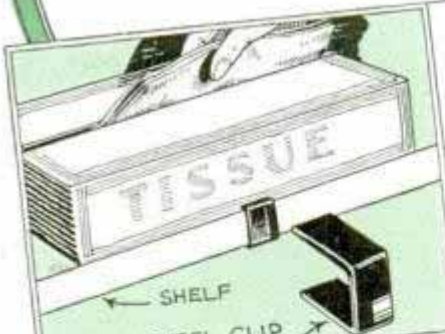

SHelf  
SPRING-STEEL CLIP

You can remove paper tissues without holding the box if you clip it to a shelf

Clipped underneath an ironing board, a whisk broom is always at hand when pressing

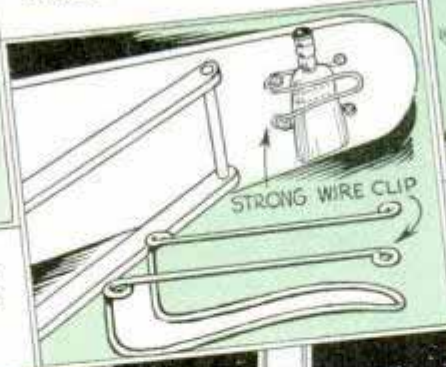

STRONG WIRE CLIP

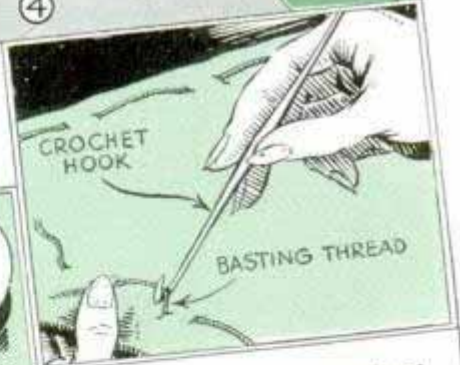

CROCHET HOOK

BASTING THREAD

You will find a crochet hook helpful for removing basting thread from large work

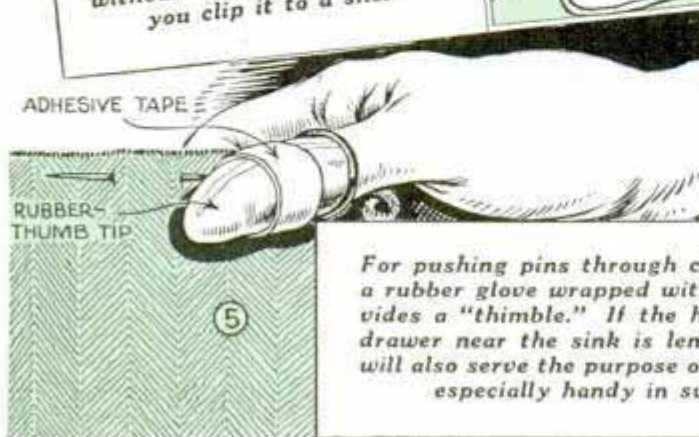

ADHESIVE TAPE

RUBBER THUMB TIP

⑤

For pushing pins through cloth, a thumb from a rubber glove wrapped with tape as in 5, provides a "thimble." If the handle on a kitchen drawer near the sink is lengthened as in 6, it will also serve the purpose of a towel rack. It is especially handy in summer cabins

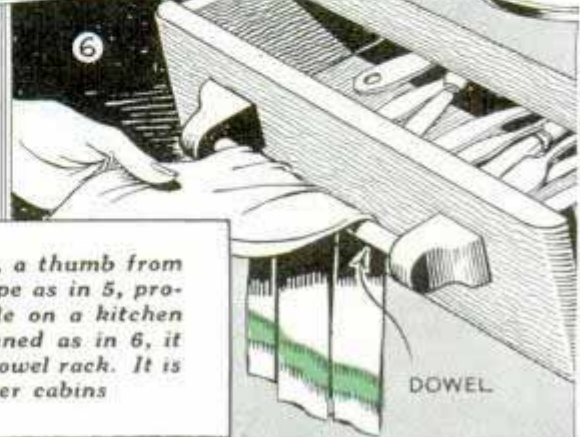

DOWEL



# PROBLEMS

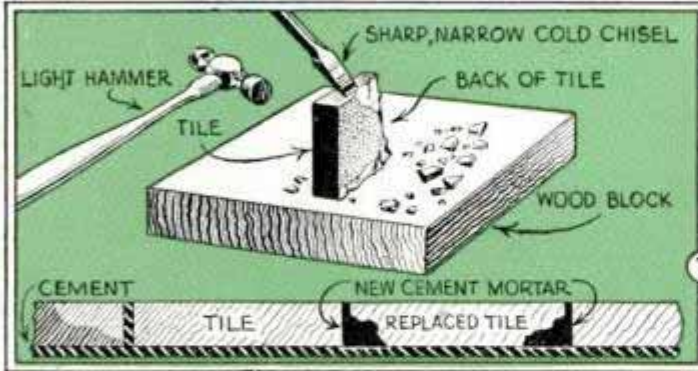

A loose floor tile can be reset by chipping off the underside at the edges as in 7, so that fresh cement can be applied without removing the old cement between the blocks, which might loosen them. Repair a spreading door with an iron strip set flush in the top edge as in 8

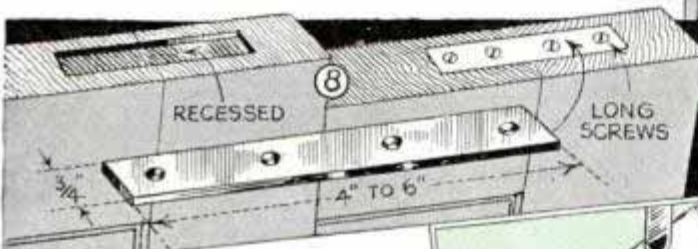

Weighted can set over a cracked bowl holds it while the cement dries

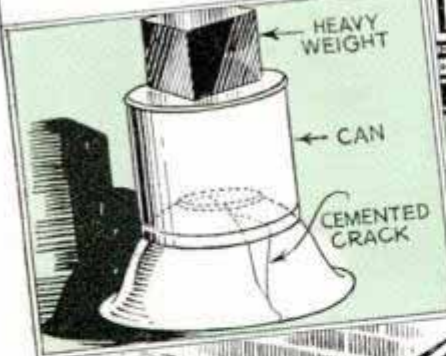

Slipped over a glue-bottle brush, a fuller ball serves as a finger grip and stopper

A small rubber band looped over the lower hinge pin, as below, silences a rattling door

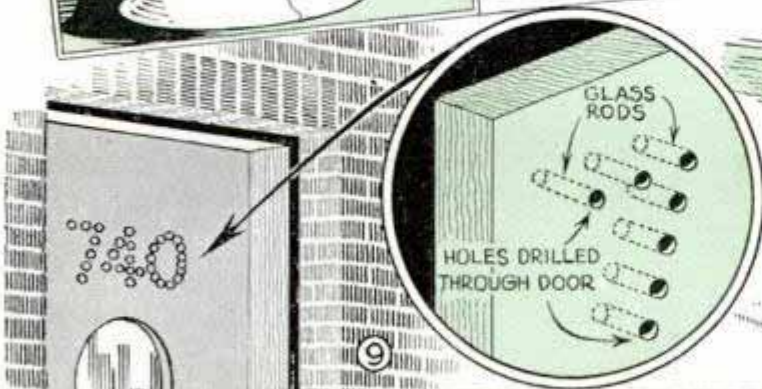
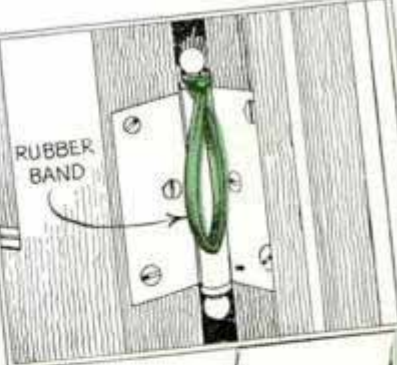

Interior light illuminates the house number in 9 which is made by inserting short lengths of glass rod into holes drilled through the door. An iron wheel mounted on a wood standard, as in 10, provides a rotating shoe scraper

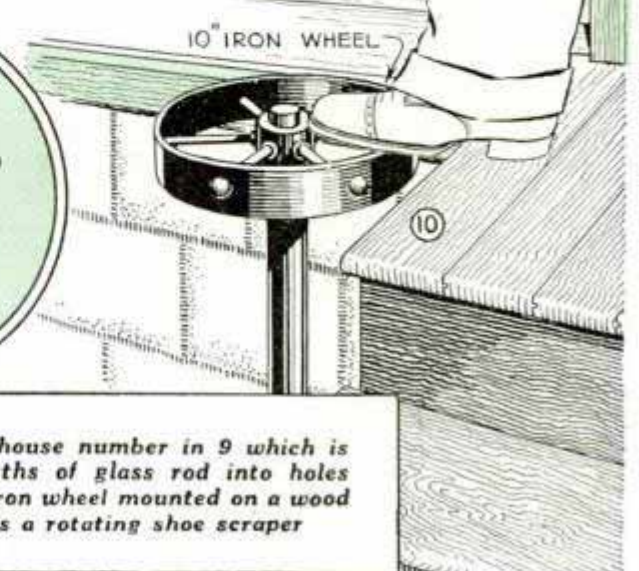



## Sundial over Entrance Door Is Useful Decoration

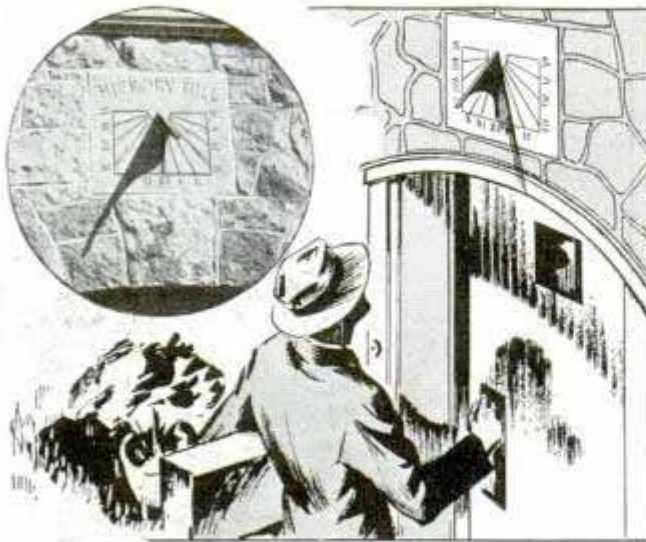

Installed primarily as a decoration, this sundial over the front door of a home on a country estate has been found so accurate

that it does not vary more than 15 min. the year around. The face of the dial is stone with the figures cut in it. The stile or shadow caster is cast from bronze.

## Sawdust "Door" on Beehives

As beehive entrances should not be sealed permanently in climates where the spring weather is extremely variable, one keeper fills the opening with sawdust as shown, in case a warm day should come and the bees might be deprived of their cleaning flight. Sawdust will protect the bees until warm weather induces them to come out, at which time they will make a passage through it.

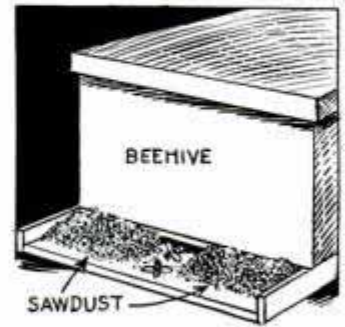

# Plenty of Fun at a Safe Speed



*This small car, having a 58-in. wheelbase and 28-in. tread, is very easy to operate and may be powered by a 1/2 to 3/4-hp. gas engine of the washing-machine type. It is equipped with effective brakes and pneumatic tires. Plans show three alternate methods of body construction. Easy to build. Our blueprints Nos. 906 to 909 incl. give you all the information necessary. This set will be sent postpaid on receipt of \$1.00.*

### OTHER THINGS TO BUILD

**"ROAMER"**—765 to 770: Outboard cabin cruiser. 16 ft. long, 66 in. beam. Requires outboard motor of 20 to 36 hp. Set of six prints \$1.00.

**"SEA SAUCER"**—893: 9 1/2-ft. sail boat. Deck, bottom and sides are 3/16-in. plywood. 25c.

**"ZIP," MODEL RACING YACHT**—880 to 883: 50 in. long. Four prints \$1.00.

**17-FT. KAYAK**—928 and 929: Light framework covered with canvas. Two prints 50c.

**LAWN CHAIR**—529: Plain sawed from 3/4-in. stock. Easily made with hand tools. 25c.

**ORNAMENTAL WOOD FENCES**—640: Five artistic designs for standard wood stock. 25c.

**VENETIAN BLINDS**—926 and 927: Three different styles covered on two prints. 50c.



### CATALOGUE OF 400 PLANS

*If you have a home workshop and want some new ideas on things to build, just send your name and address with a 3c stamp for our 32-pp. illustrated plan catalogue. Lists plans on workbenches, motor-driven machines, garden furniture, models of all kinds, boats, radio equipment, juvenile articles, etc.*

Any six of these plans (not projects) will be sent postpaid upon receipt of \$1.00

Blueprint Department, Popular Mechanics Magazine, 200 E. Ontario St., Chicago



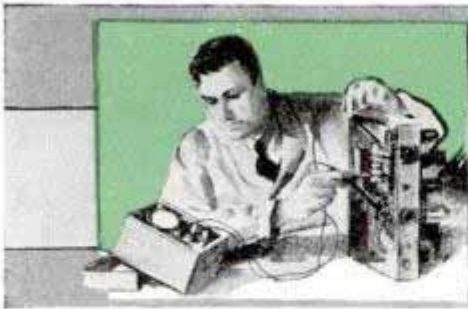

# Radio

## Radio Goes to School

MODERN aids to education include the use of radio in a wide variety of applications. Centralized sound systems transmit microphone, radio and recorded programs to classrooms and offer an important feature of two-way communication between the principal and any teacher in the school. Music, speech and radio programs also may be distributed to the school auditorium, gymnasium, cafeteria, music room and library. Photo (A) shows table-model sound system of this description. Recording instruments of the type shown in photo (B) make accurate records of voice that may be reproduced immediately to give students a sound picture of their speech faults. Student broadcasts stimulate pupils to greater effort in composition if those who write the best papers are permitted to read them over the school sound system as illustrated in sketch (C). Fig. 1 shows a radio-equipped school with suggested receiving sets and accessory equipment to meet the requirements of practically any school.

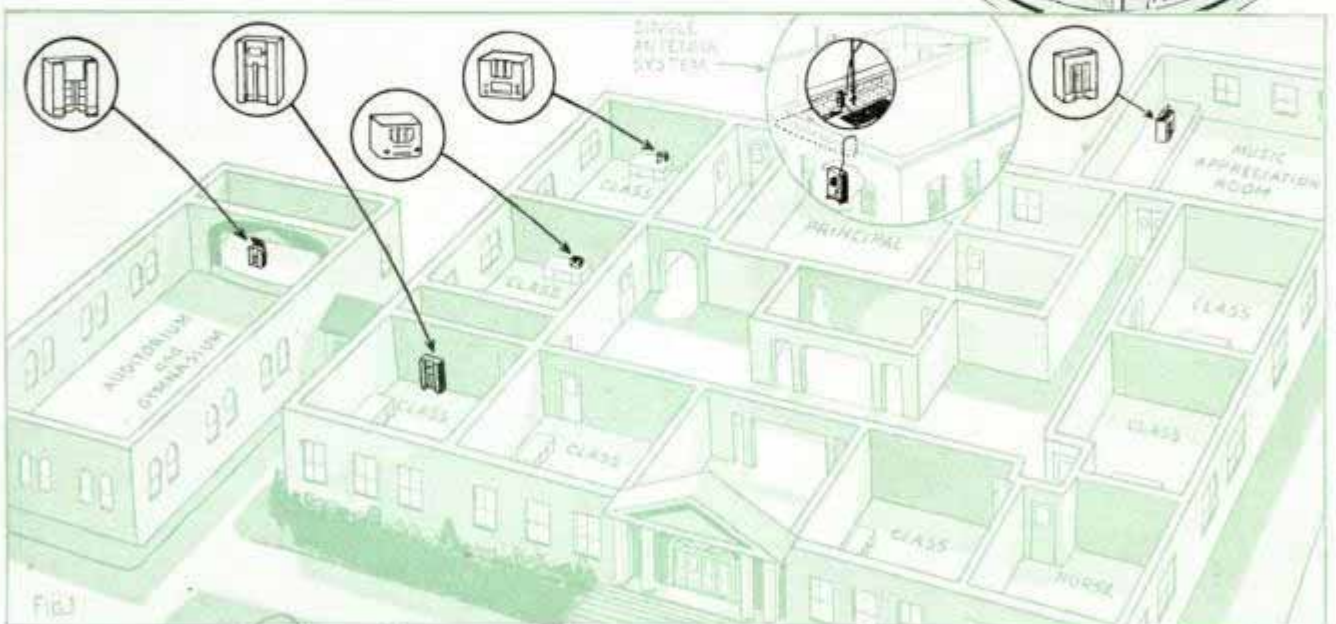











# Simplified Mechanical Push-Button Tuning



SEVERAL varieties of modern table-type receivers employ a simple mechanical method for push-button tuning that anyone can adjust with a small screwdriver from the front of the set. You can select your favorite stations and change them at will, as only one adjustment is required for setting up each station.

It is not necessary that all push buttons be set at the same time. The buttons are removable and provided with a slot for inserting the call letters of the stations desired. Several perforated sheets of call letters, which include all broadcasting stations, are supplied with each receiver as shown in photo B. In some sets the push buttons must be removed to get at the set screws; others have a hole in the front of the button into which a small screwdriver may be inserted. Photos A and C illustrate this method; however, the buttons can be removed if the operator wishes to do so.

To set up five favorite stations, tune in first as accurately as possible with the conventional

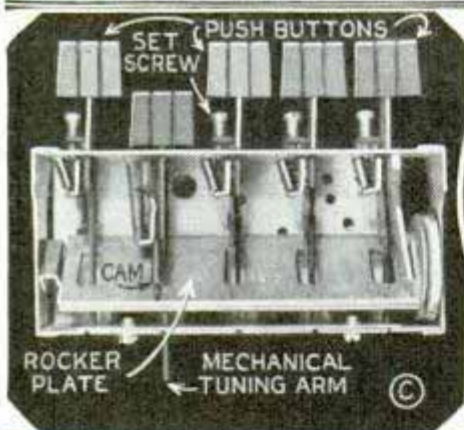

tuning knob, the one that employs the highest frequency; this No. 1 station button will be the one nearest the 1,500 kc. end of the "straight-line" dial. The set screw is loosened and the button is then pushed all the way down and held in that position while you tighten the set screw. This locks the cam at the correct position to always bring the rocker plate to the point where the tuning condenser has been manually set to tune in the station desired. The condenser rotor is coupled mechanically to the rocker plate, either with a gear wheel or pulley. This station-setting procedure is then repeated for other stations in the order of their frequency (kilocycles).

Photo D shows a similar type of small receiver with a slightly different mechanical push-button arrangement.





M. N. Weitzman  
 3929 W. 13th  
 Chicago

# Practical RADIO HINTS

Needful  
 Amperite Co 661 Broadway

near  
 25 East

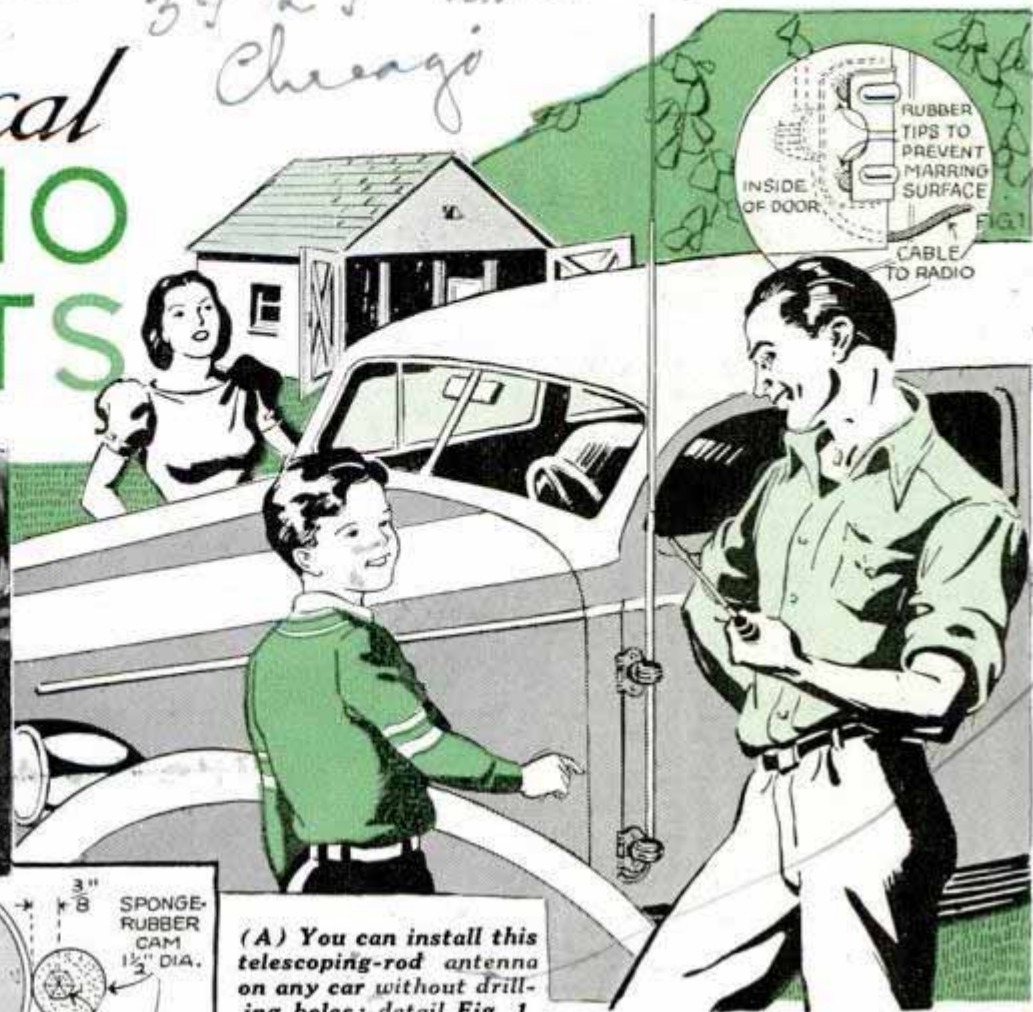

(A) You can install this telescoping-rod antenna on any car without drilling holes; detail Fig. 1

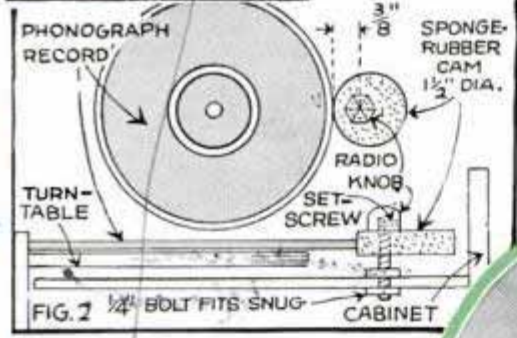
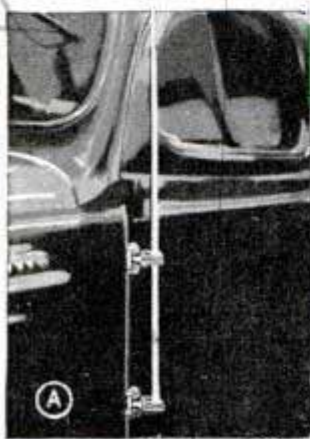

(B) Miniature permanent-magnet speaker for ultra-compact receivers; this 2-in. speaker has good quality and power-handling ability. It is available with matching transformers for all types of output tubes. (C) Foot-pedal volume-control and contact-type microphone used with radio amplified musical instrument. (D) Hard rubber caps fit snugly over high-voltage condenser terminals to protect operator from accidental contact

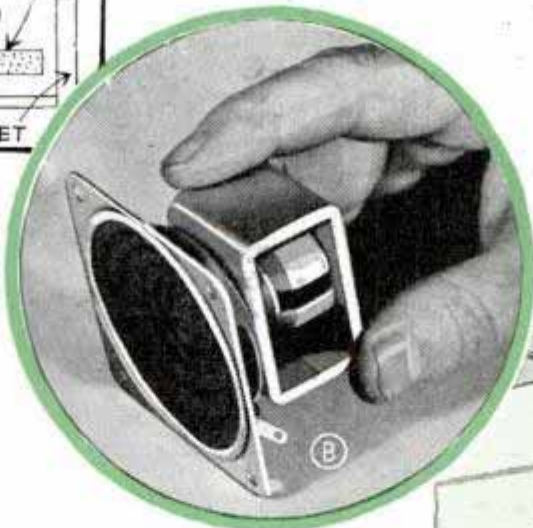

Fig. 2 shows a simple and efficient means for adding a speed control to inexpensive motor-driven record players used with radio sets; only a slight pressure of the sponge-rubber cam is required on the edge of the disk to obtain proper control for reproducing recorded music correctly

Fig. 3, insulating grommet, for antenna lead-in wire, made from electric plug cap; wood strip, mounted on angle iron, is fastened to building at any convenient point near window

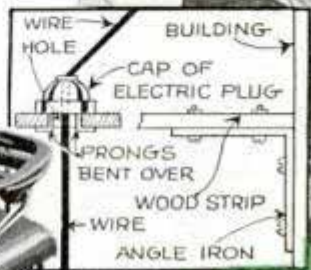
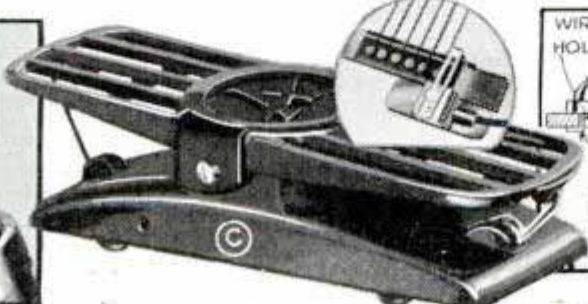
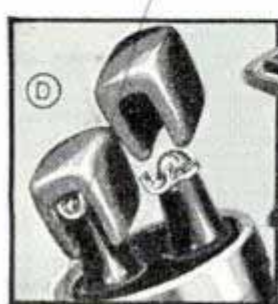

FIG. 3



Sprague Products Co



## Portable Radio Power Plant for Amateur Stations



PORTABLE  
POWER UNIT

This gasoline-driven generator supplies all necessary power to operate an amateur transmitter and receiver in the field for emergency purposes. Compact and easily portable, it is available with push-button starter, ammeter, cutout and charge control, and is completely shielded and filtered.

## Compact 100-Watt Transmitter

Including everything but the power supplies, this ultracompact transmitter is assembled on a single 19 by 10½-inch panel

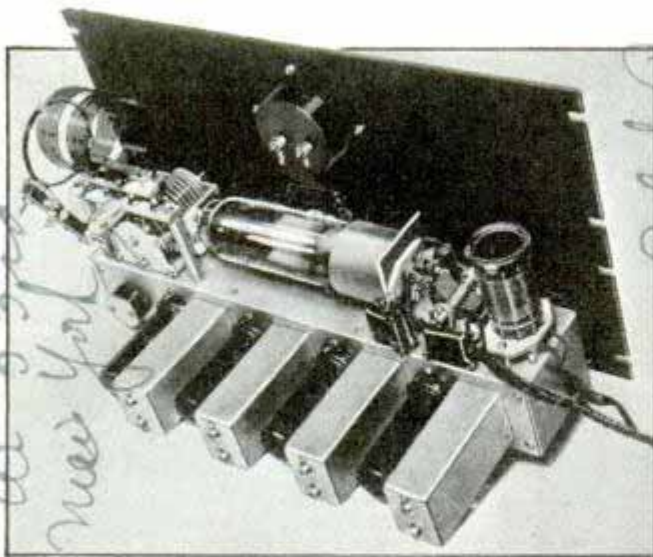

for rack or cabinet mounting. It has an improved method of band switching, works on all bands from 80 to 10 meters and there are only two tuning controls to operate.

## Filter for A.C. or D.C. Supply Line

This line-noise filter is designed for use between your radio receiver and power line to prevent line noises from entering the set.



A metal case shields the unit which is equipped with a binding post for ground connection. It may be used on 110 volt a.c. or d.c. lines.

## Nine-Inch Television Receiver

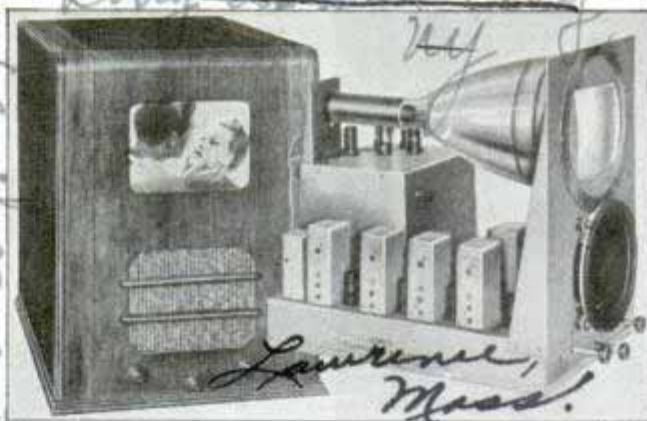

A nine-inch cathode-ray tube is used in this compact table-model receiver for sight and sound programs. Improved methods are employed to prevent the formation of spots and blemishes on the screen and avoid damage to the cathode-ray tube while it is warming up. The directly viewed image is black and white.

Blueprints covering radio construction articles in this and past issues are available for 25 cents each. Original material lists, with names of manufacturers and dealers, can be obtained from our Radio Department upon receipt of postage.

**NEXT MONTH—How to Build a One-Tube All-Electric Loudspeaker Set.** Beginners will find this an inexpensive and interesting little broadcast receiver as it employs a fixed crystal detector and an improved dual-type tube which acts as an audio amplifier and half-wave rectifier. Also—**A Push-Button Set Tester**





# SHOP NOTES

## "STEP-COLLET" CHUCK

*Speeds up turning of disks, tubing, gear blanks, etc.*



THIS tool is really a combination of the collet and step chuck and will add greatly to the speed and convenience of your lathe when machining small parts requiring a short grip. Step chucks should be recessed to approximate closely the diameter of the work to be done.

A screw-type draw-in spindle and closing ring Figs. 1, 2 and 6, are the first parts to be made. The spindle is a length of Shelby tubing fitted with a hand wheel as in Figs. 1 and 4. The wheel can be made from a casting, requiring a pattern of course, or it is possible to adapt a ready-made handwheel to this purpose. The clos-

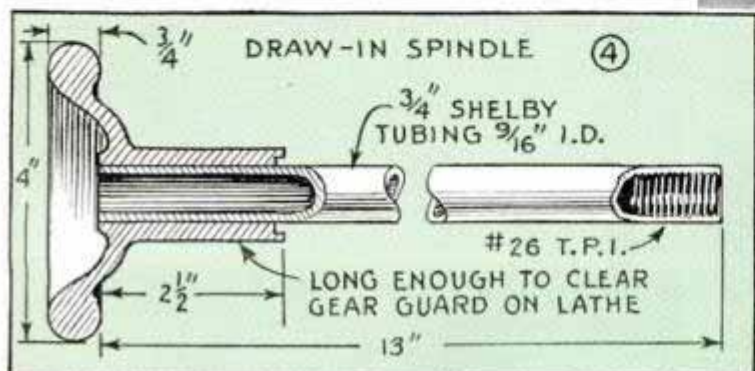



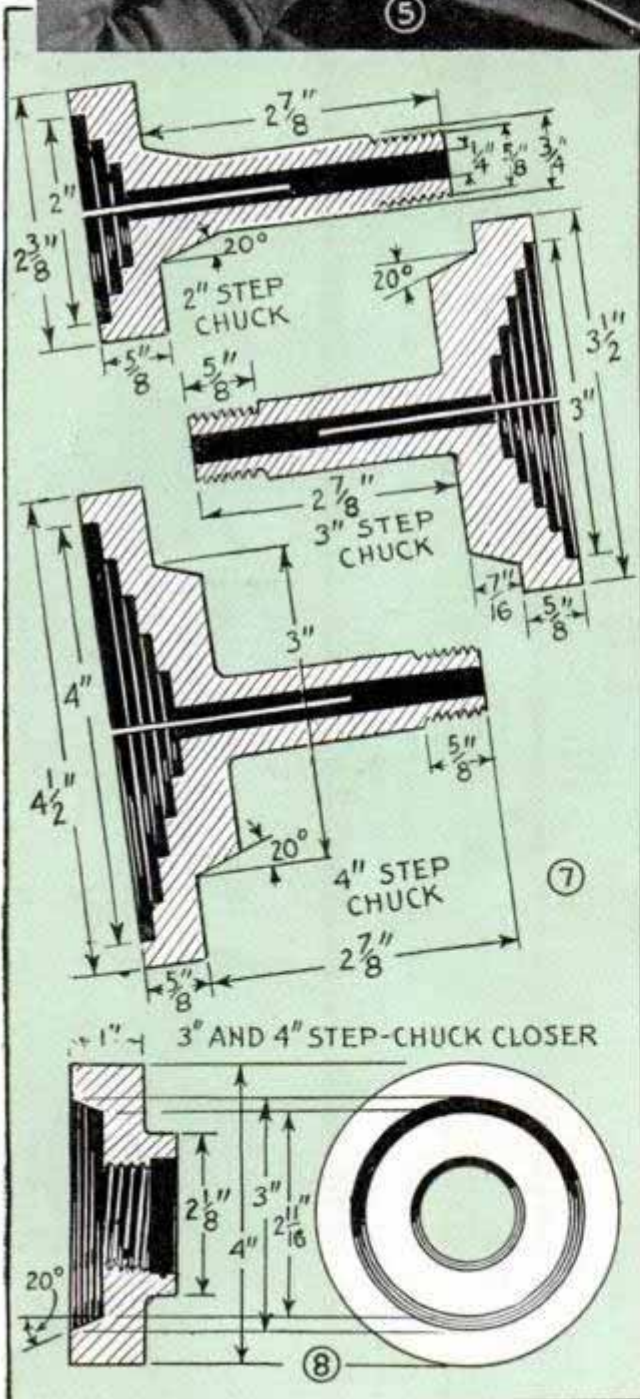
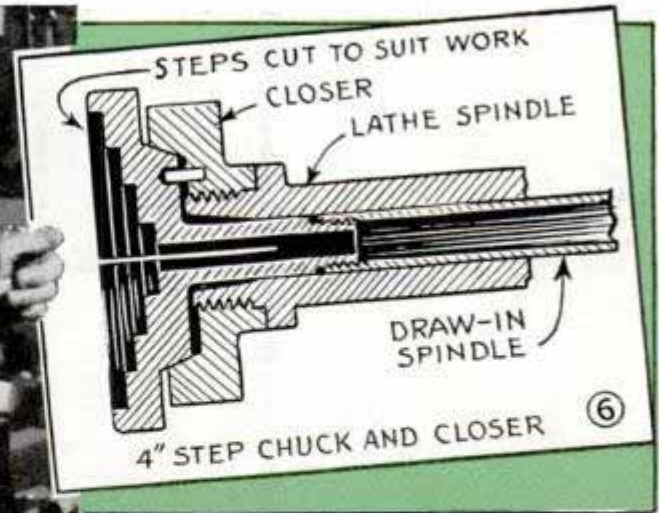
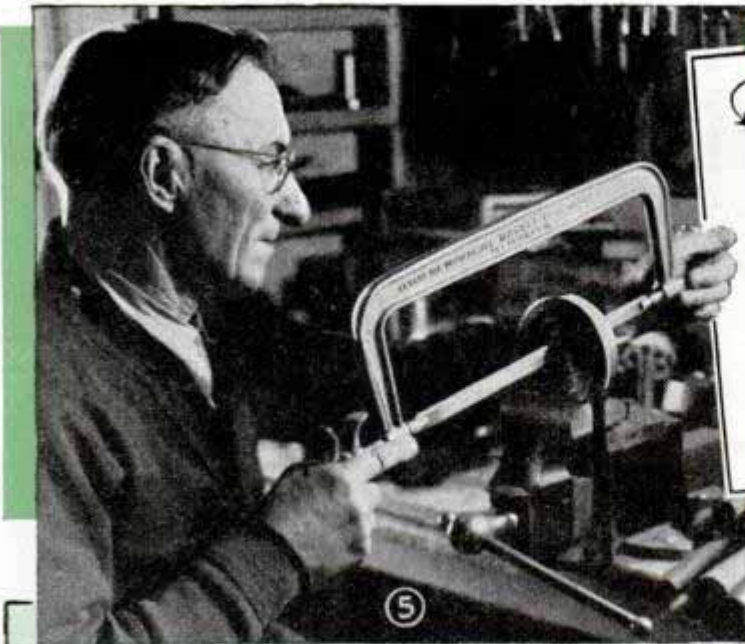

ing ring, Fig. 8, is made from cold-rolled steel and is threaded to screw on the lathe spindle. It has a tapered seat to fit the step chucks. It is usually best to make this first.

The chucks are made from iron castings, and a pattern will be needed for each size, as shown in Fig. 7. In making the patterns use 1 1/4-in. close-grained wood for turning the chuck body and a piece of 7/8-in. dowel rod for the stem. Add approximately 1/16 to 1/8 in. all around to the dimensions given in the drawings for machining. "Shake" or the loosening of the pattern in the mold will about equal the shrinkage of castings this size.

Chuck the castings with the stem out, and center drill this for the tailstock support. All the machining operations, facing, taper-turning, threading and drilling are done at this one chucking of the work. This assures concentricity of the parts and perfect-alinement with the draw-in spindle.

Remove the lathe chuck and screw the closing ring on the spindle in its place. The partly finished step chuck is inserted in the closer and firmly held in place with the draw-in spindle. The flange is turned to correct diameter and a roughing cut is taken across the face. Then the chucks are recessed to the diameters required.

The step-chuck face is marked off in three equal parts for slotting. Lacking a milling machine the slotting can be done by hand with a hack saw, Fig. 5. This will finish the chuck. Fig. 3 shows it in use on the second operation of a model locomotive wheel. You will notice, of course, the same draw-in spindle can be used with collets, Fig. 1.



# Adjustable Lathe Jig Shapes Wood Dowels

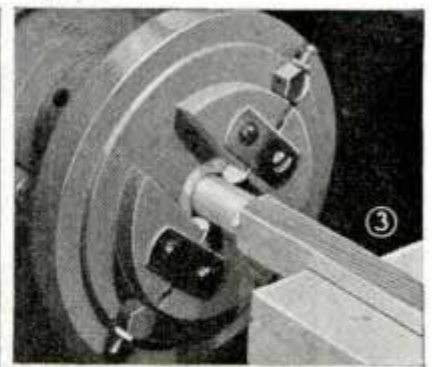
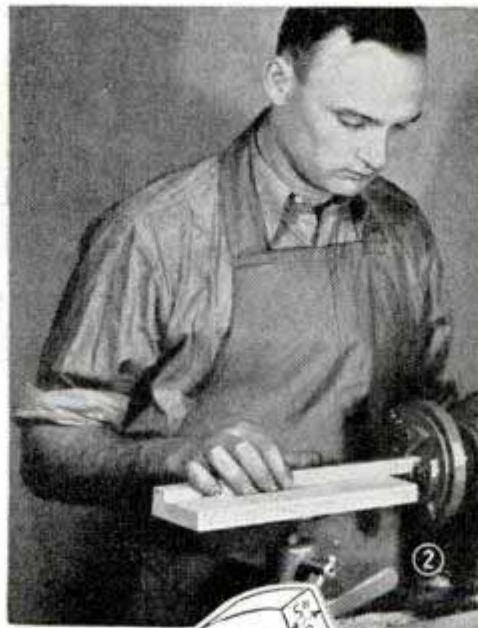
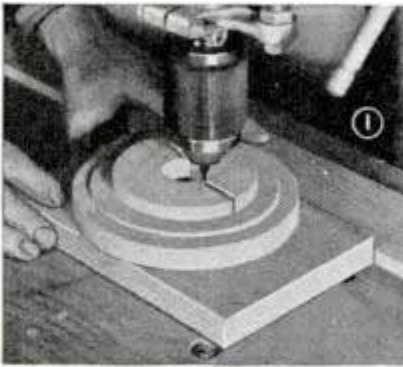

Run at high speed in a lathe, this adjustable jig enables you to quickly turn perfect dowels from square stock. High-speed steel knives,  $\frac{1}{8}$  by  $\frac{3}{8}$  by  $1\frac{3}{16}$  in., are adjusted to cut dowels from  $\frac{3}{16}$  to  $\frac{5}{8}$  in. in diameter, adjustment being made by means of round-head machine screws, as shown in Fig. 4. The knives are held in place by means of metal plates fastened with wood screws which are "eased-off" to permit adjustments. You will notice that the knife slots are offset on either side of the centerline. The slots can be cut in a drill press, Fig. 1, with a  $\frac{1}{8}$ -in. router bit. A separate brass bushing is required for each size of dowel, and the stock is supported on a wood table, Fig. 2. After being cut to

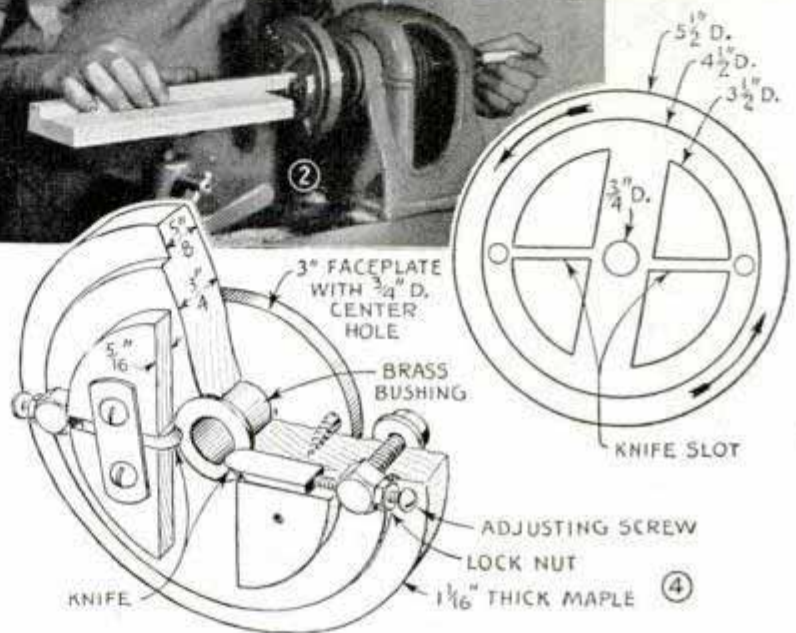

size, the work enters the brass bushing, Fig. 3, and is pushed through the hollow spindle of the lathe head. High speed of the cutters gives a smooth job.

## This H-Gauge Helps in Fitting Floor Bridging Accurately

Every builder knows how important bridging is to a sound floor and here's a gauge that helps in cutting each piece of bridging to fit exactly. Make it of two pieces of  $\frac{3}{4}$ -in. plywood and join with a bolt and wing nut. To use, set the gauge in place as shown in the lower detail, tighten the nut to hold the adjustment and then place it diagonally over the edge of the bridge stock. Marking the latter as indicated will give the correct length and also the angle.

☐ A  $\frac{1}{4}$ -in. hole drilled or stamped out near the end of a carpenter's saw blade is a great convenience, as the saw then can be quickly and easily hung up overhead.

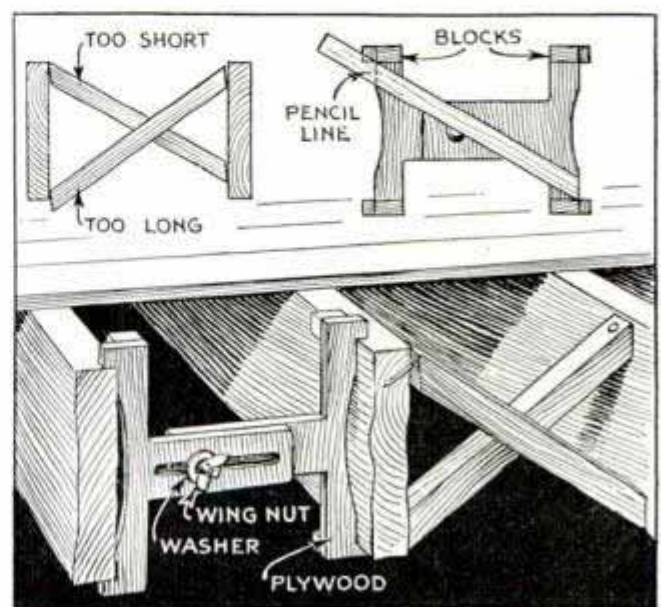



## Outdoor Iron Kettle Supported on Pipe Standards

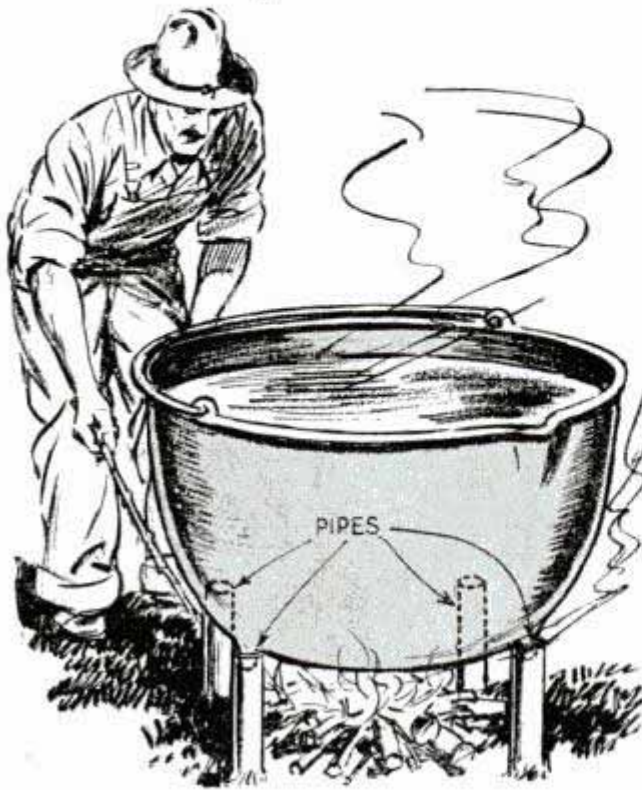

Large iron kettles often used in home butchering and soapmaking will heat water more quickly if raised 5 or 6 in. above the ground so that a fire can be built under them. To raise the kettle, one farmer drove four lengths of pipe into the ground, spacing them so that the kettle legs would slip into their upper ends.

## Office Stapling Machine Is Used for Tacking Cardboard Signs

Storekeepers will find that an inexpensive office stapling machine is handy for tacking paper and cardboard signs to wood surfaces. The pivot pin of the stapler is

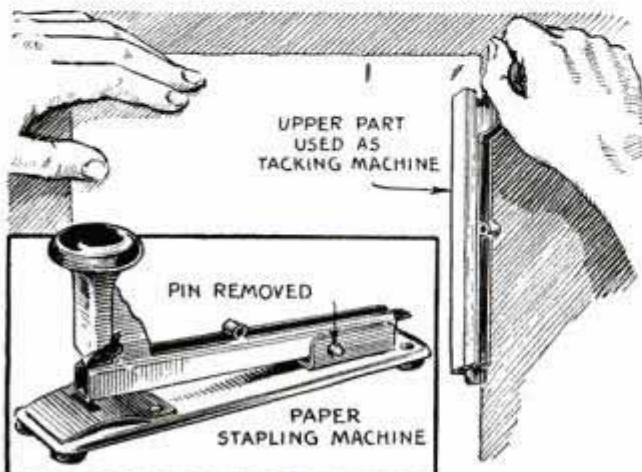

removed and the upper part is used for the work. The machine is reassembled quickly for regular use.

—Andrew Vena, New York, N. Y.

## Graphite Duster Lubricates Linotype Machines

Linotype operators who use powdered graphite on their machines, will find this duster convenient. It is merely a small tobacco sack fitted with a wire handle as indicated.

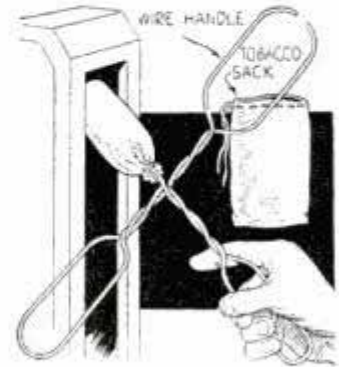

## Center Drill Has Renewable Point

If you break the point of this center drill, just loosen a set screw and lower the adjustable core, which is nothing more than a small twist drill. Broken center drills can be used as a shank for this one if they are annealed so that a hole can be drilled through the center, after

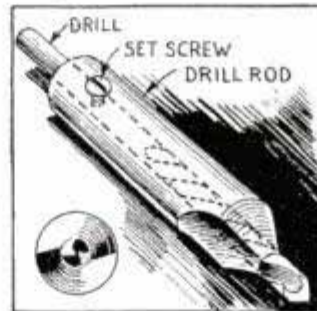

which they are again hardened. Or, you can use drill rod, tapering one end and cutting flutes of the same shape as those on a regular center drill.

## Padded Clips on Push Truck Protect Finished Surfaces

When using a push truck to move furniture and other highly finished objects, these removable clips can be put on the truck in a jiffy to protect the load. The clips are lengths of spring steel bent to a U-shape, wrapped with cloth and covered with pieces of garden hose.





## Magnet Keeps Oilcan from Falling Off Vibrating Machine

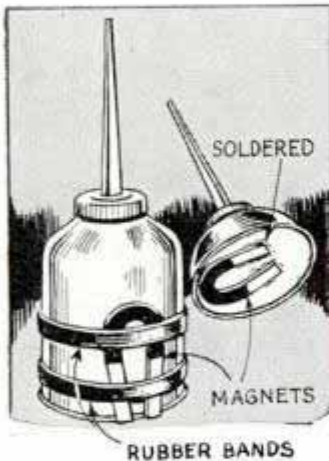

A mechanic who often had an oilcan fall off a machine when he set it down while making an adjustment, stopped the trouble by fastening a small magnet to the can. Attraction of the magnet to metal of the machine will hold the can

against ordinary vibration. The magnet can be held on the can either by rubber bands or by a drop of solder.

## Jaws of This Chicken Catcher Opened by Coil Spring

Chickens are caught easily with this pincher-like catcher, the jaws of which are opened automatically by means of a small spring slipped over the movable jaw, the opposite end of the spring being attached to the handle. A slight pull of the finger inserted in the loop of wire holds the fowl's legs securely. Short lengths of rubber tubing slipped over the jaws prevent injury to the legs.

—Benjamin Nielsen, Aurora, Neb.



## Flypaper Back of Window Signs Is Out of Sight



When putting signs in his show windows during the summer, one grocer pastes flypaper to the backs of them. The paper is hidden from view on the street and attracts flies in the windows.

## Emergency Cooling of Bearings

I have kept machines running with bad bearings where a shut down would mean considerable loss. A medium-weight fluid oil is used at all times and if a bearing shows signs of heating, I drop in a very small piece of laundry soap, which will fill all depressions and rough spots and cause the oil to film over the journal and bearing face. Should the bearing refuse to cool down, add a few drops of water, which will cause the soap to dissolve and wash out any dirt that may have collected, leaving a smooth, glassy surface. This method can be used as well on roller bearings and ball bearings as on journals although it is not as effective.—R. E. Robinson, Minot, N. D.



# WORKING

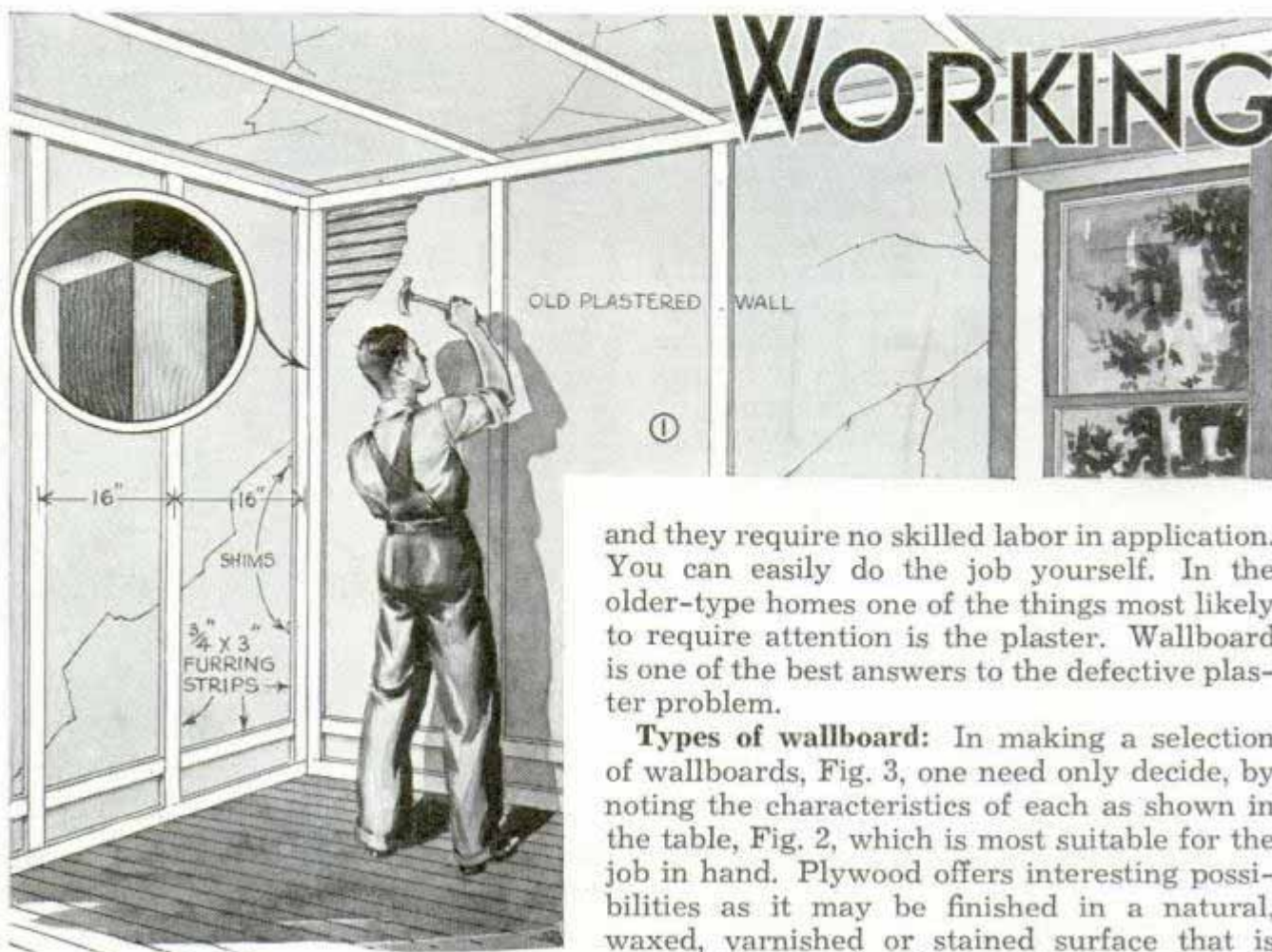

**W**HEN you're thinking of interior decorating and remodeling it's well to consider the decorative possibilities of wallboards, which are now available in a variety of surfaces, sizes and thicknesses. Although widely used in new homes, wallboards are particularly adapted for old houses

and they require no skilled labor in application. You can easily do the job yourself. In the older-type homes one of the things most likely to require attention is the plaster. Wallboard is one of the best answers to the defective plaster problem.

**Types of wallboard:** In making a selection of wallboards, Fig. 3, one need only decide, by noting the characteristics of each as shown in the table, Fig. 2, which is most suitable for the job in hand. Plywood offers interesting possibilities as it may be finished in a natural, waxed, varnished or stained surface that is very attractive for living, dining or study rooms. Another method for securing wood-grained effects is by the use of a new plaster board which has a remarkably realistic wood color and grain. This material is available in walnut, oak, knotty pine and fir.

**Sizes:** The standard size of wallboard panel for home use is the 4 by 8-ft. size. However, most boards can be obtained in lengths up to

**FIG. 2—PROPERTIES OF WALLBOARDS**

Type	Sound Insulating Value	Heat Insulating Value	Surface	Texture	Fire Resistance	Moisture Resistance	Color	Thickness in In.	Made of
Softboard	Excellent	Excellent	Rough	Porous	Slow burning	Fair	White and tan	1 1/2	Wood or cane
Semi-hard	Good	Good	Semi-rough	Porous	Slow burning	Fair	White and tan	1/2 3/8	Wood or cane
Hardboard	Fair	Fair	Smooth	Dense	Good	Excellent	Brown	1/8 1/4 3/8	Wood fiber
Plaster board	Good	Good	Smooth	Semi-dense	Good	Good	Cream	1/2	Gypsum and cardboard
Plywood	Fair	Fair	Smooth	Semi-porous	Low	Low	Wood	3/4 5/16 3/8	Douglas fir
Pressed board	Fair	Fair	Smooth	Semi-porous	Low	Low	Cream	3/4	Wood or vegetable fiber



# with WALLBOARD



12 ft. and many of them in narrower widths also. In addition, various planks in random widths, and ceiling tiles of several sizes, moldings and ornaments of the same material, are available.

**Architectural effect:** Having decided which type of material most nearly suits your requirements, the next step is to determine what architectural effect is desired. Either V-grooves or moldings, which are used to break up large plain areas into pleasing smaller units, are the basis of most architectural schemes. Practically all softboards are available with beveled edges for V-joints. This type of joint, by the simple addition of intermediate V-grooves, gives the exceptionally beautiful effect shown in the photograph of the small dining room, Fig. 4. Note the frieze molding used which is detailed in Fig. 19. The use of a wide molding over the joints produces the striking panel effect shown in Fig. 7. The wood-molding strips are 2 or 3 in. wide and  $\frac{3}{4}$  in. thick and are edged with panel molding to enhance the effect.

The two sides of both hard and soft boards present different textures and colors, owing to the method of manufacturing. This difference makes a pleasing shaded effect possible by simply reversing the pieces. Certain tile boards lend themselves to this type of treatment. The wall or ceiling should be left in the natural color. Plywood manufacturers have solved the





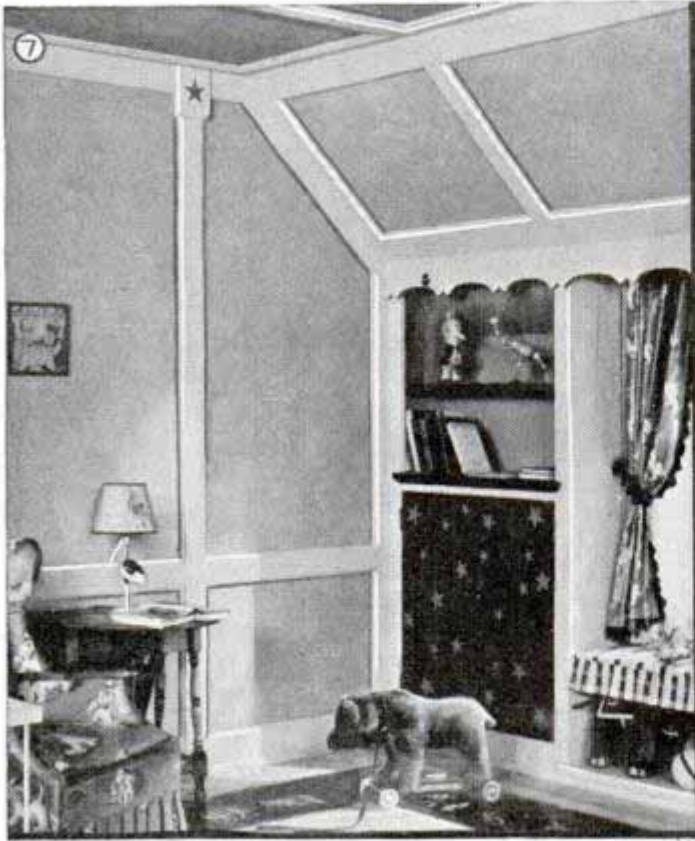

joint problem with thin molding strips set flush with the surface, as shown in Fig. 13.

Fig. 20 shows a few of the many types of wallboard moldings which are used for panel effects. Any of these moldings are simply nailed over the joints and at such intermediate spacings as may be required in your decorative scheme. V-grooves which serve a similar purpose, are also shown.

The use of metal moldings for decorative use, and incidentally to hide joints, is especially popular for modern effects. These come in chromium, stainless steel and enamel finishes. Some of them are so designed that they snap over a nailing strip, completely hiding the nails.

For kitchen and bathroom walls a special hardboard is available which is scored into squares and enameled to simulate tile. Metal moldings cover the joints and corners, as shown in Figs. 21 to 25 inclusive. For canvased or papered walls, the wallboard joints are sealed with metal tape and a special putty, making the joint wholly invisible under paper or flat paint, Fig. 18. The metal strips and cement are available from the various manufacturers of wallboards.

Whiting mixed with varnish, to a putty consistency, is excellent for filling nail holes, where the surface is to be finished

with a flat oil paint or casein paint. Do not use ordinary putty as the oil may work through and cause spots.

**Application:** The method depends largely on the condition of the walls. If the plaster is badly cracked, or the walls are uneven and the corners out of plumb, the use of furring strips is necessary. Use 1 by 2-in. pine strips, and space them accurately 16 in. on centers. They should be arranged also, as far as possible, so that they will come directly over framing members. Cross members should be added also at the bottom and top, also behind the baseboard, as shown in Fig. 11, to insure a true nailing base. Where corners or portions of the wall are out of

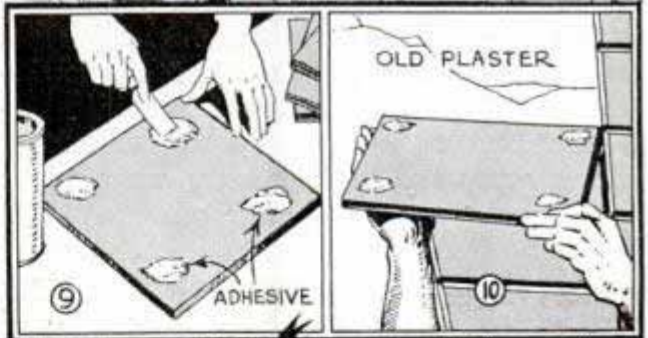



plumb the furring should be shimmed up with thin wood, Fig. 1. It is best to apply the furring strips just ahead of the board so that adjustments can be made as the work progresses.

Wallboard planks and panels are usually applied in a vertical position. However, should you wish to apply them horizontally, for a modern effect similar to that shown in Fig. 6 the furring strips should be arranged as in Fig. 17. Softboards require conditioning before application. Ordinarily you simply lay the boards singly around the room allowing them to remain for a day until they have adjusted themselves to atmospheric conditions of the room. In very dry weather or in a heated room, however, the boards should be sprinkled lightly with water, then piled and allowed to stand for a day or so for conditioning. They should be taken from the pile only as used. Hardboard is so dense in structure that conditioning is unnecessary, but both plasterboard and plywood that has been conditioned by the first method, are less likely to warp or shrink.

If the joints in softboard walls are to be covered with molding, space the boards, when applying, approximately  $\frac{1}{8}$  in. apart along all edges. Joints which are to be finished by beveling or rounding are placed in moderate contact. This is also true of

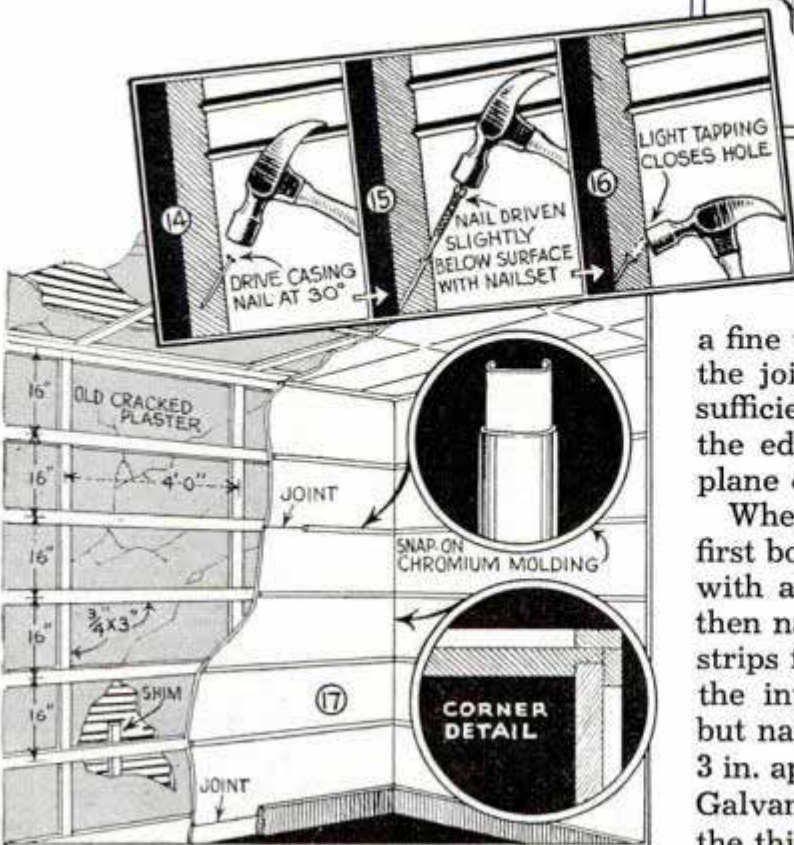
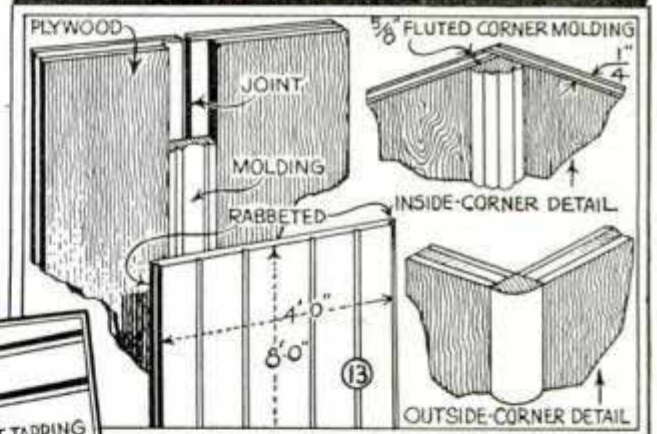
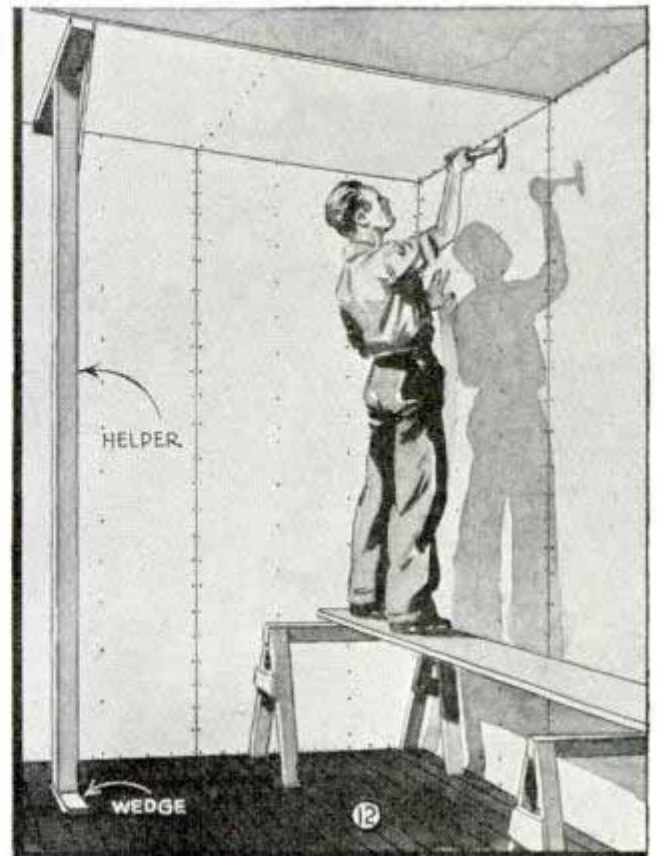

boards, planks, or ceiling squares which come already tongued and grooved or rabbeted. Any type of wallboard is readily cut with a fine tooth saw, as shown in Fig. 5, and if the joints are to be covered a saw cut is sufficiently smooth. For exposed joints the edges may be beveled with a special plane or rounded with sandpaper.

When you are ready to start nailing, the first board on each wall should be checked with a level to be sure it is plumb. It is then nailed along the intermediate furring strips first before nailing the edges. Space the intermediate nails about 6 in. apart, but nails around the edges should be only 3 in. apart and about  $\frac{3}{8}$  in. from the edges. Galvanized shingle nails 1 in. longer than the thickness of the board, are used where



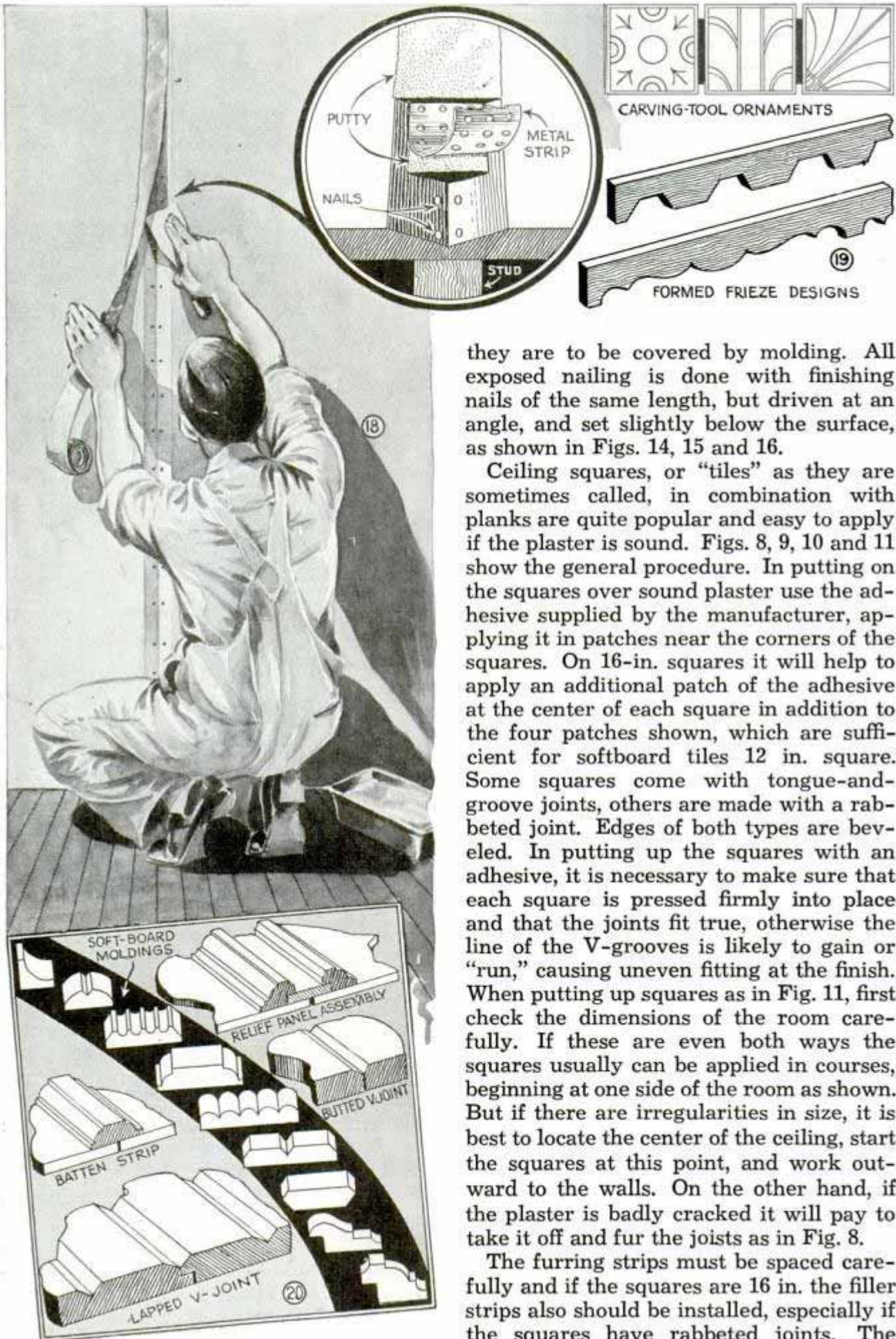

they are to be covered by molding. All exposed nailing is done with finishing nails of the same length, but driven at an angle, and set slightly below the surface, as shown in Figs. 14, 15 and 16.

Ceiling squares, or "tiles" as they are sometimes called, in combination with planks are quite popular and easy to apply if the plaster is sound. Figs. 8, 9, 10 and 11 show the general procedure. In putting on the squares over sound plaster use the adhesive supplied by the manufacturer, applying it in patches near the corners of the squares. On 16-in. squares it will help to apply an additional patch of the adhesive at the center of each square in addition to the four patches shown, which are sufficient for softboard tiles 12 in. square. Some squares come with tongue-and-groove joints, others are made with a rabbeted joint. Edges of both types are beveled. In putting up the squares with an adhesive, it is necessary to make sure that each square is pressed firmly into place and that the joints fit true, otherwise the line of the V-grooves is likely to gain or "run," causing uneven fitting at the finish. When putting up squares as in Fig. 11, first check the dimensions of the room carefully. If these are even both ways the squares usually can be applied in courses, beginning at one side of the room as shown. But if there are irregularities in size, it is best to locate the center of the ceiling, start the squares at this point, and work outward to the walls. On the other hand, if the plaster is badly cracked it will pay to take it off and furr the joists as in Fig. 8.

The furring strips must be spaced carefully and if the squares are 16 in. the filler strips also should be installed, especially if the squares have rabbeted joints. The



construction of the building will govern to a certain extent the exact method of application. Brads,  $1\frac{1}{4}$  in. long, are usually used to attach the squares to the strips. In putting up tongue-and-groove squares, care must be taken not to force the joints unduly tight. Planks, whether placed vertically as in Fig. 11, or horizontally as in Figs. 6 and 17, are usually applied over furring strips. Various manufacturers supply directions and manuals covering fully the application of their products. It is advisable to follow these carefully. For handling large sheets on the ceiling it is generally necessary to provide a "helper" to hold one end of the piece while the other is being nailed, Fig. 12.

**Finishing:** The decorating possibilities of plain softboard panels are many. The material may be painted, stained, decorated with stencils, rough finished with plastic paint or covered with wall hangings. Water paint, calcimine and the new casein paints all can be applied directly over the unsized board. It is advisable, however, to use a varnish size under calcimine.

Softboard must be sized before oil or varnish paints are applied. Wall size is available ready mixed and should be applied according to the manufacturers' directions. Two coats of any good interior wall paint over the size, will produce a beautiful and washable wall. Plastic paint can be applied over any of the wallboards after the joints have been filled as previously described, without size. Sufficient paint always should be applied to cover completely the texture of the board.

Softboard should be glue sized for all wall hangings such as paper, canvas, oil-cloth, etc. After the size is dry the material should be sanded lightly to remove protruding fibers before proceeding in the usual manner to apply the hangings with wallpaper paste.

Hardboards can be finished with any of the water paints without sizing but for oil paints and enamels a sizing of shellac, varnish, enamel undercoat or aluminum paint should be used. After applying the size, the surface should be rubbed down with steel wool or fine sandpaper to produce a smooth surface for finishing coats. Plywood will take stain, varnish, wax or paint and enamel finishes but is not suitable for water finishes or wall hangings.

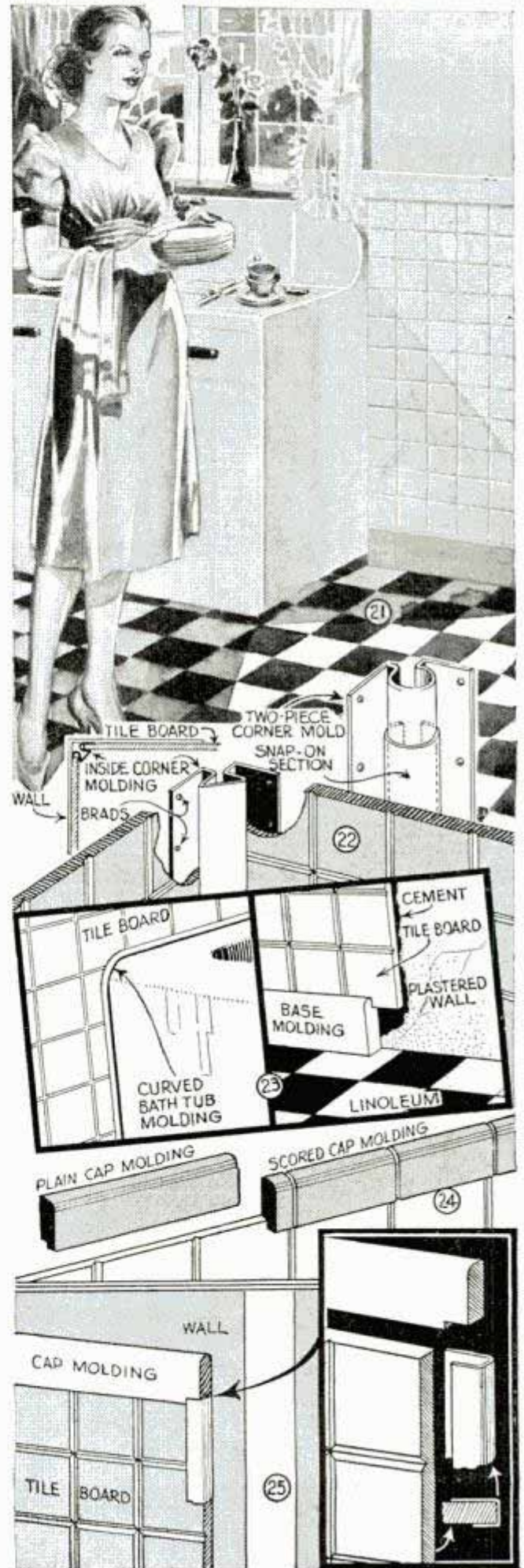



## Signwriter's Maulstick Is Fitted with Spirit Level



To aid in getting guide lines horizontal when lettering doors and windows, one signwriter fitted his maulstick with a small spirit level. A recess was made in the center of the top surface of the stick to take the level, which was then covered with a strip of sheet metal having a slot in the center so that the level bubble could be seen, the metal being set flush with the surface of the stick to avoid sharp edges that might injure the hands.

## Guide on Blade of Screwdriver to Turn Stubborn Screws

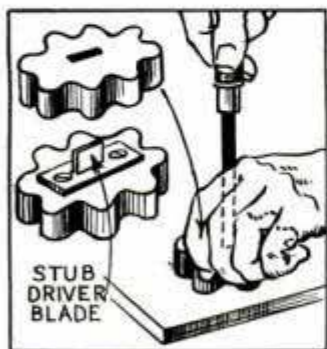

ing out the slot, and makes stubborn screws easy to remove. A slot in the center of the guide takes the screwdriver, although in some cases a stub blade is provided so that downward pressure can be

One workman who has a lot of repair work requiring the use of a screwdriver uses the steel guide illustrated to keep the blade square with the screw slot, which tends to prevent break-

exerted to remove an exceptionally tight screw.—Chas. H. Willey, Penacook, N. H.

## Tacks in Lathe Turning Chisels Prevent Rolling

Annoyance of having lathe tools roll off the table may be avoided easily by just pressing four thumbtacks in the handles as shown. The tacks do not interfere with using the tools.



## Team Hitch to Move Hog Houses and Other Portable Buildings

One farmer who had several portable hog houses, chicken coops, feed racks and platforms, used the hitch shown to move them quickly with a team. The hitch consists of two lengths of heavy chain each fitted at one end with a hook and both connected to a large ring to take a clevis for attaching a doubletree. Skids under the various units to be moved were fitted with heavy rings to which the hooks on the chains were attached.

—M. B. Birge, Hinsdale, Ill.

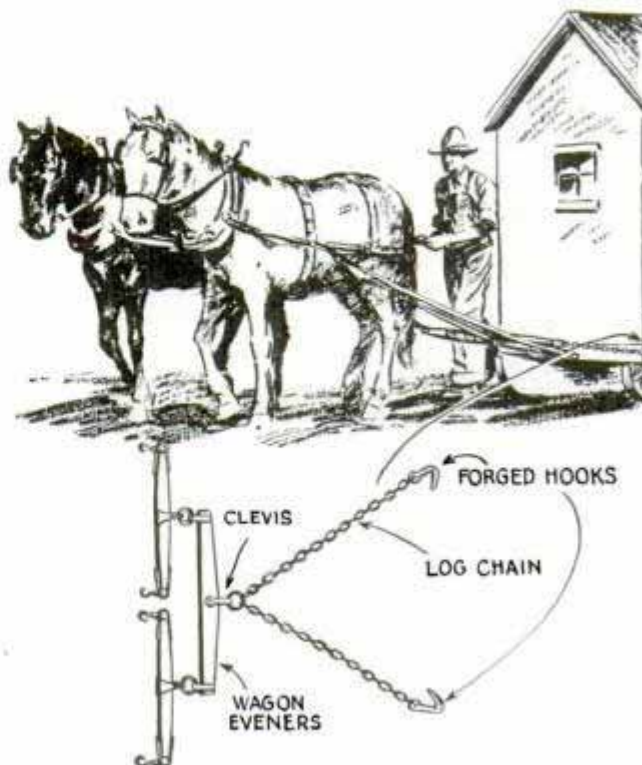



# Turned Parts Form This Sturdy Circle Cutter

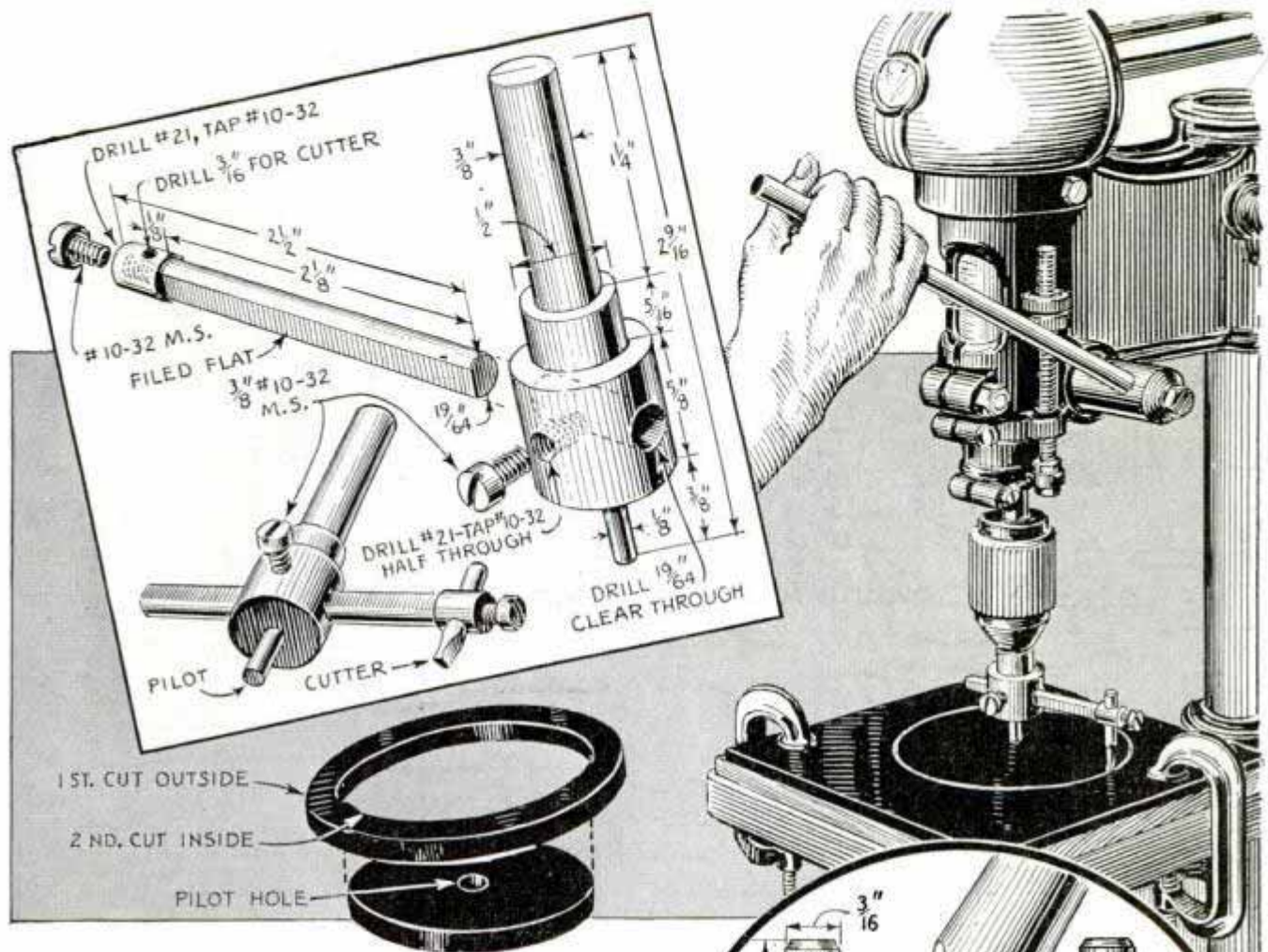

Readily turned from either cold-rolled steel or from drill rod, and employing a high-speed steel cutting bit, this handy circle cutter can be used for cutting circles up to 4 in. in diameter in Bakelite, fiber and plastics. The shaft is turned first from a length of  $\frac{3}{4}$ -in. cold-rolled steel. First turn down the shaft and the  $\frac{1}{8}$ -in. diam. pilot. Then drill the holes for the cutting arm and for the set screw. These must be  $90^\circ$  apart. The hole for the arm is drilled clear through. The side arm is next. The flat filed on one side of the arm must be

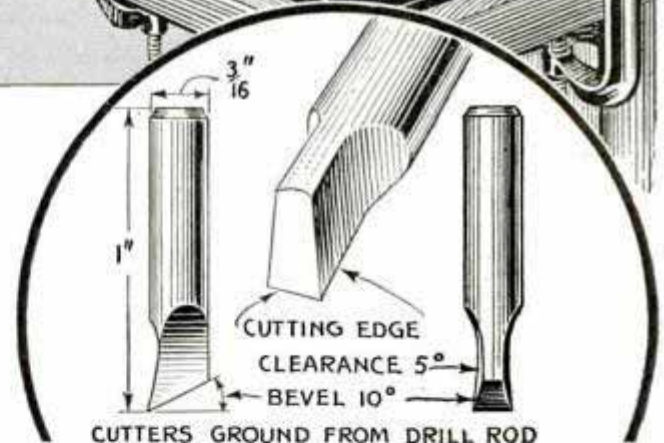

$90^\circ$  away from the hole for the bit, and can be filed before drilling the arm. The bit is ground from a round piece of high-speed steel,  $\frac{3}{16}$  in. in diameter.

## Fresh Mimeograph Stencils Aid in Getting Clear-Cut Copy

A merchant employing a stencil duplicator to print his advertising letters and circulars, is frequently asked how he repeatedly obtains such clear and uniform copies. In explanation he emphasizes the use of fresh stencils. Typing or tracing cannot be done effectively on an old stencil because the wax-like composition of the stencil has become too dry and tough.

If stencils are used only occasionally, so that it is impossible to keep a fresh supply at hand, he advises keeping the unused stencils on a shelf in the cellar or basement where humidity and temperature are usually much more uniform than on the upper floors of a store or office building. If this method is impossible, the package of stencils should be kept in an airtight box.



## Chimney from Hot-Water Tanks Has Long Life

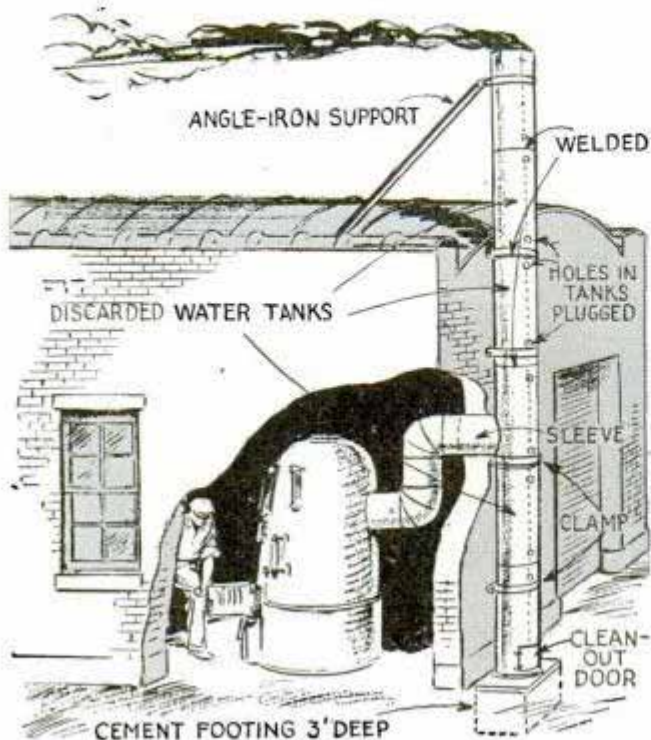

Figuring that an estimated cost of over one hundred dollars was too high for a chimney in my garage, I made a smoke-stack from discarded hot-water tanks at a cost of about seven dollars. The ends were cut out of the tanks, which were then welded together end to end. A sleeve was welded to this and insulated where it passed through the wall, after which the assembly was set on a substantial cement footing. Metal bands clamped the stack to the wall and an angle-iron brace supported the top.—T. R. Heine, Freeport, Ill.

## Lantern Suspended Safely on Special Hanger



If you use a lantern around the barn occasionally, it is a good idea to provide hangers, which will assure that it will not fall off and cause a serious fire. The hanger shown will do the trick. It consists of a rope eye attached with three screws and a bicycle guard.

One end of the latter is screwed above the eye and the other end rests on it. The guard keeps the bail from slipping off if the lantern is accidentally bumped.

## Shop Light Has Clamp-On Socket

When you are working around machinery that requires a light in many unusual positions, it will be a big help to have the lamp fitted with a fastener as shown. This is nothing more than a spring battery clip attached to an ordinary light socket by the bushing screw and then soldered to make it secure.

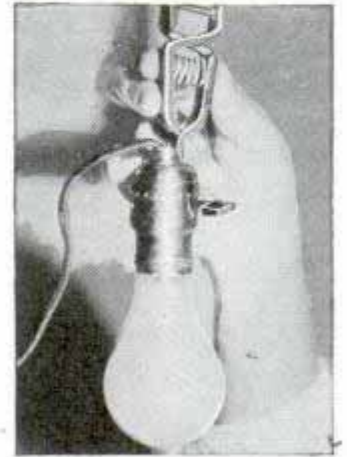

—Albert Mihalovich, Rathbun, Ia.

## Eave Gutter Between Wall Studs Provides Small-Parts Shelves

Lengths of eave gutter nailed between the studs of a garage or workshop provide convenient shelves or bins for small parts. They can be nailed to the wall and the studs, the curved sides of the gutter making it easy to pick up the part wanted.

—Everett Hanson, Argyle, Wis.





# Pepping up "TIRED" MAGNETS

Electromagnet to charge bar or horseshoe magnets such as used in truck and tractor magnetos, outboard motors, small gas engines and radio speakers

By JACK BEATER

**T**HIS magnet charger was designed for heavy-duty use in the shop, and is made of materials readily available. The three separate circuits in each of the charger coils allow great flexibility for handling magnets of various sizes on the one hand, and make for greater current flow on the other. For very small magnets, such as are used in some speedometers, one winding will develop all the strength required, while for very large magnets all three windings can be used.

The cores upon which the two coils are to be wound are cut from cold-rolled steel 2 in. in diameter, and each piece is 9½ in. long, Figs. 2 and 3. Each end is turned down ½ in. to 1¾ in. diameter as in Fig. 2 and the end of each core is drilled and tapped to a depth of 1½ in. to receive a ½-in. cap screw. The base consists of a 12-in. length of cold-rolled steel,

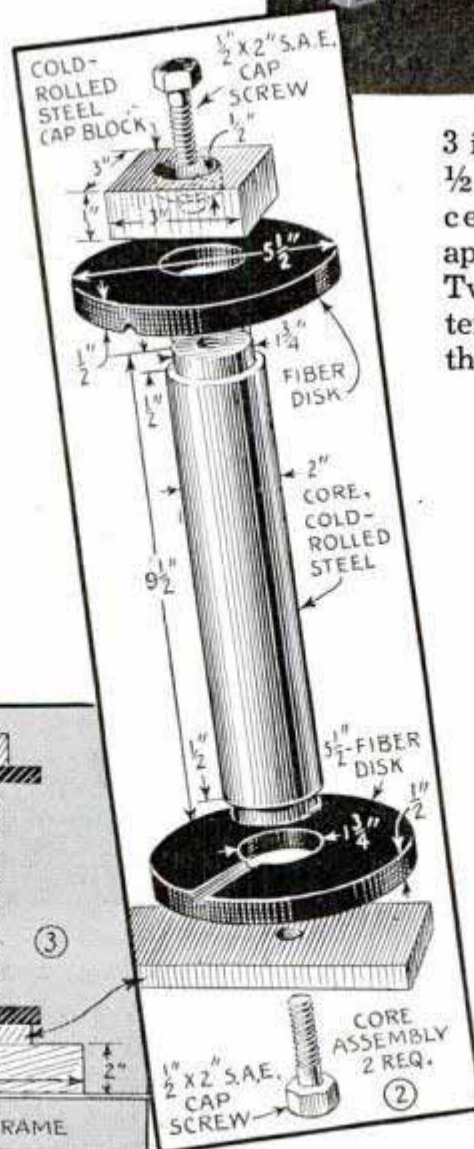

3 in. wide by ¾ in. thick. Two ½-in. holes are bored on the centerline of the base, 7 in. apart and 2½ in. from each end. Two pole caps of the same material, each 3 in. square by 1 in. thick are made up before the winding of the coils is started. A ½-in. hole is drilled in the center of each of these blocks, after which the holes should be counterbored to house the cap screws.

The four ½-in. fiber disks that fit over the ends of the cores to form the winding spools have an outside diameter of 5½ in. and a bore of 1¾ in. Make a 1/8 by 3/16-in. V-cut in each disk from the center hole to the edge as in Fig. 2. The cores must be insulated with tough wrapping paper. Cut sheets wide enough to cover the width of the core, and long enough to go around about five turns. Lay the

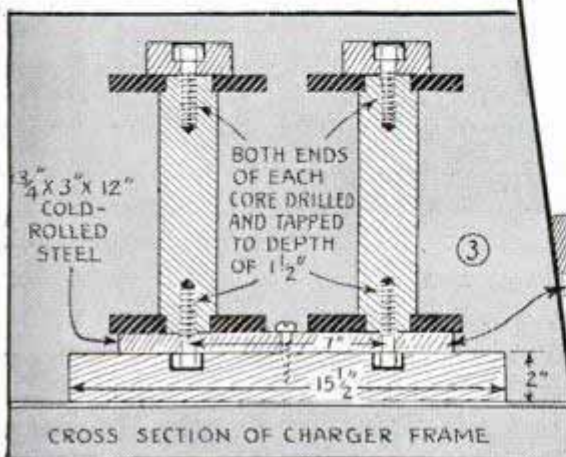



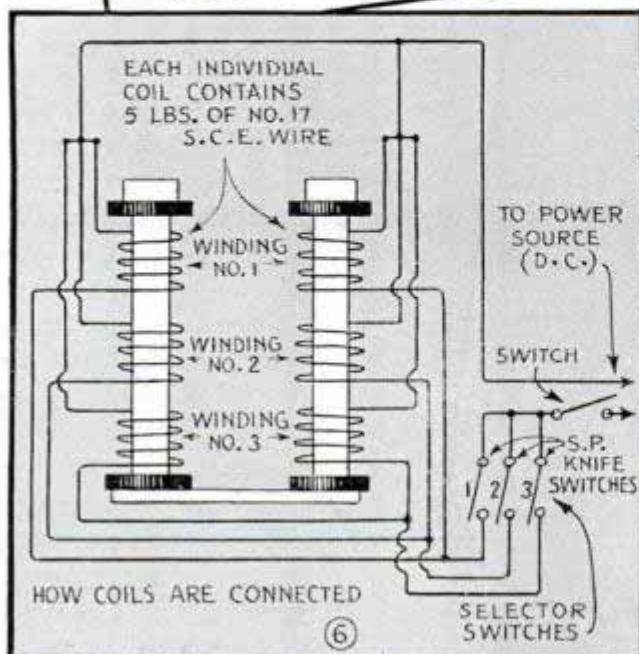
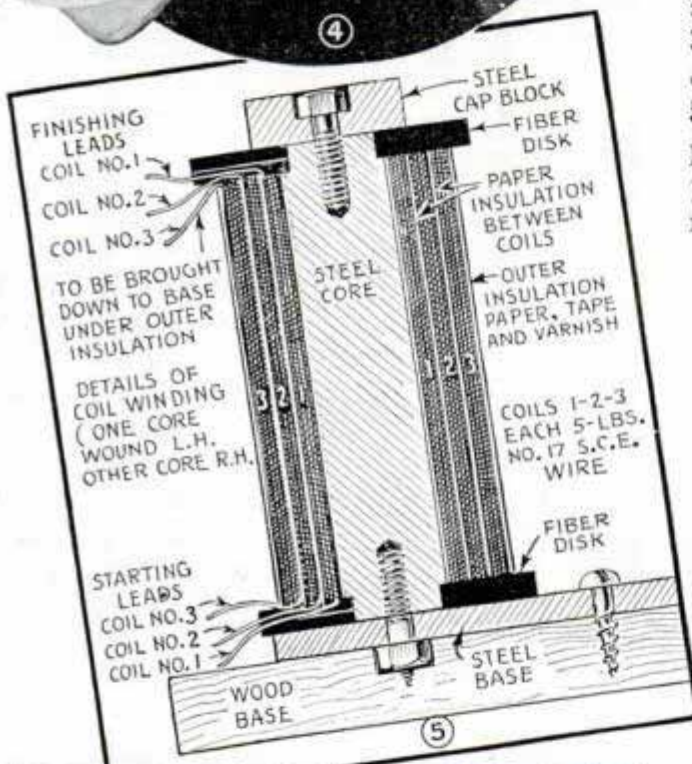

paper out flat, coat it with shellac, and wrap it around the core, using rubber bands or string to hold it until the shellac has set. The round disks are now pressed over the ends of the cores, and the cap block of each core is screwed in place to hold the upper disks. Counterbore two blocks of hardwood, duplicates of the steel cap blocks, to hold the lower disk in place on each core while winding. The best way to wind the coils is in a lathe where a steady, moderate speed can be maintained. The head of the lower cap screw can be chucked in the lathe headstock, while a center hole drilled in the head of the upper cap screw supports the core on the tailstock center. The cores are wound with 30 lbs. of No. 17 single cotton-covered, enameled wire, 15 lbs. to each core, and 5 lbs. for each of the three windings per pole. This winding will take the full amperage of a generator at 15 to 18 volts. Before starting the winding, place a protective

layer of tape or cotton sleeving over that part of the wire that will reach from the outer edge of the lower disk to the core. Place the wire in the V-groove, then wind on the first half dozen turns by hand. Start up the lathe in slow speed and feed the wire evenly along the core, then back and forth across the core until 5 lbs. have been wound. Bring the finishing end out at the top of the coil—the end opposite from the start. Tape the part of the finishing end that will be covered by the second and third windings. The second and third coils are wound in the same

manner as the first, except that the starting end of each coil is cut a little shorter than the first for later identification. A layer of heavy paper is wrapped around the coil between windings 1, 2 and 3, Fig. 5. The outer insulation of the completed coils consists of another wrapping of heavy paper, then a tight banding with cotton tape and an application of shellac. For a final trim the coils can be painted or enameled in color. The second core is wound exactly like the first except that the winding is done in the opposite direction. In other words, one coil is wound right hand, the other left hand. In this way all the starting ends will come out at the bottoms of the coils and the finishing ends at the tops. Before assembling the coils to the



plate each of the three windings on each coil should be tested with a 6-volt battery and an accurate ammeter. Each individual winding should show a current flow of approximately 2.67 amperes. A slight variation is permissible but if a full five pounds of wire have been used on each winding the readings should be within close limits. A high reading shows that a number of turns or layers are short-circuited.

The two coils are bolted to the steel base before being connected together. This assembly is then screwed to a wooden sub-base in the manner shown in Figs. 3 and 5.

Connections are made as shown in Fig. 6. Each pair of windings is connected in parallel, as this allows double the amperes to flow. All six starting ends are soldered together to form a common connection to the battery or other source of d.c. current. The two starting ends of the two No. 1 coils are soldered together and carried to a single-pole knife switch. The starting ends of the No. 2 windings are joined together and connected to No. 2 knife switch, while the starting ends of the two No. 3 windings are connected to switch No. 3, Fig. 6. With this arrangement it is possible to connect either one, two or three of the charger windings into the circuit, depending upon the magnet being charged.

The charger can be operated on from one to three or more 6-volt batteries, or from an automobile generator capable of delivering 15 or more amperes. The charger described here is connected to such a generator; the output to the charger is 26 amperes and 18 volts at 1,800 r.p.m. This overload results in no harm because the generator is used for only a minute or so at a time. In charging a magnet the north pole of the magnet must always be against the south pole of the charger. Small magnets can be spun above the charger, Fig. 4, and allowed to assume the right position of their own accord, but for the bulky magnets a pocket compass should be used to identify the proper polar relationship. Tapping on a magnet with a non-metallic mallet during the charging process aids somewhat in magnetizing, Fig. 1.

To complete the magnet charger outfit an assortment of steel blocks, Fig. 1, will be needed. These are used to make a firm contact with various shaped magnets.

## Gauge Aids in Adjusting Saw in Filing Vise

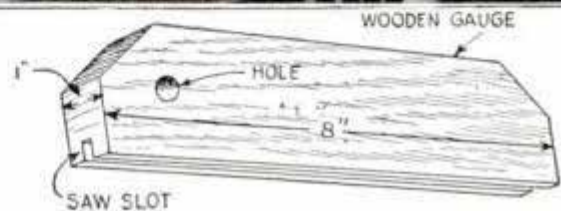
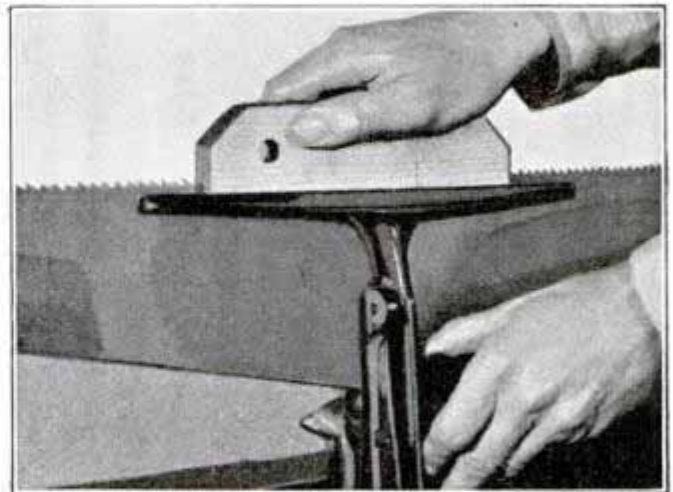

Mechanics who file saws will find this simple gauge a timesaver when adjusting the saw in a vise. It is a block of wood with one edge slotted to a depth equal to the distance the saw teeth must project above the vise jaws for filing. When the saw is to be moved in the vise, the gauge is set over the teeth and given a twist which sets the teeth into the wood so that it will not slip off. In reclamping the saw, it is lowered in the vise until the jaws touch the gauge and tighten, after which the gauge is lifted off and the filing continued.

## Post Capped with Asphalt Roofing to Waterproof the Tops

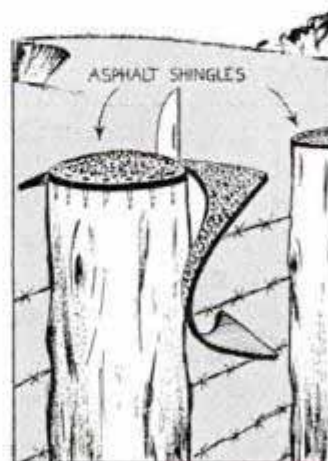

Square or hexagon asphalt shingles, or scraps of asphalt roll roofing provide good caps for fence posts to keep water from soaking into the wood. The protecting piece is nailed to the top of the post, after which it is trimmed to fit with a sharp knife. If the knife blade gets too sticky, try using a small pair of tin snips.



## Fender Guide Kept in Position by Rubber Washer

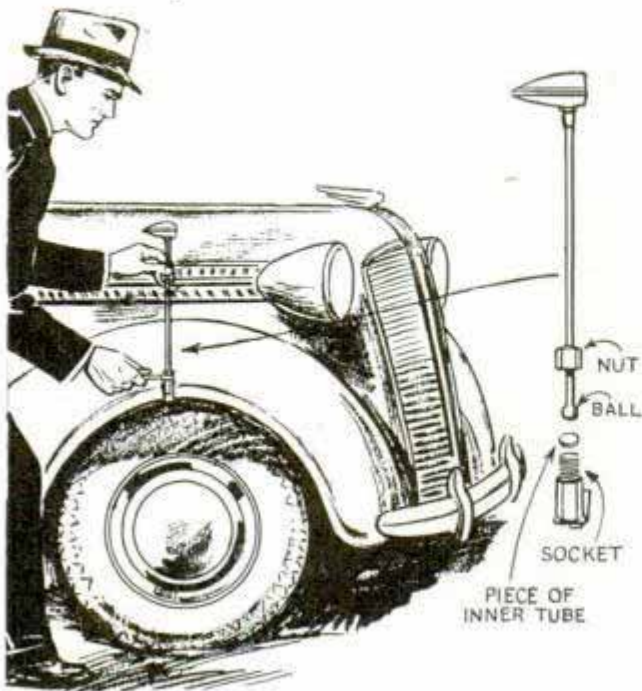

Fender guides of the ball-and-socket type that have a tendency to tip to one side can be kept in a vertical position by placing a tiny rubber washer between the ball and socket. This provides a gasket between the metal parts and gives enough friction to prevent movement caused by vibration and wind resistance, yet allows the guide to move without bending if struck by some object.

—Jack H. Lynch, La Habra, Calif.

## Motor Condition Checked with Tire Pump



You can check the condition of your motor fairly well with nothing more than a tire pump that will create both pressure and vacuum. Use a tire valve stem fitted to a spark-plug shell to connect the pump in the spark-plug hole of the cylinder under test. Now turn the crankshaft to bring the piston on top dead center of the compression stroke. If strokes of the pump meet little resistance, there is loss of compression, and if an application of heavy

oil to the piston top stops this, the rings are at fault. But if the oil is ineffective the valves are leaking. Very quick strokes of the pump will disclose a loose connecting-rod bearing, indicated by a dull rap, or a loose wrist pin, indicated by a sharp rap. Turning the crank a quarter turn will put the piston in position to check it for play. A rapid up-and-down stroke of the pump will cause side-to-side movement of the piston if it is loose.

## Worn Contacts in Headlamp Plug Cause Flickering Lights

When headlights have a tendency to flicker and there are no loose wire connections, check up on the contacts in the headlamp plugs. These sometimes wear down so that they make poor contact with the bulb bases. They can be repaired by putting a drop of solder on each one.

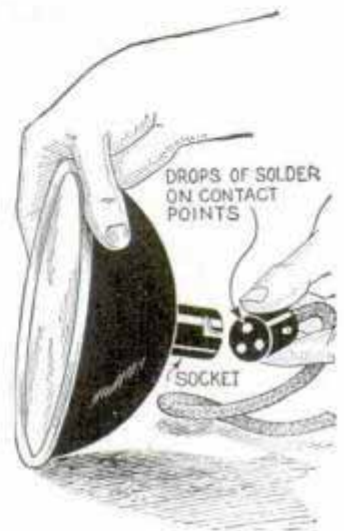

## Use a Spark Plug to Suit Your Car Motor

If your motor has been "acting up" for no apparent reason, or if your spark plugs seem to burn out too quickly, perhaps you are using the wrong type of plugs. These are made with varied heat ratings to fit all kinds of motors, and to perform under different driving conditions. If the plug runs too hot in a motor, it may burn up the electrode, crack the porcelain and cause pre-ignition with attendant knock-

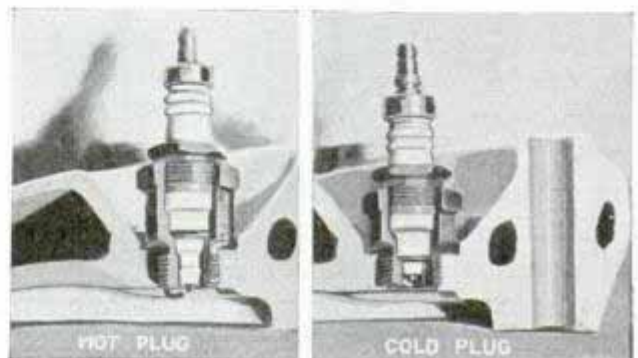



ing and loss of power. On the other hand, if the plug runs too cold, it may foul up with the oil that works up into the combustion chamber. The electrode of the plug is its hottest part, and heat from it must be carried away from the porcelain into the shell and from there through the metal of the head or block into the water. The longer this path is, the hotter the plug will run; the shorter the path, the colder the plug will run under identical conditions.

### Repairing a Cracked Bearing

If a crack is found in babbitt-metal bearings they should be repaired or replaced. If actual separation of the babbitt shell from the backing has not already occurred, repairs often may be made quite easily with solder. This is applied in the usual way, taking care that the bond between the solder and the babbitt is complete, after which the excess metal may be removed with a scraper and the bearing refitted to the shaft.

### Carburetor Needle Valve Cleaned in Drill Press

Irregular idling of a car motor is sometimes caused by scored needle valves of the idling adjustment. The valves are brass and are frequently forced into their seats so tightly that they become scored. A good way to remove the score marks is to grip the valve in a drill-press chuck and hold fine emery cloth against the pointed end as it is rotated. Care must be taken, of course, not to overdo the job.

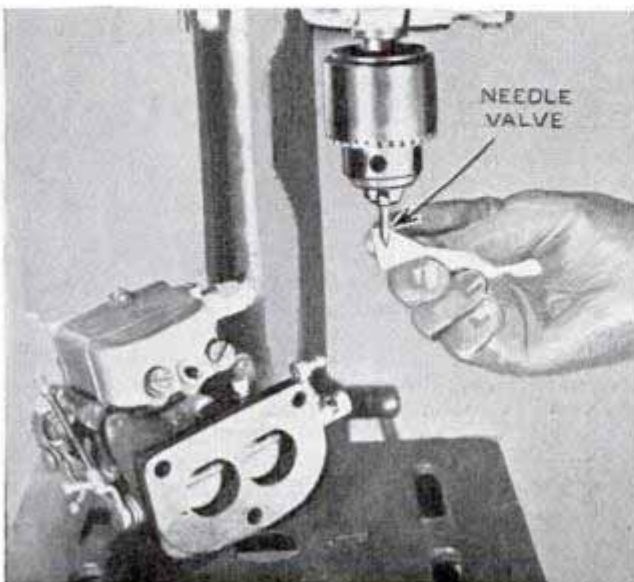

### Car Washer Is Balanced by Rope While Wiping Top



One motorist solved the problem of balancing on a narrow running board while wiping or washing the top of his car by hanging onto a rope with one hand as shown. The rope is tied to a door handle on the opposite side of the car.

—Kathleen Bell, Columbus, Ohio.

### Lowering Carburetor Float Level Improves Gas Mileage

Gas mileage is likely to be poor, and the motor will have a tendency to "die out" if the float level in the carburetor is too high. It is a simple matter to lower the float level by removing the washer under the needle-valve seat as indicated. If its removal reduces performance of the motor noticeably, thickness of the washer may be reduced by rubbing it over a piece of sandpaper held on a flat surface.



☐ In cold weather auto tires sometimes develop slow leaks due to the cold shrinking the rubber valve cores; this can be prevented by replacing the valve core in each tire.



## Slit Sack for Your Skid Chains Prevents Tangling

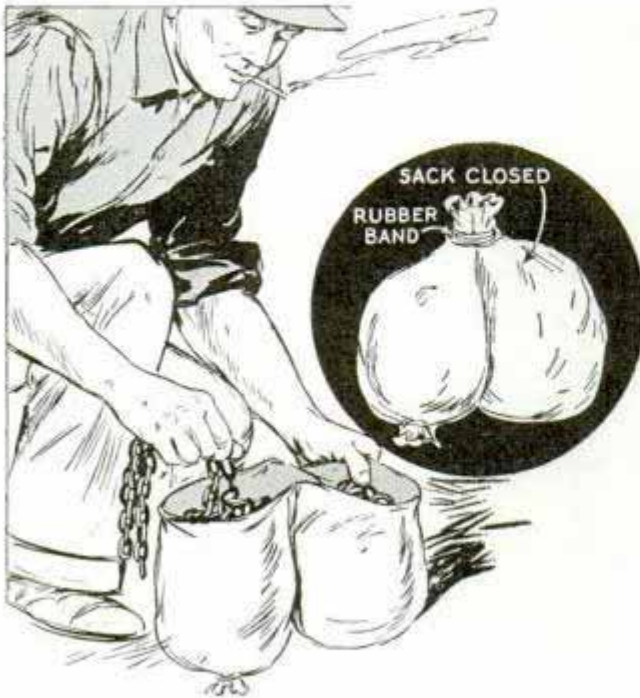

Instead of untangling his skid chains every time he used them, a motorist slit a sack to provide a separate compartment

for each one. The mouth of the sack was tied permanently with a heavy cord and a large rubber band snapped around the severed edges closed the slit opening when storing the chains.

## Leveling Solution in Battery

Electrolyte in the cells of batteries can be kept at exactly the same height if the nozzle of the battery filler or hydrometer has a tiny hole a short distance from the end. After adding water to the cells,

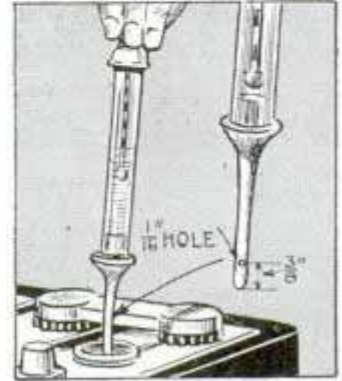

use the battery filler to withdraw some of the liquid. When this has been withdrawn level with the hole of the tube, air will enter the filler and prevent removing too much of the electrolyte.



## Tools Within Reach over Workbench

**Right at hand:** Just the type of cabinet needed to keep your bench clear of tools, yet have them available at arm's reach. It is bolted to the wall and does not touch the bench so vibration of hammering, etc., will not dislodge tools.

**Hinged Front Folds Up:** Split front is hinged to the top on which it rests when opened—out of your way when working. Tools are entirely inaccessible when the front is closed and padlocked.

**More Tool Space Possible:** When space on the cabinet back and sides is filled up, you can install hinged plywood partitions on the ends and center member to hold still more tools.

**Shelf Space for Small Parts:** There is plenty of shelf space under the cabinet for uniform-size jars to store nails, brads, screws, and numerous other small parts.

**Stock Lumber Simplifies Construction:** The front, top, sides and shelves are standard-width pieces of white pine, as you get them from the lumber yard. Plywood,  $\frac{1}{2}$  in. thick, is used for the back and partitions. Parts are screwed together and the wood is shellacked or varnished for finish.

If you want to build this cabinet, just send the coupon and ten cents for Craftplan No. 3009, which contains complete, dimensioned plans besides full instructions how to proceed.

POPULAR MECHANICS MAGAZINE  
200 E. Ontario St. Chicago

Enclosed find 10 cents for Craftplan No. 3009—  
Handy Tool Cabinet Over Workbench

Please check  I am a subscriber  
 I buy at newsstand

Name \_\_\_\_\_

Use Pencil

Address \_\_\_\_\_

City \_\_\_\_\_

State \_\_\_\_\_



# DOLLARS... AND COMMON SENSE

## For YOUR SHOP, the BEST Tools Cost You Least in the Long Run

Over the years Delta tools will cost you less per hour of satisfactory use than any tools you can buy. After all — power tools are bought not for today — but for many years. The very little extra you may pay at the beginning for Delta precision, accuracy, workmanship and design, brings back rich dividends in the splendid service you receive from your Delta equipment during thousands of hours of shop performance. No wonder Delta owners receive as high as 80% of their original purchase price when they sell their Delta tools after years of use. Truly Delta quality represents real economy.



## Why Delta Tools offer you MOST MACHINE VALUE Per DOLLAR

Delta Circular Saws, Band Saws, Shapers, Drill Presses, Jointers, Sanders, Lathes and Scroll Saws have "built-in" quality not apparent to casual inspection. Many machines have ball bearings—but Delta machines are equipped with "sealed-for-life" ball bearings, which completely seal out dust and dirt, and completely eliminate lubrication problems. Delta also goes to additional expense to "pre-load" their bearings, in order to insure minimum deflection and maximum rigidity under load. Further, plain boring and reaming of ball-bearing seats is not good enough for Delta machines, so all bearing seats are "diamond-bored" to insure absolute accuracy and precise alignment. Diamond-boring is used also for many other operations where precision fits are required. This is one example out of hundreds, where Delta design and construction insure a definitely BETTER machine.

## SEND FOR CATALOG

The latest Delta Catalog gives you full information on the complete Delta line. (Also send for new Project Book No. 5 crowded with new and "out of the ordinary" things to make. Send 10c with coupon for Delta Project Book No. 5 and latest Delta Catalog.)

**DELTA**  
MANUFACTURING CO.  
600-634 E. Vienna Ave.  
Milwaukee, Wisconsin



### New Delta Tilting Arbor Saw

This new 10" Delta Tilting Arbor Saw is the result of 7 years of study, experiment and research. It embodies numerous exclusive and unusual features. Thousands of these saws are creating remarkable records of performance on a wide variety of work. Send for catalog for full details.

Delta Manufacturing Co. Dept. A939  
600-634 E. Vienna Ave., Milwaukee, Wis.  
Send me the latest new 1939 Delta Catalog and list of Delta Dealers nearest me.  
 I enclose 10c (stamps or coin) for which please send me the new Delta Project Book No. 5.

Name .....

Address .....

City..... State.....

Check here if you are a Delta user now.



# Mercy Flier of the Arctic

(Continued from page 415)

Fairbanks as the principal operating base.

Crosson contributed to the success of Wiley Post's record globe-circling flight in July, 1933. Post's Lockheed plane was disabled at Flat, Alaska, by a damaged propeller. Crosson flew there from Fairbanks with a replacement, enabling Post to continue and set a record. Later, when Post and Will Rogers crashed near Point Barrow, Crosson received the sad task of flying there for the two men's bodies and bringing them to the states for burial.

He had been flying airplanes since he was in his teens, when he and his older sister, Marvel, assembled an old army "Jenny" in the back yard of the family home at San Diego. Both learned to fly. Arctic flying attracted Crosson to Alaska in 1926. He liked the people of the North and found that they liked him. He became a friend of Col. Carl Ben Eielson, first commercial aviator to operate in Alaska. This friendship carried them on many spectacular adventures, such as in 1927 when Sir Hubert Wilkins attempted unsuccessfully to fly over the South Pole. Sir Hubert engaged Colonel Eielson as first pilot and Crosson as second for the expedition.

In 1929 a small trading schooner "Nanuk" became icelocked off the northeast coast of Siberia. The "Nanuk" carried furs valued at a million dollars. Her owners were anxious to get them to the markets of the world without waiting for the following summer's thaw. Colonel Eielson was offered \$50,000 for freighting the furs the nearly 300 miles to Alaska.

The first round trip was made without a hitch. Fifteen hundred pounds of furs were delivered to Teller and dispatched on their way to the fur markets. In the face of adverse weather, Colonel Eielson and his mechanic, Earl Borland, set out on November 9 for their second dash to the "Nanuk." They never arrived.

No great concern was felt for several days. It was surmised that the airmen had been forced down and were waiting better weather conditions. When the period lengthened into weeks a search was organized. Crosson flew from Fairbanks to Teller where a fleet of airplanes was assembled. Such other pioneer airmen of the north as Frank Dorbandt and Harold

Gillam were in the group pledged to find Colonel Eielson and Borland at the risk of their own lives. But they found howling winds whipping blinding snowstorms across the frozen ocean day after day. And when the blizzards diminished, dense fogs cut visibility to zero.

Time and again Crosson and the others took off, but were driven back by storms. Finally, on December 22, Crosson crossed the treacherous arm of the Arctic to reach the "Nanuk," where he and the other fliers who had followed him set up headquarters on the ice. Crosson flew each day the weather would allow, patrolling the frozen ocean and the shoreline of Siberia.

On January 25, Crosson and Gillam were flying east of the "Nanuk." Crosson was over the shore, Gillam over the frozen ocean. It was one of those lucky days when a sparkling clearness afforded excellent visibility. Crosson, alone in his open plane, was peering over the side when he saw a shadow on the ice below. Circling downward he discovered the shadow was cast by a frost-coated metal wing of an airplane jutting from the ice. Landing quickly, Crosson and Gilliam found it to be the missing plane. The bodies of Colonel Eielson and Borland were near by.

Though saddened by the death of his flying comrade, Crosson was not beaten by the Arctic. He resolved to carry on the task laid down by Colonel Eielson—that of conquering the frigid wasteland by airplane for the benefit of those who live there.

## Big Brain Not Always in Big Head Study of Skulls Shows

You can't judge a man's brain by the size of his hat, as the brain may enlarge without in any way affecting the form or size of his head. Normal human beings, according to Dr. Ales Hrdlicka, anthropologist of the Smithsonian Institution, have brains varying in size from about 910 cubic centimeters to the record-breaking size of 2,100, as indicated by the institution's collection of 12,000 skulls, mostly Indian. These measurements reveal that there is a far greater difference in the extremes of normal brain capacity than in extremes of normal outer head size.

*Washington*  
*Science Service*



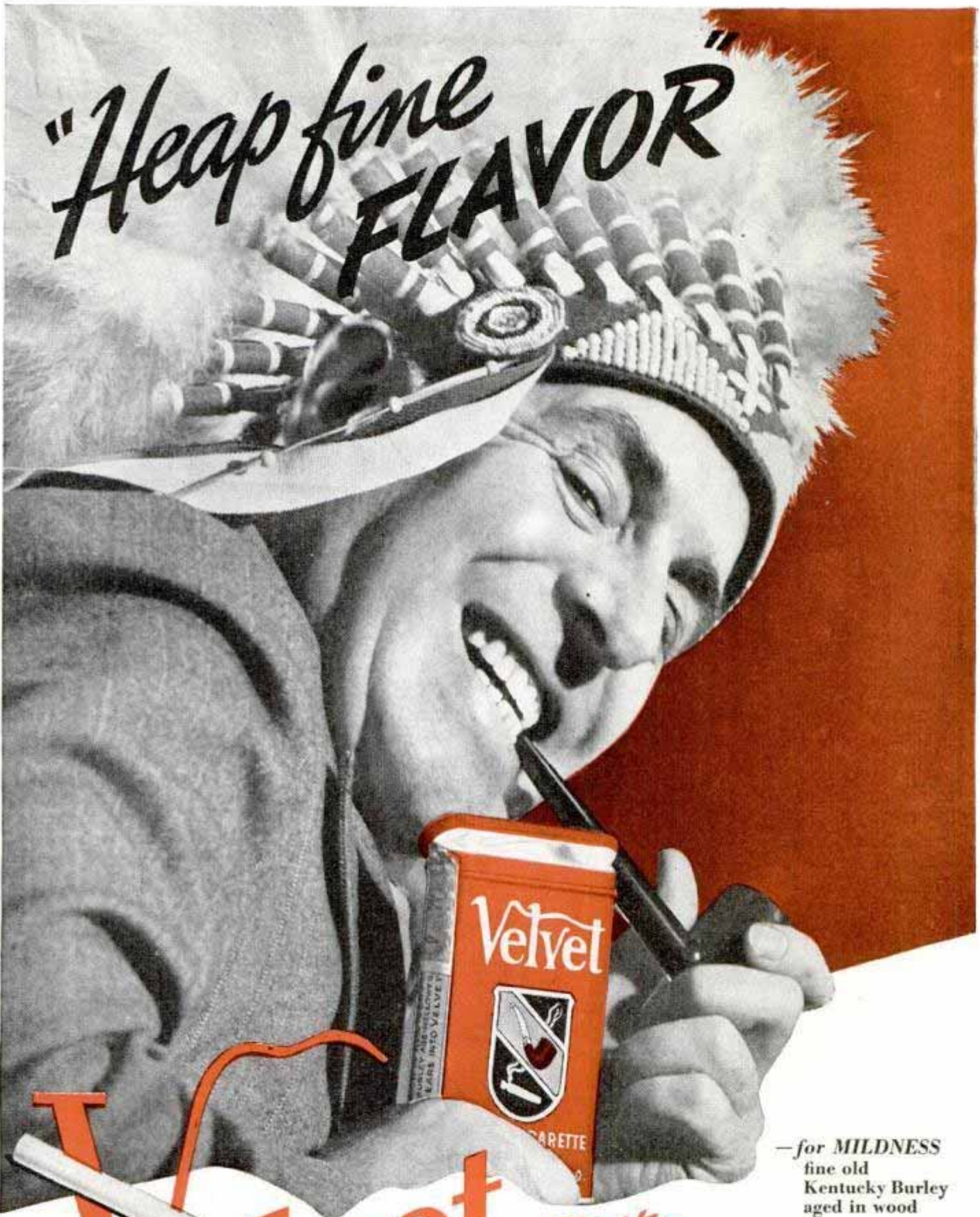

"Heap fine  
**FLAVOR**"

**Velvet**

*Better  
smoking  
tobacco*

- for **MILDNESS**  
fine old  
Kentucky Burley  
aged in wood
- the **FLAVOR**  
of pure maple  
sugar for extra  
good taste

*Velvet packs easy in a pipe  
Rolls smooth in a cigarette  
Better tobacco  
for both*



## 16,000 Miles on \$4.20

(Continued from page 383)

In digging up the ground for the garden we found several pieces of rusted iron. When our hut was completed we made it into a workshop and then turned blacksmith, carpenter, weaver, and tanner. We were busy every minute of the daylight hours, and often far into the night.

About half our time was spent in collecting food and material. In the back country we hunted the little wild pigs which supplied us with meat and much-needed leather. We collected long stringers of a tough vine for lashings, and hardwoods of various kinds to make furniture.

When the weather permitted, we would launch the canoe and skirt the island shores, collecting birds' eggs, and browsing along the beaches for anything that might serve us in some way.

Our camp soon took on the proportions of a small factory. There was a funnel-shaped affair made of small saplings which we kept constantly filled with ashes from the fire. Rainwater filtering through the ashes and collecting in an old five-gallon can below kept us supplied with lye for tanning hides and making soap. Beside this was a small fireplace in which another five-gallon can served as a rendering kettle for oil from the coconut meat and lard from the pigs. Next to that on the assembly line was a mud-covered framework of bent saplings which served as a smokehouse for curing ham, bacon, and fish. Then a small charcoal kiln, which supplied the fuel for our crude but effective forge, with its home-tanned leather bellows. Next was the worktable, made of two hewn palm boles, then the hut itself, where products of this production line eventually entered to serve their particular purpose.

One might wonder why a person would go out to a tropic island for the privilege of working his head off, but we found more pleasure in industrious, productive work than in play. True, we did spend a lot of time in exploring, swimming, and even searching for buried treasure—there is reputedly a good deal of that on Cocos—but it seemed on all these trips we were anxious to get back to camp, and usually we would find something which would give us a good excuse to return—a piece of bamboo would suggest the idea of a flower vase

or a salt shaker; an exceptionally large coconut shell which could be made into a bowl, soap dish, or ladle—or maybe some fine clay which would do for pottery.

After six months of these busy, happy days, I awoke one morning with a sharp pain in my side. Appendicitis, I guessed. And our nearest neighbor was at least 350 miles away. We wondered about the chances of operating, but by good fortune rescue came through the unexpected arrival of a tuna clipper, whose captain and crew had taken the notion to stop at Cocos for a bath in fresh water.

We hope to return to Cocos Island some day and do it all over again—minus the appendix! It's just a tiny, tropical island, most of it mountain ridges. The vegetation is dense, luxuriant, fast-growing and very tough to cut through. The yearly rainfall is enormous. But there is something about the place that makes us want to return.

About two weeks later, against the better judgment of the captain, we left the tuna boat and set off again in our canoe down the coast for Panama.

Our arrival at the Panama Canal created quite a stir among the officials. Here was a registered, United States ship, (length sixteen feet) with all of her papers in good order, knocking at their gates.

They put us through all the formalities of a big passenger liner. That was all right, but the entertainment that went along with it nearly finished off the captain and crew of the "Vagabunda."

We were supposed to transit the canal on schedule, which usually requires between eight and nine hours—the distance is about forty-nine miles—but it took us six days. At Miraflores, Pedro Miguel, Darien, and other points along the route, we were met by reception committees and invited to partake of true Panama hospitality.

But eventually we reached Cristobal, the Atlantic side of the Panama Canal, and officially ended our adventure-filled, three-year, test trip.

And now we are busily engaged in assembling equipment and making plans for the next voyage, which will be into the heart of the unexplored Maya jungle area of Mexico and Guatemala.



# DEATH LEERS as Hunter Plummets into Pit!



JAMES KIDWELL  
Mt. Vernon, Texas

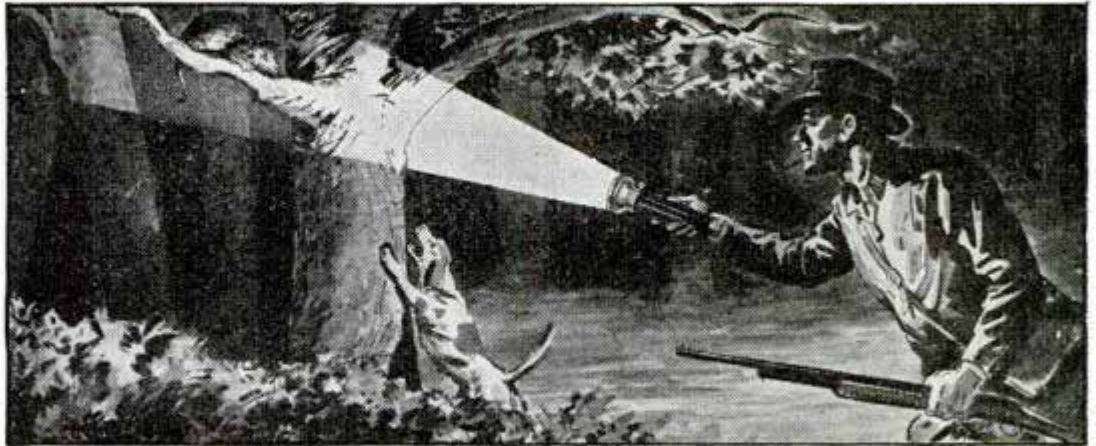

1 "With my hound Jep, I had bagged seven 'possums and was heading back for bed," writes James Kidwell. "I was cutting through the yard of an abandoned hilltop house, when the hound gave a frightened yelp and lit out for home.



2 "I chuckled, for superstitious folks down our way regard this as an ill omen. The next moment, rotten timbers crashed under me—I was falling!



3 "I landed at the bottom of an old well. It was impossible to scale the walls. I retrieved my flashlight from the icy water. She still worked.



4 "My only chance was to keep shooting the beam upward, hoping that it would be seen and that the batteries would last. My luck was good—two boys going home from town saw the strange flashes, and investigated. Those 'Eveready' fresh DATED batteries positively saved my life, as I would have died of exposure, if help hadn't come. You've got to be in the predicament I was before you really can appreciate the value of fresh batteries.

(Signed)

James Kidwell"



**FRESH BATTERIES LAST LONGER... Look for the DATE-LINE**

NATIONAL CARBON COMPANY, INC., 30 EAST 42ND STREET, NEW YORK, N. Y.

Unit of Union Carbide  and Carbon Corporation



## Be Wise Alkalize!

An Alka-Seltzer Tablet in a glass of water makes a sparkling, effervescent solution. It contains a combination of effective pain relieving and alkalizing ingredients. Because it is in complete solution it acts at once to relieve pain and correct gastric acidity. For prompt, pleasant relief from common ailments, never be without Alka-Seltzer.



At All Drug Stores  
30c-60c

TUNE IN THE NATIONAL  
BARN DANCE  
SAT. NIGHT...NBC

AT ALL DRUG STORES  
BY THE PACKAGE OR GLASS

IF HEADACHES COME OR NOSES RUN  
OR VICTUALS CAUSE OFFENSE,  
WE'LL TAKE AN ALKA-SELTZER THEN,  
THE FIRST GLASS OF DEFENSE.

KEEP ALKA-SELTZER  
IN YOUR GRIP  
AND DON'T FORGET  
TO TRY IT.

HAVE A NICE  
VACATION, FOLKS,  
BE CAREFUL  
OF YOUR DIET.



# Alkalize with Alka-Seltzer

## Science—Maker of Champions

(Continued from page 363)

plete performance will approach perfection. Motion-picture studies help correct an athlete's little mannerisms that hold him back and help point out how the best performers make their records.

Cromwell knows that everyone is different so he never changes a person's natural style completely. Refining the natural style, he finds, brings the best individual results whether it is in increasing the stride of a runner, improving the balance and lift of a jumper or hurdler, or in giving a strong finishing snap to a weight thrower.

Learning from his athletes as well as instructing them, the coach a few years ago observed that one of his high-jump pupils preferred to roll over the bar face down instead of with his back to it. This led to the development of the stomach roll that some of the best jumpers use today as a way of keeping their center of gravity low while getting over the bar.

Remarkable as is the present pole-vault record of fourteen feet eleven inches, held jointly by two of Cromwell's men, the suggestion is that if a vaulter can learn to snake his body over the bar the way a rope moves over a pulley even greater heights are going to be obtained.

To be a good vaulter you should be tall and not too heavy, with long arms and tremendous strength in the upper body. You need the strength for the pull-up at the top of the vault to elevate your body a couple of feet or more above your grip on the pole. If Cromwell were your instructor you would spend a good part of your training period on horizontal and parallel bars adjacent to the vaulting pit. Acrobatics and tumbling teach you to handle yourself in the air so that you can raise your body from the vaulting pole and wriggle over the crossbar with full control instead of doing it blindly. If you are of championship caliber there will be a drop of about fifteen feet back to earth and you have to land without hurting yourself.

Slight refinements in style and stroke are leading to new swimming records. Some pools are "faster" than others and water is sometimes faster than it is at other times. New records are usually made in fast pools filled with fast water. A good pool has splashboards that eliminate the

## DO YOU

WANT a new business profession of your own, with all the trade you can attend to? Then become a foot correctionist, and

in a few weeks earn big income in service fees,—not medical nor chiropody—easy terms for home training, no further capital needed, no goods to buy, no agency. Established 1894. Address Stephenson Laboratory, 1 Back Bay, Boston, Mass.



backwash waves that are apt to slow a swimmer on the turns and it is likewise well lighted, allowing the swimmer to follow the lane lines painted on the bottom and thus swim a straight path.

Slow water feels dead to a swimmer. Fast water is water that was well aerated on its way to the pool, that hasn't stood in the pool too long, and that hasn't been churned up so much that the air bubbles are beaten out. Soft water usually permits faster swimming than hard water and swimmers usually make their best time in water heated to between seventy-four and seventy-eight degrees.

One frequent difficulty in setting a new record of any kind is the psychological handicap of having to beat the old one. The longer a record has stood, the greater determination it seems to take to beat it. Frequently when a record that has stood for years is once beaten, a number of increasingly better marks are then made in a short period. Part of Cromwell's secret in turning out record breakers is the encouragement he gives his athletes, addressing each of them as "champ" to help give them the confidence they need.

His teams have made a reputation for taking transcontinental train rides and then breaking records at once instead of waiting to get over their staleness. The men don't get stale, Cromwell says, because he gets them off the train for a walk at every stop, and he insists that they eat nothing but salad at lunch. At other hours they eat normal meals.

Many coaches have sought for special foods that would stimulate an athlete to do better than his previous best, and recent experiments at Brooklyn's Long Island College of Medicine suggest that ordinary gelatin may be the long-sought "pep" food. The energy output and endurance of six men were doubled after they had been fed unflavored gelatin in glasses of chilled orange juice.

Are present records the best that man can do? Not at all, Cromwell asserts. Records of every sort are going to continue to be broken as long as the enthusiasm of the human race survives.

☐Inquiries as to makers of articles described in Popular Mechanics, will be answered by our Bureau of Information upon receipt of return postage.

# THE Speed Candid OF TOMORROW!

1/1000th  
Second  
Shutter

Tricolor 35mm.  
Deep Focus  
f3.5 Lens

Built-In  
Photo-  
flash  
Synchronizer

Inter-  
changeable  
Lenses



\$25



## America's Challenge To The World's Finest Cameras!

Compare the sensational new UniveX Mercury with any \$200 foreign speed-candid. In simplicity of operation... in performance... in results! The amazing new Mercury embodies every essential feature of expensive foreign-made candid, as well as many new ones not found in any candid at any price! No wonder it's *America's fastest-selling candid!*

**MERCURY PHOTOFLASH UNIT** for night action shots... Takes only two seconds to attach or detach. Only \$3.95!

**FREE BOOKLET!** Why envy those who own expensive speed candid? See the UniveX Mercury at your dealer's today, or send for free illustrated booklet. Dept. M-50, Universal Camera Corp., New York City.

Quick-Action  
Simplified  
Controls

Automatic  
Film  
Transport

Automatic  
Exposure  
Calculator

All-Metal  
Construction  
Genuine  
Leather  
Covering

It's A  
UniveX!

1/1000th SECOND  
**MERCURY**





## SAVE REPAIR COSTS WITH P.W.

Plastic Wood has 1001 uses in the home and workshop. Handles like putty; hardens quickly to permanent wood.

In cans or tubes at Paint, Hardware, 10¢ Stores.



# PLASTIC WOOD



## 3-IN-ONE QUIETS SMALL MOTORS

Regular use of HEAVY BODY 3-IN-ONE Oil will add to the life of small electric motors. It lubricates and cleans, prevents rust and tarnish. Shop equipment needs it. At Hardware, Drug, Grocery, 10¢ Stores. Try it!

Ask for

**HEAVY BODY**

**3-IN-ONE Oil**



## Driving a Bullet on Wheels

(Continued from page 351)

ishment in their one ride. Consider the weight they carry—seven tons, more than a ton on each of six tires. Consider the centrifugal throw, with the wheels revolving forty-six times per second and the outside of the tire traveling nearly 700 miles an hour. The headwind alone would cut the tires to pieces if not well shielded.

One of the odd things about riding this bullet on wheels is the trouble I have in getting out of the seat at the end of the run. I am actually locked in by the heat! When I designed Thunderbolt I particularly stressed construction of the seat. I made certain I could see clearly and far. I wanted to fit snugly, with all controls in easy reach. Although I am in the car only six minutes for the two-way run, correct posture and physical comfort are essential to ward off fatigue—and that applies to

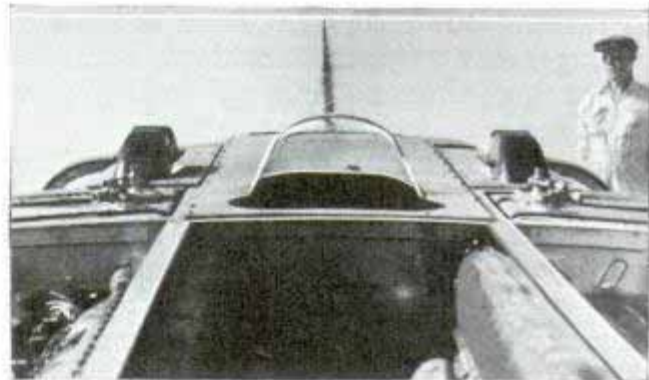

View from behind windshield toward race course

you, too, when you are on a long automobile trip. Thunderbolt's seat is built to fit my body exactly, and it has pneumatic cushions. During the speed run the heat from the twenty-four cylinders causes my body and the pneumatic cushions to swell until I am stuck fast, and at the finish I must cool off before I can extricate myself.

My instrument board is not like yours. I have no room for radio and cigar lighter—I haven't even a speedometer. How can I tell when I hit 360 miles an hour? By the tachometer reading. Top reading on the dial is 4,000 revolutions per minute. At six miles a minute the revolution counter should show 3,450. Actually, the speed is a little more than estimated from the tachometer, because of tire expansion, an unknown quantity.

One dial is a shift indicator. Because you cannot "back-shift" to a lower gear



and because there is a long interval between shifts, I must have a dial to tell what gear I am in. I shift from first into second at seventy miles an hour and into third at 200 miles an hour.

The other dials are oil-pressure and water-temperature gauges for each engine; oil-temperature gauges, and pressure gauges for the mechanical brake oil line and for the air brakes. By air brakes I mean the two fins which are projected from each side of the car to increase wind resistance.

It's not easy to describe the sensation of traveling at six miles a minute. The time is too short to think of your own feelings. Probably if you had time to think, you'd be conscious of screaming engines and almost suffocating heat, a sense of pressure in the enclosed cockpit, and ahead a white blur split by that black line on which your eyes are glued.

Spectators have told me they scarcely see Thunderbolt until the car is opposite them. There is a swift, dark blur, then a flashing broadside glimpse, and I am almost out of sight again before the peak of the engine's roar reaches the watchers a quarter mile or more from the course. Thunderbolt travels half as fast as sound.

Six months before my attempts to set world speed records I go into training, following the rules of an athlete gearing up for football or track. I refrain from alcoholics, cut down on my smoking, and drink quantities of milk. I have acquired the faculty of relaxing at will. Sometimes in the late afternoon I lie down for a nap and in fifteen minutes am up, perfectly refreshed. It would pay anyone to develop that ability to relax. Even a brief midday rest during a long automobile trip might prevent an accident caused by fatigue.

The night before a record run I retire about seven o'clock and set the alarm for one. When it rings I hustle, see that my crew has hot coffee, that each man is doing his task, and then make a final checkup on the car myself. The track has been scraped smooth with heavy iron rails and the black guide line checked with surveying instruments. I breakfast on hot cakes, a slice of bacon and coffee, don the helmet and fresh-air mask which is essential in the cockpit, and when all is ready I pull the sliding roof over my head and give the signal. I'm off for the races!

## "I GET SORE WHEN YOU KISS ME"

— said the farmer's daughter

"GET YOURSELF A BARBASOL FACE" she said. Well, I didn't realize how rough and bristly my face must have felt to her until I tried Barbasol. Boy, you should feel my skin now. Clean as a pin and smooth as silk. If you want to make a hit with women, get a Barbasol Face.



**THE TRAVELING MAN** had his shaving troubles until he switched to Barbasol. No messy brush to pack on train or plane. The quickest, sweetest shaves, too—gets your face in shape to meet the customer and leaves your skin feeling like a million.



**FEEL THE IMPROVEMENT**—Try Barbasol for just ten days. Note how much smoother, fresher your skin feels—how much younger-looking. No harsh irritants in Barbasol to bite and burn, even roughen the skin. Barbasol is a modern cream, containing beneficial ingredients that soothe the skin as well as soften the beard. Ask your druggist for Barbasol. Three sizes—25¢, 50¢, 75¢. Barbasol Blades, 5 for 15¢.



For Modern Shaving  
No Brush • No Lather • No Rub-in





● 9" Workshop Back-Geared, Screw-Cutting Metal Working Lathe now in Model A Quick Change Gear and Model B Standard Change Gear with power cross feed, also Model C without power cross feed. 38 attachments for Mfg., Laboratory, Repair Shop. OTHER SIZES: 9", 11", 13", 14 1/2", 16" and 16-24" swing, bed lengths 3' to 12', motor drive and Countershaft drive.

**SOUTH BEND LATHE WORKS**  
645 E. Madison St., South Bend, Ind., U. S. A.

**FREE!** Write for Catalog No. 46-B showing complete details of the new 9" lathe.

South Bend Lathe Works  
645 E. Madison St.  
South Bend, Ind., U. S. A.  
Send Catalog No. 46-B Free, Postpaid

Name \_\_\_\_\_  
Address \_\_\_\_\_  
City \_\_\_\_\_ State \_\_\_\_\_



**BEEN ON A Detour LATELY?**

Chances are that making turns was confusing—made you wonder if you were going in the right direction. With the Hull Streamline Auto Compass on your windshield, there is no need to even hesitate. Gives assurance of direction at all times. No more lost miles, backtracking or worry. Only \$2.95 at your dealer. Two-piece model \$1.95. Write for literature.

HULL MFG. CO., P. O. Box 246-D17, WARREN, OHIO

**EASY PROFITS IN PAINT SPRAYING**



Paint walls, ceilings, screens, furniture, radiators, machinery faster, better! 1/4 H. P. motor 110 Volt 60 Cycle AC, complete with Spray Gun, 15 ft. hose. Weighs only 44 lbs. Carry anywhere. FULLY GUARANTEED. Only \$31.15 f. o. b. Chicago. \$5 Deposit, Balance COD, or SEE YOUR DEALER. Circular FREE. Get started making money NOW!

Ideal Automatic Pump Co. Dept. PM-9, 801 Washington, Chicago **\$31.15** Complete

**DOENUT WHEELS**

DOENUTS, developed and patented by the originator of the air-wheel, absorb more surface obstructions and eliminate jolting. Protect wood and concrete floors. Do not sink in sand or soft ground. Cadmium plated disc wheel with adjustable ball bearings. Size 10"x2.75" with cap. of 225 lbs. per wheel and 12"x3.30" with load cap. of 325 lbs. per wheel. Ideal for wheelbarrows, painting rigs, spraying equipment, textile trucks, dish trucks, boat dollies, food carts, or most any portable unit that rolls. Handle same loads with less than half the labor. Send 10c postage to cover cost of mailing literature.

MUSSELMAN PRODUCTS CO.  
6225-N St. Clair Avenue, Cleveland, Ohio

233  
**On the Bridge of a Superliner**

(Continued from page 357)

the return trip to England, the time was three days twenty hours and forty-two minutes, which established a new east-bound record, I am told.

Today's modern liner is no more completely equipped for speed and passenger comfort than it is for safety. Aboard the "Queen Mary," no one can strike a match or even flick an automatic lighter in an unauthorized place without the officer of the watch being immediately aware of it. This is because of the extraordinary delicate fire detectors installed throughout the ship which give a signal on the bridge of the exact location of any uncontrolled flame. All staterooms and spaces not under constant supervision of the personnel are equipped with the latest automatic sprinkling devices. Fireproof compartments occur throughout the ship while all vertical lines of communication, such as stairs and elevators, are enclosed in fire-resisting materials with fire doors at every deck landing to eliminate drafts. In the public rooms and certain other spaces there are thermostatic devices which automatically sound an alarm when the temperature of the protected area rises above normal. In addition there are manual stations throughout the vessel whereby anyone seeing a fire can immediately signal the location of the fire to the fire-control stations. If a fire were discovered, the officer on watch would press a button to flood the scene with extinguishing gases. Hydrants, portable extinguishers, self-contained breathing apparatus, smoke helmets and asbestos suits also contribute to the comprehensive plans for virtually eliminating the hazard of a fire at sea.

Among the features making for greater safety of the ship are the double bottom and two hulls which run for a height of about forty feet, with more than enough room for a man to walk upright between the inner and outer skins. The double bottom runs the full length of the ship and contains seventy main compartments, while the principal engine room subdivisions are effected by eighteen transverse watertight bulkheads.

Ships-within-a-ship might well describe our lifeboat fleet, the largest ever carried by an Atlantic liner. There are twenty-



four massive all-steel, unsinkable<sup>2 3 3 5</sup> boats, twenty-two of which are thirty-six feet long, each big enough to accommodate 145 persons—a greater number than the entire complement of 115 passengers carried by the first Cunard liner, the "Brittania," in 1840. These boats are driven by powerful Diesel engines, capable of a speed of six knots, and two carry an up-to-date radio unit. Special engine heating circuits are provided at the davits so that the boats can be lowered fully loaded with their engines running in the coldest weather, under the control of a single man. Each boat, upon touching the water, is automatically released from the ship.

"Man overboard" is a rare alarm on the big liners, but we are ready for that sort of emergency. Automatic life preservers, located at frequent intervals along the ship's rail, can be thrown into the sea by pressing a button. Other safety devices include four sirens which can be heard ten miles—assurance against collision in fog—automatic devices for sounding the depth at any time, an automatic pilot which keeps the ship on the set course, a radio direction finder, powerful searchlight projectors, submarine signaling apparatus and powerful radio equipment for receiving weather reports, warnings from other vessels of derelicts or submerged wreckage and reports from the iceberg patrol.

So elaborate is the radio installation that the vessel literally is a floating broadcasting station. Thirty-two different radio wave lengths are used to link the ship at sea with all the world. There are nine separate antenna systems and a permanent watch on the 600-meter wave is maintained. Ship-to-shore radio-telephone service is provided either at telephone booths located in various parts of the liner or connected to any of the 500 staterooms on the ship's telephone system. For broadcasting a concert or speech, four transmitters send out signals which may be picked up and rebroadcast by American and British stations. Each of the ship's operators in the receiving station has in front of him a dial similar to those on the dial telephone. By operation of this dial he is able to start or stop a transmitter 350 feet away, increase or decrease its power as required or change to any required wave length. Each of these operations takes only a few

(Continued to page 124A)

IF ONLY THOUSANDS OF  
SKINNY MEN KNEW  
THIS SIMPLE SECRET

Posed by  
professional  
models

## 10 TO 25 LBS., NEW PEP GAINED QUICK WITH IRONIZED YEAST TABLETS

IT used to be thought that many people were just naturally skinny, puny and nervous. But today that idea has been proved untrue in great numbers of cases. Thousands of thin, tired, rundown people have gained new naturally good-looking pounds, normal health and pep, new friends and enjoyment in life—with the aid of the Vitamin B and iron in these amazing little Ironized Yeast tablets.

### Why so many build up quick

You see, scientists have discovered that today many people are underweight, rundown, often tired and jittery, simply because they don't get sufficient Vitamin B and iron from their daily food. Without enough of these two vital substances you may lack appetite and not get the most body-building good out of what you eat.

Now you get these exact missing substances in these scientifically prepared, easy-to-take little Ironized Yeast tablets. That's the secret of why with their aid thousands of men and women have put on 10 to 25 pounds of much-needed, naturally attractive flesh—gained normal health and pep, become much more popular and sought-after—often in just a few weeks!

### Make this money-back test

Get Ironized Yeast tablets from your druggist today. If with the first package you don't eat better and FEEL better, with much more strength and pep—if you're not convinced that Ironized Yeast will give you the new normally attractive pounds, new energy and life you've longed for, the price of this first package promptly refunded by the Ironized Yeast Co., Atlanta, Ga.

But just one warning! Due to the success of Ironized Yeast, cheap, inferior substitutes have sprung up. Of course inferior substitutes do not give the same results. So always insist on genuine Ironized Yeast. Look for "IY" stamped on each tablet.

### Special offer!

To start thousands building up their health right away, we make this special offer. Purchase a package of Ironized Yeast tablets at once, cut out the seal on the box and mail it to us with a clipping of this paragraph. We will send you a fascinating book on health, "Facts About Your Body." Remember, results with the first package—or money refunded. At all druggists, Ironized Yeast Co., Inc., Dept. 539, Atlanta, Ga.

**TUNE IN ON JOHN J. ANTHONY'S GOOD WILL HOUR.**  
See your local newspaper for exact time and station.





You see radiators boiling everywhere you go. Don't let this happen to you. Keep rust and scale flushed out of your cooling system. Do it yourself with Sani-Flush. It costs only 10c (25c for the largest trucks and tractors). Do it regularly—at least twice a year.

Just pour Sani-Flush in the radiator (*directions on the can*). Drain. Flush. Refill with clean water. That's all there is to it! Water circulates freely. Your car runs cooler. More power. Better mileage. And no unnecessary repair bills. Maybe you'd rather ask your garage or service station to do the job for you. Insist on Sani-Flush. It cannot injure motor or fittings. You'll find Sani-Flush in most bathrooms for cleaning toilets. Sold by grocery, drug, hardware, and five-and-ten-cent stores. 25c and 10c sizes. The Hygienic Products Company, Canton, Ohio.

**Sani-Flush** *Safe* NOT CAUSTIC  
KEEPS RADIATORS CLEAN



With this practical machine and attachments you can do all field and belt work hours faster at the low cost of 33c per day. Many units pay for themselves the first season. Unusually easy to handle and operate. Absolutely safe. Hundreds of users. Buy direct at low factory price. Two weeks' trial—satisfaction guaranteed. Write for colorful, free catalog.

**PIONEER MFG. CO.** Dept. V-99 West Allis, Wis.

(Continued from page 123A)

seconds to complete, while a system of indicators keeps the operators informed of the conditions under which the transmitters are functioning. The whole system is duplicated to guard against possible breakdown. In the possibility of grave emergency, under which generating plants for the radio system might be put out of action, a complete generating station, operated entirely from the ship's emergency lighting supply is available and, as a third alternative, power from storage batteries can be used.

Air conditioning, a floating gallery of the fine arts, all-electric kitchens, a "dog hotel," therapeutic baths, special movies for children, two interior swimming pools, twenty-one elevators, a 600-foot sports deck, a shopping center containing a smart haberdashery and clothing shop, a cigar store, telephone booths, a restaurant 160 feet long and 118 feet wide—these are some of the features that our passengers and visitors find amazing. In the kitchens, we have a "Mechanical Molly," an automatic maid-of-all work that can wash, rinse, polish and sterilize thousands of dishes in an hour, without cracking even the most delicate china. Electricity operates machines to slice bacon and bread, to toast bread, to make coffee, to burnish silver, to measure tea, to mix dough, to break ice, to cut butter, to press ducks, to clarify fat, to cut foods and to do numerous other kitchen tasks.

The great electrical system includes 30,000 electric lamps, ample to supply a town of 100,000 inhabitants.

With accommodations for 2,000 passengers, the "Queen Mary" carries about 1,500 on each of more than forty crossings of the Atlantic in a year. There are 1,132 in the crew now, but the number varies according to the number of passengers aboard. At times our crew has numbered 1,250.

Thus the modern superliner is manned, as well as equipped, to provide safety, service and speed on the high seas.

Our Bureau of Information keeps on file the names and addresses of makers of, and dealers in, all devices described in the pages of Popular Mechanics Magazine. We are glad to furnish this information to our readers upon request, accompanied by stamped, self-addressed envelope.



# HERE'S WHY WE CAN AFFORD TO OFFER YOU . . .

**20  
SHAVES  
FREE**



**CLIP  
THIS  
COUPON**

Lambert Pharmacal Co., Dept. 78, St. Louis, Mo. Please send me free and postpaid your large sample tube of  Listerine Shaving Cream;  Listerine Brushless Cream. (Check whichever is desired.)

Name \_\_\_\_\_ Address \_\_\_\_\_  
City \_\_\_\_\_ State \_\_\_\_\_

**FREE**  
WORLD'S FINEST  
RADIO CATALOG

188 pages packed with values. Everything in radio—60 great receivers—portables to phono-combinations. Build-it-Yourself Kits, "ham" equipment. Sound systems. Special new camera section. Everything at thrifty money-saving prices. Send at once for big FREE copy of Catalog 76.

LAFAYETTE RADIO CORP., 105-J SIXTH AVE., NEW YORK

**MAN IN EACH TOWN**  
To Plate Auto Parts

Reflectors, Bicycles, Fixtures, Mirrors, by late method. Simple plan of manufacturing at home starts you IN GOOD PAYING BUSINESS. Write today for FREE particulars and proofs.

**GUNMETAL CO.**  
Ave. M Decatur, Ill.

**WRITE TO Bass FOR HIS BOOK OF BARGAINS**

**ORDER FROM THIS LIST OF BASS GUARANTEED USED CAMERA BARGAINS**

- V.P. Zeiss Viotrix: ground glass, film adapter, C. Z. Tessar F:4.5 lens.....\$14.50
- V.P. Makina; f.p. adapter, F:3 lens, Compur shutter.....\$26.50
- 35 mm. Welta Watson: F:2.9 lens, Pronto shutter, like new.....\$19.50
- 2 1/4x3 1/4 Coat Pocket Tenax: Dogmar F:4.5 lens, Compound shutter, film adapter, 3 dbl. holders.....\$22.50

Write for Free Bass Bargaingram  
**BASS CAMERA COMPANY**  
179 W. Madison St. Dept. P Chicago, Ill.

**BOAT BLUEPRINTS**  
and full size paper patterns. Wide selection—designed by Naval Architect. Streamlined. Low prices. Send 10c (coin) for illustrated catalog.

**Cleveland Boat Blueprint Co.**  
Station A-666 Cleveland, Ohio

**Print Your Own**  
Cards, stationery, circulars, tags, labels, advertising, etc. Save money. **Print for Others: Big Profits; easy rules sent.** Will do popular Raised Printing like Engraving. Junior outfit \$9. Senior outfits \$17 and up. Send for free catalog and all details.  
**KELSEY PRESSES, E-37, MERIDEN, CONN.**

**CASH IN ON SPARE TIME**  
\$30 WEEKLY OR MORE EARN. Grow mushrooms HOME. Cellar, shed suitable. We buy 30c lb. Year round business. \$270 made by Mr. B. in few weeks **SPARE TIME.** Guaranteed materials. Established 1931. Write for **FREE BOOK.**  
**WASHINGTON MUSHROOM INDUSTRIES, Dept. 601, 2019 2nd Wash. Seattle.**

**GERSTNER TOOL CHESTS**  
The choice of better mechanics. Free Catalog.  
**GERSTNER TOOL CHESTS**  
439 Columbia St. Dayton, Ohio

**TRAILER BUILDERS · BUYERS · OWNERS**  
**TRAILER** Send 25c for this Big Book Today

Over 100 pages! Beautifully Printed and Illustrated! Trailer Suggestions and Ideas! Colorful Catalog shows America's greatest line of Trailer Parts and Equipment at lowest prices. Everything from wheels to top. Rush 25c today. Satisfaction positively guaranteed!  
**TRAILER SUPPLY CO. Box 438-A WAUSAU, WIS.**

**BUILD IT YOURSELF**  
*The Jim Dandy Cabin Cruiser*  
The Trailer that has everything. Classy! Roomy. Easy to build in any size with my simplified Plans and Instructions—Price \$1.00. Rush dollar bill today to **JIM DANDY Box 125-A WAUSAU, WIS.**

**WE WANT CAPABLE MEN**  
to become District Supervisors over exclusive districts in the distribution of the **NEW, KEYLESS, SNAP-UP ELECTRIC GAS TANK LOCK FOR CARS.** Entirely new distributing plan meeting with wonderful success. "LET US PROVE IT!"  
**SNAP-UP GAS CAP CO. DEPT. D. ASHLAND, KY.**

**FREE "BETTER RESULTS WITH GLUE"**

**IRON GLUE 10¢**

Send post card for booklet, "Better Results with Glue," containing many useful hints about mending, model making and home workshop jobs. Address: McCormick Sales Co., 402 Light St., Baltimore, Md.

at hardware, drug and 10c stores; also in cans from 1/4-pint to 1 gallon

**ENGINES**

Enclosed, Self-Oiling, Roller-Bearing

Cheapest reliable power for farm or factory. Uses all fuels for pumping, sawing, etc. Best engine for the money. You Pay Less to Own It—Less to Run It. Cash—Terms—Catalog FREE

**WITTE ENGINE WORKS**  
1746 Oakland Ave. KANSAS CITY, MO.

**Stoves AT FACTORY PRICES!**

**SALE CATALOG—FREE**

Nearly 200 Styles and Sizes of Heaters, Ranges, Furnaces at **FACTORY PRICES.** Easy Terms. Write today for **FREE CATALOG.** New styles, new features—24-hour shipments.

**Kalamazoo Stove & Furnace Co.,**  
391 Rochester Avenue  
Kalamazoo Michigan  
Over 1,400,000 Satisfied Users  
39 Years in Business

**"A Kalamazoo Direct to You"**

Write for **FREE CATALOG**





**Megow Commander**  
Gas-Powered MODEL \$4.95

By mail, postage 20c extra

An entirely new type gas-powered model that can be built in a couple evenings. Hollow-carved and finished Leading Edge, skin-construction of fuselage, skid mounting that takes any motor. High aspect ratio, steep climbing ability and extremely flat glides make this model ideal for contest purposes. Spec. rubber wheels. Two sizes: COMMANDER (\$4.95) 6 ft. span, for  $\frac{7}{8}$ " motors; CADET (\$3.95) 51 $\frac{1}{2}$ " span for  $\frac{5}{8}$ " motors. See catalog for other gas-powered models—world's champion QUAKER FLASH \$4.95; FLYING QUAKER \$5.95; 48" CARDINAL \$3.95 and PIPER CUB, \$3.95. When ordering by mail, include 20c for postage.



**MEGOW'S  
KWIK-DRI  
CEMENT**

A quick, firm-grip-ping, transparent, waterproof cement for model building and general household use.

Tubes 5c and 10c. Larger sizes in bottles and cans at your dealers.

Send 5c for new 100-page catalog showing scores of gas-powered, rubber-powered and scale model airplanes, also model ships and HO-Gauge railroad equipment and supplies.

### MEGOW'S

Dept. PM, Howard & Oxford Sts., Philadelphia, Pa. or 217 N. Desplaines St., Chicago, Ill., or Great Western Merc. Co., 718 Mission St., San Francisco, Cal.

## BRINGS OLD FRIENDS TOGETHER



● Holds permanently on china, glass, wood, metal, leather, paper, fabrics. Transparent, flexible, waterproof—not affected by heat. Dries quickly. Ideal for model making as well as for mending.

## DUPONT DUCO CEMENT

**10¢ For 16 PLANS** . . . Step-by-step instructions for building 16 useful indoor and outdoor articles. A good guide for both beginners and experts. Write for the Stanley Plan Book. Only 10c. **STANLEY TOOLS** Division of The Stanley Works, 105 Elm St., New Britain, Conn.

# Saw-Filing

Pays up to \$2 or \$3 an Hour in Spare Time

A FOLEY Automatic Saw Filer files hand, circular and band saws better than the best hand filer. Cash business, no canvassing, no eyestrain. No experience needed. Louis P. Wadowick, Ohio, says, "I have filed 764 saws in spare time and have earned \$850.00 in carpenter work due directly to my saw filing contacts." Send coupon for FREE PLAN, no obligation.

**FOLEY MFG. CO.**, 916-9 Foley Bldg., Minneapolis, Minn.

Send Free Plan on Saw Filing business.

Name . . . . .  
Address . . . . .



## Battling the Green Horde

(Continued from page 409)

Bacteriological warfare may be still in the future as far as battles between human armies go, but in the endless war against the green horde, it is already in use. Four types of bacteria, all deadly to grasshoppers but harmless to men and animals, are used. These four strains of bacteria are combined in one inoculation. By thus subjecting the grasshopper to multiple infections, death is made absolutely certain.

Eight days are needed to prepare the cultures. When the bacteria are first injected into laboratory grasshoppers, it takes three days for death to occur. By taking cultures of bacteria from the dead grasshoppers and reinjecting them into others, the period until death is shortened to thirty-six hours.

The chain of inoculation is carried on until the death period is cut to eight hours. Here the bacteria reach their greatest strength. A test tube of each of the four types is thrown into a vat and a sugar solution added. The edges of fields in the 'hoppers path are then sprayed with the mixture.

When the grasshoppers touch the mixture, they clean their antennae by running them across their mouths. By so doing they infect themselves with the bacteria. In turn the doomed 'hoppers infect others.

Often when minutes are precious or the supply of bran and bacteria runs low, the high command may order the last desperate method of defense:

"Burn the fields!"

Carrying flame throwers such as are used in forest-fire fighting, the men surround a field and trap the 'hoppers within walls of fire.

Perhaps the most desperate time in a grasshopper war is during the hours before the 'hoppers lose their seventh and last skin, and are ready to fly. Once they have taken wing, they can jump defense lines and attack from the rear.

There is no mercy in this battle, for it is one engagement in the final bitter war between men and insects. Many famous scientists have wondered which side would be the ultimate victor. The men who fight the green horde do not think of such things. They only fight with all that human science and ingenuity can offer.



## They Fly Without Wings

(Continued from page 405)

be serious, if not fatal. Hence performers watch their rigging constantly for signs of this failure of metal. If the metal is painted, they scrape it off periodically, to detect possible signs of crystallization. If there is any suspicion that the metal is going to pieces, the part is replaced immediately.

There is one bit of routine that some member of every act does, just before its turn comes on the show's program. That member inspects the rigging. Perhaps a

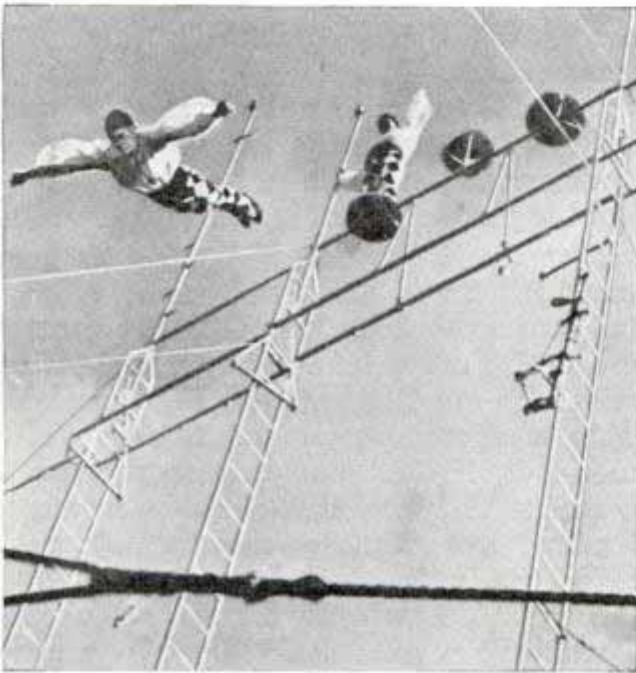

Eighty-five foot leap into space to a net below by a member of the "Aerial Ballet"

worker has pulled a rope a little too tight, or not quite tight enough. Maybe there is an adjustment that is a trifle off, but enough to endanger the members of the act.

Aerial acts are popular all over the world, and the better ones find it easy to travel the seven seas. A season in Europe, perhaps a run of fifty-two or 104 weeks in Australia—trips to the Orient, to South America, to every place where people will pay for a thrill, are possible for the headliners. But to reach that point, any performer must be willing to risk his life twice a day. It's nice work if you can do it.

Popular Mechanics Magazine can furnish the name and address of the maker of, or dealer in, any article described in its pages. If you wish this information, write to the Bureau of Information, inclosing a stamped, self-addressed envelope.

"So you think I don't need SMOOTH-ON!"

"Well then, let me see how you'd stop that leak without opening the joint!"



THIS man knows that Smooth-On is simple to apply, makes dependable repairs, costs very little, and puts the defective part back into trouble-free service in a hurry.

Usually a leaky pipe joint or connection can be sealed with Smooth-On without disassembling, and in the case of a cracked boiler section, tank puncture or similar emergency, a quick, cheap and permanent Smooth-On repair makes a mere incident out of what might otherwise be a catastrophe.

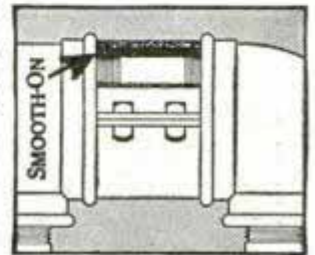

Stopping a pipe leak at a short nipple

Smooth-On holds in any metal, against gas, steam or water pressure and is not impaired by vibration or extreme temperature change. It restores perfect tightness also at stripped or loosened screws, bolts and nuts. Seeing is believing. Make any fair test, and you will be convinced.

To assist in determining correct application and getting good results, we have issued the SMOOTH-ON HANDBOOK, which explains all Smooth-On compositions and their uses, and contains simple instructions and working diagrams for stopping leakage and tightening

loose parts under all sorts of conditions. This booklet should be consulted whenever the repair procedure is in doubt. Having a small supply of Smooth-On ready for an emergency is also a wise precaution.

Buy Smooth-On in 7-oz., or 1 or 5-lb. can from your hardware store or from us.



Write for FREE BOOK

SMOOTH-ON MFG. CO.,  
Dept. 37,  
574 Communipaw Ave.,  
Jersey City, N. J.

Please send Smooth-On Repair Book.

Name .....

Address .....

9-39 .....



Do it with SMOOTH-ON



HERE'S YOUR TAXI  
TO  
*Hotel Cleveland*



● When you stay at Hotel Cleveland your red-cap takes you from train to hotel lobby in a moment, without going out-of-doors. No time wasted, no discomfort, no taxi fare.

And at Hotel Cleveland, all the city is at your doorstep. All five buildings of the Terminal development under the same roof; stores and office buildings to the east; government buildings north; wholesale district west; industrial plants south. And comfort, friendliness, welcome, *at home*—in your room and all about you in

**HOTEL CLEVELAND**  
*Cleveland*

NOW ONLY

\$5<sup>00</sup>



REAL ENGINE VALUE

Over 7,000 GHQ Gas Engine Kits were sold at \$8.50. Over 10,000 sold last year. Now is your chance to buy the *New Improved* kit for \$5.00. Absolutely complete with coil, plug, etc. For boats, planes, etc. All parts guaranteed. Send only \$1.—*Shipped Express Collect for balance same day. Send 3c for new 12-page illus. catalog. DEALERS WRITE.*

All parts finished. Only a screwdriver needed. 1.5 H.P.  
Average assembly time 30 minutes.

GHQ MOTORS, 854B East 149 St., New York, N. Y.

BURN YOUR NAME ON TOOLS

WITH THE

**ARKOGRAF**

PROTECT YOUR TOOLS FROM THEFT

Write with electricity any name or design on the hardest and finest tools and instruments, or any metal, like writing on paper with pen or pencil.

Complete Outfit \$3.50—Prepaid Anywhere. Interesting illustrated circular free. Write today.

Agents wanted. ARKOGRAF PEN CO., 3927 S.E. Stark St., Portland, Ore.

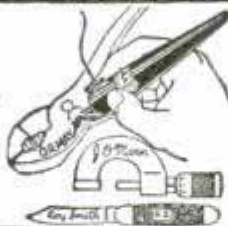

FREE TRAILER BUILDERS' GUIDE  
AND CATALOG—NEW 1939 EDITION

WORLD'S BEST LINE OF TRAILER AXLES, HITCHES AND PARTS—Complete house trailer working blue prints only 50c. WRITE TODAY FOR THIS NEW FREE CATALOG.

HAMMER BLOW TOOL COMPANY, Dept. 109, Wausau, Wis.

**NEURITIS** Relieve Pain  
in Few Minutes  
or Money Back

To relieve the torturing pain of Neuritis, Rheumatism, Neuralgia or Lumbago in a few minutes, get NURITO, the fine formula, used by thousands. No opiates. Does the work quickly—must relieve cruel pain to your satisfaction in a few minutes—or your money back. Don't suffer. Don't delay. Ask your druggist today for trustworthy NURITO on this guarantee.

## 2363 Push-Button Railroading

(Continued from page 331)

right of way in mountain regions so that a rock fall on the tracks would break the circuit and flash red lights. Flood detectors warn of danger on riverside railroads. Bridges on the Southern Pacific are protected by indicators that give warning if girders, piers, spans or abutments are out of alinement. Defective brakes or other equipment dragging from cars on some roads set a signal against the train.

Phantom pilots stand beside the motor-men on the interurban trains operating across the San Francisco-Oakland bay bridge. Here is one of the busiest lines in the world, trains operating seconds apart in fog and storm and darkness. The human engineer might make a tragic mistake—but the phantom pilot is there to stop him.

Directly in front of the engineer is a panel with five disks. One is marked "NS," indicating the train is outside the control area. The other four show the speeds at which he must operate: 35, 25, 17 and 11. This means miles per hour, and really means it; if the train exceeds the speed shown in the panel lighted at the moment, the engineer is first warned, then stopped. If "25" is indicated and the train strikes twenty-six, a whistle blows in the cab. Should the engineer fail to heed the warning the brakes are applied automatically.

The speed indicator disks are governed by the train ahead. The tracks are divided into sections of about 500 feet, each section insulated from the other. Alternating current in these tracks is interrupted a certain number of times per minute according to track conditions ahead, and the impulses are picked up by the motor car and operate the cab signal lights. One train cannot approach within braking distance of another without getting a "slow down" warning.

Another modern feature of the bridge railway is the disappearance of the traditional battery of steel switch levers. Instead, routes are lined up by push buttons akin to the interlocking systems of metropolitan railway terminals and to the centralized traffic control.

At each end of the bridge is a control tower. In front of its operator is an illuminated route map showing the position of every train. When a train leaves San



9 36 3  
 Francisco, the operator presses two buttons marking the entrance and exit of the train through the San Francisco yards; automatically the switches and signals between those two buttons line themselves up. If the normal route happens to be occupied, the electric panel thinks for itself and lines up the best alternate route. At the same time the operator over at Oakland observes the routing on his control board.

Through the first hundred years of railroading, brakemen clinging to the ladder on the caboose or striding along the catwalk atop a boxcar have wigwagged signals to the engineer with waving arms and swinging lanterns. Now that picturesque phase of railroading may be entering its twilight. The cab-to-caboose telephone is in its infancy, but it is here. In fact, the day may not be distant when you will pick up a telephone in the lounge car of your streamline train, talk to the telephone exchange in the nearest city and be connected with your own home.

When the engineer in the cab of his freight locomotive picks up the receiver and hears an order from the conductor in the caboose 100 cars back of him, the voice is not coming in by ordinary short-wave radio broadcast. It travels through the rail. Both engine and caboose carry transmitter and receiver. The impulses are transmitted to the steel rails, travel as far as ten miles in either direction by carrier current. Out of sight around a long curve, hidden in dense fog or cloud of steam, the engineer no longer is dependent on the swinging lantern for his signals. The engineer of the westbound freight can telephone the crew of an eastbound train, warn them of a hotbox or dragging brake rods. By laying wires connecting the rail with the dispatcher's line and way stations, train crews could talk at any time with the dispatcher or the station agent, receive their train orders and advice about freight pickups along the road. A wire from the rail to the way station could make the connection for telephone calls into the Bell system. One railroad is considering the use of cab telephones on long freights where a helper locomotive is at the middle of the train. If both locomotives fail to start at once, there is danger of pulling the train apart. With the telephone in both

(Continued to page 130A)

## GET OUT of the "Snapshot Class" with a Rolleiflex Camera

A sharp, well-composed picture every time you click the shutter

LET a Rolleiflex camera show you how easy it is to make pictures you will be proud to show your friends and enter in exhibits or contests. With a Rolleiflex, you see each picture in actual size before you make it. You get 12 negatives in the practical, popular  $2\frac{1}{4} \times 2\frac{1}{4}$ " size on a roll of standard 120 (or B2) film. They're sharp enough to enlarge to any size. But even inexpensive contact prints are large enough for the album.



Ask your dealer to show you genuine Rolleiflex and Rolleicord cameras. There are 5 different models reasonably priced from \$57.50 up.

If your dealer cannot supply you with literature and full information, Write: Dept. 69

**BURLEIGH BROOKS**  
 INCORPORATED  
 127 WEST 42<sup>ND</sup> STREET NEW YORK



### BUDA INBOARD ENGINES

1-6/10 H.P.—2 1/4 H.P.—5 1/2 H.P.  
 For Fishing Boats, Sail Boats, Utilities, Dinghies  
 "AIR JACKETED" (Improved Air Cooling)—Takes all engine heat out of boat—no hot pipes—better than water-cooling  
 REVERSE and REDUCTION DRIVE—"Free-wheeling clutch"  
 Price complete (with outstanding features listed above)—  
 1-6/10 H.P.—\$31.00—2 1/4 H.P.—\$94.50 (F.O.B. Harvey, Ill.)  
 BOAT PLANS! For 8 ft. Dinghy—12, 14, 16, 18 ft. Fishing Boats—18, 22 ft. Sail Boats—\$1.00 each, with complete instructions and building blue prints. Designed by prominent naval architect. Write for descriptive literature.

The BUDA Co. (Marine Dept. PM) Harvey, Ill.



### AUTO-GLIDE with the Famous CUSHMAN ENGINE

125 Miles Per Gallon—35 Miles Per Hour  
 Get on an AUTO-GLIDE, and G-O!—for inexpensive trips, to and from business, on deliveries, to school, etc. Ride with the famous trouble-free, dependable CUSHMAN ENGINE—at 35 miles per hour, 125 miles per gallon! WRITE!—or see dealer TODAY!

\$92

F.O.B. Factory

THE CUSHMAN MOTOR WORKS  
 Dept. X-9 Lincoln, Nebr.

### Choose from World's Largest Line of Power Tools!

FREE 48-page Catalog covers Metal and Woodworking Tools, accessories, motors for every purse. Write Walker-Turner Co., Inc., 199 South Ave., Plainfield, N. J.

### DRIVER Engineered POWER TOOLS

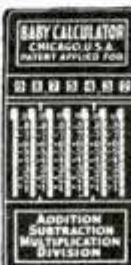

### WORLD'S LOWEST PRICED ADDING MACHINE

GUARANTEED ACCURATE. Not a toy. Operates with only a finger flick. Adds, subtracts, multiplies, divides. Counts up to a million. Pays for itself over and over. Ideal Gift—for Business, Income Tax and School use. MONEY BACK GUARANTEE. Send name and address. Pay postman only \$2.50 plus postage. (Send full cash if outside U. S.) Money back in 10 days if not delighted. AGENTS WRITE. CALCULATOR MACHINE COMPANY (Mfrs.), Dept. 109, P. O. BOX 1118, CHICAGO, ILLINOIS.

YES! POCKET SIZE  
 FREE TRIAL  
 ONLY \$2.50  
 TOTAL COST  
 SEND NO  
 MONEY



8363 (Continued from page 129A)

Technically-trained men demand this improved steel tape—with *black* markings on a crack-proof white surface. Easy to read, easy to use, easy to clean; less chance for error. Hard to kink, hard to curl; good for a long useful life. Bonded white surface protects steel from rust. 25, 50, 75, 100 ft. lengths. Mail coupon today for free sample of tape and illustrated folder.

**K & E FAVORITE WYTEFACE**  
**STEEL MEASURING TAPES**

LOOK FOR THIS DISPLAY KEUFFEL & ESSER CO. . . . Est. 1867  
 Dept. 77, Hoboken, N. J.

Name \_\_\_\_\_  
 Address \_\_\_\_\_  
 City \_\_\_\_\_ State \_\_\_\_\_

**NEW STREAMLINE BENJAMIN AIR RIFLES**  
 WITH LEVER HAND PUMP

**BENJAMIN**

**HARD ACCURATE SHOOTING WITH CHAMBERED AIR**  
 You can use new models BENJAMIN AIR RIFLE WITH LEVER HAND PUMP anywhere, for practice firing or just plinking around the house or camping, fishing, hunting, etc., at lowest cost. Shooting force is adjustable depending on AIR PRESSURE—amazing maximum power and accuracy—will penetrate to 1". Hair trigger firing without lunge or recoil. Single Shot BB \$7.50. Repeater BB \$9.00. Rifled Cal. 22 or 177 Single Shot \$5.50. Ask your dealer all about them or write for complete specifications—targets and blueprints FREE if requested. We also make a complete line of BENJAMIN AIR PISTOLS for target and small game. WRITE TODAY. BENJAMIN AIR RIFLE CO., 895 MARION ST., ST. LOUIS, MO., U. S. A.

**HANDY TAPS and DIES . . .**  
 Accurate—carefully hardened and tempered. Complete range of sizes at your local five and ten cent store  
**HENRY L. HANSON, WORCESTER, MASS.**

**DURO DRILL PRESSES ARE LOW IN Cost AND HIGH IN Quality**

Use them to speed up your drilling, tapping, routing, mortising and other operations. They are precision built of quality materials. Incorporated are features such as heavy splined spindle mounted on Four Sealed New Departure Ball Bearings; 4 step pulley independently mounted; Extra heavy castings to withstand vibration; Rugged base with "T" slots and heavy slotted table both machined and ground for accuracy—Lower Initial Cost—Lower Operating Cost—Lower Maintenance Cost.

Manufactured by  
 The Makers Of America's Finest And Most Complete Line of Workshop Machinery—  
**Duro Metal Products Co.**  
 Dept. B-9, 2657 N. Kildare Ave.  
 Chicago, Illinois

**FREE · BIG 1939 CATALOG**

cabs, the two engineers could drive as one.

Railroads have long ago passed the pioneering stage, but the inventors and technicians who keep them up to date will never cease to pioneer. Centralized traffic control and signaling have come a long way from that day when an early railroad rulebook called for a "relay race" of track workers to get word to town of a wreck along the right of way. Here's the rule as it read in 1853:

"On learning that an accident has occurred, a Plate-layer is to proceed with all possible despatch to the next gang, from which a Plate-layer will, in like manner, run to the next more distant Plate-layer, till information of the accident has by this means reached the Station."

**Models That Save Lives**

(Continued from page 395)

a month building the creatures threatened to quit because they said the half-completed monsters crawled through their dreams.

But trouble really began when the dinosaurs were photographed. Each movie sequence involving these animals is literally a series of stills. One frame of film is exposed, the animals moved a fraction of an inch, and another frame exposed. That would be simple, except that every little while somebody will move all of an animal instead of just its head, or move an animal that isn't supposed to be moved. Then the whole sequence has to be shot over. One entire day's shooting was ruined when Jackman's dog ran away with Sally, the largest brontosaurus.

In "Professor Beware," the problem was how to make Harold Lloyd run along the top of a moving freight train. To accomplish this effect a complete scale model of a freight train was built. Each car was fifteen feet long, the whole train being the length of a city block. The train was run on a track, behind which was a background showing a cloudy sky. Between the background and the train was a treadmill on which Harold Lloyd ran while the train was pulled between him and the camera. The effect was easy, but Jackman is still trying to figure out what he can do with the freight train.

One of Jackman's sons did the trick fly-



ing in "Test Pilot." Trying to figure out a way of producing plane stunts in the studio, he designed a machine that looks like a cross between a ferris wheel and a double clothesline. Miniature planes, with a wingspread of eight inches, are hooked on the double clothesline and can be pulled in either direction. The clothesline can also be rotated. By means of the ferris wheel, the lines holding the planes can be revolved in a twelve-foot circle. By combining all these motions, the models can perform any stunt. In fact, they can execute maneuvers impossible for actual planes.

Another of the regular assignments is for plane crackups. For this work, larger models are used. To the uninitiated the models may seem to lack detail, but, Jackman explains:

"If we made such models too detailed, they wouldn't seem real. When you see a plane traveling at a high speed, you don't see much detail. In fact, it would be a lot easier for us to reproduce all the detail than to try to decide how much detail the eye actually sees."

Miniature autos and boats are standard props. Houses of all types are also kept on hand. Many of these come apart, and have completely furnished rooms.

One time a call came in for a scene showing a southern plantation house being submerged by a flood. The lake was filled with miniature debris, the cameras and lights were set up, and everything was ready—when it was discovered that the lake wasn't deep enough to submerge the house.

"Get a saw!" Jackman ordered, "and cut the house in two."

When this was done, the whole house was put in the lake and the water slowly brought as high as it would go. Then the cameras were stopped and the house taken apart. Next the top half of the house was slowly lowered into the water by concealed wires. The result was the effect of the house being submerged by the flood.

Turning a hobby into a business has its problems, but Jackman says tough jobs are the most fun to solve—particularly when they involve saving some stunt man's neck.

Send return postage to our Bureau of Information to learn the name of the maker of any device described in this magazine.

## TAKE A LESSON From the Foley Automatic Saw Filer

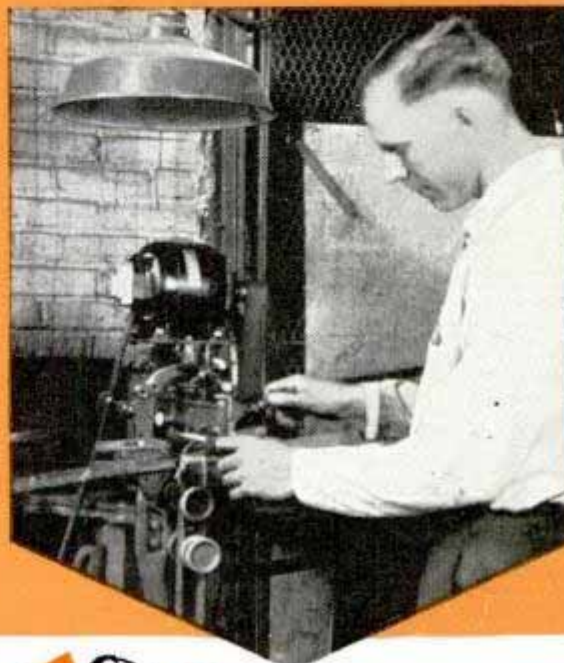

There could be no stronger testimonial to the quality of Nicholson Saw Files than the fact that they are standard equipment on Foley Saw Filing Machines. These machines must have files of uniformly high quality, with straight edges and strong, rugged teeth. The same qualities of Nicholson Saw Files which make them standard equipment on these machines are the qualities that make them best for any hand filing job.

You'll find Nicholson Saw Files in the right shapes and cuts for your saws, Cellophaned-wrapped at your hardware store.

### FREE! 28 Page File Booklet

Photos, instructions, descriptions, on how to choose and use files. Write for your copy. Nicholson File Co., 22 Acorn St., Providence, R. I., U. S. A.

A FILE FOR EVERY PURPOSE

**NICHOLSON**  
PIONEERS IN  
QUALITY PRODUCTION

75<sup>th</sup>  
ANNIVERSARY  
YEAR





**BIG OPPORTUNITY  
STUCCO SPRAYING**

Renew old buildings. Make new construction more permanent and attractive. Plastic Colorcrete is water-proofed. It fuses with any masonry surface. It fills all cracks. It can be applied in any thickness and in 30 colors. Fully proven by over 12 years actual use under all conditions and every climate.

#### OFFERS BIG EARNINGS

Owners everywhere want to enhance present values. With this machine you can supply this big waiting market with permanent Colorcrete at amazingly low cost. Operators report cost of 2c and up per sq. ft. and sell up to 7c. Some have paid for their equipment from first few jobs. Machine capacity up to 1,000 sq. ft. per hour. Get the facts. Send for the books, "Proven Business Opportunity." Write today. It offers you big extra income.

**COLORCRETE INDUSTRIES, INC.**  
570 Ottawa Ave. Holland, Mich.

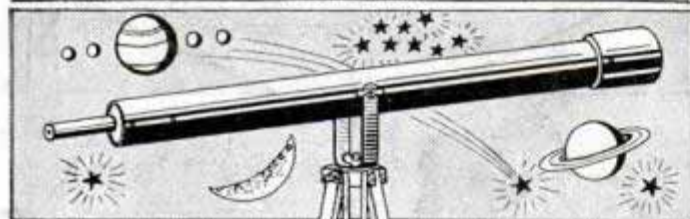

### 100X ASTRONOMICAL TELESCOPE COMPLETE LENS KIT *only* \$1.95

Make your own high powered telescope in one evening of easy work. All optical parts completely finished for 6 ft. long refracting telescope. Kit contains 3" diameter 75" F. L. ground and polished objective lens and 2 astronomical eyepieces 50X and 100X. Here is your chance to own a high powered telescope and study the mountains and craters on the moon, the ringed planet Saturn, the moons of Jupiter, double stars, and hundreds of other interesting sights. Complete kit with full directions for mounting, only \$1.95 postpaid. Send money order now for immediate delivery.

**BROWNSCOPE CO. Dept. 49 5 W. 27th St., New York**

**OTTAWA LOG SAW \$39** BIG BOOK FREE

PUTS THIS OTTAWA to work for you. MAKE MONEY! Wood is valuable. Does more than 10 men. Easily operated. Falls trees—saws limbs. Use 4-hp. engine for other work. Write for FREE Book.

SAW 10 TO 20 CORDS A DAY

OTTAWA MFG. CO.  
2327 Wood St., Ottawa, Kans.

**RADIO SEND FOR NEW 1940 CATALOG**

SETS • PARTS  
KITS • PA • HAM  
GEAR AT  
LOWEST PRICES

Now ready!—ALLIED's big new 1940 catalog, 204 pages, 5 Big Sections with Everything in Radio at Lowest Prices! 60 sensational 1940 Sets, 4-12 tubes, all types—newest phonographs, record players, phono-radios, recording equipment, latest Sound Systems, Amateur sets, new Builder's Kits, test equipment, and over 55000 radio items—all in one Big Book at lowest prices! Free—send coupon today!

ALLIED Radio Corporation,  
Dept. 5-J-O, 833 W. Jackson Blvd.  
Chicago, Illinois

Send your Free 1940 Catalog.

Name.....  
Address.....  
City..... State.....

**FREE**

## Compact Two-Tube "Phantom" Record Player

(Continued from page 457)

of ordinary tubes. These "Loktal-base" tubes and sockets will probably be used in many of the new 1940 receivers. Although the tubes require 35 volts for heater oper-

### Parts Used in Model

- 1 sheet-metal chassis base—see Fig. 1 for detail
- 1 Raytheon tube (Loktal) type 35A5 (r.f. osc.)
- 1 Raytheon tube (Loktal) type 35Z3 (half-wave rect.)
- 1 280-ohm line cord, 7 ft. long with 15 ft. ant. built in. Note—this is a 4-wire cord, with red common (see text)
- 2 Amphenol (Loktal) type sockets (grounding center contact)
- 1 Gen-Ral B.C. phono-osc. coil with 100-450 mmfd. padder (type C-5614)
- 1 500,000-ohm ¼-watt resistor; body green; tip black; dot yellow
- 1 50,000-ohm ¼-watt resistor; body green; tip black; dot orange
- 1 5,000-ohm 1-watt resistor; body green; tip black, dot red
- 1 1,000-ohm 1-watt resistor; body brown; tip black; dot red
- 1 50-ohm 1-watt resistor; wire-wound type (IRC)
- 2 .0001 mfd. mica-type fixed condensers
- 1 .00005 mfd. mica-type fixed condenser
- 3 .1 mfd. 200-volt tubular paper-type condensers
- 1 16 mfd. 150-volt tubular electrolytic condenser
- 1 40 mfd. 150-volt tubular electrolytic condenser
- 1 toggle switch (single-pole single-throw 2-lug type)
- 1 25-ft. roll No. 20 push-back hook-up wire
- 8 6-32 machine screws ½ in. long
- 9 6-32 hex. nuts
- 1 twin tip-jack strip (two insulated tip jacks)
- 1 3-lug mounting strip (two terminals insulated)
- 1 ½-in. rubber grommet (for line-cord hole in base)
- 1 Quam-Nichols microphone "Permanic type"

ation, the heater current is only .15 amp. as compared to .3 amp. for commonly used types.

The 35A5 beam-power tube serves as an r.f. oscillator and is modulated by the input signal from the phonograph pick-up or microphone. It will be noted that the antenna is loosely coupled through the .0001 mfd. mica-type fixed condenser. In ordinary cases the built-in 15-ft. flexible cloth-covered antenna cord will have to be rolled out beyond the plug for a few feet; the actual amount of additional antenna wire needed will depend upon the distance of the radio receiving set from the oscil-



lator unit. In all cases it should only be just long enough to operate properly. In an ordinary room where the oscillator unit is but a few feet from the receiver, the 15-ft. extension of the built-in antenna can be kept rolled up. For greater efficiency and better coverage the chassis base itself is used as a second radiator, and is connected to the control grid of the tube through a small .1 mfd. paper-type condenser. The metal base must not be in direct contact with any metallic object that may be mounted on the wooden case which houses the ordinary record player. A type-35Z3 half-wave rectifier tube is used to change a.c. line current to the required d.c. potential.

When using the microphone, speak directly into it, and hold it close to the mouth as indicated in the photo illustrating the method of home broadcasting. This

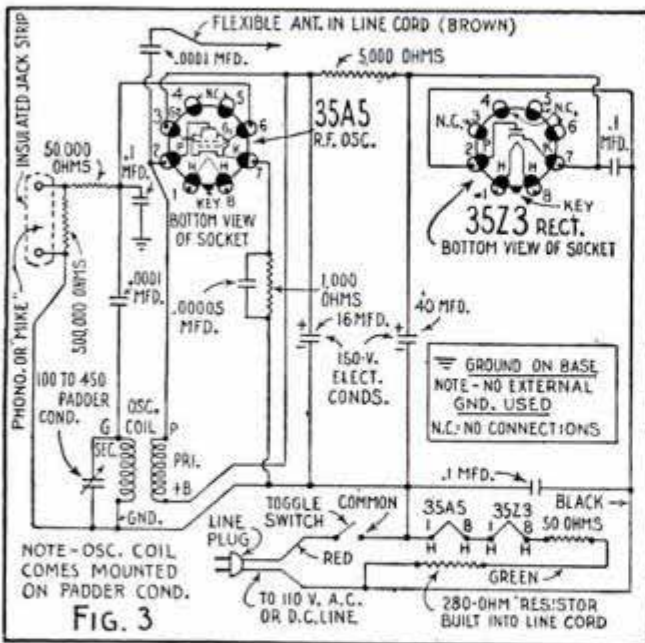
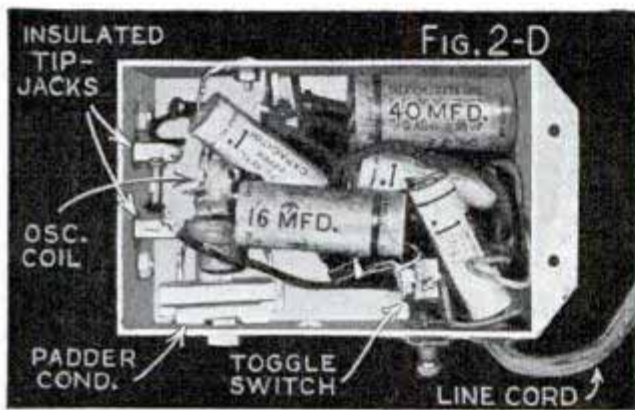

inexpensive type of microphone has certain limitations and must be held in that position for best results. The blueprint number for this article is R-270.

# MAKE BIG MONEY

## At Home!

# New Invention Electroplates by Brush

Plates  
GOLD  
SILVER  
COPPER  
TIN  
CADMIUM  
NICKEL  
Easy as  
painting

### No Tanks, Liquids, Generators DOES SAME WORK AS BIG OUTFITS

Millions of old auto-parts, and all kinds of old, worn articles in homes, stores, offices, factories everywhere can now be electroplated with a permanent brand-new sparkling coat of metal —by electrolysis—with the stroke of a brush. Easy as painting—no dismantling—plates right on the spot. Any electric light socket or car battery. Weighs only a few pounds. Take it anywhere—ready for instant use.

### Quick, Easy Way to Start Your Own Business

#### MAKE BIG PROFITS AT ONCE

Amazing low price and magic-like demonstration brings you thousands of orders for plating from garages, radio shops, bicycle shops, machine shops, home work shops, factories, offices, janitors, doctors, dentists, jewelers and farmers, homes, stores, etc.—with big profits for you! List of plating charges furnished; also reports of remarkable daily earnings.

#### 2-MINUTE DEMONSTRATION WITH SAMPLE AMAZES EVERYBODY

Send today for FREE Sample and amazing profit details and bona fide reports of big steady earnings! Also, 3-way proven sure money-making plan. Get started at once on this permanent, profitable business. No competition. Simply mail name on penny post card—NOW! Be the exclusive Warner Nu-Way Electroplater in your community.

**FREE SAMPLE PROVES CLAIMS**

**WARNER NU-WAY ELECTROPLATER CO.**  
360 N. Michigan Ave., Chicago, Ill. Dept. 5-P

Makes marvelous movies at everybody's price  
**CINÉ - KODAK EIGHT**  
See it at your dealer's

# HANDEE

Tool of 1001 Uses

### A WHOLE TOOL SHOP IN YOUR HAND

Smooth, steady power at your finger tips. Uses 300 accessories to grind, drill, polish, rout, cut, carve, sand, saw, sharpen, engrave, etc. Plugs in any AC or DC socket, 18,000 r.p.m. 16 oz.



Save Hours of Hand Work

**Get A Demonstration** at Hardware, Tool or Dept. Stores, or order on 10-Days Money-Back Trial. **\$10.75** post-paid with 3 Accessories . . . De Luxe Model, 25,000 r.p.m. 12 oz. **\$18.50** with 6 Accessories.  
Chicago Wheel & Mfg. Co., 1101 W. Monroe St., Dept. PM, Chicago, Ill.

**FREE 64-PAGE CATALOG**  
Complete information on Handee Products and their wide application in crafts work and industry all over the world.



# SpeedWay

**Real Quality Tools**

Designed, manufactured and guaranteed by SpeedWay, for 20 years leading manufacturers of industrial drills, these are really fine tools, correctly designed, correct speeds, genuine high torque drill motors. Small, handy, powerful; 1000 RPM—drill handles to 1/4" in steel. Die cast handle and gear housing. \$7.95. Grinder operates at 20,000 RPM; (high speed is essential for good grinding). With collets for 1/8" and 3/32" arbors. \$5.95. No. 250 KIT, both drill and grinder with 5 accessories in steel carrying case \$14.95. Complete line of accessories and drill press stand. Write for Circular. Dealers Write SPEEDWAY MFG. CO., 1842 S. 52nd Ave., Cicero, Illinois

**DRILL \$7.95**

**GRINDER \$5.95**

**SET \$14.95**

## New Accurate 10" Slide Rule

Enables you to do difficult calculations instantly without paper or pencil—multiplying, proportions, division, extracting roots, etc. Accurate, white composition face. Has Standard A, B, C, D, CI, and K scales.

Made in U.S.A. **50¢**

Equipped with both magnifying and standard indicator. For complete outfit, including slide rule, 32-page illustrated instruction book, carrying case, send 50c in coins or U. S. stamps (60c in Canada). Mailed postpaid. Satisfaction guaranteed or money refunded. (Schools and dealers; write for quantity price.) Send today for this great slide rule value.

**LAWRENCE ENGINEERING SERVICE, 17 Smith St., PERU, INDIANA**

**NOV!** *World's Smallest*

**Real RADIO**

BEAUTIFUL — PLASTIC — CABINETS

Midget radio fits your pocket or purse. Weighs only 4 ozs. Small as cigarette pack! Receives stations with clear natural tone. "PATENTED FIXED CRYSTAL"—NO UPKEEP—only one moving part. "WIRELESS, TUBELESS, BATTERYLESS." ENTIRELY NEW PATENTED DESIGN. Has enclosed geared luminous dial for perfect tuning. Many owners report amazing reception and distance.

**ONE YEAR GUARANTEE**

Sent completely ready to listen with instructions for use in homes, offices, hotels, hosts, in bed, etc. **TAKES ONLY A SECOND TO CONNECT—NO ELECTRICITY NEEDED!** SEND NO MONEY! Pay postman only \$2.99 plus postage on arrival or send \$2.99 (Check, M.O., Cash) and yours will be sent complete postpaid. A most unusual value. ORDER NOW! MIDGET RADIO CO., Dept. P-9, Kearney, Nebr.

**SPORS** *BOOK OF BARGAINS*

**FREE**

**WHOLESALE CATALOG OF 4000 BARGAINS**

FOR SALESMEN—DISTRIBUTORS

It has 260 pages, chock-full of unusual values. It contains selling plans; order stimulators; tested fast selling articles to dealers, stores and direct to the consumer. A new revised issue is just off the press. Cost about 25c. FREE, while stock lasts. Send for your copy, Today.

**SPORS CO. 7-39 Elm St., Le Center, Minn.**

**CAMERA BOOK FREE!**

Illustrates latest methods in Photography and Home Movie Making, for fun and profits. Offers hundreds of amazing money-saving bargains in still and movie Cameras, Lenses, Films, etc. Used equipment accepted in trade. Satisfaction guaranteed or money back with 30-day trial privilege. WRITE FOR FREE BARGAIN EGG!

**CENTRAL CAMERA CO., 230 S. Wabash, Dept. 136, Chicago, U.S.A.**

## BUILD YOUR OWN MOTOR-SCOOTER

You can build this beautiful, heavy duty—motorized scooter easily. Kits quickly assembled by anyone. All parts furnished. Costs no more than a good bicycle. \$29.50 less motor. \$59.50 with motor. Write now for complete facts and literature.

**RENMOR MFG. CO., Dept. P, 2540 So. Wabash Ave., Chicago, Ill.**

## Speedo PRINT DRYER

Dries photographic prints in 15 minutes. Prevents warping or curling. Accommodates five 11" x 14" prints and one 11" x 14" glossy, or over 400 contact 1" x 1 1/2" prints—in one drying. Electrically operated. Pat. Pend. Priced \$14.85. Write for free particulars.

**GENERAL DEVICES CORP.**  
1325 Lookout Circle, Dept. 35, Cincinnati, Ohio

**FREE** 48-page book. Pictures. Useful hints on buying, using, saws, tools, files.

**Henry Disston & Sons, Inc., 911 Tacony, Phila.**

## BUILD YOUR GRANDFATHER CLOCK

The Simple Sensible Red-i-Kut way as thousands have. DIME brings PLANS and sixty pictures "HOW" Book pricing many fine brass weight Westminster, tube chime, electric and battery movements showing nine beautiful colonial grandfather cases. WHY WAIT LONGER?

**KUEMPEL CHIME CLOCK CO., Bldg. 32, Guttenberg, Iowa.**

**AT LAST!** All Your Snapshots in Natural Colors! AMAZINGLY BEAUTIFUL!

Any size roll developed and 8 prints **25c** Natural Color Reprints **3c** each.

**Natural Color Photo Service, Dept. C-54, Janesville, Wis.**

**CATCH FISH!**

minnows, eels, minn, muskrat, with our folding galvanized Steel Wire Traps. Walton's Automatic Hooks are so constructed that when a fish gives the slightest pull on the bait the upper hook reaches down and gets a hold that lands him. 3 for 50c. Write for descriptive catalog of Traps, Hooks, Lures, and other specialties. **Walton Supply Co., 3507 Junata Ave., St. Louis, Mo.**

**Earn Cash at Home!**

We paid M. M. \$1174 for exceptional cellar crop Snow-King mushrooms! We furnish materials; buy all crops. Big FREE picture book tells if your cellar, shed, barn, suitable. Est. 1908. Write today. **United Co., 3848 Lincoln Av., Dept. 305, Chicago**

## BUILD ELECTRIC FENCE FROM OLD AUTO COIL

Costs nothing to build—Dime brings complete Plans (formerly 35c) and Big NEW catalog listing over 550 electrical items at new low money saving prices. Send 10c to

**LEJAY MFG., 1947 LeJay Bldg., Minneapolis, Minn.**

## BUILD THESE PROJECTS

For garden or lawn. Easy to build. Easy to sell. Detailed Blueprints Model B-25 Dutch Windmill 50c; Model OM-60 Old Mill. 85c. Lawn Figure Patterns—Sunbonnet Girl, Dutch Boy, Tulip Girl, Holland Pair 35c each all 4—\$1.00. Catalog illustrating many models, send 10c, today.

**CRAFTSMAN'S MODEL CO., Dept. P-33, 2030 N. 41st St., Milwaukee, Wis.**

## FREE TRAILER PARTS CATALOG

We'll save you money on—axes, springs, wheels, couplers, windows, sinks, water pumps, brakes, refrigerators, beds, lamps, inside and out, 6V lamps, furniture, jacks—everything. Special discount to mfrs. **NATIONAL TRAILER EQUIPMENT CO., Successors to Kar-A-Van Industries, Inc. Dept. P, 714 W. Wisconsin Ave., Milwaukee, Wis.**

## SECRETS THAT MAKE MONEY

1059 Money Making Formulas in Book Form. While Supply Lasts, \$1.25

Start a spare-time or full-time business of your own making products that sell. A good formula has made fortunes for others—may bring fame and fortune to you. Get this big 200-page book—tells what to make—how to make it—where to get materials. Nothing as like it. Order Money Making Formulas today. Postpaid Only \$1.25.

**Popular Mechanics Press, Dept. 939, 200 E. Ontario St., Chicago**

## Earn \$150 to \$300 Monthly with "Simplified" Arc Welding

**30 Days Trial**

Try this new "Simplified" Welder on your own work, in your own shop for 30 days at our risk. It pays for itself.

**BUILD A PROFITABLE BUSINESS** of your own with new 40-Volt Arc Welding. Get big pay jobs that mean real profit. Hobart welders are easier to operate, faster, do a better welding job.

**NO INVESTMENT TERMS**—profits pay for it. Savings make it easy to own a Hobart Welder without expense.

**PAYS FOR ITSELF** in short time. Profit on single job often pays small monthly payments. Write for details.

**HOBART BROS. CO., Box M-99, Troy, O.**

**SAVE \$300 to \$500** "Build Your Own" Portable arc welder using complete Hobart generator and coupling to old motor and chassis.

**FREE** Welding Book. Write for it today.



9. 349  
**Taking America's Picture**

(Continued from page 373)

their particular adeptness. While a transport pilot, traveling between two cities may not fly a perfectly straight line, he will arrive at his destination without material loss to his company. On the other hand a swing off line by a photographic pilot could prove very costly.

Photographing a section of country to become a part of America's picture means taking a series of exposures which, when indexed, look somewhat like a well-shingled roof. As the pilot keeps his ship accurately on a strip course some twenty miles in length, the cameraman takes his pictures so that they overlap each other approximately sixty per cent. Equipped with his detailed map and excellent visibility the pilot guides himself by land marks. In addition to flying the line as plotted on the flight map the pilot must maintain an even altitude, as a difference in scale exceeding five per cent may be cause for rejection of his pictures. The same holds true where the photographer is concerned. The camera must be perfectly level at the instant of exposure, as may be determined by the bubble gauge, otherwise such exposures as are tilted may also be rejected.

After the ship has flown its twenty-mile tightrope, it parallels its flight in the opposite direction. Here again there is a side overlap between strips. "The government specifies that this overlap must not be less than fifteen per cent nor more than forty-five per cent," says Mr. Meyer. "Our pilots try to hold this to an average of thirty per cent."

From each exposure there will be a net gain in coverage of approximately two-and-one-fourth square miles, the remainder being duplicated in the overlap of adjacent prints. The aerial photographer keeps a careful "dope sheet" of his work so that on receipt of the film at the laboratory the flight report may be checked for exposure and filter used, in order to give it the correct development.

After development, the film is carefully checked, numbered and contact prints made in order to check for coverage and scale and then photographic index maps are made, showing the location of the in-

(Continued to page 136A)

**KILL RATS WITHOUT POISON**

**YOUR MONEY BACK IF RATS DON'T DIE**



K-R-O won't kill Livestock, Pets or Poultry. Gets Rats Every Time. K-R-O is made from Red Squill, a raticide recommended by U.S. Dept. Agr. (Bul. 1533). Ready-Mixed, for homes, 35¢ and \$1.00; Powder, for farms, 75¢. All Drug and Seed Stores. Damage each rat does costs you \$200 a year. K-R-O Co., Springfield, O.

**K-R-O KILLS RATS ONLY**

**MAKE MONEY**



**WITH NASH CUSTOM TAILORED CLOTHES**

Be your own Sales Manager, take orders; earn money with this famous make of clothes. High quality men's tailoring at prices \$23.50 up. New Fall line just out. Write today. Territories open.

**THE A. NASH COMPANY**  
1712 ELM STREET CINCINNATI, OHIO



**A AND N SUPPLY CO.**

Bargains—Military, Sport Goods, Firearms, Clothes, Shoes, etc. Send 10¢ for new catalog, to be redeemed on first order.

EST. 1868 A & N Supply Co., 4772 Lester St., Richmond, Va.



**CUSHION THE ENTIRE FOOT**

**AIR CONDITIONED KUSHIONTRED SHOES!**

**EARN BIG COMMISSIONS AND YOUR OWN SHOES FREE AS BONUS WITHOUT EXTRA COST**

Steady income all year showing outstanding new Fall line—Men's, Women's, Children's Shoes. 200 styles, including wonderful Cushion Sole shoes and amazing Groffers shoes that need no breaking in! \$10,000 bond guarantees satisfaction. Free shirts, ties, hosiery offered to customers. We pay postage. No experience needed. Cash of actual shoe samples without cost. Write TODAY for full information, money-making plan and FREE Selling Kit.

**TANNERS SHOE CO., 430 BOSTON, MASS.**

**WRITE FOR FREE OUTFIT**

**ASSEMBLE THIS HIGH GRADE ELECTRIC RAZOR AT HOME**

**\$1.75 EA.**

\$1.50 ea. in Lots of 3

**Earn Big Money!**

**BUY ALL PARTS READY FOR INSTANT ASSEMBLY—**

**Highgrade Universal AC-DC Motors New Improved Close-Shave Head**

NO TOOLS NEEDED—Make \$5 or more on every razor you sell. All matched unit parts from regular production line. Motor, field coils and cord come already assembled. No soldering equipment needed. A few minutes of your spare time can start you in a profitable business of your own making a regular standard super quality electric razor—just like the ones selling in the higher-priced brackets (up to \$15.00). Order your first Kit from this AD or write for information.

*We Supply Manufacturers all over the world.*

**SIMMONS MFG. CO., 128 W. North Ave., Chicago, Ill.**



220 Volt — 25¢ Extra

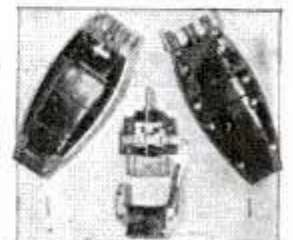

Send C. O. D. 1 sample razor kit for which I will pay postman \$1.75 plus a few cents postage.

Name .....

Address .....



# WELDING ELECTRODES

## INTRODUCTORY Big PACKAGE

Includes 60 PIECES, 1/16", 3/32" and 1/8" diameter of the Famous AGILE, AC General Purpose ELECTRODES. For iron, steel, sheet metal, ornamental iron, auto bodies, fenders and bumpers, truck bodies, tanks, farm machinery, hobby work and all light welding. Heavily coated, easy flowing, have good penetration and make EXTREMELY SMOOTH, EVEN SEAMS. WORK FAST on flat, vertical and overhead welding. For both AC and DC machines. Use less voltage, free from objectionable fumes and odors. BIG PACKAGE of 60 ELECTRODES, including Complete Catalog with HANDY AMPERAGE GUIDE, sent promptly, postpaid anywhere in U. S. or territories. Send cash, money order or check.



AMERICAN AGILE CORP., 5804 Hough Ave., Cleveland, Ohio

## NEW KIND OF MAN'S SHOE

The new sensation in men's shoes — The Chippewa Clipper. It zips on and off in a "jiffy". Right now is the right time to get into a dignified and highly profitable shoe business of your own with this fast seller, and a complete line of almost 250 styles of dress, work and sports shoes. Prices as low as \$1.98 a pair. Free 10-second demonstrator sells super-comfort air-cushion shoes like magic.

Manufacturer established 35 years wants salesmen. No experience needed. Write for complete sales kit. It's free!

MASON SHOE MANUFACTURING CO.  
Deot. E-5, Chippewa Falls, Wis.

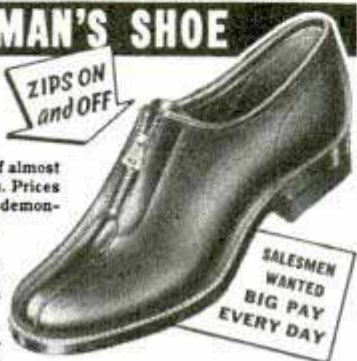

## WHY WEAR DIAMONDS?



When Diamond-Dazzling Zircons (Matura Diamonds) from the Mines of far-away, Mystic Siam are so effective and inexpensive. Stand acid; cut glass; true backs; fiery beauty; exquisite mountings. Write for catalogue. Address:

THE ZIRCON COMPANY

Dept. 122 Wheeling, W. Va.

## AUTOMATIC TYPELESS PRINTER

Amazing new Print-O-Press Stencil Dupli-cator. Automatic feeding. Automatic inking. Full 8 1/4 x 14 legal size. Other models also, at world's lowest prices. Details free, also free samples of work done. User-Agents write.

Professional Products  
Dept. 910, Silverton, O.

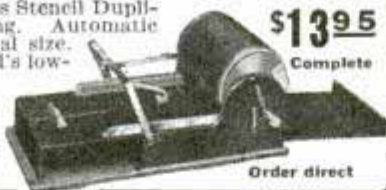

\$139.5

Complete

Order direct

VENETIAN BLINDS Make your own at low wholesale cost. It's easy under our unique plan. All materials supplied. Send 10c coin for samples of ladder tape, cord and slat, 15 color samples of tape and color chart.

VENETIAN BLIND MFG. & SUPPLY CO.

Dept. 2B, 1760 Lunt Ave., Chicago, Ill.

## PUSH-A-BIKE IS TOPS

"Fun to Own and Ride Push-A-Bike" 100 miles of travel adventure for ten cents. Also ideal for messenger & delivery service. Powerful motor drives 200 pound man over 20 MPH. Attach to any type bicycle in three minutes. See your dealer, or Write: RICHBURN COMPANY, Dept. Dm, Aurora, Mo.

## MONEY for MEN ALL FREE

THE PLASTEX Industry needs manufacturers on small scale and for big production of Lamp and Clock Stands, Art Goods and Novelties in Plastex and Marble imitation. Experience unnecessary. 1/2c material makes regular 10c store sellers. Rubber moulds furnished for speed production. Small investment brings big returns. BIG CHAIN STORE orders now being placed. Ambitious men have chance for real prosperity. Our FREE booklet will interest and benefit you. PLASTEX INDUSTRIES, Dept. P, 1085 Washington Ave., New York, N. Y.

(Continued from page 135A)

dividual exposures. Upon completion of a particular unit the material called for in the contract is made up and shipped to Washington where these photographs not only become sections of the eventual picture of the United States but accurate pictorial maps ready for use by many governmental departments.

Already sections of America's picture are being put to many uses. In the north woods for example, where large timber areas have been mapped, logging operations have been planned from the photographs and in addition it has been possible to differentiate between certain types of timber. In the farm areas, these sections of our country's portrait are being put to extensive use by the AAA to determine crop control and the amount of acreage which each farmer should plant if he agrees to meet the AAA specifications.

Undoubtedly by the time that America has finished posing for its picture, scientists and industry will find it necessary to extend that picture considerably beyond our borders. Already sections of North, Central and South America have been mapped from the air, revealing many interesting topographical features to road builders who have been encouraged to envision a practical three-continent highway stretching from the Argentine to Alaska.

## Anchor Nut Holds Joint Tight by Locking Bolt in Place

For tight joints, a bolt sunk into the two members can be locked in place by an anchor nut imbedded in the second member. The bolt has a conical pilot point and a leader which will not harm the nut threads, but forces the nut to aline itself with the bolt before the threads contact. The nut is cylindrical.

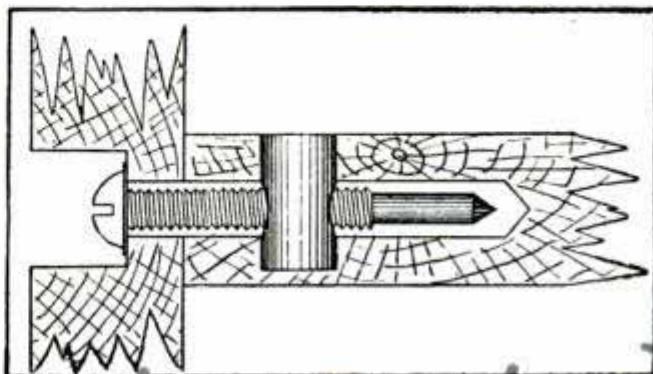

Anchor-Clamp, Dex 242, Cordeil



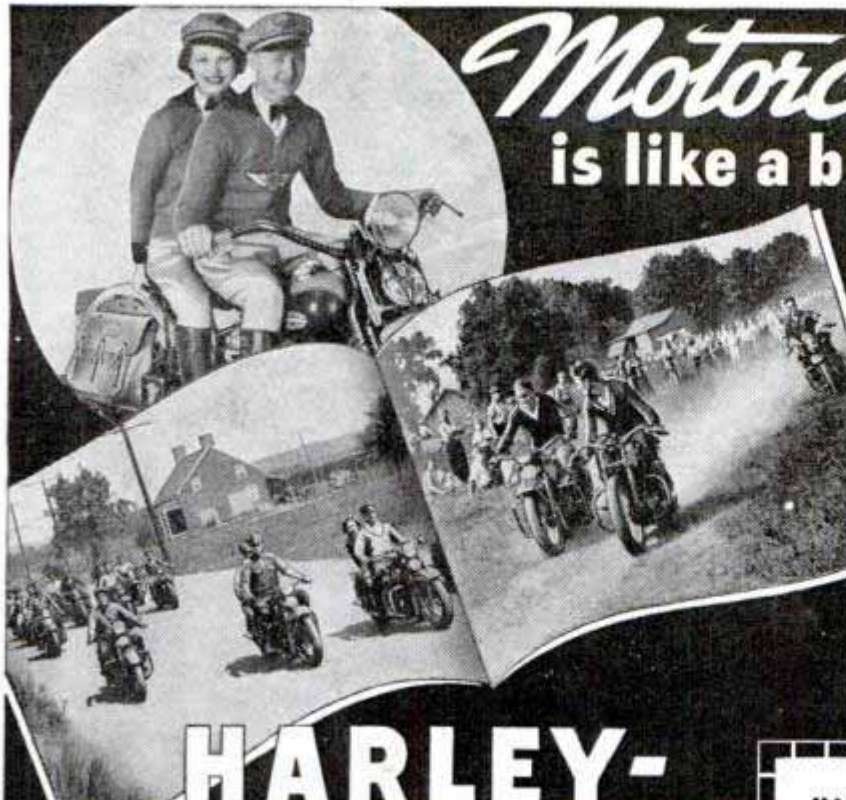

# Motorcycling.. is like a book of adventure!

**YOU** turn over a new page of thrills every day when you ride a Harley-Davidson. Swing into the saddle — go where there's plenty of fun and excitement. Make new friends — join other thrill-loving riders at hillclimbs, tourist trophy races, club runs, gypsy tours. Go to your Harley-Davidson dealer — get the complete story of motorcycling, the world's greatest outdoor sport — and ask about his Easy Pay Plans . . . **SEND THE COUPON IN NOW!**

**HARLEY-DAVIDSON MOTOR CO.**  
Dept. P Milwaukee, Wis.



## HARLEY-DAVIDSON

WORLD'S *Champion* MOTORCYCLE

Harley-Davidson Holds 200-Mile National Road Race Championship won at Daytona Beach, Fla., for second consecutive time. Eight of first ten places went to Harley-Davidson.

**HARLEY-DAVIDSON MOTOR CO.**  
Dept. P, Milwaukee, Wisconsin

Send illustrated literature and FREE copy of "ENTHUSIAST," Motorcycling Magazine. Stamp is enclosed for mailing cost.

Name.....

Address.....

**Earn MONEY** Make Color-glazed Concrete Products  
MAKE color-glazed concrete pottery, tiles, walls. New, low cost, patent method. No molds. Use only sand, cement, cheap materials. Money-making business. Booklet, cost data, details 10c.  
**NATIONAL POTTERIES COMPANY**  
Room 6, 13 W. 26th St., Minneapolis, Minn.

**NEW JUNIOR DRILL** 1/4-inch  
**\$19.95** **BLACK & DECKER**  
609 Penna. Ave., Towson, Maryland  
Write for Details

**CAPTURE THE COLOR OF LIFE!**  
**YOUR OWN MOVIES! ONLY 10c A DAY!**  
NATIONALLY ADVERTISED 8MM and 16MM Movie cameras, projectors. For home, business, church, school, club. **MONEY BACK 10 DAY TRIAL.** Payments as low as 10c A DAY. Satisfied customers throughout the world. **FREE** details. **WRITE TODAY.**  
Don Elder's Home Movies, Dept. A-9, 739 Baylston St., Boston, Mass.

**ACT NOW! SAVE MORE THAN 20%** on genuine factory-new Royal Portable Typewriters. Limited time only. For complete information—prices, models, terms, free home trial, etc., write at once to Royal Typewriter Company, Inc., Dept. D-161, 2 Park Avenue, New York.

**GRANDFATHER'S CLOCK, LOWER PRICED**  
Our newest offering, at an unheard of price for a faithful reproduction of a real Grandfather's Clock. Scroll top, narrow waist, like picture. Shipped Knock Down. Cleverly designed. Easy to assemble. Others even cheaper. Plans 10c, Catalogue **FREE.**  
**AMERICAN CHIME CLOCK CO.**  
1673 Ruffner St. (Established 1877) Philadelphia, Pa.

Always write your name and full address clearly when answering advertisements.

**BIG MONEY** Assembling **NEW MEAD KI-YAK** at Home!  
**\$6 Paddle or OARS GIVEN** With Your Ki-Yak —if you hurry  
**MEAD GLIDERS, 15 S. Market, Dept. B-99, Chicago**  
MEAD'S complete cut-to-fit KI-YAK Kit easily assembled for pleasure or profit! Can't sink. Portable. Seaworthy . . . Light . . . Fast. Highest quality. Low cost. 3 models 20 lbs. to 45 open a new world of sport for you both in sailing, paddling. Also 2 portable Outboard Models. Rush 10c for illustrated folder. \$6 Paddle now given with "CK" Ki-Yak—if you hurry!

**LOOK Here!** **Match Books** **PRINTED NOW!** **ACT NOW!** You'll Be More Than Pleased  
100 \$1.00 BOOKS **QUICK SERVICE**  
Sanderson Match Co., Ottawa, Ill.

**STEAM ENGINES for small boat models**  
Model SE-3, a two-cylinder slide valve engine is illustrated here. Bore 5/16", Stroke 1/2"  
Length 7", Width 3", Height 4"  
Price complete ready to run with boiler, safety valve, alcohol burner and propeller . . . . . \$3.00  
Postage extra, shipping wt. 1 1/4 lb.  
**Shawnee Engine Co., Box 162, Station D, Cincinnati, Ohio**

**NEW "SIMPLIFIED" ARC WELDING** Earns \$150 to \$300 EXTRA PROFIT Monthly  
30 DAYS TRIAL to prove it!  
Use Hobart welder for 30 days on your own work, at our risk. See for yourself the many profitable jobs it can do before you buy. Write today for complete details on 30 Days Trial and Easy Terms.  
**HOBART BROS. CO., Box M-991, Troy, O.**  
HUNDREDS HAVE BUILT THEIR OWN PORTABLE ARC WELDER AND SAVED \$300 to \$500 YOU CAN DO IT TOO!



2598

# HEAT for 1 1/2¢ per hour or COSTS NOTHING TO TRY



AMAZING new Radiant Heater. Makes its own gas. No piping, no installation. A few pints of cheap liquid transforms ordinary air into many hours of clean, healthful, penetrating heat like sunshine, for 1 1/2 cents an hour. Hotter than gas or electricity, at one-tenth the cost. EASY TO OPERATE. No smoke, no soot, ashes, or odor. Portable!

## 30 DAYS' TRIAL!

Write at once for special introductory low price offer. TRY IT AT OUR RISK. Prove to yourself that you

**AGENTS**  
Make Big Money!  
Write quick for Territory and Outfit Offer.

**BURNS 96% AIR  
only 4% FUEL**

can have Radiant heat at 1 1/2¢ an hour. No obligation. Send now.  
**AKRON LAMP & MFG. CO., 1199 High Street, AKRON, OHIO**

# 100 TOOLS in ONE

SAVE TIME - CUT COSTS - DO BETTER WORK

Don't confuse the genuine Dremel Moto-Tool, popular in industry, with weak, low-speed tools built to sell cheap. 110 volt AC-DC motor is packed with power. Speed—over 25,000 r.p.m. Weight—only 6 oz. Bearings—oil-less (oil sealed). Cooling—internal fan. Model 1—with chuck, 1/2" collet, only \$9.85 postpaid. Master Model 2—faster, heavier, more powerful, with chuck, only \$14.50.

**GRINDS  
POLISHES  
SHARPENS  
DRILLS  
ENGRAVES  
ROUTS  
Etc., Etc.**

10-DAY TRIAL. See the genuine Dremel Moto-Tools at better Dealer's or order direct from factory on 10 day money back trial. Catalog of Dremel tools, equipment and special combination offers, FREE.

**Only \$9.85 POST PAID MASTER MODEL \$16.50**

Dremel Mfg. Co., Dept. 119-J, Racine, Wis.

# GET UP TO 6 MILES MORE PER GAL.

OPERATES ON AMAZING NEW PRINCIPLE!

The GAS MASTER economizer is a new discovery and entirely different! It automatically injects air thru vacuum line into carburetor—produces a perfect firing mixture. Installed in one minute! Gives your car new pep, faster acceleration and more mileage.

**MONEY BACK GUARANTEE:** The Gas Master has proven so successful that we guarantee your money back if it does not save gas and running expenses. Price \$1.75 Postpaid.

**FREE to all AGENTS** For introducing the GAS MASTER we give all agents a special free offer! Because of its sensational performance and low attractive price—our agents report unusual success and big profits! Write us.

Pat. No. 2124228

**G & M MFG. Industries, Dept. W, 2161 N. Farwell, Milwaukee, Wis.**

# SHAW GARDEN and ALL-PURPOSE TRACTOR

Low "FACTORY-TO-FARM" Prices. 2 to 8 Horsepower Models. Walking and Riding Types. WRITE for 10 DAY TRIAL PLAN and BIG FREE CATALOG.

**SHAW MFG. CO., 4509 Front St., Galesburg, Kans. 5812G Magnolia Ave., Chicago, Ill.; 130G W. 42nd St., New York; 568G North 4th Street, Columbus, Ohio**

# CHRIST'S SELL BIBLICAL SIGNS

For quick sales, Big Profits, offer Sparklite triple-plated tinsel mottoes to homes, churches, hotels. Cost 5c (in 100 lots); sell at 25c. UP TO 400% PROFIT! 2 SAMPLES—10c; Mail us a dime for 2 samples, 2-way "talking" Order Blank, Sales Bulletin, 3 Success Plans. SPARKLITE, 7503 S. Exchange Ave., Dept. 805, Chicago

# WoodWORKERS Here it is!

HAROLD HUNT'S latest edition 1939 catalog. Nothing like it ever before published—136 pages—new designs, new ideas for experts; also special instructions for beginners, AND—LISTS OF ASTONISHING BARGAINS in all kinds of wood-workers' supplies. Get this book! ONLY 10c!

**CRAFTSMAN WOOD SERVICE CO.**  
2729 S. Mary Street Div. 3376 Chicago, Ill.

## Deathtrap Dramas of the Tar Pits

(Continued from page 389)

one of the strangest jobs of sculpturing the world has ever seen. Small clay models were made and then life-sized models from which huge molds were constructed. Into these molds concrete was poured, reinforced by steel rods. Finally the strange white ghosts of prehistoric monsters were transported to the meadows, each group



Sabertooth tiger in concrete stands on spot from which the real beast slipped into the pits

being placed beside the pit from which the skeletons of the beasts reproduced in concrete were recovered. In certain cases the skeletons were found mingled in such a way as to indicate the titanic struggles which had been going on between the monsters at the moment when the tar claimed victor and vanquished alike.

Groups representing such prehistoric battles were placed beside the spot where the struggle ended in black death. Seen now in the moonlight they seem like white ghosts come to finish the feud they began 500,000 years ago.

A good deal of first-rate detective work was necessary before accurate reproductions of the old dramas could be made.



2598  
One of the major problems in reconstructing the prehistoric scenes was whether the animals had been lured to the pits to drink rain water which collected above the tar. As the region is now extremely dry, this explanation looked good. But one of the museum detectives found a new set of clues. To the average person they would appear to be simply imprints of prehistoric leaves. But to the scientific detective they were the clues which upset the water-hole idea, for they represented a type of plants which grow in a wetter climate than that which prevails in the Los Angeles area today. And with more rain, the animals would tend to drink from streams rather than risk the danger of gathering at water holes.

Further research indicated that the animals were trapped in "living death chains" which started when a single animal was accidentally caught. As soon as this occurred, other animals came to make a free meal of their luckless fellow. They too were caught by the tar, and so the chain was carried on.

So with patience and detective work, scientists and artists have brought to life the dramas of the long ago. In the Los Angeles Museum a giant mural adds color and landscape reality to the scenes now captured in concrete.

But it is in the strange outdoor museum that you feel the real significance of these re-creations of a vanished era. The scene is the same—the tar bubbling exactly as it did then and the concrete figures of the gigantic beasts poised on the exact spot where they once fought. You feel in all reality that time has been run backward for 500 milleniums. In that mood you think of the one unsolved mystery of the pits—of the single human skull found among the prehistoric bones. Of course, it probably belonged to an Indian who was trapped in recent times, and his skeleton sucked to the depths by some movement of the tar. But the scientists wonder whether the beasts lingered in this region long after science thinks they were extinct, or whether that skull dates back much farther than is believed.

☞ Inquiries as to makers of articles described in Popular Mechanics, will be answered by our Bureau of Information upon receipt of return postage.

# 10¢ A DAY

## Buys Sensational NEW

# Movie

## OUTFIT!



### 30-DAY TRIAL

Think of it! Everything you need to take and show glorious, theatre-quality movies! Yours for only 10c a day! The sensational new UniveX Cine "8" gives you the simplicity of operation, the dependable performance, the thrilling, life-like results you'd expect only from cameras costing many times its price.

#### WRITTEN GUARANTEE

If UniveX does not live up to your highest expectations, you can return it and we will refund your money without question or argument. One-year written guarantee bond protects you!

Compare With Any \$30

**Camera!** Notice its magnificent styling, its compact, streamlined beauty! Check its sensational features: Fast Univar precision f 5.6 lens (interchangeable)! Optical viewfinder! Built-in exposure table! Automatic footage indicator! Powerful, quiet, spring motor—and many others! It's easy to load, easy to operate!

**ACT NOW!** Start enjoying NOW the thrills that come with owning fine movie equipment. Doubly enjoyable when you can buy it for  $\frac{1}{2}$  the price of other outfits; and on the easy, Modern 10c a day plan. Take all the movies you want for 30 days, and if this sensational UniveX outfit does not live up to your highest expectations, you can return it.

TAKE AND SHOW MOVIES

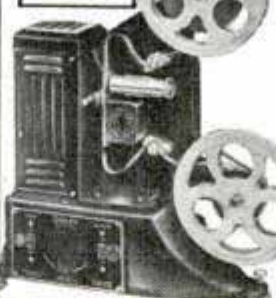

**Only 8 mm. Projector for Less Than \$26!** Takes all 8 mm. film including professionally-made movies! 15 minutes continuous projection capacity; 15 other important features. Backed by written guarantee...\$14.95

**MAIL TODAY FOR DETAILS 10¢ A DAY PLAN!**

Modern Camera Exchange, Inc.  
175 Fifth Ave., Dept. M-7, N. Y. C.

NOT AN ORDER!

Please send me FREE literature describing UniveX movie outfit and details of liberal 10c-a-day plan.

Name \_\_\_\_\_  
Address \_\_\_\_\_  
City \_\_\_\_\_ State \_\_\_\_\_



#### BUILD YOUR OWN FAN

Highly polished aluminum propellers for  $\frac{1}{2}$  inch shafts.

PRICES ON 2 BLADED	
15 inches.....	\$3.00
18 inches.....	\$3.25
20 inches.....	\$3.50
24 inches.....	4.00
PRICES ON 3 BLADED	
15 inches.....	\$3.50
18 inches.....	3.75
20 inches.....	\$4.00
24 inches.....	4.50

Money Order or C. O. D.—10% Discount on Three or More  
KLOPPENBORG FOUNDRY, Dept. B3, Davenport, Iowa



25-77

# CUT IT OUT



## WITH A SYNCRO SAW

For model builders, cabinet workers, sign makers. No motor to buy. Cut fast, smooth and accurately. Plugs into light socket. 3 sizes 16", 13½", 8" throat clearance.

**\$12.50      \$9.95      \$4.95**

At all good dealers . . . Send for free catalog A

**SYNCRO DEVICES INC. 747 BEAUBIEN ST. DETROIT**

**ACE**  
LATHE TOOL SET  
**\$14.50**

Be permanently tooled-up for every operation on your Metal Cutting Lathe

The ACE Set is complete—there's nothing more to buy. Drop forged by the manufacturer of cutting tools used by 90 per cent of the plants and shops in industry they are correctly designed, are of special steel, are finely finished, are stronger—will last a lifetime. You can cut easier, faster and more accurately with ACE TOOLS.

At your Hardware Store—Circular FREE.  
**ARMSTRONG BROS. TOOL CO.**  
"The Tool Holder People"  
368 N. Francisco Ave., CHICAGO, U.S.A.

- 3 Turning Tools, 3 Cutting Tools, Knifing Tool, Boring Tool, Threading Tool, High Speed Steel Cutters and Blades, and 2 Wrenches in Fitted Steel Case.

**PHOTO ENLARGEMENTS**

Is Photography your hobby? Do you want a profitable easy business at home? Make **PHOTO ENLARGEMENTS** for yourself and others. Your cost 5c each and less. The Ideal Photo Enlarger is **AUTOMATIC**. No experience required. Also **COPIES** any picture. **\$5.94 COMPLETE**. Interesting circular **FREE**.

**5¢ ANY SIZE**

IDEAL ENLARGER, 148 West 23rd St., New York City

**TRAILER PARTS**

Largest, most complete stock of trailer parts and equipment in America. Lowest prices, quick delivery. Marvel is the pioneer in trailer accessories with a reputation for highest quality products, refrigerators, stoves, etc. Send 10c in coin for 40 page illustrated catalog.

**MARVEL TRAILER PARTS CO.**  
19020 Celestine Ave. Detroit, Mich.

**New ELECTRIC SANDER SAVES TIME**

New Electric **GUILDSANDER** saves hours of time and labor. Gives factory finish on every job. Works on many different materials and shapes. Light, portable. Works from any light socket. Popular price. See your dealer or write for **FREE** illustrated folder.

**SYRACUSE GUILD TOOL CO., 1700-9C No. SALINA ST. SYRACUSE, N. Y.**

**ELECTRICITY ANYWHERE**

**ONAN ELECTRIC PLANTS** furnish 110 Volt, 60 Cycle, A. C. Current same as City Power Lines for Farms, Camps, Construction Jobs and Emergency Service in Hospitals, Schools, Theatres, Public Buildings. **SAVE PROPERTY**, even **LIVES** in case of Power Line Failure. Thousands in use in all parts of the World. Operate Lights, Radios, Water Systems, all Appliances. Models 350 to 50,000 Watts, 12, 32 and 110 Volt D. C.—110 or 220 Volt A. C. Also Combination A. C.-D. C. Units. Manual, Full-Automatic and Self-Starting Types. Shipped **COMPLETE—READY TO RUN**, \$99 and up. Write for details.

**D. W. ONAN & SONS**  
1037 Royalston Ave. Minneapolis, Minn.

## Riches of the Forgotten Mines

(Continued from page 367)

ground and tunnels cave in. Ore dumps slide away in the rain and brush hides old footpaths.

Forty years ago a shepherdder found a rich outcrop of silver ore near the Minarets in the Sierra Nevada range and worked it for years, taking out a small fortune. No one bothered to follow him to his mine and he never described its exact location. Years after he died the rising price of silver prompted prospectors to hunt for his old tunnels but although the area has been combed time after time no trace of his mine has been found. A winter avalanche probably covered the works.

On the other hand, last fall a fisherman in the Mother Lode country stumbled across the dumps of an ancient mine and found high-grade silver ore in the diggings. Near by were the ruins of a good-sized settlement that no one remembered. Apparently the mine and village were abandoned in 1873 when silver was demonetized. Today the fisherman and his partners are taking out ore worth ninety-eight dollars to the ton.

Another way to find some of the forgotten mines is to search the early records at the county courthouses in the mineral country. Thousands of claims have been recorded although relatively few were ever thoroughly prospected. Such claims, now abandoned, are investigated by smart prospectors who are able to follow the descriptions and relocate the ledges.

The outstanding example of prospecting in books is the case of the engineer who discovered a mine 5,000 miles away while in a Brooklyn library. His hobby was collecting data on mines worked in Biblical times. In one musty book the engineer found references to a copper deposit on the island of Cyprus that had been worked by the Romans. The present generation knew nothing of the ancient mine and the engineer journeyed to the island, drilled exploratory holes, and finally re-discovered the deposit. It is being worked today.

One of the strangest instances of a lost mine is the true story of the "Lost Leaser," a rich mine in the Rocky Mountains. Years ago leasers got \$18,000 for their share of the ore they extracted in a few months and they had hardly begun to scratch the de-

No further details available



posit. Yet no one can find the rest of the gold. One man alone can reveal at what point in the tunnel the deposit exists and he won't tell.

The original owner had dug a long tunnel into the hill without finding ore. Later, a miner leased the property on a share-and-share-alike basis. On a hunch, he drove a cross-cut from one point in the tunnel, picked up a rich deposit and he and his partners started shipping ore that ran as high as \$600 per ton. Then the owner decided he wanted all the income instead of his share and found a loophole to cancel the lease. The leaser was so angry that before leaving the property he hid every trace of his work, carefully restoring the tunnel to its original condition. So perfect was his job that the owner has been unable to locate the cross-cut or the ore. Each man is still waiting for the other to come to terms.

In Nevada the badger is known as the prospectors' best friend because this animal often digs into soft mineralized zones and prospectors have learned to pan the tops of badger mounds on the chance that they will find free gold. Sixteen or seventeen important Nevada mines were discovered with the assistance of the burrowing animals.

Many of the boulders and chunks of rock scattered on the surface in gold-bearing regions contain good percentages of gold. One prospector has spent several years in the hills south of Death Valley gathering chunks of ore on the surface. He delivers a truckload a week to a mill 100 miles away and much of the rock runs close to three ounces of gold to the ton, enough to pay him a good living.

Mineral deposits have been found while drilling water wells. In one recent case a deep well near Superior, Ariz., brought up ore that ran sixty-two per cent copper, twelve ounces of silver, and seven dollars worth of gold to the ton. The owners quit farming and went into the mining business.

Most people would be happy if either gold or oil happened to be found on their land; many people in Lea county, Tex., own rich deposits of both minerals. Test holes revealed that valuable gold-laden sands lie a short distance below shallow oil zones, at depths that can be worked easily. The deposit is classified as one of the richest placer deposits in the southwest.

Why Waste Time  
On "Snapshots"  
TAKE MOVIES AS THEY  
DO IN HOLLYWOOD!



NEW  
**UniveX**  
MOVIE  
CAMERAS  
**\$9<sup>95</sup>**  
AND  
UP

**NEW TURRET "8" (Illustrated) With f:4.5 lens—\$25**

No longer need you envy those who take their own movies! No longer need you be content with stiff, old-fashioned snapshots! Now, you too can take thrilling movies of your friends . . . your family . . . your trips. *And at less cost than snapshots!* Even though you've never touched a movie camera before, you can get glorious, theatre-quality results. Every UniveX is accompanied by an insurance policy which guarantees "satisfactory movies or a new roll of film FREE!"

**TURRET MOUNT FEATURES:** Never before has there been a Turret-Mount movie camera at such a popular price. Turret accommodates f:4.5 lens, 2.7 or 1.9 lens and f:3.5 telephoto lens at the same time • A change from one lens to another accomplished with split-second speed • Lens swings into position surely, firmly, accurately • Special view-finder automatically swings into position with telephoto lens • Enables shooting both distant and close-up scenes with equal clarity • (Uses UniveX 69¢ movie film.)

Universal Camera Corp.  
Dept. T-3, New York City

**FREE BOOKLET**

Send illustrated booklet.

Send information on Budget Plan.

Name \_\_\_\_\_

Address \_\_\_\_\_

City \_\_\_\_\_ State \_\_\_\_\_



## IF YOU OWN A CAMERA OR WANT ONE

Packs the greatest buys in photography between two covers. Everything you need for shooting, printing and developing fine pictures. Complete line of latest type, nationally advertised cameras and equipment. Every item guaranteed. Now you can order at home with complete confidence. Save yourself time and money. Buy a better camera . . . more supplies with what you save. Don't be without this valuable Guide to the Buys in Photography another day. Tear out and mail the coupon for your **FREE** copy.

SEND FOR THIS **FREE** CAMERA CATALOG



SALES OFFICES IN  
**NEW YORK**  
 100 Sixth Avenue  
**CHICAGO**  
 301 W. Jackson Blvd.  
**ATLANTA**  
 255 Peachtree Street  
 Boston, Mass. Bronx, N. Y.  
 Newark, N. J. Jamaica, L. I.

# LAFAYETTE CAMERA CORPORATION

Rush **FREE** 1939 Camera Catalog No. 77

NAME .....

ADDRESS .....

CITY .....

LAFAYETTE CAMERA CORPORATION  
 Dept. 7JC9 - 100 Sixth Ave., New York.

PASTE COUPON ON PENNY POSTCARD

**FREE**

CAMERA CATALOG

CUT OUT AND MAIL NOW

## Write with Electricity



USE THE **ELECTROGRAF**

Writes easily on the hardest metals or alloys. Positively identifies your tools, protects against theft. Absolutely permanent. Requires few seconds only—anyone can operate. Pays for itself. A Money-Maker. Send No Money — Pay Postman \$1.98 plus postage. If M.O. or check accompanies order, we pay postage. AGENTS: Write today for our proposition.

\$1.98  
 POSTPAID

NATIONAL LABORATORIES, Portland, Ore.

## 4 Ideal HOBBIES FOR YOU!

COMPLETE MODEL KITS

RAILROADS SHIPS

AEROPLANES

CHIPSHAPES CARVING SETS

COMPLETE HOBBY CATALOG 10¢

IDEAL AEROPLANE AND SUPPLY CO., Inc.  
 26 WEST 39th STREET, NEW YORK

## BE THRIFTY... use ROGERS GLUE

...for repairing chipped and splintered furniture and woodwork...incredibly strong. Send for free blue print plans for making useful articles

ROGERS • Dept. A-1 • GLOUCESTER, MASS.

## SPARE TIME MONEY . . .

There's a big demand for the many hand-tooled articles you can make with the Enasco Leathercraft Set. Easily learn to make good money in your spare time. Complete outfit including tools, leathers, patterns, etc., and full instructions, only \$2.00—on sale at leading Department Stores or order direct and pay postman on arrival, \$2.50 outside U. S.

# LEATHERCRAFT

Free When ordering direct, clip name of your Department Store to this ad, and we will include with your set, one extra free project. Illustrated catalog 10¢.

E. A. SWEET CO. Dept. A-26 Binghamton, N. Y.

## The Future of Television

(Continued from page 325)

new type of microscope having many times the useful magnification of the best types of optical microscopes. The application of this in biological research is now being undertaken by workers in this field, and it may lead to a series of new medical discoveries in connection with heretofore invisible sources of disease.

By converting the image of a source of light into an electronic image we gain another advantage, namely, the possibility of producing an image having more energy or intensity than the original. Heretofore, the brilliancy of a light image could not be increased above that of the original source, and since all optical devices absorbed a certain amount of light, only a decrease in energy could result. But by accelerating an electron image more energy can be imparted to it than was present in the original light image. In this way the old problem of a "light amplifier" has in a sense been solved. Furthermore, since photoelectric devices are sensitive to the ultra-visible rays as well as the visible, we include in our original source of energy a much wider portion of the spectrum than can be utilized in optical devices. Applications of this to astronomy, and in other fields where weak or distant sources of radiation must be dealt with, are future possibilities.

Some of the fields in which these television devices may bring about important advances are in marine or aerial navigation, by permitting vision at night or in fogs through the use of infrared rays; in metallurgical, chemical, physical and biological research; in manufacturing processes; in national defense; for advertising or display use in department stores, in showing goods exhibited at a central point throughout the store or in show windows; for personal or business communication in transmitting visual intelligence as we now transmit the voice by telephone; in printing and copying devices; in new photographic or motion-picture devices where "light amplifications" may be used to advantage; and in any other fields where an automatic, never-failing substitute for the human eye may be useful.

I have suggested some of the more immediate possibilities in the effects upon



society of the advent of television. What of the more distant future, or derivative effect?

A decline in the population of large cities is expected by the National Resources Board to set in some time between 1945 and 1960, with people moving into "satellite" areas within the metropolitan districts. We have already observed how the introduction of the automobile spurred the development of suburbs of large cities. Now, with steadily cheaper cars, increased and improved highways, it is anticipated—and the tendency is already clearly evident—that rural communities within perhaps fifty miles of the cities will increase in population and develop in scope.

All this provides a picture of a population which may increasingly center its interest once more in the home; a population with ample leisure time, of predominately mature years, and widespread distribution, in individual small houses which they will be able to afford because of the development of low-cost home construction and increased incomes per family. With such a setting radio-television will be a vital element in the lives of these people. It will link together in mind and spirit these vast numbers of individual homes, as the high-speed automobile roads and airways will link them together physically.

### Slack Taken Out of Clothesline with Simple Tightener

When the clothesline sags under the weight of hanging clothes, it can be lifted up with little effort if you have a wooden tightener that twists the line around its two "fingers." You simply insert the line between the prongs and give the tightener one, two or three turns until the rope is taut, then use a projecting section of the handle to keep it from unwinding.

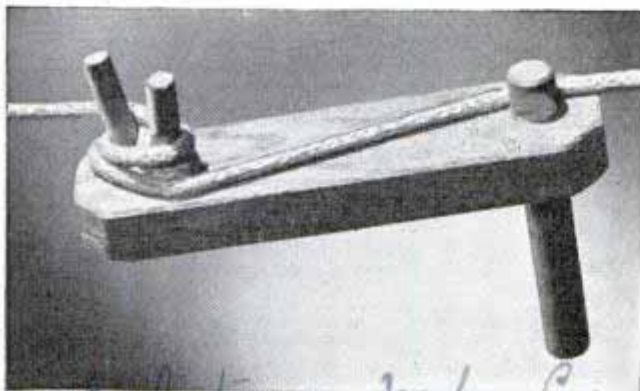

## FREES Tight Screws

In a tight spot, this Offset Screw Driver is worth its weight in gold! Gets into awkward corners, provides tremendous leverage, lets you handle difficult screws easily when as little as 1/8 turn is available. Four fine manganese steel bits, two at each end at 90° to each other and at 45° to pair at opposite end. 5 3/4" polished handles. Good for a lifetime.

**ONLY 50c AT YOUR DEALER'S OR POSTPAID**

Ask your hardware dealer, or write today, using coupon. **Tool Book Free with Offset Screw Driver.**



**Free with Screw Driver**

New book of pictures and descriptions of hundreds of fine Millers Falls tools, many new this year. 10c, or free with screw driver.

### MILLERS FALLS CO.

PM1, GREENFIELD MASS.

Enclosed is: 50c [ ] Send me Offset Screw Driver and Tool Book No. 42

10c [ ] Send me only Tool Book No. 42

Name.....

Address.....

## FOR YOUR BETTER HEARING



### Western Electric HEARING AID Ortho-technic Model

**Made by Bell Telephone makers**

The Western Electric Audiphone is based on advanced technique in hearing aid design. It should help you to hear distinctly in group conversations—at greater distances—in any position.

Your dealer will recommend the Audiphone that best meets your needs. There's a national network of service stations.

Accepted by American Medical Assn.

GRAYBAR ELECTRIC CO., Graybar Building, New York. Please send details on Western Electric Audiphone (Ortho-technic Model) and name of nearest dealer. PM-48

Name.....

Address.....

City.....

State.....



# Atlas

## NEW 1940 CATALOG

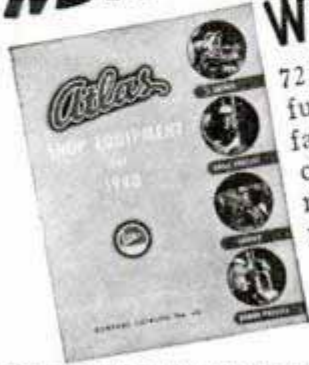

Will Soon Be Ready

72 pages crammed full of news and facts for machinery-minded men. Reserve your copy now.

**FREE**  
SEND COUPON

ATLAS PRESS CO., 943 N. Pitcher St., Kalamazoo, Mich.

Please put my name down to receive your new 1940 Catalog on  New 10" Metal Lathes  New 6" Metal Lathe  New 7" Metal Shaper  Drill Presses  Arbor Presses.

Name.....

Address.....

City and State.....

### Build this Smith Compressor



We will furnish complete instructions with a Smith Compressor Head and Accessories

With a Ford Motor and shop facilities you can easily assemble a Smith Air Compressor. You'll have a smooth performing, efficient compressor. Sixty cubic feet a minute capacity—all the power you'll need to operate rock drills and paving breakers. Here's a way to save money. Write for complete information.

**GORDON SMITH & CO., Inc.**

410 College St.

Bowling Green, Ky.



is going to town

in cutting delivery costs. Now every merchant can give prompt delivery service at a profit. 120 miles per gallon at speeds up to 35 miles per hour. Roomy delivery box—side car and trailer models also. 1½ H.P. and 2½ H.P. engines—all models equipped with clutch, brake and lights. Sport models, too.

**DEALERS**

Write for quick profit Dealer Plan

**MOTO-SCOOT MFG. CO.**  
8444 S. Chicago Ave., Chicago, U.S.A.

## Increase Your Earning Power

Apply time and labor-saving kinks to your work. Your efficiency will soon be recognized and you will be in line for advancement.

If you do machine shop work of any kind, sheet-metal work, painting, carpentry, auto repairing, farming, concrete work, plumbing, electrical work, welding, building-glass work, general repairing, tool-making, poultry raising, masonry or home repair work, get this

## LIBRARY OF 2400 TIME AND LABOR SAVING IDEAS FOR SHOPMEN AND HANDYMEN

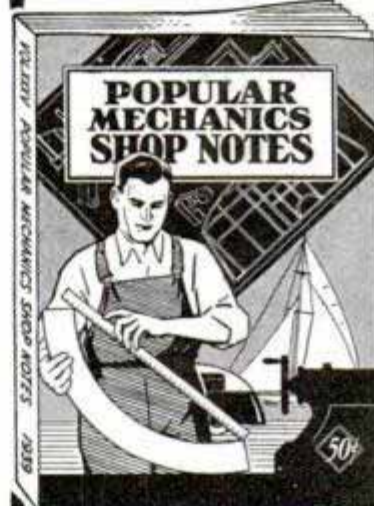

## SHOP NOTES for 1939

417 Articles  
806 Illustrations  
224 Pages  
Price 50c  
See partial list of contents below

Including the new 1939 issue illustrated above, there are six volumes in the Shop Notes Library of 2400 easily understood short cuts to every-day jobs. Here are just a few of the subjects taken from the latest issue:

- |                        |                       |                          |
|------------------------|-----------------------|--------------------------|
| Alabaster, Turning     | Grease Pit, Cover for | Printers, Hints for      |
| Auto Mechanics, Short  | Grinding              | Shaper, Homemade         |
| Cuts for               | Lathe Kinks           | Sheet Metal Work         |
| Carpentry Kinks        | Machinist's Helps     | Stainless Steel, Working |
| Drafting Room Helps    | Marble, Imitation     | Telescope Mount          |
| Electrician's Aids     | Metals, Buffing and   | Thread Cutting           |
| Electro Engraving      | Polishing             | Trailer Kinks            |
| Ferns and Garden Helps | Metals, Chemical      | Truck Driver, Helps for  |
| Finishing, Spiral      | Coloring of           | Welding                  |
| Gas Engine, Midget     | Motorist, Helps for   | Window Displays, Novel   |
| Generator, Wind-Driven | Paper Hanger's Helps  | Wood, Bending            |
| Charges Batteries      | Pattern Sanding       | Wood Lathe, Homemade     |
| Glass Blowing          | Photographic Kinks    | Wood Turning             |
|                        | Poultry Appliances    | Complete Guide to        |

Each volume contains approximately 400 articles and 600 illustrations and has 200 or more pages. This unrivaled library of shop helps may be secured for a limited time only. After the present supply of books is exhausted the offer must be withdrawn.

**\*Send No Money\***

**POPULAR MECHANICS PRESS,**  
200 E. Ontario St., Room 939, Chicago, Ill.

Send me, as per your offer, the following books. I will pay postman price and small amount of postage. My money will be refunded if I am not satisfied. (Check what you want.)

- 1939 Shop Notes and Lathe Handbook (Metal Working), both for 98c.
- Shop Notes Library (6 vols.) \$2.98.

Name.....

Street and No.....

City.....State.....

\*C. O. D. applies to U. S. and possessions only. If you reside elsewhere, remittance must accompany order.





## What does this amazing record mean to you?

*In the last 16 Indianapolis 500 Mile Races . . . 151 out of the 160 cars finishing in the money . . . including 15 winners . . . the present qualifying and race record holders . . . and 9 of the first 10 in 1939 . . . used dependable Champion Spark Plugs . . . truly an amazing record!*

When one spark plug is so consistently chosen by the racing fraternity and is conclusively outstanding in an event of such unparalleled severity on men, engines and equipment, it establishes, beyond any doubt, that Champions insure better engine performance in your car.

Champion's unequalled resources, engineering and manufacturing facilities have been exclusively devoted to building better spark plugs for well over a quarter century. Today Champions offer you advances and advantages not obtainable in any other spark plugs.

Demand Champions for your car, and you can be certain that you will get the better engine performance and dependability which have made them Champions in fact as well as in name.

ACTUAL SIZE  
V-PLUG



V-3/8" 24 Thread  
V2-1/4" 32 Thread  
65c

### MODEL BUILDERS—ATTENTION!

Specially designed for model gas engines giving the same dependable performance as regular Champions. Absolutely gas-tight, alloy needle point electrode, one-piece construction. If not available through your dealer, write Champion Spark Plug Company, 900 Upton Ave., Toledo, Ohio.

USE THE SPARK PLUGS CHAMPIONS USE



By burning 25% slower than the average of the 15 other of the largest-selling brands tested—slower than *any* of them—CAMELS give smokers the equivalent of **5 EXTRA SMOKES PER PACK!**



**SEEING  
IS  
BELIEVING!**

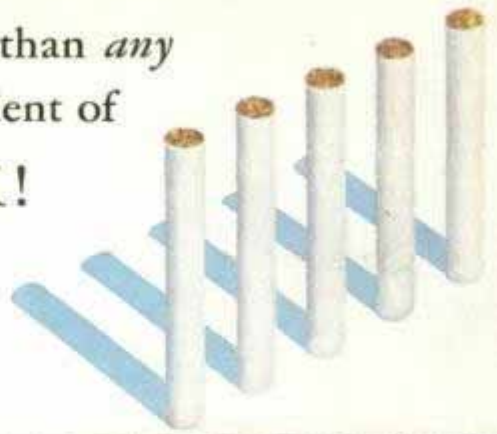

CAMEL'S expensive tobaccos, so inexpensive to smoke—is welcome news to millions who are keen for the smoking thrill of finer tobaccos! Naturally, a slower-burning cigarette, Camel, gives *more* and *better* smoking for the money. And now the impartial research of a leading laboratory proves that Camels burn *far* slower than the average of the 15 other of the largest-selling brands tested. Here are 3 cigarette facts as reported by this scientific group:

- 1** Camels were found to contain **MORE TOBACCO BY WEIGHT** than the average for the 15 other of the largest-selling brands.
- 2** CAMELS BURNED SLOWER THAN ANY OTHER BRAND TESTED—25% SLOWER THAN THE AVERAGE TIME OF THE 15 OTHER OF THE LARGEST-SELLING BRANDS! By burning 25% slower, on the average, Camels give smokers the equivalent of **5 EXTRA SMOKES PER PACK!**
- 3** In the same tests, CAMELS HELD THEIR ASH FAR LONGER than the average time for all the other brands.

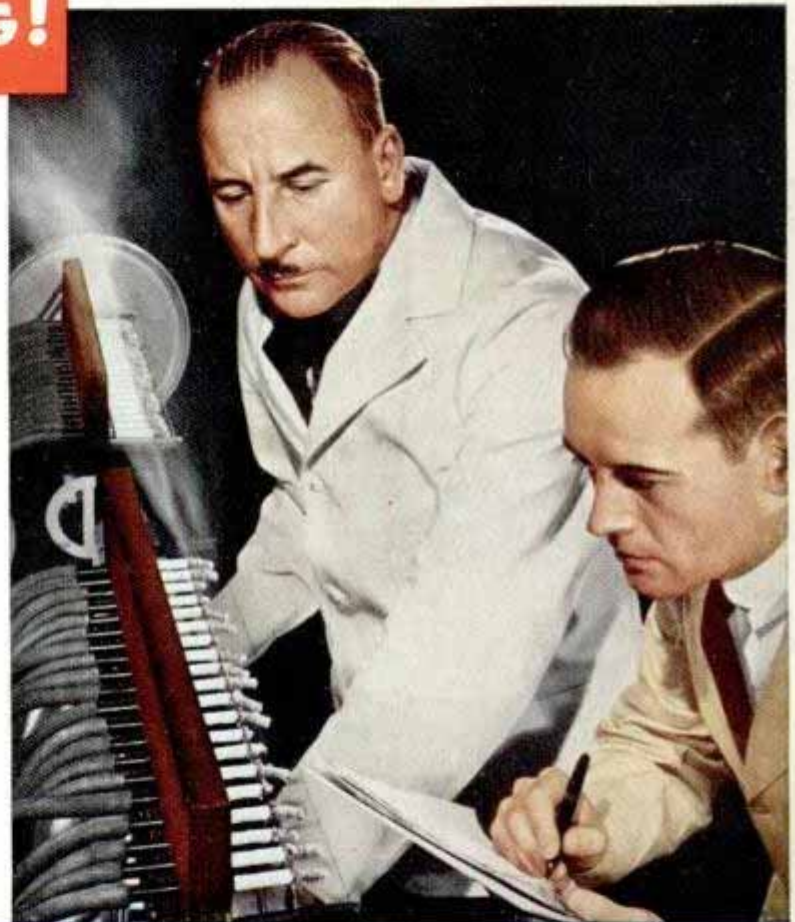

**SMOKING  
IS  
BELIEVING!**

**A BATTERY OF "SMOKERS"** determine the burning time of 16 of the largest-selling brands. Trained scientists and special equipment assured scientific control. Camels (shown here under test) proved 25% slower-burning than the average of the 15 other brands tested, giving Camel smokers the equivalent of 5 extra smokes per pack!



During the summer season of extra smoking—begin enjoying the cigarette of *extra smokes!* Everyone can afford the coolness, the true mildness, the ripe, delicate taste and fragrance of smoking pleasure at its best. *More* smoking for your money, and the added bonus of Camel's *costlier tobaccos*. Try Camels—America's favorite and *thriftiest* way to true smoking enjoyment!

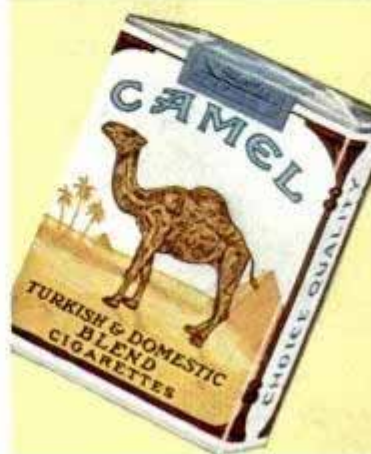

THE CIGARETTE  
OF  
**COSTLIER  
TOBACCOS**

*Penny for penny  
your best  
cigarette buy!*

Copyright, 1938  
R. J. Reynolds Tob. Co.  
Winston-Salem, N. C.