

ROBOTS HELP RUN THE WORLD

POPULAR MECHANICS

MAGAZINE

WRITTEN SO YOU CAN UNDERSTAND

REGD. TRADE MARK, GREAT BRITAIN, No. 410324

REG. U.S. PAT. OFF.

JULY
25 CENTS

SEE PAGE 8

GREATEST SHOW UNDER THE EARTH



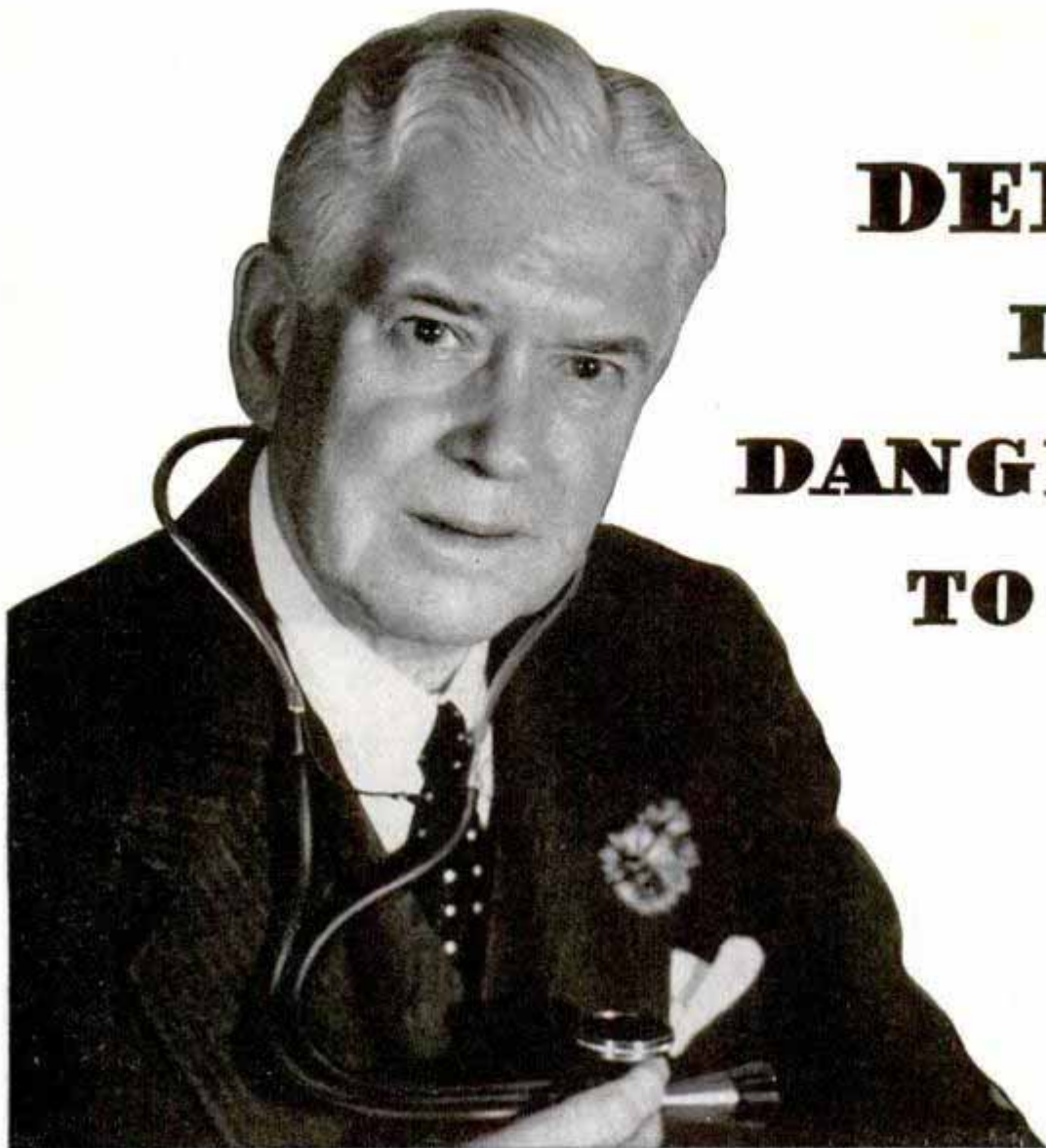

DELAY IS DANGEROUS TO ME

"A DOCTOR is always wanted in a hurry. So, with the possibility of life and death hanging in the balance, I take no chances with my car. And one thing I do every thousand miles is drive into a Texaco station and say 'Marfak my car.' And then I KNOW that the chassis, anyway, is sound and healthy."

And that's just the practice of thousands and thousands of motorists who want absolute assurance that their cars are in fine shape—always.

The Texaco Dealers who give this Marfak Service are specially schooled so they're on speaking terms with every grease cup on your car. What's more, they don't stop with efficient lubrication. They render a dozen or more

little services, often neglected, but vitally important to carefree, safe driving.

And the lubricants they use: each is best for its particular job, from stem to stern. Take Marfak. It's the toughest lubricant yet devised by the Texaco Engineers and it lasts twice as long as ordinary grease. It gives absolute lubricating protection for a full thousand miles.

This 40-Point Service costs surprisingly little, too, yet brings you carefree motoring.



TEXACO DEALERS INVITE YOU to tune in THE TEXACO STAR THEATRE—A full hour of all-star entertainment—Every Wednesday Night—Columbia Network—9:00 E.D.T., 8:00 E.S.T., 8:00 C.D.T., 7:00 C.S.T., 6:00 M.S.T., 5:00 P.S.T.

Copyright 1939
The Texas Company

THE 40-POINT LUBRICATION AT ALL TEXACO AND OTHER GOOD DEALERS

Popular Mechanics Magazine

H. H. WINDSOR, Founder

H. H. WINDSOR, Jr., Editor and Publisher

July, 1939

Vol. 72, No. 1

IN THIS ISSUE

Super-Gasoline for Your Car	1
Thrill Makers of '39	8
Logging Goes Modern	Coloroto
Streamline Highways for Safety	28
Flying Box Cars	34
Gold Is Where You Find It	40
Greatest Show under the Earth	50
Making Weather around the Globe	58
Painting the World in New Colors	66
Adventures of a Roving Cameraman	72
Electrical Brains Help Run the World	82
Modern Sherlocks Battle Crimes	92

(Continued on next page)

Electric Home of the Future

IN THE home of the future you'll cook your dinner with radio short waves, warm your house with heat units wrung from the cold outside atmosphere, and breathe germfree and dustless air. The home you live in today will be regarded as quite primitive and picturesque. Imagine roasting a ham with steam when short waves would do it in one-sixth the time! In the August issue George Bucher, president of the Westinghouse Electric & Manufacturing company, tells how the electric home of the not distant future will be operated by push buttons and switches located at convenient control stations throughout the house.

Sixteen Thousand Miles on \$4.20

DANA and Ginger Lamb turned their childhood dreams of a South Seas idyll into enchanted reality. With \$4.20 and a tiny boat they paddled and sailed 16,000 miles together, living a Robinson Crusoe existence as the lone inhabitants of Cocos Island. They tell their story of vagabondage in two adventure-filled articles, the first of which appears next month.

Next Month

FUNNY things would happen to you on Mars. You could high-jump ten or fifteen feet, but it would be an effort to sit down. Your pendulum clock would lose twenty-two minutes each hour. You couldn't strike a match—there isn't enough oxygen to light one. You'd have to carry your own air and water; in fact, if you went walking without your pressure suit you'd probably explode. Next month two Mt. Wilson observatory scientists take you on a personally conducted tour of Mars.

Building a Home?

WHAT about these prefabricated houses, bungalows without basements, plywood and steel and concrete "packaged" homes? Can you really build a low-cost home that won't sag and rot and cost you double in upkeep over a period of years? Plenty of new ideas have popped up in the construction field in the last ten years. New materials, new ways of using the old. An article in August offers many a tip on how to save money in building a home.

Trailers Grow Up

KITCHENETTE and bedroom, comfortable and safe at sixty miles an hour, with bath, running water, electric lights, heated and insulated. That's the modern trailer home, quite grown up despite its comparative infancy. One of them blew a tire at seventy miles an hour the other day, but it was scarcely noticed. A story next month, with eight Coloroto pages describes the 1939 trailer.

Why Should Your Fine New Engine Bow to These Five Threats?



From the beginning your fine new automobile engine is faced with five serious threats. Carbon that fouls valve action and steals power lingers with every piston stroke. Corrosion that eats vital metal surfaces away attacks when operation temperatures climb high. Of much present day concern is engine "varnish." This lacquer-like substance, formed in heat, binds itself upon piston faces. In many cases it presents the serious possibility of jammed or "frozen" pistons. As for sludge and gum, these accumulations are almost certain to be lurking to contaminate and harm.

Since engines must burn fuel and run in oil, these five threats form an ever present detriment to the well being of your car, new or old. But there is a way to lay these damage creators low. Pyroil will do it!

Pyroil resists and safely removes hard carbon. It prevents corrosion. It nullifies the danger of engine "varnish"—keeps this enemy's glue-like tentacles from shackling piston power. Sludge and gum are dissipated by its use.

Don't let your car succumb to the five threats of engine operation. Protect it now. Get Pyroil and use it regularly. Only a few ounces are needed in fuel tank and crankcase. It costs mere pennies. Yet it saves many dollars of expense. So Id everywhere at service stations, garages, and accessory stores. Manufactured and Guaranteed by Pyroil Company, W. V. Kidder, Founder, 57 Pyroil Bldg., La Crosse, Wisconsin, U.S.A.



NOTHING FINER FOR NON-ABRASIVE NEW CAR BREAK IN!

DISTRIBUTORS: CHECK AND MAIL COUPON FOR FRANCHISE FACTS.

SIMPLY ADD TO GAS & OIL

PYROIL COMPANY
 57 Pyroil Bldg., La Crosse, Wisconsin, U. S. A.
 Please give me further facts of how Pyroil will save my car from the five threats of engine operation.
 Also send details of your plan for Distributors.

Name.....
 Address.....
 City..... State.....

(Contents—Continued)

AUTOMOTIVE

"Pass" signal increases driving safety.....	16
Electric motor chair.....	38
Diesels help to clear mesquite "jungle".....	39
Explosives truck rides safely on ten tires.....	48
Plastics challenge steel in automobile building.....	49
Auto parts given slang names by workers.....	56
Capless rubber valve stem.....	62
Race track on factory roof tests cars.....	65
Motorcycle in streamline dress of plywood.....	76
Children race in gas-powered midget cars.....	77
"Swamp buggy" for R.F.D. defies snowdrift and mud.....	80
Radio "traffic cop" adds voice to lights.....	85

AVIATION

Six-engine transatlantic plane has two stories.....	13
Loud speakers on balloon talk to people below.....	16
Letters on warplane key to type of fighter.....	44
Balloon guides rescuers to lost pilot.....	56

BOATS AND BOATING

Racing the water fleas.....	46
Sea-going fortress.....	63
Speedboat sets five marks in one day.....	70

CONSTRUCTION

Liquid rock applied with brush to walls.....	38
Battering ram on truck breaks up old pavement.....	44
Three-room plywood house built in a day.....	54
One man guides giant "jumping frog" tamper.....	65
Colored stainless steel promises low-cost housing.....	76
Resin bath weatherproofs wood at low cost.....	81

FARMS

Talking model describes electric servants.....	38
Radio to run farm of future.....	76
Moth rescues a continent from becoming desert.....	88
Old refrigerator car used on farm.....	90

HOUSEHOLD

Talk timer for phone has bell signal.....	4
Thermometer shows humidity and health zones.....	39
Lap table with single adjustable leg.....	57
Lost furnace heat captured by flue water jacket.....	57
Stirring paddles clamped to cooking utensil.....	64
Gasoline lawnmower cuts tall grass and weeds.....	96
Tray in vacuum cleaner bag easy to empty.....	96

PHOTOGRAPHY

One trigger fires camera and gun.....	44
Motor cops carry camera and two-way radio.....	62
Ship blast movie filmed by using model boat.....	71
Remote-control magazine feed for slide projector.....	80
Trick titles made with rotating frame.....	86
Odd shots made with miniature movie camera.....	87
Cloth backing for photo applied by heating.....	96

RADIO AND ELECTRICITY

Million-volt electric "bonfire".....	4
Electric air mail map flashes landing time.....	5
Cost of farm electrification cut sixty per cent.....	16
Television trouble shooter has 648 worries.....	33
Light produced by radio waves in glass sphere.....	80
Mounted police carry radio in saddle.....	86
Sodium vapor lamps coated inside by bombs.....	90
Radio printing.....	135
Audio amplifier added to beginner's battery sets.....	136
How to build a universal set-testing meter.....	138
Practical radio hints.....	139
Compact amateur transmitter in console cabinet.....	140
Power line noise analyzer for service men.....	140
Push-button converter unit modernizes old sets.....	140
"Wireless" record player includes "mike" jack.....	140

SCIENCE AND INDUSTRY

Chemical cloth keeps goggles from fogging.....	4
G-men's supermicroscope magnifies 1,125 times.....	55
Copper "sand" sharpens X-ray image of metal.....	56
Ice on tongue kills taste of pill.....	62
Portable conveyor is powered by gravity.....	62
Missing element "43" made in atom smasher.....	80
Millionth-inch film has insulating value.....	90
Safety gadgets for industrial workers.....	91

SPORTS

Merry-go-round practice boat for oarsmen.....	13
Amplifier helps football coach talk to field.....	55
Splicing clamp for replacing racket strings.....	64

Giant crossword puzzle took two years to make.....	95
Bounce-back tennis played in small space.....	96

MISCELLANEOUS

Electric motor small as a match head.....	4
Gas masks "plug in" on oxygen pipe line.....	5
Subway car has one controller.....	6
Camouflage net hides anti-aircraft gun.....	6
Giant robot walks, talks and tells colors.....	7
Rodeo model has lifelike moving figures.....	12
Hinged pipe stem fits pocket when folded.....	16
Sun's heat trapped and stored in silo.....	33
Artist caricatures famous folk with eggs.....	45
Food sealed in rubber balloons.....	48
"Highway in the sky" climbs over the Andes.....	49
Fighting bull on wheels teaches grace of movement.....	55
"Air crash" good ad for roadside stand.....	57
Bank's stop-theft drawer empties into safe.....	64
Flexible neck and hose holder.....	64
Life span to be seventy by 1980.....	70
Spring reel keeps eraser handy on typewriter.....	70
Building motion into dummies.....	78
Explosives made from natural gas.....	81
Line-spacer on copyholder rolls letter upward.....	86
Risk lives to save comrade on cliff.....	88
Fourteen-ton typewriter prints news flashes at fair.....	91
Half ton of paper a year used by family.....	95
Giant salt shakers prevent coal mine explosions.....	96
Universal lathe tool holder.....	128A

Craftsman and Shop Notes

AUTOMOTIVE

Red reflector on motorcyclist's hand.....	122
Correcting inefficient starter operation.....	158
Hot ignition coil affects motor operation.....	158
Installing new vacuum hose on windshield wiper.....	158
Scuffing of door beading prevented by guard.....	158
Vise to hold copper tubing.....	158
Wash pan supported in brake drum.....	158
Picnic-lunch table for your car.....	159
Starting castellated nuts on burred bolts.....	159
Adjustable braces for house trailer.....	160
Door catch filed to adjust it.....	160
Making motorcycle battery easy to remove.....	160

BOATS AND BOATING

Canoe pulled over beach on linoleum cradle.....	100
Build your boat right.....	107
Removable boat windshield of celluloid.....	116
Heavy rowboat moved on oil drum.....	134

CAMPING, HUNTING, FISHING

Fisherman's flies dried with alcohol.....	100
Pitchfork shocks worms out of ground.....	100
Cork shields for hooks of fish lures.....	104
Frankfurters roasted in corn popper.....	104
Fishing-rod tip protected by bamboo.....	106
Smoked spoon hook catches trout.....	112
Hiker's tent folds into light bundle.....	113
Screw eyes hold fish stringer on boat.....	118
Castling-rod tip protected by cork.....	122
Removing hook from throat of fish.....	130
Bulb to aerate minnow bucket.....	134

FARM

Holder to grind disk-harrow blades.....	142
Spraying solutions mixed with force cup.....	143
Two bin grain spout kinks.....	143
Horseshoe supports range salt.....	144
Road rims for tractor wheels.....	146
Protecting the face against orchard sprays.....	147
Platform aids when digging postholes.....	153
Bracket to hold log while using crosscut saw.....	155
Poultry feeder and waterer in fence corner.....	155
Removing rocks from field with a horse.....	156
Seat spring attaches water-tank supply pipe.....	156

FURNITURE

Finger-tip bookends cannot tip.....	101
Porch set assembled.....	102
Picnic table slips into car trunk.....	121

HAND TOOLS

Rubber mallet repaired with shoe heels.....	100
Rubber shield on sledge.....	106
Safety clip for your vise.....	106

Combination drill holder and gauge.....	112
Wrench to remove screw caps from cans.....	118
Scraping tool from old file.....	122
Shield for plane iron.....	142
Guards keep oil off die-stock handles.....	144
Pivoted can on toolbox holds tape measure.....	144
Rubber grip for end wrenches.....	145
Chisels missing in rack noticed at a glance.....	147
Saw silencer stops screeches.....	154
Package strings cut with can opener.....	155

HOUSEHOLD

Gourd vase for cut flowers.....	112
Candelabrum for birthday cake.....	116
Removing threads from vacuum-cleaner brush.....	118
Abundant hot water from dual-tank system.....	130
Solving home problems.....	132

LAWNS AND GARDENS

Pergolas to beautify your garden.....	97
Rubber knee pads for gardeners.....	116
Ornamental pump covers lawn hydrant.....	121
Imitation fir trees decorate driveway posts.....	122

OFFICE

Card file box improved with wooden block.....	144
Drawer pulls form pockets for paper clips.....	146
Eraser snaps on typewriter.....	153

PHOTOGRAPHY

Bright objects photographed without glare.....	104
Develop your films in daylight.....	119
Running water in darkroom at low cost.....	129

POWER TOOLS

Non-slip pulleys for belt sanders.....	106
Belt sander fits your lathe.....	141
Lathe fittings from drill shanks.....	146
Spring prevents dropping through drill-press table.....	156

STORE AND SHOP

Mitten on potato barrel to keep hands clean.....	143
Height gauges increase store's business.....	146
Steak thickness guides aid butcher's customers.....	147
Clip on market basket to hold order slip.....	154

MISCELLANEOUS

Drawer on stepladder is handy.....	100
Small paper cups used in home workshop.....	101
Brick veneer for model house.....	104
Wood screw locked with wire staple.....	104
Slide for back yard.....	105
Steps to swimming hole from old tires.....	106
Repairing leaks in rubber boots.....	112
Shooter for skyrockets has windshield.....	112
Hot-dog dispensing cabinet for a bicycle.....	113
Fun with paddle-wheel toys.....	114
One-piece chimney cap.....	116
Rubber finger grip for lettering brush.....	116
What you can do with old fountain pens.....	117
Pencil pointed in abrasive pocket on sketchbook.....	118
Slots in cabinet panels prevent splitting.....	118
Repairing worn goggle frames.....	121
Cutting designs in Bakelite.....	122
Sheet-metal signs cut with hammer and chisel.....	123
Build your own log cabin.....	124
Serrated cans on fence keep out cats.....	129
Ruler held in pocket by sponge rubber.....	130
Shields to keep squirrels out of trees.....	130
Teeing golf balls to proper height.....	131
Water fowl imitated in weather vanes.....	131
Well in drawing board holds thumbtacks.....	144
Shop light adjusts three ways.....	145
Seating-arrangement map aids theater patrons.....	146
Electric wiring in the home.....	148
Ladder holders for small paint cans.....	154
Lantern globe cleaned with rubber hose.....	154
Magazine carrying bag has stepped partitions.....	154
Peek hole in bin made from tail-light rim.....	156

IMPORTANT NOTICE

It is the intention of this magazine to provide its readers with information regarding the latest developments in the mechanical arts. We take no responsibility as to whether the disclosures contained in our articles are covered by patents and advise readers to investigate this subject before making, using, or selling any of the products, machines, or processes described, in order to avoid possible liability for patent infringement.

Are YOU on the Outside... Looking in at AVIATION?

Its Stirring Deeds

—like Howard Hughes' globe-girdling flight

Its Production Achievements

—like the building of the Douglas DC-4

Its Engineering Triumphs

—like the Boeing Atlantic Clipper



Inside AVIATION ...

Aircraft Mechanics and Aeronautical Engineers share in the big things going on in the industry.

Have you ever thought of this in connection with YOUR future? Back of every plane that flies must be the Engineer and the Aircraft Mechanic. You can train to be one or the other. You can take training that gets results—Aero I.T.I. training... from which 429 men have stepped into Aviation during the last 12 months. Aero I.T.I. courses provide you with every means and every opportunity to learn what you MUST know...

to do what you must be able to do. Start your training at home—or take a full-time resident course. For details, including free booklet, send coupon.



AERO INDUSTRIES TECHNICAL INSTITUTE

5253 West San Fernando Road, Los Angeles, Calif.
Aeronautical Engineering / Aircraft Mechanics
Offering U. S. Civil Aeronautics Authority Approved
12 Months Aircraft Mechanics Training

EXECUTIVE BOARD

Robert E. Gross
President,
Lockheed Aircraft
Corporation

John K. Northrop
Formerly Pres., The Northrop
Corp., and Vice-Pres.,
Douglas Aircraft Co., Inc.

C. A. Van Dusen
Vice-President,
Consolidated
Aircraft Corp.

Aero Industries Technical Institute
5253 West San Fernando Road, Los Angeles, California

Please send information on Aero I.T.I. courses. I am interested in the branch of Aviation checked below.

Aircraft Mechanics Aeronautical Engineering
 Undecided. Please send more information.

Years of High School: None, 1, 2, 3, 4.

Name _____ Age _____

Address _____

City _____ State _____ a-19-p

When writing please mention Popular Mechanics

ELECTRICAL ENGINEERING

★ ONE YEAR Residence Course
Prepares You for Technical Positions

Thorough training in minimum time. Combines theory with practical work in well-equipped laboratories. Experienced faculty and complete facilities provide training essential for technical careers. High employment record is industry's endorsement of Bliss training. Thousands of successful graduates. Suburban campus; modern buildings; dormitory; dining hall. 47th year begins Sept. 27. CATALOG. Give age.



BLISS ELECTRICAL SCHOOL

117 Takoma Ave., Washington, D. C.

Become an expert photographer

Train at Home or in our modern completely equipped studios. For pleasure or career. Commercial, News, Portrait, Advertising, Natural Color, Motion Picture photography. Individual instruction by noted experts. 29th year. Send for Free Booklet.

NEW YORK INSTITUTE OF PHOTOGRAPHY
10 West 33 Street (Dept. 49) New York City

Regain Perfect Speech, If You

STAMMER

Send today for beautifully illustrated book entitled "DON'T STAMMER," which describes the Bogue Unit Method for the scientific correction of stammering and stuttering. Method successfully used at Bogue Institute for 38 years—since 1901. Endorsed by physicians. Full information concerning correction of stammering sent free. No obligation. Benjamin N. Bogue, Dept. 1304 Circle Tower, Indianapolis, Indiana.

CARTOON YOUR WAY TO SUCCESS!



DON'T COPY - LEARN TO ORIGINATE!

RAYE BURNS will teach you HOW to CREATE ORIGINAL CARTOONS at home that you can SELL! Course has 26 lessons and 600 illustrations. \$2.85

Send name and address for free details. Only....

RAYE BURNS SCHOOL, Dept. M-1, Box 2194, CLEVELAND, OHIO

NEW YORK SCHOOL OF MECHANICAL DENTISTRY

Earn big money in a few months. We show you how. Real Laboratory Training. OLDEST school, Day, Eve. Easy terms. Ask for free Catalog P and tool offer. N. Y. SCHOOL of MECHANICAL DENTISTRY, 125 W. 31 St., N. Y. C.

ARREST HIM, OFFICER!

I'LL HAVE COMPLETE FACTS ON THE OTHER FELLOW TONIGHT!



Secret Service Operator No. 38 is on the job... FOLLOW HIM through all the excitement of his chase after the counterfeit gang. Write NOW for

FREE Confidential Reports No. 38 Made to His Chief!

It may open your eyes to the great opportunity for YOU as a well paid Finger Print Expert. The kind of work you'd like. Excitement! Travel! Thrills! A REGULAR MONTHLY salary. REWARD MONEY. Graduates of this school HEAD 47% of all

Identification Bureaus in U. S.! Write for Free Reports, Finger Print Book, low prices. Easy Terms Offer.

Literature will be sent only to persons stating their age.

INSTITUTE OF APPLIED SCIENCE
1920 Sunnyside Ave., Dept. B-135 Chicago, Illinois

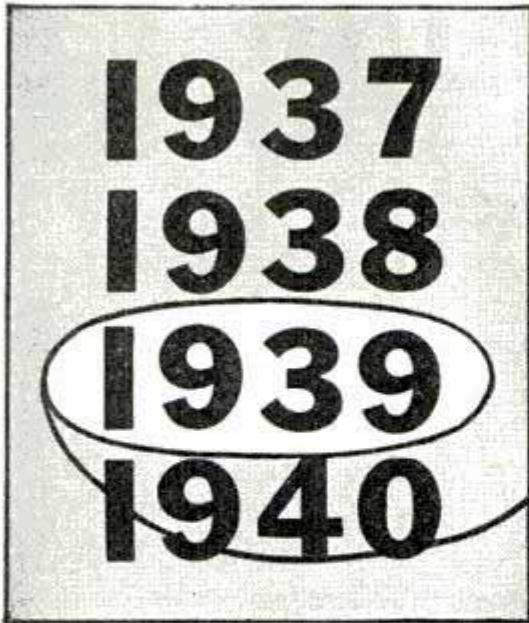

Now
is the time!

**Business is Searching
for YOU, if**

RIGHT now, in many lines, there is a search for really *good* men—managers, leaders—men who can take charge of departments, businesses, branch offices, and get things humming.

As always, there are not enough ordinary jobs to go 'round—but rarely before, in the history of American business, has there been so much room at the *top!* And new jobs are being created by the business pick-up in many lines—jobs that pay splendidly and that open the way to lifetime success.

Ordinarily, there would be plenty of men to fill these jobs—men in junior positions who had been studying in spare time. But most men have been letting their training slide during these dark years of depression . . . “What’s the use?”—You have heard them say. Perhaps there has been some excuse for sticking to any old kind of a job one could get the past few years—but the door is wide open for the man with ambition and ability *NOW!*

And don't let anyone tell you that “Opportunity Only Knocks Once”—that’s one of the most untruthful sayings ever circulated. Op-

portunities flourish for *every* American every day of his life.

Far more to the point is to be ready—to be *prepared*—to make yourself *interesting* to the big-time employer—and LaSalle offers you a short-cut method of qualifying for opportunity jobs in accounting, law, traffic, executive management, and kindred occupations.

LaSalle Extension is 30 years old—averages over 30,000 enrollments a year—60 American firms each employ 500 or more LaSalle-trained men—surveys show that many LaSalle students attain 40% salary increase after graduation—10% of all C.P.A.’s in the U.S.A. are LaSalle-alumni.

Why not find out what LaSalle has done and is doing for men in *your* position? Send and get the facts; see what LaSalle can do for you, personally!

There’s no question about it—business is picking up—jobs are looking for *men*—the time has come for you to *qualify* for prosperity. Mail this coupon today!

LASALLE EXTENSION UNIVERSITY
A CORRESPONDENCE INSTITUTION

4101 S. Michigan Ave., Dept. 764-R Chicago

I am in earnest about my success and I would like to have your special booklet—without any cost or obligation to me—about my opportunities and your success training in the business field I have checked:

- | | |
|--|--|
| <input type="checkbox"/> Business Management | <input type="checkbox"/> Industrial Management |
| <input type="checkbox"/> Higher Accountancy | <input type="checkbox"/> Modern Foremanship |
| <input type="checkbox"/> Traffic Management | <input type="checkbox"/> Business Correspondence |
| <input type="checkbox"/> Modern Salesmanship | <input type="checkbox"/> Business English |
| <input type="checkbox"/> Commercial Law | <input type="checkbox"/> Effective Speaking |
| <input type="checkbox"/> Law—Degree of LL.B. | <input type="checkbox"/> C. P. A. Coaching |
| <input type="checkbox"/> Expert Bookkeeping | <input type="checkbox"/> Stenotypy |

Name _____ Age _____
Position _____ Address _____

Ask for one of these booklets—or a similar one on your own field of business. They are free!



This One



RAAF-77Z-5XJH



When writing to advertisers please mention Popular Mechanics

THOUSANDS OF

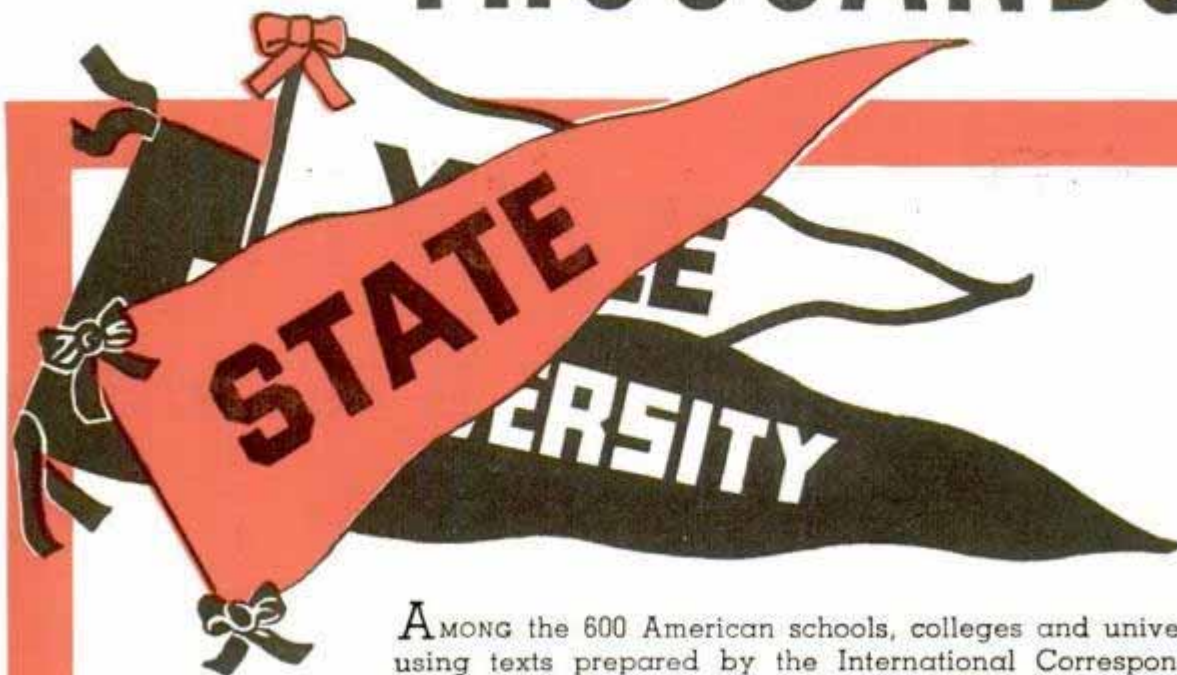

AMONG the 600 American schools, colleges and universities using texts prepared by the International Correspondence Schools are these outstanding educational institutions:

Alabama Polytechnic Institute	Syracuse University
Brown University	The Citadel
Bucknell University	Tulane University
California Institute of Technology	University of Alabama
Carnegie Institute of Technology	University of Arizona
Clemson College	University of Arkansas
College of the City of New York	University of British Columbia
Columbia University	University of California
Cornell University	University of Chicago
Dartmouth College	University of Colorado
Duke University	University of Delaware
George Washington University	University of Florida
Georgia School of Technology	University of Idaho
Harvard University	University of Kentucky
Indiana University	University of Maine
Iowa State College	University of Michigan
Johns Hopkins University	University of Minnesota
Kansas State Teachers College	University of Missouri
Lehigh University	University of Nebraska
Louisiana State University	University of Nevada
Marquette University	University of New Mexico
Massachusetts Institute of Technology	University of North Dakota
McGill University	University of Oklahoma
Michigan State College	University of Pennsylvania
Montana State College	University of Pittsburgh
New York University	University of Southern California
Northwestern University	University of Tennessee
Ohio State University	University of Texas
Oregon State Agricultural College	University of Vermont
Pasadena Junior College	University of Wisconsin
Pennsylvania State College	University of Wyoming
Rhode Island State College	Utah Agricultural College
Rose Polytechnic Institute	Virginia Polytechnic Institute
Rutgers University	Washington State College
South Dakota State College	Wayne University
Stanford University	Yale University

"I. C. S. makes effective a system of instruction designed both to fit the needs of individuals unable to attend resident institutions, and to modernize or supplement the training of individuals whose training is out-of-date or inadequate." **RALPH E. WEEKS, President**



COLLEGE GRADUATES

STUDIED I. C. S. TEXTBOOKS

Thousands of men each year admit defeat in life's battle — resign themselves to eternal failure — because "the breaks" prevented them from attending a college or university.

Other men — ambitious, determined men — decide to do something about it! They enroll with the International Correspondence Schools, and acquire the sound, essential training they need to succeed.

They get this training through a personalized student-instructor relationship — through texts so sound and authoritative that leading universities have adopted them — through methods proved successful by 48 years of experience.

If you want to be a trained man — making a trained man's salary — it will pay you to mail this coupon. Right now!

INTERNATIONAL CORRESPONDENCE SCHOOLS

BOX 5552-J, SCRANTON, PENNA.

★ Without cost or obligation, please send me a copy of your booklet, "Who Wins and Why," and full particulars about the subject *before* which I have marked X: ★

TECHNICAL AND INDUSTRIAL SUBJECTS

- | | | | | |
|--|---|---|--|---|
| <input type="checkbox"/> Agriculture | <input type="checkbox"/> Air Brakes | <input type="checkbox"/> Civil Engineering | <input type="checkbox"/> Manufacture of Pulp Paper | <input type="checkbox"/> Sanitary Engineering |
| <input type="checkbox"/> Air Conditioning and Cooling | <input type="checkbox"/> Coal Mining | <input type="checkbox"/> Contracting and Building | <input type="checkbox"/> Marine Engineering | <input type="checkbox"/> Sheet Metal Work |
| <input type="checkbox"/> Architectural Drafting | <input type="checkbox"/> Cotton Manufacturing | <input type="checkbox"/> Diesel Engineering | <input type="checkbox"/> Mechanical Drafting | <input type="checkbox"/> Steam Electric Engineering |
| <input type="checkbox"/> Architecture | <input type="checkbox"/> Electrical Engineering | <input type="checkbox"/> Electric Lighting | <input type="checkbox"/> Mine Foreman | <input type="checkbox"/> Steam Engineering |
| <input type="checkbox"/> Auto Electric Technician | <input type="checkbox"/> Fire Bosses | <input type="checkbox"/> Fruit Growing | <input type="checkbox"/> Patternmaking | <input type="checkbox"/> Steam Fitting |
| <input type="checkbox"/> Auto Technician | <input type="checkbox"/> Heating | <input type="checkbox"/> Highway Engineering | <input type="checkbox"/> Pharmacy | <input type="checkbox"/> Structural Drafting |
| <input type="checkbox"/> Aviation Engineering | <input type="checkbox"/> Heat Treatment of Metals | <input type="checkbox"/> House Planning | <input type="checkbox"/> Poultry Farming | <input type="checkbox"/> Structural Engineering |
| <input type="checkbox"/> Boilermaking | <input type="checkbox"/> Highway Engineering | <input type="checkbox"/> Machinist | <input type="checkbox"/> Public Works Engineering | <input type="checkbox"/> Surveying and Mapping |
| <input type="checkbox"/> Bridge and Building Foremanship | <input type="checkbox"/> House Planning | <input type="checkbox"/> Management of Inventions | <input type="checkbox"/> Radio | <input type="checkbox"/> Telegraph Engineering |
| <input type="checkbox"/> Bridge Engineering | <input type="checkbox"/> Heating | | <input type="checkbox"/> R. R. Locomotives | <input type="checkbox"/> Telephone Work |
| <input type="checkbox"/> Building Estimating | <input type="checkbox"/> Machinist | | <input type="checkbox"/> R. R. Section Foreman | <input type="checkbox"/> Toolmaking |
| <input type="checkbox"/> Chemistry | <input type="checkbox"/> Management of Inventions | | <input type="checkbox"/> R. R. Signalmen | <input type="checkbox"/> Ventilation |
| | | | <input type="checkbox"/> Refrigeration | <input type="checkbox"/> Welding, Electric and Gas |
| | | | | <input type="checkbox"/> Woolen Manufacturing |

BUSINESS SUBJECTS

- | | | | | | |
|--|--|--|--|---|----------------------------------|
| <input type="checkbox"/> Accounting | <input type="checkbox"/> Advertising | <input type="checkbox"/> College Preparatory | <input type="checkbox"/> Grade School Subjects | <input type="checkbox"/> Railway Postal Clerk | <input type="checkbox"/> Signs |
| <input type="checkbox"/> Bookkeeping | <input type="checkbox"/> C. P. Accounting | <input type="checkbox"/> Cost Accounting | <input type="checkbox"/> High School Subjects | <input type="checkbox"/> Salesmanship | <input type="checkbox"/> Spanish |
| <input type="checkbox"/> Business Correspondence | <input type="checkbox"/> First Year College Subjects | <input type="checkbox"/> Foremanship | <input type="checkbox"/> Illustrating | <input type="checkbox"/> Secretarial Work | |
| <input type="checkbox"/> Business Management | <input type="checkbox"/> French | | <input type="checkbox"/> Lettering Show Cards | <input type="checkbox"/> Stenography and Typing | |
| <input type="checkbox"/> Cartooning | <input type="checkbox"/> Civil Service | | <input type="checkbox"/> Managing Men at Work | <input type="checkbox"/> Traffic Management | |

DOMESTIC SCIENCE SUBJECTS

- | | | |
|---|---|--|
| <input type="checkbox"/> Advanced Dressmaking | <input type="checkbox"/> Home Dressmaking | <input type="checkbox"/> Tea Room and Cafeteria Management, Catering |
| <input type="checkbox"/> Foods and Cookery | <input type="checkbox"/> Professional Dressmaking and Designing | |

Name..... Age..... Address.....

City..... State..... Present Position.....

Canadian residents send coupon to International Correspondence Schools Canadian, Limited, Montreal, Canada
British residents send coupon to I. C. S., 71 Kingsway, London, W. C. 2, England

Will You Let Me PROVE I Can Make YOU a New Man?

LET ME START SHOWING RESULTS FOR YOU



7-DAY TRIAL OFFER

I could fill this whole magazine with enthusiastic reports from OTHERS. But what you want to know is—"What can Atlas do for ME?" Find out—at my risk! Just give me a 7-day trial. Just one week!—and even in that short time I'll start giving RESULTS. AND it will be the kind of RESULTS that you (and anyone else) can SEE, FEEL, MEASURE with a tape!

FREE BOOK

I myself was once a 97-pound weakling—sickly, half-alive. Then I discovered "Dynamic Tension." And I twice won the title, "The World's Most Perfectly Developed Man!" "Dynamic Tension" has done so much for other fellows that I simply ask you to let me prove that it can make a new man of YOU—that it can start new inches of power pushing out your chest—build up your shoulders to champion huskiness—put new, hard, firm muscles on your biceps—make those stomach muscles of yours hard ridges!

Why not risk a postage stamp? Send coupon for my 48-page illustrated **FREE BOOK AT ONCE!** Address me personally: Charles Atlas, Dept. 8-G, 115 East 23rd Street, New York, N. Y.

CHARLES ATLAS, Dept. 8-G
115 East 23rd Street, New York, N. Y.

I want the proof that **DYNAMIC TENSION** will help make a new man of me—give me a healthy, husky body and big muscle development. Send me your free book, "Everlasting Health and Strength"—and full details of your 7-DAY trial offer.

Name.....
(Please print or write plainly)

Address.....

City..... State.....

GET IN THE SWING with Slingerland . . . DRUMS GUITARS MANDOLINS



GENE KRUPA — World's Greatest Swing Drummer uses Slingerland

WONDERFUL VALUE EASY PAYMENTS

Compare the value—tone and power in Slingerland "Radio King" drums, banjos, guitars, mandolins, marimbas or bugles—before you buy. Guaranteed more for your money. Acclaimed the tops in smooth

tone, easy playing, rich power by world's leading musicians. Easy payments. 5-days free trial. See at your dealers.

Cut this ad out—good for \$1.00 credit. Free special information on how to organize drum and bugle corps. Free Catalog—mention instrument wanted.



SLINGERLAND DRUM CO.
1330 Belden Avenue Chicago, Illinois

AVIATION SPARTAN OFFERS YOU—

Unequaled advantages of "Oil Capitol of the World" finest flying weather and country. Government Approved. Factory affiliation gives you advantages of Commercial, Military All-Metal construction. Home of the DAWN PATROL, All courses Mechanical and Flight, Student Dormitories, Restaurant. Write for Illustrated Catalog. J. D. GREEN, Director, Dept. PM 21, TULSA, OKLAHOMA

SPARTAN SCHOOL OF AVIATION

JOBS in RADIO-TELEVISION

Extension and resident training in television, aviation and police radio. Let us tell you how we train men, fit them for good jobs, help them get jobs. Write for catalog. Affiliated with KMBC, major network station. Address **MIDLAND TELEVISION, Inc., 106-G Power & Light Bldg., Kansas City, Mo.**



WHY NOT spend spring, summer, fall, gathering butterflies, and moths. I buy hundreds of kinds for collections. Some worth \$1 to \$7 each. Simple work with my low cost instructions, pictures, price list. Profit—pleasure. Send 10¢ (not stamps) for Illustrated Prospectus, terms, before sending any butterflies. **MR. SINCLAIR, DEALER IN INSECTS**
Dept. 6, Box 1830 San Diego, Calif.

MONEY-MAKING OPPORTUNITY

For men of character. Over \$1,500 per month earned by California man. Over \$400 a week by Georgia man. \$1,000 in a month by Delaware man. Exclusive franchises available for an invention expected to replace a multi-million dollar industry. Install on free trial. Sells itself. Repeats. Exclusive proposition. Write **F. E. Armstrong, Dept. 1112-G, Mobile, Alabama.**

Correspondence Courses in RADIO and ELECTRICAL ENGINEERING LOW AS \$25

ELECTRICAL ENGINEERING. Get good grasp of wide electrical field. Modern. Very understandable. Theory made easy.
RADIO ENGINEERING. Extra fine course in radio, public address, photo-electric work. Trains you to be super-service man, real vacuum tube technician. Tuition ONLY \$25, either course. Deferred payment plan. Experiment kits furnished.
FREE LINCOLN ENGINEERING SCHOOL. Box 931-P7, Lincoln, Nebr.

MAKE MONEY AT HOME

RUBBER MOLDS Low as 6¢ EA.

Amazing rubber mold-making outfit makes perfect flexible molds of plaques, ash trays, book-ends, etc. Molds cost from 6¢ to 25¢ each. Each mold makes hundreds of novelties and gifts to sell up to \$1.00 apiece! No experience necessary. Quick and easy. Start profitable business in your home . . . sell to stores, gift shops, friends, resorts, road stands, by mail. Full or spare time. "Molders Handy Book" and list of buyers FREE. Write

SO-LO WORKS
Dept. X-827 Cincinnati, Ohio



You Ask Me What I Am Doing?



I Am Getting Ready to Earn More Money ... Preparing for a Bigger Job

I am a student of the American School, Chicago. A little more than half way through my course—already my increased knowledge has brought me promotion as a result of the hour or so a day I have been spending getting acquainted with the principles of the work I enjoy. I use only part of my spare time, so it doesn't interfere with my home and social life, and certainly helps me on the job.

I have been surprised at the practical manner in which even advanced work is explained. It is a lot easier than I had expected. I only wish I had started this plan of getting ahead a few years earlier. But when I was 18 to 20 I felt pretty sure of myself. I didn't take enough stock in what more experienced people told me about the importance of being thoroughly trained for the job I wanted.

You Can't Win If You Don't Try
American School, Dept. GB-45, Drexel Ave. at 58th St., Chicago

CUT ALONG THIS LINE

Try a Lesson Yourself—No Obligation

American School, Dept. GB-45, Drexel Ave. at 58th St., Chicago

I have checked the line of work in which I would like a good job. Please send me without expense or obligation on my part a copy of your Bulletin and an early lesson in the field I have selected.

- | | | |
|---|--|---|
| <input type="checkbox"/> Air Conditioning | <input type="checkbox"/> Electrical Engineering | <input type="checkbox"/> Law |
| <input type="checkbox"/> Architecture | <input type="checkbox"/> Diesel Engineering | <input type="checkbox"/> Liberal Arts (College) |
| <input type="checkbox"/> Automotive Engineering | <input type="checkbox"/> Drafting and Designing | <input type="checkbox"/> Mechanical Engineering |
| <input type="checkbox"/> Automobile Repairing | <input type="checkbox"/> Electric Refrigeration | <input type="checkbox"/> Merchandising |
| <input type="checkbox"/> Bookkeeping and | <input type="checkbox"/> Heating, Ventilating, | <input type="checkbox"/> Private Secretary |
| Cost Accounting | Plumbing | <input type="checkbox"/> Radio and Television |
| <input type="checkbox"/> Business Management | <input type="checkbox"/> Professional Accounting | <input type="checkbox"/> Salesmanship |
| <input type="checkbox"/> Civil Engineering | Incl. C. P. A. Coaching | <input type="checkbox"/> Shop Practice |
| <input type="checkbox"/> Aviation | <input type="checkbox"/> High School | <input type="checkbox"/> Steam Engineering |
| <input type="checkbox"/> Contracting, Building | <input type="checkbox"/> Highway Engineering | |

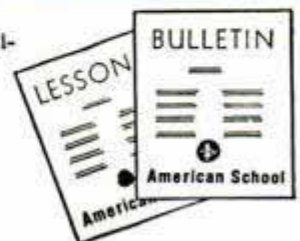

Name.....Age.....Occupation.....

Street.....City.....State.....

TRAIN FOR ELECTRICITY
12 WEEKS TRAINING
THIS QUICK EASIER WAY
ACTUAL SHOP WORK - NOT BOOKS



Have you ever dreamed of holding down a good pay job—that would give you all the things in life you wanted. If so, quit dreaming and prepare for such a job. Electricity offers you a real job and a real future if you will prepare yourself by training to take your place in this giant industry. Here at my school you are trained in 12 weeks for your start for a better job and a real future. You are trained on real electrical machinery and equipment. You work on generators, motors, dynamos, you wire houses, wind armatures, etc. You also get training in Diesel, Electric Refrigeration and Air Conditioning plus an extra 4 weeks course in Radio. My methods make it easy to learn—First you are told how to do a thing—then you are shown how to do it—then you do the work yourself.

I'LL FINANCE YOUR TRAINING

You can get this training first—then pay for the most of it after you graduate. If you need part time work to help with living expenses, we will help you get it. After Graduation you get lifetime employment service.

Send coupon today for free catalog and all details.
 Mr. H. C. Lewis, President,
 COYNE ELECTRICAL SCHOOL,
 500 S. Paulina St., Dept. B9-72, Chicago

Dear Mr. Lewis:
 Send me the book that tells the story of your training and your offer to help me get this training.

NAME.....
 ADDRESS.....
 CITY..... STATE.....

I WILL INCLUDE AN EXTRA 4 WEEKS COURSE IN RADIO

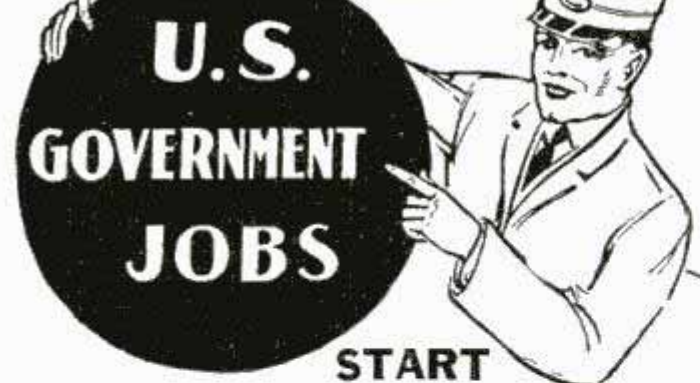

START \$1260 to \$2100 YEAR

Many appointments each year
GET READY Immediately
 Dependable Positions
 Grade School Education Usually Sufficient
 Mail Coupon Today—**SURE**

Franklin Institute
 Dept. L173
 Rochester, N. Y.

Gentlemen: Rush to me **FREE** of charge, list of U. S. Government big pay jobs. Send me **FREE** 32-page book describing salaries, vacations, hours and work. Tell me how to qualify for one of these jobs.

Name.....
 Address.....



PARKS AIR COLLEGE
 PARKS AIRPORT EAST ST. LOUIS, ILL.

Offers YOU COLLEGE and PROFESSIONAL TRAINING
Majoring in AVIATION

Accredited by the Illinois Superintendent of Public Instruction, U.S. approved as a Commercial Ground and Flying School and Mechanics' School. Open to high school graduates. **FOUR** courses lead to B.S. degrees in Professional Piloting, Aviation Operations, Maintenance Engineering, Aeronautical Engineering. **SIXTEEN TRAINING PLANES** are used in professional flight training which prepares graduates for airline flight operations. 74% of graduates enter air transportation in North and South America. 69,000 hours flight training given, 650 hours being flown monthly. **FACULTY** of 34 specialists in various fields of aviation. 1569 graduates. Enrollment limited to a total of 300. 100-acre airport, 14 buildings devoted to school purposes exclusively. Dormitories and dining hall at the College. Fall term October 2. Send postcard for new 60-page catalog.

12th YEAR Registrar, Dept. PM-7
PARKS AIR COLLEGE, East St. Louis, Ill.

Learn To MOUNT BIRDS



TAN SKINS—MAKE UP FURS
 Be a Taxidermist. We teach you at Home. Mount Birds, Animals, Pets, Heads, Fish. Save your hunting trophies. Decorate home and den. Make Money. Mount and tan for others. Fun and Profit! Don't delay. **WRITE TODAY—NOW—** for **FREE BOOK** with 100 game pictures. Hunters, get your copy—**It's Now Free.** Send post card. State your AGE. N. W. SCHOOL OF TAXIDERMY, Dept. 3378, Omaha, Nebr.

ENGINEERING

DEGREE IN TWO YEARS
 TECHNICAL AND APPLIED COURSES. Necessentials omitted. TIME AND MONEY SAVED. Degree 2 yrs., diploma 1 yr. Electrical, Mechanical, Architectural, Structural, Civil, Aeronautical, Highway. All courses include Air Conditioning, Electric Refrigeration and Diesel. Short intensive courses 3 and 4 months in Electricity, Power Plant, Diesel-Electric, Electric Refrigeration, Drafting. Extensive modern equipment. **LOW TUITION.** Part-time work for room and board. Thousands of successful graduates in U. S. and foreign lands. Approved by Industry, endorsed by educators, recommended by alumni. One and two-year courses start in Sept., short courses open year round. 40th YEAR. Residence courses. Catalog free.

FINLAY ENGINEERING COLLEGE
 1001 Indiana Avenue Kansas City, Mo.

BE A RAILWAY TRAFFIC INSPECTOR
WRITE TODAY
A JOB and GOOD PAY with OUR TRAINING

Ambitious Men—19 to 50—can qualify as Railway and Bus Passenger Traffic Inspectors by our simple home-study course. We help place our graduates at up to \$135 per month, plus expenses to start, or refund tuition. Interesting work; travel (outdoors) if you like. Get facts in Free Booklet.
STANDARD BUSINESS TRAINING INSTITUTE
 Div. 207 Buffalo, N. Y.

AUTO-MECHANICS & WELDERS

Auto Mechanics and Welders are in big demand. Complete courses in arc and acetylene welding, body and fender bumping, spray painting and metal finishing. Pay after graduation plan. Special low rates. Write today.
MICHIGAN TRADE SCHOOL
 3758 Woodward Ave., Detroit, Mich.

Write for FREE CIRCULAR

Learn to Write

Begin Today. Write for our Free Book. "How to Become a Good Penman." It contains specimens and tells how others learned to write in spare time. Your name elegantly written on a card if you enclose stamp for postage. Write today. The Tamblin School of Penmanship, Dept. 8, Ridge Bldg., Kansas City, Mo.

WILL YOU WEAR THIS SUIT
and Make up to \$12 in a Day!



Let me send you a fine all-wool union tailored suit **FREE OF ONE PENNY COST.** Just follow my easy plan and show the suit to your friends. Make up to \$12 in a day easily. **No experience—no house-to-house canvassing necessary.**
Send for Samples — FREE OF COST
 Write today for **FREE** details. **ACTUAL SAMPLES** and "sure-fire" money-getting plan. **Send no money.**
H. J. Collin, PROGRESS TAILORING CO., Dept. U-216.
 500 South Throop Street, Chicago, Illinois.

MEN — If you are
mechanically inclined
and interested in

DIESEL

INVESTIGATE

the Hemphill Diesel training programs, which have been developed over a period of years and represent the accumulated experience of many American and European Diesel engineers.

PRACTICAL

Diesel and Diesel-electric training. . . You may start the course at home, and complete it in any of the shops and laboratories operated by the Hemphill Schools—America's Original Exclusive Diesel Training Institution.

INTERESTING

You will find Hemphill Diesel training practical — absorbing — useable. Your training includes work on industrial, transport and marine engines—installation, repairs and operation. The "March of Diesel" describes the various courses.

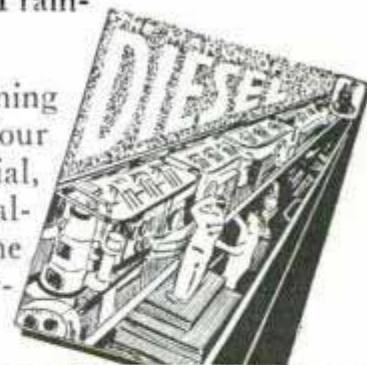

HEMPHILL DIESEL SCHOOLS

own and operate resident training schools and shops at these eight important marine and industrial centers --

Boston—114 Brookline Avenue
New York—31-26 Queens Boulevard, L. I. C.
Detroit—2341 West Lafayette Blvd.
Chicago—2014 Larrabee Street
Memphis—417 Monroe Avenue
Los Angeles—2120 San Fernando Road
Seattle—513-P Dexter Avenue
Vancouver, B. C.—1363 Granville St.

Applications for enrollment will be accepted from English speaking students residing in foreign countries. Write for special terms.

Hemphill Diesel Schools (use nearest address)

Please send data on your Diesel courses, also copy of the booklet "March of Diesel."

NAME _____ AGE _____

STREET _____

CITY _____ STATE _____ *m-39-p*

Learn this Profitable Profession



in 90 Days at Home

Hundreds of men and women of all ages 18-50 make \$10.00 to \$20.00 in a single day giving scientific Swedish Massage and Hydro-Therapy treatments. There is a big demand from Hospitals, Sanitariums, Clubs, Doctors and private patients as well as opportunities for establishing your own office.

Learn this interesting money-making profession in your own home by mail, through our home study course. Same instructors as in our **NATIONALLY KNOWN** resident school. A diploma is awarded upon completion of the course. Course can be completed in 3 to 4 months. High School training is not necessary. Many earn big money while learning.



Anatomy Charts & Booklet FREE

Enroll now and we will include uniform coat, medical dictionary, patented reducing roller and Hydro-Therapy supplies without extra cost. The reducing course alone may be worth many times the modest tuition fee.

Send coupon now for Anatomy Charts and booklet containing photographs and letters from successful graduates. These will all be sent postpaid—FREE.

THE College of Swedish Massage (Successor to National College of Massage) Dept. B64—30 E. Adams St., Chicago.

You may send me FREE and postpaid, Anatomy Charts, booklet containing photographs and letters from graduates, and complete details of your offer.

Name

Address

City State

AUDELS Carpenters and Builders Guides 4 vols. \$6



Inside Trade Information for Carpenters, Builders, Joiners, Building Mechanics and all Woodworkers. These Guides give you the short-cut instructions that you want—including new methods, ideas, solutions, plans, systems and money saving suggestions. An easy progressive course for the apprentice and student. A practical daily helper and Quick Reference for the master worker. Carpenters everywhere are using these Guides as a Helping Hand to Easier Work, Better Work and Better Pay. To get this assistance for yourself, simply fill in and mail the FREE COUPON below.

Inside Trade Information On:

How to use the steel square—How to file and set saws—How to build furniture—How to use a mitre box—How to use the chalk line—How to use rules and scales—How to make joints—Carpenters arithmetic—Solving mensuration problems—Estimating strength of timbers—How to set girders and sills—How to frame houses and roofs—How to estimate costs—How to build houses, barns, garages, bungalows, etc.—How to read and draw plans—Drawing up specifications—How to excavate—How to use settings 12, 13 and 17 on the steel square—How to build hoists and scaffolds—skylights—How to build stairs—How to put on interior trim—How to hang doors—How to lath—lay floors—How to paint.



THEO. AUDEL & CO., 49 W. 23rd St., New York City

Mail Audels Carpenters and Builders Guides, 4 vols., on 7 days' free trial. If O.K. I will remit \$1 in 7 days, and \$1 monthly until \$6 is paid. Otherwise I will return them. No obligation unless I am satisfied.

Name

Address

Occupation

Reference P.M.

AN AVIATION CAREER



OFFERS YOU GREAT FUTURE!

Demand for trained aircraftsmen is increasing and already exceeds supply. Curtiss-Wright Tech, Aviation's foremost and oldest school, is located on Grand Central Air Terminal in heart of the aircraft industry and specializes in training **MASTER MECHANICS** and **AERONAUTICAL ENGINEERS**. (No flying involved.) Graduates are obtaining immediate employment. Write for details NOW. Dept. PM-7

CURTISS - WRIGHT TECHNICAL INSTITUTE
Glendale (Los Angeles) California

ENGINEERING DEGREE IN TWO YEARS

B. S. Degree courses in engineering: Electrical, Civil, Chem., Mechanical, Radio and Television, or Aeronautical, 1 yr. Mech. Drafting. Intense, practical, thorough program. Large industrial center. Prep courses without extra charge. Earn board if desired. Low tuition and living costs. Enter September 5, December, March, June. Write for Catalog.

239-A E. Washington Blvd., Fort Wayne, Ind.

INDIANA TECHNICAL COLLEGE

LEARN WATCH REPAIRING



AT HOME You can learn by our modern and original system of instruction every part of the Watch Repairing Trade at home. You can earn money while learning and prepare yourself for a well paying position or start in business after completing our course of instruction. Good watch repairers are in demand and generally earn very good salaries. For particulars apply to the **Wisconsin School of Watch Repairing** 524 E. Mason St., MILWAUKEE, WIS.

VOICE

100% Improvement Guaranteed

We build, strengthen the vocal organs—*not with singing lessons*—but by fundamentally sound and scientifically correct *silent exercises*... and absolutely guarantee to improve any singing or speaking voice at least 100%... Write for wonderful voice book—sent free. Learn WHY you can now have the voice you want. No literature sent to anyone under 17 years unless signed by parent.

PERFECT VOICE INSTITUTE, Studio B-135
64 E. Lake St., Chicago



EARN THE DEGREE

Doctor of Psychology (Ph.D.), Philosophy, Divinity. General Courses—Arts, Secretarial, etc. A Correspondence Institution Chartered by State of Washington. Send for 32-page FREE Bulletin at once. No Obligation. Temple Bar College, Dept. 2-R, 1629 Thirteenth Avenue Seattle, Washington, U.S.A.

LEARN CARTOONING!



Let a prominent cartoonist teach you this fascinating profession by mail. PERSONAL instruction, just like private tutoring. Recommended by America's foremost cartoonists. Write for free details.

DORMAN H. SMITH, Box C597, SAN RAFAEL, CALIF.

SUCCEED IN LANDSCAPING



Send for FREE book with full details about landscape training. Study at home, earn while learning. Profitable, healthful career; interesting hobby; men, women. Give age, occupation.

AMERICAN LANDSCAPE SCHOOL

6090 Grand Avenue Des Moines, Iowa

Learn PHOTOGRAPHY at Home

Splendid opportunities. Prepare in spare time. Easy plan. No previous experience needed, common school education sufficient. Send for free booklet "Opportunities in Photography", particulars and requirements.

American School of Photography
3601 Michigan Ave., Dept. 135B, Chicago, Ill.

I WANT MEN

FORDS GIVEN TEA & COFFEE ROUTES PAYING UP TO \$45



Million dollar company needs more men at once to make regular calls on local routes. No experience needed. Earnings start at once. Ford Tudor Sedans given producers as bonus. Full particulars mailed free. Just send postcard.

E. J. MILLS, 9558 Monmouth Ave., Cincinnati, Ohio

GET A NEW KICK OUT OF VACATION DAYS with a GRETSCH DRUM



Fill this vacation with a new source of fun... there's lots of time to master the drum... easy to plan a life-long career... like Bernie Mattinson (above), popular big-money drummer. When the gang goes hiking, lead 'em with a drum... be master of ceremonies... the lad they can't leave behind because he has a drum! No difficult lessons... have fun learning... pay on easy GRETSCH terms.

Bernie Mattinson
with Horace Heidt

EASY TO PLAY: EASY TO PAY

Send penny postcard for FREE DRUM catalogue and full information about EASY PAYMENT plan and FREE TRIAL through your GRETSCH dealer. Address Dept. PM-70

The FRED. GRETSCH MFG. CO.
Musical Instrument Makers Since 1883
60 BROADWAY, BROOKLYN, N. Y.

GRETSCH also offers SUPER VALUES in Guitars, Saxophones, Trumpets, Trombones, Accordions. Send for FREE catalogue. Mention instrument.

MAKE MONEY with your CAMERA

Thousands of publications buy MILLIONS of photos yearly from amateurs. We show you what to photograph, how to do it, where to sell for biggest profits. Learn at home to become a journalistic or press photographer. Pay for course in easy installments. Use any camera. Write for FREE BOOK. UNIVERSAL PHOTOGRAPHERS, Inc., Dept. 77, 10 W. 33rd St., N. Y. C.

FREE BOOK

REAL JOBS OPEN! LEARN AUTO-DIESEL MECHANICS QUICKLY!

Don't worry with a low-pay job. Auto-Diesel mechanics offer you real opportunity to get a real job. Write either school (25 years experience!) for low tuition rates. Information FREE! Write Dept. 12-7.

McSWEENEY TRADE SCHOOLS, Kansas City, Mo. Detroit, Mich.

Free TRIAL LESSON IN DRAFTING

More good jobs now in Drafting. Learn AT HOME in spare time (or at our Chicago School). Send postcard for FREE TRIAL LESSON and see how easy to learn and get a good job.

CHICAGO TECHNICAL COLLEGE
H-200 Tech Bldg., 118 E. 26th St., Chicago, Ill.

AVIATION APPRENTICES

AIRMINDED YOUNG MEN INTERESTED IN TRAINING FOR ENTERING THE WELL PAID FIELD OF AVIATION AS APPRENTICES—Write immediately, enclosing stamp.

MECHANICAL UNIVERSAL AVIATION SERVICE CO.
Wayne County Airport, Box 857, Dept. E, Detroit, Mich.

PHOTO-ENGRAVING TASOPE' SINCE 1931

TASOPE', world's largest builders of complete Photo-Engraving Plants. We supply newspapers, printeries, studios, colleges, high schools and individuals with precision-built equipment, and give thorough training in Photo-Engraving and Photography, (home or residence)—all at one low cost! Cash in on popularity of pictures. Big money working full or part time for others, or open your own well-paying business. Amazingly small investment. Cash or terms. Catalogs free.

THE AURORA SCHOOL OF PHOTO-ENGRAVING
Dept. PM-6 Tasope' Bldg. Aurora, Mo.

MAKE ME PROVE that I can train you at home for a GOOD JOB in RADIO

MAIL COUPON FOR FREE SAMPLE LESSON

Operates Public Address System

"I have a position with the Los Angeles Civil Service operating the Public Address System in the City Hall Council. My salary is \$170 a month." R. H. ROOD, R. 136, City Hall, Los Angeles, Calif.

\$50 Monthly in Spare Time

"I work on Radio part time, still holding my regular job. Since enrolling seven years ago, I have averaged around \$50 every month." JOHN B. MORRISSETTE, 809 Valley St., Manchester, N. H.

Makes \$50 to \$60 a Week

"I am making between \$50 and \$60 a week after all expenses are paid, and I am getting all the Radio work I can take care of, thanks to N. R. I." H. W. SPANGLER, 126 1/2 S. Gay St., Knoxville, Tenn.

Many Radio Experts Make \$30, \$50, \$75 a Week

Radio broadcasting stations employ engineers, operators, station managers and pay well for trained men. Fixing Radio sets in spare time pays many \$200 to \$500 a year—full time jobs with Radio jobbers, manufacturers and dealers as much as \$30, \$50, \$75 a week. Many Radio Experts open full or part time Radio sales and repair businesses. Radio manufacturers and jobbers employ testers, inspectors, foremen, engineers, servicemen, in good-pay jobs with opportunities for advancement. Automobile, police, aviation, commercial Radio, loud speaker systems are newer fields offering good opportunities now and for the future. Television promises to open many good jobs soon. Men I trained have good jobs in these branches of Radio. Read how they got their jobs. Mail coupon.

Many Make \$5, \$10, \$15 a Week Extra in Spare Time While Learning

The day you enroll I start sending Extra Money Job Sheets; show you how to do Radio repair jobs. Throughout your training I send plans and directions that made good spare time money—\$200 to \$500—for hundreds, while learning. I send you special Radio equipment to conduct experiments and build circuits. This 50-50 method of training makes learning at home interesting, fascinating, practical. I ALSO GIVE YOU A MODERN, PROFESSIONAL ALL-WAVE, ALL-PURPOSE RADIO SET SERVICING INSTRUMENT to help you make good money fixing Radios while learning and equip you for full time jobs after graduation.

Find Out What Radio Offers You

Act Today. Mail the coupon now for sample lesson and 64-page book. They're free to any fellow over 16 years old. They point out Radio's spare time and full time opportunities and those coming in Television; tells about my training in Radio and Television; show you letters from men I trained, telling what they are doing and earning. Find out what Radio offers YOU! MAIL COUPON in an envelope, or paste on a postcard—NOW!

J. E. Smith, President
Dept. 9GP, National Radio Institute
Washington, D. C.

Mail this Now FREE Get 64-page Book

J. E. Smith, President National Radio Institute Dept. 9GP, Washington, D. C.

Dear Mr. Smith:
Without obligation, send me the Sample Lesson and your free book about the spare time and full time Radio opportunities, and how I can train for them at home in spare time. (Please write plainly.)

Age.....
Name.....
Address.....
City..... State..... 2FR3

When writing please mention Popular Mechanics

HIGH SCHOOL

At Home!

Qualify for the better Commercial, Industrial and Civil Service positions by getting a High School education in spare time!

Prepare for College, Pre-Professional, Regents, State Equivalency Examinations, and Business and Industry

U. S. Govt. figures show High School graduates average \$2112 yearly. Many Finish in 2 Years!

No classes; no time wasted going to and from school. You make rapid progress by our methods. Thousands of ambitious men and women select the American School each year.

All books furnished. School est. over 40 years. Endorsed by educators. Small monthly payments.

American School, Dept. HB-45, Drexel Ave. at 58th St., Chicago

American School, Dept. HB-45, Drexel Ave. at 58th St., Chicago

Without obligation send me your free Bulletin and information about your High School course at home, or the field I have checked.

- | | | |
|--|--|---|
| <input type="checkbox"/> Air Conditioning | <input type="checkbox"/> High School | <input type="checkbox"/> Law |
| <input type="checkbox"/> Architecture | <input type="checkbox"/> Electrical Engineering | <input type="checkbox"/> Liberal Arts (College) |
| <input type="checkbox"/> Automotive Engineering | <input type="checkbox"/> Diesel Engineering | <input type="checkbox"/> Mechanical Engineering |
| <input type="checkbox"/> Automobile Repairing | <input type="checkbox"/> Drafting and Designing | <input type="checkbox"/> Merchandising |
| <input type="checkbox"/> Bookkeeping and Cost Accounting | <input type="checkbox"/> Electric Refrigeration | <input type="checkbox"/> Private Secretary |
| <input type="checkbox"/> Business Management | <input type="checkbox"/> Heating, Ventilating, Plumbing | <input type="checkbox"/> Radio and Television |
| <input type="checkbox"/> Civil Engineering | <input type="checkbox"/> Professional Accounting Incl. C. P. A. Coaching | <input type="checkbox"/> Salesmanship |
| <input type="checkbox"/> Aviation | <input type="checkbox"/> Highway Engineering | <input type="checkbox"/> Shop Practice |
| <input type="checkbox"/> Contracting, Building | | <input type="checkbox"/> Steam Engineering |
| | | <input type="checkbox"/> Shop Management |

Name _____ Age _____ Occupation _____

Street _____ City _____ State _____



DIESELS

PREPARE FOR TOMORROW'S OPPORTUNITY

This is your opportunity to qualify as a Diesel Engineer. Men with practical training are in demand for good-paying, responsible positions. You can qualify for a place in this rapidly growing industry.

TESTED TRAINING—REAL SHOP EXPERIENCE
Internal Combustion Engines — Automotive Service
 National Schools give you actual shop methods. You learn on the latest and best equipment in a million-dollar trade school. You are taught to make good and helped to make good after you graduate. It will pay you to investigate National's Master Course.

FREE!
Transportation Allowed to Los Angeles
 Coach railroad fare allowed from any point in the United States. Earn room and board while learning. Graduate employment cooperation. Mail coupon for new 40-page Book of Diesel Facts, details of training, employment opportunities.



NATIONAL SCHOOLS LOS ANGELES

Request for FREE BOOK

NATIONAL SCHOOLS
 Dept. 7-PMA, 4000 Figueroa St., Los Angeles, Calif.

NAME _____ AGE _____

ADDRESS _____

CITY _____ STATE _____

U.S. GOV'T JOBS

Earn \$1260 to \$2100 at Start

Excellent opportunities for citizens, age 18 to 50. No special experience usually required. Railway Postal Clerks may earn \$155 first month; Customs Inspectors as high as \$3,000 a year. Send for FREE BOOK "How to Secure a Government Position." It tells about many good government positions and how our tested method will help you pass examinations. Write AT ONCE, PATTERSON SCHOOL, Arthur R. Patterson (former Gov't. Examiner), Principal, 87 Mercantile Bldg., Rochester, N. Y.

LET SCIENCE PICK A JOB FOR YOU!

Today, getting a job or choosing a career is no longer a hit-or-miss task. Science can now accurately determine for you, in advance, just what type of work or profession you are best suited for. Why waste time or money groping aimlessly when new scientific methods show you proven steps to success? Write at once for details and FREE occupational and social adjustment Test!

VOCATIONAL GUIDANCE INSTITUTE, Dept. A-17
 Greenway Station Tucson, Arizona

RADIO ENGINEERING, broadcasting, aviation and police radio, servicing, marine and Morse telegraphy taught thoroughly. 48 weeks' engineering course equivalent to three years' college radio work. School established 1874. All expenses low. Catalog free.

Dodge's Institute, Ada St., Valparaiso, Ind.

Learn to play...

Easy lessons at home. Inexpensive. 132-page Music Dictionary FREE when you enroll. Stop lessons when you like. Money back guarantee. Write for free details. **Hamann Institute**, 3016 N. 24th Place, Dept. R-7, Milwaukee, Wis.

Hawaiian Steel Guitar
 Spanish Guitar
 Piano

LEARN AVIATION IN LOS ANGELES

Nation's Aviation Capital

Hugh increase in Los Angeles aviation activity has insured good paying positions for California Flyers graduates. Only U. S. Government and industry approved school here in nation's aviation capital, offering airline piloting, engineering, mechanics, drafting, aircraft construction, one of America's most modern equipped and strategically located schools. Write for interesting free catalog.

CALIFORNIA FLYERS SCHOOL OF AVIATION—Dept. PM-7
 LOS ANGELES MUNICIPAL AIRPORT, INGLEWOOD, CALIF.

A NEW LIFE Within Your Grasp!

RESHAPE YOUR FUTURE

WHAT would you give for a chance to begin life anew—not in a hereafter, but here on earth—with all of the advantages of your past experiences and with all of your mistakes behind you?

This is not a fantastic claim, or a bombastic statement—it is reality. The body you have today is not the one you were born with—each cell of it has been reborn thousands of times—nature has seen to that. But *what of the you*—are you following the same old routine of living? If life is not what you would like it to be you can create a change.

Let the Rosicrucians, preservers of certain private wisdom of the sages, show you how to live intelligently, knowingly—converting opportunities into advantages. Become a *Master of living*.

Accept This Free Book
If you are sincere, write for a free copy of "The Secret Heritage." It tells how you may share this wisdom.

Address: Scribe H. C. B.
The

ROSICRUCIANS
(AMORC)
San Jose, California
(NOT a religious organization)

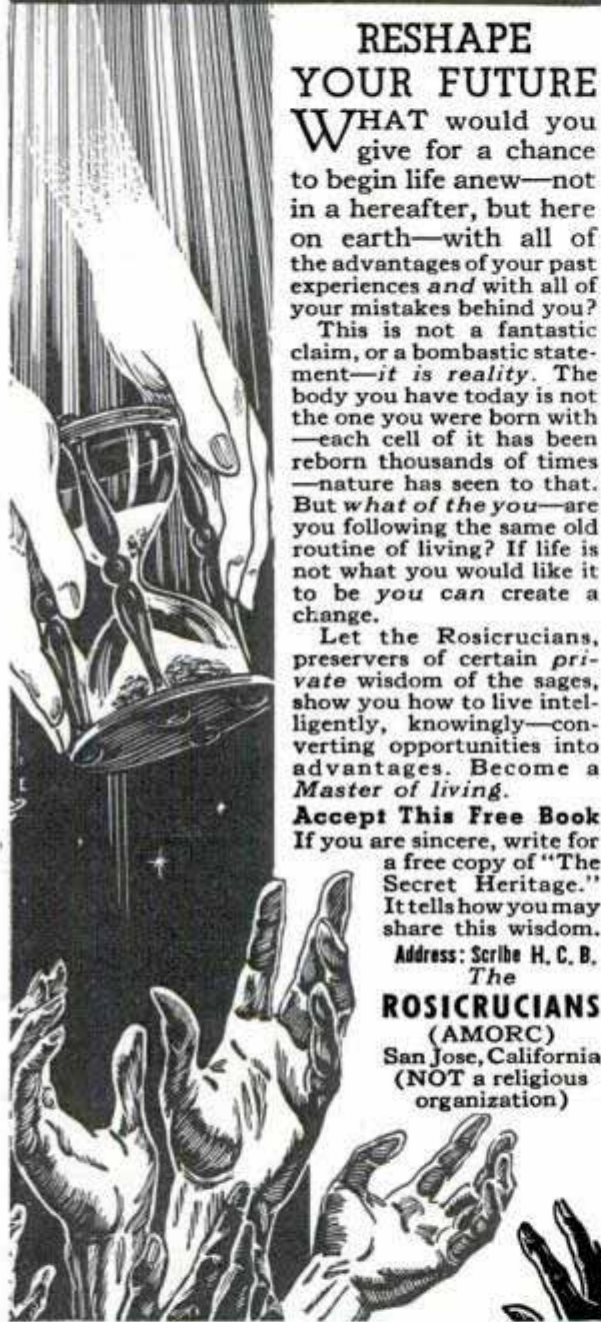

CARTOONING

FREE TRIAL LESSON! Cash in on your sense of humor—AT HOME—BY MAIL. Have fun! Make money! No experience needed to start. Write today for FREE LESSON, mailed postpaid. No obligation.
Moon Gag-Cartoon School, Dept. A, Fall Creek, Wis.



Earn Cash at Home!

We paid M. M. \$1174 for exceptional cellar crop Snow-King mushrooms! We furnish materials; buy all crops. Big FREE picture book tells if your cellar, shed, barn, suitable. Est. 1908. Write today.
United Co., 3848 Lincoln Av., Dept. 300, Chicago



Auto-Diesel

Master a real trade. Auto Mechanics, Diesel Mechanics, Arc Welding, Acetylene Welding, etc. Let us train you to be an expert Auto-Diesel Mechanic and help you get a good job. The cost to you is reasonable. Learn on modern equipment with tools under experienced instructors. Real shop work. Steam heated buildings. Room and board in our steam heated dormitory. We pay your fare to Nashville. For free catalog write

Nashville Auto-Diesel School, Dept. 75, Nashville, Tenn.

ACCOUNTANCY

One of America's best paying professions



These Are OPPORTUNITY DAYS for the Trained ACCOUNTANT!

WITH new state and federal legislation requiring more accurate accounting from businesses than ever before, the trained accountant is certainly a man to be envied. Much in demand, member of "America's best-paid profession," an important figure in affairs, he is one of the most influential and necessary individuals in the whole business scheme!

His is a profession YOU may be considering at this moment. If so, don't fail also to consider critically how, when, and from whom you will secure your Higher Accountancy training. Consider particularly LaSalle's record of more than 500,000 Accountancy-trained men and women during the past thirty years—a record unsurpassed by any other educational institution.

Remember, too, how numerous are the available accountancy schools and courses in the country. Yet, despite this fact, *approximately one-tenth of all C.P.A.'s* have been student members of LaSalle.

As to the training itself, you will find it absolutely complete; from Elements through to Accounting Systems, and a choice of twelve post-graduate electives, including C. P. A. Coaching that qualifies you thoroughly.

Spare-time study does it all! No interference with your present work and a careful analysis of thousands of student histories reveals that some have realized, in increased later earnings, as high as \$50 returns on every hour devoted to such study.

If you are actually in earnest—are willing to work devotedly for your future success, look into this subject carefully, thoughtfully, and from every angle. Full information and a 48-page survey of this opportunity field will be sent you on request.

Sign and mail coupon for complete details

LASALLE EXTENSION UNIVERSITY A Correspondence Institution

Dept. 764-HR Chicago

Kindly tell me more about the present opportunities in Accounting and how your training can help me grasp them. Also send me—free—your booklet on "Accountancy, the Profession That Pays."

Higher Accountancy

Other LaSalle Opportunities:

If more interested in one of the fields indicated below, check and mail now.

- | | |
|---|---|
| <input type="checkbox"/> Business Management | <input type="checkbox"/> Expert Bookkeeping |
| <input type="checkbox"/> Modern Salesmanship | <input type="checkbox"/> C. P. A. Coaching |
| <input type="checkbox"/> Law—Degree of LL. B. | <input type="checkbox"/> Traffic Management |
| <input type="checkbox"/> Commercial Law | <input type="checkbox"/> Stenotypy |

Name.....

Present Position.....

Address.....

When writing please mention Popular Mechanics



NEW INVENTIONS



SPECIAL gun-firing mechanism, apparently designed for fighting planes, has been patented. It provides for automatic

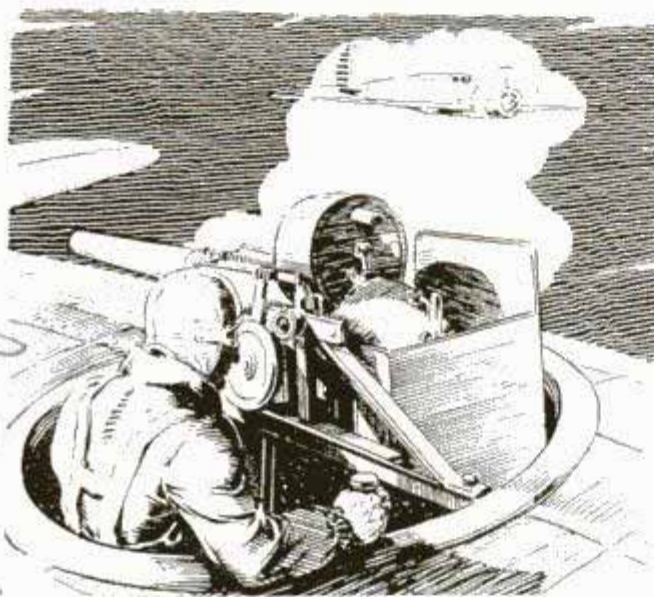

operation of the gun, including an automatically actuated breech block and automatically cocked firing means having a firing trigger. The tripping means for the trigger is self-actuated when forced in one direction and released. The gun is also equipped with mechanism operatively connected with the breech block and tripping arrangement for forcing the trip in one direction when the breech block is opened and for releasing when the block is closed.

DESIGNED for cutting tall grass ahead of the lawn mower, and thus make mowing easier, an attachment patented recently would be an aid to the lawn keeper.

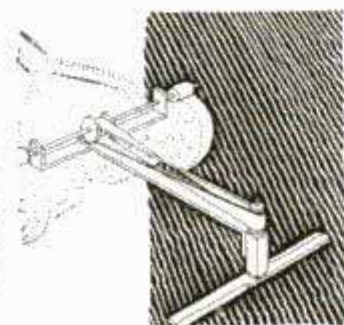

Located in front of the mower, with suitable supporting means, it is operated by belt

from a shaft rotated by contact with the lawn mower's wheels. Revolving in horizontal plane close to the ground, the cutter shears off the longer grass and clears the way for the mower to complete the job.

PROTECTION of ships against torpedo attack is the purpose of a newly patented invention.

It consists of a guard to be attached to the side of the ship above the water line, with arms pivoted for movement into vertical or horizontal position and brackets extending outwardly to support the arms. Grids pivotally suspended from the arms may be moved into position in a manner to protect the ship above and below the water line by preventing the torpedo from striking the side of the vessel.

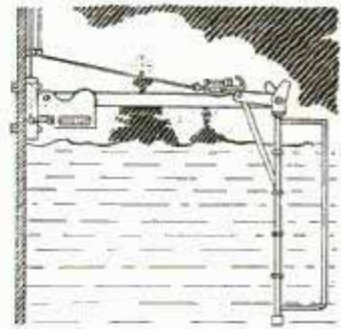

TWO patents issued recently involve means of producing unusual motion-picture effects. One is for apparatus de-

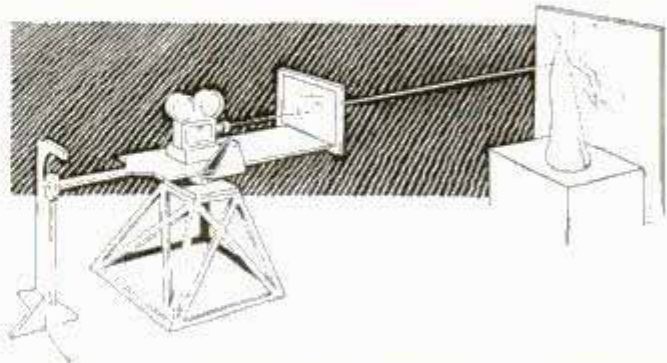

signed for obtaining diminution and growth of an image of an object in successively different positions on successive film frames. A camera and a distorting lens lo-

(Continued to page 22A)

2499
Patent lawyer
C.O. Todd,
8406 Georgia Ave.
Silver Spring Md
7.95

It's Great TO BE IN THE Spotlight



EASY, TOO!

Let the BRINDISI ACCORDION be your magic carpet to happy-land. Fun at home and at parties. Opportunity for broadcasting, dances, entertainment, etc. Easy to learn—moderate cost. Write today for FREE copy of booklet—"Music Magic with the Accordion." . . . Tonk Bros. Co., Dept. 27, 623 S. Wabash Ave., Chicago

GO INTO BUSINESS AT HOME WITH NEW GREASELESS DOUGHNUT

Go into sensational new kind of food business! Start in your kitchen. Even without previous experience big daily profits are possible making and selling amazing GREASELESS DOUGHNUTS. We supply equipment and plans. Stores sell for you. Send postcard NOW for special quick-starting offer. Send no money. BROWN BOBBY CO., 620 N. Michigan Ave., Dept. D-187, Chicago, Ill.

CARTOON YOUR WAY TO SUCCESS!



DON'T COPY - LEARN TO ORIGINATE!

RAYE BURNS will teach you HOW to CREATE ORIGINAL CARTOONS at home that you can SELL! Course has 26 lessons and 600 illustrations. **\$2.85**

Send name and address for free details. Only . . . RAYE BURNS SCHOOL, Dept. M-2, Box 2194, CLEVELAND, OHIO

MECHANICS

KNOW YOUR CAR

You Need this Book

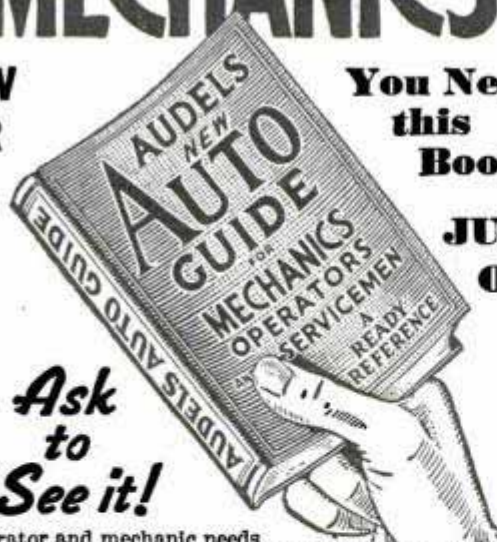

JUST OUT!

Ask to See it!

Every operator and mechanic needs AUDELS NEW AUTO GUIDE. This book saves time, money and worry. Highly endorsed. It presents the whole subject of auto mechanics: 1—Basic principles, 2—Construction, 3—Operation, 4—Service, 5—Repair. Easily understood. Over 1500 pages—1540 illustrations showing inside views of modern cars, trucks and buses with instructions for all service jobs. Diesel Engines fully treated, fully illustrated. To Get This Assistance for Yourself Simply **\$4** Fill in and Mail Coupon Today.

COMPLETE • PAY ONLY \$1. A MONTH

THEO. AUDEL & CO., 49 WEST 23rd STREET, NEW YORK Please send me postpaid AUDELS NEW AUTOMOBILE GUIDE (\$4) for free examination. If I decide to keep it, I will send you \$1 within 7 days; then remit \$1 monthly until purchase price of \$4 is paid. Otherwise, I will return it to you promptly.

Name _____
 Address _____
 Occupation _____
 Reference _____ PM

NOW LEARNING MUSIC IS LIKE PLAYING A GAME

New home method easy as A-B-C!



No special talent is required—no previous musical training. You learn to play right in your own home this U. S. School of Music way and its cost averages only a few cents a day.

There's nothing tricky about it—no complicated theories. What's more, with this short-cut system you don't have to spend hours practicing tedious scales or monotonous finger exercises. Instead you learn real tunes from the start. First you are told what to do—then a picture shows you how to do it—then you do it yourself and hear it.

Decide now to learn to play the Piano, Violin, Ukulele, Tenor Banjo, Hawaiian Guitar, Piano Accordion, Saxophone or any other instrument you like.

FREE BOOKLET AND DEMONSTRATION LESSON

Mail coupon today for Free Booklet and Free Demonstration Lesson explaining this method in detail. Mention your favorite instrument. Instruments supplied when needed—cash or credit.

U. S. SCHOOL OF MUSIC, 77 Brunswick Bldg., New York City

U. S. School of Music, 77 Brunswick Bldg., N. Y. C.

Please send me Free Booklet and Demonstration Lesson. I would like to play instrument checked below. (Do you have instrument.....)

Piano	Accordion	Clarinet	Banjo
Violin	Saxophone	Trumpet	Ukulele
Guitar	Mandolin	Trombone	Other Instrument

Name _____

Address _____



Know Electricity as Experts Know It—and Get an Expert's Pay!

What about your future? Who is safe today? Surely not the man who is contented to stand still! Know your job thoroughly—prepare yourself for jobs ahead. To do just this thousands of men have used

The Croft Library of Practical Electricity

The Croft Library is a complete electrical educator. It is founded on practice—on 20 years of shirt-sleeve experience—on work as it is actually done. It is jammed from cover to cover with the kind of hard-headed facts you want. Written so that the beginner can easily understand it, yet so sound, so thorough, that it is the daily guide of 59,000 highly paid electrical workers and engineers. Croft tells you the things you need to know about motors, generators, armatures, commutators, transformers, circuits, switchboards, distribution systems—electrical machinery of every type—illumination in its every phase—the most improved methods of lighting—lamps and lamp effects, etc.—how to do a complete job, from estimating it, to completion.

6 volumes, 2155 pages—only \$16.50 No money down—Easy payments.

Fill in and mail the coupon attached and we will send you the entire set of six volumes for ten days' Examination on approval. We take all the risk—you assume no obligation. If you decide to keep the books, send \$1.50 in ten days and the balance at the rate of \$3.00 a month. Send the coupon NOW and see the books for yourself.

EXAMINATION COUPON

McGRAW-HILL BOOK CO., 330 W. 42nd St., New York

Send me for ten days' examination on approval the Croft Library of Practical Electricity. If satisfactory I will send you \$1.50 in 10 days and \$3.00 monthly until the price of \$16.50 is paid. If not wanted, I will return the books postpaid. (To insure prompt shipment write plainly and fill in all lines.)

Name _____
 Home Address _____
 City and State _____
 Position _____
 Name of Company _____ P.M. 7-39



AUTO

BOOKS SENT FREE

on approval. Just mail the coupon and we'll send you a set of these remarkable auto books, just off the press. Whether you are a mechanic or helper, expert or apprentice, auto owner or driver, if you're interested in knowing all about automobile mechanics, take advantage of this FREE OFFER.

GET A BETTER JOB

A better job—in the gigantic auto industry. BIGGER PAY—a chance to go into business for yourself and get a share of the huge profits, are waiting for any man who even half tries to improve himself. Learn auto engineering with these wonder books a new way—without studying or memorizing. Simply use the JIFFY INDEX to look up the answer to any auto problem. Built by eleven of America's greatest automobile engineers, and written in simple language so you can understand it. Very newest cars, all covered.

[FREE Privilege of consulting Automobile Engineers of American Technical Society for one year without cost if you mail coupon immediately]

Send promptly and we will include a Brand New EXTRA volume with over 300 pages including ALL 1939 cars with wiring diagrams and data sheets on each.

CAN YOU FIX IT?

These wonder books tell step by step HOW to take out "play" in differential — to kill the shimmy in steering—to set TIMING—how to put your finger instantly on engine trouble and then the quick expert way to FIX it. Newest improvements fully covered. Equal to a complete trade course at less than a fourth the cost.

6 BIG VOLUMES
Brand New Edition
2500 pages, 2000 illustrations, wiring diagrams, etc., including Marine Engines, Aviation Motors, Diesel engines, etc. De Luxe edition, gold-stamped flexible binding.

AMERICAN TECHNICAL SOCIETY

Drexel Ave. & 58th St., Dept. AB19, Chicago, Ill.
I would like to see the new 6-volume edition of your AUTO BOOKS. I will pay the few cents delivery charges only, but if I choose to, I may return them express collect. If after 10 days use I prefer to keep them, I will send you \$2 and pay the balance at the rate of only \$3 a month, until \$24.80 is paid. Please include free membership and extra Volume No. 7, as per your offer above.
Name.....
Address.....
City..... State.....
Attach letter stating age, occupation and name and address of employer and that of at least one business man as reference.

Learn by pre-tested Training

RADIO plus TELEVISION



QUALIFY for GOOD JOBS

You want the true facts about the opportunities to earn money in Radio in all its service branches and Television. National Schools,—a million-dollar trade school,—will point out the way for you to get into this profitable field no matter what your financial circumstances may be.

FREE BOOK of details

Explains National's pre-tested plan; how you can master Radio, all branches, Sound-Recording, Public Address & Communication Systems, Broadcasting, Television. Mailed postpaid.

NATIONAL SCHOOLS
Los Angeles (EST. 1905)

Request for FREE BOOK of DETAILS

NATIONAL SCHOOLS, Dept. 7-PMR,
4000 S. Figueroa St., Los Angeles, Calif.

NAME _____ Age _____

ADDRESS _____

CITY _____ STATE _____



Only 15c A Day
Puts This All-Purpose
ELECTRIC ARC WELDER
IN YOUR SHOP

TEN-DAY TRIAL
Guaranteed: 10 Months To Pay

Now, it is EASY for every inventor, laboratory, home workshop owner, garage, repair shop, and factory to afford a complete welding service for manufacturing, maintenance, experimental, or repair work. Full size, heavy-duty Aladdin Electric Arc Welder—yours for only 15c a day! Highly efficient. Welds all weldable metals and alloys. Handles everything from fenders and light sheet metal to motor blocks and heavy castings. Also fine for soldering and brazing.

WORKS ON 110 OR 220-VOLT A. C. Simply plug into 110 or 220-volt, 60-cycle A. C. electric outlet. Costs only few pennies an hour to operate. Anyone can use easily. Comes complete with helmet, electrode holder, welding rods, full instructions, etc. Nothing else to buy. Fully guaranteed.

WRITE FOR 15c A DAY PLAN. Stop throwing away profits! Do your own welding. Get sensational facts. Write today!

COMMONWEALTH MFG. CORP.

Dept. Z-51

4208 Davis Lane,

Cincinnati, O.

for **MORE PAY** learn From An
DRAFTING **ENGINEER**

GET READY FOR PROSPERITY PAY. I will train you at your home by mail on Practical Drafting until IN POSITION, or prepare you for BETTER PAY on the Job you have. All tools and drawing table sent at once if you enroll now. WRITE FOR FREE BOOK. Give your age.

ENGINEER DOBE,

Div. B337

Libertyville, Ill.

New York Established 1902
Electrical
Ask for free illustrated **School**
booklet
44 West 17th St., N. Y. C.

FAILURE? Are you discouraged, bewildered, seeing others forge ahead to success, wealth, power while you remain in the ranks? Do you ever ask what it is that makes them successful where you fail, when they have no more intelligence than you? Don't give up... I can help you! Send name, address and 25c to H. C. McCulloch, Desk 67, Pershing Square Bldg., New Rochelle, N. Y.

AU **AERONAUTICAL UNIVERSITY**
Engineering (B.S. Degree)—Administration—Certificated Mechanics—Radio—Sheet Metal—Welding
ACCREDITED
A real technical university education in less time at less cost. Write for Illustrated Bulletin. Address Aeronautical University, Curtiss-Wright Bldg., Dept. A, 1342 S. Michigan Ave., CHICAGO, ILL.

Animated CARTOONING
SEND FOR **FREE BOOK** • **MONDELL INSTITUTE OF ANIMATED CARTOONING**
230 WEST 41st STREET New York City

LEARN TOOL and DIE MAKING **EARN BIGGER PAY THE ALLIED WAY!**
Machinist Trade and Screw Machine Work in fully equipped State Certified shops. Practical Methods on actual work; jobs open for Trained Men. Employment help given. Enter now; Low Tuition, Illustrated Book FREE.
ALLIED SCREW MACHINE CO., INC.
(School Div.) Dept. PM-7, 609-613 W. Lake St., Chicago, Ill.

MONEY IN RABBITS—CAVIES
WE BUY and put you in touch with other markets Catalog and copy of magazine 10c. Or send 25c for Book Catalog and Price List and Year's Subscription to the AMERICAN SMALL STOCK FARMER.
OUTDOOR ENTERPRISE CO., BOX 919, NEW CITY, N. Y.

BUCHSTEIN'S FIBRE LIMB
Correctly fitted. Strong, light, neat, cool, soothing. Braces for all deformities. On terms.
D. BUCHSTEIN CO.
FOR COMFORT 610 3rd Ave. South, Minneapolis, Minn.

INVENTORS

INFORMATION ON HOW TO OBTAIN PATENT AND MARKET INVENTIONS

If you have invented something, if you're interested in inventing something, you need this new 48-page book that gives the entire Story of Patents. It tells you for the first time about new phases of invention, how others succeeded, how the patent laws protect you, how to market your invention, where to obtain finances, how to form a company, partnership, or arrange for royalties from your invention's sale.

PRACTICAL BENEFITS

You will find 6 complete pages illustrated with simple inventions that have succeeded in six different fields of industry. Over 100 illustrations are in this book. You will read the stories of ten (illustrated) of America's most famous inventors. You will find an experienced and thorough survey of market conditions affecting the inventor—showing the possibilities for commercial invention today. Entire chapters are devoted to the value of a patent in promoting the final success of your invention. The

importance of quick action in applying for patent is stressed—facts revealing danger of delay are emphasized.

If you expect to realize profits from your invention you must protect it with a U. S. Patent. Otherwise you may find that all your time and labor have been lost, because it often happens that other inventors are working on the same invention. If you have an invention, or an ambition to invent—get the information on obtaining patent AT ONCE!

WHAT A PATENT DOES FOR YOU

Without a U. S. Patent, you cannot expect to reap the profits that your invention may make possible. Send at once for this book. After you get that, you'll know exactly what to do to protect yourself. Anything you write us or send us is strictly confidential between us. All letters and drawings are kept in strong, steel, fireproof files, which are open only to us or authorized members of our

staff. We have secured patents for inventors located in every State in the Union. The practice of our organization is confined entirely to Patents, Trademarks and Copyrights. We have had years of experience in Patent Matters. When you place your patentable invention in our hands, we are in position to proceed at once to secure protection for you. Our fees are reasonable, and if you desire, we can arrange convenient terms of payment.

Get
**FREE
COPY**



**48
PAGES**
Over 100
Illustrations

**CLARENCE A. O'BRIEN
and HYMAN BERMAN**

701 Adams Building, Washington, D. C.

Registered Patent Attorneys Before U. S. Patent Office

Please send me at once your Big Free 48-Page Book, "Patent Guide for the Inventor" and your specially prepared "Record of Invention" form. This request does not obligate me.

Name.....

Address.....

(Please write or print plainly)

Get This
FREE BOOK

IMMEDIATELY MAIL COUPON TODAY!

This new 48-page book of facts is absolutely FREE! You need it NOW. Simply fill out the coupon, and mail. The field of invention changes constantly—here is the latest information. Within a very few days you will receive our Free Book, together with the Record of Invention Blank. Write NOW!



LEARN TO DRAW

—at home in your spare time

Learn to be an Artist and become your "own boss". Our practical method has trained men and women of all ages since 1914. **COMMERCIAL ART, CARTOONING, and DESIGNING** all in one complete course. Trained Artists are capable of earning \$30, \$50, \$75 a week. No previous Art experience necessary. **FREE BOOK, "Art for Pleasure and Profit"** describes course and **TWO ART OUTFITS** included. Mail coupon today.

FREE BOOK gives details!

Washington School of Art, Studio 127M
1115—15th St., N. W., Washington, D. C.

Yes! I am interested in learning to draw. Please send me your Free Book, "Art for Pleasure and Profit."

Name Age

Address

City State

AVIATION Wants More LINCOLN TRAINED MEN

This Lincoln Government Approved School of Aviation wants to immediately get in touch with men interested in preparing for good-pay positions in Aviation. Huge expansion program calls for thousands more trained men. Our Graduates in demand. **BE A PILOT** Prepare here for your official Government Pilot Rating. 16 Training Planes; 5 types. Learn night, blind, beam and cross-country flying. **BE AN AERONAUTICAL ENGINEER** Students here design and build complete new airplanes. Big Pay opportunities for well trained Aero Engineers. **BE AN AIRPLANE MECHANIC** Learn to overhaul and rebuild real airplanes and engines. Training prepares you for Gov't. Mechanics Rating and immediate employment with Airline or Factory. We assist Graduates in locating employment. Our Graduates regularly taking good positions with leading companies. We furnish board and room for part-time employment while in training. **WRITE TODAY** for complete information.

LINCOLN AIRPLANE & FLYING SCHOOL
567 Aircraft Bldg. Lincoln, Nebraska

EARN A DEGREE AT HOME

From A Chartered Institution Of Higher Learning
Employers Now Demand College Graduates With Degrees

88 Degree Courses in Art; Sciences; Philosophy; Education; Psychology; Public Health; Sociology; Physics; Chemistry; Pol. Science; Theology; Law; Business Training; Accounting; Statistics; Adv.; Sales; Agriculture. Electrical, Mechanical, Civil, Structural, Diesel, Architectural, Mining, Drafting, Automotive, Aeronautical, Radio, Refrigeration, Highway, Marine, Air Conditioning, Geology, Petroleum, Industrial, Chemical Engineering. Founded 1908. 170 p. Catalog Free. McKinley-Roosevelt Graduate College, 4244 Clarendon Ave., Chicago

BIG MONEY from POULTRY



I show you how to greatly increase profits, start your own business, or help you secure a job in a poultry plant. I train you at home in spare time quickly. Show you very latest methods. Give you facts worth money to yourself or employer. Men and women in small towns or suburbs will be particularly interested because latest scientific methods mean unusual profits for them. My home-study course used by thousands. 52-page book, "How to Raise Poultry for Profit" comes to you FREE. Mail coupon today.

SCIENTIFIC POULTRY RAISING

HARRY M. LAMON, Pres., National Poultry Institute,
Dept. 45-D, Adams Center, N. Y.

Please send me your FREE Book about poultry raising, and facts about your Home-Study Course.

Name

Address

City (R.F.D.) State

NEW INVENTIONS

(Continued from page 18A)

cated between the camera and the object to be photographed are arranged, with connecting mechanism, to produce the desired effects. The second patent covers a support for an automobile, with a motorized jack to elevate the auto to the position

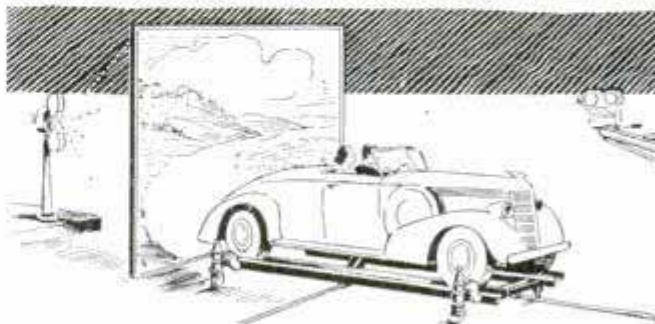

desired in front of a translucent screen. A projector behind the screen flashes moving pictures of highway and appropriate scenery into which the automobile may be set. A camera in front of the screen may then photograph the car and the background scenes appearing on the screen.

HANDY for the schoolroom, office or home is a patented illuminated terrestrial globe. An electric light built into the globe provides the illumination which throws all markings on the globe into sharp visibility. The globe may be of the translucent type, to enhance the value of the arrangement. Having an electrical cord connected to a wall socket from the bulb inside does not interfere with rotation of the globe.



SPILLING the nail polish is too common an occurrence for the housewife who cares for her own fingernails. A newly patented device, designed to grip the bottle between fingers of the hand under attention, is intended to eliminate this nuisance.



(Continued to page 24A)



Easy

YOU'LL advance faster with an easy playing Conn. Choice of world's greatest artists. Many exclusive features yet they cost no more. Home trial. Easy payments. See your dealer or write for freebook. Mention instrument. C. G. CONN, Ltd, 731 Conn Bldg. ELKHART, IND.



ATLAS STICK-ON LETTERS
Beautiful Gold Colored. New Styles. 5 Year Guarantee. Large Sizes—Penny Each. Tremendous Demand. Amazing Profits. Write for Samples and Starting Equipment. Hurry!
ATLAS Sign Works, 7943 Halsted, Chicago



WE BUY, SELL AND PUBLISH CARTOONS



WE publish in the interests of the amateur. We place your work in the hands of leading buyers of graphic humor! Cash prizes each month for best cartoons submitted! Write for full information. Enclose samples of your work with return postage and permission for publication.

CARTOONISTS' MUTUAL
235 Ravine Avenue, Rochester, New York

BOOKS—FOR TODAY'S BIG OPPORTUNITIES

List sent free upon request
Popular Mechanics Press, 200 E. Ontario St., Chicago



YOU'LL EARN MORE if You Own this valuable new ARC WELDING MANUAL and OPERATOR'S TRAINING COURSE.

The New "Simplified" ARC WELDING

340 Pages—23 Chapters—6 Parts
320 Illustrations from Photographs, Drawings, etc., clearly showing applications, methods and use of arc welding
Every Engineer, Welding Operator, Student, Executive, Supervisor, Designer, or other individual interested in Welding or any branch of Electrical, Mechanical or Metal Working

\$1.50
POST PAID

Industries, will find this new book worth many times its small cost. Written in plain, understandable, non-technical English. Order your copy now.

POPULAR MECHANICS PRESS
200 E. ONTARIO ST. Dept. 739, CHICAGO

In answering advertisements always write name and full address clearly.

TAKE YOUR PICK of these POSITIONS

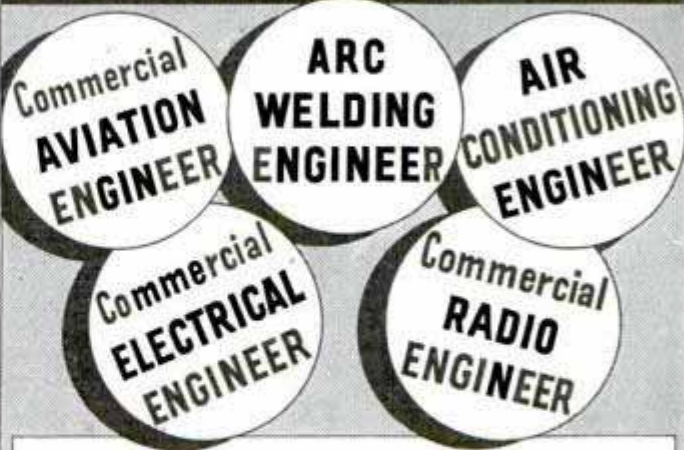

Prepare in One Year!

Fast growing industries need men who can DO THINGS—and who KNOW WHY AND HOW to do things best. They need PRACTICAL, TRAINED MEN—and are willing to pay them well. We have been training men for good positions for 36 years. You can combine a college education with actual practice in our fully equipped shops and laboratories. Personal instruction given by experts—small classes—nominal fees. Student Guidance Service aids you in obtaining work while in school and on graduation. Investigate this specialized training program which will prepare you for a better position with better pay. Act now—new classes begin within a month. Send coupon TODAY!

MILWAUKEE SCHOOL of ENGINEERING

Institute of Electrotechnics

Dept. PM-739, Broadway and East State, Milwaukee, Wis.
Without cost or obligation, please rush full details and tell me how to become in ONE YEAR—
COMMERCIAL () Aviation Engineer () Welding Engineer () Air Conditioning and Refrigeration Engineer () Electrical Engineer () Radio Engineer () Electrical Engineer with B. S. Degree (4 yrs.) **VOCATIONAL COURSES** () Welding Operator (3 mos.) () Welding Technician (4 mos.) () Air Conditioning and Refrigeration Technician (6 mos.) () Radio Technician (6 mos.) () Send details of Student Loan Plan () Earn Part Expense Plan Name..... Age..... Address..... Education..... City..... State.....

A DRAWING KIT FOR ONLY \$1.50

WITH BUILT-IN PARALLEL RULING STRAIGHTEDGE



If you like to draw, look what ESCO offers for \$1.50: A quality 12" x 14" Drawing Board with moisture-proof finish; accurate Bakelite Straightedge; built-in parallel ruling device consisting of Bakelite pulleys operating on oil sealed bearings and braided metal cable.
15" x 20" Kit \$2.25—21" x 26" Kit \$4.75.
MONEY BACK GUARANTEE - SHIPPED POSTPAID IN U.S.A.

Order your Kit today or send 10c for Pencil Pointer used by professional draftsmen, and literature on ESCO Products.

ENGINEERING SALES COMPANY
724 Clara Ave. • Sheboygan, Wis.

TRI-STATE COLLEGE

ENGINEERING DEGREE IN 2 YEARS



Courses in Civil, Electrical, Mechanical, Chemical, Aeronautical, Radio Engineering. The Mechanical course includes Diesel Engineering, Air Conditioning and Refrigeration. Essentials of engineering training included and non-essentials eliminated. Tri-State graduates in Radio Engineering can complete the Electrical course in 24 weeks. B. S. Degree granted upon completion of course. For ambitious, earnest students. Special Preparatory Department for those who lack required high school work. Graduates compete successfully with those of 4-year schools.

Technical instruction at lowest cost and in least time consistent with thorough training. Intensive instruction in accord with individual ability. Courses also in Business Administration and Accounting. Also short diploma courses (36 weeks) in Surveying, Drafting. Students from all parts of the world. Tri-State graduates make good. Tuition, living costs low. Enter September, January, March, June. **Write for catalog.**
479 College Ave., Angola, Ind.

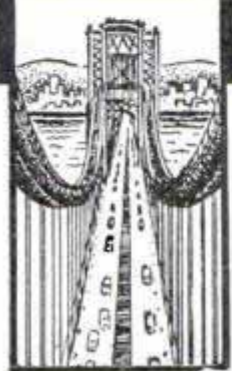



DRAFTING

BOOKS SENT FREE!

ON APPROVAL
5 VOLUMES BRAND NEW EDITION
 Only 15 minutes a day with these **WONDER BOOKS** can prepare you for a good drafting job in less than a year. Mechanical and architectural drafting from simple straight lines to important complex plans. *A step at a time!* Built especially for beginners, for men with only grammar schooling. Drafting room practice, **PLUS ENGINEERING**, made easy and clear. **Includes complete information on blue print reading for building and machine trades.**

For Beginners or Experts

Written, so you can understand every word, by 22 well known engineers and architects. De-Luxe flexible binding, nearly 2,000 pages, 1546 blueprints, charts and diagrams; prepares you for a good drafting job in mechanical or architectural lines. Sent for 10 days' free use if you mail coupon immediately.

These Instruments Included



Big Field Big Demand Big Pay
 Competent draftsmen are urgently needed right now in all building and manufacturing lines at \$30.00 to \$75.00 a week. That's just the beginning—**FOR DRAFTSMEN HAVE THE BEST CHANCES FOR ADVANCEMENT.** Pleasant, fascinating work, easy to learn and do. Learn quickly with these books—send coupon for a set and see for yourself.

A year's consulting membership in the American Technical Society now given to all readers of this famous cyclopedia of drafting. Many say that it is worth more than the cost of the books.

Complete set of drawing instruments if you send for these drafting books NOW. These instruments are made of the finest of German silver, are absolutely accurate and are packed in velvet lined leatherette pocket case. Real \$10 value, but included with these books.

AMERICAN TECHNICAL SOCIETY
 Dept. DB19, Drexel at 58th St., Chicago, Ill.

American Technical Society, Dept. DB19, Drexel at 58th St., Chicago, Ill. Send for 10 days' trial New 5 volume set of drafting. I will pay the few cents delivery charges. If I wish, I may return books in 10 days and owe you nothing, but if I decide to keep them, I will send \$2.00 after 10 days, then only \$3.00 a month until \$24.50, the advertising price, is paid. Send latest edition and include drawing instruments and Membership Certificate.

Name.....
 Address.....
 Attach letter stating age, occupation, employer's name and address and that of at least one business man as a reference.

You have a future in **RADIO ENGINEERING**
 —and the exciting new field of TELEVISION!

Our men get jobs! In past 5 years over 95% employed. CREI is recognized and approved by the Radio industry. You can train for a career in Radio and Television Engineering in our own new building in the Nation's Capital. Intensive one-year course for high school graduates. Students enjoy actual "lab" experience under outstanding engineer-instructors. Well-equipped shops and laboratories with modern radio equipment. School year begins Sept. 18th—ends in June. Home-study prep course during Summer at no extra charge. Write today for details and 48-page free book: "A Tested Plan for a Future in Practical Radio Engineering." State age. **CAPITOL RADIO ENGINEERING INSTITUTE**
 Dept. PO-7, 3224 16th St., N.W., Wash., D.C.



ARTISTS MAKE MONEY

Find out your ability. Send name, age, occupation and address for Free Vocational Art Test.
Federal Schools, Inc., 7139 Federal Schools Bldg., Minneapolis, Minn.

LEARN Short-Method Arithmetic

Simplified system used by "master minds" on stage, accountants, bankers, etc. Easy to learn. Add columns of figures short-cut method; multiply 4 figures by 4 figures without using old-fashioned multiplication; use eight method of proving addition, division, etc. Learn horsepower calculation, how to use slide rule, micrometer. Complete illustrated course only \$1.00, postpaid. Satisfaction or refund. Amaze your friends with your mental wizardry! Free details—mail coupon TODAY.

FREE

NELSON CO., G-300 Manhattan Bldg., Chicago, Ill.
 Send free details about "Short-Method Mental Arithmetic" without obligation on my part.

Name.....
 Address.....
 City..... State.....



NEW INVENTIONS

(Continued from page 22A)

AMONG the latest electrical appliances for the home is a cordless iron. Lacking the cord, the iron is easier to handle than the conventional electric iron. It is heated by contact with a stand on which it rests when not in use.



This stand has an electrical heating element and thermostatic switch for controlling operations.

INCREASED safety for persons using ladders is the intent of a newly patented device for supporting the lower end of the ladder, preventing the legs from slipping.



Two bracing legs, extending forward of the ladder's legs, are firmly attached to the ladder, one on each side. The bracing members are placed so that there is less danger of the ladder slipping to either side, as well as forward.

CHANGE in direction may be indicated to drivers behind by means of a signal mounted in the rear window of your automobile.

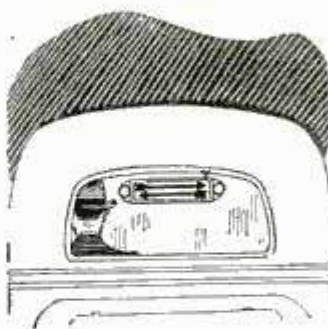

Such a signal has been patented. Rubber vacuum cups support the device on the rear window. Arrows, one pointing to the left and another to the right, flash as the driver operates a control.

Due to the fact that many of the devices described in this department are still in the patent office stage and are not on the market, Popular Mechanics Magazine cannot undertake to supply further information regarding them.



Lots of HEAT - CHEAP!

LACO OIL HEATER
Low as \$23.50

Complete line of quality oil circulating heaters — gun-type and wick-type oil burners.



L. A. COCKLIN

WRITE for surprisingly low direct - from - factory - to - dealer prices.



LACO OIL BURNER COMPANY 179 Union Ave., Griswold, Iowa

STUDY ENGINEERING AT HOME
EARN A DEGREE AT HOME

From A Chartered Institution Of Higher Learning
Employers Demand Degree Men For Key Positions

88 Degree Courses in Electrical, Mechanical, Civil, Structural, Diesel, Architectural, Drafting, Automotive, Aeronautical, Radio, Refrigeration, Air Conditioning, Highway, Mining, Geology, Petroleum, Marine, Industrial, Chemical Engineering, Arts; Sciences; Philosophy; Psychology; Chemistry; Education; Business Training; Law; etc.
McKinley-Roosevelt Graduate College, 4238 Clarendon Ave., Chicago

LEARN CARTOONING



by the method that has developed hundreds successfully. Send name, address and age for free chart to test your ability.

THE LANDON SCHOOL, 1739 National Bldg., Cleveland, Ohio

TOOL & DIE MAKING DESIGNING

Machinists Trade. Not a correspondence course. Practical shop training in the world's Industrial center. Write today for full information.

NATIONAL SCHOOL OF MECHANICAL TRADES
Dept. 108 528 W. Lake St. Chicago, Ill.

DIESEL

Get BETTER training. Realize Adcox advantages. Located in Pacific Northwest, a Diesel center. Established 25 years. Modern equipment, expert instructors. Close cooperation for YOUR success. Earn room and board while learning. Send for FREE big 40-page Diesel School Catalog No. 18. Home Study and Resident Courses.

L. L. ADCOX TRADE SCHOOL
Portland Oregon

STUDY PSYCHOLOGY

HOME-STUDY Courses leading to degrees in Psychology (Ps.D.), Divinity (D.D.). Many others. Standard texts. Send for FREE 32-page Bulletin at once. No obligation.

TEMPLE BAR COLLEGE, INC.

Dept. 55-A, 1620 Thirteenth Avenue, Seattle, Washington, U. S. A.

MYSTERIOUS DEVICE WELDS BRAZES AND SOLDERS
ANYONE CAN OPERATE



Now, an electric welding, brazing and soldering Torch, complete with power unit, goggles and supplies. **Works INSTANTLY off any light socket.** Does a thousand and one repair jobs at amazingly **LOW COST** on aluminum, iron, steel and other metals. **Indispensable** for Auto, Body and Fender Repairs, and home repairs—shop, factory, farm, engineer, janitor, sheet metal, radio and bicycle repairs. Anyone can handle without previous experience with our simple **10-DAY HOME TRIAL** instructions. Write at once for Special Introductory Low Price Offer. Try 3 in 1 Electric Torch for 10 days at our risk, or get one free by helping to introduce it. **ELECTRO-TORCH CO., 2613-ED Michigan Ave., Chicago**

68 Pages of facts for INVENTORS

These books were prepared for men of ideas—men who have an article in mind that will make money, save money, save labor or give pleasure. Leading thinkers agree that the world of a few years from now will be radically different because of the contributions to progress that inventors will make. Now is the time—if you have an idea—to see about protecting it.

Many Little Ideas May Have Big Commercial Possibilities

Don't think that to be profitable an idea needs to be complicated. Simple articles—just a person's hunch—have often proved profitable. The crinkly hair pin, the metal tip for shoe laces, the paper clip are good examples. Also improvements on patented articles sometimes prove more profitable than the original article itself.

Don't Delay—Send for These Free Books Now

Many a man has waited until too late to protect an idea by a United States Patent. Remember someone else may be thinking along the same lines that you are, and the Patent Laws favor the man who files his application for a patent first. Delays of even a few days can sometimes mean the loss of a patent. So learn the important facts about Patent Protection at once.

40 Years of Proven Service

For forty years, this capable organization has served inventors from all over the country. Our large staff of patent specialists gives you expert and prompt service. Our fees are reasonable; we also help with deferred payments.



VICTOR J. EVANS & Co.

REGISTERED PATENT ATTORNEYS
MAIN OFFICE: 112-H, VICTOR BUILDING WASHINGTON, D. C.

Pittsburgh Office: 514-N, Empire Building

Send me **FREE** copies of your books, "Patent Protection" and "When and How to Sell an Invention."

Name.....
Street and No.....
City or Town..... State.....

MAIL COUPON TODAY FOR YOUR COPIES

PATENTS

Booklet Free **Highest References**
Promptness Assured **Best Results**
 Send drawing or model.

ALL BUSINESS GIVEN PROMPT AND PROPER ATTENTION

Listed Patent Lawyer in the latest editions of the Rand-McNally Directory of Bankers and Bank-Recommended Attorneys, published by Rand-McNally & Co., Chicago, Ill.; The Baggott & Ryall Directory of Guaranteed Attorneys, published by Legal Directory Corporation, Boston, Mass.; American Lawyers Annual, Cleveland, Ohio; Bankers Service Legal Directory, published by Bankers Service Co., Boston, Mass.; Eyre's Law List, 9 Park Place, New York City; Snow-Church Directory Co. Lawyers List, published in New York City, and the Central Guarantee Co., Bankers and Lawyers Directories, 630 Fifth Avenue, New York City.

WATSON E. COLEMAN, Victor Building, 724 Ninth Street, N. W.
 REGISTERED PATENT LAWYER **WASHINGTON, D. C.**

INVENTORS PATENT YOUR IDEAS SEND FOR FREE BOOK



HOW TO OBTAIN A PATENT

Written by a Former Member of the Examining Corps (1922-24) of the U.S. Patent Office. If you want to profit by your idea, you should take steps to apply for a U. S. Patent at once. Your first step is to get this Free Book. This interesting illustrated book contains valuable information you should have. It tells you fully how to obtain a patent on your idea in the quickest way. With this Free Book you will also receive a "Record of Invention" form on which you can easily record your idea. Personal and Confidential Service: Your case will be personally handled only by a Registered Patent Attorney who is also a Former Member of the Examining Corps of the U. S. Patent Office. All communications confidential.

MAIL COUPON TODAY FOR FREE PATENT BOOK and RECORD OF INVENTION Form.

CARL MILLER
 REGISTERED PATENT ATTORNEY
 FORMER MEMBER EXAMINING CORPS U. S. PATENT OFFICE

Woolworth Bldg., 35th Floor, Dept. 79A, New York City
 MILLER BUILDING, Dept. 79A, Washington, D. C.
 Please send me your Free Book, "How to Obtain a Patent," and your "Record of Invention" form.

NAME.....

ADDRESS.....

Practical Facts You Will Want to Know About

PATENTS TRADE MARKS COPYRIGHTS

INVENTORS! If you have a new device or idea—send for our free booklets. They contain practical information based on 64 years' experience as patent attorneys. These books will tell you how to protect your invention, explain the steps in patent procedure and describe the various opportunities for capitalizing on your invention. All inquiries confidential and answered immediately. Write for free books right now.

● **C. A. SNOW & CO.**
 Registered Patent Attorneys Since 1875
 179 SNOW BUILDING WASHINGTON, D. C.

PATENTS—TRADE MARKS

All cases submitted given personal attention
 Form "Evidence of Conception" with instructions
 for use and "Schedule of Government
 and Attorneys' Fees"—FREE!

LANCASTER, ALLWINE & ROMMEL
 Patent Law Offices

412 Bowen Bldg. Washington, D. C.

New Ideas now Salable Before Patenting

Practical, useful inventions may now be safely marketed without patenting expense. Write for proof that we successfully sell both patented and unpatented inventions.

Chartered Institute of American Inventors
 Dept. 4, Barrister Building, Washington, D. C.

INVENTORS who derive largest profits know and heed certain simple but vital facts before applying for patents. Our book, Patent-Sense, gives those facts; sent free. Trade Marks—Copyrights.
LACEY & LACEY, Est. 1869, 635 F St., N. W., Dept. 5, WASHINGTON, D. C.

ALBERT E. DIETERICH
THEODORE H. RUTLEY
 REGISTERED PATENT LAWYERS
 512 B Colorado Bldg. WASHINGTON, D. C.
Booklet on Patents sent free

RUPTURED?

Get Up-To-Date Relief

Why try to worry along with old-fashioned trusses that gouge your flesh—press heavily on hips and spine—enlarge opening—fail to hold rupture? You need the Cluthe. No leg-straps or harness. Automatic adjustable pad seals opening—follows every body movement with instant increased support in case of strain. Cannot slip. Holds rupture whether at work or play, easy to wear. Waterproof. Can be worn in bath. Send for amazing **FREE** 100-page, cloth-bound book "Advice To Ruptured" and details of liberal truthful 60-day trial offer. Also names of grateful patrons in your neighborhood. Write today. Cluthe Sons, Dept. 31, Bloomfield, New Jersey.

In answering advertisements always write name and full address clearly.

To PROTECT Your INVENTION - Use this coupon, NOW

Delays are dangerous and may be very costly. My personal service assures prompt action, strict confidence, and a minimum of expense. I suggest that you send me a model or drawing, or sketch and description of your invention, and \$5.00. I will make a search and report

promptly as to its patentability and send you a copy of my 72-page booklet. Or, if you prefer to read my booklet first, mail the attached coupon at once. I will also send my "Record of Invention" form. (Over 38 years experience as a Registered Patent Attorney.)

L. F. Randolph, 302-D Victor Bldg., Washington, D. C.

Please send me at once, free of charge, your 72 page booklet and "Record of Invention" form.

Name.....

Address.....

A PERSONAL CONFIDENTIAL PATENT SERVICE

SAVE UP TO 50% MIDWEST FACTORY SALE!



CHASSIS NOW ONLY \$19.95
 PUT THIS NEW **14-TUBE** WORLD WIDE CHASSIS IN YOUR CABINET
 You get up to \$40.00 TRADE-IN on latest 17-tube, 5-band radios. Easy Pay Plan. Send 1c post card for FREE catalog, showing complete line.
 Dept. 15-PP, Midwest Radio Corp., Cincinnati, Ohio

30 DAYS TRIAL

CARTOONING PAYS WELL

Exclusive instruction by a famous cartoonist makes it easy to learn at home. Write for Free Booklet describing details of the course.
NATIONAL SCHOOL OF CARTOONING
 437 Penton Bldg. Cleveland, Ohio.

Be a MONEY-MAKING RADIO EXPERT

I'll train you for a good job in Radio, Television, or a business of your own. My new, personalized sparetime home-study Course fits you quickly, easily. You get real Radio Equipment. I show you how to earn while you learn.
 Write for complete details in new catalog "HOW TO MAKE MONEY IN RADIO" FREE! MAKE MONEY IN RADIO! Sprayberry Academy of Radio, 210-G University Place, N. W. Washington, D. C.

DIESEL Maximum training minimum time; practical and theoretical. Modern equipment, experienced teachers. Personal instruction.

40th year. Catalog free. Residence course in three months.
FINLAY ENGINEERING COLLEGE, 10th & Indiana, Kansas City, Mo.

PAY POSTMAN

These famous Pay-Raising, Extra-Money Books have helped thousands of others. Let them help you too. Check this list and mail with your name and address. Pay postman on delivery, price plus small C.O.D. fee. Or remit with order and books will be sent postpaid anywhere in the world.



EXTRA MONEY BOOKS

- Select FROM THIS LIST**
- AIR CONDITIONING**
Furnaces, Unit Heaters... \$3.00
 - AUTO RACING**
Build Midget and Other Racers... \$1.00
 - AUTO REFINISHING**
Duco With Spray Gun... \$1.50
 - AUTO SERVICE SHOP**
Management, Money-making Ideas... \$1.50
 - BLUEPRINT READING**
For Machine Trades... \$1.50
 - BRICKLAYING**
Plain and Fancy... \$1.50
 - BUSINESS COLLEGE**
Self Taught, 15 Courses Cover all Essential Subjects, 1000 Pages... \$2.39
 - CARBURETORS (All Makes)**
New, Revised Edition... \$3.00
 - CHEVROLET SIX**
Car, Truck, Operation Repair... \$2.50
 - COLONIAL FURNITURE**
Making, 95 Pieces... \$3.50
 - DANCE**
Learn at Home Without Music or a Partner... \$2.00
 - FOUNDRY WORK**
Molding, Casting, etc... \$2.00
 - HIGH SCHOOL**
Self Taught, 24 Subjects, 1000 pages... \$2.39
 - HOME GROUNDS**
Furnishing... \$0.80
 - LEATHER MAKING**
and Tanning... \$1.00
 - METAL SPINNING**
Practical New Book... \$1.00
 - METALLURGY**
New Metals, Alloys In Use To-Day... \$1.50
 - MONEY-MAKING FORMULAS**
10,000 Practical... \$4.00
 - OIL HEATER HANDBOOK**
Manufacture, Distribution, Installation, etc... \$3.50
 - PLASTICS**
148 Designs For Craftsmen... \$2.50
 - RADIO PHYSICS COURSE**
New edition, Everything about Radio... \$4.00
 - SHEET METAL**
Construction Work... \$2.50
 - STEAM ENGINEER'S LICENSE**
How to Obtain... \$2.00
 - WOOD TURNING**
Course In... \$1.50
 - WROUGHT IRON WORK**
Practical... \$1.35

POPULAR MECHANICS PRESS
 Room 739E 200 East Ontario St., Chicago

This MACHINISTS' Home-Study Course helps men get ahead



Newly assembled—specially priced—these five recent books give you the practical facts on modern machines, up-to-date methods, you need to advance in machine shop work. Take advantage of the other man's experience as found in books, to solve your problems, increase your efficiency, with

The NEW AMERICAN MACHINISTS' LIBRARY

5 volumes—2014 pages—1853 illustrations

(A combined home-study course and reference library)

This library of machine shop practice was written for practical men. It gives you the best methods for every kind of machine shop work. It fully explains lathes, drills, and other machine tools and their operation, automatic screw machines, speeds and feeds, gear design and production, punch and die work, metal surfacing, etc., etc. Plainly written—completely illustrated—the best kind of help to the machine shop man who wants to advance himself.

No money down—special price—easy payments.

EXAMINATION COUPON

McGraw-Hill Book Co., 330 W. 42nd St., New York

Send me for ten days' examination the new American Machinists' Library. If satisfactory I will send you \$1.50 in 10 days and \$3.00 monthly until the price of \$16.50 is paid. If not wanted, I will return the books postpaid. (To insure prompt shipment write plainly and fill in all lines.)

Name.....
 Home Address.....
 City and State.....
 Position.....
 Name of Company..... PM-7-39

PRESTO! ANYONE CAN MASTER GLAZE



LEAVES HARD GLASS-LIKE FINISH
 SEALS THE PORES OF THE SURFACE
 EASY TO APPLY
 WILL NOT FINGER-MARK
 NO DILY FILM AS WITH POLISH
 PROTECTS THE SURFACE
 EASY TO KEEP CLEAN
 NO SMEAR OR STREAKS AS WITH WAX
 LASTS SIX MONTHS TO A YEAR
 SAVES YOU MONEY

Car Owners! Meet Master Glaze—the sensationally different luster for new and used cars! Not a wax—not an oil polish—not a paint!—nothing that “smears” over the surface.

MASTER GLAZE is a unique discovery—a creamy liquid—quick and easy to apply! Gives a hard, glass-like surface. Even gasoline cannot dull it! Lasts six months to a year! Amazing luster—beautiful, sparkling clean and brilliant! Doesn't finger-mark—doesn't smear! A match box full glazes an entire car. Seals the pores—protects! NOTHING LIKE IT!

AGENTS
 An unusual opportunity! Quick, flashy demonstrator. Big profits. Good territory. Write today!

FREE Offer! Write now for FREE BOOK-FER. Just send your name and address. Write **MASTER GLAZE CO., 7720-114 W. Harwood Ave., Milwaukee, Wis.**

BROOKLYN YMCA TRADE SCHOOL MAIL COUPON

Y.M.C.A. Unlimited instruction until you have mastered every part of Course without additional charge. Full Shop Equipment. Unexcelled instruction. Fireproof Dormitories. Special Privileges. Check your interests on coupon to receive free literature.

Mechanical Pre-Engineering
 Diesel Engines
 Diesel Pre-Engineering
 Aeronautical Pre-Engineering
 Aviation Mechanic
 Auto Mechanic
 Refrigeration
 Television and Radio Mechanic
 Architectural-Mechanical Drafting
 Machinist
 Armature Winding

Oil Burner
 Welding
 Talking Pictures
 Air Conditioning
 Air Conditioning
 Die Making
 Electrical

1117 Bedford Ave., Dept. P.M. Brooklyn, New York City, N. Y.

Name.....
 Address.....



CLASSIFIED

Advertisements



Advertisements in this section, 35 cents per word, each insertion, minimum 10 words, payable in advance

To be inserted under proper classification in August issue, copy should be in our office June 8th

August issue on sale July 1st

Popular Mechanics Magazine, 200 East Ontario Street, Chicago, Illinois

YOU'LL PROFIT

By reading and answering the classified ads in this section. Hundreds of opportunities to make and save money.

Popular Mechanics Magazine,
200 E. Ontario St., Chicago, Ill.

Gentlemen: We have been consistent advertisers in "Popular Mechanics Magazine," more than twenty-five (25) years, and have always considered it our best medium, for the inquiries received from your publication have always been of the very highest type and consequently it has produced an unusually high percentage of orders for us. We are now running two advertisements in the magazine and both have produced results far beyond our expectations. I feel sure you always welcome such news as I have given you in this letter, and assuring you of our continued patronage and wishing your publication the continued success which it deserves, we remain,

Yours very truly,

(Original letter on file in our office)

W. HILLYER RAGSDALE, INC.

AUTOMOBILES—MIDGET CARS

MIDGET Racecars, sportcars, motor-scooters. Bargain lists—130 used motors, midgets, parts—20c. Illustrated literature, Midgets, Box 543-H, Zanesville, Ohio.

BUILD Indianapolis "Champion" racing car models. 6½" kit 25c. Free circular of other famous racer kits. Northern Aircraft & Supply Co., P.M. 4, Manitowoc, Wis.

GAS Saver—Connects to wiper line. Postpaid dime. Guaranteed. Motor Specialties, Wilkensburg, Penna.

AUTOMATIC Exhaust-gas receiver on auto, eliminates carbon-monoxide. Selling patent. Hollister, Arto de Rosales, Mich., Mexico.

1939 IGNITION Supercharger. Quick starting, mileage, pep, less carbon, \$1.25. E G Sales & Mfg. Co., New York.

MIDGET Racers, two-passenger autos, Midget motorcycles, motorscooters. Motors, wheels, parts, plans. Handbook catalog, 58 illustrations, 20c coin. Midwest, Box 1959-A, Chicago.

AUTOMOTIVE Armature winding, new book, complete, illustrated, for the mechanic, electrician or beginner. \$2 copy, postpaid. Jack Beater, Fort Myers, Florida.

ALUMINUM Alloy pistons, automotive, aviation, diesel, industrial, marine, midget, model, motorcycle, outboard. Finished or semi. Judson Mfg. Co., Hedge and Gillingham, Philadelphia, Penna.

STOP Carbon knock—Increase power. Simple, easy. Complete instructions and diagram. \$1.00. Box 277, Ventura, Calif.

MIDGET Cars, parts, plans. Catalog 20c. Derby Midgets, Woodstock, Illinois.

BUILD This powerful, inexpensive supercharger for any automobile. Adds up to 8 horsepower. Complete plans 30c, coin. Box 107, East San Diego, California.

PLANS, Parts, midget cars, light planes. Circulars 10c. Storms, 199 Broadway, Asheville, N. C.

MIDGET Parts, kits, plans. Circulars free; catalog, 10c. Shipp's Midgets, Box 543-H, Zanesville, Ohio.

FORD V-8's, 1934-1939; gasoline saving device. \$1. Walert Co., 3425 No. 10th St., Milwaukee, Wisconsin.

AUTO TRAILERS

BUILD The famous, low-cost Jim Dandy Cabin Trailer. Complete plans and instructions 50c. Plans to build the beautiful, streamlined Jim Dandy Cabin Cruiser, \$1.00. Trailer Builders Manual and catalog of trailer parts, supplies and equipment—over 100 interesting, illustrated pages, 25c. Order today. Satisfaction guaranteed. Trailer Supply Co., 411-A Jackson St., Wausau, Wisconsin.

TRAILER Instruction book containing 68 pages designs, plans, parts, illustrations, Mail 10c stamps today. A. J. Stephens, Kansas City, Mo.

AUTO SUPPLIES AND EQUIPMENT

INDICATOR—Prevent breaking handles, locks. Send 20 cents coin for two. Filling stations, garages write. The Indicator Co., Box 427, Holyoke, Mass.

BETTER Headlights! Increase headlight efficiency 100%. Fits all cars. Easily installed. Guaranteed. Postpaid 75c U.S.A. Capco, 1442-B Hayes, San Francisco.

BELL For auto foot operated from \$3.50. Other accessories. Write Jerrold, Box 10, Tremont Station, Bronx, N. Y.

MODERNIZE Your gearshift! Make simple, neat, standard shift, dash control. Illustrated instructions. 30c. Shaffer, Litchfield, Nebraska.

WINDSHIELD. Window cleaner! Labor saver! Money maker! Sample making gallon 25c! Kemiklean, 1906 Rosemont, E. Cleveland, Ohio.

CRANKCASE Oil properly refined better than new. Investigate method. Technical Laboratories, East Haven, Conn.

CARAWAY Cures sticky valves, ping. Increases compression, power, pick-up. Get "new-motor-pep." \$1.00. E-Zee-Doo, 108 North Dearborn, Chicago.

AUTO. Furniture polish concentrate. Make pint polish by adding water. Twenty cents. Gray, 375 Richmond, Buffalo, New York.

TIRE Trouble? Automatic tire inflator \$1.00. "Jiffy-Flator." Santa Monica, Calif.

RED Light that remembers any forgotten switch. Redlite, Plain, Wisconsin.

DRAIN Crankcase without getting under car. Amazing device. Simple to operate. Circular free. Bycroft, 22 Central, Bryn Mawr, Penna.

GASOLINE Substitutes, reduces operating costs to minimum. 16 guaranteed formulas. \$1.00. Dieselo Company, P.O. Box 607, Albany, New York.

HIGH-PRESSURE Nozzle—Combines air and water pressure for cleaning chassis and engines. Air controlled. Snap on-off air connector. Its efficiency will amaze you. \$5.75 postpaid U. S. and Canada. Details free. A. L. Hess, 1135 S. Atlanta St., Chicago.

SECRETS Of automobile adjusters. Learn to evaluate claims. Simplified instructions \$1.00. Burns School, Keystone Building, Pittsburgh, Penna.

CHEVROLET Body door posts, 1928-29-30 models. Send for prices. Fransen Equipment Co., 2209 N. W. Thurman, Portland, Ore.

BARGAINS—Compressors, welders, battery chargers, car washers, attractively priced. Terms, trial. Write for bargain list. Hobart Automotive Supply, Box M-795, Troy, Ohio.

AUTO Painting. Learn the short cuts and secrets of the paint shop. Complete information \$1.00. Melco Co., Box 227, Woodstock, Illinois.

USED Auto parts, half price, all cars. Century Parts Company, 1712 LaFayette, St. Louis, Missouri.

RE-REFINE Crankcase drainings, request information. Zeiball, Mount Holly, N. J.

PLATING Outfits for auto parts. Connect to a battery. No tanks used. Free particulars and proofs. Gunmetal Co., Ave. J, Decatur, Ill.

ACETYLENE Welding outfits, \$32.95; electric welders, \$74.95. Easy-payment plan. Box 331, Hamilton, Ohio.

MOTORCYCLES, BICYCLES, MOTOR SCOOTERS AND SUPPLIES

MOTORIZED Vehicles. How to build five different scooters. Harley engined Flea airplane, one wheel bicycle Diesel conversion, motorcycle trailers, midget racers, etc. No pictures, but working drawing, blueprints, etc. Large book \$1.00. Kamm Metal Products Company, 162 High Street, Oshkosh, Wisconsin.

MOTORCYCLE Parts and accessories, new and used, for all motorcycles. Write for prices. Triangle, 1111 Washington, Chicago.

MOTORCYCLES, Reconditioned. New, used, parts and accessories. All makes. Large stock. Bargains. Illustrated catalog, 15c. Indian Motorcycle Sales, Kansas City, Mo.

FREE Catalog Indians, Harleys, motor scooters. Motorcycle speed books \$1.50 each. Goggles, stop watches, helmets, Hepolite speed pistons, Clymer, P.M. 222 West Pico, Los Angeles, Calif.

MOTORCYCLE Bargains, lowest prices, bargain sheets for stamp. Motorcycle accessories. Rochester Harley Davidson Corp., 129 W. Main St., Rochester, N. Y.

NEW Scooter engines \$17. Particulars 10c. Bertelli, 2133 So. 13th, Springfield, Ill.

BUILD Scooter bike from scrap parts. Plans 15c. Readers Service, 800-75 North Clark, Chicago.

MOTORSCOOTERS! Save \$30-\$60 building latest, easiest built scoot. Steel kit \$3.95, plans free. Complete illustrated catalog 20c coin. Midwest Motors, Box 1959-B, Chicago.

BEACON Generator for bicycle lights. Guaranteed. Agents wanted. Electrical Products Co., Kendallville, Indiana.

GENERATOR Lamps for bicycles, scooters. Complete outfits \$3.00-\$4.00. Power-lite, 140 Chambers, New York City.

THOUSANDS Building own Comet motor scooters! We supply parts. Literature dime. Drawing free! Comet Cycle Company, Box 3032, Madison, Wisconsin.

MOTORSCOOTERS! Easily built. Plans and literature on wheels, tires, motors 10c. Honsakers, Masontown, Penna.

MOTOR Marvel ready! Mead's sensational new Ranger Scooter goes 120 miles per gallon, 35 m.p.h., ride, rent or sell for profit, pleasure. Dealers, agents write for special introductory offer, easy terms, free circular. Hurry! Mead Cycle Company, Dept. V-1, Chicago.

MOTORCYCLE Cylinder boring \$2.00. Aluminum pistons, stock or racing, all models, (dealers supplied). New and used Indian parts. Used motorcycles. Stamp brings list. Phila. Indian, 1635 Hunting Park, Philadelphia, Penna.

ALLOY Pistons \$3.00—Harley, Indian, Henderson, Excelsior, Cleveland, Cylinder grinding, motor rebuilding. New and used parts for less. Catalogue and wings pin 10c. Ballak, 1115 Chestnut, St. Louis, Mo.

NEW Push-A-Bike outboard motor for your bicycle. Complete with pneumatic tire. Ready to attach. Richburn Company, Aurora, Missouri.

BUILD Power scooters, midget cars. We supply tires, wheels, motors. Lowest prices. Send 10c for plans, etc. Bild-Ur-Own Devices, 5238 Lake, Chicago.

HI-LIFE Bicycle generators operate lights direct or charge miniature Kic-O storage battery. Write Kimley, 1271 E. Ferry, Buffalo, N. Y.

INSIDE Dealer prices. Overstocked, all models. Indians and Harleys. Rebuilt, guaranteed. Dime brings latest list. Crandall-Hicks, Boston, Mass.

RECONDITIONED Motorcycles. New—used parts for all makes. Authorized Harley-Davidson dealer. Whitman Motorcycle & Supply Co., 405-9 Southwest Blvd., Kansas City, Mo.

AVIATION

PROPELLERS For airplanes, sleds, boats, etc. Catalog 10c. Banks Propellers, Love Field, Dallas, Texas.

LEARN To fly. Send 10c for booklet "An Aviation Career." Midwest Flying School, 4500 W. 83rd St., Chicago, Ill.

ATTENTION! Model airplane fans. Hurler motor accessories mean finer performance and greater power. Adaptable to all type motors. Hurler sleeve valve carburetors for every need—3 capacities: 1/4 oz., 3/4 oz., 1 1/4 oz. Circle H spark coils—mounting clips. 2 piece Circle H spark plugs with pointed electrodes. Replacement timers—fit all Brown motors—ad ptable to any motor. See your dealer or write direct. Enclose stamp for new catalog. Hurler Distributing Co., Dept. P.M., 1438 W. Hunting Park Ave., Philadelphia.

SEVERAL Solo flying courses absolutely free to those who qualify. All expenses paid. Write for particulars. Gulf Correspondence School, 2728 First Ave. South, St. Petersburg, Fla.

AVIATION Apprentices — Air-minded young men interested in training for entering aviation as apprentices see ad on page 15A.

PROPELLERS: For aeroplanes, sleds, boats, fans, generators, including 3 blade Airliner type. List free. Universal Aircraft, Ft. Worth, Texas.

GRADUATE Airplane mechanic. Ten weeks. \$1.00 week. Graduates with leading concerns. Free catalog. United Air School, Elgin, Ill.

HOW To learn flying without money. Folder, dime. Ohmeyer, Box 391, Hempstead, N. Y.

PROPELLERS For airplanes, sleds. Iced-sled blueprints, supplies. Catalog dime. Lorenzen Propellers, Niles, Michigan.

AIRPLANE Mechanic's home-study course \$1.25. Engine mechanic's \$1.25. Both courses \$2.00. Prepares for license. Helps pilots immensely. Meyer Engineering, Hempstead, N. Y.

GET Into aviation. Pilots earn up to \$6000 a year! Airplane mechanics and aeronautical engineers also get big pay! Prepare at this Lincoln government approved school. Write for complete information. Lincoln Airplane & Flying School, 2004 Aircraft Bldg, Lincoln, Nebraska.

BATTERIES, GENERATORS, ETC.

FARMLITE Batteries—40% discount. Buy direct. 32 and 110 volt light plants. York Battery Co., York, Penna.

ELECTROPLATING—Motor generators or belt drive, attractively priced. Easy terms, trial. Hobart Platers, Box M-792, Troy, Ohio.

50-1 1/2 HORSE. Repulsion induction. 110-220 volt, heavy duty motors. 3400 speed, \$9.75. Also generator bargains. Electrical Surplus Company, 1885 Milwaukee, Chicago.

EDISON Storage batteries for light-power systems. Non-acid. Odorless, fifteen year life. Five year unconditional guarantee. Bargains in complete lighting systems. Low prices. Free illustrated literature. "See-Jay" Battery Co., 82 Sterling Ave., Yonkers, N. Y.

EDISON Lifetime storage batteries for light and power. Eliminates acid battery diseases. Long guarantee. All kinds rebuilt generating plants, motors, and miscellaneous articles at bargain prices. Free interesting literature. T. Hawley Smith Co., Croton Falls, N. Y.

WIND ELECTRIC PLANT

BUILD Electric plant for your cabin. Operates from wind. Complete plans and valuable catalog 10c. LeJay Manufacturing, 447 LeJay Building, Minneapolis, Minn.

ELECTRICAL SUPPLIES—EQUIPMENT

ELECTRIC Eye with wiring diagram, instructions, literature, catalog, \$1.00 postpaid. Photobell, Dept. 86, 96 Warren Street, New York.

BARGAINS—Arc welders, also motor generator. Write for new bargain list telling needs. Hobart Bros., Box M-797, Troy, Ohio.

ELECTRO-SCRIBE: Electric pencil writes—engraves all metals \$1.00. Ultra violet-infra red dual ray health lamp. Two units in one. Promotes sun-tan—vitamin "D." Automatic a.c.-d.c. current, \$3.90. Details. Beyer Mfg. Co., 4515-H Cottage Grove, Chicago.

STANDARD Electric lamp insect killer. \$2.00 up. Literature free. Sauer Bros., San Leandro, Calif.

ELECTRIC Engraver, engraves all metals deeply, dollar. Hudson Bros., East Syracuse, N. Y.

ELECTRIC FENCING

COMPLETE Electric fencing information. Write: Handbook, Box 643-M, Muncie, Indiana.

MAKE Electric fence from old automobile coil. Complete plans 10c. No extras to buy. LeJay Manufacturing, 947 LeJay Building, Minneapolis, Minn.

ELECTRIC Fence—\$9.95. Charges 25 miles. Farm radio—\$9.95. Save 50%. 30-day's trial. Catalog—free. Marco, F. Kansas City, Mo.

WELDING AND SOLDERING

STARTER Coils and \$5.00 makes powerful 110-200 volt A-C welder. (No rewinding.) Pole transformer makes 200A welder. Plans \$1.00. Information dime. Welders Supply Company, Dept. P, Bellefontaine, Ohio.

75-200 AMPERE Arc welders from Dodge generators. Complete plans 35c. 100 other generator changes. LeJay Manufacturing, 347 LeJay Building, Minneapolis, Minn.

GAS Soldering torch. Works from any gas outlet. No oxygen—no compressed air—no blower. Instant heat. Any size flame. Make soldering easy. Descriptive circular free. Choate Mfg. Co., 3467 Principio Ave., Cincinnati, Ohio.

ELECTRODE Holder, takes 1/16 to 5/16 rods. \$1.25 postpaid. Speedelec, Box 374, Oglesby, Ill.

SPOT Welders \$40; practical, powerful, guaranteed. Gale Hollinger, Glen Ely, Ill.

PLANS For powerful low cost 110v welder. \$1.00. Marvelweld, Box 1156M, San Francisco.

DEMONSTRATORS. Electric arc welders. Money-saving prices. Used by the government. Trial and terms guaranteed. Hobart Welders, M-793, Troy, Ohio.

LOW Priced arc welder. Free literature. Holgeron's Service, Canton, Kansas.

D.C. Arc-welder plans \$1.00 each. 25-200 amperes from 32 volt Delco light plant. 25-600 amperes from d.c. vehicle motors. 25-200 amperes from North-east Dodge generators. Welders Club, AB-3432 M-Mart, Chicago. For sale: New and used d.c. vehicle (truck) motors. (Special: 44 lessons in arc-welding. 50c. Foreign 75c.)

SUPERIOR Magnetic governor (engine driven welders) improved, automatic, \$6.50; blueprints 25c. Wilson's, Hollins, Alabama.

REBUILT a.c. d.c. Arc welders, all sizes; engine governors, idlers. Terms. Low prices. Guaranteed. Service Co., 3732 Cedar Ave., Cleveland, Ohio.

ARC-WELDING Outfit \$1.25. Weld fenders, braze, solder. Arrowtrading, 5014 Tillman, Detroit.

ENGINES, MOTORS, DYNAMOS

6 VOLT Fan motors. Sample 50c. Kish, 1040 Vinewood, Detroit, Mich.

"PEPY" Governors make automobile engines into power units. Most sensitive and accurate. Low price. \$9.50 postpaid. Get circular. Harris Machinery, Minneapolis, Minn.

MOTORS. Generators, converters, motor-generator sets, all types and sizes. State your needs. Queen City Electric, 519 South California, Chicago.

BARGAINS—Plating generators, motor generator sets, also arc welders. New low prices for large and small shops. Trial—easy terms if desired. Hobart Bros., Box M-796, Troy, Ohio.

50 SMALL Electric motors with flexible shaft, hand piece and chuck, \$5.75 postpaid. McConnell, 1619 Edgewood, Racine, Wis.

REWIND Electric motors rapidly by new process. 1 h.p. stator rewound in 2 hrs. No machinery. Instructions \$1.50, information 5c. Speedelec, Box 374, Oglesby, Illinois.

BARGAINS—New pricelist free. Fans, motors, grinders, drills, shavers, home workshop tools. Candid type camera \$1.10 postpaid. Mailorder Electric, 713 South Dearborn, Chicago.

AIR Compressors, new, 1 1/4x1 3/4, \$6.00; 2x2, \$7.00; 2 1/2x2, \$8.00. Guaranteed. Send check or money order. Free catalog. National, 1915 South State, Chicago, Ill.

REFINE Used oil without cost. Particulars. F. Gerwin, Fairview, Oklahoma.

ALTERNATING. 1/2 Horse, 110 volt, induction motors. Rebuilt, guaranteed, \$7.25. Wilmot Auto Supply, 2247 St. Paul Ave., Chicago.

300 MOTOR Diagrams and tables covering three phase; Star, Delta, nine lead, two and four speed; two phase; single phase; split phase, capacitor, repulsion induction, fan, armature windings, etc. Satisfaction guaranteed or money refunded. \$1.50 prepaid. Educational Advancement Company, Lakewood, New York.

BARGAIN—1/2 Hp. motors, 60 cycle, 1 phase, 110 volt, like new, guaranteed, \$7.40. Send check to Erie Electric Motor Co., 120 Church, Buffalo, N. Y.

MOTOR Winding lessons, illustrated. Send stamp for particulars. Also motor data for experienced winders. Introductory selection \$1.00. Motor Data Company, Box 7631, Kansas City, Mo.

MACHINERY, TOOLS AND SUPPLIES

MACHINIST. Craftsman! Easily made Index Tool. Practical, inexpensive. Indicates, squares, hexs, offset keyways, drill work. Indispensable with milling attachments, etc. Blue prints one dollar. Jiffy Index Tool, 101 Whiting St., Tampa, Fla.

STRETCH Your dollar with Atlas shop equipment. Metal and wood lathes, drill presses, arbor presses, shapers, vises, motors, grinders, tools, and attachments. Send for new 1939 catalog. Atlas Press Co., 2743 N. Pitcher St., Kalamazoo, Mich.

KELLOGG Air compressors \$6.00. Electric refrigerators \$25.00. Vacuum pumps. Taylor, 105 East 102nd Street, New York.

LISTS Of all United States manufacturers—5c per name. Stern, 6220 Ellis, Chicago.

BARGAINS. Demonstrators, electric arc welders, guaranteed. 30 days trial and terms. Write Hobart Welder Exchange, Box M-794, Troy, Ohio.

LATHES. Drill presses, paint sprayers, etc. Bargain folder 3c stamp. Gardner Machine Co., Defiance, Ohio.

HOLLOW Spindle combination toolpost and bench grinder. For external, internal grinding, buffing, polishing. Fits 9" South Bend lathe. Drives flexible shaft. \$300 equipment for \$36. Free folder. Wamco, Winchester, Indiana.

FOR 9" South-Bend lathes. Milling attachments, universal movement \$9; threading dial indicators \$3; 6" four jaw chucks \$9.50. Unique Manufacturing Co., 4807 North 31 Ave., Omaha, Nebr.

360° INDEXING Attachment for South Bend workshop lathes postpaid \$4.95. Circular free. Elmer Amidon, No. Girard, Penna.

DRILL Grinding attachment fits bench grinder, hand or power turned. Handles sizes 3/16 to 1 1/4". Price \$7.85. Descriptive literature on request. Tractor-Lite Co., Sidney, Iowa.

CONCRETE Building block machines and molds. Easy payments. Catalog free. Concrete Machine Co., 5129 South Compton Ave., St. Louis, Mo.

TREMENDOUS Surplus of factory tools selling out. Drills, taps, files, hacksaws, etc. Send for free lists. Include six cents postage. Travers Tool Co., 264 Jackson Ave., Long Island City, N. Y.

14" x 6" GREAVES Klusman cone head engine lathe, quick change. No. 0 Cincinnati miller, cheap. Write for particulars. Cincinnati Machinery & Supply Co., 221 E. Second St., Cincinnati, Ohio.

BOATS, OUTBOARD MOTORS, ETC.

CLARKE Troller, world's lightest practical outboard motors for their power. Twin (alternate firing) 3 horsepower, 18 pounds; single, 1.3 horsepower, 8 1/2 pounds, prices \$34.50 up; easy terms. Write Clarke Engineering Company, 6905 East Lafayette, Detroit, Mich.

KAYAK Construction kits. Easily built. Speedy. \$5.00 up. Write! H. Schenck, 156 Springfield, Rutherford, N. J.

SAILBOAT, Canoe, motorboat equipment, cut prices. Catalogue 5c. Alans, 98 Chambers, New York City.

BUILD Your own boat with Bay City Prefabricated frames and materials. Save up to 2/3s. Lumber, fittings, engines and equipment. Send requirements for quotation. Illustrated catalog 100 boats 9 to 75 feet 10c. Bay City Boats, Inc., 1552 Adams St., Bay City, Mich.

GENUINE New Evinrude and Elto outboard motors now as low as \$29.50 (plus small transportation charge.) Down payment as low as \$6.00. Fourteen advanced 1939 models to choose from. Write for catalogs, boat directory and handy Boat-&Motor Selector—all free! Address, Evinrude Motors, 4188 N. 27th St., Milwaukee, Wis.

FORD-ZEPHYR Marine conversions. Catalog 10c. Lehman Engineering Company, Dept. D, Newark, N. J.

ATTENTION! 12' Kayak kit \$10.00. Other remarkable values. Playaks, Dedham, Mass.

COMPLETE Building plans 12 foot plywood skiff—row, sail, power. May Rudder 35c. Catalog boatbuilding plans free. Rudder, 15 Murray St., New York.

ELECTRIC Outboard from old automobile generator operates with car battery. Smooth—quiet. Plans 10c. LeJay Manufacturing, 547 LeJay Building, Minneapolis, Minn.

BUILD 12 Foot boat—row, sail, outboard. Plans, 15c. Readers Service, 800-82 North Clark, Chicago.

BUILD Your own Marblehead model sailing yacht by the half-lift method. Simplifies construction. Keeps expenses down. Includes full-size station templates for 50"-800 yacht. Send 50c to Bruce-Milwaukee, 1307 Montgomery Building.

BUILD A boat by the Welch System. Its inexpensive; interesting and profitable. Everything for building; equipping or repairing boats. Use Welch Ready Cut Parts. Send 10c for catalog showing boats of many types; boat hardware; propellers; marine paints; sails; boat finishing materials and Welch White Cap marine motors. Welch Boat Company, Station K-1, Milwaukee, Wisconsin.

AIRCOOLED Inboard motorboats. Complete \$75.00. Details. Clear-View Company, Dayton, Ohio.

AERODRIVE Shallow draft boat. Blueprints, \$1. Government surplus aircooled 80 horsepower motor, \$75. Lacquer paint \$2.50 gallon. Airplane cable 2 1/2c foot. Circular 10c. Allison Aircraft, Lawrence, Kansas.

ESKIMO Boats. 12' kit \$12.50, complete \$25. 12' outboard kit \$15, complete \$27. New. Different. Marko Boats, Atlanta, N. Y.

SEE Our ad on page 134A. Cleveland Boat Blueprint Co.

MARINE Power—Easily convert any Ford motor (domestic and foreign) with Osco parts and kits. Complete catalogue 25c (coin). Osmitson, 3644 Lawrence St., Philadelphia, Penna.

SAILS For canoes, dinghies. \$5 up. Tryptail, Patterson, New York.

ASSEMBLE Your own boat. Our finished knock-down frames and materials save you 2/3 builder's cost. All types and sizes. Send 25c for big catalog. Brooks Boat Co., Inc., D4, Saginaw, Mich.

OUTBOARDS — Save 1/2. Good used parts, all makes and models. Bargains rebuilt motors. Crandall Hicks Co., 959 Commonwealth, Boston, Mass.

BOAT Designers are highly paid professionals. Complete course by mail. Catalog. Westlawn, Montville, N. J.

BUILD Your own boat—New book gives plans, methods, etc. 312 pages \$3. Popular Mechanics Press, Room (C39), 200 E. Ontario St., Chicago.

SPORTING GOODS, GUNS, FISHING TACKLE, ARCHERY

GOLF Clubs. Five club matched set \$2.50. Lincoln Surplus, 123 Galena, Freeport, Ill.

CLARKE Troller, world's lightest practical outboard motors for their power. Twin (alternate firing) 3 horsepower, 18 pounds; single, 1.3 horsepower, 8 1/2 pounds, prices \$34.50 up; easy terms. Write Clarke Engineering Company, 6905 East Lafayette, Detroit, Mich.

BARGAINS! A-1 gov't slings 50c, swivels 35c. Gun catalog 5c. J. Warshal & Sons, First and Madison-PM, Seattle, Wash.

MAKE Bass streamer flies! Real fish getters. Material, instructions 10c. Sample fly 30c. "Kingfisher," San Gabriel, California.

GUNS, Modern and antique, pistols, accessories, edged weapons, war relics. More than 1,000 items. List 15c. Martin Retting, "X," Hightstown, N. J.

HUDSON Bay blankets, complete camping, hunting, outdoor equipment. Catalog. Howe Fur Company, Coopers Mills, Maine.

SPORTSMEN—Send for free sporting goods catalog. Save money on all sports equipment. International Sports, 3301-F Lawrence, Chicago.

FREE Self-defense instructions. Body-building equipment. Send stamp. Athletic, 126 Lexington Ave., New York City.

FISHERMENS Secrets, Chinese, and others for catching fish in abundance. Formulas and instructions three dimes. Homer Renaud, 1149 Pleasant St., Fall River, Mass.

TENTS, Factory to you. Catalog dime. Refunded first order. Willis Co., Everett, Mass.

FISH Bag holder, with bag. Clamps on boat. \$1.15 postpaid. McConnell, 1619 Edgewood, Racine, Wis.

BOWS, Arrows, raw materials. Beautiful catalog (over 125 pictures) and "Essentials of Archery" a handbook on making bows and arrows 35c. Everyone intending to make their own should have this manual. Instruction folder and catalog 10c. L. E. Stemmler, Queens Village, N. Y.

ARCHERY Headquarters—617 South State, Chicago. Catalogue free. Complete instruction book 50c.

OUTDOOR Sports for everyone—Enjoy them all your round with aid of book published by Popular Mechanics. Hundreds of ideas for new and popular sports for every season; complete instructions for making necessary equipment at small cost. 350 pages and 650 illustrations. \$2 postpaid. Popular Mechanics Press, Room (C39), 200 E. Ontario St., Chicago.

FIELD GLASSES, TELESCOPES AND MICROSCOPES

ASTRONOMICAL Telescopes, binoculars, cameras, microscopes, bought, sold, repaired. Send 10c for list of instruments desired. Rasmussen, Box 294, Amsterdam, N. Y.

1000 VALUE Seekers notice. Powerful lens, long range telescope, 30 inches long. Four sections, 100% money back guaranteed. While they last, \$1.00 each. Order now. B & H Sales Company, 56 West Washington, Chicago.

BARGAINS, Telescopes, binoculars, microscopes, new, used; everything for amateur astronomy; catalog 10c. American Telescope Laboratories, Dept. 21, Hollywood, California.

BINOCULARS, Telescopes cleaned, repaired. Send glasses for estimate. W. J. Belz, Opticians, 2 E. 44 St., New York City.

TELESCOPES, Microscopes, binoculars; 1939 bargain catalog free. Brownscope Co., 5 West 27th Street, New York.

ANTIQUES, RELICS, INDIAN GOODS

ARROWHEADS; Saskatchewan glacial beauties, rainbow variations. Dan McKillop, Regina, Saskatchewan.

POPE'S World-famous osage bows. Free literature. E. F. Pope, Woodville, Texas.

RELICS, Coins, bills, gems, hobby material. Catalog 52 illustrations 5c. 100 ancient arrowheads \$3.00. H. Daniel, Hot Springs, Ark.

SWORDS, Rapiers, pistols, daggers, armor catalog 10c. Robert Abels, 860A Lexington Ave., New York.

100 GOOD Indian arrowheads, \$3.00. Catalog. George Holder, Glenwood, Ark.

INDIAN Relics, beadwork, coins, curios, minerals, old glass. Catalog 6c. Indian Museum, Northbranch, Kansas.

TAXIDERMISTRY

SPECIAL—Deer foot rack, painted mountain scene, holds guns, fishing creel, \$5.50. Ringneck pheasants \$6.00. Patton's Taxidermy, Paradise, Penna.

TAXIDERMISTRY Supplies—Quality artificial eyes, teeth, genuine Jonas head forms. Tools, materials, etc. Everything for the progressive taxidermist. Send 10c for big illustrated catalogue. Jonas Bros., 1049 Broadway, Denver, Colo.

DOGS, PETS, BIRDS

PETS, Parrots, birds, animals, monkeys, snakes. Snake King, Brownsville, Texas.

\$2500 YEAR Raising cavies, rabbits, fowls. Folder 10c. Deedie's Animalry, Fayetteville, Ark.

GUINEA Pigs—Certified quality. For laboratory; breeders. L. H. Cordell, South Pittsburg, Tennessee.

CHUBBY Saint Bernard puppies! Particulars free. Book 104 photographs all breeds described 25c. Royal Kennels, Chazy, N. Y.

BEAUTIFUL Pure white police dogs. Ansonia Kennels, Mose, N. Dak.

POULTRY AND FARM SUPPLIES

INTENSIVE Range farms. Solve poultrymen's problems. Information free. 6232 Marmion Way, Los Angeles.

SUMMER Prices on Davis chicks. Banded, Buff, White Rocks, Reds, Wyandottes, Orpingtons, English White, Brown, Buff Leghorns, Anconas \$6.50-100; 500-\$31.75. We pay postage, will ship COD. Davis Poultry Farm, Route 34, Ramsey, Indiana.

LOW Summer prices for Salem "Profit" AA grade chicks. Banded, White, Buff Rocks; Wyandottes; Reds; Orpingtons; White, Buff, Brown Leghorns; Anconas \$6.45-100. We pay postage, will ship COD. Salem Hatchery, Box 81, Salem, Indiana.

MAKE Money with poultry. Read America's leading poultry magazine for latest information. Three years \$1.00; nine months 25c. Poultry Tribune, Dept. E-93, Mount Morris, Ill.

CHICK Raisers make extra money selling our chicks to neighbors. Write Jackson County Hatchery, Box 19, Seymour, Ind.

TREES, SHRUBS, ROOTS, HERBS

JUST Out! World's greatest "Herbalist Almanac." Beautifully illustrated in natural colors. Contains over 200 old-fashioned herb medicine recipes for home use. 10c postpaid. Worth dollars! Botanics, 145 W. 112th St., Chicago.

FARMS AND FARM LANDS

THE Great Northern Railway serves an agricultural empire where rents, prices and operating costs are low in Minnesota, North Dakota, Montana, Idaho, Washington and Oregon. Write for free book. E. C. Leedy, Dept. 757, St. Paul, Minnesota.

GOOD Farms available. Washington Minnesota, Idaho, western Montana, Oregon. Dependable crops, favorable climate. Write for impartial advice, literature and list of typical bargains. Specify state. J. W. Haw, 119 Northern Pacific Ry., St. Paul, Minn.

FLORIDA Tax deed lands. Good fruit and truck land. Ten acres \$70.00. \$5.00 down. \$5.00 month. Many others. Florida Tax Deed Service, 8007D Nebraska, Tampa, Florida.

U. S. Hwy gas sta., repair garage, 7-room home, electricity, an acre in village, very heavy traffic; \$3500. \$500 down; No. 1120 page 93 free catalog 1700 bargains. Strout Realty, 255-P 4th Ave., New York City.

FARM MACHINERY AND SUPPLIES

ALL Purpose tractors at factory price. Shaw 2 to 8 horsepower, riding or walking types. Does plowing, discing, harrowing, cultivating; mows lawns, cuts weeds, does hauling; runs belt machinery. Air or steel tires. Three speeds forward and reverse. Thousands in use. Write for free catalog and 10 day trial offer. Shaw Mfg. Co., Dept. PM-7, Galesburg, Kansas.

PROFITABLE OCCUPATIONS

NATIONAL Baking Institute announces a new home study course covering all phases of commercial baking. Good field for ambitious men. Nearly a depression proof business. Common school education sufficient. Send for free booklet "Opportunities in the Baking Industry" and requirements. National Baking Institute, 3601 Michigan Avenue, Dept. 343B, Chicago, U.S.A.

HOW To earn money at home! Big, free book tells inside story—how hundreds are earning cash raising mushrooms in cellars, sheds. Cash paid for all raised. Write today. United, 3848 Lincoln Ave., Dept. 61, Chicago.

RAISE Fur rabbits for us. We pay to \$7.00 each for young. Catalogues 10c. Rabbits, Bowling Green, Kentucky.

MINK Easily raised. Profitable. Free information. Banks Minkery, Framingham, Mass.

\$30 WEEKLY. Grow mushrooms. Cellar, shed. We buy 30c lb. Mr. B made \$270 spare time. World's largest company. 40 page book free. Mushrooms, Dept. 701, 2019 Second, Seattle, Wash.

MEN—Women, operate "Specialty Candy Factory" home, all or spare time. Steady income. (Our 31st year.) Hillyer Ragsdale, Inc., Drawer 62, East Orange, N. J.

"120 WAYS To make money"—\$1.00. Descriptive literature free! Pines, P-583 Monroe, Brooklyn, N. Y.

RAISE Angora wool rabbits! Easy, profitable. Wool brings \$3 to \$6 lb. Big markets! Catalog, wool samples 10c. Clay's Farm, Sharon, Wash.

SEND \$1 For absolutely sound income projects. Then discharge your employer. McMichael, Allenhurst, N. J.

MONEY In rabbits and cavies. We buy and put you in touch with other markets. Catalog and copy of magazine 10c. Or send 25c for book catalog and price list and year's subscription to the American Small Stock Farmer. Stahl, Box 1, Holmes Park, Mo.

STANDARD Rabbit Journal, Milton, Penna., year 50c. Sample dime. Supplies.

BOOKS, PERIODICALS, PICTURES, POSTCARDS

MACHINISTS Compact reference book. Hardening helps, triangles, thread measurements, taps, drills, taper pin sizes, etc. 70 pages. Price \$1.00 postpaid. G. A. Knudsen, 523 - 48th Street, Brooklyn, N. Y.

MAGAZINES Half-price! Catalog 10c. Magazine Exchange, Baseline, San Bernardino, California.

"PUBLISH Magazine, \$1.00 capital"—10c. Bagley's, Box 2522, Portland, Ore.

SEND 10c For trial subscription. American Freeman, questions and answers magazine. Haldeman-Julius, Box 105, Girard, Kansas.

FREE List popular handbooks, all subjects. Ohio Novelty Co., 1213 Worley N.W., Canton, Ohio.

BUSINESS-BUILDING Bulletins—Idea check lists. 50¢ off. List 10c stamps. John Morris, 1040 South Paxon, Philadelphia.

LEARN To do wood turning on the lathe. Fascinating, profitable. 200 page book with 141 plates provides complete mastery of this art. \$1.50 postpaid. Popular Mechanics Press, Room (C39), 200 E. Ontario St., Chicago.

GAMES—ENTERTAINMENT

PLAYS, Operettas, musical comedies, complete minstrel first-parts with song programs, blackface skits, vaudeville acts, monologs, dialogs, recitations, juvenile plays and songs, musical readings, entertainments, make-up goods. Catalog free. T. S. Denison & Co., 203 N. Wabash, Dept. 11, Chicago.

MAGIC TRICKS, PUZZLES, JOKER NOVELTIES

TARBELL'S Magic lessons 20c each. List free. Davies, 346 North Clark Street, Chicago.

TRICKS! Novelties! Fun-makers! Send 10c for complete catalog. Lincraft, P.O. Box 1244, Dept. H, Lincoln, Nebr.

HAVE Fun! Pool your friends! Latest trick jokes, 10c brings illustrated catalog and snappy free trick! Broadway Novelty Co., Box 75, Pelham, N. Y.

GIANT Surprise catalog of jokes, tricks, puzzles, novelties. Large professional magic catalog. Both illustrated. Both rushed for 25c. Lawson Vick Co., Dept. P9, Queens Village, N. Y.

USE Regular unmarked playing cards as trick decks. Send \$1.00 for sample cards of ten different popular decks. Bee, Bicycle, others, showing keys making them trick decks. The Tellurium Co., Box 678-PM, Wallace, Idaho.

AMAZING! New 100 page catalog 500 tricks 10c. Lyle Douglas, Station A-5, Dallas, Texas.

EARN Money in any crowd. Call names of strangers, tell unspoken questions. Professional course mind reading, spirit writing, etc. \$1. Henderson, Box 341, San Bernardino, Calif.

WORLD'S Largest magic shop professional catalog, 25c. Holden, 220 W. 42nd St., New York.

BECOME A magician and earn extra money in your spare time. Send 25c today for your copy of our 168 page catalogue. This book is full of tricks for everyone, from the beginner to the professional performer. Established 1910. Chicago Magic Company, 2300 North Mason Avenue, Chicago, Illinois.

LEARN Ventriloquism, 3c stamp brings particulars. Smith, 125 N. Jefferson, Peoria, Illinois.

STAMP COLLECTING

TRIANGLES And diamonds from South America. Offered free to approval applicants. By the company that offers finest stamps at lowest prices. Take advantage of this offer. Please enclose five cents to cover handling and mailing. National Stamp Company, 4359 South Maplewood Avenue, Chicago, Illinois.

ASSOCIATED Stamps of the west. Numbers 1 to 100 for 53 cents. Pierce, Box 931, San Jose, Calif.

WILL Rogers stamp is included in our packet of 20 different airmail stamps. 5c to approval applicants only. Lindgren, 714 Market, San Francisco.

101 MIXED Stamps 3c. Approval applicants only. Quality Stamps, Englewood, Colorado.

TEN Stamps cataloging over \$1.00 to approval applicants enclosing 25c. Cowdrey Stamps, Flint, Mich.

BADEN—Scarce old genuine Baden. Librarian Bongo antelope, mystery British Colony triangle, fantastic Manchukuo, breathtaking Cayman Islands, \$5 United States, bizarre Negri Sembilan, Grande Comore Islands. Everything 3c with approvals. Viking, 1-2 Hanson Pl., Brooklyn, N. Y.

GIANT Packet 200 all different, from Africa, South America, Asia, South Sea Islands, etc. Includes world's smallest stamp, triangle and diamond-shaped stamps, animal stamps, Nicaragua Olympic "baseball" commemorative; and many others. Also packet 17 different United States (cat. 65c)—all obsolete, including \$5 denomination, commemoratives, etc. Total catalog value nearly \$5.00! All for 5c to approval applicants. Write to-day! World-Wide Stamp Co., Box 600, Camden, New York.

FREE! Royal visit packet. Postage 3c. Roberts, 312F Shearerblg., Bay City, Mich.

SEND 1c For triangle stamp. Mexican airmail, and set 6 Somali Coast. Sundman, D139, Bristol, Conn.

TEN Different United States over 40 years old. 10c. Elsea, Bowling Green, Ohio.

25 MINT Bicolors 10c. Approvals. Castle, 707 Judson, Evanston, Illinois.

FREE Stamp catalogue—World's Fair edition—Giant fifty-page quarterly listing albums, supplies, Canadians, Newfoundland, United States, new issues, foreigners and pictorials. Fully illustrated! Empire Stamp Co., Dept. PM, Toronto, Canada.

\$1.00 PACKET Given! Enclose postage, request approvals. Secrist, Muscatine, Iowa.

25 JAPAN 3c With approvals 1/4c up. Josiab Babcock, St. Joseph, Michigan.

NEVER Offered before. 21 French Colonies, pictorials, sets of 5 each (105) for 35c. French, 241 Euclid, Cleveland.

NEW York—Golden Gate world's fair issues of Ecuador. Set of (12) 5c. Approvals. "Stanley the Stamp Man," 3120 South Adams Ave., Milwaukee, Wisconsin.

25 DIFFERENT Airmails or 50 different U. S. postage 12c. Perforation gauge free. Arthur McFadden, Mt. Rainier, Md.

10 UNITED States commemoratives; 1c, 2c, 3c, list. Postage. Box 781, Tucson, Ariz.

AIRMAILS 15 Different 5c. Approvals. Wood, 324 Harford, Syracuse, N. Y.

FIFTY Including commemoratives, airmails, Panama, Spain, etc., 15c with approvals. Collins' Stamps, 1208 Valmont, New Orleans, La.

FREE Mint; packet 50 mixed 10c. McPhee Bros., Boothbay Harbor, Maine.

ATTRACTIVE Cachet with Alaska commemorative stamp. 10c. Sportsman, P-118, Ketchikan, Alaska.

EXCHANGE Stamps, postcards. Universe. "Exchangers," Bry 226 pres. Paris, France. Particulars free.

ATTRACTIVE Stamp album providing spaces for 2220 stamps with 700 illustrations, packet 300 different stamps, 500 hinges, tweezers, duplicate book, pamphlet which tells "How to Make a Stamp Collection Properly," bargain list of sets and packets, all for only 50 cents. Queen City Stamp Co., Room 36, 604 Race St., Cincinnati, Ohio.

PRECANCELS On approval. Hamilton, 1426 Alta Vista, Santa Barbara, Calif.

GAMBLERS Rainbow packet includes Goya nude, Will Rogers, bi-colors, triangles, 10c to approval applicants. Central Stamp Company, Box P372, Mattoon, Ill.

1, 2, 3c APPROVALS. Doty, 5032 So. Gramercy, Los Angeles, Calif.

COLLECTORS—Fine United States airmails, commemoratives, postage on approval. No premiums. Just fine stamps. Harvard Stamp Company, 318 Harvard Street, Brookline, Mass.

U. S. Commemoratives. Army and navy set complete, 10c to approval applicants. Lindgren, 714 Market, San Francisco.

FINE Approvals, freshly filled books and sheets. Tell me what you want and I will send it. Milton Skinner, 306 East Fourth, Long Beach, Calif.

ASSASSINATION! Complete, unused Sarajevo assassination issue from Bosnia-Herzegovina, perforation gauge, three other complete sets—all free! Approvals. Gopher Stamp, 4705 Lyndale, Minneapolis.

100 GLASSINE Envelopes, 2 1/2" x 4 1/4", 15c. Limit 100. Macek, Madison, Illinois.

60 DIFFERENT Canada including Royal Visit issue, only 40c to approval applicants. R. Lynch, Box 56, Peoria, Illinois.

UNITED States—45 different, gauge, hinges, pricelist 10c. No approvals. Seidenberg, Baroda, Mich.

NICARAGUA Will Rogers airs cpl. 5c. Approvals. Moulton Stamps, Elgin, Ill.

UNITED States approvals! Sacrifice prices! Box 822, Minneapolis, Minn.

RARE Hawaii No. 75, 3c approvals. Millhiser, 7724 Abbott, Pittsburgh, Penna.

225 DIFFERENT Selected stamps 35c, 1000 different \$1.25. Arcane, 1937 Madison, Chicago.

ROUMANIA 25 Different 3c with approvals. Excel, Box 1315, Chicago.

150 GENUINE U. S. and foreign stamps, 5c. Stanton, Niantic, Conn.

SPECIAL! 100 Different French Colonies 20c with bargain approvals. Gladstone Stamps, 5800 Markham, Chicago.

1000 MIXED Foreign, 25c. Well worth sorting for values. Plaza Stamp Co., Santa Fe, N. Mex.

WILL Rogers set complete ten cents, with fine approvals. Dwight Shedd, Laramie, Wyoming.

FREE, Looseleaf commemorative album with 2 pound mission mixture for \$1.00. Park Stamps, LaGrange, Illinois.

UNPICKED! Excellent mission mixture: two pounds 65c! 100 U. S. revenues on documents, 10c. (1000-75c.) Vanvoorhis, Hyndman, Penna.

HUNGARY'S Famous men No. 468-79; Germany Hindenburgs No. 415-31; both sets complete, 29 stamps, 10c with approvals. Sam Shock, 70 Washington Rd., Asheville, N. C.

PENNY Approvals—Thousands of fine stamps at 1c each. Heiden, 530 Parkside Ave., Brooklyn, N. Y.

1857-1938 STAMPS At 1c and 2c each. Catalogue up to 10 times my prices. Leduc, Saint Petersburg, Florida.

1000 U. S., 15c. Foreign approvals. Free premiums. Lee, Bridgeport, N. Y.

FREE 105 Different stamps to approval applicants. Write today! Blackstone, Walnut Ave., Wayne, Penna.

LILLIPUTIAN Airpost! Afghanistan, Perak, Selangor, Siberia, "Green Cross," charity, Wurttemberg, Palestine, Banana airmail. Free with approvals! Postage 3c. Saxon Co., 408-A Jay St., Brooklyn, N. Y.

WILL Rogers set 10c to approval applicants. Riedell, Greensburg, Penna.

BRITISH Rulers' American visit complete—6c. Canada has just issued a beautiful bi-colored set of 3 values to honor the King's and Queen's visit to the Dominion and New York world's fair. We will send this complete set for only 6c (actual cost) to sincere approval applicants. We will also send "on approval" all other world's fair stamps to be issued by more than 20 different nations at original prices. For an additional 5c for mailing expenses we will also send our free, fully illustrated 60-page book, "Famous Stamps and Their Stories," the most outstanding book on stamps of recent years. Do not miss this opportunity! Write us today! Approval Headquarters, Globus Stamp Company, 268 - 4th Ave., New York City, Dept. 201.

ALBANIA—3 Complete mint sets only 5c to applicants requesting my quality approvals. Nels Dolve, Box 406, Minneapolis, Minnesota.

10 DIFFERENT Airmails 4c with approvals. Mart, 3823 N. Cicero, Chicago.

60% On British West Indies of better grade. References. L. S. Myers, 58-39P 44 Ave., Woodside, N. Y.

3 BIG Sets—French Colonials, 10c. MacKay, 7200 Yale, Chicago, Ill.

FREE! Stamp tongs, watermark detector, stamp wallet and perforation gauge, to approval applicants. Enclosing 5c for postage-packing. F. Buth, 7134 So. Claremont, Chicago, Illinois.

QUEEREST Stamp packet: Mozambique, Japan, China, South, Albania, many others—5c to approval buyers. R. M. Stamp Co., Box 230P, Port Chester, N. Y.

NEWFOUNDLAND 12 Different 5c with approvals. Hudson, Box 118-P, Plainfield, N. J.

25 UNITED States, including \$4 and \$5 stamps free to approval applicants. 3c postage. Brownie Stamp Shop, Flint, Mich.

FREE! 80-Page "United States & British North America" catalog. Nearly 1,000 illustrations! Lowest prices! Large catalog "foreign stamps" also included. Harris & Co., 137 Transit Building, Boston, Mass.

COLLECT United States stamps for solid value. Our approvals are correctly numbered and reasonably priced. Southern Stamps, Box 70, Miami, Florida.

1000 DIFFERENT 75c; 600, 50c; 300, 20c. Fred Onken, 630 79th St., Brooklyn.

FREE, 50 Stamps, Iraq, etc. Postage 1c. Album 3c. Bullard, 268 Northampton, Boston, Mass.

EXCELLENT Philatelic surprise packet 25c (approvals). Casimer Nowak, 825 North Racine, Chicago.

WHOLESALE Supplements to dealers for 10c postage. Hundreds of bargains. Grossman Stampco, 102 West 42nd, New York.

50 DIFFERENT, Fine U. S. including perforation gauge, 10c with approvals. The Stamp Shop, 809 Holland Bldg., St. Louis, Mo.

CANADA Catalog, illustrated, 136 pages, \$1.00. Miniature sheet triangles (4 diff.) 10c approvals. Victoria Stamp Co., London 4, Canada.

175 U. S. commemoratives, etc., 10c. 500 25c. P. O. Box 457, Newark, N. J.

FREE—The Stamp Finder! Send today for big new edition, fully illustrated, enabling you instantly to identify all difficult stamps! Also fine packet strange, fascinating stamps from Bosnia-Herzegovina, Monaco, Patiala, Cyprus, etc., including maps, ships, animals and strange scenes. All free to approval applicants inclosing 3c postage! Garcelon Stamp Company, Box 900, Calais, Maine.

FREE—Packet Central America stamps with request for 52 page list of United States and foreign stamps. Stamps on approval. References necessary, 20 different nineteenth century U. S. 28 cts. New Hussman Stamp Co., 1122 Pine, St. Louis, Mo.

100 DIFFERENT Hungary 7c, approvals. Hazett, 701P Fourth Baycity, Mich.

PENNY Approvals, that satisfy. Neil Gronberg, Box 5441-P, Philadelphia, Penna.

AIRMAILS And commemoratives, 25 different, including Columbians, Panama-Pacific, Edison, Zeppelin, etc., only 5c with exceptionally fine United States and foreign approvals. Marco Stamp Co., Box 888, San Francisco, Calif.

PANAMA Triangle and 50 others free to approval applicants sending 3c postage. Tatham Stampco, Springfield-30, Mass.

UNITED States illustrated looseleaf catalog, \$1.00. Send postage for free United States price list, precancel list. Stanley Gibbons, 38-P Park Row, New York.

GIANT Diamond-shaped stamp! Big packet 105 all different including Alexandretta (new country), Congo, Manchukuo, Ecuador constitution, Costa Rica triangle, air-mails, commemoratives; giant diamond-shaped stamp, \$5 United States; set United States telegraphs, cataloging 30c. Packet British colonies including Burma (new country), jubilee and coronations; scarce sets 2 Siberia, cataloging 50c. Illustrated lists. Everything for only 5c to approval applicants! Write to-day! Mystic Stamp Co., Dept. 80, Camden, New York.

FREE—From every continent, 155 different, airmails, triangle, commemoratives, pictorials, many U. S. and others, with 1c approvals. Send 5c for postage and handling. Ace Stamps, Colonial Arcade, Cleveland, Ohio.

200 DIFFERENT 10c. Big 50% approvals. Covert Stamp, 39 State, Rochester, N. Y.

BRAZIL, 50 Different 10c with bargain approvals. Davis, Silver Lake, Ind.

ASK For our wonderful one cent approvals. Prospect Stamp Co., 225 Broadview, Toronto, Canada.

WHOLESALE Catalog for dealers. Illustrated. Postage 5c. Frank Co., 4900 Chalmers, Baltimore, Md.

APPROVAL Sheets. One to three cents. Frederick B. Driver, 2009 Finance Bldg., Philadelphia, Penna.

WEEKLY Stamp magazine, thirteen weeks, 10c. Stamp Journal, Kalamazoo, Mich.

RARE COINS

COINS Wanted. Gold, silver, copper, \$30 for 1856 eagle cent uncirculated. Highest prices. A. French, Route 1, Troy, N. Y.

OLD Money wanted. Will pay fifty dollars for nickel of 1913 with Liberty head (no buffalo). We pay cash premiums for all rare coins. Send 4c for large coin folder. May mean much profit to you. Numismatic Co., Dept. 20, Fort Worth, Texas.

UNCIRCULATED 1909 S. and 1909 VDB cents; pair, \$1.00. Special beginner's type collection cents—10 for \$1.00. Satisfaction guaranteed. S. Koepfel, Merritt Bldg., Los Angeles, California.

KNOW What old coins are worth. Send 10 cents for new illustrated coin book. Littlecote Stamp Shop, Utica, N. Y.

BUFFALO Nickels, San Francisco mint, 10 different, your choice \$2.50. Standing Liberty quarters, San Francisco mint, 5 different \$2.50. Lincoln cents, San Francisco or Denver, 10 different 25c. Coin Shop, Box 5466, Metropolitan Station, Los Angeles, California.

1938-D UNCIRCULATED Buffalo nickel and catalogue—10c. Eugene Morrison, Reseda, California.

INDIAN Cents, 8 different, 25c. Bishoff, 500 E. 8th, Kansas City, Mo.

CERTAIN Large cents worth \$750.00; small cents \$12.00; nickels \$250.00; dimes \$300.00. Send 15c for latest 1939 complete 36 page illustrated buying book. American Coin Co., Box 3507-A, Cleveland, Ohio.

1931-S LINCOLN, Very scarce, fine condition 25c, and free list others. Monterey Money Mart, Box 749, Beverly Hills, Calif.

FOUR Uncirculated cents and pricelist 10c. Al Johnson, Crescent, Colorado Springs, Colorado.

UNITED States and foreign coin catalog 5c. James Randall, 407 South Dearborn, Chicago.

"ROYAL VISIT" medallion 35c. Borsos, R.R. 1, Stoneycreek, Ontario, Canada.

WILL Pay \$5.00 each for certain Lincoln pennies; Indian heads \$100.00; dimes \$700.00. Catalogue 10c. Federal Coin Exchange, Columbus, Ohio.

SIX Scarce U. S. coins; silver 20c, 5c, 3c; bronze 2c; 1/2c large cent, f.o.b. \$1.50. Schultz, 419 First National Bank Bldg., Cincinnati, Ohio.

GET Profit and pleasure in collecting old coins. Send 10c for 56-page illustrated coin catalog. You'll be delighted with it. Send for it now. B. Max Mehl, 370 Mehl Bldg., Fort Worth, Texas. Largest rare coin establishment in U. S. Established 38 years.

BIG Prices paid for certain wanted coins. 1909 cent \$10.00, some silver dollars \$4000, 1864-1865 Indian head cents \$100.00 each, dimes before 1895, \$600; liberty head nickels before 1914, \$500; encased postage stamps; some large pennies \$2000; half cents, \$275.00; paper money, gold dollars \$1500, foreign coins \$165, some worth \$6000 each. You may have coins for which we pay big premiums. Therefore send 15c today for 1939 big illustrated coin book for certain wanted coins. National Coin Corporation (80), Daytona Beach, Florida.

COMMEMORATIVE Half dollars, Lincoln, Stone Mountain, Oregon, Texas, Cleveland, Kentucky, San Diego, Long Island, \$1.50 each. Illustrated catalogue No. 14, 25c. Norman Shultz, Salt Lake, Utah.

FREE! Foreign coin, banknote, and large illustrated coin catalogue. Send 4c postage. Coin approvals sent. Tatham Coinco, Springfield-125, Mass.

\$5 TO \$500 Each paid for hundreds of old or odd coins. Keep all until posted. Many very valuable. Send 10 cents for illustrated Coin Value Book, 4x6. Guaranteed buying and selling prices. 31 years in business. Coin Exchange, Box 5, Le Roy, N. Y.

HOBBIES AND COLLECTIONS

MATCH Book covers, unused, each representing a different town, 50 for \$1.00. Match Exchange, Box 154, Mt. Clemens, Michigan.

LEARN To polish stones. Free information. Smith's Agate Shop, 228 S.W. Alder St., Portland, Oregon.

WANTED Old cigarette cards. Write Bray, 1127 Jackson, Easton, Penna.

HYDROPONIC Gardens grow everything without soil or toil. Indoors, outdoors, all year around. Large instruction manual 25c. Soilless Guild, Barryton, Michigan.

SPECIMEN Oregon thunder egg, fifty cents. Box 808, Tacoma, Washington.

SWAP. Sell, exchange anything through Hobby Exchange. Receive quarterly classified membership directory. Send \$1. Designate principal hobby. Hobby Exchange, Dept. C, Box 3586, Oklahoma City, U.S.A.

UNUSED Book match covers, 100 all different. \$1.00. Free list. Charles Edelman, 1311C East 84, Cleveland, Ohio.

ALBUM Mounts 600 match book covers without paste. Information 3c. Adams Sales, Dept. 8, State Tower, Syracuse, N. Y.

PHOTO FINISHING

"BETTER Pictures" offers a complete roll and miniature film service. Rolls developed and printed 25c. Write for price list and mailing bags. "Better Pictures," 2143 Farragut Avenue, Chicago.

PROFESSIONAL Photo finishing. All prints enlarged. Rich full toned super-prints made possible by our fine grain developing of all films. Only 25c. Reprints 3c each. 36 exposure 35 mm. rolls developed and each print enlarged to 3x4 1/4. \$1.00. Coin only. Snapshot Service, Box PM 270, Ashland, Ohio.

SIX And eight exposure rolls developed, each print almost double size, 25c. Reprints, 3c each. Send negative for sample print. Mailway Photofinishers, Box 774-H, Evansville, Indiana.

PHOTO Mill. Immediate service! No delay! Roll developed, carefully printed and choice of two beautiful 5x7 professional enlargements. One tinted enlargement, or eight reprints—for 25c coin. Reprints 2c each. The Photo Mill, Box 629-12, Minneapolis, Minnesota.

FILMS Developed by exclusive Spark-Tone process in studios with 23 years experience. 6 or 8-exposure rolls, 25c. Work done by studio experts and guaranteed. Send cash with rolls. Professional Studios, P.O. Box 412, Rochester, N. Y.—"the world's photographic center."

OVERSIZE Electrogloss deckledged prints. Rolls developed, 16 prints 25c. or 8 prints, two 5x7 electrogloss enlargements 25c. Reprints 3c. Artshop, Weatherford, Oklahoma.

BRILLIANT Fine-grain candid developing. 36 exp. 35 mm. film developed and enlarged to brilliant 2 1/2 x 3 1/2 prints, only \$1.00. Real rush service! Send roll and dollar or write for beautiful free print, mailer, prices. Clark Laboratories, 5022-C Baltimore, Washington, D. C.

TWO Prints from each picture on your roll 25c. Your pictures will speak volumes when finished by our expert craftsmen. One day service. Nineteen years' experience. Lens Photos, Dept. J4, Janesville, Wis.

OIL Coloring photographs a fascinating hobby or profitable business. Learn at home by easy simplified method. Previous experience unnecessary. Common school education sufficient. Send for free information and requirements. National Art School, 3601 Michigan Avenue, Dept. 343 B, Chicago, Illinois.

MAIL Your rolls to film center of the world. Any 6 or 8 exposure roll developed and printed 25c coin. DeLuxe enlargement coupon free! Photo Finishing Shop, Est. 23 yrs., 411-II Genesee Valley Trust Bldg., Rochester, N. Y. "The Camera City."

FREE—"Get-acquainted" offer! Two sample panel prints in leatherette album. Send negatives and 3c stamp with this ad. 6 or 8 exposure roll developed, and a set of panel prints in album—25c (coin). Photo Lab., Inc., Rm. 579, 3825 Georgia Ave., Washington, D. C.

CAMERA Roll developed and 2 glossy prints of each. 25c. 35mm. fine grain and 36 3 1/4 x 4 1/2 glossy enlargements \$1.25. Immediate service. Satisfaction guaranteed. Photolab, Box 5544, Chicago, Dept. D.

ROLLS Developed—16 prints, 2 enlargements 25c. 25 reprints 25c. Trial. Filmcraft, River Grove, Illinois.

FREE Album and negative file and 2 enlargement coupons with each roll developed. 8 guaranteed prints 25c. Memrilane Studios, General P.O. Box 666, Dept. "K," New York.

ROLL Carefully developed: 8 prints; 2 enlargements 25c. Marvin Studios, Box 1793, Milwaukee, Wis.

ROLLS Developed; 16 prints, two 5x7, 25c. 25 reprints 25c. M-B-M Photo Company, B-5131 Winthrop, Chicago.

ENLARGEMENT From each picture on your roll 25c. Lifelike enlargements bringing out the best in your pictures. High quality, fast service, low price, an unbeatable combination. Cut Rate Photos, Dept. B-4, Janesville, Wisconsin.

ONE Day service. Better pictures. Eight prints, two enlargements and one 8x10 enlargement coupon, 25c (rolls or reprints.) Candid rolls developed free. Prints enlarged to 3x4 only 4c each. Campbells Photo Shop, Box 163P, Bismarck, No. Dak.

ROLLS Developed; 8 good prints 25c. Free enlargements. Satisfied customers from coast to coast. Mail Order Photos, Box 427, Vancouver, Canada.

ROLLS Developed. 2 prints each 25c. Reprints 3c. Ramsdell, Box No. 5, Portland, Maine.

ROLL Developed and eight guaranteed professional prints including two enlargements that will not fade 25c (coin). California Film Service, Box 379, Pasadena, California.

SPECIAL: 35mm. Developed; 3 1/2 x 4 1/2 enlargements; one 8x10; cartridge reloaded \$1.50. U. S. Photo Service, Walnut, Illinois.

2 ENLARGEMENTS, 8 Prints. each roll developed 25c coin. 8x10 enlargement 25c. Adelpia, 1810 Hoffnagle, Philadelphia, Penna.

ANY Photo, negative enlarged to lifelike 8x10, 15c. Quick service. Rolls developed and enlarged to postcards, 25c. Promenade Photos, 30 East 20th, New York.

ROLLS Developed 16 quality prints 25c. Weicks, 2840 Zenobia, Denver, Colorado.

ROLL Developed—24 guaranteed prints, 25c. Dick's Photo, Louisville, Ky.

FREE Enlargement with each roll developed and printed 25c. Reprints 2c each. B & M Studios, Box 921, Memphis, Tenn.

35MM ROLLS Fine grain developed and each shot enlarged to 3 1/2 x 5 \$1.00. 18 exposures 60c. Ideal Films, Birmingham, Ala.

100 POSTCARDS \$3.00. 100 photostamps \$1.00. William Filline, 3027N Kostner, Chicago.

35MM. Film finegrain developed, enlarged to 2 3/4 x 4 1/4. 36 exposures \$1.00. Economy Photo, Greensburg, PM7, Penna.

LARJARGRAPH Reprints: Five 5x7 enlargements 25c. Cardinal Photos, Summit, N. J.

ROLL Developed and 16 prints or 8 prints and two 5x7 enlargements 25 cts. Reprints 20 for 25 cts.; 50 for 50 cts coin. Queen City Service, Dept. C, Box 7, Niagara Square Station, Buffalo, N. Y.

NOW! Daily service! Roll beautifully printed, 2 professional enlargements 25c. Valuable prizes! Crosswell Laboratory, A-4106 Milwaukee, Chicago.

TECHNIPINISH—35mm. 36 Exposure rolls perfectly enlarged to 2 5/8" x 3 3/4" glossy prints—75c. Cartridge reload with Eastman Plus X—25c. Fast satisfactory service guaranteed. Write for postpaid mailing bags and information. Technifinish Laboratory, 110 Lexington, Rochester, N. Y.

35MM. Special. Developed and enlarged to 3 1/4 x 4 1/2 Velox glossy prints, \$1.30. Any 6 or 8 roll 25c. Free enlargement coupons. All work guaranteed. Kelso, Box 549-B7, Inglewood, California.

MINIATURE Film, fine grain development, 2 1/2 x 3 1/2 enlargements. 35mm. \$1.00, bantam 25c. Film Capital Service, Box 504, Rochester, N. Y.

SPECIAL—4x6 Enlargements from small negatives—Fine grain developing—8 exposure roll 25c—16 exposures 50c—36 exposure Leica \$1.00. Enlargements last forever. Flash Photo Service, P.O. Box 333, Covington, Kentucky.

NOW! Quality finishing. Instant service. Eight Velox prints, two enlargements, 25c coin. Snap Shop 12, LaCrosse, Wis.

ROLL Developed and printed 20c in coin. Reprints 3c each. The Photo Finisher, Station E, Box 42, Columbus, Ohio.

CLEAR, Sharp prints begin with good negatives. Roll developed with 6 or 8 deckle-edge prints, 25c. Panel enlargement coupon free. National Amateur Photo Club, PM-27, 367 Main St., Buffalo, N. Y.

PROMPT Service—Guaranteed work. Two beautiful portrait type doubleweight enlargements, eight neverfade gloss prints, each roll 25c. Dubuque Film Service, Dubuque, Iowa.

ROLL Developed, 16 guaranteed prints, 25c. Smart Photo, Winona, Minnesota.

MILLIONS Now know "Hollytints means better prints." Trial roll printed including two beautiful enlargements—25c. Fascinating premium coupons. Hollytints, P-1350, Hollywood, California.

EXPERT Finishing. One day service. Rolls developed 16 Velox prints or 8 Velox prints, 2 enlargements 25c. Expert Studios, LaCrosse, Wisconsin.

PROMPT Service—Quality work; 2 beautiful doubleweight gloss enlargements, 8 guaranteed neverfade prints each roll, 25c. Excel Photos, Dubuque, Iowa.

ROLL Developed, 16 prints 25c. Wilkes-Barre Photo Service, Box 64, Wilkes-Barre, Penna.

ONE 6 1/2 x 8 1/2 Wide border embossed enlargement or one 5x7 hand colored enlargement with each roll developed and 8 prints 25c. 36 exposure roll developed and 36 3 1/4 x 4 1/2 enlargements \$1.35. 18 exposure roll 75c. Vidor, 321-P Hennepin, Minneapolis, Minn.

20 REPRINTS 25c; 100—\$1.00. Rolls developed, either 16 guaranteed prints, 1 colored or 2 professional enlargements—25c. Sample enlargement 5c. Lifetone, D-9, Des Moines, Iowa.

CENTRAL Location. Fastest service. Guaranteed—Full set Velox prints, 2 professional enlargements, valuable coupon. Roll 25c. Pack 50c. Hoosier, Winamac, Indiana.

HAVE You tried our service? Roll developed 16 Velox prints or 8 prints, 2 enlargements 25c. Immediate delivery. Chicago Photo Lab., Box 3, So. Chicago, Ill.

ROLLS Developed, two prints each and two free enlargement coupons, 25c; reprints, 2c each; 100 or more, 1c. Summers' Studio, Unionville, Mo.

IDEAL Photos. Professional deckle-edge prints and free enlargement each roll only 25c. Illustrated price-list free. Write today. Ideal Photos, Box 2255, Paterson, N. J.

IMMEDIATE Service! Better pictures. Sixteen guaranteed prints from roll, 25c. One colored or two plain enlargements and 8 guaranteed prints, 25c coin. Special! Coupon for 8x10 enlargement given with every 25c worth Kodak finishing. Any 36 exposure, 35 mm. film fine-grain developed and each good negative enlarged to 3x4 prints for only \$1.00. 3x4 reprints, 4c each. One day service. Details and mailers free on request. American Studios, Box B, LaCrosse, Wis.

JOIN The thousands who are changing to Willard's Brilliantone prints—the style leaders of 1939. Roll developed, two prints each negative, only 25c. Valuable enlargement coupon. Willard's, Box 3535-A, Cleveland, Ohio.

THREE Prints each good negative in roll 25c. Reprints 3c. Fred D. Eastman, Bode, Iowa.

SPECIALIZING 35mm. Rolls fine-grain developed, 36 enlargements 3 1/2 x 5, \$1.00. Cartridge reloaded 35c. Photoshop, Linton, Indiana.

FOR The discriminating amateur, roll developed and carefully printed 25c, reprints 3c. Superior workmanship, same day service. Paramount Co., 327 E. 92nd St., New York.

ROLL Developed and 8 beautiful Velox glossy prints 25c coin or stamps. Reprints 3c each. Fotoprint Service, Roanoke, Va.

8 PLEASING Velox prints, 2 enlargements 25c coin. Please U Film Service, LaCrosse, Wis.

TWENTY Reprints 25c. Roll developed and two prints each negative, 25c. Send for free mailing envelopes, price list. Star Photos, J-109 N. Dearborn, Chicago.

20 REPRINTS 25c. 100 Reprints, \$1.00. Films developed, 2 prints each negative, 25c. Mercury Studios, Box 822-B, Chicago.

PROMPT Service! Rolls developed, two Velox prints each negative 25c. Hench Studios, Harrisburg, Penna.

PHOTO Mill. Immediate service! No delay! Roll developed, carefully printed and choice of two beautiful 5x7 professional enlargements, one tinted enlargement, or eight reprints—for 25c coin. Reprints 2c each. The Photo Mill, Box 629-12, Minneapolis, Minnesota.

ROLL Developed, 8 brilliant fadeproof Velox prints and two professional enlargements 25c. Overnight service. Young Photo Service, 405-C, Albany, N. Y.

LIFE Photo finishing lasts a life time. Roll developed, 8 prints, 2 enlargements 25c. Reprints 1 1/2c. Life Photos, Hutchinson, Kansas.

TWO Glossy enlargements. 1 colored with roll 25c. Arbor Service, 10, Joliet, Ill.

CANDID Special. 35mm. rolls enlarged to 3 1/4 x 4 1/2. \$1.00. 18mm. rolls 60c. 3 1/4 x 4 1/2 reprints 3c. Brown Photo Company, 1910-61 Emerson, Minneapolis, Minn.

16 PRINTS With roll 25c. 16 reprints 25c. Rex Photo, Ogden, Utah.

BEAUTITONE Enlargement, dime and negative. Giant Snapshots, Inc., Green Bay, Wis.

GUARANTEED. Roll developed, 16 prints 25c. 20 prints 25c. Quality Photo, Hutchinson, Kansas.

QUICK Service—Rolls developed, 8 guaranteed prints; 2 enlargements; 25c coin. OK Photo Service, Ottawa, Kansas.

CAMERAS, PHOTO SUPPLIES

NEW Free photography book now ready—lists and illustrates hundreds of sensational new and used bargains plus valuable information on modern photographic methods, high-speed miniature candid cameras, precision lenses, night equipment, enlargers, darkroom equipment, movie cameras, screens, etc. Money-back guarantee. Liberal trade-in allowance on your old equipment. Get free book today. Write Central Camera Co., Dept. 7-K, 230 South Wabash Avenue, Chicago, Illinois.

OIL Coloring photographs a fascinating hobby or profitable business. Learn at home by easy simplified method. Previous experience unnecessary. Common school education sufficient. Send for free information and requirements. National Art School, 3601 Michigan Avenue, Dept. 343 C, Chicago, Illinois.

MAKE Money in photography. Learn quickly at home. Spare or full time. Easy plan. Previous experience unnecessary. Common school education sufficient. Interesting booklet and requirements free. American School of Photography, 3601 Michigan Ave., Dept. 3431, Chicago.

EASTMAN Super-X, Agfa Ultra-Speed, Du Pont Superior 35mm. film, 25' roll, \$1.00 postpaid. Economy Photo, Greensburg PM7, Penna.

TRADE Your shot gun for a new movie camera, still camera, exposure meter, or other photographic equipment. 35mm. Argus cameras, f4.5 lenses, new condition, \$7.50. You will find our allowances for your old equipment the most liberal in the country. National Camera Exchange, 11 South 5th Street, Minneapolis, Minnesota. Established in 1914.

MAKE Real money with your camera, 10 ways to make \$100 a month \$1.00. Andell, 56 West Washington, Chicago.

AMAZING But true. Print 150 pictures from your negatives on writing paper, cloth, etc., for \$1.00. Money back guarantee. Particulars on request. L. Small, 2728 First Ave. South, St. Petersburg, Fla.

8MM. Keystone 2.7 camera like new \$25.00, 200 watt 8mm. projector \$15.00, 25 ft. double "8" including processing \$1.39. Abbe Films, 1265 Broadway, New York City.

PHOTO Mill. Immediate service! No delay! Roll developed, carefully printed and choice of two beautiful 5x7 professional enlargements, one tinted enlargement, or eight reprints—for 25c coin. Reprints 2c each. The Photo Mill, Box 629-31, Minneapolis, Minnesota.

ENLARGER \$1.59. Enlarges eight times size of small negatives. Fully guaranteed. Paramount Sales Company, 89 Dudley Street, Boston, Mass.

BASS Inventory clearance. Profit by these unusual bargains. 35 mm. Candid Midget, F:4.5 lens, \$12.50. Used Foth Derby, F:3.5, \$15.75. 2 1/4 x 3 1/4 Agfa Film Pack and plate, with F:6.3 lens, auto shutter, film adapter and holder, \$11.95. Used Argus, F:4.5 lens, \$7.75. New Candid Midget, Xenon F:2 lens, Rapid Compur and case, \$80.00 value, at \$49.75. Hundreds of other bargains in the great Bass Bargaingram and special bulletins. Your money back is unsatisfactory after 14 days trial. Write Bass Camera Company, Dept. AG, 179 W. Madison St., Chicago, Illinois.

CAMERAS Films, paper 25% to 35% discount. Paramount Photo Division, 327 East 92nd St., New York.

HAVE You a camera? Send ten cents for recent number of our big magazine, showing how to make better pictures and earn money. American Photography, 116 Camera House, Boston, 17, Mass.

IF You go to Mexico ask first for prices and pamphlets of finest German quality miniature and other cameras, binoculars, movie cameras and projectors. Foto Mantel Suer, R. Rudiger V. Carranza 11, P. O. Box 1459, Mexico City-105. Branch store: Tijuana, Baja California. Branch store: Tijuana, Lower California, Hotel Comercial. Branch store: Monterrey, N. L., Morelos Oriente No. 557.

MOTION PICTURES AND SOUND EQUIPMENT

FREE 8mm. And 16mm. discount bulletin. James A. Peters, Dept. PM, 456 Turner Street, Allentown, Pennsylvania.

16 MM. Film \$1.95 including processing. Duplicates of your own films. William Schmidt, 626 West Clybourn, Milwaukee, Wisconsin.

HERE'S News from Bass! Our 64-page Cine Bargaingram is ready! Free for the asking! 8 mm., 16 mm., and 35 mm. silent and sound equipment. Popeye, Betty Boop, and other films. Accessories to gladden the heart of amateur or professional. A few used bargains: Univex 8 camera, F:5.6 lens, each \$5.75. Univex, motor drive, 8 mm, projector, \$12.50. Bell & Howell model 57, 16 mm. projector, 200 watt, and case, \$32.50. New RCA 16 mm. sound on film camera, Newsreel model, \$250.00. Write today. The book will be mailed at once. Bass Camera Company, Dept. A, 179 West Madison St., Chicago, Illinois.

MOVIE Film. New! Sensational! 200 ft. 8mm. notched in four 25 ft. scored double 8 rolls, daylight leaders between each load \$1.75; 400 ft. 16mm. measured, notched 100 ft. lengths \$4.00. Graphichrome, B188 Randolph St., Chicago.

FOR Sale or rent—16mm. sound and silent features, cartoons, comedies. Waldo Films, Cincinnati.

8MM.-16MM.-35MM. Bargains. Dept. 35, Box 791, Cincinnati, Ohio.

16MM. Or 35MM. lists 3c. Hoffman, 57 Broad. Albany, N. Y.

8-16-35 MM. Films, equipment. Rent, sale. Free lists. Osborn & Montgomery, Lebanon, Ohio.

BARGAINS Galore — 16mm., - 8mm. No-Wat-Ka, 661 Bloomfield Ave., Bloomfield, N. J.

EARN \$17.50 Movie camera. Simple, easy method. Industrial, Box 701, Sioux City, Iowa.

HUNDRED Feet 16mm. black and white, dollar ninety-eight; twenty-five feet 8mm. Double Eight, dollar thirty-five. Processing included. Tulip City Photo Supply Company, Holland, Michigan.

NEW Lists. 35mm. silent bargains. Calderara, 5119 South St. Louis, Chicago.

GENERA Film in bulk for all movie cameras. 90 feet for Univex, \$1.10 (spools, 3 for 60 cents); 100 feet double 8mm., \$1.75; 16mm., \$1.35. Sample for stamp. Process with our powders. Fromaders, Davenport, Iowa.

FILM Sale. Entire stock 35mm. sound cheap. Sound projectors \$89.95. Motion Picture Exhibitors, 626 Film Bldg., Cleveland, Ohio.

COMPLETE 16mm. Film rental library. Attractions: "Covered Wagon," "Behind the Front," "Pony Express." Send postage for free catalog. National Cinema, 3 West 29th, New York.

SPECIAL 100-Ft. 16mm. Popeye or Betty Boop \$1.79, 50-ft. 8mm. Popeye or Betty Boop 98c. Excel Home Movies, Box 225, Toledo, Ohio.

SAMPLE Projector film, art. others, 10c. Lists free. Goodwill Company, Jackson, Tennessee.

8MM. CHROMOFILM! Guaranteed finest quality reversal! Fine grain orthochromatic! Weston 8! Free processing included! Two 30 ft. spools for Univex \$1.00! Two 25 ft. "Double 8" spools \$1.00! Bulk film specials! 100 ft. "Double 8" \$1.50! 130 ft. "Single" \$1.00. All postpaid! Order now! Chromo Films, 156-Q Springfield, Rutherford, N. J.

16MM. VELOTEX. Perfect outdoor film, 100 ft. rolls \$1.95 including free processing. Sample free. Velotex Laboratories, 600-C, Gary, Indiana.

WANTED — 16mm. Films. Supplies. Sanfilms, 44 Monroe St., Passaic, New Jersey.

ENLARGEMENTS From 16mm. 2 1/2 x 3 1/2, 25c. Garth Cinema, 1766 Gleason, Bronx, N. Y.

8-16MM. Films, silent, sound, for sale-exchange. Bargains in equipment. Trades accepted. Films rented everywhere. Free illustrated catalogue (with sample film 10c). Garden Exchange, 317 West 50th, New York.

100 FT. 16mm. Outdoor film \$1.95. 25 ft. double 8mm., \$1.35, free processing. Free 8mm., 16mm. lists. Home Movies, Box 216, Easton, Penna.

TEN Percent to twenty-five percent discount on movie cameras, projectors and equipment. Tulip City Photo Supply Company, Holland, Michigan.

ROYAL Home movies—8mm., 16mm. cartoons, comedies, westerns, travelogs. Free list. Crown Film Corp., 342 Melrose St., Boston, Mass.

FREE 400 Feet your choice 8mm. or 16mm. films. Details and catalog 3c stamp. Peerless, Box 1310A, Hollywood, Calif.

8MM., 16MM. Arts educational. Capitol Films, Box 791, Cincinnati, Ohio.

CAMERA Film 8mm.-16mm. Famous nationally advertised brand. Greatly reduced. Free circular. Crown Film Corp., 742 Melrose St., Boston, Mass.

SCHOOLS. Churches, parties. Authentic — "Across World With Martin Johnsons" — 16mm. Reasonable rental. Ohio Film Service, 1377 Penhurst Road, Cleveland, Ohio.

GUARANTEED 8MM. 24-hour reversal processing. Double 8mm., 45c. Single, 25c. Univex 15c. Eso-S, 3945 Central, Kansas City, Missouri.

MOVIE Film. Develop yourself. Univex, Eastman, etc. Chemical samples 15c. Raw film wholesale. Lake Camera Exchange, Gary, Ind.

"THE World's greatest of all Passion Plays," 16mm. and 35mm. 8-reels. Sound with dialogue or silent. Rent or purchase. Superior than Oberammergau stage play. Write Hemenway Film Co., 37 Church Street, Boston, Mass.

15% TO 25% Discount on still or movie cameras. Free circular. Paramount Co., 327 E. 92nd St., New York City.

BARGAINS! 8mm., 16mm., free literature. Elder, B-739 Boylston, Boston, Mass.

RADIOS, SUPPLIES, INSTRUCTION

RADIO Builder's Guide—10c. Laboratories, 7700-C East 14th, Oakland, Calif.

RADIO Engineering, broadcasting, aviation and police radio, servicing, marine and Morse telegraphy taught thoroughly. All expenses low. Catalog free. Dodge's Institute, Ames St., Valparaiso, Ind.

SEND For free giant money saving radio and phonograph record catalogue. United Radio Company, 1000-M, Newark, N. J.

MUSIC AND MUSICAL INSTRUMENTS

HARMONICA — Playing from music made easy. You can learn with our simple method. Teaches all professional secrets and imitations, animal calls, air-planes, train, etc. Complete course \$1.00. Merrill, Dept. 7M, 2137 E. 79th, Chicago.

"SINGING Made easy and the mastery of the voice" teaches tone placement, perfection, extended range. Immediate results! Popularly priced. Free prospectus! Whitney Vocal Method, 245 Wolf's Lane, Pelham, N. Y.

DUO-FLEX Reeds for clarinets, and saxophones eliminate your reed troubles. Write for circular. Duo-Flex Reeds, 1204 1st Ave., Evansville, Ind.

HAWAIIAN Guitar taught easy method. Write. Honolulu Conservatory, Lakeland, Florida.

SONG Poems wanted. Free examination. Send poems to McNeil, Bachelor of Music, 4153-PM S. Van Ness, Los Angeles, Calif.

SONGS Or lyrics wanted for "Musical Night Court" radio show and publication. Write to Judge Spencer, 145 West 45th, New York, Studio PM. Enclose stamped, self-addressed envelope for full particulars. Do not send songs, lyrics. Print name.

SONGPOEMS Wanted. Free melody. We publish. Great Eastern, Thomaston, Maine.

SONG Writers—Share royalty plan. Hollywood Harmonizers, 6612-P Sunset, Hollywood, Calif.

SONGWRITERS! Unequaled 50-50 plan. Write now. Songland, "PM," Thomaston, Maine.

SONGWRITERS Composing, marketing, instructive booklet free. Write today. Songwriters Institute, 1234-C Broadway, New York.

SONGWRITERS! Outstanding, amazing proposition. Hibbler, C-5, 2157 N. Avers, Chicago.

SONGWRITERS — Agents, new sales plan. National Music-D, 532 Sixteenth, Oakland, Calif.

ORCHESTRATIONS. Pianoscapes, song-writing. McManus Music, Box 95, Syracuse, N. Y.

SONGS—Arranged, revised by arranger "Linger Longer." "Gypsy Tearoom," others. Send for details. Harold Potter, 1619 Broadway (P), New York.

JAZZ And swing piano, guitar, accordion. Quick mail courses. Information free. State instrument. Erskine Studio, 810F East 14th St., Oakland, Calif.

SIMPLIFIED Swing courses! Accordion, saxophone, clarinet, trumpet. Write Swingmaster, 1259-N Bender, East Cleveland, Ohio.

SONG Poem writers wanted—Our guaranteed plan has aided many songwriters. Burl Boggs' song won a nation wide contest. Other new writers have had their songs broadcast. We may be able to help you. Send poems or write for free booklet today. Indiana Song Bureau, Dept. 53, Salem, Indiana.

SONGS Poems, bought, composed, published, royalty contract, free information. Metro-Melody Publishers, 532 Geary, San Francisco.

LEARN Swing piano! Postal brings free folder. Christensen, 751 Kimball Hall, Chicago.

SONGWRITERS: Send us your poems, wonderful proposition. Keith-Downing Publications, Clearwater, Florida.

ORIGINAL Poems, songs wanted for publication, radio. Westmore Music Corporation, Dept. 33H, Portland, Ore.

MUSIC Composed to words. Rhyming pamphlet on request. Phonograph recording of completed songs. Send poem for consideration. Keenan's Studios, Dept. PM, Box 2140, Bridgeport, Conn.

PIANO By ear. Free booklet. Day-V-Way, Woolworth Building, Dearborn, Michigan.

MUSIC Composed to words. Wonderful proposition. Bauer Bros., Oshkosh, Wis.

WRITE Songs. Big money and reputation. Write for information. J. Gordon Pub. Co., 201 N. Hoyne Ave., Chicago.

WANTED! Lyrics, melodies for songs. We arrange, publish, sell. Superior Song Studios, Passaic, N. J.

SONGWRITERS: Send your poem today for immediate consideration. Richard Brothers, 24 Woods Building, Chicago.

SONG Writers. Send for publishing agreement. McKinley Music Publishers, 1501 E. 55th St., Chicago.

BUSINESS OPPORTUNITIES

GRIND Lawn mowers! \$2.00 capital! Course \$1.00. Mower Service, Janesville, Wis.

MAKE Money distributing Phelps Foot Balm direct or by mail. Send 25c for sample bottle and merchandising plans. Phelps, 1843-D Mannering Road, Cleveland, Ohio.

OPPORTUNITIES. Ideas galore and 68 page moneymaking magazine, 10c. Dohrman, 175 Division, Madison, Wisconsin.

FORMULAS — Fast selling products. Guaranteed. Laboratory tested. Lowest prices. Catalog free. Kemico, 55K, Park Ridge, Ill.

GIANT Mail, magazines, opportunities, plans. Three months 10c. Janhonen, Spencer, N. Y.

OWN Your own business stamping social security plates. Easy work. Big profits. Send for pamphlet illustrating inexpensive outfit. Morton Sales Company, P.O. Box 93, Flatbush Station, Brooklyn, N. Y., Dept. 17.

EARN Steady income with "route" of peanut, gum and amusement machines. Small capital required. Robbins Co., 1141P DeKalb Avenue, Brooklyn, New York.

START Exterminating business from home, enjoy ever increasing income. We furnish everything. By-Products, 1758-K Lunt, Chicago.

POPCORN Machines, caramelcrisp, crispettes, cheese coat, potato chips. Long Eakins, 2035-G High St., Springfield, Ohio.

"RUBBER Molds." Make them yourself. Formulas, instructions 25c. Ideal Service, 179-R7, Park Ridge, Ill.

NEW Framed feather pictures! Retail 69c. Sample 20c stamps. Dozen \$1.80 postpaid. Marquez-PBJ, Apartado 1176, Mexico City.

STEADY Money in showcards, signs, window lettering. Easy. Amazing details free. Write Nelson Company, G-2101 Manhattan Building, Chicago.

WE Show you how to raise capital for your business; how to protect and market your invention. Write, Enterprise Bureau, Syracuse, N. Y.

M. M. Earned \$267 three weeks, raising mushrooms in cellar! Exceptional, but your cellar, shed perhaps suitable. We buy crops. Book free. United, 3848 Lincoln Ave., Dept. 59, Chicago.

COMPLETE Mailorder business of your own. Details 10 cents. Pasaak, Box 21, Sta. J, New York City.

25 NEW Successful schemes. Directories, renovating, premiums, new occupations, souvenirs, salvaging. 44 pages, 10c. Home Industries, Benson, Nebr.

CAPITAL Seekers—Put your project before 260 key-men. Cost trifling. Details free. Amster Leonard, Fox Theater Building, Detroit, Michigan.

YOU'LL Like resilvering mirrors, auto-parts, reflectors, making chipped glass signs. Write Sprinkle, Plater, 127, Marion, Indiana.

\$30 WEEKLY. Grow mushrooms. Cellar, shed. We buy 30c lb. Mr. B made \$270 spare time. World's largest company. 40 page book free. Mushrooms, Dept. 701, 2019 Second, Seattle, Wash.

SECRETS Of wealthy men revealed in book "Think and Grow Rich." Learn to think. You can be one of them. \$2.00 postpaid. Diana Service, 2805 Northeast 35 Place, Portland, Oregon.

100 PROFITABLE Mail order and local plans. Gilbert Supply, 1107 Broadway, New York.

BUILD Neon signs. A business for yourself. McMaster Sign Co., 730 State St., Bellingham, Washington.

"LEGITIMATE Home business." New! Profitable! Your labels. You control repeat orders! No canvassing! Samples, dime. Particulars free. Gardena System, 128PB, Station "S," Los Angeles.

MONEY For new or established businesses—New capital-raising plan; developed by lawyer; avoids disadvantages of partnerships, loans and security selling; wholly legal; neatly bound treatise—"The Founders Rights"—and complete set of forms for \$1.00. Price refunded if not as represented. Founders Rights System, P.O. Box 310, Atlanta, Ga.

DOLLARS For supplying amazing satisfying employment information by mail. Keep dollars received. Orders filled for you. Paul Kevilus, Laona, Wisconsin.

POPCORN Machines, all types. Caramel-corn equipment. Northside Mfg. 1925-10th, Des Moines, Iowa.

"MAKE Mirrors at home." Big profits. Little outlay. Also emboss, grind—foil, gold leaf, frost, chip and make imitation stained glass. Instruction course 25c. Ideal Service, M-7, Park Ridge, Ill.

START Mail order business. I show you how to make, sell amazing product. Enclose stamp. Konis, 56 West Washington, Chicago.

RUBBER Mold making. Plaster casting. enormous profits. 20 page booklet free. Plastic Arts, 711 Neely, Muncie, Indiana.

KANDY Kitchen course, \$2.00. Cleaning, pressing course \$2.00. Show card course \$1.00. Particulars free. Fletcher Distributing Service, Box 932, Bridgeport, Conn.

HANDY Men—Earn money home operating Community "Fix-It" Shop. Stafford, Makanda, Illinois.

300 MILLION Dollar industry provides rare opportunity starting lucrative jobbing business of your own; city or town. Very small capital involved. Eye-opening booklet mailed on request. Ace Service, 1317 Grandview Blvd., Sioux City, Iowa.

OWN Your own lucrative exterminating and insecticide business. Distribute national advertised insecticides, particulars three cent stamp. Lucas, 174 West 65th Street, New York.

UNBELIEVABLE Profits building air coolers. Homes, stores. Complete technical information, drawings, personal advice. Details for stamp. General Plans Company, Box 275, Oklahoma City, Okla.

ORIGINAL. Exclusive plan enables you to own highly profitable business, without capital, anywhere. Business Service, Olympia Bldg., New Bedford, Mass.

MAKE Artificial marble, glazed tiles, uncanny. Tabletops, plaques, floors, hones, novelties. Hard, fireproof, inexpensive, cement secrets. Brilliant tile and liquid rubber samples 3c. John A. Payn, 945 Grande Vista Avenue, Los Angeles, Calif.

PROFIT 95c On dollar. Make, sell zinc-cuts. Inexpensive, simple. Complete processes \$1.00. Meyers, 3320 E. Baltimore, Baltimore, Md.

"SCHEMER," Alliance, Ohio (41st year) prints schemes, tips, opportunities, formulas; big producers: \$10,000 to \$25,000 reported. Year, \$1.00. Get wise! Trial six months only 30c.

MAKE Sanitation compound spare time. Employ agents or mailorder. Send stamp. Luft, 5039 Winthrop, Chicago.

SUCCESS! Happiness! Free list money making books, self-improvement opportunities. Sterling Products Co., Springfield, Ill.

SUCCESSFUL Business easily started! Big profits! Formula catalog free. B. Kinford, Wayne, Penna.

LIST Of more than 70 markets for more than 30 items usually overlooked and going to waste in every home, for 25c. Maothis Advertising Co., Dept. L, Loyal, Wis.

BELTS, Suspenders, make'm and make money. Big summer sellers. Materials supplied. Sample belt 25c. Artn Leather, 40 Joseph Ave., Rochester, N. Y.

"120 WAYS To Make Money"—\$1.00. Descriptive literature free! Pines, A-583 Monroe, Brooklyn, N. Y.

MANY Opportunities for poor, ambitious, industrious, workers. Sidella, Pottsville, Penna.

IF Out of employment or wishful of own business, start advertising plan. Soon may earn good money. Laugh at employers. Hardly any capital. Circular free. Janet Specialty, Box 253, Taunton, Mass.

MAIL Order business. Small investment. Details free. No experience needed. Eco, 32 Dexter Bldg., Chicago.

LOOKING For business? 2c daily pays for individual branch office in New York and not just an ordinary room or box number address. Our 100% co-operation assures your success. Co-operative Mail Service, 126 Lexington Avenue, New York.

BUILD Cheap, portable popcorn stand, machine, icebox. Plans, recipes, sales stunts, all for 50c, no stamps. Box 354, Appleton, Wis.

WE Help start you in business, furnishing outfits and instruction, operating "Specialty Candy Factory" home. Men and women, opportunity to earn \$20.00 to \$50.00 weekly, all or spare time. (Our 31st year.) Booklet free. W. Hillyer Ragsdale, Inc., Drawer 4, East Orange, N. J.

WHOLESALE Supply Guide—1,000,000 articles. 10c. Labey, Colorado Springs, Colo.

BIG Mail of opportunity offers, ideas, plans. Copy of 68 page magazine, your name on our mailing list for one year. All for 10c. Colonial Mailing Bureau, 269 Center St., Lackawanna, N. Y.

HOW And where to obtain capital fully explained, free particulars. Star Service, Wapakoneta, Ohio.

MONEY-MAKING Projects. Color-glazed concrete pottery. Gravestones, tiles, walls. Guaranteed basement waterproofing. Operators wanted. Booklet, details 10c. National Potteries, Minneapolis, Minnesota.

COLOR Concrete with chemicals. Stucco-rock. Washing-wells. Spin concrete pottery. Benches. Miniature castles, mills. Cold glaze, marbling. Sample 10c. Hollywood Cement/Craft, 8527 Wonderland, Hollywood, California.

GIANT Mail, opportunities, added income, ideas. 68 page magazine 10c. Katz, 4254 N. Kimball, Chicago.

"MONEY From Waste Materials." A genuine money making folio; 25c. Home Service Bureau, Box 4079, South Edmonton, Canada.

\$10.00 DAILY In your own home. Booklet 10c. Logan Sales, Adel, Ga.

NEWEST Colorful plastics. Finish seven attractive articles with ordinary home tools. \$1 postpaid complete with instructions. Plastic Products, 580 Market Street, San Francisco.

MONEY In butterflies, moths. See Sinclair Display Advertisement on page 10A.

WILL Put you in business without investment. Postal brings particulars. Greenhill Service System, 521 - 5th Ave., New York City.

LEGITIMATE — Profitable mail order business. Complete plans, sample, ready to go to work. Only 10c by return mail. A. H. Riegel, Kintnersville, Penna.

BOOKLET. "Businesses of Your Own That Pay Best." 10c. Rapid Service, Edwardsville, Illinois.

MILLION Dollar storehouse. Buy wholesale from all over the world. 8 page folder free. Dixon Sales, Box 1403, Youngstown, Ohio.

OPERATE Local business. I show you how. Rogers, Waverly, Virginia.

LIQUID Marble—anyone can make! Colorful, glazed! Moulded, brushed, sprayed. Rubberlastic moulds. Composition flooring. Big money in these! Particulars free. Marbleizing Service, Edwardsville, Ill.

PROFITABLE Home business. Legitimate. No canvassing. Maywood Publishers, P-1107 Broadway, New York.

YOUR Own business! Selling by mail. Details free. Maples, 3418 South Marshfield, Chicago, Illinois.

SUCCEED With your products. Make-sell. Formulas. Accurate analyses. Catalog free. B. Thaxly Company, Washington, D. C.

INVENTORS—We successfully sell inventions, patented and unpatented. Write for proof, and tell us what you have for sale. Chartered Institute of American Inventors, Dept. 4-C, Washington, D. C.

I WANT To send you proof of the wonderful pulling power of Popular Mechanics Magazine's classified pages. What's your proposition? Write me today. F. W. Johnson, Manager Classified Advertising, 200 E. Ontario St., Chicago, Ill.

BIG Money easily made in home or office. Business of your own; booklet describing 107 money making plans free. Chilton, Box 1105, Oakland, Calif.

ARTIFICIAL Marble sanitary flooring, instruction covering wood or cement flooring 1/2 inch thick, fireproof, all colors, low cost, ornamental casting, concrete, plaster, papier-mache, garden furniture, statuary, flexible molds, particulars free. Chris Mahler, Elmont, N. Y.

DELAWARE Charters: Complete service \$35. Submitted forms. Chas. G. Guyer, Inc., Wilmington, Del.

START Your own business. Make large profits. Sell new and used auction or bankrupt bargains in clothing and general merchandise. Experience unnecessary. Free wholesale catalog. Superior Jobbing, 1250-V Jefferson, Chicago.

107 WAYS To make money, in home or office, business of your own. Full particulars free. Elite Co., 214 Grand St., New York.

SELL By mail. Books, novelties. Bargains! Big profits! Particulars free. E. Elfco, 438 N. Wells, Chicago.

ELITE Collection of business plans, contains 107 tested plans and scores of formulas. Start own business; home, office. Particulars free. Elite Co., 214 Grand St., New York.

PLASTEX Industries offers industrious men an opportunity to start a business of their own, manufacturing art goods, novelties, souvenirs, etc., in Plastex and marble imitation. 5c material makes \$1 articles. Rubber moulds furnished for speed production. Small investment brings big returns. You are just in time for big wholesale season now starting. Write for interesting booklet mailed free. Plastex Industries, Dept. A, 1085 Washington Ave., New York.

CHARTERS: Delaware; best, cheapest; free forms. Colonial Charter Co., Wilmington, Del.

WHERE To buy at lowest wholesale prices. Information free. Yorena, Box P-312, Bayonne, N. J.

MAIL Order business is your opportunity. Many began small, now earn thousands yearly. No personal contact. Boundless opportunities. Have had over 30 years experience; will help you succeed. Send 25c for valuable booklets, none free. B. Breniser, 257 S. 21st, Philadelphia.

MAN In each town to plate auto parts, reflectors, bicycles, fixtures, mirrors, by late method. Simple plan of manufacturing at home starts you in good paying business. Free particulars and proofs. Gunmetal Co., Ave. H, Decatur, Ill.

MANUFACTURE From Phospholene. Cleaning fluid 1c gallon; bleach 2c gallon; hand soap 2c pound; and ten fast sellers. Sample 25c. Details free. Western, 6615 Denison Ave., Cleveland, O.

FINANCIAL Independence obtainable by placing coin operated merchandise vending machines, out on percentage basis, no experience required, little capital needed, write for free details. Torr, 2047 1/2 South 68th Street, Philadelphia, Pennsylvania.

1059 WAYS To start a profitable business. Get Popular Mechanics book of modern formulas and methods for practical specialty manufacturing. Price only \$1.25 postpaid. Popular Mechanics Press, Room (C39), 200 E. Ontario St., Chicago.

MONEYMAKING OPPORTUNITIES

BIG Mails of opportunities, samples imprint circulars, mailorder propositions, information budgets, three months 10c. Harvey Teeple, Decatur, Indiana.

MONEY Making secrets exposed. Particulars, stamp. Woelfel, 105 South Fairview, Upper Darby, Penna.

HUNDREDS Of fine money-making plans and ideas. Stamp please. Spangler, 1724 Warwick, Baltimore, Md.

3 MONTHLY Mail order magazines, filled with money making opportunities, 10c. George Fenner, 1618 Lucia, Louisville, Ky.

START A profitable business. Income guaranteed. Stamp brings details. Howard, 1424 South Water, Wichita, Kansas.

MILLION Articles. Buy wholesale. Valuable directory. Dime. Ideal Service, D-7, Park Ridge, Ill.

YOU'LL Like resilvering mirrors, auto-parts, reflectors, making chipped glass signs. Write Sprinkle, Plater, 287, Marion, Indiana.

\$50.00 WEEKLY. Men, women, selling new nautical jewelry. Dollar sample 25c. Sestero, 275 West 73, New York.

SOILLESS Gardening, latest mail selling opportunity. Advertising counsel, service free. Sample dollar manual instructions and valuable plan 25c. Begin with \$10.00. Pyramid profits. Will help you succeed. Growers Guild, Barryton, Michigan.

HOW To make household product of 100 uses. Sell by mail or agents. Enclose stamp. Ribot, 620 East 62nd, Chicago.

BIG Profits operating mailorder business. Make own product. Details for stamp. Tatum, 6930 Greenview, Chicago.

START Your own mailorder or agency business with small capital. Details free. George F. Talbot, Norwood, Mass.

AMAZING Money making opportunities 10c. O'Neill, Box 634, Denver, Colo.

"OPPORTUNITIES Galore!" Receive dozens of new propositions, moneymaking offers, also "Opportunity Journal," Monthly, for 12 months, 25c. Raymond Schwarting, South Amana, Iowa.

FREE—Spare time profit propositions galore. Advertisers' Assistants, West Liberty, Kentucky.

RECEIVE Dollars your daily mail. 97c profit each dollar. Anyone can operate. Send stamp for particulars or \$1.00 for starting instructions. Gifford, Aberdeen, South Dakota.

EARN Money collecting reptiles, frogs, toads for us. Part or full-time opportunity! Instructions furnished. Particulars dime. Biological Research Laboratories, Dept. M-13, Springfield, Missouri.

RECEIVE Dollars in your daily mail, 97 cents profit on every dollar. Particulars and money making tips, secrets, formulas and information 10 cents. Richard Service, 1159-B Railroad Ave., Augusta, Ga.

EARN Extra money writing for publication. Simple method. Demand inexhaustible. Details free. Dona Veretts, 17 Gorton, Lowell, Mass.

OPPORTUNITIES Galore in mail order business. Make money at home. Write Gold Bond System, Box 1436, Long Beach, Calif.

FREE—300 Wonderful business, mail-order and home work money-making offers. Lewis Co., 828-D Carpenter, Oak Park, Ill.

UNEMPLOYED? Here is help you need. Genuine. Boyd, Excelsior, Minn.

MAKE Big money growing plants without soil. Amazing results. Details free. Logan Sales, Adel, Georgia.

MANUFACTURE For us or sell direct to homes and public buildings. A new invention, made from discarded tin cans. Retail for 50 cts. Full particulars and sample \$1.00. Albright Specialty Co., Burbank, Calif.

LEARN And earn with hand engraving. Simple easy instructions \$1.00. Your name beautifully engraved 10c. twelve \$1.00. The Scribe, 310 East 9th, Little Rock, Ark.

MILLION Articles, lowest wholesale prices—directory; with over \$200 in formulas, money-making plans and three issues Money Maker's Magazine only 25c. Mailingsmart, P2138 North Carlisle, Philadelphia.

MONTHLY Advisory letter service finds; analyzes; shows; latest money-making opportunities; methods. Extensive research \$1.00 yearly. Box 362, Great Neck N. Y.

PROFITABLE Home business opportunity. Details 25c. Sesby, Box 576-A, West Los Angeles, Calif.

MONEY In butterfiles, moths. See Sinclair Display Advertisement on page 10A.

EARN Good income on \$1.00 capital. Complete plan 50c coin. Corcoran, Box 2558, St. Johns, Portland, Ore.

DON'T Throw away your old radios, cameras, tools, etc. Get cash or trade for things you need. Big double offer—send 50c for year's subscription to Tell & Sell. Receive free stainless steel rule and depth gauge. Acme Publishing, Box 3332-A, Akron, Ohio.

KEEP Dollars received supplying by mail satisfying employment information. Millions jobless. We fill your orders. Co-Operative Service, 77 Swan, Buffalo, New York.

SOCIAL Security stamping outfits. I. Dunn, 116 Hale Ave., Brooklyn, N. Y.

GROW Plants without soil. Folder free. Gordon Laboratories, 509-J Fifth Ave., New York.

EARN Extra dollars spare time, details free. Mutual Service, 124 Highland Ave., Buffalo, N. Y.

ENJOY Perfect health become professional equilibrist. 3 cents brings particulars. Knoff, 2154 M North 52nd Street, Milwaukee, Wis.

START Profitable mailing business. We trust you. Monthly payments. Particulars 10c, credited first order. Hunt Co., 49 Edgemere, Trenton, N. J.

MAN In each town to plate auto parts, reflectors, bicycles, fixtures, mirrors, by late method. Simple plan of manufacturing at home starts you in good paying business. Free particulars and proofs. Gunmetal Co., Ave. N, Decatur, Ill.

RAISE Earthworms for profit. Information free, stamp appreciated. Bureau Zoological Research, 106A Broadway, Peoria, Ill.

BIG Money easily made: 107 test plans for your choice. Home, office. Descriptive booklet free. Elite Co., 214 Grand St., New York.

WHOLESALE Sources, 500,000 articles. Free directory. Maywoode, 1107 Broadway, New York.

SMALL Business of Your Own, 1000 tried and proven methods. \$1.00. Popular Mechanics, 200 E. Ontario St., Chicago.

FORMULAS, PLANS, ETC.

WINDOW Cleaner and bug remover. Just spray and wipe off. Leaves no smear. Formula \$1.00. Sample 25c. Barton, 2403 Brownsville Road, Pittsburgh, Penna.

GUARANTEED Formulas—New fast sellers. None better. Lowest prices. Catalog free. Kemico, 49N, Park Ridge, Ill.

10,000 PROFITABLE Formulas, \$2.25 postpaid. Morgan, 1223 So. G, Tacoma, Wash.

ANALYSIS. Research. Newest guaranteed formulas. Biggest catalog free. Nominal prices. Gibson Laboratory, Chemists, BD-1142 Sunnyside, Chicago.

CHANGE Automobile engine into fast pumping air compressor. Instructions \$1.00. Tuck Garage, 73 Shirley, Pontiac, Mich.

10,000 MONEY-MAKING Formulas, recipes, trade secrets, 1939 book, 883 pages. Special \$2. Satisfaction guaranteed. Adams Brown Company, Chestnut Hill, Mass.

HUNDREDS—Successful manufacturers—inexperienced beginners are using this exceptionally dependable formula service for latest interesting sellers' all lines. Stamp brings amazing details; free copy formula messenger. Miller, Chemist, 1705 Jetton, Tampa, Florida.

ONE Ingredient formulas! Big profits! Fast, repeat sellers. Catalog free. A. Kinford, Wayne, Penna.

THAXLY Formulas for perfect products. Accurate analyses. Catalog free. B. Thaxly Company, Washington, D. C.

REAL Manufacturing formulas. Lists free. Cummings, Chemist, Gordon Avenue, Syracuse, N. Y.

WATERLESS Soap guaranteed. Clean dirtiest hands in America. Formula \$1. Jerome Jones, Hollins, Alabama.

FORMULAS. Latest money makers. Literature free. Belfort, 4042 N. Keeler, Chicago.

FORMULAS: 15 Proven moneymaking formulas \$1.00. (Not stock-formula catalogue stuff), real unusual offers. List free. Marvel Laboratories, 6629 No. Maplewood, Chicago.

ELITE Formulas and plans; make and sell your own products. Descriptive booklet free. Elite Co., 214 Grand St., New York.

CHEMISTRY

FREE: 40 Page catalog of chemical and laboratory supplies for amateur chemists. Wollensak microscopes and supplies, scientific books at big discount. JE-7 Winn, 124 West 23 Street, N. Y. C.

CHEMICALS In 10c quantities. Catalog free. Chapman Chemical Company, Pittsburg, Kansas.

FREE Chemistry catalog. Supplies at 5c! Equip complete laboratory. Send 3c for postage. Kemkit Scientific Corp., 397P Bridge St., Brooklyn, N. Y.

CHEMICALS In 5c quantities. Catalog 5c. Fleischer's Laboratories, Everett, Mass.

CHEMICALS, Laboratory, glassware, apparatus. Send 3c for catalog C.P.I. Biological Supply Company, 1176 Mt. Hope Avenue, Rochester, N. Y.

HELP WANTED

MAN And wife—to run local coffee agency. Earnings up to \$175 a month. New Ford sedan given you as bonus. I send complete outfit. You don't risk a penny. Details free. Mills, 6041 Monmouth, Cincinnati, Ohio.

M. M. Earned \$267, three weeks, raising mushrooms in cellar! Exceptional, but your cellar, shed perhaps suitable. We buy crops. Book free. United, 3848 Lincoln Ave., Dept. 60, Chicago.

MAKE Money working spare time. Detailed plan, stamp. Industrial, Box 701, Sioux City, Iowa.

\$30 WEEKLY. Grow mushrooms. Cellar, shed. We buy 30c lb. Mr. B made \$270 spare time. World's largest company. 40 page book free. Mushrooms, Dept. 701, 2019 Second, Seattle, Wash.

SALARIED Positions—\$2500 yearly and up. Let us find one for you. Write for valuable information. Executive's Promotion Service, (16) Washington, D. C.

AGENTS WANTED

WEAR Fine hose I send without cost with outfit while taking orders for amazing new hosiery. Replacement guaranteed against holes, snags, and runs. Rush name and hose size. Wilknit, Desk G-37, Greenfield, Ohio.

LOCAL Agents wanted to earn bonus suits and demonstrate to friends. Up to \$12 in a day easy. Experience unnecessary. Valuable demonstrating equipment, actual samples absolutely free. H. J. Graves, 1300 Harrison, Dept. U-817, Chicago.

AGENTS—To mail or distribute our new Foot Balm literature. Excellent profits and repeats. Send 25c for sample bottle and merchandising plans. Phelps, 1843-E Mannering Road, Cleveland, Ohio.

SENSATIONAL New vacuum rubber mop with squeegee, lowest priced in field yet paying profits up to 125%, going like wildfire! Write for free details and amazing pre-tested winning sales plan. Econo, 2901M LaSalle, St. Louis, Mo.

500% PROFIT! Transfer sign letters for windows, offices, trucks, signs. Colors: gold, silver, red, many combinations. Auto monograms. Easily applied. Neonite, Akron, Ohio.

MYSTERIOUS Disc heats water instantly without coal, gas or oil. Pays up to 233% profit. New principle. No risk sample offer. Write Lux Co., Dept. H-4, Elkhart, Indiana.

PERFUMED Starch is rapidly replacing the ordinary kind. What woman wouldn't prefer the flowery fragrance it gives to clothes? Let the housewife smell it and it's sold. Write Amazul Products Co., Dept. P, P.O. Box 3427, Sta. O, Philadelphia, Penna.

SENSATIONAL New seller. Retail 25c. Samples, particulars, dime. Mango-M, 496 S. 16th, Newark, N. J.

IF Earnings up to \$45 first week will satisfy you, I'll send complete outfit to run home-operated grocery agency. Absolutely no money risk. Details sent free. Write Mills, 6041 Monmouth, Cincinnati, Ohio.

GAS Powered midget automobiles for sales promotion. Aircraft Mechanics, Colorado Springs, Colorado.

CLYMER Thru-windshield spotlight. New streamlined model. Thousands sold. Big profits to representatives. Write qualifications. Clymer Spotlight, 222 West Pico, Los Angeles, Calif.

LORD'S Prayer, Ten Commandments, Crucifixion on U. S. pennies, individually carded, \$4.50 gross. Samples 75c dozen. P.M. Perkins, 1104 Lawrence, Chicago.

JUST Out! Amazing fast selling 25c household necessity. Saves up to hundreds of dollars. Sell 3 to 4 each home. Make up to \$6.00 daily. Free sample. Puro, 3107 Pine, Dept. K-299, St. Louis, Mo.

AGENTS: Smash go prices! Santos coffee 12c lb. 4-oz. vanilla 8 $\frac{1}{2}$ c. Razor blades 10 for 8 $\frac{1}{2}$ c. 100 sticks chewing gum 12c. Christmas cards, 21 in box, 14c. 150 other bargains. Premiums. Experience unnecessary. Carnation Company, P.O. St. Louis, Mo.

500% PROFIT With new perfected (1939) quick-action, no flint, automatic gas lighter. Retail 25c. Sample 10c. New Method Co., Box PMG-79, Bradford, Penna.

BEAUTIFUL Bird pictures handmade with genuine feathers. Sell on sight! Large profits! Free particulars. Samples 10c stamps. Marquez-PJ, Apartado 1176, Mexico City.

BUSINESS Proposition resilvering mirrors, autoparts, reflectors, making chipped glass signs. Write Sprinkle, Plater, 128, Marion, Indiana.

IF You are ambitious you can make good money with a Rawleigh route. We help you get started. Sales way up this year. No experience needed. Steady work for right man. Write Rawleigh's, Box G-2-PPM, Freeport, Ill.

SELL Signs, mottoes. Write Schaffner, 1336 West Rush, Philadelphia, Penna.

WHOLESALE Catalog. Razor blades, needles, soaps. Bulger, 114 Rindge, Cambridge, Mass.

BARGAINS. 100 Razor blades 25c; electric razor 70c; candid type camera 75c; soap gloss cakes \$1.44; blankets each \$1.44. Free catalog. World's lowest priced wholesalers. Mills Sales, 901 Broadway, New York.

SELL Social security plates. Over 40 million buyers. 500% profit. Full or part time. New plan. Employ others. No money needed. Don't wait. Act now. Free outfit. Federal Name Plate Co., 287 Broadway, New York City, Dept. PM-7.

LOWEST Prices—Reversible topcoats. Tremendous profits. Yale Clothing, Meriden, Conn.

START Own business. Make, sell new utility item. Also good mail order product. Information for stamp. Young, 3148 North, Chicago.

BIG Profits selling filling stations, garages, stores, radiator cleaner, stop leak, glass cleaner, mechanic's soap, carbon remover, polish, etc. Finest quality, attractive prices, make repeats easy. E. T. Barron Co., 17 E. Lake, Minneapolis, Minn.

OPPORTUNITY To handle Winco household products. Attractive offer on reasonably priced daily used products. Write Winchester Compounds, Winchester, New Hampshire.

SWANK, New lipstick. The talk of New York. Fast seller. Tremendous repeats. 100% profit. Full size sample 50c. Charlie, Jamaica, N. Y.

SELL New electric shaver-vibrator-massager. Large commission. Particulars free. Thompson Co., Baldwin, Michigan.

SELL Gas-Miser. New, Scientific. Improved automobile operation. Saves gasoline. Unconditional guarantee. Agents coining money. Write Malone & Moles, Sioux City, Ia.

"ONE-SHOT"—Powerful radiator leak-seal. Brand new! 60c seller. Test sample free. Thermo Works, Peoria, Ill.

SPEED-EE Heater for water. New principle. 175% profit. Legitimate. Write Cleveland's, Inc., Dept. P, Elkhart, Ind.

REFLECTING House numbers, signs to stores, homes. Sample dime. Kajo, 839 Six Ave., New York City.

SOCIAL Security plates 10c (stamped, with case postpaid). Beautiful designs. Producers of only 5-line identification plate. Special designed and colored plates, souvenirs to order. Calfskin wallets, key-cases, Leather billfolds. Gold stamping free. Security Plate Co., 608 Eye Street, N.W., Washington, D. C.

SELL Signs, printed novelties, samples 10c. Churchill, 4316 South Salina, Syracuse, N. Y.

RUGS. Beautiful hand-made hooked rugs. In animal, floral, and geometric patterns. Fast sellers for agents at this season. Write for particulars. Sample prepaid \$1. Condon, Box 176, Upper Darby, Penna.

500% PROFIT. Gold and silver colored sign letters. Offices—stores. Large sizes, 1c. Free samples. Modernistic, B-3000 Lincoln Ave., Chicago.

MONEY In butterflies, moths. See Sinclair Display Advertisement on page 10A.

450% PROFIT. Millions need eyeglass cleaner. Sample 10c. Box 107, Seward, Nebr.

SAVES Gas, oil, repairs. Every motorist prospect. Sample 25c. E. Corcoran, Box 2558, St. Johns, Portland, Ore.

OPERADO—Fits any radio. Proved by thousands. No-cost sample. Mission Co., A-2013, Columbus, Kans.

SELL Fan razor blades. Sample free. National, 430 Central, Cincinnati.

MONOGRAMMING Automobiles real moneymaker. Write for samples. International Co., Box 9360, Philadelphia, Pa.

AGENTS—Speedy seller. Big profits, repeats. Samples, details free. Universal, Orange, Massachusetts.

HAVE Fun with Mexican jumping beans. 15 for 25c. Agents wanted. J. J. Frank, 525 Palm, Rockford, Ill.

GRAB This new amazing product. Seals punctures automatically. Run ice-picks into tires without losing air. Auto owners amazed. Whirlwind seller. Tremendous profits. Write immediately. Air-Seal Distributors, Inc., 8053 Beverly Blvd., Los Angeles, Calif.

REBUILT Vacuum cleaners. General Elec., Hoover, Eureka, Electrolux and other makes. look and work like new. Low prices, large profits. Economical Distributors, Box 224, Albany, N. Y.

AGENTS Make big profits on food products, bargain deals. Low wholesale prices. Rush name for trial outfit offer. Ho-Ro-Co, 2810-S Dodier, St. Louis, Mo.

WORLD'S Biggest seller. Write for particulars. Girard Company, Washingtonville, Ohio.

AGENTS—To mail our literature. Good profits. Home business. Maywood, 1105-1107 Broadway, New York.

SUCCEED With your products. Make-sell. Formulas. Accurate analyses. Catalog free. B. Thaxly Company, Washington, D. C.

ATLAS Window sign letters. Large sizes—penny each. Get beautiful samples. Atlas, 7941 Halsted, Chicago.

ENGRAVED Name plates, numbers, signs, etc., easily sold, profits large. Brett Bros., Winthrop, Mass.

300% PROFIT Selling gold leaf letters for store windows; high grade letters 1 $\frac{1}{2}$ c each. Free samples. Metallic Co., 438-B North Clark, Chicago.

SELL Social security plates. Sample 10c. Particulars free. Reliable Sales Co., 6 West 28th Street, New York City.

BIG Money applying initials on automobiles. Easiest thing today. Free samples. Also, sideline salesmen for short order decalcomania name plates. "Ralco," 1305 Washington, Boston, Mass.

AGENTS—Opportunity make money; book containing 107 successful business plans; home-office; send for free introductory booklet. Elite Co., 214 Grand St., New York.

STARTLING Invention—Pocket adding machine. Nationally advertised \$2.50. Whirlwind seller. Big profits. Baby Calculator Co., Box 1118, Chicago.

REVOLUTIONARY Window cleaning tool. Good Housekeeping approval. Only ten \$2.25 sales daily to housewives, factories, schools, stores will make you \$350.00 monthly. Carter Products Corp., 900 Front Ave., Cleveland, Ohio.

BIG Money applying initials on automobiles. Write for particulars and free samples. American Letter Company, Dept. 40, Dunellen, New Jersey.

FREE Sample—Amazing cleaner; sells homes, taverns, everywhere. Big profit—fast repeater. Betco, 5007 Irving Park, Chicago.

MANUFACTURE Specialties, hire agents yourself. Big money. Free literature. Gilbert Supply, 1107-P Broadway, New York.

AGENTS: Stamping names on pocket-key protectors. Sample check with your name, address, 25c. Stamping outfits. Emblem checks, check-fobs, name plates. Hart Mfg. Co., 303 Degraw St., Brooklyn, N. Y.

GLAZOL Makes old cars shine like new. Works like magic. Whirlwind seller. (See our display ad on page 158A June issue.) Write at once. Buell Mfg. Co., 2974 Cottage Grove Ave., Chicago.

DO You want agents for your proposition? Your ad in this space will place your message before hundreds of men seeking fast-selling products. My folder "How to Secure Agents" is filled with proof. I'll gladly send you a copy free. F. W. Johnson, Manager Classified Advertising, Popular Mechanics Magazine, 200 E. Ontario St., Chicago.

HIGH-GRADE SALESMEN

HIGH Grade salesmen. 211 actual samples in our sales-kit makes selling printing easy. Our prices are much lower than local competition because of enormous volume and specialized equipment. Every profession and business uses printing daily—letterheads, envelopes, statements, cards, tags, blotters, invoices, etc. Full or part time. Many of our best salesmen never sold printing before. Write for details, giving present occupation and references. Everybody's Printer, Dept. 11, Indianapolis, Ind.

THE Vecchio refillable economical safety fuse. 2 fuses—6 refills, price 25c complete. Fifteen or thirty ampere. Delivered any place in United States. Cash with order. Distributors wanted. Write for complete information. Vecchio Products Co., Syracuse, New York.

SELL America's largest line business necessities. Book matches, gummed labels, political items, restaurant supplies, salesbooks, shipping supplies, office supplies, advertising specialties, business stimulants, business stationery and forms. Hundreds fast sellers. New low prices. Commissions advanced daily. Experience unnecessary. Complete outfit free. Northwestern, AY-625 Jackson, Chicago.

MAKE More money with Red Comet Automatic Fire Extinguishers. Low price. Proved seven years. Splendid sales outfit free. Some good territory open. Exclusive. Write quick. 704 Red Comet Bldg., Littleton, Colorado.

SALESMEN: Distributors. 200 items, brushes, mops. Marvelous magnetic brush—excels vacuum cleaner. Big profits. Neway Brush Co., Hartford, Conn.

SELL Printing at cut prices. 2,000 business cards \$1.50, 1,000 envelopes or statements, etc. \$1.75, 25 printed sales books \$1.50, 1,000 process embossed cards \$1.50, 2,000 two-color labels, free holder \$1.50, 2,500 printed handbills \$1.75, 500 book matches \$1.50. One-third comm. Free outfit. Bargain Prtg. Co., 189-F W. Madison, Chicago.

DID You make \$50 last week? Does your job offer you real future? If not, why not start a wholesale business of your own? Start with little as \$2.50. Handle line 200 nationally advertised 5c-10c products. Show merchants new plan for increasing sales and profits. Handle everything from your home at start. Chance to operate one of our Silver Fleet service trucks. Facts free. World's Products Co., Dept. 10-G, Spencer, Ind.

BIG Commissions—selling to stores celluloid pricing tickets, metal shelf moulding. To restaurants, menu covers, signs. P. Pricing Press, 124 White St., New York.

ADVERTISING Book matches—Sell union label book matches. Fastest selling line in America. Large sales producing kit, sample matches, complete cut catalog, eight color combinations make selling easy. Commission in advance. Superior Match Co., 7530 Greenwood, Dept. M-7, Chicago.

JUST Out! Every worker buys. 100 sales daily easy. Sells 35c. Tremendous profit. Take orders. We deliver. Sample free. Manager, AA-435 North Clark, Chicago.

SELL Business cards \$1.50 thousand. Business stationery, book matches, advertising gummed tape, advertising pencils, salesbooks, rubber stamps, pricing sets, advertising specialties. 35% commission. Money making specials. Free sales portfolio. David Lionel Press, 312 So. Hamilton, Dept. HS, Chicago.

SELL Mexican novelties. Commission. Free samples. Marquez, Apartado 1176, Mexico City.

\$84.50 PROFIT In one day by Hewett; \$1100 in seven weeks by Barber; over \$200 per week all summer by Felton; all selling our special tool set to garages. Exclusive territory. Write Mesco, Beaver City, Neb.

SALESMEN: Sell me information for publication in trade journals. Pay on acceptance. Send for instructions. Cooper, Box 1470, Tampa, Florida.

BIG Profits selling "Push" to stores. Attractive packages, displays. Write for sample. T. R. Gibbs Co., 1007 H St. N.W., Washington, D. C.

OPENINGS! Call on all dealers with new trade-stimulator plans. It's "hot." \$3 commission on each \$5 sale. Big repeat commissions. No investment. Sales kit free. Universal, 6227 Broadway, Dept. C57, Chicago.

SALESMEN Sell calendars, book matches, fans, advertising novelties. Samples free. Fleming Calendar Co., 6543 Cottage Grove Ave., Chicago.

FOOD Manufacturer offers permanent, exclusive distributorship. Sell jobbers, stores, cafes. Consumer-dealer advertising furnished. Big profit. Minute Foods, 255-WE Werdin Pl., Los Angeles.

ADVERTISING Book matches offer daily cash profits. Experience unnecessary. Full, spare time. Show exclusive line to all businesses. Low prices for top quality, direct factory service bring easier orders—faster repeats. Free outfit. Match Corporation of America, 3433 W. 48th Place, Dept. E-7, Chicago.

SALESMEN. Making \$20 to \$50 daily demonstrating new Airo Plane type fans to stores, restaurants, taverns, etc. Also driveway signals to gasoline stations. Write. Universal Fan Co., Peru, Indiana.

NEW. Mysterious device enables anyone to easily weld, braze and solder. Ideal for automobile, home and shop repairs. Works instantly off light socket. Low price and amazing demonstration makes you easy sales and big profits. Get yours free for introducing. Electro Torch Co., 2613-EE Michigan Ave., Chicago.

WAGON Jobbers! At last a high quality tire patch kit retailing at 10c. Easy sales, big profits! All retailers prospects! Write for free delivery plan! Hussey Co., PM, Atlanta, Georgia.

BLADES. Finest quality. Factory prices, postpaid. Ace Blades, Buffalo, N. Y.

SPARKLING Glo-Brite signs sell fast to stores, restaurants, taverns. Lasting gold finish. Religious mottoes. J. A. Baxter, Cambridge, Ohio.

NEW Specialty—Sells every business and professional man. Four \$15 sales daily pay \$280 weekly. Farrell cleared over \$1,000.00 monthly. Write. F. E. Armstrong, President, Dept. PM, Mobile, Ala.

EXCELLENT Opportunity selling our complete line of brushes, largest commissions. Write for sales plan. Wire Grip Sanitary Brush Company, 2300 5th Ave., New York.

EDUCATIONAL AND INSTRUCTION

LEARN Welding in Hawaii—Learn while you enjoy a vacation in the most beautiful islands in the world. Hawaii contains the U. S. largest army post, second largest U. S. navy yard, employing hundreds skilled steel workers. We offer free employment service should you desire to locate here. Total price of course including round trip steamer ticket from westcoast, room-board and practical training for over 2 months \$565. Write for free booklet. Honolulu Technical Schools, Honolulu, Hawaii.

BLUEPRINT Reading course, complete, \$1.00 postpaid, or stamp for particulars. Shervin Publications, Box 116, Breathedsville, Maryland.

AIR Conditioning and refrigeration offer wonderful opportunities for trained men. Learn at home in spare time. Employment service for graduates. Universal School Air Conditioning, 612 P. Manhattan Building, Milwaukee, Wis.

WATCH Repairing is steady profitable work. Experts always in demand. You can learn watchmaking trade at home, spare time. New original instruction system. Script engraving course included. Write for free details today! Nelson Co., G-2001 Manhattan Building, Chicago.

FOR An extremely profitable lifetime business, operate a collection-credit agency. Free folder. Cole Associates, Syracuse, N. Y.

BE A good conversationalist! Our practical course "How to Become a Good Conversationalist" should repay low cost many times in social and business contacts. For information write Nankers Company, Box 884, Colorado Springs, Colo.

"UNCLE Sam" jobs. \$105-\$175 month. Prepare immediately. Full particulars—list positions—free. Franklin Institute, Dept. M3, Rochester, N. Y.

CERTIFIED Electric welders in demand everywhere—shipyards, dams, construction work. Oldest, largest school on coast. The best training pays best. Write. Dunn Welding School, 2033 NE. Union, Portland, Ore.

SHORTHAND \$1.00. New fonetic chart, 24x36, 25c. Simmons, Rocky Hill, Conn.

TOUCH Typing in six lessons. 50c. Brommer, 732½ N. Van Ness, Hollywood, California.

WRITE For newspapers—gain pleasure, good pay and perhaps fame. Full time or freelancing (part time). Hundreds of stories, articles, ideas, are needed in every issue. We successfully coach you by mail. 45 years newspaper experience—plenty of contacts for placing graduates. The Millers, Dept. 10, Carmel, California.

DRAFTSMEN Get \$175-\$250 month and more. Qualify easily at home. Experience unnecessary. Details free. Write Monroe Institute, C-812, Alton, Illinois.

PREPARE For civil service exams meteorology, engineer, postal, 50 others \$1.10 to \$2.00. Free information. Write today. Pergande, Publisher, Milwaukee.

BECOME Practical scientific investigator. Modern, illustrated course. Thorough training by former agent U. S. secret service. Particulars free. International Secret Service Institute, PM-59, Hoboken, N. J.

CLEAN. Dye and pressing shop, learn this trade without cussing an employer. Business taught in a complete course \$2. Maurice Ducharme, St. Hyacinthe, Que., Can.

LET Us solve your problems. Professional advice \$1. Vocational Guidance Institute, Boonton, New Jersey.

CLAIM Adjusting. Automobile, fire, burglary. Simplified home study. Free particulars. Burns School, Keystone Building, Pittsburgh, Penna.

OPERATE New advertising business. Refund customers' money. Retire on collections. Inexpensive training. Sure Sales Service, Empire Life, Indianapolis.

LEARN Big pay trade. Decorating, paperhanging, graining, marbling, sign painting, pictorial painting. Catalog free. Residential or home study. Chicago Painting School, 437 North Clark Street, Chicago.

MASSAGE, Hydrotherapy, dietetics, drugless therapeutics, chiropody, taught by mail. Evans Correspondence School, Montgomery, Ala.

LEARN Auto mechanics, body, repairing, welding electricity, refrigeration. Diesel. Stevinson's, 2008A Main, Kansas City, Mo.

TELEGRAPHY Taught thoroughly. Railroad retirement act creating opportunities for new operators. Expenses low. Catalog free. Dodge's Institute, Hiatt Ave., Valparaiso, Ind.

GOV'T Jobs start \$1260-\$2100 year. Men-women age 18-50. Former examiner's tested method helps qualify you. Particulars, list jobs free. Write today. Patterson School, 8C Mercantile Bldg., Rochester, N. Y.

SECRET Investigation. Experience unnecessary. Detective particulars free. George Wagner, M-2640 Broadway, N. Y.

PLAYS, STORIES, MANUSCRIPTS

FICTION, Poetry, plays criticized. Complete marketing advice. New York Publishing Service, 246 Fifth Avenue, New York.

MAKE More money writing. Particulars free. Ralph Underhill, Beebe, Arkansas.

BEGINNERS! Make splendid income weekly writing. Details, stamp. Fame, Lathrop, Calif.

WANTED. Poems, song manuscripts, for consideration, composing, publishing, transcription recording. Keenans Music Service, Dept. PM, Box 2140, Bridgeport, Conn.

SONGS Wanted—Completed manuscripts considered for publication. Poems if found suitable. Legitimate talent encouragement. Cinemat Music Publishing Company, Hollywood, California.

SHORT Stories revised, typewritten, marketed. Hursh, Box P-1013, Harrisburg, Penna.

STORIES Forcefully rewritten, typed for marketing. Welton Tinney, Winnsboro, Texas.

BEGINNERS Learn to write from writers. MacIntyre School, Pacific Palisades, Calif.

ORIGINAL Poems, songs wanted for publication, radio. Westmore Music Corporation, Dept. 33G, Portland, Ore.

CARTOONING, COMMERCIAL ART, SHOWCARD WRITING, SIGN PAINTING

HAVE Your own money making business. Learn show card writing, sign painting. Write for details. Begley Specialty, 1472D Broadway, New York.

EVERYONE Paints signs, showcards with Speedway Letter Patterns. Valuable 3 in. sample alphabet, enclose nickel. Free literature. Display Letter Co., 9537 Fourth Ave., Brooklyn, N. Y.

FREE Details! Learn original cartooning! Raye Burns School, Dept. M-C, Box 2194, Cleveland, Ohio.

PEN And ink drawings. Let us draw your advertising and catalogue illustrations, from photos, copies or objects. Best work and fair prices. Heraldic Studios, 1914P Oakdale Avenue, Chicago, Ill.

BIG Money-making raised wood letters and chromium plated signs. Complete instructions \$1.00, foreign \$1.15. Photos, information ten cents. Modern Signs, Box 765, Phoenix, Arizona.

ANIMATED Cartooning. Write for free catalog. Mondell Institute, 230 West 41st, New York City.

AMATEUR Artists, cartoonists, photographers, join the Fotoart Club. Sell your work, get supplies wholesale, converse with fellow members. Particulars. Fotoart, 857 So. 89, Wauwatosa, Wis.

AMATEUR Cartoonists wishing steady income copying and duplicating cartoons for advertisers, write Ad-Service, Argyle, Wisconsin.

ADVERTISING AGENCIES—LETTER WRITERS—FOR ADVERTISERS

SALES Letters. Lively! Enthusiastic! Energetic, quick-action letters that get business for you. \$2.50 each. 100% satisfaction guaranteed. Hutzletter, 41-44 Davies Building, Dayton, Ohio.

WANT Names, addresses auto dealers, service stations, accessory stores. Any or all states. Clymer, 222 West Pico, Los Angeles, Calif.

SELL Your product through agents, mail order. Advertise newspapers, magazines. Publishers' rates. Snappy layout your inch advertisement \$1. Martin Advertising Agency, 171M Madison Avenue, New York.

SELL By mail? Want agents? Our "guide-book" packed with helpful advice, rates, publications, sent for stamp. Chicago Advertising Agency, 20PK West Jackson, Chicago.

DIRECT-MAIL Advertising services. Sales letters that sell. Mailing lists. Omaha List & Letter Co., Box 2172, South Omaha, Nebr.

ADVERTISING Placed all magazines, newspapers, radio. Lowest rates. Free service. 54 page rate book free. Baker Advertising Agency, A-189 West Madison, Chicago. Successors to Ankrum. Established 28 years.

FREE—New Advertisers Rate Guide, 44 pages. Includes everything. Lowest rates. E. H. Brown Advertising Agency, 140 S. Dearborn, Chicago.

ADVERTISE: 24 Words in 250 newspapers \$10. Lists free. Advertising Bureau, 4515-C Cottage Grove, Chicago.

BUSINESS SERVICE

CHICAGO Mail address-phone service. Mail forwarded daily. \$1 monthly. Eco, 39 West Adams.

WORLD'S Fair address \$2.00 monthly. Hexton, 210 Fifth Ave., New York.

CHICAGO Mail address—phone service. Daily forwarding. Also secretarial service. Hancock Company, 43 East Ohio.

MAIL Service: Mail addressed to your name, forwarded as you instruct us, \$1.00 per month. Harris Service Co., P.O. Box 505, El Paso, Texas.

CHICAGO Mail address \$1 monthly. Your personal, business mail forwarded daily. Established 1919. General, 56 West Washington.

RUBBER STAMPS AND OFFICE SUPPLIES

2 LINES 25c. 3—35c. cushioned. Stamp Works, Centerport, N. Y.

2 LINES 25c. 3 Lines 35c. Stamp Works, Auburn, Nebr.

NEW Adding machines only \$4.95. Full size, five columns. Reliable. Accurate. Easy to operate. Guaranteed. Money back if not satisfied. Only \$4.95 postpaid, or C.O.D. plus postage. Kel-San Mfg. Co., Dept. 7-C, Dayton, Ohio.

TYPEWRITERS, DUPLICATORS, OFFICE DEVICES

INCREASE Business now. "Excellograph" Rotary Stencil Printer reprints thousands everything you typewrite, hand-write, draw or trace. Colors. \$19.75 to \$44. Terms. Illustrated literature free to business or professional men. Pittsburgh Typewriter Supply, Department K-2, Pittsburgh, Penna.

NEW \$3.75 Automatic adding machine. Fully guaranteed. Bassett, Box 302-K, Altadena, California.

TYPEWRITERS, Adder, mimeograph, multigraph, addressograph. Send for free lists of machines that will help you at half price. Pruitt, 28 Pruitt Bldg., Chicago.

PRINTING, MULTIGRAPHING, MIMEOGRAPHING, GUMMED LABELS

PRINT Anything. Lowest prices. Samples free. Hamilton Press, 4341-P Meade, Chicago.

BETTER Printing. Reasonable prices. Lists free. Underhill Press, Beebe, Ark.

WRITE Us before buying printing. Radio Printer, Union, New York.

FIVE Hundred each letterheads, envelopes, hundred statements, three fifty, Wickens Printing, West Lafayette, Ohio.

POSTPAID—125 8 1/2 x 11 Bond letterheads and 125 envelopes \$1.00; letterheads, statements, 300—\$1.00, Benneville, 907 West Roosevelt, Philadelphia.

100 PERSONAL Printed cards 50c. (No stamps). Beautiful leatherette card case free. 2-line limit. Satisfaction guaranteed. Pacific Card Printer, P.O. Box 1066, Los Angeles, Calif.

BOND Envelopes. 1000—\$2.20 postpaid anywhere in U. S. Samples. Feld, Elmwood Place, Ohio.

1000 ENVELOPES, Statements, billheads, \$1.95. Liberty, 48 Harding, Cambridge, Mass.

YOU'LL Like our printing. Send samples, we'll quote. Crafts Press, Elwood, Indiana.

2000 BUSINESS Cards \$1.50. Zwickell, General P.O. Box 60, Brooklyn, N. Y.

\$1.00 POSTPAID 125 Letterheads, 125 envelopes. Tucker, Box 65, Indianapolis.

225 PERSONAL Note-sheets, 125 envelopes \$1.00. Excelsior Press, Shelburne, Vermont.

1000 BUSINESS Cards \$1.00; 2x4 labels \$1.50. Paramount Press, Atlanta, Mo.

LETTERHEADS—Envelopes. Low prices, high class work. Write for prices. Samples. Wrightprint, Staunton, Virginia.

PRINTED Envelopes \$1.10 M. Letterheads, statements. Maloney Sales, 8 North Water, Rochester, N. Y.

FREE Samples unique house organ. 500 copies \$10.00. Send letterhead. Eastman Folks, South Bend, Indiana.

BUSINESS Cards 1000 75c. Catalog. Barjen Co., 22C Fox, Worcester, Mass.

ENGRAVURE Printing, lowest possible prices. Samples free. Sunco, Mohawk, N. Y.

PICTURE Post cards to order. \$8.00 thousand. Samples stamp. Goff, 5203 South Artesian, Chicago.

ESTIMATE Sheets, job tickets, billheads, etc., for registered plumbers, builders, electricians. Samples promptly mailed—mention business. Special offer—pocket-size estimate-contract book, duplicate sheets, 60c postpaid, two for \$1.00. Fink Printing Company, Laurel Springs, N. J. (Established 1896.)

400 6 3/4 WHITE Envelopes printed \$1.00 postpaid. Luft Press, Hermansville, Mich.

250 LARGE No. 10 envelopes \$1.00. The Morey Press, Springfield, Mass.

100 6 3/4 ENVELOPES, 100 8 1/2 x 11 Letterheads \$1.00. Virginia Printing Company, Roanoke, Va.

SPEND Less for quality printing. Free details. Behtol Printing, 2025 Central, Kearney, Nebr.

200 8 1/2 x 11 BOND Letterheads, 200 6 3/4 envelopes \$1.00 postpaid. Franklin Printery, 2932 Pershing, Chicago.

1000 BUSINESS Cards \$1.00 post paid. Superba Print, 912 Towne, Los Angeles, Calif.

EXCELLENT Printing. Lowest prices. Free cut service. Okayprint, Martins Ferry, Ohio. Samples.

500 FRANCONIA Letterheads and 500 envelopes to match \$3.00. Richard's Print Shop, 271 S. Grand St., Orange, Calif.

CUTS 2" x 3" From drawings and photos. Joe Rek, 118 Gazette Ave., Lexington, Ky.

1939 PRICELIST. Portfolio of samples free. McCall Press, 1326 South 27th, Omaha, Nebr.

1000 BUSINESS Cards \$1.00; 125 Letterheads, 125 envelopes \$1.00, postpaid. Sechrist Printing Co., South Bend, Ind.

MODERN Two color letterheads. Reasonable. Fechner, 202 Ashland, River Forest, Ill.

HAMMERMILL Letterheads, 300 8 1/2 x 11, any color paper and ink, \$1.48 postpaid. Free particulars. Woodruff's, 217A Lewis, Duluth, Minnesota.

500 3 1/2 x 2 1/4 FOUR Line gummed stickers, 25c. Moritz Printery, Saginaw, Mich.

PRINTING OUTFITS AND SUPPLIES

PRINT Your own cards, stationery, circulars, advertising. Save money. Easy rules furnished. Print for others, big profits. Junior outfits \$9.00, senior outfits \$17.00 up. Details free. Kelsey Presses, E-11, Meriden, Conn.

LONG Established printers warehouse. Big lists 3c. Landis, Richland, Penna.

INGENIOUS Rotary press. Furnished complete with sliding rubber type and equipment—at \$2.50. Prints pictures and several sizes of type. Free circular. Superior Type, 3942 Ravenswood, Chicago.

HAND Presses, type and complete printers' supplies. Send stamp for catalog and new price list. P. Peiffer & Co., Newark, N. J.

BARGAINS, Presses, type. List 3c. Exchange, E-15, 110 Dexter, Meriden, Conn.

PATENT ATTORNEYS

INVENTORS: Send immediately for your copies of our new free books, "Patent Protection" and "Suggestions on Selling an Invention." Sixty-eight pages of interesting facts. They tell how Patent Laws protect you; kind of sketch or model needed; simple steps to take without cost; how successful inventors have secured financial assistance; show interesting inventions; illustrate important mechanical movements. With books we also send free Evidence of Invention form to help establish date of disclosure. Prompt service, reasonable fees, special deferred payment plan. Strictest secrecy. Forty-one years' experience. Highest references. Write us today. The facts in our books are worth money to the man with a good invention. Address: Victor J. Evans & Co., Registered Patent Attorneys, 113-H Victor Building, Washington, D. C.

INVENTORS—Time counts—Don't risk delay in patenting your invention. Write for new 48-page free booklet, "Patent Guide for the Inventor." No charge for preliminary information. Clarence A. O'Brien and Hyman Berman, Registered Patent Attorneys, 58-V Adams Building, Washington, D. C.

PATENTS Obtained through associated patent attorney. Write for details. R. & S. Engineering Co., Dept. M71, 17 East 42nd Street, New York City.

PATENTS. Complete soliciting service. Ervin Johnson, 1440 Broadway, Oakland, California.

PATENTS—Trade marks. Preliminary advice, book and disclosure form free. Personal service. Irving L. McCathran, 1060 International Bldg., Washington, D. C. Registered Patent Attorney.

PATENTS. Protect your idea by securing free "Proof of Invention" folder. Exceptional personal service. Established 1906. E. E. Vrooman, 871 Woodard Bldg., Washington, D. C.

INVENTORS—Before disclosing your invention to anyone send for form "Evidence of Conception"; "Schedule of Government and Attorneys' Fees" and instructions. Sent free. Lancaster, Allwine & Rommel, 411 Bowen Building, Washington, D. C.

"INVENTOR'S Guide." 100 mechanical movements, free; advises on patenting, selling inventions. Frank Ledermann, Tribune Bldg., New York.

L. F. RANDOLPH, 302-B Victor Bldg., Washington, D. C. Low cost. Book and information free.

PATENTS. Booklet free. Highest references. Best results. Promptness assured. Watson E. Coleman, Patent Lawyer, 724 Ninth St., Washington, D. C.

INVENTORS—Send for free booklet "Patent-Sense." Information based on 64 years experience. Lacey & Lacey, Dept. 5A, 635 P St., Washington, D. C.

FOR INVENTORS

INVENTORS—Time counts—Don't risk delay in patenting your invention. Write for new 48-page free booklet, "Patent Guide for the Inventor." No charge for preliminary information. Clarence A. O'Brien and Hyman Berman, Registered Patent Attorneys, 58-V Adams Building, Washington, D. C.

WE Locate buyers meritorious patented, unpatented inventions. If will sell, reply immediately. Descriptive booklet free. Invention Reporter, 5A-11236 South Fairfield, Chicago.

GREAT Tip off. Before patenting expense. Puts dollars in inventors pockets. Free. Write, Inventors Service, 1901-18th Street, Altoona, Penna.

INVENTORS—Protect your invention for a few cents without immediate and expensive patenting. Details free. Lindlevs, Box 588, Kokomo, Indiana.

PROTECT Your invention yourself without revealing principles. Send 50c for complete material. Protection Service Bureau, 43 East Ohio, Chicago.

PROTECT Unpatented invention with outlay of 68c. Guaranteed instructions \$1.00. Lerner, 5048 8th, Philadelphia.

INVENTION Sales Bulletin describing over 500 inventions, showing how we sell inventions, patented or unpatented, with booklet and particulars 10c. Patentee System, 9443 Pleasant, Chicago.

INVENTOR'S Engineering service. Models. Confidential. Reasonable. Jos. Wittenheim, Ada, Mich.

HAVE You a sound, practical invention for sale, patented or unpatented? If so, write Chartered Institute of American Inventors, Dept. 4-A, Washington, D. C.

INVENTORS: Profit by your invention. A practical talk to inventors by an experienced manufacturer. Our 68 page booklet "Mind vs. Matter" mailed upon receipt of 25c. Rex Engineering Co., Cincinnati, Ohio, Dept. D.

INVENTORS: "Making Inventions Pay." our 32-page illustrated book, mailed upon receipt of 3c postage. Crescent Tool Co., Dept. Z, Cincinnati, Ohio.

INVENTORS—Send for 72-page book on patents. Reasonable terms. Conscientious treatment to inventors. L. F. Randolph, Registered Patent Attorney, 302-E Victor Bldg., Washington, D. C.

I SELL Patents. Established in 1900. Charles A. Scott, 773PM Garson Ave., Rochester, N. Y.

INVENTIONS WANTED

PRIVATE Party will pay cash for invention of merit, large or small. Box 402, Green Bay, Wisconsin.

WANTED—Meritorious patented, unpatented inventions. Booklet free. Invention Reporter, 5B-11236 So. Fairfield, Chicago.

INVENTIONS Wanted—patented or unpatented. Write for free literature. Sprague, 210A Fifth Ave., New York.

CASH For inventions patented or unpatented. Stamp appreciated. Mr. Ball, 9441-A Pleasant, Chicago.

WE Can help you market your invention. Write for "4-Points of Service" bulletin. R. & S. Engineering Co., Dept. M72, 17 East 42nd Street, New York City.

SMALL Inventions wanted by manufacturers. I'll help you sell your invention. Write for free circular. Stanley Hull, 7829-K Euclid Avenue, Cleveland, Ohio.

SIMPLE. Practical inventions wanted by manufacturers, patented or unpatented. For information write Chartered Institute of American Inventors, Dept. 4-D, Washington, D. C.

PATENTS FOR SALE

PROVEN Combination household necessity, folding stool, stepladder, shoe shine stand. Patent 2136354. Copy furnished. Roy Riviere, Tyler, Texas.

PATENT Available safety vehicle bumper, hinged ends. Prevents damage. E. Eaton, Park Ave., Beloit, Wis.

ARMORED Electric cable cutter. Patent pending. Ted Sherrill, Tendoy, Idaho.

SWIMMER'S Safety device. Patented. Simple. Weinsweig, 1523 Cuming, Omaha, Nebraska.

MANUFACTURERS: For new products or profitable manufacturing opportunities, inquire. Invention Reporter, 5C-11236 So. Fairfield, Chicago.

WANTED—Wholesale sash houses outside California to handle our new sash balance. Automatically opens and locks window. No side pockets necessary on frame. Costs less and easier to install than weights. Will give exclusive territory rights on royalty basis. Eagle Manufacturing Co., 1234 East 14th St., Oakland, Calif.

SELL Your patent through a small classified ad in Popular Mechanics. Many inventors have found buyers in this way. Ask me for proof—I'll gladly send it to you. F. W. Johnson, Manager Classified Advertising, 200 E. Ontario St., Chicago.

MANUFACTURING

A COMPLETE Service for inventors—50 years manufacturing experience. Inquiries invited. H & H Tool & Mfg., Company B, 308 East Third Street, Cincinnati, Ohio.

MANUFACTURING. Dies, machinery, models, brasswork, mouldmakers, catalog 3c. Baum's Metal Specialties, Kansas City, Mo.

INVENTIONS—Manufactured in any quantity at low cost by old established company. Stampings, metal specialties, dies, models, etc. Free estimates. Send for catalog. Crescent Tool Co., Dept. X, Cincinnati, Ohio.

INVENTIONS Manufactured by an experienced company, in any quantity at low cost. Metal specialties, novelties, stampings, dies, and models. Free estimates. Our booklet "Mind vs. Matter" sent upon receipt of 25c. Rex Engineering Co., Cincinnati, Ohio, Dept. C.

MODELS AND MODEL SUPPLIES

CARVED Hull ship model kits. Ship and yacht model fittings; model yacht sails. Illustrated catalog 20c. A. J. Fisher, 1002-M Etowah Ave., Royal Oak, Mich.

CATALOGUE Of over 40 engines, castings, supplies, 25c. Refunded. Howardco, A-2417 North Ashland, Chicago.

POWER Models, steam locomotives, electric railways, gasoline, steam engines, ship machinery, accessories. 84 page catalog 35c. Chas. Cole, Ventura, Calif.

CATALOG On model airplane supplies, kits, engines, boats 5c. Model Shop, 71 E. Arch, St. Paul, Minn.

MONTHLY Illustrated magazine all about model railroads and how to build them. Sample copy 20c, year's subscription \$2.00. Model Railroader, Wauwatosa, Wis.

MODELS—Your ideas developed into practical working models. 30 years successful experience; thousands of satisfied customers. Confidential service guaranteed. Bank references. Send 3c postage for our large booklet—"Making Inventions Pay." Crescent Tool Co., Dept. Y, Cincinnati, Ohio.

MODELS—Practical models put over your ideas. We develop models from the crude to perfect working devices. Your idea might have large commercial value. Services confidential. Bank references. Registered graduate engineers at your service. Send 25c for our 68 page booklet "Mind vs. Matter." Rex Engineering Co., Cincinnati, Ohio, Dept. B.

STREAMLINE Yacht, sport auto, stratosphere balloon gondola. Complete plans for three models \$1.00. R. M. Brownlee, 416 E. Main, Benton, Ill.

MODEL Supplies for the inventor. Send 3c stamp for catalog. Pierce Model Works, Tinley Park, Ill.

BLUEPRINTS AND PLANS

"**BUILD** Your Own Log Cabin," illustrated, thirty pages, approved simple plans, specifications, \$1.00. Acme, Box 271, Rossville, Georgia.

HOME CRAFTSMEN

MEXICAN Novelties easily made. Our 20 Mexican patterns and instructions 25c. 20 cowboy novelty patterns 25c. 10 lawn ornament patterns 15c. Mexican Arts, Crafts, Eagle Pass, Texas.

22 FULL Size lawn ornament patterns 25c coin. Strother, Box 383-J, Belington, West Virginia.

LEATHERCRAFTSMEN—Write for free instructions and price list of leather, tools, etc. Sample cards 5c. Wilder & Co., Dept. 6F, 1038 Crosby St., Chicago, Ill.

20 FULL Size lawn ornament patterns 25c. Wickman, 744 Brooklyn, Dept. 31, Dayton, Ohio.

CRAFTSMEN. Guaranteed moneymaker. Original, easily made. Complete plans 50 cts. Meehan, Lisbon, Ohio.

SPRINGLESS. Door-chimes striker. Electrical. Simple plan 25c. R. Swinzer, Davis Ave., Harrison, N. J.

50-PIECE Motor grinder accessory set—burs, brushes, buff, stones, sanders, etc., only \$1.00 postpaid. Stamp brings bulletin on flexible shaft tools. Foredomco, 27 Park Pl., New York.

HARD Old paint brushes renewed, simple, inexpensive, new formula 25c. Ellison-Gunning, Box 81X1, East Falls Church, Virginia.

CUTTERS Made to fit bench saw table, make moldings; cove, quarter, grooves, etc. Sandstroms, Stow, N. Y.

MAKE Money making lawn chairs. Full size blueprints. 25c. No stamps. Francis Scheurer, R. No. 3, Mankato, Minnesota.

PROJECTS For camp craft work. Catalog on request. Mankin Brothers, Box 23, Hollywood, Memphis, Tennessee.

MAKE Leaded antique lanterns. Free description folder. M. Ascherl, Lorain, O.

20 LAWN Ornament patterns 30c. 20 novelty patterns 30c. 14 silhouette patterns 30c. 15 lawn ornament patterns different from those above 30c. All for \$1.00. Modern Woodcraft, Saginaw, Michigan.

1001 WAYS to Use Concrete. Send for large free illustrated folder describing new Popular Mechanics book covering every known use of concrete for the home, farm, building, business and industry. Popular Mechanics Press, Room (C39), 200 E. Ontario St., Chicago.

OLD GOLD, WATCHES, JEWELRY, PRECIOUS STONES

REBUILT Elgins, \$2.90 up, also material. Lonnie Harmon, Sugar Grove, N. C.

BIG Money selling guaranteed reconditioned Elgin, Waltham, Hamilton watches, \$3.75 up. No investment. Free catalog. Grossman Jewelry, 4666-H State, Chicago.

WATCH Parts, tools, supplies. Write for price list 43. Dean Company, 87 Nassau Street, New York.

AUSTRALIA'S Lovely opals. Illustrated catalogue free. Good selection \$5.00. Norman Seward, Melbourne, Australia.

ELGIN. Waltham, Hamilton watches. Make big money. \$3.95. Send for free jewelry catalog. Plymouth Jewelry Exchange, 163-B Canal St., New York.

AGATES. Gems, minerals. 20 gemstones \$1.00. Pricelist free. Hill, Route 7, Salem, Oregon.

HIGHEST Prices for old gold—Mail your teeth, watches, jewelry. 100% full cash value mailed day shipment received. Satisfaction guaranteed or articles cheerfully returned. Information free. Chicago Gold Smelting Company, 300-P Champlain Building, Chicago.

5000 REBUILT Elgin, Waltham, Hamilton watches. Also ladies, gents wrist watches. Make big money! 12 size, 7 jewel, Elgin or Waltham, \$4.75; 16 size, 17 jewel, \$7.50. Send for free watch and diamond catalogue. The New York Jobbers, Dept. M, 74 Bowery, New York, N. Y.

GOLD \$35 Ounce. Ship old gold teeth, crowns, jewelry, watches—receive cash by return mail. Satisfaction guaranteed. Free information. Dr. Weisberg's Gold Refining Co., 1500-Q Hennepin, Minneapolis, Minn.

WATCHMAKERS' Supplies. tools, watches. Sold—purchased. Ben Segal Company, 5 So. Wabash, Chicago.

HOW To identify and determine value of old precious metals. Where to buy. To whom to sell. Reliable and up-to-date information. Complete instructions only \$1 postpaid. Popular Mechanics Press, Room (C39), 200 E. Ontario St., Chicago.

FOR THE HOME

DRAFT Control. Save those dollars going up the chimney. Install an automatic draft control. Suitable for coal or oil. \$3.00 postpaid. Oil Saving Devices Corporation, 921 Melrose Ave., New York, N. Y.

BEAUTIFY Your old furniture! Refinishing now made easy. Complete instructions 35c. Todds Service, 53 McGuffey, Youngstown, Ohio.

HOT? Uncomfortable? Cool your home without cost. No electricity required. Make the few changes yourself. Illustrated plans, fully explained \$1.00. Stoner Engineering, 3906 Poplar Ave., Fayette, Ohio.

TOBACCO

50 HAVANA Filler cigars \$4.00 postpaid. 100 for \$7.50. Money order or check. W. E. High, Box 2202, Tampa, Fla.

LOOK! Try cheaper tobacco! Then taste our milder golden smoking or rich ripe chewing, four pounds, postpaid, \$1.00. Riverside Ranch, 201, Hazel, Kentucky.

PIPE Smokers. Graymere finest white burley tobacco raised and cured on my plantation. Sent to you in the natural whole leaf. A delicious smoke. Send fifty cents for large trial package. John M. Gray, Richland Ave., Nashville, Tenn.

SURVEYING INSTRUMENTS

NEW Type builder's level. Simple, accurate, convenient. Complete outfit \$5.00. Details free. Prout Mfg. Co., Box 158-C, Elkhart, Ind.

WANTED—MISCELLANEOUS

CASH For used microscopes, binoculars, cameras, slide rules, drawing sets, surveying, mechanical, and scientific instruments. Highest prices paid day shipment received. Satisfaction guaranteed or shipment promptly returned. Elman's, 2302 Van Buren, Chicago.

PERSONAL

ATHLETES Foot cured. Guaranteed prescription. Mail \$1.00. P.O. Box 211, Kansas City, Mo.

LEARN The secret of being irresistible—the key to business and social success. "Winning Personality" tells how to act, dress, speak, to achieve power. 50c copy, descriptive circular 3c stamp. A. Doherty, 48-21 47th Street, Woodside, L. I., N. Y.

DANDRUFF Removed like magic. Guaranteed remedy. \$1.00. Awad, 576 Dupont, Philadelphia, Penna.

WIN Prize money: Booklet—"Successful Contesting"—shows how. 10c postpaid. Bulletin listing \$200,000.00 prizes included. World Publishers, 4515-B Cottage Grove, Chicago.

LEARN Air conditioning—America's next big industry. Thousands of opportunities. Get your start with complete book by E. W. Riesbeck. \$3.50 postpaid. Popular Mechanics Press, Room (C39), 200 E. Ontario St., Chicago.

MISCELLANEOUS

FOUNTAIN Pens cleaned, adjusted and equipped with new ink sack for 50 cents. Factory trained workmen. Est. 1897. Demaree Stationery Co., 906 Walnut, Kansas City, Mo.

CUTS Anybody can make. Zinc etching process. Specimens, particulars, testimonials for stamp. J. C. Day, Windfall, Ind.

MONEYSAVER—Men's Goodyear welt work oxfords, rawcord or leather soles, \$2.10 pair plus postage; moneyback guarantee. Duval Shoe, 51 Central, Jersey City, N. J.

10 "WHAT-NOT" Novelties. Unusual, different. \$2.00 prepaid. Worth dollars more. Guaranteed. Sattlers, Box 349, Lake Charles, La.

"RESILVERING Mirrors" and 50 other money-makers 10c. Ideal Service, M50, Park Ridge, Ill.

BEAUTIFUL Gift paper knife. Blade solid walnut, handle hand turned inlaid with contrasting Minnesota hardwoods. \$1.00 postpaid. Shattuck, Altura, Minn.

GOOD Eyesight without glasses. No drugs. Simple effective treatment. Guaranteed. A. Jacobson, Upsala, Minnesota.

BUSINESS Proposition resilvering mirrors, autographs, reflectors, making chipped glass signs. Write Sprinkle, Plater, 288, Marion, Indiana.

COATS Of arms and crests, correctly painted in colors or black and white, from heraldic description or furnished copy. \$10.00 and up. Highest grade work. Heraldic Studios, 1914P Oakdale Avenue, Chicago, Ill.

MAGNET. Alnico, new wonder alloy lifts 50 times own weight. 60c; large \$1.00. Advance, 861-Pmis8, Minneapolis, Minn.

ELECTRIC Lawn mower, list \$59.50, new direct to customer price \$39.50. Write literature. Romco, 3120 N. Cambridge, Milwaukee, Wis.

OFFICE And school supply catalog free. Ribbon Ink Co., Cicero, Ill.

E-ZEE-DOO Etches your name on tools, keys, any metal surface. Simple, permanent. \$1.00 postpaid. E-Zee-Doo, 108 No. Dearborn, Chicago.

SAVE All the gold pan in 1/4 the time. A new gold pan with recessed return lip around 3/4 of rim and removable cylindrical copper screen containing fibrous material which holds quick silver forming amalgam cushion. Pan with instructions \$2.50. Cushion 85c. Gold Savers Co., 315 Southern Title Bldg., San Diego, Calif.

SOUVENIRS New York world's fair. Bronze coin 10c. Reliable cigarette lighter \$1.00. Locket holds 2 photos, gold filled \$1.50. Zwickell, General P.O. 60, Brooklyn, N. Y.

NICKEL-SILVER Identification plates. Gun case, golf bag, luggage, dog collar, etc. Name, address imprinted, 25c; 5, \$1.00; doz, \$2.00. Identification, Box 74, Frackville, Penna.

MONEY In butterflies, moths. See Sinclair Display Advertisement on page 10A.

CARRY Lucky stone. \$1.00. Gen-Dol, 92 Stevenson, Buffalo, N. Y.

COLONIAL Hand hammered copper candlestick or ash tray, morning-glory design, sent post paid \$1.00 each or set for \$1.50. Acceptable gift, bridge prize, party favor. R. S. Ellison, Box 81X1, East Falls Church, Virginia.

TATTOOING Outfits, supplies, illustrated list free. Percy Waters, Anniston, Alabama.

LUMINOUS Paint shines in the dark. 25c bottle. Myers, 211 Broadway, Niles, Michigan.

REFINE Used oil without cost. Particulars. F. Gerwin, Fairview, Oklahoma.

MEXICAN Jumping beans. The best curiosity in the world. Joaquin Hernandez, Exporter, Alamos, Sonora, Mexico.

AMATEUR Cartoonists wishing steady income copying and duplicating cartoons for advertisers, write Ad-Service, Argyle, Wisconsin.

LAM-A-FAB. The cloth cement, acid and waterproof. Permanently repairs anything made of cloth. Sails, hunting equipment and suits, football suits and athletic equipment, rugs, canvas chairs and work clothing. S. J. Russell Co., P. O. Box 187, Peoria, Ill.

SWAPPER'S Friend, R4, Saline, Michigan. Interests swappers, collectors. 50c year, sample 10c.

Now BOAT BUILDING MADE EASY

Famous Boat Book Shows How

Detailed instructions, plans, materials, methods for building 15 most popular power, sail and row boats. Get Popular Mechanics BOAT BOOK and build your own at low cost. Prepared for those with limited skill and few tools. Includes also—"What a boat enthusiast should know." Only \$3.00. Pay postman on delivery or write for descriptive circular.

Popular Mechanics Press
Room 739D
200 E. Ontario St.
Chicago

GROW PLANTS WITHOUT SOIL Startling New Development

Complete Directions for Small and Large Scale Growing

Get the new book "Soilless Growth of Plants" and learn this new

technique which everyone is talking about. Three methods described—Water Culture, Sand Culture, Sub-Irrigation. Explains all operations. Tells how to make containers and nutrient solutions from raw materials at small cost—how to grow flowers, vegetables and fruits without soil. A fine hobby and a money-saving investment for city dwellers. A source of new business for gardeners, nurserymen, etc. Only book of its kind. Order today "Soilless Growth of Plants." Sent postpaid for \$2.75.

POPULAR MECHANICS PRESS Dent. 739 200 E. Ontario St. Chicago

The World's Biggest

Get Shop Notes for 1939! Only 50 cents. May easily be best investment of your entire lifetime. Contains 417 money-making, time-saving ideas, kinks, short cuts for mechanics, farmers, home workshop fans, handymen—for everyone who uses tools. 224 pages, 417 articles, 806 illustrations. Get 1938 Shop Notes too. Only 50c.

POPULAR MECHANICS PRESS
Room 739-C, 200 E. Ontario St., Chicago

50¢ WORTH

SHOP NOTES FOR 1939

Get this Book Now!

MONEY MAKING FORMULAS

1059 PRICELESS FORMULAS ALL IN ONE BOOK FOR \$1.25

FORTUNES MADE WITH FORMULAS LIKE THESE

Cosmetics Remedies Beverages Paints Glues Polishes Inks Soaps Fertilizers Preservatives Lubricants Auto Products Food Products Metal Products, Etc.

Hundreds of big selling products—earning millions in profits—grew from a simple formula. Your own product may bring you fame and fortune. Get this big 200 page book with 1059 formulas, and start a spare or full time business of your own. Everything explained—what to make—how to make it—where to get materials. This is the book that lifts the veil of secrecy from a profitable and fascinating business. Get your copy now. Only \$1.25 postpaid.

Popular Mechanics Press, Dent. 737-B, 200 East Ontario St. Chicago

OL' JUDGE ROBBINS

AT FT. TICONDEROGA, N.Y.

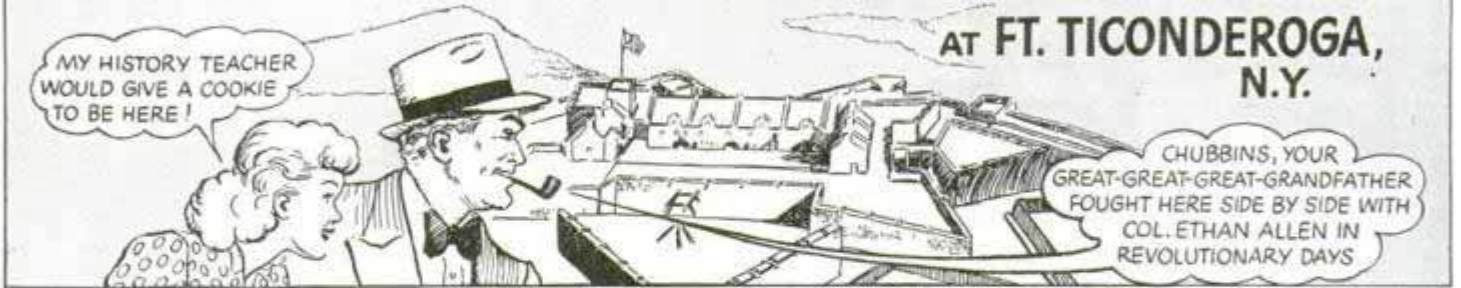

MY HISTORY TEACHER WOULD GIVE A COOKIE TO BE HERE!

CHUBBINS, YOUR GREAT-GREAT-GRANDFATHER FOUGHT HERE SIDE BY SIDE WITH COL. ETHAN ALLEN IN REVOLUTIONARY DAYS



I'LL BET THOSE OLD CANNONS GOT PLENTY HOT IN THE THICK OF BATTLE



OH, A LITTLE HEAT DIDN'T BOTHER THOSE REVOLUTIONARY SOLDIERS. AS YOU KNOW, JUDGE — THEY EVEN SMOKED PIPES MADE OF LEAD



HM-M, A HOT SMOKE ISN'T NECESSARILY THE PIPE'S FAULT. TOBACCO IN THOSE DAYS DIDN'T SMOKE TOO COOL!

HUMPH! I KNOW WHERE THERE'S AN OLD LEAD PIPE, JUDGE. LET'S TRY SOME OF YOUR TOBACCO IN IT JUST FOR THE FUN OF IT



OKAY—I'M ALL READY!

HA! HA! JUDGE, YOU WIN—WE BOTH KNOW PRINCE ALBERT WOULD SMOKE COOL IN ANY PIPE!

ETHAN ALLEN DOORS



REMEMBER, CHUBBINS, WHEN WE WERE CROSSING THE MISSISSIPPI? THAT MAN BET ME MY BRAND WOULDN'T SMOKE COOL IN A CORN-COB

YES! AND HE WASN'T SORRY TO LOSE THAT WAGER—HA! HA! HE BORROWED HALF YOUR TIN OF P.A.



PRINCE ALBERT HAS OPENED MANY A PIPE-SMOKER'S EYES TO HOW MELLOW YET RICH-FLAVORED A TOBACCO CAN BE

YES, P.A.'S JUST RIGHT—THERE'S NO OTHER TOBACCO LIKE IT!

Copyright, 1939, R. J. Reynolds Tobacco Company

Declare your independence from **TONGUE-BITE!**

Get the pipe tobacco that's

MILDER

yet **tastier—**

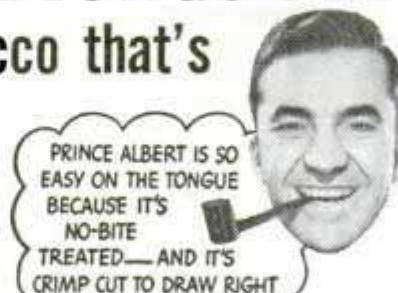

PRINCE ALBERT IS SO EASY ON THE TONGUE BECAUSE IT'S NO-BITE TREATED—AND IT'S CRIMP CUT TO DRAW RIGHT

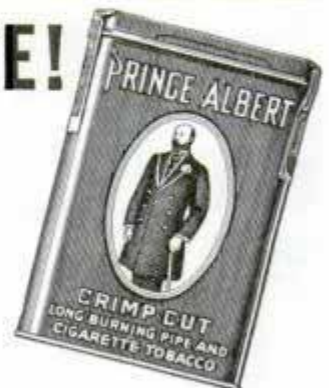

NO-RISK OFFER

Smoke 20 fragrant pipefuls of Prince Albert. If you don't find it the mellowest, tastiest pipe tobacco you ever smoked, return the pocket tin with the rest of the tobacco in it to us at any time within a month from this date, and we will refund full purchase price, plus postage.

(Signed) R. J. Reynolds Tobacco Company, Winston-Salem, North Carolina

P. A. IS MILDER, TASTIER IN YOUR "MAKIN'S" SMOKES TOO

50 pipefuls of fragrant tobacco in every pocket tin of Prince Albert

PRINCE ALBERT THE NATIONAL JOY SMOKE

Popular Mechanics Magazine

REGISTERED IN U. S. PATENT OFFICE AND CANADA

WRITTEN SO YOU CAN UNDERSTAND IT

Vol. 72

JULY, 1939

No. 1



**SUPER-
GASOLINE**
for Your
CAR

A HIGH-POWERED gasoline that is nearly ready for market will give your car the flashing performance and efficiency of premium fuel at no extra cost.

This new fuel, a revolutionary discovery of the petroleum industry, is the highest grade basic gasoline ever made. It is cheaper than present premium brands. It can be created from tar, asphalt, or refinery wastes as well as from any type of crude petroleum. Its recovery process enables a refiner to extract much more gasoline from a barrel of crude than was possible before.

Engineers worked on this super fuel for fourteen years and spent more than \$10,000,000 to perfect it. It is the creation of a French inventor, Eugene Houdry, and its secret is the use of a catalyst in the refining process. Ninety-six patents cover the process and equipment.

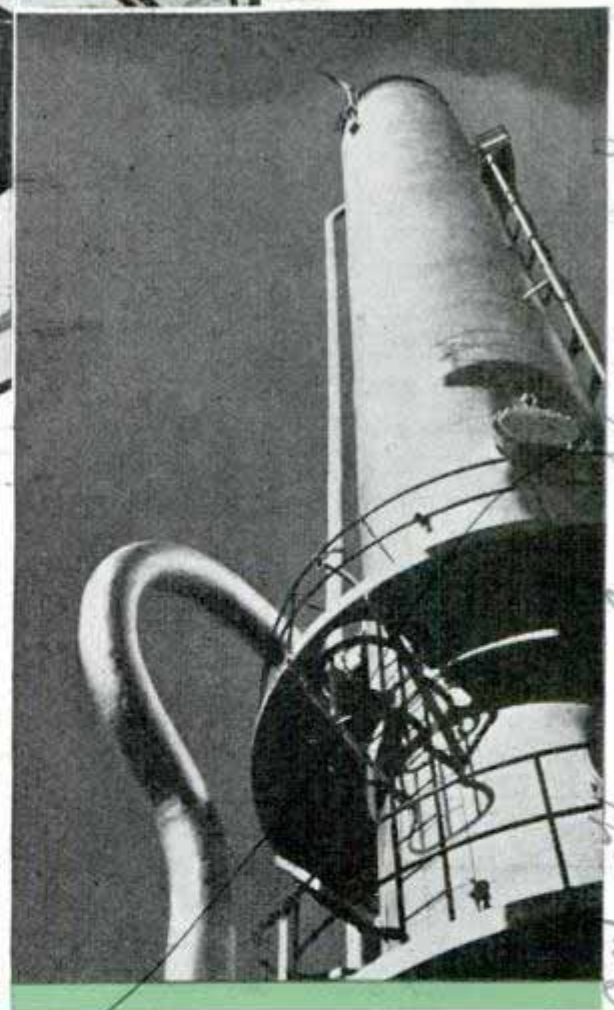

Photos courtesy Union Oil Co.

Circle, engineer in old passenger car testing acceleration and performance of different fuels in worn engine. Right, an unusual photograph of a fractionating tower in petroleum refinery

Reference: Public Relation Dept



The hot oil vapor under treatment is forced through porous masses of this catalyst. Ordinary thermal cracking requires pressures of around 1,000 pounds per square inch and temperatures of up to 1,100 degrees, but catalytic cracking takes place at only twenty to forty pounds per square inch pressure and 900 degrees temperature.

Not only does catalytic cracking create more gasoline than any other method but the gasoline can hardly be made to detonate in today's automobiles. The fuel has a natural octane rating of from seventy-eight to eighty-one, the equivalent of the best premium gasolines on the market. After

treatment catalytic gasoline has very low gum and sulphur contents.

It may be a year or so before this new gas is on the open market. Seven million gallons of it were manufactured last year but most of this was snapped up at once as the base for 100-octane aviation gasoline. Sun Oil company of Philadelphia is operating one 15,000-barrel plant and

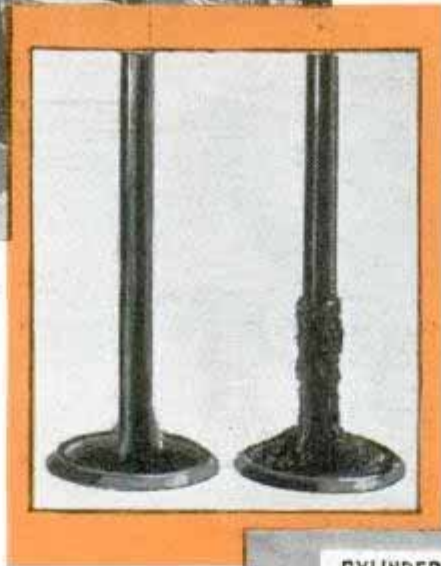

Crude petroleum is a mixture of assorted hydrocarbons in gaseous, liquid, and solid states, including some that make up gasoline. In the usual recovery process the percentage of natural gasoline in the crude is removed by distillation and then the heavy hydrocarbons that remain are subjected to heat and pressure in a thermal cracking process that breaks some of them up into smaller structures, yielding more gasoline.

In theory an entire barrel of crude oil could be converted into gasoline without waste but this does not work out in practice. Up to sixty-eight per cent can be transformed into motor fuel by modern methods but the average is less than fifty per cent. The Houdry process boosts this percentage by turning fifty per cent or more of the residue into gasoline.

Houdry discovered that the breaking down of heavy hydrocarbons of oil and tar into the hydrocarbons that form gasoline is accelerated when a quantity of aluminum silicate is present in the cracking still.

CYLINDER FROM 1915
PIERCE ARROW ENGINE

Displacement 825 cu. in.
Comp. Ratio 3.29 to 1
Horsepower 66
H. P. per cu. in. 0.98

CYLINDER FROM
MILLER RACING ENGINE

Displacement 91 cu. in.
Comp. Ratio 8.5 to 1
Horsepower 200
H. P. per cu. in. 2.2

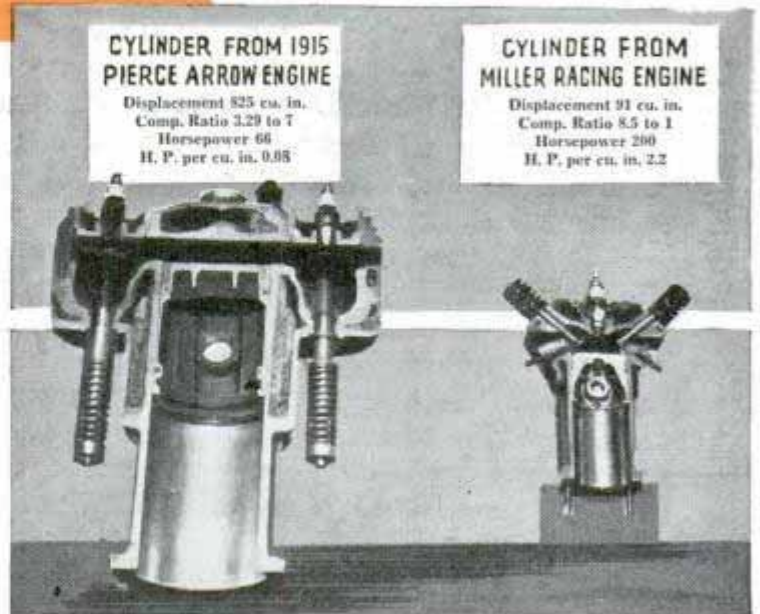

Top, measuring octane rating of fuel by placing it in "knock engine" that shows detonation. Center, comparison of engine valves in Standard Oil of Indiana test. Note valve at right has heavy gum deposit that might have been prevented by anti-oxidant in gas. Bottom, comparing early and modern cylinders

Learning agent - E. B. Badger Sons Co
 75 Pitts. Du. Ba. Ind.

2-32
2

Socony-Vacuum has three others in production. Some of the gasoline that these plants are turning out is being blended with lower-grade fuels to improve its anti-knock value. Ten new Houdry plants costing \$35,000,000 are under construction and licenses for additional plants are being issued.

The position of the United States in the air is materially strengthened because this fuel provides a source of aviation gasoline. Efficient military aviation engines need fuel of 100-octane rating or better for peak performance,

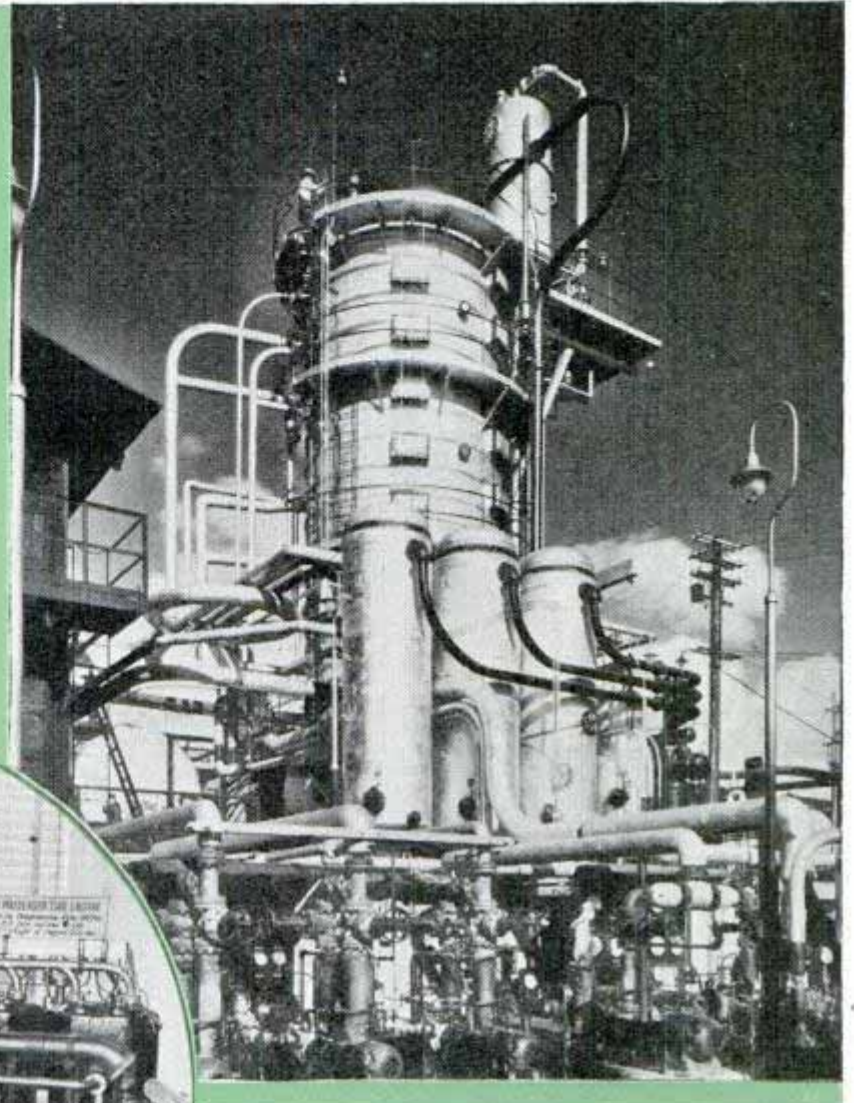

Above, vacuum distillation unit of refinery extracts lubricating oil from crude petroleum after natural gasoline has been drawn off. Circle, 200-horsepower racing engine (left) compared to old-fashioned sixty-five horsepower auto engine. Bottom, measuring power developed by engine

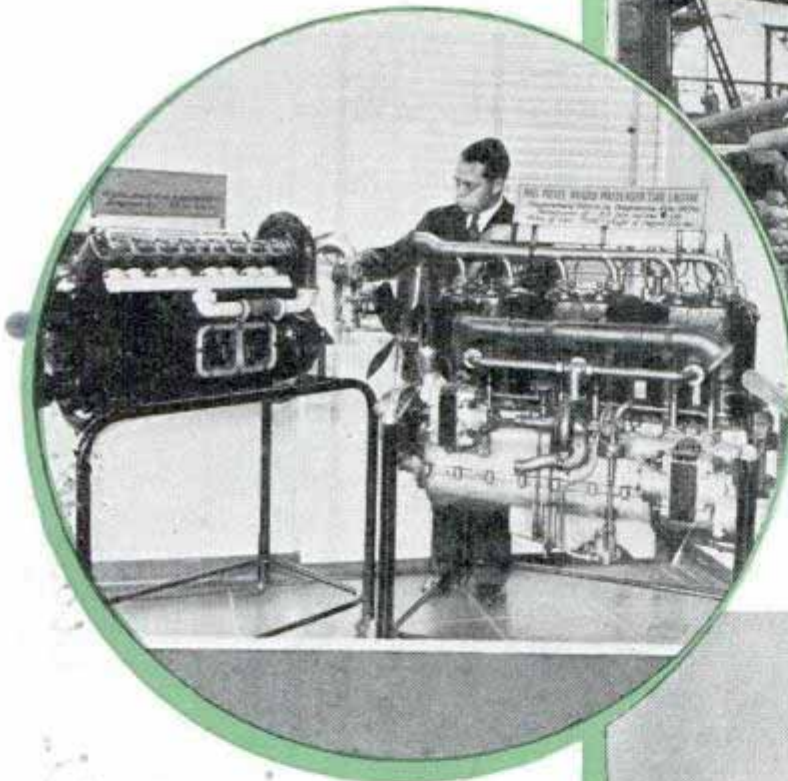

and 100-octane gasoline has been relatively rare. Such fuel has been manufactured from the highest grades of crude, doped up with large quantities of tetraethyl lead and pure iso-octane, a high anti-knock hydrocarbon. It has cost in the neighborhood of half a dollar a gallon. But only small quantities of knock inhibitors need to be added to catalytically cracked gasoline

(Continued to page 141A)

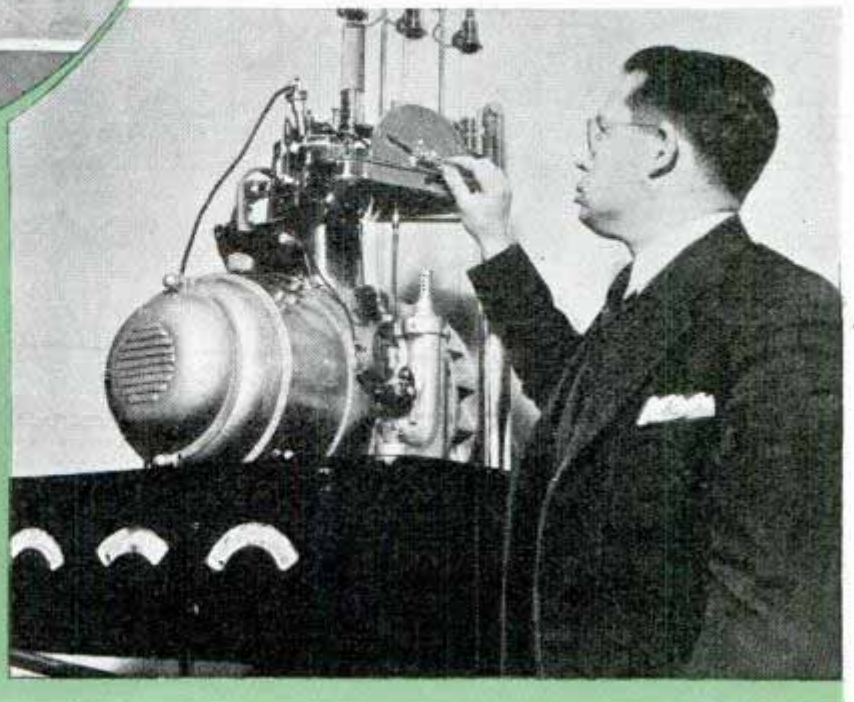

Million-Volt Electric 'Bonfire' Forms a Spectacular Display

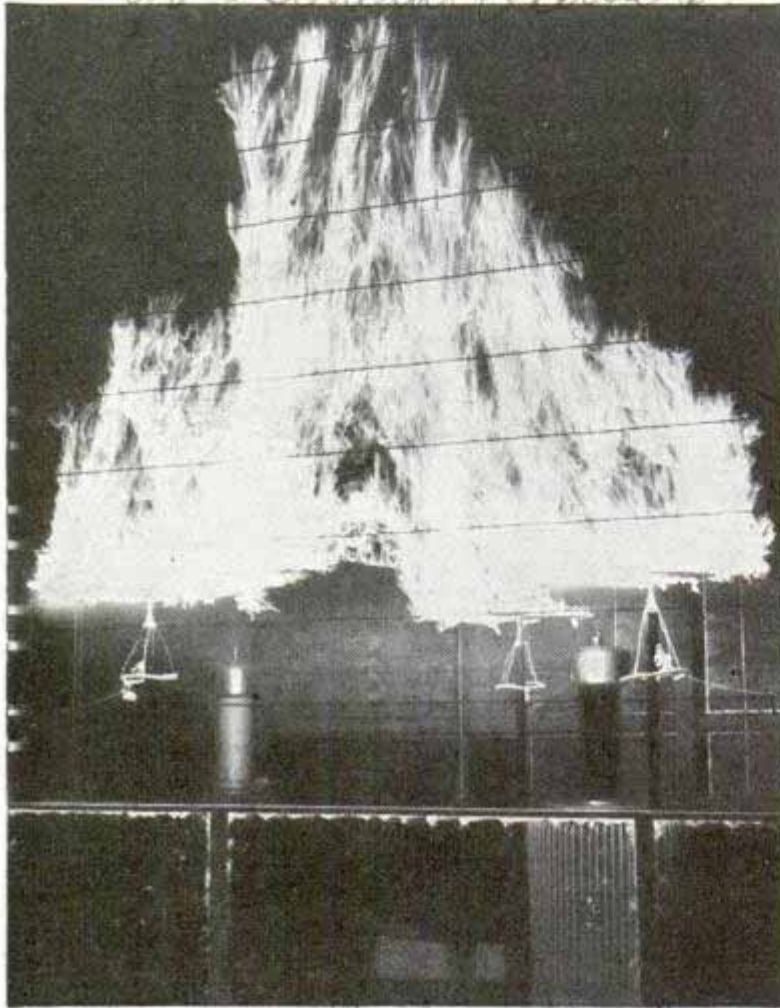

Visiting the General Electric exhibit at the New York fair you may see this vivid display of electrical fireworks

One million volts going up in flames! The weirdly beautiful spectacle—not flames at all, but electrical fireworks—is a part of the General Electric demonstration at the New York world's fair. Power is supplied from a generator feeding the transformers. It is applied at low voltage and built up gradually. As the voltage rises, the cable and spinning arms glow with the violet light of the corona and at the peak a speed of fifty revolutions a minute is reached.

Motor the Size of a Match Head Built by Swiss Craftsman

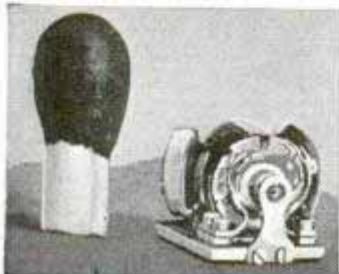

No larger than the head of an ordinary match, an electric motor built by a Swiss won an international contest at Zurich for con-

struction of the smallest motor. Placed beside an American nickel, the motor just reached as high as the buffalo's hoofs. In spite of its diminutive size it actually turns 3,000 revolutions per minute, operating on direct or alternating current and consuming 5/1,000 watt. Built with the delicacy and precision of a watch, the motor is a little over three millimeters high, with a platinum commutator and composition metal brushes. The coils are composed of thirty-five turns of hair-like copper wire.

Goggles Kept from Fogging by a Chemical Cloth

Goggles can be kept free from fogging by rubbing them with a special chemically treated cloth just introduced. Not only is condensation retarded, but the cloth cleans and polishes the glass. It is serviceable for a long period.

Talk Timer for Telephone Warns When Time's Up

Telephone charges that mount up rapidly after the initial three or five-minute period can be minimized by using a meter, now on the market, to show when the time is up. On the dial is a pointer to indicate the passing of minutes, and fifteen seconds before the end of the time limit a bell rings, warning the caller.



Set timer when starting phone conversation and it will warn you before extra charges begin to pile up

La Nature, Mar 15, 1934

M. Huguenin

Phone Co. Meter Co

393 main St. Orange, N.J.

Bieringer - Hendrickson
2755 N. 8th
Philadelphia
General Electric

Electric Map Shows Air-Mail Arrival Time

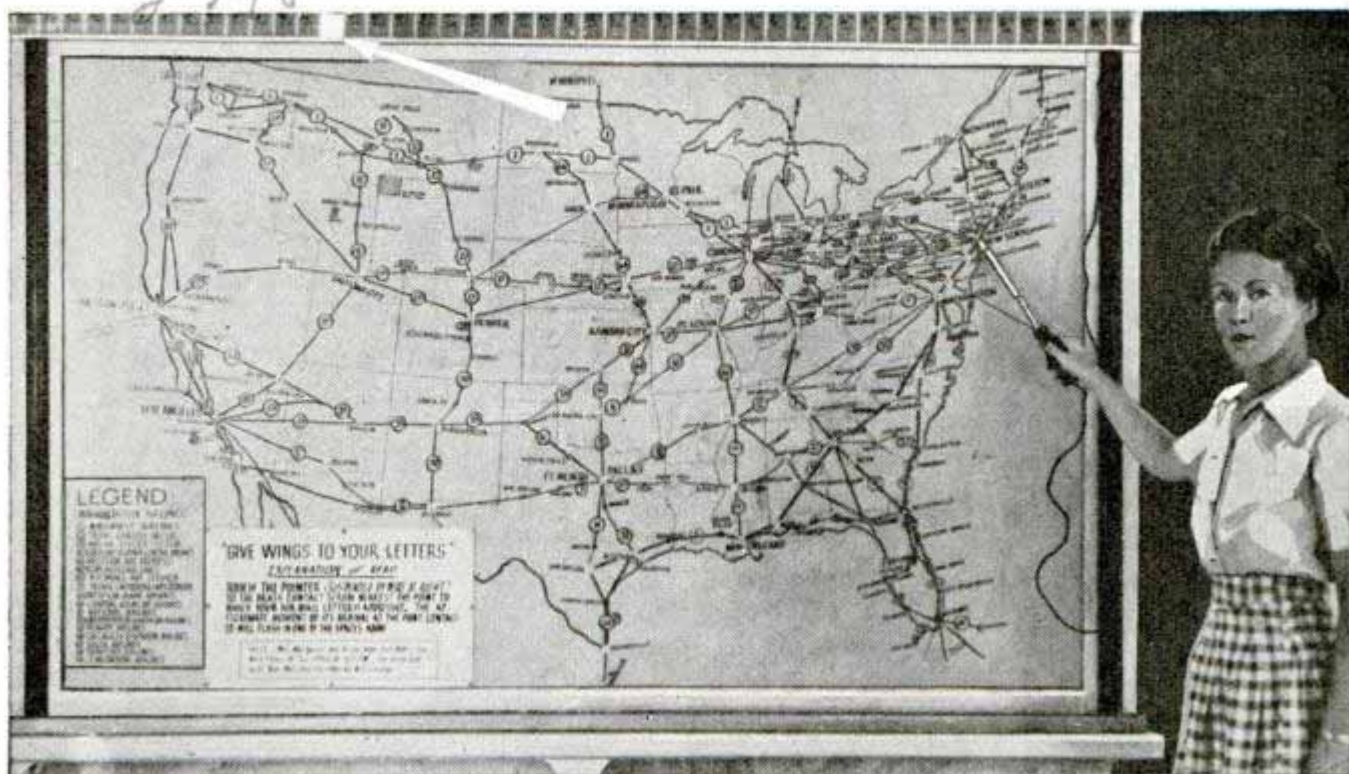

Placing pointer at New York on the map lights up window, indicated by arrow, which shows the time your air-mail letter will be delivered. There is an electric contact point at each city

Without consulting timetables, anyone who sends an air-mail letter at the post office in West Palm Beach, Fla., can learn when the plane carrying it will arrive at its destination, by touching a wired pointer to the city in question on an electrified

map. A light above immediately flashes on to indicate the scheduled "arrival time." Conceived by the local postmaster and constructed by employees using donated material, the chart, which contains over 500 feet of wiring, can be moved about easily.

Oxygen Piped from Bottles Protects Group in Gas Raid



Instead of using individual oxygen "bottles," the gas masks all tap a common pipe line fed by large oxygen tanks in air-raid refuge

Gas masks "plugged in" on an oxygen pipe line furnish protection to groups of refugees from a wartime gas attack or companies of firemen engaged in combating deadly fumes in a fire. A single tube is connected to a battery of oxygen bottles, and the individual masks are coupled to this pipe.

To prevent any increase in gasoline consumption, no new cars can be registered in Tokyo unless they are equipped to operate on charcoal gas or other substitute fuels.

Handwritten notes on the right margin:
C. B. Carr, W. C. Carr, W. C. Carr, W. C. Carr
4/16/39
used in Paris France

Equip. Suppl. New York Rapid Transit

Single Controller Operates Motor and Brakes

Manufactured by Clark Creek Equipment Co. Battle Creek Mich.

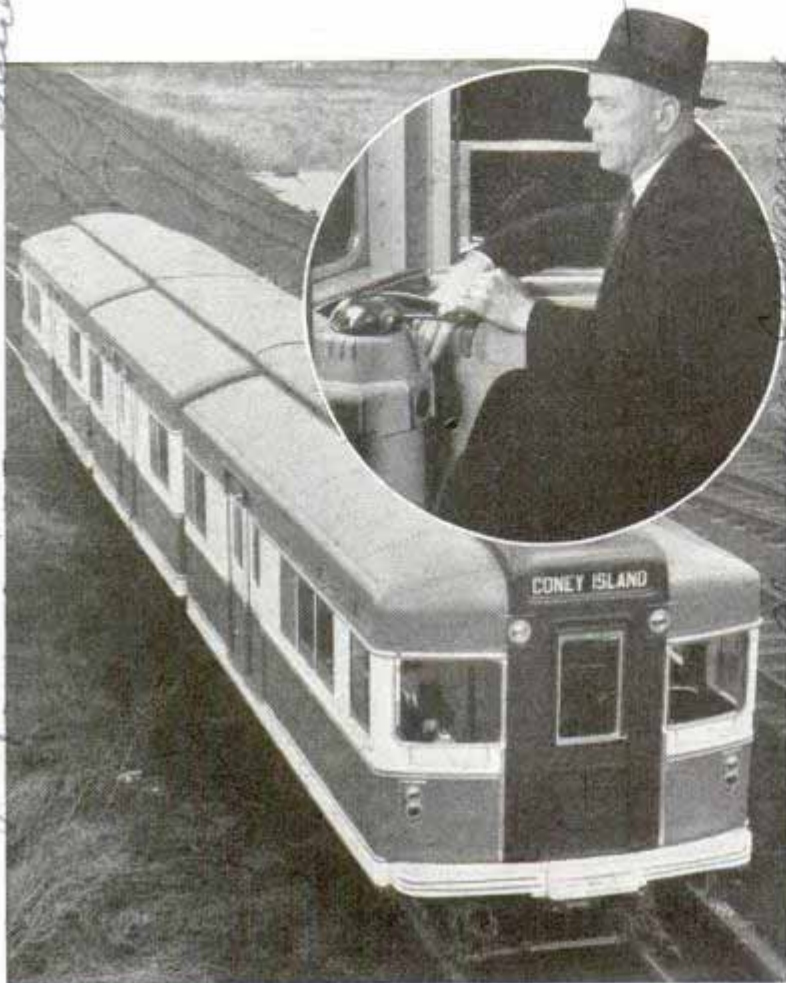

Clark Creek

Built of 12,000 pounds of aluminum and duralumin, and cushioned by more than a thousand rubber parts, the new subway car on New York's Brooklyn-Manhattan line could be driven by a one-armed motorman. Its single controller, called the "cineston," operates both motors and brakes, providing quick and smooth acceleration and deceleration. Worked from left to right, the cineston feeds current to the motors; moved up and down, it operates the brakes. The car consists of three articulated units weighing altogether 76,000 pounds, with only half the axle loading of old-type cars. Noise is absorbed by rubber used throughout the car to eliminate metal-to-metal contacts. Conical rubber springs on the trucks soften thrust in any direction, and rubber sandwiches nearly two inches thick between the steel tires and wheels dampen out shocks from rail joints and switches. The car has a three-way braking system.

Moving the handle sideways controls the power, while vertical motion of controller operates the brakes of new subway car

B. Filwood & Co. Akron

Camouflage Net Hides Gun Aimed at Invading Planes

ad Anita And Calif

Anti-aircraft gunners guarding southern California from "invading" aircraft during recent war games along the coast lay hidden under a big tent of netting. Without this protective covering the circular gun emplacement would be spotted by enemy observers.



Anti-aircraft gun mounted on circular steel platform would easily be spotted from the air but for the camouflage net covering it

A grand piano weighing 555 pounds hangs on a wire only sixty-three thousandths of an inch in diameter, demonstrating the strength of steel to visitors at the U. S. Steel company exhibit at the Golden Gate fair.

Brooklyn

Acme

at work at night
Miss Phyllis Van Deran

2-4-30

Giant Robot Walks, Talks and Tells Colors

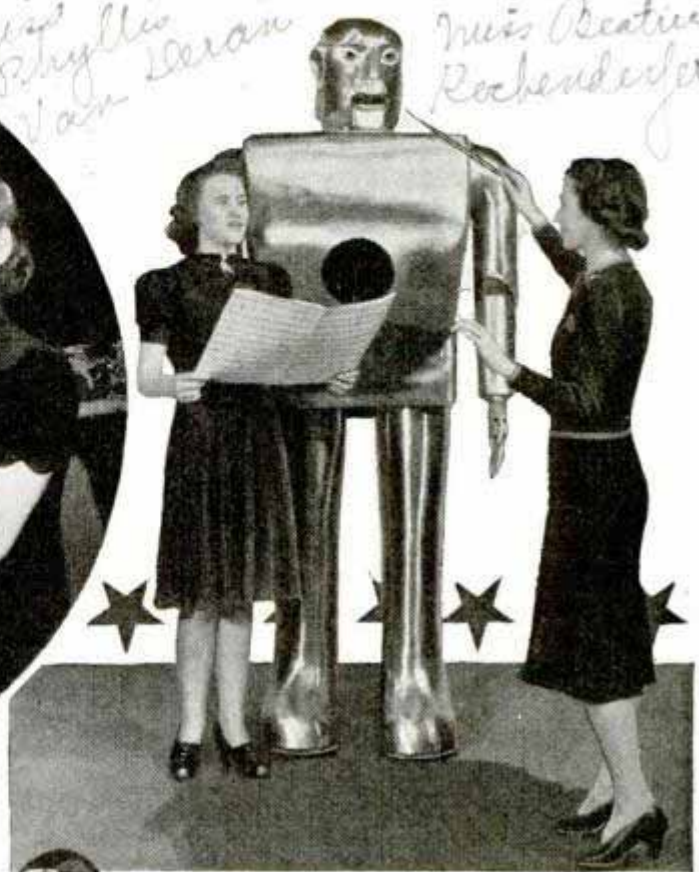

This is "Elektro," the seven-foot robot built by Westinghouse. Motors, relays and other mechanism enable him to perform thirty-six tricks

Top, left, showing some of the electrical cords used to control the moto-man. Right, the robot sings through his sound mechanism, his mouth waggling open and shut. The robot is made of 900 parts, the frame is steel and the covering is aluminum. His tricks include walking, talking, distinguishing colors, smoking and bowing

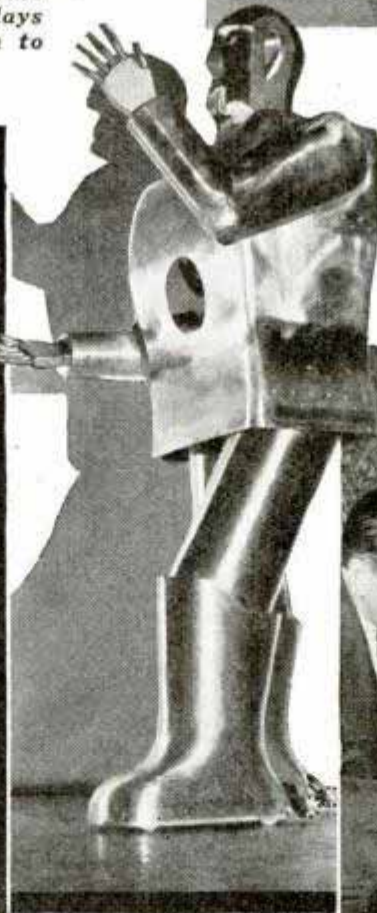
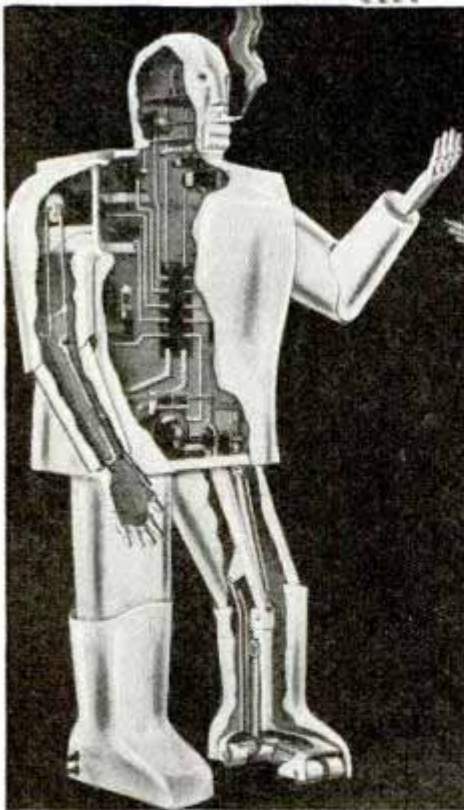

Above, showing mechanism which enables the moto-man to do his tricks. Center, the giant walking. Right, oiling the joints. The robot's brain lobes consist of forty-eight electrical relays, his spinal column is made of wire—enough of it is wound on coils to encircle the world at the equator

Westinghouse Electric & Mfg. Co.

Emb. James McQueen, 43, W. 60th Terrace,
Q 320
Kansas City,
Mo.

THRILL MAKERS

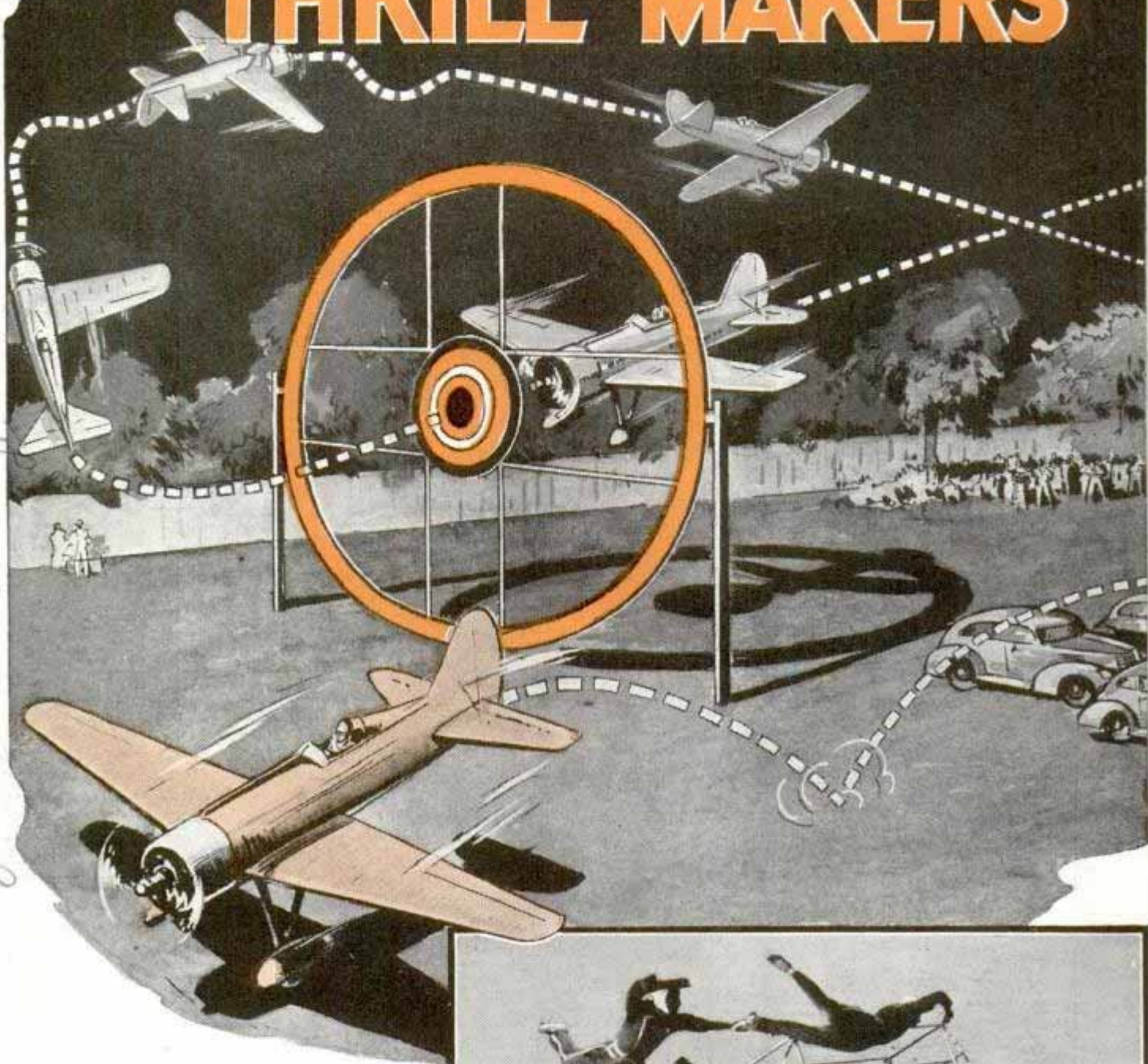

SWOOPING low across the field, the plane heads straight for the roof of a barn. Spectators grow tense as the pilot, instead of bailing out, ducks his head and sends the ship plowing into the shingles with a splintering crash.

Instantly, flames shoot from the demolished structure. Firemen hurry to the spot to extricate the pilot from the flames, if by good luck he has managed to outwit death in the crash.

But out of the debris a moment later he comes with only a few scratches on his face, and perhaps



Three daredevils perform acrobatic stunts on this odd contraption while a fourth cycles around the narrow track so fast the wheels spin in air

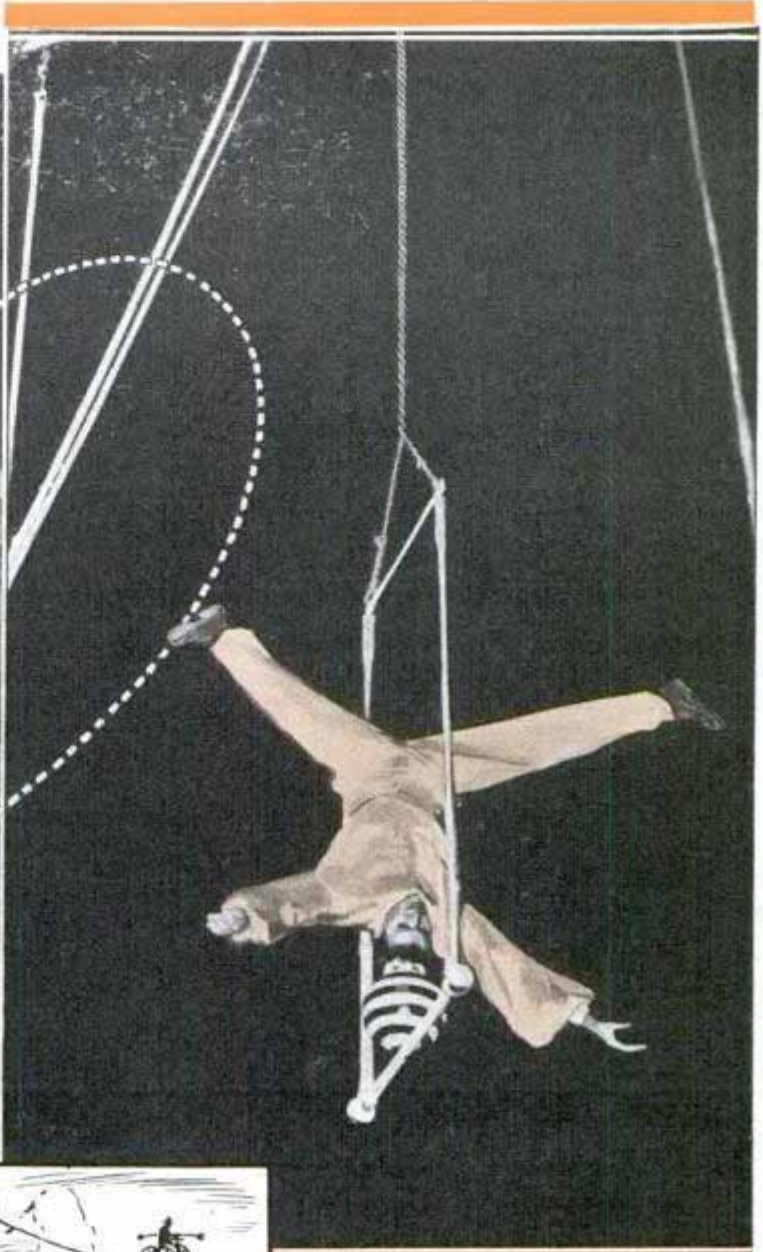
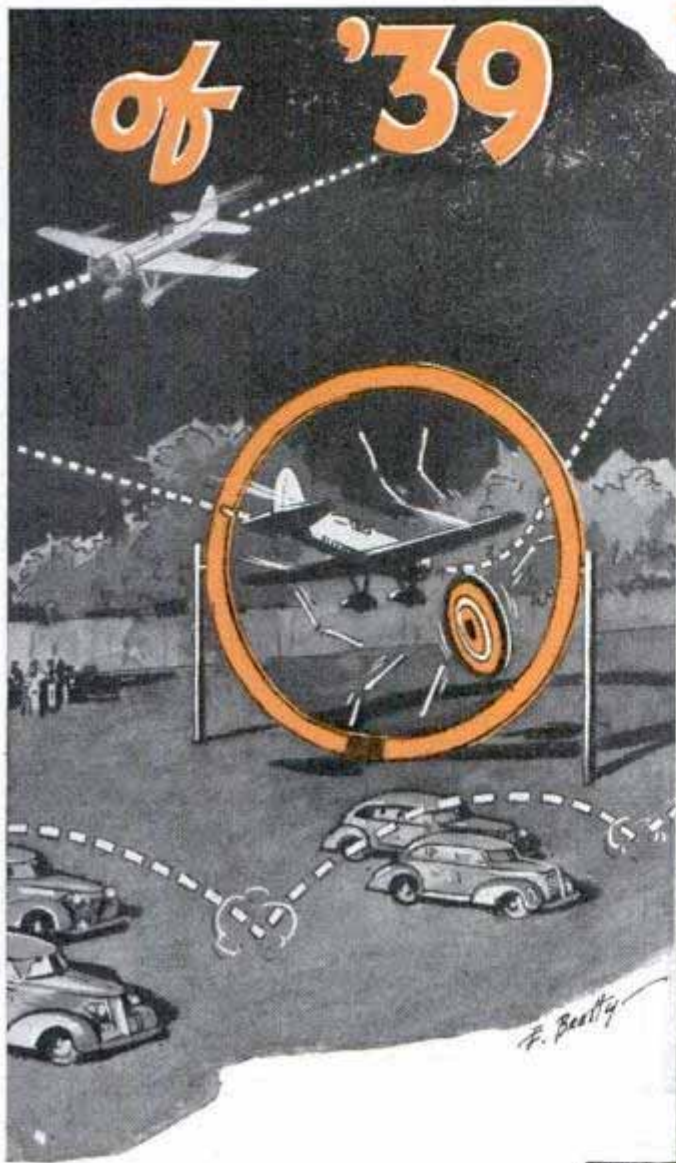

a strawberry on his elbow. Without so much as a sigh over the tangled wreckage, the flier hurries home to his family without a care in the world—or at least, not for a week or so when he will again attempt to roll an old crate into a ball. He's Captain F. F. Frakes, and this happens to be his business.

Plane crashing is not an easy way of making one's living, but neither is driving a motorcar through a brick wall, doing a backward somersault from a 110-foot ladder into a shallow tank rimmed with fire, motorcycling through a glass showcase, and a few more spine-tingling performances of the current crop of daredevils.

It's big business, this thrill-making. At 2,500 outdoor fairs and celebrations this



Across these pages and on the cover you see Dick Granere at his pulse-stopping feat of flying through two bull's-eyes and playing leapfrog over parked automobiles. At upper right, Millette holds spotlight with a balancing act on a spinning trapeze. Below, crossing Niagara on a wire—a thriller of a generation ago

summer and fall the top-liners will display the ultimate in daring for approximately 50,000,000 persons—all morbidly expecting "something to happen," which, comparatively speaking, rarely does.

Air records, fast dropping elevators, and our new sports where the accent is on speed and excitement have so jaded the modern thrill-seeker's taste that daredevils almost have to

destroy themselves to win favor. Aside from the performances of Blondin, Lincoln Beachey, and a few others, the so-called death-defying feats of the past would rate no more than a collective yawn today.



ever, and auto poloists, human flies, high-wire walkers, and divers moved into the spotlight. Lately there's been a swing back to the air and motor thrills of the shock type.

There's been a sharp increase in the number of fatalities and accidents—convincing proof the crash artists and performers are taking bigger chances than ever before. Although a defective supporting wire or a broken swivel on a trapeze causes an occasional obit-

uary in the press, the bulk of them, according to Sam J. Levy, veteran thrill merchant, are traceable to carelessness.

"A performer," explains the showman, "who does a stunt several times a day for weeks at a time occasionally loses sight of the dangers involved and becomes haphazard in taking precautions. For example, a motorcyclist traveling sixty-five miles an hour who has his mind on his income tax instead of the business at hand is likely to hit the glass wall at an angle instead of straight-on and be fatally cut.

A pioneer of thrill-making, Blondin stretched a rope across the 1,100-foot chasm below Niagara Falls and then walked across it, carrying a man on his shoulders. To top this, he later crossed the rope on stilts.

Subsequently when Beachey flew over Niagara and beneath the arches of the upper steel bridge, and later performed virtually every "impossible" air stunt, he set styles in thrill-making that survived him. The loop-the-loop artists and wing walkers began to pall on the public, how-

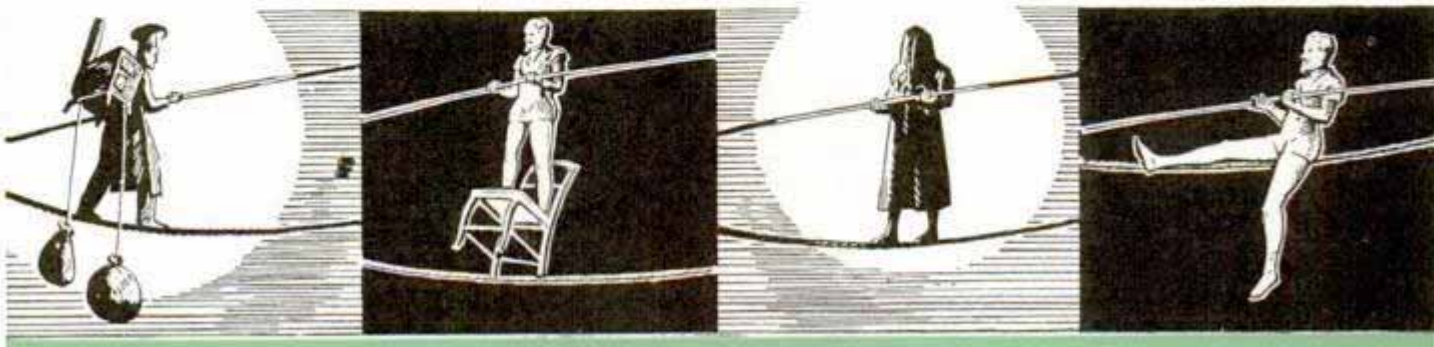

At top, left, May Merkel does her fly-walk on the ceiling, with only her suction shoes to save her from a headlong plunge. Bottom, some of the tightrope feats that amazed the crowds of bygone years

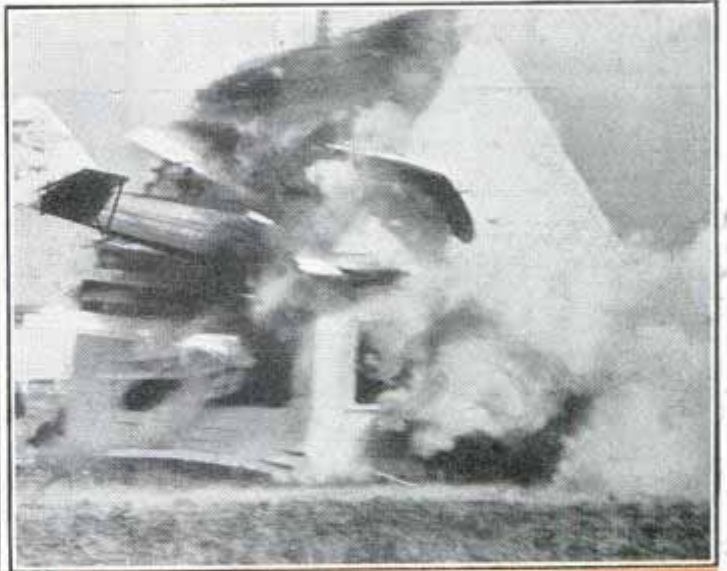
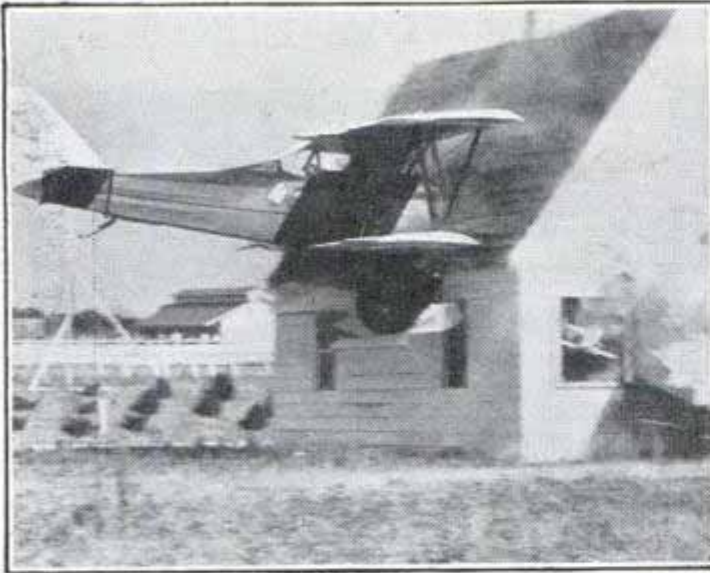

Likewise, the high diver who doesn't concentrate on knifing the water in the tank properly may be disabled permanently, if not killed outright."

Identified with aviation since the early twenties as a barnstormer and instructor, Captain Frakes saw a bonanza in cracking up old planes. He quit his job as test pilot, worked out the details of the stunt, and then sought the ear of a fair official. Upon hearing the pilot out, the official became dubious, not of the stunt's drawing power—any showman knew it would pack 'em in—but of the flier's sanity. A trial was given him, however, and Captain Frakes scored a bull's-eye. He's been at it ever since, crashing into barns, the sides of mountains, into lakes and straight on the ground—more than fifty crack-ups in all, and all for gold.

An extra dramatic punch has been added to his more recent performances, that of firing the structure the moment the plane strikes it. In this way, the crowd's excitement is enhanced by the danger of his burning alive if he isn't already smashed to death. The despair of government air officials, the daredevil uses no special protective equipment other than a crash helmet, a safety belt, and the

(Continued to page 143A)

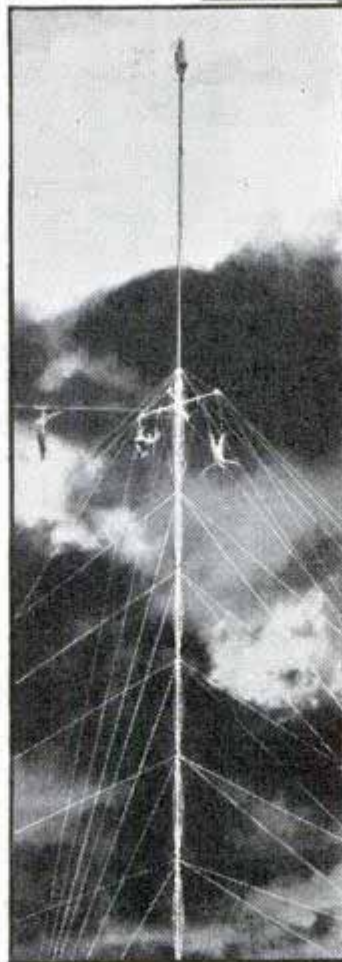
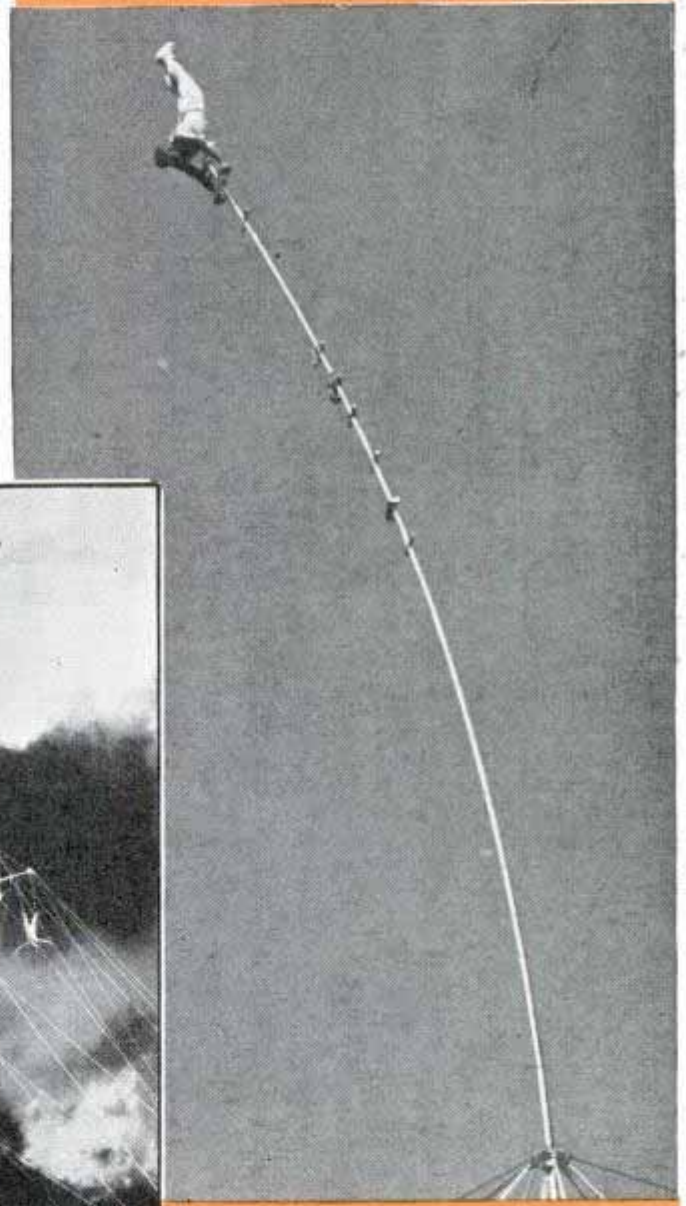

In three split-second pictures at top you see Captain Frakes crash his plane into a barn. As it bursts aflame he walks out, with maybe a little bruise. Below, A. Selden, the "stratosphere man," stunts on high trapeze, then climbs to top of the 130-foot pole to hand-balance while he sways dizzily in a twenty-five-foot arc

101 Hanelwood Ave
San Francisco, Calif

Rodeo Model Has Life-Like Moving Figures

Designed and built by: A. O. Wyndyfe
67 Alameda Street, San Francisco, Calif
A. O. Studios

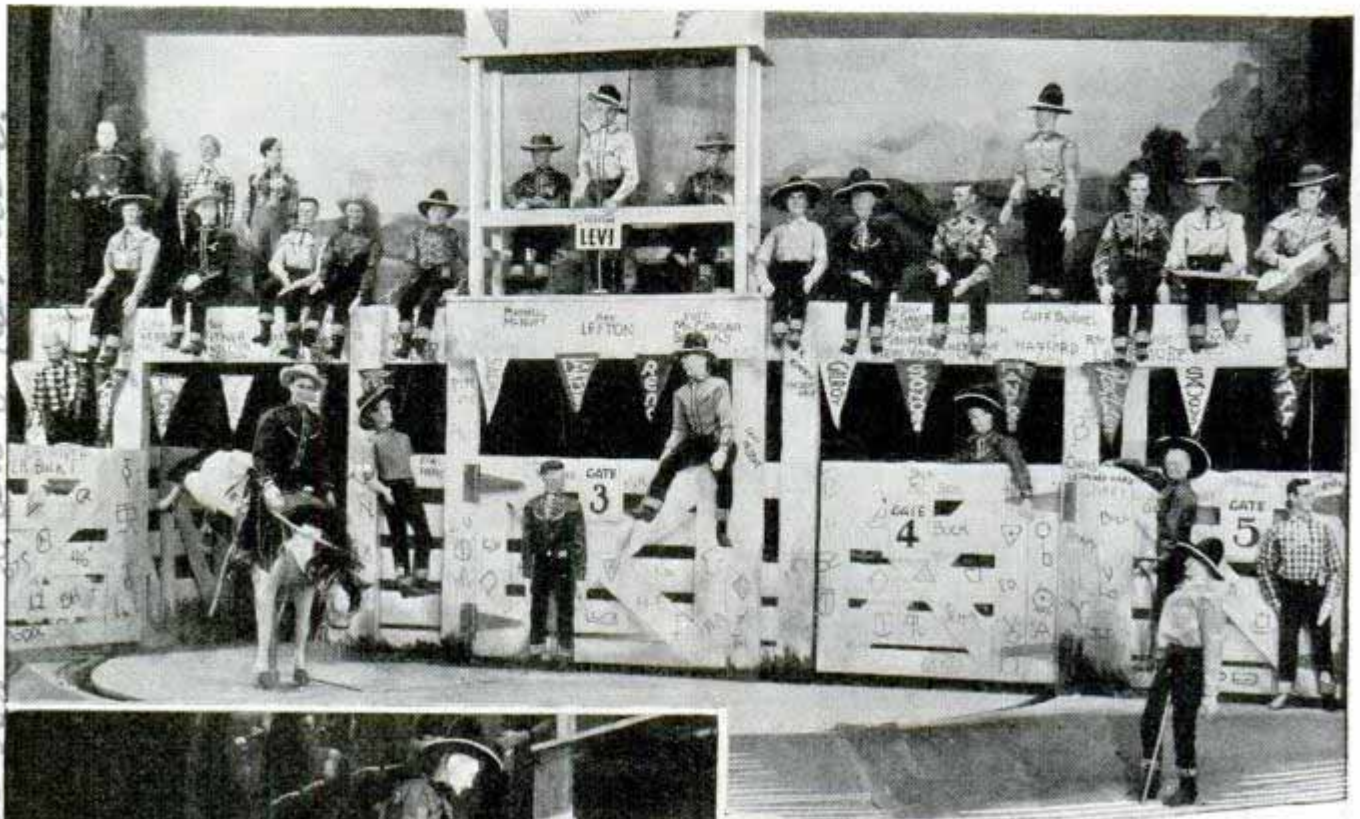

One of the largest of its kind, a model of a western rodeo scene is complete to realistic bucking horse, gaily dressed cowboys who sit on a fence waving to the crowd, a clown, a band and an announcer. The model is synchronized with a sound reproducing system that furnishes music and voices for the figures

Top, general view of the model, with bucking horse just entering arena. Center, stage in construction of horse, just after wooden legs and head were assembled



Circle, heads of cowboy figures were carved from photos of prize-winning riders. Left, intricate mechanism that animates the cowboy models makes each wave the right arm when each is introduced by name by the announcer. Action of the model is controlled by six motors and thirty-two solenoids



Two-Story Transocean Plane Has Six Engines

Six motors of 1,500 horsepower each will power the vast flying boat the French war ministry has ordered built for the transatlantic service of Air France. Its cabin will be a two-story structure with the first floor lounge and drawing room so designed that it can be converted into separate passenger cabins at night. Upstairs are the piloting and navigation posts, a room for the crew, two cabins for passengers, two drawing rooms and a kitchen. The ship will have a maximum speed of about 150 miles an hour and fuel capacity to cruise 3,750 miles nonstop. It will be 133 feet long and thirty feet high, with 173-foot wing span, and will weigh seventy-five tons.

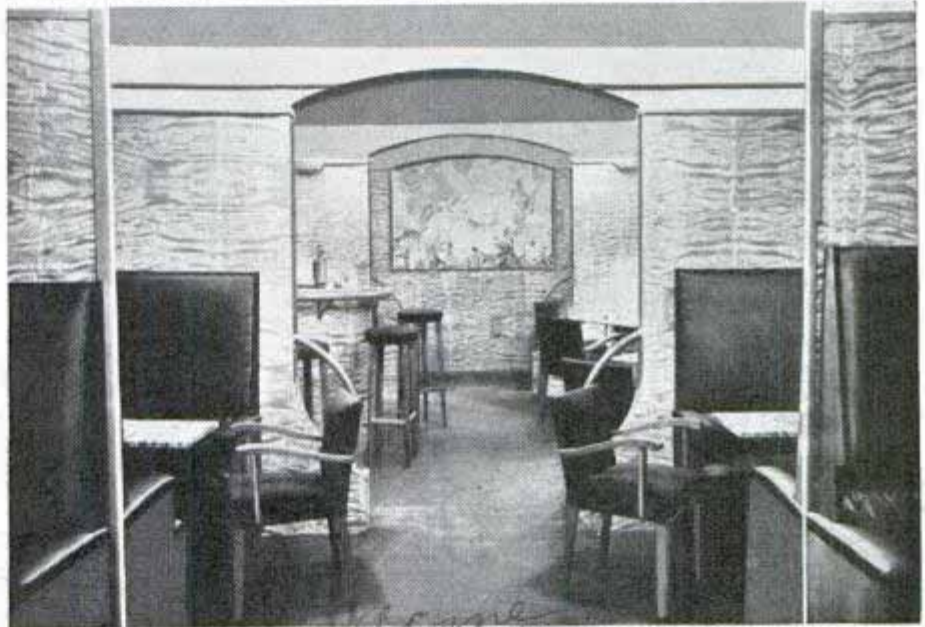

Top, drawing of six-engine transatlantic plane. Below, a view of lounge, convertible into separate cabins

Maritime News 460 w 54 St New York

Merry-Go-Round Boat Trains School's Rowing Crew



Seated at the rim of a huge wheel-shaped boat pivoted at the center, oarsmen row in circles to develop speed and endurance for races

Members of the rowing crew at a North Carolina school for boys practice for races on what they call a coffee grinder because of its circular motion. Necessity for the machine was the shortness of the lake available for their oarsmen. Now the boys can develop top speed and endurance, going around and around on long runs without grounding their craft upon the shore. The training machine was designed by a member of the school's faculty.

J-461
 Mrs. Jean A. G. Lolley, Box 60 2

355
26

H. W. ...
Stand Road, Ramsey
N.J.

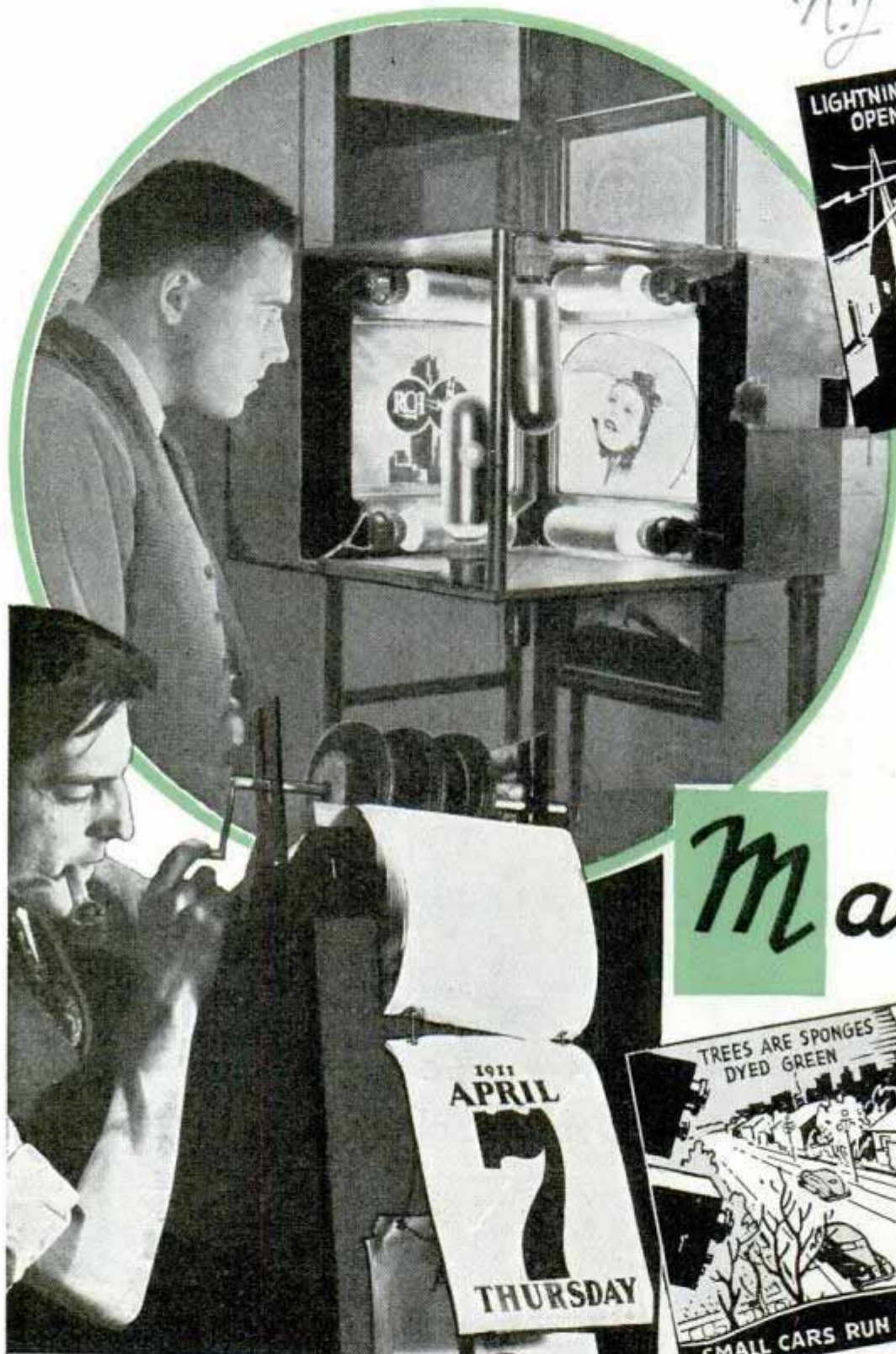

Creating dramatic effects for the television camera is beginning to occupy the attention of artists, particularly those with a flair for producing the desired results with miniature figures and objects. The sight-effects man is going to play an important role in television

Making



Top, circle, television titling machine invented by William Eddy of National Broadcasting company makes one title dissolve into another. Below, turning the handle rolls the calendar leaves, indicating the passing of time in television scenes

Sketches on this page, and the next, show how realistic scenes are created for television. Model villages with one-half candlepower lights, midget autos controlled by cable, dyed-sponge trees and shrubs and carefully constructed buildings are employed effectively. Lightning flashes are obtained for the village by opening and closing an electric switch



TELEVISION "Props"

Above, performing spiders, made of cork, felt and a few beads, appear before the television camera. Animation is provided by a motor turning wires inside the hollow members of the spider web. Bottom, left, model sailing ship gets its breeze from electric fan hidden from camera's eye. Entire fleets of model boats are used to produce naval maneuvers for television. Some realistic airplane scenes have been created by combining aerial movies and bomb bursts formed of cotton. Model airplanes are useful to the sight-effects man

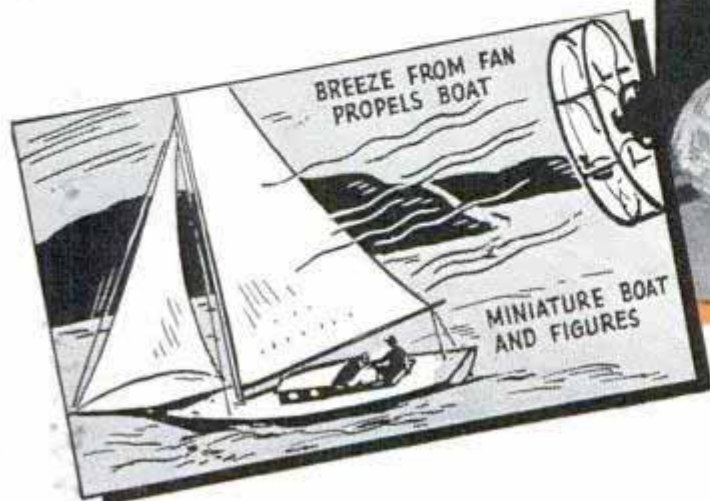
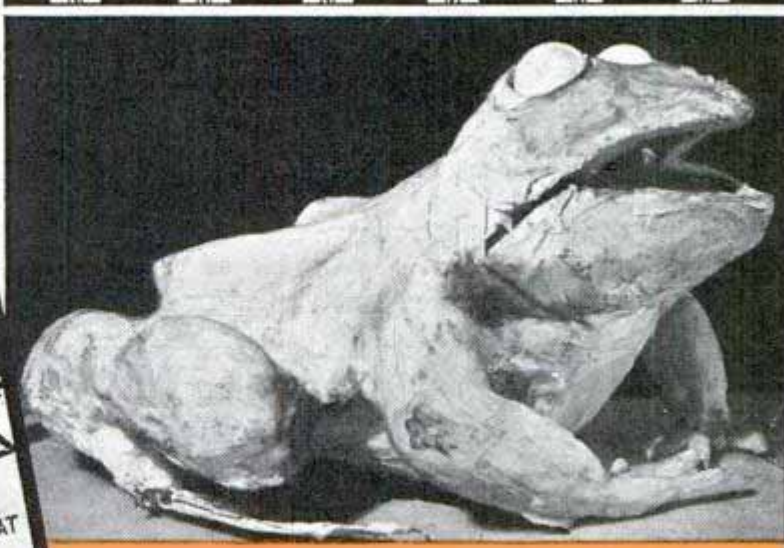

Center, illustrating how candle is dimmed, then extinguished to dramatize the passing of life. Below, animated frog is made to perform by flexible shaft. A rubber bag pulsated by compressed air simulates breathing. Cables move the ping-pong-ball eyes

Worcester, Mass

Wain

24 28

Loud Speakers in Clouds Talk to People Below



Demonstration given at Redbrooke Kent, England

Mr. Col. V. Bromley, 6401 Waring, Hollywood, Calif

Acme © Planet News, Ltd. Loud speakers carried into the clouds by captive balloon send voice over wide area to people below

Talking to the populace from the sky has been tried out in England by the Royal Air Force. Dangling on the end of a cable suspended from a captive balloon, a nest of loud speakers spreads the sound over a wide area.

W. J. Ballou Centre

Cost of Farm Electrification Cut Sixty Per Cent in a Decade

New types of electric wires, a vibration-proof tie between line and pole, and wider spacing between poles have combined to reduce the cost of bringing electricity to American farms by sixty per cent in the

Jennie Service 4/17 39

last decade. Formerly it cost \$1,200 to \$1,500 a mile to erect a distribution system. Now it costs \$500. Less expensive wire is being made of high-tensile galvanized steel and copper, or galvanized steel alone. The new tie at the pole reduces wire breakage from vibration and makes it possible to space the poles 1,000 feet apart as compared with 250 feet some years ago.

Double-Jointed Tobacco Pipe Folds to Fit in Pocket

Hinges built into a pipe stem at two places enable it to be folded around the bowl, reducing its size so the pipe will fit snugly in any small pocket. The danger of stem breakage is minimized by folding and the joints will not leak when straightened.



Dr. J. J. U. P. O. S. P. 6401 Wain

"Pass" Sign Flashed by Driver Makes Motoring Safer

Motorists who want to give the right of way to other vehicles can do so in a definite way by equipping their cars with a signal that illuminates the word "pass" when the switch button is pressed. Mounted at both front and rear, the light gives a distinct sign of the driver's intention and is said to be an added safety factor for pedestrians as well as other cars. Trucks can use the sign to signal trailing automobiles when it is safe to pass.

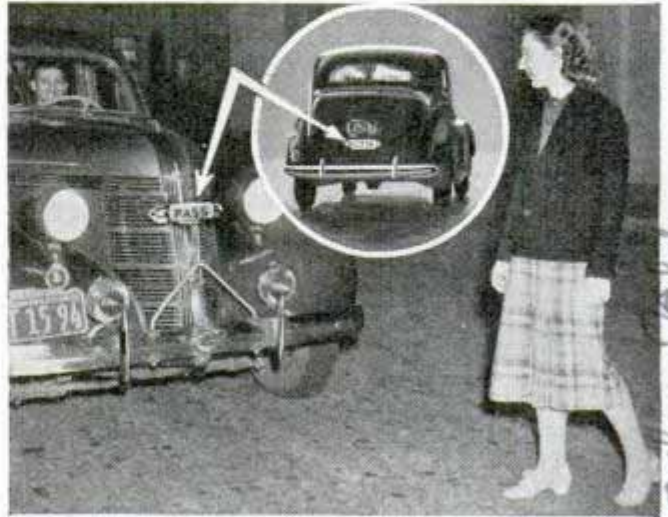

Driver flips switch to light up "pass" signal indicated by arrows at front and rear of automobile

Joe LaSerna, 1134

Angela, Cal

4177 93 Long Acre, London, W. 11
England.

LOGGING

Goes **MODERN**

Willamette Arch.

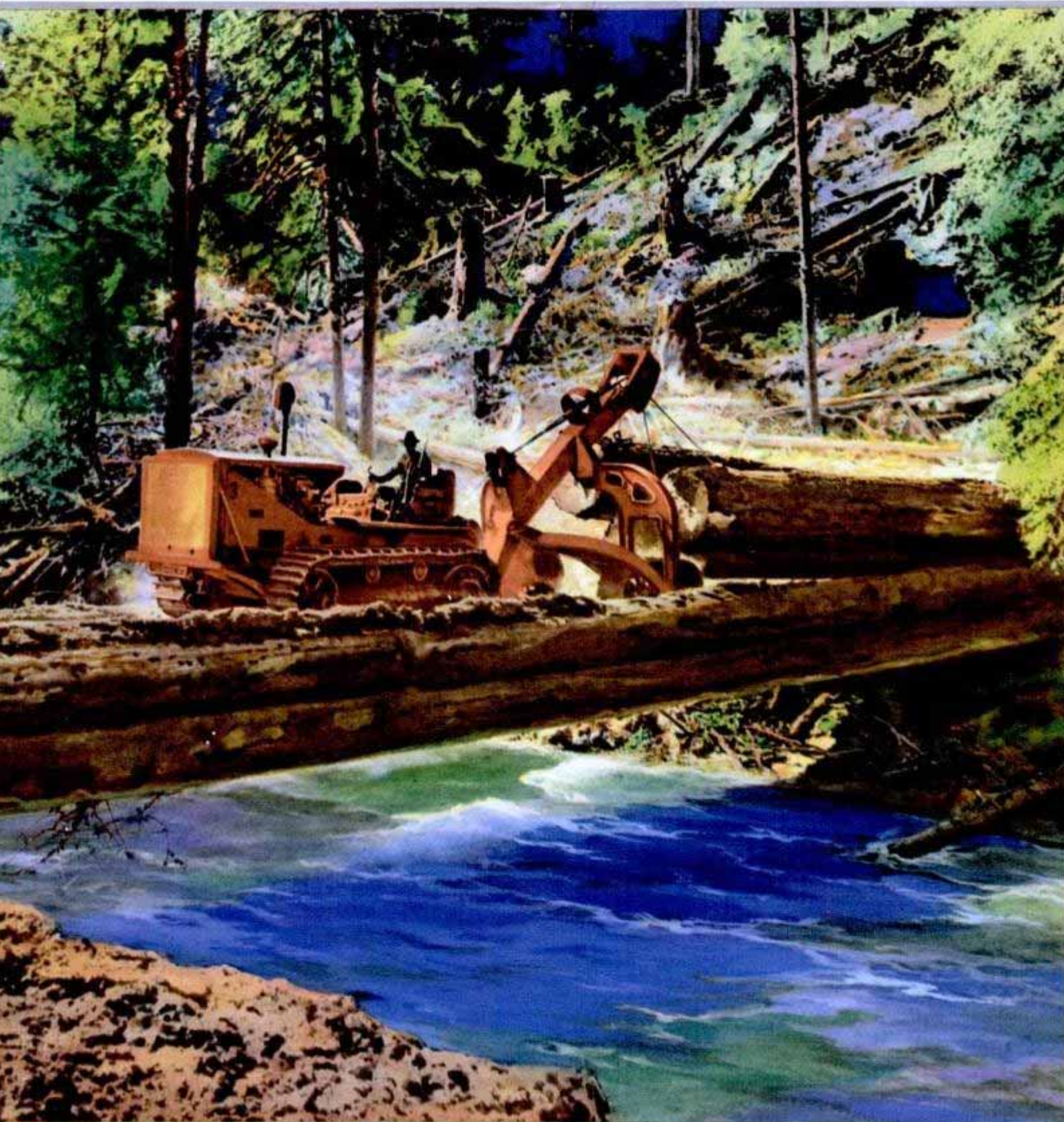

*Reference: James Stevens, West Coast
Lumbermen's Assn. Stuart Bldg.
Seattle
Wash.*

THREE giant logs in tow, a Caterpillar Diesel tractor crosses a timber trail bridge over a mountain stream on its way to an Oregon lumber camp. Notice how cables are slung to hoist "noses" of logs above ground.



Camp #10, Hyster Cruiser

141490
THERE is a new breed of lumberjacks in the northwest today. They still wear heavy mackinaws and calked boots but their resemblance to earlier woodsmen stops right there. Brute force has lost out to engineering skill and modern lumberjacks do much of their work at the switches of electric motors and at the throttles of heavy gasoline and steam engines.

Old methods of logging are almost worthless in the forests of Oregon and Washington because one great tree alone often contains more wood than an entire acre of eastern timber.

In the northwest trees are so tall that "it takes two men and a boy even to look up to the top of a big fir." Trees measure ten and twelve feet across the stump and are 200 feet high. There is frequently enough lumber in a single acre of forest to build all the houses in a full city block. The great commercial redwood trees of northern

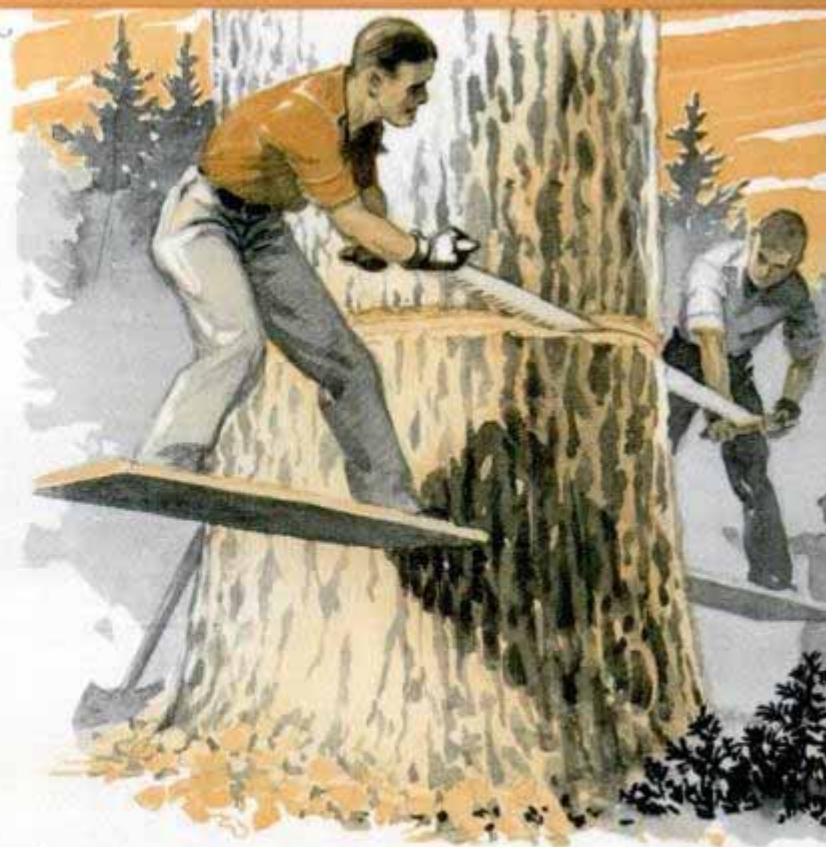

MODERN tractors handle tremendous pine and fir logs with ease, but there's still work for the lumberjack's muscle in felling and cutting the logs with ax and saw.

Inc. Thomas E. Swinson, Jr.
 10555 Holyoke Ave.
 Los Angeles, Calif.



Comax Lake

DUMPING logs from trail to lake, above. Below, jets wash dirt from log as it approaches sawmill so that saws will not be dulled by grit and mud.

Haulup

7-1490

California are largest of all though the western cedar, spruce, hemlock, and fir are close rivals. One tree may contain more than \$1,000 worth of lumber at retail prices. Some of them scale above 50,000 board feet.

Logging trees like these would have taxed the ability of Paul Bunyan, the mythical giant of the north woods. But college-trained lumberjacks, using up-to-date methods and equipment, have turned such a feat into simple routine. Far up in the woods at some isolated lumber camp you can watch a great log almost as big as a boxcar come charging through the air across the canyon from the opposite hill, supported by an aerial tight-line system of steel cables. From another direction a giant tractor chugs into view, dragging behind it the raised end of another big log. Overhead, a great wooden boom swings over, drops steel tongs around a log and lifts it as easily as a matchstick onto a waiting flat-car bound for the mill.



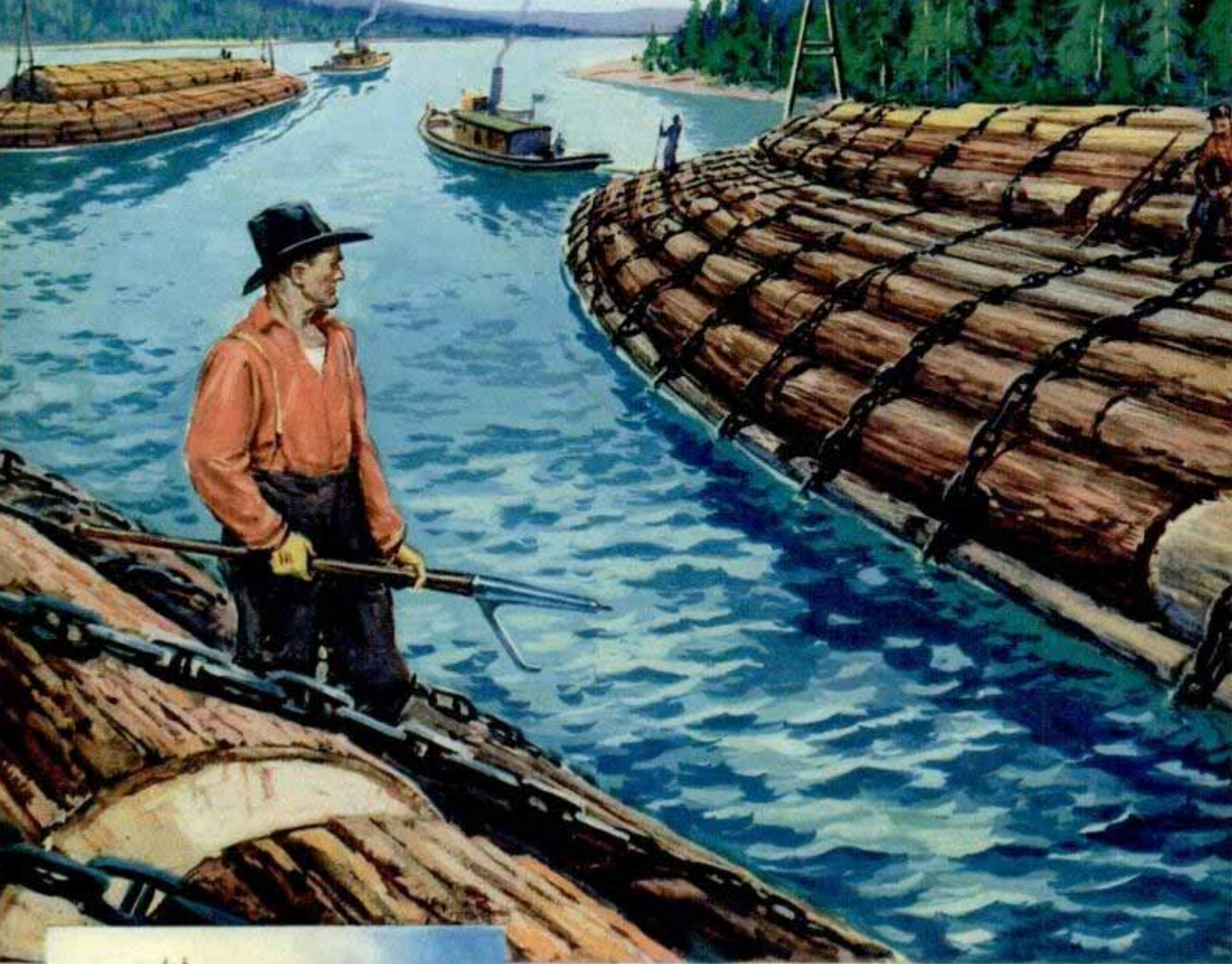

DOWN to the open sea, tiny tugs pull colossal rafts of logs chained in a solid mass to avoid losses in rough water. Left, a dangerous moment for the "high rigger" clinging to his perch 200 feet up.

Cutting a tree down is one of the few things still done by hand in the woods. Two choppers working together plan the layout, clearing a path away from the tree in a direction where its fall will do the least damage to other trees and where it can be handled easily by cables or tractor after it has been bucked up into shorter lengths. Redwoods are more brittle than other species and in redwood logging a bed of limbs and small logs is laid across the path to break the fall of the giant.

It takes much more than sheer muscle to cut down a tree, and part of the choppers' art is to make it fall exactly where planned. First part of the job is to chop a deep notch in the trunk on the side toward which the tree is to fall. Spirit levels are used to keep this undercut even. One of the choppers sights along "gun sticks," two long rods hinged together with the two ends placed in the notch of the trunk, to make sure that the notch faces in exactly the right direction.



12 1490
 Then with a long twelve-foot falling saw the two men start cutting through the tree from the opposite side, driving in steel wedges behind the saw to pry the tree off balance and make it fall in the direction of the notch.

A falling tree is a stirring spectacle. As it first starts to lean the choppers shout the warning "Timber!" and then dodge clear of the base. The crackling sound of the tree breaking through the last few inches of the cut changes to a mighty swish and roar as it gathers momentum, and it crashes to the ground with a reverberating thud. Choppers usually can drop a tree to within a foot or so of the direction planned. Working in big timber, two men may be able to cut only one and a half trees a day. Then comes the work of chopping off the limbs and "bucking" the trunk into logs from twenty-four to forty feet long.

The most spectacular job in the woods is that of the high climber, the lumberman steeplejack who performs the most hazardous task of all. At the yarding point, before any logging is done, a tall tree is selected as a spar to which the high-lead cables and the load-



*careful
 reactor*

*Le Tourneau Hyster
 Arch*

BULLDOZER at top shoves a big one into river close to sawmill camp. Below, riding herd on logs in fast water is risky business. One mistake may mean crushed limbs or drowning.

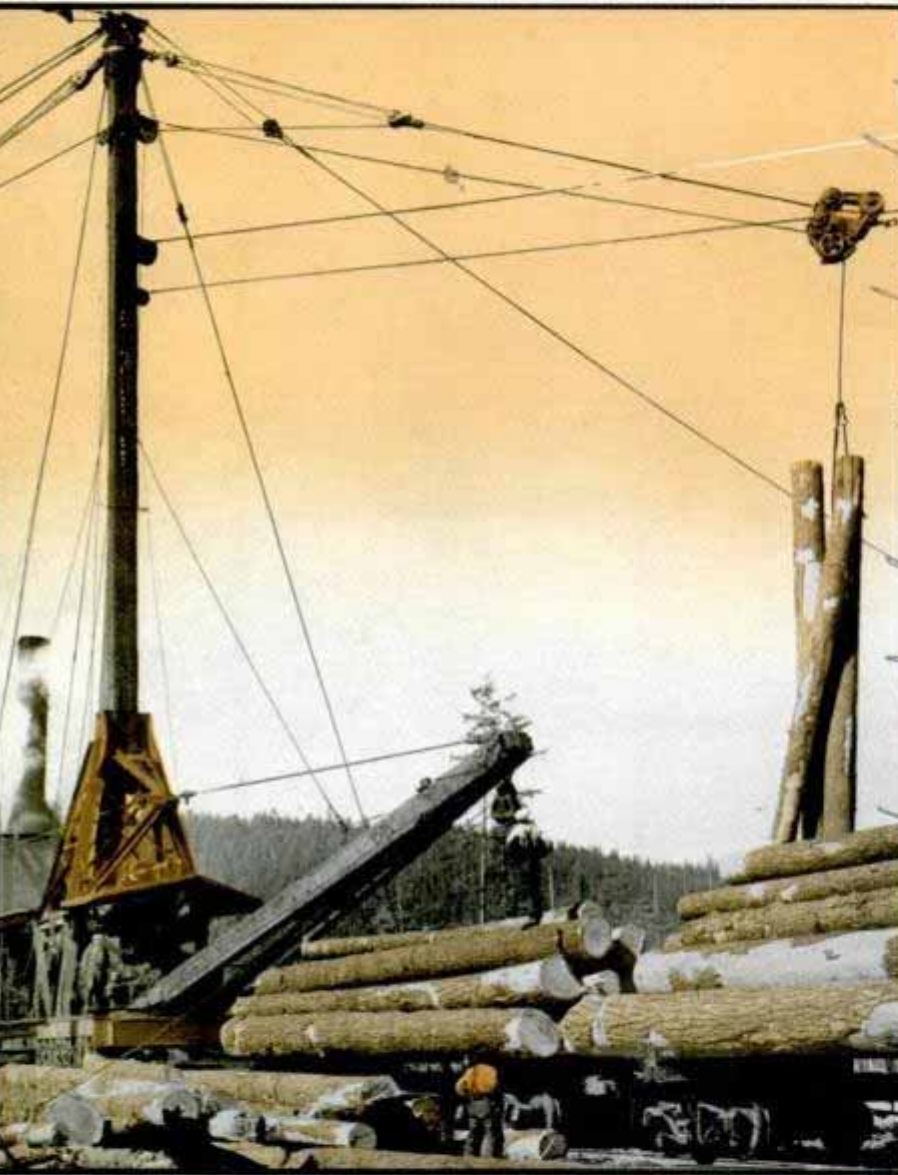
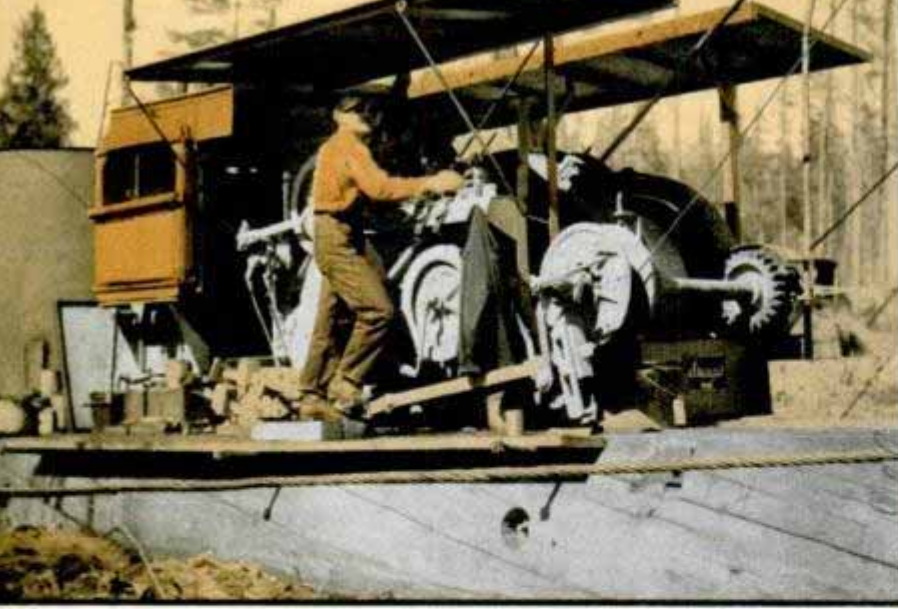

ing boom may be attached. With sharp steel spurs strapped to his legs and with an ax, saw and safety belt strapped to his waist, the high climber starts up the tree, trimming off the limbs as he ascends. At 150 feet or more above the ground, possibly seventy-five feet below the top, he leans out against the pull of his safety belt and saws through the tree. This is a ticklish job and he can take a bad beating high in the air. As the top of the tree begins to fall free it kicks back and the upper part of the trunk jerks back and forth in blurring arcs. Meanwhile the high climber has dropped his tools and is clinging to the trunk for dear life. Later the spar tree is guyed all around with steel cables running to buried deadmen and a one-ton steel block for carrying the high-lead cables is fastened to the top. A steam engine, Diesel, or even a big electric motor at the base of the spar turns the big drums that carry the cables for dragging the logs out of the woods to the loading point.

These days a group of lumberjacks can cut, load, and move a million board feet of timber to the sawmill pond in a day's time. The men live in comfortable headquarters camps on the private logging railway line and are

DIESEL "yarder," top, handles trees like toys. Center, 100-foot steel spar helps load big sticks aboard a train. Bottom, thirty-eight sled train of logs weighing 1,102 tons is hauled fifteen miles on iced road by tractor, which makes two trips a day with this tremendous load.

shaghit Iron works. Bedouin

Ridgewood and loader



Calderhill
SKIDDING tall timber to the railroad, top. Right, cross-section diagram of average Douglas fir or western hemlock; common lumber comes from heart of log, best grades of structural and clear lumber from outer areas. Bottom, a six-foot log on sawmill carriage.

1490
 carried to and from their work in large speeders. In many cases every building in the camp is mounted on wheels and is sidetracked from the working rails. After a few months or a year in one location the whole camp is moved to a new stand of timber. Bunkhouse cars, cookhouse car, dining cars, office car and recreation cars are dragged to the new location as soon as the track is laid.

For some time conservationists have been wondering how much longer our forests will last, predicting that the time would come when the last stand of timber would be cut down and one of America's great natural resources would vanish. But now the chances are that such a day will never appear. For one thing, substitute building materials have eased off the demand for wood.

At the present rate of around seven billion feet per year of cut timber, it is estimated that the forests of the northwest will last for another seventy or eighty

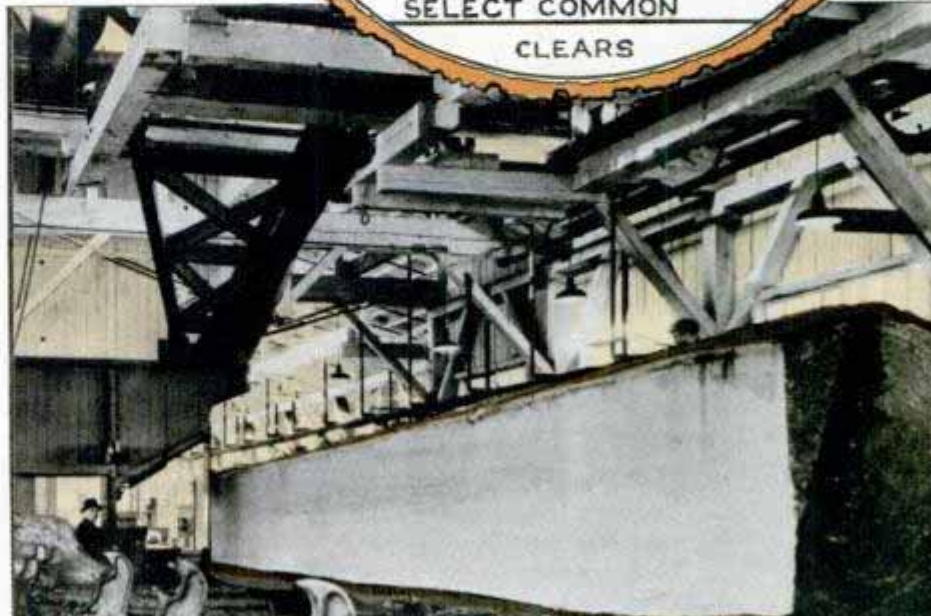
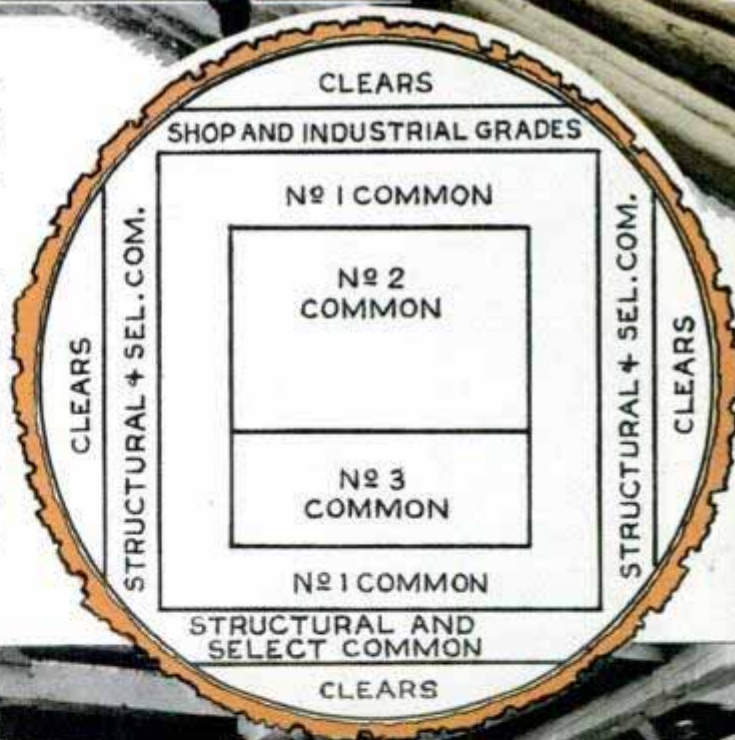

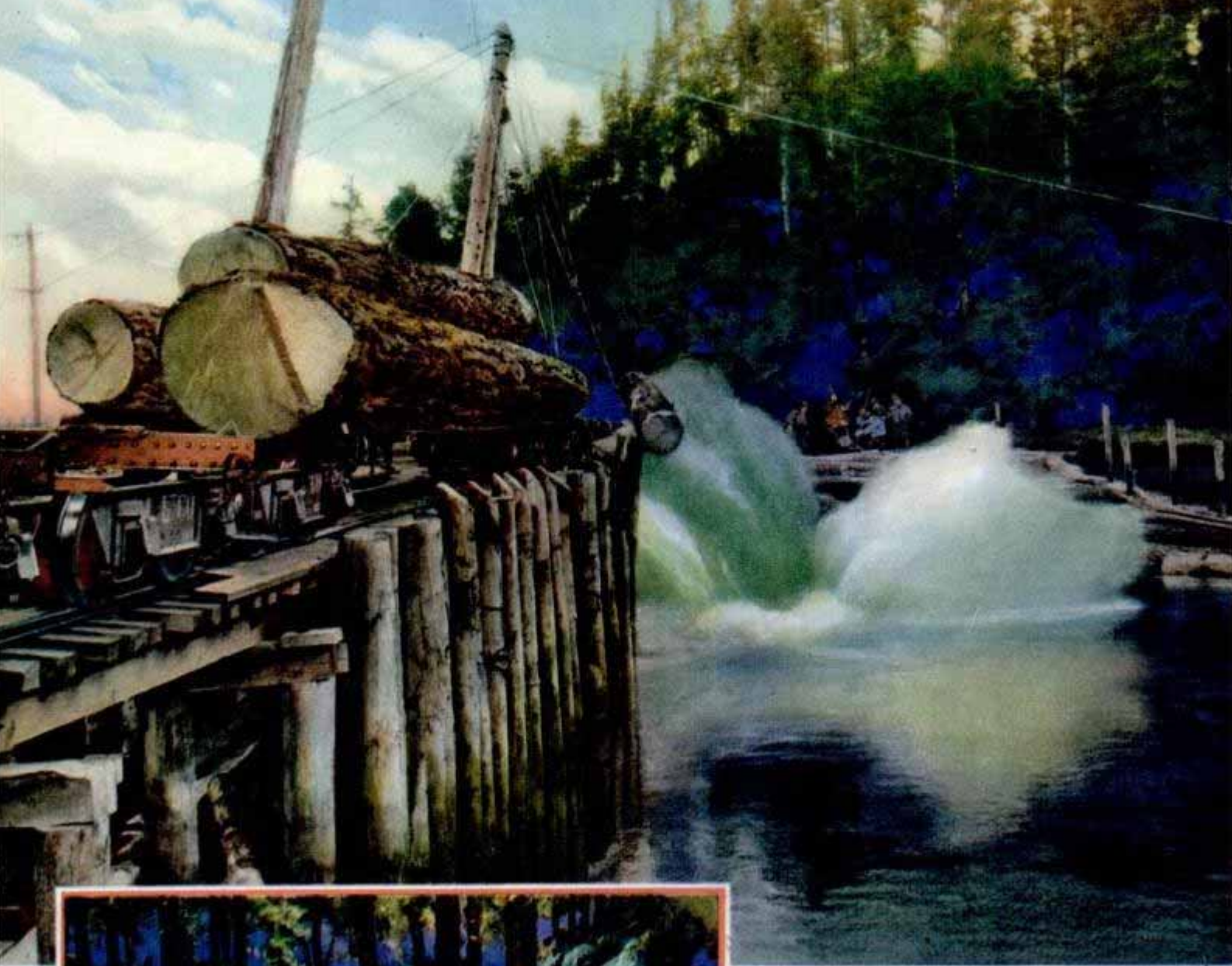

FROM the forest to your front porch, trees travel by rail, on trucks and sleds, on the tow trail, in log booms on quiet water, by flume and in chain rafts. Top, dumping logs in a pond at rail-end. Below, a tractor drags a log down a forest stream.

years, without considering replacement or new growth. There is enough Douglas fir alone to provide homes for 50,000,000 families. At present timber is still being cut faster than it is being replaced by new growth, but in spite of this woodsmen think that the country will never run out of wood. This is because of the increasing amount of forest management and conservation that is being practiced. The federal government, state governments, and such organizations as the West Coast Lumbermen's Association are fostering programs destined to replace the forests and provide a permanent lumber supply.

New forests are growing in the northwest at the rate of almost three billion board feet annually and this rate of growth is expected to continue for many years to come. (Continued on page 128A)

0841/41

Vast Projectors Paint Scenes in 'Hall of Color'



Top, the vast screen in Eastman's "Hall of Color." Right, one of the "drum" gears on each of which ninety-six color slides are bolted. The gear is forty-five inches in diameter and carries 1,440 teeth

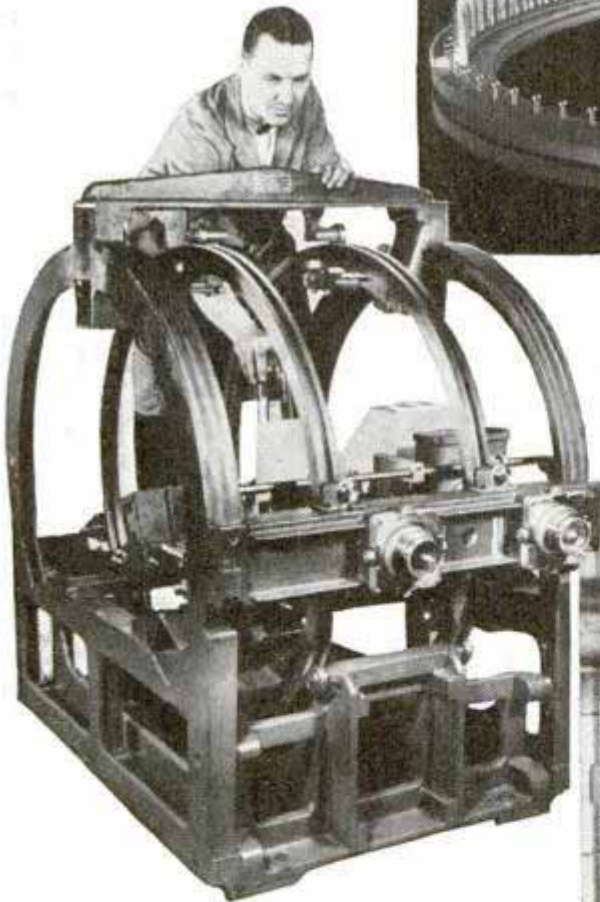

Left, installing one of two 2,500-watt lamps in twin-lens projector. Each of eleven projectors weighs 2,700 pounds. Water cells and near-freezing air blast are used for cooling. Below, the ingenious device which keeps film image centered in lens and rock-steady on screen even if slide is out of position; small plate of optical glass spins as film drum turns, refraction through glass centering the image. The natural-color transparencies used were made with cameras similar to your own

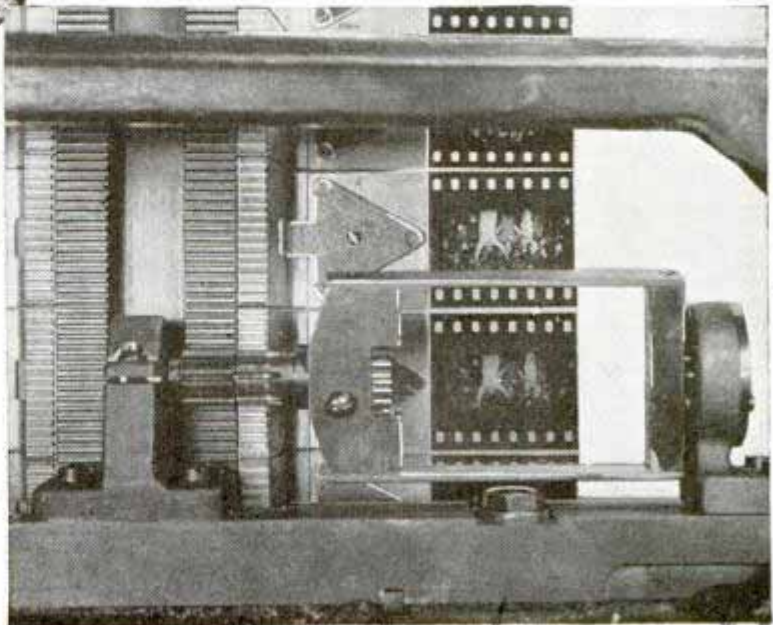

Mural paintings in colors that seem to surpass nature in vivid beauty flash from tiny Kodachrome slides in giant twin-eyed projectors to an enormous screen 187 feet long on the semi-circular wall of Eastman Kodak company's New York fair exhibit. Each one-inch frame appears seventeen feet wide, magnified 50,000 times in area. Sound and music accompany the pictures, changing constantly for twelve hours daily

Eastman Kodak Co., Rochester, N.Y.

Cosmic Ray Trap Sets Alight New York Fair

Forty-year-old rays from the star Arcturus helped inaugurate Chicago's Century of Progress Exposition by turning on its lights on the opening night in 1933. New York world's fair officials assigned that honor to cosmic rays for their 1939 show. To put the cosmic rays to work, they are collected in a Geiger counter machine which attracts and records the passage of the rays. They set molecules in motion in the gas-filled tubes; these molecules exert a force on electrons which build up enough energy to actuate a vacuum tube that turns on the electrical mechanism to light the fair grounds.

Cosmic rays captured in Geiger trap activate molecules in gas-filled tubes and build up electron energy which is used to turn on lights at fair

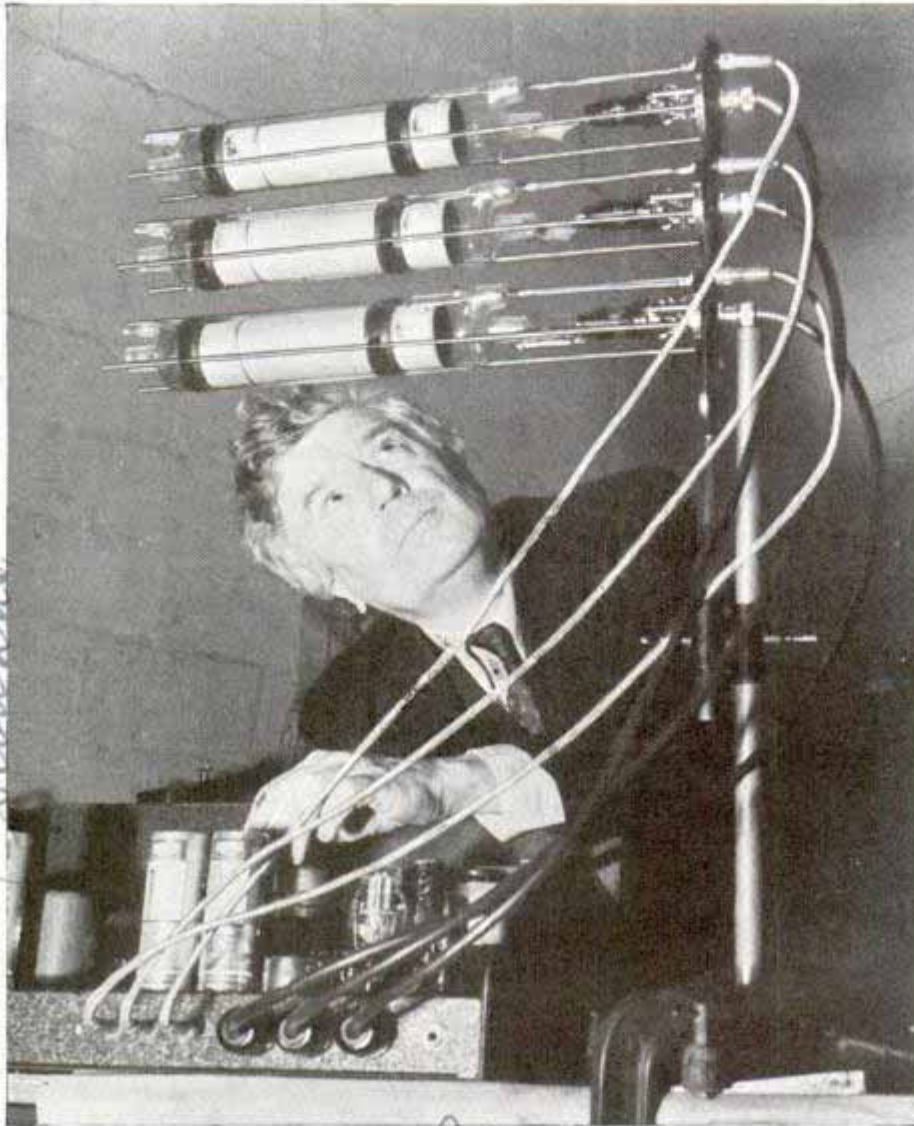

general Motors. Portiers. deluxa 6 / Quiet by Dr. W. F. L. Swanlin

9500 acme.

Auto Made of Glass and Plastic Provides "X-Ray" View

Glass and transparent plastics from roof to fenders, a "phantom" automobile at the New York world's fair reveals the sturdy body construction and interior bracing of the modern car. A crystal-clear synthetic plastic forms the body panels, hood, roof and fenders so that the structural steel parts and all the working mechanism — engine, doors, windows and ventilators—are seen as if in an X-ray picture. The car could be driven on the highway on occasion.

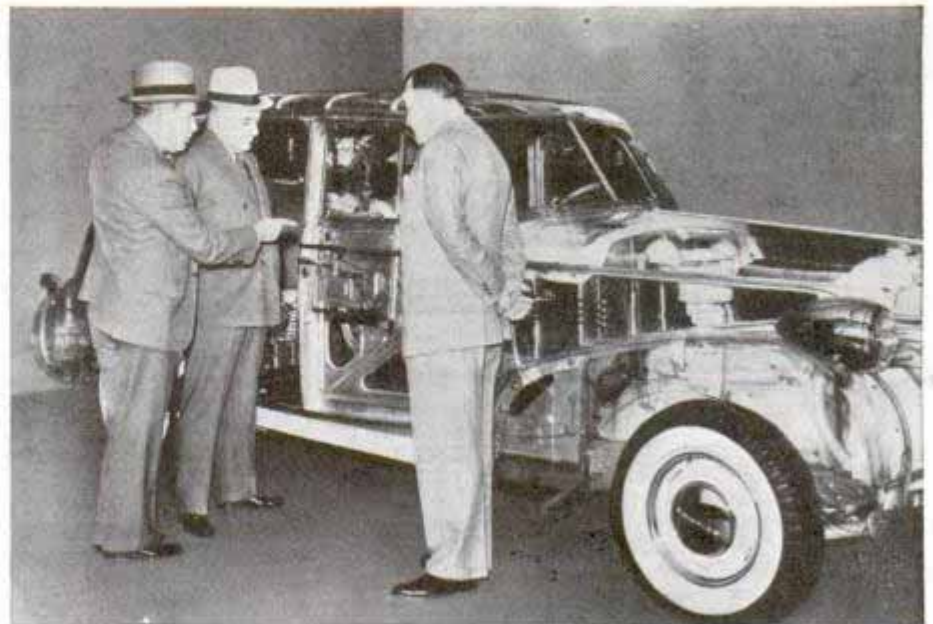

Body panels, hood, roof and fenders of "phantom" car are made of transparent synthetic plastic so that structural frame and motor are visible

Two-Cylinder Engine Drives Economy Car

Designed to average fifty to sixty miles per gallon of gasoline, cruise comfortably at forty-five miles an hour and accommodate four passengers, an entirely new economy automobile has been introduced by the Crosley Corporation. Weighing only 925 pounds, the car is powered by an air-cooled, two-cylinder engine. It has an over-all length of 120 inches, a



Crosley car with four comfortably seated. Left, view of the motor and front of chassis. The motor is air-cooled and has two cylinders

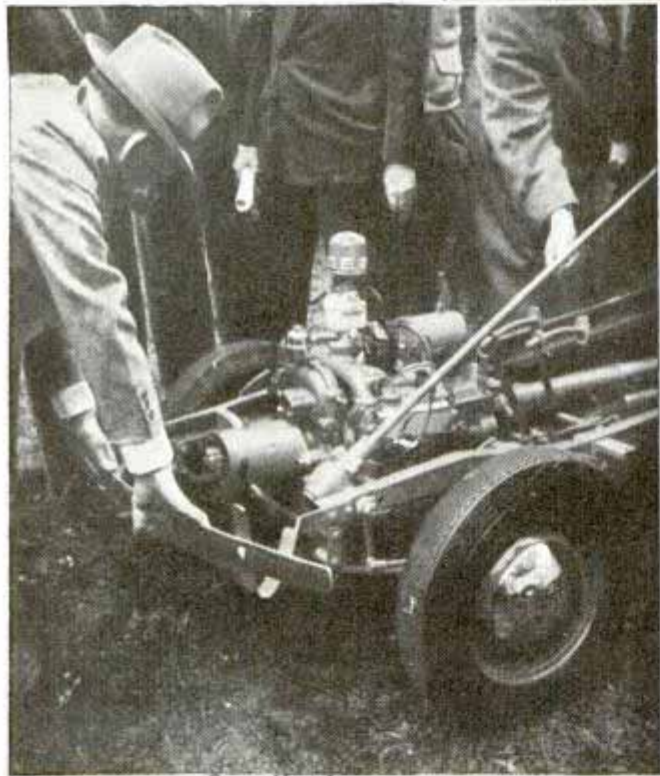

height of fifty-six inches, a tread of forty inches, has a four-gallon fuel tank and an oil capacity of two quarts. Power is transmitted to the rear wheels by a direct drive through a torque tube without use of universal joints. The four-wheel mechanical brakes, cable operated, are a new development pioneered in the aviation field. Having no riveted linings, the brakes give twice the braking surface of neutral or two-shoe brakes and can be relined by simply removing the wheel and inserting a length of brake lining in the brake drums. Front springs are semi-elliptic, rear springs are one-quarter elliptic and four shock absorbers are fitted. Safety glass, adjustable driver's seat and strongly constructed channel section frame are other features.

Six-Gun Attack Bomber Carries 800 Pounds of Bombs

Six machine guns packed into the Vultee attack bomber just delivered to the army air corps for trials make it a formidable weapon in the sky. The ship carries 800 pounds of bombs. An all-metal monoplane manned by a crew of three, it is driven 240 miles per hour by a fourteen-cylinder radial air-cooled engine.



This heavily armed attack bomber has a speed of four miles a minute

Richmond Indiana
back cover
May 1911
See ad inside
Hartford Conn
Acme
of a - 1/2 powered by wash

Cont. James M. Sweeney 431 W. 60th St. New York, N.Y. 10019
1580

Streamlining the HIGHWAYS



Left, Riverside Drive in New York demonstrates highway grade separation of cloverleaf type used at heavily traveled intersections. Above, same spot illuminated at night

opportunities for accidents could be designed out of our streets and highways.

Out of the maze of traffic surveys conducted within recent years, there has come a new type of road construction that automatically compensates for the driver's mistakes while eliminating many accident factors.

NO LONGER does America have to wrinkle its brow over the complexities of modern traffic. Slowly but surely, the traffic engineer has been getting the problem in hand.

From his years of research amid motor-car exhaust fumes and policemen's whistles and his careful study of thousands of highway-accident reports, the specialist in this field sees faulty road design as the tap-root of our accident evils. If unlimited funds were available for road building, he is confident ninety-eight per cent of the

Such roads cannot be adopted generally for the same reason everyone doesn't own a yacht, so the traffic engineer is largely concerned with incorporating the safety element into our roadways as is physically and economically feasible. The newer engineering safeguards are beginning to bear fruit as they were a prime factor in effecting a twenty-per-cent decrease in vehicle fatalities last year—an approximate saving of 8,000 lives.

Functionally, at least, a major portion of our roadways belong to the horse-and-

for SAFETY

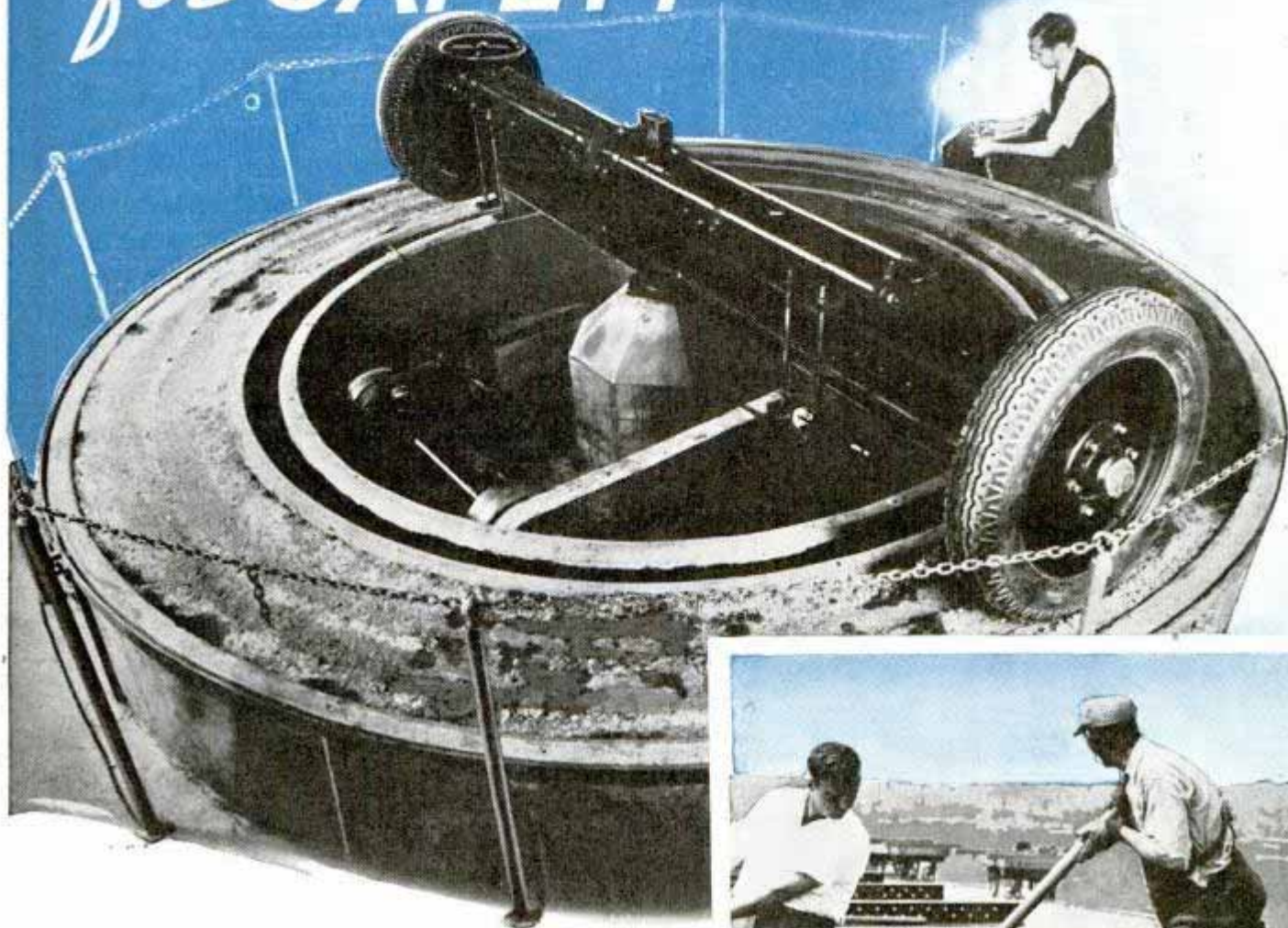

Top, testing qualities of low-type road surface in U. S. Bureau of Public Roads laboratory. Center, dividing concrete highway by moving slabs laterally with aid of compressed air in fire hose. Bottom, automatic traffic counter aids in highway planning

buggy era. In other words, motorcars capable of speeds up to eighty and ninety miles an hour are being operated on roads that were designed to carry light traffic at maximum speeds of between thirty and thirty-five miles per hour. And to complicate matters, a high percentage of the country's forty million drivers have only twenty-five-mile an hour capabilities.

Streamlining of roadways to meet the exacting requirements of present-day trucks, buses, and motorcars has been advocated for several years by Dr. Miller McClintock, head of the traffic bureau



at Yale. Whenever a city falls victim to creeping paralysis of traffic congestion, he can prescribe a sound remedy with the certainty of a family physician treating a case of measles.

The friction theory he formulated while analyzing Chicago's traffic muddle of a few years ago has become the principal working tool of traffic engineers everywhere. Every accident that occurs can be classified under one of four general types of friction.

Streets and highways carrying traffic in both directions in the same roadway give rise to what McClintock calls medial friction—the rubbing together of traffic streams moving in opposite directions. There is a constant temptation for one stream of cars to overflow in the path of those going the other way.

Where traffic streams cross, that's called intersectional friction. It is the underlying cause of the most exasperating traffic tie-ups and the front page crashes.

If all the motorcars kept in their own lanes and moved at the same rate of speed, there wouldn't be any internal stream friction, the engi-



Top, portable device used to weigh trucks. Center, elevated routes with opposing streams of traffic minimize chances of accidents. Bottom, divided roadway helps reduce accidents

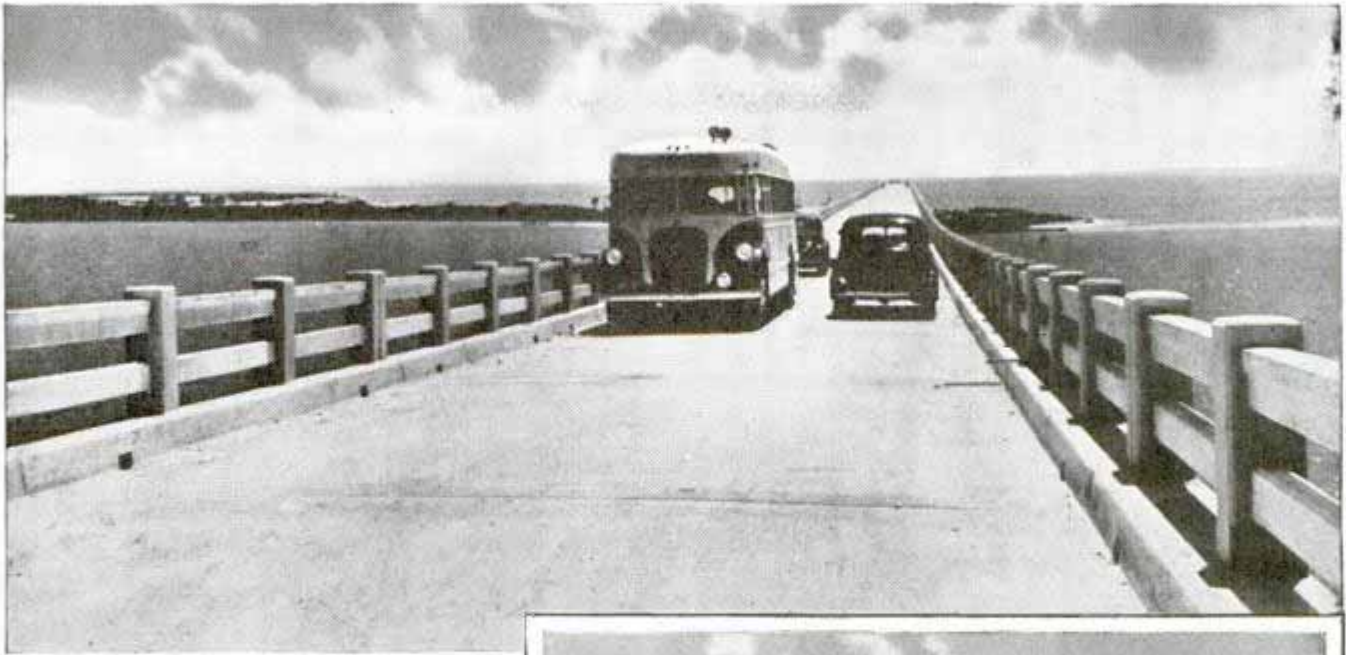

neer's way of referring to rear-end collisions and fender brushings occasioned by cars cutting in and out of their respective lanes. Forty per cent of all accidents can be laid on the doorstep of internal stream friction.

The pedestrian who steps from nowhere directly into a car's path, the delivery car that bounces onto a thoroughfare from a driveway, the parked car, and the car pulling out

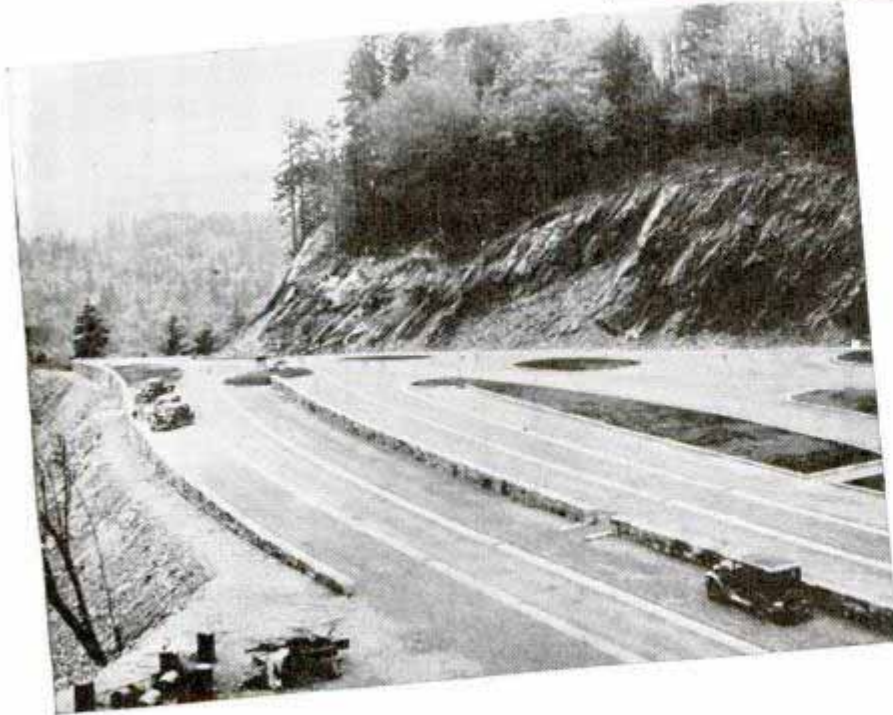
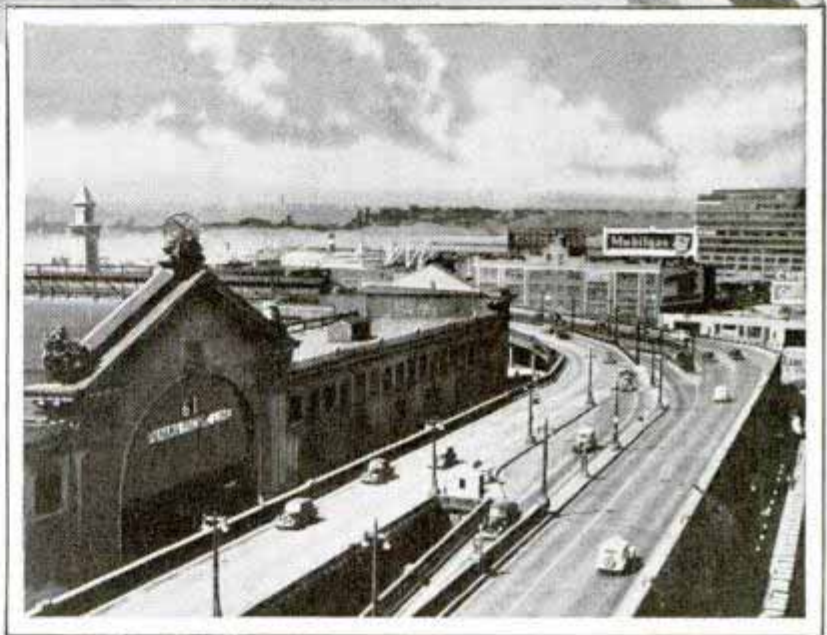

Top, overseas roadway to Key West, Fla. Center, elevated highway in New York. Bottom, roadway with special parking space

from the curbing are conditions giving rise to marginal friction, the cause of twenty per cent of the accidents.

The road designed by the Yale traffic expert which makes it difficult for a motorist to go wrong when faced with some emergency thinking is the "limited way." It calls for a separation of traffic streams by a center mall, ten to thirty feet in width, creating one-way traffic on double roadways and precluding head-on smashes and side-swipes. Intersectional jams and crashes are erased by means of grade separations, over and under passes, and clover-leaf detours for making turns.

(Continued to page 130A)

Tomorrow's America Modeled in 'Futurama'



the latter being in operation on the highways. The "futurama" gives the beholder an illusion of seeing a panorama of the city of tomorrow from a high altitude as though peering from the gondola of an airship. One of the cities is complete with air terminal, private landing fields, and a base for handling seaplanes; a zep-



Above, visitors riding in sound chairs see what world of tomorrow will look like. Below, scale-model air terminal on outskirts of large city

Dramatic views of tomorrow's countryside unfold in a vast lifelike scale model at New York World's Fair. The thrilling innovations, designed by Norman Bel Geddes for the General Motors Highways and Horizons exhibit, cover 35,738 square feet and extend for a third of a mile on several levels of the building it occupies. Seated in moving sound chairs, visitors hear the voice of one describing the different scenes as they gaze upon more than 500,000 miniature buildings and houses, 1,000,000 trees and 50,000 motor vehicles, about 10,000 of

pelin base includes a hangar resting in a pool of oil so it may be turned to meet any wind direction.

Army Plane Speeds at 575 Miles in a Power-Dive Test



This plane turned nose earthward at terrific speed of 575 miles an hour

at Montreal.

In a test before Canadian air force officials a new fighter-bomber plane was reported to have hit a speed of 575 miles an hour at the end of one of its power dives. The ship is powered by a 750-horsepower Pratt and Whitney Wasp Junior motor.

Hartford, Conn.

Wittbold Studios
Clark Churn

Constructed by George
1505

2511

Test pilot George Ayde

club.

Television Trouble Shooter Has 648 Worries

Trouble shooters in the television studio will have plenty to think about if something goes wrong. The General Electric transmitting station will have 648 vacuum tubes, every one of them essential to a television broadcast—and failure of any one of about 400 would cut the sound and pictures off the air. Frequent tests, of course, will minimize the chance of program interruptions. The tubes range from peanut to melon size, the largest being the big funnel-shaped tubes in the television camera. Most expensive of the tubes are those in the transmitting tower twelve miles from

Schenectady
my



At left are some of the 648 tubes involved in the complicated task of broadcasting television. They range in size from the big camera tubes to the midget held between fingertips. Above, one of the costly water-cooled tubes which do the real work of transmitting

the Schenectady studio; fourteen of the 163 tubes installed there cost three times as much as all the rest put together. These costly ones are the twelve-inch water-cooled tubes that perform the actual work of transmitting the broadcast. Television requires more tubes than ordinary radio

broadcasting because of the extremely complicated circuits needed for synchronizing purposes in the transmitter. Because of the larger number of tubes in the transmitting apparatus, however, the receiving sets can be simplified. Ordinary broadcasting takes less than 100 tubes.

Sun Heat Trapped and Stored in Solar Silo Would Be Used as Needed

Using a solar heater, of the focusing mirror type, invented by Dr. Charles G. Abbot, secretary of the Smithsonian Institution, it is proposed by Dr. F. G. Cottrell, Washington scientist, to capture surplus sun energy that is now wasted and store it in underground silos as trapped heat. The silo

would be a deep, concrete-lined pit filled with loose, dry sand and capped with a heat insulator like glass wool, according to a recent report of the institution. Heated air pumped through pipes from the solar heater into the silo can be withdrawn by a second set of pipes whenever needed.

2440

Washington D.C.

Quayle Service
Washington D.C. 1939

3904 *Washington D.C.*

FLYING



2563
L EADING the rest of the world in air travel, the United States lags far behind other countries in the companion service of hauling freight by air. Last year domestic air-express companies transported more than 7,000,000 pounds by plane but this figure was easily beaten, even in Canada where much larger quantities of goods are shipped by air.

This picture, it seems to aeronautical leaders, is going to reverse itself in the next few years. They think many times the present tonnage eventually will be moved by air. Large numbers of cargo planes designed as box cars

Above, drawing shows how Benny Howard's freight-carrying plane is loaded, with hinged tail swung back. Circle, loading express into compartment in the nose of an air liner

Champlain, Apr. 22, 1924, 1424 R. W. Washington, 20 P.

BOX CARS

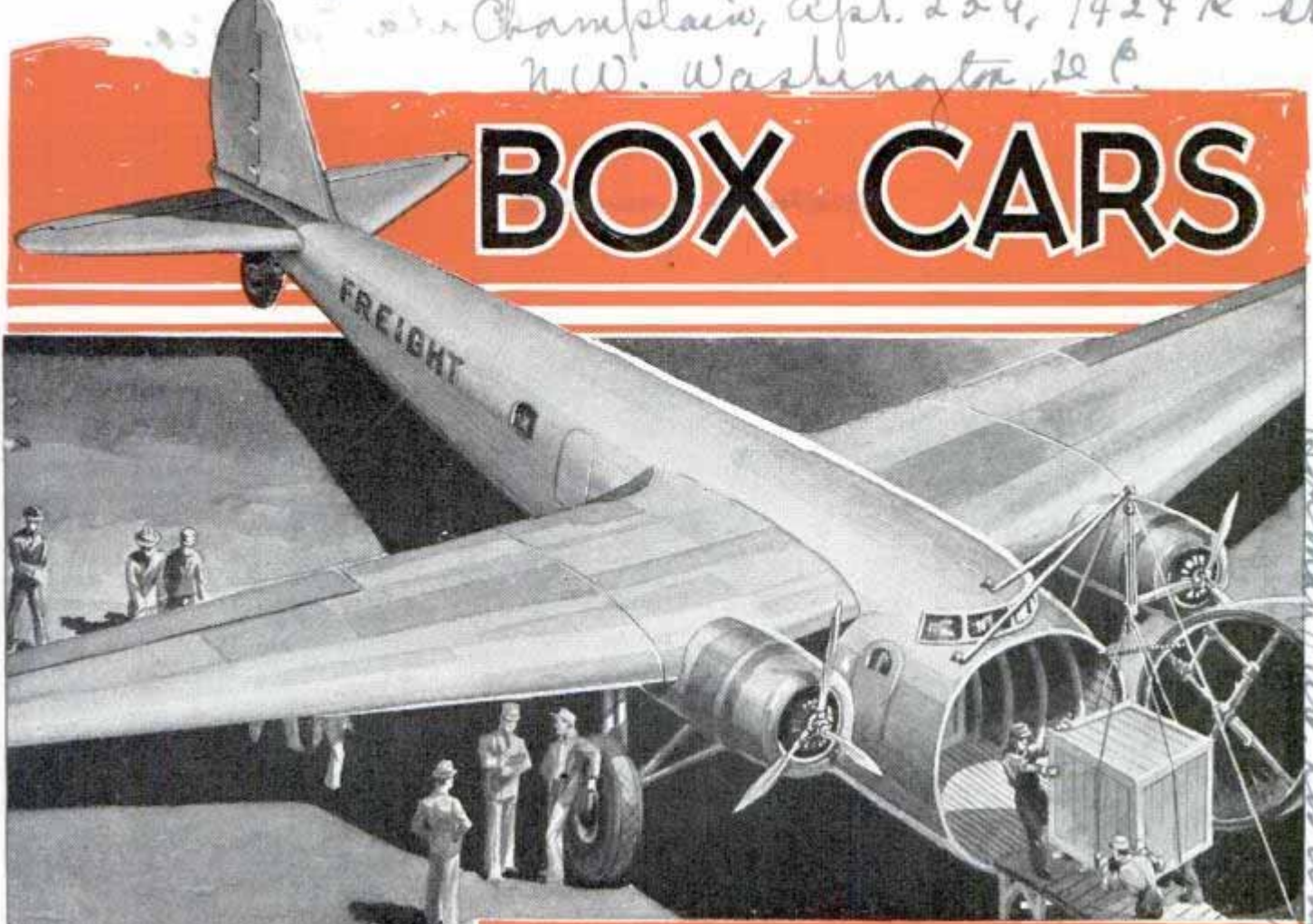

will be droning along the airways. Even dairy products, fish, and early vegetables and fruit will be moved regularly by air.

Trucking concerns in the midwest and east are studying the advantages of moving rush orders and perishables by cargo plane. Without advertising their interest, the air lines are keeping in close touch with developments.

One reason why air freight has been slow to grow in the United States is that surface transportation facilities are already reasonably fast and dependable. Again, shipping by air today is expensive because shippers have to pay for space on de luxe air liners. In other parts of the world rail and truck services are either less satisfactory or are completely lacking. Lumber

and coal are hauled by air in Alaska and logs and livestock are transported by plane in Central America simply because ground transportation takes too long and is relatively expensive.

The move to put wings on the commonplace box car got its start in part from the demands of air-freight operators abroad. These fliers have been using outmoded

Island Central Air
Top, showing how the Charles Babb plane would be loaded, with nose of ship open. Below, lobster shipment arriving by air for a middle western hotel *Snake*

*also Thomas & Stephens, Jr. 1955
terminal
celebrate. Calce*

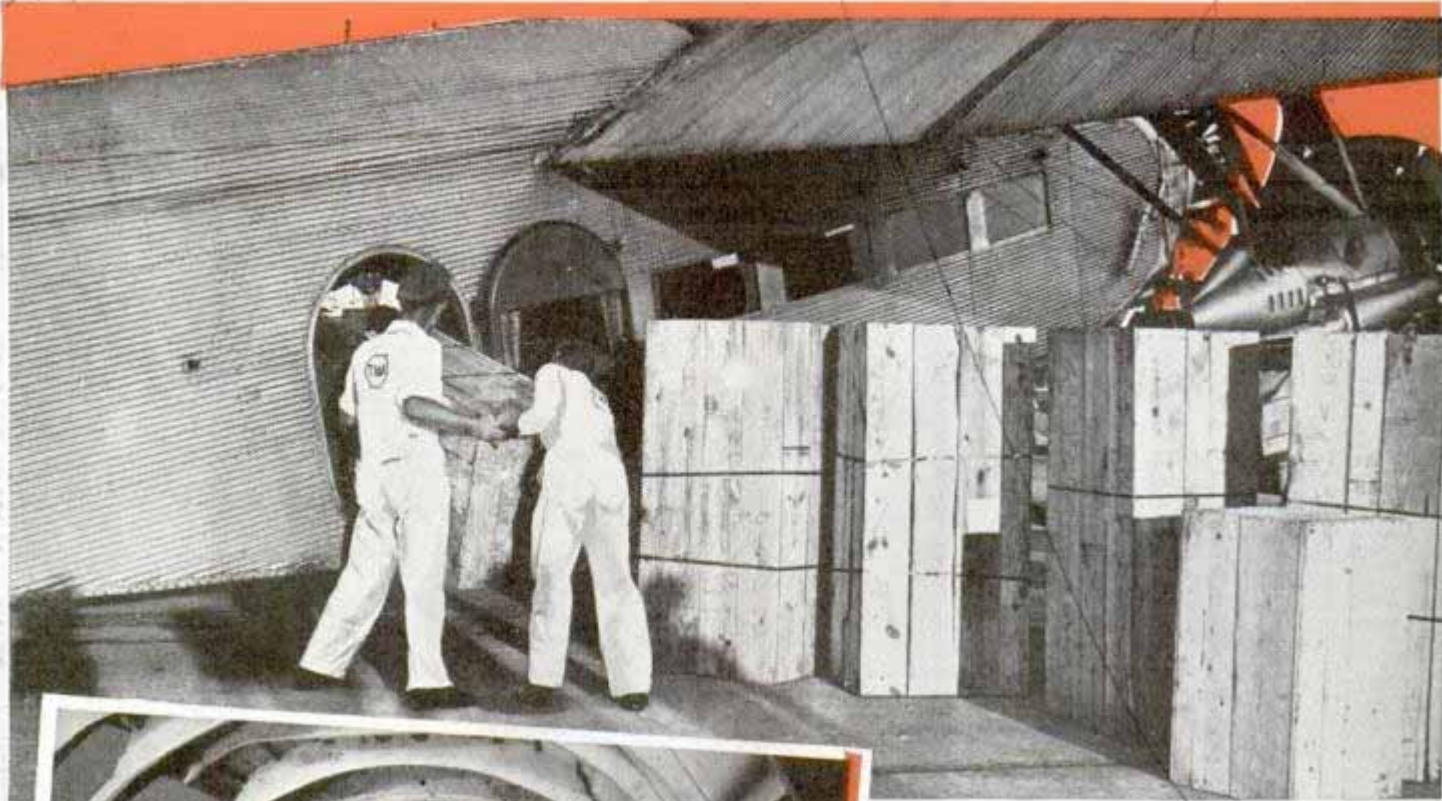
Santa Monica
Calif

Top, loading a flying box car with heavy consignment of machinery. Left, interior construction of Douglas "DC-5," which is capable of carrying a three-ton load.

Bennie Howard, well-known test pilot and designer who anticipates a boom in sky freighting. "The limousine can carry a fair load but its costs are high. It can't compete commercially with a truck built for such service. Air freight is lagging today because efficient cargo planes are not available."

American equipment, Fords, Fokkers, and Curtiss transports retired from passenger service in this country and modified for freight handling. Today this equipment is wearing out and there is nothing to replace it. Air liners retired from domestic use today are too expensive, land too fast, and are otherwise objectionable to demands of heavy cargo runs in frontier countries. What they want, the freight operators declared, is a new airplane specially designed to move heavy loads at minimum cost and capable of landing in make-shift fields.

"Hauling cargo in a converted passenger plane is about the same as yanking out the seats and boarding up the windows of a limousine to convert it into a truck," says

At present Howard is getting ready to market something new in aerial transportation, a sky truck that is designed to compete on a dollars and cents basis with fast surface transportation, moving cargo in much less travel time with only a small premium for speed.

Howard estimates that in a flying box car of 8,000 pounds cargo capacity the cost of shipping by air can be brought down to one and a half times the cost of express shipments by rail, only a fraction of what it costs to ship by air today. Including pick-up and delivery, this rate would meet operating expenses, overhead, and equipment write-off charges with the plane carrying less than half its capacity. This tentative rate rests on an estimated airplane

operating cost of thirty-nine dollars per hour, or twenty-six dollars per 100 miles of flight. This in turn breaks down to a basic rate of something like three-thousandths of a mill as the cost of flying one pound of cargo one mile.

"The flying freighters will do much of their work at night," Howard says, "because their existence will depend partly upon their ability to make over-night deliveries to points that can't be reached in the same period by train. This rules out short hauls of less than 500 miles.

"The flying freight will be faster and more dependable than the present air mail because the planes will be of a single-purpose type and will not be grounded by weather conditions that hold up the mail when passengers are booked for the same plane."

Howard's freight plane design is a high-wing monoplane with tricycle landing gear, of eighty-foot span and powered with two

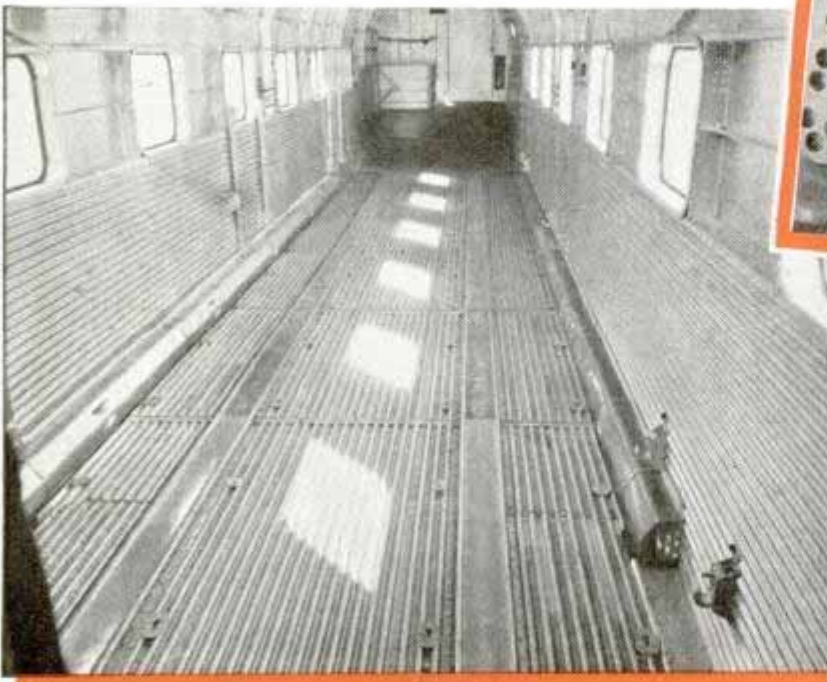
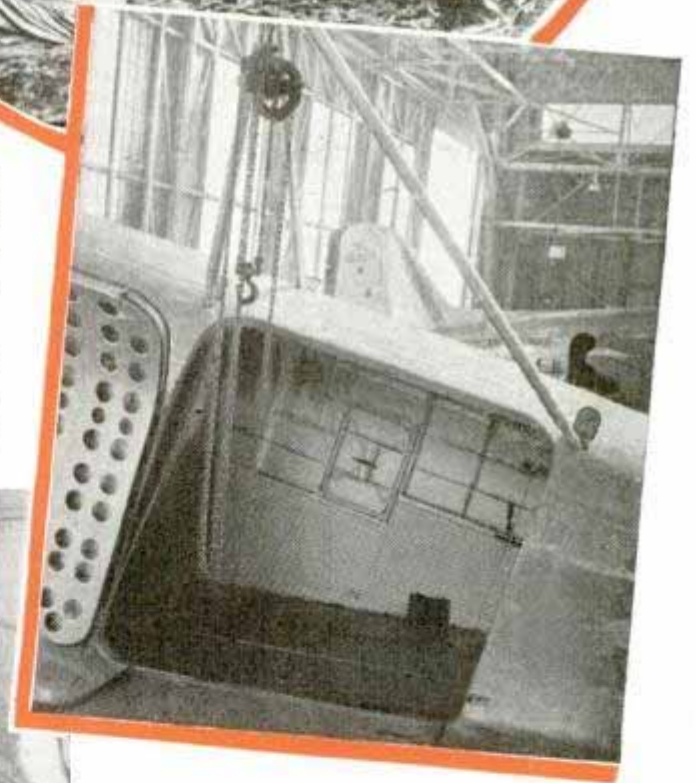

750-horsepower Cyclones. The wing is of the so-called plastic type, made of wood veneer and phenol resin for long life and cheap repair costs. The fuselage consists of a welded steel-tubing frame sheathed with dural in front and fabric toward the stern. Landing gear is non-retractable. Radio equipment is necessary since the plane would do much of its work after dark. The plane is designed to cost about \$65,000.

The most revolutionary feature of
(Continued to page 114A)

Top, attaching food package to army bomber. Released, it floats to earth by parachute. Center, wide cargo door of Douglas freighter. Bottom, tracks and cargo tie-downs in the flying box car. Note large space for the load

Electricity as Farm Servant Described by Talking Model

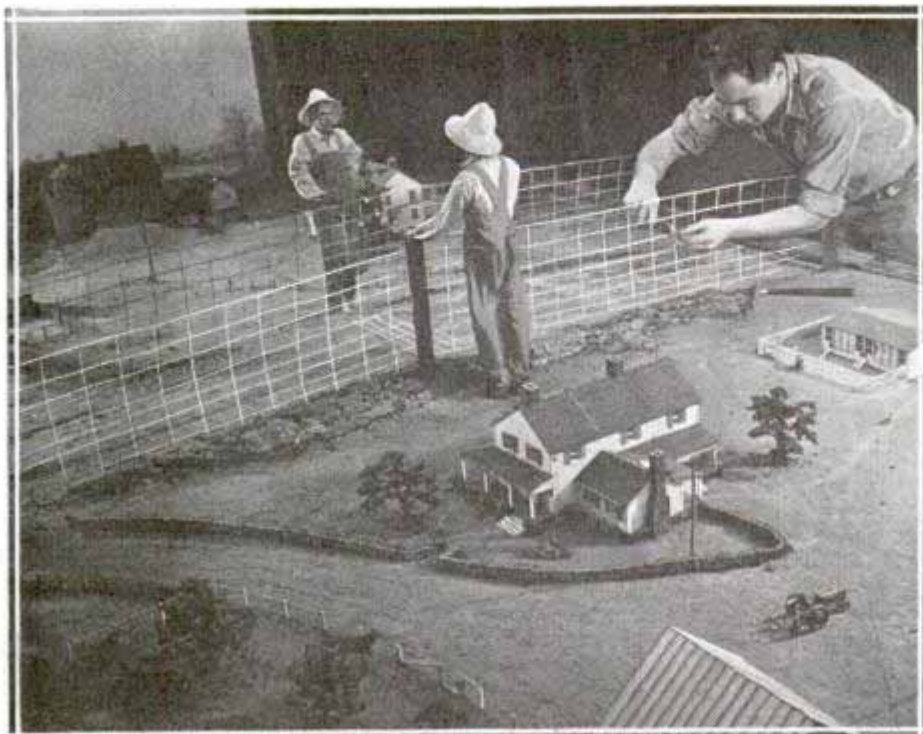

Gossiping over the fence two farmers in animated exhibit reveal advantages of employing electric power as a helper to do many daily tasks

Benefits obtained by using electricity on the farm to perform many daily chores, are placed in striking contrast with old-fashioned methods in the Westinghouse rural electrification exhibit at New York World's Fair. The exhibit portrays two miniature farms, and their tiny animated owners engaged in a lively discussion. One of the farmers employs outmoded ideas and does most of his work by hand, whereas the other uses electric power. During a five-minute dialogue, made interesting by lip movements and gesticulations of the models, the more progressive neighbor reveals how electricity milks his cows, operates the corn-sheller, tool grinder and saw, and fills the silo. The housewife, he explains, uses electric power to run the refrigerator, kitchen range, vacuum cleaner, dish washer, ironer and water heater.

Liquid Rock Applied with Brush for Waterproofing Walls

Basement walls can be waterproofed and building exteriors of concrete, brick and stone types given a strong protective covering with a dry compound that is applied with a brush. Stirred into water, this mineral and aggregate compound forms a liquid stone that is flame-repellent, and proof against moisture, acid and electrolytic ac-

tion. Muslin strips soaked in the liquid rock can be wrapped around water lines, refrigeration and steam pipes, forming a rock-hard coating within a day. Available in white and five colors, it can be applied without expert help. When brushed on porous surfaces such as concrete, plasterboard, stucco, unglazed tile and stone it becomes a part of the original surface; it cannot be used over paint, wood, metal, glass, or oily or glazed surfaces unless applied with muslin.

Wheel Chair Driven by Battery Costs Little to Run

In an electric motor chair with four-ply jumbo tires on its tricycle wheels you can ride thirty miles for about twelve cents. It is driven by two fifteen-plate auto starter batteries which, at ten miles an hour, run thirty miles per charge. The chair is especially designed for aged and disabled persons.



"Wheel chair" designed for aged or infirm persons is driven by automobile batteries

San Francisco Calif

475
Reserve Corp
438-848
Reserve Corp

Calif
Long Beach
J. 4 38
44
240.00
Electric Chair
Electric Chair

Proria. Ill

Diesels Help to Conquer Mesquite "Jungle"

Right, tractor with sharp-nosed ram held aloft clears small brush off land with heavy blade. The tractor is Diesel-powered

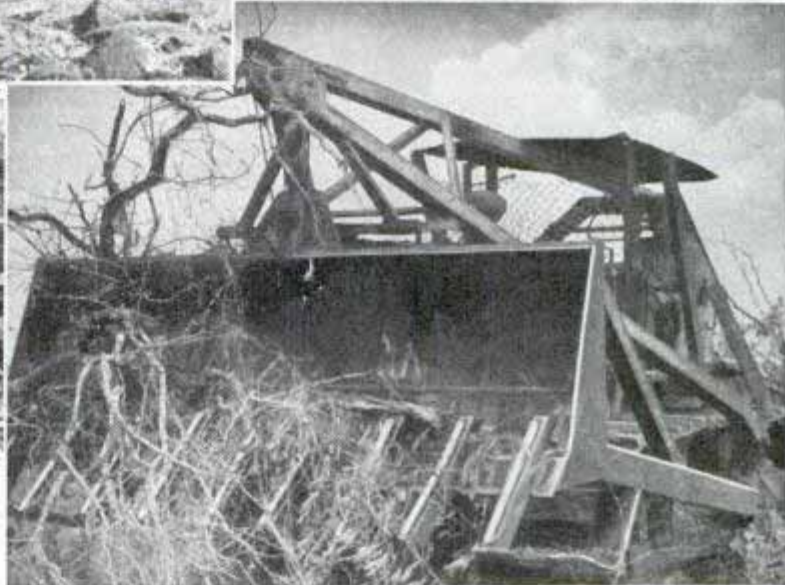
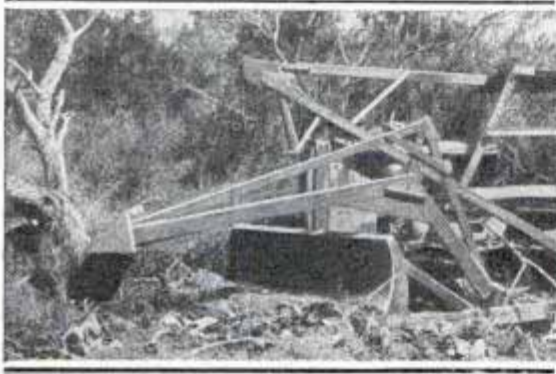

Top, left, plowing after tractor has pushed over mesquite tree (bottom, left) and swept debris into piles (bottom, right)

For clearing land quickly, development companies are using Diesel-powered equipment in South Texas. A mighty tractor equipped with a heavy blade for moving brush and a sharp-nosed ram for uprooting large mesquite trees do the work in a fraction of the time formerly required for removing the "jungle" growths which

originally covered a large part of that region. Early methods of preparing the land for agriculture called for a crew of laborers to attack the mesquite trees, catclaws, retamas, prickly pears and various cacti with machetes and axes. Discovery that the land was valuable for growing citrus trees brought a demand for faster work.

4-434

Room Comfort Can Be Read at a Glance with Rotary Thermometer

Combining the principles of both the thermometer and hygrometer, an instrument now on the market not only gives both the temperature and relative humidity in figures, but also indicates whether or not a healthful and comfortable relation between the two exists. Two revolving drums working side by side tell the story. So-called health zones, determined by experiments in room comfort, are plotted in black opposite each other on the drums and anyone can tell quickly by comparing them if the reading is within the comfort limits. The instrument registers with precision and needs no adjustments.



Carson Mfg Co. 1611 N. W. 10th St.

Harold Wise, Grants Pass, Ore. N 155

GOLD *is* WHERE

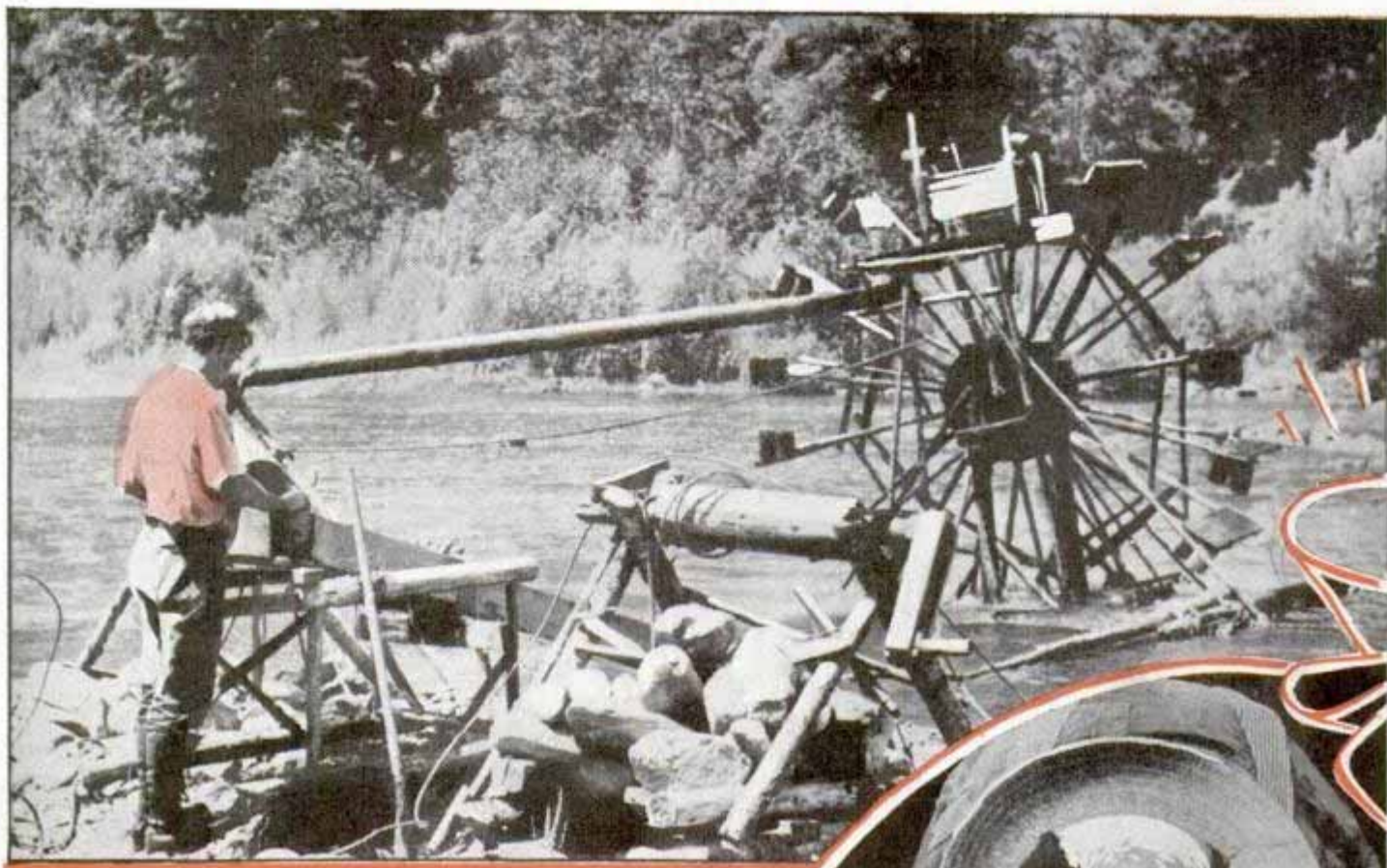

Above, homemade outfit with which two to four dollars worth of gold per day was taken from a river bed. Right, panning for gold. Bottom, cleaning out gold from sluice box

By Dr. P. G. Worcester

Chief of the Department of Geology
University of Colorado

to ridder Cold
EXPERTS agree that the days of the old-time, sour-dough prospector are about over and that modern scientific prospecting is necessary to keep up the present gold production, but after all, gold is where you find it. Do not get the idea, however, that all you have to do to make your fortune is to start digging in your own back yard, for if you do, you probably will be disappointed.

Gold was discovered in Colorado in 1858, and it was not an accident. A party headed by the Russell brothers came out from Georgia with the avowed purpose of finding gold, and they found it. Their discovery led to the great "Pikes Peak or Bust" gold rush of 1859 and 1860, when thousands of men from the East came to Colorado. These gold hunters spread all over the state, prospected all the creeks for placer



Manhattan, Nevada

You FIND IT

Right, typical old-time prospector. Bottom, ore coming from chute at a reclaimed gold mine



*Yuba
near. Early
mine
Canada*

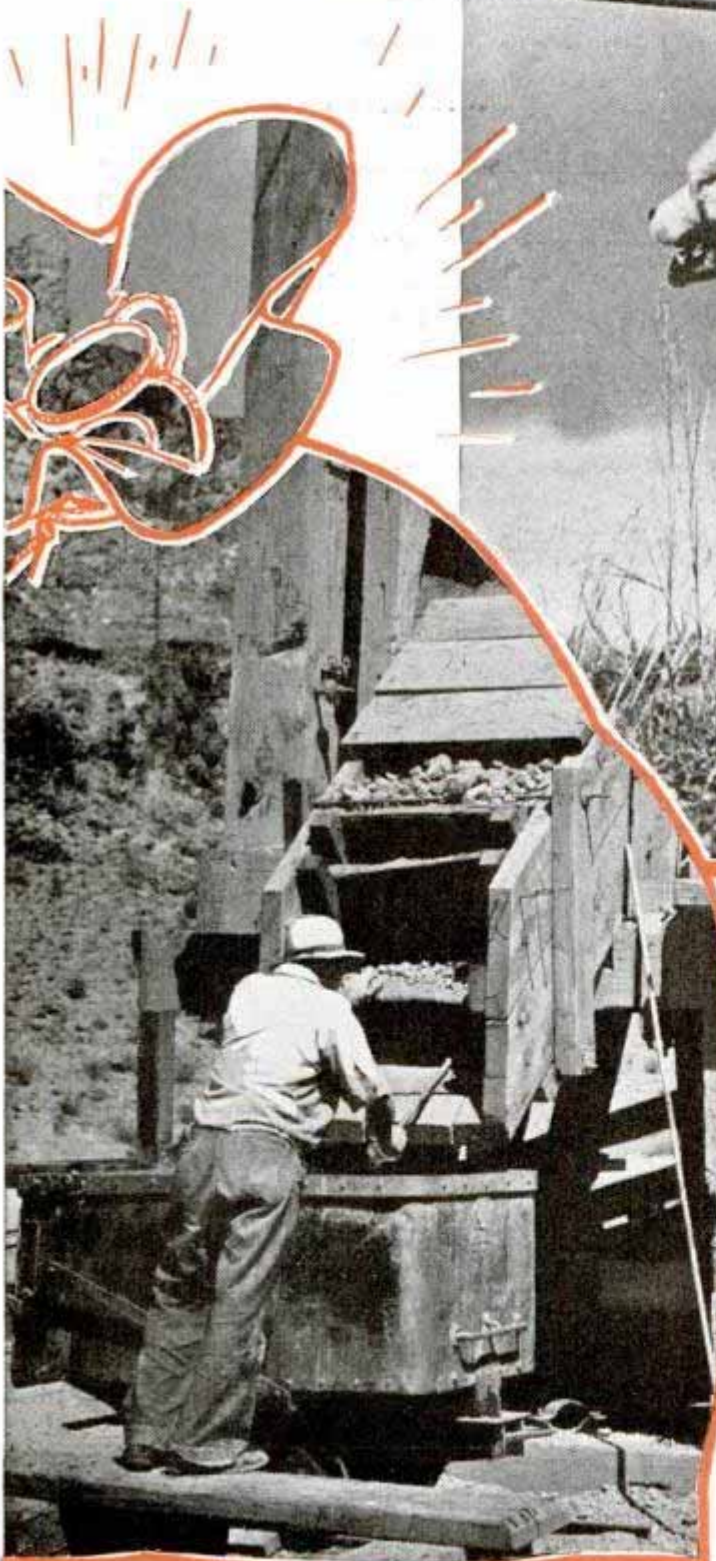

Tom Reed gold mine

gold, and traced the "colors" to their source in the veins situated in scores of different localities.

One would think that in this great gold rush all the mining districts of the state would have been discovered, but this was not the case. The world-famous Cripple Creek district was not discovered until 1891, and then largely by accident.

Bob Womack went to work for a large cattle company whose ranch covered most of the region. His duties were not very heavy, and he spent his spare time prospecting. He uncovered a few veins that carried some gold, but in most cases he did not even bother to have assays made, and although he staked out some claims, he did not take the trouble to record them. One

Bullcock Run shaft

California in 1848. They found the Comstock Lode near Virginia City, which has produced nearly \$400,000,000 in gold and silver, and discovered gold in several other districts, such as Leidy, Montezuma, Manhattan and Tonopah. Yet gold was not found in Goldfield until 1902. Even then the first prospectors did not recognize the values of the gold-bearing formations, and the district was all but abandoned. In May, 1903, someone made a rich "strike" and the boom was on. Within three years the town of Goldfield grew from nothing to a city of 15,000 people, with more than fifty mining companies operating in the district.

small discovery led to another. Finally, other more intensive prospecting was done, rich ore was found, and fortunes were made. Between 1891 and 1938 this famous old camp produced more than \$375,000,000 in gold, and it is by no means through.

Western Nevada was crossed by thousands of prospectors in the fifty-year period following discovery of gold in Cali-



Top, scene in reopened gold mine. Circle, recent mining operations at Central City, town abandoned after gold supply apparently had been exhausted. Bottom, old-style hauling method in Colorado

San Juan Mountains

Records of some of the values found at shallow depth are almost beyond belief. One group of claims, known as the Bowes-Kermach lease, netted for some time more than \$10,000 a day. Before the lease expired, early in 1905, the claims had produced more than \$1,000,000 in gold. It is estimated that within three years more than \$2,000,000 was stolen from three mines. Miners turned down wages of twenty dollars a day to work in undeveloped mines and accepted four or five dollars a day to work in mines where the



Top, modern miner wearing mask and running electric locomotive. Left, couple working on flume in hunt for gold. Bottom, using dry washer in old river bed

ore was exposed. Between the discovery date and 1936, Goldfield had produced values amounting to more than \$87,000,000, and it is still going strong with an estimated production of \$680,000 last year.

At the Red Arrow mine near Mancos, Colo., on the west side of the Laplata mountains, a discovery contrary to all geologic principles was made in 1933. The rocks of the region are thick-bedded sandstones, limestones and shales. There are no igneous intrusions near by that might account for the ore. Geologically it

(Continued to page 122A)



April 14, 1939

Mobile Ram Pounds Street to Break Up Old Pavement



Dots on pavement are marks left by the hammer as it moves along, the distance apart being regulated by speed of the truck

To prepare the way for a speedy removal of old pavement, highway engineers use a mobile battering ram that crushes the bricks or concrete. Mounted on a truck, the 2,500-pound steam-driven hammer pounds the pavement like a pile driver, striking eighty blows a minute.

Madison Combrack G. Edwards

Letters, Numbers on Warplane Are Key to Type of Fighter

Army and navy planes have a code of their own. Glance at the letters and numbers on the wing of a fighting ship flying high above your home and, if you know the key, you can tell whether it's a pursuit plane or bomber, observation or patrol ship, and whether it is on duty or still experimental. Letters refer to the type, numerals to a particular model. Usually a higher number means a more recent model, although this rule is not invariable. Bombers are designated "B." The army's flying

2-473

fortress is the B-17; when it was given superchargers for high-altitude flight it became the YB-17A, the "Y" meaning it was on service test and the "A" indicating it was slightly changed from the original flying fortress. Pursuit ships are marked "P" and an "X" is added if the plane is still in experimental stage. The XP-38 is the twin-engined army fighter that hopped from coast to coast recently at 400 miles an hour. The BT-9 is a basic trainer for student pilots, the BC-1 a basic combat ship. Attack planes are marked "A," observation planes "O" and cargo carriers which transport personnel and supplies are designated by "C."

One Trigger Fires Camera and Gun at Same Time

Police can photograph the fleeing criminal with the same gun they fire to bring him down. Big game hunters, with a single pull of the trigger, fire a bullet and "shoot" the animal's picture. The combination camera and gun was invented by a German engineer. The camera is mounted over the barrel, with its shutter release arranged so that firing the gun automatically exposes the film. The photographic "evidence" of the shot helps improve the aim.



Gun and camera are synchronized so that a pull of trigger takes picture and fires bullet

No U.S. agent here

Chicago 4445 N. 8 corner

From J. Peter Combrack

Artist Caricatures Famous Folk with Eggs

Oldy. 122 E. 42 no. needed



Here's a new recipe for serving eggs. You take an egg, a cup of wax, cotton-wool for dressing and a garnish of sealing wax; blend them in proper proportions and you have—amusing cartoons of the great and near-great. Walter Trier, the artist, is shown above with his paintbrush, completing the transformation of an egg into one of the caricatures on this page



Copious cotton-wool whiskers and eyebrows on that literary egg, at top, identify it plainly enough as George Bernard Shaw, the English writer. At left, a straw hat furnishes the finishing touch to a frowzy, bleary egg you recognize as the artist's conception of Charles Laughton, film star of "The Beachcomber"

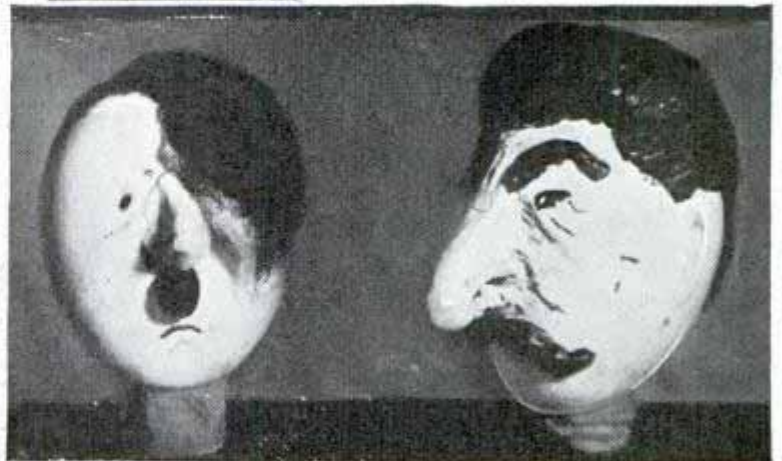

Photos © C. Anders & Co.

If you want your egg cartoons to last, they should be hard-boiled like those dictators above, Hitler and Stalin. Or, of course, the cartoonist can use hollowed eggs. At the left is the white-haired David Lloyd George, Welsh prime minister of England in world war times

Bob
Allen
Irvine
Calif.

Model Craftman
Magazine, 110 W 42nd
St New York

RACING the

2 395



Speeds up to forty miles per hour are attained by model speedboats equipped with small engines and entered in regattas held frequently in various parts of the United States. Children's wading pools make almost ideal race courses, since the water is not too deep for the boat owners to handle their craft. The boats range in design from the "engine on a shingle" to beautifully streamline hulls, while the latest power plants include four-valve jobs, with twin carburetion. Delayed action devices, which change engine adjustment after the boat gets under way and thus prevent stalling in launching, are being used. This makes it possible for the boat to start with only part of its power

Edmund Kalpus

Henry Parod's Eleanor



Top, left, "Phantom," record holder. Right, speedster making turn, with line attached to right side of boat. Circle, a flash steamer doing thirty miles per hour. Bottom, starting a boat

H. S. Brailsford's Class A 1

Number 9 395

WATER FLEAS

Right, this is how gas-engine boats are started. Owner yanks rope wrapped around the flywheel, in outboard-motor fashion, to start the tiny power plant

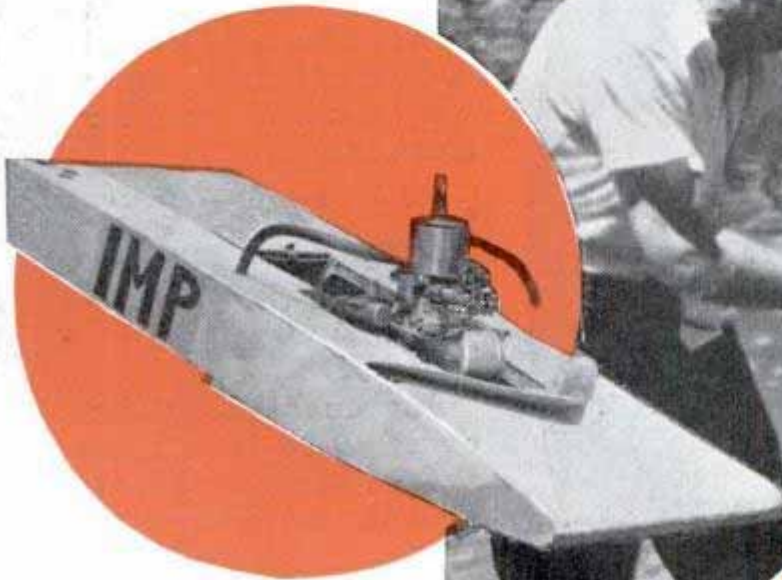

Above, typical Class C hydroplane powered by water-cooled two-cycle engine. Owned by Robert Graham of New Jersey, it will do about eighteen miles per hour. Circle, right, Archie Kimmel tuning up his boat. Note cloud of spray thrown up by the tiny propeller. The engine is four-cycle, air-cooled



Left, Walter Joss of Detroit blowing out an obstruction in one of the feed lines of his steam-powered boat. Many tricks are employed by builders to get more speed. The highly polished bottom of "Phantom" is partly responsible for its speed

Biggest way mechanics supply

Food Sold in Rubber Balloon Will Not Dry During Storage

Alway Chemical Co Cambridge



moves air within the package thus drawing the wrapper close to its contents, after which it is heat-sealed. Immersion in warm water or application of warm air then shrinks the bag to its original size, giving a lustrous, transparent covering. The food then is frozen. Meat preserved and stored in this manner has remained fresh for more than a year.

Explosives Truck Rides on Ten Big Tires

For cushioning the shock when its wheels strike a bump, as well as for aiding movement over marshy land, a truck designed for transportation of explosives is equipped with ten large tires. There are two tires at the front and four on each side of the explosives compartment. The tires help to "float" the truck over marshes through which the truck travels in carrying explosives to aid in the search for oil.

Sleevy

Quick-frozen foods are prevented from drying out while in storage by the development of transparent, vaporproof rubber balloons in which they are wrapped before being subjected to the freezing process. This also protects the contents against contamination in handling, and the rubber, consisting of compounded latex which has no sulphur in its makeup, does not impart any foreign odor or taste. The bags are supplied in any size or shape to accommodate various products, and in applying a balloon it is stretched over a wide-mouthed box and distended by either filling it with air or withdrawing air from the box. With the food inside the bag, a vacuum hose re-



Here's how the big tires support truck as it travels through marshes

Truck used by Continental

7900 Gas. Campaign
Habitat much

'Highway in the Sky' Climbs over the Andes

Literally a highway in the sky, the road through the Andes mountains in Peru rises at times to altitudes of 10,000 to 16,000 feet. At that height the air is thin, too thin for comfortable breathing and for efficient operation of automobiles adjusted for lower levels. In spots the road is so narrow that traffic is regulated by calendar, all moving in one direction one day and in the opposite direction the next. This is particularly true be-

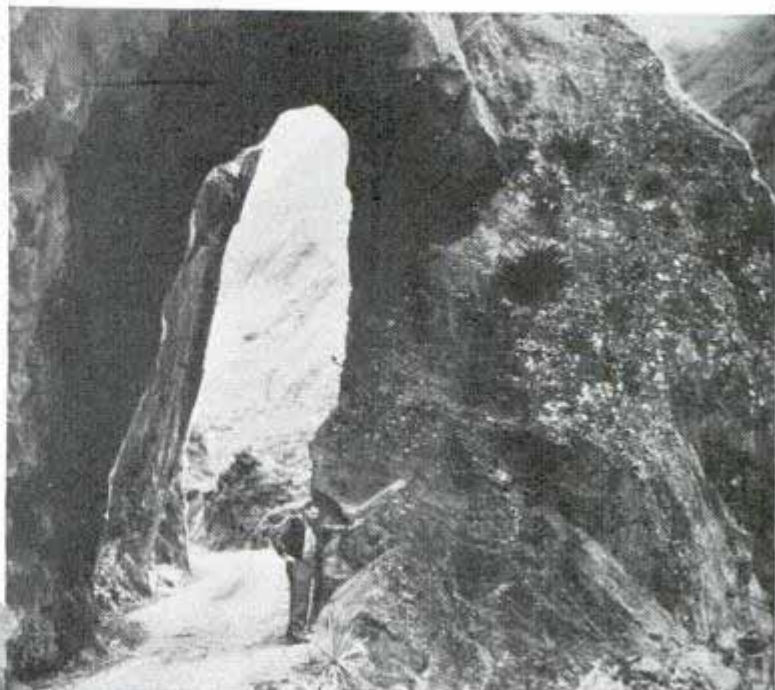

Top, one of the narrow passages cut through mountainside for the highway. Bottom, left, Dodge good-will truck passing a Llama herd on the road. Right, truck crossing deep gorge

tween Cerro de Pasco and Huanuco, where a truck equipped with dual wheels must remove the outside set to squeeze through narrow places. Often rough as a washboard and tilted in spots at alarming angles, the road passes through country en-

dowed with nature's beauties. Completion of the Pan American highway, linking North and South America, will soon make it possible for motorists from this country to visit the Andes and to travel in safety over this now almost impassable road.

"Rubber" Fender and Plastic Body Challenge Steel in Automobiles

Plastics are making a spectacular invasion of the realm of steel in the automobile industry, and research men are even working toward the day when the entire car body will be molded of plastics. A colorful ceiling of plastic instead of fabric is al-

ready being considered. One company is discussing molding "rubber" fenders, hood and trunk of plastic materials. Plastics are already common in steering wheels and instrument boards, knobs and various decorative parts of automobiles.

Chirina Chanchi says highway Peru

near Croya Peru

Huachaga River

and San Rafael

2496

Business Week April 15 1939

431 W. 60th Terrace
Kansas City, Mo



NATURE, the greatest showman of them all, outdid herself on Carlsbad Caverns. For sixty million years she worked in fashioning a fantastic spectacle under the desert of New Mexico, but it remained for modern science to make it accessible and convert it into the most dramatic natural phenomenon in the world.

Discovered shortly after the turn of the century, the caverns received scant attention until they became a national monument in 1924. Even then, tourists who did venture into the underground wonderland found it too wearying to be enjoyable. There were endless flights of stairs to climb and hours of walking over sharp stones and boulders. Its stone treasures were impressive, but many could not be seen to advantage because of inadequate lighting.

GREATEST SHOW

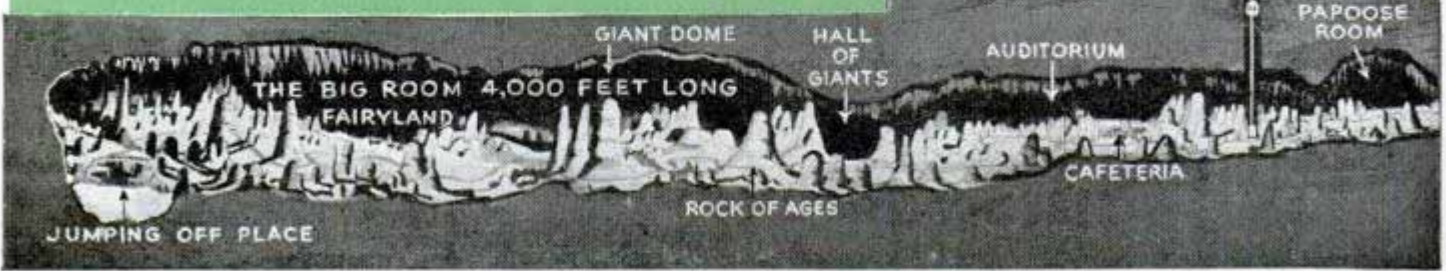
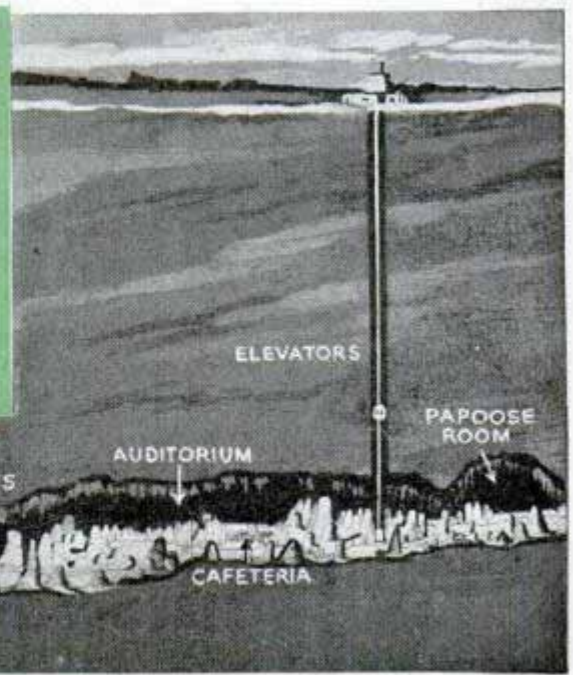

Top, entrance to Carlsbad Caverns in New Mexico, through which more than 200,000 visitors passed in 1938. Gentle grades and well-made paths have replaced most of the original stairways and two high-speed elevators, seen in diagram of caverns at bottom, bring visitors up the 750-foot shaft to surface

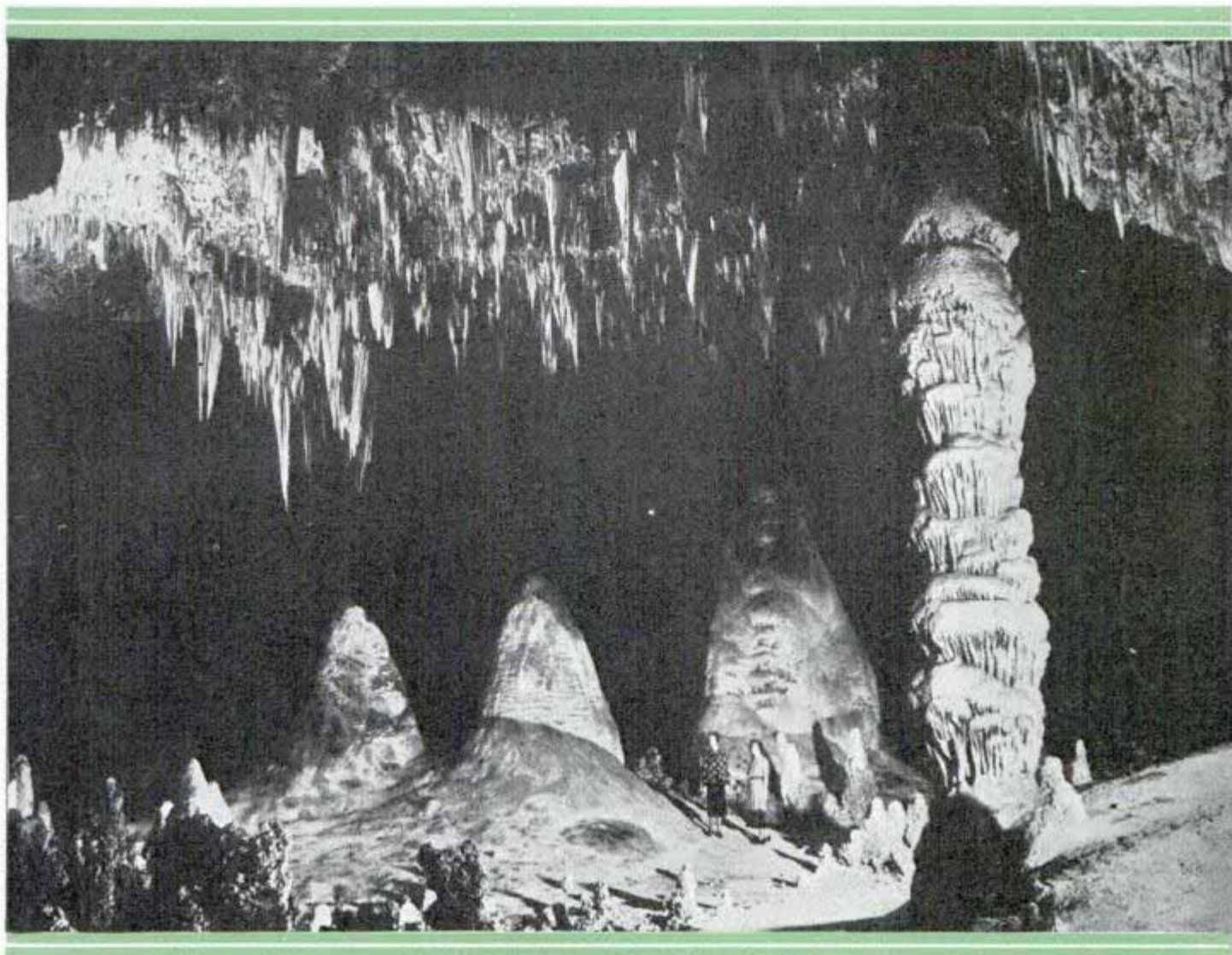

Under the EARTH

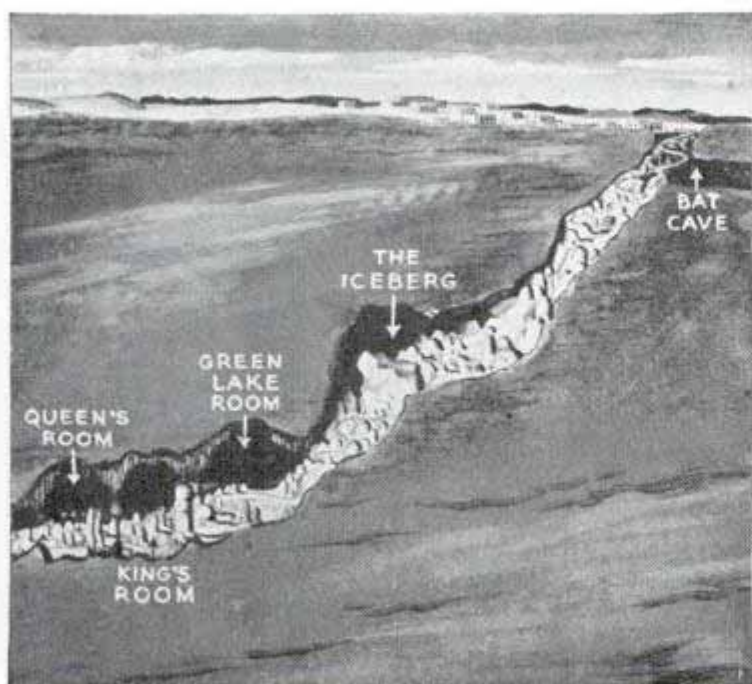

Concealed lights accentuate the beauty and delicate natural colors of the myriad stalactites and stalagmites. At top is the "Hall of the Giants"

When Colonel Thomas Boles was named superintendent of Carlsbad Caverns in 1927, however, prospects brightened. An engineer and a veteran in national park service, he saw that with certain improvements the caverns could be made into the greatest show under the earth. He set about to acquaint himself with all the features on the 750-foot first level—the great galleries, forests of stalagmites, stalactites, and helictites, huge domes, grotesque temples, and cascades frozen in stone. He learned there was another level at 900 feet, which had not been fully explored, and a third at 1,320 feet of which little was known. But the development of the known areas was his chief concern. Paths had to be built and wide ramps substituted for stairs wherever possible. The 950 steps leading down to the floor of the cave were reduced to 200, and over well kept trails

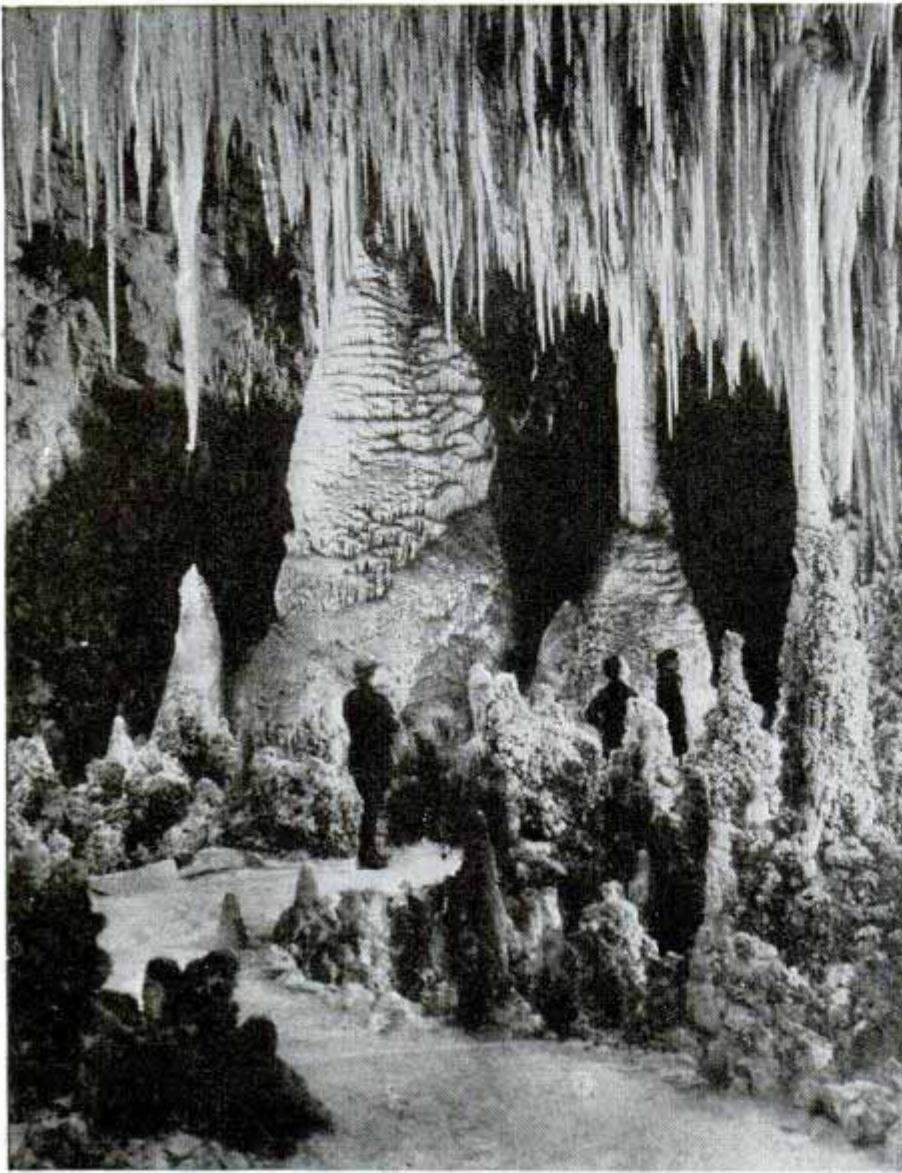

No theatrical production ever received greater attention than did the lighting of these formations. The spectator sees their full beauty almost without consciousness of the source lights. Some of the sculptured effects festooning the walls are illuminated to resemble giant jewels glistening in the night. Other beams bring out tints of tan, rose and green.

Methods employed in lighting caves are radically different from those used on other illumination projects, according to W. A. Oglesby, lighting engineer who helped design the Carlsbad system. Each effect has been obtained by trial and error and imagination. An effect may be obliterated

and passageways the five-hour trip can be made with no more discomfort than might be experienced on a shopping excursion. A shaft was sunk eighty-four stories into the bowels of the earth so two high-speed elevators might carry visitors to the 750-foot level in a minute's time. They are regarded as the second-longest single-lift elevators in America, surpassed only by those in the Empire State building.

Floodlighting the seven miles of trails was his next step. Telephones were installed in the lower chambers to connect with the administration building; water was piped from the surface to drinking fountains along the way. In one of the larger cave rooms is a cafeteria.

Engineer Boles could have rigged up an air-conditioning system had not Nature beaten him to it. Instead of the mustiness you might expect, the air is fresh and clean, the temperature remaining at fifty-six degrees the year around.



Top photo courtesy Southern Pacific Co.

Thousands of stalactites in "Temple of the Sun," at top, make it appear like a great ice palace. Below, tourists entering elevator for trip to the surface

by moving a lamp a few inches one way or another, or by use of unsuitable reflectors.

One experience Oglesby had at Carlsbad illustrates the care that must be exercised. After one chamber had been permanently wired, an excellent scene appeared to be ruined and he and his associates were on the point of ripping out the wiring and starting over when it was discovered one lamp had been installed three inches from its proper location. As soon as this error was corrected, the effect was perfect.

The lighting system is divided into twenty-four sections. As a group of tourists enters a section, the front guide pushes a button and lights flash on for 1,000 feet ahead. The ranger at the rear shuts them off as the last visitor files out. Three and four-way switches have been used extensively. Ample power is supplied by a Diesel generating plant.

Not one of the 500 floodlights ranging

(Continued to page 133A)

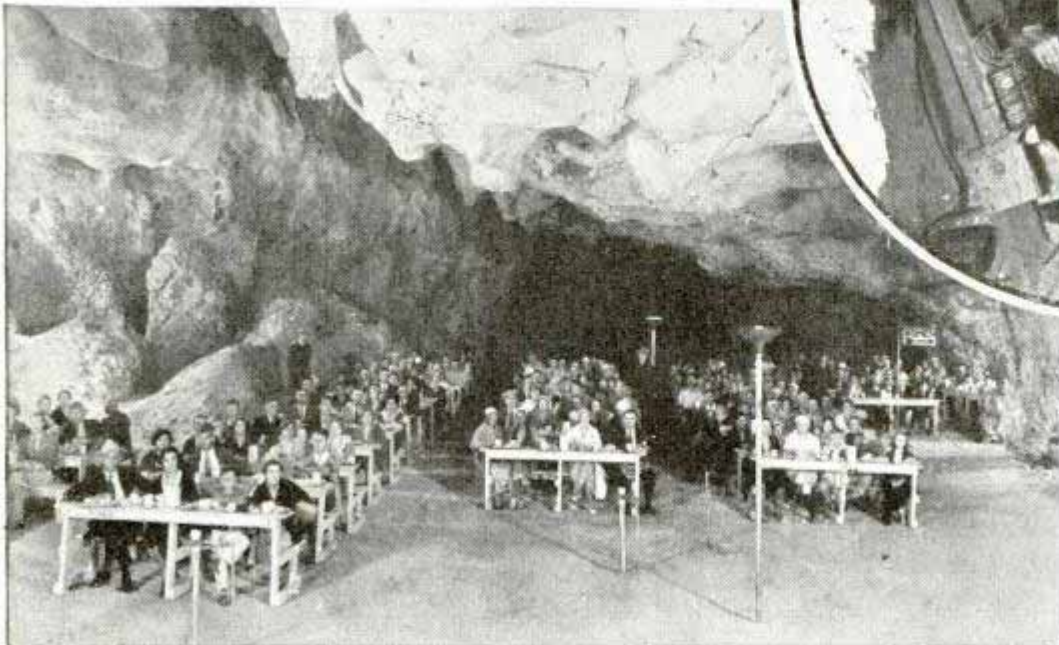
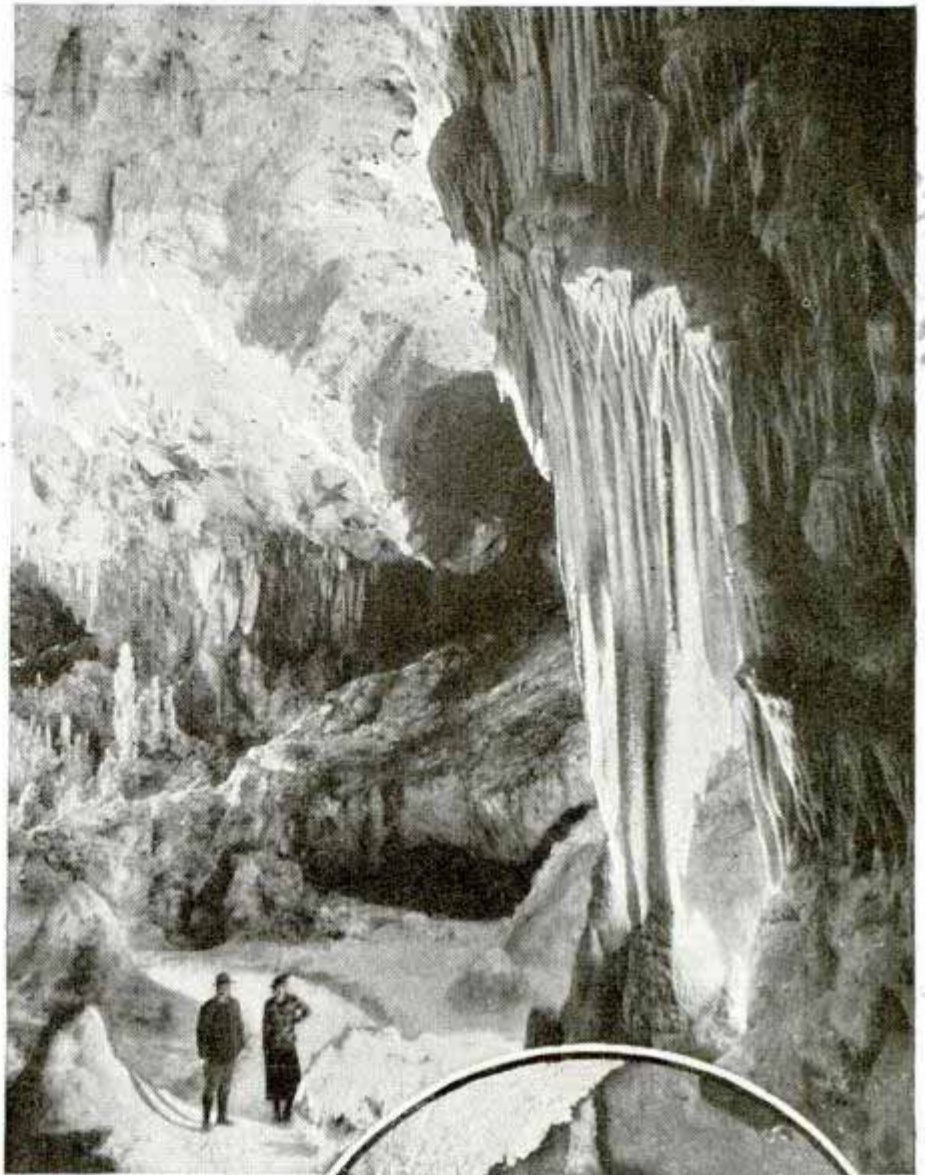

Top, a corner of the "Big Room," 4,000 feet long and 625 feet wide with ceiling as high as 350 feet. In circle, telephones hidden at strategic points enable rangers to handle large crowds without confusion. Left, tourists at luncheon in underground cafeteria, which seats 1,000 and is being enlarged

Housing Authority, 914 - 8

Clinton Park Wayne, Mich

Three-Room Plywood House Is Built in a Day

Comb. Cletus Jurek, 1409 Pemberton
Dwyer Wayne Mich

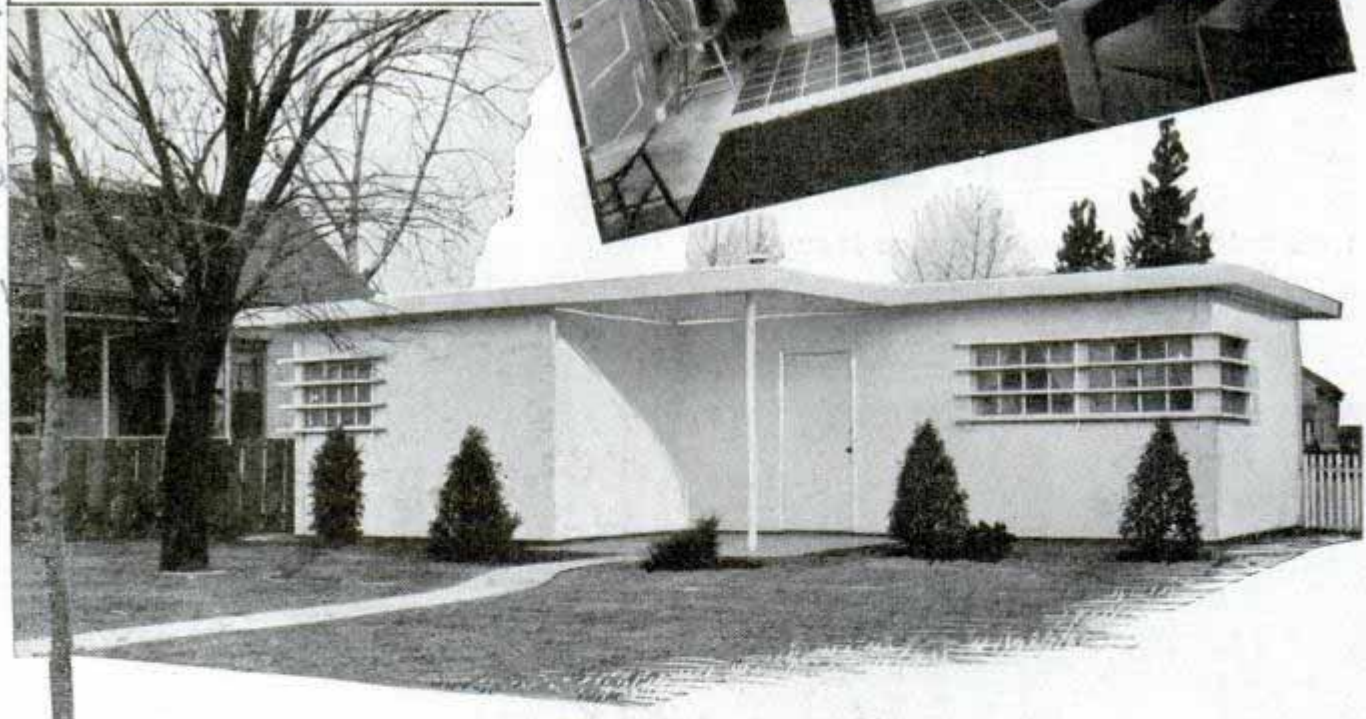
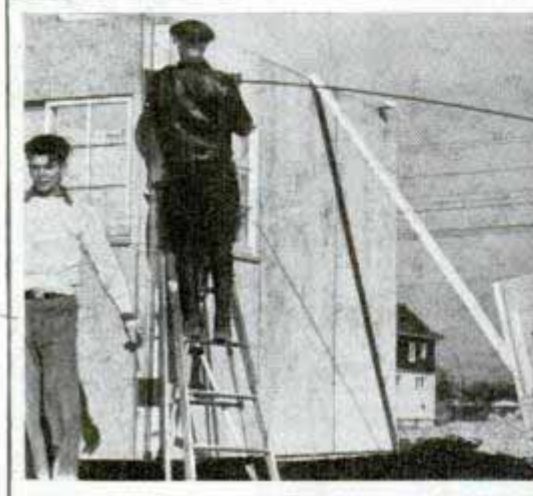

Upper left, unloading plywood panels at homesite and inserting tie rods in wall. Right, views from both ends of combination living room and kitchen. Below, finished three-room house, built for less than \$900

see letter

For less than \$900 a prefabricated house of plywood can be built in a middle western city. Once the concrete floor is laid over its nine-inch gravel bed, unskilled labor can put the house under roof in an hour and forty minutes, after which the asphalt roofing material is applied and

plumbing fixtures installed. The house is a three-room structure with walls and ceiling panels of phenol-resin bonded plywood nailed and glued to two-by-four framing members prebuilt at the factory and filled with rock-wool insulation. Paper tubes inserted in the panels form channels for

April 18, 1939

tie rods used to bolt the assembled structure together and reinforce it. There are two bedrooms, a bathroom, and combination living room and kitchen. A small "space heater" warms the house and maintains a hot-water supply in the bathroom storage tank. The house rents for \$2.50 a week.

2495

G-Men's Super-Microscope Makes Hair Cell Visible

So powerful that it makes a human hair look as big as your thumb, a specially built precision microscope is the latest weapon of the G-men. In the technical laboratory of the federal bureau of investigation, a single hair clutched in the hand of a crime victim can be compared in magnified form with a hair from a suspect's head. The two hairs are blended optically until, if they match, they appear as one hair. The super-microscope brings out the color in threads so tiny they seem colorless to the eye. The instrument enables investigators to split hairs lengthwise or in cross-section to study their individual cells.

2422

Fighting Bull on Wheels Develops Grace of Movement

For safety's sake, aspiring bull fighters should start training with a bull on two

wheels. The head of a longhorn mounted on a two-wheeled truck is used at a school for bull fighters at San Antonio, but because the matador becomes one of the most graceful persons in action, the rolling bull is also used to teach grace of movement. It affords excellent training in footwork for dancers.



Practicing footwork and grace of movement with aid of two-wheeled bull

Conducted by Edwards

Loud Speaker Helps Coach Talk to Players on the Field

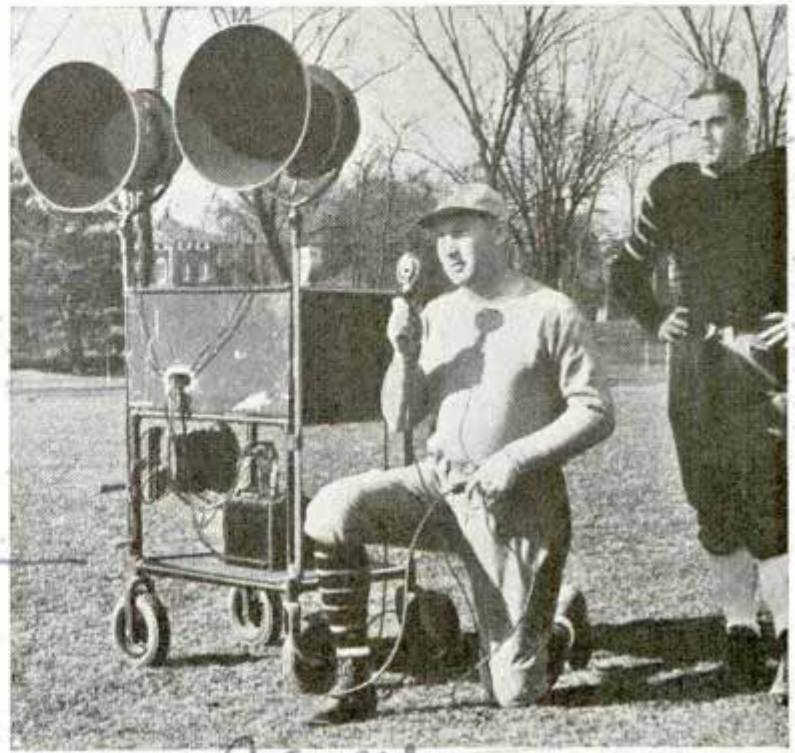

Coach directs football squad by talking into microphone of voice booster as he watches players go through maneuvers

To save his voice and yet be heard by football players in all parts of the field, a coach has added a portable loud-speaker system to his equipment. The rolling amplifier permits him to move about the gridiron during practice sessions.

Em. L. Edward. Denver

Gasoline in Saskatchewan must be white if less than sixty-five octane, red above seventy-five octane, and green or blue between sixty-five and seventy-five; purple denotes gasoline for agricultural use.

Auto Index

Balloon Guides Rescuers to Pilot Down at Sea

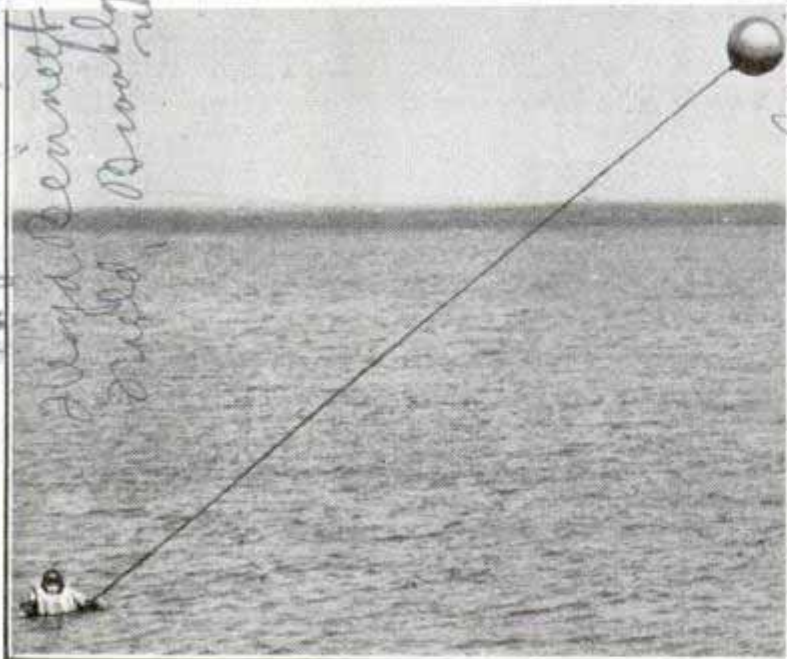

Top, "rescue balloon" fastened to pilot's arm is inflated with helium gas by pulling cartridge trigger; center, pilot inspects armband before taking off. Pilot, bottom, supported by life jacket, sends up balloon to help rescuers locate him

Balloon rescue markers may save the lives of navy pilots who are forced down at sea. Each flier would carry a balloon attached to a band on his arm, complete with a cartridge containing helium under pressure and 200 feet of strong twine. Should his plane be forced down the pilot would pull the cartridge trigger, quickly inflating the balloon and sending it aloft. Recent tests proved that this could be seen from a rescue plane ten miles away.

Tiny Shot Sharpens Image of Metal under X-Ray

X-ray photographs of irregular metal objects are more sharply defined by covering the object, such as a monkey wrench, with fine copper or steel shot—spherical particles finer than sand. Hidden to the eye, the edges of the wrench are clearly outlined in the X-ray picture. The same photograph made with the wrench held in the air would have blurred outlines. The explanation is that due to the difference in absorption of X-rays by metal and by air, the part of the negative not in back of the metal object is over-exposed, the exposure "spills over" and blurs the edges of the object.

Auto Parts Are Nicknamed by Factory Workers

You would hardly expect to find a "big bertha," "player piano," "percolator," "hay baler," "jack rabbit" or "corn popper" in an automobile plant, but such are the names by which some of the big machines are known. Workmen, shunning the technical terms of engineers, have manufactured a jargon which anyone would recognize as appropriate if they saw the machines in operation. For instance, steel rings are curled by

Experiment conducted by U.S. Naval Air Reserve Base

Bennett, Air Force Brooklyn, N.Y.

General Bennett

Alfred Bennett
Died, Brooklyn

2494

2446

Diets.
April 1939

a "permanent wave" machine, coil springs are squeezed into place by a "robot," while only the melody is lacking as the "merry-go-round's" spindles rise and fall in machining motor blocks. Car parts also come in for nicknames. A "tin hat" is worn on the rear axle, and a "hairpin" holds pedal springs in place. The muffler clamp becomes a "dog collar." Lamp guards are known as "fish," shock absorbers have a set of "horseshoes," there's a "bottle cap" on the engine water jacket, and elsewhere an auto has its "pancake," "spider," "snowshoe" and "banjo." A bit of humor enters the factory slang when a three-foot pipe wrench is called "Little Percy."

2-415

Table with Adjustable Leg Fits over Lap or Bed

Convenient for sewing, card games, reading or writing, a wooden lap table has a single adjustable leg which holds the table at the proper height when a thumbscrew is tightened. It can be rested on the lap or the arms of a chair, or used as a bedside serving table.



One-legged table can be set at any convenient height by adjusting thumbscrew

6-A Specially
2nd 2 1/2 ft

"Air Crash" Draws Diners to Roadside Eating Place



Passersby fear the worst when they see this airplane nosed through a roof, but it's only an invitation to come in and eat

Motorists who stop to examine what seems to be an airplane crashing through the roof of a house find it is simply a clever way of calling their attention to a roadside dining room. The enterprising owner makes a good living by feeding those whose curiosity causes them to stop.

Club.

near Wilmington, Del

add detail \$1.25 kb. 2 433

Lost Heat Is Captured in Flue to Keep Water Tank Hot

Heat that escapes with burned gases into the stack of a warm-air heating furnace can be put to work if a new type water heater is installed in the flue. It takes the place of a section of the pipe, and is like a water jacket with fins inside to catch the heat as it passes and transfer it to the water. From there the hot water rises to the storage tank. Flue gas temperatures in warm-air furnaces may run as high as 400 to 500 degrees Fahrenheit, and it is claimed this water jacket will equal in capacity a forty-gallon indirect heater as used in a steam-heating plant.

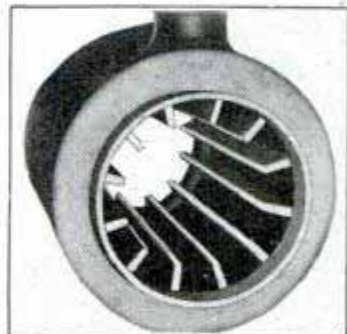

Master Craft Steel Extractor

Harvey Whipple

2. 167

newark 2/10

MAKING WEATHER around the GLOBE

Bottom of page,
left, air outlets
on liner. Right,
interior view of
U. S. Capitol air-
conditioning pow-
er plant

By
Willis H. Carrier

Chairman of Board, Carrier Corp.

Air Conditioning

ONCE confined to the needs of a few of our industries, air conditioning has been carried by American engineers to the earth's out-of-the-way corners.

No matter where you go, you find indoor weather—1,000 feet up in an office building and 8,500 feet below ground in a gold mine; in a tobacco factory near the Arctic Circle and a telephone exchange on the equator in Sumatra.

The industry has grown up. In 1932, equipment sales amounted to \$8,000,000 and just five years later they were ten times that figure. By 1945, we expect the yearly total of installations to be in proximity of \$350,000,000, and eventually, a billion-dollar-a-year market will be created.

Life along the Persian Gulf shores of Saudi Arabia was almost unbearable for a party of oil scientists, drillers, and laborers until summer-resort weather was installed in their field cabins, offices, and recreation halls. A portable unit has been carried into the jungles of Venezuela to protect the supplies of a missionary band.

*Holland-American Line
Nieuw Amsterdam*

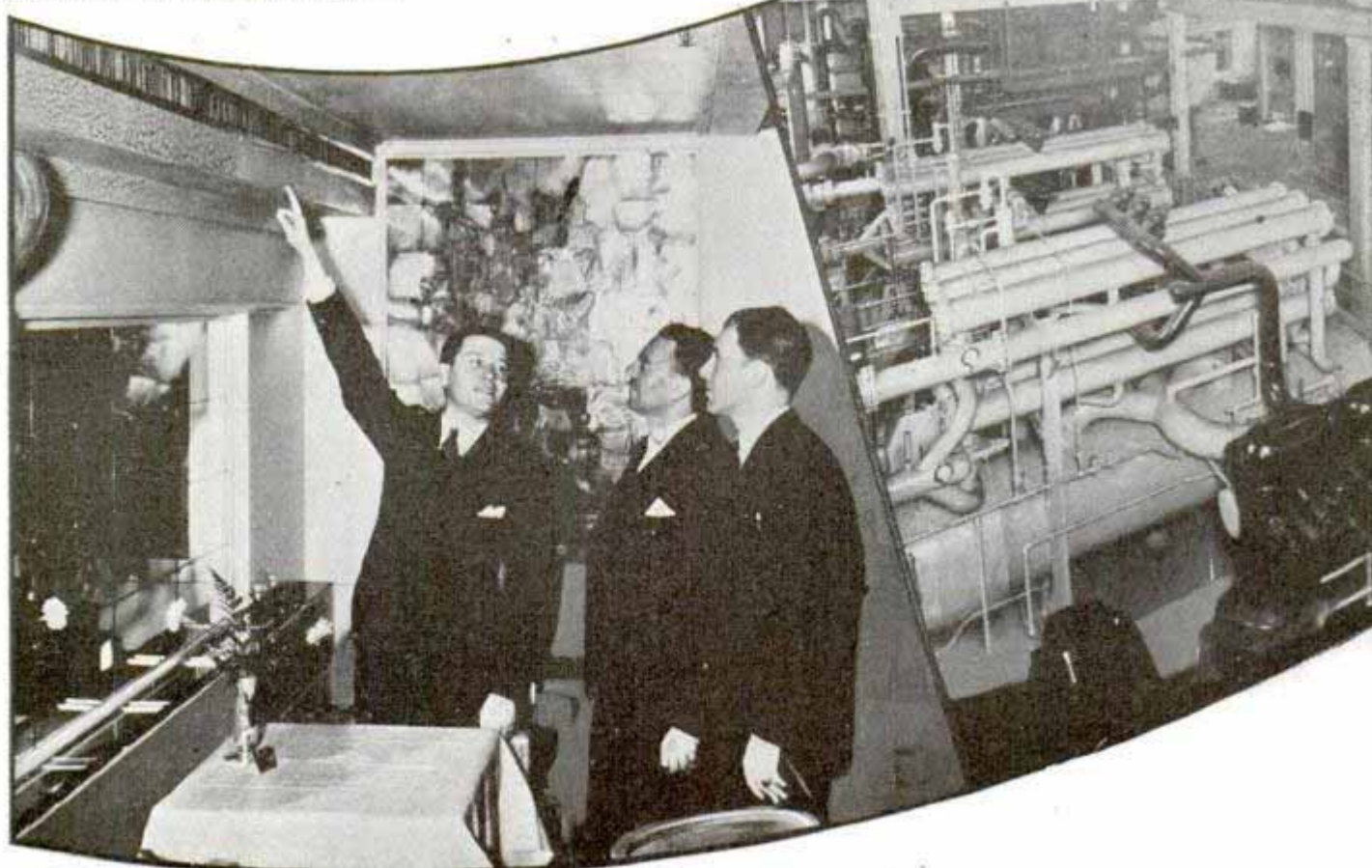

431 W. 68th Terrace
Kansas City, Mo.

Left, pump and tank for washing air supplied to NBC studios in Radio City. Below, right, control panel for regulation of temperatures in twenty-seven radio studios

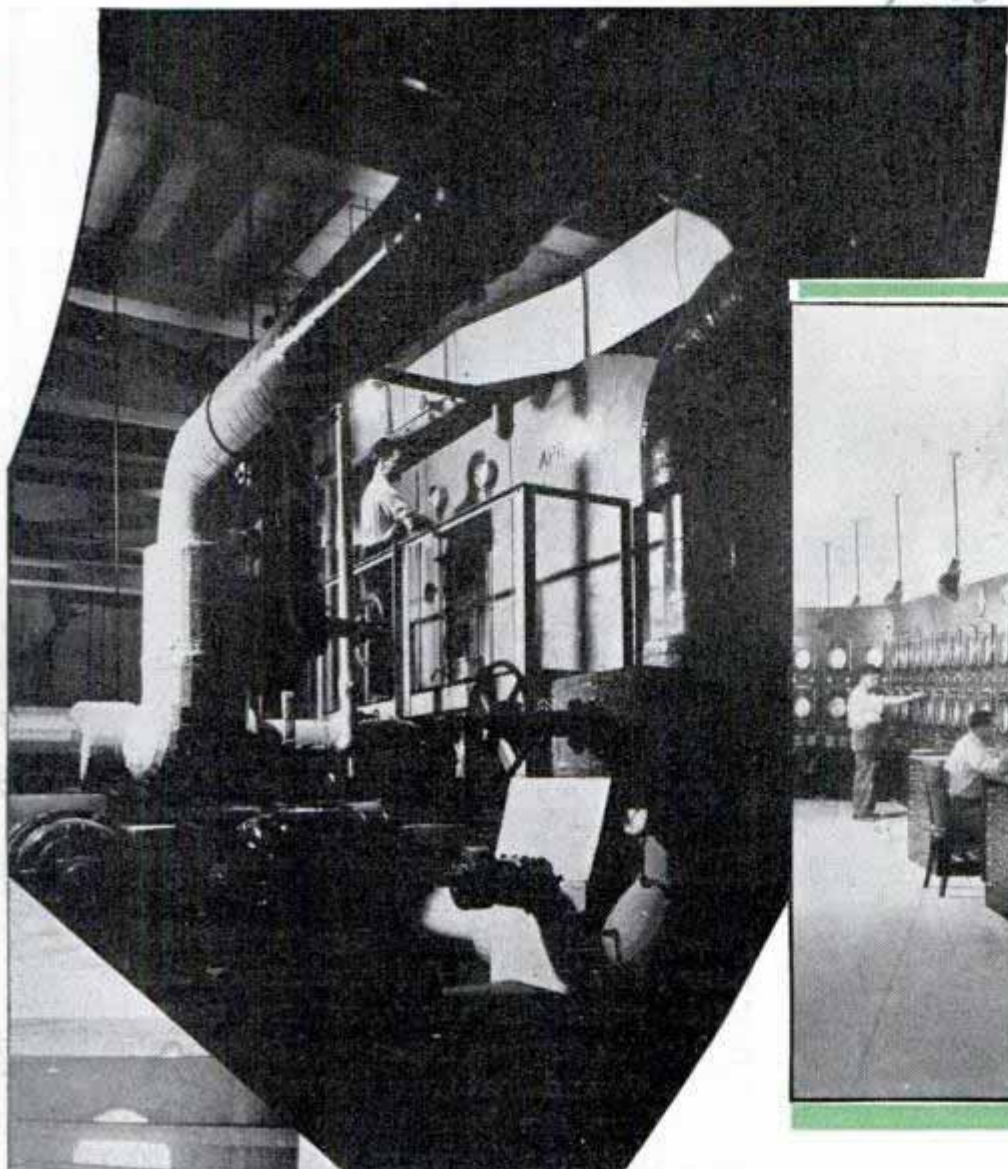

In Colombo, Ceylon, where high relative humidity and high temperatures are frequent, the stable of a prize race horse has been air conditioned in an effort to improve its stamina and speed. Tea tasters of the London Cooperative Wholesale Society find the sensitivity of their palates sharpened in the cool, clear atmosphere in which they now work. And if they or their countrymen ever have occasion to use the city's bombproof and gasproof cellars, man-made weather will make their sojourns comfortable and healthful.

Delicate scientific instruments expand in severe heat so those used in the physics department at Raffles College in hot, humid Singapore are kept in a room where atmosphere conditions are scientifically controlled. Indoor weather has been provided for the comfort of the Mah Jong players who gather at an exclusive Chinese club of the Straits Settlement city, and also in a barn housing a herd of valuable cattle.

Some of the punkah fans of Hindus and Mohammedans in India have been supplanted by more modern methods of weather making. On the backs of elephants, weather-controlling equipment has been carried to Chithhar Hill in Rajputana so that regardless of outside climate, the Maharajah may live, dine, and sleep without a moment's discomfort in his new \$4,000,000 Jodhpur palace.

Air conditioning's greatest success story has been written in the gold mines of South Africa where the available gold supply of the world has been increased fifty per cent. When we first talked with the operators of the Robinson Deep mine on the Rand, from which \$5,000,000,000 in gold has been extracted in the last forty-five years, they were

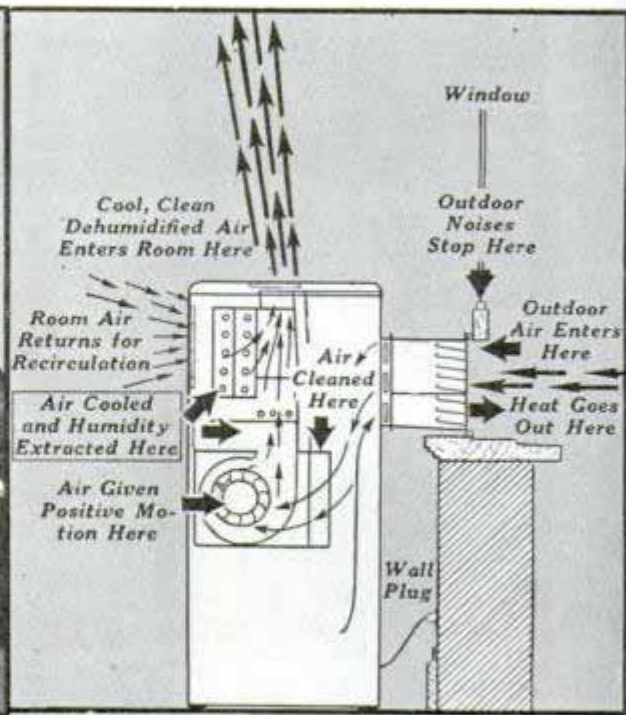

Left, unit which removes three quarts of water per hour from air of room in summer. Right, diagram which shows how portable unit prepares air, washing, cooling and dehumidifying it

anxious to improve working conditions within the mine but were skeptical of turning manufactured weather into this, the world's largest shaft. At the 8,500-foot level, with temperatures over ninety-five degrees and relative high humidities, natives could work only in short shifts, and their efficiency was far below normal.

After evolving a working theory on rock cooling in mines, we designed a plant which, by means of large fans located 6,000 feet above sea level, sends cool, washed air through the three miles of underground tunnels. Entering the shaft at the surface, the air is cooled uniformly throughout the year to a temperature of thirty-five de-

grees, permitting efficient operation of the mine at its greatest depth, although at the latter point the temperature rises to eighty-six degrees because of compression of the air and heat from the rocks.

Workers are brought up through the cold shaft from the warm, humid depths to the surface. At the outset it was feared such a temperature change would increase illness and the incidence of pneumonia already prevalent among miners. As a partial safeguard, workers were required to stop at the 4,000-foot level on their way up and put on sheepskin jackets. Contrary to expectations, however, the incidence of pneumonia has decreased more than thirty

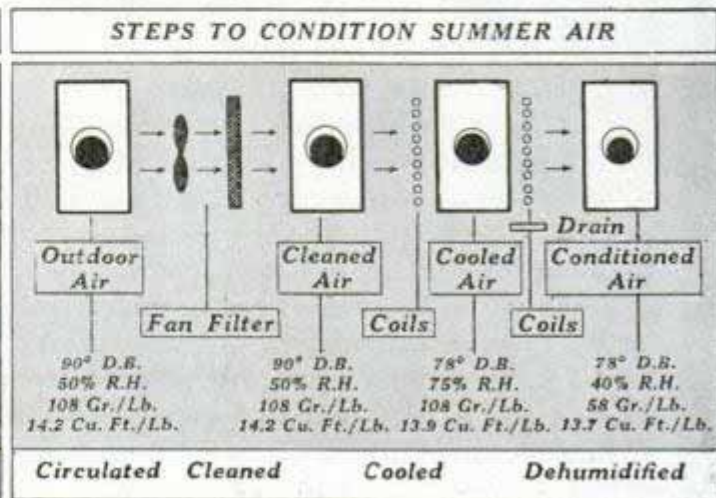
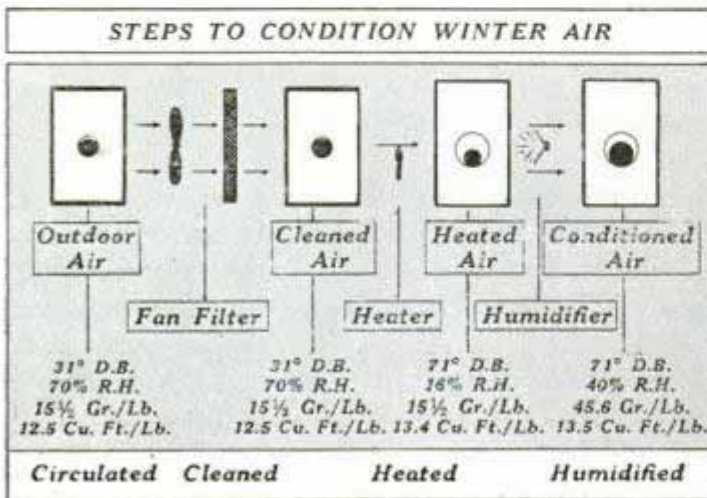

per cent since refrigeration machinery was set in operation.

Summer lay-offs occasioned by heat and humidity in the Magma Copper mine at Superior, Ariz., likewise have been averted in this manner. Operations here, too, have been stepped up by cutting the time formerly required for the cooling of a new level to a workable temperature.

With the advent of deluxe air-conditioned sleeper buses, much of the

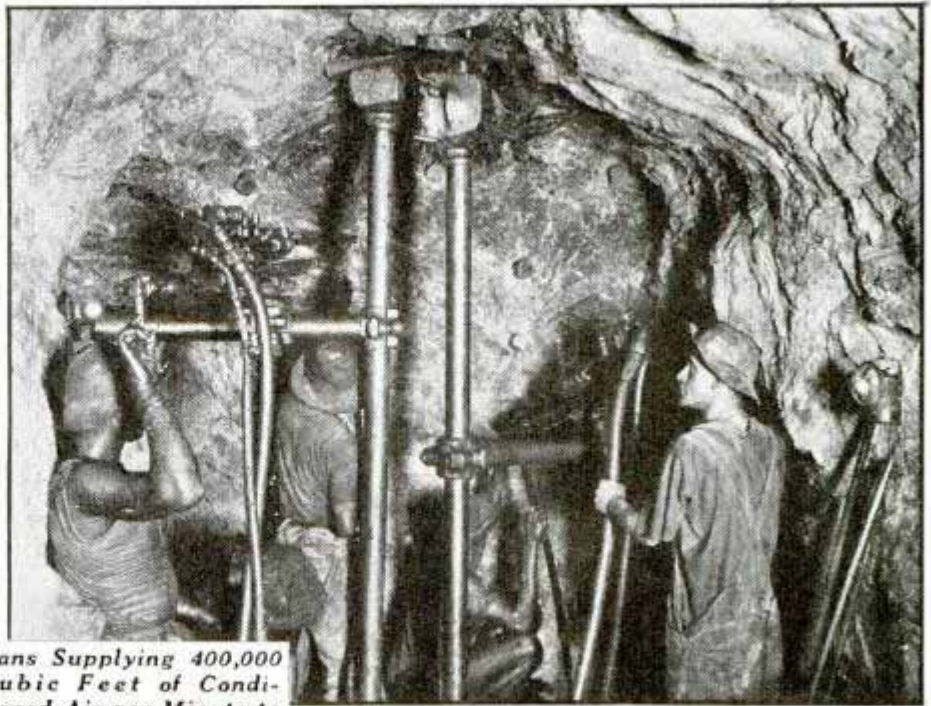

Fans Supplying 400,000 Cubic Feet of Conditioned Air per Minute to Mine Through Tunnel

Above, air conditioning has resulted in increased gold production in South African mine. Left, diagram of installation in mine. Bottom, air-conditioned telephone booth

sting has been taken out of travel across the Arabian desert. The twenty-hour ride between Beyrouth, Damascus, and Baghdad over a roadless route* covered by sand and sagebrush with temperatures around 120 degrees can now be made in comparative ease and comfort in these sealed,

Diesel-powered dromedaries. Oddly enough, this equipment supplies heating as well as cooling, air circulation, filtering, and ventilating because the mercury drops to freezing during the winter months on a high plateau in east Syria.

Noteworthy progress has been made on the high seas. Machinery with a cooling capacity equivalent to the melting of a half million pounds of ice daily supplies indoor weather for several dining rooms, main lounge, and barber shop on the "Queen Mary." The installation on the "Normandie" has made possible an innovation in marine design—that of placing the 300-foot dining room in the center of the ship and flanking it with outside staterooms, which usually are in demand and bring premium rates.

When a large circus decided to take Gargantua, a giant gorilla, on tour, veteran animal men shook their heads.

(Continued to page 137A)

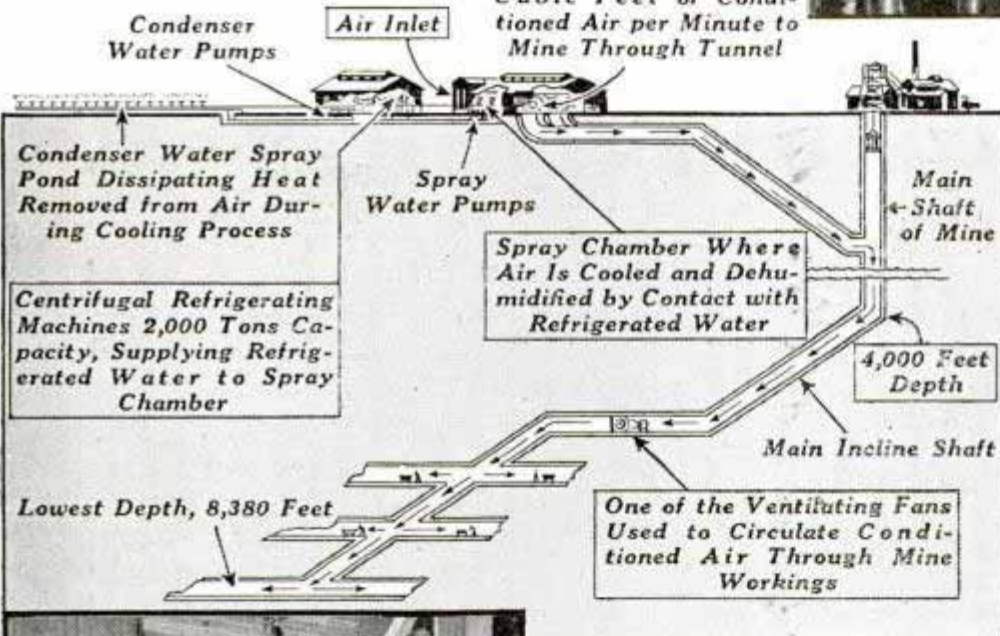

South Atlanta

Motor Cops Carry Camera and Two-Way Radio

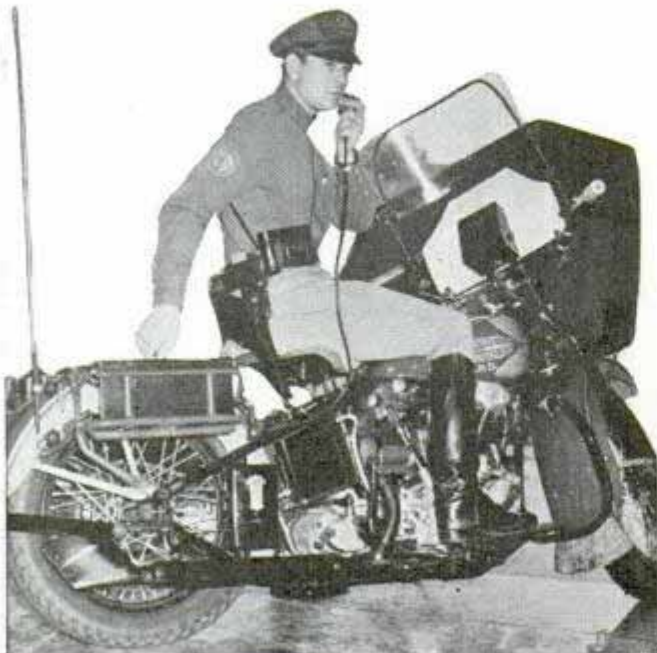

Motorcycle officer reports to headquarters by radio and takes flash picture at scene of crime

City police of Beverly Hills, Calif., have been equipped with cameras to take evidence. Carrying a camera on a shoulder strap, they ride to the scene of crime or accident on motorcycles equipped with two-way radio telephones over which they can talk with headquarters. The camera is a miniature, with flash gun.

If You Must Take a Bitter Pill Rub Ice on Your Tongue

Chill your tongue first with ice if you have to take a dose of bitter medicine. Dr. Harald Tangl of Budapest reports that

taste buds of the tongue scarcely function at all when cooled, while warmth stimulates them. Hot coffee requires less sugar to sweeten it than iced coffee. There are 3,000 taste buds on the human tongue. Antelopes have about 50,000 and cows 15,000. Whales have very few, and gulp their food so quickly that taste is no object. Fish taste with their whole body.

Capless All-Rubber Valve Stem Has No Replaceable Parts

Even though it does not wear a cap, no dirt or water can enter an all-rubber tire valve stem now on the market, a constant seal being maintained at the opening by a spring valve that keeps the air in. Its internal parts, made of non-corrosive metal, are permanently fixed and never need to be replaced. Being tough and pliable, the stem will not tear out of the tube or damage it in case of a blowout or puncture.



Conveyor Powered by Gravity Loads Freight Cars

Portable so it may be moved instantly to any desired location, a conveyor mounted on wheels requires no motive power for its operation. Packages travel by gravity on its slightly inclined track. Portability makes the apparatus especially handy for loading and unloading railway cars.



This portable conveyor lets weight of packages do the work in carrying them from one end to the other

normal medicine arsen.

both and clearly

g 393

80 whole St
New York City

g 430

g 319

g 502

Dr. Tangl

Bank's Stop-Theft Drawer Dumps Money into Safe

Useful Bank of America San Francisco



Pressing button throws money into the safe. Weight drops out, too, so tray can snap back

At the first sign of a robbery, bank tellers using a special kind of cash drawer can empty its contents into a safe by simply pressing one of four buttons, which may be done by leaning against them if hands are upraised. The drawer is controlled by five buttons, all exactly alike, but only one of them will open it, and even if a bandit succeeds in entering the cage before the cash is dumped he still would have only one chance in five of selecting the right button. If his choice goes against him the bottom of the drawer drops automatically.

Clamp Aids in Repairing Racket by Holding Broken String



Replacement of broken strings in a tennis racket is made easier by a splicing clamp just introduced. It takes an expert to make repairs when one hand is engaged holding

tight the last string with a pair of pliers. The clamp, easily and quickly applied, grips the string firmly and leaves both hands free to complete the splice. It is not used for restringing, but for replacing one or two broken strings.

Hose Is Turned into Sprinkler by Nozzle Holder

Converting the ordinary garden hose nozzle into a lawn sprinkler, a flexible metal neck attached at the end of the hose has its own stand. No special sprinkler head is needed, and it is not necessary to remove the unit in using the hose by hand. Placed on the lawn, the neck may be turned to sprinkle in any direction.

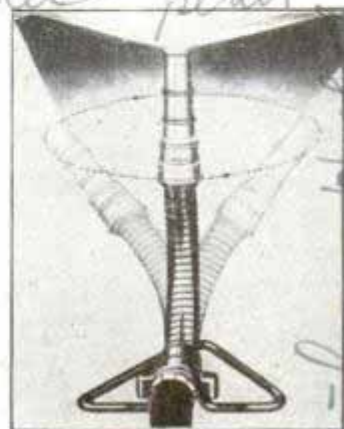

Mixer to Keep Food from Burning Fastens on Cooking Utensil

Fastened across the rim of the cooking utensil, a mixer with three paddles facilitates stirring and helps the cook keep food from burning. A cross bar holds the unit firmly in place, and it is a simple matter to give the handle a few turns as needed.



An occasional twist of the handle turns the mixing paddles, keeping food in motion so it will not burn

C. S. Osborne & Co.

Los Angeles

I R the Clintock Co Bank Protection Service Inc. 739 Snyder Ave. Minneapolis Minn.

447
458
455
463
465
466
467
468
469
470
471
472
473
474
475
476
477
478
479
480
481
482
483
484
485
486
487
488
489
490
491
492
493
494
495
496
497
498
499
500
501
502
503
504
505
506
507
508
509
510
511
512
513
514
515
516
517
518
519
520
521
522
523
524
525
526
527
528
529
530
531
532
533
534
535
536
537
538
539
540
541
542
543
544
545
546
547
548
549
550
551
552
553
554
555
556
557
558
559
560
561
562
563
564
565
566
567
568
569
570
571
572
573
574
575
576
577
578
579
580
581
582
583
584
585
586
587
588
589
590
591
592
593
594
595
596
597
598
599
600
601
602
603
604
605
606
607
608
609
610
611
612
613
614
615
616
617
618
619
620
621
622
623
624
625
626
627
628
629
630
631
632
633
634
635
636
637
638
639
640
641
642
643
644
645
646
647
648
649
650
651
652
653
654
655
656
657
658
659
660
661
662
663
664
665
666
667
668
669
670
671
672
673
674
675
676
677
678
679
680
681
682
683
684
685
686
687
688
689
690
691
692
693
694
695
696
697
698
699
700
701
702
703
704
705
706
707
708
709
710
711
712
713
714
715
716
717
718
719
720
721
722
723
724
725
726
727
728
729
730
731
732
733
734
735
736
737
738
739
740
741
742
743
744
745
746
747
748
749
750
751
752
753
754
755
756
757
758
759
760
761
762
763
764
765
766
767
768
769
770
771
772
773
774
775
776
777
778
779
780
781
782
783
784
785
786
787
788
789
790
791
792
793
794
795
796
797
798
799
800
801
802
803
804
805
806
807
808
809
810
811
812
813
814
815
816
817
818
819
820
821
822
823
824
825
826
827
828
829
830
831
832
833
834
835
836
837
838
839
840
841
842
843
844
845
846
847
848
849
850
851
852
853
854
855
856
857
858
859
860
861
862
863
864
865
866
867
868
869
870
871
872
873
874
875
876
877
878
879
880
881
882
883
884
885
886
887
888
889
890
891
892
893
894
895
896
897
898
899
900
901
902
903
904
905
906
907
908
909
910
911
912
913
914
915
916
917
918
919
920
921
922
923
924
925
926
927
928
929
930
931
932
933
934
935
936
937
938
939
940
941
942
943
944
945
946
947
948
949
950
951
952
953
954
955
956
957
958
959
960
961
962
963
964
965
966
967
968
969
970
971
972
973
974
975
976
977
978
979
980
981
982
983
984
985
986
987
988
989
990
991
992
993
994
995
996
997
998
999
1000

Race Track on Factory Roof Tests New Cars

Modern Wonder 2/25/35

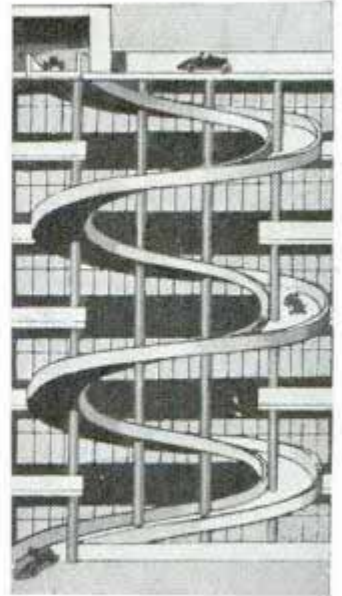

New automobiles produced by Fiat of Italy are given their first test on a race track built on the roof of two factory buildings. The track is seventy-eight feet nine inches wide and the length of two straightaways is 1,423 feet. Turns at either end are banked to permit higher speeds. Spiral roadways lead from the ground to the roof track. As the drivers pass up the roadway, they climb the production ladder of the Fiat, as each floor represents a new stage in the process until the finished car rolls out on the roof.

Left, race track on roof of factory buildings where cars are given their first test. Right, spiral roadway for reaching the roof

One Man Guides Giant 'Jumping Frog' Tamper on Road

It looks as though a superman would be needed to operate the giant tamper used to pack the surface and "shoulders" of German highways. Actually, in spite of its weight of more than 5,500 pounds, the "jumping frog" is guided with ease. At the touch of a button, an explosion of benzol lifts the tamper about sixteen inches above the ground, and because of its inclined cylinder shaft it simultaneously jumps forward about eight inches.

see Aug 1935-251



Benzol explosion controlled by operator makes tamper jump upward and forward, pounding road with 5,500-pound weight

From Air Conditioning

A "non-allergic" bedroom exhibited at Golden Gate International Exposition is designed to protect sleepers against everything that might produce an irritating effect.

U. of California

The Calhoun Co. agent.

maker. Mess. Helweg

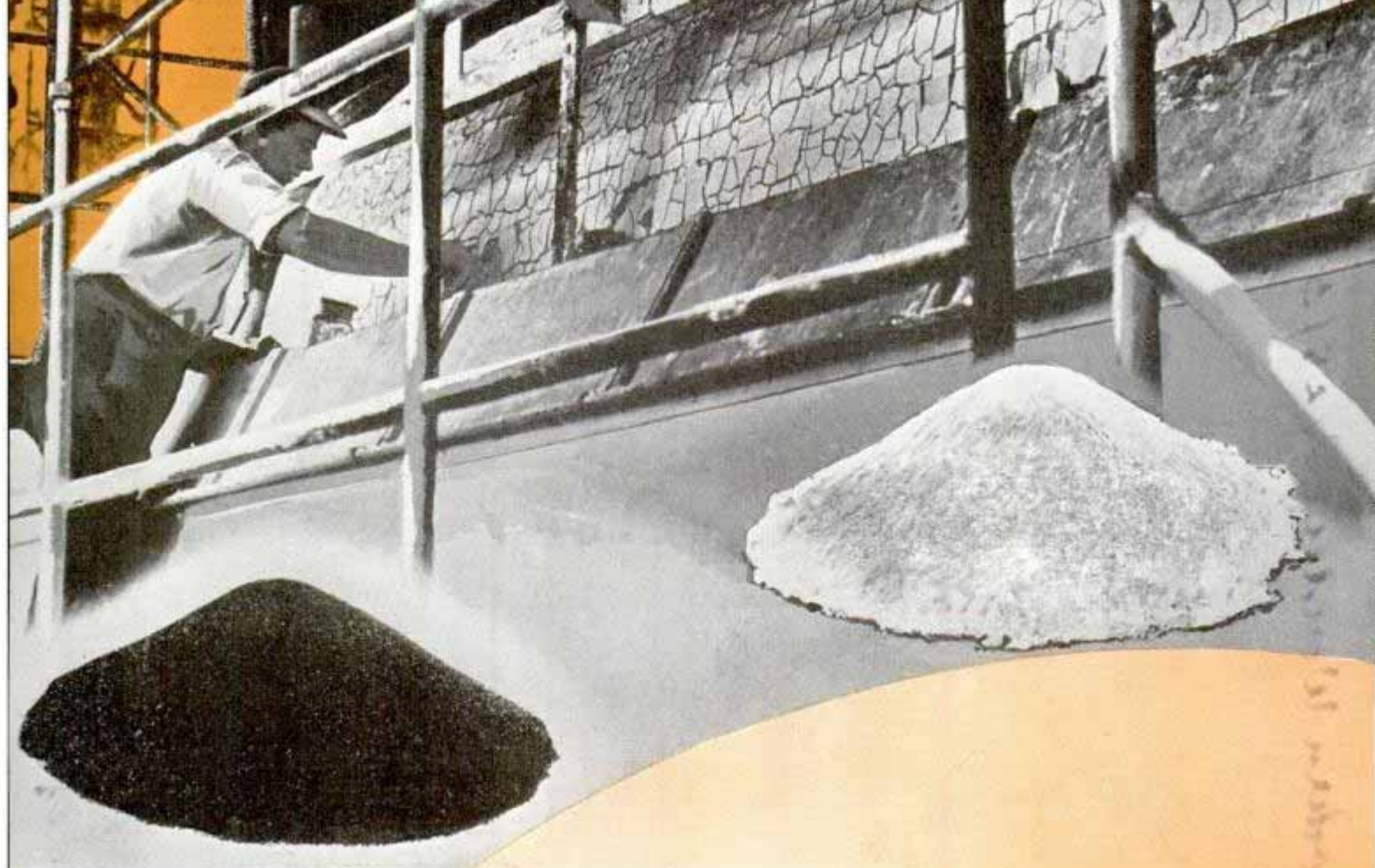

PAINTING *the* WORLD

By
Julian P. Leggett

TURNING an ultra-black ore into a super-white paint is only one of the many seeming miracles that the chemist is performing to meet demands for protective and decorative coatings for a vast majority of the things which contribute to the safety, comfort and convenience of the modern family.

Noah used pitch, the Bible tells us, when he constructed the ark about 4,000 years ago. That, apparently, was the only protective substance known then. Today millions of pounds and millions of gallons of more than 20,000



Top, "Ilmenite," fine black sand, is transformed into snow-white titanium dioxide. Background, filter for reducing water content in titanium dioxide. Bottom, sand test for determining how fast finish will dry

at Edgemoor, Leeb and Pionment Leeb

Krebs
Sept. Ed
Pont Co.
Edgemoor

Right, testing Venetian blind finishes in laboratory. Bottom, paint farm in Florida tests finishes on thousands of panels exposed to the weather. Careful record is kept on each panel

Photos courtesy
E. I. du Pont de
Nemours & Co.

Wilmington
Del.

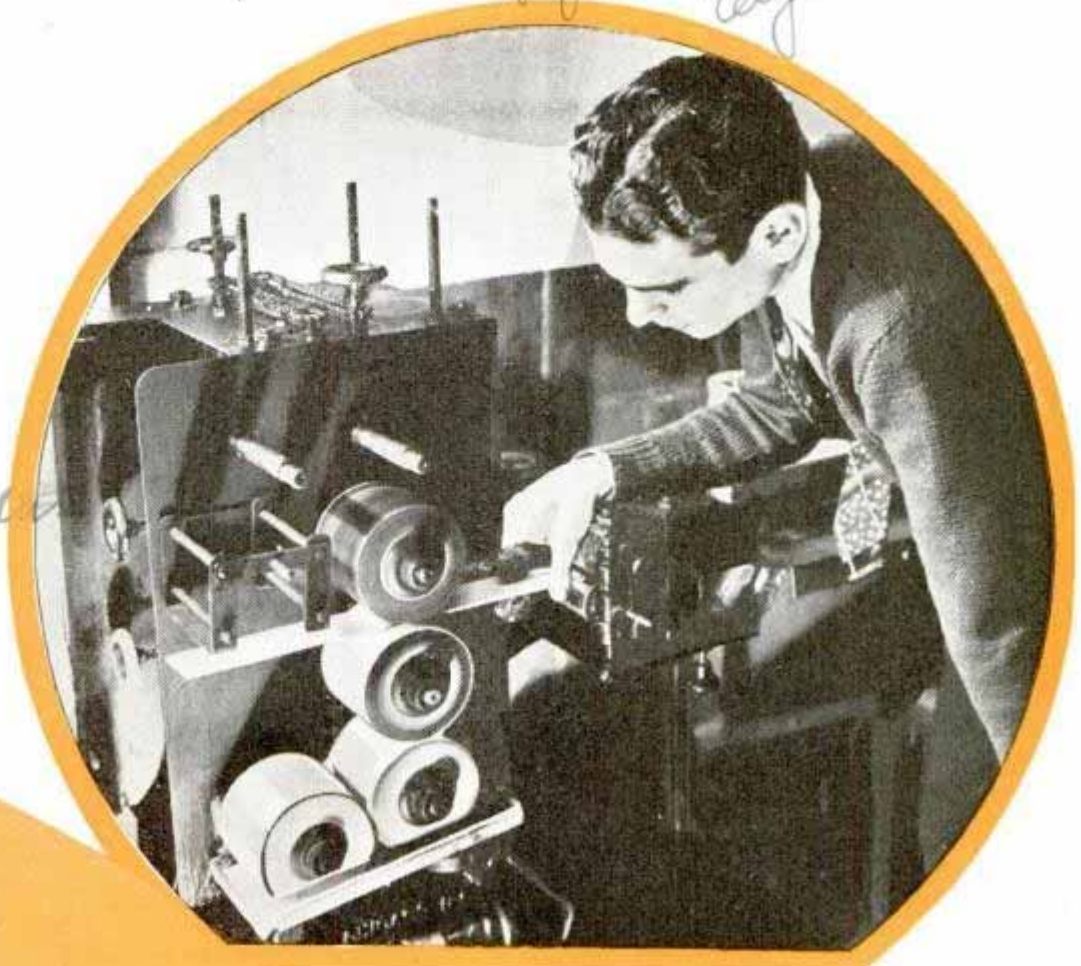

in NEW COLORS

different paint combinations are produced and sold every year in the United States. In 1937 the market value of pigments, varnishes, lacquers, enamels and other forms of paints made by more than 1,100 plants in this country amounted to \$538,460,000.

The pitch with which the ark was protected from water during the flood in Biblical times was obtained from trees. Soft and liquid at first, it hardened into a resinous substance when exposed to the air. The ancient Egyptians went a step further, adding various oils to hardened pitch or other natural resins to formulate the varnishes

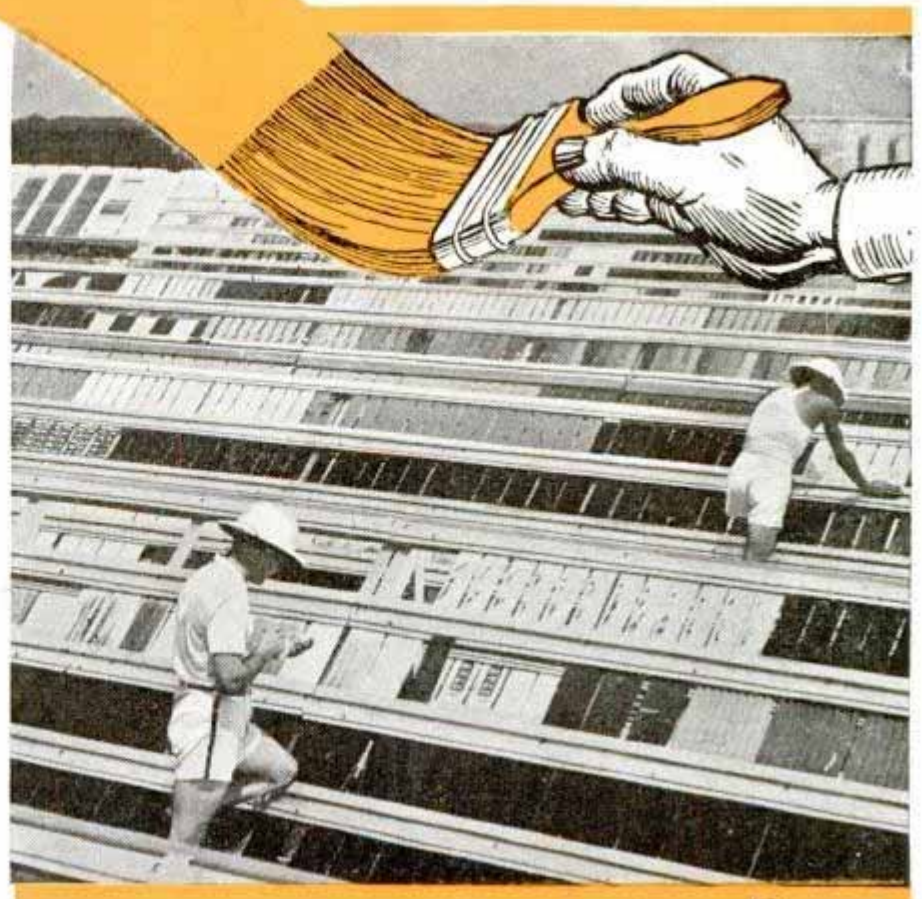

E. I. du Pont de Nemours & Co.

which oils are treated and combined with natural resins over coke fires under conditions where temperature and ingredients can be controlled closely.

Some readers may remember the closing days of the century and the gay carriages with lustrous, polished surfaces that required weeks for the application and drying of coat after coat of varnish. Some of the paint jobs on the first automobiles took two weeks to a full month to achieve because the finishes dried so slowly.

Since 1900 progress of the finishes industry has been

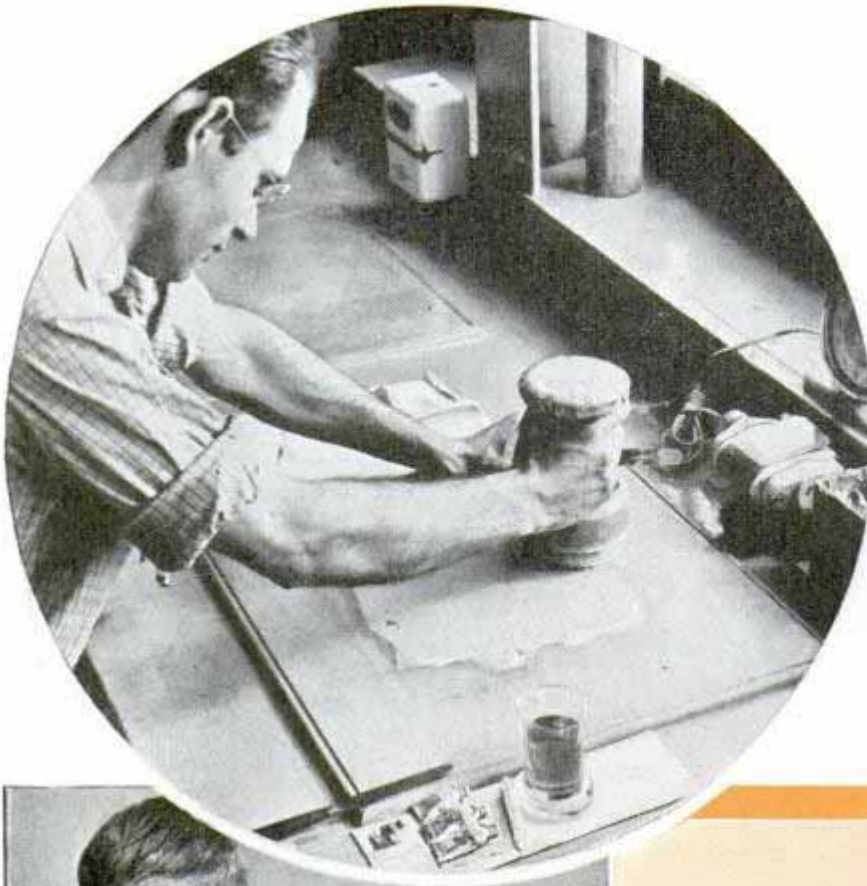

which have protected mummy cases remarkably well for as long as thirty centuries. Monks of the Middle Ages devised still other processes for combining resins with linseed oil, which was taken from the common flax seed, to produce varnishes for various uses. And so through the ages, there was a gradual development of the varnish art. Now, varnishes are made commercially in large varnish stacks in



Circle, testing hiding power of titanium pigment to assure uniformity. Center, left, examining test panel covered with auto paint. Right, light reflected from paint-covered panel helps determine degree of gloss in lacquer. Bottom, closeup of light striking the panel

rapid. New ingredients such as tung oil and soybean oil were mixed with resins to produce finishes with certain improved characteristics. Nitrocellulose lacquers revolutionized the finishing business by substituting fast spray jobs for laborious, slow hand brushing. They were quick-drying and durable, the ideal combination sought by the automobile industry to speed up the painting of cars made un-

Klarashen - used in 1939 to sold

der volume production methods. Chemists formulated synthetic resins and oils, which are of known chemical composition and therefore require fewer blending and refining processes to overcome variations found in natural resins. Great advances were made in pigment-making; the use of zinc oxides, for example, to improve the color retention of house paints; the use of finely divided aluminum powders to improve the protection of metal against the weather; and the development of lithopone and titanium oxide pigments to im-

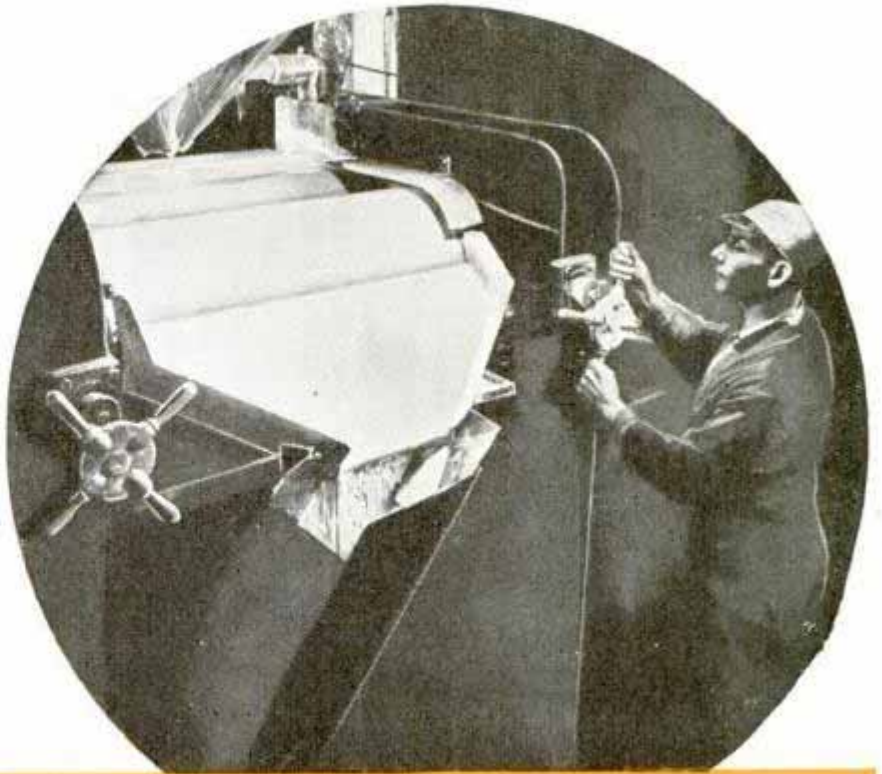

prove the whiteness, the economy and the safety of paints for many purposes. Titanium oxide, the strongest and whitest pigment known, is remarkable in that it is produced from a black ore called "Ilmenite," a veritable miracle of chemistry. This pigment, and modifications of it, are used in a wide variety of paints for both exterior and interior purposes.

Of course, no one has yet

(Continued to page 120A)



Top, bases for paint flowing through roller mill. Center strip, left to right, applying interior house finish; paint mixing and shading in fifty-gallon batch, and color test by spraying. Bottom, machine breaks color into its spectral components, making possible actual physical measurement of color values

at Philadelphia plant

Record-Smashing Speedboat Sets Five Marks in One Day



Sweeping across Miami waters, Mortimer Auerbach piloted this power boat to world records for twenty-four miles, one hour and three hours

Its broad shoulders skimming along the surface at a terrific rate, the "Emancipator VII" dropped five world speedboat records in a day at Miami recently. Piloted by Mortimer Auerbach, the streamline racing boat set new marks for twenty-four miles, one hour and three hours in the four-liter class and twenty-four miles and one hour in the unlimited class.

chase Exposition, life expectation jumped to 48.2 years, and then to fifty-three years when the Panama-Pacific Exposition was held in 1915. The sixty-year mark was passed by the time of the Century of Progress in 1933 and 1934, and today, with two simultaneous World's Fairs as the milestone, it is estimated that an additional year has been gained, bringing the figure to 61.5 years for a white male and 65.2 for a white female.

Reel Keeps Eraser Handy at Side of Typewriter

Attached conveniently at the side of the typewriter by a set screw, a reel keeps the typist's eraser always handy when needed. When released, the eraser is drawn back to its holder by a spring.

Seventy-Year Life Span by 1980 Predicted for Americans

By 1980 the average American may expect to live until he is seventy years old, say statisticians of the Metropolitan Life Insurance company—and this mark will not be exceptional, but the average age reached by individuals. Taking the dates of previous World's Fairs as convenient milestones in the record of American longevity, it was found that during the period between the Centennial Exposition of 1876 and the World's Columbian Exposition in 1893, the average length of life among white males remained unchanged at almost forty-two years, despite many advances made in medical science during that time. This was explained as being due to the lag between discoveries and their application. By 1904, at the time of the Louisiana Pur-



Spring draws eraser back to reel, shown in inset, when typist is through with it

432
One madam eve headah

acme
April 2, 1939

0.347

Seigneur Service
April 5, 1939

Havallite Products Co

*1221 1/2 Fifth Ave
Los Angeles, Calif*

Ship Blast Movie Filmed by Using Model Boat

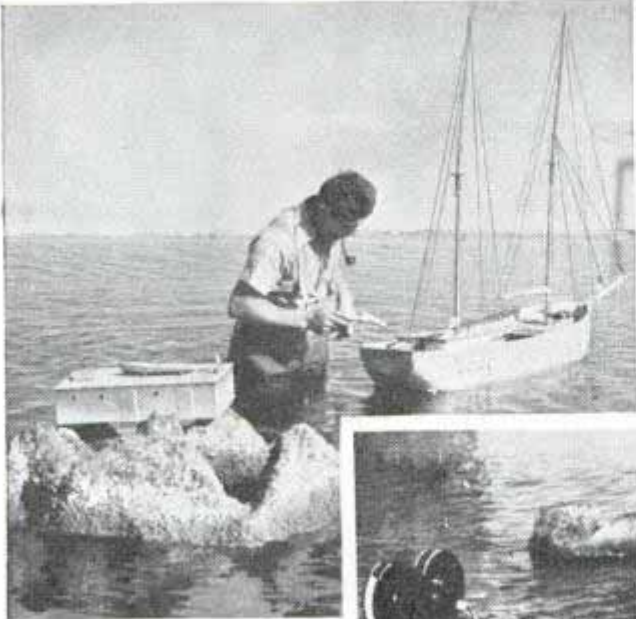

Realistic views of a ship explosion have been filmed by using a model boat in the outdoor tank of a motion-picture studio. Below, wind machine for creating waves. Note movie camera at left

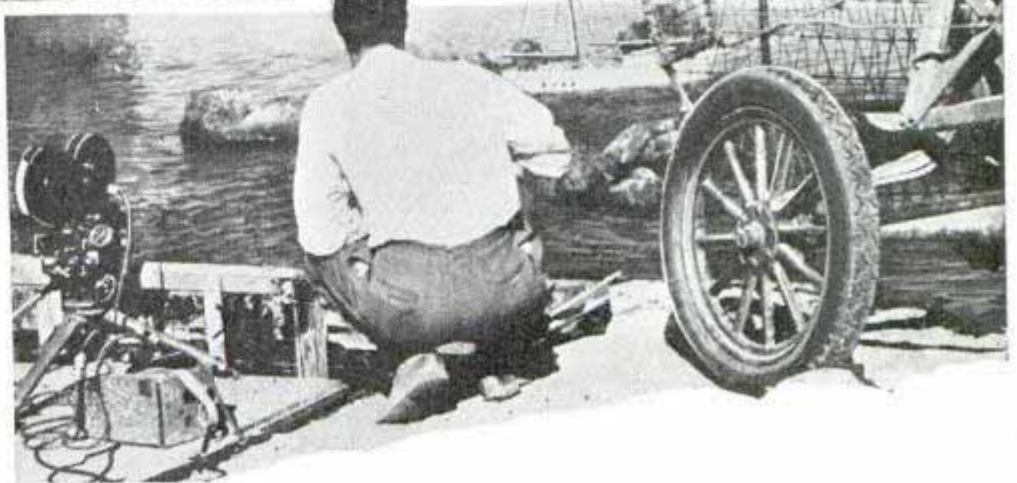

Above, workman putting black powder charge and connecting a wire so that blast may be set off with switch ashore. Cabin is replaced on schooner when charge is ready

Left, special-effects man pours kerosene on ship and sets it afire, then pours on "liquid smoke" and moves out of camera range with the bottle in his hand

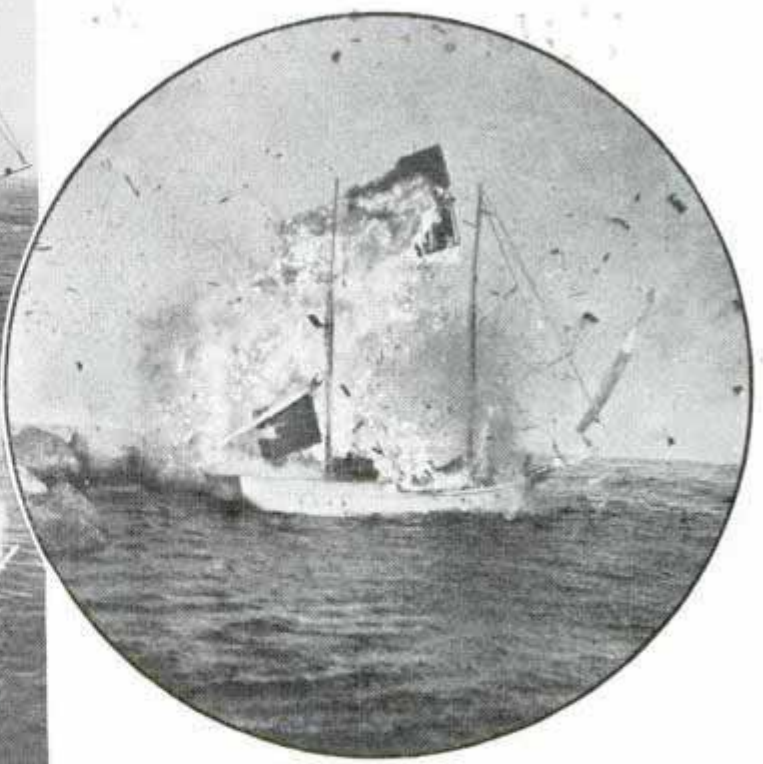

Above, the explosion—and it appears like the real thing—is set off with shore switch. Left, pouring "liquid smoke" over boat after blast to get another spectacular shot. The camera catches the scenes at about 110 frames per minute

P 225

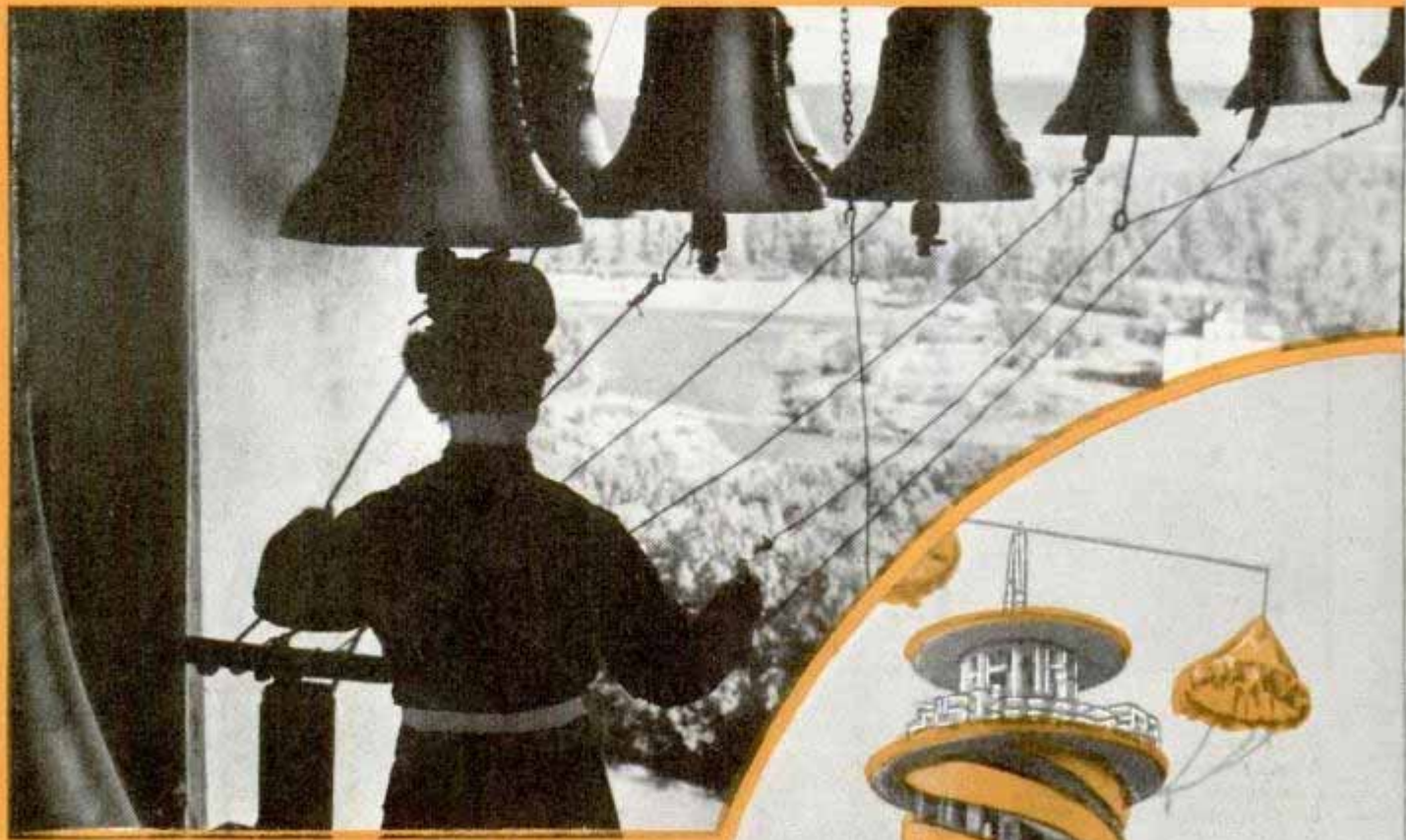

ADVENTURES *of a*

By JULIEN BRYAN
Titusville, Pa.
 PART II

PERHAPS it's adventure you crave. Or perhaps picturemaking around the world is purely business to you. Adventures aplenty will meet you, nevertheless.

Not necessarily violence and peril of death; true, I've had my share of that in nine years of roaming with a movie camera. There are thrills in filming forbidden ceremonials, bringing home uncensored movies of Nazi Germany, facing an angry crowd in the Mexican backlands. But to me the highest adventure has been to visit strange tribes, live with them in friendship and record their lives in pictures.

Five years ago I tramped across the Siberian tundra with Professor Petrie, greatest explorer of that region, to visit the Tuturi Tungus—people who have never eaten vegetables, live in birchbark wigwams and subsist on reindeer milk, game, pine nuts and cranberries. Petrie and I stood enchanted at our first sight of the

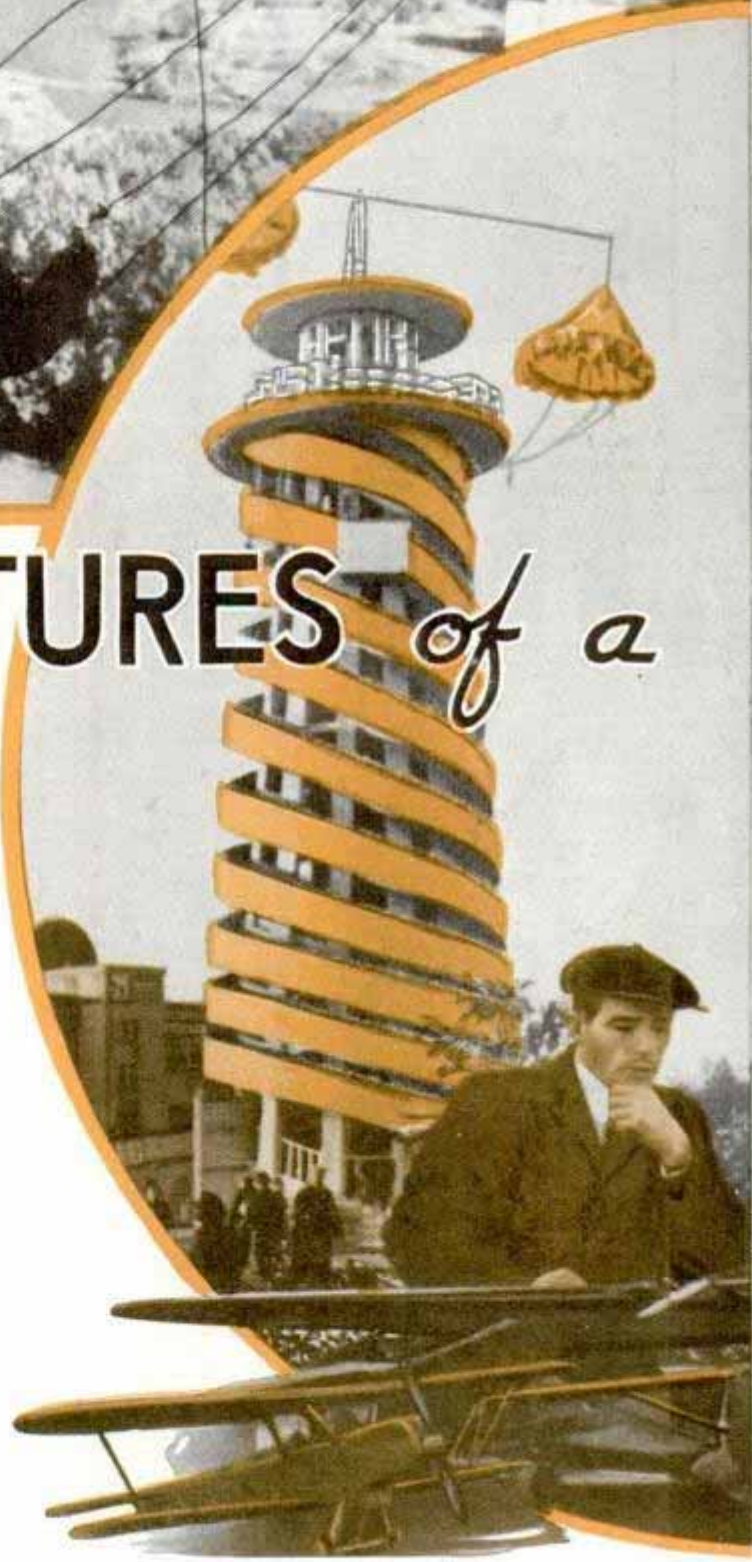

Top, ringing bells in tower of ancient monastery in Finland where monks live as in middle ages. Below, parachute jump and model planes in a Moscow park



ROVING CAMERAMAN

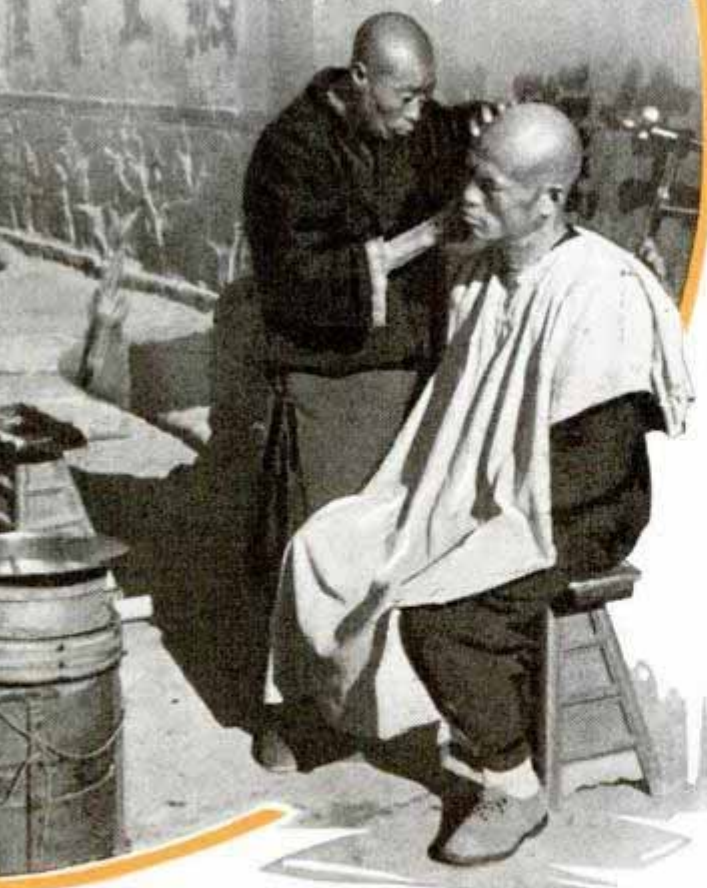

No Maypole dance is engaging Chinese laborers at top—their ropes are plying a primitive pile driver. Below, an outdoor barber shop on a street in Jehol

village. Slowly the Tungus came to meet us. There were no shouts, no gestures of greeting. Finally the old chief spoke: "From what region have you come, comrades?" Petrie explained he had come from Irkutsk. I told the chief I came from the United States of America. Puzzled looks spread over their faces; then the chief asked: "How far is your country from Irkutsk?" I explained that if you could walk thirty miles every day for nine months and cross a wide sea you might arrive in my country. His people concluded that I must be a long way from home.

So a banquet was prepared, and meanwhile I began to make friends, being careful not to show my camera nor antagonize these primitive folk in any way. It is best to let others make the advances. Within an hour they were showing me their tepees, telling how they roll up the birchbark covering and move the village whenever the domesticated reindeer have eaten all the moss in the neighborhood and need fresh forage. The women were softening animal skins for clothing, sewing birchbark



utensils, making thread from reindeer sinew. Finally it was time for the banquet around the fire in the chief's wigwam. Here was a problem of etiquette: Where was I to sit? It was a serious offense to sit in the wrong place. Professor Petrie hinted that the guest of honor should sit in the worst place—where the smoke gets in your eyes. I sat there, but the chief and his friends protested that I move to another place. I pretended reluctance, although choked with



smoke. Finally I moved a few feet, and after much argument found myself in the place of honor, next to the chief—where the smoke would not get in my eyes.

Now came the meal. Tea, a great luxury from Mongolia, diluted with rich reindeer milk. Fresh trout, followed by wild game—bear, wild goat, reindeer—with mushrooms, cranberries and pine nuts. Lastly, a special dish for me alone. I found it delicious and ate three helpings. When it was over, they told me what it was: the upper lip of the Siberian elk.

One morning I was busily taking pictures when suddenly I was lifted violently and thrown into a swamp. Luckily neither I nor the camera was hurt. I turned around to see the Tungus holding their sides with laughter, and not far from me a rather ferocious-looking reindeer which had decided I was an interloper. The Tungus were laughing because every one of them had at one time or another been tossed by his reindeer.



Top, women hod carriers working on a building in Moscow. Below, the roving cameraman grinds out movies of a Mexican woman at her baking. At the right, a Tungus priest in northern Siberia stamps out ceremonial fire; bits of cloth in his hand are used to drive away evil spirits

When we departed, we left a few gifts, among them a Santa Claus book for the children. They laughed at that, telling me reindeer never flew through the air as the pictures showed.

Gifts are always better than bribes. The best substitute for bribery is a frank manner, a smile, and patience. Now and then a few small gifts make friends—an inexpensive fountain pen, or little gilded safety pins.

Most difficult of all pictures to film is anything having to do with religion of primitive peoples. Last summer I tried many times to obtain pictures of Mexican Indians at worship. Just before sunset one day I reached the village of Ixmiquilpan. After a leisurely supper we walked to the church. What a gorgeous sight we found—hundreds of Indians crowded outside in semi-darkness, and in the great church more than a thousand more weaving about with a myriad of lighted candles. It was the greatest fiesta of the year, the day sacred to this very church. With my assistant I ran to the inn, grabbed the camera, loaded it with special film of a speed over 100 Weston, and dashed

(Continued to page 124A)

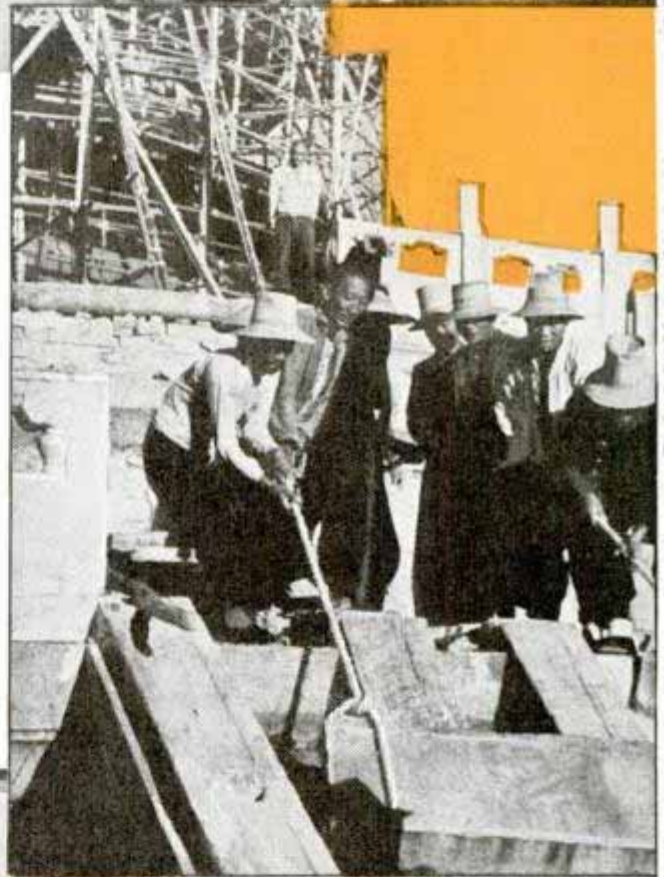
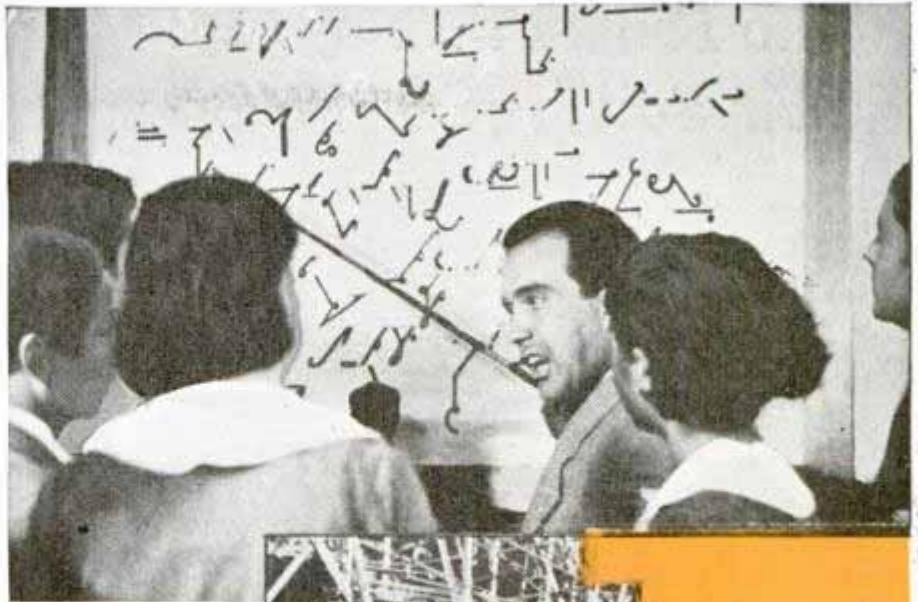

Ankora Lyell
 Top, instructor in one of Turkey's new business schools explains shorthand symbols. Center, Chinese laborers repairing Temple of Heaven, at Peiping, haul up heavy stones by hand, a method as old as Pyramids of Egypt. Bottom, a puppet show in Japan, with puppeteers in black masks

Radio Runs Farm of Future from Sowing Seed to Canning



At "nerve center" of farm depicted in diorama, "farmer of the future" sends radio signals controlling harvesting, irrigating and other machines

Tomorrow's farmer, if a diorama at the New York world's fair prophecies aright, will be rather a radio navigator and dispatcher than a tiller of the soil. The diorama depicts the farm engineer seated in his glass-enclosed radio tower, manipulating switches that transmit radio signals to the robot machines that sow and cultivate, irrigate, harvest, sort and can, freeze and pack the crop, all by remote control.

House of Colored Stainless Steel Promised at Low Cost

Stainless steel in colors, the latest product of the metallurgical engineer, promises a new rustproof housing material that may bring another revolution in the building industry. It was announced recently by Oscar B. Bach, industrial designer and metallurgist, after a long search for a

method of tinting steel. He believes that a home now costing \$10,000 could be built on a prefabricated, mass-production plan for \$3,800 with this material. It is light and strong, with a minimum of chromium content. By using asbestos as an insulating base and covering it with a thin skin of bachite, the tinted stainless steel, he developed a fireproof and verminproof material lending itself to quick assembly in sections on the building site. Mr. Bach foresees its use also in airplane and railroad construction, claiming for bachite half the weight and double the strength of duralumin.

Streamline Hood for Motorcycle Made of Plywood

Seeking protection from the discomforts of dust and wind and rain, an inventive motorcycle rider inclosed his machine in a streamline shell of plywood, bracing it with steel. The housing of the odd vehicle, with a trap-door entrance in the rear, weighs fifty pounds and cost fifteen dollars.

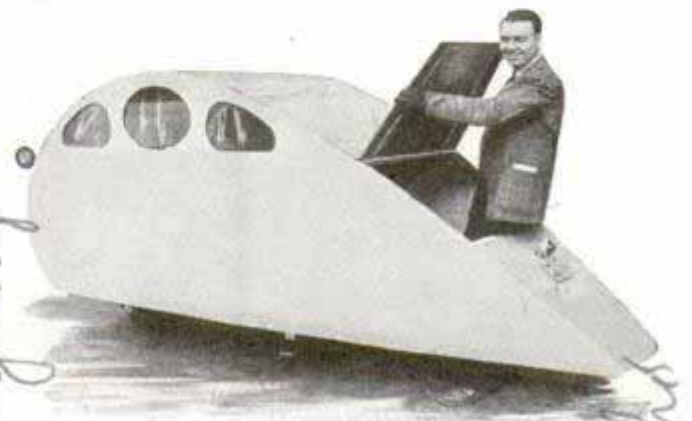

Through hatch at the rear driver slips into seat of motorcycle where he can laugh at the rain

U.S. Steel Subscribers Director
of Broadway

My James
4/1/29

Bachite development d.w. Leonard J. ...

Autos built by fathers & racers

Children Race in Gas-Powered Midget Cars



Closeup shows motor installation in young driver's gas-powered racing car. Children between six and sixteen thrill large crowds in weekly speed events at San Marino, Calif.



Above, action on the midget track. Tiny cars are powered with engines of one horsepower or less and have chain or belt drive. Speed ranges up to twenty-five miles per hour



Above, carrying car and small driver to starting position, and broadsiding on a curve. Right, the midget autos closely resemble big racing cars. Note the crash helmets worn by the drivers



Lowings 90 Star. New and Post. Pasadena, Calif.

Cent. Store

BUILDING MOTION

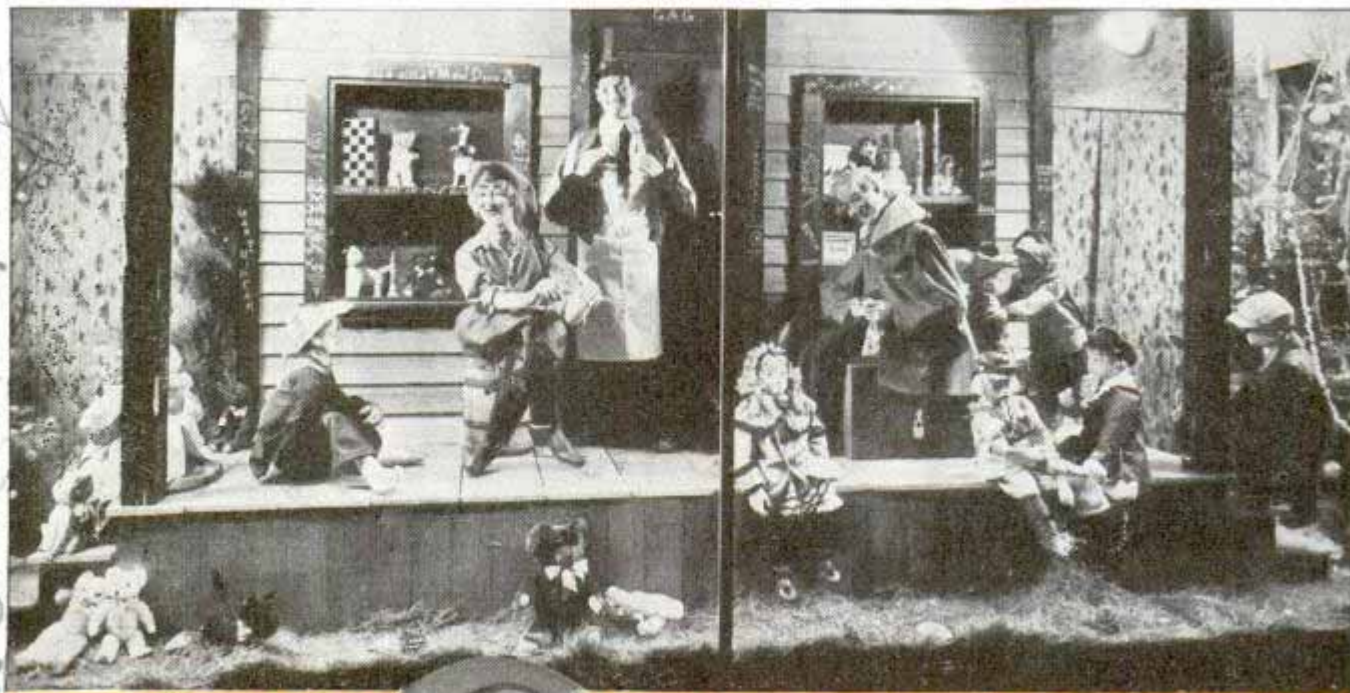

Above, "The Country Store," one of Delmar Gray's animated displays. Gray utilizes talents of artist, sculptor, stage props maker and mechanic to turn out figures that perform with surprising life-like movements. Below, framework of dummy is heavy gauge wire welded in place over steel matrix. Hinge or ball-bearing joints give action to movable parts

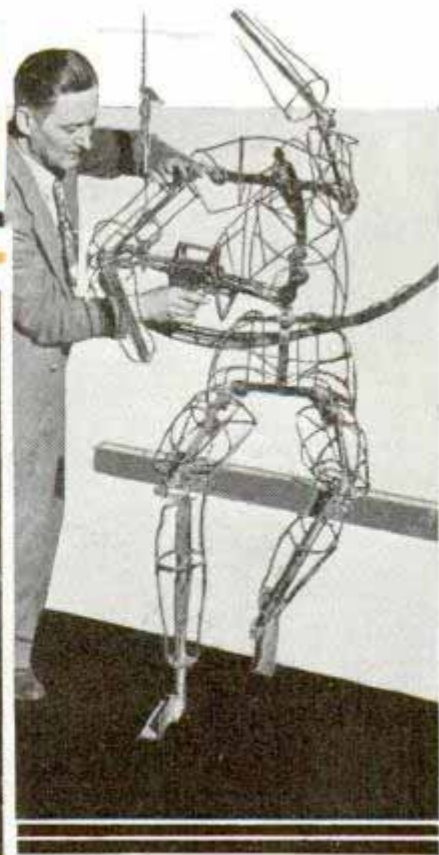

Above, installing the arm mechanism of a violin player. Right, head of dummy, made of paper in halves which are put together and the joint covered smoothly. Here the rear part of the head is being taken out of a plaster mold. Head motors operate the eyes and lips



Delmar Gray Studios 675 Steegen St. San Francisco, Calif.

799 Bay St. San Francisco, Calif. Q-289

into DUMMIES

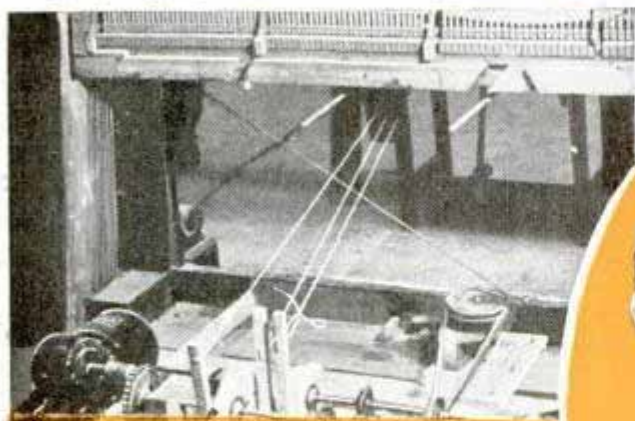

Above, controls for operating animated pianist. Right, two heads for comic figures, one with mouth cut away for articulation mechanism

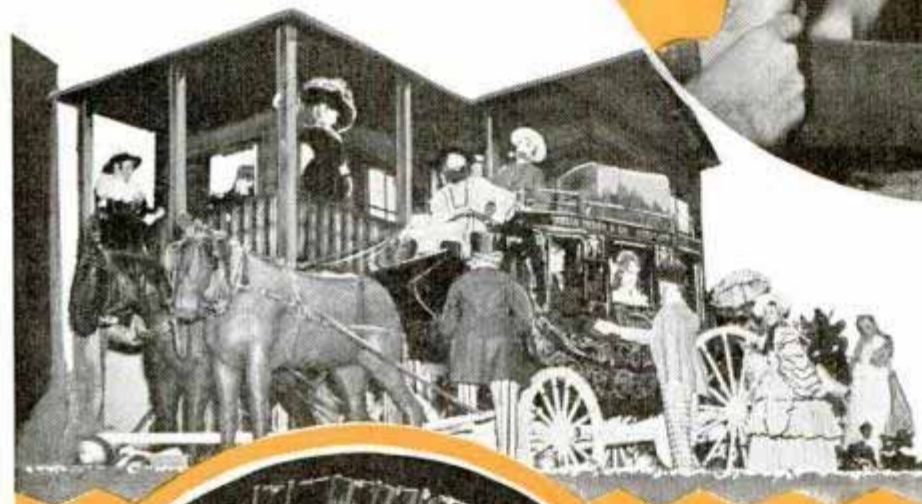

Left, part of huge set built to depict with moving dummies the day of the stagecoach. Below, installing cam and motor which operate mechanism in dummy's head. The motor operates on a 110-volt electric circuit and the pulls run up through the pipe



Above, core of horse's neck is made so that the head can be moved. Motor is mounted in the body, which is made of laminated paper. Group sets are generally operated by control boxes, each with six to fourteen cams. Interior motors in figures are controlled by mercury switches. Rockers, pitmans, working pieces of rack against tooth gear, and weight lines all help to give grace and smoothness to the dummies' actions



W. E. Freer

Radio Waves Create Light Inside Glass Sphere



Glass sphere emits yellowish green light when exposed to bombardment of high-frequency radio waves

Held aloft without any wire connections, a glass ball was made to glow a bright yellowish green in a recent demonstration by Westinghouse lighting experts. The light was produced by coating the inside of a sphere with fluorescent pigments, and then shooting radio beams through it.

"Swamp Buggy" for the R.F.D. Defies Snowdrift and Mud

Getting the mail through is pretty tough sometimes on a North Dakota rural route,



High front wheels and tractor tires on rear carry the mail through regardless of road conditions

but W. E. Freer of Dunn Center has built a "swamp buggy" that will take him on his thirty-two mile round every day, in blizzard or bog. Using the rims and tires of a hayrake, he built a pair of high front wheels for his coupe; on his rebuilt rear wheels he mounted tractor tires for extra power. With this combination of high clearance and power he travels through three-foot snowdrifts and spring mudholes without missing a day on the route.

Missing Element "43" Is Made in Giant Atom Smasher

Element Number 43, one of those missing from the chemical periodic table, has been invented rather than discovered. It was manufactured in the giant cyclotron at the University of California by bombarding the molybdenum atom with deuterons or neutrons. The element is closely related to manganese, molybdenum and ruthenium.

Remote-Control Slide Projector Operated by Cable Release

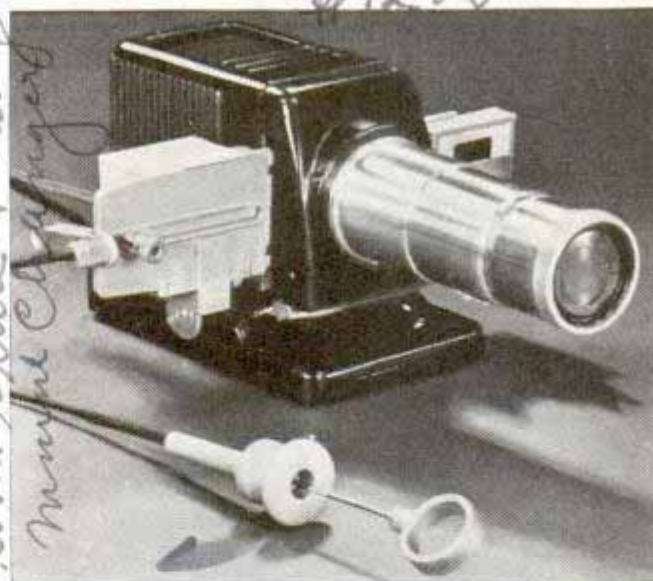

Pressing the ring plunger of cable release sends a fresh slide into projector

Fifty pictures can be thrown on the screen in proper sequence by a magazine-feed device operated by remote control. Without removing his eyes from the screen, the operator simply presses the plunger of a cable release to change the slide in the projector, then pulls the plunger out to prepare for the next slide. At the end of the showing, the slides are found in a receiving magazine in proper order.

D. H. B. Webber, Lighting Engineer

car used by W. E. Freer, Dunn Center, N.D.

Berkeley Calif 494

Kodak Slide Projector

Eastmaji Kodak Co

Resin Bath Weatherproofs Wood at Low Cost

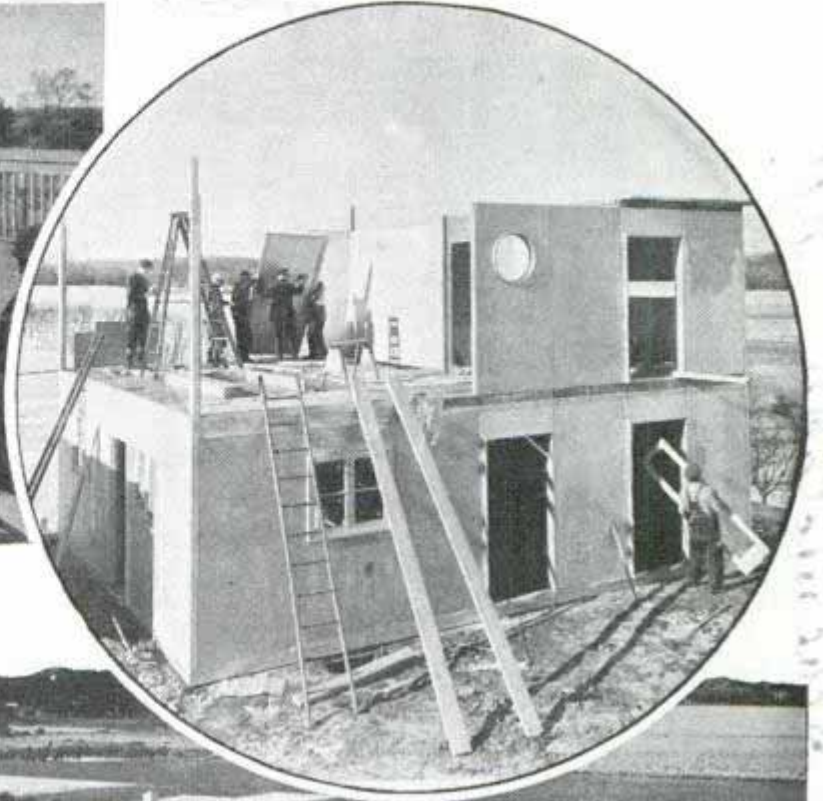
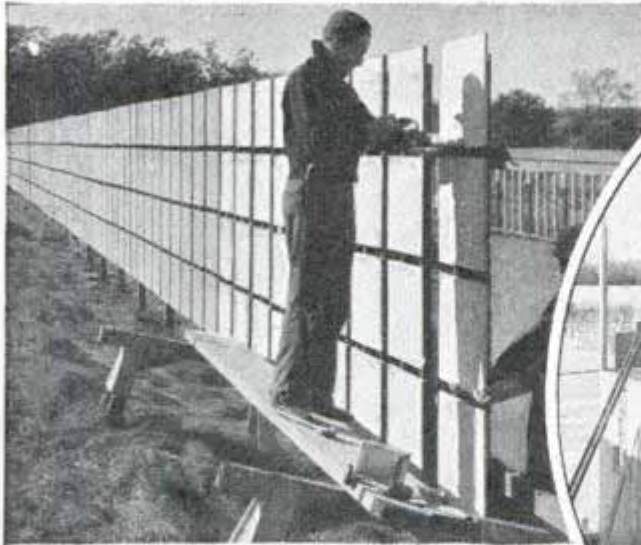

Above, exposing treated and untreated plywood panels to weathering test. Right, building plywood house of "resin-bathed" panels, and two finished houses

Chemists at the U. S. forest products laboratory at Madison, Wis., have discovered a relatively inexpensive formula for arming wood against its worst enemies—moisture, decay, acid and fire. The method is to dissolve certain chemicals in water and inject the solution into the cell structure of the wood, where it forms synthetic resins that effectively seal out moisture. Thus far the treatment has been found best adapted to plywood, and it is estimated that it would cost but one cent per square foot of one-sixteenth inch plywood veneer, although initial cost is unimportant in view of the lengthening of life achieved. If commercially successful, this resin "medication" may end the curl-



ing of plywood furniture and sagging of roofs, and add years to the life of the prefabricated plywood panel home. The wood is impregnated either by ordinary soaking in the chemical bath for eight to fifteen hours, or by hydraulic pressure. After drying, the wood is ready for gluing into plywood sheets with waterproof glue.

Explosives Made from Natural Gas Are Cheap and Safer to Handle

Natural gas, air and steam are the sources of two high explosives which chemists at Purdue University have found inexpensive to produce. Their process involves adding nitrogen to hydrocarbons and condensing the product with formaldehyde. While as powerful as nitroglycerol, used for dyna-

mite, the two new explosives are only half as sensitive and therefore can be handled with greater safety. Only an insignificant fraction of the natural gas available in this country would be required to furnish all the high explosives necessary under normal conditions.

West Lafayette, Ind.

426 W. Old St. Madison Wis
 I 399
 Prof Henry B. Hass
 Eugene A. Brown

10565 Holman Ave
Los Angeles Calif

ELECTRICAL BRAINS

g. 1
General Electric Co
Schenectady, N.Y.
Publicity Dept., Industrial Exhibitions

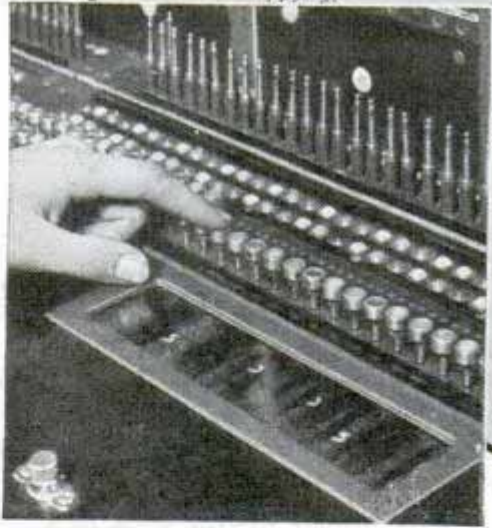
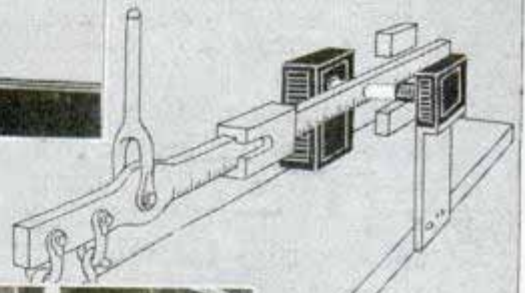
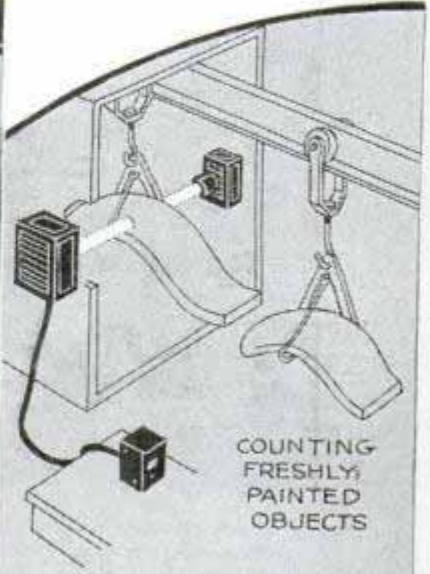
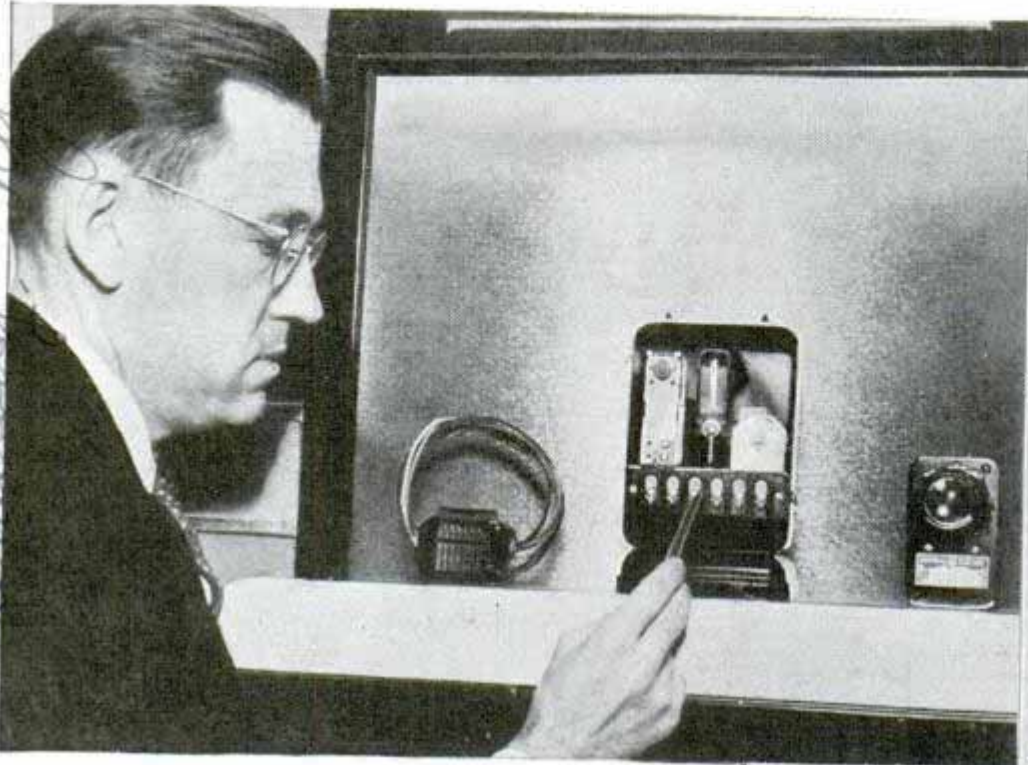

NOW that man has harnessed electricity to perform much of the world's work he is training it to do some of his thinking.

Machines that figure things out for themselves are taking over the drudgery of routine occupations. Robots, made of metal and fed with electricity, are performing complicated tasks as well and in some cases better than man could do them. Electrical brains are trained to safeguard workers at hazardous jobs.

Today, thinking machines automatically keep light and heat at proper intensities in buildings, open doors and run motors of automatic elevators, and are left in charge of such tasks as measuring and cutting paper to the right size in paper factories or labeling and capping bottles in a soft-drink plant.

In one modern furniture store an electric washing machine begins to operate as soon as you step close to it. The heat elements of an electric stove turn on as a customer approaches. Vacuum cleaners and dish-washing machines demonstrate themselves as you walk up to them. In stepping close to the displays you interrupt a light beam focused on a photoelectric cell. The cell throws a switch that starts the demonstration. How would you like to

Top, photoelectric relay. When light beam aimed at light-sensitive tube to which the man points is interrupted, a magnetic relay closes a circuit to ring bell or perform other work. Bottom, call indicator lights numbers in manual telephone exchange when call arrives from automatic exchange

attend an animated lecture in which an electric brain gives you its personal attention? One manufacturer is building such a machine at present. When you walk into this hall, devoted to a display of petroleum products, colored lights flash on a large wall map and a voice begins to explain the

Help RUN the WORLD

*Perkins
Dodge
Chicago
2-159 W.*



OPERATING ONE-WAY
DOOR-OPENING EQUIPMENT
IN RESTAURANT

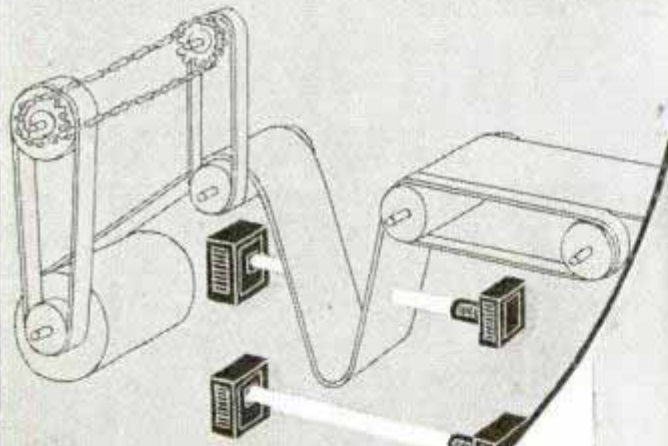

CONTROLLING LOOP OF
FABRIC BETWEEN REEL
AND CUTTING TABLE

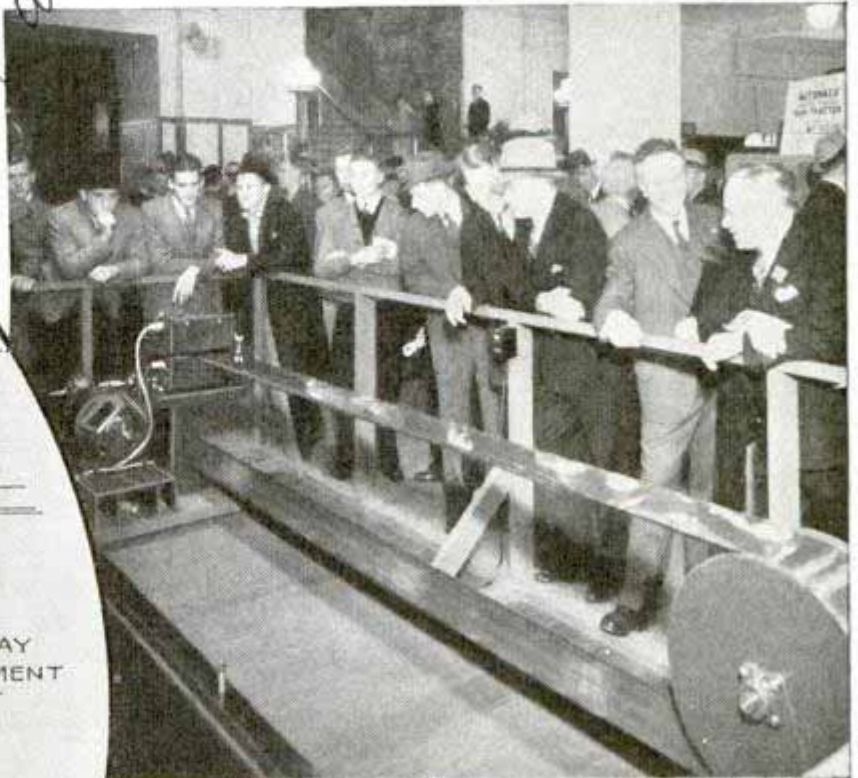

significance of the lights. As the voice continues other lights appear, drawing your attention to the places that the voice describes. In a question and answer dialogue voices from opposite sides of the room carry on a conversation, then the main speaker's voice asks you to step to a table to inspect a display of products. As you do so lights at the table flash on and a new

Left, some tasks performed by "electric brain." Right, pinhole detector for catching flaws in steel. Bottom, if player steps over foul line of bowling alley, the photoelectric detector immediately reveals the error

reciprocating P over and night Corp

Chas. Elgin d. l.

W. attach Periscope 1937

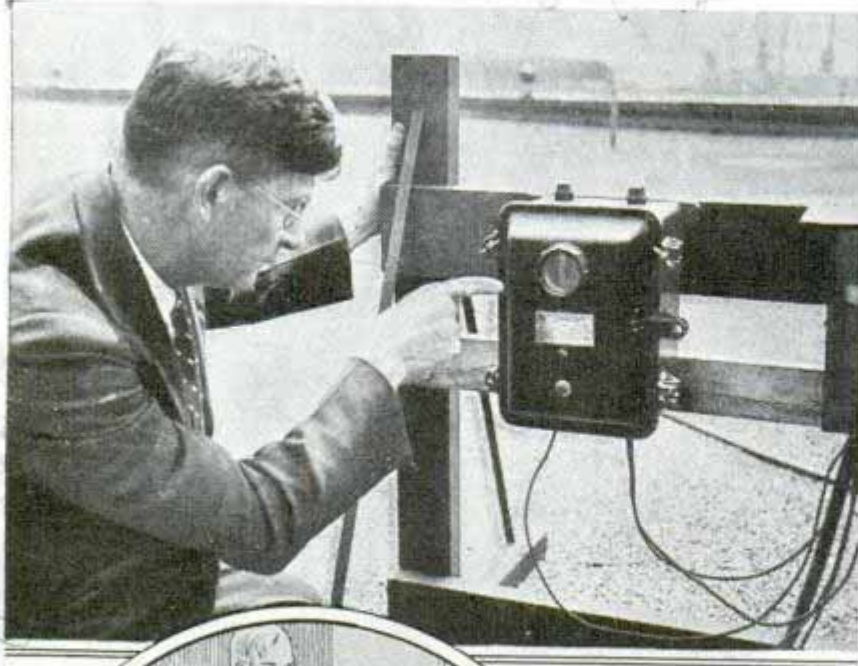

trains from San Francisco to Oakland over the Bay bridge are protected by a myriad of electric bodyguards. More than 4,000 electric relays set the track switches, signal ahead reports of approaching trains, and operate the controls that establish proper car speeds.

In industry, electrical brains are squaring up the weave in cloth in its final stages of manufacture, are automatically sorting poor from perfect watches in watch factories by comparing their ticks with those of a standard time-piece, and are refilling water

tanks when their contents have fallen to certain levels. Water-softening machines automatically test the hardness of water in municipal water systems and then inject the proper amounts of chemicals to soften it.

Electric brains are used by engraving plants for turning out perfect work, safeguarding

ballot boxes, scanning steel for flaws, and signaling when a player's foot passes over the foul line in bowling alleys. One recent invention is a photoelectric method of determining strikes and balls in a baseball game.

In hospitals, doors open automatically and water faucets turn on at the approach of doctors and



voice, close at hand, begins to describe the objects you are looking over.

The interesting thing is that you are entirely alone. An electric brain runs the whole thing. You threw the switch that turned on the brain when you broke a light beam at the entrance. When you leave the room everything turns off and the electric brain goes back to sleep, waiting for another customer. A few photoelectric cells, rotary switches, time switches, phonograph records and loud speakers comprise the invisible thinking apparatus.

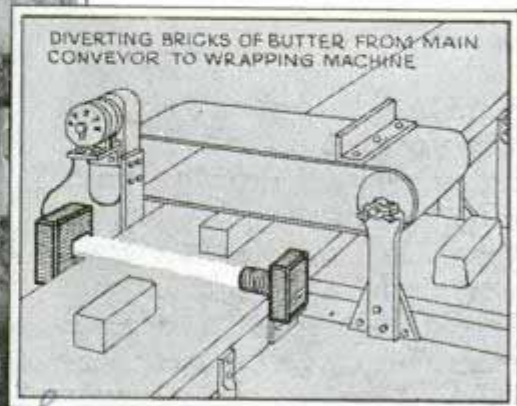
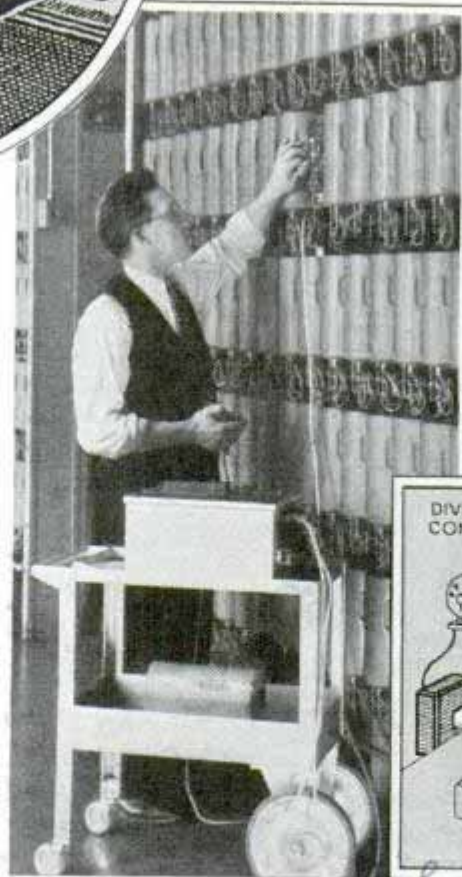

DIVERTING BRICKS OF BUTTER FROM MAIN CONVEYOR TO WRAPPING MACHINE

Top, outdoor photoelectric relay controls nine street-lighting circuits. Circle, "electric eye" sets off alarm if sleepwalker gets out of bed. Below, testing automatic telephone exchange switches. Right, another use of "electric brain"—diverting butter to wrapping room

Passengers on interurban

Used by W. D. Darrall, Esq. Eve. Works. Engineering Dept

Talking Traffic Light Warns Motorists of Dangers Ahead

technicians who have sterilized their hands and must not contaminate them.

The same kind of photoelectric cell guards operators of dangerous machines, opening the switch if the operator carelessly approaches too closely or forgets to pull his hand from under a descending press. Electric counting machines insert the correct number of drops in medicine bottles and the right number of pills per box. The "electric stool pigeon," an oscilloscope, signals the presence of guns or other metal objects being carried into a prison by visitors. In the manufacture of cardboard tubes in a paper factory, the tubes are stopped and sawed through at the proper lengths by a photoelectric device, as they issue from the tube-making machine.

In many industries a perplexing problem is the matching of exact shades of color. The quality and intensity of the light and even the color sight of an operator all help to make the exact matching of colors extremely difficult. Mistakes are avoided by a new device developed by the General Electric company, called a recording photoelectric spectrophotometer. This instrument measures color and reduces any shade to a curved line on a graph, permitting exact comparisons and duplications. No human eye could do the job as well.

In aviation, engineers have coupled the automatic pilot with the radio beam receiver, so now machinery not only attends to the details of flying the plane but also keeps it on its proper course. Another effort-saving hook-up in the cockpit ties the weather broadcast radio receiver up to an automatic typewriter, freeing the pilot from the necessity of listening to weather broadcasts and copying them down.

The weather bureau is beginning to employ mechanical men to

(Continued to page 118A)

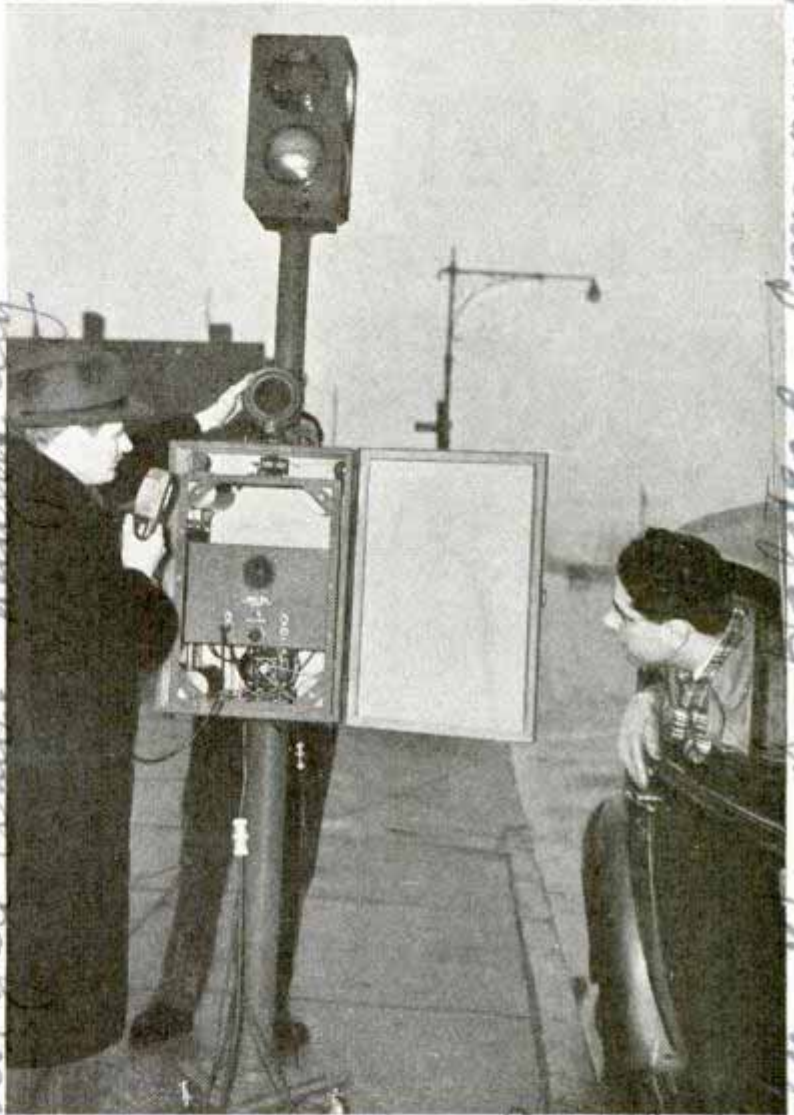

Radio traffic signal speaks a warning ten seconds before lights turn red; drivers hear it on their own radio sets

Traffic lights have been given a voice to warn pedestrians and drivers of signal changes and of special safety precautions at intersections. An experimental model of the "radio policeman," recently invented, consists of a transmitting unit mounted on a portable light standard, and makes use of a magnetic steel tape for sound recordings which are broadcast either continuously or intermittently. These messages can be changed as required. A sign placed before the radio zone would call attention of the motorists equipped with radios and give the transmitter's frequency. By adding a loud speaker pedestrians can be told in advance when the lights will change at busy street crossings.

General Motors
Cleveland
A Diesel engine of 1926 weighed 70,500 pounds—188 pounds per horsepower; its modern counterpart weighs only 19,000 pounds, or thirty-one pounds per horsepower.

Developed by Wm. J. ...
 7270-6th Ave.
 ...
 ...
 ...

Mounted Police Use Radio to Help Control Crowd



British policeman with headphone and speaker, and with radio set on saddle, directs traffic at races

Mounted policemen patrolling the course of the Grand National Steeplechase at Aintree, in England, carried two-way radio sets in the saddle. Headphones and mouthpieces enabled them to keep in constant touch with headquarters and thus coordinate traffic and control the crowds at the races.

Typist's Line-Spacing Copyholder Rolls Letter Upward

Rolling a letter upward so new lines will appear as copying progresses, a copy-

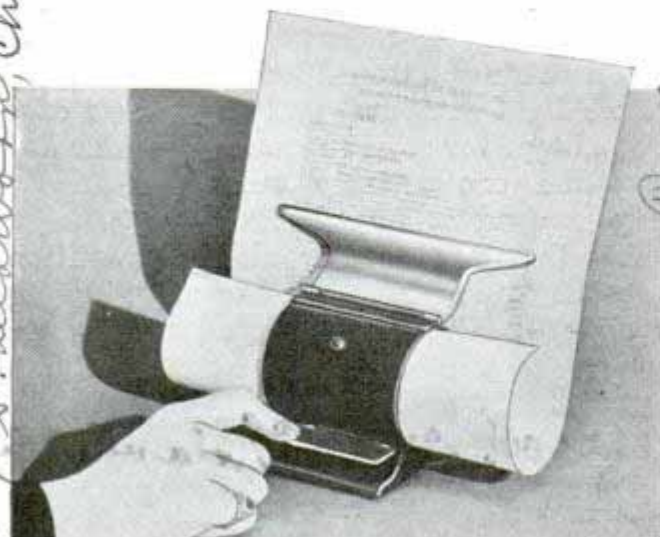

Finger-tap on space bar of copyholder moves paper upward to the next line for convenience of typist

holder now on the market includes a line spacer that operates by a tap of the typist's finger, similar to operating the space bar on a typewriter. Light in weight and portable, it is in no way connected with the typewriter but may be placed at the most convenient angle for best vision and light, and extension guides are available for handling copy twenty inches wide.

Trick Titles for Amateur Movie Filmed on Rotating Frame

Amateur moviemakers can produce many of the titling effects of the professional movies with a versatile title frame now available. Into the frame fits a revolving drum on which titles and captions can be made to turn vertically or horizon-

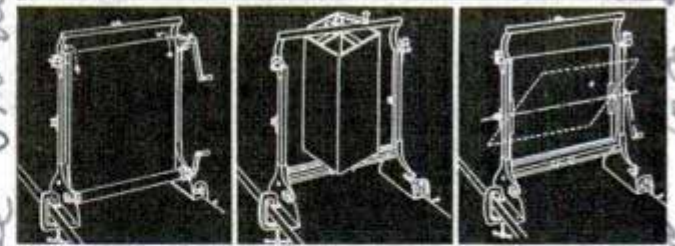
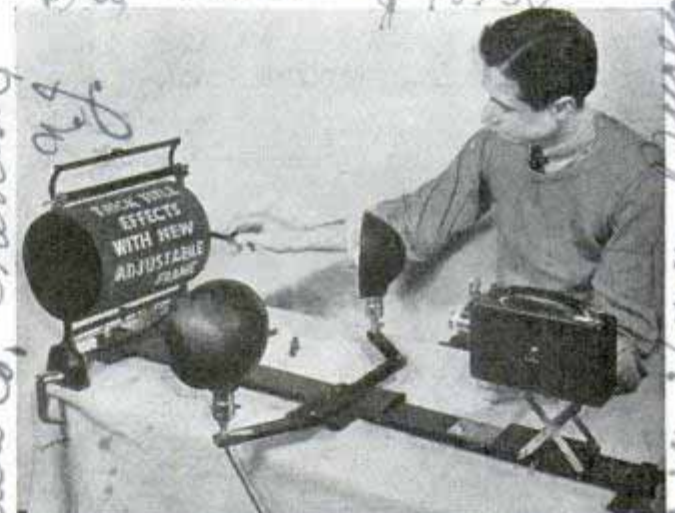

Top, set-up for making movie titles with revolving drum; below, scroll, box and "flop-over" screen

tally; a block, for similar effects; a scroll which is cranked upward or downward for moving titles, and various other accessories for "flop-over" and page-turning tricks. All the equipment for making traveling titles can be obtained in kit form.

There are about 20,000,000 automatic telephones in service around the world—probably sixty per cent of all the phones; only forty-four per cent of the phones in this country, however, are dial-operated.

acme

2364

Pro Int. \$18.50

Becher Products Co., Trenton, N.J.

Watt & Kellogg, Inc. 7 S. Dearborn, Chi.

Automatic Electric Co. 109 W. Corn

Watt & Kellogg, Inc. 7 S. Dearborn, Chi.

Auto-Line Corp.

11400 L. St. N.W.

Odd Shots Made with Small Movie Camera



Unusual effects can be obtained with the miniature movie camera. Right, snowball closeup results from tossing snowball and then the camera at the subject, who must leap aside at just the right moment. Above, ready to throw camera, which falls safely into soft snow

Above, odd photo taken by shooting from beneath glass plate (as in photo at bottom, left). Camera is fixed on revolving disk resulting in an illusion that all objects on glass are slowly moving in circles

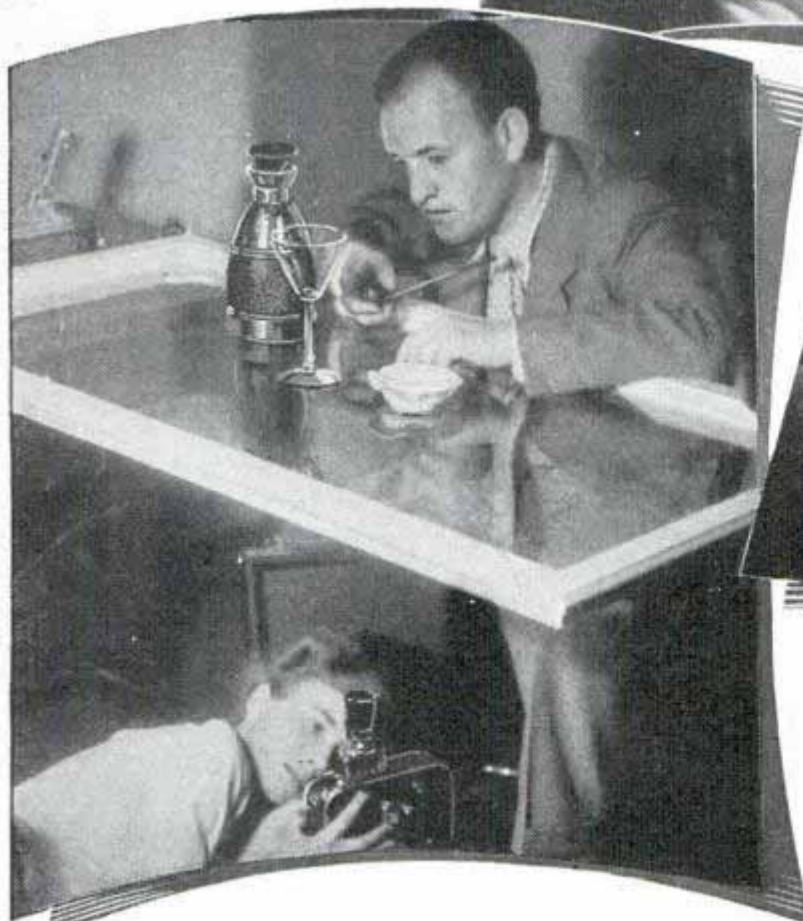

Above, camera fixed on toy railroad trucks rolls along the parallel tracks and photographs the subject as it moves closer and closer. Absence of rocking is a feature of this arrangement

Handwritten notes on the right margin:
 Herman...
 420 Lexington Ave, New York
 1100 100th Street, Astor, N.Y.

Handwritten notes at the bottom of the page:
 1100 100th Street, Astor, N.Y.

Soldiers Risk Lives to Save Comrade on Cliff



Two soldiers on Alpine duty risk their lives in precarious rescue work as they lower themselves down sheer cliff with injured companion roped to stretcher sled slung from a projecting pole

Mountain climbing takes cool nerve and steady muscle. It takes even more nerve and skill to accomplish the rescue of a helpless comrade who must be brought safely down the perpendicular rock wall of a peak. In the spectacular photograph shown here, soldiers have rigged up tackle on a pole projecting from the brink of a precipice and are working their way down the sheer face of the mountain while they support a wounded companion roped to a sled used as stretcher.

Moth Rescues a Continent from Becoming Desert

Australia was swiftly becoming a desert. More than a million acres a year were being devoured by the prickly pear. In its native habitat—the United States, Mexico and South America—this cactus is sometimes grown in gardens, and is kept under control by insects and the competition of other plants; but when it was introduced in Australian gardens a few decades ago it found a cactus paradise where there were no natural enemies. Prickly pear ran wild. By 1925 it had turned 60,000,000 acres of once good farm and grazing land into useless jungle. Scientists hunted frantically for an enemy that could quell the prickly pear without becoming a pest itself. Entomologists feared that they might introduce an insect which could attack the cactus but would also bore into apples and other fruit. At last, however, with the aid of U. S. government scientists, the tiny Argentine moth was chosen to rescue Australia. It lays eggs in strings of twenty or thirty on a cactus leaf, and the larvae bore into the leaf in a joint attack. A colony of these moths was introduced at a point in Australia where there was an almost un-

Smithsonian

The Wocho 2/22/39

2 421

broken belt of dense prickly pear jungle 100 miles long. Two years later the jungle had collapsed under the assault of the moths, and ninety per cent of the land was available again for farming. Altogether, the insect has already reclaimed 15,000,000 acres of cactus desert in Australia.

Fast Bounce-Back Tennis

Is Played in a Small Space



Tennis players have to hustle on this quarter-size practice court where the ball bounces back rapidly after striking board behind the net

Cloth Back for Map or Photo Mounted by Applying Heat

For reinforcing maps, charts and photographs with a cloth backing, there is a dry-mount cloth that is applied simply by using a flatiron. The coated side of the cloth is laid over the back of the blueprint or photo, heat is applied and when the print cools it is smooth, strong and flexible. It can be rolled or creased without cracking, and since the backing seals it against moisture the print will not curl. While an ordinary iron can be used, there are available special rotary ironers for large maps and pictures.

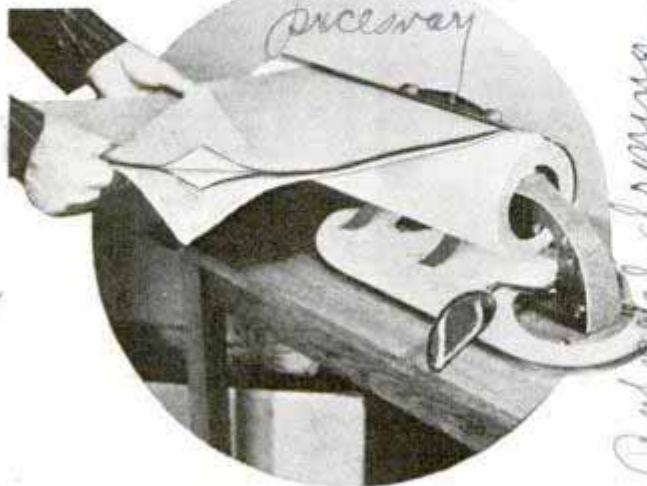

Sealing dry-mount cloth backing on big blueprint by running through rotary heating element

Affording players more than mere humdrum practice, an outdoor "battle board," devised by Mary K. Browne, instructor at Lake Erie College and a former tennis champion, provides excitement and pleasure of an actual game and calls for just as much skill. Although only one-fourth the size of a regulation court, it is said to be faster, one set giving a workout equivalent to two sets of regular tennis. The ball is served over the net and against a specially constructed board; then it is played alternately in the usual manner. Two or four players can participate in the game, using standard rackets and balls, points being scored as in tennis.

Rubber soling, now on the market for retreading and repairing overshoes, is applied with ordinary repair shop equipment.

Charles & Photos
Princesway
Acme
Instant
Seiberling Rubber Co

"Bomb" Exploded in Bulb Coats It with Sodium

W. A. Criggles, Research Laboratory



Above, indicating tiny bomb at end of filler apparatus, and bomb compared with sodium vapor lamp

Sodium vapor lamps, becoming increasingly common on highways, are given their illuminating substance by exploding inside an evacuated bulb a tiny glass "bomb" filled with sodium. This appears as a mirror-like deposit in the bulb when it is cold, but vaporizes and glows with a golden-orange light when the current is turned on. The metal is difficult to handle as it oxidizes rapidly when exposed to moist air. It will attack most non-metallic elements and hence the lamp is coated with a sodium-resistant flashing glass to prevent damage. The bombs are filled and sealed by a complicated system of glass vessels, developed by General Electric company, which involves a triple distillation process to remove impurities in the sodium. Attached by slim necks to the fourth vessel are twelve little bulbs which are filled simultaneously, providing bombs for a

dozen sodium lamps. After the lamp has been evacuated and a bomb placed inside, a high-frequency coil is used to induce heat in the sodium, causing it first to boil and then to explode its glass container. Since the glass case of the bomb is not more than six thousandths of an inch thick, the shattered particles are reduced to a fine dust and can be left in the lamp.

240

Millionth of an Inch Films Have Insulating Value

J. Reynolds

Films of organic materials such as barium stearate, so thin—a millionth of an inch—they are expressed in terms of molecules instead of inch fractions, have been found in some cases to hold insulating values comparable to those of the best known dielectrics. Molecules themselves are only 1/10,000,000 inch in thickness, but scientists of General Electric research laboratory, by electrical measurements, can tell within an accuracy of two such layers how many there are. It was through similar experiments that the laboratory samples of glareless glass were produced.

2379

Old Refrigerator Car on Farm Multiplies Profit from Fruit

Buying an old refrigerator car and moving it to his orchard, a Michigan farmer was able to make a \$900 profit on a carload of peaches. When the market was glutted,



Iceing the refrigerator car which is "parked" permanently in farmer's orchard to keep perishables fresh

Collegiate, East Lansing, Mich.

he held the fruit in his secondhand refrigerator for ten days and realized an advance of \$1.20 a bushel. The "icebox" cost him \$175 on the sidetrack. He had to pay to have it rolled over the roads to his farm, but by selling the running gear and other scrap metal totaling ten tons he brought the net cost down to \$139.89. The ice is obtained from a near-by pond and stored in his icehouse near the car. Now the farmer can always take advantage of market conditions and hold his fruit, vegetables, eggs and other produce to await better prices.

9-424

Giant Electric Typewriter Prints News Flashes

World's fair visitors at New York can watch the latest news flashes printed on a fourteen-ton typewriter, exact copy of a standard machine but as high as a two-story building. Remotely controlled from a master electric typewriter, its forty-five-pound type bars punch out the news continuously in letters three inches high, on "stationery" measuring nine by twelve feet. The ribbon is five inches wide. It took three years to build the giant, and two boxcars were required to ship it to the fair grounds. The carriage alone weighs 3,500 pounds.

Safety Togs for Any Hazard Shield Worker Against Injury

Sammy Cunningham



Wade Warka
Young lady bedecked in some of the latest safeguards worn by workmen to ward off accidents and diseases in dangerous jobs

In the drive to stop industrial diseases and accidents before they happen, an endless chain of

safety gadgets is being produced for the protection of workmen. What the well-dressed worker will wear for safety was shown at a recent exhibition. Included in the display were aluminum toe guards, fiber shin guards, a non-inflammable and adjustable eyeshield, safety belt studded with red reflectors, and a respirator for miners and stone workers that filters out dust and does not interfere with speech.



Remotely controlled, this big machine prints news bulletins at fair

Underwood Elliott Fisher, Anderson

see march 1939
see march 1932
at Spokane & Ellwood City, Pa.
show and foot guards - Ellwood

Young lady bedecked in some of the latest safeguards worn by workmen to ward off accidents and diseases in dangerous jobs
at Cleveland, Ohio
at Cleveland, Ohio
at Cleveland, Ohio

0-5
EVEN the master criminal signs every crime. He may leave behind only a silhouette in dust, a fleck of paint the spectrograph alone can "read," a telltale wisp of fiber that will tell plenty under the microscope. But somewhere the criminal leaves his signature for modern science to decipher.

One killer tried the cowardly way of murder by mail. Bombs brought by the postman, he thought, would do their deadly work and erase all traces of the sender. They did their work; two men were killed as they opened the parcels—but the murderer reckoned without the detective sci-

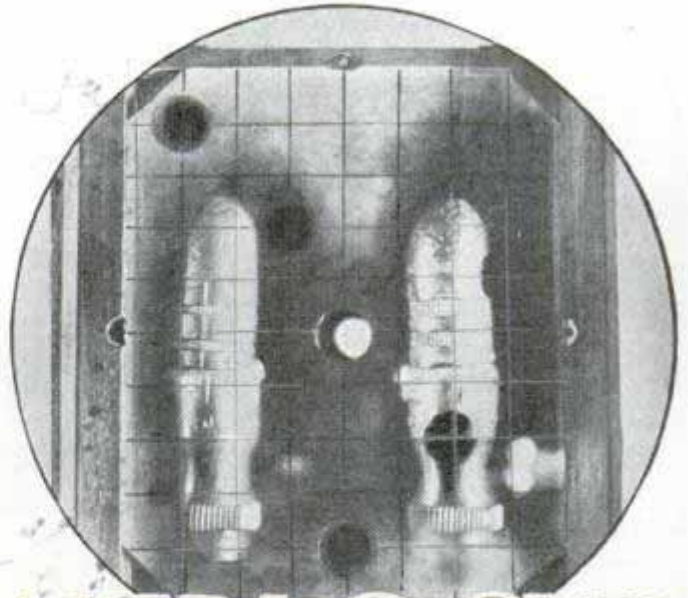

MODERN SHERLOCKS



Acme

entist. The Journal of Criminal Law and Criminology, reporting the case, tells how wood technicians examined imprints of a plane on wood fragments from the bomb, matched them with marks on wood in possession of a suspect. Chemists analyzed glue in the two wood samples, found them identical. The microscope proved that nails from the bomb and from the suspect's workshop came from identical dies.

Candle grease in a burglar's pocket sent him to prison. Infrared photographs of a

footprint trapped another criminal. Microscopic pictures of a cabbage stalk brought a farm thief to justice. Chemical analysis of the ashes of a hat identified its murdered owner as a missing Boy Scout.

These are samples of the work of the modern scientific Sherlock Holmes. You wouldn't recognize him on the street. You'd probably take him for a college professor—which he very likely is, when not engaged in "master minding." For the detective who solves the "perfect crimes" of

*3-5-34
Chromy
of ash...*

*Consulting Chemist,
Pasadena Police Dept*

At top of opposite page, two bullets seen through ground glass of camera; rifling marks on test bullet at left are being compared with fatal bullet at right. Below, demonstrating the polygraph "lie detector." On this page, top, blowing iodine vapor to develop fingerprint. Center, using dial micrometer to measure diameter of wire used on time bomb. Bottom, firing bullet into basket of cotton for ballistic test



*Mr. W. E. Brown and his laboratory
Chicago Police Scientific Laboratory*

Battle "PERFECT" CRIMES

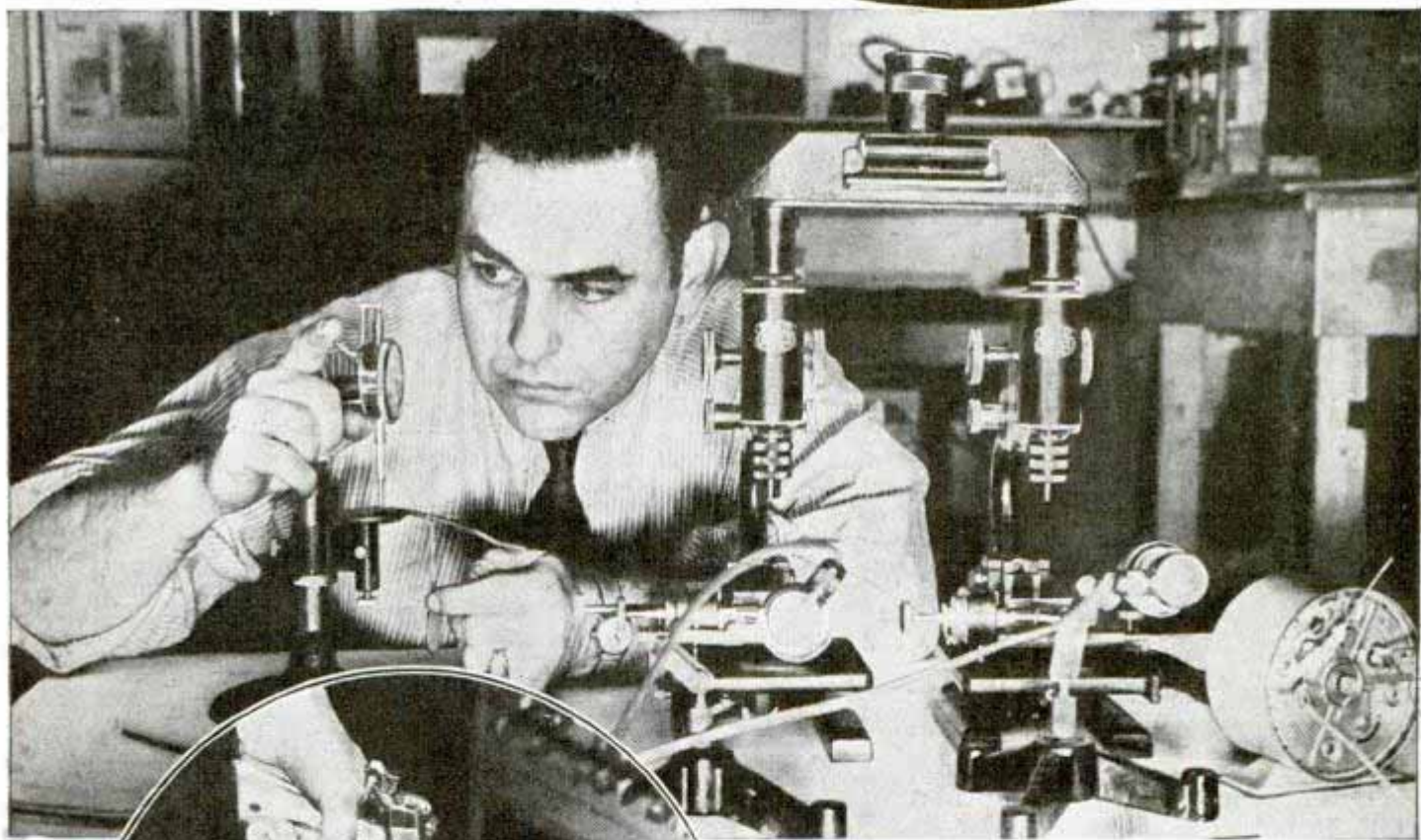

1939 is not the pipe-smoking fellow of fiction nor the burly plain-clothes man you read about in the big city newspapers. Rather he is a laboratory technician whose tools are the spectrograph and comparison microscope, the camera, electric furnace, test tube and polygraph.

Sherlock Holmes of old would sit in his clubroom, glance at a passerby and tell you instantly the stranger was an old soldier, recently discharged from the India service; a non-commissioned artillery officer,

away from

handwriting school



City police go to school these days to learn scientific methods of gathering clues. They speed to the scene of a crime in a squad car equipped with two-way radio, fingerprint kit, camera and lights, moulage set and all the essentials for collecting evidence. Then, often, they turn the clues over to trained criminologists for analysis. The Chicago police have their own laboratory, acquired from Northwestern University, which had founded the first scientific crime-detection laboratory and school.

It was experts from this Northwestern laboratory who by micro-analysis worked the first solution in a series of murders, riots and bombings in a mine field. Two suspects were in custody, accused of blasting a mine powerhouse; but they denied guilt, asserting the explosion probably was caused by coal dust or gas. The experts wrecked that defense. From the shattering effect of the blast—one 125-pound chunk of cast iron was blown 150 feet—they determined it was a "high" explosive, probably dynamite, with a velocity of 5,000 to 25,000 feet per second. Coal dust and gases, which classify as "low" explosives, were ruled out.

Federal Bureau of Investigation

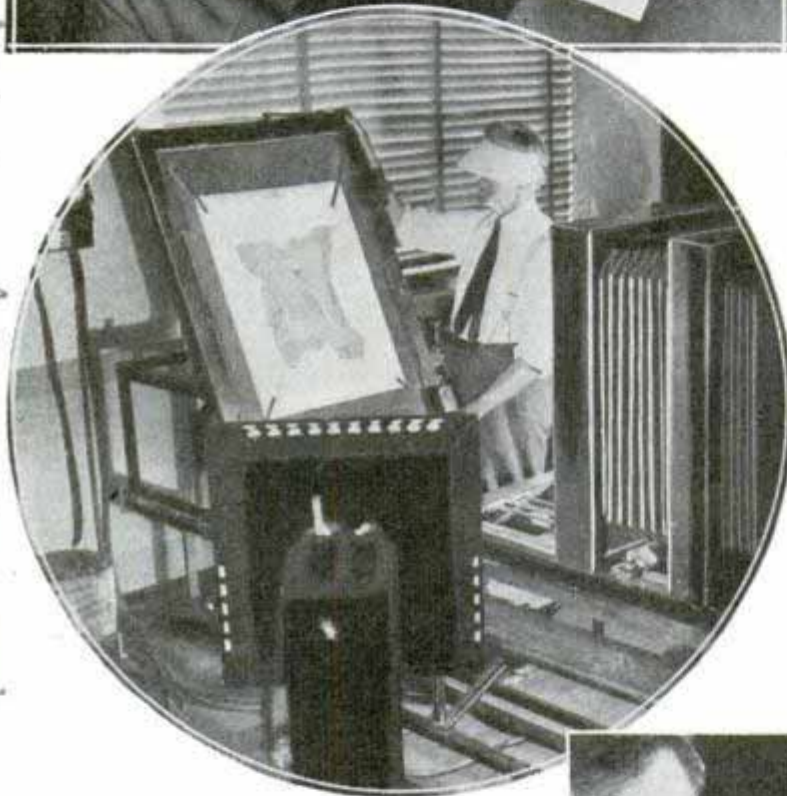

widowed, with two children. Sherlock was a master of observation and deduction.

His 1939 counterpart might be a little less keen with the naked eye, but more effective when armed with laboratory instruments. One modern Sherlock, for example, was given a bit of string that had been wound around a bundle of dynamite in a bombing. By microanalysis he sorted the debris on the fragment of string into feathers, hair and pollen; he was able to identify the locale from which the dynamite came and describe the terrain and its animal and land products.



Top, handwriting expert compares words from threatening letter with writing of suspect. Circle, photographing blood-stained handkerchief for evidence. Bottom, studying fingerprints with dactyloscope and analyzing dust on state's evidence

Who prof. make a
Dolan
former
Dr. M. S. A. Hill
New Western Crime Lab.

Dr. Robert Sears
Police

Following the radiating paths of flight of the debris to their focus, the experts found fragments of adhesive tape, copper wire and bits of an alarm clock. They reconstructed a clockwork mechanism used to set off the charge. In a radio repair shop at the home of the suspects they found bits of copper wire and a roll of adhesive tape from which two strips had been torn. But how to connect the fragments from the bombing with those in the workshop, to send two men to prison?

Under the microscope the scientists counted 322 torn filler threads in the adhesive tape found at the suspects' home; thread for thread, they matched in thickness, in numbers and in tears the tape wound on the time bomb for insulation. Using methods of the ballistic expert, they found identical grooves on the various copper wires, proving they were drawn from the same dies. Cross-sections of the wires were photographed under a metallurgical microscope; the suspects' wires and those on the bomb were identical in grain structure. The jury looked at these photomicrographs and sent the bombers to the penitentiary.

One burglar shot a man, was arrested, and five witnesses swore he was miles away at the hour of the attack. Ballistic experts proved the defendant's revolver had fired the shot, and as his alibi was shattered, the prisoner remarked with a wry smile: "This sure has put my witnesses in a hole."

Sometimes a scrap of cloth is the only clue. Even the imprint of the cloth is enough. On the fender of an automobile that police suspected was involved in a hit-and-run killing, they found a tiny imprint. Photographed and enlarged, the pattern was found to contain thirty-one lines to the inch—identical with the threads in the dead man's shirt. The shirt bore minute flakes; dissolved in alco-

(Continued to page 116A)

Giant of Crossword Puzzles Result of Two Years' Labor

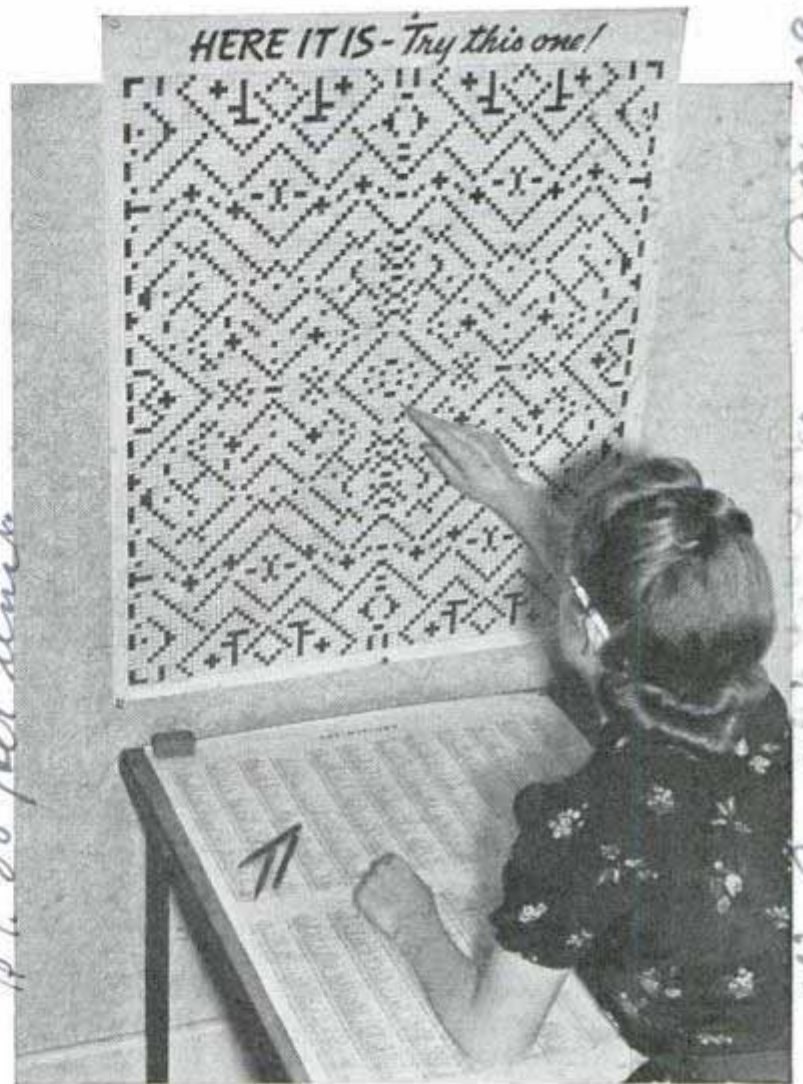

Trying to think of word that fits near center of huge crossword puzzle which may take the young lady a year to solve

It required two years of work to complete a huge crossword puzzle, now on the market, which embodies 3,071 words, and it is said that the average fan will take one year in solving it. The design measures twenty-eight by thirty-four inches.

Half a Ton of Paper Is Used Each Year by Average American Family

If yours is an average American family, you use every year more than half a ton of paper costing about forty dollars. The U. S. Forest Service reports that nearly 16,000,000 tons of paper were consumed in this country in 1937—more than half the paper produced in the world. About 100 pounds of the 246 pounds used by the average person represents newspapers, magazines, books and stationery; the rest was wrapping paper and cartons, building board and other products. Spruce, hemlock and fir furnished three-fourths of the pulpwood for paper.

Mrs. C. W. Cressinger, 1001 109th St., Berkeley, Cal.
 Dept. of Agriculture

Tall Grass Is Cut by Mower with Whirling Blades



Cutters rotate at high speed in one direction, slashing off high grass and weeds gripped between tines

Spinning freely in a horizontal plane, the cutting arms of a gasoline-powered lawnmower clip off grass and weeds up to twelve or fourteen inches high. Momentum is sustained evenly by a flywheel to which the arms with their sharp knives are attached, resulting in continuous operation with very little power. There is no rubbing or clashing of metal against metal, and the cutters do not clog, since grass clipped in front of the mower is immediately conveyed to one side where it cannot tangle with the mechanism. The driving power comes from a four-cycle engine developing 2,200 revolutions per minute.

Salt Shakers Prevent Explosion of Dust in Coal Mines

Dust explosions, one of the greatest dangers in coal mining, may be prevented by so simple a device as a giant salt shaker.

It is impossible to eliminate coal dust entirely. But British mining men have found that scattering large quantities of powdered rock in the mines would reduce the hazard, the rock dust settling with the coal and diluting it so that it would not burn. Seeking some substitute for rock dust which could be used in small quantities and make certain a non-inflammable mixture, they chose common salt. Finely powdered salt dusted throughout the mine, with powdered chalk and magnesia added to prevent caking, proved an effective deterrent to mine explosions, and it took only a tenth as much salt as rock dust.

Vacuum Cleaner Bag Has Tray Easy to Lift Out and Empty

Dust and dirt picked up from the floor are deposited into an "ash tray" built into a special vacuum-cleaner bag designed to replace the one in your cleaner. Disposal of the refuse is simplified since the tray can be removed easily by its handle and emptied without raising dust. More frequent cleaning of the bag is induced, resulting in greater efficiency of the vacuum.



It's easy to remove dust drawer from vacuum cleaner bag and empty it into trash basket without spilling

A new rotary lawn mower

420

Safety News

Research Board
No. 1001 Science

Vac. A. Labor

New York City

The



CRAFTSMAN



PERGOLAS to beautify your garden

THESE neat pergolas are an economical and satisfactory means of beautifying your garden, and anybody can build them with a hammer and saw. Any weather-resisting lumber can be used, but redwood or western red cedar are especially suitable as they are durable, hold paint well and are easy to work.

An attractive flat-topped pergola is shown in Fig. 2. First assemble the posts in pairs and

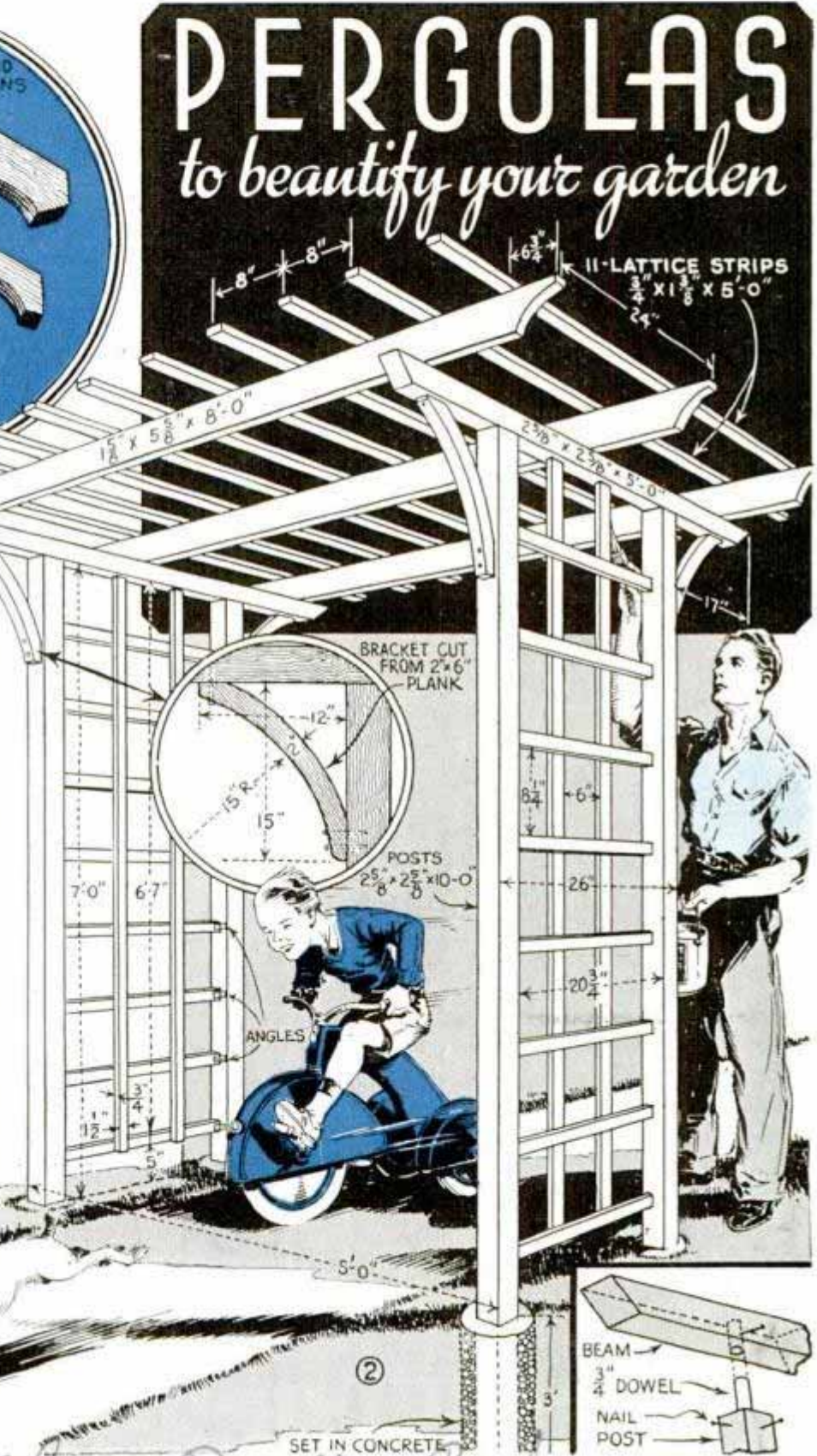

Cruskey Radio Corp.

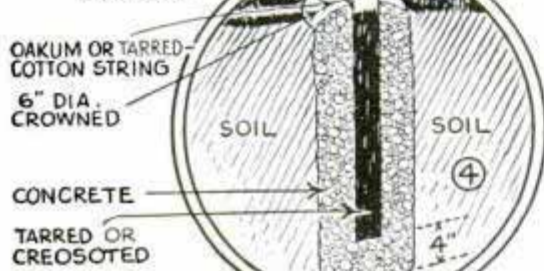
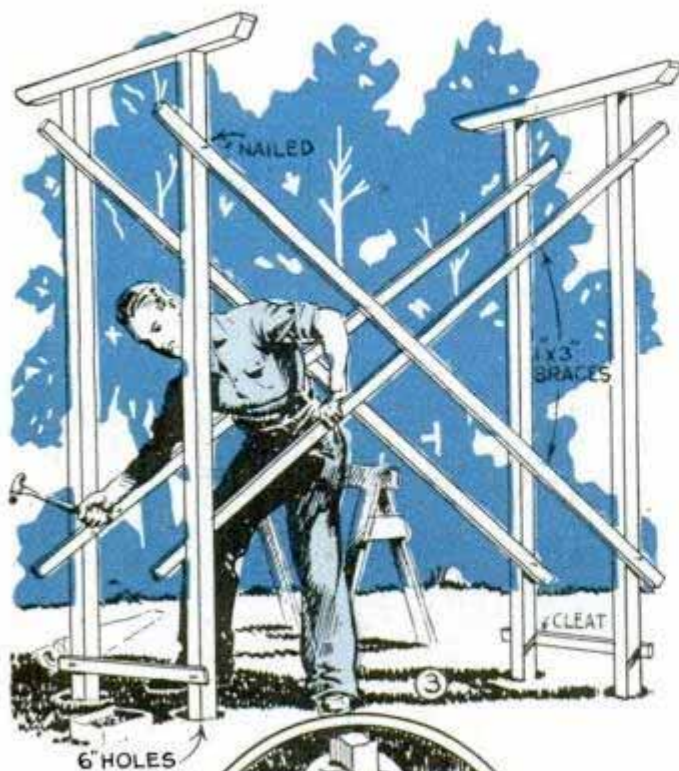

11 LATTICE STRIPS
 $\frac{3}{4} \times 1\frac{3}{8} \times 14\text{'-}0\text{'}$

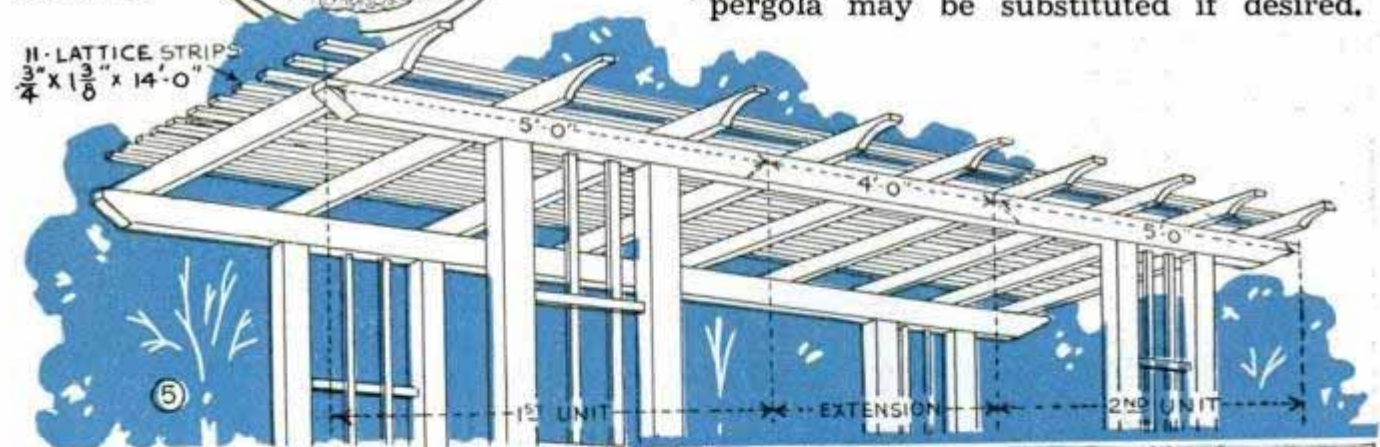

brace them temporarily with cleats across the bottom, and diagonal members between them as in Fig. 3. The two beams at the top are doweled and nailed as shown in the lower detail of Fig. 2. Holes that are dug for the posts should be 6 in. in diameter and about 4 in. deeper than the portion to be under ground. After the two end assemblies have been set in the holes, the latter are filled with well-tamped concrete. When this has dried out a slight shrinkage around the post will likely leave cracks through which water might seep, so

these should be sealed as suggested in Fig. 4. Creosoting the underground portion of the posts is also advisable. The three rafters are next toenailed into place. You can cut the scroll on the ends by hand, but most lumber yards are equipped to make these cuts at nominal cost. Fig. 1 shows alternate designs for the end scroll. The lattice pieces are laid out on a floor in their correct position and nailed where they cross to form panels. After assembling the panels, they are screwed to the posts with three small brass angles on each side, placed to the inside of the structure. Experience has shown that this method of fastening is satisfactory as the panels are not part of the main structure. It is also convenient when painting as the panels may be removed. The brackets, which have previously been sawed to shape, are next screwed in place. Installing the top lattice completes the structure.

The semicircular top pergola, shown in Figs. 7 and 8, is a bit more elaborate but far from difficult. The lattice fillers are made up of strips lapped into each other to give a level surface. However, the same method of construction as used for the first pergola may be substituted if desired.

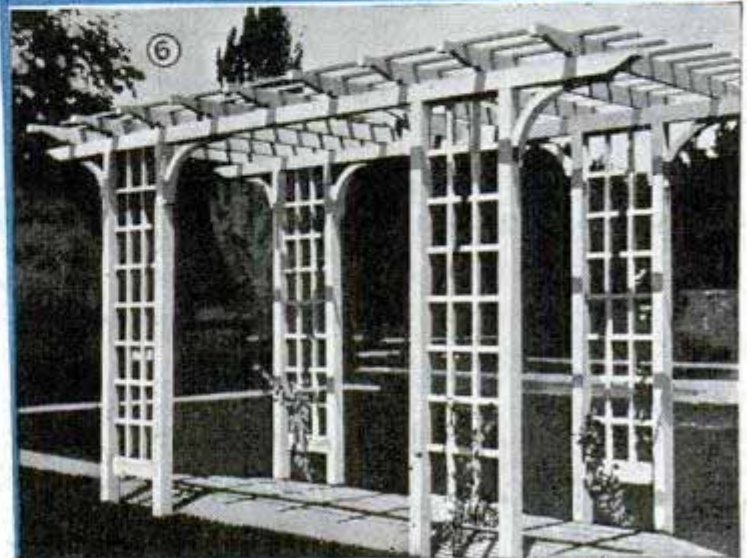

After the panels have been nailed into place, the assembled ends are constructed and erected in the same manner as previously described, using nails instead of dowels at the top of the posts. The brackets should be left off until the roof arches have been screwed into place as they would be in the way. Arches are built up of two layers of segments. A cardboard pattern of one segment is used to mark out the pieces for sawing to shape. Waterproof glue and nails, spaced at 4-in. intervals, are used to join the segments. The edges are smoothed outside with a plane and inside with a rasp. The final oper-

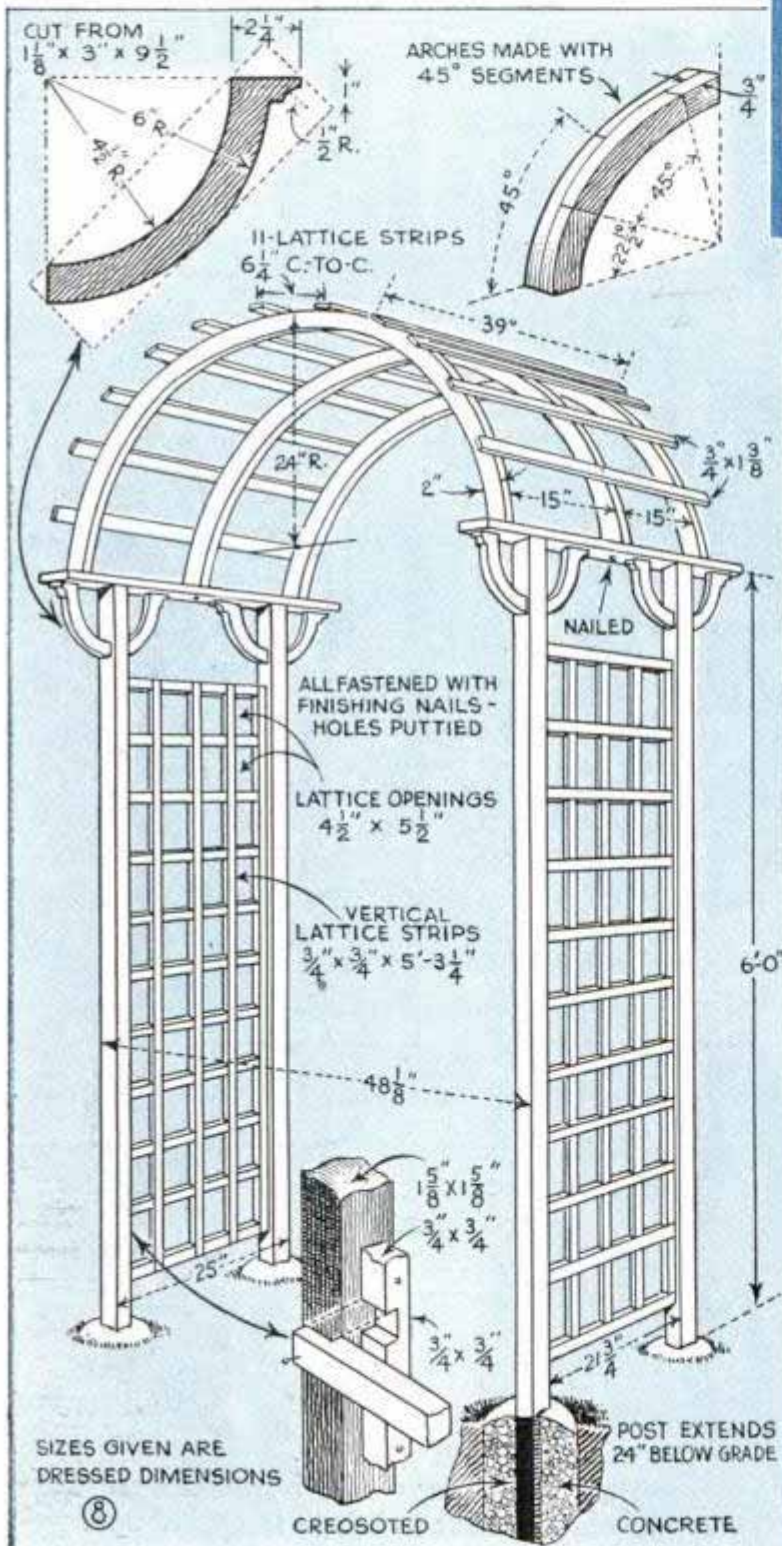
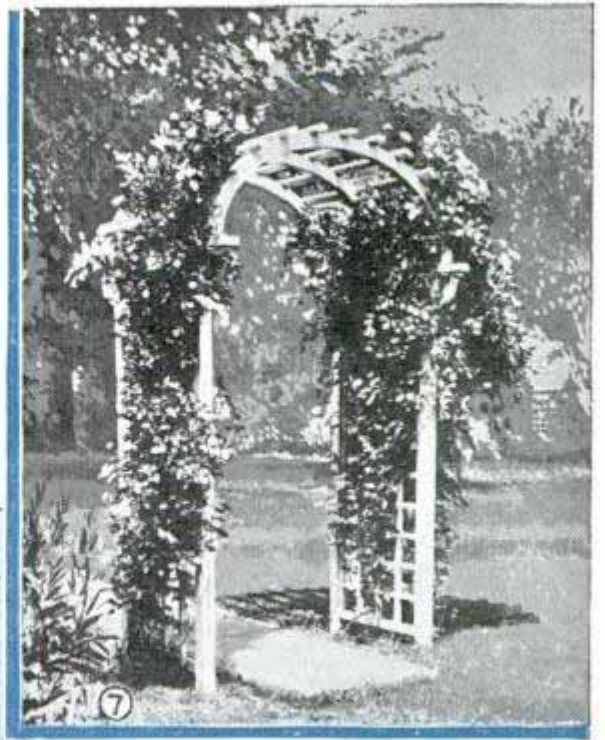

ation is to nail the roof lattice in place and install the ornamental brackets with nails.

Should you desire a longer pergola, either of the types shown may be extended by simply constructing additional units. The use of stock-size timbers results in considerable economy as there is no waste. Figs. 5 and 6 show the method of constructing an extended pergola. Pergolas are usually painted white or stained with creosote stain. This is applied before the structure is assembled, and will add to the life and appearance of the pergola. Three coats of any good paint or two of creosote stain will give ample protection for a period of years.

Making Arrows Visible

To locate your archery arrows easily after shooting them, wrap bands of tinfoil on the shafts just in front of the feathers, and shellac the bands to prevent tearing. The tinfoil will glisten in the sun so that an arrow can be seen at a distance of many yards. This method is especially effective where the arrows fall in tall grass, weeds, etc.

—Stephen Stanford, Logan, Utah.

Angle Worms Brought to Surface by Vibrating Pitchfork



The next time you have a hard time finding worms for fish bait, force the tines of a pitchfork into the ground where there should be worms and twang the handle. This sets up vibrations that cause the worms to come up to the top.

—Kenneth W. Olson, Pendleton, Ore.

Canoe Pulled over Rocky Beach on Linoleum Cradle

If you have to move your canoe over a beach covered with small rocks, the bottom will soon wear through, unless you

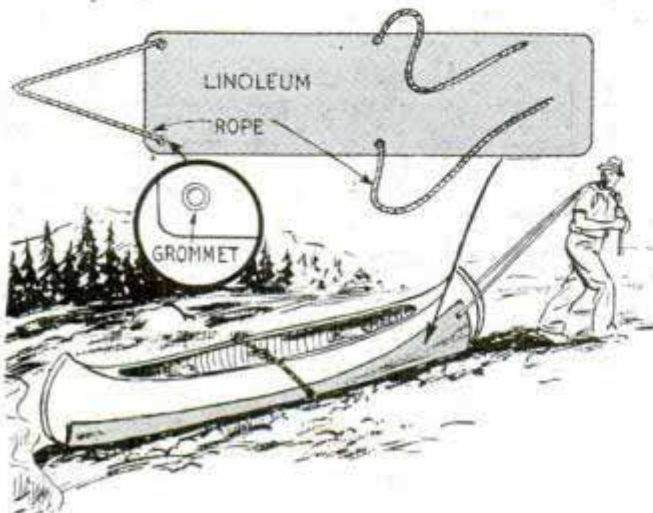

use some kind of cradle to protect it. This one is a piece of linoleum, which will stand considerable hard use if properly handled. Grommets are put near the corners of the linoleum at one end to receive the ropes, and also near the edges at the center to receive a couple of ropes with which the cradle is tied to the canoe.

—L. B. Robbins, Harwich, Mass.

Drawer in Stepladder Is Handy for Small Articles

Suspended from the underside of a stepladder top, a small drawer provides a handy place to keep small tools most frequently used when working from a stepladder. A catch should be provided for the drawer to keep it closed when the ladder is being moved.

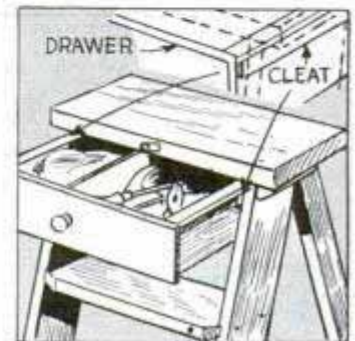

Alcohol Dries Fisherman's Flies



The problem of drying flies is solved by one fisherman who puts them in a bottle of alcohol, inserts the cork and shakes the bottle. The alcohol absorbs the water

quickly and evaporates almost instantly when the hook is exposed to the air.

Shoe Heel Repairs Rubber Mallet

When the ends of a rubber mallet become worn and battered, cheap, rubber heels will serve nicely as new facings. Cut off pieces from the mallet end equal to the thickness of the heels, cement them in place and then trim them to shape.

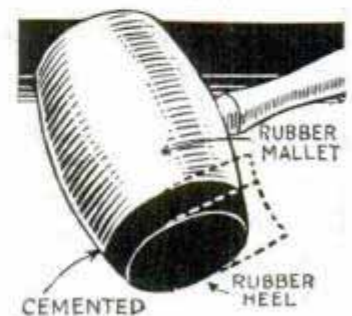

This 'Finger-Fit' Rack Holds Books Securely

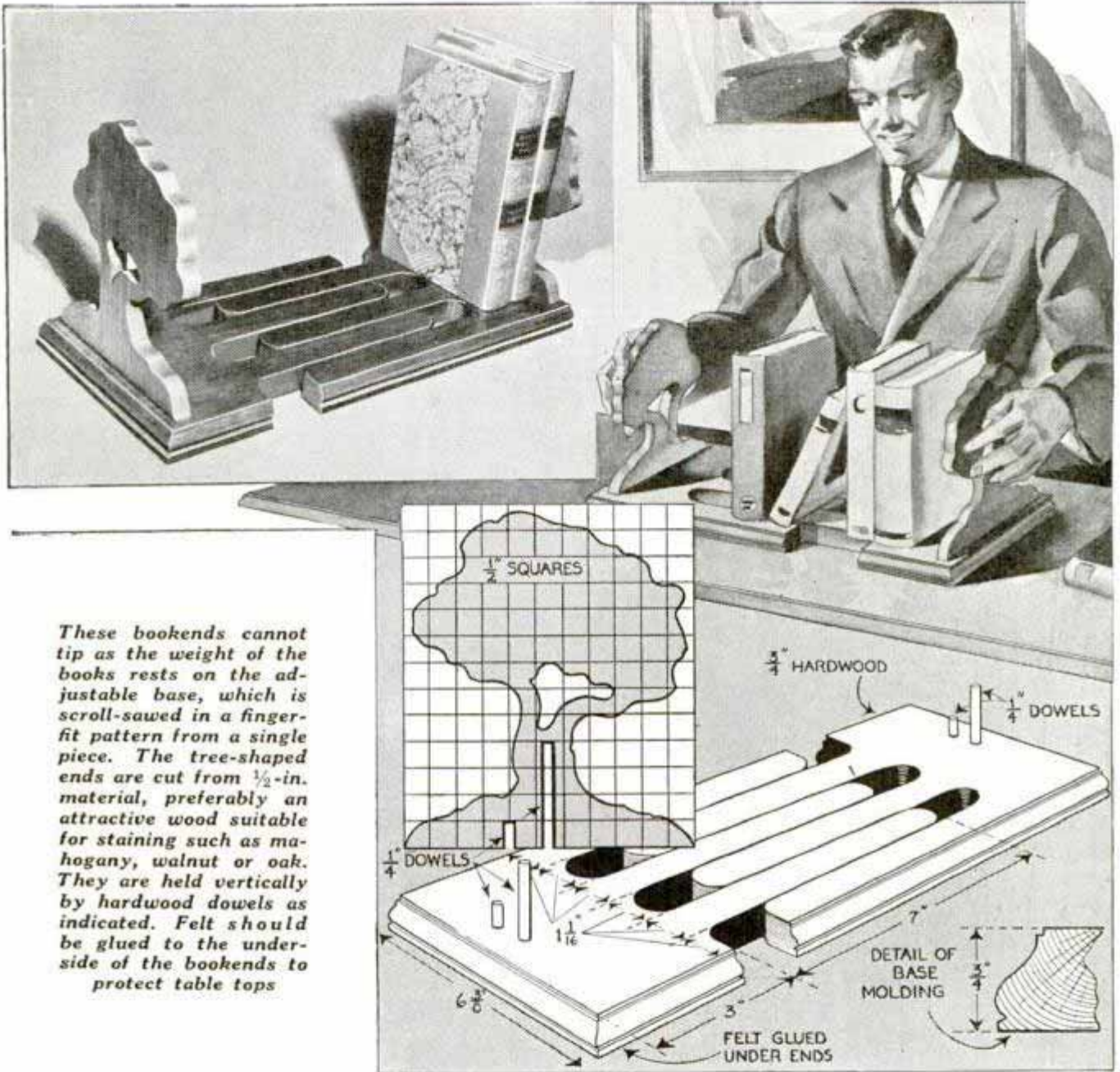

These bookends cannot tip as the weight of the books rests on the adjustable base, which is scroll-sawed in a finger-fit pattern from a single piece. The tree-shaped ends are cut from $\frac{1}{2}$ -in. material, preferably an attractive wood suitable for staining such as mahogany, walnut or oak. They are held vertically by hardwood dowels as indicated. Felt should be glued to the underside of the bookends to protect table tops

Small Paper Cups Have Many Uses in Home Workshop

An inexpensive convenience in your home workshop is a supply of small paper cups obtainable in any ten-cent store. They are particularly handy when doing small jobs of finishing, or in mixing paints and stains. When tin cans are used for this purpose they always must be cleaned for the next job, and frequently bits of skins or traces of the old color remain. But paper cups are merely thrown away when a job is finished. Labels and measures can be marked on them easily with a pencil, and liquid levels show clearly through the translucent sides. The shop worker will

find many other uses for the cups. They are handy for washing tiny parts, and similar work. Also, they provide good containers for storing small screws, brads, bolts and nuts, washers, etc., one of which can be threaded through the side of each cup to show at a glance what it contains. In addition to this, they are useful to hold screws, bolts and other small parts when dismantling small objects, such as motors, clocks and household appliances.

☐ Oranges can be peeled easily if they stand in boiling water for about 5 minutes.

PORCH SET *assembled*

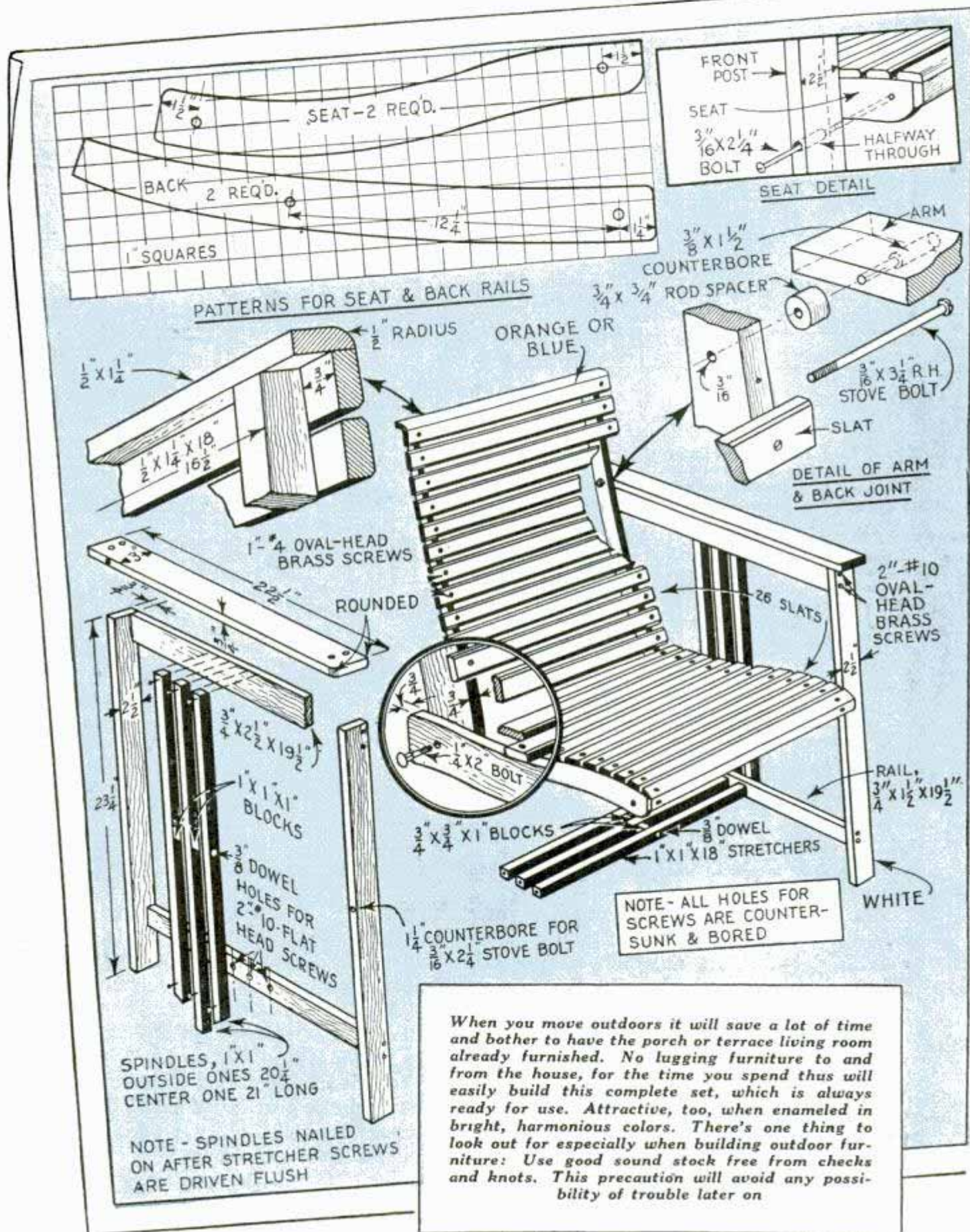

When you move outdoors it will save a lot of time and bother to have the porch or terrace living room already furnished. No lugging furniture to and from the house, for the time you spend thus will easily build this complete set, which is always ready for use. Attractive, too, when enameled in bright, harmonious colors. There's one thing to look out for especially when building outdoor furniture: Use good sound stock free from checks and knots. This precaution will avoid any possibility of trouble later on

with screws

FINISHED WITH ONE COAT OF FLAT AND TWO OF ENAMEL

MATERIAL LIST FOR CHAIR

- 26 pcs.— $\frac{1}{2}$ x $1\frac{1}{4}$ x 18 in.—Slats
- 2 pcs.— $\frac{1}{4}$ x $3\frac{1}{2}$ x 19 in.—Seat supports
- 2 pcs.— $\frac{1}{4}$ x $3\frac{1}{2}$ x 22 in.—Back supports
- 2 pcs.— $\frac{1}{4}$ x 3 x 22 $\frac{1}{2}$ in.—Arms
- 2 pcs.— $\frac{1}{4}$ x $2\frac{1}{2}$ x 19 $\frac{1}{2}$ in.—Top rails
- 2 pcs.— $\frac{1}{4}$ x $1\frac{1}{2}$ x 19 $\frac{1}{2}$ in.—Bottom rails
- 3 pcs.—1 x 1 x 18 in.—Stretchers
- 6 pcs.—1 x 1 x 21 in.—Side Spindles

MATERIAL LIST FOR TABLE

- 3 pcs.— $\frac{1}{4}$ x 8 x 24 in.—Top
 - 2 pcs.— $\frac{1}{4}$ x 2 x 7 $\frac{1}{2}$ in.—Top blocks
 - 6 pcs.—1 x 1 x 25 in.—End spindles
 - 3 pcs.—1 x 1 x 17 in.—Stretchers
 - 2 pcs.— $\frac{1}{4}$ x 1 $\frac{1}{2}$ x 12 in.—Swinging brackets
 - 2 pcs.— $\frac{1}{8}$ x $1\frac{1}{2}$ x 20 in.—Feet
 - 4 pcs.—1 x 1 x 5 $\frac{1}{2}$ in.—Brackets
- Note—1 x 1 x 1 in. spacer blocks cut from scrap

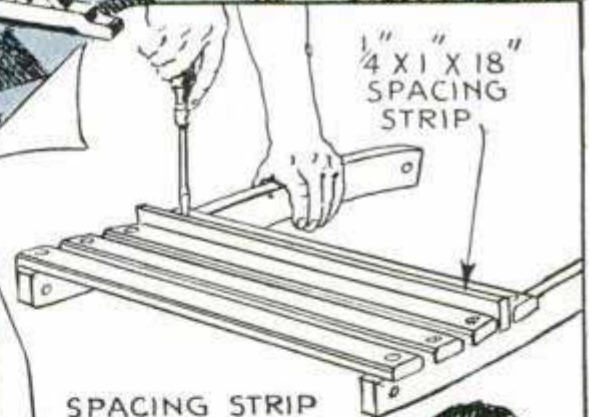
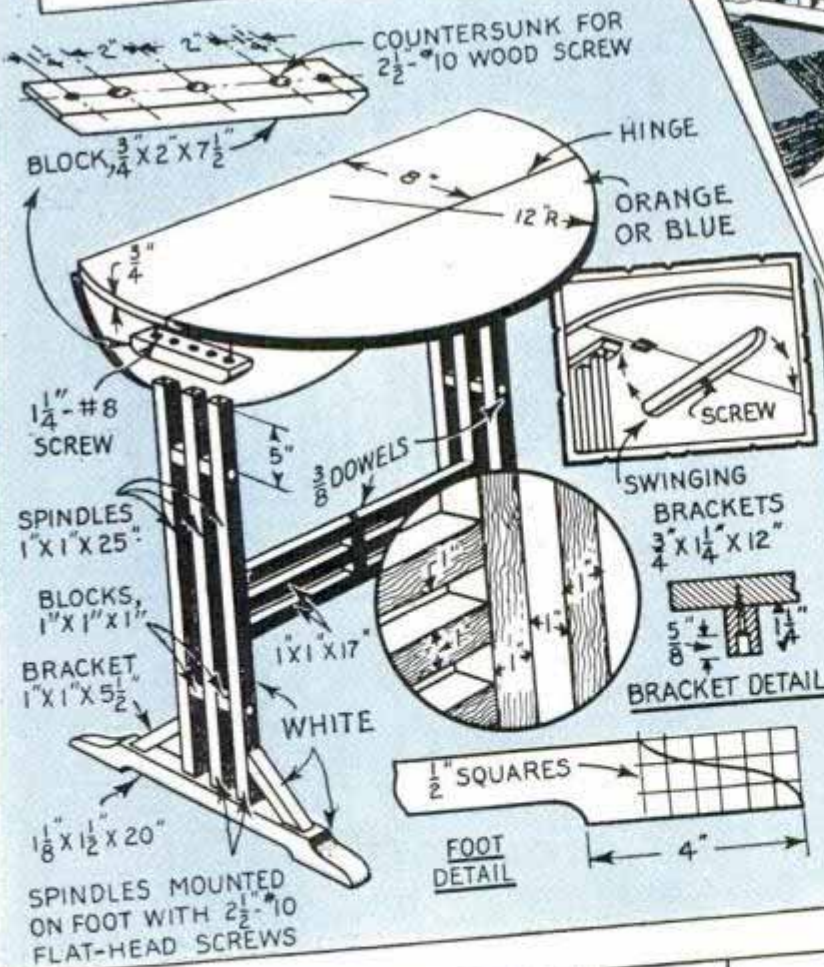
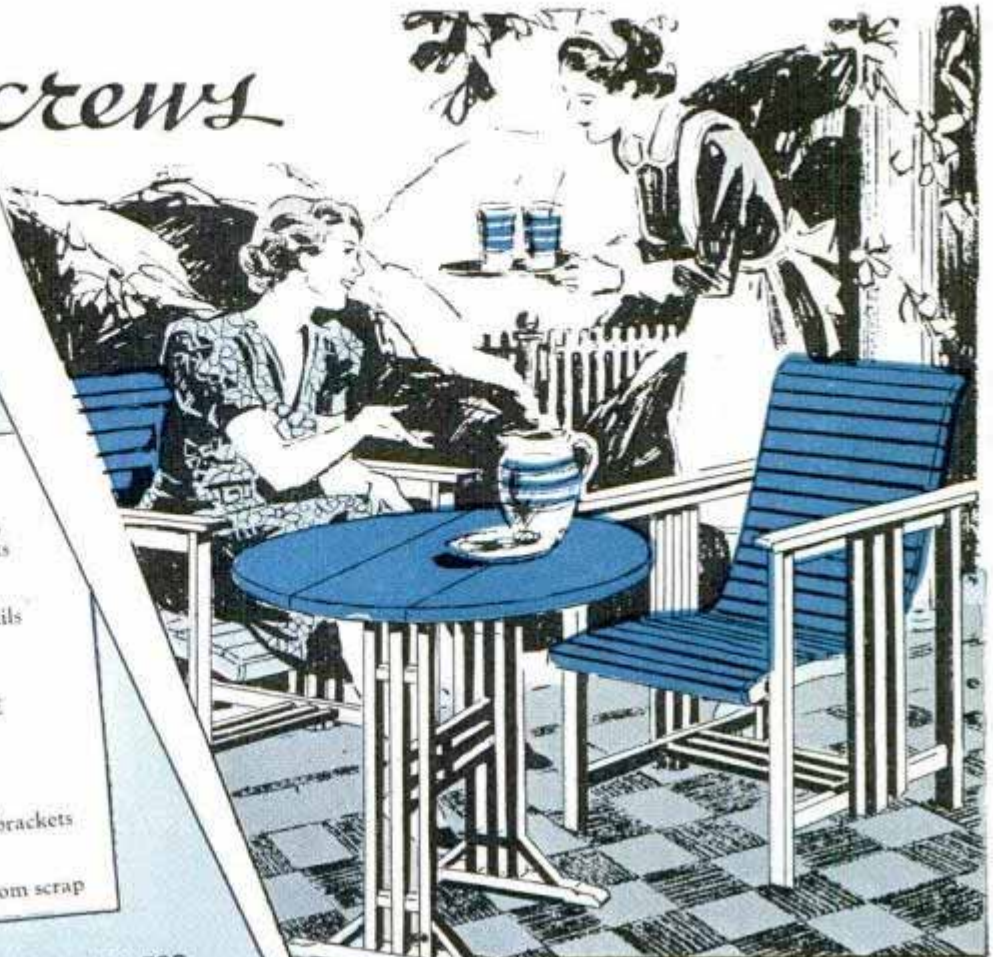

SPACING STRIP LOCATES SLATS UNIFORMLY

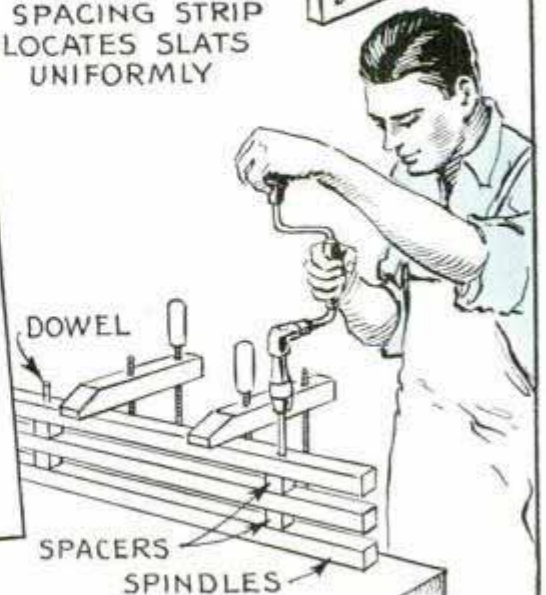

SPINDLES ARE CLAMPED TOGETHER WHILE BORING DOWEL HOLES

Roasting Several Frankfurters in Corn Popper

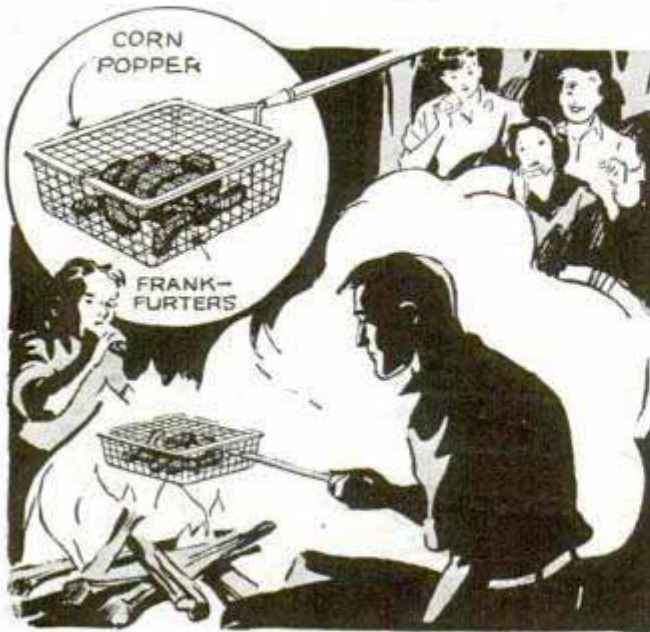

When you go on a picnic where frankfurters are to be roasted over an open fire, slip a screen-wire corn popper into the car with the provisions. Several frankfurters may be roasted in it at one time.

Brick Veneer on Model Buildings from Plastic Compounds

Model makers who desire realistic brick effects on buildings can utilize one of several materials sold for filling cracks in wood, tile or plaster. The most common of these is plaster of paris, in which a few drops of vinegar are added to retard drying, or a mixture of sal ammoniac, plaster

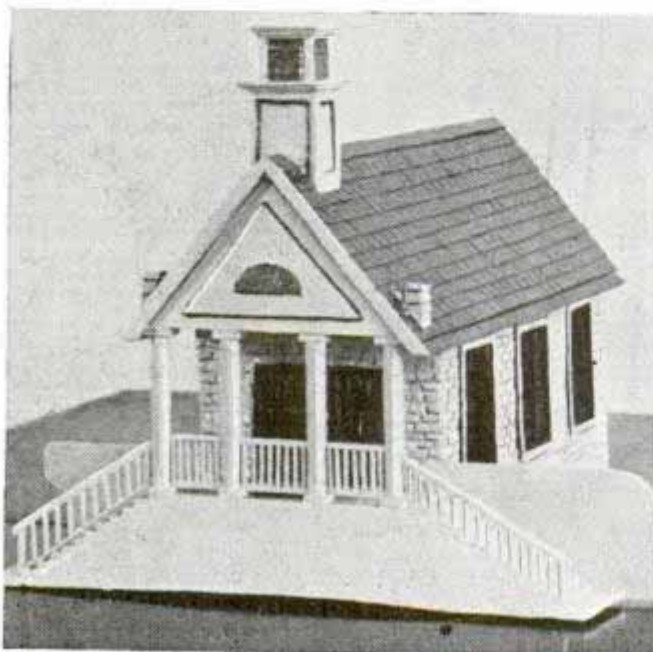

of paris and iron filings, which hardens into hard gray blocks like granite. Any of the dry filler powders mixed with water and molded, or the ready-prepared ones pressed into shape and allowed to harden look realistic when glued in place and painted a natural color.

Bright Objects Photographed Without Glare

Polaroid eye glasses often worn by motorists and others to reduce glare serve as good filters when photographing bright objects. The

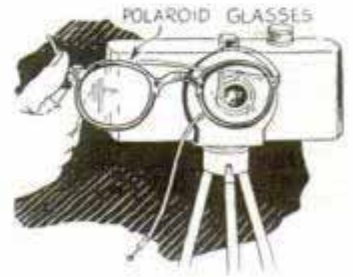

glasses can be obtained at most optical stores and are held in front of the camera lens in the same position that they are supported in front of the eyes.

—Bert S. Rohn, Chicago.

Wood Screw Locked in Position with Small Staple

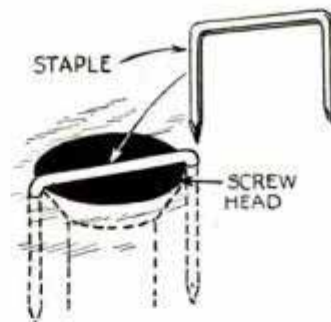

When a wood screw has a tendency to loosen, drive a small staple into the work to straddle the screw head and fit the slot as indicated. This will keep the screw

from turning, and is especially useful in soft wood, with which the trouble frequently occurs when subject to vibration.

Cork Keeps Tackle Untangled

The snarl which usually results by placing unprotected lures in a tackle box is done away with by notching a slice of cork and slipping

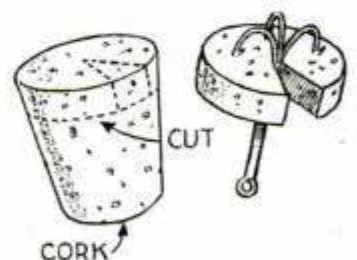

it over each of the hooks. The cork can be sliced easily with a used safety-razor blade.—Albert Zanelli, Clifton, N. J.

Daddy builds a BACKYARD SLIDE

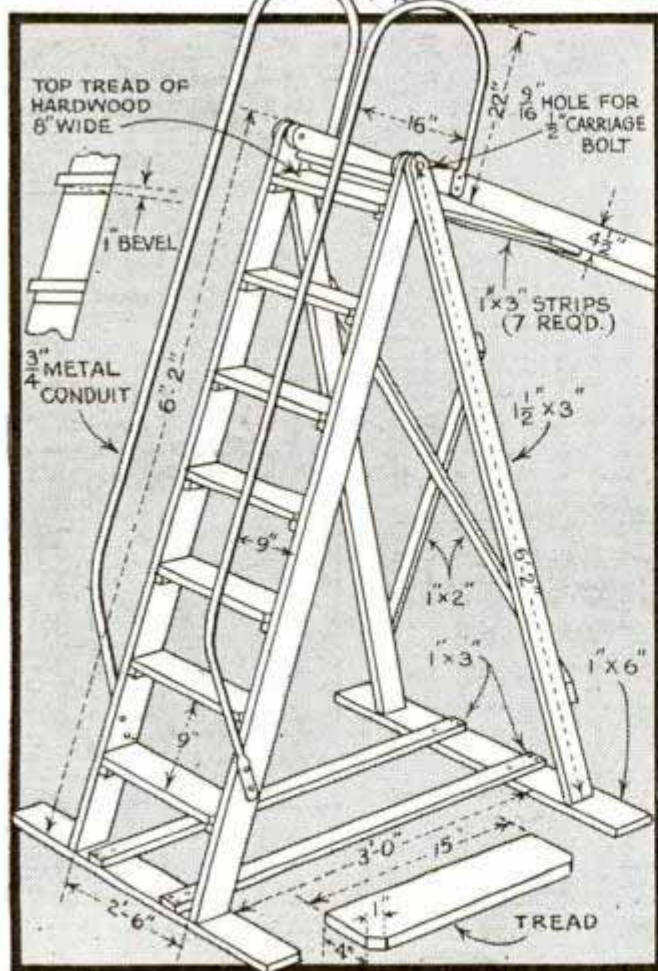

Set up in your backyard, this slide will afford your children and their friends many hours of pleasure safe from street traffic, and it can be dismantled and stored for the winter in a jiffy. A wide slide bedway, stairs and "take-off plate" all make for safety of the children, and a couple of hinged boards near the bottom of the stairs can be locked over them to keep tiny tots from climbing the slide without supervision. A sheet-iron bedway assures long life, and hardwood bedway pieces well sanded and varnished reduce the splinter hazard to a minimum

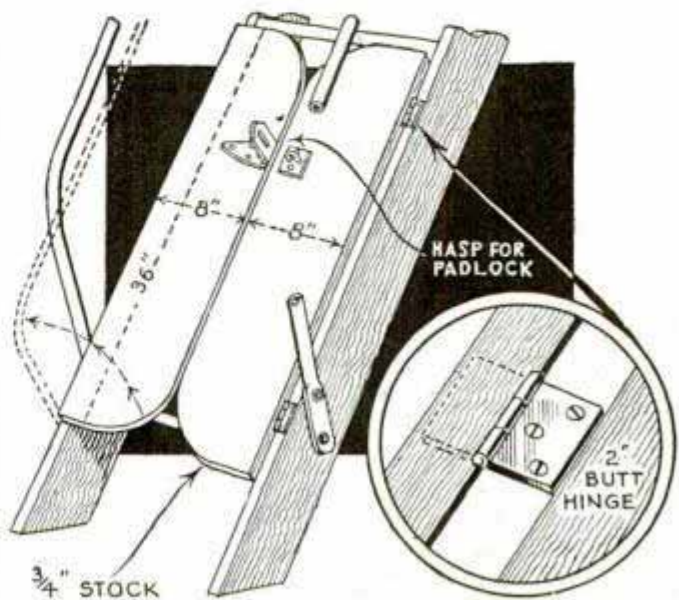

Tire Steps at 'Ol' Swimming Hole' Easy on Bare Feet



Bathers who favor certain locations on lakes or streams where a steep bank has to be descended to reach the water, will find that old tires make good steps. They are set in the bank as indicated and filled with sand to make smooth, level steps.

Rubber Shield on Hand Sledge Catches Flying Particles

The risk of flying particles hitting your eye or face, when breaking stone or concrete, can be minimized by using this



sledge shield. Cut from a piece of inner tube, the shield is slipped over the handle first and then over the head of the sledge.

Soap "Pencil" Relieves Itching of Mosquito Bites

Common yellow laundry soap moistened and rubbed over mosquito bites as soon as the wounds are made will relieve itching. One fisherman cuts pencil-shaped pieces from a soap cake and protects them with wrappings of gummed-paper, which can be torn off as the pencil is used.



Vise Clip Holds Severed Work

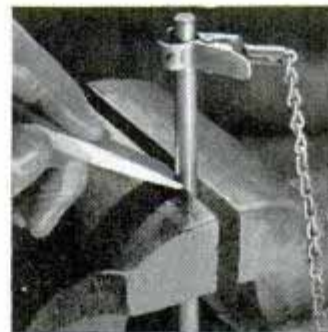

When cutting off a rod or other work while it is clamped in a vise, use this holder to keep the work from flying when it is severed. The holder is an electrical test clip fastened to a small chain, which is in turn fastened to the vise. For large work, you can use a small C-clamp in the same way.

Non-Slip Belt-Sander Pulleys

If a sanding belt has a tendency to slip on the pulleys, the trouble can be stopped by putting rubber bands on the pulleys. Before doing this, cut a number of shallow V-grooves in the surfaces of the pulleys and snap the bands into them. The bands should be slightly wider than the grooves so that their edges project a little.—Jesse Baker, Houston, Tex.

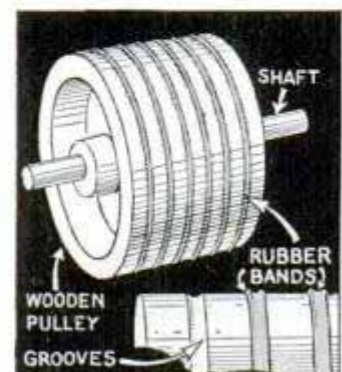

BUILD YOUR BOAT RIGHT!

Editor's Note—Before starting on a specific boatbuilding project, the amateur should become familiar with boat terminology as well as various practices and methods involved so that he knows the "how" and "why," which is customarily not explained in plans. This article explains various methods of applying planking; gives procedure of spiling; tells what to consider when making well and centerboard installations as well as other important data

PART II

HAVING erected the frames on the keel in their relative position, planking is the next step. There are several arrangements of planking, illustrated in Fig. 21. Thick planks, $\frac{3}{4}$ in. and up, can be installed on the frames without battens, because there is enough surface on the edges to permit beveling from $\frac{1}{2}$ to $\frac{1}{3}$, the thickness forming a V-groove into which cotton candle-wicking can be driven over marine glue or white lead. The thicker planks are advised for heavy-duty boats, deep-sea cruisers, and others designed for rough going rather than speed. For lighter craft such as outboard runabouts and speedboats, planks from $\frac{3}{8}$ in. to $\frac{1}{2}$ in. can be used provided battens, Fig. 20, are placed behind the joints. Overlapping planks, or lapstrake, are suitable for several types of hulls. The lap is secured with copper rivets, marine glue or white lead being applied first to the contacting surfaces.

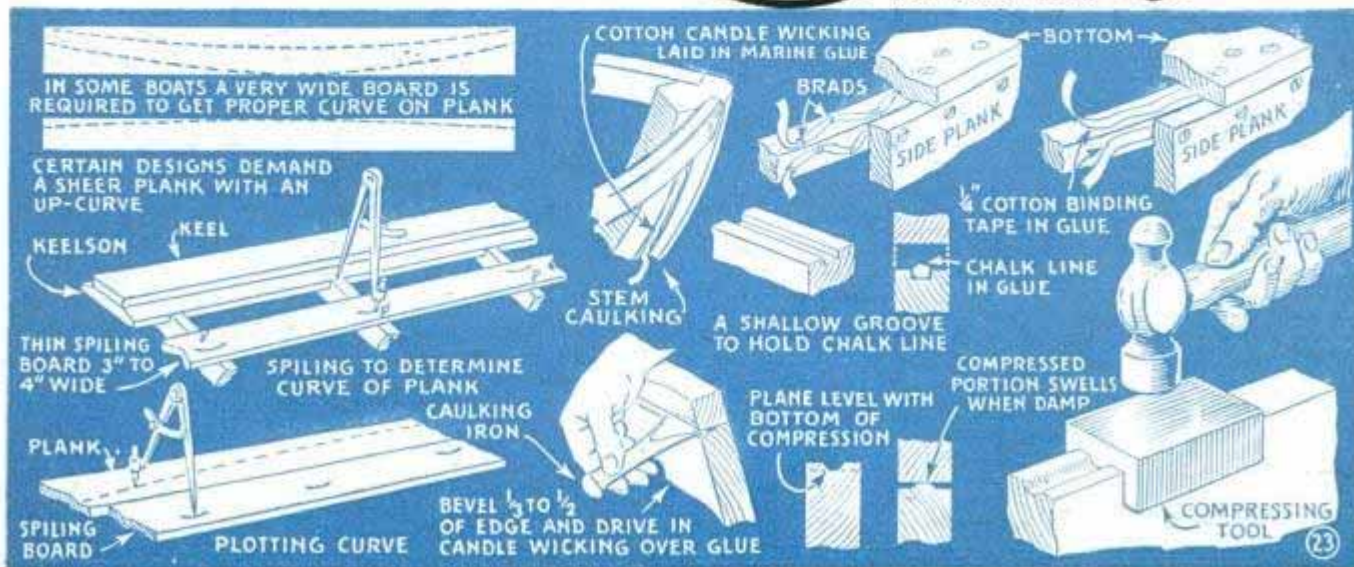
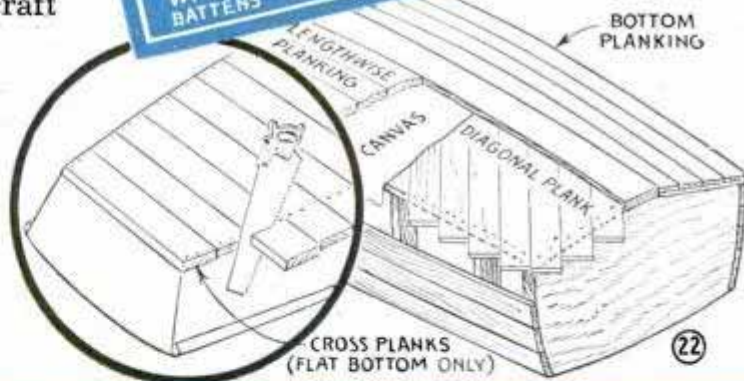
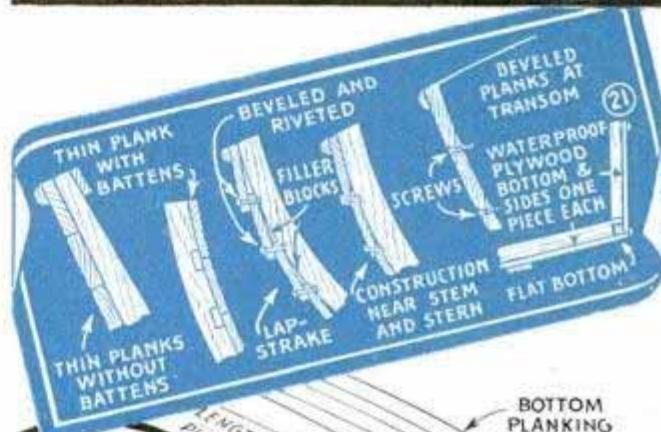

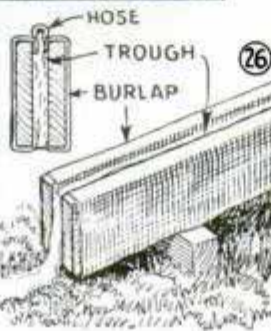
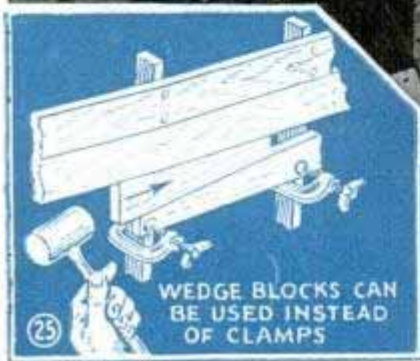

spiling board 4 or 5 in. wide is laid alongside the keel, and at each frame a mark is made with a compass, Fig. 23. The spiling board is removed, a hull plank is laid beside it and the marks are transferred to the plank. A batten is then laid along the marks to give the true curve of that plank as it fits against the keel. A handsaw is best for cutting the plank to rough shape. Allow for finishing with a jointer plane. Before drilling screw holes for the planks, they should be drawn snugly against preceding planks with either cabinetmaker's clamps, or wedges, as in Figs. 24 and 25. Only galvanized or brass screws

Toward stem and stern the bevel of the planks becomes wider, until at stem and transom the planks present a smooth surface. This arrangement of planks can be applied to round or V-bottom hulls. For small craft such as skiffs under 12 ft., $\frac{1}{4}$ -in. or $\frac{3}{8}$ -in. waterproof plywood makes construction very simple and the job needs caulking only at chines, stem and transom. In putting planks on the frame, usually the sheer planks are installed first, alternating one plank starboard, then one on the port side, and so on until all are installed. Bottom planks can be laid longitudinally, crosswise, or diagonally. In the latter case a double bottom is often made, Fig. 22, with thin diagonal planks directly upon the frames, a sheet of canvas in paint between, and lengthwise planks over that. Ends of the planks are not trimmed to chine and transom lines until all are laid.

"Spiling" planks: Very few hulls are designed to take planks that are the same width the full length. Usually they must be tapered toward the stern, or toward both stem and stern. Transferring this curve from the boat to the plank is called spiling. For instance, to lay out the garboard strake, or plank next the keel, a thin

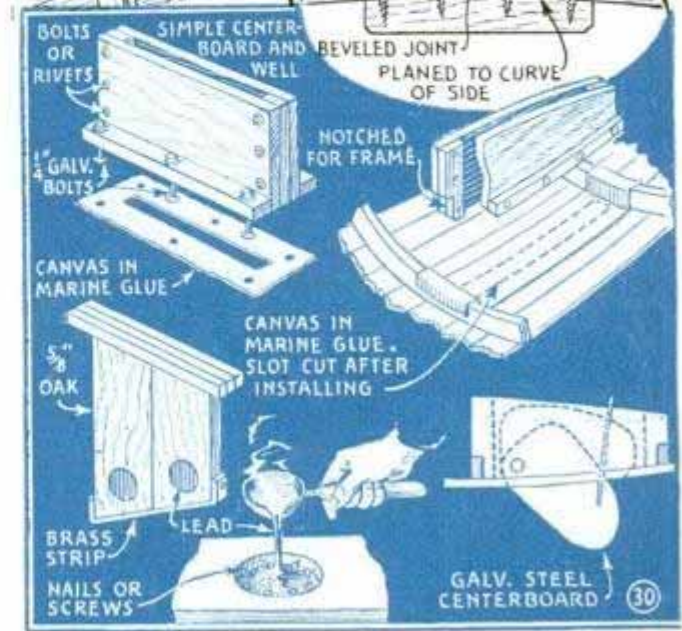
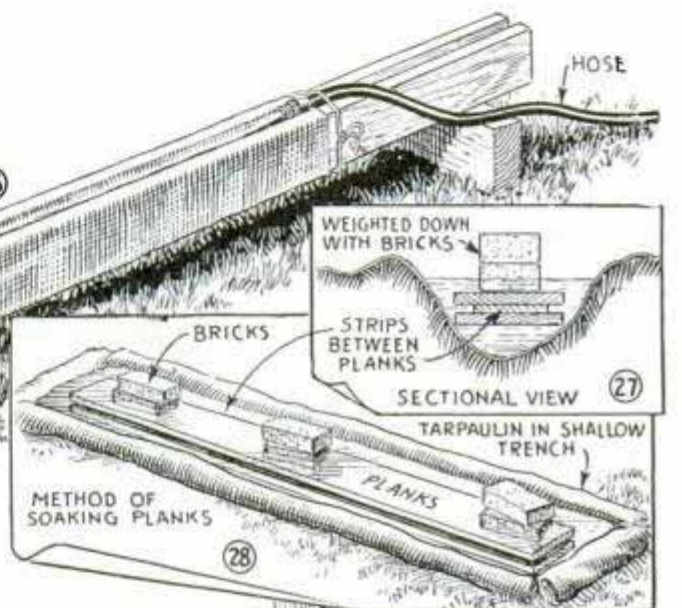
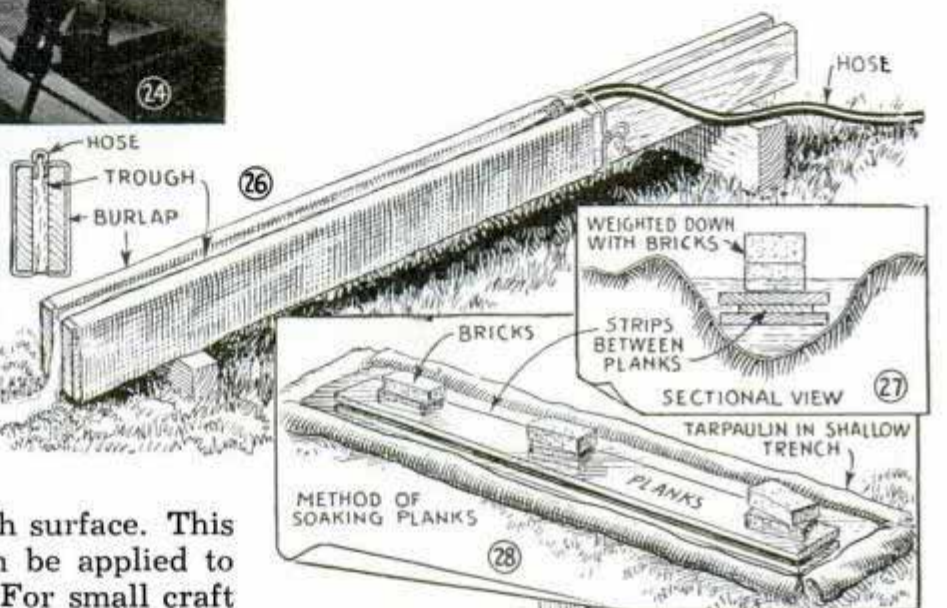

should be used, the heads countersunk, and covered with putty after the first coat of paint. Remember that the planks are first partly beveled along the edge before being installed permanently.

Caulking: As nearly every boatbuilder has his favorite method of caulking, several methods are shown in Fig. 23. When the edge of a plank has no curve it can be grooved to a depth equal to about half the diameter of a chalkline, a strip of the latter laid in on marine glue, and the next plank brought up tightly against it, compressing the chalkline. A favorite method of waterproofing at the chines is to fasten cotton candle-wicking diagonally with brads hammered over, and laid in marine glue. Binding tape serves the same purpose, with the screws staggered on each side of it.

Compressing the center portion of the plank edge with a special tool also gives satisfactory results, as shown in one of the details, Fig. 23. The wood is planed down to the level of the depression, the planks placed closely together, and subsequent dampness swells the compressed portion quickly, making a watertight joint without caulking. Then there's the old reliable method of tamping in candle-wicking with a caulking tool over marine glue. For the stem rabbet a cable of five or six strands

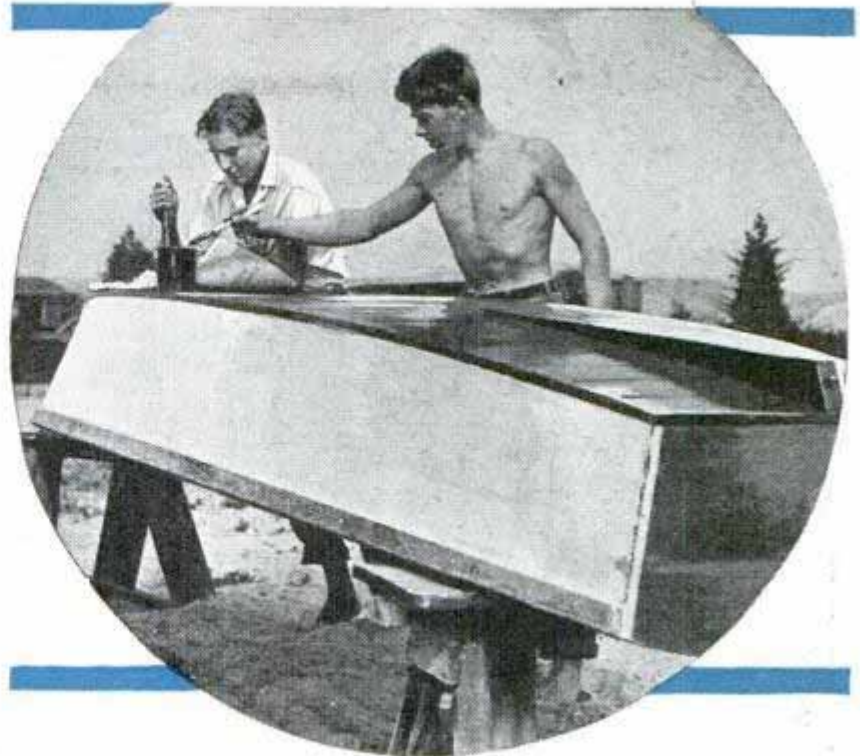

of wicking is laid in marine glue, and the same procedure followed on the edges of the transom. If the planks must take an unusual twist, and no facilities are available for steaming or boiling, a good soaking in water will limber them up. If only one end is to be bent, wrap in burlap as in Fig. 26, and let a stream from the hose trickle down, it throughout the night. For full-length soaking, dig a narrow trench, Figs. 27 and 28, lay in an old tarpaulin, fill with water and weight the planks with rocks or bricks. Place strips of wood between them so that water will reach all sides. Fig. 29 shows the method of using butt blocks where the planks are not long enough to reach the full length of the boat.

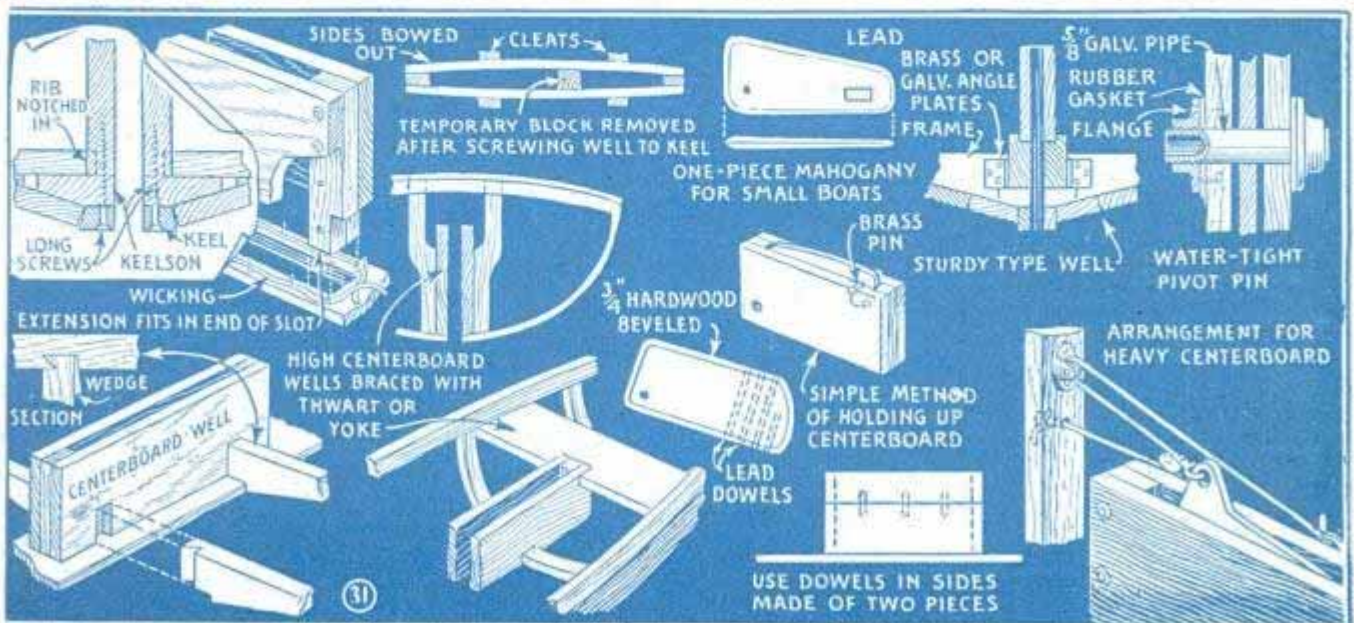

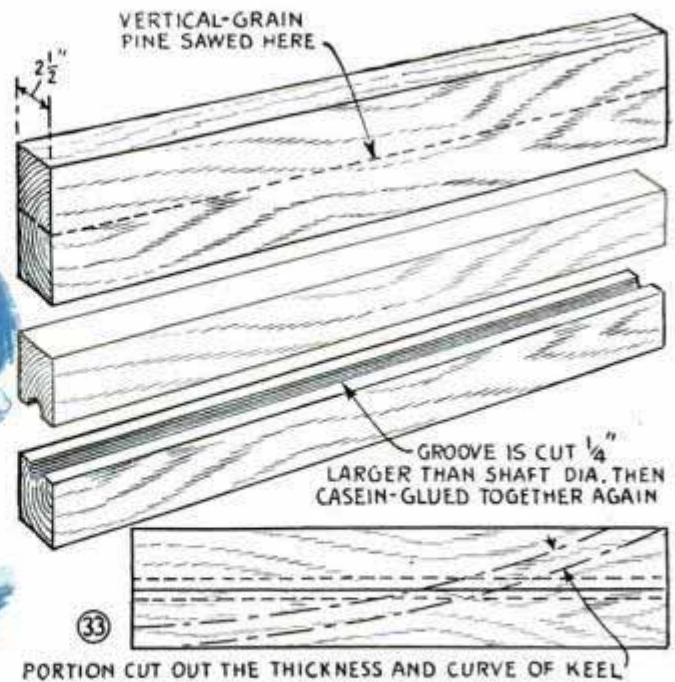

PORTION CUT OUT THE THICKNESS AND CURVE OF KEEL

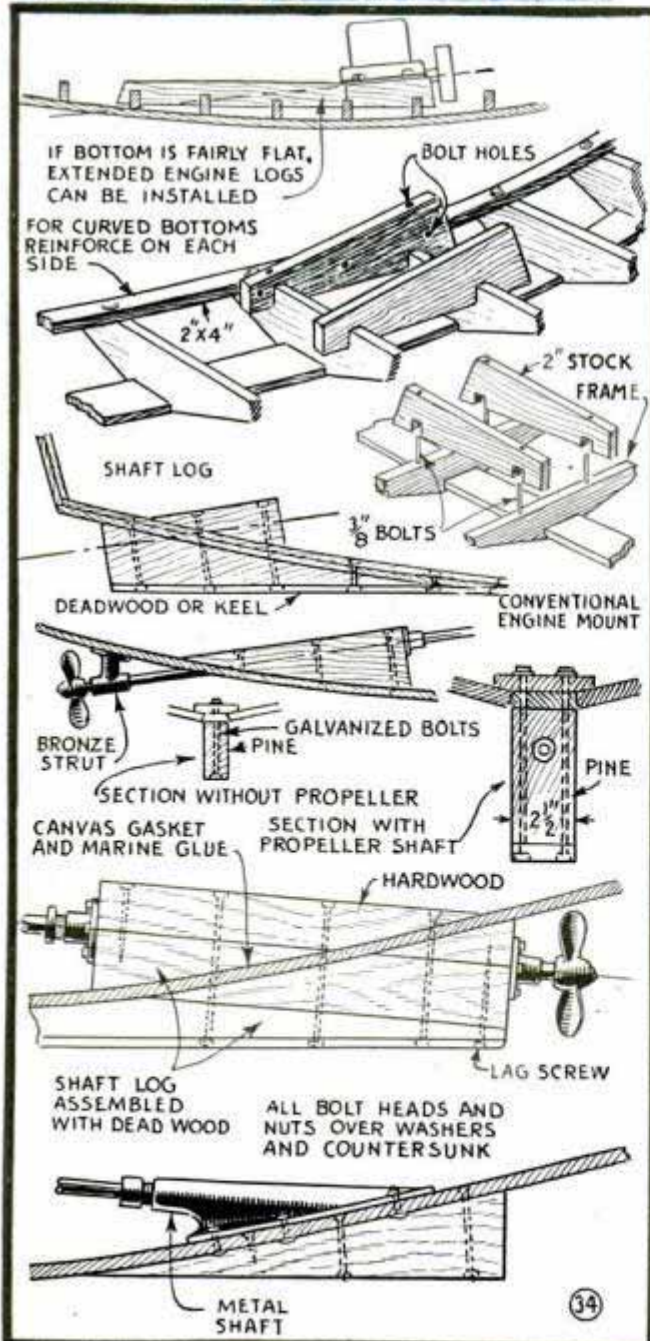

Centerboards and wells: Special care must be given to the construction of the centerboard well because it is here that leaking invariably begins after a rough sail. With considerable pressure against the board under sail, the well is subject to increased strain. A simple, satisfactory well is shown in Fig. 31. Cleats along the sides are bolted through the keelson, with a canvas gasket in marine glue laid between. The centerboard for this is $\frac{1}{2}$ -in. oak weighted with lead, anchored in circular openings with nails or screws. A brass strap along the bottom serves to reinforce the board and forestall warping. Whenever a wooden centerboard is used, allow at least $\frac{1}{4}$ in. extra width in the inside well opening to take care of swelling and warping. Another method of caulking the well is shown in Fig. 31, which also details methods of framing the well in the hull. Two important points are covered here: Wedging the well with a temporary block until it is screwed in place, which precaution counteracts the tendency of the damp inside walls to warp inward. The second point in this construction is that the inner, vertical cleat has an extension which sets down into the end of the slot in the keel, making a watertight joint. See the upper-left detail. The hull frames are notched into the well sides, or a dovetailed joint can be made which prevents the ends of the frames pulling out under stress. Steel centerboards, properly galvanized, are superior to the wooden ones since they

do not warp and at the same time serve as ballast. For small craft a one-piece mahogany or oak centerboard, weighted with lead, is permissible. Weight is added in some wooden boards by drilling holes and inserting, or pouring in lead "dowels." To hold the centerboard up, especially if steel, a brass pin can be used, or a block and pulley, with line and cleat. When a fairly high well is required, and two boards are necessary on a side, dowel the joint to keep the edges in alinement.

Engine logs: It is important that the timbers supporting the engine be substantial and very securely anchored. The usual arrangement is illustrated in Figs. 32 and 34, the timbers being cut on an angle to correspond to the angle of the propeller shaft. The timbers are notched and bolted to the hull frames but unless the bolts are put in during construction it will be necessary to use lag screws driven in from the top. To make the bed exceptionally rigid where there is too much up-curve fore and aft for long timbers, install two-by-fours on each side to cover several frames. Of course only galvanized, bronze or brass hardware should be used. Long timbers are always desirable if the design of the boat permits.

Installing shaft log and deadwood: The deadwood or keel extension is assembled as in the lower details of Fig. 34, being used on the sides of the propeller shaft. Bolt heads must be countersunk on the bottom, so that the deadwood presents a smooth surface when striking obstructions.

Making and installing a shaft log is quite easy if done as in Fig. 33. Select a piece of vertical-grain pine at least 2½ in. thick, and saw through the middle as indicated by the dotted lines. Then cut a groove in each half so that when put together the hole will be ¼ in. larger in diameter than the propeller shaft to allow for clearance. Assemble the two halves with casein waterproof glue, and then saw away on a diagonal curve corresponding to the thickness of the keel at point of installation. The completed job is shown in Fig. 34. In this detail the shaft log is assembled with

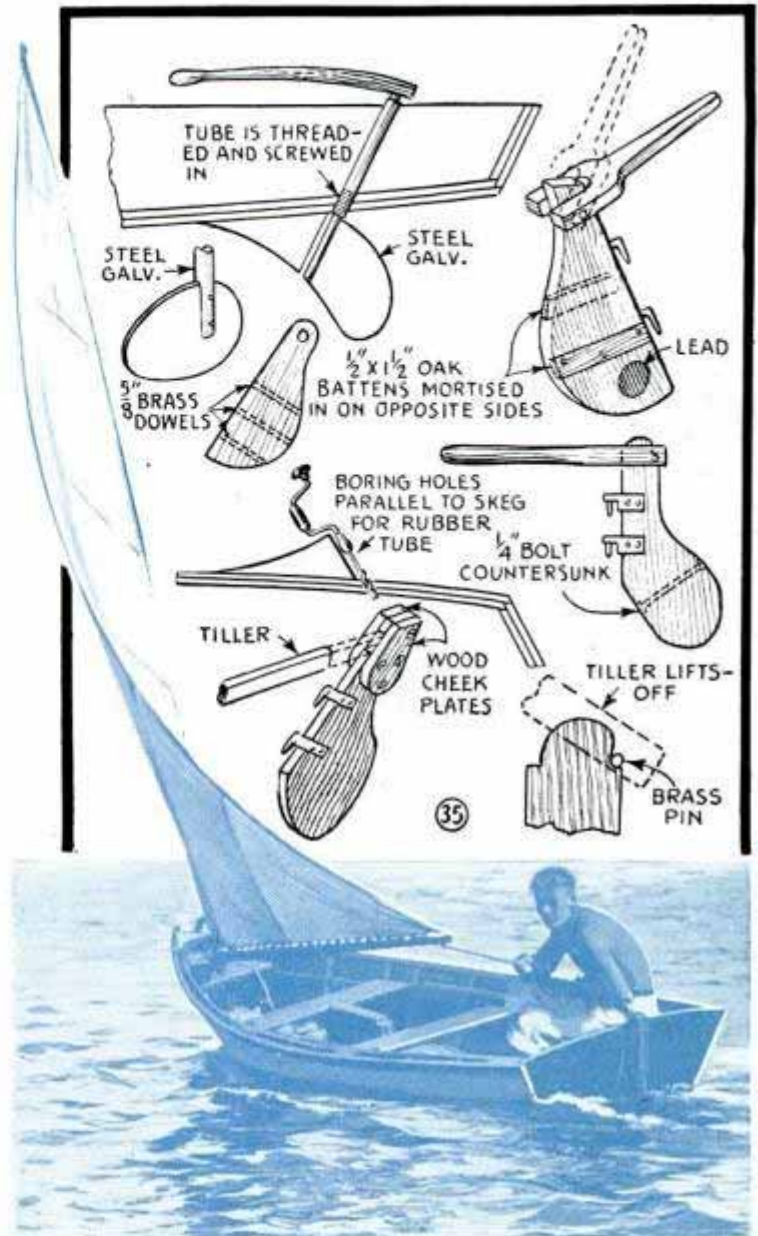

the deadwood. The latter can also serve as the lower exterior half of the shaft log. A hardwood strip is bolted along the bottom of the deadwood. Metal shaft logs, purchased from marine hardware dealers, make the work very simple. With this arrangement no woodwork is required.

Rudders: Except for racing, the simple rudder board, hinged to the transom and fitted with a tiller, is adequate. The in-board rudder post makes the neatest assembly, and requires a brass tube running through the deck and into the keel, as in Fig. 35. The rudder post should be galvanized, and the rudder can be installed in a slot and riveted. Wooden rudders, if very wide, should be re-inforced to prevent splitting under stress. Tillers in most cases are made to lift off. Edges of wooden rudders should be beveled.

(To be continued)

Windshield on Skyrocket Shooter Aids in Lighting Fuse



To set off skyrockets with safety, and also to protect the flame of a match from being extinguished in the wind when lighting the fuse, drive a length of pipe into the ground at the desired angle. Then wire a tin shield to the upper end.

Combination Holder and Gauge for Small Drills

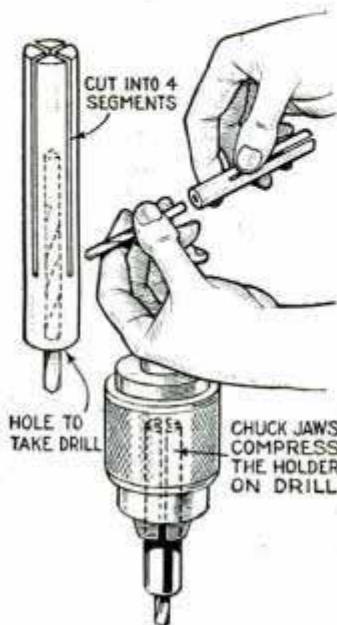

This holder not only reinforces small drills to reduce breakage to a minimum, but it also serves as a depth gauge. Made from mild steel, the holder is slit down from one end to provide four segments, and is drilled lengthwise from the other end to take the drill. When a drill is inserted

and the holder clamped in a chuck, the assembly is held securely. It is best to make a holder for each drill, although two consecutive sizes will usually fit one holder.

Smoked Spoon Hook for Trout Simulates Black Bug

The next time you are trout fishing and none of your lures tempt the fish, smoke a spoon hook and try it. A Wisconsin fisherman has good luck with such a hook because it closely simulates a black bug or beetle, on which the trout feed.



Repairing Leaks in Rubber Boots

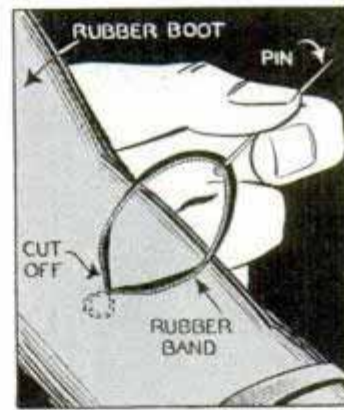

Pinhole leaks that often appear in the creases of rubber boots can be repaired by forcing small rubber bands into the holes. To do this, push a pin through the band to serve as a needle. If a rubber band is not

at hand, you can use a sliver of rubber cut from the boot heel or an old inner tube.

Test Tubes in Gourd Hold Flowers

A hanging container for cut flowers can be made from a gourd and a number of test tubes. Cut holes through the sides of the gourd at random to admit the ends of the tubes and fasten them in place with wood putty or glue, leaving as little of the tubes project as possible. Paint the gourd in gay colors and put water in the tubes.

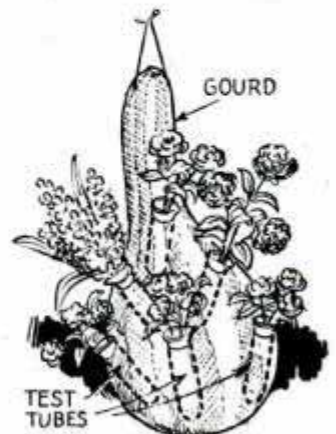

Hot-Dog Dispensing Cabinet for a Bicycle

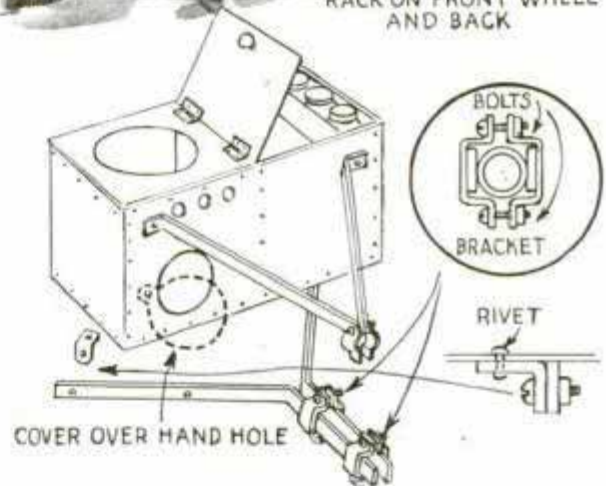
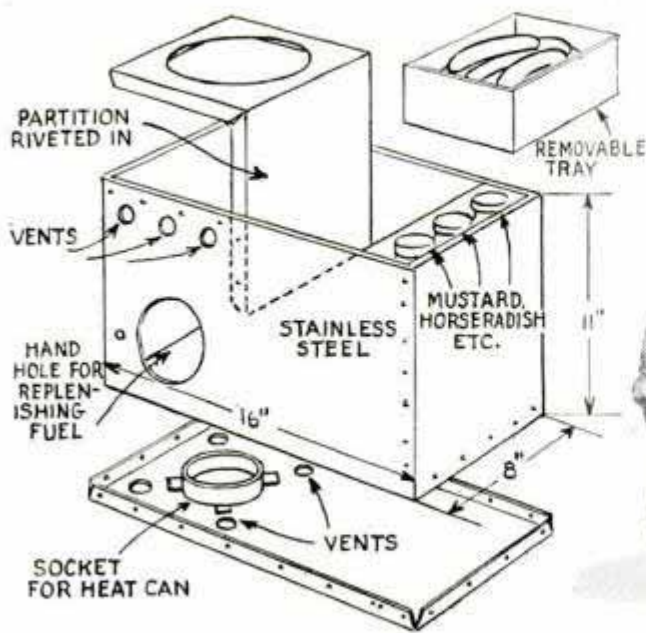

Compactly assembled of metal, this hot-dog dispensing cabinet is carried in a convenient position on the front of a bicycle. The cabinet is made of galvanized sheet iron or stainless steel, and all joints are riveted. Canned heat or a small alcohol lamp is recommended for fuel, which is replenished through a handhole in the back. A partition prevents fumes from entering the compartment where rolls and uncooked frankfurters are stored. No dimensions are given for the flat-iron frames as these must be made to fit the individual bicycle. The frame members should be wrapped with tape before bolting on the bicycle to prevent marring the finish.

Hiker's Tepee Tent Folds into Light Bundle for Carrying

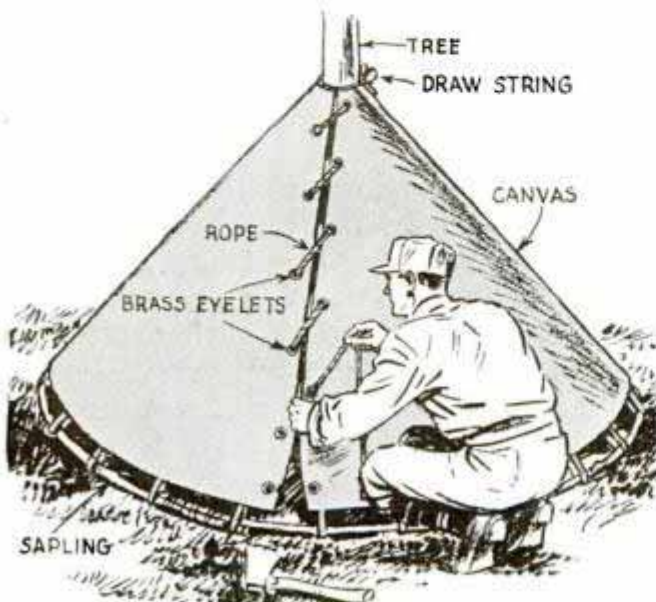

This novel tent was used several seasons by a woodsman. It is set up around a tree trunk, which serves as a center pole so that all the hiker carries is the canvas and the drawstring or top cord. The tent consists of several segments sewed together tepee fashion with a ground diameter of 10 ft. and a center hole that can be opened to 10 in. To keep the canvas taut, a number of small rope loops are sewed to the lower edge, through which small saplings are run and the ends lashed together.

☞ Peonies need plenty of water after they have bloomed as the plants are forming buds for the next season at that time; also, wood ashes are good for peonies any time.

PADDLE-WHEEL TOYS

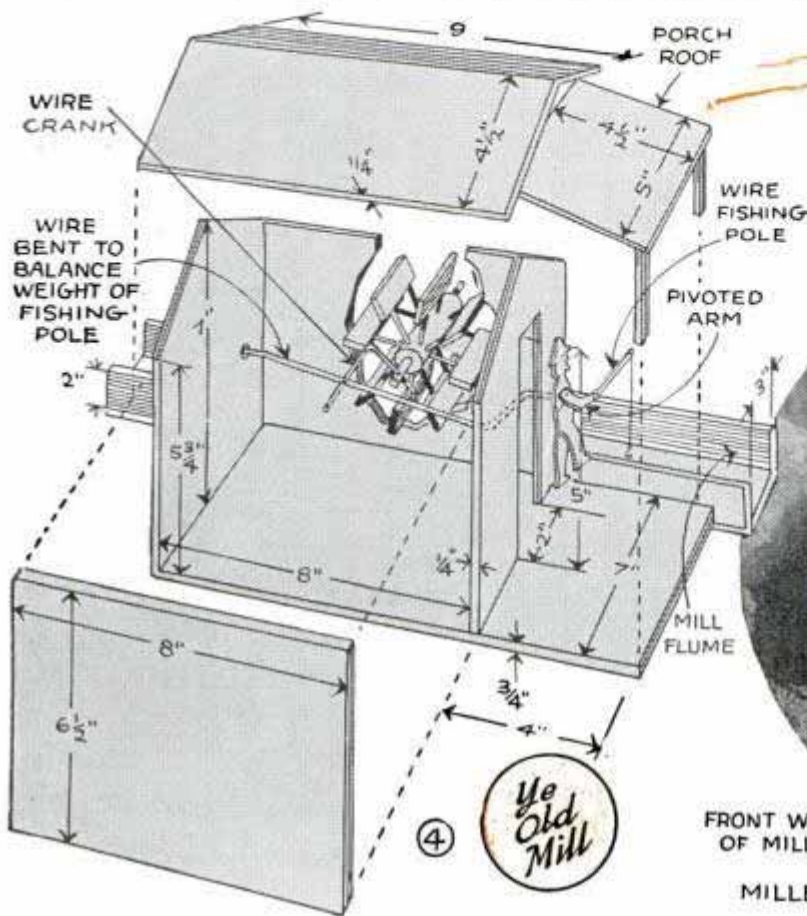

you slowly pull the boat through the water.

You can build a fancy bit of secondary motion into the side-wheeler shown in Fig. 3. As the wheels turn, a walking beam rocks up and down on its bearings. This craft is well worthy of a bit of bright paint over the first coat of aluminum paint. Make the paddle wheels red, paint black window frames and doors on the pilot house, and stripe the smokestack.

At the old mill in Fig. 4, you will find the lazy miller who spends most of his time fishing, and who gets a pole-tugging bite every time the wheel goes around. Place the mill beside a stream and cause some of the water to flow through the flume. The wheel will spin and the miller will jerk his pole up as he tries to hook imaginary fish. A wire crank in the end of the wheel axle brushes another wire, which is connected to the miller's arm to move the fishing pole. Fig. 5 shows this arrangement, and Fig. 6 gives the size and shape of the figure cut-out.

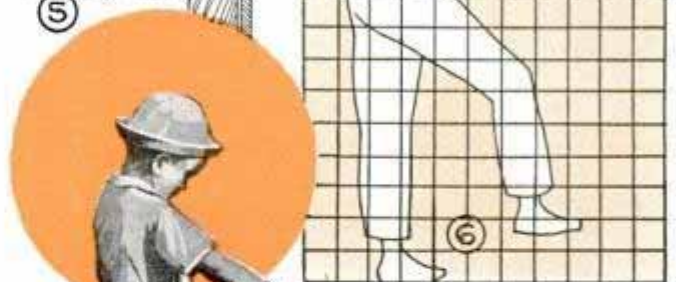
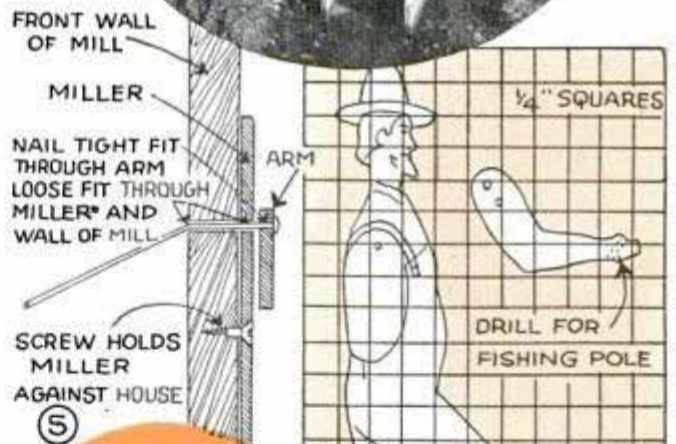

☞ To keep nickel fixtures shiny and bright, dry them carefully after washing.

'Candelabrum' for Birthday Cake Keeps Wax Off Frosting



To keep candle wax from dripping on the frosting of a birthday cake, one housewife sets it in the center of a plywood disk and sticks the candles in holes staggered around the edge of the wood. The disk is finished with enamel, and flowers are painted around the holes.

Boat Windshield of Celluloid Is Removable

Having a boat of the runabout type, I fitted it with a windshield, which could be removed when hauling it on a trailer or when diving from it. The windshield is a

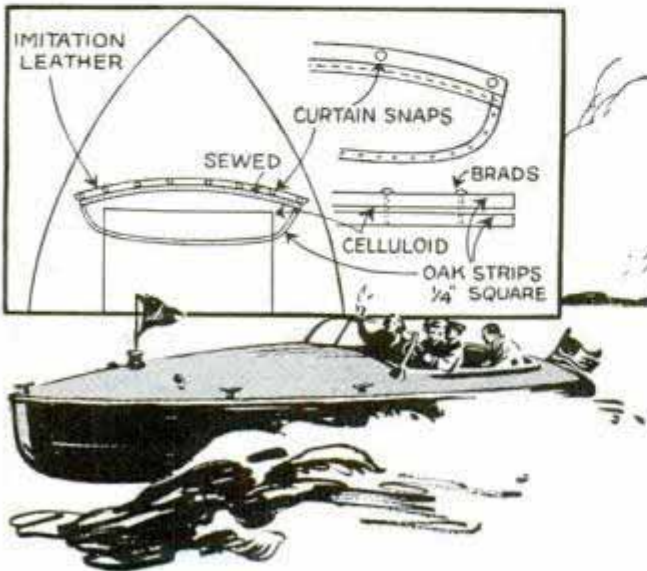

piece of heavy celluloid cut to shape and bound on the sides and top with 1/4-in. oak strips and on the bottom with imitation leather. It is fastened to the boat with heavy curtain snaps, one half of each one being sewed to the imitation leather binding at the bottom of the windshield, and the other half being screwed to the boat deck.—K. J. Abbott, Gonzales, Calif.

Gardeners' Waterproof Knee Pads

When working on your knees in the garden, a pair of pads cut from an old inner tube are waterproof and will protect your knees against damp ground. Cut a section of the tube as shown and, if it is too tight, a piece can be spliced in with rubber cement.



One-Piece Chimney Cap Attached Without Bolts or Rivets

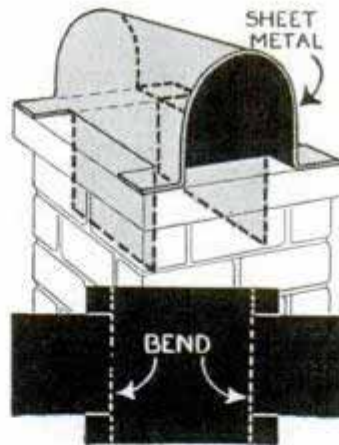

A simple cap or hood to prevent back drafts in a low chimney can be shaped from a sheet of metal and attached without the use of bolts or rivets. The metal is cut as shown and is bent along the dotted lines.

The two center fins are sprung to allow for insertion into the chimney flue, and the smaller fins, when bent outward, support the cap.

Lettering Brush Has Finger Grip

Slipped over the ferrule of a lettering brush, a pencil eraser of the type shown makes a good finger grip. The end of the eraser is cut off, forming a sleeve.



What you can do with OLD FOUNTAIN PENS

MOST fountain pens that have outlived their usefulness still have the barrel and cap in good condition. These two parts can be utilized in a number of ways, several examples of which are shown on this page. You already have the clip for carrying in the pocket, and by grinding a small blade from tool steel and fitting it in the lower end of the barrel as indicated in the detail, you have a handy knife which can be carried safely in the pocket because the blade is always protected by the cap. An old pen can be converted into a special brush for cleaning camera lenses or for photo tinting. In the latter case you provide strips to carry soluble color, which are cut to fit inside the barrel of the pen. Of course, the cap protects the brush when not in use.

Certain types of small motors have sleeve bearings designed to be lubricated through tiny pressure grease fittings. In this case an old automatic pencil fitted with a plunger as in one of the illustrations makes just the size and type of grease gun for this purpose. Another use for a fountain pen as an oil can is shown in the same illustration. Here a very small tube is inserted in the lower end of the barrel and when the tube is filled in the regular way with oil instead of ink, you have an oiler that will place a single drop of oil just where you want it. If you need a special perforator or a traveling sewing kit, details in the lower illustration show how these can be improvised.

Plain cookie sheets, obtainable in department stores, are an inexpensive source of sheet aluminum for many types of metal-working projects.

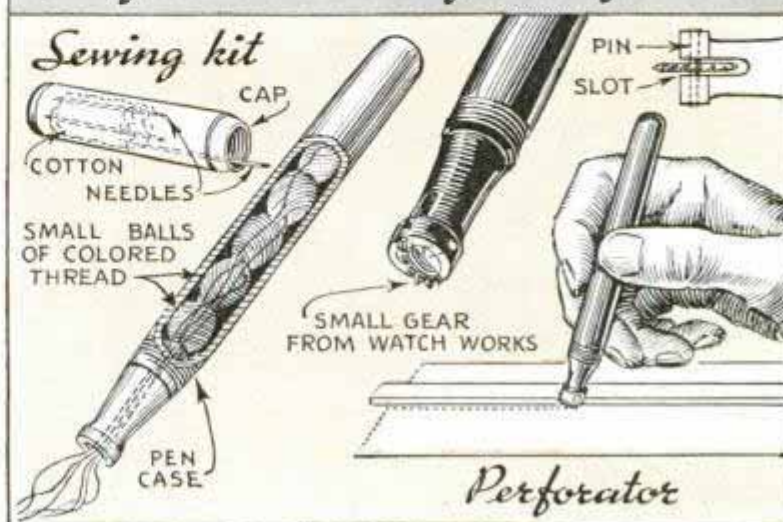
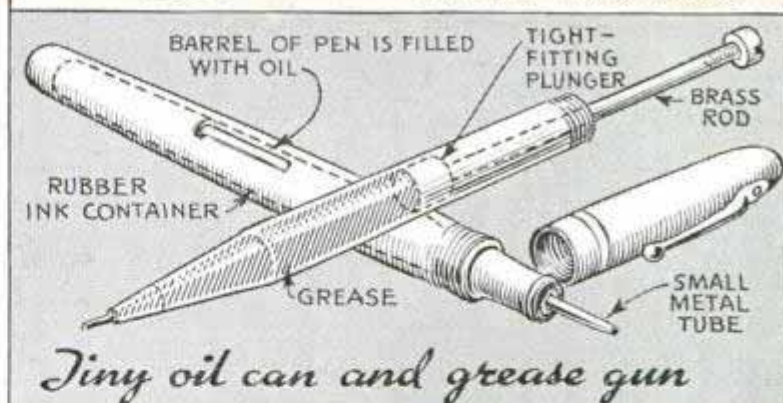
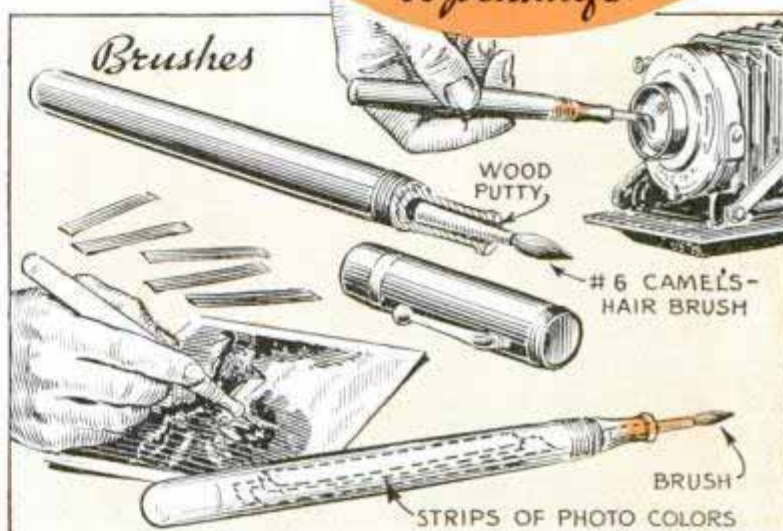
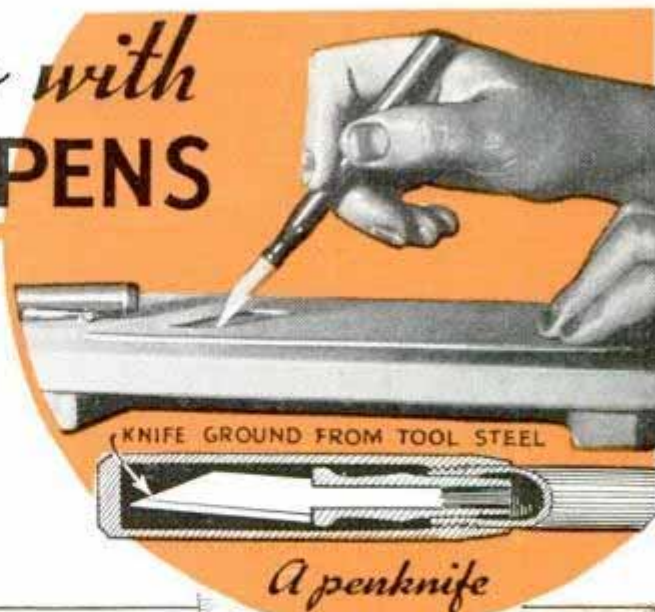

Adjustable Wrench to Open Cans Made from Timing Chain



Tight-fitting screw caps of cans are removed easily with this wrench without damaging the cap. The wrench is a length of flat iron with a piece of timing chain pivoted at one end, a slotted piece of iron being riveted to the handle to take the end of the chain after it has been wrapped around the cap to be removed.

—Benjamin Nielsen, Aurora, Nebr.

Fish Stringer Held Safely on Boat Yet Removed Quickly

To keep from tying and untying a fish stringer to an oarlock or some other part

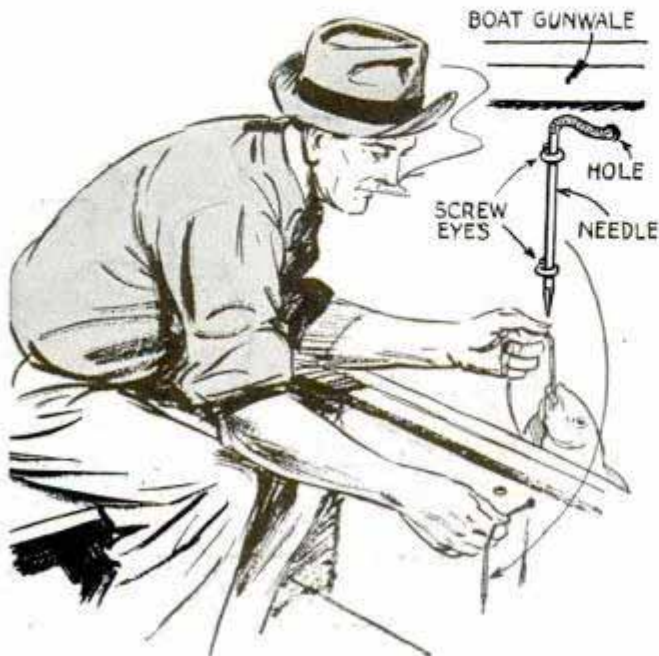

of the boat, why not attach it with a couple of screw eyes as shown? To remove the stringer, just lift the end from the screw eyes and pull it through the hole in the boat side. You can do this in a few seconds and there is no possibility of the stringer becoming dislodged.

Pencil Pointed in Abrasive Pocket Taped to Sketchbook

Instead of gluing a strip of sandpaper to your sketchbook for pointing a pencil, fold the strip with the abrasive side inward and tape it to the book. This forms a pocket to collect the powdered lead and keep it from getting on your hands and the book pages.

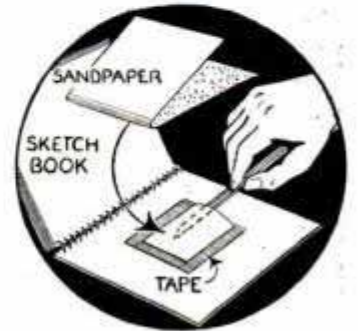

Slots in Rear Panel of Cabinet Prevent Splitting

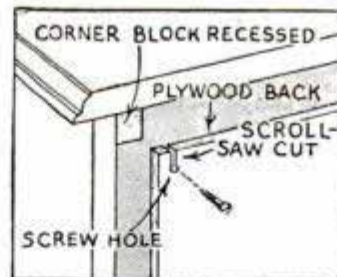

When closing the rear of cabinets, book shelves, etc., with plywood, screws that must be placed near the edge of the panel can be prevented from splitting the

wood by slotting the panel as indicated. The slots widen slightly as the screws are driven and reduce the strain on the wood.

—Raymond B. Wailes, Bethesda, Md.

Removing Threads from Brush of Vacuum Cleaner

To remove thread that winds around the rotating brush on a vacuum cleaner, run a pair of scissors lengthways through the bristles and clip the threads, then brush them off.

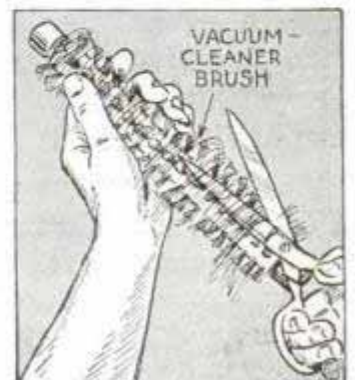

DEVELOP YOUR FILMS IN DAYLIGHT



Beginners in photography will have no troubles from over-development by using this simple method

THIS daylight method of developing pictures works on the principle of time and temperature, and the danger of over-developing, scratching or otherwise marring the negative is practically eliminated. Everything you need is shown in Fig. 1. There are several styles of tanks available. The more expensive ones enable the film to be transferred directly from the roll in daylight. Another type, shown in Fig. 2, must be loaded in a dark closet but from then on works in daylight. Other equipment needed are two fruit jars, clock, thermometer, measuring cup, a viscose sponge, $\frac{1}{2}$ gal. of borax developer and $\frac{1}{2}$ lb. of hypo fixing powder. The latter two items come in powder form. Prepare them according to the instructions on the package. These are your stock solutions and may be used over and over until exhausted. Store the jars tightly capped and in a cool, dark place.

Loading the tank requires absolute darkness. Practice threading an old film into the reel as in Fig. 2, till you can do it with your eyes shut. Handle the film by the edges to prevent the heat of your fingers from melting the gelatin and ruining the pictures. Some reels load from the middle, some from the outside. With the reel loaded, place it in the tank and press down the cap. Now step out into the daylight. The film must be developed for exactly 20 min. at a temperature of 65 degrees Fahr. There is a slight latitude permissible, but the tem-



perature of the solution never should be allowed to rise higher than 70 degrees or the gelatin on the film will soften. In winter the jars of developer and hypo may be heated by placing them in pans of warm water, and in summer, cooled to the correct temperature by placing them in pans of ice cubes. Test with the thermometer. Always test the developer first and never put the thermometer into the developer after it has been in hypo without first washing it a full minute in running water. One drop of hypo will ruin a whole jar of developer. The same rule applies to your hands and the measuring cup. Pour the borax developer into the measuring cup and fill the tank through the hole in the top, Fig. 3. Now insert the stirring rod and rotate the reel several times to break up any air bubbles. Watch the clock. Every 3 min. the reel must be rotated four or five times, gently, in a counterclockwise

direction, as in Fig. 4. At the end of 20 min. pour the developer out of the tank back into the jar. This is done through a hole provided for the purpose, Fig. 5. Do not remove the lid of the tank. The film must be washed now for 5 min. in clear water. Fill the measuring cup and pour water into the center hole of the tank, allowing the overflow to run out. Turn the rod several times, then pour out all the water and refill. At the end of 5 min. dump out the water and pour in the hypo. Agitate for the first minute after the hypo is in the tank, then allow to stand for 15 min. or longer. A cake pan and half a bath spray hose make an inexpensive and efficient washer, Figs. 6 and 7. The hose allows the water to enter at the bottom of the pan. As the hypo is dissolved the waste water is carried upward and over the edge. One hour is enough to wash a film, but 2 or 3 hrs. are permissible. Let the stream flow gently, and keep the temperature just under 70 degrees.

The final operation is drying. Remove the negative from the water very gently as the gelatin is soft. Pin the film to a clothesline by the tab end. Soak the viscos sponge in water until saturated. Squeeze dry, and lightly but firmly run it the length of the film on both sides as in Fig. 8. Make one stroke do. The film should hang in still air for 6 or 8 hrs. If the day is damp it may take longer. Do not handle it even though it tends to curl. It will straighten when completely dry.

KNOCK-DOWN PICNIC TABLE SLIPS INTO CAR TRUNK

You will always have a table for your picnic dinners if you make this one, which can be carried in the trunk of your car and set up in a minute. There are no nails or screws to drive because the table is quickly assembled by slipping the slotted members together as shown in the details. Regular $\frac{1}{4}$ -in. fir plywood will do for the purpose. It is a good idea to impregnate the edges with paraffin

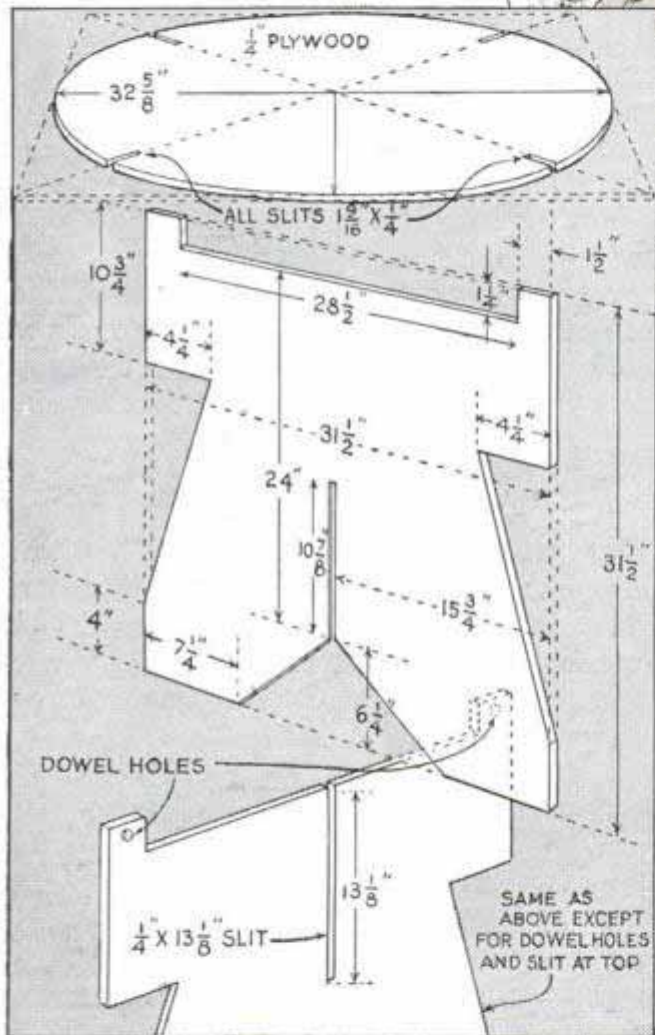
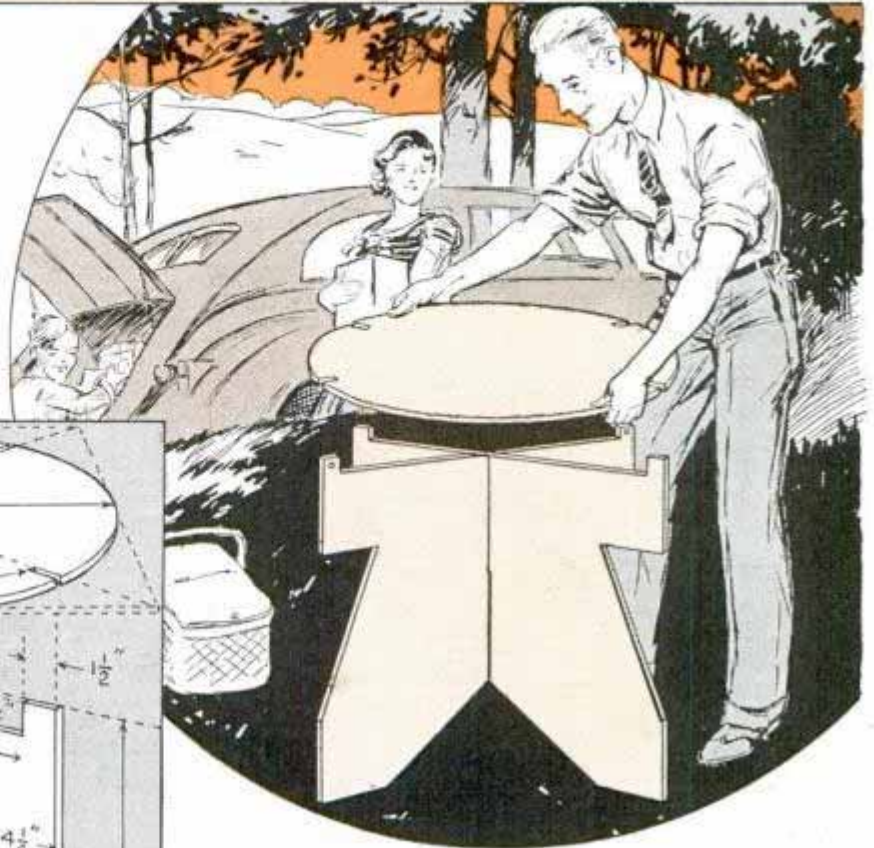

Ornamental Pump Covers Faucet in Greenhouse or Garden

A quaint, old-fashioned pump built around the hydrant in your flower garden improves the appearance considerably. The pump can be made useful by connecting the handle to the faucet so an upstroke turns on the water and the downstroke shuts it off.

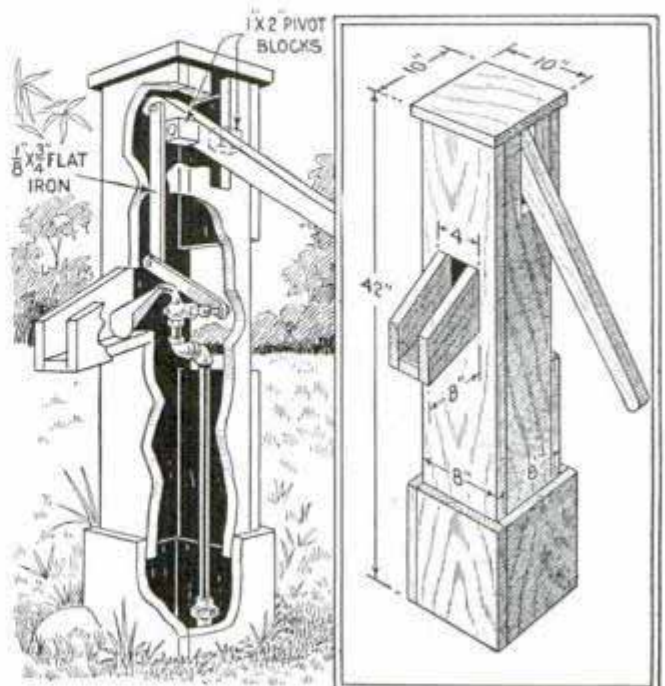

Repairing Worn Goggle Frames

When the binding used on many types of goggles begins to deteriorate, small rubber gas tubing can be used to replace it and provide a cushion for the wearer's face. Another equally effective method is to employ the special molded rubber tubing used for draft excluders. This has a rubber tongue throughout its length and is much easier to sew or cement to the goggle rims than regular gas tubing.

—Ivan J. Stretten, Detroit, Mich.

Reflector Disk Flashes Intentions of Motorcycle Rider

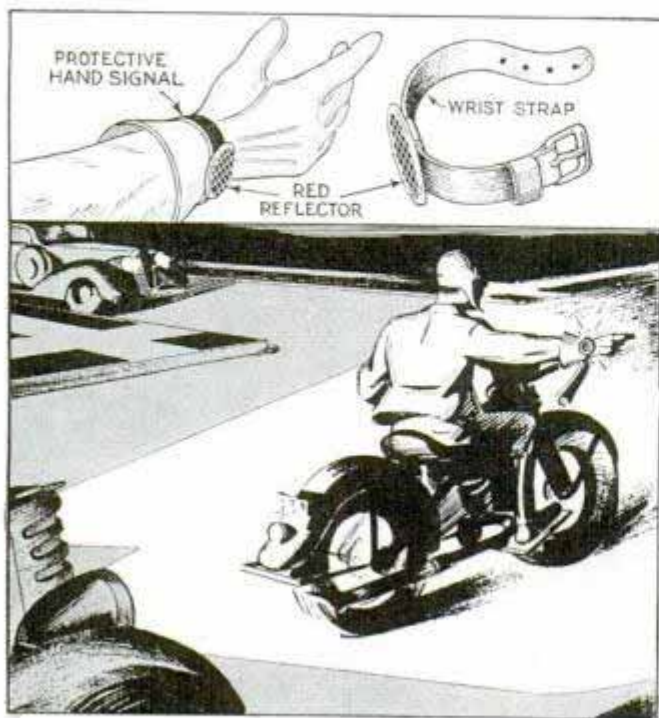

An investment in a ruby reflector and a strap to hold it to your wrist may save you from being run down in a fog or rain. When your arm is outstretched the flash of red is easily seen by the car following.

Cork Protects Casting-Rod Tip and Holds Hook Safely

Accidental breakage of the agate tip in a casting rod is prevented by inserting a tiny cork inside the guide as shown. The hook is also shielded by sticking it in the cork to cover the barbed end.

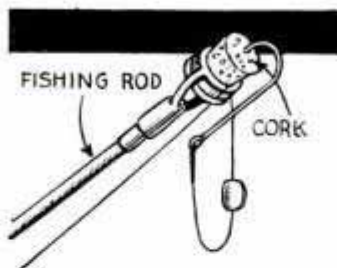

"Evergreen" Decorates Lamps on Driveway Posts



A novel and artistic effect was obtained by ornamenting the lamps of driveway posts of an Omaha estate with miniature fir trees made of copper. Imita-

tion of limbs was effected by serrating the lower edges of conical pieces of copper spaced one above the other on the electrical conduit, which projected above the tops of the posts. The conical pieces were made progressively smaller in diameter toward the top of the trees.

—Dale R. Van Horn, Lincoln, Nebr.

Cutting Designs in Sheet Plastics

Instead of scratching a design in the surface of hard plastics like Bakelite for a guide in cutting it, glue paper over the work and sketch the design on it. Then, if necessary, a correction can be made in the design without marring the surface of the work. The paper can be removed easily after the cutting or drilling has been done.

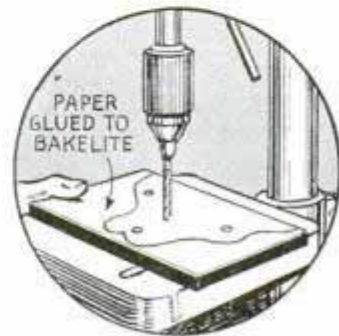

Scraping Tool from Old File

By grinding off the teeth of a worn three-cornered file and sharpening the edges on an oilstone, you have a good tool for scraping off paint or varnish on chair rungs, molded edges of tables, intricate relief work on wood and other hard-to-reach places. Also, it is handy for smoothing wood articles that are difficult to sandpaper, and it can be used on metal or for scraping carbon from motors with equally good results.

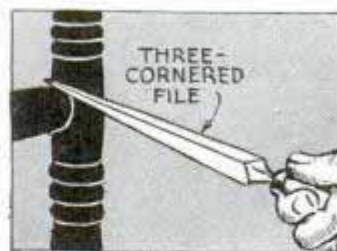

—V. Robinson, St. Paul, Minn.

Most of the short articles on these pages were contributed by our readers. If you have an idea for an article, tell us about it. You need not be an expert writer—just state the facts and illustrate your point with a rough drawing or a snapshot, or both. We will do the rest. Remember, your idea must be original, practical, and have general appeal. Address the Home-craft Editor.

SHEET-METAL SIGNS

cut with hammer and chisel

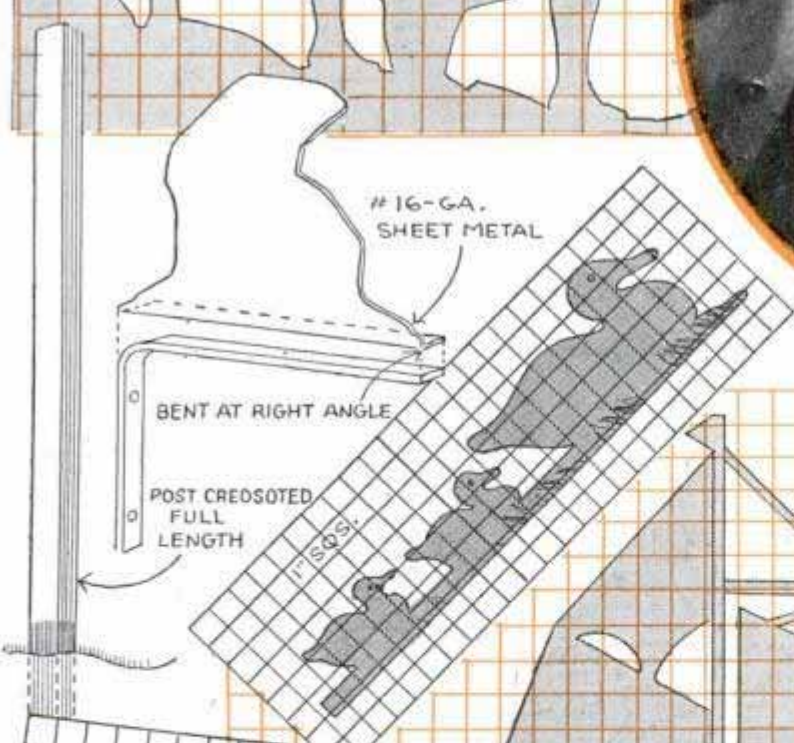
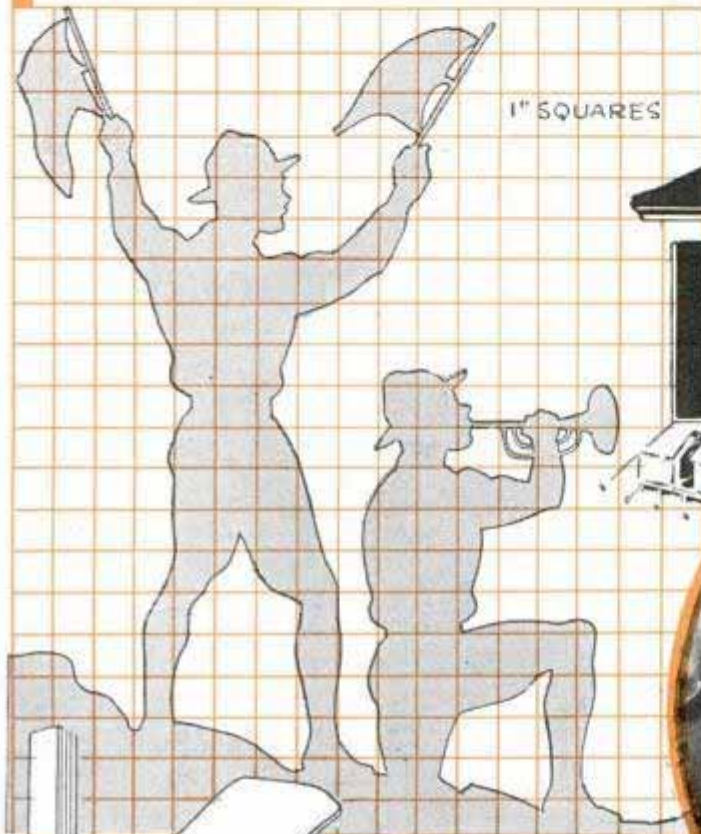

Sheet-metal signs offer an interesting and profitable hobby for your spare time. Cut from copper or brass, the designs shown are only a few of unlimited possibilities

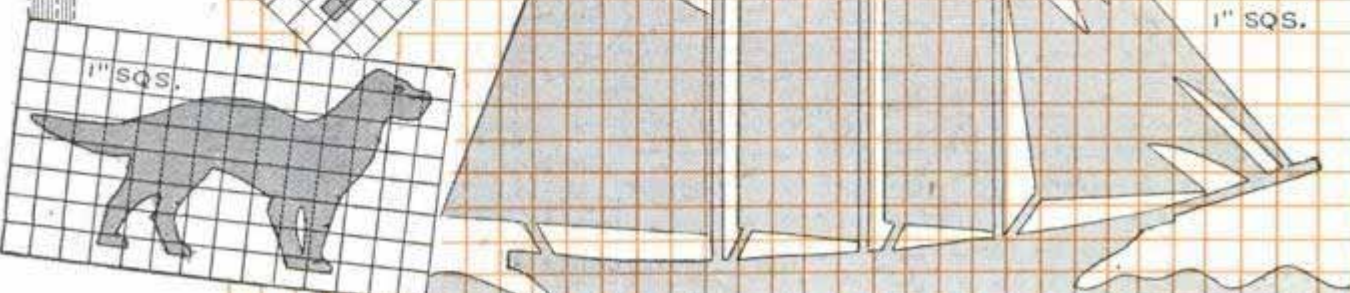



Build your own

By
LESTER LEHNHERR

A PICTURESQUE year-round cabin of logs, a week-end house, or a permanent hunting and fishing camp far off beaten trails can be yours at very little cost if you follow this simple method of construction. If you're fairly handy at building a masonry foundation and handling a hammer and saw you can do the whole job yourself, for there are no heavy materials and no tricky saddle-notched corners such as are found in the conventional log cabin. Here the logs are halved and edged as in Fig. 1 and assembled vertically, "stockade" fashion, which makes it possible to use small logs from second-growth timber such as aspen and poplar. Although these timbers do not endure for long when laid horizontally, either will be entirely satisfactory when placed vertically since there are no crevices to catch and hold moisture. Placing the logs vertically also does away with the messy and difficult job of chinking.

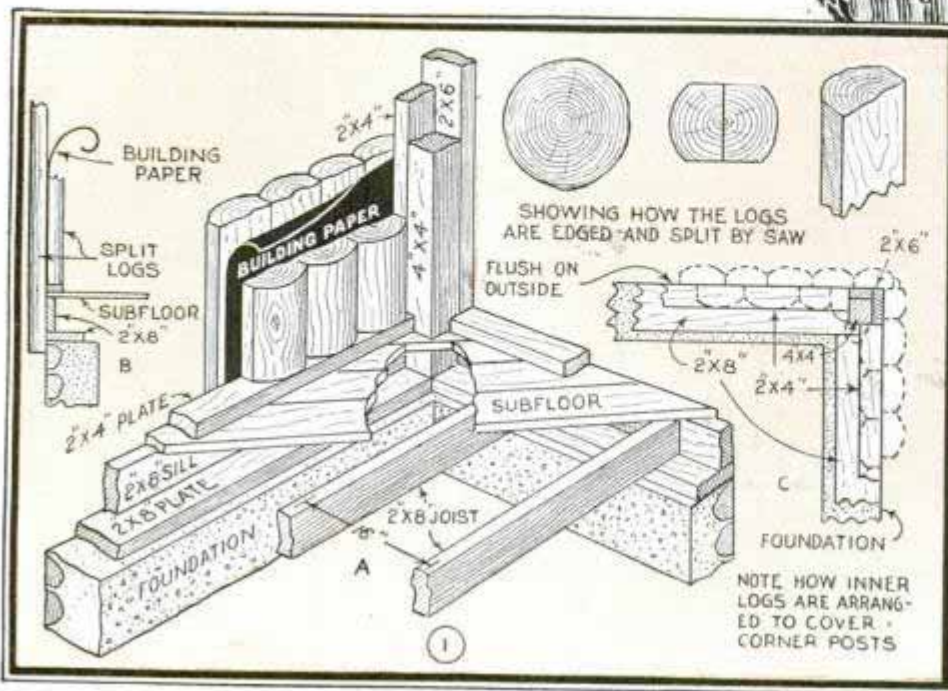
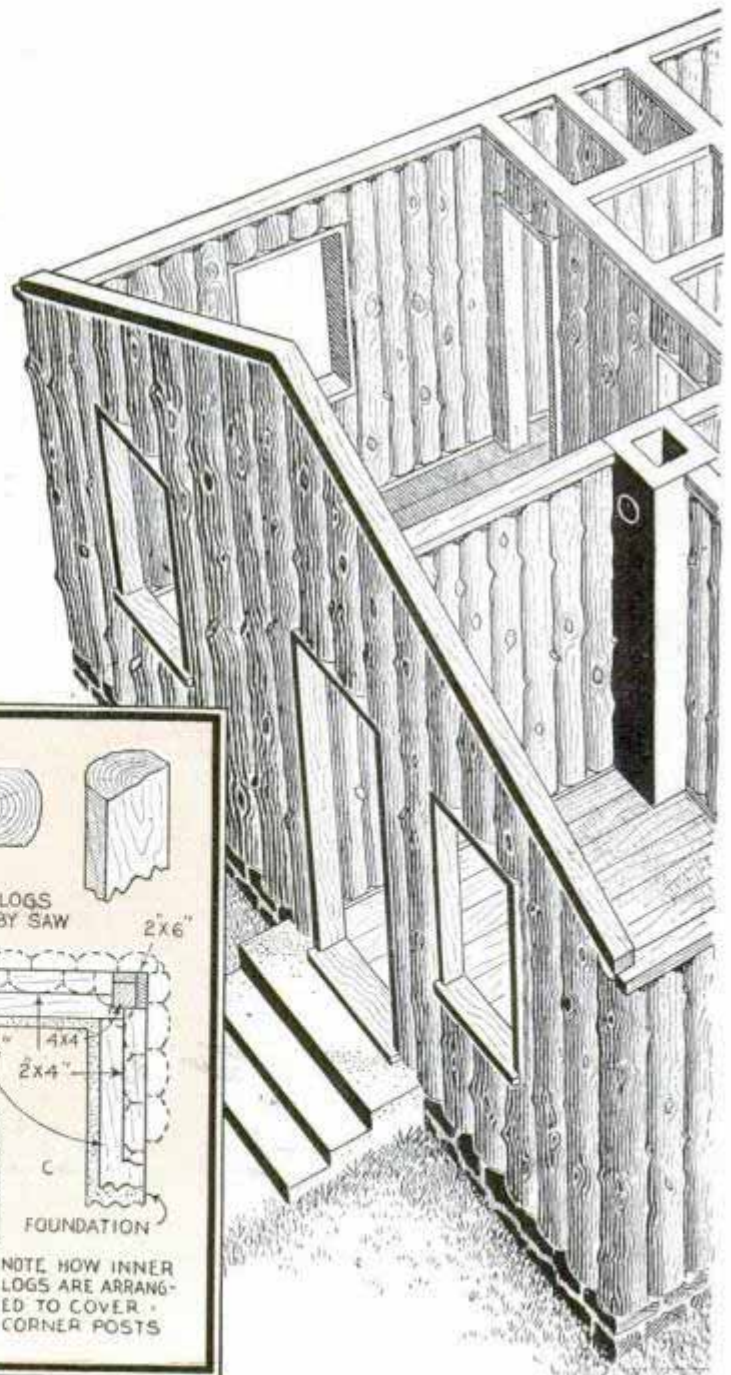

LOG CABIN

"Stockade" walls of vertical split logs do away with chinking and saddle-notching

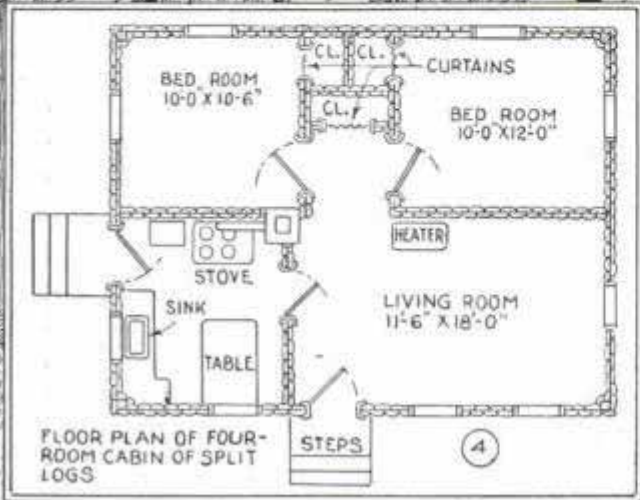
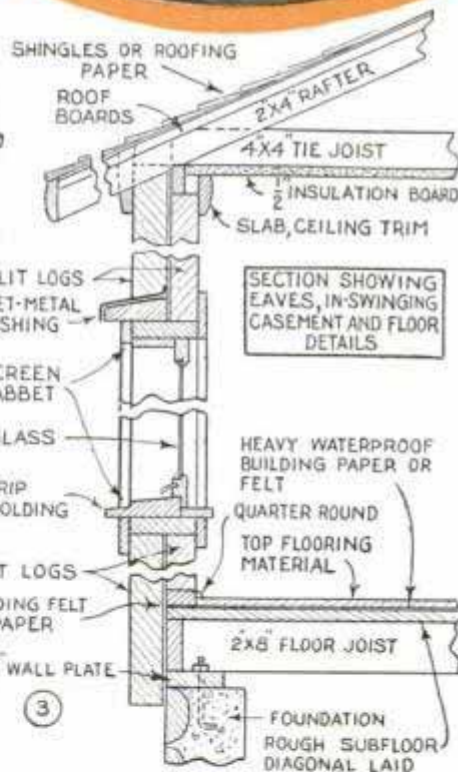
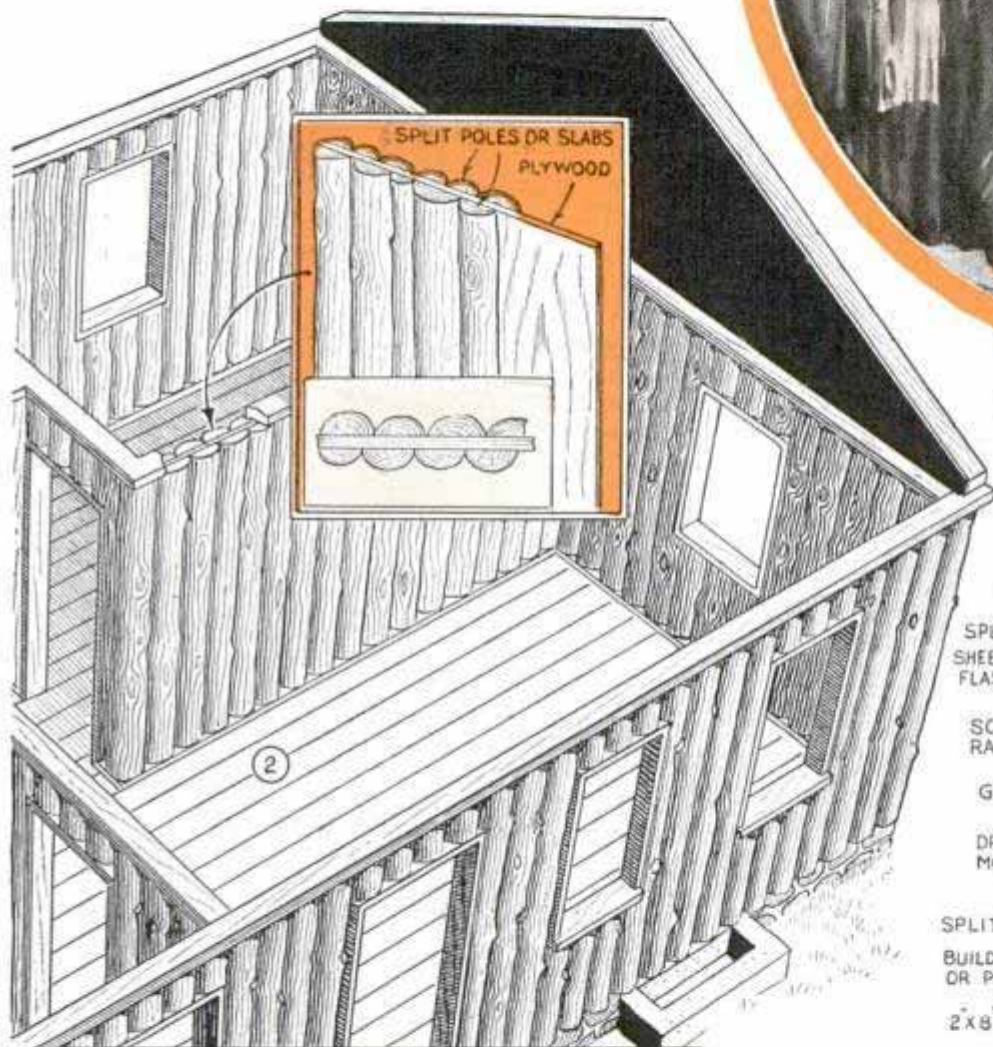

Preparing the logs: Logs should preferably be cut during the late fall or early winter so that they may have at least six months to season. As soon as cut they should be taken to the mill and split, edged and peeled. A peeled log can be treated more surely to resist decay and insects. The split logs should be coated thoroughly with boiled linseed oil thinned with a little turpentine and applied warm with a soft brush. After the first coat has dried for two weeks or more, a single coat

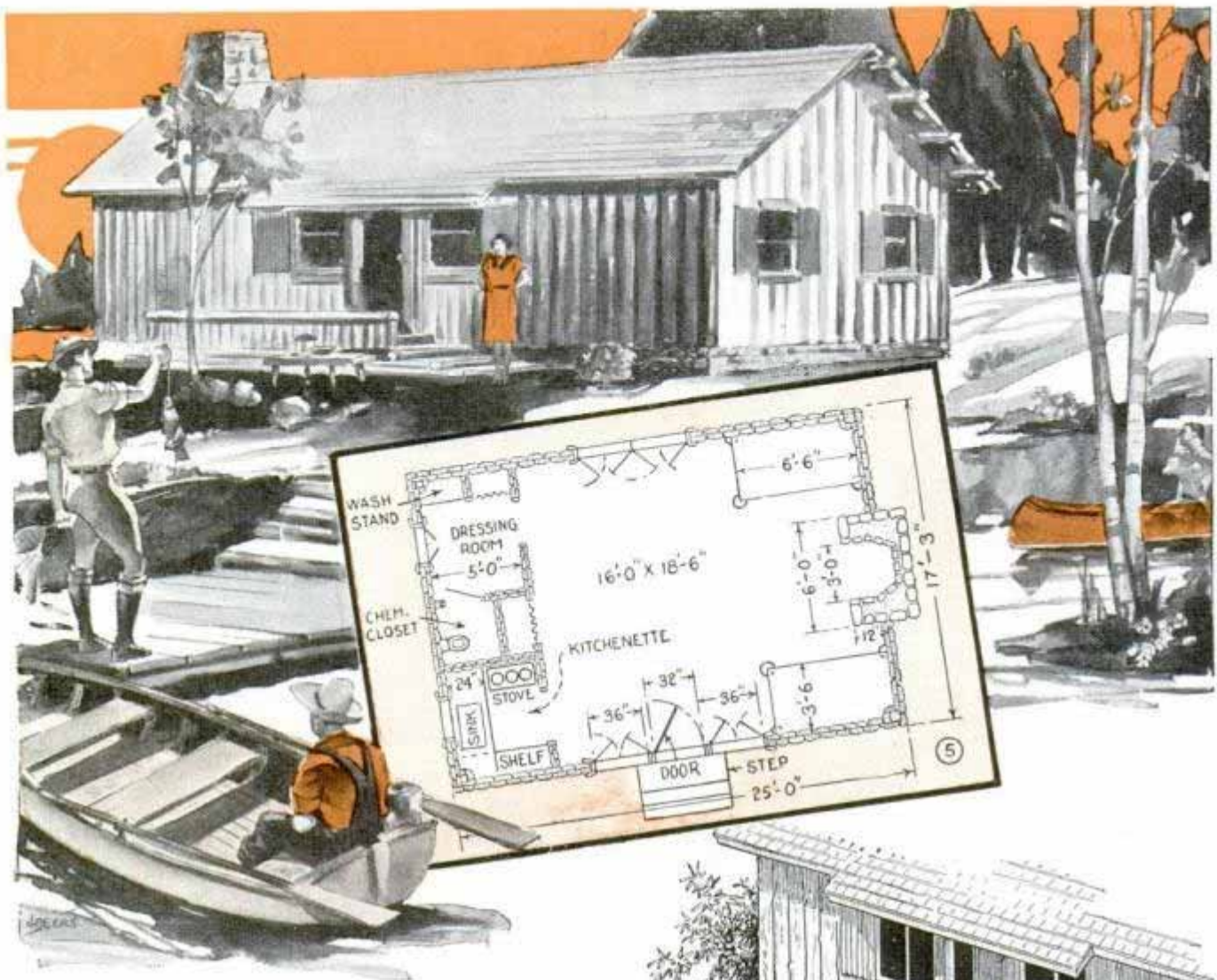

of pure linseed oil should be given. A third coat may be applied after the cabin is completed. Logs in contact with the earth should be painted with a creosote solution before being used. Creosoting the sills and floor joists is also advisable.

The foundation: Having chosen your site carefully in regard to drainage, water supply, view, etc., level the surface of the ground and mark out the locations of the walls and fireplace, Figs. 7 and 8. Then dig the foundation trench about 3 ft. deep and 16 or 18 in. wide. Excavate the space for the fireplace also. Have the sides of the trench neatly squared and you will not need a form up to the grade level. The footing should be about 6 to 8 in. deep and should cover the fireplace area as well. Use a mixture of cement, 1 part, to sand, 2 parts, and gravel, 3 parts. Once the footing has set, continue the wall about 1 ft. above the grade, using wood forms. If native rocks are handy, an attractive wall can be built by incorporating these with the cement, Fig. 7. While the concrete is

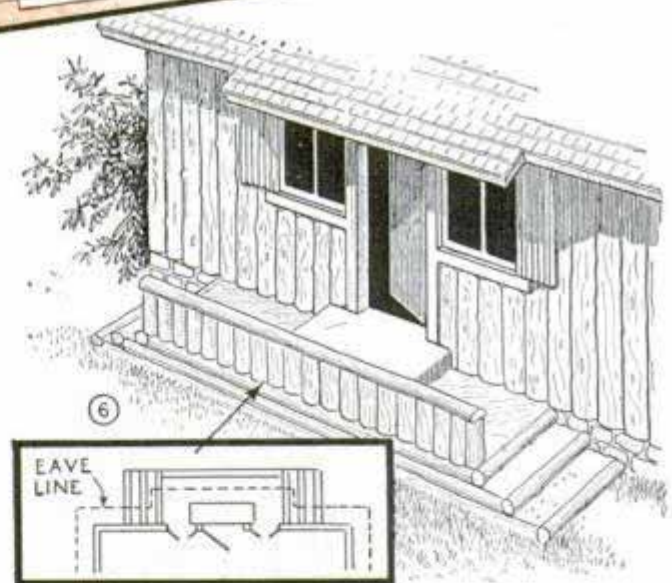

soft, long bolts or rods threaded at the top are embedded in the mixture at regular intervals to provide anchors for the plates. Care must be taken to have the plates perfectly level. Large rocks are packed into the fireplace pit on top of the footing already laid, Figs. 10 and 11. This layer will bring the level up to about 18 in. from the surface. Top this with a layer of sand and then pour on 6 in. of concrete. Add a 1-ft. layer of small stones and cover with concrete up to the grade level. Use selected rocks laid in courses to bring the fireplace foundation up to the height of the walls.

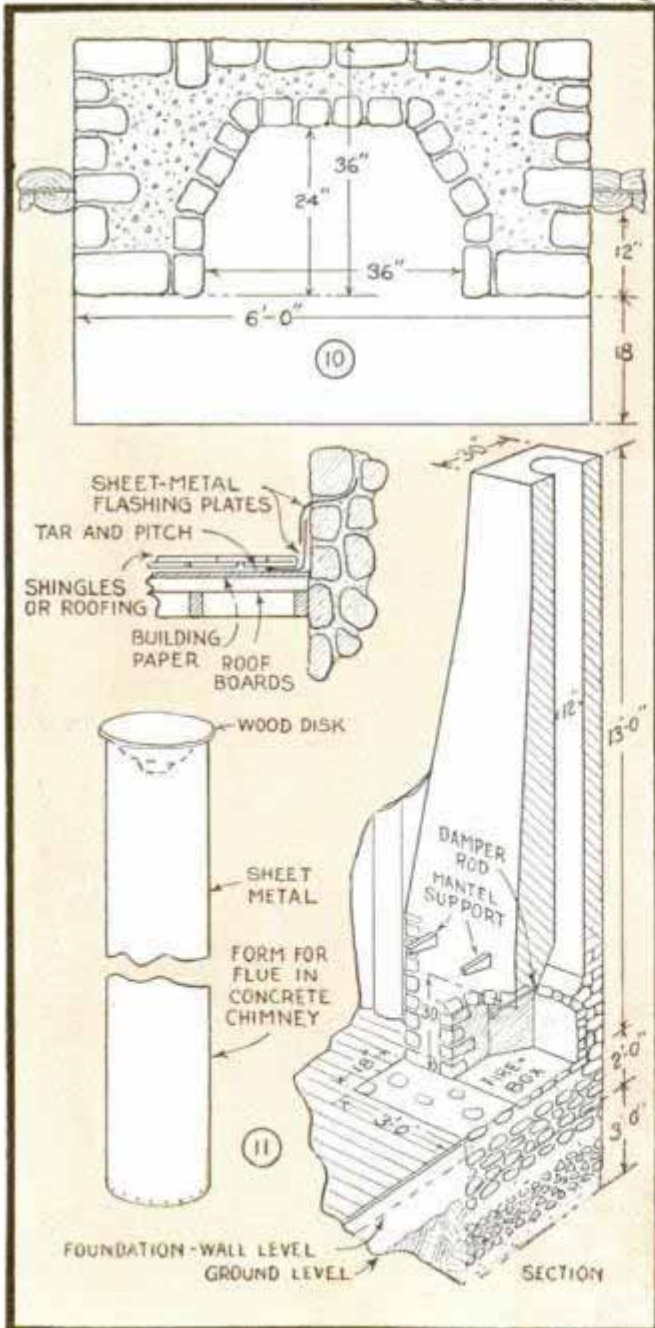

frame square and true until the outside logs are nailed on. Lastly, a 2 by 4-in. plate is nailed to the floor flush with the outside edge all around except across the door openings. Later the inside logs will be toenailed to this plate, Fig. 1, A.

The split-log walls: The frame is now ready for the outside logs. Starting at one of the front corners, two 9-ft. lengths of heavy building paper or felt are stretched between the top frame and the sill. The first length is carried around the corner about 10 in. and tacked on. The second piece overlaps the first, making a weather-proof corner. Locate the first log with the vertical edge flush with the corner post. The lower end should extend down over the sill and cover a few inches of the stonework, Fig. 1, B. It is then spiked to the sill, wall plates and the top frame. Continue nailing the logs in place, working toward a doorway, hanging sheets of building paper ahead of the logs. As you approach the window opening, nail the frame in place against the door uprights, Fig. 9. Then using short logs, cut to length, place them in under the window and nail the frame to them. On the end opposite the fireplace, begin at the center with the longest split log. This supports the ridge pole and should be located in the exact center of the wall. Of course, a length of building paper is first stretched from the nailing joist to the sill. Finish from the center log to the corners, running the paper only up to the nailing joist. After the end wall is completed, rafters are spiked to the upper ends of the logs and the latter trimmed flush with the rafters. Then tack building paper to the logs above the nailing joist. The height of the center pole determines the pitch of the roof. The roof shown in Figs. 2, 3, and 9 rises 12 in. in 3 ft., a pitch which is about right for a cabin of this type and size. Note that the logs which support the purlins carry the weight of the ridge roof down to the foundation. These logs should be full length.

Now back to the fireplace again. The ridge pole and part of the frame will rest on the stonework as in Fig. 9. The side wall of logs must be cut to fit closely to the masonry to make a weatherproof seal. A form for the flue can be made from a sheet of metal bent around two wood disks, the lower disk slightly smaller to give the

form a taper, Fig. 11. Wrap the form with paper so that it can be withdrawn from the concrete easily. After finishing the chimney to the ridge line allow to set thoroughly before the ridge pole and the two purlins are put in place. These purlins will have to be trimmed to fit onto the supporting masonry. Both purlins and ridge should extend 2 ft. over the walls to form wide eaves. With these parts in place the chimney can be finished to the desired height.

Now for the interior logs. Begin with a narrow split log in a corner and make sure that the joint between the last log and the one succeeding will fall on the flat face of the outside log in the same fashion as the "broken" joints in masonry or brick work, Fig. 1, C.

The roof: Before setting up the rafters finish up the gable ends with short logs. Center rafters can extend a few feet in front to provide a short roof overhang for a porch, Figs. 5 and 6. Use $\frac{3}{4}$ -in. stock for roof boards. A layer of building felt or paper goes on under the shingles. Flashing is built into the chimney in the manner shown in the upper detail, Fig. 11.

Finishing the interior: Figs. 3 and 9 show how the doors, windows and screens are installed and the trim put on.

After the top floor is laid, over building paper, the partitions are installed. Floor plans shown in Figs. 2, 4, and 5 are suggested interior arrangements of rooms. Partitions are built up of split, peeled saplings which are nailed to each side of plywood sheets, Fig. 2.

Serrated Cans on Fence Posts Keep Out Cats

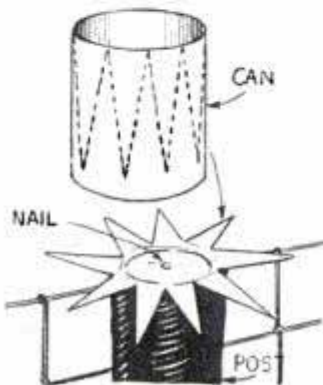

To keep cats out of his poultry yard, one fancier uses tin-can guards nailed on top of the fence posts. The cans are serrated as indicated, each point being bent out at right angles.

Running Water in the Darkroom Provided at Small Cost

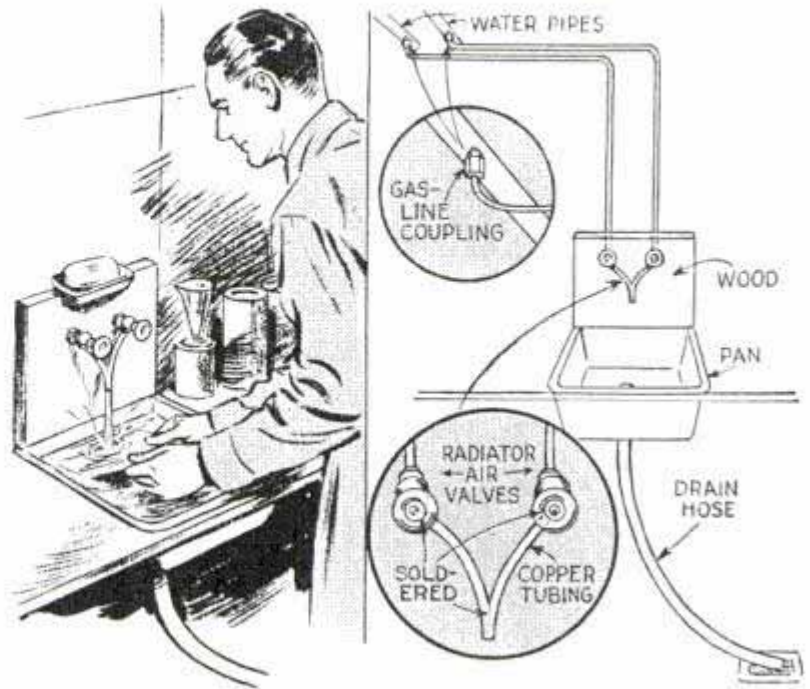

Plenty of running hot and cold water—blended to just the right temperature—may be had in any darkroom at small cost. The pipe and fittings are auto gas lines except the faucets which are radiator air valves used on hot-water systems. After shutting off the water at the main valve, the hot and cold-water pipes are tapped to take the compression couplings to which the pipes are attached. These are then led through the darkroom wall and down to the sink. This can be a tray or pan of any convenient size in which has been soldered a fitting to take a drain hose. At the back of this tank, a board is provided to hold the radiator air valves to which the water lines are soldered. From the valve outlets two lengths of copper tubing are soldered to conduct the water into the tank. To blend the water, however, these should have their sides filed away for a distance of about 2 in. and the exposed edges soldered together. To maintain the water at any desired depth in the tank, an overflow pipe can be fitted in the drain outlet to a height equal to the desired depth of the water.

☞ When washing your lamp shades remember that the quicker they are dried the better. Turn an electric fan on them as soon as you have rinsed them. Quick drying helps to prevent colors from running.

Hook Taken from Fish's Throat with Pencil Eraser



To remove fishhooks from the throat of his catch in the most humane way possible, one fisherman employs a pencil and eraser. The latter is notched so that it will slide into position along the line and allow the hook to be loosened without unnecessary tearing or injury.

Metal Squirrel Shields on Trees Bolted in Place

These shields are easily fastened on trees to keep squirrels from climbing them. Cut from galvanized sheet iron to the size and shape indicated in the circular detail, the shields can be clamped in place with stove bolts. It is a good idea to examine

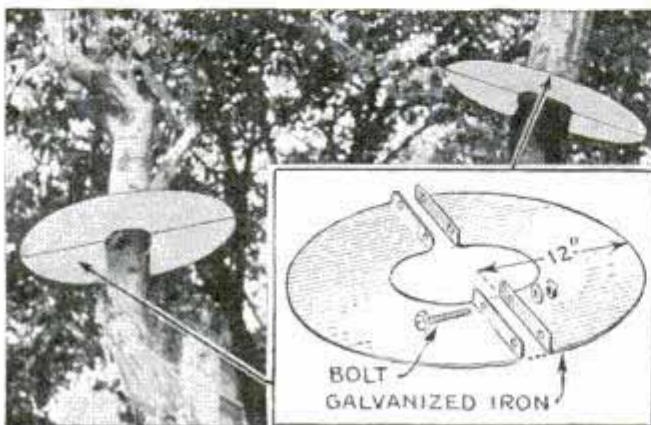

the shields annually and adjust them to compensate for growth of the trees.

-John P. Behrens, Jr., Whitestone, N. Y.

Workman's Ruler Held in Pocket by Sponge Rubber

It will be almost impossible for a folding rule to slip out of your over-all pocket if a small piece of sponge rubber is pinned inside the pocket at the top as shown. Friction of the rubber against the rule holds it securely under ordinary conditions, but does not prevent its removal.

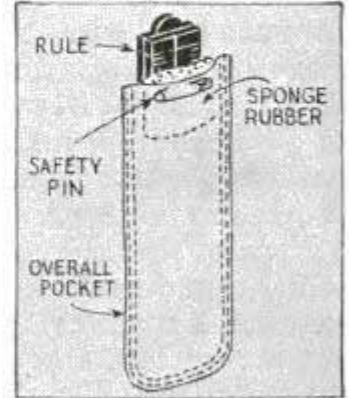

Uniform Supply of Hot Water from Dual-Tank System

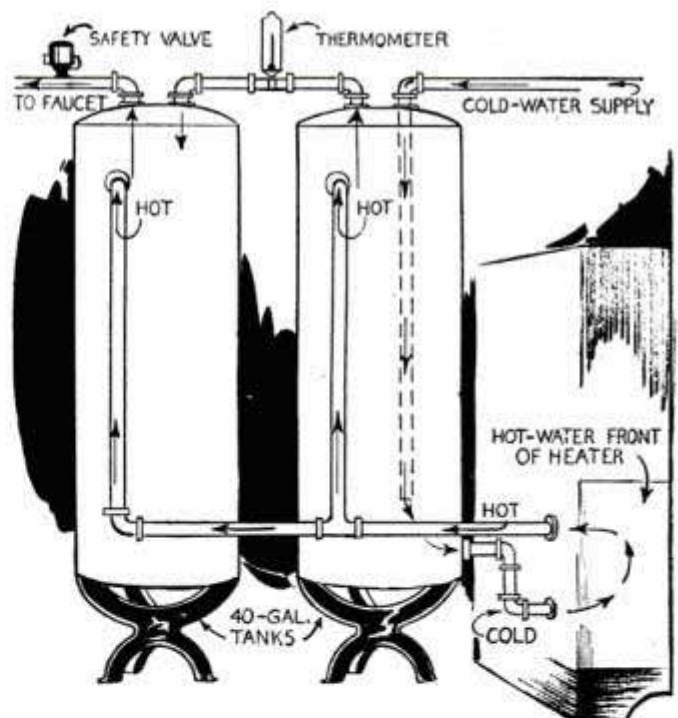

The disappointment of having the hot water chill in the middle of a shower is postponed considerably by connecting two tanks as shown, rather than using a single large one. Cold water is admitted to the first tank only, and the syphon system conducts only the hottest part to the second tank, doubling the reserve capacity. The second tank remains hot even when the first is almost filled with cold water.

Water Fowls Are Imitated in Weather Vanes

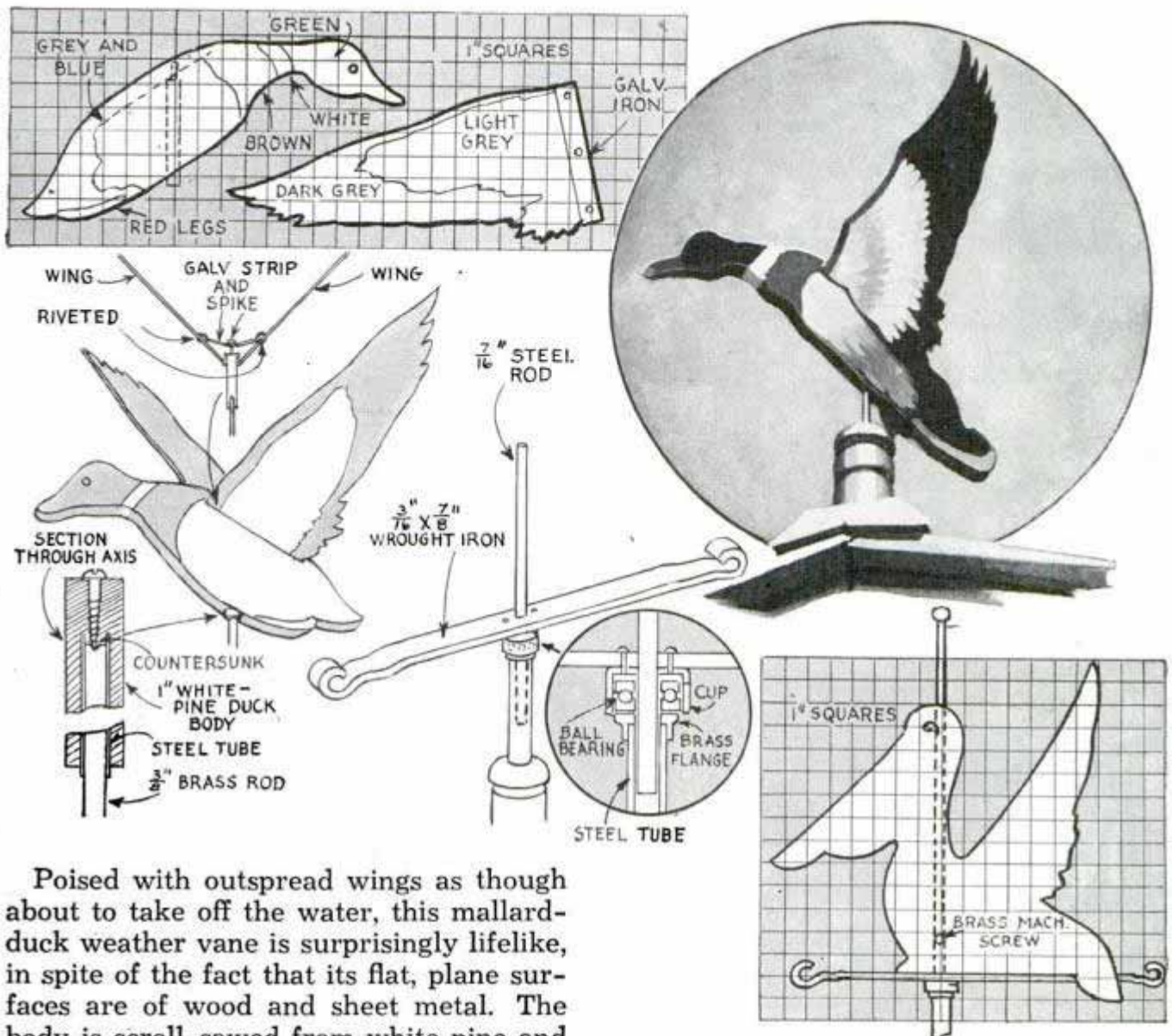

Poised with outspread wings as though about to take off the water, this mallard-duck weather vane is surprisingly lifelike, in spite of the fact that its flat, plane surfaces are of wood and sheet metal. The body is scroll-sawed from white pine and the wings are cut from galvanized sheet iron. The latter are attached to the body with small screws, and braced by a galvanized strap riveted between the wings and supported by a large spike. The duck is mounted on a weatherproof axis that turns freely without lubrication. A steel tube is installed in the body and at the top a wood screw with the point slightly

rounded is set in a countersunk brass rod. This arrangement is non-corroding, and the entire weight of the bird is carried on the point of the screw. Accurate painting of the duck has much to do with the lifelike appearance of the weather vane. The pelican weather vane is a sheet-metal cut-out mounted on a ball-bearing pivot shown in the lower details.

Golf Tee Wears a "Bracelet" to Keep the Ball at a Uniform Height

Golfers who have trouble in teeing up a ball at the proper height will find that a faucet washer slipped over the lower edge of the tee will put an end to guesswork. The hole in the washer should be enlarged just enough to permit it to be pushed on the tapered shank of the tee.—Wm. Gault, Milwaukee, Wis.

☞ Grease marks can be removed from book pages by first sponging them with benzine and then placing them between sheets of blotting paper and pressing with a hot iron.



Solving HOME



① CORRUGATED RUBBER

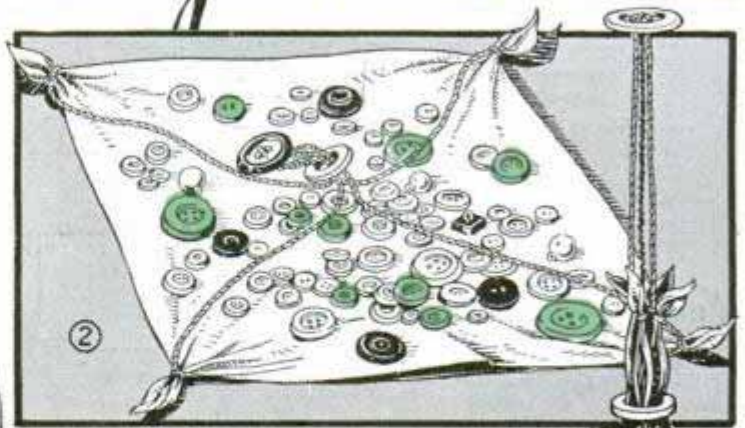

②

Mixing pans will not skid on porcelain or metal-top tables if set on a piece of corrugated rubber as in 1. Cloth button bag, Fig. 2, opens completely to expose contents and has sliding ring to hold it closed. Flies collecting at the top of a screen door, inside the house, find their way outdoors through a screen cone as in 3. Sewing-thread spools, a cork pin-cushion and a pair of scissors are all kept on a wire coat hanger, Fig. 4, which can be conveniently hung up out of the way

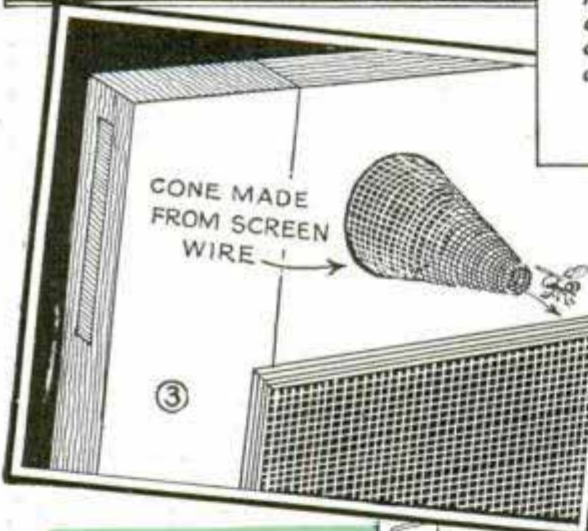

③

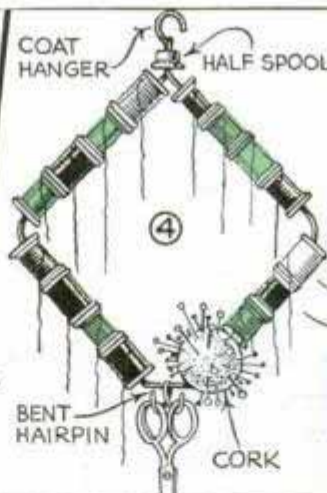

④

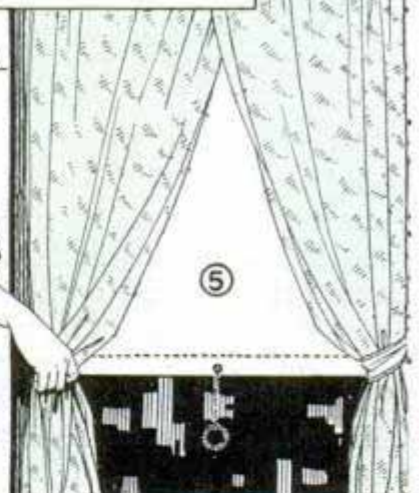

⑤



To locate curtain tie-backs accurately at the same height on both sides of a window casing, use the shade as a guide, Fig. 5.-Celluloid windows in hat boxes, Fig. 6, enable you to select the right hat at a glance without lifting the lids. A board with short dowels spaced equally along the lower curved edge as in 7 provides a handy rack for kitchen knife sharpeners, can openers, etc.



⑥

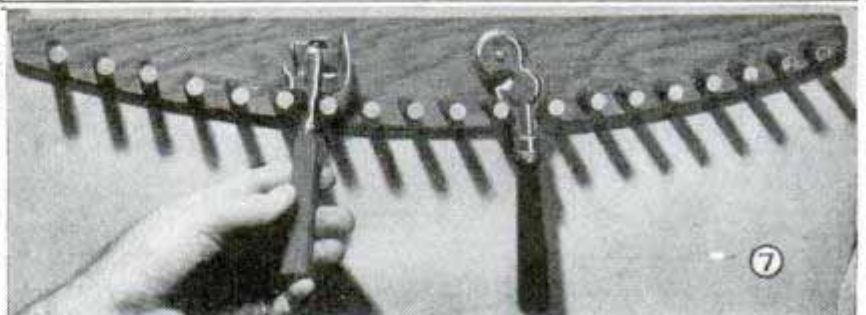

⑦

PROBLEMS

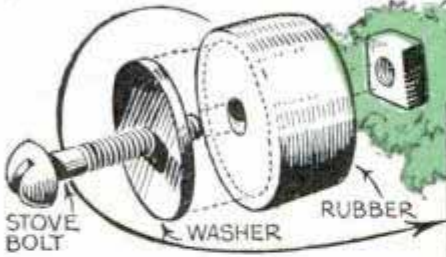

When trimming a hedge, repeated jarring of wrists and arms as the shear handles come together, can be avoided with rubber shock absorbers in 8. Locate them so that they will touch just when the blades close completely. Tightening the screws to compress the rubber will take care of any slight inaccuracy in locating the holes

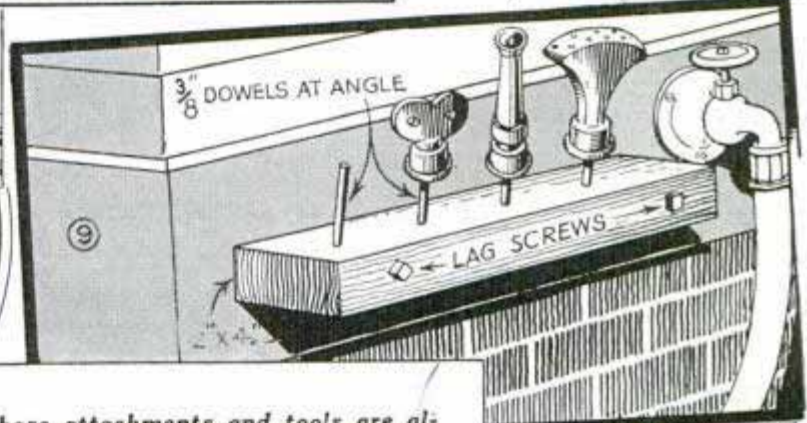
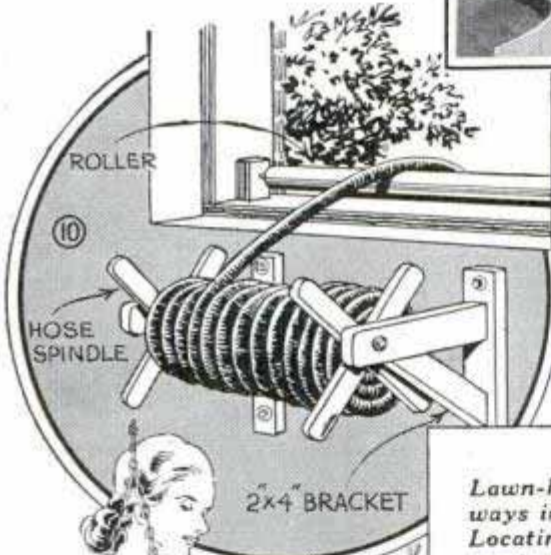
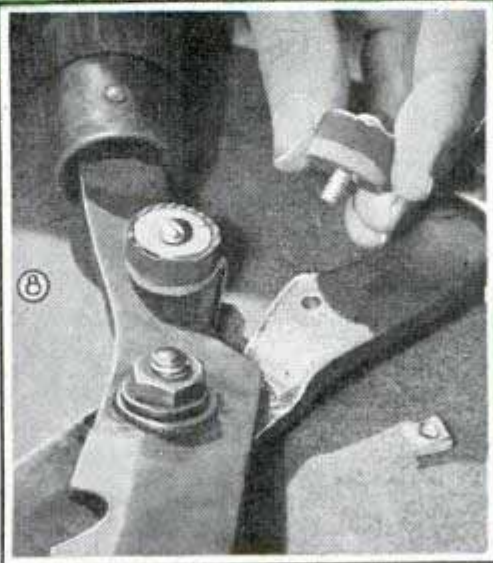

Lawn-hose attachments and tools are always in order when kept on the rack in 9. Locating your hose reel inside the basement under a window as in 10 saves carrying a heavy reel and hose outside. Just open the window and pull out the hose when needed. Footrest on porch swing as in 11 adds comfort for short persons



Lock your lawnmower with a bicycle padlock as in 12 and small children will be less apt to injure themselves. Rubber bottle stoppers forced into holes in a door casing, Fig. 13, prevent rattling of door in a draft

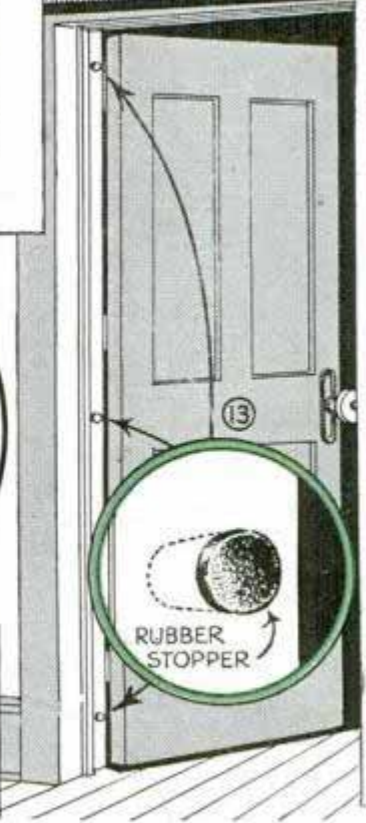

Heavy Boat Is Moved over Beach on Oil-Drum "Dolly"



Having a rowboat that was too heavy to move short distances on hard ground, one man improvised a dolly from an old drum and four large furniture casters. The lat-

ter were set in the gunwale and were spaced to contact the drum sides a little past the center as shown. When the boat was turned upside down on the drum and pushed, the casters served as bearings so that the assembly could be rolled without difficulty. If the boat is too wide at the center to fit a drum, mount the casters near the front end where it is narrower.

Bulb to Aerate Minnow Bucket

Minnows can be kept alive much longer in a bucket if a bulb with a short hose attached is used to aerate the water. A small hole should be punched in the bulb to serve as a valve, which is closed with the finger when pumping air into the water.

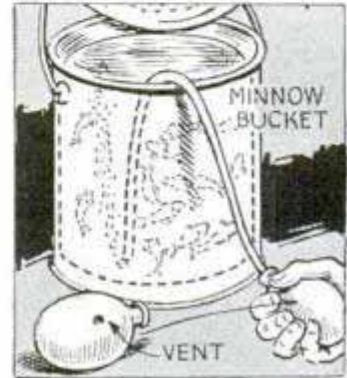

—G. E. Hendrickson, Argyle, Wis.

Sturdy Workbench

quickly dismantled for moving

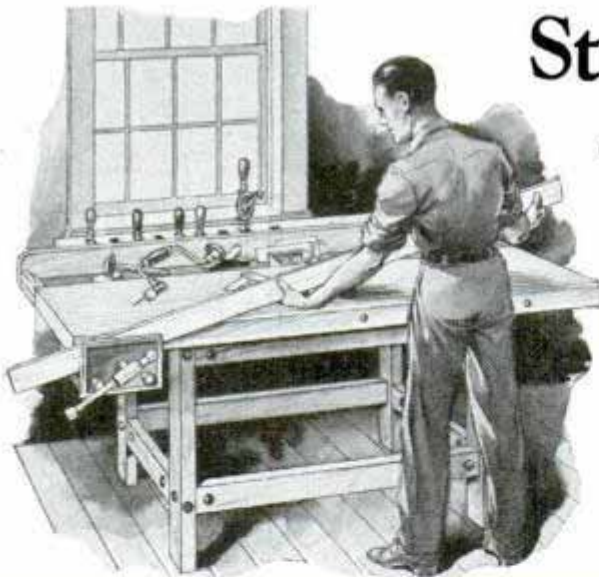

Fully Portable

It takes just a few moments to dismantle the bolted framework so that the bench can be packed flat for moving.

Unusually Rigid

The frame members are drawn together tightly by means of eight bolts. When humidity conditions cause the wood to shrink slightly, give each bolt a twist.

Maple Top of Flooring

Maple flooring, set on edge and bolted together, provides a hard-wearing top which is planed smooth.

Sunken Tray and Tool Rack

Additional convenience is furnished by a sunken tray and a rack that keep tools within easy reach.

POPULAR MECHANICS MAGAZINE
200 E. Ontario St. Chicago

Enclosed find 10 cents for Craftplan No. 3006 on
Sturdy Workbench

Please check I am a subscriber
 I buy at newsstand

Name _____

Use Pencil

Address _____

City _____

State _____



RADIO PRINTING

EXPERIMENTAL facsimile news items, weather reports, ball scores and pictures are now broadcast by Mutual chain stations during early morning hours much in the same manner as radio programs. There is nothing mysterious about "radio printing," the printer shown in photo, Fig. 3, can be assembled from a kit of parts and easily connected to any home radio set that delivers 5 watts or more. Diagrams Figs. 1 and 2 indicate simple set connections necessary to switch from speaker to printer.

An electric eye at the broadcasting station replaces the usual microphone and visualizes the material transmitted. These radio waves, tuned in and amplified on your receiver, are converted by the Finch method into text and pictures, printing a facsimile of the original on sensitized white paper in excellent detail. The specimen strip shown was the writer's home reception result of the first experimental chain broadcast sent out by stations WGN, WLW and WOR on March 11th.

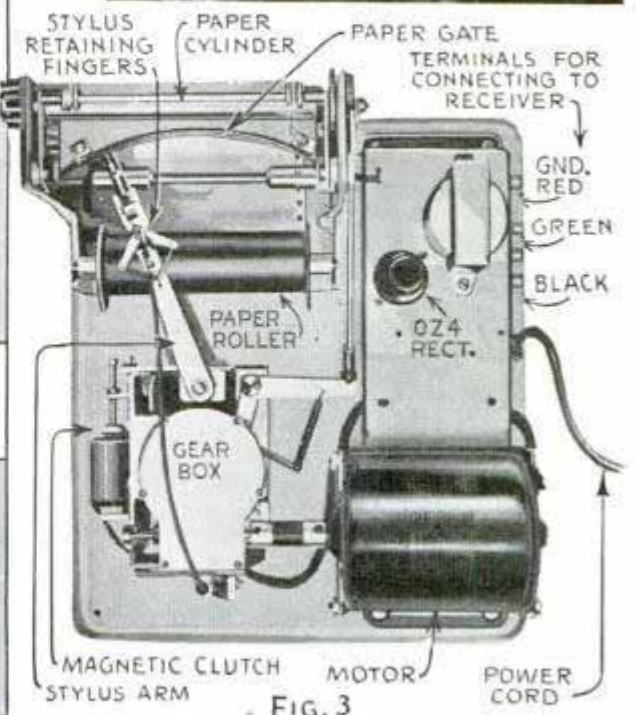
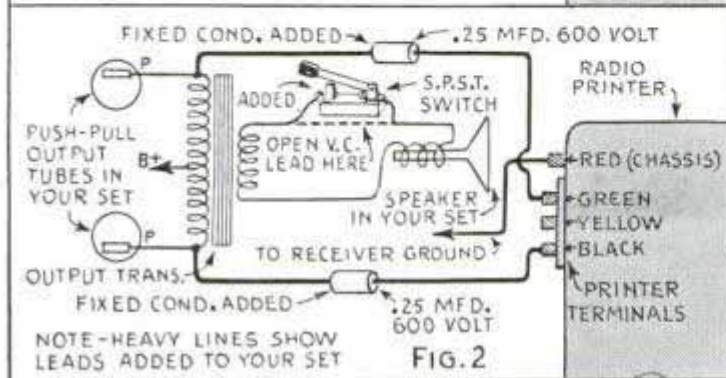
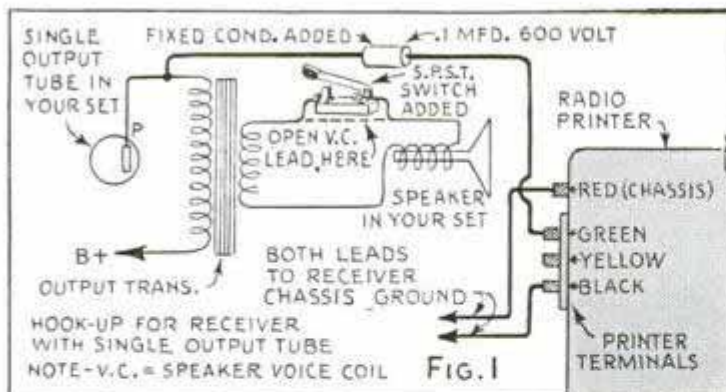

Crosley Radio Corp

BEGINNER'S BATTERY SET

Photos Figs. 2-A, 2-B, 2-C and 2-D show various views of the completed set; simplified wiring diagram Fig. 2 indicates all parts and connections above and below the base. A complete schematic diagram is given in Fig. 3, and this also shows all A, B, and C-battery connections. With 90 volts of plate (B) voltage, 9 volts of C-bias are required; if but one 45-volt B-battery is used the C-bias should be 6 volts. Because of the increased A-battery drain it is best to use No. 6 dry cells connected in parallel as shown. Although the receiver will operate on a single small 45-volt B-battery, two are advised for maximum loudspeaker volume.

When wiring the audio stage, note that the phone-tip jacks on the 1-tube set portion of the layout are wired to the primary of the added audio transformer. Also the filament prongs for the type-1C5 tube socket are wired in parallel with the filament prongs on the 6-prong RK-43 socket. The switch on the regeneration

(Continued to page 136A)

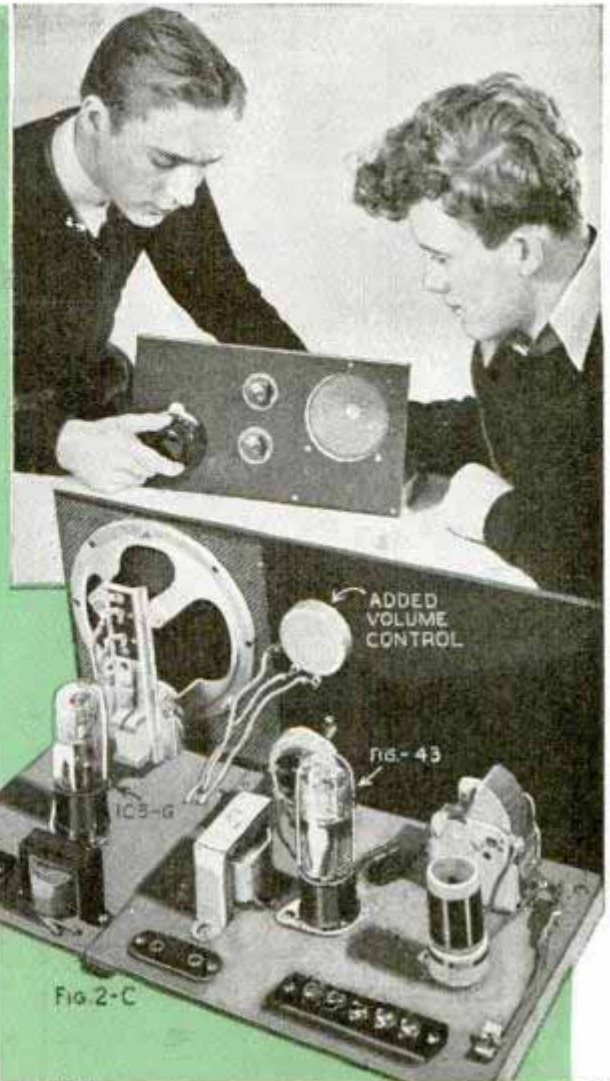
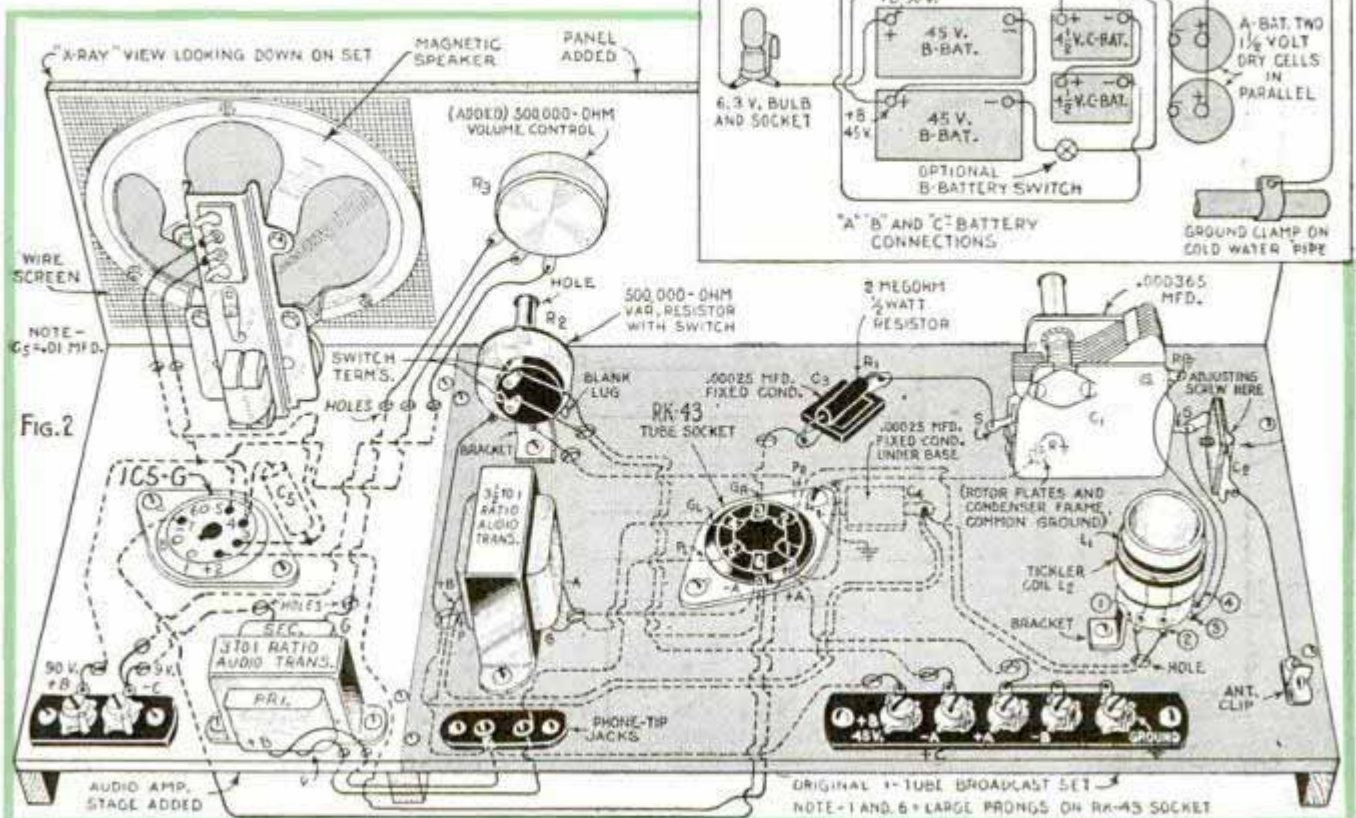
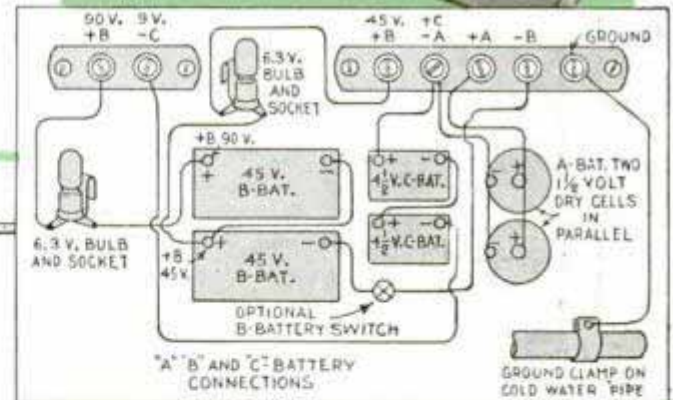

Fig. 2-C



How to Build a Universal Set-Testing Meter

By John T. Wilcox

METERS capable of measuring voltage, current and resistance constitute perhaps the most important part of the radio experimenter's equipment, enabling him to check his own construction and wiring, locate defective parts and track down circuit troubles. If separate meters were required for these various types of measurements the cost would be prohibitive to most experimenters. Fortunately, however, it is possible to use a single inexpensive standard 0 to 1 ma. milliammeter together with a few semi-precision resistors and switches to serve all of these purposes.

The homemade meter unit illustrated meets all requirements and provides the following d.c. measurement ranges: 0-1 and 0-100 milliamperes for current measurements; voltage—0-10, 0-100, 0-500 and 0-1,000 volts; resistance—0-500 and 0-100,000 ohms. Direct-reading calibrations are given on the multi-range meter scale for five of the eight ranges provided, and for the other three ranges it is only necessary to divide or multiply one of these calibrated ranges by ten. All parts, as specified and detailed in Fig. 1, cost about \$8.00 and this includes the 1/8 by 7 by 10-in. Bakelite panel. The case is a standard 7 by 9 by 2-in. sheet-steel chassis which is available "extra" either in natural or black-crackle finish. The semi-precision fixed resistors are

(Continued to page 132A)

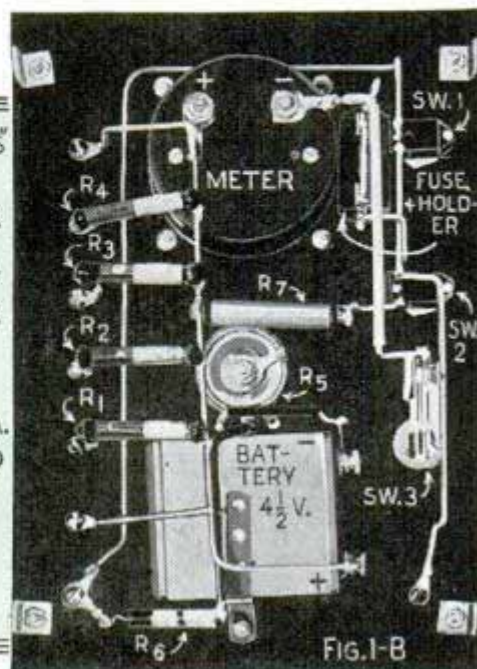
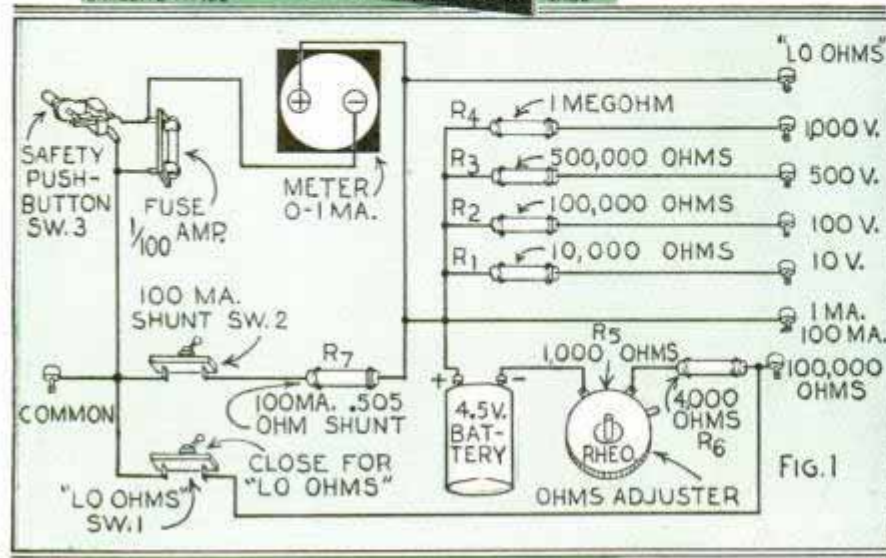

1575 Milwaukee Ave. Chicago

Practical RADIO HINTS

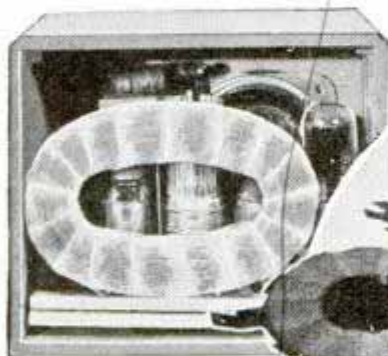

(A) Make your midget receiver really portable with a spiderweb antenna. These compact coils cost about 75 cents and may be used to replace the 25-ft. flexible antenna usually supplied. They are available in several types, some self-supporting and others wound on fiber forms provided with mounting brackets. Experimenters can rotate the coils for directional effects and use them to replace antenna coils in receiver circuits



(B) Small electron-ray twin tuning eye provides two shadows as a visual aid for accurate tuning of compact radio receivers

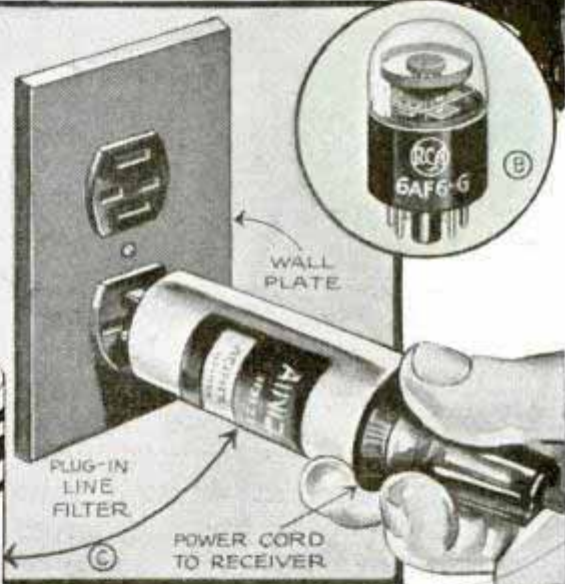
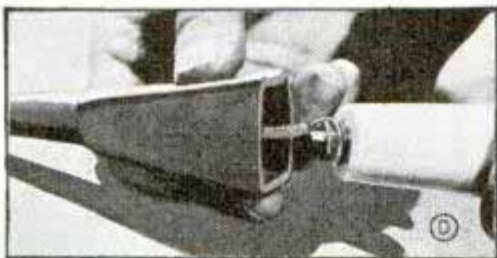

(C) Handy plug-in line filter reduces strong-intensity radio interference from electric vibrating devices

(D) Large rubber insulator, of type used on battery clips, makes good safety cover for high-voltage terminal. (E) Telescoping vertical radiator for 10 and 20-meter transmitters. Diagram and photo show mounting for flat-roof installation; outriggers are held down with sandbags

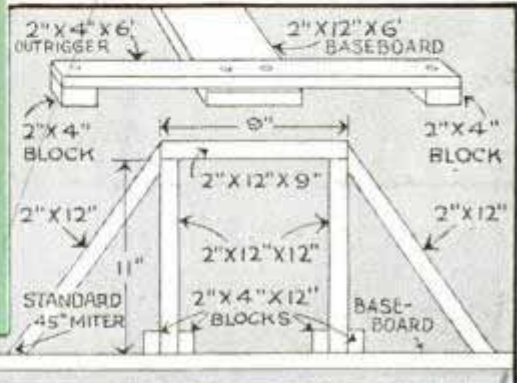
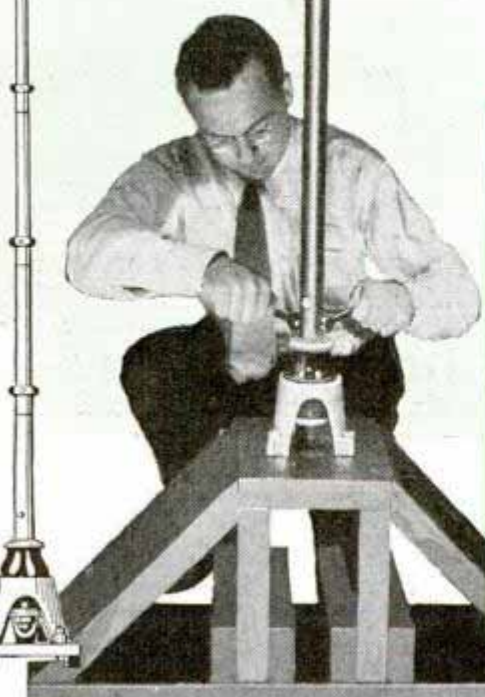

Premier Products Corp. Brooklyn, N.Y. 1575 Milwaukee Ave. Chicago

Radio Record Player Has "Mike" Jack for Home Broadcasting



When placed at any convenient point in the home and plugged into the 110-volt a.c. outlet, this "wireless" record player plays phonograph records through your radio receiver without any connection whatsoever between the two. It is also provided with a jack into which a microphone of the "home broadcasting" variety may be plugged for announcing purposes.

Power Line Noise Analyzer



Five popular types of line-filter circuits are built into this compact instrument for radio interference work. These circuits are connect-

ed to a rotary switch so that the desired interference-eliminating circuit may be inserted quickly for checking between the power line and the suspected electrical equipment or radio receiver.

Push-Button Converter Unit

This compact unit provides a complete push-button tuning system for any a.c. superheterodyne receiver which has an intermediate frequency of about 456 to 465 kc. It employs a 6A7 tube as a mixer and oscillator. Power is obtained directly from the receiver through a short connecting cable.



Ham Transmitter in Console

Housed in an attractive steel console finished in black crackle and chromium, this 450-watt de luxe amateur transmitter provides all-band operation from 10 to 160 meters. Three power units supply operating voltages. A separate table-mounting cabinet contains the speech amplifier.



Blueprints covering radio construction articles in this and past issues are available for 25 cents each. Original material lists, with names of manufacturers and dealers, can be obtained from our Radio Department upon receipt of postage.

NEXT MONTH—How to Build a Tiny Four-Tube A.C.-D.C. Receiver. New bantam-type tubes are employed in this inexpensive miniature set which has exceptionally good tone and volume. Parts cost about \$4.75 less tubes and cabinet. Also —details of **Sound and Picture Receiver Kit for Experimenters**

Jobe Deutchman, Corp.
 Cannon, Mass.
 Wholesale Radio Service Co.
 100 S. State
 Street
 Newark, N.J.

Mr. Carmel
 Ill
 S. S. Anderson, Inc.
 2611



SHOP NOTES

BELT SANDER *fits your lathe*

DESIGNED to take a standard 6-in. abrasive belt, this lathe sander is an inexpensive unit capable of handling any type of work ordinarily run on a small belt sander. Accurate adjustment for tensioning and tracking is furnished by means of an alignment bar fastened to the underside of the base, which tilts the sander laterally to align the idler with the driving drum, and, at the same time tightens the belt.

Construction should be started by making the two drums. The larger of these—the driving drum—is made from three pieces of $1\frac{3}{4}$ -in. stock, glued and screw-fastened together to permit turning as can be seen in Figs. 2 and 4. The drum is fitted on a standard 3-in. faceplate. The idler can be built up similarly or can be turned from a single solid block. Both

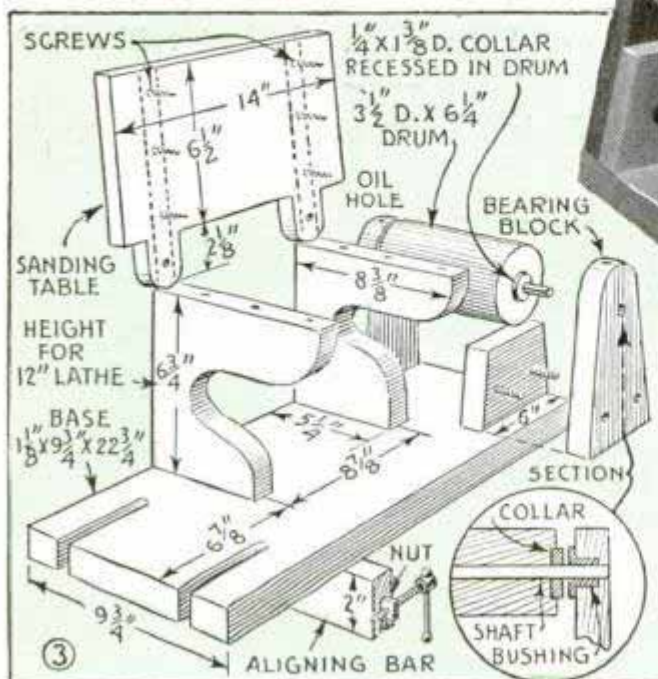
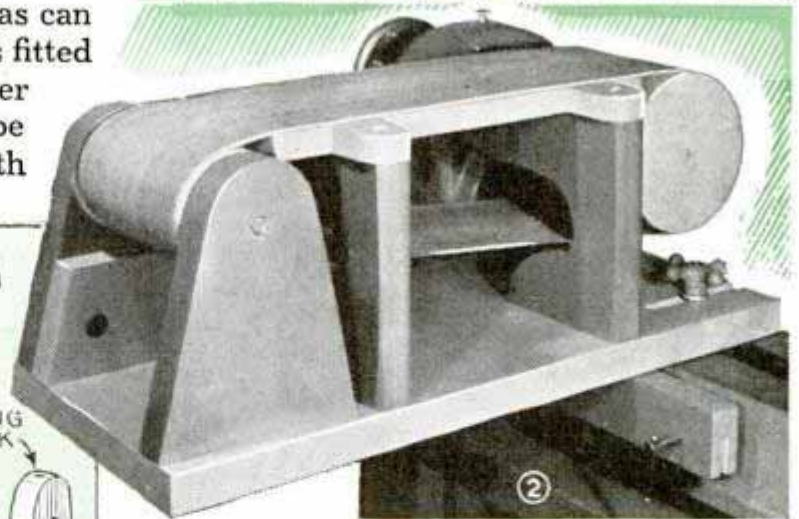

drums are $6\frac{1}{4}$ in. long. Wood stock for the other parts is $1\frac{1}{8}$ in. thick with exception of the sanding-table supports, Fig. 3, it is advisable to make these of plywood.

To fit the sanding belt in place on the completed unit, the removable bearing block at one end of the idler is taken off by

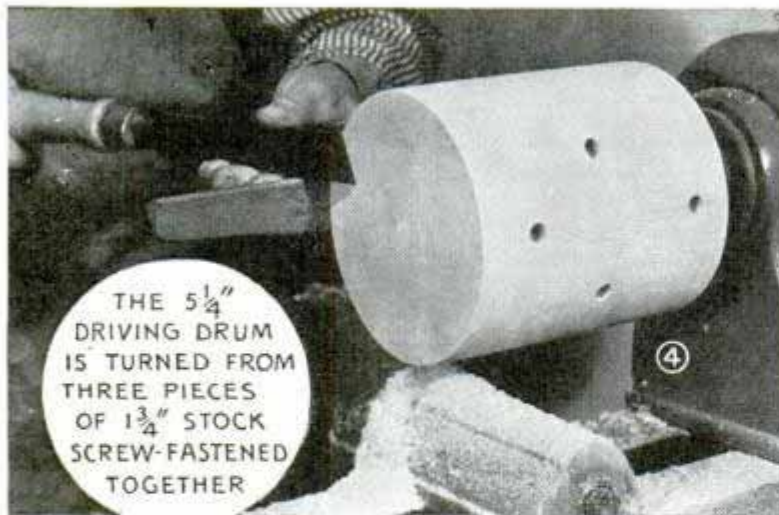

By turning one screw more than the other, proper alignment of the belt for straight tracking is assured. The adjusting screws can be obtained from small C-clamps. The screws are pointed at the free end with a file and engage in shallow holes drilled in the side of the lathe bed. Adjustments are made with the base loosely clamped to the bed, the base bolts being tightened after tensioning and tracking have been done.

loosening the wing nuts which hold it in place, Fig. 1. The belt is then slipped over the drums, after which the bearing block is replaced and the nuts tightened. The unit is fitted to the lathe by means of two studs which engage in the slot in the lathe bed. Tension is provided by means of the two screws fitting through the aligning bar.

For certain types of work a fence is handy. This is easily cut from scrap stock and attached to the solid bearing support of the idler with screws. It is not shown in the details as most users will want to adapt it to their own special needs. Use a stick belt dressing on the driving drum to prevent slipping of the belt on heavy work. An occasional application will be ample.

Sharpening Blades of Disk Harrow with Aid of Holder

Grinding the blades of a disk harrow is speeded up, and the work done with a fair degree of accuracy with this holder, which permits the blade to rotate slowly when held against a grinding wheel. The holder is assembled from two pipe tees and a close

nipple. Both tees are drilled as indicated to take an iron rod, and the lower tee and the nipple are bushed with a brass nipple to serve as a bearing on the rod. The lower end of this is threaded and fastened to a length of flat iron with two nuts. In use, the blade to be sharpened is clamped between the two tees, and the assembly held as indicated to press the blade against the grinder. A thrust washer under the lower tee permits the blade and tee assembly to rotate freely.

—J. Willard Munsil, Centerville, S. D.

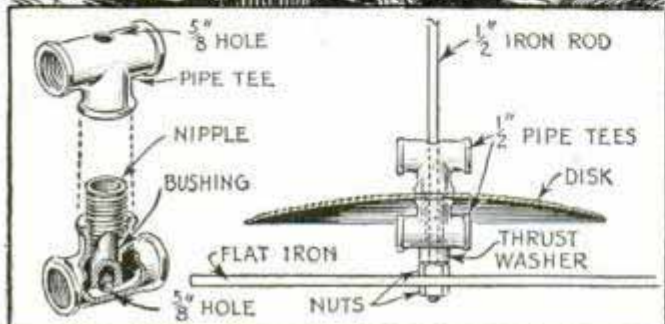

Shield Protects Plane Iron

This shield protects the cutting edge of a plane iron when the tool is stored in the toolbox or set aside temporarily. A strip of inner tube holds shield on the plane.

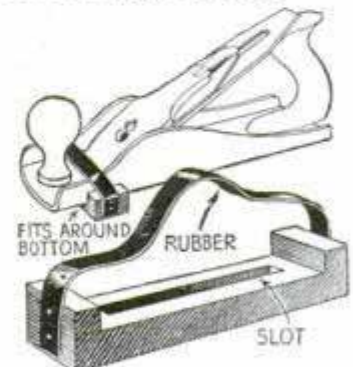

☛ You can spray-paint wicker furniture with a household fly sprayer, using a mixture of lacquer, 2 parts, and thinner, 1 part.

Sack Holder and Counter on Bin Grain Spout

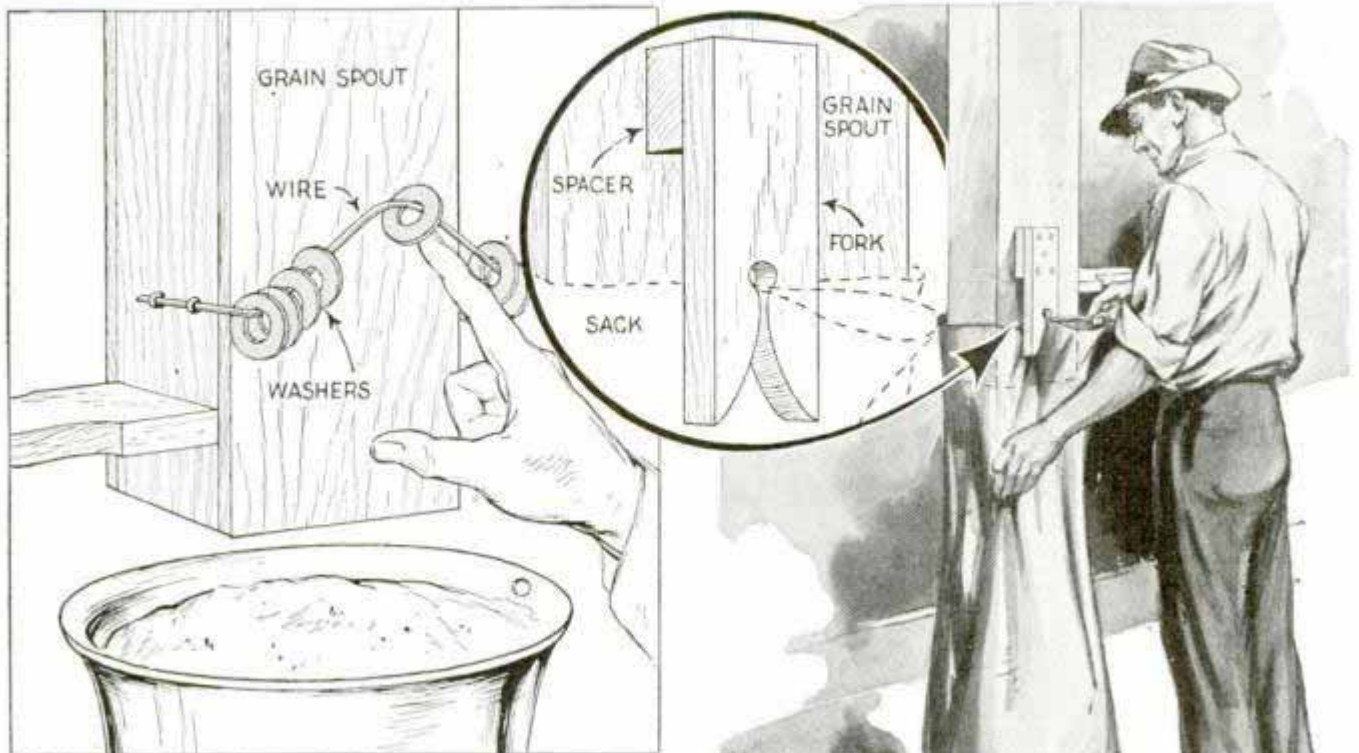

Sacks are held tightly on a bin grain spout for filling, with this fork, which has no hooks to tear the cloth. It is sawed from a piece of wood, and is nailed to the spout with a spacer block between them. In use, the sack is drawn around the spout and pulled up through the fork as indicated. To count sacks or measures, one

farmer uses washers strung on a bent wire attached conveniently to the spout. By sliding a washer along the wire each time a sack is filled, the total can be determined.

Tree-Spraying Solutions Mixed with Plumbers' Force Cup

For stirring large quantities of water to dissolve chemicals in making spray solu-

tions, one orchardist recommends a plumber's force cup. Holes are cut in it so that a short motion of the handle will pump the chemicals and water in and out of the cup. The largest cup obtainable should be used.

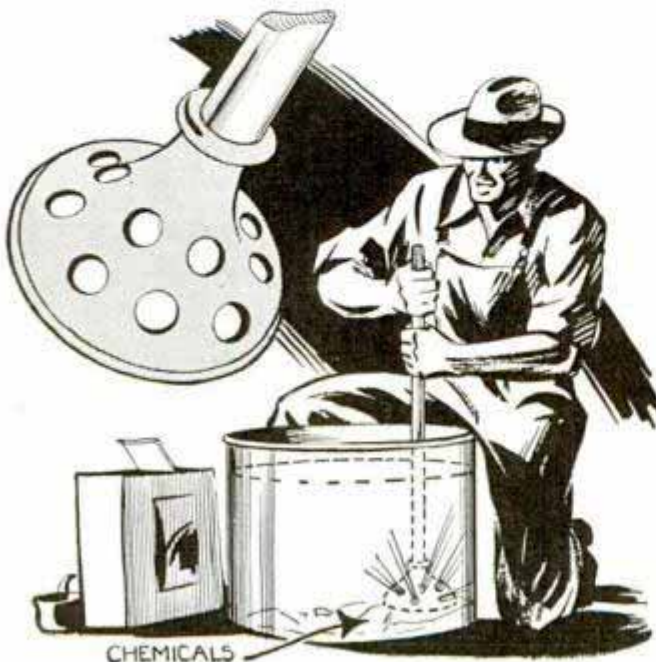

Mitten Hung on Potato Barrel to Keep Hands Clean

In order to avoid soiling one's hands when putting up orders of potatoes in a grocery store, one grocer hung a large mitten on the side of each barrel. It took only a moment for a clerk to slip the mitten on his hand before starting to fill the orders.



'Well' Holds Thumbtacks Handy in Drawing Board



Bore a hole through your drawing board near the upper right-hand corner, tack a piece of inner tube over the underside and you have a handy container for thumbtacks. Pressing on the underside of the rubber will raise the tacks so they can be picked up easily.

Horseshoe Supports Range Salt Off the Ground

Large horseshoes provide good supports for keeping blocks of range salt off the ground where live stock can reach it easily. Drill the toes and heels of the shoes for long bolts and fasten them to posts or

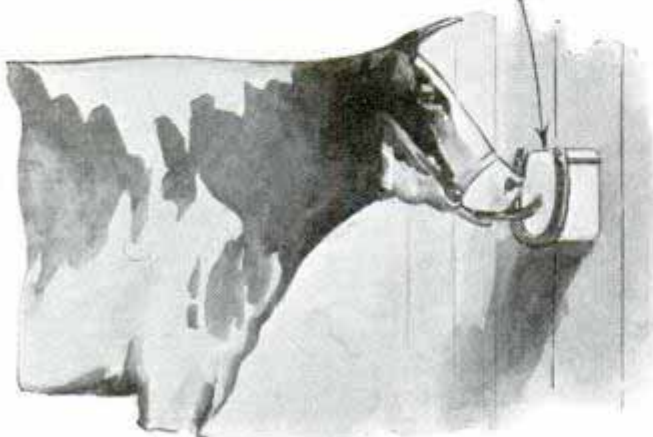
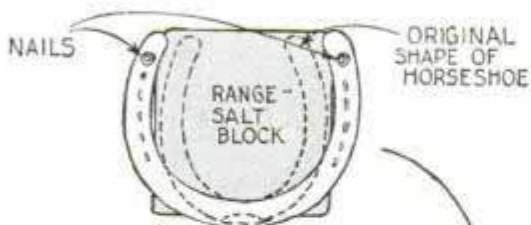

sides of a building, spacing the shoes from the post or building far enough to take the salt blocks. These can be broken in half if desired. The shoes also provide good individual salt holders in the stalls of cattle and horses.—Jack La Londe, Portland, Ore.

Oil Guards Keep Die Handles Dry While Threading Pipe

Instead of letting oil run down the die-stock handles when threading pipe, slip one half of a hollow rubber ball over each one as indicated. If a piece of waste is packed in each half of the ball, it will absorb the oil and can be discarded when the job is finished.

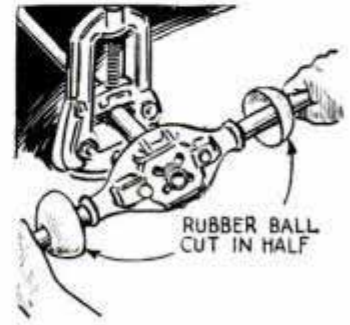

—Chester Jasin, Chicago.

Wooden Block Improves Card File



When cards in small file boxes have a tendency to extend over the front and interfere with closing of the cover, a small wedge-shaped block slipped into the box at the front end will correct this trouble. The block should be of a size to fit inside the box, and may be finished to match it.

Pivoted Receptacle on Toolbox Holds Tape Measure

Cut to the shape shown and pivoted to the end of a toolbox, a tobacco can provides a good holder for a carpenter's tape measure. Tipping the can upward, as illustrated, rolls the measure into the hand.

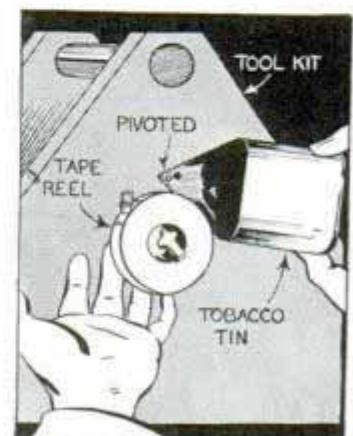

Floor-Type Shop Light Adjusts Three Ways

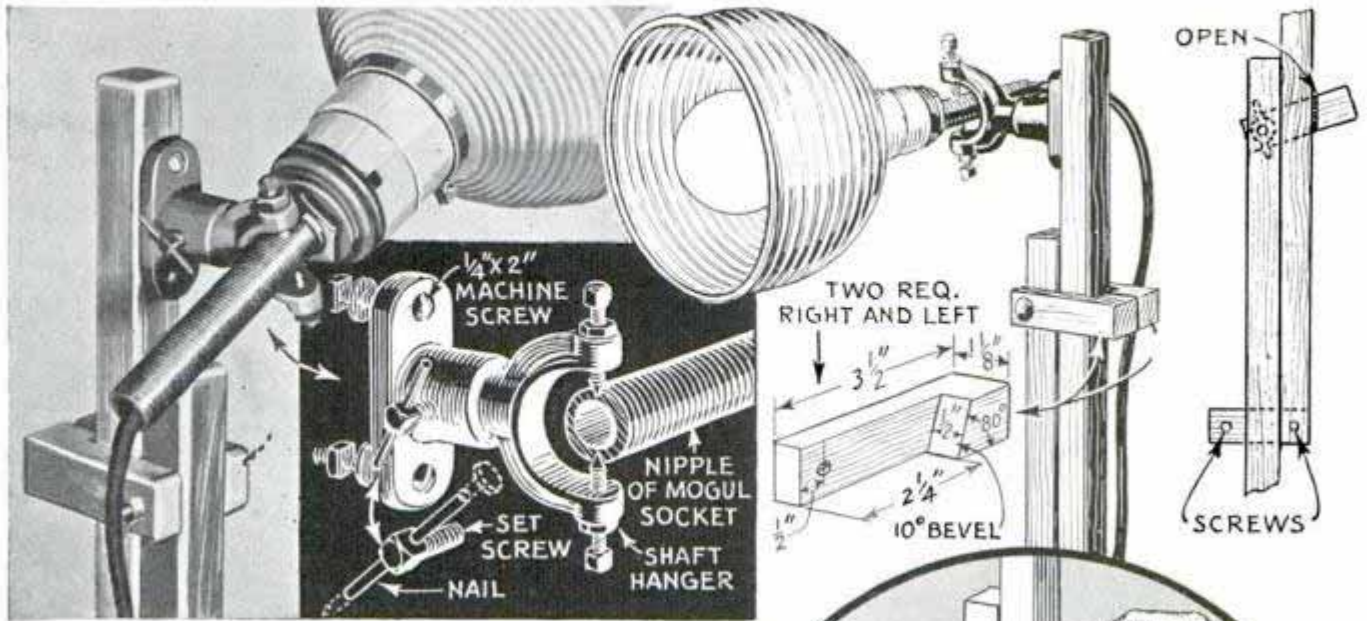

Adjustable to a height of 7½ ft., this inexpensive shop light has a pivoted lamp that can be set to direct a strong beam in any direction. The standard is made entirely of wood and consists of a base and two vertical members, one of which slides up or down against the other. These are held together by two locking pieces assembled as indicated. After adjusting the light, downward pressure of the hands on the locks sets the adjustment. The lamp assembly consists of a mogul socket, reflector and a 300 or 500-watt bulb. A bracket to hold this assembly is made from a shaft hanger. The bearing of the hanger is removed and the mogul-socket nipple is gripped between the trunnion screws. These permit lateral adjustment of the lamp, and a set screw tapped into the hanger socket and fitted with a nail through the head for a handle takes care of the vertical adjustment. Use hardwood for the base to provide weight, or recess it to take a piece of lead, if the lamp is used where it is likely to be knocked over.

Rubber Grip on End Wrenches

To assure a safe and comfortable grip on a small double-end wrench and thus protect the palm of the hand against bruises, it is a good idea to use a rubber bicycle or motorcycle handlebar grip. Except on very large wrenches, the grip can be pushed over the ends easily, and changed back and forth as required.

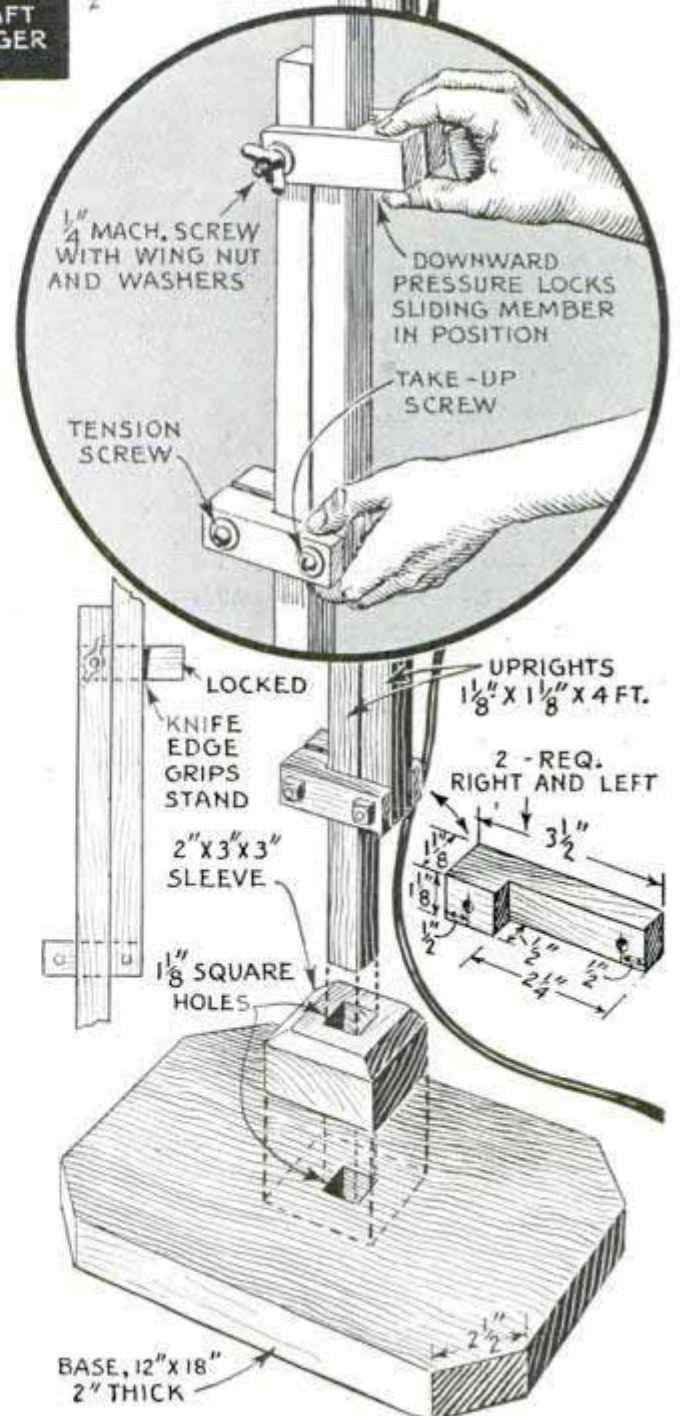

Height Gauges on Store Awning Attract Window Shoppers



One owner of a men's furnishing store increased his business by suspending height gauges from the awning in front of his store and marking the height of each manikin in the show window. This enabled window shoppers to get a better idea of how a suit would appear on them by checking their height on the gauges and picking out a manikin of the same height.

Map of Seating Arrangement Aids Theater Patrons

To prevent disturbance caused by patrons walking up and down dark aisles

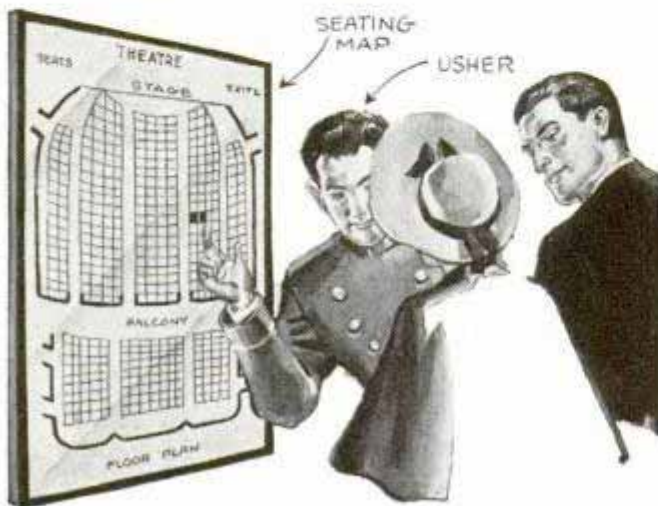

looking for desirable seats, one theater manager hung a map or plan of the seating arrangement in the lobby. This enabled the ushers to point out the locations of the vacant seats so that the patrons could walk directly to those selected.

Road Rims Shield Tractor Lugs to Travel on Pavement

Tractor owners who have occasion to travel short distances on surfaced roads will find these rims suitable as shields over the wheel lugs. The rims are thin steel bands, which fit over the lugs where they are held in place by four or five carriage bolts.

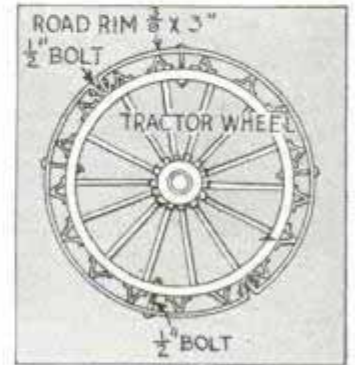

Drawer Pulls Form Pockets for Pins and Paper Clips



Inverted and screwed to the inside surface of a desk-drawer front, metal drawer pulls provide hidden receptacles for pins and paper clips. Located in this position, the desk accessories are always out of

sight, yet are easily reached any time they are needed.—Morris Katz, Aurora, Ill.

Lathe Fittings from Drill Shanks

Discarded taper-shank drills can be made into good metal and wood lathe centers, as well as arbors, drill pads and crotch centers. The drills are made of high-speed steel and can be annealed and machined for headstock use. For tailstock use, the body can be annealed, machined, hardened and ground.—Harry Nosala, Chicago.

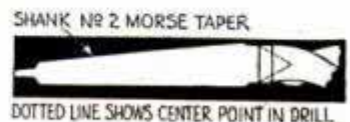

Chisels Missing in Rack Noticed at a Glance

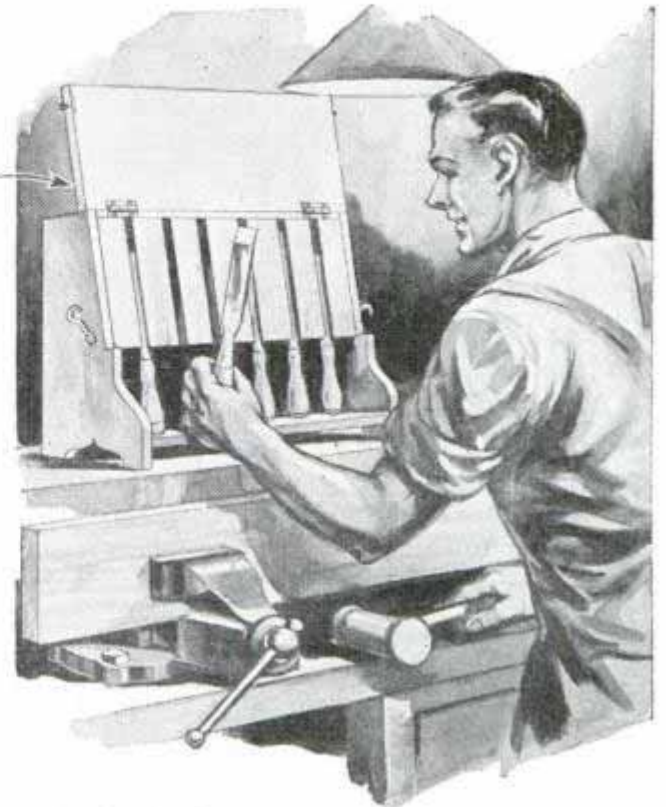
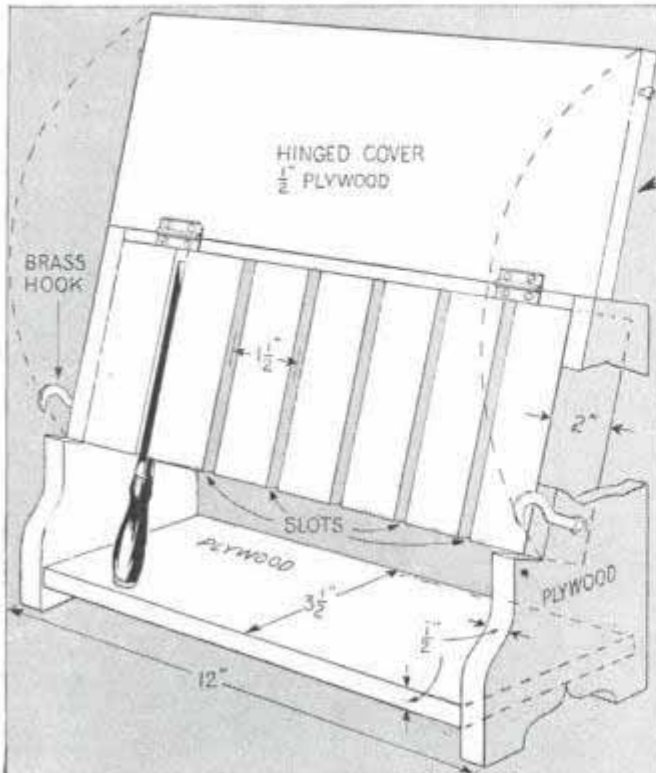

Accommodating a set of six or eight chisels, this rack will not only protect and keep them in neat order, but it will enable you to see at a glance if any are missing. The chisels rest edgewise in narrow slots cut in a 2-in. pine block, the length, width and depth of each slot being cut to suit the

individual chisels. The base and sides of the rack are cut from $\frac{1}{2}$ -in. stock, and two flat brass hooks keep the hinged cover closed. If desired, the rack can be screwed solidly to a shelf near the workbench and fitted with a small padlock.

—Wayne C. Leckey, Aurora, Ill.

Steak Thickness Guides on Store Counter Aid Shoppers

Finding that many of his customers had difficulty in indicating the thickness of meat cuts they desired, one butcher cut strips of red paper in various widths and cemented them on the front of the showcase. The strips were numbered so that the customer could look at them and call off the number of the strip corresponding to the thickness of the meat cut desired.

Protecting the Face Against Orchard Sprays

When spraying trees with insecticides, it may be desirable to protect the operator's face. This can be done by fastening a piece of clear celluloid to the front edge of the operator's hat, and letting it hang down over the face. When the mask becomes covered with spray it is discarded and replaced with a fresh sheet.



ELECTRIC WIRING

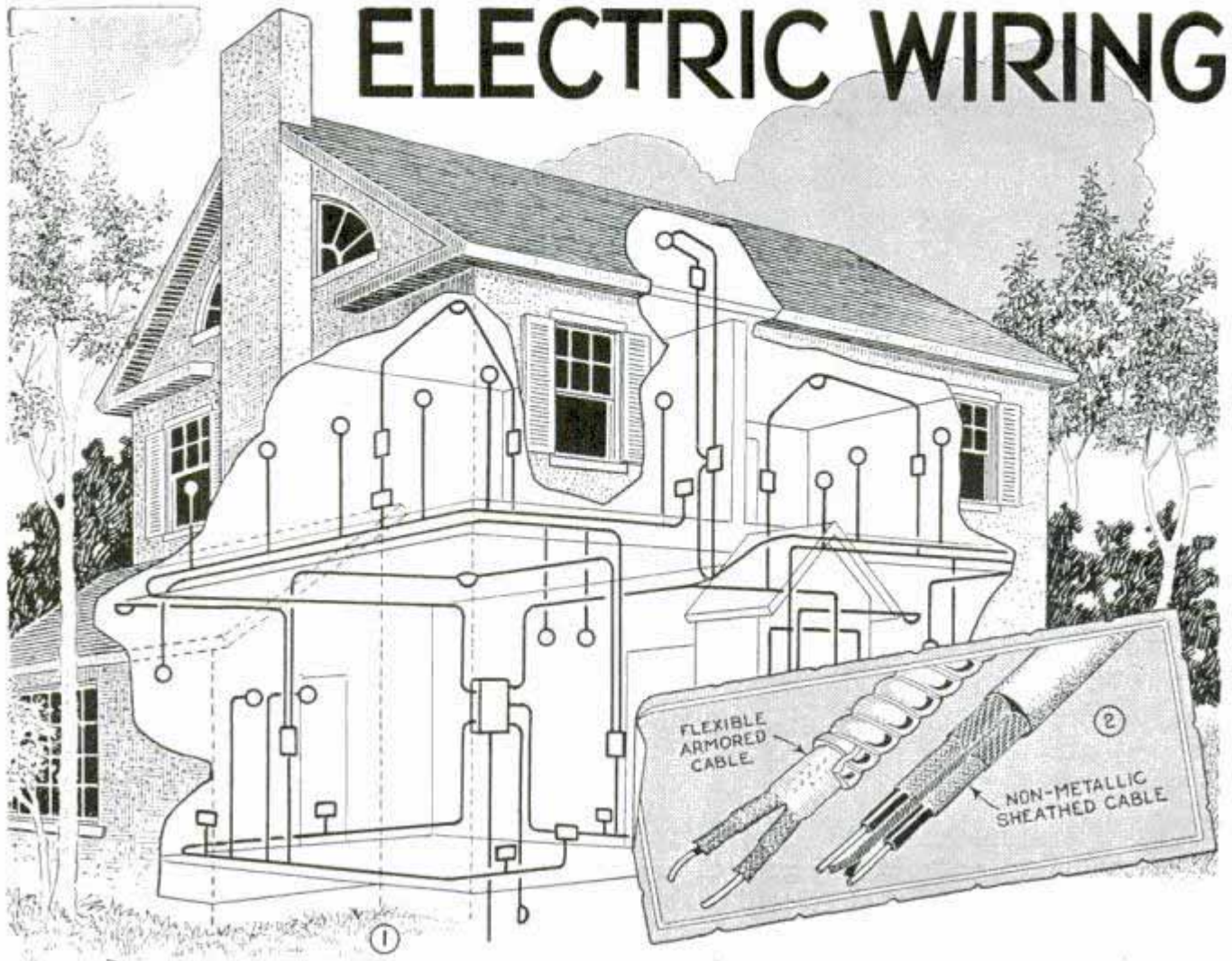

WHEN wiring old houses or adding new convenience outlets in houses already wired, it is first of all a job of careful planning to determine all the requirements including the location of the outlets, materials to use, wire size, load distribution and other factors. Then, it is just as important to do the work correctly in accordance with approved wiring practice to meet electrical and safety requirements.

Materials: For wiring an old house, the most convenient materials to use are armored cable, commonly known as "B-X," and non-metallic sheathed cable, Fig. 2. General installation methods are the same for both. Knob-and-tube and conduit installations are more difficult in finished buildings and will not be considered as they occasion considerable damage to walls and floors. Also, knob-and-tube work is not permitted in many localities.

Code Requirements: The National Electrical Code, published by the National

PART I

Planning the Installation and Arranging for Service Connections

By C. A. CROWLEY

Board of Fire Underwriters, gives minimum requirements for safe electrical installations. All recommendations contained in these articles

are in accord with the national code. However, some localities have additional restrictions and one should find out about these before undertaking a wiring job.

Types of Service: Service supplied by the power company may be alternating or direct current, usually the former at between 110 and 120 volts. Before making any plans, find out what type of service is to be used. In the case of both a.c. and d.c. there are two types of service commonly furnished; two-wire and three-wire. Fig. 3 shows the difference. Most power companies supply three-wire service, except for very small installations. The power company will install lines up to the house. From that point on the service connections (lines to the fuse boxes, including switches, meter, etc.,) are usually installed at the expense of the owner. The power company

in the HOME

lays down specifications as to type and size of equipment and its location.

Service Connections: The easiest, and in most cases the required method will be to inclose the wires from the power line inside rigid conduit, which is a special smooth pipe designed for holding electric wires. It is either galvanized or enameled. Ordinary pipe will not do. Conduit of the 1-in. size should be used for three No. 8 wires; $\frac{3}{4}$ -in. conduit will take two No. 8 wires. The conduit is run outside the building, where it is secured with pipe straps. A service cap of the type shown is installed at the top to keep out water. The conduit is bent into a curve of large radius where it enters the building as shown in Fig. 4.



All convenience outlets should be spaced the same distance from the floor for uniformity of appearance

The meter and main switch and fuses are often located in the basement, as close as possible to the service entrance. In some localities it is customary to install the meter outside the house to facilitate inspection, in which case special exterior equipment is required, which

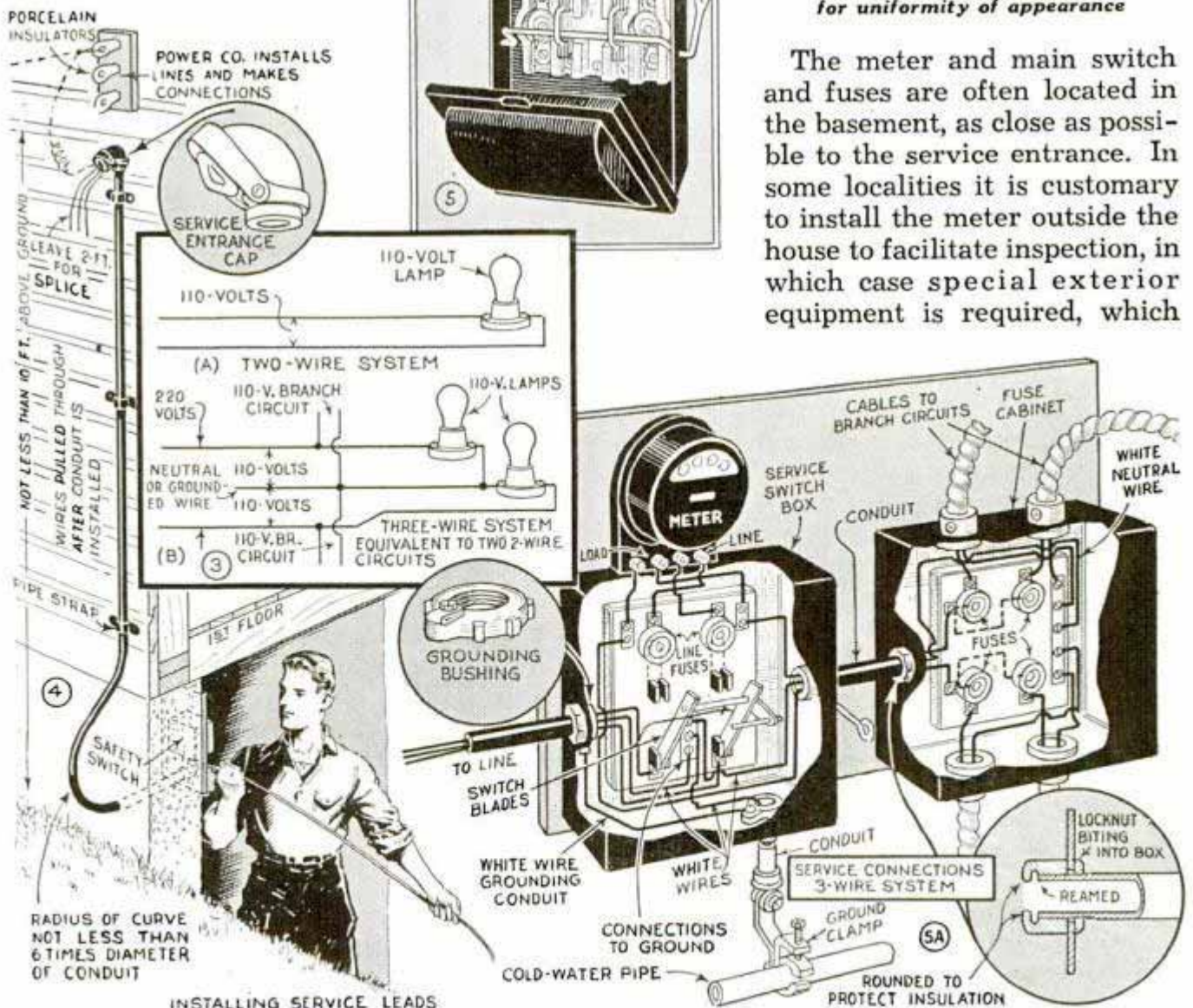

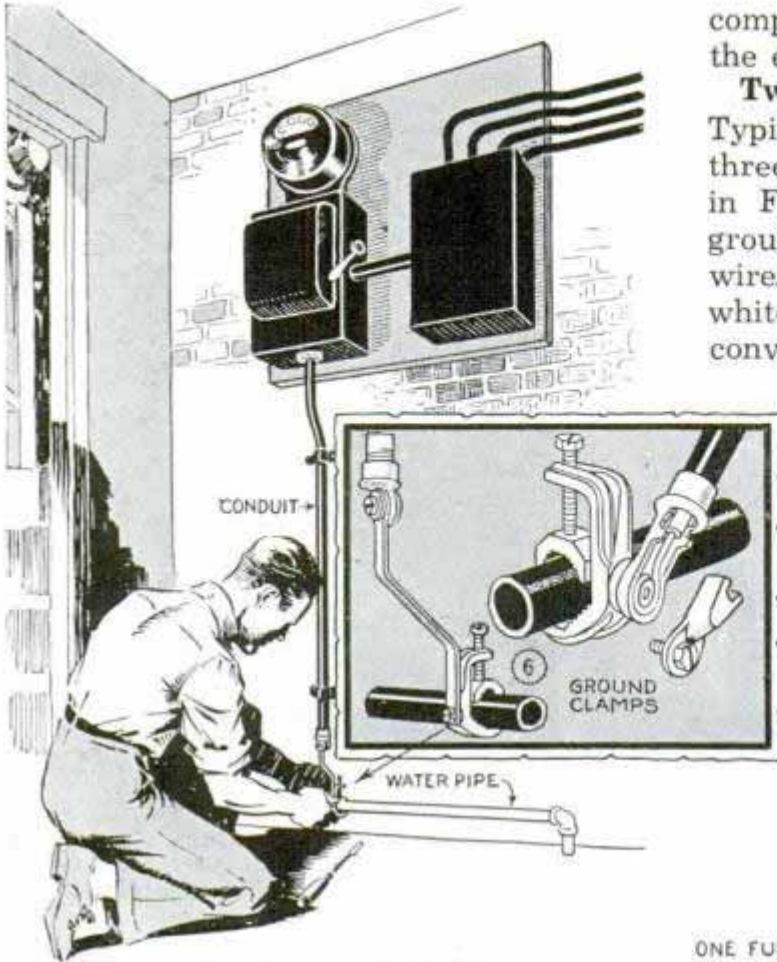

Effective grounding is accomplished by connecting a conduit from the switch box to a cold-water pipe by means of a special clamp

can be determined by consulting with the power company. For a basement installation, a board is nailed to the wall for mounting these units. The end of the conduit is cut off and threaded, leaving about $\frac{3}{8}$ in. to extend inside of the switch box. One of the numerous round depressions called "knockouts" is removed by a sharp blow with a screwdriver or hammer, and the hole is reamed to remove burrs. An approved safety-switch of the general type shown in Fig. 5 must be used. A locknut is put on the end of the conduit, the box is put in place, and a bushing is screwed onto the end of the conduit, as shown in a detail of Fig. 5A. The locknut is then tightened.

The wires are fished through the conduit by passing a light wire through the conduit, attaching the wires to it, and pulling them through. Usually, for average-size homes, the wires for service connections should be No. 8 rubber and cloth covered. One white and one or two black wires should be used. This size wire will carry a maximum load of 30 amperes. For larger loads, larger feeders are required. See Table I. As pointed out above, the power

company will generally specify this part of the equipment.

Two-Wire and Three-Wire Connections: Typical service connections for two and three-wire 110-volt a.c. or d.c. are shown in Figs. 5A and 7. The connections to ground, and the use of white and black wires should be noted in particular. The white wire always should be grounded for convenience in tracing. Grounding of all electric conduits and boxes is a matter of safety as it automatically causes a fuse to blow if a live wire accidentally touches exposed metal parts, thus preventing dangerous shocks and possible fires. For

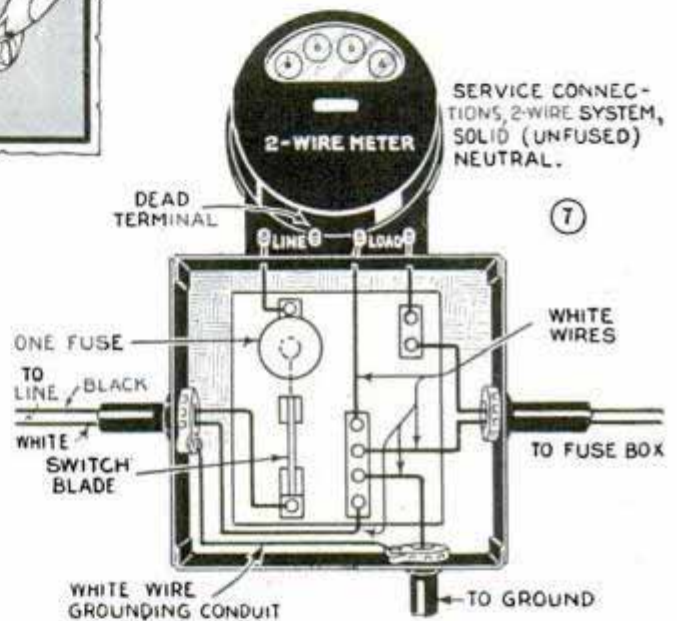

TABLE I—SERVICE CONNECTIONS

Wire Size	Fuse Size Amperes	Max. Load (Watts at 110 v.)	Minimum Conduit Size (in inches)		
			3-wire	2-wire	1-wire*
8	30	3,300 or 3,850	1	$\frac{3}{4}$	$\frac{1}{2}$
6	50	5,500	$1\frac{1}{4}$	1	$\frac{1}{2}$
4	70	7,700	$1\frac{1}{4}$	$1\frac{1}{4}$	$\frac{3}{4}$

* For grounding wire only, when required

grounding, a conduit is run from the switch box to a water pipe and clamped to the pipe with a ground clamp of the type shown in Fig. 6. A single No. 8 white wire is run inside this pipe and securely fastened to the terminal provided at the pipe. A No. 8 copper wire should be fastened to this conduit and also to the power-line conduit. The grounding bushing shown in a detail of 5A makes this easy. The wire inside the ground conduit is attached to the proper terminal on the switch.

Fuses and Meter Connections: The main-line fuses should be installed in the

box with the service switch. For most homes 30-amp. fuses are required. The connections to the meter are usually made by the power company. A short length of conduit can be run from the line switch box to the fuse cabinet, and the wires can be pulled through readily. Bushings and locknuts must be used. The fuse box or cabinet contains one fuse for each branch circuit. The neutral or grounded wire is continuous or unfused at all points. However, some localities require fusing the neutral wire also. The "hot" wire (black wires) are fused in all cases as shown. When a fuse blows, the reason should be located and eliminated. A fuse block for a four-branch circuit installation is shown in the circular insert above Fig. 10, while methods of wiring are shown in details A, B and C of Fig. 10. It is wise to get a fuse box larger than needed, to provide for future expansion.

Survey of Needs: Next determine the number and location of electrical outlets. By an outlet is meant any point at which

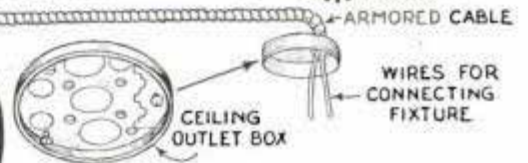
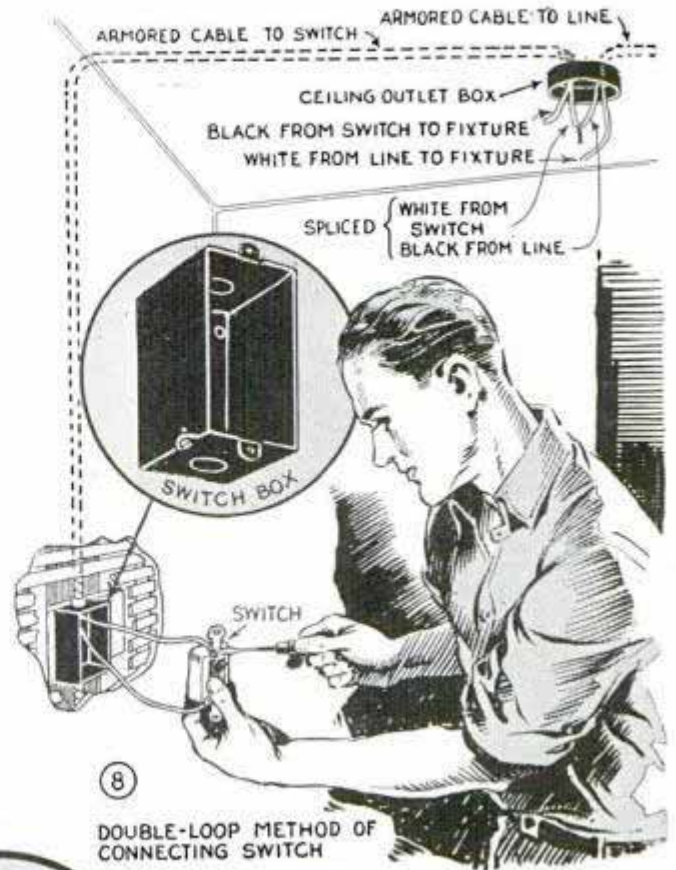

The double-loop and single-loop methods of connecting wall switches to outlets are shown in Figs. 8 and 9

electricity can be drawn from the line. This includes lighting fixtures, heating devices and machines that are permanently attached to the line, and convenience outlets for attaching portable lamps and apparatus. Switches are not counted as outlets. It is best to be rather liberal in planning outlets. There is no reason for omitting lights in any room, even closets. All ceiling lamps should be controlled by wall switches. Lights on stairways should be controlled by switches at top and bottom. Convenience outlets should be spaced about one every 10 ft. of wall space (counting doors and windows), in living rooms, and usually 15 to 20 ft. in bedrooms and dining room. It is best to locate them where particularly needed. Generally they are placed just above the baseboard. At least

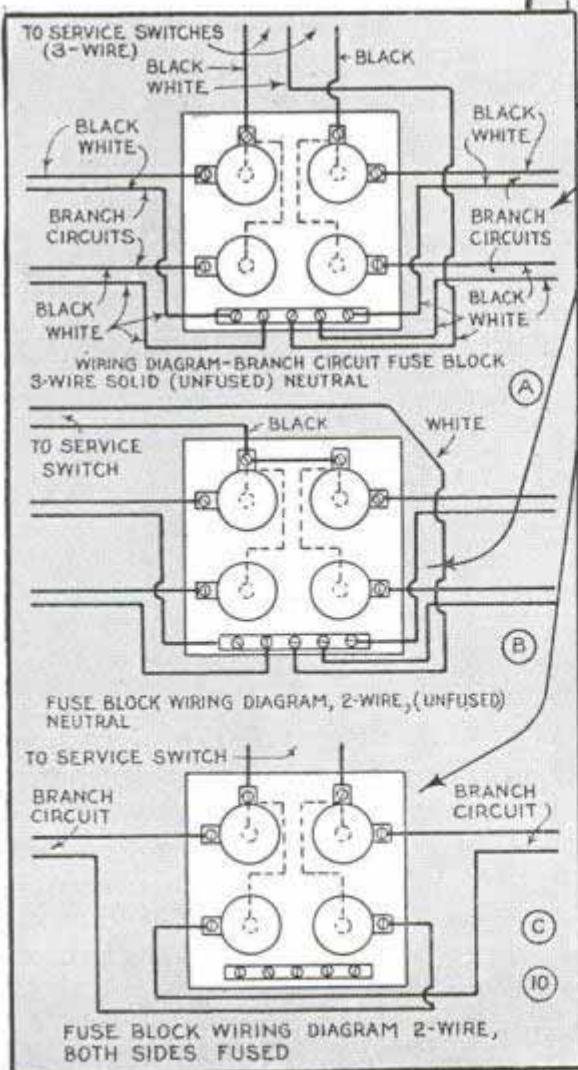

SINGLE-LOOP METHOD OF CONNECTING SWITCH

controlled by switches at top and bottom. Convenience outlets should be spaced about one every 10 ft. of wall space (counting doors and windows), in living rooms, and usually 15 to 20 ft. in bedrooms and dining room. It is best to locate them where particularly needed. Generally they are placed just above the baseboard. At least

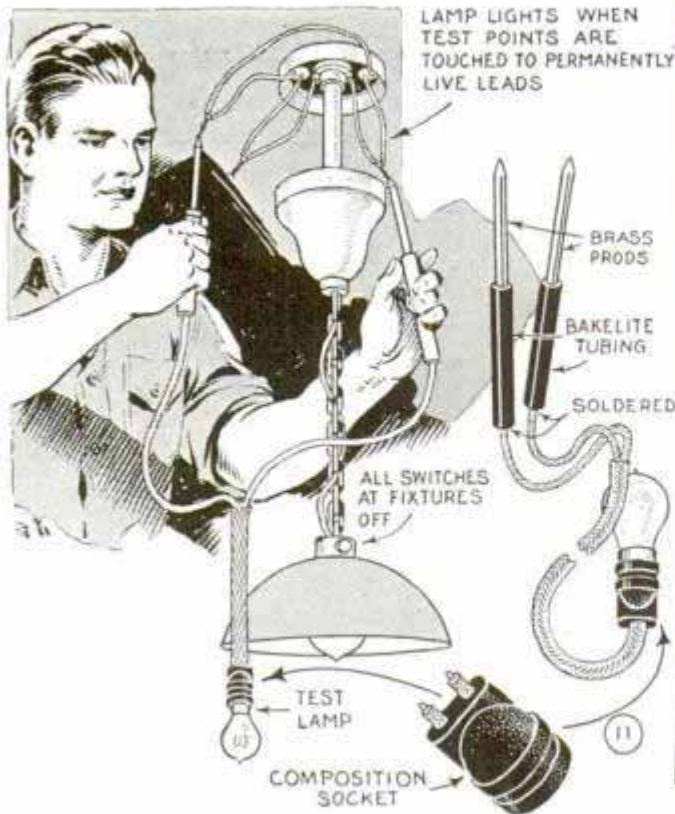

Locating live wires with test-prod and lamp assembly when adding new outlets to a branch circuit

TABLE II—WIRE SIZE FOR BRANCH CIRCUITS

Wire Size	Max. Safe Load (Watts—110 v.)	Use Fuse Size Amps.
14	1,650	15
12	2,200	20
10	2,750	25
8	3,850	35

two outlets should be provided in the kitchen and outlets in the basement should be located to care for washing machine, iron, mangle and workshop.

Branch Circuits: Each branch circuit usually feeds a number of outlets. In most homes all branch circuits are wired with No. 14 wire. The load on each branch circuit is therefore limited by the carrying capacity of this size wire, or to 15 amperes. In planning branch circuits, therefore, it is wise to limit the possible demand to a value below 15 amps. As most electrical appliances are rated according to power consumption in watts, and volts times amperes equal watts, the maximum safe load for No. 14 wires is 110 times 15, or 1,650 watts. Generally circuits are designed for an estimated load of 1,200 watts at most, as required in many cities. Frequently it is also required that no branch circuit include more than twelve outlets.

Generally it has been found that independent circuits should be used for the following devices or groups of devices: Oil

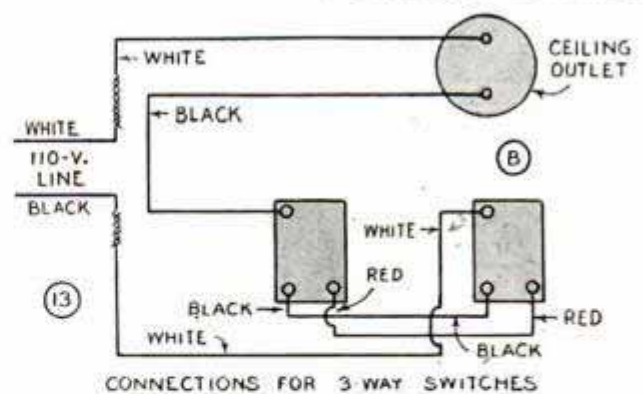
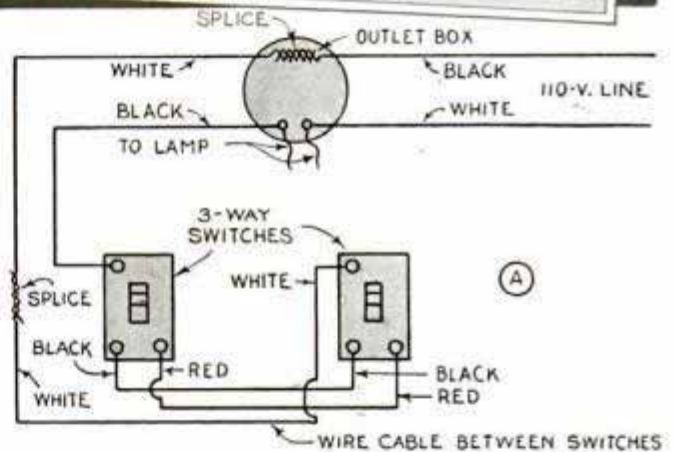
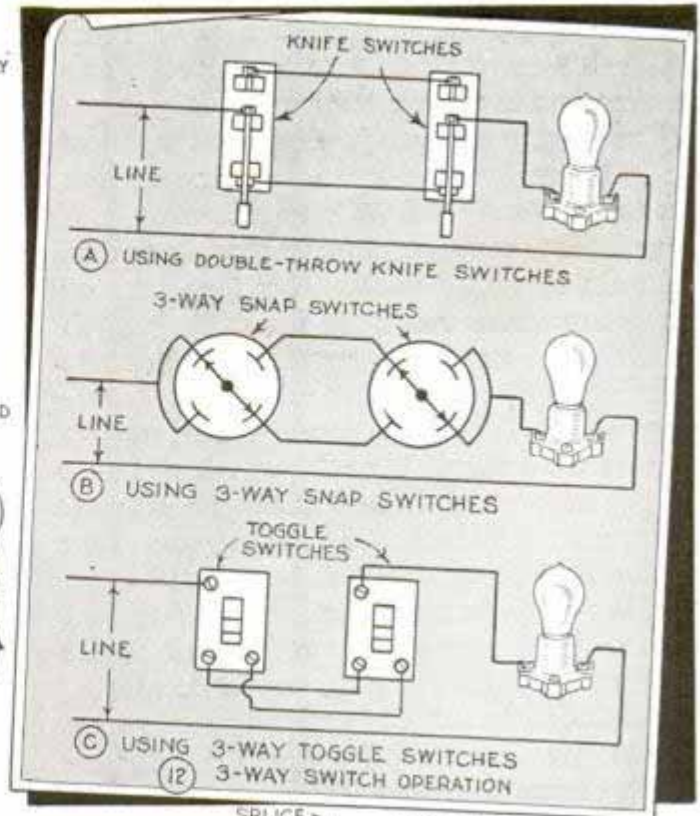

burners; laundry lights and outlet for washing machine or mangle; workshop lights and outlets for power-driven tools; refrigerator; any heating appliance drawing more than 1,000 watts; any apparatus with larger than 1/4-hp. motor. Should any appliance draw more than 1,500 watts, larger wire as specified in Table II will be required for its circuit.

In three-wire systems it is quite impor-

tant that the load be balanced or evenly distributed between the two legs of the circuit. There is a complete 110-volt circuit between each hot wire (black wire) and the grounded wire (white wire) of a three-wire system. The loads on these two legs should be approximately equal.

Connecting Wall Switches: There are two methods of connecting wall switches. In the double-loop method, Fig. 8, the hot and grounded wires are led into the outlet box. A cable is run from the outlet box to the wall switch and is connected as shown. Note particularly the use of the different colors of wire. The hot wire to the outlet box is black as usual. This is connected to the white wire leading to the switch. The black wire from the switch, which is hot when the switch is closed, and the white or grounded wire are then connected to the fixture.

The single loop is an alternative method which can be used where the double loop would be inconvenient. For example, if the lead to a fixture passes right past the site for the switch; or if the lead to a fixture must be brought up from below. Connections are made as shown in Fig. 9. The hot wire is broken before it comes into the outlet box.

Use of Three-Way Switches: Three-way switches are installed to act as illustrated in Fig. 12. They are always used in pairs so that lights may be turned on or off independently at two locations. The color scheme for single and double loop methods of connecting this type of switching circuit is shown in Fig. 13.

Locating Live Leads: When adding new outlets to a branch circuit, it is necessary to locate live wires into which the new lines can be tapped. To accomplish this, first open the switch at the meter, and then open an outlet box that you think will offer the desired leads. The tape is removed and the wires are separated carefully so that there is space of at least an inch between them and no chance of them touching each other. Then the main switch is closed and all other switches turned off. Each pair of wires is now touched with the prods of a test lamp, as in Fig. 11. If the lamp lights, the two wires it is touching are permanently hot and will serve as a starting point for the new connections.

(To be continued)

Platform Distributes Weight When Digging Postholes



Finding that his weight increased the tendency of sandy ground to cave in when digging postholes, a workman made a circular wood platform to stand on. This distributed his weight over a large area near the hole. An opening in the center of the platform permitted using the post auger.

—Opie Read, Jr., Chicago.

Eraser Snaps on Typewriter

Your typewriter eraser always will be at hand if it is attached to the machine with a large size snap fastener. One part of the fastener is soldered to the

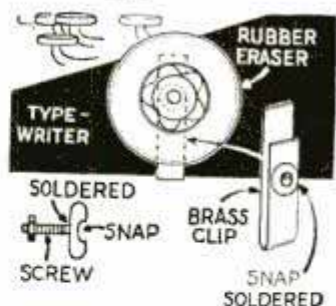

head of a screw, which fits a hole drilled in the typewriter frame. Or, if you do not want to drill in the frame, just solder one part of the fastener to a spring-brass clip, which can be slipped over some part of the machine. The other part of the fastener is similarly soldered to a screw, which is slipped through the hole in the eraser.

—Herman R. Wallin, New York, N. Y.

☞ If you form a deep depression in the center of your compost pile to catch and hold rain and snow, decomposition will be much more rapid.

Wood Silencer Stops Screeches When Filing Saw

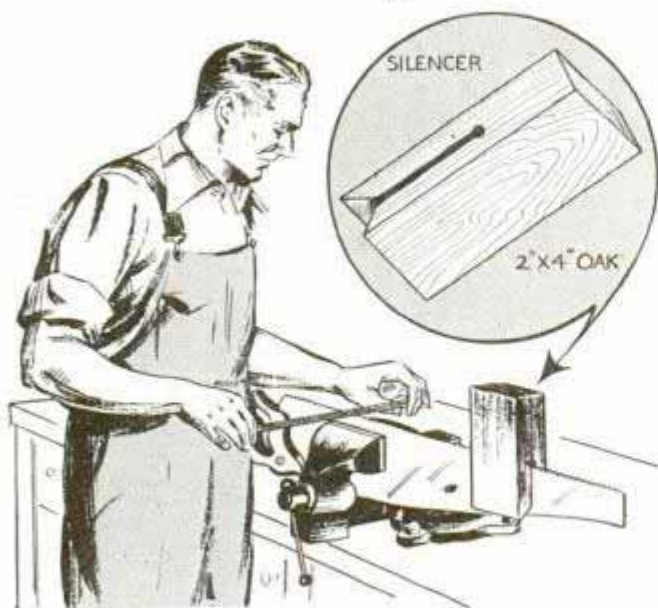

When filing saws, slip a giant "clothespin" of hardwood over the blade. This will dampen the vibration sufficiently to lower the pitch of filing to a point where it no longer irritates.

Newsboy's 'Stepped' Carrying Bag Displays Different Magazines

One newsboy who sold two or three different magazines divided his carrying bag into compartments with cloth partitions and stepped the bottoms of the compartments as indicated. This brought the titles of all the magazines into view.

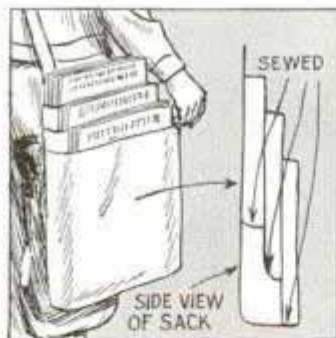

Removable Holders on Stepladder for Small Paint Cans

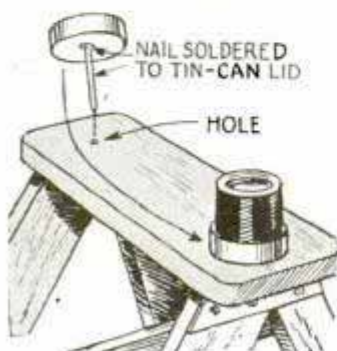

Sign writers who work from a stepladder need have no fear of small paint cans being accidentally knocked off the top if a few shallow can lids are carried in the

work kit. A nail is soldered to each can cover to fit a hole drilled in the ladder top. Small paint cans will even rest securely in these holders when the ladder is moved.

Clothespin Clip on Market Basket Holds Delivery Slip

To avoid possible error or delay in delivering groceries, by having the patron's order slip lost or removed from the basket, a grocer fastened a spring-type clothespin to the handle of each delivery basket with screws. After filling an order, the delivery slip was clamped in the clothespin.



Lantern Globes Cleaned Easily with Rubber Hose

Having a number of signal lantern globes to clean each day, one workman simplified the job by using a length of rubber hose to work the cleaning cloth around inside of them. The hose is split back from one end

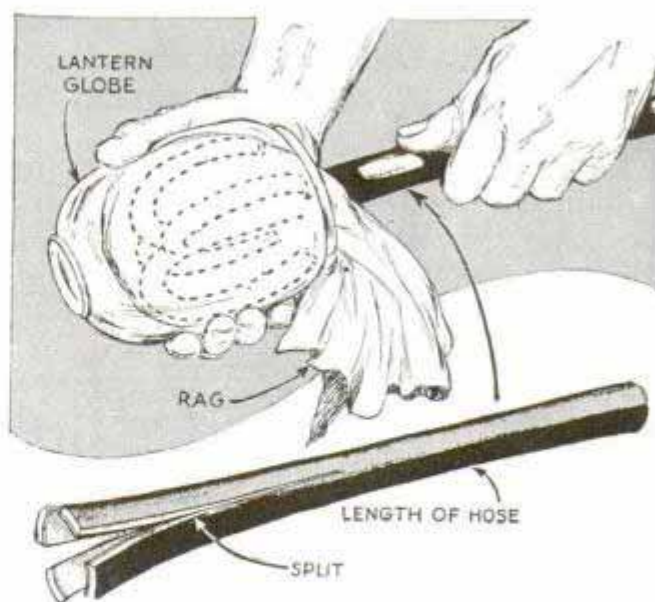

to provide four sections, which are doubled back as the cloth is pushed inside of the globe. These sections expand to press the cloth against the inside surface of the glass as the hose is turned.

Poultry Feeder and Waterer in Fence Corner

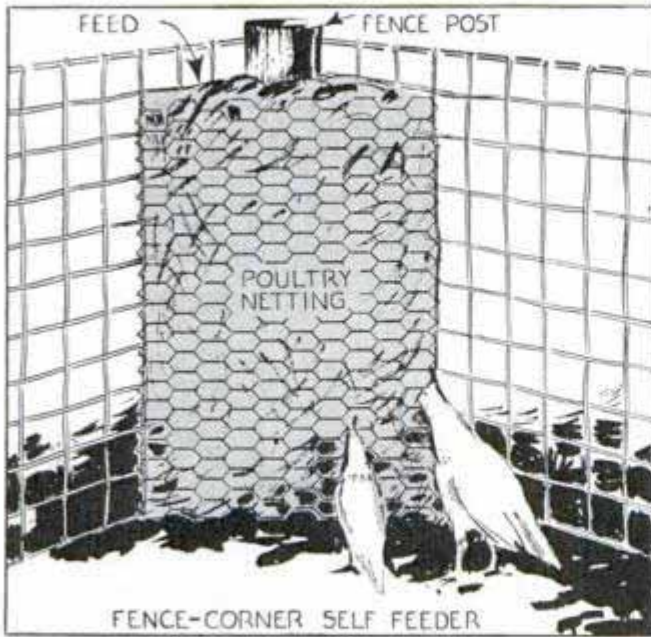

One poultryman saved space and made it easy to get at his chicken feeder and watering pan by mounting them in a fence corner. The watering pan was supported 4 or 5 in. above the ground on wood slats pushed through the fence as indicated, and wired or stapled in place. An inexpensive self-feeder for grass, chopped alfalfa, etc.,



was assembled by stretching a short piece of poultry netting across another corner of the fence. The green stuff is packed inside the three-cornered compartment. Both the feeder and watering pan can be filled without entering the poultry yard.

Log Is Anchored by "Staple" While Using a Crosscut Saw

Bent from an iron rod and pointed at the ends, this bracket takes the place of the usual ax or iron wedge to keep a log from rolling when supported on another log or

stump while using a crosscut saw. The bracket will not loosen easily, can be used on almost any size of log, and is sunk quickly into place with an ax or sledge. A slight pry with a strong stick will remove the bracket.

—C. W. Small, Meredith, N. H.

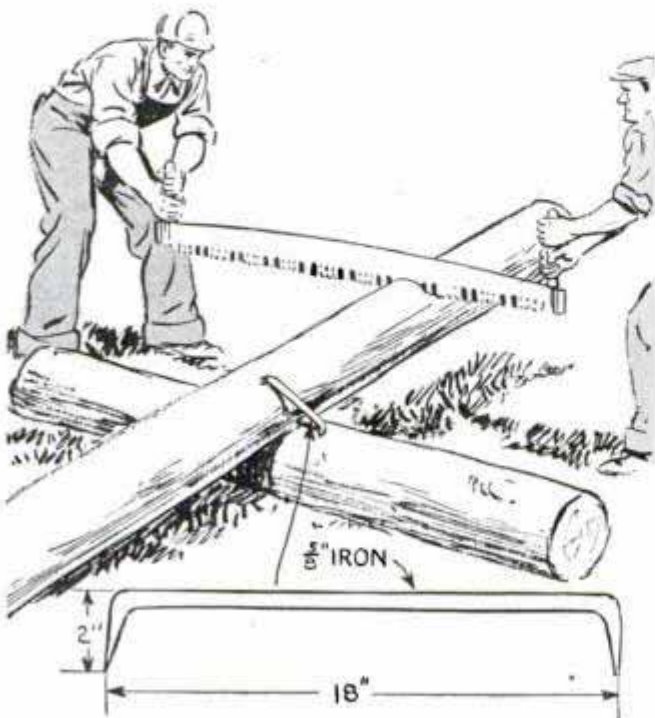

Can Opener Used as a Cutter for Package Room

Packages may be opened quickly with a can opener, which has been sharpened till it cuts string with slight pressure. It also remains in the department longer because the temptation to remove it is not so great as with a knife.

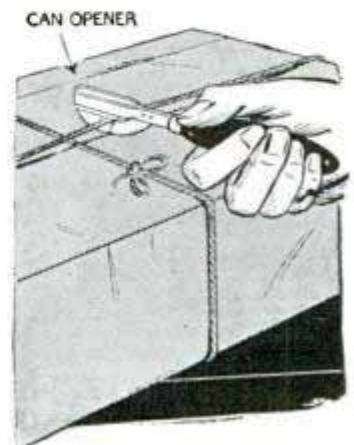

Stock-Tank Supply Pipe Attached Easily with Seat Spring



Instead of stooping to lay the end of his tank supply pipe on the well platform when it was removed from the pump, a farmer fastened it to a wagon-seat spring, which was bolted to a wood block. When he wanted to remove the pipe from the pump, he just pushed it down and to one side, reversing the operation to attach it when filling the tank.

—F. A. Tallen, Harrowsmith, Ont., Can.

Contents Gauge or Peek Hole for Boxes and Bins

When a gauge or peek hole is desired near the bottom of a large box or bin to determine when the contents are almost gone, it can be made easily from an old auto tail-light lens rim. A clear-glass disk is substituted for the old lens and the rim is screwed over an opening

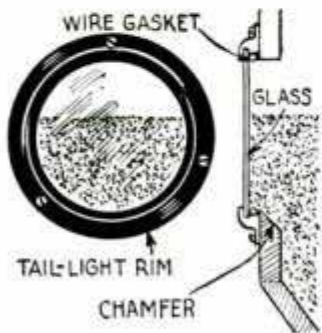

cut in the bin. A piece of insulated wire serves nicely as a gasket between the glass and bin. If the sides of the box or bin are

thick, the inside edges of the opening can be beveled to prevent the contents from lodging in the opening.

Spring under Drill-Press Table to Avoid Dropping Drills

Accidental dropping of drills through the center hole of a drill-press table when released from the chuck, can be avoided by attaching a length of clock spring under the table to cover the hole. The spring does not interfere with the regular use of the hole as it will flex under pressure of a drill.

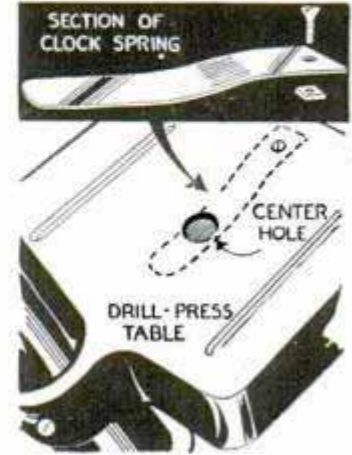

'Harness' to Remove Buried Rocks with a Horse

This harness and a horse to remove partly buried rocks when clearing a field, will save labor. The harness consists of a T-shaped assembly of pipe pointed at one end, and a length of heavy chain with a large ring welded in the center. To move a rock, put the harness around it, insert the point of the bar through the ring into the ground at an angle next to the rock, and the horse will move it.

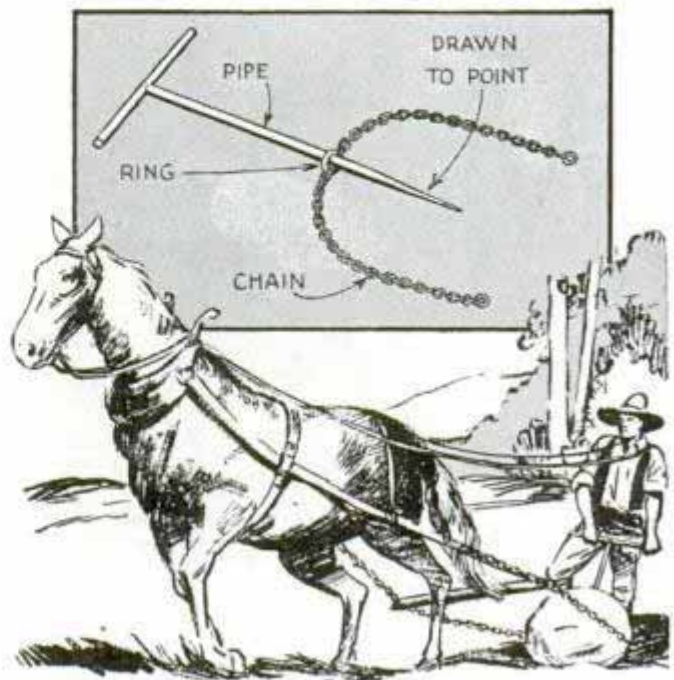

Helps for the AUTO MECHANIC

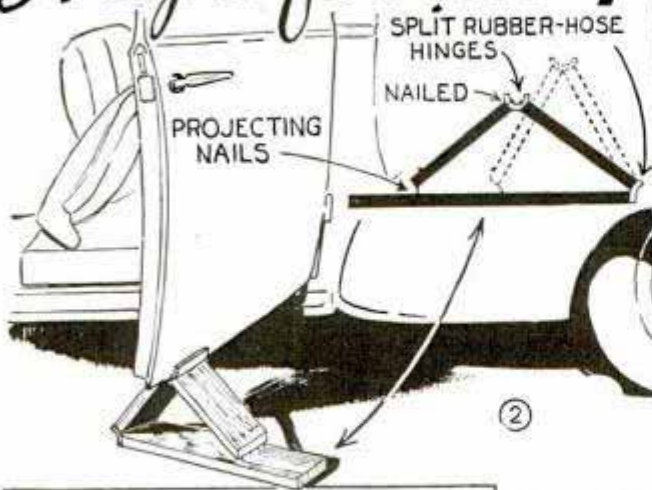

Three wooden blocks hinged together with split rubber hose as in 2, form jack to hold doors rigidly in opened position while repairing locks and windows

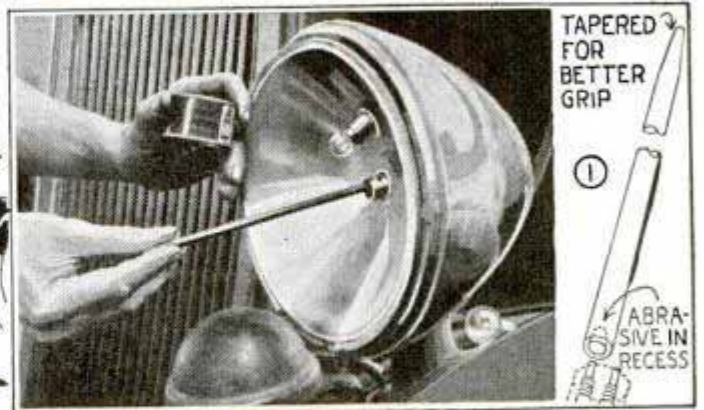

1, spring contacts in lamp sockets cleaned with $\frac{1}{4}$ -in. dowel of which one end is recessed to hold valve-grinding compound. 3, trouble-lamp cord has sliding sleeve to protect car finish against grease-and-dirt covered cord. Sleeve is moved to plug end of cord when not in use

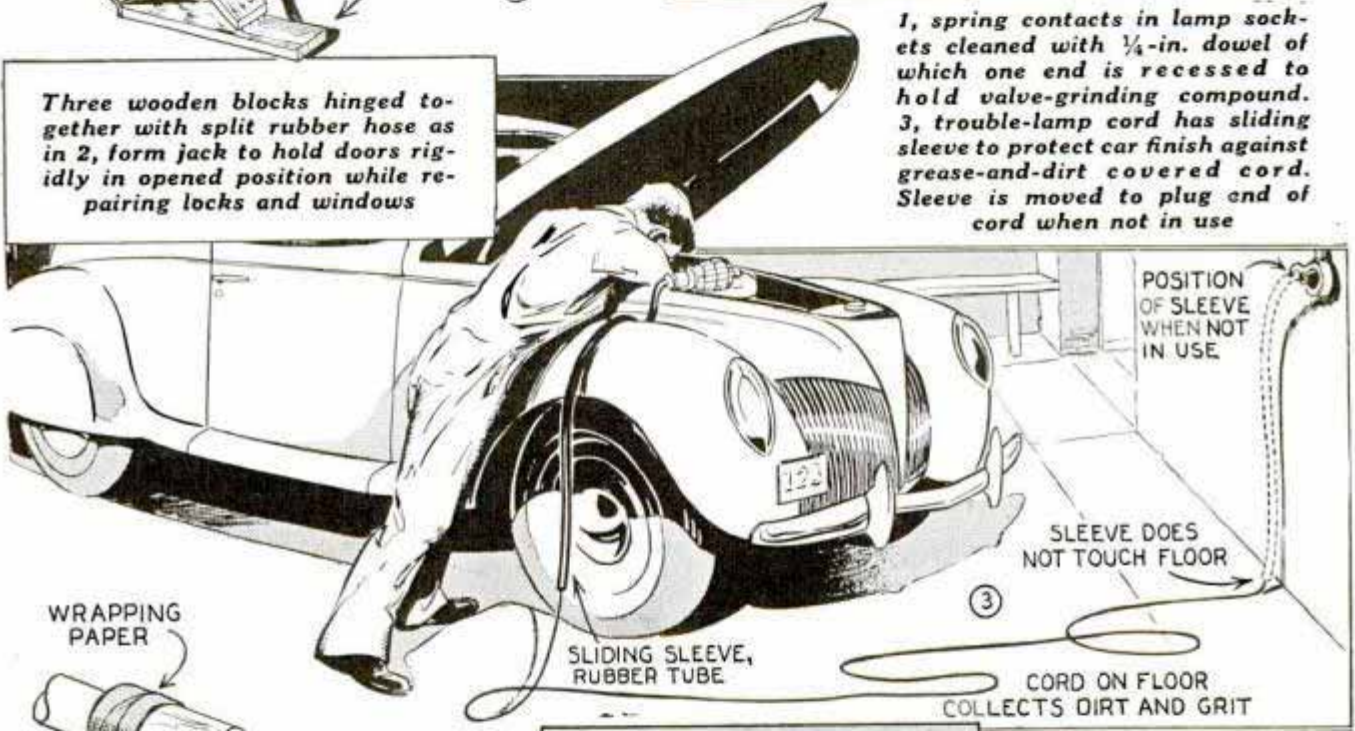

POSITION OF SLEEVE WHEN NOT IN USE

SLEEVE DOES NOT TOUCH FLOOR

CORD ON FLOOR COLLECTS DIRT AND GRIT

SLIDING SLEEVE, RUBBER TUBE

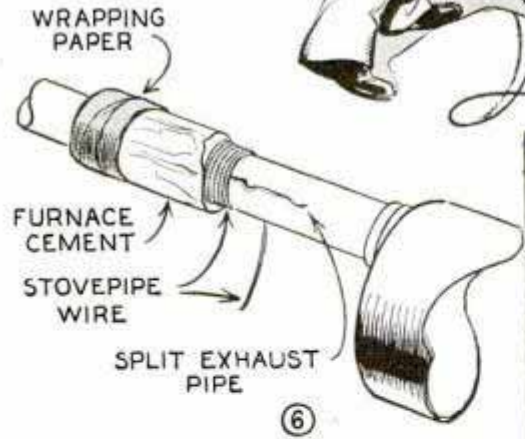

WRAPPING PAPER

FURNACE CEMENT

STOVEPIPE WIRE

SPLIT EXHAUST PIPE

6

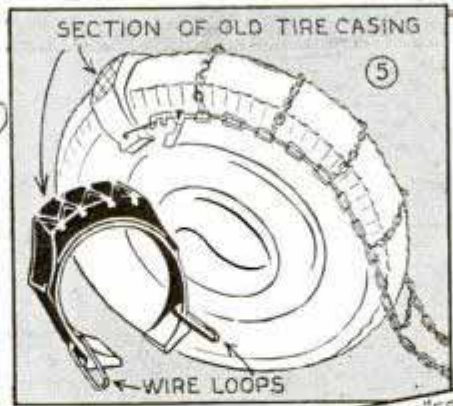

SECTION OF OLD TIRE CASING

5

WIRE LOOPS

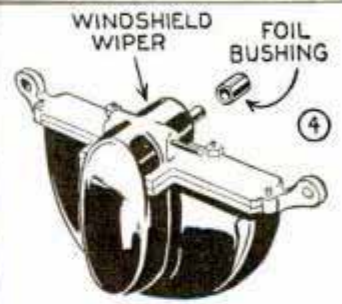

WINDSHIELD WIPER

FOIL BUSHING

4

Air leakage around the bearing of a worn shaft on a vacuum windshield wiper can be stopped often by inserting a bushing formed from tinfoil as in 4. A section of old tire provides a handy clamp for the end of a skid chain when "rolling" it on the wheel as in 5. You can repair a cracked exhaust pipe by wrapping it tightly with stovepipe wire and covering with furnace cement as in 6. A paper wrapping holds the cement until it sets, after which the paper is removed. Tappets cupped by wear can be spaced with strips of paper having a combined thickness equal to the desired clearance. When a feeler gauge is used, it bridges the cupped end as in 7 and gives inaccurate spacing

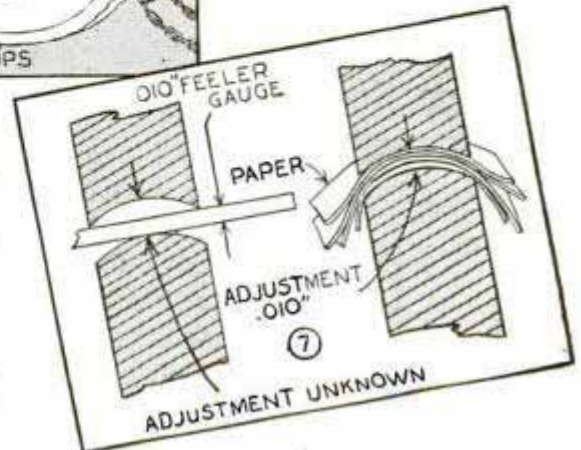

.010" FEELER GAUGE

PAPER

ADJUSTMENT .010"

7

ADJUSTMENT UNKNOWN

Small Vise Grips Copper Tubing without Crushing It

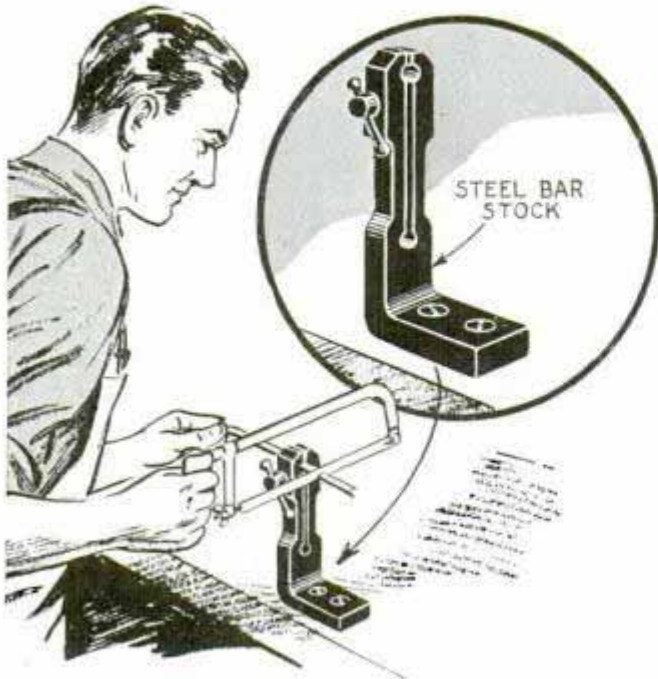

Mechanics who work with copper tubing will find this simple vise just the thing for holding it. Pressure is applied uniformly around the tubing so that there is practically no danger of crushing it if reasonable care is exercised.

Gasoline Wash Pan Set in Drum Prevents Tipping

When a pan of gasoline is kept on a workbench for cleaning small parts, the risk of tipping it over accidentally is minimized if it is set in an old brake drum. The pan should be of a size to fit into the latter without too much clearance at the sides.

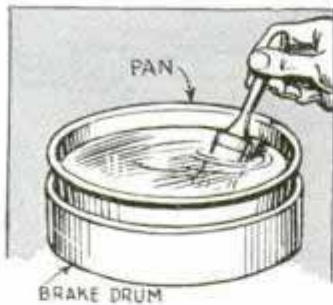

Hot Ignition Coil Affects Motor

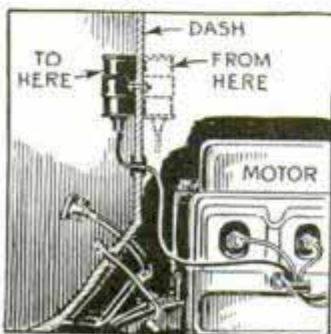

A motorist whose motor missed after it heated up found that the trouble was caused by the coil, which failed to work efficiently when it was

warmed by heat from the motor. To correct the trouble, he removed the coil from under the hood and placed it inside the dash, drilling a hole through the latter and insulating it with a fiber tube to take the wires from the coil to the motor.

—John Wiesemann, Delair, N. J.

Beading Around Door Shielded with Aluminum Sleeve

Scuffing of the cloth beading around the door in getting in or out of your car, is avoided by fitting an aluminum guard over the beading. The

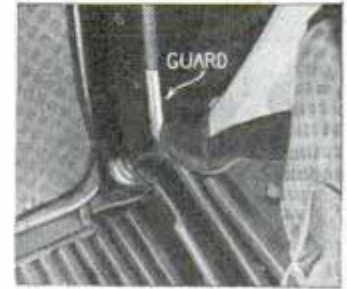

guard is fastened under the nails or screws that hold the beading in place.

—Burl Knutson, Bismarck, N. D.

Inefficient Starter Operation Caused by Bad Grounding

On some cars that have rubber engine mountings, a flexible copper strap is used to ground the motor to the frame. Wearing or breaking of this strap by vibration often results in inefficient starter operation, the latter being barely able to turn over the motor with a well-charged battery. Such trouble can be overcome by grounding the starter housing to the car frame with a piece of battery cable long enough to allow the car motor to vibrate freely.

Installing New Vacuum Hose on Windshield Wiper

If you have to install a new hose on a windshield wiper, fasten it to the end of the old one and it will be pulled into place as the old hose is pulled out. A good connector is made by cutting the head off a stove bolt, which should be larger than the inside diameter of the hose. Slot the end of the bolt and drive it halfway into the end of the new

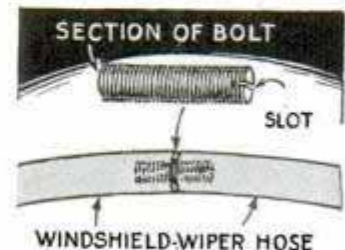

connector is made by cutting the head off a stove bolt, which should be larger than the inside diameter of the hose. Slot the end of the bolt and drive it halfway into the end of the new

hose. Then force the end of the old hose over the projecting end. It is a good idea to lubricate the outside surface of the new hose with talcum or soapstone so that it will slide through the passages easily.—W. C. Wilhite, Carlinville, Ill.

Nut Started on Bolt with Bad Threads

When the threads on a bolt fitted with a castellated nut become battered, the nut can be used as a die to clean the threads. To do this, spread the castellated end of the nut slightly with a tapered punch or drift and then drive the castellated end of the nut onto the threads. When this has been done, remove the nut and you can drive it on in the regular way. If the threads have been damaged quite badly, put a little valve-grinding compound on them before starting the nut, and then work it back and forth carefully to allow the compound to reshape them.

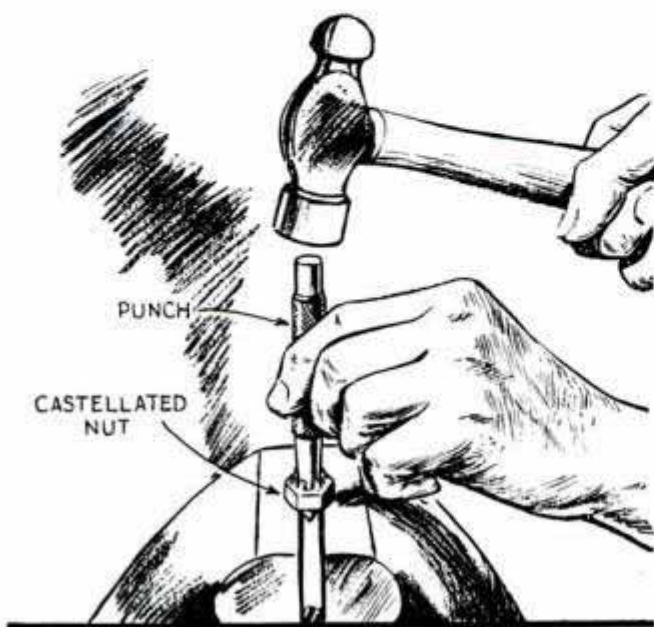

Folding Picnic Table in Car Stores Your Food and Dishes

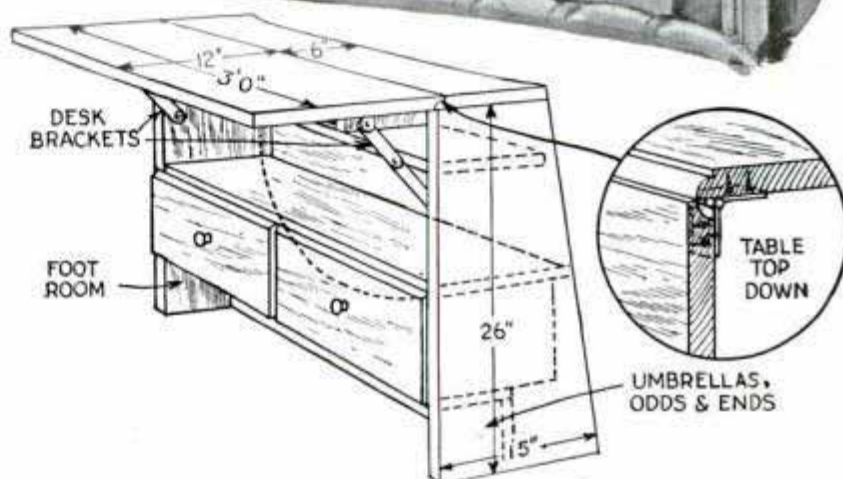

Crawling insects, damp ground and other inconveniences will not detract from the enjoyment of a picnic lunch if you have this cabinet in your car. It fits snugly on the back of the front seat and does not reduce foot room. Inside the cabinet you can pack all the necessary things for a picnic lunch where they are out of the way and protected from sun and dust. When a place to park is found, lift the lid which covers part of the cabinet front and it serves as a table. Beneath the lid are two drawers that can be removed and taken into the "kitchen" when the lunch is being made up, thus doing away with a cumbersome hamper. Another advantage is that things placed in the drawers remain right side up.

When removing carbon from a motor, the last few threads of a spark-plug hole can be cleaned with an old "long-reach" plug. Remove the center electrode and file or saw three vertical slits in the threaded part so that the plug, when screwed in carefully, will act as a tap and clear the threads without jamming.

Adjustable House-Trailer Brace Is Strong and Inexpensive



Three lengths of 2 by 4-in. stock is all you need for this trailer brace, which, because of its long base, will hold well even on soft ground. Notches at both ends of the base permit adjustment. Two braces can be carried underneath the trailer on U-shaped hangers bent from flat iron.

Removing Motorcycle Battery

Solder or weld wing nuts to the nuts that tighten the holding straps of a motorcycle storage battery and you can remove it without wrenches. The wing nuts should be bored out to clear the threads of the holding bolts.

Edge of Door Catch Filed Off to Take Up Wear

When a door catch has been taken up as far as possible and the door still does not close tightly, remove the catch and file off the edge so that it can be moved over farther. It may be necessary to lengthen the screw slots to do this.

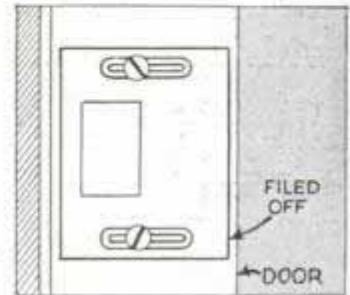

Speedy Model Boat Travels Circular Course



This 32-in. motorboat, powered by midget gas engine, develops speed of 20 to 25 m.p.h. on circular course. Set of four blueprints, Nos. 965 to 968 inclusive, which includes full-size frame patterns and all necessary constructional details, will be sent postpaid upon receipt of a \$1.00 remittance.

OTHER SUMMER PROJECTS

- DUTCH WINDMILL AND WATER WHEEL—911:** Mill, 40 in. high. Small water wheel. 25c.
- BARROW CHAIRS—924:** Two styles. Built for comfort. Simple construction. 25c.
- ORNAMENTAL WOOD FENCES—640:** Five artistic designs for standard wood stock. 25c.
- LOG CABIN CONSTRUCTION—916:** Two floor plans. Shows how to make corner joints. 25c.
- OUTDOOR FIREPLACES—917:** Several simple, but practical types, to match other items of a rock-garden setup. 25c.
- SPEEDY MOTOR SCOOTER—989 and 990:** Easily assembled on an oak-plank chassis. Gas engine of the washing-machine type drives scooter 40 to 60 miles on gallon of gas. (2 prints) 50c.

Any six of these plans (not projects) will be sent postpaid upon receipt of \$1.00

- 15-FT. ROWBOAT—644:** Flat bottom, all purpose. Heavy transom provided for outboard motor. 25c.
- SURFBOARDS AND SKIBOARD—701.** 55 and 70 in. surfboards. Skiboard is driven by small outboard. 25c.
- 16-FT. CANOE—811 and 812:** Cedar planking covered with canvas. (2 prints) 50c.
- 12-FT. SAILBOAT—524 and 525:** Flat bottom, center board type. (2 prints) 50c.

CATALOGUE OF 400 PLANS

If you have a home workshop and want some new ideas on things to build, just send your name and address with a 3c stamp for our 32-pp. illustrated plan catalogue. Lists plans on workbenches, motor-driven machines, garden furniture, models of all kinds, boats, radio equipment, juvenile articles, etc.

Blueprint Department, Popular Mechanics Magazine, 200 E. Ontario St., Chicago

KODAK PRICES SHARPLY REDUCED



New Eastman Plant, extensive addition to camera factory already the largest in the world, as it will appear when completed. Here will be produced the finest precision cameras, made by the largest group of American craftsmen ever assembled in the photographic industry.

Building an addition to the world's largest camera works means substantial savings on practically entire 1939 Kodak line

IT SEEMS that all America is making pictures. Wherever you go, you see more and more people carrying cameras. To meet this present greatly increased camera demand—and with an eye to the future—Eastman is now building an addition to the largest camera works in the world.

Facilities never known before will cut manufacturing costs. In a sweeping reduction, Kodak prices are now brought in line with these lower production costs to come. These savings to you apply on the newest and most popular models of the 1939 Kodak line. And they come to you in time to be ready for this year of World's Fairs and

unusual vacation opportunities—the greatest picture-taking year to date.

Own a brilliant, versatile, modern camera, Eastman quality throughout, at a price much lower than you expected to pay. See your Kodak dealer now . . . Eastman Kodak Company, Rochester, N. Y.

Going to the New York World's Fair?

Be sure to take your Kodak. Stop at the Kodak Building, where Eastman experts will advise you what to take and how to take it. And there you'll see the unique and gorgeous Cavalcade of Color—the *Greatest Photographic Show on Earth*. Nothing like it has ever been seen before. Don't miss it.

EXAMPLES OF THE PRICE REDUCTIONS

KODAKS

	WAS	NOW
Kodak Junior Six-20, Series II, Single lens	\$8.75	\$7.75
Kodak Junior Six-20, Series II, Bimat lens	11.00	10.00
Kodak Junior Six-16, Series II, Single lens	10.25	9.25
Kodak Junior Six-16, Series II, Bimat lens	12.75	11.50
Kodak Senior Six-20, K. A. f.7.7 lens	17.00	15.00
Kodak Senior Six-20, K. A. f.6.3 lens, Diomatic shutter	21.00	19.00
Kodak Senior Six-20, K. A. f.4.5 lens	28.00	25.00
Kodak Senior Six-16, K. A. f.7.7 lens	19.50	17.50
Kodak Senior Six-16, K. A. f.6.3 lens, Diomatic shutter	24.50	22.50
Kodak Senior Six-16, K. A. f.4.5 lens	32.00	29.00

MINIATURES

	WAS	NOW
Kodak Bantam, K. A. f.6.3 lens	\$9.50	\$8.50
Kodak Bantam, K. A. f.5.6 lens	16.50	14.00
Kodak Bantam, K. A. Special f.4.5 lens	27.50	22.50
Kodak 35, K. A. f.5.6 lens	18.50	14.50
Kodak 35, K. A. f.4.5 lens	29.50	24.50
Kodak 35, K. A. Special f.3.5 lens	39.50	33.50
Kodak Duo Six-20, Series II, K. A. f.3.5 lens (Compur-Rapid shutter)	57.50	52.50
Kodak Retina II, Anastigmat f.2.0 lens, Compur-Rapid shutter (with field case)	140.00	120.00

CINÉ-KODAKS

Ciné-Kodak Eight, Model 20, f.3.5	32.50	29.50
Ciné-Kodak, Model K, f.1.9 (without case)	88.50	80.00

Be sure to see your Kodak dealer about these remarkable price reductions.

Flying Box Cars

(Continued from page 37)

the freighter is its loading facilities. Getting a bulky load through a small hatch is always a problem in today's make-shift aerial box cars and Howard solves it by cutting his fuselage in two, hinging the tail group so that it swings away to one side and exposes the rear dimensions of the main cargo space. The cargo hold measures seven by seven by twenty-two feet. Automobiles, tractors, or even army tanks can be driven up a short ramp into the body of the plane. Control cables for the tail group are carried along the hinged side of the fuselage and the whole assembly locks back into place when cargo has been stored inside and secured.

Another entry in the flying freight picture is planned by Charles H. Babb, international airplane broker, based on his years of experience in converting and selling old passenger craft for use as freighters abroad. Babb's flying truck is an airplane stripped down to bare necessities and will cost about half the price of a new passenger air liner. It is designed with an eye on the foreign market where hours of operation are considerably fewer than in the United States due to lack of lighted airways and incomplete radio and weather services. Fewer possible revenue hours per year imply low maintenance costs and high depreciation costs, a special situation that Babb will solve on demand by making available inexpensive rebuilt engines, propellers and instruments.

Babb's plane is an all-metal twin-engined high-wing monoplane with tricycle landing gear, 100 feet along the wing with a sixty-five-foot fuselage. Much larger than Howard's design, the plane is intended to carry a normal pay load of 11,500 pounds and to cruise at 170 miles per hour over a range of 1,000 miles. The fuselage represents a circular cargo space that carries straight through the plane without obstructions, the pilot's cockpit being positioned above the cargo area. Applications have been made for patenting numerous parts of the design.

Loading is accomplished by unhinging the nose and swinging it to one side, exposing the forward end of the cargo hold. Loading is facilitated by the level position of the plane, its closeness to the ground,

the use of a short loading ramp, and mono-rails and electric hoists for pulling cargo into the plane and handling it into position.

Other entrants in the field are two new Douglas ships. One of these, the "DSC," is a typical Douglas air liner resembling the "DC-2," stripped down and modified for freight service. Known as a super-cargo transport, the type has been used by the Army Air Corps for freight and cargo hauling for a number of years. The "DSC" is a twin-engined, low-wing monoplane that cruises at just under 200 miles per hour and carries a useful load of 7,335 pounds. Wing loading is twenty-two pounds per square foot. The plane is complete to automatic pilot, radio, and other safety devices.

The main cabin is thirty-three feet long, five and a half feet wide, and six feet three inches high. The cabin walls are sheathed with corrugated sheet metal and numerous tie-downs are provided for fastening loose pieces of cargo in place. Metal tracks on the floor permit rolling or skidding heavy articles into position. A wide loading door is located at the after end of the cabin on the left side. The cargo gear includes a flat loading platform that attaches to the jamb of the main loading door, and an overhead tripod that fits into the fuselage roof to support a chain hoist for hauling cargo in and out of the plane.

The other new Douglas, the "DC-5," is a high-speed twin-engined monoplane, fitted with a high wing and retractable tricycle landing wheels. The plane was designed either for short-range air-line operation or for cargo hauling. It is built to get in and out of small airports easily and has unusual stability at low flying speeds. At sixty per cent of power on a 500-mile trip the plane can carry sixteen passengers and a crew of three, or a pay load of more than three tons when fitted as a freight carrier. It has a top speed of 248 miles per hour.

Flying the freight, Howard says, won't be the humdrum service you might think, either. The freight runs may prove to be the guinea pigs of air transportation, a service on which all the new devices and developments of aviation can be tried out before they are adopted as standard equipment on passenger liners.

...plenty of **VELVET**
and plenty of time
*best vacation for
man and pipe*



*Better
smoking
tobacco*

Velvet

- for **MILDNESS**
fine old
Kentucky Burley
aged in wood
- the **FLAVOR**
of pure maple
sugar for extra
good taste

*Velvet packs easy in a pipe
Rolls smooth in a cigarette
Better tobacco
for both*

IF YOUR GIRL HAD HER WAY—



YOU'D HAVE A BARBASOL FACE

There's a woman's side to shaving, you know.

And that's how a man appears to her, after he's shaved.

With Barbasol, your skin is cleaner looking and smoother to touch. No half-cut stubble.

For with Barbasol you shave the whiskers off close, right at the skin line, easily, comfortably.

How modern and wonderful Barbasol is, compared with the old-fashioned method that tends to dry, irritate and roughen. Barbasol leaves your skin softer, finer, younger looking.

That's why the women like a Barbasol Face.

Why not make today the day to start using Barbasol? The easiest, quickest, cleanest shave you ever had! And within several weeks, a skin so greatly improved, you'll be pleased as punch.

Your druggist carries Barbasol in three sizes. Large tube, 25¢. Giant tube, 50¢. Family-size jar, 75¢. Barbasol Blades, 5 for 15¢.

For Modern Shaving



No Brush • No Lather • No Rub-In.

Modern Sherlocks

(Continued from page 95)

hol, the flakes proved to be the same paint as that of the fender. The jury was convinced.

When the nature of a textile is an essential part of the evidence, it is submitted to burning or ignition tests, fluoroscopic, microscopic and chemical analysis. Animal fibers, such as wool, burn slowly with a pungent odor like feathers; vegetable fibers like cotton burn quickly with little or no odor.

Infrared light has long been used to detect differences in ink on questioned documents. In one instance infrared photography solved a baffling burglary. The intruder had knocked to the floor a red card and stepped on it. To the naked eye the footprint on the card was indiscernible. But the infrared picture of the card brought out clearly the outline of the shoe where its pressure had picked up infinitesimal bits of dust from the carpet. Infrared light accentuated the difference in reflective power of the dust and the red card. It has even been suggested that, although fantastic, it might be possible to guard valuables by arranging a motion-picture set-up that would take infrared pictures of an intruder entering a dark room.

Although not yet accepted in all courts, the polygraph or "lie detector" has become one of the most depended-on tools of the criminologist. Basically a medical instrument, it graphs the emotions of the "patient" in terms of blood pressure, pulse, respiration and muscular reflexes while he submits to questions. There's no use trying to fool it. One defendant thought he would pull a fast one by remaining silent whenever any specific questions about the crime were asked. He might as well have talked. The needle of the polygraph jumped out of bounds in token of the prisoner's guilty conscience.

Two bank-robbery suspects took the lie detector test and it indicated they were innocent. Three witnesses, however, swore they saw the crime committed and identified the pair as the robbers. The prosecutor succeeded in barring the lie detector's evidence from court, but two days later the real robbers confessed. If the

polygraph can't talk to a jury, it can help investigators in collecting evidence, disproving charges and wringing confessions.

Like the lie detector, scopolamine—the "truth serum"—has not won admittance to all trial courts but it, too, is a potent tool of the scientific detective. Not a serum at all, it is a drug under whose influence the conscious mind is "suspended" and the "truth must out."

Scopolamine brought a strange denouement to one murder case on record. A man was found dead under suspicious circumstances. His widow called it suicide, but skeptical police arrested a man with whom she had been friendly. He disclaimed any connection with the supposed murder and readily agreed to be questioned under the "truth serum." Even under its influence he insisted he did not kill the man, but confounded the police by saying he had thrown the pistol in the river and covered the body with branches. Something was wrong here; the man had been found dead in bed, the pistol at his side. When the question was repeated, the suspect said he had hidden the gun in a field of heather in a Canadian province.

When he returned to full consciousness and was asked about a murder in Canada, he turned pale and confessed he had killed two persons in Ontario some time ago, but of the recent murder he was innocent—the wife had killed her husband.

A bank employed the polygraph to find an embezzler among its employes. Fifty-six employes submitted to questions; the lie detector showed up not one, but nine embezzlers and twelve liars! Since then the instrument has been used to check up on employes at regular intervals; it not only uncovers any irregularities and dishonesty, but discourages any future attempts at embezzlement.

Crime detection is going into the hands of specialists. The photographic expert, the fingerprint expert, the wood specialist who traces lumber to its source by the microscopic grooves left by the plane; the spectrograph expert who sifts dust and ashes into their light rays and can identify the metal of a bullet from fragments left in passing through fabric. The Sherlock Holmes of tomorrow will be the paint expert, the student of iron and steel, the glass and soap and hair specialist.

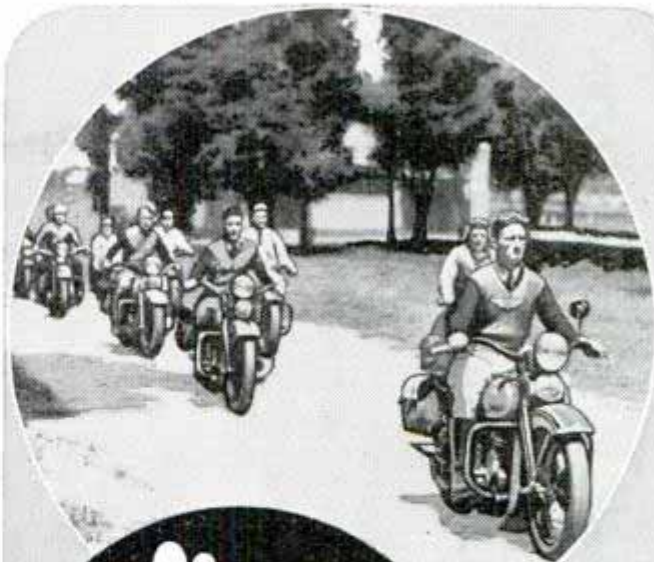

Rolling
up
GOOD
TIMES!

Yes, Siree — owning a motorcycle is great sport these days! No more nothing-to-do days! Enjoy plenty of action and fun every day — and make lots of new friends. Go in for gypsy tours, reliability and endurance runs, hillclimbs, tourist trophy races, and other thrill-packed motorcycle events. Join a live-wire riders' club. Visit your Harley-Davidson dealer — find out about the great fun club members everywhere are having — and get an eyeful of the latest model Harley-Davidsons. Also ask about his Easy Pay Plans — and above all, be sure to mail the coupon NOW!

Harley-Davidson
WORLD'S CHAMPION MOTORCYCLE

MAIL THIS COUPON
NOW!

The
Enthusiast
MAGAZINE

Harley-Davidson Motor Co., Dept. P, Milwaukee, Wis.

Please send illustrated literature on Motorcycles and FREE copy of "ENTHUSIAST," Motorcycling Magazine. Stamp is enclosed for mailing cost.

Name.....

Address.....

Be Wise Alkalize!

A sparkling glass of Alka-Seltzer should be your first defense against the pain, misery and discomfort of common, everyday aches and pains.

When you are feeling under par because of overwork, overeating, loss of sleep, or some other indiscretion, and a headache or upset stomach threatens to ruin your day, that's when a pleasant-tasting glass of Alka-Seltzer is most welcome. You'll actually be amazed how quickly your pain and discomfort disappear.

ASK YOUR DRUGGIST



TUNE IN THE NATIONAL BARN DANCE SAT. NIGHT...NBC

AT ALL DRUG STORES BY THE PACKAGE OR GLASS

DISTRESS FROM TOO MUCH FOOD OR DRINK AND HEADACHES OFT ANNOY, BE WISE AND ALKA-SELTZER-IZE AND GET YOUR SHARE OF JOY.



IT'S GREAT TO BE ALIVE, AND HOW! DON'T LOSE A SINGLE DAY. RELIEVE THOSE ACHING MUSCLES NOW, THE ALKA-SELTZER WAY.



Alkalize with Alka-Seltzer

DO YOU

in a few weeks earn big income in service fees,—not medical nor chiropody—easy terms for home training, no further capital needed, no goods to buy, no agency. Established 1894. Address Stephenson Laboratory, 1 Back Bay, Boston, Mass.

WANT a new business profession of your own, with all the trade you can attend to? Then become a foot correctionist, and

Electrical Brains Help Run World

(Continued from page 85)

keep it informed of the rise and fall of rivers and to obtain advance warning of floods. Instead of going down to a river to measure its height the weatherman merely dials a number on his phone and listens to ensuing signals with his stopwatch in hand. The robot mechanism at the river goes into operation when the phone circuit is completed, sounding an initial signal that is followed shortly by another. The time between the two signals, heard over the



Adjusting sensitive eye of photoelectric relay that switches lights in room on or off as needed

phone, informs the weatherman of the vertical height of the water above a fixed zero point.

A close relative of this machine is the automatic telephone, a complicated electrical brain that is an outstanding example of how man has trained electricity to do his thinking for him. When you dial a number in another exchange an intelligent switch called a line-finder goes on the job, fanning back and forth across the circuits to find and connect you with an idle set of lines leading to the proper exchange.

To an engineer a modern electrical brain is nothing more than a combination of a few simple switches and relays. By coupling a few circuits together he produces results that seem uncanny until their operation is explained.

One of the devices he uses is the photoelectric cell. This relay generates a small amount of current when exposed to light. It is used to start an operation either when light falls on it or when a steady light beam is interrupted. As an automatic door-opener it starts the motor that opens the door when a person's body breaks the beam of light pointed across the entrance. One of the latest uses of the photoelectric cell is to automatically control the lighting in schoolrooms and factories. A sensitive eye fastened on a wall measures the amount of light in the room and operates magnetic switches that turn on additional lamps when the light falls below a minimum level, switching them off again when the amount of external light entering the room increases.

The latest development in thermostatic switching is the new Fe-Ni-Cr-Si group of alloys that gain or lose magnetism at critical temperatures. These alloys, consisting of iron, nickel, chromium and silicon, cease to be magnetic at temperatures that depend upon the amounts of the elements in the alloys. Below the critical temperature the metal is magnetic, above that temperature the metal has no magnetism.

Another group of automatic switches is of the pressure type. Such a switch consists of a diaphragm that works against a spring, movement of the diaphragm opening or closing an electrical circuit, allowing automatic control of pressures in such devices as compressed-air tanks.

Time switches, run by electric clocks, turn lights on or off at pre-determined times, defrost electric refrigerators at the right intervals, operate domestic water heaters and furnaces, and are used in many other ways.

If split seconds are to be measured a thyatron tube is hooked into an electrical circuit. In such split-second operations as spot welding in airplane manufacture, the thyatron tube gauges the weld to the fraction of a cycle, permitting enough heat for a good weld but not enough to injure the thin sheet metal.

Switches such as these, together with various kinds of mechanical limit switches, tracks and gears, and rotary switches, are the raw materials from which an engineer builds up a complicated electrical brain.

LOOK! only \$25⁰⁰

for new-type candid camera!



AGFA 35 mm. Memo... latest improved type miniature camera featuring: *exclusive* rapid film transport, accurate shutter with speeds of 1/2 to 1/200th second, bulb and time; Agfa Memar f4.5 anastigmat lens, direct-view finder, accessory clip, tripod socket, and neckcord. Takes 24 pictures (1 7/16 x 15/16) on 35 mm. film. Camera complete, with f4.5 lens... \$25. Same camera with f3.5 lens... \$35.

New Agfa f6.3 Clipper... \$15⁵⁰

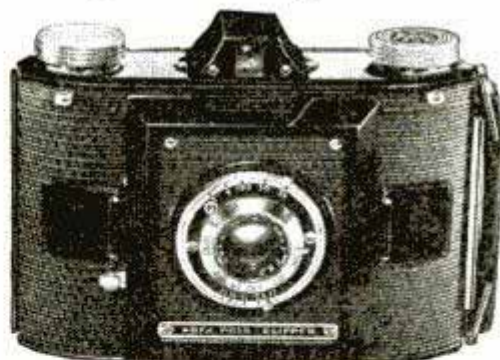

THE Agfa f6.3 Clipper Special features new telescoping front which eliminates bellows; shutter speeds of 1/25th to 1/100th second, bulb and time, hinged back, easy loading arrangement, shutter release guard, tripod socket, and built-in depth-of-field scale. Takes 15 pictures, (2 1/2 x 2 1/16) on one roll of PD16 (616) film. Complete with neckcord and lens cap, \$15.50. *Made by Agfa Ansco Corporation in Binghamton, New York, U.S.A.*

AGFA  **CAMERAS**



Rust, scale and sediment accumulate in the delicate veins of a car radiator. Water circulates poorly. The car overheats. Power is lost. And you may be heading for expensive trouble.

You can clean out your car radiator with Sani-Flush for 10c (25c for the largest trucks and tractors). It's easy to do yourself. Pour in Sani-Flush. Run the engine. Drain, flush and refill with clean water (*directions on the can*). Or, if you prefer, have your garage or service station use Sani-Flush to do the job. It cannot injure the motor or fittings. You'll find Sani-Flush in most bathrooms for cleaning toilets. Sold by grocery, drug, hardware, and five-and-ten-cent stores. 25c and 10c sizes. The Hygienic Products Company, Canton, Ohio.

Sani-Flush Safe NOT CAUSTIC
KEEPS RADIATORS CLEAN

PLUMBING SUPPLIES
AT MONEY SAVING PRICES



LATEST EDITION—JUST OFF THE PRESS
Thirty six pages showing newest styled Baths, Lavatories, Toilets, Sinks, Showers, Water Heaters, Sink Cabinets, Medicine Cabinets, Water Systems, etc.

COMPLETE LINE

Everything in pipe, fittings, valves, parts, etc. of all kinds—too numerous to mention. Save money and buy your supplies—AT WHOLESALE. Write for your FREE copy today.

Free Catalog

JOHNSON PLUMBING SUPPLY CO.
3645 S. Halsted St. Chicago

8192
Painting the World in New Colors

(Continued from page 69)

produced a single type of paint that would serve all purposes. And the paint manufacturer has had to devise special combinations for practically every use that will incorporate the properties of durability, or of hardness, or of flexibility, or of color, or of drying time that will fit the particular need. "That being the case," the home owner asks, "what kind of paint should I use in painting my house? How often should I paint for proper protection of the building and what should I use for the various interior parts of my house, the floors, the walls, the woodwork, the porches and the cellar?"

Du Pont chemists tell us that since almost every part of the United States has some peculiarity that affects exterior paint, such as salt in the air near the seashore, or smoke in the air in industrial centers, the home owner will get the best results if he will consult a reliable painting contractor or dealer in his own territory, outlining his requirements. Usually the painter and dealer have studied the local situation carefully and can recommend the paint embodying the very characteristics sought by the customer.

Generally, the chemist can give the home owner a few tips on how to do the painting himself, such as: Choose a day when the weather is clear, dry, and the temperature is above forty degrees Fahrenheit. Never paint over a wet or damp or frosty surface. Use three coats on unpainted surfaces and two on repaint jobs. He can also tell you how to figure the amount of paint to be used. This is done by multiplying the distance around the building in feet by the average height, then dividing by 350 square feet, which is the average spreading capacity per gallon for two coats of prepared paint. Thus, if the distance around the building is 140 feet and the height is fifteen feet, you get a total of 2,100 square feet. Dividing this by 350 results in six gallons, the amount of paint required for the two coats.

Paint dealers usually can supply small pamphlets telling how to paint a house, the furniture, the floors, boats and a vast number of other things. The housewife with an overwhelming urge to paint something can

9 192
do a splendid job of refinishing furniture if she follows these simple instructions: wash and sand the surface to get it thoroughly clean and smooth; use a clean, preferably new, brush about one and one-half to two inches wide; stir the paint to keep the pigment well mixed, and work with the brush well filled with paint, brushing first across, then with the grain. Directions found on cans of enamel, transparent finishes and clear varnishes should be followed. Previously finished furniture often requires only one coat, but two give a more durable finish. New wood needs at least two coats. Each coat is allowed to dry thoroughly, then the surface is sanded lightly and the dust removed before the next coat is applied.

The development of a new finish is a much more complex matter than is generally understood. In the first place there must be an understanding of the need that exists. Next there must be a determination of the properties that would have to be possessed by the finish if this need is to be served. Then comes a blending in various proportions of the almost countless possible raw materials that may produce these properties, with a testing of each composition to see if the result has been produced. And finally there is the rigorous testing of the promising products which have been formulated for the particular use. This may involve testing for resistance to humidity, hardness, flexibility, gloss, adhesion, ease of application, and finally the determination of economic value. And with these tests must be included the all important test by time and weather. This involves exposure to the effect of the sun and rain on test fences, of which du Pont has several scattered around the country, with perhaps 65,000 individual test panels on exposure. And finally, before a paint can be sold its performance actually must be tested on houses, boats, automobiles or refrigerators as the case may be.

Spray Duco lacquer, known to everyone as a fast-drying nitrocellulose finish for automobiles, was the result of a long-continued experimental program of the type described, and the many improvements which have been made in it are the

(Continued to page 122A)

DOES TWO JOBS AT ONCE



NEW
SPEEDY
WAX

(LIQUID)

MADE BY DU PONT

CLEANS the car
Gives a WAX POLISH
—at the same time!



Sure, putting a wax polish on your car used to be a long, tough job. But not today. With new Du Pont Speedy Wax, you can now give your car a grand wax finish in half the time.

Speedy Wax cleans as it waxes. And what a mirror-bright lustre it leaves—a lustre that lasts. Speedy Wax is fine for *all* car finishes. Try it.



➔ **Sample for you . . .** We'll gladly send you a generous sample of Speedy Wax—enough to shine up the fenders and hood. Just send 6¢, to help cover postage, to Du Pont, Dept. MP-3, Wilmington, Delaware.
(Offer good in U. S. only)

LEAKY AUTO TOPS, of black fabric, are easily fixed with DU PONT "THICKOTE." It seals cracks, and produces a beautiful and long lasting, jet-black glossy finish.

9 192
(Continued from page 121A)

... EASY TO READ!



Here's the steel tape engineers prefer. It's hard to kink, hard to curl. BLACK-ON-WHITE means easy reading, fewer errors. Bonded white surface protects steel from rust and is easy to clean. 25, 50, 75, 100 ft. lengths. Good for a long life of tough use. Mail coupon today for free sample of tape and illustrated folder showing new, popular-priced models.



K&E FAVORITE WYTEFACE STEEL MEASURING TAPES

KEUFFEL & ESSER CO. ... Est. 1867 .. Dept. 67, Hoboken, N. J.

Name.....
Address.....
City..... State.....

NEW SOUTH BEND Precision LATHES

\$85.00
LESS MOTOR DRIVE

TERMS \$6 A MONTH

● 9" Workshop Back-Geared, Screw-Cutting Metal Working Lathe now in Model A Quick Change Gear and Model B Standard Change Gear with power cross feed, also Model C without power cross feed. 38 attachments for Mfg., Laboratory, Repair Shop.

OTHER SIZES: 9", 11", 13", 14½", 16" and 16-24" swing, bed lengths 3' to 12', motor drive and Countershaft drive.

SOUTH BEND LATHE WORKS

643 E. Madison St., South Bend, Ind., U. S. A.

FREE! Write for Catalog No. 46-B showing complete details of the new 9" lathe.

South Bend Lathe Works
643 E. Madison St.
South Bend, Ind., U. S. A.
Send Catalog No. 46-B Free, Postpaid

Name.....
Address.....
City..... State.....



result of similar programs. And this process of improvement still continues.

Dulux enamel came into being in much the same way. Products sold under the Dulux name are fast drying, have exceptional durability and hardness, and are highly resistant to chipping. White Dulux has an unusual property of staying white. Refrigerator manufacturers have found it an ideal finish for their product. It brings beauty to woodwork in homes and institutions. Today Dulux paints and enamels provide finishes for ocean-going steamships, steel bridges, automobiles, streamline trains, airplanes and countless things in the home, such as electric ranges, kitchen cabinets, tables and furniture.

Once paint making was regarded as an art, but today it has become a science, an evolution that has meant more profit for the manufacturer and better products for the consumer.

Gold Is Where You Find It

(Continued from page 43)

is about the last place one would look for gold; yet, C. H. Starr and associates, prospecting along a fault, found gold nuggets, some as large as the end of your thumb. Nearly all were flattened by earth movements, and most were covered by iron rust, which probably explains why they were not discovered sooner. The mine has averaged \$40,000 to \$50,000 a year since the discovery, which, after all, is not bad.

Perhaps the most unusual of all recent discoveries occurred in 1938 in the oldest mining district in Colorado at Central City and Blackhawk. John Gregory discovered the first lode mine in Colorado in May, 1859. Ever since then the region has been a center of interest for gold hunters. Hundreds of mines have been located. Scores of fortunes have been made and lost. Prospectors have tramped the hills by day and the streets by night for nearly eighty years. Last summer two placer-mining outfits started operations, one in Central City, the other on north Clear Creek within sight of the town of Blackhawk. The Central City outfit, operating on a piece of ground smaller than a city block, took out \$9,000 in a few weeks. The Blackhawk outfit, with a larger area and better equipment, grossed \$7,000 to \$10,000 a week. Both

127558
 outfits used simple equipment, consisting of steam shovels that could dig twenty to thirty feet through the gravel to bedrock. The gravel was dumped into hoppers, then carried over screens to take out large boulders, pieces of timber, etc., that had accumulated along the bed of the stream. The fines were carried over sluice boxes, and the gold was caught either in these boxes or on the amalgam plates below them. Steam shovels that dig cheaply to bedrock are the secret of success.

In both Cripple Creek and Goldfield the gold occurred under geological conditions that were entirely unfamiliar to the early prospectors. At Cripple Creek the gold near the surface is combined with tellurium and silver in various proportions, making the minerals sylvanite and calaverite. These minerals do not break down readily to liberate the gold. Therefore, the streams that flow from the district contain very little placer or "free" gold. When the prospectors of the last century looked for new gold regions, they usually "panned" the creek gravels, and traced the gold to its source in the veins. This explains why Cripple Creek was so long overlooked.

The Goldfield situation is somewhat different. The region is in a desert with a multitude of low hills, small cliffs and inclosed basins. There the prospectors evidently looked for the gold in the outcropping ledges that had escaped erosion. But, strangely enough, the gold actually occurred in the disintegrated volcanic rock that covers the basins.

The recent placer mining at Central City must have made a lot of prospectors' faces red. We forget that Mother Nature operates now just as she has for countless ages. The little stream that trickles along right beside the street in this famous old town has been busy for three quarters of a century wearing off a ledge here, picking up a little gold from an old mine dump there, washing out unrecovered gold from an old mill tailings deposit somewhere else. All this was more or less concentrated in the stream gravels. It is only fair to add that the richest gravel lies on bedrock, at such a depth that it probably was not reached by the pick-and-shovel placer miners of the past.

After all, I guess we will have to agree that "gold is where you find it."

YOU NEED



POWER, ECONOMY, SAFETY

HERE'S WHAT CERTIFIED RE-WIRING MEANS TO CAR OWNERS

The importance of re-wiring has long been recognized. Corroded, frayed, or undersize cables and loose or dirty connections cause hard starting, poor gas mileage, loss of power, inefficient lighting and accessory performance, and even dangerous fires.

But, until the introduction of CERTIFIED RE-WIRING, the car owner had no assurance that the re-wiring work would be done thoroughly and expertly, or that replacements would be made with highest quality cable of the correct gauge.

Certified Re-Wiring takes the guesswork out of re-wiring service. The mechanic who does the work has been trained in the latest, most satisfactory method of checking for defects in the electrical system—he has a Certificate to prove it. Only Packard cable of the correct gauge is used in replacement—and Packard is the recognized quality cable of the automotive industry. In other words, you are assured that the job will be satisfactory.

WHERE CAN YOU GET AUTHORIZED CERTIFIED RE-WIRING SERVICE?

Authorized Certified Re-Wiring Service may be identified by the blue and gold metal sign. Other service stations have mechanics who have received their Certified Re-Wiring Certificates. Ask to see the mechanic's Certificate, and be sure that Packard cable is used in your re-wiring job. Packard Electric Division, General Motors Corporation, Warren, Ohio.

Packard
 REG. U. S. PAT. OFF.
 TRADE MARK

THE STANDARD WIRING EQUIPMENT OF THE AUTOMOTIVE INDUSTRY

A NEW SEA-HORSE



**Johnson's
MIRACLE
MOTOR!**
\$79⁵⁰
F. O. B. FACTORY

IT'S a twin! Alternate Firing! Only 21½ lbs! 2.5 N.O.A. certified brake h.p. at 4000 r.p.m.! 20 big Johnson features including 360° Steering and Reverse! Plus distinctive smoothness, quiet and easy starting of Johnson's perfected alternate firing. Ten great Sea-Horses for '39. Priced (f.o.b. factory) **\$49⁵⁰** as low as



FREE! All about the new Miracle Motor and other 1939 Sea-Horses. Illustrations. Complete specifications. Brings you up-to-date on outboard motors. Write for copy. Free!

JOHNSON MOTORS
400 Pershing Rd. Waukegan, Ill.

MENDS MOST ANYTHING



10¢ at hardware, drug and 10c stores; also in cans from ¼-pint to 1 gallon

FREE! Send post card for booklet, "Better Results with Glue," containing many useful hints about mending, model making and home workshop jobs. Address: McCormick Sales Co., 412 Light Street, Baltimore, Maryland.

GET NEXT TO THIS NEW
Atlas **LATHE**

POWER CROSS FEED Now Standard Equipment

It's the sweetest running lathe you've ever seen. Includes all modern features for precision work. 10" swing, \$99.75 and up complete less motor on easy terms through your dealer. Send for new 72 pg. catalog showing other Atlas backgeared, screw-cutting lathes from \$59.50 up.

FREE CATALOG

Atlas
ATLAS PRESS CO.
743 N. Pitcher St.
Kalamazoo, Mich.

**LATHES • DRILL PRESSES
ARBOR PRESSES • SHAPERS**

Roving Cameraman's Adventures

(Continued from page 75)

back. With fast film and an f1.3 lens I was able to record this amazing scene inside the church. Meanwhile the Indians were becoming resentful that a white man should make sport, as they thought, of this sacred event. My friend, who spoke Spanish, told me feeling was rising rapidly and I had better move off. I dashed out with film and camera while he stayed bravely behind to argue it out with the irate Indians. It took several hours of explanation before the local magistrate. Finally all was peace and we left town the next morning.



Native Mexican scraping the inside of a dugout canoe at edge of Lake Patzcuaro

By good luck I once photographed the secret shamanistic rites of the Buryat Mongolians. The ceremony took place in a yurt, a sod-roofed log cabin. In it the shaman, or medicine man, seeks to appease the spirits by talking to them through the spirits of animals. I told the Buryats I was a shaman in my own land and might work some magic. They must not be alarmed whatever happened, I explained. For hours the ceremony went on with incantations while alcohol was distilled from some sort of treated milk in a huge clay globe. Now the natives were shouting and bowing their heads to the ground. The ceremony was at its height—but how could I photograph it in the dark? I tried my magic. In my pocket were two magnesium flares. Sticking them in the earth, I lit them. The little room was flooded with light; I ground out my pictures quickly, but in a minute the smoke was so thick no one could see. I asked the Buryats to walk out quietly, and they did, continuing the rites outside.

Q 225

Two years ago I obtained a beautiful film of an ancient monastery in Finland where 500 monks live as if in the middle ages—bearded monks of eighty or more and boys with long golden hair painting murals in the dome 140 feet high.

It is a common mistake of photographers and tourists abroad to offend natives by acts which are all right in Kalamazoo, Mich., but utterly out of place in Mexico or China. Here is the sad story of my failure to get pictures of a most interesting Uzbek dance in the Crimea. In a sanitarium above the Black Sea, a former palace of the Emir of Uzbekistan, were 300 patients come from central Asia for recreation. They had never met an American and we had an exciting time together. I agreed to come back that evening with my camera if they would do their Uzbek dance in costume. They were enthusiastic. They sent a truck for me, on its floor a huge Bokhara rug worth \$5,000, spread as a courtesy to the foreign visitor.

First there was a rehearsal. I explained to the two principal dancers how they must keep within the camera's field of vision. But here I made my tragic error. I touched, very lightly, the shoulder of the leading woman dancer. It was an innocent movement, done only to show the young lady where to stand; but immediately the room was in uproar, and the male dancer was ready to have my blood. Why? Because I, a foreigner, a non-Moslem, above all a Christian, had dared touch an Uzbek woman. It was pretty exciting for awhile, but the dancer's more sober male friends held him back and things calmed down. However, there was no dancing. A chagrined American cameraman departed without pictures, leaving behind a feeling of resentment instead of friendliness.

Better luck came in the Turkish Republic—one of the most difficult lands to photograph, for the Turks have long been suspicious of foreigners, especially a foreigner with a camera.

My job was almost done. I had scenes in the mosques and bazaars, the vineyards, the new schools. To complete the story I needed pictures of President Ataturk. So far as I could determine neither outsiders nor the Turks themselves had ever made an intimate motion picture of their president. I tried the American ambassador, the

(Continued to page 126A)

Thousands now HEAR CLEARLY AGAIN

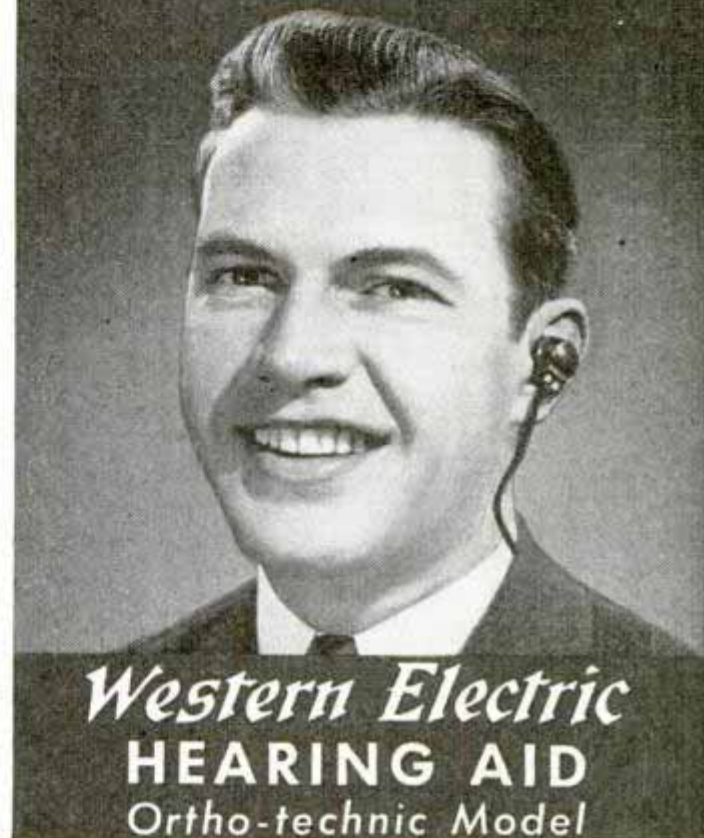

Poor hearing no longer need handicap you—for even extreme cases can be helped by the Western Electric Audiphone.

It's backed by 57 years' experience in Bell Telephone making—it's based on advanced technique in hearing aid design. Your dealer will recommend the Audiphone that best meets your individual needs.

Users say it enables them to *hear clearly* in group conversation—at greater distances—in any position. It delivers sound *naturally*, with either air or bone conduction receiver. Service stations in all principal cities.

Distributed in Canada by Northern Electric Co., Ltd., Montreal—in Europe by Western Electric Co., Ltd., Bush House, London.

GRAYBAR ELECTRIC CO., Graybar Building, New York

Please send details on Western Electric Audiphone (Ortho-technic Model) and name of nearest dealer. PM-45

Name.....

Address.....

City..... State.....

MAKE BIG MONEY

At Home! New Invention Electroplates by Brush

Plates
GOLD
SILVER
COPPER
TIN

CADMIUM
NICKEL

Easy as
painting



**No Tanks, Liquids, Generators
DOES SAME WORK AS BIG OUTFITS**

Millions of old auto-parts, and all kinds of old, worn articles in homes, stores, offices, factories everywhere can now be electroplated with a permanent brand-new sparkling coat of metal—by electrolysis—with the stroke of a brush. Easy as painting—no dismantling—plates right on the spot. Any electric light socket or car battery. Weighs only a few pounds. Take it anywhere—ready for instant use.

**Quick, Easy Way to Start Your Own
Business**

MAKE BIG PROFITS AT ONCE

Amazing low price and magic-like demonstration brings you thousands of orders for plating from garages, radio shops, bicycle shops, machine shops, home work shops, factories, offices, janitors, doctors, dentists, jewelers and farmers, homes, stores, etc.—with big profits for you! List of plating charges furnished; also reports of remarkable daily earnings.

**2-MINUTE DEMONSTRATION
WITH SAMPLE AMAZES EVERYBODY**

Send today for FREE Sample and amazing profit details and bona fide reports of big steady earnings! Also, 3-way proven sure money-making plan. Get started at once on this permanent, profitable business. No competition. Simply mail name on penny post card—NOW! Be the exclusive Warner Nu-Way Electroplater in your community.

**WARNER NU-WAY ELECTROPLATER CO.
360 N. Michigan Ave., Chicago, Ill. Dept. M-5**

**FREE
SAMPLE
PROVES
CLAIMS**

-FREE! Valuable Workshop Bulletin-

Yours for the asking: our new Home Workshop Bulletin. Helpful hints—interesting illustrations—money saving prices! Packed full of unusual bargains for faster and better work. Includes Dust Masks, Rotary Files, Circuit Testers, Wire Strippers, Insulation Scrapers, Fuse Pullers and Testers, Voltage Testers, Electricians' Knives, Electrical Etchers and many other items. Every product FULLY GUARANTEED or your money back. Write for your copy of this useful Bulletin NOW!

MARTINDALE ELECTRIC CO., 1370 Hird Ave., Cleveland, O.

Saw-Filing

Pays up to \$2 or \$3 an Hour in Spare Time

A FOLEY Automatic Saw Filer files hand, circular and band saws better than the best hand filer. Cash business, no canvassing, no eyestrain. No experience needed. Louis F. Wadowick, Ohio, says, "I have filed 764 saws in spare time and have earned \$850.00 in carpenter work due directly to my saw filing contacts." Send coupon for FREE PLAN, no obligation.



FOLEY MFG. CO., 716-9 Foley Bldg., Minneapolis, Minn.

Send Free Plan on Saw Filing business.

Name

Address

(Continued from page 125A)

governor of Istanbul, two or three members of the Turkish cabinet. To no avail. Just before I was to leave Turkey, I was lunching at my hotel. By chance the cabinet was also lunching there, without the president. An idea struck me. I sent my interpreter to say to the prime minister (who today is the president): "Mr. Prime Minister, the pictures of you and the cabinet will be taken in the garden when your lunch is over."

The cabinet apparently thought this had been arranged for some publicity purpose, so after luncheon they came into the garden obediently, I took the pictures, and that was that.

Next day I proceeded to the palace of the president, taking with me a friend on the Turkish police force and my interpreter. In an imposing car we entered the courtyard and received the sentinel's salute. What to do now? I had addressed a letter to the president explaining my case. My police friend presented it to the private secretary of Ataturk. Soon the policeman came out with a broad grin; I had been granted a five-minute interview with the secretary. I told him my story. He said there was no hope, the president had never permitted such pictures. I told him of the pictures I had taken of Turkish industry and agriculture, the schools, the cities.

"Do you think," I said, "that I will have a complete picture of modern Turkey to show in America if we omit the greatest character Turkey has had in the last 400 years?" Before the secretary could reply I added: "Will you convey to the president my disappointment, and tell him not only will I be omitting him from the picture, but will be showing pictures of all the members of the cabinet with the exception of himself?" With that I left the palace.

Three hours later Ataturk's private secretary telephoned. I was to be the guest of the president for two days at his summer home. Of course I accepted, and the pictures were mine.

Two years have passed. Ataturk is dead, a new president has been elected, and I am proud to have a historical document no one else in the world possesses, a motion picture showing the first president of Turkey in a human, natural way.

So this is the end of my story, but not of my adventures.

WILL YOU TRY A FINER, COOLER SHAVING CREAM FREE?

I'VE GOT A DATE TO-NIGHT, THINK I CAN GET BY WITHOUT A SHAVE?

NOT A CHANCE, WHY NOT USE LISTERINE SHAVING CREAM AND GET A SHAVE THAT LASTS ALL DAY!

MINE IS TOO, BUT THIS LISTERINE SHAVING CREAM GIVES ME THE CLOSEST, MOST PAINLESS SHAVE I EVER HAD

BUT, AL, I'VE GOT TO BE A TWO-TIMER—MY BEARD IS SO TOUGH

THAT FREE 20-SHAVE SAMPLE MADE ME A CUSTOMER FOR LIFE, IT SOFTENS THE TOUGHEST BEARD—LEAVES THE SKIN COOL AND PLIANT—AND BOY, WHAT ECONOMY! 24 QUARTS OF SOOTHING LATHER TO THE TUBE—IT SEEMS TO LAST FOREVER!

ME FOR IT!

LISTERINE SHAVING CREAM

Lambert Pharmacal Co., Dept. 32, St. Louis, Mo. Please send me free and postpaid your large sample tube of Listerine Shaving Cream; Listerine Brushless Cream. (Check whichever is desired.)

CLIP THE COUPON

Name _____ Address _____
City _____ State _____

SAVE MONEY

BUILD YOUR OWN FAN

Aluminum Propellers Shipped Collect	THREE-BLADE for 1/4 H.P. Motor			TWO-BLADE for 1/8 H.P. Motor		
	Size	Shaft	Price	Size	Shaft	Price
20 1/2"	1/8"	\$4.00	12"	1/8"	\$2.25	
24"	1/8"	4.50	16"	1/8"	2.50	
26"	1/8"	5.00	20 1/2"	1/8"	3.00	

MICHAEL ELECTRIC COMPANY, Dept. P., Fort Worth, Texas

TRAILER BUILDERS · BUYERS · OWNERS

TRAILER Send 25c for this Big Book Today

Over 100 pages! Beautifully Printed and Illustrated! Trailer Suggestions and Ideas galore! Catalog shows America's greatest line of Trailer Parts and Equipment at lowest prices. Everything from heels to top. Rush 25c today. Satisfaction positively guaranteed!

TRAILER SUPPLY CO. Box 438-A WAUSAU, WIS.

BUILD IT YOURSELF

The Jim Dandy Cabin Cruiser

The Trailer that has everything. Classy! Roomy. Easy to build in any size with my simplified Plans and Instructions—Price \$1.00. Rush dollar bill today to:

JIM DANDY Box 125-A WAUSAU, WIS.

CASH IN QUICK

On Two Fast-Selling Lines; Men or Women, All or Part Time

- GENUINE LEATHER TIES**
Look like Silk, Washable, cleaned with a damp cloth.
- READY-TIED SILK 4-IN-HANDS**
A brand new line. Beautiful patterns and colors.

Send 50c for sample kit of either line, specifying whether leather or silk.

CENTURY TIE CO., Mfrs., 2345-P W. Grand Blvd. Detroit, Mich. (Originators of Leather Ties)

A & N SUPPLY CO.

Bargains—Military, Sport Goods, Firearms, Clothes, Shoes, etc. Send 10¢ for new catalog, to be redeemed on first order.

EST. 1868 A & N Supply Co., 4772 Lester St., Richmond, Va.

AGENTS 300% Profit SIGN LETTERS

For Store Fronts and Office Windows. Anyone can put them on. Free Samples. Liberal Offer to general agents.

METALLIC LETTER CO., 438 N. Clark St., Chicago

Print Your Own

Cards, stationery, circulars, tags, labels, advertising, etc. Save money. Print for Others; Big Profits; easy rules sent. Will do popular Raised Printing like Engraving. Junior outfit \$9. Senior outfit \$17 and up. Send for free catalog and all details.

KELSEY PRESSES, E-37, MERIDEN, CONN.

NEW DRAIN CLEANER

WORKS LIKE MAGIC!

Saves plumbers' bills. Does work of \$10.00 to \$15.00 drain cleaners, yet costs you only \$2.95 direct from factory. Opens clogged drains in a jiffy. Water pressure combined with powerful double vacuum quickly dislodges obstruction. Easy to use. Clean. No fuss, no muss. Use it to keep drains clean and sanitary, too. Flush all household drains in a few minutes. Avoids need of using dangerous, costly drain chemicals. Quickly repays its small cost in saving of chemicals and plumbers' bills. Order today . . . only \$2.95 post-paid. Money back if not satisfied after 10 days trial.

PIONEER PRODUCTS, Dept. 67, Wooster, Ohio

Thompson BEATS the World on BOATS

Better Built Lower Prices

- Canoes \$64 and up
- Rowboats \$42 and up
- Outboards \$42 and up

Only Boats With Full Length Spray Rails

Keep passengers perfectly dry—even at high speeds. Catalog also shows today's five most popular models of sailboats. Two big factories. Prompt shipment.

CATALOG FREE

Write for your copy. State kind of boat in which you are interested.

THOMPSON BROS. BOAT MFG. CO. (87)
213 Ann St., PESHTIGO, WIS. (Write to either place) 113 Elm St., CORTLAND, N. Y.

BEEN ON A Detour LATELY?

Chances are that making turns was confusing—made you wonder if you were going in the right direction. With the Hull Streamline Auto Compass on your windshield, there is no need to even hesitate. Gives assurance of direction at all times. No more lost miles, backtracking or worry. Only \$2.95 at your dealer. Two-piece model \$1.95. Write for literature.

HULL MFG. CO., P. O. Box 246-D15, WARREN, OHIO

PERMEABILITY TUNING IS HERE

SEND FOR **Free Book!**

Q CONTROL TRADE-MARK

ALADDIN RADIO INDUSTRIES, INC.
466 WEST SUPERIOR STREET DEPT. M. CHICAGO, ILLINOIS

Licensed under one or more of the following Johnson Laboratories, Inc. patents:
1,940,228
1,978,600
1,982,689
1,982,690
2,018,626
2,031,012
2,113,903

Other patents issued and pending.



Renew old buildings. Make new construction more permanent and attractive. Plastic Colorcrete is water-proofed. It fuses with any masonry surface. It fills cracks. It can be applied in any thickness and in 30 colors. Fully proven by over 13 years actual use under all conditions and every climate.

OFFERS BIG EARNINGS

Owners everywhere want to enhance present values. With this machine you can supply this big waiting market with permanent Colorcrete at amazingly low cost. Operators report cost of 2c and up per sq. ft. and sell up to 7c. Some have paid for their equipment from first few jobs. Machine capacity up to 1,000 sq. ft. per hour.

Get the facts. Send for books "Proven Business Opportunity". Write today. It offers you big extra income.

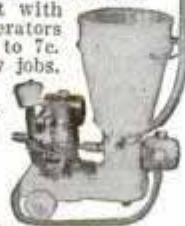

COLORCRETE INDUSTRIES, INC.
570 Ottawa Ave. Holland, Mich.

BUILD YOUR OWN EVAPORATIVE COOLER SAVE

A modern cooling system for home and business. We furnish parts, you build. "Factory to you prices." 24" unit as shown, unassembled, **\$26.70**
Write for particulars and other sizes.
Shipped collect.

MICHAEL ELEC. CO., Ft. Worth, Tex.

RIDE THE ERIE MOTOR BIKE



OVER 100 MILES TO THE GALLON;
A powerful, high grade machine with Sachs Motor; 2-speeds, and clutch, chain drive, powerful brakes, balloon tires. World's outstanding low-priced pleasure and utility motor-bike. Thousands in daily use. Speeds up

to 40 miles per hour. WRITE for Special offer today. Special Discount to Rider Agents in open territory.

STREIFTHAU MFG. CO., Dept. 104, Middletown, Ohio

ENGINES

Enclosed, Self-Oiling, Roller-Bearing

Cheapest reliable power for farm or factory. Uses all fuels for pumping, sawing, etc. Best engine for the money. You Pay Less to Own it—Less to Run it. Cash—Terms—Catalog FREE

WITTE ENGINE WORKS
174-B Oakland Ave. KANSAS CITY, MO.

Wood WORKERS Here it is!

HAROLD HUNT'S latest edition 1939 catalog. Nothing like it ever before published—136 pages—new designs, new ideas for experts; also special instructions for beginners. AND—LISTS OF ASTONISHING BARGAINS in all kinds of wood-workers' supplies. Get this book! **ONLY 10c!** Also VENETIAN BLINDS; a special circular free with catalog if so requested. Send only 10c to

CRAFTSMAN WOOD SERVICE CO.
2737 S. Mary Street Chicago, Ill.

Logging Goes Modern

(Continued from Coloroto Section)

pected to increase to close to ten billion feet per year as forest management becomes better understood and observed. If necessary it would be possible to grow twice as much wood on the Pacific slope as is now required, on land more suitable for growing timber than for any other purpose.

Modern lumbermen regard timber as a crop that can be harvested time after time instead of as a mine that is worthless after it has been worked out. Forest management and fire control are the two keystones of the new attitude and the work of providing everlasting forests is well under way. More than a million dollars is being spent every year in western Washington alone for reforestation.

Another thought that has been taking hold is that to keep a forest healthy it must be used. That is, individual trees should be logged upon reaching maturity to permit new trees to grow where they stood. Young timber grows faster than old timber and upon passing their prime some big trees become "cocky" or over-ripe. Some companies have already started programs of selective logging by which individual trees are cut down and used as soon as they come into their prime, leaving the rest of the forest growing intact. They make certain of never running out of timber by estimating the supply that is added to the forest each year by natural growth, and restrict their logging to that amount.

Many large operators are starting their own private nurseries and are growing selected stock for transplanting in cut-over land. One company is already setting out two million seedlings every year.

Left to itself, almost any cut-over area will restock itself from natural seeding if given sufficient time. This type of reforestation is far too slow to be dependable and another part of the reforestation program is to leave large clumps, rows, or a scattering of individual seed trees still standing in areas that are being logged. This permits seeds from mature trees to be scattered broadcast over the ground. Usually 1,000 or more seedlings per acre take hold from this method within a couple of years and a new forest has started.

Forest fires are the dread of the lumberjacks since one fire alone is apt to destroy

enough timber to meet a mill's requirements for several years. In the woods, one of the best ways to prevent a big forest fire is to start a fire. Normal logging leaves behind it a great deal of debris in the nature of tops, limbs, bark, and underbrush. These slashings dry out rapidly and if left to themselves would be permanent fire hazards. The debris is cleared away by burning it off, setting it afire just before a good rain is due so that it can be kept under control.

During fire weather, short periods of time in the summer months when the humidity is so low that fires start easily and spread rapidly, many lumber camps shut down all operations and pull all of their men except a few fire patrolmen out of the woods. Warnings of impending fire weather are spread to the camps by radio and many camp superintendents watch their own hygrometers to keep a check on the local relative humidity. At times of low humidity fires are almost impossible to control and they start from such unusual causes as the friction of a moving steel line against a stump, or a small limb being caught up and lodged in a pulley block.

Reforestation, fire prevention, and economical logging methods are already showing their effect in the woods. Today, lumbermen think they have found the way to grow forests that will last forever.

Universal Lathe Tool Holder

To hold the bit in almost any position required for facing, turning, boring, threading or cutting-off operations, a lathe tool holder just introduced has two openings for the bit at right angles. The bit can be locked in position or removed and reversed by a slight turn of a knurled clamp. Since only one holder is required for all operations, work can be machined rapidly and economically.

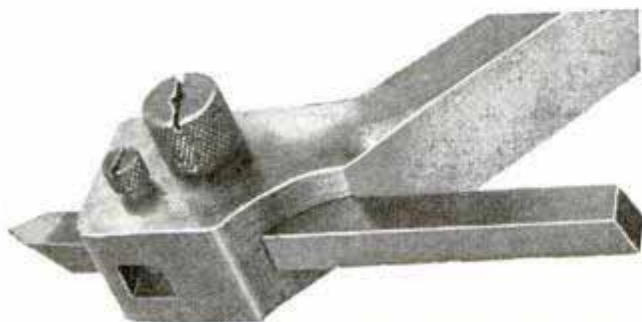

Notice the two openings at right angles for tool; a turn of knurled clamp screws locks bit in place

Elk Machine Tool Works

MOPING WON'T HELP YOU

IF YOU'RE **SKINNY, RUNDOWN, NERVOUS**



Posed by professional model

THOUSANDS GAIN 10 TO 25 LBS, NEW STRENGTH THIS SCIENTIFIC WAY



YOU may think your case is hopeless—that you're just naturally skinny, rundown—often tired and nervous. But as a result of recent scientific discoveries thousands of men and women who never could seem to gain before have put on 10 to 25 pounds of naturally attractive flesh. They've gained normal health, normal nerves, new pep, and all the new friends and good times these bring—by simply taking these scientifically prepared Vitamin B and iron tablets known as Ironized Yeast tablets, for a few short weeks.

Why this builds up so quickly

You see, it has now been scientifically proved that thousands of people are thin, wornout and cranky—hardly able to eat, sleep or work—simply because they do not get sufficient Vitamin B and iron from their daily food. Without enough of these two vital substances you may lack appetite and not get the most body-building good out of what you eat.

Now you get these exact missing substances in these easy-to-take little Ironized Yeast tablets. So by simply using their aid for a short time, great numbers of formerly rundown men and women have easily put on just the pounds they needed—gained new pep and much greater attractiveness of appearance—and thereby won new friends, new success and popularity, new joy in life.

Make this money-back test

Get Ironized Yeast tablets from your druggist today. If with the first package you don't eat better and FEEL better, with much more strength and pep—if you're not convinced that Ironized Yeast will give you the normally attractive pounds, new energy and life you've longed for, the price of this first package will be promptly refunded by the Ironized Yeast Co., Atlanta, Ga.

Only be sure you get the genuine Ironized Yeast. Don't take one of the many cheap inferior substitutes which do not give the same results. Look for the letters "IY" stamped on each tablet.

Special offer!

To start thousands building up their health right away, we make this special offer. Purchase a package of Ironized Yeast tablets at once, cut out the seal on the box and mail it to us with a clipping of this paragraph. We will send you a fascinating new book on health, "New Facts About Your Body." Remember, results with the first package—or money refunded. At all druggists, Ironized Yeast Co., Inc., Dept. 537, Atlanta, Ga.

TUNE IN ON JOHN J. ANTHONY'S GOOD WILL HOUR. See your local newspaper for exact time and station.

FREE BARGAIN BOOK  **CAMERAS & PHOTO SUPPLIES**

NEW EDITION WRITE FOR IT

Listing hundreds of **BIG BARGAINS**. Amazing reductions in new and reconditioned candid and high-speed miniature cameras; speed lenses; **MOVIE** cameras; night photography equipment; darkroom and enlarging equipment. 10-day trial, money-back **GUARANTEE**. Send for **FREE BOOK** and include **ORDER** for following bargains (enclose Money Order plus postage, or if C.O.D., include deposit for 1/2 total amount).

The BUY of the MONTH
9x12 cm.—F:6.3 lens
Film Pack and Plate Camera
\$20 BOYER only \$8.95

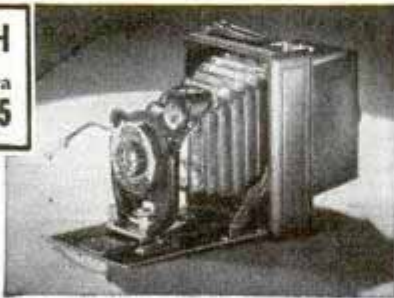

Popular and versatile camera suitable for portraiture, interior, architectural, landscape, sport, etc. **MANY UNUSUAL FEATURES:** 5 1/4 in. genuine Hermagis F: 6.3 anastigmat lens, diaphragming F:6.3 to F:3.6 precision shutter, 1/25 to 1/120, Time & Bulb; focusing by scale and ground glass to 5 ft.; brilliant reflection view finder; adjustable sliding cross movement; light-weight but strong wood and metal construction. Size 4 1/2 x 6 1/2 x 2 in.; weight 39 oz.

TYPICAL OF HUNDREDS OF OTHER BARGAINS

Write for **FREE BOOK** today!

CENTRAL CAMERA CO., Dept. K-7
230 S. Wabash Ave. Chicago, Ill.

"CENTRAL"

Photographic Headquarters Since 1899

WIND DRIVEN

This equipment opens a new field and a world of prospects for the active dealers and Distributors.

USES **NO ELECTRICITY**
KEROSENE or GAS
COSTS NOTHING TO OPERATE

We have open territory for live and responsible dealers and Distributors. Write at once

REMONTE MFG. CO.
Corpus Christi, Texas



ICE and REFRIGERATION

After more than fifteen years of experimenting and testing we are now offering to farmers, Country Estates, Hunting and Fishing Lodges, Roadside inns, etc. A **Wind Driven Refrigeration Equipment**.

Being Manufactured at a Price that is competitive with Kerosene and Electric Operated Systems



Streamlining the Highways

(Continued from page 31)

The limited way is either raised above the level of the ground or below it, which disposes of the pedestrian problem. Provision is made for accelerating and decelerating lanes for fast and slow traffic leading from the main highway.

Chicago's Outer Drive approaches the limited way design and its success has prompted the city to entertain plans for the construction of a network of elevated highways. Already New York has constructed two West Side elevated highways and eventually Manhattan will be encircled by these super highways. When com-



Specially designed electric lights are used to reduce hazard at important intersections

pleted the system will make it possible for the 200,000 cars that enter the city daily to drive for miles above traffic-clogged streets without encountering a signal light.

Conventional express highways, such as St. Louis' thirty-eight-mile stretch that delivers traffic from the outlying districts to the business district without interruption, have been hanging up convincing safety records as have the divided highways built in various sections. In fact, the double roadway idea is being generally accepted in more modern street design, and engineers predict that all roads built in the future will be of this type.

More and more road builders are looking to future traffic requirements. A striking example of this is on State Route 59 in northern Illinois. A ten-mile strip with a width of twenty-two feet has been built to carry future loads at greater speeds. It is

DOENUT WHEELS



DOENUTS, developed and patented by the originator of the air-wheel, absorb more surface obstructions and eliminate jolting. Protect wood and concrete floors. Do not sink in sand or soft ground. Cadmium plated disc wheel with adjustable ball bearings. Size 10"x2.75" with cap. of 225 lbs. per wheel and 12"x3.30" with load cap. of 325 lbs. per wheel. Ideal for wheelbarrows, painting rigs, spraying equipment, textile trucks, dish trucks, boat dollies, food carts, or most any portable unit that rolls. **Handle same loads with less than half the labor.** Send 10c postage to cover cost of mailing literature.

MUSSELMAN PRODUCTS CO.
6225-L St. Clair Avenue, Cleveland, Ohio

DOENUTS ARE USED ON:
GOLF GREEN MOWER, TURTLE TRUCK, SECTION PLANT, ICE CREAM CART, GREASE GUM, HAND TRUCK, CYLINDER TRUCK

centered on a line twelve feet from the centerline of a 100-foot right of way. Thus, when traffic warrants it, a second twenty-two-foot strip can be added, and when completed the opposing streams will be divided by an island.

There are 324,000 miles of state highway and to bring but five per cent of the total within hailing distance of the modern road designs would cost, according to R. E. Toms, chief designer of the U. S. Bureau of Roads, \$4,000,000,000.

The highway engineer cannot endow the motorist with judgment, he adds, but can provide sufficient clear vision for the exercise of good judgment. Road safety depends fundamentally upon the ability to see, particularly when traffic moves as it now does over rural highways.

If a highway is built so impatient or careless drivers are encouraged to remain behind slow-moving vehicles until they see a sufficient length of highway clear of opposing traffic for passing, he says head-on collisions and other accidents will be fewer in number than if the road is constructed with inadequate sight distances.

When you go fast you need more space than when you go slow, so highways must be wide enough to allow a clearance in keeping with road speeds. Shoulders wide enough for stopping, consistently smooth, non-skid surfaces, and the elimination of deep side ditches are safety measures that are now being practiced universally.

Approximately sixty-seven and one-half per cent of all motor-vehicle deaths in urban areas and thirty-five per cent of those on rural roads are pedestrian fatalities. To cope with this phase of the safety problem, tunnels are being built under or over heavily traveled roads near schools, large industrial plants, public beaches, playgrounds, and business districts.

Relocation of highways and grade separations are the most practical ways of handling the railroad-crossing problem.

Highway engineers visualize that in the future America will have 60,000 miles of super highways connecting centers of population and providing free nation wide travel. They will be designed for 100-mile-an-hour speeds, be four to eight lanes wide with opposing traffic streams divided, trucks segregated, pedestrian traffic eliminated, and no grade crossings.

YOUR HAIR

**- IS IT GETTING THIN?
- IS IT FALLING OUT?**

**Rent A HOME MODEL
CROSLEY
XERVAC**



If poor blood circulation of the scalp causes your trouble, try the XERVAC way to arrest it—

Scalp specialists know that good, rich blood circulating in the deep-seated blood vessels of the scalp nourishes the hair roots, aids in arresting abnormal loss of hair, helps to produce hair growth. . . It is known that VACUUM and PRESSURE around scalp, applied intermittently and properly controlled, is highly effective for forcing fresh, stimulating blood deep into these blood vessels. One way to do it has been found in the regular use of Crosley XERVAC—that popular hair and scalp device used so successfully in barber shops and clinics.

Write for New Rental Plan

Learn how you can RENT the new compact home model XERVAC and use it in your home for a small rental fee. Try it, watch results. Get the benefits of this amazing device on easiest possible terms. No obligation—just write

THE CROSLEY CORPORATION
Dept. G-10 CINCINNATI, OHIO

HOME MODEL
SAME AS ORIGINAL PROFESSIONAL,
ONLY MORE COMPACT..



WE WANT CAPABLE MEN

to become District Supervisors over exclusive districts in the distribution of the NEW, KEYLESS, SNAP-UP ELECTRIC GAS TANK LOCK FOR CARS. Entirely new distributing plan meeting with wonderful success. "LET US PROVE IT"

SNAP-UP GAS CAP CO. DEPT. D. ASHLAND, KY.

SEND 50c NOW FOR YOUR LITTLE SHAVER PLANE

(Patent applied for)

Every airplane model maker, wood carver, carpenter, cabinet maker and householder should have one of these amazingly simple but versatile tools. Weighs but 1 1/2 oz. and consists of aluminum frame, cadmium-plated blade holder and blade, adjustable to microscopically thin or heavy cuts in soft or hard woods. It can also be used as scraper or knife and its razor-sharp cutting edge is renewable instantly by inserting new razor blade.

TROPICAL PRODUCTS, INC. - Box 188 - MIAMI SPRINGS, FLA.

RENT and SELL KEEN POWER CYCLES

Popularly priced to meet all competition . . . precision built, improved powerful engine, two-speed optional, fourth successful year . . . write today for details of BIG MONEY-MAKING plan and liberal discount. Keen Mfg. Co., Madison, Wis. Dept. M.

MAKE BIG PROFITS



THE BEST MECHANICALLY

Agents and Dealers WANTED to Sell or Rent the NEW

MEAD Ranger SCOOTER



These sensational, new, improved Ranger Scooters sell like hot cakes all over the country! Order your demonstrator while territory is still open — there's big money selling to all stores needing quick, cheap delivery... sell to messengers, mechanics, garages, canvassers, friends; or rent for easy hourly profits at beaches, resorts, etc. World's CHEAPEST transportation! 120 miles per gallon, 35 m.p.h. Only \$109 and up! MEAD'S New Ranger STEEL frame, 2-speed gear, 1½ or 2½ H.P. Solo models, tandem, delivery, sidecar or trailer. HURRY! Write for FREE Circular, Easy Terms.

CYCLE CO.
Mead AMERICA'S MOST FAMOUS CYCLE NAME FOR FIFTY YEARS
17 So. Market, Dept. T-1, Chicago, U. S. A.

BIG LEAGUE BASEBALL

Exactly as played outdoors. Strictly to regulation baseball rules. 54 cards. Standard quality. Each card a play. Game contains every play and play possibility; every attraction, interest, fascination, excitement, thrill of baseball. Not simply a card game; real, big league baseball played with cards. 2 to 18 can play at one time. Great for young and old alike. Price, prepaid mail — 25c. Worth dollar in fun value. Send 25c for your set right now.

CARD GAME 25c

FRANK EFFINGER, 828 N. Broadway, Milwaukee, Wis.

60 POWER TELESCOPE . . . \$219

VARIABLE EYEPIECE 20X—40X—60X

NEW! Three telescopes in one. 3 different magnifications. 20 power for ultra-bright images with 40 and 60 power for extra long range. Guaranteed to bring distant objects, people, sports events, ships, moon, stars, etc., 60 times as close.

Most powerful made for anywhere near the money. Closes to one foot in length. Multiple lens system. 30 mm. objective lens. 5 sections. Directions included for using as a compound 4 lens microscope. American made. Prompt shipment guaranteed. We pay the postage. Only \$2.19.

BROWSCOPE CO., Dept. 47, 5 W. 27th St., New York, N. Y.

COVERED WAGON TRAILERS

AT NEW LOW PRICES

\$395 AND UP

Learn what the world's largest trailer manufacturers offer in superior construction, fine home comfort, improved riding qualities.

COVERED WAGON CO. Dept. No. 302
Mt. Clemens, Mich.

FREE: New literature with trailer plans.

CUT TRAVEL and LIVING COSTS with a COVERED WAGON TRAILER HOME!

STOP Scratching

Relieve Itch Fast — or Money Back

For quick relief from itching of eczema, pimples, athlete's foot, scales, scabies, rashes and other externally caused skin troubles, use world-famous, cooling, antiseptic, liquid D. D. D. Prescription. Greaseless, stainless. Soothes irritation and quickly stops the most intense itching. 35c trial bottle proves it, or money back. Ask your druggist today for **D. D. D. PRESCRIPTION.**

Universal Set-Testing Meter

(Continued from page 138)

1-watt carbon types supported by their own leads and the wiring, which is done with No. 12 bus-bar wire. The multi-range meter scale, meter-shunt resistor, toggle switches, push-button switch, fuse and holder are all included in the kit of parts available from radio supply houses.

The fuse introduces a little additional resistance in the circuit and this will cause inaccuracies in reading certain ranges. To avoid this, the safety push-button switch (SW3) is provided; when depressed, the

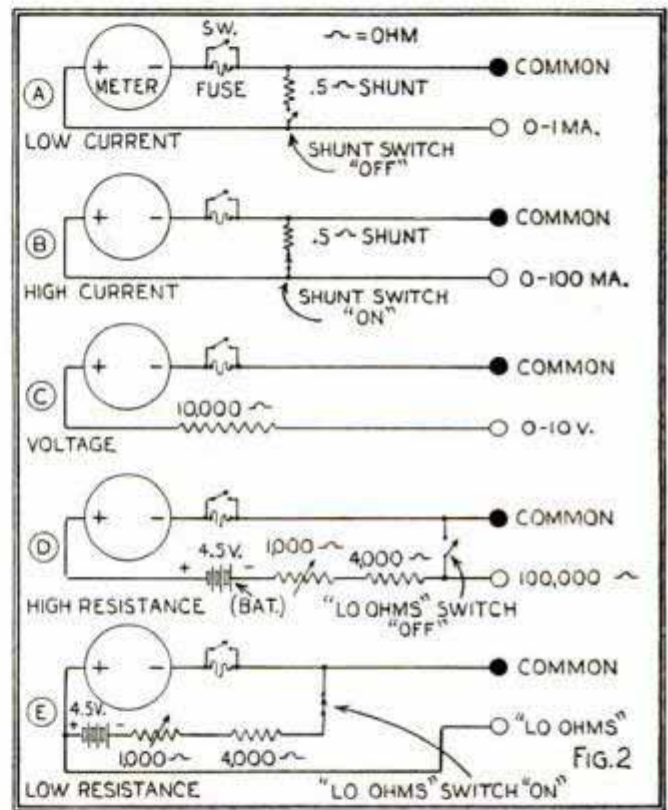

fuse is short-circuited and accurate readings thus obtained. Diagrams, A, B, C, D, and E in Fig. 2 clearly show the connections employed for making all tests. In every case one test lead is connected to the "common" binding post, the other lead being connected to the binding post marked with the desired range. To measure resistances below 500 ohms, the "lo ohms" switch is placed in the "on" position and the "ohms adjuster" knob varied until the pointer on the meter rests at the extreme right end of the scale. For high-resistance measurements a similar preliminary adjustment must be made. To do this the "common" terminal is temporarily connected directly to the 100,000-ohm terminal and the knob is adjusted as before.

Greatest Show under the Earth

(Continued from page 53)

from fifty to 2,000 candlepower is visible. All have been artfully concealed behind rock shields and mounds. Likewise, transformers and switches are out of sight and cable, pipes and conduit have been covered with dirt to preserve the naturalness of the caverns.

Colored lights have been tried, but since the formations have their own inherently delicate and beautiful coloring, it has been found desirable to present them in their natural state, hence daylight lamps are used exclusively.

The elevators are virtually the same as those found in modern office buildings. In the eighty-four-story shaft that was sunk to the floor of the cavern, a steel tower was erected to form the two hatchways and provide supports for the guide rails. All the wiring in the shaft had to be made waterproof so the various circuits would not be affected by the water which is constantly seeping through the walls.

A million and a half dollars have been spent on the improvements, but admittance fees have paid for both improvements and upkeep.

Thanks to modern science, the growth of interest in the caverns has been rapid. From a few hundred in 1925, the attendance has increased steadily to last year's record of 207,041 visitors from every state and sixty-five foreign countries. The largest crowd of the year was 3,771 persons on July 4; the smallest, 101 on February 2.

At the peak season, fifty national park rangers direct traffic, conduct tours, answer questions, and keep an eye peeled for anyone tempted to break off a formation for a souvenir.

A trained nurse is in constant attendance. Occasionally, a visitor suffers from claustrophobia and a ranger eases him out. The average is about one case among every 5,000 visitors. In case of illness, tourists are treated at first-aid stations.

One of the side shows of the Carlsbad Caverns trip is the bat spectacle. Every evening at dusk, except during the period of hibernation, three million bats come forth from their apartment 180 feet down in the earth, spiraling through the great entrance of the cave for more than three

(Continued to page 135A)

NOW! *new Camera*
catalog FREE!



**PUTS EVERYTHING-
IN- PHOTOGRAPHY INTO YOUR HANDS
and money back in your pocket!**

Send at once for the big **FREE** book that covers everything in photography. It's all camera, and all value! No "teaser" bargains in this book. Every item on every page is priced low, and there are 40 pages packed with nationally-advertised cameras, equipment and supplies. We buy in large lots from leading manufacturers and pass the savings on to you. We add our own guarantee to that of the manufacturer. Mail coupon below for your **FREE** copy of the guide to the buys in photography. Send today. Save money.

Voigtlander

BRILLIANT — A Real Buy!

Easy to operate — just aim and shoot. Mirror Finder shows exact picture you'll get. Needle focusing device for Portraits, Groups, Landscapes. Voigtar f.6.3 lens in Delayed Action Shutter, three speeds, instantaneous time and bulb. Precision built. Gets 12 pictures 2 3/4 x 2 1/4" on standard roll film. Has tripod inserts, neck strap and cable release.
Shpg. wt. 4 lbs.



\$10⁹⁵
CA1510.....

MAIL CHECK OR MONEY ORDER TODAY
Send at once for this sensational camera buy!
Simply enclose check or money order with coupon. Satisfaction guaranteed!

● **COMING TO THE FAIR?** Visit our vast camera and radio showrooms in New York. It's an education!

● **TEAR OUT AND MAIL THIS COUPON** for **FREE** catalog of 1001 "buys" in photography. Get the best for less.

**LAFAYETTE
CAMERA CORPORATION**

SALES OFFICES IN
NEW YORK 100 Sixth Avenue
CHICAGO 301 W. Jackson Blvd.
ATLANTA 255 Peachtree Street
Boston, Mass. Bronx, N. Y.
Newark, N. J. Jamaica, L. I.

Rush **FREE** 1939 Camera Catalog No. 77

NAME..... PLEASE PRINT

STREET.....

CITY..... STATE.....

**LAFAYETTE CAMERA CORPORATION
DEPT. 7G9 — 100 SIXTH AVE., NEW YORK, N. Y.**

PASTE COUPON ON PENNY POSTCARD

**FREE
NEW
CAMERA
CATALOG**

BIG OPPORTUNITIES MANUFACTURING MATERIALS FOR LOW COST BUILDING



CASH IN BIG on the great building upturn under way. Make a superior, more permanent material—the kind demanded by your trade—lighter weight, and offering big savings in construction. Sells easily up to 100% over manufacturing costs.

WE EQUIP YOU with line production machinery requiring only modest investment. Raw materials enter at one end—finished products emerge from other end. Big daily production with one to three men. You make common brick—face brick—in over 40 beautiful colors—also **DUNSTONE** in 9 sizes.

INVESTIGATE NOW. Send for "4 Keys to Success." It tells the complete story—how present manufacturers are making outstanding progress in a business offering unlimited opportunity for growth, expansion and profit. Write today.

W. E. DUNN MFG. CO.
600 W. 24th St. Holland, Mich.

EASY PROFITS IN PAINT SPRAYING



Paint walls, ceilings, screens, furniture, radiators, machinery faster, better! $\frac{1}{2}$ H. P. motor 110 Volt 60 Cycle AC, complete with Spray Gun, 15 ft. hose. Weighs only 44 lbs. Carry anywhere. **FULLY GUARANTEED.** Only \$31.15 f. o. b. Chicago. \$5 Deposit, Balance COD, or **SEE YOUR DEALER.** Circular **FREE.** Get started making money **NOW!**

\$31.15

Ideal Automatic Pump Co. Dept. PM-7, 801 Washington, Chicago

**Work Faster
Make More Money
with the**

Red UNIVERSAL TRACTOR

With this practical machine and attachments you can do all field and belt work hours faster at the low cost of 33c per day. Many units pay for themselves the first season. Unusually easy to handle and operate. Absolutely safe. Hundreds of users. Buy direct at low factory price. Two weeks' trial—satisfaction guaranteed. Write for colorful, free catalog.

PIONEER MFG. CO. Dept. V-79 West Allis, Wis.

Let's Go **MOTO-SCOOTING** For 1939, it's **MOTO-SCOOT**



The World's Greatest Economy in Motorized Transportation is making a hit with everybody. 1939 models have powerful 1 1/2 horsepower motor to give thrilling rides up to 35 miles per hour. Economical to run—120 miles to the gallon. Every model equipped with Moto-Clutch, built-in generator for powerful headlight and tail-light. Century models with two speed transmission and spring front suspension.

LOW COST DELIVERY SERVICE
Use **MOTO-SCOOT**s to make economical deliveries for stores, service stations and messenger service. Models for every purpose—Solo-Tandem, Delivery, Sidecar and Trailer. Rugged steel construction.

SEE YOUR MOTO-SCOOT DEALER or Write for Catalog
Dealers—Valuable Territory Still Open

MOTO-SCOOT MFG. CO.
8428 South Chicago Ave.
Chicago, U.S.A.

BIG PROFITS RESTRINGING RACKETS

AT HOME! WRITE US!

Save On **GUT!**
—Buy Direct from Factory **SILK!**

Earn big profits restringing tennis rackets at home. Easy work. Experience unnecessary. Save on your tennis, badminton, squash! Send for **FREE CATALOG** of Tennis Equipment—*Hurry!*

H. E. Wills Co., 1047 W. 47th St.
Dept. A-79 Chicago, U. S. A.

MAN IN EACH TOWN To Plate Auto Parts

Reflectors, Bicycles, Fixtures, Mirrors, by late method. Simple plan of manufacturing at home starts you **IN GOOD PAYING BUSINESS.** Write today for **FREE** particulars and proofs.

GUNMETAL CO.
Ave. M Decatur, Ill.

NEW Sensation

Sweeping The Country

No investment needed—no experience required. No stock to carry—No deliveries to make. We supply everything **FREE.** Millions waiting to buy. Sells everywhere shops, factories, offices, workers, etc., etc. Each sale leads to fifty more. Everyone happy to get what you have. **FREE SAMPLE.** Write quick—a postcard will do.

PRESIDENT 435 N. Clark St.
Dept. 140, Chicago.

BOAT BLUEPRINTS
and full size paper patterns. Wide selection—designed by Naval Architect. Streamlined. Low prices. Send 10c (coin) for illustrated catalog.

Cleveland Boat Blueprint Co.
Station A-666 Cleveland, Ohio

YOUR TOOLS

Will find better protection in a Gerstner Chest. Toolmakers, Machinists—Free Catalog.

GERSTNER TOOL CHESTS
439 Columbia St. Dayton, Ohio

CAPTURE THE COLOR OF LIFE! YOUR OWN MOVIES! ONLY 10c A DAY!

NATIONALLY ADVERTISED 8MM and 16MM Movie cameras, projectors. For home, business, church, school, club. **MONEY BACK 10 DAY TRIAL.** Payments as low as 10c A DAY. Satisfied customers throughout the world. **FREE** details. **WRITE TODAY.**

Don Elder's Home Movies, Dept. A-7, 739 Baylston St., Boston, Mass.

AT LAST!

All Your Snapshots in Natural Colors! AMAZINGLY BEAUTIFUL!

Any size roll developed and 8 prints **25c** Natural Color Prints 3c each.

Natural Color Photo Service, Dept. C-54, Janesville, Wis.

CATCH FISH!

minnow, eel, mink, muskrat, with our folding galvanized **Steel Wire Traps.** Walton's Automatic Hooks are so constructed that when a fish gets the slightest pull on the bait the upper hook reaches down and gets a hold that lands him. 3 for 50c. Write for descriptive catalog of Traps, Hooks, Lures, and other specialties. **Walton Supply Co., 3507 Juniata Ave., St. Louis, Mo.**

MONUMENT \$900 UP

WE PAY FREIGHT

Genuine Marble also Granite. Free Lettering. Erected if desired. Thousands of satisfied customers. Write for Catalog and samples.

U. S. MARBLE & GRANITE CO. A-18 Oneco, Fla.

FREE 48-page book. Pictures. Useful hints

on buying, using, saws, tools, files.

Henry Disston & Sons, Inc., 711 Tacony, Phila.

BUILD YOUR GRANDFATHER CLOCK

The Simple Sensible Red-I-Kut way as thousands have. **DIME** brings **PLANS** and sixty picture "HOW" Book pricing many fine brass weight **Westminster, tube chime, electric and battery movements** showing nine beautiful colonial grandfather cases. **WHY WAIT LONGER?**

KUEMPEL CHIME CLOCK CO., Bldg. 30, Guttenberg, Iowa.

(Continued from page 133A)

hours and streaming off in search of food. At dawn they return, having consumed more than eleven tons of moths, flies, beetles, and mosquitoes during the night.

On the trip through Carlsbad Caverns, you are introduced to the sights by easy stages. By the time you reach the Green Room, the walls begin to grow whiter and on all sides are grotesque figures and perfect waterfalls stopped in action and molded in stone. Farther on, there are prehistoric animals of gleaming onyx, scrolls and drapes, chandeliers and lily pads; and an infinite variety of shapes that your imagination may translate into birds, mummies, or animals. These ornate forms are all due to the deposition of limestone which has been carried in solution by ground water and which crystallizes as the water evaporates or when dissolved carbon dioxide, which it may contain, escapes to the air. The coloring results from iron or other minerals in the limestone.

The size of some of the galleries is a matter of wonderment to all. Especially is this true of the Big Room, 4,000 feet long and 625 feet wide with a ceiling scaling up to 350 feet. Here is the Giant Dome, the world's largest stalagmite. Sixty-two feet in height and sixteen feet in diameter, it grew at the rate of an inch a century so you can figure out its age yourself.

A clever dash of showmanship climaxes the visit. After circling the Big Room, a matter of two miles, visitors are seated in front of the Rock of Ages, oldest of all formations. Announcement is made that the lights are to be turned off.

A hush falls over the crowd and the switch is pulled. You are in total blackness—a fearful inky blackness. Sixty seconds tick off and there is a faint glimmer of light at the far end of the room as an unseen quartet begins to sing "Rock of Ages." One by one the lights reappear and by the time the rangers conclude the hymn the room is fully illuminated.

A dramatic fillip for the greatest show under the earth.

Popular Mechanics Magazine can furnish the name and address of the maker of, or dealer in, any article described in its pages. If you wish this information, write to the Bureau of Information, inclosing a stamped, self-addressed envelope.

Making these repairs with SMOOTH-ON No. 1 is like finding money!

Stopping leaks at screw threads, gaskets, press-fit joints, seams, connections, cracks, etc., in water, steam, gas, air or smoke pipes, boilers, furnaces, fire pots, heaters, tanks, radiators, sinks, troughs, etc.

Tightening loose wood screws, bolts, nuts, handles, drawer pulls, hinges, locks, hooks, casters, stems, bases, etc.

SMOOTH-ON No. 1 has enabled thousands of householders and home mechanics to make the above and similar repairs at absurdly low cost—to restore full usefulness to many impaired household appliances that otherwise would have required expensive replacement.

Smooth-On No. 1 hardens and its adhesion and expansion in doing so effect a tightness of parts or a seal against leakage that withstands pressure, heat, cold, vibration, moisture and chemical action. The Smooth-On restores original efficiency quicker, with less effort and at less expense than by any other practical repair procedure. Try Smooth-On (no heat, special tools or previous experience required). Your worst repair becomes simple and you can make annual savings that amount to a substantial figure.

Many Smooth-On repairs can be made in various ways. The one which produces the best results most economically is easily determined from the instructions and diagrams in the free Smooth-On Home and Auto Repair Booklet.

Mail the coupon for your copy and get Smooth-On No. 1 in 7-oz. or 1 or 5-lb. can from your hardware store.



Write for
FREE BOOK



Do it with **SMOOTH-ON**

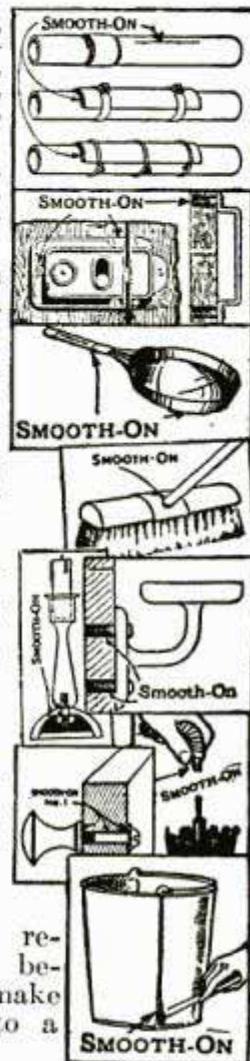

SMOOTH-ON MFG. CO.,
Dept. 37,
574 Communipaw Ave.,
Jersey City, N. J.

Please send the free Smooth-On Repair Book.

Name.....

Address.....

7-39.....

Everything in RADIO at Lowest Prices



Get ALLIED's Free 164-page Radio Catalog—save on everything in radio! 62 new Knight Sets as low as \$5.95, all types; portables, \$10.95 up! New Build-Your-Own Kits; record players, phonographs, recorders; over 14,000 Parts; new Amateur Equipment, Sound Systems, Test Equipment; tubes, tools, books, etc. Send coupon now!

SEND 10c FOR RADIO BUILDER'S HANDBOOK!
New book, written for beginners, tells how to build your own sets—select circuits, read diagrams, make chassis, etc.—only 10c and postage —send coupon now.

ALLIED Radio Corp., 833 Jackson Blvd., Dept. 5-G-9, Chicago, Ill.
 Send me your FREE Radio Catalog.
 12c enclosed for Builder's Handbook.
 Name
 Address

WRITE TO Bass FOR HIS BOOK OF BARGAINS

- ORDER FROM THIS LIST OF BASS-GUARANTEED BARGAINS**
- ARGUS—Model C2 with F:3.5 Cintar lens, 1/5 to 1/300, Coupled range finder. American made \$25
 - ROBOT—Famous sequence camera, zone focusing, built-in filter, Carl Zeiss Tessar F:2.8 lens capacity 48 pictures. Practically new. List \$147.50 \$87.50
 - VORAN—2 1/4 x 3 3/4 Roll film, with Schneider Radionar F:4.5 lens, and Prontor II—1 sec. to 1/150, self timer, mask for half size 120 film. Special \$19.50
 - V. P. DOLLY—vest pocket and half size, with Corygon F:3.5 Anastigmat lens . . . Compur shutter. \$23.50
 - 2 1/4 x 3 1/4 AGFA—single extension film and plate camera . . . with F:6.3 anastigmat lens and automatic shutter. Lists at \$30. At Bass \$12.75

BASS CAMERA COMPANY
 179 W. Madison St. Dept. P Chicago, Ill.

MOTORIZED YOUR BIKE

with a powerful electric motor made from old auto generator. Easily done with LeJay PLANS. Imagine the fun in building this one wheel power "Go-Bike"—and then more fun to ride. No more pedalling! Turn control on your handle-bars and away you go. Operates on ordinary 6 volt storage battery and goes up to 125 miles on single battery charge. Easily attached to any bicycle. Send your quarter today and get started at once.



LEJAY MFG. CO.
 1247 LeJay Bldg., Minneapolis, Minn.

BUILD DUTCH WINDMILLS

- LIGHTHOUSES, LAWN FIGURES, LAWN CHAIRS, TRELLISES, ETC., BEAUTIFY YOUR GARDEN**
- Model B-30 Windmill 24" high. Wings operate farmer at bucksaw. Blueprint 50c
 Model B-10 Windmill hexagon style, 40" high overall. A beautiful model. Blueprint 75c
 Model H-10 Lighthouse, 40" high. Blueprint 75c
 Comfortable, Sturdy Cape Cod Lawn Chair. Blueprint 50c
 12 Artistic Trellises. Blueprint all 12 only 50c



Special All Blueprints mentioned above for only \$2.00. Send 10c for Illustrated Catalog.
 "Over 35,000 Satisfied Customers"
CRAFTSMAN'S MODEL CO.
 2030 N. 41st St., Dept. P-31, Milwaukee, Wis.

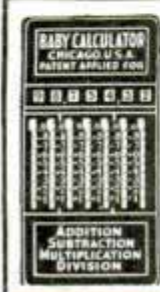

WORLD'S LOWEST PRICED ADDING MACHINE

GUARANTEED ACCURATE. Not a toy. Operates with only a finger flick. Adds, subtracts, multiplies, divides. Counts up to a million. Pays for itself over and over. Ideal Gift—for Business, Income Tax and School use. **ONLY \$2.50**
SEND NO MONEY
MONEY BACK GUARANTEE. Send name and address. Pay postman only \$2.50 plus postage. (Send full cash if outside U. S.) Money back in 10 days if not delighted. **AGENTS WRITE. CALCULATOR MACHINE COMPANY (Mfrs.), DEPT. 107, P. O. BOX 1118, CHICAGO, ILLINOIS.**

Audio Amplifier for Beginner's Set

(Continued from page 137)

control (R₂) shuts off the A-battery current for both tubes.

Receiver tuning is the same as before the amplifier was added, the volume con-

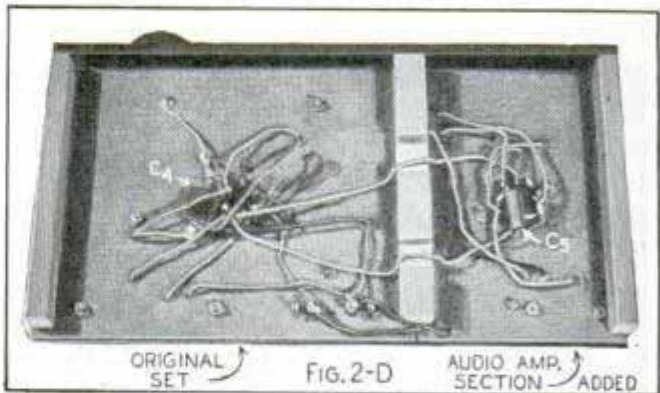

trol having no effect on the tuning but serving to keep the volume at a reasonable level. Do not use the volume "full on" as it may overload the amplifier stage. Headphones may be used by simply plugging

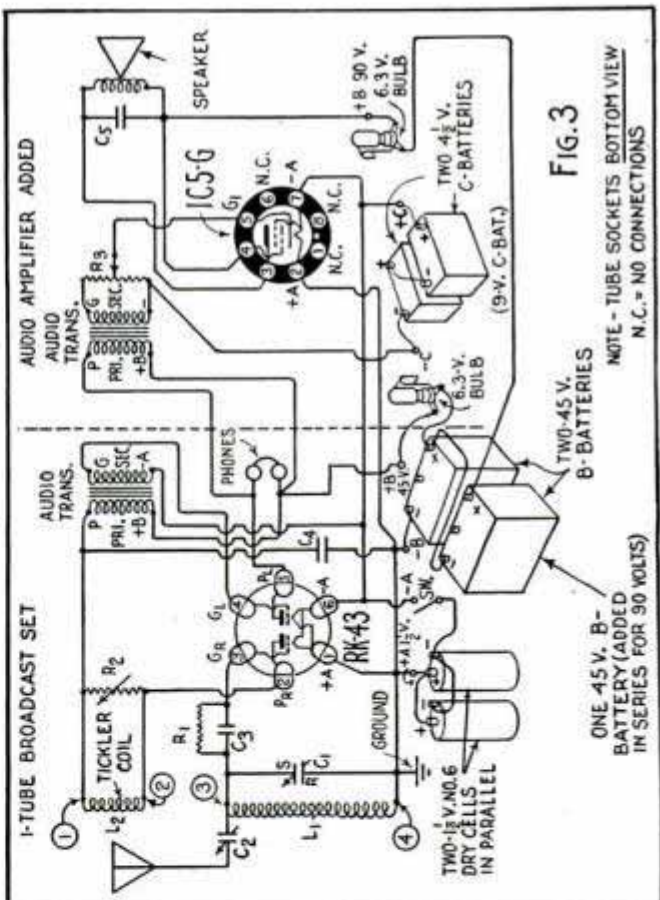

them in the phone jacks; when this is done the 1C5 tube should be removed to silence the speaker. The 6.3-volt bulbs act as fuses and protect the tubes from burning out in event of accidental short or error in wiring.

Making Weather

(Continued from page 61)

Trouping meant wide temperature variations and knowing of apes' susceptibility to respiratory diseases, they arrived at one conclusion: the 450-pound beast would be down with pneumonia before the show completed its New York run. Circus officials disagreed. They built a glass cage with 840 cubic feet of space and we were assigned to regulate the air within so it duplicated the climate found in the beast's habitat in the Belgian Congo. This was done and at the end of a 19,466-mile tour, Gargantua was very much alive. His trainer told us the gorilla not only escaped colds and illness but gained in weight and height and his pelt can only be compared to the pelt of a silver fox. It has been found any temperature change greater than one degree per hour would result in a shock that might bring Gargantua down with pneumonia.

During a hot spell, the system serving NBC's twenty-seven broadcasting studios and executive offices in Radio City will remove 10,800,000 B.T.U. of heat from the atmosphere hourly—enough to warm 250 average-size homes a whole winter. Each studio requires a separate temperature control and there are delicate, sensitive mechanisms to compensate for such factors as the number of people in attendance and the amount of illumination being used.

Providing for human comfort is but one branch of this science. To many industries, artificial weather is as important as a central power station. Without it, for example, the chemist would never have succeeded in beating the silkworm at his own game in producing the silkless silk known as rayon, because of the acid condition of the air in the spinning rooms.

New jobs for scientific weathering bob up daily. Because dirt and dry air are important causes of paper deterioration, many libraries, including the Library of Congress Annex, have made installations to help preserve rare books. Shoes, sugar, dairy products, pharmaceuticals, tobacco, electrical goods—virtually everything we eat or wear and many of the things we use are less expensive because of air conditioning. And that brings up the question: just what is air conditioning? Generally

(Continued to page 138A)

..CENTER YOUR SHOTS.. SHOOT Xpert .22's!



YOU can shoot the center out of a target at 100 yards with Western XPERT L.R. .22's, they're so accurate! Yet YOU DO NOT PAY EXTRA for their sensational accuracy. They make high scores easier, whether you use the .22 Long Rifle size, the .22 Long or .22 Short. XPERT is the REAL THING for all-around shooting. NON-CORROSIVE! Smokeless! CLEAN ammunition! Mail Coupon for free 72-page shooting guide.

Free!



WESTERN CARTRIDGE COMPANY,
Dept. G-46, East Alton, Ill.

Send, FREE, the 72-page Western Ammunition Handbook, a modern complete shooting guide.

Name _____
Address _____
Post Office _____ State _____

**ALL PURPOSE
MOTO-TOOL**

ONLY
\$9.85

New Mechanical Sensation

Speed of 25 to 27 thousand revolutions per minute without vibration makes it possible to do all kinds of fine work such as carving, grinding, engraving, drilling, routing, etc., with a Dremel Moto-Tool and to do it in a jiffy. Two models to choose from—No. 1 as shown, only \$9.85 and No. 2 for heavier work only \$16.50. Indispensable for home work shop fans, sportsmen, handy men and home owners. Many improvements not found in other tools. If your dealer is out of stock write for complete description, 10-day trial offer and booklet showing dozens of accessories which can be used and special combination offers. No obligation, booklet is FREE.

DREMEL MANUFACTURING COMPANY
Department 721 Racine, Wisconsin

HANDY TAPS and DIES . . .

Accurate—carefully hardened and tempered. Complete range of sizes at your local five and ten cent store

HENRY L. HANSON, WORCESTER, MASS.

NATIONAL MOWER CO.

821 Cromwell St. Paul, Minn.

Sickle mower, power driven, rubber tired, pulls self, cuts high grass, hay, weeds, on level or rough. Moderate price.

WRITE FOR CATALOG.



Announcing-



The NEW DAISY LIGHTNING-LOADER Carbine

Ready! — new Daisy Lightning-Loader CARBINE... fastest, easiest loading air rifle ever! New Features: Lightning-Loader 500 Shot Magazine, ADJUSTABLE DOUBLE-NOTCH Rear Sight, Pistol Grip stock, \$2.50 at Dealers. If he hasn't it, send us \$2.50. We'll mail yours postpaid!

Daisy Mfg. Co., 117 Union St. Plymouth, Mich., U. S. A.

\$2.50 Get a **DAISY AIR RIFLE!**

5 SECONDS TO POUR A FULL TUBE OF SHOT

Write for Free DAISY AIR RIFLE CATALOG

Higher in Canada

FREE TRAILER BUILDERS' GUIDE AND CATALOG—NEW 1939 EDITION

WORLD'S BEST LINE OF TRAILER AXLES, HITCHES AND PARTS

Complete house trailer working blue prints only 50c. **WRITE TODAY FOR THIS NEW FREE CATALOG**

HAMMER BLOW TOOL COMPANY, Dept. 107, Wausau, Wis.



Add POWER PEP PICK-UP TO YOUR MOTOR WITH FRETONE

SENSATIONAL MOTOR TUNE-UP!

ONE Fretone application frees sticky valves and piston rings—releases Carbon—restores PEAK ENGINE COMPRESSION. Effective "Upper Lubrication." Assures clean, longer-wearing motor. Saves oil, gas, money. Write for special trial sample—send only \$1.00. Distributors wanted. Write for details. **J. W. SPEAKER CORPORATION, Dept. P-2, 1655 North Water St., Milwaukee, Wis.**



SOFT WATER MAGIC WORDS —that are bringing big profits to Webb Salesmen!

The Webb Portable Water Softener gives every housewife, soft water in an endless flow for washing dishes, laundry, bath, shampoo and every home purpose. Softens hardest water instantly at the turn of the faucet. Provides healthful drinking water equal to many expensive bottled waters.

Distributors Salesmen FREE SALES PLAN

100% profit—simple home demonstration sells it easily. Leads to larger sales. Write today for free literature and full details of the Webb **NO RISK TRIAL OFFER!**

NO RISK TRIAL OFFER!

WEBB MFG. CO. Dept. P-79, 1813 Baltimore Ave. Kansas City, Mo.



EARN MONEY Stringing TENNIS RACKETS

Build up a business of your own stringing tennis rackets. It pays up to 140% profit **PER RACKET**. String **YOUR OWN RACKET AND SAVE MONEY**. No experience needed—we teach you how. Tennis players need new strings in their rackets two or three times yearly... every stringing means **PROFIT** for you. See how simple it is to get in this business. Costs practically nothing to start. Easy work! **GET STARTED NOW!**

FREE Write today and we will send you Free plan and special offer on strings and stringing equipment.

THOMPSON MANUFACTURING CO.
4535 Packers Ave., Chicago, U. S. A.
TOMGUT "Court-Tested" Tennis & Badminton Strings



(Continued from page 137A)

speaking, it implies control of any or all the physical qualities of the air. More specifically, it includes the simultaneous control of temperature, humidity, movement, and purity of air within an enclosure.

The centrifugal refrigeration machine contributed in a great measure to the application of air conditioning in large buildings. The safety of the refrigerant, simplicity of operation, economy, and compactness make possible efficient large tonnage installations in a limited space. Development of Freon, a gas with the property of rapidly giving off heat under pressure and rapidly absorbing it when pressure is released, and other refrigerants opened the way for the design of small machines of the reciprocating type for about half the cost of the ammonia machines formerly used.

There are two phases to the process of home air conditioning. The first, in winter, requires the addition of heat and moisture, while the second in summer involves the removal of excess heat and moisture from the air. Not much emphasis has been placed on winter conditioning but we believe it to be the more important of the two. We've found colds are caused not by low temperatures but by improper temperature distribution.

Electric Bed Exercises the Body and Aids Rhythmic Breathing

Gentle exercise for the body is the purpose of an electric bed offered for hospital or home use. As the body turns on the moving sheet, rhythmic and deeper breathing can be practiced. The motion also induces light exercise of the muscles and tissues.



Sheet moving on rollers keeps body turning rhythmically and helps induce regular, deep breathing

Caraway Machine Co. 5528 St. Louis, Mo.



"Homework is neat, business-like now!"
 (Student) . . . "A real help to all
 of us." (Parent) . . . "Smooth, steady,
 grand to use." (Ex-secretary).

NEW INVENTION! FREE

WITH EVERY ROYAL PORTABLE
 SHOWS YOU HOW TO
 TYPE RIGHT!

Royal's Instant Typing Chart is one of those
 "why-didn't-someone-think-of-it-before?"
 ideas. Shows you at a glance exactly how
 to position and use your fingers.



Try a Genuine Factory New ROYAL PORTABLE... in your own home FREE!

WITHOUT RISKING A PENNY, see exactly how a Royal Portable will help you—thanks to Royal's superior design and construction. Know that you can turn out perfect typing faster—easier than writing by hand—thanks to Royal's genuine office typewriter features. • Use the coupon below—get the facts—models, prices, terms—details of FREE HOME TRIAL. No obligation.



ACT NOW! MAIL TODAY! NO OBLIGATION!

FREE!

Royal's Instant Typing Chart, shows you how to type RIGHT.

INCLUDED

with every Royal Portable—at no extra cost—a handsome all-weather Carrying Case.

ROYAL TYPEWRITER COMPANY, Inc.
 Dept. D-149, 2 Park Ave., New York, N. Y.

Tell me how I can own—on easy monthly terms with small carrying charge—a latest model Royal Portable—with FREE HOME TRIAL. No obligation.

NAME _____ STREET _____
 CITY _____ COUNTY _____ STATE _____

IDEAL Lawnmower Sharpeners

• Go into business for yourself. Earn up to \$25 per week sharpening lawnmowers. BIG CATALOG FREE. Send post card to The Fate-Root-Heath Co., 749 Bell St., Plymouth, Ohio

WHEN YOU BUY FLASHLIGHT BATTERIES DEMAND "EVEREADY" FRESH DATED BATTERIES

The word "Eveready" is the registered trade-mark of National Carbon Co., Inc.

OTTAWA LOG SAW \$39 BIG BOOK FREE



PUTS THIS OTTAWA to work for you. MAKE MONEY! Wood is valuable. Does more than 10 men. Easily operated. Falls trees—saws limbs. Use 4-hp. engine for other work. Write for FREE Book. OTTAWA MFG. CO. 2127 Wood St., Ottawa, Kans.

Earn Cash at Home!

We paid M. M. \$1174 for exceptional cellar crop Snow-King mushrooms! We furnish materials; buy all crops. Big FREE picture book tells if your cellar, shed, barn, suitable. Est. 1908. Write today. United Co., 3848 Lincoln Av., Dept. 301, Chicago

FREE BOOK ON FILING! 28 pages of detailed information on use and care of files, packed with complete instructions, scores of photos. The complete book for every file user. Write today. Nicholson File Company, 22 Acorn St., Providence, R. I., U. S. A.
A FILE FOR EVERY PURPOSE

RE-STRING RACKETS AT HOME



•EARN MONEY•

It's pleasant, profitable work. No experience or skill required. Easy to learn. Full line of guaranteed Stringing Tools, Frames, Gut and Silk Strings. Every item high quality. Write for complete information.

FREE Write for our 1939 Catalog and Instruction sheet.
 W. A. BICKEL & CO., 137 N. Marion, Dept. A-79, Oak Park, Ill.

Choose from World's Largest Line of Power Tools!

FREE 48-page Catalog covers Metal and Woodworking Tools, accessories, motors for every purse. Write Walker-Turner Co., Inc., 179 South Ave., Plainfield, N. J.

DRIVER Engineered POWER TOOLS

VENETIAN BLINDS Make your own at low wholesale cost. It's easy under our unique plan. All materials supplied. Send 10c coin for samples of ladder tape, cord and slat, 15 color samples of tape and color chart.

VENETIAN BLIND MFG. & SUPPLY CO.

Dept. 2B, 1760 Lunt Ave., Chicago, Ill.

New ELECTRIC SANDER...Many Uses



Portable Guild Sander sands the roughest surface and leaves it smooth and clean. Saves time energy and money. Useful wherever sanding, planing and finishing is done. Removes paint and rust. Works on many different materials. Runs on either AC or DC. Popular price. See your hardware dealer or write direct for FREE folder on many uses. SYRACUSE GUILD TOOL CO. 1700-7CN, Salina St., Syracuse, N.Y.

Saves
 TIME
 and
 TOIL

Earn \$150 to \$300 Monthly with "Simplified" Arc Welding

30 Days Trial

Try this new "Simplified" Welder on your own work, in your own shop for 30 days at our risk. It pays for itself.



BUILD A PROFITABLE BUSINESS of your own with new 40-Volt Arc Welding. Get big pay jobs that mean real profit. Hobart welders are easier to operate, faster, do a better welding job.

FREE Welding Book. Write for it today.

NO INVESTMENT TERMS—profits pay for it. Savings make it easy to own a Hobart Welder without expense.

PAYS FOR ITSELF in short time. Profit on single job often pays all monthly payments. Write for details.

HOBART BROS. CO., Box M-79, Troy, O.

SAVE \$300 to \$500
 "Build Your Own" Portable arc welder using complete Hobart generator and coupling to old motor and chassis.





Calling All Cars

MYSTERIOUS DISCOVERY

SAVES UP TO 30%

on GASOLINE

or Costs Nothing to Try

Stop wasting Gas!—trim dollars off gas bills—get more power—quicker pickup—faster acceleration! AUTO OWNERS everywhere praise VACU-MATIC! Proven so efficient, it is guaranteed to satisfy, or the trial costs you nothing.

Automatic Supercharge Principle
Vacu-matic is entirely different! It operates on the supercharge principle by automatically adding a charge of extra oxygen, drawn free from the outer air into the heart of the gas mixture. It is entirely automatic and allows the motor to "breathe" at the correct time, opening and closing as required. Saves up to 30% on gas costs, with better motor performance.

FITS ALL CARS
Constructed of six parts fused into a single unit, adjusted and sealed at the factory. Easily and quickly installed by anyone in a few minutes.

AGENTS *Get Yours FREE*

FOR INTRODUCING. Here's a splendid opportunity for unusual sales and profits. Every car, truck, tractor owner a prospect. Send name and address now for big money making offer and how you can get yours free. The Vacu-matic Co., 7617-456 W. State Street, Wauwatosa, Wis.



PHOTO ENLARGEMENTS

5¢ ANY SIZE

Is Photography your hobby? Do you want a profitable easy business at home? Make PHOTO ENLARGEMENTS for yourself and others. Your cost 5¢ each and less. The Ideal Photo Enlarger is AUTOMATIC. No experience required. Also COPIES any picture. \$5.94 COMPLETE. Interesting circular FREE.

IDEAL ENLARGER, 148 West 23rd St., New York City

ONE-MAN SAWMILL

Makes lumber, shingles, lath, ties, crates, boxes, cases, all forms lumber

TURN TREES INTO MONEY WITH A BELSAW

Three capacities: 10, 14 and 20 ft. Accurate set works positive dogs. Hand or power feed. Runs on low power—Many owners use old auto engine. Pays for itself quickly—thousands in commercial service, everywhere. Write for free lumber handbook and catalog of mills, supplies, tools, saw tables, and woodworking equipment.

Belsaw Machinery Co., 8111-A Davidson Bldg., Kansas City, Mo.

FARM MODEL \$49.00



CRASH HELMETS

for racers, large & midget autos, cycles, boats, aviators, firemen. Race rules require them. Play safe, wear one. Catalog FREE.

CLYMER CO., 222 PICO, LOS ANGELES, CALIF.

MEGOW'S New Catalog NOW READY!

Shows the sensational new quick-building COMMANDER and CADET gas-powered models (see illus.). Also new CLASS C ENDURANCE CONTEST rubber-powered models. Model Ships, HO-Gauge Railroads, ready-made parts and supplies. Send 5¢ for your copy today!

MEGOW'S Dept. P M., How. & Oxf. Sts., Phila. Pa. OR 217 N. DESPLAINES ST., CHICAGO

MONEY for MEN ALL DATA FREE

THE PLASTEX Industry needs manufacturers on small scale and for big production of Lamp and Clock Stands, Art Goods and Novelties in Plastex and Marble imitation. Experience unnecessary. 1/2¢ material makes regular 10¢ store sellers. Rubber moulds furnished for speed production. Small investment brings big returns. BIG CHAIN STORE orders now being placed by us. Ambitious men have chance for real prosperity. Our FREE booklet will interest and benefit you. PLASTEX INDUSTRIES, Dept. P, 1085 Washington Ave., New York, N. Y.

OPPORTUNITY KNOCKS

a
Thousand
Times
in a



THOUSAND HELPFUL BOOKS

SELECT FROM THIS LIST. ASK ALSO FOR FREE LIST ON MANY SUBJECTS

- | | |
|--|--|
| AIR CONDITIONING
Live Field; Great
Future..... \$3.50 | MACHINE SHOP WORK
Complete. 400 Pages.
444 Illustrations... \$2.50 |
| AUTO ENCYCLOPEDIA
The Famous Dyke's
Latest Edition.... \$6.00 | MATHEMATICS
Easy Guide for the
Practical Man.... \$1.50 |
| 110-V. GENERATORS
Made From Old Auto
Units..... \$1.00 | MECHANICAL DRAWING
Learn Drafting; Good
Salaries..... \$1.00 |
| BIRD HOUSES
Build to Sell; Easy
Designs..... \$1.00 | MONEY MAKING IDEAS
1000 Ways to Make
\$1000..... \$2.50 |
| BLUEPRINT READING
for the Building
Trades..... \$1.25 | OXYACETYLENE WELD-
ing, Hard Surfacing,
Lead Burning, Cutting
New ed..... \$1.25 |
| BOAT BOOK
Power, Sail, Rowing,
Paddle Plans.... \$3.00 | PAINTING AND DECO-
rating. New book.... \$1.50 |
| BOY MECHANIC
Hundreds Things Boys
Can Make..... \$2.00 | PLUMBING
500 Facts Every
Homeowner Should
Know..... \$1.50 |
| CARPENTRY, PRACTICAL
Complete 436 pages.
Revised Edition... \$2.00 | POWER TOOLS,
AMATEUR
Wood and Metal Working,
Uses..... \$1.75 |
| CIVIL SERVICE
Home Study Courses
Federal, State, City
Positions..... \$1.00 | PROSPECTORS'
HANDBOOK
How to Mine, Appraise,
Equip..... \$3.00 |
| CONCRETE
1001 Ideas for Using.
New Popular
Mechanics Book... \$5.00 | RADIO SERVICING
Profit by Knowing Costs,
Kinks, Etc!..... \$4.00 |
| DIESEL ENGINES
For Land, Air and
Water..... \$4.00 | REFRIGERATION
Electric, Gas. Be a
Service Expert.... \$5.00 |
| ELECTRIC MOTORS
Fractional Horsepower.
How to Repair, Rewind
and Reconnect... \$3.50 | SHIP MODEL
Entire Text, Famous
"Sovereign" of 1637. \$1.00 |
| ELECTRONIC DEVICES
Design and Use of
Electric Eye, etc... \$2.00 | SOIL-LESS GROWTH OF
Plants. Just out.... \$2.75 |
| FORD V-8 CARS, TRUCKS
New, 700 Pages. In-
cludes Details 1937
Cars..... \$2.50 | STEEL SQUARE
How to Figure Angles
of Rafters, Roofs,
Etc..... \$1.00 |
| FORMULAS
1059 Money Making.
Start a Business... \$1.25 | TOYS
For Amusement or Profit.
Saleable Designs... \$1.50 |
| FURNITURE MAKING
Tools, Materials, De-
sign..... \$2.50 | UPHOLSTERY
Always a Big Market.
Start Own Business \$2.00 |
| HOUSE CONSTRUCTION
Details. Practical, up-
to-date. Complete.. \$3.00 | WIRING, HOUSE
Covers Methods, Materials,
Illustrated..... \$2.50 |
| HOUSES, SMALL
Book of, for Home
Builders..... \$2.00 | WOOD FINISHING
Methods, Tools..... \$2.00 |

Send No Money!

Order from above list and if in U. S. or possessions, pay postman on delivery plus small C.O.D. fee. We pay postage if remittance is sent with order. Ask for complete list of books on many subjects. Order today.

POPULAR MECHANICS PRESS

Room 739B

200 East Ontario St., Chicago

Super-Gasoline for Your Car

(Continued from page 3)

to bring it up to fighting grade. It is even possible, by recycling raw gasoline through the catalytic still, to reform it into a base fuel that has an octane rating as high as ninety-one before other treatment.

Catalytic cracking apparently solves another big refining problem. In the past large quantities of heavy fuel oils and asphalts were unavoidable by-products in the manufacture of gasoline. The refiner had to sell them or store them until he found a market. Today he can feed them into a catalytic cracking still and convert them into high-grade gasoline and light furnace oil without any residual waste. Within limits he can control the proportions of the products that he obtains.

The implications of this new process are much wider than merely providing an inexpensive high-octane motor fuel for today's cars. By making higher grade fuel available at a reasonable price, catalytic cracking opens up an entirely new horizon in automotive engine design.

Every one knows that the efficiency of a gasoline engine depends upon its compression, the degree to which the fuel charge is compressed before it is ignited. Since 1931 the maximum brake horsepower in the automotive field has increased sixty-two per cent while displacement has increased only three per cent. That means that more than half as much power again is developed in substantially the same engine, due to increases in compression pressures. The part that the petroleum industry has played in this advance has been to provide fuels of high anti-knock value that would not detonate at the higher pressures. To a great extent high compression has had to wait for the proper fuels.

Until recently the indications were that anti-knock fuel had reached a level in octane rating above which it was impractical to climb because of higher costs. That threatened to halt the design of efficient engines using higher compression ratios.

Now that high-compression gasoline can be manufactured at non-premium prices automobile engine manufacturers will be able to build engines of higher compressions that will take full advantage of the new fuel. Tetraethyl lead probably will

(Continued to page 142A)

NOW enjoy
EVINRUDE
FOR AS
LITTLE AS **\$34.50**



9 EVINRUDES TO CHOOSE FROM

Evinrude offers the widest range of models, from the lightest, handiest, to the swiftest, most powerful. All are famed for exceptional starting ease, smoothness, reliability. All offer advanced Hooded Power construction, Co-Pilot steering, certified horsepower.

AN ELTO FOR ONLY \$29.50 New Elto Cub weighs only 8½ pounds, costs only 2c an hour to run. Now, a complete line of 6 Elto models—built by Evinrude—offer outstanding quality at low cost. Write for free Evinrude and Elto catalogs, Boat Directory, Boat & Motor Selector.

EVINRUDE MOTORS
4207 N. 27th St. Milwaukee, Wis.

• Never before an Evinrude so inexpensive to own, so handy and economical to operate. The sensational new "Mate" fits your own or rented boats—drives row-boats up to 4½ miles an hour, canoes up to 5 miles. Runs all day on a single gallon of fuel. Amazing starting ease—a flick of the starting cord and you're away! Write for catalog today!



EVINRUDE MATE
WEIGHS ONLY 10 LBS.
RUNS 10 HRS. ON 1 GALLON

WRITE FOR FREE CATALOG
All Prices F. O. B. Factory

FREE Sensational OFFER
2 FENCING SWORDS FREE
FENCING
WORLD FINEST SPORT

HARMLESS-EXCITING FUN

Develops strong body and alert mind. **HARMLESS.** The spring-steel 3-foot-long foils (swords) are equipped with rubber buttons. Aluminum cup-shaped hand guards. Our De Luxe foils are built for hard usage.

Complete set of two foils (swords) and free instruction booklet, only \$1.98. We pay postage. Two additional fencing swords FREE for limited time. (Regular price of these two sets of foils \$3.96.) ORDER NOW.

All-American Fencers Guild, Dept. 7-PM, 48 W. 48th St., New York

EARN MONEY MAKE COLOR GLAZED CONCRETE PRODUCTS

NEW, low cost, patent method makes Color-glazed concrete pottery without molds. No experience needed. Use only sand, cement, cheap materials. Make glazed tiles, walls, gravestones, etc. Money-making business. Send 10c TODAY for booklet, colorplate, cost data, details. Descriptive folder Free.

NATIONAL POTTERIES COMPANY
Room 6, 13 W. 26th St., Minneapolis, Minn.

LIGHT POWER TOOLS
Save Time, Money, Labor



Delta tools are portable, rugged, efficient—yet astonishingly low priced. Ideal for small shops, home shops, and factories. Many new features and improvements. Complete DELTA line includes: Circular Saws, Scroll Saws, Lathes, Jointers, Shapers, Band Saws, Grinders, Drill Presses—and full line of accessories. Send today for big 48 page FREE Catalog.

DELTA MFG. CO. (Dept. A739)
600 E. Vienna Ave., Milwaukee, Wis.

332
(Continued from page 141A)

HELP! MY LEG IS
BROKEN

I'LL FIX YOU
LIKE NEW



Save money this spring . . . mend chipped, splintered and broken articles this amazingly easy way with Rogers Glue . . . makes all your furniture look and remain like new . . . incredibly strong — sells 10c and up in tube, jar or can at hardware stores *only*, or send 10c for full size bottle, glue paddle and set of blueprinted project plans for making useful articles.

ROGERS • Dept. D • Gloucester, Mass.

ROGERS
the best LIQUID FISH GLUE



Build this
Smith Compressor



We will furnish complete instructions with a Smith Compressor Head and Accessories

With a Ford Motor and shop facilities you can easily assemble a Smith Air Compressor. You'll have a smooth performing, efficient compressor. Sixty cubic feet a minute capacity—all the power you'll need to operate rock drills and paving breakers. Here's a way to save money. Write for complete information.

GORDON SMITH & CO., Inc.

410 College St.

Bowling Green, Ky.

BURN YOUR NAME ON TOOLS
WITH THE
ARKOGRAF

PROTECT YOUR TOOLS FROM THEFT

Write with electricity any name or design on the hardest and finest tools and instruments, or any metal, like writing on paper with pen or pencil. Complete Outfit \$3.50—Prepaid Anywhere. Interesting illustrated circular free. Write today. Agents wanted. ARKOGRAF PEN CO., 3927 S.E. Stark St., Portland, Ore.

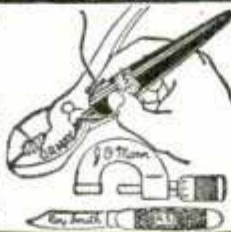

NOW ONLY

\$5.00

REAL ENGINE VALUE

Over 7,000 GHQ Gas Engine Kits were sold at \$8.50. Over 10,000 sold last year. Now is your chance to buy the New Improved kit for \$5.00. Absolutely complete with coil, plug, etc. For boats, planes, etc. All parts guaranteed. Send only \$1.—Shipped Express Collect for balance same day. Send 3c for new 12-page illus. catalog. DEALERS WRITE.

All parts finished. Only a screwdriver needed. 1/5 H.P. Average assembly time 30 minutes.

GHQ MOTORS, 854B East 149 St., New York, N. Y.

ELECTRICITY

ANYWHERE



ONAN ELECTRIC PLANTS furnish 110 Volt, 60 Cycle, A. C. Current same as City Power Lines for Farms, Camps, Construction Jobs and Emergency Service in Hospitals, Schools, Theatres, Public Buildings. SAVE PROPERTY, even LIVES in case of Power Line Failure. Thousands in use in all parts of the World. Operate Lights, Radios, Water Systems, all Appliances. Models 350 to 50,000 Watts, 12, 32 and 110 Volt D. C.—110 or 220 Volt A. C. Also Combination A. C.-D. C. Units. Manual, Full-Automatic and Self-Starting Types. Shipped COMPLETE—READY TO RUN, \$99 and up. Write for details.

D. W. ONAN & SONS

1035 Royalston Ave.

Minneapolis, Minn.

still be used with catalytically cracked gasoline to raise its octane value even higher, further increasing the range of engine design. It is estimated that an automobile engine designed to take full advantage of 100-octane fuel would be about half the size of one of today's engines, would deliver the same flashy acceleration and high speed, and would be forty per cent more economical in its use of fuel.

Aside from improving the quality of gasoline, every forward step in refining helps to put off the day when the world's petroleum resources will be used up. It is estimated that thermal cracking alone, by extracting more gasoline than otherwise could be obtained from petroleum, conserved one and a quarter billion barrels of crude oil in such a representative year as 1935. By supplying more gasoline from a smaller amount of raw material catalytic cracking likewise promises to reduce the rate at which crude oil is consumed.

More and more, petroleum refining is approaching the status of a true chemical industry. Ethyl alcohol, sulfuric acid, rubber substitutes, pickling agents, anti-freeze liquids, paint and lacquer compounds, and various plastic resins are all being manufactured from crude petroleum. As a consequence of the new developments new words by the dozen are being added to the refiners' language. Terms such as alkylation, isomerization, tri-isobutene, and methylcyclopentane are a few of the jawcrackers the refiners are learning. Gasoline, of course, remains the important product of the refinery. If necessary a great quantity of 100-octane motor fuel could be manufactured from the various gases that are by-products of cracking.

Other catalysts are being sought that will make it possible to convert petroleum into many other products on a more efficient basis than in the past.

Twenty-four years ago it took 1,325 pounds of passenger-car engine to develop sixty-five horsepower. A modern midget racing engine weighs 205 pounds and develops 150 horsepower. High-octane gasoline plus high compression plus supercharging makes this possible. Today's passenger-car engine is not as efficient as the racing engine, of course, but this comparison shows the progress already made and gives a hint of what the future holds.

Thrill Makers of '39

(Continued from page 11)

conventional aviation strap. He keeps the plane under full control until crash time. If he were to cut off his motor in advance, he's certain he'd be picked up in a wicker basket.

Just before ripping into the flimsy structure, he ducks; one arm goes up to protect his face, and the other is braced against the dashboard. A few of the pointers he's picked up would be helpful to regular pilots, he feels, if ever they had to make forced landings in suicidal surroundings.

There's never a dull moment when Dick Granere entertains fair crowds. From an altitude seldom above fifty feet he runs the



For a comedy thriller Dick Granere demonstrates how not to fly by hurdling parked cars on his course

gamut of stunts ordinarily performed at 1,500 feet. For comedy, he demonstrates how not to fly by dragging the plane's wings on the ground, leapfrogging over motorcars, and winding up with a tailspin starting at 300 feet.

His most noteworthy act is flying through a target at one end of the grandstand, pulling his plane into a loop and on the way down, with the ship in a half roll, flying through the second target. The rims are left standing, the targets shattered. The targets are forty feet in diameter and the Canadian war ace allows himself but a few feet for wing clearance.

Take a look at Arzeno E. Selden, who does what is said to be the highest trapeze and swaying pole acts in the world. Life in the "stratosphere" didn't begin for him until after he had passed the forty-year mark, even though he had for thirty years been a daring young man on the trapeze.

On a bar ninety feet off the ground, he balances himself on a kitchen chair and

(Continued to page 144A)

Plays Anywhere—Outdoors or Indoors... No "Plug-In"!



New! Lightweight
PHILCO
"Little Pal"

Only
\$19.95

- Complete with Batteries
- Nearly HALF the size!
- FULL performance!
- TWICE the battery life!

REALLY PORTABLE

Self-powered; needs no connection—no aerial, ground or "plug-in." Your "Little Pal" wherever you go, outdoors or indoors... traveling, bathing, boating, outings.

Personalized! Identification tag for your name and address attached to the radio.

AT ALL GOOD RADIO STORES



BUDA INBOARD ENGINES

1-6/10 H.P.—2 1/4 H.P.—5 1/2 H.P.
For Fishing Boats, Sail Boats, Utilities, Dinghies
"AIR JACKETED" (Improved Air Cooling)—Takes all engine heat out of boat—no hot pipes—better than water cooling!
REVERSE and REDUCTION DRIVE—"Free-wheeling clutch"
Price complete (with outstanding features listed above)—
1-6/10 H.P.—\$81.00—2 1/4 H.P.—\$94.50 (F.O.B. Harvey, Ill.)
BOAT PLANS! For 8 ft. Dinghy—\$2.34, 16, 18 ft. Fishing Boats—18, 22 ft. Sail Boats—\$1.00 each, with complete instructions and build'ng blue prints. Designed by prominent nava architect. Write for details in literature.

The BUDA Co. (Marine Dept. PM) Harvey, Ill.

NOW a DYNAMIC HEAVY DUTY INDUSTRIAL WELDER

Works Off 110-Volt Light Socket. This marvelous Dynamic Power Welder does the work of much higher priced types. It is easily portable. WELDS Cylinder Blocks, Bumpers, Fenders, Tanks, Farm Machinery, etc. RETAIL material. Works on iron, steel, tin, brass, copper and all other metals. Men without previous experience can make as much as \$5.00 on a one hour repair job. In a year's time a Dynamic Welder Costs You LESS THAN 6 CENTS A DAY. Go into business—Open a welding shop now. AGENTS—Make big profits selling to garages, factories, janitors and machine shops. Write today for our 10-DAY TRIAL OFFER. DYNAMIC WELDER CO. 226-HW Silverton Road Chicago, Illinois

for Only
\$19.75



★ More FUN at CAMP ★

This summer Leather Craft is the rage... It's America's fastest growing hobby. You can begin to enjoy an EASCO Leather Craft Set the minute you open it. Complete outfit, including tools, leathers, patterns, etc., and full instructions, only \$2.00—on sale at leading Department Stores or order direct and pay postman on arrival. \$2.50 outside U. S.

LEATHERCRAFT

Free When ordering direct, clip name of your Department Store to this ad, and we will include with your set, one extra free project. Illustrated catalog 10c.
E. A. SWEET CO. Dept. A-24 Binghamton, N. Y.

New STEREO-TACH
MAKES 3rd DIMENSION
SNAPSHOTS



With Your Own Camera

* PATENTS PENDING

Now YOU can take pictures with DEPTH and perspective. Just use a Stereo-Tach in front of lens. Fits your camera. With a single shutter click you take TWO pictures, on one film, from different angles. Place prints in Viewer and people and objects STAND RIGHT OUT from backgrounds, as in real life. Black and white or color films developed and printed or enlarged in usual way. No special skill needed. No transposing. Pictures can be projected if desired.

Complete outfit includes amazing Stereo-Tach (patents pending) and modern stereoscope, sample prints, spectacles for viewing projected pictures, and simple, easy instructions. All for only a few dollars. **SATISFACTION GUARANTEED OR MONEY BACK.** Ask your dealer today, or write direct to manufacturer for **FREE DETAILS.** Act today.

Illustrated Booklet FREE

THE COMMONWEALTH MFG. CO.
 Dept. Z-2400 4206 Davis Lane Cincinnati, Ohio

EASY TO BUILD KAYAKS
OUTBOARDS



Largest Selection—Factory built or Complete Cut-to-fit assembly kits with detailed blue prints and instructions. New round bottom

—Safer and Faster. Built to last—Paddles included. Send 10c postage for big new catalog.



KAYAK BOAT COMPANY
 152 East 129th St., N. Y. City

Accurate Shooting at Lowest Cost With Chambered Air



BENJAMIN AIR PISTOLS WITH LEVER HAND PUMP
 NEW 1940 MODELS EASY TO PUMP anywhere, for practice firing or just plinking. You can have a lot of fun with this target gun at least expense for ammunition. **Adjustable power** depending on AIR PRESSURE—amazing maximum velocity and accuracy up to 15 yards. Economical and practical indoors or camping, fishing, hunting, etc. **No license required from dealer or factory.** Single Shot—BB or Pellets \$8.50. BB 8 Shot \$10.00. Holster \$2.00. Ask for complete information—targets and blueprints FREE if requested. Enclose 10c for samples of ammunition. **WRITE TODAY.**



BENJAMIN AIR RIFLE CO., 890 Marion St., St. Louis, Mo., U.S.A.

Get a TROTWOOD MOTOR-CYCLE
PACKAGE DELIVERY



Brand new design. All-Steel construction. Front wheel drive, 2-wheel brakes. Balloon Tires. Powerful motor. Two speeds. Big compartment for pkgs. Needed by merchants everywhere for quick, cheap delivery. Write for special introductory offer—Dealers Wanted.

TROTWOOD TRAILERS, INC.
 737 Main Street TROTWOOD, OHIO

WORLD'S GREATEST all around
ELECTRIC TOOL

DRILLS — GRINDS — SANDS — SAWS
POLISHES — SHARPENS — CARVES

The new WHIZ ELECTRIC TOOL is the handiest power tool ever made. Not a delicate instrument but a real rugged tool, equally effective for both power and precision work. Drills through 3/4 inch iron plate in 42 seconds or engraves intricate designs on jewelry. Handles any material: Metals—Woods—Alloys—Plastics—Glass—Steel—etc. Saves time. Eliminates labor. Plug into any socket AC or DC, 110 volts. Chuck 3/4 inch capacity. Bull bearing thrust. Powerful, triple-gear motor. "Worth its weight in Gold." **STANDARD MODEL** with Normal Speed (uses 50 different accessories, instantly interchangeable.) Price only \$7.95.

FREE Accessory outfit (Value \$2) includes set of drills, mounted 1 1/2 inch grinder, sanding discs, cutting wheels, mounted brush, polishing wheel, carving bur, etc. **FREE** with each outfit ordered NOW. We pay postage. Will send C. O. D. if desired. **10-DAY TRIAL—MONEY BACK GUARANTEE.**



ONLY \$7.95
POSTPAID
GUARANTEED FOR ONE YEAR

Special "3-SPEED" MODEL combines Normal Speed and High Speed in one outfit (uses 200 accessories) only \$9.95 complete, with same accessory outfit (value \$2) FREE.

Paramount Products Co., Dept. 7A, 48 West 48th St., New York

(Continued from page 143A)

does a half-dozen other acrobatic turns before shinning up to the top of the 130-foot pole to do handstands while the pole sways in a twenty-five-foot arc. In the awful hush that settles over the crowd as he starts his hand balancing, the crack of a peanut shell sounds like an explosion and when he returns to the ninety-foot perch and puts a strap in his mouth for a slide down a 500-foot rope, the spectators feel as if they have been pulled through a wringer.

Selden's big trouble was not in getting up his courage but in finding the proper rigging. He consulted professional equipment builders but none could suggest ma-



Jimmy Lynch earns his bread and butter by driving stock automobiles through flaming barriers

terials that met his requirements. So he set about to make his own rigging. The alloy he used is a secret. The entire set-up weighs three and one-half tons and takes five men fifteen hours to erect.

Ever since the days of Ruth Law's thrilling changes from speeding racers to air-planes, there have been outstanding feminine performers. At the moment, Birdie Draper is driving a motorcar through a solid brick wall on the thrill circuit while May Merkel is walking upside down, a feat as difficult as it looks. The latter stunt is accomplished by means of large rubber suction cups fastened to the soles of her shoes. On every step, she must apply her full weight in order to make the rubber cups stick on the flat steel walk.

At the outset she found it difficult to grow accustomed to walking upside down because of the blood rushing to her head. She's had three falls during her career, one from a high wire sixty-five feet off the

(Continued to page 146A)

Synco JIG SAW

Faster! Safer! Cleaner! Real performance. Cuts with smooth, clean edges. No sanding required. Electric operation. No motor or reciprocating parts. Operates on 60 cycle, 110 volt A.C. Ideal for home craftsmen, and model makers. Two models.



7200 Strokes per minute Only \$4.95 (East of Rockies)

Write Today for FREE LITERATURE

Export Office: 40 Worth St., New York; Western Dist.: Federated Sales Co., 2437 W. Valley Blvd., Alhambra, Cal.

SYNCO DEVICES, INC., 511 Boydell Bldg. Detroit, Mich.

GET YOUR TRACTOR AT FACTORY PRICE



Amazing money maker for farms, truck gardens, orchards, nurseries, poultry ranches, country homes, etc. Plows, discs, harrows, cultivators, mows lawns, cuts weeds. Runs belt machinery. 2 to 8 H.P. riding or walking types. Write for FREE CATALOG. Low Factory Prices and 10 day Trial Plan. Address Nearest Office.
SHAW MFG. CO., 4507 Front St., Galesburg, Kans.
130 G West 42nd St., New York, N. Y., 5812 G Magnolia Ave., Chicago, Ill., 668 G North 4th St., Columbus, O.

SHAW DU-ALL TRACTOR

NEW JUNIOR DRILL \$19.95 BLACK & DECKER

Write for Details 607 Penna. Ave., Towson, Maryland

50c BRINGS YOU 26 PRIZE-winning plans for shop projects in new Stanley Plan Packet. Each on separate 8 1/2" x 11" sheet. Postpaid anywhere in U. S. Write STANLEY TOOLS, 105 Elm St., New Britain, Conn.

CASH IN ON SPARE TIME

\$30 WEEKLY OR MORE EARN. Grow mushrooms HOME. Cellar, shed suitable. We buy 30c lb. Year round business. **\$270** made by Mr. B. in few weeks SPARE TIME. Guaranteed materials. Established 1931. Write for FREE BOOK. **WASHINGTON MUSHROOM INDUSTRIES, Dept. 601, 2019 2nd Street, Seattle, Wash.**

STEAM ENGINES for small boat models. Two-cylinder power plants, ready to run, with boiler propeller and burner.
Model SE-1, oscillating type. Price \$2.00 Postage extra, shipping wt. 3 1/2 lb.
Model SE-3, slide-valve type. Price \$3.00 Postage extra, shipping wt. 1 1/2 lb.
Shawnee Engine Co., Box 162, Station D, Cincinnati, O.

FREE TRAILER PARTS CATALOG
We'll save you money on—axles, springs, wheels, couplers, windows, sinks, water pumps, brakes, refrigerators, beds, lamps, inside and out, 6V lamps, furniture, jacks—everything. Special discount to mfrs. **NATIONAL TRAILER EQUIPMENT CO. Successors to Kar-A-Van Industries, Inc. Dept. P. 714 W. Wisconsin Ave., Milwaukee, Wis.**

GRANDFATHER'S CLOCK, LOWER PRICED
Our newest offering, at an unheard of price for a faithful reproduction of a real Grandfather's Clock. Scroll top, narrow waist, like picture. Shipped Knock Down. Cleverly designed. Easy to assemble. Others even cheaper. Plans 10c. Catalogue FREE.
AMERICAN CHIME CLOCK CO. 1672 Ruffner St. (Established 1877) Philadelphia, Pa.

In answering advertisements always write name and full address clearly.

HANDEE

Tool of 1001 Uses

A WHOLE TOOL SHOP IN YOUR HAND

Smooth, steady power at your finger tips. Uses 300 accessories to grind, drill, polish, rout, cut, carve, sand, saw, sharpen, engrave, etc. Plugs in any AC or DC socket, 18,000 r.p.m. 16 oz.



Save Hours of Hand Work

Get A Demonstration at Hardware, Tool or Dept. Stores, or order on 10-Days Money-Back Trial. **\$10.75** postpaid with 3 Accessories . . . De Luxe Model, 25,000 r.p.m. 12 oz. **\$18.50** with 6 Accessories.
Chicago Wheel & Mfg. Co., 1101 W. Monroe St., Dept. PM, Chicago, Ill.

FREE 64-PAGE CATALOG
Complete information on Handee Products and their wide application in crafts work and industry all over the world.

WHOLESALE CATALOG OF 4000 BARGAINS

FREE FOR SALESMEN—DISTRIBUTORS
It has 260 pages, chock-full of unusual values. It contains selling plans; order stimulators; tested fast selling articles to dealers, stores and direct to the consumer. A new revised issue is just off the press. Cost about 25c. **FREE**, while stock lasts. Send for your copy, Today.

SPORS CO. 5-39 Main St., Le Center, Minn.



NOW! Real Performing RADIO
BEAUTIFUL — PLASTIC — CABINETS
Midget radio fits your pocket or purse. Weighs only 4 ozs. Small as cigarette package! Receives stations with clear natural tone. "PATENTED FIXED CRYSTAL"—NO UPKEEP—only one moving part. "AUDIOPHONE" gives superior performance. **ENTIRELY NEW PATENTED DESIGN.** Has enclosed geared luminous dial for perfect tuning. Many owners report amazing reception and distance.

ONE YEAR GUARANTEE
Sent completely ready to listen with instructions for use in homes, offices, hotels, boats, in bed, etc. **TAKES ONLY A SECOND TO CONNECT—NO ELECTRICITY NEEDED!** **SEND NO MONEY!** Pay postman only \$2.99 plus postage on arrival or send \$2.99 (Check, M.O., Cash) and yours will be sent complete postpaid. A most unusual value. **ORDER NOW! MIDGET RADIO CO., Dept. P-7, Kearney, Nebr.**

FIREWORKS FREE SALUTES Oh Boy!
THINK OF IT! An assortment of over 605 pieces of fireworks worth \$6.15, for \$2.95 cash with order. We have the famous "ZEBRA" flashlight crackers. World's loudest. You get more for your money at BANNER, 100 FREE salutes with every order. Write for free catalog.
BANNER FIREWORKS 4323 Vermas Ave. Toledo, Ohio

BE YOUR OWN BOSS!

\$20 will start you in the air-conditioning business. Make a year's salary in 4 months. See our ad page 141A and article on pages 927, 928, 929 June 1939 issue Popular Mechanics.
AIR-COND. HDQS., 914 West Ohio, Chicago

MUSICIANS SLIDE RULE
Wonderful for learning harmony and arranging at home. Gives all chords, scales, keys, signatures, Transposers. Notates all Bb, F and Eb instruments. Send only \$1.00 for slide rule, case and instructions to **F. L. PAPER CO., Dept. M, 9 Thayer St. N.Y.C.** (Guaranteed an Advertiser)

New Arc Welding Brings \$150 to \$300 EXTRA PROFIT Monthly

PAID FOR ITSELF ON THE EASY MONTHLY TERMS DIDN'T COST ME A CENT!

With the New HOBART "Simplified" WELDING

Get into profitable arc welding business with new Hobart Arc Welder. Simple to operate, faster, brings in quality welding business that means big money. No investment terms . . . easy to own a Hobart without expense.

FREE! Valuable book on arc welding. Write today.

"BUILD YOUR OWN" portable arc welder and save \$300 to \$500. Write today for complete details.

30 DAYS TRIAL in your Shop to Prove it Pays

HOBART BROS. CO., Box M-791, Troy, O.

(Continued from page 144A)

AUTO-GLIDE COSTS LESS TO RIDE

125 Miles Per Gal.—30 Miles Per Hour



What a "kick" you'll get from the AUTO-GLIDE economy-ride! Skim along at 30 miles per hour, zip up hills, through traffic—for 1/10 the cost of auto travel! 125 miles per gallon! Ride any place comfortably on big balloon tires, cushioned seat—at less than 1/3c per mile! That's AUTO-GLIDING—the cheapest way to make trips or deliveries, ride to work or school. Husky 1 1/2 or 2 H.P. engine has fast getaway, power, economy! Powerful brakes. Handles like car, rides easier than bike. Extra Rugged! Durable! Clutch (most models) makes starts, stops easy. 2-speed transmission (optional). 5 NEW MODELS Standard low-priced 2-wheel model for business, sports, De Luxe (left), streamlined pleasure model. KARI-PAC, big rear carrier. SIDE-KAR, attaches to above models, makes 3-wheel unit. Also 3-WHEEL GLIDE-KAR.

WRITE! or see dealer for free illustrated booklet. Send NOW!
THE CUSHMAN MOTOR WORKS
 Dept. Q-7, Lincoln, Nebraska

\$9.245 and up

TRAILER PARTS

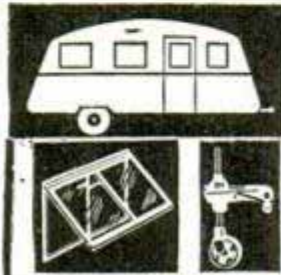

Largest, most complete stock of trailer parts and equipment in America. Lowest prices, quick delivery. Marvel is the pioneer in trailer accessories with a reputation for highest quality products, refrigerators, stoves, etc. Send 10c in coin for 40 page illustrated catalog.

MARVEL TRAILER PARTS CO.
 19020 Celestine Ave. Detroit, Mich.

Send \$1 TO
PHOTO CRAFT
 DEPT. M
 CANTON, OHIO

for FINE GRAIN DEVELOPING
35 mm. 36 exp. FILM
 In temperature controlled rooms
 —filtered water... ultra-care.

FREE ENLARGEMENTS
 3 1/4 x 4 1/4 of EVERY printable negative. On Kodabrom.

Filing container — mailing bag — and bargain catalog.

ELIMINATE FORD BRAKE TROUBLES

Your Ford Car is listed in the so-called lower priced class but has more brake lining area and larger drums than the others, in fact as much or more brake area than all but the higher priced cars. You can have safe, sure, unfailing mechanical brakes. Install easily yourself our **Simplex Floating Wedges** to center the shoes for mechanical assurance with hydraulic performance. A set of four, one for each wheel, all for \$1.75. All models 1928 to 1938—Send for circular.

SIMPLEX WEDGE EXCHANGE, Dept. PM-7, 613 Jefferson St., Ottawa, Ill.

RELIGIOUS ARTICLES and GIFTS

Rosaries (Black or Colored) .50, 75, 1.25. Rosary case .25. Sterling Silver neck chain for lady .80, for man 1.00. Sterling Silver medal (scapular or miraculous) for above chains .40. Chain and medal for boy .25, for girl .25. Lapel cross .10 ea., 1.00 doz. Madonna bracelets .25. Rosette bracelets .50. Crosses and chains .35 to 5.50. St. Christopher auto pin .25, .50. All Sterling Silver rosaries 3.50, 5.50, 7.50. Ideal gifts for Communion, Confirmation, Graduation, Wedding, Birthday, etc.

VICTOR LUSSIER—2455 North Hamlin Ave.—Dept. M—Chicago, Ill.

NEW BOAT READY!

Oars Given with your **OK KI-YAK** if you hurry!



BUILD OK-4 at Home in a Few Evenings!

Just out!—Mead's sensational 14 foot portable Outboard KI-YAK! OK-4 carries 4 adults and duffle—takes motors up to 9 H.P., oars and sail. Seaworthy. Leakproof. Biggest, lightest, strongest of its kind! You can build yours easily, quickly, perfectly at home in a few evenings from our patented, complete construction kit and save nearly **HALF!** Big money assembling, selling to others. (3 other paddle-sail KI-YAKS from 18 to 45 lbs. . . . also OK-2 for motor, sail, oars . . . weighs 50 lbs.) Rush dime for illustrated color circulars, Gift Oars Offer, amazing low Introductory Factory Prices!

MEAD GLIDERS, 15 So. Market, Dept. B-79, CHICAGO

ground that injured her severely, but these did not deter her from working out this thrill-packed novelty.

Where do the thrill-makers get their ideas? Everywhere. Jimmy Lynch, in talking to a number of people found almost all of them took a melancholy pleasure in seeing motorcar crashes. He decided to capitalize on this human foible by organizing a circus of stunt drivers who could stage head-on collisions, drive through flaming barriers, do high-speed roll-overs, and put cars over the jumps. His coterie is always in demand.

The ability to think quickly in an emergency is a quality every thrill-maker needs. A classic example of this occurred during a performance by the Balancing Wallendas on a high wire. They were doing one of their top-heavy, quivering pyramids when everything toppled. Balancing poles and a chair dropped into the arena. Two of the Wallenda brothers caught the foundation wire neatly. Another brother managed to grasp it with one hand, caught his sister, Dorothy, who was falling clear of any support, with his legs, and squeezed her in a scissors until a safety net was summoned. He then released his hold, not realizing he had strangled her unconscious. She revived quickly and soon was back in the act.

Despite the fact that thrill makers are supposed to have ice water coursing through their veins, there's one phase of their work they are reluctant to discuss. During a season, a performer for no apparent reason will falter on a stunt he's been doing for months. Just why, no one knows; but two or three bobbles and a performer becomes chary of a turn. As a result, he has to quit for a while or his career may end abruptly. A number of troupers have been killed by forcing themselves to do a stunt against an inner voice that tells them they'd better not.

Others, too, at the peak of their careers, suddenly do a fade-out. Why? No special reason, but just a feeling death is about to catch up with them.

It's not a fear, you understand—just a hunch. Even a daredevil is no fool.

Send return postage to our Bureau of Information to learn the name of the maker of any device described in this magazine.

2369.

Automatic Easel for Enlarging Squares Up Photo Paper

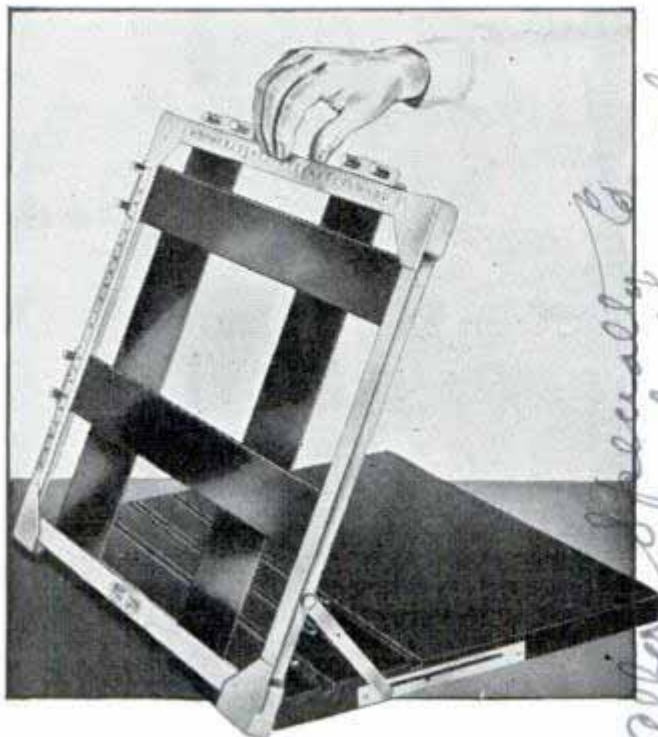

This easel simplifies enlarging work by squaring up three sizes of paper without difficult figuring

Automatically centering, squaring up, alining and holding the three standard sizes of enlarging paper—eleven by fourteen, eight by ten and five by seven—an automatic easel simplifies the enlarging work. Uniform margins are established without difficult calculations, and there is no shifting of easel when changing from one size paper to another.

2436

Reamer Cleans Tobacco Pipe Leaving a Smooth Wall

Self-adjusting by its spring tension, a reamer for tobacco pipes cleans out the cake and leaves the inside wall even from top to bottom. It does not chip, but smooths the surface like a newly ground cylinder.



Popular Mechanics Magazine can furnish the name and address of the maker of, or dealer in, any article described in its pages. If you wish this information, write to the Bureau of Information, inclosing a stamped, self-addressed envelope.

DURO
Super Value



ONLY \$119.50

8" TABLE SAW

*2-3/8" DEPTH CUT *TABLE 11" x 15" *FREE VISION GUARD *PRICE INCLUDES MITRE GAUGE AND RIP FENCE

Built to Duro high standards of quality and workmanship. It is the greatest value saw that has ever been put on the market. High quality materials machined to close limits for accuracy—gray iron base, table bracket and table give rigidity and smoothness. All Duro tools are designed for greater convenience of operation and made of quality materials for longer life. Send for new 1939 Duro Woodworking catalog illustrating America's finest and most complete line.

DURO METAL PRODUCTS CO.

2657 No. Kildare Ave. Dept. B7 Chicago, Illinois

BUILD THE SCHOONER BLUENOSE

Complete Kit \$2.50 Post Paid Makes perfect building easy



CARVED PINE HULL
Metal Anchor, Steering Wheel, Lifeboats, Anchor Chain, Casks, Masts, Dowels, Lacquer and Cement.
Send for complete catalog, 10c
IDEAL AEROPLANE & SUPPLY COMPANY, INC.
26 West 19th Street, New York

ROTARY TYPELESS PRINTER

Sensational PRINT-O-PRESS, Prints Post Cards and up to 8 1/2 x 11 letters. Many advance features. Fully warranted. Agents write. Also Legal & Post Card Duplicators.

\$995 complete

Does work of Higher priced machines



Professional Products Dept. 710, Silverton, Ohio

Order Direct

MEET FOOEY FACE THE HOTTEST NOVELTY OF THE YEAR

BE FIRST SAMPLE PRICE \$1.98



BACKED BY \$1,000,000.00 WORTH OF PUBLICITY

GADGET STICKS OUT TONGUE AT NOISY DRIVER. NEW DEVICE GIVES "RAZZ" TO SILLY AUTO HORN TOOTERS. Motorists die laughing at Foey Face. Imagine a device that will express contempt for all horn tooters, for those who blow their horns without any need for it.

Foey Face is easily operated. Just press a button from the inside of the car and it will "Razz" the driver behind. It is a combination of a clown's face. A light illuminates the grotesque features of the clown. The mouth is open, a tongue protrudes and a horn blows, giving the driver behind a razzing noise.

Millions of motorists have wanted a gadget of this type for years, and Foey Face has now been placed on the market. Orders are pouring in from every State in the Union, in every mail, and you certainly should line up with us immediately, to be first to cash in on the free publicity from the many prominent magazines and newspapers. Big profits are waiting for you. There is no time to lose. Therefore, write or wire us for full selling particulars.

IT'S A PRACTICAL FUN-MAKING "GADGET" AND AN EFFICIENT SAFETY DEVICE

ARCO SALES CO., 2917 INDIANA AVE., CHICAGO, ILL.

GENTLEMEN:

Yes, send me one FOOEY FACE. Enclosed is Money Order for \$1.98.

NAME _____
ADDRESS _____
CITY _____ STATE _____



Develop a HOBBY for PROFIT AND PLEASURE

To get the fullest enjoyment from any hobby . . . to enjoy greater satisfaction from the urge to make things and do things . . . learn what others have done . . . are doing . . . through an authoritative book. Here are a

few of the most popular books on a number of subjects . . . all selected and recommended by Popular Mechanics. Develop your hobby for pleasure or into a profitable business through spare time reading.

SELECT FROM THIS HOBBY AND HOME WORK SHOP LIST

OUTDOOR

OUTDOOR OPPORTUNITIES. A practical book on the raising and care of small animals, birds and plants for pleasure and profit. 246 pages. Illus. \$2.00.

OUTDOOR SPORTS (The Year 'Round). Hundreds of ideas for new and fascinating sports and pastimes with instructions for making many devices used in sports. 352 pages. 650 illus. \$2.00.

BOAT BOOK. Plans and instructions cover fifteen different boats. Build your own. Full directions and details for all types small pleasure craft. 312 pages. Illustrated. \$3.00.

PERMANENT BIRD HOUSES. Simplified instructions for building various types of artistic bird houses; attracting birds; holding contests, etc. Illustrated. \$1.00.

PHOTOGRAPHY

MAKING AMATEUR PHOTOGRAPHY PAY. The camera to use and how to make it pay. Why and how pictures sell. How to caption pictures, etc. \$1.00.

MAKING MONEY WITH YOUR CAMERA. Kinks and tricks—ways and means—to take and sell pictures. A money-making book for the amateur. \$2.00.

550 A WEEK WITH CAR AND CAMERA. New low priced edition. Sound, practical advice from the experience of others who have made a living with a camera. 50 cents.

PLAY DEVICES

MODEL RAILROADS. For men and boys. Deals with inexpensive equipment and the more complicated gauge-and-scale outfits. Tracks, switches, locomotives, rolling stock, signals, layout and right-of-way, operation, etc. Illustrated. \$3.00.

ARCHERY TACKLE. Tells how to make tackle, bows, bow strings and all required equipment. Full instructions for becoming a good archer. \$1.75.

EASY-TO-MAKE TOYS. 67 different items including animals, dolls, buildings, rock-

ing toys, autos, trains, boats, etc. Good book for the inexperienced craftsman. \$1.44.

HOME WORKSHOP

THE HOME WORKSHOP. Tells how to select and purchase tools and machines, how to arrange and operate the home workshop, how to operate motor driven tools. Material list and drawings for benches, tool racks, etc. Illustrated. 75 cents.

WOOD FINISHING. Usable and practical information on stains, varnishing, polishing, wax, oil, enameling and stenciling. Also refinishing of old furniture. \$1.50.

WOODWORKING PROCESSES. This book deals with the basic woodworking operations, including proper layout, use of tools, making good joints, etc. It illustrates the fundamental things the woodworker should know. \$1.64.

MACHINE WOODWORKING. The only book describing the common types of woodworking machines without favoring any particular make. Will help you and save you money and time in equipping your home shop. \$3.25.

POPULAR MECHANICS SHOP NOTES. The famous how-to-do-it and how-to-make-it Shop Notes, published yearly. Better and easier ways of doing things—money-making facts and shop information. 6 volumes, each averaging 224 pages, 400 articles and 700 illustrations. 6 volumes. \$3.00.

FURNITURE

FURNISHING THE HOME GROUNDS. Benches, gates, chairs, garden seats, trellises, fences, etc., with complete instructions and drawings from which the home craftsman can build really creditable looking and serviceable pieces. 80 cents.

FURNITURE OF YESTERDAY AND TODAY. A collection of excellent designs of other days and modern pieces of today that can be built by amateurs with great success. Beautifully illustrated. \$1.75.

COLONIAL FURNITURE. Always popular with the home furniture maker are re-

productions of early Colonial design. This book shows 95 of the best Colonial adaptations popularized by the American Furniture Industry. Illustrated. \$3.50.

UPHOLSTERED FURNITURE. A description of every operation and process in the upholstering of furniture of all types. The first book to bring upholstery within the abilities and facilities of the amateur furniture builder. Illustrated. \$2.00.

FURNITURE DESIGN AND CONSTRUCTION. Fifty projects in home furniture making, including tables, lamps, chairs, desks, etc. An excellent book for the home furniture maker. Illustrated. \$2.50.

COLLECTING

UNITED STATES COIN BOOK. Hints to collectors, a guide to values, special information, premium list of values, check-up list, etc. The ideal book for the coin collector hobbyist. 75 cents.

MODERN POSTAGE STAMP ALBUM. One of the most popular of all stamp albums. Has space for 12,000 stamps from countries all over the world. 400 pages and 5000 illustrations of stamps. \$1.00.

GETTING ACQUAINTED WITH MINERALS. Tells how to start the interesting hobby of collecting minerals, and how to build and classify a worth-while collection. Complete. 258 illustrations. \$2.50.

PEWTER. The collection of pewter ware is an intriguing and profitable hobby and this new book gives all the information the beginner needs for spinning, casting and wrought work. 328 beautiful illustrations. \$2.50.

MISCELLANEOUS

JEWELRY, METALCRAFT (Including Gem Cutting). With the aid of this book you can make a wide variety of jewelry and art metal at home. Only inexpensive materials and equipment needed. 224 pages. 128 illus. \$2.50.

GROW PLANTS WITHOUT SOIL. Startling new development. Complete directions for 3 methods. How to make containers and nutrient solutions. Grow flowers, vegetables and fruits. Illustrated. \$2.75.



SEND NO MONEY

If you live in U. S. or possessions we will send any order of \$1.00 or over and you can pay listed prices plus small C. O. D. fee to postman on delivery. If you remit with order we pay the postage to any address in the world. Order now for prompt delivery and get the most out of your hobby.

POPULAR MECHANICS PRESS, Dept. 739, 200 E. Ontario St., Chicago

CHAMPION SPARKING PLUGS

ZAPALOVACI SVICKA
CHAMPION

МОТОРНИ СВЪЩИ ШАМПИОНЪ

CHAMPION SUUTEKUUNAL

香
檳
撲
六

VELA
CHAMPION

ဘုံဘုံဘုံ "ဖျံဖျံဘုံ"

BOUGIE
CHAMPION

CHAMPION
TÄNDSTIFT

CANDELE
CHAMPION

ΜΠΟΥΖΙ ΤΣΑΜΠΙΟΝ

BUJIAS
CHAMPION

CHAMPION
SVEČU

SWIECA ZAPLONOWA
CHAMPION

CHAMPION
BUJILERI

CHAMPION SYTYTYS-TULPPA

ချန်ပီယံ ဖိ:ပလပ်

“சம்பியன்” பிளக்

CHAMPION ZÜNDKERZE

CHAMPION TENDPLUGGER

チャンピオン、スパークプラグ

ಚ್ಯಾಂಪಿಯನ್ ಪ್ಲಗ್

משעמסין ספארק פלאגס

* If you are curious about the identity of these various foreign languages, write the Champion Spark Plug Co., 900 Upton Ave., Toledo, O., and an identifying sheet will be sent you.

Symbol of Better Engine Performance in ANY language

Wherever modern internal combustion engines are engaged in serving humanity, either on highways, waterways or airways, on the farms, in the homes or in industry, Champions are recognized and preferred for the better performance they exact from every engine. Now Sillment-sealed against troublesome gas or compression leakage, common to ordinary spark plugs, new Champions with their exclusive Sillimanite insulators set *new* and *unequaled* performance standards.

ACTUAL SIZE V-PLUG



MODEL BUILDERS—ATTENTION!

Specially designed for model gas engines giving the same dependable performance as regular Champions. Absolutely gas-tight, alloy needle point electrode, one-piece construction. If not available through your dealer, write Champion Spark Plug Company, 900 Upton Ave., Toledo, Ohio.

V-3/8" 24 Thread
V2-1/4" 32 Thread
65c

IT'S THRIFTY TO INSTALL NEW SPARK PLUGS—Demand CHAMPIONS

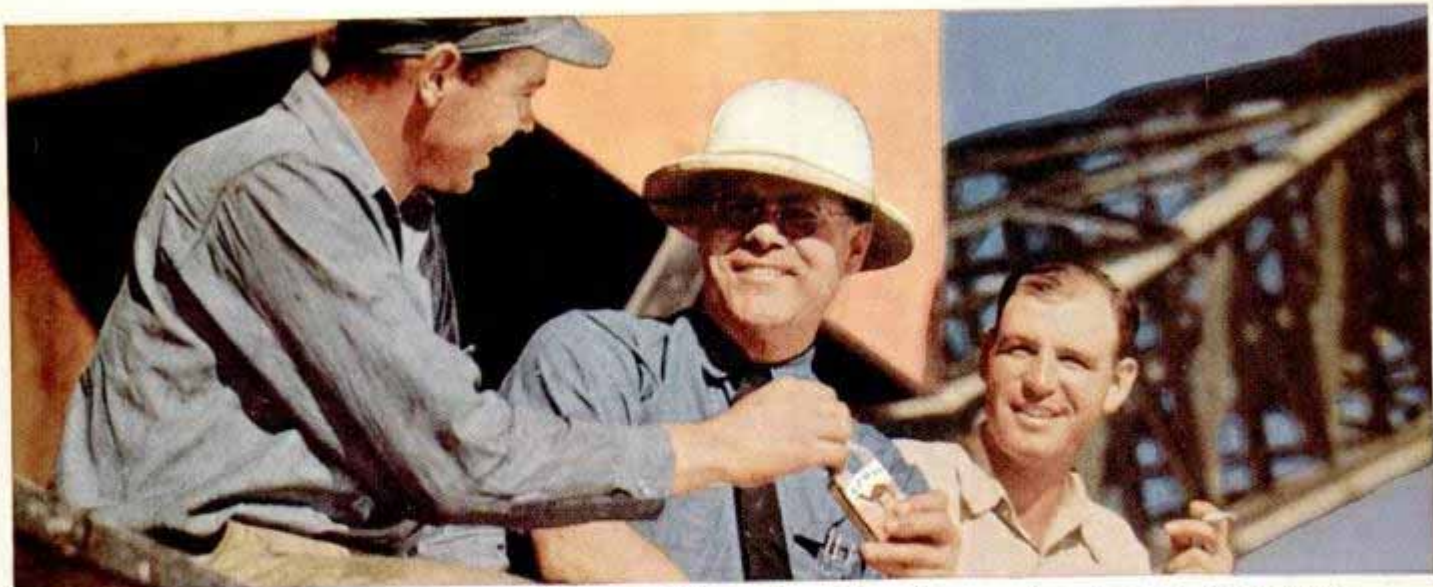

Lou Sloan (center), engineer on the great All-American Canal, pauses to enjoy a mellow Camel.

“FOR SMOKING PLEASURE AT ITS BEST
LET UP—LIGHT UP A CAMEL!”

L. R. SLOAN, JR., IRRIGATION ENGINEER



1 LOU SLOAN'S tough job is engineering an important link in the All-American Canal that winds over the desert from the Colorado River to California's Imperial and Coachella Valleys. Lou says: "Out here, where the heat hits 120 degrees, it's mighty pleasant to LET UP—LIGHT UP A CAMEL."

"Mild as a Camel" is a Camel smoker's way of describing anything that is mellow and smooth. Such a cigarette is worth trying. Decide now to smoke 6 packs of Camels. Learn why they are the largest-selling cigarette in America—a matchless blend of finer, MORE EXPENSIVE TOBACCO—Turkish and Domestic.



2 LOU SLOAN directing a giant shovel that grabs up 25 tons of dirt per scoop. Men in this barren country work like pioneers—find few high-spots in life. So Lou and most of his fellow workers are grateful for the true smoking enjoyment they get from Camels. "I like Camel's mellow mildness and delicate flavor," says Lou. "True mildness" and "flavor" are words that Camels put into many a smoker's mouth. Smokers enjoy Camels *more* because there's *more* to a Camel.

FOR SMOKING PLEASURE
AT ITS BEST—

CAMEL...

THE CIGARETTE OF COSTLIER TOBACCOS