

CHEMICAL WONDERS BY LAMMOT DU PONT

POPULAR MECHANICS



MAGAZINE

WRITTEN BY

REG'D. TRADE MARK, GREAT BRITAIN, No. 4-0438

REG. U.S. PAT. OFF.

JUNE
25 CENTS

SEE PAGE
862

How to Play **WINNING TENNIS**





THE SHOW

*must
go on!*

DELAY can spell ruin to a circus. And delay can be costly and annoying to anyone—doctor, lawyer, merchant, chief, salesman, or Mrs. Jones on her way to the bridge game.

That's why so many thousands of car owners depend on the 40-point Marfak Lubrication Service and *know* their cars are always in fine running order.

Here's why: the man who renders this service has been specially schooled so he intimately knows just how to lubricate every make and model of car. Furthermore, he works with a Texaco "Chek-Chart" in front of him so he can't miss a trick—from water-pump to shackles.

As for Marfak itself—it's the toughest, longest-lasting lubricant yet made for cars—made from heavy-bodied oils so it lasts twice as long.

You'll be surprised how little this service costs—how much peace-of-mind it brings—how often it actually increases the trade-in value of your car.

TEXACO DEALERS INVITE YOU to tune in THE TEXACO STAR THEATRE—A full hour of all-

star entertainment—Every Wednesday Night—Columbia Network—9:00 E.D.T., 8:00 E.S.T., 8:00 C.D.T., 7:00 C.S.T., 6:00 M.S.T., 5:00 P.S.T.

Copyright 1939
The Texas Company

Let us
MARFAK
your car

THE 40-POINT LUBRICATION AT ALL TEXACO AND OTHER GOOD DEALERS

WE TOOK A TIP

from the life insurance companies

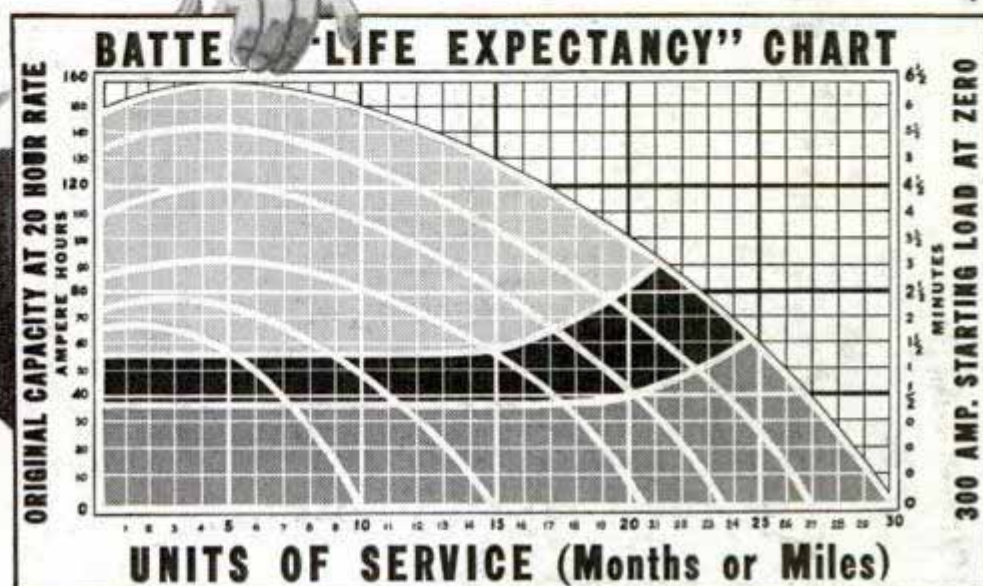

Now you can protect yourself against battery failure

You know what insurance actuary tables are like . . . the sheets that show the probable period of life remaining for people of various ages. The figures in these tables are averages, based on accurate statistics compiled throughout the years.

To make it possible for you to protect yourself against battery failure, the manufacturer of Delco batteries adopted this same principle in preparing the Battery "Life Expectancy" Chart. Information was gathered on thousands of batteries at various periods of service, and plotted into chart form to show at a glance the probable life left in a battery at any point of service.

For instance, if your battery is a 110-ampere-hour battery, you simply find that curve on the chart and follow it until it is intersected by the vertical line indicating the units of service the battery has given.

The chart then shows you at what point your battery enters the "uncertain zone" where it should be replaced, and at what point it enters the "danger zone" where it is likely to give out entirely any day.

Remember, the Battery "Life Expectancy" Chart is based on averages, which means it is correct in a great majority of cases. You can save yourself the annoyance and worry of battery failure by stopping at your Delco battery dealer's and checking your battery with him on the chart.

Delco batteries are built to meet the exacting demands of the manufacturers of all General Motors cars and trucks. As the preferred replacement battery, Delco provides sure starting power for all makes of cars.



Delco-Remy

ANDERSON, INDIANA

Delco battery sales and service requirements are available at United Motors Service Stations and dealers everywhere.



World's Largest Manufacturer of Automotive Electrical Equipment

When writing to advertisers please mention Popular Mechanics



He's *Carrying* Quite a Load

TAXES are necessary—you couldn't run a city, state or government without them. But they do mount up.

Fact is, a considerable part of the money you pay us for telephone service goes right out in taxes.

Bell System taxes for 1938 were about \$147,400,000—an increase of 56% in three years. In 1938 taxes were:

Equal to about \$550 a year per employee

Equal to \$9.50 per telephone in the Bell System

Equal to \$7.54 per share of A. T. & T. common stock

B E L L T E L E P H O N E S Y S T E M

You are cordially invited to visit the Bell System exhibit at the Golden Gate International Exposition, San Francisco



Popular Mechanics Magazine

H. H. WINDSOR, Founder

H. H. WINDSOR, Jr., Editor and Publisher

June, 1939

Vol. 71, No. 6

IN THIS ISSUE

From Test Tube to You	801
At the Wheel of the Highway Limited	808
So You're Going to Fly . . . Coloroto	
Let's Go Deeper	829
What Makes a Speedboat Champion?	834
Adventures of a Roving Cameraman	840
Hermits of the Air Waves	850
Training the Big Cats	859
Rescuing America's "Nile Valley" . . .	866
Below the Ocean's Deadline	872
"Freezing" Action in Pictures	882
How to Play Winning Tennis	892

(Continued on next page)

Robots Run the World

YOU can't get away from these electric brains that are running the world. They pilot airplanes and match paints, they count the pills dropping into a medicine bottle. They stand guard at prison gates to frisk visitors for hidden metal. They listen to the ticking of watches on a production line and toss aside the watch with a faulty heartbeat. The weatherman on flood duty dials a number, then listens while an electric robot reports how high Old Man River is running today. Read in the July issue how man has harnessed electricity not only to do his work, but to do his thinking too.

Logging Goes Modern

HIGH up in a 200-foot fir the "steeplejack" thrusts his saw in for a last bite, and the crown of the big tree tilts, cracks, then crashes to earth leaving the woodsman clinging for life to the swaying trunk. That's one of the few jobs left to muscle in the modernized logging industry, whose story is told next month with eight pages of Coloroto pictures.

Next Month

AIRPLANE builders have been so busy turning out luxurious sky liners and transoceanic clippers, super-bombers and six-mile-a-minute fighting planes that industry has had to shop for secondhand ships to fly plain freight. But now several companies are to build flying boxcars, and soon the United States may catch up with Canada in air freight. An article next month predicts that shortly we shall move millions of tons instead of millions of pounds in flying boxcars.

Scientific Sherlocks

BOMBS sent by mail should do their deadly work and leave no trace of the sender, the murderer thought. But the "mail order" killer reckoned without scientific crime detection. Fragments of the bomb—splintered wood, nails and glue—were sent to the "laboratory detectives"; test tube and microscope gave expert testimony, and the killer was found guilty. An article in the July issue tells you how modern Sherlocks battle "perfect crimes."

Painting the World

ANCIENT Egypt knew how to varnish mummy cases to last thirty centuries, but we know a lot more about paints today than Cleopatra's decorators ever imagined. We even make white paint for Cape Cod cottages from black sand! If you want to know what day to paint your house, how to estimate gallons and what paint to use, read "Painting the World in New Colors" in next month's issue.

WHY NOT GET ALL* THE SMOOTHNESS AND POWER YOUR ENGINE WILL DELIVER

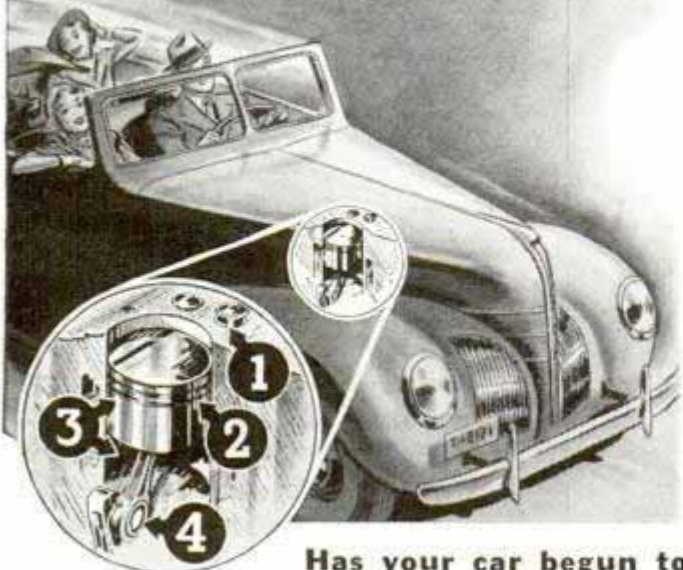

Has your car begun to lose some of its original

smoothness and power? Does it seem to falter when you want to step up speed?

If you could peek inside your engine you would see why this condition commonly exists—EVEN IN CARS FAIRLY NEW. One reason is (1) faulty valve action due to accumulations of carbon and sticky gum. This makes engine action rough, jerky. These same cement-like binders weaken the resiliency of (2) piston rings. Oil then seeps into the combustion chamber. Spark plugs are fouled. Power is lost. Corrosion (acid attack), on (3) piston faces and cylinder walls as well as on (4) bearings, actually "eats" the metal away, causing additional troubles. Needed repairs soon follow.

Pyroil is a product designed to overcome these faults in the operation of your car. It is an unduplicated combination of pure oiliness elements—unlike your regular lubricant. It breaks up hard carbon. Removes gum and sludge. PREVENTS CORROSION. Only a few ounces of Pyroil are needed in the gasoline tank and the crankcase.

Whether your car is new or old, get the FULL benefit of its smoothness and power. Treat your car with Pyroil at once. It is sold the world over at up to date service stations, garages, accessory stores. Mail coupon below for interesting Free Booklet, "QUESTIONS AND ANSWERS ABOUT PYROIL". Manufactured and Guaranteed by Pyroil Company, W. V. Kidder, Founder, 56 Pyroil Bldg., LaCrosse, Wisconsin, U. S. A.

* Tests prove Pyroil's remarkable ability to increase power, to reduce friction and to smooth operation. Used and recommended by famous auto racers and engineering authorities. Benefits any car, new or old.



NOTHING FINER FOR NON-ABRASIVE NEW CAR BREAK IN!

DISTRIBUTORS:
CHECK AND MAIL COUPON FOR FRANCHISE FACTS.

SIMPLY ADD TO GAS & OIL

PYROIL COMPANY
 56 Pyroil Bldg., LaCrosse, Wisconsin, U. S. A.
 Please send me a Free copy of your interesting Booklet, "QUESTIONS AND ANSWERS," which tells me how to save money in the operation of my car.
 Also send details of your plan for Distributors.
 Name.....
 Address.....
 City..... State.....

(Contents—Continued)

AUTOMOTIVE

"Disaster" car equipped for any emergency.....	812
One-way garage with spiral ramps.....	844
Flashlight has tester for bulbs and fuses.....	845
Rotating windshield wiper stops ice.....	848
Red light stops cars on airport road.....	849
All-wheel-drive truck for oil prospectors.....	854
Washbasin built into fender of auto.....	854
Clock on steering post has illuminated dial.....	858
Safety catch on auto door guards children.....	858
Battery charger on wheels works faster.....	870
"Bottle opener" removes caps without marring finish.....	875
Postman's four-wheel scooter.....	880
Spotlight on right side of auto.....	896

AVIATION

Rubber mount for plane engine.....	812
Attack bomber flies 330 miles an hour.....	813
Model on stick is moving target for gunner.....	833
Weather ships chart air for Atlantic clippers.....	839
Floater retract into wing tips.....	849
Safer fuels and new engines to end fire.....	854
Twin-engine plane for air line feeder.....	854
Faster plane has no rivet buttons.....	863
Twelve-cylinder in-line engine is lightweight.....	870
Wires halt aircraft landing on ship's deck.....	876
Floating hangar carries sixty planes.....	879
Sky fighter flies 500 miles an hour.....	881
Signpost points to half the world.....	887

BOATS AND BOATING

Alarm for gasoline tank warns when filled.....	886
Boat towed like trailer on its own wheels.....	886
Battery-operated radiophone for small boats.....	935

CONSTRUCTION

Sinking a pre-cast traffic tunnel.....	814
Flat-top home observatory has sliding roof.....	870
House shingled with license plates.....	876

FARMS

Tractor turns in own length.....	816
Moisture content of soil measured by electricity.....	870
Five-tractor team hauls a monster plow.....	890
Flashlight cell operates farm set for demonstration.....	940

HOUSEHOLD

Three-stage light bulb adapter.....	806
Stoker-fired space heater for small home.....	807
Nursing bottle for holder for crib or buggy.....	816
Ultraviolet lamp sterilizes air in refrigerator.....	816
Electric lawnmower saves time and labor.....	838
Non-skid feeding bowl for dog.....	838
Beef tenderized by hanging in sterilizing rays.....	844
Stoker-fired coal range for kitchen.....	845
Vacuum cleaner mows grass.....	848
Pocket size electrical tester uses small battery.....	855
Wire hat rack has three arms.....	876
Valve unit to rebuild faucets.....	886

PHOTOGRAPHY

Portable studio prints photo in two minutes.....	837
Photos trace star paths across sky.....	865
Three-dimension attachment fits any camera.....	871
"Magni-candid" camera flexible as miniature.....	896

RADIO AND ELECTRICITY

Aluminum pan floats on electric cushion.....	833
Typewriter sends radio letter.....	838
Flashlight talks to audience.....	848
Germ-killing light guards babies in nursery.....	863
Electric wave slowed to a walk for visual study.....	865
Police dog takes orders from radio.....	871
Two-way phone carried on back.....	880
Man-made lightning bolt vaporizes wire.....	887
Clamp-ammeter operated by trigger.....	891
Personal three-tube set with pillow speaker.....	936
Pocket set has built-in earphone.....	938
Hints for radio experimenters.....	939
Meter measures sound levels.....	940
Record player combines with receiver cabinet.....	940
Variable range tuning condenser for amateur bands.....	940

SCIENCE AND INDUSTRY

Thousand-ton dredge runs on road or rail.....	877
Light speed measured accurately.....	880
Trees control own heat by use of moisture.....	890

(Continued to page 6A)

Engineers Spent Years on the Trail of this *Mystery Spark*



In a More Effective Spark, leaping across the tiny gap of a new type spark plug, is found an amazing secret of improved motorear performance.



They produced a revolutionary spark plug that is amazing car owners by putting new pickup and power into sluggish, spark-weary motors

CONDUCTING countless experiments, combing the world for special materials, Auto-Lite engineers produced a new kind of spark plug. They created a new alloy—called Konium—for the electrode, developed a new insulating compound called Ziramic.

The result? A spark plug of amazing powers that gives sluggish engines sure starting, instant pickup, prevents gasoline waste.

Nearly a million motorists changed to Auto-Lite Spark Plugs last year. Why not begin at once to enjoy the great advantages they offer—all at no extra cost? Ask your service man to install a set of Auto-Lites today!

THE ELECTRIC AUTO-LITE CO.
TOLEDO • Merchandising Division • OHIO



One Out of Every 4 new cars is now factory-equipped with Auto-Lite Spark Plugs. Car manufacturers, users of conventional type plugs for years, adopted Auto-Lites after the most exhaustive tests.

IGNITION ENGINEERED BY
IGNITION ENGINEERS



They Tailored a Flash of Lightning—The spark of an Auto-Lite Spark Plug is like a tiny flash of lightning made to order by means of a special gap design and new type electrode.



They Combed the World—Materials from all over the face of the earth are required to produce this sensational new spark plug.

INSTANT PICK-UP WITH AUTO-LITE SPARK PLUGS

STANLEY HAMMERS

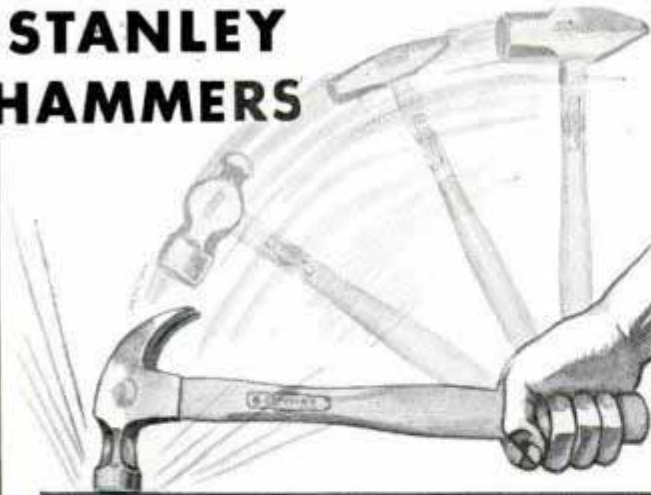

FOR EVERY CRAFT

It takes more than materials alone—or design—to make a good hammer. It's a case of "knowing how," and because they know how Stanley makes the hammers which are usually selected by top men in every craft.

"ONE HUNDRED PLUS"

Super-heat treated Chrome-Molybdenum Alloy head, *individually* tempered. The "right" handle of selected hickory with exclusive "Evertite" process to assure a permanently tight head. Claws to pull a headless brad. Unquestionably the "tops" in Nail Hammers.



No. 312
Machinists'
Hammers

Super heat treated head. "Evertite" processed selected hickory handle.

No. 233
Riveting
Hammers

No. 594
Soft Face
Hammer

For finely finished surfaces or delicate machine parts. Renewable composition tips are resilient and tough—will not mar the work.

Stanley Tool Catalog No. 34 describes the full line of Stanley Hammers. Write for a copy.

STANLEY TOOLS

Division of The Stanley Works, 106 Elm St., New Britain, Conn.

Build These PRIZE-WINNING Projects NEW Stanley Plan Packet 50¢

In Canada 75c



The 26 best of the hundreds of entries in the recent Stanley project contest. You'll want to build every one of them. Complete working plans, on separate sheets of tough paper—sent postpaid for only 50c. Send coin or stamps now for the new Stanley Plan Packet.

(Contents—Continued)

SPORTS

Target improves aim of football passers.....	807
Sailors learn to swim on tandem rafts.....	813
Skier's wings control speed on fast hills.....	845
Leather boots for hunting dogs.....	863
Batters improve hitting with captive ball.....	875
Pitchers fire at canvas "home plate" target.....	891

MISCELLANEOUS

Corn popper operated by coin fills bag.....	806
Gas mask for babies.....	806
Permanent magnet-type chuck.....	844
Automatic slide feeder for projector.....	855
"Coupe" car for rail crew.....	855
Canary rides "piggy-back" on pigeon in cockpit.....	856
Portable lumiline sign easy to change.....	856
Statue on trylon at New York fair.....	856
Submarine track meet.....	857
Electric mask for hay fever sufferers.....	858
Million-dollar iron horse new world champion.....	862
Concrete monsters depict historic age.....	864
"Singing tower of light" at New York fair.....	876
Pyramid of concrete balls protects air-raid shelter.....	877
Air valve in arc welding helmet.....	881
Weatherproof outdoor desk made of split log.....	886
Pearl replica of liberty bell at fair.....	896

Craftsman and Shop Notes

AUTOMOTIVE

Finishing the farm tractor—Part II.....	953
Auto shortcuts.....	957
Flush-handle lock for trailer door.....	958
Greasy spark plugs cause misfiring.....	958
Short circuits located with door buzzer.....	958
Sloping rack in truck helps ice man.....	958
Adjusting burned spark-plug electrodes.....	959
Relined brakes improved with asbestos paper.....	959
Theftproof nuts for car wheels.....	959
Worn tappets silenced with spring.....	959
Axle shaft puller from wheel rim.....	960
Grille guard improvised from old bumper.....	960

BOATS AND BOATING

Live bait box under seat.....	909
Overflow gauge for boat fuel tank.....	910
Motor in boat is self-draining.....	912
Build your boat right.....	920

FARM

Rubber gate in hen yard admits dog.....	901
Automatic hog feeder.....	942
Farm gate raises or swings to one side.....	944
Keeping chickens out of lawn and garden.....	946
Brace keeps tractor belt tight.....	949
Mathematical table shows number of plants to acre.....	952

HAND TOOLS

Punches made from old car valves.....	900
Forming irregular sheet-metal work.....	904
Trowels for plastic materials from teaspoons.....	904
Rubber auxiliary jaws for your vise.....	912
Glass wood scraper gripped with rubber heels.....	918
Spinner crank on bench vise.....	918
Bull-dog wrench really grips.....	919
Cloth over dirt tamper reduces cleaning.....	945
Clip to hold measuring tape with gloves.....	946
Using auger bits in a drill press.....	949
Self-adjusting countersink.....	950
Spacing guide on shingler's hatchet.....	950
Immersion heater from soldering iron.....	952

HOME IMPROVEMENTS

Powder rooms in old clothes closets.....	914
Bolt inside of door locked from outside.....	918
Simplified air cooler.....	927

HOUSEHOLD

Electric fly trap is homemade.....	897
Flypaper shielded by wire guard.....	913
Attic fan gives night comfort.....	929
Solving home problems.....	932
Folding flood-lamp stands are rigid.....	943

(Continued to page 8A)



Plan Your Future

Choose Your Field NOW For Success

Will you master fate or will fate master you? That's a question deserving your honest answer... right now! Actually it is largely up to you. You can do with Life almost what you will. LaSalle will help you establish yourself for real success by providing you with the comprehensive, specialized training for which it is so famous. Choose your field... now! Check the coupon below for the free booklet you want us to send you. It can be your first step toward assured success.

Opportunities in Traffic Management

The field of Traffic Management offers real opportunity only to the man who knows. Spare time study and the will to succeed have pushed scores of Traffic employees up the ladder to financial success. Many LaSalle-trained traffic managers—both in the railroad and industrial field—now command salaries of \$3,000.00 to \$5,000.00 a year—and better. Investigate. Find out how you can qualify for these higher positions through LaSalle home-study and guidance.

Law for Business Success

And it isn't necessary to practice law to get this Success. In fact probably most of the men who study law today have no idea of taking the bar examination or becoming lawyers—they want law training to give them mastery of men and situations in business. You know that—

- (1) the man with legal training is a leader—not a follower.
- (2) legal training keens your mind—clears away the problems that stump the ordinary fellow and makes you master instead of man.
- (3) knowledge of law simplifies the complications of executive work.
- (4) Many top executive places are filled by men who have studied law.

No matter whether you are in a big corporation or a small business—in a great city or a little town—a practical knowledge of law cannot fail to be of real and vital help to you in making a more successful career.

In every state in the union you'll find law-trained men who came up through LaSalle. What others have done, you can do.

And LaSalle offers either a full law course leading to LL. B. or a shorter business law training—whichever you prefer. All text material, including valuable 14-volume Law Library. Training comprises the most effective features of modern law instruction.

Executive Training

Executives who are efficient managers command responsible positions and good incomes. And the need for

trained executives is growing rapidly. We train you thoroughly at home in your spare time for every type of executive work—teach you the principles and practices used by our most successful business leaders and help you develop your management capacity—by a training built with the aid of outstanding executives.

Become an Expert Accountant The Profession That Pays

The demand for skilled accountants—men who really know their business—is increasing rapidly. New state and federal legislation requires much more, and more efficient accounting from business—big and small. Corporations are in constant need of expert counsel in matters relating to Auditing, Cost Accounting, Business Law, Organization, Management, Finance. Men who prove their qualifications in this important branch of business are rapidly promoted to responsible executive positions—given an opportunity to earn real salaries. The range is from \$2,000.00 to \$10,000.00 a year—even to higher income figures.

Under the LaSalle Problem Method you can at home acquire a thoro understanding of Higher Accountancy, master its fundamental principles, become expert in the practical application of these principles—this without losing an hour of work or a dollar of pay.

Your training will be under the direct supervision of a staff of legal, organization and management specialists, business efficiency engineers and Certified Public Accountants.

Preliminary knowledge of bookkeeping is unnecessary. We train you from the ground up, or from where you now are, according to your individual needs.

Mr. Salesman: What's Wrong?

Why aren't you making more sales—more money? Is it you—or your proposition? Check up first on yourself. Other men—no better than you—have found their earnings jump and stay up when they trained with LaSalle. Literally thousands of men—many of them years at the game—have increased their sales volume and earnings through home study with LaSalle guidance. Sound—practical—usable—right from field experience. Train for top-notch production with LaSalle.

LASALLE EXTENSION UNIVERSITY A CORRESPONDENCE INSTITUTION Dept. 664-R CHICAGO

I would like to have your special booklet—without any cost or obligation to me—about my opportunities and your success training in the business field I have checked.

- | | | |
|---|--|--|
| <input type="checkbox"/> Higher Accountancy | <input type="checkbox"/> Commercial Law | <input type="checkbox"/> Business English |
| <input type="checkbox"/> Law: Degree of LL.B. | <input type="checkbox"/> Expert Bookkeeping | <input type="checkbox"/> Business Correspondence |
| <input type="checkbox"/> Traffic Management | <input type="checkbox"/> C. P. A. Coaching | <input type="checkbox"/> Effective Spee |
| <input type="checkbox"/> Modern Salesmanship | <input type="checkbox"/> Industrial Management | <input type="checkbox"/> Stenotypy |
| <input type="checkbox"/> Business Management | <input type="checkbox"/> Modern Foremanship | |



This One



ZYTG-OZJ-GR2X

Name.....Age.....

Position.....Address.....

When writing to advertisers please mention Popular Mechanics

Use SMOOTH-ON No. 1 for tightening and anchoring

TRY any one of the following jobs and see for yourself how easily and quickly dependable tightness is produced.

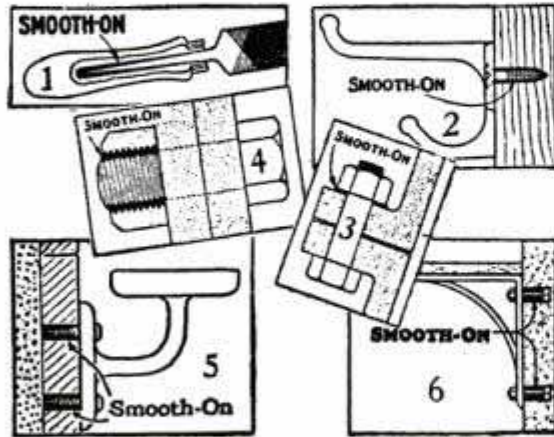

Loose tool and cutlery handles (1):—Fill hole with Smooth-On and force shank in. **Stripped wood screws (2):**—Reset in holes filled with Smooth-On. Excellent for loose hinges, locks, hooks, drawer pulls, etc. **Loose nuts (3):**—Lock by putting Smooth-On between base and seat. Try this on oven handles, etc. **Making oversize threads hold (4):**—Fill annular space with Smooth-On. **Anchoring in tile (5):**—Set screws in holes filled with Smooth-On. **Anchoring in concrete (6):**—Chip out hole, insert bolt with head in and fill annular space with Smooth-On. Use nut and washer for fastening attached part. Excellent for holding shelf brackets, cabinets, partitions, etc.

Smooth-On No. 1 is ideal for tightening parts and stopping leaks because of its low cost, its simplicity of application and its unique properties of hardening into metal and expanding while doing so. No heat, special tools or previous experience are required, and judicious use as per instructions in the Smooth-On Home and Auto Repair booklet assure perfect results.

If you take pride in doing home tinkering well and like the big savings of time and money, keep a copy of this booklet and a small can of Smooth-On No. 1 in your work bench. The first of many routine or emergency jobs on which you use Smooth-On No. 1 will repay its small cost, possibly many times over.

Mail coupon for the booklet and get Smooth-On No. 1 in 7-oz. or 1 or 5-lb. can from your hardware store or if necessary from us direct.



Mail Coupon for
FREE BOOK



Do it with SMOOTH-ON

SMOOTH-ON MFG. CO.,
574 Communipaw Ave.,
Dept. 37, Jersey City, N. J.
Please send the free Smooth-On
Repair Book.

Name.....

Address.....
6-39

(Contents—Continued)

CAMPING, HUNTING, FISHING

Suitcase with cardboard legs used as picnic table	900
Tent partitions from window shades	910
Fishing rods hung on spring penholder	930
Bottle-cap lure attracts fishes	948

LAWN AND GARDEN

Sheet-metal owl guards fruit trees	900
Seeded beds protected from birds	904
Better gardens with better watering	906
Lawn table has removable shelves	912
Plant-staking tips to avoid root injury	917
Growing strong root systems on seedlings	918
Plant duster from flour sifter	930
Gay trellis supports	931

PAINTING

Putty carried on paint bucket	918
Removing fresh paint from window glass	926
Paint bucket hanger on ladder	930
Holder keeps paint cans on ladder rung	952

PHOTOGRAPHY

Safeguarding your vacation snapshots	919
Light meter times enlargements	947
Enlarging easel	951

POWER TOOLS

Yacht hulls hollowed in drill press	926
Adapting lathe dog for threaded work	944
Jig to "mike" work rotating in lathe	950

STORE AND SHOP

Rotating book rack from car axle	945
Test board holds lamps of various sizes	945
Cork in counter top grips wrapping twine	946
Liquid fly poison dispensed from poultry fountain	946
Display trays cut from cartons	952
Sawdust shows welding temperature of aluminum	955
Grain sack held for stenciling by trouser hangers	956
Jeweler uses powder puff as tray	956
Stamp pad on swinging shelf	956

TOYS AND NOVELTIES

Jumping-lion toy is amusing	901
Surf "balloons" for thrilling ride	913
Microscope from thread spool	925
Magic pinwheel responds to voice	931
Sure-foot grip on child's scooter	948

MISCELLANEOUS

Watchful sentinels guard beds	899
Roller stamp from furniture caster	900
Hostess tray on a folding stand	902
Clocks cleaned with ruling pen	904
Rubber shield for bottom of golf bag	904
Jewelry cached in door	905
Ladies' handbag of wood	905
Heavy boxes "rolled" on blocks	909
Boots easily pulled on over silk anklets	910
Lead cast in smoked molds	910
Plumber's force cup holds acid	910
Ladder for diver to climb into boat	912
Air rifle reset with a string	913
Wood signs have stick-on letters	916
Master plan inked on drawing-board cover	919
Holding hose on mortar box while mixing cement	925
Beach blanket pegged in place	926
Charring pipe to avoid moisture absorption	926
Index tab keeps pencil from rolling	926
Cutting flower stems at angle keeps them fresh	930
Door button serves as electric switch	930
Cleaning gasoline drums	934
Filing saw to avoid cracks in blade	934
Tumble for a perfect finish	941
Cleats for temporary wiring from clothespins	943
Nail pockets on carpenter's apron	944
Wrench supports fuel-oil hose above sidewalk	945
Chemicals measured with sifter for weighing	946
Timesaving ideas for artists	949
Ruling parallel chalk lines	956

IMPORTANT NOTICE

It is the intention of this magazine to provide its readers with information regarding the latest developments in the mechanical arts. We take no responsibility as to whether the disclosures contained in our articles are covered by patents and advise readers to investigate this subject before making, using, or selling any of the products, machines, or processes described, in order to avoid possible liability for patent infringement.

**HOW DO
YOU JUDGE**

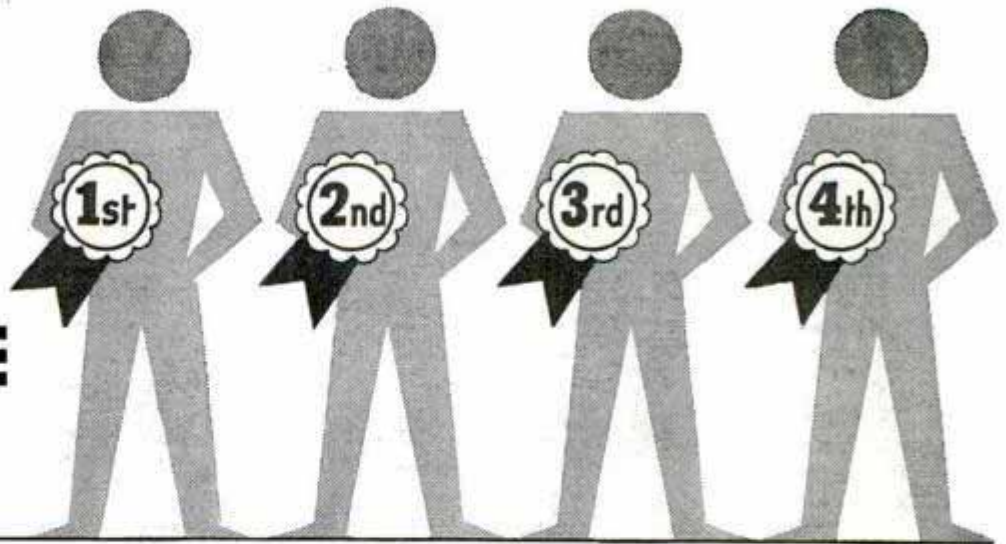

a faculty?

You judge a school's faculty by "the finished product" . . . by the character and achievements of the men and women whom the faculty has trained and educated.

Every member of the faculty of the International Correspondence Schools is thoroughly trained in the technique of home-study instruction. From Cornell University, Iowa State College, M. I. T. . . . from Purdue University, Vassar College, McGill University . . . from Williams, Swarthmore, Lehigh, Columbia, Harvard and a dozen other American and foreign institutions of higher learning come

the men and women whose teaching skill and human understanding supplement the specially prepared textbooks of the International Correspondence Schools.

This faculty wishes to be judged not by its advanced degrees, published works or extramural attainments, but by the thousands of leaders in every business and industry who attribute much of their success to I.C.S. training . . . and by the tens of thousands of ambitious men, now enrolled with these Schools, who are training for tomorrow's leadership and tomorrow's rewards. Mail the coupon—today.

INTERNATIONAL CORRESPONDENCE SCHOOLS

BOX 5549-J, SCRANTON, PENNA.



Without cost or obligation, please send me a copy of your booklet, "Who Wins and Why," and full particulars about the subject *before* which I have marked X:



TECHNICAL AND INDUSTRIAL SUBJECTS

- | | | | | |
|--|---|---|--|---|
| <input type="checkbox"/> Agriculture | <input type="checkbox"/> Air Brakes | <input type="checkbox"/> Civil Engineering | <input type="checkbox"/> Manufacture of Pulp Paper | <input type="checkbox"/> Sanitary Engineering |
| <input type="checkbox"/> Air Conditioning and Cooling | <input type="checkbox"/> Coal Mining | <input type="checkbox"/> Contracting and Building | <input type="checkbox"/> Marine Engineering | <input type="checkbox"/> Sheet Metal Work |
| <input type="checkbox"/> Architectural Drafting | <input type="checkbox"/> Cotton Manufacturing | <input type="checkbox"/> Diesel Engineering | <input type="checkbox"/> Mechanical Drafting | <input type="checkbox"/> Steam Electric Engineering |
| <input type="checkbox"/> Architecture | <input type="checkbox"/> Electrical Engineering | <input type="checkbox"/> Electric Lighting | <input type="checkbox"/> Mine Foreman | <input type="checkbox"/> Steam Engineering |
| <input type="checkbox"/> Auto Electric Technician | <input type="checkbox"/> Fire Bbses | <input type="checkbox"/> Fruit Growing | <input type="checkbox"/> Patternmaking | <input type="checkbox"/> Steam Fitting |
| <input type="checkbox"/> Auto Technician | <input type="checkbox"/> Heating | <input type="checkbox"/> Heat Treatment of Metals | <input type="checkbox"/> Pharmacy | <input type="checkbox"/> Structural Drafting |
| <input type="checkbox"/> Aviation Engineering | <input type="checkbox"/> Highway Engineering | <input type="checkbox"/> House Planning | <input type="checkbox"/> Poultry Farming | <input type="checkbox"/> Structural Engineering |
| <input type="checkbox"/> Boilermaking | <input type="checkbox"/> Management of Inventions | <input type="checkbox"/> Machinist | <input type="checkbox"/> Public Works Engineering | <input type="checkbox"/> Surveying and Mapping |
| <input type="checkbox"/> Bridge and Building Foremanship | | <input type="checkbox"/> Radio | <input type="checkbox"/> R. R. Locomotives | <input type="checkbox"/> Telegraph Engineering |
| <input type="checkbox"/> Bridge Engineering | | <input type="checkbox"/> R. R. Section Foreman | <input type="checkbox"/> R. R. Signalmen | <input type="checkbox"/> Telephone Work |
| <input type="checkbox"/> Building Estimating | | <input type="checkbox"/> Refrigeration | | <input type="checkbox"/> Toolmaking |
| <input type="checkbox"/> Chemistry | | | | <input type="checkbox"/> Ventilation |
| | | | | <input type="checkbox"/> Welding, Electric and Gas |
| | | | | <input type="checkbox"/> Woolen Manufacturing |

BUSINESS SUBJECTS

- | | | | | | |
|--|--|--|--|---|----------------------------------|
| <input type="checkbox"/> Accounting | <input type="checkbox"/> Advertising | <input type="checkbox"/> College Preparatory | <input type="checkbox"/> Grade School Subjects | <input type="checkbox"/> Railway Postal Clerk | <input type="checkbox"/> Signo |
| <input type="checkbox"/> Bookkeeping | <input type="checkbox"/> Cost Accounting | <input type="checkbox"/> C. P. Accounting | <input type="checkbox"/> High School Subjects | <input type="checkbox"/> Salesmanship | <input type="checkbox"/> Spanish |
| <input type="checkbox"/> Business Correspondence | <input type="checkbox"/> First Year College Subjects | <input type="checkbox"/> Foremanship | <input type="checkbox"/> Illustrating | <input type="checkbox"/> Secretarial Work | |
| <input type="checkbox"/> Business Management | <input type="checkbox"/> French | | <input type="checkbox"/> Lettering Show Cards | <input type="checkbox"/> Stenography and Typing | |
| <input type="checkbox"/> Cartooning | <input type="checkbox"/> Civil Service | | <input type="checkbox"/> Managing Men at Work | <input type="checkbox"/> Traffic Management | |

DOMESTIC SCIENCE SUBJECTS

- | | | |
|---|---|--|
| <input type="checkbox"/> Advanced Dressmaking | <input type="checkbox"/> Home Dressmaking | <input type="checkbox"/> Tea Room and Cafeteria Management, Catering |
| <input type="checkbox"/> Foods and Cookery | <input type="checkbox"/> Professional Dressmaking and Designing | |

Name..... Age..... Address.....

City..... State..... Present Position.....

Canadian residents send coupon to International Correspondence Schools Canadian, Limited, Montreal, Canada
British residents send coupon to I. C. S., 71 Kingsway, London, W. C. 2, England

When writing to advertisers please mention Popular Mechanics

for YOUR Future Work

... have you investigated
AN AVIATION CAREER

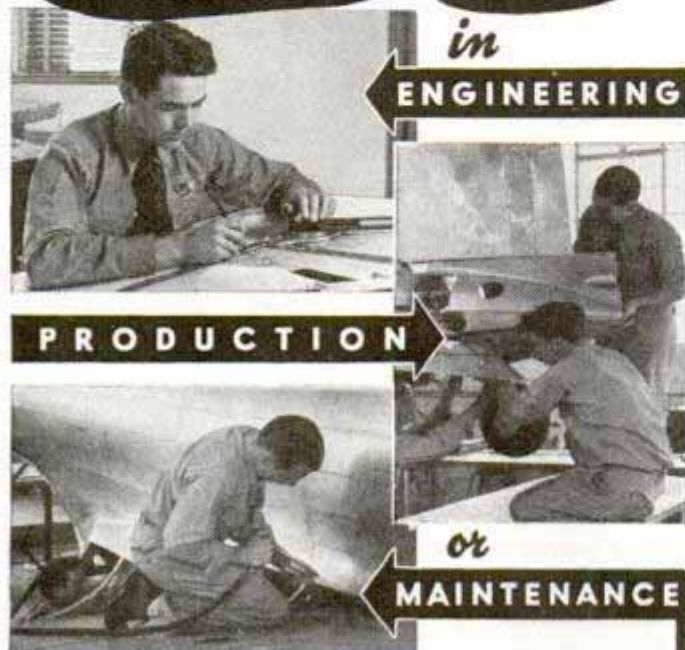

in
ENGINEERING

PRODUCTION

or
MAINTENANCE

If you have not already chosen your career—or are looking for an interesting, progressive line of work—why not DO SOMETHING about Aviation? What other field is so fascinating . . . or has such a brilliant future?

As Aviation expands, there must be more and more trained men for Engineering . . . Production . . . Maintenance. For any of these branches you can get Aero I.T.I. training . . . the same training from which hundreds of men have already stepped into the Aviation industry. The keynote of Aero I.T.I. training is instruction and practice in actual "on-the-job" duties. The pictures above are typical training scenes. You can start your course at home . . . or take a full-time resident course. For complete information, including a free booklet, send the coupon.



Aero Industries Technical Institute
 5253 West San Fernando Road, Los Angeles, Calif.

U. S. Civil Aeronautics Authority Approved School

EXECUTIVE BOARD

Robert E. Gross President, Lockheed Aircraft Corporation	John K. Northrop Formerly Pres., The Northrop Corp., and Vice-Pres., Douglas Aircraft Co., Inc.	C. A. Van Dusen Vice-President, Consolidated Aircraft Corp.
---	--	--

Please send free booklet on Aviation and Aero I.T.I. training. I am interested in the line of work checked below:

Aircraft Mechanics Aeronautical Engineering
 Undecided. Please send more information.

Years of High School: None; 1; 2; 3; 4.
 Years of Jr. College or College: 1; 2; 3; 4.

Name _____ Age _____
 Address _____
 City _____ State _____ a-18-p



Follow This Man!

Secret Service Operator No. 38 is On The Job!

Follow him through all the excitement of his chase after the counterfeit gang. See how a crafty operator solves a murder with tell-tale finger prints! Thrills! Mystery!

FREE! The Confidential Reports No. 38 Made to His Chief
Earn a Regular Monthly Salary

Write for reports and free "Blue Book of Crime." Learn how YOU can become a Finger Print Expert, at home, in spare time, at small cost. Our graduates run 47% of all

the Identification Bureaus in America! Send for list of over 600 bureaus employing our graduates. Write today! Literature sent only to persons stating their age.

INSTITUTE OF APPLIED SCIENCE
 1920 Sunnyside Avenue Dept. 135-A, Chicago, Ill.

ELECTRICAL ENGINEERING

Condensed ONE-YEAR residence course combines theory with practice in well-equipped laboratories. High employment record. Suburban campus; modern buildings; dormitory. 47th year begins Sept. 27. CATALOG. Give age.



BLISS ELECTRICAL SCHOOL
 116 Takoma Ave., Washington, D. C.

Become an expert photographer

Train at Home or in our modern completely equipped studios. For pleasure or career. Commercial, News, Portrait, Advertising, Natural Color, Motion Picture photography. Individual instruction by noted experts. 29th year. Send for Free booklet.

NEW YORK INSTITUTE OF PHOTOGRAPHY
 10 West 33 Street (Dept. 49) New York City

BE A CARTOONIST



AT HOME IN YOUR SPARE TIME UNDER personal supervision of the famous cartoonist NORMAN MARSH creator of "DAN DUNN" appearing every day in big papers. Success—Fame—Real Money may be Yours when you learn Marsh's easy simple methods and secrets. Send name and address for free details of MARSH'S Personal course. ACT TODAY!

NORMAN MARSH SCHOOL OF CARTOONING
 4554 Broadway Dept. F-100 Chicago, Ill.

JOBS in RADIO-TELEVISION

Extension and resident training in television, aviation and police radio. Let us tell you how we train men, fit them for good jobs, help them get jobs. Write for catalog. Affiliated with KMBC, major network station. Address **MIDLAND TELEVISION, Inc., 106-F Power & Light Bldg., Kansas City, Mo.**

MONEY-MAKING OPPORTUNITY

for men of character. Over \$1,600 per month earned by California man. Over \$400 a week by Georgia man. \$1,000 in a month by Delaware man. Exclusive franchises available for an invention expected to replace a multi-million dollar industry. Install on free trial. Sells itself. Repeats. Exclusive proposition. Write **F. E. Armstrongs, Dept. 1112-F, Mobile, Alabama.**

MAKE MONEY AT HOME

RUBBER MOLDS Low as 6¢ EA.

Amazing rubber mold-making outfit makes perfect flexible molds of plaques, ash trays, book-ends, etc. Molds cost from 6c to 25c each. Each mold makes hundreds of novelties and gifts to sell up to \$1.00 apiece! No experience necessary. Quick and easy. Start profitable business in your home . . . sell to stores, gift shops, friends, resorts, road stands, by mail. Full or spare time. "Molders Handy Book" and list of buyers FREE. Write

SO-LO WORKS
 Dept. U-827 Cincinnati, Ohio



You Ask Me What I Am Doing?



I Am Getting Ready to Earn More Money ... Preparing for a Bigger Job

I am a student of the American School, Chicago. A little more than half way through my course—already my increased knowledge has brought me promotion as a result of the hour or so a day I have been spending getting acquainted with the principles of the work I enjoy. I use only part of my spare time, so it doesn't interfere with my home and social life, and certainly helps me on the job.

I have been surprised at the practical manner in which even advanced work is explained. It is a lot easier than I had expected. I only wish I had started this plan of getting ahead a few years earlier. But when I was 18 to 20 I felt pretty sure of myself. I didn't take enough stock in what more experienced people told me about the importance of being thoroughly trained for the job I wanted.

You Can't Win If You Don't Try
American School, Dept. GA45, Drexel Ave. at 58th St., Chicago

CUT ALONG THIS LINE

Try a Lesson Yourself — No Obligation

American School, Dept. GA45, Drexel Ave. at 58th St., Chicago

I have checked the line of work in which I would like a good job. Please send me without expense or obligation on my part a copy of your Bulletin and an early lesson in the field I have selected.

- | | | |
|---|--|---|
| <input type="checkbox"/> Air Conditioning | <input type="checkbox"/> Electrical Engineering | <input type="checkbox"/> Law |
| <input type="checkbox"/> Architecture | <input type="checkbox"/> Diesel Engineering | <input type="checkbox"/> Liberal Arts (College) |
| <input type="checkbox"/> Automotive Engineering | <input type="checkbox"/> Drafting and Designing | <input type="checkbox"/> Mechanical Engineering |
| <input type="checkbox"/> Automobile Repairing | <input type="checkbox"/> Electric Refrigeration | <input type="checkbox"/> Merchandising |
| <input type="checkbox"/> Bookkeeping and | <input type="checkbox"/> Heating, Ventilating, | <input type="checkbox"/> Private Secretary |
| Cost Accounting | Plumbing | <input type="checkbox"/> Radio and Television |
| <input type="checkbox"/> Business Management | <input type="checkbox"/> Professional Accounting | <input type="checkbox"/> Salesmanship |
| <input type="checkbox"/> Civil Engineering | Incl. C. P. A. Coaching | <input type="checkbox"/> Shop Practice |
| <input type="checkbox"/> Aviation | <input type="checkbox"/> High School | <input type="checkbox"/> Steam Engineering |
| <input type="checkbox"/> Contracting, Building | <input type="checkbox"/> Highway Engineering | |

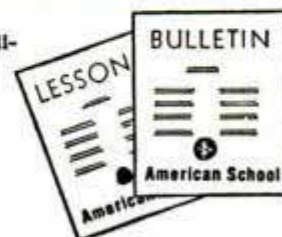

Name.....Age.....Occupation.....

Street.....City.....State.....

Here's the Kind
of MEN I Build!

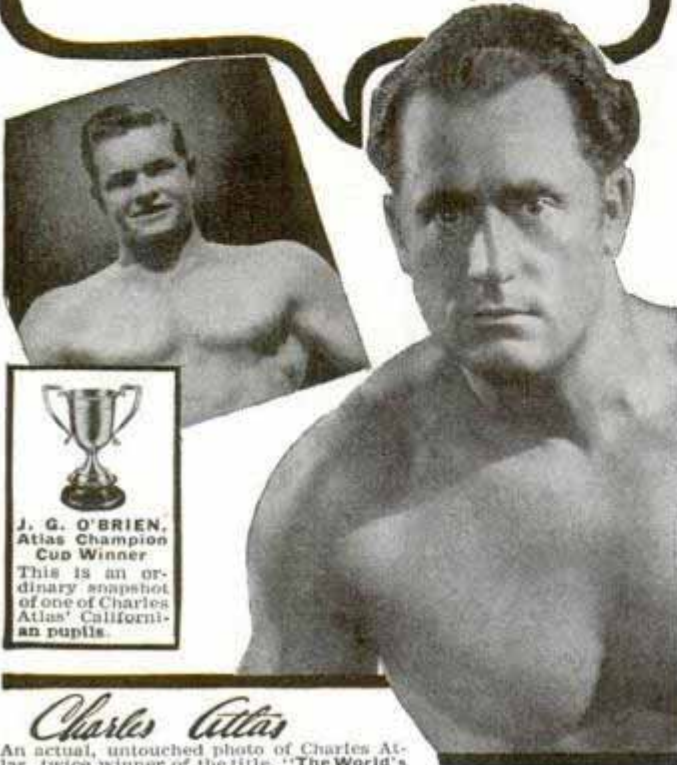

J. G. O'BRIEN,
Atlas Champion
Cup Winner
This is an ordinary snapshot of one of Charles Atlas' Californian pupils.

Charles Atlas

An actual, untouched photo of Charles Atlas, twice winner of the title, "The World's Most Perfectly Developed Man"—who offers you this 7-DAY TRIAL OFFER.

Will You Let Me PROVE I Can Make YOU a New Man?

Men—Meet J. G. O'Brien, of California, one of my Silver Cup Winners! Look at those broad, handsome shoulders—that strong neck—muscle chest and stomach. Read what he says: "Look at me NOW! 'Dynamic-Tension' WORKS! I'm proud of the natural, easy way you have made me an 'Atlas Champion!'"

Do you want a better build? Are you dissatisfied with your physical development? All I ask is a 7-DAY TRIAL. Let me show you—in even that short time—that I can give you the kind of body men respect and women admire!

I was once a skinny weakling of 97 lbs. Then I discovered the Dynamic-Tension secret that changed me into "The World's Most Perfectly Developed Man," the title I won twice. The purpose of this natural method is not only to give you powerful, rippling muscles you'd like to see in your own mirror, but also—for those whose systems are sluggish for lack of proper exercise—to help them tone up their entire body, inside and out.

Just give me a week! Make me prove—in even that short time—that continuing with my "Dynamic-Tension" method will make a New Man of you—give you bodily power and drive, put you in magnificent physical condition.

FREE BOOK Let me show you the results produced for other men! I'll send you FREE my famous book, "Everlasting Health and Strength." It shows actual photos. Write your name and address carefully on coupon. Mail to me personally today. I'll rush your free copy to you AT ONCE! Charles Atlas, Dept. SF, 115 E. 23 Street, New York, N. Y.



CHARLES ATLAS
Dept. SF, 115 East 23rd Street, New York, N. Y.

I want the proof that your system of Dynamic Tension will help make me a New Man—give me a healthy, husky body and big muscle development. Send me your FREE book, "Everlasting Health and Strength" and full details about your 7-DAY trial offer.

Name
(Please print or write plainly)
Address
City State

When writing please mention Popular Mechanics

GET IN THE SWING with Slingerland . . . DRUMS



GENE KRUPA — World's Greatest Swing Drummer uses Slingerland

**GUITARS
MANDOLINS**

**WONDERFUL VALUE
EASY PAYMENTS**

Compare the value—tone and power in Slingerland "Radio King" drums, banjos, guitars, mandolins, marimbas or bugles—before you buy. Guaranteed more for your money. Acclaimed the tops in smooth

tone, easy playing, rich power by world's leading musicians. Easy payments. 5-days free trial. See at your dealers.

Cut this ad out—good for \$1.00 credit. Free special information on how to organize drum and bugle corps. Free Catalog—mention instrument wanted.



SLINGERLAND DRUM CO.
1330 Belden Avenue Chicago, Illinois

AVIATION SPARTAN OFFERS YOU—

Unequaled advantages of "Oil Capitol of the World" finest flying weather and country. Government Approved. Factory affiliation gives you advantages of Commercial, Military All-Metal construction. Home of the DAWN PATROL, All courses Mechanical and Flight, Student Dormitories, Restaurant. Write for Illustrated Catalog.



J. D. GREEN, Director, Dept. PM 20, TULSA, OKLAHOMA
SCHOOL OF AVIATION

Learn To MOUNT BIRDS

TAN SKINS—MAKE UP FURS

Be a Taxidermist. We teach you at Home. Mount Birds, Animals, Pets, Heads, Fish. Save your hunting trophies. Decorate home and den. Make Money. Mount and tan for others. Fun and Profit! Don't delay. WRITE TODAY—NOW—for

FREE BOOK with 100 game pictures. It's Now Free. Send post card. State your AGE, N. W. SCHOOL OF TAXIDERMY, Dept. 337A, Omaha, Nebr.



Regain Perfect Speech, If You

STAMMER

Send today for beautifully illustrated book entitled "DON'T STAMMER," which describes the Bogue Unit Method for the scientific correction of stammering and stuttering. Method successfully used at Bogue Institute for 38 years—since 1901. Endorsed by physicians. Full information concerning correction of stammering sent free. No obligation. Benjamin N. Bogue, Dept. 1303 Circle Tower, Indianapolis, Indiana.

CARTOONING

PAYS WELL Turn your talent into dollars. Develop your ability with personal instruction from an internationally-known cartoonist. His exclusive, successful method of drawing and creating ideas makes it easy to learn. Write for Free Booklet explaining details of this exceptional home-study course. National School of Cartooning, 437 Penton Building, Cleveland, Ohio

LEARN WATCH REPAIRING



AT HOME You can learn by our modern and original system of instruction every part of the Watch Repairing Trade at home. You can earn money while learning and prepare yourself for a well paying position or start in business after completing our course of instruction. Good watch repairers are in demand and generally earn very good salaries. For particulars apply to the Wisconsin School of Watch Repairing 524 E. Mason St., MILWAUKEE, WIS.

MEN — If you are
mechanically inclined
and interested in

DIESEL

INVESTIGATE

the Hemphill Diesel training programs, which have been developed over a period of years and represent the accumulated experience of many American and European Diesel engineers.

PRACTICAL

Diesel and Diesel-electric training. . . You may start the course at home, and complete it in any of the eight shops and laboratories operated by the Hemphill Schools — America's Original Exclusive Diesel Training Institution.

GET YOURS

Free copy of 16 page booklet "MARCH OF DIESEL" pictures Diesel's wide usage, many interesting applications, and explains Hemphill training facilities. Send coupon for your free copy.



HEMPHILL DIESEL SCHOOLS

own and operate resident training schools and shops at these eight important marine and industrial centers—

Boston—114 Brookline Avenue
New York—31-26 Queens Boulevard, L. I. C.
Detroit—2341 West Lafayette Blvd.
Chicago—2014 Larrabee Street
Memphis—417 Monroe Avenue
Los Angeles—2120 San Fernando Road
Seattle—513-P Dexter Avenue
Vancouver, B. C.—1363 Granville St.

Applications for enrollment will be accepted from English speaking students residing in foreign countries. Write for special terms.

Hemphill Diesel Schools (use nearest address)

Gentlemen—Please send free "March of Diesel" and information on your Diesel training courses.

NAME..... AGE.....

STREET

CITY..... STATE.....m-38-p

AUDELS Carpenters and Builders Guides 4 vols. \$6



Inside Trade Information for Carpenters, Builders, Joiners, Building Mechanics and all Woodworkers. These Guides give you the short-cut instructions that you want—including new methods, ideas, solutions, plans, systems and money saving suggestions. An easy progressive course for the apprentice and student. A practical daily helper and Quick Reference for the master worker. Carpenters everywhere are using these Guides as a Helping Hand to Easier Work, Better Work and Better Pay. To get this assistance for yourself, simply fill in and mail the FREE COUPON below.

Inside Trade Information On:

How to use the steel square—How to file and set saws—How to build furniture—How to use a mitre box—How to use the chalk line—How to use rules and scales—How to make joints—Carpenters arithmetic—Solving mensuration problems—Estimating strength of timbers—How to set girders and sills—How to frame houses and roofs—How to estimate costs—How to build houses, barns, garages, bungalows, etc.—How to read and draw plans—Drawing up specifications—How to excavate—How to use settings 12, 13 and 17 on the steel square—How to build hoists and scaffolds—skylights—How to build stairs—How to put on interior trim—How to hang doors—How to lath—lay floors—How to paint.



THEO. AUDEL & CO., 49 W. 23rd St., New York City

Mail Audels Carpenters and Builders Guides, 4 vols., on 7 days' free trial. If O.K. I will remit \$1 in 7 days, and \$1 monthly until \$6 is paid. Otherwise I will return them. No obligation unless I am satisfied.

Name.....
 Address.....
 Occupation.....
 Reference..... P.M.

GET
 A Government JOB!

START \$1260 to \$2100 YEAR

34,051 appointments
 1938 Fiscal year.
 Many appointments every year
MEN—WOMEN
 Short Hours
 Dependable jobs
 Common Education
 Usually Sufficient

FRANKLIN INSTITUTE

Dept. K195
 Rochester, N. Y.

Mail Coupon Today—**SURE**

COUPON Gentlemen: Rush to me, FREE of charge, list of U. S. Government big pay jobs. Send me FREE 32-page book describing salaries, vacations, hours, work, and full particulars telling how to qualify for one of these jobs.

Name.....
 Address.....

PARKS AIR COLLEGE

PARKS AIRPORT EAST ST. LOUIS, ILL.

Offers YOU COLLEGE and PROFESSIONAL TRAINING
Majoring in AVIATION

Accredited by the Illinois Superintendent of Public Instruction. U.S. approved as a Commercial Ground and Flying School and Mechanics' School. Open to high school graduates.
FOUR courses lead to B.S. degrees in Professional Piloting, Aviation Operations, Maintenance Engineering, Aeronautical Engineering.
SIXTEEN TRAINING PLANES are used in professional flight training which prepares graduates for airline flight operations. 74% of graduates enter air transportation in North and South America. 69,000 hours flight training given, 650 hours being flown monthly.
FACULTY of 34 specialists in various fields of aviation.
 1569 graduates. Enrollment limited to a total of 300.
 100-acre airport, 14 buildings devoted to school purposes exclusively. Dormitories and dining hall at the College.
 Summer term June 10. Send postcard for new 60-page catalog.

12th YEAR Registrar, Dept. PM-6
PARKS AIR COLLEGE, East St. Louis, Ill.

DON'T CHOOSE YOUR LIFE-WORK BLINDLY

USE OUR SCIENTIFIC METHODS

... to determine the occupation in which your natural abilities, personality, and characteristics will bring your greatest success. Find out accurately in advance whether you are best fitted for art, accounting, engineering, law, mechanics, salesmanship, or whatever type of work it may be. Without wasting time or money in unsuitable work or study, you can now discover the occupation that needs exactly the qualities you possess. Take this proven step toward complete success today. Write for **FREE BOOKLET A-16**. Vocational Guidance Institute—Greenway Station, Tucson, Arizona.

LAW STUDY AT HOME

Legally trained men win higher positions and bigger success in business and public life. Greater opportunities now than ever before. Big corporations are headed by men with legal training.

More Ability: More Prestige: More Money

We guide you step by step. You can train at home during spare time. Degree of LL. B. Successful graduates in every section of the U. S. We furnish all text material, including 14-volume Law Library. Low cost, easy terms. Get our valuable 48-page "Law Training for Leadership" and "Evidence" books FREE. Send for them NOW.

LaSalle Extension University, Dept. 664-L, Chicago
 A Correspondence Institution

BE A PASSENGER TRAFFIC INSPECTOR

A GOOD-PAYING JOB IS READY FOR YOU!
 Spend a few weeks' spare time in learning the duties of Railway and Bus Traffic Inspection, and upon completion of easy, home-study course, we help place you at up to \$135 per month, plus expenses, to start, or refund tuition. Men—19 to 50 only. Free Booklet.

Standard Business Training Institute
 Div. 206 Buffalo, N. Y.

RADIO ENGINEERING, broadcasting, aviation and police radio, servicing, marine and Morse telegraphy taught thoroughly. 48 weeks' engineering course equivalent to three years' college radio work. School established 1874. All expenses low. Catalog free.

Dodge's Institute, Ada St., Valparaiso, Ind.

NEW YORK SCHOOL OF MECHANICAL DENTISTRY

Earn big money in a few months. We show you how. Real Laboratory Training. OLDEST school. Day, Eve. Easy terms. Ask for free Catalog P and tool offer.

N. Y. SCHOOL OF MECHANICAL DENTISTRY, 125 W. 31 St., N. Y. C.

CARTOONING

FREE TRIAL LESSON! Cash in on your sense of humor—AT HOME—BY MAIL. Have fun! Make money! No experience needed to start. Write today for FREE LESSON, mailed postpaid. No obligation.

Moon Gag-Cartoon School, Dept. A, Fall Creek, Wis.

WILL YOU WEAR THIS SUIT and Make up to \$12 in a Day!

Let me send you a fine all-wool union tailored suit **FREE OF ONE PENNY COST**. Just follow my easy plan and show the suit to your friends. Make up to \$12 in a day easily. No experience—no house-to-house canvassing necessary.

Send for Samples — FREE OF COST

Write today for FREE details. **ACTUAL SAMPLES** and "sure-fire" money-getting plans. Send no money.

H. J. Collin, PROGRESS TAILORING CO., Dept. T-236, 500 South Throop Street, Chicago, Illinois.

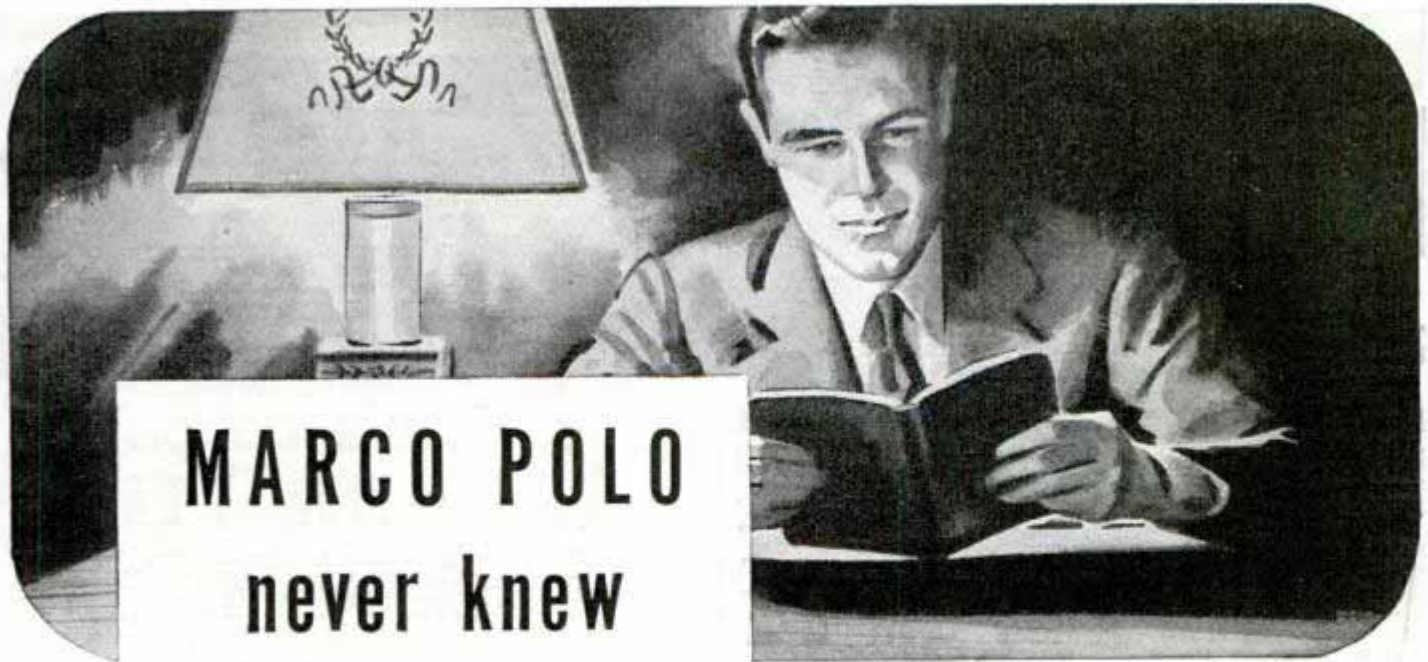

MARCO POLO never knew GREATER THRILLS

BOLD MARCO POLO, pushing eastward into the unknown, never knew greater thrills of discovery than this student of the International Correspondence Schools! His I. C. S. text is his guide-book to new and thrilling adventures in the world of knowledge.

The I. C. S. student learns the *why* while he studies at night. The very next

day, on his job, he experiences the grand ADVENTURE of seeing newly learned truths demonstrated.

For 47 years, the International Correspondence Schools have been training ambitious, adventuresome men. Today, many of them occupy high positions in Business and Industry—just as from the 100,000 I. C. S. students of today will come tomorrow's leaders, in many fields of business!

INTERNATIONAL CORRESPONDENCE SCHOOLS

BOX 5550-J, SCRANTON, PENNA.

★ Without cost or obligation, please send me a copy of your booklet, "Who Wins and Why," and full particulars about the subject *before* which I have marked X: ★

TECHNICAL AND INDUSTRIAL SUBJECTS

- | | | | | |
|--|---|---|--|---|
| <input type="checkbox"/> Agriculture | <input type="checkbox"/> Air Brakes | <input type="checkbox"/> Civil Engineering | <input type="checkbox"/> Manufacture of Pulp Paper | <input type="checkbox"/> Sanitary Engineering |
| <input type="checkbox"/> Air Conditioning and Cooling | <input type="checkbox"/> Coal Mining | <input type="checkbox"/> Contracting and Building | <input type="checkbox"/> Marine Engineering | <input type="checkbox"/> Sheet Metal Work |
| <input type="checkbox"/> Architectural Drafting | <input type="checkbox"/> Cotton Manufacturing | <input type="checkbox"/> Diesel Engineering | <input type="checkbox"/> Mechanical Drafting | <input type="checkbox"/> Steam Electric Engineering |
| <input type="checkbox"/> Architecture | <input type="checkbox"/> Electrical Engineering | <input type="checkbox"/> Electric Lighting | <input type="checkbox"/> Mine Foreman | <input type="checkbox"/> Steam Engineering |
| <input type="checkbox"/> Auto Electric Technician | <input type="checkbox"/> Fire Bosses | <input type="checkbox"/> Fruit Growing | <input type="checkbox"/> Patternmaking | <input type="checkbox"/> Steam Fitting |
| <input type="checkbox"/> Auto Technician | <input type="checkbox"/> Heating | <input type="checkbox"/> Heat Treatment of Metals | <input type="checkbox"/> Pharmacy | <input type="checkbox"/> Structural Drafting |
| <input type="checkbox"/> Aviation Engineering | <input type="checkbox"/> Highways Engineering | <input type="checkbox"/> House Planning | <input type="checkbox"/> Poultry Farming | <input type="checkbox"/> Structural Engineering |
| <input type="checkbox"/> Boilermaking | <input type="checkbox"/> Machinist | <input type="checkbox"/> Management of Inventions | <input type="checkbox"/> Public Works Engineering | <input type="checkbox"/> Surveying and Mapping |
| <input type="checkbox"/> Bridge and Building Foremanship | <input type="checkbox"/> R. R. Locomotives | | <input type="checkbox"/> Radio | <input type="checkbox"/> Telegraph Engineering |
| <input type="checkbox"/> Bridge Engineering | <input type="checkbox"/> R. R. Section Foreman | | <input type="checkbox"/> Refrigeration | <input type="checkbox"/> Telephone Work |
| <input type="checkbox"/> Building Estimating | <input type="checkbox"/> R. R. Signalmen | | | <input type="checkbox"/> Toolmaking |
| <input type="checkbox"/> Chemistry | | | | <input type="checkbox"/> Welding, Electric and Gas |
| | | | | <input type="checkbox"/> Ventilation |
| | | | | <input type="checkbox"/> Woolen Manufacturing |

BUSINESS SUBJECTS

- | | | | | | |
|--|--|--|--|---|----------------------------------|
| <input type="checkbox"/> Accounting | <input type="checkbox"/> Advertising | <input type="checkbox"/> College Preparatory | <input type="checkbox"/> Grade School Subjects | <input type="checkbox"/> Railway Postal Clerk | <input type="checkbox"/> Signs |
| <input type="checkbox"/> Bookkeeping | <input type="checkbox"/> Cost Accounting | <input type="checkbox"/> C. P. Accounting | <input type="checkbox"/> High School Subjects | <input type="checkbox"/> Salesmanship | <input type="checkbox"/> Spanish |
| <input type="checkbox"/> Business Correspondence | <input type="checkbox"/> First Year College Subjects | <input type="checkbox"/> Foremanship | <input type="checkbox"/> Illustrating | <input type="checkbox"/> Secretarial Work | |
| <input type="checkbox"/> Business Management | <input type="checkbox"/> French | | <input type="checkbox"/> Lettering Show Cards | <input type="checkbox"/> Stenography and Typing | |
| <input type="checkbox"/> Cartooning | <input type="checkbox"/> Civil Service | | <input type="checkbox"/> Managing Men at Work | <input type="checkbox"/> Traffic Management | |

DOMESTIC SCIENCE SUBJECTS

- | | | |
|---|---|--|
| <input type="checkbox"/> Advanced Dressmaking | <input type="checkbox"/> Home Dressmaking | <input type="checkbox"/> Tea Room and Cafeteria Management, Catering |
| <input type="checkbox"/> Foods and Cookery | <input type="checkbox"/> Professional Dressmaking and Designing | |

Name..... Age..... Address.....

City..... State..... Present Position.....

Canadian residents send coupon to International Correspondence Schools Canadian, Limited, Montreal, Canada
British residents send coupon to I. C. S., 71 Kingsway, London, W. C. 2, England



PREPARE FOR TOMORROW'S OPPORTUNITY

This is your opportunity to qualify as a Diesel Engineer. Men with practical training are in demand for good-paying, responsible positions. You can qualify for a place in this rapidly growing industry.

TESTED TRAINING—REAL SHOP EXPERIENCE
Internal Combustion Engines—Automotive Service
 National Schools give you actual shop methods. You learn on the latest and best equipment in a million-dollar trade school. You are taught to make good and helped to make good after you graduate. It will pay you to investigate National's Master Course.

FREE!



Transportation Allowed to Los Angeles
 Coach railroad fare allowed from any point in the United States.
 Earn room and board while learning. Graduate employment cooperation.
 Mail coupon for new 40-page Book of Diesel Facts, details of training, employment opportunities.

NATIONAL SCHOOLS LOS ANGELES

Request for FREE BOOK

NATIONAL SCHOOLS
 Dept. 6-PMA, 4000 Figueroa St., Los Angeles, Calif.

NAME _____ AGE _____
 ADDRESS _____
 CITY _____ STATE _____



Know Electricity as Experts Know It—and Get an Expert's Pay!

What about your future? Who is safe today? Surely not the man who is contented to stand still! Know your job thoroughly—prepare yourself for jobs ahead. To do just this thousands of men have used

The Croft Library of Practical Electricity

The Croft Library is a complete electrical educator. It is founded on practice—on 20 years of shirt-sleeve experience—on work as it is actually done. It is jammed from cover to cover with the kind of hard-headed facts you want. Written so that the beginner can easily understand it, yet so sound, so thorough, that it is the daily guide of 50,000 highly paid electrical workers and engineers. Croft tells you the things you need to know about motors, generators, armatures, commutators, transformers, circuits, switchboards, distribution systems—electrical machinery of every type—illumination in its every phase—the most improved methods of lighting—lamps and lamp effects, etc.—how to do a complete job, from estimating it, to completion.

6 volumes, 2155 pages—only \$16.50
No money down—Easy payments.

Fill in and mail the coupon attached and we will send you the entire set of six volumes for ten days' Examination on approval. We take all the risk—you assume no obligation. If you decide to keep the books, send \$1.50 in ten days and the balance at the rate of \$3.00 a month. Send the coupon NOW and see the books for yourself.

EXAMINATION COUPON

McGraw-Hill Book Co., 330 W. 42nd St., New York

Send me for ten days' examination on approval the Croft Library of Practical Electricity. If satisfactory I will send you \$1.50 in 10 days and \$3.00 monthly until the price of \$16.50 is paid. If not wanted, I will return the books postpaid. (To insure prompt shipment write plainly and fill in all lines.)

Name.....
 Home Address.....
 City and State.....
 Position.....
 Name of Company..... P.M. 6-39

AN AVIATION CAREER



OFFERS YOU GREAT FUTURE!

Demand for trained aircraftsmen is increasing and already exceeds supply. Curtiss-Wright Tech. Aviation's foremost and oldest school, is located on Grand Central Air Terminal in heart of the aircraft industry and specializes in training **MASTER MECHANICS** and **AERONAUTICAL ENGINEERS**. (No flying involved.) Graduates are obtaining immediate employment. Write for details NOW. Dept. PM-6

CURTISS - WRIGHT TECHNICAL INSTITUTE
 Glendale (Los Angeles) California

TRIAL LESSON IN Free • DRAFTING



More good jobs now in Drafting. Learn AT HOME in spare time (or at our Chicago School). Send postcard for **FREE TRIAL LESSON** and see how easy to learn and get a good job.

CHICAGO TECHNICAL COLLEGE
 G-200 Tech Bldg., 118 E. 26th St., Chicago, Ill.

ENGINEERING DEGREE IN TWO YEARS

B. S. Degree courses in engineering: Electrical, Civil, Chem., Mechanical, Radio and Television, or Aeronautical. 1 yr. Mech. Drafting. Intense, practical, thorough program. Large industrial center. Prep courses without extra charge. Earn board if desired. Low tuition and living costs. Enter June, September, December, March. Write for Catalog.

239-A E. Washington Blvd., Fort Wayne, Ind.

INDIANA TECHNICAL COLLEGE



Learn to Write

Begin Today. Write for our Free Book, "How to Become a Good Penman." It contains specimens and tells how others learned to write in spare time. Your name elegantly written on a card if you enclose stamp for postage. Write today. The Tamblin School of Penmanship, Dept. 8, Ridge Bldg., Kansas City, Mo.



MECHANICAL DENTISTRY AT HOME!

To make Crowns, Plates, Bridgework, etc., for Dentists. Easy practical way to learn mechanical dentistry at home in spare time. **FULL EQUIPMENT OF TOOLS AND MATERIALS INCLUDED WITH COURSE.** Low tuition. Easy terms. Write for **FREE BOOK** about this money making profession that is not affected by machine age.

McCARRIE SCHOOL OF MECHANICAL DENTISTRY
 207 N. Broad St., Dept. 746, Philadelphia, Pa.



WHY NOT spend spring, summer, fall, gathering butterflies, and moths. I buy hundreds of kinds for collections. Some worth \$1 to \$7 each. Simple work with my low cost instructions, pictures, price list. Profit—pleasure. Send 10c (not stamps) for Illustrated Prospectus, terms, before sending any butterflies.
MR. SINCLAIR, DEALER IN INSECTS
 Dept. 6, Box 1830
 San Diego, Calif.

PHOTO-ENGRAVING TASOPE SINCE 1931

TASOPE, world's largest builders of complete Photo-Engraving Plants. We supply newspapers, printeries, studios, colleges, high schools and individuals with precision-built equipment, and give thorough training in Photo-Engraving and Photography, (home or residence)—all at one low cost! Cash in on popularity of pictures. Big money working full or part time for others, or open your own well-paying business. Amazingly small investment. Cash or terms. Catalogs free.

THE AURORA SCHOOL OF PHOTO-ENGRAVING

Dept. PM-5 Tasope' Bldg. Aurora, Mo.



New LACO Sure HEATS

Brand new Oil Heater by LACO delivers tremendous heat with little fuel cost! Installs like a stove in any room, no basement needed. Easy heat regulator. Capable of developing tremendous heat. Special "Double-Flue" burner and "Inner Heating Unit" make LACO famous for cheap heat.

LOW AS \$23.50

FREE FOLDER gives full details and low prices on LACO Oil Heaters and Pressure Burners. WRITE!

LACO OIL BURNER CO., 169 Union Ave., Griswold, Iowa

Start a POTATO CHIP BUSINESS

IN YOUR KITCHEN and MAKE MONEY!

BUY potatoes for 2c a lb. Make sensational new "Greaseless" Potato Chips and sell for 35c a lb. Ideal business for men or women in spare or full time. Small investment buys complete equipment. No experience needed. I show you how to get stores to sell all you make; tell you how to make profit first day. All information, pictures, prices and terms sent free. Send a postal card for "Free Facts on this big 'Home Business' Opportunity."



G. H. HARDT, Dept. E-56, 620 N. Michigan Ave., Chicago, Ill.

U.S. GOV'T JOBS

Earn \$1260 to \$2100 at Start

Excellent opportunities for citizens, age 18 to 50. No special experience usually required. Railway Postal Clerks may earn \$155 first month; Customs Inspectors as high as \$3,000 a year. Send for FREE BOOK "How to Secure a Government Position." It tells about many good government positions and how our tested method will help you pass examinations. Write AT ONCE. PATTERSON SCHOOL, Arthur R. Patterson (former Gov't Examiner), Principal, 86 Mercantile Bldg., Rochester, N. Y.

SEVEN WONDERS of the WORLD

FREE

Pictured in FULL COLOR—Each 7 1/4 x 10 1/4". Send only 10c to cover mailing costs. The wonders you have longed to see, reconstructed from recent discoveries and painted by famous artists, so you can view them at the height of their glory and read their stories. 24 page booklet. Educational! Entertaining! Mail 10c to

WM. H. WISE & CO.; Dept. 566, 50 West 47th Street, New York City.

HOT PIANO

Ultra-modern swing



piano taught by mail. Note or Ear. Easy rapid lessons for adult-beginners. Also self-instruction-system for advanced pianists. Learn 548 Bass Styles, 976 Jazz Breaks, hundreds of Hot Rhythms, Blue Fillers, Runs, Sock, Stomp and Dirt Effects; Symphonic and Wicked Harmony in the latest Radio, Record and Orchestra Style. Write for free booklet.

WATERMAN SWING PIANO SCHOOL, 2601 Dalfon Ave., Los Angeles, Calif.



LEARN CARTOONING!

Let a prominent cartoonist teach you this fascinating profession by mail. PERSONAL instruction, just like private tutoring. Recommended by America's foremost cartoonists. Write for free details.

DORMAN H. SMITH, Box C597, SAN RAFAEL, CALIF.

Learn PHOTOGRAPHY at Home

Splendid opportunities. Prepare in spare time. Easy plan. No previous experience needed, common school education sufficient. Send for free booklet "Opportunities in Photography", particulars and requirements.

American School of Photography
3601 Michigan Ave., Dept. 135A, Chicago, Ill.



SUCCEED IN LANDSCAPING

Send for FREE book with full details about landscape training. Study at home, earn while learning. Profitable, healthful career; interesting hobby; men, women. Give age, occupation.

AMERICAN LANDSCAPE SCHOOL
6085 Grand Avenue Des Moines, Iowa

EARN THE DEGREE

Doctor of Psychology (Ph.D.), Philosophy, Divinity. General Courses—Arts, Secretarial, etc. A Correspondence Institution Chartered by State of Washington. Send for 32-page FREE Bulletin at once. No Obligation. Temple Bar College, Dept. 2-R, 1629 Thirteenth Avenue Seattle, Washington, U.S.A.



VOICE

100% Improvement Guaranteed

We build, strengthen the vocal organs—not with singing lessons—but by fundamentally sound and scientifically correct silent exercises... and absolutely guarantee to improve any singing or speaking voice of least 100%... Write for wonderful voice book—sent free. Learn WHY you can now have the voice you want. No literature sent to anyone under 17 years unless signed by parent.

PERFECT VOICE INSTITUTE, Studio A-135
64 E. Lake St., Chicago

Be a RADIO EXPERT



Learn at Home to Make

\$30, \$50, \$75 a WEEK



Chief Operator Broadcasting Station

"When I completed 20 lessons, I obtained my Radio Broadcast Operator's license and immediately joined Station WMLC, where I am now Chief Operator."—HOLLIS P. HAYES, 85 Madison St., Lapeer, Mich.

Own Business Pays \$300 a Month

"I now have my own Radio business which shows three hundred dollars a month profit—thanks, again to National Radio."—FRANK T. REESE, 39 N. Felton St., Philadelphia, Penna.



Over \$1,000 Before Graduating

"Before completing half the N. R. I. Course I was servicing sets, and I made \$1,000 to \$1,300 before graduating. I am doing Radio service work for myself now."—ASHLEY G. ALDRIDGE, 1228 Shepherd St., Petersburg, Va.

Radio broadcasting stations employ engineers, operators, station managers and pay well for trained men. Fixing Radio sets in spare time pays many \$200 to \$500 a year—full time jobs pay as much as \$30, \$50, \$75 a week. Many Radio Experts open full or part time Radio sales and repair businesses. Radio manufacturers and jobbers employ testers, inspectors, foremen, engineers servicemen in good-pay jobs with opportunities for advancement. Automobile, police, aviation, commercial Radio, loud speaker systems offer good opportunities and a future. Television promises to open many good jobs soon. Men I trained have good jobs in these branches of Radio.

Many Make \$5, \$10, \$15 a Week Extra in Spare Time While Learning

The day you enroll I start sending Extra Money Job Sheets; show you how to do Radio repair jobs. Throughout your training I send plans and directions that made good spare time money—\$200 to \$500—for hundreds, while learning. I send you special Radio equipment to conduct experiments, build circuits, get practical experience. I ALSO GIVE YOU A MODERN, PROFESSIONAL ALL-WAVE, ALL-PURPOSE RADIO SET SERVICING INSTRUMENT to help you make good money fixing Radios while learning and equip you for full time jobs after graduation.

Find Out What Radio Offers You

Act Today. Mail coupon now for "Rich Rewards in Radio." It's free to any fellow over 16 years old. It points out Radio's spare time and full time opportunities and those coming in Television; tells about my training in Radio and Television; shows letters from men I trained, telling what they are doing, earning. MAIL COUPON in an envelope, or paste on a postcard—NOW!

J. E. SMITH, President
Dept. 9FP, National Radio Institute
Washington, D. C.

Mail this Now FREE
Get 64-page Book FREE



J. E. SMITH, President,
Dept. 9FP,
National Radio Institute,
Washington, D. C.

Dear Mr. Smith: Without obligating me, send "Rich Rewards in Radio," which points out the spare time and full time opportunities in Radio and explains your 50-50 method of training men at home in spare time to become Radio Experts. (Please Write Plainly)

AGE.....
NAME.....
ADDRESS.....
CITY..... STATE.....



PROVIDING protection against smoke and fumes, as well as a new degree of freedom in movement of the head, a fire-fighting suit complete with its own air-filtering system has been patented. The



filter cartridge is strapped around the waist and connected to the head hood by a flexible tube. The hood, large enough for the wearer to move his head freely, has a flexible face piece with an elongated opening covered by a lens.

VIRTUALLY every muscle in the body is called into play by an exercising device patented recently. The apparatus occupies little space. It consists of a frame within a frame and a foot-driven gear arrangement for rotating the outer frame and



the inner frame simultaneously, thus providing a new thrill as well as a means of exercise. The operator supports himself by gripping a bar at the top of the inner frame. Rotation of the two frames is effected by the pedals at the bottom of the inner frame.

KEEPING milk fresh in warm weather for any long period is a problem for the farmer who sends his product to market in large cans. A recent invention provides a means of introducing a cooling medium that helps to preserve the milk. Into the milk can is built a channel extending downward to the bottom of the can. Ice, or Dry Ice, could be employed in the channel to cool the fluid sufficiently to prevent souring over longer periods than is possible under present methods of handling.



INTENDED to improve the grip on a golf club, a new sport device has been patented. It consists of a doubled or folded strip of absorbent material so arranged that it constitutes a loop just large enough to accommodate the thumb and first finger of one hand. When the hand grips the club, the loop restricts flexure of the thumb, resulting in a better grip.



(Continued to page 21A)

TRAIN FOR ELECTRICITY

Pay Tuition
AFTER GRADUATION

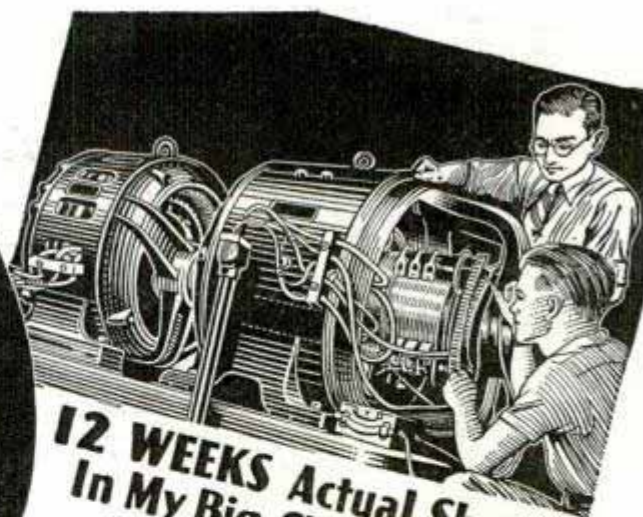

12 WEEKS Actual Shop Work
In My Big Chicago Shops

WANT TO EARN MORE MONEY?



H. C. Lewis

Have you ever dreamed of holding down a steady, good pay job? Have you ever dreamed of doing the work you really like in a job that holds promise of a real future in the years ahead?

Well, we all know that you can't get the good things in life by just dreaming about them. Hundreds of fellows are today holding down mighty fine jobs with prospects of a bright future. They are filling these jobs because they had the foresight to

equip themselves with the right kind of training. Most of these men were only average fellows a short time ago, but the proper training helped to lift them out of the low pay ranks of unskilled workers. The same opportunity is now offered to you.

The great fascinating field of **ELECTRICITY** offers a real future to many men and young men who are willing to prepare for a place in this giant industry.

Here at my school in Chicago, the world's Electrical Center, you can get **12 weeks Shop Training in ELECTRICITY** and an extra 4 weeks Course in Radio that can help give you your start towards a better job.

You will be trained on actual equipment and machinery and because of our method of training, you **don't need previous experience or a lot of education.** Many of my successful graduates never even completed Grammar School.

Here in my school you work on generators, motors, dynamos, you do house wiring, wind armatures and do actual work in many other branches of electricity and right now I'm including valuable instruction in Diesel, Electric Refrigeration and Air Conditioning at no extra cost. Our practical shop methods make it easier to learn—First the instructors tell you how a thing should be done—then they show you how it should be done—then you do the actual work yourself.



HOUSE WIRING
only one of the many branches you "Learn By Doing."



Ben Rickman, S. Car.

"... Coyne has first class instructors to teach you the simplest things to start with and they have the equipment to show you these things as you advance."

AN EXTRA
4 WEEKS
COURSE IN
RADIO
INCLUDED

I'LL FINANCE YOUR TRAINING

You can get this training first—then pay for it later in easy monthly payments, starting 60 days after your 12 weeks training period is over—then you have 12 months to complete your payments.

If you need part time work to help out with expenses while training in my shops, my employment department will give you their assistance to help you get it. Then after graduation this department will give you valuable lifetime employment service.

Send the coupon today for all details. When I get it I'll send you my big free book containing dozens of pictures of students at work in my shops. I'll also tell you about my "Pay After Graduation" Plan, extra 4 weeks Radio Course and how many earn while learning and how we help

our students after graduation. Fill in, clip coupon, mail today for your start toward a brighter future.

MAIL COUPON FOR CATALOG



H. C. LEWIS, President
COYNE
ELECTRICAL SCHOOL
500 S. Paulina St., Dept. 69-72, Chicago



H. C. LEWIS, President,
COYNE ELECTRICAL SCHOOL,
500 S. Paulina Street, Dept. 69-72, Chicago, Ill.

Dear Sir: Please send me free your big catalog and full particulars of your present offer, also your "Pay-Tuition-After-Graduation" Plan and also your extra 4 weeks Radio Course.

NAME.....
ADDRESS.....
CITY.....STATE.....

HIGH SCHOOL

At Home!

Qualify for the better Commercial, Industrial and Civil Service positions by getting a High School education in spare time!

Prepare for College, Pre-Professional, Regents, State Equivalency Examinations, and Business and Industry

U. S. Govt. figures show High School graduates average \$2112 yearly. Many Finish in 2 Years!

No classes; no time wasted going to and from school. You make rapid progress by our methods. Thousands of ambitious men and women select the American School each year.

All books furnished. School est. over 40 years. Endorsed by educators. Small monthly payments.

American School, Dept. HA45, Drexel Ave. at 58th St., Chicago

American School, Dept. HA45, Drexel Ave. at 58th St., Chicago

Without obligation send me your free Bulletin and information about your High School course at home, or the field I have checked.

- | | | |
|--|--|---|
| <input type="checkbox"/> Air Conditioning | <input type="checkbox"/> High School | <input type="checkbox"/> Law |
| <input type="checkbox"/> Architecture | <input type="checkbox"/> Electrical Engineering | <input type="checkbox"/> Liberal Arts (College) |
| <input type="checkbox"/> Automotive Engineering | <input type="checkbox"/> Diesel Engineering | <input type="checkbox"/> Mechanical Engineering |
| <input type="checkbox"/> Automobile Repairing | <input type="checkbox"/> Drafting and Designing | <input type="checkbox"/> Merchandising |
| <input type="checkbox"/> Bookkeeping and Cost Accounting | <input type="checkbox"/> Electric Refrigeration | <input type="checkbox"/> Private Secretary |
| <input type="checkbox"/> Business Management | <input type="checkbox"/> Heating, Ventilating, Plumbing | <input type="checkbox"/> Radio and Television |
| <input type="checkbox"/> Civil Engineering | <input type="checkbox"/> Professional Accounting Incl. C. P. A. Coaching | <input type="checkbox"/> Salesmanship |
| <input type="checkbox"/> Aviation | <input type="checkbox"/> Highway Engineering | <input type="checkbox"/> Shop Practice |
| <input type="checkbox"/> Contracting, Building | | <input type="checkbox"/> Steam Engineering |
| | | <input type="checkbox"/> Shop Management |

Name..... Age..... Occupation.....
 Street..... City..... State.....



Fascinating, Profitable Profession NOW OPEN to More Men & Women

If you are looking for a NEW and BETTER way to make a living, take up Swedish Massage, for now you can learn at home. This interesting big pay profession was for years available only to a few. Its secrets were guarded jealously and fabulous prices were paid for instruction. This same instruction is now available to you at a mere fraction of the former price and you need not leave your present work until you have qualified as an expert and can command an expert's pay. The demand for BOTH MEN AND WOMEN has shown a steady increase and few, if any, have ever lacked employment.

LEARN IN 90 DAYS AT HOME

Use spare time at home to master a profession which has made thousands of dollars for ambitious men and women. Many graduates have completed their training in three months but you can take your own time, it need not interfere with either work or pleasure. All instruction has been prepared by the teachers in our famous resident school—the same material is used and a DIPLOMA is awarded upon graduation.



ANATOMY CHARTS AND BOOKLET FREE No Obligation Of Any Kind SEND COUPON

THE COLLEGE OF SWEDISH MASSAGE (Successor to National College of Massage), Dept. AG-30 E. Adams St., Chicago.

You may send me FREE and postpaid, Anatomy Charts, booklet containing photographs and letters from graduates and complete details of your offer.

Name.....
 Address.....
 City..... State.....

LEARN AVIATION

IN LOS ANGELES - Nation's Aviation Capital
 Huge increases in Los Angeles aviation activity has insured good paying positions for California Flyers graduates. Only U. S. Government and industry approved school here in nation's aviation capital, offering airline piloting, engineering, mechanics, drafting, aircraft construction. Learn in America's most modernly equipped and strategically located school. Low tuition. Write for free catalog.
CALIFORNIA FLYERS
 SCHOOL OF AVIATION - Dept. PM-6
 LOS ANGELES MUNICIPAL AIRPORT, INGLEWOOD, CALIF.

FAILURE? Are you discouraged, bewildered, seeing others forge ahead to success, wealth, power while you remain in the ranks? Do you ever ask what it is that makes them successful where you fail, when they have no more intelligence than you? Don't give up... I can help you! Send your name and address to H. C. McCulloch, Desk 66, Pershing Square Bldg., New Rochelle, N. Y.

PIANO — HAWAIIAN (STEEL) GUITAR SPANISH GUITAR...easily learned at home

Become a skilled musician by our simple, short-cut note method. Play songs almost instantly. COST LESS THAN 2c A DAY! Money back guarantee. Write for free details. HAMANN INSTITUTE, 3016 N. 24th Place, Dept. R-6, Milwaukee, Wis.

Correspondence Courses in **RADIO and ELECTRICAL ENGINEERING** LOW AS \$25
ELECTRICAL ENGINEERING. Get good grasp of wide electrical field. Modern. Very understandable. Theory made easy.
RADIO ENGINEERING. Extra fine course in radio, public address, photo-electric work. Trains you to be super-service man, real vacuum tube technician. Tuition ONLY \$25, either course. Deferred payment plan. Experiment kits furnished.
FREE Write for free copies of school catalogs, student magazines, etc.
FREE LINCOLN ENGINEERING SCHOOL, Box 931-P6, Lincoln, Nebr.

X The SECRET of SELLING PHOTOS

—TO MAGAZINES, newspapers, trade journals, advertisers. Learn how to take the kind of pictures wanted. We train you at home to become a journalistic or press photographer. Show you how to take photos that sell. You may pay for course in easy installments. FREE Book tells about money-making opportunities. Write NOW. Universal Photographers, Inc., Dept. 76, 10 W. 33rd St., New York, N. Y.

NEW INVENTIONS 303

(Continued from page 18A)

NIGHT watchmen, police and others employed in guardian capacities would



find handy a newly patented flashlight designed to be attached to a pistol. The light is arranged so that its beam is parallel to the line of sight along the barrel of the pistol. The

battery case is clipped to the gun barrel, ready for instant operation. Attachment of flashlamp to the weapon would allow the watchman to open or try doors with one hand while he holds the pistol in the other.

PREVENTION of window frosting in the automobile is the purpose of a handy

little fan patented recently. The fan is attached to a movable portion of the instrument panel, so that it may be concealed back of the panel when not in use.



This is accomplished simply by pushing the movable portion downward and forward, closing it flush with the panel. The fan operates like other defrosting fans, creating air circulation to prevent condensation of moisture on the glass windshield.

TO PREVENT fractious cattle from attempting to break through fences, or



other barriers, an animal yoke has been patented recently. It consists of a collar with a pair of arms extending forward and then curving inward. The arms end in points.

Thus, when the cow tries to butt a fence or the barn door, the pointed ends of the yoke are forced against her head, causing pain.

(Continued to page 27A)

TRAIN FOR GOOD PAY AUTO-DIESEL MECHANIC'S JOB - QUICK, CORRECT McSWEENEY WAY!

**GOOD PAY JOBS
ALWAYS LOOK
FOR TRAINED
MEN—That's why
McSWEENEY MEN
MAKE GOOD!**



Yes! Trained men earn top wages in this fascinating industry—a giant, money-making industry, serving 30 million automotive engines and vehicles, and now comes the fast-growing new Diesel developments in addition! If you're content to worry along in a doubtful, low-pay job, don't answer this ad—but if you want to equip yourself for the amazing money-making opportunity this great industry offers, write us NOW.

LEARN EASILY, QUICKLY!

McSweeney-trained men make good! At the McSweeney school you get expert, technical training in Auto-Diesel mechanics, equipping you to get started in a trained man's top-pay job. Best proof of our successful methods is the success of our graduates. Read what they say!



KANSAS CITY



DETROIT

2 BIG SCHOOLS

From our two big, well-equipped schools (with 25 years experience!) go hundreds of men like G. B. Park, Ind., who says: "Had my own business for 3 years. Your training fitted me to handle any sort of job in auto field." Lee Grant, Ohio: "Just got thru writing income tax check. Money I spent at your school was best thing I ever did." J. W. Wiggins, Okla., says before we trained him he had no income. Now has own business, money to spend and money in the bank!

FREE! Write today for our Big FREE Book. Get the facts on our quick, sure training and **LOW TUITION RATES.** Mailing coupon puts it up to us to show you how YOU can train for top-pay job quickly. But write TODAY!

McSWEENEY SCHOOLS

McSWEENEY TRADE SCHOOL

Dept. 10-6, Kansas City, Mo., or Detroit, Mich.

Without cost or obligation, send me FREE information on Auto-Diesel training.

NAME.....

ADDRESS.....

City or Town.....State.....Age.....

WANT A GOOD PAY JOB?

LET ME TRAIN YOU IN

DRAFTING

UNTIL YOU GET ONE!



Take a **SHORT-CUT** to a Bigger Job, Better Pay and a **REAL** future. Learn Drafting! It's an easy way to get into your favorite work—Electricity, Aviation, Diesel, Air Conditioning, Automotive, Building, Machinery, Transportation, etc.—I agree to train you until you get a good pay job.

GET MY EFFECTIVE PAY RAISING PLAN

I have trained thousands of men ages 16 to past 50 in spare time at home to qualify for Bigger Jobs at Better Pay. Let me train you quickly by same easy, low cost "Work-Job" Method. No experience needed. High school education not necessary.

All Working Tools Furnished
You get complete Professional Draftsman's Tools and Drawing Table—sent without extra charge at once. Mail coupon for Free Book about my **EFFECTIVE PAY RAISING PLAN**. Write **TODAY!**

LEARN AT HOME IN SPARE TIME FROM AN ENGINEER

ALL WORKING TOOLS FURNISHED

GET FREE BOOK



ENGINEER DOBE, Div. A337, Libertyville, Ill.

Send me your Free Book, "SUCCESSFUL DRAFTSMANSHIP." Explain how you assist your graduates to good positions as Draftsmen.

NAME..... AGE.....
ADDRESS.....
TOWN..... STATE.....

MECHANICS

KNOW YOUR CAR

You Need this Book

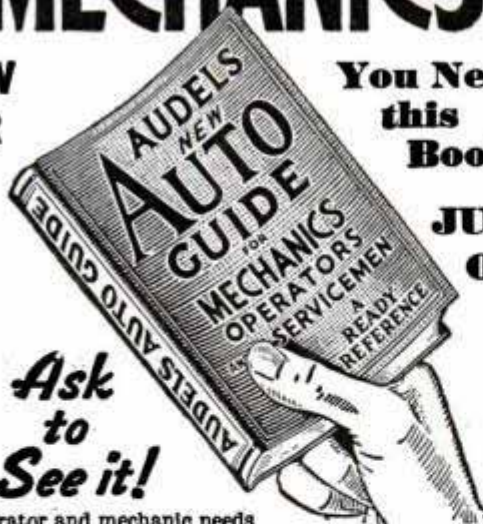

JUST OUT!

Ask to See it!

Every operator and mechanic needs **AUDELS NEW AUTO GUIDE**. This book saves time, money and worry. Highly endorsed. It presents the whole subject of auto mechanics: 1—Basic principles, 2—Construction, 3—Operation, 4—Service, 5—Repair. Easily understood. Over 1500 pages—1540 illustrations showing inside views of modern cars, trucks and buses with instructions for all service jobs. Diesel Engines fully treated, \$4 fully illustrated. To Get This Assistance for Yourself Simply **4** Fill in and Mail Coupon Today.

COMPLETE • PAY ONLY \$1. A MONTH

THEO. AUDEL & CO., 49 WEST 23rd STREET, NEW YORK
Please send me postpaid AUDELS NEW AUTOMOBILE GUIDE (\$4) for free examination. If I decide to keep it, I will send you \$1 within 7 days; then remit \$1 monthly until purchase price of \$4 is paid. Otherwise, I will return it to you promptly.

Name.....
Address.....
Occupation.....
Reference.....

It's Great TO BE IN THE Spotlight



EASY, TOO!
Let the **BRINDISI ACCORDION** be your magic carpet to happy-land. Fun at home and at parties. Opportunity for broadcasting, dances, entertainment, etc. Easy to learn—moderate cost. Write today for **FREE** copy of booklet—"Music Magic with the Accordion." . . . Tonk Bros. Co., Dept. 26, 623 S. Wabash Ave., Chicago

WANT A GOOD PAY JOB?

Trained Tool and Die Makers, precision machinists, automatic screw machine men earn as much as \$50-\$60 per week. Learn by actual work in one of America's best equipped shops. Training supervised by experts. Day-Evening classes. Enter any time. Low fee, employment help. Write **NOW** for **FREE** booklet "Practical Machine Shop Training."

ALLIED SCREW MACHINE CO., Inc.
(School Division)
Dept. PM-8 603-9 W. Lake Street, Chicago, Ill.



CARTOON YOUR WAY TO SUCCESS!

DON'T COPY - LEARN TO ORIGINATE!
RAYE BURNS will teach you **HOW** to **CREATE ORIGINAL CARTOONS** at home that you can **SELL!** Course has 26 lessons and 600 illustrations. **\$2.85**
Send name and address for free details. Only....

RAYE BURNS SCHOOL, Dept. M-2, Box 2194, CLEVELAND, OHIO

EARN A DEGREE AT HOME

From A Chartered Institution Of Higher Learning
Employers Now Demand College Graduates With Degrees

88 Degree Courses in Art; Sciences; Philosophy; Education; Psychology; Public Health; Sociology; Physics; Chemistry; Pol. Science; Theology; Law; Business Training; Accounting; Statistics; Adv. Sales; Agriculture. Electrical, Mechanical, Civil, Structural, Diesel, Architectural, Mining, Drafting, Automotive, Aeronautical, Radio, Refrigeration, Highway, Marine, Air Conditioning, Geology, Petroleum, Industrial, Chemical Engineering. Founded 1908. 170 p. Catalog Free. McKinley-Roosevelt Graduate College, 4244 Clarendon Ave., Chicago

AVIATION APPRENTICES

AIRMINDED YOUNG MEN INTERESTED IN TRAINING FOR ENTERING THE WELL PAID FIELD OF AVIATION AS APPRENTICES—Write immediately, enclosing stamp.

MECHANIX UNIVERSAL AVIATION SERVICE CO.
Wayne County Airport, Box 857, Dept. E, Detroit, Mich.

Be a MONEY-MAKING RADIO EXPERT

I'll train you for a good job in Radio, Television, or a business of your own. My new, personalized sparetime home-study Course fits you quickly, easily. You get real Radio Equipment. I show you how to earn while you learn.

FREE: Write for complete details in new catalog "HOW TO MAKE MONEY IN RADIO" Sprayberry Academy of Radio, 210-F University Place, N. W. Washington, D. C.

MYSTERIOUS DEVICE WELDS BRAZES AND SOLDERS ANYONE CAN OPERATE

Now, an electric welding, brazing and soldering Torch, complete with power unit, goggles and supplies. **Works INSTANTLY off any light socket.** Does a thousand and one repair jobs at amazingly **LOW COST** on aluminum, iron, steel and other metals. **Indispensable** for Auto, Body and Fender Repairs, and home repairs—shop, factory, farm, engineer, janitor, sheet metal, radio and bicycle repairs. Anyone can handle without previous experience with our **sim-10-DAY HOME TRIAL** instructions. Write at once for Special Introductory Low Price Offer. Try 3 in 1 Electric Torch for 10 days at our risk, or get one free by helping to introduce it. **ELECTRO-TORCH CO., 2613-OP Michigan Ave., Chicago**



for
quick
action

SEND
TO-DAY

MAIL COUPON NOW

for Free Book and Record of Invention Form

CLARENCE A. O'BRIEN AND HYMAN BERMAN
70-Z Adams Building
Washington, D. C.

Registered Patent Attorneys Before U. S. Patent Office
Please send me at once your Big Free 48-Page Book "Patent Guide For the Inventor" and your Specially Prepared "Record of Invention" Form. This request does not obligate me.

NAME.....
ADDRESS.....
CITY.....

STATE.....
(Please write or print plainly)

YOU CAN PATENT

IMPROVEMENTS IN MACHINERY, ARTICLES, DESIGNS, FORMULAS, ETC., IF NEW

Every year thousands of Patents are granted. Very few, however, represent the discovery of entirely new principles. Most of them provide new methods of doing some every-day thing in a better way—changes for greater efficiency, usefulness, adaptability, or beauty in some previously Patented thing. These IMPROVEMENTS are patentable if new, and actually represent new invention. These improvement Patents offer large chances for profit if commercially useful. The business world wants improved products and services.

MODELS AND FINISHED DRAWINGS UNNECESSARY

Our Big Book tells you how you can start immediately to apply for Patent Protection even if you haven't finished models or drawings available now. It will tell you how we can prepare the specifications and finished drawings necessary in the form prescribed by the Patent Office—so as to secure for you full Patent Protection. Mail Coupon for Our Big Book TODAY.

OUR SERVICES TO YOU

We are Registered Patent and Trade-Mark Attorneys, serving Inventors all over the United States and abroad. Our Organization is complete. We have Draftsmen, experienced Searchers and Attorneys to serve your interests. We can act as your legal adviser in all Patent Matters. Our complete service is described in Our Big Book. Mail Coupon for it NOW.

IN CASE YOU FEEL THAT YOU HAVE NOT SUFFICIENT FUNDS AVAILABLE FOR PATENT FEES

Our Big Book tells you how to legally assign an interest in your invention before filing application—to some friend willing to aid you. Better to do this than to delay indefinitely and see another inventor develop your invention and Patent it before you do. Send Coupon NOW.

REASONABLE FEES—CONVENIENT TERMS

Don't worry about finances. Our fees are very reasonable—we can arrange convenient terms of payment. It is our custom to permit clients to pay for our services in installments as the application progresses in our office. See our Big Book for fees in obtaining Patent. It explains our arrangements clearly. Send for it NOW.



REQUEST OUR BOOK —NOW!

Know exactly what you should do to secure a Patent—what must be done every step of the way—how the Patent Law protects you—what we, as Registered Patent Attorneys, can do for you. Mail the coupon NOW for our Big Booklet and "Record of Invention" Form.

CLARENCE A. O'BRIEN & HYMAN BERMAN

70-Z Adams Building

Washington, D. C.

Registered Patent Attorneys Before U. S. Patent Office

TO HELP YOU CHOOSE

WHAT
VOCATION
SHALL
I
CHOOSE
?

*Your
life work*

• Unwise choice of vocation may mean failure and despair. To help you choose wisely, here are "previews" of fifteen fields with bright futures—written by experts in each field, and sent FREE on request. Mail the coupon.

INTERNATIONAL CORRESPONDENCE SCHOOLS

BOX 5551-J, SCRANTON, PA.

Please send me at once, without obligation, a copy of the booklet, "What Vocation Shall I Choose?"

Name _____

Address _____

City _____ State _____

(Please PRINT name and address)

STUDY ENGINEERING AT HOME EARN A DEGREE AT HOME

From A Chartered Institution Of Higher Learning
Employers Demand Degree Men For Key Positions

88 Degree Courses in Electrical, Mechanical, Civil, Structural, Diesel, Architectural, Drafting, Automotive, Aeronautical, Radio, Refrigeration, Air Conditioning, Highway, Mining, Geology, Petroleum, Marine, Industrial, Chemical Engineering, Arts; Sciences; Philosophy; Psychology; Chemistry; Education; Business Training; Law; etc.
McKinley-Roosevelt Graduate College, 4238 Clarendon Ave., Chicago

PRESTO! ANYONE CAN MASTER GLAZE



LEAVES HARD GLASS-LIKE FINISH
EASY TO APPLY
PROTECTS THE SURFACE
NO SMEAR OR STREAKS AS WITH WAX
LASTS SIX MONTHS TO A YEAR
SEALS THE PORES OF THE SURFACE
WILL NOT FINGER-MARK
EASY TO KEEP CLEAN
NO OILY FILM AS WITH POLISH
SAVES YOU MONEY

Car Owners! Meet Master Glaze—the sensationally different luster for new and used cars! Not a wax—not an oil polish—not a paint!—nothing that "smears" over the surface.

MASTER GLAZE is a unique discovery—a creamy liquid—quick and easy to apply! Gives a hard, glass-like surface. Even gasoline cannot dull it! Lasts six months to a year! Amazing luster—beautiful, sparkling clean and brilliant! Doesn't finger-mark—doesn't smear! A match box full glazes an entire car. Seals the pores—protects! **NOTHING LIKE IT!**
FREE SAMPLE Write now for **FREE BOOK-LET** and **FREE TRIAL OFFER**. Just send your name and address. Write
MASTER GLAZE CO., 7720-68 W. Harwood Ave., Milwaukee, Wis.

AGENTS
An unusual opportunity!
Quick, flashy demonstrator.
Big profits.
Good territory.
Write today!



A NEW, VALUABLE
AND INEXPENSIVE
SERVICE

TECHNICAL Bulletins

\$1 Each TECHNICAL DATA SIMPLIFIED FOR THE PRACTICAL MAN!

Here is a valuable, inexpensive service for mechanics, inventors, technical specialists and practical craftsmen of all kinds. Technical Bulletins give the needed basic and practical information on a wide variety of subjects—briefly, concisely and simply presented—yet complete in every detail. No advanced mathematics, chemistry or physics needed to understand them. Material never before in print, now specially prepared in bulletin form. Postpaid \$1 each or sent C. O. D. anywhere in U. S. Ask for list of complete bulletin service.

ORDER BY NUMBER • WRITE FOR COMPLETE LIST

D-101—Using Nichrome Resistance Wire.

D-102—Cleaning Products for all Purposes.

D-103—Automobile Specialty Chemical Products.

D-104—Silver Soldering and Brazing.

D-105—Latest Gas-Welding Practice.

D-106—Rewinding Electric Motors.

D-107—Electro-Plating with Copper, Nickel and Chromium.

D-108—Electro-Plating with Gold and Silver.

D-109—Electro-Plating with Zinc and Cadmium.

D-110—Electro-Plating Non-Metallic Objects and Electro-Forming.

D-111—Designing and Building Transformers.

D-112—Designing Electro-Magnets.

D-113—How to Design Solenoids and Plunger Magnets.

D-114—Designing Thermostats for Air Conditioning and Heat Control Purposes.

D-115—Flexible Molds for Casting Small Objects.

D-116—Printing Photos on Cloth, Paper, Etc.

D-117—The A B C of Air Conditioning.

D-118—Electrical Water Pipe Thawing Equipment.

D-119—Electroplating with Alloys.

D-120—Gas Fired Blast Furnace for Melting Metals, Alloys and Heat Treating.

D-121—Corrosion, Causes and Preventive Measures.

D-122—Stainless Steel Easily Soldered, Brazed or Welded.

D-123—Mirror Silvering.

D-124—Soldering.

D-125—Buffing and Polishing Metals.

D-126—How to Design and build Hydraulic Rams.

D-127—Small Electric Light Plants, Design and Construction.

D-128—Diesel Engines, Operation and Service.

D-129—Coloring Metals Chemically.

D-130—Glass Working Technique.

D-131—Remote Control Switching.

D-132—Working With Plastics.

D-133—Spot Welder for the Small Shop.

D-134—Electrical Experiments With Simple Materials.

D-135—Electric Arc Torch.

D-138—Gold-Leafing Methods.

D-140—Etching Metals and Glass.

POPULAR MECHANICS PRESS
ROOM 639B • 200 EAST ONTARIO ST • CHICAGO

When writing to advertisers please mention Popular Mechanics

Get Into AVIATION Train At LINCOLN



Now is the time to get into Aviation! Pilots earn up to \$6000 a year! Mechanics and Engineers also get big pay! Prepare at this Lincoln Government Approved School for a good pay position and your Government Rating as Pilot or Mechanic or as Aeronautical Engineer. Learn to fly our fast modern airplanes; to design and build advanced type airplanes; to overhaul, repair and rebuild airplanes and engines. We teach you how and assist Graduates in locating positions. **WRITE TODAY** for complete information.

LINCOLN AIRPLANE & FLYING SCHOOL
566 Aircraft Bldg. Lincoln, Nebraska

M ECHANICS-WELDERS - COLLISION MEN

Good pay jobs for trained men in Auto and Diesel Mechanics, Electric Arc and Acetylene Welding. Complete courses. Practical training. Complete courses in body and fender bumping, spray painting, metal finishing. Fine equipment. Special low rates. Pay-after-graduation-plan. Write today.

Michigan Trade School
3785 Woodward Ave. Detroit, Mich.

**Write for
FREE
FOLDER**

ENGINEERING

**DEGREE
IN TWO
YEARS**

TECHNICAL AND APPLIED COURSES. Nonesentials omitted. TIME AND MONEY SAVED. Degree 2 yrs. diploma 1 yr. Electrical, Mechanical, Architectural, Structural, Civil, Aeronautical, Highway. All courses include Air Conditioning, Electric Refrigeration and Diesel. Short intensive courses 3 and 4 months in Electricity, Power Plant, Diesel-Electric, Electric Refrigeration, Drafting. Extensive modern equipment. **LOW TUITION**. Part-time work for room and board. Thousands of successful graduates in U. S. and foreign lands. Approved by industry, endorsed by educators, recommended by alumni. One and two-year courses start in Sept., short courses open year round. 40th YEAR. Residences courses. Catalog free.

FINLAY ENGINEERING COLLEGE

1001 Indiana Avenue Kansas City, Mo.

Auto-Diesel

Master a real trade. Auto Mechanics, Diesel Mechanics, Arc Welding, Acetylene Welding, etc. Let us train you to be an expert Auto-Diesel Mechanic and help you get a good job. The cost to you is reasonable. Learn on modern equipment with tools under experienced instructors. Real shop work. Steam heated buildings. Room and board in our steam heated dormitory. We pay your fare to Nashville. For free catalog write

Nashville Auto-Diesel School, Dept. 75, Nashville, Tenn.

ARTISTS MAKE MONEY

Find out your ability. Send name, age, occupation and address for Free Vocational Art Test.
Federal Schools, Inc., 6139 Federal Schools Bldg., Minneapolis, Minn.



A AND N SUPPLY CO.

Bargains—Military, Sport Goods, Firearms, Clothes, Shoes, etc. Send 10¢ for new catalog, to be redeemed on first order.

EST. 1868 A & N Supply Co., 4773 Lester St., Richmond, Va.

ATLAS STICK-ON LETTERS

Beautiful Gold Colored. New Styles. 5 Year Guarantee. Large Sizes—Penny Each. Tremendous Demand. Amazing Profits. Write for Samples and Starting Equipment. Hurry!
ATLAS Sign Works, 7943 Halsted, Chicago



Monuments \$9. Up

Best Quality Marble and Granite. Big Saving. Free Lettering. Guaranteed. Erected if desired. Write for Catalog and samples.
U. S. MARBLE & GRANITE CO., A-18, Oneeo, Fla.

MONEY IN RABBITS—CAVIES

WE BUY and put you in touch with other markets. Catalog and copy of magazine 10c. Or send 25c for Book Catalog and Price List and Year's Subscription to the **AMERICAN SMALL STOCK FARMER**.
OUTDOOR ENTERPRISE CO., BOX 919, NEW CITY, N. Y.

Earn Cash at Home!

We paid M. M. \$1174 for exceptional "cellar crop" SNOW-KING mushrooms! Big free picture book tells if your cellar, shed, barn suitable. We furnish materials, buy all crops. Write today. Est. 1908.
UNITED CO., 3848 Lincoln Ave., Dept. 311, Chicago.

This MACHINISTS' Home-Study Course



helps men get ahead

Newly assembled—specially priced—these five recent books give you the practical facts on modern machines, up-to-date methods, you need to advance in machine shop work. Take advantage of the other man's experience as found in books, to solve your problems, increase your efficiency, with

The NEW AMERICAN MACHINISTS' LIBRARY

5 volumes—2014 pages—1853 illustrations

(A combined home-study course and reference library)

This library of machine shop practice was written for practical men. It gives you the best methods for every kind of machine shop work. It fully explains lathes, drills, and other machine tools and their operation, automatic screw machines, speeds and feeds, gear design and production, punch and die work, metal surfacing, etc., etc. Plainly written—completely illustrated—the best kind of help to the machine shop man who wants to advance himself.

No money down—special price—easy payments.

EXAMINATION COUPON

McGraw-Hill Book Co., 330 W. 42nd St., New York

Send me for ten days' examination the new American Machinists' Library. If satisfactory I will send you \$1.50 in 10 days and \$3.00 monthly until the price of \$16.50 is paid. If not wanted, I will return the books postpaid. (To insure prompt shipment write plainly and fill in all lines.)

Name.....
Home Address.....
City and State.....
Position.....
Name of Company..... PM-6-39



**DO YOU
WANT
\$36.50
A WEEK?**

U. S. Government Jobs

**START \$1260
TO \$2100
A YEAR**

**FRANKLIN
INSTITUTE
Dept. K173
Rochester,
New York**

**MEN—
WOMEN**

Paid Vacations

**Common education
usually sufficient**

**Mail Coupon
Today—
SURE**

Gentlemen: Rush to me, FREE of charge, list of U. S. Government big pay positions. Send me FREE 32-page book describing salaries, hours, work, vacation, and giving full particulars on how to qualify for a position.

COUPON
Name.....
Address.....

DO YOU LIKE RADIO

DOES THE FUTURE OF TELEVISION

INTEREST YOU?



Send for your free copy

You men anxious to make good in radio and related industries want the true facts.—you want to know about employment opportunities and requirements. National Schools,—a million-dollar trade school,—will supply you with a sincerely honest statement of facts on what you should do to get into the profitable radio industry. No exaggerations,—no misstatements. Mail coupon today. [Send for your free copy. Real facts on radio employment requirements. [You need real experience. National offers complete training with modern equipment.



NATIONAL SCHOOLS

Los Angeles

Request for FREE BOOK of DETAILS

NATIONAL SCHOOLS,
Dept. 6-PMR, 4000 S. Figueroa St., Los Angeles, Calif.

NAME _____ Age _____
ADDRESS _____
CITY _____ STATE _____



DRAFTING

BOOKS SENT FREE!

ON APPROVAL
5 VOLUMES BRAND NEW EDITION
Only 15 minutes a day with these WONDER BOOKS can prepare you for a good drafting job in less than a year. Mechanical and architectural drafting from simple straight lines to important complex plans. A step at a time! Built especially for beginners, for men with only grammar schooling. Drafting room practice, PLUS ENGINEERING, made easy and clear. Includes complete information on blue print reading for building and machine trades.

Big Field Big Demand Big Pay
Competent draftsmen are urgently needed right now in all building and manufacturing lines at \$30.00 to \$75.00 a week. That's just the beginning—FOR DRAFTSMEN HAVE THE BEST CHANCES FOR ADVANCEMENT. Pleasant, fascinating work, easy to learn and do. Learn quickly with these books—send coupon for a set and see for yourself.

[A year's consulting membership in the American Technical Society now given to all readers of this famous encyclopedia of drafting. Many say that it is worth more than the cost of the books.]

Complete set of drawing instruments if you send for these drafting books NOW. These instruments are made of the finest of German silver, are absolutely accurate and are packed in velvet lined leatherette pocket case. Real \$10 value, but included with these books.

AMERICAN TECHNICAL SOCIETY
Dept. DA19, Drexel at 58th St., Chicago, Ill.

American Technical Society, Dept. DA19, Drexel at 58th St., Chicago, Ill. Send for 10 days' trial New 5 volume set of drafting. I will pay the few cents delivery charges. If I wish, I may return books in 10 days and owe you nothing but if I decide to keep them, I will send \$2.00 after 10 days, then only \$3.00 a month until \$24.50, the advertising price, is paid. Send latest edition and include drawing instruments and Membership Certificate.

Name.....
Address.....
Attach letter stating age, occupation, employer's name and address and that of at least one business man as a reference.

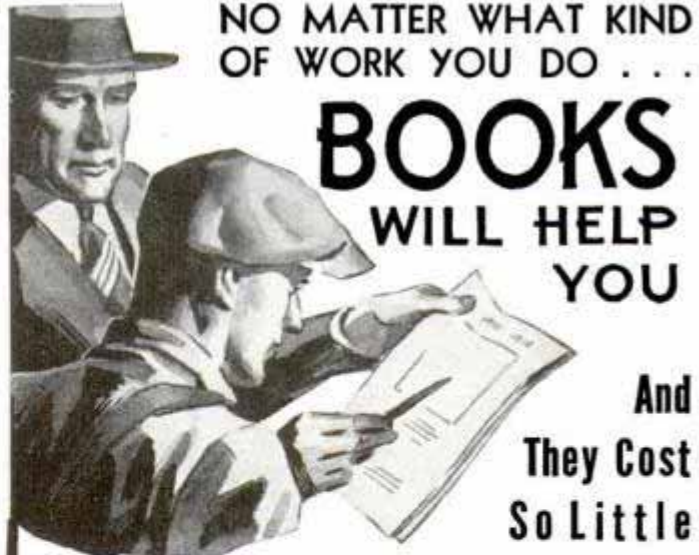

NO MATTER WHAT KIND OF WORK YOU DO . . .

BOOKS

WILL HELP YOU

And They Cost So Little

Select from this List

Here are books that will help you—on your job—to advance to a better job—to earn extra money in spare time—to develop a hobby. Choose from this list and order today.

- AIR CONDITIONING**
Live Field; Great Future. \$3.50
- ALUMINUM WORKING**
For School and Home Shops. Just Out 295 pp., illus. \$3.00
- AUTO ENCYCLOPEDIA**
The Famous Dyke's Latest Edition. \$6.00
- 110-V. GENERATORS**
Made From Old Auto Units. \$1.00
- BIRD HOUSES**
Build to Sell; Easy Designs. \$1.00
- BLUEPRINT READING**
for the Building Trades. \$1.25
- BOAT BOOK**
Power, Sail, Rowing, Paddle Plans. \$3.00
- BOY MECHANIC**
Hundreds Things Boys Can Make. \$2.00
- CARPENTRY, PRACTICAL**
Complete 436 pages. Revised Edition. \$2.00
- CIVIL SERVICE**
Home Study Courses Federal, State, City Positions. \$1.00
- CONCRETE**
1001 Ideas for Using. New Popular Mechanics Book. \$5.00
- DIESEL ENGINES**
For Land, Air and Water. \$4.00
- ELECTROPLATING**
With Copper, Nickel and Chromium Technical bulletin. \$1.00
- FORD V-8 CARS, TRUCKS**
New, 700 Pages. Includes Details 1937 Cars. \$2.50
- FORMULAS**
1059 Money Making. Start a Business. \$1.25
- FURNITURE MAKING**
Tools, Materials, Design. \$2.50
- HOUSE CONSTRUCTION**
Details, Practical, up-to-date. Complete. \$3.00
- HOUSES, SMALL**
Book of, for Home Builders. \$2.00
- MACHINE SHOP WORK**
Complete. 400 Pages. 444 Illustrations. \$2.50
- MACHINE WOOD-WORKING**
First Complete Book. \$3.25
- MATHEMATICS**
Easy Guide for the Practical Man. \$1.50
- MECHANICAL DRAWING**
Learn Drafting; Good Salaries. \$1.00
- MONEY MAKING IDEAS**
1000 Ways to Make \$1000. \$2.50
- OXYACETYLENE WELDING**
Hard Surfacing, Lead Burning, Cutting New ed. \$1.25
- PAINTING AND DECORATING.** New book. \$1.50
- PLUMBING**
500 Facts Every Homeowner Should Know. \$1.50
- PROSPECTORS' HANDBOOK**
How to Mine, Appraise, Equip. \$3.00
- RADIO SERVICING**
Profit by Knowing Costs, Kinks, Etc! \$4.00
- REFRIGERATION**
Electric, Gas. Be a Service Expert. \$5.00
- REWINDING ELECTRIC MOTORS**
Fractional Sizes. \$2.50
- SHIP MODEL**
Entire Text, Famous "Sovereign" of 1637. \$1.00
- SOIL-LESS GROWTH OF PLANTS.** Just out. \$2.75
- STEEL SQUARE**
How to Figure Angles of Rafters, Roofs, Etc. \$1.00
- TOYS**
For Amusement or Profit, Saleable Designs. \$1.50
- TRAILER BUILDING**
New Book. \$1.00
- UPHOLSTERY**
Always a Big Market. Start Own Business \$2.00
- WOOD FINISHING**
Methods, Tools. \$2.00

Use this advertisement as an order blank. Check books wanted. Add name and address and mail. Just pay postman price plus small C.O.D. fee. (In U.S. and possessions.) Or remit with order and books will be sent postpaid anywhere in the world.

Send No Money

POPULAR MECHANICS PRESS
Room 639A 200 East Ontario St., Chicago

When writing please mention Popular Mechanics

NEW INVENTIONS g 30³

(Continued from page 21A)

HITTING the curb with wheel, lower edge of fender or the running board could be eliminated by equipping the automobile with an obstruction indicator patented recently. The device is a vertical rod attached to the right end of the front bumper.

The lower end contacts the curbstone if the car approaches too closely and a ball on the upper end, visible to the driver, shows the proximity of the wheel to the curbing.

SAFETY for the bicycle rider, traffic officer or pedestrian on the street or highway is afforded by a flashlight which has a standard beam emanating from the front end and a red beam from the rear. The red light, which results from reflection of the front lamp's rays back through the tube barrel, is visible at 1,500 feet.



SOILING the pages of books, particularly expensive ones, may be prevented by using thumb pads patented recently. The pad, which is transparent, is attached easily to the thumb, with the pad lying against the palm side of the thumb. The pad is considerably larger than the thumb and thus protects the page from dirt.



Due to the fact that many of the devices described in this department are still in the patent office stage and are not on the market, Popular Mechanics Magazine cannot undertake to supply further information regarding them.

THOUSANDS ENJOY
THRILL OF PLAYING

Who Didn't Know a Note of Music



Over 700,000 people have studied music at home this easy way. See how quickly *you* can learn at home—without a private teacher, without needless study and practice. This wonderful print and picture method starts you learning to play real tunes by note in first few lessons. Best of all, the cost is surprisingly low—averaging only a few cents a day—for whatever instrument you choose. Fill out and mail coupon at once for illustrated booklet and Demonstration Lesson—FREE. Instruments supplied when needed, cash or credit. U. S. School of Music, 76 Brunswick Bldg., N. Y. C. (41st year—Est. 1898.)

FREE DEMONSTRATION LESSON

U. S. School of Music, 76 Brunswick Bldg., N. Y. C.

Please send me Free Booklet and Demonstration Lesson. I would like to play instrument checked below. (Do you have instrument.....)

Piano	Accordion	Clarinet	Banjo
Violin	Saxophone	Trumpet	Ukulele
Guitar	Mandolin	Trombone	Other Instrument

Name.....

Street.....

City.....State.....

Be An ARTIST!



LEARN TO DRAW

—at home in your spare time

The fascinating field of Art offers opportunity to both men and women. Trained Artists are capable of earning \$30, \$50, \$75 a week. We teach you right at home for a successful career in—

COMMERCIAL ART ILLUSTRATING
CARTOONING

For 24 years W. S. A. graduates have been "making good" in Art—YOU CAN, TOO! No previous Art experience necessary—our instruction is practical and thorough. Write for Booklet—"Art for Pleasure and Profit," fully describes course and TWO BIG ARTISTS' OUTFITS given. Clip coupon—mail today.

FREE BOOK gives details!

Washington School of Art, Studio 126M
1115—15th St., N. W., Washington, D. C.

Yes! I am interested in learning to draw. Please send me your Free Book, "Art for Pleasure and Profit."

Name.....Age.....

Address.....

City.....State.....



TRI-STATE COLLEGE

ENGINEERING DEGREE IN 2 YEARS

**56th
YEAR**

Courses in Civil, Electrical, Mechanical, Chemical, Aeronautical, Radio Engineering. The Mechanical course includes Diesel Engineering, Air Conditioning and Refrigeration. Essentials of engineering training included and non-essentials eliminated. Tri-State graduates in Radio Engineering can complete the Electrical course in 24 weeks. B. S. Degree granted upon completion of course. For ambitious, earnest students. Special Preparatory Department for those who lack required high school work. Graduates compete successfully with those of 4-year schools.

Technical instruction at lowest cost and in least time consistent with thorough training. Intensive instruction in accord with individual ability. Courses also in Business Administration and Accounting. Also short diploma courses (36 weeks) in Surveying, Drafting. Students from all parts of the world. Tri-State graduates make good. Tuition, living costs low. Enter September, January, March, June. **Write for catalog.** 469 College Ave., Angola, Ind.

*You have
a future in*

RADIO ENGINEERING

More Than 275 Radio Stations Employ CREI Men!

90% of last year's class have radio jobs! CREI is recognized and approved by the Radio Industry. You can train for a career in Radio and Television Engineering. Intensive one-year course for high school graduates. Students enjoy actual "lab" experience under outstanding engineer-instructors. Well-equipped shops and laboratories with modern radio equipment. School year begins in Sept.—ends in June in our own new building in the Nation's Capital. Home-study prep course during Summer at no extra charge. Write today for details and 48-page free book: "A Tested Plan for a Future in Practical Radio Engineering." State age.



CAPITOL RADIO ENGINEERING INSTITUTE
Dept. PO-6, 3224 16th St., N. W., Wash., D. C.

Monastery Secrets

... THE FORBIDDEN
KNOWLEDGE OF TIBET

What strange secrets of nature are locked within the mountain fastness of Tibet? What control over the forces of the Universe do these cloistered sages exercise? For centuries the world has sought to know the source of their power—to learn their mastery of life, and their faculty for overcoming problems with which the masses of mankind still struggle. Have they selfishly deprived humanity of these rare teachings?

**WRITE FOR THIS
FREE BOOK**

Like the streams that trickle from the Himalayan heights to the plateaus below, the great truths of these brotherhoods have descended through the ages. One of the preservers of the wisdom of the Orient is the Rosicrucian Brotherhood (not a religious organization). They invite you to write today for their FREE Sealed Book, with its amazing revelations about these mysteries of life. Address: Scribe M.H.W.

The ROSICRUCIANS
AMORC
San Jose, Calif.
U. S. A.



New York Electrical School

Established
1902

Ask for free illustrated
booklet

44 West 17th St., N. Y. C.

DEAFNESS A HANDICAP

Thousands suffer business and social handicaps because of impaired hearing. Many report they now enjoy the satisfaction and pleasures associated with improved hearing by the use of Abell's Artificial Ear Drums. They are invisible. Worn with comfort, day and night. No wires, no batteries. Easily adjusted. Write for FREE booklet on deafness and full information about TRIAL OFFER on my Artificial Ear Drums.

DR. W. T. ABELL
Siavin Bldg., Dept. 24, Pasadena, California.

Government Jobs

Write for catalog No. 47. Valuable information free.
COLUMBIAN CORRESPONDENCE COLLEGE, Washington, D. C.

S AGENTS 300% Profit SIGN LETTERS
For Store Fronts and Office Windows. Anyone can put them on. Free Samples. Liberal Offer to general agents.
METALLIC LETTER CO., 438 N. Clark St., Chicago

TOOL & DIE MAKING DESIGNING

Machinists Trade. Not a correspondence course. Practical shop training in the world's industrial center. Write today for full information.
NATIONAL SCHOOL OF MECHANICAL TRADES
Dept. 107 628 W. Lake St. Chicago, Ill.

AU AERONAUTICAL UNIVERSITY
Engineering (B.S. Degree)—Administration—Certificated Mechanics—Radio—Sheet Metal—Welding
A real technical university education in less time at less cost. Write for Illustrated Bulletin. Address: Aeronautical University, Curtiss-Wright Bldg., Dept. A, 1342 S. Michigan Ave., CHICAGO, ILL.



Only 15c A Day
Puts This All-Purpose
ELECTRIC ARC WELDER
IN YOUR SHOP

TEN-DAY TRIAL
Guaranteed: 10 Months To Pay

Now, it is EASY for every inventor, laboratory, home workshop owner, garage, repair shop, and factory to afford a complete welding service for manufacturing, maintenance, experimental, or repair work. Full size, heavy-duty Aladdin Electric Arc Welder—yours for only 15c a day! Highly efficient. Welds all weldable metals and alloys. Handles everything from fenders and light sheet metal to motor blocks and heavy castings. Also fine for soldering and brazing.
WORKS ON 110 OR 220-VOLT A. C. Simply plug into 110 or 220-volt, 60-cycle A. C. electric outlet. Costs only few pennies an hour to operate. Anyone can use easily. Comes complete with helmet, electrode holder, welding rods, full instructions, etc. Nothing else to buy. Fully guaranteed.
WRITE FOR 15c A DAY PLAN. Stop throwing away profits! Do your own welding. Get sensational facts. Write today!

COMMONWEALTH MFG. CORP.

Dept. Y-51

4208 Davis Lane,

Cincinnati, O.



Easy
 YOU'LL advance faster with an easy playing Conn. Choice of world's greatest artists. Many exclusive features yet they cost no more. Home trial. Easy payments. See your dealer or write for free book. Mention instrument.
 C. G. CONN, Ltd. 631 Conn Bldg. ELKHART, IND.



DIESEL Maximum training minimum time; practical and theoretical. Modern equipment, experienced teachers. Personal instruction. 40th year. Catalog free. Residence course in three months.
FINLAY ENGINEERING COLLEGE, 10th & Indiana, Kansas City, Mo.

BOOKS— FOR TODAY'S BIG OPPORTUNITIES
List Sent Free Upon Request
POPULAR MECHANICS PRESS-200 E. ONTARIO ST. CHICAGO

In answering advertisements always write name and full address clearly.

PAY POSTMAN These famous Pay-Raising, Extra-Money Books have helped thousands of others. Let them help you too. Check this list and mail with your name and address. Pay postman on delivery, price plus small C.O.D. fee. Or remit with order and books will be sent postpaid anywhere in the world.



EXTRA MONEY BOOKS

Select FROM THIS LIST

- AIR CONDITIONING**
Furnaces, Unit Heaters... \$3.00
- AUTO RACING**
Build Midget and Other Racers... \$1.00
- AUTO REFINISHING**
Duco With Spray Gun... \$1.50
- AUTO SERVICE SHOP**
Management, Money-making Ideas... \$1.50
- BLUEPRINT READING**
For Machine Trades... \$1.50
- BRICKLAYING**
Plain and Fancy... \$1.50
- BUSINESS COLLEGE**
Self Taught, 15 Courses Cover all Essential Subjects. 1000 Pages... \$2.39
- CARBURETORS (All Makes)**
New, Revised Edition... \$3.00
- CHEVROLET SIX**
Car, Truck, Operation Repair... \$2.50
- COLONIAL FURNITURE**
Making, 95 Pieces... \$3.50
- DANCE**
Learn at Home Without Music or a Partner... \$2.00

- FOUNDRY WORK**
Molding, Casting, etc... \$2.00
- HIGH SCHOOL**
Self Taught, 24 Subjects. 1000 pages... \$2.39
- HOME GROUNDS**
Furnishing... \$0.80
- LEATHER MAKING**
and Tanning... \$1.00
- METAL SPINNING**
Practical New Book... \$1.00
- METALLURGY**
New, Metals, Alloys In Use To-Day... \$1.50
- MONEY-MAKING FORMULAS**
10,000 Practical... \$4.00
- OIL HEATER HANDBOOK**
Manufacture, Distribution, Installation, etc... \$3.50
- PLASTICS**
148 Designs For Craftsmen... \$2.50
- RADIO PHYSICS COURSE**
New edition. Everything about Radio... \$4.00
- SHEET METAL**
Construction Work... \$2.50
- STEAM ENGINEER'S LICENSE**
How to Obtain... \$2.00
- WOOD TURNING**
Course In... \$1.50
- WROUGHT IRON WORK**
Practical... \$1.35

POPULAR MECHANICS PRESS
 Room 639E 200 East Ontario St., Chicago

FREE 68 Pages of Facts About PATENTS and SELLING INVENTIONS

Many pictures and examples from inventive history make these excellent guide books for inventors.

OTHER MEN HAVE READ AND PROFITED BY THESE FREE BOOKS

If you have an invention—or an idea for one—you should have these free books. They tell you real facts like these: How the patent laws protect you. Why you need the protection of a U. S. Patent. What a competent, registered patent attorney can do for you. They tell what kind of sketch or model is needed and how to make proper disclosure of your idea to help establish your claims. They tell how some successful inventors have secured financial assistance. They show 115 different mechanical principles.



HOW WE SERVE YOU

For more than a third of a century—we have represented thousands of inventors. We answer questions. We study each device to bring out its best patentable possibilities. Often, also, we advise inventors against going ahead with inventions which could not possibly be protected. By carefully developed methods, we try to keep expense at a minimum and we can arrange a deferred pay-

ment plan when needed. With the books, we will also send you a copy of our "Evidence of Invention" form on which you can sketch and describe your invention and establish a date of disclosure. Such a date of disclosure may later prove important to you. You can deal with us in strictest secrecy. Learn the facts. Simply sign and mail the coupon below. Take that first step today.

VICTOR J. EVANS & Co.

REGISTERED PATENT ATTORNEYS
MAIN OFFICE: 112-G, VICTOR BUILDING WASHINGTON, D. C.
Pittsburgh Office: 514-N, Empire Building
 Send me FREE copies of your books, "Patent Protection" and "When and How to Sell an Invention."
 Name.....
 Street and No.....
 City or Town..... State.....

When writing to advertisers please mention Popular Mechanics

PATENTS

Booklet Free Highest References
Promptness Assured Best Results

Send drawing or model.

ALL BUSINESS GIVEN PROMPT AND PROPER ATTENTION

Listed Patent Lawyer in the latest editions of the Rand-McNally Directory of Bankers and Bank-Recommended Attorneys, published by Rand-McNally & Co., Chicago, Ill.; The Baggott & Ryall Directory of Guaranteed Attorneys, published by Legal Directory Corporation, Boston, Mass.; American Lawyers Annual, Cleveland, Ohio; Bankers Service Legal Directory, published by Bankers Service Co., Boston, Mass.; Eyre's Law List, 9 Park Place, New York City; Snow-Church Directory Co. Lawyers List, published in New York City, and the Central Guarantee Co., Bankers and Lawyers Directories, 630 Fifth Avenue, New York City.

WATSON E. COLEMAN, Victor Building, 724 Ninth Street, N. W.
REGISTERED PATENT LAWYER WASHINGTON, D. C.

INVENTORS PATENT YOUR IDEAS SEND FOR FREE BOOK



HOW TO OBTAIN A PATENT

Written by a Former Member of the Examining Corps (1922-24) of the U.S. Patent Office. If you want to profit by your idea, you should take steps to apply for a U. S. Patent at once. Your first step is to get this Free Book. This interesting illustrated book contains valuable information you should have. It tells you fully how to obtain a patent on your idea in the quickest way. With this Free Book you will also receive a "Record of Invention" form on which you can easily record your idea. Personal and Confidential Service: Your case will be personally handled only by a Registered Patent Attorney who is also a Former Member of the Examining Corps of the U. S. Patent Office. All communications confidential.

MAIL COUPON TODAY for FREE PATENT BOOK and RECORD OF INVENTION Form.

CARL MILLER
REGISTERED PATENT ATTORNEY
FORMER MEMBER EXAMINING CORPS U. S. PATENT OFFICE

Wool worth Bldg., 35th Floor, Dept. 69A, New York City
MILLER BUILDING, Dept. 69A, Washington, D. C.

Please send me your Free Book, "How to Obtain a Patent," and your "Record of Invention" form.

NAME.....

ADDRESS.....

Inventors

FREE BOOKS

give you practical patent facts

If you are an inventor—if you have a new idea—send for our free booklets. They contain practical information based on 64 years' experience as patent attorneys. These books will explain the steps in patent procedure . . . tell how you can protect your ideas, and describe the various opportunities for capitalizing on your invention. All inquiries confidential. Mail post card for free books today. No obligation.



C. A. SNOW & CO.

Registered Patent Attorneys Since 1876

169 SNOW BUILDING

WASHINGTON, D. C.

PATENTS—TRADE MARKS

All cases submitted given personal attention
Form "Evidence of Conception" with instructions
for use and "Schedule of Government
and Attorneys' Fees"—FREE!

LANCASTER, ALLWINE & ROMMEL

Patent Law Offices

412 Bowen Bldg.

Washington, D. C.

Inventions Wanted Patented or Unpatented

We have been successfully selling inventions, patented and unpatented, since 1924. Write for proof, and tell us what you have for sale.

Chartered Institute of American Inventors
Dept. 4, Barrister Building, Washington, D. C.

INVENTORS who derive largest profits know and heed

facts before applying for patents. Our book, Patent-Sense, gives those facts; sent free. Trade Marks—Copyrights.

LACEY & LACEY, Est. 1869, 635 F St., N. W., Dept. 5, WASHINGTON, D. C.



BUCHSTEIN'S FIBRE LIMB

Correctly fitted. Strong, light, neat, cool, soothing. Braces for all deformities. On terms.

D. BUCHSTEIN CO.
610 3rd Ave. South, Minneapolis, Minn.

RUPTURED?

Get Up-To-Date Relief

Why try to worry along with old-fashioned trusses that gouge your flesh—press heavily on hips and spine—enlarge opening—fail to hold rupture? You need the Cluthe. No leg-straps or harness. Automatic adjustable pad seals opening—follows every body movement with instant increased support in case of strain. Cannot slip. Holds rupture whether at work or play, easy to wear. Waterproof. Can be worn in bath. Send for amazing FREE 100-page, cloth-bound book "Advice To Ruptured" and details of liberal truthful 60-day trial offer. Also names of grateful patrons in your neighborhood. Write today. Cluthe Sons, Dept. 31, Bloomfield, New Jersey.

In answering advertisements always write name and full address clearly.

To PROTECT YOUR INVENTION—Use this coupon, NOW

Delays are dangerous and may be very costly. My personal service assures prompt action, strict confidence, and a minimum of expense. I suggest that you send me a model or drawing, or sketch and description of your invention, and \$5.00. I will make a search and report

promptly as to its patentability and send you a copy of my 72-page booklet. Or, if you prefer to read my booklet first, mail the attached coupon at once. I will also send my "Record of Invention" form. (Over 38 years experience as a Registered Patent Attorney.)

L. F. Randolph, 302-D Victor Bldg., Washington, D.C.

Please send me at once, free of charge, your 72 page booklet and "Record of Invention" form.

Name.....

Address.....

A PERSONAL CONFIDENTIAL PATENT SERVICE

AGENTS UP TO \$32.50 IN A WEEK



Big cash profits for you; full or spare time. Over 250 household necessities—things people must buy. Proven fast sellers; steady repeaters. No experience needed. Earnings start very first day with Complete Display Outfit and my proven money-making Plan. *Ford Tudor Sedans given producers as bonus.* Big, reliable, old-established company. Full particulars mailed free. Just send postcard.

E. J. MILLS, 9557 Monmouth Ave., Cincinnati, Ohio

INVENTORS PROTECT & SELL

Your unpatented invention can be sold with positive safeguards under patent laws. New, low-cost procedure. Complete details, free. **AMERICAN PATENTS CORPORATION** Dept. 4-E Washington, D. C.

STUDY CHEMISTRY AT HOME EARN A DEGREE AT HOME

From A Chartered Institution Of Higher Learning Employers Demand Degree Men For Key Positions

88 Degree Courses in Electrical, Mechanical, Civil, Structural, Diesel, Architectural, Drafting, Automotive, Aeronautical, Radio, Refrigeration, Air Conditioning, Highway, Mining, Geology, Petroleum, Marine, Industrial, Chemical Engineering, Arts, Sciences, Philosophy, Psychology; Chemistry; Education; Business Training; Law; etc. McKinley-Roosevelt Graduate College, 4237-C Clarendon Ave., Chicago

AVIATION Practical Aviation Instruction for the layman, for the pilot, for the mechanic, and for the ground-school instructor. The transport license method of specialized aviation instruction, published since 1930. Write, enclosing stamp. **THOMPSON AVIATION PUBLISHERS** 8326 Woodward Detroit, Mich.



GROW PLANTS WITHOUT SOIL Startling New Development

Complete Directions for Small and Large Scale Growing

Get the new book "Soilless Growth of Plants" and learn this new

technique which everyone is talking about. Three methods described—Water Culture, Sand Culture, Sub-Irrigation. Explains all operations. Tells how to make containers and nutrient solutions from raw materials at small cost—how to grow flowers, vegetables and fruits without soil. A fine hobby and a money-saving investment for city dwellers. A source of new business for gardeners, nurserymen, etc. Only book of its kind. Order today "Soilless Growth of Plants." Sent postpaid for \$2.75. **POPULAR MECHANICS PRESS** Dept. 639B 200 E. Ontario St., Chicago

It's Lots of Fun to PLAY the DRUMS

...and EASY, too!



CHICK WEBB
King of the Drums

Step out in front! Be entertaining... popular... sought-after by friends. Start to play a **GRETSCH DRUM**. Begin a **BIG MONEY** career—be an ace drummer like Chick Webb; "The King of the Drums". Chick and thousands of others have won success on radio, stage and screen using **GRETSCH** equipment. **EASY TO PLAY**—no difficult lessons. Buy **GRETSCH DRUMS**, on **NEW EASY-PAYMENT** plan.

EASY TO PLAY
★
EASY TO PAY

Send penny postcard for **FREE DRUM** catalogue and full information about **EASY-PAYMENT** plan and **FREE TRIAL** through your **GRETSCH** dealer. Address Dept. PM 60

The FRED. GRETSCH MFG. CO.
Musical Instrument Makers Since 1883
60 BROADWAY, BROOKLYN, N. Y.

GRETSCH also offers **SUPER VALUES** in Guitars, Saxophones, Trumpets, Trombones, Accordions. Send for **FREE** catalogue. Mention instrument.

CARTOON YOUR WAY TO SUCCESS!



DON'T COPY - LEARN TO ORIGINATE!
RAYE BURNS will teach you **HOW TO CREATE ORIGINAL CARTOONS** at home that you can **SELL!** Course has 26 lessons and 600 illustrations. Send name and address for free details. Only... **\$2.85**
RAYE BURNS SCHOOL, Dept. M-1, Box 2194, CLEVELAND, OHIO

DIESEL

Get **BETTER** training. Realize Adcox advantages. Located in Pacific Northwest, a Diesel center. Established 28 years. Modern equipment, expert instructors. Close cooperation for **YOUR** success. Earn room and board while learning. Send for **FREE** big 40-page Diesel School Catalog No. 18. Home Study and Resident Courses.

L. L. ADCOX TRADE SCHOOL Portland Oregon

LEARN Short-Method Arithmetic

Simplified system used by "master minds" on stage, accountants, bankers, etc. Easy to learn. Add columns of figures short-cut method; multiply 4 figures by 4 figures without using old-fashioned multiplication; use sight method of proving addition, division, etc. Learn horsepower calculation, how to use slide rule, micrometer. Complete illustrated course only **\$1.00**, postpaid. Satisfaction or refund. Amaze your friends with your mental wizardry! Free details—mail coupon **TODAY**.



FREE
NELSON CO., F-300 Manhattan Bldg., Chicago, Ill. Send free details about "Short-Method Mental Arithmetic" without obligation on my part.

Name
Address
City State

BROOKLYN YMCA TRADE SCHOOL

AERONAUTICS OR DIESEL LEARN

1 and 2 year intensive courses meet technical needs. Engineering firms also need Salesmen and Executives with practical knowledge. Employment Service, Fire-proof Dormitory, Gym & Pool. Full shop equipment. Many other technical courses. Enter now. Send coupon or write for Booklet-P.M. in your field. **BROOKLYN YMCA TRADE SCHOOL** 1117 Bedford Ave., Brooklyn, New York City

- Diesel Engines
- Diesel Pre-Engineering
- Aviation Mechanic
- Aeronautical Pre-Engineering
- Auto Mechanic
- Mechanical Pre-Engineering
- Radio and Television Mechanic
- Air Conditioning
- Architectural—Mechanical Drafting
- Electrical Pre-Engineering
- Tool and Die Making
- Oil Burner
- Welding
- Machine Shop
- Talking Pictures
- Refrigeration

MAIL COUPON

1117 Bedford Ave., Dept. P.M.
Brooklyn, New York City, N. Y.

Name.....

Address.....

Be Somebody—



**Get more money; prestige; a better career
You can do it. Read this**

- "YOU KNOW, MARY, I DREAMED OF BETTER THINGS FOR US— BUT SOMEHOW I'VE FAILED TO GET WHAT WE HOPED FOR—"
- "I KNOW, JIM—WE'VE WORKED HARD, TOO. BUT YOU DO WORK ANYONE COULD DO. THERE MUST BE SOMETHING—"

AND there is something. Here it is: Become an Accountant; train at home in your spare time—with LaSalle! Fit yourself to get bigger pay in a modern respected profession. Prepare yourself to get what you want from life—a home, money for education, a car, luxury for your family—everything you've hoped for!

Accountancy through home study opens two fields for you. First, it can put you in line for higher bracket jobs in your present company. It can give you the drop on untrained men—can lift you out of their class. Your increased value will quickly be apparent in your work and noticed by your superiors. Accountancy training can give you ability and experience for which business is looking—for which it is glad to pay.

The second opportunity LaSalle Home Study Accountancy offers is a profitable profession of your own! Right now the professional accountant faces a greater demand than ever before. It is not uncommon for trained accountants to earn \$3,000, \$5,000 and more.

Three Men Who Proved It Can Be Done

Read the actual experience of three men who started accountancy training with us several years ago:

After a short period of intensive study, the first man started bookkeeping jobs on the side. Soon he got

enough of them so he opened his own business. Today he is his own boss, a successful business man with a splendid income. All in one year!

Another member—five months after starting his study—was called into the office and given a more responsible position paying \$40 a month more. His employer told him anyone studying a LaSalle home-study course was obviously more alert than most men and therefore capable of a bigger job.

To the employer of the third member we sent information about the member's study. The letter resulted in his being chosen—above five other candidates—for a better position with shorter hours and more pay.

Just three of thousands who tell us that LaSalle home study was the turning point in their lives. Their cases, which may seem extraordinary to you, are not uncommon to us. Many others have done as well. Perhaps you can, too. At least, it's worth investigating.

Send for This Free Book

The facts about LaSalle training in Accountancy and the opportunities in this growing field are clearly outlined in a 48-page book which LaSalle will send you free. If you have the urge and the will to increase your income, clip and mail the coupon for it—NOW.

LASALLE EXTENSION UNIVERSITY, A Correspondence Institution Dept. 664-HR, Chicago, Ill.

I'd like to see whether I should take up Accountancy. Send me—without obligation or cost to me—your booklet *Accountancy, the Profession That Pays*, and full information about your Accountancy training program.

Other LaSalle Opportunities:

Higher Accountancy

If more interested in one of the fields indicated below, check and mail now.

- Business Management
- Modern Salesmanship
- Law—Degree of LL.B.
- Commercial Law

- Railway Accounting
- Practical Accounting and Office Management
- Expert Bookkeeping

- C. P. A. Coaching
- Business Correspondence
- Business English
- Stenotypy

Name..... Age.....

Present Position.....

Address.....



When writing to advertisers please mention Popular Mechanics



CLASSIFIED

Advertisements



Advertisements in this section, 35 cents per word, each insertion, minimum 10 words, payable in advance

To be inserted under proper classification in July issue, copy should be in our office May 8th

July issue on sale June 1st

Popular Mechanics Magazine, 200 East Ontario Street, Chicago, Illinois

YOU'LL PROFIT

By reading and answering the classified ads in this section. Hundreds of opportunities to make and save money.

Mr. F. W. Johnson, Classified Adv. Mgr.,
Popular Mechanics Magazine,
200 E. Ontario St., Chicago, Ill.

Dear Mr. Johnson: On renewing our ad as follows for May issue, please be advised we have received replies from England, France, Russia, Italy, Canada, Japan, South America, Australia, India, Copenhagen, Denmark, and Switzerland and Ireland. This is certainly remarkable and surprising. But the biggest item of all this is that this ad of ours has brought us 52 replies in a single day. We are proud to mention this fact to you and others, so Popular Mechanics Magazine will continue to travel the world over for us, and others.

Yours truly,

BOHN COMPANY.

(Original letter on file in our office)

AUTOMOBILES—MIDGET CARS

BRAND New fifth edition Automobile Racing Book. Tells how build dirt track bodies, frames, engines. Records, superchargers, rules, formula, plans, stock, conversions, roadster racing, fast Fords. \$1.00 postpaid; \$1.15 C.O.D. Ray Kuns, Department 6, Madisonville, Cincinnati, Ohio.

MIDGET Cars, parts, kits. Priced right. Plans 50c. Catalog 20c. Derby Midgets, Woodstock, Illinois.

AUTOMOBILE Mechanics who want business or earn extra money write for samples and details of nationally distributed Self-Locking Triple-X Piston Rings. Eliminate re-boring. Guaranteed life of car. Franchises valuable. Some territories open. Triple-X Co., 2261 South Union, Dept. O, Chicago.

1939 IGNITION Supercharger. Quick starting, mileage, pep, less carbon. \$1.25. E G Sales Co., New York.

PLANS, Parts, midget cars, light planes. Circulars 10c. Storms, 199 Broadway, Asheville, N. C.

STEAM Fans, experimental work, new cars conversion units described in growing illustrated magazine. "Steam Car Developments," \$2.25 year, Little Falls, N. Y.

MIDGET Racers, two-passenger autos, Midget motorcycles, Motorscooters. Motors, wheels, parts, plans. Handbook catalog, 58 illustrations, 20c coin. Midwest, Box 1959, Chicago.

R & R Mfg. Co., Anderson, Indiana. D. O. racing motors, racing cars, midgets and parts. Speed equipment for Model A, V-8 Fords, Willys, Chevrolets. Catalog 25c.

BUILD This powerful inexpensive supercharger for any automobile. Adds up to 8 horsepower. Complete plans, 30c coin. Box 107, East San Diego, Calif.

GAS Saver—Wiper hose installation. Postpaid dime. Motor Specialties, Box 5849, Wilkinsburg, Penna.

MIDGET Parts, kits, plans. Circulars free; catalog, 10c. Shipp's Midgets, Box 543-H, Zanesville, Ohio.

MIDGET Racecars, sportcars, motorscooters. Bargain lists—130 used motors, midgets, parts—20c. Illustrated literature. Midgets, Box 543-H, Zanesville, Ohio.

ALUMINUM Alloy pistons, automotive, aviation. Diesel, industrial, marine, midget, model, motorcycle, outboard. Finished or semi. Judson Mfg. Co., Hedge and Gillingham, Philadelphia, Penna.

FORD V-8's, 1934-1939; gasoline saving device. \$1. Walert Co., 3429 No. 10th St., Milwaukee, Wisconsin.

AUTO TRAILERS

AIRPLANE Wheels, 30x5, \$1.00. Temperatures gauges, 12" new, navy stock \$1.50. Air Transport, Garden City, N. Y.

BUILD The famous, low-cost Jim Dandy Cabin Trailer. Complete plans and instructions 50c. Plans to build the beautiful, streamlined Jim Dandy Cabin Cruiser, \$1.00. Trailer Builders Manual and catalog of trailer parts, supplies and equipment—over 100 interesting, illustrated pages, 25c. Order today. Satisfaction guaranteed. Trailer Supply Co., 411-A Jackson St., Wausau, Wisconsin.

TOURISTS' Cabins, attractive 10x12 ft., how to build and 359 other practical articles in Shop Notes, Vol. 32, only 50 cents postpaid. Popular Mechanics Press, Room (C39), 200 E. Ontario St., Chicago.

AUTO SUPPLIES AND EQUIPMENT

CHEVROLET Body door posts, 1928-29-30 models. Send for prices. Fransen Equipment Co., 2209 N. W. Thurman, Portland, Ore.

BELL For auto, double chime, foot operated, three sizes \$3.50, \$5.50, \$7.50. Other interesting accessories. Write Jerrold, Box 10, Tremont Station, Bronx, New York.

BARGAINS—Compressors, welders, battery chargers, car washers, attractively priced. Terms, trial. Write for bargain list. Hobart Automotive Supply, Box M-695, Troy, Ohio.

AUTO Painting. Learn the short cuts and secrets of the paint shop. Complete information \$1.00. Melco Co., Box 227, Woodstock, Illinois.

AVOID Rundown batteries. Redlite warns if any switch has been left "on" after motor is stopped. Fully automatic. Fits all cars. Redlite, Plain, Wis.

AUTOMATIC Gas saver for all cars. Save to 25% gasoline. More power and speed. H. K. Co., 1971 E. 55th St., Cleveland, Ohio.

GASMASK, Fumes, painting, \$1.95 dumprake, attachment 30c. Paint striper \$2.00. Scoles, 6701 Prospect, Kansas City, Mo.

TURN Scrap into money. Convert old auto generators into A.C. generators for auto radio, camp and home lighting, power and other uses. Complete book \$1 postpaid. Popular Mechanics Press, Room (C39), 200 E. Ontario St., Chicago.

USED Auto parts, half price, all cars. Century Parts Company, 1712 LaFayette, St. Louis, Missouri.

RE-REFINE Crankcase drainings, request information. Zelball, Mount Holly, N. J.

PLATING Outfits for auto parts. Connect to a battery. No tanks used. Free particulars and proofs. Gunmetal Co., Ave. J. Decatur, Ill.

ACETYLENE Welding outfits, \$32.95; electric welders, \$74.95. Easy-payment plan. Box 331, Hamilton, Ohio.

MOTORCYCLES, BICYCLES, MOTOR SCOOTERS AND SUPPLIES

POWERFUL Beacon bicycle generator with large head lamp. Complete \$3.75. Generator alone \$2.95. Postpaid. Address Electrical Products Co., Kendallville, Ind.

MOTOR Marvel ready! Mead's sensational new Ranger Scooter goes 120 miles per gallon, 35 m.p.h., ride, rent or sell for profit, pleasure. Dealers, agents write for special introductory offer, easy terms, free circular. Hurry! Mead Cycle Company, Dept. S-1, Chicago.

MOTORCYCLE Generator armatures rewound \$3.25, returned postpaid. Packard, 3817 Third St., Des Moines, Iowa.

SCOOTERS, Midgets, etc.! Build yours. Wheels, tires, motors. Low prices. Literature, power scooter plans 10c. Honsakers, Masontown, Penna.

MOTO Scoot and Moto Car. Factory test models and demonstrators. Write for prices. Moto Scoot, 8440 South Chicago Ave., Chicago, Ill.

MOTORSCOOTERS! Save \$30-\$60 building latest, easiest built scoot. Steel kit, \$3.95, plans free. Complete illustrated catalog 20c coin. Midwest Motors, Box 1959, Chicago.

BUILD Scooter bike from scrap parts. Plans 15c. Readers Service, 800-74 North Clark, Chicago.

MOTORCYCLE Cylinder boring \$2.00. Aluminum pistons, stock or racing, all models, (dealers supplied). New and used Indian parts. Used motorcycles. Stamp brings list. Phila. Indian, 1635 Hunting Park, Philadelphia, Penna.

ALLOY Pistons \$3.00—Harley, Indian, Henderson, Excelsior, Cleveland. Cylinder grinding, motor rebuilding. New and used parts for less. Catalogue and wings pin 10c. Ballak, 1115 Chestnut, St. Louis, Mo.

SEND 10c For 1939 Handbook of Information just printed. New and used parts, accessories for Indian, Harley, Henderson, Excelsior. Valuable information on motorcycle rebuilding. Bootz, 622 East Grand, Des Moines, Iowa.

MOTORCYCLES, Reconditioned. New, used, parts and accessories. All makes. Large stock. Bargains. Illustrated catalog, 15c. Indian Motorcycle Sales Co., Kansas City, Mo.

NEW Push-A-Bike outboard motor for your bicycle. Complete with pneumatic tire. Ready to attach. Richburn Company, Aurora, Missouri.

BUILD Power scooters, midget cars. We supply tires, wheels, motors. Lowest prices. Send 10c for plans, etc. Build-Your-Own Devices, 5238 Lake, Chicago.

REBUILT Motor cycles, all makes, new and used Harley-Davidson parts. Send 10c for bulletin. Western Harley-Davidson Distributors, 914 E. 15, Kansas City, Mo.

MOTORCYCLE Bargains, lowest prices, bargain sheets for stamp. Motorcycle accessories, Rochester Harley Davidson Corp., 129 W. Main St., Rochester, N. Y.

HI-LIFE Bicycle generators operate lights direct or charge miniature Kic-O storage battery. Write Kimley, 1271 E. Ferry, Buffalo, N. Y.

INSIDE Dealer prices. Overstocked, all models. Indians and Harleys. Rebuilt, guaranteed. Dime brings latest list. Crandall-Hicks, Boston, Mass.

RECONDITIONED Motorcycles. New-used parts for all makes. Authorized Harley-Davidson dealer. Whitman Motorcycle & Supply Co., 405-9 Southwest Blvd., Kansas City, Mo.

AVIATION

LEARN Aviation. Command high wages. Write for free booklet No. 18. School of Aeronautics, Nauvoo, Illinois.

PROPELLERS For airplanes, sleds, illustrated catalog, 10c. Banks Propellers, Love Field, Dallas, Texas.

AVIATION For the beginner. Theory to actual flight. One complete, illustrated volume. Now 50c postpaid. Herbert Publishing Company, 3355 N. Olcott Avenue, Chicago, Illinois.

GRADUATE Airplane mechanic. Ten weeks. \$1.00 week. Graduates with leading concerns. Free catalog. United Air School, Elgin, Ill.

AVIATION Apprentices — Air-minded young men interested in training for entering aviation as apprentices see ad on page 22A.

HOW To learn flying without money. Folder, dime. Ohmeyer, Box 391, Hempstead, N. Y.

150 AIRPLANES \$45 Up. Terms, trades. Complete directory 25c. Used Aircraft Directory, Athens, Ohio.

AIRPLANE Mechanic's home-study course \$1.25. Engine mechanic's \$1.25. Both courses \$2.00. Prepares for license. Helps pilots immensely. Meyer Engineering, Hempstead, N. Y.

GET Into aviation. Pilots earn up to \$6000 a year! Airplane mechanics and aeronautical engineers also get big pay! Prepare at this Lincoln government approved school. Write for complete information. Lincoln Airplane & Flying School, 2004 Aircraft Bldg., Lincoln, Nebraska.

JUST Out. Practical course in flying. 29 chapters, illustrated, complete. Only \$1.00. Aircraft Directory, Athens, Ohio.

PROPELLERS For sleds, aircraft. Catalog 10c. Banks Propellers, Love Field, Dallas, Texas.

PROPELLERS For airplanes, sleds. Iced-sled blueprints, supplies. Catalog dime. Lorenzen Propellers, Niles, Michigan.

BATTERIES, GENERATORS, ETC.

ELECTROPLATING—Motor generators or belt drive, attractively priced. Easy terms, trial. Hobart Platers, Box M-692, Troy, Ohio.

12 VOLT Heavy duty generators \$8.50. Save money on new, used automotive electrical parts; free catalog. State Ignition, 52 Cullerton, Chicago.

FARMLITE Batteries—40% discount. Buy direct. 32 and 110 volt light plants. York Battery Co., York, Penna.

50—1/2 HORSE. Repulsion induction, 110-220 volt, heavy duty motors. 3400 speed, \$9.75. Also generator bargains. Electrical Surplus Company, 1885 Milwaukee, Chicago.

EDISON Storage batteries for light-power systems. Non-acid. Odorless, fifteen year life. Five year unconditional guarantee. Bargains in complete lighting systems. Low prices. Free illustrated literature. "See-Jay" Battery Co., 82 Sterling Ave., Yonkers, N. Y.

EDISON Lifetime storage batteries for light and power. Eliminates acid battery diseases. Long guarantee. All kinds rebuilt generating plants, motors, and miscellaneous articles at bargain prices. Free interesting literature. T. Hawley Smith Co., Croton Falls, N. Y.

WIND ELECTRIC PLANTS

BUILD Wind light plant. Complete plans and valuable catalog 10c. Welders, electric fencers. LeJay Manufacturing, 447 LeJay Building, Minneapolis, Minn.

ELECTRICAL SUPPLIES—EQUIPMENT

ELECTRIC Shavers, year guarantee, 110 a.c., d.c. \$3.50. Hamilton Sales, 7 Boyd Ave., Takoma Park, Maryland.

STANDARD Electric lamp insect killer, \$2.00 up. Literature free. Sauer Bros., San Leandro, Calif.

BARGAINS—Arc welders, also motor generator. Write for new bargain list telling needs. Hobart Bros., Box M-697, Troy, Ohio.

ELECTRO-SCRIBE: Electric pencil writes—engraves all metals \$1.00. Ultra violet-infra red. Dual ray health lamp. Two units in one. Promotes sun-tan—vitamin "D." Automatic a.c.-d.c. current, \$3.90. Details, Beyer Mfg. Co., 4515-H Cottage Grove, Chicago.

ELGIN Electric shaver, alternating current. Guaranteed \$1.50. Henkin 1397 East Second Street, Brooklyn, New York.

HEARING Aids, rechargeable batteries. Complete line, bargains. On approval. Dynamic Ear, 701 Ridge Ave., Pittsburgh.

PENLITES 15c. Key sockets 7 1/2c, pull 9 1/2c, cleat 4 1/2c. Farris, West Des Moines, Iowa.

MAGNET, Alnico, new wonder alloy lifts 50 times own weight. 60c; large \$1.00. Advance, 861-P7, Minneapolis, Minn.

ELECTRIC Engraver, engraves all metals deeply, dollar. Hudson Bros., East Syracuse, N. Y.

REPAIRING Electrical appliances and 330 other money making shop kinks in Vol. 31, Shop Notes, only 50c postpaid. Popular Mechanics Press, 200 E. Ontario St., Chicago.

ELECTRIC FENCING

ELECTRIC Fencer \$1.65. Build it yourself, safe and simple six volt plans 20c. H. C. Rose, Franklin, Nebraska.

MAKE Electric fencer from old automobile coil. Complete plans 10c. No extras to buy. LeJay Manufacturing, 947 LeJay Building, Minneapolis, Minn.

FARM Electric fence controller \$7.95. Uses battery or 110. Bond, 13139 Hamilton, Detroit, Michigan.

WELDING AND SOLDERING

POWERFUL 110-220 Volt a.c. welder from starter coils and \$5.00. (No winding.) Pole transformer makes 200A welder. Plans \$1.00. Information dime. Welders Supply Company, Box 132P, Bellefontaine, Ohio.

DODGE Arc-welder, 25-125 amperes, 0-40 volts d.c. (Two Dodges 25-200) built from North-East 12 volt automobile generators without rewinding armature. Plans \$1.00. Welders Club, AB-3432 M-Mart, Chicago. Special: "44 Lessons in Arc-welding" 50c (foreign 75c).

75-200 AMPERE Arc welders from Dodge generators. Complete plans 35c. 100 other generator changes. LeJay Manufacturing, 347 LeJay Building, Minneapolis, Minn.

ARC-WELDER 25-600 Amperes d.c., 0-75 volts, built from d.c. vehicle motors. (No rewinding.) Plans \$1.00. Welders Club, AB-3432 M-Mart, Chicago. For sale: New and used d.c. vehicle motors.

DEMONSTRATORS, Electric arc welders. Money-saving prices. Used by the government. Trial and terms guaranteed. Hobart Welders, M-693, Troy, Ohio.

ELECTRIC Brazing, soldering torch \$6.95. Apollo, 634 Union, Memphis, Tenn.

DELCO Arc-welder, 25-200 amperes d.c., 0-75 volts, built from 32 volt light plant. (No rewinding.) Plans \$1.00. Welders Club, AB-3432 M-Mart, Chicago.

PLANS For 110v arc welder. 50c. Marvelweld, Box 1156, San Francisco.

REBUILT a.c. d.c. Arc welders, all sizes; engine governors, idlers. Terms. Low prices. Guaranteed. Service Co., 3732 Cedar Ave., Cleveland, Ohio.

OXYACETYLENE Welding and cutting and 359 other informative articles in Shop Notes, Vol. 32, only 50c postpaid. Popular Mechanics Press, Room (C39), 200 E. Ontario St., Chicago.

ARC-WELDING Outfit \$1.25. Weld fenders, braze, solder. Arrowtrading, 5014 Tillman, Detroit.

BUILD 6 Volt arc welder. Plans 20c. Dicksons, Beaconsfield, Iowa.

ARC Welding, procedure handbook of design and practice. Latest world standard authority. 819 pages, illus., only \$1.50 postpaid. Popular Mechanics Press, Dept. (C39), 200 E. Ontario St., Chicago.

ENGINES, MOTORS, DYNAMOS

AIR Compressors, new, 1 3/4 x 1 3/4, \$6.00; 2x2, \$7.00; 2 1/2 x 2, \$8.00. Guaranteed. Send check or money order. Free catalog. National, 1915 South State, Chicago, Ill.

REFINE Used oil without cost. Particulars. F. Gerwin, Fairview, Oklahoma.

ALTERNATING, 1/2 Horse, 110 volt, induction motors. Rebuilt, guaranteed, \$7.25. Wilmot Auto Supply, 2247 St. Paul Ave., Chicago.

BARGAINS—Plating generators, motor generator sets, also arc welders. New low prices for large and small shops. Trial—easy terms if desired. Hobart Bros., Box M-696, Troy, Ohio.

300 MOTOR Diagrams and tables covering three phase; Star, Delta, nine lead, two and four speed; two phase; single phase; split phase, capacitor, repulsion induction, fan, armature windings, etc. Satisfaction guaranteed or money refunded. \$1.50 prepaid. Educational Advancement Company, Lakewood, New York.

ALTERNATING Current motors, grinders, drills, exhaust fans, radios, clocks, shavers, appliances. Home workshop tools. Bargain pricelist free. Mailorder Electric, 713 South Dearborn, Chicago.

FOR Sale. Small elect. motors with flexible shafts, rebuilt \$3.25 postpaid. McConnell, 1619 Edgewood Ave., Racine, Wis.

5 KVA Alternators \$125.00; also larger sizes. Motors, generators. Queen City Electric, 519 South California, Chicago.

BARGAIN—1/2 Hp. motors, 60 cycle, 1 phase, 110 volt, like new, guaranteed, \$7.40. Send check to Erie Electric Motor Co., 120 Church, Buffalo, N. Y.

MOTOR Winding lessons, illustrated. Send stamp for particulars. Also motor data for experienced winders, introductory selection \$1.00. Motor Data Company, Box 7631, Kansas City, Mo.

REWINDING Motors and 330 other valuable articles in Shop Notes, Vol. 31—50 cents postpaid. Popular Mechanics Press, Room (C39), 200 E. Ontario St., Chicago.

MACHINERY, TOOLS AND SUPPLIES

FOR 9" South-Bend lathes. Milling attachments, universal movement \$9; threading dial indicators \$3; 6" four jaw chucks \$9.50. Unique Manufacturing Co., 4807 North 31 Ave., Omaha, Nebr.

360° INDEXING Attachment for South Bend workshop lathes postpaid \$4.95. Circular free. Elmer Amidon, No. Girard, Penna.

KELLOGG Air compressors, \$6.00. Electric refrigerators, \$25.00. Vacuum pumps. Taylor, 105 East 102nd Street, New York.

DRILL Grinding attachment fits bench grinder, hand or power turned. Handles sizes 3/16 to 1 1/4". Price \$7.85. Descriptive literature on request. Tractor-Lite Co., Sidney, Iowa.

BARGAINS, Demonstrators, electric arc welders, guaranteed, 30 days trial and terms. Write Hobart Welder Exchange, Box M-694, Troy, Ohio.

FLEXIBLE Shafts and repairs. Circular 88. Love, 607 W. Scott St., Chicago, Ill.

MILLING Attachment for South Bend workshop lathe, \$9.00. Guaranteed. Literature. Alexander Machinery, 1516 Webster, Omaha, Nebr.

CONCRETE Building block machines and molds. Easy payments. Catalog free. Concrete Machine Co., 5129 South Compton Ave., St. Louis, Mo.

TREMENDOUS Surplus of factory tools selling out. Drills, taps, files, hacksaws, etc. Send for free lists, include six cents postage. Travers Tool Co., 264 Jackson Ave., Long Island City, N. Y.

HOMEMADE Drill press, belt sander, forge and 328 other practical shop articles in Shop Notes, Vol. 31, only 50c postpaid. Popular Mechanics Press, Room (C39), 200 E. Ontario St., Chicago.

14" x 6' GREAVES Klusman cone head engine lathe, quick change. No. 0 Cincinnati miller, cheap. Write for particulars. Cincinnati Machinery & Supply Co., 221 E. Second St., Cincinnati, Ohio.

BOATS, OUTBOARD MOTORS, ETC.

GENUINE New Evinrude and Elto outboard motors now as low as \$29.50 (plus small transportation charge.) Down payment as low as \$6.00. Fourteen advanced 1939 models to choose from. Write for catalogs, boat directory and handy Boat-&Motor Selector—all free! Address: Evinrude Motors, 4187 N. 27th St., Milwaukee, Wis.

MARINE Power—Easily convert any Ford motor (domestic and foreign) with Osco parts and kits. Complete catalogue 25c (coin). Osmithson, 3644 Lawrence St., Philadelphia, Penna.

BIG Kayak values. 12' kit \$10.00. Others. Request literature. Playaks, Dedham, Mass.

COMPLETE Building plans 8 foot Weldwood pram April Rudder 35c. Boat building catalog free. Rudder, 15 Murray St., New York.

ANCHOR Rope reels for all small boats. Seiden Pneumatic, Jackson, Michigan.

AERODRIVE Shallow draft boat. Motor costs \$75. Nine cylinder, aircooled, 80 horsepower. Blueprints and instructions, \$2.50. Circular 10c. Allison Aircraft, Lawrence, Kansas.

SAILS For canoes, dinghies. \$5 up. Trysail, Patterson, New York.

LOOK! Make electric outboards. Sell at profit. Kit of complete finished parts \$12. Wholesale catalog 10c. Kubat Mfg., St. Paul, Minnesota.

SEE Our boat ad. page 153A. Cleveland Boat Blueprint Co.

ESKIMO Boats for paddle, sail, outboards. Complete or assembly kits. New, different. Plans 50c. Marko Boats, Atlanta, N. Y.

KAYAK Construction kits. New designs in lightweight canvas kayaks and canoes. Nine to fifteen feet from \$9.95 to \$39.50. Also sold assembled. Mail dime for literature. Jamestown Specialty Co., Dept. P639, Titusville, Penna.

BUILD 12 Foot boat—row, sail, outboard. Plans, 15c. Readers Service, 800-81 North Clark, Chicago.

BUILD A boat by the Welch System. Its inexpensive; interesting and profitable. Everything for building, equipping or repairing boats. Use Welch Ready Cut Parts. Send 10c for catalog showing boats of many types: boat hardware; propellers; marine paints; sails; boat finishing materials and Welch White Cap marine motors. Welch Boat Company, Station K-1, Milwaukee, Wisconsin.

BUILD Your own boat with Bay City Prefabricated frames and materials. Save up to 2/3s. Lumber, fittings, engines and equipment. Send requirements for quotation. Illustrated catalog 100 boats 9 to 65 feet 10c. Bay City Boats, Inc., 1552 Adams St., Bay City, Mich.

PROPELLERS. Gear pumps, stuffing boxes, bearings, etc. Wm. Baker, Pond St., Quincy, Mass.

ASSEMBLE Your own boat. Our finished knock-down frames and materials save you 2/3 builder's cost. All types and sizes. Send 25c for big catalog. Brooks Boat Co., Inc., D4, Saginaw, Mich.

OUTBOARDS—Save 1/2. Good used parts, all makes and models. Bargains rebuilt motors. Crandall Hicks Co., 959 Commonwealth, Boston, Mass.

BOAT Designers are highly paid professionals. Complete course by mail. Catalog. Westlawn, Montville, N. J.

BUILD Your own boat—New book gives plans, methods, etc. 312 pages \$3. Popular Mechanics Press, Room (C39), 200 E. Ontario St., Chicago.

SPORTING GOODS, GUNS, FISHING TACKLE, ARCHERY

FISHERMEN—Get a genuine Richardson rod—the best you can buy! There's a Richardson priced and designed to fit your exact requirements. One piece solids, seamless tubulars with offset handles, jointed tubulars, telescopes and the completely new hexagonal seamless tubular rod. Send for the colorful, new free catalog. Richardson Rod & Reel Co., 3178 North Sawyer Avenue, Chicago, Illinois.

AIR Pistols: Haenel 177 cal. Model 26—\$6.95; model 28—177 and 22 cal.—\$9.95; Benjamin—\$6.95. Rifles: Crosman 22 cal. single—\$8.95; repeater—\$10.95. Send stamp for sporting goods, bargain catalog. Lee Sales, Dept. W, 35 West 32nd, New York City.

FISHERMENS Secrets, Chinese, and others for catching fish in abundance. Formulas and instructions three dimes. Homer Renaud, 1149 Pleasant St., Fall River, Mass.

TENTS. Factory to you. Catalog dime. Refunded first order. Willis Co., Everett, Mass.

FREE—Sporting goods catalog. Complete sports equipment and clothing. Bargain prices. Faber, 3301 Lawrence, Chicago.

FISH Bag holder, with bag. Clamps on boat. \$1.15 postpaid. McConnell, 1619 Edgewood, Racine, Wis.

GUNSMITHING Readily learned at home. Earn extra money by repairing neighborhood's firearms. Free catalog 20 firearm and gunsmithing textbooks. Samworth, Marines, North Carolina.

FISHERMEN! The Old Fishing Guide Book is full of information and suggestions. Over 75 baits and bait receipts best ever discovered. Easily prepared. Over 500 other old fisherman's lures, hints, tips, receipts and secrets, how to attract and catch fish. Book 75c, two for \$1.00. Postpaid. Linders Store, Dept. P, Delphos, Ohio.

MEN! Hand-made wristwatch straps, guaranteed sweatproof, finest genuine calf leather, outlasts others 4 to 1. Regular \$2.00 value. Special introductory "Maker-to-You" Offer only \$1.00. Western Leathercrafters, Box 3493, Portland, Ore.

NATIONALLY Known fishing tackle delivered at big discount. Catalogue free. Tackle Store, Sac City, Iowa.

TENNIS Strings, gut and synthetic at tremendous discounts. Samples free. Crescent, 2535 Patricia, Los Angeles.

BARGAINS! Gun catalog 5c. Fishing catalog 5c. Ski catalog 5c. J. Warshal & Sons, First and Madison-PM, Seattle, Wash.

BOWS, Arrows, raw materials. Beautiful catalog (over 125 pictures) and "Essentials of Archery" a handbook on making bows and arrows 35c. Everyone intending to make their own should have this manual. Instruction folder and catalog 10c. L. E. Stemmler, Queens Village, N. Y.

SINKER Molds for making your own sinkers. Free illustrated folder. Reading Instrument Co., Box 78, Reading, Penna.

ARCHERY Headquarters—617 South State, Chicago. Catalogue free. Complete instruction book 50c.

OUTDOOR Sports for everyone—Enjoy them all your round with aid of book published by Popular Mechanics. Hundreds of ideas for new and popular sports for every season; complete instructions for making necessary equipment at small cost. 350 pages and 650 illustrations. \$2 postpaid. Popular Mechanics Press, Room (C39), 200 E. Ontario St., Chicago.

FIELD GLASSES, TELESCOPES AND MICROSCOPES

BARGAINS. Telescopes, binoculars, microscopes, new, used; everything for amateur astronomy; catalog 10c. American Telescope Laboratories, Dept. 21, Hollywood, California.

BINOCULARS. Telescopes cleaned, repaired. Send glasses for estimate. W. J. Belz, Opticians, 2 E. 44 St., New York City.

TELESCOPES, Microscopes, binoculars; 1939 bargain catalog free. Brownscope Co., 5 West 27th Street, New York.

REFLECTING Telescopes—build your own. 6" kit \$3.50; all abrasives, mirrors, eyepieces, diagonal prisms. Illustrated instructions 10c. Catalog free. Optical Development Corp., Dept. G, 1560 Broadway, New York.

ANTIQUES, RELICS, INDIAN GOODS

PETRIFIED Wood, genuine specimen. Dime. Luebbers, 148 North Mayfield, Chicago.

ARROWHEADS. 100 Good or 60 fine \$3.00. Catalog. George Holder, Glenwood, Ark.

SWORDS, Rapiers, pistols, daggers, armor catalog 6c. Robert Abels, 860A Lexington Ave., New York.

100 GOOD Arrowheads \$3. Catalog. 5c. H. Daniel, Hot Springs, Ark.

INDIAN Relics, beadwork, coins, curios, minerals, old glass. Catalog 6c. Indian Museum, Northbranch, Kansas.

TAXIDERMISTRY

MODERN Taxidermist Magazine, Greenfield Center, N. Y. Crammed full with valuable taxidermy information. Three sample copies 25c.

TAXIDERMISTRY Supplies—Quality artificial eyes, teeth, genuine Jonas head forms. Tools, materials, etc. Everything for the progressive taxidermist. Send 10c for big illustrated catalogue. Jonas Bros., 1049 Broadway, Denver, Colo.

DOGS, PETS, BIRDS

CHUBBY Saint Bernard puppies! Particulars free. Book 104 photographs all breeds described 25c. Royal Kennels, Chazy, N. Y.

MINKS, Squirrels, raccoons, foxes, ferrets, muskrats, skunks, wolf pups, Tippetman, Caledonia, Minn.

BEAUTIFUL Pure white police dogs. Ansonia Kennels, Mose, N. Dak.

GREATDANES, Dependable guards, companions. Pups \$25.00. Pictures free. Kalmar Danery, Stone-Mountain, Georgia.

POULTRY AND FARM SUPPLIES

SUMMER Prices on Davis chicks. Barred, Buff, White Rocks, Reds, Wyandottes, Orpingtons, English White, Brown, Buff Leghorns, Anconas \$6.50—100; 500—\$31.75. We pay postage, will ship COD. Davis Poultry Farm, Route 34, Ramsey, Indiana.

LOW Summer prices for Salem "Profit" AA grade chicks. Barred, White, Buff Rocks; Wyandottes; Reds; Orpingtons; White, Buff, Brown Leghorns; Anconas \$6.45—100. We pay postage, will ship COD. Salem Hatchery, Box 81, Salem, Indiana.

MAKE Money with poultry. Read America's leading poultry magazine for latest information. Three years \$1.00; nine months 25c. Poultry Tribune, Dept. E-93, Mount Morris, Ill.

CHICK Raisers make extra money selling our chicks to neighbors. Write Jackson County Hatchery, Box 19, Seymour, Ind.

TREES, SHRUBS, ROOTS, HERBS

JUST Out! World's greatest "Herbalist Almanac." Beautifully illustrated in natural colors. Contains over 200 old-fashioned herb medicine recipes for home use. 10c postpaid. Worth dollars! Botanicals, 145 W. 112th St., Chicago.

FARMS AND FARM LANDS

THE Great Northern Railway serves an agricultural empire where rents, prices and operating costs are low in Minnesota, North Dakota, Montana, Idaho, Washington and Oregon. Write for free book. E. C. Leedy, Dept. 657, St. Paul, Minnesota.

\$300 GETS 174 Acre farm, easy drive to city; 75 acres fields, creek, woodland, 7-room home, large barn, silo; only \$850, \$300 down; page 38 free catalog 16 states. Strout Realty, 255-P 4th Ave., New York City.

GOVERNMENT Lands ten cents acre up. Information all states twenty-five cents. National Tax Service, 600A Majestic Bldg., Detroit, Mich.

GOOD Farms available. Washington, Minnesota, Idaho, western Montana, Oregon. Dependable crops, favorable climate. Write for impartial advice, literature and list of typical bargains. Specify state. J. W. Haw, 119 Northern Pacific Ry., St. Paul, Minn.

40 ACRES, Near White River, unimproved; poultry land. \$175, \$5 down, \$5 monthly. Free list and literature. Hubbard, 216 Grossman Bldg., Kansas City, Kans.

FARM MACHINERY AND SUPPLIES

ALL Purpose tractors at factory price. Shaw 2 to 8 horsepower, riding or walking types. Does plowing, discing, harrowing, cultivating; mows lawns, cuts weeds, does hauling; runs belt machinery. Air or steel tires. Three speeds forward and reverse. Thousands in use. Write for free catalog and 10 day trial offer. Shaw Mfg. Co., Dept. PM-6, Galesburg, Kansas.

NEW And used tractor parts at tremendous savings. Write for free 1939 catalog. Central Tractor Wrecking, Co., Boone, Iowa.

PROFITABLE OCCUPATIONS

MONEY In rabbits and covies. We buy and put you in touch with other markets. Catalog and copy of magazine 10c. Or send 25c for book catalog and price list and year's subscription to the American Small Stock Farmer. Stahl, Box 1, Holmes Park, Mo.

PROFIT At home. Replate your silverware, home fixtures, musical instruments. Send 60c. Generous package postage paid. Re-Plate-O Products, Aurora, Illinois. Salesmen wanted.

READ "Practical Essentials of Frog Farming" before buying frogs. Only \$1.00. Baxter Company, 1533 W. Burleigh, Milwaukee, Wis.

HOW To earn money at home! Big, free book tells inside story—how hundreds are earning cash raising mushrooms in cellars, sheds. Cash paid for all raised. Write today. United, 3848 Lincoln Ave., Dept. 72, Chicago.

MEN—Women, operate "Specialty Candy Factory" home, all or spare time. Steady income. (Our 31st year.) Hillyer Ragsdale, Inc., Drawer 62, East Orange, N. J.

CLOCK, Watch cleaner \$1.00. Instructions free. Bill Reif, Lockport, New York.

STANDARD Rabbit Journal, Milton, Penna., year 50c. Sample dime. Supplies.

SONGS, Song poems, bought, published. Free information. Metro Music Publishers, San Francisco.

STOP Experimenting! My plan "clicked." Steady income. Capital, peddling unnecessary. Complete instructions, dime. Stamford, 3762-A Broadway, New York.

SMALL Business of Your Own. 1000 tried and proven methods. \$1.00. Popular Mechanics, 200 E. Ontario St., Chicago.

BOOKS, PERIODICALS, PICTURES, POSTCARDS

BUSINESS-BUILDING Bulletins—Idea check lists. 50% off. List 10c stamps. John Morris, 1040 South Paxon, Philadelphia.

GOLD Book, 128 pages, 300 pictures, construction data—Bay bridges, treasure island, scenic California, 50c. Mackey, 145 Stillman, San Francisco.

SEND 10c For trial subscription, American Freeman, Questions and Answers magazine. Haldeman-Julius, Box 104, Girard, Kansas.

"PUBLISH Magazine, \$1.00 capital"—10c. Bagley's, Box 2522, Portland, Ore.

GRAMMARS, Etc., Oriental and out-of-way languages. Ask lists. Paul Carr, Warwick, N. Y.

WRITE Friends from Texas. 12 cowboy cards—You write—Send back in our container—We mail from Texas. 25c dozen—Two Pony Express cards free. Texon Studio, Texon, Texas.

NEW York World's Fair scenic postcards, 3 for 25c. Surprise your friends. Make believe you are here visiting the fair. You fill them out. Free remailing direct from fair grounds. Valkace Enterprises, 40 Yale Avenue, Jersey City, N. J.

BOOKS Bought! Appraisal form free! Bookery, Box 3941, Cleveland, Ohio.

FREE List—Rare and unusual books. Ohio Novelty Co., 1212 Worley Ave. N. W., Canton, Ohio.

SELECT Photographs, samples, complete list 25c. Albert McGoldrick, Mansfield, Mass.

BOOKS—Home study courses. Lowest prices. Catalog free. Racliffe's, 1013 High, Petersburg, Virginia.

LEARN To do wood turning on the lathe. Fascinating, profitable. 200 page book with 141 plates provides complete mastery of this art. \$1.50 postpaid. Popular Mechanics Press, Room (C39), 200 E. Ontario St., Chicago.

GAMES—ENTERTAINMENT

CARNIVAL Games make you money. Outfits supplied. Illustrated literature 10c. "Moore-Made," LaPeer, Mich.

PLAYS, Operettas, musical comedies, complete minstrel first-parts with song programs, blackface skits, vaudeville acts, monologs, dialogs, recitations, juvenile plays and songs, musical readings, entertainments, make-up goods. Catalog free. T. S. Denison & Co., 203 N. Wabash, Dept. 11, Chicago.

MAGIC TRICKS, PUZZLES, JOKER NOVELTIES

GIANT Surprise catalogue of jokes, tricks, magic, puzzles, novelties, curiosities rushed for 25c. Free mystery trick included. Lawson Vick Co., Dept. P8, Queens Village, N. Y.

MAGIC Fascinating pastime. Entertain for profit. Catalog 10c, two tricks included free. Raymonde, 848 McDonald Ave., Brooklyn, N. Y.

HAVE Fun! Fool your friends! Latest trick jokes. 10c brings illustrated catalog and snappy free trick! Broadway Novelty Co., Box 75, Pelham, N. Y.

MAGIC Catalogue, 20c. Free trick. Lynn, 105 Beach, Jersey City, N. J.

VENTRILQUIST Figures. Turner Mfg., 1214 N. 11th St., St. Joseph, Mo.

BE A magician. Large professional magic catalogue of latest tricks 25c. Cash paid for complete Tarbell Magic Courses. Write Ireland, C-109 North Dearborn, Chicago.

LOOK! New 1939 catalog professional stage magic only 10c. Big new catalog 500 pocket-parlor tricks 10c. Each different—get both. Lyle Douglas, Station A-5, Dallas, Texas.

THE Lyle Douglas catalogs are bigger and better than ever.

FREE Tricks! Join Magicians' Fraternity! Monthly magazine, sample 10c. International Magicians, Mt. Morris, Illinois.

LEARN Ventriloquism, 3c stamp brings particulars. Smith, 125 N. Jefferson, Peoria, Illinois.

EARN Money in any crowd. Call names of strangers, tell unspoken questions. Professional course mind reading, spirit writing, etc., \$1. Henderson, Box 341, San Bernardino, Calif.

WORLD'S Largest magic shop professional catalog, 25c. Holden, 220 W. 42nd St., New York.

BECOME A magician and earn extra money in your spare time. Send 25c today for your copy of our 168 page catalogue. This book is full of tricks for everyone, from the beginner to the professional performer. Established 1910. Chicago Magic Company, 2300 North Mason Avenue, Chicago, Illinois.

OLD STAMPS WANTED

WILL Pay \$100.00 for 1924 1c green Franklin stamp, rotary perforated eleven (\$1,000.00 if unused.) Send only 6c for large illustrated folder showing amazing prices paid. Vernon Baker, 444PM-6, Elyria, Ohio.

STAMP COLLECTING

BRITISH Colonials including Mauritius, Barbados, Tasmania, Newfoundland, pictorials, commems., etc. Fifty different 10c to approval applicants. "Crescent Stamps," London, Canada.

A REAL Bargain. 200 all different foreign and 60 different U. S. stamps—our pamphlet on "How to Make a Stamp Collection Properly" and our big bargain list of sets, packets and album—all for only 18c. Queen City Stamp & Coin Company, Room 36, 604 Race Street, Cincinnati, O.

GIANT Packet 200 all different, from Africa, South America, Asia, South Sea Islands, etc. Includes world's smallest stamp, triangle and diamond-shaped stamps, animal stamps, Nicaragua Olympic "baseball" commemorative; and many others. Also packet 17 different United States (cat. 65c)—all obsolete, including \$5 denomination, commemoratives, etc. Total catalog value nearly \$5.00! All for 5c to approval applicants. Write to-day! World-Wide Stamp Co., Box 600, Camden, New York.

CANNON! Set of stamps showing cannon, firing squad, cavalry charge and 200 other different stamps, only 10c to approval applicants. L. H. Reich Stamp Co., 4647 Kenmore, Chicago.

40,000 VARIETIES First quality stamps available on approvals 1/4c up. Representative selection on request. Adults only. PKelgwin Stamp Co., Vineland, N. J.

FREE! Stamp tongs, watermark detector, stamp wallet and perforation gauge, to approval applicants. Enclosing 5c for postage-packing. F. Buth, 7134 So. Claremont, Chicago, Illinois.

UNITED States price-list free! Special discounts! Approvals! Box 822, Minneapolis, Minn.

WILL Rogers' set. Nicaragua has just issued an airmail set, most unique and sensational. Will Rogers, the American idol who met an untimely death in an airmail crash, is portrayed in different poses taken when he visited there. Portrayed with him are the U. S. marines, our flag, etc. For only 5c we will send the complete set (5 values) but only to sincere approval applicants. For an additional 5c mailing expense we will also send our free, fully illustrated 60-page book, "Famous Stamps and Their Stories," the most outstanding book on stamps of recent years. We have made special arrangements of sending "on approval" all World's Fair stamps soon to be issued, at original prices, but only to collectors on our regular mailing list. Approval Headquarters, Globus Stamp Company, 268 4th Ave., New York City, Dept. 201.

150 CANADIAN Stamps, all different, half catalogue price, divided in three series. No. 1 \$1.00, No. 2 \$3.00 and No. 3 \$6.00. Three series, one shipment \$9.00. Good condition used. Satisfaction guaranteed. Limited quantity, twenty days delivery, cash with order. W. H. Semple, Grand'Mere, Que., Canada.

LILLIPUTIAN Airmail! Afghanistan, Perak, Selangor, Siberia, "Green Cross," charity, Wurttemberg, Palestine, Banana airmail. Free with approvals! Postage 3c. Saxton Co., 408-A Jay St., Brooklyn, N. Y.

BADEN—Scarce old genuine Baden. Librarian Bongo antelope, mystery British Colony triangle, fantastic Manchukuo, breathtaking Cayman Islands, \$5 United States, bizarre Negri Sembilan, Grande Comore Islands. Everything 3c with approvals. Viking, 1-Z Hanson Pl., Brooklyn, N. Y.

\$1.00 PACKET Given! Inclose postage, request approvals. Secrist, Muscatine, Iowa.

4 MINT Sets, triangles, diamonds, others 10c with penny approvals. Sholtmir, 199 Avenue B, New York.

1000 WORLDWIDE Stamp mixture 25c. Monjar, 1542 Waverly, Cincinnati, Ohio.

500 MIXED Canada, plenty pictorials, 25c; pound \$1. I. Killam, Box 587, Saint John, Canada.

BRITISH Colonials—100 different 25c; 200—95c. Approvals. Dee Taylor, Rocky Mount, N. C.

CZECHOSLOVAKIA—50 Different; 50 Poland; 10 Manchukuo; 50 Sweden; 10c each. Fuld, Dickmann Building, St. Louis, Missouri.

WILL Rogers commemorative set 10c to approval applicants of general foreign by countries. Heiken, Benson, Ill.

FALKLAND Islands coronation set on first day cover (worth 75c)—only 20c to approval applicants. Free packet and bargain lists included. W. Torgesen, Teaneck, N. J.

1000 MIXED U. S., 15c. 200 different precancels, 25c. Lee, Bridgeport, N. Y.

U. S. Mint, Byrd, 2c Hawaii, Valley Forge, N.R.A.—40c, with Red Cross free. McClay, Altadena, California.

FREE \$1.05 Catalog value. Approvals. Terry Stamp, Box, Albany, N. Y.

FREE! 50 South America to approval applicants. Stampdom, 195 Park, Lewiston, Maine.

ARMY-NAVY Sets complete. Only 10c to approval applicants. Lindgren, 714 Market, San Francisco.

ROYAL Visit stamp annual free—Sixty pages with hundreds of illustrations featuring Canadians, Newfoundlands, United States, colonials, foreign, supplies. Sent free. Gray Stamp Company, Dept. PM, Toronto, Canada.

101 MIXED Stamps 3c approval applicants only. Quality Stamps, Englewood, Colorado.

50 BRITISH Colonials, only 5c. North-east, Box 6618, Kansas City, Mo.

TEN Different United States, over 40 years old, 10c. Elsea, Bowling Green, Ohio.

WILL Rogers commemorative airmails complete 10c. Approvals. Creevey, Berwick, Penna.

INTERNATIONAL Junior album absolutely free. Particulars from Arrow Stamps, Box 453, Meriden, Conn.

OFFER 125 Fine commemoratives for 300 precancels. John Nagle, North Judson, Indiana.

STAMPS Price list free. Billings, 151-18 85 Ave., Jamaica, N. Y.

BEAUTIFUL Packet pictorials, animals, maps, five cents with attractive approvals. Ronalds Stamps, Waterloo, Ontario.

U. S. Approvals to serious collectors, No. 330 select 90c. Lundgren, 1751 Eustis, St. Paul, Minn.

25 FRENCH Colonials 10c; or 15 Egypt 3c; with approvals. Thorfig Stamp Company, Box 77, Marion, Indiana.

FREE, Packet old U. S. with super value approvals. Chautauqua, Box 210, Jamestown, N. Y.

UNPICKED! 100 U. S. revenues on documents—10c! Unpicked mission mixture: two pounds 65c! Vanvoorhis, Hyndman, Penna.

NEW Will Rogers stamps with 25 others 10c. Buckley, 208 Ludlow, Dayton, Ohio.

WHOLESALE—Canada, Newfoundland, Fifty page illustrated wholesale catalogue, featuring Canadians, Newfoundland, British Colonials, United States, supplies. Free. Empire Stamp Company, Dept. 5, Toronto, Canada.

50 DIFFERENT Pan-American stamps 20c with Western Hemisphere approvals. LaJolla Stamp Co., Box 333, LaJolla, California.

ASSOCIATED Stamps of the west. Numbers 1 to 100 for \$1.00. Pierce, Box 931, San Jose, Calif.

WEST Indies: Bargains. Approvals, catalogue. Rajnauth, Box 267, Trinidad, BWI.

50 DIFFERENT U. S. commemoratives, airmails, 15c. Approvals. Motzer, 1022 Liberty, Cincinnati, Ohio.

5 POUNDS United States mixture guaranteed over 100 varieties \$2.50; 1000 mixed precancels \$1.25. Irvin Noecker, Dauberville, Penna.

U. S.—63 different (commemoratives, airmail, etc.) with approvals 9c. 50 diff. commemoratives 1893 to date 25c. Moseley, 4932 Forestpark, St. Louis, Mo.

NEW 1938-39 Issues. 55 different. 10c to approval applicants. Foote, 309 Greeley, Webster Groves, Missouri.

U. S. Office mixture. 50c pound. C. Siegel, Box 1710, Milwaukee, Wis.

420 DIFFERENT Stamps from Germany, Czechoslovakia, Hungary, Poland only \$1.00 if you request approvals. R. Lynch, Box 56, Peoria, Illinois.

100 DIFFERENT Stamps given approval applicants. Omans, 642 Broadway, St. Paul, Minnesota.

QUALITY Approvals—Discounts. Free Czechoslovakians; lists. Sherman Shook, Nazareth, Pennsylvania.

SET of world's smallest stamps. Fine packet 100 different containing Ecuador constitution, Alexandretta and Burma (both new countries), giant diamond-shaped stamp, Nicaragua "baseball" commemorative, banana airmail, fish triangle, three-headed Hindu god, for only 5c to approval applicants. Set of world's smallest stamps included with each order. Neils Dolve, Box 406, Minneapolis, Minnesota.

U. S. Parks—Complete used 19c. Approvals. Huber, Palace Building, Minneapolis.

JUBILEES, Coronations, 15 different for 5c. Included free 10 Peru to approval applicants only. Kuzma, 1291 Washington Avenue, Bronx, N. Y.

100 DIFFERENT 5c. Approvals. Stampcraft, 142 E. 37th, New York, N. Y.

QUEEREST Stamp packet: Mozambique, Japan, China, Soruth, Albania, many others—5c to approval buyers. R. M. Stamp Co., Box 230P, Port Chester, N. Y.

CANADIAN Packets including pictorials, commemoratives, 50 different 15c. 75 different 50c. Big value. Fine approvals available. Marks Stamp Company, Toronto 2, Ontario.

BEAUTIFULLY Engraved Nyassa set: Five airmails, 3c. Alone, 2068 Daly, Bronx, N. Y.

FREE! 25 Different Japanese. Approval applicants. Lucky, 5018 Pernod, St. Louis, Missouri.

FREE: Ten stamps you haven't got. Request approvals. Cowan, 16152 Snowden, Detroit, Michigan.

CLEAN Interesting approvals, splendid value. John Stamp, 79 Holton, Montreal.

2 SAXONY (Genuine) and packet 25 British Colonials. Approvals, 5c. National, Box 408, Hollywood, California.

NEWFOUNDLAND 12 Different 5c with approvals. Hudson, Box 118-P, Plainfield, N. J.

U. S. Constitution stamp of Ecuador, gorgeous six-color stamp showing U. S. flag in natural colors and George Washington, also Marvel packet 33 different including new Cayman Islands, Gen. Franco Spanish Morocco "war stamp" 60 yr. old Luxemburg, "bull-fight" stamp, largest diamond, tropical triangle, Chinese "mid-ge" stamp, etc., all for 5c with approvals. Potomac Stamp Co., Dept. 105-D, Washington, D. C.

50 BEAUTIFUL Pictorials 25c. Gem Stamp Co., Box 194, Chicopee, Mass.

INCREASE The beauty of your collection. End "stock-book blues"; prevent gaps in page mountings. A postcard brings free sample. Address Maco Philatelic Corporation, 117 1/2 W. Harrison, Chicago.

25 UNITED States, including \$4 and \$5 stamps free to approval applicants. 3c postage. Brownie Stamp Shop, Flint, Mich.

TRIANGLES! Triangles! Triangles! Triangles! Count them. Four! With famous Rivera nude stamp. Only 3c to approval applicants. Cactus Junior, Tucson, Arizona.

FREE! 80-Page "United States & British North America" catalog. Nearly 1,000 illustrations! Lowest prices! Large catalog "foreign stamps" also included. Harris & Co., 137 Transit Building, Boston, Mass.

HINDENBURG Zeppelin, Spain nude duchess, 5c approvals. Shultes, Berne, N. Y.

GIANT And midget triangles, scarce Tannou Touva and Bolivia, many others, 4 cents with fine approvals. D. Shedd, Laramie, Wyo.

GAMBLE. Huge auction purchases broken into \$1.00 lots. Enormous value. Worldwide testimonials. Hughes, Queens Rd., Bournemouth, England.

1000 GOOD Mixed 25c. De Mers, 1851 N. 39 Street, Milwaukee, Wis.

COLLECT United States stamps for solid value. Our approvals are correctly numbered and reasonably priced. Southern Stamps, Box 70, Miami, Florida.

FREE 30 Different U. S. to approval applicants. McKee, P.O. Box 1, Scranton, Penna.

1000 DIFFERENT 75c; 600 50c; 300, 20c. Fred Onken, 630 79th St., Brooklyn.

FREE, 50 Stamps, Iraq, etc. Postage 1c. Alburn 3c. Bullard, 268 Northampton, Boston, Mass.

EXCELLENT Philatelic surprise packet 25c (approvals). Casimer Nowak, 825 North Racine, Chicago.

WHOLESALE Supplements to dealers for 10c postage. Hundreds of bargains. Grossman Stampco, 102 West 42nd, New York.

50 DIFFERENT, Fine U. S. including perforation gauge, 10c with approvals. The Stamp Shop, 809 Holland Bldg., St. Louis, Mo.

CANADA Catalog, illustrated. 136 pages, \$1.00. Miniature sheet triangles (4 diff.) 10c approvals. Victoria Stamp Co., London 4, Canada.

175 U. S. commemoratives, etc., 10c. 500 25c. P. O. Box 457, Newark, N. J.

FREE—The Stamp Finder! Send today for big new edition, fully illustrated, enabling you instantly to identify all difficult stamps! Also fine packet strange, fascinating stamps from Bosnia-Herzegovina, Monaco, Patiala, Cyprus, etc., including maps, ships, animals and strange scenes. All free to approval applicants inclosing 3c postage! Garcelon Stamp Company, Box 900, Calais, Maine.

FREE—Packet Central America stamps with request for 52 page list of United States and foreign stamps. Stamps on approval. References necessary. 20 different nineteenth century U. S. 28 cts. New Hussman Stamp Co., 1122 Pine St., St. Louis, Mo.

NEVER Offered before. 21 French Colonies, pictorials, sets of 5 each (105) for 35c. French, 241 Euclid, Cleveland.

FREE Collection, 12 different Yugoslavia for names and addresses of three active stamp collectors if you ask for approvals. Reimers, 600 Flatiron, Fort Worth, Texas.

150 GOOD Mixed foreign stamps, 5c coin. Stanton, Niantic, Conn.

100 DIFFERENT Hungary 7c, approvals. Hazett, 701P Fourth Baycity, Mich.

30 DIFFERENT Angola, Cape Verde, Guinea, Portugal, Mozambique, St. Thomas and Prince 5c, Approvals. Depraw, Ocean Park, Calif.

PENNY Approvals, that satisfy. Neil Gronberg, Box 5441-P, Philadelphia, Penna.

AIRMAILS And commemoratives, 25 different, including Columbians, Panama-Pacific, Edison, Zeppelin, etc., only 5c with exceptionally fine United States and foreign approvals. Marco Stamp Co., Box 888, San Francisco, Calif.

PANAMA Triangle and 50 others free to approval applicants sending 3c postage. Tatham Stampco, Springfield-30, Mass.

SPLENDID Estonia collection, 25 different, pictorials, semipostals, scarce imperf., only 5c. Imperial Stamps, G.P.O. 130, New York.

UNITED States illustrated looseleaf catalog, \$1.00. Send postage for free United States price list, precancel list. Stanley Gibbons, 36-P Park Row, New York.

GIANT Diamond-shaped stamp! Big packet 105 all different including Alexandretta (new country), Congo, Manchukuo, Ecuador constitution, Costa Rica triangle, air-mails, commemoratives; giant diamond-shaped stamp, \$5 United States; set United States telegraphs, cataloging 30c. Packet British colonies including Burma (new country), jubilee and coronations; scarce sets 2 Siberia, cataloging 50c. Illustrated lists. Everything for only 5c to approval applicants! Write to-day! Mystic Stamp Co., Dept. 80, Camden, New York.

FREE—From every continent, 155 different, airmails, triangle, commemoratives, pictorials, many U. S. and others, with 1c approvals. Send 5c for postage and handling. Ace Stamps, Colonial Arcade, Cleveland, Ohio.

FREE! Two coronation sets. Postage 3c. Roberts, 312P Shearerbig, Bay City, Mich.

UNITED States—45 different, perforation gauge, hinges, bargain pricelist—all for 10c. Seidenberg, Baroda, Mich.

200 DIFFERENT 10c. Big 50% approvals. Covert Stamp, 39 State, Rochester, N. Y.

BRAZIL, 50 Different 10c with bargain approvals. Davis, Silver Lake, Ind.

ASK For our wonderful one cent approvals. Prospect Stamp Co., 225 Broadview, Toronto, Canada.

WHOLESALE Catalog for dealers. Illustrated. Postage 5c. Frank Co., 4900 Chalmers, Baltimore, Md.

STAMP Dealers, your ad here will bring wonderful returns. Ask me for proof. F. W. Johnson, Manager, Classified Advertising, Popular Mechanics Magazine, 200 E. Ontario St., Chicago.

APPROVAL Sheets. One to three cents. Frederick B. Driver, 2009 Finance Bldg., Philadelphia, Penna.

WEEKLY Stamp magazine, thirteen weeks, 10c. Stamp Journal, Kalamazoo, Mich.

RARE COINS

CALIFORNIA Fair souvenir piece 15c. Lincoln cents, 10 different, either D or S 25c; buffalo nickels 1936S, 1937S, 1938D, uncirculated, 15c each; Jefferson nickels 1938S, uncirculated, 25c; California's \$1/2s 1923 Monroe fine \$1.35; 1935 San Diego, uncirculated, \$1.35; 1936 Bay Bridge, uncirculated, \$2.25; large coin book 25c. Lists 3c. Coinshop, Box 5466, Metropolitan Station, Los Angeles, California.

SIX Scarce U. S. coins; silver 20c, 5c, 3c; bronze 2c; 1/2c large cent, f.o.b. \$1.50. Schultz, 419 First National Bank Bldg., Cincinnati, Ohio.

OLD Money wanted. Will pay \$100.00 for 1894 dime, S. mint, \$50.00 for 1913 Liberty head nickel (not buffalo). Big premiums paid for all rare coins. Send 4c for large coin folder. May mean much profit to you. Numismatic Co., Dept. 20, Fort Worth, Texas.

UNITED States trade dollars 1875, San Francisco uncirculated \$1.50; five different commemorative halves, uncirculated, \$5.00. S. Koepfel, Merritt Building, Los Angeles, California.

WILL Pay \$5.00 each for certain Lincoln pennies; Indianheads \$100.00; dimes \$700.00. Catalogue 10c. Federal Coin Exchange, Columbus, Ohio.

40 INDIAN Cents, coins, tokens, 25c. Bishoff, 500 E. 8th, Kansas City, Mo.

INDIAN Head penny. Coin list 10c. Charles Banker, Salina, Kansas.

COLLECT Coins for profit and pleasure. Brilliant uncirculated coin and catalog—10c. Eugene Morrison, Reseda, California.

WANTED—Uncirculated cents, nickels, W. Allgeyer, Box 192, Newark, N. J.

GOLD Coins wanted. 55% premium. A. French, Route 1, Troy, N. Y.

RARE U. S. foreign coins, war medals. Catalogue 10c. Mengelle, Colorado Springs, Colo.

GET Profit and pleasure in collecting old coins. Send 10c for 56-page illustrated coin catalog. You'll be delighted with it. Send for it now. B. Max Mehl, 370 Mehl Bldg., Fort Worth, Texas. Largest rare coin establishment in U. S. Established 38 years.

BIG Prices paid for certain wanted coins. 1909 cent \$10.00, some silver dollars \$4000, 1864-1865 Indian head cents \$100.00 each, dimes before 1895, \$600; liberty head nickels before 1914, \$500; encased postage stamps; some large pennies \$2000; half cents, \$275.00; paper money, gold dollars \$1500, foreign coins \$165, some worth \$6000 each. You may have coins for which we pay big premiums. Therefore send 15c today for 1939 big illustrated coin book for certain wanted coins. National Coin Corporation (80), Daytona Beach, Florida.

FINE Foreign 1700 coin, 2 notes and catalog 10c. Geo. Best, Cedar Rapids, Iowa.

COMMEMORATIVE Half dollars, Lincoln, Stone Mountain, Oregon, Texas, Cleveland, Kentucky, San Diego, Long Island, \$1.50 each. Illustrated catalogue No. 14, 25c. Norman Shultz, Salt Lake, Utah.

FREE! Foreign coin, banknote, and large illustrated coin catalogue. Send 4c postage. Coin approvals sent. Tatham Coinco, Springfield-125, Mass.

\$5 TO \$500 Each paid for hundreds of old or odd coins. Keep all until posted. Many very valuable. Send 10 cents for illustrated Coin Value Book, 4x6. Guaranteed buying and selling prices. 31 years in business. Coin Exchange, Box 5, Le Roy, N. Y.

HOBBIES AND COLLECTIONS

FASCINATING—Collect woods from all the world. Complete index, sample batch of twelve, useful information, all for 25c coin plus 5c stamp. Woodcrafters Guild, Dept. 6M, Long Island City, N. Y.

50c BRINGS Specimens opalized wood, jasper, agates. Box 808, Tacoma, Washington.

MATCHLABELS Magazine and 50 different labels for 25c. Yeingst, 1013 N. Third St., Harrisburg, Penna.

DON'T Throw away match book covers! Albums, Information 3c. Adams Sales, Dept. 7, State Tower, Syracuse, N. Y.

UNUSED Book match covers, 100 all different, \$1.00. Free list, Charles Edelman, 1311C East 84, Cleveland, Ohio.

PHOTO FINISHING

PANEL Prints in leatherette album! Fine grain processing by experts. 36 exposure miniature film developed and each enlarged to 3x5, \$1.00—18 exposures, 60c—regular rolls, finished, 25c. All wide margin Panel Prints in album. Send coin. Quick service. Photo Lab., Inc., Room 569, 3825 Georgia Avenue, Washington, D. C.

BEAUTIFUL Lasting prints from perfectly developed negatives. Roll developed, 6 or 8 prints, 25c. Get our special on panel enlargements. "National," PM-16, 569 Gerrans Bldg., Buffalo, N. Y.

2 ENLARGEMENTS, 8 Prints, each roll developed 25c coin. 8x10 enlargements 25c. Adelphia, 1840 Hoffnagle, Philadelphia, Penna.

PROMPT Service—Guaranteed work. Two beautiful portrait type doubleweight enlargements, eight neverfade gloss prints, each roll 25c. Dubuque Film Service, Dubuque, Iowa.

PHOTO Mill. Immediate service! No delay! Roll developed, carefully printed and choice of two beautiful 5x7 professional enlargements, one tinted enlargement, or eight reprints—for 25c coin. Reprints 2c each. The Photo Mill, Box 629-12, Minneapolis, Minnesota.

ROLL Developed, eight highest quality Velox prints. Free de luxe album, negative file and two enlargement coupons. Prompt service. Knickerbocker Crafts, 738 Broadway, New York City.

ENLARGEMENTS From each picture on your roll 25c. Lifelike enlargements bringing out the best in your pictures. High quality, fast service, low price, and unbeatable combination. Cut Rate Photos, Dept. B-4, Janesville, Wis.

MAIL Your rolls to film center of the world. Any 6 or 8 exposure roll developed and printed 25c coin. DeLuxe enlargement coupon free! Photo Finishing Shop, Est. 23 yrs., 411-HH Genesee Valley Trust Bldg., Rochester, N. Y. "The Camera City."

ROLL Developed, 16 guaranteed prints, 25c. Smart Photo, Winona, Minnesota.

DOUBLEWEIGHT Enlargements. Glossy, semi-matte. 8x10, 35c; 4, \$1.00. Negative. Walter Asklund, Renovo, Penna.

MILLIONS Now know "Hollytints means better prints." Trial roll printed including two beautiful enlargements—25c. Fascinating premium coupons. Hollytints, P-1350, Hollywood, California.

SPECIAL Offer rolls properly developed and 8 expensive velox prints 15c. Rohs Supply, 8410 Drexel, Chicago.

20 REPRINTS 25c. 100 Reprints \$1. Roll developed with 16 prints 25c. Nordskog, 4, Maywood, Ill.

EXPERT Finishing. One day service. Rolls developed 16 Velox prints or 8 Velox prints, 2 enlargements 25c. Expert Studios, LaCrosse, Wisconsin.

ROLLS Developed—16 prints, 2 enlargements 25c—25 reprints 25c. Trial. Filmcraft, River Grove, Illinois.

20 REPRINTS 25c; 100—\$1.00. Rolls developed, either 16 guaranteed prints, 1 colored or 2 professional enlargements—25c. Sample enlargement 5c. Lifetone, D-9, Des Moines, Iowa.

TWO Prints from each picture on your roll 25c. Lens Photos, Dept. C-6, Janesville, Wis.

PROMPT Service—Quality work; 2 beautiful doubleweight gloss enlargements, 8 guaranteed neverfade prints each roll, 25c. Excel Photos, Dubuque, Iowa.

FREE Album and negative file and 2 enlargement coupons with each roll developed, 8 guaranteed prints 25c. Memrilane Studios, General P.O. Box 666, Dept. "K," New York.

CANDID Shots enlarged twenty cents. Andy's, Box 426, Phoenix, Ariz.

ROLL Developed and eight guaranteed professional prints including two enlargements that will not fade 25c (coin). California Film Service, Box 379, Pasadena, California.

ROLL Carefully developed; 8 Velox prints and coupon for 2 double-weight enlargements 25c coin. Monson Photo Service, 347 W. Page St., St. Paul, Minnesota.

ONE 6 1/2 x 8 1/2 Wide border embossed enlargement or one 5x7 hand colored enlargement with each roll developed and 8 prints 25c, 36 exposure roll developed and 36 3 1/2 x 4 1/2 enlargements \$1.35, 18 exposure roll 75c. Vidor, 321-P Hennepin, Minneapolis, Minn.

ONE Day service. Finer finishing, 8 prints, 2 enlargements and 1—8x10 enlargement coupon, 25c (rolls or reprints). Campbell's Photo Shop, Box 163P, Bismarck, N. Dak.

ROLL Developed, 16 prints 25c. Wilkes-Barre Photo Service, Box 64, Wilkes-Barre, Penna.

8 BEAUTIFUL Enlargements and roll processed 25c. Streamlined service. Perfect Pictures, Toronto, Ontario.

CENTRAL Location. Fastest service. Guaranteed—Full set Velox prints, 2 professional enlargements, valuable coupon. Roll 25c. Pack 50c. Hoosier, Winamac, Indiana.

ROLLS Developed; 16 prints, two 5x7, 25c. 25 reprints 25c. M-B-M Photo Company, B-3860 Sixteenth, Chicago.

ROLL Developed and printed 25c. Enlargement coupon free. Roache Photos, Garrett, Ky.

FREE Enlargement coupon with every order. Rolls developed, 2 brilliant professional prints of each, 25c. New Deep View process. Barclay Studios, 5520 South Shore Drive, Chicago.

ROLL Properly developed, carefully printed, and 5x7 enlargement 25c. Tri-State Studio, Dept. 3, Huntington, Ind.

HAVE You tried our service? Roll developed 16 Velox prints or 8 prints, 2 enlargements 25c. Immediate delivery. Chicago Photo Lab., Box 3, So. Chicago, Ill.

ROLLS Developed, two prints each and two free enlargement coupons, 25c; reprints, 2c each; 100 or more, 1c. Summers' Studio, Unionville, Mo.

SPECIALS On demonstrators and slightly used Bell & Howell 8mm. with turrets, Bolex, Eastman and Keystone cameras, projectors. Write for free list. Tulip City Photo Supply Co., Dept. C, Box 808, Holland, Michigan.

ROLLS Developed—24 guaranteed prints, 25c. Dick's Photo, Louisville, Ky.

DEVELOPED, 8 Quality prints, 25c. Fotoservice, 1942 Marlow, Toledo, Ohio.

IDEAL Photos. Professional deckle-edge prints and free enlargement each roll only 25c. Illustrated price-list free. Write today. Ideal Photos, Box 2255, Paterson, N. J.

ROLLS Developed, 2 prints each 25c. Ramsdell, Box No. 5, Portland, Maine.

35MM ROLLS Fine grain developed and each shot enlarged to 3 1/2 x 5 \$1.00. 18 exposures 60c. Ideal Films, Birmingham, Ala.

CANADIANS. Roll developed; 8 good prints 25c. 8x10 or 7x11 enlargements, 4 for \$1. Photo Finish, B.427, Vancouver, Canada.

MINICAMISTS! Your 35mm. film fine grain developed, one 3x4 print of each good frame, and your cartridge reloaded with new fresh Eastman Plus-X, only \$1.50. Exceptional quality, service! Send rolls or write for free print, mailers, details. Superlabs, 100, Elroy, Wis.

IMMEDIATE Service! Better pictures. Sixteen guaranteed prints from roll, 25c. One colored or two plain enlargements and 8 guaranteed prints, 25c coin. Special! Coupon for 8x10 enlargement given with every 25c worth Kodak finishing. Any 36 exposure, 35 mm. film fine-grain developed and each good negative enlarged to 3x4 prints for only \$1.00. 3x4 reprints, 4c each. One day service. Details and mailers free on request. American Studios, Box B, LaCrosse, Wis.

JOIN The thousands who are changing to Willard's Brilliantone prints—the style leaders of 1939. Roll developed, two prints each negative, only 25c. Valuable enlargement coupon. Willard's, Box 3535-A, Cleveland, Ohio.

ROLLS Developed—16 prints or reprints 25c. Fine grain. Photographers, 207 E. Chicago St., Valparaiso, Indiana.

ROLL Developed and 16 prints or 8 prints and two 5x7 enlargements 25 cts. Reprints 20 for 25 cts.; 50 for 50 cts coin. Queen City Service, Dept. C, Box 7, Niagara Square Station, Buffalo, N. Y.

THREE Prints each good negative in roll 25c. Reprints 3c. Fred D. Eastman, Bode, Iowa.

SPECIALIZING 35mm. Rolls fine-grain developed, 36 enlargements 3 1/2 x 5, \$1.00. Cartridge reloaded 35c. Photoshop, Linton, Indiana.

ROLLS Developed, 8 prints, two snappy chromium finish enlargements 25c. Prompt 6 hour service. The Picture Folks, Lincoln, Neb.

FREE! 2 Gravure-Tone enlargements. Roll developed, 8 deckle edge prints 25c. Free mailing bag! Crosswell, A-844 Rush, Chicago.

TECHNIFINISH—The new fast and economical developing and enlarging service specializing in 35mm. film. 36 exposure rolls fine grain developed and enlarged to 2 5/8" x 3 3/4"—36 gloss finish enlargements, 75c. This service plus cartridge refill, \$1.00, 18 exposure rolls, 50c for 18 gloss finish enlargements—70c for enlargements plus refill. Highest quality workmanship—fastest service guaranteed. Write for free postpaid mailing bags. Technifinish Laboratory, 110 Lexington, Rochester, N. Y.

FOR The discriminating amateur, roll developed and carefully printed 25c, reprints 3c. Superior workmanship, same day service. Paramount Co., 327 E. 92nd St., New York.

ROLL Developed and 8 beautiful Velox glossy prints 25c coin or stamps. Reprints 3c each. Fotoprint Service, Roanoke, Va.

8 PLEASING Velox prints, 2 enlargements 25c coin. Please U Film Service, LaCrosse, Wis.

TWENTY Reprints 25c. Roll developed and two prints each negative, 25c. Send for free mailing envelopes, price list. Star Photos, J-109 N. Dearborn, Chicago.

THE Modern Finishers, St. Paul, Minnesota, are the outstanding finishers in America for low prices with quality pictures. Our modern methods give quick service and bright guaranteed neverfade pictures. Roll developed, 16 prints, 25c coin; 16 reprints, 25c. Enlargement coupons. Join our thousands of satisfied customers by sending us your next roll or reprint order. Modern Finishers, Box 3537, St. Paul, Minn.

20 REPRINTS 25c. 100 Reprints, \$1.00. Films developed, 2 prints each negative, 25c. Mercury Studios, Box 822-B, Chicago.

PROMPT Service! Rolls developed, two Velox prints each negative 25c. Hench Studios, Harrisburg, Penna.

PHOTO Mill. Immediate service! No delay! Roll developed, carefully printed and choice of two beautiful 5x7 professional enlargements, one tinted enlargement, or eight reprints—for 25c coin. Reprints 2c each. The Photo Mill, Box 629-12, Minneapolis, Minnesota.

ROLL Developed, 8 brilliant fadeproof Velox prints and two professional enlargements 25c. Overnight service. Young Photo Service, 405-C, Albany, N. Y.

LIFE Photo finishing lasts a life time. Roll developed, 8 prints, 2 enlargements 25c. Reprints 1½c. Life Photos, Hutchinson, Kansas.

TWO Glossy enlargements, 1 colored with roll 25c. Arbor Service, 10, Joliet, Ill.

CANDID Special, 35mm. rolls enlarged to 3¼x4½, \$1.00. 18mm. rolls 60c. 3¼x4½ reprints 3c. Brown Photo Company, 1910-61 Emerson, Minneapolis, Minn.

16 PRINTS With roll 25c. 16 reprints 25c. Rex Photo, Ogden, Utah.

BEAUTITONE Enlargement, dime and negative. Giant Snapshots, Inc., Green Bay, Wis.

GUARANTEED. Roll developed, 16 prints 25c. 20 prints 25c. Quality Photo, Hutchinson, Kansas.

QUICK Service—Rolls developed, 8 guaranteed prints; 2 enlargements; 25c coin. OK Photo Service, Ottawa, Kansas.

CAMERAS, PHOTO SUPPLIES

FREE Camera and photo supply bargain book. Lists and describes latest inventions American and foreign speed cameras, candid and miniature cameras, exposure meters, movie cameras, night and color photography, darkroom and enlarging equipment. Big savings on everything photographic. Liberal trade-in allowance on old equipment. Don't delay, send postal card today for valuable free book. Central Camera Co., Dept. 6-K, 230 S. Wabash Ave., Chicago, Ill.

SOMETHING New. Print pictures from own negative on writing paper, cloth, etc. 150 pictures from one kit. Kit \$1.00. Money back guarantee. Literature free. L. Small, 2728 1st Ave. South, St. Petersburg, Fla.

MAKE Money in photography. Learn quickly at home. Spare or full time. Easy plan. Previous experience unnecessary. Common school education sufficient. Interesting booklet and requirements free. American School of Photography, 3601 Michigan Ave., Dept. 3431, Chicago.

PHOTO Mill. Immediate service! No delay! Roll developed, carefully printed and choice of two beautiful 5x7 professional enlargements, one tinted enlargement, or eight reprints—for 25c coin. Reprints 2c each. The Photo Mill, Box 629-31, Minneapolis, Minnesota.

ALL 35MM. films in new cartridges 65c each. Not reloads. New empty cartridges 2 for 25c prepaid. Pathe's Camera Shop, 23 East Fifth, Cincinnati, Ohio.

FREE Camera and supply catalog. Big new edition just out; everything photographic, hundreds of bargains. Abe Cohen's Exchange, 142 Fulton St., New York City.

CAMERAS, Projectors, processing service. Lists. Exchange, Box 111, South River, New Jersey.

AMAZING Free filter offer! Write "Filters," 835 Alberta, Santa Barbara, Calif.

\$50 WEEKLY With your kodak! Booklet describing 100 markets, 25c. Novex, 1210n 11th Ter., Birmingham, Ala.

KODAK Snapshots, N. Y. world's fair, 12 different \$1.00. Forman, 882 Lorimer, Brooklyn, N. Y.

CAMERAS. Enlargers, on time. See advertisement under Motion Pictures. Mogull's.

GLASSINE Envelopes—125, 25c; 600, \$1.00. 2¼x4¼; 3x3½; 3¼x5. Filing drawer—50c. Postpaid. Lutz, 414 Avery, Syracuse, N. Y.

ENLARGER \$1.59. Enlarges eight times size of small negatives. Fully guaranteed. Paramount Sales Company, 89 Dudley Street, Boston, Mass.

BASS Inventory clearance. Profit by these unusual bargains. 35 mm. Candid Midget, F:4.5 lens, \$12.50. Used Foth Derby, F:3.5, \$15.75. 2¼x3¼ Agfa Film Pack and plate, with F:6.3 lens, auto shutter, film adapter and holder, \$11.95. Used Argus, F:4.5 lens, \$7.75. New Candid Midget, Xenon F:2 lens, Rapid Compur and case, \$80.00 value, at \$49.75. Hundreds of other bargains in the great Bass Bargaingram and special bulletins. Your money back is unsatisfactory after 14 days trial. Write Bass Camera Company, Dept. AG, 179 W. Madison St., Chicago, Illinois.

CAMERAS Films, paper 25% to 35% discount. Paramount Photo Division, 327 East 92nd St., New York.

CAMERAS—Shutters repaired. Leather bellows installed in folding and view cameras. Bellows made to order. United Camera, A-1515 Belmont, Chicago.

HAVE You a camera? Send ten cents for recent number of our big magazine, showing how to make better pictures and earn money. American Photography, 116 Camera House, Boston, 17, Mass.

NO More wasted film or unnecessary expense. Take pictures you can be proud of. Sell to magazines and newspapers. Make good money wherever you live. Easy, low-cost home study course shows you how! Free catalog. Universal Photographers, Dept. 104, 10 W. 33 St., New York City.

IF You go to Mexico ask first for prices and pamphlets of finest German quality miniature and other cameras, binoculars, movie cameras and projectors. Foto Mantel Sucr. R. Rudiger V. Carranza 11, P. O. Box 1459, Mexico City-105, Branch store: Tijuana, Baja, California. Branch store: Tijuana, Lower California, Hotel Comercial. Branch store: Monterrey, N. L., Morelos Oriente No. 557.

MAKE Money with your camera. New book tells how, 46 pages, 50c. Popular Mechanics Press, Room (C39), 200 E. Ontario St., Chicago.

MOTION PICTURES AND SOUND EQUIPMENT

8MM. - 16MM. "Pancros." Camera Shoppe, 704 Mt. Hope, Cincinnati, Ohio.

SCHOOLS, Churches, parties. Authentic—"Across World With Martin Johnsons"—16mm. Reasonable rental. Ohio Film Service, 1377 Penhurst Road, Cleveland, Ohio.

EXCHANGE 16MM. silent, sound, films, Silver screens, 36"x48" mounted, roller \$2.79. Asha Film, 785 St. Johns Pl., Brooklyn, N. Y.

NEW Lists! Silent 35mm. films. Demsey, 1223 Berkley, Youngstown, Ohio.

8MM.-16MM. Giant bargain sell-outs. Box 791, Cincinnati, Ohio.

16MM. FILMS 100 Ft. Leading stars, 79c stamps. Cameras, projectors. Block, 1265 Broadway, New York City.

HOME Movies 8mm.-16mm. Cartoons, comedies, westerns, travelogs. Free list. Crown Film Corp., (P)42 Melrose St., Boston, Mass.

SILENT Projectors, two 35mm. portable DeVry \$35.00 each; 16mm. Victor \$40.00; stereopticon \$25.00; 35mm. film last Dempsey Tunney fight \$15.00; prices f.o.b. Jordan Productions, Oil City, Penna.

(PROJECTORS) DeVry portable, straight feed with amplifier. Price \$89.95. Shermco, 626 Film Bldg., Cleveland, Ohio.

CAMERA Film, 8mm. 16mm. famous nationally advertised brand. Greatly reduced. Free circular. Crown Film Corp., F42 Melrose St., Boston, Mass.

MOGULLS Improved credit plan brings luxurious equipment within easy reach! Leica, Bell-Howell, Kodak, Victor, Ampro, Speed Graphic, Rolleicord. Magnificent new-used bargains! Trades. Sound-silent movie rentals—8-16mm. Low rates. "Bargainews" free. Mogull's, 64 West 48th, New York.

BARGAINS 8mm. 16mm. Films, projectors. Empty 35mm. reels 5c. Literature. Pastime, 56, Wood-Ridge, New Jersey.

COMPLETE 16mm. Film rental library. Attractions: "Covered Wagon," "Behind the Front," "Pony Express." Free catalog. National Cinema, 3 West 29th, New York.

GENERA Film in bulk for all movie cameras. 90 feet for Univex, \$1.10 (spools 3 for 60 cents); 100 feet double 8mm., \$1.75; 16mm., \$1.35. Sample for stamp. Process with powders. Fromaders, Davenport, Iowa.

8-16MM. FILMS. Silent, sound. New York World's Fair films. 360 feet 16mm. \$8.75; 180 feet 8mm. \$5.50; other subjects. Films rented everywhere; 24 hour delivery. Free illustrated catalogue (with sample film 10c). Garden Exchange, 317 West 50th, New York.

35MM. SILENTS. Rented, sold, exchanged. Calderara, 5119 South St. Louis, Chicago.

GUARANTEED 8MM. 24-hour reversal processing. Double 8mm., 45c. Single, 25c. Univex 15c. Eso-S, 3945 Central, Kansas City, Missouri.

FOR Sale or rent—16mm. sound and silent features, cartoons, comedies. Waldo Films, Cincinnati.

MOVIE Film. New! Sensational! 200 ft. 8mm. notched in four 25 ft. scored double 8 rolls, daylight leaders between each load \$1.75; 400 ft. 16mm. measured, notched 100 ft. lengths \$4.00. Graphichrome, A188 Randolph St., Chicago.

MOVIE Film. Develop yourself. Univex. Eastman, etc. Chemical samples 15c. Raw film wholesale. Lake Camera Exchange, Gary, Ind.

TALKIES. 35mm. Rentals \$1.00 per week with projector \$23.50. Lists 5c. Motion Picture Exhibitors, 626 Film Bldg., Cleveland, Ohio.

16MM. VELOTEX. Perfect outdoor film. 100 ft. rolls \$1.95 including free processing. Sample free. Velotex Laboratories, 600-B, Gary, Indiana.

BARGAINS 8mm.-16mm. Movie supplies. Literature. Baerco, Palisades Park, N. J., Box 46.

MOVIE Title sets—500 embossed letters, 14 silhouettes, 10 backgrounds, masks. Price \$1.00. Kramark, Inc., 26 W. 19th St., New York City.

TALKIE 35MM. Films rented, sold, silent films, machines. Simpson, 1275 So. Broadway, Dayton, Ohio.

"THE World's greatest of all Passion Plays." 16mm. and 35mm. 8-reels. Sound with dialogue or silent. Rent or purchase. Superior than Oberammergau stage play. Write Hemenway Film Co., 37 Church Street, Boston, Mass.

FREE Lists. 16mm., 8mm. films, cameras, projectors, accessories. Home Movies, Box 216, Easton, Pennsylvania.

15% TO 25% Discount on still or movie cameras. Free circular. Paramount Co., 327 E. 92nd St., New York City.

BASS Wants to mail you without charge our new 52-page Cine Bargaingram No. 234—sound, silent, 8 mm., 16 mm., 35 mm. equipment, of the quality we can sell on our money back guarantee. Write for this valuable book at once. Full description of the RCA 16 mm. sound on film camera. Newsreel model is only \$250.00, and Bass is exclusive distributor. Dept. A. Bass Camera Company, 179 West Madison Street, Chicago, Illinois.

BARGAINS! 8mm., 16mm., free literature. Elder, B-739 Boylston, Boston, Mass.

RADIOS, SUPPLIES, INSTRUCTION

CODE Course on three self-teaching records. \$5 net. Upon receipt of 5c stamp instruction book will be sent free. Ralston, Poinsettia Co., Pitman, New Jersey.

RADIOS Made to order. Block's, 9 Aleya St., Newark, N. J.

LONG Distance crystal, plans 10c. k't \$1.00. Information free. Calradio, B-94M, Saugus, Calif.

ANY Radio circuit diagram 25c. Order mentioning manufacturer's name, model. Catalog free. Supreme Publications, 3727 West 13th, Chicago.

ONE Tube short wave kit \$1.00 postpaid. Zephyr, 13139 Hamilton, Detroit, Michigan.

PLANS 18 Tested crystals sets, with "Radiobuilder"—25c year. Laboratories, 7700-C East 14th, Oakland, California.

RADIOS (All kinds) \$9.95 up; auto—\$14.95; electric fencer, \$9.95. Save 50%. 30-day's trial. Catalog—free. Marco F. Kansas City, Mo.

RADIO Kits—\$2.70. A practical 1-tube receiver that really works. Two-tube model—\$3.00. Three-tube model—\$3.75. All the parts but headphone, battery and tubes. Eighteen other models up to 14-tube de luxe communications set. Write for free catalog. Dept. PM-5, Meissner Manufacturing Co., Mt. Carmel, Illinois.

RADIO Engineering, broadcasting, aviation and police radio, servicing, marine and Morse telegraphy taught thoroughly. All expenses low. Catalog free. Dodge's Institute, Ames St., Valparaiso, Ind.

SEND For free giant money saving radio and phonograph record catalogue. United Radio Company, 1000-M, Newark, N. J.

MUSIC AND MUSICAL INSTRUMENTS

PLAY Piano by ear! Negro harmony, chimes, pretty chords, novelty effects, galore. Write "Piano Bill," 207-B Ossington, Toronto, Can.

"**SINGING** Made easy and the mastery of the voice" teaches tone placement, perfection, extended range! Immediate results! Popularly priced. Free prospectus! Whitney Vocal Method, 245 Wolfs Lane, Pelham, N. Y.

LEARN How to play piano by note. 12 time proven lessons, 75c postpaid. Weaver Piano Co., Inc., York, Penna.

ORCHESTRATIONS, Pianoscapes, song-writing. McManus Music, Box 95, Syracuse, N. Y.

SONGS Arranged ready for printing \$5.00. Gregory, 1695 Broadway, New York.

SONGS—Arranged, revised by arranger "Linger Longer," "Gypsy Tearoom," others. Send for details. Harold Potter, 1619 Broadway (P), New York.

JAZZ And swing piano, guitar, accordion. Quick mail courses. Information free. State Instrument, Erskine Studio, 810F East 14th St., Oakland, Calif.

SIMPLIFIED Swing courses! Accordion, saxophone, clarinet, trumpet. Write Swingmaster, 1259-N Bender, East Cleveland, Ohio.

SONGWRITERS—Have your songs recorded. Wonderful opportunity. Information free. Lincolnshire Studios, San Francisco.

WANTED—Used phonograph records, classical or popular, Victor records. Will pay cash. Dig up your old records, ship them to us. Your check sent same day. We pay express charges. Modell's Agency Division, Dept. 271, Cortlandt St., New York City.

SONG Poem writers wanted—Our guaranteed plan has aided many songwriters. Burl Bogg's song won a nation wide contest. Other new writers have had their songs broadcast. We may be able to help you. Send poems or write for free booklet today. Indiana Song Bureau, Dept. 53, Salem, Indiana.

SONGS, Poems, bought, composed, published, royalty contract, free information. Metro-Melody Publishers, 532 Geary, San Francisco.

SONGWRITERS—Send poems—Profitable plans mailed free. Variety Service, Salem, Indiana.

LEARN Swing piano! Postal brings free folder. Christensen, 751 Kimball Hall, Chicago.

SONGWRITERS: Send us your poems, wonderful proposition. Keith-Downing Publications, Clearwater, Florida.

ORIGINAL Poems, songs wanted for publication, radio. Westmore Music Corporation, Dept. 33H, Portland, Ore.

MUSIC Composed to words. Rhyming pamphlet on request. Phonograph recording of completed songs. Send poem for consideration. Keenan's Studios, Dept. PM, Box 2140, Bridgeport, Conn.

SONG Poems wanted to be set to music. Free examination. Send poems to McNeil, Bachelor of Music, 4153-PM S. Van Ness, Los Angeles, Calif.

PIANO By ear. Free booklet. Day-V-Way, Woolworth Building, Dearborn, Michigan.

MUSIC Composed to words. Wonderful proposition. Bauer Bros., Oshkosh, Wis.

WRITE Songs. Big money and reputation. Write for information. J. Gordon Pub. Co., 201 N. Hoyne, Ave., Chicago.

WANTED! Lyrics, melodies for songs. We arrange, publish, sell. Superior Song Studios, Passaic, N. J.

SONGWRITERS: Send your poem today for immediate consideration. Richard Brothers, 24 Woods Building, Chicago.

SONG Writers. Send for publishing agreement. McKinley Music Publishers, 1501 E. 55th St., Chicago.

PIANO, Self Instruction. Play within an hour. \$1.00. Popular Mechanics, 200 E. Ontario St., Chicago.

BUSINESS OPPORTUNITIES

NATIONAL Baking Institute announces a new home study course covering all phases of commercial baking. Good field for ambitious men. Nearly a depression proof business. Common school education sufficient. Send for free booklet "Opportunities in the Baking Industry" and requirements. National Baking Institute, 3601 Michigan Avenue, Dept. 343A, Chicago, U.S.A.

POPCORN Machines, carmelcrisp, crispettes, cheese coat, potato chips. Long Eakins, 2035-F High St., Springfield, Ohio.

NEW Big-profit business opportunity! Sensational new discovery actually electroplates—gold, silver, nickel, etc.—with electric brush, easy as painting. Does same beautiful, permanent plating as big tank outfits—easier, quicker, cheaper. Amazingly low priced. Portable—do work anywhere—make big money. Write for big three-way money-making plan and free sample that proves all claims. Warner Nu-Way Electroplater Co., Dept. L-11, 360 N. Michigan, Chicago, Ill.

INVENTORS—Small ideas may have large commercial possibilities. Write us for free book, "Patent Guide for the Inventor" and "Record of Invention" form. Delays are dangerous in patent matters. Free information on how to proceed. Clarence A. O'Brien & Hyman Berman, 58-T Adams Building, Washington, D. C.

WE Help start you in business, furnishing outfits and instruction, operating "Specialty Candy Factory" home. Men and women, opportunity to earn \$20.00 to \$50.00 weekly, all or spare time. (Our 31st year.) Booklet free. W. Hillyer Ragsdale, Inc., Drawer 4, East Orange, N. J.

WHOLESALE Supply Guide—1,000,000 articles. 10c. Labey, Colorado Springs, Colo.

BIG Mail of opportunity offers, ideas, plans. Copy of 68 page magazine, your name on our mailing list for one year. All for 10c. Colonial Mailing Bureau, 269 Center St., Lackawanna, N. Y.

HOW And where to obtain capital fully explained, free particulars. Star Service, Wapakoneta, Ohio.

FORMULAS—Fast selling products. Guaranteed. Laboratory tested. Lowest prices. Catalog free. Kemico, 55K, Park Ridge, Ill.

STEADY Money in showcards, signs, window lettering. Easy. Amazing details free. Write Nelson Company, F-2101 Manhattan Building, Chicago.

START Mailorder business for pleasant profit. Drop postal. Pasaak, Box 21, Station J, New York, N. Y.

PROFITABLE Home business. Legitimate. No canvassing. Descriptive broadside free. A. Riegel, Kintnersville, Penna.

NEW Framed feather pictures! Retail 69c. Sample 20c stamps. Dozen \$1.80 postpaid. Marquez-PBI, Apartado 1176, Mexico City.

M. M. earned \$267, three weeks, raising mushrooms in cellar! Exceptional, but your cellar, shed perhaps suitable. We buy crops. Book free. United, 3848 Lincoln Ave., Dept. 70, Chicago.

EASY Way sign painting. Samples free. Clark, Ellwood City, Penna.

"**RUBBER** Molds." Make them yourself. Formulas, instructions 25c. Ideal Service, 179-R6, Park Ridge, Ill.

MONEY-MAKING Projects. Color-glazed concrete pottery. Gravestones, tiles, walls. Guaranteed basement waterproofing. Operators wanted. Booklet, details 10c. National Potteries, Minneapolis, Minnesota.

GATHER Up antiques from attics and trunks. Profitable business. 132-page catalog where to sell them, 10c. Lightner, 2810 South Michigan, Chicago.

REAL Estate foundation. All wealth. Start own office. Learn how through home study. Write Morrison School Real Estate, 100 North LaSalle, Department 9, Chicago.

YOU'LL Like resilvering mirrors, auto-parts, reflectors, making chipped glass signs. Write. Sprinkle, Plater, 127, Marion, Indiana.

SELL By mail. Big profit. Home business. Particulars free. Tilford, Box 516, Louisville, Ky.

START Home mailorder business with "Coin Coaxers" plan, samples, big magazine dime. Dixie Mailers, King, North Carolina.

MONEY Jobs yours. Man long jobless got 76 openings. Tell others how—get dollars in mail daily. No selling. Opportunity of life time. Casement Cottage Shoppe, Cedarville, Ohio.

UNLIMITED Income. Mailorder selling. Home manufacturing. Tincher, 603 Grandview, Hutchinson, Kansas.

"**RESILVER** Mirrors at home." Big profits. Little outlay. Also emboss, grind—foil, gold leaf, frost, chip and make imitation stained glass. Instruction course 50c. Ideal Service, M-6, Park Ridge, Ill.

COLOR Concrete with chemicals. Stucco-rock. Wishing-wells. Spin concrete pottery. Benches. Miniature castles, mills. Cold glaze, marbling. Sample 10c. Hollywood Cement Craft, 8527 Wonderland, Hollywood, California.

20 PAGE Catalogue, rubber mold making, plaster casting. Particulars 3c stamp. Plastic Arts, 711 Neely, Muncie, Indiana.

CAPITAL—For personal and business needs. Send dime for details. Capital Service, Arlington, Va.

HANDY Men—Earn money home operating Community "Fix-It" Shop. Stafford, Makanda, Illinois.

FORTUNES In formulas. 10,000 money-making ideas—free particulars. Ruther, 2121a E. 68th, Chicago.

GIANT Mail, opportunities, added income ideas. 68 page magazine 10c. Katz, 4254 N. Kimball, Chicago.

"**AUTO-EXERCISER**" Builds health and beauty the fast easy way—reduces—with rays investment considered. Catalogue 25c. Easyway, 3528 Franklin, St. Louis, Mo.

LUCRATIVE Mailorder business. Literature, stamp. Advertisers' Assistants, West Liberty, Kentucky.

MONEY In butterflies, moths. See Sinclair Display Advertisement on page 16A.

"**MONEY** From Waste Materials." A genuine money making folio; 25c. Home Service Bureau, Box 4079, South Edmonton, Canada.

DON'T Be misled by some claim adjusters and lawyers. Collect 100% for injury and damage claims. Complete instructions \$1.00. Burns School, Keystone Building, Pittsburgh, Penna.

RECEIVE Stacks of mail: Your name listed in 10,000 directories 25c. Liberty Sales Service-A, Sheboygan, Wisconsin.

MOLDS, Plastics, bargains. Stamp brings catalog. Colonial Art, Derry, N. H.

CRAFTSMEN Make beautiful artistic roc veneer urns, birdbaths, etc., by new unique system. Ipxensive. Roc Veneer System, Brady, Texas.

START Profitable mail order business. "Mail Order Success," 28 pages, facts, ideas, methods of getting profitable returns on every dollar invested. 25c copy. Plan Bureau, Fillmore, N. Y.

NEW Fascinating business. "Plastique Process" 50 cents copy. Large profits from a small investment. Atwater Studio, 3232 Casitas Ave., Los Angeles.

REGULAR Daily income! Profitable. Direct-mail setup 10c. Distributors, 716 "F," Northeast, Washington, D. C.

FRIED Ice cream, brand new, sweeping the country. Big profits. Complete instructions 50c. Reserve your territory. Kamac, 37 E. First, Dayton, Ohio.

WE Show you how to raise capital for your business. Write Enterprise Bureau, Syracuse, N. Y.

1939 OPPORTUNITIES; Plans; formulas for spare or full time. Literature free. Summit Services, Norwood, Mass.

BELTS, Suspenders, make'm and make money. Big summer sellers. Materials supplied. Sample belt 25c. Artn Leather, 400 Joseph Ave., Rochester, N. Y.

NEW Illustrated catalog, Moldex and models. Send stamp. Pentucket Arts, Haverhill, Mass.

MAKE Artificial marble, glazed tiles, uncanny. Tabletops, plaques, floors, hones, novelties. Hard, fireproof, inexpensive, cement secrets. Brilliant tile and liquid rubber samples 3c. John A. Payn, 945 Grande Vista Avenue, Los Angeles, Calif.

EARN Extra money writing for publication. Simple method. Demand inexhaustible. Details free. Donna Veretts, 17 Grotton, Lowell, Mass.

CALIFORNIA: Information sent about anything in the state, employment, etc., for \$1.00. Satisfaction or money refunded. W. L. Buntz, Box 8, Station M, Los Angeles, Calif.

WONDERFUL Business 25c complete. Satisfaction guaranteed. Normas, 12113 Woodward, Detroit, Mich.

NEW Extraordinary moneymaking opportunities, mail-order and locally. Sells for \$1.00. Costs 10c. \$1.00 sample, details 25c. Unity, 2133 N. 3rd, Milwaukee.

LITTLE As \$15 establishes you in profitable manufacturing business. Particulars free. National Business Bureau, Box 1127, Washington, D. C.

PROVEN Method and necessary information for profitable business 25 cents. Kelly, Box 31, Converse, Texas.

LOOKING For business? 2c daily pays for individual branch office in New York and not just an ordinary room or box number address. Our 100% co-operation assures your success. Co-operative Mail Service, 126 Lexington Avenue, New York.

GIANT Opportunity packet, including 6 different magazines—10c. Pines, P-583 Monroe, Brooklyn, N. Y.

BIG Profits! Make, sell one ingredient products. Formula catalog free. B. Kinford, Wayne, Penna.

CHAIR Cane jobs bring money. Particulars dime. Fogarty, Caner, Troy, N. Y.

SUCCESSFUL Business quickly established, without capital. Assures good lifetime income. Business Service, Olympia Building, New Bedford, Mass.

MONEYMAKING Books, plans, formulas. Literature free. M. Watson Company, Stockyards Station, Kansas City, Mo.

GRIND Lawn mowers! \$2.00 capital! Mower Service, Fourth, Janesville, Wis.

SOMETHING New. Solid perfume does not spill or stain clothes. Sample 25c. Zwickell, General P.O. Box 60, Brooklyn, N. Y.

MILLION Dollar storehouse. Buy wholesale from all over the world. 8 page folder free. Dixon Sales, Box 1403, Youngstown, Ohio.

DON'T Gamble! Save your money. I succeeded. Capital, peddling unnecessary. Particulars, dime. Stamford, 3762-B Broadway, New York.

OPERATE Local business. I show you how. Rogers, Waverly, Virginia.

LIQUID Marble—anyone can make! Colorful, glazed! Moulded, brushed, sprayed. Rubberlastic moulds. Composition flooring. Big money in these! Particulars free. Marbleizing Service, Edwardsville, Ill.

PROFITABLE Home business. Legitimate. No canvassing. Maywood Publishers, P-1107 Broadway, New York.

BIG Money—Making raised wood letter and chromium plated signs. Complete instructions \$1.00. Foreign \$1.15. Photos, information ten cents. Modern Signs, Box 1109, Phoenix, Arizona.

YOUR Own business! Selling by mail. Details free. Maples, 3418 South Marshfield, Chicago, Illinois.

BARGAIN Buyer's Guide to direct supply source. Lowest prices possible. \$1.00 postpaid. Hicks, Box 8, Brooklyn, N. Y.

SUCCEED With your products. Make-sell. Formulas. Accurate analyses. Catalog free. B. Thaxly Company, Washington, D. C.

INVENTORS—We successfully sell inventions, patented and unpatented. Write for proof, and tell us what you have for sale. Chartered Institute of American Inventors, Dept. 4-C, Washington, D. C.

I WANT To send you proof of the wonderful pulling power of Popular Mechanics Magazine's classified pages. What's your proposition? Write me today. F. W. Johnson, Manager Classified Advertising, 200 E. Ontario St., Chicago, Ill.

BIG Money easily made in home or office. Business of your own; booklet describing 107 money making plans free. Chilton, Box 1105, Oakland, Calif.

START Your own business. Make large profits. Sell new and used auction or bankrupt bargains in clothing and general merchandise. Experience unnecessary. Free wholesale catalog. Superior Jobbing, 1250-V Jefferson, Chicago.

ARTIFICIAL Marble sanitary flooring, instruction covering wood or cement flooring 1/2 inch thick, fireproof, all colors, low cost, ornamental casting, concrete, plaster, papier-mache, garden furniture, statuary, flexible molds, particulars free. Chris Mahler, Elmont, N. Y.

DELAWARE Charters: Complete service \$35. Submitted forms. Chas. G. Guyer, Inc., Wilmington, Del.

107 WAYS To make money, in home or office, business of your own. Full particulars free. Elite Co., 214 Grand St., New York.

SELL By mail. Books, novelties. Bargains! Big profits! Particulars free. E. Elfc, 438 N. Wells, Chicago.

ELITE Collection of business plans, contains 107 tested plans and scores of formulas. Start own business; home, office. Particulars free. Elite Co., 214 Grand St., New York.

PLASTEX Industries offers industrious men an opportunity to start a business of their own, manufacturing art goods, novelties, souvenirs, etc., in Plastex and marble imitation. 5c material makes \$1 articles. Rubber moulds furnished for speed production. Small investment brings big returns. You are just in time for big wholesale season now starting. Write for interesting booklet mailed free. Plastex Industries, Dept. A, 1085 Washington Ave., New York.

CHARTERS: Delaware; best, cheapest; free forms. Colonial Charter Co., Wilmington, Del.

WHERE To buy at lowest wholesale prices. Information free. Yorena, Box P-312, Bayonne, N. J.

MAIL Order business is your opportunity. Many began small, now earn thousands yearly. No personal contact. Boundless opportunities. Have had over 30 years experience; will help you succeed. Send 25c for valuable booklets, none free. B. Brenner, 257 S. 21st, Philadelphia.

MAN in each town to plate auto parts, reflectors, bicycles, fixtures, mirrors, by late method. Simple plan of manufacturing at home starts you in good paying business. Free particulars and proofs. Gunmetal Co., Ave. H, Decatur, Ill.

MANUFACTURE From Phospholene. Cleaning fluid 1c gallon; bleach 2c gallon; hand soap 2c pound; and ten fast sellers. Sample 25c. Details free. Western, 6615 Denison Ave., Cleveland, O.

FINANCIAL Independence obtainable by placing coin operated merchandise vending machines, out on percentage basis, no experience required, little capital needed, write for free details. Torr, 2047 1/2 South 68th Street, Philadelphia, Pennsylvania.

1059 WAYS To start a profitable business. Get Popular Mechanics book of modern formulas and methods for practical specialty manufacturing. Price only \$1.25 postpaid. Popular Mechanics Press, Room (C39), 200 E. Ontario St., Chicago.

MONEYMAKING OPPORTUNITIES

NEW Field of opportunities. Transform your discarded articles into profits. Book, "1100 Uses for Waste." 25c postpaid. Hollywood Publications, Box 1750B, Hollywood, California.

BE A professional scrapbooker. Big fees. Unlimited opportunities. Can be done at home. No competition. No capital needed. Write Scrapbookers Guild, 59 Park Place, New York, N. Y.

EARN \$50 A week with your kodak. Booklet describing 100 magazine markets 25c. Gordon's, 2347 Lucerne Ave., Los Angeles, Calif.

BIG Mails of opportunities, samples imprint circulars, mailorder propositions, information budgets, three months 10c. Harvey Teeple, Decatur, Indiana.

"OPPORTUNITIES Galore!" Receive dozens of new propositions, moneymaking offers, also "Opportunity Journal." Monthly, for 12 months. 25c. Raymond Schwarting, South Amana, Iowa.

YOU'LL Like resilvering mirrors, auto-parts, reflectors, making chipped glass signs. Write. Sprinkle, Plater, 287, Marion, Indiana.

3 MONTHLY Mail order magazines, filled with money making opportunities, 10c. George Fenner, 1618 Lucia, Louisville, Ky.

MILLION Articles. Buy wholesale. Valuable directory. Dime. Ideal Service, D-6, Park Ridge, Ill.

FORTUNE In pennies. No selling, operate Silver King vendors, ten machines \$55. Free instructions. Automat, 2427 Fullerton, Chicago.

MONEY Making secrets exposed. Particulars for stamp. Woelfel, 105 South Fairview, Upper Darby, Penna.

300 TESTED Moneymakers. 25c. Z. G. Enterprises, Box 243, Amsterdam, N. Y.

NEWEST Mail selling methods. Particulars. 25c, plan dime. Wamco, 273, Galveston, Tex.

FREE—300 Wonderful business, mail-order and home work moneymaking offers. Lewis Co., 828-C Carpenter, Oak Park, Ill.

DOLLARS With candid camera. New, guaranteed profitable, plan 35c. Taylor, Box 461, Alexandria, La.

KEEP Dollars received supplying by mail satisfying employment information. Millions jobless. We fill your orders. Co-Operative Service, 77 Swan, Buffalo, New York.

MONEY In butterflies, moths. See Sinclair Display Advertisement on page 16A.

EARN Money collecting reptiles, frogs, toads for us. Full or part-time opportunity! Instructions furnished. Particulars dime. Biological Research Laboratories, Dept. M-12, Springfield, Missouri.

SOCIAL Security stamping outfits. I. Dunn, 116 Hale Ave., Brooklyn, N. Y.

SAMPLES—Catalog, photos, directory 25c. P.O. Box 290-P, New Haven, Conn.

MY Questionnaire service helps you obtain all kinds of jobs, home work, agencies. Dime. Bridger, New Windsor, Ill.

"SCHEMER" Magazine, Alliance, Ohio, prints agency, advertising, mailorder and formula schemes; winners; up to \$25,000 reported; 41st year; \$1.00. First year only 50c; sample 10c.

PROFITABLE Home business plans! Rush name. Marvin Studios, 330 South Wells, Chicago.

START Your own business stamping key protectors. Outfits social security plates. Sample with name and address 25c. Catalog free. Kemp, 463-P East 178 St., New York.

QUARTERS! Get a steady stream of quarters in your daily mail. Send 25c for complete instructions. Satisfaction guaranteed. Giff's, A-519 7th, Aberdeen, South Dakota.

DOLLAR Secrets 25c. Circular free. (Dealers 21c profit.) "Unity," 2133 N. 3rd, Milwaukee.

GROW Plants without soil. Folder free. Gordon Laboratories, 509-J Fifth Ave., New York.

PERFECTED Sprayer-type window cleaner! 128 gallons concentrated \$9. Sample 25c, retails \$1.50. Kemiklean, 1906 Rosemont, E. Cleveland, Ohio.

SELFEMPLOYMENT Solved! My plan "clicked." Steady income. Capital, peddling unnecessary. Complete instructions, dime. Stamford, 3762-C Broadway, New York.

EARN Extra dollars spare time, details free. Mutual Service, 124 Highland Ave., Buffalo, N. Y.

WRITE Quick. Wonderful new moneymaking proposition. Jay-Way, Dept. M, 26 Journal Square, Jersey City, N. J.

ENJOY Perfect health become professional equilibrist. 3 cents brings particulars. Knoff, 2154 M North 52nd Street, Milwaukee, Wis.

A LEGITIMATE Plan that brought \$185.00 net profit in 15 days on a capital of \$5.00. Complete plan, 25c coin. Box 107, East San Diego, Calif.

MONTHLY Advisory letter service finds, analyzes, shows latest money-making opportunities; methods. Extensive research. \$1.00 yearly. Box 362, Great Neck, N. Y.

START Profitable mailing business. We trust you. Monthly payments. Particulars 10c, credited first order. Hunt Co., 49 Edgemere, Trenton, N. J.

INVESTIGATE This. Quick flashy demonstrator. Absolutely new. Big profits. Unlimited prospects. Moore, 1851 Jerome Ave., S. W., Grand Rapids, Mich.

SELL Cosmetics by mail. Sample powder, full particulars 10c. Cosmetics, Box 104, Wilkes-Barre, Penna.

MAN In each town to plate auto parts, reflectors, bicycles, fixtures, mirrors, by late method. Simple plan of manufacturing at home starts you in good paying business. Free particulars and proofs. Gunmetal Co., Ave. N. Decatur, Ill.

RAISE Earthworms for profit. Information free, stamp appreciated. Bureau Zoological Research, 106A Broadway, Peoria, Ill.

\$25.00 STAMPING Names per 100 key-checks. Sample 25c. Details furnished. Bohn Company, Box 86P, Wilkes Barre, Penna.

MOULDS. Guaranteed, for casting toy soldiers, Indians, trappers, warships, sinker moulds, 244 kinds. Send 5c for illustrated catalogue. Henry C. Schiercke, 645 Spencer, Ghent, N. Y.

BIG Money easily made; 107 test plans for your choice. Home, office. Descriptive booklet free. Elite Co., 214 Grand St., New York.

YOUR Name—5,000 mailing lists—25c. Get samples, opportunities galore from all over world. Pines, 583-A Monroe, Brooklyn, N. Y.

WHOLESALE Sources. 500,000 articles. Free directory. Maywood, 1107 Broadway, New York.

EARN Money in your spare time taking subscriptions to Popular Mechanics. Unlimited possibilities, every family a prospect. Easy to sell. Bonus paid in addition to liberal commission. Send postcard for further details today. Circulation Dept., Popular Mechanics Magazine, 200 E. Ontario St., Chicago.

FORMULAS, PLANS, ETC.

THAXLY Formulas for perfect products. Accurate analyses. Catalog free. B. Thaxly Company, Washington, D. C.

MAKE And sell reliable products. We do 25 formulas \$1.00. Voelker Sales Trucks, Reed City, Mich.

GUARANTEED Formulas—New fast sellers. None better. Lowest prices. Catalog free. Kemico, 49N, Park Ridge, Ill.

FORMULAS—All kinds. Real money-makers. Lowest prices. Catalog free. Clover Formulary, P-6, Niles Center, Ill.

MONEYMAKERS—Iceless ice. Oil reclaiming process. Rubber mold making. Waterless hand soap. Soilless agriculture. 25c each. Ideal Service, 179F, Park Ridge, Ill.

FORMULA For the soilless chemical garden. Cirs. free. R. Edmondson, 441 E. Main St., Rochester, N. Y.

CLEANING Compound typed formula. Safe. Instantly effective. 25c. Book Supply, Box 29, Wallingford, Connecticut.

REAL Manufacturing formulas. Lists free. Cummings, Chemist, Gordon Avenue, Syracuse, N. Y.

NEW Bubble bath creation formula 50c. Farrand Chemical, Tyrone, Penna.

FORMULAS—5 Money makers. 25c. Price. 427 So. Olive, Los Angeles.

ONE Ingredient formulas! Big profits! Fast, repeat sellers. Catalog free. A. Kinford, Wayne, Penna.

"COMPETE With the world's largest manufacturers." Genuine self-polishing liquid wax for floors and linoleum. Will not water-spot. Formula complete with information, \$25.00. Details free. Stefaniak Research Laboratories, 97 Woodell Ave., Buffalo, N. Y.

DOLLARS For you: Miller's unequalled certified formulas! Produce "Popularity" summer beverages, ices, foods, newest cosmetics, "bubble baths," foot necessities, Witeshu dressings, sensational new washing compound. Stamp brings details. Miller, Manufacturers' Chemist, Jetton, Tampa, Florida.

WATERLESS Soap guaranteed. Clean dirtiest hands in America. Formula \$1. Jerome Jones, Hollins, Alabama.

FORMULAS. Latest money makers. Literature free. Belfort, 4042 N. Keeler, Chicago.

FORMULAS: 15 Proven moneymaking formulas \$1.00. (Not stock-formula catalogue stuff), real unusual offers. List free. Marvel Laboratories, 6629 No. Maplewood, Chicago.

ELITE Formulas and plans; make and sell your own products. Descriptive booklet free. Elite Co., 214 Grand St., New York.

10,000 MONEY-MAKING Formulas. Tells you how to make and sell almost everything under the sun; cosmetics, muclage, anti-freeze solutions, battery solution, beverages, cheese, chewing gum, cleaning preparations, extracts, hair preparations, inks, bluing, leather polish, mirrors, perfumes, polishes, typewriter ribbons, carbon paper, washing powders, liquid soap, and hundreds of other profitable articles. \$4 postpaid. Popular Mechanics Press, Room (C39), 200 E. Ontario St., Chicago.

CHEMISTRY

FIREWORKS! Instructions for making many kinds 10c. Allen's, 10327 Throop Street, Chicago.

FREE: 40 Page catalog of chemical and laboratory supplies for amateur chemists. Wollensak microscopes and supplies, scientific books at big discount. JE-6 Winn, 124 West 23 Street, N. Y. C.

FREE Chemistry catalog. Supplies at 5c! Equip complete laboratory. Send 3c for postage. Kemkit Scientific Corp., 397P Bridge St., Brooklyn, N. Y.

HANDBOOK Of experiments for amateur chemists, illustrated, postpaid 50c. Experiment booklet 15c. Chemistry catalog 5c. Reading Scientific Company, Reading, Penna.

CHEMICALS In 5c quantities. Catalog 5c. Fleischer's Laboratories, Everett, Mass.

CHEMICALS, Laboratory, glassware, apparatus. Send 3c for catalog CPI. Biological Supply Company, 1176 Mt. Hope Avenue, Rochester, N. Y.

HELP WANTED

POSITION Open—Paying salary and expenses based on small sales quota with nationally known manufacturer of standardized maintenance products. We want a salesman qualified to call on industrial plants, institutions, municipalities, school boards, real estate, insurance companies and large property owners. Protected territory. Old accounts given. Rapid advancement assured right man. American Asbestos Products Co., Dept. 76, Cleveland, Ohio.

IF You need money—here's a genuine opportunity to make up to \$45.00 in a week. Operate grocery route business from your own home. I send everything; no money risk. Automobile given as bonus. Details free. Mills, 6040 Monmouth, Cincinnati, Ohio.

M. M. Earned \$267, three weeks, raising mushrooms in cellar! Exceptional, but your cellar, shed perhaps suitable. We buy crops. Book free. United, 3848 Lincoln Ave., Dept. 71, Chicago.

SALARIED Positions—\$2500 yearly and up. Let us find one for you. Write for valuable information. Executive's Promotion Service, (16) Washington, D. C.

STEADY Work—Good pay. Reliable man wanted to call on farmers. No experience or capital required. Pleasant work. Home every night. Make up to \$12 a day. Wonderful new proposition. Particulars free. Write Mcness Co., Dept. 272, Freeport, Illinois.

AGENTS WANTED

GRE-SOLVENT Cleans hands best, quickest. Users don't quit. 150,000,000 cans since 1903. No gold mine but increased weekly income yearly. You build when you sell. Protection. Write fully. Utility Co., 644 W. 44, New York City.

TO Sell household articles with many uses. New and not competitive. Double your money every day. Write for particulars and send twenty-five cents for sample. C. E. Carter Co., Girard, Penna.

DON'T Be a job hunter—Start your own business on our capital. No hard times; no lay-offs; always your own boss. Hundreds average \$3,000 to \$5,000 annual sales year after year. Sales way up this year. We supply stocks, equipment on credit. 200 home necessities. Selling experience unnecessary. Wonderful opportunity to own pleasant, dignified, profitable business backed by world-wide industry. Write Rawleigh's, Dept. F-U-PPM, Freeport, Ill.

SELL Fan razor blades. Sample free. National, 430 Central, Cincinnati.

CLOTHING Salesmen—A pattern for every taste. A price for every pocket book. Cottons, tropicals, woolens. 2 suits \$10 and up. Real Knox, Dept. P, Knoxville, Tenn.

BEAUTIFUL Bird pictures handmade with genuine feathers. Sell on sight! Large profits! Free particulars. Samples 10c stamps. Marquez-PI, Apartado 1176, Mexico City.

JUST Out! Amazing fast selling 25c household necessity. Saves up to hundreds of dollars. Sell 3 to 4 each home. Make up to \$6.00 daily. Free sample. Puro, 3107 Pine, Dept. H-299, St. Louis, Mo.

WEAR Fine hose I send without cost with outfit while taking orders for amazing new hosiery. Replacement guaranteed against holes, snags, and runs. Rush name and hose size. Wilknit, Desk F-37, Greenfield, Ohio.

500% PROFIT With new perfected (1939) quick-action, no flint, automatic gas lighter. Retail 25c. Sample 5c. New Method Co., Box PMG-78, Bradford, Penna.

MYSTERIOUS Disc heats water instantly without coal, gas or oil. Pays up to 233% profit. New principle. No risk sample offer. Write Lux Co., Dept. H-3, Elkhart, Indiana.

IF You want to get groceries and household supplies at wholesale, and a wonderful chance to make up to \$15 in a day besides, send me your name immediately. No experience necessary. New Ford sedans given producers as bonus. Mills, 6046 Monmouth, Cincinnati, Ohio.

SPECIALTY Men. A new winner. "Auto-Snuff-It" sells for 10c. 100% profit. Send dime for sample. General Supply Co., Box 618-PM, Piqua, Ohio.

WANTED—Purchasing agents, no experience or money required, write and mail 3c stamps for application to Purchasing Mgr., 176 N. Halsted St., Chicago.

BUSINESS Proposition resilvering mirrors, autoparts, reflectors, making chipped glass signs. Write, Sprinkle, Plater, 128, Marion, Indiana.

AT Home, your own manufacturing business, making popular \$1 novelties. Cost you 3c to 15c. Everything supplied. Write So-Lo Works, Dept. U-842, Cincinnati, Ohio.

BARGAINS—100 Blades 25c; electric razor 75c; candid type camera 90c; soap, gross cakes \$1.44; blankets each \$1.20. Free catalog. World's lowest priced wholesalers. Mills Sales, 901 Broadway, New York.

AGENTS, Merchants specialty sample. Dime. Refunded. Lamont Company, Beacon, New York.

GIANT Aluminum commercial orange squeezers. Hand operated. Retail \$18.50. Wholesale \$10 to \$6.50. Also cotton candy machines. Concession Specialties, 310-A East 35th, New York.

SELL Hand-colored 8x10 photographic enlargements in deluxe leatherette frame. Sells for \$1.48, commission 73c. Write for particulars. Photo Art Company, Box 412-F, Grand Central Annex, New York.

LOCAL Agents wanted to wear and demonstrate suits to friends. No canvassers. Up to \$12 in a day easy. Experience unnecessary. Valuable demonstrating equipment, actual samples free. H. J. Graves, 1300 Harrison, Dept. T-817, Chicago.

ENGRAVED Nameplates, signs, initial plates. Enamel finish, five colors, big profit. Hilton Specialty, 29 Portland, Providence, R. I.

MAGIC Roach box. Attractive sales article. Sample 10c. Nock, 1712 Valmont, New Orleans, La.

LAWN Mowers, electric-gasoline. Absolutely different. Cuts anything. Want exclusive representatives. Manhart-Rotary Mower Company, Brandeis Theatre Building, Omaha, Nebraska.

MONOGRAMMING Automobiles real moneymaker. Write for samples. International Co., Box 9360, Philadelphia, Pa.

MONEY In butterflies, moths. See Sinclair Display Advertisement on page 16A.

MILLIONS Of prospects! Buyers everywhere! Sensational social security plates with name gold-stamped on leatherette case! Fast seller! Big profits! Complete selling outfit free! Union Specialty, 1777-C Broadway, New York.

AGENTS—Speedy seller. Big profits, repeats. Samples, details free. Universal, Orange, Massachusetts.

PUT Your spare time into profit. Laboratory, 1504 Broadway, Detroit, Mich.

AGENTS. New 25c household necessity; going big. No competition. "Hang It" Company, 2612 Alcatraz, Berkeley, Calif.

500% PROFIT. Gold and silver colored sign letters. Offices, stores. Large sizes, 1c. Free samples. Modernistic, B-3000 Lincoln Ave., Chicago.

150% PROFIT Selling Famous Star Foot Remedy. Sample, details 25c. Famous Star, 911-B Bell, Sheboygan, Wisconsin.

SELL Social security plates. Over 40 million buyers. 500% profit. Full or part time. New plan. Employ others. No money needed. Don't wait. Act now. Free outfit. Federal Name Plate Co., 287 Broadway, New York City, Dept. PM-6.

EX-O-LENE For miles and power. Millions waiting. Protected territory. Big profits. Whirlwind seller. Wake up and live! Thermo Exolene Works, Peoria, Ill.

WILL Consign wholesale stock modern streamline brooms to hustlers. Sell stores. Must supply surety. Acme Brooms, Sedalia, Mo.

HAVE Fun with Mexican jumping beans. 15 for 25c. Agents wanted. J. J. Frank, 525 Palm, Rockford, Ill.

BIG Profits! Make-sell one ingredient products. Formula catalog free. C. Kinford, Wayne, Penna.

STARTLING New products; whirlwind sellers; tremendous field; immense profits; sample free. Ford Products, 7143 South Claremont, Chicago.

BIG Money taking orders; shirts, ties, hosiery, underwear, pants, uniforms, dresses, etc. Sales equipment free! Experience unnecessary. Write Nimrod, 4922-AN Lincoln, Chicago.

AMERICA'S Biggest brush bargains. Bigger and better than ever. Catalogue. Frank-Lin Brushes, Bridgeport, Conn.

BUYERS Wanted, either sex, real opportunity. Write Cody Antiques, Box 1171, Cleveland, Ohio.

GRAB This new amazing product. Seals punctures automatically. Run ice-picks into tires without losing air. Auto owners amazed. Whirlwind seller. Tremendous profits. Write immediately. Air-Seal Distributors, Inc., 8053 Beverly Blvd., Los Angeles, Calif.

REBUILT Vacuum cleaners. General Elec., Hoover, Eureka, Electrolux and other makes. look and work like new. Low prices, large profits. Economical Distributors, Box 224, Albany, N. Y.

AGENTS Make big profits on food products, bargain deals. Low wholesale prices. Rush name for trial outfit offer. Ho-Ro-Co, 2810-S Dodier, St. Louis, Mo.

LARGE Profits selling Magic Fluid. Repairs instantly any fabric or rubber, heat and laundry proof. Eureka, 1911 S. Wabash, Chicago.

QUICK Easy selling products. Large profits. Big demand. E. Corcoran, Box 2558, St. John's Station, Portland, Ore.

WORLD'S Biggest seller. Write for particulars. Girard Company, Washingtonville, Ohio.

AGENTS—To mail our literature. Good profits. Home business. Maywood, 1105-1107 Broadway, New York.

90c COMM. On \$1 repeat sale. Become mfg's. exclusive distributor for new general cleaning method. Homes and businesses buy on sight. Kleenmaster Corp., 220 Odd Fellows Bldg., South Bend, Ind.

SUCCEED With your products. Make-sell. Formulas. Accurate analyses. Catalog free. B. Thaxly Company, Washington, D. C.

SELL Lucky Brown Hair Dressing to colored folks. \$5 day possible. Famous Co., 2243-YJ Indiana Avenue, Chicago, Illinois.

ATLAS Window sign letters. Large sizes—penny each. Get beautiful samples. Atlas, 7941 Halsted, Chicago.

ENGRAVED Name plates, numbers, signs, etc., easily sold, profits large. Brett Bros., Winthrop, Mass.

300% PROFIT Selling gold leaf letters for store windows; high grade letters 1 1/2c each. Free samples. Metallic Co., 438-B North Clark, Chicago.

500% PROFIT! Gold and colored sign letters for windows, offices, trucks, signs. Auto monograms. Easily applied by agent or customer. Neonite, Akron, Ohio.

SELL Social security plates. Sample 10c. Particulars free. Reliable Sales Co., 6 West 28th Street, New York City.

BIG Money applying initials on automobiles. Easiest thing today. Free samples. Also, sideline salesmen for short order decalcomania name plates. "Ralco," 1305 Washington, Boston, Mass.

AGENTS: Smash go prices! Santos coffee 12c lb. 4-oz. vanilla 8 1/2c. Razor blades 10 for 8 1/2c. 100 sticks chewing gum 12c. 150 other bargains. Premiums. Experience unnecessary. Carnation Company, P.O., St. Louis, Mo.

AGENTS—Opportunity make money; book containing 107 successful business plans; home-office; send for free introductory booklet. Elite Co., 214 Grand St., New York.

STARTLING Invention—Pocket adding machine. Nationally advertised \$2.50. Whirlwind seller. Big profits. Baby Calculator Co., Box 1118, Chicago.

REVOLUTIONARY Window cleaning tool. Good Housekeeping approval. Only ten \$2.25 sales daily to housewives, factories, schools, stores will make you \$350.00 monthly. Carter Products Corp., 900 Front Ave., Cleveland, Ohio.

BIG Money applying initials on automobiles. Write for particulars and free samples. American Letter Company, Dept. 40, Dunellen, New Jersey.

FREE Sample—Amazing cleaner; sells homes, taverns, everywhere. Big profit—fast repeater. Betco, 5007 Irving Park, Chicago.

MANUFACTURE Specialties, hire agents yourself. Big money. Free literature. Gilbert Supply, 1107-P Broadway, New York.

AGENTS: Stamping names on pocket-key protectors. Sample check with your name, address, 25c. Stamping outfits. Emblem checks, check-fobs, name plates. Hart Mfg. Co., 303 Degraw St., Brooklyn, N. Y.

DO You want agents for your proposition? Your ad in this space will place your message before hundreds of men seeking fast-selling products. My folder "How to Secure Agents," is filled with proof. I'll gladly send you a copy free. F. W. Johnson, Manager Classified Advertising, Popular Mechanics Magazine, 200 E. Ontario St., Chicago.

HIGH-GRADE SALESMEN

BIG Cash profits—tremendous demand. Millions business men, offices, restaurants, factories, live Flash-A-Call prospects. "Loud speaker 2 way—10 station intercommunicator." Saves money, miles of walking, valuable time. No service or installation problems. Operates like radios—one electric socket connection. New low price \$17.50 opens unlimited sales possibilities. Free demonstrator offer. Write quick! Inter-communication System of America, Dept. 301, 2440 Lincoln Ave., Chicago.

ADVERTISING Book matches—Sell union label book matches. Fastest selling line in America. Large sales producing kit, sample matches, complete cut catalog, eight color combinations make selling easy. Commission in advance. Superior Match Co., 7530 Greenwood, Dept. M-6, Chicago.

SALESMEN Sell direct to stores guaranteed 10c ant killer. Striking counter display. Advertised. Write Exitto Chemical Company, Eau Claire, Wisconsin.

SALESMEN, Distributors—Established company. New automotive system all car and fleet owners vitally need. Sells for \$2.95. Lloyds of London insurance up to \$5,000. Makes quick convincing demonstration. Large repeat business. New proven merchandising plan to dealers carries 100% insurance protection for you. Profits up to \$600 per month. Exclusive territories. Guaranteed sales or money back under Plan A. Write today for details of full-size test sample and all facts. No obligation. Craver-Jay Corporation, Dept. 112, Kansas City, Missouri.

BIG Commissions—selling to stores celluloid pricing tickets, metal shelf moulding. To restaurants, menu covers, signs. P. Pricing Press, 124 White St., New York.

MEN Sell new electric arc welder. Works off 110 volt light socket. Welds cylinder blocks, fenders, frames and industrial repairs. Sells on 5 minute demonstration to mechanics, repairmen, farms, shops and factories. Retail \$19.75 complete. Write for free information. Dynamic Welder, 2226-HB Silverton Rd., Chicago, Ill.

START Exterminating business from home, enjoy ever-increasing income. We furnish everything. By-Products, 1758-G Lunt, Chicago.

DID You make \$50 last week? Does your job offer you real future? If not, why not start a wholesale business of your own? Start with little as \$2.50. Handle line 200 nationally advertised 5c-10c products. Show merchants new plan for increasing sales and profits. Handle everything from your home at start. Chance to operate one of our Silver Fleet service trucks. Facts free. World's Products Co., Dept. 10-F, Spencer, Ind.

SELL Business cards \$1.50 thousand. Business stationery, book matches, advertising gummed tape, paper towels, advertising pencils, salesbooks, rubber stamps, pricing sets, adv. specialties. 35% commission daily. Money making specials. Free sales portfolio. Willens, 2130 Gladys, Dept. GU, Chicago.

REPUTABLE Distributors are interested in Shu-Sweet, it eliminates and prevents the odor of bromidrosis in shoes. Write for proposition. Shu-Sweet, Santa Fe, New Mexico.

SELL America's largest line business necessities. Book matches, gummed labels, political items, restaurant supplies, salesbooks, embossed stationery, shipping supplies, office supplies, advertising specialties, business stimulators, business stationery and forms. Hundreds fast sellers. New low prices. Commissions advanced daily. Experience unnecessary. Complete outfit free. Northwestern, AV-625, Jackson, Chicago.

PRINTING At cut prices—1,000 baseball folder cards, \$2.00; 1,000 de luxe tear-off cards, \$2.75; (process embossed—free case) 25 printed sales books, \$1.50; 1,000 envelopes, statements, etc., \$1.50; 2,500 printed handbills, \$1.75; 500 book matches, \$1.50. One-third comm. Free outfit. Bargain Prtg. Co., 189-F West Madison, Chicago.

ADVERTISING Printed specialties—Cutouts, puzzles, tricks. Low prices, big commission. O'Keefe Specialty, 5987 Theodosia, St. Louis, Mo.

ADVERTISING Book matches. Big seller now! Daily cash commissions. Experience unnecessary. Factory direct—Peak quality at low prices. Quick repeats. Full, spare time. Complete outfit free. American Match & Printing Co., 4822 South Trumbull, Dept. 66, Chicago.

2000 BUSINESS Cards \$1.50. Letterheads, statements, business forms, 33-1/3% commission, catalogues furnished. Florence Press, 270 Lafayette Street, New York.

AMAZING New "Life Saver" and ornamental automatic device snuffs out fires like magic. Sells on sight to factories, institutions, shops, homes, garages, farms, auto owners. Retail \$1.65. Write for big money making offer. Free demonstrator to workers. "Life Saver," 2227-AP Calumet, Chicago, Ill.

MAGIC Hygroscope indicates room humidity. Sells to advertisers. Dime brings samples, proposition. Bach Company, 4709 Avalon, Los Angeles.

TIRE Accessories. Guaranteed 10,000 mile Tiger Grip Tire Patch, and complete fast-selling line tire accessories. Salesmen-distributors easily make up to \$75 weekly, and over. Protected territory. Economy Rubber Products Co., 684 Burkhardt, Dayton, Ohio.

JUST Out! Automatic burglar alarm. No wiring. Prospects unlimited. Generous commissions. Firex Corporation, 512 South Broadway, St. Louis, Mo.

OPENINGS! Call on all dealers with new trade-stimulator plans. It's "hot." \$3 commission on each \$5 sale. Big repeat commissions. No investment. Sales kit free. Regal, 6227 Broadway, Dept. C56, Chicago.

GASERVICE Signals automatically announce arrival customers at service stations, garages. Need experienced men now selling this trade. Ready market. Large profits. Universal Distributing Company, 219 S. W. Ankeny Street, Portland, Oregon.

SALESMEN, Making \$20 to \$50 daily demonstrating new Airo Plane type fans to stores, restaurants, taverns, etc. Also drive way signals to gasoline stations. Write, Universal Fan Co., Peru, Indiana.

MAKE More money with Red Comet Automatic Fire Extinguishers. Low price. Proved seven years. Splendid sales outfit free. Some good territory open. Exclusive. Write quick. 704 Red Comet Building, Littleton, Colorado.

BLADES. Finest quality. Factory prices, postpaid. Ace Blades, Buffalo, N. Y.

SALESMEN—Distributors 200 items, brushes, mops. Marvelous magnetic brush, excels vacuum cleaner. Big profits. Neway Brush Co., Hartford, Conn.

SPARKLING Glo-Brite signs sell fast to stores, restaurants, taverns. Lasting gold finish. Religious mottoes. J. A. Baxter, Cambridge, Ohio.

NEW Specialty—Sells every business and professional man. Four \$15 sales daily pay \$280 weekly. Farrell cleared over \$1,000.00 monthly. Write, F. E. Armstrong, President, Dept. PM, Mobile, Ala.

EXCELLENT Opportunity selling our complete line of brushes, largest commissions. Write for sales plan. Wire Grip Sanitary Brush Company, 2300 5th Ave., New York.

EDUCATIONAL AND INSTRUCTION

WATCH Repairing is steady profitable work. Experts always in demand. You can learn watchmaking trade at home, spare time. New original instruction system. Script engraving course included. Write for free details today! Nelson Co., F-2001 Manhattan Building, Chicago.

FOR An extremely profitable lifetime business, operate a collection-credit agency. Free folder. Cole Associates, Syracuse, N. Y.

PUBLIC Speaking simplified, 10c. Instructor, P.O. Box 4, Island Park, N. Y.

SCIENTIFIC Criminal investigation; fingerprints; ballistics; forgery; legal medicine, chemistry; etc. Free book catalog! Kessler Book Co., 708-C Hillstreet Bldg., Los Angeles.

LEARN Radio announcing! Big opportunities. Good pay. Auditionlet 25c. KFRO, Longview, Texas.

LEARN Electric arc welding—the profession with a big-money future. Factory training. Continental Welding & Engineering Co., 619 North Second St., Milwaukee, Wis.

LOCKSMITHING Instructions. Lock-picking, key-fitting, etc., \$1.00 prepaid. Locksmith, Canadian, Texas.

HOW To read blueprints, first edition, clear, concise, complete, \$1.00 postpaid. Shervin Publications, Box 116, Breathesville, Maryland.

EARN More. Adjust automobile injury, fire, burglary claims. Inexpensive home study course. Free particulars. Burns School, Keystone Building, Pittsburgh, Penna.

TEACHERS—Shorthand \$1.00. New 24x36 chart free. Simmons, Rocky Hill, Conn.

FREE Information. All civil service examinations. Write today. Pergande, Publishers, Milwaukee, Wis.

GET A drafting job. Big pay. Rapid promotion. Graduate engineer helps qualify you. Particulars free. Write today. Monroe Institute, C-711, Alton, Illinois.

QUALIFY Now for U. S. government jobs. \$105-\$175 month. Prepare for next examinations. List positions free. Write today. Franklin Institute, Dept. L3, Rochester, N. Y.

SLIDE Rule simplified, hundred illustrations, hundred pages, by Richardson. Dollar including dummy rule, 4212 24 Place, Chicago.

LEARN Big pay trade. Decorating, paperhanging, graining, marbling, sign painting, pictorial painting. Catalog free. Residential or home study. Chicago Painting School, 437 North Clark Street, Chicago.

GOVERNMENT Jobs available. Opportunities best now. Write Rand Service, 210A Colorado Bldg., Washington, D. C.

MASSAGE, Hydrotherapy, dietetics, drugless therapeutics, chiropody, taught by mail. Evans Correspondence School, Montgomery, Ala.

LEARN To be a master mechanical optician. Master mechanical opticians earn \$25 to \$50 per week. Select a field that is not overcrowded. Big demand for skilled mechanics. Write for particulars. American Institute of Mechanical Optics, Box 427, Mount Vernon, Illinois.

LEARN Auto mechanics, body, repairing, welding electricity, refrigeration. Diesel, Stevinson's, 2008A Main, Kansas City, Mo.

TELEGRAPHY Taught thoroughly. Railroad retirement act creating opportunities for new operators. Expenses low. Catalog free. Dodge's Institute, Hiatt Ave., Valparaiso, Ind.

GOV'T Jobs start \$1260-\$2100 year. Men-women age 18-50. Former examiner's tested method helps qualify you. Particulars, list jobs free. Write today. Patterson School, 8C Mercantile Bldg., Rochester, N. Y.

SECRET Investigation. Experience unnecessary. Detective particulars free. George Wagner, M-2640 Broadway, N. Y.

LEARN Air conditioning—America's next big industry. Thousands of opportunities. Get your start with complete book by E. W. Riesbeck, \$3.50 postpaid. Popular Mechanics Press, Room (C39), 200 E. Ontario St., Chicago.

PLAYS, STORIES, MANUSCRIPTS

AUTHOR'S Manuscripts thoroughly criticized, complete marketing guidance. New York Publishing Service, 246 Fifth Avenue, New York.

SONGS Wanted—Completed manuscripts considered for publication. Poems if found suitable. Legitimate talent encouragement. Cinemat Music Publishing Company, Hollywood, California.

WE Buy leaflets that you write. Instructions \$2.50. Box 493, Toronto, Canada.

BEGINNERS! Make \$35.00 up weekly writing. Details stamp. Fame, Lathrop, Calif.

ORIGINAL Poems, songs wanted for publication, radio. Westmore Music Corporation, Dept. 33G, Portland, Ore.

CARTOONING, COMMERCIAL ART, SHOWCARD WRITING, SIGN PAINTING

LOOK! Something new! Great laugh producing caricatures drawn from photograph of yourself or friend only 50c each (3 for \$1.00). Send order today, inclosing photograph plus 2 hobbies. Salber Studio, 415 Des Moines St., Des Moines, Iowa.

ARTWORK, Lettering, layouts. Expert; inexpensive. Arthur Bishop, 2423 18th N. W., Washington, D. C.

HAVE Your own money making business. Learn show card writing, sign painting. Write for details. Begley Specialty, 1472C Broadway, New York.

ANIMATED Cartooning. Write for free catalog. Perlman Studio, 516 Fifth Ave., New York City.

GET Your free copy 100 page illustrated art material catalog. Bart Supplies, 915 Marquette, Minneapolis, Minn.

FREE Details! Learn original cartooning! Raye Burns School, Dept. M-C, Box 2194, Cleveland, Ohio.

BE A lettering artist! Send \$1.00 for streamlined course in advertising lettering. Complete instructions for home study. Guild School of Lettering and Advertising Design, 324 Summit Avenue, Hackensack, N. J.

AMATEUR Cartoonists wishing steady income copying and duplicating cartoons for advertisers, write Ad-Service, Argyle, Wisconsin.

CHALK Talks. Laugh producing program. \$1.00. Catalog 10c. Balda, the Cartoonist, Oshkosh, Wisconsin.

PEN and ink illustrations for catalogue and general printing purposes at right prices. High grade work. Heraldic Studios, 1914 Oakdale Avenue, Chicago.

MAKE Art Pay. Advanced art students. \$1.00. Popular Mechanics, 200 E. Ontario St., Chicago.

ADVERTISING AGENCIES, LETTER WRITERS, FOR ADVERTISERS

LEARN Advertising quickly at home. Easy practical plan. No text books. Common school education sufficient. Interesting booklet and requirements free. Page-Davis School of Advertising, 3601 Michigan Avenue, Dept. 3431, Chicago.

INCH Display advertisement 30 magazines, year \$24. Wood's Popular Service, Atlantic City, (N. J.)

SELL Your product through agents, mail order. Advertise newspapers, magazines. Publishers' rates. Snappy layout your inch advertisement \$1. Martin Advertising Agency, 171M Madison Avenue, New York.

SELL By mail? Want agents? Our "guide-book" packed with helpful advice, rates, publications, sent for stamp. Chicago Advertising Agency, 20PK West Jackson, Chicago.

DIRECT-MAIL Advertising services. Sales letters that sell. Mailing lists. Omaha List & Letter Co., Box 2172, South Omaha, Nebr.

ADVERTISING Placed all magazines, newspapers, radio. Lowest rates. Free service. 54 page rate book free. Baker Advertising Agency, A-189 West Madison, Chicago. Successors to Ankrum. Established 28 years.

FREE—New Advertisers Rate Guide, 44 pages. Includes everything. Lowest rates. E. H. Brown Advertising Agency, 140 S. Dearborn, Chicago.

ADVERTISE: 24 Words in 250 newspapers \$10. Lists free. Advertising Bureau, 4515-C Cottage Grove, Chicago.

BUSINESS SERVICE

CHICAGO Mail address \$1 monthly. Your personal, business mail forwarded daily. Established 1919. General, 56 West Washington.

GENERAL Merchandise imported, exported. What have you? Roth, 915 Broadway, New York.

CHICAGO Mail address-phone service. Daily forwarding. Also secretarial service. Hancock Company, 43 East Ohio.

RUBBER STAMPS AND OFFICE SUPPLIES

OFFICE And school supply catalog free. Ribbon Ink Co., Cicero, Ill.

ORIGINAL, Cushion mounted. One, two lines 25c; three 35c; four 45c. Facsimile signature \$1.50. Stamp Works, 814 Bradley, Peoria, Illinois.

2 LINES 25c. 3—35c, cushioned. Stamp Works, Centerton, N. Y.

2 LINES 25c, 3 Lines 35c. Stamp Works, Auburn, Nebr.

TYPEWRITERS, DUPLICATORS, OFFICE DEVICES

DUPLICATORS, Stencils, inks, ribbons. List free. Wholesalers, 4854 Reading, Cincinnati.

TYPELESS Printer prints from post card size to 8½x14 inch sheet—low price, free details. Professional Products, Dept. 610, Silverton, Ohio.

INCREASE Business now. "Excelligraph" Rotary Stencil Printer reprints thousands everything you typewrite, hand-write, draw or trace. Colors, \$19.75 to \$44. Terms. Illustrated literature free to business or professional men. Pittsburgh Typewriter Supply, Department K-2, Pittsburgh, Penna.

NEW \$3.75 Automatic adding machine. Fully guaranteed. Bassett, Box 302-K, Altadena, California.

TYPEWRITERS, Adder, mimeograph, multigraph, addressograph. Send for free lists of machines that will help you at half price. Pruitt, 28 Pruitt Bldg., Chicago.

A. B. C. Shorthand System. \$1.00. Popular Mechanics, 200 E. Ontario St., Chicago.

PRINTING, MULTIGRAPHING, MIMEOGRAPHING, GUMMED LABELS

250 BOND Letterheads 8½x11 and 250 envelopes. \$1.75 postpaid. Martin, 60-71 Palmetto Street, Ridgewood, N. Y.

3"x6" CIRCULARS, 1000-\$1.00, 3000-\$2.00 postpaid. Cettel, 348 West 47th, New York.

200 8½x11 BOND Letterheads, 200 6¼ envelopes \$1.00 postpaid. Franklin Printery, 2932 Pershing, Chicago.

CUTS 2x3" From drawings and photos \$1.00. Joe Rek, 118 Gazette Ave., Lexington, Kentucky.

500 LETTERHEADS, 6¼ Envelopes, 6x9 circulars \$1.50; 1000-\$2.50. Prompt. Buechler's, Belleville, Ill.

100 GLASSINE Envelopes, 2½"x4¼", 15c. Limit 100. Macek, Madison, Illinois.

4x5½ LABELS \$3.25 Thousand, 1x2½ 75c. K. E. Shearrow, Kalamazoo, Mich.

PRINTED, Mailed, 1000 200 word blank back circulars \$5.00. Clark and Sons, 330 Simcoe, South Oshawa, Canada.

125 8½x11 20 LB. Bond letterheads and 125 envelopes—both printed \$1.00 postpaid. Benneville, 907 West Roosevelt, Philadelphia.

1000 BUSINESS Cards \$1.00 post paid. Superba Print, 912 Towne, Los Angeles, Calif.

EXCELLENT Printing. Lowest prices. Free cut service. Okayprint, Martins Ferry, Ohio. Samples.

ENVELOPES 6 $\frac{3}{4}$ White, 1000, \$1.60; 5,000, \$6.00. Printers, 515 - 6th Ave., Brooklyn, N. Y.

1000 BUSINESS Cards \$1.00. Vellum, free cuts. Dixie Business Card Co., E189 Jefferson, Memphis, Tenn.

MIMEOGRAPHING—Letters, lists, etc., is our business. Write for samples. Buchinger, Saranac Lake, N. Y.

SAMPLES Letterheads, billheads, envelopes, wedding invitations. Brown Press, Coleman, Georgia.

500 FRANCONIA Letterheads and 500 envelopes to match \$3.00. Richard's Print Shop, 271 S. Grand St., Orange, Calif.

CUTS 2" x 3" From drawings and photos. Joe Rek, 118 Gazette Ave., Lexington, Ky.

COMPLETE Service. Request prices. Fay, 8 Ardsley Court, Newark, N. J.

PRINTING? Quality, lowest prices. Churchill, 4316 South Salina, Syracuse, N. Y.

1939 PRICELIST. Portfolio of samples free. McCall Press, 1326 South 27th, Omaha, Nebr.

LETTERS, Pricelists, exactly like type-written, 500 8 $\frac{1}{2}$ x11—\$3.90; 1000, \$5.90 postpaid. Multigraphers, 211a Capitol, Jefferson City, Missouri.

6x9 CIRCULARS. Letterheads, envelopes, postcards, \$2.95; 5,000, \$9.45; 5,000 adv. slips, \$3.50. Samples. Goodprint, Harrisonburg, Va.

BETTER Printing. Reasonable prices. Lists free. Underhill Press, Beebe, Ark.

1000 STATEMENTS \$1.95. Business cards \$1.00. Wilson Printing, Box 858, Anderson, Indiana.

BOND Letterheads, envelopes: 500—80c. Barjen Co., 22b Fox, Worcester, Mass.

HARVEY Labels—Better values. Free samples. 6618K Quimby, Cleveland, Ohio.

1000 LETTERHEADS, Envelopes \$2.50. Otis Press, 1271 East 14th, Cleveland, Ohio.

2000 BUSINESS Cards \$1.50. C. Zwickel, General P.O. Box 60, Brooklyn, N. Y.

\$1.75—1000 BOND Envelopes, 5 $\frac{1}{2}$ x8 $\frac{1}{2}$ letterheads, 8 $\frac{1}{2}$ x11 \$2.75. Circulars cheap. Wolverine, Saugatuck, Mich.

PRINTING Cuts made; finest quality; zinc (line) \$1.25, (10 square inches); halftones; electros; mats; artist; free price list. Riteway, 1465 PP Broadway, New York.

1000 BUSINESS Cards \$1.00; 125 Letterheads, 125 envelopes \$1.00, postpaid. Sechrist Printing Co., South Bend, Ind.

QUALITY Printing, lowest prices. Samples. Tucker, P.O. Box 65, Indianapolis.

MODERN Two color letterheads. Reasonable. Fechner, 202 Ashland, River Forest, Ill.

125 LETTERHEADS, 8 $\frac{1}{2}$ x11, and 125 envelopes, 6 $\frac{3}{4}$, printed, \$1.00, postpaid. Circulars, folders, booklets. Samples free. Pine Hill Printery, Freeman, South Dakota.

HAMMERMILL Letterheads, 300 8 $\frac{1}{2}$ x11, any color paper and ink, \$1.48 postpaid. Free particulars. Woodruff's, 217A Lewis, Duluth, Minnesota.

500 3 $\frac{1}{4}$ x2 $\frac{1}{4}$ FOUR Line gummed stickers, 25c. Moritz Printery, Saginaw, Mich.

PRINTING OUTFITS AND SUPPLIES

PRINT Your own cards, stationery, circulars, advertising. Save money. Easy rules furnished. Print for others, big profits. Junior outfits \$9.00, senior outfits \$17.00 up. Details free. Kelsey Presses, D-11, Meriden, Conn.

BORDER And ornament font 50c. Catalog 10c. Daemicke, 6452 Kenwood, Chicago.

PRESSES \$5.00. Border, type fonts 40c. Business cards 29c 1000. Bond letterheads 75c 1000. Wedding cabinets 45c. Power, hand presses cheap. Send stamp bargain catalog. Bradshaw, 3214-P Huron, Chicago.

INGENIOUS Rotary press. Furnished complete with sliding rubber type and equipment—at \$2.50. Prints pictures and several sizes of type. Free circular. Superior Type, 3942 Ravenswood, Chicago.

MAKE Prints-as-it-copies-device for 15c. Instructions, 25c. Astra, Box 50, Rugby Sta., Brooklyn, N. Y.

MAKE Photo-engraving outfit yourself! Particulars free. Nu-Ideas, Carrollton, Illinois.

BARGAINS — Presses, type, supplies. Send stamp. 159 Harvard, Cambridge, Mass.

LONG Established printers warehouse. Big lists 3c. Landis, Richland, Penna.

HAND Presses, type and complete printers' supplies. Send stamp for catalog and new price list. P. Peiffer & Co., Newark, N. J.

BARGAINS, Presses, type, List 3c. Exchange, E-15, 110 Dexter, Meriden, Conn.

PATENT ATTORNEYS

INVENTORS—Small ideas may have large commercial possibilities. Write us for free book, "Patent Guide for the Inventor" and "Record of Invention" form. Delays are dangerous in patent matters. Free information on how to proceed. Clarence A. O'Brien & Hyman Berman, 58-T Adams Building, Washington, D. C.

INVENTORS: Send immediately for your copies of our new free books, "Patent Protection" and "Suggestions on Selling an Invention." Sixty-eight pages of interesting facts. They tell how Patent Laws protect you; kind of sketch or model needed; simple steps to take without cost; how successful inventors have secured financial assistance; show interesting inventions; illustrate important mechanical movements. With books we also send free Evidence of Invention form to help establish date of disclosure. Prompt service, reasonable fees, special deferred payment plan. Strictest secrecy. Forty-one years' experience. Highest references. Write us today. The facts in our books are worth money to the man with a good invention. Address: Victor J. Evans & Co., Registered Patent Attorneys, 113-G Victor Building, Washington, D. C.

PATENTS. Complete soliciting service. Ervin Johnson, 1440 Broadway, Oakland, California.

PATENTS—Trade marks. Preliminary advice, book and disclosure form free. Personal service. Irving L. McCathran, 1060 International Bldg., Washington, D. C. Registered Patent Attorney.

PATENTS. Protect your idea by securing free "Proof of Invention" folder. Exceptional personal service. Established 1906. E. E. Vrooman, 871 Woodard Bldg., Washington, D. C.

INVENTORS—Before disclosing your invention to anyone send for form "Evidence of Conception"; "Schedule of Government and Attorneys' Fees" and instructions. Sent free. Lancaster, Allwine & Rommel, 411 Bowen Building, Washington, D. C.

"INVENTOR'S Guide," 100 mechanical movements, free; advises on patenting, selling inventions. Frank Ledermann, Tribune Bldg., New York.

L. F. RANDOLPH, 302-B Victor Bldg., Washington, D. C. Low cost. Book and information free.

PATENTS. Booklet free. Highest references. Best results. Promptness assured. Watson E. Coleman, Patent Lawyer, 724 Ninth St., Washington, D. C.

INVENTORS—Send for free booklet "Patent-Sense." Information based on 64 years experience. Lacey & Lacey, Dept. 5A, 635 F St., Washington, D. C.

FOR INVENTORS

INVENTORS—Small ideas may have large commercial possibilities. Write us for free book, "Patent Guide for the Inventor" and "Record of Invention" form. Delays are dangerous in patent matters. Free information on how to proceed. Clarence A. O'Brien & Hyman Berman, 58-T Adams Building, Washington, D. C.

PATENTS Applied for \$85.00. Free information. Flecks, Warren, Ohio. Stamp.

PENDING Patent applications can be brought before thousands of manufacturers, free of charge, through Invention Magazine. Write for details. Invention, Inc., 635 F Street, Washington, D. C.

HIGH Grade patent office drawings \$10. Strictly confidential. Draftsman, 412 Washington Loan & Trust Building, Washington, D. C.

LISTS Of all United States manufacturers. 5c per name. Stern, 6220 Ellis, Chicago.

OUR 4-Points of service for inventors covers designing, developing, protection and marketing. Write for complete details. R. & S. Engineering Co., Dept. FM, 17 East 42nd Street, New York City.

MANUFACTURERS Seeking new products. Inventions commercialized. Howard W. Frank, Product Engineer, 55 West 42nd, New York.

GET Two year protection for your inventions or ideas for few cents. Details for one dollar. DeForest Romain, Pompton Lakes, N. J.

PATENTS Cost dollars and may not sell but protection can be had for pennies. Details. Lindley's, Box 588, Kokomo, Ind.

WE Locate buyers meritorious patented, unpatented inventions. If will sell, reply immediately. Descriptive booklet free. Invention Reporter, 5A-11236 South Fairfield, Chicago.

INVENTOR'S Universal Educator; contains 900 mechanical movements; 50 perpetual motions; instruction on procuring and selling patents and selecting an attorney, etc. Suggests new ideas. Price \$1 postpaid in U.S.A. Address Albert E. Dietrich, 511-B Colorado Bldg., Washington, D. C.

INVENTION Engineering service. Difficult jobs specialist. Farris, West Des Moines, Iowa.

YOUR Invention protected without immediate patenting. Details \$1.00. Elliott-Green Features, Box 127, Tullahoma, Tenn.

INVENTORS Four day convention and exhibit will be held in Chicago, June 6th to 9th. Send stamp for details. National Inventors Congress, LaSalle Hotel, Chicago.

HAVE You a sound, practical invention for sale, patented or unpatented? If so, write Chartered Institute of American Inventors, Dept. 4-A, Washington, D. C.

INVENTORS: Profit by your invention. A practical talk to inventors by an experienced manufacturer. Our 68 page booklet "Mind vs. Matter" mailed upon receipt of 25c. Rex Engineering Co., Cincinnati, Ohio, Dept. D.

INVENTORS: "Making Inventions Pay," our 32-page illustrated book, mailed upon receipt of 3c postage. Crescent Tool Co., Dept. Z, Cincinnati, Ohio.

INVENTORS—Send for 72-page book on patents. Reasonable terms. Conscientious treatment to inventors. L. F. Randolph, Registered Patent Attorney, 302-E Victor Bldg., Washington, D. C.

I SELL Patents. Established in 1900. Charles A. Scott, 773PM Garson Ave., Rochester, N. Y.

INVENTORS Consultant. Appraise applicability, patentability and marketability. Write C. G. Hall, 3133 Connecticut Ave., Washington, D. C.

INVENTIONS WANTED

WE Have clients looking for new items to manufacture on royalty. Electric goods, household items, automotive, airplane improvements, etc. Must be patented, engineering completed and ready to market. Will H. Wade & Co., Industrial Financing, 134 So. LaSalle Street, Chicago, Illinois.

WANTED—Meritorious patented, unpatented inventions. Booklet free. Invention Reporter, 5B-11236 South Fairfield, Chicago.

SMALL Inventions wanted by manufacturers. I'll help you sell your invention. Write for free circular. Stanley Hull, 7829-K Euclid Avenue, Cleveland, Ohio.

SIMPLE, Practical inventions wanted by manufacturers, patented or unpatented. For information write Chartered Institute of American Inventors, Dept. 4-D, Washington, D. C.

CASH For unpatented ideas. Stamp for particulars. Mr. Ball, 9441-A Pleasant, Chicago.

WE Have a client who wants a lock nut to buy outright or manufacture on royalty, also we want a variable speed reducer. Must be patented and ready to market. Will H. Wade & Co., Industrial Financing, 134 So. LaSalle Street, Chicago.

PATENTS FOR SALE

CAR And truck hill holder information. McCoy, 415 No. 8, Pocatello, Idaho.

UNPATENTED Metal cleaner. Cheap to make. Sell outright or royalty. Write John Hood, Cedarburg, Wis.

ATTENTION Manufacturers. Money maker. Aircraft position indicator. J. Solski, 2746 - 2nd Ave., Sacramento, Calif.

GEE Gun, skillful, fascinating; beats yoyo. 25c article. Bonesteel, Eaton, Colo.

TOY, inexpensive, different, no competition. Walter Lindeman, Box 534, Beloit, Wis.

INVENTION For sale. Something needed in every home. Edna Switzer, 129 West Church, Ellis, Kansas.

MANUFACTURERS: For new products or profitable manufacturing opportunities, inquire *Invention Reporter*, 5C-11236 So. Fairfield, Chicago.

SCREWLESS Attachment plug, Margaret Dudt, 2102 Colorado Ave., Colorado Springs, Colorado.

AUDIBLE Whistle, Fits any milking machine and signals when cows have finished milking. Costs two dollars, sells for twenty. Eliminates ruining cows. Makes machine fool proof. When demonstrated sells itself. Sale outright reasonable or royalty. Philip Martin, Rt. 1, Box 109, Riverdale, Calif.

PENDING, Decorative safe bed pin, inexpensive. T. Fukuda, 102½ Lake St., Salinas, Calif.

SELL Your patent through a small classified ad in *Popular Mechanics*. Many inventors have found buyers in this way. Ask me for proof—I'll gladly send it to you. F. W. Johnson, Manager Classified Advertising, 200 E. Ontario St., Chicago.

MANUFACTURING

MANUFACTURING, Dies, machinery, models, brasswork, mouldmakers, catalog 3c. Baum's Metal Specialties, Kansas City, Mo.

DEMONSTRATION Models built, ideas developed, blue prints drawn. Write for details. R. & S. Engineering Co., Dept. FP, 17 East 42nd Street, New York City.

INVENTIONS Made, perfected, \$150 per productive day. Farris, West Des Moines, Iowa.

INVENTIONS—Manufactured in any quantity at low cost by old established company. Stampings, metal specialties, dies, models, etc. Free estimates. Send for catalog. Crescent Tool Co., Dept. X, Cincinnati, Ohio.

INVENTIONS Manufactured by an experienced company, in any quantity at low cost. Metal specialties, novelties, stampings, dies, and models. Free estimates. Our booklet "Mind vs. Matter" sent upon receipt of 25c. Rex Engineering Co., Cincinnati, Ohio, Dept. C.

MODELS AND MODEL SUPPLIES

BUILD The sensational "Bluenose" for only \$1.45 postfree. We will send you all parts, completely finished redwood hull, cut-to-fit rails, keel, rudder, sails, metal anchor, metal steering wheel rigging and full instructions. Rush 3c stamp for catalog of many other models. Miniature Ship Models, Dept. R, Perkasie, Penna.

SHIP Model kits, 1000 fittings catalogue 5c. Polk's 429 Seventh Ave., New York.

50" FLYING Models, \$1.00; 30", 50c. Postage 10c. Hare Products, Whitinsville, Mass.

CATALOGUE Of over 40 engines, castings, supplies, 25c. Refunded. Howardco, A-2417 North Ashland, Chicago.

THREE Display models. Streamline yacht, sport auto, stratosphere balloon gondola. Complete plans \$1.00. R. M. Brownlee, 416 E. Main, Benton, Ill.

TAYLOR Cub, 50" wingspread, \$1.00. Postage 10c. Al Ames, Whitinsville, Mass.

HEMOCRAFT And model supplies, 1939 catalog now ready 10c. Hobby Supply House, Box 2014, Pittsburgh, Penna.

SUBMARINE 24" Kit to build \$1.00. Spotts, 3925 N. Broad, Philadelphia.

MINIATURE Boat and airplane supply catalog 5c. Seiley, 1377 Gates Ave., Brooklyn, N. Y.

MODELS—Your ideas developed into practical working models. 30 years successful experience; thousands of satisfied customers. Confidential service guaranteed. Bank references. Send 3c postage for our large booklet—"Making Inventions Pay." Crescent Tool Co., Dept. Y, Cincinnati, Ohio.

BUILD Miniature gasoline motors. Fascinating, educational, profitable. Details, drawing, 10c. Wright Motor Works, 3256 Lake Park Ave., Chicago.

SHIP And yacht model fittings; construction sets; model yacht sails; illustrated catalog 20 cents. A. J. Fisher, 1002-1 Etowah Avenue, Royal Oak, Mich.

MODEL Supplies for the inventor. Send 3c stamp for catalog. Pierce Model Works, Tinley Park, Ill.

MODELS—Practical models put over your ideas. We develop models from the crude to perfect working devices. Your idea might have large commercial value. Services confidential. Bank references. Registered graduate engineers at your service. Send 25c for our 68 page booklet "Mind vs. Matter." Rex Engineering Co., Cincinnati, Ohio, Dept. B.

BLUEPRINTS AND PLANS

WORKING drawings for the following items: Brake applicator for trailers makes your trailer brake automatically; gasoline scooter, lots of fun, inexpensive to build, 40c for each item, both for 75c. Tee-Jay Engineering Co., Battle Creek, Michigan.

HOME CRAFTSMEN

SQUAREKNOTTERS! Make belts, handbags, etc. Quality cord samples with catalog, free. Beginners book, catalog and samples, 10c. Special! Regular \$1 book with 50c beginners outfit, all for \$1. P. C. Herwig Co., Dept. J-16, 121 Sands St., Brooklyn, N. Y.

CUTTERS Made to fit bench saw table, make mouldings; cove, quarter, grooves, etc. Sandstroms, Stow, N. Y.

MAKE Money making lawn chairs. Full size blueprints, 25c. No stamps. Francis Scheurer, R. No. 3, Mankato, Minnesota.

NEW Manual for tool users free. Tells you how to use and care for your tools; how to sharpen your saws. Write Henry Disston & Sons, Inc., 611-C Tacony, Philadelphia, Penna.

20 FULL Size lawn ornament patterns 25c. Wickman, 744 Brooklyn, Dept. 30, Dayton, Ohio.

LEATHERCRAFTSMEN—Write for free instructions and price list of leather, tools, etc. Sample cards 5c. Wilder & Co., Dept. 5F, 1038 Crosby St., Chicago, Ill.

MAKE Beautiful mats from junk tires. Use ordinary equipment. Instructions \$3.00. Thomas Kowell, 5372 St. Clair, Detroit, Michigan.

PROJECTS For camp craft work. Catalog on request. Mankin Brothers, Box 23, Hollywood, Memphis, Tennessee.

BORING Bar for small diameters. Very rigid. Blue-prints 35c. Craftsman's House, Avoca, Penna.

22 FULL Size lawn ornament patterns 25c coin. Strother, Box 383-E, Belington, West Virginia.

EXTRAORDINARY Guaranteed wood-working moneymaking opportunities. Information. Illustrated thirty-six page catalog 10c. (refunded). Woodcraft Service, Plainview, Minnesota.

ONE Diamond for only one dollar! Home craftsmen, specimen collectors, inquire for uses. Self addressed, stamped envelope. P.O. Box 267, Metaline Falls, Washington.

MAKE Leaded antique lanterns. Free description folder. M. Ascherl, Lorain, O.

20 LAWN Ornament patterns 30c. 20 novelty patterns 30c. 14 silhouette patterns 30c. 15 lawn ornament patterns different from those above 30c. All for \$1.00. Modern Woodcraft, Saginaw, Michigan.

1001 WAYS to Use Concrete. Send for large free illustrated folder describing new *Popular Mechanics* book covering every known use of concrete for the home, farm, building, business and industry. *Popular Mechanics* Press, Room (C39), 200 E. Ontario St., Chicago.

OLD GOLD, WATCHES, JEWELRY, PRECIOUS STONES

FRAIBERG'S Diamonds, watches—approval. Savings Guaranteed. 5605 Fleet, Cleveland, Ohio.

AUSTRALIA'S Lovely opals. Illustrated catalogue free. Good selection \$5.00. Norman Seward, Melbourne, Australia.

ELGIN, Waltham, Hamilton watches. Make big money, \$3.95. Send for free jewelry catalog. Plymouth Jewelry Exchange, 163-B Canal St., New York.

SEND Broken watch. We send free estimate cost of repairing. Guaranteed. Geo. Worsham, Pulaski, Tenn.

AGATES, Gems, minerals. 20 gemstones \$1.00. Pricelist free. Hill, Route 7, Salem, Oregon.

MAKE Big money selling guaranteed reconditioned nationally known watches. \$3.75 and up. Catalog free. Grossman Jewelry Co., 4666-B State, Chicago.

MONEL Metal rings, unfinished, 50 cts., send sizes. Candee, 129 Llewellyn St., Los Angeles.

HIGHEST Prices for old gold—Mail your teeth, watches, jewelry, 100% full cash value mailed day shipment received. Satisfaction guaranteed or articles cheerfully returned. Information free. Chicago Gold Smelting Company, 300-P Champlain Building, Chicago.

5000 REBUILT Elgin, Waltham, Hamilton watches. Also ladies, gents wrist watches. Make big money! 12 size, 7 jewel, Elgin or Waltham, \$4.75; 16 size, 17 jewel, \$7.50. Send for free watch and diamond catalogue. The New York Jobbers, Dept. M, 74 Bowery, New York, N. Y.

WATCHMAKERS' Supplies, tools, watches. Sold—purchased. Ben Segal Company, 5 So. Wabash, Chicago.

WATCHMAKERS' Repair service. Save half. Paul Jewelry Co., LaCrosse, Wis.

GOLD \$35 Ounce. Ship old gold teeth, crowns, jewelry, watches—receive cash by return mail. Satisfaction guaranteed. Free information. Dr. Weisberg's Gold Refining Co., 1500-Q Hennepin, Minneapolis, Minn.

HOW To identify and determine value of old precious metals. Where to buy. To whom to sell. Reliable and up-to-date information. Complete instructions only \$1 postpaid. *Popular Mechanics* Press, Room (C39), 200 E. Ontario St., Chicago.

FOR THE HOME

BEAUTIFY Your old furniture! Refinishing now made easy. Complete instructions 35c. Todds Service, 53 McGuffey, Youngstown, Ohio.

DOC'S Lift cord—(patented). Gets you in and out of the bath-tub with ease and safety—\$2.00. G. W. Nesbitt, M.D., Sycamore, Ill.

INSTALL Your own heating system. Further information \$1.00. Heatplumb Engineering Service, 3419 Haverford Ave., Philadelphia.

METAL Furniture in modified modern design, how to make, described in Shop Notes for 1937 only 50 cents postpaid. *Popular Mechanics* Press, Room (C39), 200 E. Ontario St., Chicago.

TOBACCO

POSTPAID, Good Redleaf chewing, firstgrade 10 pounds, \$2.00; smoking, \$1.50; second grade chewing, \$1.50; smoking, \$1.25. Curtis Rogers, Dresden, Tennessee.

GUARANTEED: Cigarette, pipe or chewing, 5 lbs. \$1.00, ten \$1.75. Pay when received. Pipe and box cigars free. Rives Tobacco Co., Paducah, Ky.

LOOK! Try cheaper tobacco! Then taste our milder golden smoking or rich ripe chewing, four pounds, postpaid, \$1.00. Riverside Ranch, 201, Hazel, Kentucky.

RAZORS—BLADES—SHARPENING

MEN Wanted! For perfect shaving! Most amazing electric razor buy in the U. S.! Only \$1.00 postpaid. New 1939 de luxe Elgin electric razor, guaranteed one year. Elgin Distributors, 217 Broadway, New York City.

BLADES—Top grade double or single edge 25—35c; 50—60c, 100—\$1.00. Five blade trial package 10c. Wayne Distributing Company, Box 5895, Cleveland, Ohio.

SURVEYING INSTRUMENTS

GUARANTEED Factory rebuilt transits and levels for rent (with purchase option) or sale (cash or terms). Order now before prices advance. We will repair, trade in, or buy your old instruments. Ship prepaid for estimate and valuation. Write for List M-46 and complete information to Warren-Knight Co., 136 N. 12th St., Philadelphia, Penna.

FOR SALE—MISCELLANEOUS

100-300% PROFIT! Men's suits \$1.50, coats 50c. Dresses 10c. Many other bargains. New and used merchandise. Catalogue free. Fairmount, 160-A Monroe Street, New York.

1000 DOZEN Weekly, men's fancy half hose and anklets, slightly imperfect, at manufacturer's prices: 50c, 55c, 60c, 65c, 70c per dozen. Minimum shipment 6 dozen. Spartan Hosiery Mills, Spartanburg, S. C.

WANTED—MISCELLANEOUS

WANTED—Skillsaws, typewriters, surveying instruments, microscopes, outboard motors, drills, lathes, inventions. Mack Brothers, 2047 Chicago, Chicago.

CASH For used microscopes, binoculars, cameras, slide rules, drawing sets, surveying, mechanical, and scientific instruments. Highest prices paid day shipment received. Satisfaction guaranteed or shipment promptly returned. Elman's, 2302 Van Buren, Chicago.

PERSONAL

"NEARSIGHTEDNESS Is Preventable." Josephson, \$1.50. Chedney Press, New York City. Agents.

DON'T Throw your shirts away because the collars get ragged or torn. Buy replacement collars, in white broadcloth. Rip off the old and stitch on the new. Easy to do. Makes shirts like new. Sample collar or pair of cuffs by mail 25c. Five collars or five pairs of cuffs, \$1.00. Troy Novelty Co., 5 Union St., Troy, N. Y.

DANDRUFF Removed like magic. Guaranteed. \$1.00. Awad, 576 Dupont, Philadelphia, Penna.

AMAZING Course—"Outwitting Tomorrow"—brings secret information. Quickly overcome fear, timidity, bashfulness. Make astonishing changes mentally, physically, financially. Use secrets never before published. For individuals of all ages. "Outwitting Tomorrow"—30,000 words; beautifully bound, printed, illustrated. \$1.00 postpaid anywhere. Harry J. Gardener, Publisher, 1044 South Olive Street, Los Angeles, Calif.

MYSTIFY Friends with photo postcards showing yourself with English king, mailed in your handwriting from Canada. 25c coin brings everything. Edward Studio, 2840 West 1, Vancouver, Canada.

SMELLY Shoes? Shu-Sweet will eliminate and prevent the odor of bromidrosis in shoes. Travel size container 25c at your pharmacy or postpaid by mail from us. Postcard will bring free sample and information about shoe hygiene. Shu-Sweet, Santa Fe, New Mexico.

WIN! Free contest bulletins, literature, blanks, Personal Contesting, P. O. Box 9-A, Station P, Brooklyn, New York.

GOOD Eyesight without glasses. No drugs. Surprisingly simple treatment. Guaranteed. A. Jacobson, Upsala, Minn.

WIN Prize money: Booklet—"Successful Contesting"—shows how. 10c postpaid. Bulletin listing \$200,000.00 prizes included. World Publishers, 4515-B Cottage Grove, Chicago.

MAKE It Yourself—Hundreds of practical and useful devices described in our big book. Plain instructions and illustrations show you how. Save money on things for yourself or make profit selling to others. 900 articles, 480 pages, 823 illustrations. \$3 postpaid. Popular Mechanics Press, Room (C39), 200 E. Ontario St., Chicago.

MISCELLANEOUS

BEST Tropical Guava sweetmeat. Send \$1.98 for 5 pounds—postpaid. Gonzalez Distributors, Box 213, Mayaguez, Puerto Rico.

BUSINESS Proposition resilvering mirrors, autoparts, reflectors, making chipped glass signs. Write, Sprinkle, Plater, 288, Marion, Indiana.

TATTOOING Outfits, supplies, illustrated list free. Percy Waters, Anniston, Alabama.

PRETEND You're at World's Fair or Yellowstone Park. Beautiful postcards personally addressed (4—50c). (10—\$1.00.) Ishmael, Box 384, Lovell, Wyo.

PANTS Pressing with lasting results. Information 10c. Geo. Tefferteller, 1709 10th, Des Moines, Iowa.

MEXICAN Scenic postcards: Two, 12c stamps. Free remailing service. Marquez-PME, Apartado 1178, Mexico City.

LUMINOUS Paint shines in the dark. 25c bottle. Myers, 211 Broadway, Niles, Michigan.

REFINE Used oil without cost. Particulars, F. Gerwin, Fairview, Oklahoma.

POSTCARD Collectors: 40 scenic California. Two mailed weekly 20 weeks \$1.00. Two samples 10c. Porter's 403-M East Seaside, Long Beach, Calif.

MONEY In butterflies, moths. See Sinclair Display Advertisement on page 16A.

GUARANTEED Work socks, 6 pair guaranteed 6 months \$1.00. Standard colors. All sizes. Postage prepaid. C. O. D. or money orders. Quality Hosiery, Statesville, N. C.

MEXICAN Jumping beans. The best curiosity in the world. Joaquin Hernandez, Exporter, Alamos, Sonora, Mexico.

30 SHEETS And 30 envelopes printed with your name and address. 25 cents. Menten, 9313D Glenwood Road, Brooklyn, N. Y.

AMATEUR Cartoonists wishing steady income copying and duplicating cartoons for advertisers, write Ad-Service, Argyle, Wisconsin.

LAM-A-FAB, The cloth cement, acid and waterproof. Permanently repairs anything made of cloth. Sails, hunting equipment and suits, football suits and athletic equipment, rugs, canvas chairs and work clothing. S. J. Russell Co., P. O. Box 187, Peoria, Ill.

COCOONS, Butterflies, collectors' supplies, free lists. Maynard, 1192 Lewiston, Rochester, N. Y.

SWAPPER'S Friend, R4, Saline, Michigan. Interests swappers, collectors. 50c year, sample 10c.

COATS-OF-ARMS And crests correctly rendered in colors or black and white. Highest grade. Estimates free. Heraldic Studios, 1914 Oakdale Ave., Chicago.

BOY Mechanic—Famous library of 3 volumes covers the building of almost everything a boy might want to make. Actually covers 3,000 different articles. Each volume 460 pages, fully illustrated. Cloth. Price \$2 each or set of 3 vols.—\$5 postpaid. Popular Mechanics Press, Room (C39), 200 E. Ontario St., Chicago.



Build a BOAT FOR PLEASURE OR PROFIT



EXACTLY HOW TO BUILD 15 DIFFERENT BOATS

This is the new edition with 42 added pages, 6 new boats, and conversion of Ford motor for marine use. Full directions and details for cabin cruiser, racing, hydroplane, outboard runabout, sail boats, kayak, sled type—15 boats in all. Also sectional boat to carry on car.

SEND NO MONEY

Write for new edition of Boat Book today! Sent anywhere. Pay postman \$3.00 plus small C. O. D. fee. Outside U. S. and possessions remit with order. Money refunded if not satisfied.

POPULAR MECHANICS PRESS—Room 636A
200 East Ontario St., Chicago

EASY—LOW COST with POPULAR MECHANICS BOAT BOOK

Build a boat at home! You can do it. Just the kind you've wanted—power, sail, or row boat. The "Boat Book" shows you how in simple step-by-step directions. Specially prepared for those with limited tools, little skill and money. Build boats to sell for profit too. Book tells how.

GIVES PLANS, METHODS AND MATERIALS

Actual working plans and photos of real boats under construction makes building easy. Shows materials needed and rock-bottom costs. Hundreds of pictures. No chance for mistake. Includes also, navigation and pilot rules, handling sailing craft, boat kinks, boating terms. Everything a boat enthusiast should know. Size 7x10 inches. 312 pages. Fine cloth binding.

MIDWEST FACTORY SALE!

PUT THIS NEW 14-TUBE WORLD WIDE CHASSIS IN YOUR CABINET

SAVE 48 50%



Here it is! A big, powerful, new 14-tube world-wide Midwest. At its sensational factory-to-you price of \$19.95, this new 1939 radio is the biggest bargain in Midwest's nineteen years of pioneering! Absolute satisfaction guaranteed on a money-back basis.

UP TO \$40.00 TRADE-IN

Send 1c postcard or write for new FREE 1939 catalog telling all about our trade-in allowance offer of up to \$40.00 on latest Midwest 17-tube, 5-band radios, also Easy-Pay Plan details. Dept. 15-NN Midwest Radio Corp., Cincinnati, O.

CHASSIS NOW ONLY \$19.95 COMPLETE WITH TUBES AND SPEAKER

BIG MONEY from POULTRY



I show you how to greatly increase profits, start your own business, or help you secure a job in a poultry plant. I train you at home in spare time quickly. Show to yourself or employer. Men and women in small towns or suburbs will be particularly interested because latest scientific methods mean unusual profits for them. My home-study course used by thousands. 32-page book, "How to Raise Poultry for Profit" comes to you FREE. Mail coupon today.

SCIENTIFIC POULTRY RAISING

HARRY M. LAMON, Pres., National Poultry Institute, Dept. 44-D, Adams Center, N. Y.

Please send me your FREE Book about poultry raising, and facts about your Home-Study Course.

Name
Address
City (R.F.D.) State

OL' JUDGE ROBBINS

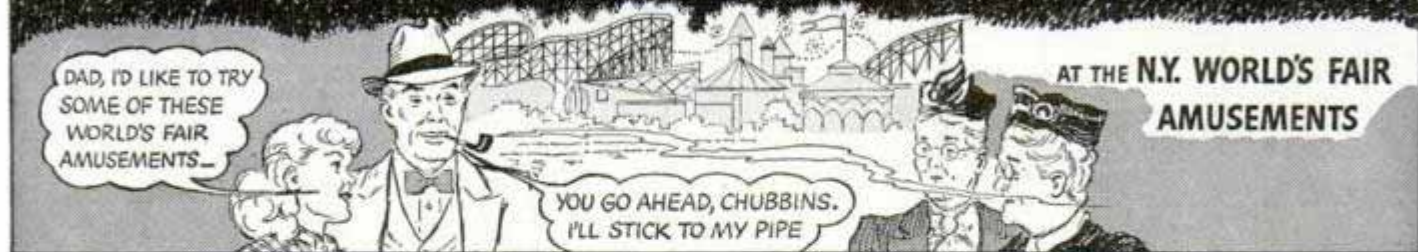

DAD, I'D LIKE TO TRY SOME OF THESE WORLD'S FAIR AMUSEMENTS—

YOU GO AHEAD, CHUBBINS. I'LL STICK TO MY PIPE

AT THE N.Y. WORLD'S FAIR AMUSEMENTS



WORLD'S FAIR MUSIC HALL

EXCUSE ME, MISS, I'D LIKE TO -- 8Z-Z-Z 8Z-Z-Z --



LET ME INTRODUCE YOU TO MY FATHER. HE'LL TELL YOU ALL ABOUT IT -- OH, DAD!

GIANT BATHYSPHERE



DUTCH VILLAGE

THIS LADY LIKES THE SMELL OF YOUR TOBACCO, DAD. SHE WANTS TO SEND A PACKAGE AS A GIFT TO HER NEPHEW BACK HOME

I'M DELIGHTED TO COOPERATE IN SUCH A WORTHY CAUSE! I'LL SHOW YOU WHERE TO GET SOME PRINCE ALBERT

OH, THANK YOU SO MUCH...



LATER

MY NEPHEW IS ALWAYS COMPLAINING ABOUT HIS PIPE'S TASTING BITTER. NOW, A TOBACCO THAT SMELLS AS GOOD AS YOURS SHOULD TASTE GOOD TOO

SUPERCHARGED RACERS



WELL, YOU SEE, PRINCE ALBERT IS BETTER TOBACCO TO BEGIN WITH -- AND THEN THEY TAKE OUT THE BITE!

TURTLE CHASE

WELL, I DECLARE! NO WONDER YOU FIND THAT TOBACCO SO MILD

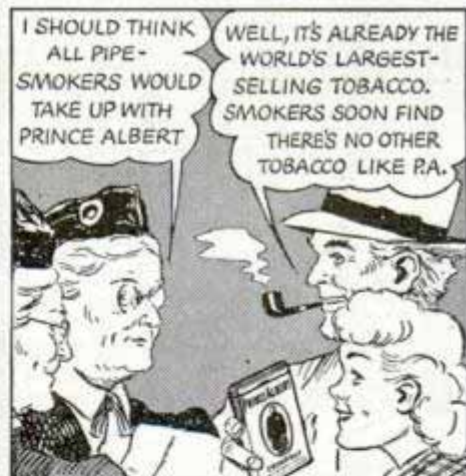

I SHOULD THINK ALL PIPE-SMOKERS WOULD TAKE UP WITH PRINCE ALBERT

WELL, IT'S ALREADY THE WORLD'S LARGEST-SELLING TOBACCO. SMOKERS SOON FIND THERE'S NO OTHER TOBACCO LIKE P.A.

WORLD'S MOST POPULAR ATTRACTION FOR SMOKERS



YOU'LL APPLAUD PRINCE ALBERT FOR **MILDNESS, RICH TASTE, AND EASY DRAWING**



SEE HOW FAST P.A.'S SPECIAL CUT SPINS UP 'MAKIN'S' SMOKES TOO. **NO BUNCHING-- AND SMOKES SLOWER**



50 pipefuls of fragrant tobacco in every pocket tin of Prince Albert

A REMINDER TO TRY P.A.

Smoke 20 fragrant pipefuls of Prince Albert. If you don't find it the mellowest, tastiest pipe tobacco you ever smoked, return the pocket tin with the rest of the tobacco in it to us at any time within a month from this date, and we will refund full purchase price, plus postage.

(Signed) R. J. Reynolds Tobacco Company, Winston-Salem, North Carolina

PRINCE ALBERT THE NATIONAL JOY SMOKE

Copyright, 1939, R. J. Reynolds Tob. Co.

Popular Mechanics Magazine

REGISTERED IN U. S. PATENT OFFICE AND CANADA

WRITTEN SO YOU CAN UNDERSTAND IT

Vol. 71

JUNE, 1939

No. 6

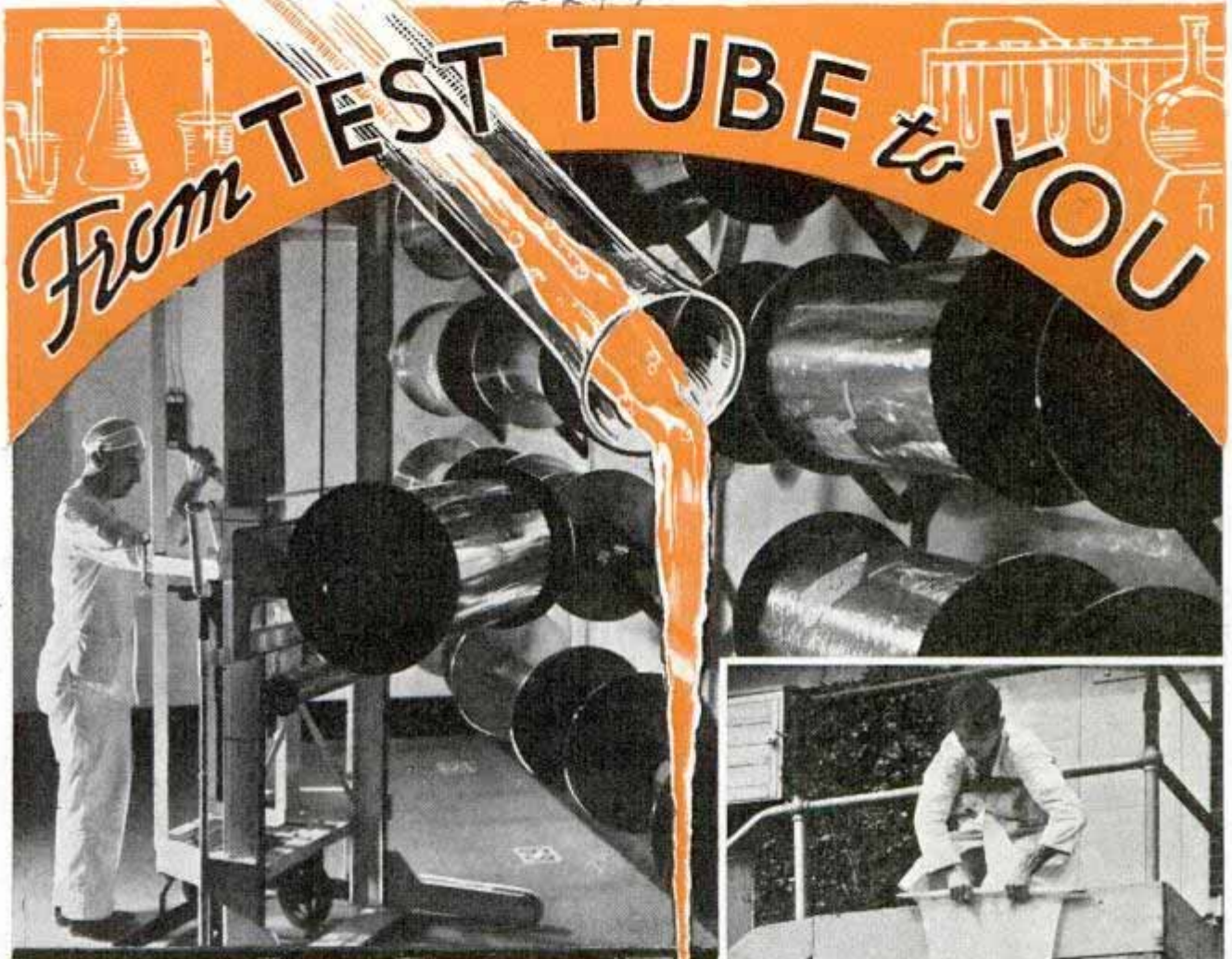

Above, storage vault where giant rolls of film are kept before being sensitized. Right, testing plastic for safety glass

Paris, N.Y.
By LAMMOT DU PONT

Wilmington, Del.
President, E. I. du Pont de Nemours & Company

IT HAPPENED May 7, 1794, in Paris. Antoine Laurent Lavoisier, France's most talented chemist, stood before the Revolutionary Tribunal to receive the death sentence. "The Republic has no need of scientists," said the court in passing sentence.

Lavoisier died, but the spirit of science lived. Chemistry, especially, was destined to bring immeasurable benefits to humanity, developing progressively in Europe in the century that followed the execution of Lavoisier and advancing phenomenally in this country in the last twenty

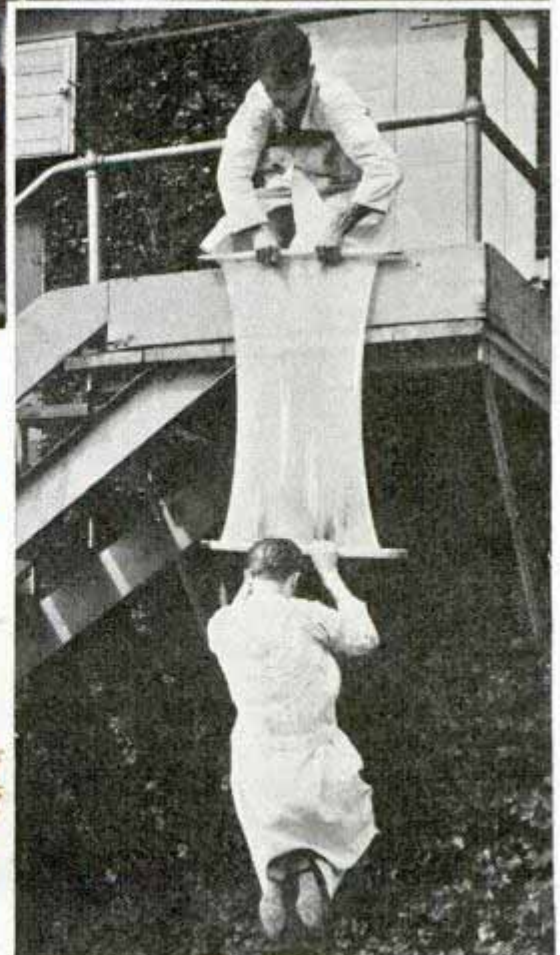

see December, 1938.

802

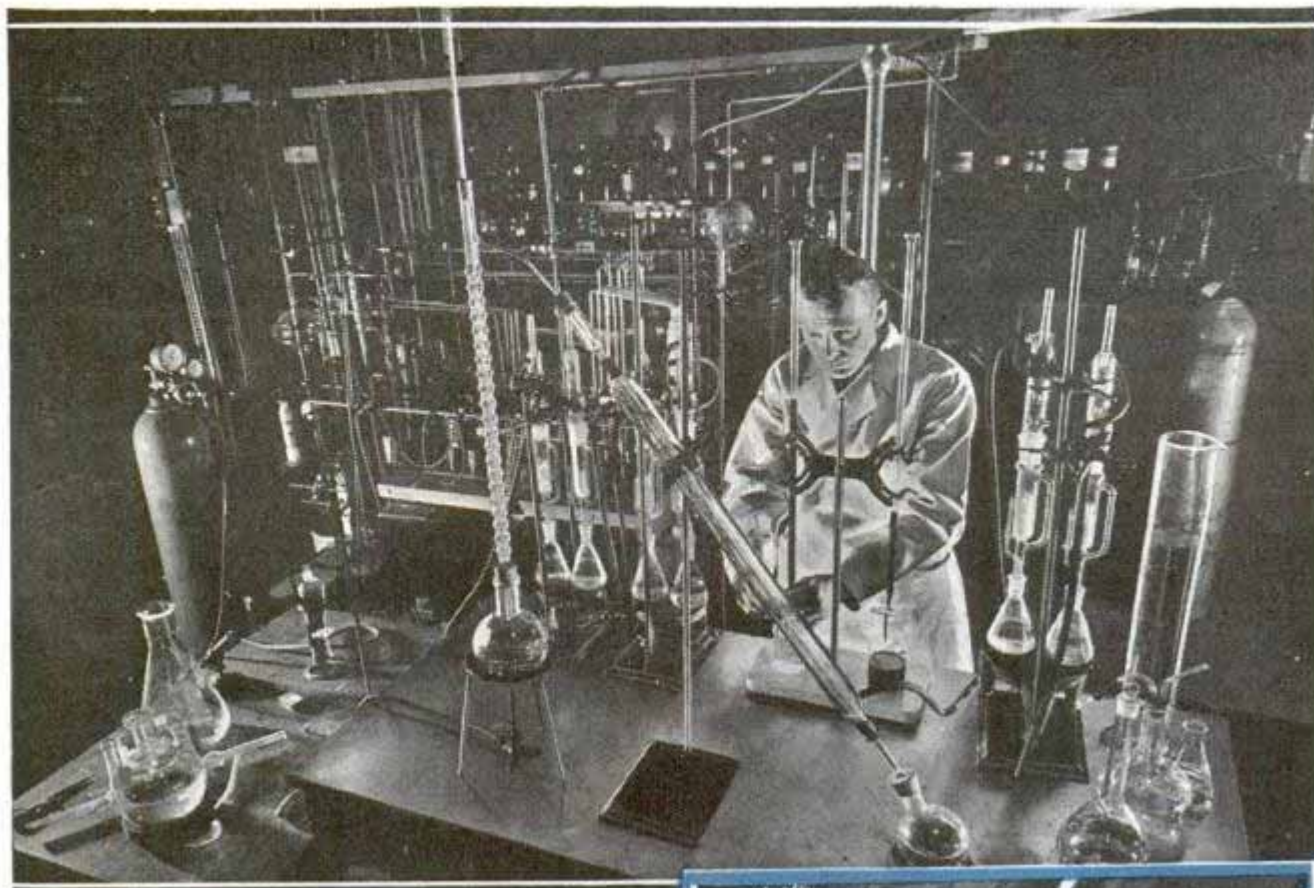

years. Today, American chemical industry and industries based on chemistry have become so important that they employ one-fifth of all factory workers and one-fourth of all industrial capital investments.

Chemistry underlies not only such patently chemical industries as the manufacture of acids, alkalis, dyestuffs, explosives, and plastics, but also such giant industries as leather tanning, petroleum refining, pulp and papermaking, the smelting of metals, and soapmaking.

How does chemistry work? If you expect magic, you will be disappointed. Rather, the chemist pursues his work methodically, carefully investigating one possibility after another, much as a salesman calls on a list of prospective customers.

Day after day, perhaps month after month, he seemingly makes no progress. Finally, he comes upon an idea that



Parlow N.Y.
 Top, the chemist at work in U. S. Rubber company laboratories. Center, "cyclones" used to recover powdered vinyl acetal resin from the air. Bottom, kiln for firing decorated glass and pottery

*Ceramic also
 U.S. Army. N.Y.*

Washington, N.Y.

g. 247



Leominster, Mass. Richmond, Va.
 Flashes from the world of chemistry. Top, machine drills holes in toothbrush handles, inserts bristles and anchors them automatically. Center, liquid viscose dripping from white tube. Right, incandescent coke being pushed out of ovens. Bottom, left, aging tanks used in manufacture of "Cellophane" cellulose film. Right, porcelain pots, glass rods and textile yarns in dye bath

Belle, Va. Technical



seems worth while. It is only an idea, however, proved solely in the test tube. The idea must be developed on progressively larger scales, until it can be operated as a factory process. Supplies of raw material must be assured; outlets determined; and the product introduced to the public.

In a few instances, such developments require only a year or two; in other instances sometimes ten, twenty or even more years elapse. For example, Count de Chardonnet's first experiments with rayon were recorded in 1884. It was not until 1911, however, that the first American plant produced rayon. Knowledge, materials and manpower are not sufficient. Money equally is needed. Usually the amount runs into the hundreds of thousands, sometimes millions of dollars, before a commercially suitable product is achieved.

Most of us are aware that the chemist has produced new products and has improved existing products. We are conscious of beautiful chemical plastics, the

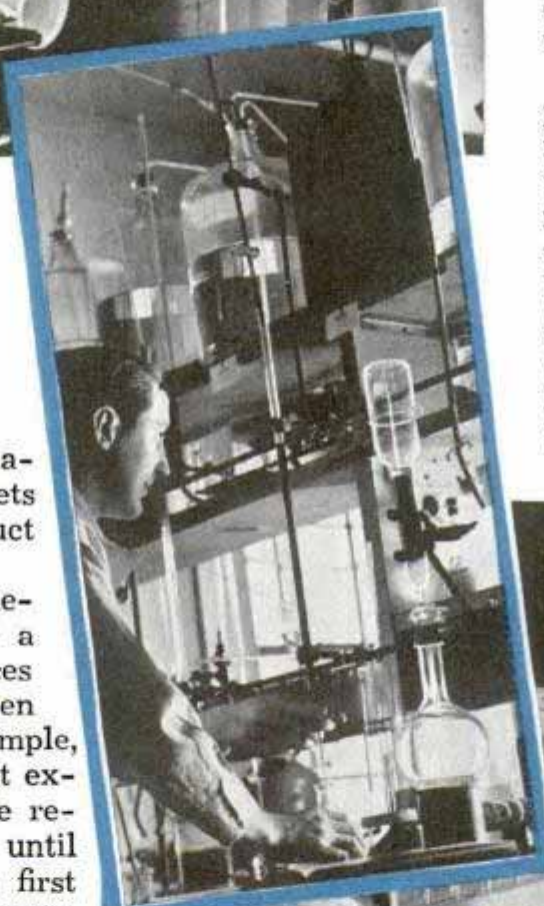

8-24

durable lacquer finishes on the automobile and refrigerator, the gleaming transparent wrapping material, the rainbow of man-made colors from coal tar, and fabrics fashioned from rayon.

But what of the significance of these things to the nation?

Consider our natural resources. The chemist has aided in conserving natural resources by developing synthetic products to supplement or wholly replace natural products.

By heat cracking, approximately twice as much gasoline is obtained from crude oil as formerly by distillation which means the doubling of our oil reserves so far as gasoline is concerned. Research has gone even further by developing processes

Top, lathe-turning operation on "Lucite," one of the newer plastics. Center, research laboratory of Krebs Pigments department of the du Pont company. Bottom, roll of "Cellophane" cellulose film being inspected and weighed after being prepared according to customer's specifications

algemone
leel

2359

Gas Mask for Small Child Provides Airtight Seal

Government will not give out information so better



Baby wearing hood that is impervious to poison gas. Mother pumps fresh air into the sealed chamber

Parents in England can now get masks to protect their infants against poison gas in case of war. Designed for babies up to two years of age, the helmet covers the entire upper portion of the body and straps closely about the waist. A constant supply of fresh air is pumped into the chamber by a hand-operated bellows.

Three-Stage Light-Bulb Adapter Fits Any Lamp Socket

Any electric-lamp or light fixture with the standard socket can be made to take



Three-stage light socket adapter at right is standard size and screws into any ordinary lamp outlet

the more modern bulbs of three light stages, by simply plugging in an adapter with special contacts for double-base bulbs and a three-way switch. This adds less than two inches to the length of the socket, but small lamp shades may be screwed onto the adapter so the bulbs will not project outside them. The original pull-chain or switch can be used, since it is possible to adjust the unit to its most used stage and let it so remain until more or less light is needed for unusual circumstances. Three sizes of bulbs readily obtainable for the adapter include the following watt ranges: 20-40-60, 40-60-100, and 50-100-150.

Corn Popper Operated by Coin Makes Bagful at a Time

Corn is freshly popped and automatically poured into a bag by a coin-in-the-slot machine that takes only about sixty sec-

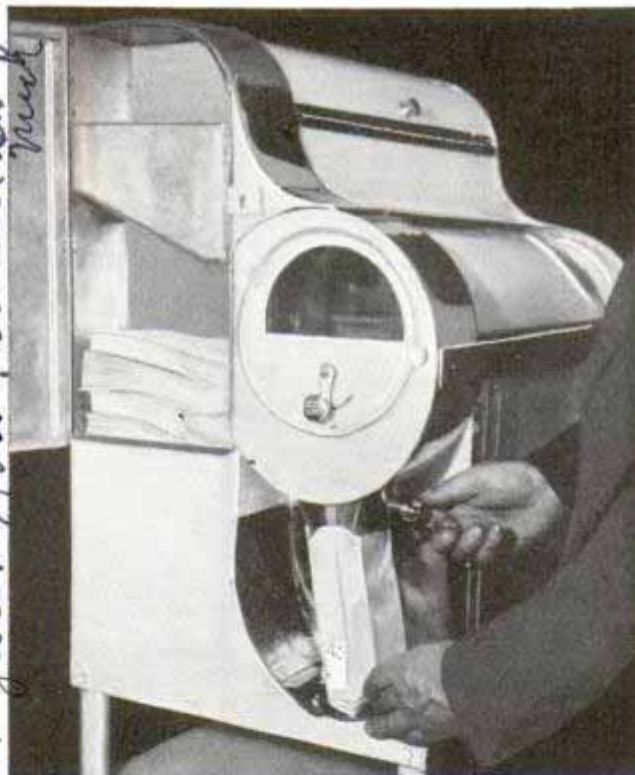

Customer holding the bag at mouth of vending machine that sells hot popcorn like chewing gum

onds for the full series of operations. Corn is heated to 400 degrees Fahrenheit in a bath of vegetable compound, and after popping is completed the finished product is conveyed to the pouring spout where the buyer holds a bag. The residue of hard kernels is removed by a strainer. All this takes place in full view behind a window.

Illustration staged by government London, England British

Best Engineering Co. 45 E. 14th, New York

Howard St. Pontiac Mich. 102 E. 7th, 102

Supernat. Popcorn Automat, 102 E. Howard.

Target for Football Passers Used in Practice

Football players coming out for the spring session at Northwestern University tried out a new target intended to improve their accuracy in making aerial passes frequently a deciding factor in the outcome of a game. A net is stretched over the hoop-like frame which has a pulley at the top so it may be slid along the cable, on which it rides to any desired position.

Footballs are sailing at hooplike target suspended on an overhead cable. It means spring training for the big fellows who will handle ball in aerial passing

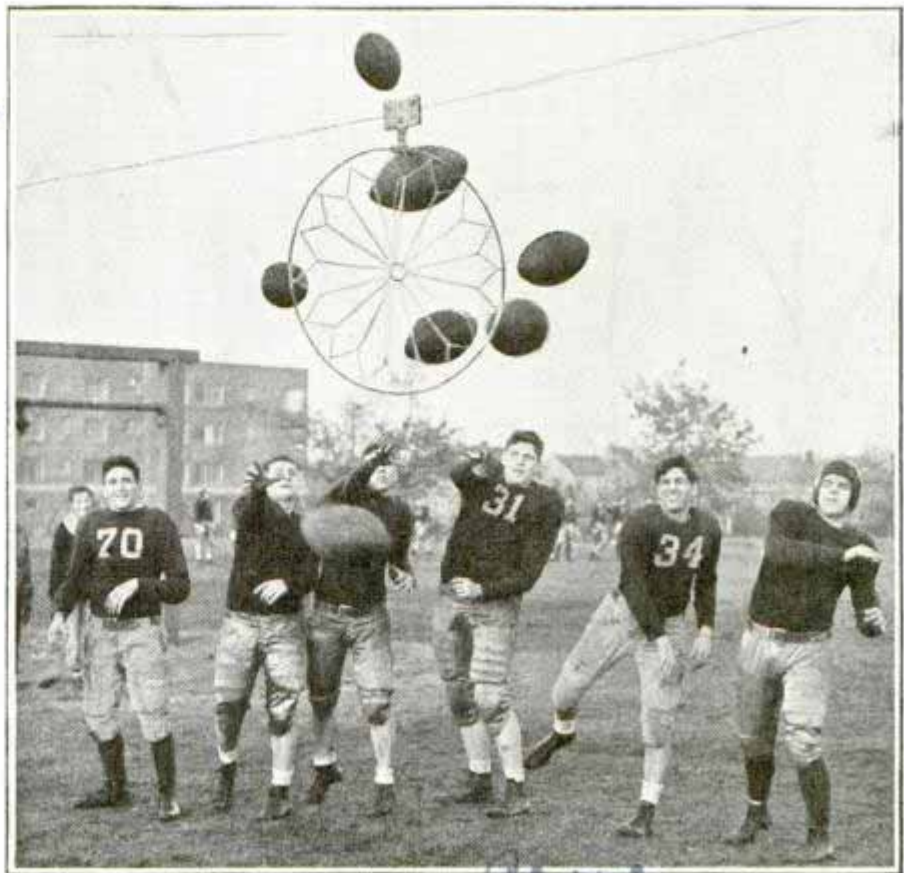

g-30²

Stoker-Fired "Space Heater" for Small Home or Store

Modern counterpart of the old-fashioned coal stove that was a familiar sight in the crossroads grocery store and the

home of the last century is an automatic, stoker-fired heater just announced. In a neat, compact unit for single rooms, small homes or stores it offers the economy of coal heat with cleanliness and thermostatic control. Instead of being merely an automatic burner in a furnace, it is a complete heat-producing unit, including a humidifier. Two sizes are available, one delivering 600 cubic feet of air per minute at 250 degrees, the other 1,200 feet; the smaller holding 200 pounds of coal in its hopper and measuring about twenty-seven by thirty-seven inches, by forty-five inches tall, the larger model being about nine inches greater in all dimensions and holding 350 pounds of coal. Both anthracite and bituminous burners are offered. The hoppers carry enough coal to feed the heater for more than a day even if operating continuously, and the ash-removal system is planned to assure cleanliness and complete use of all possible heat in the fuel. The entire unit can be dismantled easily and removed for installation in a different location.

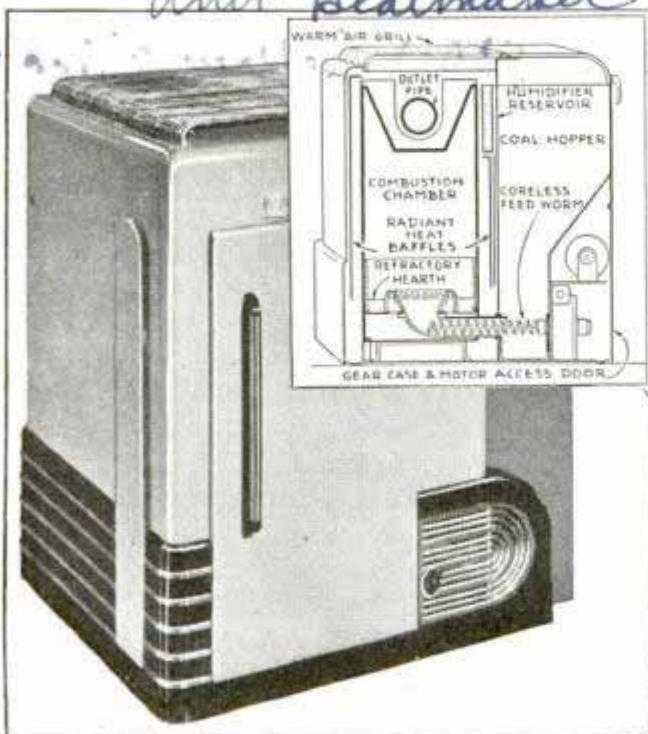

The old coal stove goes modern and efficient in this thermostat-controlled, stoker-fired space heater

g-30²
3170 W. 106th St. Cleveland, Ohio
Arden "Arcmax" Mfg Co., 4784 86

g-187

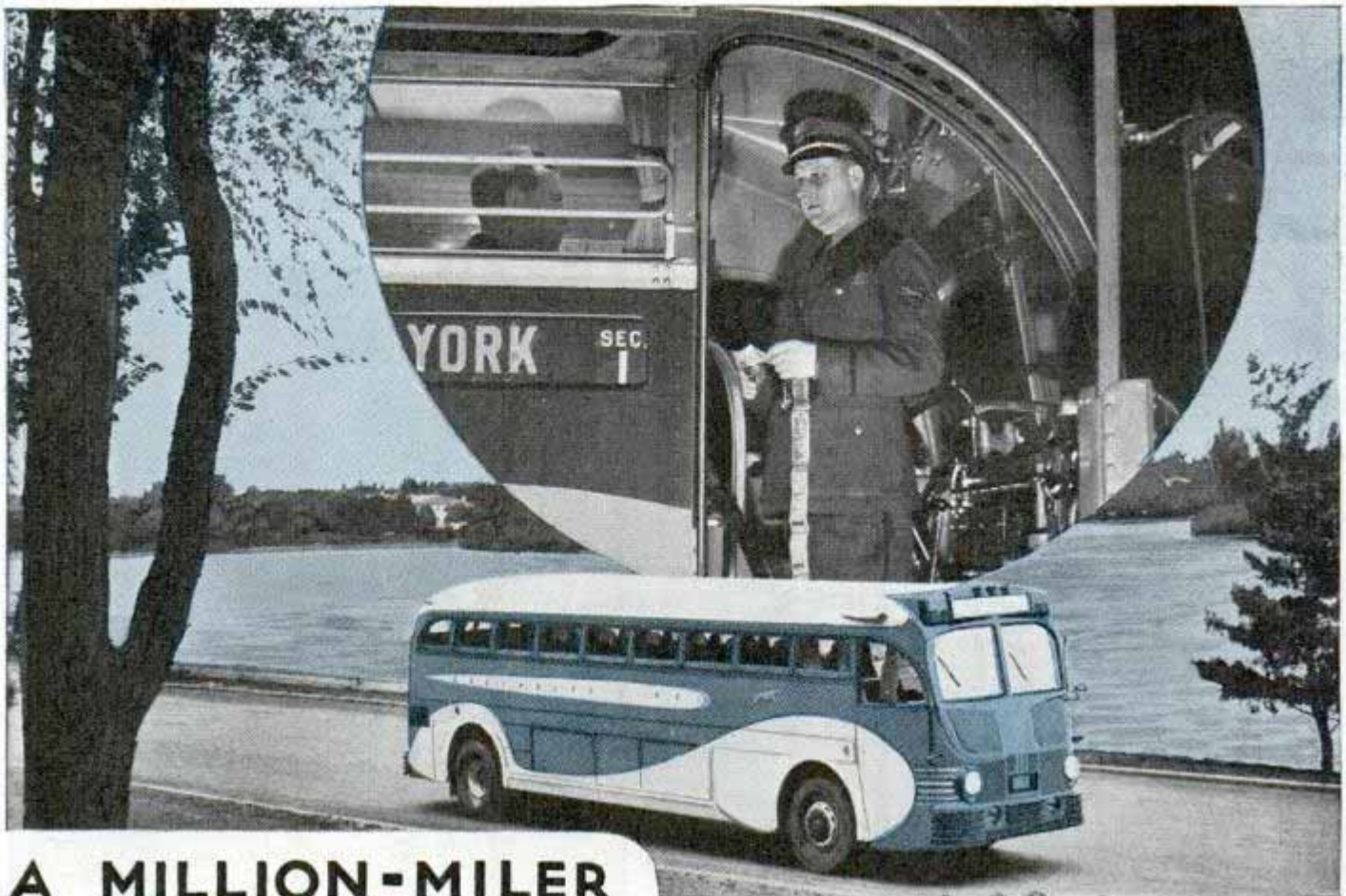

A MILLION-MILER

At the WHEEL

By M. C. ("Mike") Guzek
Veteran Driver of the Greyhound Lines

(As told to Julian Leggett)

7850 Jeffrey, Chicago

IF EVERY automobile driver were as well trained as the man at the wheel of the highway limited, the roads of America would be many times safer than they are today. A person riding in a privately operated car is fourteen times more likely to be involved in an accident than when he rides in one of our intercity motor coaches.

Charged with the responsibility for transporting nearly 50,000,000 passengers a year over a highway network totaling 50,000 miles, every one of Greyhound's 10,000 drivers faces the loss of his job if he fails to obey the standing order of "Safety First!" The company's unceasing campaign to enforce



Top, driver examining ticket of a passenger. Center, a big coach on the road. Bottom, driver stands by while mechanic adjusts the huge 200-horsepower motor located at the rear of the bus. Experimental work with Diesel-powered coaches has been under way for some time to determine whether oil-burning power plants would be better for buses than the gasoline engines now in common use

2-78



of the **HIGHWAY LIMITED**

that order, plus rigid inspection and maintenance of equipment plus every driver's natural pride in his own work, has made it possible to achieve a world's safety record of 1,249,143 miles of operation without even a scratched fender.

To most motorists the sight of a bus stopping at railroad crossings is familiar. But few can see the sense of bringing a loaded coach to a halt at crossing over which no train has run in years. They probably don't know that the bus driver is under orders to stop at every railroad crossing. On one of our eastern lines, motor coaches had been stopping at a crossing that apparently had been abandoned seven or eight years. So far as the drivers knew, no train ever crossed the highway. Not so long ago, a bus stopped there, as usual. To the driver's amazement, a train pulled slowly across in front of him. Failure to stop that one time might have caused a serious accident.

Another order under which bus drivers



Top, ready to begin a night run. Note the wide visibility afforded the driver by the large windshield. Bottom, trim front of a supercoach



operate, and which might well be adopted by the automobile driver, is that the bus shall not exceed the speed limits of any town or state through which it passes. Still another important regulation is that calling for the driver to keep the bus on his own side of the road.

Becoming a bus driver is much like joining the army. The applicant must stand a regular army physical examination after he has been found to be: between twenty-four and thirty years of age; at least five feet eight inches tall; at least 160 pounds in weight, and of good general appearance, clean cut, cleanly and gentlemanly, with at least a high-school education. After these hurdles have been taken, the applicant takes the wheel of an empty bus for a trial run under the eyes of an expert driver. If he handles the coach satisfactorily, the driver recommends that he be admitted to the drivers' training school.

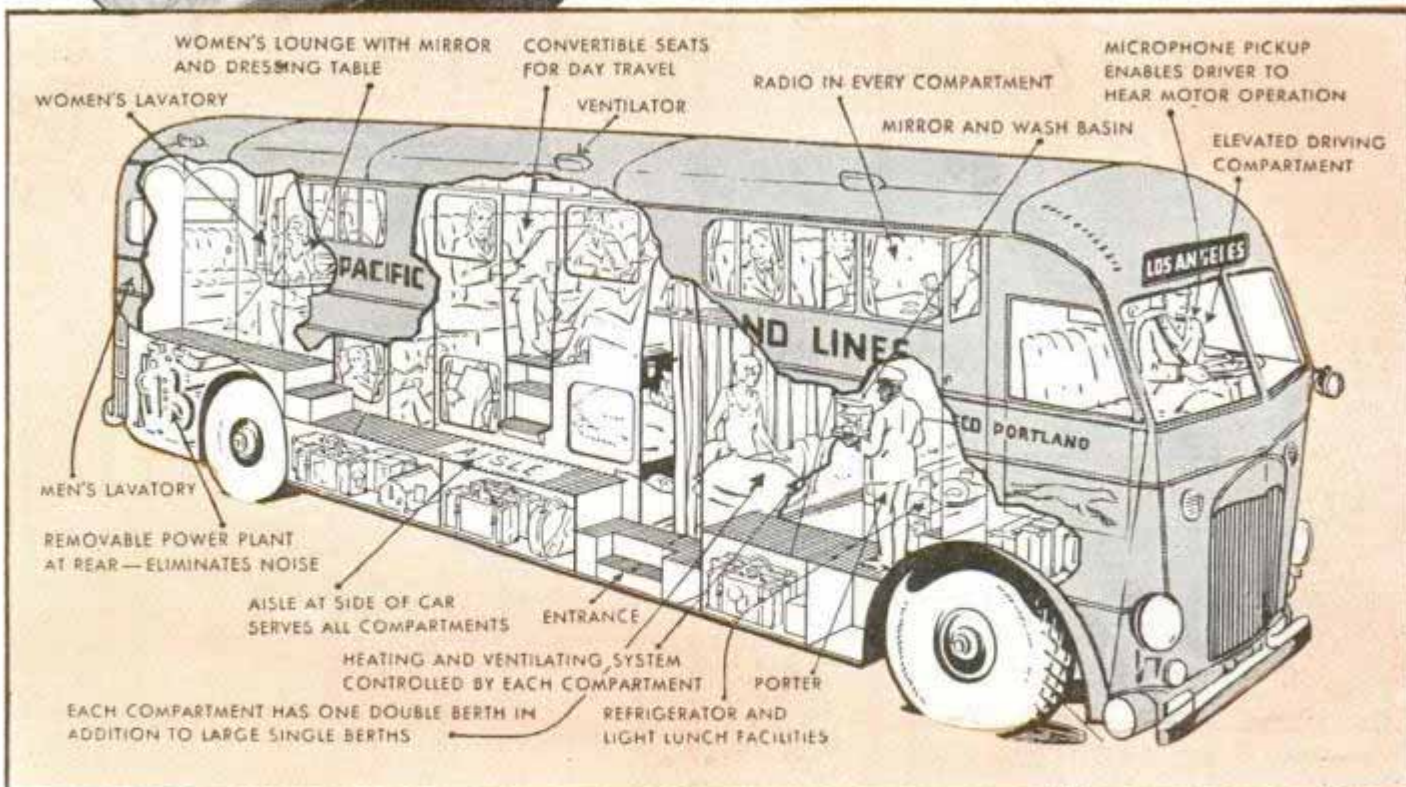

Top, Driver Guzek at the wheel. Circle, night accommodations aboard sleeper bus. Bottom, cutaway drawing shows many features for comfort incorporated into sleeper bus

Then, for one week, or two if necessary, the student is subjected to an intensive course consisting of safety lectures, mechanical instruction and driving. Half of each day is spent on the road. A written examination follows, with students expected to answer questions about parts of the 200-horsepower motor and what they would do in case of trouble on the road, such as making minor repairs or changing one of the big 325-pound tires. You know, you don't lift those tires, you just juggle them until they slip into place on the wheel. If the student passes this test, he is then assigned to selected drivers on regular runs, to give him an opportunity to learn various routes in the territory where he is to be employed. The driver observes the student's driving technique and gives such advice and instructions as may be required to acquaint the student thoroughly with the company's rules, safe driving practices, courtesy to passengers and other requirements necessary to qualify him as a careful and efficient driver. After each run the driver reports on the progress of the student until he is regarded as ready for a run of his own.

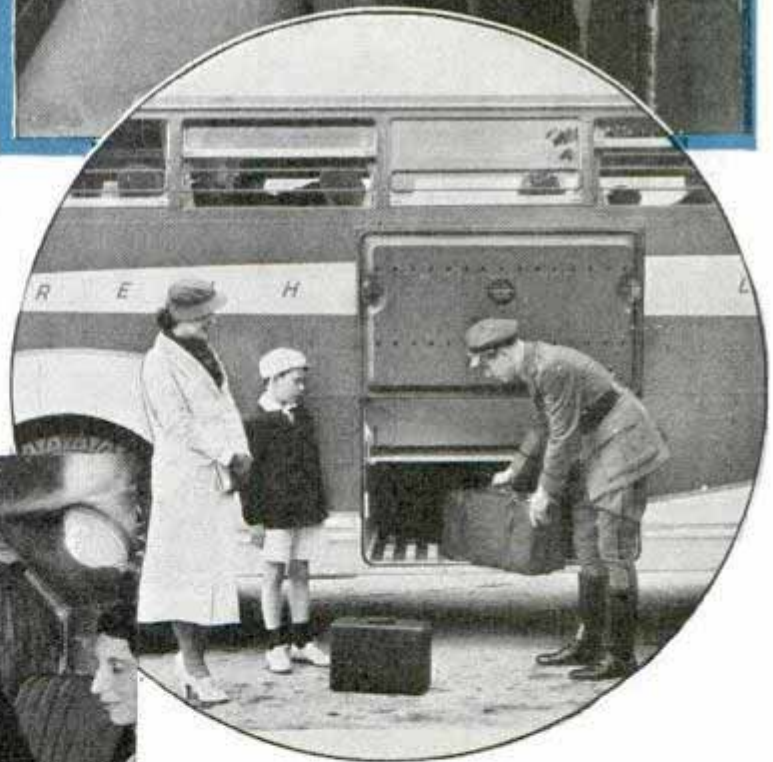

Even then the company does not relax vigilance in its safety campaign. Every six months the driver is required to stand a physical examination and frequently an inspector rides his bus to observe his actions. If a driver checks in with the dispatcher at the start of his run and appears to need sleep, he is not

Top, a drink en route. Center, loading baggage. Bottom, table set up for card game on highway limited

(Continued to page 152A)

Lifesaving Car Equipped for Any Emergency



More than 1,200 pieces of apparatus are carried by a "disaster" car recently delivered to Portland, Ore., for use in lifesaving and other rescue work. The unit is ready to cope with fire, accidents, storms, floods, and emergencies where human life may be in danger. Among other things, the equipment includes a 100-watt radio for sending and receiving; two portable sets for men in the field; a loud speaker with two-mile range; four lighting units, three of which are portable; eight large floodlights; many kinds of battery lights and flares; cutting tools, acetylene torch, lifting devices, chain hoists and all sorts of wrecking tools. In addition there is a life-line gun, hospital tent and cots, field kitchen, skis, five-horsepower outboard motor, moving picture camera, gas masks and resuscitator.

g. 390

Vibrationless Mount for Engine Makes Flying Safer

Safety in the air may be enhanced considerably by engine mounts, under development at two aircraft motor factories, which are designed to reduce vibration. Both designs contemplate the use of far more rubber than heretofore, as well as new methods of isolating vibration. In present designs, the engine mounts are sometimes suspected of transmitting instead of

Top to bottom, trained attendants at rear of truck ready for any emergency have portable radio sets strapped to their backs, one man wearing gas mask; view of lifesaving car; and expert hands taking care of victims

Capt. Henry W. Young

6834 d. 1111 B

Wright Aeronautical Corp.

given & city by Aaron M. J. rank

2-387

damping vibration and in three accidents in recent months the engine has been shaken loose from the nacelle. Although dropping the motor was not the primary cause of accident, it makes safe landing more difficult in the delicately balanced low-wing monoplanes used today. Some of the strain set up when an engine, unbalanced through breakage of a part or the propeller, continues to run, may be overcome by dynamic balance features of the new design.

Eight Taught to Swim at Once on Four-Section Tandem Raft

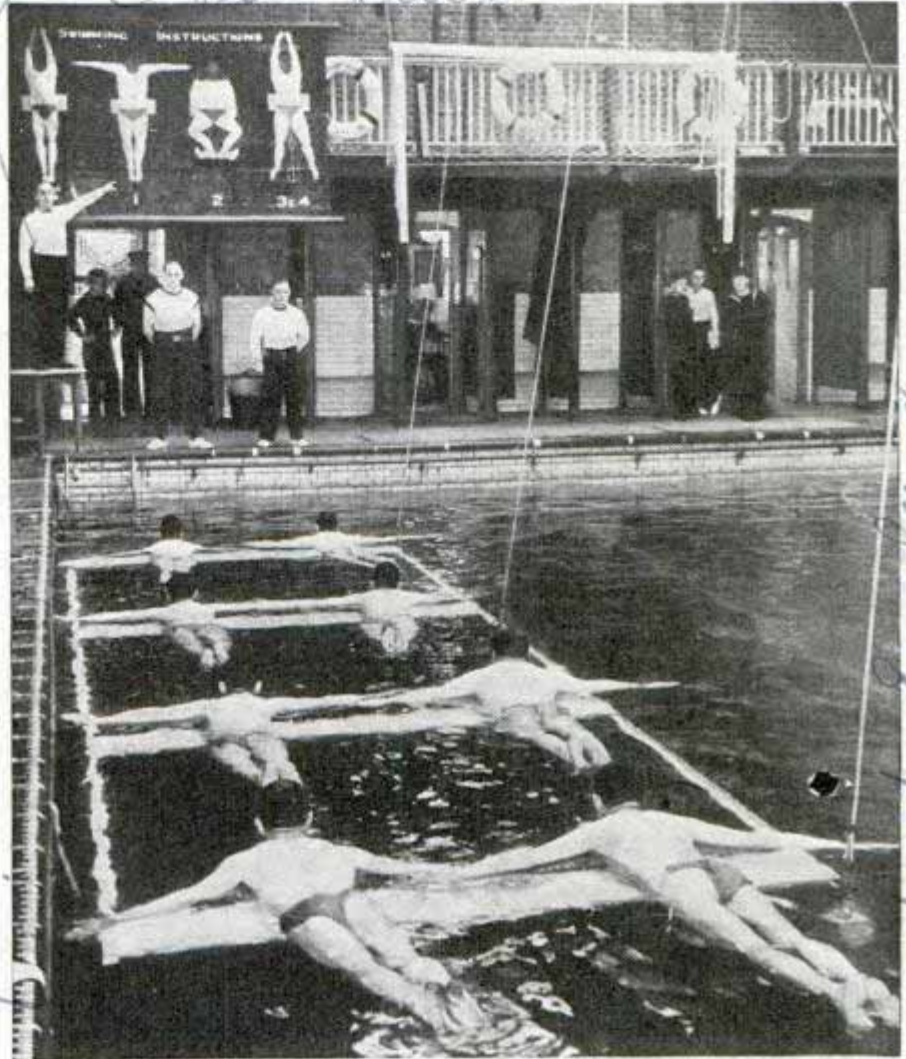

Swim students afloat on rafts learn breast stroke in water, as instructor in left background points to chart indicating arm and leg movements

Pipe Wrench Slides Open or Closed Quickly

Quick adjustment is claimed for a pipe wrench which eliminates the tedious twisting of a wheel or thumbscrew to open and close it. The mechanic merely presses two levers to disengage pins from the notched shank, and then the mouth of the wrench will slide open or closed as many notches as desired. If there is any slack this is taken up as usual by the swivel grip.

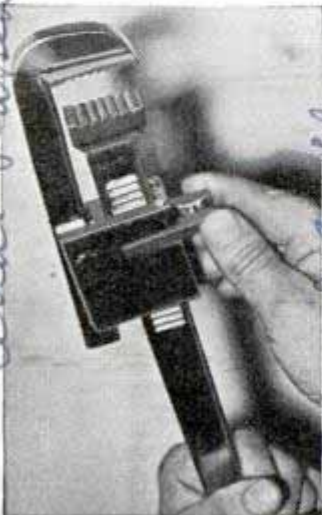

Sailors of the British navy who can't swim are taught the proper strokes in short order at the Devonport royal barracks with the help of a kind of tandem raft. Eight men can take lessons at one time, using their arms and legs freely while lying across one of the four floating supports. After four lessons they know how to paddle around.

Cement and Soil Make Low-Cost Pavement

Thousands of miles may be added to the country's hard-surfaced road system at low cost by a method of mixing concrete with surface soil, according to reports given the American Road Builders' association. The soil is first tested to determine the amount of Portland cement to be added for hardness and durability; then the ground is dug up with a tilling machine to a depth of four inches. Cement is spread over the loose soil and mixed thoroughly by the tiller. After water is added to make a moist mixture, the pavement is finished by leveling, rolling and a few days of drying.

Handwritten notes on the left side of the page: "d.w. J. W. Roege. 704 Δ 6-310. Cedar Rapids, Iowa." and "not a third Cedar Rapids, Iowa." There is also a handwritten "367" above the pipe wrench section.

Handwritten notes on the right side of the page: "Devonport, England" and "Compton's Patent Water 55".

Handwritten notes at the bottom of the page: "Automobile Industries April 1939".

Pre-Cast Concrete Tunnel Sunk in River Bed

Christian Science Monitor

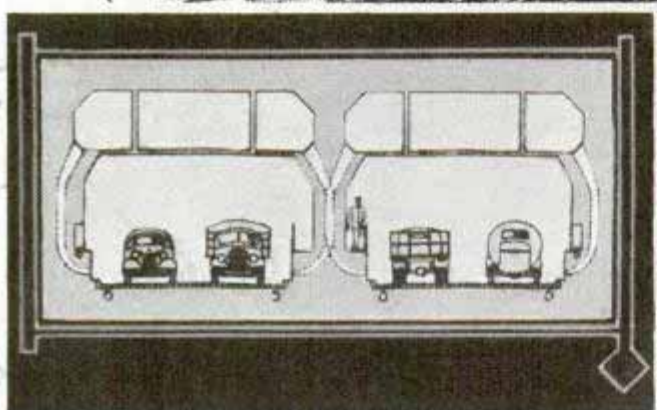
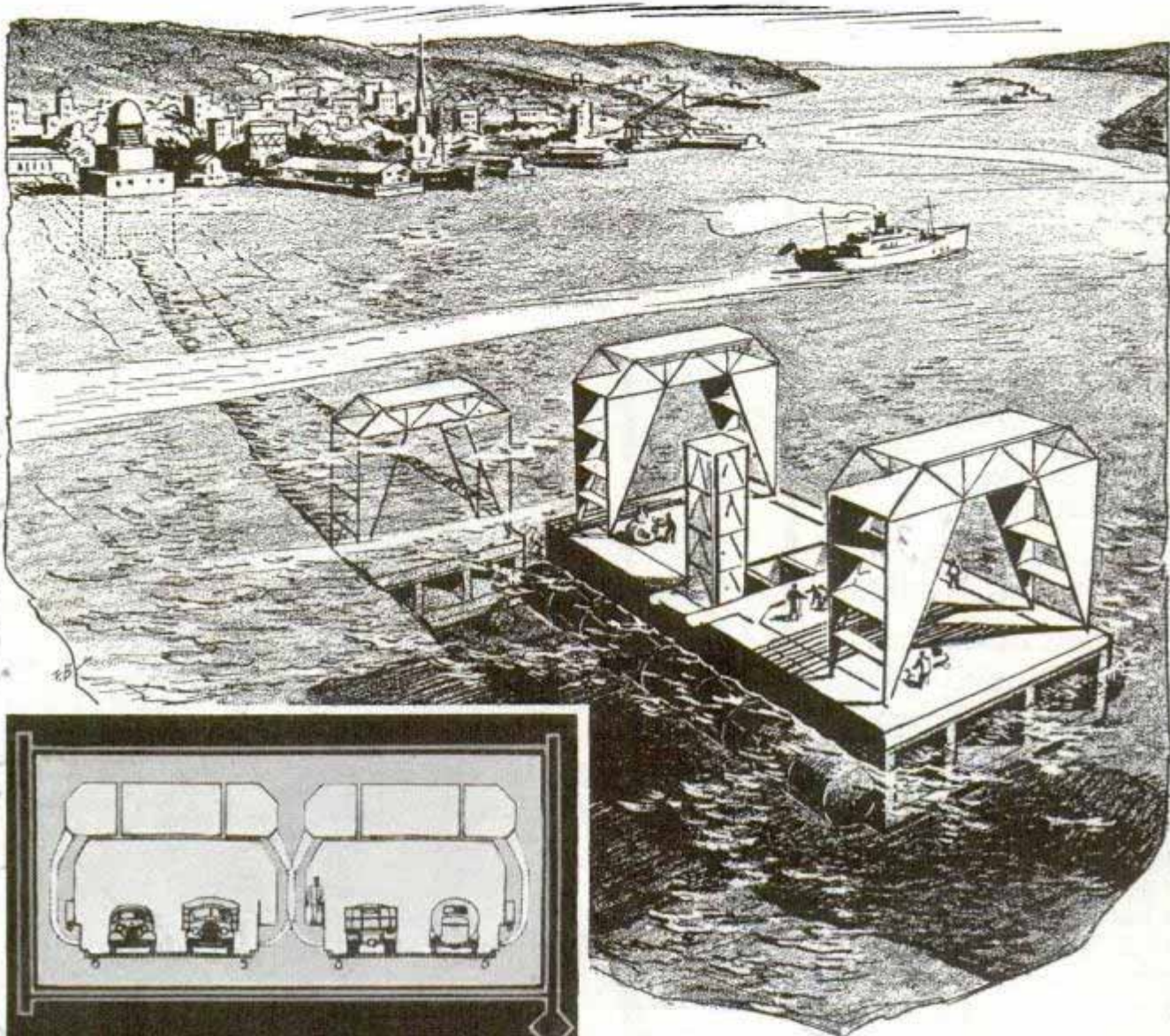

Drawing above shows how sections of three-tube traffic tunnel are floated to site, then sunk. Left, cross-sections of land (above) and river parts of tunnel (below); center, ventilation tower

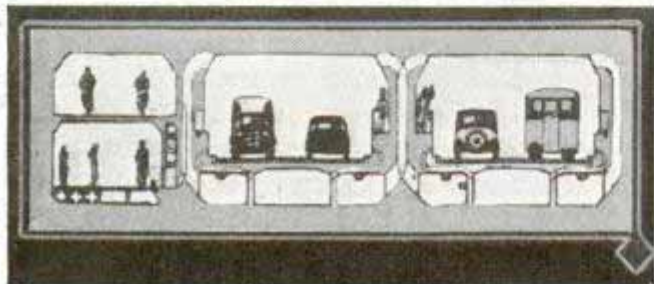
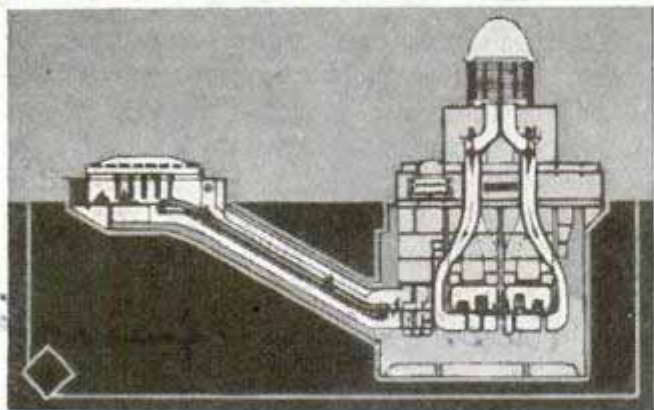

At a fraction of the cost of boring under the river, engineers are sinking to the bed of the river Meuse at Rotterdam a pre-cast concrete tunnel. More than a mile long, it will connect the two populous sections of the city, providing three separate traffic channels—two for motor vehicles and a third for pedestrians and cyclists, for whom escalators will be installed at the two shore approaches. Tunnel sections of reinforced concrete are floated to position and then sunk to the channel dredged for them. Properly alined, they are joined under water with the aid of diving bells. The builders plan to complete the \$10,000,000 tunnel in 1941.

Baby-Bottle 'Swing' in Crib Is Always in Reach



Just the right tilt is given bottle by this crib clamp so baby can drink milk to the last drop

Time and trouble of holding the baby's bottle during feeding can be saved by using a holder that attaches to the crib or buggy. Two stout rubber bands joined together are divided in the middle to accommodate the bottle, which is kept within easy reach of the infant. At the ends of the sling are rings for convenience in tying it to any handy support.

Tractor Turns in Own Length and Gives Driver Clear View

Seated forward of the four rear driving wheels the operator of a recently invented tractor has full view of the ground to be

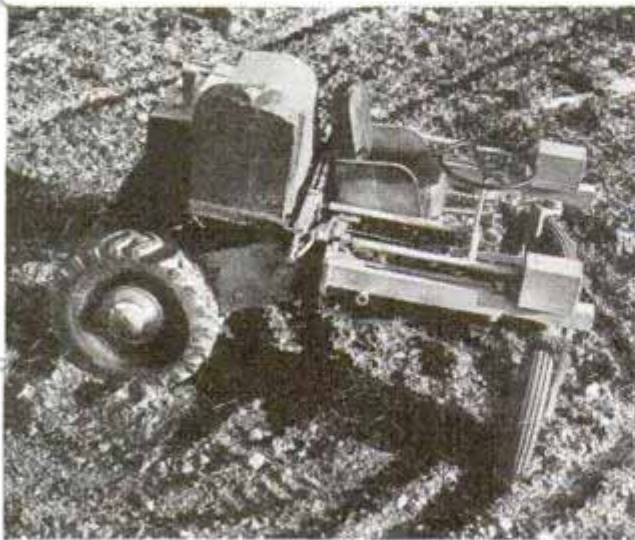

Tractor turns "pigeon-toed" to wheel around in its own length. Note forward position of driver's seat

covered and is away from the exhaust fumes. The two guide wheels in front can be extended for added length if needed, and the tractor can turn in its own length. One of each of the rear dual wheels can be removed to operate through rows of crops, giving a variable width of forty-eight to seventy-two inches. Built of welded structural steel, the tractor weighs 2,400 pounds and has a drawbar pull of 1,500 pounds at four and one-half miles per hour. It has four speeds forward and two reverse and makes two to twenty miles an hour.

2350 Sterilizing Lamp in Refrigerator Kills Germs with Sun Rays



Tube lamp emits ultraviolet rays which kill bacteria floating in air within refrigerator

Ultraviolet lamps are now available for installation in household refrigerators. Plugged into the ordinary lamp socket, they shed sterilizing rays over the food compartment to kill bacteria and microorganisms within range of their invisible light. The six and one-half inch mercury vapor lamp uses less than one-fourth the current of a twenty-five watt lamp.

The world's population makes an estimated net gain of 100,000 persons a day; the United States contributes about 3,700.

Science Monthly
April 1929

Mr. E. Houghton, 10548
Missiana St. Westwood Angeles
Calif.
Mrs. Rush Hamelton
Marysville, Calif.
Westmoreland
Blomfield, N.J.
2-80 11.45



SO YOU'RE GOING TO FLY

156077 817

Israut

PASSENGERS on "Trip Three" show their tickets as they board the coast-to-coast liner, right, and their names are checked on the manifest. Above, stewardess and co-pilot examine records at start of the flight from Newark to California.



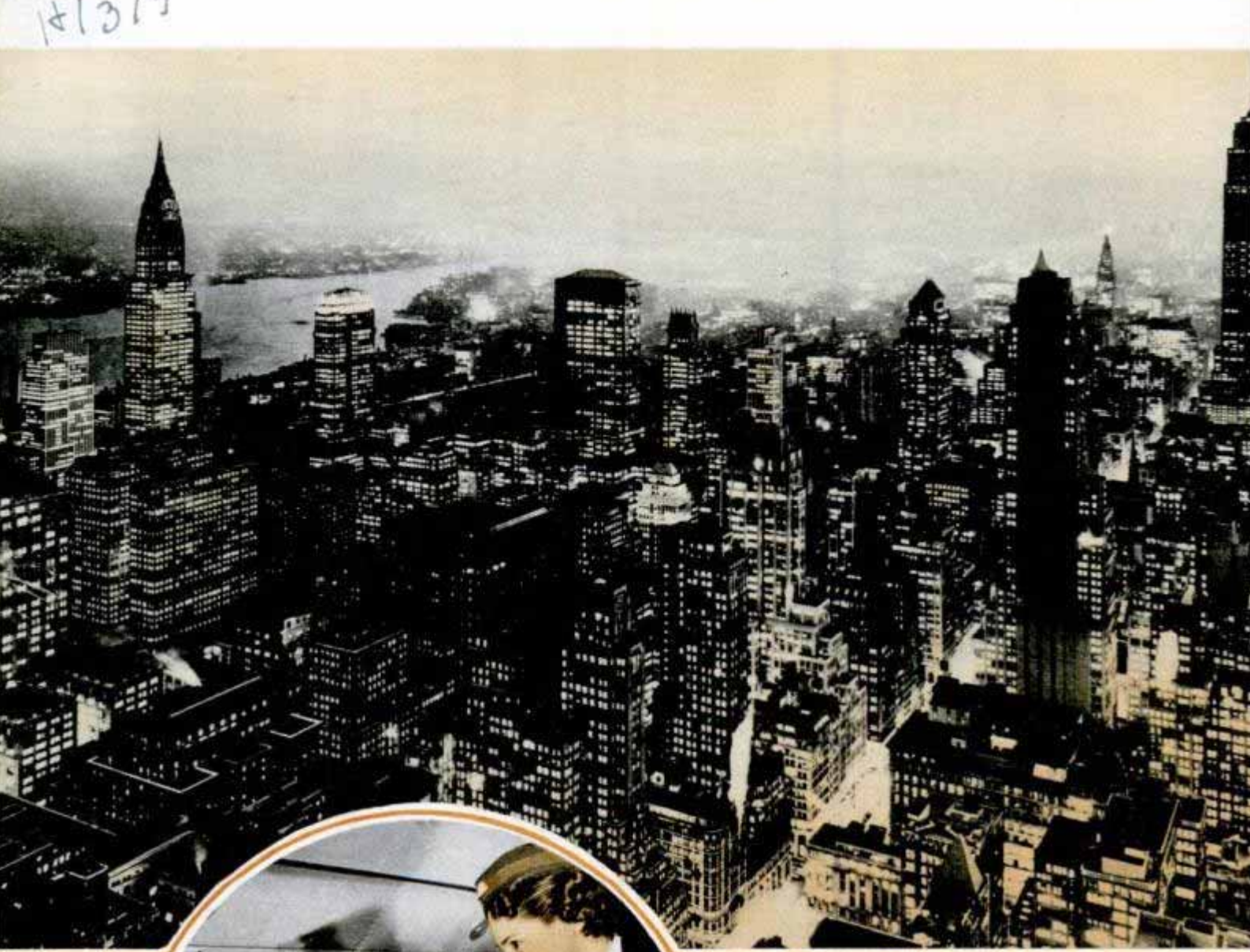

TWILIGHT settles over Manhattan, top, as your plane heads westward. City lights are a thrilling spectacle from the air. Left, stewardess points out landmarks on the route.

By Roderick M. Grant

YOU'RE going to make your first air trip? Well, it's high time. A few more years and there'll be scarcely a thrill left in it, for stratosphere planes will be taking you up where there's nothing to see but a blue blur.

Like thousands of others planning

their first flight, you probably feel right now like a pioneer packing his pony for an unblazed trail into the perilous Northwest Territory. You're pretty scared or thoroughly thrilled. Maybe a little of both. There's not much reason for either. Ten years ago, when air transport was still in rompers, you'd have waited two or three hours at the airport for mail connections to arrive, then climbed over the wing into the cramped two-seat cabin where they piled mail sacks in your lap. You waved to excited friends through a window rapidly clouding with a film of oil as the single motor hauled you across bumpy, furrowed turf, hurdled telephone wires and climbed up and away for a hedge-hopping cross-country tour.

But air transport is in long trousers

15101
now. You buy transportation, not a carnival thrill-ride. Still, there are thrills for a first-fighter. You're going to have yours.

Want to be in San Francisco Saturday? You can take United Air Lines "Continental" sleeper that leaves Newark at 5:15 p.m., Friday, and you'll be in 'Frisco at 8:15 Saturday morning.

A three-minute phone call saves a seat in your name. The air line limousine will pick you up Friday, an hour or so before departure time. Tip the red cap at the airport and pay for your ticket, and you're through spending money for 2,639 miles. As on an ocean liner, your fare includes meals. Better than an ocean liner, there's no retinue of stewards and maids to "fee." You can try to tip the stewardess if you like her looks (and you will), but she'll politely refuse.

Don't be embarrassed when the ticket agent asks your weight. He won't ask your age. But the pilot must have the exact weight of his load, gasoline and oil, passengers and crew, mail, express and baggage. You are allowed forty pounds of luggage. A few



819
SOARING above a river, you check your progress on the illustrated map of Newark-Chicago-San Francisco airway. Below, comfortable lounge chairs are adjustable to let air travelers visit and play games, read, nap, or enjoy the view.





years ago they'd have actually put you on the scales and debated whether to take you along; the air mail had to go, and no one particularly cared whether passengers were accommodated—it was the mail that "paid the freight."

At the ticket desk you peel off \$157.95 for the sleeper trip. Lucky this is 1939. Ten years ago you'd have dealt out \$400 for the one-way journey that took twice as long and involved six different planes instead of two.

They take your baggage away, after weighing it—and if you want your hairbrush and pajamas, get them right now; you won't see the bags again this side of San Francisco Bay. You are given a small suede overnight bag to hold the necessities of life on a sleeper. You can even forget the toothbrush and razor; brush, cosmetics and the like will be supplied by the stewardess. An electric razor awaits your chin in the dressing room, where it plugs into a 110-volt circuit.

Over the public-address system of the air depot, departures and arrivals are being announced, and at last the loud speaker summons you:

"United Air Lines, Trip Three, for Chicago, Omaha, Cheyenne, Salt Lake City and San Francisco, ship now ready at Gate Four."

The glittering silver sky lounge has wheeled into position, steps are rolled to the open door. Idling propeller blades flash in the setting sun. You notice the pilot peering from the forward window, radio earphones over his head. You've watched this performance at the airport many a time, yet you have a subconscious feeling that you're about



BEDTIME comes too soon on the sleeper plane, above. At sunset you may ride above a rolling bank of fleecy clouds, sun-tinted like those at left.



821

FIRST call for dinner gets an enthusiastic response. Dining in the sky is a thrill to be remembered. Right, "makeup" in the women's dressing room at rear of sleeper.

to make the first flight in history. Attempting nonchalance, you give the stewardess your name; she flashes the smile that helped get her the job, checks your name on the manifest and you follow her up the roomy lounge.

Choose a seat near the front or rear, if you can. There's no difference in comfort, but you can see better. Those vast wings shut out the view directly below the middle seats.

The stewardess goes swiftly into her routine of fastening your seat belt, but as you reach for a cigarette she points to the sign up ahead—"No smoking during takeoff or landing."



18121



MEALS are prepared on the ground and served from this flying kitchen. The vacuum bottles dispense hot and cold beverages. Below, you will never forget your first view of a great city carpeted with lights, seen from window of an air liner riding mile-high in the sky.

Jittery? Take it easy. You're not in a dentist's chair. And the pilot has flown before.

Twin motors purr. You roll along to a corner of the field, swing around, head upwind and stop. What's wrong? One motor is roaring at high pitch, the other idling. Then the other engine is revved up. It's all right, the pilot is merely giving each a final test.

Now both engines are humming. Take out your watch. You are rolling, faster,

faster, the tail lifts from the ground and you level off, ten seconds pass and the concrete runway drops away. You're in the air, first flighter! Yes, there are telegraph wires and hangars ahead, but the broad wings take a deep bite of air and you are climbing steeply. The airport is behind you—then the earth tilts up alarmingly and slanting smokestacks and trees reach for your window. You glance quickly at fellow passengers. No one seems perturbed. You're banking, of

822





course, the takeoff had been northeastward and you must wheel around to the west for Chicago.

823
Already the needles of Manhattan are dwindling, fading into the purple dusk enveloping the city. Lights are beginning to twinkle in the satellite suburbs of the metropolis, but a bright orange orb of sun shines ahead as you climb above the pall of ground haze. Twilight below, daylight still up here. Your ears crack, you swallow and hear the stewardess, above the soft drone of the engines, offer you the evening paper and a cigarette while she unfastens your belt. Ear-stoppers used to be the first offering, but today cabins are so well sound-proofed you can chat in ordinary voice. The engines that roar at earth-bound listeners sing but a humming obbligato to passengers aboard.

Funny, now that you think of it—you expected to be dizzy at this great height. Looking down from tall buildings, dropping in express elevators always annoyed you. Here you are 8,000 feet up, and you have no sensation of height or speed. You are drifting smoothly, with a sense of solidity. There is no ladder from the earth to give you a giddy feeling of height, no highway, no traffic, no houses rushing past to furnish perspective and a realization of speed. Watch those section lines down below, marking roads a mile apart, and you discover your wing is cutting across three every minute.

And smooth? It's hard to believe you're traveling 180 miles an hour or more. Recently a billiard table was installed in one of these sky lounges and a trick shot champion gave a demonstration 5,000 feet over

BOTH uppers and lowers have their own windows in the sleeper, and each has an adjustable ventilator. The stewardess may wake you gently before landing and tell you to swallow, to adjust your ears to changing altitude.

#131

824



Chicago. So vibrationless was the flight that he could balance one billiard ball on top of two others!

You used to hear a lot about airsickness. It's virtually extinct today. Occasionally, of course, there's a bumpy day, and occasionally the stewardess, who is a trained nurse before she's a stewardess, must minister to someone with a case of "mal d'air," but any old-time pilot will tell you what was really the matter!

"She tried to hold up the plane with her stomach."

Less than three in every 1,000 passengers become airsick.

By this time your own jitters have vanished, and when the stewardess pauses at Seat Three
(Continued on page 128A)



HAPPY landing at the end of the line, top. Notice upper berth windows. Below, sky tourist's view on arriving over San Francisco bay, with bridge and Treasure Island fair in foreground, Alcatraz isle in distance, San Francisco skyline and Golden Gate bridge in left background.

J-337

315 Fourth Ave
New York City

Whiskers Big as Tree Stumps Seen on Screen

Edw. William Henschel

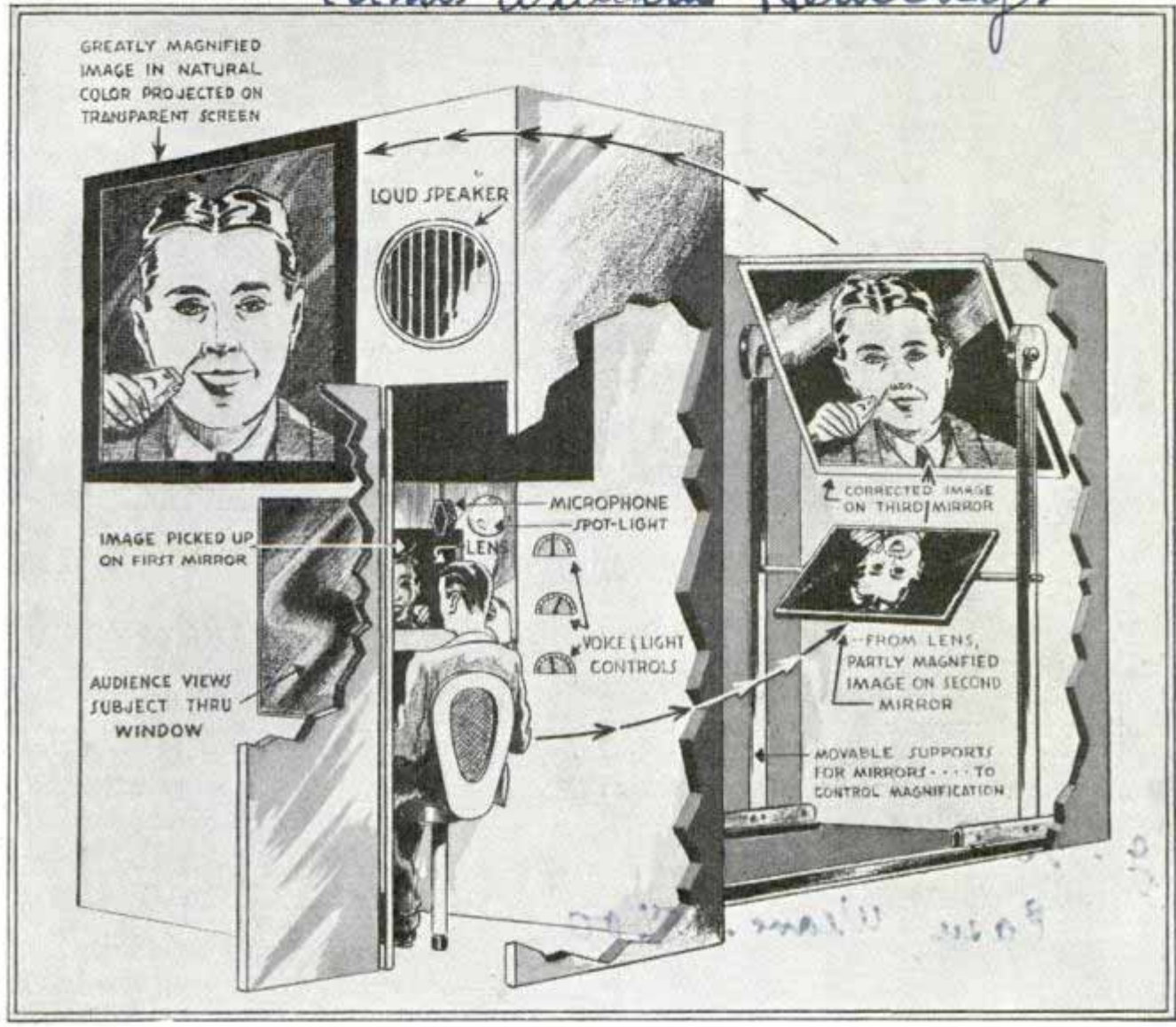

Diagram shows how image of subject is reflected through a series of mirrors and finally projected to screen greatly enlarged. Announcements come to the audience over public-address system

Images of living models, instead of slides and films, will be projected to a large screen at New York World's Fair. Enlargements up to thirty diameters can be shown. The "magnascope," as the projector is called, will be used by a manufacturer to demonstrate the technique of electric shaving, and a day-old beard will be made

to look like a forest of tree stumps. A reflection of the subject will be picked up in a small mirror, passed through a series of condensing and magnifying lenses to a second and larger mirror, thence to a third mirror, from which it is projected, greatly magnified, to a screen where visitors will see the image in natural color.

Submarine Cables 344,079 Miles Long Link the Nations

Of the 344,079 nautical miles of submarine cables that "rope" together the continents, British and American private companies operate more than two-thirds. The total, sufficient to circle the globe about fourteen times, includes 287,708 miles of privately operated cables with British companies controlling 154,949 and Ameri-

cans 94,150 miles; and government-operated cables reaching 51,973 miles. In addition, more than 4,000 miles of cables were ceded by Germany to the allied powers by the Versailles treaty and their present ownership is unknown to the Telecommunications Union. France leads in government-operated cables with 17,686 miles.

Dept. of Commerce Press Bureau
3/27/30

ce-2

British Streamliner 'Chums' with Americans



Here's a "four-horse" team representing the latest in steam, Diesel-electric and electric power. Left to right, British "Coronation Scot," two Baltimore and Ohio locomotives and a Pennsylvania electric engine

Paying an "ambassadorial" visit to Washington, D. C., recently, the "Coronation Scot" met three great American locomotives in the depot and they lined up on adjoining tracks to pose for a family portrait. The streamline steam speedster of the London, Midland and Scottish railway

was just beginning a tour of American cities. Its three streamline acquaintances in Washington were the steam-driven "iron horse" of the Baltimore and Ohio "Royal Blue," the Diesel-electric that hauls the "Capitol Limited" of that line and a Pennsylvania electric locomotive.

File Rugs with Designs Made on Small Home Loom

Easy Weave - \$1.00

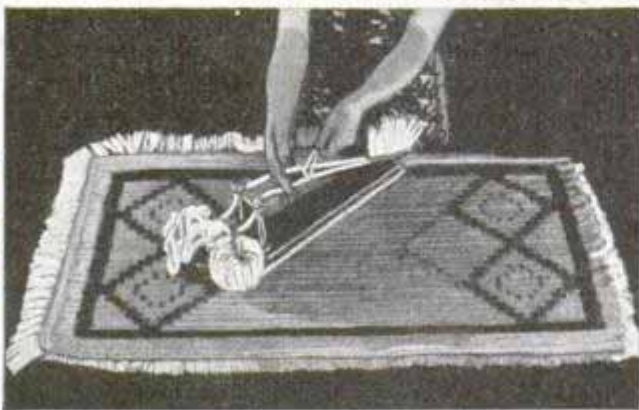
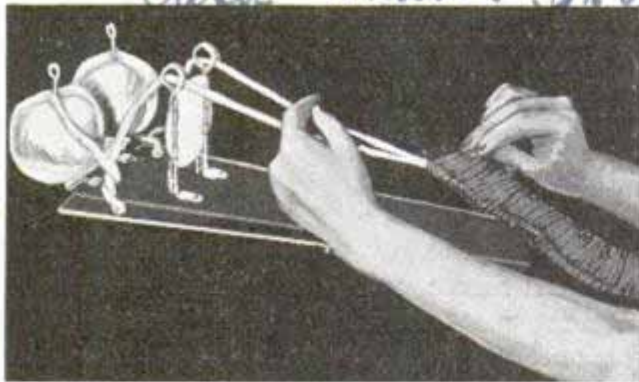

Top, using the small loom. Note its simplicity. Bottom, weaving rug fringe

By using a patented wire-frame loom, beautiful design rugs with a pile can be made in the home. Fabric cut into strips, or yarn cut to proper length, may be used, and the pile is formed with a knot similar to that used since ancient time in the making of Oriental rugs. Colored design charts, which guide the loom operator in arranging the knots on the braid, facilitate the production of beautiful designs. The charts indicate rows which correspond to lengths of braid formed on the loom, each row being divided into the colors which correspondingly occur in the design. Calibrated so that the number of knots to be tied on the braid for any color is indicated, the charts insure that the length of color on the braid will be proper, and that a uniform pile is produced on the braid and in the rug. Light, durable and small enough to be held on the lap or used on a table, the inexpensive loom lends itself to the weaving of rugs by the unskilled. The rugs, made from woolens, yarns, silk stockings,

Pat # 2,150,024

John H. Clark Co. 125 W. ...

dyed rags, old dresses and similar articles of clothing, can be vacuum or dry-cleaned. Charts illustrating a number of different designs, and yarns, especially treated so as to be particularly adaptable for use in rugs, are available. The method of making rugs from the described charts is also patented.

2365

Stratoship Ride Among Latest Thrillers

Thrills and excitement of stunt flying, plus the pleasant features of a smooth glide through space, are obtained in a stratoship ride at the New York World's Fair. Passengers ride in a car balanced by a water tank and driven by a propeller motor. The car rotates on an axis, climbing, banking, diving and going through other motions of stunt flying.

Swift Attack Bombers Race for Jobs in Army Air Corps

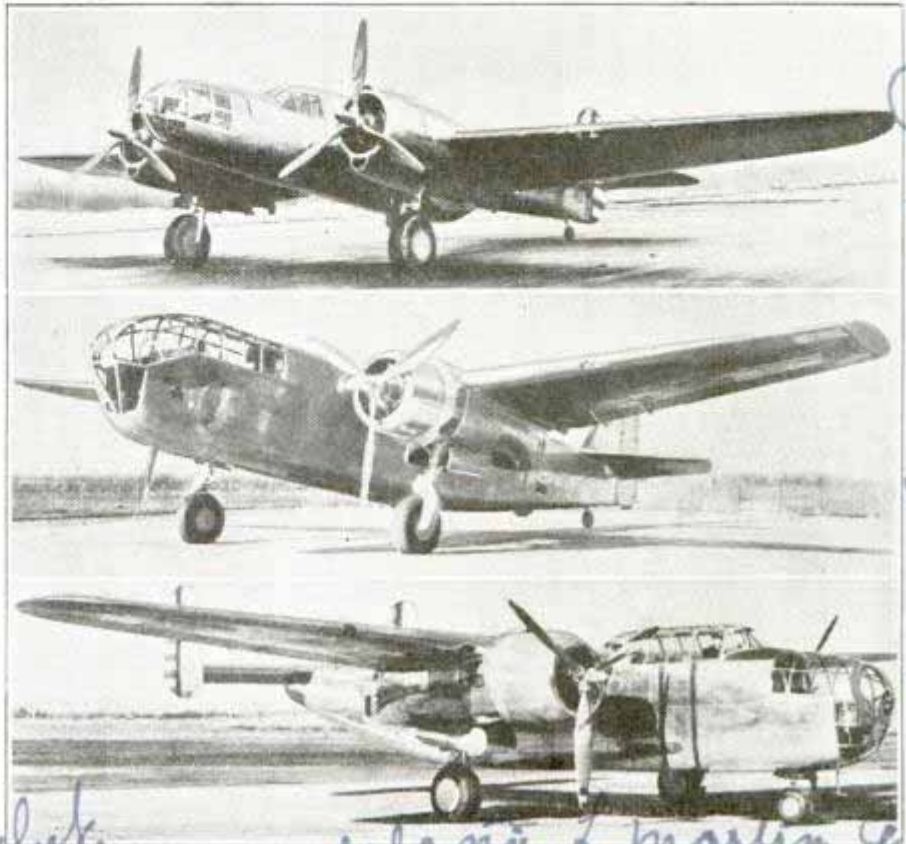

Photos U. S. Army Air Corps
Top, the Martin attack bomber; center, Stearman Aircraft's entry, and below, the tricycle-type ship offered by North American Aviation

Three fast attack bombers are engaged in keen competition for adoption by the U. S. army air corps. All twin-engined ships, they were offered for army trials by three manufacturers, and although their performance records remain secret it is understood each is capable of six miles a minute, speed enough to outrace all but the newest and fastest of pursuit planes. One of the planes has tricycle landing gear. They are heavily armed with machine guns and bombing equipment.

More than 28,700 light-houses, lightships, buoys and other markers girdling the United States coast and extending to the Hawaiian Islands are manned by 5,189 workers.

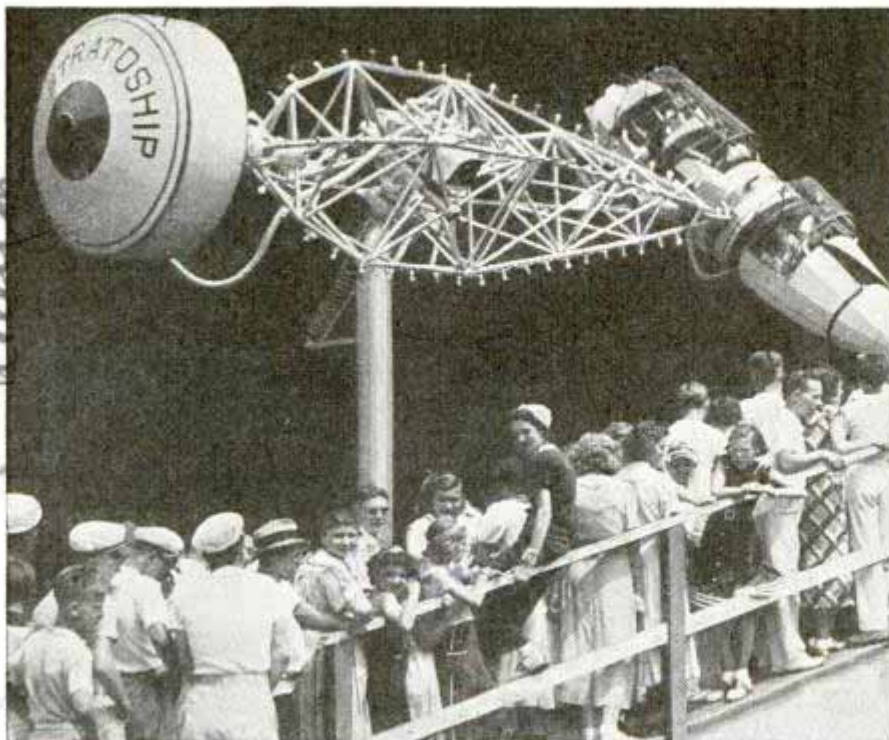

Passengers ride in car at right while water tank at left acts as ballast

Emb. H. es Traveler 2058.142 m

Drug leeward, Calif

duke
islenig & martin
to allmore md
Nicholas Kern

Christian Science
Journal 2/12 2/12

Home Pre-Built in Sections Is Trucked to Site

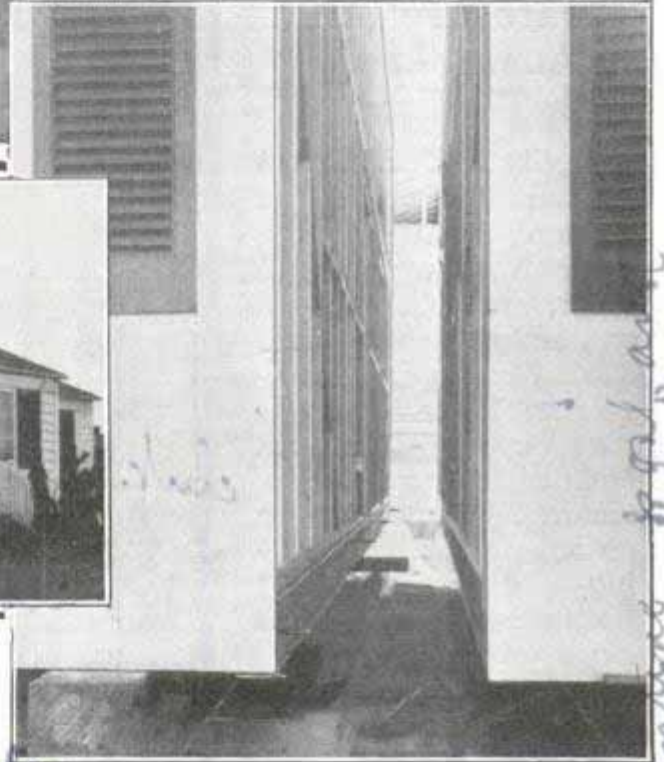
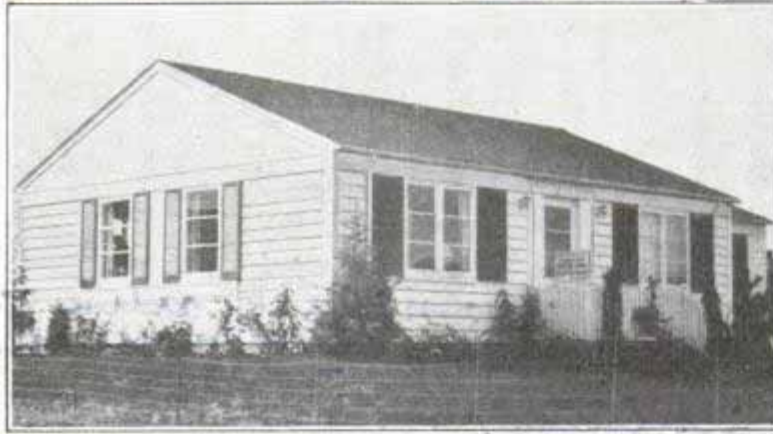
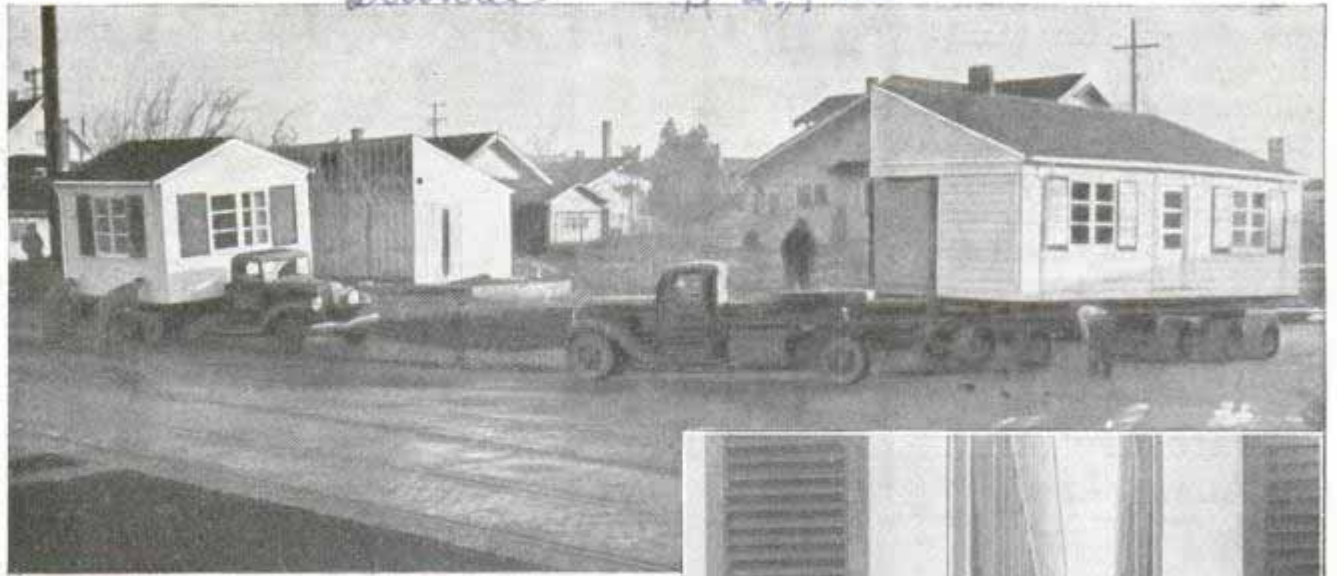

Top, trucking two pre-built sections and an "addable bedroom" to the building site. Right, the two sections, split down gable ends, ready for joining on foundation; left, the finished and landscaped house

In Seattle you can buy a factory-built timber house of four rooms, completely equipped and ready to live in, for \$2,980. It is trucked to your lot in two sections, split down the ridge pole and gable ends; it is set on the foundations, the two halves are joined by a patented method, and in three or four hours you can move your furniture in. Within forty-eight hours the shrubbery and lawn are planted and you are settled, with a house and garden. The house is constructed in a hangar-type factory building on an assembly line. Sheathing and sub-flooring are both glued and nailed; lap siding is laid over three-ply wood, which is glued and nailed to the studs. The roof is cedar-shingled; walls and ceilings are finished with insulation board, and floors are pressed hardwood. If you order it, an "addable" bedroom comes

on another truck. The house arrives already painted and decorated. Since there is no basement, the cost of excavating is eliminated. There is a disappearing laundry and heating room, concealed behind sliding panels in a space nine feet by three feet two inches, in which are an air-conditioning and oil-burning heating plant, electric hot-water tank, electric washer and laundry tray, all included, with electric fixtures and plumbing, in the original price. Kitchen equipment includes an electric stove and refrigerator.

Argentinians soon will be able to mail a vocal message anywhere in the world by telephoning the post office and dictating the letter to a disk record, the service and postage being charged on the phone bill.

General Mining Corp (1301. George Wellington Stoddard)
 Seattle Washington
 architect. Berntsen & Wach

Quintec \$2,980

available within 100 miles

Dept. of Commerce mem
 Mar 24 / 1934
 I am offering in my office...

LET'S GO DEEPER



By Dr. P. G. Worcester

Chief of the Department of Geology
University of Colorado

Boulder Colo.
YEARS ago they told us that soon we'd have to find a substitute for oil. Yet year after year the United States goes on producing more than sixty per cent of the world's oil, and digging gold and other metals at an undiminished rate.

How can this go on? The slogan of oil men and ore miners gives the answer: "Let's go deeper!"

In 1917 we were told that all the oil in the United States would be exhausted by 1929. Ironically, 1929 saw the greatest year's production of oil up to that time. Since then production has averaged a billion barrels a year, yet on January 1, 1938, there were proven reserves in this country of 15,500,000,000 barrels, enough at the present rate of production to last about twelve years. All this is crude oil recoverable through wells.

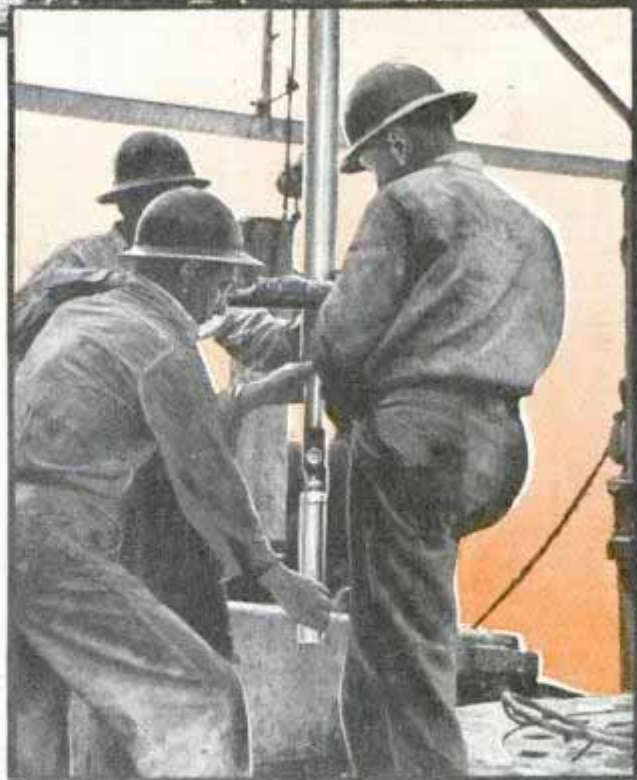

Top, even the ocean's bed is not safe from oil drillers. Below, sensitized film and tiny electric lights synchronized by stop watch are sent down into "hole" to photograph direction and angle of borings

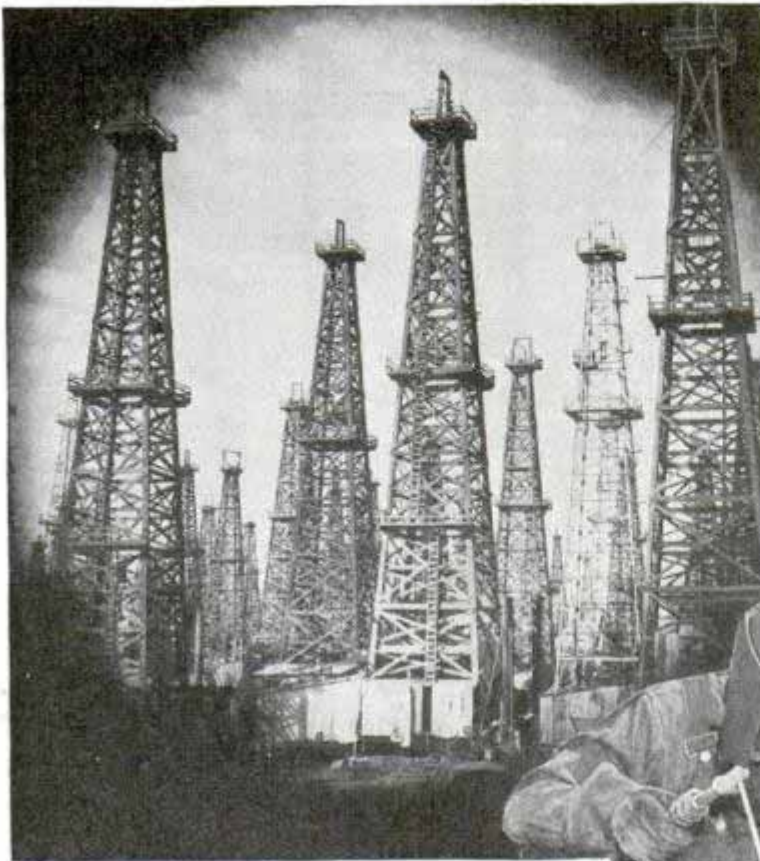

Lower photo courtesy the Colorado Association

Top, old wooden rigs and new-style metal rigs crowded together on Signal Hill in California. Right, electric-welding an oil pipe line. Bottom, "hard rock mining" with air drill

No one who is familiar with modern geological exploration, recent chemical improvements in oil refining, and new technique in drilling, believes for one minute that the present known resources represent all the oil that will be produced in this country. For the past twenty years geologists have found oil as fast as it has been needed to supply a constantly growing demand, and the engineers have got it out of the ground. They are not through yet.

The search for oil is a story in itself. Until recently, emphasis was placed on surface structures. Now we are interested in buried domes, source beds, deeper drilling, and repressuring to get more oil from the sands. The intensity of the search for "structures" twenty years ago is well illustrated by the remark of a weather-beaten old farmer in Montana in 1919. I had stopped at his ranch to get some information. Evidently he did not have much use for geologists, for he said, "If anyone should lose a dime in Montana in the

morning, some pebble-pup (his name for geologists) would find it before night."

It is safe to say that all important closed domes (anticlines) that outcrop at the surface of the ground in the United States have been drilled. Many have produced oil or gas, and a lot have been dry. Not a few will be redrilled to greater depth. This has already happened in many fields with excellent results, and the work is just beginning.



The famous old Spindletop field, at Beaumont, Tex., is a shining example of what deeper drilling in a proven field has done for the oil business. With an area of only 265 acres, it has a record of production per acre surpassed by only one other field in this country. It was discovered by Captain Anthony Lucas in 1901. Lucas, supported by optimism not shared by his associates, started drilling with a little rotary rig. At 1,139 feet the well "came in," spouting a six-inch stream 200 feet into the air and "making," on conservative estimate, 75,000 barrels a day. No provision had been made to store the oil, and it ran wild over the country, soon caught fire, and when the fire was finally extinguished, the well was ruined. Immediately other wells were started, and in 1902 Spindletop produced 17,420,949 barrels of oil. This, however, was too good to last. In 1903 production was only half that of the previous year. In 1904 only forty per cent of the 1903 oil was produced. By 1924, the field was practically exhausted after yielding some 50,000,000 barrels.

Then came deeper drilling. Encouraged by experience in neighboring fields, oil companies started systematic drilling, and encour-

(Continued to page 114A)

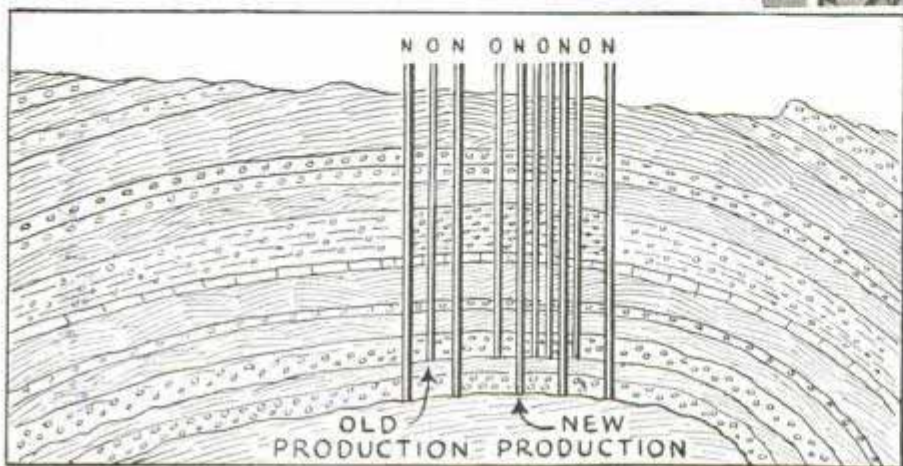

Top, loading hole preparatory to breaking up rock. Workmen can put together one of the new all-metal oil rigs, above, in a few hours. Left, diagram of Lance Creek oil structure showing how deeper drilling has tapped new pool and revived production in a field once thought to have been worked out. Redrilling has brought good results in many fields

Aluminum Pan Floats on Electric "Cushion"

With sixty-cycle electromagnets whose pole faces lie in a horizontal plane, it has been found possible to hold up aluminum disks and dishes in stable equilibrium so that they float in air. A new General Electric company machine produces this effect at the San Francisco exposition and the New York World's Fair. In effect the disk or dish "rests on" a radial field extending from a central pole to a ring pole having a diameter of nineteen inches. This field also gives stability against tipping. Stability against sliding is furnished by an additional field between the ring pole and poles still further from the center. Aluminum disks or dishes nineteen to twenty-one inches in diameter and five-sixteenths of an inch thick float readily at heights up to two and one-half inches above the pole faces. Total power of one kilowatt supports a total load, weight of disk plus added weight, of fourteen pounds one and one-half inches off the pole. The levitation

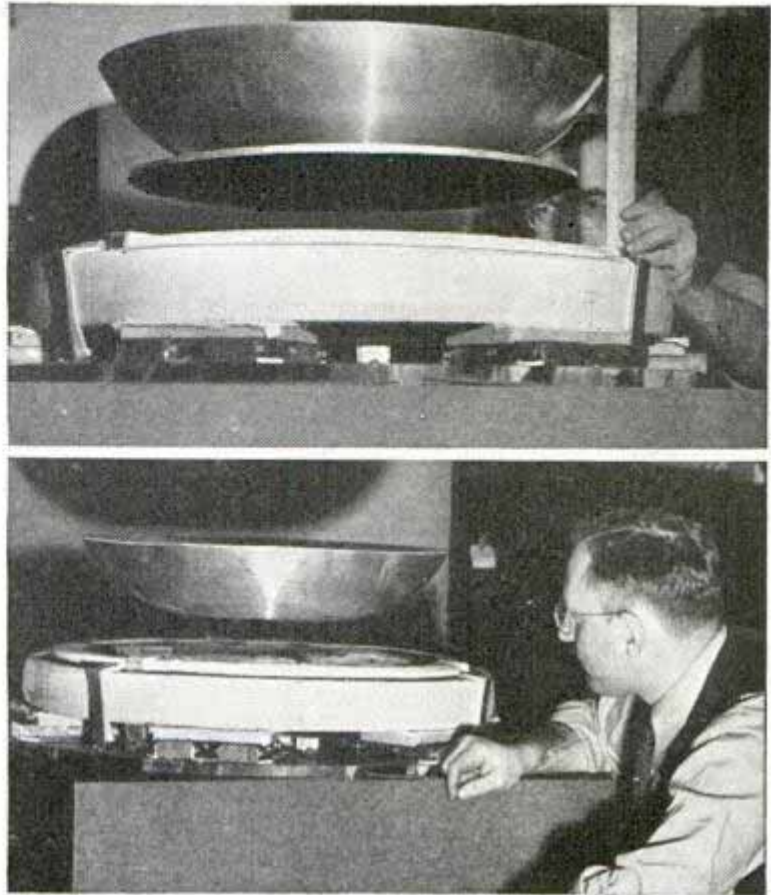

Two views of aluminum pan being supported in air only by electromagnetic force developed by new machine

posing currents are turned on and the dish begins to rise and dance above the machine.

Model Waved on End of Stick Is Target for Aerial Gunner



Recruit keeps machine gun pointed at target waved about by other man

Moving targets for practice of aerial gunners of the British Air Force are fashioned by mounting model planes on sticks. A recruit, standing in a wooden frame, learns to keep the sights of his machine gun trained on the target as another recruit moves it in imitation of a ship in flight.

There were 155 licensed airplanes in Alaska last year, compared with 101 in 1937, and they carried 26,885 passengers against 20,958 in 1937. In 1929 there were only eight planes in Alaska.

Christian Science
 Monitor 2/24/39



WHAT *Makes a*

MORE than 2,500 speed merchants of the waterways have just launched their 1939 crusade for glory, trophies and new records in motorboat racing.

They'll careen over all manner of courses before the season ends—on lakes, reservoirs, rivers, the open ocean—in hundreds of speedfests, ranging from the national outboard championships and the Gold Cup regatta, to "wild-cat" back-yard race meets.

Perhaps 125 of these drivers will attain sectional distinction in a year of racing that may cost them anywhere from a few hundred dollars to amazingly high figures. At the outside, thirty will win national honors in one of twenty-eight recognized classes. And only a half dozen will

Outboard motor being weighed in after successful run. Note drivers wearing life jackets. Below, tiny speedster arrives at regatta scene on trailer

1237 affection it
Long Beach, California



SPEEDBOAT CHAMPION ?



They're off! Boats in picture, top, are Class-C service outboard runabouts. Bottom, here's a speedster literally standing on its tail—and at a speed of close to fifty miles per hour

reach the champion-among-champions inner shrine.

Whether they drive one of the fifty-pound midget M-Class outboard cockleshell hulls, or go all the way through the ranks to the unlimited class, there is a common lure—speed and thrills. The bug to become a topflight speedboat racer can bite anybody and there are enough awards

and honors to be won in some class to fit almost any income bracket.

During ninety officially sanctioned regattas in the United States in 1938, twenty-eight new speed records were set; seventeen major inboard trophies and twenty-one outboard trophies were won. Fourteen national outboard champions were crowned, with as many other top

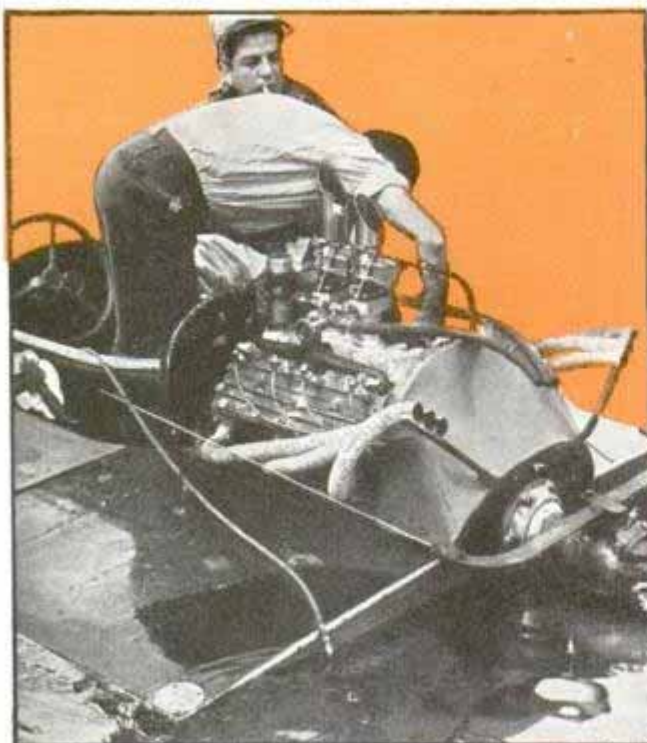

factors of stress and purpose in hull design.

Another common precept, used by some drivers who never arrive, is that "the guy with the money can build the boat to win." It does not always hold water. Champions who made the grade without benefit of some sponsoring angel have first the option of the class they want to drive and the first rule is "don't go over your head financially." Buy or build a boat you can afford to keep in first-class condition and see that you do. If you can't afford to keep up your equipment, go into a cheaper class.

Naturally, only a few drivers could follow the costly, painstaking road it would take to go into the tops of all classes—unlimited. Though plans thus far have been developed with some secrecy, it is a safe guess that around \$100,000 has been spent



honor falling to drivers of the in-board divisions.

What makes a speedboat champion?

Two accepted requisites are driving skill and daring, but these are not enough. The longest way toward a speedboat championship is traversed in the several thousand back-yard garages and workshops throughout the nation, where drivers and their mechanics play with cranky, high-speed motors, experiment with fuel mixtures and work out mathematical



Top, power plant of 225-class racer. Center, at the driving pits, waiting for start of another race. Bottom, spectacular spill shot resulting from skidding on turn

on the "Bluebird's" successor which Sir Malcolm Campbell of Great Britain plans to seek a new mile straightaway record in the early fall. He will probably try it on the densely saline waters of Salton sea, in Southern California's Colorado desert. Arthur L. Bobrick, member of the National Racing Commission, believes that improved carburetion at the 250-foot-below-sea-level altitude of the Salton sea, plus the buoyancy of its waters, may hoist the fastest speed on water by several miles an hour. If Campbell is successful in breaking his own 130.93 miles-per-hour mark, he will doubtless have proved much of value to engineers and to motorboating as a whole. But a fortune will be spent and after a year of preparation he will have a ride of a little over twenty seconds in making the record!

For money that the average man can afford, there are thrills nearly as great and they come a lot oftener in any of a dozen speedboat classes.

Ward Angilley, a \$28-a-week clerk, has achieved a record that will parallel or eclipse that of any pilot in speedboating today. He is the only top-flight amateur outboard driver who has raced for eleven consecutive years. Angilley maintains a two-boat "stable," the Class C hydroplane "Sweetheart" and the Class C runabout "Lollypop." He has five motors, to let him enter four classes on occasion; he owns a small coupe with a two-boat trailer and boasts an ace mechanic in his buddy, Bob Van Horne. In 1936 Angilley amassed enough points, traveling to sanctioned regattas throughout the United States, to win a leg on the \$5,000 Col. E. H. R. Green Round Hill trophy, emblematic of amateur outboard driving supremacy in America. He also won the National Class-C racing runabout titles in 1935, 1937 and 1938.

Angilley has captured 156 trophies, some nationally important, and won 146 merchandise awards. He has started 363 races, won 302 prizes, failed to finish fifty-seven races and finished out of the money four times. He has had forty-one "wing-dings" (spills). One time his boat flipped completely over, landed right side up and went on to win a race.

Generally speaking, any pilot aiming to reach to top brackets has a pretty well-defined course ahead:

(Continued to page 125A)

Two-Minute Photo Printed in Portable Studio

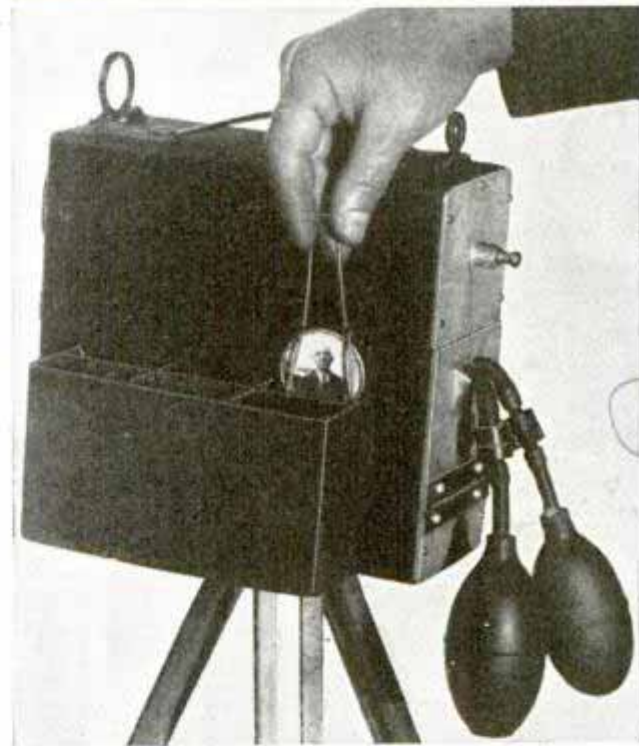
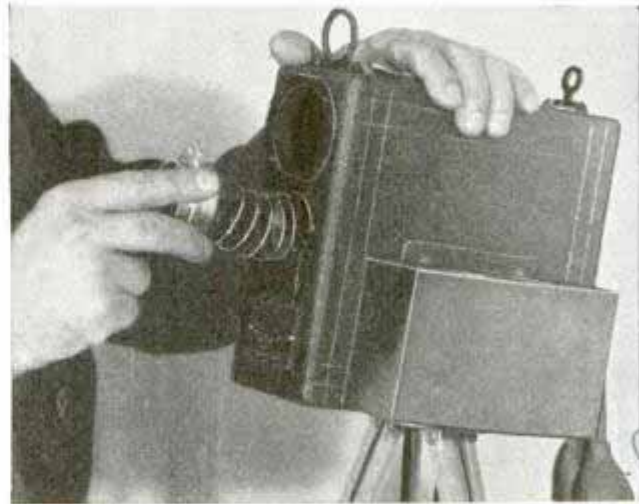

Top, loading "blanks" into camera; below, completing development process in daylight tanks

Finished photographs are delivered in two minutes by a semi-automatic camera just introduced. Its magazine holds fifty "sensitized blanks," which are fed into position for exposure by turning a knob. After each exposure a plunger drops the "blank," which is made of waterproof paper, into a developing chamber and the developing solution is fed by a rubber bulb. After thirty seconds the bulb withdraws it and water is sent in by another bulb for a rinse. Other solutions in small tanks on the side of the camera complete the development process. Since no moisture is absorbed, the prints dry almost immediately.

Chicago

Camera Co. 109 E 35th

W. B. K.

Dog's Non-Skid Feed Bowl Has a Rubber Base



Pottery bowl sets in recessed top of rubber base which clings to the floor while dog eats his dinner

To keep the dog from pushing his dinner around the kitchen floor, a non-skid feeding bowl is available. The bowl itself, made of pottery in various colors, holds more than a quart. It fits on a base of rubber, the bottom of which has concentric rings to prevent slipping.

Typewriter Sends Radio Letter by Dialing Distant Receiver

As fast as a stenographer in New York can punch the keys of an electric typewriter, a letter can be transmitted by radio to a receiving typewriter as far away as Budapest. The radio typewriter, invented by a Budapest resident, is both transmitter and receiver, operating on about 150 watts.



After dialing a distant receiving typewriter, the typist transmits his message by radio

Each set has its own call-number combination and the connection is made by a dial like that of the automatic telephone. A small light bulb on the sender's instrument board indicates when the receiver is ready to take a letter. The typewriter and radio equipment are portable, and messages could be exchanged easily between two sets in automobiles far apart. All signals are on the same wave length, but interference is prevented by an "absorber" which not only cuts out other stations from receiving the message but eliminates fading due to atmospheric disturbances. If desired, however, any number of receiving typewriters can take the radio message.

Noiseless Electric Lawnmower Saves Time and Hard Work

Silent and easy to run, a lawnmower powered by an electric motor does all its own pushing and needs only the light touch of the operator to guide it. With a



It's easy work to guide this electric lawnmower; a grass catcher can be hung on brackets if desired

new type of cutting unit adjusted to three-thousandths inch clearance there is no clattering noise from the knives. Located on the steering handle for convenience, the switch has a special automatic shut-off arrangement that stops the motor when the mower becomes stalled by refuse on the lawn. Height of the rubber-tired machine has been kept as low as possible for convenience in trimming under hedges and shrubs. A long cord is used for plugging into the nearest electric outlet.

Handwritten notes on the left margin: "Pet. Napcoy Co, 13 Second St. Bloomfield, N.J.", "L. and Lewis Katz, namensi Budapest, Hungary", "D-770 902", "286", "Michigan City, Ind.", "Robertson Mfg. Co.", "navigraph".

Weather Ships Chart Air for Atlantic Clippers

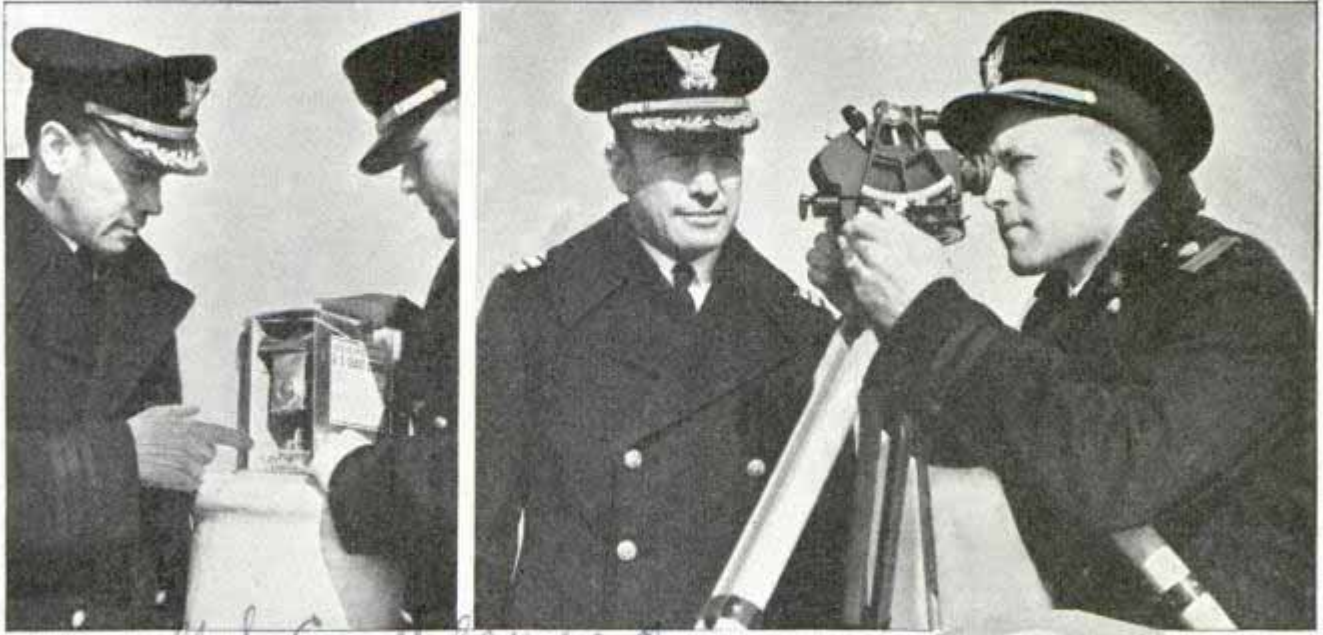

U. S. Coast Guard
 Top, left, Lieutenant Commander Edward H. Smith, commanding the cutter "Chelan," and Lieutenant Ned Sprow preparing radio meteorograph for trip aloft; right, sighting departing balloon with theodolite, to compute wind velocity and direction



Boston Mass
 Left, attaching radio meteorograph to balloon, which must be checked for proper carrying weight. Parachute is provided to bring instruments down slowly after balloon bursts in stratosphere. Above, releasing automatic weather observer, which rises until it disappears but continues signaling

Forecasts of weather along the Atlantic seaboard and over the British Isles are not enough to satisfy a pilot starting from New York for Europe with a load of passengers and mail. So, when regular transatlantic flights begin, floating weather stations will make daily observations along the air route. The U. S. Coast Guard cutters "Chelan" and "Champlain" will pioneer the service, sending aloft balloons with radio meteorographs to report temperature, pressure and humidity to ship while observers trace balloons for wind direction. Right, chief radio officer on coast guard ship tuning in to receive data from meteorograph



Alis Holden

Int.

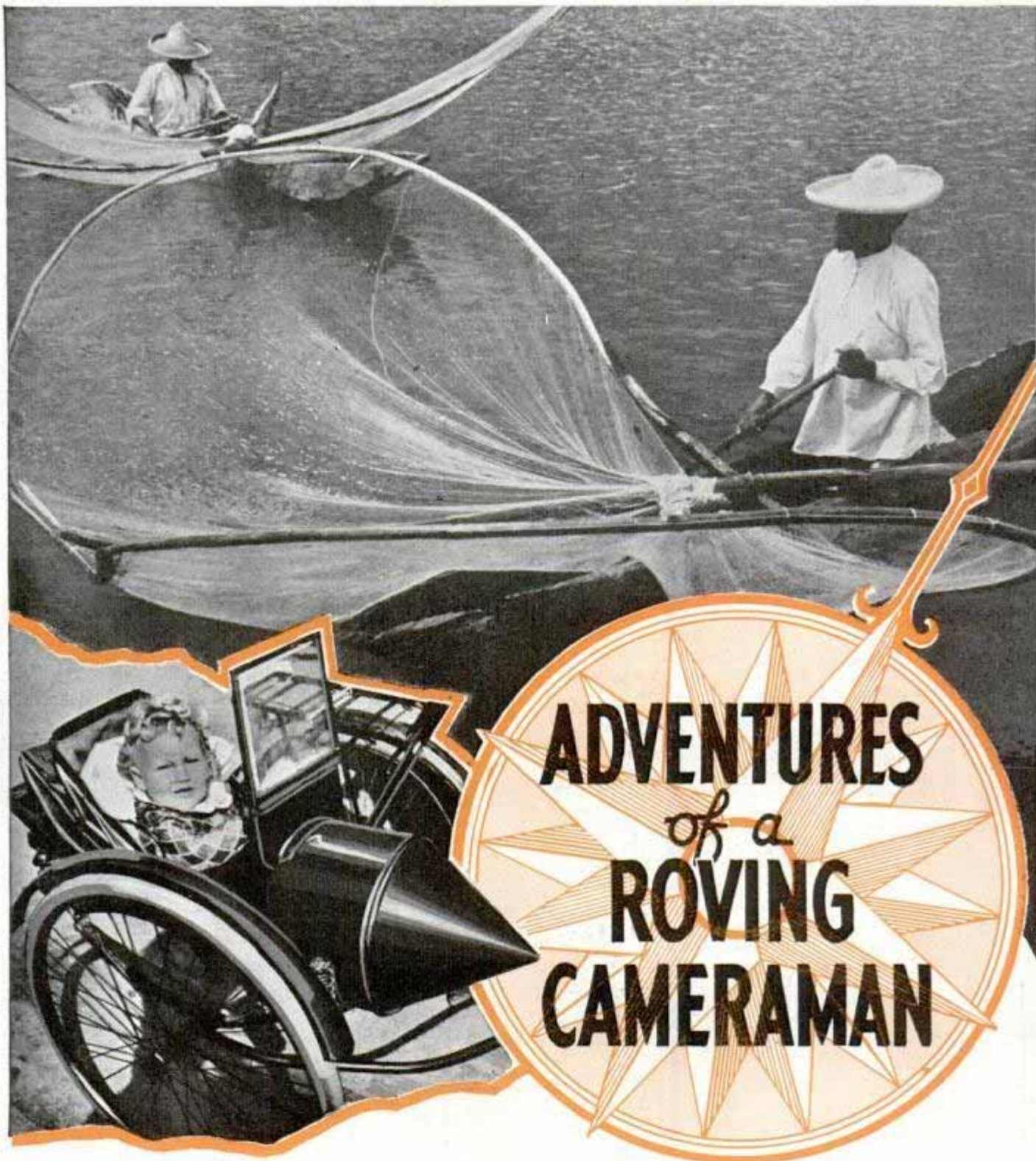

Top, natives with "butterfly" nets fishing in dugout canoes on a Mexican lake. Left, a youngster in Moscow, Russia, rides in comfort in sidecar attached to his father's bicycle

ADVENTURES of a ROVING CAMERAMAN

Lehighville, Pa
By JULIEN BRYAN

Part I

IF YOU'D call it dangerous to film a religious carnival of superstitious, camera-shy Mongolians, to be tossed by a capricious Siberian reindeer or to land an airplane in dense fog between a pair of Chinese mountains that are entirely too close for comfort, then mine is a dangerous profession.

Still, I have packed my movie camera 300,000 miles through twenty countries in the last nine years and my worst injury

has been a sprained ankle followed by a bad infection. Over in Siberia, without a doctor or a hospital, that

might have meant gangrene, probably the loss of a leg. But it happened at White Plains, N. Y. I was thrown from a horse.

As a "foreign reporter," each year I cover some country with movie and still cameras, spending some time in large cities—Moscow, Tokyo, Istanbul—but a great share of the time filming life in the interior.

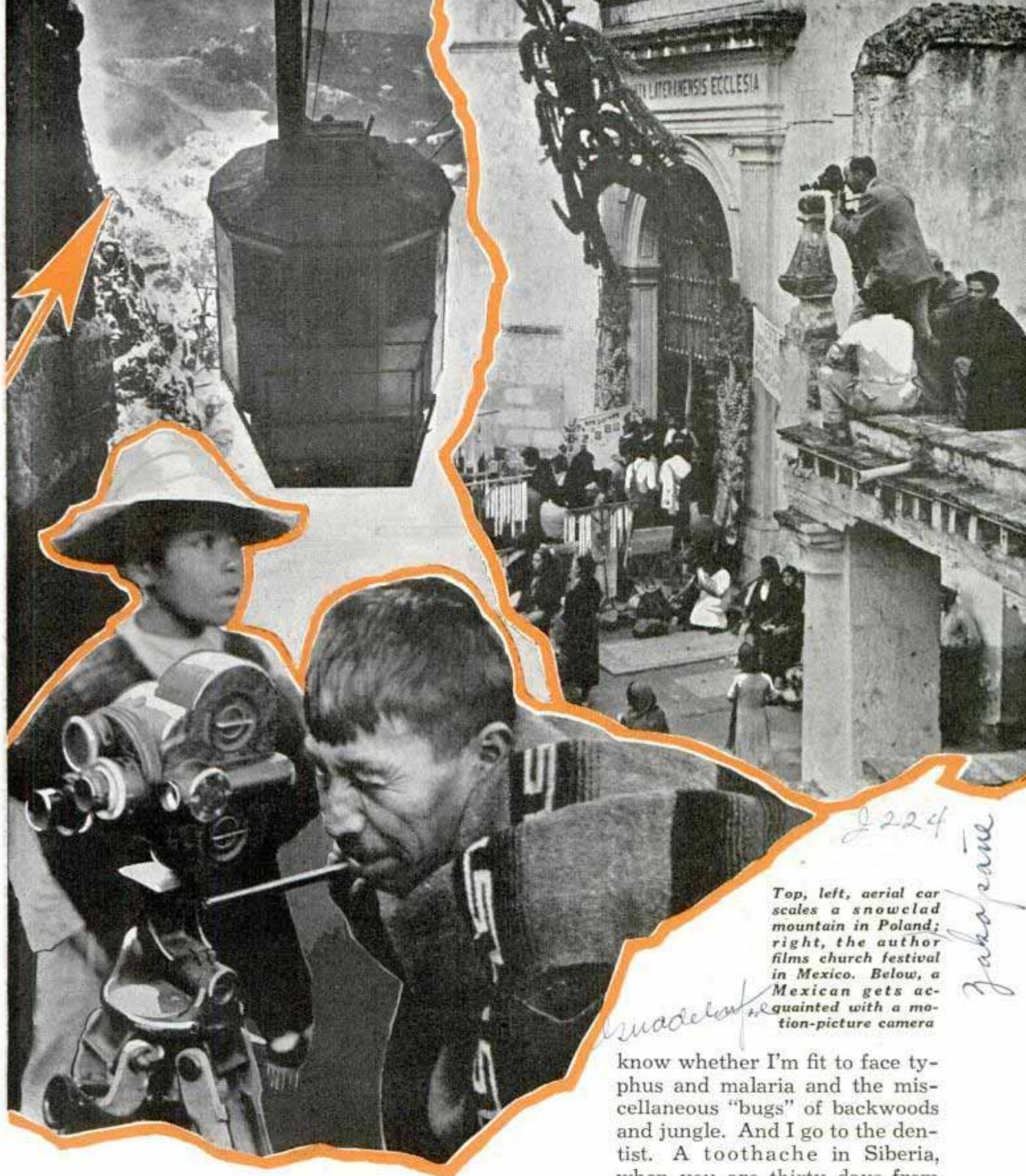

224
Madeline
Jakopani
 Top, left, aerial car scales a snowclad mountain in Poland; right, the author films church festival in Mexico. Below, a Mexican gets acquainted with a motion-picture camera

I have taken cameras where cameras are feared and where they are forbidden. Naturally these expeditions bring thrilling adventures, but they are just the by-product: my job is to cover the ground, get the photographs, bring them and myself safely back to the United States. Camera-men like myself are cautious rather than reckless. Before and after an expedition, I have a physical examination; I want to

know whether I'm fit to face typhus and malaria and the miscellaneous "bugs" of backwoods and jungle. And I go to the dentist. A toothache in Siberia, when you are thirty days from the nearest dentist, rather hampers your efficiency as a photographer.

Savage tribes are no cause for worry. Among primitive peoples the white man who is friendly, decent and polite is almost always received hospitably. Only twice have we carried a gun, and then it was hidden lest the natives become suspicious. Never have we been waylaid by bandits. Disease is the danger. Once in southern



Tom Cobb and I led an expedition over the rugged Caucasus to Svanetia, a fantastic little country of 20,000 people, shut off from the world by mountains. We called it the land without wheels, for the natives had never seen a simple wagon wheel, although airplanes had flown over their land. For transportation they had only oxen and huge, cumbersome sleds.

For five days our party, with three pack horses and three guides, slipped and stumbled up and

Russia fourteen of an expedition of sixteen were ill because they failed to boil drinking water. Once I was stranded with fourteen Americans and 800 peasants on a steamer on the Volga. That night we discovered the ceiling of every cabin covered with anopheles mosquitoes—malaria carriers! For a solid hour we swatted them until certain all were killed; then for ten days we took quinine, just to be sure.

You're likely to be accepted as a medicine man by the tribes you meet. In 1933

down the steep walls of the Caucasus, at times digging a path in the cliff for our exhausted horses. More than once our entire group held a horse to the cliff, some clinging to the bridle and others pulling his tail to keep him from dropping a sheer thousand feet. We crossed and recrossed more than thirty glacial torrents. Food ran short, and we shared dry bread, tea, and once a day a can of sardines divided among six of us. Our compensation was the sight of this hidden garden spot; valleys filled with



Photos © Julien Bryan

Two scenes in the soviet "Park of Culture and Rest" in Moscow. Mr. Bryan's movie camera took a dizzy ride in the swinging seat at top. Below, caricatures in park deride the soviet railroad administration

2229

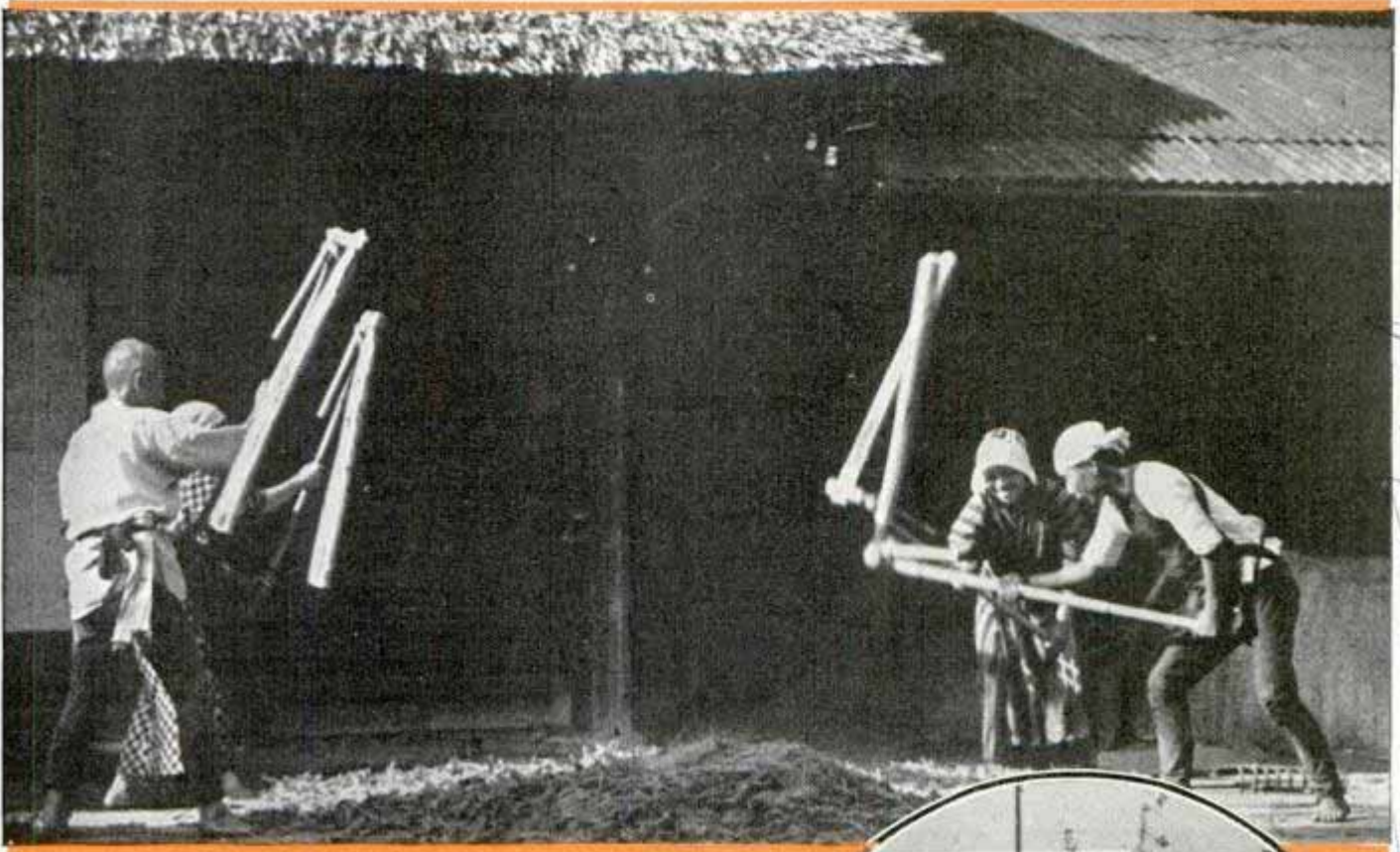

Above, Japanese thresh millet with flails like those of biblical days. Right, testing auto on proving track of Tokyo plant. Bottom, merrymakers at fiesta in Guadelupe, Mexico, pose before a painted backdrop

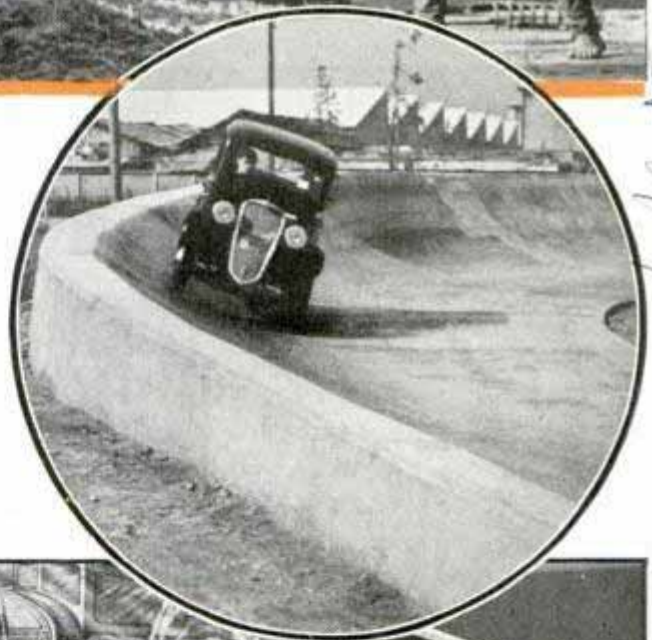

lilies, hundreds of acres of Queen Anne's lace standing ten or twelve feet high.

At last we reached our first tiny village of the Svan people. They had never seen an American; only a few Russian explorers had come here. We hoped for a rousing welcome, but there was no cheering, no laughter. Everyone was solemn, and when I walked down the main street women came with small children who were sick or had little cuts and infections. To them I was a foreigner, white man, therefore medicine man. I made up a solution of soda and spent an hour cleaning wounds, applying the solution and wrapping them with bandages. The villagers were very thankful.

Anyone roaming the world to film its peoples is apt to face death at one time or another. I have, a number of times. One incident on Lake Baikal in Siberia is particularly in-

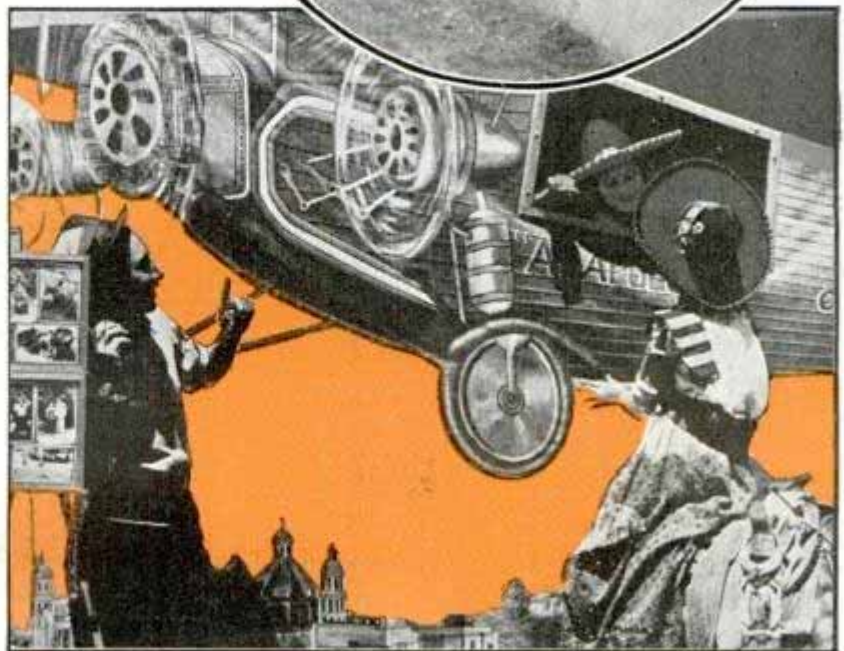

(Continued to page 132A)

Datsun Auto Works near Tokyo.

Cars in Twin Spiral Garage Can't Collide on the Ramp

*London England
Royal Institute of Architecture*

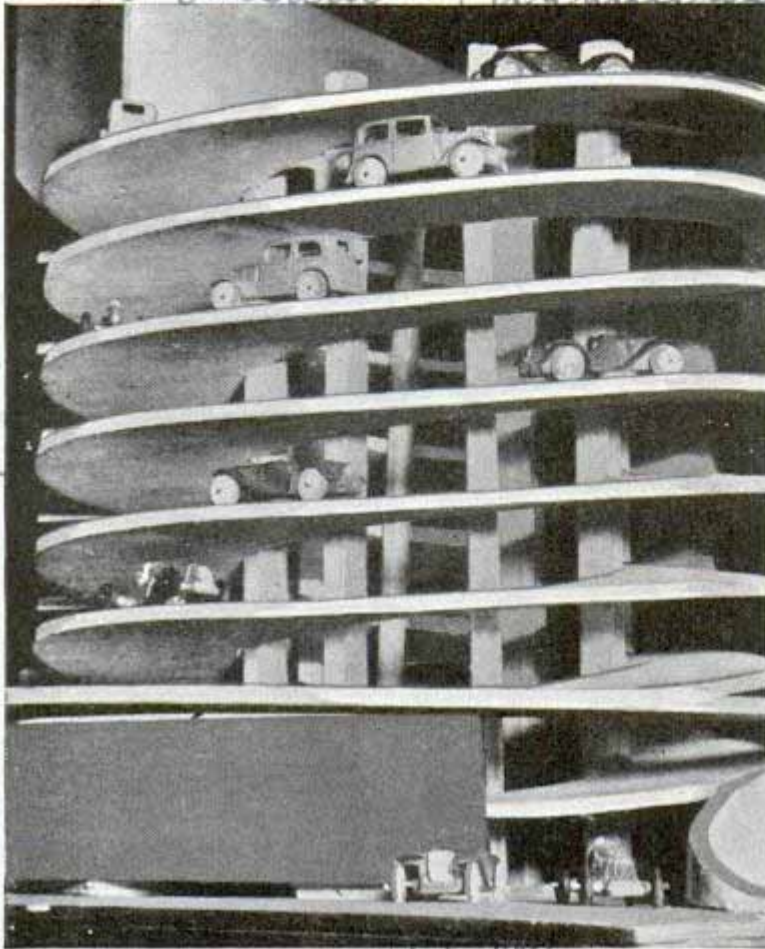

Model shows how cars travel upward on one spiral and down the other, avoiding the danger of head-on collisions

Automobiles may travel up and down in a "one-way" garage, designed in England, without danger of collision, because those going in opposite directions are carried on separate ramps due to its double spiral construction. No attendants are required on any of the floors, since cars are directed throughout the structure by a mechanical shunting arrangement which is controlled automatically from a switchboard at the entrance.

*Designed by Hermann Hervey
Chairman at Exhibition of Road Architecture*

Tough Beef Made Tender Quickly With Aid of Light Rays

Tough beef can be made tender quickly by a new process involving air conditioning and ultraviolet rays. Worked out by the Mellon Institute, the method makes possible the raising of all types of beef by one grade in palatability rating. Toughness in steaks is caused largely by connective tissues that bind together in small bundles the innumerable muscle fibers,

Pittsburgh Pa.

and it has been known for centuries that these connective tissues are softened by hanging. At customary storage temperatures of about thirty-five degrees Fahrenheit, this takes from four to eight weeks. The trick of the new process is to use high temperature and humidity to speed up the chemical reactions that turn tough tissue into a material easy to bite through. However, these conditions are ideal for growth of both bacteria and molds, so the "sterilamp" developed by Westinghouse was brought into use to kill the micro-organisms with its powerful ultraviolet radiations. Now it is possible to ripen beef in a temperature of sixty degrees, and a relative humidity of eighty-five to ninety per cent, within one to three days, about nineteen times faster than by the old method.

J 276

Permanent-Magnet Chuck Requires No Current

Electric current is unnecessary with a chuck of permanent-magnet type just put on the market. All electrical connections, switches, brushes, wires and auxiliary generators are eliminated. The magnet, made of a special alloy, has high power and indefinite

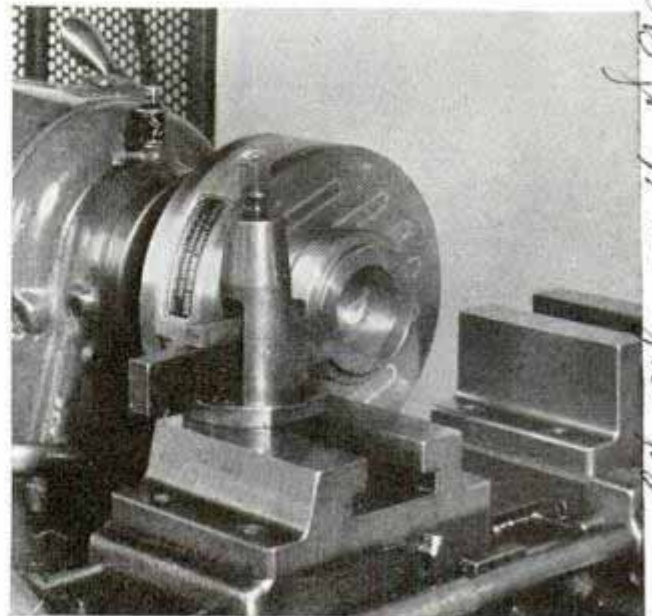

High-power magnet of this chuck obviates use of electricity, and magnetism lasts indefinitely

sold only in U.S. and possessions

*Brown and Sharpe
Mfg. Co. Providence*

*Project funded by
the Mellon Institute*

life. Since it does not depend on current, there is no danger of the work being thrown off or released by power failure. The chuck has strong holding power and is adaptable for grinding and light cuts on lathe work and other machine operations.

2-266

Stoker-Type Kitchen Range Provides Heat Control

Heat control that is possible with gas and other fuels is made available now in a coal-burning range for the kitchen. It is stoker-fired, providing steady heat and efficient combustion through the underfeed method. Oven temperature is controlled automatically. It is unnecessary to bank and restart fires, for firing is continuous, and ashes are easily removed. The stoker motor has a built-in overload protector.

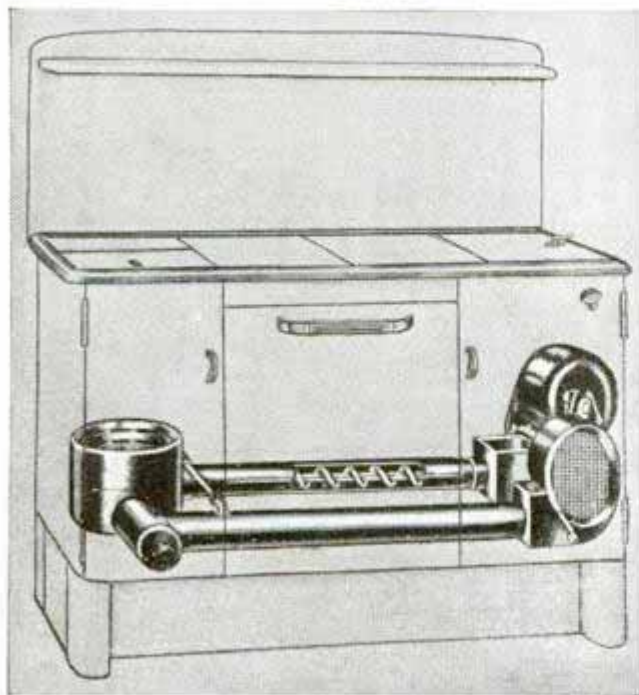

Phantom drawing of kitchen stove shows stoker motor and screw which deliver coal to burner at left

American Stove Co.

Skier Spreads Wings on Hill to Hold His Speed in Check



Skier's wings are opened like sails to check his speedy downward glide on straight, fast hills, which he negotiates without the usual turns

Worn like webs between his arms and body, a pair of "wings" enables a skier to control the speed of his descent on steep hills. In tests of the parachute idea, brought here from Europe, a sportsman at Sun Valley, Ida., demonstrated the braking ability of the billowing cloth on straight downgrade runs.

Flashlight Has Built-In Tester for Auto Bulbs and Fuses

Without affecting its primary purpose of casting a beam of light, a flashlight with extra contact points, now on the market, is used for testing headlight bulbs and automobile fuses.

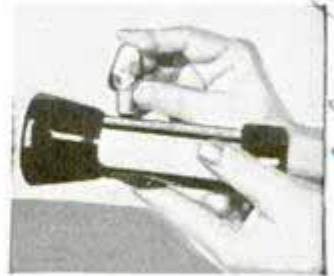

Strongly made of fiber and Bakelite, it can be handled like any other tool without fear of breakage.

Send return postage to our Bureau of Information to learn the name of the maker of any device described in this magazine.

Sung. Sol Lamp works Newark N.J. 95-8th Ave.

2-318

J 223.

Alme News Spectator
220 342nd Ave

307

SUPER-FIREBOAT *Guards*



Most powerful of the battery of monitors on the "Fire Fighter" is the bow "gun" which shoots 6,500 to 10,000 gallons of water a minute for hundreds of feet. Combined capacity of two monitors shown at left, on upper deck, is 5,000 gallons a minute. Below, fireman looks through one of the tips of the bow monitor, a sixty-five-pound ring of brass through which a roaring stream of water races at high pressure

Pride of the fleet of ten fireboats that guard the 578-mile New York waterfront with its billions of dollars in warehouses and factories, ocean liners and freighters is the "Fire Fighter," million-dollar vessel that is the floating equivalent of twenty land companies. Its twin sixteen-cylinder Diesel engines propel the ship at nineteen miles an hour and develop enough current to light a city of 150,000. Below, left to right: pilot at wheel while captain talks by short-wave radio to land station; spectacular display of plumes from nozzles that discharge 20,000 gallons of water a minute; view of power plant from stern. The "Fire Fighter" is 134 feet long with thirty-two-foot beam. Besides hoses, drills, torches, foam and other chemical equipment it has carbon-dioxide tanks to protect itself from internal fires

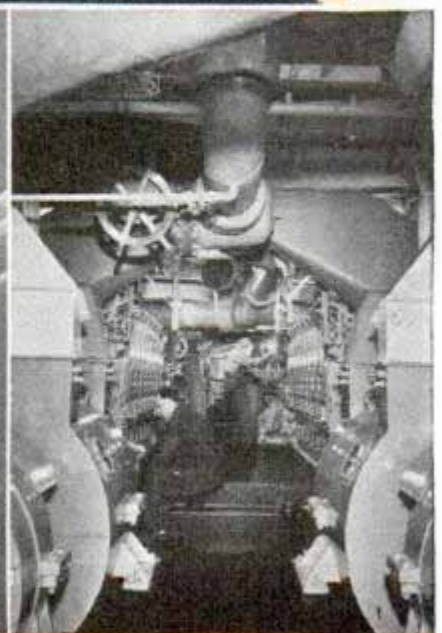
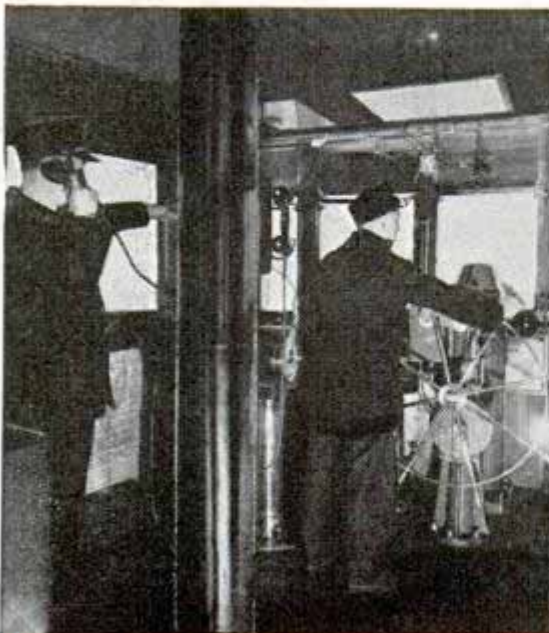

MANHATTAN WATERFRONT

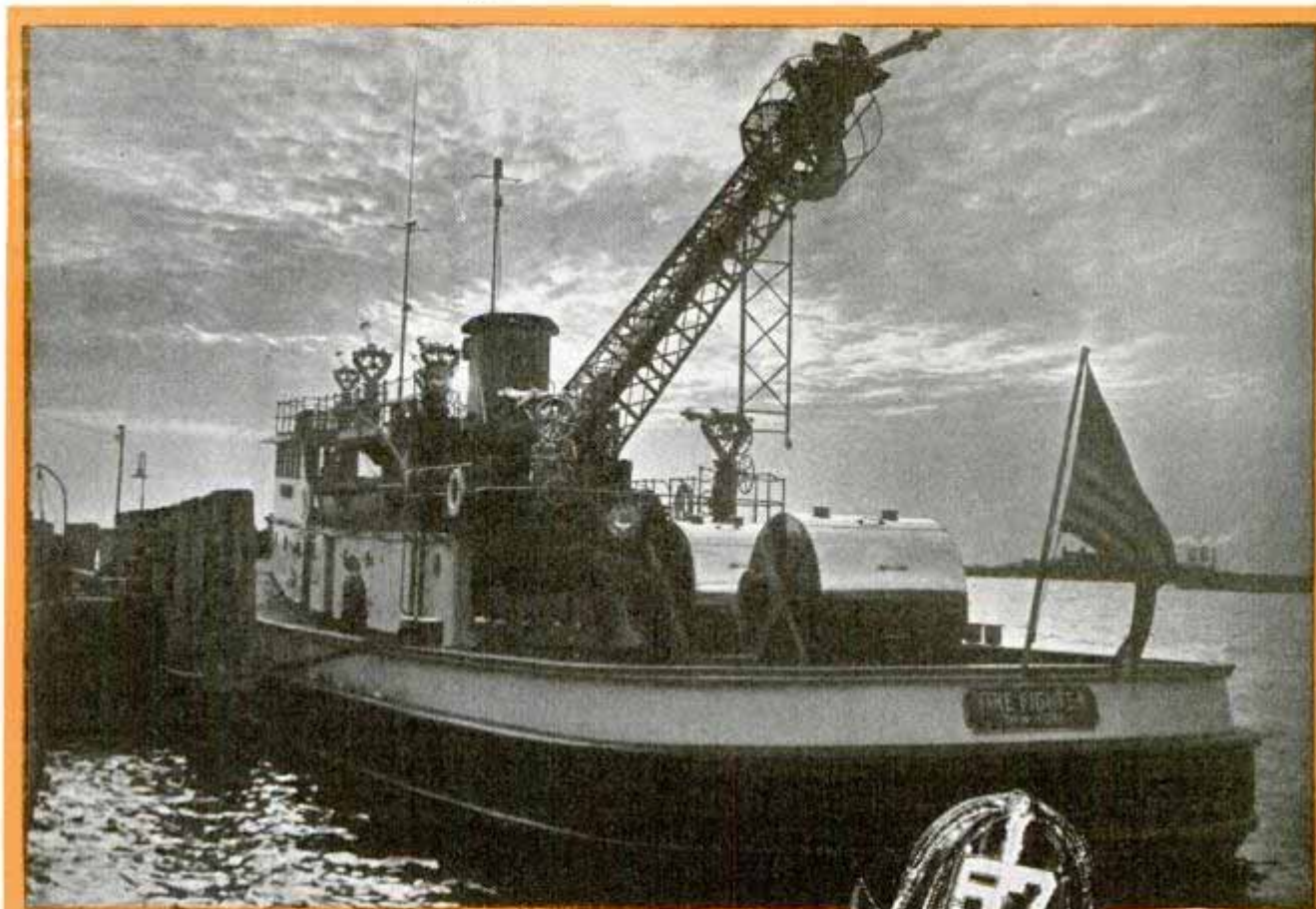

Above, raising the thirty-six-foot water tower, most spectacular of "Fire Fighter's" projecting units, which rises fifty-five feet above water line when fully extended. Electric motors rotate its nozzle to discharge in any direction a stream of 3,000 gallons per minute, high enough to reach top decks of liners. The drums seen at stern are hose reels. Right, fireman equipped to penetrate smoke-filled hold, wearing oxygen mask and carrying claw to pry open hatches



Left, polishing the fireboat's brass nozzles. They are designed to meet every situation in a waterfront blaze. Notice "pepperbox" nozzle at center, and right-angle nozzle for reaching difficult spots

Spotlight Talks to Audience as Its Light Bulb Blinks

Miss Karen Hall



Speaker's voice is picked up by microphone in flashlight and varies beam reaching electric "eye"

Vacationland building
 Words travel on light beams of a "talking flashlight" that is part of the research exhibit of General Motors at the Golden Gate fair. It is an ordinary flashlight, but with a microphone built into the battery end. This "mike" picks up sounds, which are transferred into electric vibrations and sent through a transformer. The transformer varies the battery current and thus modulates the brilliance of the flashlight bulb, which is focused on a photoelectric cell. Varying light reaching the cell is changed into pulsations which emanate from a loud speaker as sound.

its application has been extended to include ships, small boats, trains, buses and trucks. Anti-icing fluid, fed through the blade onto the windshield, stops the formation of ice, and boats navigating salt water may pump fresh water through the wiper to keep salt from encrusting the glass. Invisible to the pilot while it is spinning, the wiper blade is rotated by a flexible shaft passing through a hole in the windshield, and a dash control regulates its speed at any point up to 2,500 revolutions per minute.

2345 Vacuum Cleaner Mows Grass and Collects Cuttings in Bag

Harnessing a cutter to his vacuum cleaner, a Californian has invented an electric lawn mower. One advantage of the vacuum method is that weed seeds, instead of being scattered, are drawn into the bag with the grass cuttings. The sickle is driven by pulleys attached to the hub of the fan. Cutter bar and sickle can be attached to any vacuum cleaner.



After cutting head clips the grass, the vacuum cleaner collects cuttings and weed seeds in bag

Mr. E.A. Wapburn, 1416 W. 56th St. Los Angeles Calif

285 Rotating Wiper for Windshields



Windshields of airplanes as well as of land and water vehicles can be kept clear under all conditions by a rotating wiper operated by a small electric motor. Designed originally for aviation use,

*Air Associates
 Rosemead Field Esarden City*

Floats of Flying Boat Retract into Wing Tips

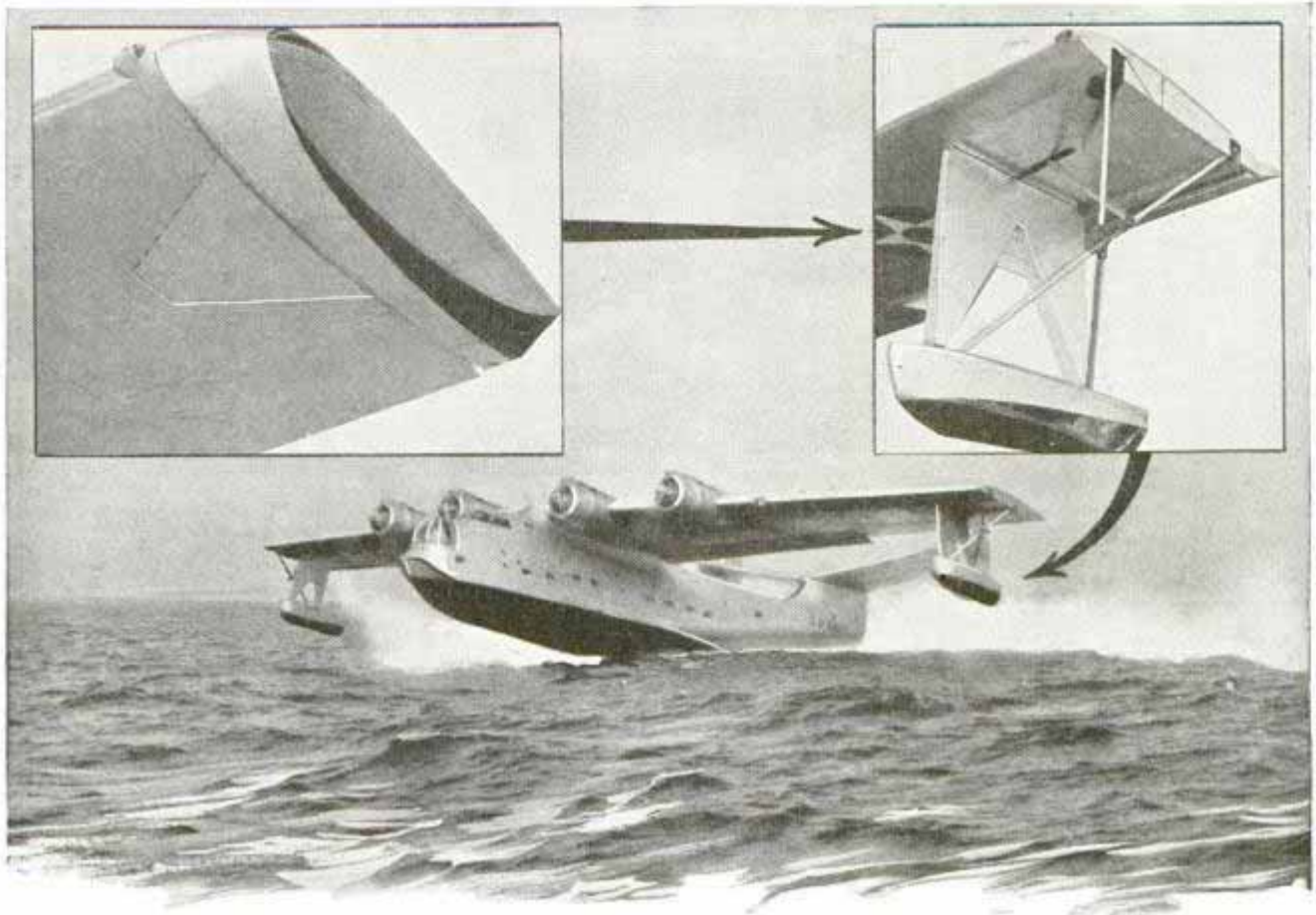

Official U. S. Navy photograph

The Consolidated "XPB2Y-1" caught at the instant it stepped from the water for full flight. Insets show wing-tip floats in retracted and lowered positions; they are sturdily built to support ship in heavy seas

To cut down their drag while in flight, the skiff-like floats of the giant "XPB2Y-1" flying boat withdraw into the wing tips, and it takes just thirty seconds to raise or lower them. The torque-tubes of the retracting mechanism travel through 100 feet of wings from the power source and must

turn 3,000 revolutions per minute. As the ship prepares to alight on the water, the lowered floats act as air brakes to slow the approach. The navy has not yet released the details or performance records of this four-motored patrol bomber built by Consolidated Aircraft Corporation.

Sandridge calls

Red Light Halts Cars on Airport Road as Planes Land

They take no chances on airplanes crashing into automobiles on the road that skirts Bolling Field, Washington, D. C. After several narrow escapes from collisions, a traffic light was erected and as planes dip low to land on the runway the airport traffic control tower sets the light red against automobiles. A warning sign emphasizes the danger.



Military plane skims over highway at edge of Bolling Field, Washington, while red light halts automobile traffic until air is clear

Capt. C. H. Steerwester

2353

C/S

8-18

Columbian 485 Madison Ave. New York

HERMITS of the

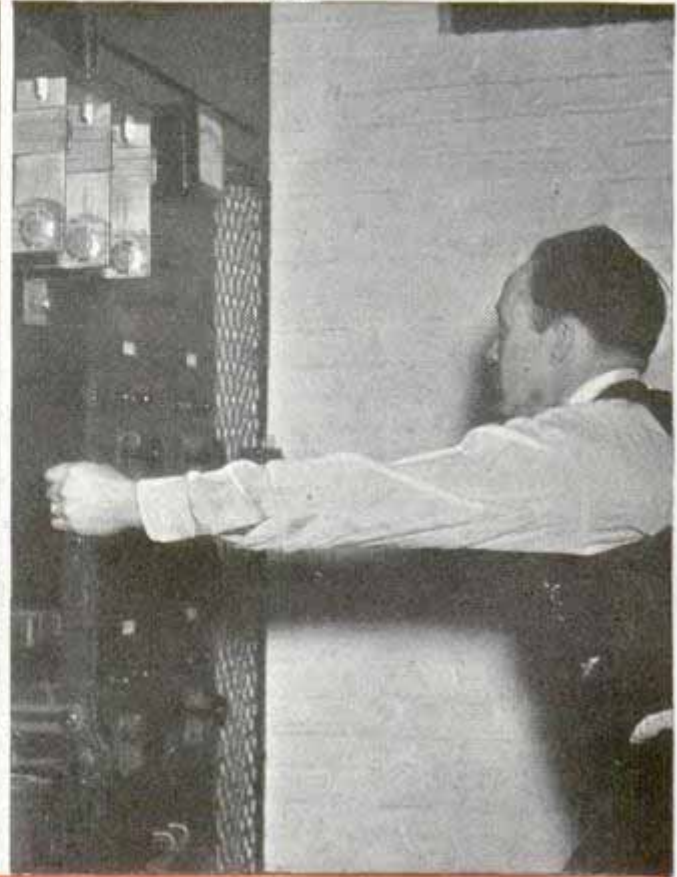

Raymond W. Newby, Supervisor

Top, left, replacing big radio tubes requires skill and dexterity. Right, main power panel controlling primary source of supply. Circle, when weather is bad, the "hermits" can't get home at all, so cots at the Wayne plant find plenty of takers

WABC W2 X H originate. Their haunt is usually a plain stone building, set on a desolate salt marsh or on the banks of a river. And there, under the shadow of a giant steel antenna, they spend their days, maintaining and operating the equipment which generates the carrier frequency over which radio programs are transmitted for many miles. There are hundreds of such

MOST people would be surprised to know that "hermits"—men who work at lonely radio transmitter plants—make it possible for radio programs to reach their homes with the volume and clarity so common today.

Transmitter technicians seldom see a radio star or go to a broadcast, for they work and dwell far away from the chromium-plated, streamline studios, where programs

hermits in the complex world of broadcasting. With 114 stations on its network, the Columbia Broadcasting System, for example, requires almost a thousand transmitter technicians, working in 114 separate plants all over the country. A majority of these plants are out in the country, five to thirty miles away from the studios.

The largest—and perhaps the loneliest—

Regular
Newby

AIR WAVES



Circle, rowing to work is a regular occurrence in transmitter technician's life. In background is the Wayne plant. Right, bird's-eye view of Columbia's transmitting plant. The steel tower, which radiates the radio impulses, is 550 feet high

of all the Columbia transmitting plants is that of its key station in New York City, WABC. WABC programs originate either in studios on Madison avenue or in three playhouses on Broadway. They are finally transmitted into the ether from a brick plant on the outskirts of Wayne, N. J. To reach the Wayne plant, one must take a train, or drive thirty miles from Manhattan to the swampy meadow country of New Jersey. A mile from the main highway, on a small dirt road, stands the plant, on a large plot of land. Pheasants, muskrats, squirrels, and even deer haunt these woods.

"There are several reasons why radio companies build their transmitters in lonely, inaccessible places," says Raymond Newby, supervisor of the Wayne plant. "For one thing, the antenna and ground system need a large plot of land and land is expensive in a large city. For another, many radio listeners still use old-fash-

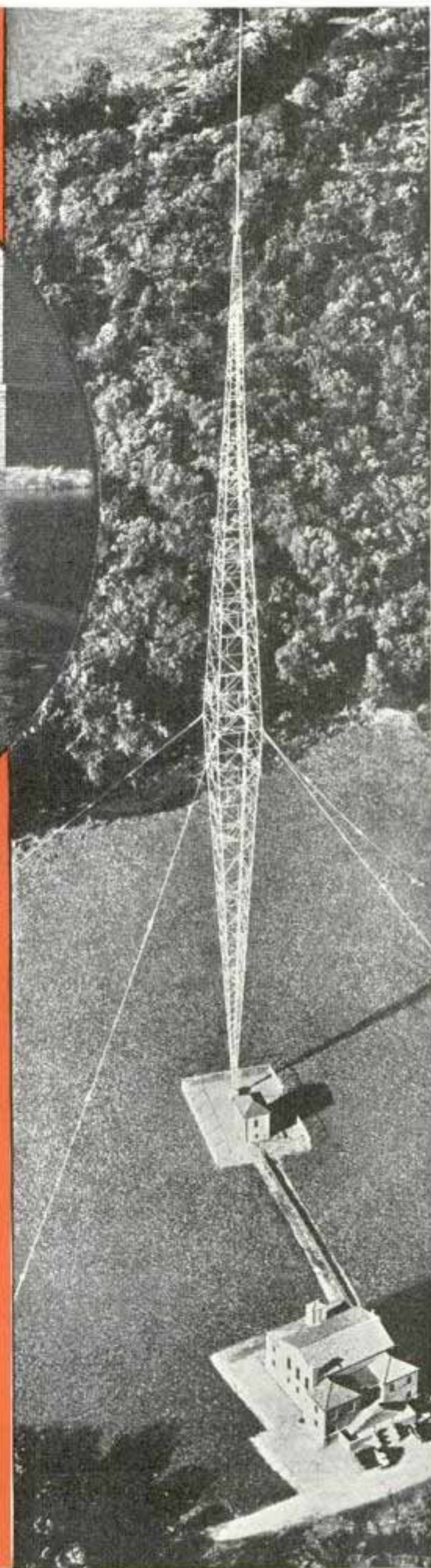



ioned receivers, which are not able to tune out the powerful waves of a nearby transmitter. If the transmitter were situated in the middle of a city, thousands of listeners would be unable to hear any other station. A third reason, probably the most important, is that flat lands with high soil conductivity are most desirable. Wet soil has the highest conductivity.

Therefore, the most efficient radio transmitters are located on salt marsh or partly flooded areas."

Their marshy environment has made double hermits out of the Wayne technicians. In the spring particularly, when a stream near by, swollen with winter snows, overflows its banks, they may be cut off from train, bus and automobile service for days on end. Several boats are always in readiness for such emergencies. In these, the men navigate back and forth from the main building to their homes on higher land several miles away. If they need pure distilled water for their water-cooling equipment, they must row to a distant town, and bring back the bottles a dozen at a time. When the weather is very bad,

they don't go home at all, but sleep in the plant itself. Provisions are also made for cooking in a modern, well-equipped kitchen, complete with electric icebox, stove, sink and table.

The Wayne plant consists of a large brick building, a small coupling house several yards away, and a 550-foot vertical guyed steel tower, mounted on a large insulator. The first floor of the main building houses the power equipment, including transformers, filter condensers, and the water-cooling system for the power tubes. Power coming from two different

sources reaches the power mat in the rear of the building at 4,400 volts. Here it is stepped down to 440 volts before entering the building. The transmitter power equipment steps it back up to 18,000 volts, and rectifies it to direct current for use in the transmitter.



Top to bottom, photos showing how useful hip boots are to the radio "hermits" when flood waters rise around the Wayne plant

Washbasin Built in Fender for Convenience on Tour



Washing up in the basin built into the waste space beneath the front fender of the car

Latest in the long line of automobile accessories is a washbasin. Introduced chiefly as a convenience for motorists on tours, the basin drops down from its recessed hiding place in the broad "skirt" of the front fender, where it occupies otherwise waste space.

All-Wheel Drive Takes Oil Men through Swamp and Ditch

Oil prospectors can't always follow paved roads to their buried treasure. They must travel over mountains and deserts, backwoods and swamps—and one answer to the problem of getting there with heavy loads of prospecting and drilling equipment is



Oil drillers' rig mounted on truck whose all-wheel drive can negotiate hill country, swamp or desert

the all-wheel-drive truck. With power applied to front as well as rear wheels the truck can walk through bog or ditch, snow or loose gravel. Heavy-duty trucks of this type can carry as much as twenty-five tons of drill rig and machinery.

New Engines to Use Safe Fuel Urged for Aviation

Danger of fire may be reduced in aviation, Frank C. Mock, of Bendix Aviation Corporation, says, by designing new engines to use denser fuels which have a "flash point" high enough to prevent explosions. To burn the special fuel, now available, the familiar carburetor will have to be replaced by special fuel injectors but larger and more powerful engine cylinders may be possible. The problem of starting such an engine presents difficulties, but it is believed that injection pumps and controls already being made could be used. It is estimated that development of a satisfactory engine would require five years.

Four-Place Twin-Engine Plane Is Copy of Big Air Liner

Having all the instruments and controls required as standard equipment on some of the large transports, a twin-engine pusher plane has been completed for feeder serv-



Four-passenger plane has controls like those in giant air liners. Wheel in nose keeps it level

ice between local points and airports on the main routes. The sleek ship, built by Miller Aircraft company, carries four passengers and has a retractable tricycle landing gear. Driven by two Menasco engines of 125 horsepower each, the plane's top speed is 175 miles per hour, cruising speed 153 miles. Flaps on both the leading and

Vertical handwritten notes on the left margin: "Horch" car made by Chemnitz, Auto Union, G. Dr. G. Hermanns, Marmor, Harrington Co. Inc, Indianapolis, Ind

Vertical handwritten notes on the right margin: "Die Wache", "2/22/39", "2-3-36", "Society of Auto Engineers", "2-3-11", "9-15,000", "Springfield, Mass", "P.O. 510 Adams Street"

2324

trailing edges of the wings permit landing on small fields at speeds lower than fifty-five miles. The black and green ship, costing about \$15,000, is twenty-six and one-half feet long and has a wing-spread of thirty-eight feet. Besides being suitable for feeder service, it may be used as a training plane for air lines having no other small two-engine planes for that purpose.

"Coupe" Car for Rail Crew Offers All-Weather Comfort



Demonstrating the modern comforts of the railroad inspectors' "coupe" motorcar at a railway equipment show

Airmont Railway motor, comfort. push

Slide Feeder for Projector Keeps Views in Order

Projection of photographic glass slides has been made automatic by a motor-driven feeder that shows 250 views without interruption. Slides drop from an upright chamber above the machine, are there projected, and then proceed to the lower chamber where they are kept in the correct order. The two containers are interchangeable. Each picture can be shown for the same length of time by setting a self-contained timer, or if desired the operator may vary the time at will by remote control.

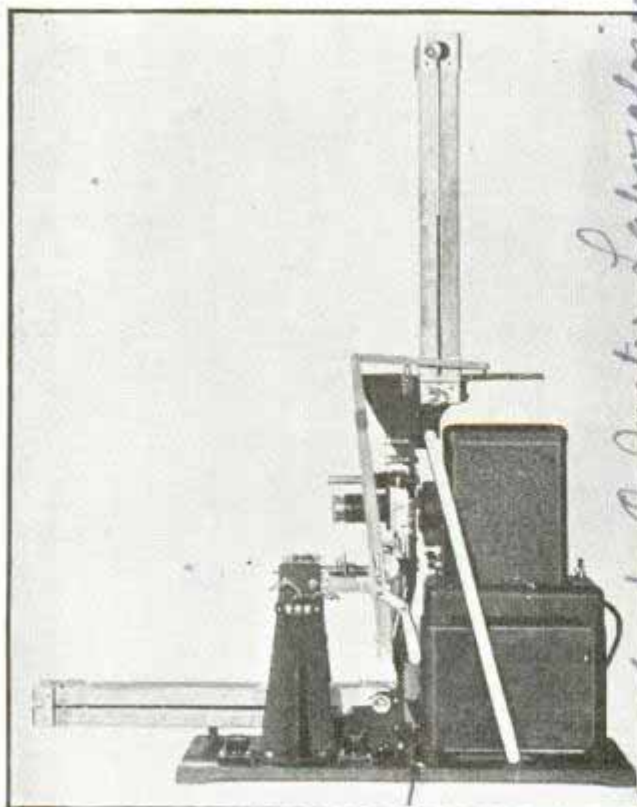

Slides drop from upright holder into machine, are projected, then move to horizontal holder below

You'd scarcely recognize the old familiar handcar in its modern dress. In the first place it is no longer a handcar but a motorcar, and now it has a roof and glassed-in front wall that provide weather protection for the inspection crew that must look over the track regularly, in hundred-degree heat or winter gale.

Pocket Size Electrical Tester Operates with Small Battery

Ready for instant use a tester that fits in the pocket or may be attached to your belt needs no more electric current than that supplied by a small battery inside its case. In making tests of fuses, light bulbs, radio bulbs, motors, electric wiring or any appliance, a red dot on the meter moves off the red line if the circuit is unbroken. Articles can be tested regardless of their voltage, but they must be detached from the power line or the current shut off.

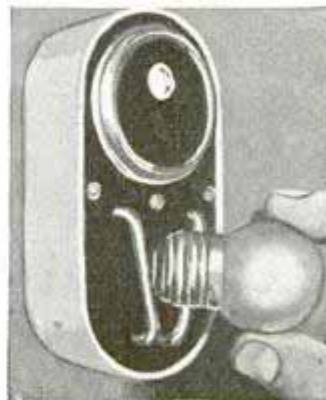

Mr. J. O. Meter Chicago

Chas. Cheag

E. Leitch chas. 731 25 1st Ave. Republic Machinery Co. 908

2340
266

Canary Rides 'Piggy-Back' on a Pigeon in Cockpit

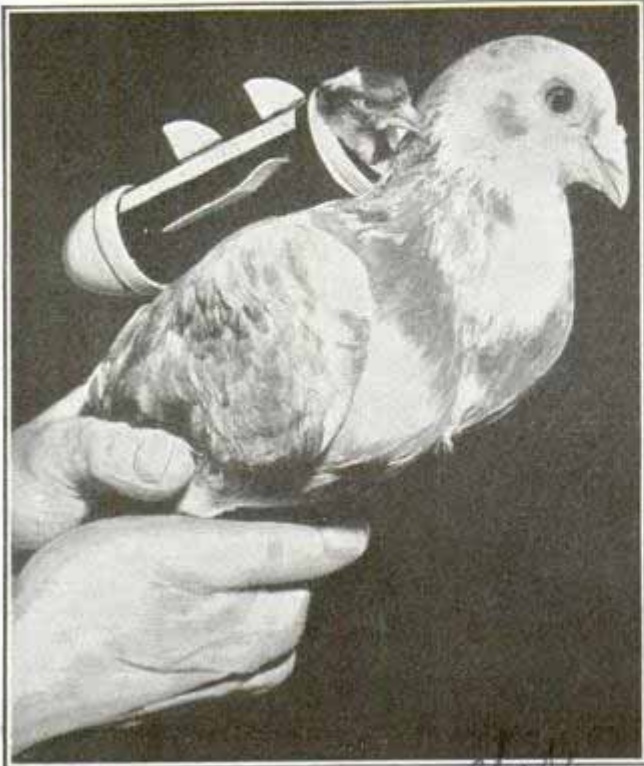

When a canary stows away for free trip on the pigeon express, the least it can do is sing for its ride

"Piggy-back" means pigeon-back to a canary that made a twenty-mile flight recently as a passenger. The canary was placed in a tiny streamline cockpit on the back of a homing pigeon to fly from Jersey City to New York, where it was presented to a child patient in a hospital.

Portable Sign in Tubular Bulb Is Easy to Change

Signs that can be moved about and changed by simply inserting a different strip into the unit, are made with the new fluorescent lamps. Used on sales counters, or in showcases and windows, they are adaptable for all kinds of businesses, small

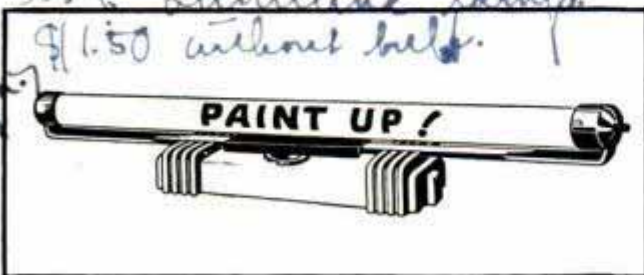

Sign may be set anywhere in store and other wording substituted by removing outer tube from light bulb

Burdick, Baron, Co.
11 W. 42nd New York

or large. The light plugs into a movable base, and a clear acetate tube, fitting snugly over the illuminating bulb, holds a transparent printed slip in place. These lettered pieces can be changed quickly and as often as desired by slipping the outer tube off the bulb. Glareless lamps using thirty watts are supplied in any color.

2344

Eight-Story Stainless-Steel Statue Tops Fair's Tallest Pavilion

Only the lofty trylon of the New York world's fair is higher than the 259-foot tower erected by Soviet Russia, tallest pavilion on the grounds. Topping it is an eight-story stainless-steel statue of a



Gigantic head and shoe lend idea of the vast size of stainless-steel "worker" topping soviet pavilion

worker, holding high a twelve-foot star. The boot alone is big enough for a comfortable bed and the worker's head is as large as a room. The statue weighs more than fifty-five tons and was shipped from Russia in twenty-five cases.

g m 2 1

Submarine TRACK MEET

at Silver Springs, Florida

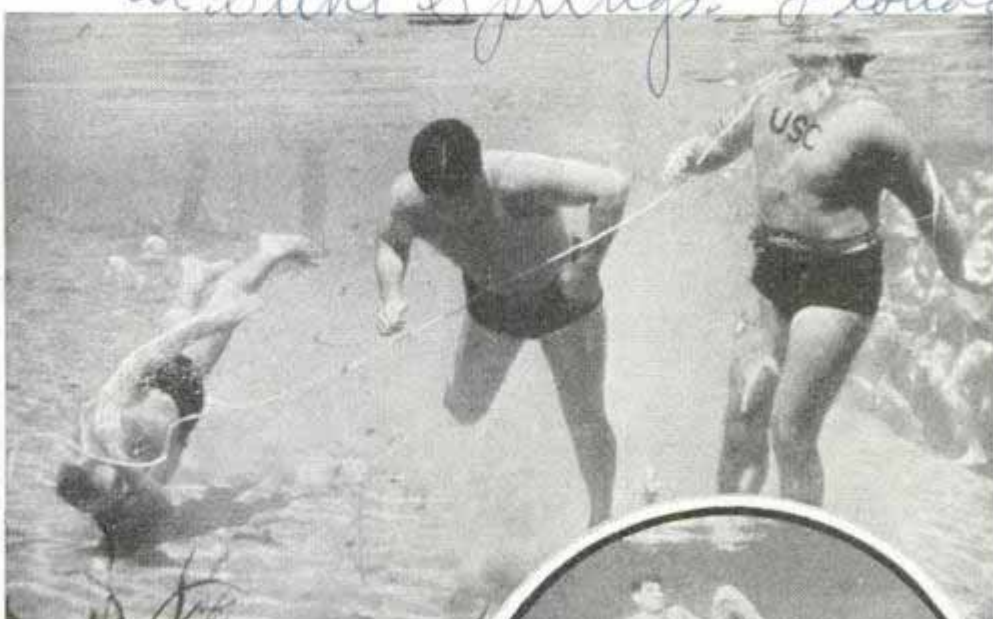

Above, at left, a subaqueous acrobat displays his skill on parallel bars, to the amazement of sea life in the neighborhood. If you think that's easy, try a hundred-yard dash on the ocean bottom. It seems farther than on land, as the winner thought when he breasted the tape, above at right. The crystal-clear water lures submarine photographers

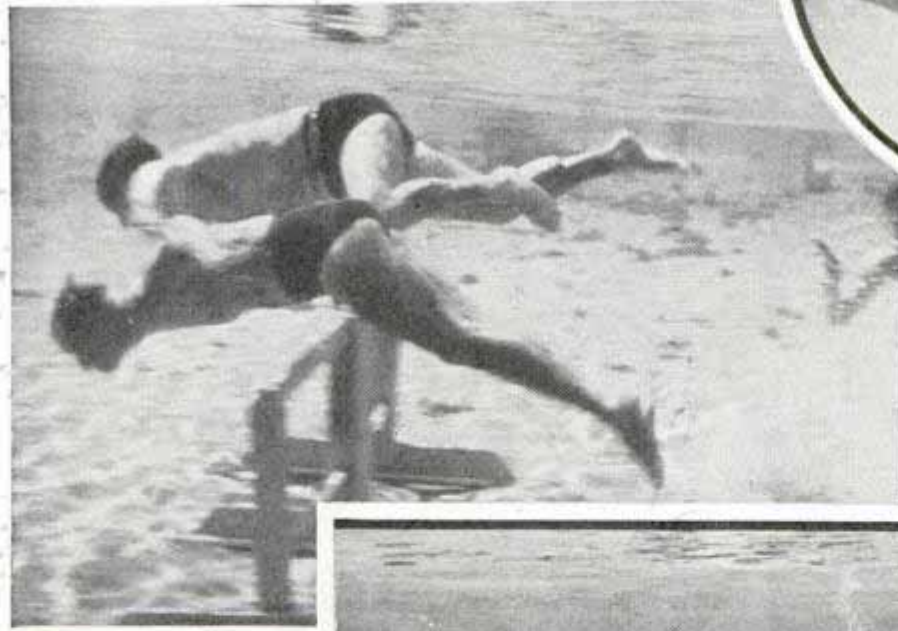

Above, undersea high jumper clears a bar that no landlubbing athlete could reach, but the hard part is to come down on the other side. Left, you lead with the chin in taking the hurdles. Below, the losers in a submarine tug of war never worry about being "dunked"; they're all wet from the start

Acme

One stadium where they never post the sign: "Game postponed; rain, wet grounds" is the fish bowl at Silver Springs, Fla., scene of an underwater track meet. Spectators in submarine "bleachers" enjoyed a series of athletic events that were breath-taking if not record-making

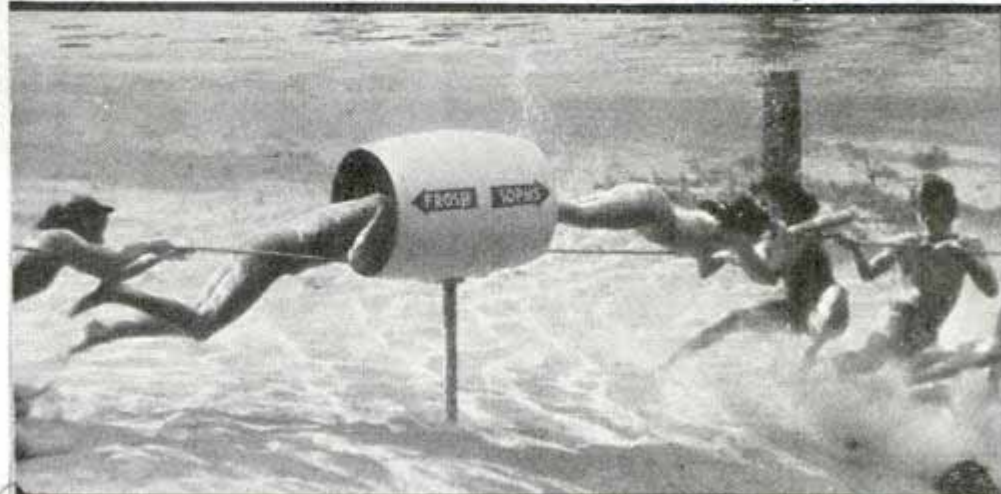

J 284

Safety Catch on Auto Door Guards Small Children



Child can't open rear door securely locked by catch shown in circle which unfastens only from outside

Small children, alone in the back of the car, cannot open the door if it is fitted with a safety catch available to Chevrolet owners. Tiny and inconspicuous, the lock does not interfere with operation of the front door, to which it is fastened by a set screw, but effectively prevents opening of the rear door from inside the automobile while the front door is closed.

J-354

Electric Clock on Steering Post Has Illuminated Dial



Fastened to the steering column of an automobile without any cutting, an electric clock held in full view of the driver has a light in its dial for easy reading at night. A

The New Haven Clock Co., New Haven, Conn.

non-magnetic hairspring reduces the possibility of error in keeping time which might be caused by temperature changes.

Electric Mask for Hay Fever Filters Pollen and Dust

Hay-fever sufferers may obtain protection from pollen and dust in the air by wearing an electric mask just invented by a Cincinnati physician. It consists of two perforated sheets of thin aluminum separated by a sheet of filter paper that acts both as insulation between the outer, negatively charged aluminum plate and the inner, positively charged screen, and also as a mechanical filter. The mask fits over nose and mouth, cushioned against the cheeks by a gauze-covered rubber protector. Positively charged pollen is caught by the outer screen, negatively ionized grains are repelled by it; any particles that penetrate to the positive inner screen will have taken a negative charge from the outer screen and will be caught and held by the positive plate. A small dry cell, renewed once a year, is connected to the screens.

And Dr. paper to... 227



In addition to filter paper in this mask, electrically charged screens stop pollen and dust

Allergy Research Institute

Dr. W. Albert, Cincinnati, Ohio

2-4-47. Capt. Roman Proske
108866 St. Nepean

Training the BIG CATS

"THE instant I tripped in the cage, the tawny Sumatra cat was on me like a flash," recalled Captain Roman Proske, who has trained animals for twenty-six years. "Almost before I fell, his teeth had sunk into my leg and a few seconds later the seven other tigers jumped in for the kill."

"There we were, a tangled, fighting mass on the cage floor while people in the audience screamed and fainted. Only I didn't die. Hudson Thomas's presence of mind got me out of that ghastly situation and into the hospital for eight weeks."

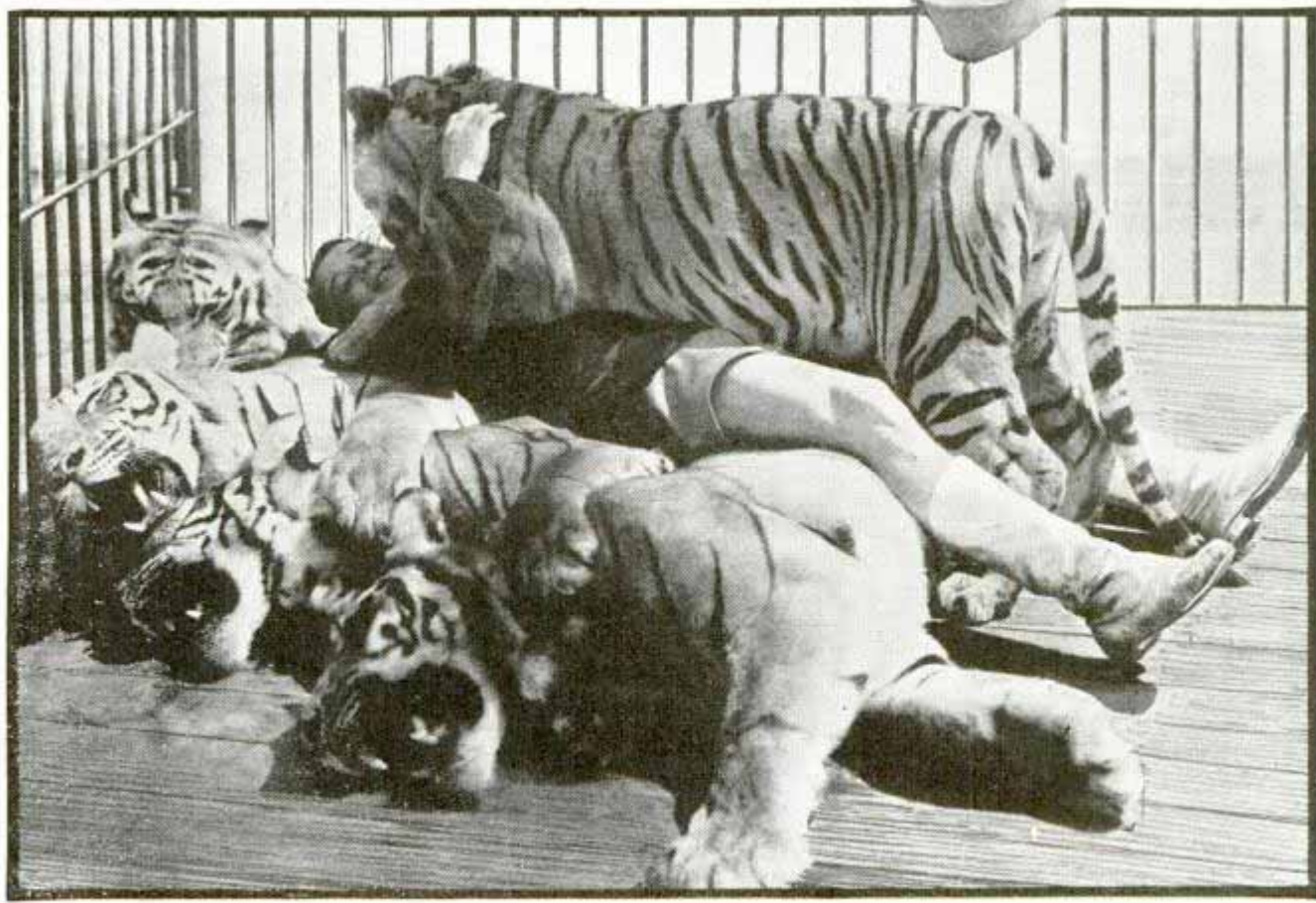

Top, a dangerous stunt with any of the cats, but particularly with the nervous tiger. Bottom, this one, too, holds a large element of danger for the trainer, Captain Proske

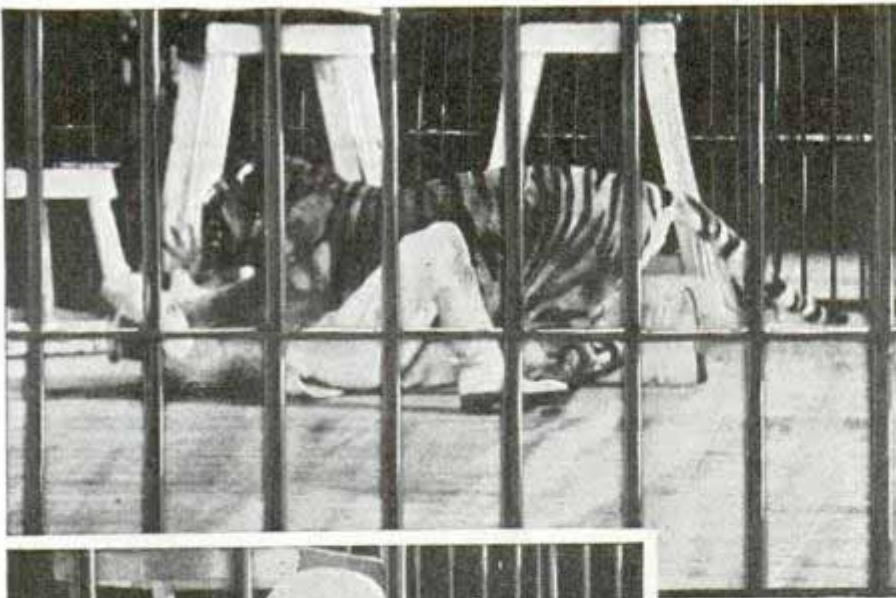

Ever since he began his career in the African jungles at the age of seventeen, Captain Proske has been training the big cats. But no man, or woman, however brave and patient, will ever really succeed in completely taming a tiger, he says.

"When you see a trainer at the circus in the arena with a group of mixed cats—lions and tigers," Captain Proske says, "you can relax with the knowledge that he's reasonably safe if he isn't overconfident, for overconfidence is responsible for ninety per cent of the cage accidents.

"Lions and tigers are natural enemies and in that antagonism is the trainer's best safeguard. Instead of watching him intent-



*Top, remarkable photo of the Sumatra pouncing on Captain Proske.
Center, attendants helping the captain from cage after the attack.
Bottom, lion with cubs born in captivity*



ly, they keep an uneasy eye on one another. If the trainer should be charged by a tiger and one of the lions jumps in and fights that tiger, it is not because the lion is trying to save the man. The real reason is that the lion thinks the tiger is off guard and it would be a good time to press the attack.

"The lion is a great bluffer. He will roar first to scare a man and in that roar there is a warning. But a tiger never utters a sound before he springs. He may appear to be deceptively sleepy before he lunges, but when he does, it is silently and with lightning speed."

While all tigers are dangerous to train, the most vindictive is the smallest, the Sumatra, which weighs up to 250 pounds. Next is the Bengal tiger of India which attains a weight of 300 to 500 pounds. Third is the Manchurian cave tiger and fourth is the Siberian tiger, both of which may range up to 1,000 pounds. So treacherous are the Sumatra cats

(Continued to page 146A)



Top, one stunt that pleases American audiences. Bottom, here's a big cat that Captain Proske taught to dance

Million-Pound Iron Horse Is 140 Feet Long

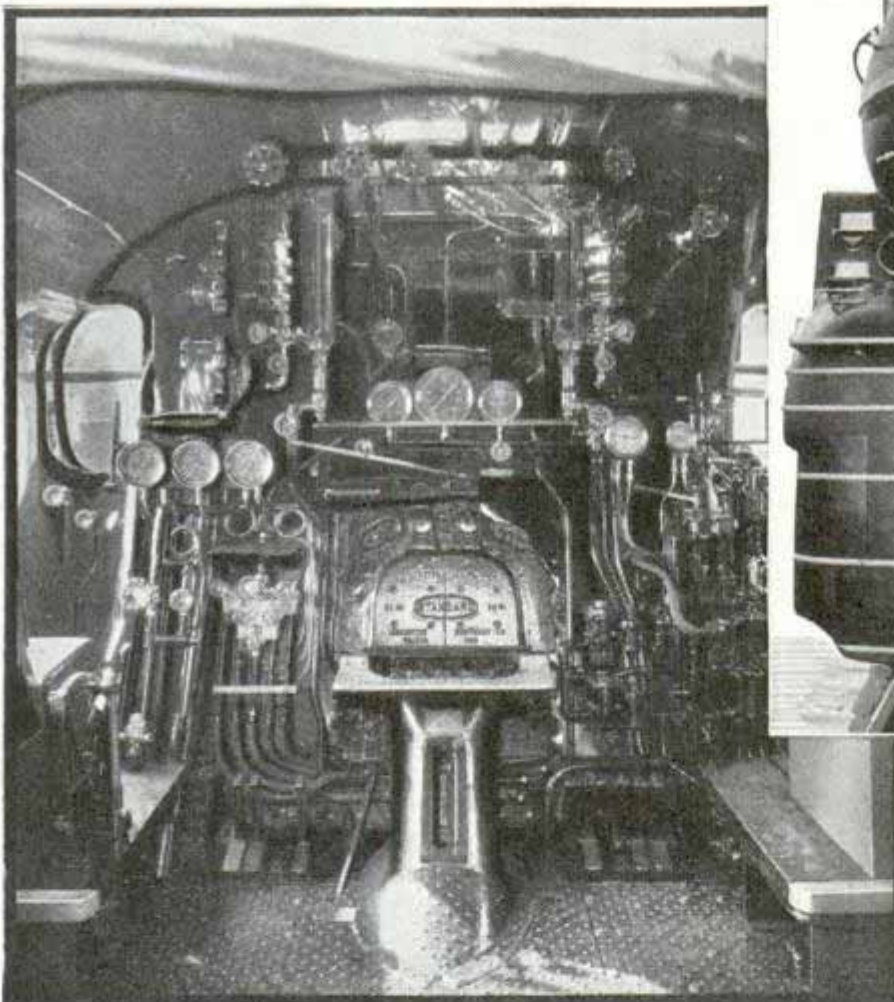
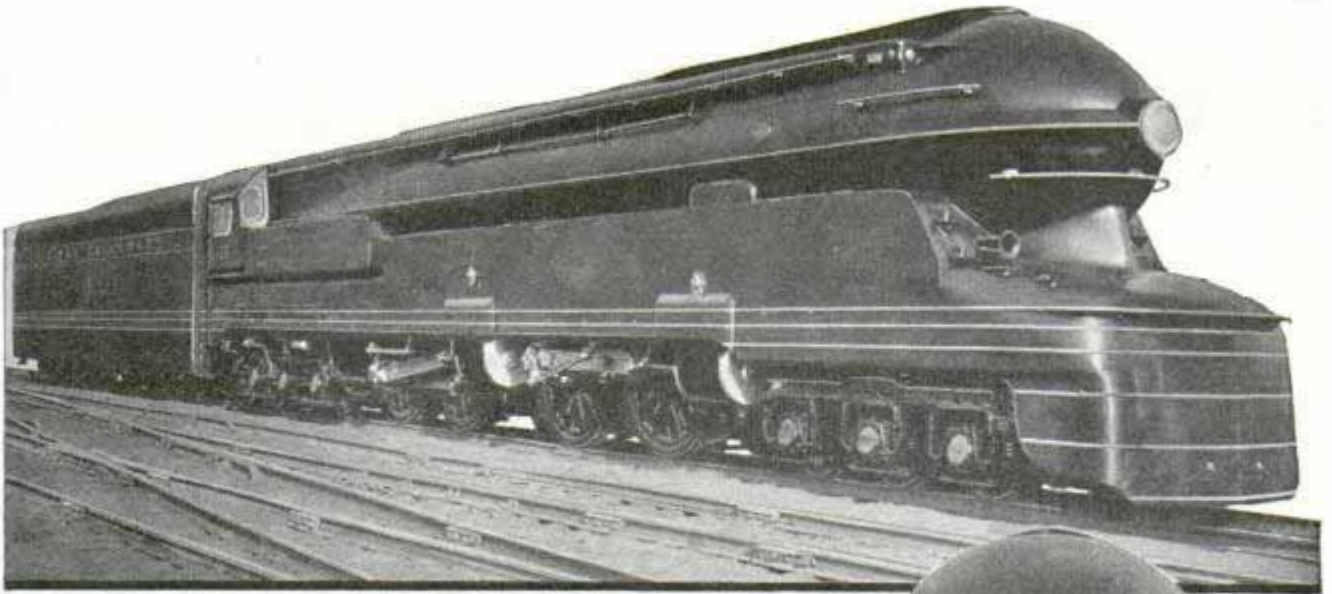

Wearing the name "American Railroads" because it is the pride of their New York World's Fair exhibit, this 140-foot steam locomotive is the largest ever built. Two of its four cylinders are visible at top. Left, the cab

For a long time the Northern Pacific's "Yellowstone Mallet" locomotive was called the world's largest. Today there is a new champion, a million-pound goliath of the rails that measures 140 feet and one inch from its pilot to the coupler of its tender. It was designed by Raymond Loewy. Pride of the American railroads,

it is a focal part of their cooperative exhibit at the New York World's Fair, after which it will pull one of the crack passenger trains of the Pennsylvania, in whose shops it was built at Altoona. Developing 6,500 horsepower at 100 miles an hour, the locomotive is capable of hauling a fourteen-car passenger train at sustained

Science Service 3/4/39

Resuscitated by... of Automobile Engineers

Walls of Germ-Killing Light Protect Babies in Nursery



Science
White lines sketched into the picture represent the invisible screen of ultraviolet light that purifies air in nursery

speeds of 100 miles or better. Top speed is unknown pending actual test runs after the fair, but it is believed it could pass with little effort the 127-mile record set by a Pennsylvania engine pulling the "Broadway Limited" in 1905. The "S 1," as the builders designate it, is a four-cylinder coal-burning locomotive of the 6-4-4-6 wheel type, each pair of cylinders providing power for two pairs of seven-foot drive wheels, with 300 pounds steam pressure. It delivers 76,400 pounds tractive effort. The engine alone weighs 600,000 pounds and its tender 452,200 more, loaded; the tender carries 50,000 pounds of coal and 24,500 gallons of water.

9265

Fast Plane Smooth as Glass Has No Rivet "Buttons"

Airplane speed is given a boost by building wings and fuselages with flush rivets instead of the projecting "button" type. This kind of riveting has emerged recently from the laboratory and is going into the production lines. While it will add to the cost of construction, one engineer estimated that a 275-mile-an-hour airplane, held together with projecting rivets but otherwise "clean" aerodynamically, would be put in the 300-mile-an-hour class by this method. An average plane may contain 30,000 rivets.

2030

Invisible walls of light stand guard against germs at the entrance of each baby's room in a large nursery at Evanston, Ill. Fluorescent tube lamps along the ceiling project a screen of ultraviolet rays so powerful they would kill any germs drifting into the nursery cubicle.

The Cradle. Rudge and Simpson

Leather Boots for Hunting Dog Tailored to Fit the Feet

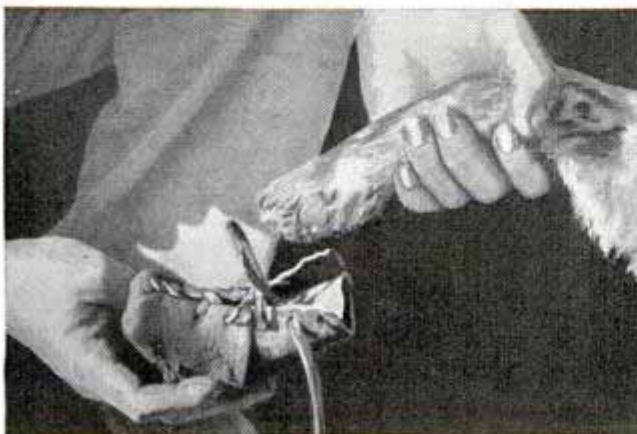

Fitting made-to-measure boot on hunting dog's paw

Hunting dogs that run through thick bramble and rough country often suffer from bruised and bleeding feet. So a Missouri harness maker fashions leather boots for dogs. They are tailored to measure, too. He first takes a cast of the dog's feet and from the casts shapes wooden models over which the leather boots are built.

by *McIntire Basin Co*
A fifty-foot motor cruiser built for the Sheik of Bahrein, on the Persian gulf, has underwater searchlights for navigating among uncharted reefs and shoals.

Ray Rhodes 1010876

Business Week Mar 25, 1939

Concrete Monsters Depict Prehistoric Life

Emb Henry Scheeler, 57 49
 W. Fletcher, Chicago

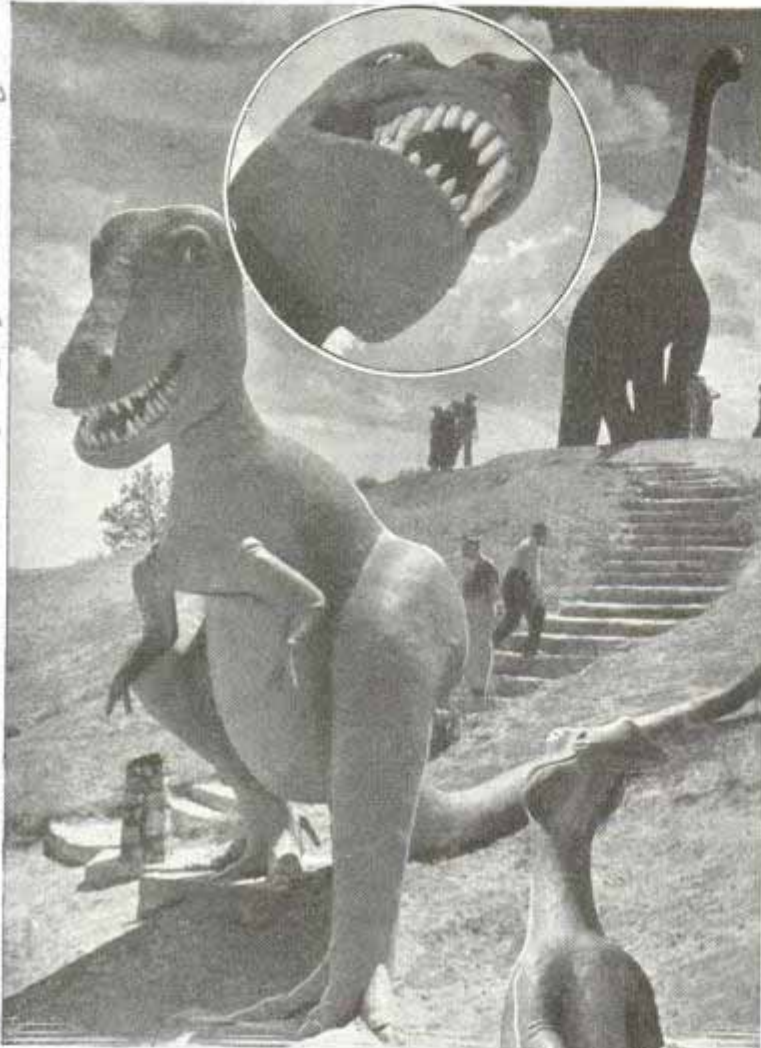

In South Dakota's Black Hills is a park in which there are reproductions of prehistoric monsters made with a framework of steel, covered with concrete. Above, the Stegosaurus, seven feet high and eleven feet long, with a tail upon which are six sharp horns and a beak armored with two sets of dermal plates

Above, Tyrannosaurus-Rex, thirty-five feet long. In the background is the Brontosaurus, giant of the concrete monsters. Inset, closeup of Brontosaurus head



Above, Trachodon, seventeen feet high, which had in real life a huge duck-billed head containing about 2,600 teeth. Right, the Triceratops, twenty-seven-foot dinosaur with three horns and a heavy coat of armor. The neck protection consists of a large horny frill. These monsters are located on a mountain overlooking Rapid City, S. D.



Photos of Star Trails Prove Rotation of Earth

Unusual photographs can be obtained on still, clear nights by pointing the camera upward and making long time exposures. They reveal the apparent movement of stars across the heavens, which actually is caused by rotation of the earth. A whirling vortex is the effect if the North Star is centered in the picture and exposed for two hours. By focusing on the different star groups and giving them an exposure of about ten minutes, familiar formations like the "Great Dipper," "Orion" and others make interesting patterns. It will be noted that each star describes an arc, those closest to the north pole traveling in a relatively small circle which becomes larger for stars as they near the celestial equator.



Slow-moving stars made this whirling vortex when the camera was pointed in a northwesterly direction and the film exposed two and one-half hours. Each star traces an arc

Electric Wave Walks in Slow Motion on Aluminum Bars

Electric waves in slow motion are reproduced mechanically by a "hobble skirt"

developed by Westinghouse engineers. Resembling a streamline xylophone with



Aluminum bars trace in "slow motion" the wave surge of electric current while engineers simulate a short circuit on a power line

fifty-six long aluminum arms, the device is a working model of a transmission line on which a surge of electric current can be prolonged from 1/10,000 second to as much as five or ten seconds. The metal arms, springs and damping or resistance elements take the place of their electrical counterparts. As the first arm is moved up or down it transmits the movement successively to the rest of the arms in the form of a wave moving in a slow "walk," permitting the engineers to study what happens when a short circuit occurs.

Central Station Elec. and Pittsburgh Pa

Assessors: Kato, C. J. ...

Rescuing AMERICA'S

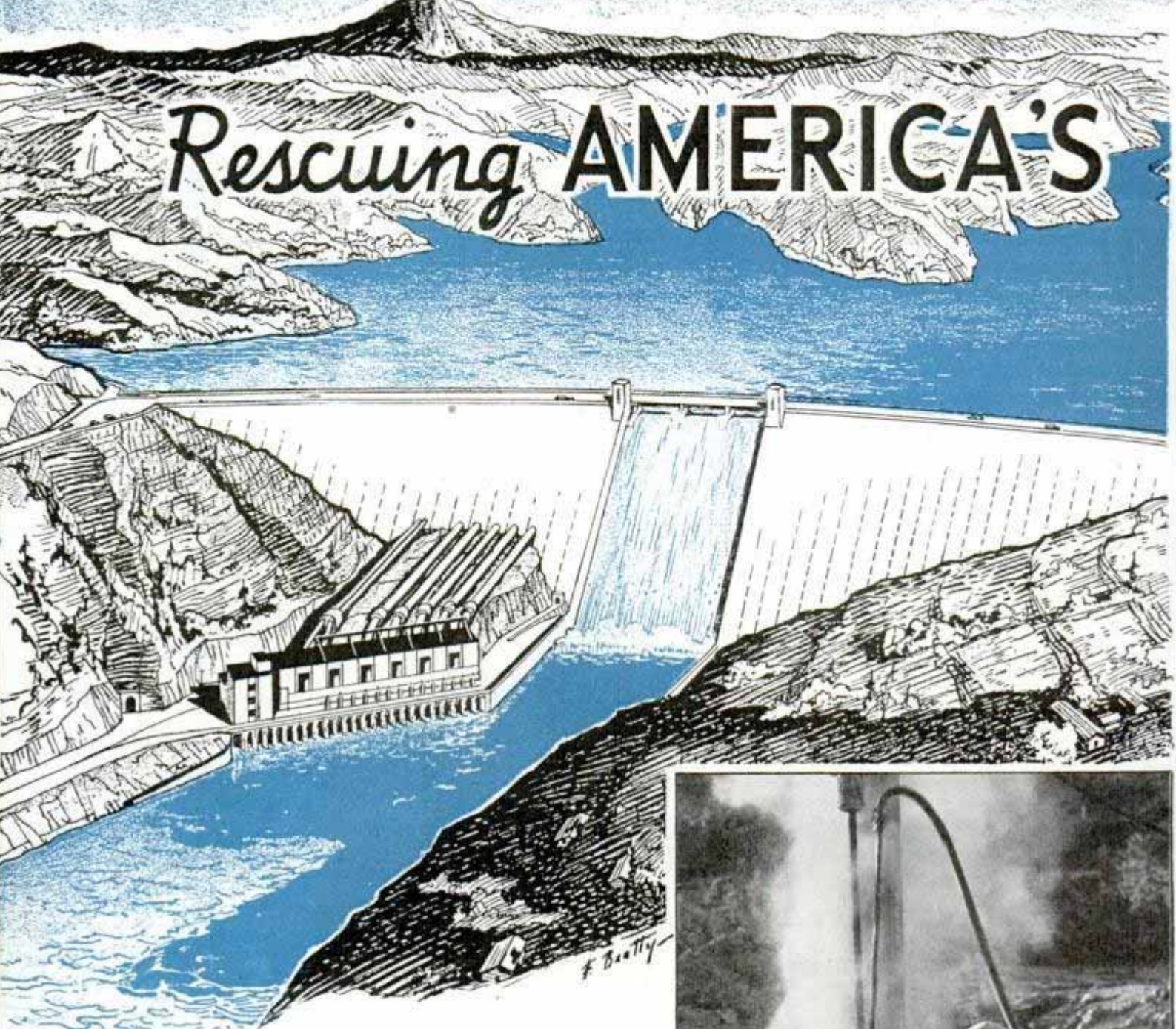

Top, drawing of Shasta Dam and power plant. Bottom, workman blowing rock dust from hole being drilled at Shasta Dam site

GREATER than all England, California's rich Central Valley, encompassing 20,000 square miles, with 45,000 farms containing more than 3,000,000 highly productive acres, is a veritable modern "Valley of the Nile." From this valley come three-fourths of the world's supply of grapes, raisins and dried fruits and more than a quarter of all the vegetables purchased by American housewives.

Here the world's greatest reclamation drama is being enacted. The valley, for a number of years, has been in urgent need of rescue from the devastation of flood, drought, soil erosion and salt-water encroachment. To escape disaster it must have a controlled water supply. Thus the great \$170,000,000 Central valley project was born to supply that necessary water to the semi-arid region comprising the Sacramento and San Joaquin river valleys.

Dept. of Interior
 Bureau of Reclamation

*no information about
 equipment & contractor*

Cont. Shasta Dam
Sacramento Calif

"VALLEY of the NILE"



The project, which is under construction supervised by the United States bureau of reclamation, is considered the greatest of its kind ever undertaken. The combination of the Shasta dam, the Friant dam, low dams and pumping plants, and 350 miles of canals and conduits is expected to solve irrigation, salt-water infiltration, high-water problems in interior California, and lengthen the navigable length of the Sacramento river to Red Bluff, 142 miles above Sacramento.

Mechanical ingenuity and the pressure of fresh water from Shasta dam are depended on to prevent encroachment of salt water from San Francisco bay upon the rich farming lands of the Sacramento river—San Joaquin river delta, thereby rescuing



Top, right, riggers at work on one of the piers for railroad bridge downstream from Shasta Dam. Bottom, tightening cable jewels in east anchorage of new bridge



more than 400,000 acres or highly developed land now in danger of reverting to salt marsh. During periods of low flow in the two rivers, salt water now penetrates the channels from which these lands are irrigated. In consequence of this saline condition more than 20,000 acres of rich land already have had to be abandoned.

More than a million of the 2,000,000 acres to be irrigated by the project face an acute irrigation crisis. In the San Joaquin valley the extraction of water from the

ground by pumping greatly exceeds the annual natural replenishment by rainfall and stream flow. Between 40,000 and 50,000 acres of producing lands have been abandoned because of lack of water, and 200,000 acres are in the process of gradual reversion to desert. At least 800,000 acres are not adequately protected against the blight of drought or salinity.

Key to the valley's water problem is the Sacramento river. It is not generally known that the

Sacramento is a considerably mightier stream than the Colorado river. The mean annual runoff of the Sacramento river is 21,000,000 acre-feet, while that of the Colorado is 16,000,000. The combined annual discharge of the Sacramento and San Joaquin rivers into the ocean has averaged about 30,000,000 acre-feet, which is water enough to cover every irrigated acre in the Central Valley to a depth of ten feet. The water supply is ample; it needs only proper seasonal and geographical distribution.

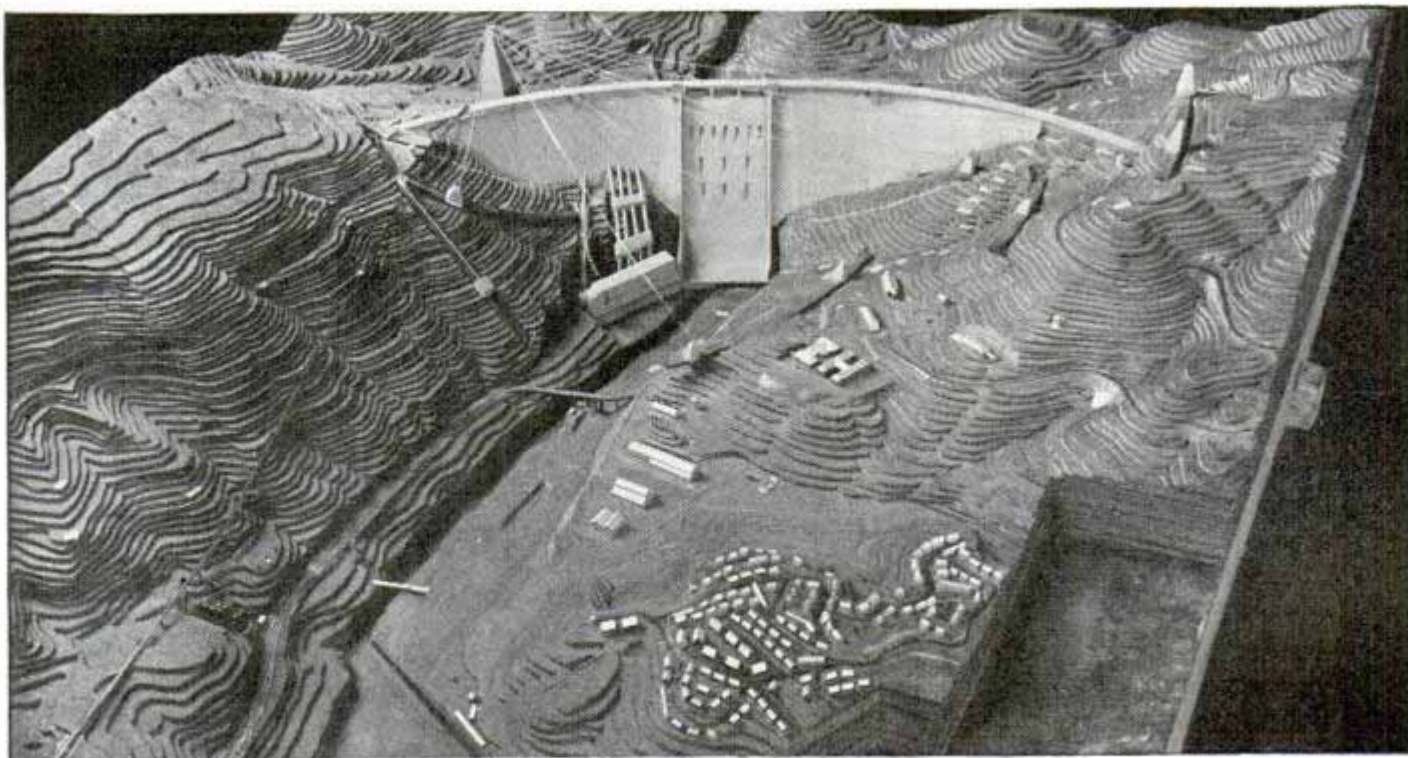

Top, cores taken from earth to sample underground structure at Friant Dam site. Bottom, construction model showing details of the 560-foot Shasta Dam and near-by region

Major unit of the Central Valley project is Shasta dam on the upper Sacramento river north of Redding. A mass of concrete that will rise higher than the tallest skyscrapers in California, this dam will be 560 feet from the lowest point of foundation in bedrock to the top of the dam, 3,500 feet long on the crest, and will contain about 5,700,000 cubic yards of concrete, enough to build a solid concrete monument a block square and slightly higher than New York's Empire State building. It will be even more massive than famed Boulder dam on the Colorado river.

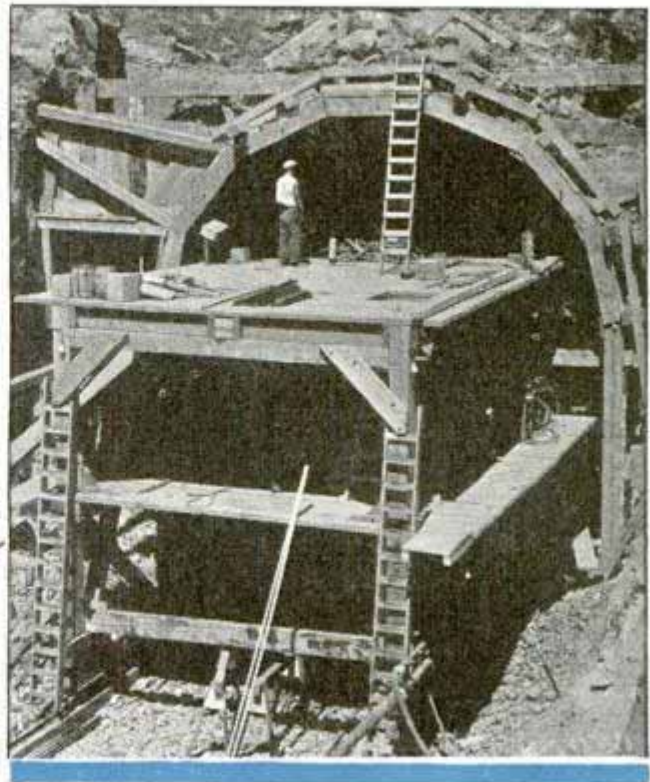

Top, drill rig at railroad by-pass tunnel entrance. Center, perspective of project. Bottom, working on Friant Reservoir survey

Behind Shasta's wall of concrete will be stored four and one-half million acre-feet of water, which will permit operation of this giant reservoir for multiple purposes of conservation. It will take the peak off the extreme floods which sometimes devastate the Sacramento valley and will stabilize the year-round flow of the Sacramento river to permit a restoration of

(Continued to page 116A)

640-Pound Airplane Engine Produces 500 Horsepower

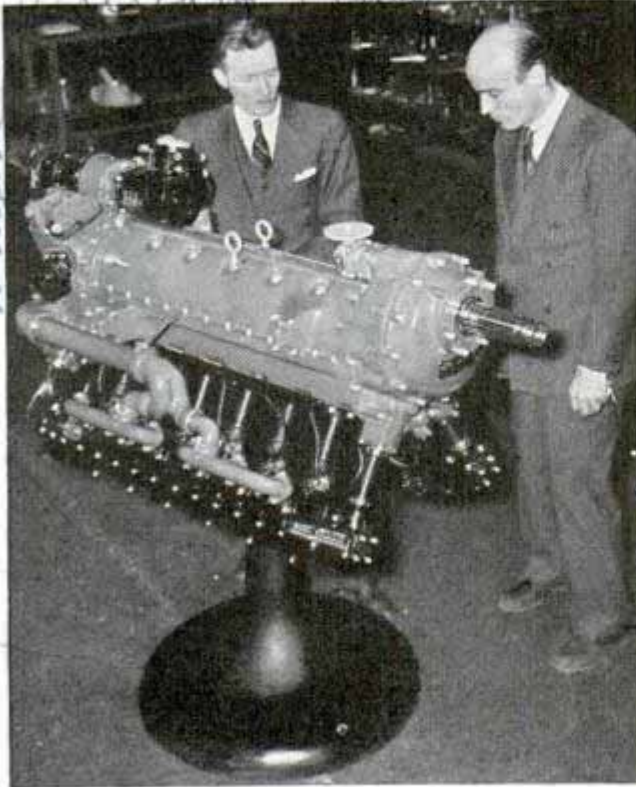

Inspecting twelve-cylinder airplane engine developing one horsepower for each 1.28 pounds of weight

Delivering more than three-fourths horsepower for each pound of its weight, a twelve-cylinder "Ranger" airplane engine tested recently weighs 640 pounds, but develops a maximum of 500 horsepower for take-off. It is air cooled.

Sliding-Roof Home Observatory Requires No Dome

Instead of building the usual dome, an amateur astronomer has secured complete protection for his instruments in a box-



Roof of home observatory rolls out of way so amateur astronomer can point telescope into night sky

shaped building with a sliding roof. It is an ordinary frame structure twelve feet square, sheathed with shingles and lined with insulating board. The roof rolls outward on two four-by-four beams, projecting twelve feet from the side, which carry a U-shaped iron track to guide six ball-bearing casters. When closed the roof is locked by two large hooks and screw eyes. The telescope is mounted permanently on a six-inch pipe set upright in concrete.

Moisture in Soil Is Measured by Current in Gypsum Block

Quick measurement of the amount of moisture in the soil, an important factor in crop production, can be obtained by a method developed at the Michigan agricultural experiment station at East Lansing. It was found that moisture in a block of gypsum buried in the earth varies with moisture in the surrounding soil, and electric conductivity of the block varies with its moisture. So a gypsum block of standard size, with wires attached to it leading to a source of current and a meter, is buried and the reading taken.

Auto Battery Charger on Wheels Works Faster and Cheaper

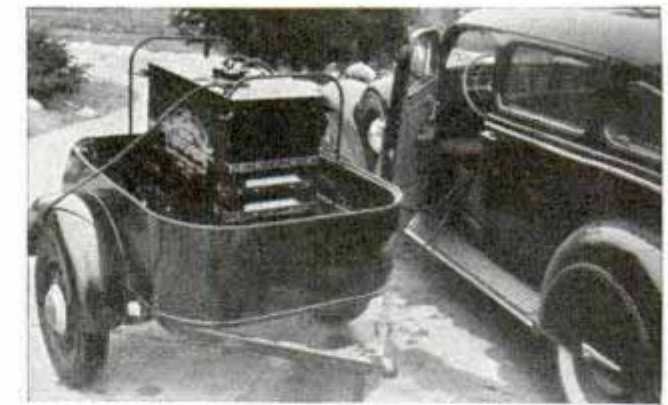

Shown in the trailer is quick-working battery charger that has its own casters for hauling it to car

Charging of automobile batteries, heretofore a slow process, has now caught up with the age of speed. A new charging unit for service stations will perform the task without removing the battery in twenty to forty-five minutes, and at less cost, while the car is in the shop for lubricating, washing, motor tune-up or other minor service. Expense of renting a tem-

Clemens - Harvey Street, 1006 Card West Hollywood, Calif Ranger Engineering Corp Farmington, Conn

Hunter - Hastman Corp 2500 Washington Blvd

Bouyoucos A. H. Nick

g. 340

g. 281

283

Alsatian Street Police Barracks
Police Dog Carries a Radio

"Zoe" Sydney Australia
and Follows Its Commands

porary battery is saved, and but three cents' worth of electricity is consumed per battery charged by this quick-current method. Rolling on ball-bearing casters, the charger is moved about easily, and a built-in testing device indicates the condition of the battery so the owner may know immediately whether or not it will take and hold a charge. Frequent chargings prolong the battery's life by preventing formation of the crystalline deposit on plates which occurs when the charge is low. The portable machine, which feeds rather than forcing the charge, is an adaptation of the constant potential method of charging and has automatic controls to forestall any damage to the battery. With little difficulty, the charger may be placed on a small trailer or light truck and taken out on emergency calls.

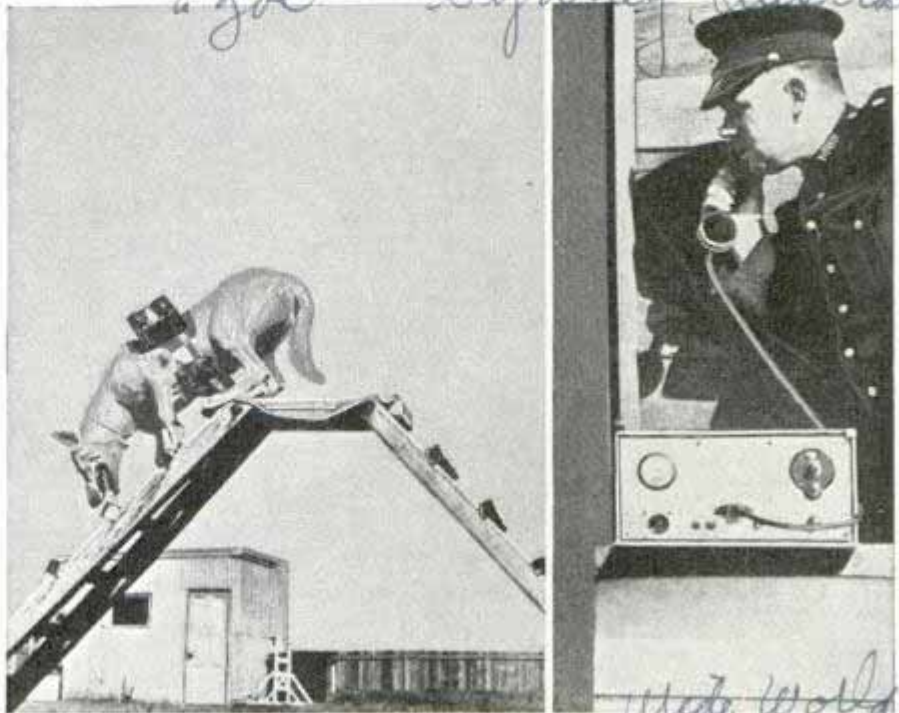

While police officer gives orders into microphone at headquarters, dog carrying receiving set obeys the command to climb and descend ladders

Police at Sydney, Australia, have trained an Alsatian dog to obey commands issued by radio. The dog carries a miniature receiving set strapped on her back. In response to orders spoken into a microphone at police headquarters the animal will walk up and down a ladder, turn a tap on and off, put on her own collar and take it off and fire a revolver.

2287
Making Three-Dimension Snapshots with Any Camera

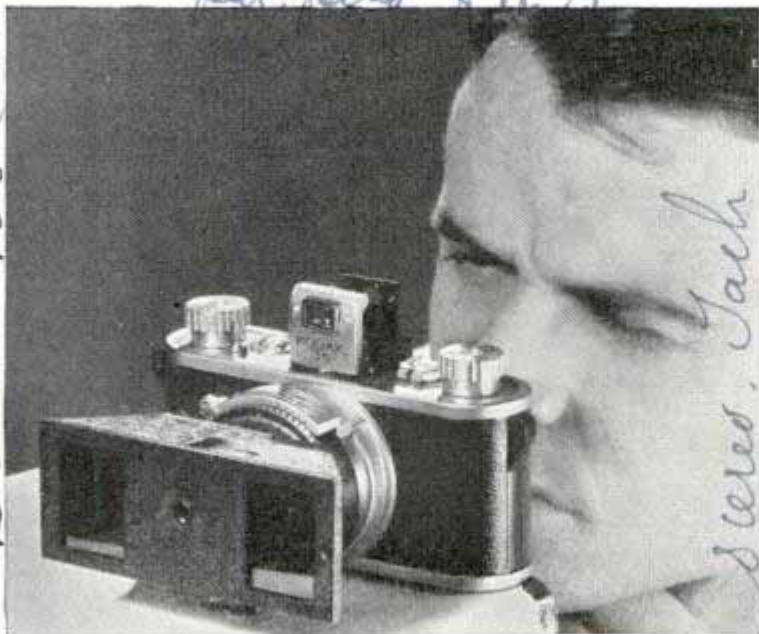

see ad 158a
Attachment in front of lens converts camera into stereoscopic instrument making three-dimension pictures with one exposure

Any camera can be used for three-dimension pictures by adding an attachment just put on the market. With the two-windowed device fitted in front of the camera lens, a single click of the shutter takes two pictures from different angles on the same film. Seen through the stereoscopic viewer which is furnished with the attachment, the twin pictures have the appearance of depth.

Names and addresses of manufacturers and dealers in articles described in this magazine will be furnished by our Bureau of Information upon request accompanied by stamped envelope.

Commonwealth
4208
Corp. A.D. 6/7/40
Chicago

1532

Below the OCEAN'S

Cmt. Emile C. Schürmacher
108 E 66th St. New York

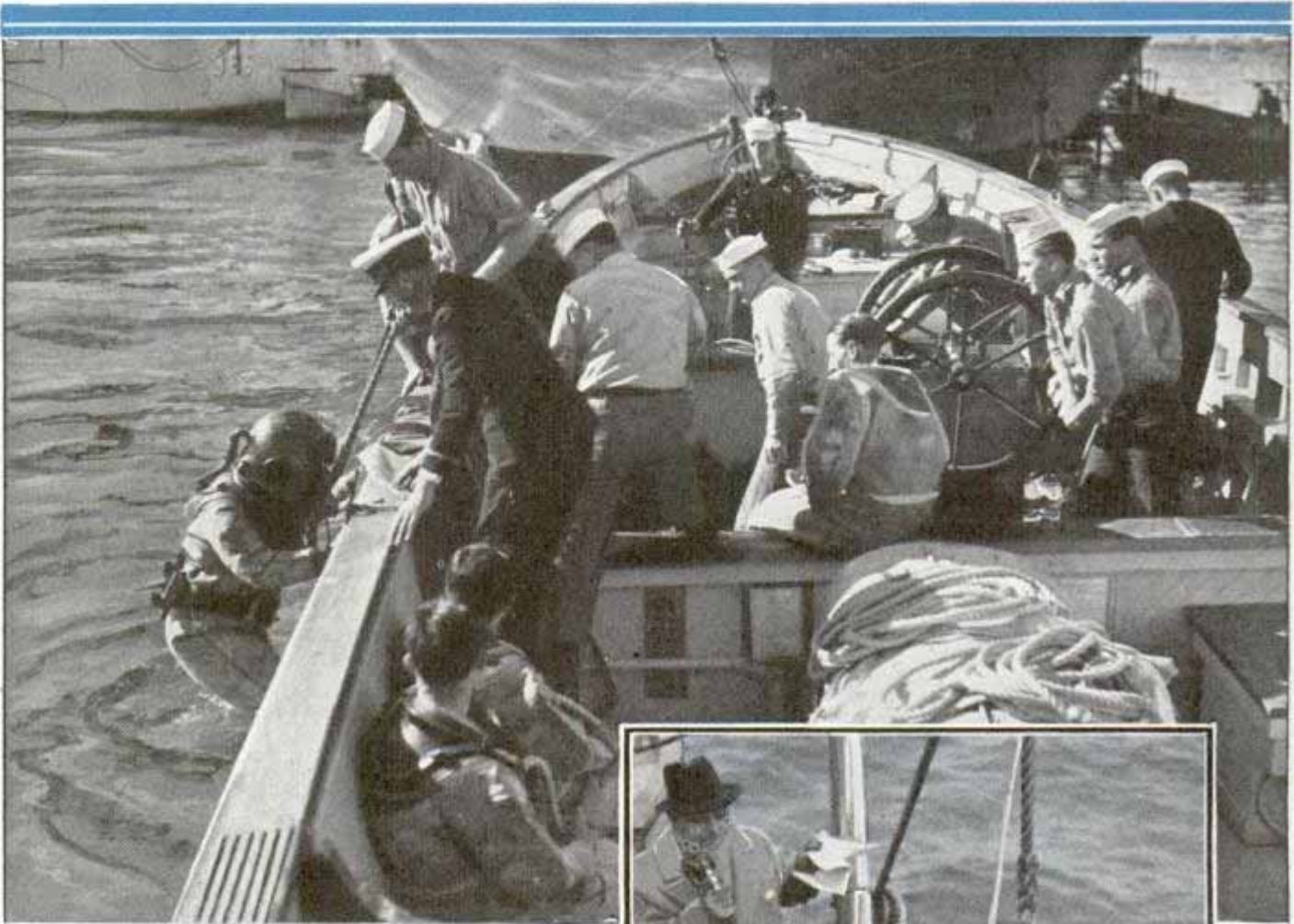

WHETHER divers are engaged in a desperate attempt to free a submarine trapped hundreds of feet beneath the surface, salvaging the cargo of a sunken vessel or seeking treasure upon the ocean floor, their most deadly peril is an invisible one.

Ever since science made it possible for human beings to submerge in diving helmets and rubber suits, the "bends" or caisson disease has placed a deadline upon the distance which they could safely descend, and the amount of time which they could remain at that depth. Now, however, after years of experiments and research, science is succeeding in conquering that deadline with the same gas, helium, which has made lighter-than-air flying safer.

In December, 1937, using a mixture of helium and oxygen, called "breathing air," Max G. Nohl descended to a depth of 420 feet below the surface of Lake Michigan, shattering a record made in 1915 when Frank Crilly in Pearl Harbor, Honolulu,

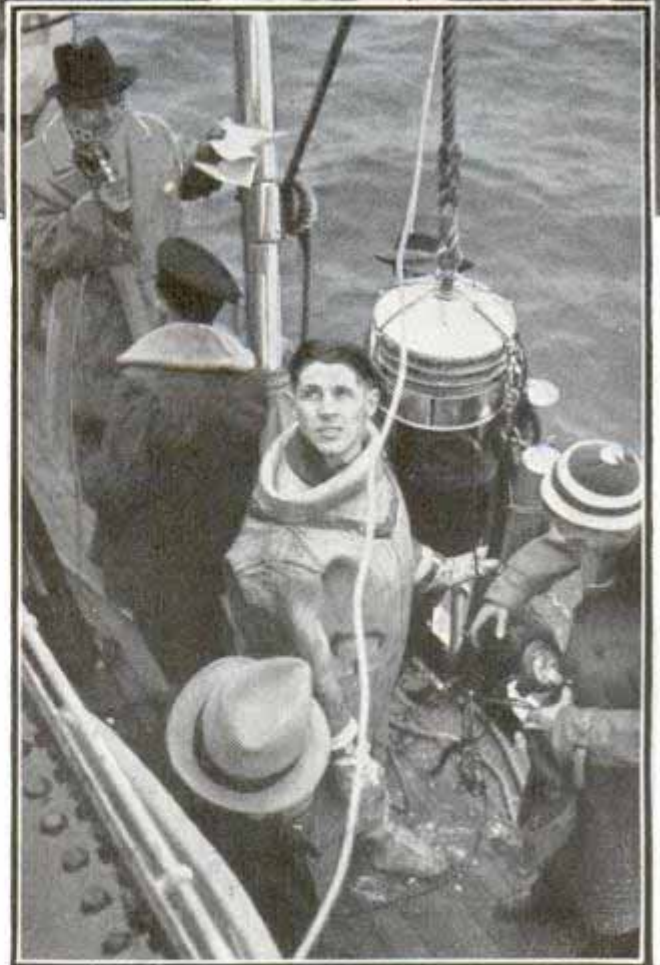

Top, U. S. Navy diver being lowered. Bottom, Max Gene Nohl after record-breaking dive. Note 360-degree visibility helmet

DEADLINE

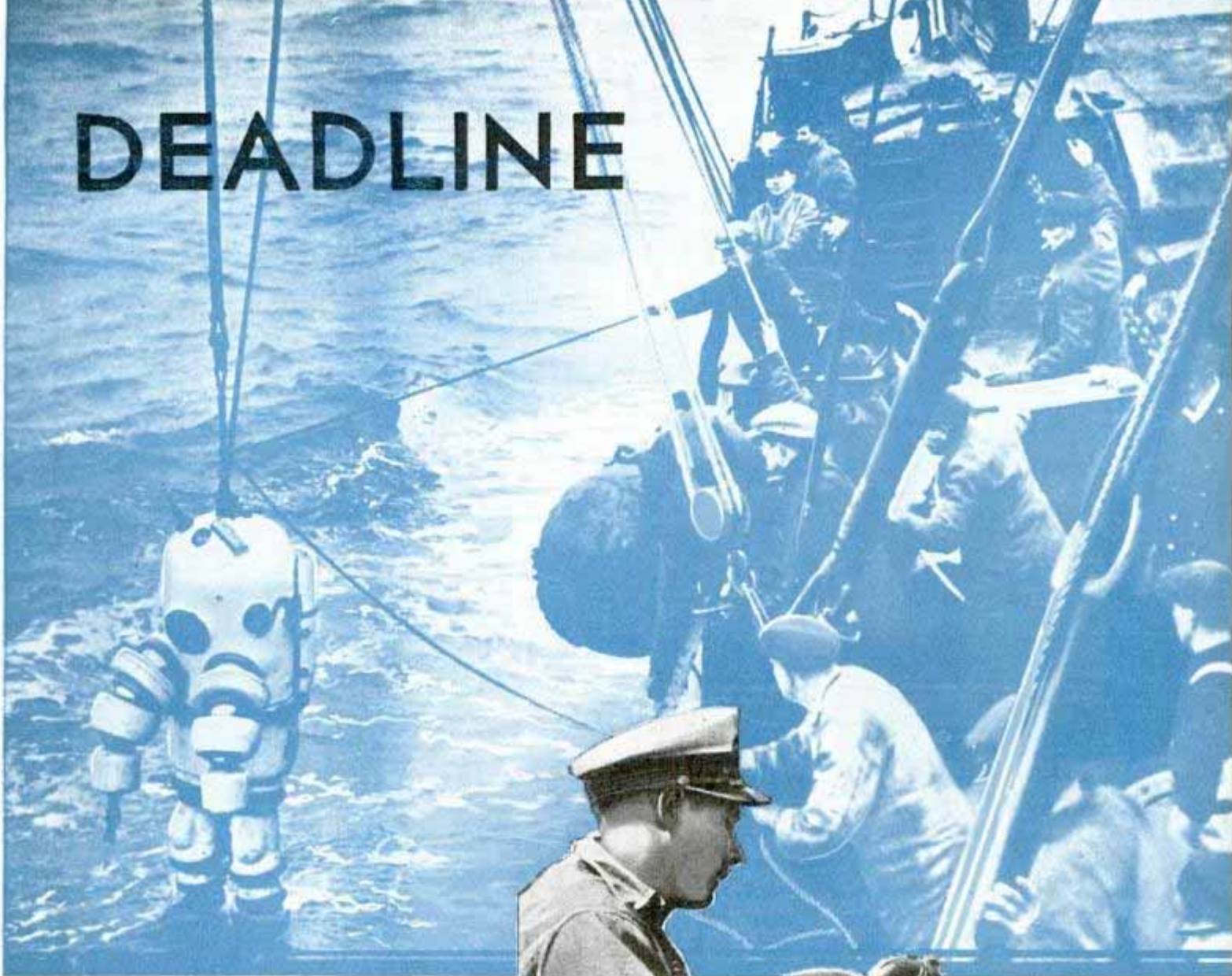

reached the sunken submarine, "S4," 306 feet down.

Few divers dared to go as deep for twenty-two years following Crilly's dramatic plunge because of that dread deadline. But since the development of breathing air, dives of even greater depths than Nohl's descent are predicted for the near future.

During 1938, depths to 500 feet were reached under simulated sea conditions in the diving tank at the Washington Navy Yard by Master Divers J. H. McDonald and William Badders, both of the navy. Actual deep-sea conditions were simulated by partially filling the tank with water and applying air pressure equivalent to sea pressure at 500 feet. All of the first-class divers of the experimental diving unit attained depths over 300 feet during the experiments and during open-

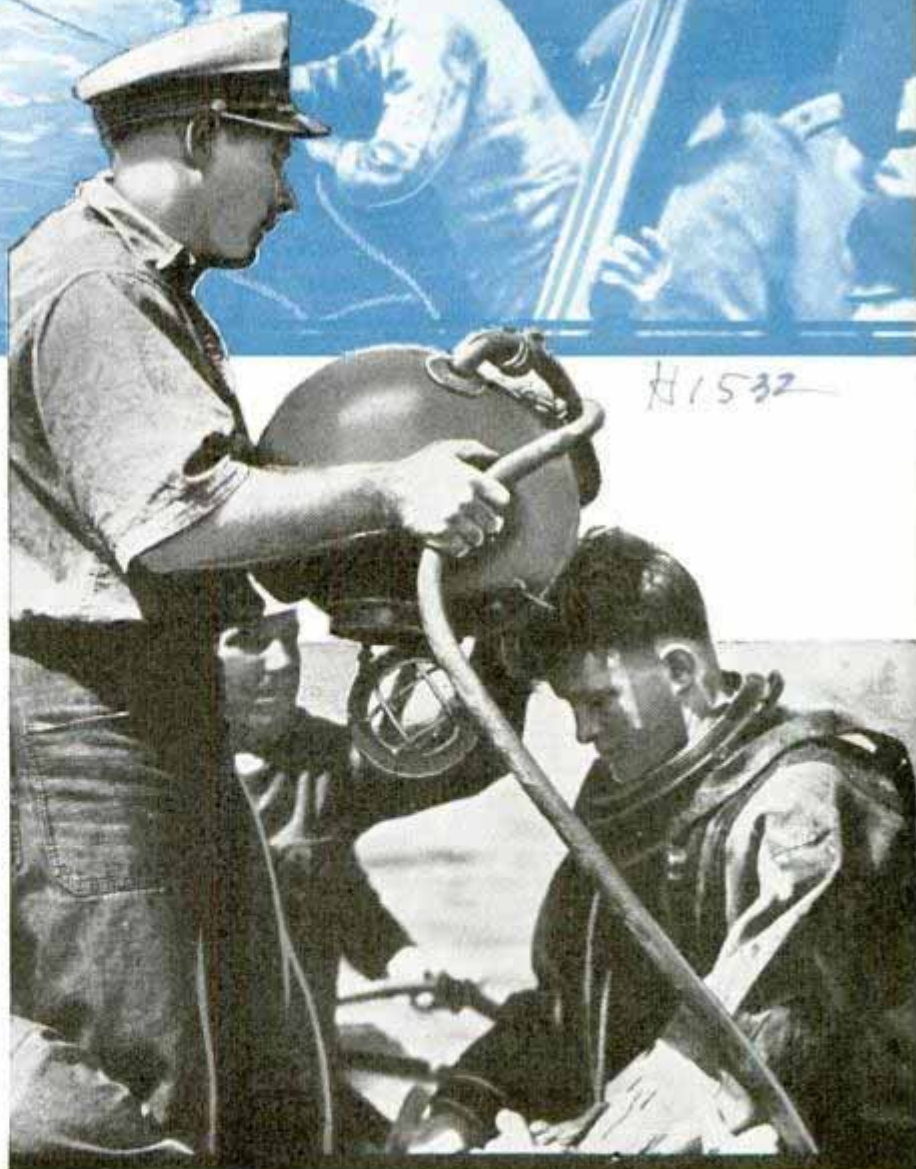

J. J. J. J.
Top, cumbersome diving suit used to reach the "Lusitania" at 312 feet. Bottom, placing helmet on navy diver

During school. U.S. Navy Yard
 Washington D.C.



great depths emphasized the necessity for devising a means whereby in case of such accident, assistance, if necessary, could be rendered by divers," says a navy spokesman.

"Various types of armored deep-sea diving apparatus were investigated, with the conclusion that while such apparatus may be beneficial for observation purposes, all of them precluded the per-

sea tests on board the U.S.S. "Falcon," Badders made a dive to more than 400 feet.

Rear Admiral W. G. Du Bose, chief of the Bureau of Construction and Repair, Navy Department, says that results of experiments indicate that attainment of greater depths than 500 feet is possible. But even 500 feet below the surface represents a tremendous victory in shattering the ocean's deadline. Many of the great lost treasures in sunken vessels lie at much less than this depth. The ill-fated "Lusitania," with a fortune in gold bullion in her hull, lies in only 312 feet of water. Captain John Craig, noted deep-sea diver who cooperated with Nohl in inventing many of the devices used in the latter's record dive, has a list of ninety-two such vessels which are said to have nearly \$2,000,000,000 in their hulls.

The original intention of the U. S. Navy in conquering the ocean's deadline was to come to the aid of submarines.

"With submarines being constructed to operate at ever increasing depths, the possibility of the sinking of such vessels in

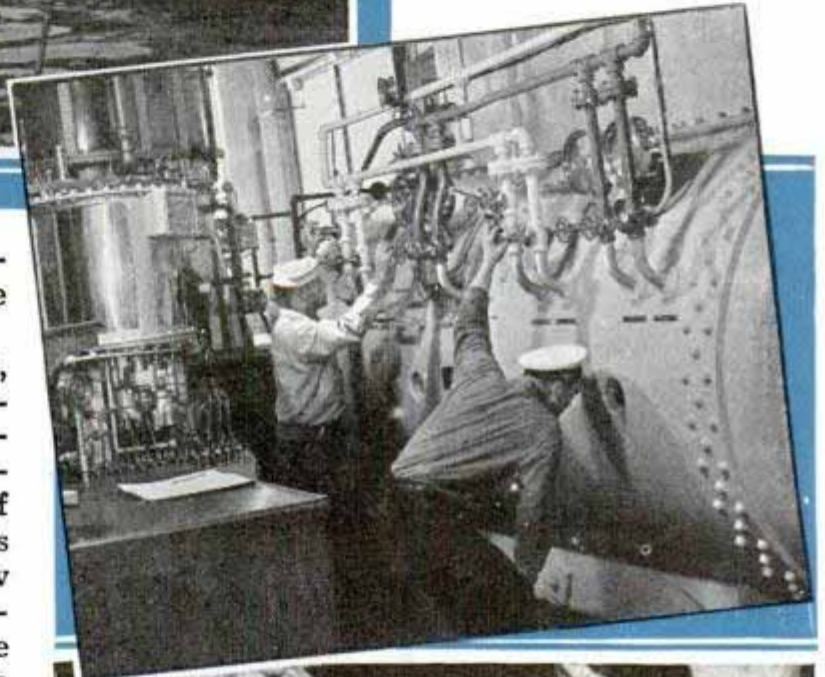

Top, student diver ready to be lowered over the side of training boat. Center, operating decompression chamber. Bottom, diver in full rig enters pressure tank for test of deep-sea equipment

formance of any actual work of the nature involved in naval salvage operation."

Treasure hunters discovered the same thing. With the exception of an Italian diving company which in 1932 salvaged the treasure of the S.S. "Egypt" lying in the Bay of Biscay and divers of the British Admiralty who succeeded in recovering almost \$25,000,000 from the hull of the "Laurentic," most of the treasure seekers returned home empty-handed. Man-made monsters and diving bells were all right for sub-surface exploration, but when it came to the actual work of getting into the wrecks and removing the treasure, rubber diving suits were necessary to permit the divers to move freely.

But here the dreaded ocean deadline intervened, becoming a hazard even at the lesser depths to which the divers managed to descend. With normal compressed air, the maximum depth which could be attained was approximately 300 feet and the time that divers could stay at that depth with reasonable safety rarely exceeded fifteen minutes. Even for a quarter hour stay at that depth using ordinary compressed air, a decompression time of four to five hours was required.

"The chief difficulty in extending safely the limits of work conducted in compressed air arises from the fact that during compression and at the working pressure, the body fluids and tissues absorb a large volume of air in accordance with the physical law governing the solubility of gases in liquids," reported Dr. R. R. Sayers, formerly chief surgeon of the Bureau of Mines, U. S. Department of the Interior, who aided in the experiments leading to the use of breathing air.

"The difficulty arises during decompression or return to the surface. If the decrease in pressure is not carefully controlled, and suf-

(Continued to page 141A)

Batters Swat "Captive" Ball to Improve Their Hitting



Here's how a batter whose weakness is for high and outside pitches would use frame to obtain needed practice

To help his players overcome weaknesses in batting, Harvard's baseball coach, Floyd Stahl, has a training apparatus that holds a captive ball for batters to hit. It is a wooden frame with a rope running from the ground to a pulley six feet high. Mounted on the rope is a ball with a hole through its center so the height may be regulated. Hitters who have a known weakness for high or low pitches set the ball at the point where practice is needed, then stand close up or farther away to imitate inside and outside throws.

'Bottle Opener' for Removing Hub Caps Prevents Marring Finish

Applied like a bottle opener, a special tool for removing hub caps protects the chromium or paint finish of the cap from scratches. A slight, gradual pressure on the lever with one hand pulls the cap from the wheel.

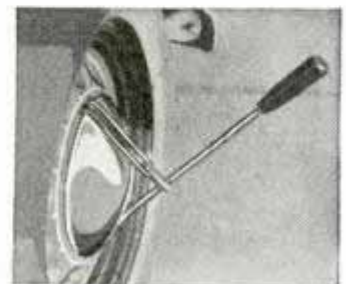

Capt. Carl Johnson

Weco Mfg Co. Quincy Mills Md

Singing Light Tower at Fair Blends Music and Color

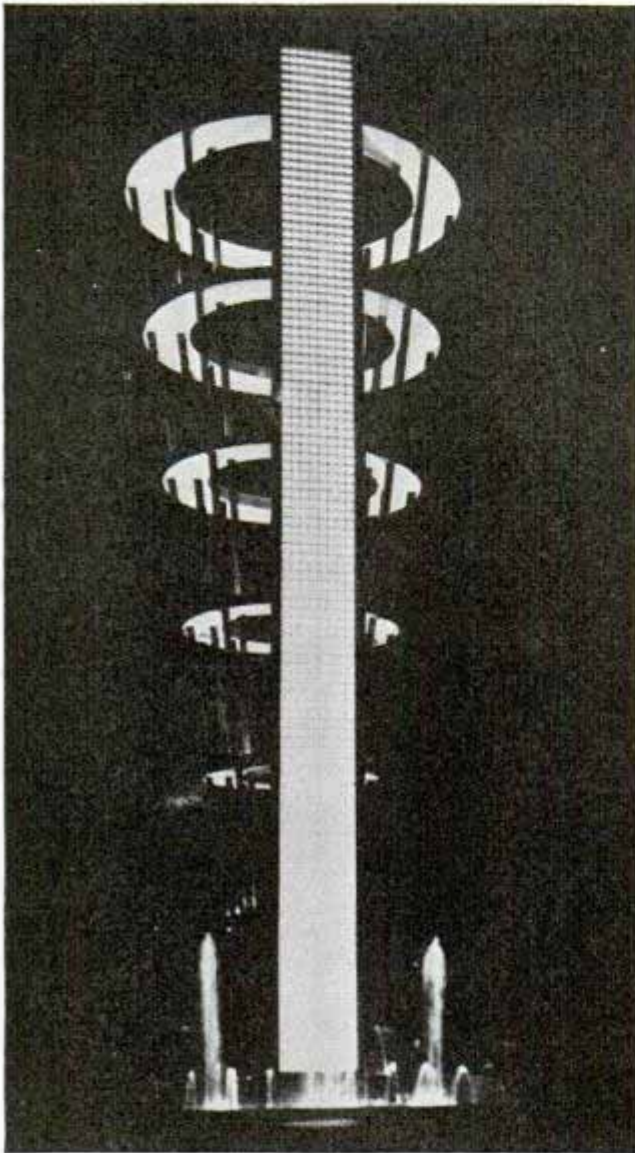

Ten-foot working model of Singing Light Tower with water fountains and lights dancing to the music

Rising 120 feet in the court of the Westinghouse building at New York World's Fair, is the "Singing Tower of Light" from which flows symphonic music, accompanied by ever-changing colored lights, water, fireworks and smoke. Formed by an open framework of six metal rings with a common center, supported by tubular rods, the tower appears to be built upside down, for the smallest ring is at the bottom and the others become progressively larger toward the top. The design is symbolic of insulators used in the electrical industry. Each of the concentric rings encloses a circle of floodlights bathing in many colors a cloud of smoke that drifts upward. As they reach heights up to seventy-five feet vertical jets

of water catch the colored beams, and fireworks crown the display in myriad hues, all synchronizing with the musical notes. The entire exhibition is governed by eight main remote-control circuits, any of which may be stopped, started or changed in intensity at will, and some last-minute developments in illumination, hydraulics and control devices have been put into use.

J-280

Wire Hat Holder Saves Space in Clothes Closet

Unfortunate experiences and continued dissatisfaction with boxes, hooks and shelves for storing hats awakened the inventive mind of a Kansas woman. Experimenting with wire, she bent and twisted it until a sort of three-armed rack was fashioned, each arm being twelve inches long and terminating in a circular top to fit the crown of a hat. The holders, finished in attractive colors, have been found a real saving in closet space—and in hats.

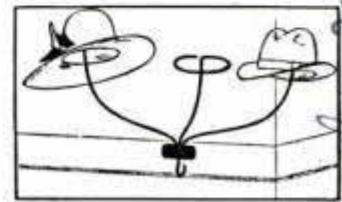

J-213

License Plates Shingle a House and the Roof Is Leakproof

License plates were used for shingles when a house near Springer, Okla., needed a new roof. The home owner obtained 3,900 excess license plates from the factory in the state penitentiary and applied them in regular shingle fashion. The result is a leakproof roof with a distinctive pattern.



Oklahoma residence shingled with leftover license plates obtained from the state factory

Kansas woman
 wire hat holder
 one back

Giant Dredge Speeds Up Coal Production

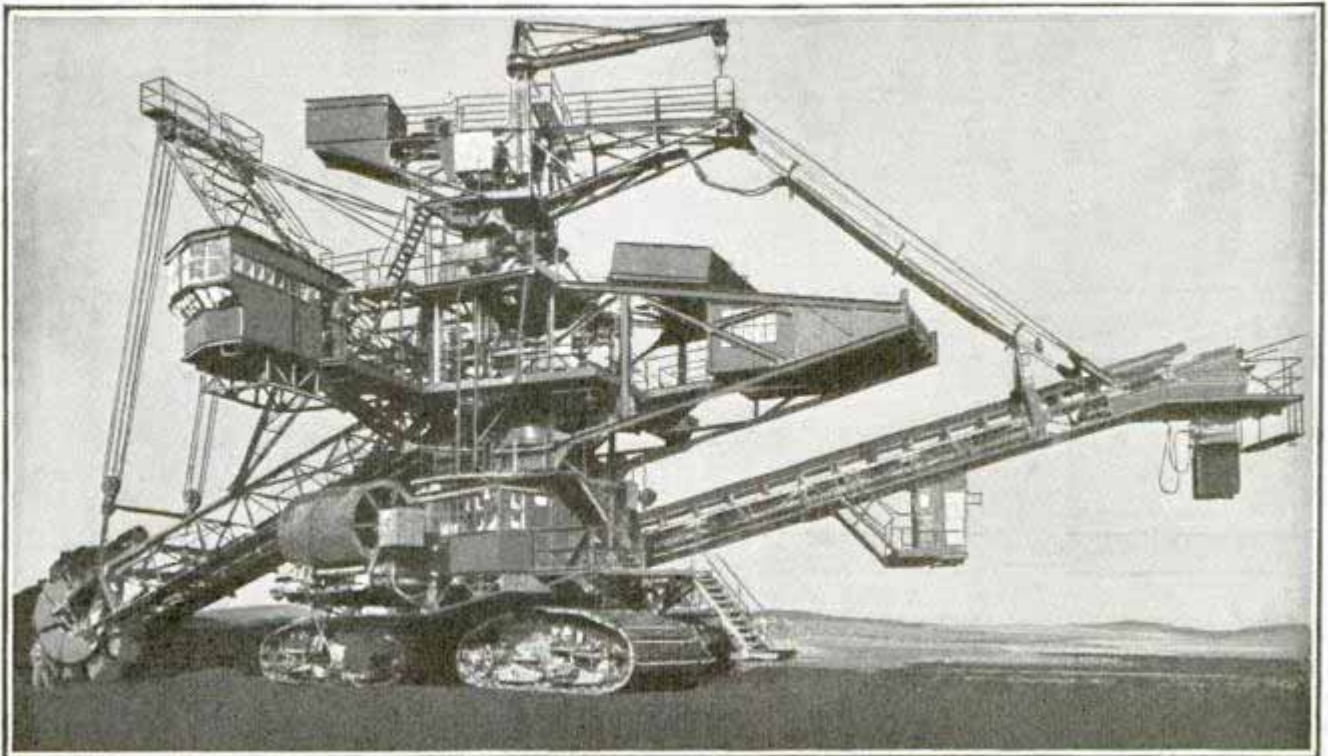

Enormous dredging machine on tractor treads digs lignite from Germany's mines to speed up production. You can get an idea of its size by noting tiny figure of man standing on upper deck

Designed for mining coal by the surface stripping method, a giant dredge weighing 1,200 tons and capable of shoveling 45,000 cubic yards in twenty-four hours has been developed in Germany to speed up production of lignite, or brown coal. Its weight is evenly distributed among 120 wheels,

and the machine can be transported by rail or on its tractor treads over a road. Rotating buckets on a swinging crane do the shoveling, each bucket holding forty cubic feet. Electricity supplies operating power. Lignite is one of the sources of chemicals being manufactured in Germany.

Pyramid of Concrete Balls Protects Shelter from Bombs

Experiments with air-raid shelters in England have led to the development of a pyramid of huge balls reminiscent of the piles of cannon balls of old-time artillery. These balls, however, are of concrete. Heaped on the ground above a subterranean shelter, the balls proved a most effective shock absorber for bombs.

Fireproof plaster to safeguard steel beams, which buckle in intense heat, has been developed at Mellon Institute of Industrial Research.



Concrete balls piled in pyramid at surface of a bombproof refuge deflect the shock of explosives falling near the shelter

Chicago Tribune 3/27/39

J. 2. 0
From...
Berlin, Germany

at British Industries Fair
Birmingham
England

Pittsburgh, Pa.

Wires Halt Aircraft Landing on Ship's Deck

Cmt. Es. H. Davis, Lymer, Col. S. W. England

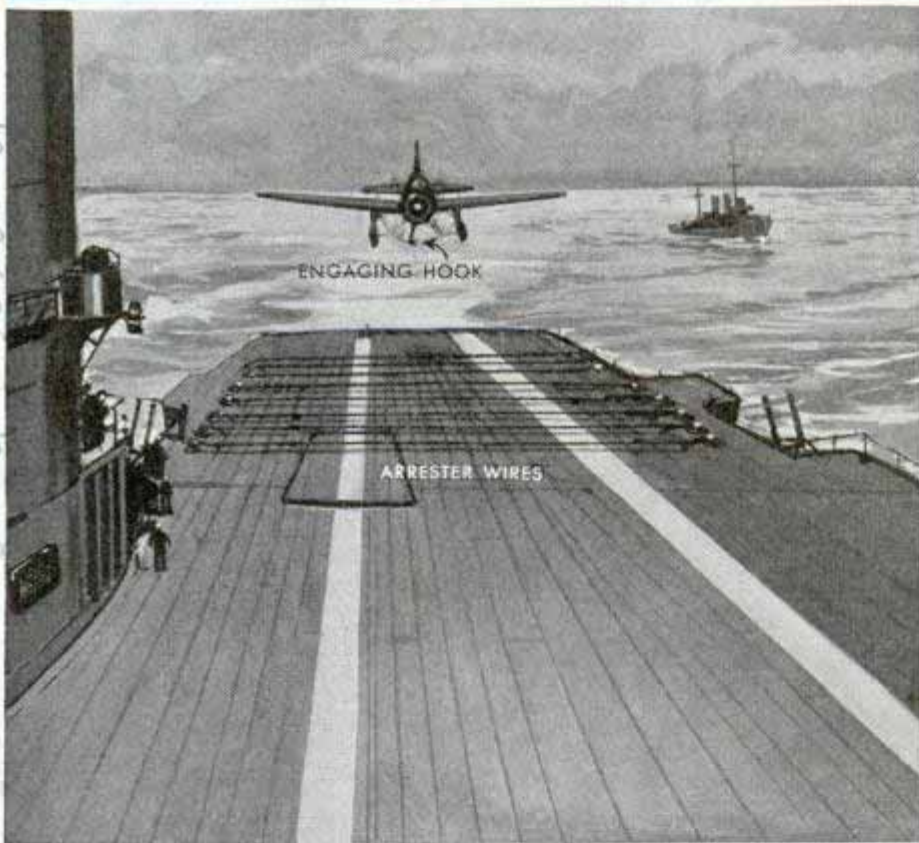
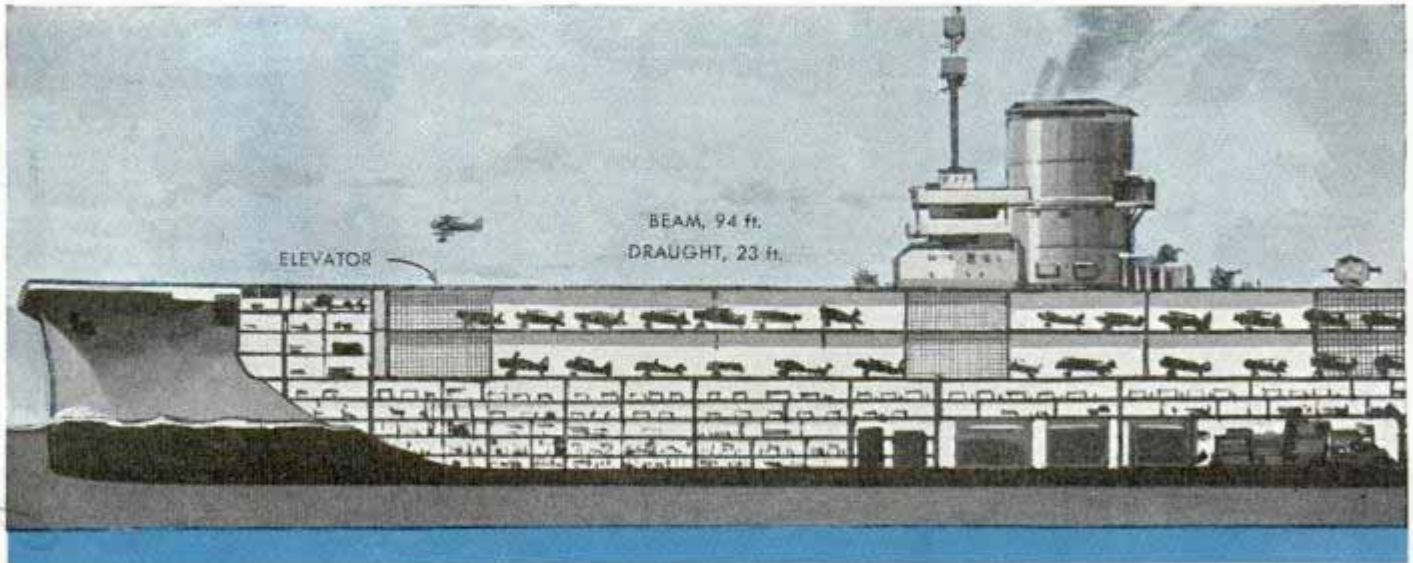

Among the many features of Great Britain's latest aircraft carrier, H.M.S. "Ark Royal," pictured at top in cross-section view, is a secret mechanism for halting planes as they land on the deck. This consists of wires stretched across the deck, as shown at left, sufficiently high to be engaged by a hook lowered by the pilot of an incoming plane. Forward of the vessel's hangars are two runways for a modified form of catapult, known in the service as "accelerators." Three elevators are provided for raising aircraft from the hangars to the flight deck. Drawings presented here were prepared with the aid of the British Admiralty

After the hook of the incoming plane has engaged one of the wires stretched across the carrier's deck, as shown at right, a new type of arrester mechanism brings the plane to a stop without a jerk, applying a gentle braking action. The arrester device is of a secret nature. Note that the wires are not high enough to trip the plane



Giant Floating Hangar Carries Sixty Planes

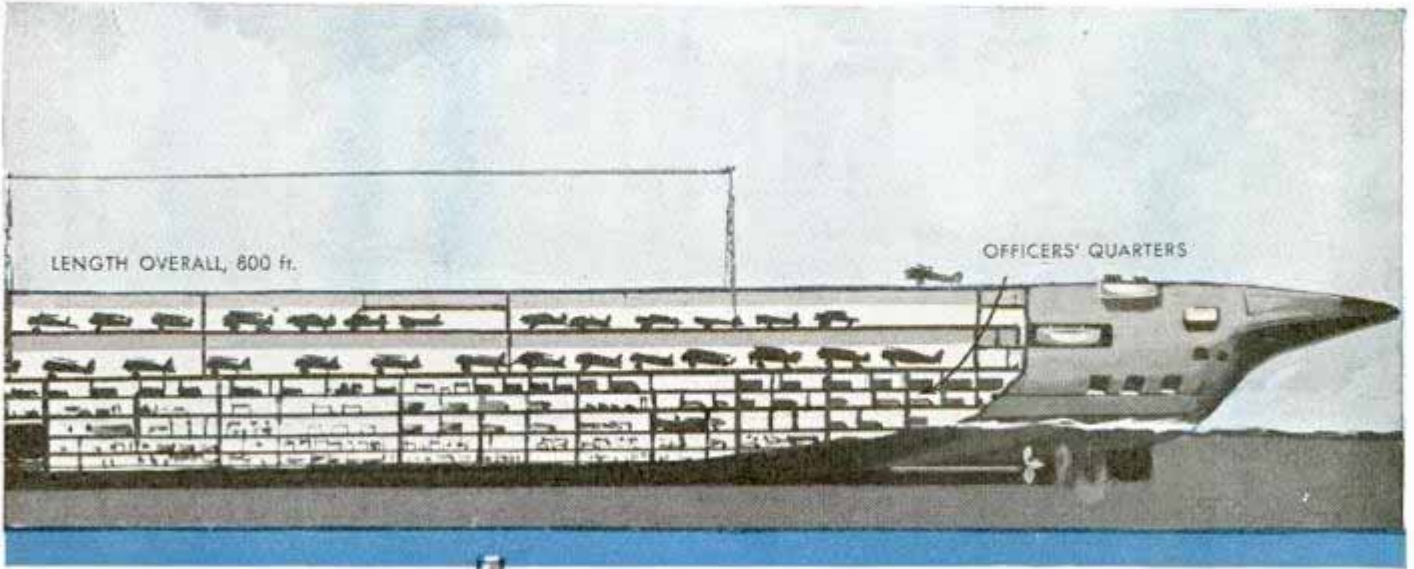

The "Ark Royal," literally a giant floating hangar, is 800 feet long and has space for sixty airplanes. The latest type of water-tube boilers and geared turbines, developing approximately 100,000 horsepower, give a speed above thirty-two knots. The flight deck extends the whole length of the vessel and has an enormous overhang at the stern, resulting in a bizarre appearance

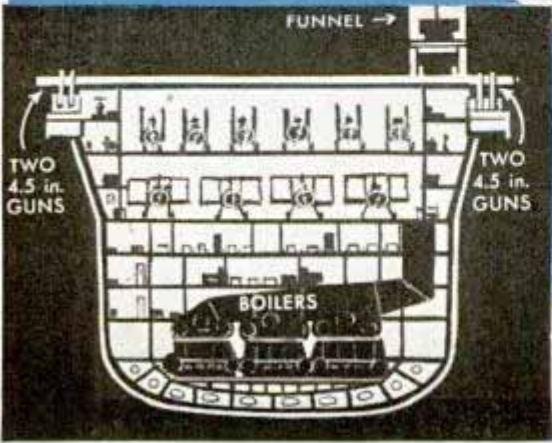
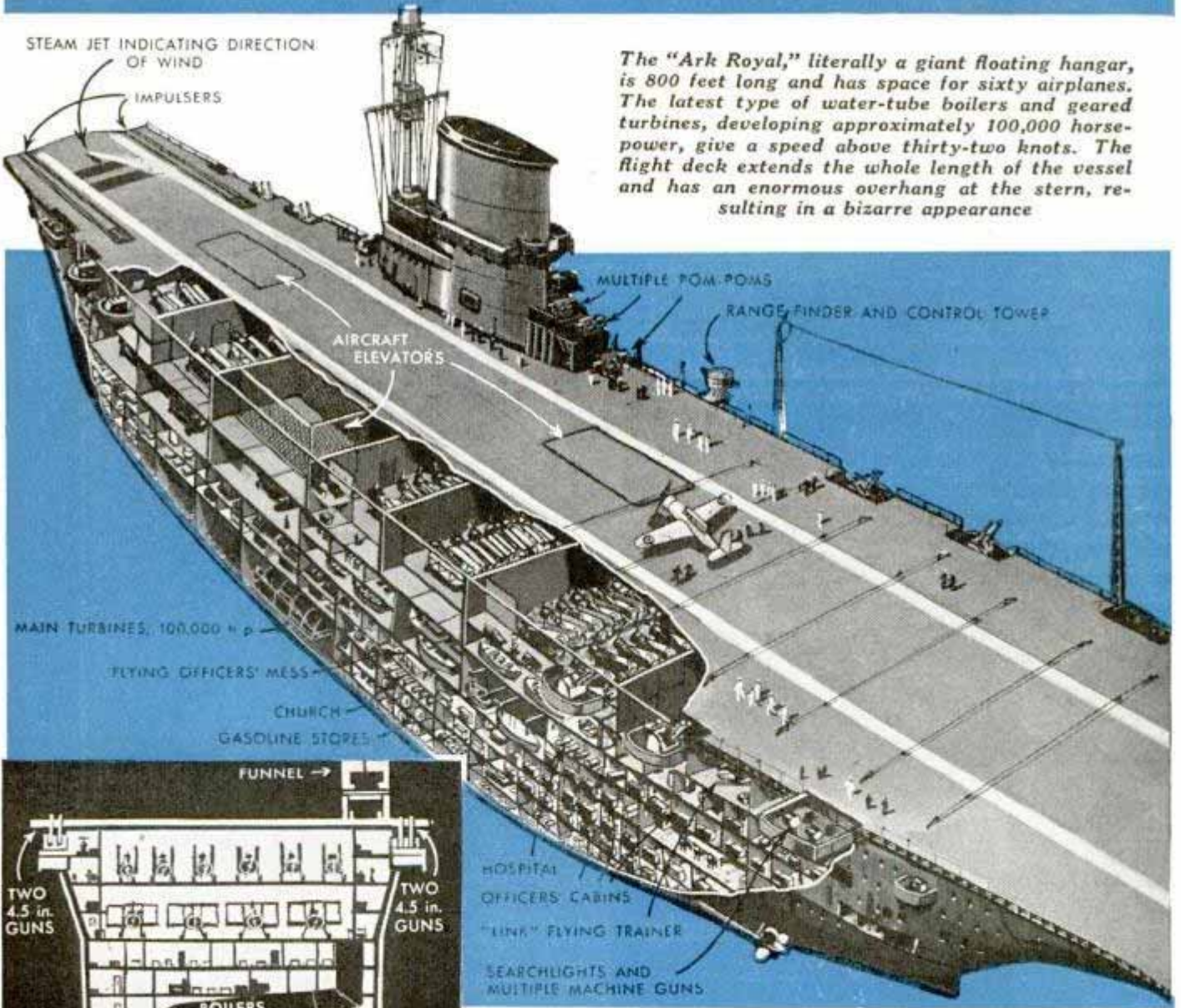

Above and left, additional details of the carrier. Note position of funnel. Armament includes sixteen dual-purpose quick-firing guns, six groups of multiple pom-poms, eight groups of multiple machine guns and anti-torpedo and armor protection

Postman's Four-Wheel Scooter Speeds City Mail Delivery



Making rounds on homemade scooter. It stops automatically when he releases lever on steering post

Riding a four-wheel motor scooter of his own invention, Henry R. Smith, a mail carrier at Columbia, S. C., makes his rounds in twenty-three per cent less time than it used to take him walking. The scooter is economically driven by a five-eighths horsepower gasoline engine taken from a miniature automobile, with combination chain and belt drive to the ten-inch rear wheels. Driving is semi-automatic, the brakes being applied and the clutch disengaged when the postman releases the combination brake and clutch lever mounted on the vertical steering-wheel shaft. Top speed is twelve miles an hour.

Light Speed Measured Accurately by Splitting Up Beam

How to measure automatically the speed of light—about 186,000 miles per second—with an error of less than two and one-half miles per second has been solved by Dr. Wilmer C. Anderson of Harvard. The

beam of a 1,000-watt projection lamp is fluctuated between bright and dim intensity 19,200,000 times a second. A small sheet of glass across its path splits the fluctuating beam, one side going up and down a hallway system of mirrors a distance of about 185 yards, and the other half being sent over a shorter path, about two yards long. By reuniting and focusing these two beams on a recording photoelectric cell, Dr. Anderson determines the wave length and multiplying wave length and frequency gives the speed. The equipment has been put to work solving one of the basic problems of modern physics and astronomy—whether the speed of light is constant under all conditions, or whether it varies. Many important theories are based on the assumption of constant velocity.

Two-Way Radio for Signal Corps Carried on Soldier's Back

Two-way radio telephones are being tested at the Signal Corps school at Fort Monmouth, N. J., for addition to the army's communication system. With this equipment, developed in laboratories of the Signal Corps, soldiers on foot can send or receive messages by ultra-short wave.



Soldier using handset of two-way radio with telescoping antenna being tested by Signal Corps

Cambridge

d. m. Henry R. Smith Columbia, S.C.
 3/14/37
 331
 100

Air Tube Changes Glass in Welder's Helmet

Both of an arc welder's hands are left free to handle work by a helmet which does not have to be raised or lowered in striking or drawing the arc. Two lenses, one of very dark and the other of clear glass, are controlled by an air valve fitted to a tube to the worker's mouth. Blowing into the tube forces the clear glass into place, allowing the worker clear vision in striking an arc and relieving him of the necessity of raising his helmet each time to make the contact.

Below, welding with black glass in place. Upper right, blowing into tube. Lower right, clear glass in place, permitting proper vision for striking arc

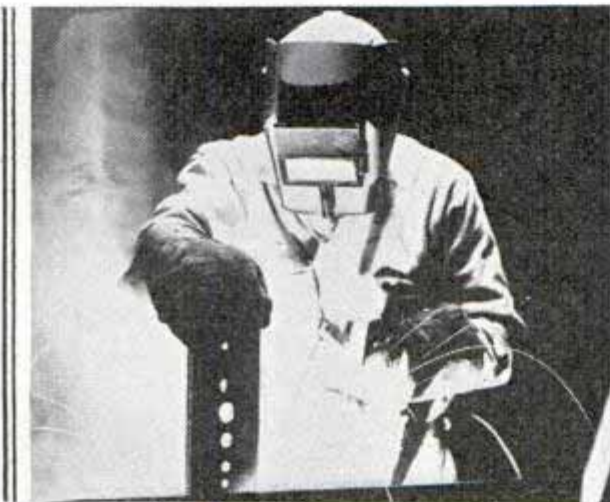
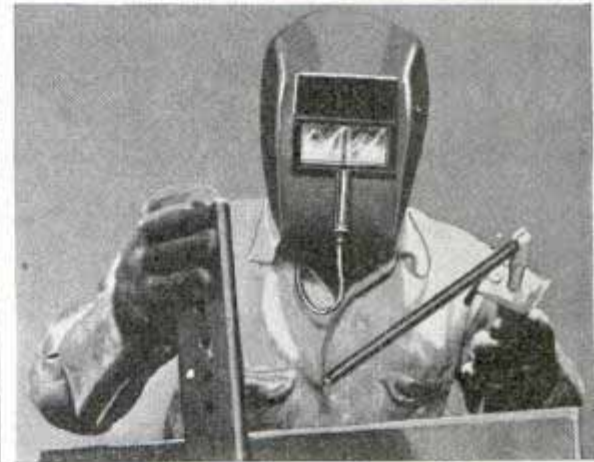

Chicago
100 circulation and wires, ch. 100
30 Tradebridge, Station 100

U. S. Army's Fastest Sky Fighter Flies 500 Miles an Hour

First small sky fighter with a super-charged cabin, the XP-38 is the U. S. Army's fastest airplane with a top speed estimated at 500 miles an hour. It was this Lockheed battleplane that Lieut Benjamin S. Kelsey flew from the Pacific to New

York in a little more than seven and a half hours. Its ceiling is nearly 30,000 feet. Nearly as smooth as curved glass, the twin-engine midwing craft is built of aluminum alloy, flush-riveted and butt-jointed, its wheels retracting in flight to achieve almost ideal streamline form. Protected by a shatterproof hood, the pilot fires machine guns through the nose of the fuselage. A tricycle landing gear and trailing-edge wing flaps facilitate safe landings, the nose wheel keeping the tail always in flying position. Two 1,000-horsepower engines drive steel full-feathering, variable-pitch propellers.

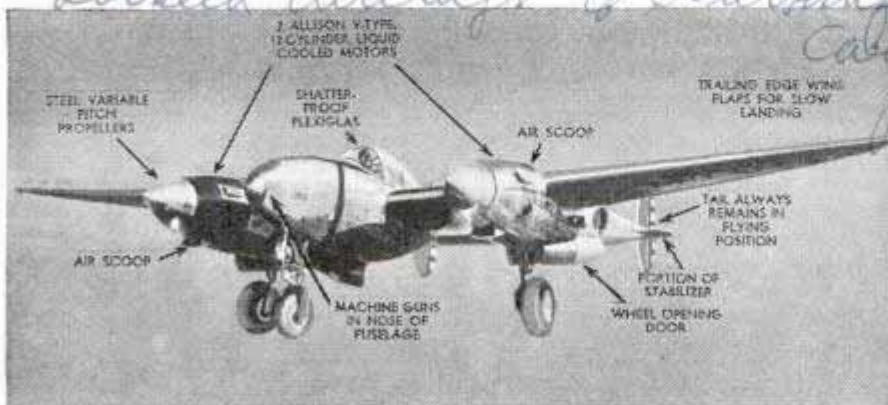

The XP-38 at takeoff, before wheels were retracted into open doors. This ship spanned the continent in just over seven and one-half hours

Lockheed Aircraft Co. Burbank

Allison

2256

in PICTURES



Exposure of 1/50,000 second catches wings of homing pigeon on downstroke as it starts swift climb. Below, high-speed electric circuit flashes intense light for 1/500,000 second to "stop" shattering of light bulb

Photos courtesy Massachusetts Institute of Technology

gave you underexposed pictures before.

Fast camera speeds reduce the number of pictures that you may spoil by failing to hold the camera absolutely still when you push the trigger, although it is always well to hold the camera as still as you can. Fast speeds also help you get clear pictures of unposed action, but the trend today is not to stop all action completely. There is much more life in a picture of a baseball batter at the plate when a slight blur shows that he is swinging hard, than in a picture in which the bat is stopped completely by a fast camera.

Professional photographers get some fast-action results by planning the pictures ahead. At the automobile races, catch the cars coming out of a turn and entering the straightaway. Moving almost directly toward you, the cars don't have as much chance to cause movement on the film as they would if you shot them flashing by directly in front of you. At the end

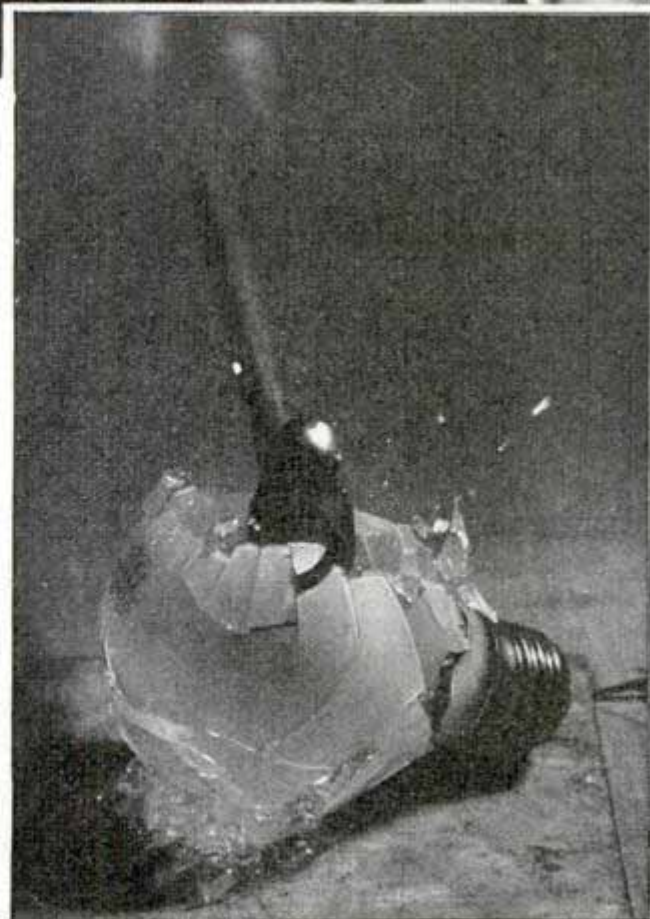

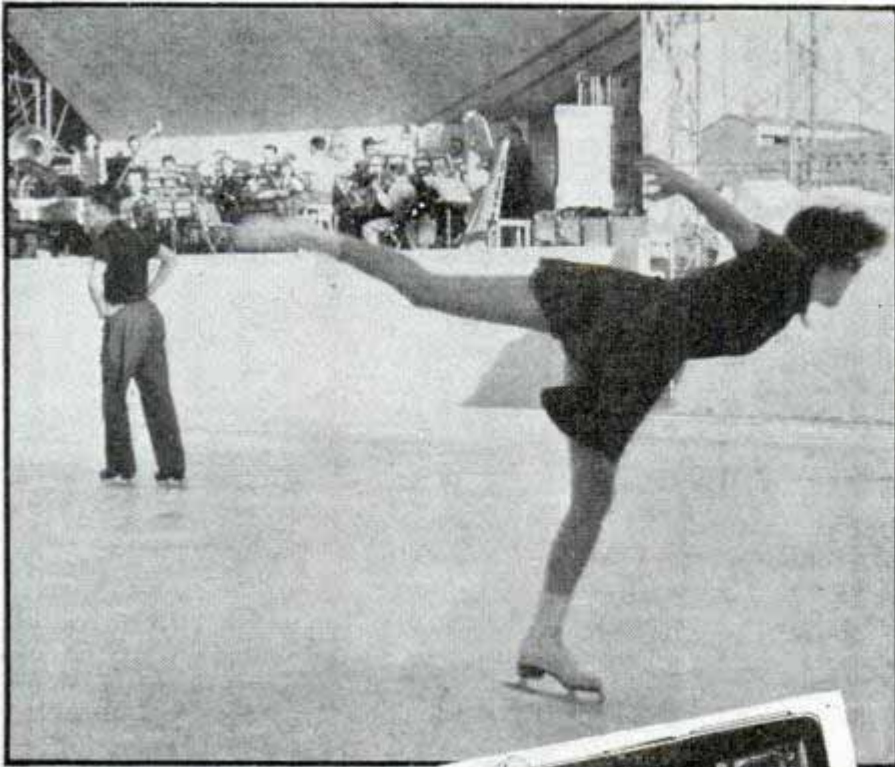

of the turn the cars are moving at their slowest speeds. Finally, much of the action and skidding occur in the turns and you are apt to get the most spectacular pictures there. Get down close to track level and don't try for action shots when the cars are closer than thirty or forty feet.

The rule to shoot action head-on or almost head-on is one of the first things a photographer learns. Next, he learns to make action shots at the instant of minimum movement. Even a fast camera is apt to record a blur while making a picture of a pole vaulter on his way up to the cross-bar. At the top, however, the athlete is practically motionless in the air and that is the time to get a sharp picture. A diver, a runner, and a galloping horse can be photographed the same way. There is always a moment of minimum motion.

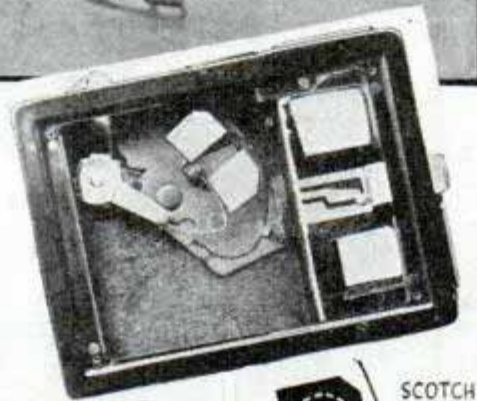

TAPE PASTED OVER $\frac{3}{4}$ OF SHUTTER OPENING INCREASES SPEED FROM $\frac{1}{25}$ TO $\frac{1}{100}$ OF A SECOND

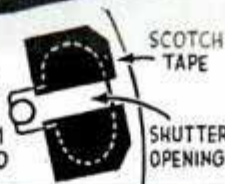

If your camera will shoot at $\frac{1}{100}$ of a second or faster there is another professional trick that will give surprising results. When a news photographer wants to "freeze" a speeding car he "pans" his camera, swinging it with the car at just the right speed to make the car stand still in his view finder. Then he clicks the shutter at will, certain he has stopped the action. In a pan shot, of course, the motionless background is fuzzy. Automobiles, speedboats, and similar moving objects close by are excellent subjects for pan shots.

Nearly half the cameras in existence, it is estimated, are of the inexpensive box type and practically all of these have a fixed shutter speed of one-twenty-fifth second. This slow speed gives a satisfactory picture of posed objects with ordinary film but it is useless

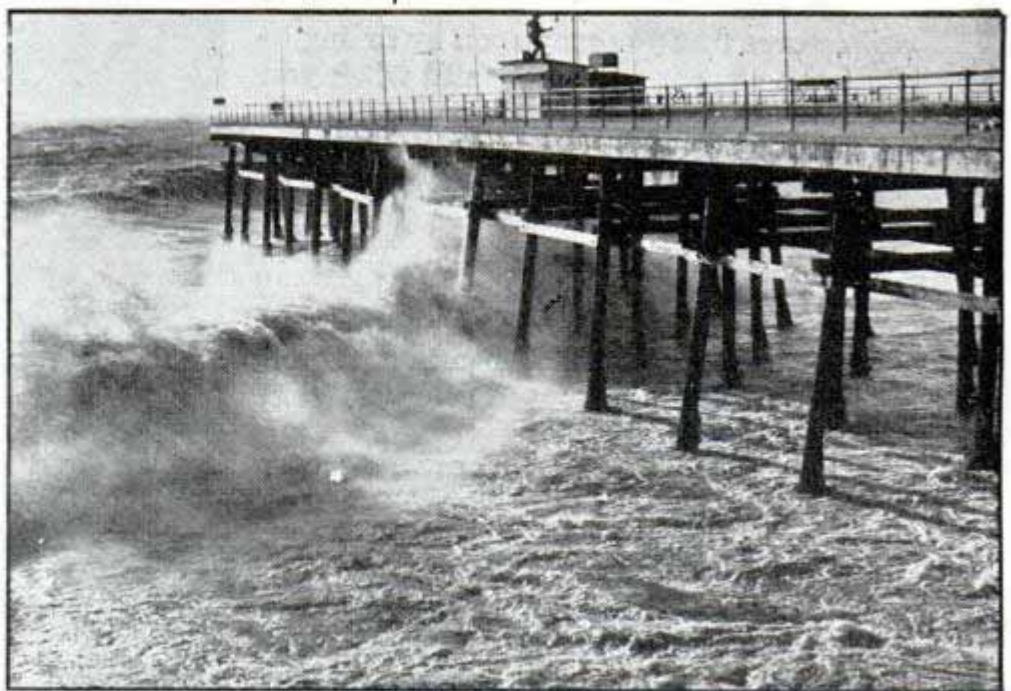

Box camera with shutter slit taped to one-fourth normal width, as shown in center, caught skater in action at top. Below, storm wave caught at $\frac{1}{100}$ second

for action. In buying high-speed film, ask how many times faster it is than the film you have been using. If it is four times as fast you can increase the shutter speed four times, holding the lens open only one-quarter as long and converting your one-twenty-fifth of a second camera into one that shoots at $1/100$ of a second.

With the camera unloaded, carefully unscrew the front plate that guards the lens and shutter mechanism. If necessary, bend flat the projecting exposure slide so that the guard plate may be slid out. The shutter is the black metal sheet that lies flat across the lens and the shutter opening is the curved open slot that moves across the lens when the trigger is clicked. Masking half of this slot with black Scotch tape or some other lightweight adhesive material doubles the shutter speed. To get a speed of $1/100$ of a second, mask three-quarters of the opening. This must be done carefully so as not to upset the delicate balance of the shutter mechanism,

(Continued to page 120A)

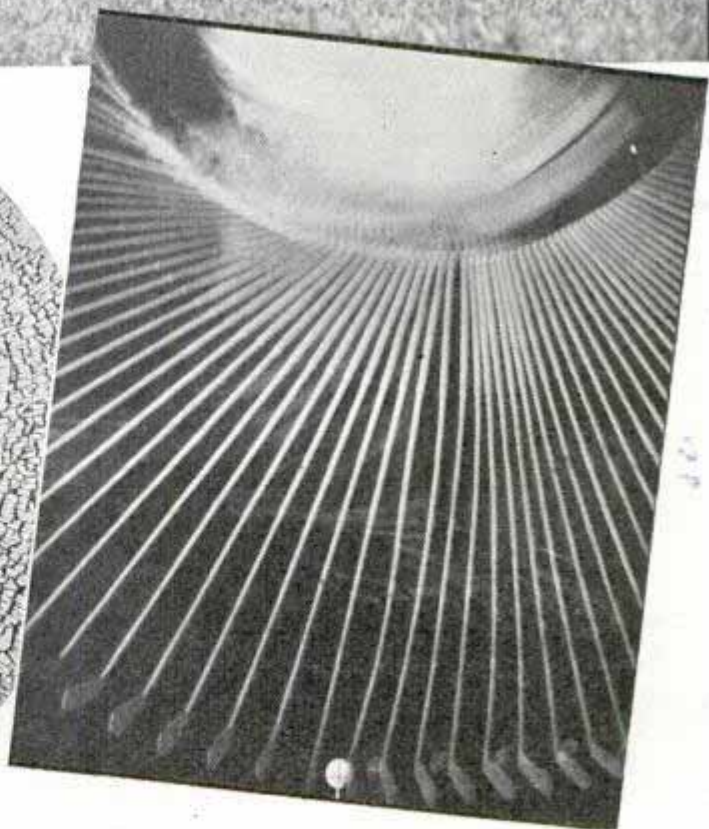
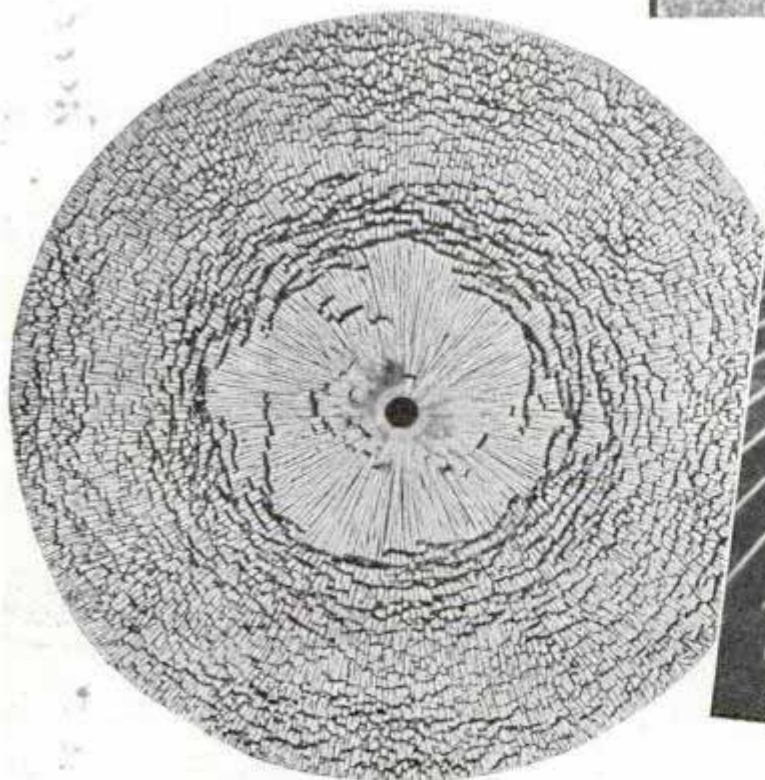

© A. G. Spalding & Bros.
Top, anti-aircraft machine gun snapped at momentary pause in action. Left, exposure of less than one-millionth second shows glass cracking at blow of metal plunger in center. Right, exposures $1/600$ second apart show club distorted by impact with ball

16/6 E 40, etc
Cleveland, Ohio

Rainproof Desk in Open Air Made of a Split Log



Top half of log is hollowed enough to fit over "desk" and form a rainproof cover

By splitting a log in half and joining the two sections with hinges, members of the C.C.C. built a weatherproof outdoor writing desk for the convenience of tourists and forest rangers in the Spearfish canyon of South Dakota's Black Hills. A planed section was beveled and fastened to the lower half of the desk to fit into the hollowed section of the upper part of the log. Messages can be left in it, and it can be locked with a padlock.

g 272

Gas-Tank Alarm Gives Warning to Prevent Overflow

Safer filling of gasoline tanks in motorboats is made possible by installing an alarm that whistles until the liquid reaches a point within two inches of the top of the tank. When the whistling stops, you stop filling. The unit is fitted to the tank at the opening provided for the vent pipe, and the vent tubing is then coupled to the alarm outlet. As air in the tank is displaced and

Vertical alarm

Walter C. Cottenden, Jr.
Middletown, Conn

driven out by the liquid, it creates enough pressure to blow the whistle. A piece of tubing from the signal projects downward two inches into the tank, and when the level of the liquid reaches the end of this tube air ceases to pass through it and the whistle stops. Installed in water and oil-fuel tanks the signal prevents overflow.

g-268

Unit to Rebuild Worn Faucets Is Easily Installed

Worn faucets can be rebuilt entirely, regardless of corrosive condition, by a unit that replaces faucet stem, seat and thread with a metal valve. Washers are eliminated. Easy to install, the unit consists of a lead and antimony gasket to seal the worn faucet seat; a threaded brass valve and brass seat as a single unit; a bronze valve stem, and a steel locking device to secure the handle to the valve stem.

Cleveland



g-206

Boat Is Towed Like a Trailer on Its Own Wheels

Always ready to be hooked to an automobile and towed over highways to the water like a trailer, a motorboat is



Boat as two-wheeled trailer towed by auto. Circle, wheels being flipped into boat after it is launched

Trailer. Boat Co.
R 206, 2832 E
Cleveland, Ohio

20 271

1032 Florida Ave Akron, Ohio

NEW PLASTIC

see July 1935-!

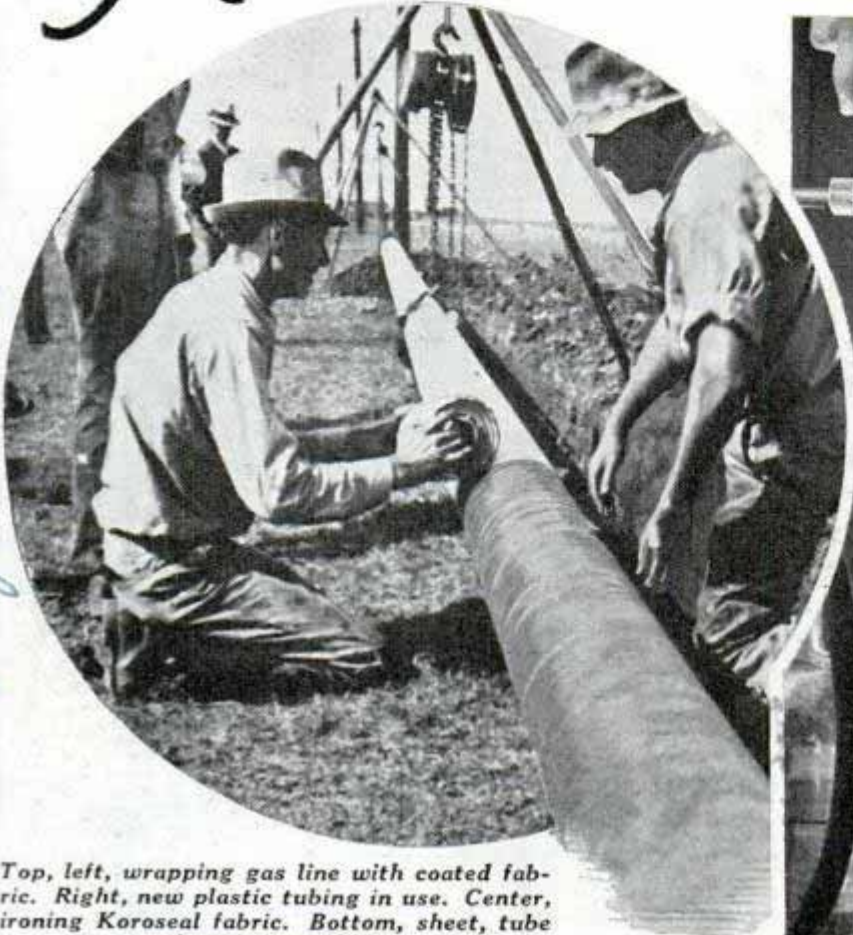

Top, left, wrapping gas line with coated fabric. Right, new plastic tubing in use. Center, ironing Koroseal fabric. Bottom, sheet, tube and calendered plastic

PAPER bags capable of holding oil, grease and various other liquids have been produced as one result of a remarkable new plastic developed in the laboratories of the B. F. Goodrich company. This material, called Koroseal, is used to coat the paper and make it resistant to water, oil and many other things. But that is only one of hundreds of uses to which the plastic has been put.

In the synthesis of the new plastic, coke, limestone and salt are converted into poly-vinyl chloride which, with suitable solvents and plasticizers, becomes a rubberlike material. By varying the plasticizers and solvents, chemists can produce a Koroseal that ranges from a soft jelly to a bonelike solid, and having various other properties. The plastic is much like rubber and can be worked with rubber-processing machinery. But it has several properties that make it superior to rubber for many uses. These include resistance to sunlight, prolonged flexing, strong corrosives such as acids and alkalis, and to water; absence

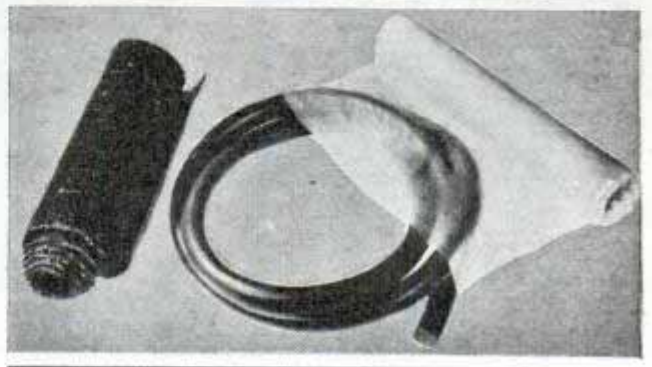

akron, Ohio

g 29
Miss Jeannette Verheyden
Rubber Ball Sueda

RIVALS RUBBER

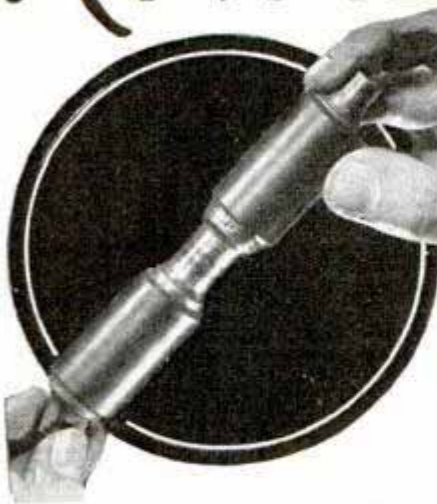

Above, coated textile roller after twenty months' use. Right, Koroseal-silk gown. Below, left, Koroseal mold for plaster casts. Right, trimming sheet of Koroseal hydraulic shock absorber gasket



of swelling or breakdown when in contact with certain oils and solvents; ability to withstand oxygen and ozone for long periods without damage; resistance to fire; insulating properties against electricity.

Gaskets made of Koroseal have been used in high-pressure oil piping where other materials failed. Similar gaskets have been used on reciprocating pistons and found to be leakproof after 17,000,000 strokes. Tubing made of Koroseal, some of it transparent enough to make visible the liquid passing through it, has been used for con-

veying beverages, ozone, sulphur chloride and other substances. In one case, Koroseal parts were exposed to boiling, concentrated nitric acid for twenty-four hours and still remained serviceable, whereas other materials had been destroyed in twenty to thirty minutes.

Koroseal is being coated on fabrics to produce a material resistant to water, sunlight and other things that damage ordinary cloth. Pure silk thus treated is

(Continued to page 130A)

Santa Ana Calif

Five-Tractor Plow Digs a Six-Foot Furrow

It takes three tractors that muster 300 horsepower to drag a monster plow that digs a furrow six feet deep. It takes two more tractors to keep those three from slipping sidewise into the cavernous fur-

rows. Designed to turn up fertile soil buried deep by floodwaters and sand, this huge plow is one of the farm machines invented and rented by two brothers who supply service to underpowered small farms around Santa Ana, Calif.

With the five-tractor plow they lift and turn five yards of soil at a time, covering one-half acre per hour. Another of their tools is a big rotary scraper hauled by nearly 100 tractor-horsepower. It picks up and carries eight cubic yards of dirt at a time, leveling off land for irrigation. Filling itself with dirt, it is tripped automatically when full and flops over backward, emptying itself.

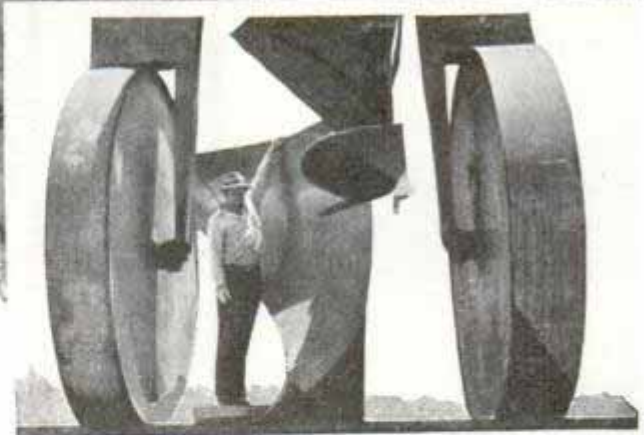
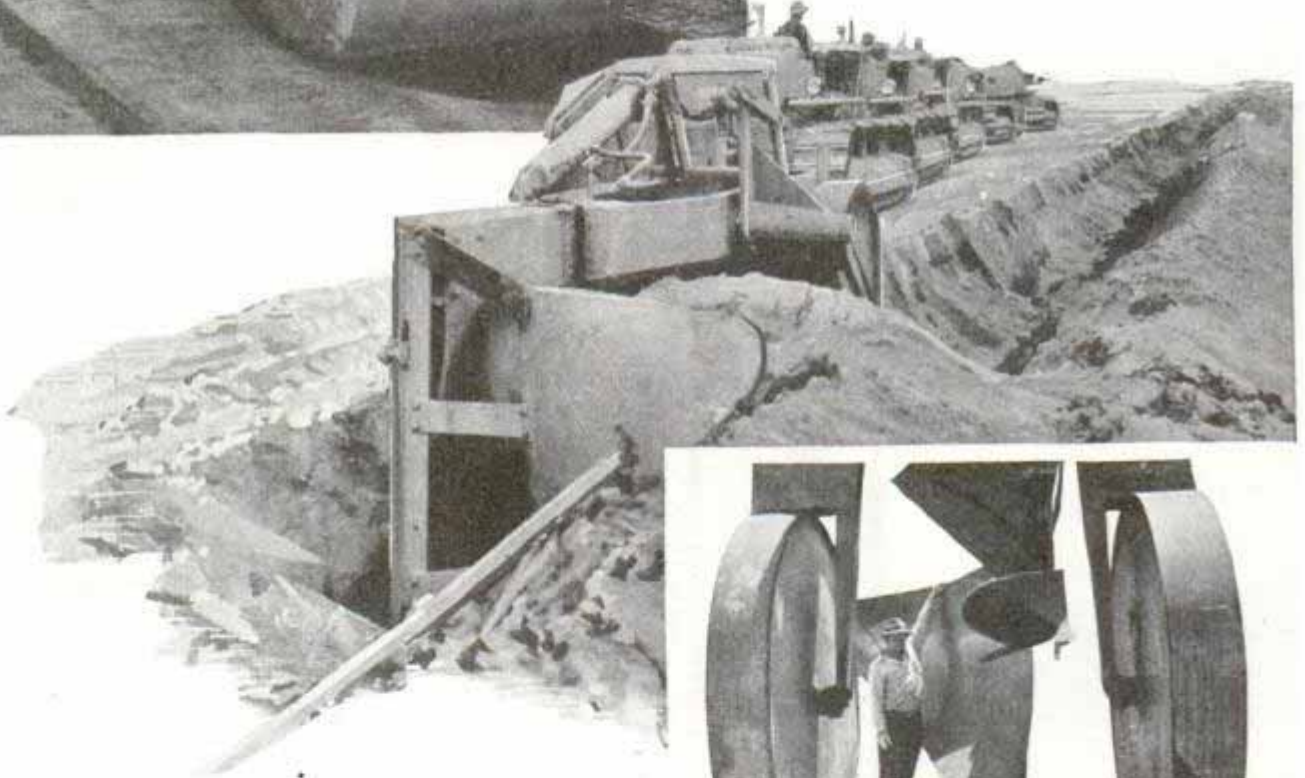
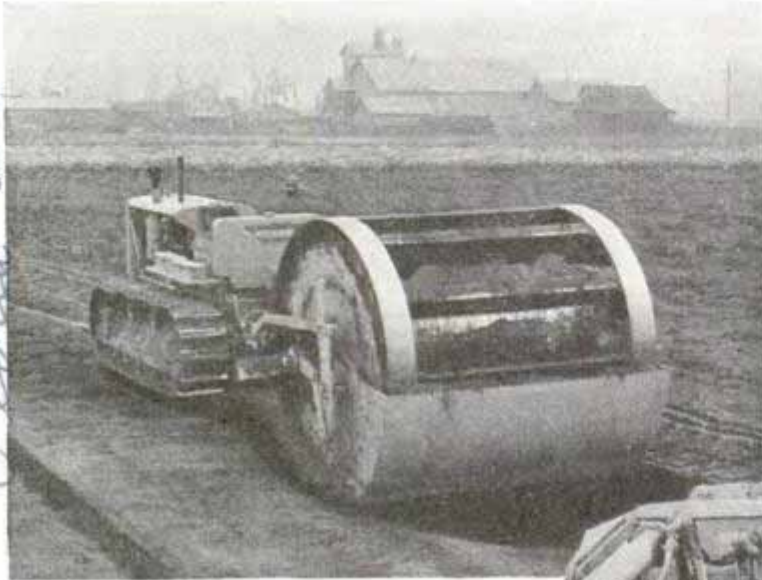

Upper left, big rotary scraper leveling land. Center and right, huge plow digging furrow six feet deep. It takes five tractors to pull it in straight line

Trees Use Internal Heat to Control Their Own Heat

Trees have thermostatic methods for resisting both freezing and overheating, Prof. E. S. Reynolds at Washington University has determined by inserting recording thermometers in the heart of a tree trunk and in the layer just under the bark. In winter the greatest resistance to

change was found at the freezing point in both rising and falling temperatures. Once this point was passed in either direction, however, the temperature of the trunk followed that of the air rather closely. This reluctance to change was explained as dependent upon the release of heat

Cmt Caterpillar Tractor Co, Georgia et al

Plant Physiological Science Service

St Louis Mo

Science Service

during the freezing of the water in the tree and the equivalent absorption of heat later to melt the ice. In summer the center of the tree dropped as low as sixty degrees and the layer below the bark was less than ninety when the air temperature was above 105. The tree keeps itself cool while in good foliage by transpiration of the leaves and evaporation of water from interior wet tissues.

2-269
Six-Range Ammeter Shaped Like Clamp Opens by Trigger

Current flow through conductors up to two and one-quarter inches in diameter is indicated, without interrupting the circuit, by an a.c. clamp-ammeter that measures high or low values. Jaws of the instrument are opened fully by moving the trigger only an inch and one-quarter. Its actual full-scale ranges are ten, twenty-five, fifty, 100, 250 and 500 amperes, and any one of the six ranges may be selected by a thumb-operated changer. It can be used at all commercial frequencies.



Pitchers Fire at 'Home Plate' Painted on a Canvas Target

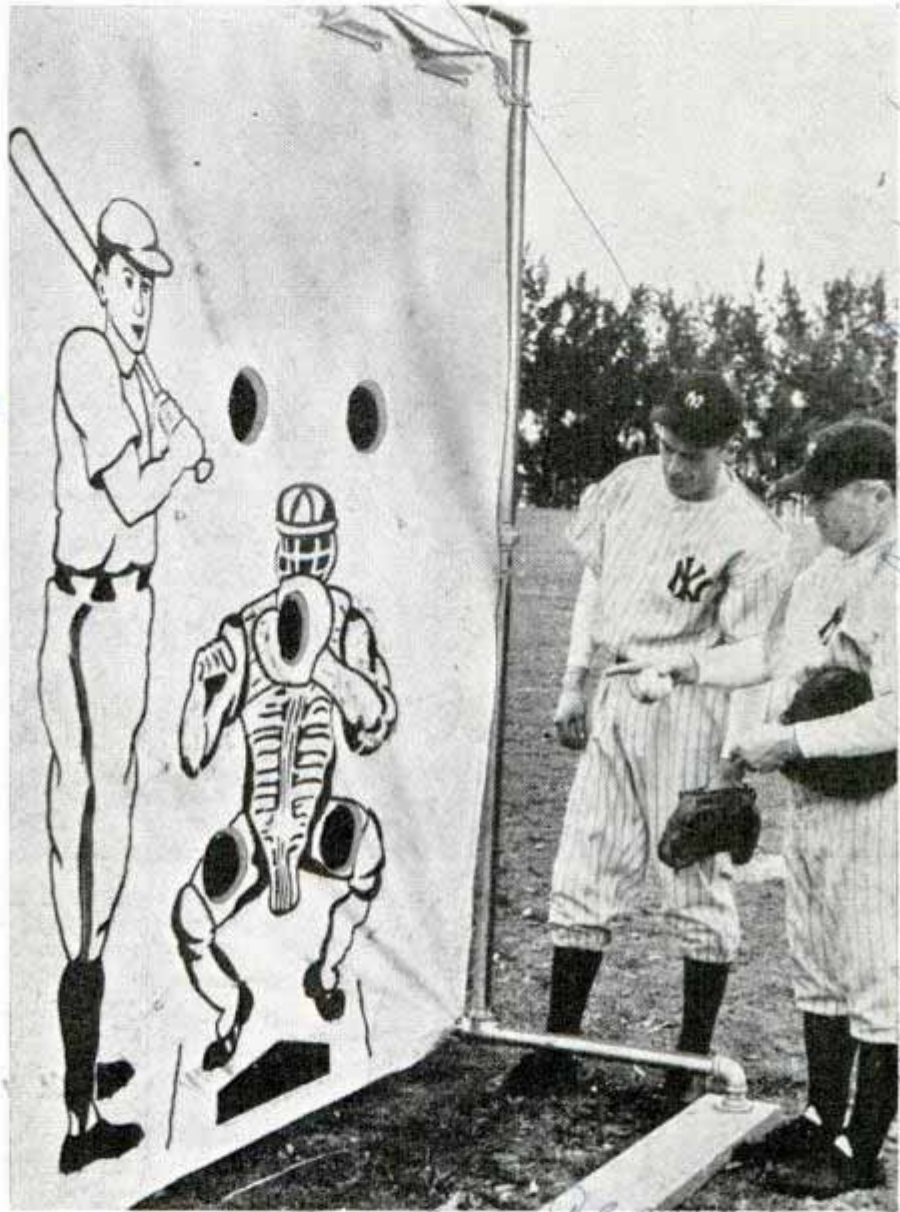

Five holes in the Yankee pitchers' target show the range for a "strike"—between the batsman's shoulder and knee, and over the plate

training camp
 Yankee pitchers put in some early season target practice firing balls at a canvas on which life-size images of the batsman and catcher were painted. Steady bombardment of this imitation home plate helped the hurlers get the ball "in the groove." Five holes in the "corners" of the target—two level with the batter's shoulders, two level with his knees and one in the middle of the catcher's glove—outlined the firing range for a strike.

St. Petersburg Florida

Railroads Set Record for Fuel Efficiency in 1938

It took an average of 115 pounds of fuel to haul 1,000 tons of freight and equipment one mile on American railroads in 1938, a new record for fuel efficiency. Hauling one passenger car a mile required 14.9 pounds of fuel.

Coach Paul Mitchell
Mr. M. S. Giel
Coach - Kawago
Plate - Drimal - Gorman

Weston Electrical Instrument Co.

129

HOW *to* PLAY



Across the top of the page you see the start, the stroke and finish of a backhand flat drive as posed by the author. Below, the American twist service



By George J. O'Connell

Former Trainer of Davis Cup Players

Chicago Town and Tennis Club

THERE are probably more than a million tennis players in the United States, yet surprisingly few ever show much improvement in their game.

Most players are out on the courts merely to hit the ball back over the net and to win. Of course the object of the game, aside from exercise and a lot of fun, is to win—but how about studying your game to see if it can be improved in any way? Analyze your shots, find out whether you are playing hit or miss tennis with no regard to the rules. Such rules as “keep your eye on the ball,” “follow through,” and “face sideways to the net,” are known to almost every racket wielder in the country, but not enough tennis enthusiasts take them seriously.

There are three recognized grips—the eastern, western and continental. The lead-

1925 W. Thome

Chicago Town and Tennis Club 1925 W. Thome

WINNING TENNIS

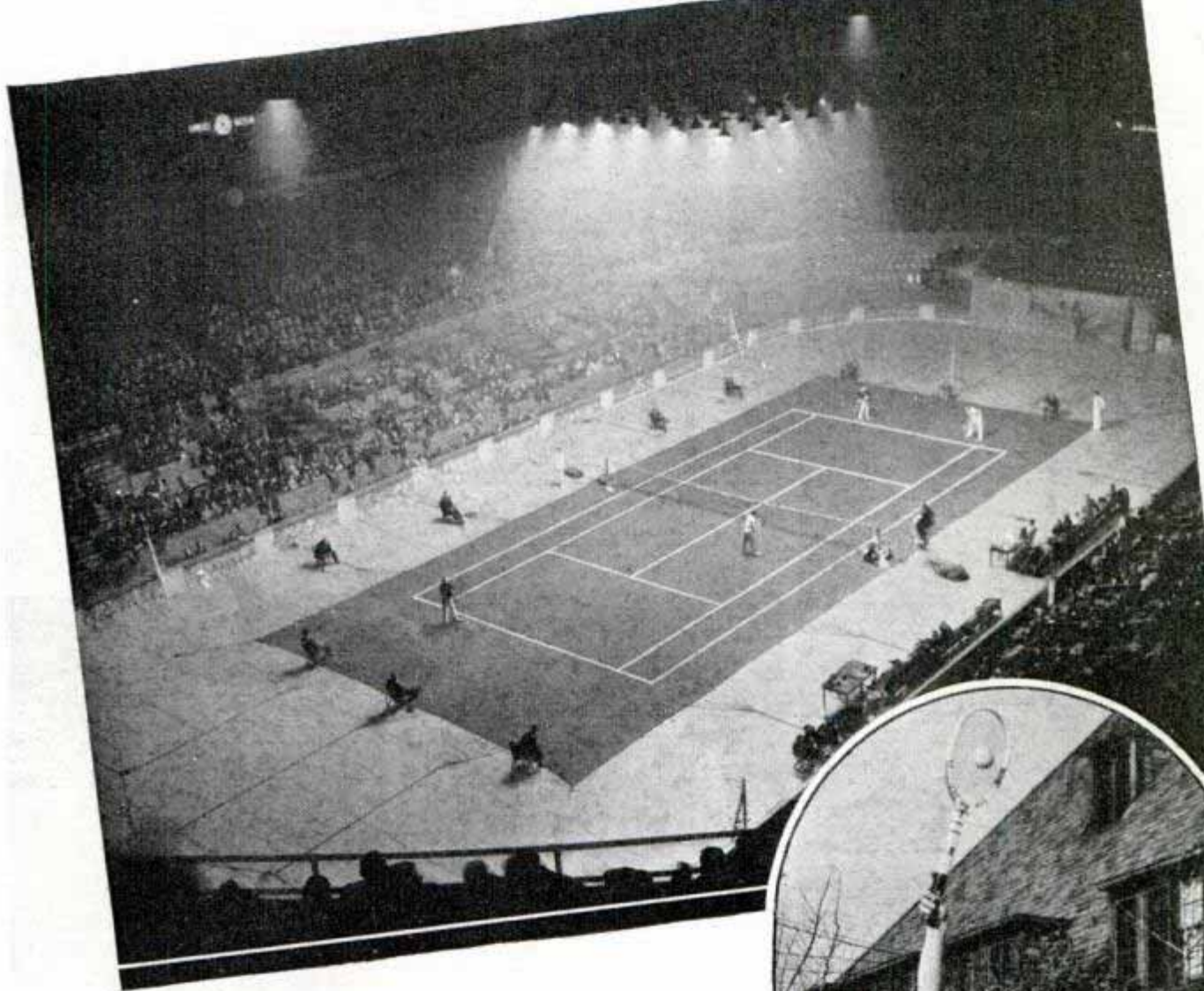

Above, a doubles match between professional tennis stars in the Chicago stadium. Right, the cannonball service

ing professionals advocate use of the eastern grip because it equips the player for all types of courts, while the other two styles are best suited to special types of bounces.

Don't get the idea that your game is hopeless just because you use a western or continental or even an unorthodox grip. Your game can be improved greatly if you sincerely try. Age makes no difference. "I am too old to play tennis" is a remark frequently heard, but ridiculous. William T. Tilden, Jr., at forty had improved his game over his Davis Cup days to an extent that amazed tennis experts all over the world.

In the eastern grip the racket is held in the left hand with the butt of the handle nearest the body and the cross strings perpendicular to the ground. Then grip the racket with the right hand as if you were shaking hands with it and you have





the correct eastern forehand. For the backhand, turn the racket one-quarter turn to the right. Tilden is the greatest exponent of this grip.

The continental grip is the same as the eastern backhand for both forehand and backhand. The continental stylist uses the same grip for all strokes. Fred Perry, present national professional champion, uses a continental grip but he is the exception to the rule, for this grip is more suited to a grass or en-tout-cas court where the bounces are low than to a high-bouncing clay court.

For the western grip, hold the racket out in front with the handle pointing toward your feet and cross strings pointing to right and left. Now place the thumb on the flat part of the handle directly in front of you, closing your fingers around the racket. Put your thumb around the racket and you have the western grip. This grip is the same for both forehand and backhand and the same side of the racket is used for both shots. Little Bill Johnston of California made this grip famous twenty years

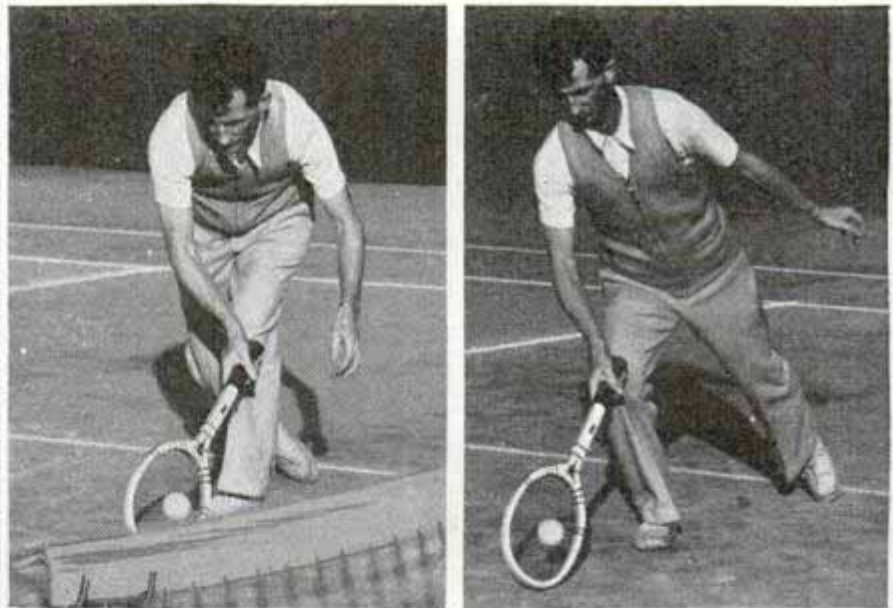

Left, top, start of forehand chop; below, starting a backhand slice. Correct and incorrect footwork in reaching for a forehand volley are shown at left and right, above

ago when he ruled tennis in the United States with one of the hardest forehand drives in the game.

My advice to the beginner is to start with the eastern grips. If the advanced player can shift to the eastern style without too great readjustment he should do so.

The most important shot in tennis is the service. A powerful service well controlled and well placed is the most valuable asset a player can have. The two most popular services of champions today are the slice and the cannonball. The American twist is still used by a few but the fact that it spends so much energy is one reason why top ranking players seldom use it. The slice is the easiest. The slice or

the American twist should always be used for the second service as the cut on the ball gives definite control and breaks it downward with a greater margin of safety than the cannonball or flat service. Hold the racket in front of the body with the cross strings pointing down, grasp the racket right on top and you have the correct grip for the slice. Now turn sideways to the net, both feet back of the base line, point the racket out toward the net and you are ready to serve. Holding two or three balls in the left hand and racket in position let the racket head drop, swinging freely; at the same time shift the weight to the right foot (weight should be on the ball of the foot, never the heel) and toss the ball up in front, slightly to the right and just high enough to reach comfortably with the racket. Now swing the racket straight forward striking the ball with a slice motion, the racket going across the right side of

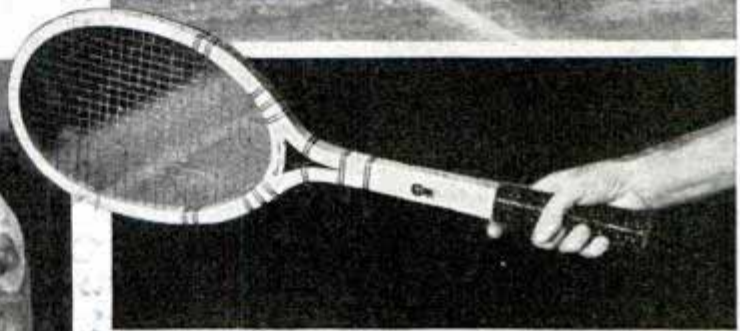
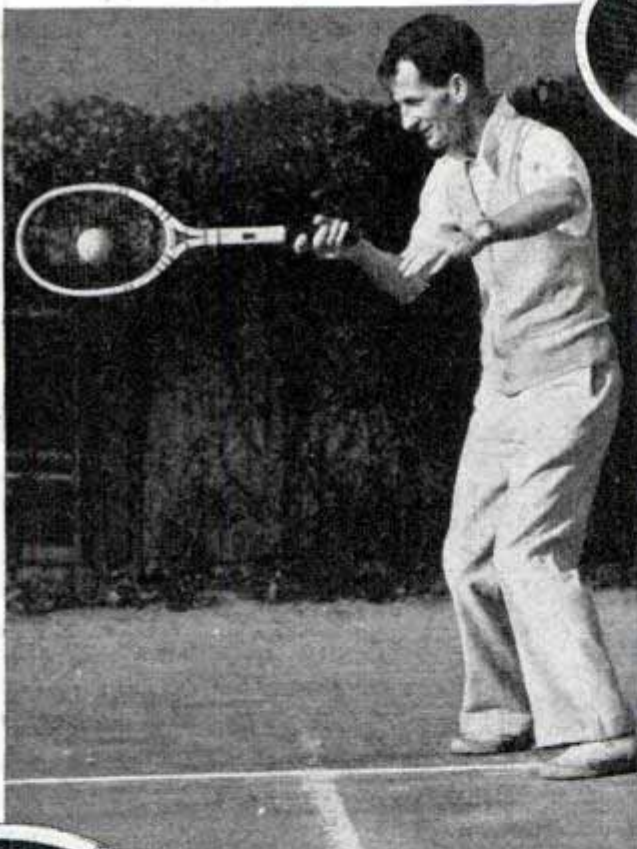
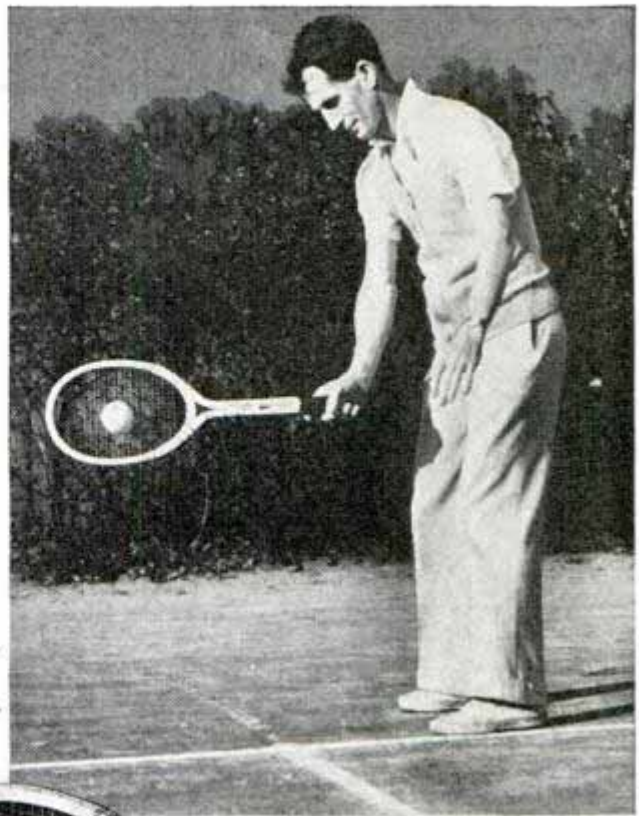

Above, eastern forehand drive and closeup of the grip; at left, the western forehand drive and grip

the ball. Let the racket finish to the left and you have delivered a slice service.

The cannonball is served in the same manner, but strikes the ball squarely and the racket finishes in the direction of the service. Strike the ball as high as you can stretch. The American twist takes the same grip as the eastern backhand and the racket goes over the top of the ball and finishes to the right of the body.

When serving, stay on the ground; drive forward with the right foot—in other words, pivot. Don't tighten your grip until the moment the racket strikes the ball. Never hurry. Look at the ball. Practice the toss until it becomes consistent. Don't twirl the ball as you toss it.

Next to the service, the forehand drive is the most important shot. Ninety-nine out of every hundred players use their forehand for a put-away or "kill" shot,

(Continued to page 122A)

Pearl Model of Liberty Bell Cost One Million Dollars



Million dollar pearl, diamond and silver model of Liberty Bell exhibited at New York World's Fair

Made of pearls, and reported to have cost \$1,000,000, a likeness of the historically famous Liberty Bell is exhibited at New York World's Fair by a Japanese company. One foot two inches high and one foot three inches in diameter, the model contains 11,600 pearls, 366 diamonds and more than twenty-six pounds of silver.

Spotlight at Right Side of Auto Keeps Glare from Driver

Giving all the extra illumination needed for night driving, a spotlight mounted on the right side of the automobile does not



Driver controls spotlight on right-hand side by cable shown in diagram. Circle, lamp mounted on car

cast its beam across the driver's line of vision. The lamp rotates to give light in any direction and is controlled from the dash through a flexible shaft. Then, too, the cruising beam does not shine in the eyes of oncoming motorists.

"Magni-Candid" Action Camera Is Flexible as a Miniature

To get the flexibility of the miniature camera and keep the advantages of an eight-by-ten view camera, a Hollywood still photographer has built what he calls a "magni-candid" camera. It is especially adapted to catching action on movie sets. Larger, yet lighter than the conventional eight-by-ten camera, it has a reflex focusing device that permits the photographer to see the picture up to the moment the shutter snaps. Focusing can be done with the aperture wide open, with a subsequent snap back to the predetermined aperture when the shutter is released. The back of the camera revolves in a full circle for easy adjustment to horizontal or vertical position. Two plugs permit flash-bulb syn-



Swinging the big "candid" camera to follow action from low angle. Despite its size it is very flexible

chronization at near or remote points. Built of aluminum and duralumin, the camera is mounted on a pan-tilt top and tripod for ease in following action at any angle; a tension arrangement holds it at any chosen position. The focal-plane shutter with opening range of three-thirty-seconds to twelve inches allows shutter speeds from four seconds to 1/2000 second.

Magnifying Glass
I want due
1206 21ab. Chicago
-246

Mr. Gordon Head 5740 Fulcher Ave. North Hollywood Calif

not on market



The CRAFTSMAN

Electric FLY TRAP is homemade

Neon-sign transformer supplies high voltage to 'hot' grid in steel box

WHERE flies are bothersome and where it is difficult or impossible to screen against them, the use of an electric fly trap is a handy way of controlling this nuisance. Such traps, connected to a 110-volt a.c. lighting circuit, are especially useful at roadside stands and in places where frequent opening of screens admits flies.

The complete trap is detailed in Fig. 2 and consists of a galvanized-iron box, open at the bottom and with a 1/2-in. flange at the top. A sheet-metal tray just large enough to fit closely over the bottom of the

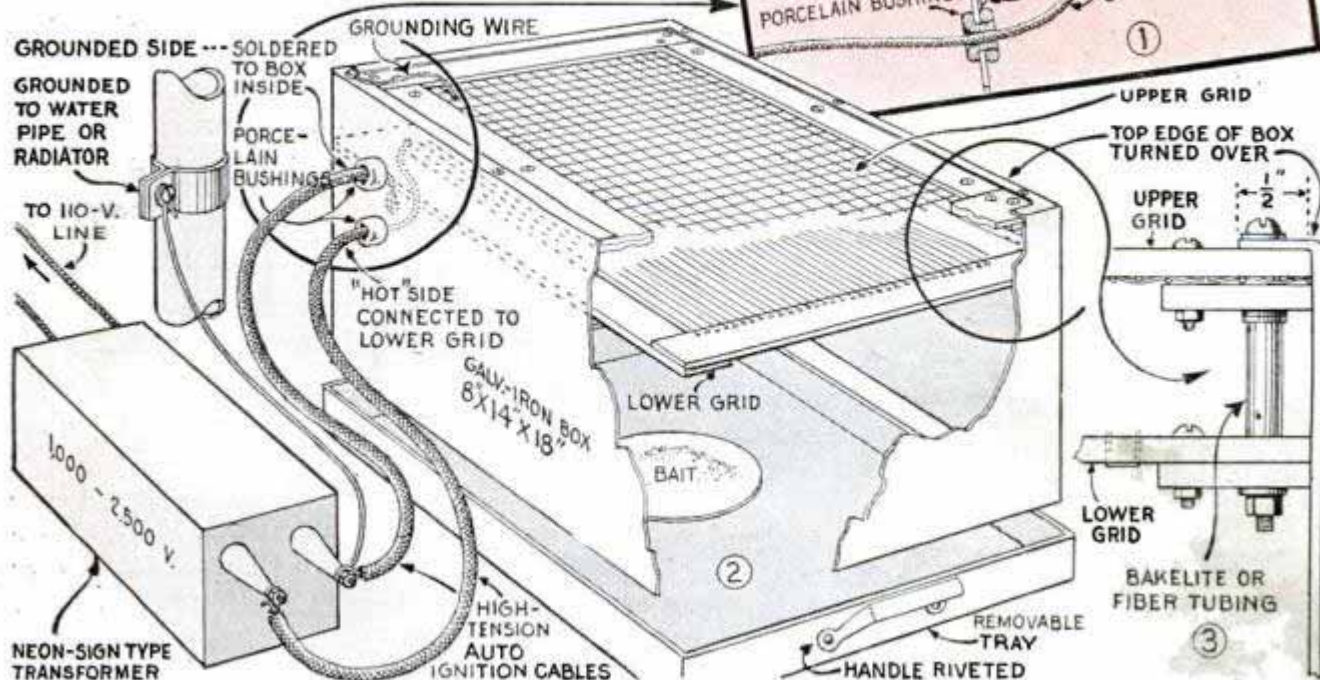
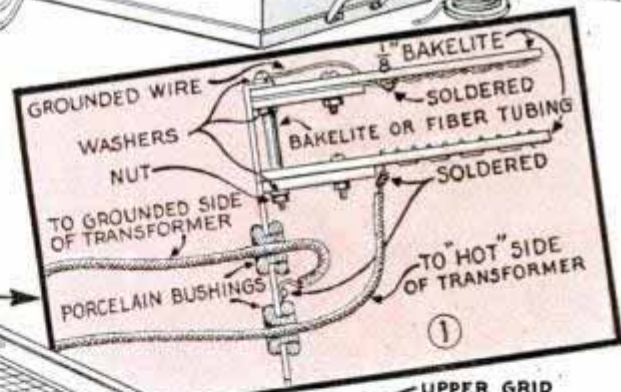
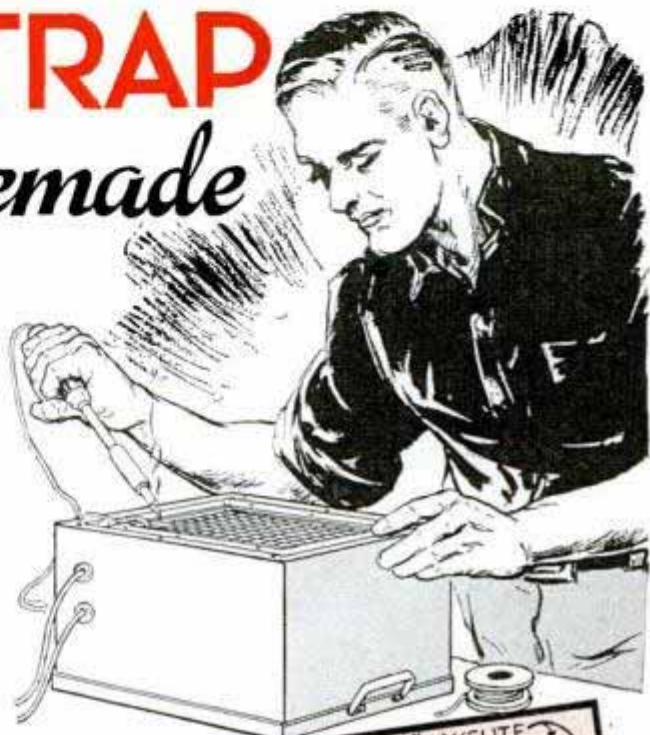



WATCHFUL SENTINELS

Guard these

LITTLE BEDS

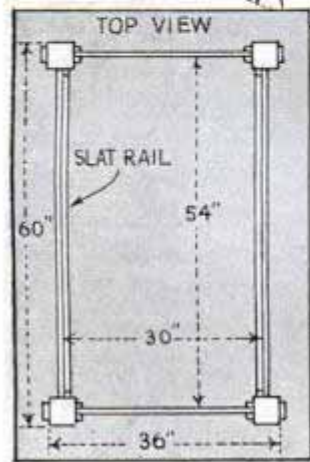
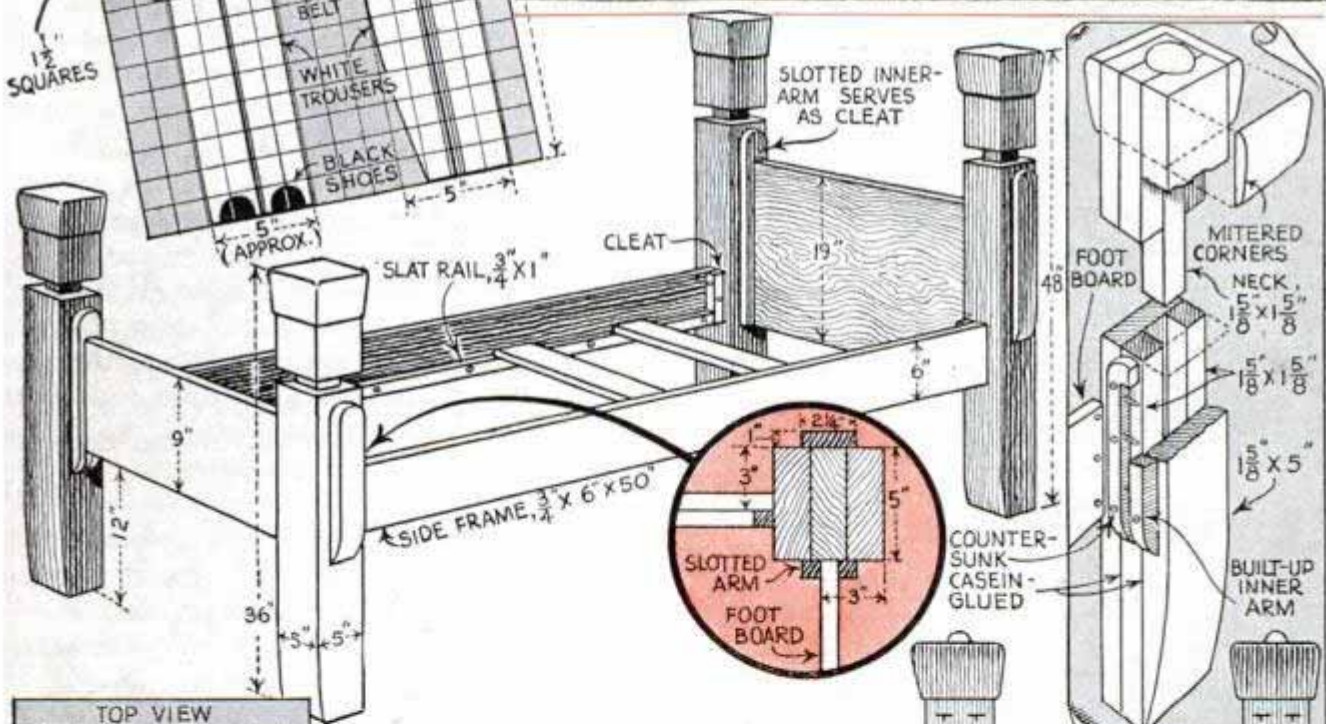
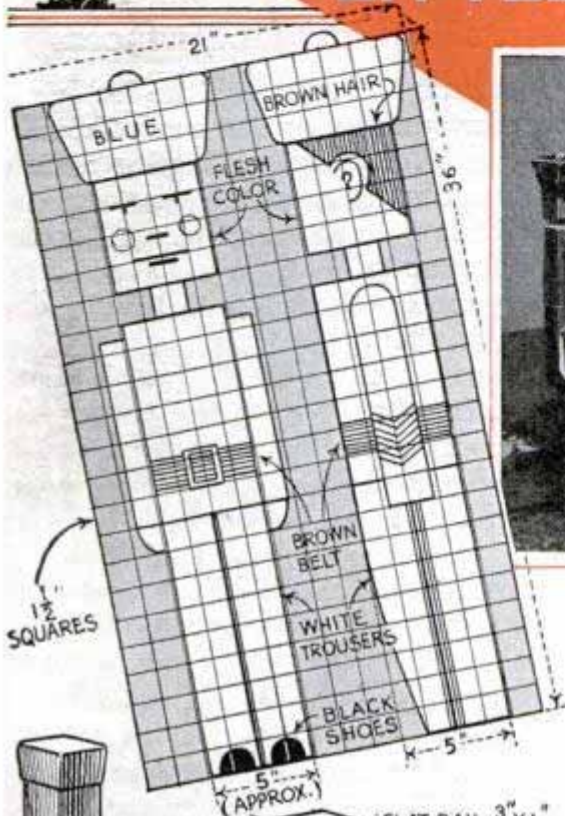

Colorful sentinels, always standing at attention, form the corner posts of these beds. The posts are built up from stock as shown in the right center detail. No intricate joining is necessary as the side rails and the head and foot boards are screwed to cleats on the posts. For the end panels, you can use 3/4-in. plywood, but hardwood is advised for the side frames or rails. In finishing, apply undercoater to the bare wood, then follow with three coats of enamel in colors as given, although you can vary this to suit your taste.

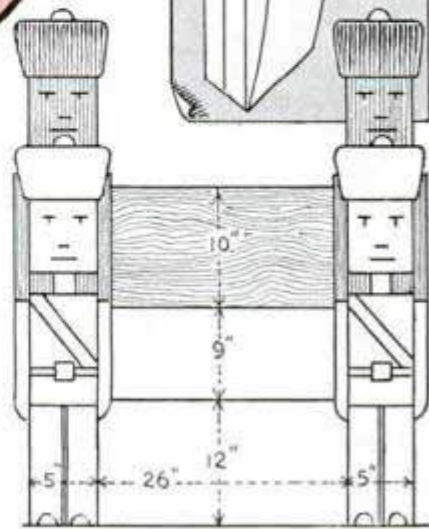

Suitcase Used as Picnic Table Has Mailing-Tube Legs



For the family who occasionally goes on a picnic, an old suitcase in which bathing suits and other articles are carried will serve as a table. Mailing tubes or similar cardboard tubes will provide temporary legs if they are slit at one end to slip over the edges of the suitcase.

Sheet-Metal Owl Saves Fruit

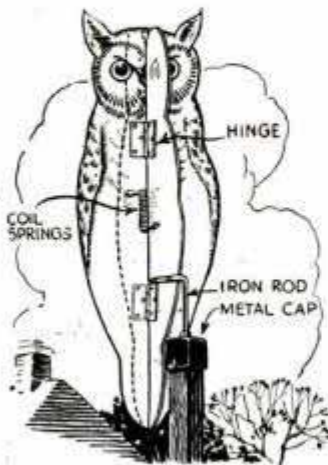

So realistic that it scares birds out of fruit trees, this owl is assembled from light sheet metal. It consists of three pieces, one cut to full-body contour and two pieces cut to half-body shape without the ears. These are hinged on opposite sides

of the main piece and are held at right angles to it by coil springs which should have just enough tension to allow the hinged

pieces to move slightly in the wind. The bird is 2 ft. long and is riveted to a length of iron rod for mounting on a standard. Eyes, face and feathers are brought out by painting.

—Dale R. Van Horn, Lincoln, Nebr.

Roller Hand Stamp from Caster Prints on Uneven Surfaces

A hand stamp that "rolls" the lettering on irregular surfaces can be made from a wooden caster. Select one having a circumference about equal to the length of the rubber strip containing the desired lettering. This can be stripped from a regular hand stamp and glued or cemented to the surface of the caster wheel if desired. A wooden file handle slipped over the shank of the caster provides a good hand grip.—Opie Read, Jr., Chicago.



Set of Small Punches and Chisels Made from Old Car Valves

You can have a set of chisels and punches for small work by simply cutting off the heads of old car valves and grinding the tappet ends of the stems to the desired

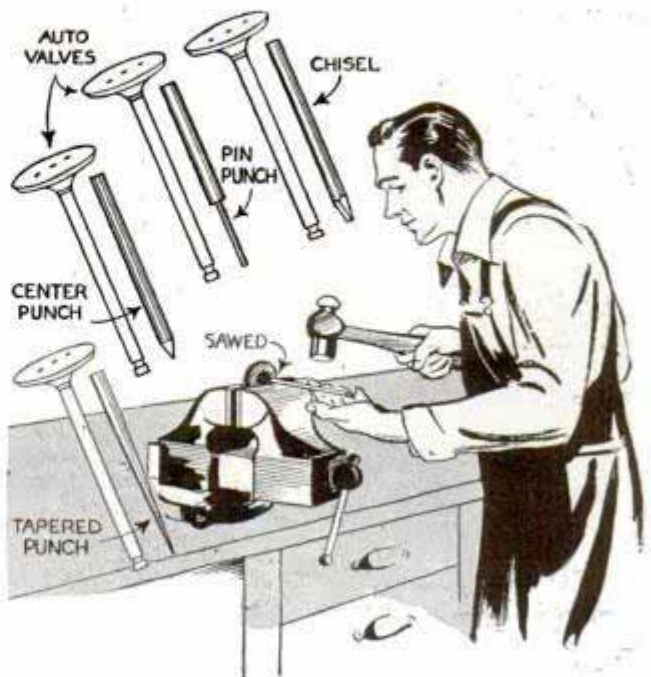

shape. If the stems are difficult to cut with a hack saw, clamp them in a vise as indicated. Then nick them deeply with a file or saw and break them off. Care must be taken in grinding not to heat the metal enough to remove the temper. If you can find some old valves from a large tractor engine, they can be used to make a set of larger tools in the same manner.—Harris Peterson, Blooming Prairie, Minn.

Inner-Tube "Gate" Admits Dog to Hen Yard

If rodents are bothering your poultry, make a gate from strips of inner tube and teach your rat dog to use it. He can nudge his way through easily but the rubber is too stiff to let the hens get out. By making the gate man-size, a person can enter with both hands full. Also, this idea can be used to allow a dog to enter the yard around a farm home.

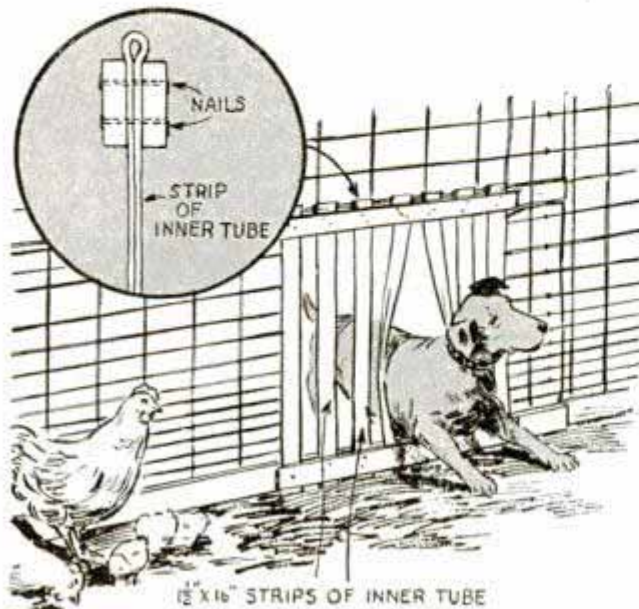

Jumping-Lion Toy Motivated by String and Rubber Bands

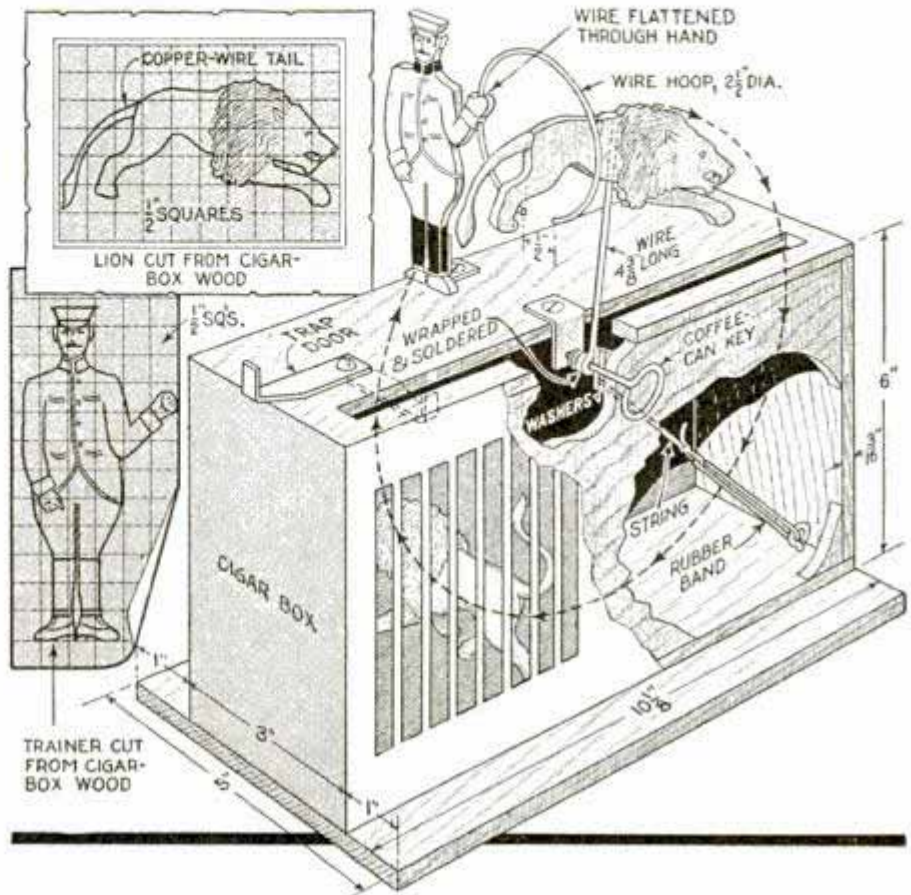

Giving the illusion of several lions jumping from cage to cage through a hoop held by a trainer, this toy is sure to provide plenty of fun for any small child. The main part of the toy is a cigar box having two sets of cage bars painted on the front with a partition between to simulate two cages. The trainer and lion are jigsaw cutouts and the latter is fastened to a coffee-can key by means of a short wire. This is assembled in the center of a slot as indicated so that it can

be rotated by a string, which is wound on the key and tied to a rubber band. The band stretches as the key is turned and when the latter is released, the pull of the band causes the key to rotate. A strip of metal pivoted to swing over the slot near one end provides a "trap door" or stop which prevents the lion from moving until it is swung to one side. The complete assembly is mounted on a wood base.

—L. B. Johnson, Spokane, Wash.

Indelible-pencil stains can be removed from a garment with a sponge dampened in denatured alcohol; after sponging the stains for about 5 min., rinse the garment in cold soapsuds and then in several changes of clear water.

••• HOSTESS TRAY

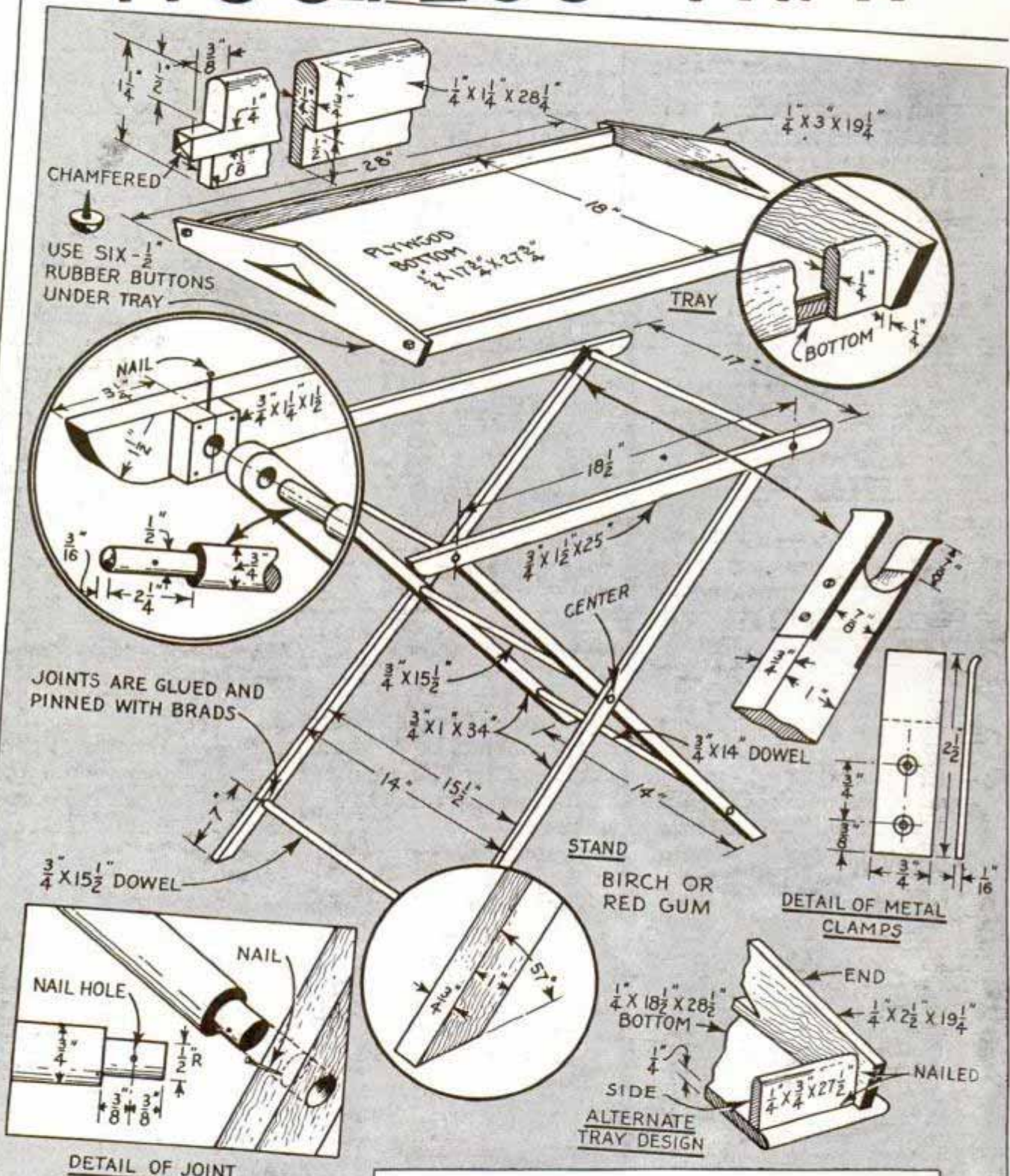

NOTE - THE RUBBER BUTTONS SHOULD BE SCREWED INTO BOTTOM OF TRAY SO THAT THEY FIT WITHIN SIDES OF STAND

Combining simplicity with utility, this hostess tray can be taken down and stored in a small space just like a folding card table. When set up ready for use there's a special place for the toaster, sandwich-filler trays, glasses or cups and the sandwich cutter detailed. Although the specifications call for walnut throughout, you can use maple finished in the popular honey color, if you have colonial furniture. Otherwise use selected walnut and finish in the natural color

on a Folding Stand

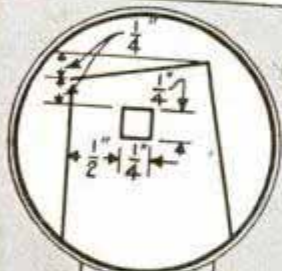
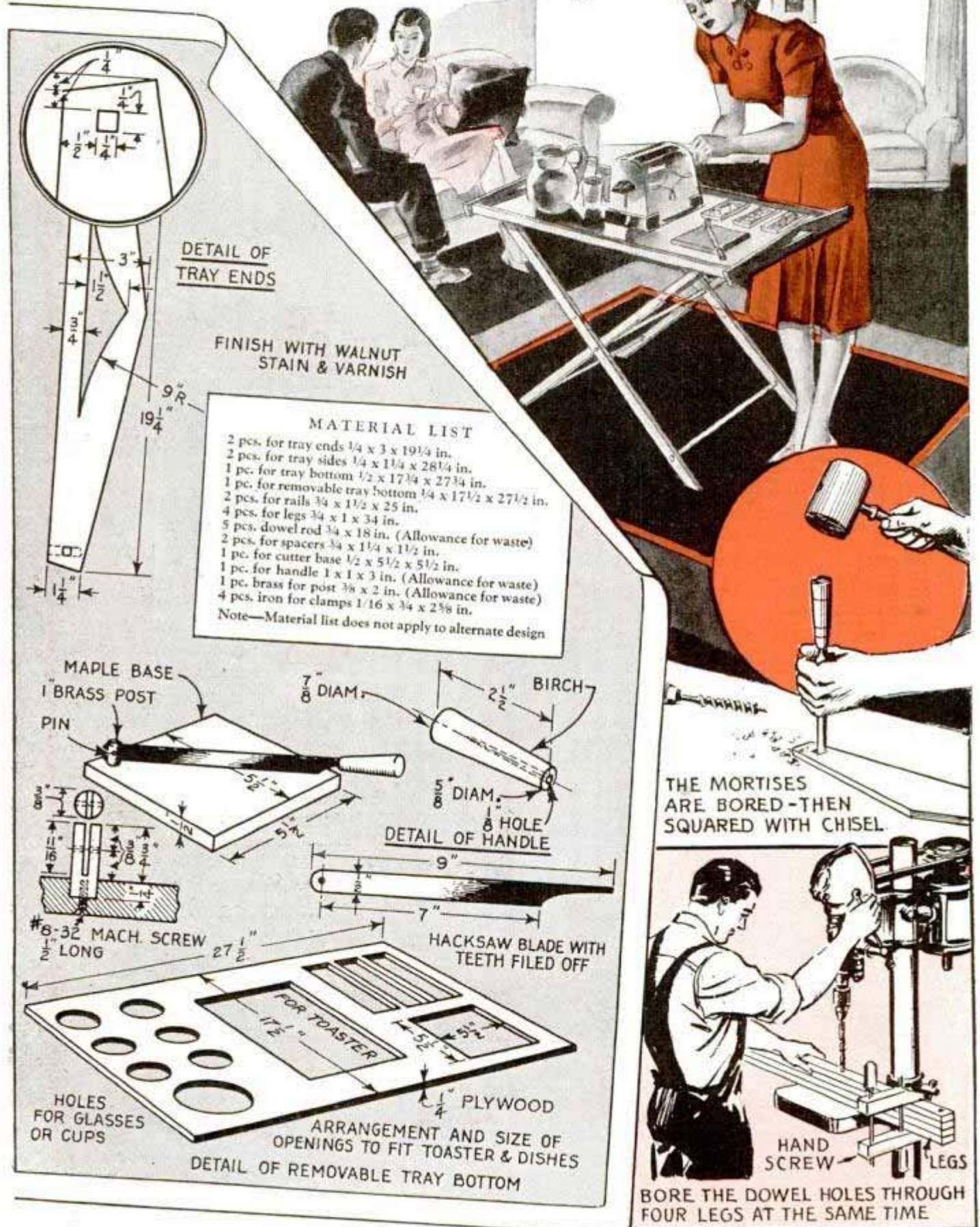

DETAIL OF TRAY ENDS

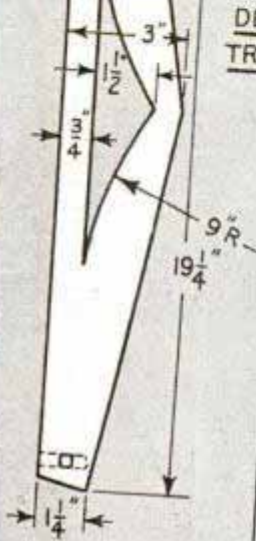

FINISH WITH WALNUT STAIN & VARNISH

MATERIAL LIST

- 2 pcs. for tray ends 1/4 x 3 x 19 1/4 in.
 - 2 pcs. for tray sides 1/4 x 1 1/4 x 28 1/4 in.
 - 1 pc. for tray bottom 1/2 x 17 3/4 x 27 3/4 in.
 - 1 pc. for removable tray bottom 1/4 x 17 1/2 x 27 1/2 in.
 - 2 pcs. for rails 3/4 x 1 1/2 x 25 in.
 - 4 pcs. for legs 3/4 x 1 x 34 in.
 - 5 pcs. dowel rod 3/4 x 18 in. (Allowance for waste)
 - 2 pcs. for spacers 3/4 x 1 1/4 x 1 1/2 in.
 - 1 pc. for cutter base 1/2 x 5 1/2 x 5 1/2 in.
 - 1 pc. for handle 1 x 1 x 3 in. (Allowance for waste)
 - 1 pc. brass for post 3/8 x 2 in. (Allowance for waste)
 - 4 pcs. iron for clamps 1/16 x 3/4 x 2 3/8 in.
- Note—Material list does not apply to alternate design

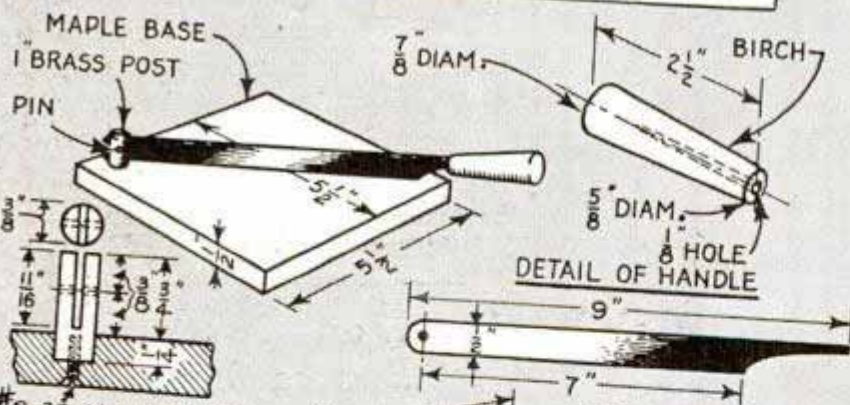

DETAIL OF HANDLE

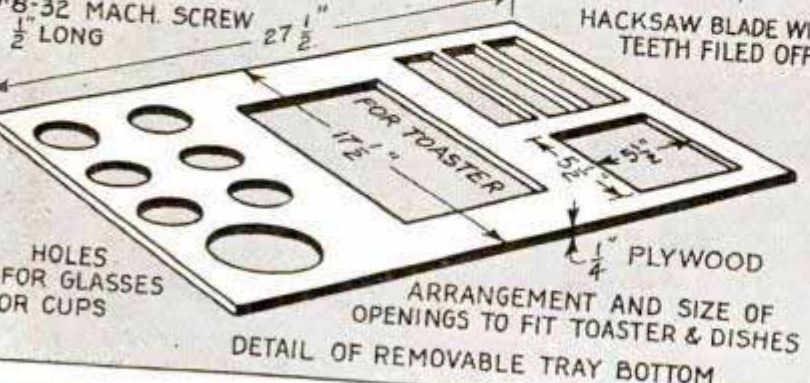

DETAIL OF REMOVABLE TRAY BOTTOM



THE MORTISES ARE BORED—THEN SQUARED WITH CHISEL.

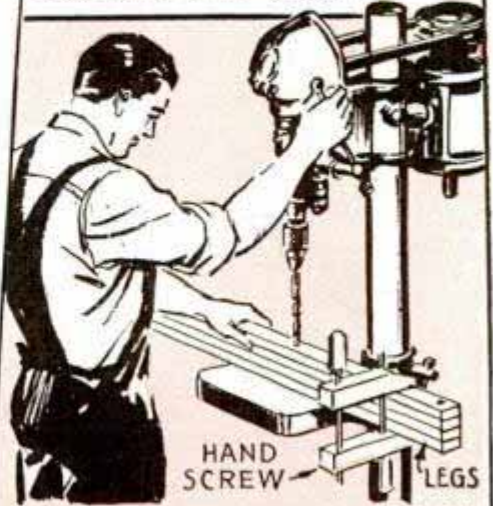

BORE THE DOWEL HOLES THROUGH FOUR LEGS AT THE SAME TIME

Irregular Sheet-Metal Work Formed in Wood Jig

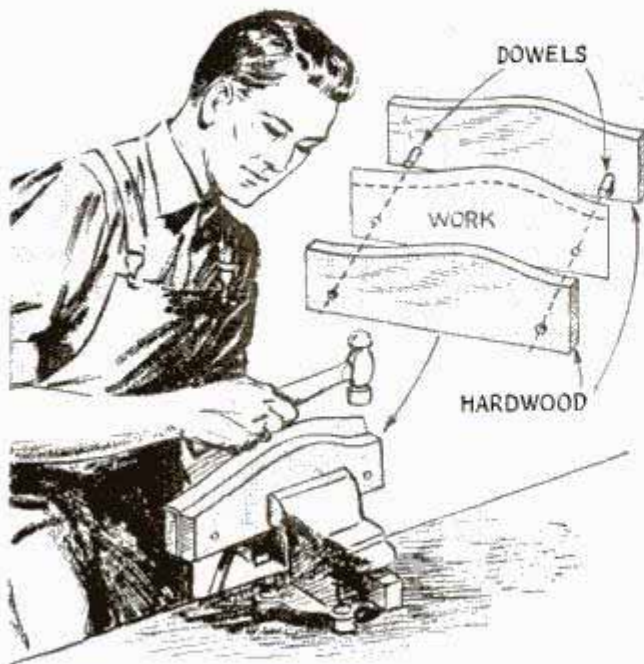

The problem of forming an irregular-shaped job on sheet metal was solved quickly by one handy man with a pair of properly shaped blocks and a sturdy vise. The metal should be worked gently over the former, and striking of any direct blows should be avoided until the final angle is to be made.

—P. F. Rossman, Kenmore, N. Y.

Wire Frames Protect Your Seeds from Birds and Chickens

Newly seeded beds are open to every bird in the neighborhood unless protected. Simple screens made of chicken wire raised several inches above the soil allow the



entrance of light and rain but keep out the birds. The screens can be removed as soon as the plants are large enough to take care of themselves.

Ruling Pen Used as Pad Holder for Cleaning Clocks

Getting at the inner movements of clocks and small machines for dust removal, cleaning or oiling is greatly simplified by a long-handled ruling pen. Grip a cloth pad, piece of sandpaper or oiled felt between the jaws of the pen.

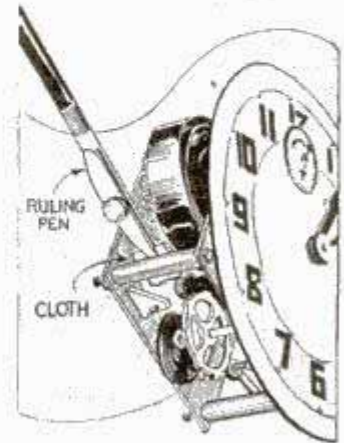

Teaspoons Converted to Trowels for Small Work

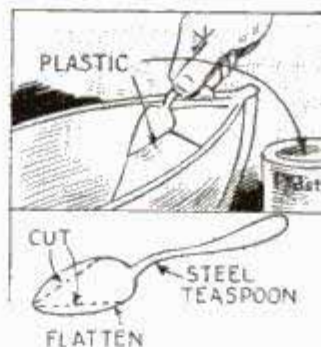

For applying plastic materials and similar compounds in corners and other hard-to-reach places, a handy trowel can be made easily from an ordinary teaspoon. The bowl of the spoon

must first be flattened, after which it can be cut to any shape desired.

Golf Bag Wears an "Overshoe" to Keep Bottom Dry

To protect the bottom of your golf bag against damp or muddy ground when you set it down, sew together one end of a short section of an old inner tube, turn it wrong side out and slip it over the bottom end of the bag.

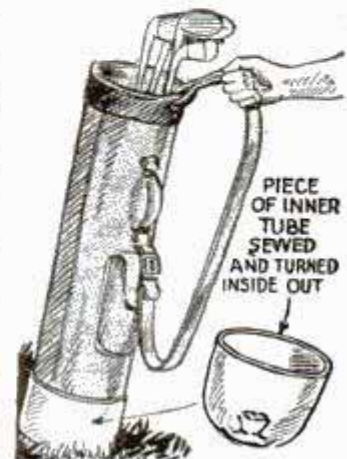

Ladies' Smart Handbag of Contrasting Wood

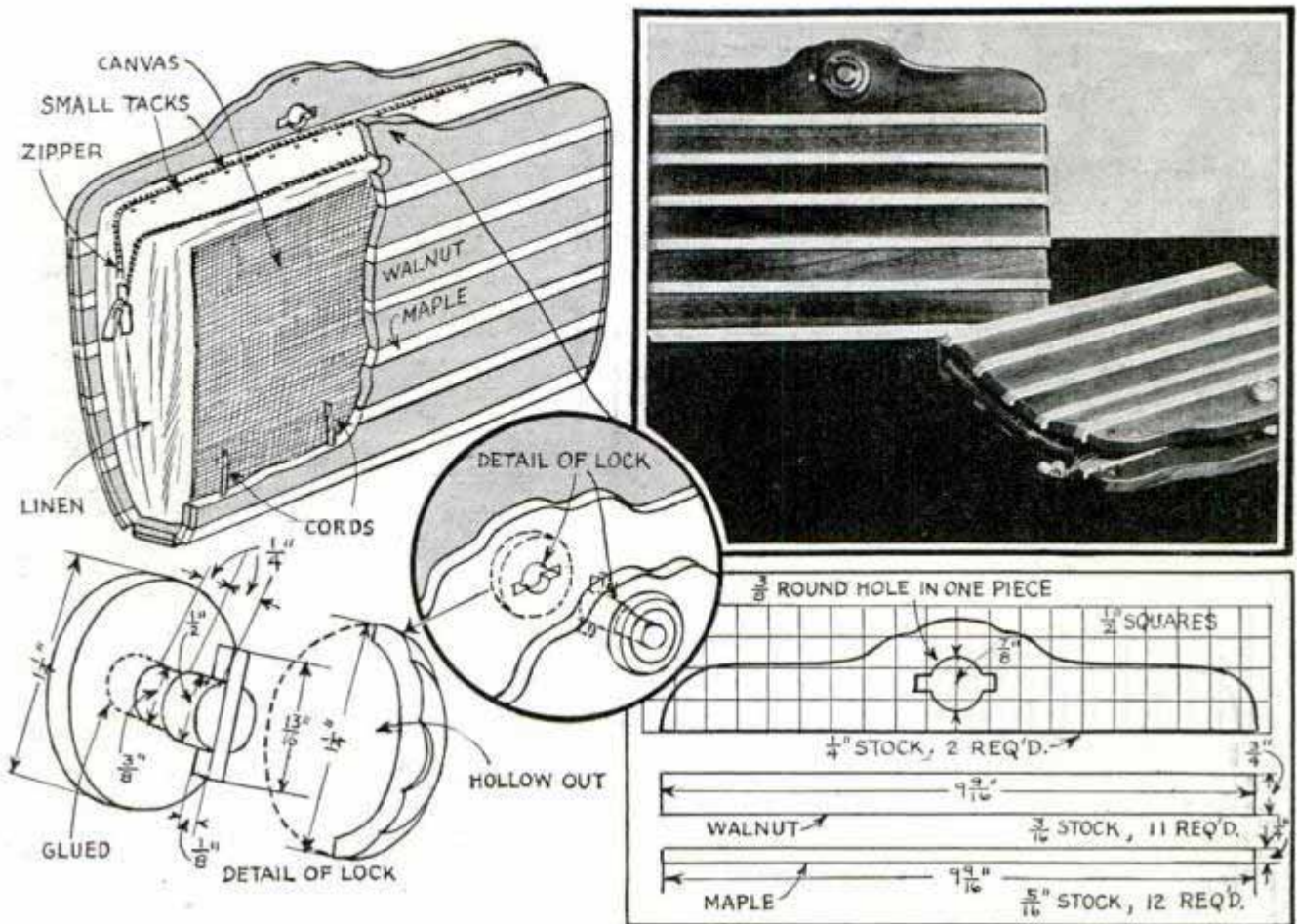

Walnut and maple strips give pleasing contrast in this handbag. After sawing out the strips, drill a hole in each top piece for the lock, which is a short dowel with a pin glued in a slot at one end and a knob on the other. A false hollow knob of the same kind is glued over the slotted hole in the

top piece to hide it from the outside. All the strips are strung on four equi-distant cords, which are knotted after passing through the end pieces. Canvas is glued to the inside of the strips, and a fabric bag is tacked in place.

—Chas. H. Deerwester, Middletown, Pa.

Emergency Jewelry Cache in Top of Door Is Doubly Safe

There are times when one cannot get to the bank, and leaving valuables in the house is always risky. The least likely place for a burglar to look is a hole bored down through the top of the front door. In the first place the cache cannot be reached without unlocking the door and standing on a chair, and secondly, by inserting a cork the hiding place is not readily detected even when the fingers are run over it.

☐ Many jobs of surfacing, rust removing and grinding can best be done with dust collecting under a grinding wheel. Mix with cup grease to form a paste and apply with flannel cloth or polishing wheel.



Smith

Better GARDENS

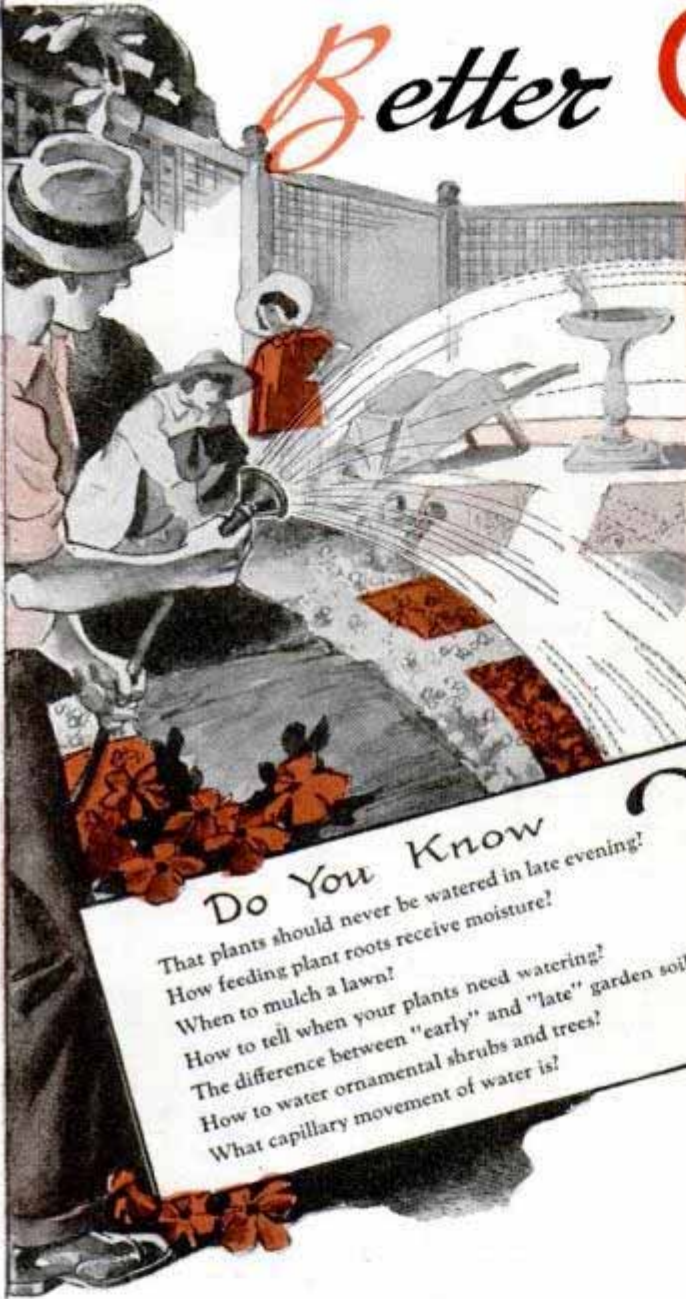

Do You Know

That plants should never be watered in late evening?
 How feeding plant roots receive moisture?
 When to mulch a lawn?
 How to tell when your plants need watering?
 The difference between "early" and "late" garden soils?
 How to water ornamental shrubs and trees?
 What capillary movement of water is?

By ROBERT STAHLER

HERE'S something to think about before you unlimber your garden hose next time: To start off with, proper watering is largely a matter of knowing your garden soil, the habits of the plants growing in it and how to time the watering to actual needs. Too frequent watering will convert the best soil into a sour, water-logged mass in which bacteria beneficial to plant life cannot possibly thrive. Most experienced gardeners agree that generous flooding several times a week or a light sprinkling almost every evening is very harmful to sturdy growth of many common plants and grasses.

Now for some of the reasons why: First

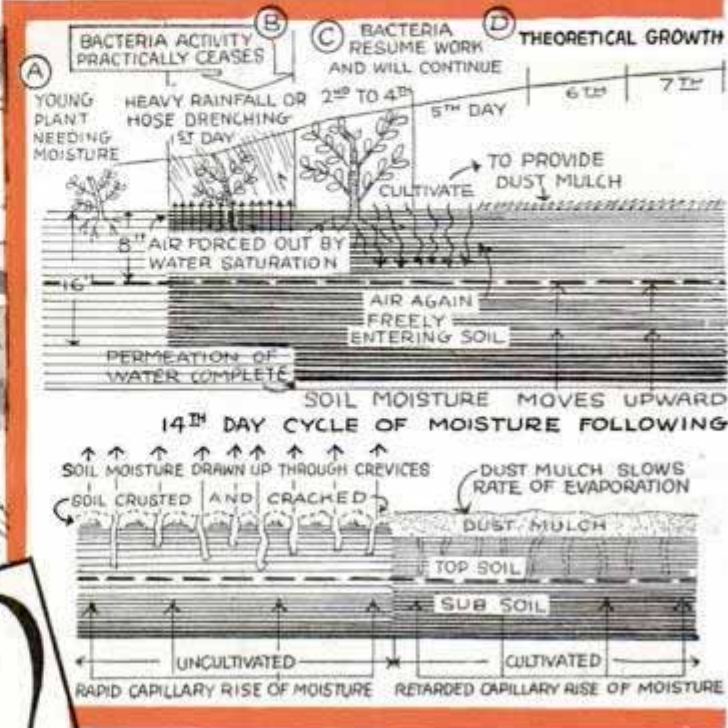

look over Fig. 1, which charts a cycle of theoretical growth from one heavy hosing or rainfall to another, with added details on capillary rise and consumption of moisture. Growing on the outer reaches of the smaller feeding roots of the plant are myriads of tubular, microscopically fine root hairs, Fig. 3. These root hairs take up moisture by a process which agronomists call osmosis. Applied to plant growth, this is the absorption through a thin membrane of a lighter liquid into a heavier one. Thus is moisture, the lighter liquid, drawn through the thin walls of the root hairs by the sugary sap (the heavier liquid) which they contain. A few hours after a drenching rain, try squeezing a handful of wet soil. Not a drop of water will come forth, because the water now surrounds the soil particles in microscopically thin films, and the humus (decayed vegetable and animal matter) is now minute reservoirs which will release their stored moisture to the plants as needed. Feeding roots receive moisture from distances several feet away from the tip ends. This is due to capillary movement of water and to osmosis. Capillary movement is the movement of water

with *Better*

WATERING

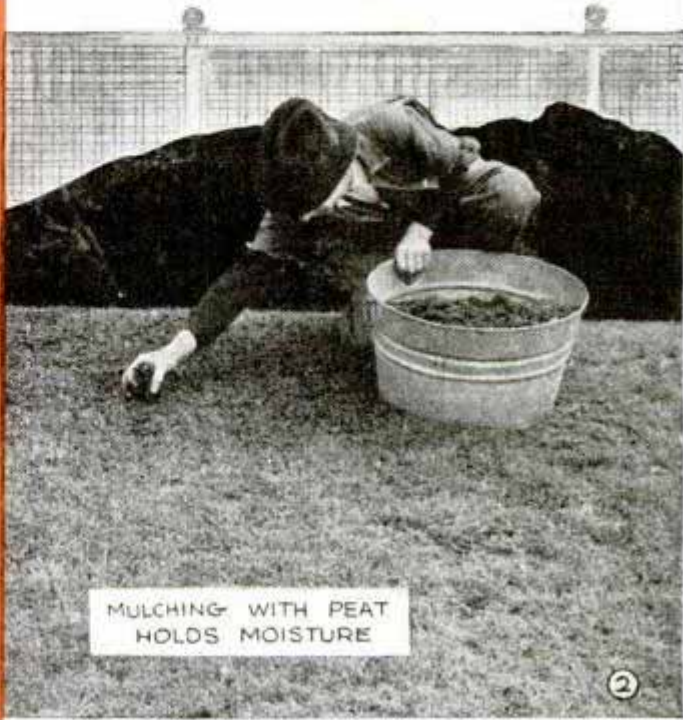
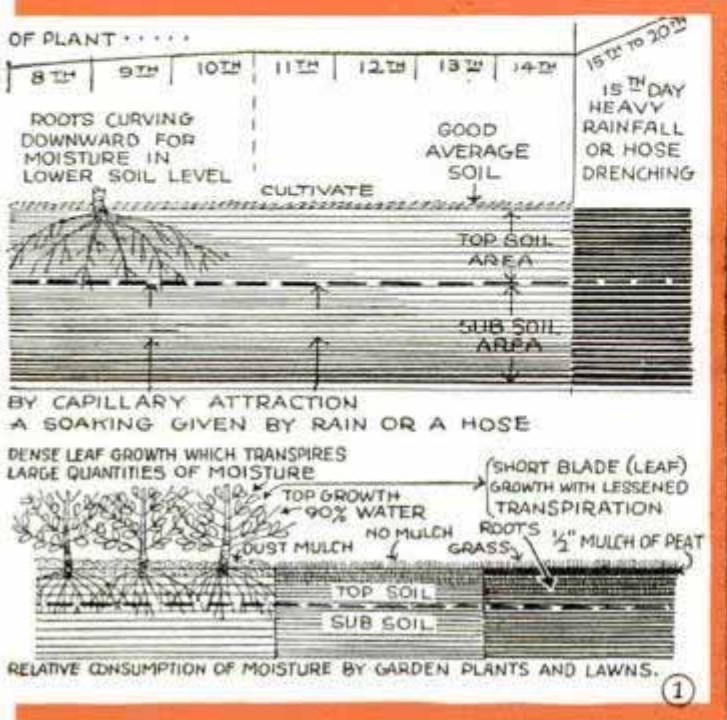

from soil particles to other particles and on to others which have lost part of their moisture. This is the reason plants thrive in a comparatively dry soil.

In the section B, Fig. 1, the soil air, vitally necessary to the roots and as a means of escape for the foul gases formed by decaying vegetation, is forced out of the soil by rainfall or hosing, but is soon entering again and bacteria resume activity. As the top soil gradually loses moisture, the roots grow longer and curve downward for moisture now coming up to them by capillary movement, which brings with it plant food washed into low levels by winter and spring rains. In the last section, Fig. 1, notice the abrupt upsweep of theoretical growth. This is due not wholly to the refreshing benefits of the applied moisture, but is the result of bacteria—those working in the dryer soil levels above the roots where they have been making available plant food, which was washed into the immediate vicinity of the roots and rapidly taken up by them. Occurring in uncounted numbers in each tablespoonful of rich garden soil, these bacteria, which are single-cell micro-organisms, break down complex compounds into simple elements

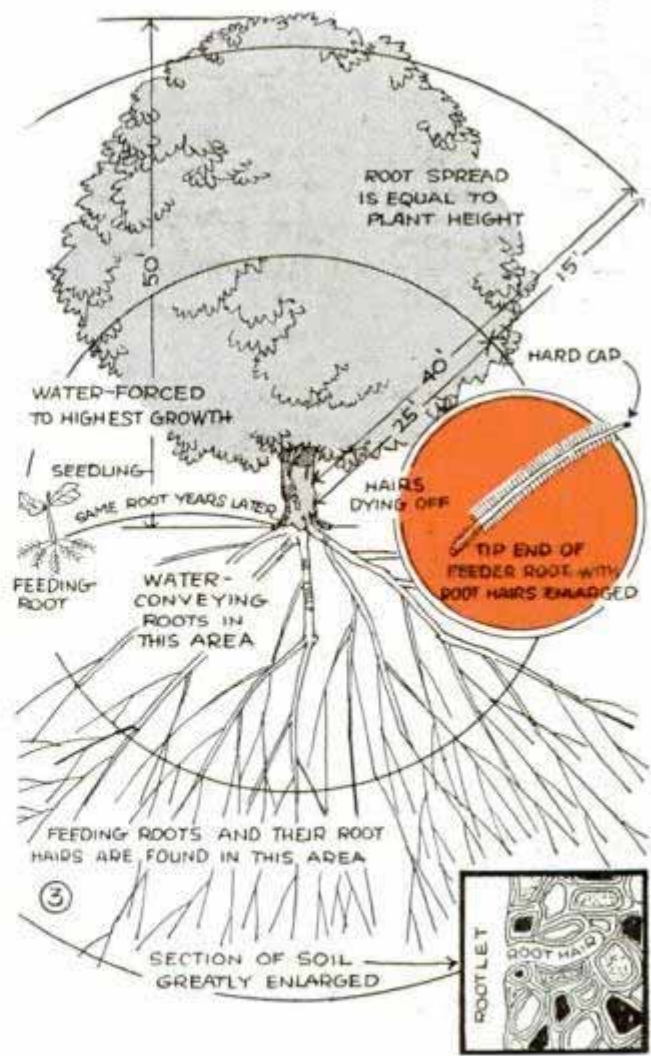

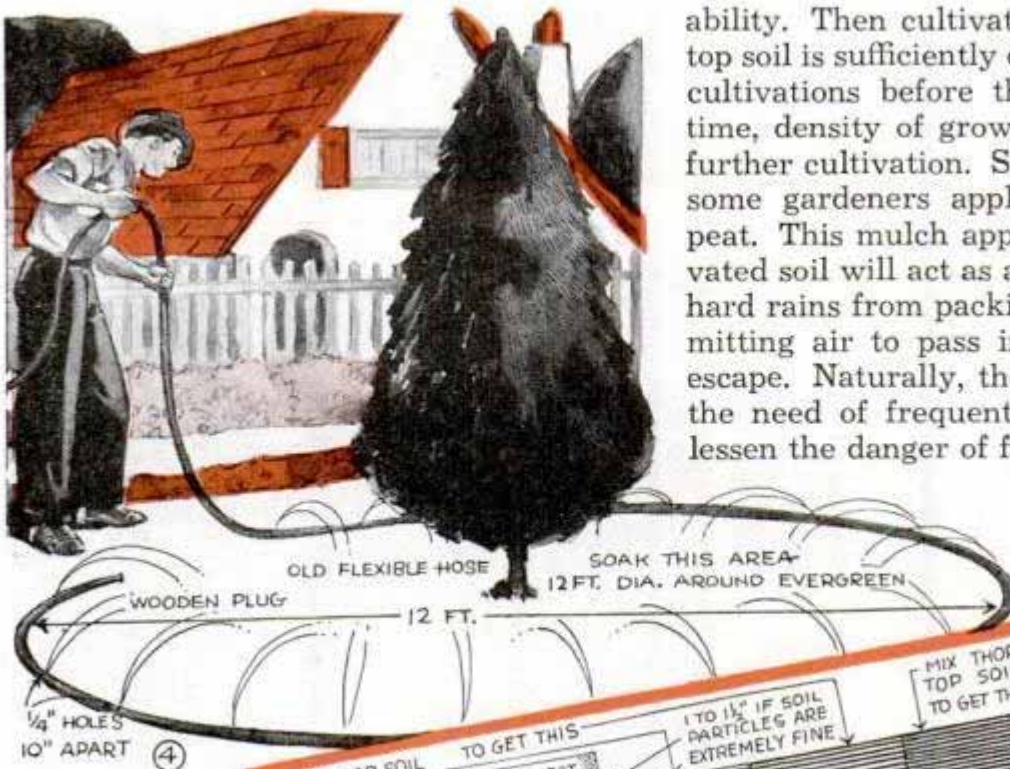

ability. Then cultivate immediately when top soil is sufficiently dry, with one or more cultivations before the next soaking. In time, density of growth makes impossible further cultivation. So, after the final one, some gardeners apply a 1-in. mulch of peat. This mulch applied to freshly cultivated soil will act as a cushion, preventing hard rains from packing the soil, and permitting air to pass in, and foul gases to escape. Naturally, the mulch will obviate the need of frequent waterings and also lessen the danger of foliage diseases.

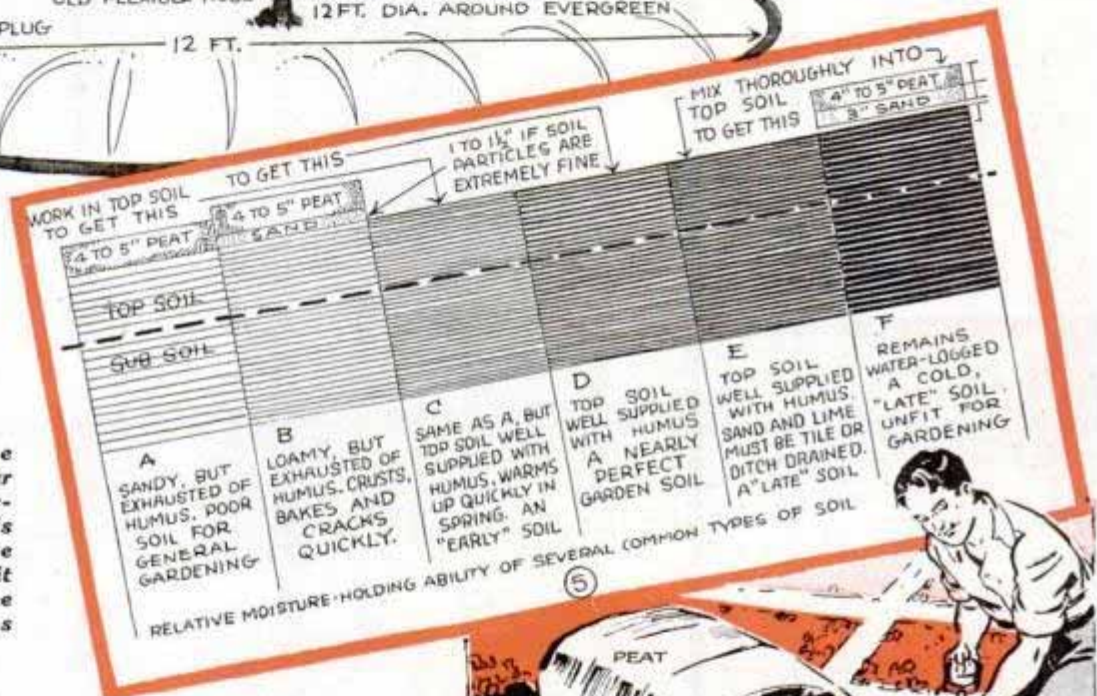

After you have classified your garden soil according to this chart, you will be able to improve it by following the recommendations given

and render them as food available to plant life. Were it not for their work, the soil would become lifeless and unproductive.

Now suppose you were to keep your garden and lawn top soil soaked during this theoretical 14-day cycle. As a result the soil would be without air, to the detriment of aerobic (air-loving) bacteria and much of the root system of the plants would perish, while the sparse remainder would function too close to the soil surface. The soil would become sour, full of poisonous gases, and the plant foliage would take on a sickly, yellowish-green color.

So, contrasting the two cycles, the following method of watering appears to be best: A heavy soaking (2 to 3 in. of water applied to the garden or lawn) at 10-day to 3-week intervals governed by temperature, texture of soil, and water-holding



Two sections of the lower right detail in Fig. 1 show the relative development of a sod. In hot, dry weather, however, your lawn may show frequent signs of flagging, or the grass may turn slightly brown, indicating need of moisture in too short an interval. This shows, either singly or in combination, a sandy soil, or a soil whose humus content is exhausted. One remedy for this condition is mulching. To apply it

effectively, first mow the grass with the mower set to cut not lower than $1\frac{1}{2}$ in. and then wait a day or two for the tips to heal. Moisten the peat and break it up into fine particles. Apply as in Fig. 2 to 1 in. depth. When matted down, the mulch should be a good $\frac{1}{2}$ in. thick. If, after matting down, it appears too thin, apply more peat as directed above. Let the grass continue to grow up through the mulch. If no rain falls before the grass needs mowing, soak the peat down and mow when the grass has dried. Never apply a mulch when the grass is short, or when its length is such that it bends over under the slight weight of the peat. Smothering is likely to result. Grass growing on banks or terraces should always be mulched.

General gardening soils should not have a clay content exceeding 30 per cent, Fig. 5. If the "physical" condition of any soil is improved by adding sand and peat, you should keep it up to par by yearly applications of peat or other humus, though in smaller quantities than those shown. Maintain fertility by adding commercial fertilizer, bone meal and, rotted manure. Although hydrated lime is not a fertilizer, it sweetens sour or acid soils, particularly of the E and F type, and should therefore be added to such soils yearly, though in smaller amounts than shown. All liming should be done in late fall or early winter and thoroughly mixed with the soil.

There are also certain plants which have special, seasonal water requirements. For example, you should keep peonies well watered throughout August for this is the season that new eyes are formed. Immediately after flowering, the foliage of early spring bulbs such as tulips, hyacinths, etc., continue to grow, and store within the bulb next season's foliage and bloom.

Many evergreens have no true dormant season, and are likely to be in active growth in fall and early winter. Thus they may winter-kill if these seasons are dry. Fig. 4 shows how to water tall-growing ornamentals such as shrubs and evergreens. As there are few feeding roots inside the spread of the foliage, Fig. 3, the area outside should be watered as shown in Fig. 4. In all cases, ground soaking is the best method, for it directs the water where needed without waste and reduces chances of foliage diseases.

Box for Live Bait in Rowboat Is under Hinged Seat

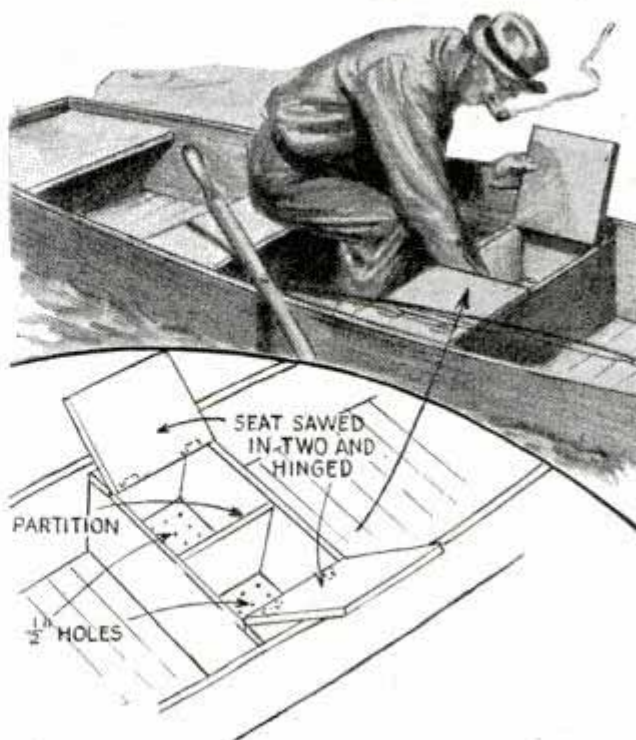

Two watertight bulkheads under the middle seat, and holes bored in the bottom provide a bait well where the water is always cool and fresh. Paint with white lead and linseed oil and calk the joints with marine glue.

Balancing Blocks Save Fingers When "Rolling" Heavy Cases

A couple lengths of 2 by 4-in. wood are very useful to have at hand when "rolling" heavy boxes or other weights. Lay one so the box will be tipped on it for the next move. Repeat until the box reaches the desired location. For extra heavy weights a lever may be used to start the lift.



Silk Anklets Reduce Friction When Pulling on Boots



Slipped over your regular socks as shown, these silk anklets make it easy for your feet to slide into tight-fitting boots. More than a dozen anklets can be cut from a single pair of discarded stockings.

Plumbers' Force Cup Holds Acid

If there is no container at hand for acid, you can improvise one from a plumbers' force cup. Remove the handle and turn the rubber cup wrong side out as shown. When finished, turn the cup back and wash it thoroughly in running water.



Overflow Gauge for Boat Tanks

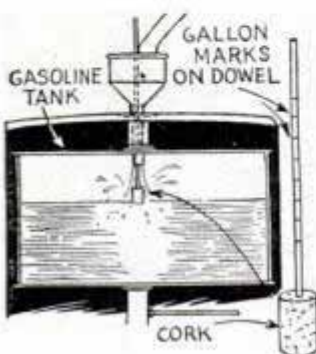

The fire hazard of slopping gasoline over into the cockpit of a motorboat when filling the tank, can be avoided with this simple gauge. First insert the gauge into the tank

and then lower the funnel over it. Stop the flow from the dock pump at intervals while the float seeks its level. A similar gauge for the water tank also will be useful.

—J. A. Emmett, Annapolis, Md.

Lead Casting Removed Easily When Mold Is Smoked

Needing several lead disks for weights I molded them in tin-can covers, first smoking the inner surfaces so the castings would part from them easily. The smoking was done by holding the covers over a candle.

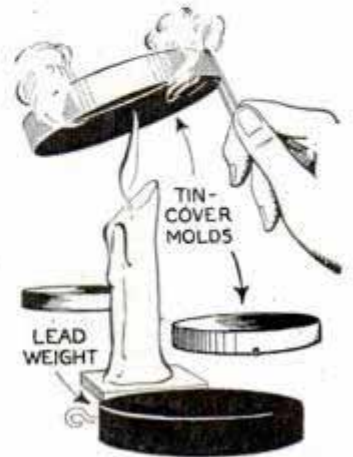

—G. E. Hendrickson, Argyle, Wis.

Tent Divided by Window Shades Gives Privacy to Campers

Tent occupants can have individual sleeping quarters by using window-shade partitions. The brackets are attached to the ridge pole so that the shades will overlap a few inches when they are pulled down. If desired, stakes may be driven into the ground so that the pull cords of the shades can be tied to prevent the shades from blowing in a breeze.

—E. P. Barnhart, Whittier, Calif.

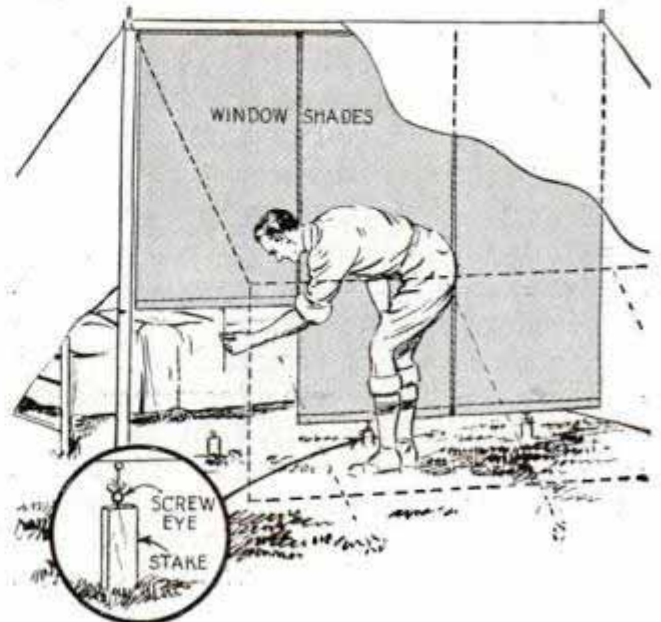

Removable Shelves on Lawn Table Clamped to Centerpost

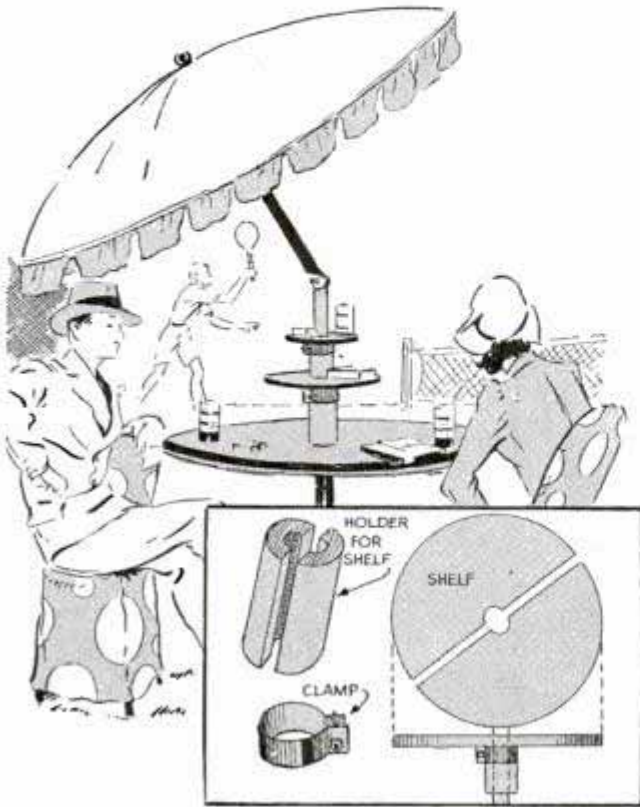

When outdoor meals are inconvenienced because the table under a lawn umbrella is too small, shelves clamped to the stem of the umbrella provide space for foods and beverages. This leaves the main table free for plates of the diners. The shelves can be removed quickly when the meal is over.

Valve in Oil Line of Motorboat Simplifies Draining Crankcase

Owners of power boats using automobile engines are often inconvenienced by having to drain oil in the usual manner, but not when a plug in the oil-pump system is removed and a valve installed. With the engine running and the valve open, the old oil will squirt out. As long as it flows the engine is lubricated, but cut the switch

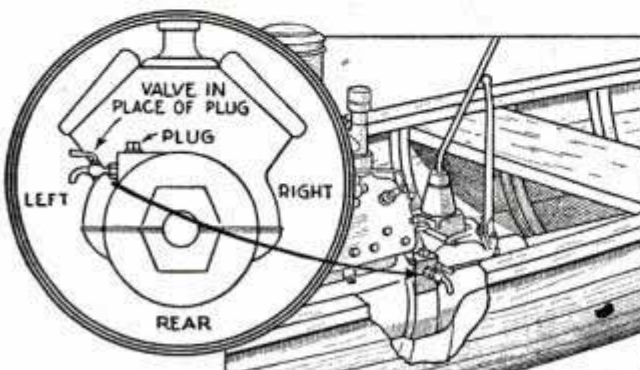

the moment the oil stream sputters. Refill with fresh oil in the usual manner. By not having to reach underneath, the engine may be lowered several inches, with a consequent increase in stability.

—C. E. Packer, Chicago.

Rubber Auxiliary Vise Jaws Protect Finished Work

Make up this pair of rubber jaws for your bench vise and you can clamp finished wood or metal work in it without marring the surface. The jaws are merely short lengths of rubber hose having strips cut out of the sides so that they can be slipped over the jaws as shown.

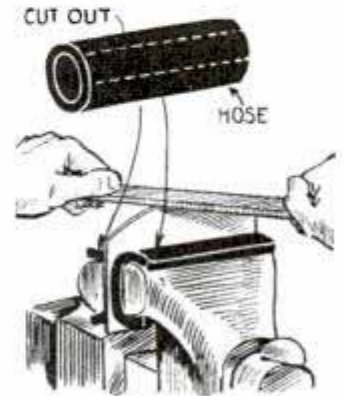

Chain Ladder Aids Swimmers When Climbing into Boat

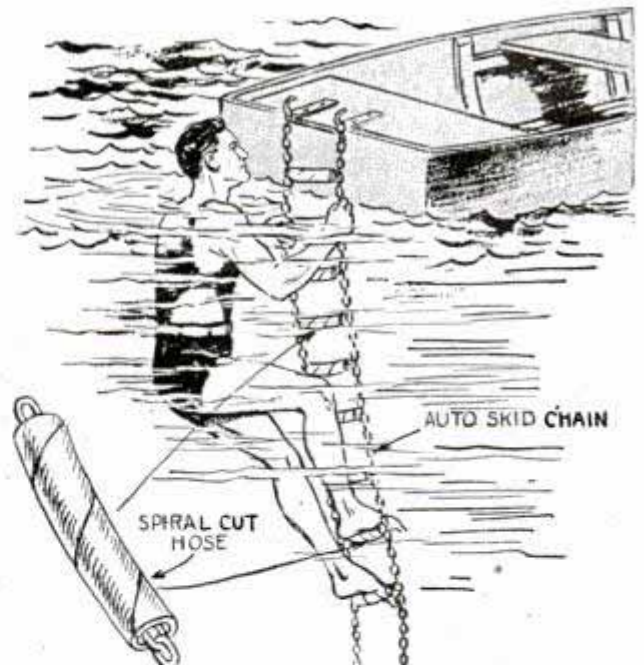

You will find that an old auto skid chain provides a handy ladder to get into a boat or onto a raft. Pieces of garden hose slit spirally to slip over the cross chains cushion them for bare feet. The chain can be suspended from a pair of stout hooks fastened securely to the stern of the boat or to the edge of the raft.

Surf "Balloons" Give You a Thrilling Ride

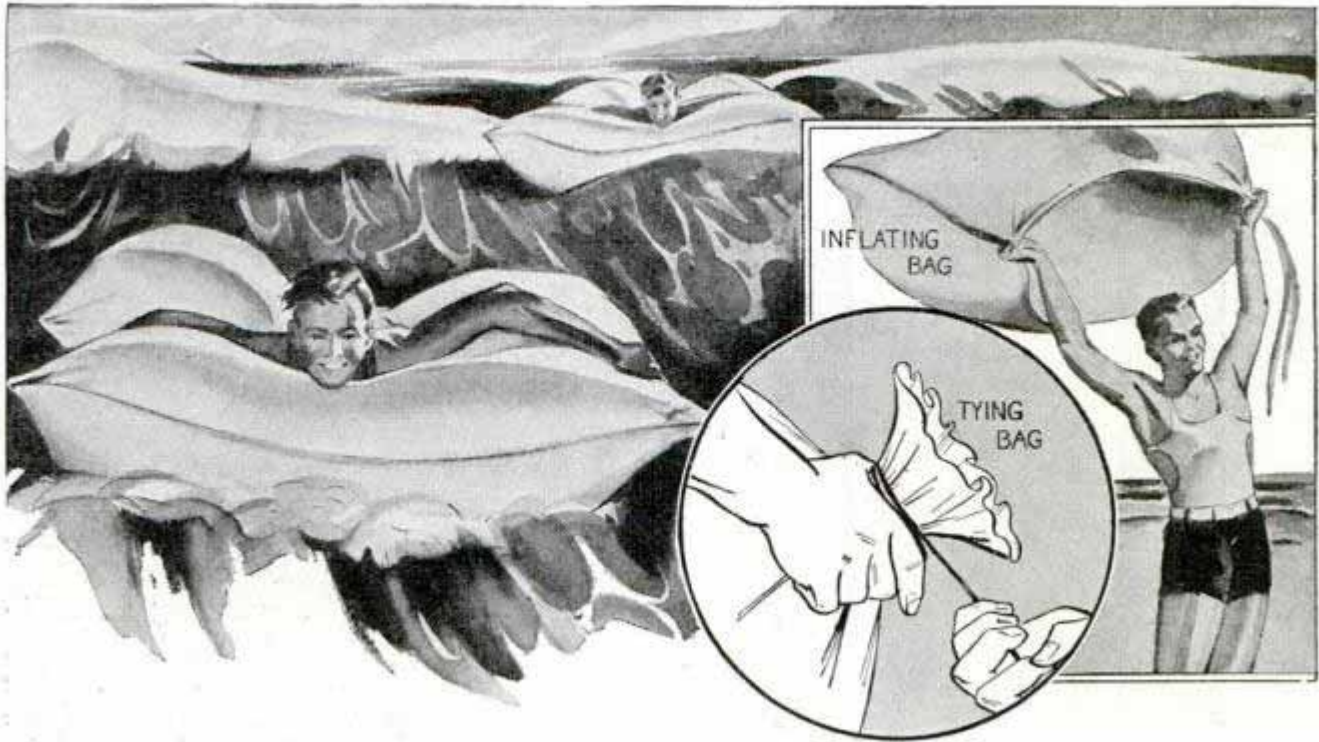

Popular at a number of California beaches, these air-filled cloth bags or "wind bags" as they are commonly called, give bathers new thrills in the surf. They are made of any closely woven material such as ordinary sheeting. Dimensions are generally 3 or 4 ft. wide and 5 or 6 ft. long, a drawstring being provided in a hem at the open end so that the bag can be closed

quickly. To fill with air, first wet the cloth thoroughly. Then, holding the neck of the bag open, run into the wind or whirl the bag around to catch the air. The inflated bag is then closed with the drawstring and the latter is tied around the closed neck. In use, grasp the center of each end, hold the bag across the chest and when a wave breaks, throw yourself forward.

This Air-Rifle Target Is Reset by Pulling a Long String

When you score a bull's-eye on this target, it can be reset by pulling a string from where you stand. The target consists of a

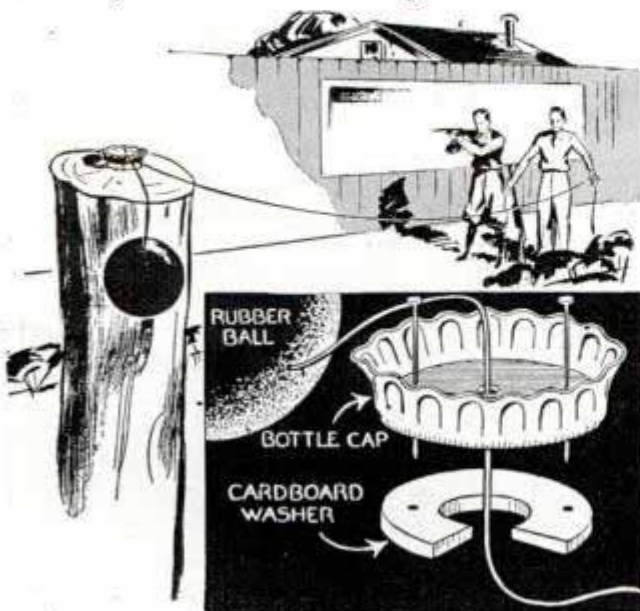

rubber ball and a bottle cap. A string is attached to the ball and is run through a hole in the cap, which is nailed to the top of a post or stake. A cardboard washer with one side cut away serves as a spacer to prevent binding the string between the cap and post.

Guard Keeps Sleeve Off Flypaper

By means of a simple wooden base and a bent wire frame, a sheet of flypaper may be used, and still not be subject to personal contact. It is thus easily carried from place to place and does not blow about in the wind.

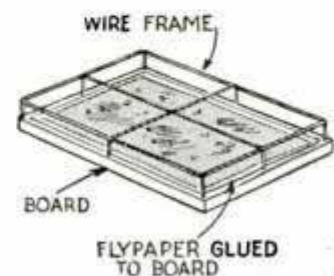

Old CLOTHES CLOSETS

wall shoe cabinet and shelves.
hat boxes gives a luxurious finish

adjacent to a doorway. Here a narrow vanity cabinet, constructed as in Fig. 3 from ordinary fir plywood, provides ample shelf space upon which to place hat stands, lamps, etc., while immediately above it, three roomy shelves fitted to the wall by means of small cleats screwed securely into the studding, provide still more space to store large hat boxes. With the exception of the height measurements, the dimensions given for the vanity, Fig. 3, are more or less general since these will need be altered to fit the available space. Plain butt joints glued and screwed are employed in assembling. Fig. 4 shows the use of a similar cabinet, detailed in Fig. 5, which can be

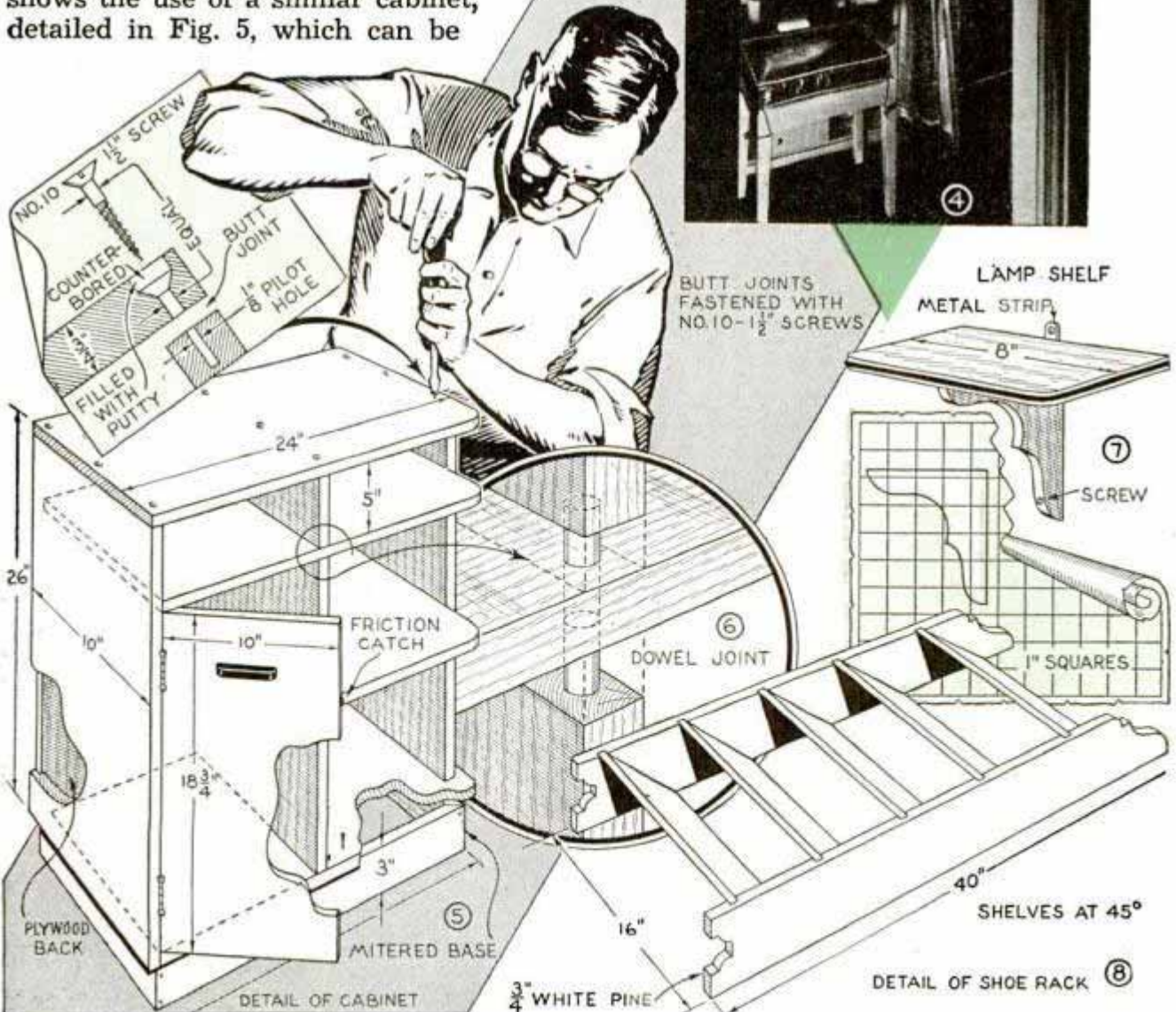
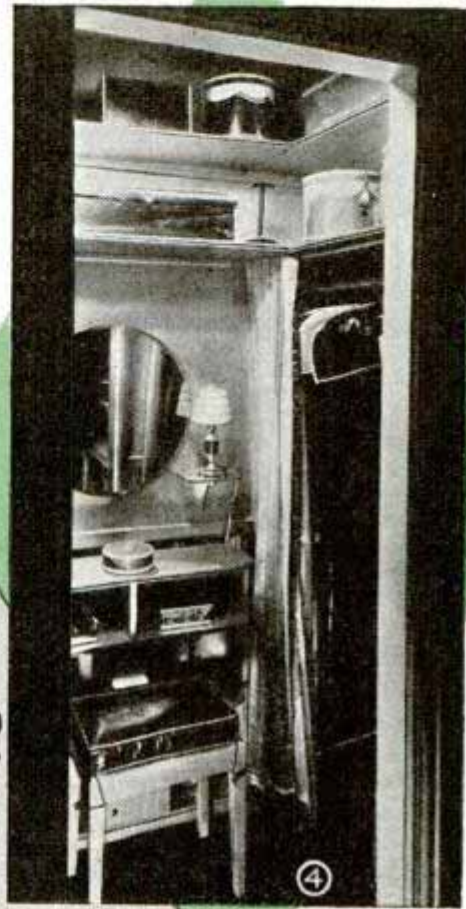



fitted along a back wall with wardrobe space at the side. Small scrolled brackets, Fig. 7, fitted at either side of a circular wall mirror, provide neat little shelves upon which to place small lamps.

The shoe and hosiery cabinet, in Fig. 2, is ideal where space is at a premium as it is made to fit flush in the wall between the

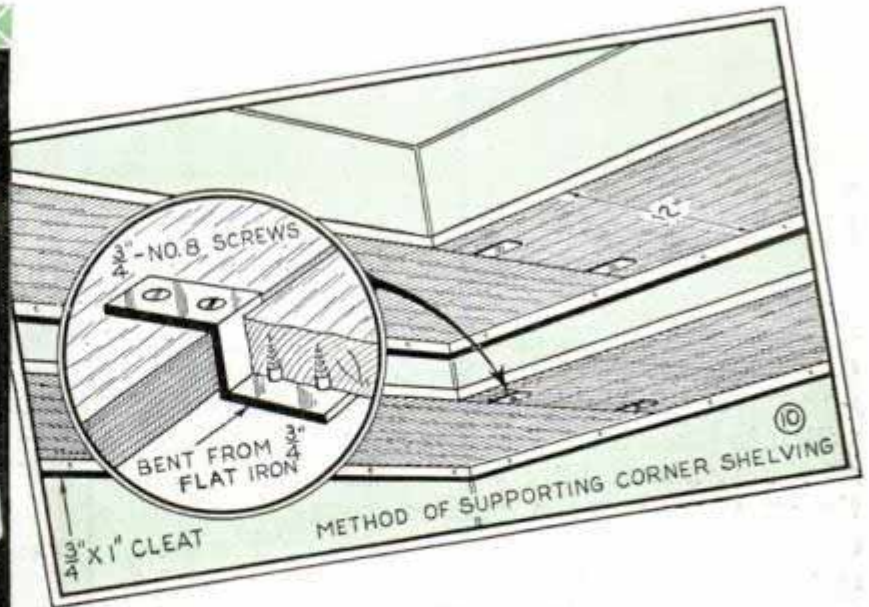

studs. Standard $\frac{1}{2}$ -in. dowel stock inserted through holes bored in the sides of the box-shape frame, provide a rack for shoes while hinged doors at the top of the cabinet make a separate compartment for socks and hosiery. The floor type shoe rack shown in Fig. 8, has 6-in. pine sides, grooved to snugly house $\frac{3}{8}$ -in. plywood shelves at approximately 45 degrees.

Shelving can be of second grade pine stock, painted on both sides to facilitate cleaning. Fig. 10 shows how shelves can be made to meet at a corner. As can be seen in the detail, small support brackets bent from $\frac{3}{4}$ -in. flat iron, are screwed into one shelf from the top and the other from the bottom. Standard parting-stop material available from your lumber dealer is just the thing for cleats to support the shelves along the wall.

Block Letters in Many Colors Cut from Cardboard Patterns

Signs made of letters mounted on a contrasting background are always popular. With a lettering book for a guide, lay out

a cardboard pattern for each letter. Trace around these and cut the letters out of lighter

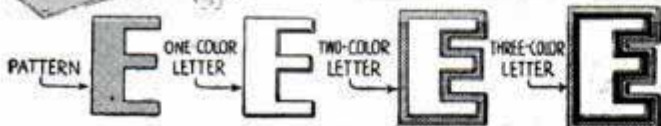

stock. The finished letters are pasted to a background of contrasting shade and complementary color. Two and three-tone letters may be had by making each tracing slightly wider than the last and stacking them together. Tinfoil, colored Christmas wrappings, etc., also may be used for novel effects.

—L. E. Ashley, Gulfport, Miss.

☞ Rinse water from milk bottles is good for your house plants.

Tips on Staking Plants to Avoid Injuring Roots

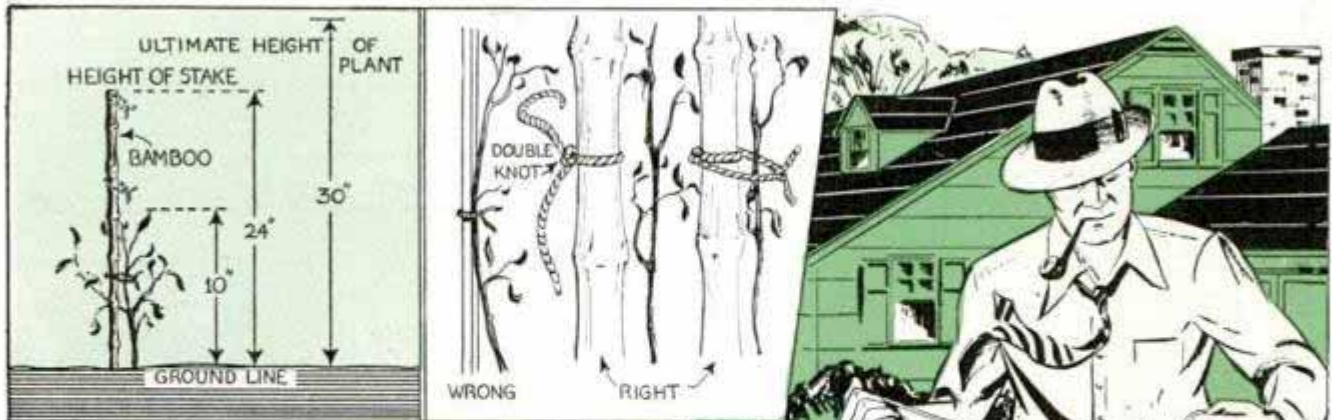

MAKESHIFT stakes mar the appearance of a flower garden, and if the staking is done improperly, it may damage the root systems and choke the stems. The best time for staking is immediately after the plants are set out or, in the case of broadcast seeding, just after the final thinning and first cultivation. Early staking permits the foliage to grow around the stakes and hide them. Height of the stake should be about 6 in. less than the expected height of the plant. Many flowering plants growing from tubers, corms and bulbs, such as dahlias, lilies and the like should be staked before setting them in the ground, for quite frequently the shoots strike an obstruction, grow out at an angle, and emerge in an untrue position. This may mislead you into driving the stake into the bulb. Square-sawed wood is satisfactory for stakes, but for most flowering plants, finger-size bamboo is neater and stronger. They are sold cheaply by seedsmen, and are either stained or unstained. The latter are preferred, and should be given a coat of spirit stain and two coats of good spar varnish. For tall, heavy plants such as dahlias, wood 1 in. square is preferred. Heavy, medium-height plants such as African marigolds may require two bamboo stakes set close together. As bamboo cannot be driven, you will have to make a hole in the ground by driving an iron rod with a diameter slightly less than that of the stake. The first tying should be done when the plants are quite small. Tie the cord to the stake with a double knot to hold it in place and then tie the plant loosely to allow for growth without pinching. Raffia, soft jute twine of $\frac{1}{4}$ -in. diameter or larger, and $\frac{1}{2}$ -in. cotton tape are

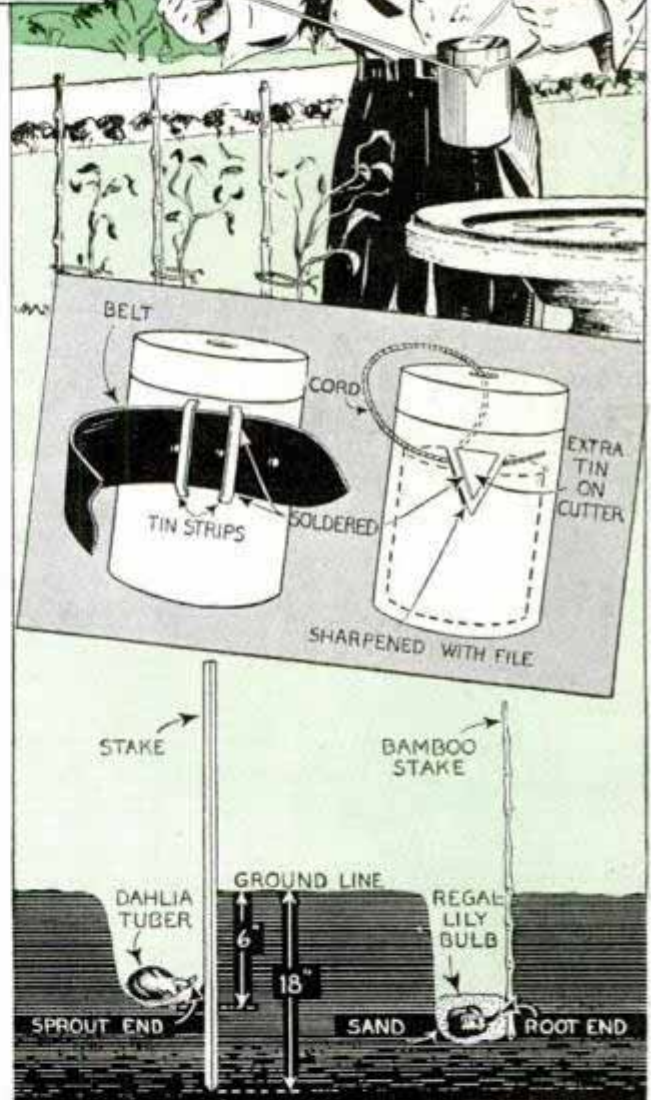

the best for tying the plants. You will find that the combined twine holder and cutter shown is very handy. The straps through which the belt is pushed are tin strips soldered to the holder. In the fall when removing the stakes from hardy bulbs and tubers that are to be left in the ground, it is advisable to insert short dowels or iron rods into the holes left by the stakes to keep them from filling up during the winter.

Sliding Bolt on the Inside of Door Locked from Outside

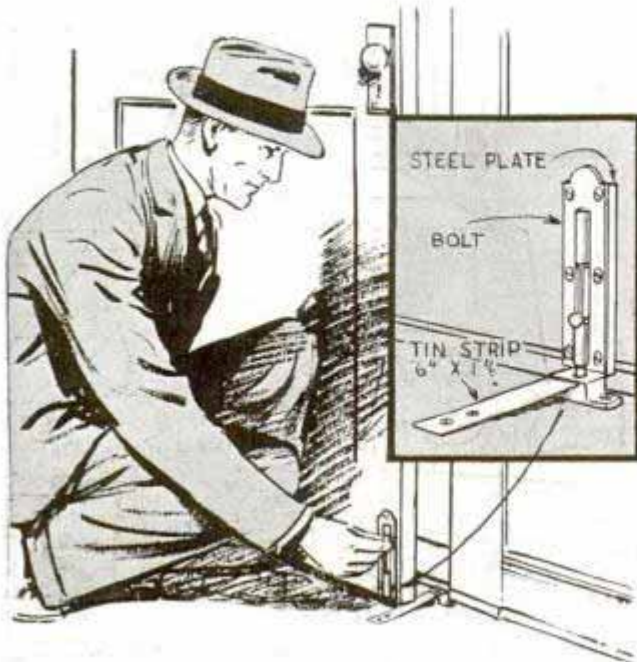

A door can be locked on the way out if you install a sliding bolt as shown. The use of a strip of metal or a hardwood wedge is also necessary. After releasing the bolt, it slides up the tiny "ramp" and drops into a catch which is screwed to the floor.—Mark Bell, Passaic, N. J.

Inducing Strong Root Systems on Seedlings

Instead of transplanting seedlings three or four times to strengthen the root systems, cut the tiny rootlets after the plants have been moved to flats or a permanent place in the ground. About an inch from the plant and on all four sides, slice



through the soil to the bottom of the flat or to a depth of at least 3 in. in the ground. A week later repeat the operation about 1½ in. from the plant, and then the second week make the final cutting about 2 in. from the plant.

Holding a Glass Wood Scraper

You can hold a piece of glass between a pair of rubber heels to scrape wood. They minimize the risk of cutting the fingers on the sharp edges of the glass and provide a large gripping surface.



Putty Carried on Paint Bucket



Bent to the shape shown and suspended over the side of a paint bucket, a piece of tin provides a handy container for carrying putty to fill nail holes when painting.

"Crank" Operates Bench Vise

Clamped to the handle of a bench vise, a steering-wheel "spinner" knob will save considerable time if the vise is in constant use. When a strong pull must be exerted to clamp large work, the vise handle can be gripped in the regular way.

—W. C. Wilhite, Carlinville, Ill.



☐ Fruit purchased at a market always should be wiped off with a clean, slightly damp cloth before it is put away, this cleans it and tends to check rot that may have gotten on it from other fruits.

How to Safeguard Your Vacation Snapshots

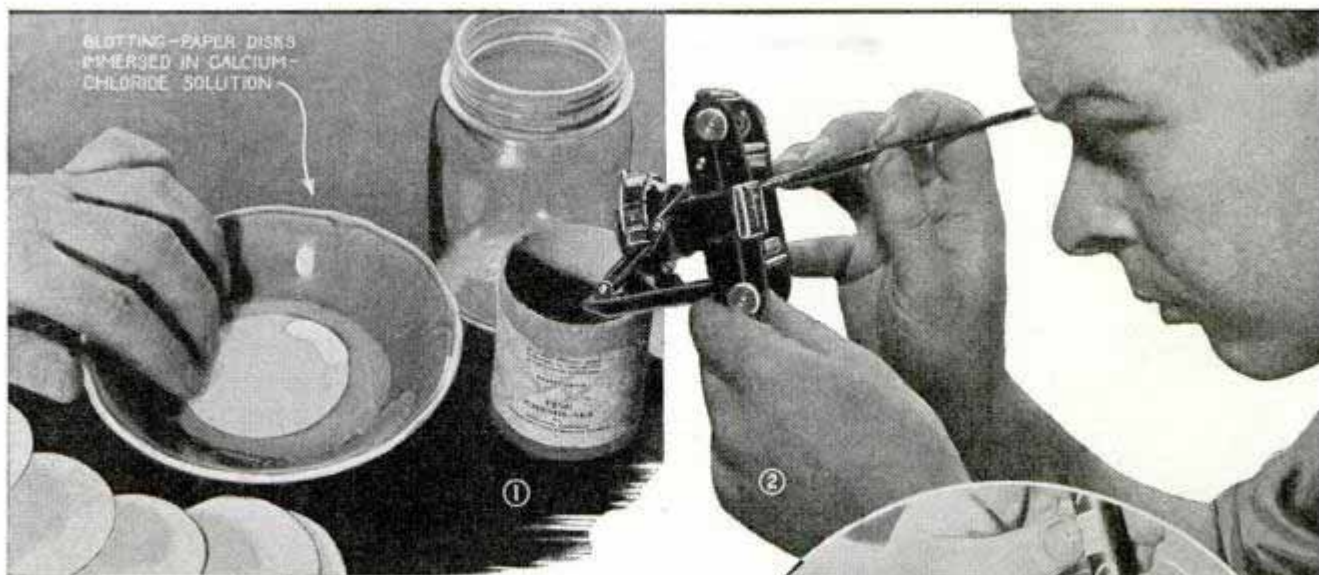

A thorough checking of your camera before starting a vacation may save the disappointment of finding some of your most prized shots ruined when you return and develop them. Dust is likely to be the most bothersome. Go after it with a sable brush, which is better than one of camel's hair for this purpose. Stroke it over your coat sleeve two or three times to get a good static charge and it will pick up every particle of dust and lint. Clean the lens and inside surface of the bellows carefully, as in Fig. 2, and you will avoid many spots when the prints are developed. Tighten all screws and nuts. A drop of celluloid cement on each one will help prevent them from loosening when riding or hiking with the camera. To protect your exposed film against excessive humidity, use an airtight container like the one shown in Figs. 1 and 3. It is a fruit jar containing six disks of blotting paper that has been impregnated with calcium chloride, which absorbs moisture from the film coating. To impregnate the disks, dissolve all the chemical possible in a teacup of water and place them in the solution, one at a time. When thoroughly soaked, remove the disks and dry them on a piece of waxed paper. Then put them in a warm oven for an hour to remove all traces of moisture, leaving the door open to avoid accidental scorching of the paper. When the disks are removed from the oven, immediately seal them in the jar. A piece of gauze should be placed on top of the disks to keep the film rolls from coming in contact with the paper.



"Bull-Dog" Wrench Really Grips without Relaxing

This high-leverage wrench differs from the usual type in that it will not let go the instant pressure is removed from the handle. Make it of hardened tool steel and you

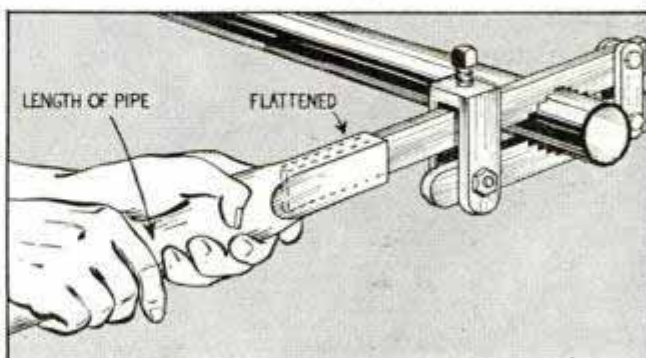

will have a wrench which can even be used with a chain fall hooked to the handle.

—Chas. H. Willey, Penacook, N. H.

BUILD YOUR



strike the centerline and on this locate the intersections of lines for the various stations, A, 1, 2, 3, 4, 5 and 6 as shown in Fig. 4 and also on your blueprints. These lines should be exactly at right angles to the centerline. Next, consult the table Fig. 2, "Half-Breadths from centerline," and you will note that the dimension of the sheer and centerline at station A is given as 0-8-7, which means 0 feet, 8 inches and $\frac{7}{8}$ inch. Mark that point then proceed with station 1, which distance from sheer to

Editor's Note: Information given in this article is intended only as general procedure for the amateur in building small boats of the types mentioned. Dimensions and details are merely to illustrate the proportions, shapes, positions and locations of the parts and are not sufficient to build any one of the boats shown, but are intended only as supplements to plans or designs for the various craft

PART I—Laying down hull lines; building frames, stem, keel and transom

AT THE outset, success in building a boat means just two things: Knowing beforehand exactly what type boat you want to build and then getting started right on the construction. Once you have the job accurately laid out the rest is easy.

Laying out plans: When you get your blueprints you will find on the first sheet a set of drawings and figures similar to those shown in Figs. 2, 4 and 5. This includes the lines profile, half-breadth lines plan and body plan, and table of offsets. From these it is possible to lay out the plans accurately to full size. The first step is to paste together sheets of wrapping paper to make a single sheet large enough to draw the details full size as in Fig. 6.

When laying off the hull lines first

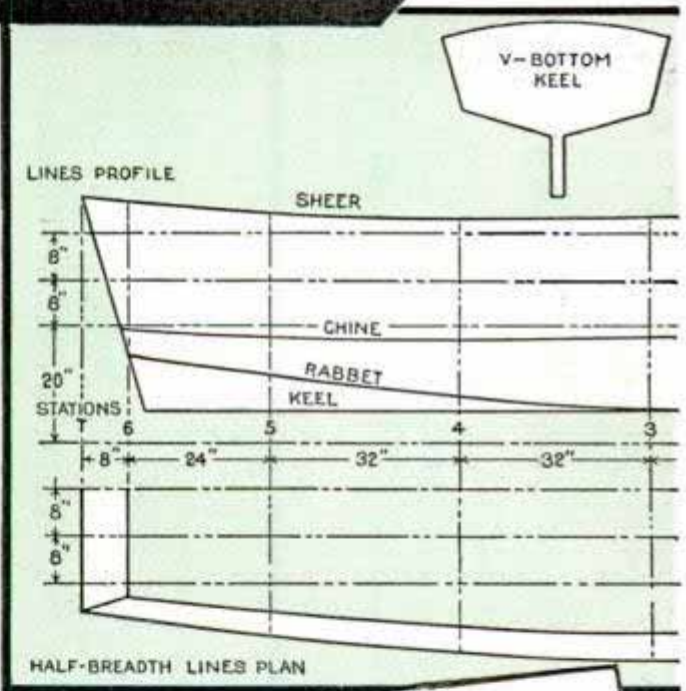

②

TABLE OF OFFSETS
DIMENSIONS ARE IN FEET, INCHES AND EIGHTHS OF INCHES AND ARE TO OUTSIDE OF PLANKING

HEIGHTS ABOVE BASELINE		0	A	1	2	3	4	5	6
STATION									
SHEER		3.11.0	3.9.5	3.7.1	3.5.0	3.3.5	3.3.4	3.4.0	3.6.0
CHINE			2.0.7	1.10.5	1.8.0	1.6.2	1.6.0	1.6.3	1.8.0
B 1				1.5.4	0.13.7	0.11.4	1.0.1	1.2.5	1.5.0
B 2					1.5.4	1.2.3	1.2.7	1.5.3	1.7.1
RABBET			1.4.0	0.11.4	0.8.7	0.8.1	0.9.7	1.0.1	1.3.0
KEEL						0.7.0	0.7.0	0.6.1	
HALF-BREADTHS FROM CENTER LINE									
CHINE			0.5.2	1.1.7	1.10.6	2.2.4	2.1.6	1.10.2	1.6.7
L W 1				0.9.7	1.8.1	2.2.6	2.1.1	1.10.1	1.6.7
L L 1				1.2.4	1.11.7	2.3.3	2.4.2	2.0.5	1.9.1
L L 2				1.4.1	2.1.6	2.5.0	2.5.6	2.1.5	1.11.0
SHEER			0.8.7	1.6.2	2.4.0	2.7.0	2.6.0	2.2.4	1.10.7

BOAT RIGHT!

centerline is 1-6-2, or 1 foot, 6 inches and $\frac{3}{8}$ or $\frac{1}{4}$ in. Continue with all other stations in like manner. When the points showing where the sheer crosses the transverse or station lines are located, bend a 1 by 1-in. pine batten along these points and strike a line. This will give you the actual sheer line of the completed boat. Use the natural curve of the batten in your work. The chine curve comes next, and, to avoid confusion, it is a good idea to use a red pencil or chalk for this. The chine is laid out in the same manner as the sheer

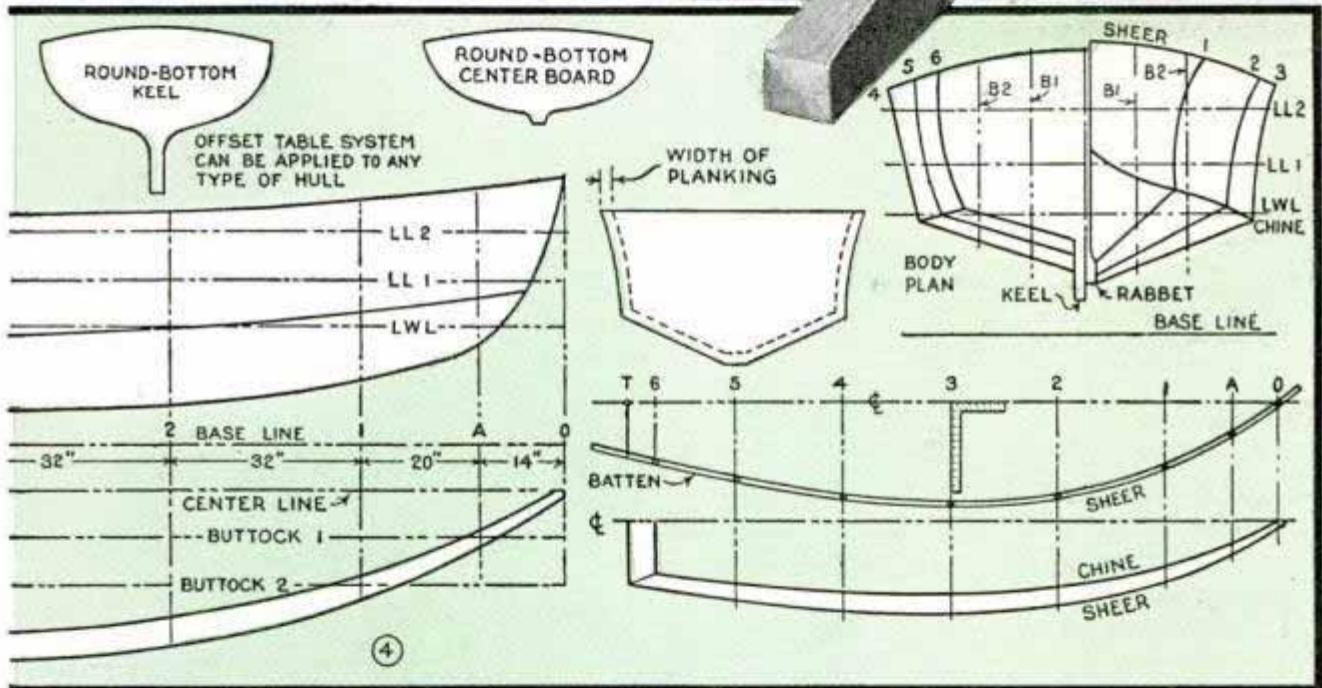
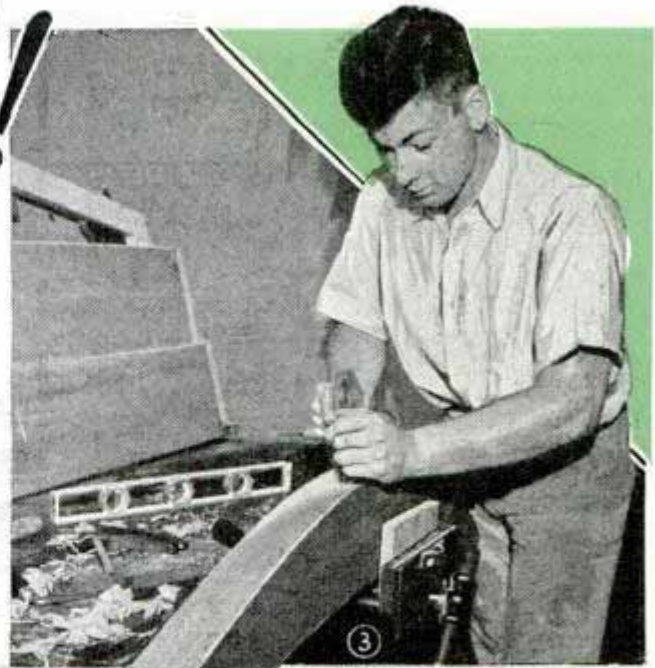

line. See the lower-right details in Fig. 4. You will note that in the half-breadth lines plan in Fig. 4 are shown two horizontal lines designated as Buttock 1 and Buttock 2. These are only necessary in round-bottom boats, that is, where the section between keel and chine is curved. Likewise the horizontal lines marked LWL (load water line), LL1 and LL2 are required only where the sides are curved, or have a bulge between the sheer line and chine.

To lay out the lines profile you must have a baseline, and if your floor space is of limited area, you can use the centerline already drawn as a baseline. Vertical lines are drawn at right angles to the baseline, and the sheer line laid out by consulting

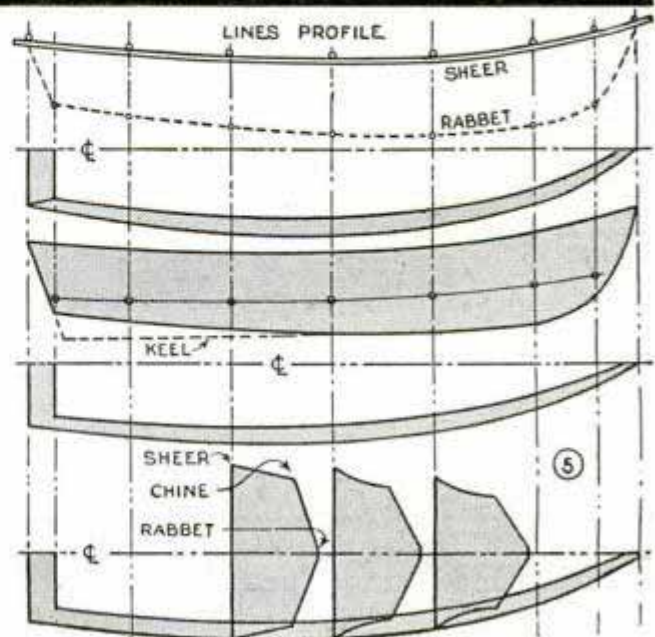

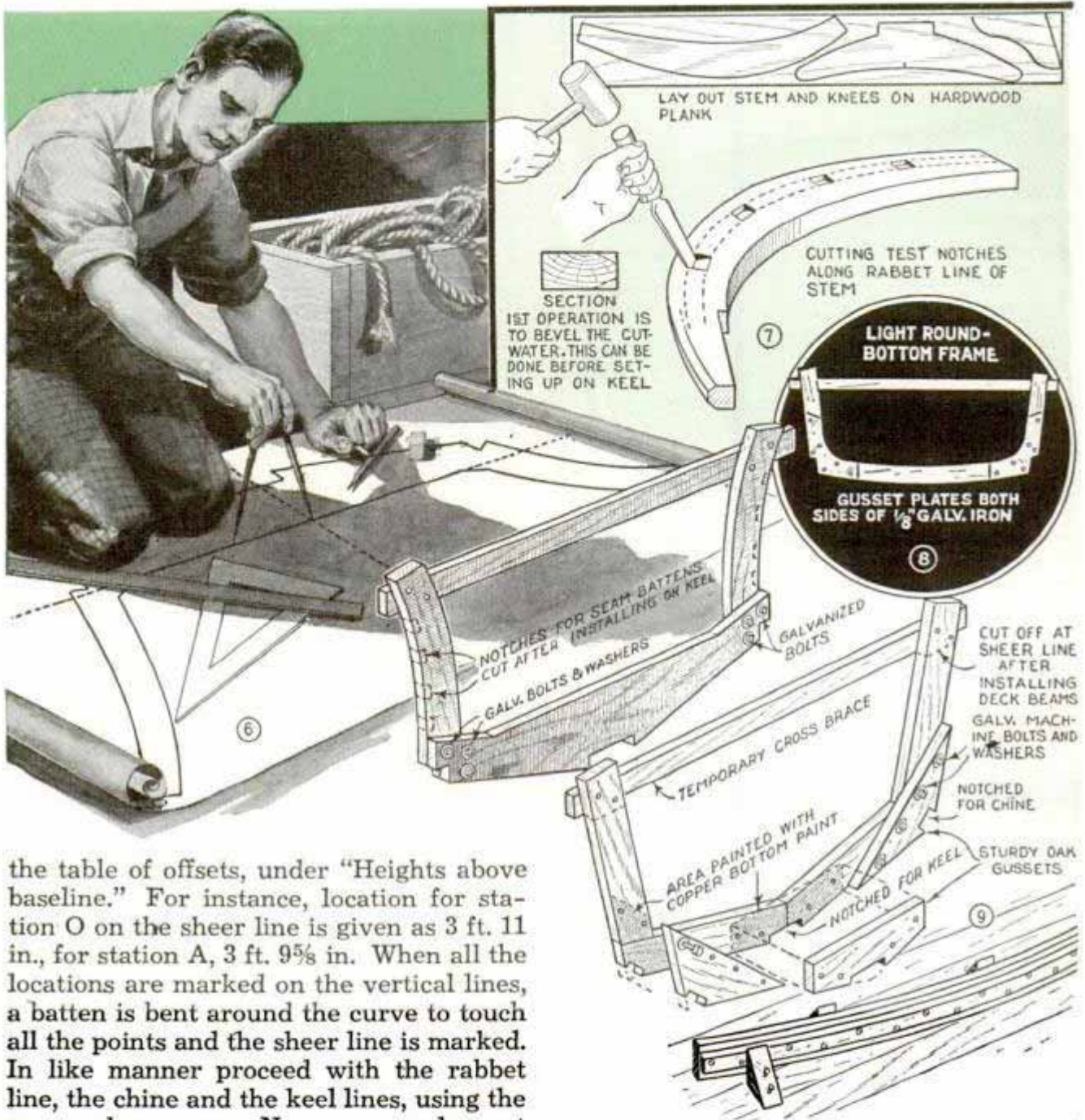

the table of offsets, under "Heights above baseline." For instance, location for station O on the sheer line is given as 3 ft. 11 in., for station A, 3 ft. 9 $\frac{5}{8}$ in. When all the locations are marked on the vertical lines, a batten is bent around the curve to touch all the points and the sheer line is marked. In like manner proceed with the rabbet line, the chine and the keel lines, using the same color crayon. Now you can lay out the frames for the stations. You have the width across the top of the frames, or distance between sheer lines, which constitutes the width of the boat at that point. You also have the width at the chine, likewise height from rabbet to chine and from chine to sheer, which completes everything necessary for laying out a V-bottom frame having flat sides. However, if there is a curve in either of these lines between chine and rabbet or sheer, you will need the body plan as in the top-right detail, Fig. 4, and the lines Buttock 1, Buttock 2 and depending on the boat, LW1, LL1 and LL2. Keep in mind that the dimensions given on the offset table, Fig. 2, are to the outside of the planking. Therefore, in making the

station frames, always allow for the width of the planking.

Building the frames: If other wood is not specified, make the frames of white oak. Usually they are made with a lap joint at the chine, bolted with galvanized bolts on the larger hulls. Side members are always longer than the completed job, with a temporary cross member to prevent their being forced in when putting on the planking, Figs. 8 and 9. This cross member is later removed. Notches for seam battens are best cut after the frame is installed on the keel, for better alignment. Notches for keel and chine are cut before fastening the frame to the keel. An exceptionally sturdy frame without excessive weight is made by

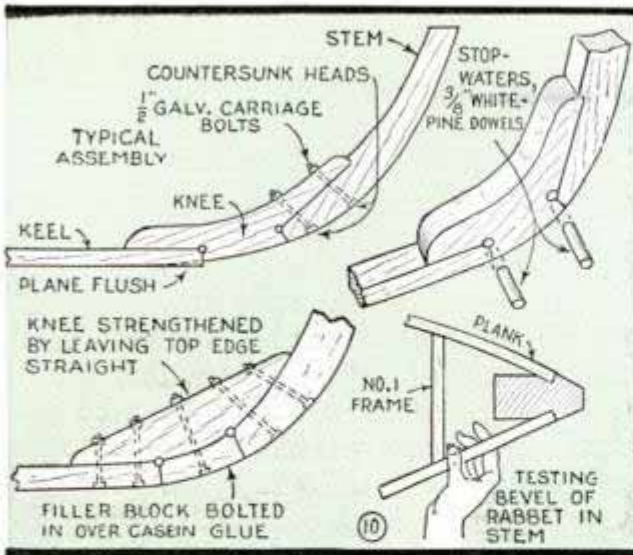

bolting on oak gussets at the chine and keel. The contacting surface is first painted over with copper bottom paint. Machine, instead of carriage bolts, are used with washers on each side. For a light sailboat or dinghy water-resistant plywood, brass or galvanized gussets can be used. Steam-bent ribs, Fig. 12, are used in many

Copper bottom paint should be used on the contacting surfaces. If pieces full length of the boat are not available, the keel can be spliced, as indicated in Fig. 13. This makes a very strong joint and if the upper block is beveled, the curve will not be impaired. In built-up frames, the keel is set in a notch, but with the steam-bent frame this is not practical, so filler blocks are used instead, as shown in Fig. 13, the cen-

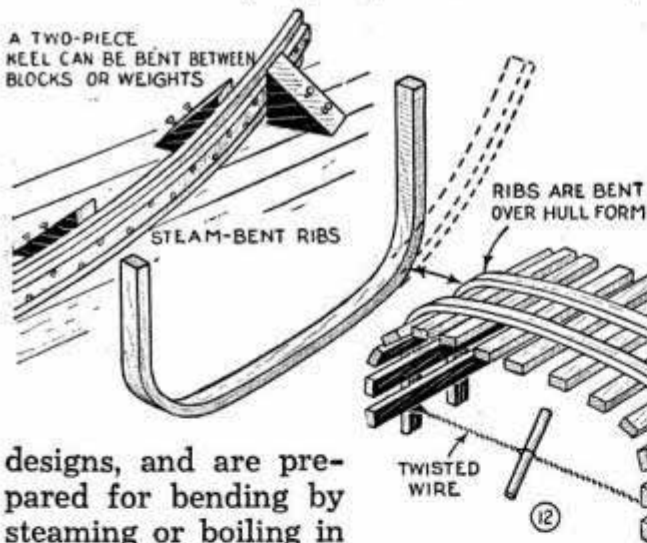

designs, and are prepared for bending by steaming or boiling in a tank or large iron pipe, Fig. 14, for about an hour. They are then bent to shape over an inverted form on which the boat is to be built, the ends clamped or screwed to the form, or drawn down by twisting wire, as shown.

Building the keel: Keels usually are of white oak and can be made in one or two pieces. The one-piece job requires roughing out the rabbet by circular saw and finishing with a plane. If there is a pronounced curve and it is necessary to assemble the two-piece keel before putting on frames, the two members can be bent between blocks nailed to the floor and screwed together in that position, Fig. 12.

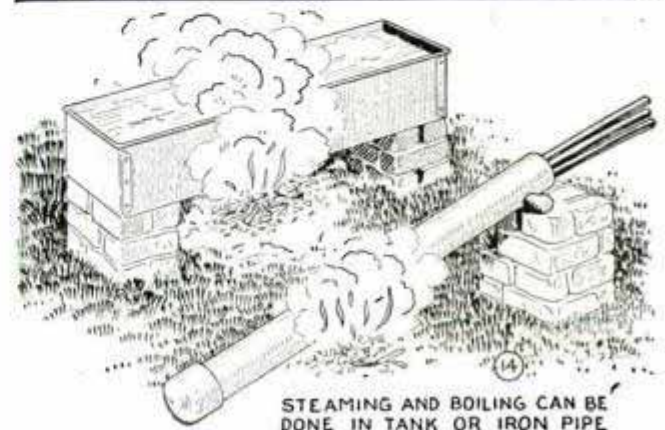
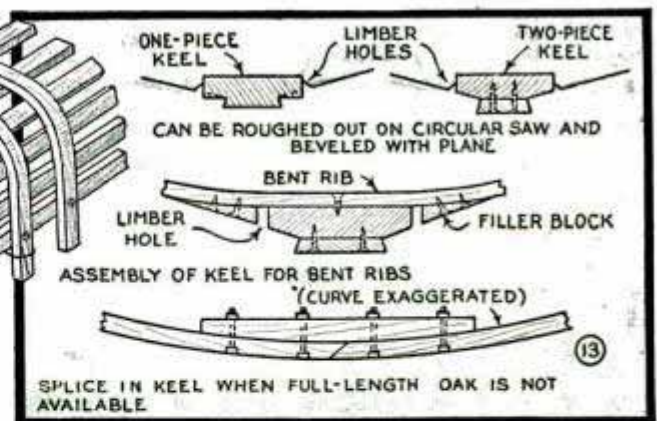

STEAMING AND BOILING CAN BE DONE IN TANK OR IRON PIPE

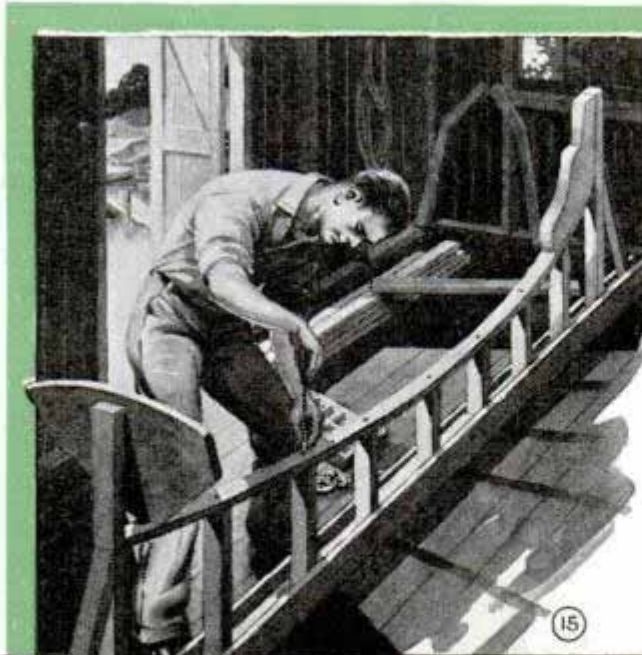

ter detail, and in Fig. 16, the lower-left details.

Shaping stem and knee: Oak may be used for stem and knee, Figs. 1, 3, 7 and 10. As a rabbet or V-groove must be cut for the ends of the planking along its curved length, the beginner may wish to make his stem in two pieces bolted together. In this manner he can form the groove with draw-shave and plane, whereas in a one-piece stem the work must be done with a chisel. In the latter case the rabbet must be finished while the stem is installed on the keel permanently. Preliminary test notches may be cut on the workbench. When set up, these notches can be tested with a stick, or "fid," held against the first frame

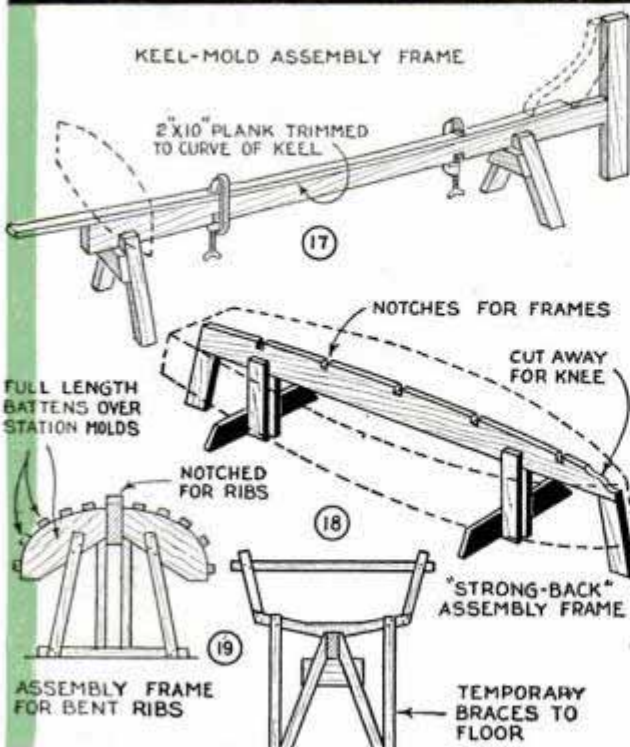
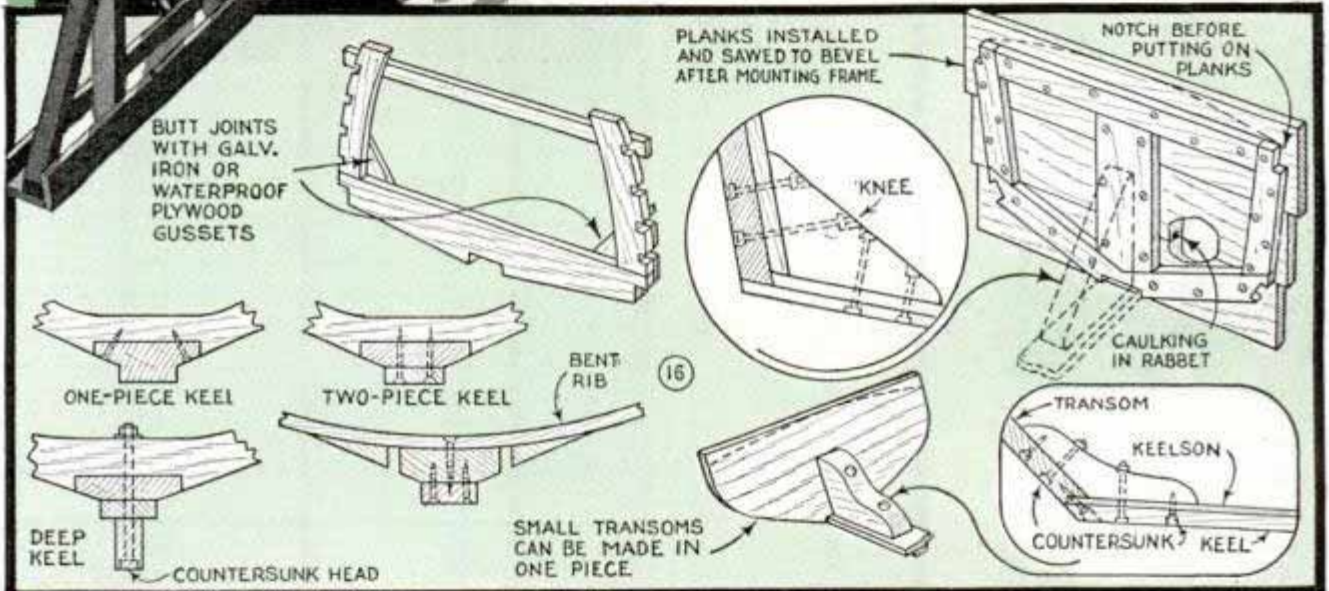

as in the lower-right detail, Fig. 10. When the test notches, Fig. 7, are the proper depth, chisel out the waste between them to the same depth. Knees, Figs. 10 and 11, are made in two or three forms, one of them being left with a straight edge at the top so as to take advantage of the full strength of the wood. Cutting a curve in a stem is partly for appearance and partly to give more room forward. Shorter bolts, however, can be used in a cut-away knee. Stop-water plugs are essential to any well built stem assembly. These are simply soft white-pine dowels, about $\frac{3}{8}$ in. in diameter, driven in to a tight fit. Moisture causes them to swell and form a watertight joint, Fig. 10.

Building the transom: The design of most boats permits transom frames being set up on the keel the same as station

frames, and the planking put on later. In this case the transom frames differ from station-frame construction only in that there are butt instead of lap joints, with gussets on the forward side as in the upper-right detail, Fig. 16. Small transoms can be made in one piece without cleats or battens, but always require a knee. Getting the proper bevel on a transom is a job demanding great care, and usually can be done best after the transom is on the keel. Roughing cuts are done with a handsaw and finished with a plane. Where two or more planks are required for the transom, a neater calking job is accomplished by setting candle wicking in a rabbet with marine glue, than in the V-joint which would be visible. Bolt heads in transoms should be countersunk far enough to be covered with a wooden plug of the same material as the transom planking.

Fastening frames to keel: Galvanized or bronze hardware should be used throughout in all boats, especially in parts below the waterline. Various methods of fastening frames to the keel are given in the lower-left details, Fig. 16, each depending more or less on the design and size of the hull. In all cases screw or bolt heads outside the hull must be countersunk.

Assembly frames: Building a boat on a specially constructed frame makes the work much simpler. An easy one to build is a simple keel-mold with an upright at one end to support the stem, Fig. 17. The keel-mold is simply a plank with the upper edge trimmed to the curve of the keel. In this type of frame the boat is built upright. By building the boat upside down the planking problem is much easier, and this plan usually is handier for small craft. Another common method is the strong back assembly frame, Fig. 18. Hulls with bent ribs are easily built over a form as shown in Fig. 19. For hulls over 20 ft. long, and of considerable weight, a frame can be built of a series of 2 by 4-in. uprights cut to the proper length and angle to conform to the rabbet line, Fig. 15. The keel or keelson is easily bent to this line by a weight after which it can be secured with four or five screws driven into the uprights. When a deep keel or shaft log is to be installed, two or three of the uprights are simply knocked out to make room.

(To be continued)

Hose Held on Side of Mortar Box While Mixing Cement

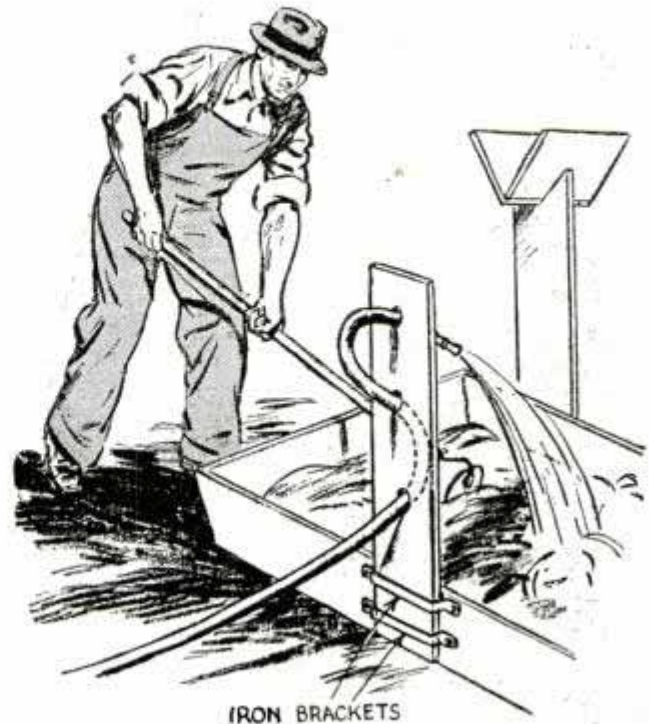

IRON BRACKETS

To facilitate adding water to cement while mixing it single-handed, one workman used a short piece of wood having three holes drilled through it to take the hose as indicated. A pair of iron brackets supported the wood vertically and permitted it to be removed quickly when not needed.

Lots of Fun with Microscope Made from Spool

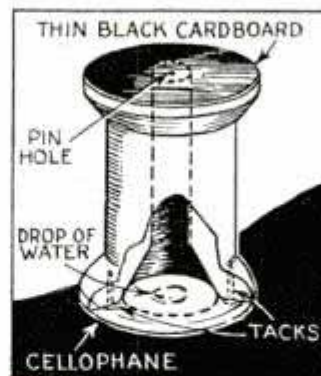

By using a well-known optical principle, with but slight effort you can make an instrument capable of magnifying certain objects considerably. Take an ordinary thread spool, enlarge the bore in one end and paint the inside surface black. Glue a piece of black cardboard over the top and pierce with a small needle. On the bottom tack a disk of Cellophane. Place a drop of water on this and lay a fly's wing or other thin, transparent object in place. Hold before a strong light and look through the pinhole.—H. Arrall, Newburyport, Mass.

Beach Blanket Fastened in Place by Clips on Pegs



Beach blankets or picnic tablecloths are easy to fasten in place by slipping a paper clip of the type shown over each corner and driving a long wooden peg or a spike through the holes in the finger grips. The clips are obtainable in various sizes and the holes vary accordingly. Small dowels sharpened to a point will provide good stakes for the purpose on sandy beaches but spikes will hold sufficiently on sod.

Model Yacht Hulls Hollowed on Drill Press

After the outside of your boat has been shaped to final dimensions, place a felt pad on the table of your drill press, adjust the depth gauge to the thickness you want the walls to be, and with a $\frac{1}{2}$ -in. high-speed wood bit, or router, remove the surplus

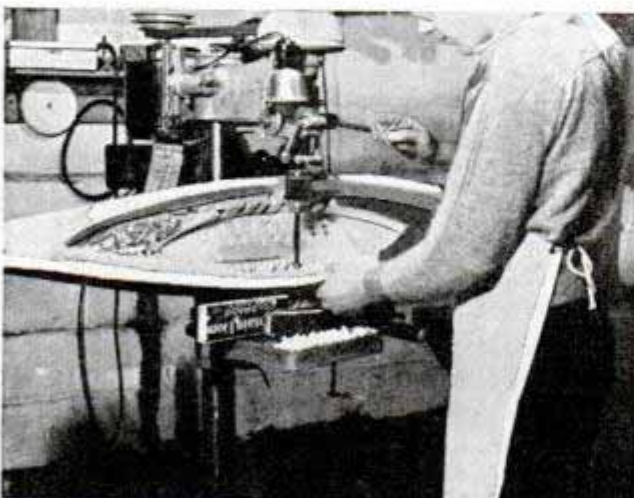

stock by boring a series of overlapping holes. This can be carried almost to the extreme bow and stern, where a smaller bit will finish the job.

—Walter K. Moss, Milwaukee, Wis.

Fresh Paint Removed from Glass with Rubber Eraser

Paint that gets on the edge of a window pane when painting the sash, is removed easily with a pencil eraser. Work the end down to a chisel edge on fine sandpaper to give it a good wiping shape. After each stroke, wipe the rubber with a clean cloth.

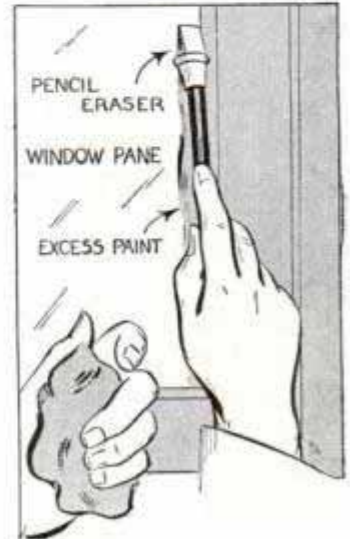

Moisture Absorption in Pipe Stem Reduced by Charring

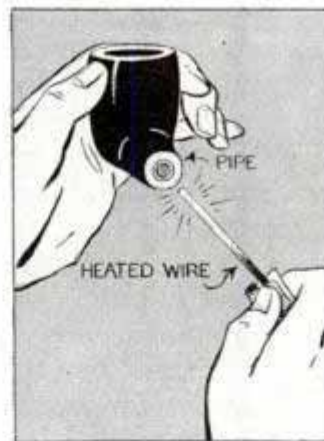

Many smokers who char the inside surfaces of their pipes to make them resistant to moisture absorption, overlook the wood portions of the stems. This is the portion where moisture collects while the pipe is in use and

soon gives it a strong taste. To char the stem, heat a wire and push it into the stem.

Keeping Pencil from Rolling

Stick a paper index tab, of the kind shown, to a round pencil and it can not roll off your desk or table. The tab is light and does not interfere with using the pencil or carrying it in the pocket.

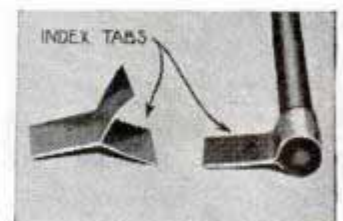

Simplified AIR COOLER for homes in arid climates

Just a large box outside the window. A fan pulls in air through a porous water-cooled wall of excelsior

HOMEMADE air-cooling outfits built at moderate cost are bringing comfort to thousands of residents in the southwestern semi-arid states. Ranch houses, city dwellings, stores, offices, shops, even theaters and a radio station have been cooled satisfactorily, interior tempera-

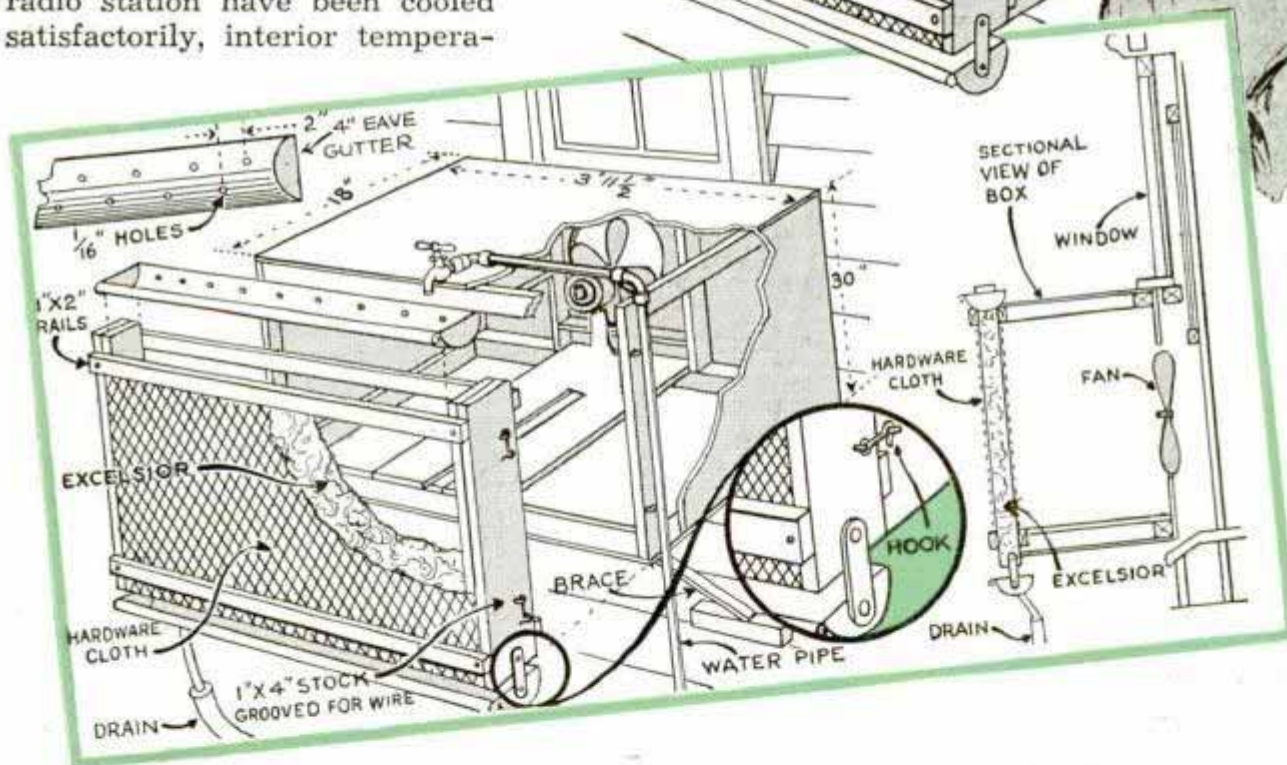
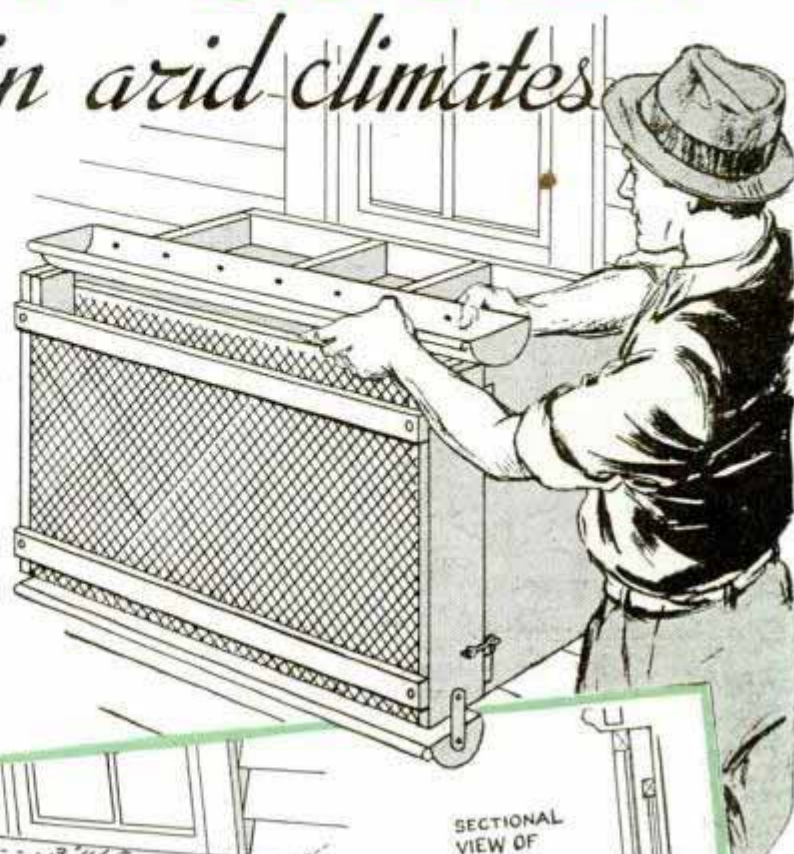

tures being reduced from 10 to 20 degrees. However, it must be remembered that this method of cooling has been successful in regions where the air is dry but is not recommended for use in regions where summer humidity is relatively high.

Incoming air is drawn through a water-moistened layer of excelsior by means of a ventilator type of fan. An ordinary circulating type of house fan is not designed for this type of work and will not be effective. The layer of excelsior, about 2 in. thick, is

held snugly between two screens of wire mesh or hardware cloth placed on one or more sides of a large box that fits against an open window on the shaded side of the building. The fan is placed in the side of the box opposite the excelsior wall. To assure that all the air will be drawn through the excelsior, the box must be fitted against the building carefully and accurately so that leakage of air at this point will be reduced to a minimum. By opening a window or door on the side of the building

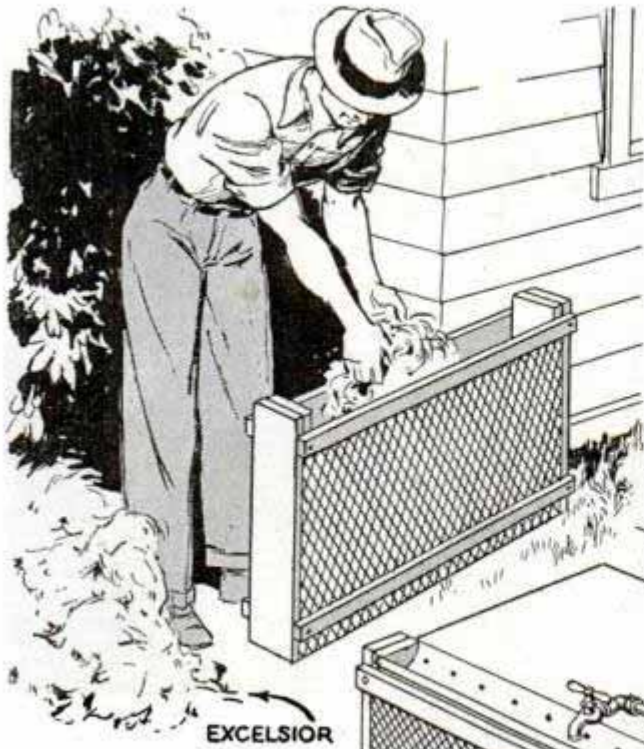

opposite the intake box, or by opening an attic louver and a door or register to the attic, and closing all other windows and doors, a constant circulation of fresh, cool air is assured. Fresh air must be brought in constantly, as recirculated air in the building would soon become humid to an uncomfortable point.

The fan capacity is determined by the amount of air that must be replaced; a fan that will replace the air in rooms to be cooled at least once in 3 min. has been found satisfactory. The velocity of air passing through the excelsior should be kept below 200 ft. per minute. This can be accomplished with excelsior padding, packed at somewhat less than 2 lbs. per cubic foot. The padding also helps to filter dust and pollen from the air. When the excelsior becomes heavily coated with dust, breaks down from any cause, or if objectionable odors arise due to continuous wetting, it should be replaced with fresh material. A screen panel or a baffle can be placed in front of the fan inside the building to deflect the air and avoid direct drafts. To distribute water to the excelsior pad and to carry off the excess water, two short troughs are provided, one directly over the pad and the other one under it.

The upper trough is perforated to distribute the water and the water-supply line is provided with a petcock so that the rate of flow can be controlled. Generally about $5\frac{1}{2}$ gals. of water per hour produces sufficient cooling effect on air coming in at the rate of 1,600 cubic feet per minute, through a pad of excelsior 2 in. thick and having an area of 8 sq. ft. However, it is advisable to allow fifty per cent more than this to assure thorough wetting of the entire pad. The holes in the upper trough should not

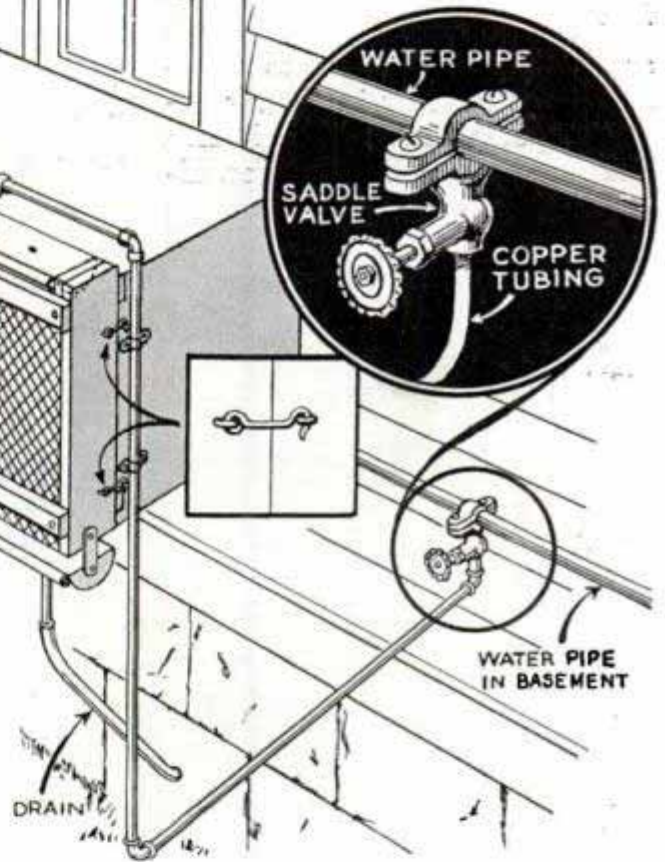

be larger than $\frac{1}{16}$ in. in diameter, are spaced 1 in. apart and are staggered along each side of the center line. To the lower trough, a length of pipe or hose is attached to carry off excess water.

An excelsior cooling unit can be installed in the cold-air duct of a warm-air furnace system having fan circulation. Close the air-return register so that air will not be recirculated, but outside air will be brought in. In making such an installation, do not overlook the need of adequate drainage from the cooling unit.

☛ Iron rust on marble can be removed by rubbing the stain with lemon juice.

ATTIC FAN *gives* NIGHT COMFORT

With this arrangement it takes only a few minutes to notice cool, refreshing evening air coming into your house to replace hot, humid day air. A discharge fan is installed in a tight box that fits snugly over a large wood or metal grille in the attic floor. Open louvers in the attic wall permit the hot air from the lower rooms to be exhausted outdoors quickly, and suction caused by the fan draws cool air through opened doors and windows. Previous methods of installing discharge fans in attic walls are not generally effective in drawing up a large volume of air from lower rooms because of leaks at eaves which permit entrance of outside air at less resistance

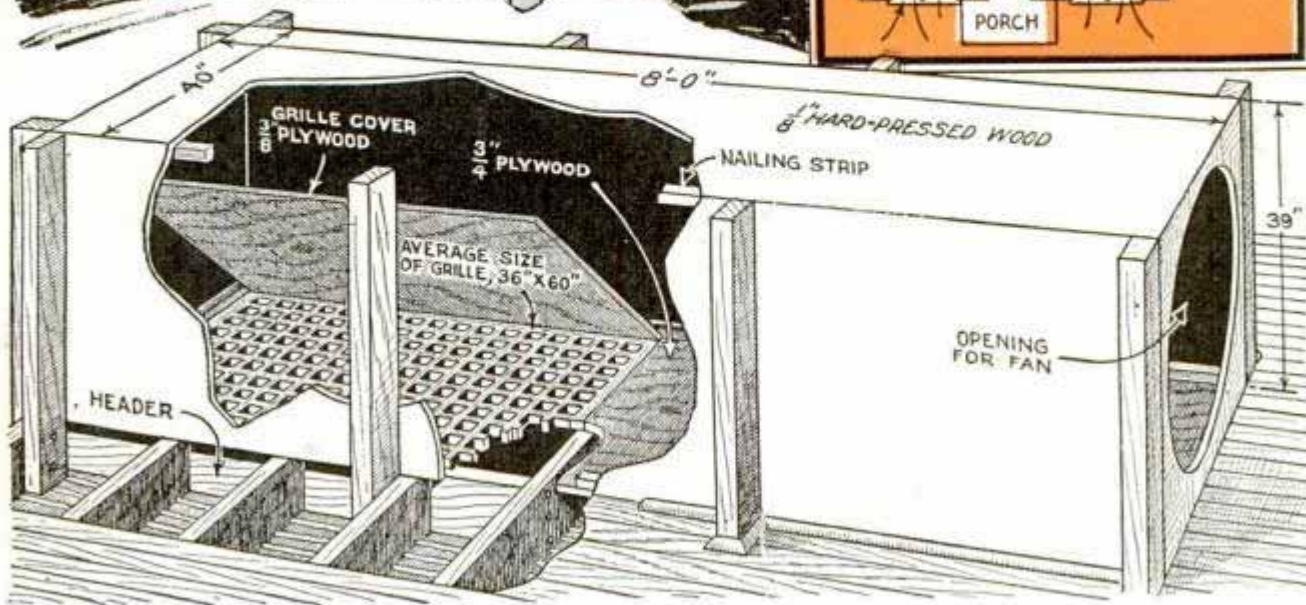
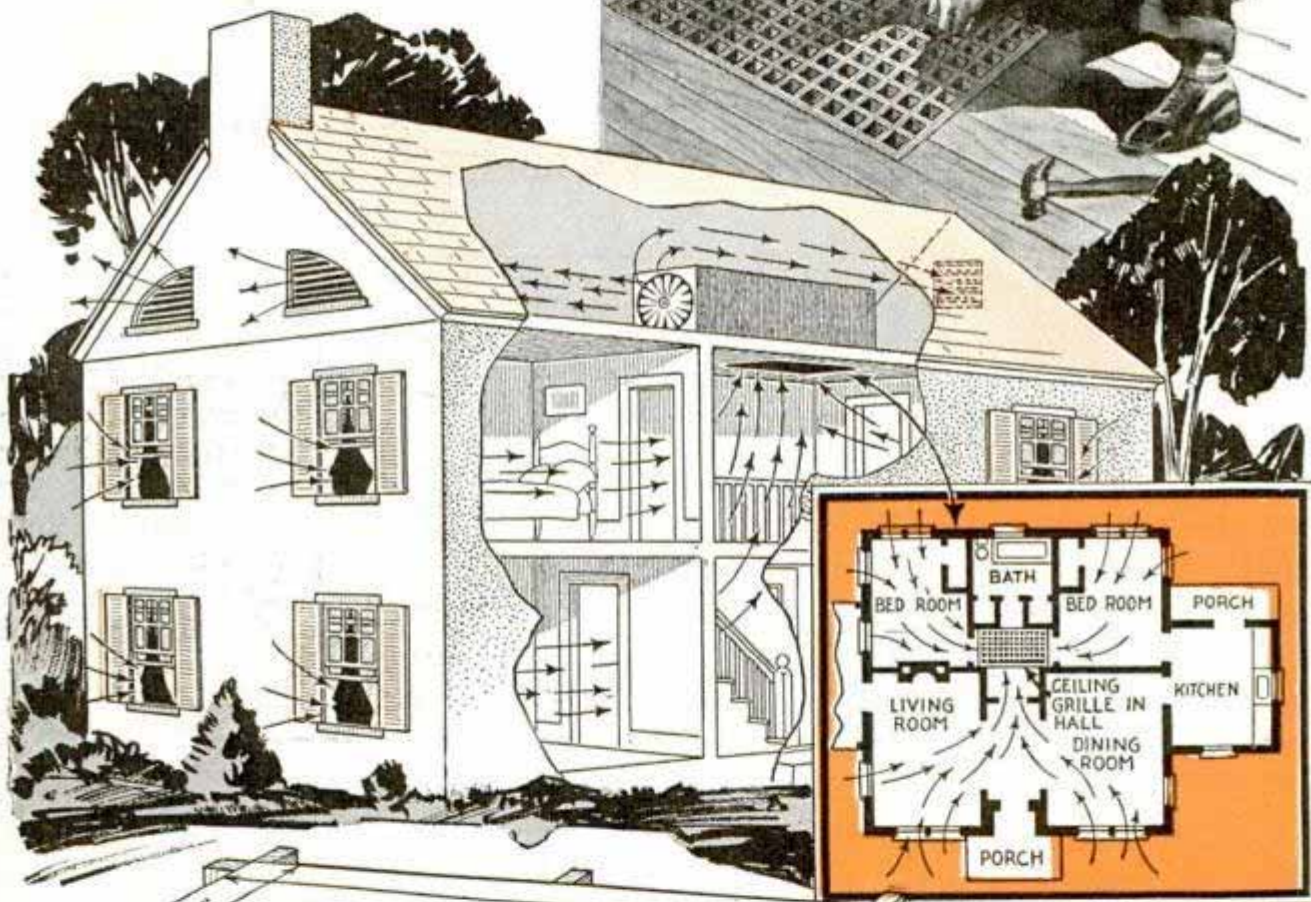

Paint-Bucket Hanger on Ladder Hooks over Rung

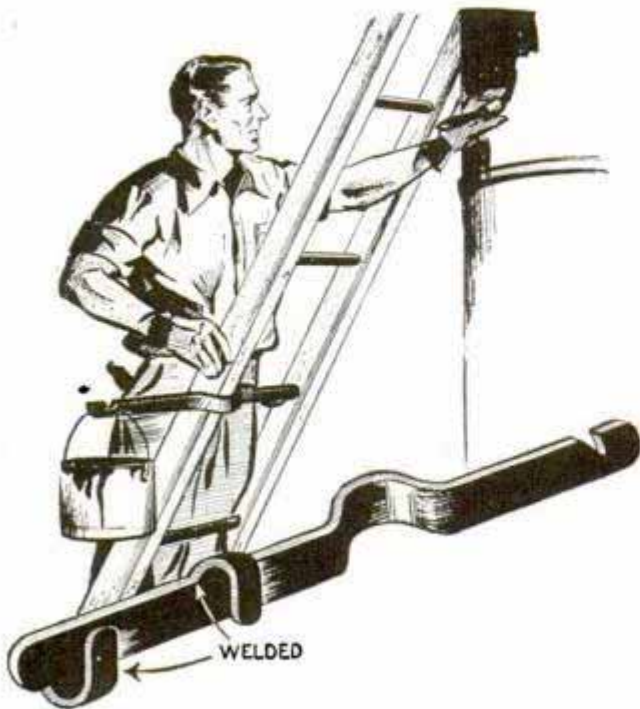

Both hands of the worker are left free and the paint bucket is still easily reached and readily moved if this metal hanger is used. It is made of flat iron and has two lugs welded in place which are bent to fit over and under a ladder rung.

Insect Powder Dusted on Plants with Skirted Sifter

Needing a plant duster that could be used on windy days as well as on calm days, a gardener made one inexpensively from a flour sifter and a piece of cloth. The



latter was tied around the sifter and a wire ring was put in a seam in the bottom to give the cloth a cone shape.

Flowers with Stems Cut at Angle Remain Fresh Longer

Before placing flowers in a vase, cut off the stems at an angle as indicated. This exposes more of the plant cells in the stem to the water, which results in keeping the blossom fresh for a longer period of time than when the stem is cut straight across.

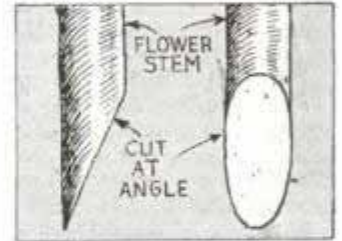

Penholder Supports Casting Rods and Protects Tips

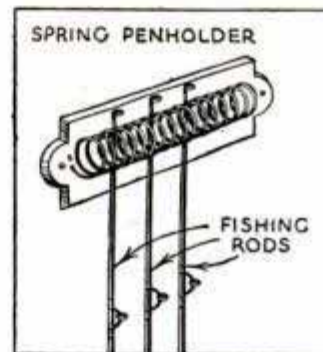

Screw a book-keeper's spring-type penholder to the wall of your summer cottage and hang your casting rods in place so that they will not slide and bump the agate tips against the

floor or furniture. A holder of this type will support several light rods.

Using Door Turnbutton as Switch on Low-Voltage Current

Door turnbuttons provide handy switches at the electrical experimenter's bench where electric currents no stronger than those from a storage battery or toy transformers are handled. The but-



ton is mounted between two screws, which serve as wire terminals. The paint must be scraped from the bottom of the button to afford good electrical contact.

Gay Supports for Trellises and Flower Boxes

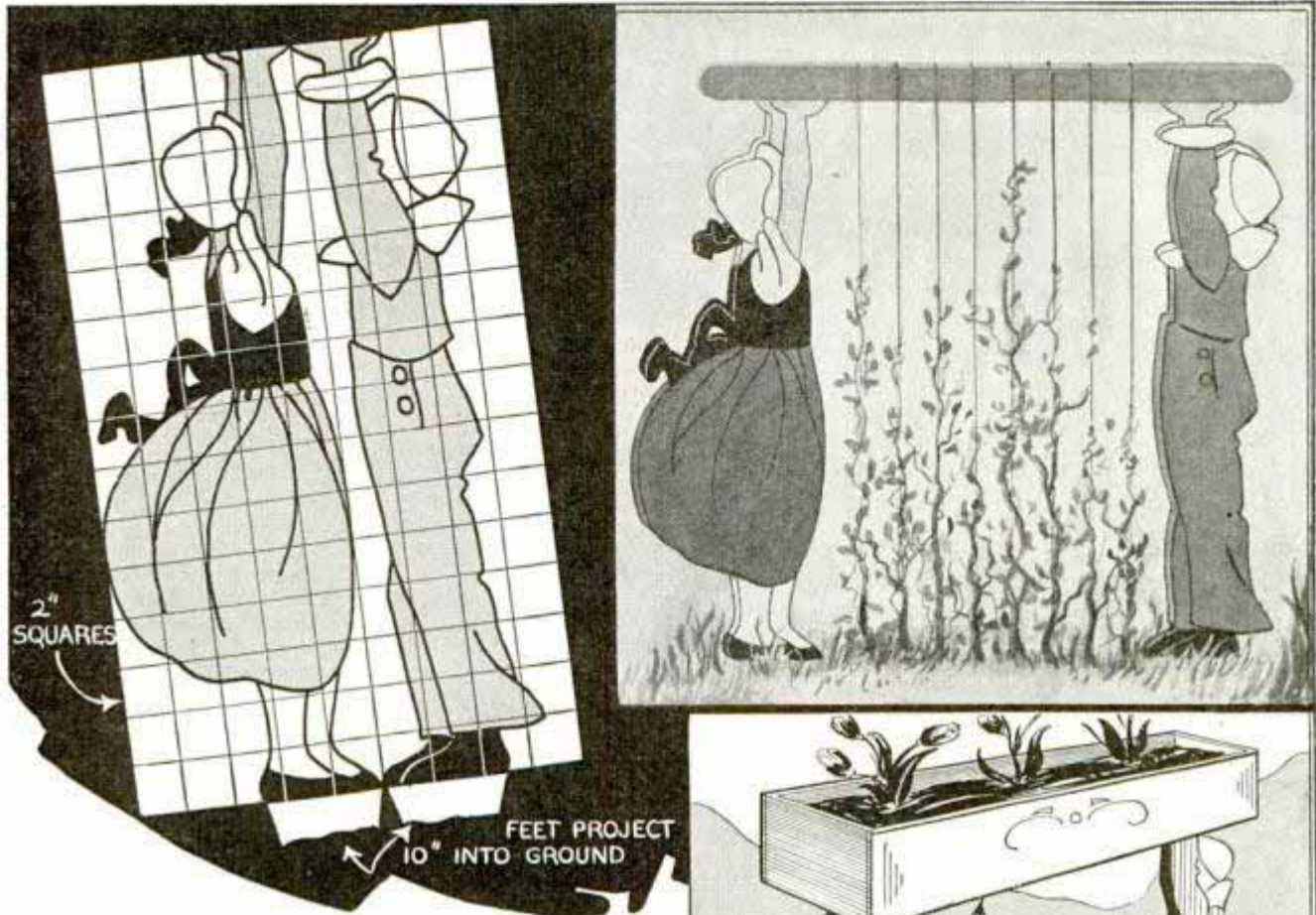

Painted to resemble folk costumes, these wooden cutouts make pleasing decorations in your garden. They may be used to support a bar with cords for vines, a flower box or a trellis. If the figures are to stand on the ground, the wood should project below the feet about 10 in. It is best to fasten them to wood or angle-iron stakes

driven deeply into the ground. The appearance is pleasing with the girl costumed in black, red and white and the boy in a blue with white trim.

Magic Pinwheel Changes Rotation at Command of Voice

You can have fun mystifying your friends with this trick pinwheel, which changes direction of rotation at a spoken command. The secret of making it spin is in the way the handle is rubbed. Grip the handle and rubbing stick as in Fig. 1 and, with a forward and backward movement, rub the stick over the notches, allowing the index finger to slide along one side as in Fig. 2. To reverse the direction, continue rubbing but lift the index finger as in Fig. 3, and let the end of the thumb nail rub against the opposite side.

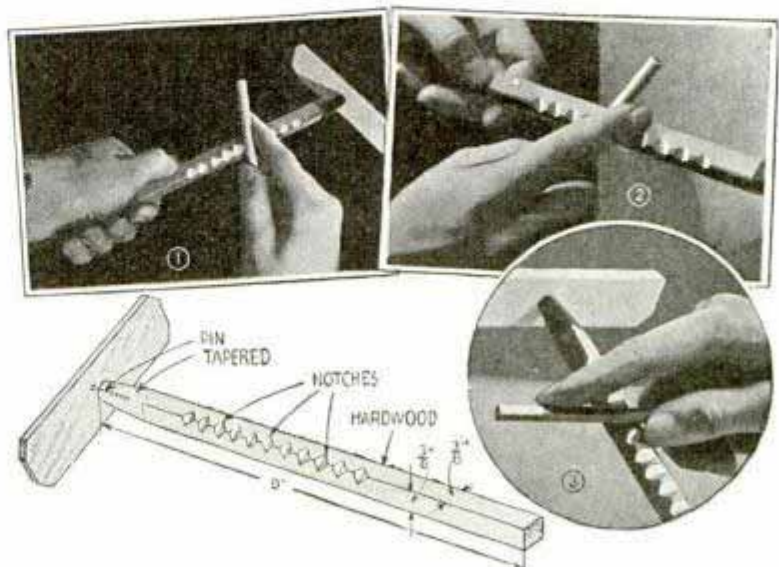

Solving HOME

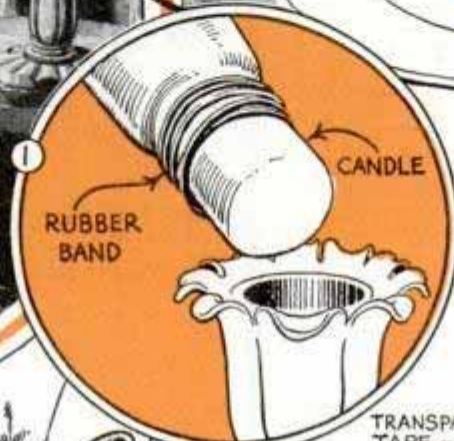
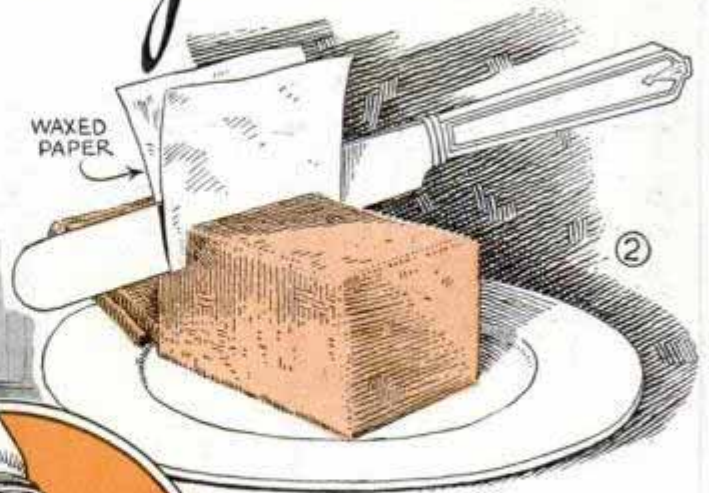

1, Rubber bands on lower end of candle make it fit tightly in a holder. You can slice many kinds of cheese neatly by slipping a piece of waxed paper over the knife, 2. Pages in your cookbook that contain favorite recipes can be protected with Cellophane held in place by transparent tape as in 3



4, If finger cots are worn while working in the garden or doing household tasks, they will protect the fingers and nails and give more freedom than gloves besides being cooler and more comfortable. When bristles of a shoe brush tend to spread so that it is of little use, tape as in 5 to make the brush serviceable again



6, Save old velvet garments and tear them into pieces to use as polishing cloths, especially for polishing highly-finished furniture as they do not leave lint on the surface

PROBLEMS

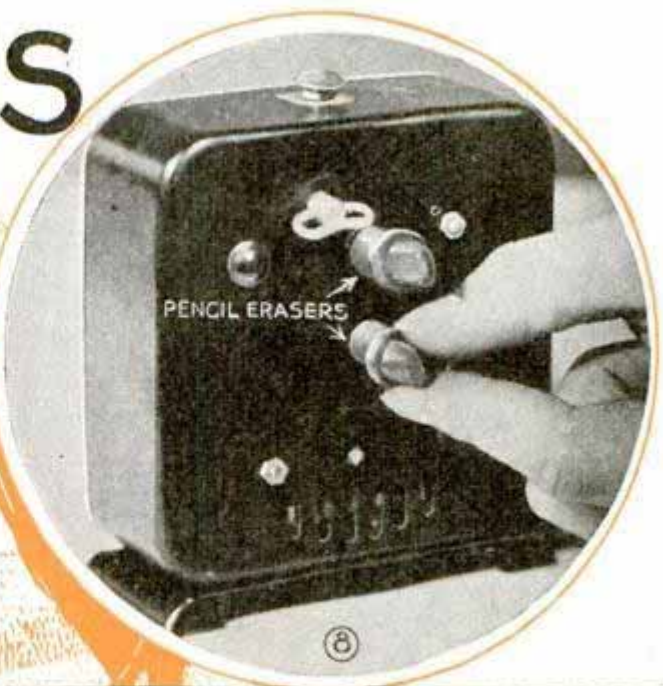
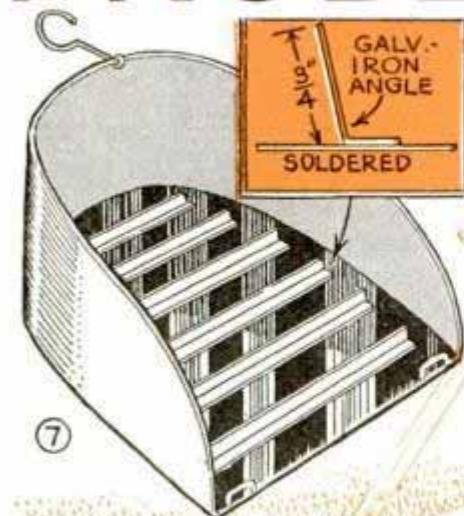

You can turn the hand-adjusting knobs of a small alarm clock easily if you slip pencil erasers of the type shown at 8 over them. Grass clippings are less likely to work out of the front of a grass catcher if sheet-metal angles are soldered or riveted to the bottom as in 7. Sagging screen doors that have a wood panel in the lower half can be strengthened with a piece of plywood securely screwed to the door frame as in 9

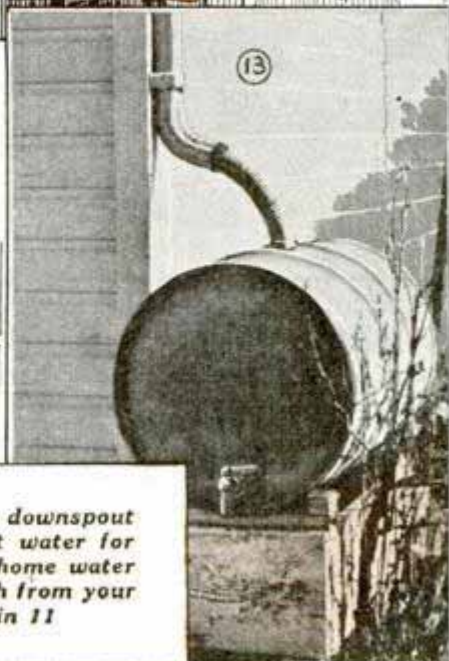
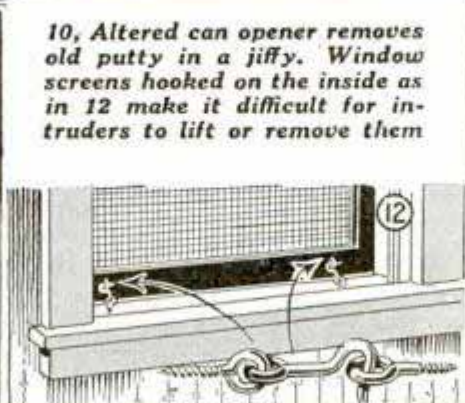
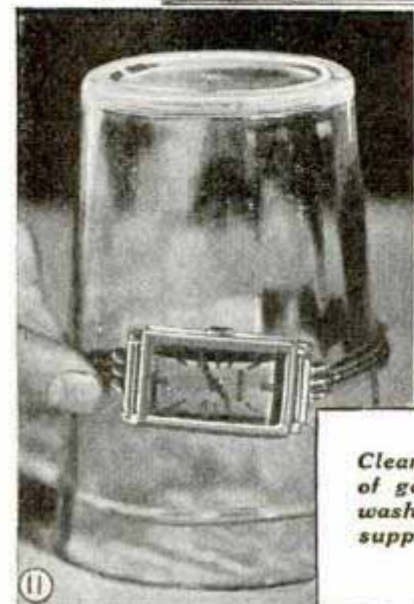
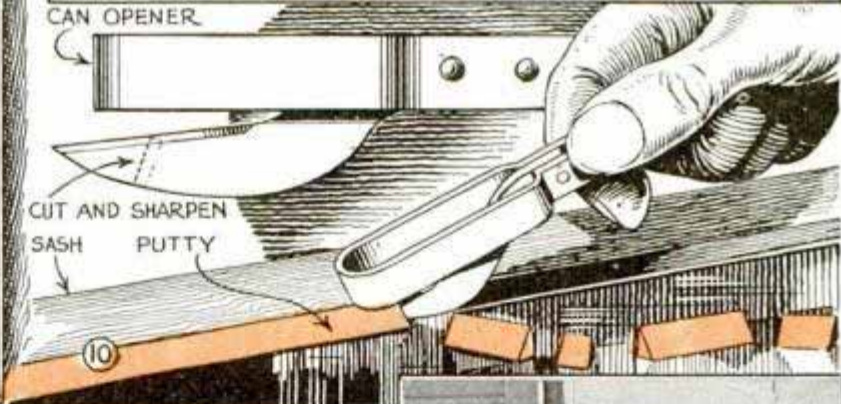
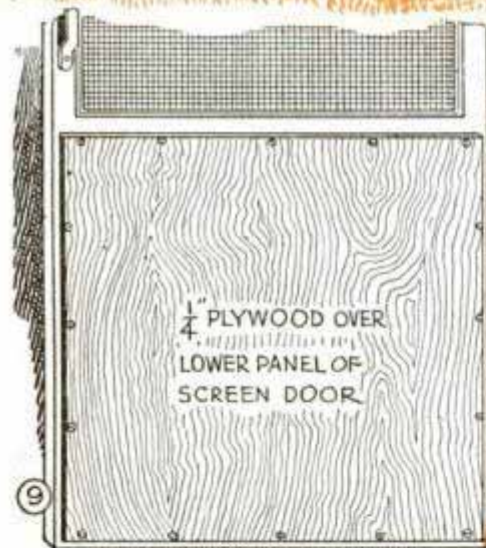

10, Altered can opener removes old putty in a jiffy. Window screens hooked on the inside as in 12 make it difficult for intruders to lift or remove them

Cleaned gasoline drum connected to eave downspout of garage as in 13, stores supply of soft water for washing hair and similar uses where the home water supply is hard. You can read a wrist watch from your bed if you slip it over a tumbler as in 11

Protecting Throat of Saw Teeth When Filing



Cracks in a large circular saw are often the result of careless sharpening by allowing the file to slip down and nick the edge

of the blade between the teeth. When this happens, vibration of the saw in use soon causes a crack to start from the nick. To avoid this trouble, one saw filer places a short length of sash cord between the teeth as shown.

Removing Traces of Gasoline in Steel Drums

When it is desired to utilize an empty steel gasoline drum for water storage all traces of gasoline can be removed as follows: First rinse the inside thoroughly with denatured alcohol, about 2 or 3 gals. After swishing the alcohol around so that it washes every portion of the inside surface, dump it out and repeat with a second alcohol wash in the same way. Then wash the interior of the barrel thoroughly with a boiling solution consisting of lye, 2 lbs., dissolved in water about $\frac{1}{4}$ of the drum capacity. After the lye solution has been drained, copious applications of water will eliminate all traces of the lye. In obstinate cases, it may be found necessary to repeat the entire process.

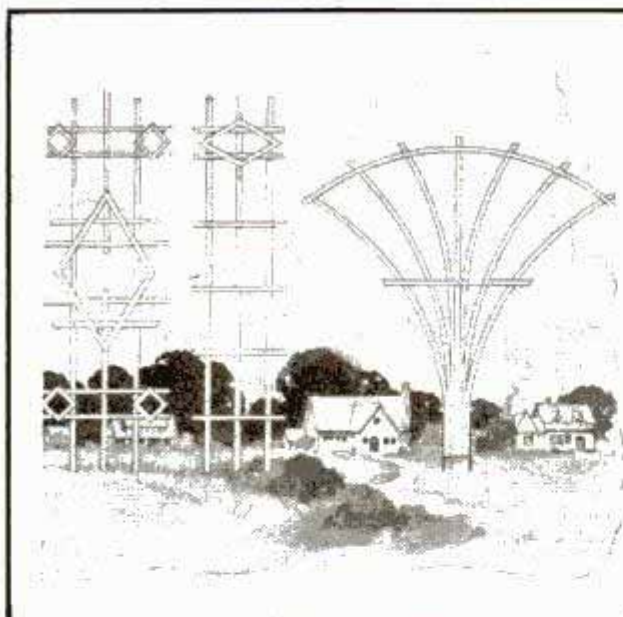

Three Simple TRELLISES to improve your home

Easy to Make:

Anyone can make these simple trellises with a few ordinary tools found around the average home. All three of them can be built and painted in a few evenings.

Cost Is Slight

All the material you need is some standard molding strips available at lumber dealers in practically all localities. The cost is about a cent per running foot.

Craftplan Shows How

For complete information on building these trellises, together with detailed drawings that give all dimensions and show exact method of assembling, send for Craftplan No. 3007, which we will forward upon receipt of the coupon and ten cents. Be sure to print your name and address plainly.

POPULAR MECHANICS MAGAZINE
200 E. Ontario St. Chicago

Enclosed find 10 cents for Craftplan No. 3007—
Three Simple Trellises

Please check I am a subscriber
 I buy at newsstand

Name _____

Use Pencil

Address _____

City _____

State _____



Radio

Radio Phone for SMALL BOATS

SMALL pleasure and commercial craft operating in sounds, bays, or at moderate distances off shore are now provided with a means for direct communication with land telephones, other boats and the Coast Guard. A "Ship Station" license is required to cover the particular type of equipment to be used and a "Third Class Radiotelephone Operator's" license is also necessary. Such a license is obtained by passing a simple examination covering the general rules and regulations applicable to mobile communication services; no code test is required.

The combination receiver-transmitter shown in photos Figs. 1 and 2 is completely self-contained and all power is supplied directly from a 12-volt storage battery. Covering the 2,100-2,900 kc. marine and the standard broadcast bands, the receiver operates through a loud speaker, or through the handset for two-way communication. The transmitter provides a 50-watt carrier on three crystal-controlled frequencies, each of which may be selected instantly. A shore station receiver adapted for marine work appears in photo Fig. 3. This is an 8-tube, 4-band, 110-volt a.c.-d.c. super.

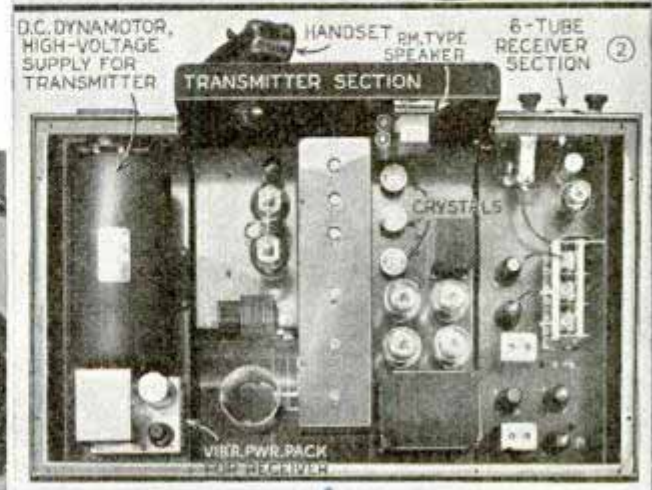
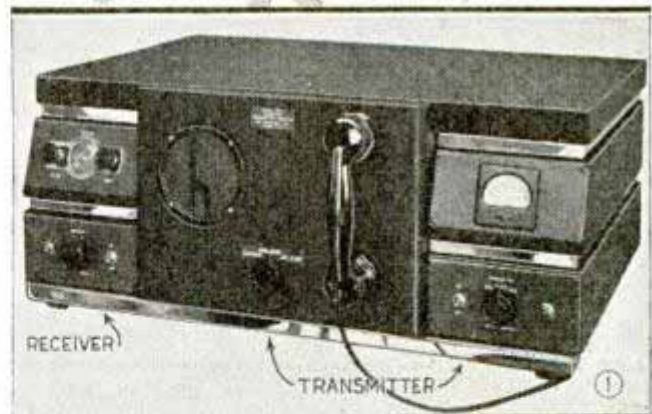
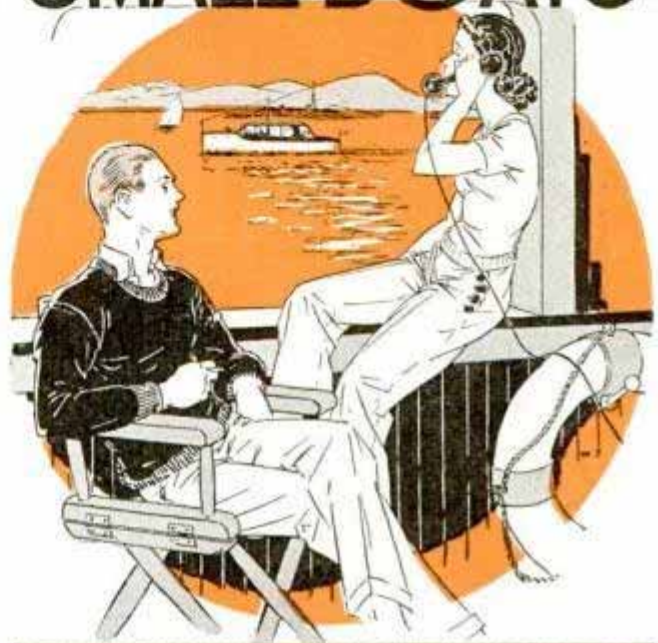

*Hallicrafters, Inc.
54 "Indiana Ave"*

Low-Cost Pocket Set Has Built-In Earphone



ONLY a few parts are required to build this efficient little portable receiver which is entirely self-contained and actually small enough to slip into your pocket. It employs a modern fixed crystal in a simple circuit which is assembled in an unusually compact manner.

As most radio listeners know, a good crystal set will pull in local stations with ample volume and excellent tone, provided an antenna and ground are available. To make this possible under portable conditions, the circuit is arranged so that it may be clipped to any metal drain pipe, cold-water pipe, or bare metal part on a telephone, which will serve as an antenna. Operated in this manner, the range is from 2 to 12 miles, if the building is not of metal construction. In the home, where a good long outside antenna is available, a receiving range of about 30 miles for powerful stations is possible, under good conditions.

The coil is close-wound in clockwise fashion, on a short length of Bakelite or fiber tubing, and tapped for a 5-point coil switch in the manner shown in Fig. 1 and schematic diagram Fig. 2. These taps may be made by twisting the wire at the desired turn and pulling it through a small hole in the Bakelite tube. The ends of the twisted wire are bared of enamel and then soldered to the switch contacts as indicated in Fig. 1-A. The four taps on the coil aid in "peaking" the volume of the set which tunes quite broadly. The completed coil winding, which is continuous, is protected by a heavy piece of paper cemented over it. A disk of pressed wood, or thick card-

(Continued to page 136A)

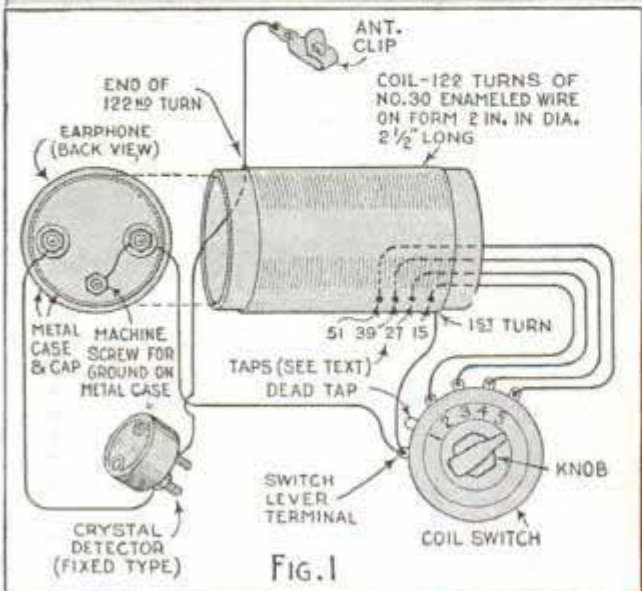

Hints for RADIO EXPERIMENTERS

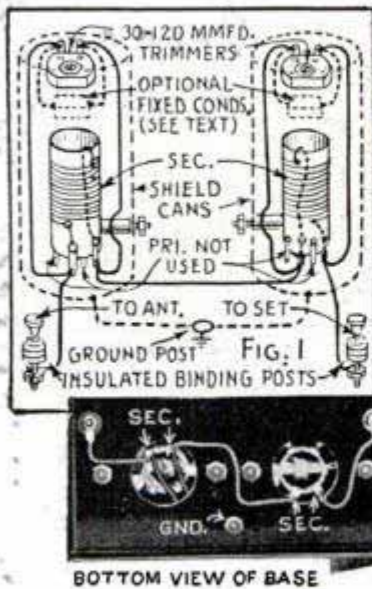

If your radio set receives a high-power local station "all over the dial" or, if any powerful station prevents good reception from some weaker one desired, the double wave trap illustrated in Figs. 1 and 1-A should solve your problem. It consists of two ordinary r.f. coils and two mica trimmers or "padding" condensers housed in shield cans 3 in. high and 2 in. in diameter. These parts are mounted on a 3/8 by 3 by 6-in. sheet-metal base. All assembly and wiring details appear in Fig. 1; connect secondaries as shown, primaries are not used. This wave trap is connected in series with the antenna lead at set and trimmers are adjusted with a small screwdriver. Using trimmers only, without fixed condensers, adjust to eliminate interference from any station operating between 1,200 and 1,750 kc.; for 1,000 to 1,200 kc. use .0001 mfd. mica condensers shunted across each trimmer. For 800 to 1,000 kc. use .0002 mfd.; for frequencies below 800 kc., .00025 mfd.

Fig. 2 shows a simple method for suppressing radio interference from belt and machine static. Fixed condensers are connected in series across the supply line and center point is grounded; also ground motor and machine frames

Mounted on the front panel of an amateur phone transmitter and connected to the final r.f. stage, the modulation monitor illustrated in Fig. 3 flashes a red warning signal when 100 per cent modulation is exceeded

(A) sensitive plug-in relay for delicate photocell control applications; (B) suppressor eliminates troublesome self-oscillations in amateur transmitters; (C) paper clip aids in holding coil turns

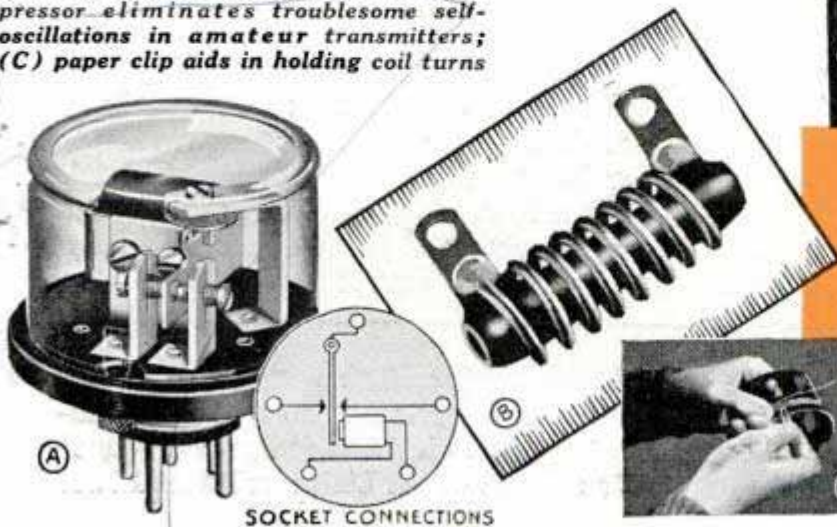
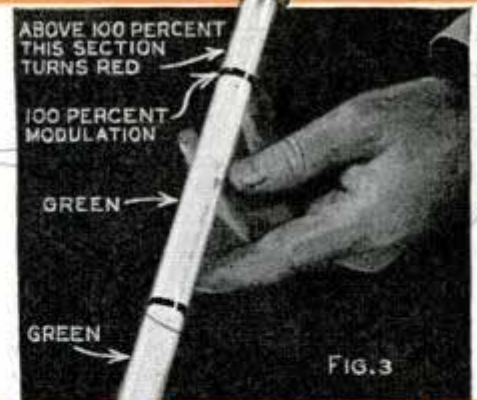
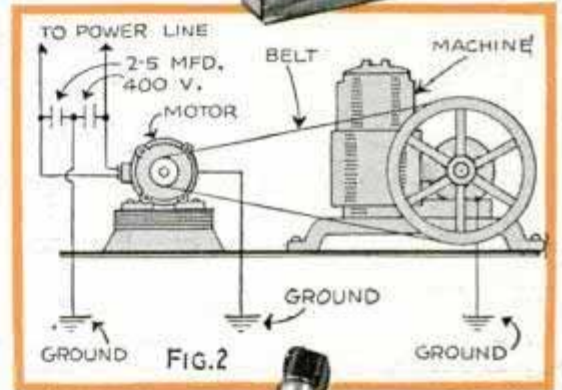

Acoustic Consultants chue
1074 S. 1st St. St. Paul, Minn.

Signia of instruments chue

Flashlight Cell Runs Big Radio



One small 1½-volt flashlight battery is used by a St. Louis dealer to operate this large farm-type battery receiver for short demonstrations; the set employs new low-drain tubes.

Phono-Attachment Is Portable

This radio-phonograph converter is designed to be placed on top of your large

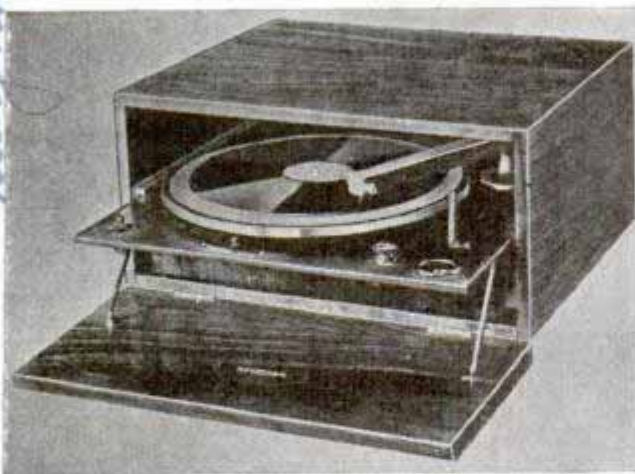

console or underneath a midget receiver. The record player pulls out like a drawer; it employs a crystal pick-up and self-starting motor.

Meter Measures Sound Levels

Operating entirely from self-contained batteries, this sound meter employs a non-directional microphone and is said to measure accurately the sound level produced by a public-address system for checking audience coverage, and to permit comparison of speaker efficiencies; the range is from 50 to 130 db.



Multi-Band Variable Condenser

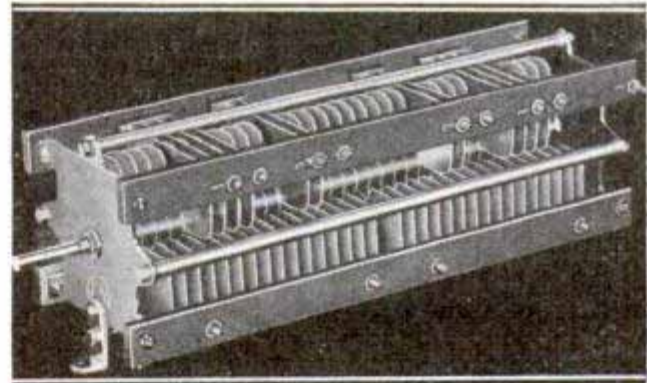

With a single rotor, this transmitting-type condenser provides several separate dual-section variable condensers in a frame only 11 in. long. Split-stator values are thus available for all amateur bands, from 5 meters to 160 inclusive.

Blueprints covering radio construction articles in this and past issues are available for 25 cents each. Original material lists with names of manufacturers and dealers can be obtained from our Radio Department upon receipt of postage.

NEXT MONTH—How to Build an Audio Amplifier for Beginner's Battery Set. Complete construction details for adding a loud-speaker stage to a simple one-tube broadcast receiver; of special interest to those who built the "Three-in-One" Progressive Sets R-256. Also—**An Inexpensive Home-Built Universal Test Meter**

Vertical handwritten notes on the left margin:
 Recatorn Corp. 17 E. Prince St. New York City
 P. Macelfree

Handwritten notes at the top right:
 164 n. May Chevy
 neck

Vertical handwritten notes on the right margin:
 Prospect St. Brooklyn N.Y.
 Allen L. Carver



SHOP NOTES

TUMBLE for a Perfect Finish

EXTENSIVELY used in industry for finishing small parts of wood, metal and plastic, the tumbling barrel, Fig. 1, affords an excellent method of finishing in home shop work. A beautiful surface of velvety smoothness can be obtained in this manner—a finish practically impossible to duplicate by any other method.

The first requirement is the barrel, Fig. 3. Stock used in the construction should be hard maple. The assembly is first made by nailing the



Wood, metal or plastics can be given beautiful finishes

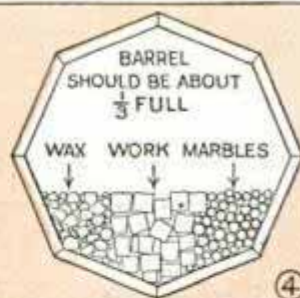
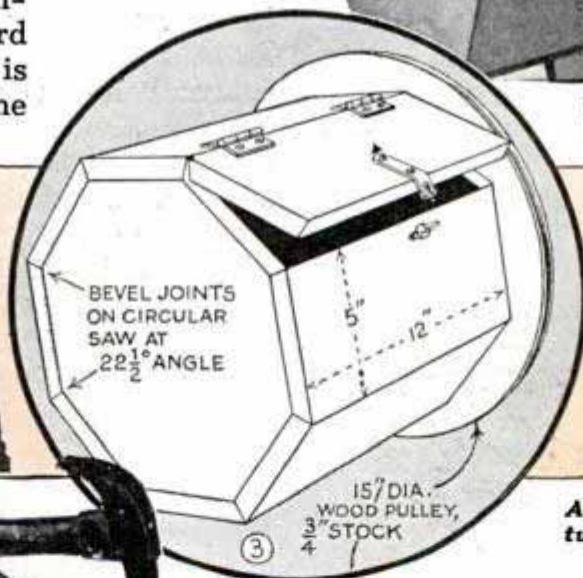
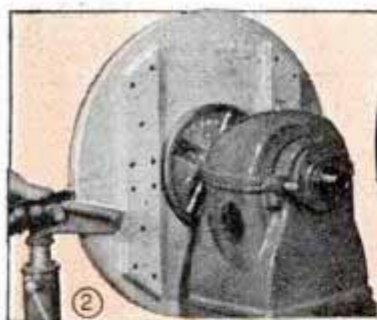

Above, suitable mix for wax tumbling wooden parts, using paraffin

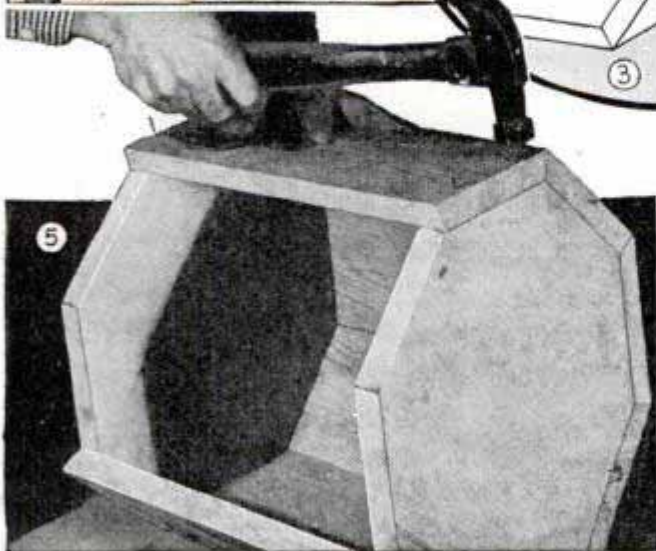

pieces together, as shown in Fig. 5, after which the joints should be permanently fastened with screws. One section is hinged to form a lid. Then the barrel is fastened to a pulley turned from hardwood as in Figs. 2 and 3. This completes the tumbling unit.

Plastics, wood or metal objects can be tumbled successfully, but slightly different methods must be used in each case. For wood parts, the work should first be sanded smooth and colored with stain.



The speed of the barrel should be in a range from 40 to 90 revolutions per minute. Photo at left shows a simple cord drive for light work, while diagram below shows a suitable installation for regular work

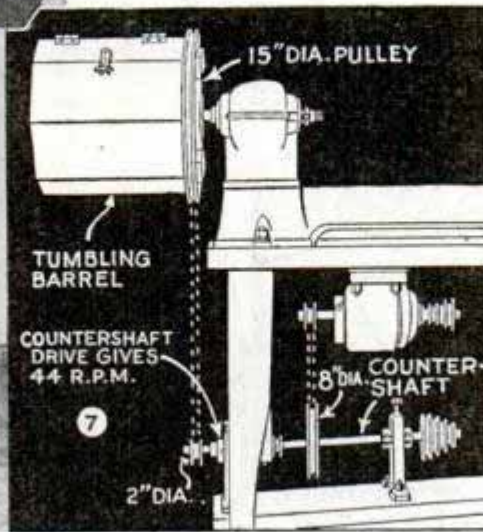

Then, into the barrel, together with a quantity of paraffin cubes and steel balls or glass marbles, the proportions being about as shown in Fig. 4. The paraffin finish can be applied in about 1½ hours; harder waxes such as carnauba and bees-wax require a longer period of tumbling. If the resulting coat of wax should be too heavy, decrease the amount of wax cubes and increase the amount of work and marbles. A further luster can be given waxed work by tumbling the pieces with small squares of cloth.

The speed of the barrel is most important. It is essential that this be kept below 90 r.p.m. At slightly higher speeds the work will bounce, with the result that the finish will be pitted; at about 150 r.p.m. the work will not tumble at all, but will simply cling to one side of the barrel through centrifugal force. For light loads, a suitable speed can be obtained by using a belt made from stout cord, running this directly over the ¾-in. lathe counter-shaft, Fig. 6. Slight slippage will result in a speed of about 60 r.p.m. For regular work, the drive shown in Fig. 7 is suitable.

Automatic Hog Feeder Assembled from Drum and Wheel

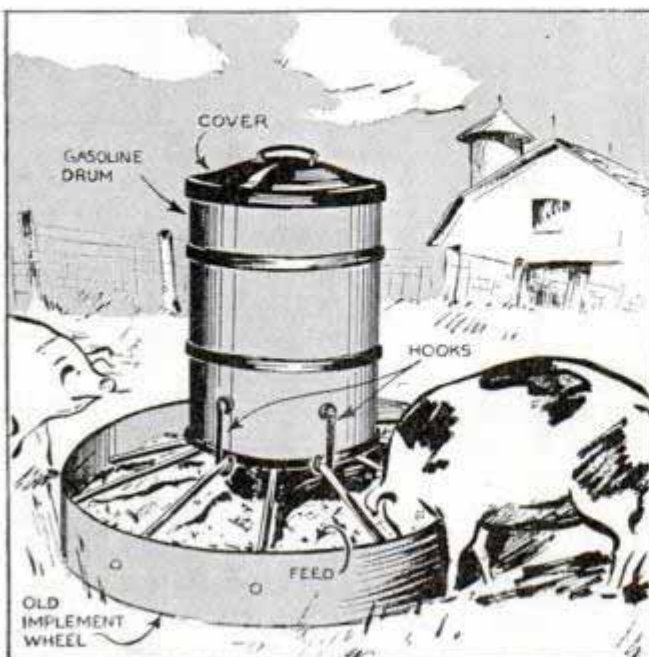

All-metal construction of this feeder assures long life and plenty of weight to prevent tipping. It consists of a steel oil drum having both ends removed and fastened to the center of a large implement wheel. Hooks bent from iron rods are slipped over the wheel spokes and bolted to the drum to keep it in place. It is a good idea to set the feeder on a concrete platform. In addition to making it more sanitary, this will help keep damp ground from causing the dry feed to rot.

—A. S. Wurz, Jr., Carbon, Alberta, Can.

¶ If you cover door hinges, locks, etc., with vaseline before painting the woodwork, the paint can be wiped off easily if it gets on these articles.

These Folding Flood-Lamp Stands Are Rigid

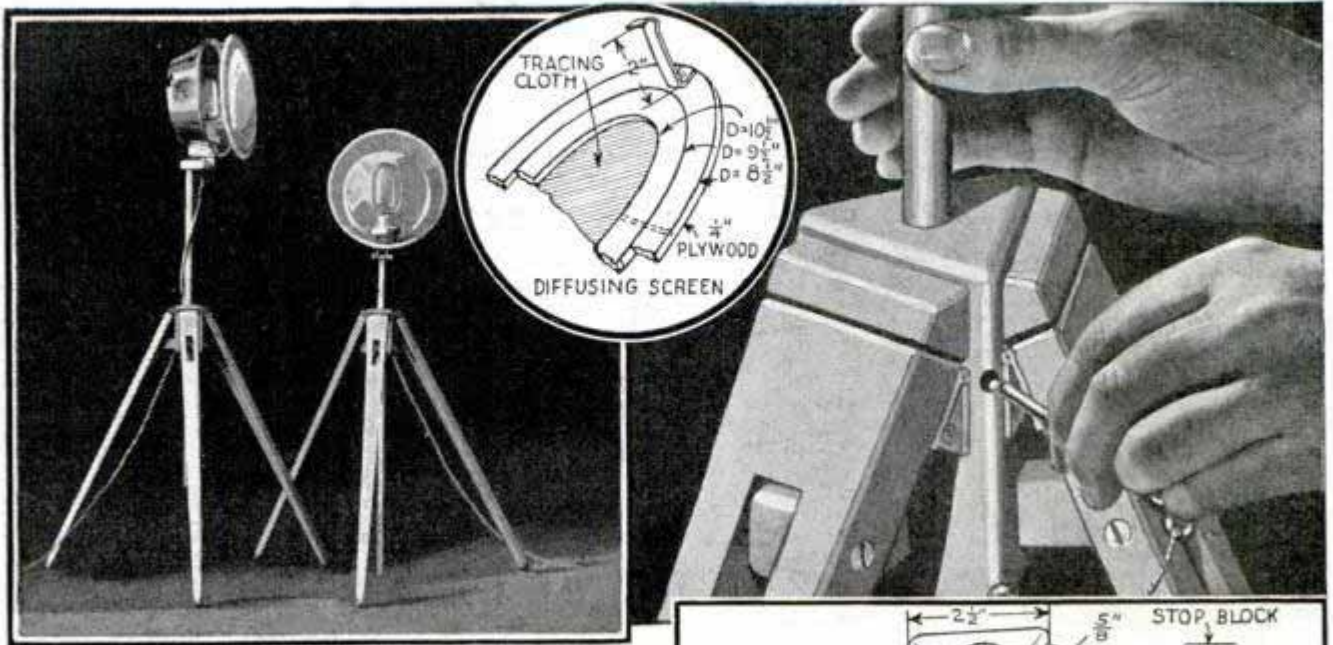

Folding compactly, the legs of these stands lock rigidly when opened. They are hinged to a triangular block or body bored lengthwise to take a $\frac{5}{8}$ -in. dowel, which serves as a lamp standard. Hardwood arms pivoted in slots in the legs open horizontally to brace the latter against the body, and stop blocks glued and nailed to the body above the ends of the legs prevent them from opening too far. Height adjustment of the standard is obtained by a pin, which passes through a hole in the body to engage one of a number of small holes bored part way through the standard. The lamps are homemade, and each one consists of a 10-in. aluminum-pan reflector carrying a socket and bulb. For mounting, the pan is nailed between two wood blocks, and the assembly is drilled for the lamp cord, a porcelain socket being screwed to the block inside the pan. To provide a tilting arrangement for the reflector, the assembly is pivoted to a slotted block on the standard by means of two metal angles as indicated in the lower detail. A diffusing screen for the lamp consists of two ply-

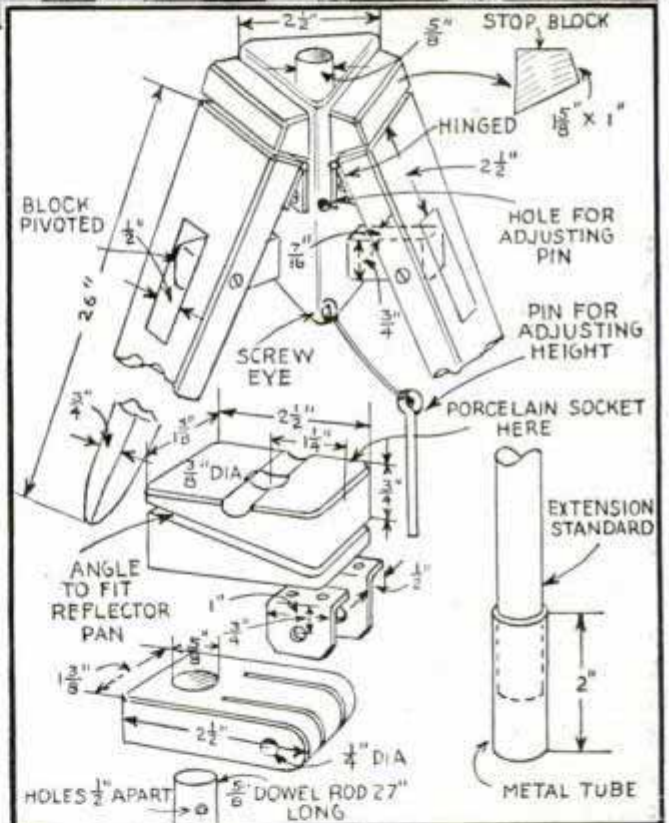

wood rings, one to fit snugly inside the other, with a piece of tracing cloth stretched tightly and clamped between them as shown in the circular detail.

Cleats to Hold Temporary Wiring Made from Spring Clothespins

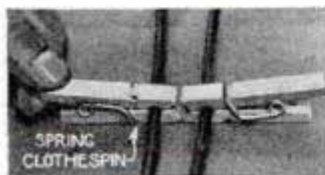

If you have occasion to string insulated wires for temporary lighting or other uses, spring-type clothespins provide good cleats for anchoring the wires. Take the pins apart, which is done easily, and cut off a short piece from one leg of each one. Then screw the short legs to the wall or other anchoring place and reassemble the pins.

"Button-On" Pockets Hold Nails of Different Sizes

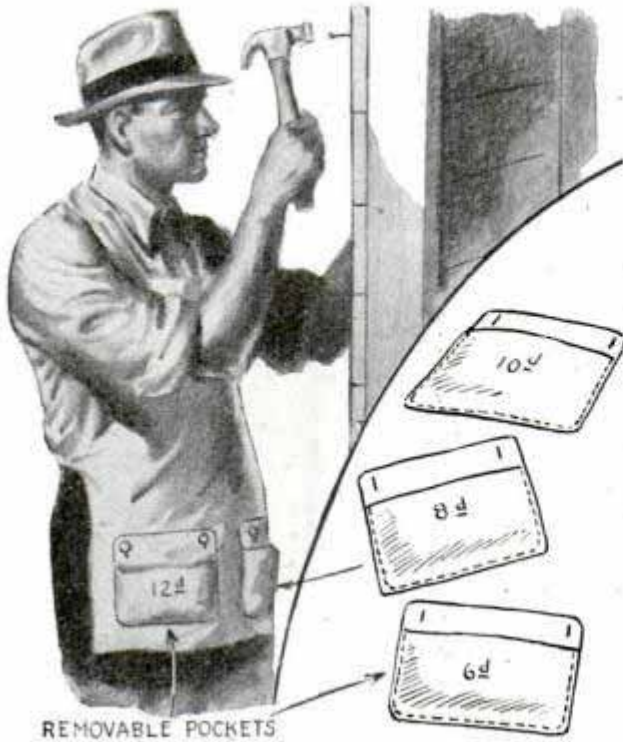

Annoyed by the necessity of emptying nails of one size from his apron pocket when changing to other work, a Wisconsin carpenter made several pockets with buttonholes in the upper corners so that they might be attached or removed in a jiffy. Each pocket was lettered to indicate the size nail it contained.

Adapting Lathe Dog for Threads

Whenever it is necessary to use a lathe dog on the threaded end of work, I use the method shown, which prevents any possibility of the dog slipping and damaging the threads. The dog is drilled and tapped for a stud, which projects into the faceplate slot along with the end of the dog. In use, a nut is run on the work and the dog is

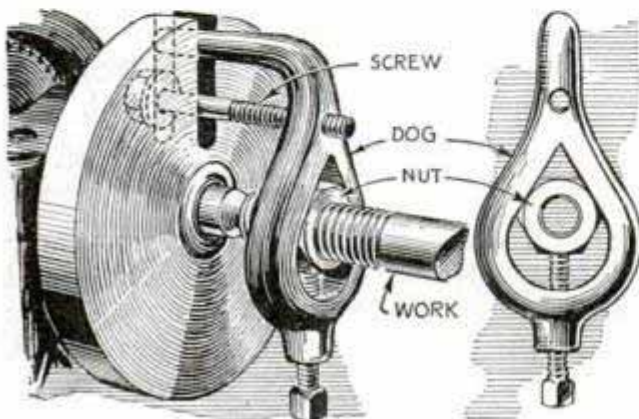

clamped to the nut. Then the stud is inserted into the faceplate and screwed into the dog. The stud, which has a head, keeps the dog and nut from turning on the work.
—H. Moore, Leeds, Eng.

This Farm Gate Can Be Raised or Swung to One Side

This gate can be opened in the usual manner, or it can be raised to permit hogs and other small animals to walk under it, without passing horses and cattle. The gate proper is made in the usual way except the vertical member at the hinged end. This member is hinged to the gate post and the gate is attached to it by two flat-iron loops or slides, which permit the gate to be moved up or down. An adjustable concrete counterbalance makes this action easy, the

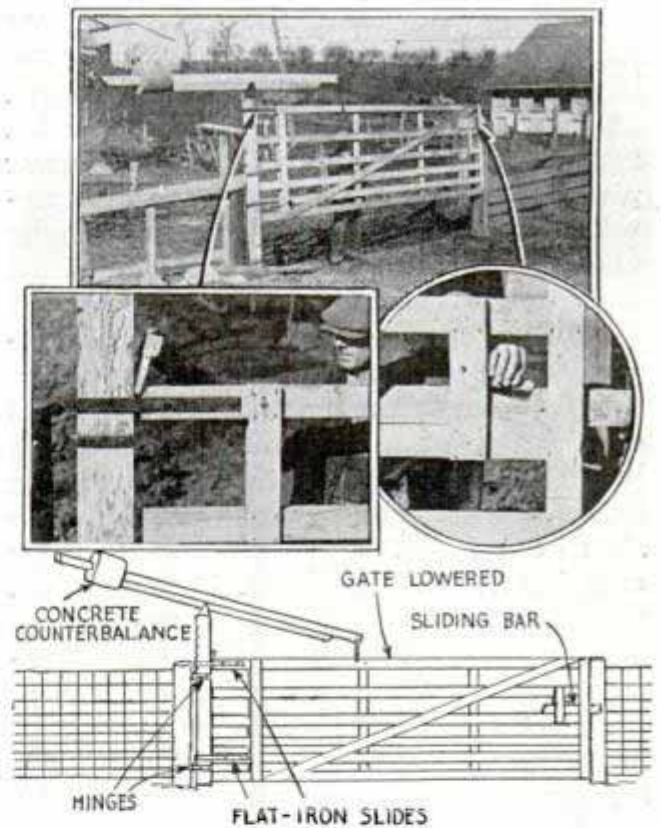

counterbalance being supported on the end member. This has notches at the rear edge so that the upper slide will slip into one of them when the gate is raised and a wedge inserted between the member and the end of the gate, as shown in the left center photo. The latch is self-locking. It consists of a length of 2 by 4-in. stock mounted in the usual way and slips into a notch in the gate post. The lock is different,

however, and consists of a block pivoted between the short vertical members to drop in a tapered notch in the latch, as shown in the circular photo.

Fuel-Oil Hose Propped by Wrench to Prevent Sagging

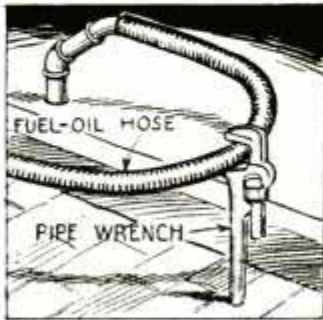

A truck driver who delivers fuel oil to the building where I live uses a pipe wrench as shown to support the oily hose and keep it off the sidewalk or lawn. The jaws of the

wrench are tightened against the hose just enough to hold it in place.

—Wm. Swallow, Brooklyn, N. Y.

Test Board Accommodates Lamps of Various Sizes

It always creates a better impression if the lamps a customer buys are tested while he is watching. By using a mogul base, the ordinary bulb can be tested in a second or two without removing it from the wrapper, and the same applies to the candelabra bulbs which are tested in an ordinary socket. Radio and flashlight bulbs are tested with a doorbell transformer. A fixed radio rheostat hooked in series with the socket will lower the current to 2½ volts or whatever needed.—Morris Katz, Aurora, Ill.

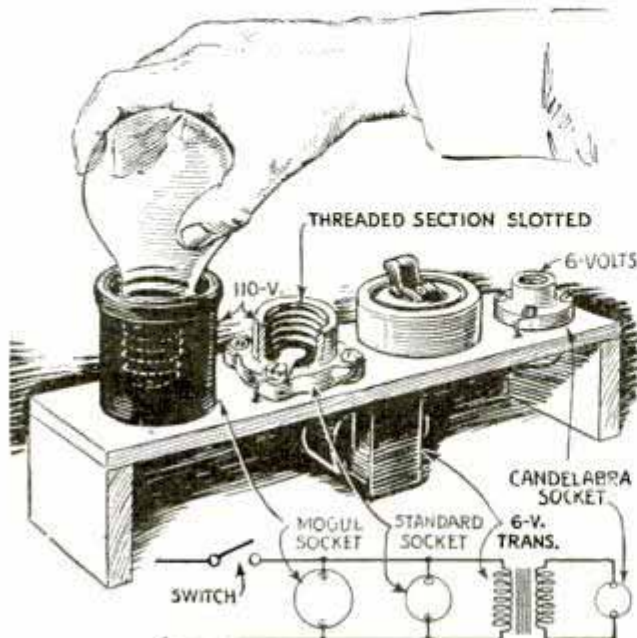

Book Display Rack from Car Axle Rotated by Customer

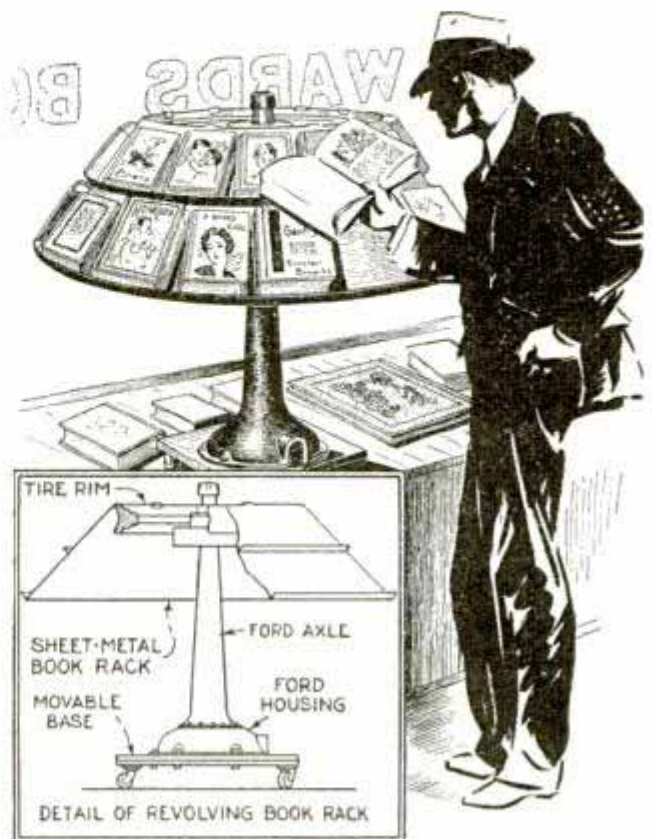

The problem of reaching books near the front of a show window was solved by this rack, which can be rotated. It consists of one-half a car-axle assembly complete with the wheel. This is bolted to a casted platform so that it can be moved, and the wheel is fitted with a sheet-metal skirt, which flares downward at a 45° angle to provide a display rack. Turning up the bottom of the skirt forms a ledge to support one row of books. Two rows can be supported by riveting or soldering a sheet-metal rim around the center of the skirt.

Dirt Tamper Cleans Easily with Cloth over Face

You can minimize the trouble caused by wet soil sticking to a dirt tamper by tying a cloth over it. Dirt does not stick to cloth as readily as to metal, making fewer cleanings necessary.



Cord Is Pulled Through Cork in Counter



To keep the end of wrapping twine conveniently at hand on his counter, one merchant bored a hole in the counter top through which the twine was fed from below. A split-cork insert provided enough friction to prevent the string from slipping back, yet allowed it to be pulled up easily when wanted.

Springs on Tops of Fence Posts Keep Chickens Out of Yard

If you are bothered by having chickens fly up on fence posts around your yard or garden and then drop down inside the lot, try stapling coil springs from a bed spring or auto cushion on top of the posts. When a chicken tries to alight on the spring, its



weight causes the spring to tilt. After a few attempts to alight on the springs, the chickens are broken of the habit.

Fly Poison Dispensed Safely from Poultry Fountain

Wishing to use liquid fly poison about a produce warehouse, one merchant placed it in a small poultry water fountain, which he suspended from the ceiling by means of a wire harness and a screw hook.

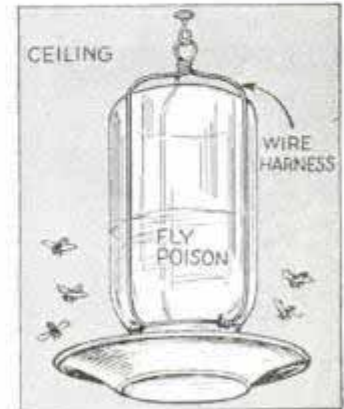

Metal Tab on Measuring Tape to Hold It with Gloves

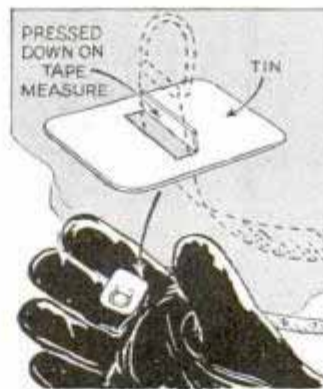

To stretch and hold a long measuring tape while wearing gloves, a workman cut a washer from a piece of tin and clipped it to the tape end as shown. A U-shaped slit in the clip permitted the center piece to

be bent up for the insertion of the tape and closed again to hold it securely in place.

Chemicals Measured with Sifter for Accurate Weighing

It is difficult to release just the right amount of chemicals from a scoop when weighing them on a balance scale, but you can do it easily and save time if you use a flour sifter. This enables you to stop pouring the instant the beam tips.

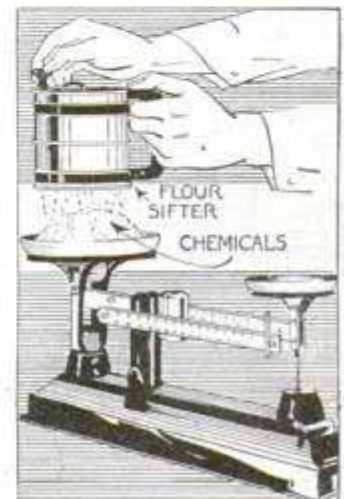

LIGHT METER TIMES ENLARGEMENTS

THIS light-meter attachment saves time and minimizes guesswork in timing enlargements or contact prints. All you do to check a negative for exposure time is lay it over an opening in the top of the attachment, turn on the lamp, set your exposure meter on top of the negative and pull out a calibrated slide until the correct light value is indicated by the meter pointer. Then a glance at the slide gives you the correct exposure time. The attachment will accommodate any type of electric exposure meter on the market, and the volume of light it can measure, or the size and number of divisions on the dial, make no difference.

The attachment is made of hard-pressed board, although metal or any light wood will do. The parts are shown in Fig. 2, and consist of a top plate with a 2-in. hole over which the eye of the meter rests; two side pieces or legs and a dowel stretcher for reinforcement. The lamp is 60 watts with a porcelain socket, which is screwed to one of the side pieces. Assembly is best accomplished with waterproof casein glue or cellulose cement.

The heart of the device is the wedge-shaped slide in Fig. 4. It works on a piece having a square opening, which is aligned directly under the round hole in the top

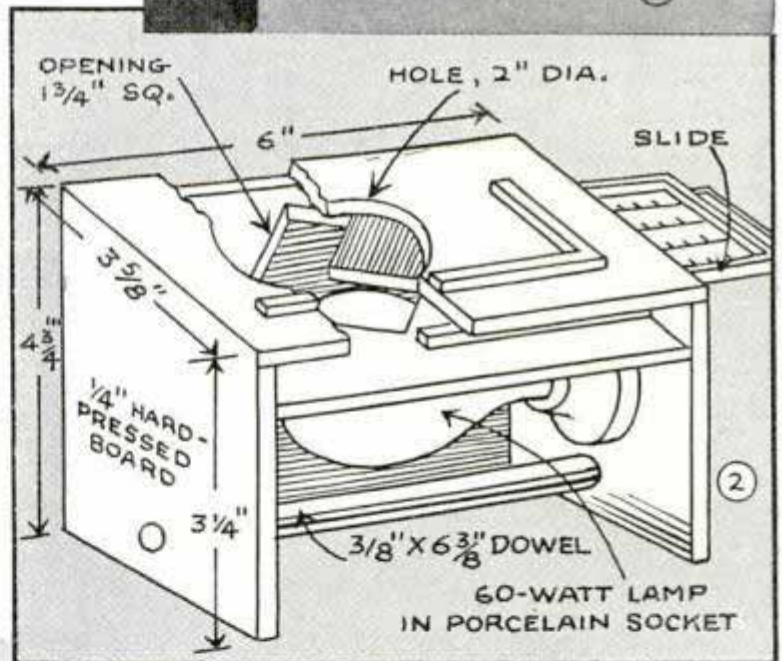
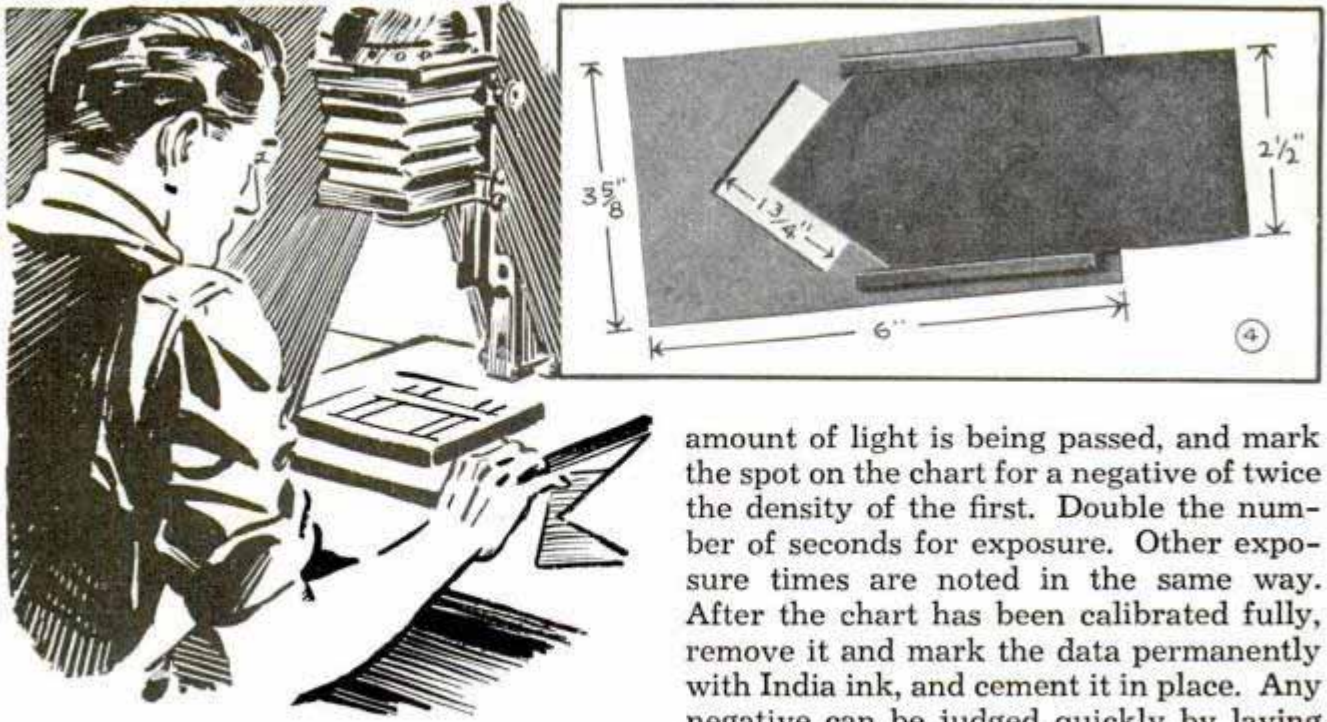

plate. On pushing the slide in, through a slot made in one of the legs, the wedge-shaped point gradually reduces the amount of light that can pass from the lamp to the eye of the meter. If desired, the light can be graduated further by making the point of the wedge narrower.

To make a chart from which the correct exposure time is read, temporarily cement a strip of paper to the slide. Carefully test a negative to determine its exact printing time for both contact and enlarging. Then lay it over the hole in the top plate, and place the meter on top as in Fig. 1. Select



a low light value on the meter (4 was chosen for the meter illustrated) and withdraw the slide until the needle is exactly over the light value. At this point make a pencil line on the paper chart under the wire indicator shown in Fig. 3. Mark the line as the correct point on the chart for a negative of this density by noting the number of seconds for contact printing and enlarging. Pull the slide further until the meter needle indicates twice the previous

amount of light is being passed, and mark the spot on the chart for a negative of twice the density of the first. Double the number of seconds for exposure. Other exposure times are noted in the same way. After the chart has been calibrated fully, remove it and mark the data permanently with India ink, and cement it in place. Any negative can be judged quickly by laying it in place under the meter and withdrawing the slide until the needle is over light value No. 4 on the dial, or over whatever value you have selected. The chart will then show the correct number of seconds exposure when the enlargement is to be made on medium-contrast paper. If a hard grade of paper is used it will require $\frac{1}{4}$ more time, and a soft paper $\frac{1}{4}$ less time. If desired, you can mark these figures in separate columns on the chart.

Toe Stop on Child's Scooter Provides Sure Grip for Foot

Noticing that his small son had difficulty keeping his foot on a scooter, one father

tacked the toe of an old shoe to the foot board as shown. This was especially useful when the boy's shoe soles were wet or muddy and consequently slippery. The old shoe toe should be plenty large to allow the foot to slip in or out of it easily.



Bottle-Cap Lure Attracts Fishes

The nature of some fishes to investigate a shiny object can be utilized by the still fisherman to attract them to his baited hook. A good way to do this is to crimp a bright bottle cap over the lead sinker. Be sure the edges of the cap do not touch the line and wear it in two.



—A. H. Waychoff, Phoenix, Ariz.

Timesaving Ideas That Help the Draftsman

You will always have a pencil pointer at hand when using a T-square if a piece of sandpaper or emery cloth is cemented to the head of the square as shown at the right. A strip of celluloid pivoted to the head swings over the abrasive and provides a shield to avoid soiling the hands. The free end of the shield is slotted to slip under a small nail head, which keeps it in place. Artists and draftsmen who do work that can be sketched on inexpensive paper will find the drawing board below a timesaver. Jobs having a number of

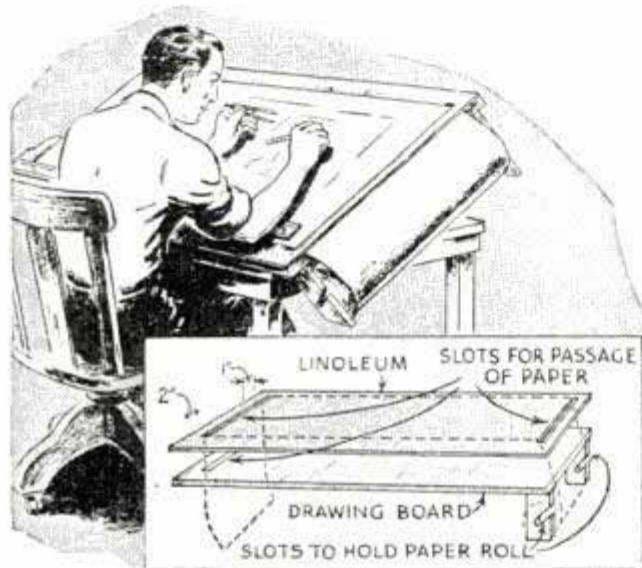
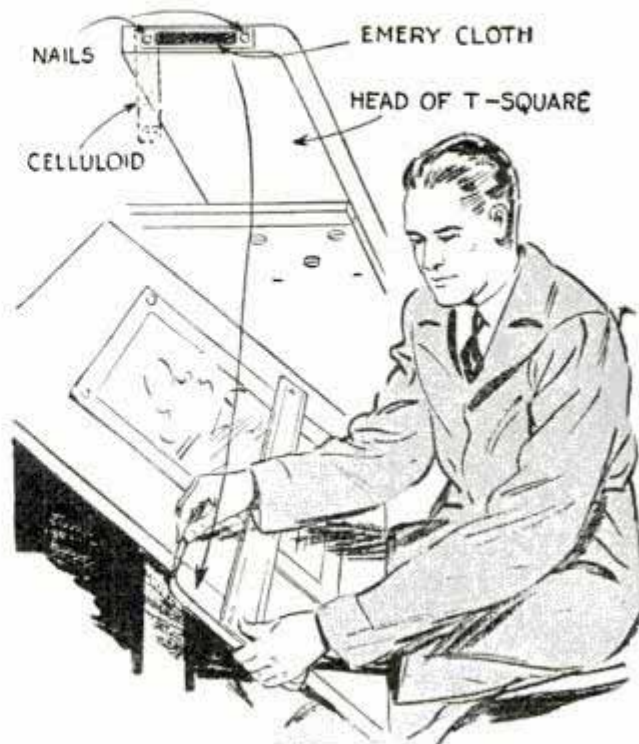

sketches that usually require several sheets of regular paper can be drawn on one continuous sheet by unrolling the paper as required. Strips of cellulose tape can be used to hold the paper in place on the board while sketching on it. The tape is removed and replaced easily when you have to unroll more paper.

Brace to Keep Tractor Belt Tight Better than Wheel Chock

Why risk injuring your hands while chocking a wheel to tighten a tractor belt? The brace shown almost automatically prevents forward movement when a tractor is backed into the belt. The hook end

of the brace drops over the axle housing and the other end drags on the ground. When the belt is tight, a helper sinks the free end of the brace into the ground by striking it with a sledge.

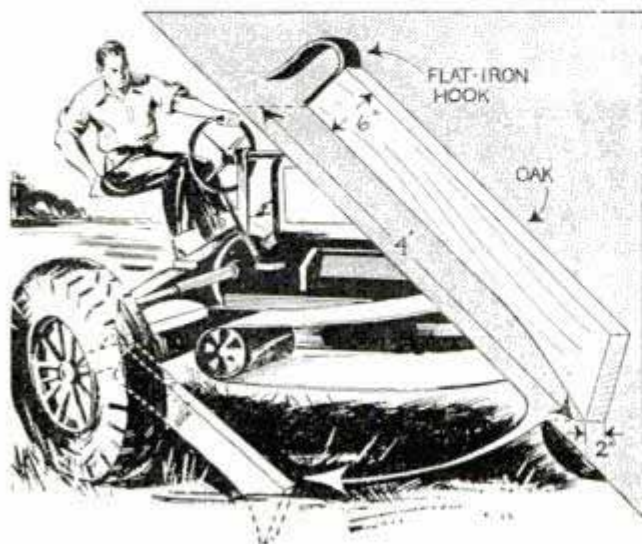

Using Auger Bit in Drill Press

You can use an auger bit in a drill press simply by cutting off the square shank and filing the screw point till the threads are smooth. This keeps it from biting into the wood and jamming, and it then may be operated at medium speed with good results.

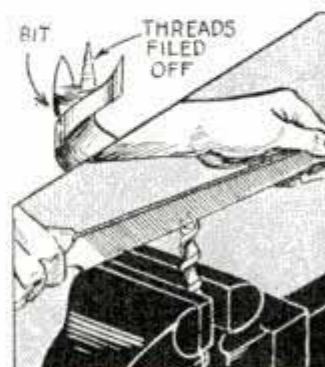

Set Screw on Shingler's Hatchet Gives Uniform Spacing

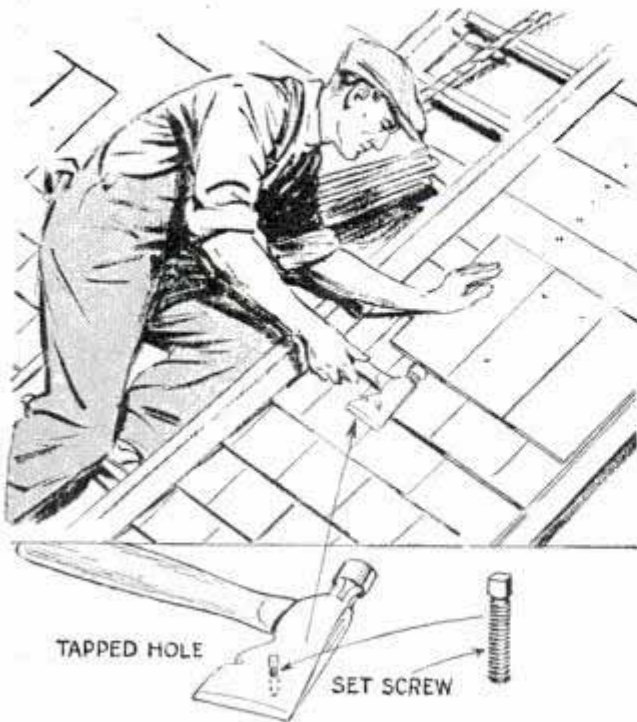

Three or more courses of shingles can be laid at once and they will all be straight and even when each shingle is gauged before nailing down. Measure $4\frac{1}{2}$ in. down from the head of your hatchet, drill and tap a hole to take a $\frac{1}{4}$ by 1-in. screw. In use, the projecting screw bears against the lower edges of shingles already nailed in place, while shingles to be laid are slid down against the hatchet head, in which position they are ready for fastening.

—W. E. Satterfield, Danville, Ill.

Self-Adjusting Countersink

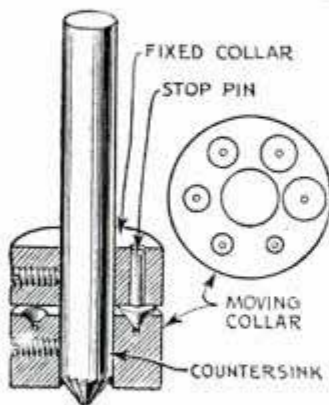

This adjustable countersink is superior to most others as it is quickly adjusted. Make up two collars for a sliding fit on the countersink and drill and tap them for set screws. Then fit the upper one with a tapered stop pin as shown. In the upper surface of the lower collar drill a number of countersunk depressions of different diameters to take the head of the stop pin. In use, the lower collar is loosened so that

the stop pin engages the depression which is the same depth as that desired for the hole to be countersunk.

Rotating Work Is "Miked" with Aid of This Fixture

When turning a number of duplicate pieces this fixture will enable you to check the work with a micrometer without stopping the lathe. The fixture is bored at one end to slip snugly over the tailstock spindle, and is held in place with a set screw. A closed slot in the center has a slide bar running through it lengthwise, and two steel pins drilled to fit snugly on the bar and in the slot, which keeps them parallel. They are drilled and tapped at the ends for set screws to lock them on the slide bar. In use, the lower pin is moved down to touch the top of the work after it has been turned to size, and is locked in place. Then the

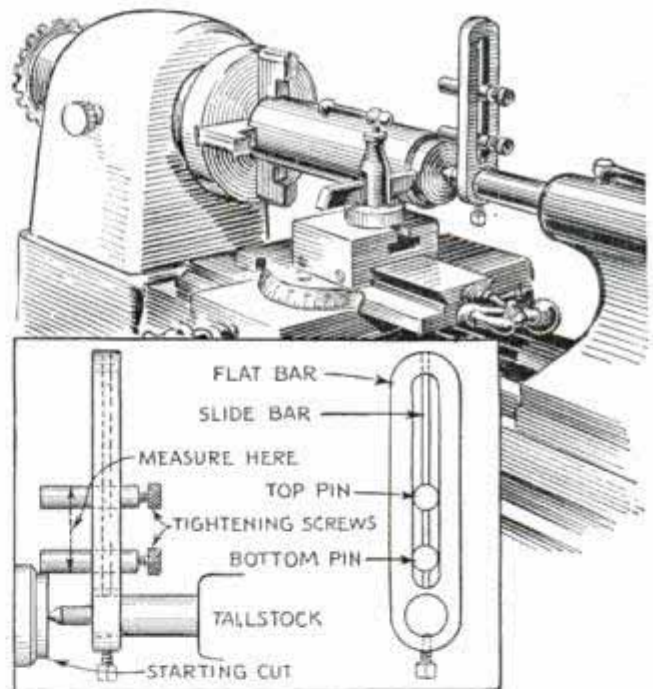

top pin is adjusted so that the distance from its top surface to the underside surface of the other one is equal to the diameter of the work. Now, when a new piece is being turned, the lower pin is loosened and rests on top of the work. When you want to "mike" the work, just tighten the lower pin and adjust the micrometer over both of them, loosening the pin after the measurement has been taken. If the measurements are critical, the fixture must be made carefully so that all parts fit snugly.

ENLARGING EASEL

has quick-adjusting masks

CONSISTING essentially of a bread-board, a steel square and two sections of telescoping curtain rod, this easel has just about every feature that the camera fan needs for turning out projection prints. From the details you will see how the steel square is hinged to the easel and how the curtain rod is attached to the square to form slides for the masking arms. Coming to the assembly of the sliding members, which, of course, are duplicates, you will see this clearly from the lower-right detail. Part A is the inner telescoping section of the curtain rod, cut to approximately 2 in. in length. Also the top guide B is the same length and bent to the shape shown. The head of the clamping screw is soldered to the sliding member A, and passes through holes drilled in the clamping piece B and the masking arm. After squaring the latter with the easel board, it is soldered to the clamping piece.

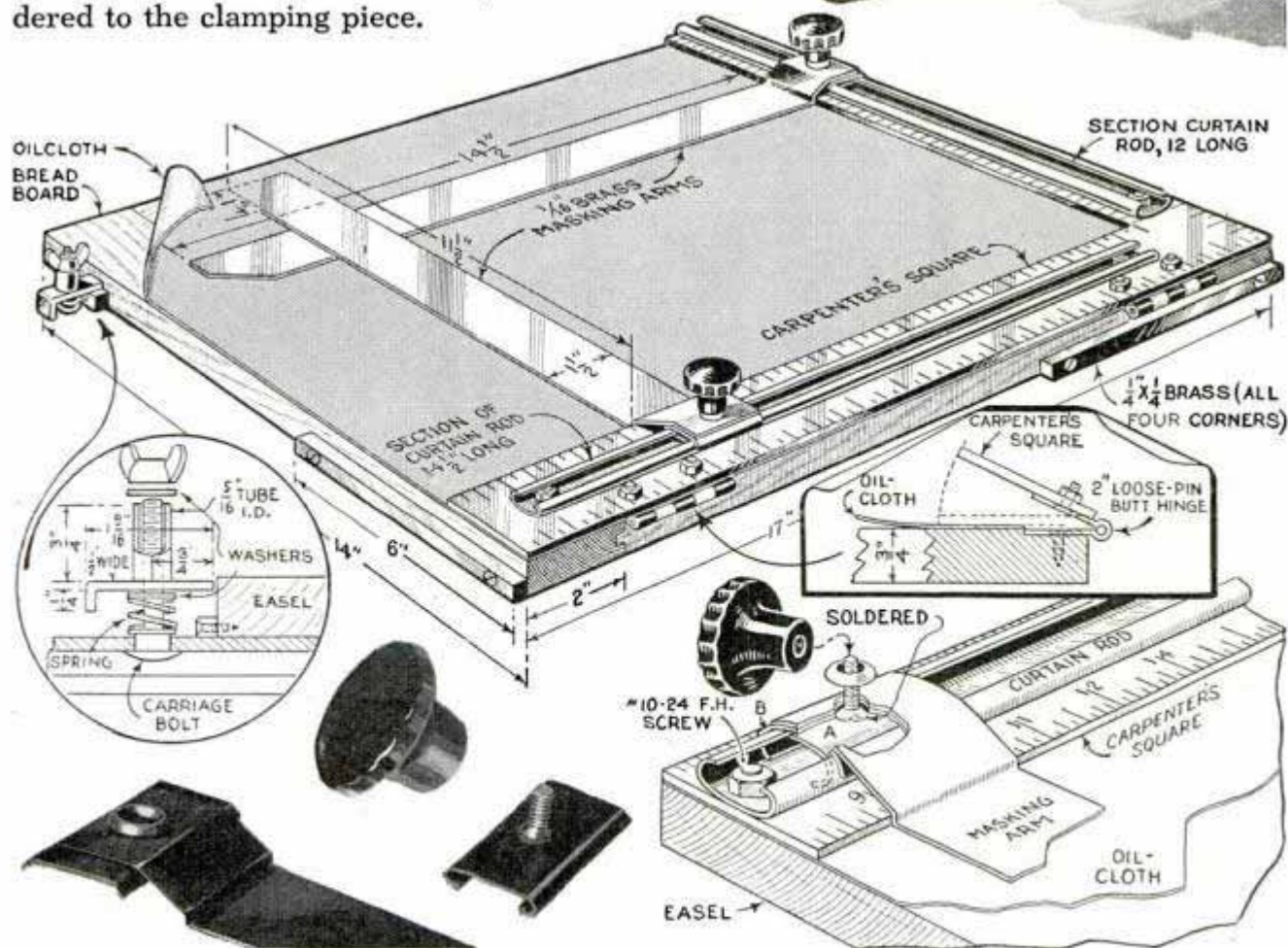
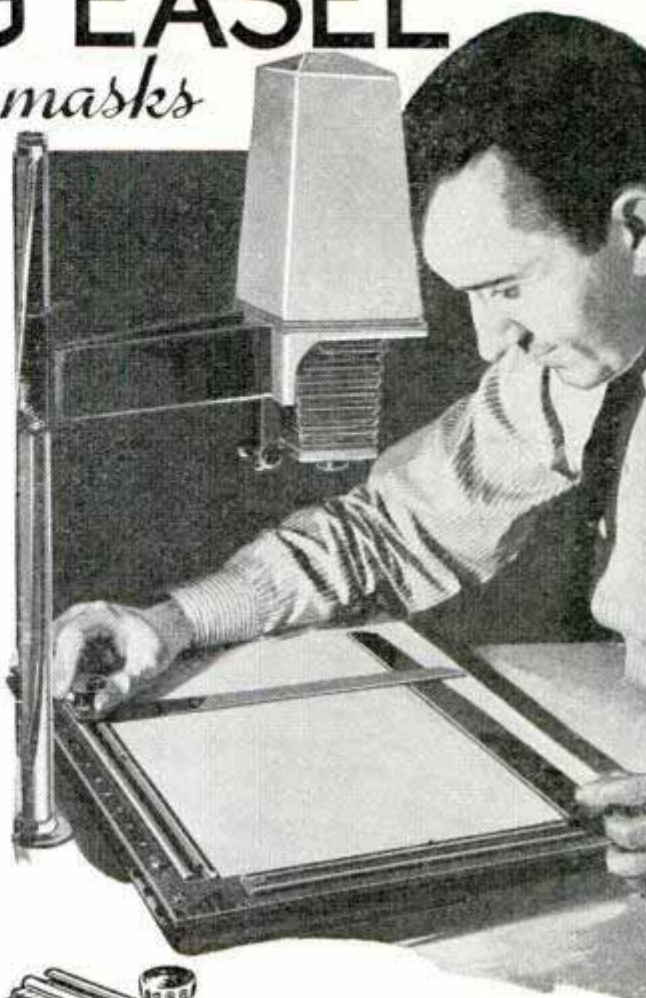

Neat Display Trays in Fruit Store Quickly Cut from Cartons



These simple but neat trays to display fruit and vegetables will help to increase sales. With a ruler and sharp knife, cut up some empty cartons, as shown in the detail. Each tray consists of two parts, both of which are corners cut from the box. A coat of furniture lacquer or automobile enamel improves the appearance considerably and gives your store an exclusive atmosphere at a slight cost.

—W. C. Wilhite, Carlinville, Ill.

Space Needed for Plants and Trees Specified in Chart

If you have a certain number of plants and wish to know how much space they will occupy, this chart tells at a glance. If you want to know the exact number of

DISTANCE		NUMBER
1 FT.	X 1 FT	43560
1 1/2 "	X 1 1/2 "	19360
2 "	X 2 "	10890
2 1/2 "	X 2 1/2 "	6970
3 "	X 3 "	4410
3 "	X 2 "	7260
3 "	X 3 "	4840
4 "	X 4 "	2722
5 "	X 5 "	1742
6 "	X 6 "	1210
9 "	X 9 "	537
12 "	X 12 "	302
15 "	X 15 "	194
18 "	X 18 "	134
20 "	X 20 "	103
25 "	X 25 "	70
30 "	X 30 "	40
40 "	X 40 "	27



plants an acre will accommodate, read the table backwards. Figured on the basis of one acre, 43,560 sq. ft. of ground, the number and spacing of everything from tomato vines to fruit trees can be determined.

—M. B. Birge, Hinsdale, Ill.

Small Quantities of Water Heated with Soldering Iron

When small quantities of liquids must be heated in the shop, you can do the job quickly with a soldering iron. A brass or copper tube large enough to take the iron is flattened at one end and bent over as indicated to prevent liquid from entering. In use, just insert the iron and tube into the liquid like an immersion heater.



—M. G. Winterton, Ft. Lewis, Wash.

Holder for Paint Can Straddles Rung on Ladder

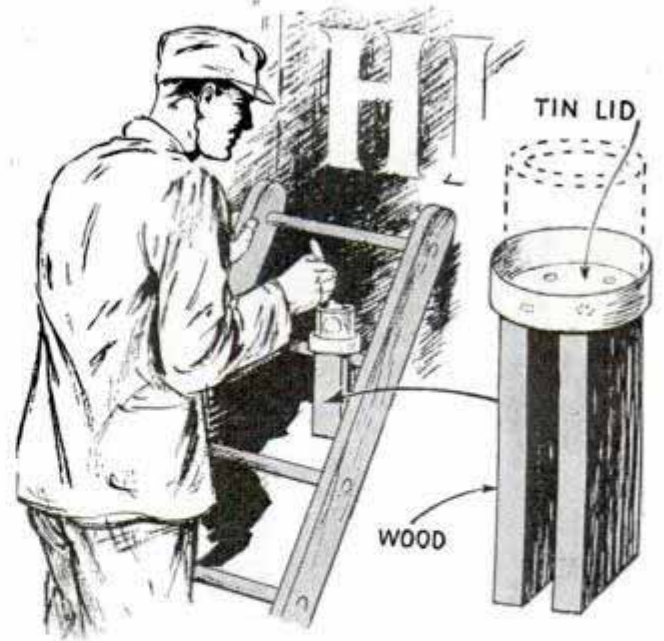

Painters and sign writers will find this holder just the thing for small cans of trim or lettering paint. It consists of two strips of wood nailed to a can lid so that they will straddle a rung. The strips act as a counterweight to keep the holder from tipping.

Finishing the FARM TRACTOR

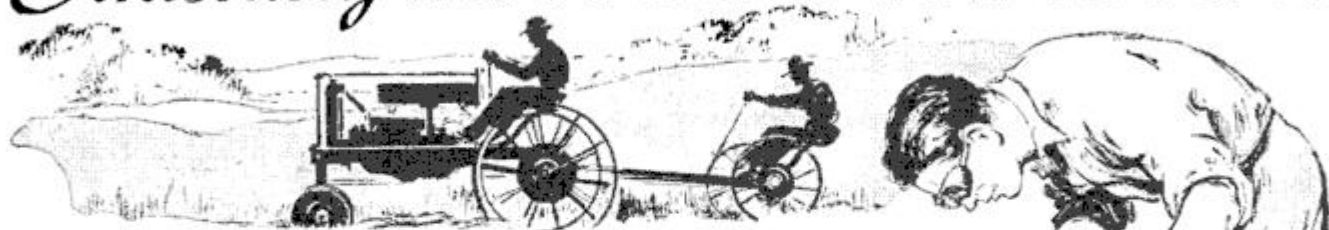

PART II

Assembling rear wheels, installing radiator, battery and ignition system, drawbar, driver's seat, etc.

By HAROLD SUDDABY

AFTER finishing the tractor frame and installing the motor, driving mechanism and rear end, you are ready for the wheels. Each rear wheel consists of a wagon-wheel tire 40 in. in diameter and 3 in. wide, twelve angle-iron spokes 16 in. long, and the disk wheel that came with the truck rear end as shown in Fig. 12. First cut off the rim of the truck wheel as in Fig. 13 and place it level on a floor. Next place the wagon tire over the wheel and support it 6 in. above the wheel. Space the spokes equi-distant around the wheel and tire and weld them in place as in Fig. 11. If desired, you can hot-rivet the spokes to the wheel, and if possible electric weld them to the tire as this gives a stronger joint than a welding torch. Now drill the tire and bolt angle-iron or steel lugs to it 6 in. apart. If the work has been done carefully, you now have a wheel with a 6-in. dish that is strong enough to withstand the pulling strain of the tractor. If you care to go to the added expense you can use rubber tires instead of the steel rims. If this is done, cut the spokes to suit the rims and assemble the wheel in the same way.

Next comes the fuel tank. As the model-A motor has an updraft carburetor with a gravity feed, the tank must be elevated above the motor in a manner similar to that shown in Figs. 15 and 16. Install the radiator so that you can have the regular hose connections, using the original spring-type mounting as in Fig. 14. Install the original model-A ignition system complete with generator and starter. Make up a

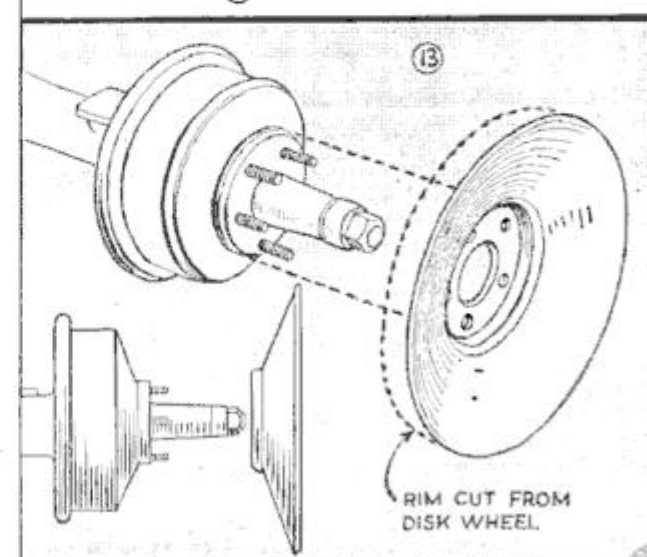
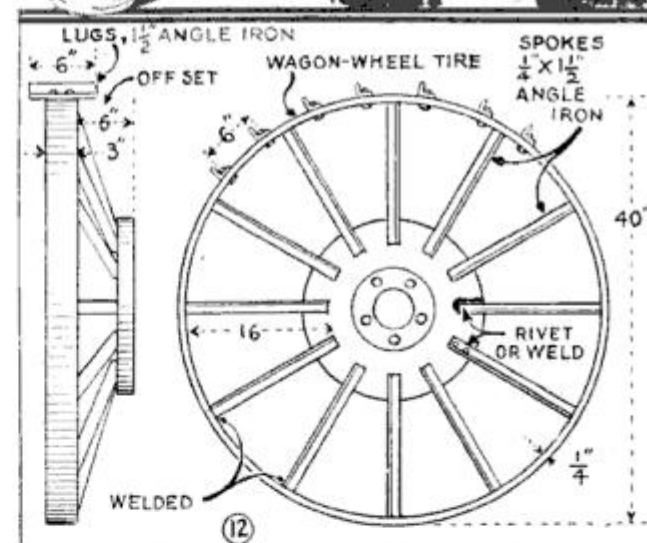
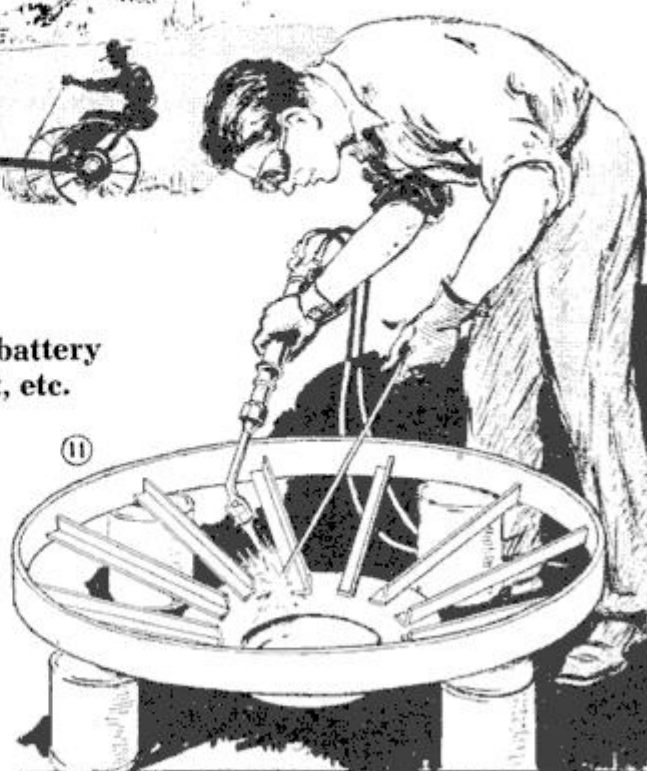

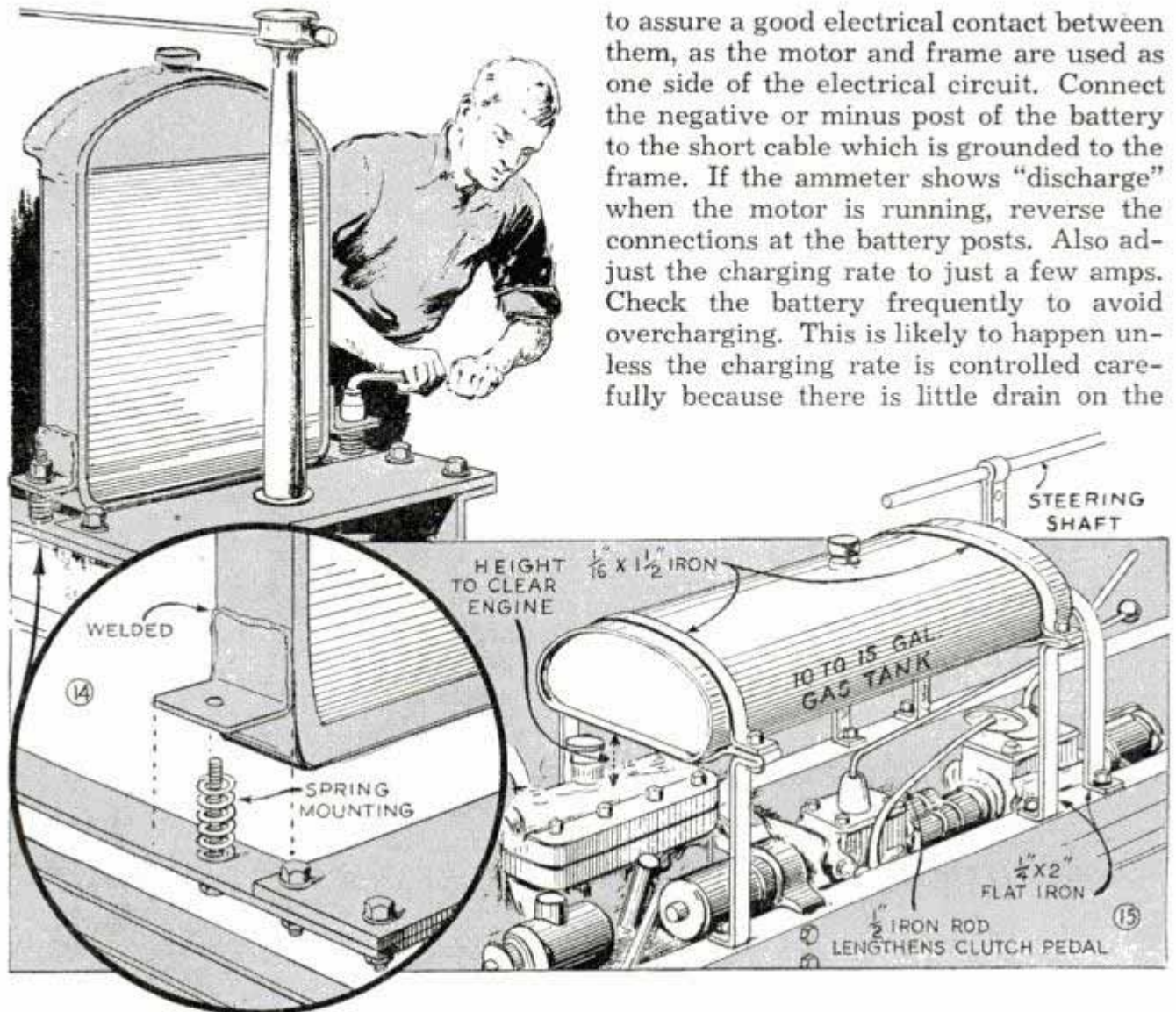

to assure a good electrical contact between them, as the motor and frame are used as one side of the electrical circuit. Connect the negative or minus post of the battery to the short cable which is grounded to the frame. If the ammeter shows "discharge" when the motor is running, reverse the connections at the battery posts. Also adjust the charging rate to just a few amps. Check the battery frequently to avoid overcharging. This is likely to happen unless the charging rate is controlled carefully because there is little drain on the

wood instrument panel for the ammeter and switch and mount it at the rear of the gas tank. Bolt the coil to the front end of the gas-tank support and run a wire from one terminal of the coil to the ignition switch. Connect the other terminal of the coil with the starter button. The wire from the generator to the starter completes the primary circuit. A wire from the center of the coil to the distributor cap completes the high-tension circuit. The throttle and choke are operated with dash-type controls, and should be placed close at hand. In fact, all of the controls are on the right-hand side of the steering-post support.

Any good 6-volt storage battery will do for the tractor, and you can use the original Ford battery cables, grounding the short one to the tractor frame and running the longer one to the starter terminal. As the tractor is operated under dusty conditions, it is a good idea to solder a heavy copper wire to the motor and to the frame

battery when the tractor is in the field. The starter switch is attached to the starter housing so you will have to run a small iron rod from it to within easy reach of the seat so that the motor can be started from this point.

The seat should be mounted so that it will support several times the normal weight of the driver. This is important as serious accidents can result if the seat breaks while the tractor is pulling an implement such as a disk harrow. Fig. 17 shows a way of mounting an ordinary implement seat to give ample strength. A spring back like that shown adds both comfort and safety for it will help to prevent the driver being thrown from the seat when running over rough ground. Bolt the seat to the frame a suitable distance from the steering wheel as in Fig. 17, using lock washers under the nuts. It is a good idea to use lock washers under all nuts throughout the tractor as the shocks received in

this type of work have a tendency to loosen them. The method of attaching a simple drawbar is shown in Fig. 17.

The rest of the job consists of finishing touches. You may question the fact that standard Chevrolet disk wheels are used on the front without additional rims but this was found entirely satisfactory in actual use. You can add individual brakes on each rear wheel which will help in turning while pulling heavy loads. This can be accomplished by bolting two 1-in. flat-iron handles on each

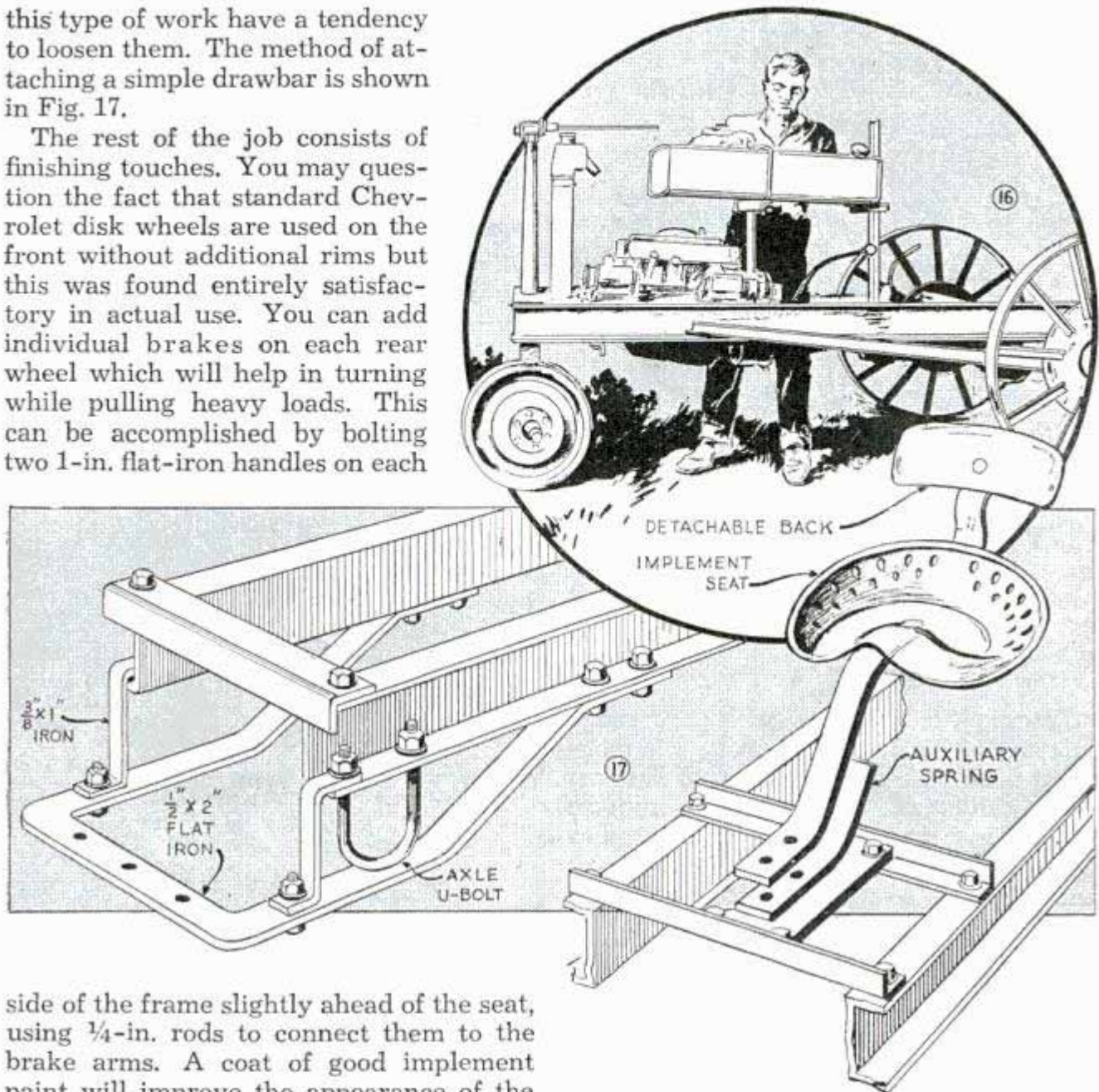

side of the frame slightly ahead of the seat, using $\frac{1}{4}$ -in. rods to connect them to the brake arms. A coat of good implement paint will improve the appearance of the finished machine. The first time you run the tractor it may be a little puzzling because of the two gear shift-levers. The first thing to do is to place both of them in low gear and use the Ford transmission

for higher speed if necessary. When you have completed this machine, you will find that it has plenty of power and that its turning ability and usefulness are far superior to most tractors built from car parts.

Welding Temperature of Aluminum Shown by Sawdust

When aluminum is to be welded, preheating of the metal should not exceed 850 degrees Fahr. While experienced workers can judge when the correct temperature is being approached by tapping with a rod, or by visual inspection, beginners can determine approximate temperature by using thoroughly dry, fine, hardwood sawdust. This is sprinkled uniformly on the metal with a corn popper or flour sifter. The degree of charring of the sawdust

when applied to the metal not only shows when the right temperature is reached, but also indicates the uniformity of preheating. If the sawdust is partly charred promptly after it touches the hot metal, the temperature is sufficiently high. Sawdust containing any appreciable degree of moisture will resist charring to a greater extent than thoroughly dry sawdust, and for this reason it should be stored in a very dry place.—John E. Hyler, Peoria, Ill.

Trouser Hangers Stretch Sacks for Stenciling

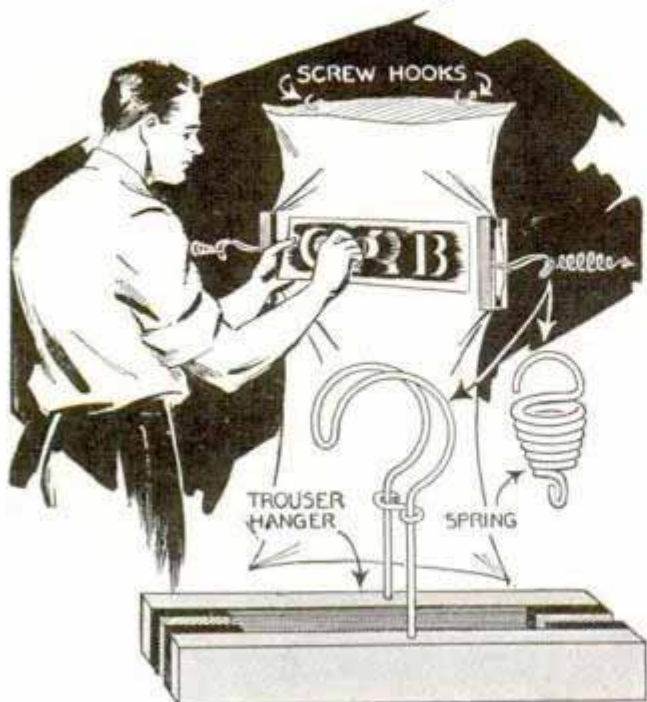

Finding it difficult to stretch grain sacks for stenciling initials on them, a grain merchant attached a couple of trouser hangers to the wall to hold them. The hangers were suspended from coil springs and spaced to spread the sack between them. Screw hooks in the wall above supported the upper portion of the sack out of the way.

Ruling Lines on Blackboard with Multiple Chalk Holder

Corrugated cardboard glued to two pieces of plywood provides a multiple chalk holder for ruling parallel lines on blackboards. The pieces of chalk are

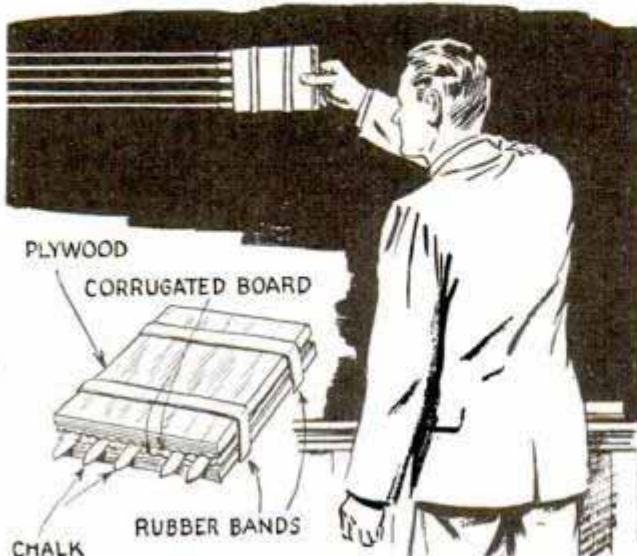

slipped in the grooves and rubber bands are snapped on the holder to keep the whole assembly tightly together.

Tiny Parts Placed on Powder Puff Are Picked Up Easily

Annoyed by the difficulty of picking up small parts used in watch repairing, a jeweler uses a powder puff as a substitute for a tray, from which the tiny parts are lifted with tweezers. It is a good idea to cement the powder puff to a fairly heavy base to prevent it from being knocked off the table.



Swinging Shelf under Table Holds Stamp Pad

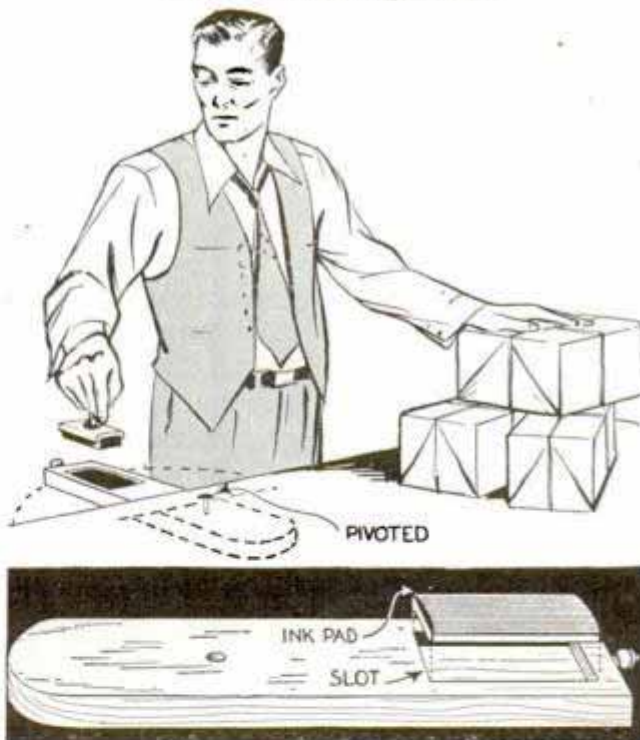

To have his stamp pad out of the way when not in use, yet handy when needed, a shipping clerk keeps it on a swinging shelf pivoted to the underside of his worktable. The pad fits in a slot or recess so that it is flush with the top of the shelf.

Use mild soap on gold-decorated glassware; strong soap may remove the gold.

AUTO SHORTCUTS . . .

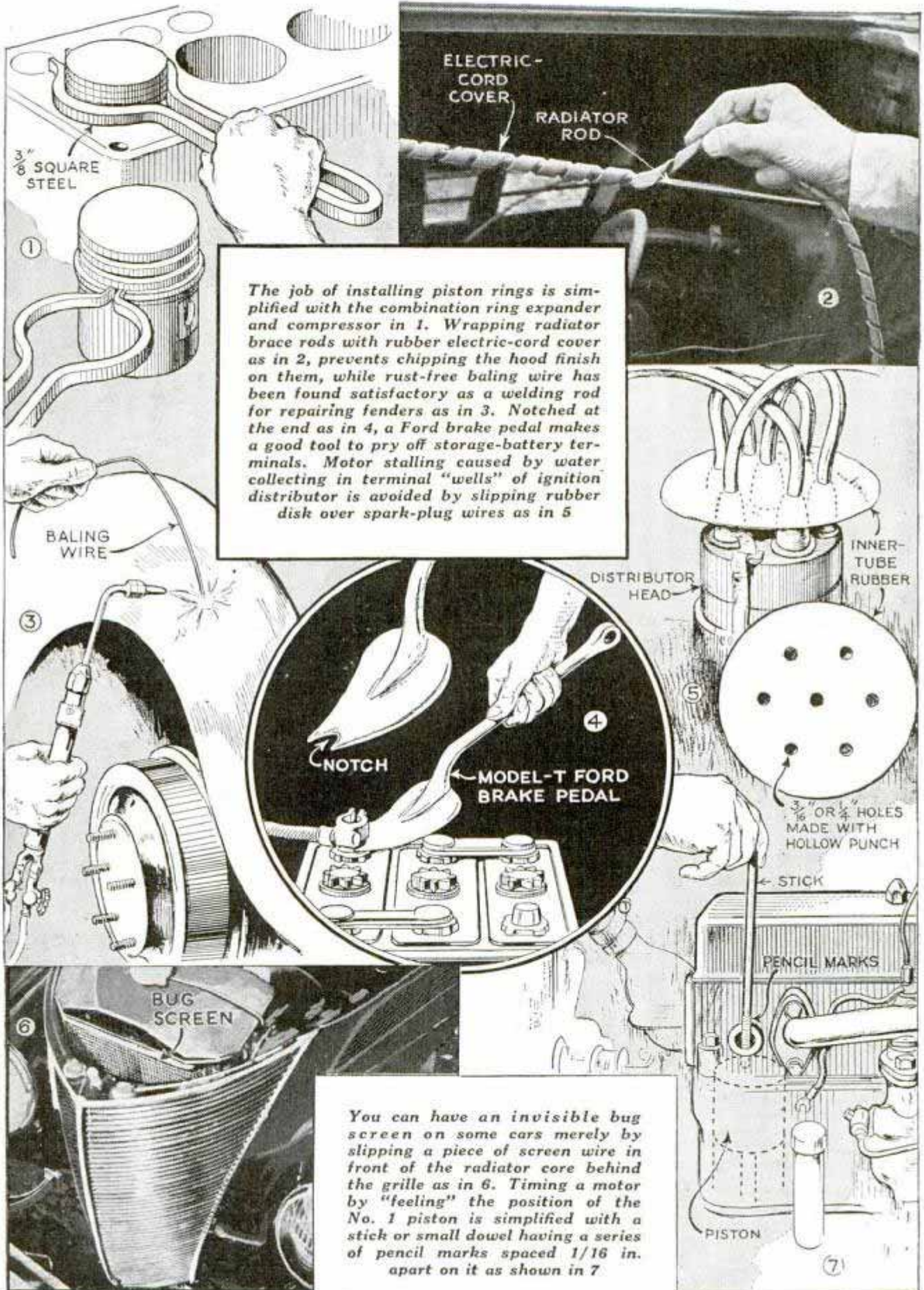

The job of installing piston rings is simplified with the combination ring expander and compressor in 1. Wrapping radiator brace rods with rubber electric-cord cover as in 2, prevents chipping the hood finish on them, while rust-free baling wire has been found satisfactory as a welding rod for repairing fenders as in 3. Notched at the end as in 4, a Ford brake pedal makes a good tool to pry off storage-battery terminals. Motor stalling caused by water collecting in terminal "wells" of ignition distributor is avoided by slipping rubber disk over spark-plug wires as in 5

You can have an invisible bug screen on some cars merely by slipping a piece of screen wire in front of the radiator core behind the grille as in 6. Timing a motor by "feeling" the position of the No. 1 piston is simplified with a stick or small dowel having a series of pencil marks spaced 1/16 in. apart on it as shown in 7.

Sloping Rack on Ice-Truck Floor Saves Climbing Inside



To avoid climbing inside an ice truck to move heavy cakes forward, one driver installed a rack that sloped toward the rear so that they would tend to slide into position. The rack should reach to within about 2 ft. of the rear of the body. This will allow one cake to rest on the floor and help keep the others from sliding out.

Trailer Lock Has Handle Flush with Door Surface

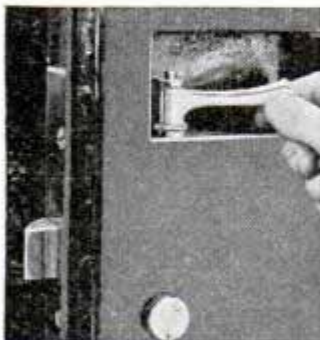

A car-door lock of the type that has the inside handle projecting vertically through the window frame, can be used to provide a fingertip control for the door of a trailer so that no handle projects beyond the outside surface of the door. Locks of this type were used on cars several years ago and can be picked up at most junk yards. To install the lock, which is placed with the vertical handle outside,

cut a recess in the door panel at the proper point to allow a finger to reach the top latch handle as shown. The projecting handle is placed on the inside surface of the door. Slight changes in the mechanism make it possible to lock the door from the inside with the regular push button and from the outside with the key.

—A. H. Vance, McNaughton, Wis.

Grease on Spark-Plug Insulators Causes Motor to "Miss"

If your motor misfires badly when first started during exceptionally damp weather, the trouble is probably caused by dirt and grease on the surface of the spark plugs. This grime collects moisture from the air and allows the plug to short circuit across the porcelain insulator. Usually such trouble can be avoided by keeping the porcelain clean.

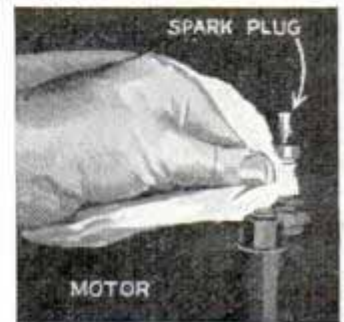

Audible Check for Short Circuits Better Than Sight

Connected into the ground cable between the frame and battery, a door buzzer is handy to check wiring for a short circuit as it will sound when the "short" occurs. To make the check, remove all lamps in the car and insulate the distributor points by slipping a piece of heavy paper between

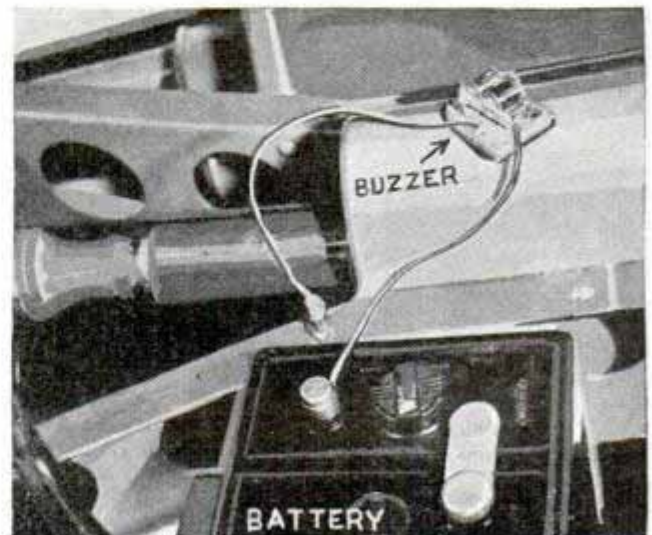

them. Then turn on all switches and go over the wiring, moving it from side to side and back and forth, especially where it passes over or through metal objects.

Improving Relined Car Brakes



By the time brake lining has worn to a point where it has to be replaced, the brake drums have usually worn off to some extent too, or maybe they have become rough and have to be turned down slightly. In such cases, when new linings are applied,

their curvature and that of the drums will not be the same with the result that uniform contact between them is impossible, and the effectiveness of the brakes is greatly reduced. To compensate for wear on the drums, a strip of thin sheet asbestos is cemented to the brake shoe before riveting the lining in place.

Noisy Tappets Are Silenced by Screen-Door Spring

Due to side thrust of cams as a camshaft raises and lowers the valves, the tappets eventually wear in their guides and cause a rapping noise. Generally this can be prevented for many thousands of miles by

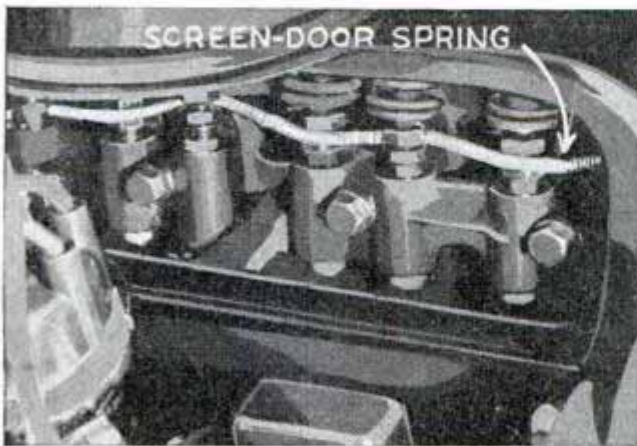

exerting slight side pressure on the tappets with a screen-door spring threaded between them as indicated.

Theft-Proof Nuts for Car Wheels Require Special Wrench

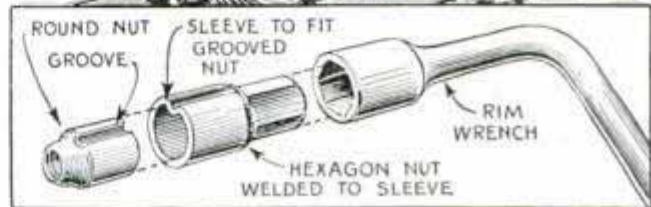
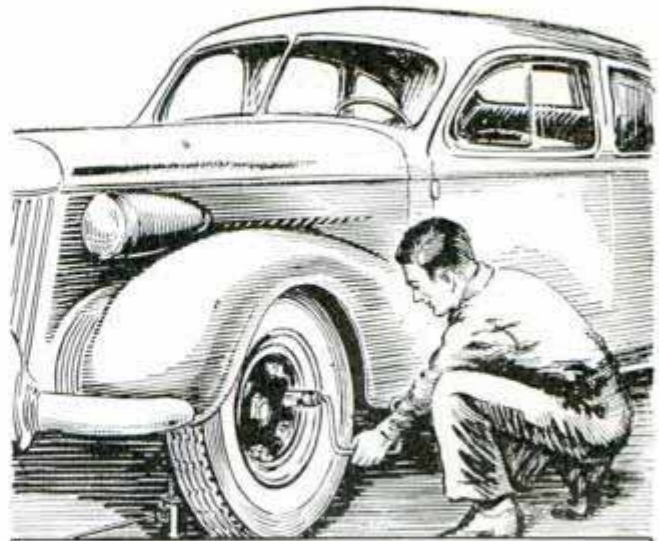

Thieves will have difficulty in taking your wheels and tires if you alter one nut on each wheel as shown. Grind it off round and file a groove in one side. Then make up a socket from a short piece of heavy tubing that will just slip over the altered nut and form a depression in one side to fit the groove. Weld a wheel nut to the socket so you can use the regular wheel wrench. Keep the socket hidden in the car.

Adjusting Worn Spark Plugs

After a spark plug has been in use for some time, an arc is usually burned in the side electrode so that it is impossible to adjust the gap correctly with a flat feeler gauge. This trouble can be overcome by bending the end of the gauge so it will fit into the arc.

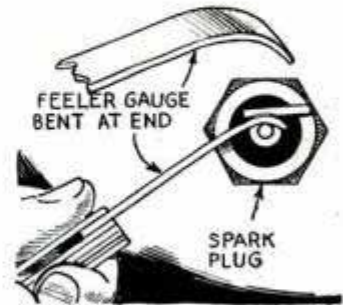

☐ A thin spot in a poor-grade auto casing will cause shimmy because of an excessive flexing at this point; this allows the wheels to tramp and then at a slightly higher speed develop a definite shimmy.

Stubborn Axle Shafts Pulled with Wheel Rim



A puller that will remove most stubborn axle shafts is made in a jiffy from an old wheel rim. Enlarge the valve-stem hole

to slip over the threaded end of the axle. Then run on the nut and strike the rim with a hammer or light sledge as indicated.

—J. Collins, Arlington, N. J.

Radiator-Grille Guard Formed from Old Bumper

A strong radiator-grille guard can be made from the end of an old bumper bar. Just saw off the length desired and bend the attached bracket down. Then drill a hole through the bracket and lower end of the bumper piece and clamp in place with a bolt.

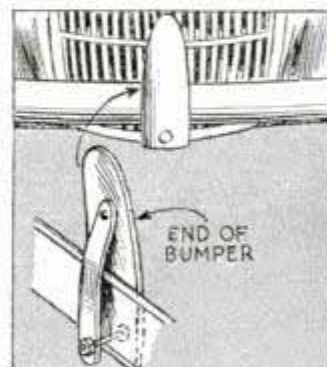

Venetian Blinds to Dress Up Your Windows

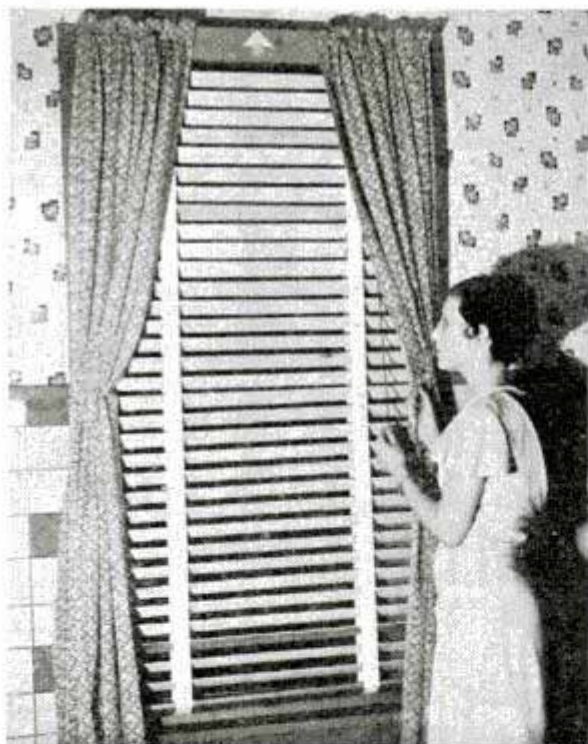

CATALOGUE OF 400 PLANS

If you have a home workshop and want some new ideas on things to build, just send your name and address with a 3c stamp for our 32-pp. illustrated plan catalogue. Lists plans on workbenches, motor-driven machines, garden furniture, models of all kinds, boats, radio equipment, juvenile articles, etc.

Tilted slats let in air and light without glare. They provide pleasant shade in summer, draft-free windows in winter and privacy the year 'round. Our blueprints 926 and 927 cover the construction of three different types of Venetian blinds and will be sent postpaid upon receipt of a 50c remittance.

MORE BLUEPRINTS ON GOOD SUMMER PROJECTS

"ZIP," MODEL RACING YACHT—880 to 883: 50 in. long. Plans include full-size lift templates. Four prints \$1.00.

LAWN AND GARDEN FURNITURE—920 to 922: Collection of designs for arbor-and-seat combinations and swings. 3 prints 75c.

LAWN CHAIR—529: Plain sawed from $\frac{3}{4}$ -in. stock. Easily made with hand tools. 25c.

TRELLIS SUGGESTIONS—639: Six types that will help beautify your home. 25c.

DUTCH WINDMILL AND WATER WHEEL—911: Mill, 40 in. high. Small water wheel. 25c.

MIDGET AUTO—906 to 909: Small car having a 58-in. wheelbase and 28-in. tread. Powered by small gas engine of the washing-machine type. Four prints \$1.00.

Any six of these blueprints (not sets of prints) will be sent postpaid upon receipt of \$1.00

Blueprint Department, Popular Mechanics Magazine, 200 E. Ontario St., Chicago

NEW LOW PRICES ON KODAKS

Addition to the world's largest camera works, now building, means a substantial saving on your new camera—latest models included

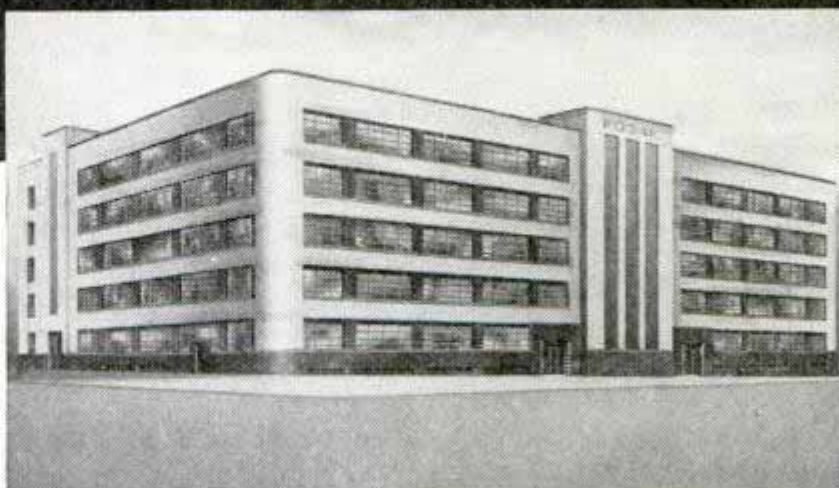

New Eastman Plant, extensive addition to camera factory already the largest in the world, as it will appear when completed. Here will be produced the finest precision cameras, made by the largest group of American craftsmen ever assembled in the photographic industry.

EVERYWHERE you go, more and more people are carrying cameras. Picture making has grown beyond all experience, forcing camera production to the limit. Eastman is looking ahead, building an addition to the world's largest camera works, installing production facilities on a scale never known before.

YOU SAVE, BEGINNING RIGHT NOW. In a sweeping reduction, Kodak prices are now brought in line with these lower production costs to come. And that saving applies on the newest, most popular models which constitute the 1939 Kodak line.

What an opportunity to get ready for the new season—this time of World's Fairs—

this greatest of picture-taking years.

See your Kodak dealer now. He will show you brilliant, versatile, up-to-the-minute models that will increase your pride and skill in picture making—traditional Eastman quality at a saving that sounds almost too good to be true . . . Eastman Kodak Company, Rochester, N. Y.

Going to the New York World's Fair?

Be sure to take your Kodak. Stop at the Kodak Building, where Eastman experts will advise you what to take and how to take it. And there you'll see the unique and gorgeous Cavalcade of Color—the **GREATEST PHOTOGRAPHIC SHOW ON EARTH.** Nothing like it has ever been seen before. Don't miss it.

EXAMPLES OF THE PRICE REDUCTIONS

KODAKS	WAS	NOW	MINIATURES	WAS	NOW
Kodak Junior Six-20, Series II, Single lens	\$8.75	\$7.75	Kodak Bantam, K.A. f.6.3 lens.	\$9.50	\$8.50
Kodak Junior Six-20, Series II, Bimat lens	11.00	10.00	Kodak Bantam, K.A. f.5.6 lens.	16.50	14.00
Kodak Junior Six-16, Series II, Single lens	10.25	9.25	Kodak Bantam, K.A. Special f.4.5 lens.	27.50	22.50
Kodak Junior Six-16, Series II, Bimat lens	12.75	11.50	Kodak 35, K.A. f.5.6 lens.	18.50	14.50
Kodak Senior Six-20, K.A. f.7.7 lens.	17.00	15.00	Kodak 35, K.A. f.4.5 lens.	29.50	24.50
Kodak Senior Six-20, f.6.3 lens, Diomatic shutter	21.00	19.00	Kodak 35, K.A. Special f.3.5 lens.	39.50	33.50
Kodak Senior Six-20, K.A. f.4.5 lens.	28.00	25.00	Kodak Duo Six-20, Series II, K.A. f.3.5 lens (Compur-Rapid shutter)	57.50	52.50
Kodak Senior Six-16, K.A. f.7.7 lens.	19.50	17.50	Kodak Retina II, Anastigmat f.2.0 lens, Compur-Rapid shutter (with field case)	140.00	120.00
Kodak Senior Six-16, K.A. f.6.3 lens, Diomatic shutter	24.50	22.50	CINÉ-KODAKS		
Kodak Senior Six-16, K.A. f.4.5 lens.	32.00	29.00	Ciné-Kodak Eight, Model 20, f.3.5.	32.50	29.50
			Ciné-Kodak, Model K, f.1.9 (without case)	88.50	80.00

Be sure to see your Kodak dealer about these remarkable price reductions.

Let's Go Deeper

(Continued from page 831)

tered oil in older formations at depths of 2,400 to 5,000 feet. Between 1925 and 1932 Spindletop did not have the spectacular gushers of old, but it did produce another 50,000,000 barrels, and it is not yet through.

Recent work in Louisiana and California, illustrates how the geologist is using geophysical instruments—the seismograph, torsion balance and gravimeter—to locate deeply buried or in other ways hidden structures. Proposals to drill 10,000 or 15,000 feet no longer make the driller “bat an eye.”

Most of the very deep wells are drilled with a rotary rig—a far cry from the little

tion on a pipe 15,000 feet long being churned into the ground by a rotary rig when the hole is straight. Then try to imagine the additional friction if the hole is crooked! But with modern electrical apparatus, the holes are surveyed and kept straight. Not all, however, are vertical. Many are slanted to drill under towns, under oceans, or to take advantage of underground structural conditions.

How deep can we go? Well, no one knows; but I, for one, am willing to predict that geologists will locate promising oil structures at 20,000 to 25,000 feet, and if they find them, engineers will drill them!

Now let's take a look at deep mining. First, we want to know how deep the veins go, and, then, how deep can we go? Some veins play out at shallow depth, and, of course, that ends mining as far as they are concerned. Others persist to great but unknown depths. But what about the values in the vein; do they also persist with depth? After the geologist has passed judgment, and he is by no means infallible, it is up to the engineer to go down and see what is there. This may not be as simple as it sounds. The oil man's problems are easy compared with the miner's. With modern technique we can drill a hole, telescoping it downward so it is perhaps four or six inches in diameter at 10,000 or 15,000 feet. But sinking a vertical shaft 5,000 feet or more is easier said than done. Recently one gold-mining company is said to have appropriated \$3,000,000 to drive a vertical shaft one mile deep and equip it with modern hoisting machinery. We don't all have three million dollars to spend, and if we do, we want to know there is enough ore at that depth to warrant the expenditure. So we call on the geologist. He examines the minerals in the exposed vein, and tells us what to do. Sometimes he is too conservative, and we decide to “bet against him.” Then the “blood is on our own heads” if we go deeper and fail to find ore.

As everyone knows, the recent “depressions” and “recessions,” coupled with pegging the price from \$20.00 to \$35.00 an ounce, have caused a tremendous increase in the search for gold. An old, very rich mine, within eight miles of my desk was

(Continued to page 116A)



Electric locomotive hauling ore cars in a deep mine. Notice the ventilation pipe at right

outfit used by Captain Lucas to present rigs. Excluding derrick and casing, the rig for the Lucas well, including boilers and all equipment, weighed about five tons and cost perhaps \$1,000. The equipment for the deepest well in the world, the Continental Oil company's A-2, in Kern County, Calif., weighed about 7,500 tons and cost in the neighborhood of \$125,000. This well is bottomed at 15,004 feet, and had an initial production of 3,000 barrels a day from sands at 13,085 feet.

As late as 1912 the deepest well in the United States was a 6,004-foot water well in Connecticut. Very few wells were 5,000 feet deep. Now 10,000-foot wells are commonplace, and there are at least a dozen more than 13,000 feet deep, and, most of them are producing oil from depths greater than 13,000 feet.

A few years ago crooked holes were the drillers' “bugaboos.” Imagine the fric-

see July 1940-32

1155

Mobiloil Protects with 3 Films

WITH CLEARANCES $\frac{1}{2}$ THE THICKNESS OF
A CIGARETTE PAPER - THE LIQUID FILM
OF THE FINEST OIL CAN BREAK!



YOU CAN NEVER BREAK MOBILLOIL'S
"3-FILM" PROTECTION



"IT'S A MYSTERY TO ME," motorists often say, "why some cars run better than others."

Oil can be that reason. Especially in hot-running, close-fitting modern motors!

Protection from wear is vital. Mobiloil does that with 3 films. It *also* resists gum, carbon, wasteful "oil drag." You get *all* good oil qualities . . . not just one or two! Socony-Vacuum Oil Co., Inc.

MOBILLOIL *For Balanced Protection*

(Continued from page 114A)

supposedly worked out before 1900. Idle many years, it was taken over recently by mining men who decided to sink it 300 feet deeper. They were rewarded by finding a large rich "shoot."

Perhaps the world-renowned Cripple Creek district is the best illustration of a region where the miners decided to go deeper. The district was discovered in 1891, and the rich gold ore near the surface made millionaires of many miners. By 1906 study of the district discouraged any hope for finding much ore below 1,000 feet. Yet in 1937 the district produced 354,034 ounces of fine gold, which, at \$35.00 an ounce, amounts to the respectable sum of \$12,391,190. While the ore came from all depths between the grass roots and 2,600 feet, the greater part of it was mined well below the 1,000-foot level.

Steam shovels and other modern machinery are aiding the placer miner, too; but in many places even modern machinery is unnecessary. Manhattan Gulch, Nev., is one. There, in the early part of this century, fortunes were made washing out gold left by streams in near-surface sands and gravel. Now the enterprising

placer miner rigs up a little hoist with an automobile engine for his power plant, sinks a small shaft fifty or sixty feet deep to bedrock, and drives tunnels on the contact of bedrock and the overlying gravels. He hoists gold-laden gravel to the surface and runs it through long sluice boxes to catch the gold, then goes back underground and sweeps up flakes and nuggets of gold from the cracks and irregular surface of the bedrock with a whisk broom!

Our ability to go deeper is a result of modern engineering. We still may find a prospector lifting his ore by the "strong arm" method with a homemade windlass. But near him there may be an up-to-the-minute electric hoist dropping the miners and lifting the ore through an electric-lighted, concrete-lined shaft at the speed of an express elevator in a skyscraper. Air drills, which run a six-foot hole in six minutes, are rapidly replacing the single jack; electric locomotives are replacing man power and mules for hauling ore. When, at great depths, our mines are too hot for men to work efficiently, we air-condition them. Evidently we are going deeper because we can!

Rescuing America's "Valley of the Nile"

(Continued from page 869)

steamboat and barge navigation far above the city of Sacramento; to afford improved irrigation in much of the Sacramento valley, and to check the seasonal encroachment of salt water into the channels of the Sacramento-San Joaquin delta.

The release of stored waters at Shasta dam will generate a billion and a half kilowatt-hours of electricity annually, a demand for which is definitely in sight. Finally, when the conserved waters of the Sacramento river have performed all of these functions, and have passed every possible user on that river, they will afford a surplus for delivery by canal to Contra Costa county and the lower San Joaquin valley for irrigation.

The next section of the project is the Delta cross channel which will facilitate the fresh-water flushing of delta waterways with Sacramento river water, and the delivery of an adequate supply to the intakes of the Contra Costa canal and the San Joaquin pumping system.

The Contra Costa canal, which is under construction, will extend forty-six miles from the San Joaquin river at Rock Slough to a small reservoir above Martinez. It will afford a constant supply of fresh water for industrial use in manufacturing and processing plants along the south shore of Suisun bay, for domestic use in at least five Contra Costa county municipalities, and for agricultural use in an upland area of orchard and field crops.

The San Joaquin pumping system is the all-important geographical link which integrates the water resources of the Sacramento valley with those of the San Joaquin. It will comprise a series of pumping plants and connecting canals from the delta up the northern San Joaquin valley some 135 miles as far as the Mendota weir on the San Joaquin river west of Fresno. This feature of the project has been described as "making the San Joaquin river run backwards." While this is not strictly

(Continued to page 118A)

"MY STORE BLEW AWAY, *with me in it!*"



E. D. CORNELIUS

**STORE TAKES OFF IN TORNADO
CARRIES STOREKEEPER 200 FEET**

1 E. D. Cornelius, of Daisy, Oklahoma, used to run a store near Antlers, until a tornado blew it away, *with him in it!* He writes:

2 "At ten o'clock the night of June 9th, I was wakened by terrific thunder and lightning. I grabbed a flashlight and started pulling on my clothes. The howl of the wind became a scream. The store began to rock. An avalanche of merchandise tumbled from the shelves... *and over she went!*

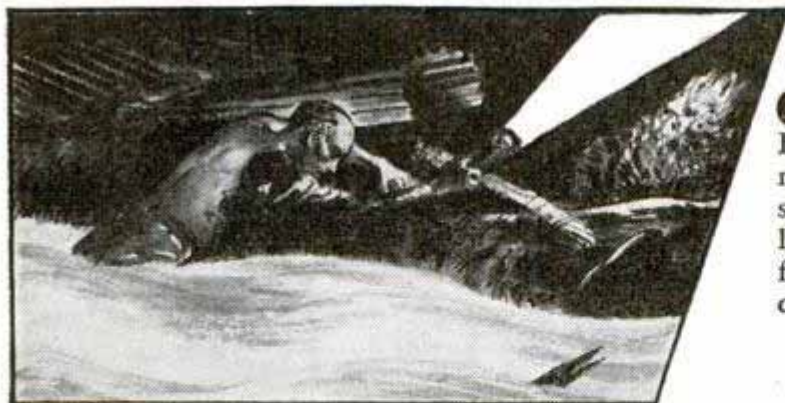

3 "Something hit me and I went out like a light—but my flashlight didn't and I still hung on to it. My store landed 200 feet from its foundations, and then went on..."

4 "...but it left me at the first stop. Neighbors who saw my store was gone started looking for me. They found me alive only because the 'Eveready' *fresh DATED* batteries in my flashlight were still working. I lay battered and unconscious on the bank of a rapidly rising stream. A matter of minutes and I would have drowned. No two ways about it, I owe my life to 'Eveready' batteries, the kind that can take it!

(Signed) *E. D. Cornelius*

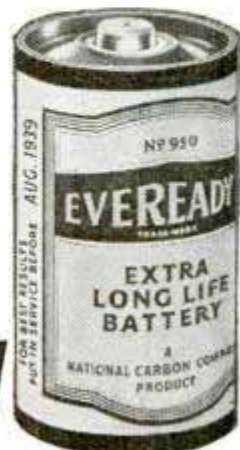

FRESH BATTERIES LAST LONGER... Look for the DATE-LINE

NATIONAL CARBON COMPANY, INC., 30 EAST 42nd STREET, NEW YORK, N. Y.

Unit of Union Carbide **UCC** and Carbon Corporation

When writing to advertisers please mention Popular Mechanics

(Continued from page 116A)

true, the purpose of the San Joaquin pumping system will be to furnish substitute water from the Sacramento river to lands in the lower San Joaquin valley now irrigated by San Joaquin river waters. At the present time practically all of the natural flow of the San Joaquin river is appropriated for irrigation, except in times of flood.

With irrigators on the lower San Joaquin river partly supplied with surplus Sacramento river water, in lieu of some of their present San Joaquin river supply, it will be practicable to conserve a large part of the natural flow of the San Joaquin

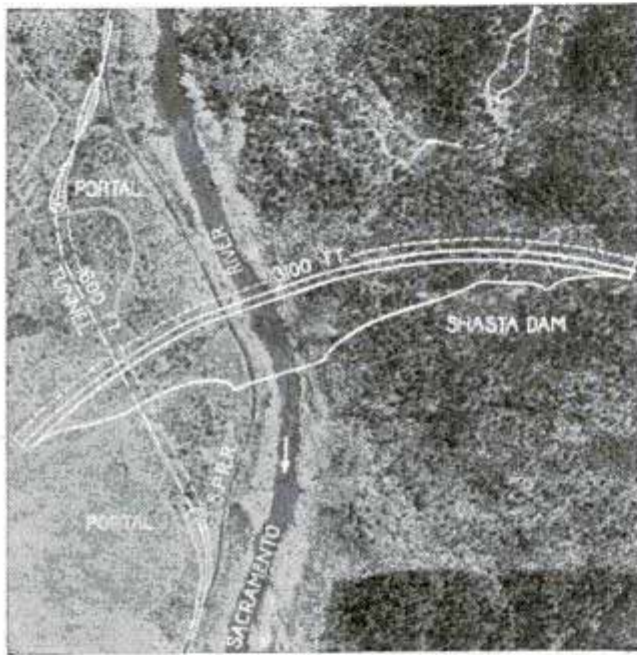

Showing how Shasta Dam will appear when completed. Note change in railroad route at left

river at Friant dam, and from there divert it to Madera, Fresno, Tulare, Kings and Kern counties.

Friant dam, 300 miles south of Shasta dam, on the upper San Joaquin river, will be a sizable structure in itself, more than eight average city blocks from end to end along the crest. It will link the Madera and Fresno county hillsides by a straight gravity-section wall of concrete, twenty feet wide at the top, as much as 220 feet thick at the bottom, and 300 feet high from the lowest foundation.

Friant reservoir will have a gross storage capacity of 520,000 acre-feet. Friant dam will have an overflow spillway with a 300-foot crest in the river section, controlled by three movable drum gates on top of the dam. There will be river outlets through the dam regulated by ring-seal

gates and needle valves, and similar outlets to the Friant-Kern and Madera canals.

The largest canal will be the Friant-Kern which will skirt the foothills east of Fresno and Visalia, and will extend 160 miles to the Kern river west of Bakersfield. The canal will have a diversion capacity of 3,500 second-feet to be maintained for the first thirty miles to the Kings river, decreasing to 3,000 second-feet for the section between the Kings river and the Kaweah river, and to smaller capacities beyond. Plans for the first thirty miles call for a bottom width of thirty feet, a water depth of fifteen feet, and a top width at the surface of sixty-eight feet.

The Madera canal, which will extend from Friant dam northerly forty miles to the Chowchilla river, will have a diversion capacity of 1,000 second-feet, decreasing at the Fresno river to 500 second-feet.

A necessary accessory job at Shasta is reconstruction around the reservoir site of thirty-seven miles of the Southern Pacific's main railroad line between Sacramento and Portland, Ore. The new line, thirty miles long, will include twelve tunnels and eight bridges. One of these bridges, in itself, will be a noteworthy structure—a double-deck combined railroad and highway bridge across the Pit River canyon, which is later to be flooded. It will be 3,300 feet in length and the highway deck will be 470 feet above the normal level of the river—almost twice the height of the San Francisco bay bridge roadway above the water of the bay. A railroad by-pass tunnel, 1,820 feet in length, is now under construction at Shasta dam. This tunnel will temporarily pass the railroad under the west abutment of the dam site, enabling foundation and preliminary work to proceed on the dam itself simultaneously with construction of a new permanent railroad line. Another incidental job is the reconstruction of fifteen miles of the Golden State highway.

Conceived more than sixty-five years ago the project will be completed in 1944 or 1945.

☐ Popular Mechanics Magazine can furnish the name and address of the maker of, or dealer in, any article described in its pages. If you wish this information, write to the Bureau of Information, inclosing a stamped, self-addressed envelope.

THOUSANDS MARVEL TO SEE THEIR SKINNY BODIES FILL OUT...

As Wonderful *IRONIZED YEAST* Tablets Add 10 to 25 Pounds in a Few Weeks

SCIENTISTS have discovered that thousands of people are thin and rundown only because they don't get enough Vitamin B and iron from their daily food. Without these vital substances you may lack appetite and not get the most body-building good out of what you eat.

Once these substances are supplied—and you get them now in these amazing little Ironized Yeast tablets—the improvement that comes in a short time is often astonishing. Thousands report wonderful new pep, gains of 10 to 25 pounds in a few weeks—complexions naturally clear—a new natural attractiveness that wins friends everywhere.

Food chemists have found that one of the richest sources of marvelous health-building Vitamin B is the special rich yeast used in making English ale. Now by a costly process, this rich imported ale yeast is combined with Vitamin B concentrate from yeast and with 3 kinds of strength-building iron.

The result is these new, easy-to-take Ironized Yeast tablets, which thousands of formerly skinny people who needed their vital substances hail as one of the greatest weight-building, health-building discoveries of all time.

Make this money-back test

Get Ironized Yeast tablets from your druggist today. If with the first package you don't eat better and **FEEL** better, with much more strength and pep—if you're not convinced that Ironized Yeast will give you the normally attractive flesh, new energy and life you have longed for, the price of this first package promptly refunded.

Only be sure you get genuine Ironized Yeast, and not some cheap, inferior substitute which does not give the same results. Look for "IY" stamped on each tablet.

Special offer!

To start thousands building up their health right away, we make this special offer. Purchase a package of Ironized Yeast tablets at once, cut out the seal on the box and mail it to us with a clipping of this paragraph. We will send you a fascinating new book on health, "New Facts About Your Body." Remember, results with the first package—or money refunded. At all druggists. Ironized Yeast Co., Inc., Dept. 536, Atlanta, Ga.



IMPORTANT

Beware of substitutes.
Be sure you get genuine
IRONIZED YEAST.
Look for the letters "IY"
on each tablet.



Posed by
professional
models

THE JOY OF A BARBASOL FACE



Your Wife will be the first to shower you with flattering words: "My, how much younger you're looking here of late. Now aren't you glad I bought you that tube of Barbasol?"



or your Sweetheart (if you're still on the loose) will have her say: "How smooth, soft, positively nice the skin is, on your cheeks, jaw and chin."

and you Yourself will feel as proud as a peacock. Not only the quickest, cleanest shaves you ever had, but a finer-looking skin by far. No half-cut stubble, either. That's the joy of a Barbasol Face.

YOU'LL GET SWELL RESULTS with Barbasol in ten short days or so. That's because Barbasol does more than give you the sweetest shaves you ever had. Its beneficial oils protect the skin from irritation, coarseness, roughness—oils that smooth and soothe, soften and freshen the skin. Your druggist carries three sizes. The large tube, 25¢. Giant tube, 50¢. Family jar, 75¢. Barbasol Blades, scalpel sharp, only 15¢ for 5.

For Modern Shaving



No Brush • No Lather • No Rub-In

"Freezing" Action in Pictures

(Continued from page 885)

and is practical only with inexpensive cameras with the so-called rotary shutters. Never attempt to change the spring tension. The masking material must be as light as possible since if it is heavy the shutter will move across the lens slowly and give a longer exposure. Use care in replacing the front guard plate exactly in its original position.

If your camera has a focal-plane shutter you can improve its efficiency in getting action shots by holding it properly. Most



Diver, in shade, was caught at one-fiftieth second by waiting for instant of minimum motion

photographers hold focal-plane cameras upright so that the open slit in the shutter snaps downward, no matter what action they are taking. In many cases better pictures would be obtained by holding the camera so that the shutter moves in the same direction as the object. Since the lens has inverted the picture on the film, the shutter travels in the opposite direction to the image inside the camera, materially reducing movement.

Animals are difficult to photograph close up except at speeds of 1/100 of a second or

438
faster. A stamping foot or a toss of the head just as you click the shutter may spoil the picture if a slow speed is used. One of the hardest places from which to take clear pictures is from a small boat in rough water; the faster shutter speed you can use, the better your pictures. On the other hand, pictures may be snapped of the ground from a speeding airplane at 1/100 of a second or even one-fiftieth, simply because the object being photographed is a long distance away from the camera. Of course, care should be taken not to hold the camera against the window of the plane, to avoid vibration.

Taking care of your camera is mainly a matter of common sense. Sand in a camera usually means a repair job, as a few grains are apt to work into the shutter mechanism. Shutters should never be oiled. Nearly half the cameras sent to camera hospitals were put out of commission by a drop of oil on the shutter. Cameras should never be dropped since a hard blow is apt to derange the timing gear or focusing alinement.

The lens should always be kept clean, brushed off with a camel's-hair brush. The best way to clean the glass is with a half-and-half solution of water and alcohol, just enough to moisten a small patch on a clean linen handkerchief. Never use acid, even a weak solution, for cleaning the lens. Even perspiration contains a small amount of acid and it will leave a mark if a fingerprint is allowed to remain on the glass.

Cameras that have been exposed to moisture should be wiped off carefully and dried before being put away. A good harness dressing rubbed on the bellows and leather parts helps preserve them. A ground glass may be washed with soap and water. A lens should never be unscrewed and the sun should never be allowed to shine directly into it. In the summer time keep your camera in a cool place and out of the sunlight. Heat hardens the bellows and may result in small leaks.

Practice and a fast camera are important in getting good action pictures. Don't be discouraged if you spoil some film. Professionals spoil plenty. You see only the good ones.

☐ Send return postage to our Bureau of Information to learn the name of the maker of any device described in this magazine.

Unheard-of Value in Fine-Camera Field!

New AGFA Memo

only \$25⁰⁰

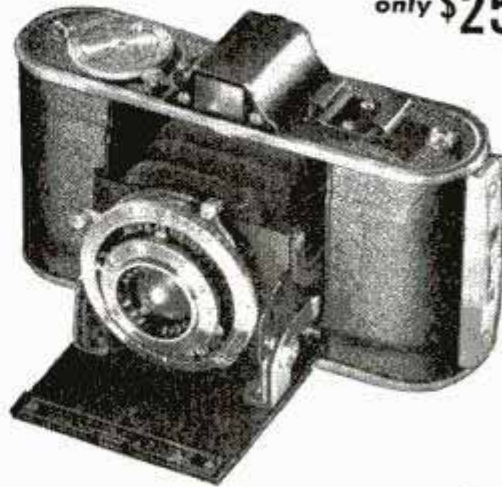

THE camera sensation of 1939... Agfa's 35 mm. MEMO... a fine, precision-built instrument... for only \$25.00! Exclusive rapid film transport; accurate shutter with speeds of 1/2 to 1/200th second, bulb and time; Agfa Memar f4.5 anastigmat lens; direct-view finder; accessory clip, tripod socket, and neck cord. Takes 24 pictures (1 7/16 x 15/16) on 35 mm. film. Camera complete, with f4.5 lens... \$25.00. With f3.5 lens... \$35.00.

Also new... Agfa f6.3 Clipper

...only \$15⁵⁰



THE Agfa f6.3 Clipper Special is another astonishing value! New telescoping front eliminates bellows... shutter gives speeds of 1/25 to 1/100th second, bulb and time... hinged back, easy loading arrangement, shutter release guard, tripod socket, and built-in depth-of-field scale. Takes 15 pictures (2 1/2 x 2 1/16) on one roll of PD16 (616) film. Camera complete with neck cord... only \$15.50. Made by Agfa Anasco Corporation in Binghamton, New York, U. S. A.

AGFA  CAMERAS

You Get Better-Looking Shaves
Double-Quick With This New
Gillette Blade
at $\frac{1}{2}$ Price!



Super-Keen Edges of
Radically New Kind
Protect Your Skin
from Smart and
Burn Caused by
Misfit Blades.

4 for 10c
8 for 19c



FOR guaranteed shaving comfort at a real saving... the new Thin Gillette is the blade for you. Selling at only 10c for 4... this blade has edges of an improved kind honed on easy-flexing steel hard enough to cut glass. That's why it shaves tender skin smoothly without smart or burn... outperforms and outlasts ordinary blades two to one! Buy a package from your dealer today.

You Men Who Want Utmost Shaving
Luxury Of Course Demand...

The **Gillette Blue Blade**

MEN who want the finest razor blade money can buy, get it by asking for the Gillette Blue Blade. Here is a luxury every man can afford—for it costs less than one cent a day. Don't let anyone talk you out of it. Rely on your own judgment and try today's Gillette Blue Blade. Buy a package of these superior blades from your dealer today on our positive money-back guarantee of complete satisfaction.

5 for 25¢



How to Play Winning Tennis

(Continued from page 895)

and unless a player can finish off a point after making an opening he can never hope to defeat any top ranking player. There are two forehand drives, the flat drive and topspin. The flat drive hits the ball squarely in the center with the cross strings pointing directly up and down and following through with the racket head holding this straight up-and-down position. In the topspin the racket meets the ball in the same manner but at the moment of impact the head of the racket turns very slightly to go across the top of the ball. The racket head should meet the ball in the same plane and stay in that plane for the follow through on a flat drive. For the topspin the racket follows through with a slight upward trend. If the body is turned sideways to the net the feet naturally fall into correct position. The weight should be shifted forward at the moment the racket meets the ball. The body should pivot and not lunge forward. The knees should be slightly flexed and should bend down to the ball.

Besides the forehand drive there are two other shots made from the forehand side after the ball has struck the ground. (Of course if the ball is struck before the bounce it is a volley and is ordinarily played close to the net.) They are the forehand chop and the forehand slice. In making a chop the racket head starts high and is swung down to the ball, meets the ball in back and passes directly under, imparting a heavy back spin. In a forehand slice the racket head starts directly behind where the ball is to be struck, and afterwards passes around to the left.

The most difficult shot for most players to master seems to be the backhand—chiefly because it is practiced least. A player hitting twenty-five forehand shots to three or four on the backhand will naturally become more proficient in his forehand. The backhand drive can be made absolutely flat, with a slight backspin or a slight topspin. Take the backhand grip as explained earlier; spread the fingers up the handle and under no condition point the thumb up the handle. Take the racket back with a circular or a straight backswing, keep the body sideways to the net and have the head of the racket and the wrist on

(Continued from page 133A)

to my surprise and delight they had no objections. But before we approached Cheran we had visited a famous and beloved Indian woman at a neighboring village and had brought her to Cheran with us. Unquestionably that is why we were well received. In photographing strangers I think friendliness is better than trickery.

Perhaps my most interesting expedition was to the reindeer country of the Tungus north of Lake Baikal. I was accompanied only by Professor Petrie, most famous explorer of all Siberia. Our first destination on leaving the railroad was the town of Kachug on the Lena river, 200 or 250 miles distant, and we were lucky to find a bus leaving for the gold fields. There were no roads on the Siberian steppes; thirty miles north the bus broke down. The driver said repairs might take a week. The Russians took it philosophically, but I couldn't. I suggested a plan to Petrie. We laid a barricade of knapsacks and suitcases at the edge of a gully to blockade any automobile coming our way. By good fortune, a truck came along that night. While Petrie chatted with the driver I roped our luggage on top, and when I gave the signal we got aboard. All night and sixteen hours of the next day we rode the roughest ruts I ever traveled. At Kachug the driver thanked us, rather sullenly, for the tip and dumped us out. We borrowed four horses and two wagons from the Red army and for two days pushed on across the Siberian plains and into the tundra. On the last day the luggage wagon turned over five times.

Now we were stuck not only in the swamp, but in a deep forest. Wagons could proceed no farther. We loaded our packs on two horses and rode the other two. Trees were so close together that the pack horse was always having its load scraped off. I had plenty of time to wonder what would happen if my horse fell in the swamp, in eighteen inches of water, with me underneath. In two hours he did fall five times, but I was able each time to kick free of the stirrups and jump aside. Professor Petrie took it calmly, but it was no picnic to me. Finally I got down and walked. For long miles I slogged and stumbled through the muck until, two days later, utterly exhausted, we reached our first Tungus village. And this is the story I shall tell in a second article next month.



NOW Exclusive twin aluminum cylinder block reduces weight of Johnson's famous all-purpose "LT" twin to 33½ lbs. Power increased to 5.0 N. O. A. certified brake h. p. at 4000 r. p. m. All sinew — no "fat"! \$109.50. De luxe model with Ready Pull Starter \$129.50. (Shown here.)

Also see the new Miracle Motor — only 21½ lbs. — ban-tam edition of the above. Only \$79.50! Other models as low as . . . **\$49.50**
All prices f. o. b. factory.

Free Handy Chart
NEW! Sizes, specifications of the 10 great Sea-Horse motors for '39. New models. New features. Illustrated. Send for your copy!

JOHNSON MOTORS
400 Pershing Road, Waukegan, Ill.

JOHNSON GIVES YOU "ALL THREE"!

1. Perfected Alternate Firing — backed by 10 years experience in building.
2. Quiet. Built-in Underwater Exhaust.
3. Reverse! With 3600 Steering!

JOHNSON SEA-HORSES

Send \$1 to **PHOTO-CRAFT** for FINE GRAIN DEVELOPING

35 mm. 36 exp. FILM
In temperature controlled rooms — filtered water . . . ultra-care.

ENLARGEMENTS FREE
3¼ x 4½ of EVERY printable negative. On Kodabrom.

DEPT. M
CANTON, OHIO

Filing container — mailing bag — and bargain catalog.

GET NEXT TO THIS NEW Atlas LATHE

POWER CROSS FEED Now Standard Equipment

It's the sweetest running lathe you've ever seen. Includes all modern features for precision work. 10" swing. \$99.75 and up complete less motor on easy terms through your dealer. Send for new 72 pg. catalog showing other Atlas background, screw-cutting lathes from \$59.50 up.

FREE CATALOG

Atlas
ATLAS PRESS CO.
643 N. Pitcher St.
Kalamazoo, Mich.

**LATHES • DRILL PRESSES
ARBOR PRESSES • SHAPERS**



WIDE-AWAKE BUSINESSMEN in every field are relying on Public Address to boost business.

THE ECONOMY LINE: Save money with Lafayette P. A. Save on Lafayette's low prices . . . save on Lafayette's operating economy. If you operate a ballroom, plant, theatre, store or travelling show, investigate Lafayette—today!

Attract more people and make your message stick with a Lafayette Sound System. Every model in this, the world's most complete line redesigned for 1939. Prices for systems complete ready-to-operate as low as \$23.86.

EARN MONEY SELLING: Sell Lafayette internationally known Sound equipment. Generous profits, pleasant "white collar" work—steady or spare time.

SEND AT ONCE for FREE CATALOG. Find out what Lafayette P. A. can do for you. Simply tear out and mail coupon.

LAFAYETTE RADIO CORP., 100 SIXTH AVE., NEW YORK

LAFAYETTE PUBLIC ADDRESS EQUIPMENT

Yes—send me complete information on how I can increase my business with P.A.

Name

Address

City

State

LAFAYETTE RADIO CORPORATION

Dept. 7FP9-100 Sixth Ave., New York, N. Y.

60 POWER TELESCOPE . . . \$219

VARIABLE EYEPIECE 20X—40X—60X

NEW! Three telescopes in one. 3 different magnifications. 20 power for ultra-bright images with 40 and 60 power for extra long range. Guaranteed to bring distant objects, people, sports events, ships, moon, stars, etc., 60 times as close.



Most powerful made for anywhere near the money. Closes to one foot in length. Multiple lens system. 30 mm. objective lens. 5 sections. Directions included for using as a compound 4 lens microscope. American made. Prompt shipment guaranteed. We pay the postage. Only \$2.19. **BROWNSCOPE CO., Dept. 46, 5 W. 27th St., New York, N. Y.**

BIG PROFITS for RIDERS, DEALERS! RIDE, RENT OR SELL

The NEW Mead Ranger SCOOTER



Everybody's riding the marvelous new Ranger Scooter! Order your demonstrator while territory is still open—there's big money selling to all stores needing quick, cheap delivery . . . sell to messengers, mechanics, garages, canvassers, friends; or rent for easy hourly profits at beaches, resorts, etc. World's **CHEAPEST** transportation! 120 miles per gallon, 35 m.p.h. Only \$99.00 and up! Mead's New Ranger **STEEL** frame, 2-speed gear, 1½ or 2½ H.P. Solo models, tandem, delivery, sidecar or trailer. **HURRY!** Write for **FREE** Circular, Easy Terms.

CYCLE CO. Mead
17 So. Market, Dept. R-1, Chicago, U.S.A.

AMERICA'S MOST FAMOUS CYCLE NAME FOR FIFTY YEARS

Low-Cost Pocket Set

(Continued from page 938)

board, is cut and drilled for the switch which is mounted in one end of the form by means of china cement.

A standard 1,000 or 2,000-ohm single earphone of the type which has a metal

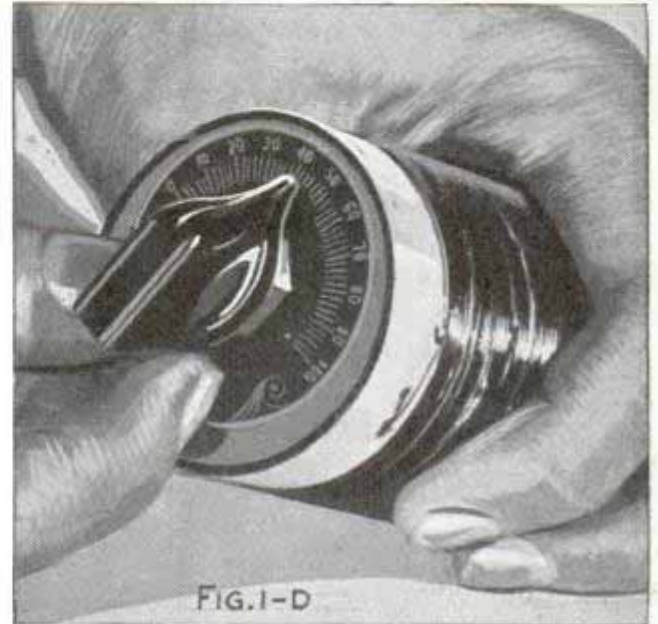

FIG. 1-D

case and cap is available from radio supply houses for less than one dollar; this earphone should be new as most old ones are weak. A piece of wire is bolted to the metal case of the earphone by means of a short machine screw through a hole drilled in the case. This wire is then run to the terminal that is connected to the "ground" end of the coil. The fixed crystal detector

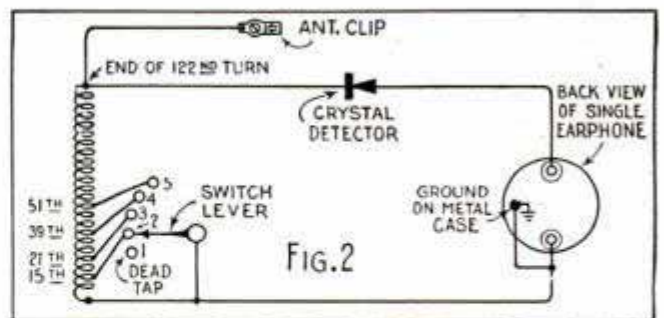

FIG. 2

is connected in the circuit with flexible insulated leads and wrapped in cotton or a piece of cloth to keep it from moving about; the earphone is then cemented in the end of the coil form. Photos Figs. 1-B, 1-C and 1-D show various views of the completed assembly. All connections must be soldered carefully. The antenna lead should be a 4 or 5-ft. length of flexible insulated wire and terminate in a good strong clip, preferably of the battery type.

Announcing— The New DAISY LIGHTNING-LOADER

Carbine



Fastest-Loading Air Rifle In History!

WRITE FOR FREE

DAISY AIR RIFLE CATALOG

"Like my own Carbine"



Prices slightly higher in Canada

LOOK AT IT! . . . Daisy's brand-new, grand new Lightning-Loader **CARBINE**—a 500 Shot Repeater—with three sensational "first-in-history" features: (1) First and only **Lightning-Loader Shot Magazine** making it the fastest-loading, easiest-loading Air Rifle in history! (2) First and only **Adjustable Double-Notch Rear Sight** for long and short range shooting, target and "snap" shooting! (3) First and only **CARBINE** in Daisy Air Rifle history. Looks, feels, shoots like the powerful **CARBINES** used by famous Frontiersmen. Husky Wooden Fore-piece for steadier aim—rich walnut-finish Pistol Grip stock. **AND**—how your heart will thump and jump for joy when you learn that Lightning-Loader **CARBINE** costs you only \$2.50—the most air rifle and the most fun for the least money. Hurry—get your new Daisy **CARBINE** now at any hardware, sporting goods, department store! (If your dealer hasn't it in stock, rush \$2.50 to us—we'll mail yours postpaid.)

\$2.50

DAISY MANUFACTURING COMPANY
116 Union Street, Plymouth, Michigan, U. S. A.

DAISY AIR RIFLES



PHOTO ENLARGEMENTS
5¢ ANY SIZE

Is Photography your hobby? Do you want a profitable easy business at home? Make **PHOTO ENLARGEMENTS** for yourself and others. Your cost 5¢ each and less. The Ideal Photo Enlarger is **AUTOMATIC**. No experience required. Also **COPIES** any picture, **\$5.94 COMPLETE**. Interesting circular **FREE**.

IDEAL ENLARGER, 148 West 23rd St., New York City

FIREWORKS FREE SALUTES Oh Boy!

THINK OF IT! An assortment of over 605 pieces of fireworks worth \$6.15, for \$2.95 cash with order. We have the famous "ZEBRA" flashlight crackers. World's loudest. You get more for your money at **BANNER, 100 FREE salutes** with every order. Write for free catalog.

BANNER FIREWORKS
4323-Vermaas Ave. Toledo, Ohio

EASY PROFITS IN PAINT SPRAYING

Paint walls, ceilings, screens, furniture, radiators, machinery faster, better! $\frac{1}{4}$ H. P. motor 110 Volt 60 Cycle AC, complete with Spray Gun, 15 ft. hose. Weighs only 44 lbs. Carry anywhere. **FULLY GUARANTEED**. Only \$31.15 f. o. b. Chicago. \$5 Deposit, Balance COD, or **SEE YOUR DEALER**. Circular **FREE**. Get started making money NOW! **\$31.15 Complete**

Ideal Automatic Pump Co. Dept. PM-6, 801 Washington, Chicago

DO YOU WANT a new business profession of your own, with all the trade you can attend to? Then **become a foot correctionist**, and in a few weeks earn big income in service fees.—not medical nor chiropody—easy terms for home training, no further capital needed, no goods to buy, no agency. Established 1894. Address **Stephenson Laboratory, 1 Back Bay, Boston, Mass.**

When writing please mention Popular Mechanics

A
♠

TOPS IN PORTABLES

SPEEDLINE CORONAS

L. C. Smith & Corona Typewriters Inc
Desk 6, 723 E. Washington St.,
Syracuse, N. Y.

I understand the **SPEEDLINE CORONA** comes in three models, and can be bought from dealers everywhere for as little as \$1.00 a week plus small down payment. Please mail me free folder.

Name _____
Address _____
City _____ State _____

♠
V

Everything in Radio

AT LOWEST PRICES!

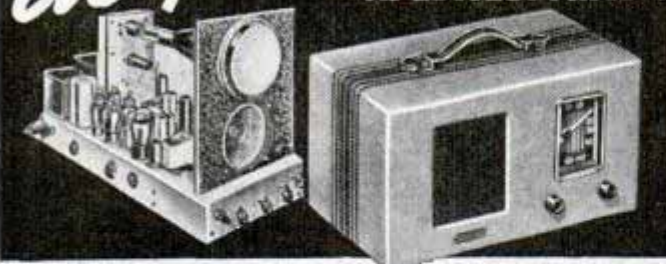

62 NEW SETS • KITS • 14,000 PARTS AMATEUR GEAR • SOUND SYSTEMS

Send for ALLIED's new Spring Catalog, just out! See your every radio need, at lowest prices! New "Knight" Radios, with Push-Button Tuning and "Air-Magnet" built-in aerials at prices never before possible. New Portable, AC, AC-DC, 1½, 6, and 32 volt models—some as low as \$5.95. Dozens of Build-Your-Own Kits; Television, amateur gear; record players, phonographs, phonoradios; over 14,000 parts, books, tools, test equipment; Sound Systems for every purpose; recording equipment, discs, etc. Get

ALLIED's Spring Catalog—Radio's Complete Supply Guide! It saves you time and money on every radio need. It's FREE—just send coupon.

FREE! Builder's Parts Lists of matched kits for building any circuit described in this or any other magazine. BEGINNERS—Send for ALLIED's "Radio Builder's Handbook"—only 10c—thousands sold!

ALLIED Radio Corporation,
833 W. Jackson Blvd., Dept. 5-F-9, Chicago

- Send your Spring Radio Catalog Free.
- Enclosed find 10c (and 3c postage) for Builder's Handbook.
- Send Free Parts List for.....

Name.....
Address.....



Free CATALOG

BUILD YOUR OWN SAVE EVAPORATIVE COOLER

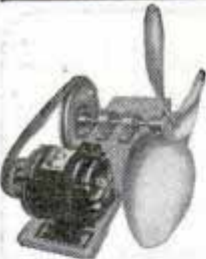

A modern cooling system for home and business. We furnish parts, you build. "Factory to you prices." 24" unit as shown, unassembled, **\$26.70**
Write for particulars and other sizes.
Shipped collect.

MICHAEL ELEC. CO., Ft. Worth, Tex.

ENGINES

Enclosed, Self-Oiling, Roller-Bearing

Cheapest reliable power for farm or factory. Uses all fuels for pumping, sawing, etc. Best engine for the money. You Pay Less to Own it—Less to Run it.

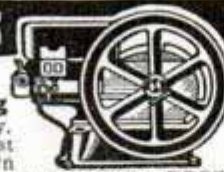

Cash—Terms—Catalog FREE
WITTE ENGINE WORKS
174-A Oakland Ave. KANSAS CITY, MO.

TEST-O-LITE

Tests Everything Electrical
From 100 to 550 Volts



A real necessity for electricians and home because it has 1001 uses. Equipped with a Neon light which tells instantly where trouble lies in electric circuits, fuses, cut-outs, motors, radios, all kinds of electric appliances, etc. Tells A. C. from D. C. Far superior to ordinary clumsy test bulb. Fountain pen size with clip for carrying in vest pocket. Lifetime guarantee.

PATENTED

L. S. BRACH MFG. CORP.
55 Dickerson St., Newark, N. J.



A.C.-D.C. Three-Tube

(Continued from page 937)

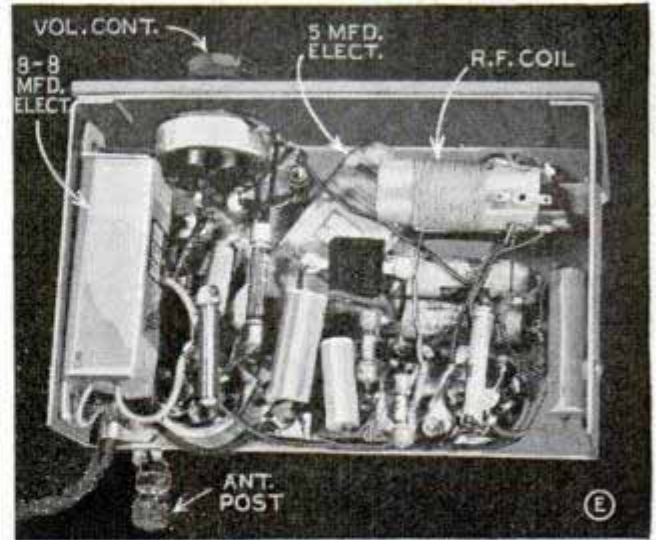

both sides, turn trimmers on one side out as far as possible, and leave them open. A list of the original parts used in the model can be obtained from Popular Mechanics radio department without charge. A 20-ft. antenna of the flexible cloth-covered roll-up type may be used for local stations. Blueprint number is R-268.

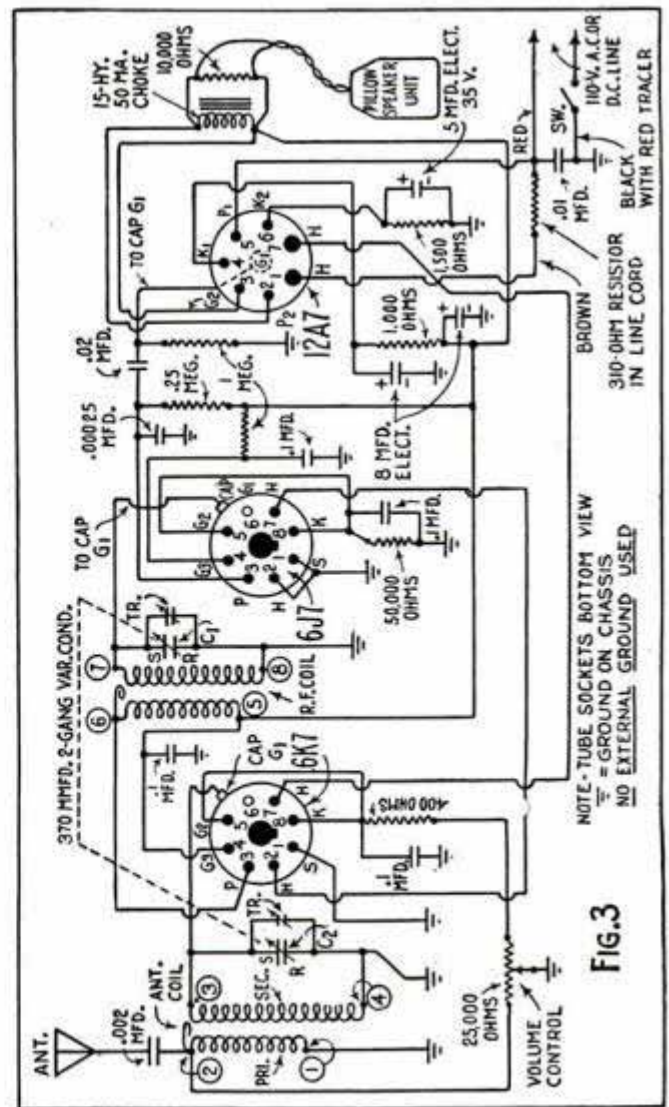



**TRY A ROYAL—THE PORTABLE
WITH OFFICE TYPEWRITER FEATURES
IN YOUR OWN HOME FREE!**

READ WHAT OWNERS SAY:
"Homework is neat, business-like now!" (Student) . . . "A real help to all of us." (Parent) . . . "Smooth, steady, grand to use." (Executive Secretary).

SEND NO MONEY—don't spend a cent—until you've seen right in your own home how easy a Royal makes writing—how its many "big machine" features and controls help you turn out a professional looking job easier and faster than by hand. Remember—the Royal Portable is made, tested, guaranteed by the Makers of World's No. 1 Typewriter for the office. Use the coupon for facts—all about the Royal Portable. Mail it today. No obligation.

FREE HOME TRIAL



A YEAR TO PAY!

ROYAL TYPEWRITER COMPANY, INC.,
DEPARTMENT D-122, 2 PARK AVE., NEW YORK CITY
Tell me how I can get a Royal Portable on **Free Home Trial**; also how I can own one on **Easy Monthly Terms**.

NAME _____
STREET _____
CITY _____ COUNTY _____ STATE _____

ACT NOW! . . NO OBLIGATION

FREE!

INCLUDED

Royal's Instant Typing Chart, shows you how to type **RIGHT**.



with every Royal Portable at no extra cost—a handsome, all-weather Carry-all Case.

**MAN IN EACH TOWN
—To Plate Auto Parts—**

Reflectors, Bicycles, Fixtures, Mirrors, by late method. Simple plan of manufacturing at home starts you **IN GOOD PAYING BUSINESS**. Write today for **FREE** particulars and proofs.

Ave. M GUNMETAL CO. Decatur, Ill.

STANDARD GARDEN TRACTORS

Plow Seed Cultivate Mow Hay and Lawns Powerful Gas Tractors for Small Farms, Gardeners, Florists, Nurseries, Fruit Growers, Poultrymen.
1 & 2 Cylinders High Wheels. Rubber or Steel Tires. Walk or Ride.
Do Belt Work—**Free Catalog**
STANDARD ENGINE CO.
Minneapolis, Minn. Philadelphia, Pa. New York, N. Y.
3221 Como Ave. 2546 Market St. 290 Cedar St.



ONE-MAN SAWMILL

Makes lumber, shingles, lath, ties, crates, boxes, cases, all forms lumber.
TURN TREES INTO MONEY WITH A BELSAW **FARM MODEL \$49.00**
Three capacities: 10, 14 and 20 ft. Accurate set works positive dogs. Hand or power feed. Runs on low power—Many owners use old auto engine. Pays for itself quickly—thousands in commercial service, everywhere. Write for free lumber handbook and catalog of mills, supplies, tools, saw tables, and woodworking equipment.
B. I. Saw Machinery Co., 8110-Z Davidson Bldg., Kansas City, Mo.

EARN MONEY MAKE COLOR GLAZED CONCRETE PRODUCTS

NEW, low cost, patent method makes Color-glazed concrete pottery without molds. No experience needed. Use only sand, cement, cheap materials. Make glazed tiles, walls, gravestones, etc. Money-making business. Send 10c **TODAY** for booklet, colorplate, cost data, details. Descriptive folder **Free**.
NATIONAL POTTERIES COMPANY
Room 6, 13 W. 26th St., Minneapolis, Minn.



**EARN MONEY
Stringing TENNIS RACKETS**



Build up a business of your own stringing tennis rackets. It pays up to 140% profit **PER RACKET**. String **YOUR OWN RACKET AND SAVE MONEY**. No experience needed—we teach you how. Tennis players need new strings in their rackets two or three times yearly . . . every stringing means **PROFIT** for you. See how simple it is to get in this business. Costs practically nothing to start. Easy work! **GET STARTED NOW!**
FREE Write today and we will send you **Free** plan and special offer on strings and stringing equipment.

THOMPSON MANUFACTURING CO.
4535 Packers Ave., Chicago, U. S. A.
TOMGUT "Court-Tested" Tennis & Badminton Strings

Saw-Filing

Pays up to \$2 or \$3 an Hour in Spare Time

A **FOLEY** Automatic Saw Filer files hand, circular and band saws better than the best hand filer. Cash business, no canvassing, no eyestrain. No experience needed. **Louis P. Wadwick, Ohio**, says, "I have filed 764 saws in spare time and have earned \$850.00 in carpenter work due directly to my saw filing contacts." Send coupon for **FREE PLAN**, no obligation.



FOLEY MFG. CO., 616-9 Foley Bldg., Minneapolis, Minn.

Send Free Plan on Saw Filing business.
Name.....
Address.....

When writing please mention Popular Mechanics



Renew old buildings. Make new construction more permanent and attractive. Plastic Colorcrete is waterproofed. It fuses with any masonry surface. It fills cracks. It can be applied in any thickness and in 30 colors. Fully proven by over 13 years actual use under all conditions and every climate.

OFFERS BIG EARNINGS

Owners everywhere want to enhance present values. With this machine you can supply this big waiting market with permanent Colorcrete at amazingly low cost. Operators report cost of 2c and up per sq. ft. and sell up to 7c. Some have paid for their equipment from first few jobs. Machine capacity up to 1,000 sq. ft. per hour.

Get the facts. Send for books "Proven Business Opportunity". Write today. It offers you big extra income.



COLORCRETE INDUSTRIES, INC.

570 Ottawa Ave.

Holland, Mich.

9" or
SUPER VALUE
MODERN DESIGN
UNEXCELLED
PERFORMANCE
Get DURO Tools

They are built of the finest materials and workmanship to offer unsurpassed values. Their modern design and unexcelled performance will convince you, as it has thousands of others, that it's wise to buy Duro Tools. Duro's new 15 inch Jig Saw above incorporates upper and lower tension springs, driving mechanism operating in oil, and many other features at an exceptionally low price.

DURO METAL PRODUCTS CO.,
 2659 No. Kildare Ave., Dept. B5, Chicago, Illinois

★ **FREE! BIG NEW CATALOG!** ★

WHY SCRATCH

Lucky Tiger Ointment is made to make itchy folks happy. To allay Rectal Irritations — To correct externally caused Pimples — To soothe insect bites, fire or sunburns. To make friends everywhere. Thousands never without it.

Antiseptic to minor wounds when in proper contact as bandage. At Druggists, Barbers, 10¢ Stores —

FREE — 25¢ Trial Tube, if you send 6¢ in stamps to pay packing and postage.

LUCKY TIGER MFG. CO., Dept. 29, Kansas City, Mo.

WoodWORKERS
Here it is!

HAROLD HUNT'S latest edition 1939 catalog. Nothing like it ever before published — 136 pages — new designs, new ideas for experts; also special instructions for beginners. AND—LISTS OF ASTONISHING BARGAINS in all kinds of woodworkers' supplies. Get this book! **ONLY 10¢!** Also VENETIAN BLINDS: a special circular free with catalog if so requested. Send only 10c to

CRAFTSMAN WOOD SERVICE CO.
 2736 S. Mary Street Chicago, Ill.

MONEY for MEN ALL DATA FREE

THE PLASTEX Industry needs manufacturers on small scale and for big production of Lamp and Clock Stands, Art Goods and Novelties in Plastex and Marble imitation. Experience unnecessary. 1/2c material makes regular 10c store sellers. Rubber moulds furnished for speed production. Small investment brings big returns. **BIG CHAIN STORE** orders now being placed by us. Ambitious men have chance for real prosperity. Our **FREE** booklet will interest and benefit you. **PLASTEX INDUSTRIES, Dept. P, 1085 Washington Ave., New York, N. Y.**

BUILD TRAINS — AUTOS — AIRPLANES — SHIPS — GAS MODELS — ALSO CAMERAS, etc.

Low priced C-D quality Kits by the master model designers. Passenger loco 50c, Switcher 50c, 27 diff. freight Cars, ea. 10c, F1 C-2 Airplane 85c, 3 Foreign Race cars, 3 Indianapolis winners, ea. 10c. Hundreds of others, and thousands of supplies. Add 15c for pack. & post, all orders, or part shipment deducted. Catalog only 10c.

Cleveland Model & Supply Co. Inc.
 4508-C42 Lorain Ave., Cleveland, Ohio, U.S.A.

GET YOUR TRACTOR AT FACTORY PRICE

3 Speeds Fwd. and Reverse. Runs 4 to 8 hrs. per gallon

Amazing money maker for farms, truck gardens, orchards, nurseries, poultry ranches, country homes, etc. Plows, discs, harrows, cultivators, mows lawns, cuts weeds. Runs belt machinery. 2 to 8 H.P. riding or walking types. Write for **FREE CATALOG**. Low Factory Prices and 10 day Trial Plan. Address *Nearst Office*

SHAW MFG. CO., 4506 Front St., Galveston, Kans.
 130 S West 42nd St., New York, N. Y., 5812 G Magnolia Ave., Chicago, Ill., 668 G North 4th St., Columbus, O.

SHAW DU-ALL TRACTOR

fun building a radio!

Get the **THRILL** of building it yourself! There's a lot of he-man kick in a short-wave radio of your own. Send for **FREE** 1939 catalog that has everything you need. Build-It-Yourself Kits, nationally advertised parts, tubes, tools, instruction books. Thousands of items at money-saving prices! Send postcard today, ask for Catalog 76.

LAFAYETTE RADIO CORPORATION **188 PAGE CATALOG FREE**
 Dept. 7F9—100 Sixth Ave., New York, N. Y.

BURN YOUR NAME ON TOOLS WITH THE ARKOGRAF

PROTECT YOUR TOOLS FROM THEFT Write with electricity any name or design on the hardest and finest tools and instruments, or any metal, like writing on paper with pen or pencil. **Complete Outfit \$3.50—Prepaid Anywhere.** Interesting illustrated circular free. Write today. Agents wanted. **ARKOGRAF PEN CO.,** 3927 S.E. Stark St., Portland, Ore.

OTTAWA LOG SAW \$39 **BIG BOOK FREE**

PUTS THIS OTTAWA to work for you. MAKE MONEY! Wood is valuable. Does more than 10 men. Easily operated. Falls trees—saws limbs. Use 4-hp. engine for other work. Write for **FREE Book.** **OTTAWA MFG. CO.,** 2927 Wood St., Ottawa, Kans.

FREE ELECTRICITY

From Wind. Build your own windcharger. Cost 98c for material plus used car generator. Send 10c for copyright drawings, instructions today.

WESCO, 8 Terminal, Minneapolis, Minn.

CASH IN ON SPARE TIME

\$30 WEEKLY OR MORE EARN. Grow mushrooms HOME. Cellar, shed suitable. We buy 30c lb. Year round business.

\$270 made by Mr. B. in few weeks **SPARE TIME.** Guaranteed materials. Established 1931.

Write for **FREE BOOK**

WASHINGTON MUSHROOM INDUSTRIES
 Dept. 601, 2019 2nd Seattle, Wash.

Below the Ocean's Deadline

(Continued from page 875)

efficient time is not permitted for the gas to escape quietly into the blood and thence from the lungs, bubbles will form in the tissues and blood vessels. The bubbles are most dangerous if formed in the spinal cord and brain, causing paralysis or death. If bubbles form, an additional danger is their tendency to increase in size on further lowering of pressure. There is also the possibility that a number of small bubbles may aggregate to form large ones."

Preliminary experiments with varying proportions of oxygen and helium were conducted on animals with no detrimental effects. When the scientists had worked out a formula of what they considered the correct amounts of oxygen and helium which should be mixed for under-water breathing air, Chief Gunner C. L. Tibbals of the "Falcon" was submitted in a test tank to pressure equivalent to that at an ocean depth of 150 feet. He decompressed himself in fifteen minutes and felt no ill effects. Breathing air was a success.

Captain Craig and Nohl saw the possibilities of breathing air in a great adventure they were planning. Ever since the sunken hull of the "Lusitania" had been located and Jim Jarrat, a diver, had descended 312 feet to reach her in an all-metal diving dress, Captain Craig had planned to enter her hull. So they designed a new type of rubber diving suit especially adapted for breathing air. They constructed a diving helmet which, instead of having limited vision like others, had a heavy circular glass window. The rubber suit was specially fitted with pads to withstand bumps and prevent chafing. When joined to the helmet the outfit could be lowered into the depths by a rope attached to the top of the helmet.

The oxygen and helium tanks were attached to the back of the diver's suit, being carried like a knapsack. In case the diver should be trapped in a sunken wreck, air purifiers and check valves made it possible for him to continue to inhale breathing air until rescued, even if he was not hauled up until several hours later.

Breathing air has about doubled the depth at which divers can work and decreased safe decompression time to a small fraction of that required when ordinary compressed air is used.



Be Your Own Boss
GET INTO AIR CONDITIONING

WORK OUT OF YOUR HOME—IN SPARE TIME—
Newspaper and phone book ads work for you. Make summer coolers and fans so cheap they sell themselves. \$20 and a little work will start you in business. No books—no studying—just assemble and sell. Easy sales—quick profits—easy work!

MAKE A YEAR'S PAY IN 4 MONTHS

Last summer Borelli made \$3600 gross—Lewis made \$6100 gross—Whitlow made \$2700 gross—Wolters made \$6800 gross—Cox made \$3200 gross—Colet made \$2300 gross. You can make \$1500 to \$5000 gross in 4 months. Don't wait! Get in the money now!

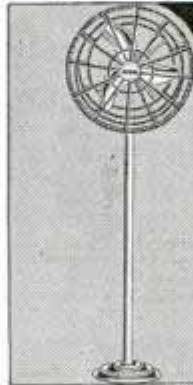

MAKE Pedestal FANS

We sell you all the parts for a \$60 store, office or factory cooling fan for as little as \$13.20 and you assemble it yourself. You can make \$10 to \$25 on every sale! Restaurants, stores, offices, factories buy thousands.

20 in. Set No. 1 of parts consisting of 20 in. blade, G. E. motor, plated guard, chromium 6 1/2 ft. column, 20 in. floor base, cord, plug and switch.

Hundreds of men found comfortable incomes selling these fans!

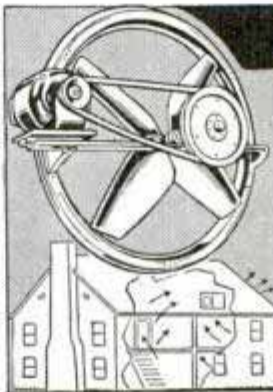

MAKE Attic FANS

We sell you all the parts for a \$120 job, that will keep an entire home 10 deg. cooler ALL DAY, for only \$36.91! Every home, every builder, every store is a hot prospect!

30 in. Set No. 2 of parts for a 30 in. attic night fan consisting of quiet approved 1 piece cast aluminum blade, cast frame, Fafnir bearings, shaft, G. E. motor, pulleys and belt, cord, plug and switch—complete \$36.91.

This is a big, profit opportunity. Air conditioning SELLS!

MAKE Evaporative COOLERS

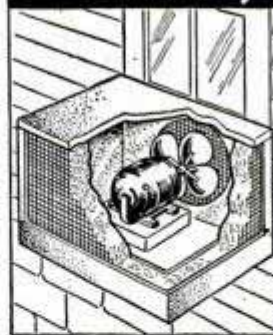

Where Humidity is under 45 deg., in summer, desert coolers sell best. A little chicken wire, copper tubing and a cabinet you can build plus our motor and blade units at \$8.40 up will make a unit you can sell for \$50. Every home and business needs them.

- 12 in. blade with proper motor for 1900 C.F.M. unit.
- SET No. 3 only \$8.40
- 16 in. blade with proper motor for 2200 C.F.M. unit.
- SET No. 4 only \$8.75
- 18 in. blade with motor for 4180 C.F.M. unit.
- SET No. 5 only \$12.95

This is a BIG BUSINESS west of the Mississippi.

INSTALL A UNIT IN YOUR HOME NOW!

BLUE PRINTS FURNISHED WITH EACH ORDER

AIR CONDITIONING HEADQUARTERS.

912-918 W. Ohio St., Chicago, Ill., U. S. A.

Show me the way to earn a year's pay this summer in my own business and rush me the items ordered below:

Sets	Description	Price	Total
.....	No. 1, 20 in. Pedestal fan	\$13.20
.....	No. 2, 30 in. Attic fan	36.91
.....	No. 3, 12 in. Desert Cooler set	8.40
.....	No. 4, 16 in. Desert Cooler set	8.75
.....	No. 5, 18 in. Desert Cooler set	12.95
.....	Parts circulars and plans	.25 (Free with order)

\$10 UNIVEX 8MM MOVIE Camera only \$5.95 with any order.

I am enclosing \$.....cash Balance \$.....C.O.D.

Name..... City.....

Street..... State.....

All mater. sold on money-back guarantee

WIN INDEPENDENCE - ORDER NOW!

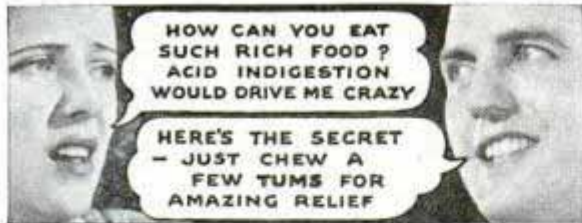

YES—TUMS bring amazing quick relief from indigestion, heartburn, sour stomach, gas caused by excess acid. For TUMS work on the true basic principle. Act unbelievably fast to neutralize excess acid conditions. Acid pains are relieved almost at once. TUMS are guaranteed to contain no soda. Are not laxative. Contain no harmful drugs. Over 2 billion TUMS already used—proving their amazing benefit. Get TUMS today. Only 10c for 12 TUMS at all druggists.

You never know when or where



Tums are anti-acid—notlaxative. When you need a laxative get—**Nature's Remedy** NR—TABLETS—NR. This all vegetable laxative brings such gentle, dependable relief for conditions due to constipation.

ACCURATE SHOOTING WITH CHAMBERED AIR BENJAMIN AIR PISTOLS WITH LEVER HAND PUMP



NEW 1940 MODELS EASY TO PUMP anywhere, for practice firing or just plinking. You can have a lot of fun with this target gun at least expense for ammunition. Adjustable power depending on AIR PRESSURE—amazing maximum velocity and accuracy up to 15 yards. Economical and practical indoors or camping, fishing, hunting, etc. No license required from dealer or factory. Single Shot—BB or Pellets \$8.50. BB 8 Shot \$10.00. Holster \$2.00. Ask for complete information—targets and blueprints FREE if requested. Enclose 10c for samples of ammunition. WRITE TODAY. BENJAMIN AIR RIFLE CO., 890 Marion St., St. Louis, Mo., U. S. A.



QUICK DETACHABLE TRAILER COUPLING

On and off in a jiffy! Strong, durable! Load capacity: 4,000 lbs. Fits all bumpers. Heavy pressed steel construction. Padslocks against trailer theft. Complete with bumper clamp, special introductory price: \$2.50; post paid, U. S. and possessions. Shipping weight: 7 lbs. Order yours today! Ask about other Fulton Accessories. **THE FULTON CO., Dept. TC-6, Milwaukee, Wis.**



CHEAPER THAN SHOE LEATHER AUTO GLIDE

Why walk or use an auto when you can Glide for 1/3c per mile! Ride to work, school... for fun, business—take long trips or short picnic jaunts—save with AUTO-GLIDE—everywhere! Amazing 1 1/2 or 2 H.P. engine goes 125 miles per gallon, 30 miles per hour! Zips up hills, through traffic. Clutch (most models) makes starts, stops easy. Powerful brakes. Comfortable seat. Parks any place. Extra rugged! 2-speed trans. (optional). **5 NEW MODELS** Standard (right) low-priced 2-wheel model for business, sport. DeLuxe, streamlined pleasure model. **KARI-PAK**, big rear carrier, **SIDE-KAR**, attaches to above models, makes 3-wheel unit. **3-WHEEL GLIDE-KAR** (left).



\$92.45 UP

Dealers Get. Spl. Offer NOW!

WRITE! Or see your dealer for free booklet showing all models. Send NOW! **THE CUSHMAN MOTOR WORKS DEPT. M-6 LINCOLN, NEBRASKA**

Rheumatism Relieve Pain In Few Minutes

To relieve the torturing pain of Neuritis, Rheumatism, Neuralgia, Lumbago in few minutes, get **NURITO**, the Doctor's formula. No opiates, no narcotics. Does the work quickly—must relieve cruel pain to your satisfaction in few minutes—or money back at Druggist's. Don't suffer. Get trustworthy **NURITO** on this guarantee. Don't wait.

Increase Your Earning Power

Apply time and labor-saving kinks to your work. Your efficiency will soon be recognized and you will be in line for advancement.

If you do machine shop work of any kind, sheet-metal work, painting, carpentry, auto repairing, farming, concrete work, plumbing, electrical work, welding, building-glass work, general repairing, tool-making, poultry raising, masonry or home repair work, get this

LIBRARY OF 2400 TIME AND LABOR SAVING IDEAS FOR SHOPMEN AND HANDYMEN

JUST PUBLISHED

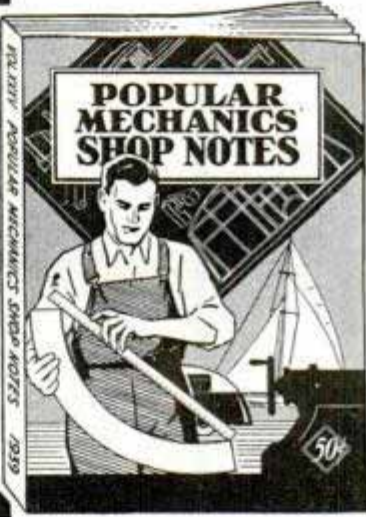

SHOP NOTES for 1939

417 Articles
806 Illustrations
224 Pages
Price 50c
See partial list of contents below

Including the new 1939 issue illustrated above, there are six volumes in the Shop Notes Library of 2400 easily understood short cuts to every-day jobs. Here are just a few of the subjects taken from the latest issue:

- Alabaster, Turning
- Auto Mechanics, Short Cuts for
- Carpentry Kinks
- Drafting Room Helps
- Electrician's Aids
- Electro Engraving
- Farm and Garden Helps
- Fluting, Spiral
- Gas Engine, Midget
- Generator, Wind-Driven
- Charges Batteries
- Glass Blowing
- Grouse Pit, Cover for
- Grinding
- Lathe Kinks
- Machinist's Helps
- Marble, Imitation
- Metal, Buffing and Polishing
- Metal, Chemical Coloring of
- Motorist, Helps for
- Paper Hanger's Helps
- Pattern, Sanding
- Photographic Kinks
- Poultry Appliances
- Printers, Hints for
- Shaper, Homemade
- Sheet Metal Work
- Stainless Steel, Working
- Telescope Mount
- Thread Cutting
- Trailer Kinks
- Truck Driver, Helps for
- Welding
- Window Displays, Novel
- Wood, Bending
- Wood Lathe, Homemade
- Wood Turning, Complete Guide to

Each volume contains approximately 400 articles and 600 illustrations and has 200 or more pages. This unrivaled library of shop helps may be secured for a limited time only. After the present supply of books is exhausted the offer must be withdrawn.

Send No Money

POPULAR MECHANICS PRESS, 200 E. Ontario St., Room 639, Chicago, Ill.

Send me, as per your offer, the following books. I will pay postman price and small amount of postage. My money will be refunded if I am not satisfied. (Check what you want.)

1939 Shop Notes and Lathe Handbook (Metal Working), both for 98c.

Shop Notes Library (6 vols.) \$2.98.

Name.....

Street and No.....

City..... State.....

*C. O. D. applies to U. S. and possessions only. If you reside elsewhere, remittance must accompany order.

Hermits of the Air Waves

(Continued from page 853)

which automatically shuts off all voltage. It takes less than two minutes to replace one of these giant tubes.

Twelve technicians, a supervisor, and a building maintenance man form the staff at Wayne and they work in three shifts. The transmitter is off the air from one o'clock in the morning till 6:30 a.m., but work at the plant goes on just the same. In fact, night duty is often twice as hard for the technicians as the day shifts. For it is during the night, when the current is turned off, that most of the repair work must be done.

One of the more curious duties men at Wayne perform is to keep the "Tube Pedigree" file. This consists of a large wooden box, packed with cards, each one of which represents a tube which has been, or is being used in the transmitter. The tube's number, the date it was bought, and the date it was inserted into the transmitter are all neatly typed in red on its individual card. Every morning, the men examine each active card, to determine the number of hours its tube has been in use. The big expensive tubes may last anywhere from 100 to 5,000 hours. When a tube seems nearing the end of its life's cycle, the men remove it during the night hours when the transmitter is off the air, and test it carefully to determine its probable longevity.

Another odd job is the announcing the Wayne technicians do for the short-wave programs of W2XE. A great many of the WABC programs are broadcast to South America and Europe by CBS over its W2XE directional antennas. But in most cases, the announcements for WABC programs are not appropriate for European and South American audiences. So it is up to the transmitter technicians at Wayne to substitute special announcements of their own, and insert them in each program, as it is broadcast.

Night and day, radio programs blare through the echoing rooms of the brick buildings at Wayne. There is at least one loud speaker in every room. But the Wayne technicians have developed a peculiar technique of listening and yet not listening to the radio. They won't be able to tell you what that program is about, unless they

(Continued to page 144A)

Xpert .22's GIVE YOU GREATER ACCURACY

and how!



WESTERN XPERT L.R. .22's are so accurate that many of the nation's best shots WIN with them in big rifle matches. Their sensational accuracy is YOURS for all-around shooting, at no extra cost over ordinary .22's. Clean, non-corrosive priming! Smokeless powder! Greased lead bullets! .22 Long Rifle, .22 Long and .22 Short sizes. Mail the Coupon for FREE useful handbook.

Rifle in foreground: bolt action Winchester 69. The other: slide action Winchester 61, repeater. Both are big values.

Western Cartridge Company
Dept. F-46, East Alton, Illinois

Mail your 72-page modern shooting guide, the Western Ammunition Handbook, FREE, to:

Name _____

Address _____

Post Office _____

State _____



— NEW — SENSATIONAL —
KEYLESS — ELECTRIC GAS TANK LOCK

Cap unlocks—SNAPS open by pressing a button on your dash. Close the cap and it locks automatically. Fully guaranteed. A MONEY MAKER for Agents and Dealers. Write immediately for exclusive distributorship proposition. Territory going fast. SNAP-UP GAS CAP CO., DEPT. C. ASHLAND, KY.

POWERlite

AMERICA'S FINEST—
MOST POWERFUL
ELECTRIC LANTERN

80 to 100 HOURS LIGHT
On One 6-Volt Dry Battery

● TWO LIGHTS on a double action switch. 800 ft. spot beam from front reflector; broad floodlight from top. Handle reverses. Unbreakable lens, 6 1/2" high. At sport, hardware, electrical dealers or write for literature.

DELTA ELECTRIC COMPANY \$3.35
300 W. 33rd ST., MARION, INDIANA Less Battery



Buy Only a GENUINE DELTA

(Continued from page 143A)

listen to it carefully. However, there's one thing they always notice. And that is, when the programs suddenly stop.

Radio programs coming out of the loud speakers at Wayne very seldom stop. If they do, lightning may have struck the antenna or a tube may have blown out. No matter what happens, it is up to the transmitter technicians to begin working at breakneck speed to repair the damage.

The Wayne plant is equipped with dozens of safety devices to insure the minimum of emergency conditions. For instance, a special pendulum is used in the danger cage, which, when the high voltage is removed by accident, will automatically swing back and put it on again in a second's time.

Last fall a hurricane swept along the eastern seaboard. Among other ruined lines were the power cables feeding the Wayne transmitter of WABC. For four hours not an ampere of current got through to the plant. The men could do nothing except wait around in the pitch darkness, listening to the storm outside, until the power lines were repaired again. Master Control back in New York City switched WABC programs to the transmitter of WNYC, which temporarily broadcast the programs on WABC's frequency.

Once a mouse crawled into the danger cage during the night. When the technicians turned on the current for the day's programs, the animal was instantly electrocuted. But his body caused an arc in the transmitter which shot it off the air. It took the technicians hours to get him out.

The men at Wayne get laughs out of a lot of things too. A few months ago the men discovered that their coupling house, at the base of the steel tower, was "haunted" by WABC programs. Day and night, its steel cage of condensers and coils gives out a faint reproduction of everything that is being played or spoken over WABC. There is no loud speaker in the house, and normally it should be perfectly quiet. A copper rainspout on the outside of the coupling house also gives out WABC programs, when it is touched with a key. A transmitter technician may be a hermit, and far from the beaten paths of radio—but when his steam pipes, his radiator and his coffeepot make music, he can't feel really lonesome.

Spraygun with 'Rifle' Barrel Shoots Fog into Treetops



Top, sending fine stream into treetops. Below, operator's left hand grips the focusing control

Without any bulbous, projecting nozzle at the end of its "rifle" barrel, a pistol-grip spraygun shoots a fine fog in a straight line under perfect control, varying from a wide cone to a pencil-like stream that breaks into fog as it reaches the treetops. Inside and out, the gun is designed to throw a straight stream without loss of velocity. The focusing control is mounted around the barrel, and a pistol grip operates a stainless steel free ball cut-off.

Send return postage to our Bureau of Information to learn the name of the maker of any device described in this magazine.

What? ... AN ENGINE THAT WILL NEVER WEAR OUT!

Not quite that, of course!
... but a perfectly amazing increase in engine life through Chrysler's new **Superfinish!**

TO CLAIM Chrysler engines will never wear out would be foolish.

But we do assert that Chrysler has doubled and tripled the life of engine operating surfaces ... achieved performance so smooth that owners of the 1939 Chryslers say, "These are the greatest motor cars ever built!"

Theoretically, if properly lubricated and kept clean, Chrysler engines ought never to wear out.

For the vital parts of every Chrysler—from brake drums to crankshaft—are *Superfinished*.

These Superfinished discs are so smooth they adhere together.

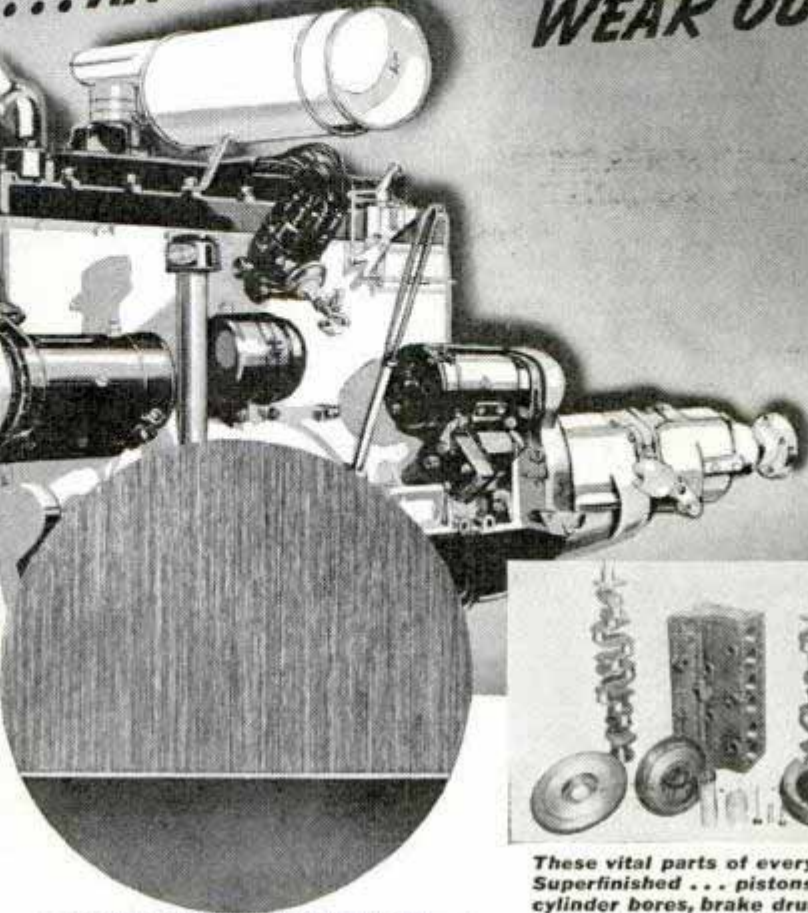
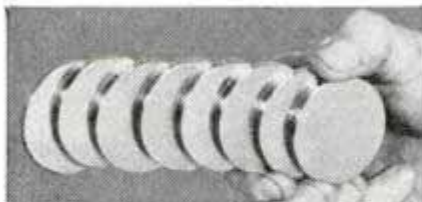

Upper: Previous commercial best ... photomicrograph of lapped surface.

Lower: Superfinish ... smooth to 2-millionths of an inch.

And Chrysler's *Superfinish* is a new scientific process which finishes motor surfaces to a smoothness as fine as one-millionth of an inch.

Where formerly the finest processes of metal surface finishing left a "fuzz" of jagged edges, Chrysler *Superfinish* makes surfaces literally as smooth as glass.

There is no "wearing down" of bearing surfaces to get smooth operation in a Chrysler. Quietness and smooth action are scientifically assured. The original close fit of the parts is maintained. Lubrication is

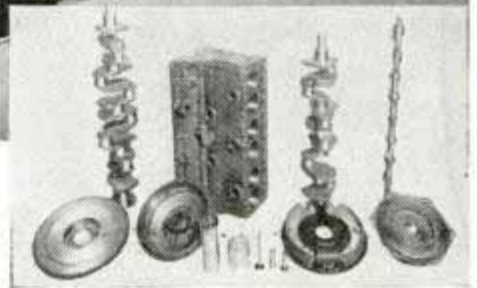

These vital parts of every Chrysler are Superfinished ... pistons, crankshaft, cylinder bores, brake drums, camshaft, clutch face, tappet heads, valve stems.

perfect on a perfect surface.

How *Superfinish* is accomplished is a highly technical story. What *Superfinish* does you can see at a glance.

Superfinish is the greatest protection that can be given your motor car investment...it means better operation, smoother running for many extra years... the longest lived, best running motor you ever handled.

If you are interested in the story of *Superfinish*, write Chrysler Sales Corp., Detroit, for a handsome, illustrated book and an attractive pocket piece; one side finished by fine grinding, the other *Superfinished* to the smoothness of glass.

FOR LONG LIFE

Buy Chrysler!

When writing to advertisers please mention Popular Mechanics

Training the Big Cats

(Continued from page 861)

that few trainers will work with them.

"The best period to train a tiger," says Captain Proske, "is when he is between one and two years of age. Most trainers will not take them after that age although I have successfully trained them at five and six years of age.

"The impulse which people have to poke a wild animal with an umbrella at the zoo somehow reaches a high point with the tiger. And that impulse starts right in the jungle when the cat is captured and natives prod him with sticks.

"It is no wonder then, that by the time a tiger gets into my hands he is even more ill tempered and treacherous than he was in the jungle and regards man as his natural enemy. Further beatings will not help. You can never punish them to a point where you can break their spirit enough to drive treachery out of them.

"Tigers can't just be thrown together and expected to work in harmony. They've got to be introduced. I've worked out a system of scientifically designed cages to make this possible. Each large cage opens out to a long runway where the cats can get acquainted—after they've become used to each other in neighboring cages."

Patience, in a large measure, explains Captain Proske's remarkable success in training the big cats. That, together with the courage to refrain from punishing them and to go into the arena without a chair or big whip to protect himself with.

After Captain Proske has tamed a tiger to the point where he can get it to enter a cage with him and disregard the pedestals and other apparatus, he puts a piece of meat on a slender pole and tempts the cat, moving the pole as he does so. The tiger may climb a pedestal or go over a hurdle after it and in this way he gradually learns his routine and goes through his paces.

The familiar "pyramid" which is the climax of many such acts in this country isn't really a stunt at all according to the captain, while the apparently difficult trick of making a tiger roll over is one of the easiest to learn and he has taught that in less than half an hour.

"A cat will keep its eyes on anything moving—especially if it is low," he says. "I get a tiger to lie down, then place a light whip across its neck and wriggle the end.

The cat naturally wants to see what's doing at the end of the whip and so rolls over. After awhile I discard the whip and motion with my finger."

The least treacherous tigers have the brownest eyes, the most vicious have the lightest eyes, says the trainer. A light-eyed Bengal tiger nearly got Captain Proske in Budapest a few years ago when he was showing his act of nine big cats. He was terribly mangled and went to the hospital for six months. No truth in the belief that once tigers have tasted human blood they become man killers, says Proske and he explains:

"Every tiger is a potential man killer, but once a big cat has attacked a man, he gets to realize how helpless a human being is and what easy prey he may become."

When the Sumatra attacked him in Los Angeles, things moved so rapidly the trainer did not get a clear picture of what was happening other than the fact that his manager, Hudson Thomas, got him out.

"I was standing outside of the cage near the bars," recalls Thomas. "Captain Proske works with tigers individually at close range and when he does so with one he turns his back on the others. I watch them and give a low hiss to make him turn quickly if I think it necessary. Most times it isn't, because trainers develop a sort of sixth sense and many times, I have seen the captain wheel around before I was aware of the danger.

"This time, however, he didn't. He tripped on a loose board, stumbled and in that split second the Sumatra had him by the leg. I fired a blank cartridge pistol at him and the cat let go momentarily. Then the tiger grabbed the captain by the shoulder. I fired more blanks but the cat held on. Frantically I tried to get into the cage, but couldn't budge the door.

"I fired my last blank cartridge at the cat, then threw the gun at him but he wouldn't relax his death-like grip. Then the other cats piled on.

"Finally I grabbed a feeding fork, thrust it through the bars, prodded the big cats away and jabbed the Sumatra which let go of Proske and slunk into a corner. The captain crawled to the bars under the protection of the fork. Then we opened the door and removed him."

FISHER FACTS

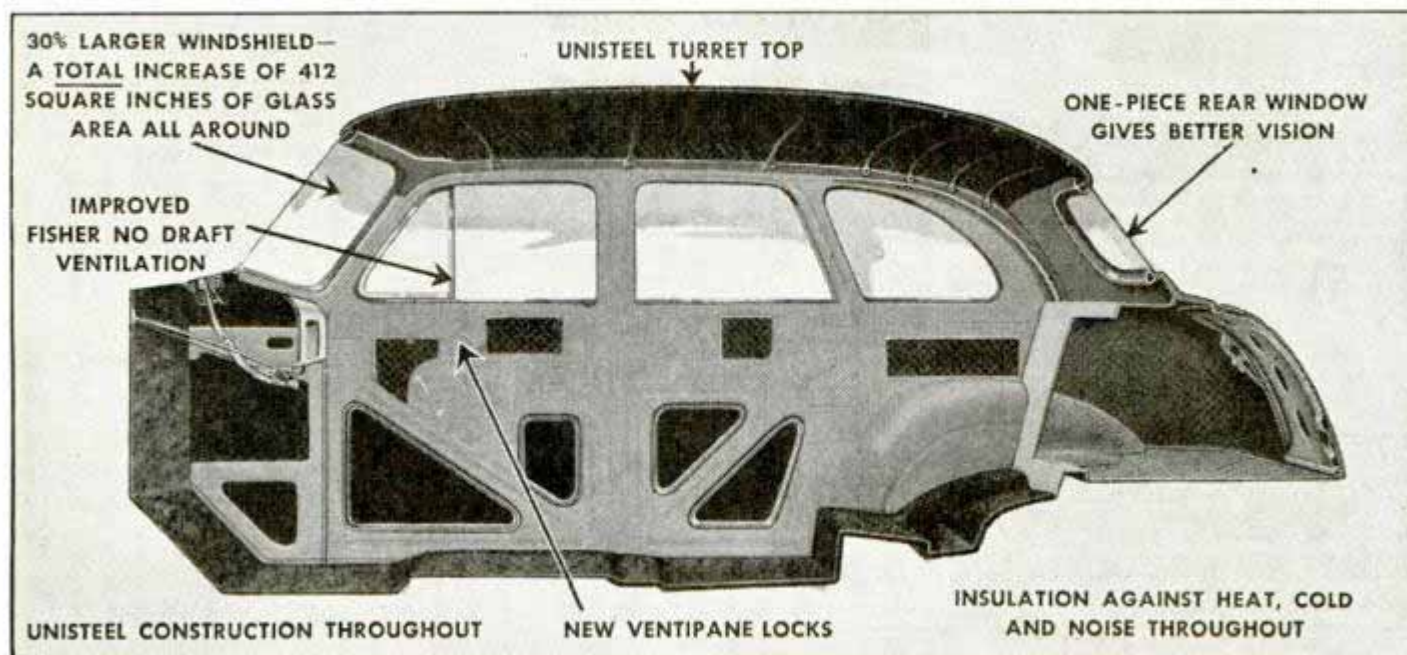

COMFORT MADE TO ORDER .. in the 1939 BODY by FISHER

IT'S not easy to make a motor car body comfortable for everybody—for short people and tall ones, for those who like lots of fresh air and those who prefer it in smaller quantities, for drivers and passengers who want more visibility.

But it can be done! Fisher engineers have certainly proved that.

Check the new Bodies by Fisher on the 1939 General Motors cars. Note, for example, that in the Series 70 & 80 Oldsmobile sedans there's an actual increase of 412 square inches in total window and windshield area . . . a 30% increase in glass area in the windshield alone.

Note, too, that not only are front seats adjustable two ways—but even the rear view mirror is more efficiently placed to everybody's

advantage, regardless of their height. While as for passengers' personal fresh air preferences, the improved regulator handles now make famed Fisher No Draft Ventilation still easier to adjust to everyone's individual comfort.

In these and in many other ways—with the silent, solid security of Unisteel construction—with wider seats and roomier interiors—the new Body by Fisher puts comfort on a "suit yourself" basis.

Obviously it pays to heed what smart motorists everywhere are saying, "For '39 better pick the car with Body by Fisher" — which means a General Motors car, of course.



BODY BY FISHER

ON GENERAL MOTORS CARS ONLY: CHEVROLET • PONTIAC • OLDSMOBILE • BUICK • LA SALLE • CADILLAC

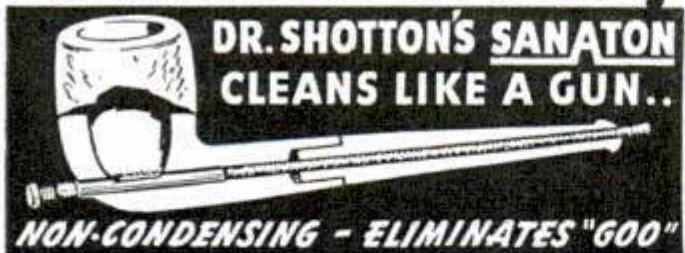
AMAZING NEW PIPE!**SMOKER AGENTS WANTED**

Dr. Shotton's Sanaton is a sensational and utterly new pipe invention. Brings pipe smokers, at last, a cool, dry, sweet smoke. New principle avoids condensation of moisture that forms bitter "goo." Cleans like a gun—straight through from END TO END! Has FULL FREE OPEN straight draft! Stem never needs removing! Open slot across entire bottom of bowl permits FULL down draft—even burning—STAYS LIT! Porous, unvarnished, unsealed briar bowl, absorbs tobacco tar, permits evaporation, and COLORS NATURALLY. Patented in United States, Canada and England. No other pipe like it.

FREE SAMPLE OFFER! Send at once for special Free Sample Offer we are making to introduce this wonderful new kind of pipe. Agents can earn up to 150% PROFIT. One-minute startling demonstration with Free "Cut-away" Demonstrator sells it. Pipe smokers wild about it. Rush name and address for smoker agents' offer.

FOSTER PRODUCTS, INC., Dept. F-50
1965 East 66th Street Cleveland, Ohio



FREE TRAILER BUILDERS' GUIDE AND CATALOG—NEW 1939 EDITION
WORLD'S BEST LINE OF TRAILER AXLES, HITCHES AND PARTS

Complete house trailer working blue prints only 50c. WRITE TODAY FOR THIS NEW FREE CATALOG.

HAMMER BLOW TOOL COMPANY, Dept. 106, Wausau, Wis.

LEVEL STOVES, PLUMBING, CLOCKS, Etc.

Patented—In Stock at Dealers Craftsmen Everywhere.
EMPIRE LEVEL MFG. CO., Dept. P3, 717 S. 6th St., Milwaukee, Wis.

WORLD'S GREATEST all around ELECTRIC TOOL

DRILLS — GRINDS — SANDS — SAWS
POLISHES — SHARPENS — CARVES

The new WHIZ ELECTRIC TOOL is the handiest power tool ever made. Not a delicate instrument but a real rugged tool, equally effective for both power and precision work. Drills through 1/4 inch iron plate in 42 seconds or engraves intricate designs on jewelry. Handles any material: Metals—Woods—Alloys—Plastics—Glass—Steel—etc. Saves time. Eliminates labor. Plug into any socket AC or DC, 110 volts. Chuck 1/4 inch capacity. Ball bearing thrust. Powerful, triple-gear motor. "Worth its weight in Gold." STANDARD MODEL with Normal Speed (uses 29 different accessories, instantly interchangeable.) Special Introductory Price for limited time, only \$6.95. **FREE** Accessory outfit (Value \$2) includes set of drills, mounted 1 1/2 inch grinder, sanding discs, cutting wheels, mounted brush, polishing wheel, carving bur, etc. **FREE** with each outfit ordered NOW. We pay postage. Will send C. O. D. if desired. **10-DAY TRIAL—MONEY BACK GUARANTEE.**

Special "2-SPEED" MODEL combines Normal Speed and High Speed in one outfit (uses 200 accessories) only \$8.95 complete, with some necessary outfit (value \$2) FREE.
Paramount Products Co., Dept. 6A, 48 West 48th St., New York

PLUMBING SUPPLIES AT MONEY SAVING PRICES



JUST OFF THE PRESS—New large thirty-two page catalog shows newest styled plumbing fixtures, water heaters, septic tanks, water systems, medicine cabinets, etc. at wholesale prices. Complete line of fittings, pipe, valves, washers and plumbing repair parts of every description. Catalog shows hundreds of items—too numerous to mention. Write for your copy today—Don't delay.

Free Catalog **JOHNSON PLUMBING SUPPLY CO.**
3645 S. Halsted St. Chicago

When writing please mention Popular Mechanics

2-247
From Test Tube to You

(Continued from page 805)

electrical-instrument panels, radio cabinets, and gear wheels, supplementing, or wholly replacing, such natural materials as wood, steel and slate. Because of its beauty and fire-resistant qualities, laminated plastic wall board was extensively used in the de luxe staterooms of the liner, "Queen Mary."

One of the latest additions to the plastics family is "Lucite" methyl methacrylate plastic, which is light in weight, substantially unbreakable, water-white, and as transparent as optical glass. This new plastic should find wide application for both decorative and industrial purposes.

In perfume manufacture, materials known as fixatives are employed which cause the odor to be more lasting and pleasing. Until recently all fixatives were of animal origin, such as musk from a Tibetan deer. The characteristic ingredient of natural musk, in a perfectly pure state, would be worth \$40,000 a pound. The research chemist has produced a synthetic musk, substantially identical with the characteristic ingredient of natural musk, though costing only a fraction as much.

Our supply of such metals as gold, silver, copper, lead, and zinc is being conserved through improved metallurgical processes. Ores once regarded as too low in metal content to justify working, are being worked by improved processes, at fair profit. Each advance of this kind increases the potential supply of our minerals.

For nearly a century we were largely dependent upon the Chilean deposits of sodium nitrate for "fixed" nitrogen so essential to agriculture and industry. It was known that the natural deposits of sodium nitrate in Chile eventually would be depleted. In 1898, fear was expressed that widespread famine might occur from a shortage of nitrogen for agricultural use.

Within recent years, however, research has developed processes for combining the nitrogen of the air with hydrogen from water to produce ammonia, from which fertilizers and nitric acid are made. Several million tons of nitrogen are extracted from the air each year; all fear of famine has been allayed.

Under Japanese control, camphor at times has reached well-nigh prohibitive prices. Chemical research on the synthesis of this material was finally successful in

2 249

developing a process by which turpentine from our southern pine trees is converted into camphor suitable for medicinal and industrial use. The United States now produces a substantial proportion of the total camphor consumption. In an emergency, additional plant capacity could be provided to meet all domestic requirements. Whereas imported camphor cost three dollars and seventy-five cents a pound in 1918, the synthetic product, chemically identical, sells today for approximately thirty-five cents a pound.

Rubber long has been an essential material for modern life. Recently chemists developed a synthetic material which they have sought over the years, produced from coal, limestone, and salt. It is called neoprene. It serves all the purposes of natural rubber and for many uses, it is superior to rubber.

Time was when the United States was virtually wholly dependent upon Germany for the potash so essential to agriculture and industry. This no longer is the case, since chemical methods have been devised for producing potash from mineral deposits in California, New Mexico and Texas. In 1936 the United States produced enough potash to supply sixty-five per cent of our consumption. Should necessity demand, we could produce all we need.

Although most of our newsprint paper comes from beyond our borders, the late Dr. Charles H. Herty showed that newsprint can be made from the southern slash pine. Several paper mills are being erected in the south to utilize this new domestic source. The significance of the development is better appreciated when one realizes that our annual consumption of newsprint is more than 4,000,000 tons, eighty per cent of which is imported. Dr. Herty also showed that chemical cellulose, suitable for the manufacture of rayon and "Cellophane" cellulose film, can be made from the southern pine.

Unless the cost of producing a commodity is sufficiently low, there can be no widespread consumption of that commodity. Moreover, the cost must be low enough to compete with similar imported goods. Therefore, the question of cost probably is the most common question asked daily. When the answer to that question is satisfactory to a majority of the public, business prospers and men work at fair wages.

(Continued to page 151A)

NOW enjoy
EVINRUDE

FOR AS
LITTLE AS **\$34.50**



9 EVINRUDES TO CHOOSE FROM

Evinrude offers the widest range of models, from the lightest, handiest, to the swiftest, most powerful. All are famed for exceptional starting ease, smoothness, reliability. All offer advanced Hooded Power construction, Co-Pilot steering, certified horsepower.

AN ELTO FOR ONLY \$29.50 New Elto Cub weighs only 8½ pounds, costs only 2c an hour to run. Now, a complete line of 6 Elto models—built by Evinrude—offer outstanding quality at low cost. Write for free Evinrude and Elto catalogs, Boat Directory, Boat & Motor Selector.

EVINRUDE MOTORS
4206 N. 27th St. Milwaukee, Wis.

• Never before an Evinrude so inexpensive to own, so handy and economical to operate. The sensational new "Mate" fits your own or rented boats—drives rowboats up to 4½ miles an hour, canoes up to 5 miles. Runs all day on a single gallon of fuel. Amazing starting ease—a flick of the starting cord and you're away! Write for catalog today!



EVINRUDE MATE
WEIGHS ONLY 10 LBS.
RUNS 10 HRS. ON 1 GALLON

WRITE FOR FREE CATALOG

All Prices F. O. B. Factory

SPORT OF Thrills!



Get into motorcycling—world's greatest outdoor sport. Join a motorcycle club—meet new pals, have good times galore! See your Harley-Davidson dealer and the snappy 1939 models. Write for FREE copy of "ENTHUSIAST," Motorcycling Magazine.

HARLEY-DAVIDSON MOTOR CO.
Dept. P Milwaukee, Wisconsin

HARLEY-DAVIDSON
Motorcycles

WORLD'S FINEST RATCHET WRENCH

Handiest Tool Ever Owned—1,000 Uses! Includes Adapter for Standard Sockets and Extension



5½" long—double ended—sockets ¼" and ⅜"—each with handy pawl to change direction of turn. Short ratchet action. Great for "tight" places. Well balanced—good leverage! Sturdy—will take all you can give it! Accurate-precision built! Handsome—tool steel, chromium plated! Compare it with tools selling for 4 to 8 times its price! Rush only \$1.00 today—we ship postpaid—pay balance \$2.00 on delivery. Don't delay! Money back guarantee! Agents wanted—exclusive territory.

PACKWAY CO., Dept. PM6
1207 Leland Chicago, Illinois

NOW

ONLY \$3.50

Postpaid

RUSH \$1.00 BALANCE C. O. D.

Work Faster
Make More Money
with the



Red UNIVERSAL TRACTOR

With this practical machine and attachments you can do all field and belt work hours faster at the low cost of 33c per day. Many units pay for themselves the first season. Unusually easy to handle and operate. Absolutely safe. Hundreds of users. Buy direct at low factory price. Two weeks' trial—satisfaction guaranteed. Write for colorful, free catalog.

PIONEER MFG. CO. Dept. V-69 West Allis, Wis.

Stretch dimes into dollars with SPORS 4000 BARGAINS

260 Pages of Amazing Values Like These

This new 1939 Wholesale Book for salesmen, dealers, etc., describes and offers you over 4000 Tested Fast Sellers; Money-Making Ideas; Sales Building Plans; office specialties, home necessities. Read about the customer whose orders total \$46,000 retail value in 5 months. Same opportunity for you. There is room here for only a few examples. This catalog costs about 25c and we are sending it to you for One Dime to cover the cost of mailing and packing etc. You get your dime back with your first order. Our money back guarantee protects you. Send the dime or stamps and see how you can turn dimes into dollars. Today! Now!



5 Yr. GUARANTEED FOUNTAIN PEN

No. R400. Features: plunger filler; visible ink supply; non-tarnishing size 4 point; guaranteed. Jet black color. When offered for 69c you make over 400% profit. (Full line of writing instruments in our catalog.) Sample 13c. Dozen \$1.40.

ELGIN DRY SHAVER

No. E308. Precision motor chrome plated head; operates on 110 A.C. Ready to operate. 1 year guarantee with each shaver. Money back if not pleased. Sample 79c. Dozen 75c each. 6 dozen 69c each.



HEAT-KWIK WATER HEATER

No. E541. Tested and approved by Automotive Test Laboratories of America. Heats water quickly from any 110 volt light socket. Every home, camp, office, store, farm are ready prospects. Money back if not pleased. Sample 85c. Dozen \$8.88.



SEND WITH ONE DIME TO

SPORS COMPANY

4-39 ELM ST., LE CENTER, MINN.

Dear Spors Co.: Yes I want your new 1939 Wholesale Catalog right away. Here's your dime. I want it back with my first order.

NAME

ADDRESS

CITY..... STATE.....



COLUMBIAN METAL BOATS

Light weight, durable, carefully built boats at remarkably low prices. Made of toughest galvanized copper bearing steel. Wood gun-wales. Heavy transoms for outboard motors. Two or more built-in air chambers for extra buoyancy in case of upset. Real wave riders; easy to handle. Never leak or warp. Always ready for use. Both round and flat bottom boats; all sizes and styles.

Write For Free Boat Booklet with description and prices of complete line of metal boats—knockabouts for fishermen, light weight lively boats for parks and resorts, heavy duty craft for outboard motors.

Dealers Wanted—who can develop volume sales. COLUMBIAN STEEL TANK COMPANY. P. O. Box A-4226 Kansas City, Missouri

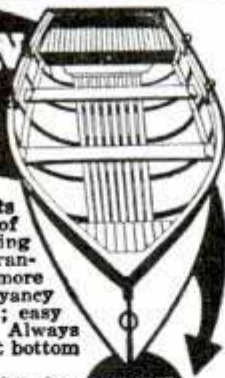

BUILD IT YOURSELF

USE OLD AUTO-PARTS AND SAVE MONEY!

Build a Complete Wood & Metal Work-Shop of Drill Press, Metal Lathe, 14" Band-Saw, 10" Circular-Saw, Shaper, Jig-Saw, 42" Lathe. Easy-to-follow Designs & Plans to build from—ONLY \$2.00 (Reg. \$4. Value) 1000's SATISFIED! Send \$2. bills, check, M-O, Today. (Also C.O.D.) 10c coin brings Literature.



B. J. MEZO CO. 8532 Vanderbilt Ave., Desk-M, Detroit, Mich.

ELIMINATE FORD BRAKE TROUBLES

Your Ford Car is listed in the so-called lower priced class but has more brake lining area and larger drums than the others, in fact as much or more brake area than all but the higher priced cars. You can have safe, sure, unflinching mechanical brakes. Install easily yourself our Simplex Floating Wedges to center the shoes for mechanical assurance with hydraulic performance. A set of four, one for each wheel, all for \$1.75. All models 1928 to 1938—Send for circular.

SIMPLEX WEDGE EXCHANGE, Dept. PM-6, 613 Jefferson St., Ottawa, Ill.



TRAILER PARTS

Largest, most complete stock of trailer parts and equipment in America. Lowest prices, quick delivery. Marvel is the pioneer in trailer accessories with a reputation for highest quality products, refrigerators, stoves, etc. Send 10c in coin for 40 page illustrated catalog.

MARVEL TRAILER PARTS CO. 1920 Celestine Ave. Detroit, Mich.

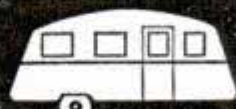

CAPTURE THE COLOR OF LIFE! YOUR OWN MOVIES! ONLY 10c A DAY!

NATIONALLY ADVERTISED 8MM and 16MM Movie cameras, projectors. For home, business, church, school, club. MONEY BACK 10 DAY TRIAL. Payments as low as 10c A DAY. Satisfied customers throughout the world. FREE details. WRITE TODAY. Don Elder's Home Movies, Dept. A-6, 739 Baylston St., Boston, Mass.



NEW 1/4-inch JUNIOR DRILL \$19.95

Write for Details **BLACK & DECKER** 606 Penna. Ave., Towson, Maryland

MODEL YACHT FITTINGS

Largest, most up-to-date line of proven fittings and sails for MARBLEHEAD 50-800, Class A, 6 Metre and 36" Class. Send 3c stamp for illustrated list. List of beautiful carved hull models now ready. For 44 page illustrated catalog, send 20c (coin).

A. J. FISHER 1002-1 Etowah Ave., Royal Oak, Mich.

AMAZING NEW MOWER SHARPENER

New, simplified lawn mower sharpener \$1.00. Anyone can use. Sharpens like costly equipment. Agents—Two big profit plans. Rush name and address for Free details. Professional Products Corp., Dept. 20-F, Cincinnati, O.

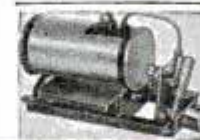

STEAM ENGINES for small boat models. Two-cylinder power plants, ready to run, with boiler propeller and burner. Model SE-1, oscillating type. Price \$2.00 Postage extra, shipping wt. 3 1/2 lb. Model SE-3, slide-valve type. Price \$3.00 Postage extra, shipping wt. 1 1/2 lb. Shawnee Engine Co., Box 162, Station D, Cincinnati, O.

Welding Business Earns \$150 to \$300 for You Each Month



"BUILD-YOUR-OWN"

Just couple your own skills to this unit, mount it on chassis and you have money making advantage of a portable welder at a saving of \$300 to \$500.



30 DAY'S TRIAL AT HOBART'S RISK AND EASY "PAYS FOR ITSELF" TERMS

Free! VALUABLE BOOKLETS ON WELDING. CHECK YOURS AND MAIL THE COUPON TODAY. How to Build-Your-Own New Profits in Arc Welding New Arc Welding Catalog

New low prices make this profitable welding service available to everyone. Opens doors to big pay jobs that carry real profit. Hobart Welders are easier to operate, faster, guaranteed to bring you quality welding business . . . extra profits will pay for welder without expense to you.

NO INVESTMENT TERMS—PROFITS PAY FOR IT Extra earnings and savings possible with Hobart Welders make it easy to own without expense. You can even rent a new Hobart and later purchase it without loss. Coupon brings details.



HOBART THE FASTEST SELLING ARC WELDER ON THE MARKET TODAY

HOBART BROS., BOX M-69, TROY, OHIO

Gentlemen: Send me information on () Build Your Own Welder () Electric Drive Welder () 30 Days Trial, Easy Terms () Rental Plan. Also send me free books I've checked.

Name

Address

(Continued from page 149A)

Cost is the common denominator of our economic system. It fixes the quality of the food we buy, the kind of clothes we wear, the sort of homes we occupy, and the value of the dollars we earn. Economically, we rise or fall on whether or not most of us can afford to pay the price set by the seller, or on whether or not the seller can afford to sell at the price most of us can afford to pay.

Progressive elements of business have long recognized that the cure for many of our economic ills lies in a consistent and honest application of the doctrine of giving more for less. Mass production, so-called, reaching still further, aims at progressively creating more value per dollar with every gain in output.

Suppose we consider a few specific examples of cost reduction through chemistry. In 1924, the price of viscose rayon yarn was approximately two dollars a pound. Today the same type of yarn, though vastly improved in quality, sells at approximately fifty cents a pound. The price of cellulose acetate rayon yarn has declined in twelve years from nearly three dollars a pound to about fifty cents a pound.

In 1925, the price of crude rubber, under foreign control, rose to one dollar and twenty-four cents a pound. Today neoprene sells at sixty-five cents a pound, although it has been on the market only seven years. Today's crude rubber price is much less than the price of neoprene; however, the existence of neoprene assures a ceiling for natural rubber prices. Today's automobile tires give about three times the mileage of tires made fifteen years ago, yet sell for one-third as much.

The rayon example is especially significant, as it illustrates how a chemical advance has affected millions of people, how it has made possible a very wide distribution of one of the good things of life. Before the advent of rayon, the better dresses could be afforded by only a few. Today the American production of rayon, if converted entirely into dress goods, would provide seven dresses for every woman above the age of fifteen.

Technological advance keeps on, and it is a part of our civilization. In this advance, the chemist is playing a leading role—a role that affects not only our personal welfare, but the economy and the security of the nation.

MAKE MONEY *With this AMAZING* HOME ELECTRO-PLATING SET IN YOUR OWN BUSINESS



A REMARKABLE NEW INVENTION

Men! Boys! Here's an unusual opportunity to get into your own Electro-Plating Business right at home! The remarkable new SUPER-PLATER Set requires no tanks or large equipment. (Exactly same as used in bigger units, by world's largest industries.) SIMPLY BRUSH ON! New Lustrous plating appears! Plates gold, silver, copper, brass, bronze, cadmium, nickel, zinc, tin on fixtures, lamps, metal ware, jewelry, musical instruments, auto accessories, silverware, etc. Guaranteed equal to or better than—regular shop methods. No training. Anyone can use it. Carry complete set anywhere.

ONLY \$12.95 COMPLETE with easy instructions, cleaning compound, polish, plastic copper, nickel, silver, ready to use. **FREE!** With each set "How to Build a Profitable Business—where to sell—how to make Big Money." Send only \$12.95 at once (or \$2.00, Balance C.O.D.) Or, write for FREE Details. BE FIRST!

DR. C. PUSHECK, INC., (Established 1890), 6005 N. Clark St., Chicago, Ill.

SpeedWay

Real Quality Tools

Designed, manufactured and guaranteed by SpeedWay, for 30 years leading manufacturers of industrial drills, these are really fine tools, correctly designed, correct speeds, genuine high torque drill motors. Small, handy, powerful; 1000 RPM—drill handles to 1/4" in steel. Die cast handle and gear housing. \$7.95. Grinder operates at 20,000 RPM. (high speed is essential for good grinding). With collets for 1/8" and 3/32" arbors, \$5.95. No. 250 KIT, both drill and grinder with 5 accessories in steel carrying case \$14.95. Complete line of accessories and drill press stand. Write for Circular. Dealers Write SPEEDWAY MFG. CO. 1842 S. 52nd Ave., Cicero, Illinois

DRILL \$7.95
GRINDER \$5.95
SET \$14.95

STORM KING KAYAKS AND BOATS



Build your own Kayak, Outboard, Row or Duckboat from our cut to fit sets or buy them ready made from us.

Send 10 cents in coin for our illustrated folder. Dime will be returned with order.

STORM KING KAYAK & BOAT CO., Dept. P, BETHEL, CONN.

ARE YOU A KEY FUMBLER?

THEN USE KEYMATIC!

This marvelous automatic key case holds your four most important keys, each identified by a special marker. Operates with one hand—a push of the patented Selling for button and out pops the desired key. Streamlined in design, it does not bulge in your pocket. Constructed of solid, non-tarnishing nickel silver. **50¢** Send Coin or Stamps



MONARCH MFG. CO., Dept. E-1, 711 W. Lake St., Chicago, Ill.

NEW LIFE IN OLD TENNIS BALLS

An easily-operated ball inflator makes old balls lively as new, increases size, restores weight nearer standard and improves your game. Make money living tennis or any thick-walled hollow ball. \$1.00 postpaid or information from **INFLATOR CO., 603 Wallace Ave., Indianapolis, Indiana**



New ELECTRIC SANDER

New Electric GUILDSANDER saves hours of time and labor. Gives factory finish on every job. Works on many different materials and shapes. Light, portable. Works from any light socket. Popular price. See your dealer or write for FREE illustrated folder.

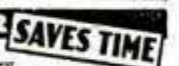

SYRACUSE GUILDTOOL CO., 1700-6C No. SALINA ST., SYRACUSE, N. Y.



IDEAS WANTED

Cash Paid For Good Ideas On New Products Made Of CORRUGATED BOARD.

You've seen hundreds of unusual products made of corrugated board... floor and counter displays, typewriter desks, children's play houses, tables, chairs, etc. If you have an idea for a new product that can be made of corrugated board, write us about it. We'll put you in touch with a nationally known and responsible manufacturer. Write

IDEAS, P. O. Box 525

Marion, Ohio

"I LOOK TERRIBLE"

"I'LL FIX THAT"

Fix chipped, splintered and broken articles to look and remain like new when restored with **ROGERS GLUE**. Made only from cod fish skins. Incredibly strong. 10¢ and up in tube, jar or can at hardware stores only, or send 10¢ for full size bottle, glue paddle and set of blueprinted project plans for making useful articles.

ROGERS, Dept. C, Gloucester, Mass.

ROGERS
the best LIQUID FISH GLUE

GLUEKY

UNIVERSAL VARI-SPEED MOTORS

Operate on any 105-130 Volt house lighting current.

AT BARGAIN PRICES!

These Motors Have Hundreds of Uses for Grinding, Buffing, Polishing, Drilling, Sawing, Operating blowers, dental machines, phonographs, fans, sewing machines, models, lathes, etc.

HEAVY DUTY, 1/30 H.P. From 900 to 8,000 R.P.M. according to load. Height 3 1/2", Length 7", Width 4 1/4", Shaft 1/4", 1 3/4" long. Ship. Weight, 8 lbs. **\$2.98**

1/50 H.P., 1,500 R.P.M., nickel plated. Height 4 1/2", Length 7 1/2", Width 5 1/2", Shaft 5/16", 1 3/4" long. Ship. Weight, 8 lbs. **\$1.98**

All motors thoroughly overhauled and fully guaranteed. Prices F.O.B. N. Y. We issue no catalog. Send check or P. O. money order.

CITY WHOLESALE HARDWARE CORP., 68 Murray St., Dept. PM, New York

Add POWER PEP PICK-UP TO YOUR MOTOR WITH FRETONE

SENSATIONAL MOTOR TUNE-UP! ONE Fretone application frees sticky valves and piston rings—releases Carbon—restores PEAK ENGINE COMPRESSION. Effective "Upper Lubrication." Assures clean, longer-wearing motor. Saves oil, gas, money. Write for special trial sample—send only \$1.00. Distributors wanted. Write for details.

J. W. SPEAKER CORPORATION, Dept. P-1, 1655 North Water St., Milwaukee, Wis.

BUILD A ROLLER TOBOGGAN

Loads of fun for the whole family. Inexpensive, safe. Send only 50¢ for detailed drawings that even a ten year old can understand.

BUILD-A-THRILL CO., 554 W. Adams St., Chicago, Ill.

KILL THEM WITH DIXON'S GRAPH-AIR GUNS

SQUEAKS FRICTION RATTLES

Shoot to kill squeaks, rattles and friction with Dixon's Graph-Air Guns. A puff of Dixon's Mierofyne powdered flake graphite plates friction surfaces with a tenacious, unctuous film that cannot squeeze, burn or wash out with water, acids or alkalis. No drip, no gumming, no freezing, no dilution.

PERFECT FOR LOCKS

"Junior" Graph-Air Gun, filled with about 900 applications, Flexigun Model, 30¢ at all dealers. Rubber Refillable Graph-Air Gun Model, 75¢. Nothing like Mierofyne Graphite on machines, auto, firearms, fishing tackle, household and store equipment and 1001 other applications. Write Dept. C-G 26.

JOSEPH DIXON CRUCIBLE CO., JERSEY CITY, N. J.

RUBBER REFILLABLE MODEL 75¢

A Million-Miler at the Wheel of the Highway Limited

2187 (Continued from page 811)

permitted to take out the bus. Always the company is on guard against starting a run unless the driver is in first class physical condition.

I think the bus driver's job is much harder than that of a railroad engineer. We have to take care of tickets, baggage, operation of our "train," comfort of passengers and a lot of other things, while the engineer only has to watch his schedule and run his locomotive. Too, we are always facing traffic conditions that an engineer doesn't have. My job calls for ingenuity, too, in getting the passengers to their destination, or to safety, when the roads get dangerous or a storm makes the going difficult.

Driving a bus at night isn't as bad as the average automobile driver might think. We don't get sleepy at the wheel because we start out in good physical condition. The lights don't bother us because the bus driver's seat is located at a level just slightly above the beam of the average automobile's lights. Too, we get accustomed to meeting other vehicles at night, after about six months of regular driving. Even on the two-lane highways, night driving isn't difficult. We gauge our distance pretty well and stay on our side of the road. I remember meeting one auto driver who must have been asleep at the wheel. He was coming down my side of the road, his car wobbling. I flashed my spotlight on him—and that apparently woke him up, because he immediately pulled over to his side of the pavement.

Operation of night buses, in my opinion, is helping to teach safety to automobile drivers. We always dim our lights when meeting other vehicles and keep them dimmed until we have passed. Auto drivers, after receiving this courteous treatment from every bus they meet, are inclined to dim their own lights, thus helping to make the roads safer for everybody.

Motorists also have learned that the bus is apt to get through in bad weather when automobiles might be stalled or perhaps wrecked if their owners tried to go on their own. Frequently in fog I have completed a run into Chicago with a string of thirty



BOAT BLUEPRINTS

and full size paper patterns. Wide selection—designed by Naval Architect. Streamlined. Low prices. Send 10c (coin) for illustrated catalog.

Cleveland Boat Blueprint Co., Station A-566 Cleveland, Ohio

FREE 48-page book. Pictures. Useful hints on buying, using, saws, tools, files.

Henry Disston & Sons, Inc., 611 Tacony, Phila.



OVERHEAD GARAGE DOORS

You can install this hardware on your old doors or new ones. Door opens in one piece. Heavy steel springs do the work. Closes weather-tight, only 3" overhead room. Easily installed. Complete with instructions. Free circular. Agents wanted.

WILKIE, INDEPENDENCE, MISSOURI

TOYS—HOME FOUNDRY—SUPPLIES

WRITE FOR FREE CATALOG

showing Casting, Pyrography, Sand Pen and Metal-Tap Sets; large sets, \$2. Also supplies. HOME FOUNDRY MFG. CO., Dept. P6, 3122 Fifth Av., Chicago, Ill.



BUILD THESE PROJECTS

For garden or lawn. Easy to build. Easy to sell. Detailed Blueprints Model B-25 Dutch Windmill 50c; Model OM-60 Old Mill, 85c. Lawn Figure Patterns—Sunbonnet Girl, Dutch Boy, Tulip Girl, Holland Fair, 35c each all 4—\$1.00. Catalog illustrating many models, send 10c today.

CRAFTSMAN'S MODEL CO., Dept. P-30, 2030 N. 41st St., Milwaukee, Wis.

In answering advertisements always write name and full address clearly.

MAKE YOUR FILM WORLD'S FASTEST

Super-sensitize any camera film you use! Simple. Quick. No chemicals. Professional Super-Sensitizer (Patent applied for) \$1.95 postpaid in U.S.A. Crush name for Free details. Professional Products Corp., Dept. 10-F, Cincinnati, O.



CATCH FISH!

minnows, eels, mink, muskrat, with our folding galvanized Steel Wire Traps. Walton's Automatic Hooks are so constructed that when a fish gives the slightest pull on the bait the upper hook reaches down and gets a hold that lands him. 3 for 50c. Write for descriptive catalog of Traps, Hooks, Lures, and other specialties. Walton Supply Co., 3507 Juniata Ave., St. Louis, Mo.



Big Tombstone

Guaranteed Marble and Granite Memorials of lasting beauty. Lettering FREE. Overall size, height 30 in., width 20 in., thk. 8 in. Footstone FREE. Freight paid. Satisfaction guaranteed. Free catalog. American Memorial Co., Dept. B-25 Atlanta, Ga.

Choose from World's Largest Line of Power Tools!

FREE 48-page Catalog covers Metal and Woodworking Tools, accessories, motors for every purse. Write Walker-Turner Co., Inc., 169 South Ave., Plainfield, N. J.

DRIVER Engineered POWER TOOLS



Earn Cash at Home!

We paid M. M. \$1174 for exceptional "cellar crop" SNOW-KING mushrooms! Big free picture book tells if your cellar, shed, barn suitable. We furnish materials, buy all crops. Write today. Est. 1908. UNITED CO., 3848 Lincoln Ave., Dept. 312, Chicago.

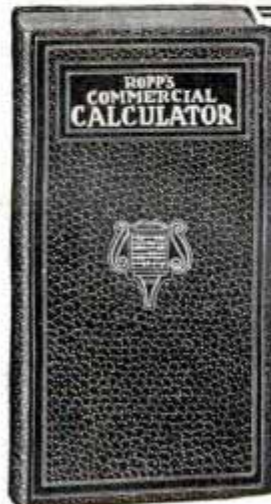

Mathematics Made Easy by ROPP'S CALCULATOR AND SHORT-CUT ARITHMETIC

Shows the Answer as Quickly as a Watch shows the Time to all Problems likely to occur in the Office, Store, Shop, Bank, Farm, or Factory.

Over 2,000,000 Sold

Explains and simplifies every principle in Arithmetic, Mechanics, and Mensuration.

PRICES POSTPAID

Desk Size, Flexible Keratol Binding... \$2.00
Pocket Size, Art Leather Binding... \$1.00
Pocket Size, Cloth Binding... \$0.50

POPULAR MECHANICS PRESS
Room P-6 200 E. Ontario St. CHICAGO

When writing please mention Popular Mechanics



SHOOT WINCHESTER

Regular or High Speed .22 CARTRIDGES

GET your .22 rifle the flatter shooting, finer accuracy and harder socking that come in Winchester Stayless Cartridges. Leader Stayless regular Short, Long, or Long Rifle for practice and sport. Super Speed Stayless in same sizes for high speed and long range—choice of solid or hollow-point hunting bullets. Best for shooting small farm and ranch pests: gophers, prairie dogs, jackrabbits, snapping turtles, crows, woodchucks. . . . Both kinds at regular prices. Ask your dealer.

Send Coupon NOW Winchester Repeating Arms Co., Dept. 46-C (Division of Western Cartridge Co.) New Haven, Conn., U. S. A.

YES, send me FREE the new 44-page Winchester Ammunition Book.

Name _____
Address _____

EASY TO BUILD KAYAKS OUTBOARDS



Largest Selection—Factory built or Complete Cut-to-fit assembly kits with detailed blue prints and instructions. New round bottom

—Safer and Faster. Built to last—Paddles included. Send 10c postage for big new catalog.

KAYAK BOAT COMPANY
152 East 129th St., N. Y. City



50 PIECE ACCESSORY SET for Motor Tools & Flexible Shaft Tools \$1.00



OUTSTANDING VALUE—burs, brushes, buff stones, sanders, etc., a real \$1.50 value. Send postpaid anywhere in U. S.

FLEXIBLE SHAFT TOOLS \$9.95 & UP

Foredom makes a complete line, all equipped with pencil-sized handpieces for easy control and accurate work, available with or without accessory sets. We have 300 accessories to choose from all with 3/32" shanks. Circular free.

FOREDOM ELECTRIC CO. DEALERS
27-H PARK PLACE, NEW YORK WRITE

Let's Go MOTO-SCOOTING
For 1939, it's MOTO-SCOOT



The World's Greatest Economy in Motorized Transportation is making a hit with every body. 1939 models have powerful 1 1/2 horsepower motor to give thrilling rides up to 35 miles per hour. Economical to run—120 miles to the gallon. Every model equipped with Moto-Clutch, built-in generator for powerful headlight and tail-light. Century models with two speed transmission and spring front suspension.

LOW COST DELIVERY SERVICE

Use MOTO-SCOOTS to make economical deliveries for stores, service stations and messenger service. Models for every purpose—Solo-Tandem, Delivery, Fiderat and Trailer. Rugged steel construction.

SEE YOUR MOTO-SCOOT DEALER or Write for Catalog
Dealers—Valuable Territory Still Open

MOTO-SCOOT MFG. CO.
8428 South Chicago Ave.
Chicago, U.S.A.

8297

(Continued from page 152A)

AMAZING NEW BOAT



\$27⁵⁰
KNOCKED DOWN

LIGHTER, STURDIER

SUPPLIED complete or knocked down. Made of Weldwood plywood, weighs only 90 lbs.! So light one man can carry it or put on top of automobile. Use oars or outboard. Sturdy and roomy, holds four people. One-piece, crown-bottom, non-tipping. Only one joint; leakproof. Cannot shrink when exposed to sun or heat. Ideal for fishermen, campers, boat liveries, and as yacht tender or dinghy. Price complete, painted with two coats heavy marine paint, \$37.50 f.o.b. Cincinnati. Price knocked-down, with blue prints and full directions, \$27.50 f.o.b. Cincinnati. Send for **FREE** booklet.

THE ROBT. MITCHELL MFG. CO., 521 W. 2nd St., Cincinnati, O.

BUILD THIS ELECTRIC OUTBOARD

FOR FISHING • PLEASURE RIDES • RENTALS • SALES •



ONLY 10¢ FOR PLANS

It's easy to build this 1939 model electric outboard from LeJay's simplified plans. Old auto generator is all you need to start with; we'll show you how to do the rest. Clean, silent, lightweight. Runs up to 6 miles per hour. Variable speed control makes it ideal for fishing and trolling. Enjoy the double pleasure of making and using it. Send 10c today, and get started at once.

LEJAY MFG. CO., 1547 LeJay Bldg., Minneapolis, Minn.

New Accurate 10" Slide Rule

Enables you to do difficult calculations instantly without paper or pencil—multiplying, proportions, division, extracting roots, etc. Accurate, white composition face. Has Standard A, B, C, D, CI, and K scales.



Made in U.S.A.

50¢

Equipped with both magnifying and standard indicator. For complete outfit, including slide rule, 16-page illustrated instruction book, carrying case, send 50c in coins or U. S. stamps (60c in Canada). Mailed postpaid. Satisfaction guaranteed or money refunded. (Schools and dealers: write for quantity price.) Order Today.

LAWRENCE ENGINEERING SERVICE, 16 Smith St., PERU, INDIANA

DRESS YOUR OWN LUMBER—SAVE \$ \$

12" x 4" Capacity Thickness Planer



Finished lumber from low cost rough stock in your own shop with a B-C 12"x4" Thickness Planer. Save planing cost and waiting at the mill. Pays for itself. E-Z Terms. Also, B-C Saws, Jointers, Sanders, Shapers, Band and Jig Saws.

BOICE-CRANE TOOLS
Dept. 269, Toledo, O.

Send for Catalog

SNUFFS OUT FIRES LIKE MAGIC

"LIFE SAVER" 3 Way Fire Extinguisher



Works Automatically — also as hand sprinkler or grenade

At last a real fire extinguisher for homes, factories, barns, garages, stores, boats, trailers, summer homes, etc. (Attractive in appearance.) priced within the reach of all. Automatically releases 26 ounces by weight of fire extinguishing fluid to snuff out fires. (Ornamental shade furnished extra, as shown.) **FREE AGENT'S OFFER.** The "LIFE SAVER" is easy to sell and pays agents up to 100% profit. Demonstrator furnished free to those who help introduce it. Write

LIFE SAVER CO., 2227-AL Calumet Ave., Chicago, Ill.

Standard Model
\$1⁶⁵

or forty automobiles following the bus, all the drivers depending upon my knowledge of the road to reach our destination safely. Of course, we operate at greatly reduced speed under such conditions.

Since the time I started driving for Greyhound, motor coaches and terminals have been improved wonderfully and schedules have been speeded up. It is a rare thing for a bus to have motor trouble these days, principally because the engines are manufactured to be reliable and because they are given expert attention. Motors are inspected after every trip, the driver reporting if anything is wrong. Every two weeks, on "red letter day," the bus comes



Motor coach at one of the modern rest stops being erected on many routes

in for checking of carburetor, wheel bearings, steering, lights, brakes, etc. At 10,000 miles the motor is completely overhauled and worn parts are replaced.

The coaches are vastly more comfortable today. Standard equipment consists of large balloon tires; soft reclining seats with plenty of leg room; wide windows allowing for excellent visibility; dustproof baggage compartments; indirect lighting, and countless other improvements. One of the latest developments that means a lot in the way of passenger comfort is air conditioning. The system with which about 200 of our supercoaches already have been equipped gives a complete change of air in the coach every four minutes. Heating and cooling apparatus keeps the temperature between seventy-two and seventy-six degrees, winter and summer. Air conditioning probably will bring an increase in the use of night sleeper coaches, of the type

(Continued to page 156A)

at Westport, Conn.

YOUNG MECHANIC'S AMAZING INVENTION OPENS NEW WAY for Men Who Want a Steady BIG-MONEY BUSINESS AT HOME



**HIS PATENTED INVENTION REVOLUTIONIZES ELECTROPLATING
...YOU ACTUALLY DO IT WITH A BRUSH AS EASY AS PAINTING**

NO TANKS, LIQUIDS, GENERATORS DOES SAME WORK AS BIG OUTFITS

Sensational news! Marvelous new invention actually electroplates with electric brush. As easy as painting. Deposits heavy layer of actual metal—gold, silver, nickel, cadmium, copper, etc.—by electrolysis. Does same beautiful, PERMANENT work as big, costly tank outfits. Anyone can use from auto battery or house current. Complete outfit weighs only 11 lbs.—take it anywhere—ready for instant use.

← HUGE DAILY PROFITS

No Experience Necessary. You May Be An Expert In An Hour With My Simple Directions.

NO BIG INVESTMENT — NO COMPETITION

Free Advisory Service to help you make money quick. Also generous supply of common and precious plating metals free.

FREE SAMPLE FOR ACTION AT ONCE! Send today for amazing profit details—FREE SAMPLE AND BIG MONEY-MAKING PLAN. Get started in a profitable business of your own. Full or spare time. Be the WARNER NU-WAY ELECTROPLATER IN YOUR TOWN. Simply mail coupon below.



**PLATE THOUSANDS OF ARTICLES SPARKLING NEW
With Stroke of Brush . . . Big Earnings Reported in Short Time**

Amazing low price and magic-like demonstration brings you thousands of orders for plating from garages, radio shops, bicycle shops, machine shops, home work shops, factories, offices, janitors, doctors, dentists, jewelers, farmers, homes, stores, etc.—with big profits for you! Schedule of plating charges furnished; also reports of big money users are making with WARNER NU-WAY ELECTROPLATER.

WARNER NU-WAY ELECTROPLATER CO., Dept. L-5
General Offices, 360 North Michigan Avenue, Chicago, Illinois

RUSH THIS COUPON—TODAY!

WARNER NU-WAY ELECTROPLATER CO.
360 N. Michigan Ave., Chicago, Ill. Dept. L-5
RUSH me FREE SAMPLE, and BIG Money-Making Plan to start my own business.

Name

Address

City State

RE-STRING RACKETS AT HOME



•EARN MONEY.

It's pleasant, profitable work. No experience or skill required. Easy to learn. Full line of guaranteed Stringing Tools, Frames, Gut and Silk Strings. Every item high quality. Write for complete information.

FREE Write for our 1939 Catalog and Instruction sheet.
W. A. BICKEL & CO., 137 N. Marion, Dept. A-69, Oak Park, Ill.

CONSTRUCTA-SCOOT

The best motor scooter value in America that easily and quickly assembles from fully finished factory kits.

AT ONLY BICYCLE COST!

\$29.50

Less Motor

Complete

F.O.B. Chicago, Ill.

\$59.50

With Motor

Complete

Write for Literature!

RENORM MFG. CO. Not Inc. A-2544 So. Wabash Ave., Chicago, Ill.



MEGOW'S New Catalog NOW READY!

Shows the sensational new quick-building COMMANDER and CADET gas-powered models (see illus.). Also new CLASS C ENDURANCE CONTEST rubber-powered models. Model Ships, HO-Gauge Railroads, ready-made parts and supplies. Send 5c for your copy today!

MEGOW'S Dept. P M., How. & Oxf. Sts., Phila. Pa.
OR 217 N. DESPLAINES ST., CHICAGO

FIREWORKS

Buy them direct

Assortments \$1.00 and up. Make your selection from FREE catalog. Send postal for it today.

ROEHRS FIREWORKS CO. Dept. 3 Closter, N. J.

NOW a DYNAMIC HEAVY DUTY INDUSTRIAL WELDER

Works Off 110-Volt Light Socket. This marvelous Dynamic Power Welder does the work of much higher priced types. It is easily portable. **WELDS** Cylinder Blocks, Bumpers, Fenders, Tanks, Farm Machinery, etc. Will also solder and braze on the lightest material. Works on iron, steel, tin, brass, copper and all other metals. Men without previous experience can make as much as \$5.00 on a one hour repair job. In a year's time a Dynamic Welder Costs You **LESS THAN 6 CENTS A DAY.** Go into business—Open a welding shop now. **AGENTS**—Make big profits selling to garages, factories, janitors and machine shops. Write today for our 10-DAY TRIAL OFFER. **DYNAMIC WELDER CO. 2226-HC Silverton Road Chicago, Illinois**



Calling All Cars

**MYSTERIOUS DISCOVERY
SAVES UP TO 30%
on GASOLINE
or Costs Nothing to Try**

Stop wasting Gas!—trim dollars off gas bills—get more power—quicker pickup—faster acceleration! **AUTO OWNERS everywhere praise VACU-MATIC!** Proven so efficient, it is guaranteed to satisfy, or the trial costs you nothing.

Automatic Supercharge Principle
Vacu-matic is entirely different! It operates on the supercharge principle by automatically adding a charge of extra oxygen, drawn free from the outer air into the heart of the gas mixture. It is entirely automatic and allows the motor to "breathe" at the correct time, opening and closing as required. Saves up to 30% on gas costs, with better motor performance.

AGENTS Get Yours FREE

FOR INTRODUCING. Here's a splendid opportunity for unusual sales and profits. Every car, truck, tractor owner a prospect. Send name and address now for big money making offer and how you can get yours Free. **The Vacu-matic Co., 7617- 444 W. State Street, Wauwatosa, Wis.**

Always write your name and full address clearly when answering advertisements.



Only $\frac{1}{1000}$ th Second Candid Under \$100!

If you've been looking for a super-speed candid that takes exciting pictures by day or night, here's great news! The sensational new UniveX Mercury, at only \$25, gives you the lightning speed, precision performance and breath-taking results you'd expect only from foreign-made candid costing \$100 and more! $\frac{1}{1000}$ th-of-a-second shutter speed—to stop and hold breathless action at its peak! New automatic film transport to make double exposures impossible! And to cap the climax—this amazing new Mercury cuts your negative costs in half, because it uses economical UniveX 35 mm. film! See the UniveX Mercury at your dealer today, or send for free illustrated booklet! Universal Camera Corp., Dept. M-17, New York City.

For night action shots!

The built-in photo-flash synchronizer times flash perfectly with the shutter!

Also available with deep-focus Hexar f2 lens.



UNIVEX $\frac{1}{1000}$ th Second
MERCURY



(Continued from page 154A)

now used on some western runs. These coaches have large compartments, each with a radio, which are converted into berths at night. There is enough room to stand up straight while undressing. The coaches also have a women's lounge and men's lavatory. Another type of de luxe bus now in operation is fitted with buffet for serving light lunches and cold drinks en route. It runs from Cincinnati, Ohio, to Jacksonville, Fla., with only three stops. Air conditioning and toilet facilities make such a schedule possible.

Terminals, too, have been improved. Big, modern depots are being constructed in many cities, and more are contemplated. Rest stops and restaurants on our routes are being renovated, or rebuilt, in order that our passengers may have the very best facilities. The bus lines are attracting more and more passengers, so they are preparing to handle them efficiently, as well as satisfactorily. And the taxes that our company pays, approximately \$3,000 per year for each of nearly 4,000 buses—\$450 a year for every mile of highway over which the line operates—probably will have some influence in the matter of giving the public wider and safer roads in the future.

We learn a lot of tricks at the wheel of the bus that we find handy in driving our own automobiles, such as "sanding the brakes" to prevent skidding on slippery surfaces. This consists of feeding a little gas to the motor with the right foot and applying the brakes gently with the other, thus stopping the car against the pull of the motor. The practice of watching every other driver on the road, thus being ready for any emergency, is something else that we carry from our jobs into our private lives. Perhaps the most important thing that I have learned in driving one million miles without an accident is this:

"Never lose your temper. Give the other fellow a break, and sooner or later, he will give you a break on the road. And that will make driving easier and safer for every man at the wheel."

Names and addresses of manufacturers and dealers in articles described in this magazine will be furnished by our Bureau of Information upon request accompanied by stamped, self-addressed envelope.

2 400
**Binoculars Help Small Camera
 Snap Distant Scenes**



With camera mounted at right eyepiece of binoculars, distant view is brought into focus through left side

Mounting an ordinary miniature camera on a simple frame in conjunction with a pair of binoculars, a photographer has provided himself with a telephoto lens for making pictures of distant views. After carefully lining up the camera lens with the eyepiece, he attached cleats to the mount to keep the instruments in place. Close-up pictures of far-away objects are obtained with an eight-fold magnification.

2-397
**"Bleeding" Bait Lures Big Fish
 by Imitating Hurt Minnow**

To produce the extra bit of realism that attracts fish to the hook, an artificial lure just introduced will "bleed" and flounder in the water like a wounded minnow. Inside the "bleeder" is a small tablet which dissolves in water and trickles out like blood. The pills are harmless and do not stain.

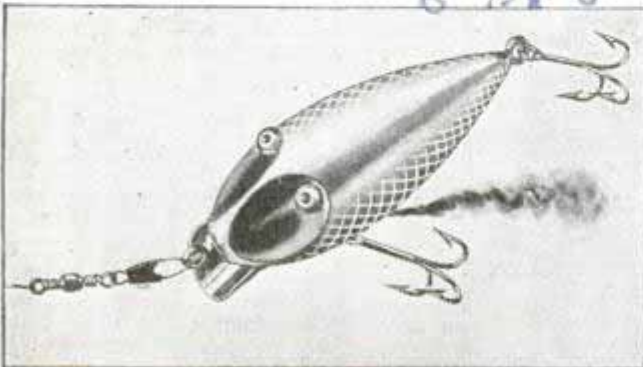

Red stream from pill dissolving in body of lure simulates blood from a wounded minnow

NOW *You Can Afford
 A Movie Camera!*

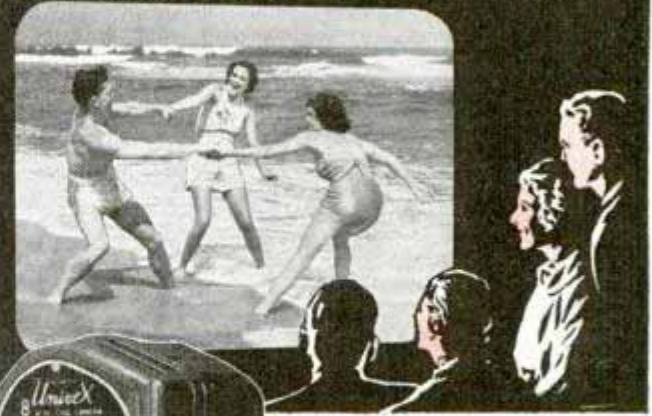

**America's
 No. 1 Value!**

\$15 **USES
 69¢
 FILM!**
Prices Higher Outside U.S.A.

**Sensational New Guarantee
 Insures Your Movies!**
"Satisfactory movies if instructions are followed or a new roll of film free."
 Your guarantee of perfect results with this \$15 camera.

New Built-In View Finder! Faster f4.5 Lens

Wouldn't you like to own a fine movie camera? Now you can afford it! The sensational new 1939 UniveX, at only \$15 gives you the precision performance...the simplicity of operation... the brilliant, true-to-life results you'd expect only from highest-priced movie cameras! This year, get in the movie camera class with the sensational new 1939 UniveX! It's the only camera that takes movies at less cost than snapshots! (Uses economical 69¢ UniveX cine film.) See the new UniveX at your dealer's today! Or send coupon for free illustrated booklet.

UNIVEX MOVIE CAMERA PRICES START AT \$9.95

UNIVERSAL CAMERA CORP.
 Dept. C-21 New York City

FREE BOOKLET

Send me illustrated booklet which describes the New 1939 UniveX Cine "8" and its sensational guarantee.

Name _____
 Address _____
 City _____ State _____

NEW 1939 UniveX

Bleeding Bait mfg
 3404 E 06 Ave. Dallas, Texas

START YOUR OWN SHOP with Light Power Tools



Learn how you can build up a profitable spare or full-time business in your own home. This new book "How to Make Money in Woodworking" is crammed with practical tested ideas, plans, and suggestions. Tells you exactly what to make, how to make it and how to sell it. Describes plans that have worked for others. Woodworking, the new way, is light, pleasant, and profitable. Send only 10c and complete book will be mailed postpaid. Satisfaction guaranteed or money refunded. Write to

DELTA MFG. CO. (Dept. A639)
600-634 E. Vienna Ave., Milwaukee, Wis.

NEW KIND OF MAN'S SHOE

The new sensation in men's shoes—The Chippewa Clipper. It zips on and off in a "jiffy". Now is the right time to get into a dignified and highly profitable shoe business of your own with this fast seller, and a complete line of almost 250 styles of dress, work and sports shoes. Prices as low as \$1.98 a pair. Free 10-second demonstrator sells super-comfort air-cushion shoes like magic.

Sales division for manufacturers established 36 years wants salesmen. No experience needed. Write for complete sales kit. It's free!

VICTOR THOMAS SHOE CO.
6803 No. Clark St., Desk H, Chicago, Ill.



AIR CIRCULATING FANS

Deluxe Chrome Finish Aluminum Blades

Shelf model 3 feet high, 18-inch blade \$22.50 — 20-inch blade \$25.00
Floor model 7 feet high, 20-inch blade \$27.50 — 24-inch blade \$37.50

ATTIC FANS—NIGHT AIR COOLERS

24-inch fan \$42.50—36-inch fan \$73.50—48-inch fan \$93.50. Motors 110 volt, 60 cycle, 1 phase.

Large stocks, immediate delivery—Remit check, postal or international money order. Build your own fans, coolers, blowers and exhaust fans. **SAVE 25%**. Send 10c coin or stamps for descriptive literature and fan parts circular.

CMCO Electric Mfg.
1111 Washington, Chicago, Illinois.



100% PROFIT

NEW WHIRLWIND SELLER
A GOLD MINE FOR AGENTS

Here you have it. **GLAZOL**. Cleans—polishes autos in one operation. Works like magic. No hard rubbing. Lasts indefinitely. No pre-cleaning. Dust proof—beautifies car. Simple demonstration makes instant sale. Priced low for big profits. Grab this agency NOW. Write immediately for Amazing Facts.

BUELL MFG. CO., 2975 Cottage Grove Ave.
Dept. P.M.6, Chicago, Ill.

New STEREO-TACH MAKES 3rd DIMENSION SNAPSHOTS WITH ANY CAMERA

Now YOU can take pictures with DEPTH and perspective. Just use a Stereo-Tach in front of lens. Fits any camera. With a single shutter click you take TWO pictures, on one film, from different angles. Place prints in Viewer and people and objects STAND RIGHT OUT from backgrounds, as in real life. Films developed and printed or enlarged in usual way. No special skill needed. Pictures can be projected if desired.

Complete outfit includes amazing Stereo-Tach (patents pending) and modern stereoscope, sample prints, spectacles for viewing projected pictures, and simple, easy instructions. All for only \$11.75. **SATISFACTION GUARANTEED OR MONEY BACK.** Ask your dealer today, or rush order direct to manufacturer. Send check or money order and we ship Prepaid. Act TODAY.

\$11.75 COMPLETE Illustrated Booklet FREE
THE COMMONWEALTH MFG. CO.
Dept. Y-2400 4206 Davis Lane Cincinnati, Ohio

World's Smallest

NOV! Real RADIO

BEAUTIFUL — PLASTIC — CABINETS

Midget radio fits your pocket or purse. Weighs only 4 ozs. Small as cigarette package! Receives stations with clear natural tone. "PATENTED FIXED CRYSTAL"—NO UPKEEP—only one moving part. "AUDIOPHONE" gives superior performance. ENTIRELY NEW PATENTED DESIGN. Has enclosed geared luminous dial for perfect tuning. Many owners report amazing reception and distance.

ONE YEAR GUARANTEE

Sent completely ready to listen with instructions for use in homes, offices, hotels, boats, in bed, etc. **TAKES ONLY A SECOND TO CONNECT—NO ELECTRICITY NEEDED!** SEND NO MONEY! Pay postman only \$2.99 plus postage on arrival or send \$2.99 (Check, M.O., Cash) and yours will be sent complete postpaid. A most unusual value. **ORDER NOW! MIDGET RADIO CO., Dept. P-6, Kearney, Nebr.**

HANDY TAPS and DIES...

Accurate—carefully hardened and tempered. Complete range of sizes at your local five and ten cent store

HENRY L. HANSON, WORCESTER, MASS.

New "Champion" Race Car Model Kit

1/4" Scale reproduction of Sir Malcolm Campbell's famous "BLUEBIRD" 14" long, 2" wheels, Colored Blue with Aluminum Trim Black details. Kit is complete all parts materials ready to shape and assemble. Accurate full size plans. Circular of other "CHAMPION" MODEL KITS FREE.

60c POSTPAID **NORTHERN AIRCRAFT, PM4, Manitowoc, Wis.**

Get Shop Notes for 1939! Only 50 cents. May easily be best investment of your entire lifetime. Contains 417 money-making, time-saving ideas, kinks, short cuts for mechanics, farmers, home workshop fans, handymen—for everyone who uses tools. 224 pages, 417 articles, 806 illustrations. Get 1938 Shop Notes too. Only 50c.

POPULAR MECHANICS PRESS
Room 639-A, 200 E. Ontario St., Chicago

The World's Biggest

50¢ WORTH

SHOP NOTES FOR 1939

In answering advertisements always write name and full address clearly.

MONEY MAKING Formulas

NOW ONLY \$1.25

Millions from Formulas Like These

- Cosmetics
- Remedies
- Auto Products
- Beverages
- Food Products
- Paints
- Glues
- Polishes
- Inks
- Fertilizers
- Preservatives
- Soaps
- Lubricants
- Metal Products, Etc.

1059 Priceless Recipes.
The kind that have made Fortunes for others. Now in Book Form.

Do you want to make extra money—establish a part-time or full-time business of your own? Then get **MONEY-MAKING FORMULAS** now. It tells you how to make hundreds of saleable products. Tells you what to use, where to get materials and how to turn simple, inexpensive ingredients into real profits. No experience required. Practically no capital needed. Order this amazing 200-page book and get started on an interesting and profitable career.

Big fortunes have been made from a simple formula. Hundreds of well known, advertised articles you see in the stores were started on a "shoestring"—with a good formula and just a few dollars. The hit of this year might easily be yours—even bring you fame and fortune.

Complete in one book—1059 priceless formulas—all instructions and manufacturing processes—where to get the raw materials—everything you need to know. Send for your copy now.

Get the book that lifts the veil of secrecy from an interesting, fascinating and money-making business opportunity. Complete—Only \$1.25 postpaid. Write today.

Popular Mechanics Press, Dept. 639C, 200 E. Ontario St., Chicago

"HEAP BIG NEW BOAT READY!"

HOLD 'UM 4 BIG PALEFACES! CARRY HIM ON SHOULDER! USE 'UM BANG! BANG! MOTOR UP TO 9 PONY-POWER! OARS & SAIL!

~ Chief Eaglebeak



OARS and OARLOCKS GIVEN—if you hurry!



OK-4 is ideal for Sportsmen! Light, long, strong and roomy!



Even with 4 passengers, a light weight motor gives plenty of power!



Here's OK-4 speeding along with a 9 horsepower motor.



The new 69 lb. OK-4 easily lifted to car-top. Portable!



Two girls easily launch this sensational 14 footer!

The Biggest, Lightest and Strongest Boat of Its Kind!

BIG MONEY ASSEMBLING NEW OK-4! IN A FEW EVENINGS AT HOME!

Everybody—even grumpy old Chief Eaglebeak—is mighty excited over Mead's big, new 14-foot portable **Outboard KI-YAK!** Think of it!—ANYONE, without previous experience, can build OK-4 at home in a few evenings and save nearly **HALF** the factory-built cost—or sell to others at Big Profit! **And get these startling OK-4 features:** Carries 4 adults comfortably, and duffel—takes motors 9 h.p. or less, oars and sail—weighs only about **69 pounds** for easy portability on shoulder or car-top for fishing, camping, touring, hunting, Seaworthy, Leakproof, Durable, Double canvas bottom for **double-safety!** The biggest, lightest, strongest boat of its kind—**AND—made only by MEAD—in knock-down kits for quick home-assembly,** or factory-built, ready for the water. **Rush dime for Chief Eaglebeak's Circular, amazing Low Introductory Factory Prices! Oars and oarlocks GIVEN with your OK-4—if you hurry!**



4 OTHER GREAT KI-YAKS

A Mead for every need! Paddle-and-sail models: The baby "CK-1", 10 footer, 20 pounder! The Sportsman's 30 lb. CK-2! The "Big bad CK-3" with 90 square feet of sail on 45 pounds of boat—the sailor's delight! Then there's the 50 pound "OK-2"—Spitfire Of The Fleet—takes up to 4 1/2 h.p. motor, oars, sail and REMEMBER—Mead is America's largest Ki-Yak manufacturer—so buy your Ki-Yak from **HEADQUARTERS.** Rush Coupon and dime now!

\$6 PADDLE GIVEN with your CK Ki-Yak—if you hurry!



5 1/2 Year Old Carries CK-1



CK-2



The 50 Lb. OK-2—Uses Oars, Motor, Sail Rig.

"MAIL 'UM COUPON!"

To: CHIEF EAGLEBEAK, c/o Mead Gliders, 15 So. Market, Dept. B-69, CHICAGO, U. S. A.
Rush 'um new KI-YAK Boat Circulars! **Me much interested** in heap low Factory Prices. Send 'um details on Free Oars and Paddle Offers. I enclose 10¢ postage, packing charges! (Please PRINT plainly.)

NAME.....
St. and No.....
City..... State.....

MEAD GLIDERS
15 S. MARKET ST. DEPT. B-69 CHICAGO, U.S.A.

When writing to advertisers please mention Popular Mechanics

South Bend 9" WORKSHOP *Precision* Lathes

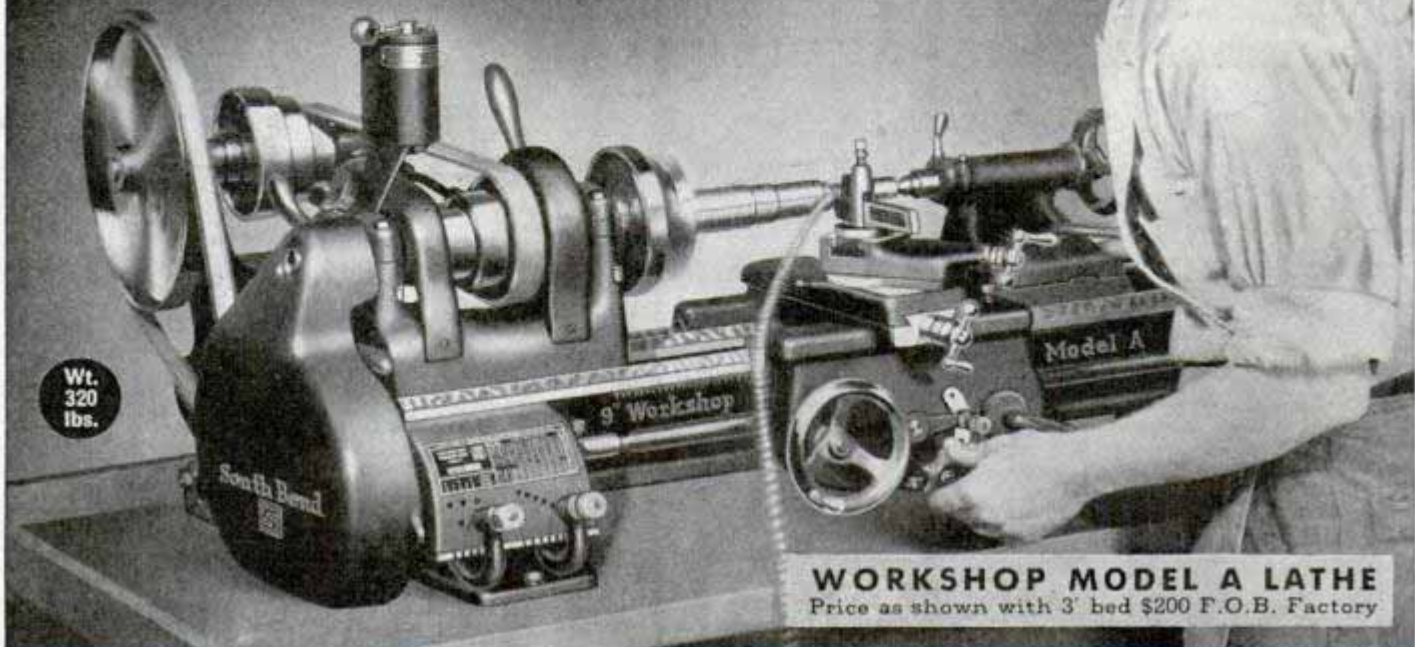

WORKSHOP MODEL A LATHE
Price as shown with 3' bed \$200 F.O.B. Factory

Three Models

Prices Start at \$85
\$15 Down, \$6 Monthly

To meet the requirements of every type of shop, South Bend 9-inch Workshop Back-Gearred, Screw-Cutting Lathes are now made in three models; with bench or floor legs; motor drive or countershaft drive.

MODEL A has full quick change gear mechanism, making all threads and feeds instantly available, also automatic apron with friction clutch for operating power cross feeds and power longitudinal feeds. This is a practical lathe for light manufacturing and accurate tool work.

MODEL B has plain change gear equipment for threads and feeds, also automatic apron with friction clutch for operating power cross feeds and power longitudinal feeds. This lathe is recommended for laboratory and instrument work.

MODEL C which we have been manufacturing for over five years has lead screw and half-nut power longitudinal feeds. This popular model is the same as Models A and B, except that it does not have the gear box and the friction clutch in the apron.

Send Coupon for this book

Complete information on Models A, B and C in 3', 3½', 4', and 4½' bed lengths, Sent Free Postpaid.

SOUTH BEND LATHE WORKS,
642 E. Madison St., South Bend, Ind., U.S.A.
Please Send Catalog No. 43 Free.

Class of Work.....
Name.....
Address.....
City.....State.....

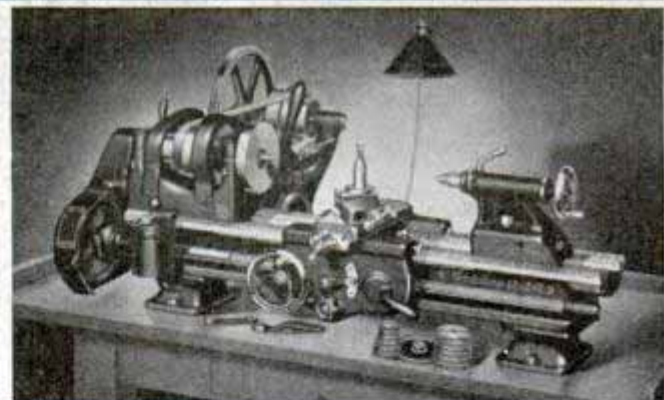

WORKSHOP MODEL B LATHE
Price as shown with 3' bed \$150 F.O.B. Factory

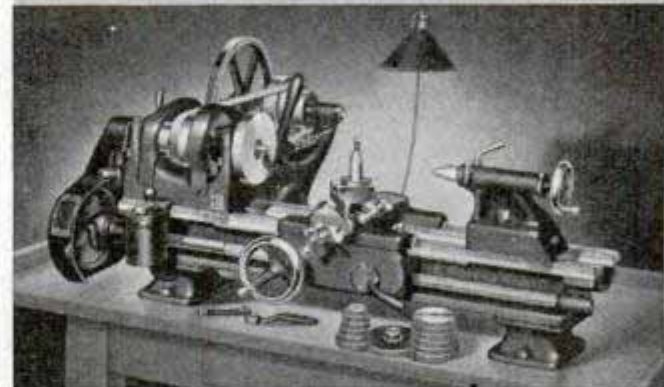

WORKSHOP MODEL C LATHE
Price as shown with 3' bed \$117 F.O.B. Factory

South Bend Lathe Works 642 East Madison Street
South Bend, Ind., U. S. A.

It's thrifty to install
New Champion Spark Plugs



We, Champion Spark Plug dealers everywhere, extend to you this invitation to bring your car to one of us during National Spark Plug Change Week for a check-up of your spark plugs. We will test them, clean them, and show you how old, worn spark plugs waste gas and oil; why a new set of Champions will soon save their cost and insure quick starting, faster acceleration and all around better engine performance.

Our new Sillment-sealed Champion Spark Plugs permanently eliminate troublesome leakage common to ordinary spark plugs. We strongly urge every motorist, not using these new and improved Champions, to install a set now—especially if your present plugs have gone 10,000 miles or more—because even one "leaker" in a set can cause rough, uneven, and wasteful engine operation.



Your Champion Spark Plug Dealer



... the catch of the season
for more smoking pleasure

In every part of the country
smokers are turning to Chesterfields
for what they really want in a cigarette...*refreshing mildness...better taste
...and a more pleasing aroma.*

