

A NEW ERA IN LIGHTING

# POPULAR MECHANICS MAGAZINE



WRITTEN SO YOU CAN UNDERSTAND IT

REG'D TRADE MARK, GREAT BRITAIN, NO. 410426

MAY  
25 CENTS

SEE PAGE  
703

Secrets of a WORLD CHAMPION PITCHER



# NEW TIRE SWEEPS WET ROADS SO DRY YOU CAN LIGHT A MATCH ON ITS TRACK

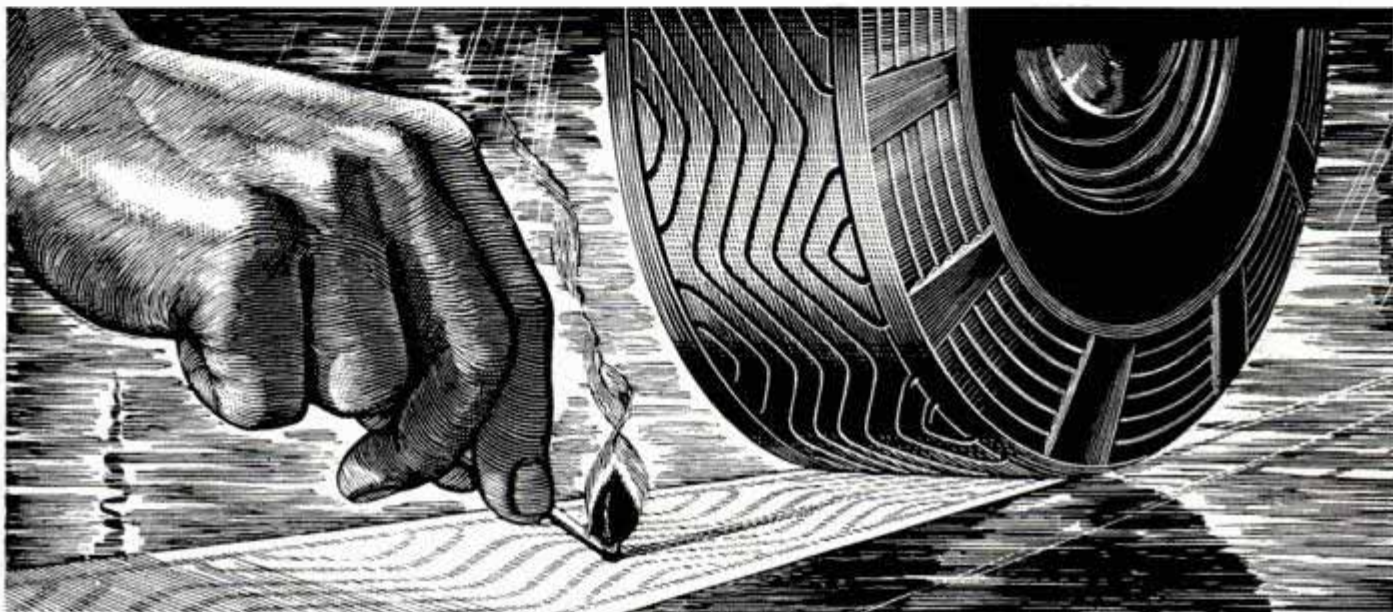

## How This Road-Drying Tire Gives You QUICKEST NON-SKID STOPS Ever Seen

● Sensational? You bet! For here at last is a tire that *automatically* sweeps wet roads so dry that you can actually *light matches on its track*—convincing proof that the new Goodrich Safety Silvertown will give you the quickest non-skid stops you've ever had!

Non-skid tests made by the independent Pittsburgh Testing Laboratory, against *regular* and *premium-priced* tires of America's six largest tire manufacturers, including *new* tires

which have recently been introduced, proved that *no tire tested* came up to this new Silvertown in non-skid action.

And whether roads are wet or dry, Goodrich Silvertowns at *all times* have that other great life-saving protection—the famous Golden Ply—to safeguard you against dangerous high-speed blow-outs. See your Goodrich Dealer or Goodrich Silvertown Store about these life-saving Silvertowns now. *There is no extra cost!*

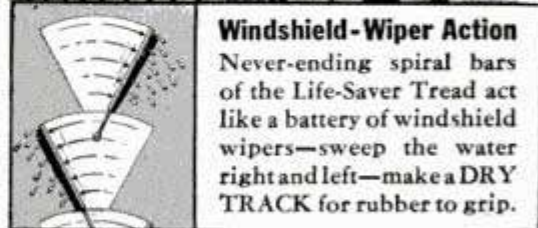

### Windshield-Wiper Action

Never-ending spiral bars of the Life-Saver Tread act like a battery of windshield wipers—sweep the water right and left—make a DRY TRACK for rubber to grip.

The *new* **Goodrich** SAFETY Silvertown

COPYRIGHT 1938 BY THE B. F. GOODRICH CO.



# Facts Show It— Owners Know It

**PLYMOUTH  
IS THE  
MOST FOR  
LOW PRICE**



STANDARD on "De Luxe" models—Perfected Remote Control Gear Shifting with Auto-Mesh Transmission.

Of the leading low-priced cars, Plymouth is *biggest*—5 inches longer than one; 6 inches longer than the other!

Every Plymouth model has the same big, 82-h.p. "L-head" engine—giving full power, *plus* exceptional economy.

The only low-priced car

with coil springs—standard equipment *on all models*.

The only low-priced car with a completely rust-proofed Safety-Steel body.

And Plymouth is the only low-priced car with steering-post gear shift standard in De Luxe models at *no extra cost*.



THE NEW PLYMOUTH has famed Floating Power engine mountings and time-proven Hydraulic Brakes.

**COUPES** START AT **\$645**

**SEDANS** START AT **\$685**

—DELIVERED IN DETROIT, including front and rear bumpers, bumper guards, spare wheel, tire and tube, foot control for headlight beam with indicator on instrument panel, ash-tray in front and rear, sun visor, safety glass and big trunk space (19.3 cubic feet). Plymouth prices include all federal taxes. Transportation and state, local taxes, if any, not included. PLYMOUTH DIVISION OF CHRYSLER CORPORATION, Detroit, Michigan.

MAJOR BOWES' AMATEUR HOUR, C. B. S. NETWORK, THURSDAYS, 9 TO 10 P. M., E. S. T.

## PLYMOUTH BUILDS GREAT CARS

THE "ROADKING"  
THE "DELUXE"

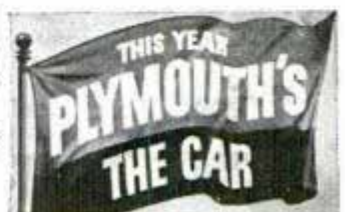



# AUTOMOTIVE MECHANICS!

## Re-Wiring Service is a BIG BUSINESS

*Become  
an Expert!*

There is a big demand for expert electrical service. Defective cables and poor connections waste gas, reduce power and pick-up, cause hard starting, and sometimes result in dangerous fires.

You can become an expert at correcting these common troubles. All the information you require is contained in the Certified Re-Wiring Manual, "Copper Nerves"—prepared and produced by the manufacturer of Packard cable. It is the only book of its kind in the field.

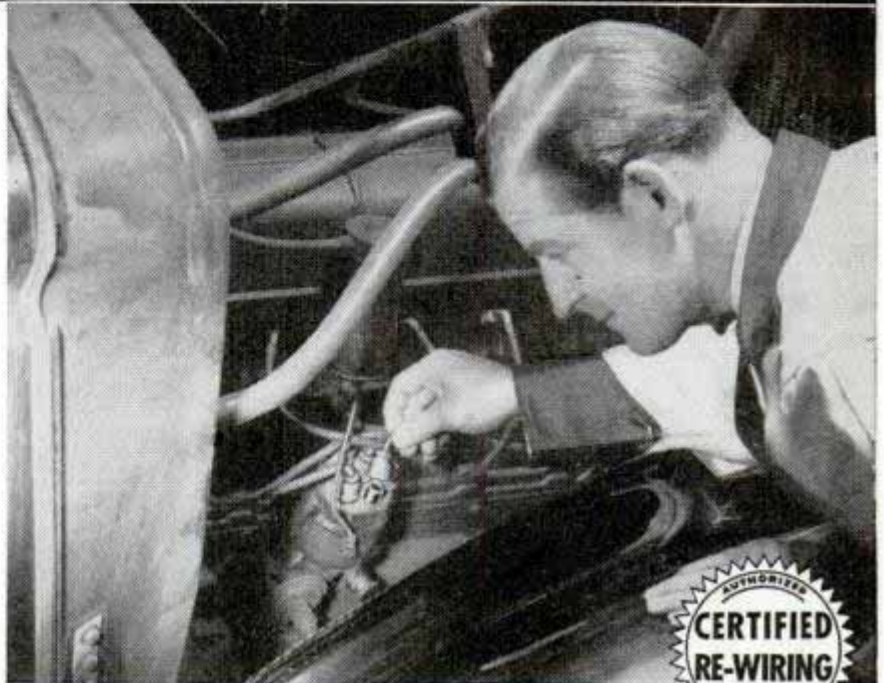

**FREE**



24 pages! 75 illustrations! The Certified Re-Wiring Manual, "Copper Nerves," contains complete step-by-step instructions on checking the electrical circuits for corroded or undersize cable and loose or dirty connections—complete instructions on replacement procedure, using cables of the correct gauge and construction—useful information on other parts of the electrical system. A textbook that will make you an expert! A reference book you can use every day!

**BOOST YOUR OWN IMPORTANCE** When you have studied the Certified Re-Wiring Manual, fill out the examination blank enclosed and mail to Packard Electric. In return for a passing examination, you will receive a **CERTIFICATE** imprinted with your name. This is your proof that you are a Certified Re-Wiring expert—prepared to give car owners the quality electrical service they need. It is an important job, and it will increase *your* importance.

**BRING MORE BUSINESS TO YOUR STATION** When you have received your Certificate, have the owner of your station call his Packard jobber. He will give complete details on how to qualify for Authorized Certified Re-Wiring Service. Certified Re-Wiring stations are supplied with metal identification signs, envelope stuffers, steering-wheel cards, and other sales support. It will mean more business for your station—and a bigger job for *you*.

**GARAGE MECHANICS AND SERVICE MEN** For your copy of the Certified Re-Wiring Manual, send your name, firm name and address, and the name of your Packard jobber to: Packard Electric Division, General Motors Corporation, Warren, Ohio.

**Packard**  
REG. U.S. PAT. OFF.  
TRADE MARK

**CAR OWNERS**—Write for folder explaining Certified Re-Wiring Service. Shows why it pays to get electrical service from mechanics who have received their Certified Re-Wiring Certificate. Packard Electric Division, General Motors Corporation, Warren, Ohio.

THE STANDARD WIRING EQUIPMENT OF THE AUTOMOTIVE INDUSTRY

When writing to advertisers please mention Popular Mechanics



# Popular Mechanics Magazine

H. H. WINDSOR, Founder

H. H. WINDSOR, Jr., Editor and Publisher

May, 1939

Vol. 71, No. 5

## IN THIS ISSUE

<u>Magic Tubes of Daylight</u>	- - -	641
<u>At the Throttle of the "Century"</u>	-	648
<u>Lilliput Outgrows Gulliver</u>	-	Coloroto
<u>New York to Europe by Clipper</u>	-	668
<u>Secrets of a Champion Pitcher</u>	- -	674
<u>Listening In on America at Work</u>	-	680
<u>New Cars for the Kings of Speed</u>	-	690
<u>Seeing the World in Ten Minutes</u>	-	696
<u>How Smart Is Your Dog?</u>	- - -	706
<u>Test-Flying the Sky Giants</u>	- - -	712
<u>Challengers of Disaster</u>	- - -	723
<u>"Bathtub Gardening"</u>	- - -	730

(Continued on next page)

## Chemists Outdo Nature

**Y**OU might as well stop worrying about shortages of gasoline and rubber and nitrates in the United States. Lamot du Pont, president of the great chemical company, tells in the June issue how chemists are outdoing Mother Nature in producing the resources this country lacks. We used to depend upon Germany for potash; now we produce it chemically from New Mexico minerals. Japan once controlled a monopoly of camphor; now we make our own from the turpentine of southern pines. Don't miss this authoritative story by Mr. du Pont revealing how chemists are conserving our natural resources and making us secure.

## So You're Going to Fly

**R**IDING into the sunset over pink cotton clouds, you suddenly remember as the stewardess produces a slice of roast beef that you expected to be dizzy or airsick—and you're not! The diary of your first air trip, Newark to San Francisco by sleeper plane, appears in next month's issue with eight pages of Coloroto pictures taken on board a great sky liner.

## Next Month

**F**IFTEEN minutes from death on a storm-lashed Siberian lake. Fog-bound with a Japanese airplane pilot between mountains in China. Medicine man to a strange people living high in the Caucasus—people who had never seen a wheel. Adventure? That's the principal by-product of Julien Bryan. His business is taking pictures around the world. You'll taste some of the thrills he has experienced in his "Adventures of a Roving Cameraman," Part One of which will be printed next month.

## Diving Past Deadline

**B**ACK in 1915 a diver went down 306 feet in Pearl Harbor, Honolulu, to reach the sunken submarine S4. Beyond that deadline no diver would go, despite the lure of \$2,000,000,000 in sunken treasure and the demands of deep-sea rescue work. Beyond that came the "bends," dread aftermath of pressure too quickly withdrawn. But today the deadline is thrust back. Helium has defeated the "bends." Read "Below the Ocean's Deadline" in the June issue.

## Saving Our Nile

**A**MERICA'S Nile valley was re-turning to desert. Flood, drought, erosion, encroachment of salt water from the Pacific threatened the rich fruitlands of central California with death. But rescue is on the way with a \$170,000,000 reclamation project including Shasta dam, more massive than Boulder, higher than Grand Coulee dam. The story of this vast undertaking will appear in June.



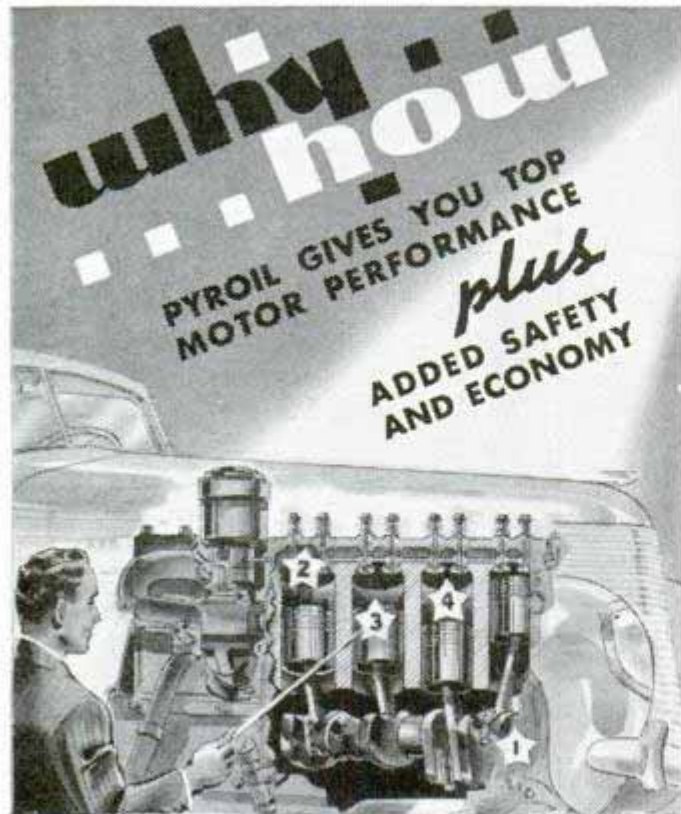

There's no secret to the manner of Pyroil's efficiency. Pyroil is a *super* lubricant composed only of the finest, purest lubricating elements. Merely a few ounces are needed in the gasoline tank, also the crankcase of your car.

Then, coming in contact with (1) bearings and crank shaft, Pyroil's slippery film adheres ruggedly to the metal. Unlike the regular lubricant, this Pyroil film does not drain away. It withstands greater "shock load," higher temperature. Greatly reduces friction. These features markedly reduce wear on the metal.

In the engine head, Pyroil breaks up hard carbon and gum deposits on (2) valves and (3) rings. This defeats conditions that waste power and consume oil. Wear on (4) piston and cylinder wall surfaces is likewise measurably decreased. And, throughout the whole engine Pyroil prevents dangerous corrosive (acid) attack.

Pyroil costs only pennies. Yet it saves dollars in operation expense. It gives you top motor performance. Try Pyroil today. Sold everywhere. Manufactured and Guaranteed by Pyroil Company, W. V. Kidder, Founder, 55 Pyroil Bldg., La Crosse, Wisconsin, U. S. A.

**FREE** — Interesting and important Booklet, "Questions and Answers." Whether your car is new or old, this Booklet tells you how to save money in its operation. Mail coupon below.



NOTHING FINER FOR  
NON-ABRASIVE NEW  
CAR BREAK IN!

**DISTRIBUTORS:**  
CHECK AND MAIL  
COUPON FOR FRAN-  
CHISE FACTS.

**SIMPLY  
ADD TO  
GAS & OIL**

**PYROIL COMPANY**  
55 Pyroil Bldg., La Crosse, Wisconsin, U. S. A.  
Please send me a Free copy of your interesting Booklet, "Questions and Answers," that tells me how to save money in the operation of my car.  
 Also send details of your plan for Distributors.

Name.....  
Address.....  
City..... State.....

(Contents—Continued)

**AUTOMOTIVE**

Lightweight auto designs to give economy.....644  
Light weight marks latest model.....645  
Tractor made from junked auto parts.....646  
Cutaway auto in museum runs at touch of button...647  
Hose and ladder car washes power line insulators...652  
Safety chock for auto trailer.....673  
"Curb finders" warn when car touches curb.....678  
Floating-ride seat adjustable to road.....678  
Streamline fire truck with cab forward.....693  
Two-wheeled auto has retractable parking gear...700  
Scooter tourist travels 31,000 miles in trailer.....701  
Safety car broadcasts recorded messages.....722

**AVIATION**

Perforated wings and blower remove air drag.....693  
Position and direction finders add to safety.....693  
Flares show night wind direction at sea.....694  
Synchronizer for multi-engine planes.....700  
Lights flash if plane instruments go wrong.....702  
Sky freighter swings hinged tail for loading.....703  
Bombing class practices aim on linoleum map.....704  
Glider-to-ground phone helps in taking off.....705  
Airplanes with motors in the wings.....716  
Anti-aircraft shells with "eyes" see target.....718  
Fast climbing plane to chase bombers.....727  
Dummy pilot's cabin displays plane controls.....728

**BOATS AND BOATING**

One-man yacht built to scale from 33-footer.....645  
Sawtooth protector for propeller cuts fouled ropes...685  
Stern-wheel paddles designed to prevent waves...688  
Aircraft carrier "Ranger".....711  
Folding lightweight anchor of welded metal.....721

**HOUSEHOLD**

Folding grill cooks both sides at once.....646  
Window ventilator stops dust and drafts.....646  
Automatic loader fills hopper of coal stoker.....653  
Dripless mustard server.....653  
Locking jewel tray in bureau drawer.....684  
Roast meat thermometer tells when roast is done...688  
Two-gallon electric hot-water tank.....702  
Light socket adapter points bulb at angle.....710  
Toothbrush rack holds tube dispensing toothpaste...710  
Flashlight battery can be renewed by charging....720  
Gas makes electricity to run heater control.....722  
Glass window and light in oven door.....734

**MODELS**

Marines play war game on miniature battlefield....694  
Dutch village is built for tulip festival.....695  
Shipyard builds model fleet for war drill.....701  
World's fair model carved in soap.....718  
Model of Solomon's temple.....726

**PHOTOGRAPHY**

Still camera teams with movie on same tripod....647  
Movie camera takes entire film roll nonstop.....653  
Natural color prints made with sensitive paper....673  
Dudes pose for picture on a stuffed broncho.....718  
Eye camera and copying stand has two lights.....735

**RADIO AND ELECTRICITY**

Automatic recorder counts radio program listeners.652  
Riderless "bike" balanced by electric eye.....673  
Magnetic wind blows out lightning.....679  
Bell rings when called by portable set.....684  
Giant electric scoreboard is set like type.....689  
Automatic telegraph sends facsimile message.....700  
"Rumba" radio wave handled like light beam.....736  
Sight and sound receivers.....737  
Cabinet holds receiver on arm of chair.....738  
Three-unit set for beginners—Part II.....740  
Practical radio hints.....741  
Automatic A-B power unit.....742  
High-speed telephone-type relay.....742  
Radio printer for experimenter.....742  
Short wave set has noise limiter.....742

**SCIENCE AND INDUSTRY**

Electric ear controls grinding mill.....678  
Supersensitive calorimeter feels one-millionth degree 711  
Steel rods in rupture test in furnace.....716  
Sun clock tells exact time to the minute.....720  
Plastics from coffee bean form wallboard.....726  
Blink test measures eye fatigue.....727  
Portable reflecting telescope fits into shoulder case.736

(Continued to page 6A)



# F I S H E R F A C T S



**WIDER VISION** for greater safety! The total window and windshield area of De Luxe Six and De Luxe Eight Pontiac four-door sedans (illustrated) is 412 square

inches larger than last year, includes a 30% larger windshield. Also, the rear view mirror is more efficiently placed and the rear window post eliminated.

## The Inside Story of SAFETY in the 1939 BODY by FISHER

**B**UILD a steel body as solid and weave-proof as possible — you still can't assure its passengers complete protection, until you've made it *safe inside*, too!

That's why Fisher engineers took such great care with the interiors they built for the new General Motors cars — why they gave the new Body by Fisher a *new visibility* as well.

You can see in the illustration above what a broader outlook you get — for bringing overhead traffic lights into easy view, for providing a better picture of the traffic situation on both sides and behind, for giving passengers wider vision, as well.

And to add to this inside

story of safety, all Ventipanes are fitted with locks to protect the car and its passengers from intrusion.

Likewise in comfort, the 1939 Body by Fisher leaves nothing undone. Its interiors have more ride-easy roominess—front and back. What's more, improved Fisher No Draft Ventilation now makes it easier than ever to control the circulation of fresh air to suit yourself.

While as for style, just take a look at any of the new General Motors cars—the only cars with Unisteel Turret Top Body by Fisher.



## BODY BY FISHER

ON GENERAL MOTORS CARS ONLY:  
CHEVROLET • PONTIAC • OLDSMOBILE • BUICK  
LA SALLE • CADILLAC

When writing to advertisers please mention Popular Mechanics





**FIX IT!**

with  
**"WOOD-  
IN-CANS"**

Seal **CRACKS AROUND BATH-TUBS** with **PLASTIC WOOD!** It's waterproof and permanent for replacing loose tiles and bathroom fixtures, too. Handles like putty — hardens into wood that won't split or crumble. Get it at paint, hardware and 10¢ stores. Try it!

**PLASTIC WOOD**

**HEAVY BODY  
3-IN-ONE KEEPS  
ELECTRIC MOTORS  
ON-THE-RUN!**

RIGHT for electric refrigerators and washing machines, too! Gives electric tools longer life. LUBRICATES, CLEANS, PREVENTS RUST.

At Hardware, Drug, Grocery, 10¢ Stores.



**3-IN-ONE OIL**

## (Contents—Continued)

### SPORTS

Rainproof canopy on duck blind.....	655
Ski slide brings winter fun to fair.....	655
Golf tea retrieved by magnet on string.....	684
Safety reflectors on bike pedals.....	694
Non-revolving metal fish lure.....	702
"Fish eats fish" used as lure for big ones.....	705
Casting rod with pistol grip and thumb rest.....	710
"Anti-aircraft" shooting gallery.....	717
"Windows" in bait transmit light below.....	720

### MISCELLANEOUS

Portable steel air-raid shelter holds four.....	645
Submerged weir above Niagara Falls.....	647
Sea life under glass.....	654
Stenciled wall lamp depicts item on menu.....	678
"Floating lamp" balanced by spring.....	679
Pipeline does hairpin turn for expansion.....	684
Motorized cowboys round up a buffalo herd.....	685
Earthquake shuts off gas valve to prevent fire.....	688
Cooling system reversed to heat building.....	704
Paintbrushes kept soft in vapor-filled can.....	704
Push-button library flashes book titles.....	710
Self-heating can cooks food without fire.....	716
Insurance policies sold by slot machine.....	717
Fiber ring for tuning violins.....	720
Malabar Indians fish in curious ways.....	721
Streamline steam table rolls dinners to patrons.....	722
Powered dustpan and broom sweeps near walls.....	728
Tension wrench flashes light to show pull.....	728
Flame tempering violin bows for resiliency.....	729
Boom encloses oil for removal from harbor.....	734
Buzzer sounds end of line on typewriter.....	734
Electric vibrator shakes up can of paint.....	736

## Craftsman and Shop Notes

### AUTOMOTIVE

Auto shortcuts.....	797
Cleaning rust from wheel rims.....	798
Improvised wrench to turn studs.....	798
Pulling battery terminals with turnbuckle.....	798
Rubber taillight lens.....	798
Ash drawer on car.....	799
Slip-on canoe rack.....	799
Bumper for garage door.....	800
Spark plug gap sawed to correct width.....	800

### BOATS AND BOATING

Rubber strips improve loose oars.....	760
Rowboat seat adjusted easily.....	768
Bicycle aquaplane is skill tester.....	769
Eliminating spray at stern of boat.....	770
New canvas on old boats.....	772

### CAMPING AND FISHING

Safe camp stove.....	750
Fisherman's seat improvised from cans.....	780
Live minnows transported with aid of ice.....	788

### FARM

Metal guards prevent locking of singletrees.....	784
Storm-cave window from tile.....	786
Farm-wagon seat has auto-tire "springs".....	788
Chain helps plow under weeds.....	789
Tractor built for \$60.....	790
Piling baled hay safely.....	796

### FURNITURE

Magazine rack with woven-splint panels.....	748
Three smart benches.....	755
Folding lawn chair can't collapse.....	768

### HAND TOOLS

Clamping miter box in vise.....	754
Vacuum depth gauge for hand saw.....	762
Cupping small washers.....	768
Jig to shape small wedges.....	769
Round-nose spinning tool from hinge pin.....	770
Cutting closed slit in metal.....	776
Simple rack for small tools.....	776
Cock substituted for oilcan spout.....	784
Renewable points for a beam compass.....	784
Tool chest has removable carrying box.....	785
Screwdriver fits small and large screws.....	786
Setup for large shafts.....	786
Toolbox hung from ladder by handle.....	786
Lubricating small drills.....	796

(Continued to page 8A)



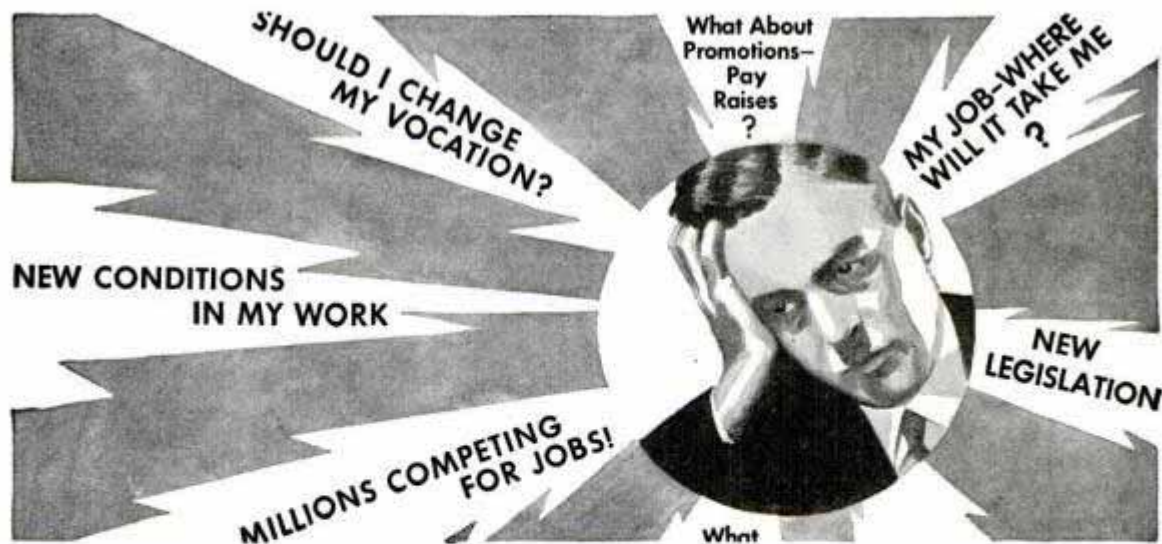

## WHERE DO YOU GO FROM HERE?

**Y**OU'RE like a million other men—you're facing a big question. The depression turned business topsy-turvy and now the rebuilding period stares you in the face.

Are the things that are happening today going to help or hinder you—what will they mean in your pay check? Where will they put you five, ten, twenty years from now? How can you take full advantage of this period of opportunity?

We believe you will find the answer here—a suggestion the soundness of which can be proven to you as it has been to thousands of other men.

The whole trend today—legislation, spirit, action—is to put men back to work, raise earning and spending power, *give every man a fair chance to work out his own salvation.*

The road to success remains unchanged but, bear this in mind, *what it takes to win is radically different!*

No employer today would dare risk an important post in the hands of a man who had not learned the lesson of '29. Why should he, when right at this moment he can pick and choose and get almost any man he wants at his own price?

Business organizations are rebuilding—reorganizing for the new conditions. Before it is over every man and every method will be judged in the cold light of reason and experience—then dropped, remade or retained. This spells real opportunity for the man who can meet the test—but heaven help the man who still tries to meet today's problems from yesterday's standpoint! Out of the multitude still

jobless there are sure to be many frantically eager to prove him wrong and take his place.

### Some Men Have Found the Answer

Seeing these danger signs, many aggressive men and women are quietly training at home—are wisely building themselves for more efficient service to their employers.

You naturally ask, "Has your training helped men withstand conditions of the last few years?"

Our answer is to point to a file of letters from many of our students reporting *pay raises and promotions while business was at its lowest ebb*—together with a myriad of others telling of greater success during these recent months of recovery.

Unusual evidence is ready for your investigation. We have assembled much of it in a booklet that is yours for the asking, along with a new and vitally interesting pamphlet on your business field.

This is a serious study of the possibilities and opportunities in that field. It is certain to contain an answer to vital questions bothering you today about your own work and earning power.

Send for these booklets—coupon brings them free. Be sure to check the LaSalle training that interests you most. We will tell you also how you can meet and take fullest advantage of today's situation. No cost or obligation—so why not mail the coupon now?

### LASALLE EXTENSION UNIVERSITY

A Correspondence Institution

Dept. 564-R, Chicago

Please send me—without cost or obligation—full information about how I can, through your training, equip myself for the new problems and opportunities in the business field I have checked.

- |  |  |
|--|--|
| <input type="checkbox"/> Higher Accountancy    | <input type="checkbox"/> Business Management     |
| <input type="checkbox"/> Law: Degree of LL.B.  | <input type="checkbox"/> Traffic Management      |
| <input type="checkbox"/> Commercial Law        | <input type="checkbox"/> Business Correspondence |
| <input type="checkbox"/> Industrial Management | <input type="checkbox"/> Business English        |
| <input type="checkbox"/> Stenotypy             | <input type="checkbox"/> Salesmanship            |
| <input type="checkbox"/> Modern Foremanship    |  |



This One



8AAZ-Q7F-NDJR

**LaSalle Extension University**  
A CORRESPONDENCE INSTITUTION

Name ..... Age.....

Position.....

Address.....



## BE YOUR OWN FIXER AND SAVE THE REPAIR MONEY

Typical repairs that can be made perfectly with Smooth-On:—Stopping leaks in steam, water, gas, oil or stove pipes; mending cracks, breaks or leaks in furnaces and boilers, radiators, tanks, sinks, pots and pails; making loose handles tight on umbrellas, knives, hammers, brushes, drawers, etc.; tightening loose screws, hooks, locks, door knobs, etc.

On the Automobile:—Making cracked water jackets and pumps good as new; stopping leaks in radiator, hose connections, gas tank and gas, oil and exhaust lines; making a fume-proof joint between exhaust pipe and tonneau heater; tightening loose headlight posts; keeping grease cups, hub caps, and nuts from loosening and falling off, etc.

Practically every householder spends at least \$10.00 to \$50.00 each year and many spend several times that much on the above and other simple repairs that can be made quickly, easily and well with Smooth-On No. 1.

With a can of Smooth-On you can save this money in your own home—and by doing similar repair work for others, you can make money.

No skill is required to make repairs and the amount of Smooth-On used on any one job seldom costs more than a few cents. To get perfect results, write to us for and

use the Smooth-On Repair Book. Get the booklet from us and Smooth-On No. 1 in 7-oz., 1-lb. or 5-lb. tins from any hardware store.

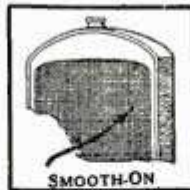

SMOOTH-ON  
Radiator



Leaky Pail

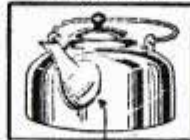

Leaky Kettle

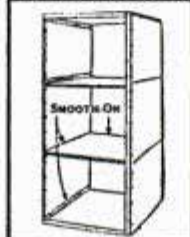

Leaky Tank



Stove Pipe



Oil Leaks



Mail Coupon for  
FREE BOOK



SMOOTH-ON MFG. CO.,  
Dept. 37,  
574 Communipaw Ave.,  
Jersey City, N. J.

Please send the free Smooth-On  
Repair Book.

Name.....

Address.....

5-39

Do it with **SMOOTH-ON**

## (Contents—Continued)

### HOME IMPROVEMENTS

Ball-bearing rollers for sliding doors.....	760
Screens fastened to windows with screws.....	760
Flower box watered underground.....	777

### HOUSEHOLD

Adjustable hanger has many uses.....	745
Compact bed table folds flat.....	762
Hinged window ventilators easy to handle.....	776
Solving home problems.....	778

### LAWN AND GARDEN

Wheeled lounge in the garden.....	743
Footrest on lawn-swing platform.....	745
Garden novelties in wood and brick.....	761
Non-clog overflow pipe for garden pool.....	768
Hotbed from old incubator.....	775

### OFFICE

Desk pigeonholes notched to remove papers.....	754
Hand pencil sharpener fitted with shaving receptacle.....	770
Crayon suspended above shipping clerk's bench.....	786
Correcting mimeograph stencils.....	788
Self-contained weights at corners of blueprint.....	788

### PHOTOGRAPHY

Remote control for camera shutter.....	777
Removing hot photoflood lamps.....	780
Personalize your letters with photo stamps.....	783
Rocking print washer saves time.....	787

### POWER TOOLS

Protecting threaded end of lathe spindle.....	768
Set of lathe drill pads easily made.....	781
Gauge to position work on power hack saw.....	782
Cutting keyway in a lathe.....	789
Using two chucks in drill press.....	789
Altering drill-press locating pads quickly cleaned.....	796

### STORE AND SHOP

Kit to carry window-trimming equipment.....	763
Reflector concentrates heat on melting pot.....	783
Bill holder for door catch.....	788
Strong corners for shipping crates.....	796

### TOYS AND NOVELTIES

Reflectors in bicycle handlebars.....	746
Rubber stirrups for stilts.....	746
It's kite time again.....	751
Dropping parachutes adds zest to kite flying.....	753
Back yard pony swing.....	763
Rustic bridge set has several compartments.....	775

### MISCELLANEOUS

Breakage of saw blades avoided with alcohol.....	746
Hollow plaster casts made without using cores.....	746
Figure in lamp reflected under light.....	747
Thumb indexes on reference books.....	747
Drawer pulls adjust drawing board.....	750
Gluing up strips to form curved work.....	750
Installing leather pump valves.....	750
Novel corner ladder on garage.....	753
Holders for storing skates.....	754
Paper insulators for low-wattage current wires.....	754
Watertight purse for the beach.....	754
Emergency ladder jacks made easily.....	760
Model-ship steering apparatus.....	762
Picture frames from linoleum.....	763
Light up with colorful fixtures.....	764
Preserving magazine pictures.....	769
Irons to burn names on wood.....	770
Venting-funnel spout.....	770
Duck windmill is realistic.....	776
Notched rod removes patch from gun barrel.....	776
Protecting walls from roofer's pitch bucket.....	784
Thermometer readings marked with pin.....	785
Tieless rope cleats of rubber.....	785
Altering flashlight to carry extra bulb.....	789
Temporary signposts from shovels.....	796

### IMPORTANT NOTICE

It is the intention of this magazine to provide its readers with information regarding the latest developments in the mechanical arts. We take no responsibility as to whether the disclosures contained in our articles are covered by patents and advise readers to investigate this subject before making, using, or selling any of the products, machines, or processes described, in order to avoid possible liability for patent infringement.





**BUT  
DAYDREAMS  
DON'T PAY  
BILLS!**

Daydreams may build fine "castles in the air"— but *training builds bright futures!* If you want to be realistic — and your boss is! — consider whether you are sufficiently trained to hold that better job you'd like to have. And be honest!

100,000 ambitious men — men like yourself — are now getting the training they need to succeed through the International Correspondence Schools! They find that I. C. S. textbooks (prepared at a cost of over \$5,000,000) and methods (perfected through 47 years' experience) give them knowledge and training they could not otherwise acquire!

**INTERNATIONAL CORRESPONDENCE SCHOOLS**

BOX 5547-J, SCRANTON, PENNA.

★ Without cost or obligation, please send me a copy of your booklet, "Who Wins and Why," and full particulars about the subject *before* which I have marked X: ★

**TECHNICAL AND INDUSTRIAL SUBJECTS**

- |  |   |   |  |   |
|--|---|---|--|---|
| <input type="checkbox"/> Agriculture                     | <input type="checkbox"/> Air Brakes             | <input type="checkbox"/> Civil Engineering        | <input type="checkbox"/> Manufacture of Pulp Paper | <input type="checkbox"/> Sanitary Engineering       |
| <input type="checkbox"/> Air Conditioning and Cooling    | <input type="checkbox"/> Coal Mining            | <input type="checkbox"/> Contracting and Building | <input type="checkbox"/> Marine Engineering        | <input type="checkbox"/> Sheet Metal Work           |
| <input type="checkbox"/> Architectural Drafting          | <input type="checkbox"/> Cotton Manufacturing   | <input type="checkbox"/> Diesel Engineering       | <input type="checkbox"/> Mechanical Drafting       | <input type="checkbox"/> Steam Electric Engineering |
| <input type="checkbox"/> Architecture                    | <input type="checkbox"/> Electrical Engineering | <input type="checkbox"/> Electric Lighting        | <input type="checkbox"/> Mine Foreman              | <input type="checkbox"/> Steam Engineering          |
| <input type="checkbox"/> Auto Electric Technician        | <input type="checkbox"/> Fire Bosses            | <input type="checkbox"/> Fruit Growing            | <input type="checkbox"/> Navigation                | <input type="checkbox"/> Steam Fitting              |
| <input type="checkbox"/> Auto Technician                 | <input type="checkbox"/> Heating                | <input type="checkbox"/> Heat Treatment of Metals | <input type="checkbox"/> Patternmaking             | <input type="checkbox"/> Structural Drafting        |
| <input type="checkbox"/> Aviation Engineering            | <input type="checkbox"/> Highway Engineering    | <input type="checkbox"/> House Planning           | <input type="checkbox"/> Pharmacy                  | <input type="checkbox"/> Structural Engineering     |
| <input type="checkbox"/> Boltermaking                    | <input type="checkbox"/> Machinist              | <input type="checkbox"/> Management of Inventions | <input type="checkbox"/> Plumbing                  | <input type="checkbox"/> Surveying and Mapping      |
| <input type="checkbox"/> Bridge and Building Foremanship | <input type="checkbox"/> R. R. Locomotives      |   | <input type="checkbox"/> Poultry Farming           | <input type="checkbox"/> Telegraph Engineering      |
| <input type="checkbox"/> Bridge Engineering              | <input type="checkbox"/> R. R. Section Foreman  |   | <input type="checkbox"/> Public Works Engineering  | <input type="checkbox"/> Telephone Work             |
| <input type="checkbox"/> Building Estimating             | <input type="checkbox"/> R. R. Signalmen        |   | <input type="checkbox"/> Radio                     | <input type="checkbox"/> Toolmaking                 |
| <input type="checkbox"/> Chemistry                       | <input type="checkbox"/> Refrigeration          |   | <input type="checkbox"/> R. R. Signalmen           | <input type="checkbox"/> Ventilation                |
|  |   |   | <input type="checkbox"/> Welding, Electric and Gas | <input type="checkbox"/> Woolen Manufacturing       |

**BUSINESS SUBJECTS**

- |  |  |  |  |   |                                  |
|--|--|--|--|---|----------------------------------|
| <input type="checkbox"/> Accounting              | <input type="checkbox"/> Advertising                 | <input type="checkbox"/> College Preparatory | <input type="checkbox"/> Grade School Subjects | <input type="checkbox"/> Railway Postal Clerk   | <input type="checkbox"/> Signs   |
| <input type="checkbox"/> Bookkeeping             | <input type="checkbox"/> Cost Accounting             | <input type="checkbox"/> C. P. Accounting    | <input type="checkbox"/> High School Subjects  | <input type="checkbox"/> Salesmanship           | <input type="checkbox"/> Spanish |
| <input type="checkbox"/> Business Correspondence | <input type="checkbox"/> First Year College Subjects | <input type="checkbox"/> Foremanship         | <input type="checkbox"/> Illustrating          | <input type="checkbox"/> Secretarial Work       |                                  |
| <input type="checkbox"/> Business Management     | <input type="checkbox"/> French                      | <input type="checkbox"/> French              | <input type="checkbox"/> Lettering Show Cards  | <input type="checkbox"/> Stenography and Typing |                                  |
| <input type="checkbox"/> Cartooning              | <input type="checkbox"/> Civil Service               |  | <input type="checkbox"/> Managing Men at Work  | <input type="checkbox"/> Traffic Management     |                                  |

**DOMESTIC SCIENCE SUBJECTS**

- |   |   |  |
|---|---|--|
| <input type="checkbox"/> Advanced Dressmaking | <input type="checkbox"/> Home Dressmaking                       | <input type="checkbox"/> Tea Room and Cafeteria Management, Catering |
| <input type="checkbox"/> Foods and Cookery    | <input type="checkbox"/> Professional Dressmaking and Designing |  |

Name.....Age.....Address.....

City.....State.....Present Position.....

Canadian residents send coupon to International Correspondence Schools Canadian, Limited, Montreal, Canada  
British residents send coupon to I. C. S., 71 Kingsway, London, W. C. 2, England



**If YOU are  
STANDING on the SIDELINES  
of AVIATION**

**WATCHING** it grow  
**READING** about its  
stirring triumphs  
**HEARING** about its  
spectacular progress  
**But Not DOING** anything  
about it, why not . . .

**... GET INTO  
THIS PICTURE**



Here you see men who are doing something about Aviation's swift growth. Like them, you too can learn how to design, build, or maintain today's great planes—the Aero I.T.I. way.

The Aero I.T.I. way to prepare for an Aviation career means that you use the same tools, operate the same equipment, and perform the same duties you'll find right in aircraft repair stations . . . at air line maintenance bases . . . in aircraft plants.

Even if you start your course at home, this actual shop practice is a part of your training. For free booklet and information on Aviation and Aero I.T.I. training—send the coupon NOW.



**Aero Industries Technical Institute**  
5253 West San Fernando Road, Los Angeles, Calif.  
U. S. Civil Aeronautics Authority Approved School

**SEND  
COUPON  
Now**

**EXECUTIVE BOARD**

**C. A. Van Dusen**      **John K. Northrop**      **Robert E. Gross**  
Vice-President,      Formerly—      President, Lockheed  
Consolidated      Pres., The Northrop      Aircraft Corporation  
Aircraft Corp.      Corp., and Vice-Pres.,  
Douglas Aircraft Co., Inc.

Please send free booklet on Aviation and Aero I.T.I. training. I am interested in the line of work checked below:

- Aircraft Mechanics       Aeronautical Engineering  
 Undecided. Please send more information.

Years of High School:  None;  1;  2;  3;  4.  
Years of Jr. College or College:  1;  2;  3;  4.

NAME \_\_\_\_\_ AGE \_\_\_\_\_

ADDRESS \_\_\_\_\_

CITY \_\_\_\_\_ STATE \_\_\_\_\_ a-17-p

**GET IN THE SWING  
with Slingerland . . . DRUMS  
GUITARS  
MANDOLINS**



**GENE KRUPA** — World's Greatest Swing Drummer uses Slingerland

**WONDERFUL VALUE  
EASY PAYMENTS**

Compare the value—tone and power in Slingerland "Radio King" drums, banjos, guitars, mandolins, marimbas or bugles—before you buy. Guaranteed more for your money. Acclaimed the tops in smooth

tone, easy playing, rich power by world's leading musicians. Easy payments. 5-days free trial. See at your dealers.

Cut this ad out—good for \$1.00 credit. Free special information on how to organize drum and bugle corps. Free Catalog—mention instrument wanted.



**SLINGERLAND DRUM CO.**  
1330 Belden Avenue Chicago, Illinois

**LEARN WATCH REPAIRING**



**AT HOME** You can learn by our modern and original system of instruction every part of the Watch Repairing Trade at home. You can earn money while learning and prepare yourself for a well paying position or start in business after completing our course of instruction. Good watch repairers are in demand and generally earn very good salaries. For particulars apply to the Wisconsin School of Watch Repairing 524 E. Mason St., MILWAUKEE, WIS.

**CARTOONING**

**PAYS WELL** Turn your talent into dollars  
Develop your ability with personal instruction from an internationally-known cartoonist. His exclusive, successful method of drawing and creating ideas makes it easy to learn. Write for Free Booklet explaining details of this exceptional home-study course. National School of Cartooning, 437 Penton Building, Cleveland, Ohio



**VOICE**

**100% Improvement Guaranteed**

We build, strengthen the vocal organs—not with singing lessons—but by fundamentally sound and scientifically correct silent exercises. . . and absolutely guarantee to improve any singing or speaking voice at least 200% . . . Write for wonderful voice book—sent free. Learn WHY you can now have the voice you want. No literature sent to anyone under 17 years unless signed by parent.

**PERFECT VOICE INSTITUTE, Studio 1355**  
64 E. Lake St., Chicago

**Learn  
PHOTOGRAPHY  
at Home**

Splendid opportunities. Prepare in spare time. Easy plan. No previous experience needed, common school education sufficient. Send for free booklet "Opportunities in Photography", particulars and requirements.

**American School of Photography**  
3501 Michigan Ave., Dept. 1355, Chicago, Ill.

**MAKE MONEY AT HOME**

**RUBBER MOLDS** Low as 6¢ EA.

Amazing rubber mold-making outfit makes perfect flexible molds of plaques, ash trays, book-ends, etc. Molds cost from 6c to 25c each. Each mold makes hundreds of novelties and gifts to sell up to \$1.00 apiece! No experience necessary. Quick and easy. Start profitable business in your home . . . sell to stores, gift shops, friends, resorts, road stands, by mail. Full or spare time. "Molders Handy Book" and list of buyers FREE. Write



**SO-LO WORKS**

Dept. T-827 Cincinnati, Ohio



# You Ask Me What I Am Doing?



## I Am Getting Ready to Earn More Money ... Preparing for a Bigger Job

I am a student of the American School, Chicago. A little more than half way through my course—already my increased knowledge has brought me promotion as a result of the hour or so a day I have been spending getting acquainted with the principles of the work I enjoy. I use only part of my spare time, so it doesn't interfere with my home and social life, and certainly helps me on the job.

I have been surprised at the practical manner in which even advanced work is explained. It is a lot easier than I had expected. I only wish I had started this plan of getting ahead a few years earlier. But when I was 18 to 20 I felt pretty sure of myself. I didn't take enough stock in what more experienced people told me about the importance of being thoroughly trained for the job I wanted.

**You Can't Win If You Don't Try**  
American School, Dept. G545, Drexel Ave. at 58th St., Chicago

----- CUT ALONG THIS LINE -----

### Try a Lesson Yourself—No Obligation

**American School, Dept. G545, Drexel Ave. at 58th St., Chicago**

I have checked the line of work in which I would like a good job. Please send me without expense or obligation on my part a copy of your Bulletin and an early lesson in the field I have selected.

- |   |  |   |
|---|--|---|
| <input type="checkbox"/> Air Conditioning       | <input type="checkbox"/> Electrical Engineering  | <input type="checkbox"/> Law                    |
| <input type="checkbox"/> Architecture           | <input type="checkbox"/> Diesel Engineering      | <input type="checkbox"/> Liberal Arts (College) |
| <input type="checkbox"/> Automotive Engineering | <input type="checkbox"/> Drafting and Designing  | <input type="checkbox"/> Mechanical Engineering |
| <input type="checkbox"/> Automobile Repairing   | <input type="checkbox"/> Electric Refrigeration  | <input type="checkbox"/> Merchandising          |
| <input type="checkbox"/> Bookkeeping and        | <input type="checkbox"/> Heating, Ventilating,   | <input type="checkbox"/> Private Secretary      |
| Cost Accounting                                 | Plumbing   | <input type="checkbox"/> Radio and Television   |
| <input type="checkbox"/> Business Management    | <input type="checkbox"/> Professional Accounting | <input type="checkbox"/> Salesmanship           |
| <input type="checkbox"/> Civil Engineering      | Incl. C. P. A. Coaching                          | <input type="checkbox"/> Shop Practice          |
| <input type="checkbox"/> Aviation               | <input type="checkbox"/> High School             | <input type="checkbox"/> Steam Engineering      |
| <input type="checkbox"/> Contracting, Building  | <input type="checkbox"/> Highway Engineering     |   |

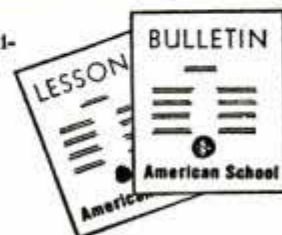

Name.....Age.....Occupation.....

Street.....City.....State.....



**"GIVE ME YOUR MEASURE  
AND I'LL PROVE  
IN THE FIRST 7 DAYS  
YOU CAN HAVE  
A BODY  
LIKE MINE!"**

**No other Physical In-  
structor in the World  
has ever DARED make  
such an offer!**

I'LL give you PROOF in 7 days that I can turn you, too, into a man of might and muscle. Right in the first week you will see and feel the improvement! Then I continue to re-build, renew and "overhaul" your body. Soon you are the proud owner of a powerful build like mine. People will notice the ruddy glow of health in your face, the sparkle in your clear eyes, the breadth of your shoulders. You will be the fellow who will walk off with the prettiest girl and the best job. Mail coupon below for a FREE copy of my new book. It reveals the secrets that changed me from a 97-pound weakling into a husky who won the title of "The World's Most Perfectly Developed Man."

Are you underweight? I'll add pounds where needed! Are you fat in spots? I'll pare you down to fighting trim!

And I'll also give you rugged health that banishes constipation, pimples, skin blotches and similar conditions that rob you of the good things of life!

I haven't any need for contraptions that may strain your heart and other vital organs. I don't dose you or doctor you. **Dynamic Tension** is all I need. It's the natural, tested method for developing real men inside and out.

**48-Page Book FREE**

Tells all about my method and what it has done to make big-muscled men out of run-down specimens. Shows, from actual photos, how I develop my pupils to my own perfectly balanced proportions. My system can do the same for you too. Don't keep on being only half of the man you CAN be! Put your name and address on the coupon, or a postcard, and mail it today. **CHARLES ATLAS**, Dept. 8-E, 115 East 23rd Street, New York, N. Y.

**CHARLES ATLAS, Dept. 8-E  
115 East 23rd Street, New York, N. Y.**

I want the proof that your system of Dynamic Tension will make a new man of me—give me a healthy, husky body and big muscle development. Send me your free book, "Everlasting Health and Strength"—and full details of your 7-DAY TRIAL OFFER.



**Actual photo showing how CHARLES ATLAS Looks TODAY**



**Big Silver Cup Being Given Away**

This valuable solid sterling silver cup stands about 14 inches high. I will award it to my pupil who makes the most improvement within the next 3 months. Therefore, no matter what your measurements may be now, you have an equal chance to win this cup—with YOUR name engraved on it!

Name .....  
(Please print or write plainly)  
Address .....  
City..... State.....

**ELECTRICAL  
ENGINEERING**

**★ ONE YEAR Residence Course  
Prepares You for Technical Positions**

Thorough training in minimum time. Combines theory with practical work in well-equipped laboratories. Experienced faculty and complete facilities provide training essential for technical careers. High employment record is industry's endorsement of Bliss training. Thousands of successful graduates. Suburban campus; modern buildings; dormitory; dining hall. 47th year begins Sept. 27. CATALOG. Give age.



**BLISS ELECTRICAL  
SCHOOL**

115 Takoma Ave., Washington, D. C.

**Regain Perfect Speech, If You  
STAMMER**

Send today for beautifully illustrated book entitled "DON'T STAMMER," which describes the Bogue Unit Method for the scientific correction of stammering and stuttering. Method successfully used at Bogue Institute for 38 years—since 1901. Endorsed by physicians. Full information concerning correction of stammering sent free. No obligation. **Benjamin N. Bogue, Dept. 1302 Circle Tower, Indianapolis, Indiana.**

**LEARN AVIATION  
IN LOS ANGELES - Nation's Aviation Capital**

Huge increases in Los Angeles aviation activity has insured good paying positions for California Flyers graduates. Only U. S. Government and industry approved school here in nation's aviation capital, offering airline piloting, engineering, mechanics, drafting, aircraft construction. Learn in America's most modernly equipped and strategically located school. Low tuition. Write for free catalog.

**CALIFORNIA FLYERS  
SCHOOL OF AVIATION - Dept. P M-5  
LOS ANGELES MUNICIPAL AIRPORT, INGLEWOOD, CALIF.**

**LAW STUDY AT HOME**

Legally trained men win higher positions and bigger success in business and public life. Greater opportunities now than ever before. Big corporations are headed by men with legal training.

**More Ability: More Prestige: More Money**  
We guide you step by step. You can train at home during spare time. Degree of LL. B. Successful graduates in every section of the U. S. We furnish all text material, including 14-volume Law Library. Low cost, easy terms. Get our valuable 48-page "Law Training for Leadership" and "Evidence" books FREE. Send for them NOW.  
**LaSalle Extension University, Dept. 564-L, Chicago**  
A Correspondence Institution

**ARREST HIM, OFFICER!  
I'LL HAVE COMPLETE FACTS ON THE OTHER  
FELLOW TONIGHT!**



Secret Service Operator No. 38 is on the job . . . FOLLOW HIM through all the excitement of his chase after the counterfeit gang. Write NOW for

**FREE Confidential Reports  
No. 38 Made to His Chief!**

It may open your eyes to the great opportunity for YOU as a well paid Finger Print Expert. The kind of work you'd like. Excitement! Travel! Thrills! A REGULAR MONTHLY salary. REWARD MONEY. Graduates of this school HEAD 47% of all

Identification Bureaus in U. S. ! Write for Free Reports, Finger Print Book, low prices. Easy Terms Offer.

Literature will be sent only to persons stating their age.  
**INSTITUTE OF APPLIED SCIENCE  
1920 Sunnyside Ave., Dept. 1355 Chicago, Illinois**





*I jumped from \$18 a week to \$50*  
*-- a Free Book started me toward this*  
**GOOD PAY IN RADIO**

**HERE'S**  
*How it*  
*Happened*  
 by S. J. E.  
 (NAME AND ADDRESS  
 SENT UPON REQUEST)



"I had an \$18 a week job in a shoe factory. I'd probably be at it today if I hadn't read about the opportunities in Radio and started training at home for them."



"The training National Radio Institute gave me was so practical I was soon ready to make \$5, \$10, \$15 a week in spare time servicing Radio sets."



"When I finished training I accepted a job as serviceman with a Radio store. In three weeks I was made service manager at more than twice what I earned in the shoe factory."

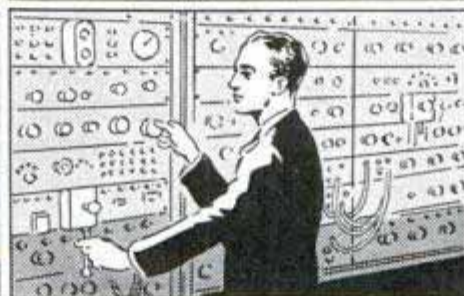

"Eight months later N.R.I. Employment Department sent me to Station EWCR as a Radio operator. Now I am Radio Engineer at Station WSUL. I am also connected with Television Station WQXK."



"N.R.I. Training took me out of a low-pay shoe factory job and put me into Radio at good pay. Radio is growing fast. The field is wide open to properly trained men."



**J. E. SMITH,**  
 President  
 National Radio  
 Institute  
 Established  
 25 years

*Find out today* how I Train You at Home  
**to BE A RADIO EXPERT**

**Many Radio Experts  
 Make \$30, \$50, \$75  
 a Week**

Radio broadcasting stations employ engineers, operators, station managers and pay well for trained men. Fixing Radio sets in spare time pays many \$200 to \$500 a year

—full time jobs with Radio jobbers, manufacturers and dealers as much as \$30, \$50, \$75 a week. Many Radio Experts open full or part time Radio sales and repair businesses. Radio manufacturers and jobbers employ testers, inspectors, foremen, engineers, servicemen, in good-pay jobs with opportunities for advancement. Automobile, police, aviation, commercial Radio, loudspeaker systems, are newer fields offering good opportunities now and for the future. Television promises to open many good jobs soon. Men I trained have good jobs in these branches of Radio. Read how they got their jobs. Mail coupon.

**Many Make \$5, \$10, \$15 a Week Extra  
 in Spare Time While Learning**

The day you enroll I start sending Extra Money Job Sheets; show you how to do Radio repair jobs. Throughout your training I send plans and directions that made good spare time money—\$200 to \$500—for hundreds, while learning. I send you special Radio equipment

to conduct experiments and build circuits. This 50-50 method of training makes learning at home interesting, fascinating, practical. I ALSO GIVE YOU A MODERN, PROFESSIONAL ALL-WAVE, ALL-PURPOSE RADIO SET SERVICING INSTRUMENT to help you make good money fixing Radios while learning and equip you for full time jobs after graduation.

**Find Out What Radio Offers You**

Act Today. Mail the coupon now for "Rich Rewards in Radio." It's free to any fellow over 16 years old. It points out Radio's spare time and full time opportunities and those

coming in Television; tells about my training in Radio and Television; shows you letters from men I trained, telling what they are doing and earning. Find out what Radio offers YOU! MAIL COUPON in an envelope, or paste on a postcard—NOW!

**J. E. SMITH,**  
 President  
 Dept. 9EP,  
 National Radio  
 Institute,  
 Washington,  
 D. C.



**J. E. SMITH, President, Dept. 9EP,  
 National Radio Institute, Washington, D. C.**

Dear Mr. Smith: Without obligating me, send "Rich Rewards in Radio," which points out spare time and full time opportunities in Radio, and explains your practical method of training at home in spare time to become a Radio Expert. (Please write plainly.)

Name..... Age.....

Address.....

City..... State.....





## Fascinating, Profitable Profession NOW OPEN to More Men & Women

If you are looking for a **NEW** and **BETTER** way to make a living, take up Swedish Massage, for now you can learn at home. This interesting big pay profession was for years available only to a few. Its secrets were guarded jealously and fabulous prices were paid for instruction. This same instruction is now available to you at a mere fraction of the former price and you need not leave your present work until you have qualified as an expert and can command an expert's pay. The demand for **BOTH MEN AND WOMEN** has shown a steady increase and few, if any, have ever lacked employment.

### LEARN IN 90 DAYS AT HOME

Use spare time at home to master a profession which has made thousands of dollars for ambitious men and women. Many graduates have completed their training in three months but you can take your own time, it need not interfere with either work or pleasure. All instruction has been prepared by the teachers in our famous resident school—the same material is used and a **DIPLOMA** is awarded upon graduation.



### ANATOMY CHARTS AND BOOKLET FREE No Obligation Of Any Kind SEND COUPON

THE COLLEGE OF SWEDISH MASSAGE (Successor to National College of Massage), Dept. 564-30 E. Adams St., Chicago. You may send me **FREE** and postpaid, Anatomy Charts, booklet containing photographs and letters from graduates and complete details of your offer.

Name.....  
 Address.....  
 City..... State.....

## AUDELS Carpenters and Builders Guides 4 vols. \$6



**Inside Trade Information** for Carpenters, Builders, Joiners, Building Mechanics and all Woodworkers. These Guides give you the short-cut instructions that you want—including new methods, ideas, solutions, plans, systems and money saving suggestions. An easy progressive course for the apprentice and student. A practical daily helper and Quick Reference for the master worker. Carpenters everywhere are using these Guides as a Helping Hand to Easier Work, Better Work and Better Pay. To get this assistance for yourself, simply fill in and mail the **FREE COUPON** below.

### Inside Trade Information On:

How to use the steel square—How to file and set saws—How to build furniture—How to use a mitre box—How to use the chalk line—How to use rules and scales—How to make joints—Carpenters arithmetic—Solving mensuration problems—Estimating strength of timbers—How to set girders and sills—How to frame houses and roofs—How to estimate costs—How to build houses, barns, garages, bungalows, etc.—How to read and draw plans—Drawing up specifications—How to excavate—How to use settings 12, 13 and 17 on the steel square—How to build hoists and scaffolds—skylights—How to build stairs—How to put on interior trim—How to hang doors—How to lath—lay floors—How to paint.



### THEO. AUDEL & CO., 49 W. 23rd St., New York City

Mail Audels Carpenters and Builders Guides, 4 vols., on 7 days' free trial. If O.K. I will remit \$1 in 7 days, and \$1 monthly until \$6 is paid. Otherwise I will return them. No obligation unless I am satisfied.

Name.....  
 Address.....  
 Occupation.....  
 Reference..... P.M.

## TRI-STATE COLLEGE

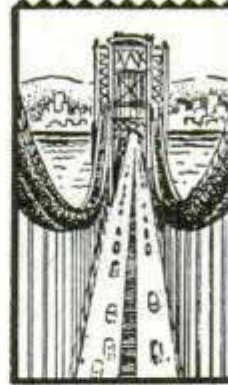

### Degree in 2 years

B. S. Degree in Civil, Electrical, Mechanical, Chemical, Radio, Aeronautical Engineering; Business Administration and Accounting. World famous for technical two-year courses. Also short diploma courses (36 weeks) in Surveying and Drafting. Non-essentials eliminated. Tuition and living costs low. For ambitious, earnest students. Special Preparatory Department for those who lack required high school work. Students from all parts of the world. 56th year. Graduates successful. Enter June, September, January, March. Write for catalog. 459 College Ave., Angola, Ind.

### SCHOOL OF ENGINEERING

## AVIATION SPARTAN OFFERS YOU—

Unequaled advantages of "Oil Capitol of the World" finest flying weather and country. Government Approved. Factory affiliation gives you advantages of Commercial, Military All-Metal construction. Home of the DAWN PATROL. All courses Mechanical and Flight, Student Dormitories, Restaurant. Write for Illustrated Catalog. J. D. GREEN, Director, Dept. PM 19, TULSA, OKLAHOMA



### SPARTAN SCHOOL OF AVIATION



Master a real trade. Auto Mechanics, Diesel Mechanics, Arc Welding, Acetylene Welding, etc. Let us train you to be an expert Auto-Diesel Mechanic and help you get a good job. The cost to you is reasonable. Learn on modern equipment with tools under experienced instructors. Real shop work. Steam heated buildings. Room and board in our steam heated dormitory. We pay your fare to Nashville. For free catalog write

Nashville Auto-Diesel School, Dept. 75, Nashville, Tenn.

## PHOTO-ENGRAVING TASOPE SINCE 1931

TASOPE, world's largest builders of complete Photo-Engraving Plants. We supply newspapers, printeries, studios, colleges, high schools and individuals with precision-built equipment, and give thorough training in Photo-Engraving and Photography, (home or residence)—all at one low cost! Cash in on popularity of pictures. Big money working full or part time for others, or open your own well-paying business. Amazingly small investment. Cash or terms. Catalogs free.

THE AURORA SCHOOL OF PHOTO-ENGRAVING  
 Dept. PM-4 Tasope' Bldg. Aurora, Mo.

## Learn MECHANICAL DENTISTRY AT HOME!

To make Crowns, Plates, Bridgework, etc., for Dentists. Easy practical way to learn mechanical dentistry at home in spare time. **FULL EQUIPMENT OF TOOLS AND MATERIALS INCLUDED WITH COURSE.** Low tuition. Easy terms. Write for **FREE BOOK** about this money making profession that is not affected by machine age. **McCARRIE SCHOOL OF MECHANICAL DENTISTRY** 207 N. Broad St., Dept. 745, Philadelphia, Pa.



## Learn to Write

Begin Today. Write for our Free Book, "How to Become a Good Penman." It contains specimens and tells how others learned to write in spare time. Your name elegantly written on a card if you enclose stamp for postage. Write today. The Tamblin School of Penmanship, Dept. 8, Ridge Bldg., Kansas City, Mo.



**WHY NOT** spend spring, summer, fall, gathering butterflies, insects. I buy hundreds of kinds for collections. Some worth \$1 to \$7 each. Simple outdoor work with my instructions, pictures, price list. Profit—pleasure. Send 10c (not stamps) for Illustrated Prospectus before sending butterflies. **MR. SINCLAIR, DEALER IN INSECTS** Dept. 6, Box 1830 San Diego, Calif.

## Correspondence Courses In RADIO and ELECTRICAL ENGINEERING LOW AS \$25

**ELECTRICAL ENGINEERING.** Get good grasp of wide electrical field. Modern. Very understandable. Theory made easy. **RADIO ENGINEERING.** Extra fine course in radio, public address, photo-electric work. Trains you to be super-service man, real vacuum tube technician. Tuition ONLY \$25, either course. Deferred payment plan. Experiment kits furnished. **FREE LINCOLN ENGINEERING SCHOOL.** Box 931-P5, Lincoln, Nebr.

When writing please mention Popular Mechanics



# MECHANICAL ENGINEERING

— A FIELD WITH A FUTURE



This course has meant advancement to hundreds of ambitious men, mechanics, draftsmen, blacksmiths, foundrymen, patternmakers, apprentices, and mechanical engineers — men who wanted to get ahead and to earn more money. You, too, will find that enrolling for an I. C. S. Course is a real investment.



# RADIO with Experimental Television

holds great rewards for trained men. Radio is already an industrial giant, and still growing. Television will present endless opportunities when it "breaks." The I. C. S. Radio Course with Experimental Television, prepared by leading authorities, will help prepare you for success in this lucrative field. FREE booklet on request.



# DIESEL POWER

## A COMING AMERICAN INDUSTRY

The internal-combustion engine represents man's supreme triumph of machine power. Diesel engineers are in great demand. Many are acquiring necessary knowledge through spare-time study of this modern I. C. S. Course on Diesel engines. Send for free booklet!

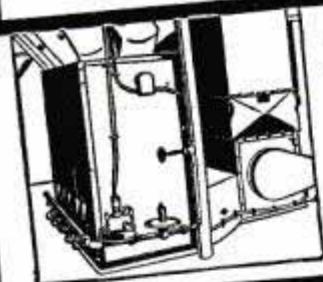

# AIR CONDITIONING

## THE NEXT BIG INDUSTRY

Plumbing and heating engineers must know Air Conditioning — the field in its broader aspects invites ambitious men. Write for information on the new Air Conditioning Course offered by the International Correspondence Schools.

# ADVERTISING

Would you like to become an advertising man? Would you like to know if you possess the necessary qualifications? Then here's your chance! Send the coupon — today!

## INTERNATIONAL CORRESPONDENCE SCHOOLS

BOX 5548-J, SCRANTON, PENNA.

★ Without cost or obligation, please send me a copy of your booklet, "Who Wins and Why," ★ and full particulars about the subject *before* which I have marked X:

<input type="checkbox"/> MECHANICAL ENG.	<input type="checkbox"/> RADIO	<input type="checkbox"/> DIESEL ENG.	<input type="checkbox"/> AIR CONDITIONING	<input type="checkbox"/> ADVERTISING
<b>TECHNICAL AND INDUSTRIAL SUBJECTS</b>				
<input type="checkbox"/> Agriculture	<input type="checkbox"/> Civil Engineering	<input type="checkbox"/> Manufacture of Pulp Paper	<input type="checkbox"/> Sheet Metal Work	<input type="checkbox"/> Steam Electric Engineering
<input type="checkbox"/> Architectural Drafting	<input type="checkbox"/> Coal Mining	<input type="checkbox"/> Marine Engineering	<input type="checkbox"/> Steam Engineering	<input type="checkbox"/> Steam Fitting
<input type="checkbox"/> Architecture	<input type="checkbox"/> Contracting and Building	<input type="checkbox"/> Mechanical Drafting	<input type="checkbox"/> Structural Drafting	<input type="checkbox"/> Structural Engineering
<input type="checkbox"/> Auto Electric Technician	<input type="checkbox"/> Cotton Manufacturing	<input type="checkbox"/> Mine Foreman	<input type="checkbox"/> Surveying and Mapping	<input type="checkbox"/> Telegraph Engineering
<input type="checkbox"/> Auto Technician	<input type="checkbox"/> Electrical Engineering	<input type="checkbox"/> Patternmaking	<input type="checkbox"/> Telephone Work	<input type="checkbox"/> Toolmaking
<input type="checkbox"/> Aviation Engineering	<input type="checkbox"/> Electric Lighting	<input type="checkbox"/> Pharmacy	<input type="checkbox"/> Ventilation	<input type="checkbox"/> Welding, Electric and Gas
<input type="checkbox"/> Boilermaking	<input type="checkbox"/> Fire Bosses	<input type="checkbox"/> Public Works Engineering	<input type="checkbox"/> Woolen Manufacturing	
<input type="checkbox"/> Bridge and Building Foremanship	<input type="checkbox"/> Fruit Growing	<input type="checkbox"/> R. R. Locomotives		
<input type="checkbox"/> Bridge Engineering	<input type="checkbox"/> Heating	<input type="checkbox"/> R. R. Section Foreman		
<input type="checkbox"/> Building Estimating	<input type="checkbox"/> Heat Treatment of Metals	<input type="checkbox"/> R. R. Signalmen		
<input type="checkbox"/> Chemistry	<input type="checkbox"/> Highway Engineering	<input type="checkbox"/> Refrigeration		
	<input type="checkbox"/> House Planning	<input type="checkbox"/> Sanitary Engineering		
	<input type="checkbox"/> Machinist			
	<input type="checkbox"/> Management of Inventions			
<b>BUSINESS SUBJECTS</b>				
<input type="checkbox"/> Accounting	<input type="checkbox"/> College Preparatory	<input type="checkbox"/> Grade School Subjects	<input type="checkbox"/> Railway Postal Clerk	<input type="checkbox"/> Signs
<input type="checkbox"/> Bookkeeping	<input type="checkbox"/> Cost Accounting	<input type="checkbox"/> High School Subjects	<input type="checkbox"/> Salesmanship	<input type="checkbox"/> Spanish
<input type="checkbox"/> Business Correspondence	<input type="checkbox"/> C. P. Accounting	<input type="checkbox"/> Illustrating	<input type="checkbox"/> Secretarial Work	<input type="checkbox"/> Stenography and Typing
<input type="checkbox"/> Business Management	<input type="checkbox"/> First Year College Subjects	<input type="checkbox"/> Lettering Show Cards	<input type="checkbox"/> Traffic Management	
<input type="checkbox"/> Cartooning	<input type="checkbox"/> Foremanship	<input type="checkbox"/> Managing Men at Work		
<input type="checkbox"/> Civil Service	<input type="checkbox"/> French			
<b>DOMESTIC SCIENCE SUBJECTS</b>				
<input type="checkbox"/> Home Dressmaking	<input type="checkbox"/> Professional Dressmaking	<input type="checkbox"/> Foods and Cookery	<input type="checkbox"/> Tea Room and Cafeteria Management.	<input type="checkbox"/> Catering

Name..... Age..... Address.....  
 City..... State..... Present Position.....  
 If you reside in Canada, send this coupon to the International Correspondence Schools Canadian, Limited, Montreal, Canada.  
 If you reside in England, send coupon to I. C. S., 71 Kingsway, London, W. C. 2, England



# DRAFTING

**BOOKS SENT FREE!**

**ON APPROVAL**  
**5 VOLUMES BRAND NEW EDITION**  
 Only 15 minutes a day with these **WONDER BOOKS** can prepare you for a good drafting job in less than a year. Mechanical and architectural drafting from simple straight lines to important complex plans. *A step at a time!* Built especially for beginners, for men with only grammar schooling. Drafting room practice, **PLUS ENGINEERING**, made easy and clear. Includes complete information on blue print reading for building and machine trades.

**Big Field Big Demand Big Pay**  
 Competent draftsmen are urgently needed right now in all building and manufacturing lines at \$30.00 to \$75.00 a week. That's just the beginning—**FOR DRAFTSMEN HAVE THE BEST CHANCES FOR ADVANCEMENT.** Pleasant, fascinating work, easy to learn and do. Learn quickly with these books—send coupon for a set and see for yourself.

*A year's consulting membership in the American Technical Society now given to all readers of this famous cyclopedia of drafting. Many say that it is worth more than the cost of the books.*

Complete set of drawing instruments if you send for these drafting books **NOW**. These instruments are made of the finest of German silver, are absolutely accurate and are packed in velvet lined leatherette pocket case. Real \$10 value, but included with these books.

**AMERICAN TECHNICAL SOCIETY**  
 Dept. D519, Drexel at 58th St., Chicago, Ill.

American Technical Society, Dept. D519, Drexel at 58th St., Chicago, Ill. Send for 10 days' trial New 5 volume set of drafting. I will pay the few cents delivery charges. If I wish, I may return books in 10 days and owe you nothing but if I decide to keep them, I will send \$2.00 after 10 days, then only \$3.00 a month until \$24.80, the advertising price, is paid. Send latest edition and include drawing instruments and Membership Certificate.

Name.....  
 Address.....  
 Attach letter stating age, occupation, employer's name and address and that of at least one business man as a reference.

## DO YOU LIKE RADIO DOES THE FUTURE OF TELEVISION INTEREST YOU?

Send for your free copy

You men anxious to make good in radio and related industries want the true facts,—you want to know about employment opportunities and requirements. National Schools,—a million-dollar trade school,—will supply you with a sincerely honest statement of facts on what you should do to get into the profitable radio industry. No exaggerations,—no mis-statements. Mail coupon today. [Send for your free copy. Real facts on radio employment requirements. You need real experience. National offers complete training with modern equipment.

**NATIONAL SCHOOLS**  
 Los Angeles

Request for **FREE BOOK** of DETAILS

**NATIONAL SCHOOLS,**  
 Dept. 5-PMR, 4000 S. Figueroa St., Los Angeles, Calif.

NAME \_\_\_\_\_ Age \_\_\_\_\_  
 ADDRESS \_\_\_\_\_  
 CITY \_\_\_\_\_ STATE \_\_\_\_\_

## PARKS AIR COLLEGE

PARKS AIRPORT EAST ST. LOUIS, ILL.

Offers **YOU COLLEGE** and **PROFESSIONAL TRAINING**  
 Majoring in **AVIATION**

Accredited by the Illinois Superintendent of Public Instruction, U.S. approved as a Commercial Ground and Flying School and Mechanics' School. Open to high school graduates.  
**FOUR** courses lead to B.S. degrees in Professional Piloting, Aviation Operations, Maintenance Engineering, Aeronautical Engineering.  
**SIXTEEN TRAINING PLANES** are used in professional flight training which prepares graduates for airline flight operations. 74% of graduates enter air transportation in North and South America. 69,000 hours flight training given, 650 hours being flown monthly.  
**FACULTY** of 34 specialists in various fields of aviation.  
 1569 graduates. Enrollment limited to a total of 300.  
 100-acre airport, 14 buildings devoted to school purposes exclusively. Dormitories and dining hall at the College.  
 Summer term June 10. Send postcard for new 60-page catalog.

**12th YEAR Registrar, Dept. PM-5**  
**PARKS AIR COLLEGE, East St. Louis, Ill.**

## SEVEN WONDERS of the WORLD

**FREE** Pictured in **FULL COLOR**—Each 7 1/4 x 10 1/4". Send only 10c to cover mailing costs. The wonders you have longed to see, reconstructed from recent discoveries and painted by famous artists, so you can view them at the height of their glory and read their stories. 24 page booklet. Educational! Entertaining! Mail 10c to  
**WM. H. WISE & CO., Dept. 565, 57 West 47th Street, New York City.**

## U.S. GOV'T JOBS

**Earn \$1260 to \$2100 at Start**  
 Excellent opportunities for citizens, age 18 to 50. No special experience usually required. Railway Postal Clerks may earn \$155 first month; Customs Inspectors as high as \$3,000 a year. Send for **FREE BOOK "How to Secure a Government Position."** It tells about many good government positions and how our tested method will help you pass examinations. Write **AT ONCE, PATTERSON SCHOOL, Arthur R. Patterson (former Gov't. Examiner), Principal, 85 Mercantile Bldg., Rochester, N. Y.**

**NEW YORK SCHOOL of MECHANICAL DENTISTRY**  
 Earn big money in a few months. We show you how. Real Laboratory Training. **OLDEST** school. Day, Eve. Easy terms. Ask for free Catalog P and tool offer.  
**N. Y. SCHOOL of MECHANICAL DENTISTRY, 125 W. 31 St., N. Y. C.**

**ABC OF NAVAL ARCHITECTURE**  
 written in non-technical words for beginners, students and yachtsman. For those who wish to design their own boat, with illustrations. Also plan for single hand cruiser. Send for it to-day. \$1.00 Post Paid.  
**J. SASSANY PUBLISHING CO.**  
 1955 S. BONSALL ST. PHILADELPHIA, PA.

**MONEY-MAKING OPPORTUNITY**  
 for men of character. Over \$1,600 per month earned by California man. Over \$400 a week by Georgia man—\$1,000 in a month by Delaware man. Exclusive franchises available for an invention expected to replace a multi-million dollar industry. Install on free trial. Sells itself. Repairs. Exclusive proposition. Write **F. E. Armstrong, Dept. 1112-E, Mobile, Alabama**

**CARTOON YOUR WAY TO SUCCESS!**  
**DON'T COPY - LEARN TO ORIGINATE!**  
**RAYE BURNS** will teach you **HOW** to **CREATE ORIGINAL CARTOONS** at home that you can **SELL!** Course has 26 lessons and 600 illustrations. \$2.85  
 Send name and address for free details. Only....  
**RAYE BURNS SCHOOL, Dept. M-F, Box 2194, CLEVELAND, OHIO**

**LACO Oil Burner**  
 Unusually Low Prices This Month!  
 Investigate this outstanding burner value, famous for Low Price and Low-Cost Heat! Simple (only 1 moving part). Quiet. Uses little fuel (often cheaper than coal). Exclusive "High Pressure Carburetor" transforms heavy oil into finest mist, produces extra rich mixture, extra hot flame. **GUAR.**  
**FREE Folder**  
**LACO OIL BURNER CO., 159 Union Ave., Griswold, Iowa**

When writing please mention Popular Mechanics





*You've heard about  
ALL THESE DIESELS*

*... But Have You  
Ever Connected Them  
With Your Future?*

- If you have been wondering how to get ahead . . . if you have been thinking about various "lines of work" . . . have you stopped to give Diesel any real thought?
- As a suggestion, think of the man-power side to "Diesel" . . . which has become the "line of work" for many men. Diesels must be designed, sold, installed, serviced, and operated by MEN . . . by men who KNOW Diesels.
- Here is just as real a line of work for you to consider as civil engineering, law, or medicine . . . so find out more about Diesel, now. All you need do is send the coupon below to the Hemphill Diesel Schools, America's first exclusively Diesel training institution.
- In return you receive interesting information about Diesels and Diesel industry. Also, complete information about Hemphill Diesel training—the day and night courses, and the Combination Home Study and Later Shop Training course. Highly illustrated booklet "The March of Diesel"—new issue—sent free. Use the coupon below.

*On the Rails*



*On the Sea*



*In the Air*



*On the Highways*



*On Construction Jobs*



*On Farms*



*In Power Plants*

## HEMPHILL DIESEL SCHOOLS

*Schools for Diesel and Diesel-electric training  
located in the cities listed below.*

BOSTON, 114 Brookline Avenue  
NEW YORK, 31-26 Queens Blvd., Long Island City  
DETROIT, 2341 West Lafayette Blvd.  
CHICAGO, 2014 Larrabee Street  
MEMPHIS, 417 Monroe Avenue  
LOS ANGELES, 2120 San Fernando Road  
SEATTLE, 513 Dexter Avenue  
VANCOUVER, B. C., 1363 Granville Street

Please send me information on the Diesel industry, including my free copy of "March of Diesel" booklet and details on Hemphill Diesel training.

NAME \_\_\_\_\_ AGE \_\_\_\_\_

ADDRESS \_\_\_\_\_

CITY \_\_\_\_\_ STATE \_\_\_\_\_

Send this Coupon to Nearest Address Shown at Left

m-37-p





*J 203*  
**G**REATER safety at sea is the purpose of a lifeboat unloading arrangement patented some time ago. It is intended for a ship having a system of interior decks within an inclosed hull and superstructure, of the streamline design. The lifeboats would be moved on rollers out to the end of a part of the superstructure constructed

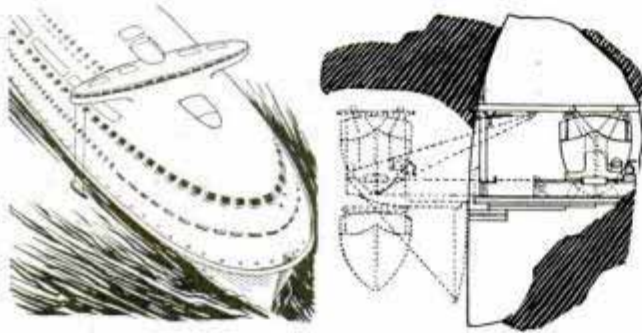

at right angles to the main portion of the ship. From that point, the lifeboats would be lowered to the deck level to be loaded, then swung down to the surface of the water. Loading would be through a door at the deck level. This manner of handling is intended to prevent damaging the lifeboat by contact with the side of the ship.

**D**ESIGNED to speed up location of a storm center, a new meteorological instrument has been patented. It comprises a supporting member having points of the compass indicated thereon and disposable upon a map in corresponding relation

to the North direction on the map, with its center at a given observation point. The instrument has means for indicating the direction of the wind and for indicating

graphically the proper barometric reading at a given point. Wind and barometer indications form two legs of an angle, the angle being fixed for any particular barometric reading. The projection of the second leg intersects a previously plotted line indicating the known or probable course of a storm so that the point of intersection will indicate the approximate location of the storm center at any given time.

**M**OTORISTS would find a late invention handy if they desired to use the telephone without leaving their cars. The invention consists of a post, which would be erected at the curb, with a housing for a telephone at its upper end. The telephone

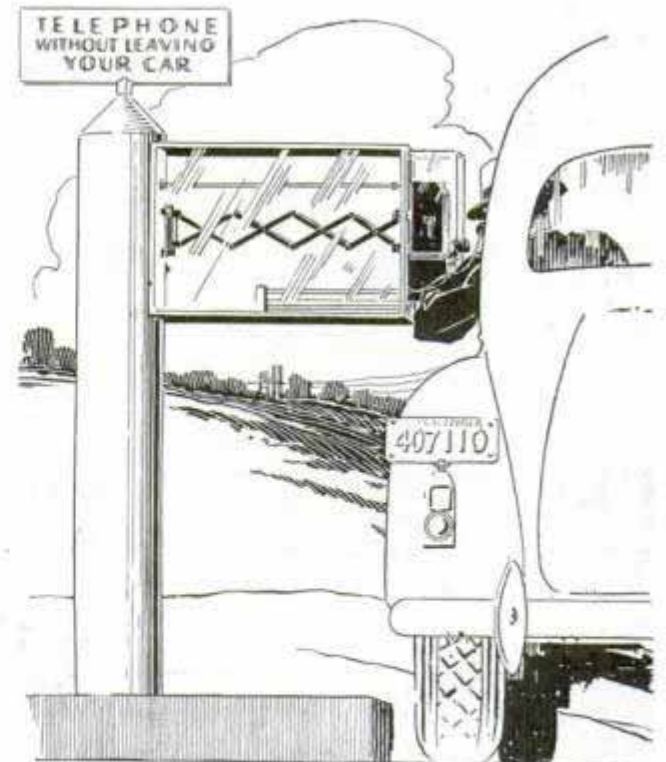

is fitted with an extensible carrier so that it may be pulled into the car while in use. Standard coin operation would be used.

(Continued to page 24A)





H. C. Lewis

**QUICK, EASIER WAY**  
**TO TRAIN FOR**  
**ELECTRICITY**  
**12 Weeks** *Practical WORK*  
**IN MY CHICAGO SHOPS**

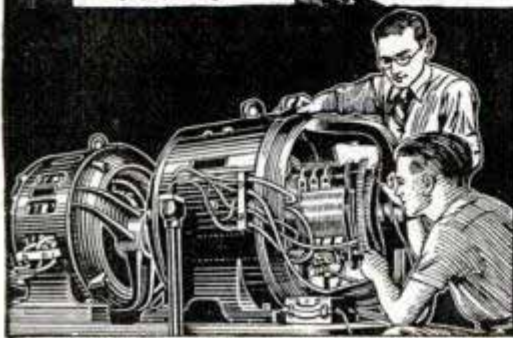

FIRST--You are told and shown how to do it.

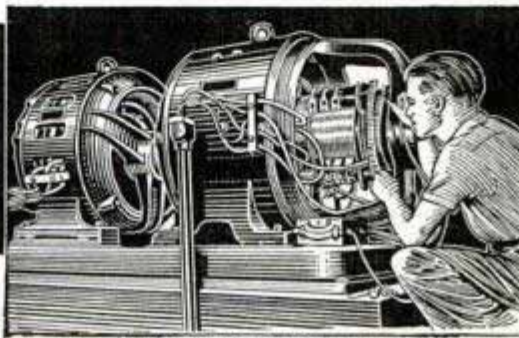

THEN--You do the job yourself.



**HOUSE WIRING**  
 only one of the many branches you "Learn By Doing."

**WANT TO EARN**

Have you ever dreamed of holding down a steady, good pay job? Have you ever dreamed of doing the work you really like in a job that holds promise of a real future in the years ahead?

Well, we all know that you can't get the good things in life by just **dreaming** about them. Hundreds of fellows are today holding down mighty fine jobs with prospects of a bright future. They are filling these jobs because they had the foresight to equip themselves with the **right kind of training**. Most of these men were only average fellows a short time ago, but the proper training helped to lift them out of the low pay ranks of unskilled workers. The same opportunity is now offered to you.

The great fascinating field of **ELECTRICITY** offers a real future to many men and young men who are willing to prepare for a place in this giant industry.

**MORE MONEY?**

Here at my school in Chicago, the world's Electrical Center, you can get 12 weeks' **Shop Training in ELECTRICITY**, that can help give you your start towards a better job.

You will be trained on actual equipment and machinery and because of our method of training, you **don't need previous experience or a lot of education**. Many of my successful graduates never even completed Grammar School.

Here in my school you work on generators, motors, dynamos, you do house wiring, wind armatures and do actual work in many other branches of electricity and right now I'm including valuable instruction in **Diesel, Electric Refrigeration and Air Conditioning** at no extra cost. Our practical shop methods make it **easier to learn**—First the instructors tell you how a thing should be done—then they show you how it should be done—then you do the actual work yourself.



"... Everything was just as stated in literature. And by Coyne methods plenty of instructors to take care of everything, easy to learn. I really was satisfied with Coyne Training."  
 J. Halyk, Canada



"... Coyne has first class instructors to teach you the simplest things to start with and they have the equipment to show you these things as you advance."  
 Ben Rickman, S. Car.

**I'LL FINANCE YOUR TRAINING**

You can get this training first—then pay for it later in **easy monthly payments**, starting 60 days after your 12 weeks' training period is over—then you have 12 months to complete your payments.

If you need **part time work** to help out with expenses while training in my shops, my employment department will help you get it. Then after graduation this department will give you valuable **lifetime employment service**.

Send the coupon today for all details. When I get it I'll send you my big free book containing dozens of pictures of students at work in

my shops. I'll also tell you about my "Pay After Graduation" plan, how many earn while learning and how we help our students after graduation. Fill in, clip coupon, mail today for your start toward a brighter future.



**MAIL NOW**

H. C. LEWIS, President,  
 COYNE ELECTRICAL SCHOOL,  
 500 S. Paulina Street, Dept. 59-72, Chicago, Ill.

Dear Sir: Please send me free your big catalog and full particulars of your present offer, also your "Pay-Tuition-After-Graduation" Plan.

NAME.....  
 ADDRESS.....  
 CITY..... STATE.....

**H. C. LEWIS, President**  
**COYNE ELECTRICAL SCHOOL**  
 500 S. Paulina St., Dept. 59-72, Chicago



# HIGH SCHOOL

## At Home!

Qualify for the better Commercial, Industrial and Civil Service positions by getting a High School education in spare time!

**Prepare for College, Pre-Professional, Regents, State Equivalency Examinations, and Business and Industry**

**U. S. Govt. figures show High School graduates average \$2112 yearly. Many Finish in 2 Years!**

No classes; no time wasted going to and from school. You make rapid progress by our methods. Thousands of ambitious men and women select the American School each year.

All books furnished. School est. over 40 years. Endorsed by educators. Small monthly payments.

**American School, Dept. H-545, Drexel Ave. at 58th St., Chicago**

**American School, Dept. H-545, Drexel Ave. at 58th St., Chicago**

Without obligation send me your free Bulletin and information about your High School course at home, or the field I have checked.

- Air Conditioning
- Architecture
- Automotive Engineering
- Automobile Repairing
- Bookkeeping and Cost Accounting
- Business Management
- Civil Engineering
- Aviation
- Contracting, Building

- High School
- Electrical Engineering
- Diesel Engineering
- Drafting and Designing
- Electric Refrigeration
- Heating, Ventilating, Plumbing
- Professional Accounting Incl. C. P. A. Coaching
- Highway Engineering

- Law
- Liberal Arts (College)
- Mechanical Engineering
- Merchandising
- Private Secretary
- Radio and Television
- Salesmanship
- Shop Practice
- Steam Engineering
- Shop Management

Name.....Age.....Occupation.....

Street.....City.....State.....

# MECHANICS

**KNOW YOUR CAR**

**You Need this Book**

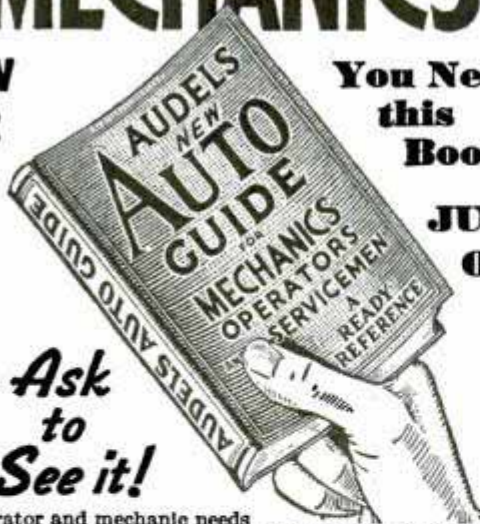

**JUST OUT!**

**Ask to See it!**

Every operator and mechanic needs AUDELS NEW AUTO GUIDE. This book saves time, money and worry. Highly endorsed. It presents the whole subject of auto mechanics: 1—Basic principles, 2—Construction, 3—Operation, 4—Service, 5—Repair. Easily understood. Over 1500 pages—1540 illustrations showing inside views of modern cars, trucks and buses with instructions for all service jobs. Diesel Engines fully treated, fully illustrated. To Get This Assistance for Yourself Simply **4** Fill In and Mail Coupon Today.

**4 COMPLETE • PAY ONLY \$1. A MONTH** ←

**THEO. AUDEL & CO., 49 WEST 23rd STREET, NEW YORK**  
Please send me postpaid AUDELS NEW AUTOMOBILE GUIDE (\$4) for free examination. If I decide to keep it, I will send you \$1 within 7 days; then remit \$1 monthly until purchase price of \$4 is paid. Otherwise, I will return it to you promptly.

Name.....  
Address.....  
Occupation.....  
Reference.....

# BE A RAILWAY TRAFFIC INSPECTOR

**A Real Job—at Good Pay—Can Be Yours**

Write for the Story of Railway and Bus Passenger Traffic Inspection. Our short, home-study course trains you and upon completion we help place you at up to \$135 per month, plus expenses to start, or refund tuition. Ambitious men—19 to 50—make rapid advancement. Free Booklet.

**STANDARD BUSINESS TRAINING INSTITUTE**  
Div. 205 Buffalo, N. Y.



# Learn to MOUNT BIRDS

**Tan SKINS, Make Up FURS**

Be a Taxidermist. We teach you at Home.

Mount Birds, Animals, Pets, common specimens. Save your hunting trophies; decorate home and den. Make genuine KROME LEATHER, tan and make up furs for sparetime profit.

**FREE BOOK** 48 pages—tells all about it. Hunters, get this wonderful book. It's Now Free. Send postal card Today—This Minute! State your AGE.

**N. W. School of Taxidermy, 3375 Elwood Bldg., Omaha, Nebr.**



# BE A CARTOONIST



**AT HOME IN YOUR SPARE TIME UNDER personal supervision of the famous cartoonist NORMAN MARSH creator of "DAN DUNN" appearing every day in big papers. Success—Fame—Real Money may be Yours when you learn Marsh's easy simple methods and secrets. Send name and address for free details of MARSH'S Personal course. ACT TODAY!**

**NORMAN MARSH SCHOOL OF CARTOONING**  
4554 Broadway Dept. E-100 Chicago, Ill.

# EARN MONEY MAKE COLOR GLAZED CONCRETE PRODUCTS



**NEW, low cost, patent method makes Color-glazed concrete pottery without molds. No experience needed. Use only sand, cement, cheap materials. Make glazed tiles, walls, gravestones, etc. Money-making business. Send 10c TODAY for booklet, colorplate, cost data, details. Descriptive folder Free.**

**NATIONAL POTTERIES COMPANY**  
Room 6, 13 W. 26th St., Minneapolis, Minn.



# AN AVIATION CAREER



## OFFERS YOU GREAT FUTURE!

Demand for trained aircraftmen is increasing and already exceeds supply. Curtiss-Wright Tech, Aviation's foremost and oldest school, is located on Grand Central Air Terminal in heart of the aircraft industry and specializes in training MASTER MECHANICS and AERONAUTICAL ENGINEERS. (No flying involved.) Graduates are obtaining immediate employment. Write for details NOW. Dept. PM-5

**CURTISS - WRIGHT TECHNICAL INSTITUTE**  
Glendale (Los Angeles) California

# Want a Career in photography?

Big opportunities to make money! Train at Home or in our completely equipped studios. Commercial, News, Portrait, Advertising, Natural Color, Motion Picture and other branches of photography. Famous experts will be your teachers. 29th year. Send for free booklet.

**NEW YORK INSTITUTE OF PHOTOGRAPHY**  
10 West 33 St. (Dept. 49) New York City

## DON'T CHOOSE YOUR LIFE·WORK BLINDLY

### USE OUR SCIENTIFIC METHODS

... to determine the occupation in which your natural abilities, personality, and characteristics will bring your greatest success. Find out accurately in advance whether you are best fitted for art, accounting, engineering, law, mechanics, salesmanship, or whatever type of work it may be. Without wasting time or money in unsuitable work or study, you can now discover the occupation that needs exactly the qualities you possess. Take this proven step toward complete success today. Write for **FREE BOOKLET A-15**. Vocational Guidance Institute—Greenway Station, Tucson, Arizona.

**New York Electrical School** Established 1902

Ask for free illustrated booklet

44 West 17th St., N. Y. C.

# Free TRIAL LESSON IN DRAFTING

More good jobs now in Drafting. Learn AT HOME in spare time (or at our Chicago School). Send postcard for **FREE TRIAL LESSON** and see how easy to learn and get a good job.

**CHICAGO TECHNICAL COLLEGE**  
E-200 Tech Bldg., 118 E. 26th St., Chicago, Ill.

# JOBS in RADIO-TELEVISION

Extension and resident training in television, aviation and police radio. Let us tell you how we train men, fit them for good jobs, help them get jobs. Write for catalog. Affiliated with KMBC, major network station. Address **MIDLAND TELEVISION, Inc., 106-E Power & Light Bldg., Kansas City, Mo.**

**BE A LANDSCAPE ARCHITECT**

Ambitious? Here's a profession for men and women. Year-round occupation—also interesting hobby! Home study course used by hundreds. Write for free booklet "Success thru Landscape Training." Write today.

**AMERICAN LANDSCAPE SCHOOL**  
6078 Grand Avenue Des Moines, Iowa

# ARTISTS MAKE MONEY

Find out your ability. Send name, age, occupation and address for Free Vocational Art Test.

**Federal Schools, Inc., 5139 Federal Schools Bldg., Minneapolis, Minn.**

**TOOL & DIE MAKING DESIGNING**

Machinists Trade. Not a correspondence course. Practical shop training in the world's industrial center. Write today for full information.

**NATIONAL SCHOOL OF MECHANICAL TRADES**  
Dept. 106 628 W. Lake St. Chicago, Ill.

**START \$1260 to \$2100 YEAR**

**34051 APPOINTMENTS in 1938 Government Year**

### Railway Postal Clerks

Railway Postal Clerks get \$1,900 the first year regular, being paid on the first and fifteenth of each month. (\$79.17 each pay day.) Their pay is automatically increased yearly to \$2,450. Advance may be had to Chief Clerk at \$2,700 a year. (\$112.50 each pay day.)

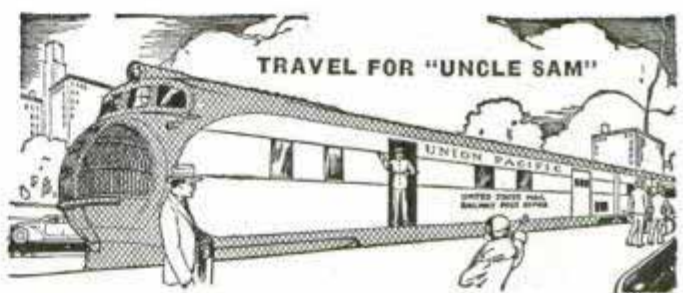

### 3 Days On—3 Days Off—Full Pay

Railway Postal Clerks on long runs usually work 3 days and have 3 days off duty or in the same proportion. During this off duty their pay continues just as though they were working. They travel on a pass when on business. When they grow old, they are retired with a pension.

### City Mail Carriers, Post Office Clerks

Clerks and Carriers now get \$1,700 the first year on regular and automatically increase \$100 a year to \$2,100 and \$2,300.

### GOVERNMENT CLERK



### File Clerk—Clerk

Open to Men—Women 18 to 50. Entrance salary \$1,260—\$1,440 year. Appointments as File Clerks and Clerks in the Departments at Washington, D. C., and elsewhere are made from this examination.

### Many Other Positions

Many other positions are obtainable. Those wishing these positions should qualify at once.

### Get Free List of Positions

Fill out the following coupon. Tear it off and mail it today—now, at once.

This investment may result in your getting a big-paid government job.

**FRANKLIN INSTITUTE, Dept. J195, Rochester, N. Y.**

Rush to me, entirely free of charge (1) a full description of U. S. Government Jobs; (2) Free Copy of illustrated 32-page book, "U. S. Government Positions and How to Get Them"; (3) List of U. S. Government Jobs; (4) Tell me what to do to qualify for one of these.

Name.....

Address.....

**Use This Coupon Before You Mislays It. Write or Print Plainly**



**YOU CAN BECOME A MONEY-MAKING RADIO EXPERT WITH THE New SPRAYBERRY Personalized HOME TRAINING in RADIO and TELEVISION**



**You Learn Easily in Your Spare Hours...By Doing Many Experiments with Up-To-Date Equipment**

Here's a really fine, up-to-the-minute Radio and Television Training that's specially designed to give you quick results.

**Training Prepares You For Good Radio Jobs... at Excellent Pay**

My training starts right at the beginning of Radio... unfolds each subject in a simplified, logical, understandable style. You easily learn Television, Electronics, Facsimile Radio, Radio Set Repair and Installation Work, etc.

**I Supply**

- 146 RADIO PARTS**
- RADIO TOOLS**
- ALL PURPOSE ANALYZER**

**No Previous Experience Needed**

It makes no difference what your education has been. I can fit you for a good-paying Radio job. Your success is my full responsibility.

**You Get Professional Test Equipment Plus Experimental Outfits**

... Includes 146 Radio Parts (to build complete Receiver), Tools, All-Wave, All-Purpose Analyzer, and Experimental Outfits for conducting actual experiments with your own hands.

**Earn While You Learn**

My **BUSINESS BUILDERS** show you how to put your Equipment to practical use in handling actual money-making Radio Service Jobs shortly, after you begin training.

**The Sprayberry Course is Sold Under a Money-back Agreement**

**RUSH COUPON for BIG FREE BOOK**

Sprayberry Academy of Radio  
F. L. Sprayberry, President  
210-E University Place, N. W., Washington, D. C.

Please rush me FREE copy of "HOW TO MAKE MONEY IN RADIO"

Name.....Age.....  
Address.....  
City.....State.....  
(Mail in envelope or paste coupon on penny postcard)

**M ECHANICS-WELDERS - COLLISION MEN**

**GOOD JOBS and Mighty GOOD PAY**

Do you want to earn big money? If so let us know which of the following trades you prefer. You learn by doing. Practical work. Expert teachers. Low tuition. Personal attention. It will pay you to investigate AT ONCE. Just check the courses you'd like to take and mail today. You will receive full information, absolutely without cost or obligation. But don't delay.

**Check the Trade You'd Like to Learn**

- Complete Auto Mechanics (including Diesel)
- Auto Collision
- Metal Finishing
- Electric Arc and Acetylene Welding
- Spray Painting
- Body and Fender Bumping

**Ask about our "Pay After Graduation Plan"**

Name .....

Address .....

Mail the above at once to

**MICHIGAN TRADE SCHOOL**

3758 Woodward Ave. Detroit, Mich.

**Write for FREE FOLDER**

**Only 15c A Day Puts This All-Purpose ELECTRIC ARC WELDER IN YOUR SHOP**



**TEN-DAY TRIAL Guaranteed: 10 Months To Pay**

Now, it is EASY for every inventor, laboratory, home workshop owner, garage, repair shop, and factory to afford a complete welding service for manufacturing, maintenance, experimental, or repair work. Full size, heavy-duty Aladdin Electric Arc Welder—yours for only 15c a day! Highly efficient. Welds all weldable metals and alloys. Handles everything from fenders and light sheet metal to motor blocks and heavy castings. Also fine for soldering and brazing.

**WORKS ON 110 OR 220-VOLT A. C.** Simply plug into 110 or 220-volt, 60-cycle A. C. electric outlet. Costs only few pennies an hour to operate. Anyone can use easily. Comes complete with helmet, electrode holder, welding rods, full instructions, etc. Nothing else to buy. Fully guaranteed.

**WRITE FOR 15c A DAY PLAN.** Stop throwing away profits! Do your own welding. Get sensational facts. Write today!

**COMMONWEALTH MFG. CORP.**  
Dept. X-51 4208 Davis Lane, Cincinnati, O.

**AVIATION APPRENTICES**



**AIRMINDED YOUNG MEN INTERESTED IN TRAINING FOR ENTERING THE WELL PAID FIELD OF AVIATION AS APPRENTICES—Write immediately, enclosing stamp.**

**MECHANIX UNIVERSAL AVIATION SERVICE CO.**  
Wayne County Airport, Box 857, Dept. E, Detroit, Mich.

**EARN A DEGREE AT HOME**

**From A Chartered Institution Of Higher Learning Employers Now Demand College Graduates With Degrees**

**88 Degree Courses in Art; Sciences; Philosophy; Education; Psychology; Public Health; Sociology; Physics; Chemistry; Pol. Science; Theology; Law; Business Training; Accounting; Statistics; Adv.; Sales; Agriculture; Electrical, Mechanical, Civil, Structural, Diesel, Architectural; Mining, Drafting, Automotive, Aeronautical, Radio, Refrigeration, Highway, Marine, Air Conditioning, Geology, Petroleum, Industrial, Chemical Engineering. Founded 1908. 170 p. Catalog Free.**

**McKinley-Roosevelt Graduate College, 4244 Clarendon Ave., Chicago**

**ENGINEERING DEGREE IN TWO YEARS**

B. S. Degree courses in engineering: Electrical, Civil, Chem., Mechanical, Radio and Television, or Aeronautical. 1 yr. Mech. Drafting. Intense, practical, thorough program. Large industrial center. Prep courses without extra charge. Earn board if desired. Low tuition and living costs. Enter June, September, December, March. Write for Catalog.

**239-A E. Washington Blvd., Fort Wayne, Ind.**

**INDIANA TECHNICAL COLLEGE**

**Send for my book how to develop STRONG ARMS and BROAD SHOULDERS** **25c**



with 20 full pages of illustrations, showing and fully describing exercises that will quickly develop, beautify and make you gain great strength in your Shoulders, Arms, Wrists, Hands and Fingers. Without any apparatus. This is really a remarkable course of Physical Culture exercises. Don't fail to send for it NOW. 25c coin or 30c U. S. Stamps.

**ANTHONY BARKER**  
1235 Sixth Ave. Studio P-1 New York City

**CARTOONING**



**FREE TRIAL LESSON!** Cash in on your sense of humor—AT HOME—BY MAIL. Have fun! Make money! No experience needed to start. Write today for FREE LESSON, mailed postpaid. No obligation.

**MOON Gag-Cartoon School, Dept. A, Fall Creek, Wis.**

**PIANO — HAWAIIAN (STEEL) GUITAR SPANISH GUITAR...easily learned at home**

Become a skilled musician by our simple, short-cut note method. Play songs almost instantly. **COST LESS THAN 2c A DAY!** Money back guarantee. Write for free details. **HAMANN INSTITUTE, 3016 N. 24th Place, Dept. R-5, Milwaukee, Wis.**

**Earn Cash at Home!**



We paid M. M. \$1174 for exceptional cellar crop Snow-King mushrooms! We furnish materials; buy all crops. Big FREE picture book tells if your cellar, shed, barn, suitable. Ed. 1908. Write today.

**United Co., 3848 Lincoln Av., Dept. 309, Chicago**



# INVENTORS

## INFORMATION ON HOW TO OBTAIN PATENT AND MARKET INVENTIONS

If you have invented something, if you're interested in inventing something, you need this new 48-page book that gives the entire Story of Patents. It tells you for the first time about new phases of invention, how others succeeded, how the patent laws protect you, how to market your invention, where to obtain finances, how to form a company, partnership, or arrange for royalties from your invention's sale.

### PRACTICAL BENEFITS

You will find 6 complete pages illustrated with simple inventions that have succeeded in six different fields of industry. Over 100 illustrations are in this book. You will read the stories of ten (illustrated) of America's most famous inventors. You will find an experienced and thorough survey of market conditions affecting the inventor—showing the possibilities for commercial invention today. Entire chapters are devoted to the value of a patent in promoting the final success of your invention. The

importance of quick action in applying for patent is stressed—facts revealing danger of delay are emphasized.

If you expect to realize profits from your invention you must protect it with a U. S. Patent. Otherwise you may find that all your time and labor have been lost, because it often happens that other inventors are working on the same invention. If you have an invention, or an ambition to invent—get the information on obtaining patent AT ONCE!

### WHAT A PATENT DOES FOR YOU

Without a U. S. Patent, you cannot expect to reap the profits that your invention may make possible. Send at once for this book. After you get that, you'll know exactly what to do to protect yourself. Anything you write us or send us is strictly confidential between us. All letters and drawings are kept in strong, steel, fireproof files, which are open only to us or authorized members of our

staff. We have secured patents for inventors located in every State in the Union. The practice of our organization is confined entirely to Patents, Trademarks and Copyrights. We have had years of experience in Patent Matters. When you place your patentable invention in our hands, we are in position to proceed at once to secure protection for you. Our fees are reasonable, and if you desire, we can arrange convenient terms of payment.

*Get This*  
**FREE BOOK**

**IMMEDIATELY MAIL COUPON TODAY!**

This new 48-page book of facts is absolutely FREE! You need it NOW. Simply fill out the coupon, and mail. The field of invention changes constantly—here is the latest information. Within a very few days you will receive our Free Book, together with the Record of Invention Blank. Write NOW!

*Get*  
**FREE COPY**



**CLARENCE A. O'BRIEN**  
**and HYMAN BERMAN**

70-Y Adams Building, Washington, D. C.

Registered Patent Attorneys Before U. S. Patent Office

Please send me at once your Big Free 48-Page Book, "Patent Guide for the Inventor" and your specially prepared "Record of Invention" form. This request does not obligate me.

Name.....

Address.....

(Please write or print plainly)



# Get Into DRAFTING

**THE FRONT DOOR TO A GOOD PAY JOB**

In **ELECTRICITY—AVIATION  
TRANSPORTATION—BUILDING  
AUTOMOTIVE—MACHINERY  
AIR CONDITIONING**  
or Other Favorite Work

It's easier to get a better job with Bigger Pay through Drafting. Every industry needs Draftsmen. The Draftsman comes **FIRST** in every line. There is a Big Opportunity for you in your favorite field.

*Ill Train You until You Get a Good Pay Job*

**START NOW—BE PREPARED**

**GET MY FREE BOOK!**

*Successful DRAFTSMANSHIP*

**ENGINEER DOBE, Div. 3375, Libertyville, Ill.**

Send me your Free Book, "SUCCESSFUL DRAFTSMANSHIP." Explain how you assist your graduates to good positions as Draftsmen.

NAME..... AGE.....

ADDRESS.....

TOWN..... STATE.....

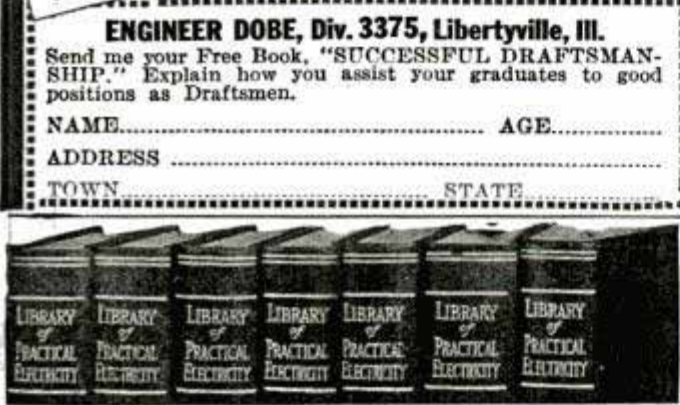

## Know Electricity as Experts Know It—and Get an Expert's Pay!

What about your future? Who is safe today? Surely not the man who is contented to stand still! Know your job thoroughly—prepare yourself for jobs ahead. To do just this thousands of men have used

## The Croft Library of Practical Electricity

The Croft Library is a complete electrical educator. It is founded on practice—on 20 years of shirt-sleeve experience—on work as it is actually done. It is jammed from cover to cover with the kind of hard-headed facts you want. Written so that the beginner can easily understand it, yet so sound, so thorough, that it is the daily guide of 59,000 highly paid electrical workers and engineers. Croft tells you the things you need to know about motors, generators, armatures, commutators, transformers, circuits, switchboards, distribution systems—electrical machinery of every type—wiring for light and power—wiring of finished buildings—underwriters and municipal requirements—illumination in its every phase—the most improved methods of lighting—lamps and lamp effects, etc.—how to do a complete job, from estimating it, to completion.

### No money down—easy payments

Fill in and mail the coupon attached and we will send you the entire set of seven volumes for ten days' Examination on approval. We take all the risk—you assume no obligation. If you decide to keep the books, send \$1.50 in ten days and the balance at the rate of \$2.00 a month. Send the coupon NOW and see the books for yourself.

**EXAMINATION COUPON**

McGraw-Hill Book Co., 330 W. 42nd St., New York

Send me for ten days' examination on approval the Croft Library of Practical Electricity. If satisfactory I will send you \$1.50 in 10 days and \$2.00 monthly until the price of \$19.50 is paid. If not wanted, I will return the books postpaid. (To insure prompt shipment write plainly and fill in all lines.)

Name.....

Home Address.....

City and State.....

Position.....

Name of Company..... PM-5-39

When writing to advertisers please mention Popular Mechanics

2203 **NEW INVENTIONS**  
(Continued from page 18A)

**C**ONTENTS of cartons may be protected by a device patented recently for home use. It is a means of closing tightly the covering flaps of the carton, thus keeping the contents sanitary and free from dust. It also affords protection from atmospheric

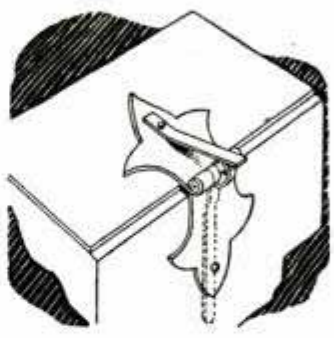

changes. The device permits the covering flaps to be opened to dispense the contents at will. When the carton is empty, the device may be removed and placed on another container.

**S**TREET-CORNER salesmen, or house-to-house vendors, would find use for a combination carrier and suitcase patented recently. The case has two folding legs, at the lower end of which are attached small caster wheels. With a supporting strap fastened around the salesman's body and the legs in supporting position, the case may be opened to display or demonstrate the contents. When not in use, the legs may be folded over the case to form a handle.



**F**OR the convenience of the camera fan, the latest invention combines camera and flash lamp, with suitable mechanism for operation of flash and shutter at the same time. The lamp socket is built into the underside of the camera.

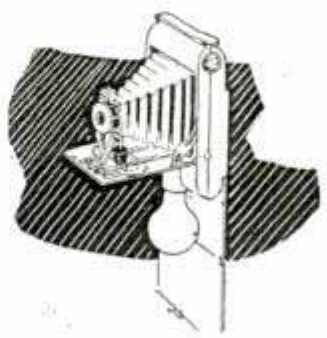

Due to the fact that many of the devices described in this department are still in the patent office stage and are not on the market, Popular Mechanics Magazine cannot undertake to supply further information regarding them.



# AVIATION Wants More LINCOLN TRAINED MEN

This Government Approved Lincoln School wants to immediately get in touch with men interested in preparing for positions as Pilots and Airplane Mechanics. Aviation's great expansion program calls for thousands more trained men.

**PILOT Training at Lincoln** includes elementary flight maneuvers, night and blind flying, beam and cross-country flying. 16 Training Planes; 6 types, gives you wider Piloting experience and prepares you for your Pilot Rating.

**MECHANICS Training at Lincoln** includes Practical experience in Airplane and Engine Maintenance, Rebuilding, Overhaul, Repair; Sheet Metal, Welding, Radio. A few months training prepares you for Mechanics position. Advanced Training meets all requirements for your Mechanics Rating.

**WRITE TODAY** for complete information. Our Advisory Staff will gladly help you plan your career in Aviation.

**LINCOLN AIRPLANE & FLYING SCHOOL**  
565 Lincoln Aircraft Bldg. Lincoln, Nebraska



## STUDY ARCHITECTURE AT HOME EARN A DEGREE AT HOME

From A Chartered Institution Of Higher Learning  
Employers Demand Degree Men For Key Positions  
88 Degree Courses in Electrical, Mechanical, Civil, Structural, Diesel, Architectural, Drafting, Automotive, Aeronautical, Radio, Refrigeration, Air Conditioning, Highway, Mining, Geology, Petroleum, Marine, Industrial, Chemical Engineering; Arts; Sciences; Philosophy; Psychology; Chemistry; Education; Business Training; Law; etc.  
McKinley-Roosevelt Graduate College, 4237 Clarendon Ave., Chicago

### HOW TO GET MORE PLEASURE AND PROFIT OUT OF YOUR CAMERA

Don't waste good film! Make every picture a good picture! Win contest prizes! Sell your photos for cash to magazines and newspapers! Write today for FREE Catalog that explains our home-study course—an easy way to learn photography at home. Convenient! Inexpensive! UNIVERSAL PHOTOGRAPHERS, Dept. 75, 10 West 33 Street, New York City.

## WANT A JOB? LEARN DIESEL — AUTO MECHANICS QUICKLY!

Why worry with a low-pay job? Diesel and Auto Mechanics offer you real opportunity to earn more. Learn easily, quickly. Write either school for low tuition rates. Information free! Dept. 10-5.

**McSWEENEY TRADE SCHOOLS** Detroit, Mich. Kansas City, Mo.

**RADIO ENGINEERING**, broadcasting, aviation and police radio, servicing, marine and Morse telegraphy taught thoroughly. 48 weeks' engineering course equivalent to three years' college radio work. School established 1874. All expenses low. Catalog free.  
**Dodge's Institute, Ada St., Valparaiso, Ind.**

### LEARN CARTOONING

by the method that has developed hundreds successfully. Send name, address and age for free chart to test your ability.  
**THE LONDON SCHOOL, 1739 National Bldg., Cleveland, Ohio**

## Government Jobs

Write for catalog No. 47. Valuable information free.  
**COLUMBIAN CORRESPONDENCE COLLEGE, Washington, D. C.**

### AERONAUTICS DIESEL AUTOMOTIVE AIR CONDITIONING ETC.

### Technical Careers

Intensive Course. Meeting Technical needs. Engineering firms also need Salesmen and executives with practical knowledge. Employment Service. Fireproof Dormitory. Gym & Pool. Full shop equipment. Day or Eve. Send coupon or write for Booklet P. M. in your field.  
**BROOKLYN YMCA TRADE SCHOOL**  
1117 Bedford Ave. Brooklyn, N. Y. City



Easy as A-B-C

## Be Your Own MUSIC Teacher

**LEARN AT HOME** by wonderful improved method. Simple as A-B-C—a child can learn it. Your lessons consist of real selections, instead of tiresome exercises. Each of these delightfully easy lessons adds a new "piece" to your list. You read real notes, too—no "numbers" or trick music. Method is so thorough that many of our 700,000 students are band and orchestra LEADERS.

### Be Popular

Everything is in print and pictures. First you are told what to do. Then a picture shows you how. In a few short months you may become an excellent musician—the life of every party!

Free Book and Demonstration Lesson Write at once for our illustrated Free Book and Free Demonstration Lesson. Please mention your favorite instrument. No obligations. Instruments supplied when needed, cash or credit. (Fortieth Year—Est. 1898.)

**U. S. SCHOOL OF MUSIC**  
75 Brunswick Bldg., New York City, N. Y.

### Pick Your Course

- |                              |              |
|------------------------------|--------------|
| Piano                        | Guitar       |
| Violin                       | Saxophone    |
| Organ                        | Mandolin     |
| Cornet                       | Ukulele      |
| Trombone                     | Harp         |
| Piccolo                      | Clarinet     |
| Flute                        | Cello        |
| Hawaiian                     | Steel Guitar |
| Trumpet                      |              |
| Piano Accordion              |              |
| Italian and German Accordion |              |
| Voice and Speech Culture     |              |
| Modern Elementary Harmony    |              |
| Drums and Traps              |              |

## DRUM YOUR WAY TO FAME AND FORTUNE!



Bill Gladstone (pictured above) of the famous Radio City Music Hall did it...so did Jack Waltzer...and Bernie Mattinson with Horace Heidt—all of them, and scores of other stars using famous **GRETSCH DRUMS**. Today they are among the "ace" drummers of America, all making big money in famous orchestras. You, too, can become a top-flight drummer. **IT'S EASY...IT'S FUN!** But start with a real drum, a **GRETSCH DRUM**, made by the oldest drum house in the country. **HOW TO START:** We will send you **ABSOLUTELY FREE** a new **DRUM CATALOGUE** showing many different models of these famous instruments. Just write on a penny postcard: "Send me your new **DRUM CATALOGUE**," sign your name and address and mail to Dept. PM50.

**The FRED. GRETSCH Mfg. Co.**  
Musical Instrument Makers Since 1883  
60 BROADWAY, BROOKLYN, N. Y.

<input type="checkbox"/> Diesel Engines	<input type="checkbox"/> Oil Burner	<b>MAIL COUPON</b> 1117 Bedford Ave., Dept. P. M. Brooklyn, New York City, N. Y. Name..... Address.....
<input type="checkbox"/> Diesel Pre Engineering	<input type="checkbox"/> Welding	
<input type="checkbox"/> Aviation Mechanic	<input type="checkbox"/> Talking Pictures	
<input type="checkbox"/> Aeronautical Pre-Engineering	<input type="checkbox"/> Machine Shop	
<input type="checkbox"/> Auto Mechanic	<input type="checkbox"/> Radio and Television Mechanic	
<input type="checkbox"/> Refrigeration	<input type="checkbox"/> Air Conditioning Pre-Engineering	
<input type="checkbox"/> Architectural-Mechanical Drafting	<input type="checkbox"/> Electrical Pre-Engineering	
<input type="checkbox"/> Armature Winding		



# Be An ARTIST



**Trained Artists Are Capable of Earning \$35, \$50, \$75, Weekly**

**Learn at Home-In Your Spare Time**

New opportunities for trained Artists each year. Magazines, advertisers, newspapers, printing houses, etc., pay good money for art work. Our practical, proven method makes it fun to learn Commercial Art, Cartooning and Designing AT HOME, in spare time.

**Two Big Artist's Outfits Given**

Drawing board, paints, brushes and all materials you need come with very first lessons. The second outfit is given later in the course. Actual fun learning to draw this way.

**Write Today for FREE BOOK**

Our Free Book "Art for Pleasure and Profit" describes wonderful opportunities in this fascinating field and gives full details of our simple method of instruction. Tells all about our students—their successes—what they say—actual reproductions of their work—and how some earned money even while learning. Mail coupon below or paste on postcard today.

**\$40 Extra Per Month**

In spare time, writes student R. G. Reid, Jr. of Oklahoma.

**Paid for Course**  
W. R. Kent of New Jersey earned more than twice the tuition while studying.

**\$25 for One Drawing**  
One small picture brings easy money to Mrs. G. A. Wemmer of Kansas.



**FREE BOOK gives details!**

Washington School of Art, Studio 125M  
1115—15th St., N. W., Washington, D. C.

Yes! I am interested in learning to draw. Please send me your Free Book, "Art for Pleasure and Profit."

Name..... Age.....  
Address.....  
City..... State.....



# AUTO

**BOOKS SENT FREE**

on approval. Just mail the coupon and we'll send you a set of these remarkable auto books, just off the press. Whether you are a mechanic or helper, expert or apprentice, auto owner or driver, if you're interested in knowing all about automobile mechanics, take advantage of this FREE OFFER.

**GET A BETTER JOB**

A better job—in the gigantic auto industry. BIGGER PAY—a chance to go into business for yourself and get a share of the huge profits, are waiting for any man who even half tries to improve himself. Learn auto engineering with these wonder books a new way—without studying or memorizing. Simply use the JIFFY INDEX to look up the answer to any auto problem. Built by eleven of America's greatest automobile engineers, and written in simple language so you can understand it. Very newest cars, all covered.

**FREE Privilege of consulting Automobile Engineers of American Technical Society for one year without cost if you mail coupon immediately**

Send promptly and we will include a Brand New EXTRA volume with over 300 pages including ALL 1939 cars with wiring diagrams and data sheets on each.

**CAN YOU FIX IT?**

These wonder books tell step by step HOW to take out "play" in differential—to kill the shimmy in steering—to set TIMING—how to put your finger instantly on engine trouble and then the quick expert way to FIX it. Newest improvements fully covered. Equal to a complete trade course at less than a fourth the cost.

**6 BIG VOLUMES**  
Brand New Edition  
2500 pages, 2000 illustrations, wiring diagrams, etc., including Marine Engines, Aviation Motors, Diesel engines, etc. De Luxe edition, gold-stamped flexible binding.

AMERICAN TECHNICAL SOCIETY,  
Drexel Ave. & 58th St., Dept. A519, Chicago, Ill.

I would like to see the new 6-volume edition of your AUTO BOOKS. I will pay the few cents delivery charges only, but if I choose to, I may return them express collect. If after 10 days use I prefer to keep them, I will send you \$2 and pay the balance at the rate of only \$3 a month, until \$24.80 is paid. Please include free membership and extra Volume No. 7, as per your offer above.

Name.....  
Address.....  
City..... State.....  
Attach letter stating age, occupation and name and address of employer and that of at least one business man as reference.

# OPPORTUNITY KNOCKS

a  
Thousand  
Times  
in a



# THOUSAND HELPFUL BOOKS

**SELECT FROM THIS LIST. ASK ALSO FOR FREE LIST ON MANY SUBJECTS**

- AIR CONDITIONING**  
Live Field; Great Future..... \$3.50
- AUTO ENCYCLOPEDIA**  
The Famous Dyke's Latest Edition..... \$6.00
- 110-V. GENERATORS**  
Made From Old Auto Units..... \$1.00
- BIRD HOUSES**  
Build to Sell; Easy Designs..... \$1.00
- BLUEPRINT READING**  
for the Building Trades..... \$1.25
- BOAT BOOK**  
Power, Sail, Rowing, Paddle Plans..... \$3.00
- BOY MECHANIC**  
Hundreds Things Boys Can Make..... \$2.00
- CARPENTRY, PRACTICAL**  
Complete 436 pages. Revised Edition... \$2.00
- CIVIL SERVICE**  
Home Study Courses Federal, State, City Positions..... \$1.00
- CONCRETE**  
1001 Ideas for Using. New Popular Mechanics Book... \$5.00
- DIESEL ENGINES**  
For Land, Air and Water..... \$4.00
- ELECTRIC MOTORS**  
Fractional Horsepower. How to Repair, Rewind and Reconnect... \$3.50
- ELECTRONIC DEVICES**  
Design and Use of Electric Eye, etc... \$2.00
- FORD V-8 CARS, TRUCKS**  
New, 700 Pages. Includes Details 1937 Cars..... \$2.50
- FORMULAS**  
1059 Money Making. Start a Business... \$1.25
- FURNITURE MAKING**  
Tools, Materials, Design..... \$2.50
- HOUSE CONSTRUCTION**  
Details. Practical, up-to-date. Complete... \$3.00
- HOUSES, SMALL**  
Book of, for Home Builders..... \$2.00
- MACHINE SHOP WORK**  
Complete. 400 Pages. 444 Illustrations... \$2.50
- MATHEMATICS**  
Easy Guide for the Practical Man.... \$1.50
- MECHANICAL DRAWING**  
Learn Drafting; Good Salaries..... \$1.00
- MONEY MAKING IDEAS**  
1000 Ways to Make \$1000..... \$2.50
- OXYACETYLENE WELDING**  
Hard Surfacing, Lead Burning, Cutting New ed..... \$1.25
- PAINTING AND DECORATING**  
New book.... \$1.50
- PLUMBING**  
500 Facts Every Homeowner Should Know..... \$1.50
- POWER TOOLS, AMATEUR**  
Wood and Metal Working, Uses..... \$1.75
- PROSPECTORS' HANDBOOK**  
How to Mine, Appraise, Equip..... \$3.00
- RADIO SERVICING**  
Profit by Knowing Costs, Kinks, Etc!..... \$4.00
- REFRIGERATION**  
Electric, Gas. Be a Service Expert... \$5.00
- SHIP MODEL**  
Entire Text, Famous "Sovereign" of 1637... \$1.00
- SOIL-LESS GROWTH OF Plants**  
Just out.... \$2.75
- STEEL SQUARE**  
How to Figure Angles of Rafters, Roofs, Etc..... \$1.00
- TOYS**  
For Amusement or Profit, Saleable Designs... \$1.50
- UPHOLSTERY**  
Always a Big Market. Start Own Business \$2.00
- WIRING, HOUSE**  
Covers Methods, Materials, Illustrated... \$2.50
- WOOD FINISHING**  
Methods, Tools..... \$2.00

**Send No Money!**

Order from above list and if in U. S. or possessions, pay postman on delivery plus small C.O.D. fee. We pay postage if remittance is sent with order. Ask for complete list of books on many subjects. Order today.

**POPULAR MECHANICS PRESS**

Room 539B

200 East Ontario St., Chicago

When writing please mention Popular Mechanics



# MIDWEST FACTORY SALE!

PUT THIS NEW  
**14-TUBE** WORLD  
WIDE  
CHASSIS IN YOUR CABINET

SAVE  
**UP TO 50%**



30  
DAYS  
TRIAL

Here it is! A big, powerful, new 14-tube world-wide Midwest. At its sensational factory-to-you price of \$19.95, this new 1939 radio is the biggest bargain in Midwest's nineteen years of pioneering! Absolute satisfaction guaranteed on a money-back basis.

CHASSIS  
NOW ONLY  
**\$19.95**  
COMPLETE  
WITH TUBES  
AND SPEAKER

UP TO \$40.00 TRADE-IN

Send 1c postcard or write for new FREE 1939 catalog telling all about our trade-in allowance offer of up to \$40.00 on latest Midwest 17-tube, 5-band radios, also Easy-Pay Plan details. Dept. 15-MM Midwest Radio Corp. Cincinnati, O.

# ENGINEERING

DEGREE  
IN TWO  
YEARS

TECHNICAL AND APPLIED COURSES. Nonesentials omitted. TIME AND MONEY SAVED. Degree 2 yrs., diploma 1 yr. Electrical, Mechanical, Architectural, Structural, Civil, Aeronautical, Highway. All courses include Air Conditioning, Electric Refrigeration and Diesel. Short intensive courses 3 and 4 months in Electricity, Power Plant, Diesel-Electric, Electric Refrigeration, Drafting. Extensive modern equipment. LOW TUITION. Part-time work for room and board. Thousands of successful graduates in U. S. and foreign lands. Approved by Industry, endorsed by educators, recommended by alumni. One and two-year courses start in Sept., short courses open year round. 40th YEAR. Resident courses. Catalog free.

FINLAY ENGINEERING COLLEGE

1001 Indiana Avenue

Kansas City, Mo.

# WANT A GOOD PAY JOB?

Trained Tool and Die Makers, precision machinists, automatic screw machine men earn as much as \$50-\$60 per week. Learn by actual work at one of America's best equipped shops. Training supervised by experts. Day-Evening classes. Low fee, employment help. Write NOW for free booklet "Practical Machine Shop Training."

**ALLIED SCREW MACHINE CO., Inc.**  
School Division  
Dept. PM-5 603-9 W. Lake Street, Chicago, Ill.



# BIG BUSINESS AT HOME With New Greaseless DOUGHNUT

Go into sensational new kind of food business! Start in your kitchen. Even without previous experience big daily profits possible even in small towns. Make and sell amazing GREASELESS DOUGHNUTS. We supply equipment and plans. Stores sell for you. Send postcard NOW for special quick-starting offer. Send no money.

BROWN BOBBY CO., 620 No. Michigan Av., Dept. D-185, Chicago, Ill.

# DIESEL

Get BETTER training. Realize Adcox advantages. Located in Pacific Northwest, a Diesel center. Established 28 years. Modern equipment, expert instructors. Close cooperation for YOUR success. Earn room and board while learning. Send for FREE big 40-page Diesel School Catalog No. 18. Home Study and Resident Courses.

L. L. ADCOX TRADE SCHOOL  
Portland Oregon

# FILEWORTHINESS

Not all items in the average newspaper are fileworthy. But there are, on the average, about six items in each issue of a newspaper that I find necessary to clip and put into properly identified folders in my Newsclip Filing System. The average good magazine gives me about twice as many fileworthy clippings. It's important to be able to call such clippings back into use at one time or another, and it's here that an efficient, handy, simple, filing kit is essential. The H-J Newsclip Filing System is right down your alley. It solves the problem of how best to file clippings so they may be available in a few seconds when wanted for reference purposes. Send me only \$1 (plus 25c for packing, handling and carriage) and I'll send you the H-J Newsclip Filing System, containing 100 folders, gummed labels, and full instructions on how to put away 5,000 fileworthy clippings. Address: E. Haldeman-Julius, Box 18, Girard, Kansas.

When writing please mention Popular Mechanics



# ARE YOU AFRAID of YOUR BOSS?

Even though you don't admit it to yourself, away down within you there may be a fear of your boss. That fear robs you of aggressiveness—holds you back—keeps you from developing into a man worth a bigger job and bigger pay. Your boss senses your fear of him, and mistakes it for lack of initiative. Overcome that fear NOW...at once...and you'll find yourself with ten chances for progress where only one existed before. It's easy, once you know HOW, and the Self-Study Foundation can show you how. Send at once for FREE Self-Analysis Chart that will immediately reveal many things of great importance about yourself, together with 16-page booklet, "Going Ahead" which explains the Self-Study Course fully. Mail this coupon today.

Self-Study Foundation, Inc.  
50 North Michigan Ave., Dept. B-22  
Chicago, Illinois

Please send me, free of charge, instructions for analysis of my capabilities and 16-page booklet, "Going Ahead," which explains how you can help me. I understand this places me under no obligation.

Name \_\_\_\_\_  
Address \_\_\_\_\_  
City \_\_\_\_\_ State \_\_\_\_\_



# NOW LEARN A NEW LANGUAGE

in your own home quickly, easily, correctly by the world-famous LINGUAPHONE Method. Endorsed by thousands of students, schools and colleges. Send for FREE Book and 7 Days Trial.

LINGUAPHONE INSTITUTE  
55 RADIO CITY NEW YORK CITY

# It's Easy and Great Fun to SWING an ACCORDION

SAYS TITO  
Radio's Swing Accordion Artist  
YOU can learn to "Swing" an accordion. Often in only 2 weeks you'll play popular tunes. Accordion playing gives you pleasure—friends—popularity. Many professional opportunities in bands, orchestra, night-club, radio, etc. EXCELSIOR is world's finest accordion—unsurpassed in sweetness, fullness and range of tone. See your music dealer or send for FREE BOOKLET—"Hints on Swing Music" by TITO (of Tito and his Swingette). Contains: arranging, fingering, harmony, learning, developing, secrets, listing of Tito's arrangements and recordings.

**EXCELSIOR**  
333 Sixth Ave., Dept. PM-539, New York  
Name \_\_\_\_\_  
Address \_\_\_\_\_  
City \_\_\_\_\_ State \_\_\_\_\_  
Make of Accordion I now Play \_\_\_\_\_

**FREE BOOKLET**





# DIESELS

## PREPARE FOR TOMORROW'S OPPORTUNITY

This is your opportunity to qualify as a Diesel Engineer. Men with practical training are in demand for good-paying, responsible positions. You can qualify for a place in this rapidly growing industry.

**TESTED TRAINING—REAL SHOP EXPERIENCE**  
**Internal Combustion Engines—Automotive Service**  
 National Schools give you actual shop methods. You learn on the latest and best equipment in a million-dollar trade school. You are taught to make good and helped to make good after you graduate. It will pay you to investigate National's Master Course.

**FREE!**



**Transportation Allowed to Los Angeles**  
 Coach railroad fare allowed from any point in the United States.  
 Earn room and board while learning. Graduate employment cooperation.  
 Mail coupon for new 40-page Book of Diesel Facts, details of training, employment opportunities.

# NATIONAL SCHOOLS

LOS ANGELES

Request for FREE BOOK

NATIONAL SCHOOLS  
 Dept. S-PMA, 4000 Figueroa St., Los Angeles, Calif.

NAME \_\_\_\_\_ AGE \_\_\_\_\_  
 ADDRESS \_\_\_\_\_  
 CITY \_\_\_\_\_ STATE \_\_\_\_\_

# BIG MONEY from POULTRY



I show you how to greatly increase profits, start your own business, or help you secure a job in a poultry plant. I train you at home in spare time quickly. Show to yourself or employer. Men and women in small towns or suburbs will be particularly interested because latest scientific methods mean unusual profits for them. My home-study course used by thousands. 32-page book, "How to Raise Poultry for Profit" comes to you FREE. Mail coupon today.

## SCIENTIFIC POULTRY RAISING

HARRY M. LAMON, Pres., National Poultry Institute, Dept. 43-D, Adams Center, N. Y.

Please send me your FREE Book about poultry raising, and facts about your Home-Study Course.

Name \_\_\_\_\_  
 Address \_\_\_\_\_  
 City (R.F.D.) \_\_\_\_\_ State \_\_\_\_\_



**EASY, TOO!**

Let the BRINDISI ACCORDION be your magic carpet to happy-land. Fun at home and at parties. Opportunity for broadcasting, dances, entertainment, etc. Easy to learn—moderate cost. Write today for FREE copy of booklet—"Music Magic with the Accordion." . . . Tonk Bros. Co., Dept. 25, 623 S. Wabash Ave., Chicago



# QUICK CASH IN NEW POTATO CHIPS



## START AT HOME

Here's your chance—a money-making business of your own. Turn potatoes into cash by making new kind of Potato Chips with my improved outfit. Makes delicious, superior, "NON-GREASY" Chips at low cost. A few hours' practice does it. Begin anywhere—city, village, town. Potatoes cheap and plentiful. Wholesale or retail. Steady year 'round business.

Groceries, markets, restaurants, taverns, do the retailing for you. **WE HELP START YOU IN BUSINESS.** Great quantities of Chips are eaten daily. Profit large—unusually so. You can start this money-making business on a "next to nothing" outlay of cash. Write for Potato Chip Booklet.

LONG-EAKINS COMPANY  
 528-S High St. Springfield, Ohio

# NEW! COMPLETE and Up-to-the Minute Book on HOUSE WIRING

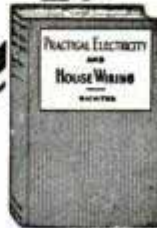

Covers, in great detail, all phases of practical wiring for homes, garages, farm buildings, etc. Written in the simplest language; describes and illustrates fuses, circuits, switches, installation plans; also wiring diagrams; over 200 illustrations; cloth binding \$1.50 post-paid. 5-day money-back guarantee.

**FREE** Catalog of practical books on Painting; Decorating; Commercial Art; Sheet Metal; Welding; Radio; Heating and Ventilating.

**DRAKE & CO., 171 N. Michigan Av., Chicago**  
 Drake's Books Sold at All Good Book Stores

# STUDY ENGINEERING AT HOME EARN A DEGREE AT HOME

From A Chartered Institution Of Higher Learning  
 Employers Demand Degree Men For Key Positions  
**88 Degree Courses in** Electrical, Mechanical, Civil, Structural, Diesel, Architectural, Drafting, Automotive, Aeronautical, Radio, Refrigeration, Air Conditioning, Highway, Mining, Geology, Petroleum, Marine, Industrial, Chemical Engineering; Arts; Sciences; Philosophy; Psychology; Chemistry; Education; Business Training; Law; etc.  
 McKinley-Roosevelt Graduate College, 4238 Clarendon Ave., Chicago

# MYSTERIOUS DEVICE WELDS BRAZES AND SOLDERS ANYONE CAN OPERATE



Now, an electric welding, brazing and soldering Torch, complete with power unit, goggles and supplies. **Works INSTANTLY off any light socket.** Does a thousand and one repair jobs at amazingly LOW COST on aluminum, iron, steel and other metals. **Indispensable for Auto, Body and Fender Repairs, and home repairs—shop, factory, farm, engineer, janitor, sheet metal, radio and bicycle repairs.** Anyone can handle without previous experience with our simple **TO-DAY HOME TRIAL** instructions. Write at once for Special Introductory Low Price Offer. Try 3 in 1 Electric Torch for 10 days at our risk, or get one free by helping to introduce it. **ELECTRO-TORCH CO., 2613-DE Michigan Ave., Chicago**

# LOOK! Baby Chicks

**THOUSANDS WEEKLY ALL YEAR.** Finest quality & Layers in 40 breeds. Hybrid Baby Pullets and Cockerels. B. W. D. Tested. Ducklings, Goslings, Baby Turkeys, Guinea. In business 30 years. Catalog free. **ORDER NOW.** Make BIG money raising NABOB QUALITY CHICKS.  
**NABOB HATCHERIES, BOX M, GAMBIER, OHIO**

# I WANT MEN

**FORDS GIVEN** **TEA & COFFEE ROUTES PAYING UP TO \$45**  
 Million dollar company needs more men at once to make regular calls on local routes. No experience needed. Earnings start at once. **Ford Tudor** Sedans given producers as bonus. Full particulars mailed free. Just send postcard.  
**E. J. MILLS, 9511 Monmouth Ave., Cincinnati, Ohio**

When writing please mention Popular Mechanics



# PATENT and SELL your INVENTION

## A Simple Recipe for Inventive Success

PROBABLY the simplest recipe for inventive success would be this: First, a practical, useful invention; second, a good strong Patent; third, a buyer or a market. The inventor needs all three to get anywhere. Lacking any one, he is likely to get nowhere. The recipe is simple. Working it out isn't so simple. That is why inventors—and others inventively inclined—have found the two books shown here so helpful. We've gone into each part of the recipe carefully. Exactly what is an invention? We tell you. What is a strong patent? We tell you. How can I go about finding a buyer? We tell you.

## Many Questions Answered

But there's much more. For example, just how an Application for a Patent is made; how an inventor can safeguard himself with dated sketches as he goes along; how the pertinent Patent Office records are checked to see what other inventors may have done along the same line; how some successful

inventors have secured financial backing; simple ways to contact manufacturers; and many other points.

## 41 Years in the Business of Helping Inventors

The world needs, can use and will pay for practical, useful inventions. Manufacturers are on the alert for new articles, or improvements that will help them increase sales. Maybe you have one. Maybe not. These books will help you in deciding that. From that standpoint alone, they are valuable.

For more than 41 years, it has been our business to help inventors. We answer your questions and supply complete information about Patent procedure, costs, steps to take, kind of sketch or model needed, and much more. Our staff is made up of experienced Registered Patent Attorneys, Draftsmen, Searchers. Fees are reasonable—deferred payments arranged. Whether your idea is large or small, finished or still in the rough stage, you should have the facts both about Patenting and Selling. The information which we give you—based on long experience with thousands of inventors—is yours for the asking. No need to delay. These two books of facts may save you time, trouble, money, even later disappointment. Return the coupon—or write us a confidential letter—today.

## 115 Mechanical Movements Shown

In our book "Patent Protection" you will find illustrated 115 different mechanical movements. Maybe you'll find just what you need to work out some of your own ideas. Many other interesting pictures are shown in this book. Both books and an "Evidence of Invention" form sent to you FREE the same day we hear from you.

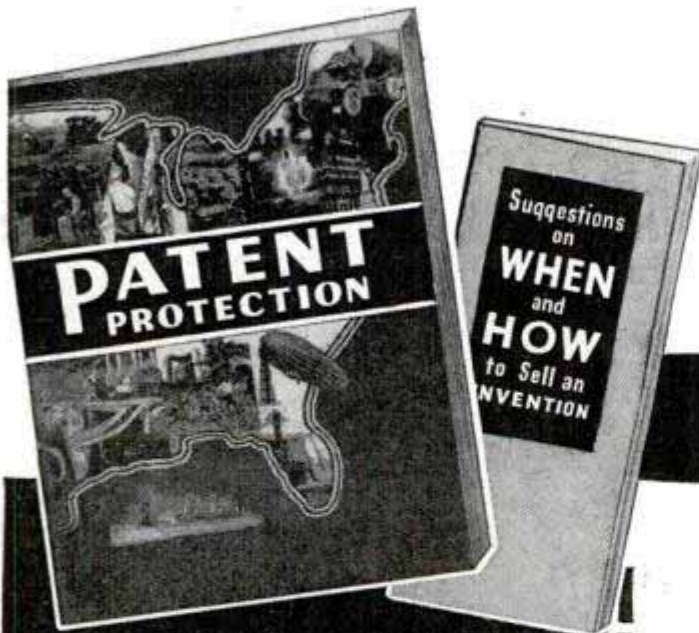

These 2 books tell you  
how to go about it ..  
Both Sent FREE >

## VICTOR J. EVANS & Co.

REGISTERED PATENT ATTORNEYS

MAIN OFFICE: 112-E, VICTOR BUILDING  
WASHINGTON, D. C.

Pittsburgh Office: 514-N, Empire Building

Send me FREE copies of your books, "Patent Protection" and "When and How to Sell an Invention."

Name.....

Street and No.....

City or Town..... State.....



# PATENTS

Booklet Free Highest References  
Promptness Assured Best Results

Send drawing or model.

## ALL BUSINESS GIVEN PROMPT AND PROPER ATTENTION

Listed Patent Lawyer in the latest editions of the Rand-McNally Directory of Bankers and Bank-Recommended Attorneys, published by Rand-McNally & Co., Chicago, Ill.; The Baggott & Ryall Directory of Guaranteed Attorneys, published by Legal Directory Corporation, Boston, Mass.; American Lawyers Annual, Cleveland, Ohio; Bankers Service Legal Directory, published by Bankers Service Co., Boston, Mass.; Eyre's Law List, 9 Park Place, New York City; Snow-Church Directory Co. Lawyers List, published in New York City, and the Central Guarantee Co., Bankers and Lawyers Directories, 630 Fifth Avenue, New York City.

**WATSON E. COLEMAN,**  
REGISTERED PATENT LAWYER

Victor Building, 724 Ninth Street, N. W.  
**WASHINGTON, D. C.**

## INVENTORS PATENT YOUR IDEAS SEND FOR FREE BOOK



### HOW TO OBTAIN A PATENT

Written by a Former Member of the Examining Corps (1922-24) of the U. S. Patent Office. If you want to profit by your idea, you should take steps to apply for a U. S. Patent at once. Your first step is to get this Free Book. This interesting illustrated book contains valuable information you should have. It tells you fully how to obtain a patent on your idea in the quickest way. With this Free Book you will also receive a "Record of Invention" form on which you can easily record your idea. Personal and Confidential Service: Your case will be personally handled only by a Registered Patent Attorney who is also a Former Member of the Examining Corps of the U. S. Patent Office. All communications confidential.

MAIL COUPON TODAY for FREE PATENT BOOK and RECORD OF INVENTION Form.

### CARL MILLER

REGISTERED PATENT ATTORNEY  
FORMER MEMBER EXAMINING CORPS U. S. PATENT OFFICE

Woolworth Bldg., 35th Floor, Dept. 59A, New York City  
MILLER BUILDING, Dept. 59A, Washington, D. C.

Please send me your Free Book, "How to Obtain a Patent," and your "Record of Invention" form.

NAME.....

ADDRESS.....

## INVENTORS PROTECT & SELL

Your unpatented invention can be sold with positive safeguards under patent laws. New, low-cost procedure. Complete details, free.  
**AMERICAN PATENTS CORPORATION**  
Dept. 4-E Washington, D. C.

## PATENTS—TRADE MARKS

All cases submitted given personal attention  
Form "Evidence of Conception" with instructions  
for use and "Schedule of Government  
and Attorneys' Fees"—FREE!

**LANCASTER, ALLWINE & ROMMEL**  
Patent Law Offices

412 Bowen Bldg.

Washington, D. C.

## Are You the Owner of a UNITED STATES PATENT?

If so, let us sell your patented article to some industry in the United States where it will bring you the most cash and highest royalties. Our fee is nominal. **IF YOUR PATENT CAN BE SOLD ANYWHERE IN THE WORLD WE WILL SELL IT FOR YOU.** For new patentable ideas see a Patent Attorney. Write Patent Department for full particulars.

## THE INDUSTRIAL CORPORATION

Trust Company Building

Clearfield, Pa.

## New Ideas now Salable Before Patenting

Practical, useful inventions may now be safely marketed without patenting expense. Write for proof that we successfully sell both patented and unpatented inventions.

**Chartered Institute of American Inventors**  
Dept. 4, Barrister Building, Washington, D. C.

**ALBERT E. DIETERICH**  
**THEODORE H. RUTLEY**

REGISTERED PATENT LAWYERS

512 B Colorado Bldg. WASHINGTON, D. C.

*Booklet on Patents sent free*

## INVENTORS

who derive largest profits know and heed certain simple but vital facts before applying for patents. Our book, Patent-Sense, gives those facts; sent free. Trade Marks—Copyrights.

LACEY & LACEY, Est. 1869, 635 F St., N. W., Dept. 5, WASHINGTON, D. C.

## RUPTURED?

### Get Up-To-Date Relief

Why try to worry along with old-fashioned trusses that gouge your flesh—press heavily on hips and spine—enlarge opening—fail to hold rupture? You need the Cluthe. No leg-straps or harness. Automatic adjustable pad seals opening—follows every body movement with instant increased support in case of strain. Cannot slip. Holds rupture whether at work or play, easy to wear. Waterproof. Can be worn in bath. Send for amazing FREE 100-page, cloth-bound book "Advice To Ruptured" and details of liberal truthful 60-day trial offer. Also names of grateful patrons in your neighborhood. Write today. Cluthe Sons, Dept. 31, Bloomfield, New Jersey.

## To PROTECT YOUR INVENTION—Use this coupon, NOW

Delays are dangerous and may be very costly. My personal service assures prompt action, strict confidence, and a minimum of expense. I suggest that you send me a model or drawing, or sketch and description of your invention, and \$5.00. I will make a search and report

promptly as to its patentability and send you a copy of my 72-page booklet. Or, if you prefer to read my booklet first, mail the attached coupon at once. I will also send my "Record of Invention" form. (Over 38 years experience as a Registered Patent Attorney.)

**L. F. Randolph,** 302-D Victor Bldg., Washington, D. C.

Please send me at once, free of charge, your 72 page booklet and "Record of Invention" form.

Name.....

Address.....

**A PERSONAL CONFIDENTIAL PATENT SERVICE—**



# Inventors

## FREE BOOKS

give you practical patent facts

If you are an inventor—if you have a new idea—send for our free booklets. They contain practical information based on 64 years' experience as patent attorneys. These books will explain the steps in patent procedure . . . tell how you can protect your ideas, and describe the various opportunities for capitalizing on your invention. All inquiries confidential. Mail post card for free books today.



## C. A. SNOW & CO.

Registered Patent Attorneys Since 1875

159 SNOW BUILDING

WASHINGTON, D. C.

Free Book shows you how to



**MAKE MONEY with MONEY**

NICE 'SIDE' INCOMES BEING MADE BY KEEPING BEES.

We supply everything in Beginners' Outfits at a small cost. Write for free booklet "Does Beekeeping Pay?" containing 30 letters from beekeepers. New catalog full of beekeeping information. Gleanings in Bee Culture 64-pages. New readers, 6 months 25 cents. The A. I. Root Co., Dept. M-28, Medina, O.

### AIRPLANE DRAFTSMEN NEEDED

Prepare at home quickly. Endorsed by Industry. No previous training necessary. Unlimited future. Send for free booklet. **WESTWOOD CORRESPONDENCE SCHOOL**, 125 Village Station, Los Angeles, Calif.

### AVIATION

Practical Aviation Instruction for the layman, for the pilot, for the mechanic, and for the ground-school instructor. The transport license method of specialized aviation instruction, published since 1930. Write, enclosing stamp.

**THOMPSON AVIATION PUBLISHERS**  
8326 Woodward Detroit, Mich.

### DIESEL

Maximum training minimum time; practical and theoretical. Modern equipment, experienced teachers. Personal instruction.

40th year. Catalog free. Resident course in three months.

**FINLAY ENGINEERING COLLEGE**, 10th & Indiana, Kansas City, Mo

### BUCHSTEIN'S FIBRE LIMB

Correctly fitted. Strong, light, neat, cool, soothing. Braces for all deformities. On terms.

**D. BUCHSTEIN CO.**  
610 3rd Ave. South, Minneapolis, Minn.

**FOR COMFORT**

## NEW models EASIER TO PLAY

Find out about these sensational new Conn Band Instruments. Many wonderful, exclusive features! Today, more than ever, Conns are the "choice of the artists." You'll advance faster and take more pride in a genuine Conn—made by the world's largest manufacturer. See your dealer or write us for Home Trial, Easy Payment offer. Mention instrument.

**C. G. CONN, LTD.**  
531 Conn Bldg., Elkhart, Ind.

**WRITE FOR FREE BOOK**

# CONN

BAND INSTRUMENTS

## There's MONEY IN ARC WELDING!

"No more tiresome work for me. I get a real thrill out of being an arc welder—and don't forget it, I'm getting more money than I ever earned on hit or miss jobs."

You, too, can become part of this great new industry! There's almost no limit to what welders can accomplish—they cut manufacturing costs way down. Because they know the "How and Why" of Welding, Metallurgy, Drawing, Blueprint Reading, Set-Up Work and Fabrication.

No wonder manufacturers all over the country are demanding practically trained School of Engineering Welding Operators, Welding Technicians, and Welding Engineers!

Don't be content with ordinary work at low pay—when in a short time you can become a thoroughly Trained Specialist in Welding.

## MILWAUKEE SCHOOL of ENGINEERING

Institute of Electrotechnics

Dept. PM-539 Broadway and E. State, Milwaukee, Wis.

Send Free Booklet "ARC WELDING, World-Wide Dawn of a Gigantic Industry." Also tell me how I can become an Arc Welding Operator in 3½ months. . . . Gas Welding Operator (6 weeks) . . . . . Welding Technician (4 months) . . . . . Welding Engineer (1 year) . . . . .

Send details of Student Loan Plan. . . . . Earn Part Expense Plan. . . . .

Name . . . . . Age . . . . .

City . . . . . State . . . . .

(If interested in other courses, check here. Refrigeration and Air Conditioning Technician (3 mo.) . . . . . Radio and Television Service Man (6 Mo.) . . . . . Commercial Radio Engineer (1 Yr.) . . . . . Electrical Engineer B.S. Degree (4 yrs.) . . . . .

PM-539

## LEARN Short-Method Arithmetic

$\div$   
 $\times$   
 $=$   
 $+$   
 $\checkmark$

Simplified system used by "master minds" on stage, accountants, bankers, etc. Easy to learn. Add columns of figures short-cut method; multiply 4 figures by 4 figures without using old-fashioned multiplication; use sight method of proving addition, division, etc. Learn horsepower calculation, how to use slide rule, micrometer. Complete illustrated course only \$1.00, postpaid. Satisfaction or refund. Amaze your friends with your mental wizardry! Free details—mail coupon TODAY.

**FREE**

**NELSON CO.**, B-300 Manhattan Bldg., Chicago, Ill.  
Send free details about "Short-Method Mental Arithmetic" without obligation on my part.

Name . . . . .

Address . . . . .

City . . . . . State . . . . .

## Saw-Filing

Pays up to \$2 or \$3 an Hour in Spare Time

A FOLEY Automatic Saw Filer files hand, circular and band saws better than the best hand filer. Cash business, no canvassing, no eyestrain. No experience needed. Louis P. Wadowick, Ohio, says, "I have filed 764 saws in spare time and have earned \$850.00 in carpenter work due directly to my saw filing contacts." Send coupon for FREE PLAN, no obligation.

**FOLEY MFG. CO.**, 516A-9 Foley Bldg., Minneapolis, Minn.

Send Free Plan on Saw Filing business.

Name . . . . .

Address . . . . .



# Do You want to get ahead?.. then... Read these 8 letters!

## Two Raises, One Promotion After But 7 Months

Today, after 7 months of study, I have received one promotion and two raises in salary—sufficient to pay the entire cost of the training in a short while. It can easily be seen that I haven't even begun to reap the benefits I expect to get in the next 7 months!  
T. G. Jr., Tex.

## Two Promotions in First Year

At the time of my enrollment about a year ago, I was in our Yakima office in charge of collections. 3 months from that time I was moved to a district office as office manager. 6 months later came my transfer to Lewiston as district manager. My LaSalle training has certainly paid big dividends. And I haven't even completed it yet!  
D. E. W., Idaho

## Clerk Aided by LaSalle Is Now Auditor

Several years ago, I graduated from LaSalle in Accountancy. At the time I enrolled, I was a clerk. At the present time, I hold the position of auditor. I have always found LaSalle training good training.  
W. A. S., Ky.

## University Executive Finds Training Comprehensive and Well-Presented

My work is that of cashier and manager of \_\_\_\_\_ University's Accounting Department. I am in direct connection with education and, with my background, feel able to judge accurately the worth of any extension course. I have not yet found another as comprehensive and well-presented as that offered by LaSalle, and believe anyone who will put the effort into it is bound to succeed.  
R. M. B., S. D.

## Clerk to Ass't Mgr. in Only 8 Weeks

In less than 8 weeks from my enrollment for your Higher Accountancy Training I was promoted from clerk to assistant manager of the largest A. & P. super-market in central New York.  
T. F. F., N. Y.

## C.P.A. Firm Recommends Simplicity of Training

Many, many times men have asked members of our firm for advice regarding an effective, well-taught accounting course. I have recommended LaSalle invariably. The Problem Method used is an ideal, practical presentation and is so simplified that the average man can readily master the work.  
H. A. S., S. D.

## Easily Pays Tuition by Outside Work

My progress the first 6 months was sufficient to enable me to handle several outside audits which more than paid my complete tuition. Other tangible results have been a raise in salary at my original position, and, later, a change to my present work as assistant budget director for the State of \_\_\_\_\_.  
V. C. G., \_\_\_\_\_.

## Skeptic Becomes Booster When Given Raise —Promised Promotion

When I enrolled in your Higher Accountancy 8 months ago, I was skeptical regarding any immediate benefit. Now all doubt has been dispelled. Within 4 months, I received a 25 per cent increase in salary, equal to 300 per cent of my monthly payments to LaSalle. And this is only the beginning, since I have been promised further increases in salary and promotion.  
O. L. F., Ill.

## They are evidence that success and promotion come fast to trained men!

Stop *hoping* for that raise or promotion! Begin *earning* it—in the way that *cannot be overlooked by your employers!*

Isn't it pretty obvious that maybe so far you aren't going about things in the right way? And isn't it equally obvious that the men of those letters quoted above found a more effective way—through LaSalle accountancy training?

Take a tip from these experienced men. Reason it out for yourself! What has worked out so well

for those men—and for thousands and thousands like them—*IS ALSO PRETTY APT TO WORK FOR YOU!* That's just common sense.

Like them, why not investigate? Send the coupon—that's the first move.

Next we will gladly lay before you all the details of this proved success-building program—without obligation. Then make your own decision in the light of all the facts. The coupon will bring you full information in this fascinating *FREE* book of 48 pages. Send for it—*NOW!*

**LaSalle  
Extension  
University**  
A CORRESPONDENCE  
INSTITUTION

Dept. 564-HR

Chicago

I'd like to have your free booklet, "Accountancy, the Profession That Pays," about the training that these 8 men liked so well.

Name .....

Address .....

Position ..... Age .....



**WORLD'S  
BEST  
WANT AD  
MEDIUM**

# CLASSIFIED Advertisements



Advertisements in this section, 35 cents per word, each insertion, minimum 10 words, payable in advance

To be inserted under proper classification in June issue, copy should be in our office April 8th

June issue on sale May 1st

Popular Mechanics Magazine, 200 East Ontario Street, Chicago, Illinois

## YOU'LL PROFIT

By reading and answering the classified ads in this section. Hundreds of opportunities to make and save money.

Popular Mechanics Magazine,  
200 E. Ontario Street, Chicago, Ill.

Dear Sirs: After using your magazine for a number of consecutive issues we find it has pulled far more actual orders than any other publication we have used, and we have tried a number of them with circulations as large or larger than yours. Orders have come from within our own county as well as every state in the union and as far as Alaska, Cuba, and other far away countries. We find Popular Mechanics advertising different from most publications due to the fact that it is kept sometimes for as long as ten years or more for reference and its life as an advertising medium continues for many months after the date of publication. With best wishes for your continued success, we are, very truly,

THE EDGEWOOD PRESS.

(Original letter on file in our office)

## 1027 CLASSIFIED ADVERTISEMENTS 1027 OPPORTUNITIES FOR YOU

### AUTOMOBILES—MIDGET CARS

**BRAND** New fifth edition Automobile Racing Book. Tells how build dirt track bodies, frames, engines. Records, superchargers, rules, formula, plans, stock, conversions, roadster racing, fast Fords, \$1.00 postpaid; \$1.15 C.O.D. Ray Kuns, Department 5, Madisonville, Cincinnati, Ohio.

**MIX** High test gasoline for 4c gallon. Guaranteed to triple any car mileage, performance. Formula \$1.50. Carburetor Motor Company, Box 596, Wichita Falls, Texas.

**1938 IGNITION** Supercharger. Quick starting, mileage, pep, less carbon, \$1.25. E. G. Sales Co., New York.

**GAS Saver**—Wiper hose installation. Postpaid dime. Motor Specialties, Box 5849, Wilkensburg, Penna.

**MIDGET** Cars, parts, plans. Special introductory offer! Catalog 20c. Derby Midgets, Woodstock, Illinois.

**MIDGET** Parts, kits, plans. Circulars free; catalog, 10c. Shipp's Midgets, Box 543-H, Zanesville, Ohio.

**SPORTCAR** Body, fits any chassis, easily built, illustrated literature 10c. Bill Hager, 428 N. Water, Gallatin, Tenn.

**CAN** You test a used car? "Ingenious Used Car Tips" shows how. 50c coin. Box 49, Station Y, Brooklyn, New York.

**BUILD** Fast pumping air compressor from automobile engine. Instructions \$1.00. Tuck's Garage, 73 Shirley, Pontiac, Michigan.

**MIDGET** Racers, two-passenger autos. Midget motorcycles. Motorscooters. Motors, wheels, parts, plans. Handbook catalog, 58 illustrations, 20c coin. Midwest, Chicago, 25c.

**R AND R** Mfg. Co., Anderson, Indiana. Racing cars, midgets and speed equipment. Catalog 25c.

**NO** More flat tires, with the new puncture proof innertube fluid. "Formula" 10c coin. Box 107, East San Diego, Calif.

**MIDGET** Racecars, sportcars, motorscooters. Bargain lists—130 used motors, midgets, parts—20c. Illustrated literature. Midgets, Box 543-H, Zanesville, Ohio.

**ALUMINUM** Alloy pistons, automotive, aviation, Diesel, industrial, marine, midget, model, motorcycle, outboard. Finished or semi. Judson Mfg. Co., Hedge and Gillingham, Philadelphia, Penna.

**FORD** V-8's, 1934-1939; gasoline saving device. \$1. Walert Co., 3429 No. 10th St., Milwaukee, Wisconsin.

### AUTO TRAILERS

**AIRPLANE** Wheels, new, \$1.00. Closeout. Air Transport, Garden City, N. Y.

**BUILD** The famous, low-cost Jim Dandy Cabin Trailer. Complete plans and instructions 50c. Plans to build the beautiful, streamlined Jim Dandy Cabin Cruiser, \$1.00. Trailer Builders Manual and catalog of trailer parts, supplies and equipment—over 100 interesting, illustrated pages, 25c. Order today. Satisfaction guaranteed. Trailer Supply Co., 411-A Jackson St., Wausau, Wisconsin.

### AUTO SUPPLIES AND EQUIPMENT

**BARGAINS**—Compressors, welders, battery chargers, car washers, attractively priced. Terms, trial. Write for bargain list. Hobart Automotive Supply, Box M-595, Troy, Ohio.

**USED** Auto parts, half price, all cars. Century Parts Company, 1712 LaFayette, St. Louis, Missouri.

**SAVE** Half! Guaranteed reconditioned truck and auto parts. All models, makes. Catalog free. Salesmen wanted. General Auto, 7008AA Cottage Grove, Chicago.

**BEARINGS**—Piston rings. All makes, sizes; ball, roller, thrust. Big discounts. List 10c. Kostka, 2350 South Crawford, Chicago.

**BATTERY** Drain detector. Connects to ammeter terminal and automatically lights red dash light if any switch is left "on" after motor is stopped. Universal. Complete \$2.50. Redlite, Plain, Wis.

**COLLISION** Feeling! What's your defense? Seco, the automatic synchronized, warning flicker! New 1939! Your stop light always signals differently when slowing down or stopping. Attach Seco behind speedometer quickly. Send \$1.00. State car and year. Smith Engineering Co., 197 Brunswick, Buffalo, N. Y.

**NEON** Stoplight penetrates fog, easily installed by anyone. Complete with 21" neon tube \$3.00. Complete kit for use with model T Ford coil \$1.75. Complete plans and information 25c. Bohlman, 125-19 Jamaica Ave., Richmond Hill, N. Y.

**REFINE** Used oil without cost. Particulars. F. Gerwin, Fairview, Oklahoma.

**RE-REFINE** Crankcase drainings, request information. Zelball, Mount Holly, N. J.

**PLATING** Outfits for auto parts. Connect to a battery. No tanks used. Free particulars and proofs. Gunmetal Co., Ave. J, Decatur, Ill.

**ACETYLENE** Welding outfits, \$32.95; electric welders, \$74.95. Easy-payment plan. Box 331, Hamilton, Ohio.

### MOTORCYCLES, BICYCLES, MOTOR SCOOTERS AND SUPPLIES

**MOTORIZED** Vehicles. How to build five different scooters. Harley engined Flea airplane, one wheel bicycle Diesel conversion, motorcycle trailers, midget racers, etc. No pictures, but working drawing, blueprints, etc. Large book \$1.00. C.O.D. \$1.25. Refund if dissatisfied. Kamm Metal Products Company, 162 High Street, Oshkosh, Wisconsin.

**BUILD** Your motorscooter. Complete steel kit \$3.95, dollar construction plans free. Illustrated parts catalog 20c. Midwest, 1-C, Box 1959, Chicago.

**MOTORCYCLE** Cylinder boring \$2.00. Aluminum pistons, stock or racing, all models, (dealers supplied). New and used Indian parts. Used motorcycles. Stamp brings list. Phila. Indian, 1635 Hunting Park, Philadelphia, Penna.

**ALLOY** Pistons \$3.00—Harley, Indian, Henderson, Excelsior, Cleveland. Cylinder grinding, motor rebuilding. New and used parts for less. Catalogue and wings pin 10c. Ballak, 1115 Chestnut, St. Louis, Mo.

**SEND** 10c For 1939 Handbook of Information just printed. New and used parts, accessories for Indian, Harley, Henderson, Excelsior. Valuable information on motorcycle rebuilding. Bootz, 622 East Grand, Des Moines, Iowa.

**MOTORCYCLES**, Reconditioned. New, used, parts and accessories. All makes, Large stock, Bargains. Illustrated catalog, 15c. Indian Motorcycle Sales Co., Kansas City, Mo.

**MOTORSCOOTERS!** Save \$30-\$60 building latest, easiest built scooter. Steel kit \$3.95, plans free. Complete illustrated catalog 20c coin. Midwest Motors, Box 1959, Chicago.

**NEW** Push-A-Bike outboard motor for your bicycle. Complete with pneumatic tire. Ready to attach. Richburn Company, Aurora, Missouri.



**MOTORCYCLE** Parts and accessories, new and used, for all makes and model motorcycles. Write for prices. Triangle, 1111 Washington, Chicago.

**MOTORSCOOTERS!** New design. Build yourself—easily, cheaply. Plans, instructions, 25c. Shipps, Box 543-H, Zanesville, Ohio.

**BUILD** Power scooters, midget cars. We supply tires, wheels, motors. Lowest prices. Send 10c for plans, etc. Build-Your-Own Devices, 5238 Lake, Chicago.

**REBUILT** Motor cycles, all makes, new and used Harley-Davidson parts. Send 10c for bulletin. Western Harley-Davidson Distributors, 914 E. 15, Kansas City, Mo.

**MOTORCYCLE** Bargains, lowest prices, bargain sheets for stamp. Motorcycle accessories. Rochester Harley Davidson Corp., 129 W. Main St., Rochester, N. Y.

**HI-LIFE** Bicycle generators operate lights direct or charge miniature Kic-O storage battery. Write Kimley, 1271 E. Ferry, Buffalo, N. Y.

**INSIDE** Dealer prices. Overstocked, all models, Indians and Harleys. Rebuilt, guaranteed. Dime brings latest list. Crandall-Hicks, Boston, Mass.

**RECONDITIONED** Motorcycles. New—used parts for all makes. Authorized Harley-Davidson dealer. Whitman Motorcycle & Supply Co., 405-9 Southwest Blvd., Kansas City, Mo.

### AVIATION

**GET** Into aviation. Pilots earn up to \$6000 a year! Airplane mechanics and aeronautical engineers also get big pay! Prepare at this Lincoln government approved school. Write for complete information. Lincoln Airplane & Flying School, 2004 Aircraft Bldg., Lincoln, Nebraska.

**AVIATION** Apprentices — Air-minded young men interested in training for entering aviation as apprentices see ad on page 22A.

**150 AIRPLANES** \$50 Up. Terms, trades. Complete catalogue 25c. Used Aircraft Directory Athens, Ohio.

**AIRCRAFT** Mechanics, welding, flying courses. Swallow Airplane Company, Wichita, Kansas.

**JUST** Out. Practical course in flying. 29 chapters, illustrated, complete. Only \$1.00. Aircraft Directory, Athens, Ohio.

**PROPELLERS** For sleds, aircraft. Catalog 10c. Banks Propellers, Love Field, Dallas, Texas.

**PROPELLERS** For airplanes, sleds. Ice-sled blueprints, supplies. Catalog dime. Lorenzen Propellers, Niles, Michigan.

**PROPELLERS**—All types, including latest three blade airliners. American Flea Special \$12.50 down. Universal Aircraft, Ft. Worth, Texas.

**AIRPLANE** Mechanic's home-study course \$1.25. Engine Mechanic's \$1.25. Both courses \$2.00. Prepares for license. Helps pilots immensely. Meyer Engineering, Hempstead, N. Y.

**LEARN** To fly free. Folder, dime. Ohmeyer, Box 391, Hempstead, N. Y.

### A. C. GENERATORS

**PRACTICAL** Changes for automobile generators. See our advertisement at bottom of page 142A. Autopower.

### BATTERIES, GENERATORS, ETC.

**FARMLITE** Batteries—40% discount. Buy direct. 32 and 110 volt light plants. York Battery Co., York, Penna.

**PLATING** Generators and motor generator sets. Write for information Hobart's new line electro plating equipment. Payments low as \$12.40 monthly. Quality machines, quick delivery guaranteed. Hobart Bros., Box M-592, Troy, Ohio.

**LOOK!** Save 50-75% on all type wind-chargers, batteries, generators, propellers —through our "Cooperative Wind Electric Association." Dime brings membership and valuable wholesale catalog. Kubat Mfg., St. Paul, Minnesota.

**12 VOLT** Heavy duty generators \$8.50. Save money on new, used automotive electrical parts; free catalog. State Ignition, 52 Cullerton, Chicago.

**50-1½ HORSE** Repulsion induction, 110-220 volt, heavy duty motors, 3400 speed, \$9.75. Also generator bargains. Electrical Surplus Company, 1885 Milwaukee, Chicago.

**12 VOLT** Airplane generators, new, complete, closeout. \$3.95. Air Transport, Garden City, N. Y.

**EDISON** Storage batteries for light-power systems. Non-acid. Odorless. Fifteen year life. Five year unconditional guarantee. Bargains in complete lighting systems. Low prices. Free illustrated literature. "See-Jay" Battery Co., 82 Sterling Ave., Yonkers, N. Y.

**EDISON** Lifetime storage batteries for light and power. Eliminates acid battery diseases. Long guarantee. All kinds rebuilt generating plants, motors, and miscellaneous articles at bargain prices. Free interesting literature. T. Hawley Smith Co., Croton Falls, N. Y.

### ELECTRICAL SUPPLIES, EQUIPMENT

**BARGAINS**—Arc welders, also motor generator. Write for new bargain list telling needs. Hobart Bros., Box M-597, Troy, Ohio.

**ELECTRIC** Shavers—Guaranteed one year, 110 a.c.-d.c., \$3.50. No C.O.D. orders. Hamilton Sales, Takoma Park, Maryland.

**MAGNET**, Alnico, new wonder alloy lifts 50 times own weight. 60c; large \$1.00. Advance, 861-P6 Minneapolis, Minn.

**TUNGAR** Bulbs \$1.65 postpaid. Genuine G. E. 2½ amp. Full wave type. E. B. Lewis, Southington, Conn.

**ELECTRIC** Engraver, engraves all metals deeply, dollar. Hudson Bros., East Syracuse, N. Y.

**ULTRA** Violet—Infra red. Dual ray health lamp. Two separate units in one. Promotes sun tan—vitamin "D". Automatic control. AC-DC current. \$3.90 postpaid. Details. Beyer Mfg. Co., 4515-P Cottage Grove, Chicago.

**ELECTRO-SCRIBE**: Electric pencil writes, engraves all metals. \$1.00 postpaid. Details. Beyer Mfg. Co., 4515-K Cottage Grove, Chicago.

### ELECTRIC FENCING

**MAKE** Electric fence from old automobile coil. Complete plans 10c. No extras to buy. LeJay Manufacturing, 947 LeJay Building, Minneapolis, Minn.

### WELDING AND SOLDERING

**DODGE** Arc-welder, 25-125 amperes, 0-40 volts d.c. (Two Dodges 25-200) built from North-East 12 volt automobile generators without rewinding armature. Plans \$1.00. Welders Club, AB-3432 M-Mart, Chicago. Special: "44 Lessons in Arc-welding" 50c (foreign 75c).

**WELDERS** Take notice! For \$1.10 we can furnish a new field and specifications. How to make big money with your welder. Zemans Radio Elec., Wa Keeney, Kansas.

**DODGE** Generator makes 150 amp. arc-welder. Two make 300 amp. No armature rewinding. Instructions 50c. Practical Methods, St. Paul, Minn.

**ARC-WELDING** Outfit \$1.25. Weld fenders, braze, solder. Arrowtrading, 5014 Tillman, Detroit.

**75-200 AMPERE** Arc welders from Dodge generators. Complete plans 35c. 100 other generator changes. LeJay Manufacturing, 347 LeJay Building, Minneapolis, Minn.

**DELCO** Arc-welder, 25-200 amperes d.c., 0-75 volts, built from 32 volt light plant. (No rewinding.) Plans \$1.00. Welders Club, AB-3432 M-Mart, Chicago.

**PLANS** For 110v arc welder. 50c. Marvelweld, Box 1156, San Francisco.

**BUILD** Your own a.c. arc welder, 115 or 230 volts. Send stamped envelope for circular. 474 Summer Ave., Newark, N. J.

**POWERFUL** 110-220 Volt a.c. welder constructed for less than \$5.00 uses starter coils. No winding. Pole transformer makes 200A. welder. Plans \$1.00. Information dime. Welders Supply Co., Box 132, Bellefontaine, Ohio.

**NEW** Arc welder cheap. Free literature. Holger's Service, Canton, Kansas.

**DEMONSTRATORS**, Electric arc welders. Money-saving prices. Used by the government. Trial and terms guaranteed. Hobart Welders, M-593, Troy, Ohio.

**ALUMINUM** Solder, 25c postpaid. Hammond, 120 W. Susquehanna, Philadelphia, Penna.

**REBUILT** a.c. d.c. Arc welders, all sizes; engine governors, idlers. Terms. Low prices. Guaranteed. Service Co., 3732 Cedar Ave., Cleveland, Ohio.

**APOLLO** 110 Volt electric brazing torch. A.C.-D.C. Produces 3 inch flame similar to acetylene. Welds, brazes, solders all metals including aluminum. Literature free. Apollo Mfg. Co., 634 Union, Memphis, Tenn.

**ARC-WELDER** 25-600 Amperes d.c., 0-75 volts, built from d.c. vehicle motors. (No rewinding). Plans \$1.00. Welders Club, AB-3432 M-Mart, Chicago. For sale: New and used d.c. vehicle motors.

### ENGINES, MOTORS, DYNAMOS

**300 MOTOR** Diagrams and tables covering three phase; Star, Delta, nine lead, two and four speed; two phase; single phase; split phase, capacitor, repulsion induction, fan, armature windings, etc. Satisfaction guaranteed or money refunded. \$1.50 prepaid. Educational Advancement Company, Lakewood, New York.

**25 AND 60** Cycle rebuilt motors. Fully guaranteed, priced to sell. Sommers Electrical, Tavistock, Ont., Can.

**ALTERNATING** Current motors, grinders, drills, exhaust fans, radios, clocks, shavers, appliances. Home workshop tools. Bargain pricelist free. Mallorder Electric, 713 South Dearborn, Chicago.

**BARGAINS**—Plating generators, motor generator sets, also arc welders. New low prices for large and small shops. Trial—easy terms if desired. Hobart Bros., Box M-596, Troy, Ohio.

**PRECISION** Double action steam engine \$2.00. Ready to run. 50 to 4000 r.p.m. Send stamped addressed envelope for description. Pruett Novelty Wks., 1828 W. 43rd Place, Dept. 6, Los Angeles, Calif.

**FOR** Sale. Small elect. motors with flexible shafts, rebuilt \$3.25 postpaid. McConnell, 1619 Edgewood Ave., Racine, Wis.

**MAKE** Money, rewind auto generators, washing machine motors, construct arc welder. 10c brings particulars. Catalog material. Ernest Knight, LaSalle, Illinois.

**5 KVA** Alternators \$125.00; also larger sizes. Motors, generators. Queen City Electric, 519 South California, Chicago.

**BARGAIN**—½ Hp. motors, 60 cycle, 1 phase, 110 volt, like new, guaranteed, \$7.40. Send check to Erie Electric Motor Co., 120 Church, Buffalo, N. Y.

**MOTOR** Winding lessons, illustrated. Send stamp for particulars. Also motor data for experienced winders, introductory selection \$1.00. Motor Data Company, Box 7631, Kansas City, Mo.

**ALTERNATING**, ½ Horse, 110 volt, induction motors. Rebuilt, guaranteed, \$7.50. Wilmot Auto Supply, 2247 St. Paul Ave., Chicago.

### MACHINERY, TOOLS AND SUPPLIES

**DRILL** Grinding attachment fits bench grinder, hand or power turned. Handles sizes 3/16 to 1¼". Price \$7.85. Descriptive literature on request. Tractor-Lite Co., Sidney, Iowa.

**CASTINGS**, Drill press vise \$1. Lathe grinding attachment \$2.50. R. Baumgartner, 400 N. 2nd, Corvallis, Ore.

**NEW** Catalog! Lathes, motors, spray equipment, jig saws, drill presses, supplies of all kinds. Enclose 5c. Balco, 605-R Washington, Chicago.

**BARGAINS**, Demonstrators, electric arc welders, guaranteed, 30 days trial and terms. Write Hobart Welder Exchange, Box M-594, Troy, Ohio.

**KELLOGG** Air compressors, \$6.00. Electric refrigerators, \$25.00. Vacuum pumps. Taylor, 105 East 102nd Street, New York.

**CONCRETE** Building block machines and molds. Easy payments. Catalog free. Concrete Machine Co., 5129 South Compton Ave., St. Louis, Mo.

**LAWN**MOWER Parts catalog, new sharpening clamp. Write: Collet Supplies, Miami, Florida; Hosse & Hosse, Nashville, Tenn.; Malahan, 1207 Bedford Avenue, Brooklyn, New York.

**TURRET** Type boring tool holder with ½x6" and ¾x9" boring bars \$8.50. Collet chuck sets \$13.50. Circular free. Northwest Tools, Box 1486, Boise, Idaho.

**TREMENDOUS** Surplus of factory tools selling out. Drills, taps, files, hacksaws, etc. Send for free lists, include six cents postage. Travers Tool Co., 264 Jackson Ave., Long Island City, N. Y.

**AIR** Compressors, new 1½x1¼, \$6. 2x2 \$7. 2½x2 \$8. Guaranteed. Send check or money order. National, 560 Washington, Chicago, Ill.



14" x 6' GREAVES Klusman cone head engine lathe, quick change. No. 0 Cincinnati miller, cheap. Write for particulars. Cincinnati Machinery & Supply Co., 221 E. Second St., Cincinnati, Ohio.

### BOATS, OUTBOARD MOTORS, ETC.

**OUTBOARD Motors.** \$25.00 buys new 1.2 h.p. magneto ignition, weight 17 lbs. Troll fishing or pleasure motor. Dime for catalogue with parts, prices and operating instructions. Outboard, 305 Atlantic Ave., Boston, Mass.

**MARINE Reverse gear** easily converted from auto transmission 80% reverse. (Not model T Ford.) Instructions and plans \$1.00 postpaid. Speed Specialties, 629 10th St., Oakland, California.

**OUTBOARD Motors.** All makes of used motors and parts. Outboard Headquarters, 315 Atlantic Ave., Boston, Mass.

**BUILD A boat** by the Welch System. Its inexpensive; interesting and profitable. Everything for building, equipping or repairing boats. Use Welch Ready Cut Parts. Send 10c for catalog showing boats of many types; boat hardware; propellers; marine paints; sails; boat finishing materials and Welch White Cap marine motors. Welch Boat Company, Station K-1, Milwaukee, Wisconsin.

**DUXBURY Dinghies and prams**—\$35.00 up. Weldwood construction. Duxbury Boats, Duxbury, Mass.

**BUILD Your own boat** with Bay City Prefabricated frames and materials. Save up to 2/3s. Lumber, fittings, engines and equipment. Send requirements for quotation. Illustrated catalog 100 boats 9 to 65 feet 10c. Bay City Boats, Inc., 1552 Adams St., Bay City, Mich.

**PROPELLERS.** Gear pumps, stuffing boxes, bearings, etc. Wm. Baker, Pond St., Quincy, Mass.

**ASSEMBLE Your own boat.** Our finished knock-down frames and materials save you 2/3 builder's cost. All types and sizes. Send 25c for big catalog. Brooks Boat Co., Inc., D4, Saginaw, Mich.

**OUTBOARDS**—Save 1/2. Good used parts, all makes and models. Bargains rebuilt motors. Crandall Hicks Co., 959 Commonwealth, Boston, Mass.

**12 FOOT Flat bottom rowboat,** complete plans 25c. Free boatbuilding catalog. The Rudder, 15 Murray St., New York.

**FORD-ZEPHYR Marine conversions.** Catalog 10c. Lehman Engineering Company, Dept. D, Newark, N. J.

**BOAT Designers** are highly paid professionals. Complete course by mail. Catalog. Westlawn, Montville, N. J.

**SEE Our display ad** on page 153A. Cleveland Boat Blueprint Co., Station A-66, Cleveland, Ohio.

### SPORTING GOODS, GUNS, FISHING TACKLE, ARCHERY

**MEN!** Hand-made wristwatch straps, guaranteed sweatproof, finest genuine calf leather, outlasts others 4 to 1. Regular \$2.00 value. Special introductory "Maker-to-You" Offer only \$1.00. Western Leathercrafters, Box 3493, Portland, Ore.

**LIFELIKE Imitation baits,** angleworms, grubs, helgamites, etc. Hollow rubber using filler proper color. Dozen baits, two large tubes filler \$1.00. Peters Company, Dept. M, Whittier, Calif. Attractive for agents.

**NATIONALLY Known fishing tackle** delivered at big discount. Catalogue free. Tackle Store, Sac City, Iowa.

**BOWS, Arrows, raw materials.** Lowest prices. Lloyd Morrison, Waldport, Oregon.

**GOLF Clubs.** Five club matched set \$2.50. Lincoln Surplus, 123 Galena, Freeport, Ill.

**FREE 1939 Fly tying material catalog.** Work Fly Company, Pueblo, Colorado.

**GUNSMITHING** Learned at home. Repair personal and neighbor's firearms. Free catalog 20 firearm and gunsmithing books. Thomas Samworth, Marines, North Carolina.

**TENNIS Strings,** gut and synthetic at tremendous discounts. Samples free. Crescent, 2535 Patricia, Los Angeles.

**RIFLES, Shotguns, target pistols, air rifles, hunting knives, binoculars, telescopes, cameras, police goods, badges, holsters, etc.** Bargain catalog 3c. Lee Sales, (Dept. W), 35 West 32nd St., New York.

**TREASURE Finders?** Read Goldak advertisement on page 137A.

**BARGAINS!** Gun catalog 5c. Fishing catalog 5c. Ski catalog 5c. J. Warshal & Sons, First and Madison-PM, Seattle, Wash.

**BOWS, Arrows, raw materials.** Beautiful catalog (over 125 pictures) and "Essentials of Archery" a handbook on making bows and arrows 35c. Everyone intending to make their own should have this manual. Instruction folder and catalog 10c. L. E. Stemmler, Queens Village, N. Y.

**SINKER Molds** for making your own sinkers. Free illustrated folder. Reading Instrument Co., Box 78, Reading, Penna.

**ARCHERY Headquarters**—617 South State, Chicago. Catalogue free. Complete instruction book 50c.

**HUDSON Bay blankets, Indian pack baskets, camp stoves, knives, compasses, outdoor equipment.** Free catalog. Howe Fur Co., Box P, Coopers Mills, Maine.

**MUSCLE Building course** 25c, large size \$1.00. Sid's System, Southgate, California.

### FIELD GLASSES, TELESCOPES AND MICROSCOPES

**TELESCOPES, Microscopes, binoculars;** 1939 bargain catalog free. Brownscope Co., 5 West 27th Street, New York.

**TELESCOPES**—New, used \$5.00 up; amateur kits, Pyrex, 4" \$4.50; 6" \$5.50; 8" \$10.00; 10" \$15.00; 12" \$24.00. Also parts, accessories, mounts, astronomical books, maps. Pancro aluminizing. Microscopes 20X 95c; 60X \$1.95; 200X \$2.95; 250X \$3.95; 500X \$5.95. Astronomical jig saw puzzle \$1.00; map for puzzle 75c. Send 10c for catalogue, interesting articles. American Telescope Laboratories, Inc., Dept. 210, Hollywood, California.

**EXTRAORDINARY Value**—Super power dreading field glasses. Will do work of \$10.00 glasses. Guaranteed. Length closed 5 1/4 inches. \$3.00 prepaid. Order today. B & H Sales Co., 56 West Washington, Chicago.

**REFLECTING Telescopes**—build your own. 6" kit \$3.50; all abrasives, mirrors, eyepieces, diagonal prisms. Illustrated instructions 10c. Catalog free. Optical Development Corp., Dept. G, 1560 Broadway, New York.

**BOYS**—A powerful telescope for 20c. Have real fun. Send today for free information. B & H Sales Co., 56 West Washington, Chicago.

### ANTIQUES, RELICS, INDIAN GOODS

**ARROWHEADS,** 100 Good or 60 fine \$3.00. Catalog. George Holder, Glenwood, Ark.

**ARROWHEADS;** Saskatchewan glacial beauties, rainbow variations. Dan McKillop, Regina, Saskatchewan.

**SWORDS, Rapiers, pistols, daggers, armor** catalog 6c. Robert Abels, 860A Lexington Ave., New York.

**100 GOOD Arrowheads** \$3. Catalog. 5c. H. Daniel, Hot Springs, Ark.

**INDIAN Relics, beadwork, coins, curios, minerals, old glass.** Catalog 6c. Indian Museum, Northbranch, Kansas.

### TAXIDERMISTRY

**MODERN Taxidermist Magazine,** Greenfield Center, N. Y. Crammed full with valuable taxidermy information. Three sample copies 25c.

**TAXIDERMISTRY Supplies**—Quality artificial eyes, teeth, genuine Jonas head forms. Tools, materials, etc. Everything for the progressive taxidermist. Send 10c for big illustrated catalogue. Jonas Bros., 1049 Broadway, Denver, Colo.

### DOGS, PETS, BIRDS

**A BUNNY** Makes a dandy pet. Clean. Low feed cost. Write. Box 135, Gillespie, Illinois.

**STANDARD Rabbit Journal,** Milton, Penna., year 50c. Sample dime, supplies.

**REAL Saint Bernard puppies** priced right! Royal Kennels, Chazy, N. Y.

**BEAUTIFUL Pure white police dogs.** Ansonia Kennels, Mose, N. Dak.

**BIRDS?** Get American Canary Magazine monthly. Year, \$1.00. 2839-P North Halsted, Chicago.

**GREATDANES,** Dependable guards, companions. Pups \$25.00. Pictures free. Kalmar Danery, Stone-Mountain, Georgia.

### POULTRY AND FARM SUPPLIES

**CAN Make immediate delivery on A Grade Reds, Barred, Buff, White Rocks, Wyandottes, Orpingtons,** \$7.00—100; pullets \$9.90; cockerels \$6.90; White, Buff, Brown Leghorns, Anconas, \$6.75—100; pullets \$14.50; cockerels \$3.00. 90% accuracy guaranteed on pullet chicks. Supreme matings 75c—100 higher than above prices; all pullet chicks from supreme matings. Write for quantity discount and free catalogue. We pay postage, guarantee 100% live delivery, ship C.O.D. Salem Hatchery, Box 81, Salem, Indiana.

**FREE Sample poultry magazine.** Twelve issues 25 cents. Unexcelled. Poultry Item, Box 71, Sellersville, Penna.

**\$3.00—100 FOR Cockerels, Barred, Buff and White Rocks, S. C. Reds, White Wyandottes, Buff Orpingtons** \$7.45—100; pullets \$9.45; cockerels \$6.95; special heavy mixed lot \$5.40. English White, Brown and Buff Leghorns and Anconas \$7.25—100; pullets \$13.90. Assorted \$4.95. All chicks from tested, culled, thoroughbred flocks. Write for quantity prices and free catalog. Davis Poultry Farm, Route 34, Ramsey, Indiana.

**5 ALL-EXPENSE Trips to World's Poultry Congress.** Write for contest rules and free catalog telling how to make money with Davis chicks. Tom Barron White, Brown, Buff Leghorn, Ancona pullets \$14.90—100; cockerels \$3.00; unsexed \$7.75. Unsexed Barred, Buff, White Rocks, Reds, Wyandottes, Orpingtons, \$7.95—100; pullets \$9.95; cockerels \$7.45; heavy mixed \$6.45; assorted \$5.50. Write for complete price list. Turkey poult and ducks. Davis Poultry Farm, Route 34, Ramsey, Indiana.

**MAKE Money with poultry.** Read America's leading poultry magazine for latest information. Three years \$1.00; nine months 25c. Poultry Tribune, Dept. E-93, Mount Morris, Ill.

**CHICK Raisers** make extra money selling our chicks to neighbors. Write Jackson County Hatchery, Box 19, Seymour, Ind.

### TREES, SHRUBS, ROOTS, HERBS

**COLORADO Evergreens,** 25 three year old. We will prepay for \$1.00. Rocky Mountain Evergreen Co., Evergreen, Colo.

**JUST Out!** World's greatest "Herbalist Almanac." Beautifully illustrated in natural colors. Contains over 200 old-fashioned herb medicine recipes for home use. 10c postpaid. Worth dollars! Botanics, 145 W. 112th St., Chicago.

### FARMS AND FARM LANDS

**VALUABLE Waterfront,** 90 acres, greenhouse 25x45, poultry houses for 1000 birds, basement barn 50x85; rich level fields, river frontage, 2 small private lakes; 7-room home on lovely hill-top location; bay view; catalog price \$1500 cut to \$1200 to close quickly; page 6 new 100-page free catalog. Strout Realty, 255-P 4th Ave., New York City.

**GOVERNMENT Lands** ten cents acre up. Information all states twenty-five cents. National Tax Service, 600A Majestic Bldg., Detroit, Mich.

**FLORIDA Tax deed lands,** \$6.00 acre up. Terms. Farming, trucking, fruit growing. Fine hunting, fishing. Well located. Florida Tax Deed Service, 8007b Nebraska, Tampa, Florida.

**CANADIAN Tax sale lands** for a dollar an acre and up. Small monthly payments. Farms, timber, hunting and fishing camps, minerals. Limited number of properties. Write at once for free illustrated booklet. Tax Sale Service, Room 613, 72 Queen St., W., Toronto, Canada.

**FARMS** That pay in the Great Northern Railway agricultural empire, Minnesota, North Dakota, Montana, Idaho, Washington, Oregon. Fertile black soil, high production crops, grain, fruit, vegetables, feed and livestock. Many kinds of farms for selection. Write for book on state you prefer. E. C. Leedy, Dept. 457, G. N. Ry., St. Paul, Minn.

**GOOD Farms** available. Washington, Minnesota, Idaho, western Montana, Oregon. Dependable crops, favorable climate. Write for impartial advice, literature and list of typical bargains. Specify state. J. W. Haw, 119 Northern Pacific Ry., St. Paul, Minn.

**40 ACRES,** Near White River, unimproved; poultry land. \$175, \$5 down, \$5 monthly. Free list and literature. Hubbard, 216 Grossman Bldg., Kansas City, Kans.



**FARM MACHINERY AND SUPPLIES**

ALL Purpose tractors at factory price. Shaw 2 to 8 horsepower, riding or walking types. Does plowing, discing, harrowing, cultivating; mows lawns, cuts weeds, does hauling; runs belt machinery. Air or steel tires. Three speeds forward and reverse. Thousands in use. Write for free catalog and 10 day trial offer. Shaw Mfg. Co., Dept. PM-5, Galesburg, Kansas.

"PEPY" Governor makes automobile engines into power units. Most sensitive and accurate. Low price. \$9.50 postpaid. Get circular. Harris Machinery, Minneapolis, Minn.

NEW And used tractor parts at tremendous savings. Write for free 1939 catalog. Central Tractor Wrecking, Co., Boone, Iowa.

**PROFITABLE OCCUPATIONS**

M. M. earned \$267, three weeks, raising mushrooms in cellar! Exceptional, but your cellar, shed perhaps suitable. We buy crops. Book free. United, 3848 Lincoln Ave., Dept. 69, Chicago.

AMAZING Steady income. Angora wool rabbits. Complete instructions 10c. Logangora Industries, Logan, Utah.

RATTLESNAKES. Make money seven ways. Find, capture without danger. Business never overdone. Collector answers all questions \$1.00. Jim Payne, Fabens, Texas.

TREASURE Finders? Read Goldak advertisement on page 137A.

MEN—Women, operate "Specialty Candy Factory" home, all or spare time. Steady income. (Our 29th year.) Hillyer Ragsdale, Inc., Drawer 62, East Orange, N. J.

COUNTRY Drives or movies afternoons! Work mornings home. No canvassing! Folio-H. Station D. Los Angeles.

POSITIONS At sea. Details free. No employment agency. Julius, Amarillo, Texas.

BOOKKEEPING. Home, personal, business. \$2.25. Popular Mechanics, 200 E. Ontario St., Chicago.

**BOOKS, PERIODICALS, PICTURES, POSTCARDS**

SELECT Photographs, samples, complete list 25c. Albert McGoldrick, Mansfield, Mass.

"PUBLISH Magazine, \$1.00 capital"—10c. Bagley's Box 2522, Portland, Ore.

SEND 10c For trial subscription, American Freeman, Questions and Answers magazine, Haldeman-Julius, Box 103, Girard, Kansas.

BACK Number magazines—Popular Mechanics, Fortune, National Geographic, Esquire, or most any magazine you want. Large stock. Send 5c stamp for price list. James G. Anderson, Broad and Stanton Sts., Trenton, N. J.

BOOKS Bought! Appraisal form free! Write! Bookery, Box 3941, Cleveland, O.

HEALTH & Physique Magazine for body culturists. Sample 15c. Box 563A, Reading, Penna.

N. Y. World's fair snapshots, 12 different \$1.00. Forman, 882 Lorimer, Brooklyn, N. Y.

STURDY Magazine binders for Popular Mechanics, 12 wire separators, 3" back, \$1 prepaid. Agents discount. Gold Shield Products, 350-M Greenwich St., New York.

BOOKS—Home study courses. Lowest prices. Catalog free. Racliffe's, 1013 High, Petersburg, Virginia.

**GAMES—ENTERTAINMENT**

BINGO Games. 300 cards, 75 numbers, complete, postpaid \$2.00. List free. WarNovCo, Conimicut, R. I.

COSTUME Kit. Fourteen items professional equipment. Paints, mustaches, etc. 75c. Peter Punch Studios, Ardmore, Penna.

HOME Movies 8mm.-16mm. Cartoons, comedies, westerns, travelogs. Free list. Crown Film Corp., (Z)42 Melrose St., Boston, Mass.

PLAYS, Operettas, musical comedies, complete minstrel first-parts with song programs, blackface skits, vaudeville acts, monologs, dialogs, recitations, juvenile plays and songs, musical readings, entertainments, make-up goods. Catalog free. T. S. Denison & Co., 203 N. Wabash, Dept. 11, Chicago.

**MAGIC TRICKS, PUZZLES, JOKER NOVELTIES**

HAVE Fun! Fool your friends! Latest trick jokes. 10c brings illustrated catalog and snappy free trick! Broadway Novelty Co., Box 75, Pelham, N. Y.

TRICKS! Novelty! Fun-makers! Send 10c for complete catalog. Funcraft, P.O. Box 1244, Dept. F., Lincoln, Nebraska.

LATEST Card tricks 10c. Raftery, 724 W. 47th St., Chicago.

MAGIC Easily learned. Fascinating, profitable. Catalogue, five free tricks, 20c. Solomonson, 415 Woodstock, Stratford, Conn.

YOU Will want this. After cutting any pack of cards, name every card. \$1.00. Thomas Williams, 10550 Avenue "G," Chicago.

AMATEUR Funster offers unusual trick. Will perplex and amuse all including professionals. Complete 20c. Box 46, Brooklyn, New York.

BARGAINS. Used magic! Lists 5c stamps. Manly, 1315 Ferris, Los Angeles.

GIANT Magic and fun catalog with knockout surprise trick. All for 25c. Lawson Vick, Dept. P7, Queens Village, N. Y.

BE A magician. Large professional magic catalogue of latest tricks 25c. Cash paid for complete Tarbell Magic Courses. Write, Ireland, C-109 North Dearborn, Chicago.

LOOK! New 1939 catalog professional stage magic only 10c. Big new catalog 500 pocket-parlor tricks 10c. Each different—get both. Lyle Douglas, Station A-5, Dallas, Texas.

THE Lyle Douglas catalogs are bigger and better than ever.

FREE Tricks! Join Magicians' Fraternity! Monthly magazine, sample 10c. International Magicians, Mt. Morris, Illinois.

LEARN Ventriloquism, 3c stamp brings particulars. Smith, 125 N. Jefferson, Peoria, Illinois.

EARN Money in any crowd. Call names of strangers, tell unspoken questions. Professional course mind reading, spirit writing, etc., \$1. Henderson, Box 341, San Bernardino, Calif.

WORLD'S Largest magic shop professional catalog, 25c. Holden, 220 W. 42nd St., New York.

BECOME A magician and earn extra money in your spare time. Send 25c today for your copy of our 168 page catalogue. This book is full of tricks for everyone, from the beginner to the professional performer. Established 1910. Chicago Magic Company, 2300 North Mason Avenue, Chicago, Illinois.

**OLD STAMPS WANTED**

WILL Pay \$100.00 for 1924 1c green Franklin stamp, rotary perforated eleven (\$1,000.00 if unused). Send only 6c for large illustrated folder showing amazing prices paid. Vernon Baker, 444PM-5, Elyria, Ohio.

**STAMP COLLECTING**

GIVEN! World's largest and most beautiful airmail stamp. Also 50 different stamps from Cuba, Congo, Mozambique, etc., including maps, savages, airmail and animal stamps. 5c with approvals. G-M Stamps, Box 5523, Chicago, Illinois.

FREE Stamp catalogue—World's fair edition—Giant fifty-page quarterly, listing albums, supplies, Canadians, Newfoundland, United States, new issues, foreigners and pictorials. Fully illustrated! Empire Stamp Co., Dept. PM, Toronto, Canada.

THE World in a packet. An outstanding value! 100 stamps from 100 different countries, including Abyssinia, Afghanistan, Brunei, Falkland, Samoa and others from Africa, Asia, South America, West Indies, etc. Our pamphlet, which tells "How to Make a Stamp Collection Properly," together with our large bargain list of albums, packets, sets, etc. All for only 20c. Queen City Stamp Co., 604 Race St., Room 36, Cincinnati, Ohio.

40,000 VARIETIES First quality stamps available on approvals 1/4c up. Representative selection on request. Adults only. PKeigwin Stamp Co., Vineland, N. J.

TRIANGLES! Following 8 triangles, 10c to approval applicants. Bolivia, Costarica (fish, exhibition), Guatemala (bird), Liberia (bird, airplane), Mozambique (airplane), Netherlands (warrior), Moulblow, Box 11, Rosebank, N. Y.

GIANT Packet 200 all different, from Africa, South America, Asia, South Sea Islands, etc. Includes world's smallest stamp, triangle and diamond-shaped stamps, animal stamps, Nicaragua Olympic "baseball" commemorative; and many others. Also packet 17 different United States (cat. 65c)—all obsolete, including \$5 denomination, commemoratives, etc. Total catalog value nearly \$5.00! All for 5c to approval applicants. Write to-day! World-Wide Stamp Co., Box 600, Camden, New York.

BEAUTIFUL Packet pictorials, animals, map, five cents with attractive approvals. Ronald Stamps, Waterloo, Ontario.

WILL Rogers stamp is included in our packet of 15 different airmails. Only 5c to approval applicants. Lindgren, 130 Geary, San Francisco.

CHRISTOPHER Columbus issue of 3 large triangle ship stamps from Spain, only 7c to approval applicants. F. Buth, 7134 South Claremont, Chicago, Illinois.

TRIANGLES! Triangles! Triangles! Triangles! Count them. Four! With famous Rivera nude stamp. Only 3c to approval applicants. Cactus Junior, Tucson, Arizona.

RUSSIA North Pole set, Congo, Iceland, Serbia, Jaipur, 10 other stamps, 5c with approvals. Ronzio, 5432 Bischoff, St. Louis, Mo.

50 BRITISH Colonies with prize set and approvals, 10c. Mercer Stamp Company, 211 Broad Street Bank Building, Trenton, New Jersey.

STAMP Dealers, read America's top stamp-trade monthly—The Stamp Wholesaler. 3 years \$1.00, sample 10c. (Stamp dealers only! Stamp Wholesaler, (PM), Burlington, Vermont.

173 ALL Different U. S. postage. Extra select. Many commemoratives. Only \$1.03. Jungkind, Box 806-8, Little Rock, Ark.

FREE! 80-Page "United States & British North America" catalog. Nearly 1,000 illustrations! Lowest prices! Large catalog "foreign stamps" also included. Harris & Co., 137 Transit Building, Boston, Mass.

FREE Packet with approvals free. Baker, 1917 Chrywd., New Castle, Ind.

EXCHANGE Service for advanced collectors. Responsible organization, large membership. Elco, New Lisbon, N. J.

REQUEST Attractive Canada approval selections—references. Price list free with surprise packet. Cartier Stamp Co., Box 77, Delorimier Station, Montreal, Canada.

APPROVALS For beginners. Write United, 219 First Street, Claremont, Calif.

CZECHOSLOVAKIA 25 Different Mozambique 12 different, 8c to approval applicants. Theodore Stevens, 3576 Maryland Avenue, Detroit, Michigan.

20 DIFFERENT Airmails 10c. Kerstetter, 25 North Walnut, Mount Carmel, Penna.

100 WORLD Wide with 5 odd shaped stamps only 10c. Approvals included. Avenue Stamp Co., 426 3rd Ave., San Francisco, Calif.

267 OF World's most beautiful stamps, 25c. Vandal, Stamford, Texas.

EXCELLENT Foreign approvals. Lowest possible prices. Berger, 3496 Brookline, Cincinnati, Ohio.

U. S., Canada, Newfoundland, Mexico: "Four Star approvals." Nothing like them! Write today. 312 mixed U. S. only 10c. Kessels, Tucson, Arizona.

HINDENBURG Zeppelin, Spain nude duchess, 5c approvals. Shultes, Berne, N. Y.

FREE 15 Different Peru to approval applicants. Wright, 2825 W. 28 St., Brooklyn, N. Y.

THE 1939 International Stamp Almanac will be released May 15th. Now only 50c. International Stamp Almanac Publishing Co., 135 S. Main, Port Chester, N. Y.

SEND For my one cent stamps, 200 in each packet. Many fine stamps or entire packet one dollar. H. Codwise, Garland Street, Lynn, Mass.

COMMEMORATIVES, Airmails, obsoletes, coils, etc. Guaranteed over 100 face different. 1000 U. S. stamps in all. Only \$1.00. Onjay's, 1008B Third, Bay City, Michigan.

WHOLESALE—Canada, Newfoundland—Fifty page illustrated wholesale catalogue, featuring Canadians, Newfoundland, British Colonies, United States, supplies, free. Empire Stamp Company, Dept. 5, Toronto, Canada.



**JUST Arrived!** Ireland-U. S. Constitution issue. This is the 14th nation to issue stamps in honor of the U. S. Constitution. We have them all and will also have all special stamps issued by 13 different nations for the New York and San Francisco World's Fairs—also the Will Rogers stamp of Nicaragua. Get on our mailing list now and enjoy the best approval service in the world. For 15c we will send the complete set of Irish-U. S. Constitution to new and sincere approval applicants, and for an additional 5c mailing expense we will also send our free, fully illustrated, 60-page book, "Famous Stamps and Their Stories," one of the most outstanding books on stamps of recent years. Write today. Approval Headquarters, Globus Stamp Company, 268 Fourth Ave., New York City, Dept. 201.

**UNPICKED!** 100 U. S. revenues on documents—10c. (1000—60c.) Vanvoorhis, Hyndman, Penna.

**AMAZING Value—**25 Canada, 8 Estonia, 5 Philippines, 10 Chile—only 5c. Approvals, Wilhelm, Box 21, Station Y, New York, N. Y.

**FREE—**Valuable packet; approvals; enclose postage. Payne, 1216 West 63, Kansas City, Missouri.

**INTERNATIONAL** Junior album absolutely free! Write today. Arrow Stamp Co., Box 453, Meriden, Conn.

**FREE!** 101 Stamps 3c postage to applicants requesting approvals. Quality Stamps, Englewood, Colorado.

**AT 1/10 Catalog—**U. S. and foreign. Higgins, Dept. Y, 1850 - 52 St., Brooklyn, N. Y.

**TEN Different United States, over 40 years old, 10c.** Eisen, Bowling Green, Ohio.

**FREE 25 Different Czechoslovakia.** Approval applicants. Lincoln, 5535 May, Chicago.

**CANADA** Mission mixture, pound 50c. Newfoundland 30 different 25c. Odias Demers, Sanford, Maine.

**BETTER** United States approvals. Speedy service. Unistate, Box 2, Uptown Station, St. Paul, Minn.

**\$1.00 PACKET Free!** Inclose postage, request approvals. Secrist, Muscatine, Iowa.

**25 WORLDWIDE** Pictorials 15c with approvals. Cowles, 755 Anderson, Grantwood, N. J.

**MEXICAN \$1.00 Bill** and 25 different airmail stamps 15c. Nagle, 451 Douglass, Reading, Penna.

**CZECHOSLOVAKIA (50); China (25); Japan (25); Spain (25); France (50); Germany (100).** All different. One country 10c. All 50c. Approvals? Wollaston Stamps, Wollaston, Mass.

**\$2 VALUE** For collector's name and stamp. Northeast, Box 6618, Kansas City, Mo.

**1857—1938 STAMPS** At 1c and 2c each. Catalogue up to 10 times my prices. Ledue, Saint Petersburg, Florida.

**GIANT** And midget triangles, scarce Tannou Touva and Bolivia, many others, 4 cents with fine approvals. D. Shedd, Laramie, Wyo.

**GAMBLE.** Huge auction purchases broken into \$1.00 lots. Enormous value. Worldwide testimonials. Hughes, Queens Rd., Bournemouth, England.

**\$1.00 WILSON 9c.** With approvals. \$2.00 Harding 39c. Hollinbeck, 250 Nicollet, Minneapolis.

**25 DIFFERENT** Roumania 3c with approvals. Excel, Box 1315, Chicago.

**FREE!** Goya nude stamp. 3c postage. Approvals. "Jewels." Tamaqua, Penna.

**SWEDEN** 50 Different, 7c. (Approvals.) Stamps, 801 Cooper, Lexington, Kentucky.

**PRECANCELS** On approval. 35 different to applicants 3c. Gierhart, Baltimore, Ohio.

**CANADA** 35 Different only 5c to approval applicants. "Crescent Stamps," London, Canada.

**1000 WORLDWIDE** Stamp mixture 25c. Monjar, 1542 Waverly, Cincinnati, Ohio.

**U. S. Postage only—**25 different before 1905 only 25c. Franklin, 225 Franklin, Rochester, N. Y.

**FINE Approvals,** freshly filled books and sheets. Tell me what you want and I will send it. Milton Skinner, 306 East Fourth, Long Beach, Calif.

**1000 GOOD** Mixed 25c. De Mers, 1851 N. 39 Street, Milwaukee, Wis.

**1000 MIXED** Foreign, 25c. Well worth sorting for values. Plaza Stamp Co., Santa Fe, N. Mex.

**500 DIFF.** 20 Cents to approval applicants. Labis, 745 So. 12 St., Newark, N. J.

**CANADIAN** Stamps wanted, also letters dated before 1880. Edward Goodchild, 4250 Marcell Avenue, Montreal.

**WORLD'S** Largest map stamp, silver jubilee, 3c. Approvals. Whipple, 2011 Ravenna Blvd., Seattle, Wash.

**1000 MIXED** United States, 15c. 3 pounds \$1.00. Shaffer, 8544 Keene Avenue, Floral Park, New York.

**COLLECT** United States stamps for solid value. Our approvals are correctly numbered and reasonably priced. Southern Stamps, Box 70, Miami, Florida.

**100 DIFFERENT** 5c. Approvals. Stampcraft, 8 West Fourth, New York, N. Y.

**\$10 STAMP** Free to approval applicants. Foote, 309 Greeley, Webster Groves, Mo.

**UNITED** States on approval. Kantor, 1154 Sheridan Ave., Bronx, N. Y.

**TRANSJORDANIAN** (Unusual) stamps free! Including approvals. Rosenberg, 3527 Adams, Chicago.

**FREE 30 Different** U. S. to approval applicants. McKee, P.O. Box 1, Scranton, Penna.

**TRY** Cent-hi penny approvals. Ransom, 1333 Pontiac, Ann Arbor, Mich.

**WILL** Buy your unused United States stamps. Small discount. What have you? Mint Sheet Brokerage Co., 418 Caxton Building, Cleveland, Ohio.

**PENNY Approvals—**Thousands of fine stamps at 1c each. Heiden, 530 Parkside Ave., Brooklyn, N. Y.

**U. S. Constitution** stamp of Ecuador, gorgeous six-color stamp showing U. S. flag in natural colors and George Washington, also Marvel packet 33 different including new Cayman Islands, Gen. Franco Spanish Morocco "war stamp" 60 yr. old Luxemburg, "bull-fight" stamp, largest diamond, tropical triangle, Chinese "midget" stamp, etc., all for 5c with approvals. Potomac Stamp Co., Dept. 104-D, Washington, D. C.

**GREENLAND** Complete. Unused 40c. Approvals. Security Stamp Shop, Binghamton, N. Y.

**FIFTY** Different U. S. ten cents. Mampe, 4204 N. Wolcott, Chicago.

**INCREASE** The beauty of your collection. End "stock-book blues"; prevent gaps in page mountings. A postcard brings free sample. Address Maco Philatelic Corporation, 117 1/2 W. Harrison, Chicago.

**WHOLESALE** Approvals. References. Lists free. Fuld, Dickmann Building, St. Louis, Missouri.

**NEWFOUNDLAND** 12 Different 5c with approvals. Hudson, 116 Nassau, N. Y. C.

**NICE** Premium with my penny approvals. Box 462, Youngstown, Ohio.

**BELGIUM—**Two Koekelberg cathedral, three Prince Albert and one Liege exhibition on cover to approval applicants sending 10c. 10 Belgian Congo as free gift. Henry Louis, (Dept. 122), Wetteren, Belgium.

**1000 DIFFERENT** 75c; 600, 50c; 300, 20c. Fred Onken, 630 79th St., Brooklyn.

**LILLIPUTIAN** Airpost! Afghanistan, Perak, Selangor, Siberia, "Green Cross," charity, Wurttemberg, Palestine, Banana airmail. Free with approvals! Postage 3c. Saxon Co., 408-A Jay St., Brooklyn, N. Y.

**FREE, 50 Stamps,** Iraq, etc. Postage 1c. Album 3c. Bullard, 268 Northampton, Boston, Mass.

**CLEAN** Interesting approvals representing sound values at substantial discounts. Write today. John Stamp, 79 Holton, Montreal.

**WORLD'S** Small airmail, free stamp magazine! \$2.00 U. S. stamp, commemoratives, special issues, scarce stamps from 25 countries, 5c with approvals. Capital Stamps, Dept. PM, Little Rock, Arkansas.

**100 FOREIGN** Stamps given approval applicants. Oman, 642 Broadway, St. Paul, Minn.

**SPECIAL** Bargain list. Sets, singles, packets. Write Mitchell, Box 23, Jersey City.

**1000 MIXED** U. S. 25c. Including presidentials. Keyser, Box 653, Journal Square, Jersey City, N. J.

**FREE** Canada \$1 stamp to approval applicants. Munday, 1052 Manning, Verdun, Que., Canada.

**BADEN—**Scarce old genuine Baden, Liberian Bongo antelope, mystery British Colony triangle, fantastic Manchukuo, breathtaking Cayman Islands, \$5 United States, bizarre Negri Sembilan, Grande Comore Islands. Everything 3c with approvals. Viking, 1-Z Hanson Pl., Brooklyn, N. Y.

**75 AIRMAILS** 79c, 15—7c. Approvals. George Davis, Webster, Mass.

**SCARCE** Coronation! Beautiful Turks and Caicos Islands. Also set midget triangles, complete set Japan pictorials, diamond shaped airmail from Costa Rica; Canal Zone, Guadaloupe, U. S. revenue, and others, all for 10c with approvals. Edward H. Dillon, Box 113, Mercer, Penna.

**COLLECTIONS.** 5000 \$14.95, 10000, \$49.95, 20000 \$225.85. Return duplicates for cash. Dutton Efker, Anaheim, Calif.

**MINT** Coronations, dominions, complete \$5.00. Money back guarantee. Kennedy, Harriston, Ontario.

**1000 MIXED** U. S., includes commemoratives, precancels, 20c. Lee, Bridgeport, N. Y.

**SET** of world's smallest stamps. Fine packet 100 different containing Ecuador constitution, Alexandretta and Burma (both new countries), giant diamond-shaped stamp, Nicaragua "baseball" commemorative, banana airmail, fish triangle, three-headed Hindu god, for only 5c to approval applicants. Set of world's smallest stamps included with each order. Nels Dolve, Box 406, Minneapolis, Minnesota.

**FREE** Surprise with approvals. Story Service, Exchange Street, Gloucester, Massachusetts.

**UNITED** States approvals! Reasonable to sincere collectors. Box 822, Minneapolis.

**150 FOREIGN.** All different, 10c with approvals. Rosebar Stamp, Box 581A, 1474 Broadway, New York City.

**EXCELLENT** Philatelic surprise packet 25c (approvals). Casimer Nowak, 825 North Racine, Chicago.

**WHOLESALE** Supplements to dealers for 10c postage. Hundreds of bargains. Grossman Stampco, 102 West 42nd, New York.

**50 DIFFERENT.** Fine U. S. including perforation gauge, 10c with approvals. The Stamp Shop, 809 Holland Bldg., St. Louis, Mo.

**CANADA** Catalog, illustrated, 136 pages, \$1.00. Miniature sheet triangles (4 diff.) 10c approvals. Victoria Stamp Co., London 4, Canada.

**EXCHANGE** Stamps, postcards. Universe, "Exchangers," Bry 226 pres. Paris, France. Particulars free.

**175 U. S. commemoratives, etc., 10c.** 500 25c. P. O. Box 457, Newark, N. J.

**FREE—**The Stamp Finder! Send today for big new edition, fully illustrated, enabling you instantly to identify all difficult stamps! Also fine packet strange, fascinating stamps from Bosnia-Herzegovina, Monaco, Patiala, Cyprus, etc., including maps, ships, animals and strange scenes. All free to approval applicants inclosing 3c postage! Garcelon Stamp Company, Box 900, Calais, Maine.

**PHILIPPINES** On approval. Send references and 16c for registration. Afran Stamp, Box 1181, Manila, Philippines.

**FREE—**Packet Central America stamps with request for 52 page list of United States and foreign stamps. Stamps on approval. References necessary. 20 different nineteenth century U. S. 28 cts. New Hussman Stamp Co., 1122 Pine, St. Louis, Mo.

**NEVER** Offered before. 21 French Colonies, pictorials, sets of 5 each (105) for 35c. French, 241 Euclid, Cleveland.

**FREE** Collection, 12 different Jugoslavia for names and addresses of three active stamp collectors if you ask for approvals. Reimers, 600 Flatiron, Fort Worth, Texas.

**FREE!** Hindenburg Zeppelin airmails complete. Approval applicants. Riedell, Greensburg, Penna.

**150 GOOD** Mixed foreign stamps, 5c coin. Stanton, Niantic, Conn.

**MONTHLY** Stamp and coin magazine, six months and 25 foreign stamps, 25c. American Stamp Journal, Cedar Rapids, Iowa.

**100 DIFFERENT** Hungary 7c, approvals. Hazett, 701P Fourth Baycity, Mich.

**30 DIFFERENT** Angola, Cape Verde, Guinea, Portugal, Mozambique, St. Thomas and Prince 5c. Approvals. Depraw, Ocean Park, Calif.



**PENNY Approvals**, that satisfy. Neil Gronberg, Box 5441-P, Philadelphia, Penna.

**AIRMAILS** And commemoratives, 25 different, including Columbians, Panama-Pacific, Edison, Zeppelin, etc., only 5c with exceptionally fine United States and foreign approvals. Marco Stamp Co., Box 888, San Francisco, Calif.

**STAMPS**, A superb selection sent on approval. Quality at low prices. Fred Herzberg, Box 91-P, Elmhurst, Ill.

**HEADQUARTERS** For United States. Send 50 cents and two references for 50 different, including scarce 572 and 573. Approvals included. Price lists on request. R. M. Stamp Co., Box 230P, Port Chester, N. Y.

**PANAMA Triangle** and 50 others free to approval applicants sending 3c postage. Tatham Stampco, Springfield-30, Mass.

**SPLENDID Estonia** collection, 25 different, pictorials, semipostals, scarce imperf. only 5c. Imperial Stamps, G.P.O. 130, New York.

**UNITED States illustrated looseleaf catalog**, \$1.00. Send postage for free United States price list, precancel list. Stanley Gibbons, 38-P Park Row, New York.

**GIANT Diamond-shaped stamp!** Big packet 105 all different including Alexandretta (new country), Congo, Manchukuo, Ecuador constitution, Costa Rica triangle, air-mails, commemoratives; giant diamond-shaped stamp, \$5 United States; set United States telegraphs, cataloging 30c. Packet British colonies including Burma (new country), jubilee and coronations; scarce sets 2 Siberia, cataloging 50c. Illustrated lists. Everything for only 5c to approval applicants! Write to-day! Mystic Stamp Co., Dept. 80, Camden, New York.

**FREE**—From every continent, 155 different, airmails, triangle, commemoratives, pictorials, many U. S. and others, with 1c approvals. Send 5c for postage and handling. Ace Stamps, Colonial Arcade, Cleveland, Ohio.

**FREE!** Two coronation sets. Postage 3c. Roberts, 312F Shearerbldg, Bay City, Mich.

**UNITED States**—45 different, perforation gauge, hinges, bargain pricelist—all for 10c. Seidenberg, Baroda, Mich.

**200 DIFFERENT 10c**. Big 50% approvals. Covert Stamp, 39 State, Rochester, N. Y.

**BRAZIL**, 50 Different 10c with bargain approvals. Davis, Silver Lake, Ind.

**ASK** For our wonderful one cent approvals. Prospect Stamp Co., 225 Broadview, Toronto, Canada.

**WHOLESALE Catalog** for dealers. Illustrated. Postage 5c. Frank Co., 4900 Chalmers, Baltimore, Md.

**STAMP Dealers**, your ad here will bring wonderful returns. Ask me for proof. F. W. Johnson, Manager, Classified Advertising, Popular Mechanics Magazine, 200 E. Ontario St., Chicago.

**APPROVAL Sheets**. One to three cents. Frederick B. Driver, 2009 Finance Bldg., Philadelphia, Penna.

**WEEKLY Stamp magazine**, thirteen weeks, 10c. Stamp Journal, Kalamazoo, Mich.

**AUSTRIA 25 Different 15c**; airmails, pictorials 40. 7c with approvals. Business Builders, Brentwood, Missouri.

#### RARE COINS

**100 INDIAN Cents** \$1.65. Benz, 4928 North Claremont, Chicago, Illinois.

**OLD Money wanted**. Do you know that coin collectors pay up to \$100.00 for certain U. S. cents? And high premiums for all rare coins? We buy all kinds. Send 4c for large coin folder. May mean much profit to you. Numismatic Co., Dept. 20, Fort Worth, Texas.

**BARGAINS!** Large cents 12 dates \$1.00, 20—\$2.00, 30—\$3.50, 40—\$5.50, 50—\$10.00, 55—\$15.00, 60—\$25.00, 64 complete collection \$50.00. 30 dates Indian cents \$1.00, 40—\$2.00. Rare Lincoln cents 1911S, 1912S, 1913S, 1915S, 1922D, 1924S, 1926S, 1931D, 1932, 10c each, 1914S—15c, 1909S—30c, 1914D—\$1.00, 1924D—35c, 1931S—30c. Complete collection 83 coins \$5.50. 10 dates Liberty nickels \$1.00, 20—\$2.50. Trade dollar \$1.15, gold dollar \$2.25, \$3 gold \$6.00, \$2.50—\$4.50, \$5.00—\$8.50, \$10.00—\$16.50, \$20.00—\$32.50. 6 different commemorative half dollars \$5.00, 10—\$10.00. Worthy Coin Corporation, 184 Summer Street, Department 35, Boston, Massachusetts.

**WANTED Uncirculated nickels**, cents. W. Allgeyer, Box 192, Newark, N. J.

**1935-S, 1937-S, 1938D UNCIRCULATED Buffalo nickels** 15c each. Complete coin lists 5c. Eugene Morrison, Reseda, Calif.

**CERTAIN Large cents** worth \$750.00; small cents \$12.00; nickels \$250.00; dimes \$300.00. Send 15c for latest 1939 complete 36 page illustrated buying book. American Coin Co., Box 3507-A, Cleveland, Ohio.

**WANTED**—Uncirculated cents, nickels. W. Allgeyer, Box 192, Newark, N. J.

**100 DIFFERENT Coins** \$2.50, 6 different 10c. Otto Oddehon, Overland Station, St. Louis, Mo.

**25 DIFFERENT Indianhead cents** \$1.00. Henry Writesel, 40 South Mill, Columbus, Ohio.

**55 COINS, Tokens, 25c**. Bishoff, 500 East 8th, Kansas City, Mo.

**GOLD Coins** wanted, 55% premium. A. French, Route 1, Troy, N. Y.

**1939 AMERICAN Coin catalog** gives values all American coins 60c postpaid anywhere. Yuma Coin Exchange, Yuma, Arizona.

**UNITED States trade dollars 1875**, San Francisco uncirculated; five different commemorative halves, uncirculated, \$5.00. S. Koepfel, Merritt Building, Los Angeles, California.

**UNCIRCULATED Lincoln cents**, San Francisco mint, 5 for 25c; 12 for 50c; 2 1916S to 1930S your choice free with each \$1.00 order. Penny boards 50c. Monterey, 749 Beverly Hills, Calif.

**COMMEMORATIVE Half dollars**, Lincoln \$1.19; Cleveland \$1.19; Long Island \$1.19; Texas \$1.19. Selling price list free. Bob Cohen, Box 3507-G, Cleveland, Ohio.

**RARE U. S.**, foreign coins, war medals. Catalogue 10c. Mengelle, Colorado Springs, Colo.

**BRILLIANT 1938-S Uncirculated cent** and list 10c. 3 different 25c. Landon, Box 1733 Wilshire, Station, Los Angeles.

**UNITED States**. Large cent, 2c bronze, 3c nickel and bargain list, 25c. Eleven dates large cents, \$1. George P. Coffin Co., Augusta, Maine.

**GET Profit and pleasure** in collecting old coins. Send 10c for 56-page illustrated coin catalog. You'll be delighted with it. Send for it now. B. Max Mehl, 370 Mehl Bldg., Fort Worth, Texas. Largest rare coin establishment in U. S. Established 38 years.

**BIG Prices** paid for certain wanted coins. 1909 cent \$10.00, some silver dollars \$4000, 1864-1865 Indian head cents \$100.00 each, dimes before 1895, \$600; liberty head nickels before 1914, \$500; encased postage stamps; some large pennies \$2000; half cents, \$275.00; paper money, gold dollars \$1500, foreign coins \$165, some worth \$6000 each. You may have coins for which we pay big premiums. Therefore send 15c today for 1939 big illustrated coin book for certain wanted coins. National Coin Corporation (80), Daytona Beach, Florida.

**FINE Foreign 1700 coin**, 2 notes and catalog 10c. Geo. Best, Cedar Rapids, Iowa.

**COMMEMORATIVE Half dollars**, Lincoln, Stone Mountain, Oregon, Texas, Cleveland, Kentucky, San Diego, Long Island, \$1.50 each. Illustrated catalogue No. 14, 25c. Norman Shultz, Salt Lake, Utah.

**FREE!** Foreign coin, banknote, and large illustrated coin catalogue. Send 4c postage. Coin approvals sent. Tatham Coinco, Springfield-125, Mass.

**55 TO \$500** Each paid for hundreds of old or odd coins. Keep all until posted. Many very valuable. Send 10 cents for illustrated Coin Value Book, 4x6. Guaranteed buying and selling prices. 31 years in business. Coin Exchange, Box 5, Le Roy, N. Y.

#### HOBBIES AND COLLECTIONS

**50c BRINGS** Specimens opalized wood, jasper, agates. Box 808, Tacoma, Washington.

**SHELL Collectors**: Summer museum expedition to the Caribbean will bring back twelve tropical shells for one dollar. The Shell Corner, Box 412, New Canaan, Conn.

**DON'T Throw away match book covers!** Albums information 3c. Adams Sales, State Tower, Dept. 5, Syracuse, N. Y.

**SWAPPERS!** Collectors! Subscribe to "Swapper's Digest" today! Covers the nation! Only 50c year, sample copy 10c. Swapper's Digest, Colorado, Texas.

**UNUSED Book match covers**, 100 all different. \$1.00. Free list. Charles Edelman, 1311C East 84, Cleveland, Ohio.

#### PHOTO FINISHING

**ROLLS Developed** new electric eye way. 8 beautiful, guaranteed, never-fade, dated, deckled edge enlargements 116 or smaller. All for 35c coin each roll. Extra enlargement coupon free. Bonus certificate free. 2-day service guaranteed. Send rolls now to Bostonian Photo Laboratories, 17 Uphams Corner, Boston, Mass.

**PHOTO Mill**. Immediate service! No delay! Roll developed, carefully printed and choice of two beautiful 5x7 double weight professional enlargements, one tinted enlargement, or eight reprints—for 25c coin. Reprints 2c each. The Photo Mill, Box 629-12, Minneapolis, Minnesota.

**MINICAMISTS!** Your 35mm. film fine grain developed, one 3x4 print of each good frame, and your cartridge reloaded with new fresh Eastman Plus-X, only \$1.50. Exceptional quality service! Send rolls or write for free print, mailers, details. Superlabs, 100, Elroy, Wis.

**8 BEAUTIFUL Enlargements** and roll processed 25c. Streamlined service. Perfect Pictures, Toronto, Ontario.

**20 Striking enlargements**, eight snappy prints, 25c coin. Snap Shop, 10, La Crosse, Wisconsin.

**20 REPRINTS 25c**. Films developed two prints each negative 25c. Skrudland, 6444-8 Diversey, Chicago.

**MAIL Your rolls to film center** of the world. Any 6 or 8 exposure roll developed and printed 25c coin. DeLuxe enlargement coupon free! Photo Finishing Shop, Est. 23 yrs. 411-GG Genesee Valley Trust Bldg., Rochester, N. Y. "The Camera City."

**FREE Album** and negative file and 2 enlargements coupons with each roll developed, 8 guaranteed prints 25c. Membrane Studios, General P.O. Box 666, Dept. "K," New York.

**MINIATURE Films** ultra-finegrain developed; highest quality enlarging. Largest laboratories devoted exclusively to miniature photography. Write for free sample mailing-bag and valuable information booklet PM-1. Miniature Photo Laboratories, 429 Seventh Avenue, New York.

**IMMEDIATE Service!** Better pictures. Sixteen guaranteed prints from roll, 25c. One colored or two plain enlargements and 8 guaranteed prints, 25c coin. Special! Coupon for 8x10 enlargement given with every 25c worth Kodak finishing. Any 36 exposure, 35 mm. film fine-grain developed and each good negative enlarged to 3x4 prints for only \$1.00. 3x4 reprints, 4c each. One day service. Details and mailers free on request. American Studios, Box B, LaCrosse, Wis.

**JOIN The thousands** who are changing to Willard's Brilliantone prints—the style leaders of 1939. Roll developed, two prints each negative, only 25c. Valuable enlargement coupon. Willard's, Box 3535-A, Cleveland, Ohio.

**ROLLS Developed**—16 prints or reprints 25c. Fine grain. Photographers, 207 E. Chicago St., Valparaiso, Indiana.

**ROLL Developed and printed 20c**. Univex 15c, 2 for 25c. Finer Foto Service, Chillocothe, Illinois.

**CAMERA Roll** developed and 2 glossy prints of each, 25c. 35mm. fine grain and 36 3 1/4 x 1 1/2 glossy enlargements \$1.25. Immediate service. Satisfaction guaranteed. Photolab, Box 5544, Chicago, Dept. D.

**DO You want quality prints?** Then send us your films. Kodak rolls developed and printed 25c. Cain's, Dept. M, Box 883, Station H, Los Angeles, Calif.

**MILLIONS** Now know "Hollytints means better prints." Trial roll printed including two beautiful enlargements—25c. Fascinating premium coupons. Hollytints, P-1350, Hollywood, California.

**ROLL Developed**, eight deckled velp prints 25c. Lescault Studio, Rockland, Mass.

**CANADIANS**, Roll developed, 8 good prints 25c. 8x10 or 7x11 enlargements, 4 for \$1. Photo Finish, B. 427, Vancouver, Canada.

**ROLL Developed** and 16 prints or 8 prints and two 5x7 enlargements 25c. Reprints 20 for 25c.; 50 for 50c. Queen City Service, Dept. C, Box 7, Niagara Square Station, Buffalo, N. Y.



**IDEAL Photos.** Professional deckle-edge prints and free enlargement each roll, only 25c. Illustrated price-list free. Write today. Ideal Photos, Box 2255, Paterson, N. J.

**ONE Day service.** 8 dated and guaranteed Lifetime prints and 2 doubleweight enlargements, 25c. Quality that pleases the most exacting kodaker. Supertex Photo Service, Dept. 40, Box 1166, Dallas, Texas.

**35MM. FILM** Finegrain developed, enlarged to 2 3/4 x 4 1/4. 36 exposures, \$1.00. Economy Photo, A2, Greensburg, Penna.

**A SURPRISE** Is waiting for you. Send roll and 25c to Adamson, 41, Yale, Okla.

**THREE Prints** each good negative in roll 25c. Reprints 3c. Fred D. Eastman, Bode, Iowa.

**SPECIALIZING 35mm.** Rolls fine-grain developed, 36 enlargements 3 1/2 x 5, \$1.00. Cartridge reloaded 35c. Photoshop, Linton, Indiana.

**PHOTO Stamps** 1c each. Reproduced from any size photo of yourself, sweetheart, children, pets, hunting, fishing, sport pictures. Wonderfully clear, gummed, perforated, glossy, 100 for \$1.00. Satisfaction guaranteed. American Photo Stamps, Box 507A, Elmira, N. Y.

**FOR Exacting amateurs.** Roll developed 8 superior prints, 5x7 enlargement 25c. Thorp Photo, Thorp, Wisconsin.

**ROLLS Developed,** 8 prints, two snappy chromium finish enlargements 25c. Prompt 6 hour service. The Picture Folks, Lincoln, Nebr.

**ROLL Developed,** two prints each, 25c; reprints, 2c each; 100 or more 1c. Summers' Studio, Unionville, Mo.

**ROLL Beautifully finished** 25c. Photocraft Laboratories, 436 East 58, New York.

**ROLLS Developed;** 16 prints, two 5x7, 25c. 25 reprints 25c. M-B-M Photo Company, B-3860 Sixteenth, Chicago.

**ROLLS Developed and printed** plus two hand colored enlargements 25c. 25 reprints 25c. Trial, Colorgraph, River Grove, Illinois.

**ROLLS Developed—24 prints** or reprints, 25c. Fuchs', St. Cloud, Minnesota.

**FREE! 2 Gravure-Tone enlargements.** Roll developed, 8 deckle edge prints 25c. Free mailing bag! Crosswell, A-844 Rush, Chicago.

**TECHNIFINISH—The new fast and economical** developing and enlarging service specializing in 35mm. film. 36 exposure rolls fine grain developed and enlarged to 2 3/4" x 3 3/4".—36 gloss finish enlargements, 75c. This service plus cartridge refill, \$1.00. 18 exposure rolls, 50c for 18 gloss finish enlargements—70c for enlargements plus refill. Highest quality workmanship—fastest service guaranteed. Write for free postpaid mailing bags. Technifinish Laboratory, 110 Lexington, Rochester, N. Y.

**FOR The discriminating amateur,** roll developed and carefully printed 25c, reprints 3c. Superior workmanship, same day service. Paramount Co., 327 E. 92nd St., New York.

**PHOTO Mill. Immediate service! No delay!** Roll developed, carefully printed and choice of two beautiful 5x7 double weight professional enlargements, one tinted enlargement, or eight reprints—for 25c coin. Reprints 2c each. The Photo Mill, Box 629-12, Minneapolis, Minnesota.

**ROLL Developed and 8 beautiful Velox glossy prints** 25c coin or stamps. Reprints 3c each. Fotoprint Service, Roanoke, Va.

**EXPERT Photo finishing—One day service—8 genuine expensive Velox prints.** Two double weight professional enlargements 25c. Expert Studios, LaCrosse, Wis.

**8 PLEASING Velox prints,** 2 enlargements 25c coin. Please U Film Service, LaCrosse, Wis.

**ROLL Finished—Two enlargements,** 25c. Snappy Photo, B56 Colvin, Syracuse, N. Y.

**\$25 In Weekly prizes** for best amateur prints from rolls developed, 25c. Free enlargement coupon, photoflat, album. Largest studio in states. Streamline, Box 5699-K1, Cleveland, Ohio.

**MINIATURE Film,** fine grain development, 2 1/2 x 3 1/2 enlargements. 35mm, \$1.00, bantam 25c. Film Capital Service, Box 504, Rochester, N. Y.

**GET Clear, brilliant pictures** the modern Artcraft way. Roll developed, 2 prints each negative only 25c. Valuable enlargement coupon. Artcraft, Box 1822-A, Washington, D. C.

**TWENTY Reprints 25c.** Roll developed and two prints each negative, 25c. Send for free mailing envelopes, price list. Star Photos, J-109 N. Dearborn, Chicago.

**20 REPRINTS 25c.** 100, \$1.00. Rolls developed, 16 sparkling Lifetone prints, 2 studio enlargements—25c. Lifetone Studios, B-8, Des Moines, Iowa.

**IDEAL Photos.** Professional deckle-edge prints and free enlargement with each roll for only 25c. Ideal Photos, Box 2255, Paterson, N. J.

**THE Modern Finishers, St. Paul, Minnesota,** are the outstanding finishers in America for low prices with quality pictures. Our modern methods give quick service and bright guaranteed neverfade pictures. Roll developed, 16 prints, 25c coin; 16 reprints, 25c. Enlargement coupons. Join our thousands of satisfied customers by sending us your next roll or reprint order. Modern Finishers, Box 3537, St. Paul, Minn.

**20 REPRINTS 25c.** 100 Reprints, \$1.00. Films developed, 2 prints each negative, 25c. Mercury Studios, Box 822-B, Chicago.

**PROMPT Service!** Rolls developed, two Velox prints each negative 25c. Hench Studios, Harrisburg, Penna.

**A PROFESSIONAL 4x6 enlargement** of each exposure. Eight exposure rolls, Coin 25c. Wells, Box 5556M, Cleveland.

**ROLL Developed,** 8 brilliant fadeproof Velox prints and two professional enlargements 25c. Overnight service. Young Photo Service, 405-C, Albany, N. Y.

**LIFE Photo finishing lasts a life time.** Roll developed, 8 prints, 2 enlargements 25c. Reprints 1 1/2c. Life Photos, Hutchinson, Kansas.

**TWO Glossy enlargements,** 1 colored with roll 25c. Arbor Service, 10, Joliet, Ill.

**ROLL Developed,** 16 guaranteed prints, two coupons on enlargements 25c. Smart Photo, Winona, Minnesota.

**CANDID Special.** 35mm. rolls enlarged to 3 1/4 x 4 1/2. \$1.00. 18mm. rolls 60c. 3 1/4 x 4 1/2 reprints 3c. Brown Photo Company, 1910-61 Emerson, Minneapolis, Minn.

**16 PRINTS With roll 25c.** 16 reprints 25c. Rex Photo, Ogden, Utah.

**BEAUTITONE Enlargement,** dime and negative. Giant Snapshots, Inc., Green Bay, Wis.

**GUARANTEED.** Roll developed, 16 prints 25c. 20 prints 25c. Quality Photo, Hutchinson, Kansas.

**QUICK Service—Rolls developed,** 8 guaranteed prints; 2 enlargements; 25c coin. OK Photo Service, Ottawa, Kansas.

**ROLLS Developed and printed 10c.** Trial, Quality Finishers, Maywood, Ill.

**FINER Finishing.** Rolls developed and printed, with one colored enlargement, or two professional enlargements. All for 25c (coin). Genuine, nationally known, Moentone superior quality. Moen Photo Service, La Crosse, Wis.

#### CAMERAS, PHOTO SUPPLIES

**BASS Inventory clearance.** Profit by these unusual bargains. 35 mm. Candid Midget, F:4.5 lens, \$12.50. Used Foth Derby, F:3.5, \$15.75. 2 1/4 x 3 1/4 Agfa Film Pack and plate, with F:6.3 lens, auto shutter, film adapter and holder, \$11.95. Used Argus, F:4.5 lens, \$7.75. New Candid Midget, Xenon F:2 lens, Rapid Compur and case, \$80.00 value, at \$49.75. Hundreds of other bargains in the great Bass Bargaingram and special bulletins. Your money back is unsatisfactory after 14 days trial. Write Bass Camera Company, Dept. AG, 179 W. Madison St., Chicago, Illinois.

**CAMERAS And supplies.** Free illustrated catalog listing everything photographic—still and movie cameras, films, lenses—at tremendous savings. Hundreds of bargains, new and used. All guaranteed. We take your old camera or equipment in trade. Write now for your free copy of our newest money-saving bargain book—just out! Limited edition. Hurry! Central Camera Co., (Photographic Headquarters Since 1899), 230 South Wabash, Dept. 5-K, Chicago.

**"PORTRAITS That please"** now made easy! Follow modern make-up methods. Get professional results without retouching. Complete instruction booklet "Making Up for the Camera" with Miner's Foto-Matic Make-up Kit—\$2.00 postpaid or C.O.D. plus charges. Miner's 14-C East 12th St., New York.

**SPEED-TONE Photographs:** Trial size 25c. Albert McGoldrick, Mansfield, Mass.

**MAKE Money in photography.** Learn quickly at home. Spare or full time. Easy plan. Previous experience unnecessary. Common school education sufficient. Interesting booklet and requirements free. American School of Photography, 3601 Michigan Ave., Dept. 3431, Chicago.

**CANDID Camera:** Takes time and snapshots; 16 pictures on one film; eye level finder; \$2.00 postpaid. Cash or money order. Douglass Bain, Saco, Maine.

**FOR The why? and how? of better photography.** Write Cam-Facts, 1242 10th Ave., San Francisco, California.

**EASTMAN Super-X, Agfa Supreme,** du Pont Superior 35mm. film, 25' roll, \$1.00 postpaid. Economy Photo, A1, Greensburg, Penna.

**ENLARGER \$1.59.** Enlarges eight times size of small negatives. Fully guaranteed. Paramount Sales Company, 89 Dudley Street, Boston, Mass.

**TREASURE Finders? Read Goldak advertisement** on page 137A.

**CAMERAS, Enlargers,** on time. See advertisement under Motion Pictures. Mogull's.

**CAMERAS Films,** paper 25% to 35% discount. Paramount Photo Division, 327 East 92nd St., New York.

**CAMERAS—Shutters repaired.** Leather bellows installed in folding and view cameras. Bellows made to order. United Camera, A-1515 Belmont, Chicago.

**HAVE You a camera?** Send ten cents for recent number of our big magazine, showing how to make better pictures and earn money. American Photography, 116 Camera House, Boston, 17, Mass.

**NO More wasted film or unnecessary expense.** Take pictures you can be proud of. Sell to magazines and newspapers. Make good money wherever you live. Easy, low-cost home study course shows you how! Free catalog. Universal Photographers, Dept. 104, 10 W. 33 St., New York City.

**PHOTO Mill. Immediate service! No delay!** Roll developed, carefully printed and choice of two beautiful 5x7 double weight professional enlargements, one tinted enlargement, or eight reprints—for 25c coin. Reprints 2c each. The Photo Mill, Box 629-31, Minneapolis, Minn.

**IF You go to Mexico ask first for prices and pamphlets** of finest German quality miniature and other cameras, binoculars, movie cameras and projectors. Foto Mantel Sucr. R. Rudiger V. Carranza 11. P. O. Box 1459, Mexico City-105. Branch store: Tijuana, Baja California. Branch store: Tijuana, Lower California. Hotel Comercial. Branch store: Monterrey, N. L., Morelos Oriente No. 557.

**MAKE Money with your camera.** New book tells how. 46 pages, 50c. Popular Mechanics Press, Room (C38), 200 E. Ontario St., Chicago.

#### MOTION PICTURES AND SOUND EQUIPMENT

**RENT Movies** for your party, school entertainment, church social. Historical, religious, and dramatic features; comedies and cartoons, 16mm. silent and sound. Reasonable rentals. Submit references with order. Church & School Films, Box 524, Cincinnati.

**8-16MM. FILMS.** All subjects. Sold, exchanged, complete rental library, silent and sound. Films rented everywhere. Bargains in equipment. Trades accepted. Free illustrated catalogue (with sample film 10c). Garden Exchange, 317-A West 50th, New York.

**RELIGIOUS Pictures** for rent or sale. 16mm. and 35mm. sound or silent. All-Sacred Film Co., 31 Melrose St., Boston, Mass.

**TITLE Cards** professionally designed. Information. Hayhow, Alger Ave., Taunton, Mass.

**8 AND 16mm. Film.** Weston speeds 8 to 50. \$1.00 a roll and up. Processing included. Write for list. Texas Motion Picture Film, P.O. Box 2181, San Antonio, Texas.

**MOVIE Film.** Develop yourself. Univex, Eastman, etc. Chemical samples 15c. Raw film wholesale. Lake Camera Exchange, Gary, Ind.

**CHILD Health films,** for schools, health departments and homes. 16mm. silent and sound. Dr. David B. Hill, Salem, Oregon.

**35MM. FEATURES, Shorts.** Lists 3c. O'Donnell, 340 Woodside, Newark, N. J.



16MM. FILMS, List and samples 10c. Joseph Mandela, 114 Krakow Street, Elizabeth, New Jersey.

8MM., 16MM. Specials. Camera Shoppe, 704 Mt. Hope, Cincinnati, Ohio.

TALKIES, 35mm. Rentals \$1.00 per week with projector \$22.50. Lists 5c. Motion Picture Exhibitors, 626 Film Bldg., Cleveland, Ohio.

ACCESSORIES, Cameras, projectors (discounts). Exchange, P.O. Box 111, South River, N. J.

CRYSTAL Beaded screen—36x48—Unmounted \$4.80, mounted \$7.50. Improved Products Company, Roslyn Heights, N. Y.

16MM. 100 FEET, Outdoor \$1.75. Panchromatic \$3.50. Superior panchromatic \$4.50. Processed, postage paid. Criterion Films, P.O. Box 1233, Paterson, N. J.

16MM. VELOTEX. Perfect outdoor film. 100 ft. rolls \$1.95 including free processing. Sample free. Velotex Laboratories, 600-B, Gary, Indiana.

GENERA Films for all movie cameras. 100 feet for Univex, \$1.00; double 8mm, \$1.75; 16mm, \$1.35. Sample for stamp. Processing powders, outfits. Fromaders, Davenport, Iowa.

8MM. FILM! Spooled for Univex. "Double 8" cameras. Quality! Sensational prices! Processing included! Write! Chromofilms, Springfield, Rutherford, N. J.

PROJECTOR Films, sample 10c; lists free. Goodwill Company, Jackson, Tenn.

GUARANTEED 8MM. 24-hour reversal processing. Double 8mm, 45c. Single, 25c. Univex 15c. Eso-S, 3945 Central, Kansas City, Missouri.

1000 FEET 35MM. 90c. Other bargains. Calderara, 5119 South St. Louis, Chicago.

HOME Movies 8mm.-16mm. Cartoons, comedies, westerns, travelogs. Free list. Crown Film Corp., (W)42 Melrose St., Boston, Mass.

DIRECTORY Of 1500 free 16mm. films, classified. Price 60c. Box 409, Ashtabula, Ohio.

WHY Wait? Get your camera, movie outfit, accessories now. No down payment. Small monthly installments. Bell-Howell, Kodak, Victor, Ampro, Leica, Rolleicord, Speed Graphic, Graflex—all makes. New, used. Trades. Sound projectors from \$125. Rent home movies! 8-16 mm., silent, sound, low rates. Write for bargains. Mogul's, 64 West 48th, New York.

8-MM-16 PRICELISTS Free. Illustrated catalog 3c. Taylor, Bx-234, Corning, N. Y.

BARGAINS 8mm.-16mm. Movie supplies. Literature. Baerco, Palisades Park, N. J., Box 46.

MOVIE Title sets—500 embossed letters, 14 silhouettes, 10 backgrounds, masks. Price \$1.00. Kramark, Inc., 26 W. 19th St., New York City.

TALKIE 35MM. Films rented, sold, silent films, machines. Simpson, 1275 So. Broadway, Dayton, Ohio.

35MM. FILMS. List 5c. Bedner, 5300 S. Talman, Chicago.

"THE World's greatest of all Passion Plays," 16mm. and 35mm. 8-reels. Sound with dialogue or silent. Rent or purchase. Superior than Oberammergau stage play. Write Hemenway Film Co., 37 Church Street, Boston, Mass.

FREE Lists. 16mm., 8mm. films, cameras, projectors, accessories. Home Movies, Box 216, Easton, Pennsylvania.

15% TO 25% Discount on still or movie cameras. Free circular. Paramount Co., 327 E. 92nd St., New York City.

COMPLETE 16mm. and 8mm. film rental library. Attractions: "White Hell of Pitts Palau," "Lost World," "Pony Express." Free catalog. National Cinema, 3 West 29th, New York.

BASS Wants to mail you without charge our new 52-page Cine Bargaining No. 234—sound, silent, 8 mm., 16 mm., 35 mm. equipment, of the quality we can sell on our money back guarantee. Write for this valuable book at once. Full description of the RCA 16 mm. sound on film camera. Newsreel model is only \$250.00, and Bass is exclusive distributor. Dept A, Bass Camera Company, 179 West Madison Street, Chicago, Illinois.

LEARN Motion picture theatre management, advertising, projection. Free catalog. Give age. Theatre Institute, Elmira, N. Y.

BARGAINS! 8mm., 16mm., free literature. Elder, B-739 Boylston, Boston, Mass.

## RADIOS, SUPPLIES, INSTRUCTION

CRYSTAL, Selective set plans 15c. Trent, Box 291, New Brunswick, N. J.

RADIO Kits—\$2.70. A practical 1-tube receiver that really works. Two-tube model—\$3.00. Three-tube model—\$3.75. All the parts but headphone, battery and tubes. Eighteen other models up to 14-tube de luxe communications set. Write for free catalog. Dept. PM-5, Meissner Manufacturing Co., Mt. Carmel, Illinois.

PLANS 18 Tested crystal sets, with "Radiobuilder"—25c year. Laboratories, 7700-C East 14th, Oakland, California.

RADIOMENS' Specials—RCA tubes 50-10-10% discount list. Any quantity. Free specials bulletin. Radilectric, Hudson, Wis.

RADIOS, \$6.50 Up. Buy direct. Factory prices. All types. Free catalog. A. R. Co., 3855 N. Hamilton Ave., Chicago, Ill.

RADIO Engineering, broadcasting, aviation and police radio, servicing, marine and Morse telegraphy taught thoroughly. All expenses low. Catalog free. Dodge's Institute, Ames St., Valparaiso, Ind.

RADIOS—\$9.95 Up. All kinds. Save 50%. Factory surplus. Agents wanted. Catalog—free. 30 day's trial. Write Marco-F, Kansas City, Mo.

SEND For free giant money saving radio and phonograph record catalogue. United Radio Company, 1000-M, Newark, N. J.

DON'T Buy a radio. Get our catalog first listing over 400 nationally known standard make sets. Also 700 electric specialties for the home. Big special, 10 inch phonograph dance records, 12 for \$1. Write today. Modell's, 56 Cortlandt St., New York.

## MUSIC AND MUSICAL INSTRUMENTS

"SINGING Made easy and the mastery of the voice" teaches tone placement, perfection, extended range. Immediate results! Popularly priced. Free prospectus! Whitney Vocal Method, 245 Wolf's Lane, Pelham, N. Y.

SONGS Or lyrics wanted for "Musical Night Court" radio show and publication. Write to Judge Spencer, 145 West 45th, New York, Studio PM. Enclose stamped, self-addressed envelope for full particulars. Do not send songs, lyrics. Print name.

SONG Poem writers wanted—Our guaranteed plan has aided many songwriters. Burl Bogg's song won a nation wide contest. Other new writers have had their songs broadcast. We may be able to help you. Send poems or write for free booklet today. Indiana Song Bureau, Dept. 53, Salem, Indiana.

SONGPOEMS, Melodies. Outstanding offer. Hibbeler, C-5, 2157 N. Avers, Chicago.

SONGWRITERS—Verse or music. Brilliant opportunity. Write immediately. VanBuren, B-106, Rockhaven, Kentucky.

LATE Popular phonograph records, bargain prices. Details write Malenius, 2443-K Belleplaine, Chicago.

PLAY Piano by ear \$1.00. Shorthand Music Co., Springfield, Illinois.

SONGS, Poems, bought, composed, published, royalty contract, free information. Metro-Melody Publishers, 532 Geary, San Francisco.

"SONG Writing as a profession." Send for this interesting circular. The Jewel Guild, 203-B South Dearborn, Chicago.

SONGS Wanted, royalty plan. Melody World Music Publishers, Garfield Bldg., San Francisco.

SONG Writers. Send for publishing agreement. McKinley Music Publishers, 1501 E. 55th St., Chicago.

SONGS—Arranged, revised by arranger "Cherry Blossom Lane," "Gypsy Tea-room," others. Send for details. Harold Potter, 1619 Broadway (P), New York.

SONGWRITERS—Send poems—Profitable plans mailed free. Variety Service, Salem, Indiana.

PIANO Jazz guaranteed by mail in 20 lessons. Write today for free sample lesson. Erskine Studio, 810B East 14th St., Oakland, Calif.

SIMPLIFIED Swing courses! Accordion, saxophone, clarinet, trumpet. Write Swingmaster, 1259 Bender, East Cleveland, Ohio.

DUO-FLEX Reeds for clarinets, and saxophones eliminate your reed troubles. Write for circular. Duo-Flex Reeds, 1204 1st Ave., Evansville, Ind.

LEARN Swing piano! Postal brings free folder. Christensen, 751 Kimball Hall, Chicago.

SONGWRITERS: Send us your poems, wonderful proposition. Keith-Downing Publications, Clearwater, Florida.

ORIGINAL Poems, songs wanted for publication, radio. Westmore Music Corporation, Dept. 33H, Portland, Ore.

MUSIC Composed to words. Rhyming pamphlet on request. Phonograph recording of completed songs. Send poem for consideration. Keenan's Studios, Dept. PM, Box 2140, Bridgeport, Conn.

SONGWRITERS—Get free the inside facts on successful songwriting by famous Broadway composer. Write today. Songwriters Institute, 1234-C Broadway, New York.

SONG Poems wanted to be set to music. Free examination. Send poems to McNeill, Bachelor of Music, 4153-PM S. Van Ness, Los Angeles, Calif.

PIANO By ear. Free booklet. Day-V-Way, Woolworth Building, Dearborn, Michigan.

MUSIC Composed to words. Wonderful proposition. Bauer Bros., Oshkosh, Wis.

WRITE Songs. Big money and reputation. Write for information. J. Gordon Pub. Co., 201 N. Hoyne Ave., Chicago.

WANTED! Lyrics, melodies for songs. We arrange, publish, sell. Superior Song Studios, Passaic, N. J.

SONGWRITERS: Send your poem today for immediate consideration. Richard Brothers, 24 Woods Building, Chicago.

PIANO, Self Instruction. Play within an hour. \$1.00. Popular Mechanics, 200 E. Ontario St., Chicago.

## BUSINESS OPPORTUNITIES

NEW Big-profit business opportunity! Sensational new discovery actually electroplates—gold, silver, nickel, etc.—with electric brush, easy as painting. Does same beautiful, permanent plating as big tank outfits—easier, quicker, cheaper. Amazingly low priced. Portable—do work anywhere—make big money. Write for big money-making plan and free sample that proves all claims. Warner Electric, Dept. K-11, 360 N. Michigan, Chicago, Ill.

M. M. earned \$267, three weeks, raising mushrooms in cellar! Exceptional, but your cellar, shed perhaps suitable. We buy crops. Book free. United, 3848 Lincoln Ave., Dept. 67, Chicago.

BIG Profits, selling by mail, home, spare, full time. Samples, instructions, free. Mailway Co., 325 Walnut, Springfield, Missouri.

OPPORTUNITY Seekers. Send for free details of the greatest money making information. National Exchange System, 1391 E. 30th Street, Cleveland, Ohio. Member Gold Bond Makers of America.

NEW, Patent method makes color-glazed concrete pottery, tiles, walls. Use only sand, cement, cheap materials. Booklet, colorplate, details 10c. National Potteries, 13 West 26th, Minneapolis, Minnesota.

INVENTORS—Time counts in applying for patents. Don't risk delay in protecting your invention. Send sketch or model for instructions or write for free book. "Patent Guide for the Inventor" and "Record of Invention" form. No charge on how to proceed. Prompt, careful, efficient service. Clarence A. O'Brien and Hyman Berman, Registered Patent Attorneys, 58-S Adams Building, Washington, D. C.

OIL Coloring photographs a fascinating hobby or profitable business. Learn at home by easy simplified method. Previous experience unnecessary. Common school education sufficient. Send for free information and requirements. National Art School, 3601 Michigan Avenue, Dept. 3435, Chicago, Illinois.

"RUBBER Molds." Make them yourself. Formulas, instructions 25c. Ideal Service, 179-R5, Park Ridge, Ill.

START Your own business making yeast. Less \$5 needed. Very profitable. Formula \$2. Papa, 120 Providence, West Warwick, Rhode Island.

CALLING All ambitious persons. Send for free opportunity listings. George Hans, 428 South Halsted Street, Chicago, Illinois.



**LEARN** Radio announcing! Easy work. Big pay. Auditionlet 25c. KFRO, Longview, Texas.

**YOU'LL** Like resilvering mirrors, auto-parts, reflectors, making chipped glass signs. Write. Sprinkle, Plater, 127, Marion, Indiana.

**FRIED** Ice cream, sweeping the country, big profits, brand new, complete instructions, send 50c full details. Kamac, 37 E. First, Dayton, Ohio.

**STEADY** Money in showcards, signs, window lettering. Easy. Amazing details free. Write Nelson Company, E-2101 Manhattan Building, Chicago.

**CASH** Daily with a route of nut and candy vendors. Small investment. Eamco, 350 Mulberry, Newark, N. J.

**FORMULAS** — Fast selling products. Guaranteed. Laboratory tested. Lowest prices. Catalog free. Kemico, 55K, Park Ridge, Ill.

**POPCORN** Machines, carmelcrisp, crispettes, cheese coat, potato chips. Long Eakins, 2035-E High St., Springfield, Ohio.

**MAKE** \$5-\$15 Daily with beautiful feather pictures. Free details. Samples 12c stamps. Marquez-PBH, Apartado 1176, Mexico City.

**"RESILVER** Mirrors at home." Big profits. Little outlay. Also emboss, grind—foil, gold leaf, frost, chip and make imitation stained glass. Instruction course 50c. Ideal Service, M-5, Park Ridge, Ill.

**LIQUID** Marble—anyone can make! Colorful, glazed! Moulded, brushed, sprayed. Rubberlastic moulds. Composition flooring. Big money in these! Particulars free. Marbleizing Service, Edwardsville, Ill.

**BIG** Profits selling new social security plates, particulars free; sample with number 25c; stamping outfits. Station L, Box 34, A. Reiman, New York City.

**EARN** Steady income with "route" of peanut, gum and amusement machines. Small capital required. Robbins Co., 1141P DeKalb Avenue, Brooklyn, N. Y.

**BELTS,** Suspenders, make 'em and make money. Big summer season ahead. We supply materials. Sample belt 25c. Artin Leather, 400 Joseph Ave., Rochester, N. Y.

**HANDY** Men—Earn money home operating Community "Fix-It" Shop. Stafford, Makanda, Illinois.

**"MAIL** Order Secrets" booklet 25c. Free literature. Cyr, Willmar, Minn.

**AMAZING** Profits making "Krispuffs." Sell themselves. No machinery. Cook in five seconds. Get free sample. Be convinced. Vita-Fresh Products, 1543-P East 57th St., Chicago.

**SEWING** Machines—Refinished, reconditioned. Motors, parts. H. N. FitzGerald, 54 Oberlin St., Maplewood, N. J.

**SWAP** Your plans, formulas for new ones. We have the bargains. Stamp appreciated. Mail Exchange, 1311 Univ. Sta., Des Moines, Iowa.

**MONEY** In butterflies, moths. See Sinclair Display Advertisement on page 14A.

**MAKE** Artificial marble, glazed tiles, uncanny. Tabletops, plaques, floors, hones, novelties. Hard, fireproof, inexpensive, cement secrets. Brilliant tile and liquid rubber samples 3c. John A. Payn, 945 Grande Vista Avenue, Los Angeles, Calif.

**BE** Independent! Secrets of riches fascinatingly revealed. Details. Todd's Service, 53 McGuffey, Youngstown, Ohio.

**GROCHOWSKI & Zinder** Sales Promotion covers state of Michigan. Your products distributed on commission. 2617 Harper, Detroit, Michigan.

**SOAP** Making. Learn at home. No machinery needed. Stamp. Posera, C-4545 Bartlett, Milwaukee, Wisconsin.

**LAWN** Mower grinding pays. Factory process grinder cheaply, easily built. Mowerservice, 222 Fourth, Janesville, Wis.

**CEMENT** That sets in 15 minutes. Makes highest glossy sheets, any size, don't warp. Liquid rubber one application makes mold. Dime brings sample. Marblelike Co., Crayling, Mich.

**ORIGINAL.** Exclusive service assures you highly profitable business without capital. Business Service, Olympia Bldg., New Bedford, Mass.

**WE** Show you how to raise capital for your business. Write, Enterprise Bureau, Syracuse, N. Y.

**WHOLESALE** Supply Guide—1,000,000 articles. 10c. Labey, Colorado Springs, Colo.

**AMAZING** New liquid plastic opens up an entirely new and very profitable field to the home manufacturer. Make costume jewelry, chessmen, advertising novelties, etc. right in your own home. No experience or expensive equipment needed. Simply pour new liquid plastic in rubber, plaster or metal mold. It sets in about 20 minutes at low temperature, transforming into a beautiful solid plastic. Tough, resilient, non-inflammable. You can do a big production business. But, don't delay. Get started immediately. "Complete plastic kit, everything you need to get started, only \$1.00 postpaid!" Mail your order today! Stewart's Studio, Dept. P5, 2927 Wilcox, Chicago.

**RECAST** Old batteries into new. Latest achievements. Battery Laboratories, St. Paul, Minn.

**LAWYERS** Corporation laws mailed free. Charters, Arizona, \$46; Delaware, \$29; New York, \$48; plus tax fees. Lawyers Corporation Service, 154 Nassau, N. Y.

**PROFITABLE** Home business. Legitimate. No canvassing. Maywood Publishers, P-1107 Broadway, New York.

**75** Year Old firm with distribution facilities metropolitan area wants to handle additional product or commodity. Might consider manufacturing or assembling. Box 53, Room 211, 140 Nassau St., New York.

**1,642,222** CIRCULATION (Guaranteed) one inch advertisement \$15.40. Gets results. Diener-Dorskind, 1474 A Broadway, New York.

**CASH** Instead of promises! After years of experimenting, my plan "clicked"! No capital, canvassing, manufacturing, addressing, circularizing. Mainly homework. Steady income. Don't experiment, losing time, money. Complete operating instructions, 25c. Stamforde, 3762-B Broadway, New York.

**SELL** By mail! Inspiring, constructive literature. Jay, 6054-P Kenwood, Chicago.

**THIS** Book can make you independent. Price \$1.00. Marigold Sale, 7153 Devon St., Philadelphia, Penna.

**20** PAGE Booklet mold making, plaster casting. X. L. rubber. Particulars free. Plastic Arts, 711 Neely, Muncie, Indiana.

**BIG** Money—Making raised wood letter and chromium plated signs. Complete instructions \$1.00. Foreign \$1.15. Photos, information ten cents. Modern Signs, Box 1109, Phoenix, Arizona.

**BE** Your own boss. Customers everywhere. Amazing profits. Read our ad page 142A. Rogers Manufacturing Company.

**TREASURE** Finders? Read Goldak advertisement on page 137A.

**YOUR** Own business! Selling by mail. Details free. Maples, 3418 South Marshfield, Chicago, Illinois.

**BARGAIN** Buyer's Guide to direct supply source. Lowest prices possible. \$1.00 postpaid. Hicks, Box 8, Brooklyn, N. Y.

**START** Own mailorder business! New magazine tells how. Sample copy 10c. Mailograph, AB-651 South State, Chicago.

**CAPITAL**—How and where obtained for personal and business needs. Capital Service, Arlington, Va.

**MONEY** Daily by mail. Plan and big mail 10c. Satisfaction guaranteed. Thomasson's, Minneapolis, Minn.

**OPPORTUNITIES** Plenty! Moneymakers that "click"! Latest offers free! Planagram, P-1079 Madison St., Brooklyn, N. Y.

**15c** WORTH Of materials moulds \$1.00 instant seller welcomed every Christian home. You cast own rubber moulds. Details free. Finart, 189-199 Van Rensselaer St., Buffalo, N. Y.

**24** MONEymaking Formulas 25c. Logan Formula Bureau, 101 Market, Logansport, Ind.

**HANDY.** Salesmen America's fastest selling, new patented necessity. Longlife, 11 East 17th, New York City.

**SUCCEED** With your products. Make-sell. Formulas. Accurate analyses. Catalog free. B. Thaxly Company, Washington, D. C.

**PLASTIC** Art for profit. Stamp brings catalog. Colonial Art, Derry, N. H.

**INVENTORS**—We successfully sell inventions, patented and unpatented. Write for proof, and tell us what you have for sale. Chartered Institute of American Inventors, Dept. 4-C, Washington, D. C.

**MONEY** Making plans you won't regret. Satisfaction guaranteed. Hamilton, 1353 Hastings St., Chicago, Ill.

**I WANT** To send you proof of the wonderful pulling power of Popular Mechanics Magazine's classified pages. What's your proposition? Write me today. F. W. Johnson, Manager Classified Advertising, 200 E. Ontario St., Chicago, Ill.

**BIG** Money easily made in home or office. Business of your own; booklet describing 107 money making plans free. Chilton, Box 1105, Oakland, Calif.

**"LEGITIMATE** Home business." New! Profitable! Your labels. You control repeat orders! Amazing system! No canvassing! Samples, dime. Particulars free. Gardena System, 128PB, Station "S," Los Angeles.

**AFTERNOONS** Free for outdoors, shows, \$340 month home. Unique plans. No canvassing. Prepare for surprise. Folio-F, Station D, Los Angeles.

**START** Your own business. Make large profits. Sell new and used auction or bankrupt bargains in clothing and general merchandise. Experience unnecessary. Free wholesale catalog. Superior Jobbing, 1250-V Jefferson, Chicago.

**COLOR** Concrete with chemicals. Benches, Washing-wells. Spin concrete pottery. Stucco-rock. Miniature castles, mills. Cold glaze, marbling. Sample 10c. Hollywood CementCraft, 8527 Wonderland, Hollywood, California.

**WHO'S** Who and what's new in "The Mail Order World." Monthly—10c. Pines, 583-A Monroe, Brooklyn, N. Y.

**EARN** Extra money writing for publication. Simple method. Demand inexhaustible. Details free. Dona Veretts, 17 Groton, Lowell, Mass.

**"MONEY** By Mail" brings proven, tested money makers to start your own business. Sample copy 10c. Universal, Laccochee, Florida.

**ARTIFICIAL** Marble sanitary flooring, instruction covering wood or cement flooring ½ inch thick, fireproof, all colors, low cost, ornamental casting, concrete, plaster, papier-mache, garden furniture, statuary, flexible molds, particulars free. Chris Mahler, Elmont, N. Y.

**DELAWARE** Charters: Complete service \$35. Submitted forms. Chas. G. Guyer, Inc., Wilmington, Del.

**107** WAYS To make money, in home or office, business of your own. Full particulars free. Elite Co., 214 Grand St., New York.

**SELL** By mail. Books, novelties. Bargains! Big profits! Particulars free. E. Elfco, 438 N. Wells, Chicago.

**ELITE** Collection of business plans, contains 107 tested plans and scores of formulas. Start own business; home, office. Particulars free. Elite Co., 214 Grand St., New York.

**PLASTEX** Industries offers industrious men an opportunity to start a business of their own, manufacturing art goods, novelties, souvenirs, etc., in Plastex and marble imitation. 5c material makes \$1 articles. Rubber moulds furnished for speed production. Small investment brings big returns. You are just in time for big wholesale season now starting. Write for interesting booklet mailed free. Plastex Industries, Dept. A, 1085 Washington Ave., New York.

**CHARTERS:** Delaware; best, cheapest; free forms. Colonial Charter Co., Wilmington, Del.

**WHERE** To buy at lowest wholesale prices. Information free. Yorena, Box P-312, Bayonne, N. J.

**100** PROFITABLE Mail order and local plans. Gilbert Supply, 1107 Broadway, New York.

**MAIL** Order business is your opportunity. Many began small, now earn thousands yearly. No personal contact. Boundless opportunities. Have had over 30 years experience; will help you succeed. Send 25c for valuable booklets, none free. B. Breniser, 257 S. 21st, Philadelphia.

**HOW** And where to obtain capital fully explained, free particulars. Star Service, Wapakoneta, Ohio.

**WE** Help start you in business, furnishing outfits and instructions, operating "Specialty Candy Factory" home. Men and women, opportunity to earn \$20 to \$50 weekly, all or spare time. (Our 29th year.) Booklet free. W. Hillyer Ragsdale, Inc., Drawer 4, East Orange, N. J.



**MAN** In each town to plate auto parts, reflectors, bicycles, fixtures, mirrors, by late method. Simple plan of manufacturing at home starts you in good paying business. Free particulars and proofs. Gunmetal Co., Ave. H. Decatur, Ill.

**MANUFACTURE** From Phospholene. Cleaning fluid 1c gallon; bleach 2c gallon; hand soap 2c pound; and ten fast sellers. Sample 25c. Details free. Western, 6615 Denison Ave., Cleveland, O.

**WANT** More business? 2c daily, opens individual New York branch office requiring no room number on your stationery or advertisements. Co-operative Mail Service, 126 Lexington Avenue, New York.

**FINANCIAL** Independence obtainable by placing coin operated merchandise vending machines, out on percentage basis, no experience required, little capital needed, write for free details. Torr, 2047 1/2 South 68th Street, Philadelphia, Pennsylvania.

**DELAWARE** Charters—Sell shares. Raise capital. Low cost. Free details. Corporation Fiscal Co., Wilmington, Del.

**1059 WAYS** To start a profitable business. Get Popular Mechanics book of modern formulas and methods for practical specialty manufacturing. Price only \$1.25 postpaid. Popular Mechanics Press, Room (C38), 200 E. Ontario St., Chicago.

### MONEYMAKING OPPORTUNITIES

**YOUR** Own local or mail order business. Economical 7 purpose lotion, perfumes, etc., can now be made at home, no equipment necessary. We show you how with instructions, sales promotion plans. Complete start, sample, system for dollar, or send quarter for plans, instructions, without sample. Mailadvertising Associates, Greene, New York.

**GET** Cash for used stamps. Sell them for 75c and \$1.50 per pound. Any kind of used stamps, even common 1c, 1 1/2c, 2c, 3c and stamps off parcel post packages. Unpicked and unsorted. Above information included without additional cost to all who send 25c for The B-F-A Budget of money making information. John A. Stager, 1391 E. 30th St., Cleveland, Ohio.

**BIG** Interesting moneymaking opportunity magazine. Homework, mail, local. 3 months 25c. Publisher, 2620 Stromberg, Pittsburgh, Penna.

**YOU'LL** Like resilvering mirrors, auto-parts, reflectors, making chipped glass signs. Write. Sprinkle, Plater, 287, Marion, Indiana.

**3 MONTHLY** Mail order magazines, filled with money making opportunities, 10c. George Fenner, 1618 Lucia, Louisville, Ky.

**SELL** Cosmetics by mail. Sample powder, full particulars 10c. Cosmetics, Box 104, Wilkes-Barre, Penna.

**MILLIONS** Jobless! Supply satisfying employment information by mail. Keep dollars received! We fill your orders. Co-Operative Service, 77 Swan, Buffalo, New York.

**INVESTIGATE** This. Quick flashy demonstrator. Absolutely new. Big profits. Unlimited prospects. Moore, 1851 Jerome Ave., S. W., Grand Rapids, Mich.

**MILLION** Articles. Buy wholesale. Valuable directory. Dime. Ideal Service, D-5, Park Ridge, Ill.

**BIG** Profits day and night without selling. Operate Silver Kings. Details free. Automat, 2427 Pullerton, Chicago.

**"THINK** And Grow Rich"! Astounding book explains thirteen necessary steps. Stamp brings details. Novex, 1210n 11th Terrace, Birmingham, Ala.

**WIN** \$1.00 Check answering three questions. Schemer prints schemes, tips, opportunities, formulas, established 1899. How old? Yearly price? Copies yearly? With answer send 25c (half price) for six copies. Schemer Monthly, Alliance, Ohio.

**"WIN** Profits!" Mailorder business at home. "Spare time." Particulars, moneymaking magazine. Postal, Raymond Schwarting, South Amana, Iowa.

**GRAIN** Traders. Send for our dependable forecasts or system. Sample 10 cents. Mark-O-Graph, 210 W. 8th, Kansas City, Mo.

**MAILORDER** Opportunities, plans, formulas, information. Circulars free. Harvey Teeple, Decatur, Indiana.

**JOBLESS?** Get a job you'll like, work easy; keep dollars coming. Details dime; money making opportunities. Cap Waller, Black River Falls, Wisconsin.

**LATEST** Propositions. Name on mailing list for stamp. Advertisers' Assistants, Box 445, West Liberty, Kentucky.

**OPPORTUNITY.** Collection 100 tested moneymakers \$1.00. Sample 25c. Rabiro, 210 5th Ave., New York.

**MONEY** In butterflies, moths. See Sinclair Display Advertisement on page 14A.

**CARPENTERS:** Sell, install overhead garage door hardware. Paying business. Circular free. Wilkie, Independence, Mo.

**MAKE**—Sell your own goods. Details free. Pederson, 1609 1/2 East 5th, Duluth, Minn.

**PERFECTED** Window cleaner! 128 gallons concentrated \$9. Sample 25c. Kemiklean, 1906 Rosemont, E. Cleveland, Ohio.

**SPLENDID** Opportunity collecting reptiles, frogs, toads, for us. Our instructions make collecting easy. Contract and particulars dime. Biological Research Laboratories, Dept. M-11, Springfield, Missouri.

**EXCELLENT** Moneymaking book loaned 30 days for quarter. "What I Would Do" folio complimentary. Anderson Lending Library, Box 548, Muskogee, Okla.

**SPARE-TIME** Business plans. Marvin Studios, 203 So. Dearborn, Chicago.

**JUST** Out! \$100's await you. 10,000 formulas—1000's recipes. Big 883 page book. \$2 prepaid. Adams-Brown, Chestnut Hill, Mass.

**CANDY.** Ten selected professional formulas. Fast sellers. \$1. A. Poirier, Dutton, Mont.

**RAISE** Earthworms for profit. Information free, stamp appreciated. Bureau Zoological Research, 106A Broadway, Peoria, Ill.

**MAN** In each town to plate auto parts, reflectors, bicycles, fixtures, mirrors, by late method. Simple plan of manufacturing at home starts you in good paying business. Free particulars and proofs. Gunmetal Co., Ave. N. Decatur, Ill.

**DOLLARS** By mail with "Dollarmor" choice opportunities. Sample dime. Lawn-dale Press, Franklin, N. H.

**STOP** Squealing—Start crowing! Work mornings home—country drives or movies—afternoons! No canvassing! Pollo-A, Station "D," Los Angeles.

**HELPERS** Wanted! Big money introducing advertising necessity. Capital, experience unnecessary. Details stamp. Hurry! Johnston, P-257 North Washington, Timm, Ohio.

**DOLLARS** In Pixit service. Particulars. Houlgate, Station C. Pasadena, California.

**12 RED** Hot, slickest, legitimate ways to make money quick. This is rare information. Write Dixon, Box 1403, Youngstown, Ohio.

**\$25.00** STAMPING Names per 100 key-checks. Sample 25c. Details furnished. Bohn Company, Box 86P, Wilkes Barre, Penna.

**MOULDS,** Guaranteed, for casting toy soldiers, Indians, trappers, warships, sinker moulds, 244 kinds. Send 5c for illustrated catalogue. Henry C. Schiercke, 645 Spencer, Ghent, N. Y.

**BIG** Money easily made; 107 test plans for your choice. Home, office. Descriptive booklet free. Elite Co., 214 Grand St., New York.

**YOUR** Name—5,000 mailing lists—25c. Get samples, opportunities galore from all over world. Pines, 583-A Monroe, Brooklyn, N. Y.

**WHOLESALE** Sources, 500,000 articles. Free directory. Maywoode, 1107 Broadway, New York.

**ADVERTISING** Coupon book deal that clicks. Details, samples \$1.00. Dale Wolfe, Randalia, Ia.

**START** New, profitable business, in home, making sensational, quick-selling printed raised-letter stationery, without press, type, or printing experience. New simple process. Get sample sheet, starting instructions quickly. Profits big. Write Home Embossers, 1071 Niagara, Buffalo, New York.

**IDEAS** Guaranteed to make you money. Krueger, 5751 Justine, Chicago.

**HOME-WORKER'S** Prosperall Guide, 64 page magazine, 10c. Sanvoy, Arlington, Kentucky.

**1,000,000** ARTICLES Wholesale. Free samples. Directory 10c. Jelsmith, Waltham, Mass.

**AMAZING** Mailorder plan. Marvelous possibilities. Just send stamp. Box 116, Bluford, Ill.

**MILLIONS** Made prospecting Ontario's rich gold fields. Ontario's 1937 gold production was \$90,522,454.00; California's was \$40,932,200.00. Combine healthy outdoor vacationing with opportunity of great wealth. Map showing gold prospecting areas and comprehensive information in plain talk \$1.00. Old Prospector, Box 623, Kirkland Lake, Ontario.

**MONEY,** Money, we can put you next to the best money-getter of them all. Send \$1.00 today. You will never regret it. American Laboratories, P.O. Box 87, Clinton, Mass.

**25c** COIN Brings telescopic charm and money making opportunities. Michon, 616 South Park, Buffalo, N. Y.

**TREASURE** Finders? Read Goldak advertisement on page 137A.

**\$50 A WEEK** With a kodak. Booklet describing 100 magazine markets 25c. Modern Distributing Agency, Box 51, Hedley, B. C., Canada.

**EARN** Money in your spare time taking subscriptions to Popular Mechanics. Unlimited possibilities, every family a prospect. Easy to sell. Bonus paid in addition to liberal commission. Send postcard for further details today. Circulation Dept., Popular Mechanics Magazine, 200 E. Ontario St., Chicago.

### FORMULAS, PLANS, ETC.

**SELF** Vulcanizing cement—Typed formula. Formula Agency, 490 Western Ave., Lynn, Mass.

**MORE** Money! Make and sell reliable products. 25 formulas \$1.00. Voelker Sales Trucks, Reed City, Mich.

**MONEYMAKING** Formulas! 50c brings 100. Schroeder, 803 Wisconsin, Peoria, Illinois.

**WATERLESS** Soap guaranteed. Clean dirtiest hands in America. Formula \$1. Jerome Jones, Hollins, Alabama.

**FORMULAS**—All kinds. Real moneymakers. Lowest prices. Catalog free. Clover Formulary, P-5, Niles Center, Ill.

**MOTOR** Oil 2c gallon. Reclaim used oil. Formula 25c coin. George, 285 Queen, Germantown, Philadelphia, Penna.

**GUARANTEED** Formulas—New fast sellers. None better. Lowest prices. Catalog free. Kemico, 49M, Park Ridge, Ill.

**SPECIAL!** Eleven selected formulas, \$1.00. Soilless agriculture, Kleervision cloth, iron cement, plastic wood, mechanic's soap, illuminous paint, antifreeze, motor reconditioning compound, cracked block sealer, rebuild batteries, meat tenderizer. Dunco, Middletown, Ohio.

**ANALYSIS.** Research. Newest guaranteed formulas. Biggest catalog free. Nominal prices. Gibson Laboratory, Chemists, BD-1142 Sunnyside, Chicago.

**CHEMICAL** Garden formula 65c in stamps. R. Edmondson, 441 E. Main St., Rochester, N. Y.

**REFINE** Used oil without cost. Particulars. F. Gerwin, Fairview, Oklahoma.

**25** MONEYSAVING Formulas 25c. Cosmetics, waterproofing, cleaners, refinishing firearms, polishes, etc. Lawrence, 11126 Raymond, Los Angeles, California.

**WOOD** Finishing, without paints, stains, etc. Formula, quarter. Shervin, Box 116, Breathedsville, Maryland.

**WHY** Gamble with "cheap" formulas? Here's manufacturers' certified-tested, formulas. Reasonable—responsible service, producing for you, bankable results! Making today's newest, successful products! All lines! Miller, Chemist, 1706PM, Tampa, Florida.

**MONEYMAKERS**—Iceless ice. Oil reclaiming process. Rubber mold making. Waterless hand soap. Soilless agriculture. 25c each. Ideal Service, 179X, Park Ridge, Ill.

**THAXLY** Formulas for perfect products. Accurate analyses. Catalog free. B. Thaxly Company, Washington, D. C.

**FORMULAS.** Latest money makers. Literature free. Belfort, 4042 N. Keeler, Chicago.

**FORMULAS:** 15 Proven moneymaking formulas \$1.00. (Not stock-formula catalogue stuff), real unusual offers. List free. Marvel Laboratories, 6629 No. Maplewood, Chicago.

**ELITE** Formulas and plans; make and sell your own products. Descriptive booklet free. Elite Co., 214 Grand St., New York.



## CHEMISTRY

**FREE** Chemistry catalog. Supplies at 5c! Equip complete laboratory. Send 3c for postage. Kemkit Scientific Corp., 397P Bridge St., Brooklyn, N. Y.

**HANDBOOK** Of experiments for amateur chemists, illustrated, postpaid 50c. Experiment booklet 15c. Chemistry catalog 5c. Reading Scientific Company, Reading, Penna.

**FREE:** 40 Page catalog of chemical and laboratory supplies for amateur chemists. Wollensak microscopes and supplies, scientific books at big discount. JE-5 Winn, 124 West 23 Street, N. Y. C.

**CHEMICALS** in 5c quantities. Catalog 5c. Fleischer's Laboratories, Everett, Mass.

**CHEMICALS**, Laboratory, glassware, apparatus. Send 3c for catalog CPI. Biological Supply Company, 1176 Mt. Hope Avenue, Rochester, N. Y.

## HELP WANTED

**MEN!** Earn \$5 daily extra. Retain your position. Sell beautiful etched metal social security plate and double cellophane leather case. 70% commission. Send your S. S. number and 10c for agent's equipment. Wm. Hament, 665 W. Lexington St., Baltimore, Maryland.

**M. M.** Earned \$267, three weeks, raising mushrooms in cellar! Exceptional, but your cellar, shed perhaps suitable. We buy crops. Book free. United, 3848 Lincoln Ave., Dept. 68, Chicago.

**IF** You are ambitious you can make good money with a Rawleigh route. We help you get started. Sales way up this year. No experience needed. Steady work for right man. Write Rawleigh's Box E-2-PPM, Freeport, Ill.

**EARN \$5** Daily extra. Retain your position. Sell etched metal social security plate and double cellophane leather case. C. Bunn, 665 W. Lex. St., Baltimore, Md.

**MEN** Wanted for coffee routes. Earnings up to \$42.50 first week. Brand-new Ford sedan given you as bonus. I send everything; you don't risk a penny. Details free. Mills, 6039 Monmouth, Cincinnati, Ohio.

**AMAZING** Magic crystals make powerful all purpose cleaner. Take orders everywhere. Pays up to 200% profit. Sample free. Write Emsee, Dept. 104, Monroe, Michigan.

**STEADY** Work—Good pay. Reliable man wanted to call on farmers. No experience or capital required. Pleasant work. Home every night. Make up to \$12 a day. Wonderful new proposition. Particulars free. Write McNess Co., Dept. 272, Freeport, Illinois.

## AGENTS WANTED

**REBUILT** Vacuum cleaners. General Elec., Hoover, Eureka, Electrolux and other makes, look and work like new. Low prices, large profits. Economical Distributors, Box 224, Albany, N. Y.

**MOTH** Tablets. Headquarters moth tablets, crystals, wafers, deodorants, etc. Write for lowest prices. Best quality. Distributors, agents wanted. Dept. P, Smico Products, 1123 Draper St., Cincinnati, O.

**AGENTS** Make big profits on food products, bargain deals. Low wholesale prices. Rush name for trial outfit offer. Ho-Ro-Co, 2810-S Dodier, St. Louis, Mo.

**500% PROFIT** With new perfected (1939) quick-action, no flint, automatic gas lighter. Retail 25c. Sample 5c. New Method Co., Box PMG-77, Bradford, Penna.

**COUNTY** Distributors, truck jobbers, agents in cosmetics, flavoring extracts, household and medicinal specialties; quality products; unusual proposition; investigate. Sweet Manufacturing, Wabash Station, Pittsburg.

**JUST** Out! Amazing fast selling 25c household necessity. Saves up to hundreds of dollars. Sell 3 to 4 each home. Make up to \$6.00 daily. Free sample. Puro, 3107 Pine, Dept. E-299, St. Louis, Mo.

**DON'T** Be a job hunter—Start your own business on our capital. No hard times; no lay-offs; always your own boss. Hundreds average \$3,000 to \$5,000 annual sales year after year. Sales way up this year. We supply stocks, equipment on credit. 200 home necessities. Selling experience unnecessary. Wonderful opportunity to own pleasant, dignified, profitable business backed by world-wide industry. Write Rawleigh's, Dept. E-U-PPM, Freeport, Ill.

**LARGE** Profits selling Magic Fluid. Repairs instantly any fabric or rubber, heat and laundry proof. Eureka, 1911 S. Wabash, Chicago.

**MYSTERIOUS** Disc heats water instantly without coal, gas or oil. Pays up to 233% profit. New principle. No risk sample offer. Write Lux Co., Dept. H-2, Elkhart, Indiana.

**BEAUTIFUL** Bird pictures handmade with genuine feathers. Sell on sight! Large profits! Free particulars. Samples 10c stamps. Marquez-PH, Apartado 1176, Mexico City.

**SWANK** New lipstick. The talk of New York. Fast seller. Tremendous repeats. 100% profit. Sample free. Charlie, Jamaica, N. Y.

**BUSINESS** Proposition resilvering mirrors, autoparts, reflectors, making chipped glass signs. Write, Sprinkle, Plater, 128, Marion, Indiana.

**BARGAINS**—100 Blades 25c; electric razor 75c; candid type camera 90c; soap, gross cakes \$1.44; blankets each \$1.20. Free catalog. World's lowest priced wholesalers. Mills Sales, 901 Broadway, New York.

**WEAR** Fine hose I send without cost with outfit while taking orders for amazing new hosiery. Replacement guaranteed against holes, snags, and runs. Rush name and hose size. Wilknit, Desk E-37, Greenfield, Ohio.

**QUICK** Easy selling products. Large profits. Big demand. E. Corcoran, Box 2558, St. John's Station, Portland, Ore.

**FASTEST** Selling amusement novelty. Dancing Sambo, tap dancing dummy. Samples 50c. Seslen's, 5730 Kingsbury, St. Louis, Mo.

**BUILD** Your own paying business. Particulars free. Sidney, Pottsville, Penna.

**SELL**—"Perfumed personal stationery"—embossed. Rienzi Press, 31½ Sixth Ave., Newark, N. J.

**AGENTS** Earn up to \$45 in a week with nationally known, fast selling food products and everyday necessities. Marvelous sales, bargain and premium deals. Particulars and trial offer mailed free. Zanol, 6045 Monmouth, Cincinnati, Ohio.

**NECESSITIES** Always in demand! Experience unnecessary to earn steady income selling shirts and sportswear factory to wearer. Gigantic variety; one year guarantee; customized fit (90 sizes). Half price offer creates amazing values. World's largest concern of its kind. Our sales force earns \$100,000.00 yearly. Get your share! Simply write orders. We deliver and collect. Postcard brings you complete money-making outfit free. Write Dept. 236, Rose-cliff-Quaker, 1239 Broadway, New York.

**QUICK** Seller and repeater. Write Geiger, 6538 North Maplewood, Chicago.

**WORLD'S** Biggest seller. Write for particulars. Girard Company, Washingtonville, Ohio.

**MONEY** in butterflies, moths. See Sinclair Display Advertisement on page 14A.

**AGENT**, Manufacture specialties. Hire agents yourself. Particulars free. Tilford, Box 516, Louisville, Ky.

**DISTRIBUTORS** Sell nationally known ant, roach, fly, bed bug killers, each \$15 daily, every home, hotel, food store needs, full particulars and sample 25c. Lucas, 174 West 65th St., New York.

**SELL** Social security plates. Over 40 million buyers. 500% profit. Full or part time. New plan. Employ others. No money needed. Don't wait. Act now. Free outfit. Federal Name Plate Co., 287 Broadway, New York City, Dept. PM-5.

**CHINESE** Checkers. Fastest selling game of the year. Factory connection. \$1.00 brings samples and prices. Anthony Novelty Co., Lamoni, Iowa.

**AMAZING** Zipper clothesline. Instant demonstration. Sells on sight. Dunn Mfg., Hempstead, N. Y.

**NEW** Attractive 25c store signs, changeables, price sets. Big profit. Marvin, 504 McDonald Ave., Brooklyn, N. Y.

**MEXICAN** Art goods, 4x7 beautiful sample. Details, quarter. Deluxe Creations, Laredo, Texas.

**SELL** By mail: New magazine tells how. Sample copy 10c. Mallograph, AG-651 South State, Chicago.

**COSTS** 6c; Sells 35c. Household necessity. Carry day's supply in pocket. Sample 10c. Mero, Box 344, Punxsutawney, Penna.

**MILLIONS** Of prospects! Buyers everywhere! Sensational social security plates with name gold-stamped on leatherette case! Fast seller! Big profits! Complete selling outfit free! Union Specialty, 1777-B Broadway, New York.

**AGENTS**—Quick selling combination. Big profits, repeats. Samples, details free. Universal, Orange, Massachusetts.

**\$100 WEEK**, \$3.95 Automatic fire extinguisher. Sells dealers, homes, factories, motorists. Biggest profit! Exclusive! Firefoe, Madison, Wis.

**AGENTS**—To mail our literature. Good profits. Home business. Maywood, 1105-1107 Broadway, New York.

**90c COMM.** On \$1 repeat sale. Become mfg's. exclusive distributor for new general cleaning method. Homes and businesses buy on sight. Kleenmaster Corp., 220 Odd Fellows Bldg., South Bend, Ind.

**500% PROFIT.** Gold and silver colored sign letters. Offices—stores. Large sizes, 1c. Free samples. Modernistic, B-3000 Lincoln Ave., Chicago.

**NO-RISK** Famous flavor plan. Amazing profits. Super Products, 1259 West Main, Decatur, Illinois.

**AGENTS**—Fast selling American boom-erang, 50c each; \$2.50 dozen; \$15.00 hundred. Postpaid. Sall-Bak Factory, 1510 S. Noland, Independence, Mo.

**MONUMENTAL** Salesmen, agents, wanted. Lowest manufacturers prices. Mikelich Company, St. Cloud, Minn.

**COSTS** 3c; Sells 50c. Household necessity made at home. Send 10c for dollars worth with labels. Home Occupations, St. Paul, Minn.

**BIG** Money taking orders; shirts, ties, hosiery, underwear, pants, uniforms, dresses, etc. Sales equipment free! Experience unnecessary. Write Nimrod, 4922-AN Lincoln, Chicago.

**EX-O-LENE!** Brand new! Power and mile increaser! Millions interested. Protected territory! Big profits! Be first. Information free. Thermo Exolene Works, Peoria, Ill.

**SUCCEED** With your products. Make-sell. Formulas. Accurate analyses. Catalog free. B. Thaxly Company, Washington, D. C.

**SELL** Lucky Brown Hair Dressing to colored folks. \$5 day possible. Famous Co., 2243-YJ Indiana Avenue, Chicago, Illinois.

**ATLAS** Window sign letters. Large sizes—penny each. Get beautiful samples. Atlas, 7941 Halsted, Chicago.

**ENGRAVED** Name plates, numbers, signs, etc., easily sold, profits large. Brett Bros., Winthrop, Mass.

**300% PROFIT** Selling gold leaf letters for store windows; high grade letters 1½c each. Free samples. Metallic Co., 438-B North Clark, Chicago.

**SALESMEN** Work in new way, demonstrating to man or woman "Look-well Kit" (not toilet preparation). Work homes; offices; stores. All or part time. Sells \$1.25 most all profit. Gladly send details. Be quick. Le Cliff Distributing Co., Gold Street, Cedar Lake, Ind.

**500% PROFIT!** Gold and colored sign letters for windows, offices, trucks, signs. Auto monograms. Easily applied by agent or customer. Neonite, Akron, Ohio.

**SELL** Social security plates. Sample 10c. Particulars free. Reliable Sales Co., 6 West 28th Street, New York City.

**200% PROFIT.** No investment, fast seller, field unlimited. Danna, Box 57, West New York, New Jersey.

**BIG** Money applying initials on automobiles. Easiest thing today. Free samples. Also, sideline salesmen for short order decalcomania name plates. "Ralco," 1305 Washington, Boston, Mass.

**ELGIN**, Waltham, Hamilton watches. Make big money. \$3.95. Send for free jewelry catalog. Plymouth Jewelry Exchange, 163-B Canal St., New York.

**AGENTS:** Smash go prices! Santos coffee 12c lb. 4-oz. vanilla 8½c. Razor blades 10 for 8½c. 100 sticks chewing gum 12c. 150 other bargains. Premiums. Experience unnecessary. Carnation Company, P.O. St. Louis, Mo.

**AGENTS**—Opportunity make money; book containing 107 successful business plans; home-office; send for free introductory booklet. Elite Co., 214 Grand St., New York.

**SELL** Fast repeating cleaner everywhere. Sample free. Cary Company, Joliet, Ill.



**STARTLING Invention**—Pocket adding machine. Nationally advertised \$2.50. Whirlwind seller. Big profits. Baby Calculator Co., Box 1118, Chicago.

**REVOLUTIONARY** Window cleaning tool. Good Housekeeping approval. Only ten \$2.25 sales daily to housewives, factories, schools, stores will make you \$350.00 monthly. Carter Products Corp., 900 Front Ave., Cleveland, Ohio.

**BIG Money** applying initials on automobiles. Write for particulars and free samples. American Letter Company, Dept. 40, Dunellen, New Jersey.

**FREE Sample**—Amazing cleaner; sells homes, taverns, everywhere. Big profit—fast repeater. Betco, 5007 Irving Park, Chicago.

**MANUFACTURE** Specialties, hire agents yourself. Big money. Free literature. Gilbert Supply, 1107-P Broadway, New York.

**AGENTS:** Stamping names on pocket-key protectors. Sample check with your name, address, 25c. Stamping outfits. Emblem checks, check-fobs, name plates. Hart Mfg. Co., 303 Degraw St., Brooklyn, N. Y.

**MAKE** Big money selling paint and liquid roofing direct from factory. Easy terms and no down payment. Work either full or part time. Write today for free sample case. Electric Paint and Varnish Co., Dept. C, Cleveland, Ohio.

**YOUR Own** business, dignified. No selling. A few weeks of your time insures you steady income for years. We do the work. Small investment. Printograph Co., 563 Warren St., Roxbury, Mass.

**DO** You want agents for your proposition? Your ad in this space will place your message before hundreds of men seeking fast-selling products. My folder "How to Secure Agents," is filled with proof. I'll gladly send you a copy free. F. W. Johnson, Manager Classified Advertising, Popular Mechanics Magazine, 200 E. Ontario St., Chicago.

#### HIGH-GRADE SALESMEN

**FREE.** New style printing catalog makes selling easy. Pays big profits. No experience necessary. Fits in with any line. High quality printing on Arrow or Hammermill bond paper at attractively low prices. Arrow Service makes satisfied customers and repeat orders. Amazing values for your customers on letterheads, billheads, statements, envelopes, cards, labels, sales books, tags, guest checks, etc. Union label if desired. Every business uses printed stationery. Write giving home address, state present occupation and name two references. Arrow Press, Inc., 664 Produce Exchange Bldg., Minneapolis, Minn.

**LARGE** Paint and roofing manufacturer wants reliable men to sell direct to factories, stores, warehouses, schools, homes, and farmers, at factory prices on credit. Big demand. Good profits. District manager's position open for right man. Reply: The Madison Paint Co., Dept. C-913, Cleveland, Ohio.

**SELL** Business cards \$1.50 thousand. Business stationery, book matches, advertising gummed tape, advertising pencils, salesbooks, rubber stamps, pricing sets, adv. specialties, 35% commission. Money making specials. Free sales portfolio. David Lionel Press, 312 So. Hamilton, Dept. FP, Chicago.

**DID** You make \$50 last week? Does your job offer you real future? If not, why not start a wholesale business of your own? Start with little as \$2.50. Handle line 200 nationally advertised 5c-10c products. Show merchants new plan for increasing sales and profits. Handle everything from your home at start. Chance to operate one of our Silver Fleet service trucks. Facts free. World's Products Co., Dept. 10-E, Spencer, Ind.

**MAKE** More money with Red Comet Automatic Fire Extinguishers. Low price. Proved seven years. Splendid sales outfit free. Some good territory open. Exclusive. Write quick. 704 Red Comet Building, Littleton, Colorado.

**MAN** Wanted to supply Rawleigh's household products to consumers. We train and help you. Good profits for hustlers. No experience necessary. Pleasant, profitable, dignified work. Sales way up this year. Write today. Rawleigh's, Dept. E-53-PPM, Freeport, Ill.

**SELL** Stores lace handkerchief sensation. 100% profit. Sample 10c. Kittrells, Ackley, Iowa.

**SALESMEN.** Distributors — Established company. New automotive system all car and fleet owners vitally need. Sells for \$2.95. Lloyds of London insurance up to \$5,000. Makes quick convincing demonstration. Large repeat business. New proven merchandising plan to dealers carries 100% insurance protection for you. Profits up to \$600 per month. Exclusive territories. Guaranteed sales or money back under Plan A. Write today for details of full-size test sample and all facts. No obligation. Craver-Jay Corporation, Dept. 110, Kansas City, Missouri.

**ADVERTISING** Book matches—Sell union label book matches. Fastest selling line in America. Large sales producing kit, sample matches, complete cut catalog, eight color combinations make selling easy. Commission in advance. Superior Match Co., 7530 Greenwood, Dept. M-5, Chicago.

**SOCIAL** Security plate salesmen: Engrave or stamp your own plates. Keep all the profit. Electrograver Company, 653 South State, Chicago.

**SALESMEN** — Distributors 200 items, brushes, mops. Marvelous magnetic brush, excels vacuum cleaner. Big profits. Neway Brush Co., Hartford, Conn.

**BIG** Commissions selling to stores celluloid pricing tickets, metal shelf moulding. To restaurants, menu covers, signs. P. Pricing Press, 124 White St., New York.

**AMAZING** Seller. All weather coat guaranteed ten years, \$9.95. Commission \$3.00. Selling outfit free. Tenyear Raincoat Co., Dept. 30, Templeton, Mass.

**COCKROACHES** Killed new way. Food form in permanent container. Big profit. Repeat sales. Free starting offer and sample carton 25c. Gilles Products Company, 513-D South Tenth, Fargo, N. D.

**NEW** Framed feather pictures! Retail 69c; sample 20c stamps. Dozen \$1.80 postpaid. Marquez-PHA, Apartado 1176, Mexico City.

**GLOVES**—Sell wholesale, retail. Wickizer Glove Co., 564 Hooper Rd., Johnson City, New York.

**MAGIC** Hygroscope indicates room humidity. Sells to advertisers. 25 cent coin brings 6 samples, proposition. Bach Company, 4709 Avalon, Los Angeles.

**FAST** Selling line automotive equipment, accessories. Bought by jobbers, oil companies, fleet owners for years from established manufacturer. Exceptional opportunity. Equipment Manufacturing Co., St. Joseph, Mo.

**NOVELTY** Salesmen: Big money main or sideline. Dollar for sample and proposition. Refunded on third order. Hill Specialties, 9804 Avenue "J," Chicago, Illinois.

**SALESMEN.** Making \$20 to \$50 daily demonstrating new Airo Plane type fans to stores, restaurants, taverns, etc. Also drive way signals to gasoline stations. Write. Universal Fan Co., Peru, Indiana.

**FREE** Saleskit latest 1939 fast selling products. Variety, Lima, Ohio.

**BOOK.** Magazine, specialty salesmen. The book that sells itself. No sales effort. Creative Crafts, Box 133, South Chicago, Illinois.

**OLDEST** Guaranteed gasoline station signal. Air-Matic Signal Co., Delphos, Ohio.

**SALESMEN** Sell calendars, book matches, fans, advertising novelties. Samples free. Fleming Calendar Co., 6543 Cottage Grove Ave., Chicago.

**COUNTER** Card salesmen: Sensational new 10c sellers for all stores. Nothing else like it. Write Manufacturer, 653 South State, Chicago.

**BIG** Money taking orders: shirts, ties, hosiery, underwear, pants, uniforms, dresses, etc. Sales equipment free! Experience unnecessary. Write Nimrod, 4922-BG Lincoln, Chicago.

**ADVERTISING** Book matches offer big daily cash earnings! Full or part time. Experience unnecessary. Top quality at new low prices. Big 1939 line. Free baseball schedule offer. Fast repeats. Factory direct. Free outfit. Match Corp. of America, 3433 West 48th Place, Dept. E-5, Chicago.

**OPENINGS!** Call on all dealers with new trade-stimulator plans. It's "hot." \$3 commission on each \$5 sale. Big repeat commissions. No investment. Sales kit free. Regal, 6227 Broadway, Dept. C55, Chicago.

**SPARKLING** Glo-Brite signs sell fast to stores, restaurants, taverns. Lasting gold finish. Religious mottoes. J. A. Baxter, Cambridge, Ohio.

**NEW Specialty**—Sells every business and professional man. Four \$15 sales daily pay \$280 weekly. Farrell cleared over \$1,000.00 monthly. Write, F. E. Armstrong, President, Dept. PM, Mobile, Ala.

**BLADES.** Finest quality. Factory prices, postpaid. Ace Blades, Buffalo, N. Y.

**EXCELLENT** Opportunity selling our complete line of brushes, largest commissions. Write for sales plan. Wire Grip Sanitary Brush Company, 2300 5th Ave., New York.

**BIG** Money making opportunity for right man. Take over exclusive territory brand new specialty for lunch rooms, taverns, drug stores. Quick demonstration. \$5.00 profit every \$10.00 sale. Write today your territory may be open. Ellwood, 709 So. Cicero, Chicago.

**AMERICA'S** Biggest brush bargains. Bigger and better than ever. Catalogue. Frank-Lin Brushes, Bridgeport, Conn.

#### EDUCATIONAL AND INSTRUCTION

**LEARN** To be a master mechanical optician. Many earn \$25.00 to \$60.00 weekly. Select a field that is not overcrowded. Write American Institute of Mechanical Optics, Box 427, Mount Vernon, Illinois.

**HOW** To read blueprints, first edition, clear, concise, complete, \$1.00 postpaid. Shervin Publications, Box 116, Breathedsville, Maryland.

**WATCH** Repairing is steady profitable work. Experts always in demand. You can learn watchmaking trade at home, spare time. New original instruction system. Script engraving course included. Write for free details today! Nelson Co., E-2001 Manhattan Building, Chicago.

**FOR** An extremely profitable lifetime business, operate a collection-credit agency. Free folder. Cole Associates, Syracuse, N. Y.

**WOULD** Work in foreign countries interest you? Can furnish list of 100 firms operating in foreign field. Details free. Lakeside Service, Box 36, South Chicago, Ill.

**U. S. Government** jobs. Commence \$105-\$175 month. Prepare at home, for next examinations. Experience usually unnecessary. Full particulars—list positions, free. Write today. Franklin Institute, Dept. K3, Rochester, N. Y.

**DOUBLE** Entry bookkeeping mastered 60 hours with keys; guaranteed. (Diplomas.) International Bookkeeping Institute 8, Springfield, Mo.

**LEARN** Touch typing, 35 cents coin. Palmo System, Box 413, West Palm Beach, Fla.

**INVENTIVE** Minded can become independent. Explanation free! O-Higbee, Cantil, Calif.

**LEARN** Tool and die designing. Evenings. Write. Belton Tool Designing Course, 2935 No. Harding, Chicago.

**LEARN** Soap making at home. Stamp. Posera, B-4545 Bartlett, Milwaukee.

**AIR** Conditioning course, now book form. 160 pages 8½" x 11". Interesting, instructive. Reduced price \$2.00. E. Moore, 805 Eckman, South Bend, Indiana.

**DRAFTSMEN** In great demand now. Big pay. Learn at home. Information free. Write Monroe Institute, Alton, Illinois, immediately.

**FREE** Information. All civil service examinations. Write today. Pergande, Publishers, Milwaukee, Wis.

**NEW** Phonetic chart, 24x36, teaching English, 25c. Simmons, Rocky Hill, Conn.

**BIGGEST** Paying trades. More steady work. Decorating, paperhanging, graining, marbling, sign painting, pictorial painting. Residential and home study courses. Catalog free. Chicago Painting School, 437 North Clark Street, Chicago, Illinois.

**VENTRILQUIISM** — Complete course \$1.00. Tauriello, 45 Scholes St., Brooklyn, N. Y.

**GOVERNMENT** Jobs available. Opportunities best now. Write Rand Service, 210A Colorado Bldg., Washington, D. C.

**SHORTHAND**—Learn quickly, easily, in spare time. Complete system, postpaid, \$1.00. Stedi-Stroke System, Hearst Tower, Baltimore, Md.

**BECOME** Practical scientific investigator. Modern, illustrated course. Thorough training by former agent U. S. secret service. Particulars free. International Secret Service Institute, PM-59, Hoboken, N. J.



**SLIDE** Rule simplified by Richardson, 4212 - 24 Place, Chicago. Hundred pages, hundred illustrations. Dolar.

**MONEY** in cartooning! See Raye Burns School advertisement on page 137A.

**MASSAGE**, Hydrotherapy, dietetics, drugless therapeutics, chiropody, taught by mail. Evans Correspondence School, Montgomery, Ala.

**LEARN** To be a master mechanical optician. Master mechanical opticians earn \$25 to \$50 per week. Select a field that is not overcrowded. Big demand for skilled mechanics. Write for particulars. American Institute of Mechanical Optics, Box 427, Mount Vernon, Illinois.

**LEARN** Watchmaking. Complete instructions \$3.00. Catalog wholesale tool, material, watches 5c. Stewart's, 721 Olive, St. Louis, Mo.

**GROW** Plants without soil. Complete outfit \$1.00. Folder free. Gordon Laboratories, 509-L Fifth Ave., New York.

**LEARN** Auto mechanics, body, repairing, welding electricity, refrigeration. Diesel. Stevinson's, 2008A Main, Kansas City, Mo.

**GOV'T** Jobs start \$1260-\$2100 year. Men-women age 18-50. Former examiner's tested method helps qualify you. Particulars, list jobs free. Write today. Patter-son School, 8C Mercantile Bldg., Rochester, N. Y.

**TELEGRAPHY** Taught thoroughly. Rail-road retirement act creating opportunities for new operators. Expenses low. Catalog free. Dodge's Institute, Hiatt Ave., Valpara-iso, Ind.

**SECRET** Investigation. Experience un-necessary. Detective particulars free. George Wagner, M-2640 Broadway, N. Y.

#### PLAYS, STORIES, MANUSCRIPTS

**STORIES**, Articles, books criticized, marketed. Collaboration on percentage. Poetry department in charge former editor Poetry World, New York Publishing Service, Literary Agents, 246 Fifth Avenue, New York City.

**WANTED:** Radio scripts and ideas. De-tails free. Script Exchange, Studio 6, 3819 Wilshire, Los Angeles.

**ORIGINAL** Poems, songs wanted for publication, radio. Westmore Music Cor-poration, Dept. 33G, Portland, Ore.

#### CARTOONING, COMMERCIAL ART, SHOWCARD WRITING, SIGN PAINTING

**HAVE** Your own money making busi-ness. Learn show card writing, sign paint-ing. Write for details. Begley Specialty, 1472P Broadway, New York.

**ANYONE** Can paint signs with Speed-way Letter Patterns. Send nickel for sam-ples, information, instructions. Display Letters Co., 8309 Third Ave., Brooklyn, N. Y.

**LETTERING** Artists! \$1.00 buys our fa-mous ten-lesson course in advertising let-tering. Full instructions for home study. Information on membership courses on re-quest. Guild School of Lettering, 324 Summit Ave., Hackensack, N. J.

**HOW** To sell drawings, photographs. Details for stamp. Carlon, P-651 South State, Chicago.

**AMATEUR** Cartoonists wishing steady income copying and duplicating cartoons for advertisers, write Ad-Service, Argyle, Wisconsin.

**SNAPPY!** New! Hand drawn colored cartoons. Sure fire seller to bars and in-dividuals. 25c brings sample 7x9 and de-tails. Harbeck, 2320 Calumet, Chicago.

**SHOWCARDS**, Signs. Make them your-self. Quickly, artistically perfect. Any size lettering numbers. New method. Sys-tem complete with instructions \$1.00. W. A. Boyd, Box 1907, Washington, D. C.

**LEARN** Cartooning then sell me your cartoons. Course 50c postpaid. DeChris, 4465 Leiper, Philadelphia, Penna.

**BE A** cartoonist— animator. We buy your cartoons when you learn by our meth-od. Start at once! Send 25c for beginners charts and instructions. National Cartoon Features, Box 1901, Dallas, Texas.

**CHALK** Talks. Laugh producing pro-gram, \$1.00. Catalog 10c. Balda, the Car-toonist, Oshkosh, Wisconsin.

**CARTOONING**, Sketching, etc.—46 les-sons, 600 illustrations, including drawing paper, pens, pencils, \$1.00 complete. Fraba Service, Cashton, Wisconsin.

**PEN** And ink illustrations for catalogue and general printing purposes at right prices. High grade work. Heraldic Stud-ios, 1914 Oakdale Avenue, Chicago.

**MAKE** Art Pay. Advanced art students, \$1.00. Popular Mechanics, 200 E. Ontario St., Chicago.

#### ADVERTISING AGENCIES—LETTER WRITERS—FOR ADVERTISERS

**MAILING** List 128 manufacturers elec-tric motors, washing machines, vacuum cleaners, 25c. Bochet, 1344 Buchanan, Minneapolis, Minn.

**SELL** Your product through agents, mail order. Advertise newspapers, magazines. Publishers' rates. Snappy layout your inch advertisement \$1. Martin Advertising Agency, 171M Madison Avenue, New York.

**LEARN** Advertising quickly at home. Easy practical plan. No text books. Com-mon school education sufficient. Interest-ing booklet and requirements free. Page-Davis School of Advertising, 3601 Mich-igan Avenue, Dept. 3431, Chicago.

**ORIGINAL** Letters \$2, folders, booklets, Taylor-made, 1336-P North Clark, Chicago.

**INCH**, 28 Magazines, 3 months, \$3.00. Paramount Press, Atlanta, Missouri.

**SELL** By mail? Want agents? Our "guide-book" packed with helpful advice, rates, publications, sent for stamp. Chi-cago Advertising Agency, 20PK West Jack-son, Chicago.

**DIRECT-MAIL** Advertising services. Sales letters that sell. Mailing lists. Omaha List & Letter Co., Box 2172, South Omaha, Nebr.

**ADVERTISING** Placed all magazines, newspapers, radio. Lowest rates. Free service. 54 page rate book free. Baker Advertising Agency, A-189 West Madison, Chicago. Successors to Ankrum. Estab-lished 28 years.

**FREE**—New Advertisers Rate Guide, 44 pages. Includes everything. Lowest rates. E. H. Brown Advertising Agency, 140 S. Dearborn, Chicago.

**ADVERTISE:** 24 Words in 250 newspa-pers \$10. Lists free. Advertising Bureau, 4515-C Cottage Grove, Chicago.

#### BUSINESS SERVICE

**CHICAGO** Mail address—phone service, daily forwarding, also secretarial service. Hanock Company, 43 East Ohio.

**WHERE** To buy anything! Wholesalers, manufacturers. 25c (coin). Jeans, 824 Prendergast, Jamestown, N. Y.

#### RUBBER STAMPS AND OFFICE SUPPLIES

**ORIGINAL**, Cushion mounted. One, two lines 25c; three 35c; four 45c. Fac-simile signature \$1.50. Stamp Works, 814 Bradley, Peoria, Illinois.

**2 LINES** 25c, 3—35c, cushioned. Stamp Works, Centerport, N. Y.

**GUARANTEED** Typewriter ribbons, 35c delivered; adding machine ribbons, 50c. Economy, 126 Kinzie, Chicago.

**2 LINES** 25c, 3 Lines 35c. Stamp Works, Auburn, Nebr.

#### TYPEWRITERS, DUPLICATORS, OFFICE DEVICES

**AUTOMATIC** Adding machines. Adds, divides, subtracts, multiplies. \$2.50. Star, 5012 South Ashland, Chicago.

**SPEEDY** Printer is best all purpose du-plicator. Pekas Duplicator Co., Lester-ville, So. Dakota.

**INCREASE** Business now. "Excello-graph" Rotary Stencil Printer reprints thousands everything you typewrite, hand-write, draw or trace. Colors, \$19.75 to \$44. Terms. Illustrated literature free to business or professional men. Pittsburgh Typewriter Supply, Department K-2, Pitts-burgh, Penna.

**NEW** \$3.75 Automatic adding machine. Fully guaranteed. Bassett, Box 302-K, Altadena, California.

**TYPEWRITERS**, Adder, mimeograph, multigraph, addressograph. Send for free lists of machines that will help you at half price. Pruitt, 28 Pruitt Bldg., Chi-cago.

**A. B. C.** Shorthand System, \$1.00. Pop-ular Mechanics, 200 E. Ontario St., Chi-cago.

#### PRINTING, MULTIGRAPHING, MIMEO-GRAPHING, GUMMED LABELS

**200** 8½x11 BOND Letterheads, 200 6¾ envelopes \$1.00 postpaid. Franklin Print-ery, 2932 Pershing, Chicago.

**5000** 6¾ ENVELOPES; \$6.25—1000 Busi-ness cards; 85c (shipping extra). Rein-deer Press, 1089a Lincoln Place, Brooklyn, New York.

**QUALITY** Mimeographing, 500—\$2.50. Free samples. Mimeocraft, Box 352, Low-ell, Mass.

**LETTERHEADS** In raised gold. Nothing finer anywhere. Trifling cost. Samples, Details, dime. Refunded first order. U. Shumway, Painted Post, N. Y.

**250** BOND Letterheads, 8½x11 and 250 envelopes, \$1.75 postpaid. Martin, 6071 Palmetto St., Ridgewood, N. Y.

**125**—8½x11 BOND Letterheads and 125 envelopes, both printed, \$1.00 postpaid. Benneville, 907 West Roosevelt, Philadel-phia.

**1000** BUSINESS Cards \$1.00; 125 Letter-heads, 125 envelopes \$1.00, postpaid. Se-crister Printing Co., South Bend, Ind.

**PRINTING**—Lowest prices in America. Samples free. Pitz, Middle, Iowa.

**SUPERIOR** Printing, priced right. Grange work specialized. Art-Craft, Lanes-boro, Mass.

**\$1.89** THOUSAND—Quality envelopes; Hammermill papers. Cameron Printing, Thompsettown, Penna.

**2000** BUSINESS Cards \$1.50. Letter-heads, statements, etc. Lowest prices. Florence Printing Company, 270 Lafayette Street, New York. (Salesmen wanted.)

**QUALITY** Printing, lowest prices. Sam-ples. Tucker, P.O. Box 65, Indianapolis.

**MODERN** Two color letterheads. Reason-able. Fehner, 202 Ashland, River For-est, Ill.

**MIMEOGRAPH** Stencils. Letter or legal, \$1.75 quire (24). Guaranteed. Mishek, Waseca, Minnesota.

**250** LETTERS Multigraphed (20 lines) \$1.45; also cut price printing. Multigraph-ers, Ashland, Virginia.

**\$1.65** THOUSAND Envelopes! Agents wanted. Caslon, Worth St., Stamford, Conn.

**6x9** CIRCULARS, Letterheads, enve-lopes, postcards, \$2.95 1000; 5,000, \$7.50-\$9.45. Folders. All printing low prices. Samples. Goodprint, Harrisonburg, Penna.

**69c** POSTPAID. 100 8½x11 Bond letter-heads, 100 6¾ envelopes, both printed in beautiful rich blue ink. Attention! 500 letterheads mimeographed \$2.50. 500 let-terheads multigraphed \$3.50. Lowest prices in U.S.A. Budenkaye Press, Plymouth, Penna.

**135** 8½x11 BOND Letterheads and 135 6¾ envelopes—only \$1.00, 1000 of either \$2.75. All postpaid! Beautiful work! Premier, 454 Christopher Ave., Brooklyn, N. Y.

**500**—5 LINE Gummed stickers, ¾x2¼, 20c. O. P., Box 52, Flint, Michigan.

**125** LETTERHEADS, 8½x11, and 125 en-velopes, 6¾, printed, \$1.00, postpaid. Cir-culars, folders, booklets. Samples free. Pine Hill Printery, Freeman, South Da-kota.

**UNUSUALLY** Fine printing reasonable. Hildebrand's, 4554 North Uber Street, Philadelphia, Penna.

**500** LETTERHEADS, Envelopes, bill-heads 80c. B-JCo, 22 Fox, Worcester, Mass.

**PROCESSED** Engraved wedding or grad-uation announcements, 100 folders, en-velopes, \$4.85. Letterheads, envelopes, circulars, 1000 \$2.75; 5000 \$9.25. Quality Printing, 416 Brook Avenue, Richmond, Virginia.

**PRINTING**, Quick incomparable work-manship, reasonable. Samples. Gibson-print, 5413 Calumet, Chicago.

**BUSINESS** Cards (raised printing) 250 —\$1.75. 500—\$2.35. C-R Company, Rose-dale, New York.

**SPEND** Less for quality printing. Free details. Beghtol Printing, 2025 Central, Kearney, Nebr.

**135** EACH Letterheads, envelopes, \$1.00 postpaid. Kressman, Washington, New Jersey.

**ENVELOPES**, 500, 6¾, \$1.00, Morey Press, 87 Somerset, Springfield, Mass.

**1000** STICKERS, Four lines, 50c. Fine labels. Cott's, Spickard, Missouri.



**HAMMERMILL** Letterheads, 300 8½x11, any color paper and ink, \$1.48 postpaid. Free particulars. Woodruff's, 217A Lewis, Duluth, Minnesota.

**PRINTING?** Get lowest prices. Churchill, 4316 South Salina, Syracuse, N. Y.

500 ¾x2¼ **FOUR** Line gummed stickers, 25c. Moritz Printery, Saginaw, Mich.

**THOUSAND** Envelopes, 6¾, \$1.75. Bohman, 13 State, Schenectady, New York.

**HAMMERMILL** Letterheads, 1,000, \$3.50. Reply cards, 1,000, \$5.50. Press, Plano, Ill.

### PRINTING OUTFITS AND SUPPLIES

**PRINT** Your own cards, stationery, circulars, advertising. Save money. Easy rules furnished. Print for others, big profits. Junior outfits \$9.00, senior outfits \$17.00 up. Details free. Kelsey Presses, E-11, Meriden, Conn.

6x9 **STEEL** Casters \$3.95. Casting, dime. Service, 1466 Broadway, Haverhill, Mass.

**MAKE** Halftone cuts, trifling cost, with ordinary photographic equipment. Photographic halftone screen (5x7x85) \$5 with complete instructions. Instructions only, \$1. Fotocolor, 1472 Broadway, New York.

**TYPELESS** Printer prints from post card size to 8½x14 inch sheet—low price, free details. Professional Products, Dept. 510, Silverton, Ohio.

**PRESSES**, Type, cabinets, supplies. Send stamp. Lincoln Press, 220 Hartwell, Fall River, Mass.

**BARGAINS** — Presses, type, supplies. Send stamp. 159 Harvard, Cambridge, Mass.

**LONG** Established printers warehouse. Big lists 3c. Landis, Richland, Penna.

**HAND** Presses, type and complete printers' supplies. Send stamp for catalog and new price list. P. Peiffer & Co., Newark, N. J.

**USED** Presses, type, supplies. Lists 3c. Turnbaugh Service, Loysville, Penna.

**BARGAINS**, Presses, type, List 3c. Exchange, E-15, 110 Dexter, Meriden, Conn.

4 **COLORS** Printing inks 50c, sample 20c. Eisen, 4511 - 4th Avenue, Brooklyn, N. Y.

### PATENT ATTORNEYS

**INVENTORS:** Send immediately for your copies of our new free books, "Patent Protection" and "Suggestions on Selling an Invention." Sixty-eight pages of interesting facts. They tell how Patent Laws protect you; kind of sketch or model needed; simple steps to take without cost; how successful inventors have secured financial assistance; show interesting inventions; illustrate important mechanical movements. With books we also send free Evidence of Invention form to help establish date of disclosure. Prompt service, reasonable fees, special deferred payment plan. Strictest secrecy. Forty-one years' experience. Highest references. Write us today. The facts in our books are worth money to the man with a good invention. Address: Victor J. Evans & Co., Registered Patent Attorneys, 113-E Victor Building, Washington, D. C.

**INVENTORS**—Time counts in applying for patents. Don't risk delay in protecting your invention. Send sketch or model for instructions or write for free book, "Patent Guide for the Inventor" and "Record of Invention" form. No charge on how to proceed. Prompt, careful, efficient service. Clarence A. O'Brien and Hyman Berman, Registered Patent Attorneys, 58-S Adams Building, Washington, D. C.

**PATENTS.** Protect your idea by securing free "Proof of Invention" folder. Exceptional personal service. Established 1906. E. E. Vrooman, 871 Woodard Bldg., Washington, D. C.

**INVENTORS**—Before disclosing your invention to anyone send for form "Evidence of Conception"; "Schedule of Government and Attorneys' Fees" and instructions. Sent free. Lancaster, Allwine & Rommel, 411 Bowen Building, Washington, D. C.

"**INVENTOR'S** Guide," 100 mechanical movements, free; advises on patenting, selling inventions. Frank Ledermann, Tribune Bldg., New York.

**L. F. RANDOLPH**, 302-B Victor Bldg., Washington, D. C. Low cost. Book and information free.

**PATENTS.** Booklet free. Highest references. Best results. Promptness assured. Watson E. Coleman, Patent Lawyer, 724 Ninth St., Washington, D. C.

**INVENTORS**—Send for free booklet "Patent-Sense." Information based on 64 years experience. Lacey & Lacey, Dept. 5A, 635 F St., Washington, D. C.

### FOR INVENTORS

**INVENTORS**—Time counts in applying for patents. Don't risk delay in protecting your invention. Send sketch or model for instructions or write for free book, "Patent Guide for the Inventor" and "Record of Invention" form. No charge on how to proceed. Prompt, careful, efficient service. Clarence A. O'Brien and Hyman Berman, Registered Patent Attorneys, 58-S Adams Building, Washington, D. C.

**EXTENDED** Laboratory facilities now offer expert consulting service for inventors' problems in electricity, chemistry, mechanics, electrochemistry. Flat fee basis. Unless assistance rendered no payment required. Inventors Research Service, 135 University Ave., Rochester, N. Y.

**MODELS**, Special machinery and manufacturing of metal specialties. Pierce Model Works, Tinley Park, Ill.

200 **MANUFACTURERS** Wanting new ideas. 25c. Glen Sigafosse, 56 West Washington, Chicago.

**WE** Locate buyers meritorious patented, unpatented inventions. If will sell, reply immediately. Descriptive booklet free. Invention Reporter, 5A-11236 South Fairfield, Chicago.

**INVENTORS** Four day convention and exhibit will be held in Chicago, June 6th to 9th. Send stamp for details. National Inventors Congress, LaSalle Hotel, Chicago.

**BEFORE** You take any steps write for bulletins on our complete services, to save you money. R. & S. Engineering Co., Dept. PP1, 17 East 42nd Street, New York City.

**HAVE** You a sound, practical invention for sale, patented or unpatented? If so, write Chartered Institute of American Inventors, Dept. 4-A, Washington, D. C.

**FINANCIAL** Assistance for invention to be patented. Working models built. E. Worsham, Box 1356, Washington, D. C.

**INVENTORS:** Profit by your invention. A practical talk to inventors by an experienced manufacturer. Our 68 page booklet "Mind vs. Matter" mailed upon receipt of 25c. Rex Engineering Co., Cincinnati, Ohio, Dept. D.

**INVENTORS:** "Making Inventions Pay," our 32-page illustrated book, mailed upon receipt of 3c postage. Crescent Tool Co., Dept. Z, Cincinnati, Ohio.

**INVENTORS**—Send for 72-page book on patents. Reasonable terms. Conscientious treatment to inventors. L. F. Randolph, Registered Patent Attorney, 302-E Victor Bldg., Washington, D. C.

**I SELL** Patents. Established in 1900. Charles A. Scott, 773PM Garson Ave., Rochester, N. Y.

**INVENTORS** Consultant. Appraise applicability, patentability and marketability. Write C. G. Hall, 3133 Connecticut Ave., Washington, D. C.

### INVENTIONS WANTED

**PRACTICAL** Inventions wanted. Full protection guaranteed. Write for "4-Point Service" bulletin. R. & S. Engineering Company, 17 East 42nd Street, New York, N. Y., Dept. P-5.

**WANTED**—Meritorious patented, unpatented inventions. Booklet free. Invention Reporter, 5B-11236 South Fairfield, Chicago.

**IF** You'd like steady income inventing for special markets, write for my booklet "Cashing In On Unpatented Ideas." Stamp appreciated. Hendrickson, Argyle, Wisconsin.

**INVENTIONS** Wanted for promotion to manufacturers. Howard Frank, 55 West 42nd, New York.

**PENDING** Patent applications can be brought before thousands of manufacturers, free of charge, through Invention Magazine. Write for details. Invention, Inc., 635 F Street, Washington, D. C.

**PRACTICAL** Inventions wanted. Full protection guaranteed. Write for "4-Point Service" bulletin. R. & S. Engineering Company, 17 East 42nd Street, New York, N. Y., Dept. PP2.

**INVENTORS:** Sell your idea direct. We furnish names, capital rating, any type manufacturer. Dime brings information. Garinger, Associates, Box 1959, Chicago.

**SMALL** Inventions wanted by manufacturers. I'll help you sell your invention. Write for free circular. Stanley Hull, 7829-K Euclid Avenue, Cleveland, Ohio.

**SIMPLE**, Practical inventions wanted by manufacturers, patented or unpatented. For information write Chartered Institute of American Inventors, Dept. 4-D, Washington, D. C.

**CASH** For unpatented ideas. Stamp for particulars. Mr. Ball, 9441-A Pleasant, Chicago.

### PATENTS FOR SALE

**PATENTED**, Hand operated machine for cleaning air filter on automobile engines. Efficient, handsomely designed. Service stations, garages, fleet owners, make exceptionally large market. Charles Lester, Kimball, West Va.

**MARINE** Reverse gear—patented, 100% reverse. Free wheeling. Adaptable for all automobile and marine conversion. Tested and proved absolutely dependable. Charles Heckman, 321 Trinity Place, West Palm Beach, Fla.

**SALE** Or royalty. Any car theftproof using my patented license holder. Simple but safe. It's tamperproof. Neat on all late cars. Good for replacements. Cheap to manufacture. J-P, Box 4336, Takoma Park, D. C.

**MANUFACTURERS:** For new products or profitable manufacturing opportunities, inquire, Invention Reporter, 5C-11236 So. Fairfield, Chicago.

**DIES**, Patent, copyright including 1800 metal golf kits. Never marketed. Must sell. Link, 4341 Monroe, Gary, Ind.

**COMBINATION** Lead pencil clip and sharpener. Home shoe polisher holder. Automobile valve adjusting wrench. Chester Mummert, 810 No. 6th St., Harrisburg, Penna.

**SELL** Your patent through a small classified ad in Popular Mechanics. Many inventors have found buyers in this way. Ask me for proof—I'll gladly send it to you. F. W. Johnson, Manager Classified Advertising, 200 E. Ontario St., Chicago.

### MANUFACTURING

**INVENTIONS** Manufactured in any quantities. Tools, dies, metal stampings; working models built; industrial designing. Complete blueprint and engineering service. Write for "4-Point Service" bulletin. R. & S. Engineering Company, 17 East 42nd Street, New York, N. Y., Dept. PM-5.

**MANUFACTURING** At low cost. Dies, stampings, wire forms, spot welding. Southern Products, P59, Independence, Missouri.

**INVENTIONS** — Manufactured in any quantity at low cost by old established company. Stampings, metal specialties, dies, models, etc. Free estimates. Send for catalog. Crescent Tool Co., Dept. X, Cincinnati, Ohio.

**INVENTIONS** Manufactured by an experienced company, in any quantity at low cost. Metal specialties, novelties, stampings, dies, and models. Free estimates. Our booklet "Mind vs. Matter" sent upon receipt of 25c. Rex Engineering Co., Cincinnati, Ohio, Dept. C.

### MODELS AND MODEL SUPPLIES

**SHIP** Model kits, fittings. Catalogue 5c. Polk's, 429 Seventh Ave., New York.

**AUTHENTIC** Kits for period reproductions of historic houses. Super detail custom models of historic and modern boats and aircraft. Prices on request. Atkins Better Craftsmanship, The ABC of Model Making, P.O. Box 416, Natick, Mass.

**CATALOGUE** Of over 40 engines, castings, supplies, 25c. Refunded. Howarco, A-2417 North Ashland, Chicago.

**LIVE** Steam locomotives \$9.50 to \$200. Catalogue 25c. Steam-Electric Company, Bloomfield, N. J.

**MODEL** Midget racer kits make your favorite midget racer easy to build. Postpaid 60c. Hollywood Hobbies, 9423 Pico Blvd., Los Angeles, Calif.

**MODEL** Airplanes, boats, trains, and motors. Complete supplies. Immediate shipments. Catalog 10c postpaid. Model Builders Supply, 2328 Danforth, Hamtramck, Michigan.

**HOME**CRAFT And model supplies. 1939 catalog now ready 10c. Hobby Supply House, Box 2014, Pittsburgh, Penna.



**SPEED Boat hulls, kits \$3.25 up.** Literature. St. Louis Model Boat Co., 225 N. Meramec. Clayton, Mo.

**SUBMARINE 24"** Kit to build \$1.00. Spotts, 3925 N. Broad, Philadelphia.

**MINIATURE Boat and airplane supply catalog 5c.** Selley, 1377 Gates Ave., Brooklyn, N. Y.

**MODELS—Your ideas developed into practical working models.** 30 years successful experience; thousands of satisfied customers. Confidential service guaranteed. Bank references. Send 3c postage for our large booklet—"Making Inventions Pay." Crescent Tool Co., Dept. Y, Cincinnati, Ohio.

**RAILWAY Models.** Catalog handbook 25c. Walthers, 247 E. Erie, Milwaukee.

**BUILD Miniature gasoline motors.** Fascinating, educational, profitable. Details, drawing, 10c. Wright Motor Works, 3256 Lake Park Ave., Chicago.

**MODEL Railroad Shop,** Dept. PM, Dunellen, New Jersey. New 24 page illustrated catalog 10c postpaid.

**SHIP And yacht model fittings; construction sets; model yacht sails; illustrated catalog 20 cents.** A. J. Fisher, 1002-1 Etowah Avenue, Royal Oak, Mich.

**MODEL Supplies for the inventor.** Send 3c stamp for catalog. Pierce Model Works, Tinley Park, Ill.

**MODELS—Practical models put over your ideas.** We develop models from the crude to perfect working devices. Your idea might have large commercial value. Services confidential. Bank references. Registered graduate engineers at your service. Send 25c for our 68 page booklet "Mind vs. Matter." Rex Engineering Co., Cincinnati, Ohio, Dept. B.

#### BLUEPRINTS AND PLANS

**GRASSHOPPERS—Build machine for spreading poison.** Complete plans and photo \$2.00. H. Stowell, P. O. Box 105, Albuquerque, New Mexico.

**WORKING Drawings for the following items:** Brake applicator for trailers, makes your trailer brake automatically. Gasoline scooter, inexpensive to build, 40c for each drawing, both for 75c. Tee-Jay Engineering Co., 31 Elm, Battle Creek, Michigan.

**BUILD And install complete, 40" attic fan for \$25.00 total cost.** Cools seven room house, or average size store, cafe, etc. No machine work—only ordinary tools. Blueprints, templates, parts list, installation diagrams and instructions all for only \$5.00. Included, diagrams and instructions for adding washed cooled air unit. John L. Hull, 2808 Commerce Street, Dallas, Texas.

#### HOME CRAFTSMEN

**3c STAMP Brings latest price list rare lumber, veneer, inlay pictures, etc.** Woodcraft Supply, 413 N. Hoyne, Chicago.

**KNOCKDOWN Furniture, lumber, plywood, veneers.** Illustrated catalog 10c. Giles-Kendall Co., Decatur, Alabama.

**NEW Manual for tool users free.** Tells you how to use and care for your tools; how to sharpen your saws. Write Henry Disston & Sons, Inc., 511-C Tacony, Philadelphia, Penna.

**20 FULL Size lawn ornament patterns 25c.** Wickman, 744 Brooklyn, Dept. 29, Dayton, Ohio.

**BORING Bar for small diameters.** Very rigid. Blueprints 35c. Craftsman's House, Avoca, Penna.

**TURN Alabaster! Four butts, f.o.b. \$1.00.** Demonstrators, 1743 Harrison, Chicago.

**MAKE Mats from junk tires.** Instructions \$2. Thomas Kowell, 5372 St. Clair, Detroit.

**MAKE Leaded antique lanterns.** Free description folder. M. Ascherl, Lorain, O.

**22 FULL Size lawn ornament patterns 25c coin.** Strother, Box A-383, Belington, West Virginia.

**CHAIR Cane, reed, webbing, seating materials.** Fogarty, Caner, Troy, N. Y.

**MAKE Beautiful artistic roc-veneers, urns, birdbaths, etc., by unique system.** Inexpensive. Write Roc. Veneer System, Brady, Texas.

**EXTRAORDINARY Guaranteed wood-working moneymaking opportunities.** Information. Illustrated thirty-six page catalog 10c. (refunded). Woodcraft Service, Plainview, Minnesota.

**20 LAWN Ornament patterns 30c.** 20 novelty patterns 30c. 14 silhouette patterns 30c. 15 lawn ornament patterns different from those above 30c. All for \$1.00. Modern Woodcraft, Saginaw, Michigan.

**LEATHERCRAFTSMEN—Write for free instructions and price list of leather, tools, etc.** Sample cards 5c. Wilder & Co., Dept. F, 1038 Crosby St., Chicago, Ill.

**WOODWORKERS Dowel templet makes perfect joints.** \$1.25 prepaid. Fred Fay, Meadville, Penna.

**1001 WAYS to Use Concrete.** Send for large free illustrated folder describing new Popular Mechanics book covering every known use of concrete for the home, farm, building, business and industry. Popular Mechanics Press, Room (C38), 200 E. Ontario St., Chicago.

#### OLD GOLD, WATCHES, JEWELRY, PRECIOUS STONES

**10 DIAMOND Platinum wedding rings, \$28.00.** Pistilli Brothers, Bridge Street, Newark, N. J.

**HIGHEST Prices for old gold—Mail your teeth, watches, jewelry.** 100% full cash value mailed day shipment received. Satisfaction guaranteed or articles cheerfully returned. Information free. Chicago Gold Smelting Company, 300-P Champlain Building, Chicago.

**5000 REBUILT Elgin, Waltham, Hamilton watches.** Also ladies, gents wrist watches. Make big money! 12 size, 7 jewel, Elgin or Waltham, \$4.75; 16 size, 17 jewel, \$7.50. Send for free watch and diamond catalogue. The New York Jobbers, Dept. M, 74 Bowery, New York, N. Y.

**WATCHMAKERS' Supplies, tools, watches.** Sold—purchased. Ben Segal Company, 5 So. Wabash, Chicago.

**WATCHMAKERS' Repair service.** Save half. Paul Jewelry Co., LaCrosse, Wis.

**AUSTRALIA'S Lovely opals.** Illustrated catalogue free. Good selection \$5. Norman Seward, Melbourne, Australia.

**GOLD \$35 Ounce.** Ship old gold teeth, crowns, jewelry, watches—receive cash by return mail. Satisfaction guaranteed. Free information. Dr. Weisberg's Gold Refining Co., 1500-Q Hennepin, Minneapolis, Minn.

#### FOR THE HOME

**EASILY Built lawn chair, plans 50 cents.** Carver, 1322 29 Street, South Bend, Ind.

**REFINISHING Your furniture made easy!** Complete instructions 35c (coin). Todd's Service, 53 McGuffey, Youngstown, Ohio.

**SMELLY Shoes? Self addressed stamped envelope brings information about shoe hygiene and free sample.** Shu-Sweet, Box 1066, Santa Fe, New Mexico.

#### TOBACCO

**GUARANTEED: Cigarette, pipe or chewing, 5 lbs. \$1.00, ten \$1.75.** Pay when received. Pipe and box cigars free. Rives Tobacco Co., Paducah, Ky.

#### FOR SALE—MISCELLANEOUS

**FOR Sale, new and used marble games guaranteed.** Write for lists. River Amusement Co., 152 West 42nd St., New York City.

#### WANTED—MISCELLANEOUS

**CASH For used microscopes, binoculars, cameras, slide rules, drawing sets, surveying, mechanical, and scientific instruments.** Highest prices paid day shipment received. Satisfaction guaranteed or shipment promptly returned. Eiman's, 2302 Van Buren, Chicago.

#### PERSONAL

**NERVOUSNESS! Afflicted? Feel discouraged? Overcome your fears!** Free (personal) information. Investigate! John Englund, Ps.D., Ironwood, Mich.

**NEWLY Discovered dandruff remover.** 50c. Shumer's, 181 Rockaway Parkway, Brooklyn, N. Y.

**WHOLESALE! Five large milk magnesia toothpaste \$1.00, sample 25c.** Jocar, Wellesley, Mass.

**TREASURE Finders? Read Goldak advertisement on page 137A.**

**EMBARRASSED By smelly shoes? Shu-Sweet prevents that odor.** Money-back guarantee. 25c postpaid. Shu-Sweet, Box 1066, Santa Fe, New Mexico.

**SCALP Disorders banished forever!** Prevent baldness, dandruff, falling hair, itching. Results guaranteed. Details free. 116 Church, Foxchase, Philadelphia.

**DEAFNESS Is misery.** Abell's invisible ear drums recommended. Free book. Dr. Abell, Slavlin Bldg., Pasadena, California.

**GOOD Eyesight without glasses.** No drugs. Surprisingly simple treatment. Guaranteed. A. Jacobson, Upsala, Minn.

**WIN Prize money: Booklet—"Successful Contesting"—shows how.** 10c postpaid. Bulletin listing \$200,000.00 prizes included. World Publishers, 4515-B Cottage Grove, Chicago.

**SMALL Business of Your Own.** 1000 tried and proven methods. \$1.00. Popular Mechanics, 200 E. Ontario St., Chicago.

#### MISCELLANEOUS

**LAM-A-FAB, The cloth cement, acid and waterproof.** Permanently repairs anything made of cloth. Sails, hunting equipment and suits, football suits and athletic equipment, rugs, canvas chairs and work clothing. S. J. Russell Co., P. O. Box 187, Peoria, Ill.

**NITE Lite, switch, adjustable shade,** plugs into any outlet. 25c coin postpaid. Erman's, Monroe, Mich.

**COCOONS, Butterflies, collectors' supplies, free lists.** Maynard, 1192 Lewiston, Rochester, N. Y.

**MEXICAN Scenic postcards: Two, 12c stamps.** Free remailing service. Marquez-PMD, Apartado 1176, Mexico City.

**TATTOOING Outfits, world's fair electrotyping machines.** "Waters," 965 Putnam, Detroit.

**BUSINESS Proposition silvering mirrors, autographs, reflectors, making chipped glass signs.** Write, Sprinkle, Plater, 288, Marion, Indiana.

**ELECTRIC Razors \$1.00.** Books, tricks, novelties. Bryant, 857 West Broad, Columbus, Ohio.

**"SECONDS" High grade men's socks,** latest fashions, all colors, six pairs \$1.00. Watertown Specialty Co., P. O. Box 88, Watertown, Massachusetts.

**GET Informed: Latest bulletin fluorescent and other high priced rocks and minerals; interesting, profitable.** 15c stamps. Brandex Laboratories, Box 180, Oakland, California.

**ABUNDA-GRO Performs planting miracles without soil.** Unique Club, Upsala, Minn.

**MONEY In butterflies, moths.** See Sinclair Display Advertisement on page 14A.

**LUMINOUS Paint shines in the dark.** 10c bottle. Myers, 211 Broadway, Niles, Michigan.

**AMATEUR Tattooing outfits.** Free circular. Tatuco, A-651 South State, Chicago.

**AMATEUR Cartoonists wishing steady income copying and duplicating cartoons for advertisers, write Ad-Service, Argyle, Wisconsin.**

**PLASTICS: Introductory kits from 55c postpaid.** Free catalog. Carlson Plastics Products, 70 Fox, Buffalo, N. Y.

**BOOK, 500 Useful kinks.** Engineers, janitors. \$1.00. Mikkelsen, 4832 45th Ave. S. W., Seattle, Wash.

**TREASURE Finders? Read Goldak advertisement on page 137A.**

**SMELLY Shoes? Shu-Sweet prevents that odor.** Simple to use. Money-back guarantee. 25c postpaid. Shu-Sweet, Box 1066, Santa Fe, New Mexico.

**SWAPPER'S Friend, R4, Saline, Michigan.** Interests swappers, collectors. 50c year, sample 10c.

**COATS-OF-ARMS And crests correctly rendered in colors or black and white.** Highest grade. Estimates free. Heraldic Studios, 1914 Oakdale Ave., Chicago.

**10,000 MONEY-MAKING Formulas.** Tells you how to make and sell almost everything under the sun; cosmetics, mucilage, anti-freeze solutions, battery solution, beverages, cheese, chewing gum, cleaning preparations, extracts, hair preparations, inks, bluing, leather polish, mirrors, perfumes, polishes, typewriter ribbons, carbon paper, washing powders, liquid soap, and hundreds of other profitable articles. \$4 postpaid. Popular Mechanics Press, Room (C38), 200 E. Ontario St., Chicago.



# OL' JUDGE ROBBINS

MY, WILL THIS CITY EVER BE FINISHED! THOSE TELEPHONE MEN ARE AT IT AGAIN, EH, DAD?

GOSH, THAT REMINDS ME... WE WERE TO VISIT THAT BIG TELEPHONE EXCHANGE!

IN NEW YORK  
THE  
TRANSOCEANIC  
TELEPHONE



JUST THINK — HUNDREDS OF OPERATIONS TO COMPLETE A DIAL PHONE CALL!

YES — BUT OUR OVERSEAS SERVICE IS EVEN MORE INTERESTING

RECEIVING STATION CUPAR, SCOTLAND

RECEIVING STATION HOULTON, ME

TRANSMITTING STATION RUGBY, ENGLAND

TRANSMITTING STATION ROCKY POINT, N.Y.

ONE OF 4 CIRCUITS ON N.Y. TO LONDON PHONE CALL

N.Y. VOICE GOES BY RADIO FROM LONG ISLAND TO SCOTLAND, BY WIRE TO LONDON.

LONDON VOICE GOES BY RADIO FROM RUGBY TO MAINE, BY WIRE TO N.Y.

WE CAN REACH THE LONDON OPERATOR BEFORE YOU COULD TAKE A DOZEN PUFFS FROM A PIPE-LOAD OF PRINCE ALBERT

CAN ANYONE WITH A RADIO LISTEN IN?

YES, BUT IT WOULDN'T SOUND LIKE ANYTHING. THE RADIOED WORDS ARE 'SCRAMBLED' AND REASSEMBLED

"JUDGE ROBBINS" IN TELEPHONE CRYPTIC (SCRAMBLED WORDS) SOUNDS LIKE "BLURZ RADDIMZ"

THIS IS THE 'VOICE MIRROR.' SPEAK INTO THAT PHONE AND YOUR VOICE WILL ECHO BACK THROUGH THE THREE RECEIVERS

THERE'S NO OTHER TOBACCO LIKE PRINCE ALBERT!

THERE'S NO OTHER TOBACCO LIKE PRINCE ALBERT!

YOU'LL GET THAT ECHO FROM A LOT OF PIPE-SMOKERS, TOO, JUDGE! P.A. CERTAINLY SHOWED ME HOW MILD AND TASTY A TOBACCO CAN BE

Copyright, 1939, R. J. Reynolds Tobacco Company

## Hello! Smokers...



I CREDIT MY PIPE PLEASURE TO PRINCE ALBERT. IT'S COOLER, MELLOWER WITH GOOD, RICH BODY!

P. A. IS TASTIER, TOO, IN "MAKIN'S" CIGARETTES. ROLLS FASTER, NEATER AND SMOKES SLOWER

50 pipefuls of fragrant tobacco in every handy tin of Prince Albert

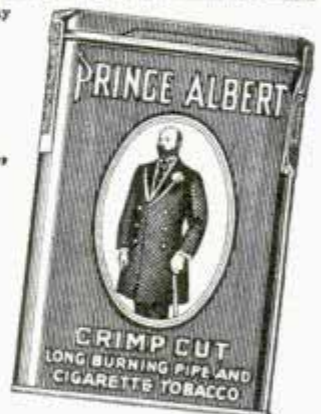

**P.A. PLEASURES OR "REVERSE THE CHARGES!"**  
Smoke 20 fragrant pipefuls of Prince Albert. If you don't find it the mellowest, tastiest pipe tobacco you ever smoked, return the pocket tin with the rest of the tobacco in it to us at any time within a month from this date, and we will refund full purchase price, plus postage.  
(Signed) R. J. Reynolds Tobacco Company, Winston-Salem, North Carolina

# PRINCE ALBERT

THE NATIONAL JOY SMOKE

When writing to advertisers please mention Popular Mechanics



# Popular Mechanics Magazine

REGISTERED IN U. S. PATENT OFFICE AND CANADA

WRITTEN SO YOU CAN UNDERSTAND IT

Vol. 71

MAY, 1939

No. 5

## Magic TUBES of DAYLIGHT



*Amv.*

**R**IGHT next to Edison's invention of the carbon filament lamp and the later introduction of tungsten filaments, put the new fluorescent "daylight" lamp. Lighting engineers call it the third milestone in man's conquest of night by electricity.

For a long time they have wanted to wave a wand or mix a magic powder to create a really accurate and inexpensive imitation of daylight. Today they have both wand and powders—a tube of glass and an assortment of inorganic chemicals in powdered form; together, the fluorescent lamp.

Patient research has resulted in the perfection of powders or "phosphors" to generate practically any color desired. Fluorescence, an old friend you first met in physics class, is the basis of the lamps. There are certain chemicals that, under



Left, using "daylight" lamps beside boudoir mirror for daytime makeup; warmer light can be used at night. Right, placing twenty-watt fluorescent tube in fixture

*Northlight Mfg Co* 641

*Chicago*



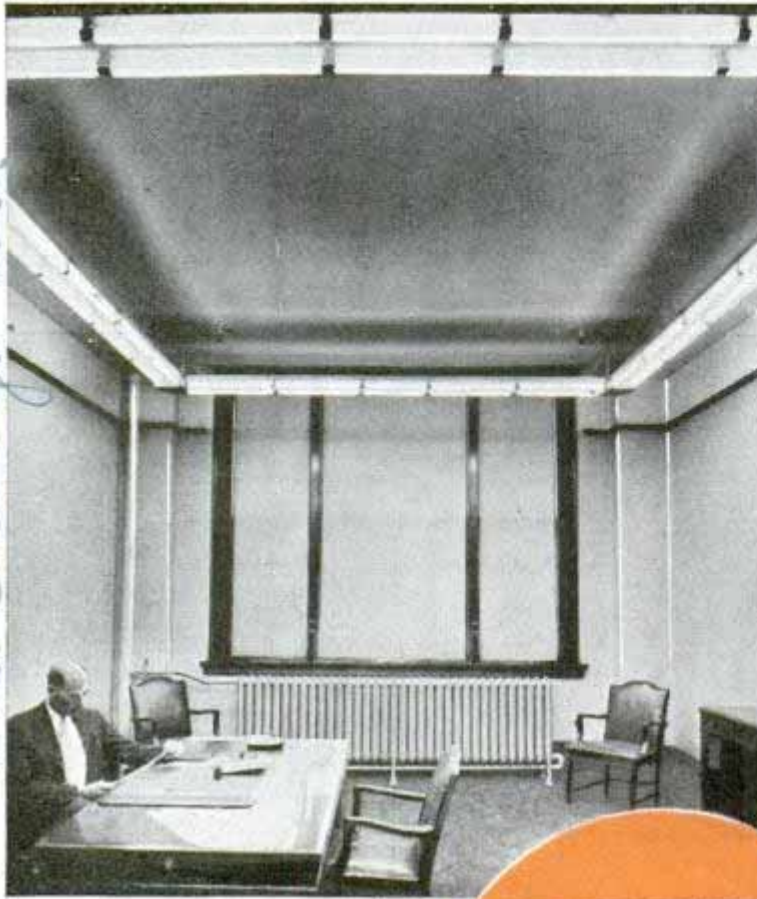

tions can be varied to give almost any desired color. In this way, artificial daylight more like natural daylight than anything produced before at comparable efficiencies has been made possible.

Incandescent lamps, equipped either with a blue-green bulb or a special glass filter, were the best daylight sources until the fluorescent lamp came along. The efficiency of producing artificial daylight with incandescent lamps is low, only ten to thirteen lumens per watt; and when a filter is used for more accurate color characteristics, it falls to one to five lumens per watt. Yet 50,000,000 daylight lamps and many thousands of color-matching devices using daylight filters have been sold. The daylight fluorescent lamp is more than twice as efficient as the daylight incandescent, and delivers thirty lumens per watt. All the fluorescent lamps excel in efficiency as compared with incandescent sources. With colored lamps, the differ-

invisible, short-wave light, produce visible light. Ordinarily, when any light is absorbed, the energy it contains is transformed into heat. But in fluorescence, the absorbed radiation makes the molecules of the material vibrate in such a manner that visible light is given off instead of heat alone. Always, the wavelength produced is longer than that absorbed. A familiar device that has employed fluorescence for years is the fluoroscope, used to make X-ray images visible.

Ultraviolet radiation, which activates the phosphors, is produced by a mercury arc, started by heating coiled tungsten electrodes at each end of the tube and then automatically breaking the circuit through the electrodes to permit the current to flow through the arc. There is a small amount of argon gas in the lamp to make starting easier.

When light of a single color is desired, one kind of powder is used in the tube. By careful blending of three powders, white light is produced. The propor-

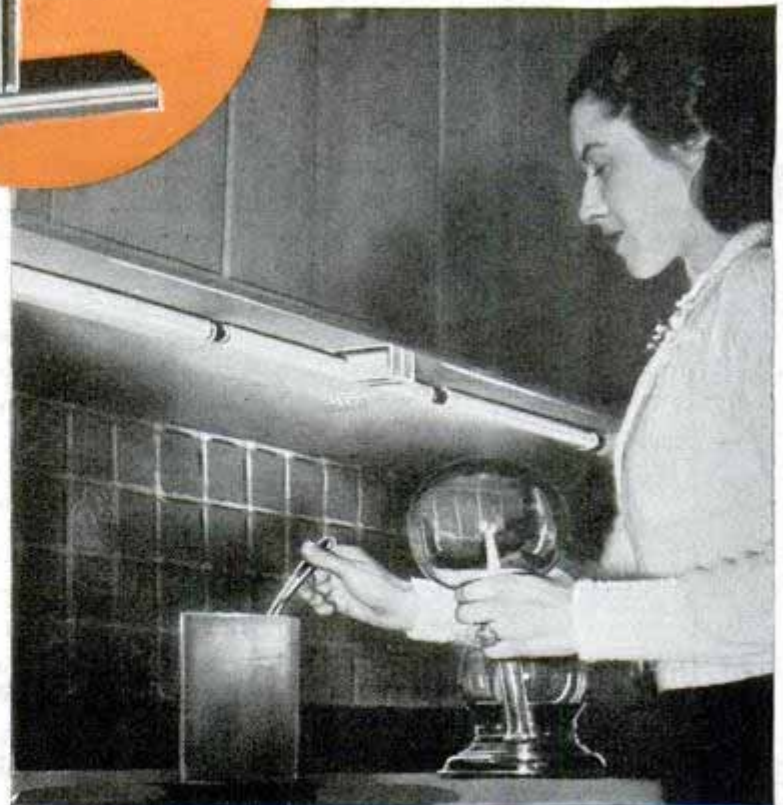
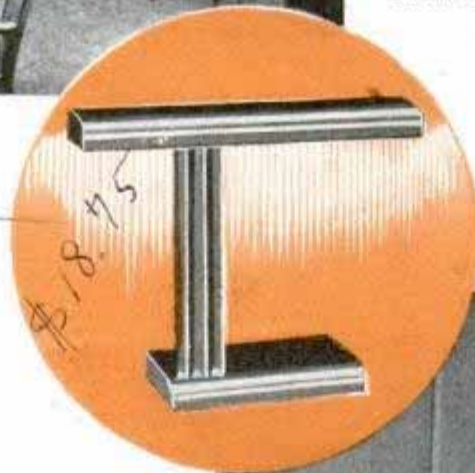

Top, fluorescent lighting in indirect trough fixture. Center, cool "daylight" desk lamp. Below, illuminating work surface in kitchen with the new tubes

*Esential Electric Co.*

Illuminating Co. 2110 Commercial Ave. North Chicago, Ill.



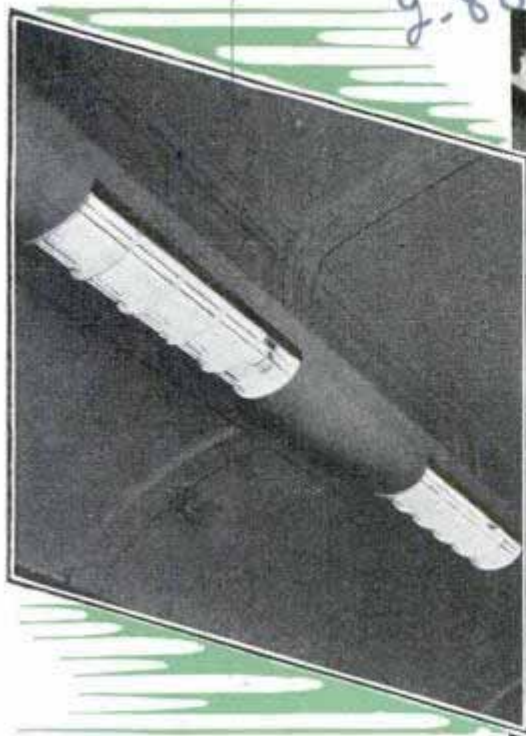

ence is especially pronounced. A green incandescent lamp has an efficiency of one or two lumens per watt, while the green fluorescent lamp, most efficient of all because its radiation is near the region of the spectrum where the eye is most sensitive, develops fifty to sixty lumens for each watt consumed.

Fluorescent lamps are made in three different lengths, two bulb diameters and five colors besides daylight and warm white: green, blue, red, pink, gold. Each lamp consumes about ten watts for each foot of length, the longest being thirty-six inches.

The lamps are more rugged mechanically than filament lamps because they have no delicate filament to break. The coiled electrodes are so sturdy and operate at so low a temperature that they are not likely to be damaged by mechanical shock, or to burn out as do ordinary lamp filaments. However, fluorescent lamps do have one or two weaknesses, but these will, in time, be eliminated or reduced.

Chief of these is the fact that the lamps are sensitive to temperature. The mercury-vapor pressure inside the tube must be at a certain value for the lamp to operate most efficiently. When the temperature goes up, the pressure becomes greater, and

(Continued to page 146A)



Top, left, daylight tubes in railroad car; right, fluorescent lamps help match paintings with color press proofs. Below, "outdoor" light in fur salon



# Lightweight Auto Designed to Give Economy



*Champion*

Left, driving compartment of the new lightweight Studebaker. Note that the gear lever is located beneath the steering wheel. Circle, door opened to show construction details resulting from omission of running board. Note the weather seal strip against which the door closes

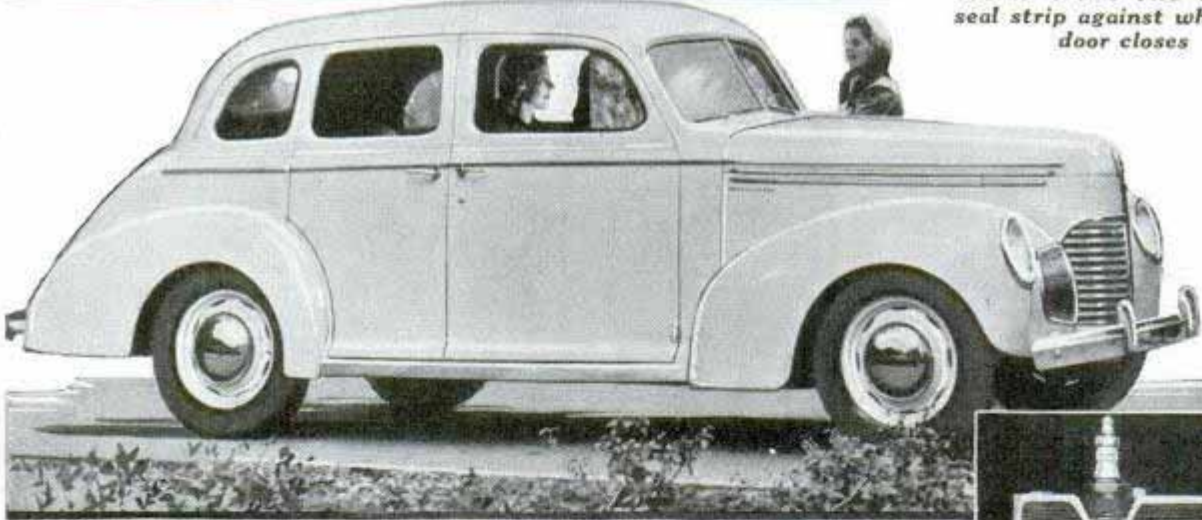

Center, exterior view of the new car, demonstrating the styling in the manner of Raymond Loewy, including headlamps set flush into front fenders. Bottom, left, cutaway view of the six-cylinder engine shows how water jackets extend the full length of the cylinders to give efficient cooling. Bottom, right, another cutaway, of a cylinder, to show cooling and oiling passages. Motor design is simplified to achieve a reduction in weight, as well as to improve performance. The engine delivers seventy-eight horsepower and the car weighs slightly less than 2,400 pounds, a combination resulting in unusually low fuel consumption

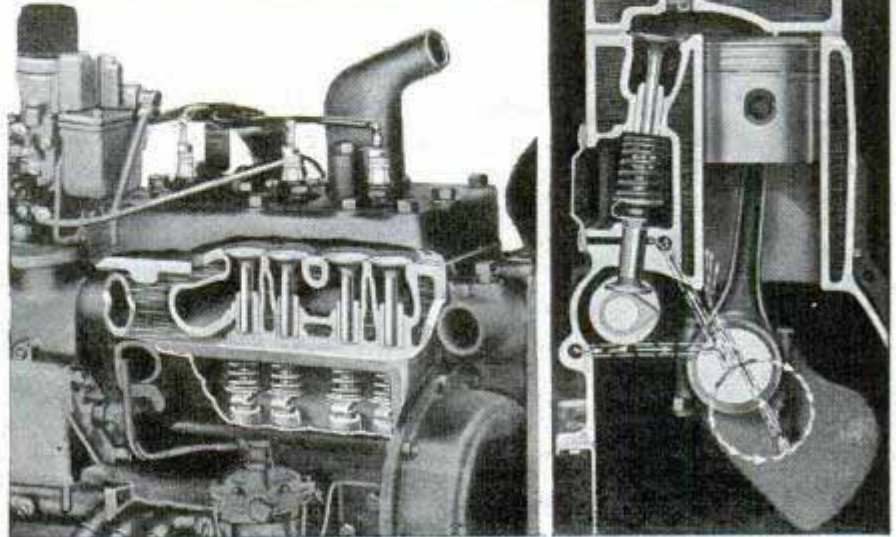



221 see also page 0

220.

### New Auto Marks Trend to Lighter Weight

Representing a new trend in the automobile industry—that of lightweight construction to achieve exceptional economy without sacrifice of performance—a new Studebaker has just been introduced. The car will sell in the lowest price field of standard size automobiles. Produced in three models, four-door sedan, two-door sedan and coupe, the Champion, as it is called, weighs approximately 2,400 pounds. It is powered by a six-cylinder engine that develops seventy-eight horsepower and delivers more than twenty-five miles per gallon of fuel. The transmission is three-speed synchro-mesh, operated by gear lever located under the steering wheel. Front suspension is of the planar type, pioneered by Studebaker. The car is equipped with hydraulic brakes. The frame is said to be thirty per cent lighter in weight but stronger than competitive car frames. Liberal use of welds and reinforcements serves to make the frame a closely knit unit. A weight saving also has been achieved in the engine, which is about 200 pounds lighter than competitive motors. It has a comparatively short crankshaft, lightweight reciprocating parts, short, lightweight connecting rods, large Celeron gear for driving the camshaft, full pressure oil system, aluminum alloy pistons, water jackets extending the full length of cylinder walls and a high turbulence combustion chamber with a compression ratio of 6.5-1. The body is all-steel, the headlamps recessed into the fenders. Attractive styling of the Champion is the work of Raymond Loewy, industrial designer. There are no running boards and door hinges are concealed. Rotary door locks are standard equipment. Available for installation on the new car is the overdrive.

### Portable Steel Air-Raid Shelter Has Room for Four Persons

*Tested in London, England*



*Air-raid shelter standing under collapsing wall in severe test simulating war conditions remained undamaged from shock*

Britain's drive for air-raid precautions has brought forth the development of a bell-shaped steel shell able to withstand the shock of falling bricks or shrapnel. Four people can occupy one of the shelters and come out unscathed even if a wall tumbles upon it, as demonstrated in a recent test.

216

### One-Man Yacht Model Built to Scale from Thirty-Three-Footer

Just big enough to carry a "crew" of one, a scale model power cruiser has been built by a California craftsman. Patterned after a thirty-three-foot boat, the yacht is only eight and one-quarter feet long, with a twenty-eight-inch beam, and draws six inches. A three-quarter-horsepower motor drives her tiny bulk at six to ten miles an hour.



*Undersized boat built to scale of three inches to the foot carries one man at ten miles per hour*

*W. H. Letcher, Cal. Lu and 1521 S. Western Ave.*



# Tractor from Junked Cars Does All the Garden Work

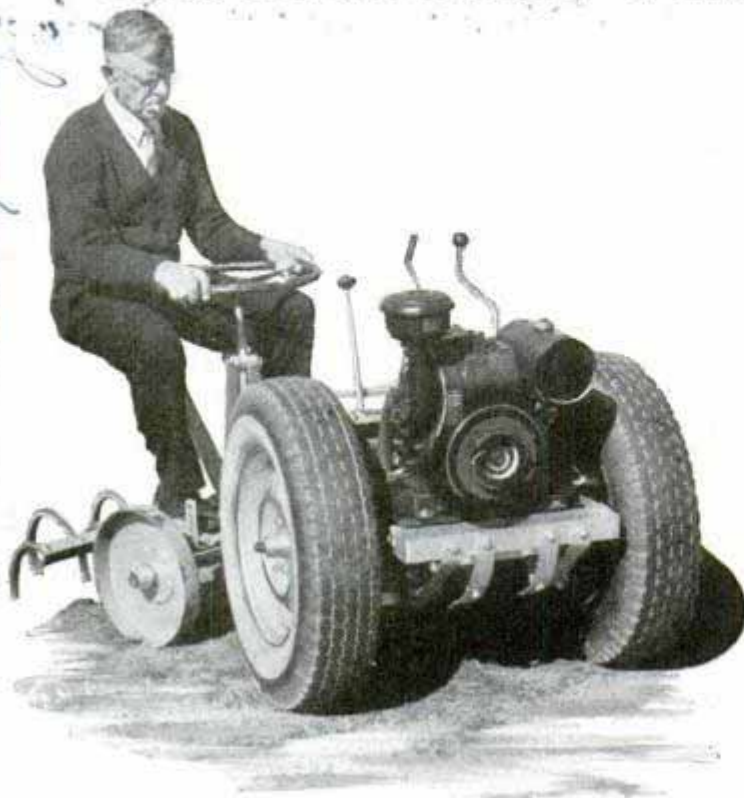

Homemade tractor assembled from parts of junked automobiles does all the garden work, also mowing and rolling lawn

To save hand labor in his garden, the owner of an acre of ground assembled a tractor from parts of automobiles purchased at junk yards for seventy-five dollars; the motor, which was new, costing sixty-three dollars. Front wheels and tires came from a Buick, while the rear wheels were made from Chevrolet brake drums. An old Star car yielded the gear box, and a model "T" Ford the axle. There are four forward speeds and reverse, and the tractor makes fifteen miles an hour. An ingenious belt drive forms the clutch, the engine being shifted laterally until the belt is taut or slack. Cultivator, roller, lawnmower, scraper and harrow are interchangeable. Each tire carries about 100 pounds of water to increase the weight.

## Folding Grill for Top of Stove Cooks Both Sides at Once



Meat can be cooked uniformly on both sides at the same time in a folding grill that is used on the top

burner of any flame-type stove. The upper cooking plate, hinged to the lower, rests on the meat or toast with just enough pressure to transfer heat without crushing. The lower plate is heated directly by flame, the upper takes its heat from the hot gases which pass through ducts and baffles of a circulation system and finally escape through eight long windows in a chimney along the top. It takes four minutes to bring the grill to full heat, which is indicated by a button rising from the top of the chimney; cooking is then very rapid. Made of aluminum and steel, the grill has a cooking space five and a quarter by eight and three-quarters inches. It takes two to four minutes to grill a steak.

## J-191 Ventilator Cleans Air and Stops Drafts

Clean outside air flows into the room without creating drafts through an adjustable window ventilator that removes particles of dirt and dust. An eddy current is produced in its interior, depositing all heavier-than-air material into a dustpan which is cleaned easily. On leaving the ventilator, the air is

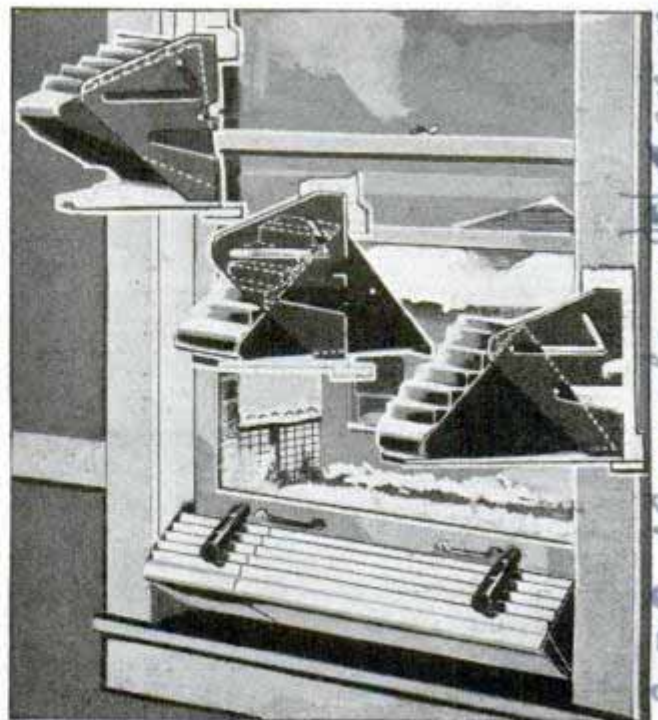

Metal window ventilator. Inset, left to right, shows three adjustments from closed position to fully open

8227

Universal Button Badall Engineering and Mfg Co  
Co. 2250 W. 70th St.

Build by Richard H. Theid  
El Monte, Calif.

and  
leaves  
be



directed toward the ceiling so drafts are not possible, and many adjustments are obtainable to provide for admission of fresh air in stormy and wet as well as during calm, dry days. It is made in five sizes for windows ranging from sixteen to sixty-eight inches wide.

*g 209*  
**Still Camera Teams with Movie on the Same Tripod**

When you are taking movies of a good action scene you lose many a chance for a perfect snapshot with your still camera. A twin assembly unit now available makes it easy to operate both cameras at once. Still and movie cameras are fastened side by side on the unit which is mounted on a single tripod, and the shutter of the still can be snapped without disturbing the movie operation.



Without disturbing action of movie camera, still pictures can be snapped with camera on-twin mount

*g. 160.*  
**Museum Auto Sliced in Half Runs at Touch of a Button**

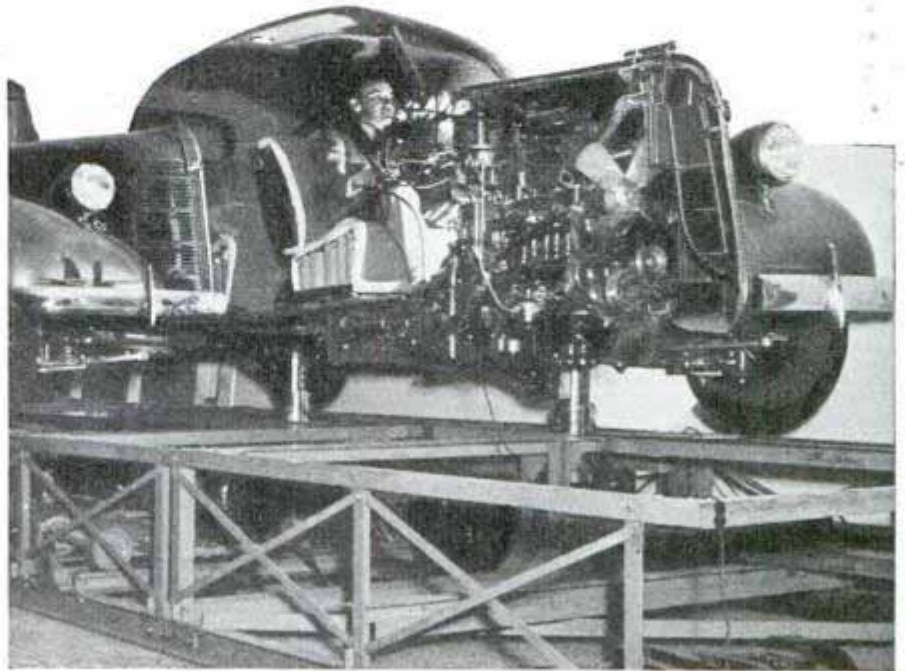

When visitor to Rosenwald Museum presses button, half of this "sliced" automobile moves forward and exposed engine is seen in action

*Jackson Park*  
Visitors to the Rosenwald Museum of Science and Industry in Chicago may press a button and watch the wheels go around in a cutaway automobile. The car is sliced in half vertically, one half, including the driver's seat and motor, moving forward on a track to permit full view as the exposed pistons slide up and down in the cutaway cylinders. The demonstration is electrically operated.

*g 242.*  
**New Weir above Niagara Falls Adds to Power and Beauty**

Hidden beneath the rushing waters of the Niagara river, less than a half mile above the falls, is a concrete weir recently completed by a Canadian power company. Its purpose was to divert a larger volume of water to the plant and bring it to the level that existed when the power station was installed thirty-five years ago, but it has also directed a greater volume of water to the crest of Horseshoe Falls and thus enhanced its beauty. The weir is submerged throughout its length of 930 feet.

*Compressed Air Magazine Feb. 1939*  
Of the 3,996,754 automobiles built throughout the world in 1938, the United States produced 2,489,635; the United Kingdom 447,561; Germany 328,000; France 220,343 and Russia 215,000.

*The Thrasher Co. 121-123 S. E. Automobile Industries 2/25/39*



Approved by Dept. of Equipment  
W. W. Wilder, New York Central P.R.  
Cherry

98.

# At the THROTTLE



Ed Wilson 1020

By Lou Wilson

Veteran Engineer of the  
20th Century Limited

As Told to Julian Leggett

ROARING along at seventy to eighty miles per hour, with 900 tons of steel pounding the rails behind his big locomotive, the engineer has even more to think about than his schedule and the safety of 150 or more passengers.

Watching the public—that part of it that I can see from my cab—is perhaps the most important part of my job. Of course, there is the feeling of great responsibility for my passengers, but in time that becomes instinctive. As I sit at the throttle, I keep thinking about automobile drivers and pedestrians. Four-wheel brakes can stop the modern car quickly, but the way many drivers use them is enough to give every engineer a bad case of the jitters. I see an automobile coming, but I don't know what the driver is going to do. Per-



Top, Engineer Wilson at the throttle. Bottom, the "Century" pulling out for long run between Chicago and New York

haps he will speed right up to the crossing and stop on a dime—or he may ignore ringing bells, flashing lights and the locomotive's warning screech to shoot over the crossing, without more than a couple of inches to spare. If the motorists would slow up as they approach a crossing, the engineer would breathe easier because he



298

# of the "CENTURY"

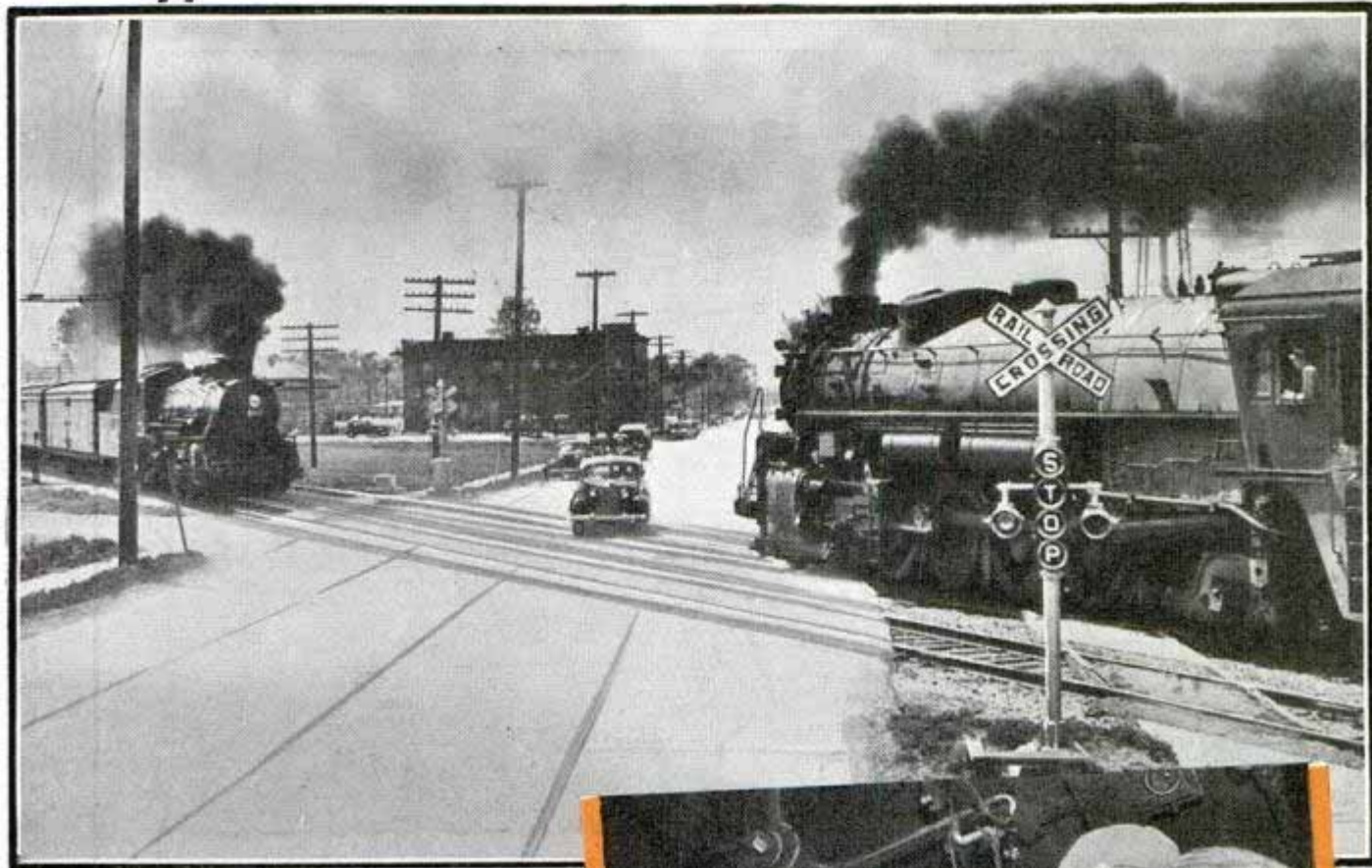

would know they had a better chance of hearing his whistle and more time to stop.

The pedestrian is my other big worry. That man standing beside the track ahead of me may decide suddenly to cross. Some people walking the track will stay on until the locomotive is almost on top of them. Then they step off, the engine pilot fanning their coattails. Ignorant of their close brush with death, they sometimes laugh at me.

These fellows who turn the engineer's hair gray by taking chances don't seem to know that it's impossible for me to stop the thirteen to fourteen-car "Century" in much less than one-third of a mile when I'm doing eighty miles an hour, even when I apply the emergency brake. Unless the engineer figures he has the time and



*Top, motorist in a bad spot after failing to note fast train at left. Locomotive at right is standing still. Bottom, Wilson and fireman in locomotive cab*



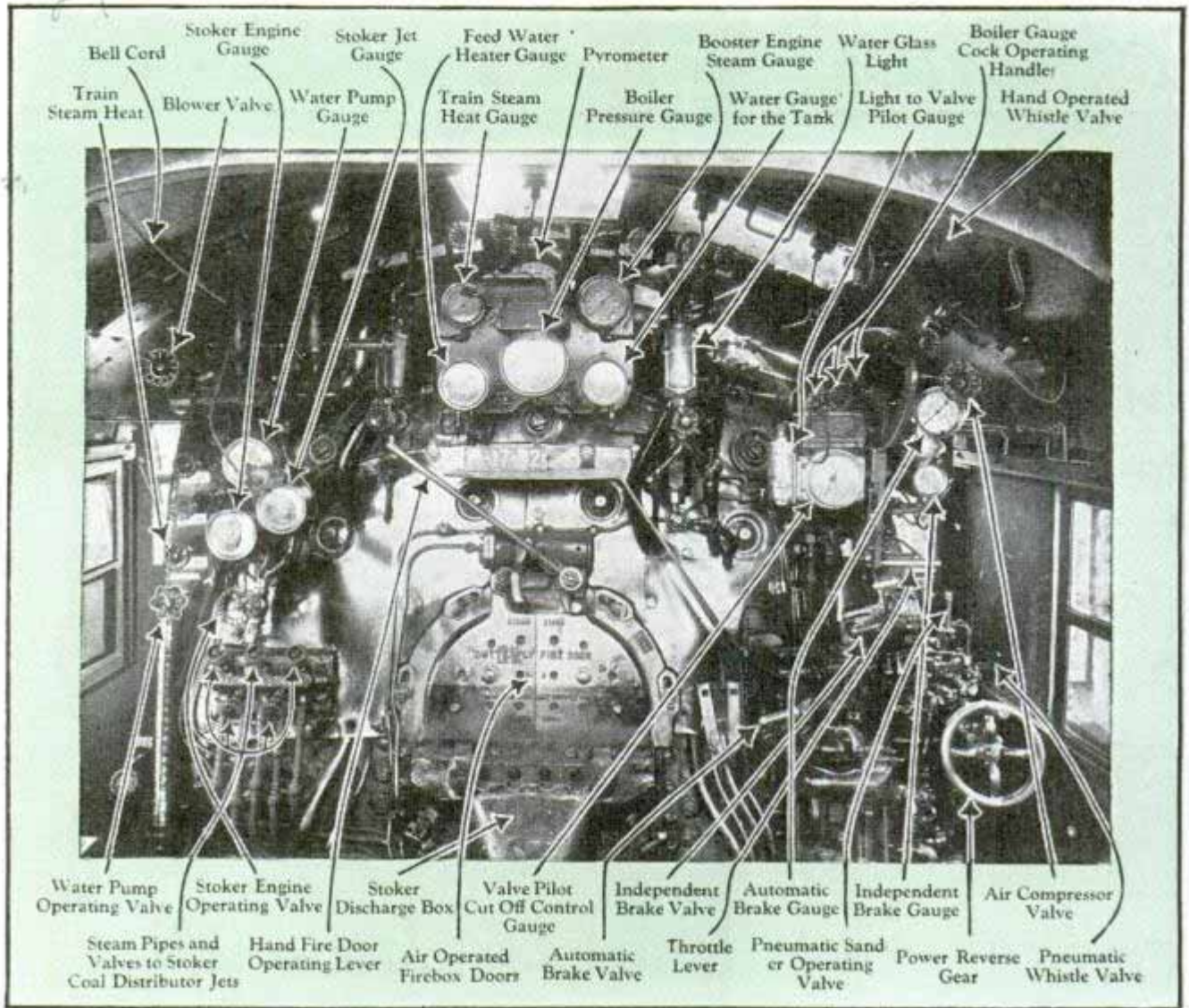
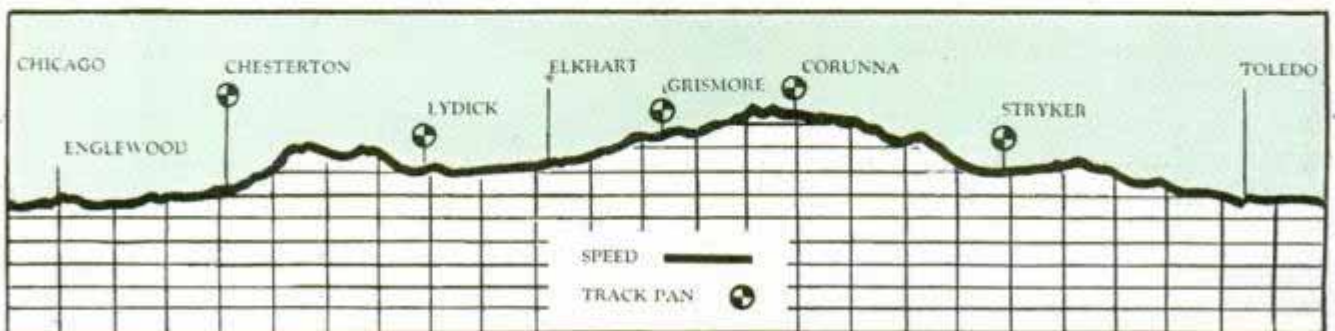

Photo courtesy American Locomotive Co.

stopping distance, and that he will save lives by doing it, application of the emergency brake would be futile. An emergency stop of a heavy passenger train costs the railroad from \$1,200 to \$1,500, depending upon the number of cars in the train. Full application of brakes flattens every wheel on the train, scraping off as much metal as would be worn away in a year's normal service. Added to the loss of that metal is the cost of labor for turning down

each flat wheel in the shops before it can run again. Usually an emergency stop means that the train must be halted right at that point and its passengers, baggage and mail transferred to another train. Regulations forbid operation of a train with flat wheels.

Not so many years ago, the engineer's chief fear was that his locomotive would strike an automobile or a truck, particularly a truck loaded with explosives or in-



Top, unusual view of Twentieth Century locomotive cab, with essential controls and gauges identified. Bottom, contour scale drawing of Chicago-Toledo run on the New York Central





flammables. Today, he also dreads the motorist who runs into the side of his train. In the year ending June 30, 1937, forty-eight per cent of the people killed or injured in grade-crossing accidents in New York state received their injuries as a result of vehicles smashing into the sides of trains. The causes of this new problem might be that motorists approach crossings too fast to notice a train is there, particularly at night, and that drivers are careless.

Accidents are being reduced at crossings, through the spending of millions of dollars by the railroads to install under- or overpasses, thus eliminating crossings. But the railroads do not have the financial resources to do this work alone, because there are approximately 235,000 crossings in this country, an average of nearly one per mile of rail line. Approximately 25,000,000 motor vehicles make use of these crossings.

I've been driving an automobile since 1916 and have had only one close call at a crossing. Knowing the danger, I had been teaching my wife to watch for crossing signs. Not long after we left Fort Atkin-

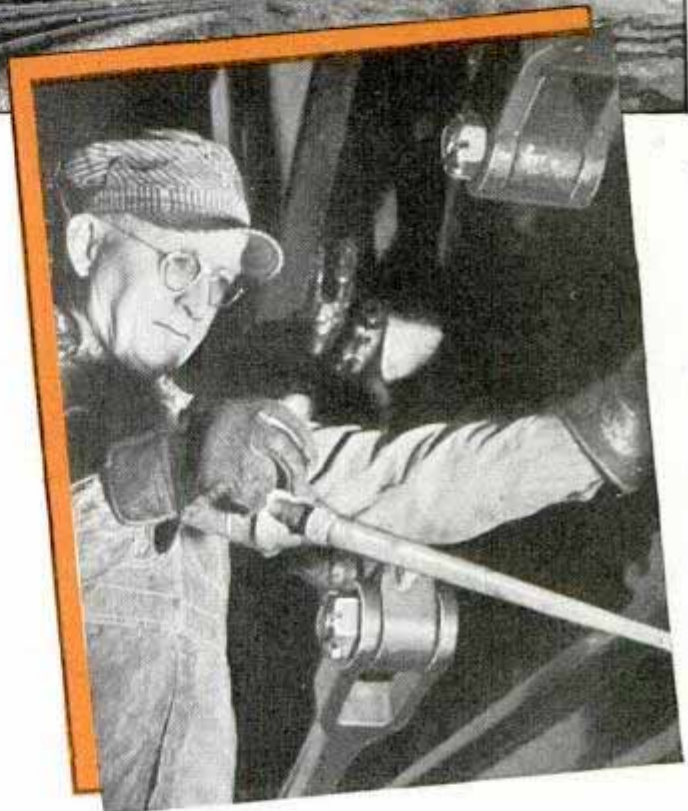

son, Wis., she suddenly said, "Railroad crossing!" I didn't see it, but I slammed on the brakes. Just as I did a big freight locomotive rushed by right in front of me, coming from behind a building at the left. I twisted the wheel and sent the car into the ditch to keep from hitting the train.

(Continued to page 132A)

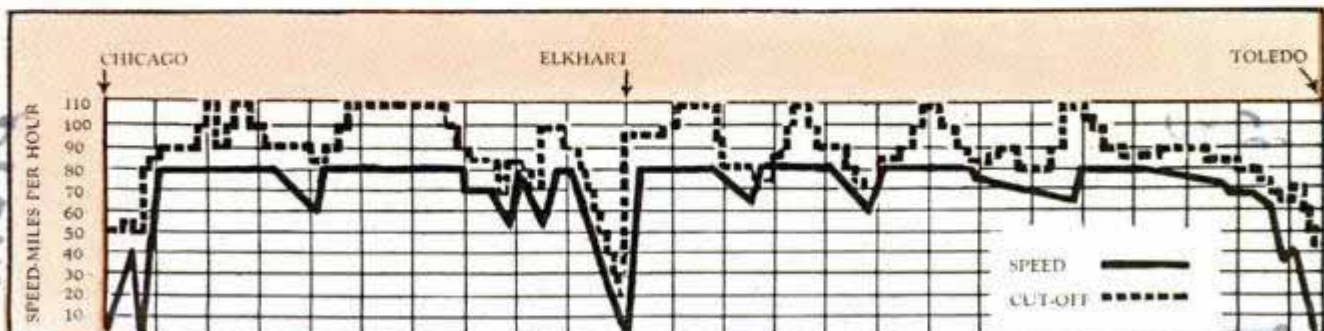

Top, the "Century" on curve. Center, oiling locomotive. Bottom, sample of speed indicator tape. If the speed and cut-off lines are fairly close together, engine operating efficiency is high



# Hose Car for 'Wash Day' on the Power Line

*Truck designed and built by Crown Body Corp., 3500 E. 12th St. Los Angeles, Calif.*



High-tension lines are kept at the peak of efficiency in Los Angeles by a hose and ladder truck that would make many a fire department envious. On "wash day" the truck moves along the power line, raising the platform atop its seventy-five-foot ladder to the level of the insulators, which are then sprayed clean of corrosion and dust. Its tanks carry 910 gallons of a special cleaning fluid, and a three-cylinder pump throws a stream at 1,000 pounds pressure through a three-quarters-inch hose. On each side of the truck is a container holding 150 feet of high-pressure hose. Rubber tires, rubber pads on the turret floor and pads under the legs which brace the truck on the pavement furnish insulation to protect the crew from shock. A driver and two workmen of the Bureau of Power and Light form the crew. The 27,000-pound truck is forty-seven feet long over-all and has a wheelbase of 222 inches. It has its own suction hoses for quick re-loading and is driven by a 125-horsepower engine.

*Above, spraying corrosion and dust from power-line insulators with high-pressure stream of cleaning fluid. Right, with seventy-five-foot turret ladder retracted, the "wash truck" moves on to a new location*

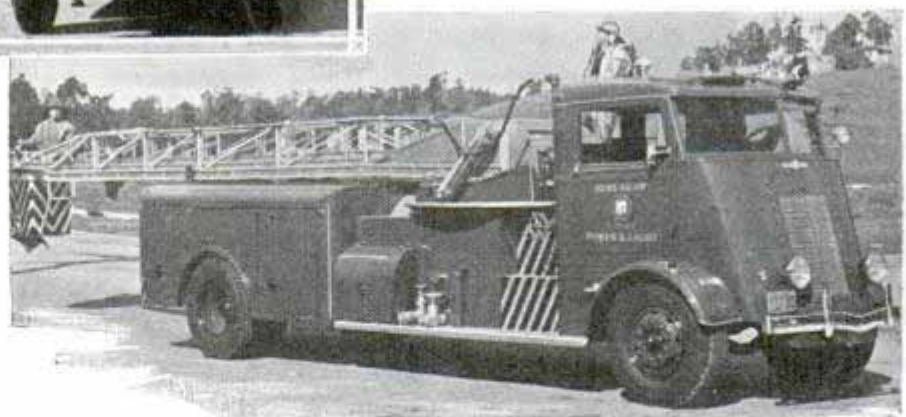

*Quarner Week. 2/25/37*

## Meter Counts Radio Listeners by Recording the Stations Tuned In

To check up for advertisers on the number of listeners on their programs, two automatic meters have been developed. One consists of a clock which unrolls a tape an inch and a half wide while a stylus

writes a record of the stations to which the radio is tuned. As the listener changes to a different station, the stylus moves to a new position. By installing a number of these meters the survey company can ob-

*Howard.*

*A.C. Neilson Co 2101 E Howard  
Chicago Ill 3714 42 Chicago*



tain a sample of program popularity. Another system is a multiple-unit recorder which has no tape or stylus attached to the individual radio but transmits to a revolving drum in a central office.

*129 Spruce St. Hartford Conn*  
**Dripless Server for Mustard Ends "Goosey" Paddles**



*J 200*  
 Spurting mustard or other sauces in neat dabs through an opening at the bottom, a dripless server eliminates untidy paddles. The server is filled through the top, and the contents are expelled gradually by pressing or tapping a flexible rubber ejector. When not in use the dispenser rests in a separate Bakelite base, which makes an airtight seal.

*could be chrome 99¢*  
**Automatic Loader for Stoker Fills Hopper with Coal**

Coal stokers which are fed by a hopper can be made completely automatic by installing a loader that delivers coal from bin to hopper. It has a capacity of ten tons an hour and can be adjusted to fit the requirements of the stoker room. Picking up coal from a trough at the bottom of the bin, it continues loading until the hopper is filled and the motor automatically shuts off. The loader can be suspended from the ceiling or supported on a platform.

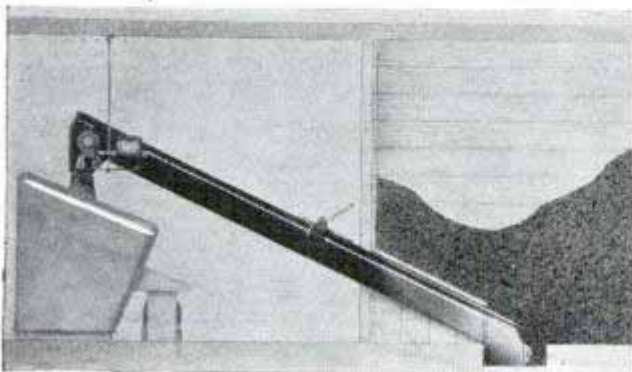

*J. 185*  
 Loader delivers coal from bin to hopper of stoker until the latter is filled, then stops automatically

*755.00 Curvign 4*  
**Battery-Run Movie Camera Takes Film Roll Non-Stop**



Top, movie-making with the electric camera. Below, inserting a fresh dry battery in place

Driven by a self-contained electric motor instead of the conventional spring, an eight-millimeter movie camera makes it possible to expose an entire twenty-five-foot film roll non-stop. Its standard dry battery, costing twenty cents, will run at least 500 feet of film and leave probably 100 per cent reserve, according to its makers. The back of the camera consists of two sliding compartments, one containing battery and motor, the other the film and its moving mechanism. There are no sprockets, a single spring-loaded claw above the f 2.5 lens aperture moving the film. On the front is a safety catch which either locks the camera in operation or prevents its operation. The camera has but one speed, the normal sixteen frames per second.

*Norman Willets Co. 216 W. Washington, Chicago*

*U. J. Murray Mfg. Co.*



March 1938. 285

# SEA LIFE *under* GLASS

*Left, huge captive porpoise takes a mullet from the diver's hand while large turtle hovers nearby in Florida tank. The porpoise and its baby are the only two of the species in captivity*

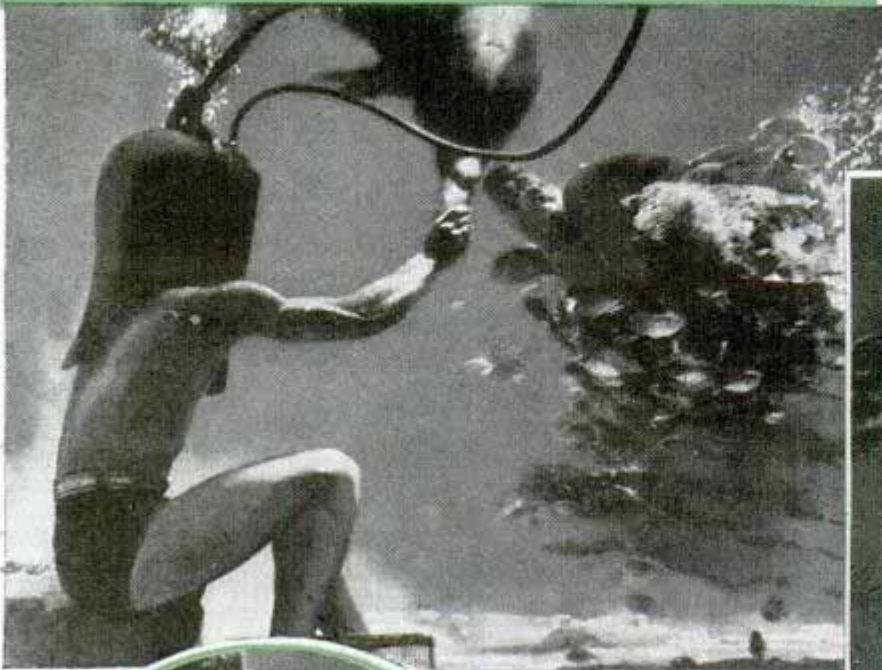

*Scene*

*Undersea life seen hitherto only by divers can now be watched by visitors to the Marineland aquarium, twelve miles south of St. Augustine, Fla. At the left is a school of mullets swimming past one of 207 portholes of the aquarium, twelve feet below the surface. They find safety from larger fish in coral garden seen in background*

*Above, a 235-pound loggerhead turtle idles lazily over the beautiful coral gardens. The brick and steel tanks, filled with sea water and vegetation, duplicate as nearly as possible actual conditions of normal ocean life*



*Just in case the eleven-foot, eight-inch ground shark isn't in friendly mood, the diver carries a hammer. The shark, largest known to have been captured alive, was quieted by hypodermic drug before transfer from the specially built fishing boat "Porpoise" to the aquarium*



# Ski Slide Brings Winter Fun to California Fair

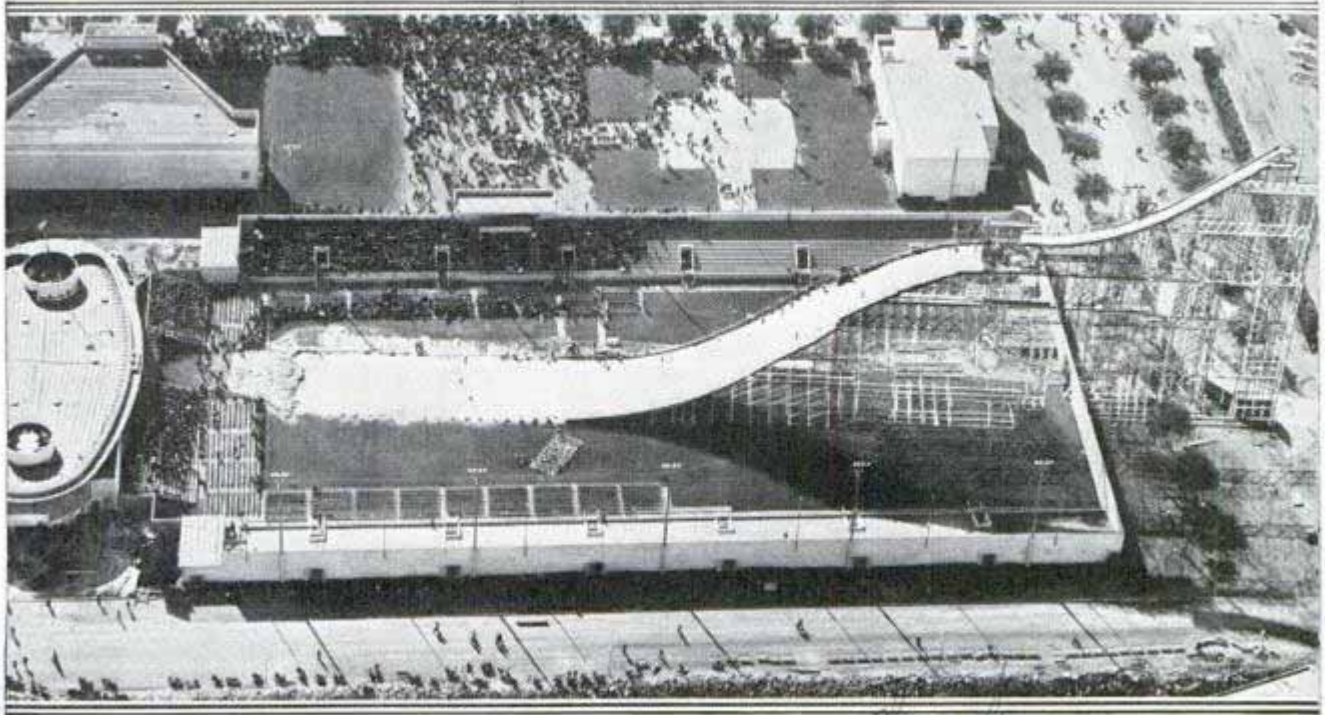

Spectacular ski slide erected on Treasure Island, where topnotch ski jumpers will show their skill to Golden Gate fair visitors. Winter sports will compete side by side with summer games

Treasure Island is the summer playground of the Golden Gate exposition, but that is no bar to winter sports. In fact there will be open season for skiers throughout the fair. A lofty ski slide has

been built on the exposition grounds and champion ski jumpers will take off for the entertainment of exposition visitors, vying for interest with the open-air swimming show not many yards away.

## Rainproof Top of Duck Blind Drops When Gun Is Lifted

Rainy days are no hardship for a Salt Lake City duck hunter who has built himself a blind with "buggy top" rainproof canopy that disappears instantly when he lifts his gun to shoot. The entire blind can

be installed in a boat in a few minutes. Its exterior is a rectangular framework two feet high, the sides fitting together with dowel pins. Inside is a cushioned chair, underneath which there is a case of drawers to store ammunition, boots and supplies. The stock of the shotgun rests in a slot at the right of the seat, holding a catch in place; when the gun is raised for action, the lock is released and the folding top drops out of the way. Paint on the top and reeds inserted in slots along the side makes the blind look like a muskrat house.



Left, gunstock rests in slot locking rainproof canopy over hunter as he waits in blind. Right, top drops automatically when he rises to shoot

George Mueller  
1486 Military Way

The life expectancy of passenger autos has increased from 7.04 years in 1924 to 8.58 years in 1938.

Auto Industries  
2/25/39



# 'Fish Tail' Drives Boat at Ten Miles an Hour



Borrowing ideas from the swimming methods of fish and the flying technique of birds, a Californian has invented a combination rudder-propeller that drives a canoe through the water at ten miles an hour or better. It is a "half mackerel tail" made of laminated silk set in a frame. When power is applied and the gear set to vibrating, water is trapped in a pocket. Its release as the fin vibrates creates a strong forward motion. The inventor has installed this device on electric-driven toy boats and on a model airplane suspended by a string. On boats, the fin sucks water in from the tip rather than throwing it out, and as it vibrates there is a continuous flowing stream on both sides.



## Super-Pure Metal Guarded to Prevent Corrosion

Metallurgists attempting to produce pure metals have developed lead that is 99.9999 per cent fine. Here, as in other phases of human progress, a mysterious resistance against perfection is met. The closer metals approach final purity the more susceptible to corrosion they become, and extreme care must be exercised in the preparation of what are termed super-pure metals. Handling samples without tweezers is avoided, and problems of storage constantly call for solution. Transparent wrappings must be examined to prevent contamination. It is not necessary to start the production of super-pure metals from refined commercial grades, since it has been found that when a major impurity is precipitated out many other impurities go with it. At present aluminum, antimony, bismuth, cadmium, copper, iron, magnesium, nickel, silver, tin, gold, carbon and platinum of high purity, besides lead, are available in moderate quantities.

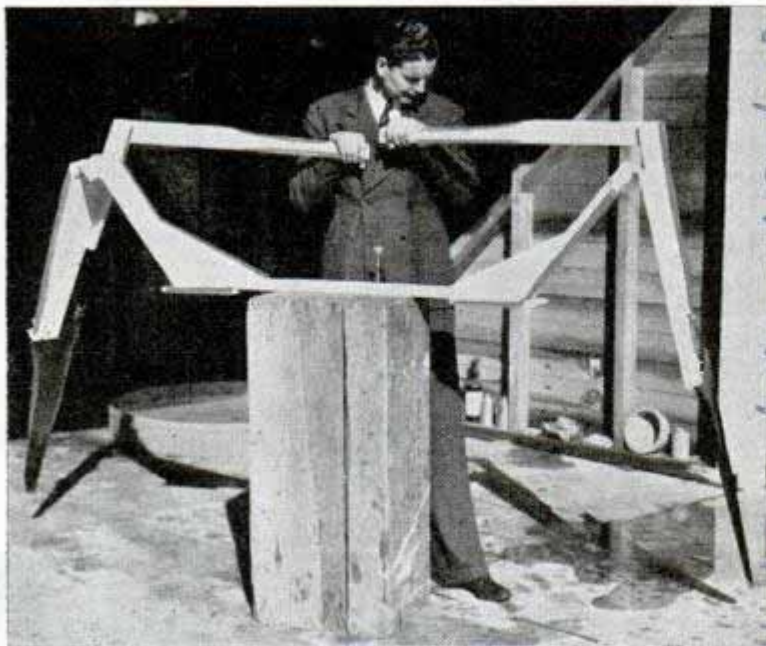

Top, "pumping" the propeller-rudder unit; waves in wake of canoe show it can attain unusual speed. Lower pictures show construction of "mackerel tail" fin of laminated silk set in frame

*Frank, Arthur W. Hill Jr.  
2657 Cochrane Ave  
Los Angeles Calif*

*g 241*  
*Reported in Bulletin of Arthur D. Little, Inc.*  
*30 Charles River Road, Cambridge, Mass*  
*Science Service*



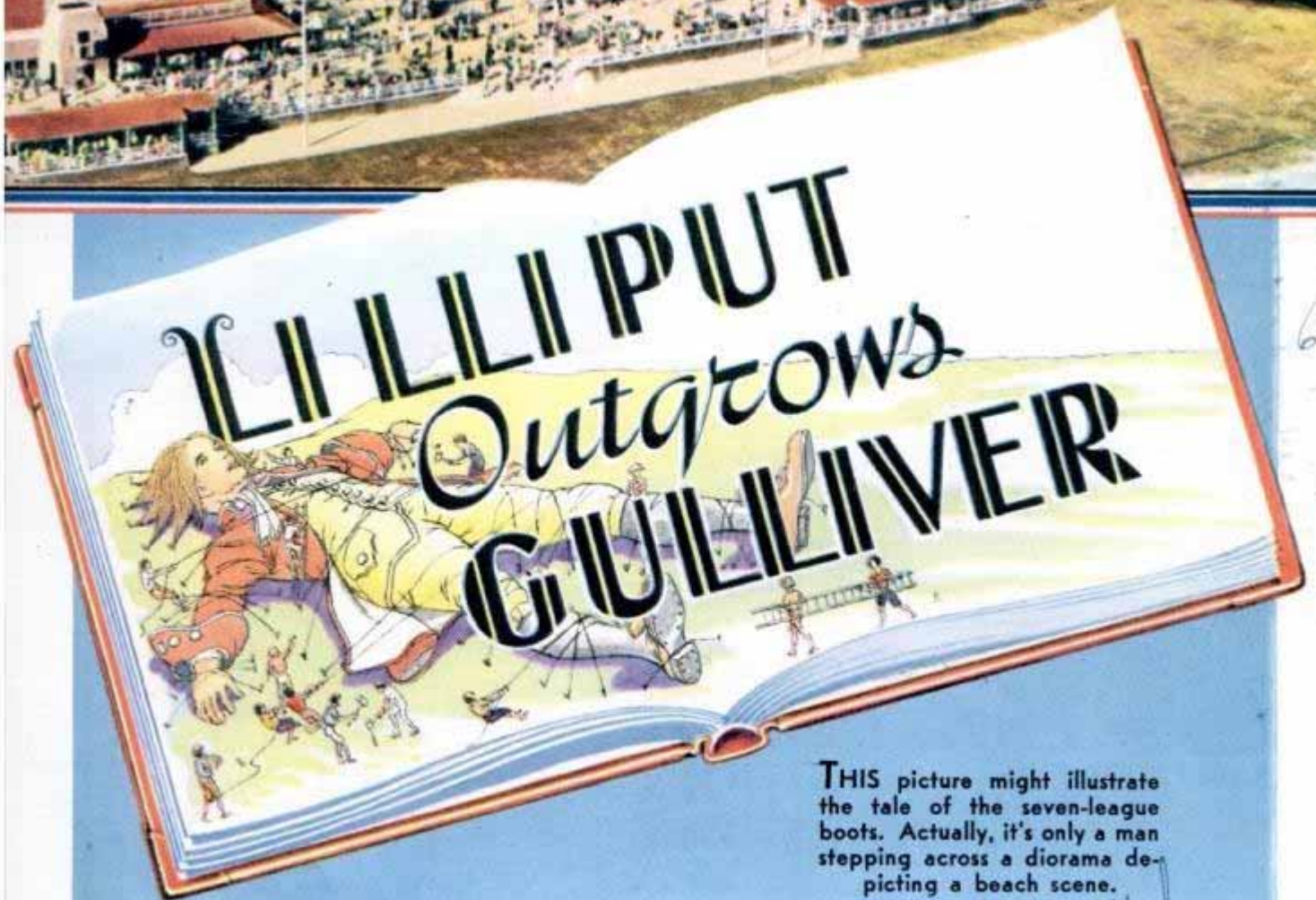

THIS picture might illustrate the tale of the seven-league boots. Actually, it's only a man stepping across a diorama depicting a beach scene.

*new York*

657



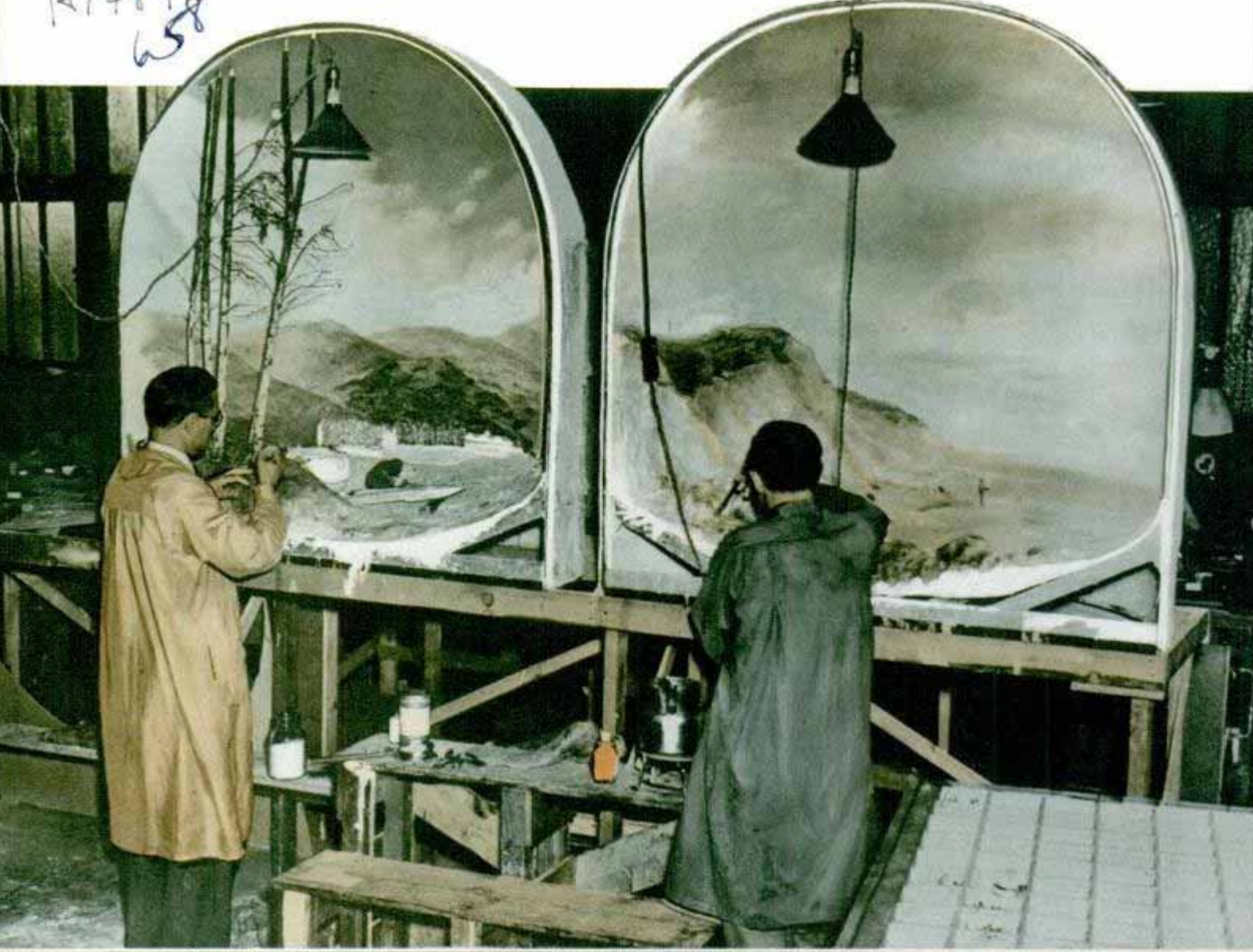

THESE were average size dioramas a year or two ago, but today thirty and fifty-foot ones are not uncommon and one is 170 feet long.

By EDWARD HECKLER BURDICK

Industrial Exhibit Designer

WHEN Swift wrote his famous story of Gulliver's travels among the tiny folk of Lilliput, he added a final, startling note of surprise by sending his hero into the land of Brobdingnag, where a race of giants had sprung up.

No less surprising has been the gigantic growth of a new American industrial development, the manufacture of the diorama, during the past year.

Since the dawn of history, the diorama has been a miniature representation of a scene made lifelike by clever application of foreshortened perspective and realism. Down through the centuries, it has remained a miniature.

Within the past few months, dioramas have been completed that extend a whole city block in length. Diorama buildings that have often been fashioned three-

sixteenths of an inch in height now have suddenly mushroomed into three-story structures. Whole cities, patterned from the real and inspired by the imagination, are being reproduced in true scale, or with the effect of true scale. Big, as dioramas go, they still are tiny when compared to actual cities.

Thus, at last, the diorama has outstripped its maker in size.

Diorama craftsmen, trained to do meticulously fine work on trees an eighth of an inch tall, today are climbing thirty-five foot scaffolds carrying out specifications from architectural blueprints. Exactly the same thing has happened to the diorama business as a whole. Eighteen months ago, there was one American corporation specializing in dioramas. Today there are twenty-five. The field, of course, has been made

*Diorama Corporation of America, 27-01 Bridge Plaza, North, Long Island City, N.Y.*



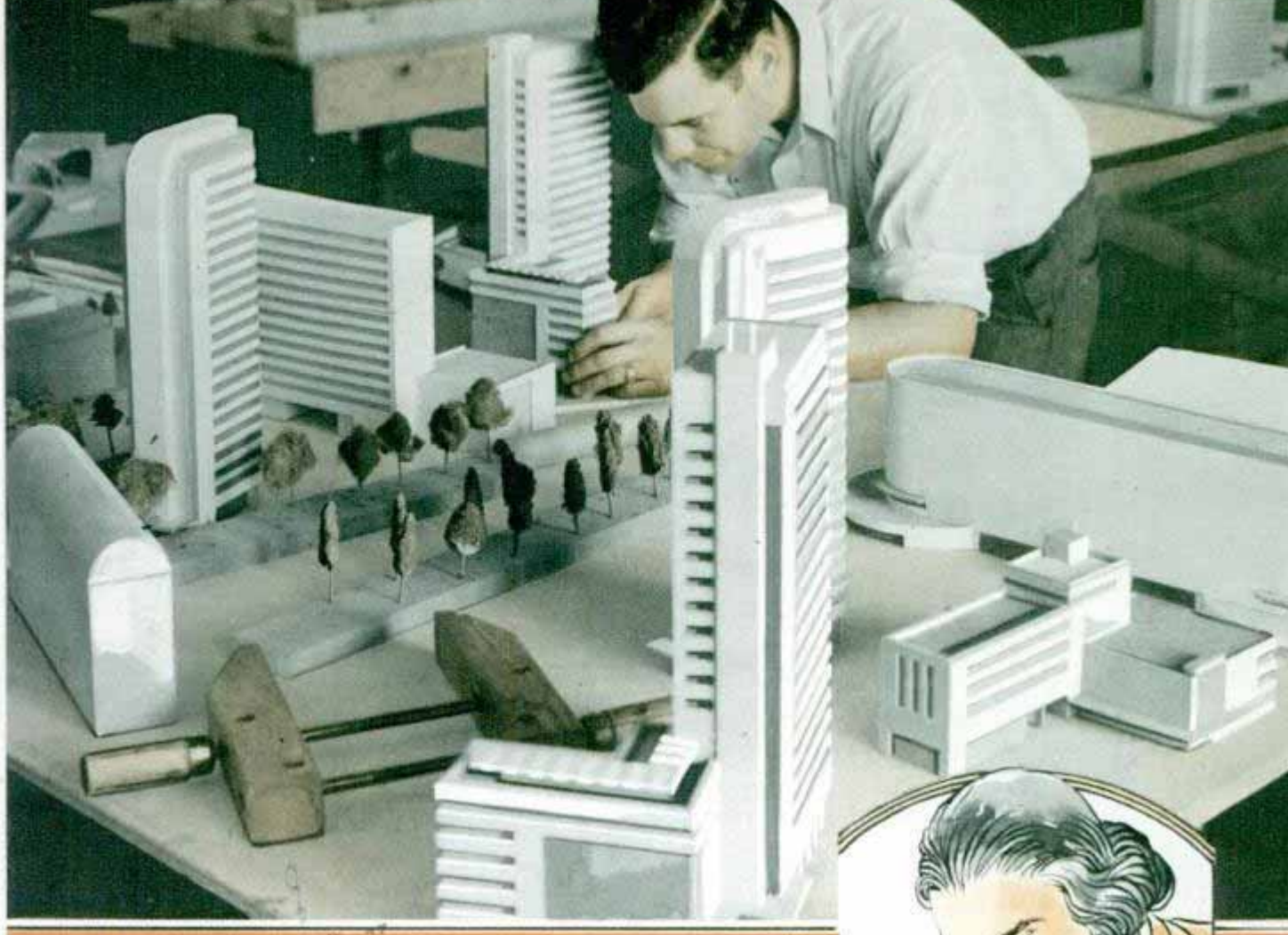

12/48

fertile by the demands of hundreds of exhibitors in two great fairs. Few exhibits lack dioramas, or one of its less artistic relatives masquerading under the name.

With the passing of the special condition which made Brobdingnagian dioramas desirable for huge exposition displays, the size of the product will simmer down to the proportions normally expected of a miniature. Diorama manufacture then will be established as a big business of making little things.

Since a world's fair is essentially an advertising medium, and since these fairs have caused a tremendous demand for dioramas, it is easy to understand that the diorama is likely to become an important factor in advertising, not in competition with published advertisement, or the radio, but in all fields where three dimensions are especially suitable.

Some of these future uses for dioramas which the present generation will live to see developed are as traveling exhibits, for industrial museums, permanent world's fairs,

659

PART of huge diorama depicting a city of the future. It will be 160 feet in diameter and contain more than 1,000 buildings. Below, ball and racket beside tennis-court dioramp.

New York Recreation Centre







660  
EDWARD HECKLER BURDICK, author of this article and president of the Diorama Corporation of America, beside buildings which form part of miniature diorama of the Island of Manhattan and near-by territory.

FIGURES in diorama below are made of wire and solder. The sunshades are upholstery tacks, the grass is ground cork, the hedges are rubber sponge and the foliage is fireproofed moss from the Florida Everglades.

*Long Island  
Amusement  
Center*

trade expositions and outdoor advertising. A greater percentage of the dioramas of the future will be activated by moving figures and lighting effects.

Introduced from Europe for the Century of Progress exposition in Chicago, the use of the diorama has increased and the size of the products themselves has expanded until today America has brought this art into full blossom.

We have produced dioramas showing the making of a long line of products from dog biscuits to steel; from a garden scene in Japan to the waterfront of Louisville; from the digging of asphalt in Trinidad to the digging of sillimanite in California; from jungle life in Brazil to jungle life in Manhattan; from an industrial plant in Detroit of today to a small room where the first cash register was made; from a street scene in the gay nineties to an unbuilt dream city of

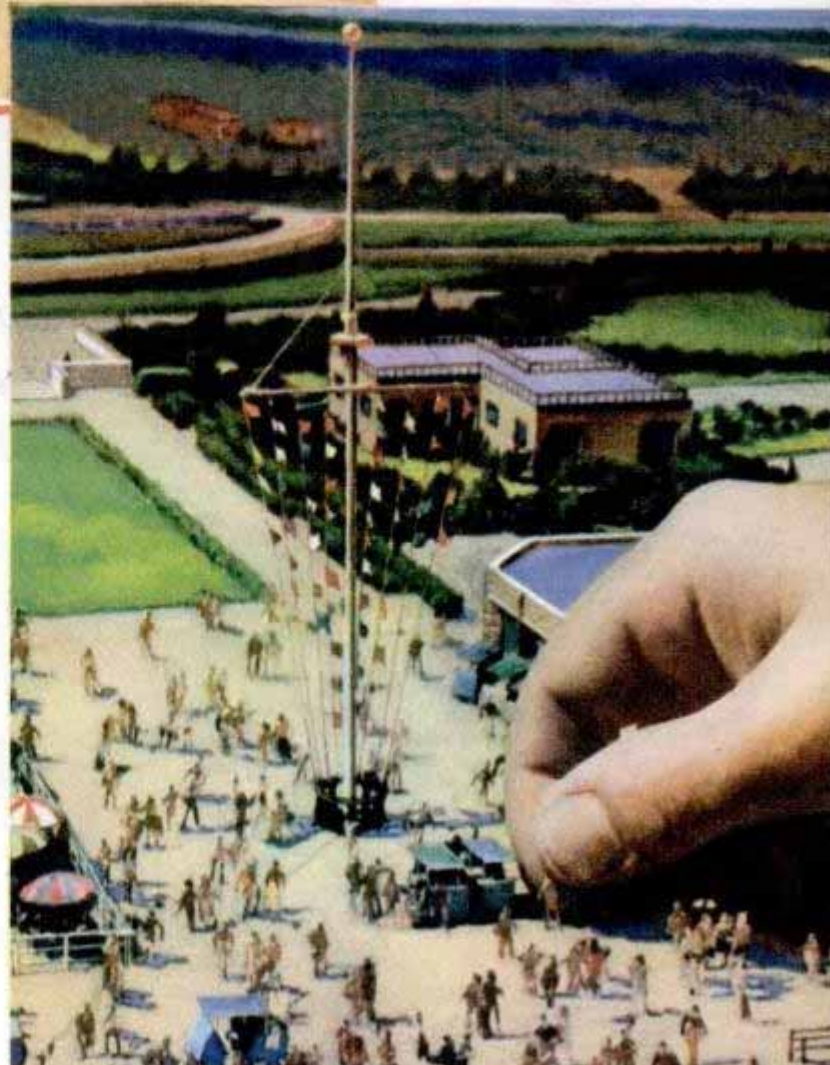



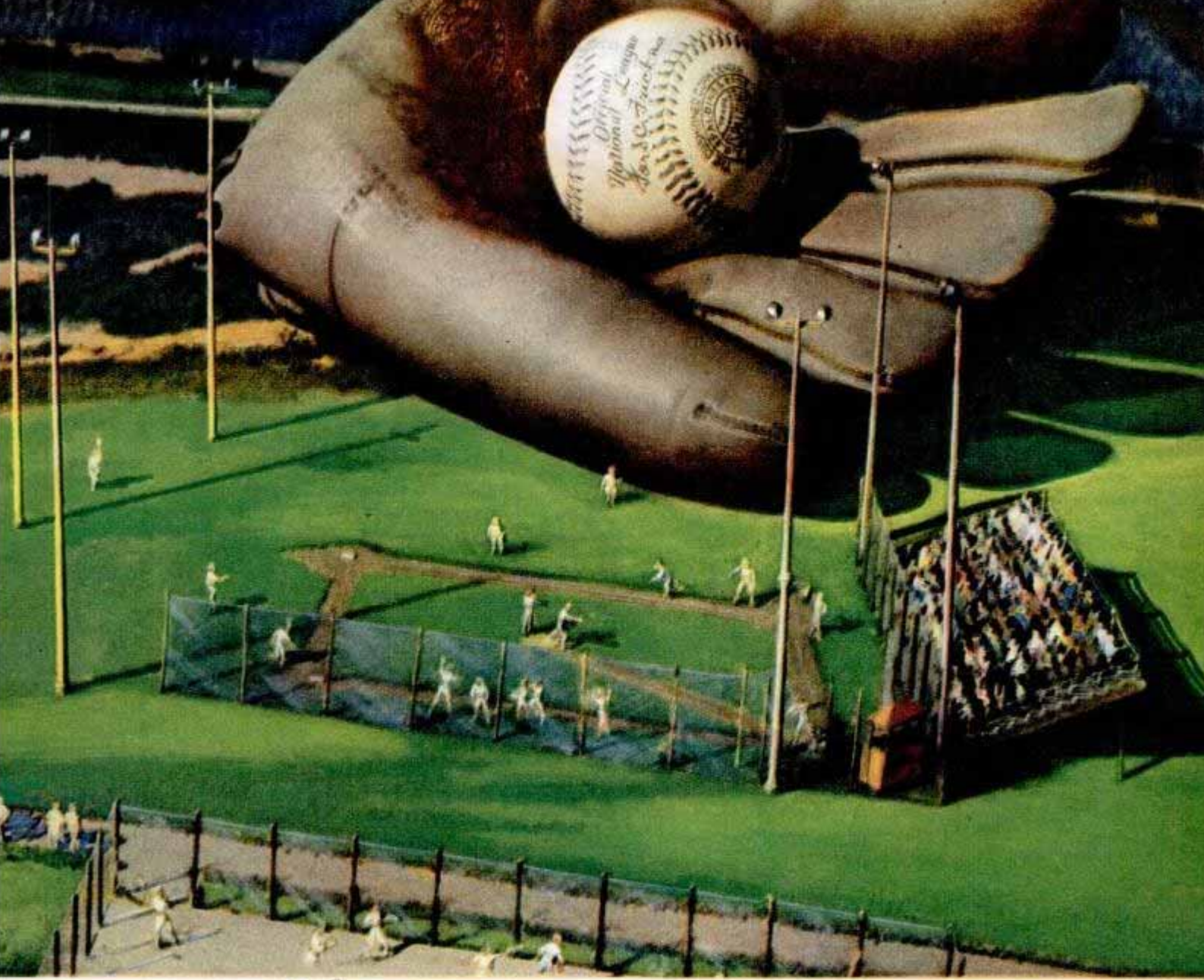

K 1487  
THIS tiny ball park, modern even to equipment for night lighting, is an accurate miniature of a free ball park maintained by New York City. 661

some distant day in the future.

This wide range of dramatic possibilities indicates that public acceptance of the diorama is not a temporary fad. Rather that it is pitched on as high a scale of artistic realism as any other contemporary form of art. Indeed, the diorama appeals strongly to two of mankind's most powerful senses, sight and hearing, as no other form of display can, because, aside from being cast in nature's own three dimensions, the modern diorama also usually is animated and enhanced by lighting and sound effects.

An example is the fact that by the use of mechanism one entirely automatic exhibit may show as many as eight dioramas in series, telling a complete story in a natural manner. An ordinary light switch sets it into motion.

The natural manner of presentation

should be stressed because a correctly made diorama causes the person viewing it to project himself into the scene just as a member of a stage or movie audience projects himself into the plot if it is a plausible one.

The dome-shaped case which corresponds to nature's sky, is an American development. The increased size, the discovery of fast colors, the lightweight methods of construction and the incredible permanency of the finished product all have been discovered during the past seven years that the diorama has been made in America.

The result is that in this comparatively short time the diorama, once an unimportant member of the same family with the cyclorama and the panorama, has now risen above them to become head of the family.



H 148  
Langley Field

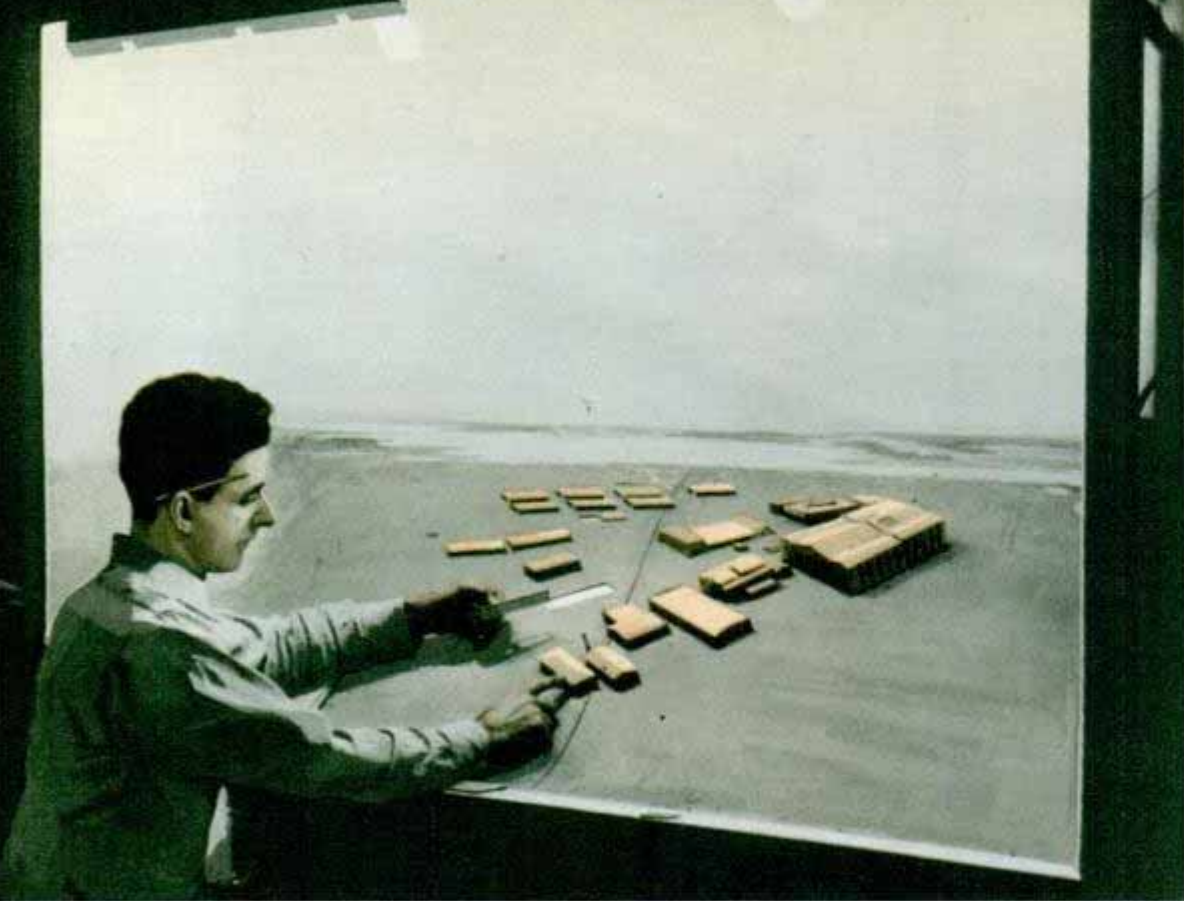

**DIORAMA** at left represents what you would see from an airplane one-fourth of mile from buildings and a similar distance from the ground. Below, all the cars were placed in one diorama, the requirements of perspective making it necessary for those in background to be smaller.

662

As an example of the development of the diorama, it is doubtful that fifty Americans knew the meaning of the word in 1932. Certainly 20,000,000 recognize the word—meaning “to see through”—today and it is included in nearly every American dictionary, unfortunately, however, with an incorrect definition in almost every case.

An important reason for the slow development of the art in this country, and one which will cause a rapid decrease in the number of diorama manu-

facturers after their first productions are put to test, is the fact that it is almost impossible to find a sufficient number of skilled men to manufacture lifelike dioramas.

It is a safe wager, for example, that if we were to select the 100 best artists and painters in the world today and substitute them for 100 of the men in our studio the company would go out of business within two months, so intricate and tricky is the method of producing quick and accurate perspective.





This perspective is modified by a shift in both vertical and horizontal values, changed again by convex and concave base surfaces and again by angles of sight and finally by the need for perfect merging of the free-standing modeling section into a sky that curves in its own peculiar manner. It is a fact that a true right angle almost never exists in a properly made diorama, even though the scene may portray the rigid architecture of a group of big city skyscrapers.

Another thing which works hardships on beginners is the fact that ninety-five per cent of the cost of dioramas rests with high-

663



**WORKMAN** at top is painting in fine details on section of thirty-foot diorama. Bottom, huge dioramas in the making. Ball in background holds sketch in three dimensions of city of the future. At left are buildings to be included in "panorama of New York" diorama.





141487  
 DIORAMA at left is nearly a city block long and three stories high. It is a colored, lighted, animated model of the New York metropolitan area with 4,000 buildings and 130,000 windows. Below, a golf ball is not very large but it looms like a balloon above the tiny golfers in this diorama of a New York City golf links.

*for Consolidated  
 Edison Company  
 of New York*

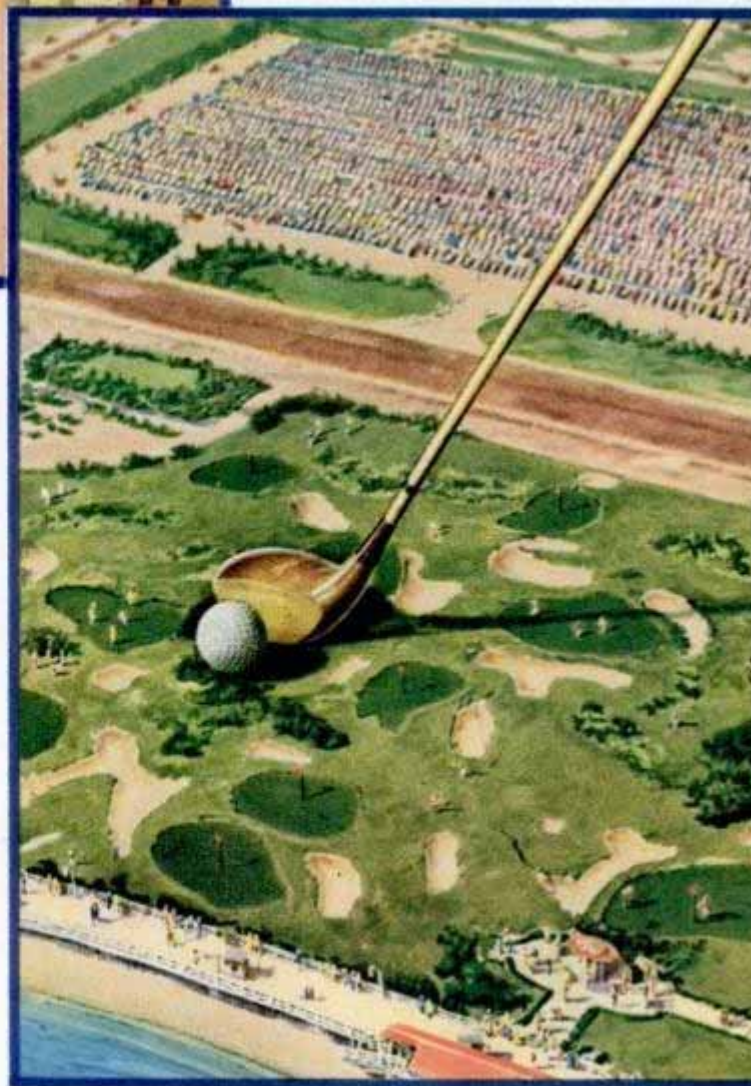

664.

priced labor, and the correct method of estimating a man's time when he is engaged on an involved artistic problem comes only after years of heart-breaking trial and errors.

Realism and fact, not fancy, are demanded by the public today, which explains the success of a magazine like Popular Mechanics. The public demanded realism on the lighted screen. Moving pictures replaced the stereopticon. Sound was developed; then color. Long ago, magazines and newspapers responded to this demand first with sketches, then photographs, and, more lately, with color.

Now billboards and other out-door advertising facilities are taking a lesson from dioramas and gradually moving into the three-dimensional field and are being activated by lighting effects.



*Participation, The Victoria Falls Exhibit*  
**Giant Waterfall Among World Fair Thrillers**  
*World's Fair, 347 - Fifth Avenue near York*

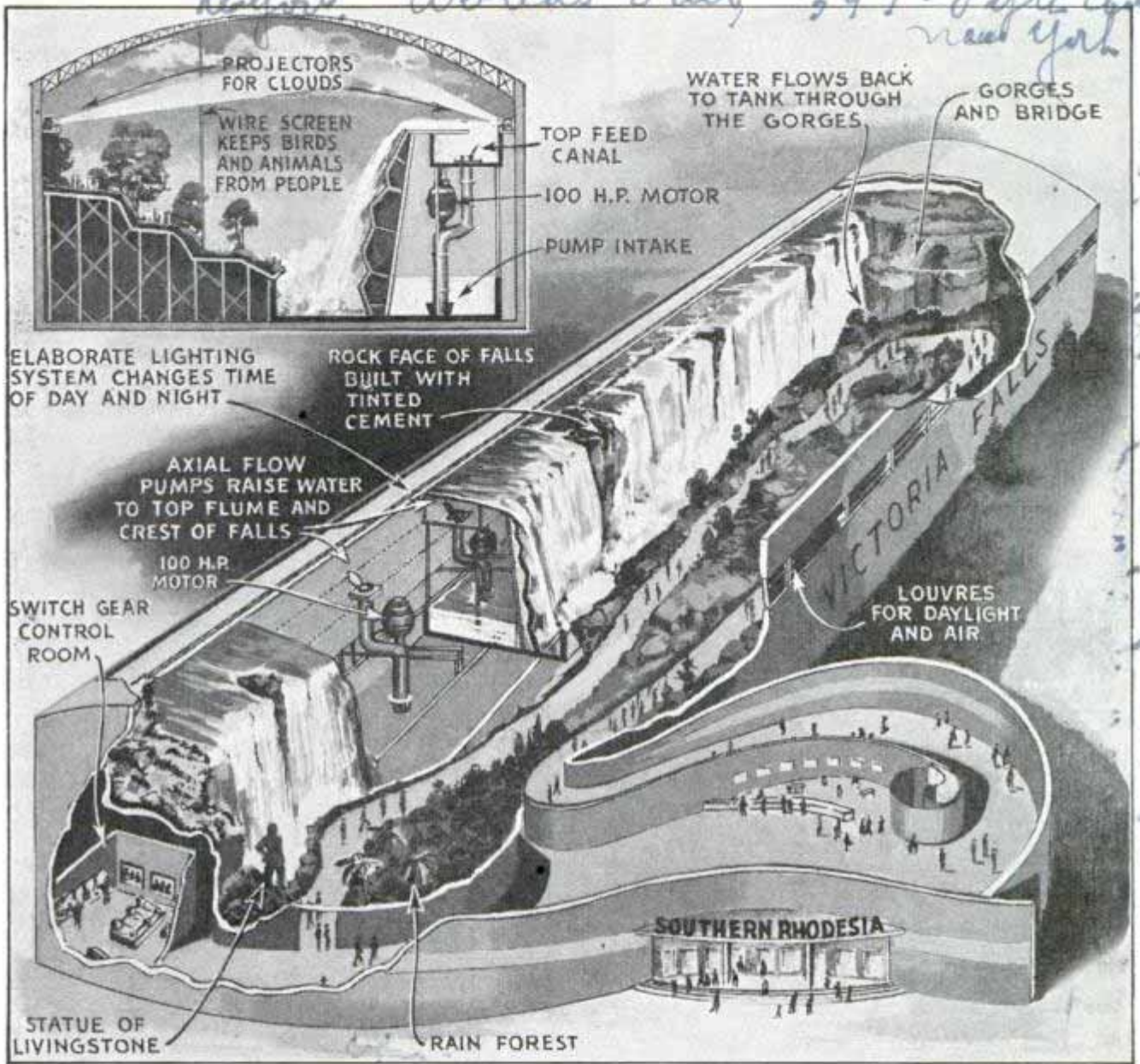

**VICTORIA Falls**, in Southern Rhodesia, will be brought to the New York World's Fair in a model 180 feet long and twenty-two feet high. Sixty thousand gallons of water per minute crashing over the brink into a ravine will give a realistic impression of the falls. Spectators will be able to walk close to the falls and to view jungle animals and birds. At one end of the falls will be a control room for regulation of several 100-horsepower pumps which will maintain the flow of water and of an elaborate lighting system which will permit simulation of day and night through dimming. Water will flow from the ravine into which it falls back to a giant tank through gorges, then be pumped to the crest again. The rock face of the falls will

be built of tinted cement, in the exact coloring of the real falls. Artificial cloud effects will be achieved through the use of projectors on either side of the falls.

*2-243*

**Putty Tool Makes Neat Corners**

So simple to use that a novice can do creditable work with it, an inexpensive hand tool for glazing windows is on the market. The putty tool keeps the glass free from surplus material and is especially adapted for making neat corners.

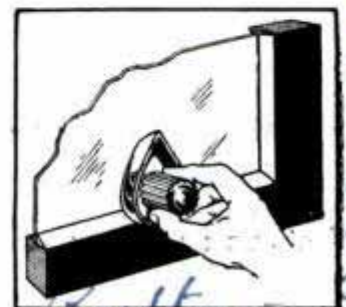

*Simplex Putty Applicator Co.*

*4835 W. 40th Street, Minneapolis, Wash.*



# X-Ray Gun on Wheels Finds Faults in Metal

21-16 43 pa Sh. NY  
Lena and Ciba

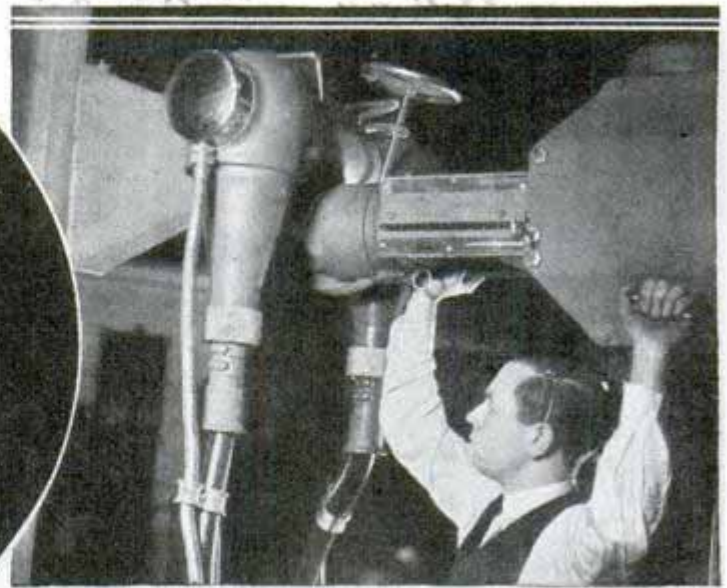

Portable X-ray machine, above, shoots 220,000 volts through three-inch steel plates. Top, left, examining pictures that tell the story, and, below, focusing upon a steel weld

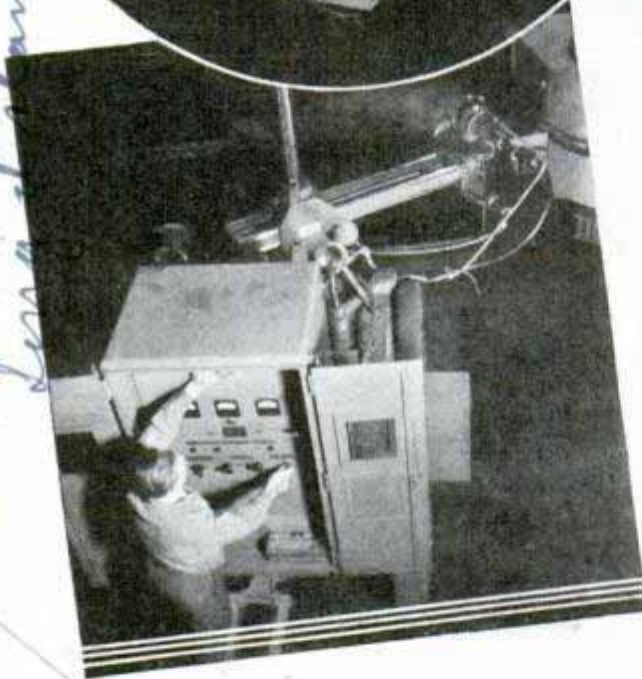

as strong as the surrounding plates will show up somewhat like a white formation of fluffy round clouds unbroken by any of the black marks. The porosity of steel castings makes it impossible to tell from the outside surface whether they are strong internally. Under the bombardment of X-rays, however, a steel casting three inches thick will, in less than a minute, provide an expert with a reliable basis for computing its strength by the pattern of slag holes.

9-24-5

## Reflector Inside Photoflood Bulb Focuses Light on Subject

Borrowing an idea from Hollywood where cameras are wheeled about studio lots, engineers of Westinghouse X-ray company have designed and built a portable X-ray camera for detecting concealed weakness in metal. Giant metal parts can be diagnosed by photographs obtained as the jobs move along the production lines of industrial shops. A twenty-inch-long X-ray tube converts 220,000 volts of pulsating direct current into invisible bullets which the 45,000-pound "gun" fires through steel castings and welded seams in the warfare against defective products. If a weld is faulty, X-rays reveal the imperfections as dark spots or "slag holes" on the photographic film; but a weld which is

Photoflood lamps that have their own self-contained reflectors have just been introduced. They offer increased flexibility, since they need only to be screwed into an ordinary socket and the photographer need not carry bulky reflectors with him. The cone of light from the 500-watt lamp covers about sixty degrees and can be used for black and white or color photography.



Westinghouse Electric  
& Mfg. Co. E. P. Ottobrun



g 251 Schell Trailers, Inc.

Charles, Jr.

# Home and Office Combined in Land Yacht

Chevrolet

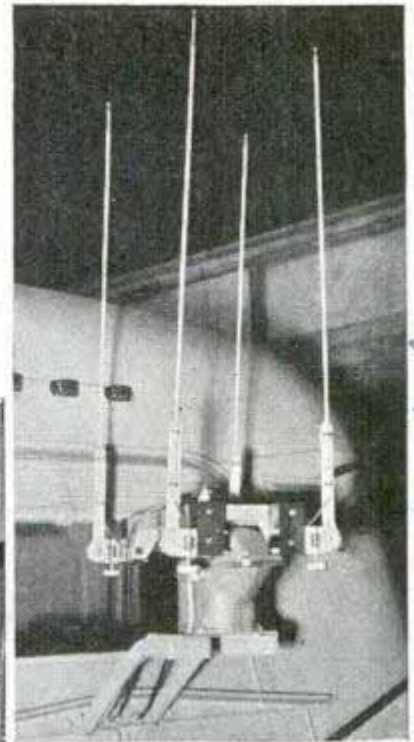

Top, left, luxurious trailer with complete home and office designed by New York advertising man who travels constantly about the country, and, right, radio antennas for short-wave transmitter

Office in forward section, above, is complete with desk, typewriter, dictating machine and filing space. Leather seat on balcony can be made up into double bed, and observation window above enables passengers to look ahead over cab. Right, 1,000-watt radio transmitter, used only for amateur purposes, obtains power from special generator producing 1,750 volts



Left, combination living room, dinette and bedroom, with galley and tile bath beyond, as seen from balcony. Roomy davenport opens into double bed. Entire unit including radio cost more than \$20,000. It is air conditioned and has electric lights throughout. There are beds for six and ample lounging room for ten persons

Myron Label, President  
Larewich







Four 1500 hp  
Wright Cyclone engines. 238

# by CLIPPER

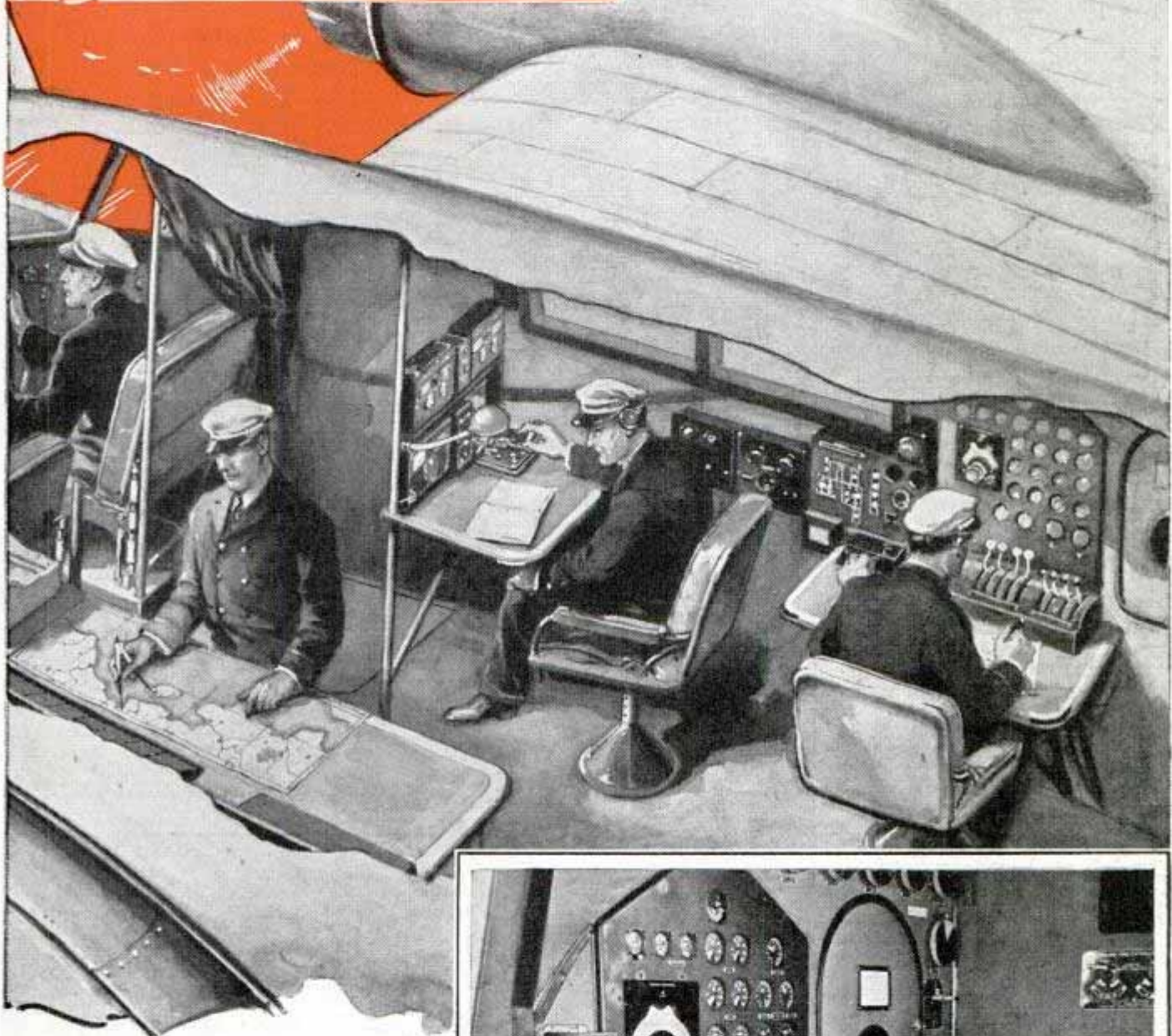

Opposite page (bottom), striking night photo of the Yankee Clipper. On this and opposite page, cutaway sketch of the clipper's flight deck with officers at their posts. The master is not pictured. Right, flight engineer at the controls

J. E. Prentiss

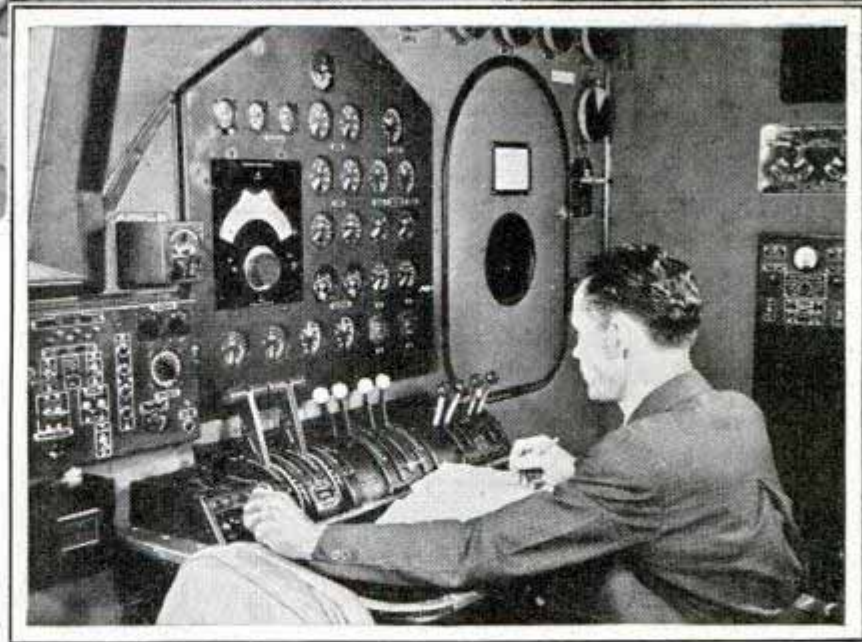

route, which will be used during summer, is by Shediac, New Brunswick, to Botwood, Newfoundland, thence across a 1,995-mile overwater jump to Foynes, Ireland, and

finally to Southampton, England. Passengers may reach London by air taxi or train. Flying time will be approximately twenty-four hours, necessitating an overnight



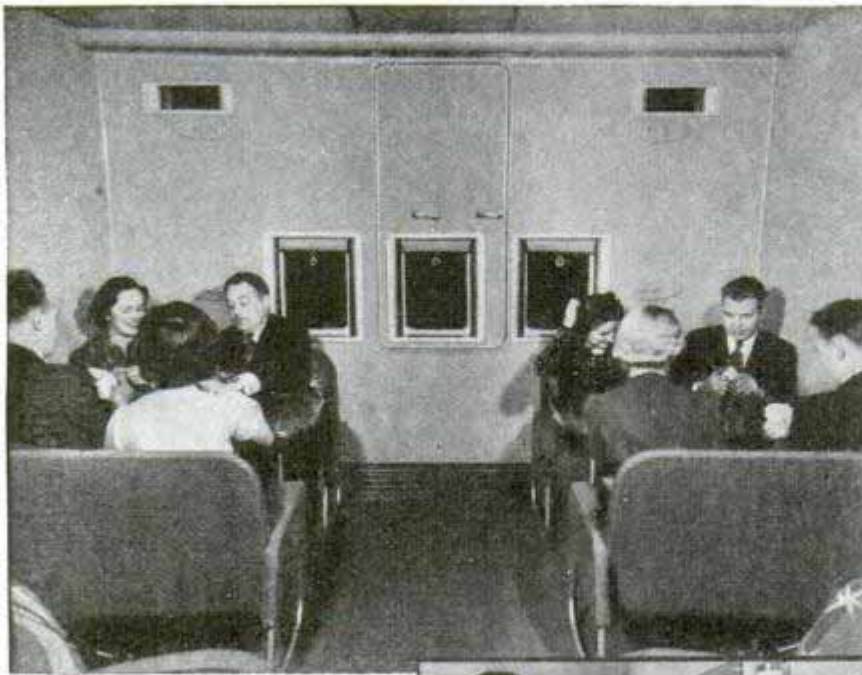

flight for the trip across the open Atlantic; hence capacity of the clippers will be limited to that of night service, forty passengers. Another route, known as the southern, is by way of The Azores and Lisbon, Portugal, to Marseilles, France. Requiring about thirty-six hours, this route is the one the most favored for winter service and is being considered for the maiden flight. Baltimore probably will be the terminal for winter flights.

Even persons accustomed to the best in air travel will find clipper accommodations a surprise. With its two decks and eighteen separate rooms, its soft carpeted floors, its davenport-type lounging chairs and its modern styling throughout, the Atlantic air queen is virtually a "Park Avenue suite on wings." You board the ship by gangplank that leads to the broad upper surface of one of the hydro-stabilizers, which is a 1,500-gallon fuel reservoir but serves as a loading deck. Entering the passenger deck by a side door, you step down three steps into the dining saloon and recreation center, the largest room in the ship with the exception of the control room on the upper deck. The ten and one-half by twelve-foot dining room has a gay color scheme, with a spirited blue pattern on furniture uphol-



stery, rich carpeting and walls of silvery beige. Double windows on either side of the room have modern Venetian-type blinds, as do windows of all passenger compartments. There are five dining tables of polished black walnut and deeply upholstered chairs for fifteen persons to be served at a time.

Arched doorways at either end of the central lounge lead to passenger quarters fore and aft. Going aft, you pass through three standard compartments, each with floor dimensions of seven and one-half by twelve feet and a height of seven and one-half feet. Seats are upholstered in beige wool tapestry, tailored with leather trimmings. The cabins are exceptionally quiet, the result of double insulation and sound-proofing in the walls and



*Top, dining saloon in use as recreation room. Center, men's room, with electric razor in use. Bottom, berths made up for night flight, such as the clipper will make across the Atlantic*



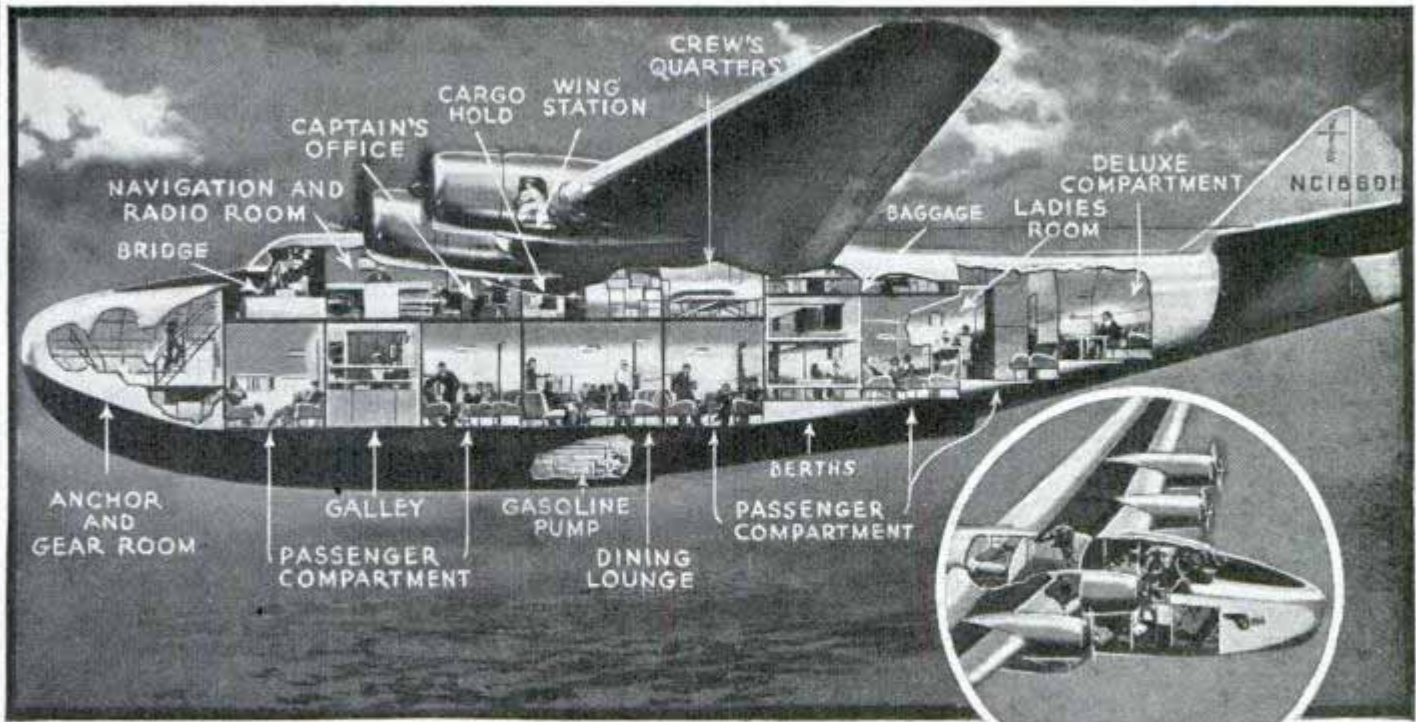

soft carpeting on the floors.

At night two triple seats and two double seats in each compartment will be converted into upper and lower berths all more than six feet long. Each berth has an outside window, individual ventilator, reading light, steward's call button, clothes rack and hangers.

Farther toward the stern you find a four-passenger port side compartment, opposite which is the women's dressing room. Furnishings of this dressing room include leather-covered upholstered dressing table stools, long double dressing table with two plate-glass mirrors and modern lighting fixtures, wash basin with hot and cold running water, another large mirror and a dental lavatory. Finally, in the aft-most section, you enter a de luxe compartment, or "bridal suite." This room contains a love

(Continued to page 151A)

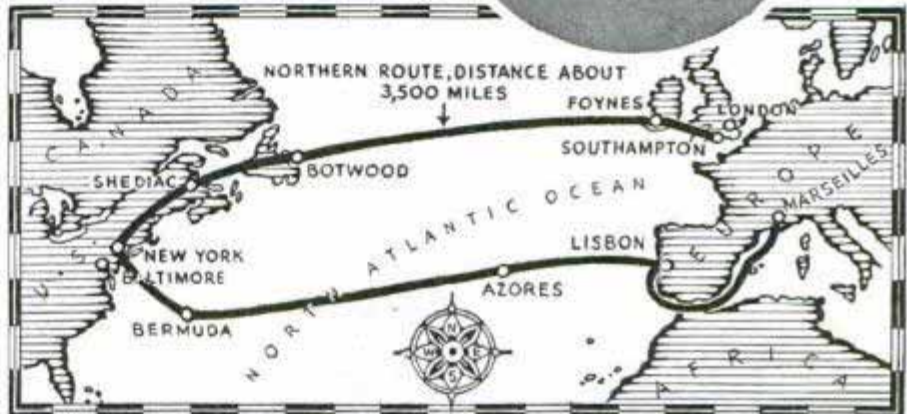

Top, cutaway view of the clipper showing spacious passenger quarters and the flight deck. Inset, motors and control section at front of giant ship. Center, map showing northern and southern routes over which the clipper will fly to Europe. Bottom, one of the ten-passenger compartments made up for day travel



# Rustless Steel House Washed Like Automobile

*Yoloy \$5,000*



Alloy steel house and two interior views. Center, living room, and, below, kitchen trimmed with rustless steel

Built of little else but alloy steel, a streamline house has a framework of prefabricated, lightweight metal, and the outside walls are sheets of high-grade, corrosion resistant alloy—a new metal that is also used in making many things from jewelry to tank cars and building decorations. Besides being fireproof, it is claimed the structure is proof against termites and warping, tornadoes and earthquakes, heat and cold, as well as noise and creaks. The house may be washed with a garden hose like the family car, and makes a suitable home in any climate from the arctic to the tropics. All the conveniences of an apartment are incorporated, as exemplified by the one built in Youngstown, Ohio, for all of its five rooms are on one floor, and there is no basement. It has two bedrooms, a living room, bathroom, kitchen and dinette, and a utility room containing air-conditioning equipment, gas or oil heater, automatic clothes dryer and laundry tubs. Oak floors are set in mastic cement to prevent warping, and the finish is steamed so it will not scratch or mar. The only other wood is in the doors, all molding and finishing being of steel. Inner walls are of composition material with a four-inch layer of air between, and a six-inch air layer between the roof and ceiling provides insulation. On the flat roof is an attractive sun deck. This type of house is manufactured to sell for \$5,000, which does not include cost of lot.

## Radio Lights for Blind Landing Guide Pilot on Straight Glide Path

Radio waves only seventeen inches long "light up" a straight glide path for airplanes in a blind landing system that has been tested successfully at East Boston airport. The spotlight beam of the shortest waves ever used in aeronautical radio activates three lighted dots in a cathode-ray tube on the dashboard of the plane. When

the three lights are lined up horizontally, with the middle dot centered, the plane is on course, and at all times during the glide it is in proper landing position. The center light is controlled by four overlapping radio beams, and if the plane rises or falls or moves to right or left of the path the light will vary from true center.

*Developed by Mass. Institute of Technology  
Cambridge, Massachusetts*

*g 218*  
*Boob. Reese Realty Co. / Youngstown*  
*Leola Bank Bldg.*  
*3/1/39*  
*Valene Service*

*Girl armories Youngstown, O. C.*



# Riderless "Bike" Is Balanced by Electric Eye

Ready for a hundred-thousand-mile riderless run that starts at the New York world's fair in May is a bicycle that balances itself with the help of a photoelectric cell. In a test run at the Westinghouse laboratories it clipped off twenty-eight miles an hour, and it is expected to pace off nearly 400 miles a day for 365 days at New York. There are no supporting wires or braces. The bicycle coasts along on three metal rollers, getting nowhere rapidly, of course, but demonstrating that it can stay erect and straight without human hands to steer it. It can even take a three-pound side push against its saddle before losing its balance. The electric "eye" is focused on a mirror under the pedals, which reflects varying amounts of light as the bicycle tilts from true upright position. As the tilting varies the light, a motor steers the front wheel and moves two weights, attached to the front mudguard and over the front wheel, to balance the bicycle. A similar method is used by the U. S. Army to

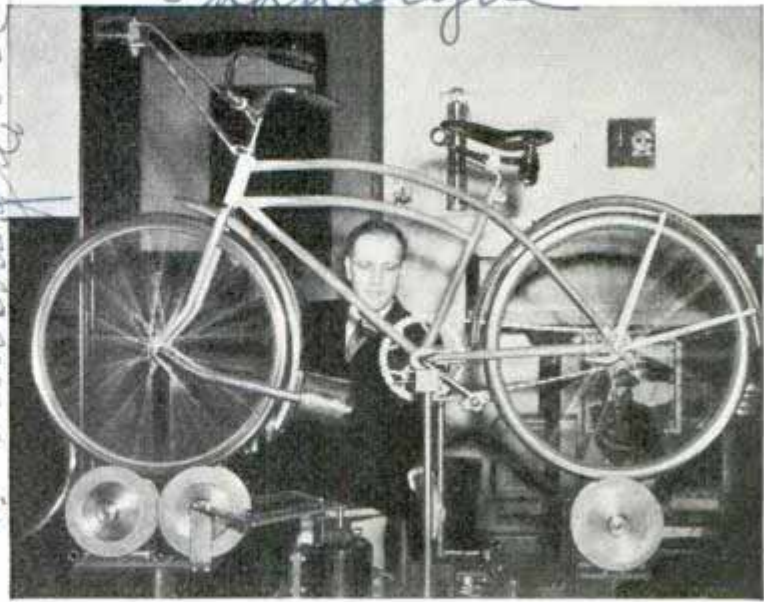

Weights over front wheel and behind front mudguard help balance bicycle. Electric eye is focused on mirror under pedals

direct giant searchlights by remote control. An observer standing outside the glare of the big light sights an object through binoculars mounted on a movable arm, and every movement of the binoculars sends an electric impulse to a regulating motor which actuates balancers to direct the beam of the searchlight.

# Safety Chock for Auto Trailer Prevents Backslide on Hill

Immediate protection in any emergency stop on a hill is provided by a safety chock that fits between the wheels of a trailer,

preventing it from sliding back downhill. It acts independently of the brakes, and is instantly operated from the driver's cab. When released, the chock drops to the pavement and braces the trailer. Should momentum carry the trailer farther back, the chock would ride over to its second or third cleats, doubling its own holding surface on the road and finally lifting the trailer wheels clear of the road.

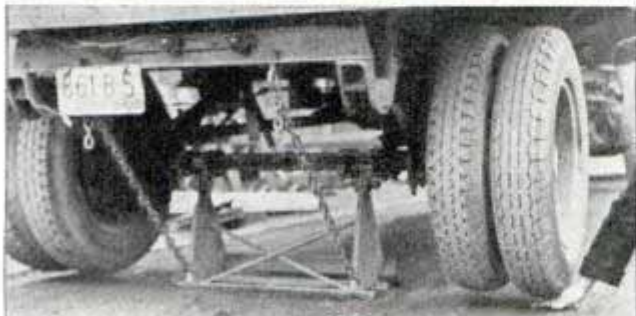
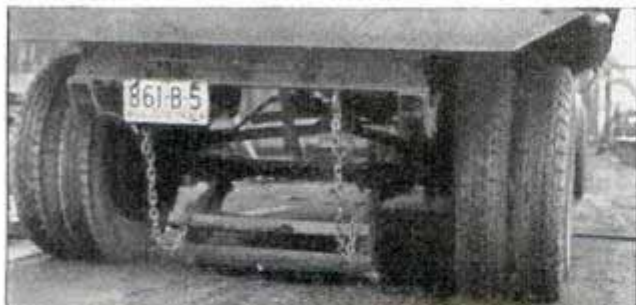

Safety chock in first position, and, below, in final position with truck wheels lifted off pavement

# Contact Prints in Natural Color Made on Sensitive Paper

Amateur photographers can make natural-color prints with a color-sensitive paper which does not require the use of separate negatives for each primary color. The print is made direct from the original full-color film. For contact printing, an exposure of twenty to twenty-five minutes by the light of a photoflood lamp held a foot away is recommended.

Vitachrome Film Corp  
1400 Columbus Ave  
New York, N.Y.

Automobile Co  
7801 Madison Ave  
New York, N.Y.

paper \$2.00 per 100 sheets up for use. \$5 cents up



# SECRETS of a

By Monte Pearson

Member of the Yankees Pitching Staff

2029 Clay Ave. Fresno, Calif

**B**IG-LEAGUE baseball is a slugger's game today. The smooth and lively ball that we use hardly permits a pitcher to throw anything except a fast, straight delivery that the batter can sock out of the park.

That's the secret of the big scores. That's the reason for the numerous batting sprees and that's why no-hit games are only half as common as they were five or six years ago. The public likes it but the pitchers don't.

When you toss in a ball that's as slick as glass and has stitching so smooth that you have to feel for the threads twice, you reduce the pitcher's ability to throw deceptive curves. He can't grip the ball firmly enough to impart the spin that he wants and he can't even get the grip on the stitches. It's true that after an inning the ball becomes easier to hold, but just about

Position of fingers around ball indicates pitcher above is winding up for fast straight throw, although change of wrist position might still produce a curve ball

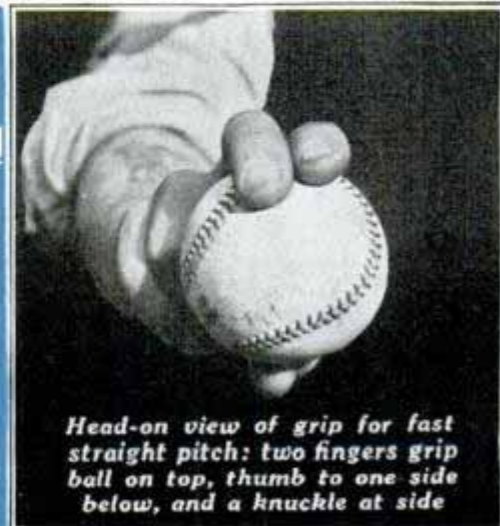



L/S Columbus, Ohio  
10555 Holman Ave.  
Los Angeles, Calif.

# CHAMPION PITCHER

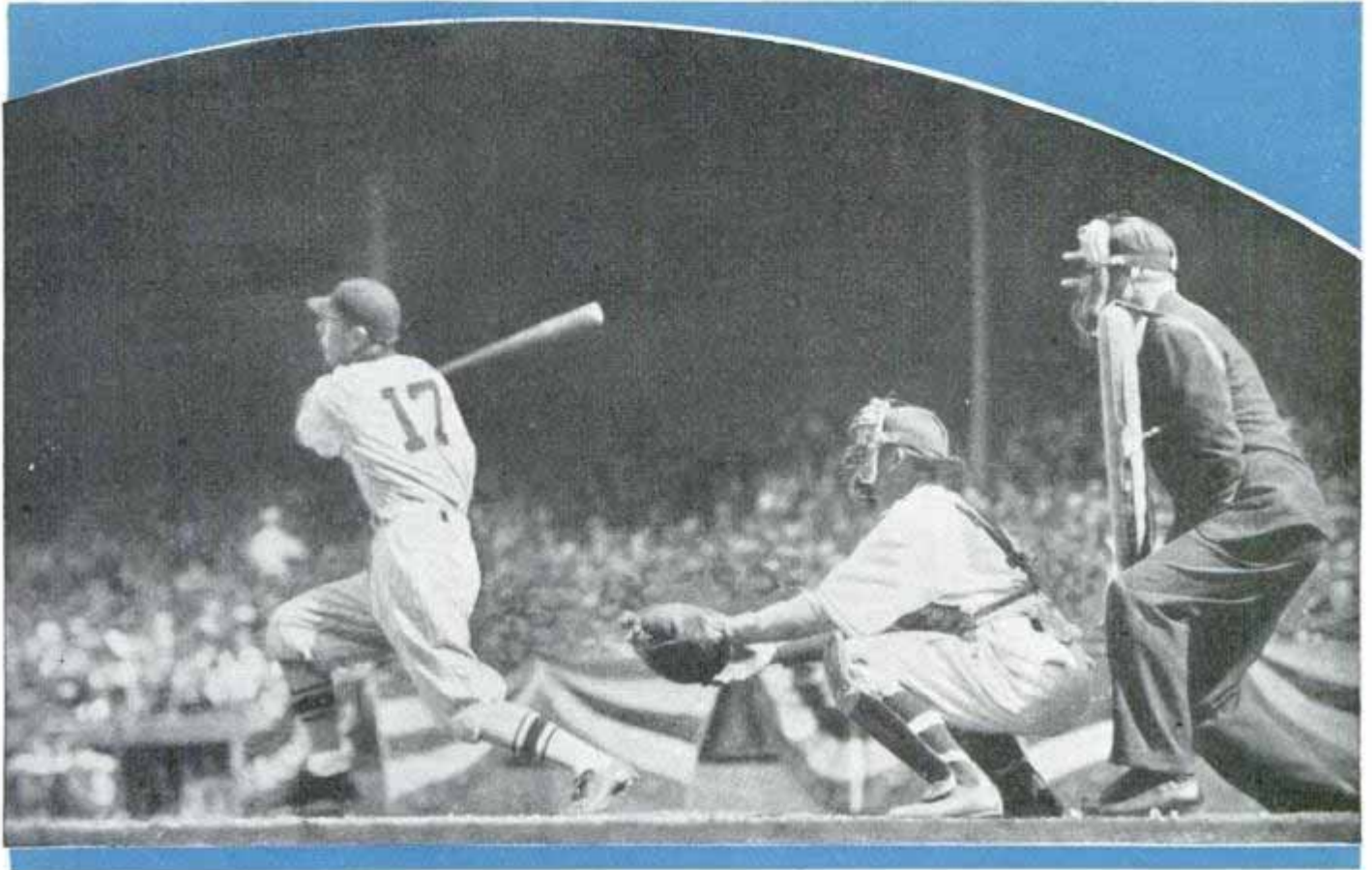

*Crack! A big league batsman has just connected with a fast one and the bat is still swinging*

that time the batter is apt to complain that the ball has been roughened by use and call for a new one.

The result is that the art of pitching has been transformed. The straight fast ball, the change of pace, and a curve or two when the condition of the ball permits make up a pitcher's repertoire in that order of importance. In the world series game

that I pitched last fall I don't think I threw more than half a dozen curves. But curves are important and whenever you have a ball that's rough enough to grip you can throw good ones.

First, let's take up the straight pitch. Hold the ball at three points, the parallel forefinger and middle finger gripping it above, the thumb below to the left, and the

knuckle of the ring finger below to the right. Don't smother the ball close to the palm. Hold it more by the finger tips so that it is as much as an inch away from the palm. Grip it tightly, letting it fly out from under the forefinger and middle finger at the end of the throw. Those two fingers, being above it, impart reverse English to the ball in flight, making it rotate upward.

As far as I can make out,

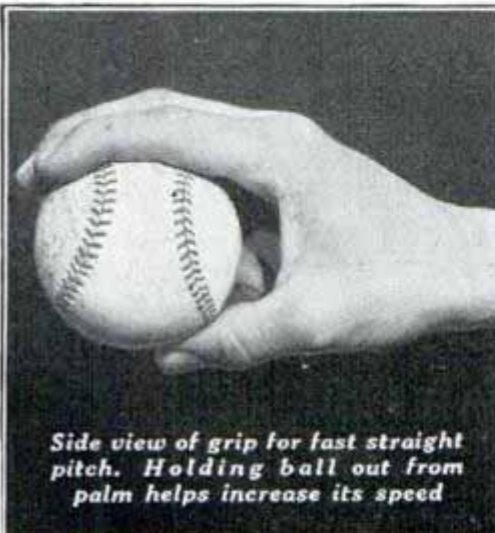

*Side view of grip for fast straight pitch. Holding ball out from palm helps increase its speed*

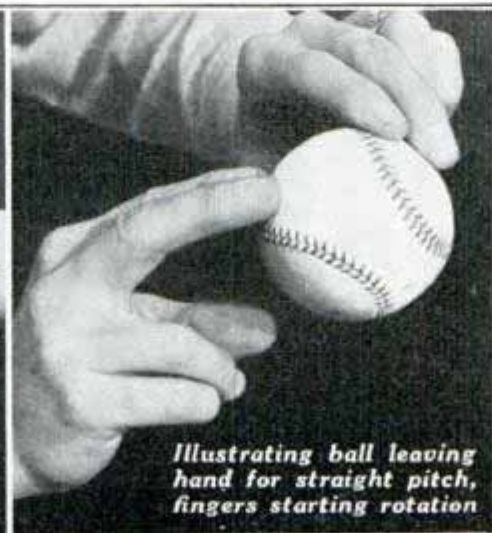

*Illustrating ball leaving hand for straight pitch, fingers starting rotation*



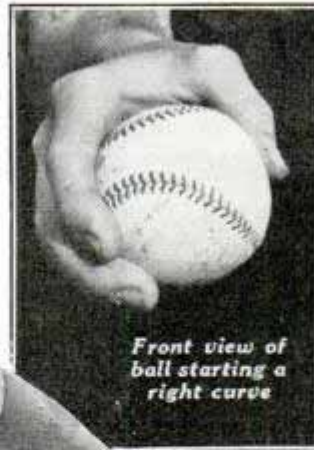
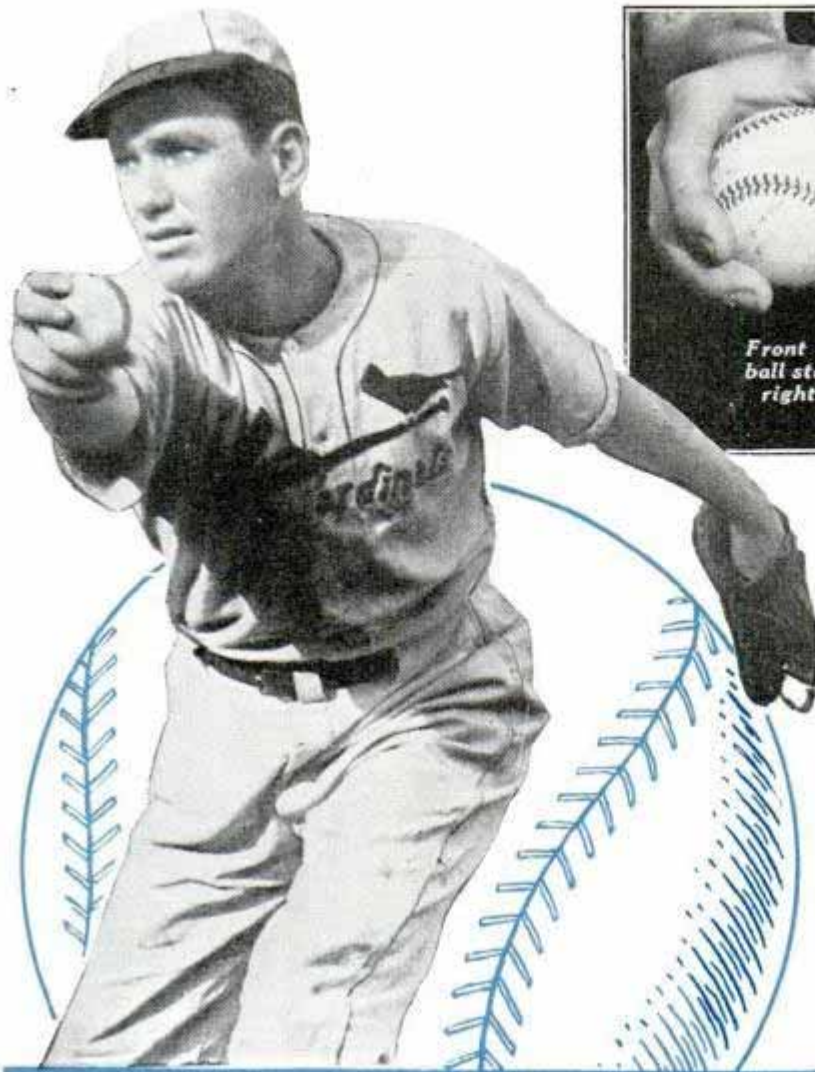

*Front view of ball starting a right curve*



*Grip for side-arm curve. Fingers extended on right of ball will make it break to right*

*At left, pitcher is seen at the moment of releasing ball that will curve to right*

a really fast ball is something some people can throw and others can't. Nearly any green pitcher can learn to throw a curve but there isn't much to learn to help you throw faster than your normal speed. A fast pitcher has a ball that acts lively. It tends to rise as it nears the plate.

The more you spin it the more it tends to rise. It's really an upward curve with gravity fighting to keep it from breaking too much. A baseball will curve in the direction of its own rotation. Throw it with reverse English and it tends to go up. Spin it like a wheel and it will drop. The reason for this is the difference in pressure on opposite sides of the ball.

A rotating ball carries a thin layer of air with it. This layer of air is sticky and it moves with the surface of the ball. Suppose you make a pitch and spin the ball so that it rotates from right to left. At the left side of the ball the layer of air is rotating away from the head wind. On the right side the layer of air is moving forward, meeting the head wind. The density of the air is increased at the right side, and decreased at the left. Obviously the path of the ball is going to curve toward the side



*With two "control" fingers under ball and thumb behind it, pitcher can impart a rolling motion indicated by dotted line. This makes the ball curve downward or break into a drop at the plate*

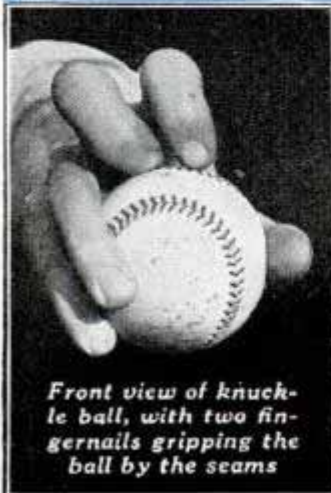

*Front view of knuckle ball, with two fingernails gripping the ball by the seams*

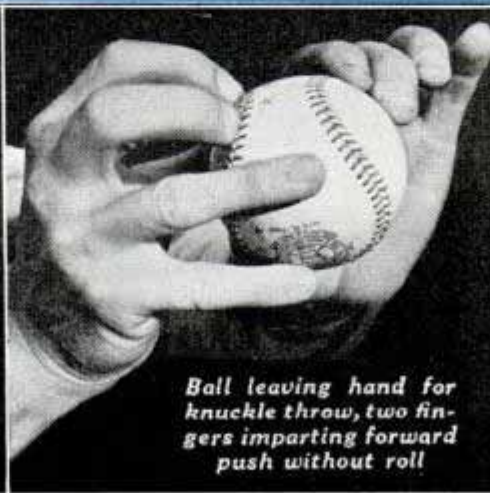

*Ball leaving hand for knuckle throw, two fingers imparting forward push without roll*





*Ball thrown in direction indicated by right arrow, and rotating to right, meets heavier air pressure on left side than on right and will curve to right*

*Monte Pearson of the Yankees pitching to a Cleveland batter. One day last summer when he didn't feel like pitching Pearson shut out Cleveland without a hit*

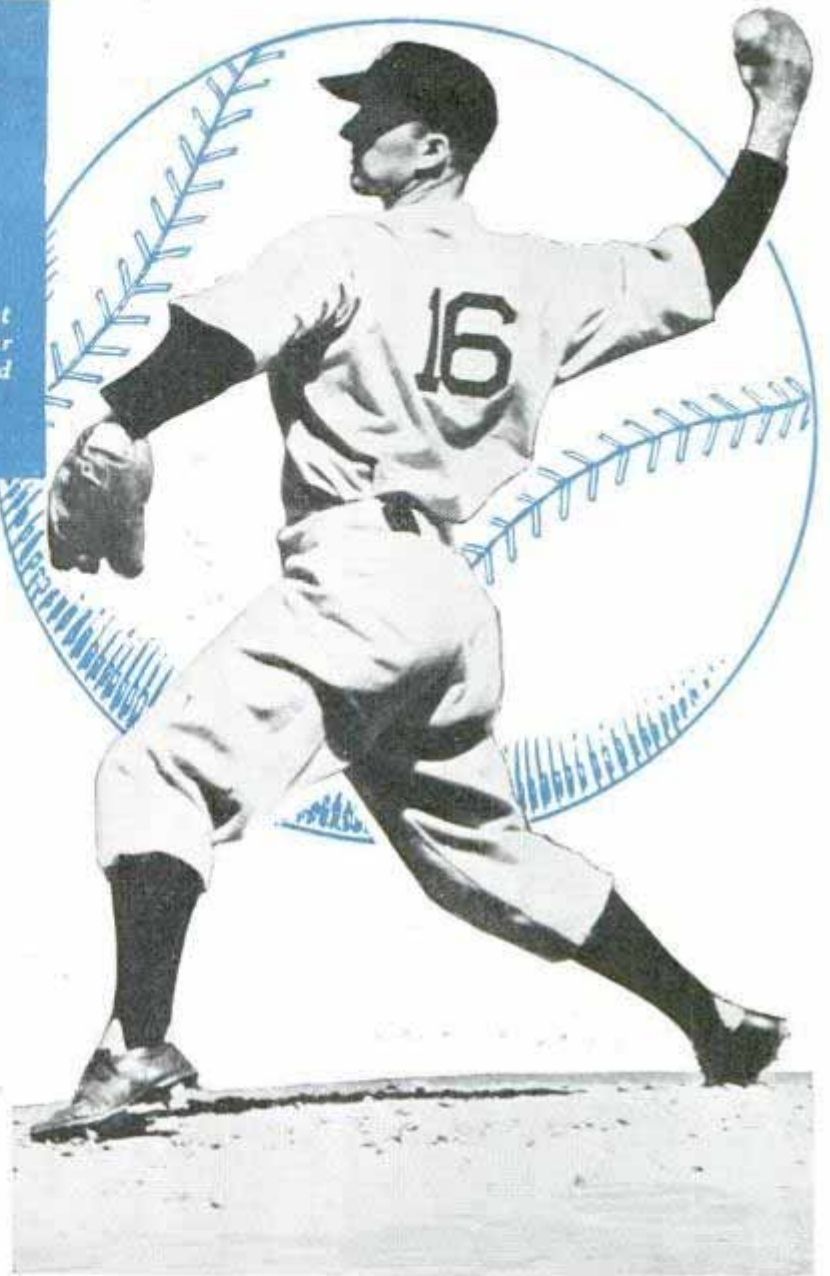

of least pressure. Greater pressure at the right forces the ball to the left.

Theoretically a spinning ball should start a gentle curve as soon as it leaves your hand. The faster you throw a ball, the farther it will travel in a straight line before beginning to curve. When such a ball does start to curve it "breaks" rapidly. That's important because you can throw a fast curve straight at the plate and the ball travels in a straight line until only a foot or so in front of the batter. Then it breaks in the direction you want it to.

Now that you understand why a curved ball acts the way it does, it will be easier to try to throw one. Your extended parallel forefinger and middle finger plus wrist action are what make

the ball spin, so you will get the direction of curve that you want simply by the way you hold your hand at the end of the pitch. The ball will tend to break in the direction of your two fingers.

To throw a drop curve start out just as if throwing a fast straight ball, but at the end of the pitch twist the wrist out and down, releasing the ball so that it travels over the forefinger. That makes it spin as if it were rolling along the ground and assures a drop.

For a right curve, hold your wrist so that the

(Continued to page 144A)

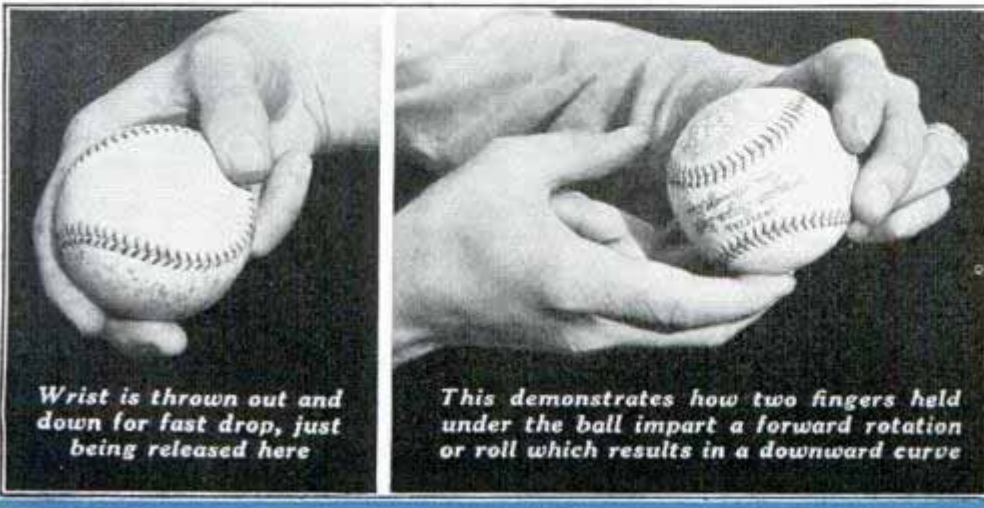

*Wrist is thrown out and down for fast drop, just being released here*

*This demonstrates how two fingers held under the ball impart a forward rotation or roll which results in a downward curve*







Spring Balances Floating Lamp at Any Angle

Right, the "floating" lamps used as reflectors for home photography. Below, installed in pit to illuminate greasing work on car, and lighting a workbench. Coil spring which balances lamp in any position without thumbscrew or other adjustments is in the lower elbow



Responding to a fingertip touch, a "floating" lamp just introduced will assume any position and hold it without any tightening of thumbscrews or other adjustment. An ingenious coil spring balances the double arms of the lamp and produces the "floating" effect. One hand can make any horizontal or vertical adjustment of position; a double swivel at the lamp socket and a full-circle pivot at the base render it highly flexible and convenient for use over the card table or hospital bed, in the workshop or greasing pit, the photographer's darkroom or studio, the physician's and dentist's office, or as a study lamp. There are various models with pedestals, brackets or clamps for attachment to work desks. Because of the facility of adjustment and steadiness of the lamp it is an easy matter to focus light exactly where needed without reflecting glare into the eyes.

Magnetic Wind That Blows Out Lightning Flash Protects Power Lines

Acting as quick as electricity, a blast of magnetic wind, developed by Westinghouse engineers, blows out a flash of man-made lightning. The lightning flash, occurring on high-voltage power lines when a circuit breaker opens, leaps in a hot arc

across the gap between open ends of the circuit and makes a noise like thunder, sometimes filling a workroom with fumes. A puff of the magnetic wind reduces this to a wisp of flame, "muffles" the thunder to a puny bang and permits no great odor.

L. D. Ludwig and Co. S. S. Lussinger

62/42/39  
Tribune





# LISTENING IN *on*

**Y**OU are probably an American at work in one of the 22,000 basic occupations in the United States. Very likely you do your job every day without finding much that's unusual about it.

"Americans at Work," the Columbia Broadcasting System's weekly survey of the country's jobs, brings to the listening audience the story of working America—both the history and background of such outstanding industries as mining, steel work, baking, railroad engineering, dynamiting, bricklaying, bus driving. It also brings to the microphone each week actual workmen in each one of these industries—workmen who know their jobs and can tell people just how they mine or lay bricks or put up skyscrapers or drive steam engines.

Since its beginning in April, 1938, it has brought more than forty occupations to the microphone.

A steel worker on the Tower of the Sun in San Francisco told listening America about the time a "heater" threw him a hot



Top, radio staff gets interview from miners 700 feet underground. Bottom, boarding bus to get driver's story on the air

485 Madison Ave New York

Leggett

Cross country

Ken Ellinger  
P.B. - audience.



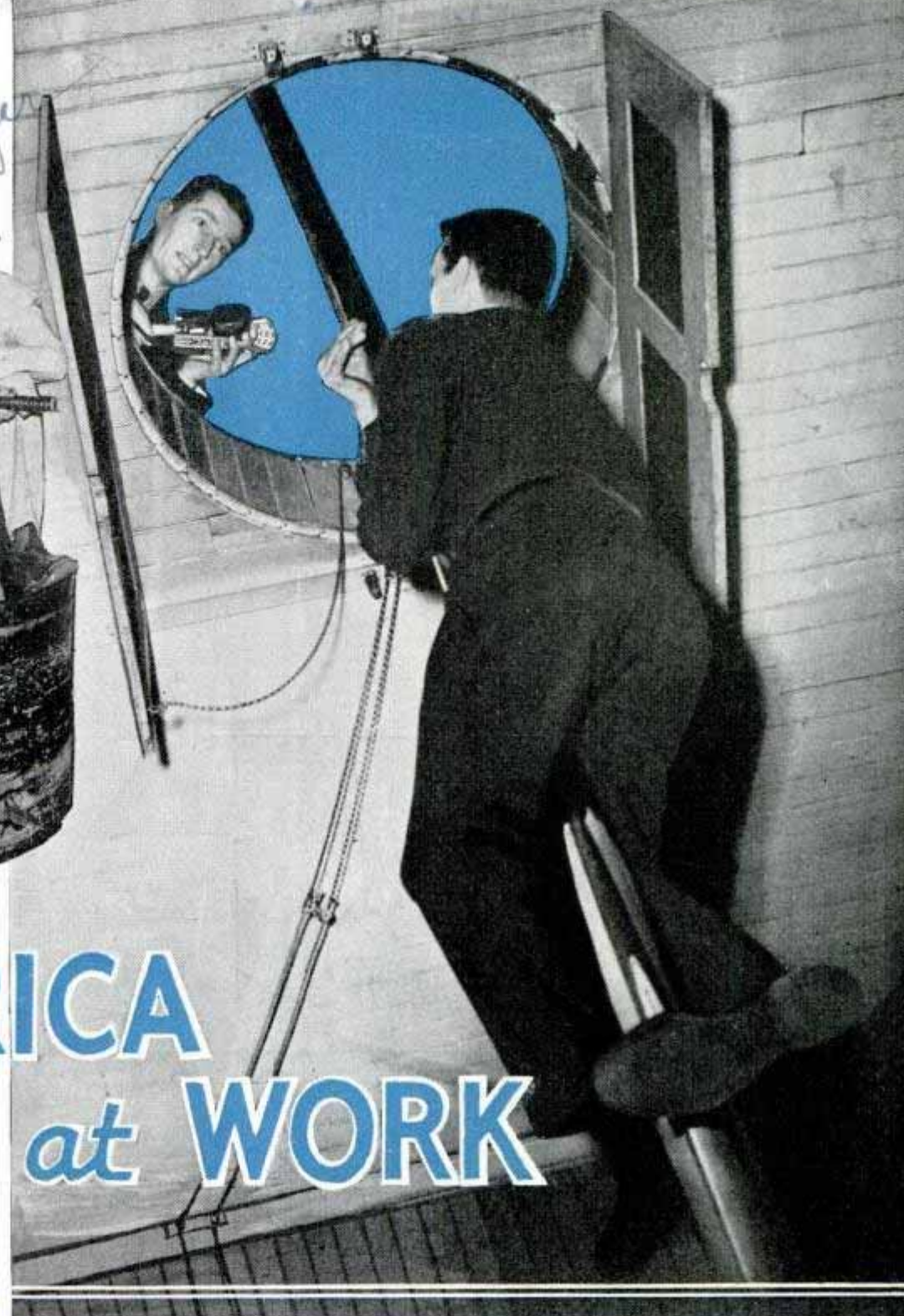

# AMERICA *at* WORK

rivet when he wasn't looking.

"I had to do some tall dancing on that girder—I say I did!" said the steel worker reminisciently into the mike while listeners gasped—and looked with greater understanding and interest next time they passed a tall building under construction and saw the specks of men nonchalantly catching hot rivets and putting them expertly into place forty or fifty floors above the street.

A longshoreman, working on the United States Lines ship, "George Washington," talked about the time he and his partner fell into water in the hold of a ship they were unloading—and had the unusual experience of being forced to swim on the inside of a boat instead of the outside.

The Americans at work on "Americans

*Left, interviewing express handler on his tractor. Right, down the pole slides Fireman Walter Brown while CBS Announcer Alan Scott watches*

*Rise man*

at Work" also have brand new experiences. The industry chosen for the first broadcast was the mole-like one of digging America's tunnels—the work of the sandhog. In order to talk to the sandhogs, CBS announcer Bob Trout, and technicians Bob Trago, Frank Evans, and James Kenny had to penetrate nearly a hundred feet underground where real sandhogs were digging at New York's new Six Avenue subway.

Before any of them were allowed to go underground, they had to have complete physical examinations, with special atten-



*Thomas Edison*  
*Longshoreman*  
*John Reed King*  
*Third Officer H. Seal*

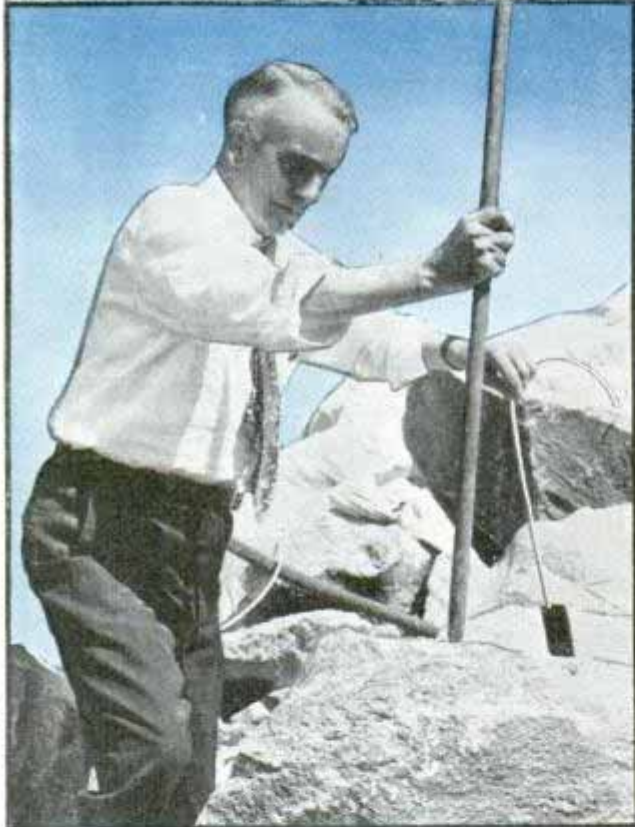

Top, keeping the mike dry during broadcast from deck of lifer. Left, dynamiter preparing to set off blast before going on air

*Sam Russell*

tion to their heart action. Sandhogs work under greatly increased air pressure, and it is extremely dangerous to enter the region where they are digging unless you take the same precautions they take.

This means approaching them through a special air compression chamber which is a huge airtight cylinder, about twenty feet long and six feet high. In this chamber,

the air pressure is gradually increased from normal to nearly thirty-five pounds per square inch.

To the CBS staff, this experience became a little fantastic when all of them were provided with the special badges worn by all sandhogs as a protection against the "bends," an after-effect which sometimes takes place as a result of too-quick passage through the air compression chamber.

The badges tell strangers that if the wearer suddenly becomes paralyzed or staggers peculiarly, he probably has the "bends" and is to be taken to the special hospital of the subway construction company for treatment.

Not only did the technicians themselves have to be put through the compression chamber for this broadcast, but so did their telephone lines. Holes had to be drilled through the air chamber, with especial care not to admit the slightest breath of air, in order to get the lines to the scene of the broadcast. Then, after it was all over, the holes had to be just as carefully plugged up again.

Such problems as passing lines through an air compression chamber quickly became routine for the CBS technicians. Each time they packed up their suitcases full of remote equipment and set out for

*Washington*

*du Pont*



*New York Telephone Long distance Exchange*

some hospital, coal mine, automobile factory, bakery, airport, or railway terminal, they knew there would be problems to meet. But just what these problems would be were never discovered till they were on the job.

Take the second time they went underground with microphones and amplifiers to the site of the new subway where the dynamiters were at work.

Mikes were set up on a platform about fifty feet from where an actual blast was expected to take place. When the equipment was set up, the chief blaster decided the mike was not close enough to catch the full effect of the sound to go out over the air.

This was a real problem for technician Kenny, as there seemed to be no place to hang a mike any closer. Finally, he discovered a narrow girder about fifty feet high and climbed along that to hang a mike directly over the spot where the blast would occur.

And, after all that trouble, the mike was of no use anyhow.



*Mel Allen*



*Woman in background is laughing in CBS radio telegraph*

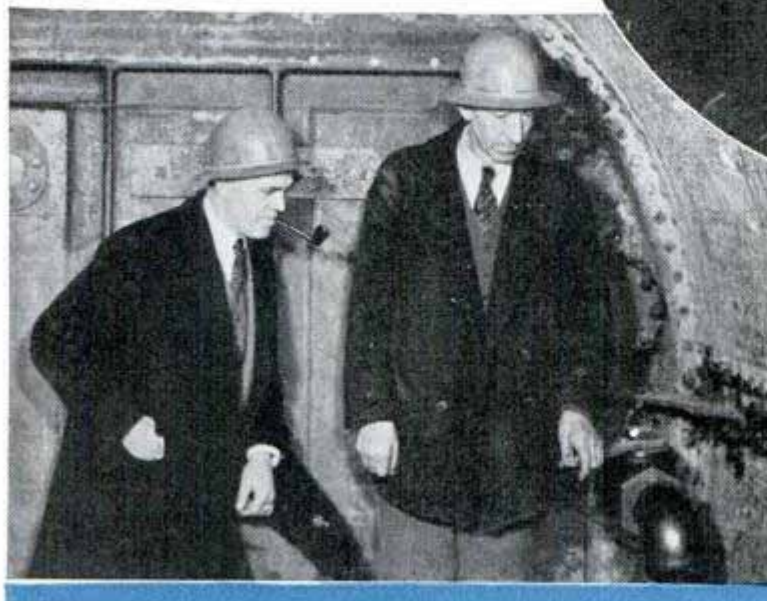

Top, getting 'phone operators' story. Circle, veteran woman telegraph operator at mike. Bottom, air compression chamber through which radio men passed to get sandhog story

When the blast came, it was so terrific that it ruined the microphone, even though Kenny had, as a precaution, turned it off just in time.

Another time Kenny had to crawl along a four-inch string piece above the Hudson river to get at the lines he had to connect to his equipment on board a fishing boat at the Fulton street docks.

One difficulty the program pro-

(Continued to page 141A)

*Excavation for New York*



100. 47th  
New York

### Pipeline Does Hairpin Turn to Allow for Expansion

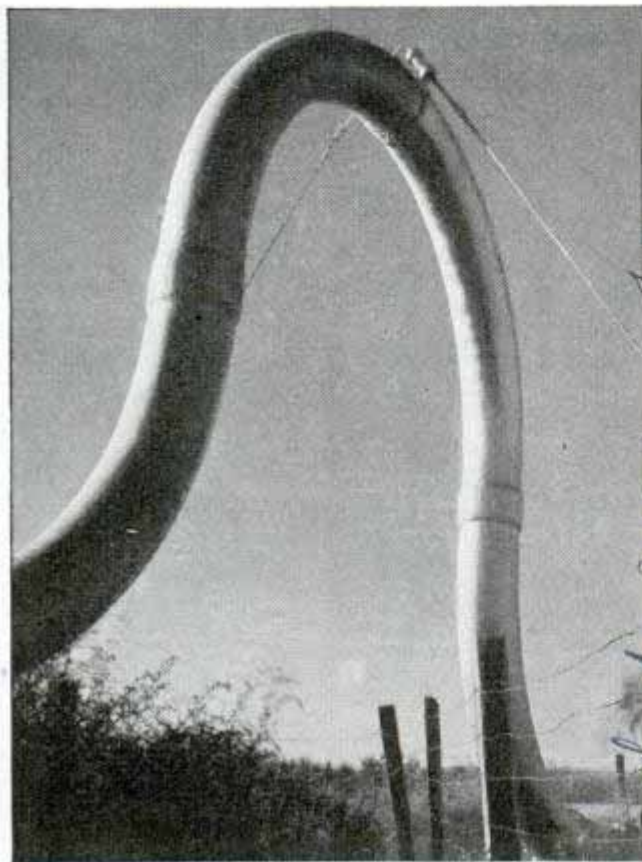

Natural gas line does "sky loop" to allow expansion and contraction from temperature changes in open

Where it crosses the San Diego river on a trestle, the natural gas pipeline of the San Diego Consolidated Gas and Electric company climbs into the sky for a graceful hairpin turn. Actually this is a "safety valve." Emerging from the ground to cross the river, the line is subject to changes of temperature in the open and some provision had to be made to allow contraction and expansion. This semi-loop acts as a safety spring, rising or flattening with expansion and contraction.

See lucky magnet.

sary, and when several stations are included in one network a series of code-rings is possible. This bell-ringing system operates at less expense than the usual loudspeaker arrangement, and it keeps a constant twenty-four hour vigil.

J-215

### Golf Tee Retrieved by Magnet Which Clings to Head of Club

You now can put your golf tee on a leash so it will not dart out of sight when the ball is struck. At the other end of the string is a tiny but powerful magnet made of Alnico, and after teeing off you simply wave the club near the magnet and it will attach itself to the bottom of the steel shaft. The tricky retriever saves hunting for lost tees and you don't even have to stoop.

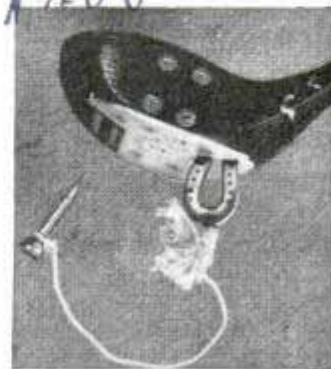

and after teeing off you simply wave the club near the magnet and it will attach itself to the bottom of the steel shaft. The tricky retriever saves hunting for lost tees and you don't even have to stoop.

J-149

### Locking Tray Built in Drawer Keeps Jewels Safe

Jewelry and valuables are guarded in a locking tray which is built into the drawer of a bureau or dresser. The tray slides from front to back and can be unlocked only with a key or by dialing the correct combination. The interior compartment is lined with tarnish-resisting fabric.



Sliding tray in top of drawer keeps jewels out of sight and can be unlocked with key or combination

### Bell in Radio Receiver Is Rung by Call to Lookout Tower

Emergency radio calls ring the bell of a receiving set developed in the Forest Service radio laboratory at Portland, Ore. Intended for installation in fire lookout towers, ranger and dispatcher stations, the bell can be rung by any ultra-high frequency set—even the lightest eight-pound portable. Signals can be carried to men working outside their stations, if neces-

U.S. Dept. of Agriculture  
Washington, D.C.  
194

Free Lane Photographers would

Cavalier Corp.  
Chattanooga Tenn



9-181 - 20th Century. Flors  
 21st Century Corp. 2101 Champa,  
 Denver Colo

# Motorized Cowboys Round Up a Buffalo Herd

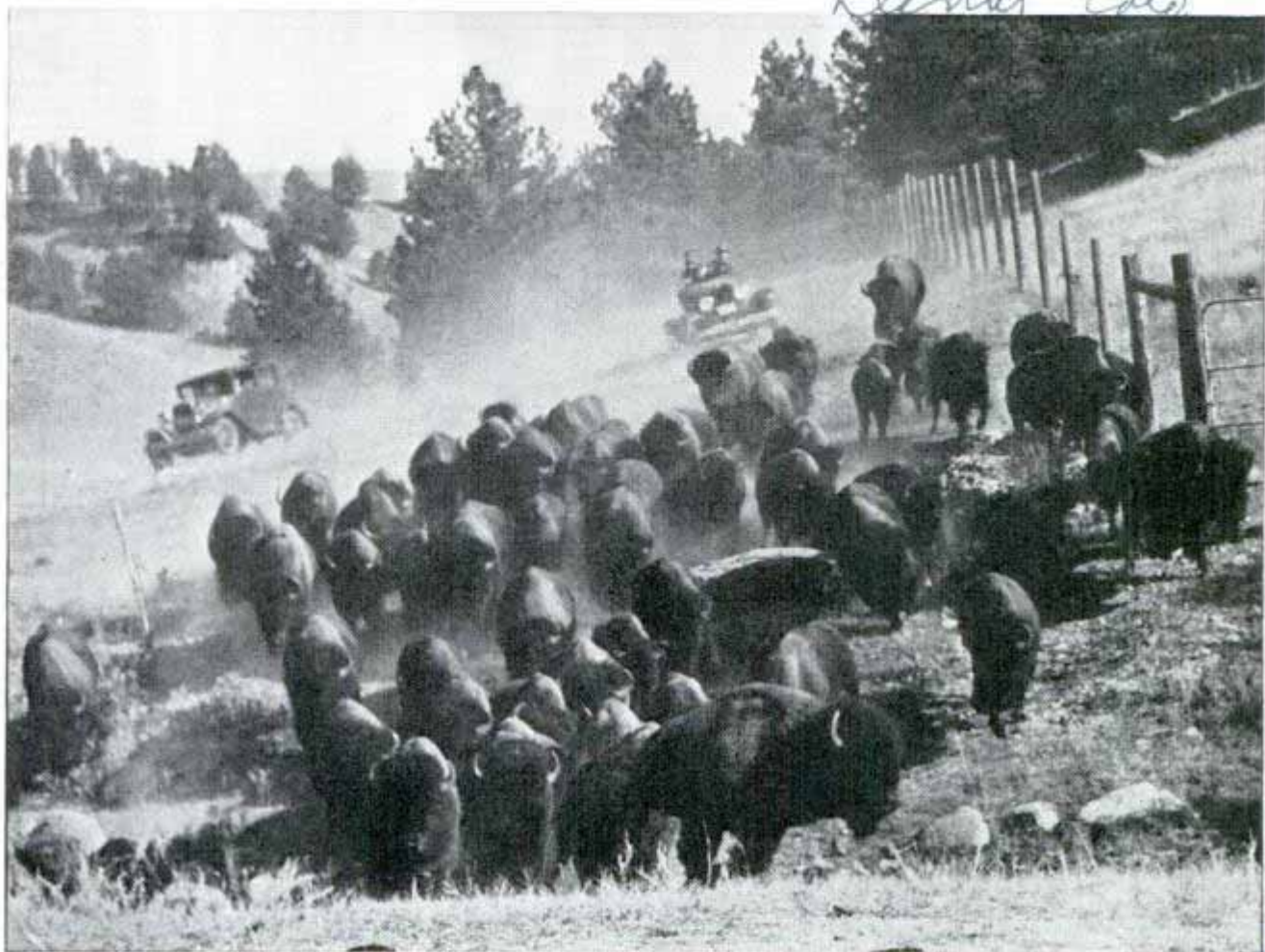

*Park rangers in South Dakota's Wind Cave National Park "ride herd" on buffaloes in old "jalopies." Riding the range in a car may be rough, but it's safer, for automobiles command respect from buffaloes*

Riding the buffalo range in decade-old automobiles is not like touring the city boulevards in a comfortable sedan, but at that it's safer to chase buffaloes in cars than saddles. So the park rangers at Wind Cave National Park in South Dakota conduct their annual buffalo roundups with mechanical steeds instead of the western

ponies traditionally used. Under the expert handling of the motorized cowboys the old, light cars can get around almost anywhere the buffalo can. They stand the rough terrain well, and buffaloes have more respect for the chugging car than for the pony. The rangers say the roundup in automobiles is faster, safer and more economical.

## Sawtooth Guard Boat Propeller from Fouling on Ropes

To protect a boat's propeller shaft and bearings from damage by fouled ropes, a sawtooth sleeve has been developed. Fitting over the exposed shaft, it prevents a rope from wrapping tight around it, and the sawteeth quickly "chew" off the obstruction. Perforations along the sleeve permit the bearings to "breathe" even when the protector is momentarily fouled.

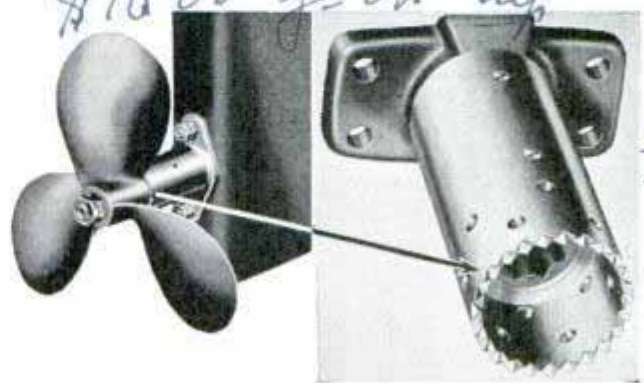

*Sawteeth on sleeve of propeller shaft quickly cut through ropes or weeds and prevent fouling propeller*

Gasoline used in 1938 reached a record total of 521,657,000 barrels.

Chicago News 2/9/39

Thomas Harris, 159 Georgia Ave  
 Providence R.I.



# GIANT DIESELS *Drive*

CROSS SECTION OF THE "DOMINION MONARCH"

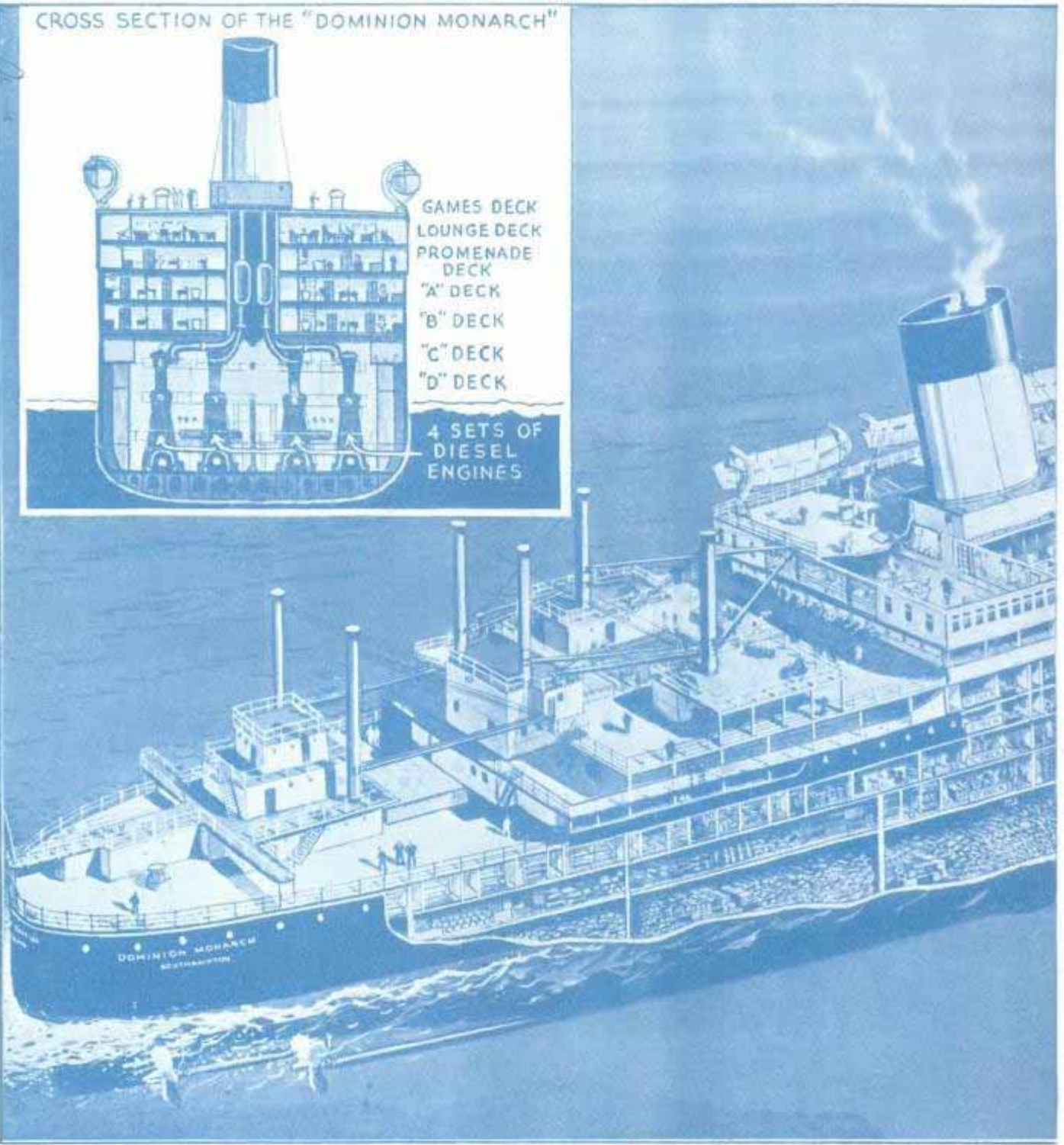
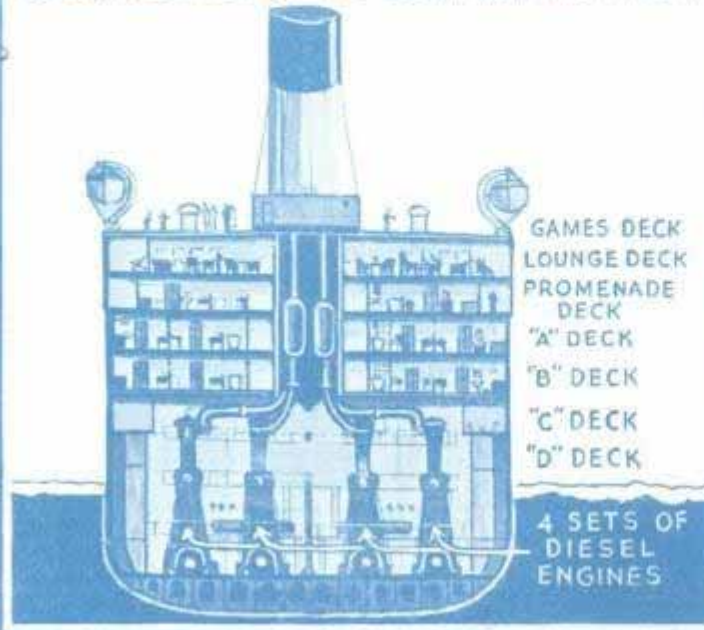

**P**OWERED by quadruple Diesel engines capable of developing 32,000 horsepower, England's latest queen of the seas, "Dominion Monarch," is regarded as the most powerful British motor ship afloat. The battery of engines, turning quadruple screws, gives the ship a service speed of twenty-one and one-half knots. Only first-class passengers will be carried on this

liner, which is rated at 27,000 tons, and accommodations are unusually extensive. The area of the sports deck alone is 18,500 square feet. Passenger cabins and public rooms embody the latest features in modern design. Cargo space, too, is large, as the diagrammatic drawing on these two pages shows. Refrigerating machinery, to supply cooling for cargo and passenger

95  
 Cliner Shaw, Savill, and Albion Co  
 24, Leadenhall St. London E.C.3 England



# New OCEAN QUEEN



needs, requires four 160-horsepower motors. Two ninety-horsepower motors are used in connection with steering. An emergency lighting plant is driven by a 150-horsepower engine coupled to a 100-kilowatt generator. Equipment of the vessel includes a complete sewage installation, electrically operated watertight doors, fire-and-smoke protecting system, a special

fire-extinguishing system, echo sounder, radio and complete gyrocompass, as well as a sound-reproducing system with fifty-five loud speakers. The vessel, the largest engaged in regular passenger and cargo trades between England and New Zealand, via South Africa and Australia, is scheduled to reach Capetown in fourteen days, and New Zealand in thirty-five days.



# Paddles That Prevent Swell Built for River Boat

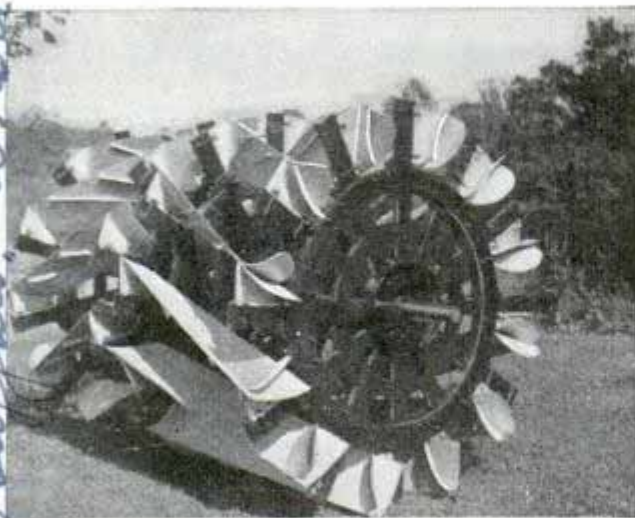

Unusual design of this stern paddle for river boats prevents high swells which would damage shore

Heavy waves can cause considerable damage to banks along small rivers, and to prevent the waves raised by ordinary paddle-wheel boats a special stern wheel has been designed. It has twelve curved paddles on each side with curved fins at the end of each blade.

# Earthquake Shuts Off Gas Valve to Prevent Outbreak of Fire

Fire following an earthquake often does more damage than the shock itself, and frequently the cause of fire is the ignition of gas from broken mains and pipes. To prevent escape of gas after a quake, an automatic shutoff valve has been devised which is operated by the earthquake itself. A heavy weight is suspended in the base of the valve by three metal wires, and

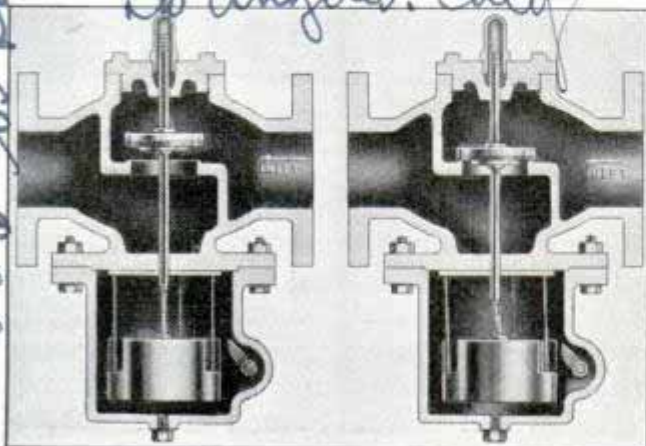

Left, gas valve in open position; right, quake shakes stem from balanced spindle and valve drops shut

when the body of the valve, attached to the building, is moved by the shock, the weight remains steady because of its flexible suspension. Thus the valve stem, which has been poised on a spindle projecting up from the weight, is displaced and the valve drops to its seat and shuts off the gas. A short curved lever or cam at one side of the weight can be operated manually to shut off the gas in the building in case of fire without an earthquake.

# Roast Meat Thermometer Tells When to Remove from Oven

Correct roasting time for different kinds of meat is assured by a special thermometer with a pointer that tells the cook when to remove it from the oven. Mounted on a long stem which is inserted deep into the

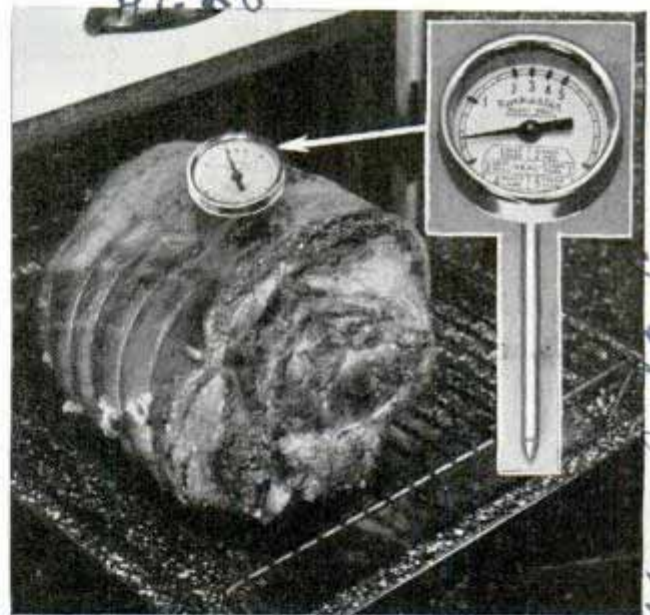

Roast is done when pointer reaches correct figure as indicated on thermometer dial shown in inset

lean part of the meat, the instrument has a dial separated into five sections showing stages of roasting time. When the pointer which moves clockwise over the face, reaches the numbered section recommended for the kind of meat being prepared, the roast is done. To meet individual tastes, it may be done extra well by allowing the hand to advance a little farther than called for in the table, or not quite so far if a rare roast is preferred.

In the manufacture of 1,000,000 automobiles, it is estimated that agricultural products from 500,000 acres are used.

Auto Facts

Charles Fife, W. Va.  
128  
656  
Sentinel Earthquake Valve Co. Angeles, Calif.  
163

Roast Meat Thermometer, N.Y.  
\$1.25  
201  
Starcher



# Giant Electric Scoreboard Is Set Like Type

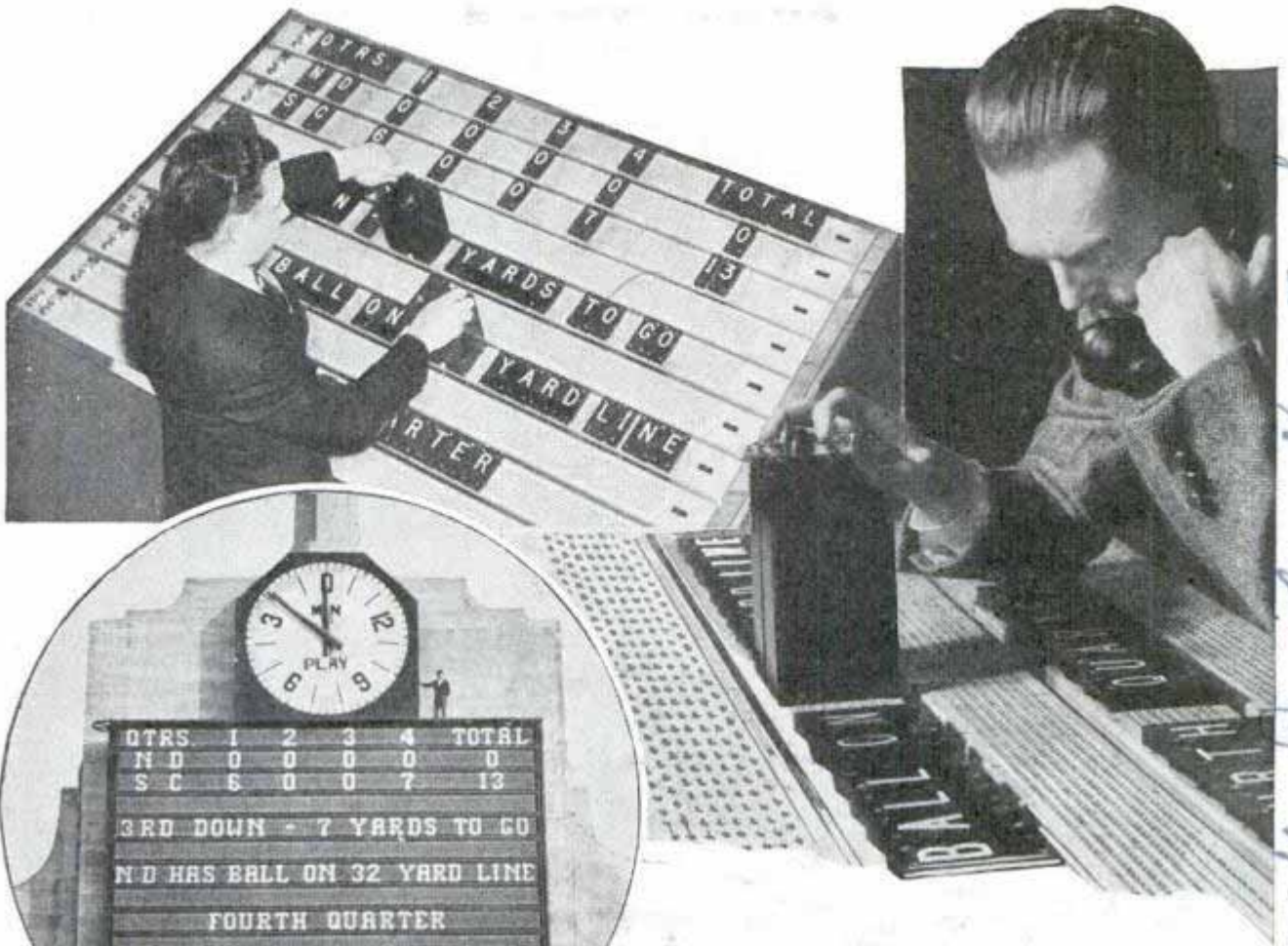

You can write in any language on the vast electric scoreboard of the Los Angeles Coliseum and the letters, two feet high, flash instantly as you plug them into the "makeup" board behind the scenes. At left, above, is operator at layout board and below the sign as it appeared from football field. Top, right, operator receives report from field by telephone and manipulates tall control panel to change yardage numeral. Face of scoreboard comprises 12,000 forty-watt lights

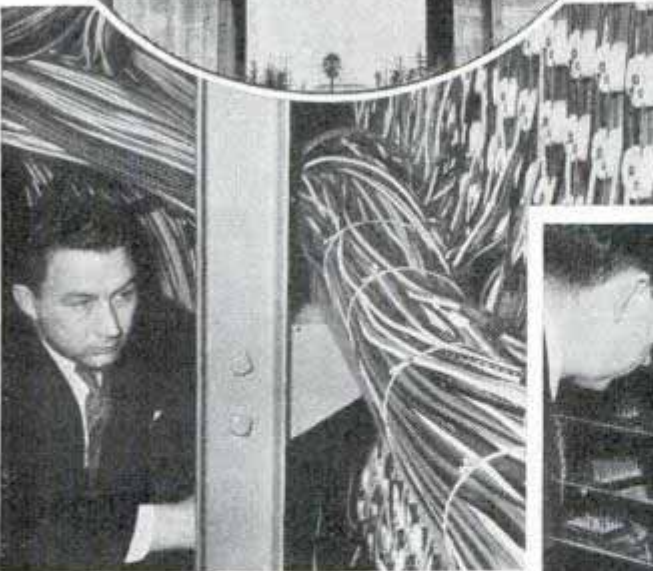

One hundred miles of wire, above, connect light sockets with plugs in layout table. Right, letters are filed alphabetically like typesetter's case. Men who operate board never see events, but receive orders by phone and loudspeaker and set letters in fiber strips as a printer sets line of type. One line can be set while another is lighted. Rheostats permit three light stages

Calif. Council  
 With member 4457  
 Los Angeles



1545  
 10555  
 Thomas L. Dymson, Jr.  
 Holman Co  
 Los Angeles Calif

# NEW CARS

for

# the KINGS of SPEED

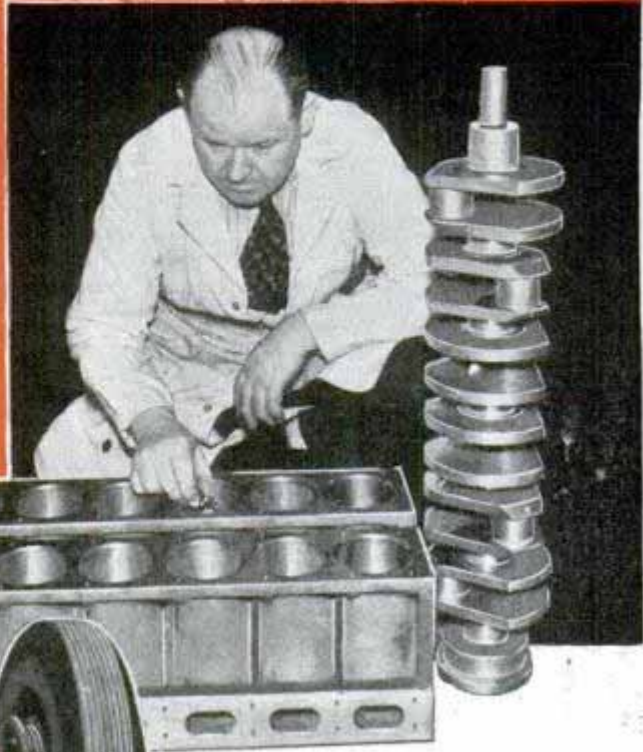
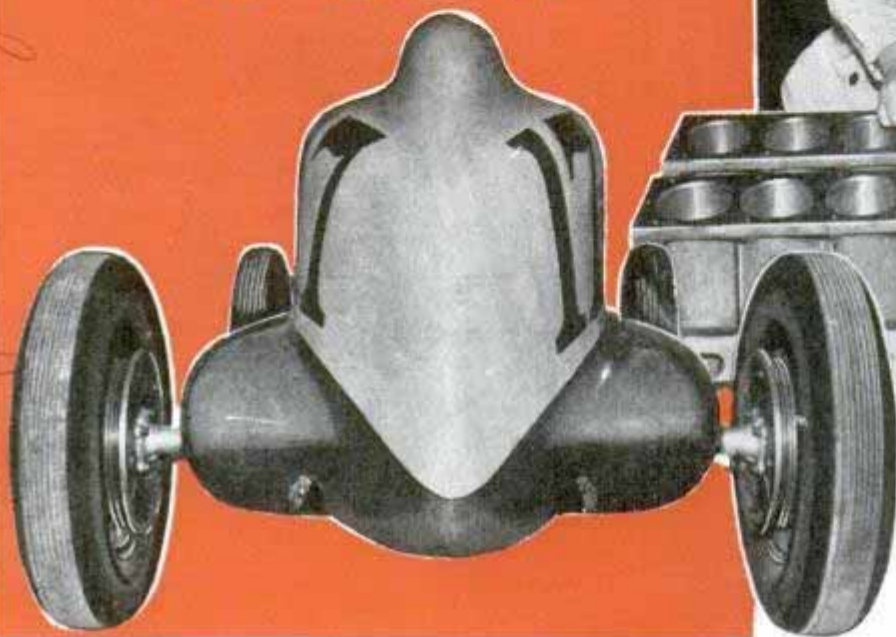

**F**OR six consecutive years the world's best drivers, bent over the wheels of the fastest cars in the world, have smashed speed records at the Indianapolis race.

This year likewise, barring unforeseen accidents or weather, speeds never attained before will be made at the 500-mile Memorial Day classic.

Never has the fight to win America's blue-ribbon race event been so strenuous. The race really started last fall when owners, drivers, and mechanics began to plan cars and engines. The thirty-three entries will represent a cost of nearly half a million dollars.

An up-to-date race car costs from \$12,000 to \$25,000 and nearly every part is made by hand. A sixty-five-pound crankshaft is turned down from a fat forging that weighs 356 pounds; a six-pound wheel hub is made from a chunk of metal that weighed seventy pounds at the start. As much as 125 hours of labor are spent creating a single connecting rod.

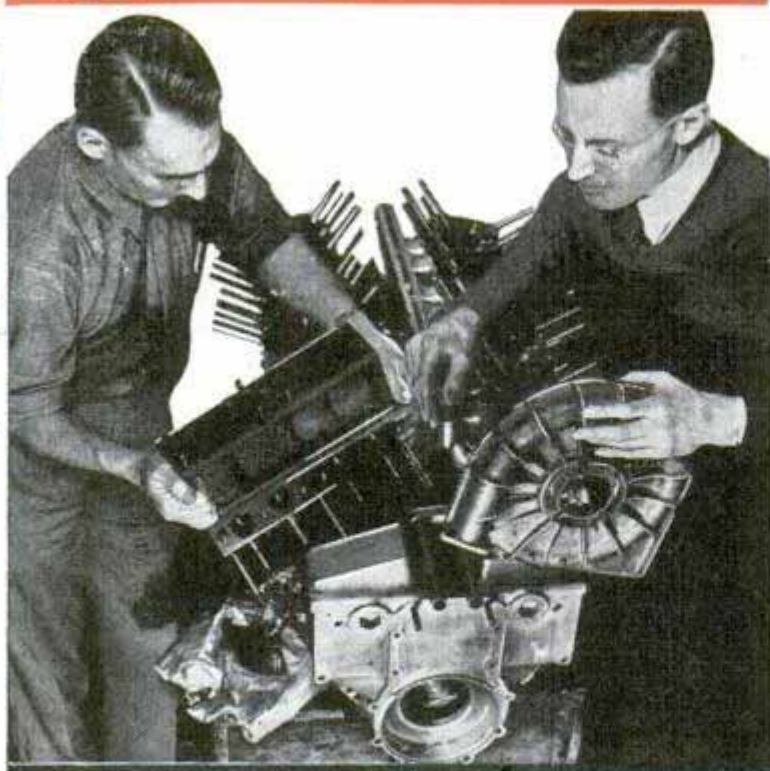

Top, rear of 1939 racer showing streamline headrest, body and frame. Right, Fred Offenhauser checking bore of engine blocks. Beside him is heavily balanced crankshaft. Bottom, mounting supercharger and four-cylinder block on sixteen-cylinder motor

Reference: Fred Offenhauser, 2935 W. ...  
 62 ...  
 St. ...  
 Los Angeles, Calif.



H1545

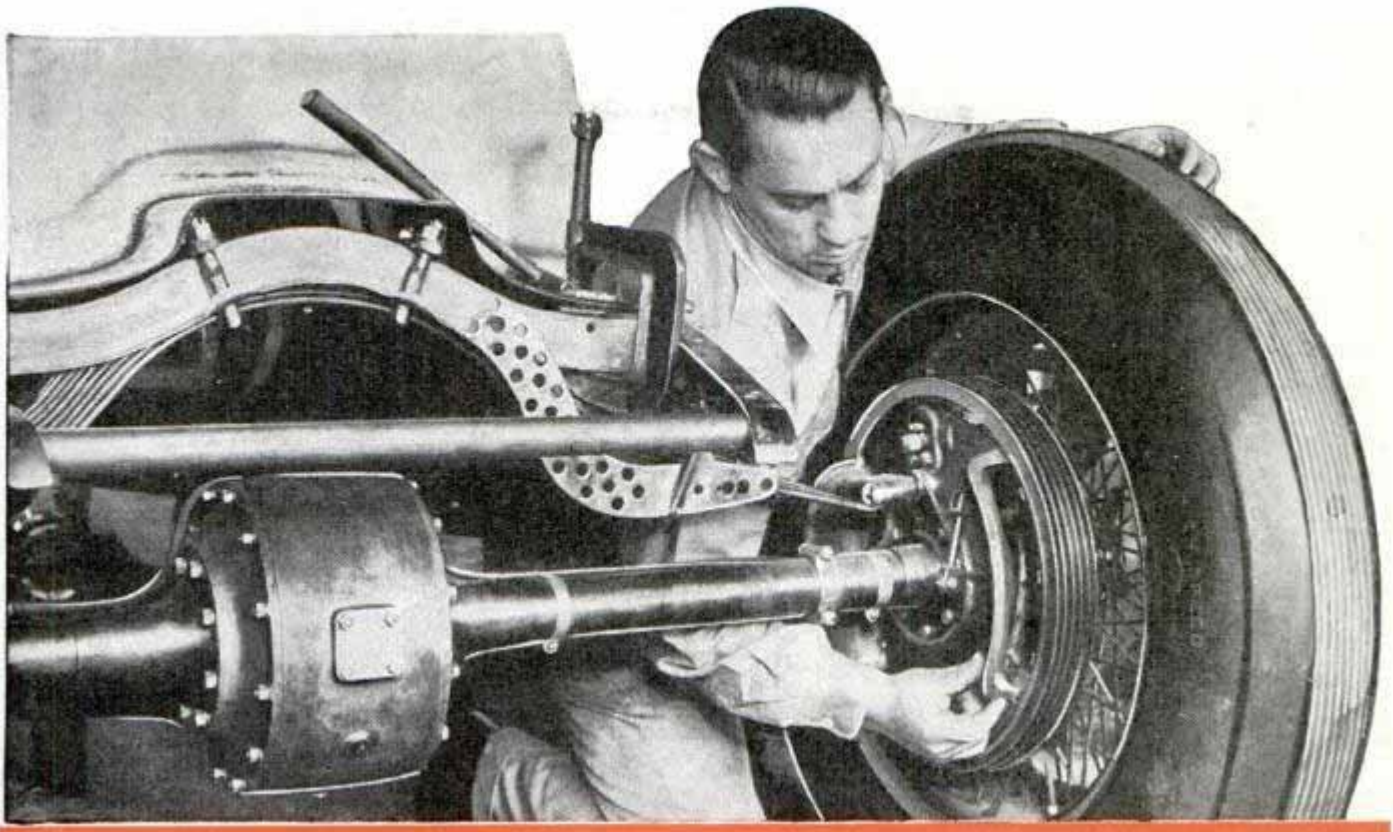

One owner is using a full-scale duplicate of the camshaft and valve assembly of his engine to study valve and spring action at different speeds through a stroboscope.

This year, as usual, men who drive with their heads as well as their feet are going to lead. Nearly half a dozen former winners are competing. Most of them expect it will take an average of 120 miles an hour including pit stops to win, nearly three miles an hour faster than the winning speed last year. The one who gets the pole position may have to qualify at close to 135 miles per hour, for the qualifying runs will be only four laps long, a distance so

short that drivers won't have to worry about wearing out tires.

Although the speed may be faster than ever, the drivers will not receive as much punishment as in the past. The two-and-a-half-mile track was originally surfaced with brick; wear gradually turned it into a bumpy course hard on both cars and drivers. Last year the turns were resurfaced, permitting faster driving, and this year the long backstretch has also been repaved. Last year's rules apply this year as well.

One of the outstanding cars this year is powered with a sixteen-cylinder engine

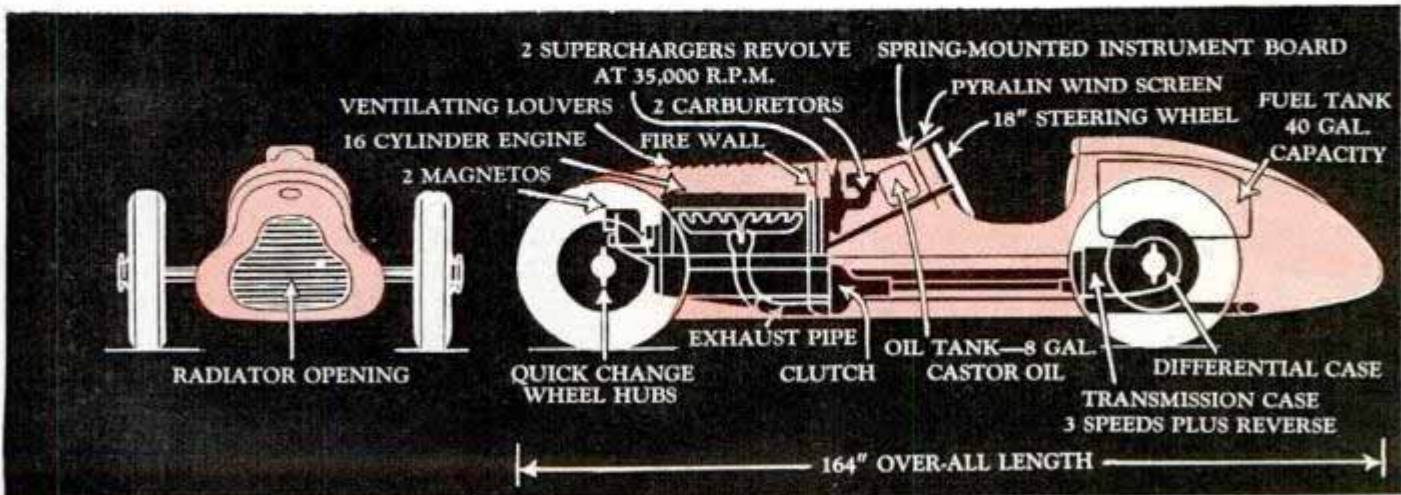

Top, ventilating orifice and ribbed surface of brake housing promote rapid cooling of four-wheel brakes on Joe Thornb's car. Below is a diagram of the sixteen-cylinder Sampson "Comet"

see May 1940 - 705



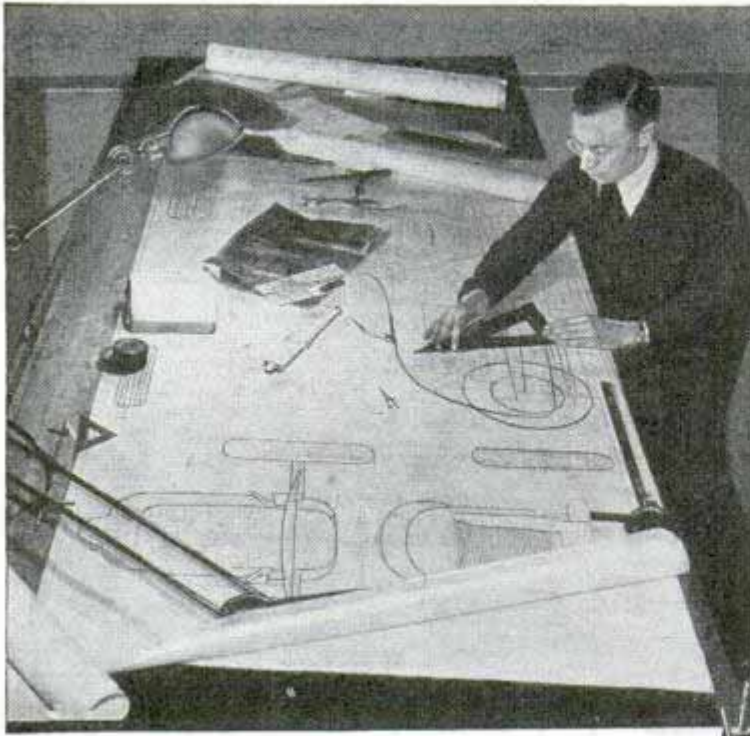

of 183 cubic inches displacement and "winds up" to nearly 7,000 revolutions per minute. Bore is two and three-sixteenths inches and stroke is three inches. Each bank of cylinders has a supercharger and the engine is cooled by a double interconnected radiator.

The car itself looks more like a bullet than do most race cars and is seven inches lower than the av-

that develops close to 500 horsepower, more than twice as much as some of the other motors. The car is to be driven by Bob Swanson and is owned by Sampson Motors Corporation. The motor, originally built by Frank Lockhart, consists of two eight-cylinder in-line engines mounted side by side on a common crankcase. The two crankshafts are geared to the drive shaft at the rear of the block. The motor is

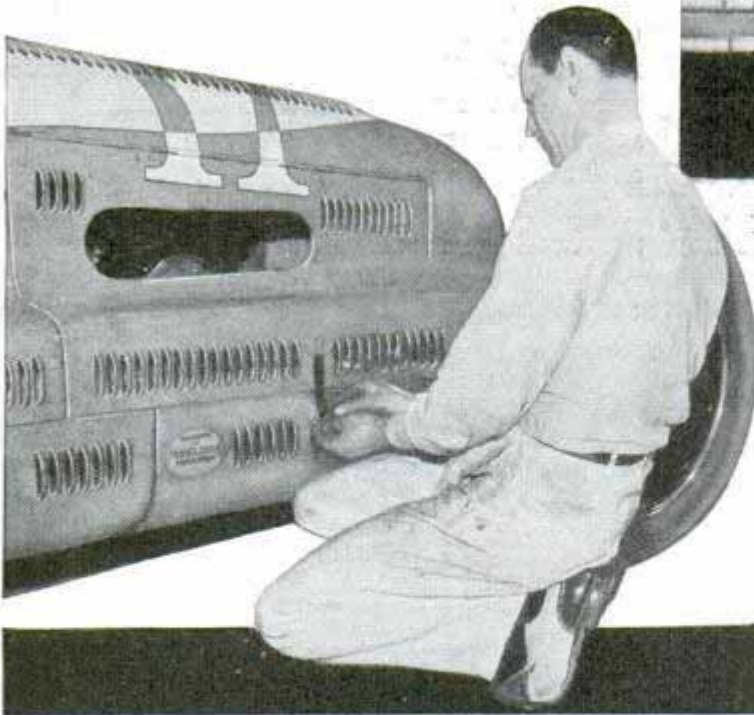
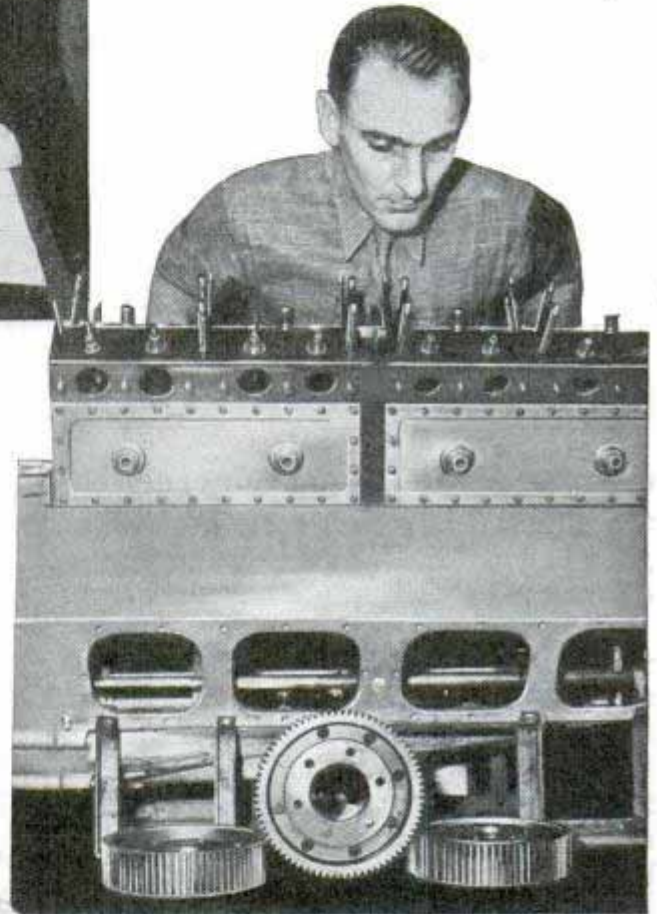

*Top, Leo Goossen laying out plans for racer. Right, Alden Sampson, owner, inspects sixteen-cylinder supercharged engine before mounting it in car to be driven by Bob Swanson. Bottom, mechanic straps hood; louvers ventilate engine and oil supply*

erage, the top of the driver's headrest being forty-one inches above the ground. To reduce unsprung weight, Leo Goossen, the designer, employed the European practice of using an underslung transmission carried just ahead of the rear axle, both transmission and differential being supported rigidly from the frame. Gear shifting is accomplished through a conventional shift stick attached to a rod leading back to the transmission.

To obtain maximum traction and roadability the car has double quarter-elliptic springs in front and a torsion-bar type of suspen-

(Continued to page 116A)



# Position and Direction Finders Help Air Safety

Radio has given to aviation two additional safety features, developed in England, one of which is virtually an automatic navigator showing the pilot his position within a radius of two miles at all times. Two automatic direction finders, operating continuously and simultaneously, are actuated by a robot leading to a map on which two pointers cross; at their intersection is the airplane's current position. With the other apparatus, also in the nature of a direction finder, radio-equipped planes flying in fog can be brought safely to earth from distances as great as 500 miles from the "checkerboard" hut in which the equipment is housed.

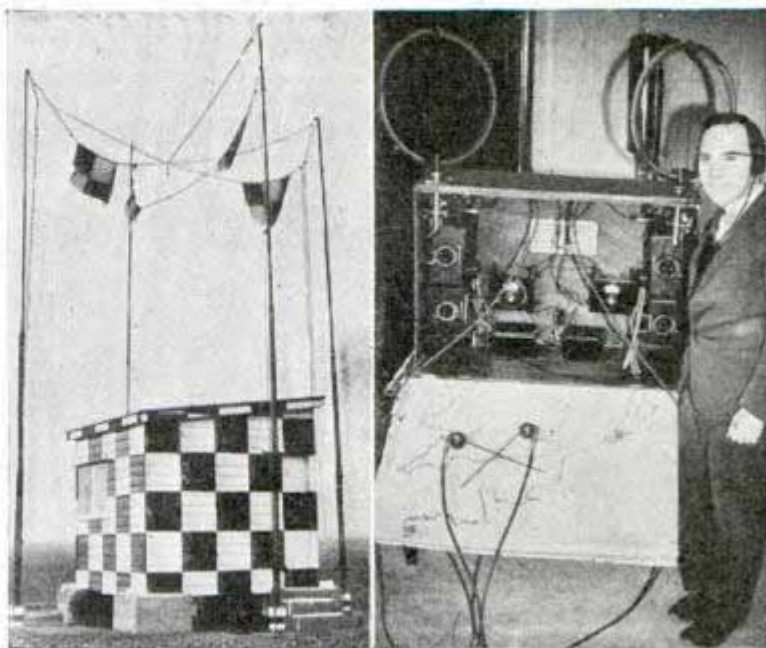

Left, hut containing direction-finding equipment. Right, pilot always knows his position by noting where pointers cross

# Fire Engine with Cab Forward Maneuvers at High Speed

Six firemen ride in safety in the cab of a streamline fire engine whose cab-forward construction offers greater visibility and

ease of maneuvering at high speed. Glass windows above the regular windshield give a better view overhead in approaching

a fire. The wheelbase is six feet shorter than the average conventional truck, and weight is evenly balanced. This, combined with low center of gravity, permits fast turns in congested traffic. The turning radius is about ten feet shorter than average. The cab is steel welded. Ladders, axes and other equipment are carried in the rear, and the pumps, at 400 pounds maximum pressure, deliver from 500 to 4,000 gallons per minute.



With low center of gravity and a wheelbase six feet shorter than the average fire truck, this pump and ladder car makes short turns at high speed

# Perforated Wings of Airplane Give Greater Speed and Faster Climb

Perforating the wings of an airplane may seem to be an invitation to disaster, but a British aeronautical engineer has demonstrated that such an arrangement increases the rate of climb and speed. When an airplane flies at high speed, the air acts very much like a liquid, adhering to the wings

and body of the ship and creating a drag that hinders its progress. To remove this "sticky" air from the wings, their surfaces have been perforated and a blower is installed in the airplane to provide suction for drawing away the speed-killing layer of atmosphere.

Swair Service 2/27/39

United Fire Engine Corp. 4226

J. A. McCallumray  
United Fire Engine Corp. 4226  
See articles on pages 20, 21, 22, 23

*From British magazine Flight, June 20, 1939*

*H. S. Miles, London, England  
Managing Director*



# Student Marines Play at War on Miniature Field of Battle

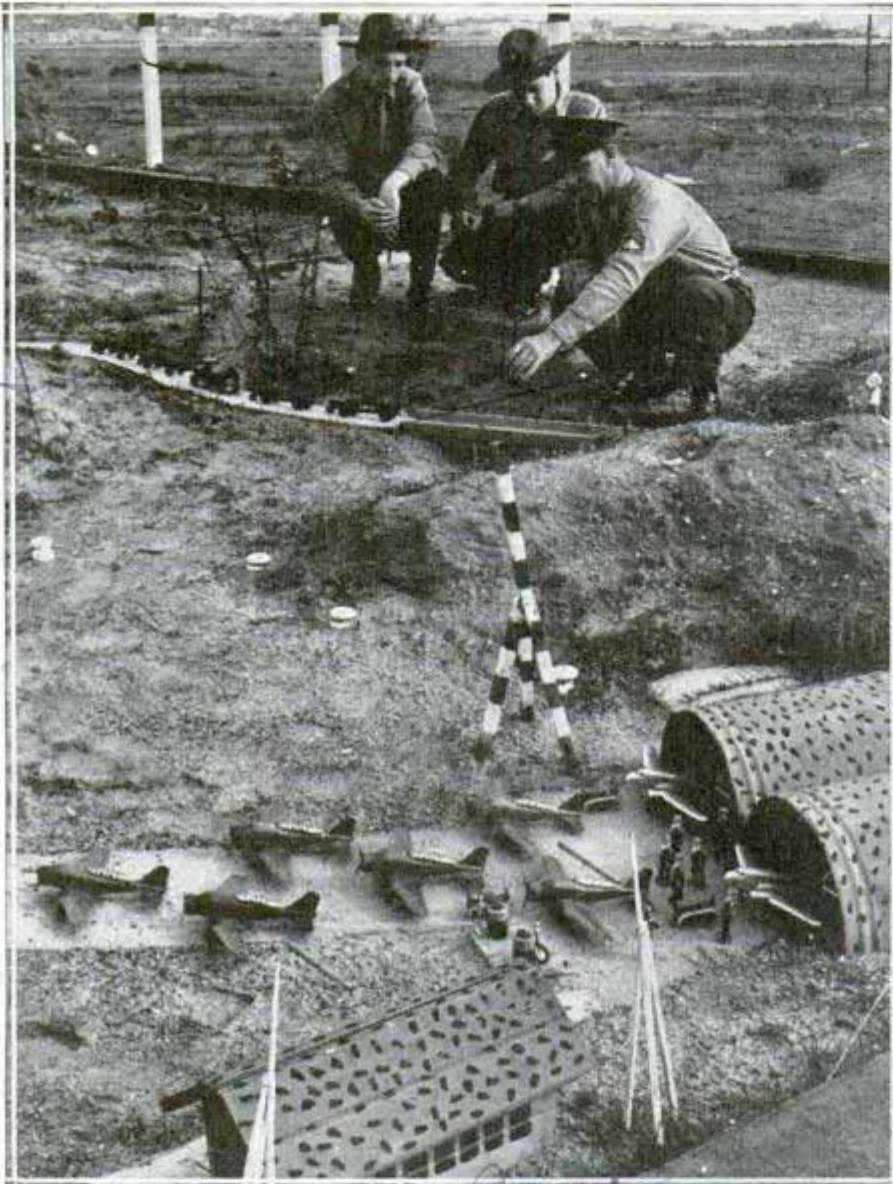

Privates at marine corps school have a lesson in tactics made realistic by use of models on miniature outdoor battlefield

To lift their study of war tactics out of the routine of paper problems, the marines at San Diego, Calif., play war games on a miniature battlefield in the open air. Model tanks and field artillery are moved along roads laid across the rough terrain, there is an airport with a fleet of tiny planes housed in improvised hangars, and the theater of war even has its miniature radio station.

## Wind Direction at Night Is Shown by Flares Attached to Balloons

Thin rubber balloons carrying aloft a series of magnesium flares help take soundings of night winds at sea, and reveal not

only the direction and the force of the wind but also the turbulent areas and eddies. A pair of 180-degree cameras record the progress of the balloons as shown by the flashing flares which are fired at regular intervals. Heretofore a theodolite was used to measure the progress of a balloon carrying a light, but these observations could be made only every thirty seconds, which is too slow to obtain the detailed data that are particularly important for pilots attempting to land their planes on the comparatively small deck of an airplane carrier.

## Reflectors on Bike Pedal "Wigwag" Up and Down

Bobbing up and down in constant motion, reflectors set in the pedals of a bicycle can be seen at a distance of 150 to 200 yards. As the pedals turn, light beams entering the glasses in ever-changing angles are easily observed from the front or rear by motorists. The rows of reflector buttons, cushioned in rubber, cannot be obscured by the heels of the rider.

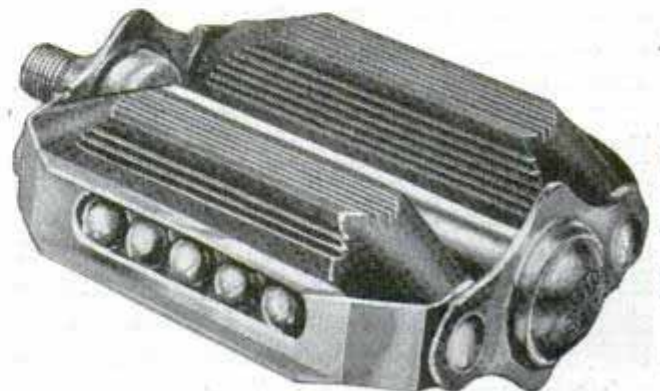

Pedal reflectors, always in motion, attract eyes of motorists following behind or approaching rider

*Handwritten notes in blue ink on the left margin: "and James Henke Feb. 15", "Private Reynolds", "and James Henke Feb. 15", "Private Reynolds"*

*Handwritten notes in blue ink on the left margin: "Private Reynolds", "and James Henke Feb. 15", "Private Reynolds"*

*Handwritten notes in blue ink on the right margin: "Private Reynolds", "and James Henke Feb. 15", "Private Reynolds"*

*Handwritten signatures and notes at the bottom of the page: "Mr. Prof. Atchelstain", "J. J. Tarrington Co.", "Tarrington Co.", "Tarrington Co."*



2/18 Mr. J. B. M...  
 manager, W. E. Stern  
 Mfg Co / Holland, Mich 695

# Model Dutch Village Built for Tulip Festival



Hobbyists of Holland, Mich., joined in a community undertaking to build a miniature Dutch village that will be featured during annual tulip-time festival in May. Above, sculptor working on some of eighty costumed figures which people the village. At right and below, scenes in village and a thatch-roofed farm cottage, built to scale of one inch to the foot. The tiny figures, posed at labor, love-making, fighting and frolicking, are of clay coated with copper to stand weather

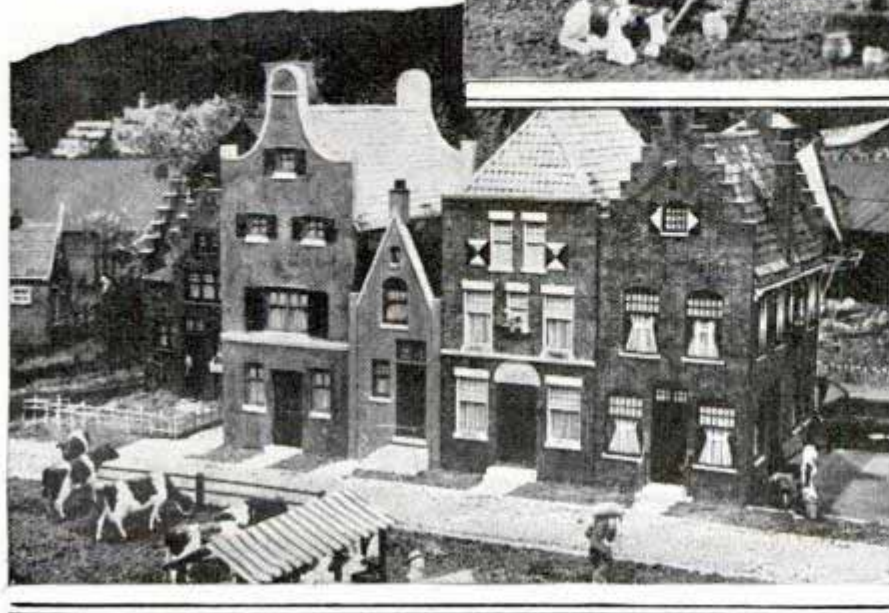

Blunt-nosed boats in model town ride canals of tar-painted galvanized iron. Tile roofs are made of inch strips of iron pressed in hill-and-dale form and painted orange-red. Houses of quarter-inch waterproof plywood are given antique brick effect by rubber pad stamped in brick-red oil color. Dry color is dusted on, dark green on the thatched roofs to produce effect of age, dark red over brick finish of houses and walks, dirt color on brick streets. The house walks are painted dirty white before imprinting with paint-covered pad. Farm animals all are hand-carved from white pine



187514

# Seeing the WORLD

Emile C. Schürmayer, 1088666 St. New York

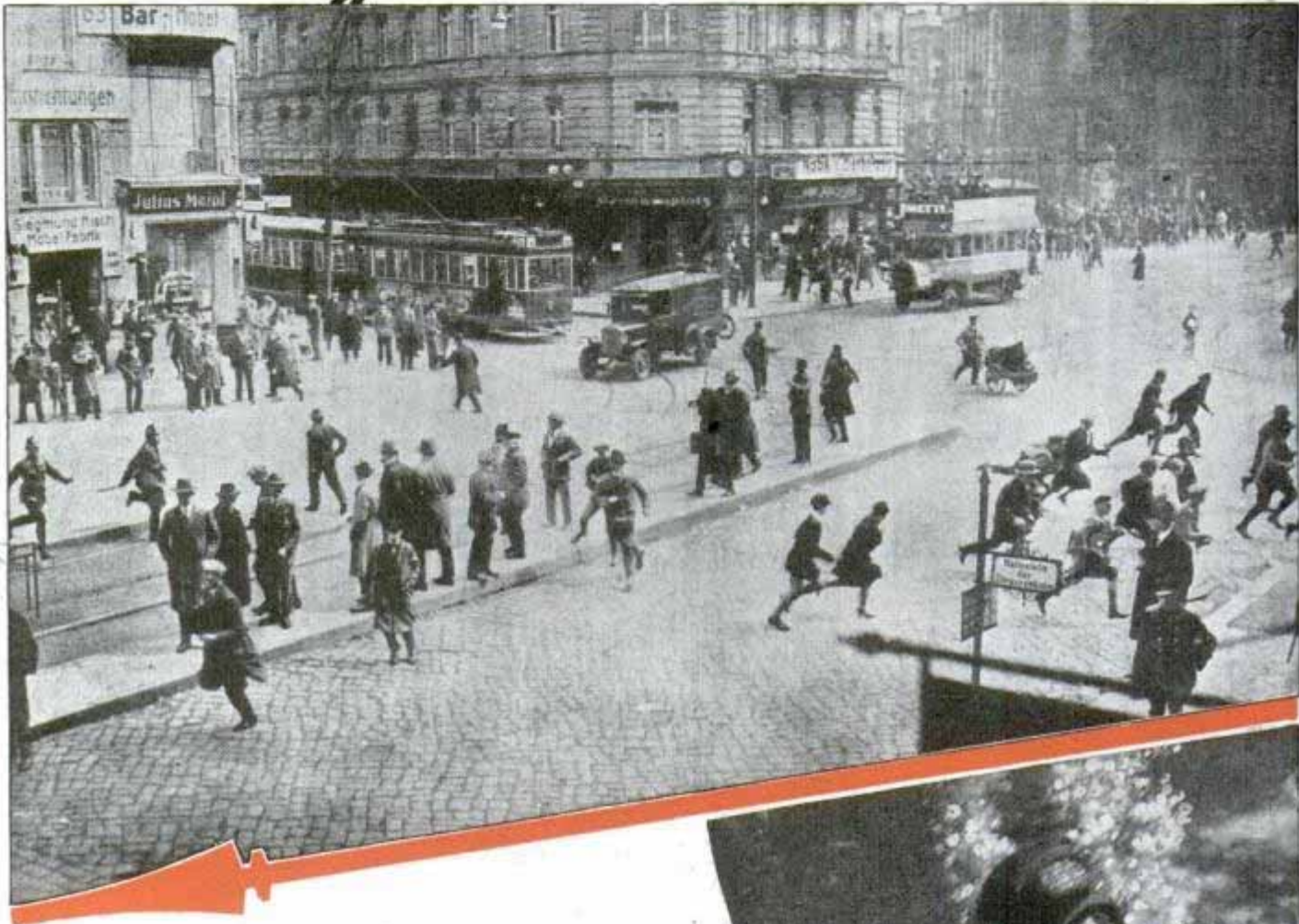

**S**TRAIGHT on its course toward the French border the little two-seater raced. Cameraman Marcel Dufay hugged seven precious cans of film as he looked anxiously over his shoulder. Just a few minutes before, the pilot's trained eyes had detected a black spot above and behind him. Now that speck had taken the ominous shape of one of General Franco's warplanes.

"A Heinkel!" the pilot shouted above the roar of the motor. "It's going to be a close shave."

Dufay nodded grimly and hugged the cans even more tightly. There were 7,000 feet of newsreel in those seven cans. For weeks Dufay, ace cameraman for Pathe News, had been with the Loyalist army. He had risked his life a score of times. He had shot the Abraham Lincoln Brigade in action, been sniped at by Moors and dodged bombs in Barcelona but kept his camera grinding all the while.

*Riot, top, was "shot" from canopy where newsreel man was safe from clubs but not from bullets which killed twenty-four people. Below, a "short" takes cameraman under the sea*

Then, his job finished, the iron hand of censorship had clamped down. Refused permission to take his films out of the country, he hired a plane to fly them out.

With a last burst of speed the little two seater went into a power dive. They were over Hendaye on the French-Spanish frontier. Fifteen minutes later they con-



# *in* TEN MINUTES

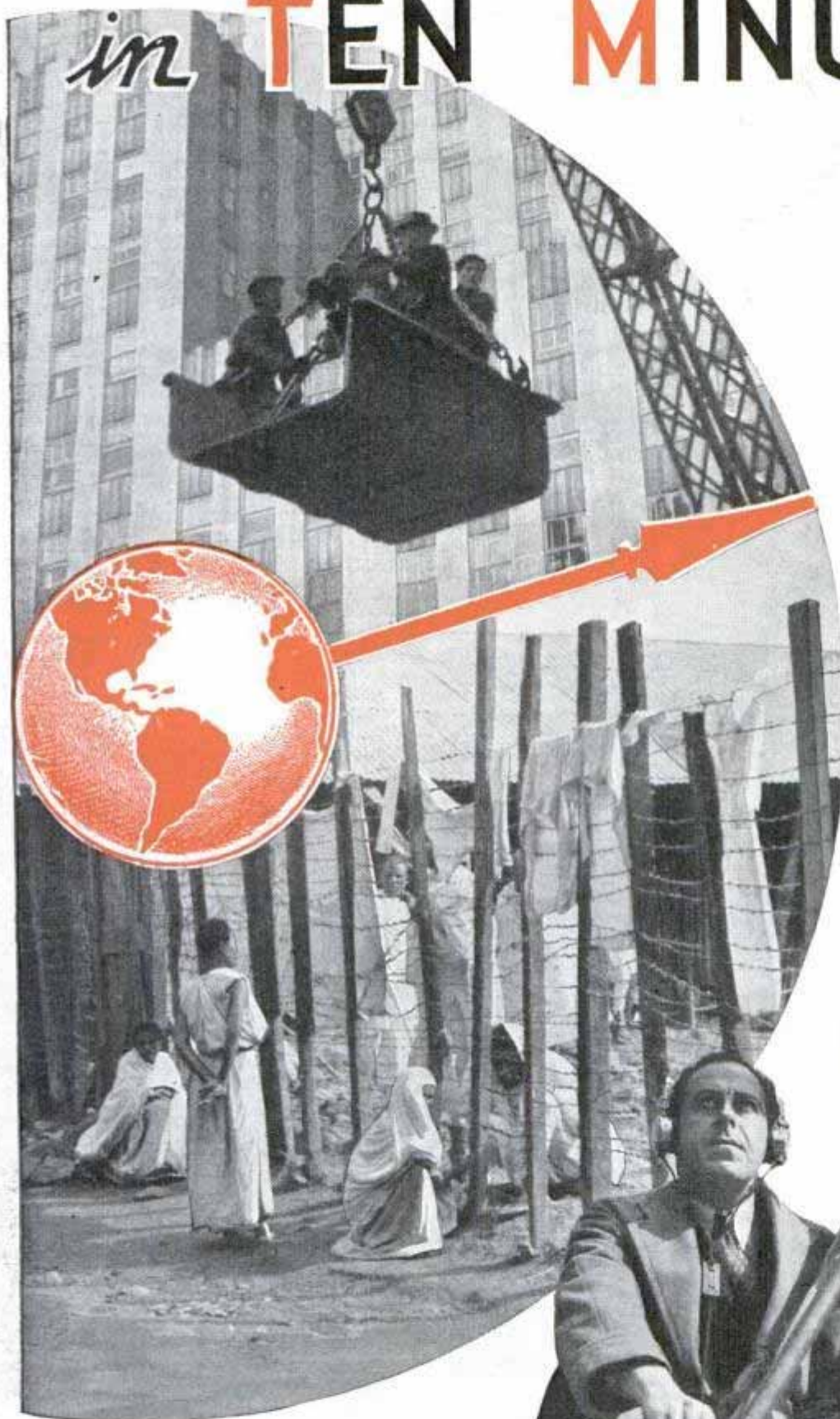

gratulated each other as they came down on French soil.

A French customs guard came up to inspect their plane.

"What have you in those cans?" he asked.

"Exposed film. I'm a Pathe News cameraman," answered Dufay.

Despite Dufay's frantic pleading, the customs man ripped the tape off each can, lifted the protective lids, peeped at the contents.

"You're right, monsieur," he said apologetically. "It is film."



*Top, camera crew borrows derrick for "angle" shot. Center, Ethiopian scene by Universal newsreel photographer. Film men found the war in Africa costly and generally unsatisfactory subject. Right, RKO-Pathe News crew with sound camera costing \$10,000*





Above, telephoto lens resembles gun too closely for comfort at war front. Right, Fox Movietone men stuck in Ethiopian mud. Below, helmeted cameraman films history in making

Dufay looked ruefully at his 7,000 feet of lightstruck film, all ruined. He thought of those weeks of dangerous work. Then he cabled the Pathe assignment editor in New York City. A few hours later he received a laconic reply. "Too bad. Try again."

"That is one of the reasons why it costs from \$20,000 to \$25,000 to issue a newsreel these days," says Frederic Ullman, Jr., vice president and general manager of Pathe News. "At that, it's not too much to pay so that the public may see history enacted before its eyes."

"Dufay went back again, of course. He shot more footage. He figured a different way to smuggle the film out of Spain and did it successfully, as you may have seen on the screen in your own theater."

The newsreel today is different from the newsreel of a few years ago. Gone are many of the baby parades, beauty contests, cute animal sequences and other chestnuts which formerly were shot year after year. Faster, shorter, more important

is the yardstick of this world-wide business. Now within the span of five hours—and in the case of outstanding events such as the New England hurricane, three hours—a New York audience sees the subject on the screen. Within a week 60,000,000 Americans have seen it. In a little more than a month it has been shown all over the civilized world. Then it becomes a living archive for historians of the future to mull over and resurrect a vivid picture of what really happened and what was said.

"Motion picture film travels through a projection machine at ninety feet a min-





187074  
Box Melone

ute," says Mr. Ullman. "In that minute a monarch could be dethroned, a city destroyed, a nation's future decided on a piece of treaty paper, a race or a battle won. Since the war the public has been conscious of the significance of events. A man may read his destiny in streamer headlines across his morning paper. The average reader is as familiar with the Sudeten incident as he formerly was with the batting average of Gehrig, or the domestic difficulties of Jiggs. Beauty contests no longer excite as much interest as the home life of a politician. People want more than idle diversion. They want to see history in the newsreel because they realize they are living in it."

Because of this trend there have been many changes in the newsreel business. The day of the free-lance cameraman is about done, for he can neither afford the expensive equipment nor can he compete in speed and efficiency with the crew assigned the big story. Every once in a while, however, some free lance or amateur who happens to be on the spot when a major news break occurs, sells his footage at a good price. Even an amateur's sixteen-



Camera historians cover the world. Top, "shooting" a state pageant in Cairo, Egypt. Below, Universal's Roy Edwards films the New England hurricane

millimeter film has been bought when the story was exclusive and important, although the absolute minimum of this is transferred to thirty-five-millimeter film as it "blows up" badly when projected on a large theater screen.

(Continued to page 126A)



# Motorcycle and Car in One Parks on Extra Wheels

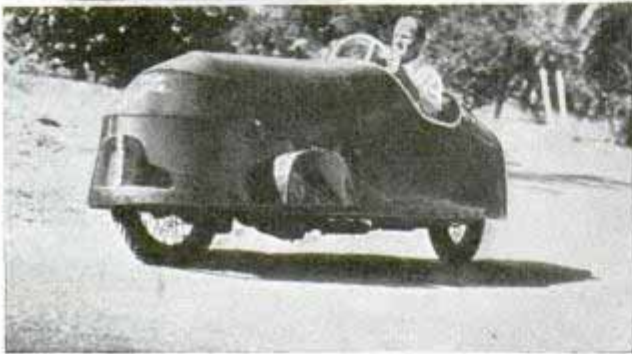
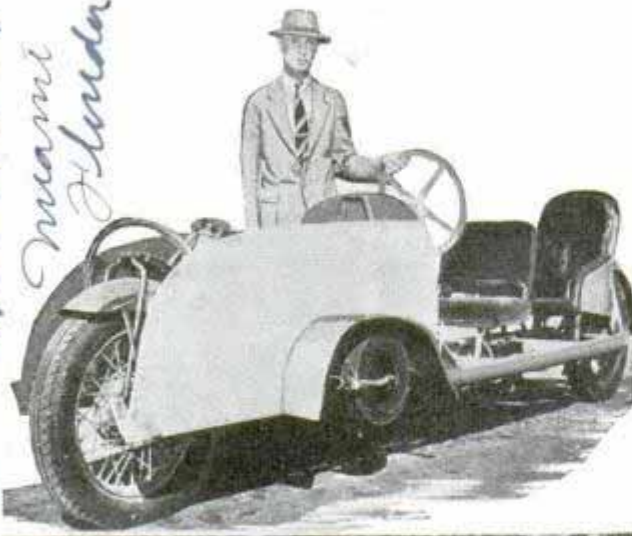

Above, parking wheels being lowered at curb. Below, they retract when two-wheeled auto takes to road

By combining into one vehicle features of both the automobile and motorcycle, an inventor of Miami, Fla., has built a two-wheeled automobile with two extra "outrigger" parking wheels. At regular driving speed the latter are retracted into the car away from the road, but are lowered for parking at the curb and may be used also while starting or running at slow speed, since they are turned with the front wheel by a synchronized steering apparatus. The machine has a small four-cylinder motor.

# Plane Engines' Speeds Equalized by Automatic Synchronizer

Bumpy "beats," produced in airplanes with more than one engine when their propellers spin at different speeds, are eliminated by an automatic synchronizer that drives both engines at exactly the same speed, and keeps them more finely adjusted than could the most skillful pilot. The heart of the unit is a small electric motor of the differential type having two

windings, one of which is fed from an alternating current generator driven by one engine, and the other with current from a generator powered by the second engine. If the two engines are operating at the same speed, the current fed into each winding will be of the same frequency and the differential motor will not operate. On the other hand, if the two engines run at unequal speeds, the current derived from the faster engine will be of greater frequency and will turn the differential motor. When this occurs the differential motor alters the setting of the propeller blades to bring the speeds of the two engines into line. The action is quick and sure, because it does not have to "hunt" for the exact synchronization point.

# Automatic Telegram "Mailbox" Sends Facsimile Message

With an automatic telegraph transmitter developed by Western Union, it is as easy to send a telegram as to mail a letter. The procedure is virtually the same except that you must push a button. You deposit the message through a slot in the instrument, which is inclosed in a cabinet not unlike a mailbox, and immediately a facsimile of your message is transmitted automatically



Dropping message in telegraph box, whence facsimile is automatically transmitted to the central office

Hamilton Standard  
Prop. Div. United Aircraft

Tringle 49 & Co.  
Miami Florida  
J. Brady  
2/10/37  
202



*European 353-5th Ave New York*

to the main telegraph office. The upper left-hand corner of the telegram blank is cut off diagonally and the machine will take it only if inserted face outward. When a message enters it is wound around a transmitting cylinder and revolved in front of a photocell, the apparatus being capable of sending fifteen square inches of matter a minute. Several machines may be connected with the same line, but if one of them is busy it is impossible to deposit a telegram until the line clears. In such cases the words "Line busy" become illuminated on a panel. Another panel at the proper time tells you "Message being transmitted," and when the process is finished a third panel reading "Thank you" lights up. Then the original telegram is "peeled" from the cylinder and dropped into a container. This type of telegraphy was made possible by the development of a carbon-bearing fibrous paper patented by the telegraph company.

## Shipyard Builds Model Fleet for War Drill or Showcase



*Miniature fleet "on review" in Berlin shipyard which produces model boats for naval training schools and for shipping company advertisements*

*Wickering Company*  
Great fleets of ocean vessels—navy dreadnaughts, freighters and passenger liners—are "launched" from a model shipyard in Berlin. Building model ships has become an industry itself, with naval schools calling for tiny ships to teach battle strategy and reconstruct war maneuvers. Shipping companies, too, are using models more and more for window advertisements of their cruises.

## 2-127 Scooter on 31,000-Mile Tour Hauls Telescoping Trailer



*Acme*  
**Touring America on a scooter with bed packed in the trailer**

When this picture was taken, Tom Herridge of Tarkio, Mo., had rolled up 31,031 miles on his motor scooter and was bound west through Arizona. He had visited thirty-nine states, Cuba, Canada, Mexico, Nova Scotia and the Bahamas and the tour was not ended. He could camp wherever he halted, for the small trailer telescopes out to provide sleeping space.

Unaided, a California miner spent thirty-two years digging a 2,000-foot tunnel to his gold mine.

*Compressed Air Magazine*



### Small Electric Hot-Water Tank Has Temperature Control

*Sold by Commonwealth Edison Co*

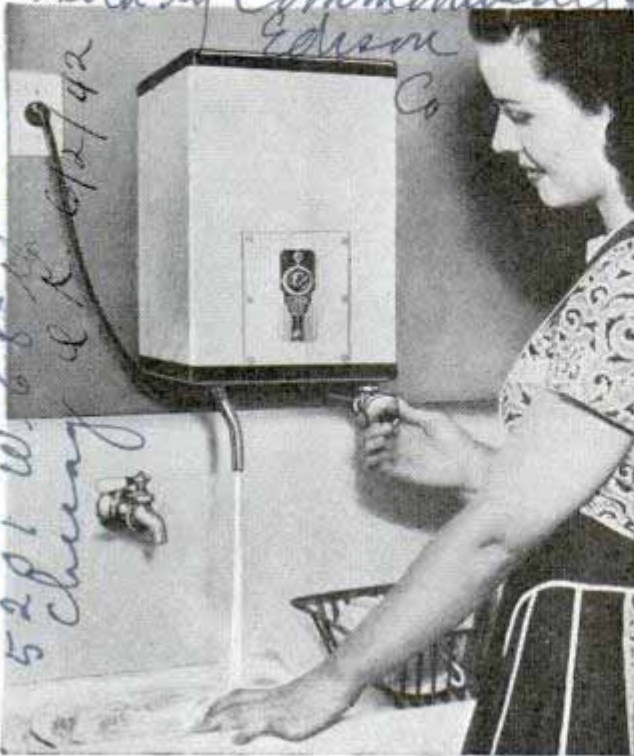

Tapping hot water from two-gallon tank with automatic switch that snaps on or off as required

For kitchens, offices or shops where hot water is used in small quantities, an electric heater easy to install holds two gallons. Its heating element is built similar to the larger ones, and an automatic thermostat switch operates to maintain the desired temperature at all times. Thick mineral wool insulation prevents escape of heat and saves electricity. To install the unit, you need only to screw a bracket plate to the wall, lift the tank into position, plug a cord into the nearest electric outlet, and connect a hose, piece of tubing or length of pipe to the water supply.

### Non-Revolver Metal Fish Lure Easy for Catch to Strike



Shaped entirely from one piece of seamless brass tubing, a non-revolving fish lure will not twist the line and reduces missed strikes by traveling in a straight line. You can fish the bottom

of the lake by allowing the lure to sink before starting to retrieve, or you may reel a little faster to fish the surface of shallow, weedy waters. The bait produces a lifelike and vigorous swimming action and is said to attract fish at long distances. It is supplied with either a single or double set of treble hooks, being used both for casting and trolling.

### Telltale Lights Warn the Pilot If Instruments Go Wrong

Pilots who fly the new thirty-passenger Curtiss-Wright airplane will not have to read all its instruments to be certain the controls and vital parts are working efficiently before a take-off, landing or other maneuver. They simply will turn to a new robot pilot, press a pre-selector switch corresponding to the operation contemplated, and telltale lights will flash signals to show whether the plane is functioning satisfactorily and the maneuver is being executed properly. Immediate warning is given if any instrument or control is not set correctly and needs to be adjusted. Developed from indicating systems used in the power industry and by railroads, the

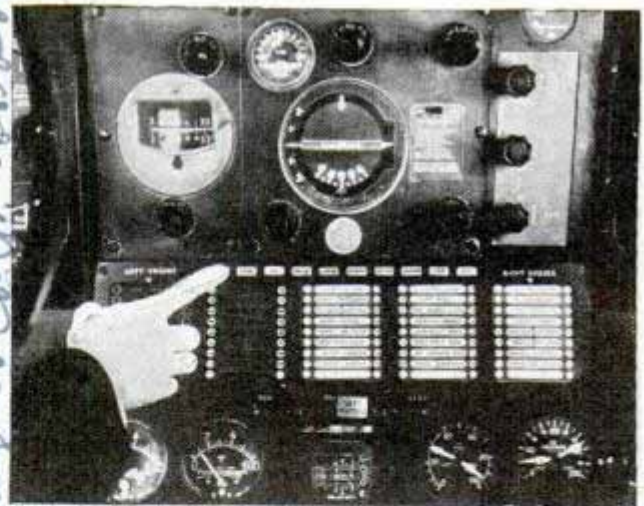

If telltale lights flash when pilot presses button adjustments are needed. No light means "all's well"

robot is electrically connected to the various parts of the plane so a continuous report of their operation may be obtained. Giving the pilot a ready check on what he himself is doing is regarded as an added safety measure. Though the twin-motored airplane will be flown in the stratosphere, passengers will feel no ill effects from thin air in its pressurized cabin.

*McBraw Electric Co  
Clark Water Heater 2 Gal  
5291 W. 65th St  
Chicago, Ill. 60642  
Julius Swenberg, 612 4th St. Kildare  
Chicago, Ill.*

*Edison Co  
Curtiss-Wright  
Stones*

*146  
\$1.50  
\$1.00  
metallic*

*pen*



# Sky Freighter Swings Hinged Tail for Loading

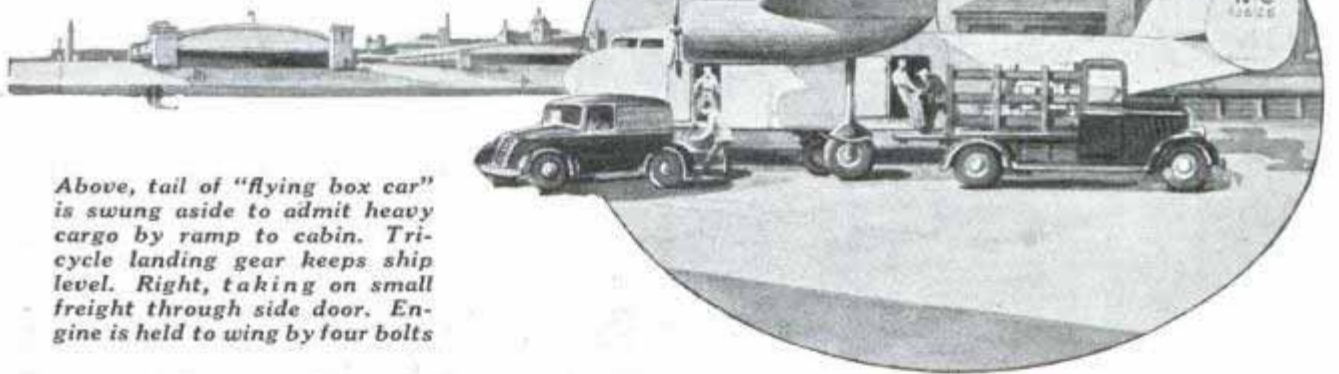
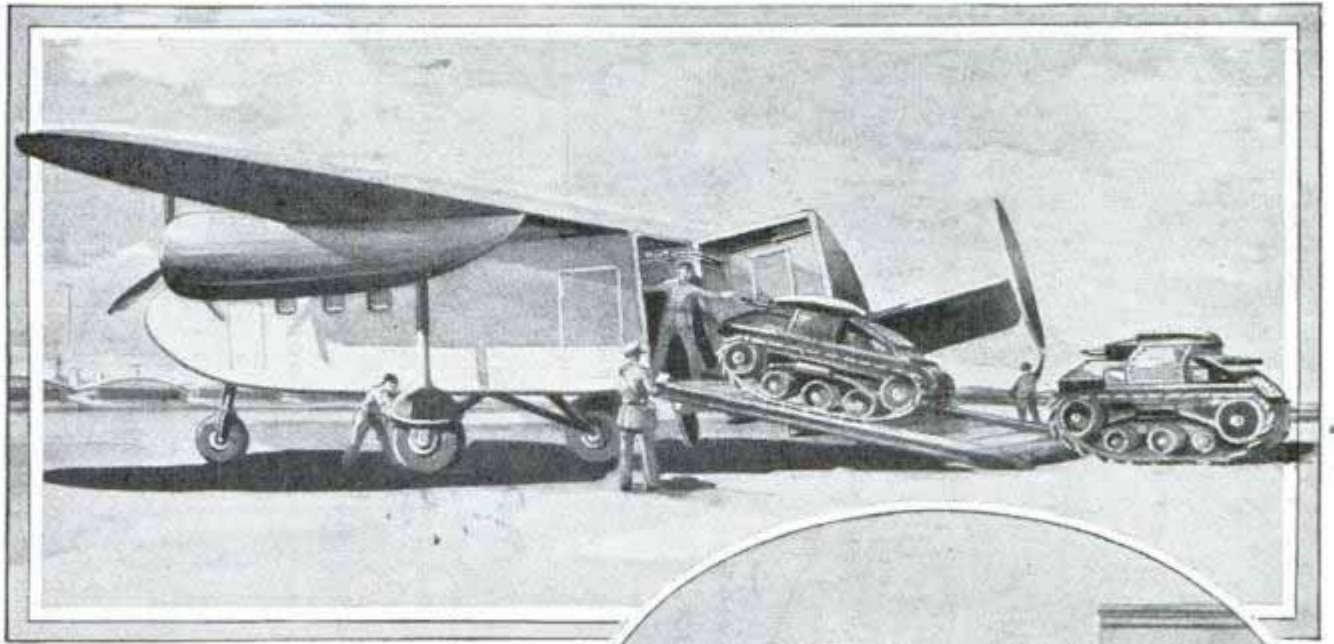

Above, tail of "flying box car" is swung aside to admit heavy cargo by ramp to cabin. Tricycle landing gear keeps ship level. Right, taking on small freight through side door. Engine is held to wing by four bolts

Freight carrying in the air until now has been done chiefly in rebuilt transport planes too old and obsolescent for further passenger service. From the aircraft plant of Benny Howard, noted racer, designer and air line engineer comes now a plan for a sky freighter whose tail swings on hinges to permit loading heavy cargo from the rear into its "hold," twenty-two feet long and a little more than seven feet high and wide. The cargo space is big enough to accommodate a small truck, and the plane, designed for powerful lift rather than great speed, can carry four tons of pay load at 150 miles an hour. Small cargo could be loaded through a side door without swinging open the tail. Tricycle landing gear holds the body level on the ground, and makes it safe to land a heavy load in a small field and take off again, lightened. The twin motors are to be suspended under the wings, fastened by four bolts. Thus it would be simple to remove engine and

housing, which encloses also the fuel tank, and quickly install a new power plant. The engine nacelles would be of standard dimensions so that motors removed from passenger ships after operating their legal limit of 5,000 hours, but still capable of plenty of travel, could be installed on the freight plane along with propellers which have gone the allowed limit of 2,500 hours on passenger carriers. The sky freighter would have an eighty-two foot wing span and overall length of sixty-three feet four inches. Besides its use by companies requiring a strictly freight-carrying airplane, passenger lines could use the "flying box car" for mail and express when heavy shipments might otherwise crowd out passengers. Although designed primarily to fill a peacetime need for strictly freight-carrying planes, the ship would be adaptable for army transport purposes in war, carrying supplies, equipment, small artillery, troops, and even light tanks as shown.



*Emerjudo*

# Bombing Class Practices Aim on Linoleum Map of Terrain

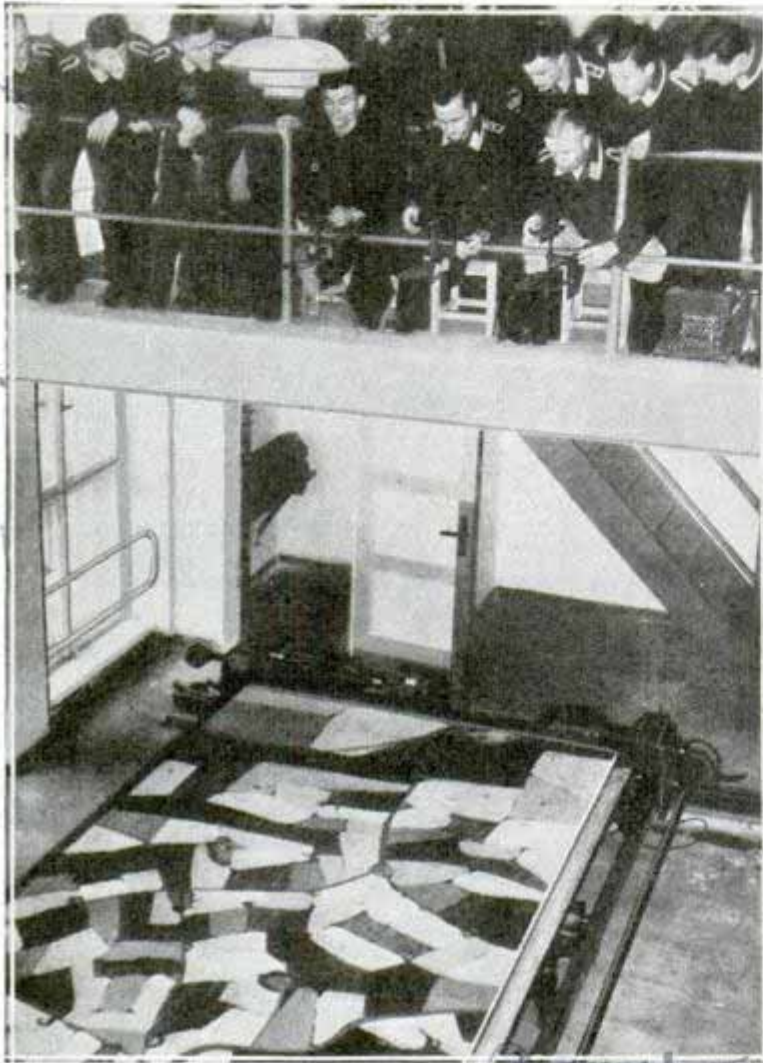

Practicing for destructive work in wartime, students in gallery of "bomb school" take sights on targets on a moving carpet

Target practice for beginners in the bombing class at a German military flying school is conducted indoors. From a gallery at one end of the classroom the student bombers take aim at strategic points on a patchwork terrain map printed on a linoleum carpet which is moved at a prescribed speed beneath the bomb sight instruments. The map is intended to represent enemy territory as seen from several thousand feet up. This training school for combat flyers is at Tutow, Germany.

# Heat "Wrung" from Winter Air by Reverse Cooling System

No matter how cold the weather may be, there is always enough warmth left outdoors to heat a building—if you know how to get it. By reversing the operation of the

cooling system in an office building of Westinghouse Electric and Manufacturing company near San Francisco, Calif., engineers have succeeded in capturing heat units outside and releasing them into the rooms through hot-air ducts. In hot weather, the refrigerator again reverts to its original duty of removing excess heat. Investigation has disclosed that electrical energy applied in this way will deliver two to ten times as many heat units as the same amount of energy applied directly to ordinary electric heaters.

# Old Paintbrushes Stay Soft in Vapor-Filled Can

While still wet after being used for painting, brushes can be preserved by storing them in a can containing vapor that keeps the bristles soft and flexible. It is seldom necessary to wash them and they are always ready for use without cleaning. Also, old and partly hardened brushes can be reclaimed and put back into service after a week in the conditioner. A slowly evaporating liquid in the container generates a heavy non-inflammable vapor, driving out all the oxygen and preventing oxidization of the paint. One pint of the liquid will last several months, since the brushes are not immersed in it but remain suspended in the vapor.



Pouring liquid into brush container, and, right, view of can with brushes suspended from holder at top

*Wisconsin Laboratories*

*Magi Military Flying School, Germany Tutow*

*Protein pend.*

*Melwaukee, Wis.*

*2234*

*2224 N. Wisconsin*



2-113  
228 E 46 St.  
New York City

# Glider-to-Ground Phone Helps Pilot Take Off

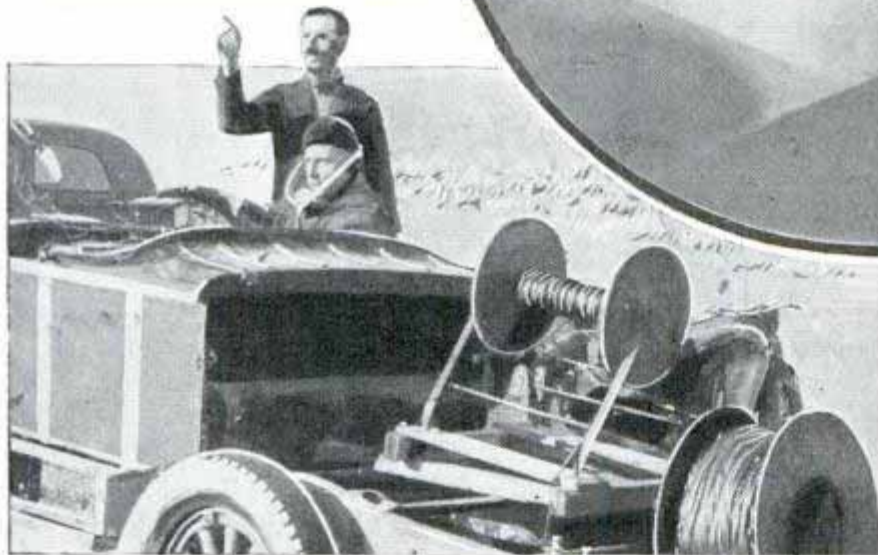

Above, pilot ready to be towed adjusts head-phone and mouthpiece. Left, two seated glider in air. Bottom, towing cable at back of car contains telephone wire

at the Sloop, Brighton, England

Telephone hook-up between glider and launching car, tried at the Sussex gliding club in England, helps the pilot to be certain that flying speed is maintained for the takeoff. Wires are threaded through the

towing cable, and the pilot keeps in communication with the ground crew until he is in mid-air, since the phone connection is not broken until the moment he cuts his plane loose from the towing cable.

2-158

## "Fish Eats Fish" Used as a Lure to Catch the Big Ones

funny sack

When a Chicago fisherman hooked a fish and found a larger fish attacking his catch, he had an idea. It resulted in development of a "fish eats fish" lure, with one artificial fish swallowing another. The bait is calculated to attract big ones.

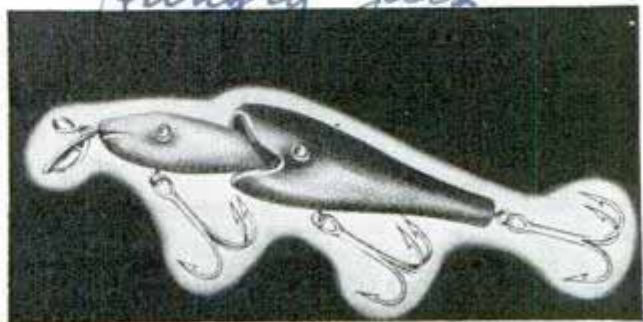

Fish swallowing fish is one of the newest lures

Motorists spent \$4,500,000,000 on vacation trips in 1938, the Automobile Manufacturers' Association estimates.

Chicago Slattery news  
2/9 3/9

Lloyd and Co. Lincoln  
3486



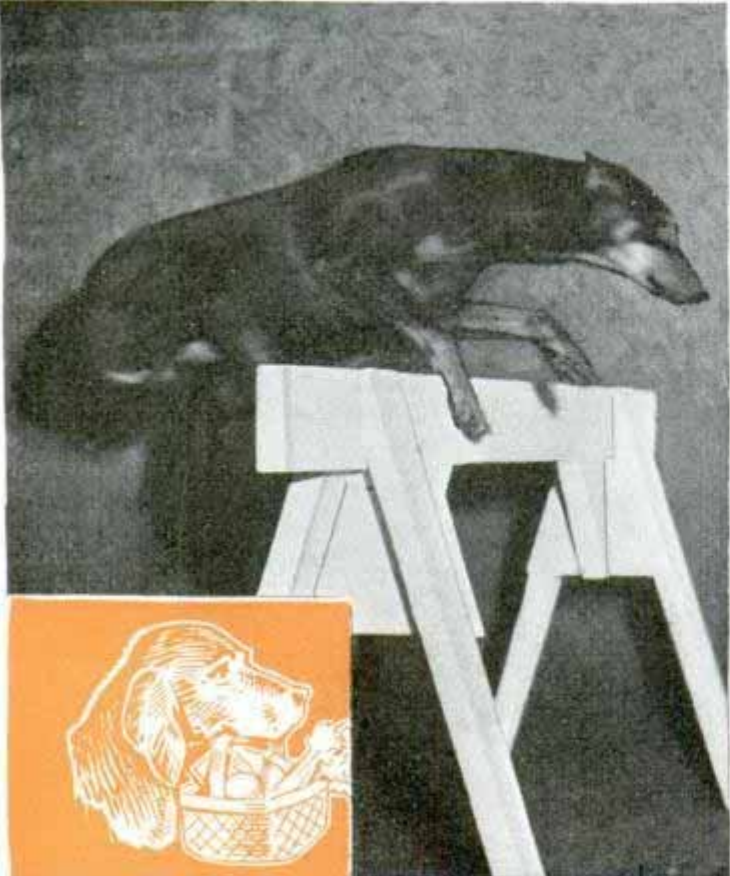

# HOW SMART *is your*

*Wide World*  
445 E Erie *Chicago*

**Y**OU can buy the smartest dog on the vaudeville stage—a dog that can add and subtract and spell and fool any audience at “mind reading;” but if you’re not smart yourself the best-trained pup in the world will be a spoiled darling without a trick in his head within a week.

What breed is the smartest? That depends on the master. You may assert your shepherd dog or Doberman pinscher or setter or spaniel comes from the brainiest family. But Michael von Motzeck, owner and “dean” of the V. & M. training kennels at Chicago and three other midwestern cities, will tell you it makes little difference. Like his father and his Austrian grandfather before him, von Motzeck has spent a lifetime schooling dogs for stage and radio, for police and guardian work, and as companions for children, the deaf and the blind. To him dogs are individuals, not breeds. There are bright poodles and dumb Dobermans, just as there are clever Chinese and stupid Aryans. If you’re a smart enough teacher, the chances are your dog will be a bright enough pupil.

Yes, you can teach an old dog new tricks, but it’s better to start before the dog has a lot of bad habits to unlearn. Three months is a good time



Ten-year-old Alsatian shown balancing water-filled goblet on his forehead can climb a ladder with a biscuit on his nose. He has a big repertoire of tricks, and wears a gold medal for saving his master's life

*Bob of "The Tailor" - Elliott  
Leicham: Northwood  
Middletown England*

*50 N. W. State, Chicago*



Prize Alsatian

0.15110

Alsatian show  
at Crystal Palace  
London by law

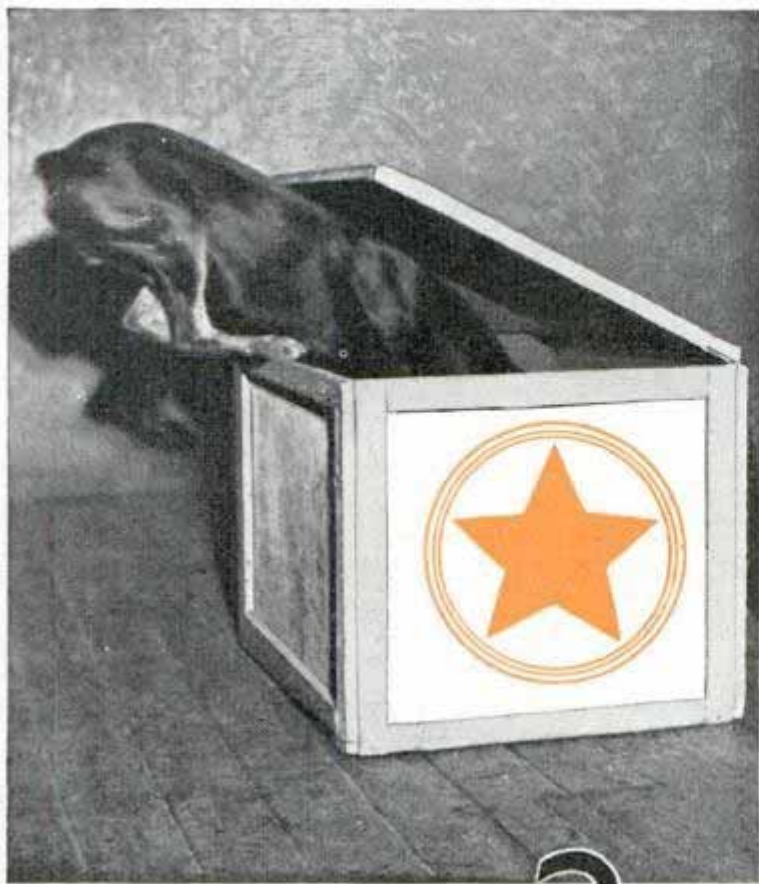

# DOG ?

to start school, but your friend can still learn at ten years if he has confidence in you.

Obedience is the first lesson in dog kindergarten. Obedience is what saves the dog trainer on the vaudeville stage from embarrassment, for the four-footed actor will never fail to go through his routine properly if he has learned to be obedient. Get the confidence of your pet. Let him know you are the boss. Not by whipping or beating him. That would break his spirit, and no one wants a cringing, sulking dog even if it follows orders perfectly. Don't lose your temper. If the dog seems to be tiring of his lesson, drop it for the day and



Photo courtesy John Morrell Co.

Across top of two pages, von Motzeck puts Doberman pinscher through triple routine of jumping horse, leaping hoops and climbing into box. Top, right, going over jump at dog show after retrieving dumbbell. Below, training dog for protection work. Told to watch baby, the Doberman leaps at von Motzeck's arm to knock him down when he approaches pram





play with him. But once you have given an order to "heel" or "sit" or "stay" or "jump," see that the order is obeyed. Never let a dog get away with a refusal or inattention. He'll soon learn who's "head of the house" if you are firm, and he'll just as quickly learn to ignore you if he gets away with it once or twice.

Heel, sit, lie down, stay, come on. Those are the primary lessons in dog school. Teach them by using a leash and training collar. A well-mannered companion should walk with nose at your left knee, sitting when you pause, and not dashing off on investigations of his own until you give the command. Hold the lead in your right hand, slack, and with the left hand restrain the dog as you order him to "heel" or pull him back to sitting position at the command "sit." Repetition drums the lesson home. Von Motzeck will walk a pupil around, giving rapid-fire commands to "heel, sit, heel, sit, heel, sit" so fast the pup can scarcely keep up with him. In that way he holds the attention.

Once those primary commands are



learned, the dog should be accustomed to taking orders from your fingers. Use your fingers right from the start. Two fingers of the left hand in beckoning position for "come on" and "heel." The index finger moving downward tells the dog to sit. Point the fingers down for "lie down." Accompany the spoken command with the gesture and in time the dog should respond to the gesture without the voice.

How smart your dog is depends upon how smart you are. If you keep your eyes open you can discover some little habit the dog has developed which can be turned into a clever trick. For a simple example, Mr. von Motzeck found one of his own pups liked to lie down beside his bed and cover his eyes with his forepaws. He looked so abject that von Motzeck made it a point to say "Aren't you ashamed?" whenever the dog assumed the attitude. A few repetitions, and soon the

*Top, newspaper is used for first lesson in teaching dog to carry objects. Center, learning to climb a ladder. A bone or rubber ball placed on ladder steps will give him incentive to climb. Bottom, Irish setter obeys the finger command to "sit"*



dog would take the apologetic pose at the word "shame."

Make training a game and the dog will join in enthusiastically. If it isn't necessary to beat a slow or unruly pupil, neither is it necessary to reward him with bonbons or bones. A rubber ball will do just as well. The other day at the "V. & M." boarding school von Motzeck started a dog at the rather complicated routine of jumping from the top of a small, theater piano to the floor, then through two hoops held widely apart, over a hurdle and into a hamper-type wooden box. The

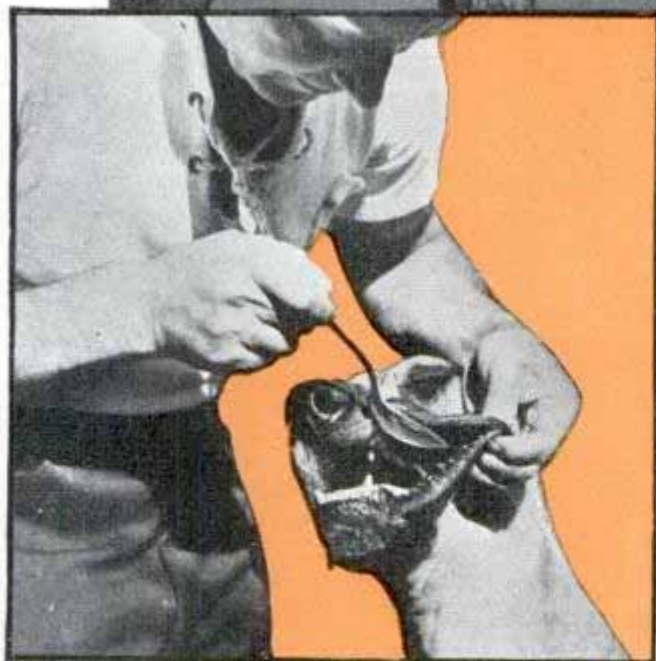
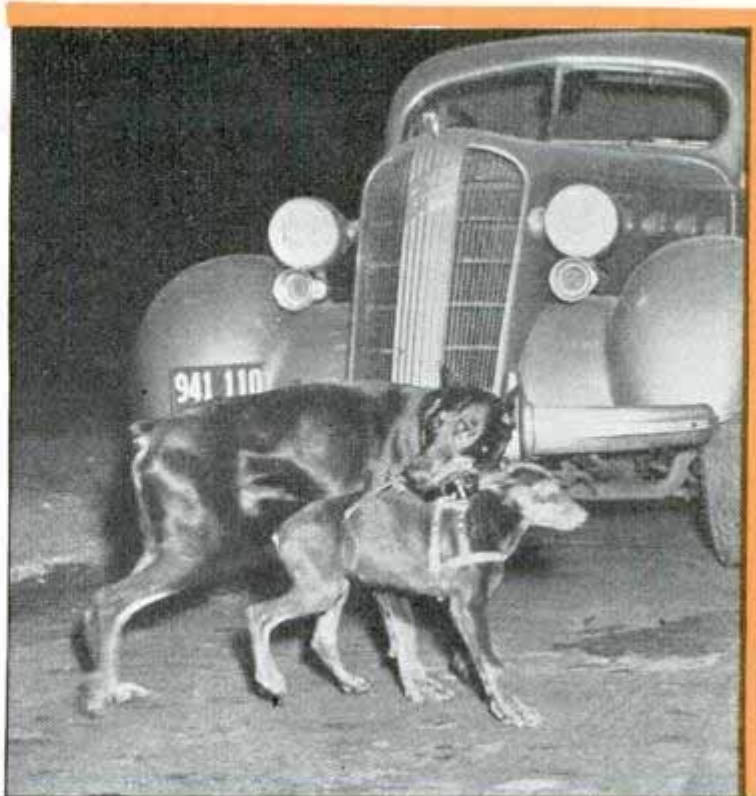

*Top, Doberman carries puppy across street, and is also taught to lead puppy by leash. Center, dog guarding pocketbook. Bottom, administering medicine; corner of mouth forms funnel and dog swallows if head is held high*

only incentive was a red ball the dog was allowed to play with. It was placed in the box, and to get it the dog had to nose up the hinged lid, climb in, and then stay inside the closed box. In four hours of practice, broken up with rest, play and other routines, the dog learned the trick perfectly. Actually there were about twenty minutes of training on the stunt, counting out the interruptions.

Incidentally, to start a pup jumping through a hoop, over a hurdle or through similar maneuvers, use the same method you used for the teaching of primary commands—lead him through the maneuver with a leash the first few times. And to break him of chasing cars or crossing the curb, let him run on a long line and jerk it as he reaches the curb. By repetition

(Continued to page 122A)



# Push-Button Index Flashes Hobby Book Titles

*Miss Lois W. Amalie*



Pressure of button will light up window giving list of books and literature about your favorite hobby

Push the right button of a mechanical librarian at the Chicago public library and the "hobby-o-meter" will give you a list of books about your pet hobby. Buttons are labeled to indicate several of the most popular avocations, and when a hobbyist presses the one representing his own particular pursuit, a window lights up, revealing the title of at least one appropriate book and the name of its author.

## Casting Rod with a Pistol Grip Has Adjustable Thumb Rest

Firmer grip of the casting rod and more sensitive control of the reel are given the fisherman by combining the pistol grip with an adjustable thumb rest. The latter may be set to fit any hand and leaves the

*\$8.00 #12175*

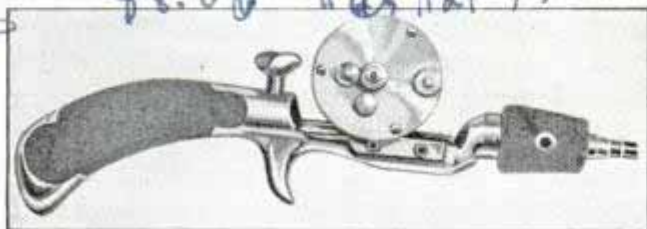

Pistol grip does not tire hand and permits firmer grip of the casting rod

*Nelson "Pistolgrip" Rod Co. 1010 Franklin*

thumb free to "feel" the line. An adjustable reel bed allows the reel to be moved back and forth and locked in any desired position. Both left and right-handed persons can use the rod with equal ease.

## Electric-Light Socket Adapter Points Bulb at Any Angle

Electric-light bulbs may be swung to point in any direction by fitting an adapter into the standard socket. Placed in a ceiling socket, it can be adjusted at any angle vertically within seventy degrees, and may be turned 340 degrees horizontally. Light in weight and held in position by a set-screw, the adapter is made of composition and porcelain.



## Toothbrush Rack Holds Tube Dispensing Toothpaste

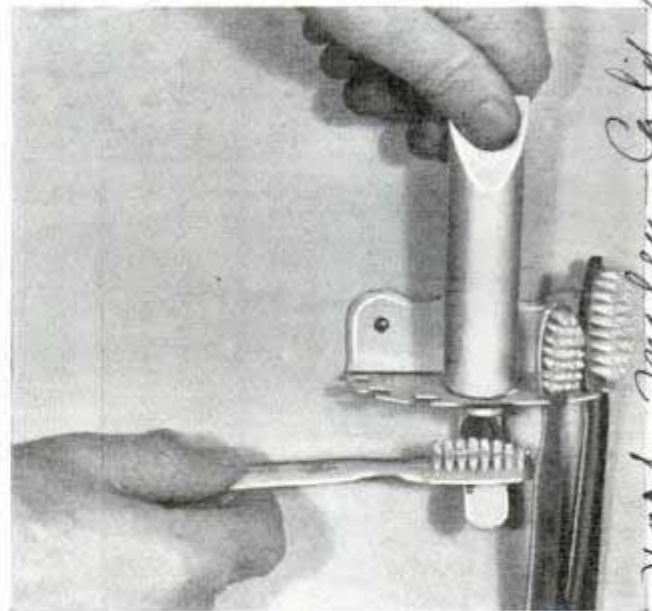

Squeezing paste from tube screwed into center of toothbrush rack. The cap is attached to prevent loss

Toothbrush rack becomes a dispenser for toothpaste in a combination unit being offered. It accommodates six brushes, and at the center the toothpaste tube is screwed into standard threads and covered by a specially attached cap. Thus the tube is always handy and its cap cannot be lost.

*Elmer Jones, Box 118 Ross Calif*

*Kelly, Wild Regional  
Metzger, Chicago Public Library  
Branch, Chicago  
Rockford, Ill  
147*

*Mudgecho  
Dun  
are.  
1285 Boston*

*Harley, Calif  
555*



2105

# Planes with Folded Wings Ride Carrier's Deck

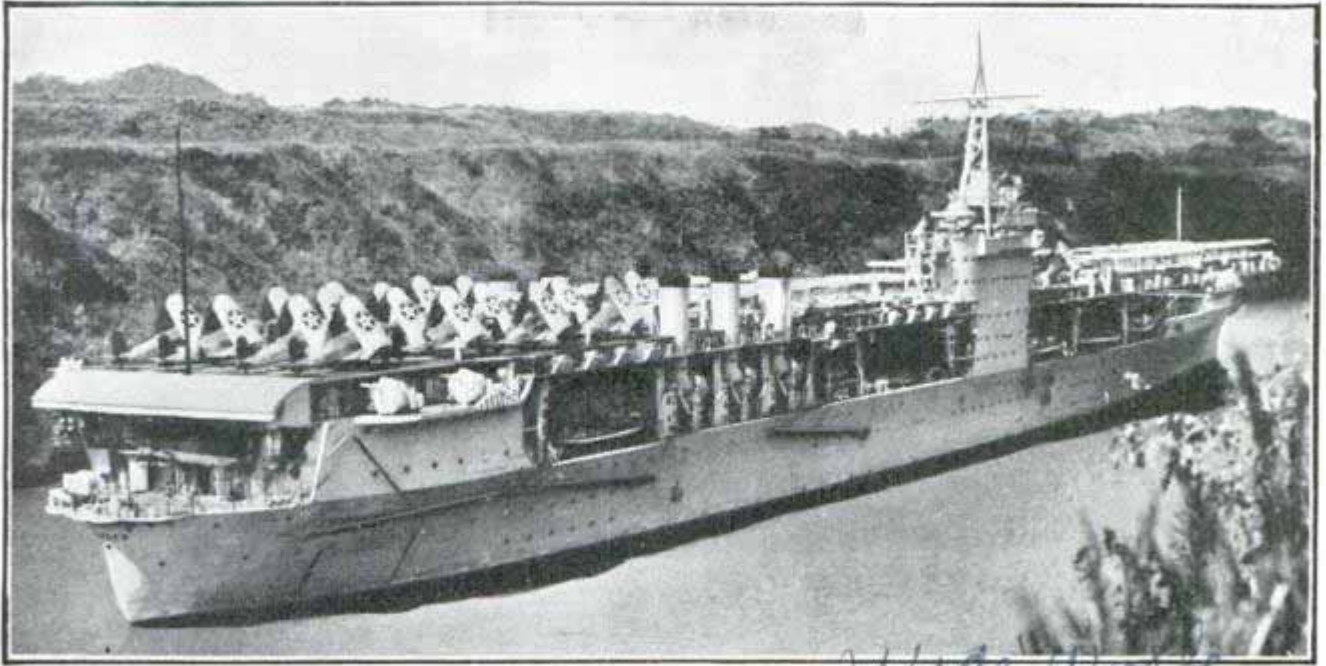

*Wide Water*  
 Airplane carrier "Ranger" passing through the Panama Canal; her planes with wings folded upward nestle closely together. Carriers gave good account of themselves in recent U. S. fleet maneuvers

When a fleet of Uncle Sam's fighting forces moved through the Panama Canal for recent maneuvers in the Atlantic ocean, a camera shot caught the aircraft carrier

"Ranger" with a deckload of flying fighters. Airplanes fold their wings upward after landing on the deck to conserve space on this "floating air base."

*9-126*  
**Supersensitive Calorimeter Feels One-Millionth Degree**

So highly sensitive is a calorimeter with which two Northwestern University chemists are working that it can actually measure the heat produced when sugar dissolves in water. It is capable of recording a temperature change of only one-millionth of a degree. The substance undergoing study is placed in a metal vessel suspended over a vat, and temperature changes are recorded automatically. The calorimeter was designed for experiments on destruction of proteins.



*come*  
 Measuring minute temperature changes in a substance placed in one of the metal containers above vat. Heat graph is recorded on paper roll

It takes 12,000 man-hours of work to produce one of the huge dies used to shape auto body tops.

*Auto Facts  
 Jan. 6, 1939*

*Chemistry  
 Dr. Hugh Richard  
 771 North Esplanade  
 Port*



141228

# TEST - FLYING *the*

Capt. Ross L. Cunningham.  
4516 W Concord St.  
Seattle, Wash

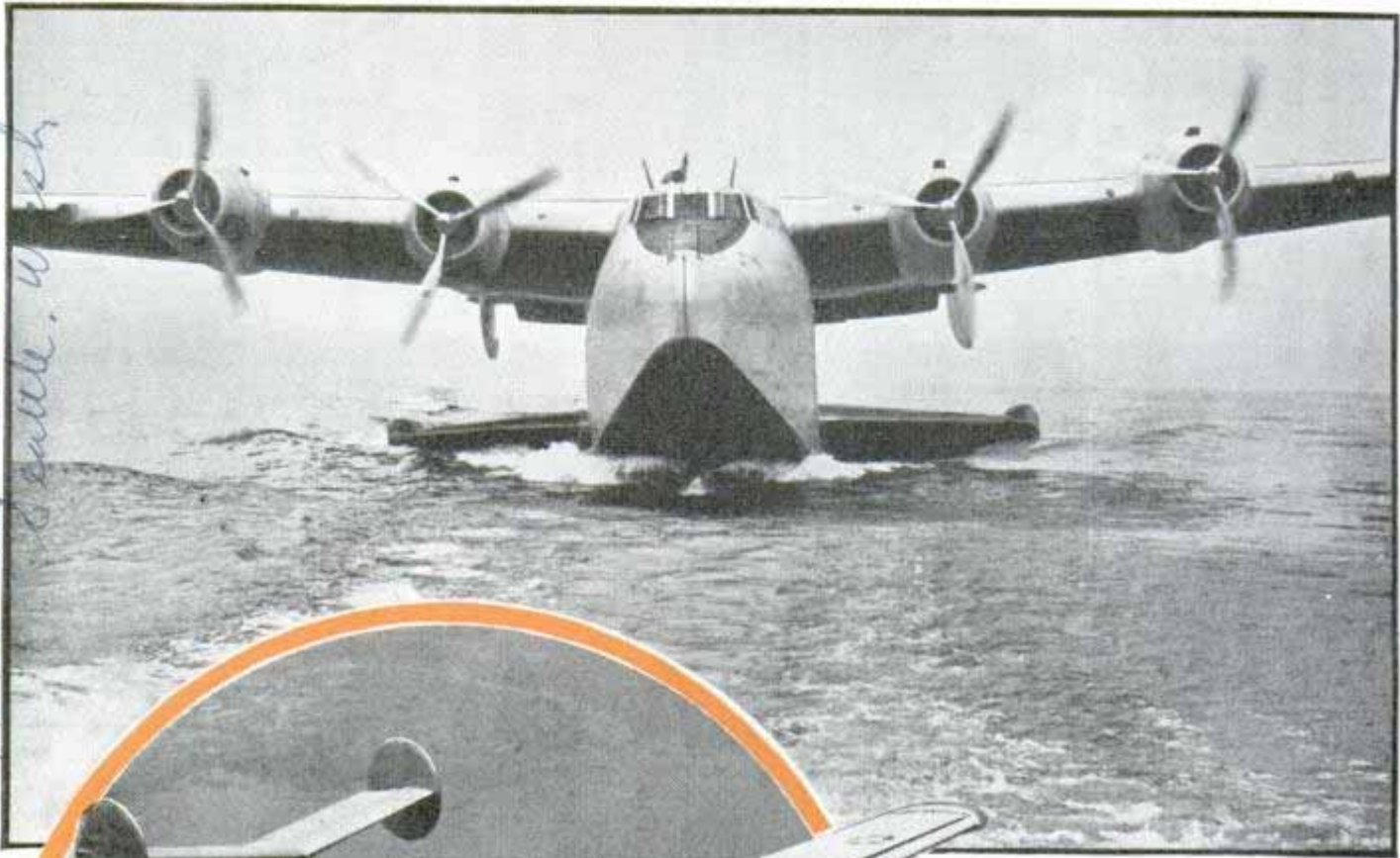

*Giant Boeing clipper taxiing in wake of tender. Circle, Consolidated navy patrol bomber on which Eddie Allen was consulting test pilot*

lack of oxygen. The arrow of the altimeter quivered at the 29,000-foot mark when darkness blotted the throb of the motor from the pilot's ears. Allen's right hand, writing notes—data of the experimental flight—on a pad thonged to a knee of his heavy flying suit, became limp and dropped. His left hand, maneuvering the

**T**HERE was no fighting off this sudden oblivion brought on by rarefied atmosphere at the tremendous altitude. Alone in the tiny pursuit plane, Test Pilot Edmund T. Allen—the conqueror of untried planes—was in the most critical jam of his career.

No human could retain consciousness without special equipment to offset the

controls to drive the plane to its nearly six-mile height, loosened and slipped downward.

The pilot's body wavered as the plane began to buck and sway crazily, then toppled forward, crumpling over the control stick and jamming it forward, throwing the plane into a power dive. With the wind screaming over its wires, the plane hurtled



# SKY GIANTS



Official photo  
U. S. Army Air Corps

down, down and down, carrying its master toward destruction.

The plane rocketed for 7,000 feet before the more normal air allowed Allen's mind to begin to live again. For seconds the dazed aviator grappled with the problem of whether he was in a bad dream or an out-of-control airplane plummeting downward. Slowly his mind brushed the last of the darkness away and he recovered the controls, then quickly maneuvered the plane into proper flight. Spiraling downward and landing was a simple routine.

Adventures like this are not all in a day's work for Eddie Allen, who since that day ten years ago has burned his name into aviation history as a premier test pilot, or aviation consulting engineer, as he prefers to be known.



*Top, taking this huge warplane into the air on its first test flight was Allen's job. Bottom, Allen talks by radio with ground crew while testing open plane*





It was, however, the most exciting series of seconds in his twenty years of flying. Allen, like all steady aviators, has no lack of regard for longevity. This makes him careful, almost afraid, of untried planes and undoubtedly is one of the contributing factors to his having been selected to test many of the large planes built for trans-oceanic, commercial sub-stratosphere or military flying.

His hands were at the controls during test flights of the Boeing XB-15 "Flying Fortress," the world's largest military plane the Sikorsky S-43 clippers that span oceans; the forty-one-and-a-quarter ton Boeing clipper, and the Sikorsky XPBS-1 "Flying Dreadnought," pride of the United States navy. And he was consulting test pilot on the Consolidated XPB 2Y-1 patrol bomber built for the navy.

Recently Allen has been



*Top, Allen studying clipper's controls before attempting test flight. Center, Baby Clipper" which was test-flown by Allen. Bottom, Stratoliner on test hop with Allen at the controls*

*Sukorsky*





busy with the new Boeing Stratoliner, the first airplane built commercially for carrying passengers at high altitudes.

Allen's flying days began during the world war when the United States government dispatched him to England to learn test flying from the British. Since then he has flown through the hair-raising boot-and-helmet days when feel of the seat underneath him took the place of instruments, to these days of slide-rule flying.

The test pilot's work, Allen tells you, begins before the first rivet is driven in the new airplane. When the projected plane is being laid out on the drafting board, Allen is called in for advice. He studies the de-

sign and offers suggestions as to making the plane more economical, useful and practical. He watches the material and workmanship that go into the plane after it leaves the engineers' drafting boards, helps with production problems in the factory as they affect construction of the plane and assists in selecting the proper instruments needed for the type and intended use of the airplane.

Then, when the plane is pushed from the hangar for its first flight, it is his job to fly it. And it is his neck that is to be broken if anything goes askew.

(Continued to  
page 114A)



*Sukorsky*  
Top, another sky giant, the "Flying Dreadnaught," which was tested by Eddie Allen. Bottom, gasoline trucks go to sea on barges to service the mighty Boeing clipper during test flights



Wright Field Dayton Ohio

# Steel Rods Hung by 'Thumbs' in Rupture Test in Furnace

Threeman

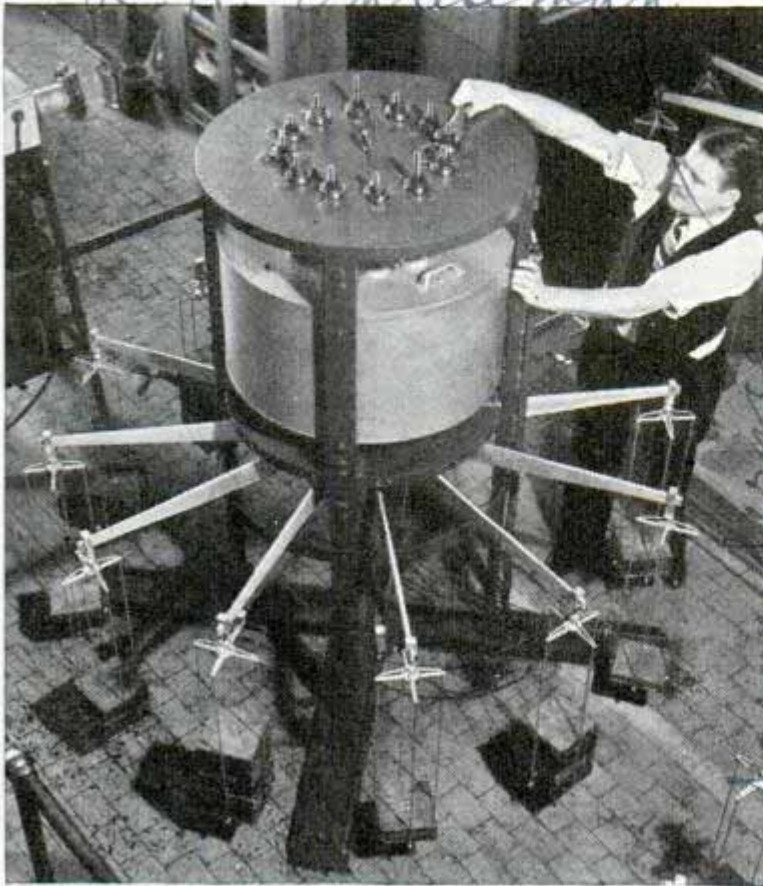

Engineer adjusts one of steel rods being subjected to breakdown test by weighted levers protruding from electric furnace

There are about 100,000,000 atoms clinging to each other along every inch of steel. If a thousand should slip or change position in an hour's time, the steel would eventually be badly distorted. It is to prevent this "creep" in steel that metallurgists are constantly hunting strong alloys and putting steel rods to severe tests which reveal expansions as small as a millionth of an inch per inch of steel. In one test of steel for turbines, the rods are placed in electric furnaces at temperatures around 1,200 degrees Fahrenheit and hung "by their thumbs" while a lever pull as high as 60,000 pounds per square inch is applied to their "toes." The rods are deliberately broken to learn their limit of strength. General Electric engineers also test various steel samples in electric furnaces at 1,200 degrees for a full ten years and then measure their creep and strength at the end of the period. Molybdenum, tung-

Schemelady, NY

sten, nickel and chromium are alloys used to reduce distortion in steels that meet high temperatures in use. The high heat encountered in turbines may soften metal, and steel must be found which will not expand more than 1/100,000,000 inch per hour, and any changes must be symmetrical or the turbine shell might leak.

2-142

# Airplanes Faster and Safer with Motors in Wings

Within the next few years airplane engines will disappear into the wings, and propellers will grow on long shafts. Army engineers predict immediate adoption of these two improvements in design and believe that they will permit higher top speeds, greater range, longer life and easier landings. Separate streamline housings cause too much drag, and building the engines in the wings may reduce the drag as much as one-fifth.

2-142

896

# Self-Heating Food Can Cooks with Chemical

Food cans that carry their own heating plant make possible hot meals without a stove for the fac-



Left, closeup of self-heating can showing inner wall; chemical is sealed between walls. Right, serving hot food from can

Beverly Hills, Calif

W. Leg Katz



Holcan Jones  
Von Lengerke  
Antoine A. W. Gabriel

tory or field worker, hot picnic suppers when the firewood is wet or you've forgotten matches. The self-heating can, just invented, carries a chemical compound in a space between its double walls. When you want to warm the food in the inner can, punch four holes in the top of the outer casing. Air rushes in, and its action on the dry chemicals develops heat that will warm the contents within ten minutes. There is no danger of explosion or fire, and the chemical is odorless. The inventor expects the extra casing and the low-cost chemicals will add but one cent to the retail price of canned food, and he foresees wide use of the self-heating can in trailer travel, arctic exploration, and supplying food for armies and war refugees.

# "Anti-Aircraft" Target Gun Fires Beams of Electricity

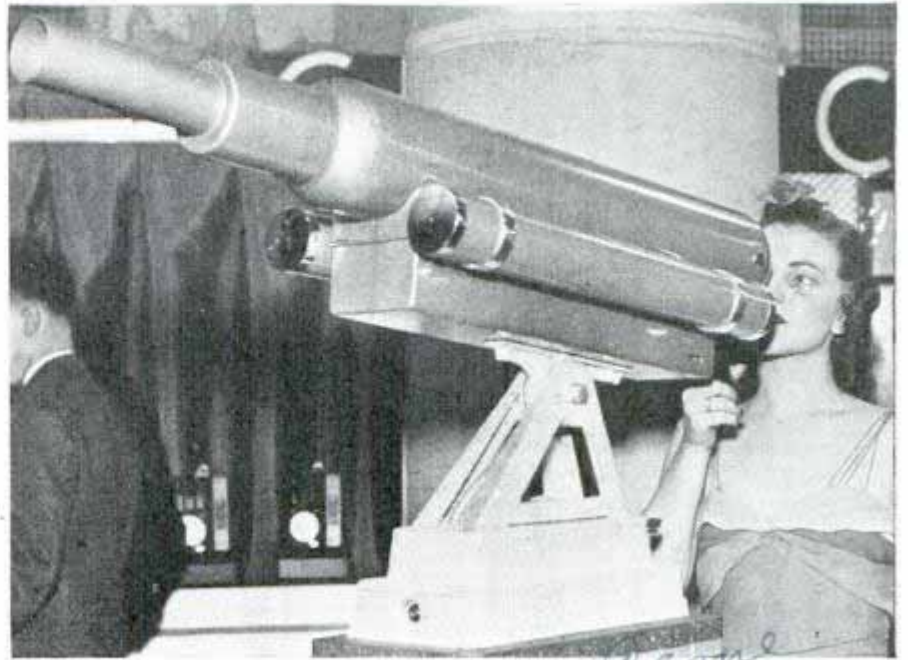

*acme*  
Drawing a bead on projected picture of airplane fitting across sky in "anti-aircraft" shooting gallery. Gun uses electric beams for bullets

Airplanes appearing to fly across the sky are "shot down" just for fun in a novel shooting gallery. The "anti-aircraft" gun, trained on planes that are flashed inside the drum by a movie projector, fires a pulsating electric beam at the target, and when hits are scored they are indicated by a meter.

## Coin Machine Sells Insurance Policies Good for One Day



*Standard Register Co.*  
*Clayton, Ohio*  
Accident insurance policies, good for twenty-four hours, are sold for a quarter by slot machine. You deposit the coin, write your name and that of the beneficiary, and press a lever to release the certificate. A duplicate policy is retained in the machine to prevent forgery. The machines will be installed in railway waiting rooms and similar public places.

More than 25,000,000 pounds of explosives were used in blasting tunnels of the 392-mile aqueduct carrying Colorado river water to Los Angeles.

Silent insurance salesman stamps time and date on policy that patron fills out after depositing a quarter. Right, accident insurance vendor

*Esreal Northern Life Ins Co*

*Explosives Engineer*  
*Jan 1939*

Bel  
care



6140 W. J. Ketcher  
Chicago

# "Dudes" Pose on a Broncho but It's Only a Stuffed Pony

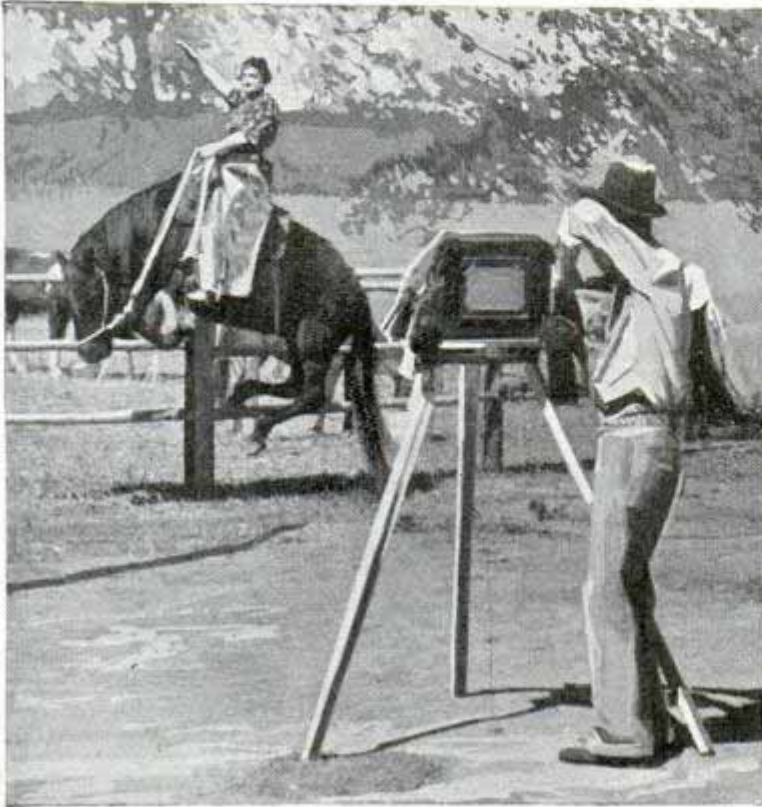

The pose may seem quite daring to the dude's friends back home, but the pony is stuffed, a "prop" of the photographer

Out in the dude-ranch country the tenderfoot tourists like to have their pictures taken riding a wild broncho. However, most of them can't stay in the saddle long enough for the shutter to click. An accommodating and enterprising roadside photographer in South Dakota fixed things up for the dudes. From a taxidermist he obtained a stuffed pony, mounted in bucking posture on a rail fence with a corral full of western ponies for realistic background, and the visitors climb into the comfortable saddle for a picture to send home.

# Shells "See" Target in Air and Explode Near It

Shells used in anti-aircraft warfare are given "eyes" by the Bofors ordnance factory in Sweden, so they can "see" their target and burst when they approach it. In the nose of the shell is a cartridge of magnesium which burns brilliantly during flight and sends out long fingers of light through

radial openings in the shell casing. If some of these beams strike an airplane they are reflected back to the shell, where they are caught by photocells. These are connected electrically to operate the detonating mechanism. It is not necessary for the shell to make a direct hit to bring down a plane, since the concussion and the flying steel splinters ordinarily are enough to destroy it.

# World Fair Model in Soap Carved with Kitchen Knife

On a three-foot square a Philadelphia man—radio cabinetmaker by trade and soap sculptor in his spare time—has laid out a scale model of the New York world's fair in which every tiny piece is carved from soap. It has taken him four months to shape and place the 500 pieces of soap comprising the finished model. The buildings are wired for lights, and each is painted according to the color scheme of the real fair. His tool was a small kitchen knife.

Ralph D. Rodolise



Sharpening up the "pylon" in a scale model of the New York world's fair hand-carved from soap. There are 500 pieces

Scena dermi g.

Stockholm



Copyright © William C. Tuttle  
1341 N. Portland Blvd.  
Portland, Oregon

# MAGIC HANDS

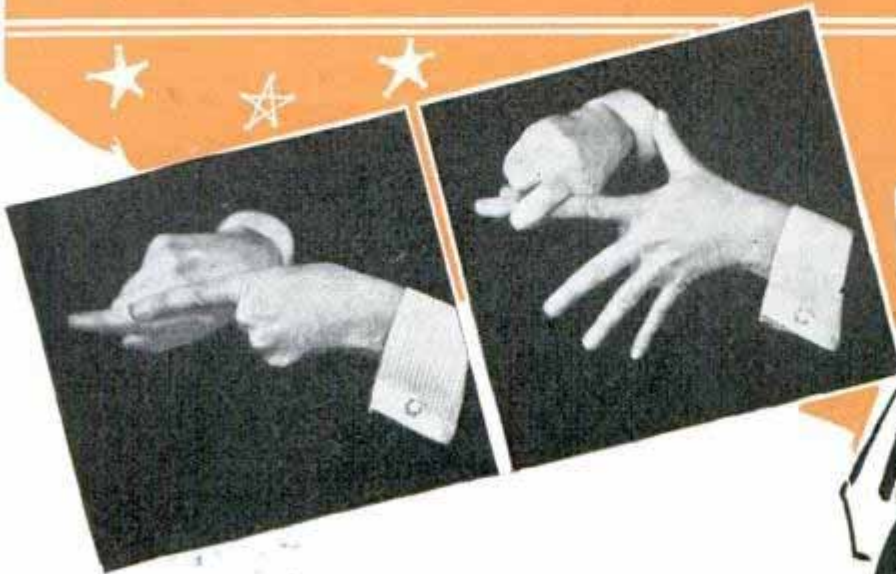

Here are tricks to perform with your fingers. Practice makes them appear bewildering. Top, (left and right) stretching a finger: first, place left index finger on right index finger, then right second finger on top of left index fingernail, curling it around to hide joint. Keep both index fingers straight. Right (top to bottom) amputating a thumb: place left thumb with joint bent inward; then right thumb against left thumb, also with bend at first joint; next, right index finger hides gap of joint; finally, right thumb is slid back and forth along left index finger to get best effect

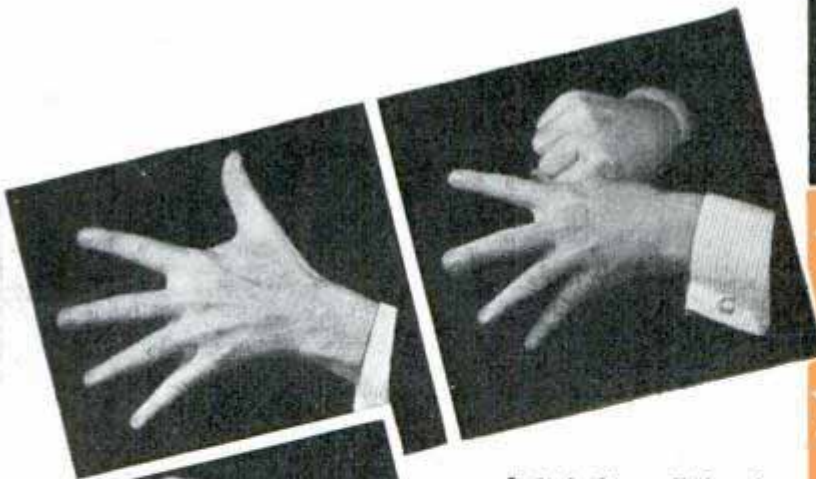

Left, jerking off thumb: left hand is stretched, then right hand grabs quickly at left thumb. Left thumb is placed down behind the hand against palm. Right fist next comes away with right thumb sticking out between second and third fingers. Thumb can be wiggled as though still alive, though apparently jerked off the hand





# Sundial Tells Exact Minute When Adjusted for Date



Sun clock's crescent is adjustable for seasonal movement of sun so that it can tell exact time

By combining the ordinary sundial and the analemma, a sun clock that tells the exact time to the minute has been built. The analemma represents the path traced by the declination of the sun during a year. The sun shines through a hole in the upper arm of the metal crescent of the clock, falling on the analemma design on the lower arm. When the crescent is adjusted so that the sun spot falls on the current date on the analemma design, a pointer at the base of the crescent indicates the exact hour and minute. The clock is adjustable for any latitude and longitude.

# Flashlight Battery Lasts a Year by Renewing Charge

Permanently sealed, a regular size flashlight battery, now on the market, can be recharged by a storage battery. The battery, which lasts about a year, can be

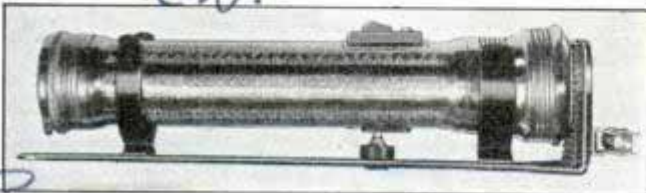

Flashlight equipped with rechargeable batteries. Special bracket makes contact with storage battery

charged daily or as required by placing it in a special bracket that is then attached to the battery. A rectifier permitting the use of house current for charging is available.

# "Windows" in Bait Attract Fish by Flashing Light Below

Brightly colored artificial bait ordinarily reflects light upward and sidewise, but appears as a dark object from beneath. This deficiency is corrected in a metal lure which is fitted with unbreakable transparent "windows." In addition to reflecting light to the sides and above, the new bait transmits colored beams downward to attract fish lurking below.



# Fiber Ring for Tuning Violins "Sings" When Pitch Is Right

Even without musical training you can tune a violin quickly and perfectly with the aid of a small tuning device that fits under the neck of the instrument. As each



Placing the tuning device in position for tuning. A novice could put violin in perfect pitch this way

string is keyed up, a fiber ring on a corresponding bar of metal inside the tuner vibrates in sympathy, indicating that correct pitch has been reached. The tuner is removed before starting to play.

Edwin Griffiths, 2215 S. Sepulveda

2-123

Charger Co

W. Minnie, Chicago

2-148

2-137

Edwin Griffiths

San

Anderson, And

Frederick Alyn G 3829



Natives of India Hunt Fish in Clever Ways

Right, native of Malabar with crossbow, ancient weapon still used for fishing. Below, fishing with twin canoes. If fish are not caught in nets under boats, they try to escape by leaping from water and are trapped in the canoes



Harpoons and giant nets and casting rods may seem essential to the fishermen of the western world, but old-world peoples cling to the methods their ancestors used for centuries—and they seem to work. The natives of Malabar, India, still “hunt” fish with ancient crossbows, and trap them with

reed screens and trick canoes. One curious method is to harness two dugout canoes together and drag chains and nets in the water beneath. This frightens or traps the fish, and if they try to escape by leaping from the water they land in the boats or the nets stretched along their outer edges.

Folding Anchor of Light Metal Has High Holding Power

Made of lightweight welded metal, an anchor with folding arms has great holding power for each pound of weight. The eleven-pound size will hold a boat thirty-eight feet long, while the general rule is to allow one to two pounds in anchor weight for each foot of boat length. Its arms, equipped with a set of sharp-pointed triangular flukes, are pinned to the stock at right angles so they can be folded for stowing. The metal is resistant to corrosion and will not rust in fresh or salt water. Its light weight and small size permit ease of handling and reduce the danger of damage to hull and topsides. The anchor is available in a variety of sizes weighing from six to forty-seven pounds.

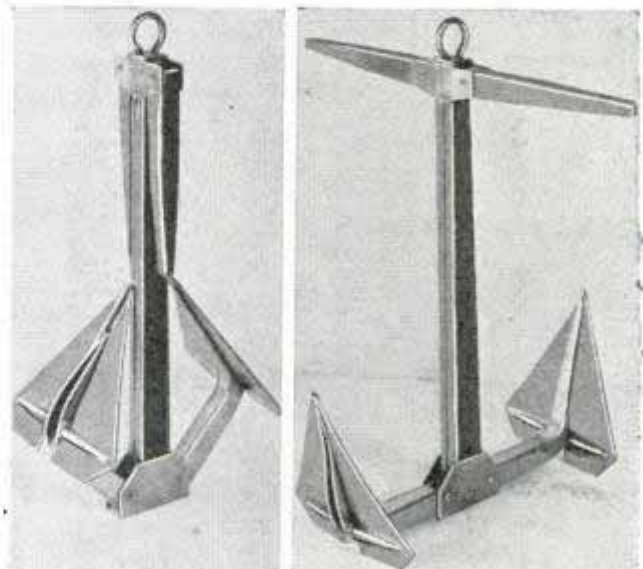

Stock and arms folded. Right, anchor open for use

Youngstown Welding and Engineering

Emb. International Herald Co. 67 Wall St. New York



# Safety Studio in Police Car Delivers Recorded Speech

*Plymouth 1939*



*Policeman speaking through microphone. Note cabinet on back seat with turntable for playing records*

To reach more pedestrians and vehicle drivers with safety messages in the constant fight against accidents, police of Detroit, Mich., operate an automobile containing amplifiers and sound equipment for broadcasting recorded speech and music. A built-in cabinet for playing records fills half of the back seat, and loud speakers outside the car deliver educational lectures or music.

*g. 42.*

# Pilot Flame Generates Current to Control Gas Heater

*about \$17.00*

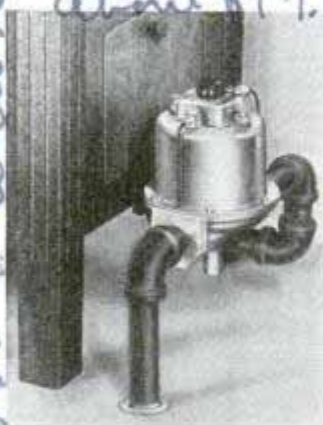

Heat from gas, without the help of batteries or other outside source of current, produces electricity to operate a heater valve as well as an electric-type thermostat. Power is developed by the thermocouple. To obtain automatic

heater control, a pilot burner generator is employed, which, in addition to serving as pilot flame for the burner of the heater itself, produces a constant flow of current. A threefold purpose is accomplished by the

pilot burner generator. It checks the pilot flame providing automatic control, supplies current for operation of the main valve, shown in the picture, and permits use of the thermostat. Failure of the pilot flame would cause the valve to close through inability of the generator to supply power. Mounted close to the floor level where it quickly responds to the colder air, the automatic control can be used to operate circulating heaters, gas radiators and range heaters.

*g-139*

# Chef Delivers Dinners Hot on Rolling Steam Table

Meats and vegetables are brought piping hot to the tables in a Los Angeles restaurant, on a streamline aluminum steam table. The food is cooked in the kitchen, but is rolled right to the patron on this serving cart. Beneath the compartment for foods is a water vat, heated from below with a canned heating fluid. At the bottom is a storage compartment.



*Chef serving dinner from aluminum steam table which is rolled direct to patron's table*

*General Controls Co. Chicago 450  
Detroit St. Chicago*

*Los Angeles  
roadway  
444  
Hotel Supply Co.  
Stainless Steel*



# CHALLENGERS of DISASTER

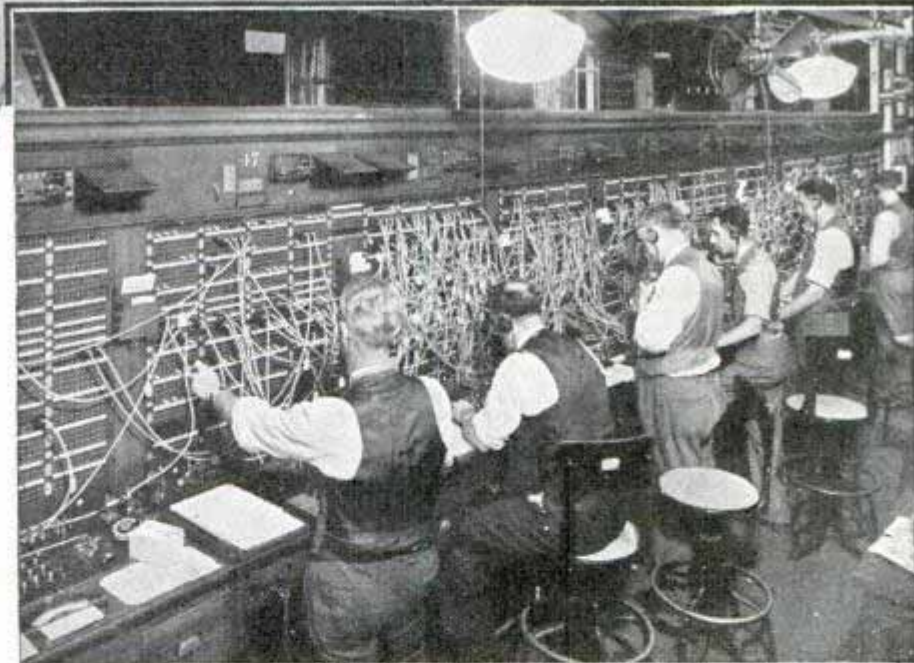
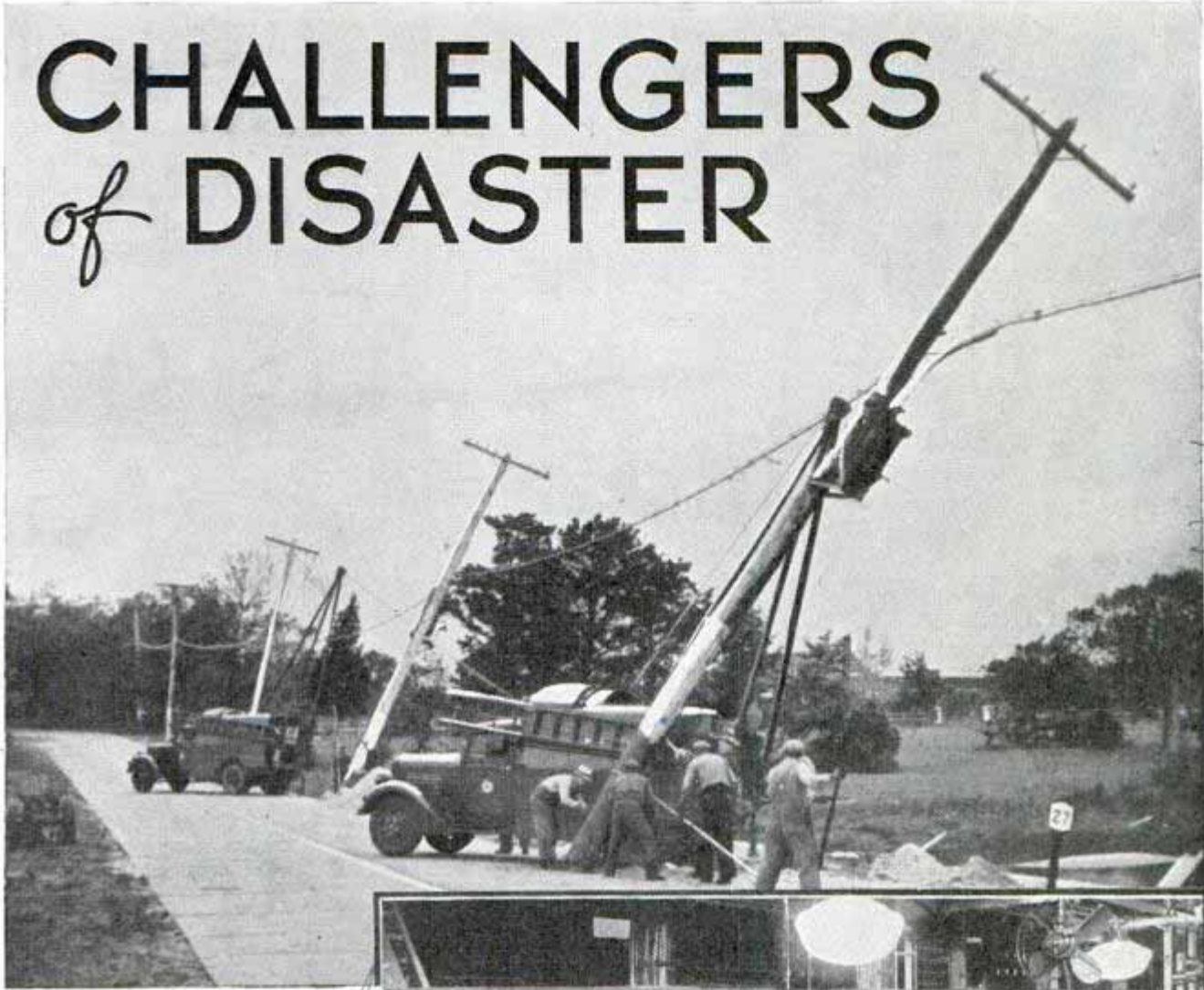

Top, resetting telephone poles after disaster. Bottom, test board showing "patches" that detour calls from damaged wires to those working

By <sup>New York</sup>  
E. C. Schnurmacher

"PROVIDENCE calling Red Cross headquarters, Washington, D. C. Medical supplies urgently needed here. The hurricane has just struck."

"Westhampton, N. Y., calling the Coast Guard. Everything flooded. Send boats quickly for rescue work..."

"Hello, New York. Southern New England Telephone company calling. Tremendous hurricane damage in Connecticut. 100,000 telephones out. We need poles . . cable . . drop wire . . ."

Whether it be a hurricane, a flood, a fire or a tornado, after every disaster the shattered links in the country's vital nerve system, communication, must be restored

quickly. Telephone poles, uprooted by wind and water, must be replaced and damaged wires must be restrung.

Keeping the eighty-three million miles of telephone lines open in normal times is in itself a tremendous task for the 60,000 maintenance men of the Bell telephone

near highway Westhampton  
 Mohawk Highway Bridge  
 Westhampton  
 32-6th Ave. New York  
 New England Long Distance Bldg  
 New York  
 Recitem





system. And when a catastrophe descends swiftly upon a section of the country, the job of replacement is not only increased a hundred-fold, but it must be speeded up as quickly as scientific equipment and skillfully directed human energy make possible.

Almost before the catastrophe has completed its first stunning blow, the challengers of disaster, men and women of the nation-wide system of the American Telephone and Telegraph company, are mobilizing their forces to restore communication so that the work of rescue may be expedited. As they take the field the huge supply plants of the Western Electric company begin readying the equipment which will be needed for replacement so that with the first messages from the stricken area, material will be dispatched speedily by truck, rail, plane and sometimes private cars.

"As soon as it became ap-

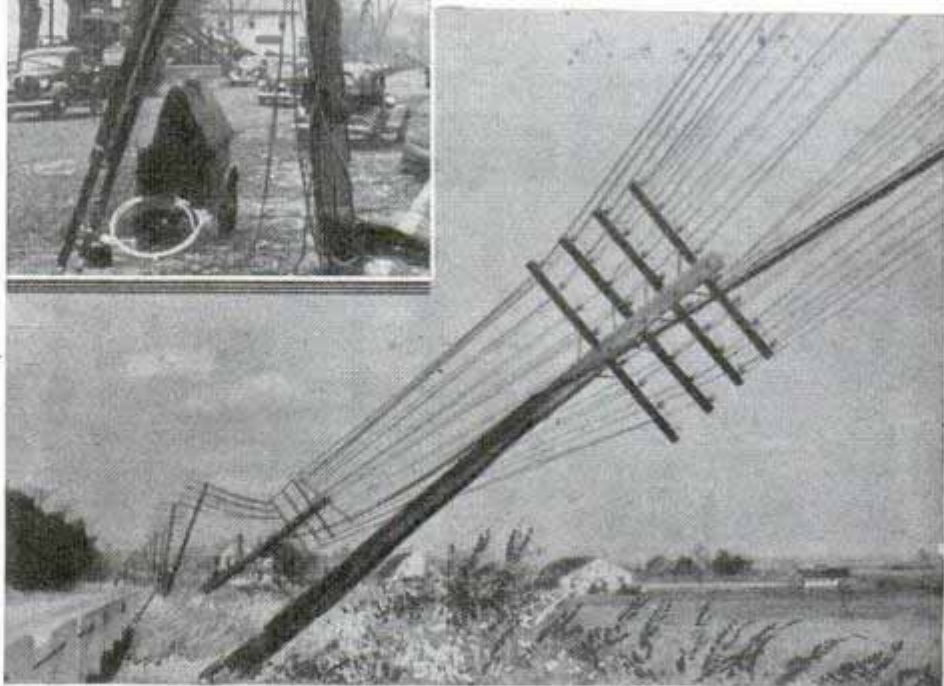

Top, traffic-control bureau which keeps track of "re-routes" around stricken areas. Center, Pittsburgh worker on job in Connecticut. Bottom, string of telephone poles in New England damaged by the wind. Thousands of poles were in this condition after the disaster

parent that the recent New England storm was developing into a hurricane, cutting a swath of death and destruction through eight states, operators off duty and those on leave returned to their central offices, reported, took places at the switchboards—all as a matter of course," said an official of the American Telephone and Telegraph company.

"Whether it was an operator heroically putting through her calls in a small Rhode Island town, a maintenance man hauling himself by rope across a raging Connecticut torrent to string an emergency telephone wire, or a fleet of repair men from the west, driving into the stricken area and literally making their own roads as they did so, the challengers of disaster met their greatest test in the New England hurricane.

"Former operators vol-



unteered everywhere, were welcomed and put to work. Plant forces knew no hours. Beside them worked commercial employes, salesmen, business office representatives, anyone who could be of help. Engineers took to the field with the plant crews. Paymasters with cash in hand set up offices at central locations. Men from the accounting department went out to relieve foremen and supervisors of time-consuming details. Many a subscriber was startled by a masculine response to a request for "information!"

When the Connecticut river rose to its highest crest on record, in 1936, water filled the basements of the two main telephone buildings in Hartford, Conn., and flooded the first floor of one to a depth of several feet. Batteries and associated power equipment were drowned and telephone service in much of the city was disrupted for several hours.

The engineers moved the power plant upstairs, reinforced and waterproofed the basements of the buildings and built removable watertight bulkheads for all the

(Continued to page 118A)

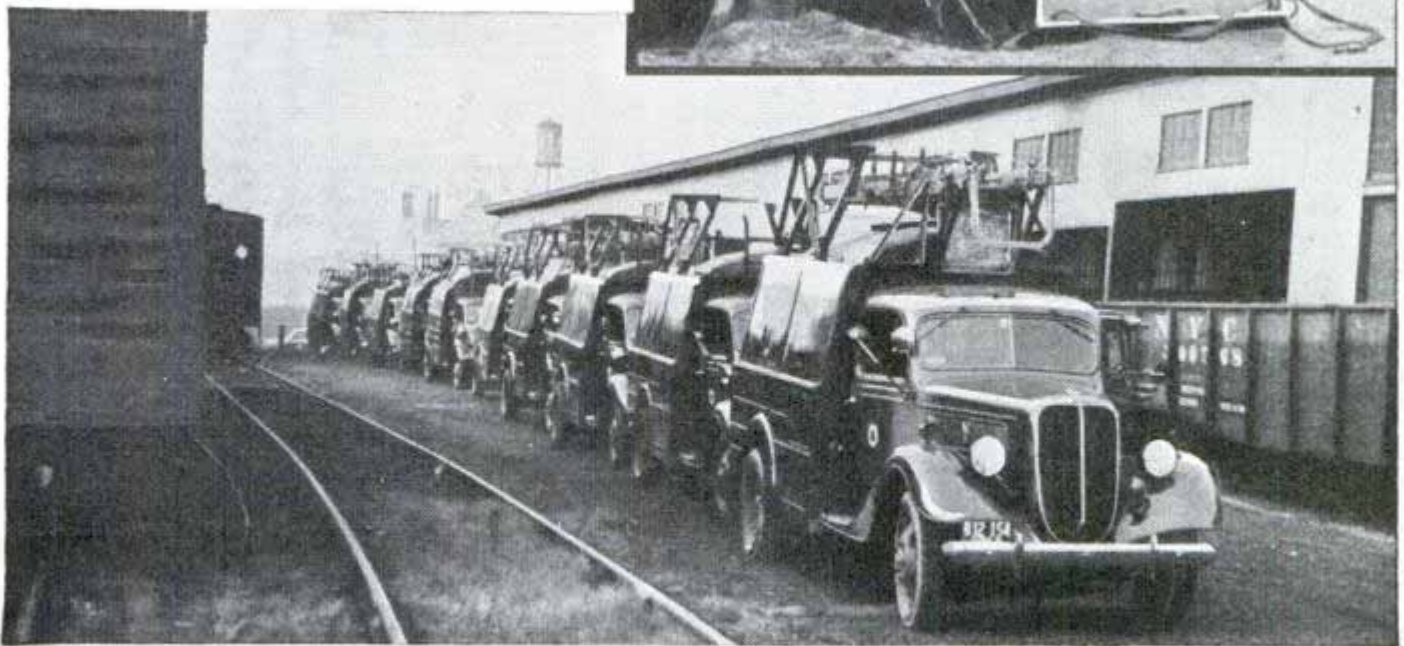

Top, New Jersey telephone men preparing to string a new cable at Mystic, Conn.; one, riding the wire, is placing rings to support the cable. Bottom, group of Illinois Bell Telephone company aerial cable tower trucks lined up at freight depot, waiting to be loaded on special trains for shipment to stricken area. These are some of the forty-three pieces of motor equipment rushed into the hurricane zone from Illinois to aid in reconstructing lines

*Demarest, N.J.  
Trenton, N.J.*

*1875  
Charles Ross,  
Elizabeth, N.J.*

*Edward Lloyd*



# Model of Solomon's Temple Is Built to Scale

Ancient literature guided a Brooklyn scholar in building a plaster model of Solomon's temple. The project took him two years, and was done with the utmost faithfulness to detail. Accurate in scale, it covers 125 square feet. The builder is a schoolteacher and student of religion.

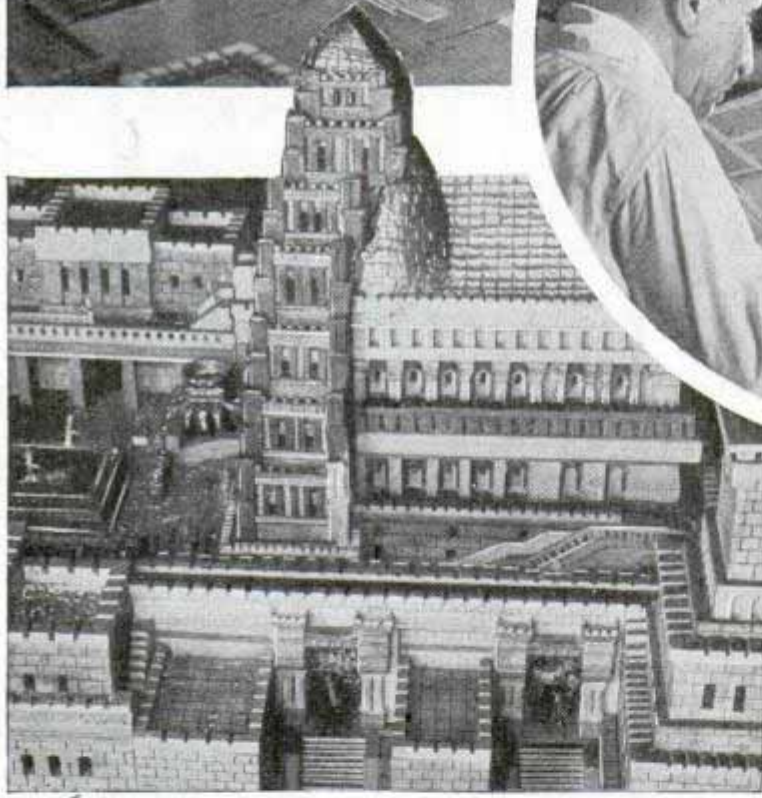

Three views of plaster model of Solomon's temple, constructed over two-year period by a Brooklyn schoolteacher and student of religion. In circle, the builder is shown checking dimensions of the model with ancient literature

# Plastics Made from Coffee for Wallboard and Insulation

Since the world doesn't drink all the coffee it produces, chemists have found a way to dispose of the surplus by turning coffee beans into plastics. South Americans may soon build homes with roofs and floors of coffee, insulating and acoustical wallboard of coffee, and even electrical fixtures and radio parts made of coffee plastic, which is a non-conductor of elec-

tricity. These plastics, now in the experimental stage, are made from unroasted beans and are therefore odorless. They can be produced in almost any color and any stage of translucency or opacity except pure transparency, and little has to be added in the manufacturing. The bean itself furnishes the dyes, the bulk material and plasticizers. Furthermore, it is ex-

Developed by H. S. Polin (Polin)

Coml. Black & Co. 420 Lexington Ave. New York

Business Week 2-165 1/29/37



pected that the process will offer valuable by-products such as an oil similar to linseed, a fertilizer, vitamin D, vegetable dyes and caffeine. At present there is an annual surplus of about 4,000,000 bags of coffee in South America. It is contemplated that coffee plastics would be manufactured only for use in South America.

## 'Mosquito' Plane Climbs Mile in a Minute and One-Half

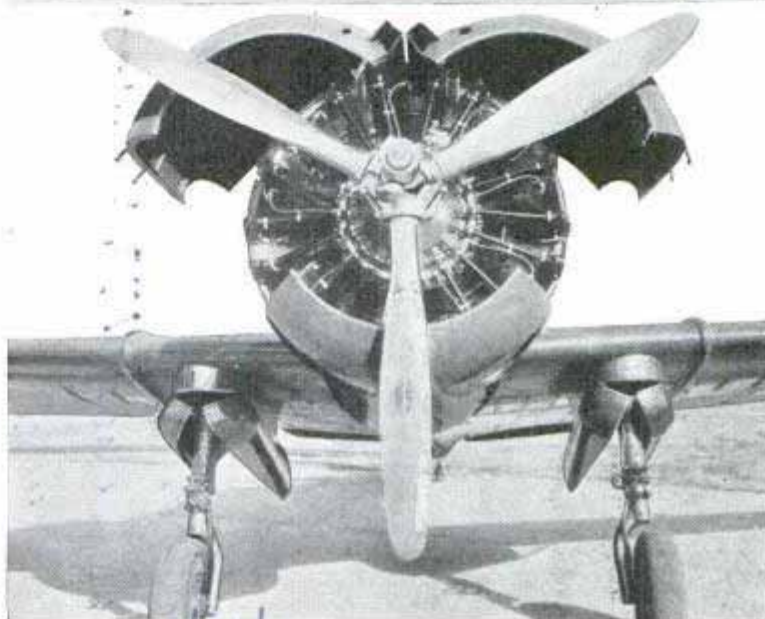

Notice how the landing gear of this fast climber retracts into streamline housing with folding hoods

Small but carrying plenty of "sting," a fighting plane that climbs nearly a mile in a minute and a half is trying out for an army job chasing bombers.

This trim little speedster can be up in the sky training its twin machine guns on the enemy within three minutes after an invading bomber is reported. It climbs 5,000 feet in the first ninety-six seconds, reaches 10,000 feet in two minutes forty-eight seconds, 15,000 feet in four minutes twelve seconds, and is up 20,000 feet in less than six minutes. Capable of 300 miles an hour at 17,500 feet, the ship can cruise at 35,000 feet with its two-speed supercharger and oxygen supply for the pilot. It is called an "interceptor fighter." Landing wheels retract into a streamline housing with a folding hood.

### "Blinks" Counted in Test to Show Eye Fatigue

Close measurement of the degree of human fatigue produced by visual tasks under various lighting conditions, is obtained by a "comfort meter" which determines the frequency of blinking. Results of the tests are being applied by General Electric research laboratories as a more exact means for finding the proper quality, brightness and distribution of light. Blinking increases proportionately as visual discomfort becomes greater. A complicated device records the number of blinks per minute. Tiny electrodes touching the skin near the eye pick up electrical currents generated in the blinking process. These currents are amplified millions of times and, finally, two pencils of light draw a graphic record of the frequency and nature of the blinks.



Subject in right foreground reads while complicated apparatus behind him counts "blinking rate" to determine eye fatigue

Wela Park Cleveland Ohio

Lighting Research

Dr. Matthew Luckiesh  
and Frank Mos

Built by Curtiss-Wright Corp. Rochester, N.Y.



g. 122.  
**Powered Dustpan and Brush Sweeps Close to Walls**



Operator rides along to steer dustpan. Pressure of broom on floor is fixed and always remains the same

Driven by a one-horsepower motor, a dustpan and broom picks up dirt, from tiny particles to stones the size of a hen's egg, while traveling at about three miles an hour. Although it is seventy-two inches long, the sweeper can be turned around by hand in an aisle sixty inches wide. Cleaning either factory floors or city streets, the broom, which can be made of flexible fiber or stiff wire, will lift refuse an inch and one-half from a wall.

g. 75.  
**Tension Wrench Flashes Light to Indicate Proper Pull**

For precise control of tension when working on delicately adjusted bearings, thin-walled cylinder blocks and clutch assemblies, a wrench is provided with a sig-



Turn of knob, as shown in inset, exposes scale and pointer is set to recommended tension

nal light that flashes at the instant the required tension is reached. A finger turn of its control knob brings into view various scales showing inch-pounds, foot-pounds, and recommended pulls for spark plugs and bolts. Then the pointer is set to the recommended pull, tension is applied and the flash tells when to stop adding pressure.

g. 119  
**Dummy Airplane Cockpit Shows How Ship Is Controlled**

Complete with radio equipment and all flying instruments, a mock-up, or dummy of a pilot's cabin constructed by one of the large air lines, dramatizes the work of the pilot and depicts safety features of transport planes. Here the public can see the instruments that give a complete picture of the flight and make it possible to navigate the ship through inclement weather, and others which keep a record of how the motors are operating. The radio equipment consists of a short-wave transmitter and three short-wave receivers. By adjusting

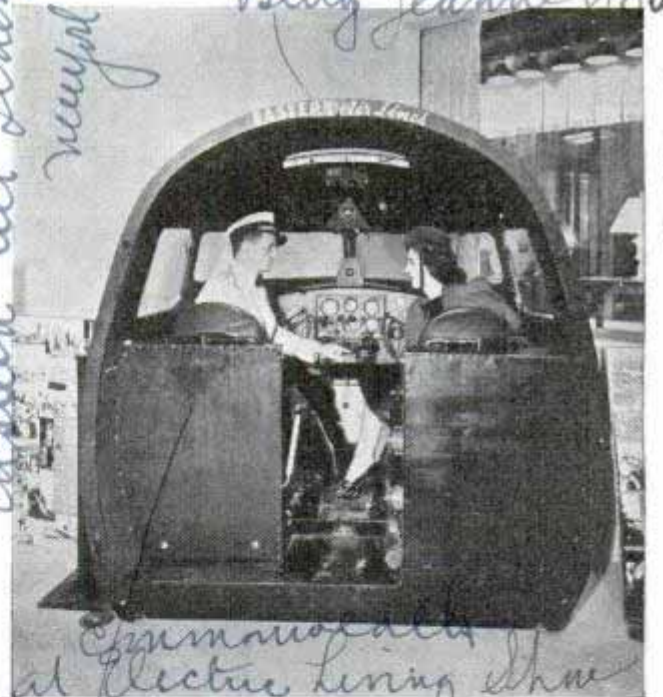

Airplane instruments and controls are exhibited by "dummy" so public may see safety features of flying

controls located above the cabin windows the pilot can tune in on the radio beam, the radio marker signals, or the company two-way radio stations along the air lane. Also included in the replica are controls for adjusting the ship for flight under various load conditions and for regulating the mixture of gas and air in the motors.

Blackhawk Hwy G. 5325 W. Rogers  
Michigan, W. 1775 Broadway

Betty Jeanne Smith  
here is with

Eastern Air Lines, 1775 Broadway

Flight Instructor  
H. Schriener



# Flame-Tempering Violin Bows for Resiliency



Above, violin bows are first sawed from block of brazilwood, then worked into shape with a file since this wood is too hard for cutting tools. Top, right, placing hairs on the tempered bow. Specially selected horsehair is obtained in bunches as shown, and a bow requires 100 to 110 hairs

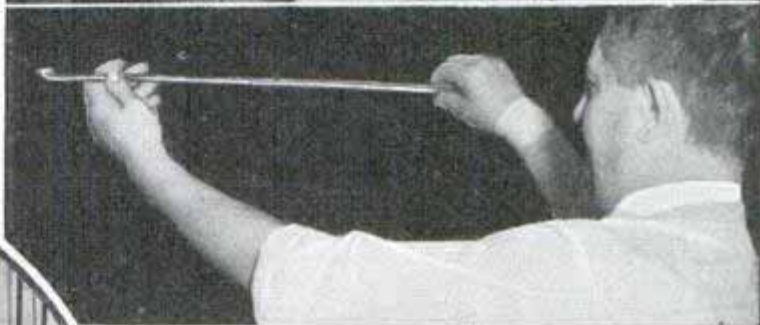
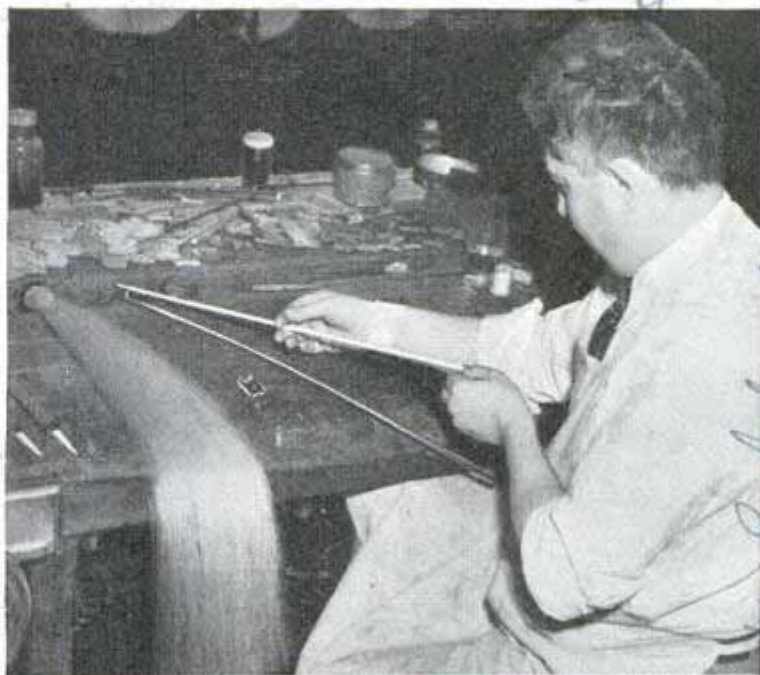

Above, bowmaker watches process closely while tempering "stick" of brazilwood over flame. It is heated at certain places to an exact temperature to set up stresses in fiber for proper resiliency. Left, collection of bows from which concert violinist matches a bow to his instrument. Bottom, as a final inspection of bow, maker presses it against bench as shown and notes "comeback"

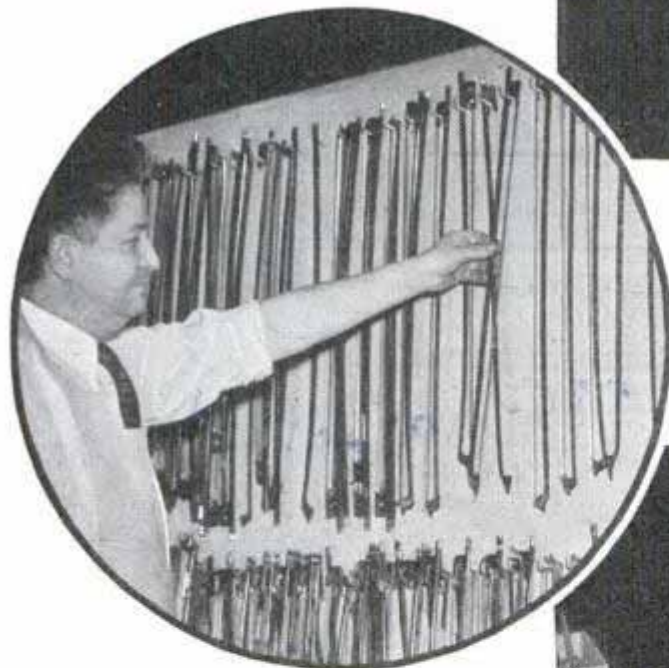

One of the secrets of the violinmaker's trade is the method of obtaining resilient bows from such dense, heavy woods as brazilwood, snakewood and ironwood. Actually this wood is tempered over a flame. Accurate heat treatment sets up stresses causing the fibers to tighten up in certain places. Later, as the bow is used, the fibers lapse into their original forms and the bow must be retempered. If this is done by a skilled bowmaker, repetition of the tempering process improves the wood each time. Experts believe that "tuning" violin bows with fire is the only instance of flame-tempering wood in industry

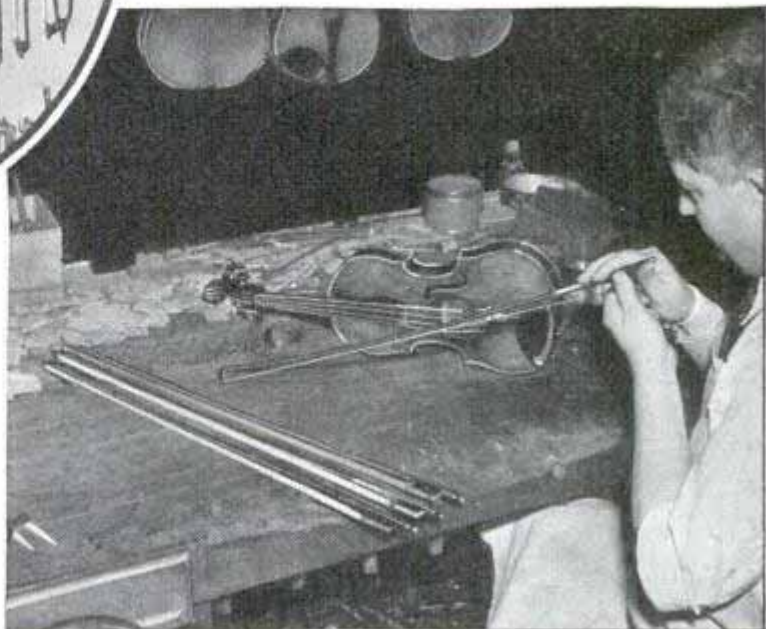

Cmd. George H. Eckhardt  
204 N. Park Ave. Philadelphia



14 15 69  
 R.A. Langbey  
 near Durango, Colo.  
 Jeanette Smulhey  
 Corinne Felice  
 from San Jose local school

# "BATHTUB



Above, showing how vegetables grow in hydroponics garden. Left, Dr. Gericke with tobacco plants grown without soil

785 By Frank J. Taylor  
 Market St.

SCARCELY five years have slipped by since word leaked out that Dr. William F. Gericke of the University of California had discovered a sensational method of growing vegetables and flowers without the use of soil. Within that brief span, hydroponics—"labor of water," as this brilliant professor called his new method of feeding plants—has caught the popular fancy as has no other scientific development of recent years.

Literally by the bale, letters have poured into the university asking for instructions on how to mix the mysterious plant nutrients. Farmers, nurserymen, greenhouse growers, amateur gardeners and indoor "bathtub horticulturalists" tackled the new way of growing plants with enthusiasm.

San Francisco Calif









Top, Rolland Langley exhibits root system of dahlia in blossom in mid-winter. Center, preparing seed bed of excelsior and rice hulls over a tank. Bottom, lifting seed bed of a tomato planting to inspect root growth in the plant nutrient

tle as four cents a pound for as much as two dollars, with inadequate instructions for using them.

Since Dr. Gericke refused to reveal his secrets, the university authorities, bombarded by inquiries from everywhere, felt it their obligation to tell what they knew, since theirs was a state institution supported by the taxpayers. They assigned two other scientists, Dr. D. R. Hoagland and Dr. D. I. Arnon, to parallel the Gericke experiments, test the various formulas, and publish a report, which was made available to the public. In the last two years, repeated printings of this report have been exhausted.

That hydroponics has definite commercial possibilities has been demonstrated. Pan-American Airways, which operates the trans-Pacific clipper ship route from San Francisco to Hong Kong, encountered a peculiar horticultural problem on Wake Island, an important base in the trans-Pacific chain. Wake is a low, sandy atoll, with so little soil that only scrubby desert plants can maintain life on it. The company maintains not only a base, but the Airways Inn, on the isle. The problem of supplying fresh vegetables and fruit was acute, because the supply vessel came but twice a year, and cargo space in the clippers was entirely too expensive for crates of fresh produce. Pan-American Airways officials appealed to Dr. Gericke, who had con-

Ernest Brundin at Waste Bell

Brundin farm  
Cali



tended from the start that hydroponics farms would be most successful in the deserts, where sunshine is at a maximum and pests are reduced to the minimum, and where water is scarce. Curiously enough, chemical culture takes far less moisture than agriculture.

**FREE FORMULAS**

Tested formulas for mixing tank garden plant foods may be obtained free by enclosing stamped, self-addressed envelope with your request to Popular Mechanics' Bureau of Information

Dr. Gericke dispatched one of his students, Lamory Laumeister, to Wake to lay out the first model commercial outdoors hydroponics garden. Within two weeks after his arrival, Laumeister had his tanks built, the seeds carefully planted in the moist excelsior and peat that rested on the wire nettings above the nutrient solution. In the brilliant, warm mid-Pacific sun-

(Continued to page 128A)

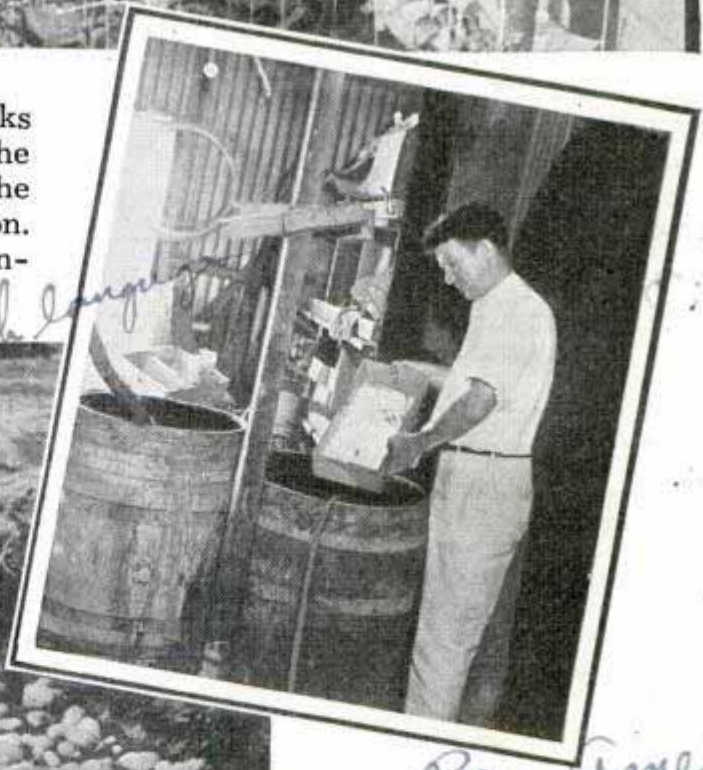
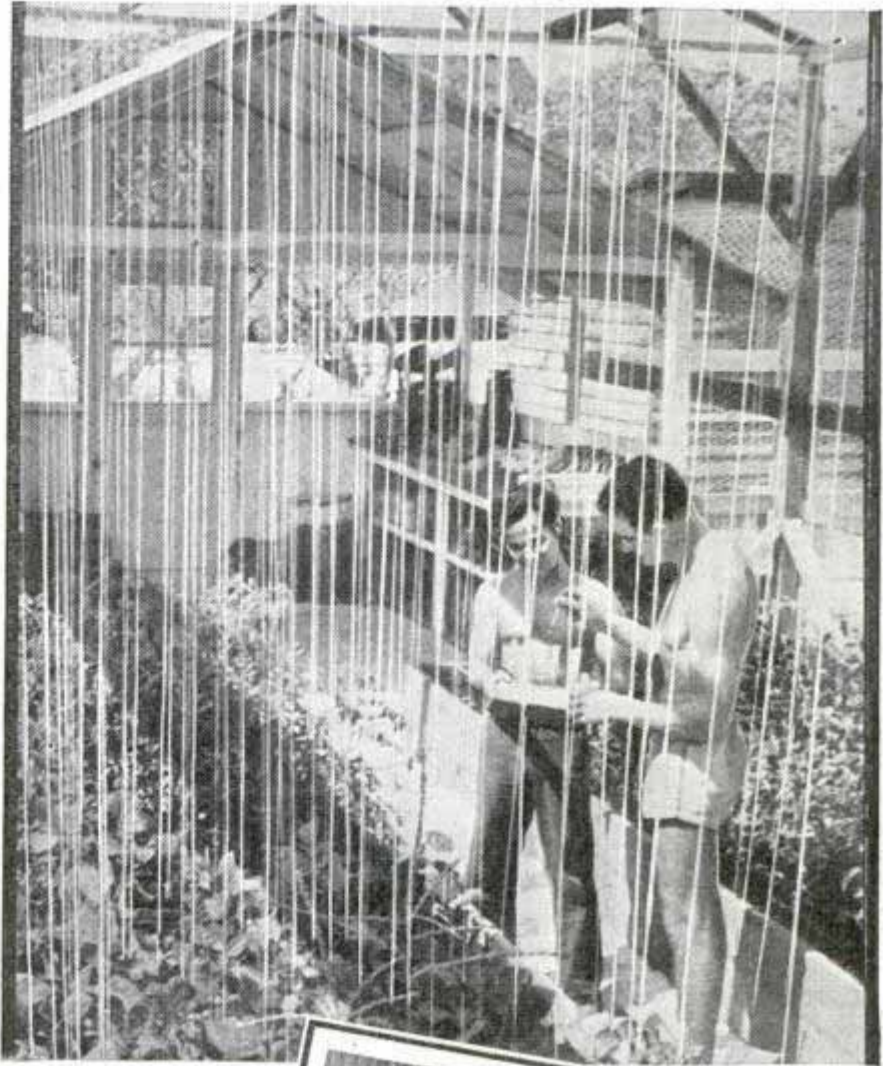

Pan American  
Top, "bathtub gardens" on Wake Island. Center, feeding nutrient salts into sump. Bottom, hydroponics-grown potatoes

Handwritten notes in blue ink on the right margin, including the name 'Lamory Laumeister' and other illegible scribbles.

Handwritten notes in blue ink at the bottom left, including the name 'Lamory Laumeister' and other illegible scribbles.



# Window and Light in Oven Allow Inspection of Food

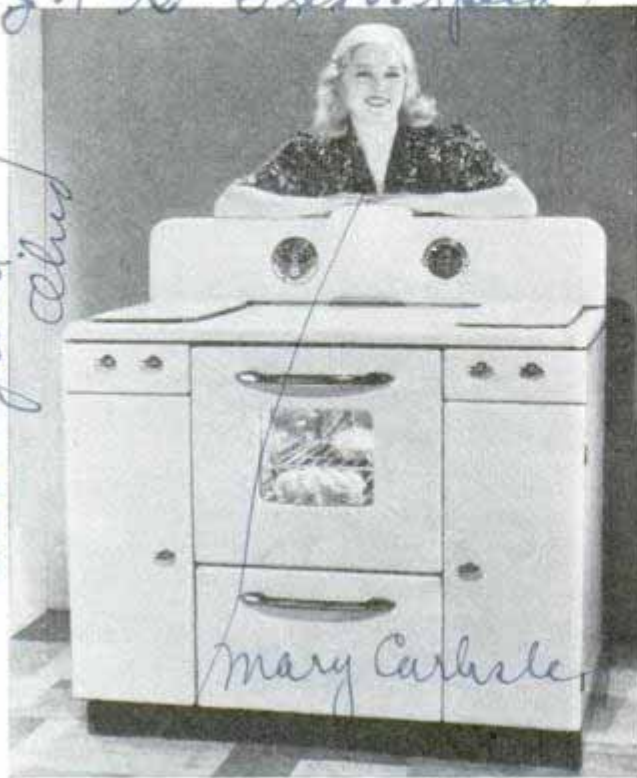

Biscuits bake in plain view in this windowed oven and there's no need for opening the door to check

Through a Pyrex window in the oven of one of the latest model stoves, the housewife can watch her turkey, cake or biscuits turn a perfect brown. No need to open the door for inspection, and thus lose oven heat and warm up the kitchen. The food is always visible, and there is a twenty-five watt electric light in the oven.

## Electric Buzzer on Typewriter Warns of End of Paper

An electric buzzer signals "end of the paper" on one of the latest model type-

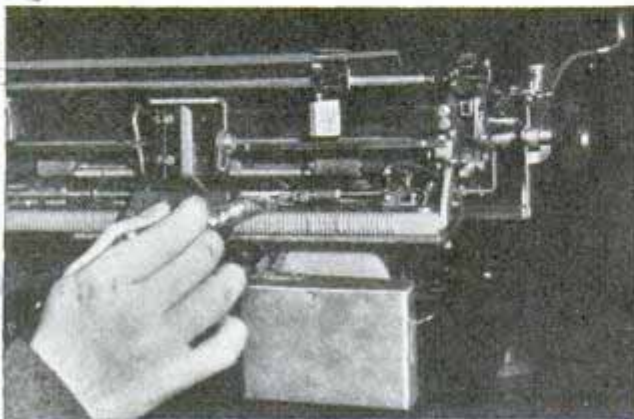

Adjustable cradle in back of typewriter contacts band in roller and signals when end of paper is near

writers. A countersunk contact band girdles one edge of the roller, and beneath the roller, at the back, is an adjustable cradle that makes contact with the band when anywhere from one to ten lines remain on the paper. This sounds the buzzer, which is inclosed in a case with a small battery.

## Barrier Encircles Floating Oil and Stops Water Pollution

Oil discharged into harbor waters has always been a bane to fisheries and unpleasant to bathers. At some ports oil companies and vegetable-oil plant owners have been fined heavily for such oil "spills," and in order to meet anti-pollution laws a San Pedro, Calif., sailmaker has developed a floating barrier which encircles the pool of oil to facilitate removal. The boom is made of leakproof cork-filled sections 120 feet long, covered with asbestos, and two or three sections comprise an average-size barrier. When an oil leak is dis-

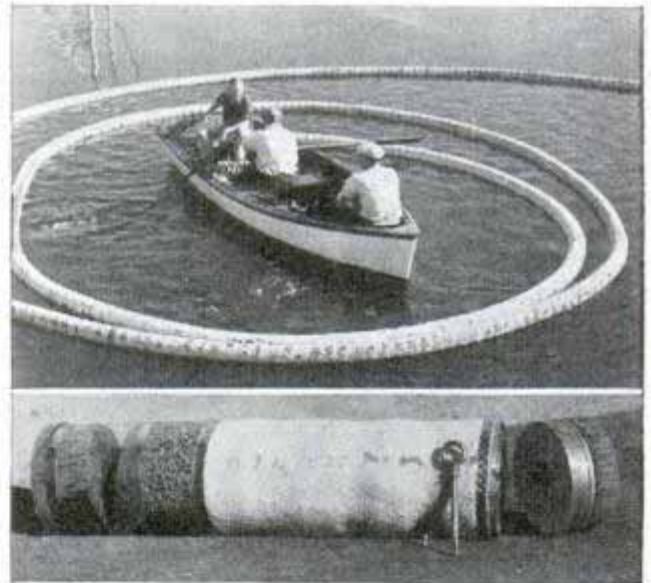

Top, placing snakelike barrier on water to retain spilled oil. Bottom, view of cork-filled section

covered, whether from plant or ship, the flexible boom prevents spreading by enclosing the spot. Men in boats then sprinkle sawdust or shavings on the surface, later "mopping up" the oil-soaked shavings and taking them ashore. Enforcement officers of both health departments and marine fisheries have approved this oil-retention device as an adequate means for protecting harbor and beach waters. It can be used for many years before it requires cleaning, and this is done with a simple solvent.

Chas. Roy Hook  
San Pedro, Calif.

Japan level  
Madison field  
Chas  
Mary Carls  
Los Angeles, Calif.  
Clark Becker  
7665 Wilcox

Visualite  
g-130 Flexo-Speed

g-106



# Camera Snaps Eye in Color or Makes Copies

Life-size or magnified photographs of the eye, in color or black and white, can be made for clinical purposes with a camera and synchronized lighting assembly recently developed. With special attach-

*Right, camera in position to photograph eye of patient. Left, note minimized reflection in enlarged photo of eye. Bottom, copying page of book. Lens is focused with ground-glass tube which swings out of way when picture is made*

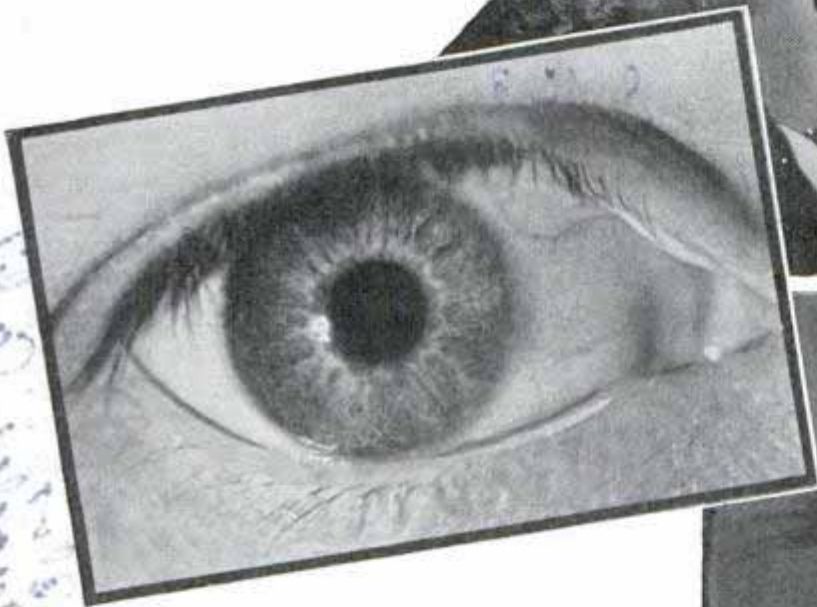

ments it is adaptable for copying pictures and postage stamps, making partial face photos, and for fitting to microscopes. Magnifications of the eye are obtained with interchangeable lens extension tubes. The lamps, mounted to left and right of the camera, have clear instead of frosted glass to reduce reflection of light from the cornea. If only one light is needed the other may be cut out. A special two-way resistance keeps the lamps burning at low intensity to relieve the patient of any strain while focusing, and the synchronizing shutter switch causes the current to bypass the resistance, throwing full voltage into the photoflood bulbs. The switch can be set to give full brilliancy at the time of exposure. Subjects are brought in focus with a ground-glass tube; then the camera, which is hinged to the stand, is swung up-

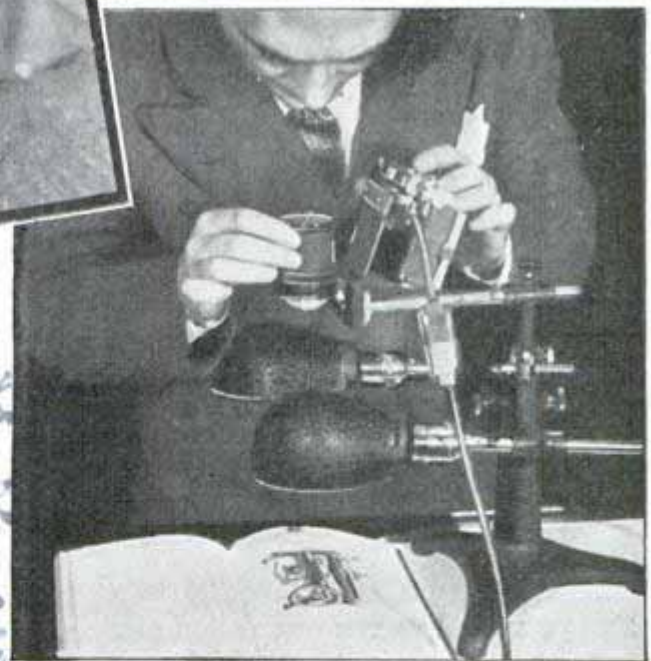
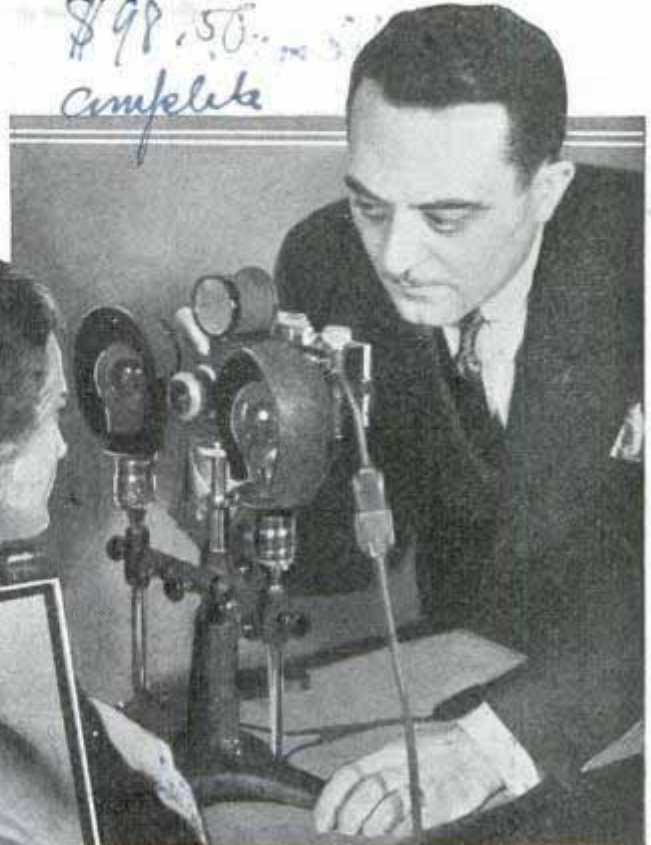

ward into contact with the lens. As the unit is simple in operation, an inexperienced person can photograph cases with little or no assistance. To adapt it for copy work, the camera is lifted out of the upright position and a "T" connection slipped into its place. This holds the camera arm in a horizontal position with the lens pointed downward toward the book or picture that is to be copied.



# Electric Shaker Mixes Paint to 'Condition' It for Use



Clamped on the electric vibrator, the can of paint is given a vigorous shaking to prepare it for use

Paint stores and workshops are using an electric vibrator to mix paint for use. Any standard can from a half-pint to a gallon will fit the shaker. After clamping the can in place, the current is turned on and the can is shaken up and down and sideways 675 times per minute. The paint "conditioner" is fastened to the floor, rubber shock absorbers preventing vibrations.

## Four-Inch "Rumba" Radio Wave Handled Like Light Beam

Revolutionary changes in radio transmission may result from the development of a "rumbatron" transmitter that emanates powerful waves controlled almost as easily as a searchlight beam. These waves, less than four inches long—commercial aircraft use a wave of nearly forty inches—can be concentrated and reflected, and the Stanford University scientists who developed the rumbatron believe that many waves could be shot simultaneously through a metal tube carrying a multitude of telephone conversations or telegraphic messages. A single narrow wave could be used to guide airplane pilots to blind landings, or harnessed to an altimeter to tell a

pilot by reflection his exact distance above earth. The instrument is based on the fact that an electric field influences the speed of electrons. An electron stream from a cathode tube is run parallel to the lines of force in an electric field, and as the field speeds up the slower electrons and slows down the faster ones, the electrons aline themselves in waves with spaces between. These electron bunches pass into a tank containing a high-frequency current. The current picks up energy from the electron bunches and bombards a metal plate three billion or more times every second to produce the ultra-short wave. The rhythmic darting of electrons suggested the "rumba" dance, and when a Greek professor reported "rhumba" was Greek for rhythm in motion, the nickname "rumbatron" was given the new radio instrument.

## Portable Reflecting Telescope Fits into Shoulder Case

You can spot the time on a watch a quarter of a mile distant with a powerful four-and-one-half inch reflecting telescope that fits, with its folding tripod, into a handy case carried on the shoulder. This lightweight telescope, weighing but twenty-three pounds, has an aluminized mirror, and eyepieces up to eighty power.



Portable telescope is shown in its shoulder case and set up on folding tripod

Handwritten notes on the left margin: *and signed Russell J. Vaniam, Research associate*

Handwritten notes at the top right: *990... P. Smith, Ch... Washington, D.C.*

Handwritten note: *revised James 7 20/39*

Handwritten note on the right: *2215-D - Dept of the Army, West Los Angeles, Calif*

Handwritten note at the bottom left: *Patented by*

Handwritten note at the bottom right: *Esuffiths Telescope*





# Sight and Sound RECEIVERS

TABLE model television receivers designed for reception of experimental sight and sound programs from the New York television stations operating in the metropolitan area, are now available in both kit and complete form, as illustrated in the accompanying photos.

The compact instrument in Figs. 1 and 2 has 21 tubes; the cathode-ray tube has a diameter of 14 in. and the black and white television image measures a full 8 by 10 in. Synchronized sound of the broadcast issues from the speaker grille below; it is claimed that a dozen persons can comfortably follow the visual program. This model sells for about \$395 complete with tubes.

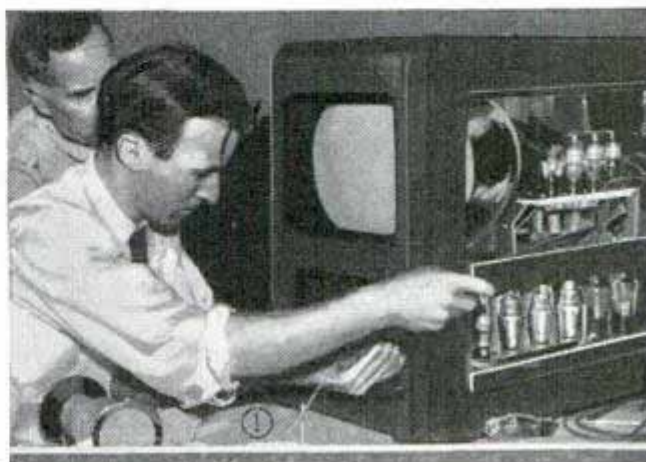

Photos Figs. 3 and 4 are front and rear views of a well designed kit assembly available to experimenters and service men who wish to build their own instrument at minimum cost. It is a 16-tube unit and the picture tube is a 5-in. type. The kit includes the front panel, chassis and all parts, except tubes, for about \$80; the complete set of tubes cost a little over \$50 at present list prices.

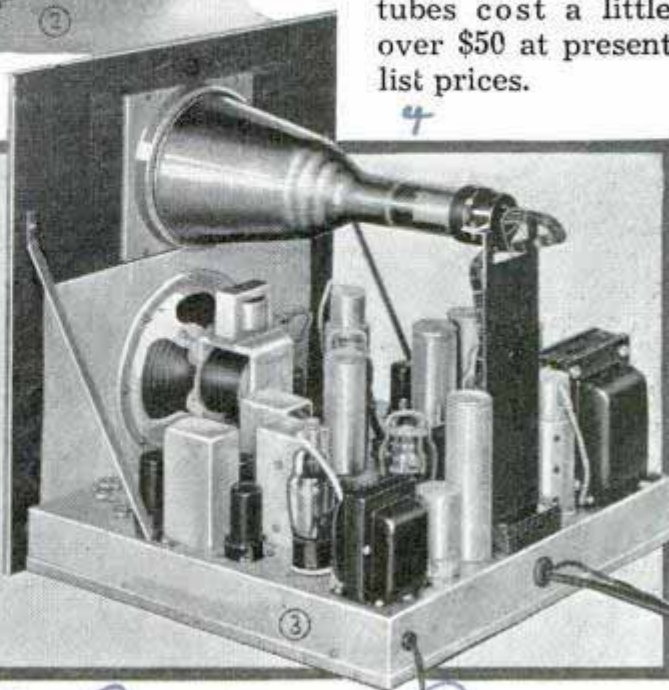

3 and 4 Andrea Radio Corp. 787  
1 and 2 Allen B. Blumstein are  
Laboratory 2. Major



# "On-a-Chair" CABINET



HANGING conveniently on the arm of your easy chair, this simple cabinet arrangement serves several useful purposes. Almost any standard midget receiver, of the type shown in photos Figs. 1 and 2, can be installed in the radio-housing compartment in a position where all of the set controls may be adjusted with ease. It is not even necessary to remove the receiver chassis from its original cabinet, in fact, the set cabinet becomes a part of the assembly. In addition to providing a handy tuning location for the receiver, it also includes a useful ash well and a convenient mounting hole for an electric clock.

All materials are inexpensive and you can build the cabinet in your home workshop. The over-all size of the midget set that you happen to have on hand governs the size of the chair cabinet and therefore it must be built accordingly. However, the general dimensions given in Fig. 4 will take care of the average size set with over-all measurements near those given in Fig. 1. Plywood is used for the inner parts of the assembly since its lightness will tend to keep the weight of the cabinet to a minimum. Jig-sawing the waste from the center of the pieces as shown will also help. Joints may be cut on the saw as illustrated in Fig. 3, or you can merely use plain, butt joints securely glued and nailed. The exposed ends and shelves of the cabinet should be made of fine cabinet wood such as walnut. Fig. 5 clearly shows how the assembly will look at this stage when glued together. Care must be taken

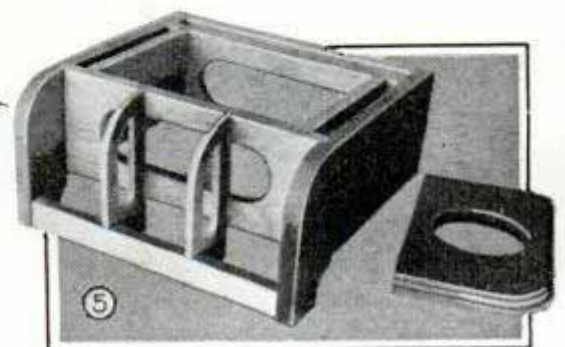
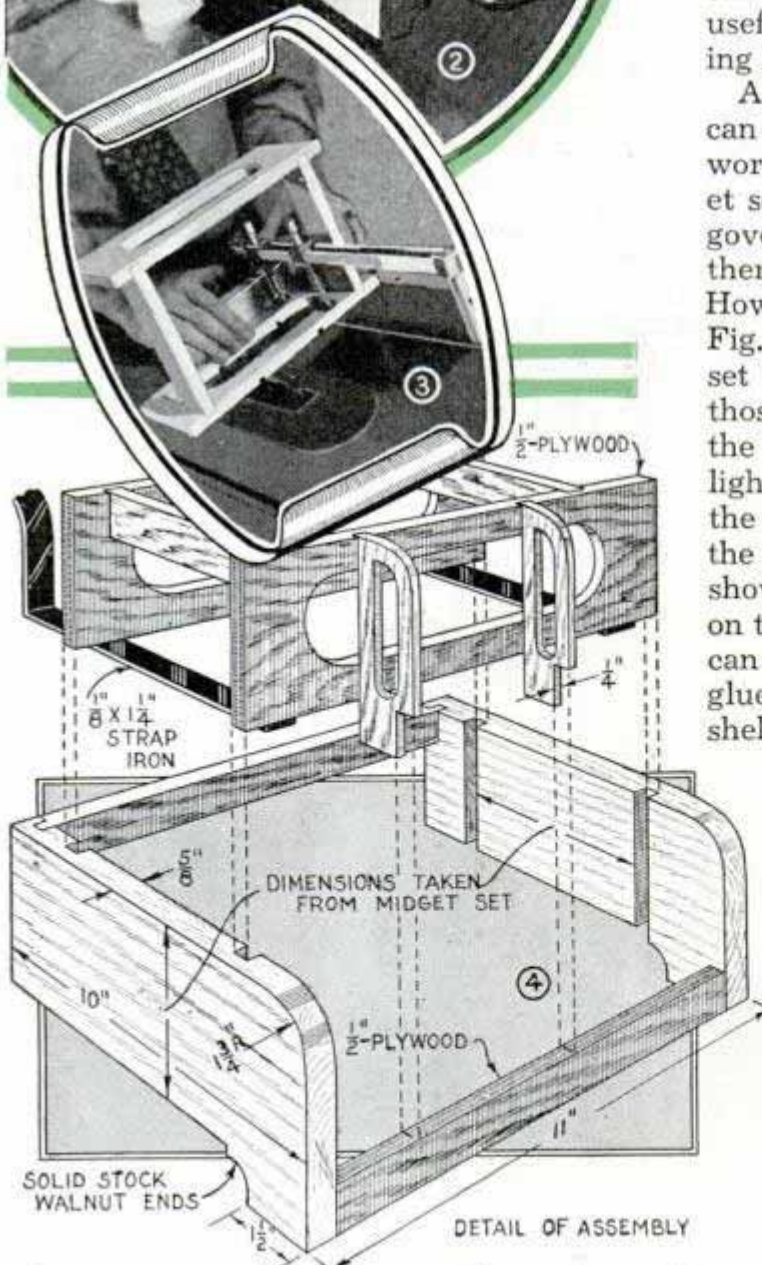



# for your MIDGET SET has built-in ash well and clock

to allow ample clearance in the frame so that the little receiver will slip in freely.

You are now ready to cover the top of the framework in the manner illustrated in Fig. 7. For this covering you will require a sheet of  $\frac{1}{20}$ -in. thick wood veneer. If you wish to finish this bone white, which contrasts nicely as shown in photo Fig. 6, a cheap grade of birch stock can be used for a paint job, or, if you prefer an all walnut finish, select a nicely grained piece of walnut veneer. Please note that the grain should run lengthwise so that the veneer will bend over easily at the front. The veneer sheet should be a little oversize so that it can be trimmed flush with the edges of the cabinet; the small grille slots must, of course, be cut before applying the veneer. Several clamps, or heavy weights, may be used to press it firmly while the glue is drying. When dry, the veneer covering the center well of the cabinet is cut out. The extending shelves which support the ash container and clock may be fastened in place with either short dowel pins or wood screws. If proper equipment is not available for shaping the outer

(Continued to page 138A)



ARM STRAPS HOOK  
UNDER LOWER RAIL

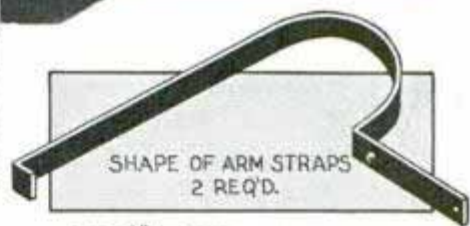

FOR  $3\frac{1}{2}$ "-ELECTRIC CLOCK MOVEMENT

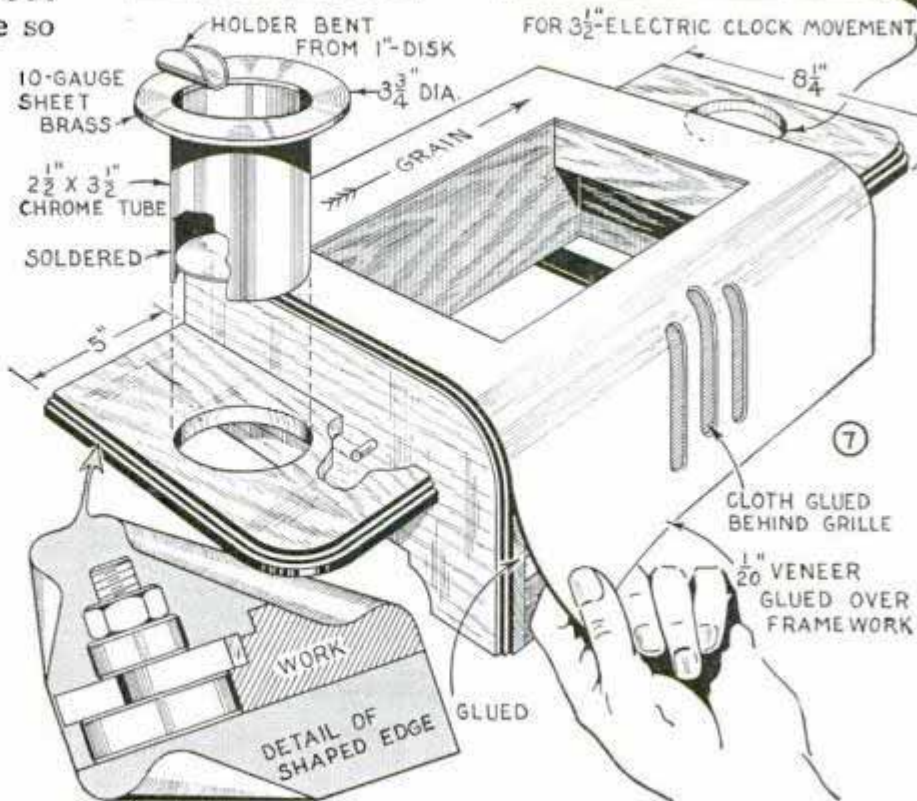



# Three-Unit Broadcast Receiver for Beginners

## PART II

**A**FTER completing the detector and audio-amplifier units described in the April issue, most builders will wish to add the r.f. amplifier unit which provides sharper tuning and extends the range to include distant stations.

No additional batteries are required to operate the r.f. stage to be described, and no changes are necessary in the wiring

of the first two units. This r.f. stage is merely connected to the unused clips that were wired into the detector circuit and arranged along the right-hand side of the base of that unit, as will be noted by referring to the simplified wiring diagram Fig. 2 in Part I. The antenna and ground wires are shifted from the detector unit to similar clips mounted on the r.f. unit base; short jumper wires are then used to connect all remaining clips on both stages.

A simplified wiring diagram of the r.f. amplifier appears in Fig. 5 and the schematic circuit diagram is given in Fig. 6. A type 1H5-G tube is also employed in this stage and the same kind of variable condenser as used in the detector. The panel and baseboard dimensions are identical with those given for the previous units. All wiring details are clearly shown in Fig. 5 and the parts should be arranged just as indicated, for best results. Care must be taken when soldering the leads to the prongs on the underside of the tube socket that each connection is made to the proper

(Continued to page 136A)

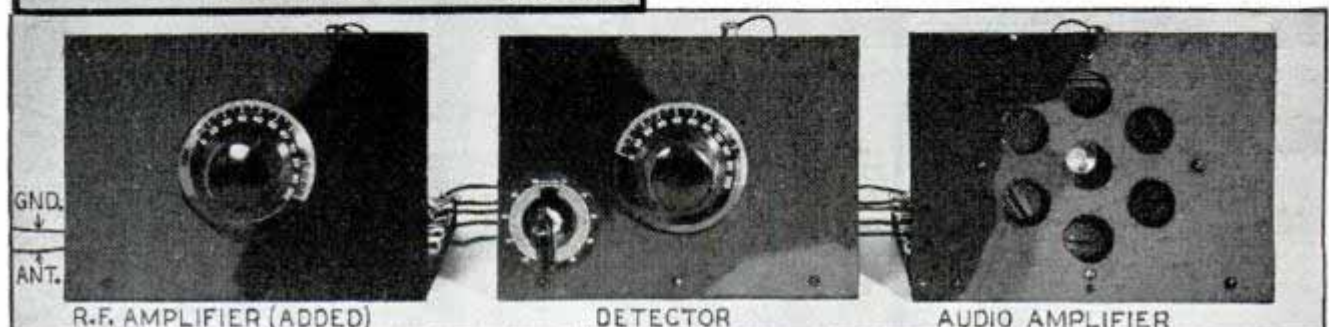
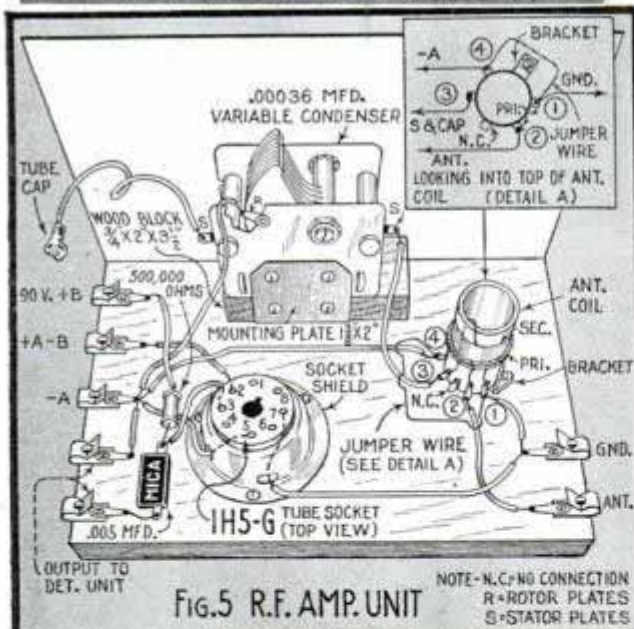
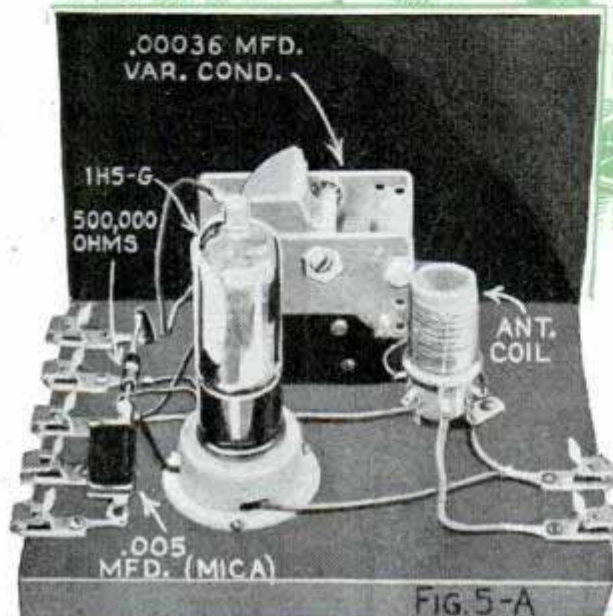



# PRACTICAL RADIO HINTS

Rod antenna eliminates all overhead wires, requires little space and is easy to erect. It may be attached to a vent pipe on the roof as illustrated in Fig. 1, or it can be mounted on a flat surface near a window in the manner shown in Fig. 3. A lightning arrester is built into the 3-section aluminum rod; the total length when assembled is 12 ft. All necessary parts are included in the kit which appears in photo Fig. 2. When mounted on the iron vent pipe no ground is necessary; if installed as shown in Fig. 3, a ground wire is employed

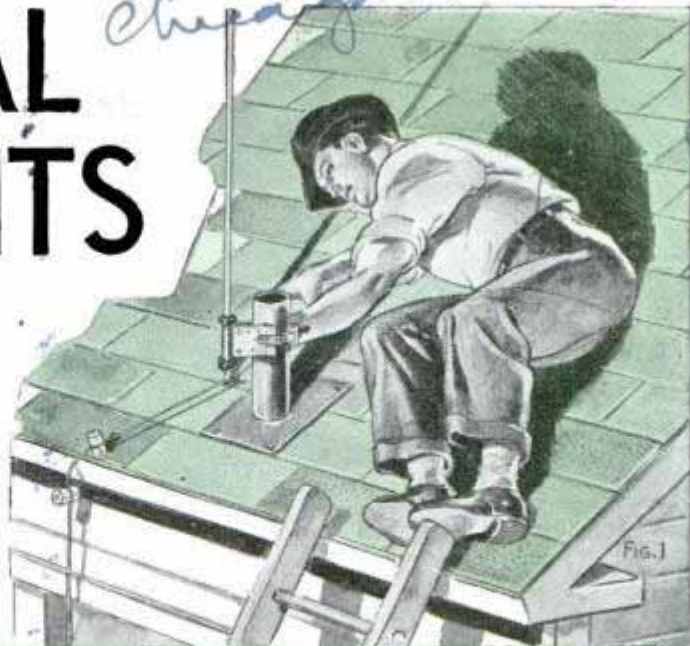

Fig. 1

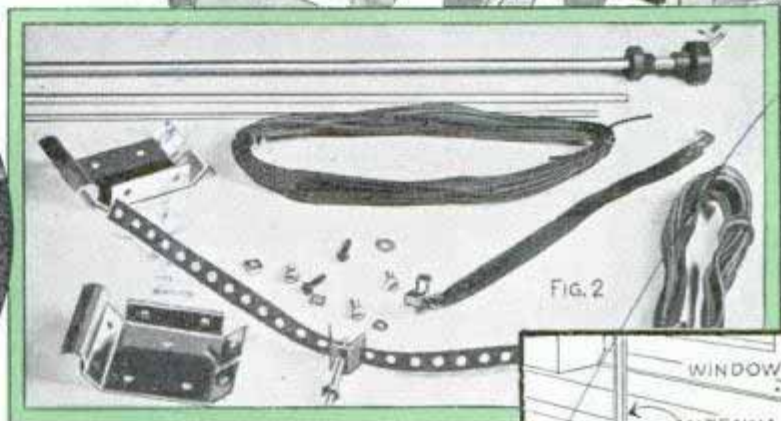
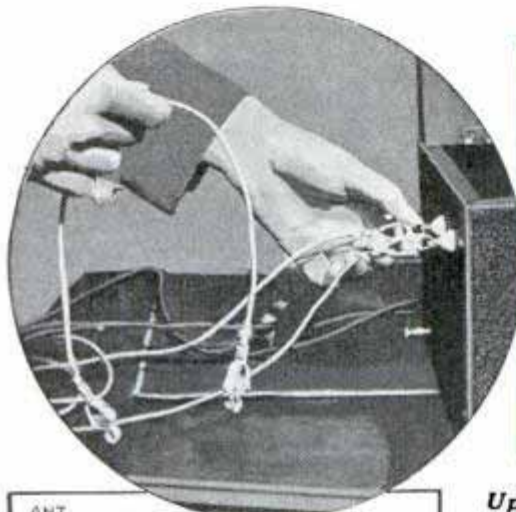

FIG. 2

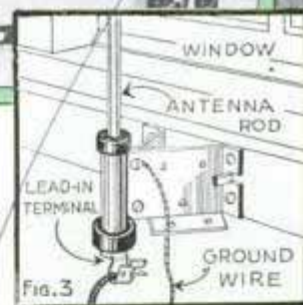

FIG. 3

Upper left, battery clips connected to short lengths of flexible rubber-covered wire save time and trouble at the radio workbench. Instead of soldering temporary leads, these connectors serve to add filter condensers in power supply unit, or make battery, antenna and similar connections

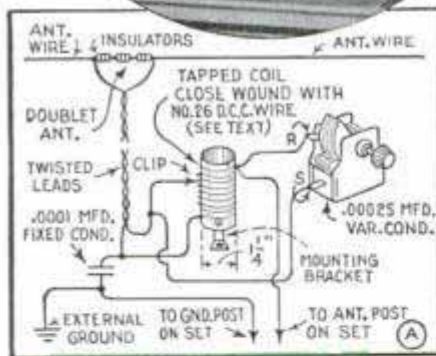

Diagram "A" shows method for using doublet antenna with older sets. Coil should have slightly fewer turns than first grid coil in receiver; taps along coil permit experimenting to find best reception point. Assemble parts on small board inside or outside cabinet

Below, "B," complete course of six radio code lessons now available on three records; "C," lever-action toggle switch for single or gang assembly; Right, long-life A-battery for 1.4-volt tubes



*21387*  
*Chicago*  
*Central Lab. Co. Keep 900 & Milwaukee W.*

*National Carbon Co.*  
*4800 N. New Blvd.*

*Ralston Record Co.*  
*5th St. & 1st Ave. St. Louis*



Radio Printer for Experimenters



You can assemble the printer section of this facsimile receiver from a kit listing for about \$49, and operate it with your own broadcast receiver, if you have one which has 5-watt output and automatic volume control. The standard wired model illustrated is mounted on a 7-tube receiver specially designed for switching quickly from sound programs to printed news and pictures. This set can be used to demonstrate facsimile printing from phonograph records with a suitable record player. At present thirteen stations are equipped to transmit experimental programs.

Sensitive Telephone-Type Relay

Speedy and highly sensitive, this compact d.c. relay is now available for experimental and educational applications in

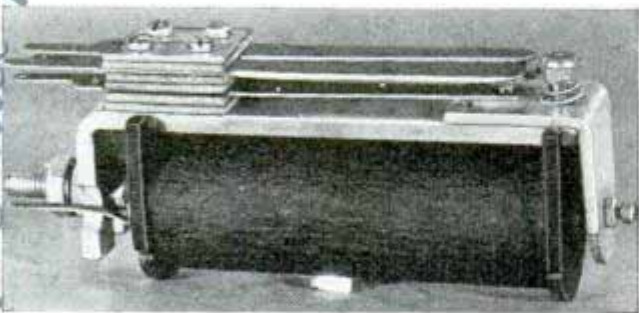

plate circuits of electronic tubes for remote-control, signaling, communication and similar uses.

Automatic A-B Power Supply

Working on a 6-volt storage battery, wind charger, or any 6-volt source of d.c. power, this unit operates directly and automatically by means of the switch on the front of your receiver. It replaces 2-volt dry or wet "A" batteries and all of the "B" batteries on 1 1/2 or 2-volt receivers.



Short-Wave Set Has Noise Limiter

This 12-tube receiver has a tuning range from 540 kilocycles to 31 megacycles, covered in 6 bands. Outstanding features include an efficient noise limiter which fol-

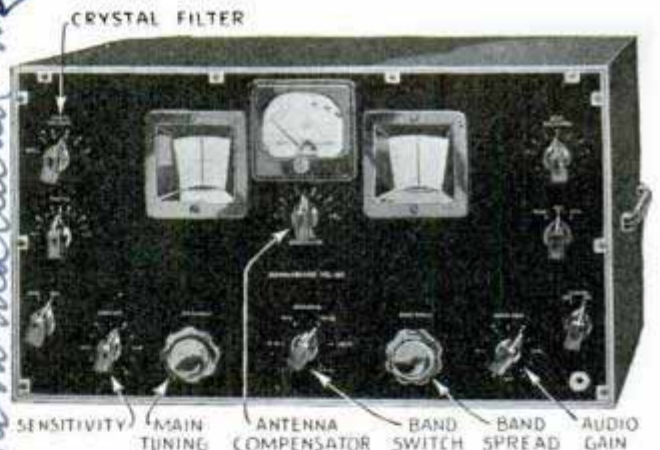

lows automatic volume control for quiet reception; antenna compensating control for maximum signal-to-noise ratio; 310 degrees band spread and crystal filter.

Blueprints covering radio construction articles in this and past issues are available for 25 cents each. Original material lists, with names of manufacturers and dealers, can be obtained from our Radio Department upon receipt of postage.

**NEXT MONTH—How to Build a Three-Tube A.C.-D.C. Pillow-Speaker Receiver.** A pillow-speaker unit takes the place of the usual loud speaker or head phones in this inexpensive little set which is designed for "quiet" or personal-receiver use in homes or hospitals. Also, **Portable Crystal Set That Fits Your Pocket**

Slayspiss Electrical Product Co. St. Paul, Minn.

Hammarlund Mfg. Co. 424 Alameda Way

Crosley Radio Mfg. Laboratories 349 W. Raymond Chicago





# Wheeled LOUNGE in the Garden



By R. DE WITT MILLER

WHEN you move outdoors on mild summer days this combination lounge and chair will provide just the sort of comfort you need for a period of relaxation in the garden or on the lawn. There's nothing fussy or difficult about the construction as you will see from Figs. 1, 2, 3 and 4. You

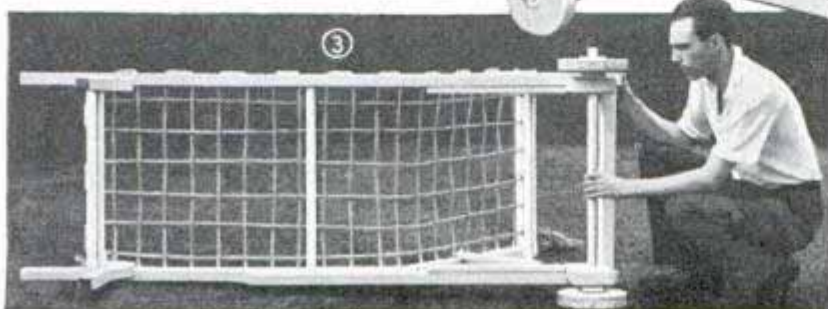

Rope "springs" and a day-bed or camp mattress make this garden lounge comfortable on summer days. It can be wheeled anywhere



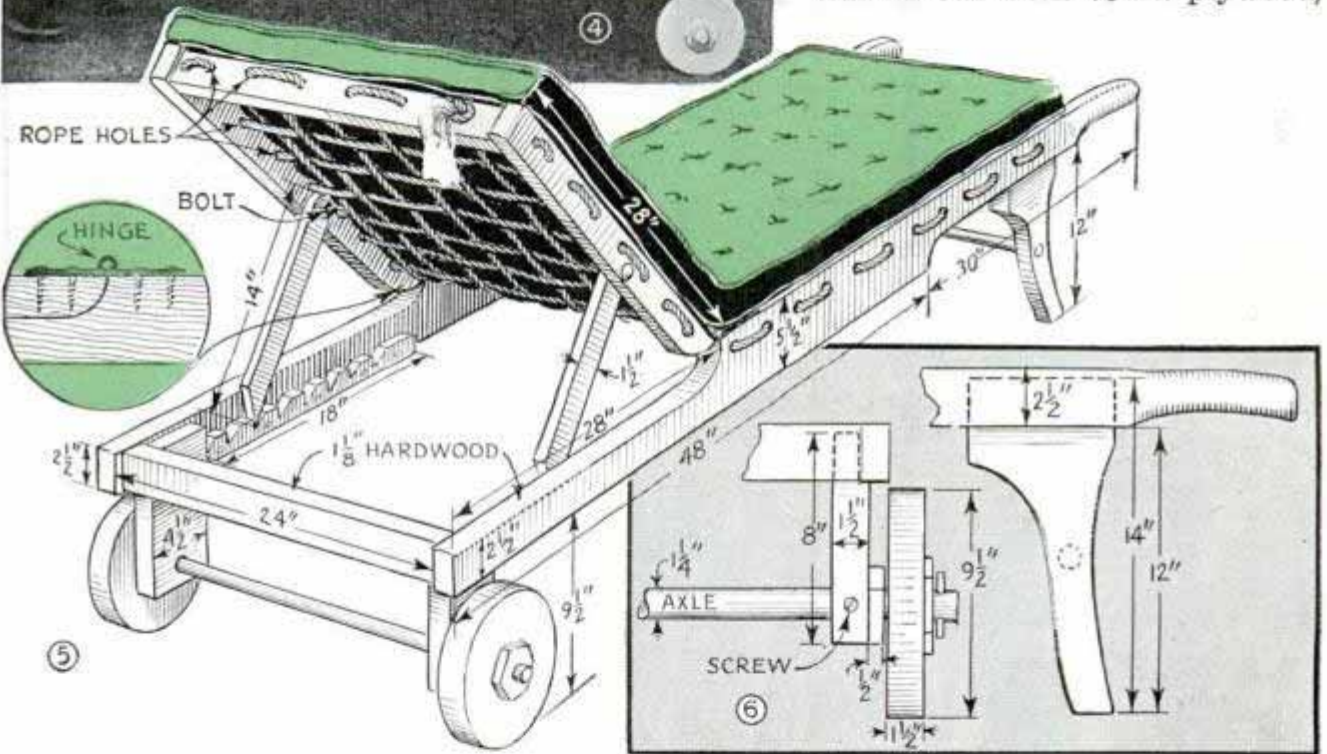

can make it in a few hours, ready for use.

The frame is made of  $1\frac{1}{8}$ -in. oak or other hardwood cut to the dimensions given in Figs. 5 and 6. Notice how duplicate cuts are made in the side members to form a handle at one end and the adjustable back at the other, Fig. 5. There are three cross members, all exactly the same length. The two joining the frame side members are  $2\frac{1}{2}$  in. wide, while the one joining the top of the adjustable back is only 2 in. wide. The wheels are simply disks cut from  $1\frac{1}{2}$ -in. hardwood. No need to be particular about the thickness, though, for  $1\frac{3}{4}$ -in. stock will do as well. Fig. 6 specifies a round hardwood rod  $1\frac{1}{4}$  in. in diameter for the axle, but, if you do not have a lathe, se-

lect a straight-grained dowel, 1 in. in diameter. The rising back is hinged to the frame with two strap hinges and supported by a rack-and-pawl arrangement made from hardwood scrap. Duplicate racks of suitable length are easily cut with a hand saw and screwed to the frame. The pawls which support the rising back are fastened to the side members with a small bolt as in Figs. 1 and 5.

Screws through the axle support into the axle prevent its turning and allow the wheels to run loose. A  $\frac{1}{4}$ -in. dowel and a round washer cut from  $\frac{1}{4}$ -in. plywood,

Fig. 6, hold the wheels in place on the axle.

Light rope or clothesline is laced through holes in the frame spaced 4 in. apart. This is drawn taut and secured at each end with a knot. The natural stretch of the rope will form a springy support for the cushion which can be either a day-bed or camp mattress of suitable size.

The finish of the frame can be most any color that suits your fancy. If you want the wood in the natural color, first sand all surfaces smooth and then apply two coats of spar varnish to protect against weathering. Or, if a colored enamel finish is desired, the wood should be sanded thoroughly and given a flat coat, followed by two coats of high-gloss enamel.



## Portable Hanger Fits over Door or Window

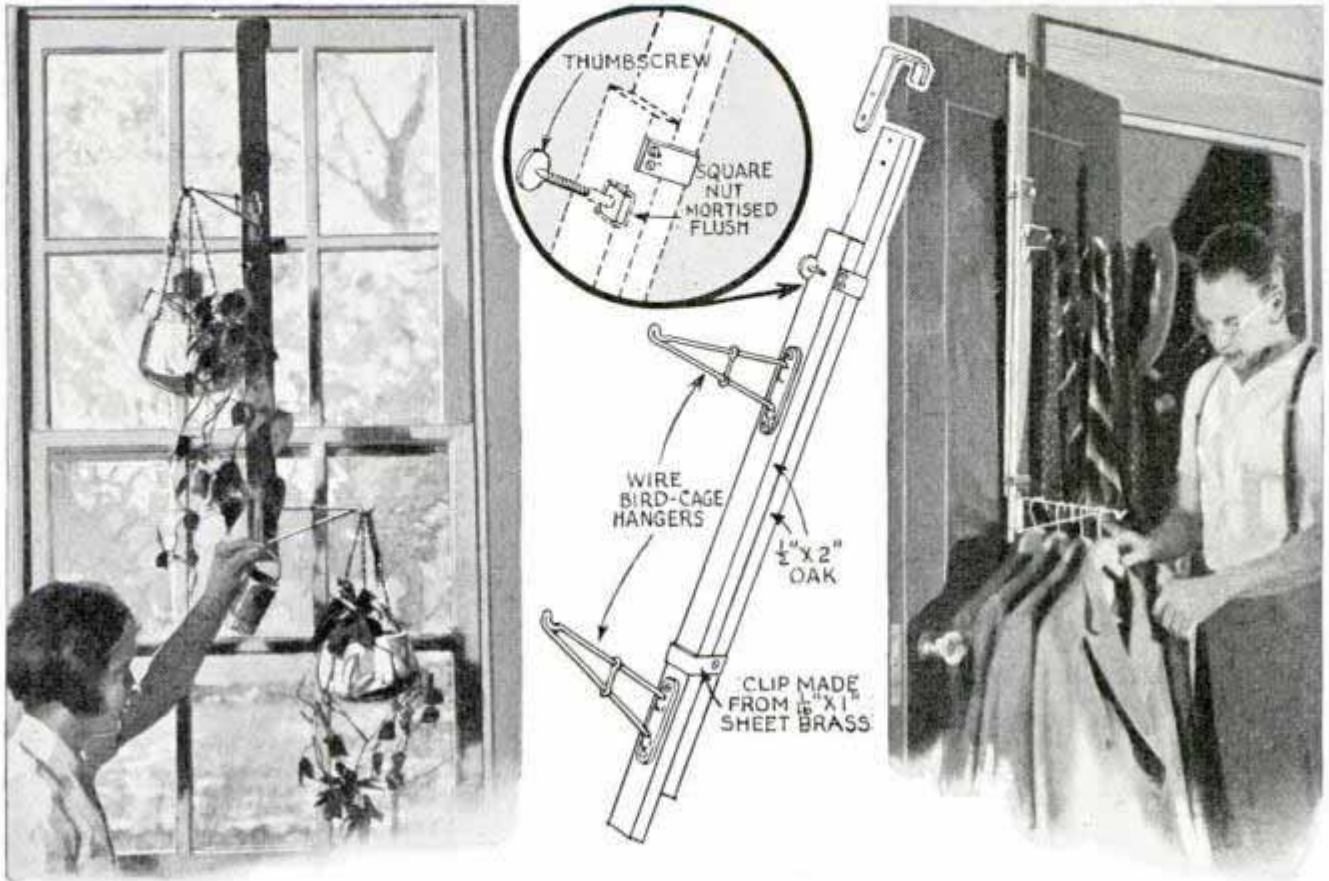

Here is an adjustable hanger that can be hung on the inside of a closet door to support clothing, as shown at the right, or it can be suspended from a window sash or frame to take hanging flowerpots, fish bowls, bird cages, etc. The hanger consists

of two strips of wood that slide in metal bands and can be locked together with a thumbscrew. Bird-cage hangers from which articles are suspended, are screwed to one of the strips, and a U-shaped hook is screwed to the other strip.

## Footrest on Lawn-Swing Platform Assures More Comfort

For adults who like to do reading, knitting, or some household jobs while sitting in a lawn swing, and find that the slatted platform is sometimes rather tiresome on the feet, more comfort can be assured by providing a simple footrest of the kind shown on the right. The rest consists of two triangular-shaped blocks to which suitable lengths of thin stock are nailed. If desired, corrugated sheet rubber can be cemented over the wood. Almost any method of rigidly bolting the footrest to the platform will do.



☐ By pressing your hand lightly around a can containing dog food or other semi-solid substances, such as cranberry sauce, salmon, etc., the contents usually will slip out intact.



## Alcohol Dissolves Rosin in Wood to Avoid Breaking Saw Blades

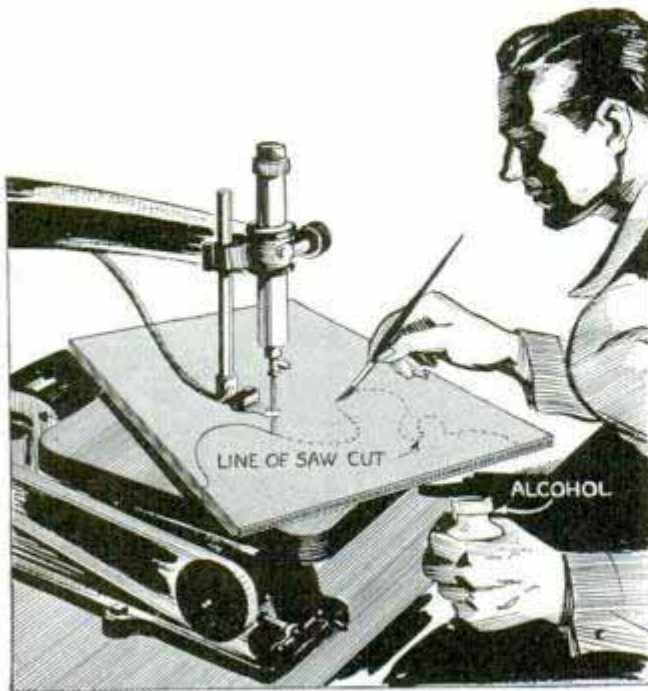

A home-workshop owner who had a number of very resinous plywood panels to cut on a scroll saw prevented sticking and breaking of the blades by first painting over the saw line on the wood with alcohol. This penetrated the wood quickly and cut the rosin under the heat of the blade. Each piece of the plywood was treated just before it was to be sawed, in order that none of the alcohol would be lost by evaporation.

## Making Hollow Plaster Casts Without Cores

One tradesman finds that it is unnecessary to use a core to produce hollow castings from plaster of paris. The trick is accomplished by first pouring a thin mix of the plaster into the mold, then closing the opening and shaking or rotating the mold so that the plaster is thrown into

contact with all surfaces. If mixed to the proper consistency, the plaster will cling to the inside of the mold, and set to produce a hollow casting.

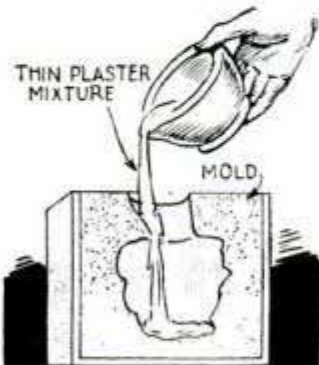

## Bicycle Handlebar Has Reflectors in Ends of Grips

One boy who used his bicycle at night put red reflectors in the rear ends of the handlebar grips in addition to a large one on the rear fender. As the handlebar is moved almost constantly to keep the bicycle balanced, the reflectors attract attention of motorists. To install the reflectors, the rear ends of the grips are cut out, leaving just enough rubber around the outside to serve as a retaining edge.



## Rubber Stirrups on Stilts Safe and Comfortable

Difficulty often encountered in making a pair of stilts is in providing stirrups that are safe and comfortable. Don't overlook



the possibilities of using old auto tires for the purpose. You can cut out pieces to the shape shown and nail them to the stilts.

☛ You will find that scissors are more efficient than a knife when removing seeds and pulp from peppers, especially when they are to be stuffed.



## Figure in Lamp Is Reflected under Soft Light

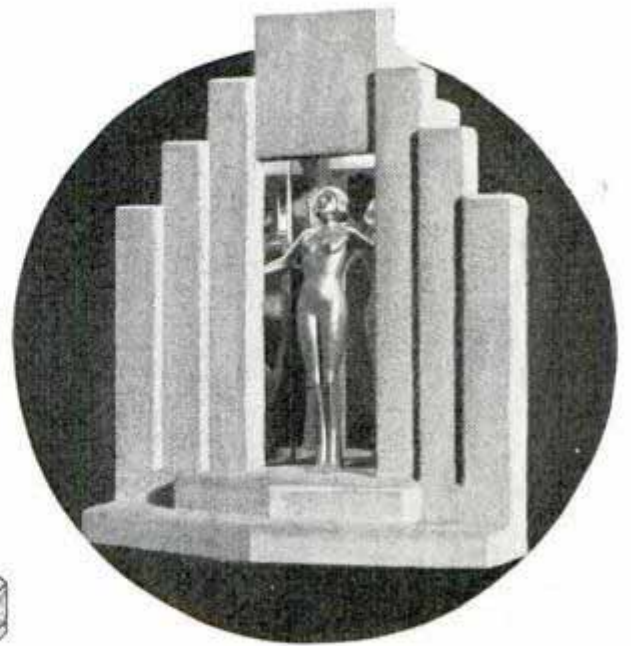
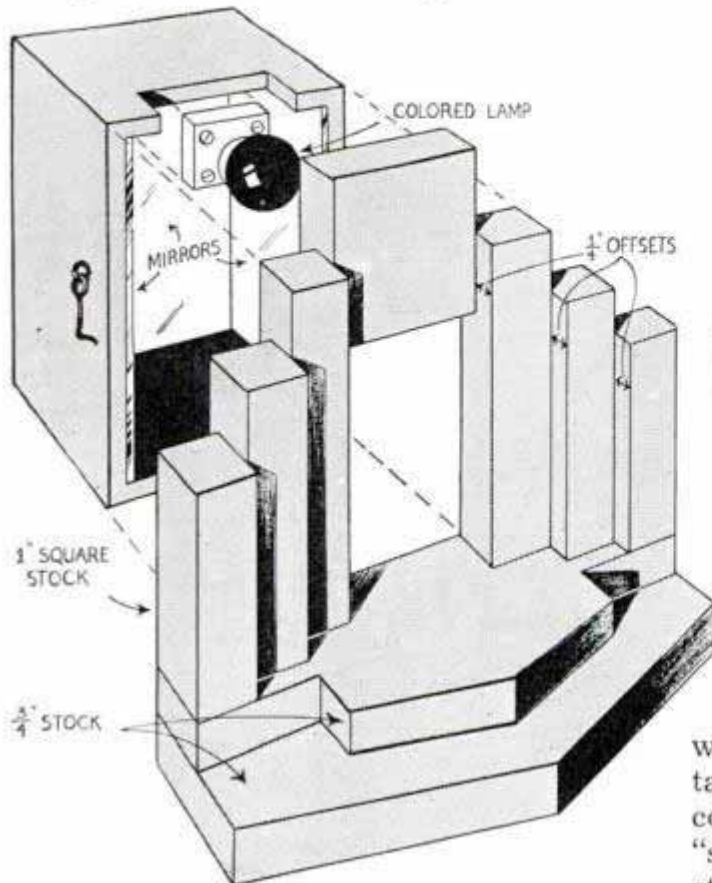

Charm and beauty of back-lighting and reflection, so popular in the newer public buildings, may be yours on a small scale in this ornamental radio lamp. The centerpiece is a chromium-plated radiator ornament or a pure white porcelain statuette of simple design. The stage is made of scrap

wood. Cover with clear varnish and when tacky sprinkle with "silver" sand, or, if a color is preferred, with sign-painters' "smalt," or with colored sand sold by toy stores for use in children's sand pens. The box behind the stage is lined with mirrors in which the centerpiece is reflected under colored illumination from a tiny lamp such as a 110-volt Christmas tree lamp, mounted overhead where it cannot be seen from the front.

—J. H. Dunnewin, Grand Rapids, Mich.

## Thumb Indexes on Reference Books Will Save User's Time

Anyone can cut thumb index notches with a  $\frac{1}{2}$ -in. inside-bevel chisel or gouge, so that phone directories and reference books frequently used, will be more convenient. A piece of thin plywood or hard-pressed board serves as a stop, this being inserted at the page where a tab is to be placed. Tabs can be lettered by hand or with a typewriter; they should be larger in size than the cut-out portions of the pages and are glued in position after all the cuts have been made.

—James R. Griffin, Corvallis, Ore.

☐ A curling iron is handy for stretching the fingers of gloves after washing them. Slip the iron in the finger and press the handles together to stretch the material.

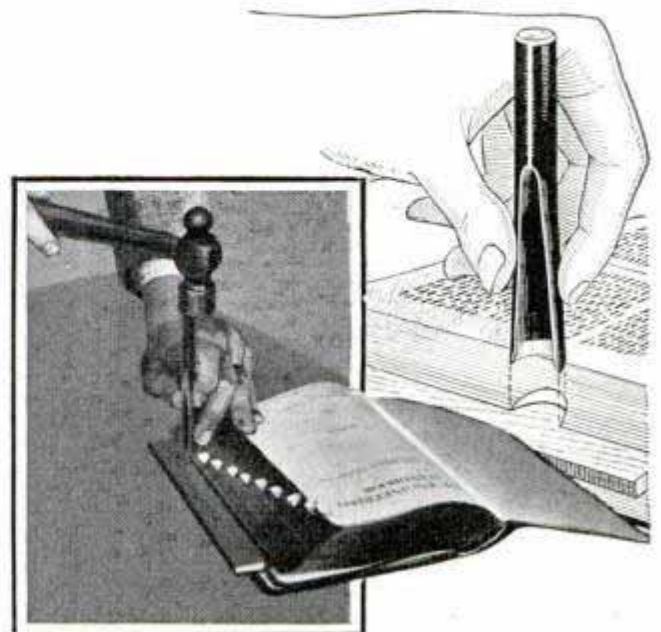







# with Woven-Splint Panels

MAKE ALL PIECES OF MAPLE FINISH IN WALNUT

ALL PIECES MADE WITH  $\frac{1}{2}$ " DOWEL ROD AT END

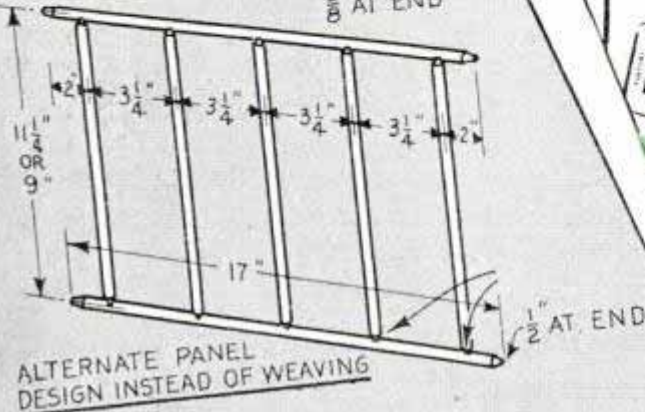

## MATERIAL LIST

- 2 Pcs.  $1\frac{1}{2}$  x  $1\frac{1}{2}$  x 20 in.—Vertical posts
- 4 Pcs.  $1\frac{1}{2}$  x  $1\frac{1}{2}$  x 16 in.—Corner posts
- 2 Pcs.  $1\frac{1}{4}$  x 3 x 15 in.—Base
- 1 Pc.  $\frac{3}{4}$  x  $8\frac{1}{2}$  x  $15\frac{3}{4}$  in.—Bottom
- 1 Pc.  $\frac{3}{4}$  x  $1\frac{1}{2}$  x 17 in.—Handle
- 6 Pcs.  $\frac{5}{8}$  x 17 in. dowel rod—Horizontal rails
- 4 Pcs.  $\frac{5}{8}$  x 9 in. dowel rod—Slant-side panels
- 2 Pcs.  $\frac{5}{8}$  x  $11\frac{1}{2}$  in. dowel rod—Vertical rails
- Ash splints or leather thongs for panels

ASH OR HICKORY SPLINTS OR LEATHER THONGS

HORIZONTAL RAIL

VERTICAL RAIL

THE LETTERED SPLINTS ARE ALL WRAPPED AROUND FIRST—THEN #1 IS WOVEN OVER TWO LETTERED SPLINTS THEN UNDER TWO, ETC. #2 IS OVER ONE THEN UNDER TWO ETC. AFTER COMPLETING FOUR, THE WEAVE STARTS OVER AS AT #1

DETAIL OF WEAVING

UNDER SIDE SAME AS TOP

Neat because of its graceful turnings and unusual woven ash or hickory-splint panels, this magazine basket is also sturdy and will withstand long usage. It holds about thirty average size magazines in a convenient position for easy removal. A handle on the center panel provides ease in carrying. If desired, leather thongs may be used for the woven panels instead of the wood splints

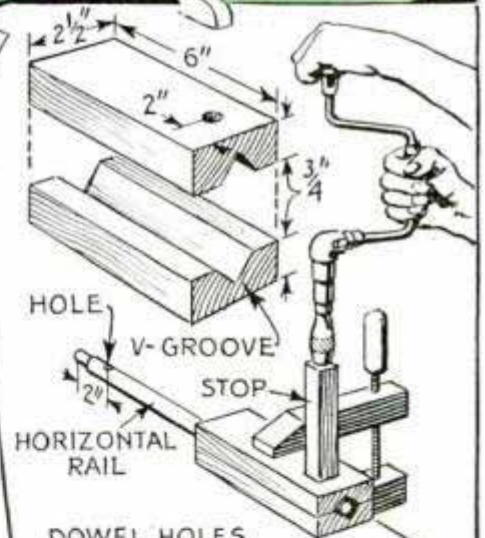

DOWEL HOLES IN THE HORIZONTAL RAILS ARE BORED IN A JIG

SPOKE SHAVE

HANDLE

HANDLE IS SHAPED WITH A SPOKE SHAVE AND SANDPAPER





## This Improved "Camp Stove" Smothers the Fire



To avoid starting forest fires by careless handling of a campfire, one sportsman recommends this stove for campers who stay only a short time in one place. It consists of two or more iron rods supported on rolls of sod, which are turned back to provide a bare spot for the fire. When finished with the fire, the rods are removed and the sod is rolled back into place, covering the coals and effectually smothering all flames or sparks that may remain.

## Installing Leather Pump Valves

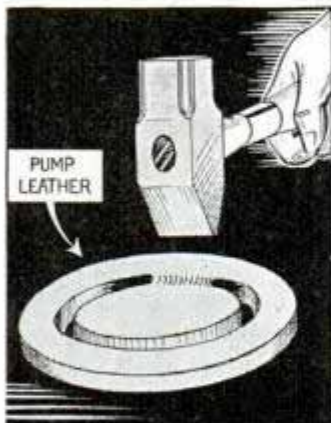

When installing leather pump valves, some workmen score the hinge section with a sharp knife so that it will work efficiently from the beginning with the result that sand works into the score and the valve wears rapidly at this point. A better way is to dent the hinge portion with a hammer, which softens the leather so that the valve works freely without leaving a crevice where sand can enter.

## Forms to Glue Curved Work

Gluing together a number of narrow strips to produce a curved surface is done easily and accurately by using forms of the type shown. Use hardwood and band-saw them to the desired curve, leaving shoulders at each end. Then joint the edges of the strips at a slight bevel to suit the curve, apply the glue and lay strips in the forms. Wedges driven between the outside strips and the shoulders of the forms force all of the strips tightly together.—John E. Hyler, Peoria, Ill.

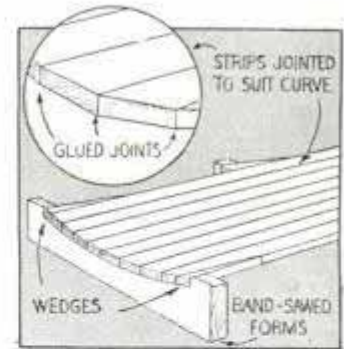

## Drawing Board Hinged to Wall Adjusted by Drawer Pull

Any amateur draftsman who works at home and has a drawing board hinged to a



wall to save space will find that a drawer pull, attached as indicated, will provide a slot to support the leg of the board and hold it at the proper working angle.

☞ If you want wild ferns to grow in your garden, plant them in plenty of black soil in which they grew in the woods.







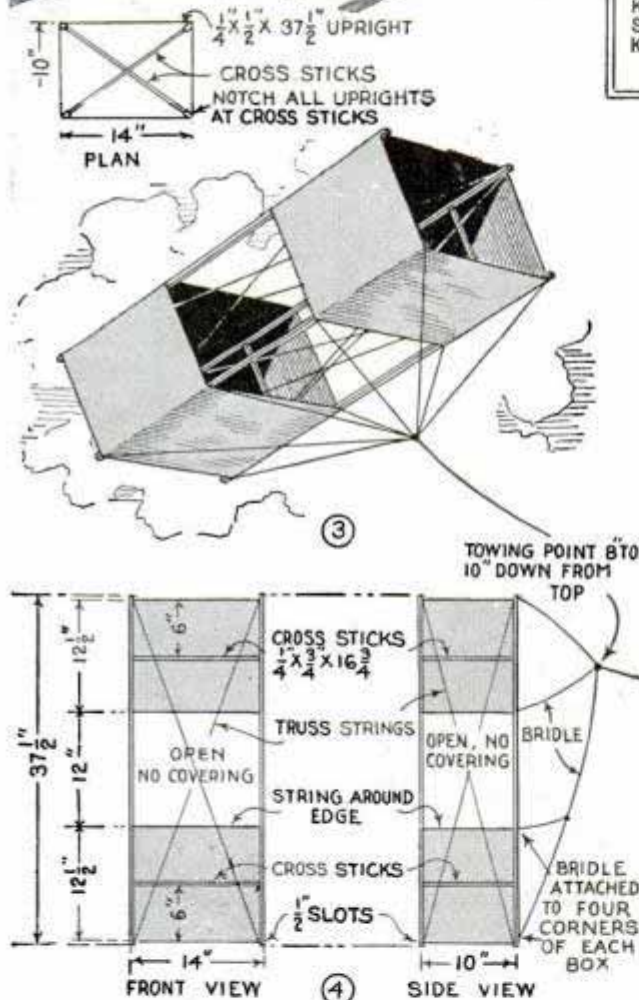
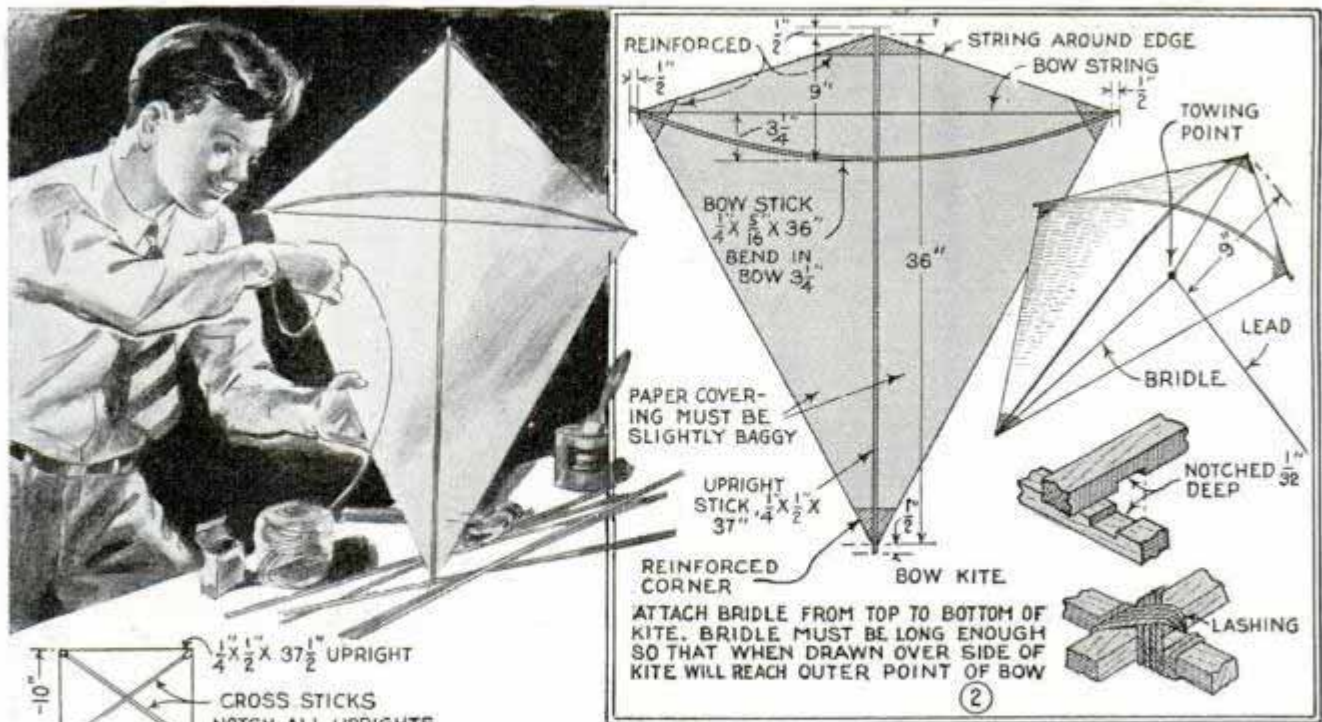

triangular shaped assembly. When dry, run a string around the inner edges of the triangles to support the covering and, then brace them with several cross strings stretched on each side. Parchment or heavy-grade kite paper is the best covering material. Cellophane can be used also.

Cover the three sides of the two triangles and fold and glue the edges of the paper over the string. The covering of the

lower triangle is made  $\frac{1}{2}$  in. wider than that on the upper one. This is done to correct balancing. The capacity of the wing surface should be smaller than the surface covering of the triangle. This prevents the kite from diving. The ends and center, you will notice, are left open. The wings are covered next, turning and gluing the edges over the strings as before. Do not pull the covering tight, but allow it to bag slightly to catch all the air currents. Protect the corners of the wings by reinforcing with an extra covering of paper. The bridle should be attached to the top and run to a point two-thirds the way down. The towing point should be 4 to 6 in. from the top.

The simplicity of the bow kite, shown in Fig. 2, makes it very easy to construct. Here a cross strip, bowed  $3\frac{1}{4}$  in. with a cord stretched through slots made in the ends, is notched  $\frac{1}{32}$  in. at midpoint as shown, to fit a similar notch cut in a center upright. When these two are joined a string is run around the outside of the kite and then the covering is applied as before.

To make the box kite in Fig. 3, four slotted uprights of identical size are assembled into two pairs of corresponding units by notched cross sticks. The units are joined then, into box-shape, and truss strings are stretched from the corner slots to keep it rigid and straight. The paper covering is made  $\frac{1}{2}$  in. wider on the lower box than on the upper. The towing point should equal the length of the kite.



## Dropping Parachutes Adds Zest to Kite Flying

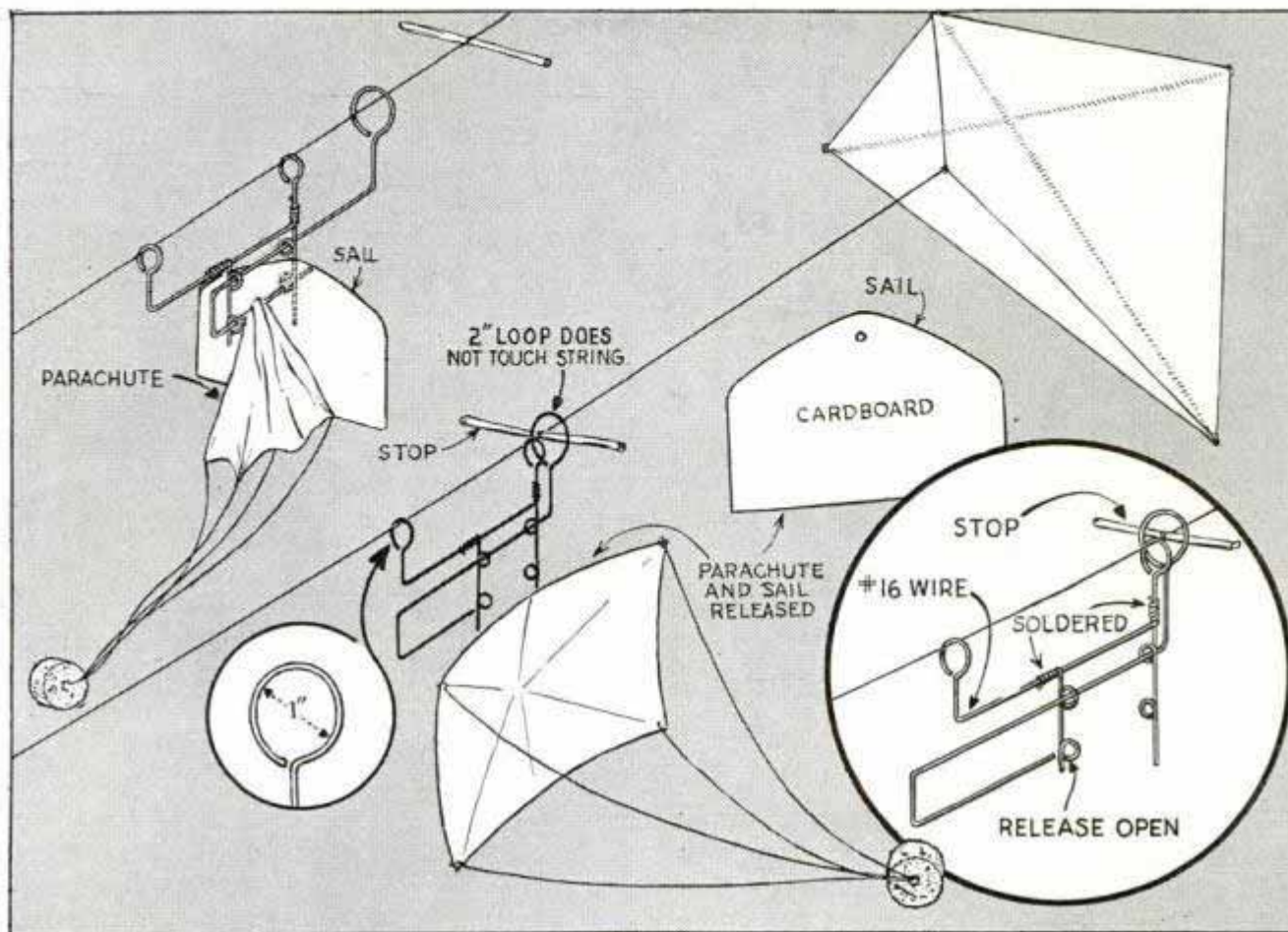

Parachutes carried up to a lofty kite and automatically released when the carrier hits a cross stick tied in the kite line, will keep up a lively interest. The carrier must be lightweight and there should be very little friction on the line so that ascent of the carrier will not be impeded. A cardboard sail and a parachute are held on a sliding member, which is pushed back when it strikes the cross stick, releasing

both sail and parachute. By carefully going over all of the details you will readily see how the releasing device works. While you can make it from aluminum wire, if readily available, ordinary No. 16-gauge iron wire should not be too heavy. Be sure that the sliding parts work easily yet will not shift without the proper impulse. You will have to experiment with the sail to get a cardboard of the proper size.

## Sun Deck on Garage Reached by Novel Corner Ladder

Easy access to the top of a flat-roof garage, which was utilized by children as a sun deck, was made possible by means of an improvised ladder consisting of 14-in. lengths of 1-in. dowel stuck through holes bored in the corner as shown. A small nail was driven into each dowel to keep it in position. This was found much safer than a separate ladder and also much neater in appearance. If at any time the dowel corner ladder would fall into disuse, it would serve nicely as a corner trellis for climbing vines and flowers.

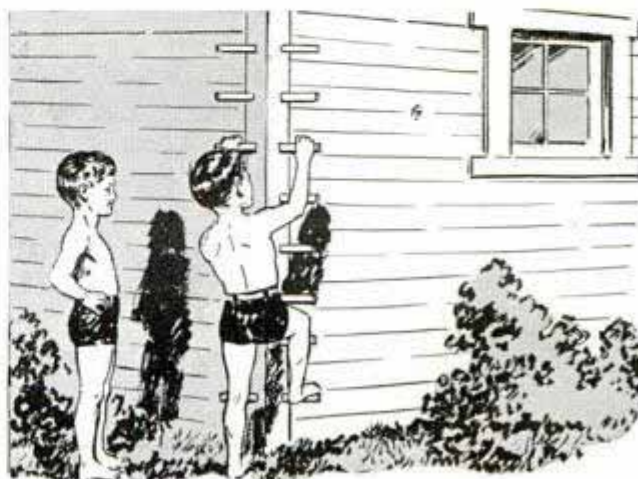



## Small Purse in Bather's Headband Holds Valuables

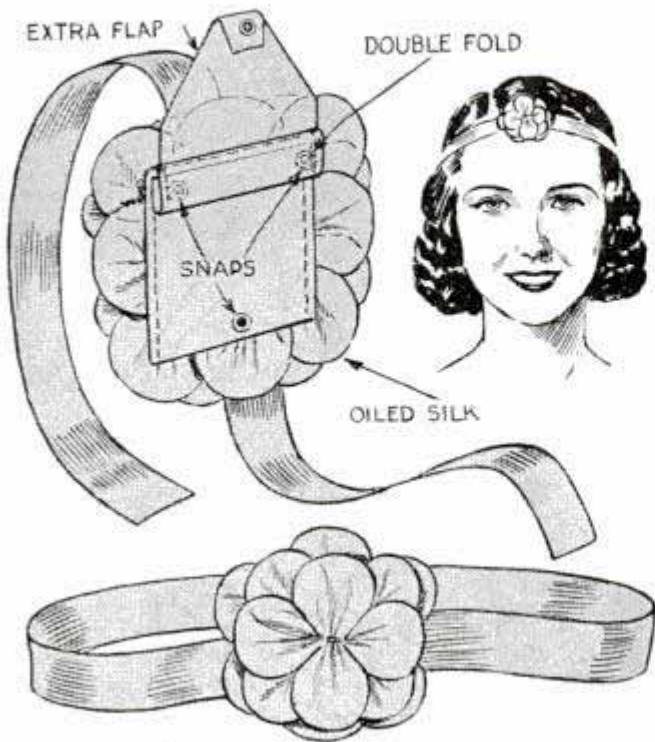

This ornamental flower headband, made of oiled silk, has a purse on the back to hold a bather's coins, keys and other valuables. The petals of the flower are 3 by 1½-in. strips, cut round at the ends and gathered and sewed together at the center with thread or yarn of contrasting color. The purse is a 2 by 5-in. strip of material, folded about ½ in. beyond the center and sewed at the sides to the flower. The flap is folded over and is fastened in place with small snaps. An extra flap, over the first one, may also be provided. A narrow strip of material for the headband is then slipped between the flower and the purse.

## Clamping Miter Box in Vise

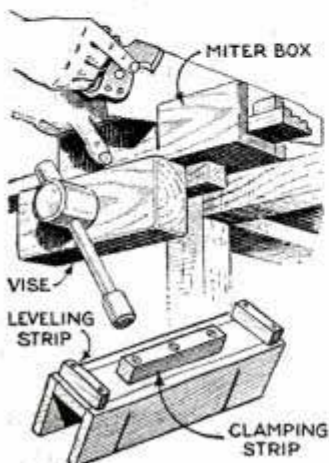

By screwing a hardwood strip to the bottom of your miter box, it can be clamped rigidly in a vise where it is at the right working height, making it unnecessary to clear off space on the bench. Two strips of the stock, the

same thickness as the clamping block, can be screwed across the ends of the box to keep it level when you want to use it on top of the bench.

## Pigeonholes of Desk Notched to Remove Papers Easily

Notches cut in the front edge of pigeonholes of a desk permit you to remove papers and envelopes easily. The cutting can be done with a coping saw or a sharp knife.

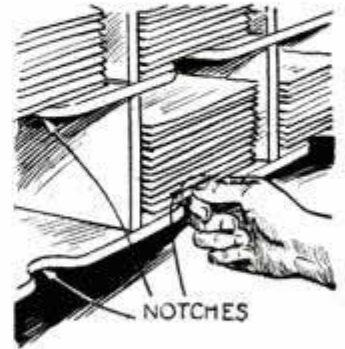

## Low-Voltage Wires Held Neatly by Corrugated Paper

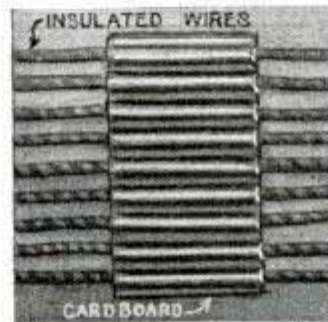

In model and experimental work where insulated bell wire carrying low voltages is used for temporary circuits, strips of corrugated paper provide handy clips

or brackets for fastening the wire. The paper is especially handy where the use of staples is objectionable. Just glue the strips in place and thread the wires through the corrugations.

## Rubber Holders to Store Skates

Your skates will be well protected against nicking if you store them in these holders, which are nailed to the wall. Cut off two suitable lengths of auto casing and nail wood disks into the lower ends.

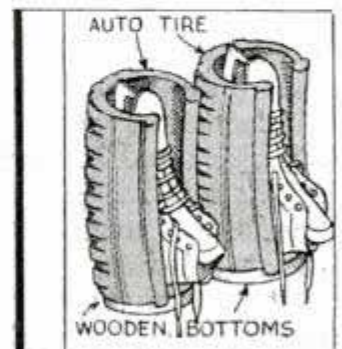

☞ To blow large soap bubbles, add a little glycerin to warm, soapy water.



# 3 *Smart* BENCHES



*Finished in bone-white and black, and neatly upholstered, these distinctive benches for the home consist almost entirely of plywood. Magazine baskets and book racks are incorporated in two designs*



By WAYNE C. LECKEY

**S**IMPLE upholstery makes any one of these benches easy to construct in your home workshop. The one shown in Fig. 2, is, perhaps, the least difficult of the three since the construction centers around a simple, box-like framework of plywood. Fig. 6, gives full dimensions for this and assembly is made with plain, butt joints glued and nailed. The corners may be glued-blocked also, although the top when nailed in place provides great rigidity. Support through the center is made with a cross-piece of scrap stock. After the glue has dried, a rabbet is cut around the entire top edge as shown in the detail. This can be cut easily with a dado head either before or after the top is fitted. Putty all exposed nail heads at the corners and sand the end grain smoothly prior to the application of three successive coats of bone-white enamel, rubbed lightly between coats with fine steel wool.

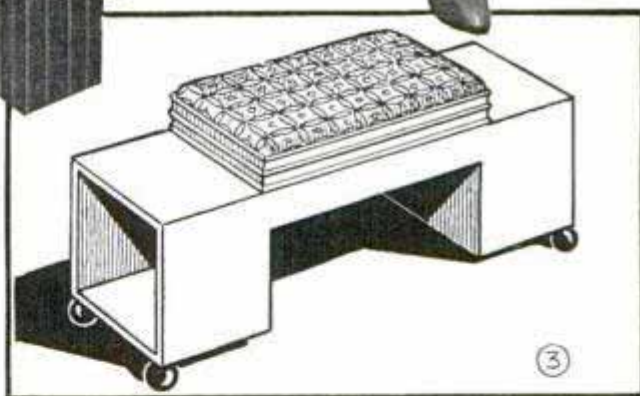

While this is drying you can cut the legs to size. These were made of walnut stock to contrast with the white finish but if you wish, they can be made of cheaper wood and stained to give a very close imitation. Note that the legs must be made in pairs when laying out the stock. Inverting the pattern will minimize waste. When cut, respective pieces are glued and nailed together to form a right angle, using clamps, if available, to draw the joints tight. The nail heads are sunk well beneath the surface so as not to interfere with fluting. The top and bottom edges are then chamfered





45 degrees as shown. If a molding head to make a cove cut is available, you can flute the legs quickly on the circular saw as shown in Fig. 4. Here the cuts are made on the face, working each way from the corner of the work. If it is necessary to cut these by hand, with straight-grain stock you can easily guide a 1-in. gouge along a straightedge clamped in position on the work as in Fig. 5. Use a large dowel or roundnose block wrapped with sandpaper to smooth up the cuts. The legs when finished are attached 2 in. down from the top with four 1-in. screws driven from the back.

To upholster the top, it is necessary to first form a roll edge around the top to retain the filling. For this you will need a long strip of burlap cut  $4\frac{1}{2}$  in. wide. With a pencil line drawn around the top  $\frac{3}{4}$  in. in from the edge, begin tacking one edge of the strip along this line, using No. 2 tacks. Next add sufficient tow to form a  $1\frac{1}{4}$ -in. diameter roll and tack as in the detail, Fig. 6. Firmness of the roll can be had by stuffing with additional tow, using a long, slender screwdriver as a regulator. Use plenty of tow to fill the top within the roll edge, over which place several thick layers of cotton. As no welt is used on this bench, the cover is applied evenly by first tacking one edge

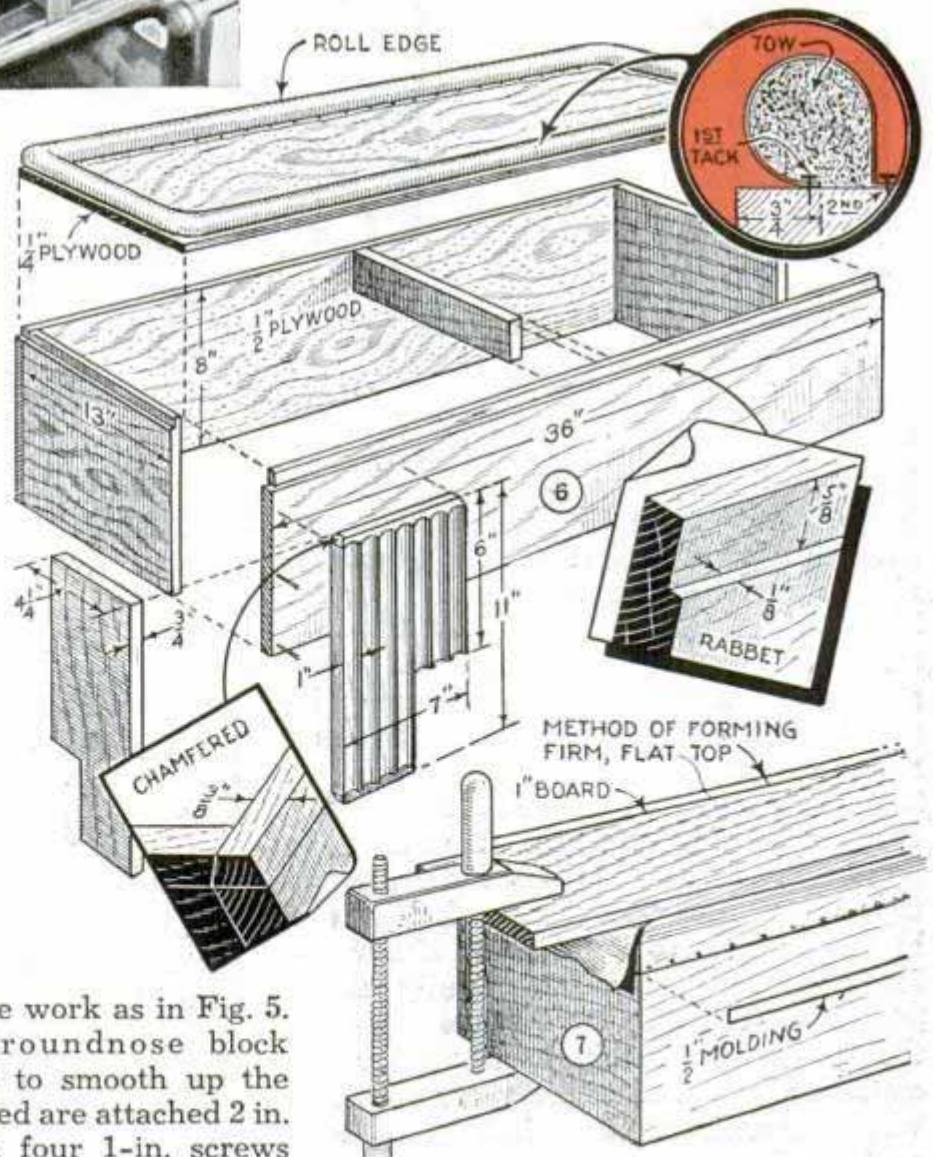



straight along the rabbet cut, after which the opposite edge is drawn fairly taut and tacked temporarily in place. A wide board placed on top of the cover as in Fig. 7, and pulled down with a clamp at each end, will allow you to tack the loose edge evenly and permanently. When the clamps are removed, the filling will expand, producing a firm, flat seat which will hold its shape. Strips of 1/2-in. aluminum molding, mitered at the corners, conceal the tack heads.

The attractive bench shown in Fig. 1,

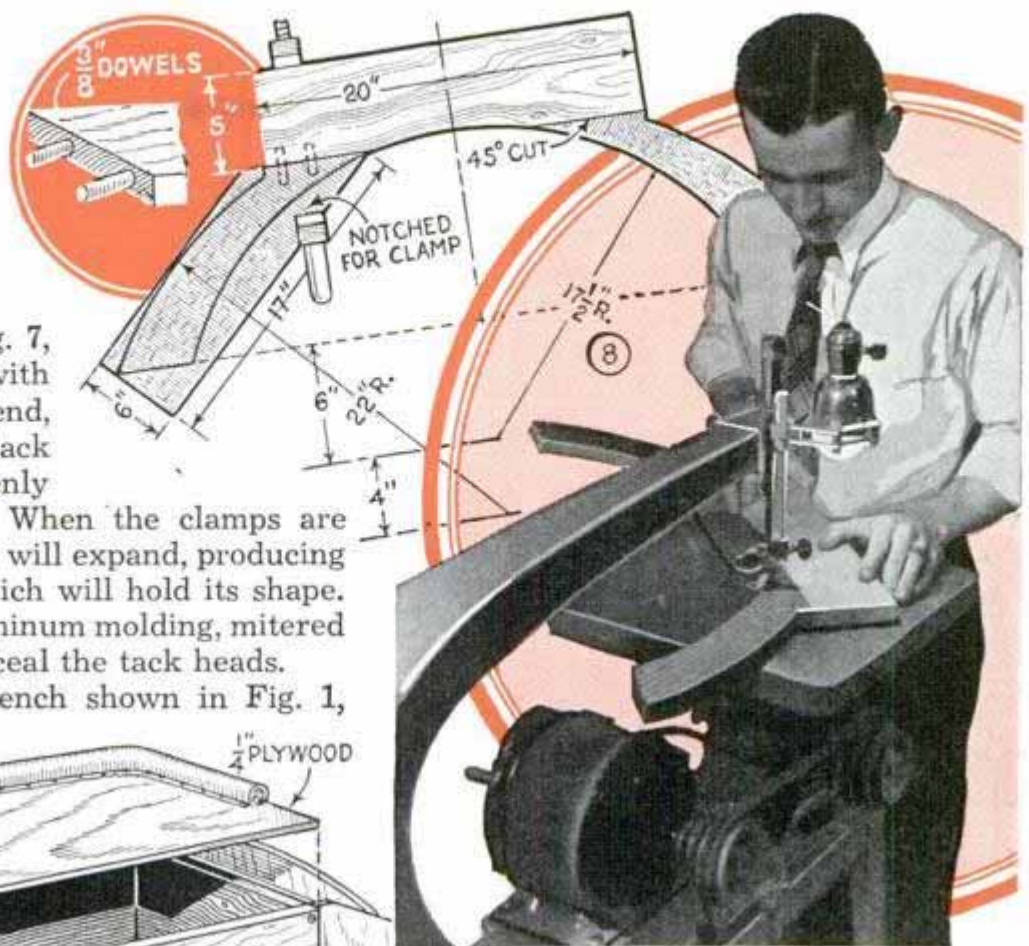
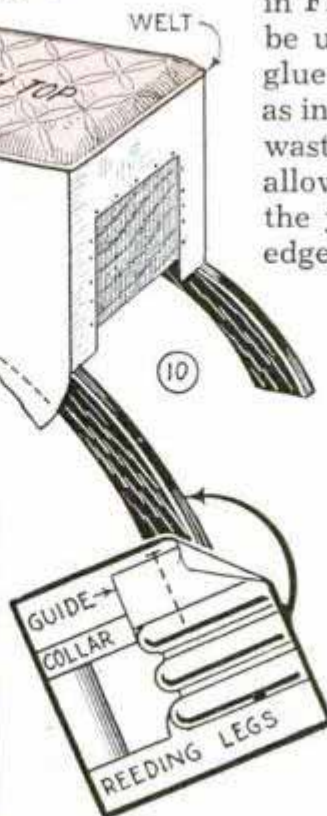
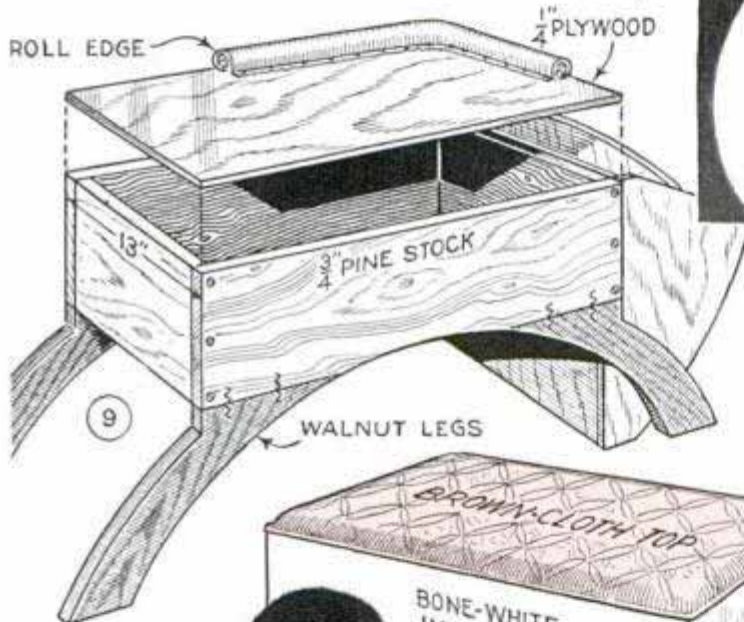

provides extra utility by having magazine containers at each end. The arched legs which continue into the frame are of walnut, joined at 45 degrees to a 5-in. pine board as shown in Figs. 8 and 9. Dowels may be used here as in Fig. 8, or glue and corrugated fasteners as in Fig. 9. A notch cut in the waste portion of the legs will allow a handscrew to draw the joint up tightly. The top edges of the legs may be left plain or if a shaper is available, you can reed the outer radius with three 1/4-in. beads as shown in the insert in Fig. 10. In this case a template of scrap wood, identical in contour, must be tacked temporarily to the face of the legs against which the spindle collar of the shaper can ride. Therefore, cut the outer radius first so that you will have



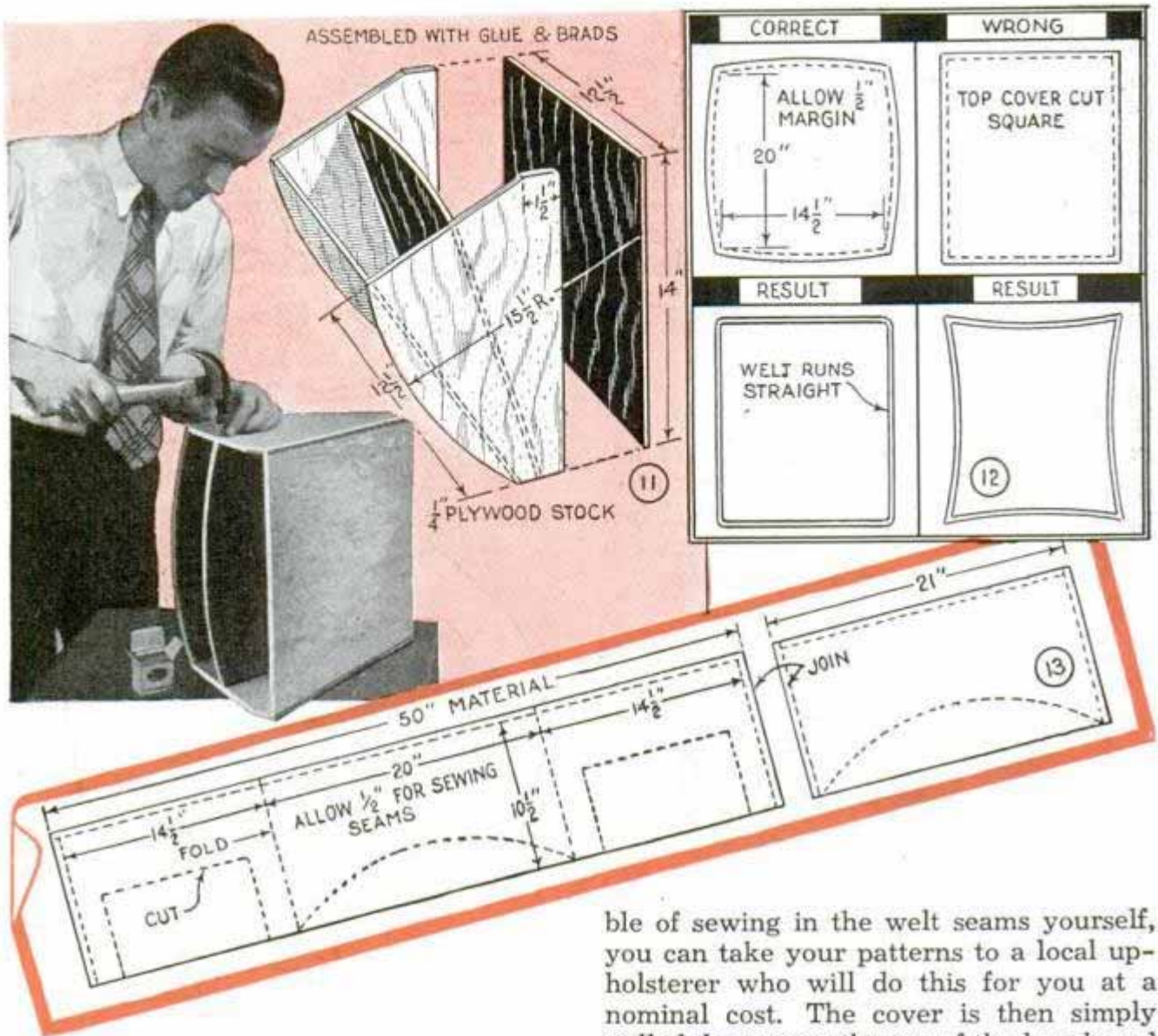

waste in which to tack the template. The sides are then joined together with pieces butted, glued and screwed at the ends, Fig. 9, after which, a plywood panel is nailed to the top. For a pleasing contrast, select a dark brown modern cloth for the top of the cover and imitation, bone-white leather for the sides. A roll edge is formed as previously described and filled with tow and cotton. From here on the procedure varies somewhat in that a muslin cover is tacked smoothly over the filling to allow the final cover to be slipped on without disturbing the padding. Fig. 12 gives the correct size and method for cutting the top cover, allowing  $\frac{1}{2}$  in. additional for sewing in the welt. Cut the edge slightly curved rather than straight. Fig. 13 shows how the side cover can be laid out on just about the minimum of material. This necessitates joining one side cover which will bring a seam at two corners. If you are not capa-

ble of sewing in the welt seams yourself, you can take your patterns to a local upholsterer who will do this for you at a nominal cost. The cover is then simply pulled down over the top of the bench and tacked as in Fig. 10. The magazine pockets which fit between the legs are constructed of  $\frac{1}{4}$ -in. plywood and assembled with  $\frac{3}{4}$ -in. brads and glue, Fig. 11. Since the bench depends almost entirely upon these pockets for support, attach them solidly in place with screws. To avoid marring the paint while inserting them between the legs, spread the lower ends of the legs with a stretcher.

Also serving a two-fold purpose is the bench shown in Fig. 3, and fully dimensioned in Figs. 14, 15 and 16. As you will note, the construction is entirely of plywood, employing simple butt joints glued and nailed. Waste from the side pieces can be utilized for inner members. A rectangular frame of  $\frac{3}{4}$ -in. pine surmounts the center of the bench to which is nailed a top panel of  $\frac{1}{4}$ -in. plywood. Upholstery procedure is the same as before, tacking the sides of the cover as shown in Fig. 14. A



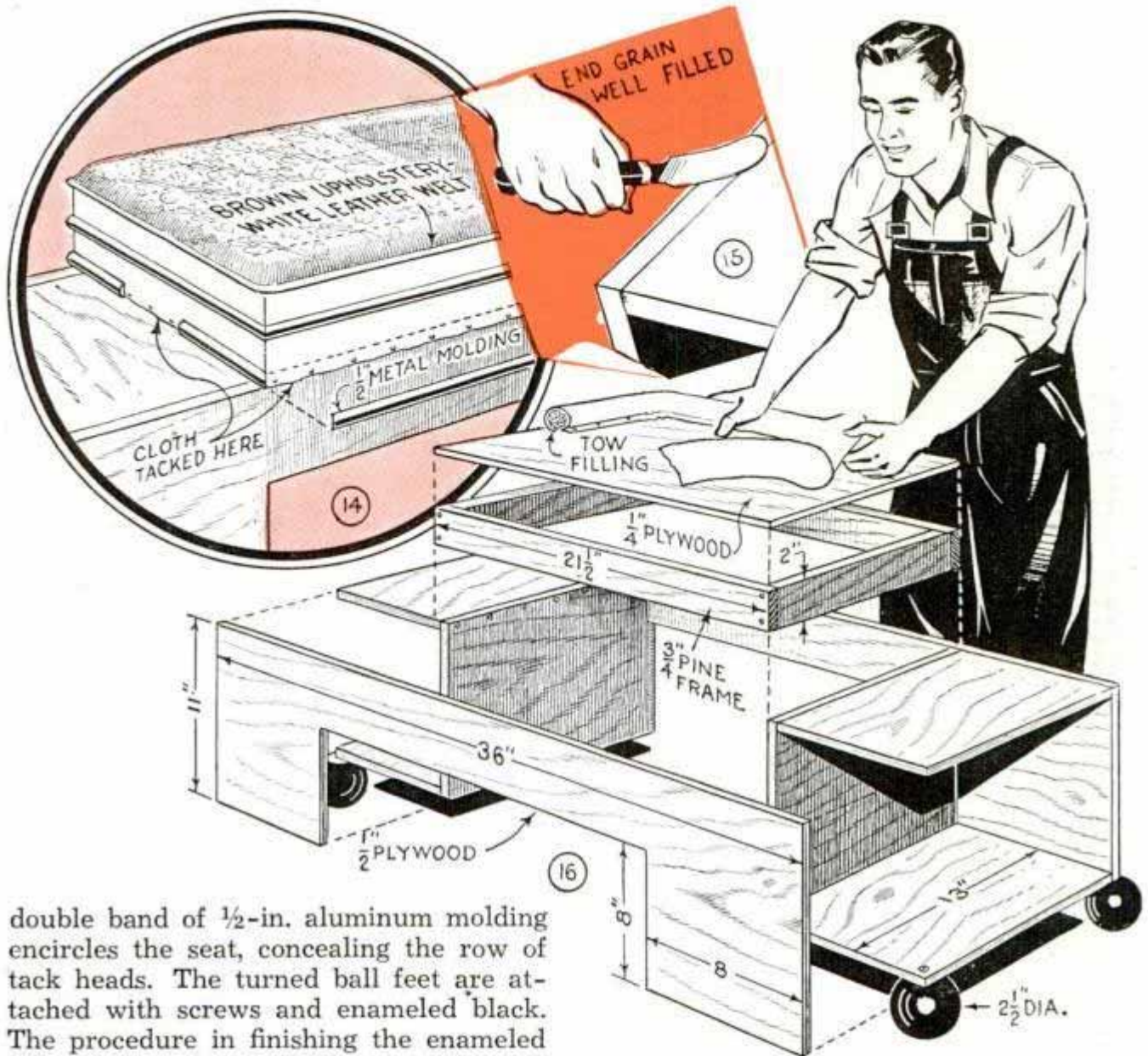

double band of  $\frac{1}{2}$ -in. aluminum molding encircles the seat, concealing the row of tack heads. The turned ball feet are attached with screws and enameled black. The procedure in finishing the enameled parts of all three benches begins with carefully filling all exposed end grain of the plywood. White-lead paste is excellent for this but it is necessary to give it plenty of time to dry. Wood putty will do, but it must be carefully sanded flush with the surface. It is important to sand all parts smooth with progressively finer grade of

sandpaper before applying the enamel undercoater. Be sure to allow the undercoater to dry thoroughly. Follow this with three coats of good quality bone-white enamel, sanding lightly after the first and second coats with very fine sandpaper.

BALL FEET ATTACHED WITH SCREWS

## Cardboard 'Focusing Cloth' Helps Get Sharp Photographs

This cardboard "focusing cloth" is especially useful on shots made without a tripod. The image is focused sharply, the plate holder inserted, and the picture then composed in the finder. The large end is the same size as the camera's ground glass and the small end  $2\frac{1}{2}$  in. wide. Use sturdy cardboard and paint the inside black.

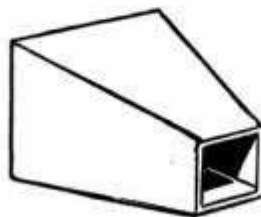



## Ladder Jacks Improvised Quickly from Wood and Rope

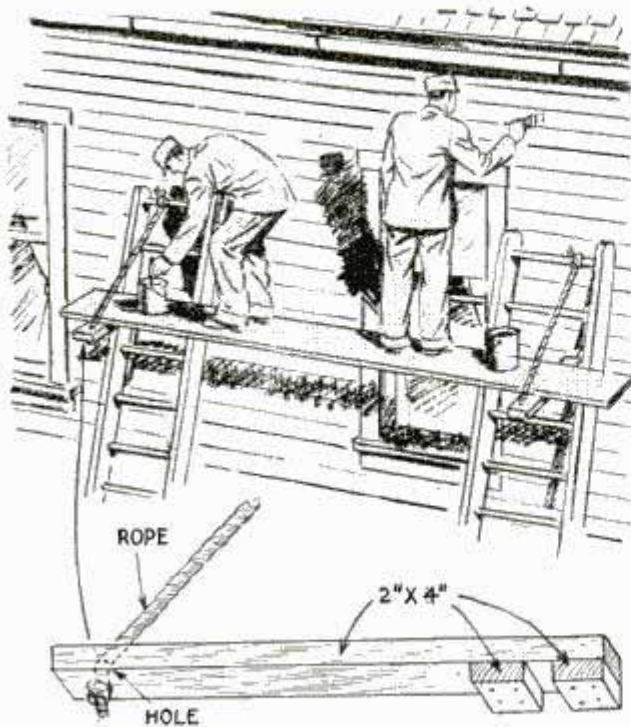

A pair of ladder jacks are improvised easily from two lengths of 2 by 4-in. stock and some rope. Drill the stock at one end to take the rope, which is knotted on the underside to keep it from slipping through the hole. Then nail wood blocks at the other end as indicated, spacing them to straddle the ladder rungs.

—Bill Ball, Bellingham, Wash.

## Easy Method of Fastening Screens and Storm Sash

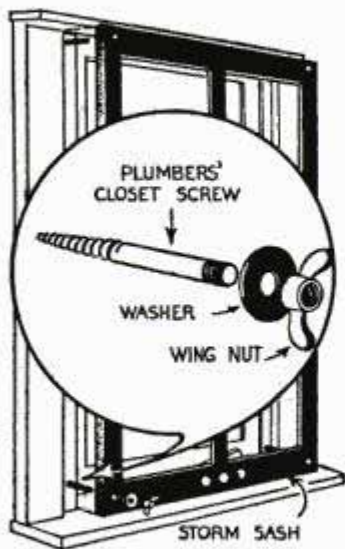

The semi-annual changing of screens and storm sash can be simplified by fastening them to the window casings with plumbers' closet screws, which are bronze wood screws with a machine threaded end in place of a head. The screws also make

it possible to pull up the sash tightly at any point desired. Once installed, and the screen and sash frames bored to slip over

them, the screws need not be removed. Regular nuts can be used to hold the screens in place, although wing nuts are handier. Washers can be used to take up the difference in thickness between the sash and screen frames.

—Elwyn Tabbutt, Augusta, Me.

## Rubber Strips on Loose Oars Prevent Loss or Twisting

To allow sufficient flexibility of your boat oars and at the same time keep them from twisting easily in your hands, cut two strips of rubber from an inner tube, perforate the ends to fit them

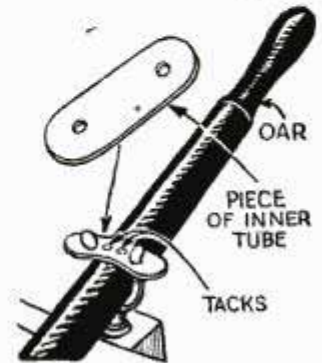

snugly over the lock, and tack the strips onto the oars at the desired point. These detachable fasteners will also help prevent the oars from being lost overboard.

—G. E. Hendrickson, Argyle, Wis.

## Ball-Bearing Rollers for Doors

Rollers for sliding doors can be had inexpensively by utilizing ball-bearing assemblies from differentials and rear axles of junked cars. The doors are suspended from the bearings by lengths of flat iron,

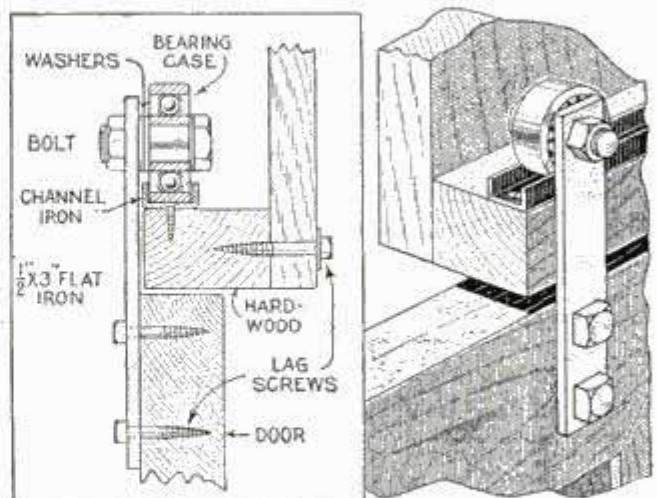

as shown in the detail, using channel iron as a track. This is screwed to a hardwood strip, which is in turn fastened to the wall above the doorway by means of lag screws.

—C. H. Myers, Galesburg, Ill.



# GARDEN NOVELTIES

... in wood and brick

This imitation well and "old oaken bucket" makes an interesting feature in your garden, and is just the thing for a corner where nothing seems to fit in, especially when the structure is weather-stained and rock plants are established in the brick parapet. Or, a windmill of the novel design shown below, which projects above shrubbery instead of being perched on the peak of the garage, is colorful and sure to attract attention

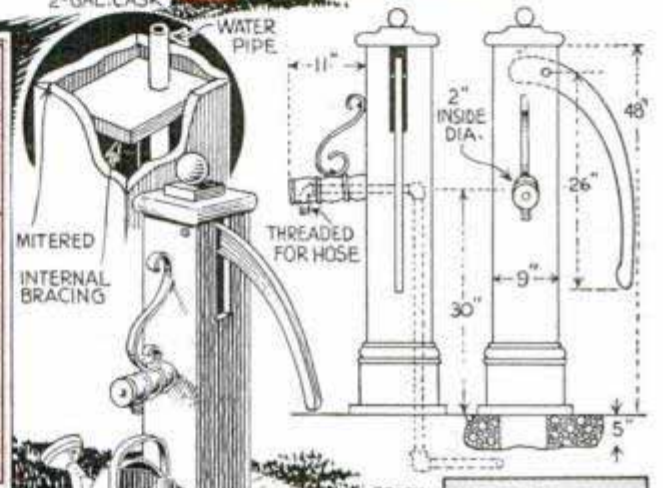
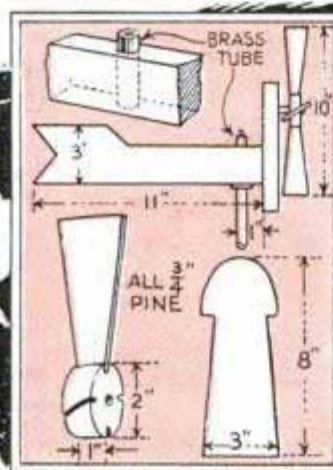
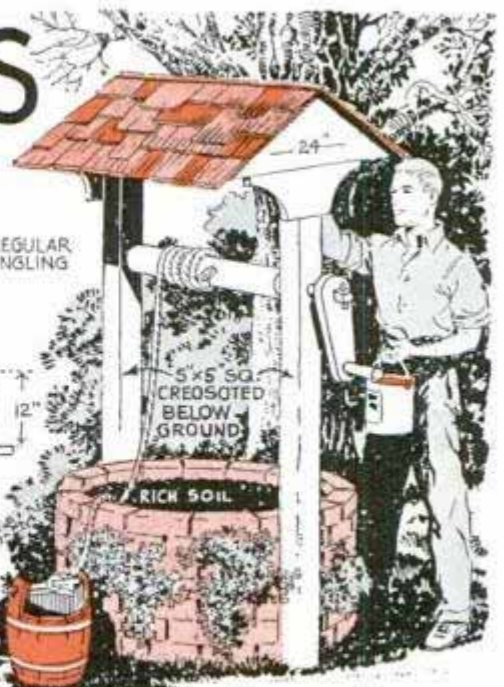
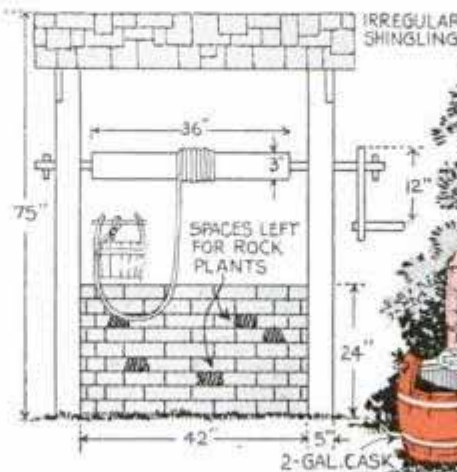

As picturesque as its counterpart of a generation ago, the pump at the right never needs priming; just raise the handle and water flows out the spout. It is connected to the home water supply and the handle operates the valve. If you would rather not connect it permanently with pipe, use a length of garden hose. The "water-dome" fountain below includes a pool lined with waterproof cement, and is built of brick on a concrete base

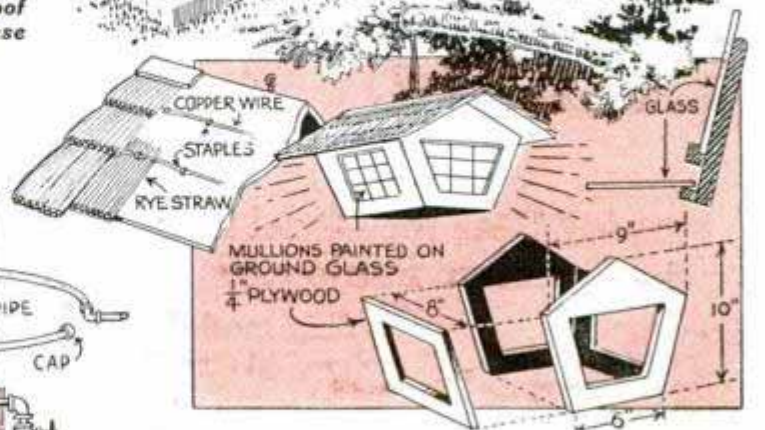
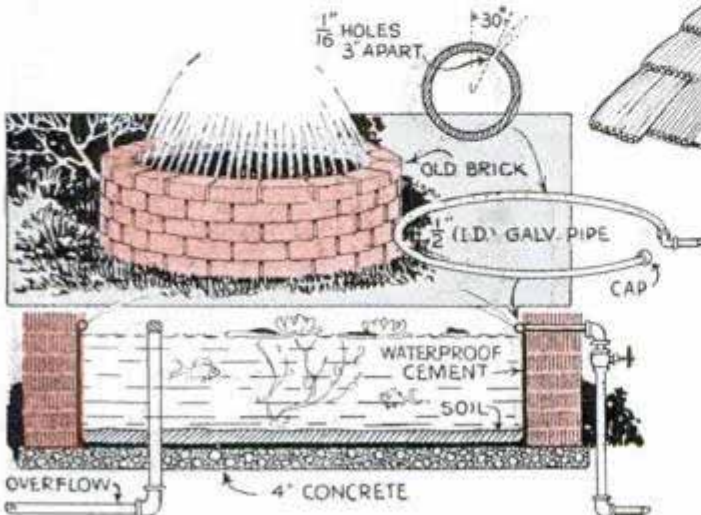

Stained to obtain a weathered effect, this hanging garden lamp, which resembles a miniature cottage, has a thatched roof and ground-glass windows



## Compact Bed or Beach Table Can Be Folded for Storage

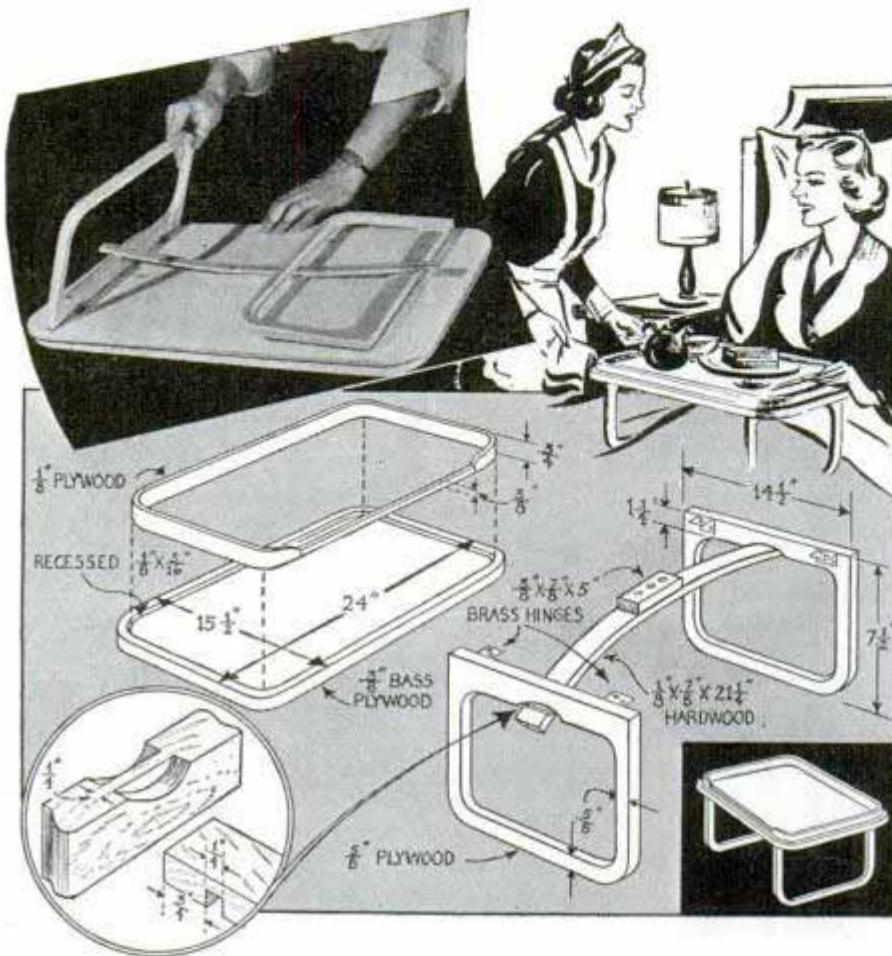

Assembled from plywood, this little table is light and sturdy, and the legs fold inward so that it takes little space when stored. It has a thin rim around three sides to keep dishes from slipping off the top, which is recessed near the edges to take the rim. A thin strip of hardwood screwed to the center of the table top on the underside is notched near the end to slip into notches in the legs and keep them opened as shown in the circular detail. The spring action of the wood strip also keeps the legs in position when they are folded.

—Frank Skalla, Niles, Mich.

## Steering Gear for Model Ship Made from Banjo Key

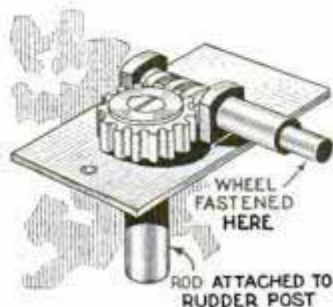

Ship modelers who want a realistic steering gear for a sailing ship will find that a tightening key from an old banjo serves the purpose

nicely. If one is not at hand, it can be purchased for a few cents. Generally, the keys are made up in sets, but it is a simple matter to divide the strip on which they are mounted. By removing the finger piece or handle and substituting a ship's wheel, and by extending a rod from the rudder post up through the poop deck, the portion of the key upon which the banjo string was intended to be wound may be joined to the rod with a small sleeve. A post must be set in place to take the key, after which the entire assembly can be inclosed in the model.

## Vacuum Cup Serves as Depth Gauge on Hand Saw

You will find that a small vacuum cup provides a handy depth gauge for a hand saw. Just stick the cup on the blade with the lower edge at exactly the same distance from the teeth as the depth of cut desired. If the cup doesn't stick tightly, put a little glycerin or oil on the edge.

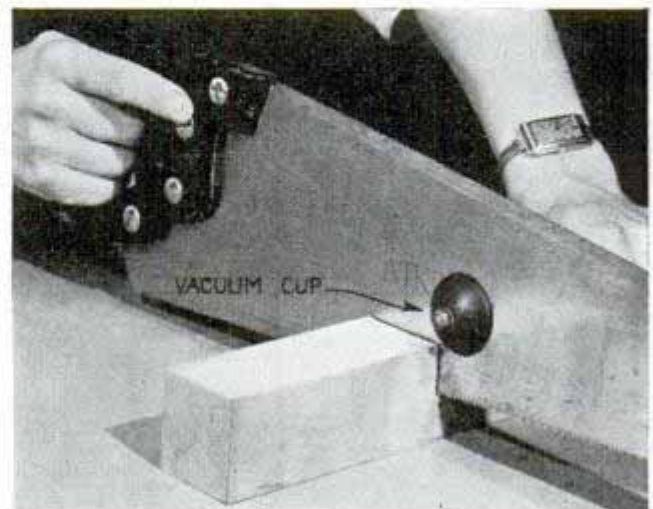



## Linoleum Photo Frames Look Like Leather

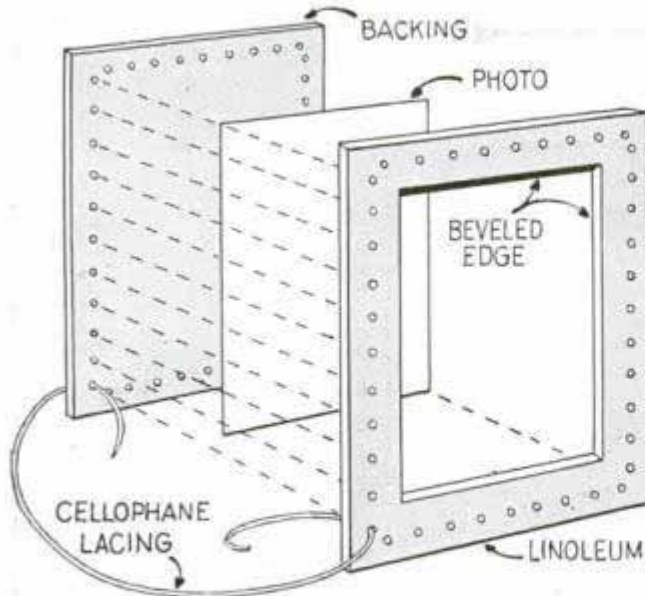

Novel photo frames that resemble leather can be made from black or brown linoleum, or even hard-pressed board. Use leather thongs, heavy cord or similar ma-

terial to lace the edges of the frames. Or, if you want to add a little color, Cellophane ribbon provides an attractive lacing.

—Kenneth Murray, Colon, Mich.

## Playground Pony Swing Is Pumped by Hands and Feet

Children get plenty of excitement and healthy exercise from this novel swing, which is shaped like a horse and pumped with the hands and feet. The body, about 40 in. long, is a 4 by 6-in. timber with the edges rounded to suit. The seat is set far enough back to give leg room for the child.

The upright has metal hand holds and looped stirrups, and is pivoted to the body with a  $\frac{1}{2}$  by 5-in. carriage bolt. For added wear, this bolt should turn in bushings made of pipe. Either rope or chain can be used to suspend the swing as indicated. The horse shown in the photo was hung from 30-ft. lengths of chain, which gave a tremendous sweep.

—Dale R. Van Horn, Lincoln, Nebr.

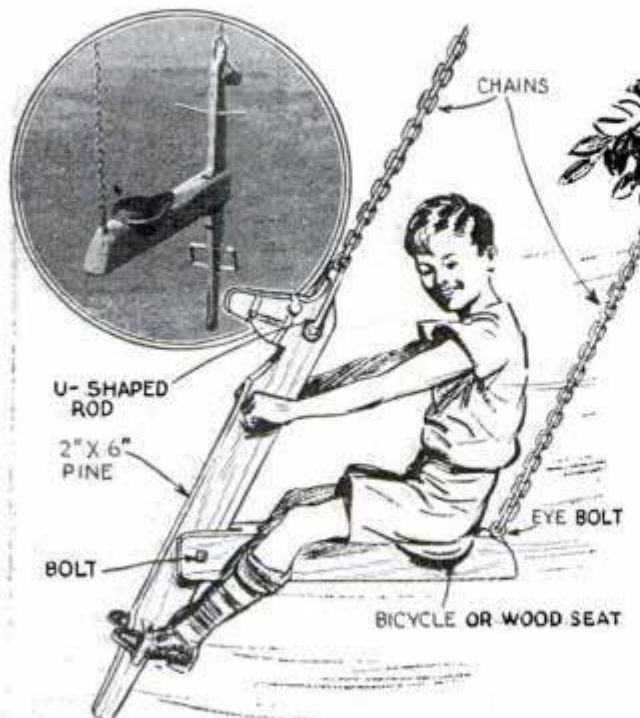

## Kit to Carry Small Cans and Tools from Paint Bucket

When trimming windows while standing on a ladder, an empty gallon paint pail with the sides cut out makes a good kit for carrying putty, cans of paint and small tools. The kit can be suspended from a ladder rung.

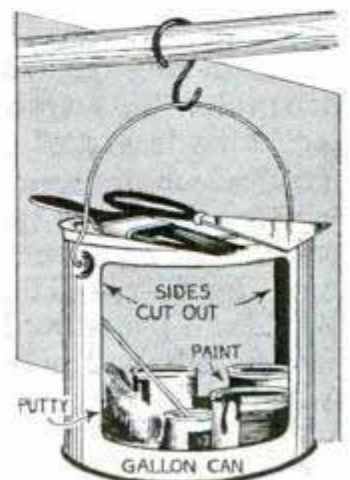



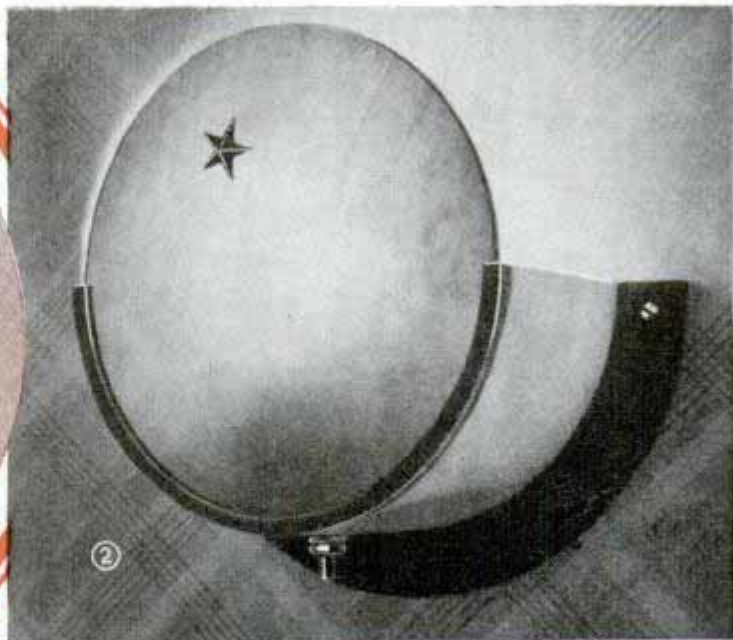

# LIGHT UP

**P**LASTIC cylinders, obtainable in various sizes and colors, can be converted readily into charming bracket lights. Figs. 1 and 2 are typical examples. The construction of the first of these is shown in Fig. 3. The coloring should be translucent, such as pink, rose or emerald quartz. A standard size of plastic rod is used for the spacers and for the two ornamental buttons on the front of the cylinder. The backplate is sheet-plastic stock, although wood, smoothly enameled or lacquered, can be substituted. The lighting arrangement consists of a porcelain ring (sign) receptacle. This type of socket consists of two parts, which are screwed together through a  $\frac{1}{8}$ -in. plastic disk cemented inside the cylinder. A similar disk seals the lower end and also provides a mounting for the small rotary canopy switch. The bulb is of the tubular type, 6 in. long.

Figs. 4 and 5 show the construction of the second bracket light. A half cylinder of

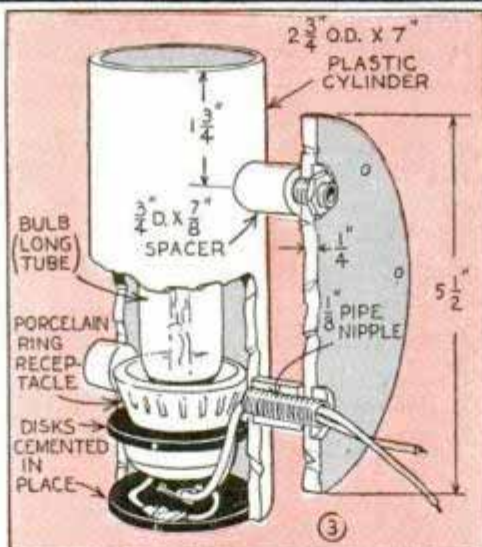

plastic is mounted to a plastic wall plate, using cement and drive screws. Fastened to the backplate is a small ledge of crystal plastic, cut out in the center to accommodate the sign receptacle.

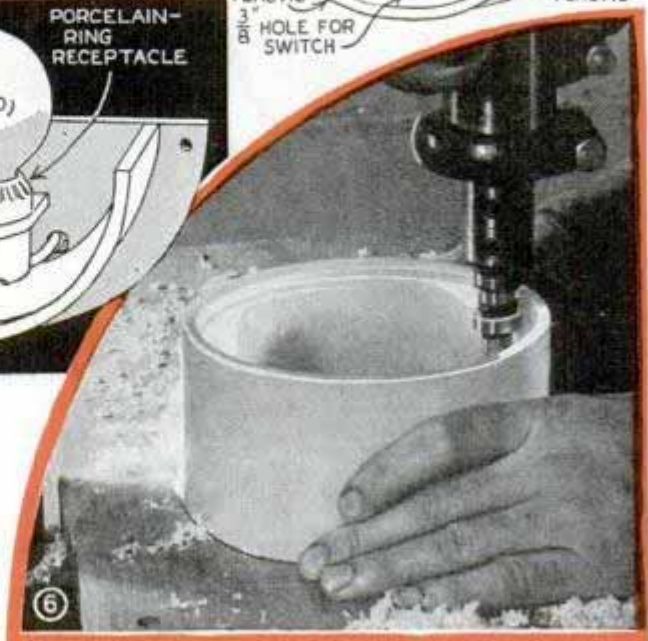
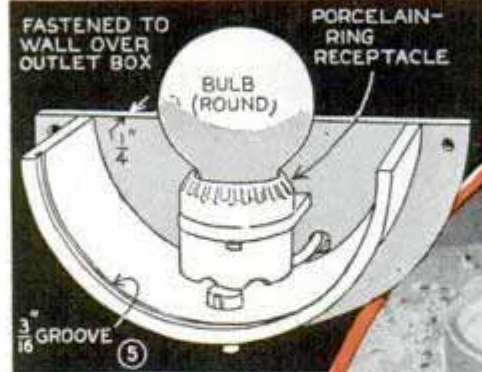
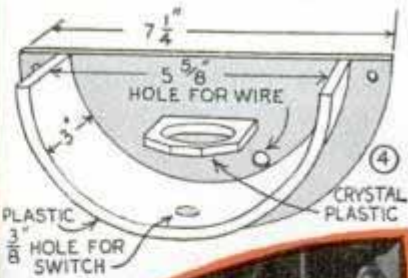





# With These Colorful FIXTURES

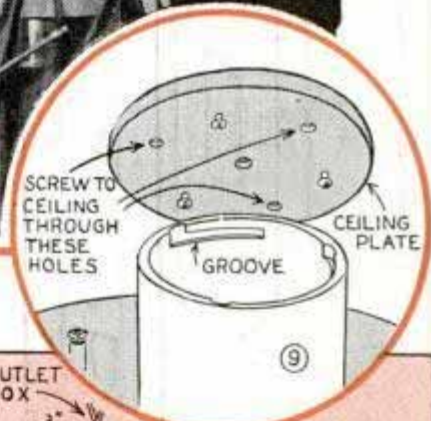

A disk of  $\frac{3}{16}$ -in. rose quartz, which fits into a groove cut in the cylinder, completes the construction. The groove for the disk is easily cut with a small shaper cutter on the drill press, as shown in Fig. 6.

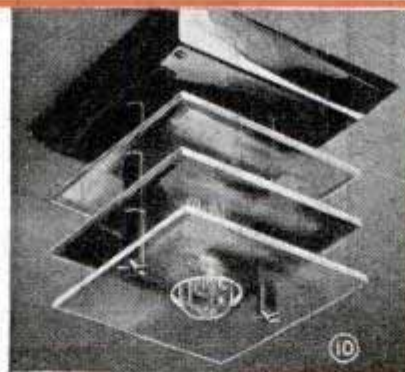

Disks cut from sheet plastic make up nicely for both large and small ceiling fixtures. The one shown in Figs. 7 and 8 uses a 4½-in. cylinder and three 12-in. disks, the assembly being made as shown in Fig. 11. The cylinder is pink quartz, as is also the bottom ring. The second ring is ruby and the top ring is sapphire (both of these are transparent). The unit is mounted to the ceiling plate by means of three screws, which fit corresponding grooves cut in the top of the cylinder, as shown in Fig. 9. Other attractive lights on the same order can be made, as shown in Figs. 12 and 13. Fig. 12 uses the same cylinder as before and has two rings,

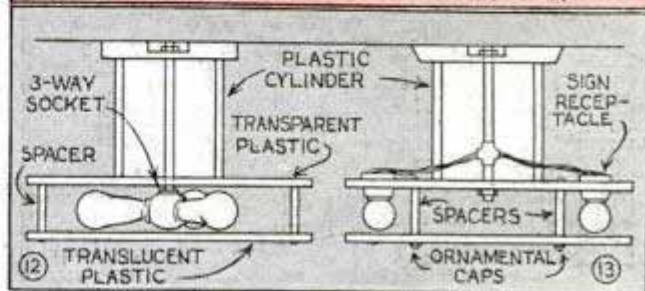
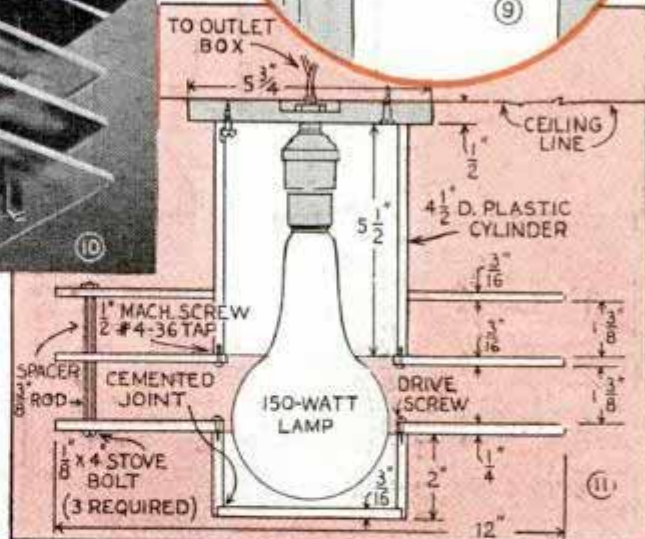



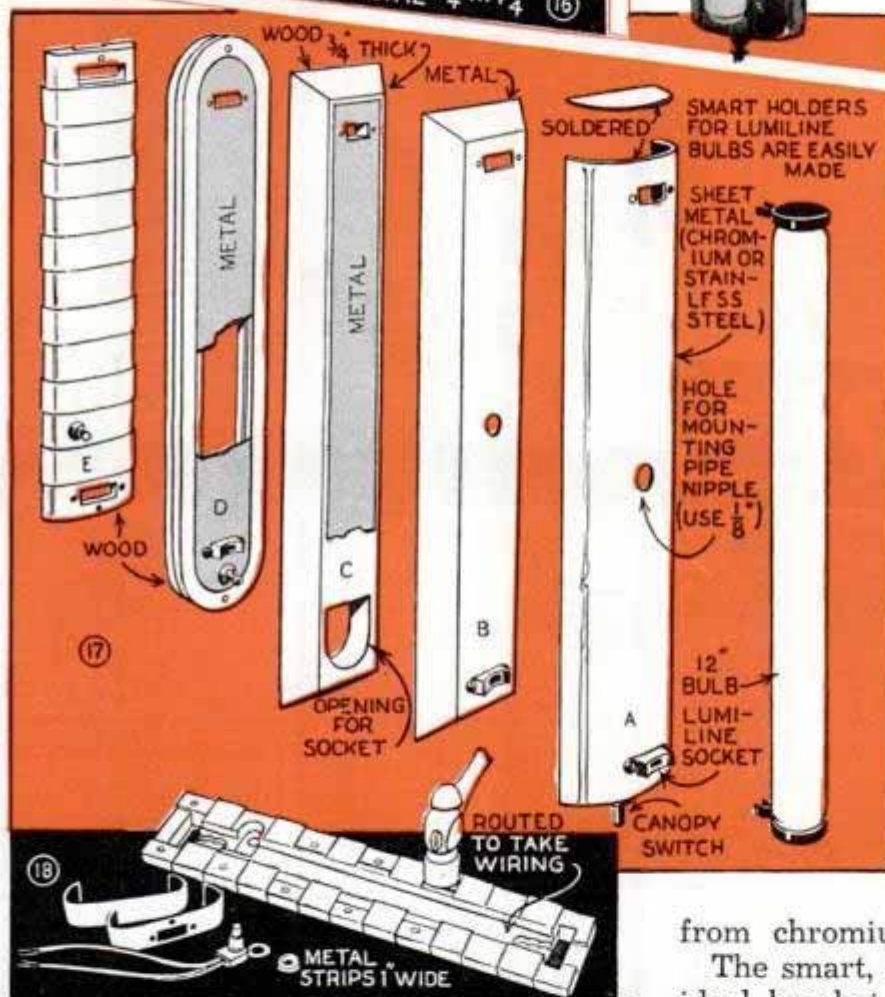
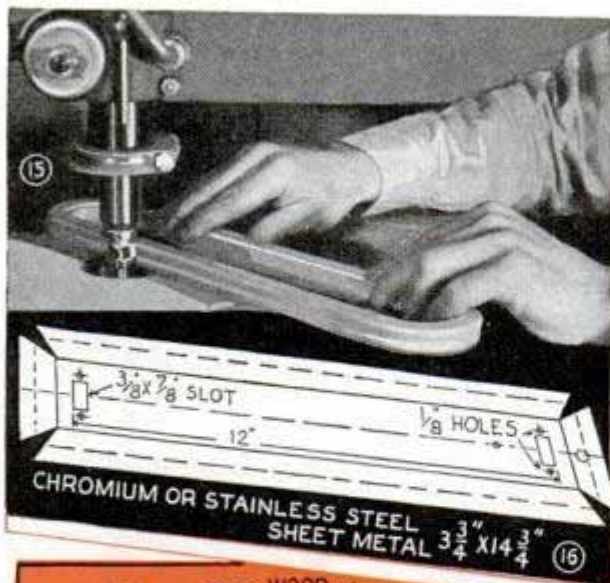

the bottom one being translucent while the upper one is transparent. A  $\frac{1}{8}$ -in. pipe fitting through the unit serves as a support and also connects to a 3-way socket. The light shown in Fig. 13 can be made with either three or four lights around the edge of the plastic ring. The bottom disk is held in place with ornamental caps as it must be removed to permit changing bulbs. Fig. 10 shows a small hall light made from three squares of plastic—crystal, ruby, and crystal. The ceiling plate is a sheet-metal box made from chromium or stainless-steel stock.

The smart, new "Lumiline" bulbs make ideal bracket lights for the bathroom or kitchen and can be used also in other rooms. These bulbs are obtainable in 12 and 18-in. lengths, the ones shown in Fig. 14 being the shorter type. The socket consists of two parts—a cap which fits over the end of the bulb, and a receptacle into which the prongs of the cap fit. A socket is required at each end of the bulb. Fig. 17 shows various wall plates which can be made to accommodate these bulbs. The one shown at A, Fig. 17, can be made from chromium or stainless-steel sheet metal,



the end caps being soldered in place. Style B is also all-metal, and is cut according to the dimensions given in Fig. 16, which also show the correct dimensions for any other style of wall plate. Style C is a wood plate, cut out to accommodate the sockets and wiring, and covered on the face with sheet metal cemented in place. Stainless steel with fiber backing is ideal for this purpose. Style D is a wood frame, molded at the edges, Fig. 15, and cut out and routed in the center to take the sockets and a sheet-metal plate. Style E is a wood frame, shaped and grooved with molding head knives, and is alternately banded with strips of stainless steel cemented and tacked in place. All of the units use a rotary canopy switch, which can be mounted at any suitable point. The best finish for the wood brackets is baking enamel, although ordinary enamel or lacquer can be used. The units can be mounted with either an ornamental cap fitting a 1/8-in. pipe nipple, or by screws through the bracket. In all cases, the outlet box is immediately behind the fixture, although exposed lampcord wiring can be used in places permitting it. A simple ceiling fixture employing three bulbs is shown in Fig. 20. The ceiling box is cut to take the six receptacles wired in parallel, Fig. 21.

Lighting styles of current popularity are flush, cove, and louver lighting, Figs. 22 to 27 inclusive. The flush type of light can be fitted to either the ceiling or to the wall. Frosted or opal glass can be used although 1/8-in. translucent plastic is better adapted for intricate shapes. The glass is held in place with a suitable molding in either plastic or chromium. Cove or built-in lighting can be used above doors or windows, or in a vertical bank flanking mantels or bookshelves. The window cornice is perhaps the most popular and least expensive style to install. Louver lights are similar to flush lights except that a louver plate is used instead of glass, making a more shielded light. Louver plates in different sizes and in chromium or enamel finish can be purchased or made up from sections of enameled metal-window ventilators, as in Fig. 27. Other styles resembling small venetian blinds can be made up readily, and can be made adjustable.

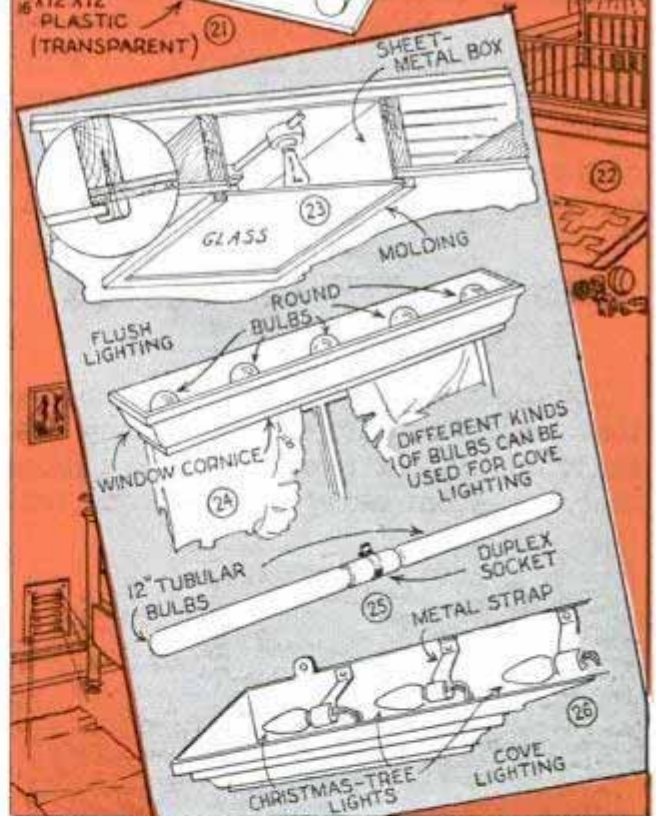
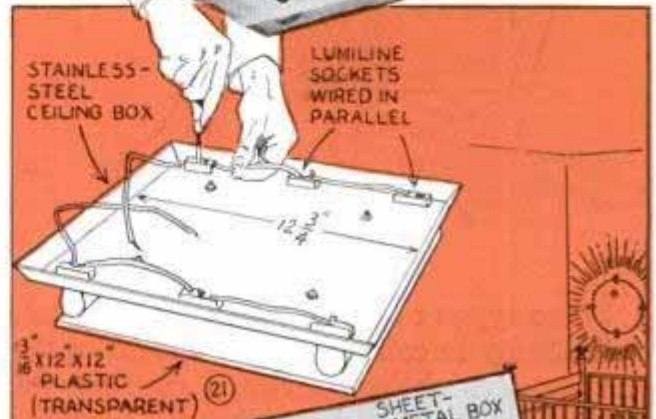
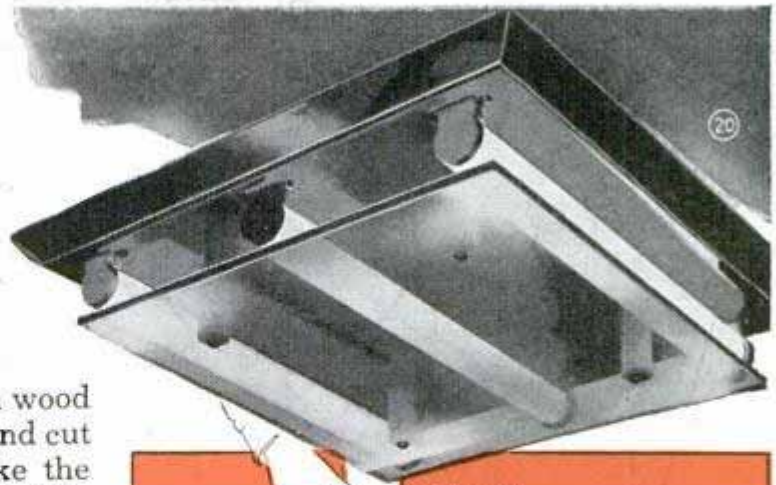



## Hook on Folding Lawn Chair Prevents Collapse

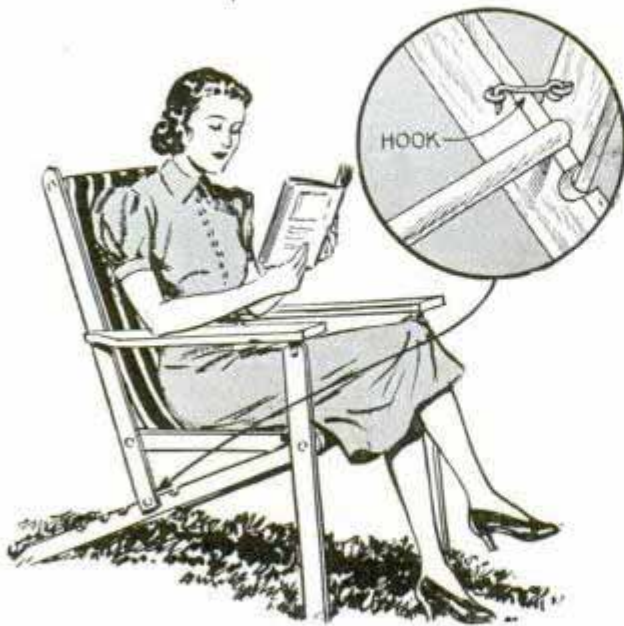

Some types of folding lawn chairs have a tendency to collapse if the weight of the occupant is shifted forward causing the rung to slip out of the notches. To avoid this trouble, use a screen-door hook and screw eye as indicated. If the adjustment of the chair is changed often, a separate screw eye can be provided at each notch.

## Boat Seat Is Easily Adjusted in Split Rubber Hose

To adjust the seat of a rowboat easily so that persons of different height may row conveniently, cut two lengths of rubber hose, slit them along one side and nail

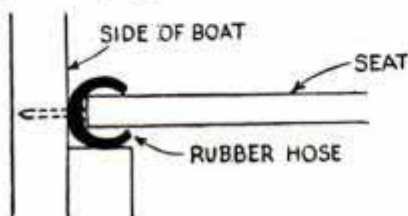
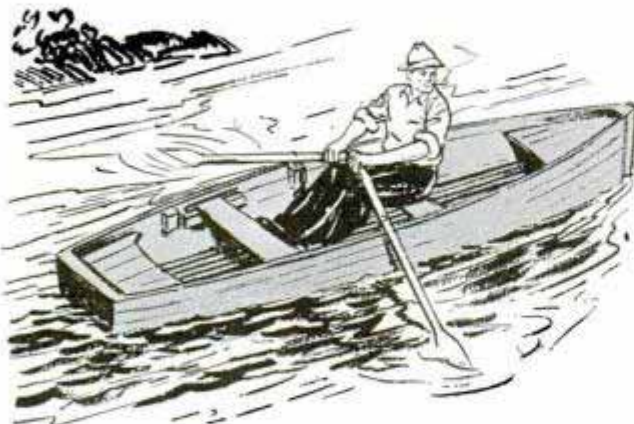

them inside the boat just above the cleats that support the seat. By fitting the ends of the seat into the slits, it will remain securely in place under the weight of the rower. When the weight is removed, the seat may be slid back and forth.

## Non-Clogging Overflow Pipe in Garden Pool

If the overflow pipe in your garden pool has a tendency to clog, notch the upper end of the pipe and slip over it a nipple fitted with a pipe cap as shown. The nipple diameter must be about  $\frac{1}{2}$  in. larger

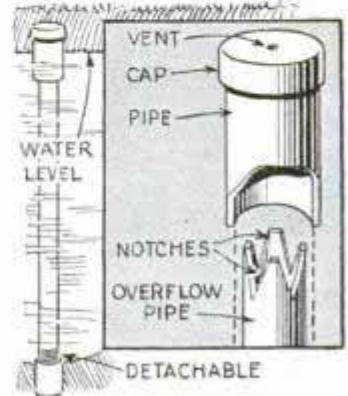

An air vent is necessary in the cap to prevent the nipple-and-cap assembly from acting as a siphon.

## Making Cup Washers



Small cup washers can be formed easily for use under flathead bolts when the holes have been countersunk too deep, or for protecting wood parts where

flathead screws are removed frequently. Just drill and countersink a hole in a piece of metal and rest it over the slightly opened jaws of a vise. Then place a flat washer over the hole, insert a flathead screw and drive it down with a hammer.

## Shield for Lathe Spindle

To protect the threaded end of a lathe spindle from dirt and damage, a short rubber hose may be slipped over it. A piece of ordinary garden or radiator hose is satisfactory for the purpose.



—Howard R. Heydorf, Missoula, Mont.



## "Bicycle Aquaplane" Is a Real Skill Tester

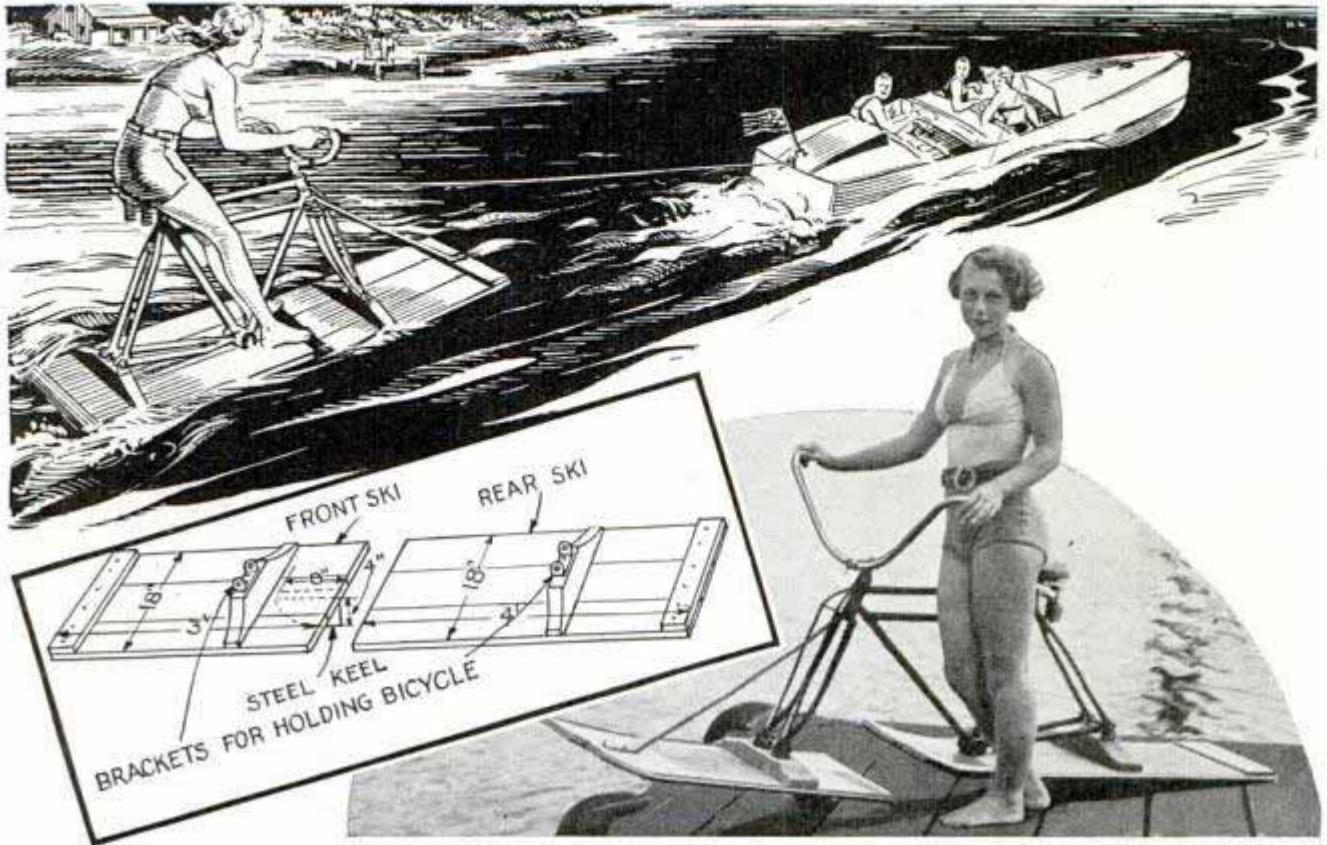

This bicycle aquaplane will provide great water sport and test your skill to avoid a ducking. Nothing more than an old bicycle frame fitted with wide skis, the aquaplane can be towed at a good clip behind a motorboat once you have mastered the art of

riding it. The skis are pivoted to the bicycle forks and are braced rigidly to hold them at the desired angle. A 4 by 8-in. steel keel located at the rear of the front ski is an aid in steering.

—Carlton Groat, Peach, Wash.

## Small Wedges Can Be Shaped Easily in This Wooden Jig

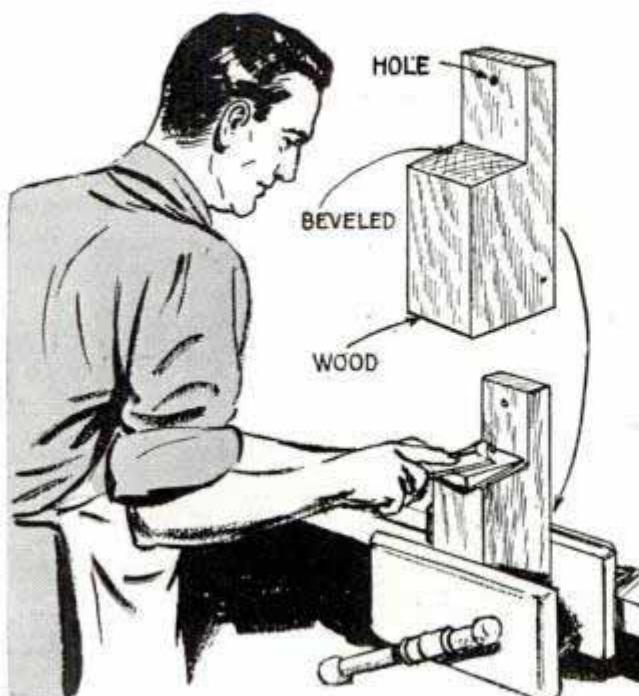

Holding small pieces of thin stock to make small wood wedges is an easy job with this simple jig, which is made from a thick block and is clamped in a vise. The shouldered portion is beveled slightly to provide a good working angle, and a hole near the top permits the jig to be hung up.

—John A. Van Dusen, Delmar, N. Y.

## Preserving Magazine Pictures

Pictures and paintings printed in magazines and newspapers can be given the appearance of oil paintings for framing by applying a coat of amber-colored sealing wax. This is dissolved in denatured alcohol to produce a mixture of about the consistency of molasses. Spread this over the picture and press cheesecloth against the tacky surface for a couple of minutes.



## Irons to Brand Wood Articles with Name or Initials



Anyone can make up these simple branding irons to burn names, initials or other data on wood articles such as beach chairs, camp stools, etc. The irons can be bent from 18-ga. iron wire, leaving one end projecting to serve as a tang for a wood handle. They can be made up as single letters or as complete names.

—B. Lifshay, Jackson Heights, L. I., N. Y.

## Eliminating Spray at Stern of Boat

While experimenting with 16 to 33-hp. outboard motors mounted on large free-running and planing boats of different types, one manufacturer found that spray at the stern, which interfered with motor operation at times, was caused by the keel. The spray was evident only on boats

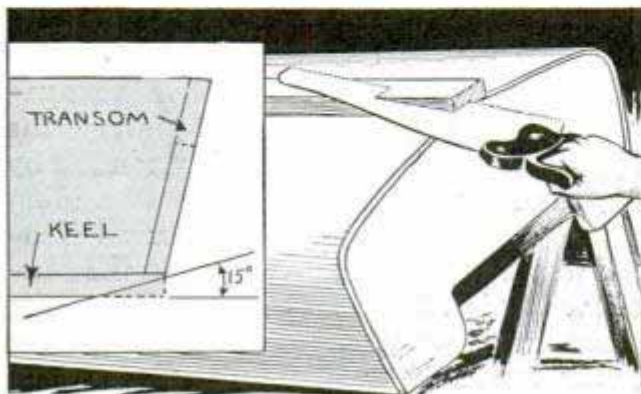

where the full depth of the keel extended to the extreme rear end of the boat. To eliminate this trouble, the keel was tapered at the transom as indicated.

## Round-Nose Spinning Tool from Hinge Pin

Having occasion to spin a concave edge on several copper disks, I improvised a smooth round-nose tool from a large hinge pin by fitting it with an old screw-driver handle. The surface on the ball tip produced a mirror-smooth finish on the work.

—V. L. Howard, Evanston, Ill.

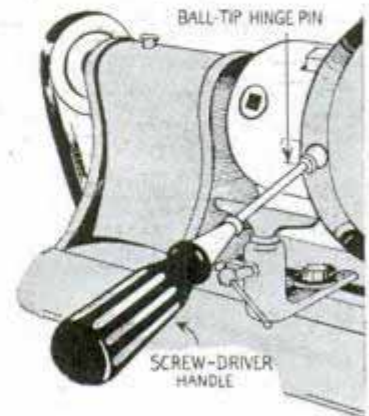

## Funnel Vented with Cotter Key



To fill small bottles with a funnel when the spout fits so snugly that air cannot escape, slip a cotter key over the edge of the spout. This will provide a space between the funnel and bottle neck and the key will remain in place without attention.

## Hand Pencil Sharpener Fitted with Shaving Receptacle

A small hand pencil sharpener can be fitted with a receptacle to catch the shavings by attaching it to the screw-type lid of a small jar such as a face-cream jar. Just drill a hole in the lid, large enough to take a pencil, and attach the sharpener on the underside of the lid in line with the hole.





## Rustic Bridge Set Has a Trump-Suit Marker

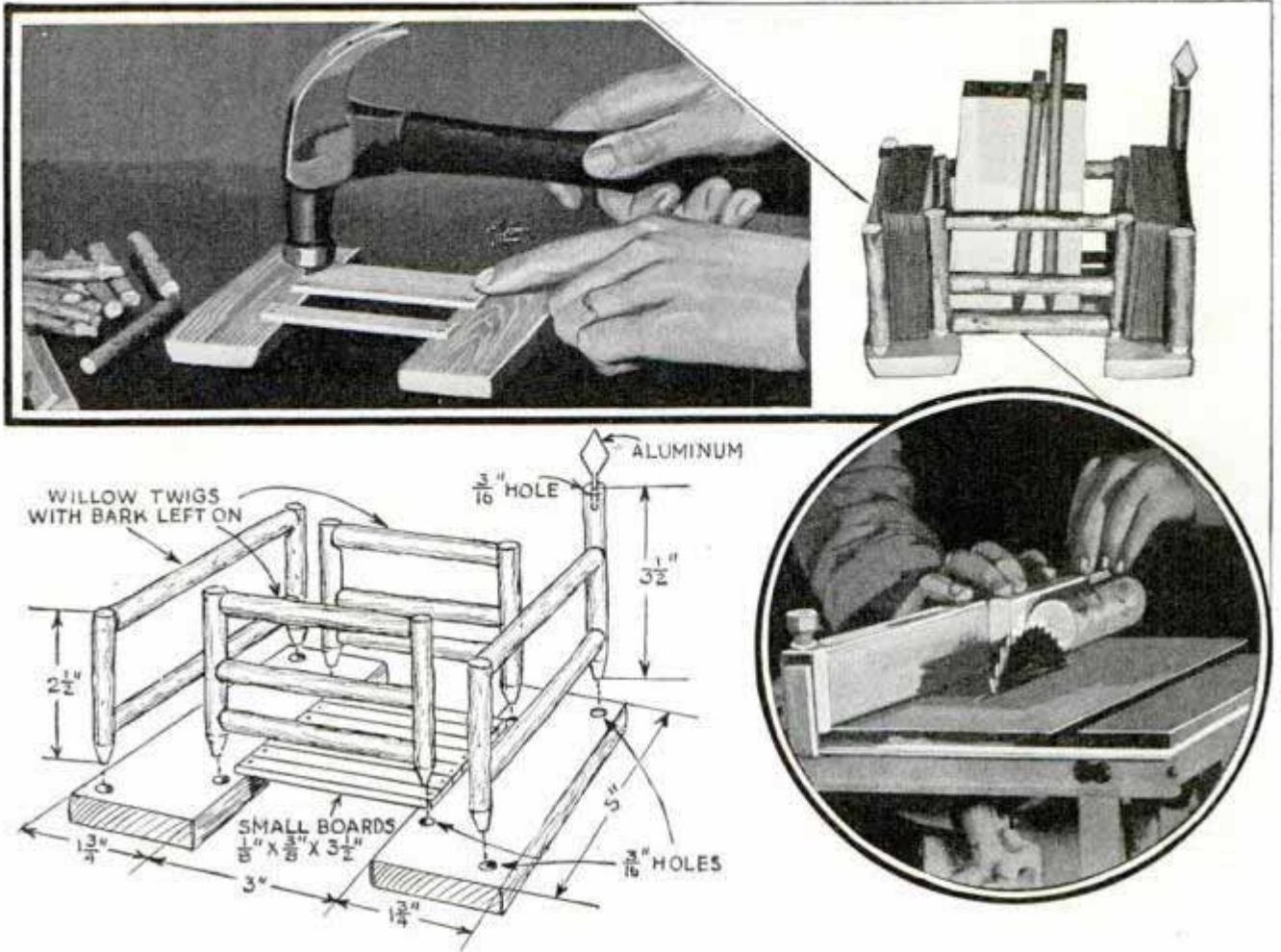

In this little bridge set there are compartments for pencils, score pads, two decks of cards and there is even a trump marker, which is stuck in one of the posts to serve as a reminder of the trump suit for each hand. The signs are aluminum cut-outs of each suit in the deck. The set is made of willow sticks  $\frac{1}{4}$  to  $\frac{3}{8}$  in. in

diameter, which have been dried with the bark on. If desired, the two base pieces can be ripped from a large willow branch so that bark will be on the edges to carry out the effect, or you can use other stocks. Be sure that all the wood is well dried so that the set will not shrink and pull apart at the joints. Finish with clear varnish.

## Electric "Hotbed" Assembled from Parts of Egg Incubator

Using the water coils, heating unit and thermostat of an old electric incubator, a home owner improvised this hotbed or seedling starter in which more than 1,000 plants of various kinds were started so that they matured two weeks early in the garden. The box was built to take the coils and to accommodate a number of individual trays on a shelf and the bottom. The glass sides admit sunlight and protect the plants against low temperature.

☑ Stand on a thick rug when washing or ironing and you will not tire so easily.

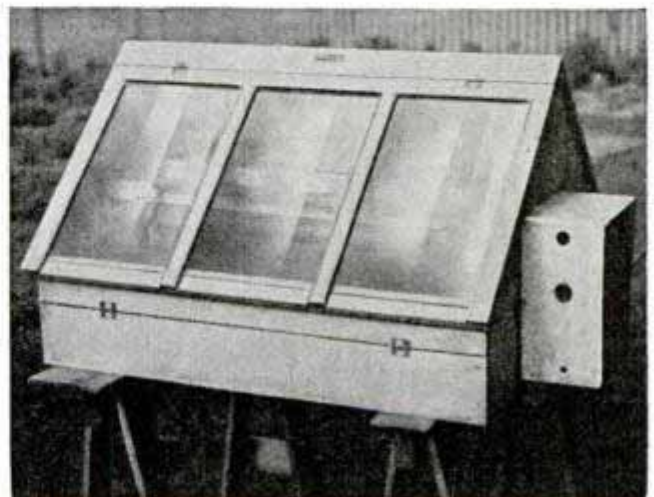



# NEW CANVAS

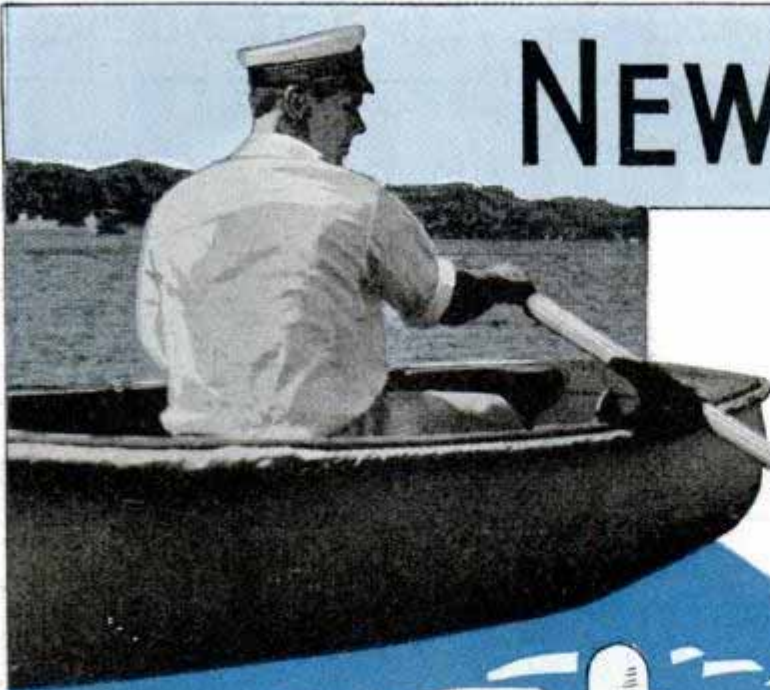

Old canoes and dinghies recovered simply by dropping them into a one-piece canvas "hammock" and tacking at stem and transom

By W. E. STEWART

WHEN your canvas-covered dinghy or canoe was new the covering was made from a single piece. When replacing that worn-out covering, the proper thing to do is use another single piece of canvas. By employing the single piece as compared with two pieces usually applied, you will eliminate the risk of leaks which are likely when a seam runs the entire length of the keel.

Your craftsmanship is the greater part of the job so it is well to select only the best of materials. The canvas, or duck, as it is known commercially, should weigh about 14 oz. to the square yard. Purchase it in a width at least 6 in. wider than the girth of the boat amidships. For a dinghy the length should be about 5 ft. more than the distance from transom to forward part of the stem. For a canoe, the canvas should be about 3 ft. longer than the over-all length. You will require about  $\frac{1}{4}$  lb. of  $\frac{1}{4}$ -in. copper tacks for fastenings. For setting, filling and preserving the canvas use white lead and boiled linseed oil. You will need about  $12\frac{1}{2}$  lbs. of white lead and  $\frac{1}{2}$  gal. of oil.

First prepare the dinghy or canoe for the new covering. The stem piece, keel, rub-

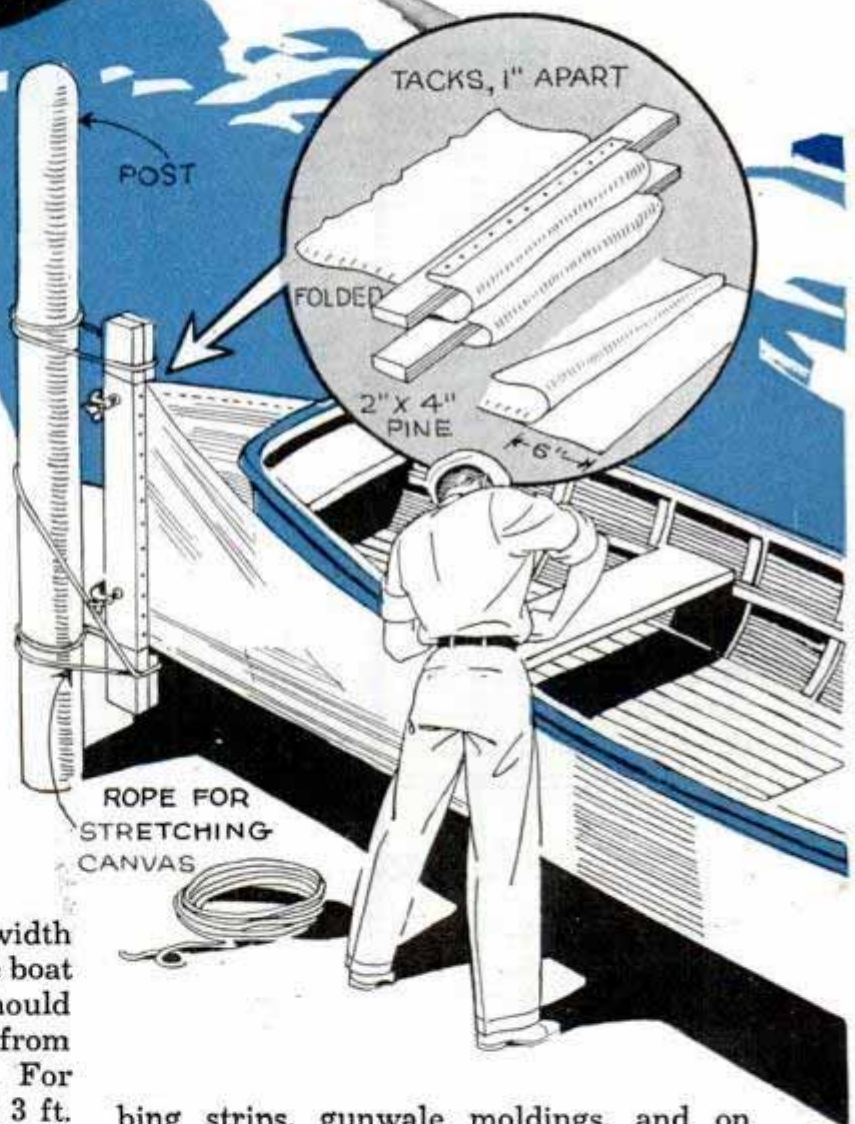

bing strips, gunwale moldings, and on dinghies, the outer planking of the transom, are held in place by screws started from the outside. Remove these carefully, Fig. 1, and put the woodwork in first-class condition for re-use later. Place the bent pieces in positions which will preserve the curvature which they have as they come from the boat. Now strip off the old canvas



# ON OLD BOATS

and pull out the old tacks which held it in place. Observe carefully how the folds of canvas at the transom and the lap joint at the bow have been made, as you will have to duplicate them when putting on the new cover.

Carefully inspect the entire hull for dry rot, loose fastenings and broken planks and ribs, Fig. 2. Dry rot can be corrected only by replacing the wood which is affected, but you will find it entirely feasible to replace only a small portion of any plank or rib in this type of boat. Replace loose fastenings, pins, screws, etc., with longer ones or with some of larger diameter, Fig. 3. Finally, use a plane and sandpaper block on the hull to restore a perfectly smooth, curved surface. Remember that no part of the surface of the hull should be flat. If all parts are not smoothly curved,

seams will show through the covering and the flat place will be the first to get scuffed or torn.

Fold the canvas lengthwise and make a 6-in. slit

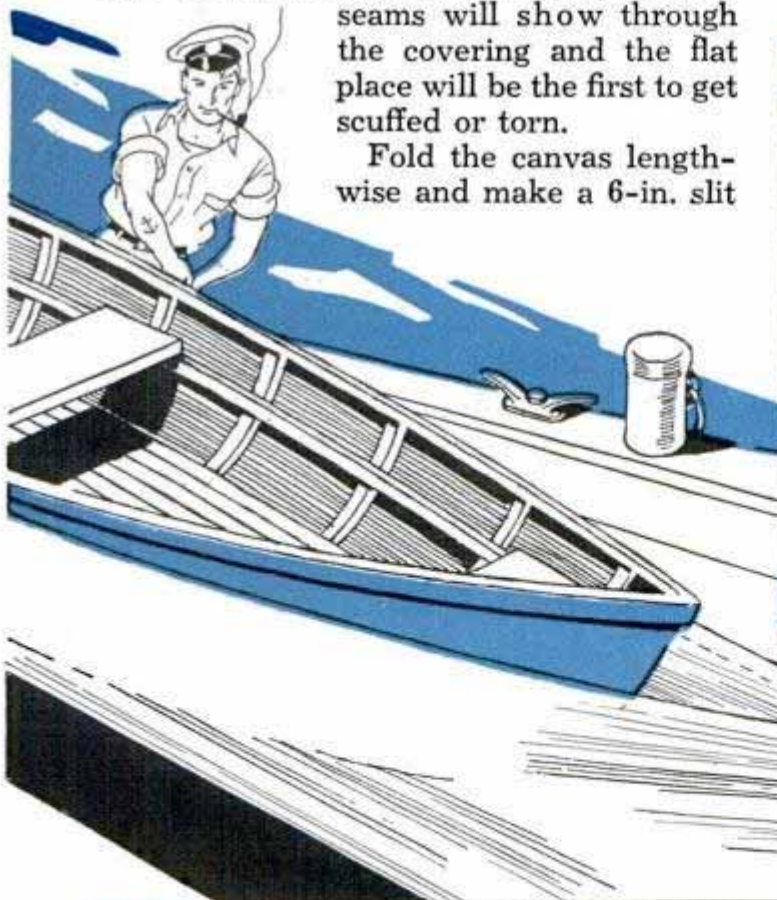

4 THEN STRETCH THE CANVAS "HAMMOCK" AND LOWER THE BOAT INTO IT

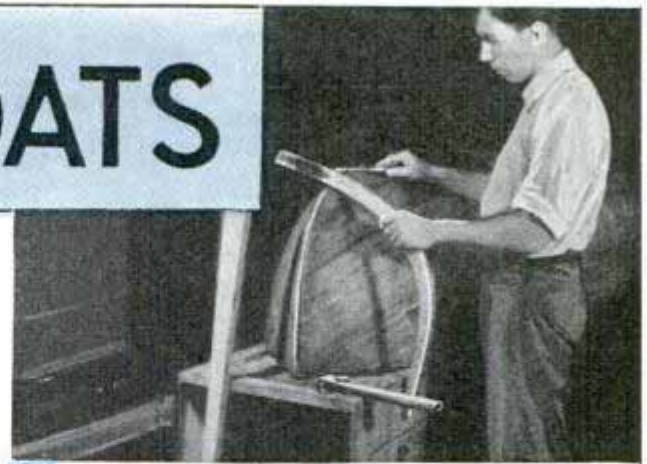

1 REMOVE STEM AND KEEL AND THE OLD CANVAS



2 CHECK PLANKING FOR DRY ROT AND PATCH WITH NEW STOCK



3 REPLACE WEAK FASTENINGS AT STEM AND TRANSOM

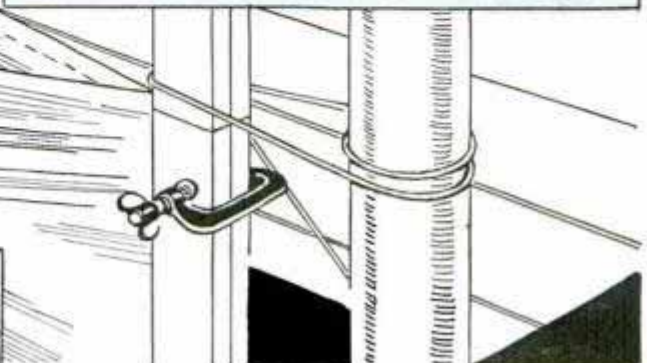



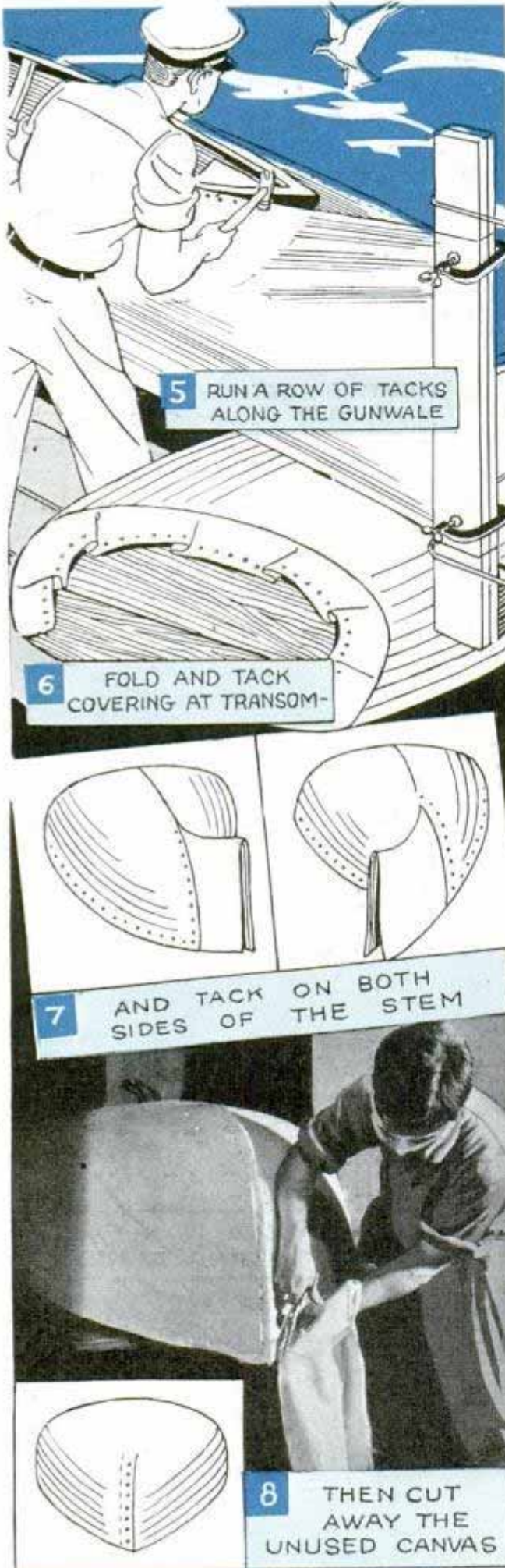

in the crease at each end. Tack the extreme ends of the canvas to four 2-by-4-in. scantlings, as shown in Fig. 4. The three-fourth turn shown is sufficient to absorb the tremendous strain which later will be placed on the canvas. Clamp each pair of scantlings together so that the canvas is held between them and stretch the canvas between two rigid supports such as posts in the cellar, corner frames in a garage, or two large trees, and secure with ropes. Take up the ropes so that the canvas will be stretched almost rigid. You may further tighten the ropes by covering them with water-soaked cloths.

After stretching, the upper edges of the canvas may be pulled apart a distance of 2 ft. Lower the dinghy or canoe into the pocket, right side up. With someone's help on the opposite side, work the boat down into the envelope of canvas. As it approaches its final position have a third person sit in the boat to give it added weight. Wet the canvas after the boat has been pushed well down into it. This shrinks the fabric to conform to the shape of the boat.

Start tacking the canvas to the boat at the gunwales. Drive a few tacks amidships, then start working toward the stern, alternating at 6-in. intervals from one side of the boat to the other, Fig. 5, and each time work the canvas up tightly and smoothly from the keelson. When you have reached the stern, begin again amidships and work toward the bow. This half of the boat will be more difficult to sheath smoothly, as the canvas must be distorted more. However, by working the canvas up firmly from the keelson and securing each place as you go, you will be able to get a perfectly smooth fit. Canoes are a much simpler problem than dinghies as the change in shape of the boat is less acute. In a canoe it makes no difference which end is finished first. At a point about 12 to 18 in. from the stem of either canoe or dinghy, you will find that the angle of the canvas is such that it no longer bears against the hull. When both sides have been secured to this point, remove the stretchers and invert the boat on a pair of sawhorses, or boxes, to complete the work. On a dinghy, cut off the excess canvas about 6 in. beyond the transom, pull the flap tightly over the edge of the transom and tack it down, Fig. 6. It will be neces-



sary to make a number of overlapping folds to get the canvas to lie smoothly on the transom. Do not cut out any of the cloth to eliminate the necessity for folds; its continuity is additional insurance against leakage.

Return now to the bow. At the point where the stem begins to curve away from the keel, let the canvas extend straight on. Work the canvas smoothly against the sides of the bow, allowing the surplus to accumulate both beyond the gunwale and at the keelson. When this has all been made smooth and tacked on each side all the way to the stem, Fig. 7, dispose of the excess along the keelson and stem. Pull this tightly over to one side and set a row of tacks into the stem about  $\frac{1}{2}$  in. off center. Next, pull the canvas over to the other side and run a similar row of tacks along the opposite side of the stem. Then trim off the excess canvas, but leave enough material on each side to make an overlap of about  $1\frac{1}{4}$  in., Fig. 8. Before tacking down the overlap, paint the wood underneath and the two flaps of canvas liberally with white lead and boiled linseed oil. The mixture should be of the consistency of heavy cream. At the end of the cut in the canvas make a small tapering fold to keep it taut on the hull. When the keel is added, this fold will be covered completely.

A number of commercial canvas fillers are available, and most of these will give a smoother finish in fewer coats than will white lead and boiled linseed oil, but nothing is more durable or economical than the latter. Mix white lead, 6 lbs., with boiled linseed oil, 1 qt. Be sure that the oil is boiled, not raw, as the latter practically never dries. Paint every bit of the canvas with the mixture, not excluding the part which is folded over the transom. Allow this coat to dry very thoroughly, perhaps three or four days, before applying a second coat. When the second coat has dried, sand it down lightly with No. 4/0 sandpaper. Remove all lumps of paint but avoid raising the nap of the fabric underneath. When this is done you are ready to replace the outer transom planks, keel, outer stem and gunwale moldings, Fig. 9. Before fastening them, paint their undersides and the areas of canvas against which they bear very liberally with a creamy mixture of white lead and linseed oil. Wipe off any

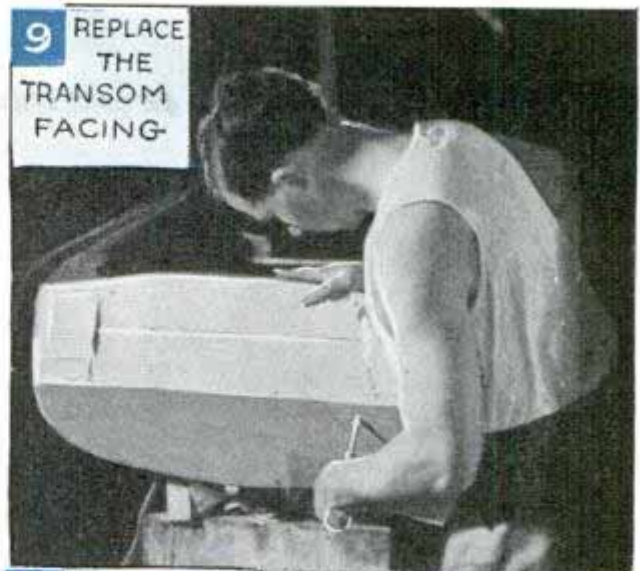

9 REPLACE THE TRANSOM FACING

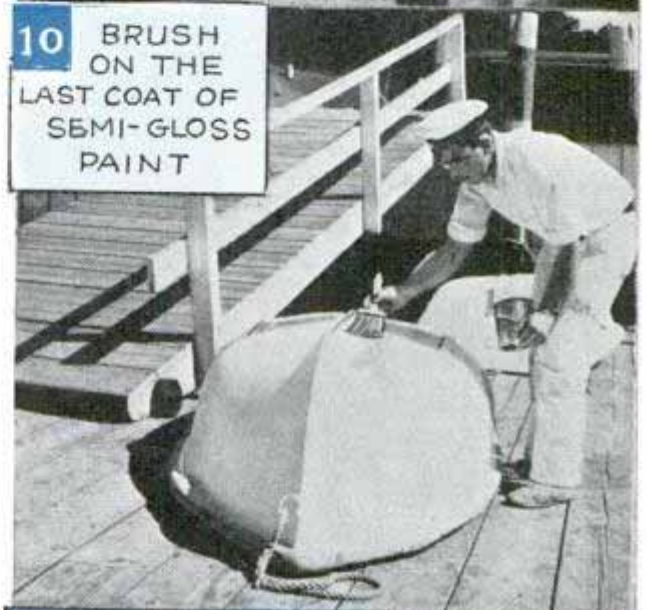

10 BRUSH ON THE LAST COAT OF SEMI-GLOSS PAINT



excess which may be squeezed out, then apply a coat of lead base, flat white paint to the entire exterior of the boat. Allow 24 hrs. to dry and paint with one coat of yacht white, semi-gloss paint as in Fig. 10. Replace the fender rope and painter.



### Ventilator Hinged in Center Is Easy to Handle



I find that a window ventilator hinged in the center is easier to handle than the regular sliding type because you just start the ends in place and push it. I made the one shown, using white-pine frames, which were covered with sheet iron with openings cut as indicated. Use butt hinges and screw them facing the outside.

—M. W. Kraynak, Scranton, Pa.

### Wooden Duck Wings Its Way in the Garden



Ornamental for lawn or garden, this duck has wings that simply rotate but give a realistic impression of flying. An over-enthusiastic hunter even riddled this one before discovering his mistake. The

body of the duck is about 16 in. long and the wings were made from wide shingles. These were mounted at a slight angle on a bolt which runs through the body, small

flanges being used as bearings. Owing to the taper and pitch of the wings, they revolve in almost any wind from any direction and as the wings rotate the duck's body weaves from side to side.

### Notch in Gun Cleaning Rod Removes Patch from Barrel

When a cleaning patch became disengaged from the rod, one sportsman flattened the end of his rifle cleaning rod and then filed the flattened tip to make a two-tined fork.

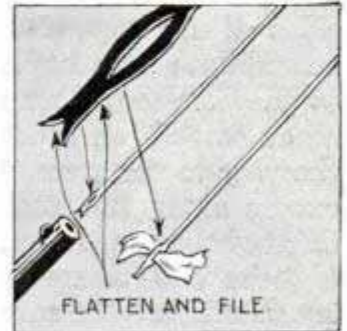

With this implement, he removed the lodged patch by merely pushing the fork against the cloth and twisting so that the tines became entangled in the fabric.

### Simple Rack for Small Tools

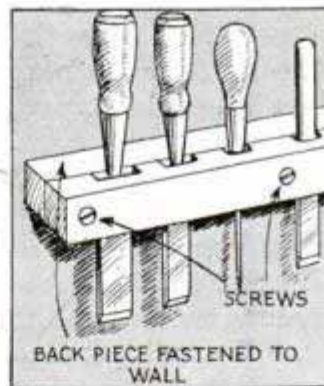

This rack for chisels, screwdrivers and other small tools permits easy rearrangement and additions when necessary. The back piece is fastened to the wall and only the front one is mortised to

receive the tools. You will find this method of making a rack simpler than boring or mortising holes in a single piece.

### Cutting Closed Slit in Metal

In the absence of a circular slitting saw, a closed slit can be cut in thin sheet metal with a hack saw by bending it over a wood former. Screws driven into the heads project-

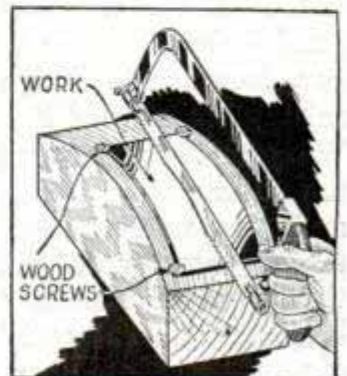

*see July 1939 weather vane 131*

*Chicago. Harlowe & Larich.*

*similar. sold by Chicago. Harlowe & Larich.*



ing over the edges of the work will hold it in place. The curvature of the former will be governed by the thickness of the sheet and the length of slit desired. A single saw cut will give a narrow slit, or by using two blades in the same frame, a cut double the width will be made. Where a still wider slit is desired, drill a hole at each end of the proposed slit and make two cuts, removing the metal strip thus formed.—John Drummond, Edinburgh, Scotland.

### Flower Box Watered by 'Underground' System

Made from an old hot-water tank, this flower box has a simple underground watering system that assures adequate moisture for the plant roots, and prevents caking of the top soil. A pipe having tiny holes drilled in it passes through the center of the tank lengthwise. An elbow and a reduction nipple on the end of the short vertical pipe outside one end of the tank act as a funnel for pouring in water.

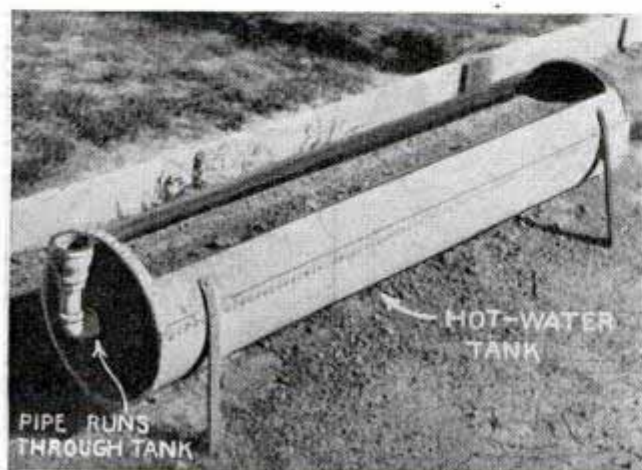

## Camera Is Controlled Remotely to Photograph Birds and Animals

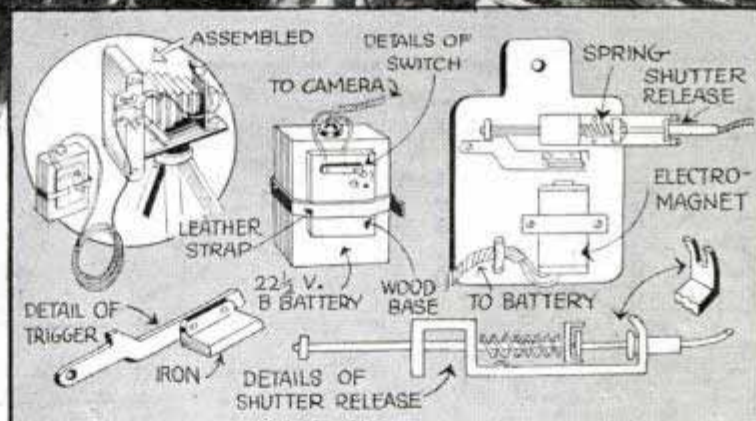

Easy to carry and hook up, this electrical control for a camera shutter release enables you to set up the camera in the open and then hide some distance away to get a photo of a bird or wild animal. All you need is a 22½-volt radio B-battery, some insulated wire, a small electromagnet, which can be taken from an old doorbell, and a few small pieces of brass. The arrangement and shape of the parts are shown in the details. When the switch on the battery is thrown current passes through the magnet and causes it to trip the trigger. This action releases the spring-loaded plunger, which snaps forward and pushes the camera shutter release.

—Dwight Loudermilk, Caldwell, W. Va.

☛ Glass or aluminum pushpins provide attractive knobs for cupboard doors of light plywood. The points of the pins should be clinched to keep them from pulling out.



# Solving HOME



TISSUE PAPER

*It's easy to grease a waffle iron by placing tissue paper soaked in hot lard between the grids while the iron is heating and again when storing it. Right, loss of stitches when knitting work is laid aside is avoided by slipping fuller balls over ends of the needles*



FULLER BALL

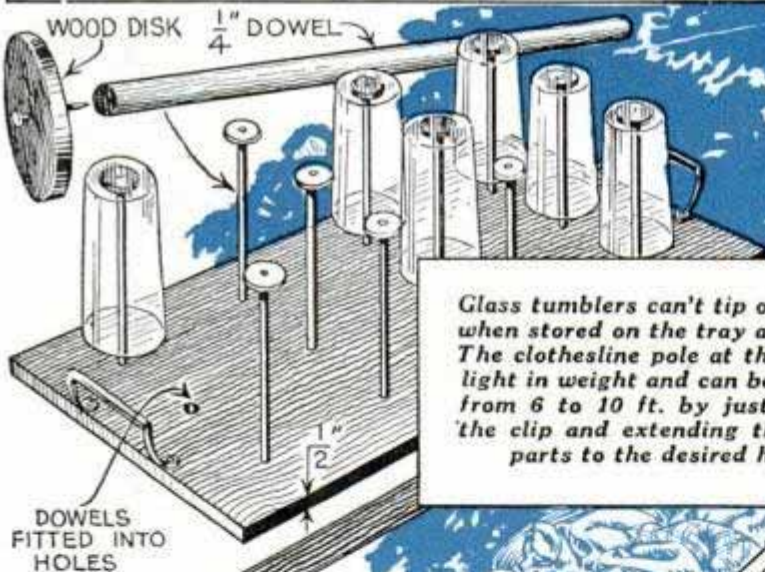

WOOD DISK  $\frac{1}{4}$ " DOWEL

DOWELS FITTED INTO HOLES

*Glass tumblers can't tip or slide off when stored on the tray at the left. The clothesline pole at the right is light in weight and can be adjusted from 6 to 10 ft. by just pressing the clip and extending the sliding parts to the desired height*



COMPRESSION SPRING IN SOCKET

CLIP ON END OF CLOTHESLINE POLE

COMPRESSION SPRING



COPPER-WOOL SCOURING PAD

CELERY

*Celery stalks cleaned easily with copper-wool scouring pad*

*Left-over wallpaper makes dainty shelf covering if it is washable*

FLOWERED WALLPAPER

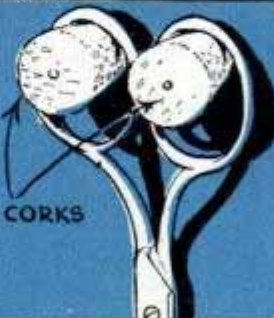
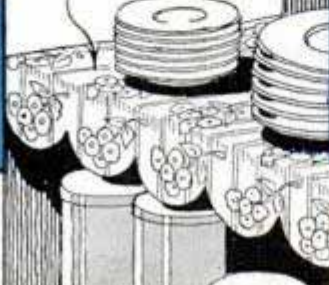

CORKS

*Two corks nailed to a wall or shelf hold a pair of scissors neatly*

*Sealing wax keeps nuts of an electric-appliance plug from loosening*



SEALING WAX



# PROBLEMS



Right, two turns of cotton cord wrapped under hinge pin and kept oiled furnish lubrication and eliminate squeaks. Attach a screen-door hook with a small spring as above and it will hold the door snugly and allow enough flexibility to fasten the hook easily

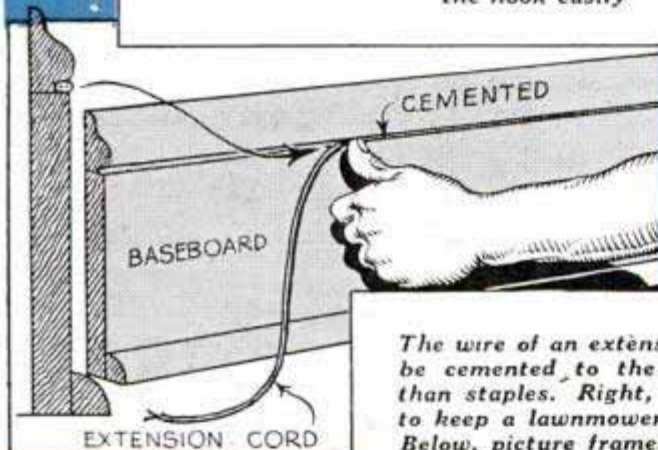

The wire of an extension electrical outlet can be cemented to the baseboard—it's neater than staples. Right, using a clothes hanger to keep a lawnmower handle against a wall. Below, picture frames converted to trays by adding a bottom of plywood and glass with a photo or fancy paper between them

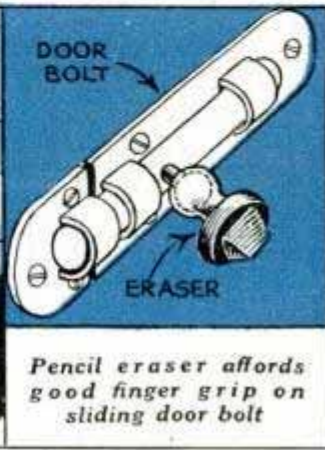
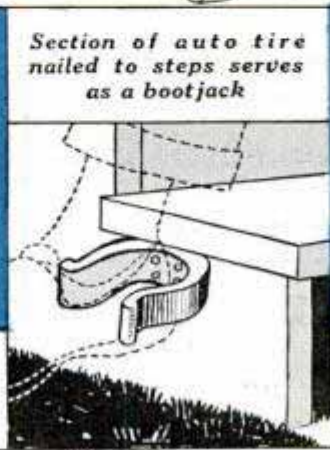
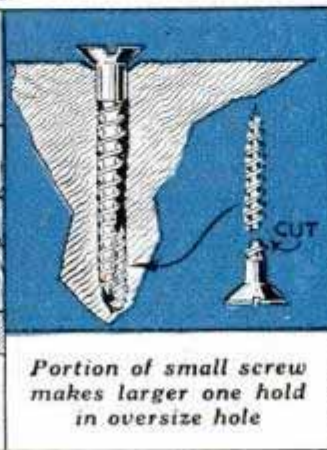
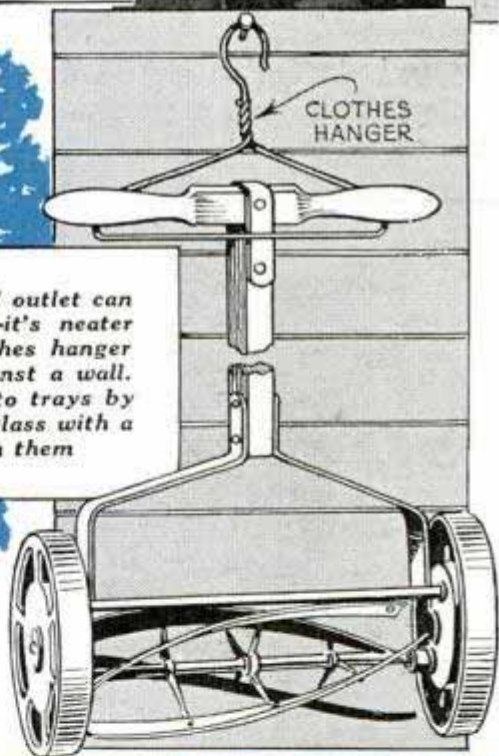
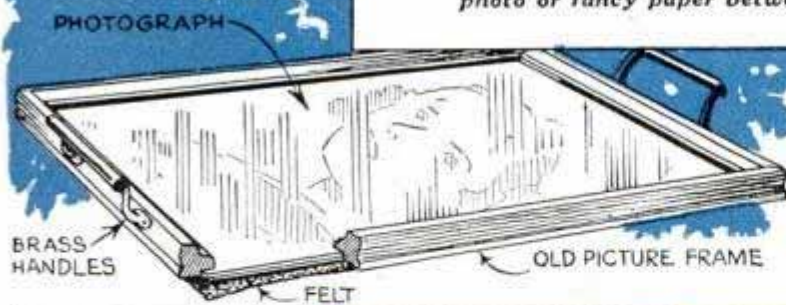



## Fisherman's Seat Improved from Tin Cans

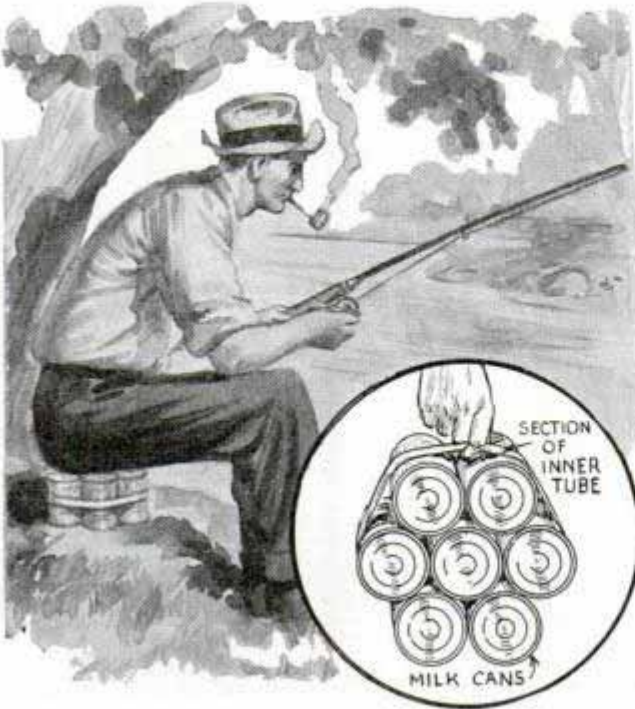

If you dislike to sit on damp ground while fishing, gather up a number of tin cans of the same height and bundle them

together with a rubber band cut from an inner tube, to provide a seat as indicated. The seat is light and easy to carry and will not sink quickly if accidentally dropped into the water.

## Hot Photoflood Lamp Removed with Paper Carton

When a photoflood or other lamp burns out and it is necessary to remove it immediately, use the empty paper carton of the new lamp to unscrew the hot one. The carton prevents burned fingers.



☛ Lipstick stains can be removed from white linen by soaking the cloth in strong vinegar; if the stain is on colored material, use equal parts vinegar and water.

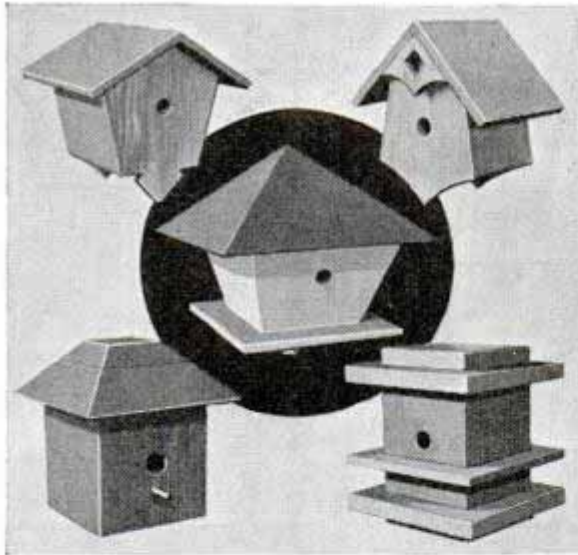

## Five Little WREN HOUSES easy to make

Hung six to twelve feet high from tree limbs or in vine-covered trellises, these snug little houses are sure to attract the vivacious birds.

### Single-Evening Projects

You need not be an expert with tools in order to make these simple houses. Any one of them can be sawed and nailed together in an hour or so. Ordinary grocery boxes and other scrap wood will do, although a material list is given if you have to purchase the wood.

### All Designs in One Plan

All five designs are fully dimensioned and complete instructions tell just how to proceed in doing the work. A fine opportunity for children to start making useful things with hand tools. Send ten cents and coupon for Craftplan No. 3005.

POPULAR MECHANICS MAGAZINE  
200 E. Ontario St. Chicago

Enclosed find 10 cents for Craftplan No. 3005—  
Five Wren Houses

Please check  I am a subscriber  
 I buy at newsstand

Name \_\_\_\_\_

Use Pencil

Address \_\_\_\_\_

City \_\_\_\_\_

State \_\_\_\_\_





# SHOP NOTES

## Set of Lathe **DRILL PADS** *easily made*

Fitted in a lathe tailstock spindle these accurately turned pads enable you to do precision drilling on a variety of work

By CHESTER W. WOODSON

**T**HERE'S a definite advantage in making drill pads in sets for you are then able to handle a greater range of work. For example, if the object to be drilled is of fairly large size, Fig. 1, you can select a pad which will give sufficient brazing surface for adequate support of the material or part being drilled, and where you make the pads yourself it's an easy matter to adapt their range to your own work. Fig. 6 gives the general dimensions for a set of four pads adapted for use with a 9-in. lathe. Of course, if you should have special requirements, these sizes need not be followed closely. But whether made larger or smaller than the sizes given, it's a good idea to keep the proportions very nearly the same.

First of all, you will need to turn wood patterns as in Fig. 2. These should be turned from a close-grained wood such as maple, sanded smooth and given at least two coats of shellac. Allow  $\frac{3}{32}$  in. all over for shrinkage of the casting and for machining. Also, it is necessary to bevel the edge and the center hub slightly

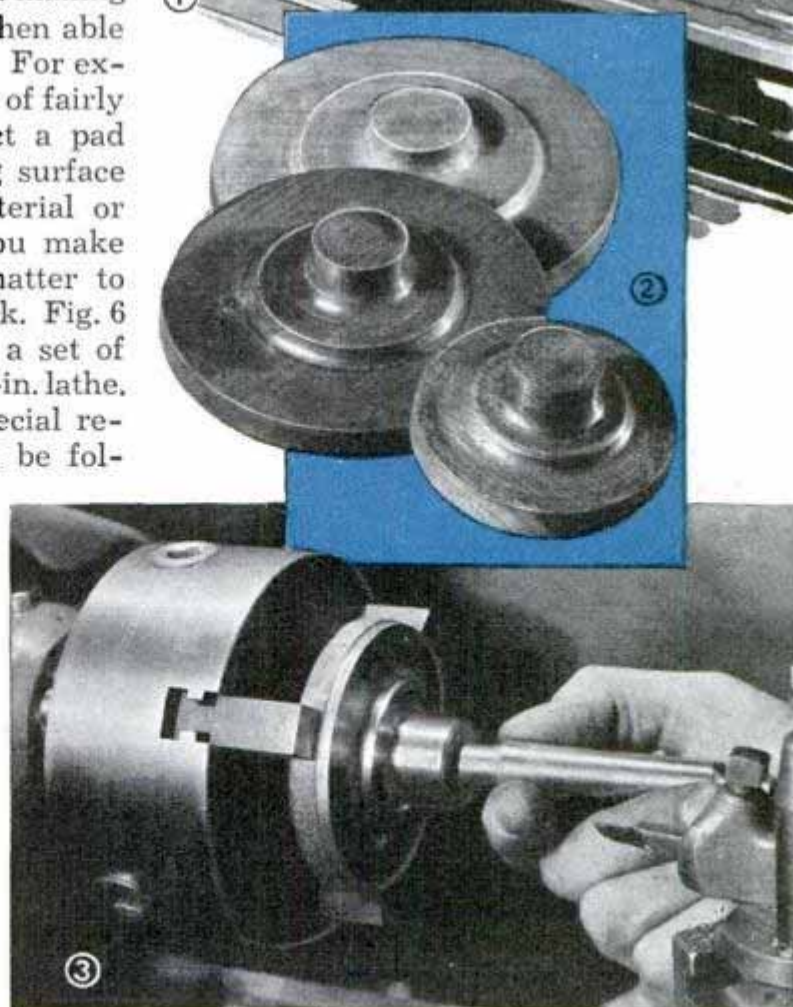



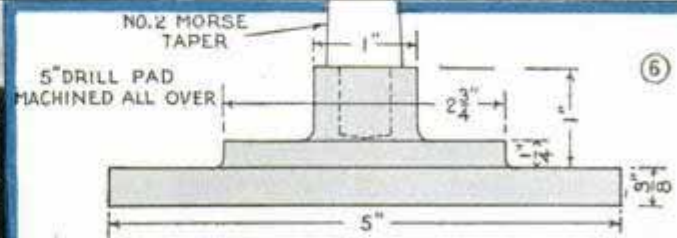
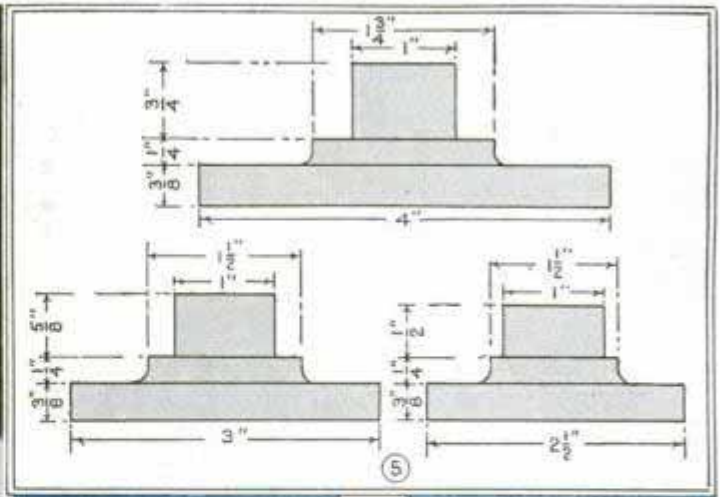

so that the pattern will draw from the mold. You can see this bevel on each of the three patterns in Fig. 2. When you take your patterns to the foundry, specify gray iron castings, for this material machines easily.

Center the castings in the lathe chuck with the hub out as in Figs. 3 and 7. Finish all over and bore for the No. 2 Morse taper shank. The latter can be made easily from a discarded drill bit by shouldering the shank to a force fit as indicated in Figs. 3 and 4, the latter showing how the Morse taper shank is forced into the hub of the pad with an arbor press. Of course, you

have to be very particular about measurements on the taper shank to get a proper force fit.

Finally, the chuck is removed from the lathe and the tapered shank of the pad inserted in the headstock spindle. Then you turn down the rim to the required diameter and true the face of the pad, finishing with a light, slow cut to give a smooth surface. Finish all four pads the same way.

### Gauge Locates Work on Hacksaw

Cut from heavy sheet metal and screwed to the saw guide, this gauge enables you to locate work in the right position on a power hacksaw without lowering the blade. The lower end of the pointer must be bent so that it is directly in line with the blade, and the pointer must be located so it will not interfere with the full stroke of the saw.

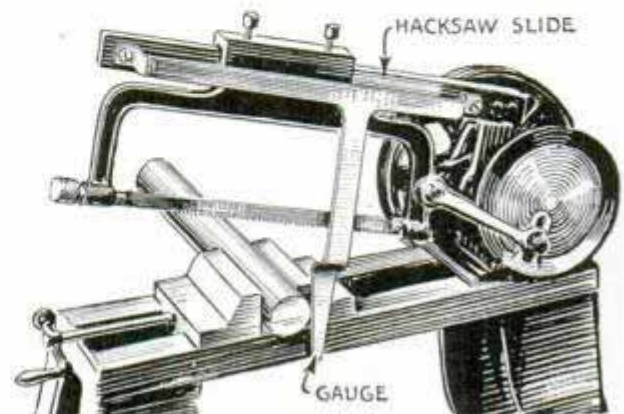



# Tool Chest Has a Removable Carrying Box

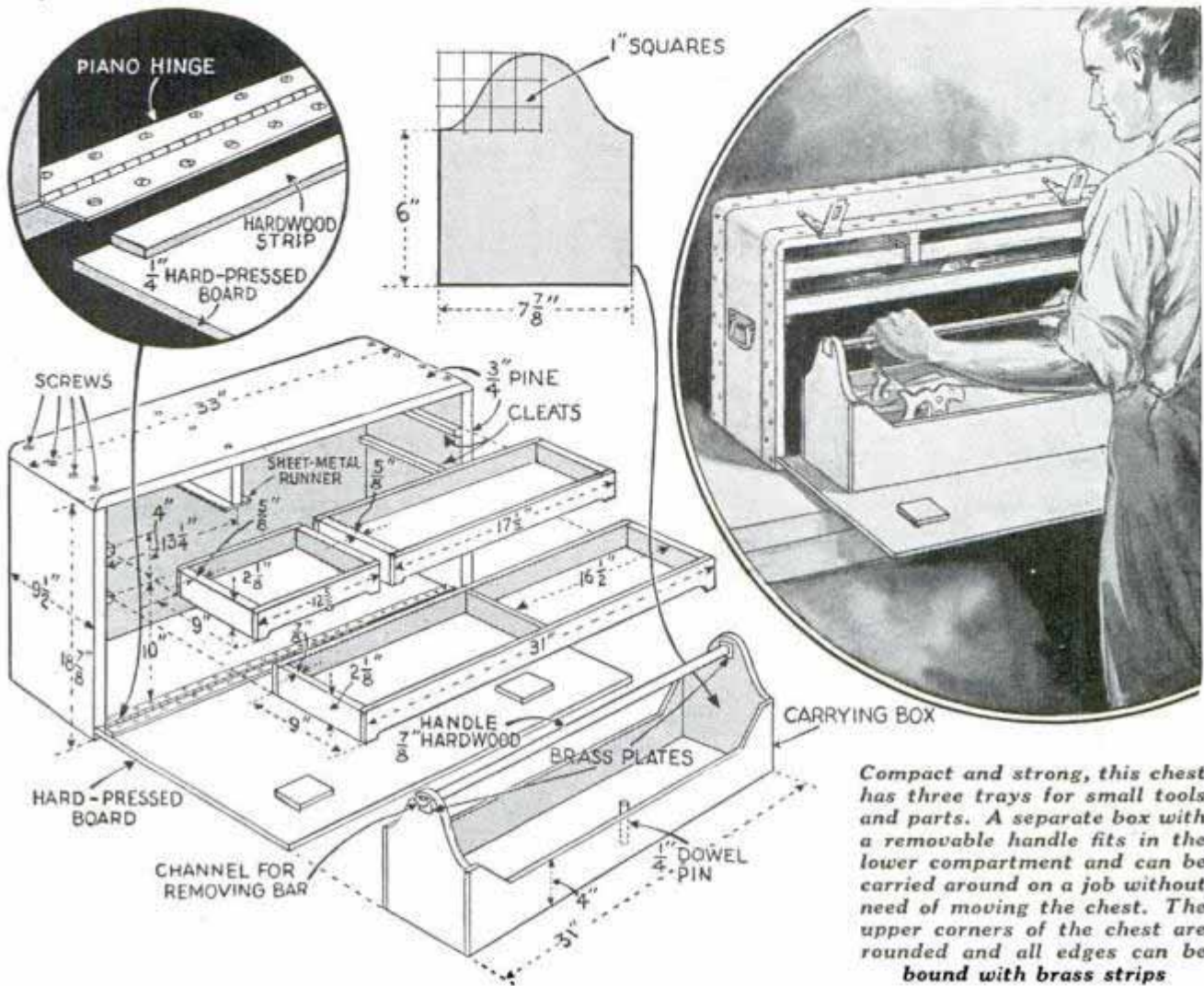

*Compact and strong, this chest has three trays for small tools and parts. A separate box with a removable handle fits in the lower compartment and can be carried around on a job without need of moving the chest. The upper corners of the chest are rounded and all edges can be bound with brass strips*

## Thermometer Readings Marked with Pin on Rubber Grip

Instead of trying to remember previous temperature readings, one dairyman provided a simple thermometer marker. This is nothing more than a pin pushed through

the wall of a short piece of rubber tubing, which is split lengthwise so that it can be slipped over the edge of the thermometer. It's a simple matter to slide the whole tube up or down as may be necessary.

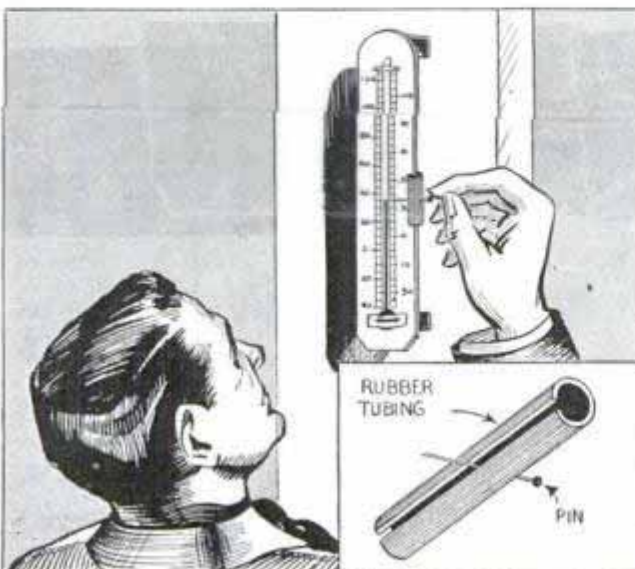

## Rope Cleats from Old Tires

Improvised tieless cleats for use on boats or with awnings can be made from strips of old auto tires, which are nailed in place as indicated. The elasticity of the rubber will permit the rope to be wrapped around the cleat two or three times.

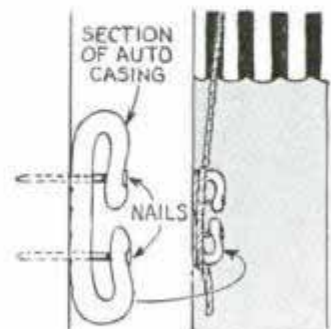



## Toolbox Handle Bent to Hang from Ladder Rung

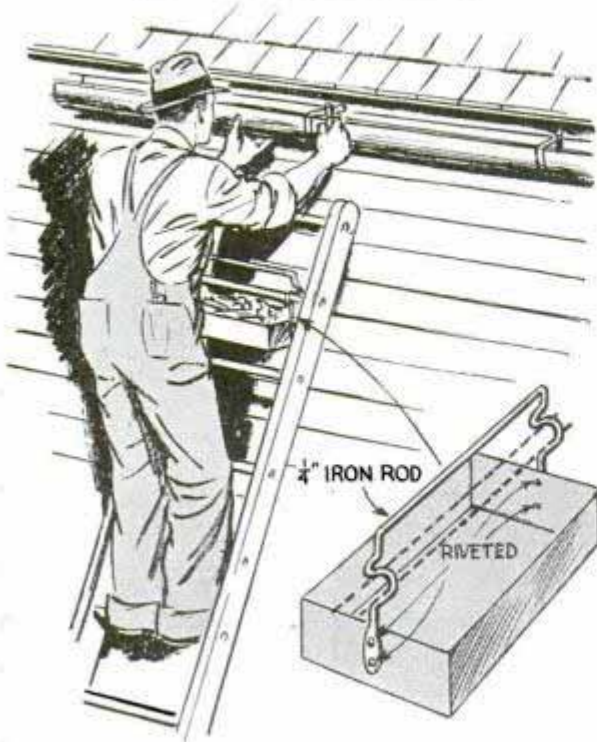

One tinsmith who had many jobs of putting up eave troughs and similar work, fitted his toolbox with an iron-rod handle, which he bent as indicated so that he could hang it on a ladder rung. The handle keeps the tools conveniently at hand and can be removed from the ladder by simply lifting it off.

## Rigid Setup for Large Shafts

When a large shaft has to be laid in V-blocks and there is none at hand large enough to take it, you can use two small ones with the setup shown. Two vises of similar size and two angle plates are necessary. The V-blocks are first set in the

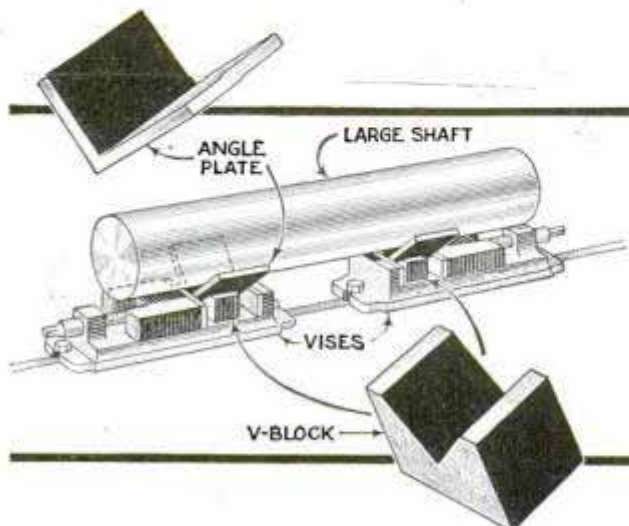

vises, after which the angle plates are set in them and tightened up. This lines up both plates accurately and a rigid setup is obtained.—H. Moore, Leeds, England.

## Shipping Clerk Suspends Crayon with Length of Elastic

To keep his marking crayon within easy reach, yet out of the way, a shipping clerk suspended it above his bench with a length of elastic and an ink-dropper bulb. One end of the elastic was tied into the bulb, which was then slipped over the end of the crayon. The elastic permitted the crayon to be pulled down for marking.



## Tile Forms Window in Storm Cave



Light and ventilation are provided in this farm cave by using a short piece of 14-in. tile as a window. A glass disk fitted into the bell end of the tile and re-

tained with a wood ring keeps out cold winds in winter, and a screen disk substituted for the glass affords ventilation in warmer weather.

## Two Screwdrivers in One

Time can be saved on assembly jobs requiring two screwdrivers of different sizes by using the combination one shown. It is nothing more than a large screwdriver with

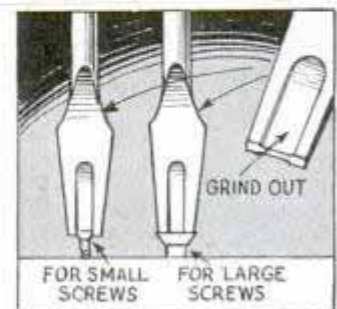

the blade ground down in the center to fit the heads of small screws. This does not interfere with using it for large screws.



# Rocking PRINT WASHER

## *Saves Time in the Darkroom*

This washer gives just the right degree of agitation for thorough washing of prints and its action is fully automatic, requiring no attention during the washing process. Also, the gentle rocking motion prevents the prints from sticking together where a number are washed at the same time. The sheet-metal tray is fitted in a base which is pivoted at the center as you see in the detail below. The tray is fitted with an extension or "pocket" from which a small quantity of waste water drains away each time the tray rocks back and forth. A length of rubber tubing from the faucet supplies fresh water to replace that which drains away

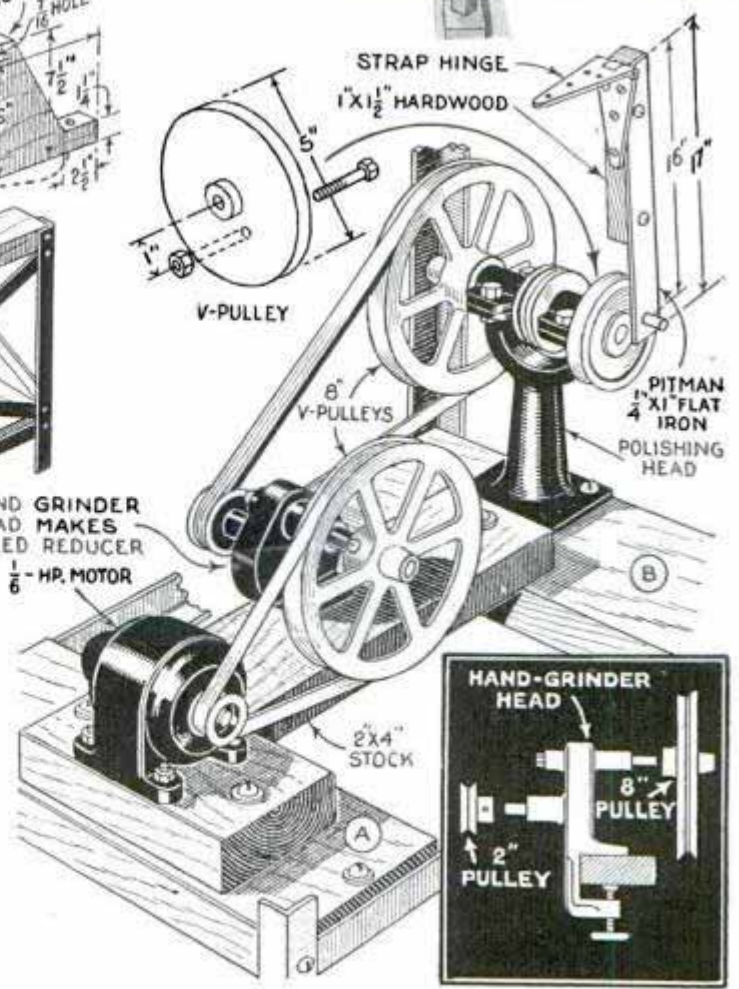
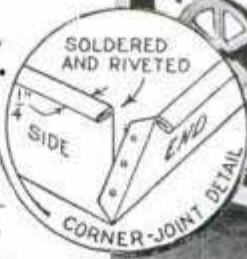
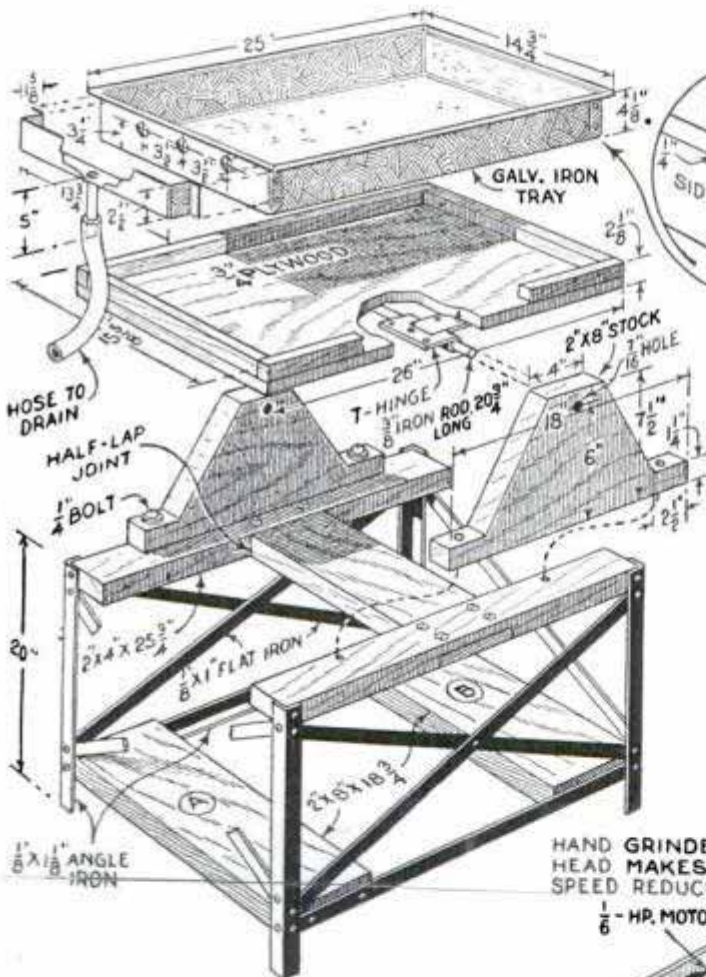
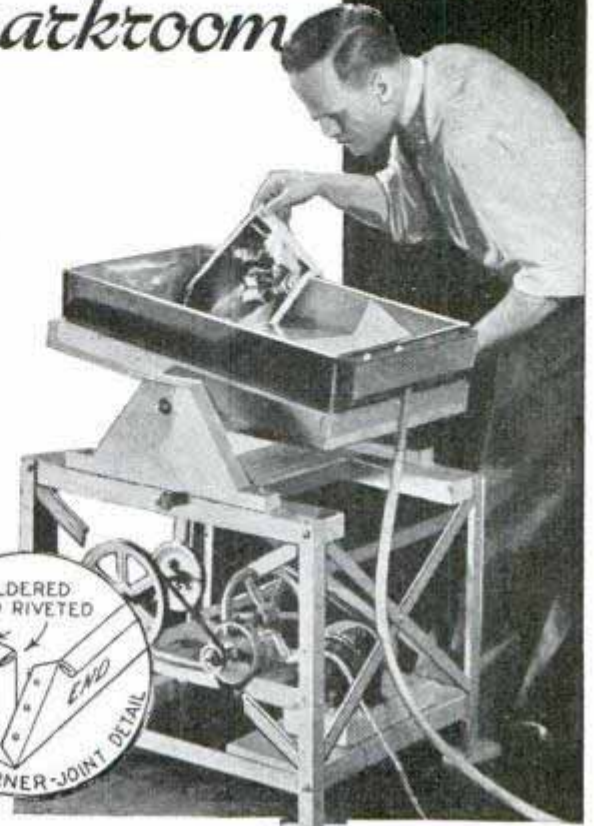

Materials used in the construction are easy to obtain anywhere. Although angle-iron legs and flat iron for the braces are used in the stand, these parts can be hardwood if desired. The reduction gear is made from an old hand-grinder head combined with a polishing head as shown in the detail at the right. The heavy cross-members, A and B in the detail above, support the reduction-drive assembly. Any small motor of 1,750 r.p.m. will operate the washer at the proper speed



## Improved Seat for Farm Wagon Has Auto-Tire "Springs"

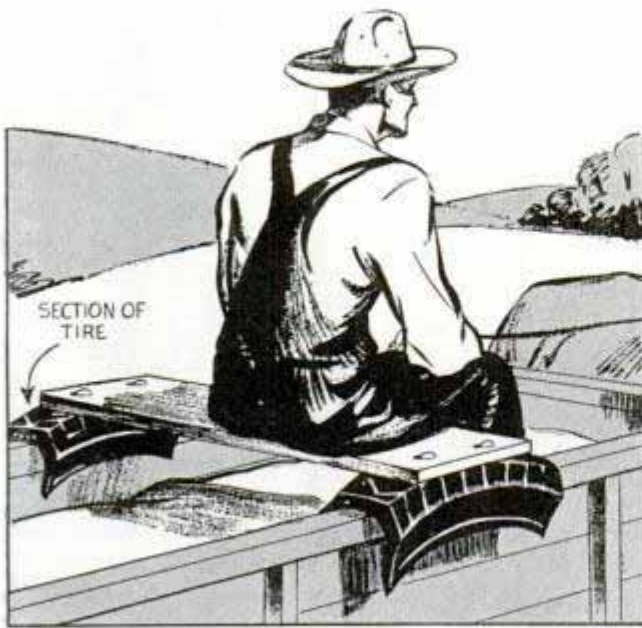

A resilient seat for the farm wagon may be provided by bolting two sections of auto tire to the underside of a suitable board as shown. The tire sections straddle the sides of the wagon box to hold the seat in place and also give a cushioning effect.

## Blueprint Held Flat on Table by Small Washers

Difficulty of keeping a blueprint spread on a bench or table may be eliminated by attaching a small metal washer at each corner with gummed-paper tape, as indicated.

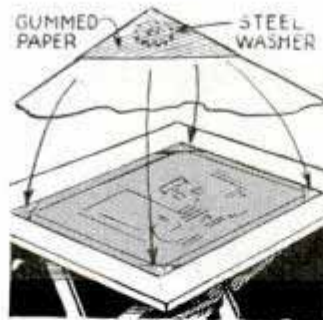

## Transporting Live Minnows



The conservation department of Wisconsin reduced the mortality of live minnows being transported to restock lakes and streams by allowing ice water to drip into the water cans while in transit. This was

done by using milk cans in which pieces of cloth were suspended to hold lumps of ice as indicated. Melting of the ice keeps the water in the can from becoming too warm, and also helps to increase the supply of oxygen in the water.

## Correcting Mimeograph Stencils

It is unnecessary to cut a new mimeograph stencil by the usual method, because of an error in which the letters of a few words have been ruined beyond repair, if you use the following idea: With a sharp knife cut out the damaged part and trim the edges of the opening cleanly. Then make the correction on a fresh stencil and cut it out, making the piece slightly larger than the section removed

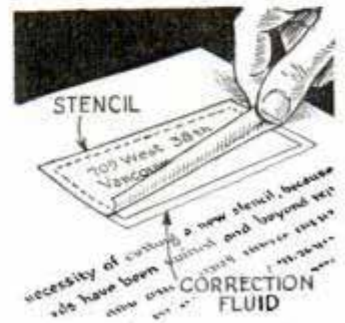

from the original. Fasten this in the proper place with regular correction fluid. If possible, the corrected strip should be placed on the side of the stencil next to the ink pad, as the ink will tend to loosen the patch if it is placed on the outside.

—Lawrence E. Petery, Vancouver, Wash.

## Paper Holder from Door Catch Grips Firmly

Screwed to a block, a screen-door catch of the type shown provides a good holder for labels, shipping tags, etc. The top roller of the catch allows papers to be re-

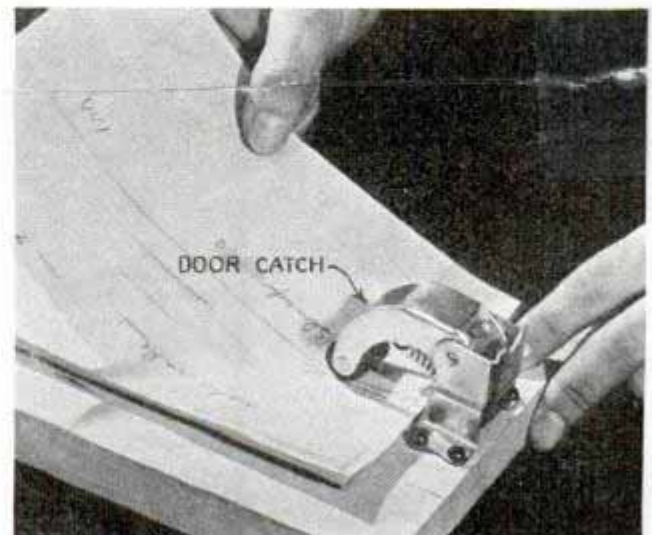



moved easily without tearing and also permits one paper to be removed without the whole pack moving forward.

—Harvey Paisley, Edmonton, Alta., Can.

### Using Two Chucks in Drill Press at Same Time

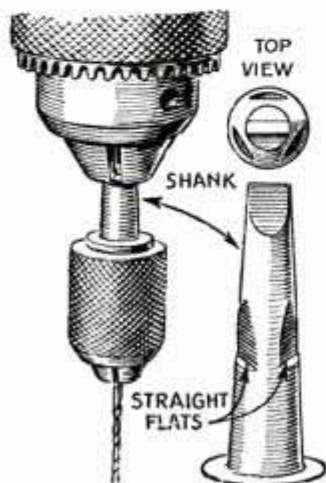

Mechanics who use drill presses that have separate chucks for small and large drills, can save time in changing the chucks by altering the taper shank of the small one so that it can be clamped in the large one. This is done by filing

three equidistant flats on the shank, making them about  $\frac{3}{4}$  in. long. The shank is not weakened appreciably, and the flats do not interfere with using the shank in the drill-press spindle when desired.

### Auto Skid Chain Good Substitute for Weed Hook

Weeds and trash that are difficult to turn under with a plow can be covered if a skid chain is fastened to the front end of the beam and allowed to drag back in the furrow. The chain needs no attention as it follows the work automatically.



### Cutting Keyways on Your Lathe in an Emergency

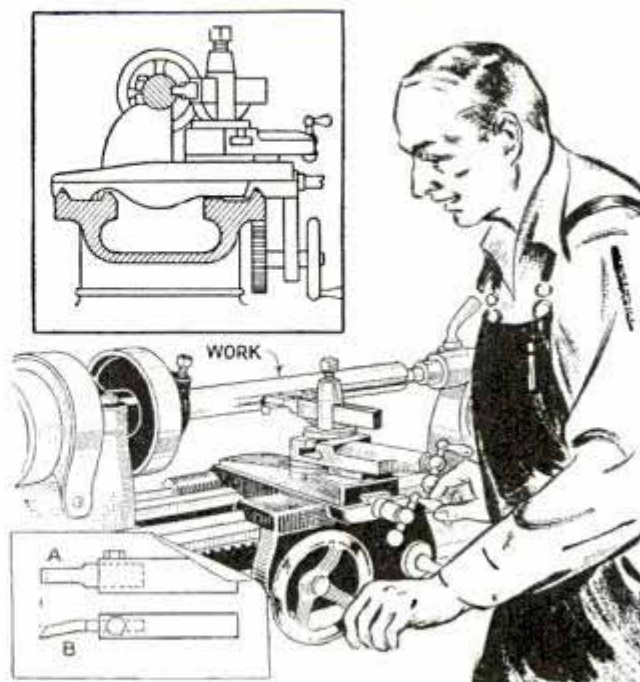

On a job where a keyway had to be cut in a shaft, and a shaper or milling machine was unavailable, I did the work on a lathe. The shaft was centered tightly so it would not turn, and a tool was ground to the shape shown at A and B, making the cutting edge the same width as that desired for the keyway. After mounting the tool, the carriage was run back and forth by hand, taking very light cuts until the keyway was the desired depth.

—Walter F. Purkis, St. James, Man., Can.

### Carrying Spare Flashlight Bulb

Workmen who use flashlights considerably and would like to carry a spare bulb, but do not have room in the bottom of the flashlight, can provide the necessary space by soldering a small metal lid to the cap.

Before doing this, drill a hole in the cap to take the base of the bulb, which extends into the lid. Another way of gaining the extra space is to solder the reflector of an old flashlight to the cap, making the hole in the latter large enough to screw the bulb into the threaded neck of the reflector.—W. C. Wilhite, Carlinville, Ill.

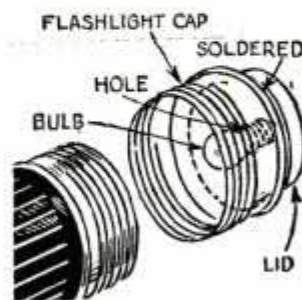



# TRACTOR *Built*

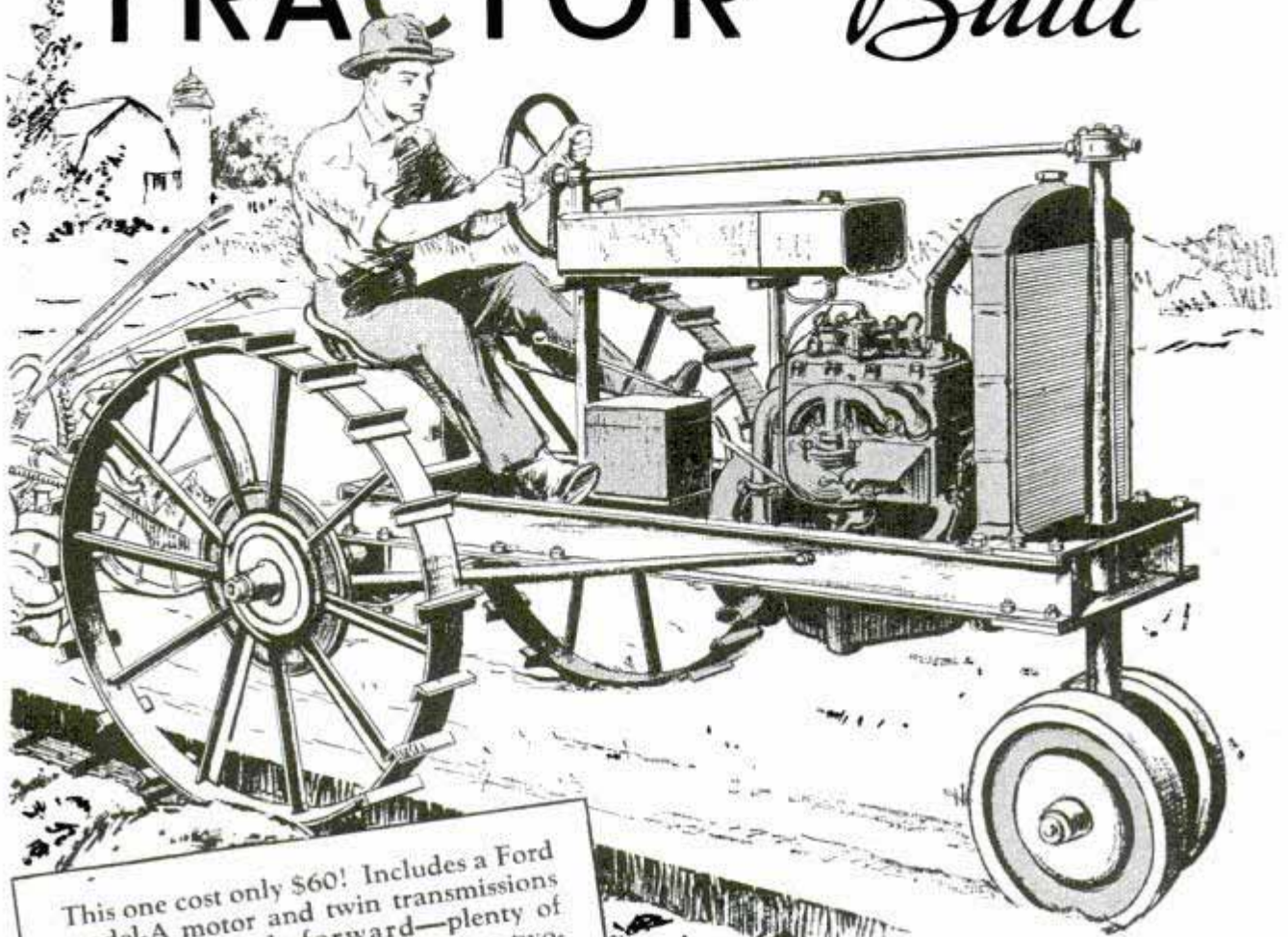

This one cost only \$60! Includes a Ford model-A motor and twin transmissions giving six speeds forward—plenty of power to pull a two-bottom plow, a two-row cultivator and other implements. Wrenches, hacksaw and drill are about the only tools needed—except some welding at your local machine shop

By H. SUDDABY

## PART I

### Frame, Motor, Steering Gear and Driving Mechanism

**H**ERE is power and plenty of it for truck gardeners or owners of small farms who want a dependable tractor at low cost. Its high wheels and wide tread make this tractor ideal for modern row-crop tillage. Under average soil conditions, it will handle a two-bottom 12-in. plow, a 6 or 7-ft. tandem disk harrow, and with a little altering, some two-row cultivators can be adapted to use with it. In some cases, wheel weights will add considerably to the tractive effort under heavy pulls. Anyone can build the tractor as it consists of old

car and truck parts so ingeniously selected that the assembling can be done with wrenches, a hack saw and a little welding, the latter being done for a few dollars by your local machine shop.

Begin construction with the steering assembly, which is detailed in Figs. 1 to 5. For this you will need one Chevrolet steering column complete, one differential housing, two axles, two front spindles complete with wheels, and one model-T Ford truck drive-shaft housing. First cut off one end of the differential housing at the spring saddle 4 in. from the brake assembly. Remove the rivets that hold the brake flange. Next cut off the end of the drive-shaft housing 4½ in. from the universal casting, removing enough from the other end of the housing to make it 37½ in. long. Now weld the short piece of differential housing to the drive-shaft housing as in Fig. 3. Notice that the rear-axle bearing is used to



# from Old Car Parts

## WITHOUT MACHINING

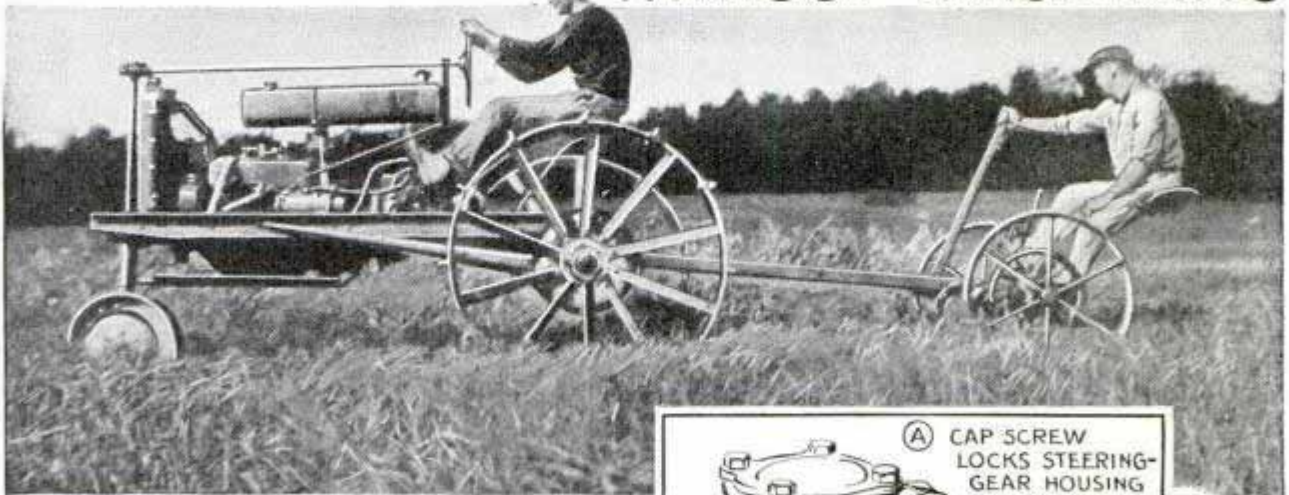

support the front end. It is a good idea to examine this bearing closely for wear. If undue wear shows, it will pay to replace it. The dust plate and grease container are cut in half so that they can be bolted to the axle after it has been inserted.

Then assemble the Chevrolet axles inside the housing, using one full length and a 12-in. length of the other. To save machining the shafts, you can connect their splined ends together with the rear half of a Chevrolet truck universal joint as in Fig. 2. The shoulder or flange is sawed off to leave a splined sleeve, which ties them together without play. Mount the steering column on top of the assembly as in Fig. 1, and weld the end of the shaft that projects from the gear housing to the axle end. You will have to drill and tap the upper end of the drive-shaft housing for a cap screw to keep the column in position. The steering-wheel shaft will have to

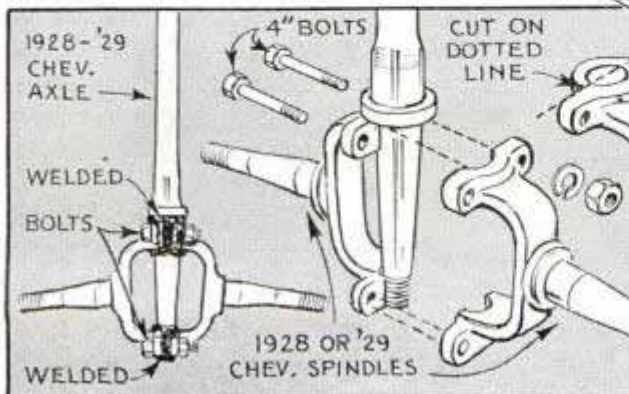
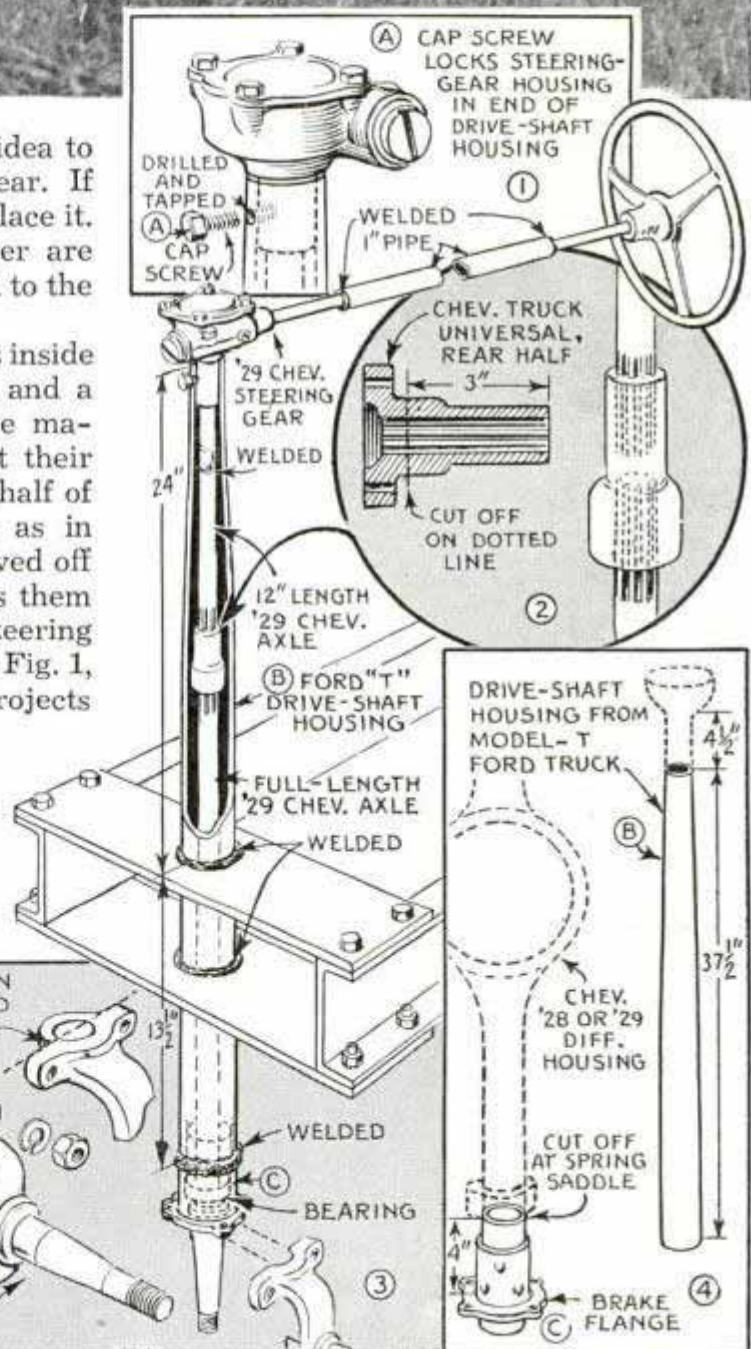



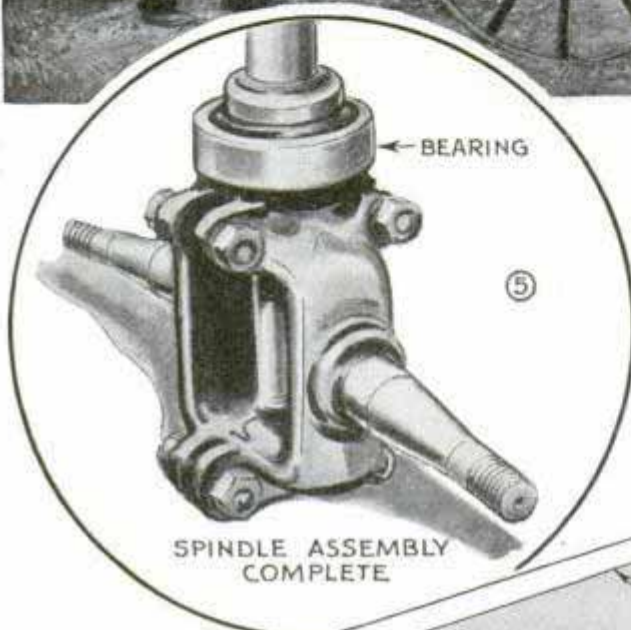
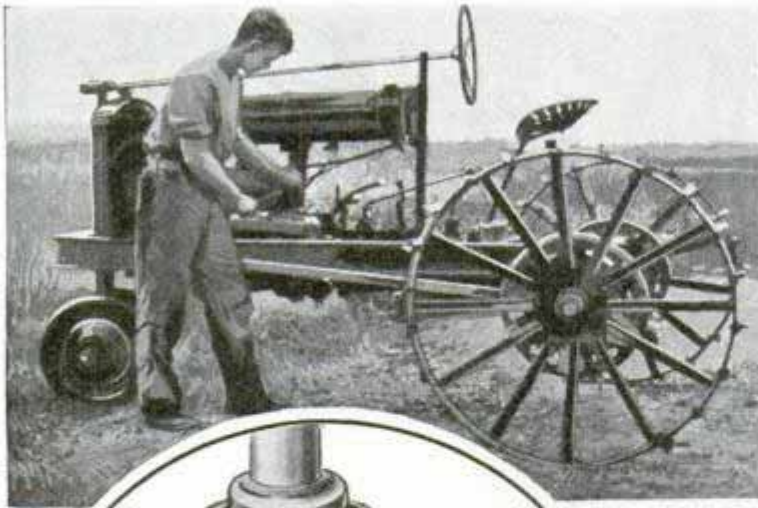

be cut in the center and a 4-ft. length of  $\frac{3}{4}$ -in. pipe slipped over the ends and welded to lengthen the shaft so that it will reach back to the operator's seat. Next comes the wheel spindles, which are bolted and welded to the tapered lower end of the steering assembly after cutting the bosses off the spindles as shown in Fig. 3. Care must be taken with this assembly to make sure that both spindles are tilted to the same angle as indicated. In the vertical plane the spindles should aline exactly, otherwise, the front wheels would toe in or out, making the tractor difficult to steer.

Now you are ready for the frame. The side members are made from channel steel as in Fig. 6. They are drilled as indicated  $37\frac{1}{2}$  in. from the front

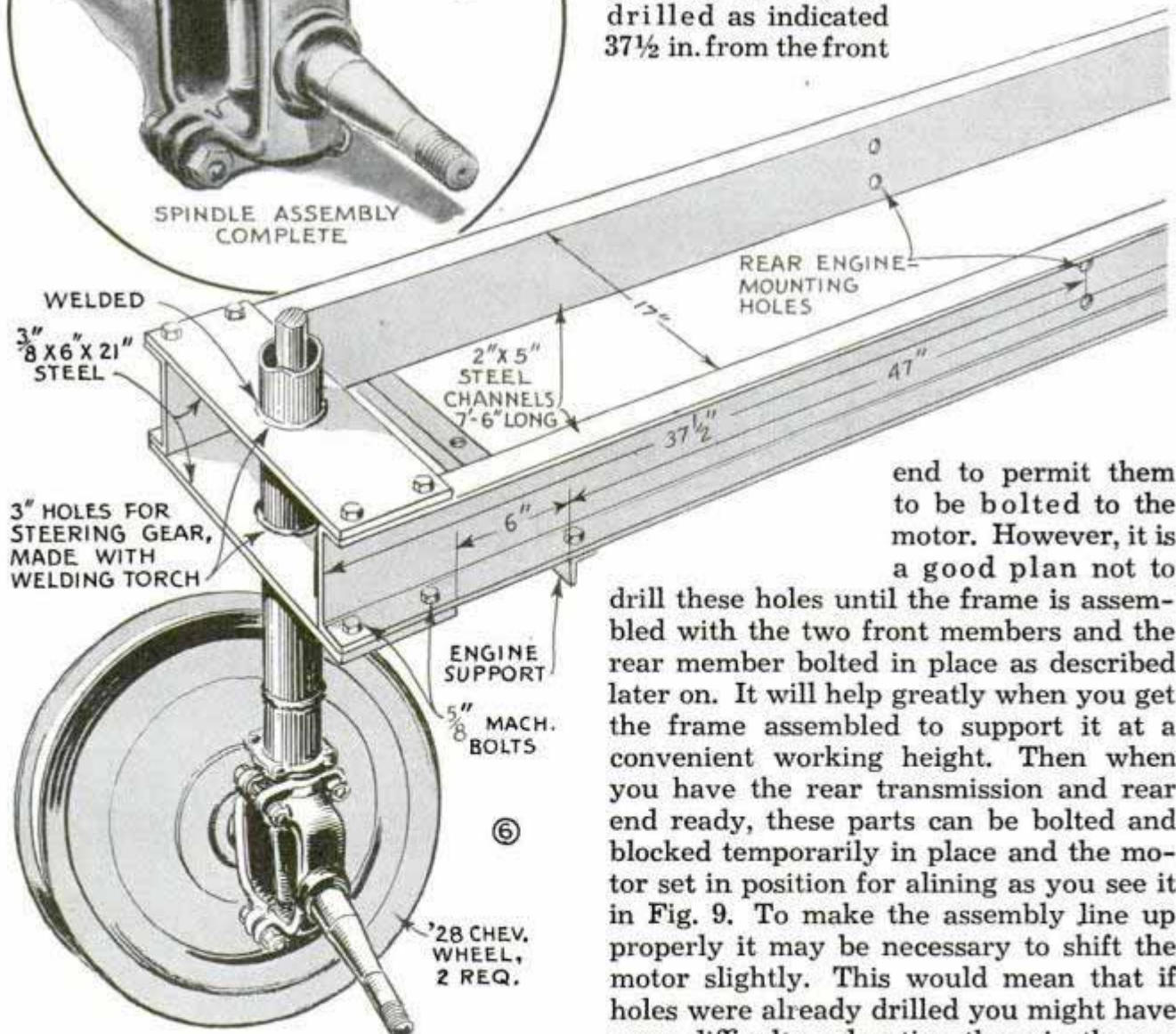

FASTENING SPINDLE ASSEMBLIES TO TAPERED END OF AXLE SHAFT TILTS WHEELS AT JUST THE RIGHT ANGLE FOR EASY STEERING

end to permit them to be bolted to the motor. However, it is a good plan not to drill these holes until the frame is assembled with the two front members and the rear member bolted in place as described later on. It will help greatly when you get the frame assembled to support it at a convenient working height. Then when you have the rear transmission and rear end ready, these parts can be bolted and blocked temporarily in place and the motor set in position for alining as you see it in Fig. 9. To make the assembly line up properly it may be necessary to shift the motor slightly. This would mean that if holes were already drilled you might have some difficulty relocating them in the required position. The two cross members that support the front-end assembly have 3-in. holes drilled or burned in the center



with a welding torch to allow the steering column to be inserted and welded as shown in Fig. 3. These members must be welded 5 in. apart to allow them to be slipped over the ends of the frame members and fastened with  $\frac{5}{8}$ -in. bolts, the top front member being located 24 in. from the top of the drive shaft. As the front of the frame is subjected to rather severe twisting strains, it is best to drill the holes with a  $\frac{5}{8}$ -in. drill bit, using each cross member as a jig so that the holes register perfectly. Applying lard oil while drilling will help assure a clean, true

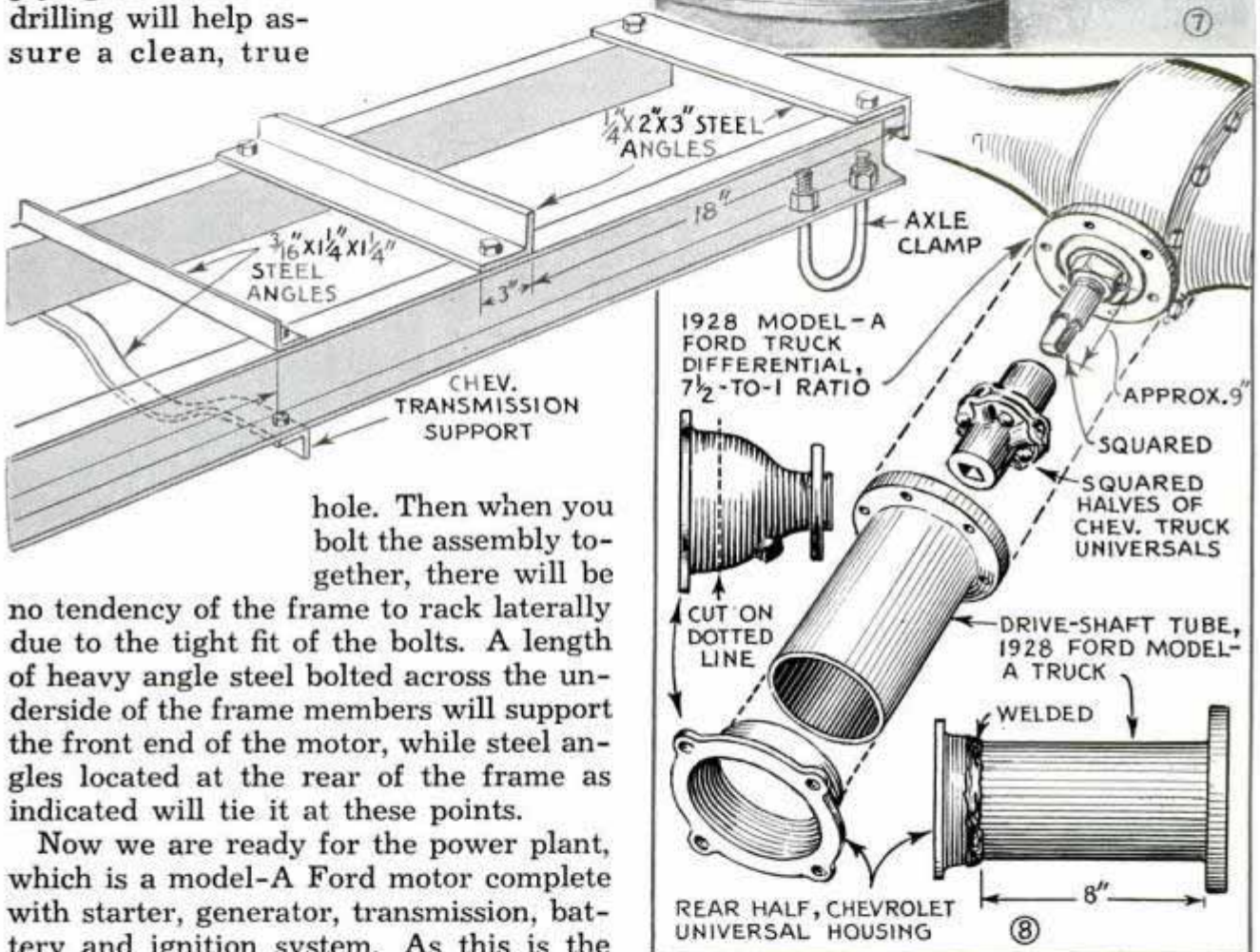

hole. Then when you bolt the assembly together, there will be no tendency of the frame to rack laterally due to the tight fit of the bolts. A length of heavy angle steel bolted across the underside of the frame members will support the front end of the motor, while steel angles located at the rear of the frame as indicated will tie it at these points.

Now we are ready for the power plant, which is a model-A Ford motor complete with starter, generator, transmission, battery and ignition system. As this is the heart of the tractor, it must be in good condition. If the motor has seen considerable service, it should be reconditioned completely and any worn parts replaced. The same goes for the transmission. Remove the cover, wash out all old grease with gasoline and inspect the gears and bearings for excessive wear. If some are worn badly, replacement at this time may avoid breakdowns later. Assemble the transmission and fill it with fresh lubricant. Now mount the motor assembly temporarily in position in the frame. Then get a four-speed Chevrolet truck transmission and a model-A Ford truck differential

assembly to complete the driving mechanism. Clean them thoroughly and inspect for wear, replacing any parts that seem to be worn badly. If this is not done, additional wear will be rapid due to continuous strain on these parts when the tractor is pulling a load. To connect the transmission and differential, carefully square the stub shaft of the latter with a file to take the square opening of a connector made by bolting the rear halves of two Chevrolet-truck universal joints together as in Fig. 8. Then cut off the model-A Ford drive-shaft tube that came with the



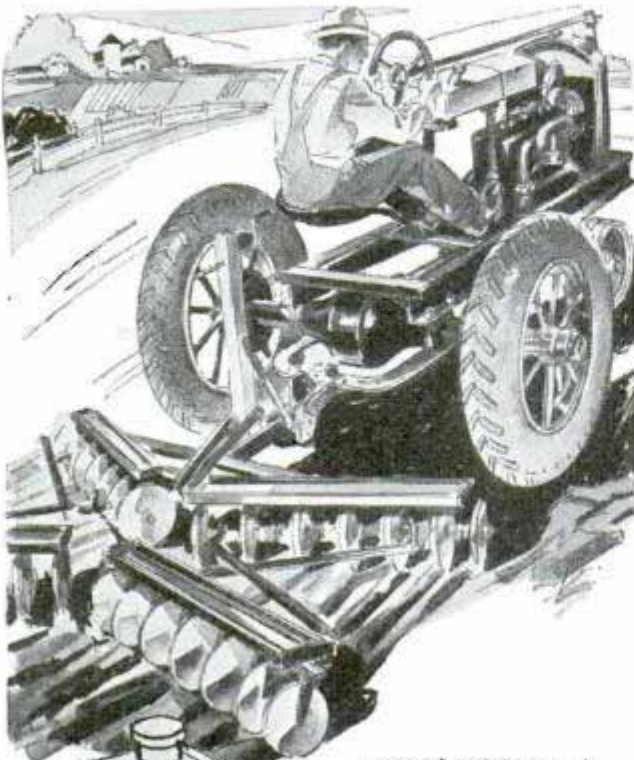

FORD' MODEL - A  
MOTOR COMPLETE  
WITH TRANSMISSION,  
STARTER AND  
GENERATOR

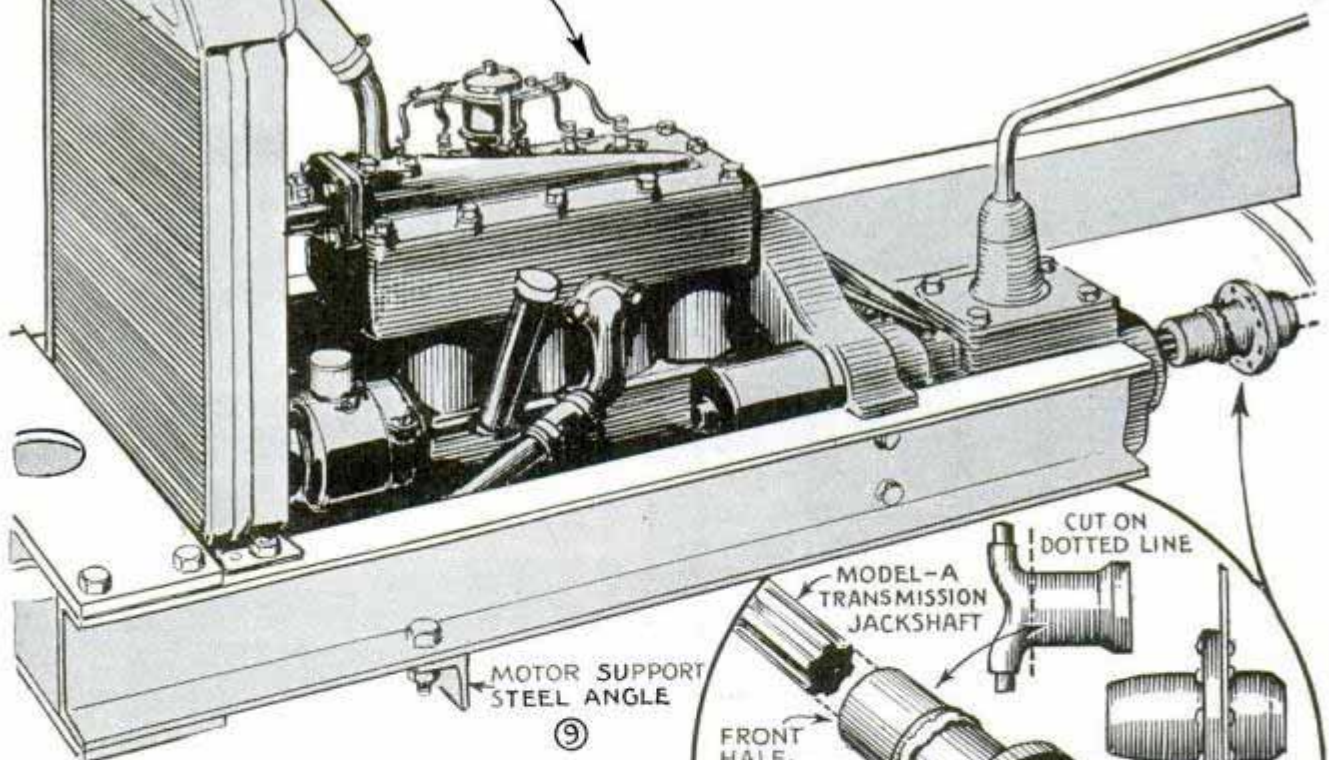

truck differential 8 in. from the flange at the rear end and weld the rear half of a Chevrolet universal-joint housing to the severed end as in Fig. 7, first cutting off the rear end of the universal housing as indicated in Fig. 8. This allows you to bolt the transmission and differential rigidly together as shown in Figs. 9 and 10. Now set this assembly temporarily under the

rear end of the frame. A connector to fasten the stub shafts of the two transmissions together and complete the driving mechanism is shown in the circular detail of Fig. 9. This consists of a Chevrolet clutch hub, with the clutch disk removed, welded to the front half of a model-A Ford universal joint, which has been sawed off as indicated by the dotted lines. This gives you a strong connector that will slip over the splined ends of the two transmission shafts of different diameters without expensive machining in having a sleeve made for this purpose.

Now you are ready to align the motor, transmissions and differential and bolt them in their respective positions in the frame. This must be done perfectly, otherwise the bearings will wear rapidly. The motor has to be tilted down in the rear so that the transmissions and drive shaft are in a straight line with one another. After all shafts have been lined up, an angle steel support should be bent and bolted in place on the front end of the Chevrolet



transmission, holding it rigidly to the frame. Several short bolts must be screwed into the holes in the front end of this transmission, that formerly held the clutch housing to the transmission, to prevent the gear oil from leaking out. However, two of the bolts are used to hold the support previously mentioned. Next, the front motor support may have to be bent up or down to aline the transmissions with one another. If the two are in alinement, the jack shaft at the rear end of the Chevrolet transmission can be turned freely with the hand if both transmissions are in neutral.

After this work has been done, bolt the rear end assembly to the Chevrolet transmission and fasten the axle housing rigidly to the frame with heavy U-bolts. Be sure, before you draw up the bolts between the transmission and rear end, that meeting surfaces are entirely free from hardened grease or accumulations of dirt. Use lock-

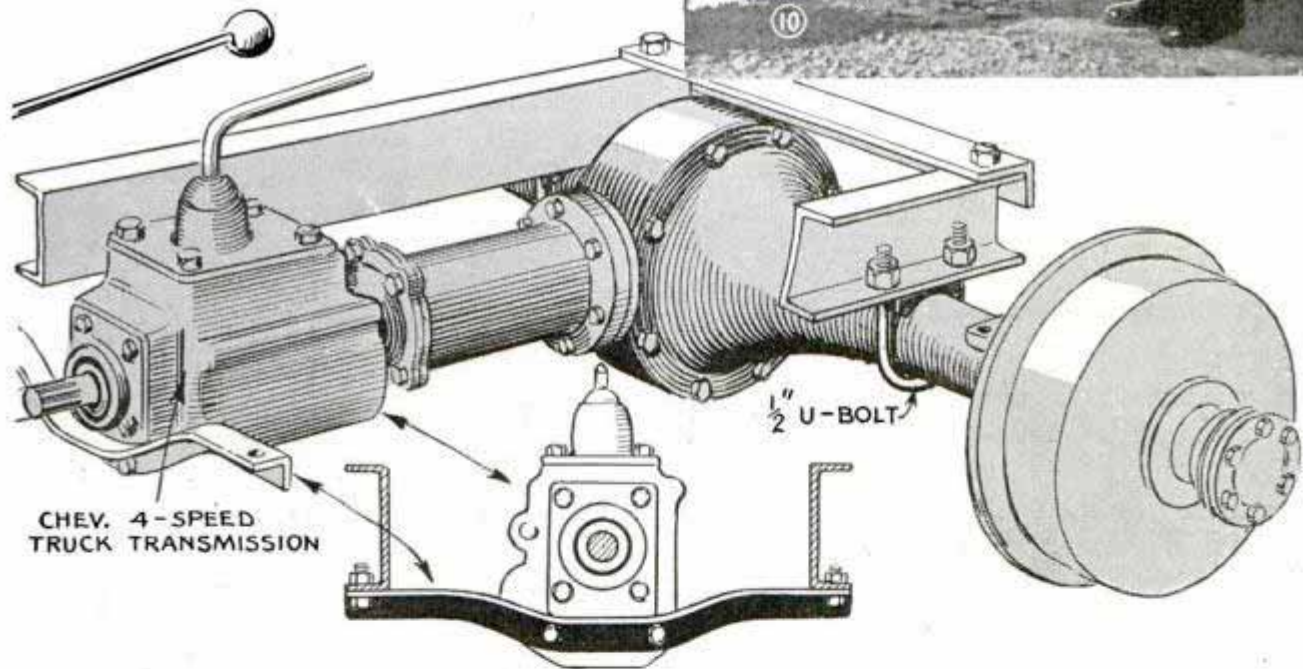

washers under all nuts and cap screws and draw them up evenly to avoid stripping threads. See that the driving assembly is not thrown out of alinement in doing this. It is a good idea to tack-weld the U-bolts

to the axle housing after perfect alinement has been assured. You are now ready for the wheels, seat, drawbar, etc., which will be given next month.

(To be continued)

## Avoiding Leaks in Sewer Before Joint Cement Hardens

When sealing joints of a sewer pipe which must be used before the cement can set, you will have no trouble from leaks caused by water thinning it if you try the following method: Fill the joints with cement that has been mixed to a stiff consistency. Then at intervals of one half hour

or so, sprinkle a little dry cement over the joint. As the water seeps through, it will be absorbed by the dry material, which will harden and stop the leak. In some cases, two or three applications of dry cement may be necessary.

—J. E. Polisso, Rochester, Pa.



## Loose Hay Holds Bales Safely When Piled for Storage



Baled hay is difficult to keep piled so that it will not slip or roll with danger to the workman who handles it. To avoid this, one dealer uses loose hay or straw which is scattered over each layer or row of bales to bind them together.

## Three-Way Corner for Crates

Shipping crates nailed by this method cannot pull apart no matter which way the strain comes. When nailing the first two pieces at the corner, one is allowed to extend beyond the other the thickness of the stock. The third piece will then lie naturally in place.

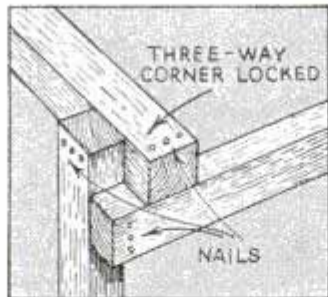

## Shovel as Temporary Signpost



There are many instances when a sign must be posted hurriedly, on account of temporarily closing of roads, etc. A regular shovel will serve as an excel-

lent signpost for such emergencies, the shovel being forced handle first into the earth and the sign then attached by means of a string, looping it over the back as shown.—Opie Read, Jr., Chicago.

## Small Drills Kept Lubricated with Fixed Brush

When using tiny drills in production work, it was found that a small brush dipped in oil saved time in lubricating them. The brush handle was fastened to a spring-type clothespin so that it could be clipped to a sheet-metal holder which was fastened to the drill block. To lubricate the drill, it was raised and the block slid slightly to touch the brush against the drill. One dip of the brush in the oil was found to be sufficient for several minutes use.

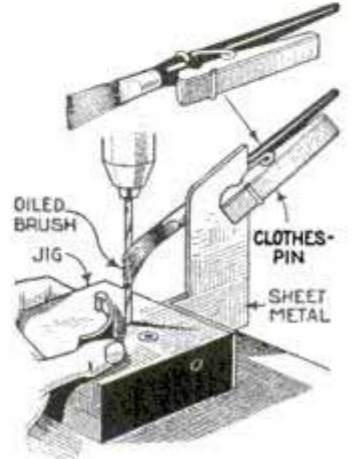

—W. F. Cowgill, Dayton, Ohio.

## Drill-Press Locating Pads Are Cleaned Quickly

Time wasted in cleaning dirt and chips from a drill press or milling-machine jig, when standard locating pads are used, is saved by altering the pads as shown. One wipe with a small sash brush will clean off the pad because the dirt and chips slide down the sloping slots instead of lodging on the base of the jig.

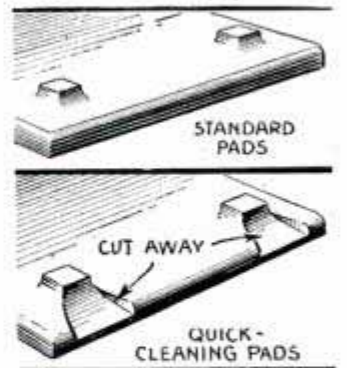

—George B. Harran, Westfield, Mass.

Photographic developing solutions keep better in brown-glass bottles, and if the latter are unavailable, coat the outside of clear bottles with asphalt varnish.



# Auto SHORTCUTS

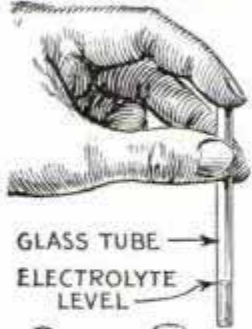

GLASS TUBE  
ELECTROLYTE  
LEVEL

When cleaning your car, the bench in 1 solves the problem of reaching the top. The legless end rests on the running board. Battery electrolyte level is determined quickly by inserting a glass tube to touch the plates, then closing the upper end with a finger, and removing the tube as in 2



①

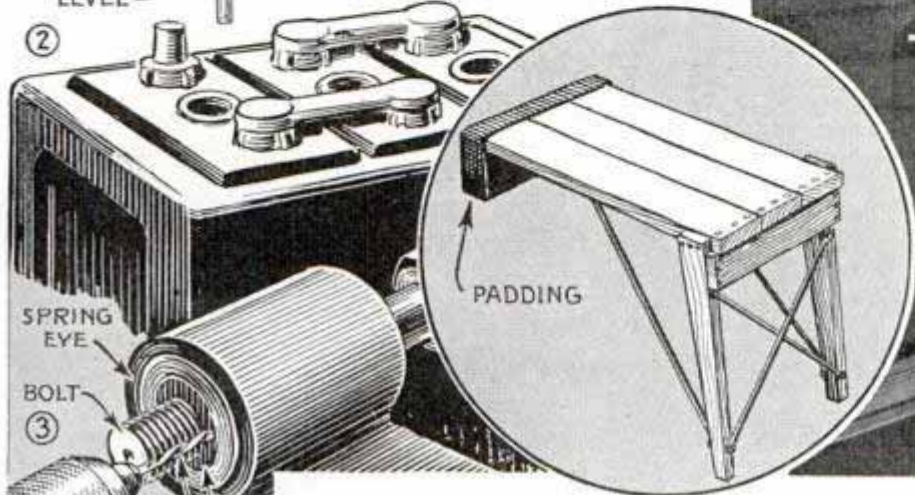

②

SPRING  
EYE

BOLT

③

PADDING

A fabric-type shackle bushing is removed easily if a small drill is run between the bolt and the outer casing as in 3, so that the bushing can be compressed slightly. If you purchase motor oil in bulk, an old gas tank fitted with a faucet at one end and a gauge on top as in 4, is a handy storage container

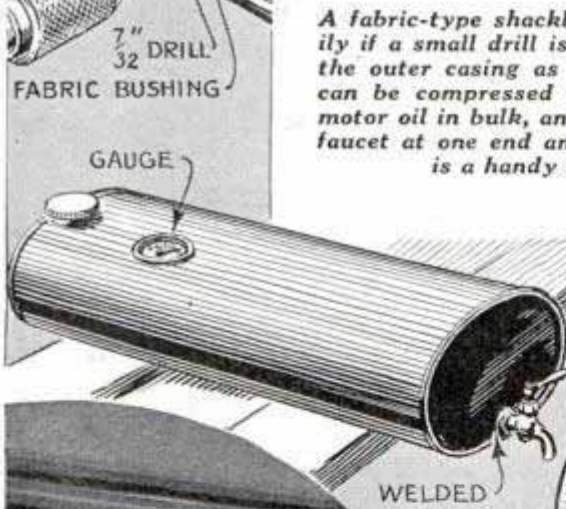

7" DRILL  
32  
FABRIC BUSHING

GAUGE

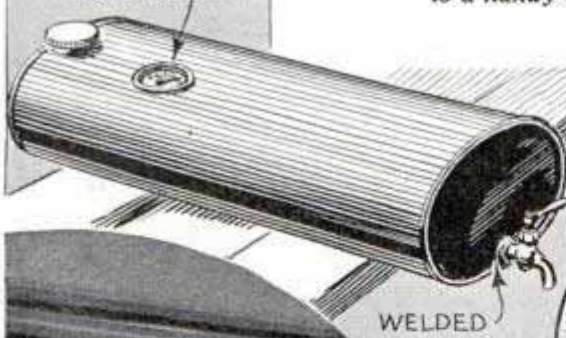

OLD  
GAS  
TANK

④

WELDED

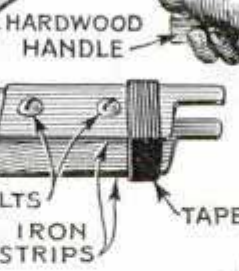

HARDWOOD  
HANDLE

BOLTS  
IRON  
STRIPS

TAPE

PRONGS  
CROSS BAR

⑤

Headlamp latches of the type having spring-loaded cross bars are operated easily with the tool in 5. A wrapping of tape on the tool prevents marring the lamp. Your stoplight housing is a handy place to carry a spare set of keys as in 6. Half of a hollow rubber ball slipped over the air-hose nozzle as in 7 causes a better distribution of air when blowing out cylinders after a motor-cleaning job



HALF  
RUBBER  
BALL

⑦

AIR JET  
ENGINE  
CYLINDER



## Stud Bolts Removed with Tool Improved from Nut

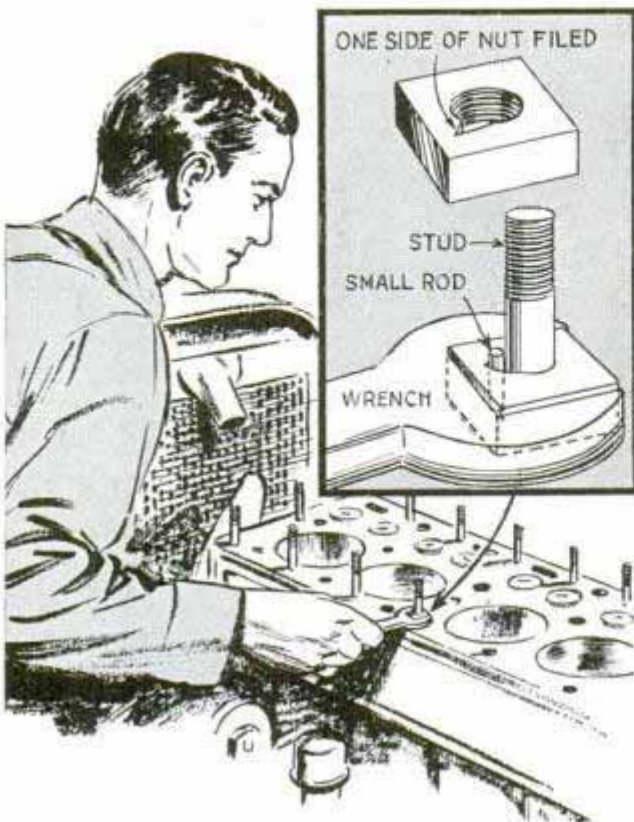

When you have a stud bolt to remove and there is no special stud wrench at hand, you can use an end wrench and a nut altered as shown. Just file a notch in the threaded hole of the nut, sloping one side. Then slip it over the stud with the sloped side facing opposite the way the stud is to be turned. Drop a short piece of small rod into the slot and turn the nut with a wrench. The rod will roll up the sloping side of the notch and bind tightly against the stud so that it can be turned.

## Storage-Battery Terminals Pulled with Altered Turnbuckle

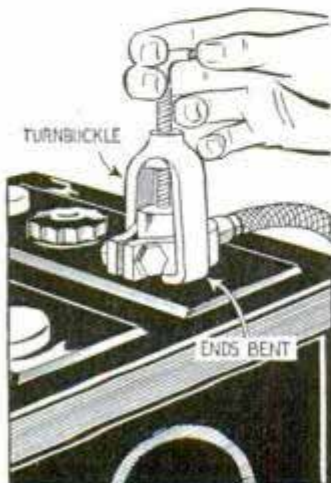

Instead of loosening a battery terminal with a hammer or pry bar, take a few minutes and make up this tool, which will do the job easily without danger of damaging the post or pulling the plates loose. Saw off one end of a

turnbuckle and bend in the resulting legs at right angles to straddle the post and slip underneath the terminal. Then bend the end of the remaining turnbuckle screw at right angles to form a handle and the tool is ready for use.

## Emergency Taillight Lens

When the glass in the rear lamp of a car is broken, and a new one is not available, a temporary substitute can be provided with a section of a red-rubber toy balloon. This should be stretched over the rim of the lamp and held in place with a piece of string or rubber band.

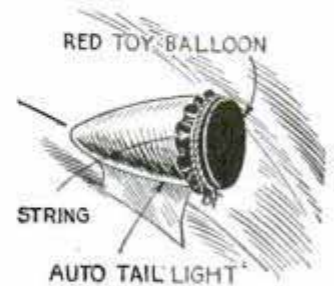

—Ivan J. Stretten, Detroit, Mich.

## Wooden Arm Holds File Safely to Clean Wheel Rim

After a workman had been injured slightly while cleaning rust from the rim of a rotating wheel, a mechanic constructed this simple holder for the file. A stout oak stick was notched and provided with staples to hold the file in place while the wheel was driven in reverse. It was possible to apply the pressure easily, and the cleaning was accomplished in less time.

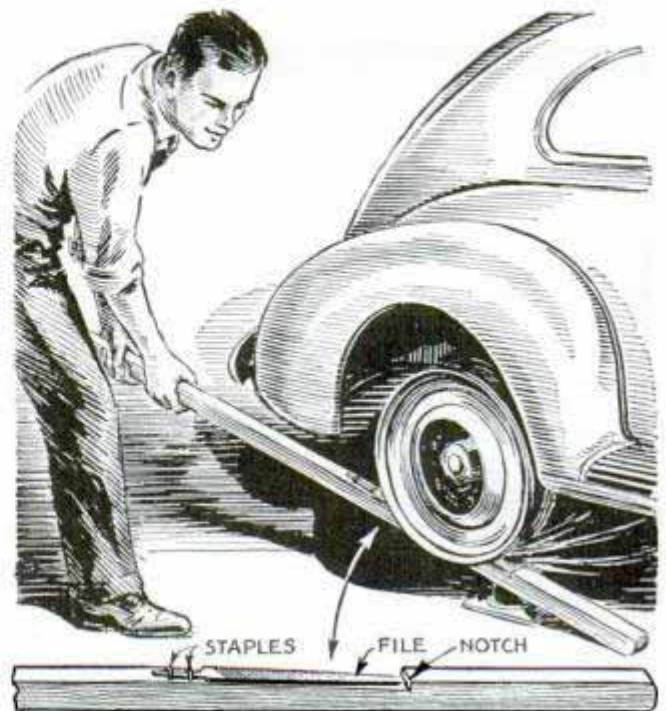



## Slip-On Canoe Rack Fits Pins on Bumpers

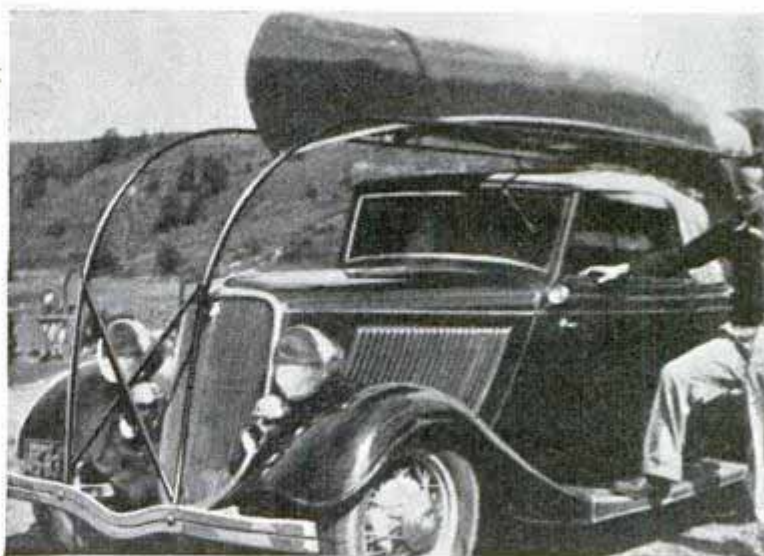
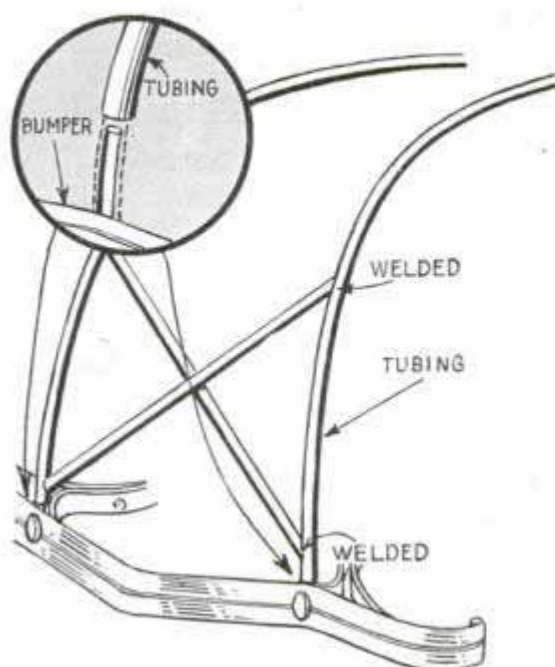

Highly convenient in that it can be instantly removed from the car because it merely slips on four pins attached to the bumpers, this canoe rack is a compact and rigid unit which holds the canoe well up over the top of the car and does not interfere with the opening of doors or with driving. Steel tubing,  $\frac{1}{2}$  in. inside diam-

eter, is used to make the rack. Flat-iron crosspieces welded to the ends provide the necessary rigidity. The pins on which the tubing fits, are lengths of  $\frac{1}{2}$ -in. steel rod, projecting about 8 in. above the bumpers as shown in the circular detail. The rods are bolted to the bumper brackets, which may be accomplished by flattening part of each rod and drilling the flattened part to take the bumper bolt.

—Robert D. Forster, Montreal, Que., Can.

## Driver Scrapes Out Pipe in Ash Drawer with One Hand

I have found that a strip of metal fastened inside the ash drawer of my car enables me to scrape out ashes from a pipe

with one hand conveniently. This method eliminates fire hazard involved in knocking hot ashes out of an open window as they are frequently blown back into the upholstery of the rear seat. The metal strip is tapered at one end to fit the pipe bowl and is drilled and bent at the other end to fit under the drawer-pull screw.

—J. Modroch, Danbury, Conn.

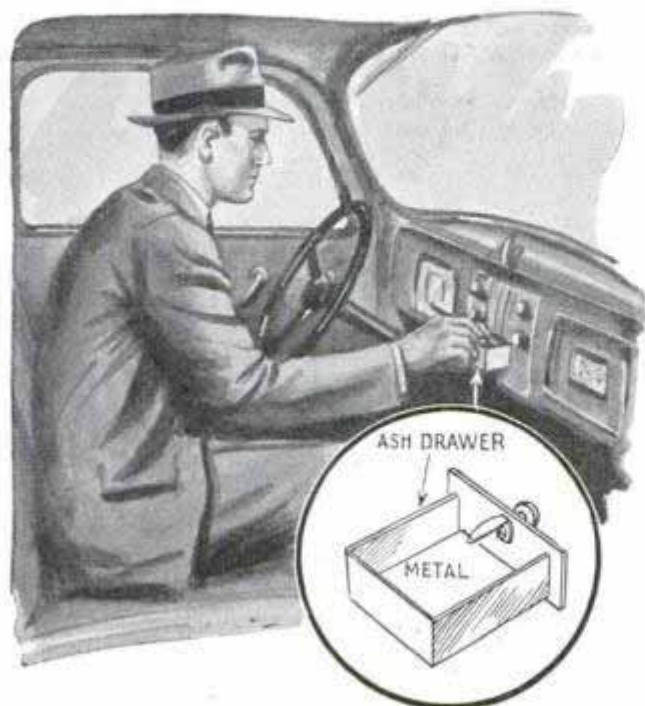

## Locating Break in Drive Assembly

One mechanic uses the following method to locate trouble in the driving mechanism of a car. First he jacks up one rear wheel and, with the car in "high," moves the ring gear with a screw driver inserted through the grease hole in the differential. If the gear moves freely, the break is in the drive-shaft assembly. If the gear does not move the break is between the gear and rear wheels, probably an axle shaft or key.

—C. E. Packer, Chicago.



## Rubber Bumper on Garage Wall Protects Door Finish

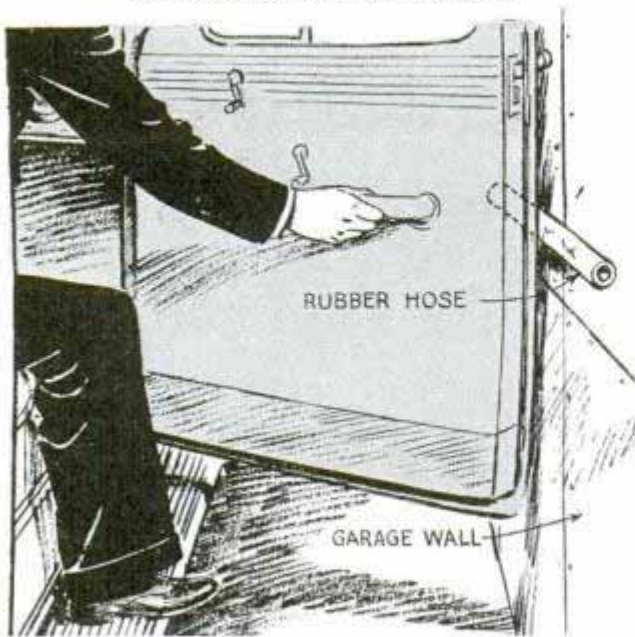

If your garage is narrow so that the door sometimes strikes the wall when opened, fasten a length of garden hose at this point. The hose will absorb the jar and prevent the paint from being nicked off the door. In cases where the door handle strikes a plaster or soft-board wall, and is apt to

puncture it, the same method of providing a bumper can be used.

—Harry W. Boedecker, Pittsburgh, Pa.

## Gap in Spark Plugs Adjusted with Hack-Saw Blade

Automotive engineers have found that flat surfaces in spark plugs last longer in service than curved ones, with the result that the gap between the electrodes or "points" is often made with a milling cutter or circular saw. When readjusting the gaps after the plugs have been used, practically the same setting as the original can be obtained by using a hack-saw blade. This is ground to the right thickness, usually .025 in., after which the electrodes are closed together so that the blade cannot be slipped between them, and the gap is sawed to the correct setting.



## "Skipper"—Low-Cost, 14-ft. Outboard Runabout



At an expenditure of only \$30 to \$40 you can build this trim, five-passenger runabout, which is powered by a 4 to 24-hp. outboard motor. Its speed ranges from 9 to 24 m.p.h. depending on the size motor used. The boat has a 54-in. beam, 15½-in. freeboard, 24-in. depth, a 5-in. draft at 725 lbs., and a weight of about 275 lbs. Six plans (Nos. 1018 to 1023 incl.) showing details of building besides sheets giving material list and outline of procedure will be sent postpaid on receipt of \$1.

### 400 Build-It-Yourself Plans

Every home workshop owner should have our illustrated catalogue for constant reference to get ideas on what to build. Shows nearly all projects as they look when finished. Includes modern and colonial furniture, home and garden improvements, workbenches, tool cabinets, motor-driven machines, models of all kinds, outdoor-sport devices, radio equipment, electrical devices, toys and novelties, juvenile articles, etc. The only cost to get this new catalogue is a three-cent stamp. Be sure to print your name and address carefully when ordering.

### Other Boats You Can Build

- "Roamer"—765 to 770: Outboard cabin cruiser; two berths. Six prints \$1.00.
- "Sea Saucer"—893: 9½-ft. sail boat. Deck, bottom and sides are 3/16-in. plywood. 25c.
- 12-Ft. Utility Rowboat—707: Flat bottom. Four seats. Sturdy design. 25c.
- 16-Ft. Canoe—811 and 812: Cedar planking covered with canvas. Two prints 50c.
- "Arrowhead" Sloop—944 to 951: Fast sailboat 21 ft. long, 5 ft. 11 in. beam. Set of 8 prints \$1.50.

Any six of these plans (not projects) will be sent upon receipt of \$1

Address Plan Service, Popular Mechanics Magazine, 200 East Ontario St., Chicago



# Champion Spark Plugs

—the overwhelming choice of  
“Doodlebug” Champions!



Bunched like hounds on a scent, wheel to wheel and fighting every inch of the way, a pack of midget race cars or “doodlebugs” roars and slides ’round a small race track. In this, one of the fastest-growing sports in the nation, midget race car drivers must have split second response to accelerator. They know their spark plugs must withstand fouling, and pre-ignition due

largely to leakage—common to ordinary spark plugs—and eliminated by Champion’s patented Sillment seal. Records show practically every “doodlebug” champion, national and sectional, as well as the majority of all racing drivers, insists on dependable Champion Spark Plugs. Use the spark plugs champions use and you will insure all ’round better engine performance in your car.

**IT'S THRIFTY TO INSTALL NEW SPARK PLUGS — Demand CHAMPIONS**



# Test-Flying the Sky Giants

(Continued from page 715)

Allen does not fit the popular version of the test pilot who climbs aboard and shouts to the mechanics to pull out the wheel blocks so he can swoop aloft. He spends days, and sometimes weeks, on the ground



Pilot Allen lifting the Boeing clipper onto its planing step for a takeoff

with the plane before taking it aloft. Engines must be tuned to perfection. Controls must be adjusted to a fine degree. In the case of the XB-15 bomber, Allen taxied it back and forth on Boeing Field at Seattle for days after most preliminary work had been done. He was not to be hurried. Day after day he wheeled the huge bomber the length of the field, sometimes getting up speed enough to lift the tail wheel into the air, only to taxi back to the hangar for further adjustments. Finally, when he did take the bomber aloft, he knew everything was right. And it was. The immense plane lifted with the ease of the smallest plane. And the first landing was as gentle as if he had flown it for years.

His great amount of practical experience and technical knowledge takes a certain amount of risk out of test hopping. He can size a plane up and know whether to take it aloft or walk away from it. This latter alternative doesn't happen often. Allen merely points out to the manufacturer that such and such should be changed.

Allen always wears a parachute and he insists that any assistants (these huge modern planes require four and five men on test hops) wear parachutes.

A fine code of ethics must be observed by the free-lance test flyer. A pilot like Allen, testing for a half dozen builders, necessarily must have the confidence of each. He has detailed information as to the innovations planned by each manufacturer in the highly competitive military and

commercial fields. This information, Allen finds, must be stored in individual compartments, so to speak, in his mind so that he doesn't accidentally reveal to the Boeing company a secret new tail assembly which Sikorsky engineers have perfected, or vice versa.

Once the War Department had called for bids for a new type of plane and two of Allen's employers were competing. Each asked Allen to demonstrate his plane. The test pilot was in a quandary. But not for long. The solution was simple. He would test both planes. The manufacturers were agreeable. Allen, when the tests got underway, demonstrated both planes to the utmost of his ability and to the planes' abilities, being extremely careful not to

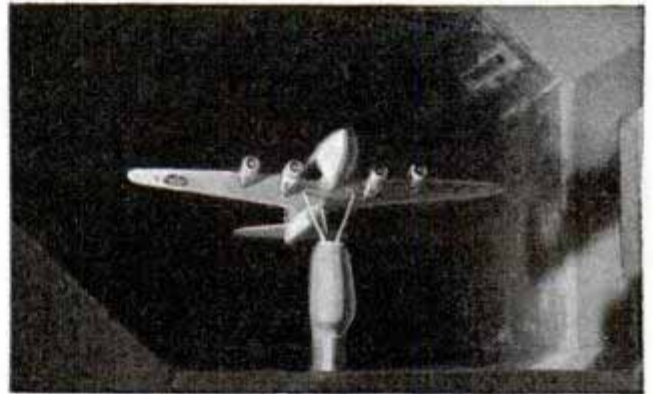

Miniature of the Stratoliner being tested in University of Washington wind tunnel

voluntarily or involuntarily give one or the other an unearned advantage.

Allen predicts with confidence that the day is near at hand when the mechanical hands will replace the human hands in flying even more than they have today.

## Seedless Watermelons Grown in Greenhouse Patch

Watermelons without seeds, long sought by scientists, have been grown at Michigan state college by a Chinese graduate student, Cheong-Yin Wong. The exterior shape has been changed somewhat, being more pear-like than oval, but the taste is about the same. The new melon has smaller whitish, veiny sections than the normal melon, and Mr. Wong said that field production might be difficult but it has decided advantages for growing in greenhouses.

g-169  
East Lansing, Mich.  
value above



*Best cigarette  
I ever rolled*  
..give me **VELVET**  
every time

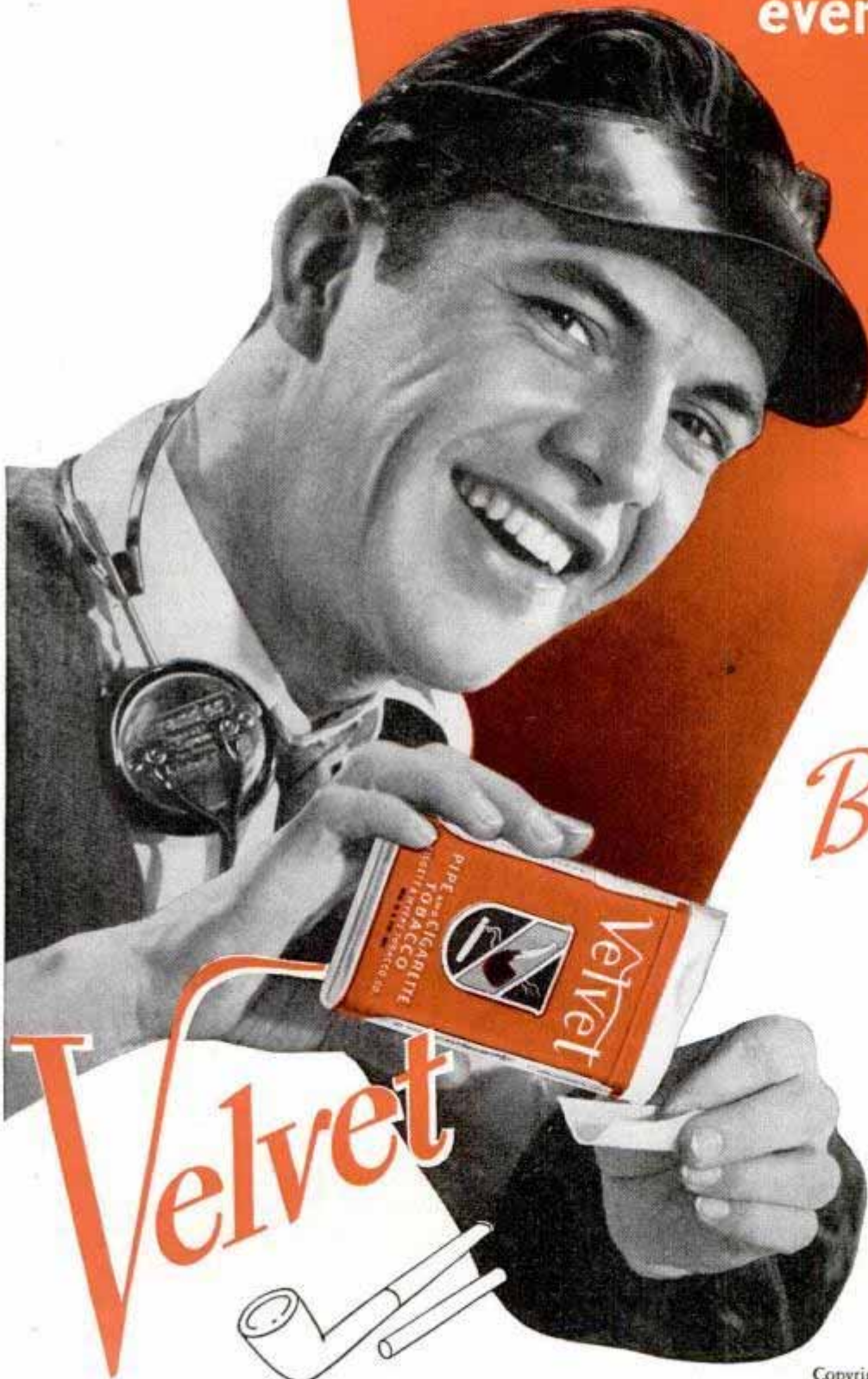

*Better  
smoking  
tobacco*

*Velvet packs easy in a pipe  
Rolls smooth in a cigarette*

*Better tobacco  
for both*

- the MILDNESS  
of fine old  
Kentucky Burley  
aged in wood*
- the FLAVOR  
of pure maple  
sugar for extra  
good taste*



# New Cars for the Kings of Speed

(Continued from page 692)

sion in the rear. In torsion suspension the usual spring action is obtained through the twisting of long bars of special alloy. Since there is no universal joint on the drive shaft, the two rear axles have two universal joints each. Shock absorbers are of a combination hydraulic and friction type. Rear tires are eighteen by seven and one-half inches and the front tires are half an inch narrower. Engine exhaust stacks, instead of being carried out on the side of the car, are smoothed into the streamlining along the lower part of the frame. The in-



Turning solid billet of metal in lathe to create counterbalanced crankshaft for four-cylinder engine

strument board in the driver's cockpit is mounted on springs to reduce vibration. The car has a duralumin body and weighs 1,900 pounds.

Fred Offenhauser, well-known race-engine builder, is finishing a six-cylinder, 265-cubic-inch non-supercharged engine for Joe Lencki of Chicago. It will develop about 225 horsepower. The motor has three carburetors. Due to lack of room in the spherical combustion chambers two valves instead of four per cylinder are used.

Another Offenhauser was built for Anthony Gullota of Kansas City, to power a car to be driven by Ralph Hepburn. This is a conventional four-cylinder racing engine of 270 cubic inches, developing about 225 horsepower, and employing four valves per cylinder and two camshafts. Another four-cylinder Offenhauser was built for Ted Horne, owner and driver. The motor

has a displacement of 240 cubic inches and develops about 200 horsepower. All of these engines are nonsupercharged and each of them has a compression ratio of thirteen to one.

Joe Thorne, Rex Mays, and Jimmie Snider will comprise a team driving powerful cars designed by the Thorne Engineering company of Los Angeles. The cars are a year old, having competed first in the 1938 event, and are being changed to deliver more speed. Art Sparks, chief engineer for Thorne, is "souping up" two of the engines from an original 310 horsepower each to about 350 horsepower.

Two of the Thorne cars have supercharged motors of 179 cubic inches displacement each, burning alcohol fuel, and turning up to 7,000 revolutions per minute. The third motor is nonsupercharged and develops peak power at 5,500 revolutions. This motor has a three and seventeen-thirty-seconds-inch bore and a four and three-eighths-inch stroke. All of the Thorne cars have cross springs front and rear and four-wheel ventilated brakes with dual pressure cylinders on each.

Louis Meyer, three-time winner of the Indianapolis race, is driving for Robert Bowes of Indianapolis, using the same eight-cylinder in-line supercharged motor of 179 cubic inches that he drove last year, with some modifications to produce greater speed. Wilbur Shaw will drive the same car he entered last year, altered to develop greater horsepower. Floyd Roberts, 1938 winner, is likewise driving the car he used last year. Babe Stapp is driving an Alfa Romeo owned by William S. White of Indianapolis, and Kelly Petillo is driving his 1938 car. Ronnie Householder is driving for Leon Duray, using a supercharged 183-cubic-inch four-cylinder engine in a new chassis.

This year the race is much more than a thirty-three-cornered battle. It is a competition between supercharged and non-supercharged engines, between four-cylinder, six-cylinder, eight-cylinder, and sixteen-cylinder engines, between designers who think moderate horsepower plus reliability is best and other designers who are banking on much more powerful engines for greater speed.

1935 W. 62nd St. Los Angeles

12154



# 4 Big Qualities in One Gasoline

POWER, PICK-UP,  
LONG MILEAGE,  
A CLEAN ENGINE

All in  
One  
Gasoline

BALANCED MOBILGAS GIVES  
BALANCED PERFORMANCE

**T**HEY LOOK ALIKE—but don't be fooled! You can buy gasoline with one or two good qualities, or you can get the Big 4: *Pick-up... Power... Mileage... Cleanliness!*

You get all 4 in Mobilgas. This gasoline is made for modern, high-speed engines. It atomizes fast...fires quickly and completely. It's cleaned not once...but *6 times!* And every drop is selected for high octane value. Try Mobilgas today! Socony-Vacuum Oil Company, Inc.



**MOBILGAS** *For Balanced Performance*



# Challengers of Disaster

(Continued from page 725)

ground-floor doors and windows. When the Connecticut's rising waters again threatened the buildings in 1938, the operators moved to upper floors and the bulkheads were put in place and calked. The river rose to within two feet of its 1936 level but the bulkheads held. As a result, telephone damage in Hartford during the hurricane due solely to high water was comparatively slight.

In many sections of the stricken area, emergency batteries and power plants were ready to be hooked up to supply light and power when regular sources failed. The carefully planned, standardized equipment, the results of years of research by



*Putting a cable across a raging torrent after the bridge had been swept away by high water*

engineers and scientists of the Bell telephone system, made it possible for a challenger of disaster from a distant state to step in and utilize that equipment as familiarly as his own. To that extent, science had anticipated and forestalled disaster.

Fighting against the forces of nature, however, was another matter. As the lines went out by thousands, the remaining ones were needed for more and more messages, first for summoning aid and directing rescue, then, as the toll of the dead and injured mounted, for information by relatives, and individual pleas for assistance.

The A, B and C cables between New York and Boston—the "underground"

backbone of eastern seaboard communication—failed just before the full force of the hurricane struck, when a normally quiet stream went berserk and demolished a bridge at Atwoodville, Conn., a few miles above Willimantic where the cables crossed. A section of an important route between Norwich, Conn., and Providence, R. I., was practically demolished, as was the New Haven-Providence line which runs along the shore. This was caused by falling trees. The Springfield-Albany cable and the most important cable route entering Vermont were severed when a bridge over the Connecticut river at Chicopee Falls was carried away.

Lines entering Vermont from New Hampshire were also down. So many cities and towns in these two states were temporarily without service that both were virtually "off the map" for a time. So was the western part of Cape Cod when a bridge washed out at Wareham, Mass., severing a cable.

This was the situation faced by the challengers of disaster. Nearly a half million telephones out of commission. Lines down. People dead and dying.

Before the first rescue workers had taken the field, 8,000 disaster fighters in the area were already stringing wires and erecting poles. But the work had to be speeded up. And so, as the first emergency lines were erected and circuits completed, telephone companies in other states learned of the havoc and immediately mobilized their forces.

"Men and materials, these were the vital requirements," says an official of the American Telephone and Telegraph company. "Almost at once there appeared on the highways and streets of these stricken territories telephone trucks—singly and highballing in convoy behind police escort—bearing the license plates of distant states. Plants as far west as Illinois slipped into well-oiled emergency gear, all coordinated in one effort to one end—to get the supplies into New England and Long Island where they were needed, as they were needed and all that was needed. They did. By the second week after the disaster, more than 2,300 trained men and

(Continued to page 120A)



HERE'S A CHANCE  
FOR MANY  
**SKINNY**  
FOLKS TO GAIN  
FIRM FLESH.



**THOUSANDS GAIN 10 TO 25 LBS.  
NEW PEP, BETTER LOOKS**  
—with Ironized Yeast Tablets

Now thousands of thin, run-down people can say goodbye to skinny bones, tired feeling and nervous crankiness. For with these scientific, easy-to-take little Ironized Yeast tablets, great numbers who never could gain before have put on 10 to 25 solid pounds, gained new pep and strength—in just a few weeks!

The reason is simple. Scientists have discovered that many folks are skinny and jittery—can hardly eat, sleep or work—only because they don't get enough Vitamin B and iron from their daily food. Without these vital substances you may lack appetite and not get the most body-building good out of what you eat.

But you can now get these exact missing substances in these pleasant little Ironized Yeast tablets. So with them thousands of men and women have easily put on just the pounds they needed, gained new pep and natural attractiveness they hardly ever hoped to have.

**Make this convincing  
money-back test**

Get Ironized Yeast tablets from your druggist today. If with the first package you don't eat better and FEEL better, with much more strength and pep—if you're not convinced that Ironized Yeast will give you normally attractive flesh, new energy and life, the price of this first

package promptly refunded. Only be sure you get the genuine Ironized Yeast, and not some cheap, inferior substitute which does not give the same results. Look for "IY" on each tablet.

**Special offer!**

To start thousands building up their health right away, we make this special offer. Purchase a package of Ironized Yeast tablets at once, cut out the seal on the box and mail it to us with a clipping of this paragraph. We will send you a fascinating new book on health, "New Facts About Your Body." Remember, results with the first package—or money refunded. At all druggists. Ironized Yeast Co., Inc., Dept. 535, Atlanta, Ga.

**Gains 14 lbs.,  
strength, energy**



Don Russo

"I had been losing weight and had no pep or energy. I looked so bad I was ashamed to go out and meet anybody. Then I tried Ironized Yeast. In 3 months I gained 14 lbs. My new huskiness and pep has brought me lots of new friends."  
Don Russo, Phila., Pa.

**Gains 12 lbs.,  
admired now**



R. Loeffler

"Was losing weight and pep. Then I got Ironized Yeast. In 6 weeks I gained 12 lbs. and am full of pep. Everybody admires my physique, too." Ralph Loeffler, Arlington, Wash.

**TUNE IN ON THE GOOD WILL HOUR**  
every Sunday Evening. See paper for exact time and station.



Posed by  
professional  
model

When writing to advertisers please mention Popular Mechanics



81590.

(Continued from page 118A)

Did you know the **NEW UNIVEX** has a **FASTER f4.5 LENS?**

... and a built-in **VIEW-FINDER** too! ... The **NEW UNIVEX** is tops!



AMERICA'S GREATEST *Movie Camera* Value \$15

Prices Higher Outside U.S.A.

Everybody's talking about it! The new 1939 Univex that gives you the simplicity of operation . . . the dependable performance . . . the thrilling, true-to-life results you'd expect only from high-priced movie cameras! Check its sensational features! The new, faster f4.5 lens! New built-in optical view-finder! New snaplock hinged cover! New improved governor! New automatic shutter! Powerful, quiet motor—and many others! No wonder Univex can guarantee "satisfactory movies or a new roll of film free!" Film for the new Univex costs only 69¢ a roll—actually making movies cost less than snapshots!

See America's greatest movie camera value—the new 1939 Univex—at your dealer's today. (Many dealers are now offering convenient easy-payment terms.)

Univex Movie Camera Prices Start At \$9.95



VIEW-FINDER  
Features Like These Found Only In High Priced Models!



HINGED COVER

**Sensational Guarantee**  
"Satisfactory movies if instructions are followed or a new roll of film free."

It's Smart To Own The **NEW 1939 Univex**

UNIVERSAL CAMERA CORP. Dept. C-12, N. Y. C. **Free Booklet**

Send me illustrated booklet which describes the New 1939 Univex Cine "8" and its sensational guarantee.

Name \_\_\_\_\_  
Address \_\_\_\_\_  
City \_\_\_\_\_ State \_\_\_\_\_

615 motor vehicles had managed to roll into the territory, loaned by fourteen telephone companies.

When a bridge at Chicopee Falls, Mass., collapsed and carried important cables away, the disaster fighters tried various methods of getting a line across the 700-foot-wide torrent. When other methods failed, they called the Coast Guard. From Rockaway, Long Island, a chief boatswain's mate flew to Chicopee Falls with a Lyle gun. Standing on the bridge approach, he loaded, aimed, fired. The projectile easily cleared the turbulent river and carried a light line with it intact. With this, rope was pulled across, to be followed in turn by wire and then by strand. Soon linemen were riding it to rig up temporary circuits. By morning, a new section of cable, placed and spliced, was supported high above the roaring river.

Radio telephone service, one of the newest offerings of science to the disaster fighters, played an interesting and important part in bridging gaps in telephone service. The ultra short-wave radio telephone station between the New England company's station at Great Harbor, Mass., and Provincetown afforded the only communication between Cape Cod, Provincetown, Hyannis and the rest of the world. Portable equipment provided a link between Boston and Keene, N. H., and other points of that state. These emergency radio circuits carried a heavy load of traffic until physical circuits were restored.

8115 **Foot-Operated Wire Stripper Leaves Hands Free**

Mounted on a bench and controlled by foot pedal, a wire stripper removes insulation cleanly from eight-gauge to the finest electrical wiring. Open side feed keeps the material always in view, and hands are free to guide the work.

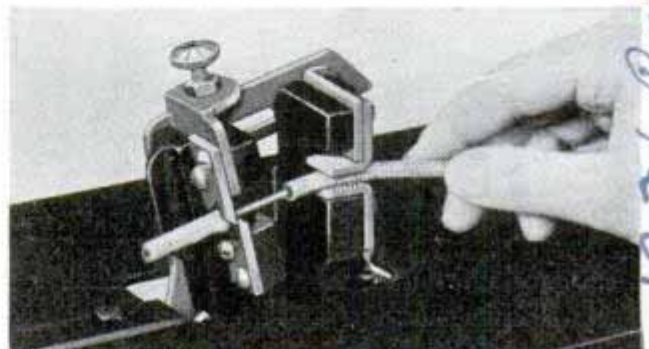

A deal Computer Business Co

8115 Park Ave. Spamer



Continuous Projector for Movie  
Eliminates Film Scratching

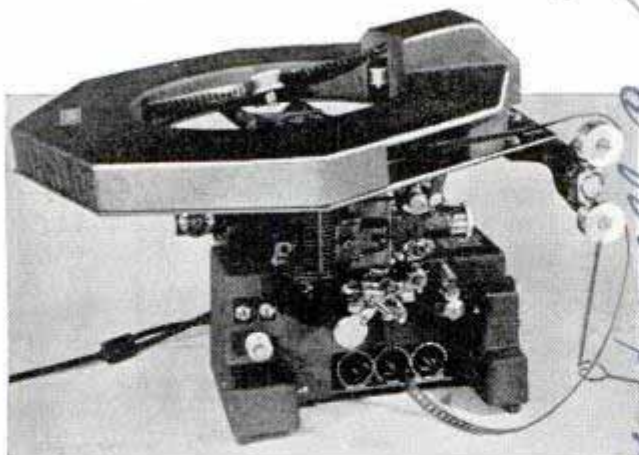

Horizontal attachment on movie projector permits continuous projection and eliminates friction

Continuous projection of movies is offered in an attachment that can be installed on several models of sixteen-millimeter projectors. Its reel is mounted on a horizontal plane. This attachment eliminates friction between film layers and thus prevents film scratches.

Streamline Auto Smooth as Egg  
Gives Driver Wide Visibility

Under production in a German automobile plant is a streamline car with an exterior almost as smooth as an egg. The broad windows form a band of glass that

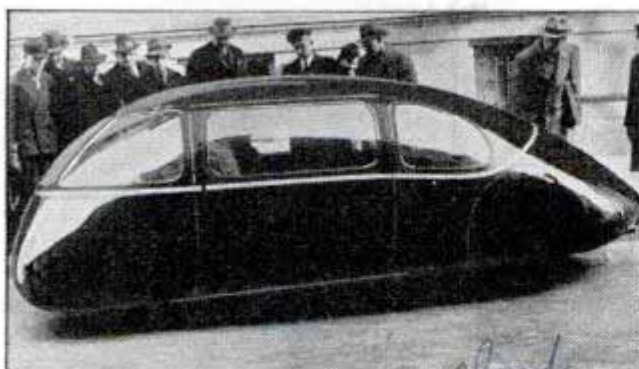

Approaching the ideal in streamline form, this automobile is in production in Germany

nearly encircles the car, giving the driver unusually wide vision forward and to the sides. It has a low center of gravity, the roof of the automobile coming scarcely to the shoulders of pedestrians.

Send return postage to our Bureau of Information to learn the name of the maker of any device described in this magazine.

Only  $\frac{1}{1000}$  Second  
Candid Under  
\$100



TRICOR f3.5 LENS

Photoflash Synchronizer Built-In

Automatic Film Transport

Here's the only completely All-American Made camera that gives you the speed, the performance and the prize-winning results you'd expect only from the most expensive foreign makes! Think of halting a 200-mile-per-hour racing automobile! A shutter with 1-1000th-of-a-second speed gets it—true, sharp, clear! Think of taking perfect nighttime shots—indoors or out! The built-in photoflash synchronizer switch makes it easy! Think of cutting your negative costs in half! The most economical UniveX 35 mm. film makes it possible!

No longer need you envy those who own expensive foreign-made speed cameras. See the amazing UniveX Mercury today! Many dealers offer convenient, easy-payment terms. Or send coupon for FREE illustrated booklet!

CHECK THESE  
FEATURES!

- All-metal focal plane shutter!
- Built-in optical view-finder!
- Automatic film transport—double exposures impossible!
- Interchangeable lens equipment!
- Helical focusing mount; graduations from 1½ ft. to infinity!
- Range finder mounting!
- Automatic exposure calculator!
- Quick-action simplified controls!
- Uses new ultra-speed, inexpensive 35 mm. film!

BACKED BY  
WRITTEN GUARANTEE!

ACTION SHOTS  
AT NIGHT!



Universal Camera Corp.  
Dept. M-12, New York City

FREE BOOKLET

Please send me illustrated booklets describing in detail the many features of the new UniveX Mercury Super-Speed Camera.

Name \_\_\_\_\_

Address \_\_\_\_\_

City \_\_\_\_\_ State \_\_\_\_\_

UNIVEX  $\frac{1}{1000}$  Second MERCURY

THE CAMERA THAT KNOWS NO LIMITATIONS!



# The 1<sup>st</sup> GLASS of Defense



against....

**Headache  
Sour Stomach  
Muscular Fatigue  
Colds and Everyday  
Aches and Pains**

● A sparkling glass of Alka-Seltzer, should be your first glass of defense against the pain, misery and discomfort of common everyday aches and pains.

Too much rich food—too much work or pleasure—too much eating, drinking or smoking—these are the common excesses that cause **TOO MUCH ACID**, and **EXCESS ACID** usually goes hand in hand with Headaches, Acid Stomach, Distress of Colds and Muscular Aches and Pains. If you're wise—you'll alkalize. Take a sparkling glass of Alka-Seltzer. It's a pleasant, effervescent alkalizing solution and pain reliever. Alka-Seltzer was unknown seven years ago—*today* it is used by more than 20 million people. All druggists have Alka-Seltzer in 30 and 60 cent size packages.

Alkalize with  
**Alka-Seltzer**

## DO YOU

WANT a new business profession of your own, with all the trade you can attend to? Then become a foot correctionist, and

in a few weeks earn big income in service fees,—not medical nor chiropody—easy terms for home training, no further capital needed, no goods to buy, no agency. Established 1894. Address Stephenson Laboratory, 1 Back Bay, Boston, Mass.

## How Smart Is Your Dog?

(Continued from page 709)

he'll soon find out the street is forbidden.

That, by the way, is part of the training against crossing streets in traffic. The dog should learn to sit at the curb until traffic is clear. Some say the dog can learn to recognize green and red traffic lights and obey them; most trainers believe dogs are color-blind, and simply respond to traffic conditions. When automobiles come to a stop in one direction, the dog knows it is safe to cross. Von Motzeck is not convinced about the color vision of dogs. His trainers have tried teaching pups to pick up the colored ball named from a group of balls of assorted colors, and they've had some success. But they aren't certain whether the dog really recognized the color or was just too smart—he may have identified the balls in his mind by smell, or it may have been pure guesswork. Half the time the dog would watch his trainer and try to fool him into giving away the answer by a telltale glance or movement toward the right ball.

What about the dog with the superbrain, the dog that can add and subtract, read numbers on a blackboard, even spell out words by barking once for "A," four times for "D," and so on? Does he actually reason it out, or are we being "taken in?"

Well, no college-educated dog is going to spill his trade secrets for you, nor will his master. After watching a smart young fellow in a snappy wire-haired suit bark the answers to multiplication and division problems for a theater audience, you need not expect to go backstage and have his trainer tell you the dog actor really hasn't a brain in his head, it was all a simple little trick.

Nevertheless, it's pretty safe to say dogs can't learn a multiplication table any more than a six-months-old baby. Watch the dog performing and you'll never discover the deception. Watch the trainer and you might. You might observe that the dog, told to count eight, stops barking at the count of eight just as his master moves a finger almost imperceptibly, or flutters an eyelid. You'll notice that the dog is paying concentrated attention to his master. Somewhere he caught a signal.

A famous newspaperman was once fooled into believing a dog could answer prob-



lems in arithmetic by his own reasoning power. Well, you'd have been fooled, too. The trainer stood with his back to the dog, uttering no word. The newspaperman was allowed to put the question: "Divide twenty-seven by three."

Immediately the animal started barking. At the count of nine he stopped. The newspaperman never "caught on." He never discovered that the dog stopped "counting" the instant he saw the trainer's toe move a fraction of an inch to the right.

Not every dog is clever enough to learn "arithmetic." More significantly, not every dog owner is clever enough to teach it. It takes obedience, persistence, control. One method of beginning the lesson in numbers is to say: "Count five," or "What's three plus two," while you hold a piece of meat for the dog. He'll bark for the meat; at the fifth bark let him have it—naturally he'll stop barking. Keep up this routine with various numbers. Gradually cut down the size of the meat, but always use the same gesture. Eventually the dog should respond to the gesture without the meat, until he will stop barking at a finger flick the audience would never notice.

An old method of teaching a dog not to jump up on people was to step on his toes. That sort of training doesn't go with von Motzeck. Another method is to grasp the dog's forepaws when he jumps and make him walk backwards a few steps. They don't like that. Von Motzeck's method is to invite the dog up, beg him to paw you, then thrust your knee into his chest to push him away. A few repetitions and the dog will never offend again.

That is the basis for one clever stage stunt. A vaudeville actor will introduce his pup to the audience as the brightest dog on the circuit, a dog that obeys infallibly and never makes mistakes. Then he'll call the dog to him and the dog will sit down; he'll order him in exasperated tone to sit and he'll come running; he'll beg him to jump up and instead he'll lie down. And so on, always acting contrary to the spoken order the audience hears, but responding to the gesture or tone of voice which means something else.

One of von Motzeck's most dangerous jobs is to train watchdogs for attack work. He has been torn many a time by dogs who learned their lessons too well. Teaching a

(Continued to page 124A)

Quick! Easy! Spick-and-Span  
Shaves with This New

# Gillette Blade at 1/2 Price!



New Kind of Edges on the Easy-Flexing New Thin Gillette Blade Give You Good-Looking, Refreshing Shaves Every Time.

GENUINE shaving comfort at rock-bottom cost! That's what the new Thin Gillette Blade gives you. Making full use of its world-renowned facilities Gillette has produced a top-quality razor blade that sells at 10c for 4. The Thin Gillette gives quicker, easier, better-looking shaves... protects your face from smart and irritation caused by misfit blades. Buy a package from your dealer and save money on shaves!

4 for 10c  
8 for 19c



You Men Who Want Utmost Shaving  
Luxury of Course Demand...

## The Gillette Blue Blade

THERE'S one best in everything. Among razor blades, based on world preference, it's the Gillette Blue Blade. This heavy-duty blade gives immaculate, comfortable shaves that make your face look and feel its best. Every man can afford this luxury—for it costs less than one cent a day. Your dealer knows you take pride in your purchase when you ask for these superior blades. Get a package today.



5 for 25¢





It's time right now to clean out your car radiator. Clean out anti-freeze, rust, scale and lime deposits all in one simple operation. Pour 10c worth of Sani-Flush in the radiator (25c for the largest trucks and tractors). Run the engine. Drain. Flush. Refill with clean water. The job is well done. *Follow directions on the can.*

If you prefer, ask your garage or service station to use Sani-Flush in your radiator to clean it out. Motors run cooler. Power is saved. You may save expensive repairs. Sani-Flush cannot injure motor or fittings. You'll find Sani-Flush in most bathrooms for cleaning toilets. Sold by grocery, drug, hardware, and five-and-ten-cent stores. 25c and 10c sizes. The Hygienic Products Company, Canton, Ohio.

**Sani-Flush** *Safe*  
KEEPS RADIATORS CLEAN *NOT CAUSTIC*

## WHY SCRATCH

Lucky Tiger Ointment is made to make itchy folks happy. To allay Rectal Irritations — To correct externally caused Pimples — To soothe insect bites, fire or sunburns. To make friends everywhere. Thousands never without it.

**Antiseptic** to minor wounds when in proper contact as bandage. At Druggists, Barbers, 10¢ Stores—

**FREE** — 25¢ Trial Tube, if you send 6¢ in stamps to pay packing and postage.  
**LUCKY TIGER MFG. CO., Dept. 29, Kansas City, Mo.**



1875/0  
(Continued from page 123A)

dog to protect a baby from kidnapers or to guard a cash register or safe or a woman's purse is ticklish business. You have to get it across to the dog that it's a game between him and his tutor but serious business when he's really on guard. The attack dog is taught to leap for the throat of an intruder and knock him down, or to carry out any other specific plan of attack desired. Von Motzeck won't put any dog through the attack course unless convinced there is real need for that protection.

Your dog has a head on his shoulders. It's your responsibility to develop his brain and his personality. Treat him as an individual. Make him respect and obey you. Keep up his training at least fifteen minutes every day. If he's ill-mannered and surly, people will say—like the neighbors about unruly children—"It's his home training." But if he's alert and well-mannered they'll tell you, "Smart dog."

## Electric Fan at Base of Table Blows Cool Air from Floor

On the hottest days next summer you can eat your meals in comfort if you have an "air conditioned" table with a fan built into its base. A gentle breeze rising from the floor, where it is always coolest, is deflected by a special plate to prevent drafts. Diners' feet are kept from the whirling blades by a grating around the unit.



Fan beneath table guarded by grating keeps diners cool with refreshing breeze on hot summer days



# I'M GLAD I BOUGHT AN IDEAL LAWNMOWER SHARPENER AND WENT INTO BUSINESS FOR MYSELF . . .

## YOU, TOO, CAN HAVE A PROFITABLE BUSINESS OF YOUR OWN . . .

Our free plans show you how to build a successful business of your own sharpening lawnmowers. Most men earn up to \$25 a week, even in spare time. Howard Hellen, Minn., writes, "I sharpened 745 lawnmowers, sold 60 used mowers and grossed \$1100.00 from April 5 to Sept. 15." Roy F. Stier, Wis., writes, "I paid for my Ideal Sharpener in exactly 36 days." Like magic, the Ideal Lawnmower Sharpener makes old, dull, badly worn mowers cut like new. Simply set the mower in the Ideal, make a few simple adjustments and the machine does the rest. Sharpens any mower to perfect edge in 15 to 20 minutes—usual charge \$1.00 to \$1.50. Attach to light socket. Start in your basement or garage. Work spare time or full time. Attachments for grinding skates, grass shears, hedge shears, sickles, scythes and axes. FREE CATALOG tells complete story.

**THE FATE-ROOT-HEATH CO.**  
549 Bell St. Plymouth, Ohio



**Make Money! SHARPEN LAWNMOWERS THE "IDEAL" WAY!**

SAN FRANCISCO  
WORLD'S FAIR

NEW YORK  
WORLD'S FAIR

# FUN ALL THE WAY ON A Harley-Davidson



SEE the Golden Gate International Exposition at San Francisco—or the New York World's Fair—the most exciting way! Zoom along on a fast, dependable Harley-Davidson—pack your trip with EXTRA thrills. See ALL the sights along the way. Stop over whenever and wherever you please—take in famous scenic spots—be free to enjoy the things you like most. You'll be surprised how little it will cost with a Harley-Davidson. See your Harley-Davidson dealer. He'll tell you about the fun-packed times motorcycle club members are having all year 'round. Ask about his Easy Pay Plans—and send in the coupon now! HARLEY-DAVIDSON MOTOR COMPANY MILWAUKEE, WISCONSIN



MAIL COUPON NOW

HARLEY-DAVIDSON MOTOR CO.  
Dept. P, Milwaukee, Wisconsin  
Send illustrated literature and FREE copy of "ENTHUSIAST," Motorcycling Magazine. Stamp is enclosed for mailing cost.

Name \_\_\_\_\_ Address \_\_\_\_\_

**HARLEY-DAVIDSON**  
WORLD'S CHAMPION MOTORCYCLE





## EASY TO READ!

Easy to use, hard to wear out, this new popular-priced steel tape makes a hit with technical men—with everyone who needs accuracy of measurement. Black markings on white surface are as clean cut as the face of your watch. Tape resists rust, is hard to kink, easy to clean, doesn't backlash. 25, 50, 75, 100 ft. lengths. Mail coupon for free sample of line and illustrated folder showing sizes and prices.



LOOK FOR THIS DISPLAY

## K&E FAVORITE WYTEFACE STEEL MEASURING TAPES

KEUFFEL & ESSER CO., Est. 1867, Dept. 54, Hoboken, N. J.

Name.....  
Address.....  
City..... State.....

## CAN YOU BEAT THESE POWER COSTS?

Save  
up to  
**\$293<sup>80</sup>**  
Per  
Month  
on  
power  
costs

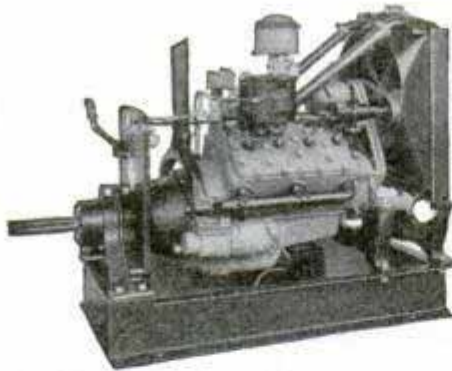

### with a KRW FORD V8 Unit

50 H. P. with KRW V8 Unit using natural gas (1125 BTU) @ 30c per 1000 cu. ft. .... \$ 46.80 per month  
50 H. P. with KRW V8 Unit using gasoline @ 10c per gal. (no tax) ..... \$140.40 per month

Above figures show primary fuel costs (lubricating oil not included) for operating a KRW V8 Unit to develop 50 H. P. for 10 hours per day—26 days per month. Compare this with electricity @ 3c per KWH which amounts to \$340.60 per month. You can pay for a KRW Unit in a few short weeks **out of actual savings!**

KRW V8 Units are daily saving money for operators of air conditioning and refrigeration equipment, mills, factories, shops, welders, compressors, pumps, well-drilling outfits, contractors' equipment, etc. New KRW "GUARDIAN" automatically stops engine in case of cooling or lubrication failure.

Write for new bulletin just off the press—packed with useful information, engineering data, etc. You can buy through your local Ford Dealer and benefit by local service and low-cost Ford engine replacement feature.

**K. R. WILSON 17 Lock St. BUFFALO, N. Y.**  
Builders of Shop Equipment for Ford Dealers Since 1916  
West Coast Branch: 722 Mateo St., Los Angeles.  
Export Office: 90 West St., New York.

## Seeing the World in Ten Minutes

(Continued from page 699)

Ever since the conquest of Ethiopia, which newsreel companies found a costly and generally unsatisfactory adventure, the many battles and dramatic incidents in Europe and Asia have been conducted on a scale and over an area difficult to cover as a newsreel subject. Yet a destiny-conscious public demands them and those demands are filled by fearless cameramen.

Covering a war zone assignment today, the newsreel man is insured and the monthly premium paid by his company is approximately \$500. His sound camera equipment costs approximately \$10,000. Since most of his shots must be made on the run and over wide territory he uses a small hand camera costing approximately \$1,000 and equipped with telephoto lenses. It places him in great danger, as many an adventurous cameraman has discovered, for, from a distance he might well be mistaken for a combatant with a gun.

The occasional lucky break—being on the right spot at the right time—still does occur. It happened on December 12, 1937, when Norman Alley of Universal Newsreel and Eric Mayell of Fox Movietone News were on board the U. S. Gunboat Panay in the Yangtze river, when she was bombed and sunk by a Japanese plane.

The newsreel picture record made on that dramatic occasion was so important that it was rushed to Manila by a destroyer and, closely guarded, flown to America where a special print was run off for the State Department. It cost nearly \$25,000 to deliver this "break" to the newsreel office but considering the tremendous crowds which came to the theaters to see it, it was worth the expense.

The modern cameraman, in addition to being an expert with his equipment, has had to learn diplomacy—especially in the dictator countries where he sometimes has to resort to clever smuggling to avoid the censors. A difficult job for foreign news correspondents who can put their story on a few sheets of paper, it is more difficult for the cameraman handling bulky film.

Once the newsreel footage is on its way, however, and the censor safely behind, things move fast. An express liner or airplane rushes it to New York where a waiting motorcycle speeds it to the newsreel



101514  
 office. Quickly developed, it is dried and taken to the projection room for the waiting editors and technicians. Then things really begin humming, for where the subject has been shot "silent," the comment, music and incidental crowd or other noises must be "dubbed in." The destiny-making subject—Chamberlain returning by airplane from his interview with Hitler, the Germans marching into Czechoslovakia, the defense of Madrid, or whatever else it may be, is projected once in the negative, which is handled quickly but with extreme care as it scratches easily. Meanwhile other subjects, national, features, sports, have been developed and projected. Five thousand feet or more may be run off.

After the last foot of negative has been run off, a conference is held. Those 5,000 feet must be trimmed down to 1,000. The running comment must be written quickly from "dope sheets" supplied by the cameramen. Additional material must be looked up to give the commentator a smooth continuity. In a surprisingly short time the reel is ready to be put in sequence. "Dramatic smash first," says Mr. Ullman, "Sports last." And if it's during football season, theater goes on a Saturday night will see action pictures of prominent games played that afternoon.

The edited reel flashes on the screen. The commentator reads his voice into a microphone to suit the action. In the sound booth the music editor turns on his canned music, works his sound effects as the voice of the commentator is piped in. The sound man mixes them all, letting the sound and music "come through" where the narrator pauses. The sound goes onto a raw film to be added later to the reel.

The multiple printer, turning out fifty prints an hour, begins clacking. And in five hours the newsreel, ten minutes of destiny, is ready for the theater.

The shipping department pounces on the reels. By plane and fast express to all parts of the country they go. By plane and steamer to all the civilized world. But as far as the newsreel cameramen and editors are concerned the reel just finished is already an old story. In the editorial room, the news teletype is clicking out more news of great importance. The assignment editor reaches for telephone and cable blanks. The next newsreel make-up night is just three days away.

## Daddy, what's a Jollop?



**Young Buster and I** are manicuring the lawn and chinning together when he pipes up, "Daddy, what's a jollop? Tommy Beals says we have one." Well, for the love of Mike! I happen to know Bill Beals' bus is a couple of years older than ours!

**Now next door I notice** Bill Beals fussing around his car, so we mosey over for a look. And there is Bill putting the final licks on as nifty a polish job as I ever saw. When my eyes get accustomed to the dazzle, I see he's been using something out of a green can with a big 7 on it.



**So I take the hint** and get a can, which turns out to be Du Pont No. 7 Polish. Well, I remember polishing as a tough job. But say, with this No. 7 I take years off the old bus' looks in no time. A jollop, is it? Look, before you can say "No. 7 Polish made by Du Pont," I have that car shining so bright I tell Buster to run and get my dark glasses!

 **Sample for you.** We'll gladly send you a generous sample of the improved No. 7 Polish, enough for hood and fenders. Just send 6¢, to help cover mailing costs, to Du Pont, Dept. MP-2, Wilmington, Delaware.



**DU PONT**  
**NO 7 POLISH**  
*Improved...works even quicker, easier*

**WINDSHIELD and TOP MOULDING LEAKS** are stopped quickly and securely with DU PONT TOP SEALER. It's good for rear window leaks, too. Use the handy tube.





"Yes - we bought a NEPTUNE! For \$35.50 we've rented the whole lake for the summer. We go places we've never been before, hunt out the deepest pools, haul in the biggest fish, then hurry home again. We didn't know a few dollars could mean so much pleasure . . ."

If YOU didn't know you could buy a top-quality outboard for so little - send to-day for free literature on the NEPTUNE line. Easy starting - low-cost operation - smooth trolling - plenty of power and speed - that's NEPTUNE! Sizes range from 1.2 H.P. at \$35.50 to 16 H.P. at \$164.50, including a powerful new "Five" Alternate-Fire Twin.

MUNCIE GEAR WORKS, Inc.  
Muncie, Indiana  
New York Office: 45 E. 17th St.,  
Gramercy 7-6310



NEW NEPTUNE  
"FIVE"  
Alternate-Fire  
Twin

From  
\$35.50  
UP

**free** "STRAIGHT SHOOTING" New booklet by Marlin, packed with useful information on handling and care of firearms. "Mistakes to Avoid in Shooting; How to Set Up a Range; Dictionary of Terms;" etc.; plus diagrams and photos to improve marksmanship. FREE at your dealer's or send 6c to Marlin Firearms Co., 22 Willow Street, New Haven, Conn.

**Marlin FIREARMS CO.** NEW HAVEN CONNECTICUT

**Free! 72 PAGE BOOK ON NIGHT FISHING**

Every fisherman will want this book! Written by Cal Johnson, noted angler. Tells tried ways, methods of night fishing for bass, wall-eyes, other fish. How, when to cast or troll after dark. Froging. 72 pages of night fishing thrills. Shows the Powerlite and other Delta electric lanterns. Write for this book. Free!

**DELTA ELECTRIC COMPANY**  
300 W. 33rd St. Marlon, Indiana

Power-lite  
\$3.35  
less battery

## "Bathtub Gardening"

(Continued from page 733)

shine, the young plants burst almost overnight from the seeds, then disappeared as quickly as they came. The young hydroponics farmer discovered that he had unexpected enemies with which to cope in the rats and birds that infested the island. Raising his tanks on stilts to defeat the rats and caging the garden to keep out the birds, he soon had a new crop on its way. Within three months, he was supplying the

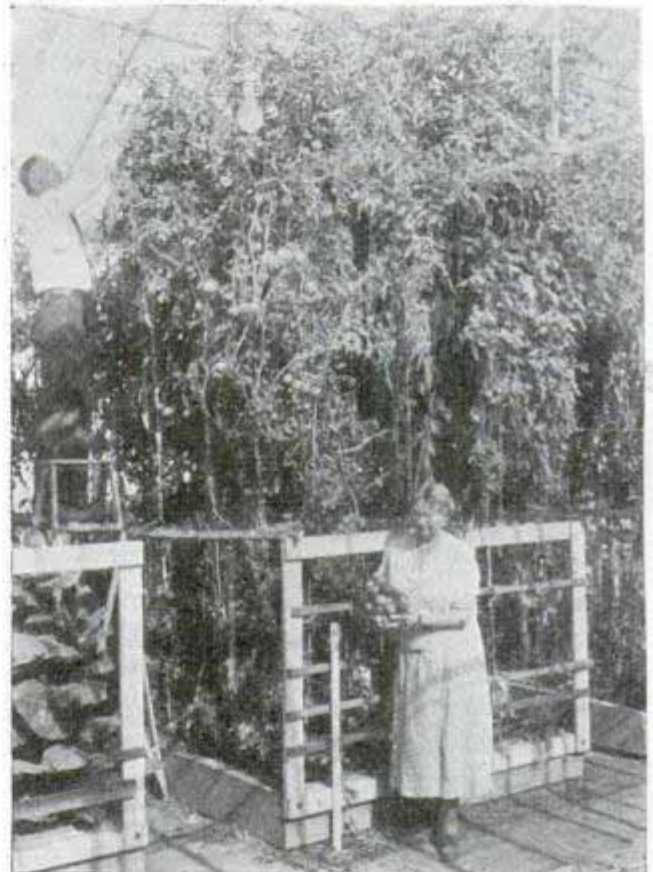

Dr. and Mrs. Gericke picking their hydroponics-grown tomatoes with aid of stepladder

inn with tomatoes, radishes, lettuce, and a short time later, corn, beans and table flowers. The original "bathtub gardens of Wake," as fascinated visitors called Lau-meister's farm, quickly passed out of the experimental stage and was increased tenfold in size by Pan-American Airways, which is now planning similar "farms" in other out-of-the-way posts where fresh vegetables are costly to bring in.

Another project which vindicated Dr. Gericke's prophecy of commercial success for hydroponics was the greenhouse tomato farm of Ernest Brundin in California. Brundin saw possibilities in tomatoes ripened for mid-winter, when prices were at



a peak. His outstanding contribution to liquid farming was a means of heating the fluid economically. Dr. Gericke's scheme was to use soil-heating cables in the tanks, but this proved so costly that the first commercial tomato grower to try the method failed because of the prohibitive cost of electric power. The Brundin method connects a hundred tanks in a huge greenhouse with a centrally located sump, where the liquid is raised to the desired temperature by steam boilers, then boosted under pressure back to the tanks by a small pump. The nutrient liquid trickles by gravity back through pipes to the sump. Thus the plants dangle their roots in constantly moving streams which make the round trip from sump to tanks four times every twenty-four hours.

Brundin tests his nutrient at least once a day and if it is deficient in any of the necessary plant foods, he adds that at the sump and within a few hours, every plant on the farm is healthy again. Under ordinary circumstances, the nutrient leaves the sump at seventy-six degrees and comes back about four degrees cooler. However, if Brundin wants to hustle the ripening of his tomatoes to catch a certain high priced market, he can give them the speed up by raising the temperature to eighty degrees.

Among the other large commercial growers is the California Packing Corporation, which maintains a 100-tank "farm" near Sacramento, under the direction of a former student of Dr. Gericke's. On this farm, the liquid culture farmers are "working backwards," to find out what nutrients tomatoes and other vegetables need to make them more solid after they are canned.

One of the most potent commercial possibilities is the discovery by Rolland Langley of Mountain View, Calif., that mushroom spore will run along excelsior moistened by liquid nutrients, just as it does in manure beds. The bane of mushroom growers is the back-breaking work involved in hauling the used manure out of the cellars and bringing in the new, every six months or so. If the mushroom experiments prove a commercial success, all they will have to do is turn a spigot and run the used plant food out.

Progress in hydroponics is not confined to the universities that have taken up the science, notably California, Purdue, Illi-

(Continued to page 130A)

## ... What is "LIGHT CONDITIONING"?

**ENOUGH LIGHT**  
in enough places



**for easy Seeing**



**without eyestrain**



Why not try it? Costs little to begin light conditioning. Ask your dealer to help you choose the size G-E MAZDA lamps you need.

100-watt . now only **15¢**

150-watt . . . **20¢**

75, 60, 40, 25, 15-watt **15¢**



**GENERAL ELECTRIC**

**MAZDA LAMPS**



141569

(Continued from page 129A)

## IT'S EASY AS PIE TO MEND WALLS WITH RUTLAND PATCHING PLASTER



Just mix with water..Rutland makes a perfect patch as lasting as the wall itself.

## 60 POWER TELESCOPE . . . \$2 19

VARIABLE EYEPIECE 20X-40X-60X

**NEW!** Three telescopes in one. 3 different magnifications. 20 power for ultra-bright images with 40 and 60 power for extra long range. Guaranteed to bring distant objects, people, sports events, ships, moon, stars, etc., 60 times as close.

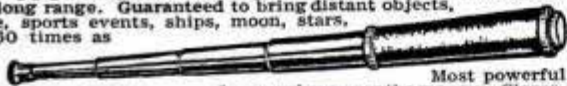

Most powerful made for anywhere near the money. Closes to one foot in length. Multiple lens system. 30 mm. objective lens. 5 sections. Directions included for using as a compound 4 lens microscope. American made. Prompt shipment guaranteed. We pay the postage. Only \$2.19. **BROWSCOPE CO., Dept. 45, 5 W. 27th St., New York, N. Y.**

## WORLD'S LOWEST PRICED ADDING MACHINE

VEST POCKET SIZE  
FREE TRIAL

GUARANTEED ACCURATE. Not a toy. Operates with only a finger flick. Adds, subtracts, multiplies, divides. Counts up to a million. Pays for itself over and over. Ideal Gift—for Business, Income Tax and School use. **MONEY BACK GUARANTEE.** Send name and address. Pay postman only \$2.50 plus postage. (Send full cash if outside U. S.) Money back in 10 days if not delighted. **AGENTS WRITE. CALCULATOR MACHINE COMPANY (Mfrs.), DEPT 105, P. O. BOX 1118, CHICAGO, ILLINOIS.**

# Saw-Filing

Pays up to \$2 or \$3 an Hour in Spare Time

A FOLEY Automatic Saw Filer files hand, circular and band saws better than the best hand filer. Cash business, no canvassing, no eyestrain. No experience needed. Louis P. Wadwick, Ohio, says, "I have filed 764 saws in spare time and have earned \$850.00 in carpenter work due directly to my saw filing contacts." Send coupon for FREE PLAN, no obligation.



**FOLEY MFG. CO., 516-9 Foley Bldg., Minneapolis, Minn.**

Send Free Plan on Saw Filing business.

Name.....  
Address.....

nois, Wisconsin and Rutgers, and the big commercial pioneers. Several score dealers in plant nutrients are now offering their wares to amateurs, ranging from packets containing a nickel's worth of salts that sell for a dollar to reasonably priced complete kits that are practically fool-proof. In several communities there are now hydroponics gardening clubs which provide the means of swapping experiences. The most successful amateurs have been those with small greenhouses in which they can control temperature.

One of the truly astonishing fields for hydroponics has been its use in schools, where thousands of teachers, particularly in the western states, are using liquid culture as a method of visualizing botany. The trays can be lifted out of the tanks day after day to let the youngsters see how the root system develops parallel to the plant growth. Langley is also the pioneer in this field, being the originator of a small leakproof window-box hydroponics kit complete with tank, tray, excelsior, rice hulls, and the plant nutrients. The latter are so arranged that when plants develop "the yellows," or any other ailment, the class can give them the proper "medicine" and note the improvement.

At the San Francisco Golden Gate Exposition is a hydroponics garden. In place of the customary wood or metal tanks, glass tanks are used, enabling visitors to study the private lives of plants from the topmost bud to the deepest root tip.

This exhibit offers a cue for perhaps the simplest and least expensive means of trying "bathtub farming" in your own home. Get out the old goldfish bowl, bend a piece of wire netting to form a tray two inches deep to hold excelsior and rice hulls, or some peat, for the seed bed, purchase plant food ingredients from your chemist or from a dealer in hydroponics materials, and try the new plant magic.

Different plants thrive on different diets. Also, a combination of "foods" that may make a tank garden thrive in one climate, where sun is plentiful, may throw the plants too far on the acid side, on the one hand, or the alkaline side, on the other. On the large hydroponics farms, the "P.H." balance, as this is known, is determined by test daily. For the amateur tank gardener, there is no simple substitute at the present for trial and error.



2-172  
555 Huntington Ave  
Boston, Mass.

## "Iron Lung" for Four Patients Is as Large as a Room



Four patients lie comfortably in "iron lung" room large enough for doctors and nurses to enter

Artificial respiration is afforded four patients at a time at the Children's hospital in Boston, in a room large enough for physicians and nurses to enter. The room is made of welded steel plates, and there are four cots with springs and mattresses which may be raised or lowered at the head or foot from either inside or outside. Emergency cases can be placed in the respirator and examined inside the room while under artificial respiration, and even operations may be performed as the interior is well lighted. Doctors and nurses feel no discomfort other than a sensation in the ears, which may be relieved by placing cotton in them.

☐Inquiries as to makers of articles described in Popular Mechanics, will be answered by our Bureau of Information upon receipt of return postage.

**Most Important  
Thing About  
SAWS Is . . .**

**Keep 'em Sharp!  
These Two Files  
By NICHOLSON  
Are Ideal . . . .**

**For Most Saws  
Used On Your  
Farm, In Your  
Yard or Home  
Workshop . . .**

Ask your hardware store what brand skilled saw filers buy and Nicholson Files will steal the show! No wonder—for the world's file leader knows how to make saw files that are uniformly keen and long-lasting Nicholson Mill and Slim Taper Files, shown, are awaiting you at your hardware store, factory-new in cellophane wrapping. Nicholson File Company, Providence, R. I., U. S. A. Canadian Plant, Port Hope, Ontario

**A FILE FOR EVERY PURPOSE**

**NICHOLSON FILES**  
PIONEERS IN  
QUALITY PRODUCTION

**75th  
ANNIVERSARY  
YEAR**



# SAND 10 TIMES FASTER

— get *Better* jobs this  
*Easy* way!

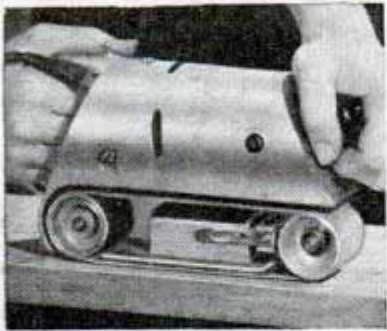

SANDS—GRINDS  
POLISHES  
BUFFS—SHARPENS  
REMOVES PAINTS,  
VARNISHES,  
LACQUERS

## New Guild **Sander** PORTABLE ELECTRIC

This handy power sander turns out better work 10 times faster and easier. Ends all the drudgery of hand sanding. Anyone can use it without practice.

Driven by a powerful motor, the endless abrasive belt sands with the grain. Leaves no ugly swirls, no cross-grain scratches. Gives uniform finish on flat surfaces . . . is handier around curves. Sands wood, wall board, metal, slate, marble, bone or plastics.

GuildSANDER is a popular-priced precision tool —with a 5-year guarantee. Works from any light socket. Weighs only 9 lbs. Try it at your hardware dealer's, or write direct for details.

SYRACUSE GUILD TOOL COMPANY  
1700-5C N. Salina St., Syracuse, N. Y.



ONLY  
**10c**  
FOR  
PLANS

## BUILD IT YOURSELF and have an **Electric Outboard Motor**

this summer. Enjoy the double pleasure of making and using it. All you need to start with is an old auto generator; we'll show you how to do the rest. A dime brings you complete plans and a valuable catalog. The finished job is Easy to Operate, Clean, Silent, Lightweight, and will run for 8 to 12 hours on a 6-volt battery. Its variable speed control makes it fine for fishing and trolling. Send us your dime and get started right away.

LEJAY MFG. CO., 1547 Lejay Bldg.,  
Minneapolis, Minn.

CARRIES 250  
POUND  
LOAD



**TAKE THE FAMILY or  
DELIVER at LOW COST**

## AUTO-GLIDE

NOW! Take the whole family 100 miles for 50c! Go Anyplace! Spend Less! Comfortable family roadster, great for picnics, outings! Ideal for deliveries, too. Increases store business, reduces cost nearly half! Side-Kar on or off in five min. Heavy steel trunk, removable cover and seat. Lock. Lively 1½ or 2 H. P. Cushman engine has pick-up, speed, power to spare! Zips up steep hills. Most rugged machine built. Electric welded all-steel frame. Rides, handles like auto. Big brake stops machine on a dime. 2-speed transmission. Clutch (most models). Balloon tires. Soft, springy cushion seat. Windshields available.

5 HANDSOME MODELS FOR ALL PURPOSES! Standard and De Luxe 2-wheel AUTO-GLIDE for sport, business, school. Kari-Pac and Glide-Kar (left) for deliveries.

WRITE! or ask dealer for illustrated booklet, full details, low prices, NOW!



New 3-Wheel  
Delivery  
Model

Make deliveries for less! 400 lb. cap'y. Greater economy, safety, beauty, convenience.

DEALERS: Write for special offer, facts about rental profits!  
THE CUSHMAN MOTOR WORKS, Dept. J-5, Lincoln, Nebr.

## At the Throttle of the "Century"

(Continued from page 651)

Had I been going fast, we might have had a serious accident. Now that I'm nearing seventy years of age, I've learned the danger of speed on the highway and most of my driving is under fifty. But in spite of that, I feel a lot safer in the cab of the "Century" when it is doing eighty than I do in my car at any speed.

Railroad equipment, particularly the locomotives, has improved wonderfully since I started working for the New York Central nearly fifty-three years ago. Then I was with the old Lake Shore and Michigan Southern, which later became a part of the New York Central. The last few years, especially, have brought a lot of progress.

In the early days the railroads lost a lot of time by having to take on coal frequently. Today, between Chicago and New York, three locomotives are used on the "Century." Each is coaled before it is hooked onto the train. The change of engines requires only about three minutes. This eliminates the jolting of passengers that would result from moving the train from one coal chute to another. It's a hard job to handle a heavy train at the coal chutes.

Taking on water today isn't a problem because we can scoop it up on the run from water pans placed between the rails. At sixty miles an hour, our locomotive can take on 5,000 gallons of water while running over a water pan 2,000 feet long. The pans are heated by steam in winter to keep the water from freezing. As soon as a locomotive passes, a pump starts refilling the pan.

One of the biggest contributions to railroad safety is the automatic block signal and automatic train-control system. It's a wonderful thing, that train stop. Running through a storm, if the fireman and I both should miss a signal, the train stop will do the job of setting the brakes. About eighty feet in front of the signal post is a magnetic element in the track. In the front end of the locomotive tank is a receiver. The magnet operates an actuating valve which unlatches the automatic brake and sets the train brakes, stopping the train. Then the fireman must get down on the ground and latch the automatic brake control before the locomotive can be moved.

Speaking of brakes, I remember an in-



cident in 1895 when I was first firing on a freight run. Our train was equipped with the first air brakes used on a freight on that line. We were coming downgrade with twenty-four cars of ore. Because too few of the cars were equipped with air brakes, and those all at the front of the train, the engineer was whistling every few seconds for the train crew to set the hand brakes on the cars. South of Ashtabula, Ohio, our tracks crossed those of the Nickel Plate railroad. Looking ahead I could see the target set against us. That meant that a Nickel Plate train was blocking the crossing. Our train kept rolling faster and faster because the crew didn't have time to set the brakes before we would reach the crossing. I got down on the gangway, ready to jump, and told the engineer he'd better do the same. We were pretty close to that crossing when the target changed suddenly and our train tore through at about forty miles an hour. The crossing watchman had heard our engineer whistling for brakes and had gotten the Nickel Plate crew to split their train in time for us to go through the crossing. We ran a couple of miles before we could get our train under control.

Once on a switch engine, the live pipe to the left injector let go and I had to dive out the window head first. If I had taken a deep breath of that hot steam, it would have burned my lungs.

But accidents are comparatively few. The new locomotives are built for greater endurance and higher speeds. The parts are heavier and manufactured of tested materials. Maintenance is much better than in the old days and this is especially true of lubrication. The boys in the round-house grease the engine, then take it out on the getting-ready track and go over the rods again to be sure the grease has reached every spot.

The new "Century" engines are much faster and able to take it. They are built for a top speed of 120 miles an hour, but operating regulations forbid speeds much greater than eighty. The weight per yard of rail has been increased from sixty to 127 pounds in order that trains may be operated at greater speeds with safety.

The first 20th Century pulled out on June 15, 1902. I was her fireman on the second run. Then our running time to New York was twenty hours. In 1905 the

(Continued to page 135A)

## WIN PRIZES with GRAFLEX



"Puppy Love"—a Graflex-made, Prize-Winning Picture by William D. Barkley

THE results of 1939's first important photographic contests are further evidence that the slogan "Prize-Winning Cameras" used by Graflex is founded on fact. Graflex-made Cameras captured all the major prizes for the third consecutive year in the New York Press Photographers' Association's Exhibit and established their fourth grand slam in a row in Editor & Publisher's National News Picture Contest.

Whether you take pictures for prizes, money, glory, or fun—or for all—you will do well to choose as your next camera a Graflex or Speed Graphic American-made, Prize-Winning Camera. You have a wide choice of models to choose from. Be sure to have your Dealer show you the

### Miniature 2 $\frac{1}{4}$ x 3 $\frac{1}{4}$ SPEED GRAPHIC

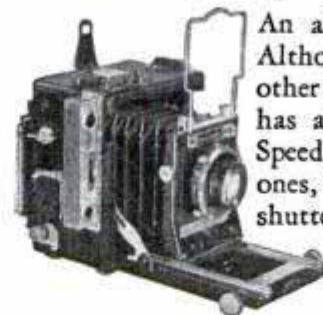

An all-purpose camera for you! Although 36% smaller than any other Speed Graphic ever built, it has all the features of the larger Speed Graphics PLUS many new ones, including built-in focal plane shutter flash synchronization. See it and other Graflex-made Winners at your Dealer's.

**FREE!** Send today for free catalog of Graflex and Speed Graphic American-made, Prize-Winning Cameras and Accessories and free folder on the new Miniature 2 $\frac{1}{4}$  x 3 $\frac{1}{4}$  Speed Graphic. Paste coupon—or write your request—on penny post card, if you wish. Folmer Graflex Corporation, Dept. PM-1, Rochester, N. Y., U. S. A.

FOLMER GRAFLEX CORPORATION  
DEPT. PM-1, ROCHESTER, N. Y., U. S. A.

Send me free catalog of Graflex and Speed Graphic American-made, Prize-Winning Cameras and Accessories and free folder on the new Miniature 2 $\frac{1}{4}$  x 3 $\frac{1}{4}$  Speed Graphic.

NAME \_\_\_\_\_  
ADDRESS \_\_\_\_\_  
CITY \_\_\_\_\_ STATE \_\_\_\_\_

**GRAFLEX Prize-Winning CAMERAS**

When writing please mention Popular Mechanics



# MEGOW'S Model Airplanes

**GAS POWERED**

## PIPER CUB

with Megow's ready-carved **LEADING EDGE** shown here. Most practical size—span 52 1/2". Easy to build. Scale spacing of struts and ribs. Less motor, \$3.95 plus 20c postage.



In flight, Megow's gas-powered models attract all eyes with their beauty and behavior. On the ground, they win praise from experts on fine details. Among other Megow models, the **QUAKER FLASH** holds the world's championship, the **FLYING QUAKER** is a consistent winner in the larger class, and the **48" CARDINAL** won easily against larger models at the Southern California Meet. Without motor, the **QUAKER FLASH** is priced at \$4.95, the **FLYING QUAKER**, \$5.95 and **CARDINAL**, \$3.95. By mail, 20c extra for postage.

### PLANEFILM The Magic Covering

Light, tough, elastic, non-porous, smooth as glass, opaque, colorful. Stretches drumlike over irregular curves. Easy to use. No glue, dope, finishing or stretching. Exclusive distributors.

There's no end of fun and practical experience in building a Megow model. See your dealer, or order direct from us. Send 5c for 100-page illustrated catalog of model airplanes, ships, HO-Gauge railroads, parts and supplies.



### MEGOW'S

Dept. PM., Howard & Oxford Sts., Phila., Pa., or 217 N. Desplaines St., Chicago, Ill.

### NEW BENJAMIN AIR PISTOLS WITH MULTIPLE LEVER HAND PUMP FOR TARGET-SMALL GAME-CAMPING-ETC.



Guaranteed—Accurate—Practical—Economical—Safe—Clean—Quiet. Adjustable Force—Amazing Maximum Velocity. No smoke or fumes. Bolt Action—Hammer Fire—Hair Trigger—Safety Lock—Hand Pump. Single Shot BB \$8.50; Single Shot cal. 177 or 22 with rifled barrel \$8.50; BB 8-Shot \$10.00; Holster \$2.00. Also a complete line of Benjamin Genuine Compressed Air Rifles for BB and cal. 177 or 22. No license required from dealer or factory. Ask for complete specifications and Free Targets. **BENJAMIN AIR RIFLE CO., 850 Marion St., St. Louis, Mo., U.S.A.**

**WRITE TODAY!**

### NEW KIND OF MAN'S SHOE

The new sensation in men's shoes — The Chippewa Clipper. It zips on and off in a "jiffy". Right now is the right time to get into a dignified and highly profitable shoe business of your own with this fast seller, and a complete line of almost 250 styles of dress, work and sports shoes. Prices as low as \$1.98 a pair. Free 10-second demonstrator sells super-comfort air-cushion shoes like magic.

Manufacturer established 35 years wants salesmen. No experience needed. Write for complete sales kit. It's free!

**MASON SHOE MANUFACTURING CO.** Dept. S-34, Chippewa Falls, Wis.



### RIDE THE ERIE MOTOR BIKE



**OVER 100 MILES TO THE GALLON;** A powerful, high grade machine with Sachs Motor; 2-speeds, and clutch, chain drive, powerful brakes, balloon tires. World's outstanding low-priced pleasure and utility motor-bike. Thousands in daily use. Speeds up

to 40 miles per hour. **WRITE** for Special offer today. Special Discount to Rider Agents in open territory.

**STREIFTHAU MFG. CO., Dept. 102, Middletown, Ohio**

## Work Faster Make More Money with the

### Red UNIVERSAL TRACTOR

With this practical machine and attachments you can do all field and belt work hours faster at the low cost of 33c per day. Many units pay for themselves the first season. Unusually easy to handle and operate. Absolutely safe. Hundreds of users. Buy direct at low factory price. Two weeks' trial—satisfaction guaranteed. Write for colorful, free catalog.

**PIONEER MFG. CO. Dept. V-59 West Allis, Wis.**

### BUILD THE SCHOONER BLUENOSE

Complete Kit

**\$2.50**

Post Paid

Makes perfect building easy



### CARVED PINE HULL

Metal Anchor, Steering Wheel, Lifeboats, Anchor Chain, Casks, Masts, Dowels, Lacquer and Cement.

Send for complete catalog, 10c

**IDEAL AEROPLANE & SUPPLY COMPANY, INC.** 26 West 19th Street, New York

### NOW ONLY \$5.00 REAL ENGINE VALUE

Over 7,000 GHQ Gas Engine Kits were sold at \$8.50. Over 10,000 sold last year. Now is your chance to buy the *New Improved* kit for \$5.00. Absolutely complete with coil, plug, etc. For boats, planes, etc. All parts guaranteed. Send only \$1.—*Shipped Express Collect for balance same day. Send 3c for new 12-page illus. catalog. DEALERS WRITE.*

All parts finished. Only a screwdriver needed. 1 1/2 H.P. Average assembly time 30 minutes.

**GHQ MOTORS, 854B East 149 St., New York, N. Y.**

### BIG PROFITS RESTRINGING RACKETS AT HOME! WRITE US!

Earn big profits restringing tennis rackets at home. Easy work. Experience unnecessary. Save on your tennis, badminton, squash! Send for **FREE CATALOG** of Tennis Equipment—*Hurry!*

**H. E. Wills Co., 1047 W. 47th St. Dept. A-53 Chicago, U. S. A.**

**Save On GUT!**  
—Buy Direct from Factory SILK!

### TRAILER PARTS

Latest type heating stoves, window assemblies, couplers. Everything for the trailer. 40 page illustrated catalog, 10c.

**MARVEL TRAILER PARTS CO.** 19020 Celestine Ave., Detroit, Mich.

### PRACTICAL MAGNIFIERS

New type magnifier with swivel joints. Six sizes—1 1/2" dia. to 5" dia. lens. Prices, 50c to \$10. Send for **FREE** Catalog of these attractive, well-built instruments.

**MAG-NI-LINE PRODUCTS,** Dept. 12, 3456 E. Jefferson, Detroit, Mich.

### Wind Electric Plant

*Build Your Own—We Show You How.*

Easily made from old auto generator. Dime brings complete plans and Big NEW catalog of 500 electrical items. 100 other generator changes to 6, 12, 32, 110 volt Plants, Motors, Welders, Electrical Fencer. Write today.

**LEJAY MFG., 1447 LeJay Bldg., Minneapolis, Minn.**

### MONEY for MEN ALL DATA FREE

THE PLASTEX Industry needs manufacturers on small scale and for big production of Lamp and Clock Stands, Art Goods and Novelties in Plastex and Marble imitation. Experience unnecessary. 1/2c material makes regular 10c store sellers. Rubber moulds furnished for speed production. Small investment brings big returns. **BIG CHAIN STORE** orders now being placed by us. Ambitious men have chance for real prosperity. Our **FREE** booklet will interest and benefit you. **PLASTEX INDUSTRIES, Dept. P, 1085 Washington Ave., New York, N. Y.**



(Continued from page 133A) *89*

schedule was cut to eighteen hours. From then until 1933, the schedule varied between eighteen and twenty hours. That year it was cut to seventeen hours and forty-five minutes. The time now has been reduced to sixteen hours—and it's pretty sure to go lower as improvements and operating conditions warrant.

Every engineer has at least one pet crossing where he hangs onto the whistle. At Mishawaka, Ind., I never let go, because between Mishawaka and Elkhart there are several important highway crossings. My engine hit an automobile there in 1929. Fortunately no one was killed. It happened as we met a silk train going east. Just as that train's caboose cleared the crossing, the car shot across and right into our path. Since it came from the left, I never saw the automobile until after we hit it.

Many people ask me what they should do if their car stops on the railroad track and a train is coming. I think they should get out of the car immediately and try to push it off the track, instead of trying to start the engine. Then, if they can't get it off the track, they are in the clear, ready to jump to one side when the train gets too close. But my advice to all motorists and pedestrians is this:

"Stop, look—and wait for the train to go by."

*J. 236*

**Chisel and Plane Blade Clamp  
Grips Tools for Sharpening**

*\$1.28*

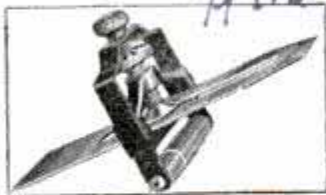

Blades of chisels and planes are held rigidly by a rolling clamp for sharpening at any desired bevel, resulting in a saving

of both time and honing. The degree or angle of the bevel is determined by the distance at which the edge is set from the clamp, and a knurled thumbscrew aids in making the desired adjustment. With the blade gripped firmly in the tool it is honed in the usual manner by a back-and-forth motion with pressure at the cutting edge, permitting the roller bearing to rest lightly at the rear of the oilstone. If necessary, the clamp may be operated likewise on a grindstone.

*Muller Falls Co.  
Springfield Mass*

**THE SPORT OF SPORTS!**

**GO PLACES**

ON AN **Indian** **\$215.** FULLY EQUIPPED

**The JUNIOR SCOUT**  
**AMERICA'S LOWEST PRICED "TWIN"**

SEE the country as you never have before — enjoy this thrill and adventure with America's greatest motorcycle "buy" — the 1939 Indian Junior Scout! This twin cylinder engineering marvel flashes you over the open road with peppy power and zooming speed, takes you 70 miles on a gallon of gas. Also three other improved Indian models you can buy on your Indian dealer's pay-as-you-ride plan. See him today!

**INDIAN is America's fastest stock motorcycle**

**FREE!** A YEAR'S SUBSCRIPTION to thrilling "Indian News" for the price of mailing. Handsome Indian Sport Jersey FREE when you order your new Indian motorcycle. Mail coupon today!

INDIAN MOTORCYCLE CO., Springfield, Mass.

Please send me items checked [ ] Indian News for one year (I enclose 15c in stamps to cover mailing cost). [ ] Certificate of Value entitling me to Indian Sport Jersey FREE when I order my new Indian motorcycle. [ ] Indian catalog.

Name .....

Address .....

PM59

Please be sure to check your age group  
[ ] 16-19 yrs. [ ] 20-30 yrs. [ ] 31 yrs. and up [ ] under 16 yrs.

**INDIAN MOTORCYCLE CO., Springfield, Mass.**



# GROWING EVERY DAY

*use of Sound Equipment by*

## ALERT BUSINESS!

If your job is reaching people—in ballroom, stadium, factory, school, church, auditorium—in fact, wherever people gather in crowds, you can reach them better with a Lafayette sound system. People want to hear as well as see! Make your place up-to-date, inviting. Install a modern, economy Lafayette Public Address system. Prices for complete systems ready to operate start as low as \$23.86.

### READ WHAT THESE ALERT BUSINESSMEN SAY ABOUT LAFAYETTE PUBLIC ADDRESS



**DANCE HALL:** I operate a ballroom. When business fell off, I investigated. Found my competitors had got the jump on me with Public Address. So I installed a Lafayette economy system. It's a beaut—and the only one around here. Now I have the jump on them all!



**SCHOOL SUPER:** As a Superintendent of Schools, I cannot stress too strongly the importance of Public Address in modern education. We chose a Lafayette because we wanted the best quality money could buy.



**ELECTRICIAN:** Last Fall I installed a Lafayette sound system in the Municipal Stadium. Now I have the contract for the golf-club house and ball park. Seems everybody likes Lafayette performance and economy.



**PLANT OWNER:** Since I installed a Lafayette sound system in the plant, efficiency has been stepped up 35%. We save valuable time, avoid needless confusion, and keep phone wires clear for important calls. Lafayette has paid for itself twenty times over!



**JUST ONE** in Lafayette's complete line of money-saving sound systems. A super-power streamlined amplifier—70 to 100 watts, operates 4 miles. No finer system for super-theatre, or sports stadium. Model 792-T.

**FIND OUT** how Public Address can help you in your business. Find out how much you can save with Lafayette. Send at once for new **FREE 1939 catalog**. Contains full information about the entire line of thrifty Lafayette sound systems. **Tear off coupon and mail today.**

LAFAYETTE RADIO CORP., 100 SIXTH AVE., NEW YORK

## LAFAYETTE PUBLIC ADDRESS EQUIPMENT

Yes—send me complete information on how I can increase my business with P.A.

DEPT. 7EPL LAFAYETTE RADIO CORP. 100 SIXTH AVE., NEW YORK

Name \_\_\_\_\_

Address \_\_\_\_\_

City \_\_\_\_\_

State \_\_\_\_\_

## Broadcast Set for Beginners

(Continued from page 740)

prong. These connections are all shown top view, in "X-ray" fashion, in the simplified wiring diagram, and bottom view in the schematic. The Amphenol sockets specified for all three units have each

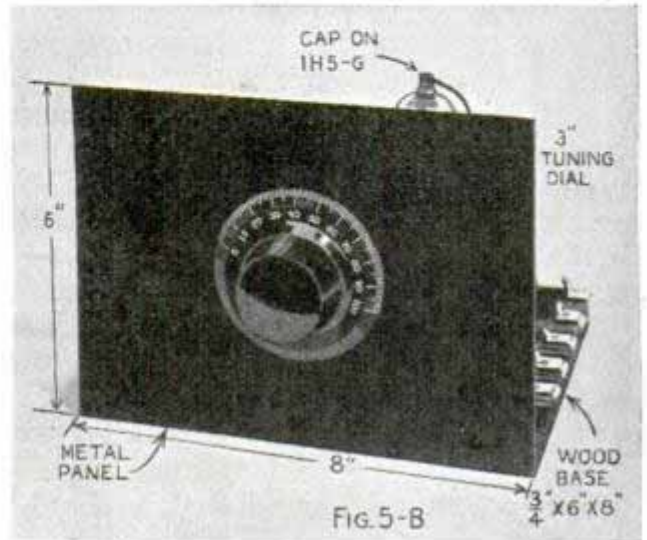

prong clearly numbered on the under side; solder all wires to the socket terminals before mounting on the baseboard.

All battery connections are automatically made when the jumper wires are used to connect the units together. The antenna coil is a standard Litz-wound unshielded type and each connection is plainly indicated in Fig. 5 and the insert detail A, which shows a view looking down into the

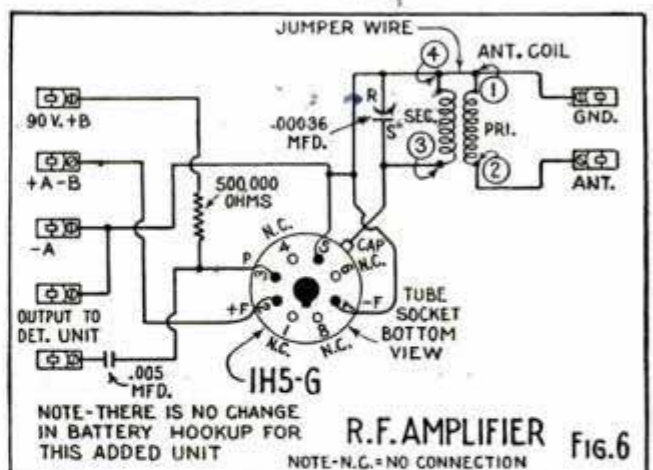

top of the coil form. Front and rear views of the completed r.f. unit appear in photos Figs. 5-A and 5-B; and a front view of the final R-266 three-unit assembly is shown.

When tuning the 3-unit set keep the dials on the detector and r.f. stages at about the same setting. Use a 50 or 75-ft. antenna and a good ground for best results.



## Synco JIG SAW

Faster! Safer! Cleaner!  
Real performance. Cuts  
with smooth, clean edges.  
No sanding required. Elec-  
tric operation. No motor  
or reciprocating parts.  
Operates on 60 cycle, 110  
volt A.C. Ideal for home  
craftsmen, and model  
makers. Two models.

7200  
Strokes  
per  
minute



Only  
\$4.95  
(East of  
Rockies)

Write Today for  
FREE LITERATURE

Export Office: 40 Worth St.,  
New York; Western Dist.:  
Federated Sales Co., 2437 W.  
Valley Blvd., Alhambra, Cal.

**SYNCO DEVICES, INC.,** 511 Boydell Bldg.  
Detroit, Mich.

## FINDS BURIED TREASURE! NEW GOLDAK RADIOSCOPE



Most efficient metal and mineral ore locator ever known.  
Money-back guarantee to detect buried GOLD, SILVER, or any  
other metal. Extremely powerful new models. Put your pro-  
specting on a scientific basis. If you know of buried treasure, find  
it with the new Goldak. Write world's largest manufacturer  
of successful mineral locators for information.

**THE GOLDAK CO., Dept. P**  
1031 South Broadway, Los Angeles, Calif.

## CARTOON YOUR WAY TO SUCCESS!

**DON'T COPY - LEARN TO ORIGINATE!**  
RAYE BURNS will teach you HOW to CREATE  
ORIGINAL CARTOONS at home that you can  
SELL! Course has 26 lessons and 600 illustrations.  
Send name and address for free details. Only... **\$2.85**

RAYE BURNS SCHOOL, Dept. M-B, Box 2194, CLEVELAND, OHIO

## TRAILER BUILDERS • BUYERS • OWNERS TRAILER

Send 25c for this Big Book Today

Over 100 pages! Beautifully Printed and Illustrated! Trailer Sug-  
gestions and Ideas galore! Catalog shows America's greatest line of  
Trailer Parts and Equipment at lowest prices. Everything from  
wheels to top. Rush 25c today. Satisfaction positively guaranteed!  
TRAILER SUPPLY CO. Box 438-A WAUSAU, WIS.



## BUILD IT YOURSELF

**The Jim Dandy Cabin Cruiser**

The Trailer that has everything. Classy! Roomy.  
Easy to build in any size with my simplified Plans and  
Instructions—Price \$1.00. Rush dollar bill today to  
JIM DANDY Box 125-A WAUSAU, WIS.

## EMPIRE TORPEDO LEVEL . . .



**Handiest Tool In Your Kit**  
Won't tear pocket. 9" long. Shows  
Plumb, Level, 45°, 1" and 2" pitch.  
Grooved bottom for pipe work. Satin  
finish aluminum. \$1.25. Send 10c  
for catalog of 74 different levels.  
"Empire 'Extreme Accuracy' Levels  
Used by Good Craftsmen Everywhere."

In Stock At All Dealers  
EMPIRE LEVEL MFG. CO., Dept. P-2  
717 S. 6th St., Milwaukee, Wis.

**ATLAS STICK-ON LETTERS**  
Beautiful Gold Colored. New Styles.  
5 Year Guarantee. Large Sizes—  
Penny Each. Tremendous Demand.  
Amazing Profits. Write for Samples  
and Starting Equipment. Hurry!  
ATLAS Sign Works, 7943 Halsted, Chicago



## EARN MONEY MAKE COLOR GLAZED CONCRETE PRODUCTS



NEW! low cost, patent method makes Color-glazed  
concrete pottery without molds. No experience  
needed. Use only sand, cement, cheap materials.  
Make glazed tiles, walls, gravestones, etc. Send  
10c TODAY for booklet, colorplate, cost data, de-  
tails. Descriptive folder Free.

**NATIONAL POTTERIES COMPANY**  
Room 6A, 13 W. 26th St., Minneapolis, Minn.

## BUILD YOUR GRANDFATHER CLOCK

The Simple Sensible Red-i-Knit way as thousands have. DIME brings  
PLANS and sixty picture "HOW" Book pricing many fine brass weight  
Westminster, tube chime, electric and battery movements showing  
nine beautiful colonial grandfather cases. WHY WAIT LONGER?  
KUEMPEL CHIME CLOCK CO., Bldg. 28, Guttenberg, Iowa.



## MAKE BIG MONEY AT HOME Electroplating by Brush! AMAZING NEW INVENTION!



**NO TANKS, LIQUIDS, GENERATORS** Only  
**DOES SAME WORK AS BIG OUTFITS** \$9.85

Sensational news! Marvelous new  
invention actually electroplates  
with electric brush. As easy as  
painting. Deposits heavy layer of  
actual metal—gold, silver, nickel,  
cadmium, copper, etc.—by electrolysis. Does  
same beautiful, PERMANENT work as big,  
costly tank outfits. Non-liquid. Anyone can  
use from dry cells, storage battery or house-  
hold current. Complete outfit weighs only 3  
lbs.—take it anywhere—ready for instant use.

**STARTS  
YOU IN  
BUSINESS**

**PLATE THOUSANDS OF ARTICLES  
SPARKLING NEW WITH STROKE OF BRUSH**  
**BIG EARNINGS REPORTED IN SHORT TIME**

Amazing low price and magic-like demonstration  
brings you thousands of orders for plating from  
garages, radio shops, bicycle shops, machine  
shops, home work shops, factories, offices, jan-  
itors, doctors, dentists, jewelers and farmers,  
homes, stores, etc.—with big profits for you!  
Schedule of plating charges furnished; also re-  
ports of big money users are making with the  
WARNER NU-WAY ELECTROPLATER.

**FREE SAMPLE PROVES ALL CLAIMS!**

Send today for amazing profit details with this  
revolutionary electroplating invention. FREE  
SAMPLE & BIG MONEY-MAKING PLAN.  
Get started in a profitable business of your own.  
Full or spare time. Be the WARNER NU-WAY  
ELECTROPLATER IN YOUR TOWN. Simply  
mail post card with your address.

**Warner Nu-Way Electroplater Co., Dept. K-5**  
360 North Michigan Ave. Chicago, Ill.



## Enjoy the OPEN ROAD

Don't let confused directions spoil the pleasure of mo-  
toring. You always know the right road with the Hull  
Streamline Auto Compass on your windshield. Shows  
direction of travel at all times, avoiding lost miles,  
worry and delay. Only \$2.95 at your dealer. Two-piece  
model \$1.95. Write for circular.

**HULL MFG. CO., P. O. Box 246-D13, WARREN, OHIO**

## PRESTO! ANYONE CAN MASTER GLAZE

LEAVES HARD  
GLASS-LIKE  
FINISH  
EASY TO APPLY  
PROTECTS  
THE SURFACE  
NO SMEAR OR STREAKS  
AS WITH WAX  
LASTS SIX MONTHS  
TO A YEAR



**SAVES  
YOU MONEY**

Car Owners! Meet Master Glaze—the sensationally different  
luster for new and used cars! Not a wax—not an oil polish  
—not a paint!—nothing that “smears” over the surface.

**MASTER GLAZE** is a unique discovery—a creamy liquid  
—quick and easy to apply! Gives a hard,  
glass-like surface. Even gasoline cannot dull  
it! Lasts six months to a year! Amazing  
luster—beautiful, sparkling clean and bril-  
liant! Doesn't finger-mark—doesn't smear!  
A match box full glazes an entire car. Seals  
the pores—protects! NOTHING LIKE IT!  
**AGENTS**  
An unusual  
opportunity!  
Quick, flashy  
demonstrator.  
Big profits.  
Good territory.  
Write today!

**FREE SAMPLE** Write now for FREE BOOK-  
**FREE Offer!** LET and FREE TRIAL OF-  
FER. Just send your name and address. Write

**MASTER GLAZE CO., 7720-65 W. Harwood Ave., Milwaukee, Wis.**





SERVICE MEN  
RADIO BUILDERS  
AMATEURS

GET ALLIED'S **SPRING CATALOG**  
JUST OUT!



**SAVE**  
on everything in  
**RADIO**

**SETS ... AT NEW LOW PRICES**

Send for ALLIED's Spring Catalog—just out! See the new 1939 KNIGHT sets with "Air-Magnet" built-in aerials, Push-Button Tuning, etc.—at new low prices. 62 new models, some as low as \$5.95—new AC, AC-DC, portable battery, 1½ volt, 6 volt and auto sets; new Phono-radios, phonographs, record players! Send coupon for ALLIED's Super-Value Catalog!



**NEWEST KITS** READY TO BUILD: SEND FOR FREE PARTS LISTS



Dozens of new kits—new Meissner 1, 2, and 3 tubers, "Pee Wees", "Mystery" Phono and Mike kit, and many others. Write for free parts lists showing all parts required to build any kit. Just send name and date of issue of magazine. **BEGINNERS! SEND FOR ALLIED'S RADIO BUILDERS HANDBOOK.** A new and different type of book, planned especially for radio beginners. Tells how to select circuits, read diagrams, build radios, make chassis, wind coils, etc. Includes valuable short wave transmitting and receiving data. Send coupon with 10c for your copy. Only 10c.

**NEW SOUND SYSTEMS!**

Revolutionary new P.A. for every purpose from 8 to 65 watts. Standard and de luxe models—permanent, portable, and mobile—with Monitor Speakers and Remote Control. Also, Radio's biggest selection of recording equipment, discs, and accessories. Read all about the sensational new "Flex Disc."



**PARTS! HAM GEAR! TESTERS!**



ALLIED's new Spring Catalog brings you **Everything in Radio at Lowest Prices!** Thousands of parts, new Amateur Receivers and transmitters, new test equipment, etc.

ALLIED Radio Corp.  
Dept. 5-E-9  
833 W. Jackson Blvd.  
Chicago, Ill.

- Send me your new Spring Catalog  
 Enclosed find 10c (plus 3c postage) for Builder's Book  
 Send me parts list for.....

Name.....

Address.....

**FREE**  
Catalog

## "On-a-Chair" Cabinet

(Continued from page 739)

edges with the molding shown in the insert detail in Fig. 7, you can simply make a chamfered edge with a hand plane.

The ash well is formed from a short length of 2½-in. diameter chrome tubing by soldering a disk at the bottom and a 3¾-in. flange at the top. The flange is turned to size from soft sheet brass on your lathe face plate, first turning the outside diameter and then the inside; this is then nicked to match the tube before soldering. Small cigarette holders bent from disks of shiny tin are soldered to the top surface of the flange after first filing off a spot of the plating so that the solder will adhere. See that the tube fits the hole freely for easy removal. A standard 3½-in. electric clock movement can be mounted in the opposite shelf.

Two metal straps hold the cabinet to the arm of the chair; these are bent from ⅛ by

### BILL OF MATERIALS

- 2 pcs.—⅝" x 5½" x 10"—Ends
- 2 pcs.—⅝" x 5" x 8½"—Shelves
- 1 pc.—1/20" x 11½" x 15"—Veneer
- 1 pc.—½" x 12" x 12"—Plywood
- 2 pcs.—¼" x 1¼"—Strap iron (approx. 30")
- 1 pc.—2½" dia. x 3½"—Chrome tube
- 1 pc.—10 ga. 4" x 4"—Soft sheet brass
- 1—¾" standard electric clock movement

1¼-in. strap iron. The proper contour may be determined easily by bending a length of wire solder around the chair arm as a pattern. To make sharp bends in the iron you will probably have to heat the metal at the point of bend; however, the curve may be formed cold by working it to shape in the customary manner through the open jaws of a monkey wrench clamped horizontally in a vise. From the insert photo in Fig. 6 it will be noted that the straps are shaped to pass down alongside the cushion of the chair and hook under the lower upholstery rail of the arm. The straps may be chromeplated, painted or covered with fabric as preferred. When these straps are screwed to the bottom of the cabinet as shown in Fig. 4, they will form cross supports upon which the midget set rests. If set power cord is too short to reach wall socket, use an extension cord. Do not cut or add to the set cord itself. Blueprint number of this article is R-267.



## KILL RATS WITHOUT POISON

**YOUR MONEY BACK IF RATS DON'T DIE**



K-R-O won't kill Livestock, Pets or Poultry; Gets Rats Every Time. K-R-O is made from *Red Squill*, a raticide recommended by U.S. Dept. Agr. (Bul. 1533). Ready-Mixed, for homes, 35¢ and \$1.00; Powder, for farms, 75¢. All Drug and Seed Stores. Damage each rat does costs you \$200 a year. K-R-O Co., Springfield, O.

## K-R-O KILLS RATS ONLY

**OH BOY! WHAT FIREWORKS!**



FREE

**CATALOG AND COUPON**

Return coupon with order for Fireworks and get big 35¢ box of SALUTES FREE

**SPENCER FIREWORKS CO.,** Box PM 150, POLK, OHIO

## PHOTO ENLARGEMENTS

Is Photography your hobby? Do you want a profitable easy business at home? Make **PHOTO ENLARGEMENTS** for yourself and others. Your cost 5¢ each and less. The Ideal Photo Enlarger is **AUTOMATIC**. No experience required. Also **COPIES** any picture. **\$5.94 COMPLETE**. Interesting circular **FREE**.

**IDEAL-O, 122 East 25th Street, New York City**

5¢

**ANY SIZE**

## BURN YOUR NAME ON TOOLS WITH THE ARKOGRAF

**PROTECT YOUR TOOLS FROM THEFT**  
Write with electricity any name or design on the hardest and finest tools and instruments, or any metal, like writing on paper with pen or pencil. **Complete Outfit \$3.50—Prepaid Anywhere**. Interesting illustrated circular free. Write today. Agents wanted. **ARKOGRAF PER CO., 3927 S.E. Stark St., Portland, Ore.**



## MAN IN EACH TOWN To Plate Auto Parts

Reflectors, Bicycles, Fixtures, Mirrors, by late method. Simple plan of manufacturing at home starts you **IN GOOD PAYING BUSINESS**. Write today for **FREE** particulars and proofs.

**GUNMETAL CO.** Ave. M Decatur, Ill.

## CASH IN QUICK

ALL OR PART TIME—MEN AND WOMEN—MAKE EASY MONEY SELLING **GENUINE LEATHER TIES**



Sell on Sight

4-in-Hands and Bows, for Men and Boys. Beautiful patterns and colors. **LOOK LIKE SILK**. Won't wrinkle. Wear indefinitely. Cleaned with a damp cloth. Big profits; repeat orders. No sales ability needed. Big leader in necktie sales. Send 50 cents for sample kit. Information free.

**CENTURY TIE CO., Mfrs.,** 2345-P W. Grand Blvd. Detroit, Mich. (Originators of Leather Ties)

# "I've Never Made Money So Fast in My Life!"



## "20 HOURS BROUGHT ME \$52.50 CASH PROFIT"

**W**ITHOUT any experience in calling on gasoline stations, R. L. Rich was handed a machine he had never seen before. In a one minute demonstration, he showed how the garage owner could double or triple his profitable oil sales by **GIVING AWAY** a service job. Tremendous national advertising campaigns, on which hundreds of thousands have been spent already, have sold the public the need for this type of service. Rich made his first call—

## PFITT- and the Sale was Made!

He made forty calls in 20 hours. He sold thirty machines. He made \$1.75 cash on each sale. He pocketed \$52.50 Thursday, Friday and Saturday morning. The whole country is open now to men like Rich. Nothing has been reserved. This is brand new. Opportunities are unlimited. Earning possibilities stagger the imagination.

## FREE—Send Name

Do you want to cash in? Don't send money. Nothing for you to buy. Send your name on a postcard or send the attached coupon, or send a telegram. By the quickest way you know, get your name to us for complete details of what promises to be the most spectacular money-maker of the year.

**ACE EQUIPMENT CO.** Dept. 165, Walnut Bldg., Des Moines, Iowa

ACE Equipment Co., Dept. 165, Walnut Bldg., Des Moines, Ia. Rush all facts, pictures, operation details and cost and profit figures on your new machine. Everything is Free. I am not obligated in any way. (Write name in margin of this page and mail)

## EARN MONEY Stringing TENNIS RACKETS



YOU GET 'EM LIKE THIS



and



DELIVER 'EM LIKE THIS

Build up a business of your own stringing tennis rackets. It pays up to 140% profit per racket. String your own racket and save money. No experience necessary—we teach you how. Tennis players need new strings in their rackets two or three times yearly... every stringing means profit for you. See how simple it is to get in this business. Costs practically nothing to start. Easy work! **Get started NOW!**

**THOMPSON MFG. CO., 4535 Packers Ave., CHICAGO, U. S. A.**  
Makers of TOMGUT "Court-Tested" Tennis Strings & Restringing Equipment

## Thompson BEATS the World on BOATS

**Only Boats With Full Length Spray Rails**  
Keep passengers perfectly dry—even at high speeds. Catalog also shows today's five most popular models of sailboats. Two big factories. Prompt shipment.

**CATALOG FREE**

Write for your copy. State kind of boat in which you are interested.

**THOMPSON BROS. BOAT MFG. CO. (87)**  
213 Ann St. PESHIGO, Wis. (Write to either place)

**Better Built Lower Prices**

-  Canoes \$64 and up
-  Rowboats \$42 and up
-  Outboards \$42 and up
-  Very fast utility model

**113 Elm St., CORTLAND, N. Y.**



# Get the **THRILL** of building it yourself



Get the **THRILL** of building it yourself! There's a lot of he-man thrill in a short-wave radio of your own. But the biggest thrill is putting this magic Voice-of-the-World together **YOURSELF**. Our new **FREE** radio catalog No. 76 features a wide selection of Build-it-Yourself kits and items designed to make that thrill come true. But that's not all. This big 188 page book also contains thousands of other items—tubes, accessories—everything you need in radio. And at real money-saving prices. Don't miss it!

## WORLD'S FINEST RADIO CATALOG FREE!

Why wait? Begin now to save on everything you need in radio. This catalog points the way. Mail the coupon for your **FREE** copy at once.

### LAFAYETTE RADIO CORPORATION

NEW YORK, N. Y. CHICAGO, ILL. ATLANTA, GA.  
 100 SIXTH AVENUE 401 W. JACKSON BLVD. 345 PEACHTREE STREET  
 BOSTON, MASS. BRONX, N. Y. NEWARK, N. J. JAMAICA, L. I.  
 110 FEDERAL STREET 242 E. FOREMAN RD. 312 CENTRAL AVENUE 40-06 164th STREET

### WHOLESALE RADIO SERVICE CO. INC.

Rush New **FREE** Radio Catalog No. 76.

Name..... **188 PAGE CATALOG FREE**  
 PLEASE PRINT  
 Address.....  
 City..... State.....

LAFAYETTE RADIO CORPORATION  
 DEPT. 7E9 - 100 SIXTH AVE., NEW YORK, N. Y.

PASTE COUPON ON PENNY POSTCARD

## COLUMBIAN METAL BOATS

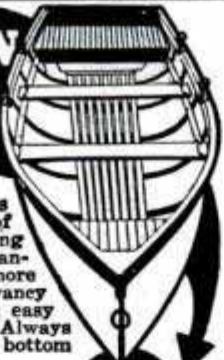

Light weight, durable, carefully built boats at remarkably low prices. Made of toughest galvanized copper bearing steel. Wood gun-wales. Heavy transoms for outboard motors. Two or more built-in air chambers for extra buoyancy in case of upset. Real wave riders; easy to handle. Never leak or warp. Always ready for use. Both round and flat bottom boats; all sizes and styles.

Write For Free Boat Booklet with description and prices of complete line of metal boats—knockabouts for fishermen, light weight livery boats for parks and resorts, heavy duty craft for outboard motors. Dealers Wanted—who can develop volume sales.



COLUMBIAN STEEL TANK COMPANY, P. O. Box A-4226 Kansas City, Missouri

## FREE CAMERA BOOK!

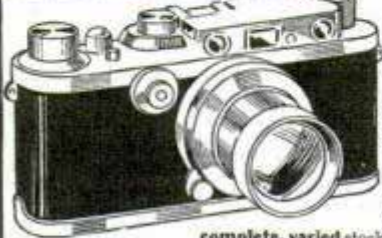

Illustrates latest developments in photography and Home Movie Making, for fun and profit. Offers hundreds of new and used still, movie cameras, lenses, films, exposure meters, enlargers, darkroom supplies—everything photographic. All guaranteed—many at big savings. Central offers you America's most

complete, varied stock of foreign and domestic merchandise from world's leading makers: Eastman Kodak, Zeiss, Bell & Howell, Graflex, Gevaert, Korona, Bausch & Lomb, etc. SAVE at Central Satisfaction guaranteed or money back. We take your old camera and equipment in trade. Write for Free camera book!

CENTRAL CAMERA CO., 230 S. WABASH Dept. K-5, CHICAGO, U.S.A.  
**PHOTOGRAPHIC HEADQUARTERS since 1899**

# JUST OUT

## 100 Million Customers NEW BIG MONEY MAKER

Amazing new invention. No competition. Everybody wants it. 2 to 8 every home. Sells on sight. Bond-Orde orders 2188, less than 60 days. May-Wise: 720, less than 30 days. Phillips-Ky: Ship 12 doz. Quote price 1000 lots. Hutch-Wiser: rush 144. Everybody wants it. Ridgely-Calif: Rush 864 Dental Steros. Draft enclosed.

### ACT NOW—CASH IN QUICK

Handiest method ever known for care of tooth-brushes. Sell 50c brush & 25c glass sanitary container & sterilizer with wall-bracket—all for only 50c. Big surprise awaits you. Chance for real clean-up. Spare or full-time workers. Make dollar or more every hour. Save time; get quick start. Send 55c in stamps for two complete outfits or write for full details.



DENTAL-STERO CO., 1404 W. Bancroft St., Toledo, Ohio



### NEW—SENSATIONAL—KEYLESS—ELECTRIC GAS TANK LOCK

Cap unlocks—SNAPS open by pressing a button on your dash. Close the cap and it locks automatically. Fully guaranteed. A MONEY MAKER for Agents and Dealers. Write immediately for exclusive distributorship proposition. Territory going fast. SNAP-UP GAS CAP CO., DEPT. C. ASHLAND, KY.

## RE-STRING RACKETS AT HOME



### EARN MONEY

It's pleasant, profitable work. No experience or skill required. Easy to learn. Full line of guaranteed Stringing Tools, Frames, Gut and Silk Strings. Every item high quality. Write for complete information.

FREE Write for our 1939 Catalog and Instruction sheet. W. A. BICKEL & CO., 137 N. Marion, Dept. A-59, Oak Park, Ill.

## FREE "BETTER RESULTS WITH GLUE"



Send post card for booklet, "Better Results with Glue," containing many useful hints about mending, model making and home workshop jobs. Address: McCormick Sales Co., 402 Light St., Baltimore, Md. at hardware, drug and 10c stores; also in cans from 1/4-pint to 1 gallon

Keeping them in GERSTNER TOOL CHESTS  
 Machinists and toolmakers protect their tools. Free Catalog  
 GERSTNER TOOL CHESTS  
 439 Columbia St. Dayton, Ohio

TRAILER PARTS  
 New Catalog FREE! Aste bargains. Straight, square axles for Fords, Chevrolts, etc. \$4. Drop axles \$7 up. Undercarriage with axle, hubs, bearings, wheels, springs and fittings, \$19.50. BRAKES: Cable-controlled, \$15. Booster and car control, \$19.95. Electric brakes—prices on request.  
 SHAMROCK TRAILER PARTS, 12321 Turner, DETROIT, MICH.

CATCH FISH!  
 minnows, eels, mink, muskrat, with our folding galvanized Steel Wire Traps. Walton's Automatic Hooks are so constructed that when a fish gives the slightest pull on the bait the upper hook reaches down and gets a hold that lands him. 3 for 50c. Write for descriptive catalog of Traps, Hooks, Lures, and other specialties. Walton Supply Co., 3507 Juniata Ave., St. Louis, Mo.

TYPEWRITER Brand NEW!  
 only \$19.95 and up  
 10-Day Trial—Easy Terms  
 Guaranteed Brand New latest HEM-INGTON GAE DET models only \$19.95 during this sensational sale. Also Royal, Corona and famous Feather-weight Portables at real money-saving prices. Also standard full size office models rebuilt and fully guaranteed at 1/3 saving.  
 International Typewriter Exch., Dept. 501, Chicago  
 10c A DAY

When writing please mention Popular Mechanics



## Listening In on America at Work

(Continued from page 683)

ducers ran into was that of finding Americans at work at the time the program went on the air—10:30 at night. The time has since been changed to Saturdays at 7:00 p.m. This problem first developed when the longshoreman was to bring the story of his job to the microphone. But longshoremen, it seems, are not usually at work at 10:30 at night. So the broadcasting system became the employers of twenty-two longshoremen for the time of the program, paying them the union scale for overtime work. And the S.S. "George Washington," by special arrangement, was unloaded that one time at night.

Submarines, too, are ordinarily daytime workers. So when it was planned to bring to the mike some of these deep sea sailors, the program producers had to get in touch with the Navy department in Washington, which instructed the commander of the submarine base at New London, Conn., to put a submarine to sea especially for the broadcast.

Since the first half of the show always dramatizes the historical background and history of each industry, industrial sound effects must be used. To get the studio sound effects as accurate as possible, experts in each field are brought into the studios—a navy officer, a technical expert from the du Pont company, special technicians from the Western Union company, or the American Telephone and Telegraph company. So successful have these consultations with experts proved that, following the submarine broadcast, for instance, a retired navy officer phoned in. He insisted that the second half of the broadcast, the part that came directly from the underwater boat at New London, was faked. But he accepted the sound effects from the studio as perfect.

One of the most difficult of these sound effects, according to Producer Norman Corwin, was that of dynamiting ice. It was necessary, the experts said, to simulate the explosion, then the sound of the ice buckling and crashing and falling into the water. A thunder drum gave the sound of the explosion all right. But Producer Corwin couldn't get the sound of the ice breaking up. Suddenly he reached in his pocket and

(Continued to page 143A)

# MAKE "FAIR" PICTURES perfect PICTURES

take a  
**WESTON**  
along!

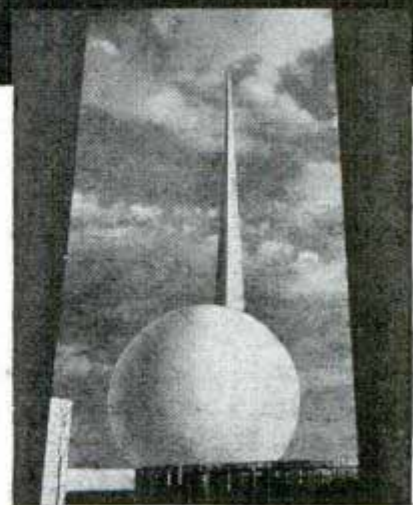

Don't return from the fair and find that many of the pictures you took are worthless or disappointing... *incorrectly exposed*. Before you start your trip, get a **WESTON Exposure Meter**. Then you can be sure that every still or movie you take, even your color pictures, will be brilliant and life-like... pictures you'll treasure and be proud to show. This tiny and inexpensive meter tells exactly what camera settings to use for any picture, in or out-of-doors. Used by amateurs everywhere. See the **WESTON** at your dealer's today, or send coupon for literature.



## WESTON Exposure Meter

Weston Electrical Instrument Corporation  
671 Frelinghuysen Avenue, Newark, N. J.

Send full information on the **WESTON Junior**.

Name.....

Address.....

City..... State.....

# HANDEE

Tool of 1001 Uses

**A WHOLE TOOL SHOP  
IN YOUR HAND**

Smooth, steady power at your finger tips. Uses 300 accessories to grind, drill, polish, rout, cut, carve, sand, saw, sharpen, engrave, etc. Plugs in any AC or DC socket, 20,000 r.p.m. 16 oz.

**Get A Demonstration**  
at Hardware, Tool or Dept. Stores, or order on 10-Days Money-Back Trial. **\$10.75** post-paid with 3 Accessories... De Luxe Model, 25,000 r.p.m. 12 oz. **\$18.50** with 6 Accessories.

Chicago Wheel & Mfg. Co., 1101 W. Monroe St., Dept. PM, Chicago, Ill.



Save  
Hours  
of Hand  
Work

**FREE 64-PAGE CATALOG**  
Complete information on Handee Products and their wide application in crafts work and industry all over the world.



THE DIP, DIP, DIP OF AN

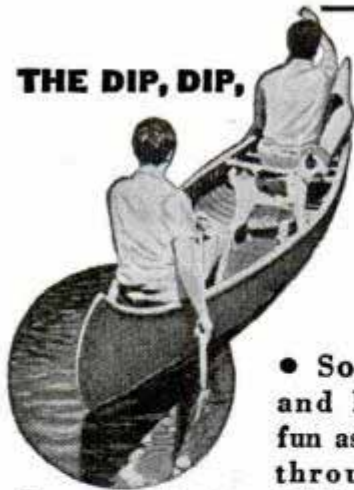

# Indian Blade

● SOAK up sun and have more fun as you paddle through Indian pleasures. Hunt and fish, and set up camp away from the world on the water. Winding rivers and lonely lakes invite you to sport and adventure. An Old Town Canoe brings you years of pleasure. It costs very little to own one.

**FREE CATALOG** shows all kinds of Canoes for paddling, sailing or outboards. Also Outboard Boats, including big all-wood family boats, Rowboats, Dinghies. Write today. Address Old Town Canoe Company, 535 Main Street, Old Town, Maine.

*"Old Town Canoes"*

**ALL PURPOSE MOTO-TOOL**

**ONLY \$9.85**

**New Mechanical Sensation**

Speed of 25 to 27 thousand revolutions per minute without vibration makes it possible to do all kinds of fine work such as carving, grinding, engraving, drilling, routing, etc., with a Dremel Moto-Tool and to do it in a jiffy. Two models to choose from—No. 1 as shown, only \$9.85 and No. 2 for heavier work only \$16.50. Indispensable for home work shop fans, sportsmen, handy men and home owners. Many improvements not found in other tools. Write for complete description, 10-day trial offer and booklet showing dozens of accessories which can be used and special combination offers. No obligation, booklet is FREE.

**DREMEL MANUFACTURING COMPANY**  
Department 521 Racine, Wisconsin

**New Device PROLONGS LIFE OF YOUR CAR BATTERY** *Only \$1*

**NO CUTTING—NO DRILLING—EASILY INSTALLED**

"Remindo" a new automatic battery water gauge shows you when your battery is in danger and indicates when to add water. "Remindo" ends battery failures. Prolongs the life of your battery—saves costly repair bills and towing charges—"A Real Battery Life Saver," strongly built to last the life of your car. For all makes of cars and all types of batteries. Easy to install on dash in a few minutes, ready for immediate use. Satisfaction or money back.

**SEND NO MONEY** Sent postpaid to you for \$1 postage. Also at Wards and Sears.

**NICOUD MFG. CO., 9 W. Illinois, Dept. 11, Chicago, Ill.**

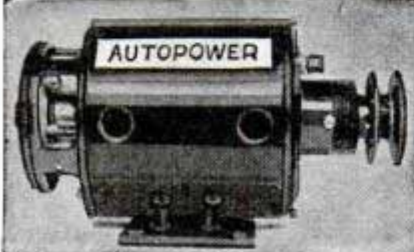

## TURN SCRAP INTO MONEY

AUTOPOWER tells you how in plain, easy, simple and illustrated instructions that anyone can follow. Change auto generators into useful, practical A C and D C generators and motors with voltage from 2 to 1,000 volts, for power, light, welding, radio, sound, etc. No previous experience nor special tools needed. Generators can be driven by wind, water, fan belt, etc. **INSTRUCTIONS FOR BUILDING AN A C WELDER THAT ACTUALLY WORKS UP TO A 3/16" ROD. ALSO COMPLETE PLANS FOR WIND AND WATER POWER PLANTS.** Send for your copy of "AUTOPOWER." Already used and endorsed by thousands. Only \$1.00 postpaid.

**S. W. DUNCAN, Publisher.**  
419 S. Hoyne Ave., Chicago



# ELECTRICITY

FROM YOUR OWN ELECTRIC PLANT WHEN POWER LINES FAIL

ONAN ELECTRIC PLANTS furnish 110 Volt, 60 Cycle, A.C. Current same as City Power Lines. Models for Farms, Camps, Construction Jobs and for Emergency Service in Hospitals, Schools, Theatres and Public Buildings. **SAVE PROPERTY** and even LIVES in case of Power Line Failure. Thousands in use in all parts of the World. Operate Lights, Radios, Water Systems, all Appliances. New Models 350 to 50,000 Watts, 12, 32 and 110 Volt, D.C.—110 and 220 Volt A.C. Also Combination A.C.-D.C. Units. Manual, Self-starting and Full-automatic Starting Types. \$29 and up. Shipped COMPLETE—READY TO RUN

Write for Details  
**D. W. ONAN & SONS**  
1033 Royalston Ave. Minneapolis, Minn.

# CAPE COD CHAIRS

Style "B", "C", "A", Blueprint 50c. All 3 for \$1.00. TRELLISES—12 original designs. Blueprint of all 12 only 50c.

**BENCH ARBOR**—A beauty, 8" high, 5' 6" long, 2' wide. Blueprint 75c. Knockdown Kit. \$42.50. Send 10c for catalog illustrating many projects. Over 35,000 Satisfied Customers." **Craftsman's Model Co., Dept. P-29, 2030 N. 42nd St., Milwaukee, Wis.**

# FLAME-GUN Destroys Weeds

**Does Work of 4 Men!**

**Hauck Kerosene Flame-Gun**—2000° F. controlled heat—quickly, easily, economically destroys weeds (seeds and all), brush, other objectionable growths. Keeps roadways, fences, irrigation ditches, orchards, etc., clean. Hundred and one uses. Inexpensive—Safe—Easy to use. Pays for itself in time and money saved. 10 day Free Trial. Write for Free booklet and special introductory price.

**Hauck Mfg. Co., 139 Fenth St., Brooklyn, N. Y.**

# BE YOUR OWN BOSS

## BUILD A BUSINESS

with **ROGERS UNIVERSAL LAWN MOWER GRINDER**

**LATEST INVENTION** Sharpens reel blades as well as inside face and edge of stationary blade without dismantling mower—makes mowers operate easier, cut smoother, stay sharp longer. Takes less time and effort. Every job perfect—Every customer satisfied. Tool grinding attachment FREE. Compare this Grinder with others. Write for descriptive literature.

**ROGERS MANUFACTURING CO. LINDSEY, OHIO**

# WORLD'S BEST LINE OF TRAILER AXLES, HITCHES and PARTS

Send Only 50c Today for our Complete House Trailer Working Blue Prints. **WRITE FOR FREE LITERATURE.**

**HAMMER BLOW TOOL COMPANY, Dept. 105, Wausau, Wis.**

# YOUR OWN MOVIES! 10¢ A DAY!

**NATIONALLY ADVERTISED 8MM and 16MM Movie camera, projectors.** For home, business, church, school, club. **MONEY BACK 10 DAY TRIAL.** Payments as low as 10¢ A DAY. Satisfied customers throughout the world. **FREE details. WRITE TODAY.**

**Don Elder's Home Movies, Dept. A-5, 739 Baylston St., Boston, Mass.**

# STEAM ENGINES for small boat models.

Two-cylinder power plants, ready to run, with boiler propeller and burner.

**Model SE-1, oscillating type. . . . . Price \$2.00**  
Postage extra, shipping wt. 3/4 lb.

**Model SE-3, slide-valve type. . . . . Price \$3.00**  
Postage extra, shipping wt. 1 1/4 lb.

**Shawnee Engine Co., Box 162, Station D, Cincinnati, O.**

# Print Your Own

Cards, stationery, circulars, tags, labels, advertising, etc. Save money. **Print for Others; Big Profits;** easy rules sent. Will do popular Raised Printing like Engraving. Junior outfit \$9. Senior outfit \$17 and up. Send for free catalog and all details.

**KELSEY PRESSES. E-37, MERIDEN, CONN.**

Advertisement for Autopower generator, S. W. DUNCAN, Publisher, 419 S. Hoyne Ave., Chicago



(Continued from page 141A)

pulled out a dollar's worth of change. When he scattered this on the thunder drum, the effect was exactly right.

When an announcer interviewed a policeman as he drove his radio car through the streets of Los Angeles on his nightly rounds, special arrangements had to be made with the Federal Communications Commission. They granted Columbia permission to re-broadcast that portion of the program on the short wave length used by police cars.

And then, as if to make the broadcast even more realistic, an emergency call came in for the policeman while he was on the air, and the interview had to be interrupted—while this American went back to work.

For the railroad engineer's program, the entire roundhouse at Harmon, N. Y., was put at Columbia's disposal. It took an entire day to get the technical equipment set up inside for the evening's interview between CBS announcer Mel Allen and veteran locomotive engineer "On Time" Bob Butterfield.

In order to get the most accurate picture possible of each industry, CBS sends representatives all over the country. Gilbert Seldes went to Detroit and talked to the men who make automobiles from a spot in the Cadillac factory. On the broadcast about telephone operators, special pickups were made from phone exchanges in three cities, with three announcers at work on a complicated traffic set-up by which each could hear the other throughout the program.

Bob Trout went out to Newark airport and talked to the men whose job it is to guide airplanes into the landing field by radio. The structural steel workers' interview had to come from San Francisco where, because of the time difference between the west and the east coast, structural steel workers were still at work out there when the program went on from New York. To talk to coal miners, technicians and announcers went 700 feet underground in the Marvin colliery at Scranton, Pa.

☐Inquiries as to makers of articles described in Popular Mechanics, will be answered by our Bureau of Information upon receipt of return postage.

## Down Under the Tread OF A Gillette BICYCLE TIRE

If you want to see how a good bicycle tire is made, ask the dealer to show you the cross section of a Gillette. Notice the extra depth of the live rubber in the tread, and the deep-cut design which gives plenty of skid-safe traction. But down under the tread is construction that's equally important. Gillette uses extra plies of tough, gum-coated cord fabric, the same careful workmanship and material that goes into Gillette auto, truck, bus and tractor tires. That's why Gillette holds leadership in bicycle tires year after year. When you get a new bike, or replace tires, insist on Gillette quality.



*Gillette Tires are also made for wheel toys, midget auto racers and wheel barrows.*



**Gillette Rubber Co.**  
EAU CLAIRE, WISCONSIN

## BIG NEWS FOR MODELBUILDERS & HOMECRAFTSMEN

in values and prices featured in the big No. 6 C-D Handbook Catalog—now ready! Bargains galore. Thousands of items—including 135 world-famous C-D flying model airplanes. Also O, CD, OO and HO gage model RR equipment, and toy trains at 20c up. Gas model airplanes, and engines; hand tools, ship kits. Everything in supplies. Microscopes, Cameras, etc. Nothing else like it. Edition limited. Act quick. Rush name, address and **10c**

Also catalog No. 7 (exclusively HO RR Gage) 10c. Or 20c for both catalogs.

Cleveland Model & Supply Co. Inc., 4508-C33 Lorain Ave., Cleveland, Ohio



EVER-SILENT \$ **1 75**

**AUTO TRAILER COUPLER**

Rocky Mt. States West, \$2.00. Postpaid

**ADJUSTABLE \$ 1 35**

**BUMPER HITCH**

This hitch can be put on, taken off, or adjusted to 6 different positions with a wrench. Postpaid, \$1.35 without ball. (Rocky Mt. States West \$1.50). Write for catalog on trailer hardware and folding trailer camps.

● **Build Your Own Trailer!**  
**We'll Furnish the Camp!** ●



**ZAGELMEYER AUTO CAMP CO.**  
1495 S. Henry St. Bay City, Mich.

## WoodWORKERS Here it is!

**HAROLD HUNT'S** latest edition 1939 catalog. Nothing like it ever before published—136 pages—new designs, new ideas for experts; also special instructions for beginners. AND—LISTS OF ASTONISHING BARGAINS in all kinds of woodworkers' supplies. Get this book! **ONLY 10c!**

**CRAFTSMAN WOOD SERVICE CO.**  
2735 S. Mary Street

Chicago, Ill.





# THE MOTOR MILLIONS WANTED

.. A GENUINE EVINRUDE  
AT  
EVERYMAN'S PRICE



AN **Elto**  
BUILT BY EVINRUDE  
NOW ONLY \$29.50

All Prices  
F. O. B.  
Factory

The "MATE"  
\$34.50

WEIGHS ONLY  
10 POUNDS—  
RUNS 10 HRS. ON  
A GALLON ..

Here's a smart and capable bundle of boat power that turns rowing toil into boating pleasure . . . puts more fish in fishing . . . packs more fun into every hour on the water . . . at a price of only \$34.50! In every ounce and every inch it's a genuine Hooded Power Evinrude — offering the overshadowing advantages of famed Evinrude starting ease . . . Co-Pilot steering and finger-tip controls . . . underwater silencing and trouble-proof Centrifugal Pump Cooling — all with *new* low cost, *new* handiness, *new* operating economy. Catalog free!

#### WRITE FOR EVINRUDE AND ELTO CATALOGS

Evinrude offers a motor to fit every boating need — 9 models to choose from! Write today for Evinrude and Elto catalogs, Boat Guide of Leading Builders, handy Boat-and-Motor Selector — All free! Address

**EVINRUDE MOTORS**  
4131 N. 27 St., Milwaukee, Wis.  
Evinrude Motors of Canada,  
Peterboro, Canada.



# EVINRUDE

9 GREAT EVINRUDES TO CHOOSE FROM

## 2.15 Secrets of a Champion Pitcher

(Continued from page 677)

forefinger is to the right of the ball when it is released. Thus you get rotation in that direction.

The knuckle ball is another deceiver and it's not used much because it's hard on the thrower. You grip the ball by the seams with the fingernails of your forefinger and middle finger, imparting a push at the end of the throw by straightening your fingers out. Thrown that way, the ball doesn't spin. It's hard to hit, though the pitcher himself can't be certain just which way it will break. You can conceal the way you are holding the ball until the last second by holding your glove over the throwing hand almost until the instant the ball is released.

Concealment, incidentally, is one reason for following through after the pitch. Keep the arm swinging until the elbow almost hits the opposite knee. The follow through is a lot easier on yourself. Your arm has a chance to slow down without being jerked.

With the emphasis today on the fast ball, an occasional slow ball is often good strategy. This is the change of pace. Here you have a batter at the plate, tense, waiting to take a crack at a ball that he expects will come like an express train. You've fed him one or two fast ones already and he's set for another. Then you drift a slow ball toward him. You've used the same wind-up with not so much steam at the end. Instead of holding the ball tightly you've held it loosely in your hand. It's a slow ball and easy to hit, the only trouble being that the batter recognizes it too late. He's thrown off stride and maybe he waves at it maybe he doesn't. The chances are he won't be able to set himself for the swing.

That's another thing you should remember about the ball. Hold it hard and it's a hard ball. Hold it loosely and it's an easier one. If you grip it tightly for a curve it breaks fast. If you hold it loosely it breaks into a slower curved pitch.

If you throw many curves you are going to learn something else and that is that the direction of the wind is important. If you are pitching into the wind your curved balls will really explode, flying straight at the batter, then changing direction abruptly. If the wind is at your back the curve will be slower and not so sharp.



Incidentally, the way you feel at the start of a game doesn't always indicate what kind of ball you will pitch. I've been hit out of the box in two innings after warming up and feeling like a million dollars. On the other hand one day last summer I felt before the game that I wouldn't be able to throw one good pitch. That was the day I shut out Cleveland with no hits.

Of all the things that go to make good pitching, nothing is more important than control. A pitcher may be great in everything else and can still be beaten if he hasn't control, although much of the so-called wild pitching today results from the slippery ball. This season the league is using one more thread in the stitching to give the pitchers a better grip.

Marksmanship is the word for control and the best way to get it is constant practice. You have to rifle a ball that is as smooth as a billiard ball sixty feet five inches through the air and into a space fourteen inches wide and not much higher. To pitch a strike, the ball must not only be over the plate but between the knees and shoulders of a batter. Anyway, from sixty feet away the target is mighty small. A pitcher with good control can hurl the ball into any corner of that space that he chooses. He gets that skill by practice and the best thing to do in practice is to throw at the catcher's mitt, having him hold it at different parts of the target space. When you can hit his motionless glove four times out of seven, you've got good control.

We are going into the ninth now, so here are a couple of final tips. Always warm up that arm before trying fast balls or curves. Lots of good throwing arms have been ruined by starting out cold, without a few minutes of easy tossing the ball around. Lastly, a word for rookie pitchers who think they don't stand a chance because the headliners are so much better than they: remember that you are apt to improve with experience, and the headliners aren't going to stay on top forever.

Our Bureau of Information keeps on file the names and addresses of makers of, and dealers in, all devices described in the pages of Popular Mechanics Magazine. We are glad to furnish this information to our readers upon request, accompanied by stamped, self-addressed envelope.

IT PAYS TO PLAY

Get your



HILLERICH & BRADSBY  
*Official*  
SOFT BALL RULE BOOK

FROM YOUR  
LOUISVILLE SLUGGER DEALER

This official rule book also contains 1938 records and complete information on the 1939 Louisville Slugger Soft Ball Bat line. If your Louisville Slugger dealer cannot supply you, send 10c in stamps or coin to Dept. P-31 Hillerich & Bradsby Co., Louisville, Ky.

Remember—in Softball as in Baseball—  
one trademark stands supreme.



LOUISVILLE  
SLUGGER  
SOFT BALL BATS

ANNOUNCING—  
...the NEW DAISY  
LONE SCOUT Carbine



Now ready... the brand-new LONE SCOUT CARBINE with the fastest-loading invention in air rifle history... LIGHTNING-LOADER SHOT MAGAZINE! New ADJUSTABLE DOUBLE-Notch Rear Sight. PISTOL GRIP stock... many other features. Looks, feels, shoots like carbines used by frontier scouts. Only \$2.50 at your hardware, sporting goods, department stores! (If dealer hasn't it in stock, send us \$2.50. We'll mail rifle POST-PAID.)

Featuring  
THE FIRST AND ONLY  
LIGHTNING-LOADER  
SHOT MAGAZINE  
In Air Rifle History!

"Like My Own Carbine!"

\$2.50

DAISY MFG. CO.  
115 Union St.  
Plymouth, Michigan

Get a DAISY AIR RIFLE

STAR  
METAL  
BOATS



NON-SINKABLE • ECONOMICAL  
Newly developed construction used in 60 models. Rowboats, outboards, sailboats, low priced in-board launches and a 50-lb. Downmetal boat. Rubber cushioned—quiet performance. Save money, get better quality. No wood to caulk, leak or rot. Light, buoyant. Specials for resorts and liveries.

Send for FREE CATALOG

STAR METAL BOAT CO. BOX P GOSHEN, INDIANA The Winner





g-80

# OIL TAKES A HOLIDAY



**BEST FOR  
LOCKS AND  
FIREARMS**

Millions of users know Graphite in dry form is longer-lasting and far superior to oil or grease for thousands of miscellaneous lubricating applications. Heat, cold, water, oil, other solvents, pressures, and speeds cannot destroy or displace it. Never hardens, gums, drips, smells, or fails... In other applications, Graphite added to oil or grease makes the truly super-lubricant. A "shot" of Graphite makes everything work, run, or operate noiselessly; drives and keeps out power-wasting friction. Keep a "Gun" near you for daily use in your home, car, work or play.

## JUNIOR MODEL 30¢

Made of Flexophane—throw away when empty—contains 900 applications—individually mounted on directions-and-display card.

## RUBBER MODEL REFILLABLE 75¢

Lasting, durable construction—for shop, bench and all servicing—often preferred by mechanics. 8 refills cost only 50¢. Full directions on wrapper.



**JUST SQUEEZE!**

Users, dealers, jobbers: write Dept. C-G 26 JOSEPH DIXON CRUCIBLE CO., JERSEY CITY, N. J.



**DIXON'S GRAPH-AIR GUNS AND MICROFYNE GRAPHITE**  
PATENTED U. S. AND FOREIGN COUNTRIES

## Amazing New Welding Goggles Banish Eye-strain



New bifocal type, permits clear, easy view of work through standard colored lense. Lower portion, plain, allows quick glance at work without raising goggles. Meets Navy Dept. specifications. Needed by all gas welders. Special discounts to quantity buyers. Price, postage prepaid

2300 Warren Blvd. **Only \$2.50**  
Chicago Eye Shield Co. CHICAGO, ILL.

# GIVE YOUR HAIR A FIGHTING CHANCE



**LUCKY TIGER With Oil** is made from our perfected formula to help you control unruly hair, and in getting rid of unsightly dandruff—a menace to normal hair and scalp. Also—To allay that annoying itching—To relieve scalp irritations and therefore to aid in checking excessive falling hair and—To groom and beautify the hair.

Get a bottle at druggists or Ten Cent Stores or applications at your Barber's.

**FREE!** Our New Lucky Tiger WITH OIL is now being made for excessively dry hair and scalp. A 35¢ bottle will be sent upon receipt of 12¢ in stamps to pay packing and postage.  
**LUCKY TIGER MFG. CO., Dept. 31, Kansas City, Mo.**

## Magic Tubes of Daylight

(Continued from page 643)

drops with falling temperature. Under normal air-temperature conditions of seventy to eighty degrees Fahrenheit, the one-inch fluorescent lamps operate with a bulb wall temperature of 104 to 113 degrees. If the air temperature goes to ninety or 100, there is a slight reduction in lumen-per-watt output, actually not enough to worry about. But when the air temperature falls to the freezing point (thirty-two degrees Fahrenheit), the lamps



Mercury vapor and other gases in tubes of floor lamp produce cool light of various hues

produce only twenty-five per cent of normal light. By inclosing the lamps in a jacket of glass or transparent plastic, practically normal light output is obtained at near-zero temperatures. Heat loss is caused mostly by conduction, not radiation.

An ordinary forty-watt, inside-frosted incandescent lamp develops about 464 lumens, and radiates about seventy-eight per cent of the energy it uses, or thirty-one watts, as heat. A fifteen-watt warm white fluorescent lamp develops about 450 lumens but radiates only forty-seven per cent of its energy, or eight watts. Thus fluorescent lamps radiate only about one-fourth as much heat per lumen as filament types. This explains why fluorescent lighting is so comfortable to work under.

(Continued to page 148A)

Colonial Premier Mechanical Corp.





# WHAT HAS HE THAT YOU HAVEN'T?

**WHAT DID YOU DO** about that big idea? Did you work it up, present it? When he had *your* job he did . . . that's often the difference, the way the man ahead gets there. And perhaps he used a Royal Portable—thousands do—salesmen, executives, engineers, mechanics, students, teachers—for reports, letters, home courses. Royals are simple to use—with genuine office typewriter features that make perfect typing, faster, *easier than writing by hand*. Learn more about the Royal Portable—it will be a revelation to you. Use the coupon below, no obligation. **ACT NOW!** Find out how you can try a Royal Portable right in your own home without *risking a penny*.

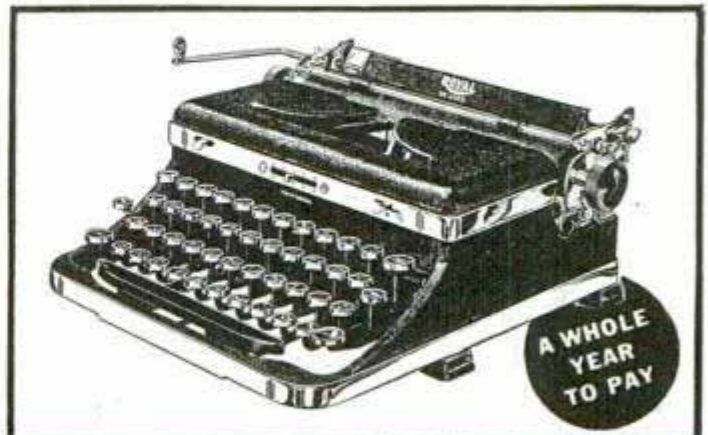

## GET A ROYAL PORTABLE ON FREE HOME TRIAL

**FREE**  
with every Royal portable—  
Royal's Instant Typing Chart.  
**INCLUDED**  
at no extra cost, a handsome  
Carrying Case.

Royal Typewriter Company, Inc.  
Dept. D-105, 2 Park Avenue, New York City.

I'd like to know more about the Royal Portable—models, prices, terms, details of **FREE HOME TRIAL**.

Name \_\_\_\_\_

Street \_\_\_\_\_

City \_\_\_\_\_

County \_\_\_\_\_

State \_\_\_\_\_

### ELIMINATE FORD BRAKE TROUBLES

Your Ford Car is listed in the so-called lower priced class but has more brake lining area and larger drums than the others. In fact as much or more brake area than all but the higher priced cars. You can have safe, sure, unflinching mechanical brakes. Install easily yourself our Simplex Floating Wedges to center the shoes for mechanical assurance with hydraulic performance. A set of four, one for each wheel, all for \$1.75. All models 1928 to 1938—Send for circular.

**SIMPLEX WEDGE EXCHANGE, Dept. PM-5, 613 Jefferson St., Ottawa, Ill.**



### HOLD-E-ZEE

#### Automatic Grip Screwdrivers

Hold, start and set-up screws in unhandy places. Gripper instantly released by spring action, sliding up out of way when not in use. Finest materials throughout, chrome vanadium blades; many have transparent, insulating, unbreakable handles. Models for recessed-head screws. No more expensive than ordinary screwdrivers. At auto-supply, hardware or electrical stores.

**UPSON  
BROS., INC.  
86 Exchange St.  
Rochester, N. Y.**



### WORLD'S GREATEST all around ELECTRIC TOOL

**DRILLS — GRINDS — SANDS — SAWS  
POLISHES — SHARPENS — CARVES**

The new WHIZ ELECTRIC TOOL is the handiest power tool ever made. Not a delicate instrument but a real rugged tool, equally effective for both power and precision work. Drills through 3/4 inch iron plate in 42 seconds or engraves intricate designs on jewelry. Handles any material: Metals—Woods—Alloys—Plastics—Glass—Steel—etc. Saves time. Eliminates labor. Plug into any socket AC or DC, 110 volts. Chuck 3/4 inch capacity. Ball bearing thrust. Powerful, triple-gear motor. "Worth its weight in Gold." **STANDARD MODEL**, with Normal Speed (uses 50 different accessories, instantly interchangeable.) Special Introductory Price for limited time, only \$6.95. **FREE** Accessory outfit (Value \$2) includes set of drills, mounted brush, polishing wheel, grinder, sanding discs, cutting wheels, mounted brush, polishing wheel, carving bar, etc. **FREE** with each outfit ordered NOW. We pay postage. Will send C. O. D. if desired. **10-DAY TRIAL—MONEY BACK GUARANTEE.**

Special "2-SPEED" MODEL combines Normal Speed and High Speed in one outfit (uses 200 accessories) only \$8.95 complete, with same accessory outfit (value \$2) **FREE**.

**Paramount Products Co., Dept. 5A, 48 West 48th St., New York**

**ONLY  
\$6.95  
POSTPAID  
GUARANTEED  
FOR ONE YEAR**



### WINDOW AND SCREEN for Cabin, Cottage and Camp

Complete assembly of window and screen. All metal, welded construction. Insect-proof and weatherproof. Waterproof, sponge rubber seal. Easily opened, closed and locked. Handsome appearance.

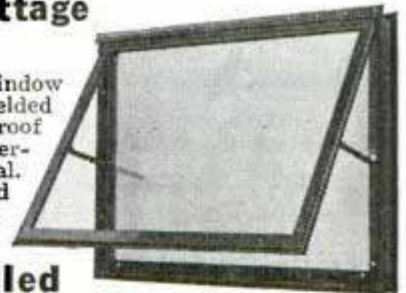

#### Easily Installed

Easy operation, with 3 different open positions. Fit snug and flush. Best materials and workmanship. Low prices for all sizes.

**Write Today for Free  
Folder and Prices**

**HERRON-ZIMMERS MOLDING CO.**  
3902 E. Outer Drive  
Detroit, Mich.

### NEW BOAT READY!

**Oars  
Given  
with  
your  
OK  
KI-YAK  
if you  
hurry!**



**BUILD OK-4 at Home  
in a Few Evenings!**

Just out!—Mead's sensational 14 foot portable Outboard KI-YAK! OK-4 carries 4 adults and duffel—takes motors up to 9 H.P., oars and sail. Seaworthy. Leakproof. Biggest, lightest, strongest of its kind! You can build yours easily, quickly, perfectly at home in a few evenings from our patented, complete construction kit and save nearly **HALF!** Big money assembling, selling to others. (3 other paddle-sail KI-YAKS from 18 to 45 lbs. . . . also OK-2 for motor, sail, oars . . . weighs 50 lbs.) Rush dime for illustrated color circulars, Gift Oars Offer, amazing low Introductory Factory Prices!

**MEAD GLIDERS, 15 So. Market, Dept. B-59, CHICAGO**

When writing please mention Popular Mechanics



2-80

# A NEW SEA-HORSE



**Johnson's  
MIRACLE  
MOTOR!**  
**\$79<sup>50</sup>**  
F. O. B. FACTORY

**IT'S a twin!** Alternate Firing! Only 21½ lbs! 2.5 N.O.A. certified brake h.p. at 4000 r.p.m.! 20 big Johnson features including 360° Steering and Reverse! Plus distinctive smoothness, quiet and easy starting of Johnson's perfected alternate firing. Ten great Sea-Horses for '39. Priced (f.o.b. factory) **\$49<sup>50</sup>** as low as . . . . .



**FREE!** All about the new Miracle Motor and other 1939 Sea-Horses. Illustrations. Complete specifications. Brings you up-to-date on outboard motors. Write for copy. Free!

**JOHNSON MOTORS**  
400 Pershing Rd., Waukegan, Ill.

(Continued from page 146A)

When a room or building is being air-conditioned, the heat developed by the lamps must be taken into account. Because of the higher efficiency of fluorescent lamps, the air-conditioning engineer does not have to install equipment with as much capacity for cooling a fluorescent-lighted room as he would need if the same amount of light were being produced by incandescent lamps. With fluorescent lamps, illumination in a room can be doubled without disturbing the air-conditioning setup.

Because of the low brightness of the new lamps, which for a one and one-half-inch diameter lamp is about two and one-half to three candlepower per square inch, they can be used in the line of vision without excessive discomfort. However, General Electric lighting experts at Nela Park, Cleveland, where the new lamps were developed, recommend that the lamps be concealed. That is, for general illumination, the tubular bulbs can be placed behind a diffusing screen or mounted so that their light is reflected. For purely decorative lighting, the use of unconcealed lamps is usually not objectionable.

Because fluorescent lamps are arc lamps, the current passing through the arc would build up to damaging proportions if some sort of regulating device were not employed. Each lamp has to be connected with a ballast unit which consists essentially of a choke coil, condenser and automatic switch for disconnecting the electrodes and starting the arc. Usually these units are mounted close to the lamp. They are small enough to be placed beneath the reflector or base upon which the lamp sockets are mounted.

The rated life of a fluorescent lamp is 1,500 hours. This does not mean that the lamp will cease operating suddenly at the end of its life span. Unlike a filament lamp, which burns out in a fraction of a second as a result of filament breakage, a fluorescent lamp may continue to operate after its useful life has been exhausted. The bulb darkens gradually because of the effect of the mercury on the powder coating and the depositing of material given off by the electrodes. The useful life means the period during which a reasonably efficient light output is obtained, and during which the lamp can be started with the voltage

## Build this Smith Compressor



We will furnish complete instructions with a **Smith Compressor Head and Accessories**

With a Ford Motor and shop facilities you can easily assemble a Smith Air Compressor. You'll have a smooth performing, efficient compressor. Sixty cubic feet a minute capacity—all the power you'll need to operate rock drills and paving breakers. Here's a way to save money. Write for complete information.

Address Department D  
**GORDON SMITH & CO., Inc., Bowling Green, Ky.**

## New 1939 Model



**WRITE FOR CATALOG**

Attractive—Durable—Economical, the 1939 MOTO-SCOOT is the sensation of the highways. Many exclusive features including 1½ H.P. motor, with 2 forward speed transmission, spring suspension, built in generator for lights; 30 miles per hour, 120 miles per gallon.

Thrilling - Safe - ideal for pleasure rides and business deliveries. All Moto-Scouts are available in Solo, Delivery, Sidecar and Tandem Models. Special proposition for dealers and concessionaires.

MOTO-SCOOT MANUFACTURING COMPANY  
8429 South Chicago Ave. - CHICAGO, ILL. U. S. A.



used. After that, it is cheaper to replace the lamp, even though it still will burn.

Every time a lamp is started there is a momentary drop of higher than normal voltage across the electrodes, which causes the active electron-producing material with which they are coated to sputter off. If the lamp is started frequently, therefore, the electrodes wear out before the useful life of the lamp has been exhausted. For this reason, fluorescent lamps in their present form are not recommended for flashing operation.

Fluorescent lamps are available only in tubular form because that is the best way to operate an arc so that it produces good fluorescence. If these lamps replace the familiar round ones now so widely used, future lighting fixtures will be wholly different from those now in use. In many respects, store owners and others who have been quick to adopt the new lamps find them more convenient to use than the older types. The slender tubes and small sockets required to hold them can be tucked beneath shelf edges, inside show-cases, mounted over desks or counters, and other places where an ordinary lamp would be too bulky.

Being an arc lamp operating on alternating current, fluorescent lamps vary in light output with alternations of the current, as do sodium-vapor lamps, ordinary arc lamps and neon signs. However, in most of the lamps the fluorescent powder is also slightly phosphorescent, so that it continues to glow after the current has dropped to zero. This serves to smooth out the flicker or stroboscopic effect. Blue fluorescent lamps show the most flicker, green very little and red and pink least of all.

The green, blue and pink lamps, as well as the daylight and white types, appear white to the eye when not in operation. The red and gold lamps, however, are colored. The lamps that appear white are coated only with the fluorescent powders, while the other two have also a dye coating to absorb some of the visible light and produce the color desired.

Popular Mechanics Magazine can furnish the name and address of the maker of, or dealer in, any article described in its pages. If you wish this information, write to the Bureau of Information, inclosing a stamped, self-addressed envelope.

# Spring Brings

## NEW FUN AND PROFIT to Driver Tool Owners

An old-fashioned garden gate and trellis, lawn furniture, bird houses, a boat! The many wants created by fair weather, lucky owners of Driver Tools can have for almost nothing . . . sell them to others at a nice profit, too.

Don't miss all of the enjoyable Spring projects. Driver can turn your dream shop into reality within a few days, or help you make your present shop into a "dream" with the new 1939 Driver Tools like this . . .

### "TOPS" IN BAND SAWS

It's the new Model BN905—14", with a blade, traveling at 2535 feet per minute, that zips through heavy oak or a scrolled panel. It makes rip, cross-cut curved, angle or mitre cuts. Has a big 16"x16" tilting table and a lot of other features you'll like. Models from \$20 to \$67.50 to choose from. Send for the new Catalog or see local dealer. Walker-Turner Co., Inc., 159 South Ave., Plainfield, N. J.



## DRIVER *Engineered* POWER TOOLS

### Home Craftsmen, Schools, Hobbyists BRONZE FOUNDRY



in your own workshop will allow you to design and build your own GASOLINE ENGINES, STEAM ENGINES, STATUARY, ART OBJECTS, SPECIAL TOOLS, NEW INVENTIONS, ETC. You can also make forgings and case harden steel. Your shop is not complete without a FOUNDRYETTE. Three sizes are available capable of making bronze castings of 1½, 3, and 6 pounds weight, aluminum, copper, brass, etc., in proportion to specific gravity. Clean scrap metal suitable for use. Each outfit includes a complete Blast furnace.

Domestic gas supply and 110 volt AC or DC Electric energy required for operation. Size Crucible Shipping Wt. Price Capacity Wt. Casting Complete

351	6 cu. in.	25 lbs.	1½ lbs.	\$13.50
352	12 cu. in.	40 lbs.	3 lbs.	19.00
353	24 cu. in.	65 lbs.	6 lbs.	27.50

Above price includes Universal high speed blower. Prices f. o. b. K. C. Check or money order acceptable, express charges C. O. D. Write for circular.

KANSAS CITY SPECIALTIES CO.

P. O. Box 6022

Dept. PM

Kansas City, Mo.

## this FREE book SAVES: CAMERA ENTHUSIASTS TIME and MONEY

Let the greatest catalog in photography be your guide to savings. Thousands of photographers — both amateur and professional — make it their "buy-word". New enlarged 1939 edition — just out — contains all the leading nationally advertised cameras, latest equipment and supplies. Everything you need in photography delivered to you at real money-saving prices. To get your FREE catalog (No. 76) send penny postcard TODAY!

LAFAYETTE CAMERA CORPORATION  
DEPT. 7EC9 — 100 SIXTH AVE., NEW YORK, N. Y.



"PHEW...AND FAR BETWEEN!

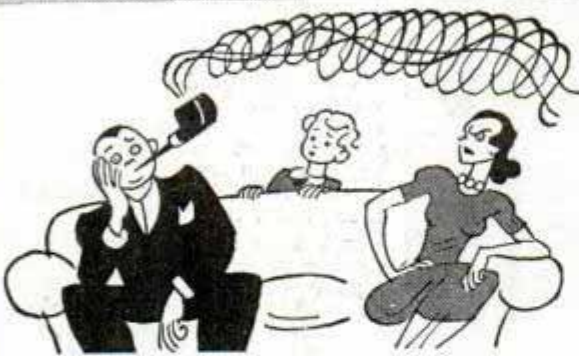

"MY SISTER IS NUTS about this guy. But that stinko pipe of his doesn't help any. Think I'll swipe it... clean it... and refill it with some of Dad's brand."

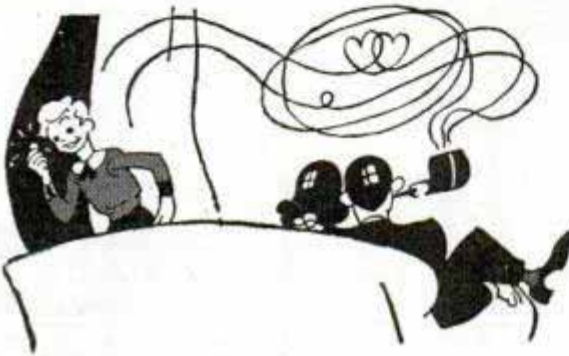

JUNIOR GOT HIS DIME, and Romeo got his dame! And they pledged their love with a ring—a ring of Sir Walter Raleigh smoke—that mild, fragrant burley.

IT SMOKES  
AS SWEET  
AS IT SMELLS



UNION  
MADE

HOW TO  
TAKE CARE  
OF  
YOUR PIPE

**FREE BOOKLET** tells how to make your old pipe taste better, sweeter; how to break in a new pipe. Write for your copy today. Brown & Williamson Tobacco Corporation, Louisville, Kentucky, Dept. P-95.

**TUNE IN** Tommy Dorsey and his orchestra. Every Wednesday night, coast-to-coast, NBC Red Network.

## PLUMBING SUPPLIES AT MONEY SAVING PRICES



**JUST OFF THE PRESS**—New large thirty-two page catalog shows newest styled plumbing fixtures, water heaters, septic tanks, water systems, medicine cabinets, etc. at wholesale prices. Complete line of fittings, pipe, valves, washers and plumbing repair parts of every description. Catalog shows hundreds of items—too numerous to mention. Write for your copy today—Don't delay.

**Free Catalog** **JOHNSON PLUMBING SUPPLY CO.**  
3645 S. Halsted St. Chicago

A NEW, VALUABLE  
AND INEXPENSIVE  
SERVICE

METHODS  
FACTS

## TECHNICAL Bulletins

**\$1 Each** TECHNICAL DATA SIMPLIFIED  
FOR THE PRACTICAL MAN!

Here is a valuable, inexpensive service for mechanics, inventors, technical specialists and practical craftsmen of all kinds. Technical Bulletins give the needed basic and practical information on a wide variety of subjects—briefly, concisely and simply presented—yet complete in every detail. No advanced mathematics, chemistry or physics needed to understand them. Material never before in print, now specially prepared in bulletin form. Postpaid \$1 each or sent C. O. D. anywhere in U. S. Ask for list of complete bulletin service.

### ORDER BY NUMBER • WRITE FOR COMPLETE LIST

D-101—Using Nichrome Resistance Wire.

D-102—Cleaning Products for all Purposes.

D-103—Automobile Specialty Chemical Products.

D-104—Silver Soldering and Brazing.

D-105—Latest Gas-Welding Practice.

D-106—Rewinding Electric Motors.

D-107—Electro-Plating with Copper, Nickel and Chromium.

D-108—Electro-Plating with Gold and Silver.

D-109—Electro-Plating with Zinc and Cadmium.

D-110—Electro-Plating Non-Metallic Objects and Electro-Forming.

D-111—Designing and Building Transformers.

D-112—Designing Electro-Magnets.

D-113—How to Design Solenoids and Plunger Magnets.

D-114—Designing Thermostats for Air Conditioning and Heat Control Purposes.

D-115—Flexible Molds for Casting Small Objects.

D-116—Printing Photos on Cloth, Paper, Etc.

D-117—The A B C of Air Conditioning.

D-118—Electrical Water Pipe Thawing Equipment.

D-119—Electroplating with Alloys.

D-120—Gas Fired Blast Furnace for Melting Metals, Alloys and Heat Treating.

D-121—Corrosion, Causes and Preventive Measures.

D-122—Stainless Steel Easily Soldered, Brazed or Welded.

D-123—Mirror Silvering.

D-124—Soldering.

D-125—Buffing and Polishing Metals.

D-126—How to Design and build Hydraulic Rams.

D-127—Small Electric Light Plants, Design and Construction.

D-128—Diesel Engines, Operation and Service.

D-129—Coloring Metals Chemically.

D-130—Glass Working Technique.

D-131—Remote Control Switching.

D-132—Working With Plastics.

D-133—Spot Welder for the Small Shop.

D-134—Electrical Experiments With Simple Materials.

D-135—Electric Arc Torch.

D-138—Gold-Leafing Methods.

D-140—Etching Metals and Glass.

**POPULAR MECHANICS PRESS**  
ROOM 539B • 200 EAST ONTARIO ST. • CHICAGO



## New York to Europe by Clipper

(Continued from page 671)

seat by the starboard window, two end tables, a davenport-style triple seat that converts into berths, a combination dressing table and writing desk, a folding washstand cabinet, an occasional chair and a coffee table.

Ahead of the lounge you find another standard compartment, then a section containing a galley to the port and a men's dressing room to the starboard, and beyond is another standard compartment. The men's dressing room has a dental lavatory, two wash basins with hot and cold running water, two plate-glass mirrors and a plug-in for electric razors. The galley contains compact equipment designed by Pan American for serving full-course meals en route and an arrangement for setting up a cocktail bar between meals.

For the comfort of the passengers, the clipper has a thermostatically controlled heating system capable of circulating five times more warm air than the heating system of the modern seven-room home. There are two "furnaces" using exhaust heat from two of the four engines.

Up on the flying bridge, which is entirely lined with black to eliminate glare, will be two pilots to handle the controls on the clipper's maiden scheduled journey. Back of the bridge is the navigation and radio room, directive brain of the mighty ship. Here will be the radio officer, pilot-navigator and flight engineer, all of whom have telephone communication with the bridge. Curtained off and just behind this room is the master's office.

Actual operation of the power plant, consisting of four 1,500-horsepower Wright engines, will be supervised by the flight engineer. Engine stations are maintained in the big nacelles, one behind each motor, and are connected to the flight deck by telephone. One panel before the flight engineer contains twenty-six instruments which serve the functions of sixty-two different indicators. Most of the instruments are dual indicators and one multiple indicator gives engine head and base temperatures at sixteen different points. The radio officer has charge of three transmitters and three receivers, with which he will maintain contact with land stations and ships

(Continued to page 152A)



## BUILD YOUR OWN FACSIMILE RADIO PRINTER

COMPLETE  
KIT  
**\$49<sup>50</sup>**

### CROSLY READO

GET IN ON THE  
GROUND FLOOR  
WITH RADIO'S  
MOST PROMISING  
DEVELOPMENT

Already early morning broadcasting and daytime ultra high frequency experiments from leading radio stations offer fascinating study and fun. This new art holds promise of a great future, and another chance to grow up in a field as prolific of personal profit and satisfaction as radio was 20 years ago.

The Crosley "Reado" radio printer is a development of the Finch method and is being used in many spots throughout the country today. When you have built the printer it is easily attached to your own radio receiver.

We provide all the necessary parts carefully precision machined ready to build, packed in a special kit. Most Crosley dealers will display them. If none are convenient to you, write us.

### THE CROSLY CORPORATION

Reado Department  
101 Arlington Street

Home of WLW—  
"The Listening Habit  
of the Nation"

POWEL CROSLY, Jr., Pres.  
CINCINNATI, OHIO

### Get a TROTWOOD MOTOR-CYCLE PACKAGE DELIVERY



Brand new design. All-Steel construction. Front wheel drive, 2-wheel brakes. Balloon Tires, Powerful motor. Two speeds. Big compartment for pkgs. Needed by merchants everywhere for quick, cheap delivery. Write for special introductory offer—Dealers Wanted.

TROTWOOD TRAILERS, INC.  
735 Main Street TROTWOOD, OHIO

### HANDY TAPS and DIES . . .

Accurate—carefully hardened and tempered. Complete range of sizes at your local five and ten cent store

HENRY L. HANSON, WORCESTER, MASS.



### COMB-A-TRIM The New Quick Trimmer

Something New! Trim your hair without any experience. It's easy! The excess hair comes off smoothly and easily by just pulling trimmer through hair like an ordinary comb. Save on hair-cut bills . . . Trim your own hair or the whole family's. Send 49¢ and your Comb-A-Trim will be sent at once, postpaid.

Comb-A-Trim Co., 510 Bell Block, Dept. P-2, Cincinnati, Ohio

### Start YOUR OWN BUSINESS



Engrave  
YOUR WAY  
TO PROFITS

Sensational new ELECTROGRAVER makes engraving of names, numbers, monograms, etc., amazingly easy. No experience needed to learn to operate. Engraves all kinds of name plates, key checks, dog tags, jewelry, fountain pens, pipes, cigarette cases, etc. Operates from A.C. light socket, 6-volt battery or 4 dry cells. Small investment. Large profits. Big field. Lifetime opportunity.

#### FOR SOCIAL SECURITY PLATES

The ELECTROGRAVER is especially adapted for engraving permanent Social Security Plates. SOCIAL SECURITY PLATES SELL LIKE WILDFIRE RIGHT NOW! We furnish everything. Send 25¢ today for sample of our beautiful Goldtone S. S. Plate, engraved with your name and number, or write for Free details.

William Moore Mfg. Co., 653 S. State, Chicago



238

(Continued from page 151A)

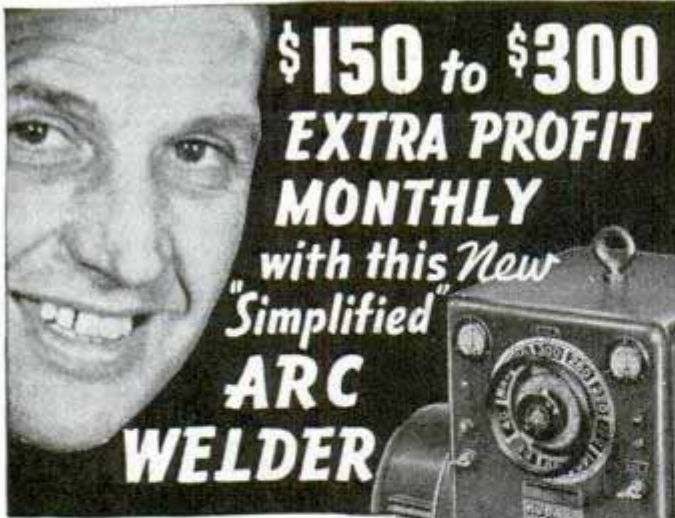

**IT'S EASY TO GET BIG PROFITS WITH HOBART ARC WELDING EQUIPMENT**

Because of big profits realized with the Hobart 40-Volt "Simplified" Arc Welder you can start a big paying business of your own . . . with almost no investment! Arc welder prices are the lowest in history, making it possible for even the smallest shop to own one of these money-makers. Extra profit from a single job is often more than enough to take care of the small monthly payments. Arc welding is today's profit opportunity . . . don't miss it!

**Remote Control.** This is an important feature you get at no extra cost with Hobart. It lets you control your welder from any working point. Saves time, temper and eliminates the need for a helper on overhead or concealed work.

**Easy to Operate.** Hobart Welders have "Simplified" operation. This means faster welding—with the right current for every job. Hobart is so simplified that any one of your men can weld easily and successfully. The mystery and uncertainty of obtaining correct welding current settings are removed.

**60% Extra Capacity** over old style 25-Volt Welders . . . necessary for welding with the new coated rods. Automatic reactance lets you handle light welder work without losing the arc. Users don't understand how they got along with old style welders after trying this new Hobart.

**"Pays-for-Itself" Terms.** You can try this complete Hobart Welder in your own shop for 30 Days Trial to prove that extra earnings and savings obtainable with this improved welder makes it easy for you to own a Hobart with practically no cash outlay.

**HOBART BROS. CO., Box M-59, Troy, Ohio**  
One of the World's Largest Builders of Arc Welders.



**BUILD YOUR OWN Simplified ARC WELDER**

It's easy and profitable to build your own portable electric arc welder with the aid of this complete Hobart Generator. Simply attach to old motor and mount on chassis and you have the factory equivalent and equipment costing from \$300 to \$500 more! This equipment lets you operate anywhere, especially on the profitable outside jobs. Check coupon for detailed information.

**FREE!**  
THIS VALUABLE BOOK ON ARC WELDING

THE ADVANCED HOBART MULTI-RANGE ARC WELDER

PAYS FOR ITSELF WITHOUT EXPENSE TO YOU...  
**30 DAYS TRIAL TO PROVE IT**

ASK ABOUT THE HOBART RENTAL PLAN

This liberal plan lets you rent a new Hobart Welder for use for any length of time. If you later decide to buy, all rental applies on the purchase price without the loss of a cent to you.

**HOBART BROS. CO., Box M-59, TROY, OHIO**

Tell me more about—

- Building My Own Portable Welder
- Complete Gas Engine Drive
- Hobart Rental Plan
- Electric Drive Welder
- Send FREE Book On Arc Welding
- 30 Days Trial and Easy Terms

NAME.....

ADDRESS.....

CITY..... STATE.....

throughout the flight. Over his equipment will flash weather reports and instructions to the clipper's master from both sides of the Atlantic, with Pan American Airways and the governments of the United States and Great Britain cooperating to guard every air voyage from the ground.

Behind the spacious control room, within the wings, are the main cargo compartments for mail and express, and directly behind them are complete sleeping and living quarters for the crew. At the bow of the ship is the anchor and gear room, which also holds a mooring post which slides out when the hatch is opened. Beneath the main, or passenger deck, are watertight compartments running the length of the ship, an additional safety feature.

When the Yankee Clipper—flagship of the fleet—takes the air on the first voyage, its officers will follow a carefully charted route that has been surveyed by Pan American's weather and flight experts. Many survey flights have been made by company planes, in conjunction with similar journeys made by Imperial Airways of England. On July 6, 1938, Capt. Harold Gray and his crew aboard the Pan American Clipper III crossed from Botwood to Foynes in twelve hours and twenty-nine minutes. Flying above 10,000 feet all the way, this survey crew took astronomical observations from sun and stars to make certain of bearings and picked up messages radioed from ships at sea. The clipper, which weighed twenty-two and three-fourths tons, about half that of Christopher Columbus' ship, the Nina, averaged 156 miles per hour. At the same time, Imperial Airways' flying boat, the Caledonia, flew the route from east to west in fifteen hours and twenty-eight minutes, averaging 132 miles per hour. This crossing is the more difficult because of prevailing headwinds.

Upon completion of that survey flight, Captain Gray said: "The trip was fairly easy, but it would hardly be fair to judge Atlantic weather on the basis of one journey. Nevertheless, I do not think there should be any difficulty in operating a regular service across the Atlantic."

Transatlantic air service, made safer by Pan American's experience in regular flights across the Pacific, is about to become a reality, and Captain Gray's opinion is about to become a certainty.



# 1¢ SALE

## BIG 25¢ TUBE LISTERINE BRUSHLESS SHAVING CREAM for 1 cent

**WHEN YOU BUY  
A REGULAR 25¢  
TUBE**

**BOTH FOR 26¢**

AT ALL DRUG  
COUNTERS NOW!

### STANDARD GARDEN TRACTORS

Plow Seed Cultivate Mow Hay and Lawns

Powerful Gas Tractors for Small Farms, Gardeners, Florists, Nurseries, Fruit Growers, Poultrymen.

**1 & 2 Cylinders**  
High Wheels. Rubber or Steel Tires. Walk or Ride.

Do Belt Work—Free Catalog

**STANDARD ENGINE CO.**  
Minneapolis, Minn. Philadelphia, Pa. New York, N. Y.  
3221 Como Ave. 2546 Market St. 290 Cedar St.



### SOCIAL SECURITY PLATES

Operate your own business. We start you without one penny investment. Over 400% profit. New plan—hire your own agents. Sell thru stores and direct. Over 40 million buyers waiting for this beautiful bronze plate. Postcard brings FREE OUTFIT.



U. S. NAME PLATE CO., Box 769, Dept. 324, Chicago

### MODEL YACHT FITTINGS

The largest and most up-to-date line of fittings and sails for **MARBLEHEAD 50-800**

Class A, 6 Metre and 36" Class. Equip your model with proven fittings! Send 3c stamp for illustrated list. List of beautiful carved hull models now ready. For complete, 44 page illustrated catalog, send 20c (coin).

**A. J. FISHER, 1002-1 Etowah Ave., Royal Oak, Mich.**

**AT LAST!** All Your Snapshots in Natural Colors! **AMAZINGLY BEAUTIFUL!**  
Any size roll developed and 8 prints in NATURAL COLORS, for only... **25c** Natural Color Reprints 3c each.  
Natural Color Photo Service, Dept. C-54, Janesville, Wis.

**VENETIAN BLINDS** Make your own at low wholesale cost. It's easy under our unique plan. All materials supplied. Send 10c coin for samples of ladder tape, cord and slat, 15 color samples of tape and color chart.

**VENETIAN BLIND MFG. & SUPPLY CO.**

Dept. 2B, 1760 Lunt Ave., Chicago, Ill.

**TOMBSTONES \$9.00 UP** FREIGHT PAID or ERECTED  
Marble or Granite of Best Quality. Lettered. Guaranteed. Thousands sold. Write for Free Catalog and samples.  
U. S. MARBLE & GRANITE CO., Dept. A-18, Oneco, Florida

**TOYS—HOME FOUNDRY—SUPPLIES**  
WRITE FOR FREE CATALOG

showing Casting, Pyrography, Sand Pen and Metal-Tap Sets; large sets, \$2. Also supplies. **HOME FOUNDRY MFG. CO., Dept. P5, 3122 Fifth Av., Chicago, Ill.**

**GRANDFATHER'S CLOCK, LOWER PRICED**  
Our newest offering, at an unheard of price for a faithful reproduction of a real Grandfather's Clock. Scroll top, narrow waist, like picture. Shipped Knock Down. Cleverly designed. Easy to assemble. Others even cheaper. Plans 10c. Catalogue FREE.  
**AMERICAN CHIME CLOCK CO.**  
1671 Ruffner St. (Established 1877) Philadelphia, Pa.

When writing please mention Popular Mechanics

**I LOOK TERRIBLE**

**"I'LL FIX THAT"**

Fix chipped, splintered and broken articles to look and remain like new when restored with **ROGERS GLUE**. Made only from cod fish skins. Incredibly strong. 10¢ and up in tube, jar or can at hardware stores only, or send 10¢ for full size bottle, glue paddle and set of blueprinted project plans for making useful articles.

**ROGERS, Dept. C, Gloucester, Mass.**

**ROGERS**  
the best LIQUID FISH GLUE

**GLUEKY**

### EARN SPARE-TIME MONEY with Light Power Tools



Learn how you can build up a profitable spare or full-time business in your own home. This new book "How to Make Money in Woodworking" is crammed with practical tested ideas, plans, and suggestions. Tells you exactly what to make, how to make it and how to sell it. Describes plans that have worked for others. Woodworking, the new way, is light, pleasant, and profitable. Send only 10c and complete book will be mailed postpaid. Satisfaction guaranteed or money refunded. Write to

**DELTA MFG. CO. (Dept. A539)**  
600-634 E. Vienna Ave., Milwaukee, Wis.

### You Can Figure INSTANTLY On This NEW SLIDE RULE

New accurate 10 in. slide rule enables you to do difficult calculations instantly without paper or pencil—multiplying, proportions, division, extracting roots, etc. Accurate, white composition face. Has Standard A, B, C, D, CI, and K scales.

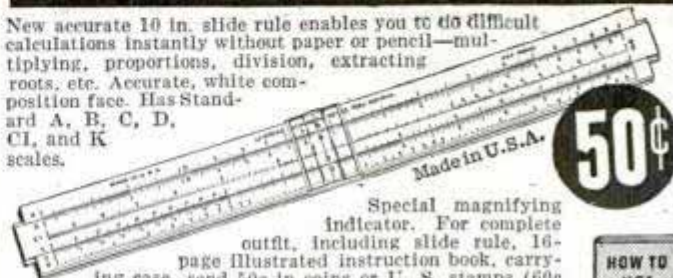

Made in U.S.A. **50¢**

Special magnifying indicator. For complete outfit, including slide rule, 16-page illustrated instruction book, carrying case, send 50c in coins or U. S. stamps (50c in Canada). Mailed postpaid. Satisfaction guaranteed or money refunded. (Schools and dealers; write for quantity price.) Send today for this great slide rule value.

**LAWRENCE ENGINEERING SERVICE, 15 Smith St., PERU, INDIANA**

HOW TO USE THE SLIDE RULE



**RIDE with SHAW DU-ALL**

**to BIGGER PROFITS!**

**NEW "MASTER" DU-ALL**

**TWO "SURPRISE" MODELS**

SHAW surprises the tractor industry with two new models... the MASTER DU-ALL, a big 4-wheel tractor... and the DE LUXE DU-ALL, a streamlined 2-wheel tractor with detachable riding equipment.

There is a SHAW tractor for every acreage or power problem large or small! The MASTER DU-ALL comes with 3, 4, 5, 6 and 8 H.P. models. DE LUXE DU-ALL has 2, 3, 4 or 5 H.P. Single or twin cylinder engine in 5 H.P. model. **IMPORTANT FEATURES**—SHAW tractors shift gears like a car, 3 speeds forward and reverse. Special 6-speed gear (optional)—runs 1/2 to 15 mi. per hr. Air-cooled engines, run on gasoline or kerosene. Air or steel tires. Tool attachments for all field, road and belt work.



**AGENTS**  
and dealers—liberal proposition for qualified men. Write for low prices, discounts, and terms.

**10-DAY TRIAL** Use MASTER or DE LUXE DU-ALL on your own work for 10 days at our risk. Write for details, low **FACTORY** prices, **FREE** catalog.

**THE SHAW MFG. CO.**

4505 Front St., Galesburg, Kans.; 130-G West 42nd St., New York, N. Y.; 5812-G Magnolia Ave., Chicago, Ill.; 668-G No. 4th St., Columbus, Ohio.

**WRITE FOR LOW FACTORY PRICES!**

**THE NEW BLACKSTONE COIN PACKER**

Count and wrap \$12.00 in nickels per minute—new double speed, two barrel coin packer. Penny, nickel and dime sizes. Price \$2.00.

**BLACKSTONE COIN PACKER CO.**  
208 King St. Madison, Wis.

**Adjustable PARKING MIRROR**

Patent Pending

A new development that simplifies parking problems. 8-way adjustable & interlocking mirror. Driver can easily guide car to park safely along curb with no assistance. Chromium plated, durable. Clamps on to fender.

Prepaid \$3.98

Remit with order, or send \$1. now; balance to postman plus small C. O. D. charge

**AGENTS WANTED!** Write for details

**EVERLAST MFG. CO.** 17 East 42nd St., N.Y.C.

**DOENUT WHEELS**

DOENUTS, developed and patented by the originator of the air-wheel, absorb more surface obstructions and eliminate jolting. Protect wood and concrete floors. Do not sink in sand or soft ground. Cadmium plated disc wheel with adjustable ball bearings. Size 10"x3.75" with cap. of 225 lbs. per wheel and 12"x3.50" with load cap. of 325 lbs. per wheel. Ideal for wheelbarrows, painting rigs, spraying equipment, textile trucks, dish trucks, boat dollies, food carts, or most any portable unit that rolls. Handle same loads with less than half the labor. Send 10c postage to cover cost of mailing literature.

**MUSSELN PRODUCTS CO.**  
6225-J St. Clair Avenue, Cleveland, Ohio

**NOW a DYNAMIC HEAVY DUTY INDUSTRIAL WELDER**

for Only **\$195**

Works Off 110-Volt Light Socket. This marvelous Dynamic Power Welder does the work of much higher priced types. It is easily portable. **WELDS** Cylinder Blocks, Bumpers, Fenders, Tanks, Farm Machinery, etc. Will also solder and braze on the lightest material. Works on iron, steel, tin, brass, copper and all other metals. Men without previous experience can make as much as \$5.00 on a one hour repair job. In a year's time a **Dynamic Welder Costs You LESS THAN 5 CENTS A DAY.** Go into business—Open a welding shop now. **AGENTS**—Make big profits selling to garages, factories, janitors and machine shops. Write today for our 10-DAY TRIAL OFFER. **DYNAMIC WELDER CO.** 2226-MA Silverton Road Chicago, Illinois

**RETAIL**

**FIX YOUR ROOF WITH COLORED ASPHALT**

Right over old wood, composition shingles, tar paper or metal. Will not run or crack. Applied cold. Brush or spray. Gray, green, red and black.

**AZTEC ASPHALTS** 218 North Canal CHICAGO

**FREE 48-page book. Pictures. Useful hints on buying, using, saws, tools, files.**

**Henry Disston & Sons, Inc., 511 Tacony, Phila.**

**FREE TRAILER PARTS CATALOG**

We'll save you money on—axles, springs, wheels, couplers, windows, sinks, water pumps, brakes, refrigerators, beds, lamps, inside and out, 6V lamps, furniture, jacks—everything. Special discount to mfrs. **NATIONAL TRAILER EQUIPMENT CO.** Successors to Kar-A-Van Industries, Inc. Dept. P. 714 W. Wisconsin Ave., Milwaukee, Wis.

Complete Plans and Building Instructions, 10c

**For Your Class or Club**

Pins, rings and emblems. Over 300 designs. Finest quality. Reasonable prices from 30c up. Write today for our attractive, free catalog.

Dept. N, **METAL ARTS CO., Inc., Rochester, N.Y.**

Makes marvelous movies at everybody's price

**CINÉ-KODAK EIGHT**

See it at your dealer's

**NEW "CHAMPION" RACE CAR MODEL KIT**

1/4" Scale reproduction of Sir Malcolm Campbell's famous "BLUEBIRD" 14" long, 2" wheels. Colored Blue with Aluminum trim. Black details. Kit is complete all parts materials ready to shape and assemble. Accurate full size plans. Postpaid . . . 60c.

Gas Model Race Car Kit \$16.50 (less motor). Circular of other "CHAMPION" MODEL KITS FREE.

**NORTHERN AIRCRAFT, PM 3 Manitowoc, Wis.**

**MYSTERY CONTROL Improves Your Record Player**

New invention. Plays phonograph records better. No wires . . . no connections. Mystery control for record player plays records through any radio. Better tone, greater volume. Connects to and improves any record player. Get the best out of your records. Makes your player portable because you need no wires to any radio. Details free. Money back guarantee. Order today, postpaid \$4.95.

**PHONO-RADIO INVENTIONS** Dept. 1 Upper Montclair, N. J.

**AGENTS 300% Profit SIGN LETTERS**

For Store Fronts and Office Windows. Anyone can put them on. Free Samples. Liberal Offer to general agents

**METALLIC LETTER CO., 438 N. Clark St., Chicago**

**A AND N SUPPLY CO.**

Bargains—Military, Sport Goods, Firearms, Clothes, Shoes, etc Send 10¢ for new catalog, to be redeemed on first order.

EST. 1868 **A & N Supply Co., 4773 Lester St., Richmond, Va.**

**Big Tombstone**

Genuine Marble and Granite Memorials of lasting beauty. Lettering FREE. Overall size, height 30 in., width 20 in., thk. 8 in. Footstone FREE. Freight paid. Satisfaction guaranteed. Free catalog.

**American Memorial Co., Dept B-25 Atlanta, Ga.**

**Earn Cash at Home!**

We paid M. M. \$1174 for exceptional cellar crop Snow-King mushrooms! We furnish materials; buy all crops. Big FREE picture book tells if your cellar, shed, barn, suitable. Ed. 1908. Write today.

**United Co., 3848 Lincoln Av., Dept. 310, Chicago**



# Big Profits for RIDERS/DEALERS!

# MEAD Ranger

# SCOOTER

Rent or Sell the **NEW**

Everybody's riding the marvelous new, improved RANGER Scooter! Order your demonstrator while territory is still open—there's big money selling to all stores needing quick, cheap delivery . . . sell to messengers, mechanics, garages, canvassers, friends; or rent for easy hourly profits at bike shops, beaches, resorts, etc. 120 miles per gallon, 35 m.p.h.! World's CHEAPEST Power Transportation.

- Start Your Own Delivery Service and Earn Real Money!
- STORE OWNERS—Cut Cost of Deliveries!
- Laborers! CLERKS! Ride To and From Work at Almost NO Gas Cost!
- FARMERS! Save on Tires, Gas! HOUSEWIVES! Do Your Shopping, Errands, Quickly, Cheaply, Safely.
- SPORTSMEN! Go Where Cars Can't—SAFE, New Thrill!
- TOURISTS! Go Across U. S. A. For \$6.00 Gas Money!

### SOLO-TANDEM-TRAILER-SIDE CAR MODELS!

Learn about our complete new line of models starting at \$99. P.O.B. Chicago—to fit every need and every purse. MEAD Ranger Scooters are the finest, most reliable you can buy! Have GIANT-X-Member 1-piece ALL STEEL frame, 2-speed transmission, spring suspension, and all latest features. Powerful 1½ or 2½ H.P. Engine!—Also 3-wheel miniature auto!

### EASY TERMS—Send for FREE Circular!

Easy payment terms available in most states. Rush postcard or write for our big, new 3-color circular . . . Special Agents' Introductory Prices, full details. Hurry—do it now!

# MEAD

CYCLE CO.

1750. Market, Dept. P-1, Chicago, U. S. A.

AMERICA'S MOST FAMOUS CYCLE NAME FOR FIFTY YEARS



## ENGINES

A real money maker for farm or factory. Uses Cheap fuels. Pays for itself out of savings. Costs Less to Own—Less to Operate.

## LOG SAWS

Make Money—Start a wood sawing business—turn spare timber into cash. Cash or Terms—Engine and Saw Catalog. 1745 OAKLAND AVE. KANSAS CITY, MO.

**WITTE ENGINE WORKS**

## CURE "STICKY" VALVES—

Stop "Motor ping" . . . Get a KARBOUT "Motor Cleanout Treatment" at your service station or garage for "new-motor" pep and power. Made by THE SHALER CO., Dept. Karbout, Waupun, Wis.

## SOCIAL SECURITY PLATES

12 Beautiful Fast-selling Designs—40,000,000 Prospects Men and women are making big profits taking orders for SOCIAL SECURITY PLATES. Start your own business without investing a single penny. Postcard brings full information and FREE sales outfit. SOCIAL SECURITY CARD MANUFACTURING COMPANY 36 S. Penn. St., Dept. PM-49. Indianapolis, Ind.

## ITALIAN ACCORDIONS

HAND MADE. Very best. Lowest prices. Direct from Factory Representative. Send your name and address for FREE catalog. ITALIAN ACCORDION COMPANY 323 W. POLK ST., DEPT. P-1 CHICAGO, ILL.

## RADIOS..SAVE UP TO 50%

DEAL DIRECT...FACTORY PRICES! Many models to select from: AC-DC; All-Wave; armchair models; automatic tuning; car radios; Farmsets that operate like city radios! Send postcard for NEW Bargain Catalog FREE. 10-DAY TRIAL plan and agent-user proposition!

**Free Catalog**

**\$4.95 EACH** in lots of 3

**R.C.A. GOLDENTONE RADIO CO. DEPT. 120 DEARBORN, MICHIGAN**

## STORM KING KAYAKS AND BOATS

Build your own Kayak, Outboard, Row or Duckboat from our cut to fit sets or buy them ready made from us. Send 10 cents in coin for our illustrated folder. Dime will be returned with order.

**STORM KING KAYAK & BOAT CO., Dept. P, BETHEL, CONN.**

## BUY STAYNLESS WINCHESTER

TRADE MARK .22 CARTRIDGES

**FREE** GET their new-profile bullets—shoot flatter. Get their Staynless priming—prevents rust, saves cleaning. Buy Winchester Leader Staynless for practice and sport. Enjoy their new finer accuracy. For extra speed and long range, especially for gophers, prairie dogs, jackrabbits, other small farm pests, buy Winchester Super Speed Staynless. Choice of solid or hollow-point hunting bullets—and do they sock! Regular sizes and prices. Ask your dealer.

Send **Coupon NOW** Winchester Repeating Arms Co., Dept. 46-C (Division of Western Cartridge Co.) New Haven, Conn., U. S. A. Send me FREE the 44-page Winchester Ammunition Book.

Name \_\_\_\_\_  
Address \_\_\_\_\_



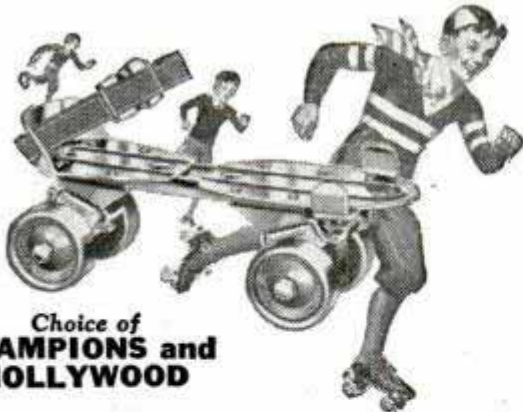

Choice of  
**CHAMPIONS and  
HOLLYWOOD**



**CHICAGO SCOUT**  
**FLYING** Roller Skates

STEEL WHEELS with 3 LIVES.  
More Miles and Thrills with greater  
SPEED on OVERSIZE BALL-  
BEARINGS.  
Demand "CHICAGOS."  
Write for BOOKLET  
"How to Roller Skate"

**FREE SKATE PIN AND ANKLE PADS**

Send picture of "Our Gang" out from skate wrapper  
with 10c to cover mailing, and get beautiful Gold F.  
Skate Pin and Ankle Pads.

**CHICAGO ROLLER SKATE CO.**  
Quality Roller Skates for over 37 Years  
4414 W. Lake St. Chicago, Ill.



**20 FILTER TIP  
CIGARETTES 6¢**

MAKES 20 IN 5 MINUTES. Loose  
or tight as you prefer. Use your favorite  
tobacco—granulated—mentholated  
—pipe—Turkish or Domestic.  
**ALL METAL EASY MAKER \$1.00**  
EASY MAKER with sufficient supply  
of best tobacco and tubes to make 100  
cigarettes sent Postpaid for \$1.30.  
Enough to make 200 cigarettes \$1.60.  
Send money order or cash.

**Distributors—Crew Managers—Sales-  
men**—Sells on sight to men and  
women in Homes, Offices, Stores  
and Shops, also to stores for re-sale.  
Highly profitable, permanent re-  
peat business on Filter-Tip Tubes.  
Write for Distributors' confidential  
prices and money-making sales plan.  
**Easy Cigarette Maker Co.**  
Box 310 Sullivan, Ill.



**\$1.00 WE PAY  
POSTAGE**  
**2 BATTERIES FREE**  
and 1 BULB  
**1001 USES**

Throws a powerfully bright light. De-  
pendably efficient. The ideal LANTERN  
for tourists, scouts, farmers, camp-  
ers, hunters, aviators, sportsmen,  
boys, truckers. **ORDER NOW!** Send  
only \$1.00 (in cash or stamps) for your  
"RED GUARD" Electric Lantern now.  
**MID-WEST SALES**  
Dept. PM5, 549 Randolph St., Chicago, Ill.  
(Dealers—write for prices)

**DECORATIVE  
Decalcomania Transfers**

Imported Designs of all Sizes and Types—Flowers,  
Fruits, Figures, Butterflies, Birds, Juvenile, Conven-  
tional, Ships, Dogs, etc. for Furniture, Doors, Walls,  
Trays and what not; metal, wood, glass, painted and other surfaces.  
Catalog with 800 illustrations in color sent for 25c in coin. Deductible on  
first purchase of \$1.00 up.  
**L. C. WELLS, Dept. P. M. 95, 25 East 26th Street, New York**



Renew old buildings. Make new construction more  
permanent and attractive. Plastic Colorcrete is water-  
proofed. It fuses with any masonry surface. It fills  
cracks. It can be applied in any thickness and in 30  
colors. Fully proven by over 13 years actual use un-  
der all conditions and every climate.

**OFFERS BIG EARNINGS**

Owners everywhere want to enhance present values. With this  
machine you can supply this big waiting market with  
permanent Colorcrete at amazingly low cost. Operators  
report cost of 2c and up per sq. ft. and sell up to 7c.  
Some have paid for their equipment from first few jobs.  
Machine capacity up to 1,000 sq. ft. per hour.

Get the facts. Send for books "Proven Business  
Opportunity". Write today. It offers you big  
extra income.

**COLORCRETE INDUSTRIES, INC.**  
670 Ottawa Ave. Holland, Mich.

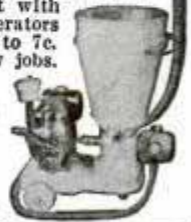

**WET BASEMENTS!**  
Amazing new  
Seal-Seep method,  
anyone can use. Applied to  
inner masonry wall and floor surfaces;  
no digging. Guaranteed permanently effective. Agents  
write for unusual earnings opportunity. Details FREE.  
**National Seal-Seep Co., Dept. 592, Cincinnati, O.**

**Waterproof  
Your Own  
Save up to  
\$100 to \$150**

**CONSTRUCTA-SCOOT**

The best motor scooter value in America that  
easily and quickly assembles from fully finished  
factory kits.

**AT ONLY BICYCLE COST!**

**\$29.50**

Less Motor  
Complete

**\$59.50**

With Motor  
complete

F.O.B. Chicago, Ill. Write for Literature!

**RENMOR MFG. CO. Inc. 2544 So. Wabash Av., Chicago, Ill.**



**ARE YOU A KEY FUMBLER?**

**THEN USE KEYMATIC!**

This marvelous automatic key case holds  
your four most important keys, each iden-  
tified by a special marker. Operates with  
one hand—a push of the patented setting  
button and out pops the desired key. 50¢  
Streamlined in design, it does not  
bulge in your pocket. Constructed of  
solid, non-tarnishing nickel silver. Send  
Coin or Stamps  
**MONARCH MFG. CO., Dept. E, 711 W. Lake St., Chicago, Ill.**



In answering an advertisement with a coupon, be  
sure to write name and complete address clearly.  
Sometimes advertisers are unable to respond to in-  
quiries due to lack of complete information.



**NOV!** World's Smallest  
Real Performing RADIO  
BEAUTIFUL — PLASTIC — CABINETS

Midget radio fits your pocket or purse. Weighs only  
4 ozs. Small as cigarette package! Receives stations  
with clear natural tone. "PATENTED FIXED CRYSTAL"  
— NO UPKEEP—only one moving part. "AUDIOPHONE"  
gives superior performance. ENTIRELY  
NEW PATENTED DESIGN. Has enclosed geared  
luminous dial for perfect tuning. Many owners re-  
port amazing reception and distance.

**ONE YEAR GUARANTEE**

Send completely ready to listen with instructions for use in homes, offices, hotels, boats,  
in bed, etc. **TAKES ONLY A SECOND TO CONNECT—NO ELECTRICITY NEEDED!**  
**SEND NO MONEY!** Pay postman only \$2.99 plus postage on arrival or send \$2.99  
(Check, M.O., Cash) and yours will be sent complete postpaid. A most unusual value.  
**ORDER NOW! MIDGET RADIO CO., Dept. P-3, Kearney, Nebr.**



**Make More Money — Have More Fun**  
with *Atlas* EQUIPMENT



**NEW *Atlas* LATHE**

It's the only popular priced precision lathe with power cross feed and many other modern features as standard equipment. 10" swing.

**NEW *Atlas* SHAPER**

Combines all the features of larger shapers into a compact 7" stroke machine.

**NEW *Atlas* DRILL PRESS**

New features — adjustable feed tension, column collar, new accessories. 4 sizes.

*Send for New 1939 Catalog*



Everything you could want—for tool room laboratory, for production work, for your small shop—is built into these modern Atlas machine tools. They're ruggedly constructed—built for extra power. They turn out true precision work at low cost. You can buy them at reasonable prices on terms if desired. Real discoveries are in store for you in the new 1939 Atlas Catalog. Send for your copy today.

**ATLAS PRESS CO.**  
543 N. Pitcher St., Kalamazoo, Mich.

**ATLAS PRESS CO., 543 N. Pitcher St., Kalamazoo, Mich.**

Please send me your 1939 Catalog describing:

- New 10" Metal Lathes
- New 7" Shaper
- Drill Presses
- Wood Lathes
- New 6" Metal Lathe
- Arbor Presses
- Vises
- Motors and Grinders.

Name ..... (Please print plainly)

Address .....

City and State .....

(I now own some Atlas equipment )

**LATHES · DRILL PRESSES · ARBOR PRESSES · SHAPERS**

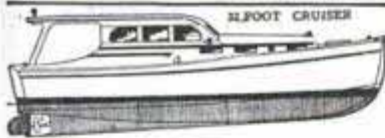

**BOAT BLUEPRINTS**

and full size paper patterns. Wide selection—designed by Naval Architect. Streamlined. Low prices. Send 10c (coin) for illustrated catalog.

**Cleveland Boat Blueprint Co.**  
Station A-666 Cleveland, Ohio

**KINKADE GARDEN TRACTOR**

and Power Lawnmower

A Practical Power Plow and Cultivator for Gardeners, Suburbanites, Florists, Truckers, Nurserymen, Fruit Growers

Low Prices - Easy Terms

**American Farm Machine Co.**  
1058 33rd Av. SE. Minneapolis, Minn.



Catalog Free

**50c BRINGS YOU 26 PRIZE**-winning plans for shop projects in new Stanley Plan Packet. Each on separate 8 1/2" x 11" sheet. Postpaid anywhere in U. S. Write **STANLEY TOOLS**, 105 Elm St., New Britain, Conn.

**OTTAWA LOG SAW \$39**



**PUTS THIS OTTAWA** to work for you. **MAKE MONEY!** Wood is valuable. Does more than 10 men. Easily operated. Falls trees—saws limbs. Use 4-hp. engine for other work. Write for **FREE BOOK**. **OTTAWA MFG. CO.** 1927 Wood St., Ottawa, Kans.

**CASH IN ON SPARE TIME**

**\$30 WEEKLY OR MORE EARN.** Grow mushrooms HOME. Cellar, shed suitable. We buy 30c lb. Year round business. **\$270** made by Mr. B. in few weeks **SPARE TIME.** Guaranteed materials. Established 1931.

Write for **FREE BOOK**

**WASHINGTON MUSHROOM INDUSTRIES**  
Dept. 601, 2019 2nd Seattle, Wash.

**EASY PROFITS IN PAINT SPRAYING**



Paint walls, ceilings, screens, furniture, radiators, machinery faster, better! 1/4 H. P. motor 110 Volt 60 Cycle AC, complete with Spray Gun, 15 ft. hose. Weighs only 44 lbs. Carry anywhere. **FULLY GUARANTEED.** Only \$31.15 f. o. b. Chicago. \$5 Deposit, Balance COD, or **SEE YOUR DEALER.** Circular FREE. Get started making money NOW!

Ideal Automatic Pump Co. Dept. PM-5, 801 Washington, Chicago **\$31.15** Complete

**EASY TO BUILD KAYAKS OUTBOARDS**



Largest Selection—Factory built or Complete Cut-to-fit assembly kits with detailed blue prints and instructions. New round bottom

—Safer and Faster. Built to last—Paddles included. Send 10c postage for big new catalog.

**KAYAK BOAT COMPANY**  
152 East 129th St., N. Y. City



**SpeedWay**

**Real Quality Tools**

Designed, manufactured and guaranteed by SpeedWay, for 30 years leading manufacturers of industrial drills, these are really fine tools, correctly designed, correct speeds, genuine high torque drill motors. Small, handy, powerful; 1000 RPM—drill handles to 1/4" in steel. Die cast handle and gear housing. \$7.95. Grinder operates at 20,000 RPM. (high speed is essential for good grinding). With collets for 1/8" and 3/32" arbors. \$5.95. No. 250 KIT, both drill and grinder with 5 accessories in steel carrying case \$14.95. Complete line of accessories and drill press stand. Write for Circular. Dealers Write **SPEEDWAY MFG. CO.** 1842 S. 52nd Ave., Cicero, Illinois

**DRILL \$7.95**

**GRINDER \$5.95**

Set \$14.95



## Stretch dimes into dollars with SPORS 4000 BARGAINS

### 260 Pages of Amazing Values Like These—

This new 1939 Wholesale Book for salesmen, dealers, etc., describes and offers you over 4000 Tested Fast Sellers; Money-Making Ideas; Sales Building Plans; office specialties, home necessities. Read about the customer whose orders total \$46,000 retail value in 5 months. Same opportunity for you. There is room here for only a few examples. This catalog costs about 25c and we are sending it to you for One Dime to cover the cost of mailing and packing etc. You get your dime back with your first order. Our money back guarantee protects you. Send the dime or stamps and see how you can turn dimes into dollars. Today! Now!



**5 Yr. GUARANTEED FOUNTAIN PEN**

No. R400. Features: plunger filler; visible ink supply; non-tarnishing size 4 point; guaranteed. Jet black color. When offered for 69c you make over 400% profit. (Full line of writing instruments in our catalog.) Sample 13c. Dozen \$1.40.

#### ELGIN DRY SHAVER

No. E308. Precision motor chrome plated head; operates on 110 A.C. Ready to operate. 1 year guarantee with each shaver. Money back if not pleased. Sample 79c. Dozen 75c each. 6 dozen 69c each.



#### HEAT-KWIK WATER HEATER



No. E541. Tested and approved by Automotive Test Laboratories of America. Heats water quickly from any 110 volt light socket. Every home, camp, office, store, farm are ready prospects. Money back if not pleased. Sample 85c. Dozen \$8.88.

#### FOCUSING OPERA GLASS

No. V225. Has 17 ligne, non-achromatic lens. Metal body, covered with imitation mother-of-pearl. Brings distant objects closer to field of vision. You would expect to pay \$1.95 for it. Each in velvet-like bag. Satisfaction guaranteed or money back. Sample 20c. Dozen \$1.95.



### SEND WITH ONE DIME TO SPORS COMPANY

3-39 ELM ST., LE CENTER, MINN.  
Dear Spors Co.: Yes I want your new 1939 Wholesale Catalog right away. Here's your dime. I want it back with my first order.

NAME .....

ADDRESS .....

CITY..... STATE.....



### FOR HIS BOOK OF BARGAINS

#### ORDER FROM THIS LIST OF BASS-GUARANTEED BARGAINS

- Candid Midget—Hugo Meyer F:4.5 lens. Vario shutter to 1/100th, T&B . . . for 35mm B&W and color. List \$21.50...\$12.50
- Argus Speed Camera C2-F:3.5 Cintel color-corrected anastigmat lens . . . speeds 1/5 to 1/300 . . . Built-in Coupled Range Finder.....\$25
- Dollina II—35mm. Coupled range finder, with Schneider Radionar Anastigmat F:2.9 . . . Compur Rapid Shutter, \$42.75
- Zeiss ICA Plaskop Stereo . . . 45 x 107mm . . . with matched Meniscus lenses, ground glass, film adapter, holders.....\$7.50 Verichrome packs 12 exp. 65c
- Super Sport Dolly with built-in exposure meter . . . Xenon F:2.8 lens . . . and Range Finder. List \$70.....\$52.50

**BASS CAMERA COMPANY**  
179 W. Madison St. Dept. P Chicago, Ill.

# NEURITIS Relieve Pain In Few Minutes

To relieve the torturing pain of Neuritis, Rheumatism, Neuralgia, Lumbago in few minutes, get **NURITO**, the Doctor's formula. No opiates, no narcotics. Does the work quickly—must relieve cruel pain to your satisfaction in few minutes—or money back at Druggist's. Don't suffer. Get trustworthy **NURITO** on this guarantee. Don't wait.

When writing to advertisers please mention Popular Mechanics

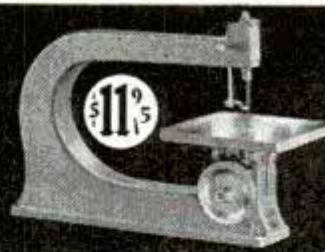

For **SUPER VALUE MODERN DESIGN UNEXCELLED PERFORMANCE**  
Get **DURO** Tools

They are built of the finest materials and workmanship to offer unsurpassed values. Their modern design and unexcelled performance will convince you, as it has thousands of others, that it's wise to buy Duro Tools. Duro's new 15 inch Jig Saw above incorporates upper and lower tension springs, driving mechanism operating in oil, and many other features at an exceptionally low price.

**DURO METAL PRODUCTS CO.,**  
2659 No. Kildare Ave., Dept. B5, Chicago, Illinois

★ **FREE BIG NEW CATALOG** ★

## ONE-MAN SAWMILL

Makes lumber, shingles, lath, ties, crates, boxes, cases, all forms lumber

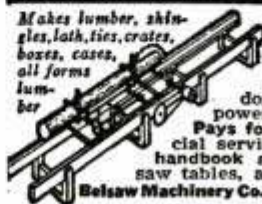

### TURN TREES INTO MONEY WITH A BELSAW

Three capacities: 10, 14 and 20 ft. Accurate set works positive dogs. Hand or power feed. Runs on low power—Many owners use old auto engine. Pays for itself quickly—thousands in commercial service, everywhere. Write for free lumber handbook and catalog of mills, supplies, tools, saw tables, and woodworking equipment.

FARM MODEL **\$49.00**

Belsaw Machinery Co., 8110-Y Davidson Bldg., Kansas City, Mo.



## FREE-GUITAR BOOK

GOOD TIMES — POPULARITY AHEAD

If you play Guitar, Banjo, Mandolin. Send this coupon for free big Gibson Book.

**GIBSON, INC.,**  
Ray Whitley  
RKO Pictures 120 Parsons St., Kalamazoo, Mich.

NEW 1/4-inch JUNIOR DRILL **\$19.95**

Write for Details

## BLACK & DECKER

605 Penna. Ave., Towson, Maryland



MYSTERIOUS DISCOVERY **SAVES UP TO 30% ON GASOLINE**

or Costs Nothing to Try

Stop wasting Gas!—trim dollars off gas bills—get more power—quicker pickup—faster acceleration! **AUTO OWNERS everywhere** praise VACO-MATIC! Proven so efficient, it is guaranteed to satisfy, or the trial costs you nothing.

**Automatic Supercharge Principle** Vacu-matic is entirely different! It operates on the supercharge principle by automatically adding a charge of extra oxygen, drawn free from the outer air into the heart of the gas mixture. It is entirely automatic and allows the motor to "breathe" at the correct time, opening and closing as required. Saves up to 30% on gas costs, with better motor performance.

**FITS ALL CARS**  
Constructed of six parts fused into a single unit, adjusted and sealed at the factory. Easily and quickly installed by anyone in a few minutes.

**AGENTS** Get Yours **FREE**

**FOR INTRODUCING.** Here's a splendid opportunity for unusual sales and profits. Every car, truck, tractor owner a prospect. Send name and address now for big money making offer and how you can get yours Free. **The Vacu-matic Co., 7617-443 W. State Street, Wauwatosa, Wis.**



**HOT WATER QUICK • ANY ANY TIME PLACE**  
**FROM ANY 110-VOLT LIGHT SOCKET WITH**

**SPEED KING**



Furnaces will soon be shut down for the summer. Millions of homes will soon be without hot water. Millions of housewives will soon be on the market for an easy, cheap, clean way to **HEAT WATER QUICK!** From now until next September, Speed King, the speedy electrical Hot Water Heater can easily be the fastest seller on the market. Send the coupon today. Get your sample at once. Get my three easy plans. Get ready to cash in on this tremendous market. Don't send money. Just send name. I give you the Demonstrator if you are honest with me and will send in orders for **SPEED KING.**

**60-SECOND Demonstration Amazes Housewives**

**H**ERE it is! The new, amazing **SPEED KING ELECTRIC WATER HEATER**—that heats water so fast that one **60-SECOND DEMONSTRATION** amazes the doubters—convinces the skeptical. No fuss! No muss! No waiting! Drop the **SPEED KING** into water—plug in any AC or DC socket—and presto... **HOT WATER** for shaving, dishwashing, cleaning, washing hose, lingerie, and for emergency needs.

wire from C. W. Colman of W. Va.: "Rush me 50 more immediately. I can make plenty selling Speed Kings." And here's another one from N. H. Phillips of Penn.: "Here is my third order in two weeks. I am putting out six men at once in my county. Rush."

**QUICK CASH DAILY**

Under my Order-Taking Plan, all that you need is the **SPEED KING** demonstrator. Then you secure orders fast and furious with your big cash commission in advance. I make all deliveries! Here's a plan that lets you step right out on a spare time, side line or full time basis—with quick cash right in your pocket. No waiting! No delay! No big investment in stock of goods.



**SEND NAME**

**I Give You This Pocket Demonstrator If You Will Take Orders.**

*All Information and Demonstrator Offers Are*

**Free**

**SAMPLE OFFER COUPON**

**WHAT A SELLER**

Look at this letter from Alice Parmer: "Enclosed find \$25 for which please rush 100 more **SPEED KING HEATERS**, balance to be paid C.O.D. Am delighted with them and have interested some women for a crew." And here's a

**NO MONEY—JUST MAIL COUPON**

Now—right now—is the time to step in with **SPEED KING.** Millions of furnaces will soon be shut down and millions of gas and oil heaters will be disconnected for the Summer season—yet hot water is still a daily necessity. No time to lose if you want to "cash in" on this enormous field. Cut out the Coupon **NOW** before you turn the page—and mail it quick for my **FREE OFFER** of **POCKET DEMONSTRATOR** and complete instructions for making money the first hour after your demonstrator arrives. Don't send me a cent. But don't waste a minute. Send your name and address to me quick and let me get you started at once as livewires should be able to clean up enormous profits in the next few months.

**NU-WAY MFG. CO. Dept. 165, Walnut Bldg., DES MOINES, IOWA**

**L. B. Patterson, Pres., Nu-Way Mfg. Co., Dept. 165, Walnut Bldg., Des Moines, Iowa**

Rush me your **FREE OFFER** for a **SPEED KING DEMONSTRATOR** and full details of the plan by which I can make as much as 160% profit.

Name.....  
 Address.....  
 City.....State.....

*When writing to advertisers please mention Popular Mechanics*



A BACK-GEARED SCREW-CUTTING PRECISION LATHE  
Weight 320 Lbs.

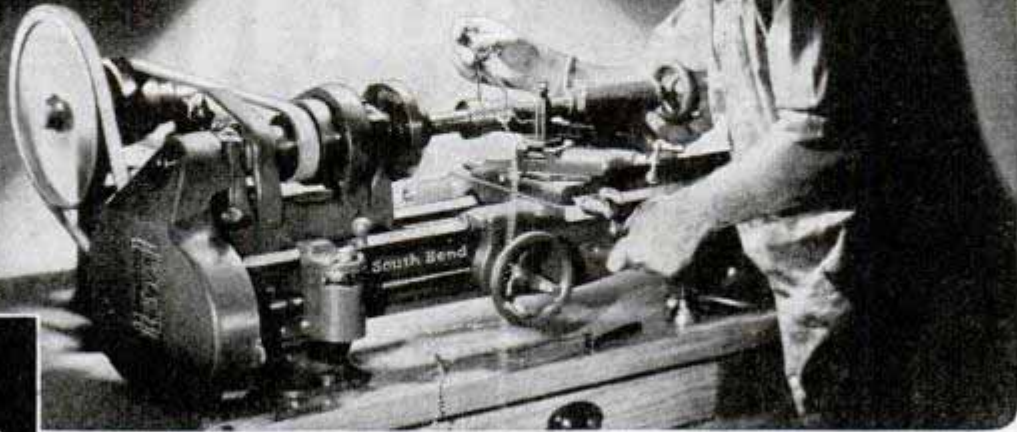

**\$15**  
Down Payment  
**PLACES THIS  
LATHE IN YOUR  
SHOP**  
Balance \$6 Monthly

No. 415-YA, 9 1/4" swing by 3' bed Workshop Bench Lathe with Horizontal Motor Drive, 1/4 h.p. Reversing Motor, Switch, Belts and Adjustable Belt Tension Countershaft..... **\$117.00**

**SOUTH BEND  
9-INCH WORKSHOP  
PRECISION LATHE**

Used by:

**MANUFACTURERS  
TOOL ROOMS  
LABORATORIES  
MACHINE SHOPS**

- Automotive
- Electrical
- Gun Smiths

**U. S. GOVERNMENT  
SCHOOLS  
HOME WORK  
SHOPS  
INVENTORS**

The 9"x3' South Bend Precision Lathe does these operations:

**URNS—BORES  
—CUTS SCREW  
THREADS—FACES  
—DOES MILLING,  
CHUCKING, REAM-  
ING, DRILLING,  
FILING AND HUN-  
DREDS OF OPERA-  
TIONS IN STEEL,  
IRON AND OTHER  
METALS.**

**THE MOST USEFUL OF ALL TOOLS  
IN ANY AUTO SERVICE SHOP**

**C**UT your investment in shop equipment, and do your work on this profitable all-purpose lathe. 95% of the modern motor service work can be done on the 9-inch "Workshop" South Bend Lathe. With attachments it handles the six most important auto jobs—refaces valves—finishes pistons—bores re-babbitted connecting rods—makes bushings—cuts screw threads—trues commutators. Also get the profits from other machine operations this all-around tool handles.

**Send Coupon FOR THESE NEW BOOKS**  
Auto Workshop Bulletin—No. 33-J shows how to do important auto service jobs on this one lathe.  
How to Run a Lathe—128 pages, 350 illustrations on lathe operation.  
Catalog No. 46-B—Illustrates and describes 9" lathe in all sizes and drives.

**Features—**Hand-scraped V-ways on Lathe bed, Precision Machine Cut Steel Gears, Twin Gear Reverse to Lead Screw for right and left hand screw threads and automatic feeds, Ball Thrust Bearing on spindle, cuts screw threads from 4 to 480 per inch, 3/4" hole through headstock spindle has collet capacity of 1/2", all steel and iron construction, Automatic Longitudinal screw feed to carriage, 5/8" tailstock set-over for taper turning.

Made in 3', 3 1/2', 4', and 4 1/2' bed lengths. Operates from lamp socket at 2 cents per hour.

Write for free books about the Modern Motor Service shop. Learn how to do many profitable jobs.

**SOUTH BEND LATHE WORKS**  
641 E. Madison St., South Bend, Ind., U.S.A.



**SOUTH BEND LATHE WORKS,**  
641 E. Madison St., South Bend, Ind., U.S.A.  
 No. 33-J, Auto Workshop Bulletin, Free  
 No. 34LB, "How to Run a Lathe," 25c  
 No. 46-B, 9" Workshop Catalog, Free  
 Easy Payment Plan

Class of Work.....  
Name.....  
Address.....  
City.....State.....

There are 5 sizes of South Bend Lathes—9", 11", 13", 15" and 16" swing with bed lengths 3' to 12'. In motor or countershaft drives. Priced \$85 to \$1500.

**SOUTH BEND Precision LATHES**



## THE DESPERATE CASE OF F. L. FAULK...



**"Morning after morning,  
I was late..."**



F. L. FAULK  
Monroe, La.

"... it got so I was absolutely dependent on my neighbors to give my car a 'push' to get started. There was no other way for me to get to work, so, morning after morning I was late.

"When the Boss spoke to me, I explained that I was doing everything I could... that I had been to the garage several times... that I had even bought a new battery but still had trouble starting.

"He told me his Willard Dealer had an instrument that could locate the trouble, so, after work that day I went over. With his *Electrical Check Instrument* he discovered that undersize cables were causing the starting motor to draw so much 'juice' it starved the ignition system.

"Your Dealer rectified the trouble, including all the necessary parts, for less than \$2.75. **THAT** made a *Willard Starting Service* believer out of me."

*F. L. Faulk*

### How YOU Can Avoid Trouble

A majority of starting failures are caused NOT BY THE BATTERY but by little things like

worn or undersize cables, loose connections, worn or faulty wiring, that drain the life out of a perfectly good battery without warning.

This new *Willard Starting Service* protects you against these hidden flaws—saves you money—saves you trouble. Let your Willard Dealer "x-ray" the starting system of *your* car—under actual load conditions—with his *Electrical Check Instrument*.

*We offer you this Willard Starting Service, as our way of EARNING your patronage. Come in and try it.*

*Your Willard Dealer*

*You can identify our station by this sign.*



**STARTING  
Willard  
SERVICE**

If you are interested in the "why" and "how" of the instrument that makes this service possible, send a letter or postcard to Willard Storage Battery Company, Department M-5, Cleveland, Ohio.



The day of Richard E. Waggener, leading television engineer, is full of complicated problems. He welcomes pleasant leisure moments spent with mild, rich-flavored Camels. He says: "It's a comfort to

## LET UP—LIGHT UP A CAMEL!"



**1** A TELEVISION BROADCAST is all set to start—time for everyone to be cool, steady. Engineer Richard E. Waggener of Philco (left) passes his Camels to Katharine Aldridge and Shane Kelly. All welcome a mild, good-tasting Camel. "Easing off to let up—light up a Camel is a grand way to lessen nerve strain," says Dick Waggener.



**2** ON THE AIR! The eye of television is an amazing scanning beam that zigzags over a scene 13,000 times per second. Reception is remarkably clear, thanks to engineers who forget the clock as they work. Many of these experts are Camel smokers. They find a pause and a Camel a delightful way to smooth out the rough spots of busy days.



**3** A HOME RECEIVING SET: Mrs. Dorothy Temple is taking in the televised show while she enjoys a Camel. Mrs. Temple finds Camels an important contribution to the pleasure of living. She says: "Camels have a wonderful mildness. I find a pause and a Camel soothing to my nerves."

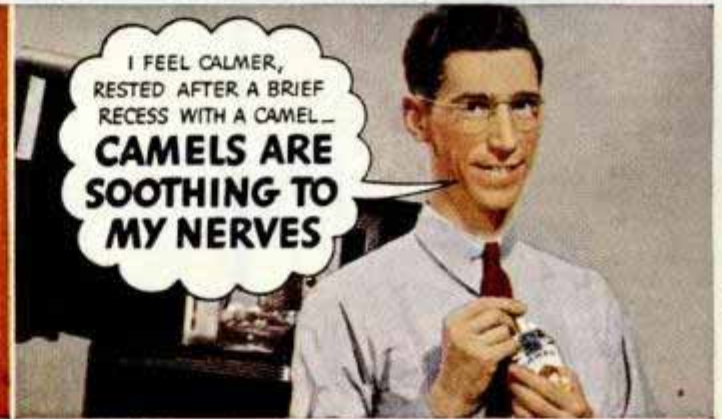

**4** "MY JOB CALLS FOR intense concentration," says television engineer Waggener, "and that might mean a lot of nerve strain if I didn't take it easy now and then to let up—light up a Camel!" For real smoking pleasure, let up—light up a Camel—the cigarette for mildness—for rich flavor!



Smoke 6 packs of Camels and find out why they are the LARGEST-SELLING CIGARETTE IN AMERICA



HE'S RESTING HIS NERVES

... AND SO IS HE!

Above—the Harlequin Great Dane relaxing. Although the dog's nerve system is high-keyed like our own, when he tires, he halts instinctively! We are apt to keep going long past the capacity of our nerves. Rest your nerves. Do it pleasantly. Pause now and then—LET UP—LIGHT UP A CAMEL! There's a world of comfort, pleasure in milder, richer-tasting tobaccos. And smokers find Camel's costlier tobaccos are soothing to the nerves.

