

HUNTING LIVE TREASURE

# POPULAR MECHANICS

MAGAZINE

WRITTEN SO YOU CAN UNDERSTAND IT

REGD. TRADE MARK, GREAT BRITAIN, NO. 410421

REG. U.S. PAT. OFF.

APRIL  
25 CENTS

SEE PAGE 539







**"PEACE OF MIND'S  
WORTH SOMETHING"**  
*Says the Marfak Man*

**D**ID you ever wonder, when you got your car back from a grease job, if they got to all those hard-to-reach places on the chassis? I went to Marfak College to put your mind at rest on that subject. Bring your car to our station every thousand miles and you won't have any more worries about lubrication.

Marfak is a complete lubrication service worked out for all cars by the Texaco engineers. I don't rely on my memory when I Marfak your car. We've got a "Chek-Chart" for every car made and all kinds of special equipment that makes for better jobs.

*Let us*  
**MARFAK**  
*your car*

Each Marfak job includes 40 different operations, including a lot of extras you wouldn't think of in a month of Sundays.

Surprising how little this service costs, and how often it adds to the trade-in value of a car.

. . .

**TEXACO DEALERS INVITE YOU** to tune in **THE TEXACO STAR THEATRE**—A full hour of all-star entertainment—Every Wednesday Night—Columbia Network—9:00 E.S.T., 8:00 C.S.T., 7:00 M.S.T., 6:00 P.S.T.

Copyright 1939  
The Texas Company

**THE 40-POINT LUBRICATION AT ALL TEXACO AND OTHER GOOD DEALERS**



# Plymouth Saves You Money—Three Ways!

**1 MOST FOR  
LOW PRICE**

**2 NEW OPERATING  
ECONOMY**

**3 HIGHER RESALE  
VALUE**

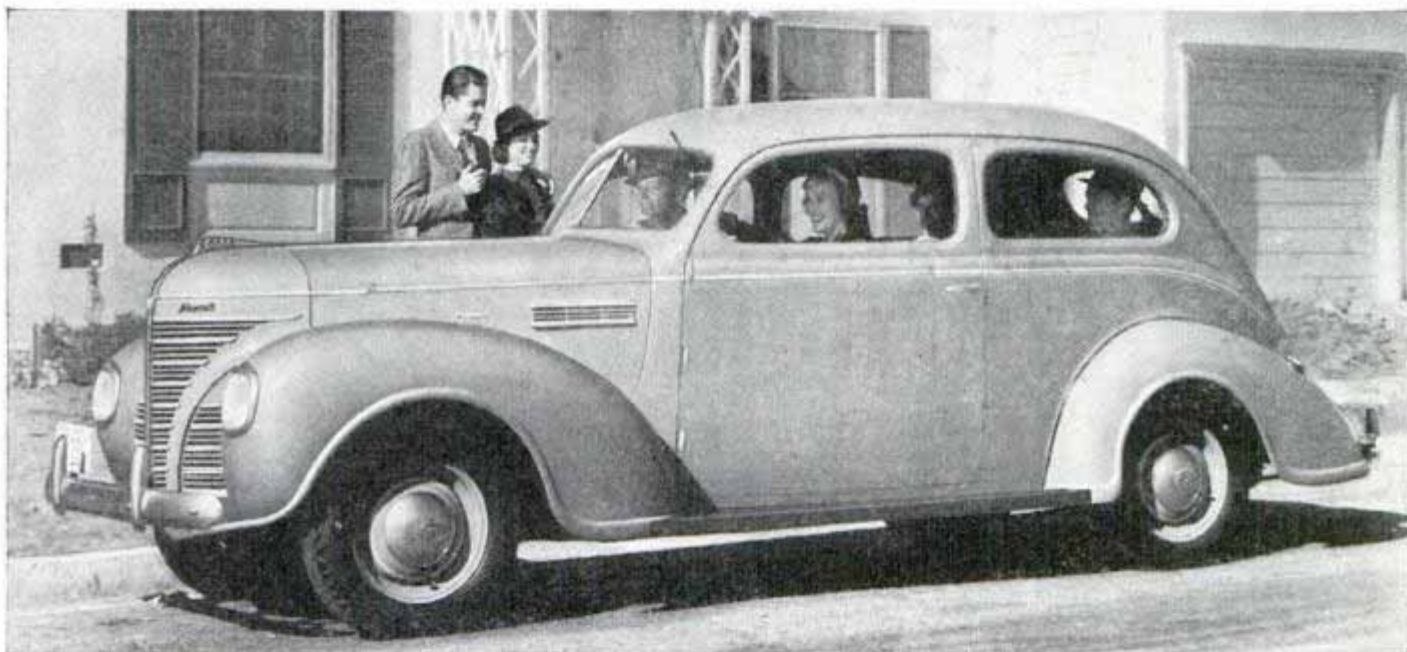

**P**LYMOUTH is not only a big money-saver—it's the *biggest* of the leading low-priced cars: 5 in. longer than one; 6 in. longer than the other!

And all models have the same big, 82-horsepower "L-head" engine for full power *and* economy—*plus* luxurious new riding smoothness...new safety and ease of control. Drive it today!

MAJOR BOWES' AMATEUR HOUR, COLUMBIA NETWORK, THURSDAYS, 9 TO 10 P. M., E. S. T.



STANDARD EQUIPMENT on "De Luxe"—Perfected Remote Control Shifting with Auto-Mesh Transmission.

**COUPES** START AT \$645

**SEDANS** START AT \$685

—DELIVERED IN DETROIT, including front and rear bumpers, bumper guards, spare wheel, tire and tube, foot control for headlight beam with indicator on instrument panel, ash-tray in front and rear, sun visor, safety glass and big trunk space (19.3 cu. ft.). Prices include all federal taxes, Transportation and state, local taxes, if any, not included. See your Plymouth dealer. *Plymouth Division of Chrysler Corporation, Detroit, Michigan.*

**PLYMOUTH BUILDS  
GREAT CARS** NEW "ROADKING"  
NEW "DE LUXE"

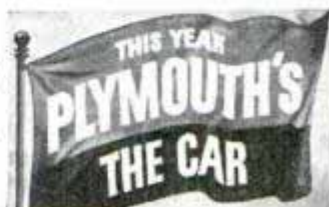





Seventy million times a day the public tests the quality of Bell System service. The measure of this service is not only its promptness, reliability and low cost. It is also the courtesy with which it is given.

Our genuine desire is to make the Bell System a friendly and helpful institution . . . and to give you the best, the most and the cheapest telephone service in the world.

**BELL TELEPHONE SYSTEM**

*You are cordially invited to visit the Bell System exhibit at the New York World's Fair*





# Popular Mechanics Magazine

H. H. WINDSOR, Founder

H. H. WINDSOR, Jr., Editor and Publisher

April, 1939

Vol. 71, No. 4

## Special Features

|  |     |
|--|-----|
| Wonders of the New York Fair . . .     | 481 |
| Talking Without Words . . . . .        | 488 |
| Color "Spies" Join the Army - Coloroto |     |
| Secrets of Big-Time Racing . . . . .   | 508 |
| Peace Officers of the New West . . . . | 514 |
| Hunting Live Treasure in the Jungle    | 520 |
| Canaries Sing for Science . . . . .    | 534 |
| Frontier Guards on the Wing . . . . .  | 541 |
| Painting Pictures with Light . . . . . | 546 |
| Thirteen Slaves for a Nickel . . . . . | 552 |
| Heroes of the Radio "Flash" . . . . .  | 562 |
| Guarding Your Gold . . . . .           | 573 |

(Continued on next page)

## Test Flying the Sky Giants

UNCONSCIOUSNESS was creeping over him. As the black needle of the altimeter quivered at 29,000 feet, the throb of the motor seemed to die away. His right hand, jotting notes on the test flight of this speedy pursuit plane, suddenly went limp and hung helpless at his side. Pilot Eddie Allen crumpled in his seat, fell forward and jammed the stick, sending the plane into a power dive. Down, down they streaked for 7,000 feet, then in the thickening air his numbed senses returned and Allen, fighting off mental fog, pulled the ship out of its dive and spiraled smoothly to earth. Those were Allen's most exciting seconds in twenty years of flying that began in world war days and have brought him today to the post of consulting engineer for American airplane builders and test pilot for the flying fortresses and stratoliners and trans-oceanic clippers. His story is told in the May issue.

## Next Month

SINCE Chicago's fair in 1933 popularized dioramas, the business of fashioning three-dimension scenes in foreshortened perspective has grown out of bounds. You can travel by diorama from Japanese gardens to the Louisville waterfront, dramatize products from dog biscuits to steel, relive the gay Nineties or project the city of tomorrow. An article next month, with eight pages of Coloroto, describes this industry and its big baby, an animated diorama three stories high.

## Speed Kings Tune Up

SPEED records have gone to smash for six consecutive years on the Indianapolis track and the world's greatest racing drivers figure they'll have to average 120 miles an hour to win this year. More than thirty cars, ranging from four-cylinder speedsters to powerful twin eights are after the May 30 prize money. Preview them in the May issue.

## Pitching Secrets

ONE day last summer Monte Pearson went to the mound for the world champion Yankees feeling he couldn't pitch a ball. He shut out Cleveland without a hit. The fast ball has made big league baseball a slugger's game and changed the pitcher's art. Pearson offers many a tip in a signed story, "Secrets of a World Champion Pitcher," appearing next month.





Starting the engine of your car throws a thousand piston strokes into action. Unless complete lubrication is INSTANTANEOUS, these sledge hammer-like blows fall on bare metal. Serious wear and damage to vital parts result. Pyroil assures immediate and positive lubrication for this emergency. It gives you continuous protection!



Cars made with greater precision than ever before—clearances less than ever between surfaces of swift moving engine parts—these conditions tax lubrication to provide complete protection against damage.

Pyroil is a unique, unmatched oiliness product with special, exclusively blended ingredients that far excel in lubrication efficiency. In either new car or old, it gets between closest fittings. Just a few ounces in gas tank and crankcase are swiftly carried to every vital frictionized surface of your engine. There, Pyroil establishes its slippery, friction defeating, wear resisting film of super lubrication. This special film does not drain away. It gives you immediate lubrication at the first turn of the engine. Gives you easier starting. Gets in its good work from the first piston stroke on.

Pyroil's greater oiliness content keeps metal heating down. It prevents corrosive (acid, high-temperature) attack and wear on bearings and other surfaces. Wonderfully smooths operation. Increases power. Reduces operation costs.

Pyroil costs only pennies to use. Just a few ounces in gas tank and crankcase will constantly cushion the thousands of hammer blows pounding in your engine. It saves you money. Ask for a Pyroil treatment today at your favorite service station or garage. Or, mail coupon. Manufactured and Guaranteed by Pyroil Company, W. V. Kidder, Founder, 54 Pyroil Bldg., La Crosse, Wisconsin.

**NOTHING FINER FOR  
NON-ABRASIVE NEW  
CAR BREAK IN!**

**DISTRIBUTORS:  
CHECK AND MAIL  
COUPON FOR FRAN-  
CHISE FACTS.**



**SIMPLY  
ADD TO  
GAS & OIL**

**PYROIL COMPANY**  
 54 Pyroil Bldg., La Crosse, Wisconsin.  
 Please tell me how I can expect Pyroil to benefit the car I drive and save me money. I drive a \_\_\_\_\_ (year) \_\_\_\_\_  
 Also send details of your plan for Distributors.  
 Name \_\_\_\_\_  
 Address \_\_\_\_\_  
 City \_\_\_\_\_ County \_\_\_\_\_ State \_\_\_\_\_

(Contents—Continued)

**AUTOMOTIVE**

Three-wheel auto has air-cooled engine ..... 485  
 Spare tire connection inflates from outside ..... 492  
 Pneumatic tire mounting tool ..... 495  
 Mobile fuel tester traps gasoline cheaters ..... 513  
 Windshield area tested by electric-light eye ..... 524  
 Check up on your driving ..... 526  
 Lighted mirror and vanity kit for driver ..... 538  
 Six-cylinder motorcycle gives smooth ride ..... 540  
 Amber cover for headlight lens ..... 544  
 "Elephant trains" at exposition ..... 545  
 "Marsh buggy" has welded steel tires ..... 551  
 Speed governor allows full power for uphill ..... 556  
 Handfuls of speed ..... 558  
 Changes needed in auto designs to stop noise ..... 560  
 Fuel economizers help governors save gas ..... 566  
 Tractor vacuum cleans beach sand ..... 571  
 Grooves in center of road deflect cars ..... 572  
 Neon sign identifies police car ..... 576  
 Fuel for auto engine made of ammonia ..... 114A

**AVIATION**

Amphibion to aid pilots down at sea ..... 485  
 Periscope in floor of plane ..... 495  
 Quick-righting fliers' compass ..... 518  
 Attack bomber most versatile military plane ..... 519  
 Wood-plastic propeller blades save engine power ..... 524  
 Position-finding protractor for air pilot ..... 529  
 Double-slot wing flaps promote safer flight ..... 544  
 Radio echoes to help make aerial maps ..... 544  
 Non-icing carburetor assures constant flow ..... 556  
 "Free-wheeling" plane propeller ..... 128A

**HOUSEHOLD**

Electric beverage mixer "bounces" glass ..... 486  
 Bed folds into attractive chest ..... 492  
 Illuminated switch plate ..... 494  
 Electric stove for office cooks entire meal ..... 496  
 Paintbrush with curved handle for corners ..... 513  
 Flexible steam-cooker cover fits under rim ..... 528  
 Electric plug with teeth "bites" into cord ..... 530  
 Glass furniture for modern home ..... 531  
 Screen door storm panel blocks winter drafts ..... 538  
 Seamless rubber shower bath receptor ..... 538  
 Automatic dishwasher run by water power ..... 540  
 Automatic keyhole lock ..... 544  
 Draftproof ventilation for baby's crib ..... 544  
 Thermostatic valve for radiator saves heat ..... 556  
 Beater with twin-speed gear ..... 567  
 Drain cleaner uses hot water and air pressure ..... 568  
 Washing machine with retractable legs ..... 571  
 Mirror worn like a necklace ..... 576

**PHOTOGRAPHY**

Electric "welder" irons photo in album ..... 528  
 Accordion file for photo negatives ..... 556  
 Dustproof film drying tube ..... 572  
 Photo bulbs flash hundreds of times ..... 576

**RADIO AND ELECTRICITY**

Sound bouncing from audience affects tone ..... 492  
 Electricity produced by gas operates heater control ..... 494  
 Staticless radio promised by short-wave system ..... 496  
 Parabolic ceiling reflector distributes light evenly ..... 530  
 Auxiliary mercury bulbs on light unit ..... 572  
 Combination panel for S-W receiver ..... 577  
 Three-unit broadcast set for beginners ..... 578  
 One all-wave antenna serves twenty receivers ..... 580  
 Practical radio suggestions ..... 581  
 Five and ten-meter receiver ..... 582  
 Inter-communication unit of compact design ..... 582  
 Long and short television tubes ..... 582  
 Record player and amplifier ..... 582

**SCIENCE AND INDUSTRY**

Chlorophyll in plants measured ..... 486  
 Transparent book on series of plastic pages ..... 486  
 "Robot eye" reproduces defective vision ..... 493  
 Fingerprinting thought waves on paper tape ..... 518  
 Short-wave radio cannon shoots heavy atoms ..... 529  
 Photo-electric cell controls steelmaking ..... 530  
 Million-volt X-ray pillbox to treat cancer ..... 532  
 Scale forming in water pipes prevented ..... 540  
 Electric detective uncovers secrets of sleep ..... 545  
 Mountain top blasted to open copper mine ..... 561  
 From sirup to yarn the story of rayon ..... 569

**SHIPS AND SHIPPING**

Amphibian auto seats three persons ..... 519  
 300-mile railway to carry ships is planned ..... 539

(Continued to page 6A)

will appear 22 May 1939





# Yours for better engine performance

In addition to Sillimanite insulators, Champions are the only spark plugs with Sillment construction, a compressed dry powder, which permanently seals them against troublesome leakage common to ordinary spark plugs. This patented and exclusive Champion feature insures perfectly uniform combustion in every cylinder, eliminates pre-ignition, service troubles, compression loss and early electrode destruction. This results in greater economy and marked improvement in all around engine performance. They are the spark plugs champions use.

**IT'S THRIFTY TO INSTALL NEW SPARK PLUGS—DEMAND CHAMPIONS**



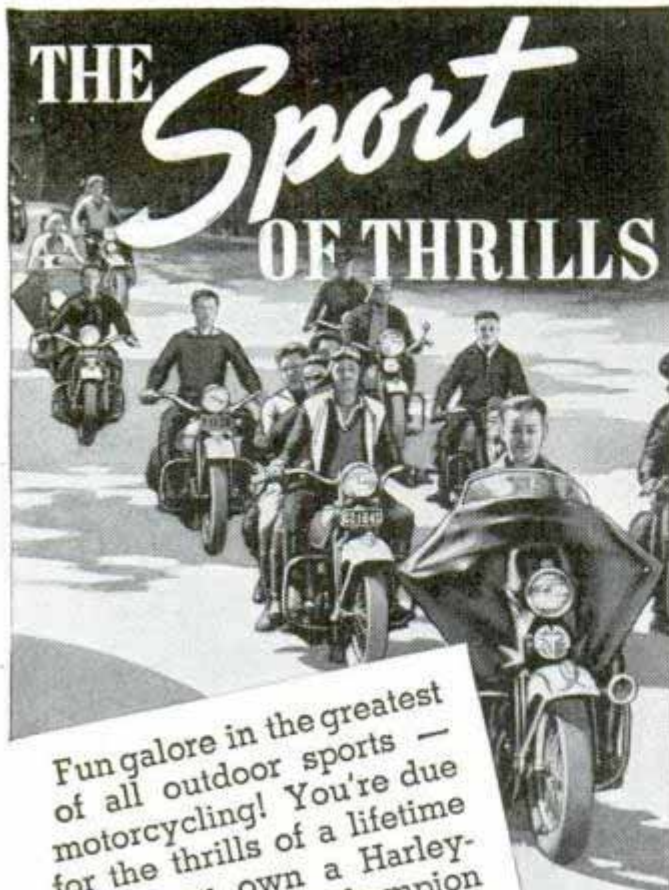

# THE Sport OF THRILLS

Fun galore in the greatest of all outdoor sports — motorcycling! You're due for the thrills of a lifetime when you own a Harley-Davidson, world's champion motorcycle. Join a live-wire riders' club. Make new friends and ride with them on club tours, reliability and endurance runs. Take in hillclimbs, tourist trophy races, speed events, and other interesting affairs. See your Harley-Davidson dealer — take a free ride on one of these staunch mounts — learn the thrill of motorcycling — ask about his Easy Pay Plans. And send coupon NOW!

**HARLEY-DAVIDSON**  
WORLD'S CHAMPION MOTORCYCLE  
**DAVIDSON**



HARLEY-DAVIDSON MOTOR CO.  
Dept. P. Milwaukee, Wisconsin

Send illustrated literature and FREE copy of "ENTHUSIAST", Motorcycling Magazine. Stamp is enclosed for mailing cost.

Name.....

Address.....

## (Contents—Continued)

|  |     |
|--|-----|
| Tender and mailman to the harbor lights.....   | 557 |
| Nonmagnetic ship built without steel.....      | 568 |
| Ships floated in drydock are not launched..... | 570 |

### SPORTS

|   |     |
|---|-----|
| Mileage meter on roller skate.....                  | 494 |
| Stop light on putter signals incorrect swing.....   | 494 |
| Projector throws bowling scores on screen.....      | 528 |
| Casting reel for fishermen eliminates backlash..... | 576 |

### TOOLS

|  |     |
|--|-----|
| Key cutter makes duplicates by code..... | 530 |
| Micrometer with automatic feel.....      | 566 |
| Portable hydraulic pipe bender.....      | 567 |

### MISCELLANEOUS

|   |     |
|---|-----|
| Elephants are shaved with a blowtorch.....        | 487 |
| Fan-shaped megaphone spreads voice farther.....   | 492 |
| Arms used as feelers in the dark.....             | 493 |
| Diamond in capitol floor guarded by sound.....    | 518 |
| "Robot" breaks in your pipe.....                  | 518 |
| Gasproof perambulator.....                        | 524 |
| Engineer visions underground torpedo-trains.....  | 525 |
| Disk brakes for streamliners.....                 | 533 |
| Piano with double keyboard.....                   | 533 |
| Paper tear-gas bomb will not wound.....           | 537 |
| Non-reflecting lamp eliminates "sun phantom"..... | 538 |
| Air compressor gets power from own heat.....      | 539 |
| Portable typewriter table in a suitcase.....      | 540 |
| Film record guides hand of robot.....             | 550 |
| Optician fits dog with specs.....                 | 551 |
| Prehistoric monsters in Dinosaur park.....        | 551 |
| Newsreels shown by vending machine.....           | 560 |
| Sugar-cane harvester plows two rows.....          | 560 |
| Music from mixing bowls and salvaged junk.....    | 561 |
| Binocular magnifier worn on headband.....         | 566 |
| Snow shovel swings overhead to dump load.....     | 567 |
| Toy train tows target on army range.....          | 568 |
| Feeding pens for dogs prevent fighting.....       | 571 |
| Rear signal switch on gearshift ball.....         | 572 |

## Craftsman and Shop Notes

### AUTOMOTIVE

|  |     |
|--|-----|
| Motorized garage doors.....                    | 637 |
| Loose heat regulator overheats motor.....      | 639 |
| Two-step ladder pivoted to delivery truck..... | 639 |
| Battery truck improvised from spring leaf..... | 640 |
| Repairing broken window crank.....             | 640 |

### BOATS AND BOATING

|   |     |
|---|-----|
| Block helps prevent loss of outboard motor..... | 601 |
| Lantern held on boat by rubber band.....        | 602 |
| "Skipper," low-cost outboard—Part II.....       | 604 |

### FARM

|  |     |
|--|-----|
| Underground muffler for lighting-plant engine..... | 622 |
| Farm twine dispensed from burlap bag.....          | 623 |
| Fence posts anchored with cement.....              | 624 |
| Splash guard for well platform.....                | 624 |
| Building barn foundation to avoid dampness.....    | 626 |
| Smokehouse from large barrel.....                  | 632 |
| Wheel guards for hay rake.....                     | 633 |
| Seed grain duster.....                             | 634 |

### FURNITURE

|   |     |
|---|-----|
| Four-shelf bookcase in walnut.....        | 588 |
| Novel fireside bench.....                 | 593 |
| Gate-leg table folds into small unit..... | 599 |

### HAND TOOLS

|   |     |
|---|-----|
| Paper sealer from cork.....                             | 586 |
| Using two-man crosscut saw single-handed.....           | 587 |
| Rubber protects chisel handle.....                      | 590 |
| Nails held for driving with paint brush.....            | 592 |
| V-notches in vise to grip round stock.....              | 592 |
| Faucet handle operates reamer.....                      | 609 |
| Auxiliary caliper jaws to take inside measurements..... | 610 |
| "Clothespin" holds small moldings in miter box.....     | 616 |
| Cutting large pieces of sheet metal.....                | 617 |
| Angle-iron straightedge for marking pipe.....           | 620 |
| Drill stiffener for removing broken taps.....           | 624 |
| An improved bar clamp.....                              | 626 |
| Dividers set with aid of indented strip.....            | 634 |

### HOME IMPROVEMENTS

|   |     |
|---|-----|
| Flower shelves and brackets enhance home..... | 583 |
| Oil heater improved by electric fan.....      | 590 |
| New house numbers.....                        | 591 |

(Continued to page 8A)



# WHICH OF THESE MEN IS YOU?



Is This You?

OR

Is This You?



1. "My name is Stark. I'm never late mornings. I get back promptly from lunch—often work overtime cheerfully. I carefully do every single job they give me and in six years I have done each job so many times that I'm letter-perfect! Only one little raise so far, but some day I ought to get a good one. I'm probably the steadiest, most loyal employee in the whole office. One of these days the boss will realize that I'm the best man who ever worked on this job. Then I'll show these other fellows a thing or two!"

2. "My name is Baker. I've only been here a year, but the jobs they give men like Stark and me are too easy. In three months I saw I could never get far ahead on routine work like this. So I began to look for ways to increase and improve the work in my department. I'm taking home-study training that's helping me a lot. My boss heard about it and complimented me. Next month I'm going to be made Assistant Department Head at 40% more money. After that—well, we'll see. But you can bet I'm still studying!"

**D**ON'T you recognize both these men in your office? One is a slow plodder—the other an energetic go-getter. Stark thinks of himself—Baker, of his company.

Stark runs along comfortably in a rut—*hopes* for a big raise. Baker pulls himself out of ruts—*gets* a big raise. And goes right on training for *another* one!

It's men like Baker who turn to LaSalle business training because of what it *gets* them! And they know it gets them *plenty* because the proof is plain to read in the grateful letters—and the successful lives—of thousands of LaSalle graduates.

You too can join the ranks of the "comers" like Baker if you'll "train on the

job you've got—to get the job ahead!" It all depends on you—the height of your ambition and your readiness to investigate, then study systematically and seriously.

The LaSalle Success Road is cleared and ready for earnest adults—has been traveled for thirty years. Its first sign-post has always been a man's name on a coupon like the one below.

It costs absolutely nothing to send such a coupon. But sending it may mean the turning-point in your whole life. Mail it! At least *find out* about LaSalle's road to better jobs—more money—success! There's no time like *NOW!*

LASALLE EXTENSION UNIVERSITY, A Correspondence Institution  
Dept. 464-R CHICAGO

I am ambitious like Baker. Tell me how I can prepare for larger success—and send me your free booklet on the field I have checked below:

Executive Management     Law: LL.B. Degree     Salesmanship  
 Accounting     Traffic Management

Name.....Age.....

Position.....

Address.....



This One



HEYT-27W-AYJY

**LaSalle** EXTENSION UNIVERSITY  
A CORRESPONDENCE INSTITUTION





**FIX IT!**

with  
**"WOOD-IN-CANS"**

Repair loose DRAWER PULLS quickly and permanently with PLASTIC WOOD! Fixes loose casters, bathroom tiles and fixtures, too. PLASTIC WOOD handles like putty—hardens into waterproof, weatherproof wood. Get it at paint, hardware and 10¢ stores. Try it!

**PLASTIC WOOD**

**HEAVY BODY  
3-IN-ONE KEEPS  
ELECTRIC MOTORS  
ON-THE-RUN!**

RIGHT for electric refrigerators and washing machines, too! Gives electric tools longer life. LUBRICATES. CLEANS. PREVENTS RUST.

At Hardware, Drug, Grocery, 10¢ Stores.



**3-IN-ONE OIL**

(Contents—Continued)

|  |     |
|--|-----|
| Porch mailboxes .....                                    | 594 |
| Sulphur locks sagging ceiling plaster .....              | 598 |
| Circulating heated air uniformly through the house ..... | 602 |
| Fireplace screen folds inside out of the way .....       | 603 |

HOUSEHOLD

|   |     |
|---|-----|
| Motorized floor polisher .....                  | 585 |
| Window tables to hold potted plants .....       | 586 |
| Controlling width of spray in shower bath ..... | 596 |
| Fruit juicer polishes kitchenware .....         | 601 |
| Walnuts cracked without damaging meats .....    | 609 |
| Rubber balls on porch swing protect wall .....  | 616 |
| Fluff rug woven on simple loom .....            | 617 |
| Solving home problems .....                     | 618 |

HUNTING AND FISHING

|  |     |
|--|-----|
| Crimper for metal nocks on arrows .....        | 586 |
| Fisherman's fly protected by rubber ball ..... | 596 |
| Fishhook easily removed from clothing .....    | 601 |

LAWN AND GARDEN

|   |     |
|---|-----|
| Rubber tire for wheelbarrow from hose ..... | 590 |
| Marking young trees and shrubs .....        | 592 |
| Emergency transplanting tongs .....         | 596 |
| Lasting plant labels .....                  | 611 |
| Tree guard of metal lath .....              | 620 |

PHOTOGRAPHY

|  |     |
|--|-----|
| Photo prints washed rapidly .....                  | 586 |
| Cork provides grip on camera shutter release ..... | 596 |
| Ground-glass focusing with a box camera .....      | 612 |

POWER TOOLS

|  |     |
|--|-----|
| Jig to split round stock on scrollsaw .....  | 593 |
| Increasing capacity of lathe chuck .....     | 602 |
| Drill-vice milling unit on small lathe ..... | 621 |

STORES AND SHOPS

|  |     |
|--|-----|
| Jig for making lampshade frames .....            | 625 |
| Can cover holds phone safely on bench .....      | 626 |
| Apron on job press protects work .....           | 636 |
| Jig to weld mitered angle-iron frames .....      | 636 |
| Window pocket holds tags on shipping cases ..... | 636 |

WOODWORKING

|  |     |
|--|-----|
| Rack for guns and books .....              | 587 |
| Stops on sawhorse hold board on edge ..... | 610 |
| Making wood brackets easily .....          | 615 |
| Sanding floors by hand .....               | 616 |
| Adjustable tool bores wood .....           | 623 |

MISCELLANEOUS

|  |     |
|--|-----|
| Scavenging rain barrel from bottom .....                 | 585 |
| False bottom in coat pocket for valuables .....          | 586 |
| Tiny parts held on greased board .....                   | 587 |
| Cellulose tape makes celluloid ruler easy to see .....   | 590 |
| Clip on spectacle case prevents loss .....               | 590 |
| Mouse trap clamps small parts .....                      | 592 |
| Twin-propeller model plane .....                         | 592 |
| Cleaning underground pipes .....                         | 596 |
| Wall sconce in bow-and-arrow motif .....                 | 597 |
| Clips over coat sleeves keep out wind .....              | 598 |
| Driving brads through thin work .....                    | 598 |
| Soap carvings painted with sealing wax .....             | 598 |
| Music rack clips on leg .....                            | 602 |
| Simple sundial from wood and tin .....                   | 603 |
| Extra straps on brief case carry packages .....          | 609 |
| Automatic light for record-playing machine .....         | 610 |
| Coaster has drag brake for quick stops .....             | 611 |
| Non-slip feet for ladder .....                           | 611 |
| Wood soles help when standing on ladder .....            | 615 |
| Locating lock strike plate easily .....                  | 616 |
| Hotel communicating system .....                         | 623 |
| Lantern bail held up by rubber hose .....                | 624 |
| Rubber rollers to move roofing ladder easily .....       | 626 |
| Building and using a wattmeter .....                     | 627 |
| Painting signs in two colors at one time .....           | 632 |
| Signal detects buried pipes when drilling concrete ..... | 632 |
| Sign painter's palette from muffin tin .....             | 632 |
| Putty carried on paint pail .....                        | 633 |
| Rubber strip improves chopping block .....               | 633 |
| Singeing elevator rope to remove fibers .....            | 633 |
| Wings on signal lantern convert it to flasher .....      | 633 |
| Scale in drawing board is useful .....                   | 634 |
| Connecting pipes to a tank .....                         | 636 |

IMPORTANT NOTICE

It is the intention of this magazine to provide its readers with information regarding the latest developments in the mechanical arts. We take no responsibility as to whether the disclosures contained in our articles are covered by patents and advise readers to investigate this subject before making, using, or selling any of the products, machines, or processes described, in order to avoid possible liability for patent infringement.





# FOOD IN BOTH HANDS!

Lunch box in one hand, I.C.S. textbook in the other—all over this country today there are men who will devote those extra moments at the lunch hour to learning something that will help them on their present jobs—something that will help them prepare for the bigger, better paying jobs up the ladder. International Schools offer training courses prepared by experts, and taught by instructors who are personal counselors to their students. This evening over 100,000 ambitious men will absorb benefits from this forty-eight-year-old educational institution.

## INTERNATIONAL CORRESPONDENCE SCHOOLS

BOX 5544-J, SCRANTON, PENNA.

★ Without cost or obligation, please send me a copy of your booklet, "Who Wins and Why," and full particulars about the subject *before* which I have marked X: ★

### TECHNICAL AND INDUSTRIAL SUBJECTS

- |  |   |   |  |   |
|--|---|---|--|---|
| <input type="checkbox"/> Agriculture                     | <input type="checkbox"/> Air Brakes               | <input type="checkbox"/> Civil Engineering        | <input type="checkbox"/> Manufacture of Pulp Paper | <input type="checkbox"/> Sanitary Engineering       |
| <input type="checkbox"/> Air Conditioning and Cooling    | <input type="checkbox"/> Coal Mining              | <input type="checkbox"/> Contracting and Building | <input type="checkbox"/> Marine Engineering        | <input type="checkbox"/> Sheet Metal Work           |
| <input type="checkbox"/> Architectural Drafting          | <input type="checkbox"/> Cotton Manufacturing     | <input type="checkbox"/> Diesel Engineering       | <input type="checkbox"/> Mechanical Drafting       | <input type="checkbox"/> Steam Electric Engineering |
| <input type="checkbox"/> Architecture                    | <input type="checkbox"/> Electrical Engineering   | <input type="checkbox"/> Electric Lighting        | <input type="checkbox"/> Mine Foreman              | <input type="checkbox"/> Steam Engineering          |
| <input type="checkbox"/> Auto Electric Technician        | <input type="checkbox"/> Fire Bosses              | <input type="checkbox"/> Fruit Growing            | <input type="checkbox"/> Navigation                | <input type="checkbox"/> Steam Fitting              |
| <input type="checkbox"/> Auto Technician                 | <input type="checkbox"/> Heating                  | <input type="checkbox"/> Heat Treatment of Metals | <input type="checkbox"/> Patternmaking             | <input type="checkbox"/> Structural Drafting        |
| <input type="checkbox"/> Aviation Engineering            | <input type="checkbox"/> Highway Engineering      | <input type="checkbox"/> House Planning           | <input type="checkbox"/> Pharmacy                  | <input type="checkbox"/> Structural Engineering     |
| <input type="checkbox"/> Boilermaking                    | <input type="checkbox"/> House Planning           | <input type="checkbox"/> Machinist                | <input type="checkbox"/> Plumbing                  | <input type="checkbox"/> Surveying and Mapping      |
| <input type="checkbox"/> Bridge and Building Foremanship | <input type="checkbox"/> Management of Inventions | <input type="checkbox"/> Poultry Farming          | <input type="checkbox"/> Public Works Engineering  | <input type="checkbox"/> Telegraph Engineering      |
| <input type="checkbox"/> Bridge Engineering              |   | <input type="checkbox"/> Radio                    | <input type="checkbox"/> R. R. Locomotives         | <input type="checkbox"/> Telephone Work             |
| <input type="checkbox"/> Building Estimating             |   | <input type="checkbox"/> R. R. Section Foreman    | <input type="checkbox"/> R. R. Signalmen           | <input type="checkbox"/> Toolmaking                 |
| <input type="checkbox"/> Chemistry                       |   | <input type="checkbox"/> Refrigeration            | <input type="checkbox"/> Welding, Electric and Gas | <input type="checkbox"/> Ventilation                |

### BUSINESS SUBJECTS

- |  |  |   |  |   |                                  |
|--|--|---|--|---|----------------------------------|
| <input type="checkbox"/> Accounting              | <input type="checkbox"/> Advertising                 | <input type="checkbox"/> College Preparatory  | <input type="checkbox"/> Grade School Subjects | <input type="checkbox"/> Railway Postal Clerk   | <input type="checkbox"/> Signs   |
| <input type="checkbox"/> Bookkeeping             | <input type="checkbox"/> Cost Accounting             | <input type="checkbox"/> C. P. Accounting     | <input type="checkbox"/> High School Subjects  | <input type="checkbox"/> Salesmanship           | <input type="checkbox"/> Spanish |
| <input type="checkbox"/> Business Correspondence | <input type="checkbox"/> First Year College Subjects | <input type="checkbox"/> Foremanship          | <input type="checkbox"/> Illustrating          | <input type="checkbox"/> Secretarial Work       |                                  |
| <input type="checkbox"/> Business Management     | <input type="checkbox"/> French                      | <input type="checkbox"/> Managing Men at Work | <input type="checkbox"/> Lettering Show Cards  | <input type="checkbox"/> Stenography and Typing |                                  |
| <input type="checkbox"/> Cartooning              | <input type="checkbox"/> Civil Service               |   | <input type="checkbox"/> Traffic Management    |   |                                  |

### DOMESTIC SCIENCE SUBJECTS

- |   |   |  |
|---|---|--|
| <input type="checkbox"/> Advanced Dressmaking | <input type="checkbox"/> Home Dressmaking                       | <input type="checkbox"/> Tea Room and Cafeteria Management, Catering |
| <input type="checkbox"/> Foods and Cookery    | <input type="checkbox"/> Professional Dressmaking and Designing |  |

Name..... Age..... Address.....  
 City..... State..... Present Position.....

Canadian residents send coupon to International Correspondence Schools Canadian, Limited, Montreal, Canada  
 British residents send coupon to I. C. S., 71 Kingsway, London, W. C. 2, England



**THINK** ... of the thousands of planes **NOW**



... and the thousands **MORE TO COME**

That *You* can learn to *Design-Build-Maintain*

THINK all this over . . . in relation to *your future*:

- ✈ ---Airlines are growing fast . . . in size, numbers and miles flown.
- ✈ ---Public and private airports are beehives of activity.
- ✈ ---Aircraft plants face a huge military aircraft building program.
- ✈ ---Big backlogs of orders already piled up amount to years of production ahead.

Isn't this real food for thought? In some branch of Aviation, isn't there a place for you, and a big future?

Get this **FREE BOOKLET** . . .



. . . and find out about Aero I.T.I. training for Aeronautical Engineering and Airplane or Engine Mechanics work. Aero I.T.I. training gives you actual practice in the very duties you must understand and perform. You may start your course at home or take a full-time course at the school. For complete information, and free booklet, send the coupon NOW.

**EXECUTIVE BOARD**

|  |   |   |
|--|---|---|
| <b>C. A. VAN DUSEN</b><br>Vice-Pres. Consolidated Aircraft Corporation | <b>JOHN K. NORTHROP</b><br>formerly Pres. The Northrop Corp., and Vice-Pres. Douglas Aircraft Co., Inc. | <b>ROBERT E. GROSS</b><br>Pres. Lockheed Aircraft Corporation |
|--|---|---|

**Aero Industries Technical Institute**  
5253 West San Fernando Road, Los Angeles, Calif.  
*U. S. Civil Aeronautics Authority Approved School*

Please send free booklet on Aviation and Aero I.T.I. training. I am interested in the line of work checked below:

Aircraft Mechanics                       Aeronautical Engineering  
 Undecided. Please send more information.

Years of High School:     None;     1;     2;     3;     4.  
Years of Jr. College or College:     1;     2;     3;     4.

NAME \_\_\_\_\_ AGE \_\_\_\_\_

ADDRESS \_\_\_\_\_

CITY \_\_\_\_\_ STATE \_\_\_\_\_ a-16-p

**ELECTRICAL ENGINEERING**

★ **ONE YEAR Residence Course**  
**Prepares You for Technical Positions**

Thorough training in minimum time. Combines theory with practical work in well-equipped laboratories. Experienced faculty and complete facilities provide training essential for technical careers. High employment record is industry's endorsement of Bliss training. Thousands of successful graduates. Suburban campus; modern buildings; dormitory; dining hall. 47th year begins Sept. 27. CATALOG. Give age.



**BLISS ELECTRICAL SCHOOL**  
134 Takoma Ave., Washington, D. C.

**GET INTO THE BAKING BUSINESS!**

● National Baking Institute announces a new home study course in commercial baking. Baking now America's fifth industry in wages. Nearly a depression-proof business. Good field for ambitious men. Common school education sufficient. Send for free booklet "Opportunities in Commercial Baking" and requirements.

**National Baking Institute**  
3601 Michigan Ave. Dept. 1354 Chicago, U. S. A.



**LAW**

**STUDY AT HOME** for Personal Success and Larger Earnings. 28 years of successful student guidance assures expert instruction. LL.B. Degree awarded. All text material furnished. Easy payment plan. Send for **FREE BOOK**—"Law and Executive Guidance," at ONCE.

**AMERICAN EXTENSION SCHOOL OF LAW**  
Dept. T-4, 737 N. Michigan Ave., Chicago, Ill.

**CARTOON YOUR WAY TO SUCCESS!**



**DON'T COPY - LEARN TO ORIGINATE!**

**RAYE BURNS** will teach you **HOW TO CREATE ORIGINAL CARTOONS** at home that you can **SELL!** Course has 26 lessons and 600 illustrations. **\$2.85**  
Send name and address for free details. Only....

**RAYE BURNS SCHOOL, Dept. M-F, Box 2194, CLEVELAND, OHIO**

**EARN A DEGREE AT HOME**  
**From A Chartered Institution of Higher Learning**

Home Study Courses leading to Degrees in Arts; Sciences; Philosophy; Education; Public Health; Psychology; Sociology; Physics; Chemistry; Geology; Pol. Science; Theology; Law; Business Training; Accounting; Statistics; Adv.; Agriculture; Sales; Electrical, Civil, Mechanical, Drafting, Architectural, Automotive, Steam, Diesel, Aeronautical, Radio, Structural, Industrial, Highway, Petroleum, Mining, Marine, Refrigeration, Air Conditioning, Chemical Engineering. Founded 1908. Chartered. **McKinley-Roosevelt Graduate College, 4213 Clarendon Ave., Chicago**

**DIESEL**

Get **BETTER** training. Realize Adcox advantages. Located in Pacific Northwest, a Diesel center. Established 28 years. Modern equipment, expert instructors. Close cooperation for YOUR success. Earn room and board while learning. Send for **FREE** big 40-page Diesel School Catalog No. 14. Home Study and Resident Courses.

**L. L. ADCOX TRADE SCHOOL**  
Portland Oregon

**SEVEN WONDERS of the WORLD**

**FREE**

Pictured in **FULL COLOR**—Each 7 1/4 x 10 1/4". Send only 10c to cover mailing costs. The wonders you have longed to see, reconstructed from recent discoveries and painted by famous artists, so you can view them at the height of their glory and read their stories. 24 page booklet. Educational! Entertaining! Mail 10c to

**WM. H. WISE & CO., Dept. 564, 57 West 47th Street, New York City.**



# On His Record— Which Man Would YOU Hire?

| ELECTRICAL ENGINEERING               |  | Book Sent | Exam. Ret'd | ELECTRICAL ENGINEERING               |          | Book Sent | Exam. Ret'd | %  |
|--------------------------------------|--|-----------|-------------|--------------------------------------|----------|-----------|-------------|----|
| Subject                              |  |           |             | Subject                              |          |           |             |    |
| Wiring                               |  |           |             | Wiring                               |          |           |             |    |
| Batteries                            |  |           |             | Batteries                            | 14.35    | 5.2.35    |             | 87 |
| Electrical Appliances                |  |           |             | Electrical Appliances                | 14.35    | 6.18.35   |             | 90 |
| Meters                               |  |           |             | Meters                               | 5.2.35   | 8.1.35    |             | 83 |
| Principles of Motors and Generators  |  |           |             | Principles of Motors and Generators  | 5.20.35  | 8.17.35   |             | 85 |
| Maintenance of Motors and Generators |  |           |             | Maintenance of Motors and Generators | 6.18.35  | 9.27.35   |             | 91 |
| Armature Winding                     |  |           |             | Armature Winding                     | 1.35     | 11.9.35   |             | 89 |
| Power Station and Equipment          |  |           |             | Power Station and Equipment          |          | 1.4.36    |             | 92 |
| Diesel Electric Plants               |  |           |             | Diesel Electric Plants               |          | 2.10.36   |             | 82 |
| Practical Mathematics                |  |           |             | Practical Mathematics                |          | 3.30.36   |             | 84 |
| Mechanical Drawing                   |  |           |             | Mechanical Drawing                   |          | 5.9.36    |             | 94 |
| Electrical Layouts                   |  |           |             | Electrical Layouts                   |          | 8.29.36   |             | 88 |
| Practical Physics                    |  |           |             | Practical Physics                    | 5.9.36   | 10.4.36   |             | 91 |
| Elements of Electricity              |  |           |             | Elements of Electricity              | 8.29.36  | 11.20.36  |             | 80 |
| First Year Algebra                   |  |           |             | First Year Algebra                   | 10.4.36  | 12.3.36   |             | 94 |
| Plane Geometry                       |  |           |             | Plane Geometry                       | 11.20.36 |           |             | 86 |
| Trigonometry                         |  |           |             | Trigonometry                         |          | 5.26.37   |             | 81 |
| Industrial Electricity               |  |           |             | Industrial Electricity               | 3.18.37  | 8.10.37   |             | 79 |
| Alternating-Current Electricity      |  |           |             | Alternating-Current Electricity      | 5.26.37  | 12.20.37  |             | 83 |
|                                      |  |           |             |                                      | 8.10.37  | 3.22.38   |             | 85 |

*Not Started*

*Graduated*

**You Are Hired on YOUR Record—**

**Employers Want to Know, Are YOU Prepared for Promotion**

Your own ability to hold the better jobs depends entirely on the preparation you have made to accept the opportunities offered every month in the year in the active fields of today such as Air Conditioning, Diesel Engineering, Drafting and Design, etc. Men in these fields and others with preparation as accountants and in merchandising are being advanced into such openings as department heads, managers, foremen, superintendents, travelling auditors, etc.

Your opportunity today simply means being ready for the good jobs looking for good men—your chance for a worthwhile position depends on whether or not you will prepare to meet the demands of employers all over the country who are offering the big jobs to men who can handle them!

Without training a man is no more valuable at 40 than at 30, is old at 50. But the doctor at 40 or 50 is a better doctor than he was at 30—and it's the same with

men trained in other fields—executives, draftsmen, engineers, merchants, architects are young at 40, at 50—and still have many good pay years ahead. Promotion, increased pay, reward properly prepared men!

American School, an educational institution incorporated "not for profit," has used for over 40 years a direct and practical method for preparing men to handle the bigger jobs in business and industry.

American School graduates hold important positions as engineers, accountants, experts, draftsmen, managers, etc., or successfully operate their own business. Thousands of our High School graduates have entered colleges, universities, normal schools, etc., have attained success in business or industry.

Find out how American School can help YOU, the difference it may make in your entire future success and happiness! Mail coupon today for free Bulletin and early lesson in field of your choice. No obligation on your part.

**American School, Dept. G445, Drexel Ave. at 58th St., Chicago**

Cut Along This Line

**Try a Lesson Yourself—No Obligation**

**American School, Dept. G445, Drexel Ave. at 58th St., Chicago**

I have checked the line of work in which I would like a good job. Please send me without expense or obligation on my part a copy of your Bulletin and an early lesson in the field I have selected.

- |  |   |   |
|--|---|---|
| <input type="checkbox"/> Air Conditioning                | <input type="checkbox"/> Electrical Engineering         | <input type="checkbox"/> Law                    |
| <input type="checkbox"/> Architecture                    | <input type="checkbox"/> Diesel Engineering             | <input type="checkbox"/> Liberal Arts (College) |
| <input type="checkbox"/> Automotive Engineering          | <input type="checkbox"/> Drafting and Designing         | <input type="checkbox"/> Mechanical Engineering |
| <input type="checkbox"/> Automobile Repairing            | <input type="checkbox"/> Electric Refrigeration         | <input type="checkbox"/> Merchandising          |
| <input type="checkbox"/> Bookkeeping and Cost Accounting | <input type="checkbox"/> Heating, Ventilating, Plumbing | <input type="checkbox"/> Private Secretary      |
| <input type="checkbox"/> Business Management             | <input type="checkbox"/> Professional Accounting        | <input type="checkbox"/> Radio and Television   |
| <input type="checkbox"/> Civil Engineering               | <input type="checkbox"/> Incl. C. P. A. Coaching        | <input type="checkbox"/> Salesmanship           |
| <input type="checkbox"/> Aviation                        | <input type="checkbox"/> High School                    | <input type="checkbox"/> Shop Practice          |
| <input type="checkbox"/> Contracting, Building           | <input type="checkbox"/> Highway Engineering            | <input type="checkbox"/> Shop Management        |
|  |   | <input type="checkbox"/> Steam Engineering      |

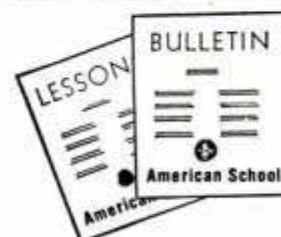

Name.....Age.....Occupation.....

Street.....City.....State.....



# Will You Give Me 7 Days to PROVE I Can Make YOU a New Man?

LET ME START SHOWING YOU RESULTS LIKE THESE



## 7-DAY TRIAL OFFER

I could fill this magazine with enthusiastic reports from OTHERS. But what you want to know is—"What can Charles Atlas do for ME?"

Find out—at my risk! Right in the first 7 days I'll start to PROVE I can turn YOU into a man of might and muscle. And it will be the kind of PROOF you (and anyone else) can SEE, FEEL, MEASURE with a tape.

## FREE BOOK

I myself was once a 97-pound weakling—sickly, half-alive. Then I discovered "Dynamic Tension." And I twice won the title, "The World's Most Perfectly Developed Man!"

I have no use for apparatus. "Dynamic Tension" ALONE (right in your own home) will make you the powerful, muscular NEW MAN you have always longed to be!

Make me PROVE IT! Gamble a postage stamp. Send coupon for my FREE BOOK AT ONCE! Address me personally: Charles Atlas, Dept. 8-D, 115 East 23rd Street, New York, N. Y.

**CHARLES ATLAS, Dept. 8-D**  
115 East 23rd Street, New York, N. Y.

I want proof that DYNAMIC TENSION will make a new man of me—give me a healthy, husky body and big muscle development. Send me your free book, "Everlasting Health and Strength"—and full details of your 7-DAY trial offer.

Name.....  
(Please print or write plainly)  
Address.....  
City..... State.....



# EASY TO PLAY — EASY TO OWN



You've always wanted to play this fascinating instrument. Now there is no reason to delay. Now you may thrill family and friends, with a chance to earn extra cash at dances, entertainments and on the radio. For now there is a genuine DEAGAN Marimba (including complete, easy lessons) at the lowest price in history. . . . To write for details TODAY may easily mean a LIFE-TIME of pleasure, profit and popularity!

J. C. DEAGAN, Inc., 3454 Deagan Building, CHICAGO

## Big PAY in AVIATION



Be a Transport Pilot, an Airplane Mechanic or Aeronautical Engineer! Aviation pays Pilots up to \$6000 a year! Airplane Mechanics also get good pay! You can train at this LINCOLN GOVERNMENT APPROVED SCHOOL for a good-pay position in Aviation. Train here on fast modern airplanes; repair and overhaul aircraft motors; help design and build real airplanes. We teach you how and assist Graduates in locating positions. Part-time employment for board and room while training. WRITE TODAY for complete information. LINCOLN AIRPLANE & FLYING SCHOOL 564 Aircraft Bldg., Lincoln, Nebraska

## Learn To MOUNT BIRDS

### TAN SKINS—MAKE UP FURS

Be a Taxidermist. We teach you at Home, Mount Birds, Animals, Pets, Heads, Fish. Save your hunting trophies. Decorate home and den. Make Money. Mount and tan for others. Fun and Profit! Don't delay. WRITE TODAY—NOW—for FREE BOOK with 100 game pictures. Hunters, get your copy. It's Now Free. Send post card. State your AGE. N. W. School of Taxidermy, 3374 Elwood Bldg., Omaha, Nebr.



Free Book shows you how to

**DOES BEEKEEPING PAY?**

**MAKE MONEY with HONEY**

**NICE SIDE INCOMES BEING MADE BY KEEPING BEES.**

We supply everything in Beginners' Outfits at a small cost. Write for free booklet "Does Beekeeping Pay?" containing 30 letters from beekeepers. New catalog full of beekeeping information. Gleanings in Bee Culture 64-pages. New readers, 6 months 25 cents. The A. I. Root Co., Dept. M-27, Medina, O.

## do-it-with-squabs

Ready for market ONLY 25 DAYS OLD. Write a post-card, get FREE EYE-OPENING PICTURE BOOK. Why breed for ordinary trade when these great luxury national markets are wide open for all the SQUABS you can ship, every day in the year? Go after this desirable, profitable trade now. RICE FARM, 636 H St., Melrose, Mass.

**Best Poultry Paper 6 BIG ISSUES 10¢**

Helps Increase Poultry Profits. Send coin or stamps. 50 cents for 3 years or 10 cents for 6 months trial. Agents wanted. American Poultry Journal 632 So. Clark Street Chicago, Illinois

**EARN and BIG PROFITS**

**FREE SUITS AS BONUS**

**SELL MADE-TO-MEASURE CLOTHES**

Do you know a dozen or two men to whom you can sell fine, Made-to-Measure Suits if you show them BIG Savings? If you do, you can make easy money for yourself and get your own clothes FREE of cost as a Bonus. No experience needed. Work spare time. Every garment made-to-measure. Guaranteed to fit and satisfy. Beautiful outfit—100 Big Samples—Style Plates sent FREE. Write TODAY! JIM FOSTER, INC. 2250-56 So. Spaulding Ave. Dept. 24, Chicago, Illinois

**\$14.95 UP**



# HE THOUGHT HE WAS LICKED—THEN A TIP GOT BILL A GOOD JOB!

MY RAISE DIDN'T COME THROUGH MARY—I MIGHT AS WELL GIVE UP. IT ALL LOOKS SO HOPELESS.

IT ISN'T HOPELESS EITHER, BILL. WHY DON'T YOU TRY A NEW FIELD LIKE RADIO?

TOM GREEN WENT INTO RADIO AND HE'S MAKING GOOD MONEY, TOO. I'LL SEE HIM RIGHT AWAY.

BILL, JUST MAILING THAT COUPON GAVE ME A QUICK START TO SUCCESS IN RADIO. MAIL THIS ONE TONIGHT

TOM'S RIGHT—AN UNTRAINED MAN HASN'T A CHANCE. I'M GOING TO TRAIN FOR RADIO TOO. IT'S TODAY'S FIELD OF GOOD PAY OPPORTUNITIES

TRAINING FOR RADIO IS EASY AND I'M GETTING ALONG FAST— SOON I CAN GET A JOB SERVICING SETS— OR IN A BROADCASTING STATION

THERE'S NO END TO THE GOOD JOBS FOR THE TRAINED RADIO MAN

YOU SURE KNOW RADIO—MY SET NEVER SOUNDED BETTER

THAT'S \$15 I'VE MADE THIS WEEK IN SPARE TIME

THANKS!

I HAVE A GOOD FULL TIME RADIO JOB NOW--AND A BRIGHT FUTURE AHEAD IN RADIO

OH BILL, IT'S WONDERFUL YOU'VE GONE AHEAD SO FAST IN RADIO.

## I'LL TRAIN YOU AT HOME In Your Spare Time For A GOOD RADIO JOB

**Many Radio Experts Make \$30, \$50, \$75 a Week**

Radio broadcasting stations employ engineers, operators, station managers and pay well for trained men. Fixing Radio sets in spare time pays many \$200 to \$500 a year—full time jobs with Radio jobbers, manufacturers and dealers as much as \$30, \$50, \$75 a week. Many Radio Experts open full or part time Radio sales and repair businesses. Radio manufacturers and jobbers employ testers, inspectors, foremen, engineers, servicemen, in good-pay jobs with opportunities for advancement. Automobile, police, aviation, commercial Radio, loudspeaker systems are newer fields offering good opportunities now and for the future. Television promises to open many good jobs soon. Men I trained have good jobs in these branches of Radio. Read how they got their jobs. Mail coupon.



**J. E. SMITH, President National Radio Institute**  
Established 25 years  
He has directed the training of more men for Radio than anyone else.

### HERE'S PROOF THAT MY TRAINING PAYS



**Broad-cast Operator After Twenty Lessons**

**\$10 to \$25 a Week in Spare Time**



"When I had completed the first twenty lessons I had obtained my license as Radio Broadcast Operator and immediately joined the staff of WMPC, where I am now Chief Operator."  
—HOLLIS F. HAYES, 85 Madison St., Lapeer, Mich.

"I am making from \$10 to \$25 a week in spare time while still holding my regular job as a machinist. I owe my success to N. R. I."—W.M. F. RUPP, 203 W. Front St., West Conshohocken, Pa.



**\$3,500 a Year in Own Business**

"After completing the N. R. I. Course I became Radio Editor of the Buffalo Courier. Later I started a Radio service business of my own, and have averaged over \$3,500 a year."  
T. J. TELAAK, 657 Broadway, Buffalo, N. Y.



### Many Make \$5, \$10, \$15 a Week Extra in Spare Time While Learning

The day you enroll I start sending Extra Money Job Sheets; show you how to do Radio repair jobs. Throughout your training I send plans and directions that made good spare time money—\$200 to \$500—for hundreds, while learning. I send you special Radio equipment to conduct experiments and build circuits. This 50-50 method of training makes learning at home interesting, fascinating, practical. I ALSO GIVE YOU A MODERN, PROFESSIONAL, ALL-WAVE, ALL-PURPOSE RADIO SET SERVICING INSTRUMENT to help you make good money fixing Radios while learning and equip you for full time jobs after graduation.

### Find Out What Radio Offers You

Act Today. Mail the coupon now for "Rich Rewards in Radio." It's free to any fellow over 16 years old. It points out Radio's spare time and full time opportunities and those coming in Television; tells about my training in Radio and Television; shows you letters from men I trained, telling what they are doing and earning. Find out what Radio offers YOU! MAIL COUPON in an envelope, or paste on a postcard—NOW!

**J. E. SMITH, President, Dept. 9DP National Radio Institute, Washington, D. C.**

**J. E. SMITH, President, Dept. 9DP National Radio Institute, Washington, D. C.**

Dear Mr. Smith: Without obligating me, send "Rich Rewards in Radio," which points out the opportunities in Radio and explains your 50-50 method of training men at home to become Radio Experts. (Please write plainly.)

NAME.....AGE.....  
ADDRESS.....  
CITY.....STATE.....

**THIS FREE BOOK HAS HELPED HUNDREDS OF MEN MAKE MORE MONEY**



Now... You can enjoy a pleasant, profitable career-

# Be an ARTIST



Opportunities for trained artists in many fields!

Here's how you can plan for a real future in the pleasant and profitable field of Commercial Art. W. S. A. has been training men and women for successful Art careers since 1914. You have the same opportunity to make good. Be an Artist and be your "own boss."



## COMMERCIAL ART CARTOONING and DESIGN

Learn at Home in Your Spare Time!

### Learn to draw—Trained artists EARN \$30, \$50, \$75 WEEKLY

Our practical, proven home-study method includes all the important branches of Commercial Art in ONE complete course. New fields offer more opportunities for trained artists each year. Magazines, stores, manufacturers, newspapers, printers, etc., pay good money for art work. Our individualized instruction makes learning to draw practical for everyone to follow. No previous Art experience necessary. Free book gives all details. Mail coupon below today.

### TWO REAL ARTISTS' OUTFITS GIVEN

As soon as you enroll we send you the first of two Artists' Outfits, including Drawing Board—Paper—Pens—Paints—Brushes—Pencils—and all materials you need to start with. Later in the course you receive the more advanced outfit.

#### BETTER JOB & SALARY

—V. R. Morse of New York City, credits WSA art training for larger salary and better position. He has had many prize-winning displays.



#### \$25 Drawing for Lady

—Mrs. Goldie A. Wemmer, of Kansas has sold 125 small pictures for \$25. She credits WSA for her success in Art.



### FREE BOOK gives details!

Washington School of Art, Studio 124M  
1115—15th St., N. W., Washington, D. C.

Yes! I am interested in learning to draw. Please send me your Free Book, "Art for Pleasure and Profit."

Name.....Age.....  
Address.....  
City.....State.....

When writing please mention Popular Mechanics

## PARKS AIR COLLEGE

PARKS AIRPORT

EAST ST. LOUIS, ILL.

### Offers YOU COLLEGE and PROFESSIONAL TRAINING Majoring in AVIATION

Accredited by the Illinois Superintendent of Public Instruction. U.S. approved as a Commercial Ground and Flying School and Mechanics' School. Open to high school graduates.

FOUR courses lead to B.S. degrees in Professional Piloting, Aviation Operations, Maintenance Engineering, Aeronautical Engineering.

SIXTEEN TRAINING PLANES are used in professional flight training which prepares graduates for airline flight operations. 74% of graduates enter air transportation in North and South America. 69,000 hours flight training given, 650 hours being flown monthly.

FACULTY of 34 specialists in various fields of aviation.

1569 graduates. Enrollment limited to a total of 300.

100-acre airport, 14 buildings devoted to school purposes exclusively. Dormitories and dining hall at the College.

Summer term June 10. Send postcard for new 60-page catalog.

12th YEAR Registrar, Dept. PM-4  
PARKS AIR COLLEGE, East St. Louis, Ill.

## WANT A JOB?

### LEARN DIESEL & AUTO MECHANICS PAY LATER!

Why worry with a low-pay job? Diesel and Auto Mechanics offer you real opportunity to earn more. Learn easily, quickly. Write either school for low tuition rates. Information free! Dept. 10-4.

McSWEENEY TRADE SCHOOLS Detroit, Mich.  
Kansas City, Mo.

## New York Electrical School

Established 1902

Ask for free illustrated booklet

School

44 West 17th St., N. Y. C.



### Selected HELPFUL BOOKS

SEND NO MONEY—Sent C. O. D. Anywhere in U. S.

|   |  |
|---|--|
| <b>AIR CONDITIONING</b><br>Furnaces, Unit Heaters. \$3.00           | <b>HIGH-SPEED DIESELS</b><br>New, practical, non-technical. \$2.50                 |
| <b>AIRPLANE SERVICING</b><br>Manual. New. 1000 Pages. Illus. \$6.00 | <b>HOME GROUNDS</b><br>Furnishing. \$0.80  |
| <b>AUTO RACING</b><br>Build Midget and Other Racers. \$1.00         | <b>LEATHER MAKING</b><br>and Tanning. \$1.00                                       |
| <b>AUTO REFINISHING</b><br>Duco With Spray Gun. \$1.50              | <b>METAL SPINNING</b><br>Practical New Book. \$1.00                                |
| <b>AUTO SERVICE SHOP</b><br>Management, Money-making Ideas. \$1.50  | <b>METALLURGY</b><br>New, Metals, Alloys In Use To-Day. \$1.50                     |
| <b>BLUEPRINT READING</b><br>For Machine Trades. \$1.50              | <b>MONEY-MAKING FORMULAS</b><br>10,000 Practical. \$4.00                           |
| <b>BRICKLAYING</b><br>Plain and Fancy. \$1.50                       | <b>OIL HEATER HANDBOOK</b><br>Manufacture, Distribution, Installation, etc. \$3.50 |
| <b>BUSINESS CORRESPONDENCE</b><br>and Office Management. \$1.75     | <b>PLASTERING</b><br>Best Instruction Manual. \$1.25                               |
| <b>CARBURETORS (All Makes)</b><br>New, Revised Edition. \$3.00      | <b>RADIO PHYSICS COURSE</b><br>New edition. Everything about Radio. \$4.00         |
| <b>CHEVROLET SIX</b><br>Car, Truck, Operation Repair. \$2.50        | <b>SHEET METAL</b><br>Construction Work. \$2.50                                    |
| <b>COLONIAL FURNITURE</b><br>Making, 95 Pieces. \$3.50              | <b>STEAM ENGINEER'S LICENSE</b><br>How to Obtain. \$2.00                           |
| <b>DANCE</b><br>Learn at Home Without Music or a Partner. \$2.00    | <b>WOOD TURNING</b><br>Course In. \$1.50   |
| <b>FOUNDRY WORK</b><br>Molding, Casting, etc. \$2.00                | <b>WROUGHT IRON WORK</b><br>Practical. \$1.35                                      |

These famous Pay-Raising, Extra-Money Books have helped thousands of others. Let them help you too. Check this list and mail with your name and address. Pay postman on delivery, price plus small C.O.D. fee. Or remit with order and books will be sent postpaid anywhere in the world.

POPULAR MECHANICS PRESS  
Room 439D, 200 East Ontario St., Chicago



The only man  
who could talk  
to the  
Superintendent



FOR nearly a year, he was "just one of the men" in the plant. He did his job well — but it looked as though he'd be doing the same job well, at the same pay, the rest of his life.

One day he started to think — about himself, his work, his future. He asked questions. He "figured things out." And then — he enrolled with the International Correspondence Schools.

"Soon after I began studying," he wrote to us recently, "we had a change in management. A new superintendent came in. And thanks to I. C. S. and the course I was studying, I was the only man on the floor who could talk to him in his own language. As a result, I've been pro-

moted over men who have been here years longer than myself. I'm making real money now — but I've enrolled in a more advanced course with your schools. I've just begun!"

It's easy to blame "the breaks" when you don't get ahead. But it's almost as easy to TRAIN YOURSELF FOR SUCCESS the I. C. S. way. I. C. S. texts have been adapted by scores of leading colleges (including 25 state universities). I. C. S. instruction is personal and individual. I. C. S. methods are proved by the achievements of thousands of former students in highly paid positions. Send coupon for complete information.

## INTERNATIONAL CORRESPONDENCE SCHOOLS

BOX 5545-J, SCRANTON, PENNA.

★ Without cost or obligation, please send me a copy of your booklet, "Who Wins and Why," and full particulars about the subject *before* which I have marked X: ★

### TECHNICAL AND INDUSTRIAL SUBJECTS

- |  |   |   |  |   |
|--|---|---|--|---|
| <input type="checkbox"/> Agriculture                     | <input type="checkbox"/> Air Brakes               | <input type="checkbox"/> Civil Engineering        | <input type="checkbox"/> Manufacture of Pulp Paper | <input type="checkbox"/> Sanitary Engineering       |
| <input type="checkbox"/> Air Conditioning and Cooling    | <input type="checkbox"/> Coal Mining              | <input type="checkbox"/> Contracting and Building | <input type="checkbox"/> Marine Engineering        | <input type="checkbox"/> Sheet Metal Work           |
| <input type="checkbox"/> Architectural Drafting          | <input type="checkbox"/> Cotton Manufacturing     | <input type="checkbox"/> Diesel Engineering       | <input type="checkbox"/> Mechanical Drafting       | <input type="checkbox"/> Steam Electric Engineering |
| <input type="checkbox"/> Architecture                    | <input type="checkbox"/> Electrical Engineering   | <input type="checkbox"/> Electric Lighting        | <input type="checkbox"/> Mechanical Engineering    | <input type="checkbox"/> Steam Engineering          |
| <input type="checkbox"/> Auto Electric Technician        | <input type="checkbox"/> Fire Bosses              | <input type="checkbox"/> Fruit Growing            | <input type="checkbox"/> Mine Foreman              | <input type="checkbox"/> Steam Fitting              |
| <input type="checkbox"/> Auto Technician                 | <input type="checkbox"/> Heating                  | <input type="checkbox"/> Heat Treatment of Metals | <input type="checkbox"/> Navigation                | <input type="checkbox"/> Structural Drafting        |
| <input type="checkbox"/> Aviation Engineering            | <input type="checkbox"/> Highway Engineering      | <input type="checkbox"/> High School Subjects     | <input type="checkbox"/> Patternmaking             | <input type="checkbox"/> Structural Engineering     |
| <input type="checkbox"/> Boilermaking                    | <input type="checkbox"/> House Planning           | <input type="checkbox"/> Illustrating             | <input type="checkbox"/> Pharmacy                  | <input type="checkbox"/> Surveying and Mapping      |
| <input type="checkbox"/> Bridge and Building Foremanship | <input type="checkbox"/> Management of Inventions | <input type="checkbox"/> Lettering Show Cards     | <input type="checkbox"/> Plumbing                  | <input type="checkbox"/> Telegraph Engineering      |
| <input type="checkbox"/> Bridge Engineering              |   | <input type="checkbox"/> Managing Men at Work     | <input type="checkbox"/> Poultry Farming           | <input type="checkbox"/> Telephone Work             |
| <input type="checkbox"/> Building Estimating             |   |   | <input type="checkbox"/> Public Works Engineering  | <input type="checkbox"/> Toolmaking                 |
| <input type="checkbox"/> Chemistry                       |   |   | <input type="checkbox"/> Radio                     | <input type="checkbox"/> Ventilation                |
|  |   |   | <input type="checkbox"/> R. R. Locomotives         | <input type="checkbox"/> Welding, Electric and Gas  |
|  |   |   | <input type="checkbox"/> R. R. Section Foreman     | <input type="checkbox"/> Woolen Manufacturing       |
|  |   |   | <input type="checkbox"/> R. R. Signalmen           |   |
|  |   |   | <input type="checkbox"/> Refrigeration             |   |

### BUSINESS SUBJECTS

- |  |  |  |  |   |                                  |
|--|--|--|--|---|----------------------------------|
| <input type="checkbox"/> Accounting              | <input type="checkbox"/> Advertising                 | <input type="checkbox"/> College Preparatory | <input type="checkbox"/> Grade School Subjects | <input type="checkbox"/> Railway Postal Clerk   | <input type="checkbox"/> Signs   |
| <input type="checkbox"/> Bookkeeping             | <input type="checkbox"/> Cost Accounting             | <input type="checkbox"/> C. P. Accounting    | <input type="checkbox"/> High School Subjects  | <input type="checkbox"/> Salesmanship           | <input type="checkbox"/> Spanish |
| <input type="checkbox"/> Business Correspondence | <input type="checkbox"/> First Year College Subjects | <input type="checkbox"/> Foremanship         | <input type="checkbox"/> Illustrating          | <input type="checkbox"/> Secretarial Work       |                                  |
| <input type="checkbox"/> Business Management     | <input type="checkbox"/> French                      |  | <input type="checkbox"/> Lettering Show Cards  | <input type="checkbox"/> Stenography and Typing |                                  |
| <input type="checkbox"/> Cartooning              | <input type="checkbox"/> Civil Service               |  | <input type="checkbox"/> Managing Men at Work  | <input type="checkbox"/> Traffic Management     |                                  |

### DOMESTIC SCIENCE SUBJECTS

- |   |   |  |
|---|---|--|
| <input type="checkbox"/> Advanced Dressmaking | <input type="checkbox"/> Home Dressmaking                       | <input type="checkbox"/> Tea Room and Cafeteria Management, Catering |
| <input type="checkbox"/> Foods and Cookery    | <input type="checkbox"/> Professional Dressmaking and Designing |  |

Name.....Age.....Address.....  
City.....State.....Present Position.....

Canadian residents send coupon to International Correspondence Schools Canadian, Limited, Montreal, Canada  
British residents send coupon to I. C. S., 71 Kingsway, London, W. C. 2, England

When writing to advertisers please mention Popular Mechanics



**Get this Proven PAY-RAISING PLAN**



LET ME TRAIN YOU IN

**DRAFTING UNTIL YOU GET A GOOD PAY JOB!**



ENGINEER DOBE

**FREE! BOOK!**



Take a *short cut* to a Bigger Job, Better Pay and a REAL future. Learn Drafting! It's an easy way to get into your favorite work—Electricity, Aviation, Diesel, Air Conditioning, Automotive, Building, Machinery, Transportation, etc. I agree to train you until you get a good pay job.

**Draftsmen Draw Good Pay**

I have trained thousands of men ages 16 to past 50 in spare time at home to qualify for Bigger Jobs at Better Pay. Let me train you quickly by same easy, low cost "Work-Job" Method. No experience needed. High School education not necessary.

**All Working Tools Furnished**

You get complete Professional Draftsman's Tools and Drawing Table—sent without extra charge at once. Mail coupon for Free Book about my PROVEN PAY RAISING PLAN. Write TODAY!

ENGINEER DOBE, Div. 3374, Libertyville, Ill.

ENGINEER DOBE, Div. 3374, Libertyville, Ill.

Send me your Free Book "SUCCESSFUL DRAFTSMANSHIP." Explain how you assist your graduates to good positions as Draftsmen.

NAME.....AGE.....

ADDRESS.....

TOWN.....STATE.....

**AUDELS Carpenters and Builders Guides 4 vols. \$6**



Inside Trade Information for Carpenters, Builders, Joiners, Building Mechanics and all Woodworkers. These Guides give you the short-cut instructions that you want—including new methods, ideas, solutions, plans, systems and money saving suggestions. An easy progressive course for the apprentice and student. A practical daily helper and Quick Reference for the master worker. Carpenters everywhere are using these Guides as a Helping Hand to Easier Work, Better Work and Better Pay. To get this assistance for yourself, simply fill in and mail the FREE COUPON below.

**Inside Trade Information On:**

How to use the steel square—How to file and set saws—How to build furniture—How to use a mitre box—How to use the chalk line—How to use rules and scales—How to make joints—Carpenters arithmetic—Solving mensuration problems—Estimating strength of timbers—How to set girders and sills—How to frame houses and roofs—How to estimate costs—How to build houses, barns, garages, bungalows, etc.—How to read and draw plans—Drawing up specifications—How to excavate—How to use settings 12, 13 and 17 on the steel square—How to build hoists and scaffolds—skylights—How to build stairs—How to put on interior trim—How to hang doors—How to lath—lay floors—How to paint.



THEO. AUDEL & CO., 49 W. 23rd St., New York City

Mail Audels Carpenters and Builders Guides, 4 vols., on 7 days' free trial. If O.K. I will remit \$1 in 7 days, and \$1 monthly until \$6 is paid. Otherwise I will return them. No obligation unless I am satisfied.

Name.....

Address.....

Occupation.....

Reference.....P.M.

**Have You Ever Thought About Training For The Job You Want**

**Just as the Doctor—Lawyer—Engineer or Accountant trains for his work?**

You say, "I will train just as soon as I get the job." Isn't that admitting that you are not fitted for the better job at the present time? Doesn't such an attitude directly ask the employer to pay for your training? Why should he?

Write for "PROMOTION FACTS"—No Obligation American School Dept. GA445 Drexel at 58th, Chicago

**Speed Up That Next Promotion**

**AN AVIATION CAREER**



**OFFERS YOU GREAT FUTURE!**

Demand for trained aircraftmen is increasing and already exceeds supply. Curtiss-Wright Tech. Aviation's foremost and oldest school, is located on Grand Central Air Terminal in heart of the aircraft industry and specializes in training MASTER MECHANICS and AERONAUTICAL ENGINEERS. (No flying involved.) Graduates are obtaining immediate employment. Write for details NOW. Dept. PM-4

**CURTISS - WRIGHT TECHNICAL INSTITUTE**  
Glendale (Los Angeles) California



**CARTOONISTS**

Learn to draw original Cartoons. Send one dollar for my book, FIRST STEPS TO A CARTOON CAREER. Written and illustrated by a nationally known cartoonist. 22 lessons based on 20 years experience as cartoonist on great metropolitan dailies. Printed on strong paper. Spiral binding. **\$1**

DORMAN H. SMITH, Box C597, San Rafael, California

**FAILURE?**

Are you discouraged, bewildered, seeing others forge ahead to success, wealth, power while you remain in the ranks? Do you ever ask what it is that makes them successful where you fail, when they have no more intelligence than you? Don't give up... I can help you! Send your name and address to B. C. McCulloch, Desk 64, Pershing Square Bldg., New Rochelle, N. Y.



**LOOK! Baby Chicks**

THOUSANDS WEEKLY ALL YEAR. Finest quality & Layers in 40 breeds. Hybrid Baby Pullets and Cockerels, B. W. D. Tested. Ducklings, Goslings, Baby Turkeys, Guinea. In business 30 years. Catalog free. ORDER NOW. Make BIG money raising NABOB QUALITY CHICKS. NABOB HATCHERIES, BOX M, GAMBIER, OHIO



**Earn Cash at Home!**

We paid M. M. \$1174 for exceptional "cellar crop" SNOW-KING mushrooms! Big free picture book tells if your cellar, shed, barn suitable. We furnish materials, buy all crops. Write today. Est. 1908. UNITED CO., 3848 Lincoln Ave., Dept. 307, Chicago.



**MONUMENT \$9.00 UP WE PAY FREIGHT**

Genuine Marble also Granite. Free Lettering. Erected if desired. Thousands of satisfied customers. Write for Catalog and samples. U. S. MARBLE & GRANITE CO. A-18 Oneco, Fla.

**STUDY ENGINEERING AT HOME**

From A Chartered Institution of Higher Learning  
Home Study Courses leading to Degrees in Electrical, Civil, Mechanical, Drafting, Architectural, Automotive, Steam, Diesel, Aeronautical, Radio, Structural, Mining, Industrial, Highway, Petroleum, Marine, Refrigeration, Air Conditioning, Chemical Engineering; Arts; Sciences; Philosophy; Education; Public Health; Psychology; Sociology; Physics; Chemistry; Geology; Pol. Science; Theology; Law; Agriculture; Business Training; Accounting; Statistics; Adv.; Sales. Founded 1908. Chartered McKinley-Roosevelt Graduate Colleges, 4220 Clarendon Ave., Chicago

When writing please mention Popular Mechanics



*They Needed*  
**TRAINED**  
*Diesel Men\**

★ INDICATES HEMPHILL DIESEL RESIDENT SCHOOLS

\* Letters from employers and H. D. S. graduates on file at Hemphill Diesel Schools headquarters

*and H.D.S. Graduates went on the jobs!*

The Nevada gold mine, the lumber camp in the far north, the big Texas refinery, the west coast Diesel manufacturing plant, the great motorship bound for the Orient... ALL needed trained Diesel men...and Hemphill graduates went on those jobs—just as other H. D. S. men—before and since—have gone to other Diesel jobs in this country and abroad.

## WOULD YOU LIKE TO KNOW MORE ABOUT DIESELS and DIESEL TRAINING?

On the map above you see pictured only a few of the ways and places Diesel engines are used today. If you would like to know more about Diesels... and see interesting pictures of new and unusual applications of Diesel power, send the coupon for your free copy of "March of Diesel."

You will also see eight full pages of pictures of Hemphill Diesel students learning Diesel

by working on and operating actual Diesel engines... from small stationary power plants to huge motorship Diesels.

Day or night courses are open to you, or you can start at home and obtain your practical shop training in any one of the eight Hemphill schools. To get complete information... and your free "March of Diesel"... send the coupon NOW.

## HEMPHILL DIESEL SCHOOLS

Diesel and Diesel-Electric—Full-Time Resident Courses... Or You Can Start Your Training at Home

### HEMPHILL DIESEL SCHOOLS

Please send my free copy of "March of Diesel" booklet and information on Hemphill Diesel training.

NAME..... AGE.....

STREET .....

CITY..... STATE..... m-36-p

### Send Coupon to Nearest Address

BOSTON... 114 Brookline Avenue  
NEW YORK... 31-26 Queens Blvd., L.I. City  
DETROIT... 2341 West Lafayette Blvd.  
CHICAGO... 2014 Larrabee Street  
MEMPHIS... 417 Monroe Avenue  
LOS ANGELES... 2120 San Fernando Rd.  
SEATTLE... 513 Dexter Avenue  
VANCOUVER, B. C. ... 1363 Granville St.

**SEND COUPON TODAY!**





# NEW

# INVENTIONS

*Jan 17*  
**N**EW safety for the deep-sea diver is afforded by a communication system



patented recently. It provides for communication between a central station and a plurality of distributed stations, as from headquarters to several divers. The system comprises a sound conversion unit at each point for reception and transmission of messages. A small case houses the unit that would be used aboard ship or on shore. Power

would be derived from some electrical source. The diver's apparatus includes a line connected to his diving dress and to a receiver-speaker inside the helmet. The system would make for safety by permitting voice transmission, eliminating reliance upon life-line signals.

**I**NCREASED safety in landing is the objective of an airplane invention patented recently. It consists of a plane constructed with a wing resting on top of the fuselage housing and extending from the front of the fuselage to the rear, just short of the tail assembly. This wing would conform in shape to that of the fuselage. In landing,



this wing could be raised at its front end to provide a plane surface inclined from front to rear in a manner calculated to result in safe landing at slow speed. Controls inside the ship would permit the pilot to raise the wing when the occasion arose.

**S**OMETHING new in motor-propelled vehicles has just been patented. It has front and rear ground wheels and means for effecting steering movement of the

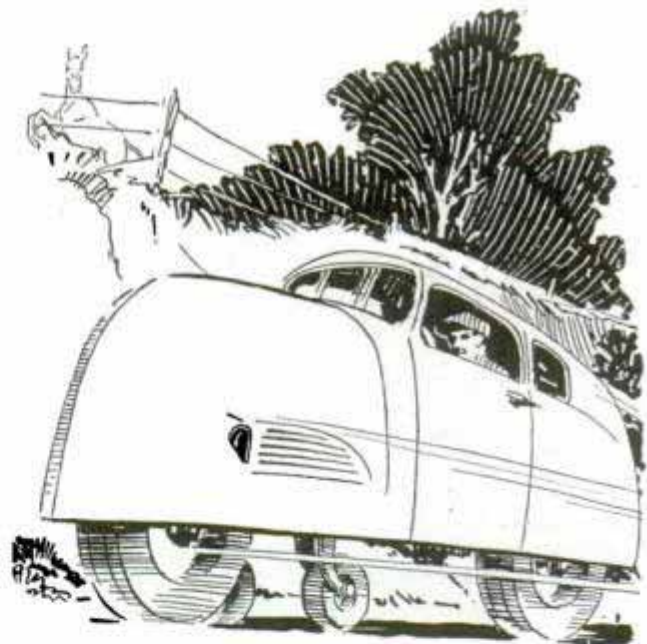

front wheel. This steering apparatus consists of a steering shaft, a pair of caster prop wheels located just back of the front wheel and means for raising and lowering the prop wheels, as well as for steering the prop wheels. The caster wheels normally would be used to help hold the vehicle in upright position while at a standstill. After the vehicle is in motion, the wheels would be raised clear of the ground. The cycle car is designed with a streamline body in which there are front and rear seats.

(Continued to page 33A)





H. C. Lewis

**TRAIN THIS QUICK EASIER WAY FOR**

# ELECTRICITY

**12 Weeks Practical WORK IN MY CHICAGO SHOPS**

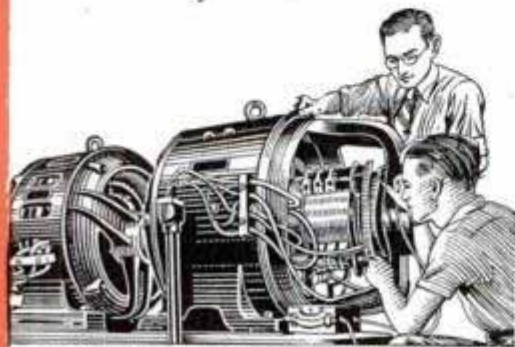

FIRST—You are told and shown how to do it.

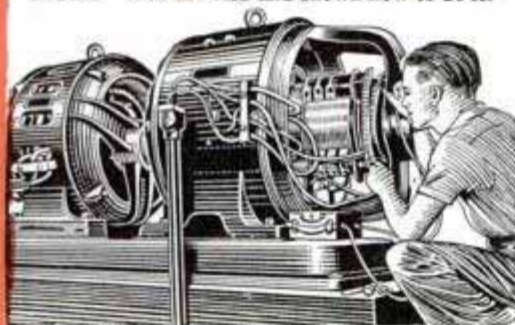

THEN—You do the job yourself.



HOUSE WIRING only one of the many branches you "Learn By Doing."



"... Everything was just as stated in literature. And by Coyne methods plenty of instructors to take care of everything, easy to learn. I really was satisfied with Coyne Training." J. Halyk, Canada



"... Coyne has first class instructors to teach you the simplest things to start with and they have the equipment to show you these things as you advance..." Ben Rickman, S. Car.

## WANT TO EARN MORE MONEY?

Have you ever dreamed of holding down a steady, good pay job? Have you ever dreamed of doing the work you really like in a job that holds promise of a real future in the years ahead?

Well, we all know that you can't get the good things in life by just dreaming about them. Hundreds of fellows are today holding down mighty fine jobs with prospects of a bright future. They are filling these jobs because they had the foresight to equip themselves with the right kind of training. Most of these men were only average fellows a short time ago, but the proper training helped to lift them out of the low pay ranks of unskilled workers. The same opportunity is now offered to you.

The great fascinating field of ELECTRICITY offers a real future to many men and young men who are willing to prepare for a place in this giant industry.

Here at my school in Chicago, the world's Electric Center, you can get 12 weeks Shop Training in ELECTRICITY, then I'll include an extra 4 weeks Course in Radio that can help give you your start towards a better job.

**AN EXTRA 4 WEEKS COURSE IN RADIO INCLUDED**

You will be trained on actual equipment and machinery and because of our method of training, you don't need previous experience or advanced education.

Here in my school you work on generators, motors, dynamos, you do house wiring, wind armatures and do actual work in many other branches of electricity and right now I'm including valuable instruction in Diesel electricity, Electric Refrigeration and Air Conditioning at no extra tuition cost. Our practical shop methods make it easier to learn—First the instructors tell you how a thing should be done, then they show you how it should be done—then you do the actual work yourself.

## I'll Finance Your Training

You can get this training first—then pay for it later in easy monthly payments, starting 60 days after your 12 weeks training period is over—then you have 12 months to complete your payments.

Send the coupon today for all details. When I get it I'll send you my big free book containing dozens of pictures of students at work in my shops. I'll also tell you about my "Pay After Graduation" plan, how many earn while learning and how we help our

students after graduation. Fill in, clip coupon, mail today for your start toward a brighter future.



**SEND FOR FREE BOOK**

The Coyne Electrical School is 40 years old. Many hundreds of young men have become successful through Coyne training. My free book tells you how you, too, can get a training that will give you your start to a better job and a real future.

H. C. LEWIS, President

# COYNE ELECTRICAL SCHOOL

500 S. Paulina Street, Dept. 49-72, Chicago, Illinois

H. C. LEWIS, President, Coyne Electrical School, 500 S. Paulina Street, Dept. 49-72, Chicago, Ill.

Dear Sir: Please send me free your big catalog and full particulars of your Extra 4 Weeks Radio Course, also your "Pay-Tuition-After-Graduation" Plan and all other features.

Name.....

Address.....

City..... State.....

Mail in envelope or paste on postcard



# HIGH SCHOOL

## At Home!

Qualify for the better Commercial, Industrial and Civil Service positions by getting a High School education in spare time!

**Prepare for College, Pre-Professional, Regents, State Equivalency Examinations, and Business and Industry**

**U. S. Govt. figures show High School graduates average \$2112 yearly. Many Finish in 2 Years!**

No classes; no time wasted going to and from school. You make rapid progress by our methods. Thousands of ambitious men and women select the American School each year.

All books furnished. School est. over 40 years. Endorsed by educators. Small monthly payments.  
**American School, Dept.H445, Drexel Ave. at 58th St., Chicago**

**American School, Dept.H445, Drexel Ave. at 58th St., Chicago**

Without obligation send me your free Bulletin and information about your High School course at home, or the field I have checked.

- Air Conditioning
- Architecture
- Automotive Engineering
- Automobile Repairing
- Bookkeeping and Cost Accounting
- Business Management
- Civil Engineering
- Aviation
- Contracting, Building

- High School
- Electrical Engineering
- Diesel Engineering
- Drafting and Designing
- Electric Refrigeration
- Heating, Ventilating, Plumbing
- Professional Accounting Incl. C. P. A. Coaching
- Highway Engineering

- Law
- Liberal Arts (College)
- Mechanical Engineering
- Merchandising
- Private Secretary
- Radio and Television
- Salesmanship
- Shop Practice
- Steam Engineering
- Shop Management

Name \_\_\_\_\_ Age \_\_\_\_\_ Occupation \_\_\_\_\_

Street \_\_\_\_\_ City \_\_\_\_\_ State \_\_\_\_\_

## DO YOU LIKE RADIO DOES THE FUTURE OF TELEVISION INTEREST YOU?



Send for your free copy

You men anxious to make good in radio and related industries want the true facts,—you want to know about employment opportunities and requirements. National Schools,—a million-dollar trade school,—will supply you with a sincerely honest statement of facts on what you should do to get into the profitable radio industry. No exaggerations,—no mis-statements. Mail coupon today. **Send for your free copy. Real facts on radio employment requirements. You need real experience. National offers complete training with modern equipment.**



**NATIONAL SCHOOLS**  
*Los Angeles*

Request for **FREE BOOK** of DETAILS

**NATIONAL SCHOOLS,**  
 Dept. 4-PNR, 4000 S. Figueroa St., Los Angeles, Calif.

NAME \_\_\_\_\_ Age \_\_\_\_\_

ADDRESS \_\_\_\_\_

CITY \_\_\_\_\_ STATE \_\_\_\_\_

## LEARN AVIATION IN LOS ANGELES - Nation's Aviation Capital



Huge increases in Los Angeles aviation activity has insured good paying positions for California Flyers graduates. Only U. S. Government and industry approved school here in nation's aviation capital, offering airline piloting, engineering, mechanics, drafting, aircraft construction. Learn in America's most modernly equipped and strategically located school. Low tuition. Write for free catalog.

**CALIFORNIA FLYERS SCHOOL OF AVIATION—Dept. PM-4**  
 LOS ANGELES MUNICIPAL AIRPORT, INGLEWOOD, CALIF.

## Learn PHOTOGRAPHY at Home

Splendid opportunities. Prepare in spare time. Easy plan. No previous experience needed, common school education sufficient. Send for free booklet "Opportunities in Photography", particulars and requirements.

**American School of Photography**  
 3601 Michigan Ave., Dept. 1354, Chicago, Ill.

## Learn MECHANICAL DENTISTRY AT HOME!



To make Crowns, Plates, Bridgework, etc., for Dentists. Easy practical way to learn mechanical dentistry at home in spare time. **FULL EQUIPMENT OF TOOLS AND MATERIALS INCLUDED WITH COURSE.** Low tuition. Easy terms. Write for **FREE BOOK** about this money making profession that is not affected by machine age.

**McCARRIE SCHOOL OF MECHANICAL DENTISTRY**  
 207 N. Broad St., Dept. 744, Philadelphia, Pa.

## MAKE MONEY AT HOME

**RUBBER MOLDS** *Low as 6¢ EA.*



Amazing rubber mold-making outfit makes perfect flexible molds of plaques, ash trays, book-ends, etc. Molds cost from 6c to 25c each. Each mold makes hundreds of novelties and gifts to sell up to \$1.00 apiece! No experience necessary. Quick and easy. Start profitable business in your home... sell to stores, gift shops, friends, resorts, road stands, by mail. Full or spare time. "Molders Handy Book" and list of buyers **FREE.** Write

**SO-LO WORKS**  
 Dept. S-827 Cincinnati, Ohio



# Over 700,000 People have studied music this easy way



## Learn to Play Your Favorite Instrument Without a Teacher

MANY of these 700,000 students didn't know one note from another—yet they started right in, almost at once, learning real tunes by note. For this wonderful method makes it easy as A-B-C to learn music at home, without expensive private lessons.

No drudgery—no tedious study and practice. Every step is right before your eyes in print and pictures. You can't go wrong. First you are told how to do a thing, then a picture shows you how, then you do it yourself and hear it. Soon you are actually playing popular pieces on your favorite instrument—to the surprise and delight of your friends.

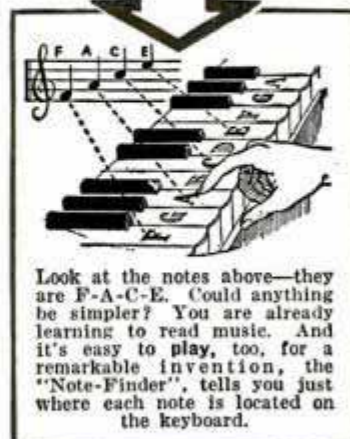

Look at the notes above—they are F-A-C-E. Could anything be simpler? You are already learning to read music. And it's easy to play, too, for a remarkable invention, the "Note-Finder", tells you just where each note is located on the keyboard.

### LEARN TO PLAY BY NOTE

- Piano
- Guitar
- Violin
- Saxophone
- Organ
- Mandolin
- Tenor Banjo
- Hawaiian Guitar
- Piano Accordion
- Or Any Other Instrument

## FREE Demonstration Lesson

See how easily the joy of playing can be yours. Send for illustrated Booklet and Demonstration Lesson, FREE, showing how this wonderful simplified method works—how you may learn to play your favorite instrument in spare time at home, at amazingly little cost. Instruments supplied when needed, cash or credit. Address: U. S. School of Music, 74 Brunswick Bldg., New York City.

U. S. SCHOOL OF MUSIC,  
74 Brunswick Bldg., New York City

Please send me FREE Demonstration Lesson and illustrated Booklet. I am interested in the following instrument: ..... (Do you have instrument? .....)

Name.....

Address.....

## BECOME AN EXPERT ACCOUNTANT

Executive Accountants and C. P. A.'s earn \$2,000 to \$10,000 a year. Thousands of firms need them. Only 17,000 Certified Public Accountants in the U. S. We train you thoroughly at home in spare time for C. P. A. examinations or executive accounting positions. Previous experience unnecessary. Personal training under supervision of staff of C. P. A.'s, including members of the American Institute of Accountants. Write for free book, "Accountancy, the Profession That Pays." LaSalle Extension University, Dept. 454-H, Chicago  
A Correspondence Institution

## BE A PASSENGER Traffic Inspector

GIVE A FEW WEEKS OF SPARE TIME FOR A WELL-PAID JOB!  
Ambitious Men—19 to 50 qualify as Railway and Bus Passenger Traffic Inspectors by our easy, home-study course. Our graduates are in demand. Upon completion of course, we help place you at up to \$135 per month, plus expenses to start, or refund tuition. Rapid Advancement. Get Free Booklet, STANDARD BUSINESS TRAINING INSTITUTE, Div. 204, Buffalo, N. Y.

## CARTOONING PAYS WELL

Turn your talent into dollars  
Develop your ability with personal instruction from an internationally-known cartoonist. His exclusive, successful method of drawing and creating ideas makes it easy to learn. Write for Free Booklet explaining details of this exceptional home-study course. National School of Cartooning, 437 Penton Building, Cleveland, Ohio

## Learn to MOUNT BIRDS Tan SKINS, Make Up FURS

Be a Taxidermist. We teach you at Home. Mount Birds, Animals, Pets, common specimens. Save your hunting trophies; decorate home and den. Make genuine KROME LEATHER, tan and make up furs for sparetime profit.  
**FREE BOOK** 48 pages—tells all about it. Hunters, get this wonderful book. It's Now Free. Send postal card Today—This Minute! State your AGE.  
N. W. School of Taxidermy, 3374 Elwood Bldg., Omaha, Nebr.



## GOOD MONEY to be made in POULTRY

Many Earn Extra Spare - Time Profits —  
Or You May Build a Business of Your Own



Whether you want a job at good pay or a profitable business of your own, Poultry offers you many opportunities. Poultry meat and eggs are always in demand, and at times there is a shortage of trained poultrymen. My Home Study Course shows you how to succeed—how to save money and make money, either for yourself or for an employer.

### CASH IN SPARE TIME or FULL TIME

No matter where you live or what you do now, my proved course will show you what to do with poultry right from the start. If you choose to start a business of your own, I'll show you how to make a small investment grow, show you how to expand. Send for the facts today.

### FREE Book Shows the Way to Big Pay and Big Profits

Mail coupon below TODAY —for my Big NEW FREE Book, "How to Raise Poultry for Profit." My forty years of experience are yours. The poultry industry may need you, and therefore you need my free book. Get it—and get in line for the extra money that can be made in poultry!



## Mail NOW for FREE Book

NATIONAL POULTRY INSTITUTE, Dept. 42-D  
Adams Center, N. Y., Att'n: Harry M. Lamon, Pres.

Dear Mr. Lamon: Send me your FREE Book, "How to Raise Poultry for Profit". I want to know more about my opportunity to make extra money spare or full time.

Name.....

Address.....

When writing please mention Popular Mechanics



# PATENTS

## DELAYS ARE DANGEROUS IN PATENT MATTERS

The Free Book shown here was prepared for inventors, to show them what steps they must take to secure a PATENT. If you have an inven-

tion, you should send for this book AT ONCE. It will tell you how an application for a Patent is made, what information you must furnish your attorney, and what steps he must take in order to protect your interests. Remember, inventing an article is one thing—securing the exclusive right to manufacture it, use it or sell it is another. Without a U. S. Patent, you cannot expect to reap the profits that your invention may make possible. Send at once for this book. After you get that, you'll know what to do to protect yourself.

### Small Ideas May Have Large Commercial Possibilities

Inventions do not have to be complicated to be profitable when Patented. The 5c and 10c stores flourish on simple Patented products which are commercially successful. The zipper, safety pin, thumb tack, paper clip, collar button—all are simple yet familiar inventions—brought their inventors rich rewards. If you have a Patentable invention—act to protect it. Send for our FREE 48-Page Book that tells you how.

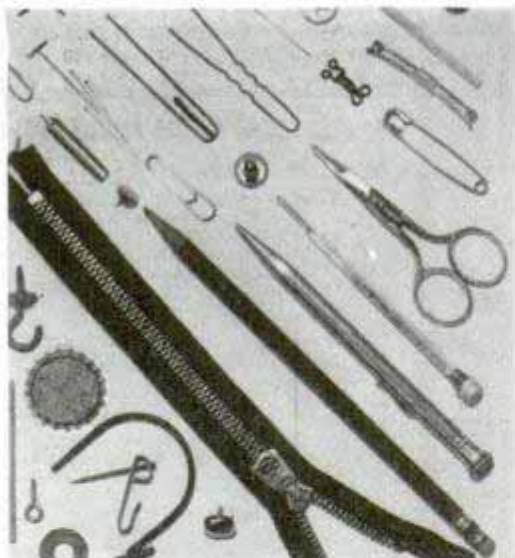

### WE SERVE YOU QUICKLY AND SECRETLY

Anything you write us or send us is strictly confidential between us. All letters and drawings are kept in strong, steel, fireproof files, which are open only to ourselves or authorized members of our staff. We have secured patents for inventors located in every state in the Union. Our organization is a large and efficient one. Our practice is confined entirely to Patents, Trade-Marks and Copyrights. We have had years of experience in Patent Matters. When you place a patentable invention in our hands, we are in position to proceed at once to secure protection for you. Our fees are reasonable, and, if you desire, we can arrange convenient terms of payment.

### IMPORTANT!

Please understand that you are not under the slightest obligation in sending for this book. We will mail it, together with the Record of Invention form, the same day we receive your request. Use the coupon on next page to save yourself time and trouble. After that, you will be in position to proceed or not as you choose, to make your application for a patent.

## CLARENCE A. O'BRIEN & HYMAN BERMAN

70-X Adams Building

Washington, D. C.

REGISTERED PATENT ATTORNEYS BEFORE U. S. PATENT OFFICE



# RECORD OF INVENTION BLANK *Free*

We will send you our Record of Invention form FREE. This blank will enable you to make a sketch of your invention in proper form and have it witnessed in such manner that it may be of value to you as evidence should the occasion for evidence arise. In our book, we tell you how to use this form to protect your interests.

## YOU CAN PATENT

**IMPROVEMENTS IN MACHINERY, ARTICLES, DESIGNS, FORMULAS, ETC. IF NEW.**

Every year thousands of Patents are granted. Very few, however, represent the discovery of entirely new principles. Most of them provide new methods of doing some everyday thing in a better way—changes for greater efficiency, usefulness, adaptability, or beauty in some previously Patented thing. These IMPROVEMENTS are Patentable if new, and actually represent new invention. These improvement Patents offer large chances for profit if commercially useful. The business world wants improved products and services.

### OUR LOCATION IN WASHINGTON

Our offices in Washington are convenient to the Patent Office, and we and our assistants can, therefore, appear promptly before the officials and Examiners.

### REASONABLE FEES AND CONVENIENT TERMS

We have served thousands of inventors in all parts of the United States and we are able to serve you very reasonably and extend liberal terms of payment. So don't waste valuable time.

AND THIS

## *Free* BOOK

**TELLS HOW!**

How your Patent Application is made; what kind of sketches or drawings are necessary; what other papers must be made out; how the Patent Laws protect you; why it is important to avoid loss of time in getting your application filed; and many other important points. Even a very simple invention, if new and useful, may prove very valuable. You may have much to gain and nothing to lose by sending for this book TODAY.

*Mail Coupon*  
**NOW**

## CLARENCE A. O'BRIEN and HYMAN BERMAN

70-X Adams Building, Washington, D. C.  
Registered Patent Attorneys Before U. S. Patent Office

Please send me at once your Big Free 48-Page Book, "Patent Guide for the Inventor" and your Specially Prepared "Record of Invention" form. This request does not obligate me.

Name.....

Address.....

(Please write or print plainly)



Wear the  
**VITO BELT**  
for 10 days  
at our expense!

Appear  
**SLIMMER AT ONCE!**

**DON'T** let your friends poke fun at your "bay window"! The successful man of today appears trim-waisted, ready for action... streamlined!

If the Vito Belt does not make that paunchy belt line appear inches slimmer at once... it will cost you nothing!

Take care of that ugly paunch the safe way... with a Vito Belt. Excessive exercise may strain your heart... dieting and drugs may be dangerous.

The Vito Belt is made of pure Para rubber, molded to give maximum support. Hundreds of tiny perforations allow air to penetrate. The special lace back permits you to adjust the belt to take care of any change in size. Illustrated folder and details of 10-day FREE trial offer will be sent in plain envelope on request!

**HAMILTON BELT COMPANY, 264 Hill Street, New Haven, Conn.**



Waistline fat often stretches abdominal muscles, allowing stomach and intestines to fall forward and downward. The Vito Belt brings welcome support to strained and sagging internal organs and helps prevent constipation and fatigue.

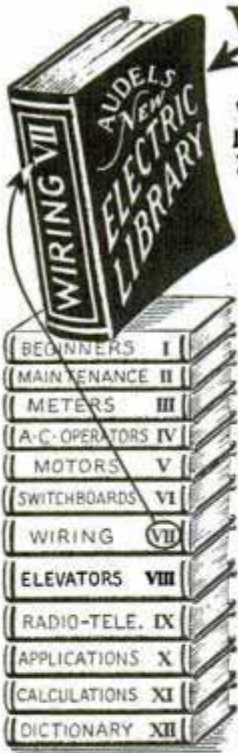
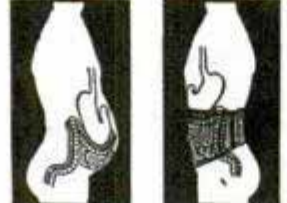

**WIRING**

**VOL. VII AUDELS NEW ELECTRIC LIBRARY—A MASTER BOOK ON WIRING**  
728 PAGES, 1200 ILLUSTRATIONS. \$1.50  
House and Power Wiring  
Diagrams—Problems  
and Calculations

fully explained in clear practical language, easy to use and understand including helps and hints for all electrical workers that will save time, trouble and money.

**AUDELS NEW ELECTRIC LIBRARY—** A progressive Home Study and Reference Course in applied electricity. Easy to understand. Questions and answers plainly written for a complete working knowledge of modern electrical practice, necessary to every electrician, engineer, mechanic and student.

**LEARN THE AUDEL WAY!** You ask the question—Audel's New Electric Library gives the answer—9500 simplified outlines, graphic illustrations and precise explanations covering Construction, Operation and Machine Maintenance.

**BOOK A MONTH PLAN—** Order the volume that interests you—today! We will send that volume on 7 days' free trial. If the book helps you, send us \$1.50. If it does not help you, mail book back to us.

**FREE EXAMINATION COUPON**

Theo. Audel & Co., 49 W. 23rd St., New York City  
Mail Vol. VII on 7 days free trial. If O.K. I will remit \$1.50 otherwise I will return it. Also please send further information about the Electric Library—no obligation unless I am satisfied.

Name.....  
Address.....  
Occupation.....  
Reference..... PM

You have a future in **RADIO ENGINEERING**

One Year Residence Course Prepares You for Technical Career

Learn Radio and Television Engineering in an intensive one-year course for high school graduates. Students enjoy actual "lab" experience under outstanding engineer-instructors in well-equipped shops and laboratories. Graduates qualify for professional radio jobs. CREI men now in more than 275 radio stations. School year begins in Sept.—ends in June. New, modern school building. Dormitory. Preparatory home-study training at no extra cost. Write now for free booklet: "A Tested Plan for a Future in Practical Radio Engineering." State age.



**CAPITOL RADIO ENGINEERING INSTITUTE**  
Dept. PD-4 3224 16th St., N. W., Wash., D. C.

**AVIATION SPARTAN OFFERS YOU—**

Unequaled advantages of "Oil Capitol of the World" finest flying weather and country. Government Approved. Factory affiliation gives you advantages of Commercial, Military All-Metal construction. Home of the DAWN PATROL. All courses Mechanical and Flight. Student Dormitories, Restaurant. Write for Illustrated Catalog.



**J. D. GREEN, Director, Dept. PM 18, TULSA, OKLAHOMA**

**LEARN MECHANICAL DENTISTRY SEND FOR FREE BOOK**



**Special Tool Offer—Now!**  
Don't waste the best years of your life. Learn this **money-making** business in a few months, Day or Evening, and become independent. Big demand. Highly endorsed—oldest school. Practical, individual training. Easy terms. Write NOW for free catalog P and trial offer.



**New York School of Mechanical Dentistry, 125-127 West 31st Street, Dept. 9, New York City**

*Learn to Write*



Begin Today. Write for our Free Book, "How to Become a Good Penman." It contains specimens and tells how others learned to write in spare time. Your name elegantly written on a card if you enclose stamp for postage. Write today. The Tamlyn School of Penmanship, Dept. 8, Ridge Bluff, Kansas City, Mo.

**Minstrels** Comedy Skits & Plays  
Unique First Parts for complete show with special songs and choruses. Make-up, Catalog Free.  
**T. S. Denison & Co., 203 N. Wabash, Dept. 19, Chicago**

**CARTOONING**



**FREE TRIAL LESSON!** Cash in on your sense of humor—AT HOME—BY MAIL. Have fun! Make money! No experience needed to start. Write today for FREE LESSON, mailed postpaid. No obligation.  
**MOON Gag-Cartoon School, Dept. A, Fall Creek, Wis.**



**WHY NOT** spend spring, summer, fall, gathering butterflies, insects. I buy hundreds of kinds for collections. Some worth \$1 to \$7 each. Simple outdoor work with my instructions, pictures, price list. Profit—pleasure. Send 10c (not stamps) for Illustrated Prospectus before sending butterflies.  
**MR. SINCLAIR, DEALER IN INSECTS**  
Dept. 6, Box 1830 San Diego, Calif.

**MAIL FOR FREE INFORMATION**

**BROOKLYN YMCA TRADE SCHOOL**

- 1117 Bedford Ave., Dept. PM-71  
Brooklyn, New York City, N. Y.
- Diesel Engines  Oil Burner
  - Diesel Pre Engineering
  - Aviation Mechanic  Welding
  - Aeronautical Pre Engineering
  - Auto Mechanic  Talking Pictures
  - Refrigeration  Machine Shop
  - Radio and Television Mechanic
  - Air Conditioning
  - Architectural-Mechanical Drafting
  - Electrical  Window Display
  - Armature Winding
- Name.....  
Address.....





## New LACO Oil Heater

• Write for free folder describing best-heating, most durable oil heater in LACO history! Installs like stove, no basement needed. Self-contained tank, easy heat-regulator. Capable of developing tremendous heat. Special unit utilizes utmost of heat.

**LOW \$23<sup>50</sup> AS**

**FREE FOLDERS**

LACO's famous Pressure-Type fuel-oil burner (right) designed by L. A. Cacklin, one of the industry's outstanding builders. New simplicity, new economy, new low price! Improves the value of your home. WRITE direct to factory for illustrated booklet, full details, low dealer price!



**WRITE!**

LACO OIL BURNER CO., 149 Union Ave., Griswold, Iowa

## ENGINEERING

**DEGREE IN TWO YEARS**

TECHNICAL AND APPLIED COURSES. Nonesentials omitted. TIME AND MONEY SAVED. Degree 2 yrs., diploma 1 yr. Electrical, Mechanical, Architectural, Structural, Civil, Aeronautical, Highway. All courses include Air Conditioning, Electric Refrigeration and Diesel. Short intensive courses 3 and 4 months in Electricity, Power Plant, Diesel-Electric, Air Conditioning, Electric Refrigeration, Drafting. Extensive modern equipment. LOW TUITION. Part-time work for room and board. Thousands of successful graduates in U. S. and foreign lands. Approved by industry, endorsed by educators, recommended by alumni. One and two-year courses open in Sept., short courses open year round. 39th YEAR. Catalog free.

**FINLAY ENGINEERING COLLEGE**

1001 Indiana Avenue

Kansas City, Mo



Operator No. 38

### FOLLOW THIS MAN

Secret Service Operator No. 38 is on the job! Running down dangerous Counterfeit Gang. Tell-tale finger prints in murdered girl's room.

**Free** The Confidential Report Operator No. 38 made to his chief. Write for it. Earn a Regular Monthly Salary

YOU can become a Finger Print Expert at home, in your spare time, at small-cost. Write for confidential full report and details. Literature will be sent only to persons stating their age.

**INSTITUTE OF APPLIED SCIENCE**  
1320 Sunnyside Ave.  
Dept. 1354 Chicago, Ill.

## Write and Speak MASTERLY ENGLISH



Learn correct English with Sherwin Cody's new invention. No rules to memorize. Like a fascinating game. Spare-time study, 15 minutes each day, quickly gives you command of English. Send for free book, "How You Can Master Good English in 15 Minutes a Day." Write today. **SHERWIN CODY SCHOOL OF ENGLISH**  
54 Searle Bldg. Rochester, N. Y.

## 5¢ EACH LITTLE BLUE BOOKS

Send postcard for our free catalogue. Thousands of bargains. Address: **HALDEMAN-JULIUS CO.**, Catalogue Dept. Desk M-305, GIRARD, KANSAS.

## I Wish I Knew How to Jump My Salary to \$40 a Week

**A \$5 or \$10 a week raise would solve a lot of your financial troubles, wouldn't it?**

Have you ever thought about training definitely for a given job just as the doctor, the lawyer, the engineer or the accountant trains for his work?

**Don't trust to luck but prepare for the job you want.**

**Write for "PROMOTION FACTS"—No Obligation**  
American School Dept. G445 Drexel at 58th, Chicago

**Speed Up That Next Promotion**



**DO YOU WANT \$36.50 A WEEK?**



**START \$1260 to \$2100 YEAR**  
**MANY APPOINTMENTS EACH YEAR**

Railway Postal Clerks get \$1,900 the first year regular, being paid on the first and fifteenth of each month. (\$79.17 each pay day.) Their pay is automatically increased yearly to \$2,450. Advance may be had to Chief Clerk at \$2,700 a year. (\$112.50 each pay day.)



**3 Days On—3 Days Off—Full Pay**  
Railway Postal Clerks on long runs usually work 3 days and have 3 days off duty in the same proportion. During this off duty their pay continues just as though they were working. They travel on a pass when on business. When they grow old, they are retired with a pension.

**City Mail Carriers, Post Office Clerks**  
Clerks and Carriers now get \$1,700 the first year on regular and automatically increase \$100 a year to \$2,100 and \$2,300.

**File Clerk—Clerk**  
Open to Men—Women 18 to 50. Entrance salary \$1,260—\$1,440 a year. Appointments as File Clerks and Clerks in the Departments at Washington, D. C., are made from this examination.

**Many Other Positions**  
Many other positions are obtainable. Those wishing these positions should qualify at once.

**Get Free List of Positions**  
Fill out the following coupon. Tear it off and mail it today—now, at once.

This investment may result in your getting a big-paid government job.

**FRANKLIN INSTITUTE, Dept. J173, Rochester, N. Y.**  
Rush to me, entirely free of charge (1) a full description of U. S. Government Jobs, (2) Free copy of illustrated 32-page book, "U. S. Government Positions and How to Get Them"; (3) List of U. S. Government Jobs; (4) Tell me how to qualify for a job.

Name.....  
Address.....  
Use This Coupon Before You Mislays It. Write or Print Plainly



**FOR MEN WHO WANT TO LEARN A PROFITABLE TRADE**

*Complete*

# DIESEL TRAINING

**NO MATTER WHERE YOU ARE OR WHAT YOU DO — we have a training plan for YOU!**

IF you are sincerely ambitious and interested in making good in the Diesel field, be sure to immediately investigate our flexible training plan that will fit your circumstances. A Plan for every Man. A Plan for those seeking immediate shop training as well as for those who cannot give up their present employment and income. For 34 years National Schools, a recognized leader in the field of trade education, has helped wide-awake men to success. This million-dollar trade school will supply you with a sincere, honest statement of facts of what you should do to quickly get into the profitable Diesel Industry. No exaggerations—no misstatements; and a definite plan to fit you.

**Write Today for Full Details**

Mail the coupon below. Find out how you can get the finest in Diesel training without delay. See how this great trade school operates and makes its facilities available to every ambitious man. Actual work in modern training shops, a part of every man's instruction. Shop methods time-tested for 34 years. Fascinating, efficient preparation. Get the facts.

**WE ARE DEFINITELY INTERESTED IN HELPING MEN OF LIMITED INCOME AND "BLIND ALLEY" JOB HOLDERS.**

**NATIONAL SCHOOLS**

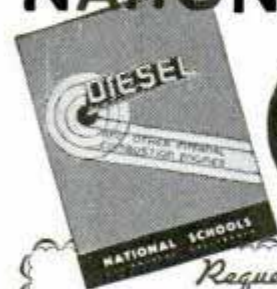

**FREE BOOK**

*Los Angeles*

*Request for Free Book*

NATIONAL SCHOOLS (established 1905) Dept. 4-PMA  
4000 South Figueroa Street, Los Angeles

Please send me, without obligation, your FREE BOOK and information regarding Diesel Employment Opportunities and Requirements.

NAME \_\_\_\_\_ AGE \_\_\_\_\_

ADDRESS \_\_\_\_\_ CITY \_\_\_\_\_ STATE \_\_\_\_\_

# The WISE MEN OF ANCIENT EGYPT

*told*  
**HERODOTUS**

That the Sun moves north as men travel south, until finally it shines continuously in the north.

For 1,500 years men laughed at the "gullibility" of the ancients, until, by sailing past the Equator, Europeans of the Middle Ages

DISCOVERED what the Egyptians KNEW thousands of years before.

**Suppressed Knowledge of Ancient Sages**

—lost to the world for 3,000 years, but preserved by the FEW who could appreciate and use it — is available to you, through association with the Rosicrucians. Their unique and successful methods of mastering life's problems and developing Personal Power are even more effective today. Try their formulas on your own personal and practical problems.

**Successful? — Happy?**

Have you realized the highest possibilities of which you are capable? Are you going through life with your greatest assets — social, business, intellectual — locked in a chest, without looking for the key?

Send for a Free Copy of "The Secret Heritage." It may open up a new world of personal satisfaction and practical achievement; it might have a startling effect upon your own future. It is sent free to the serious. Address Scribe W.C.S.

*The* **ROSICRUCIANS**  
AMORC

San Jose

California

(Not a religious organization)

**MAKE MONEY AT HOME!**

Learn to color photos and miniatures in oil. No previous experience needed. Good demand. Send for free booklet, "Make Money at Home" and requirements.

**NATIONAL ART SCHOOL**  
3601 Michigan Ave. Dept. 1354 Chicago

Correspondence Courses in **RADIO and ELECTRICAL ENGINEERING** **LOW AS \$25**

**ELECTRICAL ENGINEERING.** Get good grasp of wide electrical field. Modern. Very understandable. Theory made easy.  
**RADIO ENGINEERING.** Extra fine course in radio, public address, photo-electric work. Trains you to be super-service man, real vacuum tube technician. Tuition ONLY \$25, either course. Deferred payment plan. Experiment kits furnished.

**FREE** Write for free copies of school catalogs, student magazines, etc.  
**FREE LINCOLN ENGINEERING SCHOOL, Box 531-P4, Lincoln, Nebr.**

# AVIATION APPRENTICES



AIRMINDED YOUNG MEN INTERESTED IN TRAINING FOR ENTERING THE WELL PAID FIELD OF AVIATION AS APPRENTICES—Write immediately, enclosing stamp.

**MECHANIX UNIVERSAL AVIATION SERVICE CO.**

Wayne County Airport, Box 857, Dept. E, Detroit, Mich.



# GET IN THE SWING with Slingerland . . . DRUMS



**GENE KRUPA** — World's Greatest Swing Drummer uses Slingerland

tone, easy playing, rich power by musicians. Easy payments. 5-days free trial. See at your dealers.

Cut this ad out—good for \$1.00 credit. Free special information on how to organize drum and bugle corps. Free Catalog—mention instrument wanted.

**SLINGERLAND DRUM CO.**  
1330 Belden Avenue Chicago, Illinois

## GUITARS MANDOLINS

### WONDERFUL VALUE EASY PAYMENTS

Compare the value—tone and power in Slingerland "Radio King" drums, banjos, guitars, mandolins, marimbas or bugles—before you buy. Guaranteed more for your money. Acclaimed the tops in smooth



# Prepare at Home for JOBS in

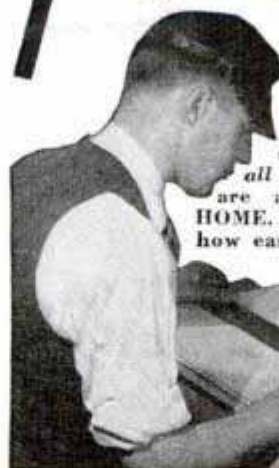

With this expert drawing outfit—drafting table, drawing board, superior drawing instruments . . . all sent without additional cost, you are all set to learn **DRAFTING AT HOME. FREE TRIAL LESSON** shows how easy. Mail coupon.

**THIS DRAWING OUTFIT YOURS**

# DRAFTING

The draftsman's work comes first. When business improves . . . and it is improving . . . there is new construction work, new buildings, new machines, repairs and reconstruction work. All these must first be laid out on paper. So the **FIRST** man that must be hired is the **DRAFTSMAN**.

## Drafting Is Well-Paid Work

Drafting is clean, interesting professional-type work. It pays well to start . . . offers real opportunities for promotion. You need no previous training or experience . . . no special talent—to learn Drafting. It is one of the steadiest employment fields. No machine ever did the Draftsman's work . . . and no machine can be invented. So your job is *always secure*.

## Learn AT HOME

in your spare time (or at the College in Chicago) by the fascinating, easy, step-by-step plan originated by this 35-year old school for Draftsmen.



Sample this easy-lesson system of learning Drafting. Send postal card or this coupon. No charge now or later for this **FREE LESSON**. Prove to yourself how easy it is to learn Drafting by the C. T. C. method in your spare time right in your **OWN HOME**.

## VOICE

**100% Improvement Guaranteed**

We build, strengthen the vocal organs—*not with singing lessons*—but by fundamentally sound and scientifically correct *silent exercises* . . . and absolutely guarantee to improve any singing or speaking voice at least 100% . . . Write for wonderful voice book—sent free. Learn WHY you can now have the voice you want. No literature sent to anyone under 17 years unless signed by parent.

**PERFECT VOICE INSTITUTE, Studio 1354**  
64 E. Lake St., Chicago

## Regain Perfect Speech, If You STAMMER

Send today for beautifully illustrated book entitled "DON'T STAMMER," which describes the Bogue Unit Method for the scientific correction of stammering and stuttering. Method successfully used at Bogue Institute for 38 years—since 1901. Endorsed by physicians. Full information concerning correction of stammering sent free. No obligation. Benjamin N. Bogue, Dept. 1301 Circle Tower, Indianapolis, Indiana.

## PHOTO-ENGRAVING

TASOPE' SINCE 1931

TASOPE', world's largest builders of complete Photo-Engraving Plants. We supply newspapers, printeries, studios, colleges, high schools and individuals with precision-built equipment, and give thorough training in Photo-Engraving and Photography, (home or residence)—all at one low cost! Cash in on popularity of pictures. Big money working full or part time for others, or open your own well-paying business. Amazingly small investment. Cash or terms. Catalogs free.

**THE AURORA SCHOOL OF PHOTO-ENGRAVING**  
Dept. PM-3 Tasope' Bldg. Aurora, Mo.

## LEARN WATCH REPAIRING

**AT HOME** You can learn by our modern and original system of instruction every part of the **Watch Repairing Trade** at home. You can earn money while learning and prepare yourself for a well paying position or start in business after completing our course of instruction. Good watch repairers are in demand and generally earn very good salaries. For particulars apply to the **Wisconsin School of Watch Repairing**  
524 E. Mason St., MILWAUKEE, WIS.

## ENGINEERING DEGREE IN TWO YEARS

B. S. Degree courses in engineering: Electrical, Civil, Chem., Mechanical, Radio and Television, or Aeronautical. 1 yr. Mech. Drafting. Intense, practical, thorough program. Large industrial center. Prep courses without extra charge. Earn board if desired. Low tuition and living costs. Enter June, September, December, March. Write for Catalog.

239-A E. Washington Blvd., Fort Wayne, Ind.

### INDIANA TECHNICAL COLLEGE

## CHICAGO TECHNICAL COLLEGE

D-200 Tech Bldg., 118 E. 26th Street, Chicago, Illinois.

Please send me **FREE Trial Lesson** in **DRAFTING** and show me how I can prepare for good positions in spare time **AT HOME**.

Name..... Age.....

Address.....

P. O..... State.....

When writing please mention Popular Mechanics





## Know Electricity as Experts Know It—and Get an Expert's Pay!

What about your future? Who is safe today? Surely not the man who is contented to stand still! Know your job thoroughly—prepare yourself for jobs ahead. To do just this thousands of men have used

### The Croft Library of Practical Electricity

The Croft Library is a complete electrical educator. It is founded on practice—on 20 years of shirt-sleeve experience—on work as it is actually done. It is jammed from cover to cover with the kind of hard-headed facts you want. Written so that the beginner can easily understand it, yet so sound, so thorough, that it is the daily guide of 59,000 highly paid electrical workers and engineers. Croft tells you the things you need to know about motors, generators, armatures, commutators, transformers, circuits, switchboards, distribution systems—electrical machinery of every type—wiring for light and power—wiring of finished buildings—underwriters and municipal requirements—illumination in its every phase—the most improved methods of lighting—lamps and lamp effects, etc.—how to do a complete job, from estimating it, to completion.

### No money down—easy payments

Fill in and mail the coupon attached and we will send you the entire set of seven volumes for ten days' examination on approval. We take all the risk—you assume no obligation. If you decide to keep the books, send \$1.50 in ten days and the balance at the rate of \$2.00 a month. Send the coupon NOW and see the books for yourself.

#### EXAMINATION COUPON

McGraw-Hill Book Co., 330 W. 42nd St., New York

Send me for ten days' examination on approval the Croft Library of Practical Electricity. If satisfactory I will send you \$1.50 in 10 days and \$2.00 monthly until the price of \$19.50 is paid. If not wanted, I will return the books postpaid. (To insure prompt shipment write plainly and fill in all lines.)

Name.....

Home Address.....

City and State.....

Position.....

Name of Company..... PM-4-39



## Fascinating, Profitable Profession NOW OPEN to More Men & Women

If you are looking for a NEW and BETTER way to make a living, take up Swedish Massage, for now you can learn at home. This interesting big pay profession was for years available only to a few. Its secrets were guarded jealously and fabulous prices were paid for instruction. This same instruction is now available to you at a mere fraction of the former price and you need not leave your present work until you have qualified as an expert and can command an expert's pay. The demand for BOTH MEN AND WOMEN has shown a steady increase and few, if any, have ever lacked employment.

### LEARN IN 90 DAYS AT HOME

Use spare time at home to master a profession which has made thousands of dollars for ambitious men and women. Many graduates have completed their training in three months but you can take your own time, it need not interfere with either work or pleasure. All instruction has been prepared by the teachers in our famous resident school—the same material is used and a DIPLOMA is awarded upon graduation.

### ANATOMY CHARTS AND BOOKLET FREE No Obligation Of Any Kind SEND COUPON

THE COLLEGE OF SWEDISH MASSAGE (Successor to National College of Massage), Dept. 464-30 E. Adams St., Chicago. You may send me FREE and postpaid, Anatomy Charts, booklet containing photographs and letters from graduates and complete details of your offer.

Name.....

Address.....

City..... State.....



# EASIEST to master!

## THIS NEW P-A

● Such beautiful tone, and so easy to play! Just touch a key and blow normally; you can't miss. Nothing to compare with these new P-A Saxes, Clarinets, Trumpets, and other P-A instruments. Fully guaranteed; your success assured. See your music dealer or write direct for beautiful free book. No obligation. Easy terms. Greatest fun, easiest with P-A. Write today sure.

PAN-AMERICAN  
403 P-A BUILDING ELKHART, INDIANA

## Want a Career in photography?

Big opportunities to make money! Train at Home or in our completely equipped studios. Commercial, News, Portrait, Advertising, Natural Color, Motion Picture and other branches of photography. Famous experts will be your teachers. 29th year. Send for free booklet.

NEW YORK INSTITUTE OF PHOTOGRAPHY  
10 West 33 St. (Dept. 49) New York City

## BIG PROFITS in DRY-CLEANING!

Good times or bad, dry-cleaning and redyeing stores prosper. Good-paying opportunities in even smallest towns. Easy to learn at home—requires no capital. Training costs but a few cents a day. Not a get-rich-quick scheme, but a substantial, well-paying field that can mean a steady income, your own home, car and all the other things that make life worthwhile. FREE book gives details. Write TODAY to  
Deot. AG-101,  
HUBBARD DRY CLEANING & REDYEING SCHOOL, SILVER SPRING, MD.



## Auto-Diesel

Master a real trade. Auto Mechanics, Diesel Mechanics, Arc Welding, Acetylene Welding, etc. Let us train you to be an expert Auto-Diesel Mechanic and help you get a good job. The cost to you is reasonable. Learn on modern equipment with tools under experienced instructors. Real shop work. Steam heated buildings. Room and board in our steam heated dormitory. We pay your fare to Nashville. For free catalog write

Nashville Auto-Diesel School, Dept. 75, Nashville, Tenn.



## SUCCEED IN LANDSCAPING

Send for FREE book on landscape training. Study at home, earn while learning. Profitable, interesting career; men, women. Initiative rewarded. Write today, give age, occupation.

AMERICAN LANDSCAPE SCHOOL  
6067 Grand Ave. Des Moines, Ia.

## Learn ADVERTISING at Home

Greater opportunities now in advertising. Learn easily and quickly in spare time. Practical work. No text books. Old established school. Low tuition—Easy terms. Send for free booklet and requirements.

Page-Davis School of Advertising  
Dept. 1354, 3601 Mich. Av., Chicago

**RADIO ENGINEERING**, broadcasting, aviation and police radio, servicing, marine and Morse telegraphy taught thoroughly. 48 weeks' engineering course equivalent to three years' college radio work. School established 1874. All expenses low. Catalog free.  
Dodge's Institute, Ada St., Valparaiso, Ind.

## U.S. GOV'T JOBS

Earn \$1260 to \$2100 at Start

Excellent opportunities for citizens 18 to 50. No special experience usually required. Railway Postal Clerks may earn \$153 first month; Customs Inspectors as high as \$3,000 a year. Send for FREE BOOK "How to Secure a Government Position." It tells about many good government positions and how our tested method will help you pass examinations. Write AT ONCE. PATTERSON SCHOOL, Arthur R. Patterson (former Gov't. Examiner), Principal, 84 Mercantile Bldg., Rochester, N. Y.



# PATENT and SELL your INVENTION

## A Simple Recipe for Inventive Success

PROBABLY the simplest recipe for inventive success would be this: First, a practical, useful invention; second, a good strong Patent; third, a buyer or a market. The inventor needs all three to get anywhere. Lacking any one, he is likely to get nowhere. The recipe is simple. Working it out isn't so simple. That is why inventors—and others inventively inclined—have found the two books shown here so helpful. We've gone into each part of the recipe carefully. Exactly what is an invention? We tell you. What is a strong patent? We tell you. How can I go about finding a buyer? We tell you.

## Many Questions Answered

But there's much more. For example, just how an Application for a Patent is made; how an inventor can safeguard himself with dated sketches as he goes along; how the pertinent Patent Office records are checked to see what other inventors may have done along the same line; how some successful

inventors have secured financial backing; simple ways to contact manufacturers; and many other points.

## 41 Years in the Business of Helping Inventors

The world needs, can use and will pay for practical, useful inventions. Manufacturers are on the alert for new articles, or improvements that will help them increase sales. Maybe you have one. Maybe not. These books will help you in deciding that. From that standpoint alone, they are valuable.

For more than 41 years, it has been our business to help inventors. We answer your questions and supply complete information about Patent procedure, costs, steps to take, kind of sketch or model needed, and much more. Our staff is made up of experienced Registered Patent Attorneys, Draftsmen, Searchers. Fees are reasonable—deferred payments arranged. Whether your idea is large or small, finished or still in the rough stage, you should have the facts both about Patenting and Selling. The information which we give you—based on long experience with thousands of inventors—is yours for the asking. No need to delay. These two books of facts may save you time, trouble, money, even later disappointment. Return the coupon—or write us a confidential letter—today.

## 115 Mechanical Movements Shown

In our book "Patent Protection" you will find illustrated 115 different mechanical movements. Maybe you'll find just what you need to work out some of your own ideas. Many other interesting pictures are shown in this book. Both books and an "Evidence of Invention" form sent to you FREE the same day we hear from you.

# VICTOR J. EVANS & Co.

### REGISTERED PATENT ATTORNEYS

Main Office: 112-D, Victor Building,  
Washington, D. C.

OTHER OFFICES:

514-N Empire Building, Pittsburgh  
405-N Garfield Building, Los Angeles  
1010-N Hobart Building, San Francisco

Send me FREE copies of your books, "Patent Protection" and "When and How to Sell an Invention." (Note: Same books supplied by any of branch offices listed above.)

Name.....

Street and No.....

City or Town.....State.....

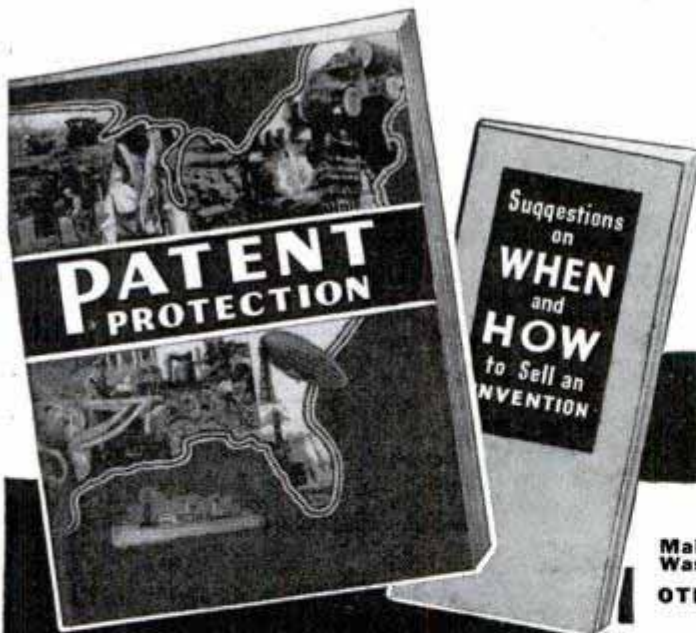

These 2 books tell you  
how to go about it ..  
Both Sent FREE >

When writing to advertisers please mention Popular Mechanics



# PATENTS

Booklet Free Highest References  
Promptness Assured Best Results

Send drawing or model.

## ALL BUSINESS GIVEN PROMPT AND PROPER ATTENTION

Listed Patent Lawyer in the latest editions of the Rand-McNally Directory of Bankers and Bank-Recommended Attorneys, published by Rand-McNally & Co., Chicago, Ill.; The Baggott & Ryall Directory of Guaranteed Attorneys, published by Legal Directory Corporation, Boston, Mass.; American Lawyers Annual, Cleveland, Ohio; Bankers Service Legal Directory, published by Bankers Service Co., Boston, Mass.; Eyre's Law List, 9 Park Place, New York City; Snow-Church Directory Co. Lawyers List, published in New York City, and the Central Guarantee Co., Bankers and Lawyers Directories, 630 Fifth Avenue, New York City.

**WATSON E. COLEMAN,** Victor Building, 724 Ninth Street, N. W.  
**REGISTERED PATENT LAWYER** **WASHINGTON, D. C.**

## INVENTORS PATENT YOUR IDEAS SEND FOR FREE BOOK



### HOW TO OBTAIN A PATENT

Written by a Former Member of the Examining Corps (1922-24) of the U.S. Patent Office. If you want to profit by your idea, you should take steps to apply for a U. S. Patent at once. Your first step is to get this Free Book. This interesting illustrated book contains valuable information you should have. It tells you fully how to obtain a patent on your idea in the quickest way. With this Free Book you will also receive a "Record of Invention" form on which you can easily record your idea. Personal and Confidential Service: Your case will be personally handled only by a Registered Patent Attorney who is also a Former Member of the Examining Corps of the U. S. Patent Office. All communications confidential.

MAIL COUPON TODAY for FREE PATENT BOOK and RECORD OF INVENTION Form.

**CARL MILLER**  
REGISTERED PATENT ATTORNEY  
FORMER MEMBER EXAMINING CORPS U. S. PATENT OFFICE

Woolworth Bldg., 35th Floor, Dept. 49A, New York City  
MILLER BUILDING, Dept. 49A, Washington, D. C.  
Please send me your Free Book, "How to Obtain a Patent," and your "Record of Invention" form.

NAME.....

ADDRESS.....

## Inventions Wanted Patented or Unpatented

We have been successfully selling inventions, patented and unpatented, since 1924. Write for proof, and tell us what you have for sale.

**Chartered Institute of American Inventors**  
Dept. 4, Barrister Building, Washington, D. C.



## G E A R S

In Stock — Immediate Delivery

Gears, speed reducers, sprockets, thrust bearings, flexible couplings, pulleys, etc. A complete line is carried in our Chicago stock. Can also quote on special gears of any kind. Send us your blueprints and inquiries.

Send 10c for Complete Catalog No. 10

**CHICAGO GEAR WORKS**  
769-773 W. Jackson Blvd. CHICAGO, ILL.

## PATENTS—TRADE MARKS

All cases submitted given personal attention  
Form "Evidence of Conception" with instructions  
for use and "Schedule of Government  
and Attorneys' Fees"—FREE!

**LANCASTER, ALLWINE & ROMMEL**

Patent Law Offices

412 Bowen Bldg.

Washington, D. C.

## INVENTORS PROTECT & SELL

Your unpatented invention can be sold with positive safeguards under patent laws. New, low-cost procedure. Complete details, free.  
**AMERICAN PATENTS CORPORATION**  
Dept. 4-E Washington, D. C.

**INVENTORS** who derive largest profits know and heed certain simple but vital facts before applying for patents. Our book, Patent-Sense, gives those facts; sent free. Trade Marks—Copyrights.  
**LACEY & LACEY, Est. 1869, 635 F St., N. W., Dept. 5, WASHINGTON, D. C.**

## RUPTURED?

### Get Up-To-Date Relief

Why try to worry along with old-fashioned trusses that gouge your flesh—press heavily on hips and spine—enlarge opening—fail to hold rupture? You need the Cluthe. No leg-straps or harness. Automatic adjustable pad seals opening—follows every body movement with instant increased support in case of strain. Cannot slip. Holds rupture whether at work or play, easy to wear. Waterproof. Can be worn in bath. Send for amazing FREE 100-page, cloth-bound book "Advice To Ruptured" and details of liberal truthful 60-day trial offer. Also names of grateful patrons in your neighborhood. Write today. Cluthe Sons, Dept. 31, Bloomfield, New Jersey.



### BUCHSTEIN'S FIBRE LIMB

is soothing to your stump—strong, cool, neat, light. Easy payments. Braces for all deformities. Agents wanted.

**D. BUCHSTEIN CO.**  
610 3rd Ave., So., MINNEAPOLIS, MINN.

Send for Catalog Today

## MONEY-MAKING OPPORTUNITY

for men of character. Over \$1,600 per month earned by California man. Over \$400 a week by Georgia man. \$1,000 in a month by Delaware man. Exclusive franchises available for an invention expected to replace a multi-million dollar industry. Install on free trial. Sell itself. Repeat. Explosive proposition. Write F. E. Armstrong, Dept. 1112-D, Mobile, Alabama.

## To PROTECT YOUR INVENTION—Use this coupon, NOW

Delays are dangerous and may be very costly. My personal service assures prompt action, strict confidence, and a minimum of expense. I suggest that you send me a model or drawing, or sketch and description of your invention, and \$5.00. I will make a search and report

promptly as to its patentability and send you a copy of my 72-page booklet. Or, if you prefer to read my booklet first, mail the attached coupon at once. I will also send my "Record of Invention" form. (Over 38 years experience as a Registered Patent Attorney.)

**L. F. Randolph,** 302-D Victor Bldg., Washington, D. C.

Please send me at once, free of charge, your 72 page booklet and "Record of Invention" form.

Name.....

Address.....

**A PERSONAL CONFIDENTIAL PATENT SERVICE—**





**Skin So Awful  
He Was Ashamed  
To Go Swimming  
Because of**

# PSORIASIS

**Free Trial Treatment!**

Success, romance, complete happiness are denied thousands who are disfigured by psoriasis lesions. A marred, scaly skin brings on a sense of shame and inferiority complexes, yet many have found discomforts are relieved with NINAL. Crusts, scales on the outer skin, and red patches have gradually diminished—many report the thrill of a clearer skin once again!

Ninal is used externally—does not stain clothing or linen. A trial bottle will be sent absolutely free and without any obligation to any psoriasis sufferer so that a 10-day test may be made without spending one penny. Write today for free bottle. Print name plainly.

**SEEDOL COMPANY, Dept. PM**

51-12 21st Street Long Island City, N. Y.

## BE A CARTOONIST



AT HOME IN YOUR SPARE TIME UNDER personal supervision of the famous cartoonist NORMAN MARSH creator of "DAN DUNN" appearing every day in big papers. Success—Fame—Real Money may be Yours when you learn Marsh's easy simple methods and secrets. Send name and address for free details of MARSH'S Personal course. ACT TODAY!

**NORMAN MARSH SCHOOL OF CARTOONING**

4554 Broadway Dept. D-100 Chicago, Ill.

## AVIATION

Practical Aviation Instruction for the layman, for the pilot, for the mechanic, and for the ground-school instructor. The transport license method of specialized aviation instruction, published since 1930. Write for FREE circular.

**THOMPSON AVIATION PUBLISHERS**

8326 Woodward Detroit, Mich.

## Air Conditioning

**3 Texts of Special Value to Architects, Contractors and Carpenters**

These Instruction Manuals are fully illustrated, up-to-date, practical. Invaluable to men engaged in any phase of Air Conditioning.

**All 3 only \$9.50!**

Get the complete set of Air Conditioning manuals covering practical phases of this growing industry. Send for yours Today!

*Air Conditioning*  
**Furnaces and Unit Heaters**  
\$3.00

*Air Conditioning*  
**Insulation**  
\$2.50

*Air Conditioning*  
**Heating and Ventilating**  
\$4.00

### Special Offer—Use for 15 Days!

**AMERICAN TECHNICAL SOCIETY**  
Dept. K419, Drexel Ave., at 58th St., Chicago, Ill.

I want to take advantage of special offer permitting me to use Air Conditioning manuals for 15 days. I've checked those I want and will pay \$1 and small delivery charges upon arrival. If after 15 days I realize how valuable they are, I will send balance due. (Important! If you order 2 manuals or Complete Set you need send only \$2 at end of 15 days and pay balance at rate of \$2 a month.) If I return Texts they are to be sent back express charges collect, and I will receive full and immediate return of my \$1 payment.

Complete Set of 3, \$9.50  Heating and Ventilating, \$4.00  
 Furnace and Unit Heaters, \$3.00  Insulation, \$2.50

Name.....  
Occupation..... Age.....  
Address.....  
City..... State.....

# Inventors- FREE BOOKS



**Now Tell You How To PROTECT  
And To CAPITALIZE On Your  
Invention • Save Time, Money**

● At last here are the patent facts you want. Competent advice on patent procedure is essential to good results. Our 63 years' experience enables us to clearly explain everything you need to know about protecting and commercializing your idea. You will find the answers in these free booklets that are yours for the asking. If you want prompt advice from reputable patent attorneys, tear out and mail the coupon below at once.

**C.A. SNOW & CO.**  
Registered Patent Attorneys Since 1875

**FREE FACTS  
FOR YOU**

**149 SNOW BUILDING, WASHINGTON, D. C.**

Gentlemen: Please send me—without cost or obligation—your FREE books, "Suggestions on How to Commercialize Your Invention" and "How We Protect You." Also Certification of Invention form.

Name .....

Street and No. ....

City or Town..... State.....

# Know! YOUR CAR

ASK TO SEE IT!



**GOOD NEWS—JUST OUT**

**AUDELS NEW AUTOMOBILE GUIDE** is NEW from cover to cover. Explaining the Theory, Construction and Servicing of modern motor cars, trucks and buses; and the application of auto type Diesel Engines. . . . **PRACTICAL INFORMATION IN HANDY FORM, 1540 PAGES COVERING . . .**

**AUTO REPAIRS & SERVICE HELPS**

All the Parts of an Automobile—Automotive Physics—The Gas Engine—How a Gas Engine Works—Gas Engine Principles—Multi-Cylinder Engines—Horse Power—Automobile Engines—Engines; Stationary Parts—Engines; Moving Parts—Pistons—Piston Rings—Connecting Rods—Crank Shafts—The Valves—The Valve Gear—Cams and Cam Action—Valve Timing—Cooling Systems—Gasoline—Fuel Feed Systems—The Mixture—Carburetors—Automatic Choke—Super-Chargers—Transmissions—Synchro-Mesh—Clutches—Universals and Propeller Shafts—The Differential—Rear Axles—The Running Gear—Brakes—Wheel Alignment—Knee Action—Steering Gear—Tires—Lubricants and Lubrication—Automotive Electricity—Ignition Systems—Magneto Ignition—Spark Plugs—Ignition Coils—Distributors—Automatic Spark Control—Ignition Timing—Generators—Starters—Generator and Starter Testing—Lighting Systems—Storage Batteries—Battery Charging—Battery Testing Troubles. **Automotive Diesel Engines. Inside Views of all Automobile Parts Fully Illustrated. To Get This Assistance for Yourself Simply Fill in and Mail Coupon Today.**

**\$4 COMPLETE • PAY ONLY \$1. A MONTH**

**THEO. AUDEL & CO., 49 WEST 23rd STREET, NEW YORK**  
Please send me postpaid AUDELS NEW AUTOMOBILE GUIDE (\$4) for free examination. If I decide to keep it, I will send you \$1 within 7 days; then remit \$1 monthly until purchase price of \$4 is paid. Otherwise, I will return it to you promptly.

Name .....

Address .....

Occupation .....

Reference .....

PM



# PLUMBERS & STEAM FITTERS

Audels Plumbers and Steamfitters Guides



4 Vols. \$6

A practical, illustrated, Reference Library and Study-Course for Master Plumbers, Journeymen and Apprentice Steamfitters, Gas Fitters and Helpers, Sheet Metal Workers, Draughtsmen, Master Builders, Engineers and all Building Trade Students. This valuable set of handy, pocket-size Guides explains in practical concise language and well-done illustrations all the principles, advances and short cuts of the Plumbing and Heating trade—based on modern practice. Contains careful, detailed instructions

on how to figure and estimate various jobs. Use FREE COUPON below to examine, without obligation, this valuable work.

### INSIDE TRADE INFORMATION ON:

Soldering, tinning. Joint wiping, bending, beating. Pipe—iron—steel, threading. Mathematics, tables, physics. Materials—iron, steel, copper, brass, lead, tin, antimony, etc. Sheet metal—galvanized—plate. Sanitation, syphonage, tanks. Drainage, sewage, purification. Fixtures—bath—kitchen. Pipe fittings, soil pipe, tools. Laying out work. Roughing. Screwed fittings, flanges, joints. Pipe bending, examples. Elbows. Heating, ventilation, air conditioning, refrigeration. Water supply, mains, wells, tanks. Gas-fittings. Sheet metal work, problems, methods. Brazing, heating, lead burning. Welding, various welds, methods. Blacksmithing, forges, tools. **Air Conditioning.**

**THEO. AUDEL & CO., 49 W. 23rd St., New York City**

Mail Audels Plumbers Guides, 4 vols., on 7 days' free trial. If O. K. I will remit \$1 in 7 days, and \$1 monthly until \$6 is paid. Otherwise, I will return them. No obligation unless I am satisfied.

Name .....

Address .....

Occupation .....

Reference ..... P. M.



## MECHANICS-WELDERS - COLLISION MEN

### GOOD JOBS and MIGHTY GOOD PAY

Do you want to earn big money? If so let us know which of the following trades you prefer. You learn by doing. Practical work. Expert teachers. Low tuition. Personal attention. It will pay you to investigate AT ONCE. Just check the courses you'd like to take and mail today. You will receive full information, absolutely without cost or obligation. But don't delay.

#### Check the Trade You'd Like to Learn

- |   |   |
|---|---|
| <input type="checkbox"/> Complete Auto Mechanics (including Diesel) | <input type="checkbox"/> Electric Arc and Acetylene Welding |
| <input type="checkbox"/> Auto Collision                             | <input type="checkbox"/> Spray Painting                     |
| <input type="checkbox"/> Metal Finishing                            | <input type="checkbox"/> Body and Fender Bumping            |

#### Ask about our "Pay After Graduation Plan"

Name .....

Address .....

Mail the above at once to

**MICHIGAN TRADE SCHOOL**  
3758 Woodward Ave. Detroit, Mich.

Write for FREE FOLDER

## BOEING SCHOOL STARTS AVIATION CAREERS



The air industry looks to Boeing School for men trained to make good in aviation. Jack Knight, 2,400,000-mile ace pilot, says: "IF YOU WANT TO GET BEYOND FIRST BASE IN AVIATION, I RECOMMEND BOEING SCHOOL." United Air Lines founded Boeing School, closely supervises all Boeing courses. School buildings adjoin United's hangars at A-1-A Oakland Airport. Boeing School classes are kept small. Equipment is complete, modern. At Boeing School you're inside aviation! Write today for FREE 1939 BOEING SCHOOL BULLETIN. Describes Pilot, Ground, and Engineering courses. Gives lines of promotion. Tells opportunity for high school graduates. Address: BOEING SCHOOL OF AERONAUTICS, Dept. E-15, Airport, Oakland, California.

A DIVISION OF UNITED AIR LINES

## X The SECRET of SELLING PHOTOS

—TO MAGAZINES, newspapers, trade journals, advertisers. Learn how to take the kind of pictures wanted. We train you at home to become a journalistic or press photographer. Show you how to take photos that sell. You may pay for course in easy installments. FREE Book tells about money-making opportunities. Write NOW. Universal Photographers, Inc., Dept. 74, 10 W. 33rd St., New York, N. Y.

## Free AIR CONDITIONING AND REFRIGERATION TRIAL LESSON

Trained men needed. Good pay. Opportunities. Learn easily AT HOME in spare time (or at our Chicago School). Send for FREE TRIAL LESSON. No charge for this now or later. Write today. CHICAGO TECHNICAL COLLEGE D-303 Tech Bldg., 118 E. 26th St., Chicago, Ill.

## TRI-STATE COLLEGE

B. S. Degree in 2 Years

World famous for technical 2-year courses in Civil, Electrical, Mechanical, Chemical, Radio, Aeronautical Engineering, Business Administration and Accounting. Special preparatory department for those who lack required high school work. Short diploma courses (36 weeks) in Surveying, Drafting. Low tuition. Low living costs. Students from every state and many foreign countries. 54th year. Enter March, June, September, January. Write for catalog. 449 College Ave., ANGOLA, IND.

## JOBS in RADIO-TELEVISION

Extension and resident training in television, aviation and police radio. Let us tell you how we train men, fit them for good jobs, help them get jobs. Write for catalog. Affiliated with KMBC, major network station. Address MIDLAND TELEVISION, Inc., 106-D Power & Light Bldg., Kansas City, Mo.

## ARTISTS MAKE MONEY

Find out your ability. Send name, age, occupation and address for Free Vocational Art Test. Federal Schools, Inc., 4139 Federal Schools Bldg., Minneapolis, Minn.

## PIANO — HAWAIIAN (STEEL) GUITAR SPANISH GUITAR...easily learned at home

Become a skilled musician by our simple, short-cut note method. Play songs almost instantly. COST LESS THAN 2c A DAY! Money back guarantee. Write for free details. HAMANN INSTITUTE, 3016 N. 24th Place, Dept. R-4, Milwaukee, Wis.

## WANT A GOOD-PAY JOB?

Trained Tool and Die Makers, precision machinists, automatic screw machine men earn as much as \$50-\$60 per week. Train at one of America's best equipped shops. Training work supervised by experts. Day-Evening classes. Low fee, employment help. Write NOW for free booklet "Practical Machine Shop Training." Allied Screw Machine Co. Inc. (School Division) Dept. PM4 603-9 Lake St. Chicago, Ill.





**NEW INVENTIONS**

(Continued from page 18A)

**I**F A TIRE goes flat while the automobile is parked in the owner's garage, a newly

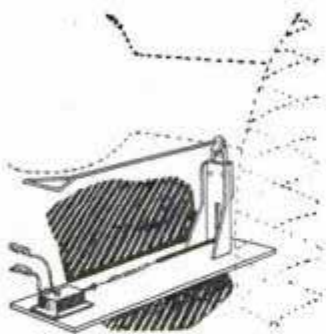

patented device immediately gives warning by ringing a bell in the house. It is installed in the garage. When the car is parked for the night, it is so

placed in the garage that its axles are just above the device. If the tire loses air sufficiently to bring the car's axle into contact with a switch on the alarm mechanism, an electrical circuit is closed and a bell rings in the house. The alarm should be useful to doctors and others who must know their car is ready for driving at all times.

**T**RAFFIC officers and others whose work requires them to remain outdoors in bad weather probably would find useful a newly patented rain and sun shield. The device consists of an umbrella-like covering that is attached to the wearer's head by a chin strap. When not in use, it may be folded and stored in the pocket.



**M**OTORISTS who smoke would find handy a newly patented steering wheel into the hub of which is built a cigarette box, ash tray and lighter. Thus, everything necessary is placed so that the driver may smoke without taking his eyes off the road.



Due to the fact that many of the devices described in this department are still in the patent office stage and are not on the market, Popular Mechanics Magazine cannot undertake to supply further information regarding them.

**AGENTS UP TO \$50 IN A WEEK**

Big cash profits for you; full or spare time. Over 250 household necessities—things people must buy. Proven fast sellers; steady repeaters, earnings very first day. FORD TUDOR SEDAN GIVEN YOU AS BONUS. I'll show you how to start at once; send you everything—Big Display Outfit and quick cash plans. Details FREE—no obligation. Just send name on postcard. E. J. MILLS, 9437 Monmouth Ave., Cincinnati, Ohio.



**MIDWEST SALE-FACTORY-TO-YOU!**

**PUT THIS NEW CHASSIS IN YOUR CABINET**

**14-TUBES**

WORLD-WIDE CHASSIS



**NEW!**

**SAVE UP TO 50%**

HERE it is—the greatest radio value we have ever offered. A big, powerful, new 14-tube world-wide Midwest. Why be content with an 8 or 10-tube set . . . when it is so easy to install this big, new, powerful 14-tube chassis in your own cabinet for the same price! For a little more than the cost of new tubes, you can modernize your old radio and get exciting world-wide reception—during this special sale!

COMPLETE CHASSIS  
Only \$19.95  
WITH TUBES AND SPEAKER

**30 DAYS TRIAL**

**LIBERAL TRADE-IN ALLOWANCE**

**UP TO \$40 ON YOUR OLD RADIO**



. . . when you trade it in on the beautiful 17-tube 5-band Model "D" console shown here. Tell us the make and age of your present radio, so we can determine how much to allow you on it. New Time-Payment Plan makes it easier than ever before to own a Midwest. Midwest makes a radio to suit every purse . . . 6-tube to 17-tube 5-band models . . . and prices start as low as \$10.95. Absolute satisfaction guaranteed on a money-back basis.

Write for FREE 1939 catalog

**MIDWEST RADIO CORPORATION**  
Dept. 15-KK Cincinnati, Ohio

EASY TERMS

PASTE COUPON ON 1" POSTCARD...OR WRITE TODAY!

MIDWEST RADIO CORPORATION  
Dept. 15-KK  
Cincinnati, Ohio

Name.....

Send me your new FREE catalog, complete details of your liberal 30-day Trial offer, factory-to-you, wholesale prices and big TRADE-IN offer.

Address.....

Town.....State.....

User-Agents Make Easy Extra Money. Check here ( ) for details.



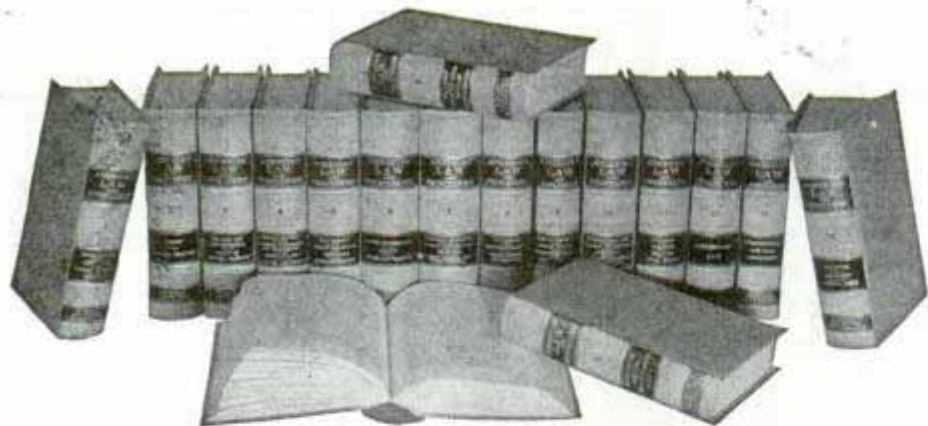

# Acquire LAW nights at HOME

—the law library illustrated here—written by outstanding law professors—supplemented by lectures—cases—and personal tuition by qualified lawyer-instructors, will give you law training by home study.

**T**HOUSANDS of men, who never intend to practice before the bar, are studying law.

They realize that the law trained man is a leader—that law training makes keen, clear, quick, correct thinking—that there is a real reason why legally trained men head many of America's greatest corporations.

## Practical Law Training Through HOME STUDY

The home study Law training offered by LaSalle has proven itself practical and valuable far beyond the time and money cost.

In certain permitted states every year, LaSalle trained men pass bar examinations with high honors.

But many, many more men, take their LaSalle law training to use in business and find in it a quick, sure key to progress and leadership—to the avoidance of pitfalls and the picking of the sure and certain paths of progress.

Many of the leaders of 1945-1950 will be determined in 1939. Will you be one of them?

## A Most Unusual Law Library

The basis of LaSalle law instruction is a fourteen volume library—we believe the most remarkable set of law books you have seen—compiled by leading professors and authorities.

This library might well be called—“Law Simplified and Condensed”—for it covers the whole basic field of law in an orderly, classified and simple manner. In many resident schools, the LaSalle Law Library is a reference work regularly used by students. In one great law school, fourteen sets of LaSalle's Law Library are at the student's disposal and constantly used.

Supplementing this great library, are lectures and personal instruction of the highest grade, all under a definite, clear plan involving continual use of the Problem Method, where you train in law by dealing with actual legal problems—learn by doing the work—not by memorizing rules.

To get the whole story, you must investigate. And the coupon below is the easy way to start that.

# LASALLE EXTENSION UNIVERSITY DEPT. 464-LR CHICAGO

## A CORRESPONDENCE INSTITUTION

**Law: Degree of LL.B.** I would like to have full information about your law training, together with a copy of “Law Training for Leadership” and your booklet “Evidence,” all without obligation.

Other LaSalle Opportunities: LaSalle opens the way to success in every important phase of business. If more interested in one of the fields indicated below, check and mail now.

- |  |  |  |   |
|--|--|--|---|
| <input type="checkbox"/> Commercial Law      | <input type="checkbox"/> Industrial Management | <input type="checkbox"/> Business Correspondence | <input type="checkbox"/> Traffic Management                   |
| <input type="checkbox"/> Business Management | <input type="checkbox"/> Modern Foremanship    | <input type="checkbox"/> C. P. A. Coaching       | <input type="checkbox"/> Effective Speaking                   |
| <input type="checkbox"/> Modern Salesmanship | <input type="checkbox"/> Expert Bookkeeping    | <input type="checkbox"/> Business English        | <input type="checkbox"/> Credit and Collection Correspondence |
| <input type="checkbox"/> Higher Accountancy  |  |  |   |

**THIS BOOK FREE**



Name.....

Present Position..... Age.....

Address..... City.....

When writing to advertisers please mention Popular Mechanics





# CLASSIFIED

## Advertisements



Advertisements in this section, 35 cents per word, each insertion, minimum 10 words, payable in advance

To be inserted under proper classification in May issue, copy should be in our office March 8th

May issue on sale April 1st

Popular Mechanics Magazine, 200 East Ontario Street, Chicago, Illinois

## YOU'LL PROFIT

By reading and answering the classified ads in this section. Hundreds of opportunities to make and save money.

Popular Mechanics Magazine,  
Chicago, Illinois.

Gentlemen:—We must say that your readers appreciate a bargain when they see one. To date we have received 2,743 inquiries and orders from your December issue. Inasmuch as we had only 200 motors to dispose of, you can see the position this placed us in, and we earnestly advise anyone who doesn't want to be swamped with mail not to advertise in the Popular Mechanics Magazine. For sheer pulling power, like we've never seen before, we can only say that your magazine is it!

(Original letter on  
file in our office)

Yours very truly,  
THE CRAFT PRINTING CO.

# 1061 CLASSIFIED ADVERTISEMENTS 1061 OPPORTUNITIES FOR YOU

### AUTOMOBILES—MIDGET CARS

**BRAND** New fifth edition Automobile Racing Book. Tells how build dirt track bodies, frames, engines. Records, superchargers, rules, formula, plans, stock, conversions, roadster racing, fast Fords. \$1.00 postpaid; \$1.15 C.O.D. Ray Kuns, Department 4, Madisonville, Cincinnati, Ohio.

**RACE** Car Miller Eight single seater. Winner Indianapolis 500 mile race. H. Kohler, St. Charles, Illinois.

**MECHANICS** Test circuits instantly. New invention. Guaranteed. \$6.50. Irwin Mfg. Co., Box 190, Lewiston, Idaho.

**"HOP** Up your car." Build this powerful inexpensive supercharger for any automobile. Adds up to 8 horsepower. Complete plan \$1.00. Box 107, East San Diego, Calif.

**SAVE** Dollars. Make your own vapor-screen for a better vaporized mixture, smoother performance. Information with material 50c. Accessory Annex, McKeesport, Penna.

**MIDGET** Racecars, sportcars, motor-scooters. Bargain lists—130 used motors, midgets, parts—20c. Illustrated literature. Midgets, Box 543-H, Zanesville, Ohio.

**SALE!** Bargain prices. Midget cars, kits, parts, plans. Catalog 20c. Derby Midgets, Woodstock, Illinois.

**FORD** V-8's, 1934-1939; gasoline saving device. \$1. Walert Co., 3429 No. 10th St., Milwaukee, Wisconsin.

**MIX** High test gasoline for 4c gallon. Guaranteed to triple any car mileage, performance. Formula \$1.50. Carburetor Motor Company, Box 596, Wichita Falls, Texas.

**ALUMINUM** Alloy pistons, automotive, aviation, Diesel, industrial, marine, midget, model, motorcycle, outboard. Finished or semi. Judson Mfg. Co., Hedge and Gillingham, Philadelphia, Penna.

**R & R** Mfg. Co., Anderson, Indiana. Racing cars, midgets and speed equipment. Catalogue 25c.

**MIDGET** Two-passenger autos, midget racers, midget motorcycles, motorscooters, motors, wheels, parts, plans. Handbook catalog, illustrations, 20c coin. Midwest, Box 1959, Chicago.

### AUTO TRAILERS

**FAMOUS** Watson 5 ton coupler and Watson 2 ton axle, any tread. Both \$12. Watson Machine Co., Box 18, Mansfield, Ohio.

**BUILD** The famous, low-cost Jim Dandy Cabin Trailer. Complete plans and instructions 50c. Plans to build the beautiful, streamlined Jim Dandy Cabin Cruiser, \$1.00. Trailer Builders Manual and catalog of trailer parts, supplies and equipment—over 100 interesting, illustrated pages, 25c. Order today. Satisfaction guaranteed. Trailer Supply Co., 411-A Jackson St., Wausau, Wisconsin.

### AUTO SUPPLIES AND EQUIPMENT

**NEON** Stoplight penetrates fog, easily installed by anyone. Complete with 21" neon tube \$3.00. Complete kit for use with model T Ford coil \$1.75. Complete plans and information 25c. Bohlman, 125-19 Jamaica Ave., Richmond Hill, N. Y.

**BARGAINS**—Compressors, welders, battery chargers, car washers, attractively priced. Terms, trial. Write for bargain list. Hobart Automotive Supply, Box M-495, Troy, Ohio.

**REFINE** Used oil without cost. Particulars. F. Gerwin, Fairview, Oklahoma.

**INEXPENSIVE** Guaranteed protective puncture seal. Airluck Laboratory, 1460 Hollywood, Chicago.

**BATTERY** Discharge indicator. Red light warns of battery discharge at any time. Avoids rundown battery. Fully automatic. Fits all cars. Complete \$2.50. Reditte, Plain, Wis.

**RE-REFINE** Crankcase drainings, request information. Zelball, Mount Holly, N. J.

**NEW!** Your automobile stop light becomes a stop guide. Attach Seco behind your speedometer quickly. Makes your stop light flicker according to how fast or slow you stop. Introductory price \$1.00. State car and year. Smith Engineering Co., 197 Brunswick Blvd., Buffalo, N. Y.

**PLATING** Outfits for auto parts. Connect to a battery. No tanks used. Free particulars and proofs. Gunmetal Co., Ave. J, Decatur, Ill.

**ACETYLENE** Welding outfits, \$32.95; electric welders, \$74.95. Easy-payment plan. Box 331, Hamilton, Ohio.

### MOTORCYCLES, BICYCLES, MOTOR SCOOTERS AND SUPPLIES

**BUILD** Power scooters, midget cars. We supply tires, wheels, motors. Lowest prices. Send 10c for plans, etc. Build-Your-Own Devices, 5238 Lake, Chicago.

**SEND** 10c For catalog of accessories, new and used parts. Bootz, 622 E. Grand, Des Moines, Iowa.

**FREE** Catalog Indians, Harleys, motor scooters. Motorcycle speed books \$1.50 each. Goggles, stop watches, helmets, Hepolite speed pistons. Clymer, P. M., 434 West Pico, Los Angeles, Calif.

**BUILD** Scooter bike from scrap parts. Plans 15c. Readers Service, 800-60 North Clark, Chicago.

**GENERATOR** Armatures rewound. Harley, Indian, \$3.25; return postage paid. Packard, 623 Des Moines St., Des Moines, Iowa.

**MOTORSCOOTERS!** New streamline model—easy to build, costs little. Parts furnished. Complete plans, instructions, 25c. Pictures, prices included. Shipp's Midgets, Box 543-H, Zanesville, Ohio.

**NEW** Push-A-Bike outboard motor for your bicycle. Complete with pneumatic tire. Ready to attach. Richburn Company, Aurora, Missouri.

**BICYCLES** For boys. Earn Shelby Speedline special deluxe job or others. Make money. See ad page 159A. Jim Thayer, Dept. 877, Crowell Publishing Co., Springfield, Ohio.

**REBUILT** Motor cycles, all makes, new and used Harley-Davidson parts. Send 10c for bulletin. Western Harley-Davidson Distributors, 914 E. 15, Kansas City, Mo.

**SEND** 15c For illustrated used motorcycle catalog. Bargains. Largest stock genuine Indian parts and motorcycles. Indian Motorcycle Sales, Kansas City, Mo.

**MOTORCYCLE** Bargains, lowest prices, bargain sheets for stamp. Motorcycle accessories. Rochester Harley Davidson Corp., 129 W. Main St., Rochester, N. Y.

**HI-LIFE** Bicycle generators operate lights direct or charge miniature Kic-O storage battery. Write Kimley, 1271 E. Ferry, Buffalo, N. Y.

**INSIDE** Dealer prices. Overstocked, all models. Indians and Harleys. Rebuilt, guaranteed. Dime brings latest list. Crandall-Hicks, Boston, Mass.

**ALLOY** Pistons—Harley, Indian, Henderson, Excelsior, Cleveland. New and used parts for less. Cylinder grinding. Catalogue and wings pin 10c. Ballak, 1115 Chestnut, St. Louis, Mo.

**RECONDITIONED** Motorcycles. New—used parts for all makes. Authorized Harley-Davidson dealer. Whitman Motorcycle & Supply Co., 405-9 Southwest Blvd., Kansas City, Mo.



### AVIATION

THREE Books for \$1.00: "Gliding and Soaring," "Manual of Gliders and Soarers," "Starting and Landing." Kenyon Press, Wauwatosa, Wisconsin.

GET Into aviation. Pilots earn up to \$6000 a year! Airplane mechanics and aeronautical engineers also get big pay! Prepare at this Lincoln government approved school. Write for complete information. Lincoln Airplane & Flying School, 2004 Aircraft Bldg., Lincoln, Nebraska.

130 AIRPLANES \$35 Up. Terms, trades. Complete catalogue 25c. Used Aircraft Directory, Athens, Ohio.

TRADE Your old model airplane motor on a brand new engine. Liberal allowance. We buy, sell, and exchange all makes model airplane engines. Model Motors Exchange, 2612 North Laramie, Chicago.

AIRCRAFT Mechanics, welding, flying courses. Swallow Airplane Company, Wichita, Kansas.

JUST Out. Practical course in flying. 29 chapters, illustrated, complete. Only \$1.00. Aircraft Directory, Athens, Ohio.

LEARN To fly free. Folder, dime. Corrigan, Box 391, Hempstead, N. Y.

AVIATION Apprentices — Air-minded young men interested in training for entering aviation as apprentices see ad on page 26A.

AIRPLANE Mechanic's home-study course \$1.25. Engine mechanic's \$1.25. Both courses \$2.00. Prepares for license. Helps pilots immensely. Meyer Engineering, Hempstead, N. Y.

PROPELLERS For sleds, aircraft. Catalog 10c. Banks Propellers, Love Field, Dallas, Texas.

PROPELLERS For airplanes, sleds. Iced-sled blueprints, supplies. Catalog dime. Lorenzen Propellers, Niles, Michigan.

GRADUATE Airplane mechanic. Ten weeks. \$1.00 week. Graduates with leading concerns. Free catalog. United Air School, Elgin, Ill.

PROPELLERS—All types, including latest three blade airliners. American Flea Special \$12.50 down. Universal Aircraft, Ft. Worth, Texas.

### BATTERIES, GENERATORS, ETC.

FARMLITE Batteries—50% saving. Buy direct. Battery Exchange, Albers, Illinois.

WINDCHARGER Light plants. We show you how used car generators make inexpensive windchargers. Instructions 10c. Wesco, 820 Terminal, Minneapolis, Minn.

PLATING Generators and motor generator sets. Write for information Hobart's new line electro plating equipment. Payments low as \$12.40 monthly. Quality machines, quick delivery guaranteed. Hobart Bros., Box M-492, Troy, Ohio.

LOOK! "Electra" direct drive windplants. 1200 watt \$69.50, 700 watt \$36.95. Aerodynamic propellers, generators. Wholesale catalog. Kubat Mfg., St. Paul, Minn.

50—1/2 HORSE. Repulsion induction, 110-220 volt, heavy duty motors. 3400 speed, \$9.75. Also generator bargains. Electrical Surplus Company, 1885 Milwaukee, Chicago.

EDISON Lifetime storage batteries for light and power. Eliminates acid battery diseases. Long guarantee. All kinds rebuilt generating plants, motors, and miscellaneous articles at bargain prices. Free interesting literature. T. Hawley Smith Co., Croton Falls, N. Y.

12 VOLT Heavy duty generators \$8.50. Save money on new, used automotive electrical parts; free catalog. State Ignition, 52 Cullerton, Chicago.

EDISON Storage batteries for light-power systems. Non-acid. Odorless, fifteen year life. Five year unconditional guarantee. Bargains in complete lighting systems. Low prices. Free illustrated literature. "See-Jay" Battery Co., 82 Sterling Ave., Yonkers, N. Y.

### ELECTRICAL SUPPLIES, EQUIPMENT

INVENTORS, Experimenters — Special manufacturers' surpluses — thermostats, mercury switches, relays, electric valves, thermometal, solenoids, coils, fibre terminal boards, fittings, springs, cables, resistance wire, rheostats, thermometers, etc. Sensational sample assortments \$1.00, \$3.00, \$5.00, \$10.00 cash. Astonishing values guaranteed. Hurry. Box 103, Hamilton, Missouri.

MAGNET, Alnico, lifts over 50 times own weight. 60c; large \$1.00. Jay Service, Tomahawk, Wis.

BARGAINS—Arc welders, also motor generator. Write for new bargain list telling needs. Hobart Bros., Box M-497, Troy, Ohio.

ELECTRIC Engraver, engraves all metals deeply, dollar. Hudson Bros., East Syracuse, N. Y.

NEW Wonder magnet lifts 50 times own weight \$1.00. Advance, 861-P5, Minneapolis, Minn.

ULTRA Violet—Infra red. Dual ray health lamp. Two separate units in one. Promotes sun tan—vitamin "D". Automatic control. AC-DC current. \$3.90 postpaid. Details. Beyer Mfg. Co., 4515-P Cottage Grove, Chicago.

ELECTRO-SCRIBE: Electric pencil writes, engraves all metals. \$1.00 postpaid. Details. Beyer Mfg. Co., 4515-K Cottage Grove, Chicago.

### ELECTRIC FENCING

ELECTRIC Fencer — \$9.75 complete! Guaranteed. Details free. Sentinel, Dept. W-929, Cincinnati, Ohio.

MAKE Electric fence from old clock. Keep prowlers away from buildings. Instructions \$1.00. The Novelty Shop, 3375 South Washington Street, Englewood, Colorado.

### WELDING AND SOLDERING

ARC-WELDER 25-600 Amperes d.c., 0-75 volts, built from d.c. vehicle motors. (No rewinding). Plans \$1.00. Welders Club, AB-3432 M-Mart, Chicago. For sale: New and used vehicle d.c. motors.

POWERFUL 110-220 Volt a.c. welder constructed for less than \$5.00 uses starter coils. No winding. Plans \$1.00. Information dime. Welders Supply Co., Box 132, Bellefontaine, Ohio.

DEMONSTRATORS, Electric arc welders. Money-saving prices. Used by the government. Trial and terms guaranteed. Hobart Welders, M-493, Troy, Ohio.

WANT Distributor to handle rod for soldering and welding white metal and aluminum. Big discount. Fred Hoogerhyde, 1033 Leonard, Grand Rapids, Mich.

NEW Arc welder. Cheap. Free literature. Holgeron's Service, Canton, Kans.

APOLLO 110 Volt electric brazing torch. A.C.-D.C. Produces 3 inch flame similar to acetylene. Welds, brazes, solders all metals including aluminum. Literature free. Apollo Mfg. Co., 634 Union, Memphis, Tenn.

DELCO Arc-welder, 25-200 amperes d.c., 0-75 volts, built from Delco 32 volt light plant. (No rewinding.) Plans \$1.00. Welders Club, AB-3432 M-Mart, Chicago.

ALUMINUM Solder, guaranteed a genuine metal bar \$1.00. American Laboratories, Box 6, Chicago, Illinois.

HELP! Surplus stock (must be sold) for sale: new and used d.c. electric (vehicle) truck motors. Welders Club, AB-3432 M-Mart, Chicago. Special: Trade in old electric drills, motors, generators, etc., as part payment.

REBUILT a.c. d.c. Arc welders, all sizes; engine governors, idlers. Terms. Low prices. Guaranteed. Service Co., 3732 Cedar Ave., Cleveland, Ohio.

DODGE Arc-welder, 25-125 amperes, 0-40 volts d.c. (Two Dodges 25-200) built from North-East 12 volt automobile generators without rewinding armature. Plans \$1.00. Welders Club of America, AB-3432 M-Mart, Chicago.

BLUEPRINTS For powerful 110v. a.c. welder, \$1.50. Write for information. Marvelweld, Box 1156, San Francisco.

44 "LESSONS In Arc-Welding" 50c. (Foreign 75c.) Welders Club, AB-3432 M-Mart, Chicago.

### ENGINES, MOTORS, DYNAMOS

ELECTRIC Motors repaired. Expert workmanship guaranteed. Schaefer Associates, 1420 Carlisle Street, Philadelphia.

BARGAINS—Plating generators, motor generator sets, also arc welders. New low prices for large and small shops. Trial—easy terms if desired. Hobart Bros., Box M-496, Troy, Ohio.

FOR Sale. Small elect. motors with flexible shafts, rebuilt \$3.25 postpaid. McConnell, 1619 Edgewood Ave., Racine, Wis.

ALTERNATING Current motors, grinders, drills, exhaust fans, radios, clocks, shavers, appliances. Home workshop tools. Bargain pricelist free. Mailorder Electric, 713 South Dearborn, Chicago.

NEW Split phase 1/3 h.p. motor. Guaranteed two years. Double drive shaft. Built-in starting switch. New departure ball bearings. Every part is extra strong. 110-120 volt, 60 cycle ac., 1750 rpm. Only \$8.95 plus 65c postage. Address Dept. D94, Sears-Roebuck, Chicago.

MOTORS, 1/4 H.P. General Electric, etc. \$3.50, guaranteed. Larger sizes. List 10c. A. C. Motors, 3008 Bailey, Philadelphia, Penna.

BUILD It yourself. 12" exhaust attic fan \$16, tall air circulators 24" blade, complete material \$36. Arcade Electric, Freeport, N. Y.

MAKE Money, rewind auto generators, washing machine motors, construct arc welder, 10c brings particulars. Catalog material. Ernest Knight, LaSalle, Illinois.

5 KVA Alternators \$125.00; also larger sizes. Motors, generators. Queen City Electric, 519 South California, Chicago.

BARGAIN—1/2 Hp. motors, 60 cycle, 1 phase, 110 volt, like new, guaranteed, \$7.40. Send check to Erie Electric Motor Co., 120 Church, Buffalo, N. Y.

MOTOR Winding lessons, illustrated. Send stamp for particulars. Also motor data for experienced winders, introductory selection \$1.00. Motor Data Company, Box 7631, Kansas City, Mo.

ALTERNATING, 1/2 Horse, 110 volt, induction motors. Rebuilt, guaranteed, \$7.50. Wilmot Auto Supply, 2247 St. Paul Ave., Chicago.

### MACHINERY, TOOLS AND SUPPLIES

SHAPER Attachment fits any lathe 8" to 12" swing, 8" stroke, automatic feeds, easily attached. Write Fuchs Machinery, 11th & Farnam, Omaha, Nebr.

DRILL Grinding attachment fits bench grinder, hand or power turned. Handles sizes 3/16 to 1 1/4". Descriptive literature on request. Tractor-Lite Co., Sidney, Iowa.

KELLOGG Air compressors, \$6.00. Electric refrigerators, \$25.00. Repair instructions, \$1.00. Taylor, 105 East 102nd Street, New York.

BARGAINS, Demonstrators, electric arc welders, guaranteed, 30 days trial and terms. Write Hobart Welder Exchange, Box M-494, Troy, Ohio.

SEND For your free 1939 wholesale tool booklet. Machinery, tools, supplies. Homecraft Tool Supply, 236 Neptune Ave., Brooklyn, New York.

FOR 9" South-Bend lathes. Milling attachments, universal movement \$9. Threading dial indicators \$3; 6" four jaw chucks \$9.50. Unique Manufacturing Co., 4807 North 31 Ave., Omaha, Nebr.

NEW, Hollow spindle, toolpost, internal, external grinder for 9" South Bend lathe. Special base for bench grinding, buffing, and flexible shaft operations. Unconditionally guaranteed. Wamco, Winchester, Ind.

COLLET Chucks for 9" lathes. Complete with one collet \$11.50. Extra collets \$2.25. Guaranteed. Circular free. Northwest Tools, Box 1486, Boise, Idaho.

ATLAS Drill presses, lathes, slightly used. 15 Harper, Detroit, Michigan.

LATHES 7" x 18" Metal working \$19.50. Limited number. Gardner Electric, Defiance, Ohio.

ATTENTION! Experimenters, craftsmen, inventors: You need this giant ten pound hardware kit. Big box full of screws, nuts, washers, gears, springs, rivets, brackets, etc. Over 1000 parts—price \$1.49—worth \$7.50. Guaranteed satisfaction. Manufacturers Screw, 223-A West Illinois, Chicago.

COMPLETE Rebuilt portable paint spray outfits \$15. General Electric 1/4 horse power motors \$3. 15 Harper, Detroit, Mich.

TREMENDOUS Surplus of factory tools selling out. Drills, taps, files, hacksaws, etc. Send for free lists, include six cents postage. Travers Tool Co., 264 Jackson Ave., Long Island City, N. Y.

250 POPULAR Sizes of cap and machine screws, stove bolts, nuts, washers, rivets, etc. Standard and S.A.E. threads. Assortment would cost \$2.50 retail. My price \$1.00 delivered in U.S.A. Money back if not satisfied. H. Sackmann, 76 W. Exchange St., Akron, Ohio.

AIR Compressors, new 1 3/4 x 1 3/4, \$6. 2 x 2 \$7. 2 1/2 x 2 \$8. Guaranteed. Send check or money order. National, 560 Washington, Chicago, Ill.

14" x 6" GREAVES Klusman cone head engine lathe, quick change. No. 0 Cincinnati miller, cheap. Write for particulars. Cincinnati Machinery & Supply Co., 221 E. Second St., Cincinnati, Ohio.



**BOATS, OUTBOARD MOTORS, ETC.**

**BUILD** Your own boat with Bay City Prefabricated frames and materials. Save up to 2/3s. Lumber, fittings, engines and equipment. Send requirements for quotation. Illustrated catalog 100 boats 9 to 65 feet 10c. Bay City Boats, Inc., 1552 Adams St., Bay City, Mich.

**GENUINE** New Evinrude and Elto outboard motors now as low as \$29.50 (plus small transportation charge.) Down payment as low as \$6.00. Fourteen advanced 1939 models to choose from. Write for catalogs, boat directory and handy Boat-&Motor Selector—all free! Address: Evinrude Motors, 4008 N. 27th St., Milwaukee, Wis.

**USED** Outboard motors, all makes. Stamp brings list. Used parts, propellers and accessories. Outboard Headquarters, 305 Atlantic Ave., Boston, Massachusetts.

**ELECTRIC** Outboard from old automobile generator operates with car battery. Smooth—quiet. Plans 10c. LeJay Manufacturing, 547 LeJay Building, Minneapolis, Minn.

**BUILD** 12 Foot boat—row, sail, outboard. Plans, 15c. Readers Service, 800-58 North Clark, Chicago.

**ELECTRIC** Outboard motors. Automatic pitch propellers for your gasoline outboard makes trolling a pleasure. Minn-Kota Manufacturing Company, Dept. B, Fargo, North Dakota.

**MARINE** Power—Easily convert any Ford motor (domestic and foreign) with Osco parts and kits. Complete catalogue 25c (coin). Osmitson, 3644 Lawrence St., Philadelphia, Penna.

**PROPELLERS**, Gear pumps, stuffing boxes, bearings, etc. Wm. Baker, Pond St., Quincy, Mass.

**BUILD** Your favorite boat by the Welch System. Its inexpensive; interesting and profitable. Everything for building, equipping or repairing boats. Use Welch Ready Cut Parts. Send 10c for catalog showing boats of many types; boat hardware; propellers; marine paints; sails; boat finishing materials and Welch White Cap marine motors. Welch Boat Company, Station K-1, Milwaukee, Wisconsin.

**FOUR** New cruiser designs, 16 to 22 ft., illustrated catalog dime. Abbot Boats, Bellmore, N. Y.

**ASSEMBLE** Your own boat. Our finished knock-down frames and materials save you 2/3 builder's cost. All types and sizes. Send 25c for big catalog. Brooks Boat Co., Inc., D4, Saginaw, Mich.

**BOAT** Blueprints and full size paper patterns, priced 50c up. Wide selection. Cruisers, runabouts, sloop, snipe, outboard boats, etc. Designed by leading naval architect. Rush 10c (coin) for illustrated catalog. Cleveland Boat Blueprint Co., Station A-66, Cleveland, Ohio.

**OUTBOARDS** — Save 1/2. Good used parts, all makes and models. Bargains rebuilt motors. Crandall Hicks Co., 959 Commonwealth, Boston, Mass.

**12 FOOT** Flat bottom rowboat, complete plans 25c. Free boatbuilding catalog. The Rudder, 15 Murray St., New York.

**FORD-ZEPHYR** Marine conversions. Catalog 10c. Lehman Engineering Company, Dept. D, Newark, N. J.

**BOAT** Designers are highly paid professionals. Complete course by mail. Catalog. Westlawn, Montville, N. J.

**SPORTING GOODS, GUNS, FISHING TACKLE, ARCHERY**

**BARGAINS!** Gun catalog 5c. Fishing catalog 5c. Ski catalog 5c. J. Warshal & Sons, First and Madison-PM, Seattle, Wash.

**GOLF** Clubs. Five club matched set \$2.50. Lincoln Surplus, 123 Galena, Freeport, Ill.

**FENCING** Equipment. Foils, swords, masks, etc. Low prices. Free catalog. Industrial Products, Dept. 24, 48 West 48th Street, New York.

**TENNIS** Strings, sheep gut and synthetic at sensational reductions. Write for free samples. Crescent, 2535 Patricia, Los Angeles.

**1939 FLY** Tying material catalog free. Work Fly Company, Pueblo, Colorado.

**BOWS**, Arrows, raw materials. Beautiful catalog (over 125 pictures) and "Essentials of Archery" a handbook on making bows and arrows 35c. Everyone intending to make their own should have this manual. Instruction folder and catalog 10c. L. E. Stemmler, Queens Village, N. Y.

**SINKER** Molds for making your own sinkers. Free illustrated folder. Reading Instrument Co., Box 78, Reading, Penna.

**ARCHERY** Headquarters—617 South State, Chicago. Catalogue free. Complete instruction book 50c.

**HUDSON** Bay blankets, Indian pack baskets, camp stoves, knives, compasses, outdoor equipment. Free catalog. Howe Fur Co., Box P, Coopers Mills, Maine.

**FIELD GLASSES, TELESCOPES AND MICROSCOPES**

**REFLECTING** Telescopes—build your own. 6" kit \$3.50; all abrasives, mirrors, eyepieces, diagonal prisms. Illustrated instructions 10c. Catalog free. Optical Development Corp., Dept. G, 1560 Broadway, New York.

**POWERFUL** Opera glasses and case—\$1.00 postpaid! Sold on money-back guarantee! Clover, Niles Center, Ill.

**MICROSCOPE**, Mineralogy, chemistry, binoculars. Catalog free. Tracey Laboratories, Evanston, Illinois.

**BOYS**—A powerful telescope for 20c. Have real fun. Send today for free information. B & H Sales Co., 56 West Washington, Chicago.

**ASTRONOMICAL** Telescopes, binoculars, cameras, microscopes, bought, sold, repaired. Send 10c for list of instruments desired. Rasmussen, Box 294, Amsterdam, N. Y.

**TELESCOPES**, Microscopes, binoculars; 1939 bargain catalog free. Brownscope Company, 5 West 27th Street, New York.

**ANTIQUES, RELICS, INDIAN GOODS**

**ARROWHEADS**, 100 Good or 60 fine, \$3.00. Catalog. George Holder, Glenwood, Ark.

**COLLECTION** Indian arrows, glacial beauties \$10. Dan McKillop, Regina, Sask.

**BIG** List Indian material 2c stamp. Bernard, Box 192, Oakland, Calif.

**SWORDS**, Rapiers, daggers, pistols, armor catalog 6c. Abels, 860A Lexington Avenue, New York.

**100 GOOD** Arrowheads \$3. Catalog. 5c. H. Daniel, Hot Springs, Ark.

**INDIAN** Relics, beadwork, coins, curios, minerals, old glass. Catalog 6c. Indian Museum, Northbranch, Kansas.

**TAXIDERMY**

**PRICES** Slashed! New 36-page 1939 supply catalogue free. New items. New ideas. Postcard brings yours. Taxidermic Manufacturers, Memphis, Tenn.

**MODERN** Taxidermist Magazine, Greenfield Center, N. Y. Crammed full with valuable taxidermy information. Three sample copies 25c.

**TAXIDERMY** Supplies—Quality artificial eyes, teeth, genuine Jonas head forms. Tools, materials, etc. Everything for the progressive taxidermist. Send 10c for big illustrated catalogue. Jonas Bros., 1049 Broadway, Denver, Colo.

**DOGS, PETS, BIRDS**

**SAINT** Bernard puppies priced to please! 30c brings book of 104 photographs and particulars. Royal Kennels, Chazy, N. Y.

**SELLING** St. Bernard puppies! Good ones. Registered. Fine pictures, information free. Manitou Kennels, Watrous, Sask., Canada.

**BEAUTIFUL** Pure white police dogs. Ansonia Kennels, Mose, N. Dak.

**MINKS**, Squirrels, raccoons, foxes, ferrets, muskrats, skunks, wolf pups. Tippman, Caledonia, Minn.

**BIRDS?** Get American Canary Magazine monthly. Year, \$1.00. 2839-P North Halsted, Chicago.

**POULTRY AND FARM SUPPLIES**

**IMMEDIATE** Delivery on Reds, Barred, Buff, White Rocks, Wyandottes, Orpingtons, \$7.65—100; pullets \$9.90; cockerels \$7.40; White, Buff, Brown Leghorns, Anconas, \$7.45—100; pullets \$15.45; cockerels \$3.00. 90% accuracy guaranteed on pullet chicks. Write for discount and free catalog. We pay postage, guarantee 100% live delivery; ship COD. Salem Hatchery, Box 81, Salem, Indiana.

**SEXED** And sex-linked chicks. 6 popular hybrids; 52 purebreds. Large new book free. Mrs. Berry's Farm, Route A, Clarinda, Iowa.

**95% ACCURACY** Guaranteed on Seymour sexed pullets. Can make immediate shipment; Barred, Buff, White Rocks, Reds, White Wyandottes, Buff Orpingtons, \$7.40—100; pullets \$11.45; cockerels \$7.95; English White, Buff, Brown Leghorns, Anconas \$6.95—100; pullets \$15.95; cockerels \$3.00. AA grade chicks 1c higher. Write for catalog and quantity discounts, prices on turkey poultts—ducks. We pay postage, guarantee 100% live delivery. Ship COD. Seymour Hatchery, Box 36, Seymour, Ind.

**90% ACCURACY** On pullets guaranteed or cash refund. White, Brown, Buff Leghorns, Anconas \$6.90—100. Pullets \$15.40; cockerels \$3.00. Barred, White, Buff Rocks, Reds, White Wyandottes, Buff Orpingtons, \$7.40—100. Pullets \$9.90; cockerels \$7.45. Heavy mixed \$6.40; assorted \$5.40. Write for quantity discounts. Free catalog, prices on turkey poultts and ducks. We pay postage, guarantee 100% live delivery. Ship COD. Dubois County Hatchery, Box 912, Huntington, Ind.

**5 ALL-EXPENSE** Trips to World's Poultry Congress. Write for contest rules and free catalog telling how to make money with Davis chicks. Tom Barron White, Brown, Buff Leghorn, Ancona pullets \$14.90—100; cockerels \$3.00; unsexed \$7.75. Unsexed Barred, Buff, White Rocks, Reds, Wyandottes, Orpingtons, \$7.95—100; pullets \$9.95; cockerels \$7.45; heavy mixed \$6.45; assorted \$5.50. Write for complete price list. Turkey poultts and ducks. Davis Poultry Farm, Route 34, Ramsey, Indiana.

**SAVE** 2c to 3c per chick on Greensburg Bloodtested Chicks for broilers and layers. Immediate delivery on Barred, White, Buff Rocks, Reds, Wyandottes, Orpingtons, \$7.45—100; White, Buff, Brown Leghorns, Anconas, \$6.95—100. Heavy mixed, \$6.40; assorted, \$5.50. Sexed chicks, heavy breed pullets, \$11.00—100; cockerels, \$7.45—100. English White, Brown, Buff Leghorn, Ancona pullets \$15.45—100; cockerels \$3.50. Greensburg Hatchery, Box 40, Greensburg, Indiana.

**WHITE** Crested Black Polish eggs for hatching. Jeffers Poultry Place, Oskaloosa, Iowa.

**FREE** Sample poultry magazine. Twelve issues 25 cents. Unexcelled. Poultry Item, Sellersville, Penna.

**LOW** Factory prices on electric brooders, batteries, parts, wire fabrics, etc. Free 76 page catalog. Bussey, 5151 West 65th, Chicago.

**MAKE** Money with poultry. Read America's leading poultry magazine for latest information. Three years \$1.00; nine months 25c. Poultry Tribune, Dept. E-93, Mount Morris, Ill.

**CHICK** Raisers make extra money selling our chicks to neighbors. Write Jackson County Hatchery, Box 19, Seymour, Ind.

**TREES, SHRUBS, ROOTS, HERBS**

**GINSENG** Growing instructions free, seeds reasonable. Specialty Farm, Rockford, Minn.

**COLORADO** Evergreens, 25 three year old. We will prepay for \$1.00. Rocky Mountain Evergreen Co., Evergreen, Colo.

**JUST** Out! World's greatest "Herbalist Almanac." Beautifully illustrated in natural colors. Contains over 200 old-fashioned herb medicine recipes for home use. 10c postpaid. Worth dollars! Botanicals, 145 W. 112th St., Chicago.

**FARMS AND FARM LANDS**

**FARMS** That pay in the Great Northern Railway agricultural empire, Minnesota, North Dakota, Montana, Idaho, Washington, Oregon. Fertile black soil, high production crops, grain, fruit, vegetables, feed and livestock. Many kinds of farms for selection. Write for book on state you prefer. E. C. Leedy, Dept. 457, G. N. Ry., St. Paul, Minn.

**GOOD** Farms available. Washington, Minnesota, Idaho, western Montana, Oregon. Dependable crops, favorable climate. Write for impartial advice, literature and list of typical bargains. Specify state. J. W. Haw, 119 Northern Pacific Ry., St. Paul, Minn.

**40 ACRES**, Near White River, unimproved; poultry land, \$175, \$5 down, \$5 monthly. Free list and literature. Hubbard, 216 Grossman Bldg., Kansas City, Kans.

**CANADIAN** Tax sale lands for a dollar an acre and up. Small monthly payments. Farms, timber, hunting and fishing camps, minerals. Limited number of properties. Write at once for free illustrated booklet. Tax Sale Service, Room 613, 72 Queen St., W., Toronto, Canada.



**INCOME** Farm, 23 cattle, horse, machinery, crops included; 224 acres, good 6-room house, electricity, milk checks about \$2000, owner paid \$6000, sacrificing at \$3500, part down; picture page 37 free 100-page bargain catalog. Write today. Strout Realty, 255-F 14th Ave., New York City.

#### FARM MACHINERY AND SUPPLIES

**ALL** Purpose tractors at factory price. Shaw 2 to 5 horsepower, riding or walking types. Does plowing, discing, harrowing, cultivating; mows lawns, cuts weeds, does hauling; runs belt machinery. Air or steel tires. Three speeds forward and reverse. Thousands in use. Write for free catalog and 10 day trial offer. Shaw Mfg. Co., Dept. PM4, Galesburg, Kansas.

**GARDEN** Tractor. Build from old parts for few dollars. Information dime. Drawings \$1.00. G. R. Warren, 432 Broadway, Pittsfield, Penna.

**PUMP** Jacks, electric, \$29.50. Stamp for circular. Dealers inquiries invited. Gardner Electric, Defiance, Ohio.

**NEW** And used tractor parts at tremendous savings. Write for free 1939 catalog. Central Tractor Wrecking Co., Boone, Iowa.

#### PROFITABLE OCCUPATIONS

**NATIONAL** Baking Institute announces a new home study course covering all phases of commercial baking. Good field for ambitious men. Nearly a depression proof business. Common school education sufficient. Send for free booklet "Opportunities in the Baking Industry" and requirements. National Baking Institute, 3601 Michigan Avenue, Dept. 3434, Chicago, U.S.A.

**M. M.** earned \$267, three weeks, raising mushrooms in cellar! Exceptional, but your cellar, shed perhaps suitable. We buy crops. Book free. United, 3848 Lincoln Ave., Dept. 66, Chicago.

**STANDARD** Rabbit Journal, Milton, Penna. Year 50c. Sample dime, supplies.

**101 PROFITABLE** Occupations, details stamp. Hartman, 2438 W. Lincoln, Nebr.

**RAISE** Rabbits for us. We pay to \$7.00 each. Catalogues 10c. Rabbitries, Bowling Green, Kentucky.

**RAISE** Guinea pigs. Make money. Thousands needed. We supply breeders and buy the young. Free illustrated book. Research Supply, 2436 W. York Street, Philadelphia, Penna.

**MEN—Women**, operate "Specialty Candy Factory" home, all or spare time. Steady income. (Our 29th year.) Hillyer Ragsdale, Inc., Drawer 62, East Orange, N. J.

**GROW** Vegetables, flowers in water with our dry chemicals. Directions, chemicals \$1.00. Holland Plant Chemicals, 1519 Eggert Rd., Eggertsville, N. Y.

**COUNTRY** Drives or movies afternoons! Work mornings home. No canvassing! Folio-H, Station D, Los Angeles.

**POSITIONS** At sea. Details free. No employment agency. Julius, Amarillo, Texas.

#### OLD BOOKS WANTED

**WE** Pay up to \$5000 each for old books, also high cash prices for old magazines, letters, newspapers. A single story book, school book, old Bible, travel book, almanac, etc., that looks worthless may bring you \$50, \$100 or \$500 in cash. Thousands wanted. Send 10c now for latest price list. American Book Mart, 140 S. Dearborn, Dept. 2713, Chicago.

#### BOOKS, PERIODICALS, PICTURES, POSTCARDS

**YOUR** Life is your fortune. "How to Reorganize Your Life" for success, happiness, friends, money, \$1 postpaid. Money back guarantee. Gateway Publishing Company, 22 E. 17th St., New York.

**SEND** 10c For trial subscription, American Freeman, Questions and Answers magazine. Haldeman-Julius, Box 102, Girard, Kansas.

**YOUR** Favorite magazines—Half price. Catalog, 10c. Magazine Exchange, Baseline, San Bernardino, Calif.

**BOOKS** Bought! Appraisal form free. Bookery, 3941 Shaker Square Station, Cleveland, Ohio.

#### GAMES—ENTERTAINMENT

**BINGO.** 300 Card game complete \$2.00. WarNovCo, Conimicut, R. I.

**PLAYS, Operettas, musical comedies, complete minstrel first-parts with song programs, blackface skits, vaudeville acts, monologs, dialogs, recitations, juvenile plays and songs, musical readings, entertainments, make-up goods. Catalog free. T. S. Denison & Co., 203 N. Wabash, Dept. 11, Chicago.**

#### MAGIC TRICKS, PUZZLES, JOKER NOVELTIES

**LOOK!** New 1939 catalog professional stage magic only 10c. Big new catalog 500 pocket-parlor tricks 10c. Each different—get both. Lyle Douglas, Station A-5, Dallas, Texas.

**TARBELL'S** Magic lessons 20c each. List free. Davies, 346 North Clark Street, Chicago.

**GIANT** Surprise catalogue of jokes, tricks, magic, puzzles, novelties, 25c. Refunded with first \$1.50 order. Free mystery trick included. Lawson Vick Co., Dept. P6, Queens Village, N. Y.

**ILLUSTRATED** Magic catalogue 20c. Lynn, 105 Beach, Jersey City, N. J.

**MAGIC** Mirror free with professional catalog (25c) refunded first order. Cairo, Box 43, Kensington Station, Brooklyn, New York.

**BE** A magician. Large professional magic catalogue of latest tricks 25c. Cash paid for complete Tarbell Magic Courses. Write, Ireland, C-109 North Dearborn, Chicago.

**THE** Lyle Douglas catalogs are bigger and better than ever.

**FREE** Tricks! Join Magicians' Fraternity! Monthly magazine, sample 10c. International Magicians, Mt. Morris, Illinois.

**LEARN** Ventriloquism, 3c stamp brings particulars. Smith, 125 N. Jefferson, Peoria, Illinois.

**EARN** Money in any crowd. Call names of strangers, tell unspoken questions. Professional course mind reading, spirit writing, etc., \$1. Henderson, Box 341, San Bernardino, Calif.

**WORLD'S** Largest magic shop professional catalog, 25c. Holden, 220 W. 42nd St., New York.

**BECOME** A magician and earn extra money in your spare time. Send 25c today for your copy of our 168 page catalogue. This book is full of tricks for everyone, from the beginner to the professional performer. Established 1910. Chicago Magic Company, 2300 North Mason Avenue, Chicago, Illinois.

#### OLD STAMPS WANTED

**WILL** Pay \$100.00 for 1924 1c green Franklin stamp, rotary perforated eleven (\$1,000.00 if unused). Send 6c for large illustrated folder showing amazing prices paid, and giving much other valuable information. Vernon Baker, 444PM4, Elyria, Ohio.

**BUYING** List with 333 illustrations, 10c. Liberty Stamp Co., St. Louis.

#### STAMP COLLECTING

**ANNOUNCEMENT.** We will send free the new, enlarged edition of "Famous Stamps and Their Stories." Size: 60 pages. Illustrations: over 300. Binding: de luxe. Printed on fine paper, fit to grace any library. Do you know that Abraham Lincoln was an honorary citizen of the Republic of San Marino? That Columbia issued the largest stamp in the world? And that Switzerland has a stamp which is sold only from a traveling omnibus? These and hundreds of other stamps are fully illustrated and their stories told. Nothing like it has ever been attempted. This book is more fascinating than fiction, more thrilling than a movie and more instructive than years of study. We will send it free for 5c mailing expenses but only to really serious approval applicants, together with a fine approval selection. Approval Headquarters, Globus Stamp Company, 268 - 4th Ave., New York City, Dept. 201.

**FINE** Airmails! Packet fine airmails only from Russia, Bolivia, Mozambique, Brazil, Indo-China, etc., including the largest and smallest airmail stamp in the world. Also big packet 45 different Asia, including Malay (tiger), Manchukuo, Tannou Touva, Mongolia; many others. Both packets—with total catalogue value of \$2.00!—for only 5c to approval applicants. R. V. McAllester, Dept. 1, 153 Linden Street, Everett, Mass.

**WHOLESALE** Supplements to dealers for 10c postage. Hundreds of bargains. Grossman Stampco, 102 West 42nd, New York.

**GIANT** Packet 200 all different, from Africa, South America, Asia, South Sea Islands, etc. Includes world's smallest stamp, triangle and diamond-shaped stamps, animal stamps, Nicaragua Olympic "baseball" commemorative; and many others. Also packet 17 different United States (cat. 65c)—all obsolete, including \$5 denomination, commemoratives, etc. Total catalog value nearly \$5.00! All for 5c to approval applicants. Write to-day! World-Wide Stamp Co., Box 600, Camden, New York.

**ATTRACTIVE** Stamp album providing spaces for 2220 stamps with 700 illustrations, packet 300 different stamps, 500 hinges, tweezers, duplicate book, pamphlet which tells "How to Make a Stamp Collection Properly," bargain list of sets and packets, all for only 50 cents. Queen City Stamp Co., Room 36, 804 Race St., Cincinnati, Ohio.

**CANNIBALAND!** Immense Gilbert Ellice commemorative, \$5 United States, Liberian Bongo antelope, mystery British Colony triangle (thrilling surprise!), fantastic Manchukuo mausoleum, breathtaking beauty from Cayman Islands, etc. This astounding packet of bizarre and intriguing stamps absolutely free to approval applicants enclosing 3c postage. Viking Stamp Co., 1-Z Hanson Pl., Brooklyn, N. Y.

**1939 STAMP** Annual free. Features Canadians, Newfoundland, United States, colonials, foreigners, supplies. Sixty pages with hundreds of illustrations. Sent free. Gray Stamp Company, Dept. PM, Toronto, Canada.

**PRODIGIOUS** Gift! Bicolored banana airmail, Perak, Selangor, Siberia, "Green Cross" charity, Wurttemberg, world's tiniest airmail—Free with approvals! Postage 3c. Saxton Company, 408-A Jay Street, Brooklyn, N. Y.

**FREE**—\$1 U. S. stamp with request for 52 page list of United States and foreign stamps. Stamps on approval. References necessary. 20 different nineteenth century U. S. 28 cts. New Hussman Stamp Co., 1122 Pine, St. Louis, Mo.

**100 DIFFERENT** Stamps 10c with approvals. Ross, 3408 W. Augusta Blvd., Chicago.

**PHILATELIC** Mailing—"Worldwide Offers." Dime covers cost. Mail service, Hollydale, California.

**150 DIFFERENT** Turkey, 85c! Quinn Co., 2 Berkeley Street, Easthampton, Mass.

**500 FINE** Mixed United States with rare cover from Civil War period 25c. Approvals. Wright Brothers, 201 Mealey, Hagerstown, Maryland.

**SENSATIONAL** Offer! 100 stamps including triangle, airmails, commemoratives, pictorials, colonials, only 5c with approvals. Leo, 853 North Martel, Los Angeles, California.

**25 FRENCH** Colonies, 10c with approvals. Rosebar Stamp Co., Box 581A, 1474 Broadway, New York City.

**FREE**—World's only octagonal (eight-sided) set and 25 different Japanese pictorials to approval applicants. Charles Cleveland, 806 North Humphrey, Oak Park, Illinois.

**1000 MIXED** United States, 18c. 2 pounds \$1.00. Halay, 452 West 58th, New York.

**FREE** Premium—U. S. approvals. Saturn Stamps, Market Arcade, Buffalo, N. Y.

**5 LIBERIA**, 50 Diff, 6c. Northeast, Box 6618, Kansas City, Mo.

**267 WORLD'S** Most beautiful stamps, 25c. Address Vandal, Stamford, Texas.

**50 DIFFERENT** U. S. 10c with approvals. Bohlen, Middletown Road, Pearl River, N. Y.

**BIG** Bargains. Approvals 1/4c up. Josiab Babcock, St. Joseph, Michigan.

**TEN** Different United States, over 40 years old, 10c. Elsea, Bowling Green, Ohio.

**EARN** Cash, stamps. Sell my approval books—nickel packets. Ellison, 2841 West 37th, Brooklyn, N. Y.

**COLOMBIA** No. 346 catalogs 25c, only 3c with approvals. Vance Whitten, Bridgman, Michigan.

**BARGAIN** Approvals, up to 70% discount. Bargain Service, Punta Gorda, Florida.

**50 DIFFERENT**, Fine U. S. including perforation gauge, 10c with approvals. The Stamp Shop, 809 Holland Bldg., St. Louis, Mo.

**CANADA** Catalog, illustrated, 136 pages, \$1.00. Miniature sheet triangles (4 diff.) 10c approvals. Victoria Stamp Co., London 4, Canada.



**ILLUSTRATED Album.** Spaces 4000 stamps; to approval applicants 20c. Swan Stamps, 604 Swan, Dunkirk, N. Y.

**EXCHANGE Stamps, postcards.** Universe. "Exchangers," Bry 226 pres. Paris, France. Particulars free.

**SCARCE Spanish ship triangles complete** 7c with exceptional approvals. Benson, 2167 Lakewood, Detroit, Michigan.

**TRIANGLES! Triangles! Triangles!** Triangles! Count them. Four! With famous Rivera nude stamp. Only 3c to approval applicants. Cactus Junior, Tucson, Arizona.

**NORTH Borneo's queerest stamp; U. S. commemoratives; revenues and envelopes;** foreign airmails and 60 other stamps for only 5c to approval applicants. Lenott Stamp Company, Dept. 4, Oxford, Maryland.

**500 MIXED.** Including fifty different U. S. 10c! Approvals. Paul Baringer, Defiance, Ohio.

**FREE! World's smallest triangle, gigantic airmail diamond, Bolivia triangle, Costa Rica diamond, Congo, Soudan, Montecarlo, Devil's Island, Kouangtcheouwan, Tunisia, Manchukuo, Palestine, Mozambique, West Indies, British Colonials, Southseas pictorials, commemoratives, perforation gauge, millimeter scale, packet hinges.** Postage 3c. Davidson, 2297-P 6E, Salt Lake City, Utah.

**200 DIFFERENT Stamps 20c; 600, 50c; 1000, \$1; 2000, \$3; 3000, \$7.** Fred Onken, 630 79th St., Brooklyn.

**NEWFOUNDLAND 12 Different 5c with approvals.** Hudson, 116 Nassau, New York City.

**EXCELLENT Packet of 105 different stamps from the Orient, Africa, South Sea Islands, etc., showing beautiful women, ships, savages, airplane, scenery, birds and beasts.** All for 3c to approval applicants. Write today! Blackstone, Walnut Ave., Wayne, Penna.

**CANADIAN Packets, including jubilees, pictorials, commemoratives, 50 different 15c; 75 different 50c; 100 different \$1.00.** Bargains. Marks Stamp Company, Toronto, Ontario.

**500 U. S. Mixed 10c.** Keyser, Box 653, Journal Square, Jersey City, N. J.

**WANTED — Precancel accumulations, U. S. collections.** Moore, Box 646, Little Rock, Ark.

**1000 MIXED U. S. stamps, 15c.** Foreign approvals. Lee, Bridgeport, N. Y.

**FREE! Bolivia triangle.** Approvals. Apex, 1933 SE. 45, Portland, Oregon.

**65 DIFFERENT! Strange countries; Tasmania, Malta, Perak, British Colonies, triangle airmail, pictorials, (no Europe), 5c to approval applicants.** Bargain Co., Box 39P, Times Sq. Sta., New York.

**TWO Czech sets, 5c.** Approvals. Stamps, 801 Cooper, Lexington, Kentucky.

**SENSATIONAL Values.** Penny approvals. Ernest Springer, West Point Pleasant, N. J.

**410 U. S. Commemoratives, 41 varieties, \$1.** Inland Stamp Service, Box 5642, Chicago.

**FREE Dollar packet.** Inclose postage, request approvals. Secrist, Muscatine, Iowa.

**CORONATIONS 10 Different 7c to approval applicants.** Kuzma, 1291 Washington Avenue, Bronx, N. Y.

**FREE—U. S. flag stamp in red, white and blue; 28 different Turks Caicos, triangle, diamond, etc., all free with approvals.** Send 3c postage. Baer, Box P-222, Chilloicthe, Ill.

**COLLECT United States stamps for solid value.** Our approvals are correctly numbered and reasonably priced. Write today. Southern Stamp Co., 270 Halcyon Arcade, Miami, Florida.

**WORLD'S Small airmail, also world's largest diamond stamp, free stamp magazine! \$2.00 U. S. stamp, commemoratives, special issues, scarce stamps from 25 countries, 5c with approvals.** Capital Stamps, Dept. PM, Little Rock, Arkansas.

**INCREASE The beauty of your collection.** End "stock-book blues"; prevent gaps in page mountings. A postcard brings free sample. Address Maco Philatelic Corporation, 117½ W. Harrison, Chicago.

**175 U. S. commemoratives, etc., 10c.** 500 25c. P. O. Box 457, Newark, N. J.

**100 DIFF. 6c; 300, 20c; 1000, 90c.** Gunning, 8606 Woodhaven Blvd., Woodhaven, N. Y.

**100 DIFFERENT U. S. including commemoratives, 25c.** Catalogues \$3.00. Liberal Stamps, Salem, Virginia.

**BUILD Collections new way.** 111 different selected stamps free with year's membership 25c. Pacific Exchange, 1911 1st West, Seattle.

**PHILIPPINES 15 Different including large pictorials with approvals.** Swedell, 3038 Harriet Ave., Minneapolis, Minn.

**FREE—20 Different commemoratives.** Postage 3c. Penny approvals that satisfy. Dolve, 621 - 15th Avenue S.E., Minneapolis, Minnesota.

**U. S. Approvals! Real bargains for real collectors!** Box 822, Minneapolis.

**COLLECTIONS, 10,000 Different \$49.95, 5,000—\$14.95, 2,000—\$2.50, 1,000—65c, 500—30c.** Dutton Efker, Anaheim, California.

**200 DIFFERENT—6c with approvals.** Far Seas Co., Box 2154, Houston, Texas.

**BEAUTIFUL Nyassa set free to approval applicants enclosing postage.** W. C. Kohl, Reading, Mass.

**UNPICKED! 100 U. S. revenues on documents—10c! (1000—60c.)** Vanvoorhis, Hyndman, Pennsylvania.

**200 DIFFERENT Foreign stamps 10c.** Monjar, 1542 Waverly, Cincinnati, Ohio.

**SELL Stamps: Salesmen (12 years up)** earn cash commissions. Everglades Stamp Company, Halcyon Arcade, Miami, Florida.

**DOLLAR Lots, 150 mixed U. S. commemoratives catalogue over \$5.00, only \$1.00.** Oroc, 12-P Geary, San Francisco.

**U. S.—63 different (commemoratives, airmail, etc.) with approvals 9c.** 50 diff. commemoratives 1893 to date 25c. Moseley, 4932 Forestpark, St. Louis, Mo.

**15 MONTENEGRO, Too late issue, only 10c.** Approvals. Box 408, Hollywood, California.

**FREE! "American Packet"—approvals 3c.** Loring, Winona Street, Brockton, Massachusetts.

**AUSTRALIA—20 Different only 5c to approval applicants.** "Crescent Stamps," London, Canada.

**SILVER Jubilees and coronations, 15 different only 20c; 30 different 65c; 50 different \$1.50; 100 different British Colonies 20c; 200 different 70c.** Approvals to responsible collectors. Lists free. Westamp, 506 Oxford, London, Canada.

**U. S. Mint 765, 757, 718, 704—35c, with 736 free.** McClay, Altadena, California.

**VERIGOOD Stamp mixture, 20c per 100.** Sweet, PB165, Winsted, Conn.

**1000 U. S., Over 100 face different \$1.00.** Onjay's, 1008A Third, Bay City, Michigan.

**75 DIFFERENT U. S. including 40 commemoratives only 50c with western hemisphere bargain approvals.** LaJolla Stamp Co., Box 333, LaJolla, California.

**100 U. S. 1870-1907, 25c.** Approvals. Coe, Box 775, Ponca City, Okla.

**200 MIXED Really fine foreign stamps, 5c.** Wilfred Brophy, Galesville, Wis.

**EXTRAORDINARY—Two fine bi-colors, cat. \$2.25.** Dime and 3c stamp. Wright, Box 4X, Bay City, Mich.

**PREMIUM To applicants for approvals and new issues.** Wests, Box 1686, Wichita Falls, Texas.

**FREE—The Stamp Finder! Send today for big new edition, fully illustrated, enabling you instantly to identify all difficult stamps! Also fine packet strange, fascinating stamps from Bosnia-Herzegovina, Monaco, Patiala, Cyprus, etc., including maps, ships, animals and strange scenes.** All free to approval applicants inclosing 3c postage! Garcelon Stamp Company, Box 900, Calais, Maine.

**WALDO Stamp Exchange, Box 266, Dallas, Texas, sends 10 different U.S.A. 19th century, for 100 mixed postage stamps (any kind).**

**75% DISCOUNT Off catalog prices.** Mostly 19th century stamps. Reference please. H. Codwise, Garland Street, Lynn, Mass.

**PHILIPPINES On approval.** Send references and 16c for registration. Afran Stamp, Box 1181, Manila, Philippines.

**150 U. S. Including many commemoratives, 10c.** Lloyd Johnson, Hawarden, Iowa.

**THE Stamp Commentator—America's finest.** 25c year; 4 months 10c. Dallas, Texas.

**BRITISH Colonials, Mixed, off paper, pictorials, Geo. VI, 1000 \$1.** Atherton, Beech Road, Bebington, Birkenhead, England.

**130 DIFFERENT 25c Includes 30 U. S. commemoratives.** Held, 4880 Sheridan, Chicago.

**U. S. Commemoratives. Army and navy set complete 10c to approval applicants.** Lindgren, 130 Geary, San Francisco.

**15 AIRMAILS 7c.** Airmail, U.S. approvals. George Davis, Webster, Mass.

**FREE—Packet Central America stamps with request for 52 page list of United States and foreign stamps.** Stamps on approval. References necessary. 20 different nineteenth century U. S. 28 cts. New Hussman Stamp Co., 1122 Pine, St. Louis, Mo.

**ATTRACTIVE Illustrated stamp collectors atlas, 6c.** Approvals Golden, 613 Parrish, Philadelphia.

**UNITED States mixtures 35c lb.** Mission, 4512 North Racine, Chicago.

**UNBELIEVABLE Unbeatable! 220 different United States stamps, 50 before 1905.** Catalog value over eight dollars. Limited supply. Hurry! Price \$1.00. Franklin, 225 Franklin, Rochester, N. Y.

**CLEAN, Interesting approvals at substantial discounts.** Write today. John Stamp, 79 Holton, Montreal.

**U. S. Mixture, unpicked, pound 75c; 3 lbs. \$2.00.** Brooks, 2502C Kenmore Place, Brooklyn, N. Y.

**EXCHANGE Stamps! 5,000 philatelists in 125 countries want correspondence with other collectors.** Membership \$1.00. Magazine 10c. Information free. Stamp Collectors' Exchange Club, Sarnia, Canada.

**S.P.A. Sheet.** Hindenburg, Zeppelin, German Lufthansa, four constitutions, all 10c. Unexcelled approvals. Moulton Stamps, Elgin, Illinois.

**PRECANCELS, 60 Different 10c.** C. Siegel, Box 1710, Milwaukee, Wis.

**U. S. Parks, used, complete 19c.** Approvals? Hubers, Palace Building, Minneapolis.

**FIFTEEN Scarce airmails 5c with approvals.** Lindgren, 130 Geary, San Francisco.

**NEVER Offered before, 21 French Colonies, pictorials, sets of 5 each (105) for 35c.** French, 241 Euclid, Cleveland.

**FREE Collection, 12 different Yugoslavia for names and addresses of three active stamp collectors if you ask for approvals.** Reimers, 600 Flatiron, Fort Worth, Texas.

**FREE! 101 Stamps to approval applicants sending postage.** Quality Stamp Shop, Englewood, Colorado.

**FREE! Hindenburg Zeppelin airmails complete.** Approval applicants. Riedell, Greensburg, Penna.

**150 GOOD Mixed foreign stamps, 5c coin.** Stanton, Niantic, Conn.

**MONTHLY Stamp and coin magazine, six months and 25 foreign stamps, 25c.** American Stamp Journal, Cedar Rapids, Iowa.

**100 DIFFERENT Hungary 7c, approvals.** Hazett, 701P Fourth Baycity, Mich.

**30 DIFFERENT Angola, Cape Verde, Guinea, Portugal, Mozambique, St. Thomas and Prince 5c.** Approvals. Depraw, Ocean Park, Calif.

**U. S. Constitution stamp of Ecuador, gorgeous six-color stamp showing U. S. flag in natural colors and George Washington, also Marvel packet 33 different including new Cayman Islands, Gen. Franco Spanish Morocco "war stamp" 60 yr. old Luxemburg, "bull-fight" stamp, largest diamond, tropical triangle, Chinese "midget" stamp, etc., all for 5c with approvals.** Potomac Stamp Co., Dept. 103-D, Washington, D. C.

**PENNY Approvals, that satisfy.** Neil Gronberg, Box 5441-P, Philadelphia, Penna.

**SPLENDID Approvals—United States, foreign.** Discounts. Lincoln Stamp Co., Shelbyville, Illinois.

**AIRMAILS And commemoratives, 25 different, including Columbians, Panama-Pacific, Edison, Zeppelin, etc., only 5c with exceptionally fine United States and foreign approvals.** Marco Stamp Co., Box 888, San Francisco, Calif.

**STAMPS, A superb selection sent on approval.** Quality at low prices. Fred Herzberg, Box 91-P, Elmhurst, Ill.

**HEADQUARTERS For United States.** Send 50 cents and two references for 50 different, including scarce 572 and 573. Approvals included. Price lists on request. R. M. Stamp Co., Box 230P, Port Chester, N. Y.

**PANAMA Triangle and 50 others free to approval applicants sending 3c postage.** Tatham Stampco, Springfield-30, Mass.

**SPLENDID Estonia collection, 25 different, pictorials, semipostals, scarce imperf.** only 5c. Imperial Stamps, G.P.O. 130, New York.

**UNITED States illustrated looseleaf catalog, \$1.00.** Send postage for free United States price list, precancel list. Stanley Gibbons, 38-P Park Row, New York.



**GIANT** Diamond-shaped stamp! Big packet 105 all different including Alexandra (new country), Congo, Manchukuo, Ecuador constitution, Costa Rica triangle, air-mails, commemoratives; giant diamond-shaped stamp, \$5 United States; set United States telegraphs, cataloging 30c. Packet British colonies including Burma (new country), jubilee and coronations; scarce sets 2 Siberia, cataloging 50c. Illustrated lists. Everything for only 5c to approval applicants! Write to-day! Mystic Stamp Co., Dept. 80, Camden, New York.

**FREE**—From every continent, 155 different, airmails, triangle, commemoratives, pictorials, many U. S. and others, with 1c approvals. Send 5c for postage and handling. Ace Stamps, Colonial Arcade, Cleveland, Ohio.

**SOUNDS** Impossible! 120 different—Afghanistan, Azerbaijan, Zanzibar, triangle, diamond stamps; United States commemoratives, Civil War issue, \$2, \$5 high denominations; everything—5c. Abell's, 1818 St. Paul, Baltimore, Md.

**BEAUTIFUL** Irish girls. Second set of souvenir stamps issued by Irish Hospitals' Trust Limited, Dublin. Specimen sheet of 20 stamps supplied free of charge to all writing to Mr. J. O'Sheehan, Department PM, 28 Earlsfort Terrace, Dublin, Ireland.

**UNBELIEVABLE!** 62 Different, six triangles and diamonds; airmail, animal, war stamps—China, Japan, Manchukuo, insurgent Spain; Asia, Africa, South Seas. Everything, 5c! Crowder's, 127E North, Baltimore, Md.

**CANNON!** Set of stamps showing cannon, firing squad, cavalry charge and 200 other different stamps, only 10c to approval applicants. L. H. Reich Stamp Co., 4647 Kenmore, Chicago.

**FREE!** Two coronation sets. Postage 3c. Roberts, 312F Shearerbldg, Bay City, Mich.

**UNITED STATES**—45 different, perforation gauge, hinges, bargain pricelist—all for 10c. Seidenberg, Baroda, Mich.

**FREE!** "United States and British North America"—our valuable, complete, illustrated, 64-page catalog quoting lowest prices. Big illustrated list of foreign stamps also included. H. E. Harris & Co., 137 Transit Building, Boston, Mass.

**200 DIFFERENT** 10c. Big 50% approvals. Covert Stamp, 39 State, Rochester, N. Y.

**BRAZIL**, 50 Different 10c with bargain approvals. Davis, Silver Lake, Ind.

**ASK** For our wonderful one cent approvals. Prospect Stamp Co., 225 Broadview, Toronto, Canada.

**WHOLESALE** Catalog for dealers. Illustrated. Postage 5c. Frank Co., 4900 Chalmers, Baltimore, Md.

**STAMP** Dealers, your ad here will bring wonderful returns. Ask me for proof. F. W. Johnson, Manager, Classified Advertising, Popular Mechanics Magazine, 200 E. Ontario St., Chicago.

**APPROVAL** Sheets. One to three cents. Frederick B. Driver, 2009 Finance Bldg., Philadelphia, Penna.

**25 UNITED STATES**, including \$4 and \$5 stamps free to approval applicants. 3c postage. Brownie Stamp Shop, Flint, Mich.

**WEEKLY** Stamp magazine, thirteen weeks, 10c. Stamp Journal, Kalamazoo, Mich.

**U. S. Postage** dues, 1/2c to \$5.00—15c—35 common, 15c. Pauls Stamps, 4550 P4 North Mobile, Chicago.

#### RARE COINS

**3 COINS**, 3 Notes 10c; 100 Indian head cents \$2.00. Lists free. Maurice Gould, Box 73, Brighton, Mass.

**INDIAN** Head penny, coin list 10c. Chales Banker, Salina, Kans.

**OLD** Money wanted. Will pay fifty dollars for nickel of 1913 with Liberty head (no buffalo). We pay cash premiums for all rare coins. Send 4c for large coin folder. May mean much profit to you. Numismatic Co., Dept. 20, Fort Worth, Texas.

**ROMAN** Coins, silver, large, medium and small bronzes, genuine, classified, four for \$3.50. S. Koepfel, Merritt Bldg., Los Angeles, California.

**COMMEMORATIVE** Half dollars. Lincoln \$1.19; Cleveland \$1.19; Long Island \$1.19; Texas \$1.19. Selling price list free. Bob Cohen, Box 3507-G, Cleveland, Ohio.

**10 COINS**, Bills, tokens, 10c. Otto Oddehon, 44 Overland, St. Louis, Mo.

**INDIAN** Heads, 10 different, 25c. Paget, 546 Westfield, Rochester, N. Y.

**OLD** Coins wanted. Send list for offer. Paul Seitz, Glen Rock, Penna.

**BARGAINS!** United States coins all different dates: 5 half cents \$1.00, 12 large cents \$1.00, 30 Indian head cents \$1.00, 5 nickels before 1894 \$1.00, 4 dimes before 1838 \$1.00, 5 half dollars before 1837 \$3.50, silver dollars before 1804 \$3.75, trade dollar \$1.15, gold dollar \$2.25, \$3 gold \$5.00. Colonial cents: Connecticut 45c, New Jersey 50c, Franklin \$1.00, Washington \$1.00, Massachusetts 75c, 6 different commemorative half dollars \$5.00, Missouri \$11.00, Panama Pacific \$10.00, Alabama \$3.00, Connecticut \$3.50, Hudson \$7.00, Spanish Trail \$4.50, Roanoke \$1.50. Complete collection Lincoln cents \$5.00. Worthy Coin Corporation, 184 Summer St., Dept. 34, Boston, Massachusetts.

**WE** Will pay \$5.00 each for certain Lincoln pennies; Indianheads \$100.00; dimes \$700.00. Catalogue 10c. Federal Coin Exchange, Columbus, Ohio.

**RARE** U. S., foreign coins, war medals. Catalogue 10c. Mengelle, Colorado Springs, Colo.

**50 OLD** Coins all different \$1.00, 25 different dates large cents \$3.00, 30 different dates Indian head cents \$1.00, Cleveland half dollar \$1.00. Claud Denney, Box 1825, Dallas, Texas.

**10 INDIAN** Cents different, 25c. 35 coins, tokens, 25c. Bishoff, 500 E. 8th, Kansas City, Mo.

**GOLD** Coins wanted, 40% to 50% premium. A. French, Route 1, Troy, N. Y.

**BRILLIANT** 1938-S Uncirculated cent and list 10c. 3 different 25c. Landon, Box 1733 Wilshire, Station, Los Angeles.

**UNITED STATES**. Large cent, 2c bronze, 3c nickel and bargain list, 25c. Eleven dates large cents, \$1. George P. Coffin Co., Augusta, Maine.

**GET** Profit and pleasure in collecting old coins. Send 10c for 56-page illustrated coin catalog. You'll be delighted with it. Send for it now. B. Max Mehl, 370 Mehl Bldg., Fort Worth, Texas. Largest rare coin establishment in U. S. Established 38 years.

**BIG** Prices paid for certain wanted coins. 1909 cent \$10.00, some silver dollars \$4000, 1864-1865 Indian head cents \$100.00 each, dimes before 1895, \$600; liberty head nickels before 1914, \$500; encased postage stamps; some large pennies \$2000; half cents, \$275.00; paper money, gold dollars \$1500, foreign coins \$165, some worth \$6000 each. You may have coins for which we pay big premiums. Therefore send 15c today for 1939 big illustrated coin book for certain wanted coins. National Coin Corporation (80), Daytona Beach, Florida.

**FINE** Foreign 1700 coin, 2 notes and catalog 10c. Geo. Best, Cedar Rapids, Iowa.

**COMMEMORATIVE** Half dollars, Lincoln, Stone Mountain, Oregon, Texas, Cleveland, Kentucky, San Diego, Long Island, \$1.50 each. Illustrated catalogue No. 14, 25c. Norman Shultz, Salt Lake, Utah.

**FREE!** Foreign coin, banknote, and large illustrated coin catalogue. Send 4c postage. Coin approvals sent. Tatham Coinco, Springfield-125, Mass.

**\$5 TO \$500** Each paid for hundreds of old or odd coins. Keep all until posted. Many very valuable. Send 10 cents for illustrated Coin Value Book, 4x6. Guaranteed buying and selling prices. 31 years in business. Coin Exchange, Box 5, Le Roy, N. Y.

#### HOBBIES AND COLLECTIONS

**COLLECTORS!** Swappers! Big mail hobby, swapper publications. Dime refund coupon. Free ad. Dime, McCampbell, Calexico, Calif.

**UNUSED** Book match covers, 100 all different. \$1.00. Free list. Charles Edelman, 1311C East 84, Cleveland, Ohio.

**DON'T** Throw away match book covers! Albums information 3c. Adams Sales, State Tower, Syracuse, N. Y.

**COLLECTING** Is the king sports and sport of king. Hobbies, W. Palm Beach, Florida.

#### PHOTO FINISHING

**PHOTO** Mill. Immediate service! No delay! Roll developed, carefully printed and choice of two beautiful 5x7 double weight professional enlargements, one tinted enlargement, or eight reprints—for 25c coin. Reprints 2c each. The Photo Mill, Box 629-12, Minneapolis, Minnesota.

**FREE!** 2 Gravure-Tone enlargements. Roll developed. 8 deckle edge prints 25c. Free mailing bag! Crosswell, A-844 Rush, Chicago.

**TECHNIFINISH**—The new fast and economical developing and enlarging service specializing in 35mm. film. 36 exposure rolls fine grain developed and enlarged to 2 1/2" x 3 3/4"—36 gloss finish enlargements, 75c. This service plus cartridge refill, \$1.00. 18 exposure rolls, 50c for 18 gloss finish enlargements—70c for enlargements plus refill. Highest quality workmanship—fastest service guaranteed. Write for free postpaid mailing bags. Technifinish Laboratory, 110 Lexington, Rochester, N. Y.

**35MM. FILMS** Given individual development for superfine grain and hard surface in the new Panthermic "777" developer, and one enlarged print 2 1/2" x 4" from each on glossy bromide—\$1.50 cash with order. Try this new, finer-grain, finer-results service on your miniature films. Beautiful sample 8" x 10" Washoff Relief full-color print from Kodachrome original Pacific Ocean scene—\$1.00. Whirry, 2119 Boyer Avenue, Seattle, Washington.

**WE** Will mount any regular photo print into a beautiful, plastic handled, hand mirror—3 1/2" in diameter. 50c complete. Parisian Novelty Company, 35th and Western Ave., Chicago, Illinois.

**YOUR** Success in getting good clear pictures is often choosing the right photo finisher. Willard's modern, scientific methods and 50 years experience assures you of the best possible prints. Roll developed, two clear, brilliant prints each negative, only 25c. Valuable enlargement coupon. Daily service. Willards, Box 3535-A, Cleveland, Ohio.

**MAIL** Your rolls to film center of the world. Any 6 or 8 exposure roll developed and printed 25c coin. DeLux enlargement coupon free! Photo Finishing Shop, Est. 23 yrs. 411-FF Genesee Valley Trust Bldg., Rochester, N. Y. "The Camera City."

**ROLL** Developed and 8 beautiful Velox glossy prints 25c coin or stamps. Reprints 3c each. Fotoprint Service, Roanoke, Va.

**ROLL** Developed, printed and 5x7 enlargement 25c. Square Deal Studio, Dept. P, Huntington, Ind.

**EXPERT** Photo finishing—One day service—8 genuine expensive Velox prints. Two double weight professional enlargements 25c. Expert Studios, LaCrosse, Wis.

**ROLLS** Developed; 16 prints, two 5x7, 25c. 25 reprints 25c. M-B-M Photo Company, B-3860 Sixteenth, Chicago.

**20 REPRINTS** 25c. 100 Reprints \$1. Roll developed with 16 prints 25c. Newtowne, 4, Maywood, Ill.

**PERFECT** Enlargements. 5x7—10c; 8x10—20c. Send negatives. Photo Print, Box 184, Duncan, Oklahoma.

**ANY** 8 Exposure roll, including 2 free enlargements 25c. 35mm., each exposure enlarged on 4x5 inch paper, 36 exposures \$1.50. Empire Photo Laboratory, Sea Breeze, New York.

**8 PLEASING** Velox prints, 2 enlargements 25c coin. Please U Film Service, LaCrosse, Wis.

**35MM. ROLLS** Supertone fine grain developed 36 enlargements 3 1/2x5, \$1.00. Texas Studios, (M15), Sweetwater, Texas.

**ENLARGEMENT** From each picture on your roll 25c. Cut Rate Photos, Janesville, Wisconsin.

**25 STAMP** Photos made from any photograph for only 25c! Glossy. Generous size. Bowdle Photo Co., Bowdle, So. Dak.

**35MM. ROLLS** Fine grain developed free. 36 enlargements 3 1/2x5, \$1.00. Cartridge reloaded 35c. Photoshop, Linton, Ind.

**ROLL** Developed New Style prints 25c. Reprints 3c. Free enlargement coupon. Andrea Studio, Box 596-C, Baltimore, Md.

**ROLL** Finished—Two enlargements, 25c. Snappy Photo, B56 Colvin, Syracuse, N. Y.

**35MM. ROLLS** Fine grain developed and each shot enlarged to 3 1/2x5 \$1.00. 18 exposures 60c. Ideal Films, Birmingham, Ala.

**DOLLARS** For your best snapshots! Earn extra cash with camera! Instructions, one dime. Hippenstiel, Russell Ave., Bethlehem, Penna.

**ONE** Day service. 8 dated and guaranteed Lifetime prints and 2 doubleweight enlargements, 25c. Quality that pleases the most exacting kodaker. Supertex Photo Service, Dept. 40, Box 1166, Dallas, Texas.

**ROLLS** Developed—24 prints or reprints 25c. Fuchs, St. Cloud, Minnesota.

**\$25** In Weekly prizes for best amateur prints from rolls developed. 25c. Free enlargement coupon, photoflat, album. Largest studio in states. Streamline, Box 5699-K1, Cleveland, Ohio.



**ROLL** Developed 16 deckle edge prints 30c. Best Photo Service, 2441 Ridgeway, Chicago.

**FILMS** Developed—Two beautiful wide border enlargements, 8 quality prints, 25c. Sunbeam Film Service, LaCrosse, Wis.

**GENUINE** Velox fadeless prints, 20 reprints 25c. Roll developed 2 sets prints and 2 professional enlargements 25c. Four 5x7 enlargements 25c. Filmshop, PM2, Sweetwater, Texas.

**WORTH** Talking about! See for yourself; mail your next roll of exposed film to ApSCO. Roll developed, 8 prints and 2 enlargements 25c. Roll developed, 16 prints and no enlargements 25c. 8 reprints and 2 enlargements 25c. 16 reprints and no enlargements 25c. "Our business is national." Allied Photo Service Company, Sparta, Wisconsin.

**DO** You want quality prints? Then send us your films, Kodak rolls developed and printed 25c. Cain's, Dept. M, Box 883, Station H, Los Angeles, Calif.

**BEAUTIFUL** Prints, roll finished 25c. Free specialty list, Photocraft, 436 East 58, New York.

**20 REPRINTS** 25c. 100, \$1.00. Rolls developed, 16 sparkling Lifetone prints, 2 studio enlargements—25c. Lifetone Studios, B-8, Des Moines, Iowa.

**IDEAL** Photos. Professional deckle-edge prints and free enlargement with each roll for only 25c. Ideal Photos, Box 2255, Paterson, N. J.

**THE** Modern Finishers, St. Paul, Minnesota, are the outstanding finishers in America for low prices with quality pictures. Our modern methods give quick service and bright guaranteed neverfade pictures. Roll developed, 16 prints, 25c coin; 16 reprints, 25c. Enlargement coupons. Join our thousands of satisfied customers by sending us your next roll or reprint order. Modern Finishers, Box 3537, St. Paul, Minn.

**MINIATURE** Film, fine grain development, 2 1/2 x 3 1/2 enlargements, 35mm, \$1.00, bantam 25c. Film Capital Service, Box 504, Rochester, N. Y.

**GET** Clear, brilliant pictures the modern Arcraft way. Roll developed, 2 prints each negative only 25c. Valuable enlargement coupon. Arcraft, Box 1822-A, Washington, D. C.

**TWENTY** Reprints 25c. Roll developed and two prints each negative, 25c. Send for free mailing envelopes, price list. Star Photos, J-109 N. Dearborn, Chicago.

**IMMEDIATE** Service! Better pictures. Sixteen guaranteed prints from roll, 25c. one colored or two plain enlargements and 8 guaranteed prints 25c. Sixteen reprints only 25c coin. Candid rolls developed free! Prints enlarged to 3x4, only 4c each. One day service. Details and mailers free on request. American Studios, Box B, LaCrosse, Wis.

**20 REPRINTS** 25c. 100 Reprints, \$1.00. Films developed, 2 prints each negative, 25c. Mercury Studios, Box 822-B, Chicago.

**PROMPT** Service! Rolls developed, two Velox prints each negative 25c. Hench Studios, Harrisburg, Penna.

**A PROFESSIONAL** 4x6 enlargement of each exposure. Eight exposure rolls. Coin 25c. Wells, Box 5556M, Cleveland.

**35MM. DEVELOPED** And printed in strips of three nicely booked, 50c coin. Wells, Box 5556M, Cleveland.

**ROLL** Developed, 8 brilliant fadeproof Velox prints and two professional enlargements 25c. Overnight service. Young Photo Service, 405-C, Albany, N. Y.

**ROLL** Developed and 16 prints 25c. Reprints 20 for 25c, 50 for 50c coin. Queen City Service, Dept. C, Box 7, Niagara Square Station, Buffalo, N. Y.

**ROLLS** Developed, printed, two 5x7 enlargements included—25c. Reagan, 406 Tenth North, Seattle, Wash.

**LIFE** Photo finishing lasts a life time. Roll developed, 8 prints, 2 enlargements 25c. Reprints 1 1/2c. Life Photos, Hutchinson, Kansas.

**TWO** Glossy enlargements, 1 colored with roll 25c. Arbor Service, 10, Joliet, Ill.

**ROLL** Developed, 16 guaranteed prints, two coupons on enlargements 25c. Smart Photo, Winona, Minnesota.

**CANDID** Special. 35mm. rolls enlarged to 3 1/4 x 4 1/2, \$1.00. 18mm. rolls 60c. 3 1/4 x 4 1/2 reprints 3c. Brown Photo Company, 1910-61 Emerson, Minneapolis, Minn.

**16 PRINTS** With roll 25c. 16 reprints 25c. Rex Photo, Ogden, Utah.

**BEAUTITONE** Enlargement, dime and negative. Giant Snapshots, Inc., Green Bay, Wis.

**GUARANTEED.** Roll developed, 16 prints 25c. 20 prints 25c. Quality Photo, Hutchinson, Kansas.

**QUICK** Service—Rolls developed, 8 guaranteed prints; 2 enlargements; 25c coin. OK Photo Service, Ottawa, Kansas.

**ROLLS** Developed and printed 10c. Trial. Quality Finishers, Maywood, Ill.

**ROLLS** Developed, 2 prints each and 2 free enlargement coupons, 25c; reprints, 2c each; 100 or more, 1c. Summer's Studio, Unionville, Mo.

**FOR** The discriminating amateur, roll developed and carefully printed 25c, reprints 3c. Superior workmanship, same day service, Paramount Co., 327 E. 92nd St., New York.

**PHOTO** Mill. Immediate service! No delay! Roll developed, carefully printed and choice of two beautiful 5x7 double weight professional enlargements, one tinted enlargement, or eight reprints—for 25c coin. Reprints 2c each. The Photo Mill, Box 629-12, Minneapolis, Minnesota.

### CAMERAS, PHOTO SUPPLIES

**MAKE** Money in photography. Learn quickly at home. Spare or full time. Easy plan. Previous experience unnecessary. Common school education sufficient. Interesting booklet and requirements free. American School of Photography, 3601 Michigan Ave., Dept. 3431, Chicago.

**"MAKING** Up For the Camera" simplified! Better black and white portraits without retouching. Complete instruction booklet free. Send 3c stamp. Miner's, 12 East 12th, Dept. 4KC, New York.

**BUY** Your camera on time payments. See our advertisement under Motion Pictures. Mogull's.

**SPEED-TONE** Portraits. Trial size 25c. Albert McGoldrick, Mansfield, Mass.

**OIL** Coloring photographs a fascinating hobby or profitable business. Learn at home by easy simplified method. Previous experience unnecessary. Common school education sufficient. Send for free information and requirements. National Art School, 3601 Michigan Avenue, Dept. 3434, Chicago, Illinois.

**SENSATIONAL** Film sale. Price list 10c. 30 Summer, Manchester, Connecticut.

**WHAT** 15c Can do for camera fans. Get newest information on all phases of photography, better picture making, candid, color, latest developments, money making ideas, kinks, etc. Written by experts for amateurs. A treasure chest of practical information for only 15c. Get Everyday Photography at your camera shop or newsstand today! Send 25c for next two issues or \$1.00 for next nine issues. Everyday Photography, 67B West 44th Street, N. Y.

**ENLARGER** \$1.59. Enlarges eight times size of small negatives. Fully guaranteed. Paramount Sales Company, 89 Dudley Street, Boston, Mass.

**STAMP** Photos from your photo 1c each. Wonderfully clear, glossy finish, gummed, perforated. Attach them to stationery, exchange them with friends, employment applications, hundreds of other uses, 100 for \$1.00. Satisfaction guaranteed. Send any size photo for reproduction. American Photo Stamps, Box 507-A, Elmira, N. Y.

**CAMERA** Booklet: "Picking Checks from Newspapers," 25c. Holden, Germantown, Tenn.

**MINIATURE** Camera complete with developing—printing set. Films, instructions included. 50c. Roxie Fotomart, 4512M Mitchell, Philadelphia.

**WE** Buy, sell and exchange cameras, binoculars, microscopes, shotguns, rifles, etc. Aladdin Camera Exchange, 4 East 32nd, New York.

**TAKE** Better photos:—Helpful hints for amateur photographers, 64 pages, completely illustrated—50c. Poplar Company, 3739 Poplar Ave., Brooklyn, N. Y.

**CAMERAS**—Shutters repaired. Leather bellows installed in folding and view cameras. Bellows made to order. United Camera, A-1515 Belmont, Chicago.

**CAMERAS** Films, paper 25% to 35% discount. Paramount Photo Division, 327 East 92nd St., New York.

**CAMERAS**—Shutters repaired. Leather bellows installed in folding and view cameras. Bellows made to order. United Camera, A-1515 Belmont, Chicago.

**HAVE** You a camera? Send ten cents for recent number of our big magazine, showing how to make better pictures and earn money. American Photography, 116 Camera House, Boston, 17, Mass.

**BASS** Inventory clearance. Profit by these unusual bargains. 35 mm. candid midget, F:4.5 lens, \$12.75. Used Foth Derby, F:3.5, \$15.75. 2 1/4 x 3 1/4 Agfa Film Pack and plate, with F:6.3 lens, \$10.75. 9x12 or 3 1/4 x 4 1/4 Zeiss Ikon Film Pack and plate, single ext., F:6.3 lens, auto shutter, film adapter and holder, \$11.95. Used Argus, F:4.5 lens, \$7.75. New candid midget, Xenon F:2 lens, Rapid Compur and case, \$80.00 value, at \$54.75. Hundreds of other bargains in the great Bass Bargain-gram and special bulletins. Your money back if unsatisfactory after 14 days trial. Write Bass Camera Company, Dept. AG, 179 W. Madison St., Chicago, Illinois.

**NO** More wasted film or unnecessary expense. Take pictures you can be proud of. Sell to magazines and newspapers. Make good money wherever you live. Easy, low-cost home study course shows you how! Free catalog. Universal Photographers, Dept. 104, 10 W. 33 St., New York City.

**PHOTO** Mill. Immediate service! No delay! Roll developed, carefully printed and choice of two beautiful 5x7 double weight professional enlargements, one tinted enlargement, or eight reprints—for 25c coin. Reprints 2c each. The Photo Mill, Box 629-31, Minneapolis, Minn.

**IF** You go to Mexico ask first for prices and pamphlets of finest German quality miniature and other cameras, binoculars, movie cameras and projectors. Foto Mantel Sucr. R. Rudiger V. Carranza 11. P. O. Box 1459, Mexico City.-105. Branch store: Tijuana, Baja California. Branch store: Tijuana, Lower California. Hotel Comercial. Branch store: Monterrey, N. L., Morelos Oriente No. 557.

**CAMERAS** And supplies. Free illustrated catalog listing everything photographic—still and movie cameras, films, lenses—at tremendous savings. Hundreds of bargains, new and used. All guaranteed. We take your old camera or equipment in trade. Write now for your free copy of our newest money-saving bargain book—just out! Limited edition. Hurry! Central Camera Co., (Photographic Headquarters Since 1899), 230 South Wabash, Dept. 4-K, Chicago.

### MOTION PICTURES AND SOUND EQUIPMENT

**WHY** Wait? Get your camera, movie outfit, accessories now on small monthly installments. No down payment. Bell-Howell, Kodak, Victor, Ampro, Leica, Rolleicord, Speed Graphic, Graflex—all makes. New, used. Trades. \$198.00 sound film projector \$9.13 per month! Rent home movies! 8, 16mm. silent or sound, low rates. Write for bargain list. Mogull's, 64 West 48th, New York City.

**16 AND 35MM.** Films rented. Bargain lists 3c. Hoffman Films, 57 Broad, Albany, N. Y.

**8MM.-16MM.** Specials. Vision Films, 704 Mt. Hope, Cincinnati, Ohio.

**BARGAINS** 8mm.-16mm. Movie supplies. Literature. Baerco, Palisades Park, N. J., Box 46.

**BARGAINS!** Silent 35mm. films. Projectors. Demsey, 1223 Berkley, Youngstown, Ohio.

**WESTERNS,** Comedies, 1,000 feet \$1.00. Jersey Films, 2075 Richland, Lakewood, Ohio.

**PROJECTOR** Films: Sample 10c; lists free. Goodwill Company, Jackson, Tenn.

**DIRECTORY** Of 1010 free 16mm. films, classified. Price 60c. Box 409, Ashtabula, Ohio.

**MOVIE** Title sets—500 embossed letters, 14 silhouettes, 10 backgrounds, masks. Price \$1.00. Kramark, Inc., 26 W. 19th St., New York City.

**TALKIE** 35MM. Films rented, sold, silent films, machines. Simpson, 1275 So. Broadway, Dayton, Ohio.

**FREE** Lists cameras, projectors, film bargains. 8mm., 16mm. W. N. Gravlee and Son, Kennedy, Alabama.

**35MM. FILMS,** List 5c. Bedner, 5300 S. Talman, Chicago.

**GENERA** Film for all movie cameras. 100 feet 8mm. \$1.00; double 8mm. \$1.75; 16mm. \$1.35. Sample for stamp. Processing powders and outfits. Fromaders, Daventport, Iowa.

**MOVIES!** Bargain catalogue free! Mickey's Movies, 126 Fourth, Paterson, N. J.

**"THE** World's greatest of all Passion Plays." 16mm. and 35mm. 8-reels. Sound with dialogue or silent. Rent or purchase. Superior than Oberammergau stage play. Write Hemenway Film Co., 37 Church Street, Boston, Mass.



**HOME Movies**—8mm., 16mm. Cartoons, comedies, westerns, travelogs. Free list. Crown Film Corp., H 42 Melrose St., Boston, Mass.

**YOU Can make talkies!** Send us silent 16mm. movies. We add sound like newsreels. Big profits for good 16mm. cameramen producing talkies for business, churches, schools. Pan-American Films, 325 West Huron, Chicago.

**8-16MM. FILMS.** "Latest subjects" for sale, exchange. Films rented everywhere. Free illustrated catalogue (with sample film 10 cents.) Parkway Exchange, 1040 Eastern Parkway, Brooklyn, New York.

**FREE!** Giant list 35mm. silents. Calderara, 5119 South St. Louis, Chicago.

**PASSION Play.** 16mm. silent. Seven reels. Price reduced. Crown Film Corp., K42 Melrose St., Boston, Mass.

**PENN-CRAFT** Movie films. Save. Write. Pennsylvania Photo, Box 423-A, Williamsport, Pennsylvania.

**FREE Lists.** 16mm., 8mm. films, cameras, projectors, accessories. Home Movies, Box 216, Easton, Pennsylvania.

**15% TO 25% Discount** on still or movie cameras. Free circular. Paramount Co., 327 E. 92nd St., New York City.

**COMPLETE 16mm. And 8mm. film rental library.** Attractions: "White Hell of Pitts Palau," "Lost World," "Pony Express." Free catalog. National Cinema, 3 West 29th, New York.

**BASS** Wants to mail you without charge our new 52-page Cine Bargaining 100. 234—sound, silent, 8 mm., 16 mm., 35 mm. equipment, of the quality we can sell on our money back guarantee. Write for this valuable book at once. Full description of the RCA 16 mm. sound on film camera. Newsreel model is only \$250.00, and Bass is exclusive distributor. Dept. A, Bass Camera Company, 179 West Madison Street, Chicago, Illinois.

**LEARN** Motion picture theatre management, advertising, projection. Free catalog. Give age. Theatre Institute, Elmira, N. Y.

**BARGAINS!** 8mm., 16mm., free literature. Elder, B-739 Boylston, Boston, Mass.

**BARGAINS—35MM.** cameras, projectors, films. Avond, 747 6th Avenue, New York.

#### RADIOS, SUPPLIES, INSTRUCTION

**RADIO Kits**—\$2.70. A practical 1-tube receiver that really works. Two-tube model—\$3.00. Three-tube model—\$3.75. All the parts but headphone, battery and tubes. Eighteen other models up to 14-tube de luxe communications set. Write for free catalog. Dept. PM-4, Meissner Manufacturing Co., Mt. Carmel, Illinois.

**RADIO Engineering,** broadcasting, aviation and police radio, servicing, marine and Morse telegraphy taught thoroughly. All expenses low. Catalog free. Dodge's Institute, Ames St., Valparaiso, Ind.

**ANY** Radio circuit diagram 25c. Order mentioning manufacturer's name, model. Catalog free. Supreme Publications, 3727 West 13th, Chicago.

**CRYSTAL.** Selective set plans 15c. Trent, Box 291, New Brunswick, N. J.

**"CRYSTAL Detector"** handbook: 3 beginner's plans; "Radiobuilder"—year. All—25c. Laboratories, 7700-C East 14th, Oakland, California.

**RADIOS.** \$6.50. Buy direct, factory prices. All types. Free catalog. A. R. Co., 3855 N. Hamilton Ave., Chicago, Ill.

**RADIOS—\$9.95 Up.** All kinds. Save 50%. Factory surplus. Agents wanted. Catalog—free. 30 day's trial. Write Marco-F. Kansas City, Mo.

**SEND** For free giant money saving radio and phonograph record catalogue. United Radio Company, 1000-M, Newark, N. J.

**TRANSFORMERS**—Design, build any size, type, frequency. Instructions, \$1.00. Translab, 2827 Third Ave. W., Hibbing, Minnesota.

**DON'T** Buy a radio. Get our catalog first listing over 400 nationally known standard make sets. Also 700 electric specialties for the home. Big special, 10 inch phonograph dance records, 12 for \$1. Write today. Modell's, 56 Cortlandt St., New York.

#### MUSIC AND MUSICAL INSTRUMENTS

**SAXOPHONISTS.** Scientifically designed invention attaches to reed. Produces marvelously vibrant tone. 3 for 25c with professional secrets. Ovaltone, 126 Lexington Ave., New York, N. Y.

**HAWAIIAN** Guitar lessons and music. Ray Collett Publications, R-1, Clarksburg, W. Va.

**SONGWRITERS**—We revise your melody and arrange complete piano parts for only \$8. Strauss Music Service, P. O. Box 392, Elizabeth, N. J.

**SONGWRITERS**—Agents, new sales plan. National Music-D, 532 Sixteenth, Oakland, Calif.

**SONGWRITERS**—Verse or music. Brilliant opportunity. Write immediately. Vanburen, B91, Rockhaven, Kentucky.

**SONG** Writers. Send for publishing agreement. McKinley Music Publishers, 1501 E. 55th St., Chicago.

**SONGS**—Arranged, revised by arranger "Cherry Blossom Lane," "Gypsy Tea-room," others. Send for details. Harold Potter, 1619 Broadway (P), New York.

**SONG** Poem writers wanted, our 50-50 plan has aided many songwriters. Burl Bogg's song won a nation wide contest. Other new writers have had their songs published. We may be able to help you. Send poems or write for free booklet today. Indiana Song Bureau, Dept. 53, Salem, Indiana.

**SONGWRITERS**—Send poems—Profitable plans mailed free. Variety Service, Salem, Indiana.

**PIANO** Jazz guaranteed by mail in 20 lessons. Write today for free sample lesson. Erskine Studio, 810B East 14th St., Oakland, Calif.

**SWISS** Musical movements. Catalog 10c. 1637-9 West 105 Place, Chicago.

**PIANO** By ear! Free information. Hollywood Radio School, 6842 Sunset, Hollywood, California.

**SIMPLIFIED** Swing courses! Accordion, saxophone, clarinet, trumpet. Write Swingmaster, 1259 Bender, East Cleveland, Ohio.

**DUO-FLEX** Reeds for clarinets, and saxophones eliminate your reed troubles. Write for circular. Duo-Flex Reeds, 1204 1st Ave., Evansville, Ind.

**300 UKULELE.** Guitar chords. 25c brings essential parts to make. Chordfinder, Box 3890, Chicago.

**SONGS, Poems,** bought, composed, published. Royalty plan. Free advice. Metro-Melody Music Publishers, San Francisco.

**ORIGINAL** Music composed to your words. \$5. 200 printed copies \$10. Reginald Belcher, Chatham, New Jersey. 30 years church organist.

**ORCHESTRATIONS** Popular back numbers. 10—\$1.00. Silverman, 3305 Lawrence, Chicago.

**PLAY** Piano by ear \$1.00. Shorthand Music Company, Springfield, Illinois.

**LEARN** Swing piano! Postal brings free folder. Christensen, 751 Kimball Hall, Chicago.

**SONGWRITERS:** Send us your poems, wonderful proposition. Keith-Downing Publications, Clearwater, Florida.

**ORIGINAL** Poems, songs wanted for publication, radio. Westmore Music Corporation, Dept. 33H, Portland, Ore.

**SONGPOEMS, Melodies.** Outstanding offer. Hibbler, C-5, 2157 No. Avers, Chicago.

**MUSIC** Composed to words. Rhyming pamphlet on request. Phonograph recording of completed songs. Send poem for consideration. Keenan's Studios, Dept. PM, Box 2140, Bridgeport, Conn.

**SONGWRITERS**—Get free the inside facts on successful songwriting by famous Broadway composer. Write today. Songwriters Institute, 1234-C Broadway, New York.

**SONG** Poems wanted to be set to music. Free examination. Send poems to McNeil, Bachelor of Music, 4153-PM S. Van Ness, Los Angeles, Calif.

**PIANO** By ear. Free booklet. Day-V-Way, Woolworth Building, Dearborn, Michigan.

**MUSIC** Composed to words. Wonderful proposition. Bauer Bros., Oshkosh, Wis.

**WRITE** Songs. Big money and reputation. Write for information. J. Gordon Pub. Co., 201 N. Hoyne Ave., Chicago.

**WANTED!** Lyrics, melodies for songs. We arrange, publish, sell. Superior Song Studios, Passaic, N. J.

**SONGWRITERS:** Send your poem today for immediate consideration. Richard Brothers, 24 Woods Building, Chicago.

**PIANO, Self** Instruction. Play within an hour. \$1.00. Popular Mechanics, 200 E. Ontario St., Chicago.

#### BUSINESS OPPORTUNITIES

**MAKE** Color-glazed concrete pottery, tiles, walls. New, patent method. Use only sand, cement, cheap materials. Men (only). Write for booklet, details. National Potteries, 13 West 26th, Minneapolis, Minn.

**M. M.** earned \$267, three weeks, raising mushrooms in cellar! Exceptional, but your cellar, shed perhaps suitable. We buy crops. Book free. United, 3848 Lincoln Ave., Dept. 64, Chicago.

**MAKE** Big steady money manufacturing Pinless Clothes Line to supply demand your territory. Equipment cost small. G. Dhein, 5201 Humboldt, Minneapolis, Minn.

**STEADY** Job for life, own boss, easy money, repairing sewing machines. Book instructions \$1.00. Connan, 508 S. W. Second, Portland, Ore.

**SPLENDID** Profits in mail order, simple, inexpensive, no merchandise guaranteed. Instructions \$1.00. Refunded if not more than pleased. Moese, 275 Post St., San Francisco.

**"MAKE** Mirrors at home." Big profits. Little outlay. Also emboss, grind—foil, gold leaf, frost, chip and make imitation stained glass. Instruction course 50c. Ideal Service, M-4, Park Ridge, Ill.

**SUCCEED** With your products. Make-sell. Formulas. Accurate analyses. Catalog free. B. Thaxly Company, Washington, D. C.

**YOU'LL** Like resilvering mirrors, auto-parts, reflectors, making chipped glass signs. Write. Sprinkle, Plater, 127, Marion, Indiana.

**DIME** Brings money making plan. A. Taylor, Dorchester, N. J.

**FORMULAS**—Fast selling products. Guaranteed. Laboratory tested. Lowest prices. Catalog free. Kemico, 55K, Park Ridge, Ill.

**POPCORN** Machines, carmelcrisp, crispettes, cheese coat, potato chips. Long Eakins, 2035-D High St., Springfield, Ohio.

**INCREASE** Your income. Several profitable propositions to select from. Send for details today. No obligation. Geo. F. Talbot, Norwood, Mass.

**"RUBBER** Molds." Make them yourself. Formulas, instructions 25c. Ideal Service, 179-R4, Park Ridge, Ill.

**MAKE** Money electroplating! Marvelous patented invention plates with electric brush—easy as painting. Does same beautiful, permanent electroplating—gold, silver, nickel, cadmium, etc.—as big tank outfits. No liquids—lightweight—portable. Anyone can use from battery or household current. Only \$6.85 complete. Write for details and sample of work done. Warner Electric Co., 360 N. Michigan, Dept. H-11, Chicago.

**PROFITABLE** Business by mail. Small investment. Big profits. Open to a few reliable persons. Write, Byers Service, West Plains, Mo.

**PLASTIC** Art for profit. Stamp brings catalog. Colonial Art, Derry, N. H.

**STEADY** Money in showcards, signs, window lettering. Easy. Amazing details free. Write Nelson Company, 2030 Manhattan Building, Chicago.

**20 FULL** Size lawn ornament patterns 25c. Wickman, 744 Brooklyn, Dept. 28, Dayton, Ohio.

**INVENTORS**—We successfully sell inventions, patented and unpatented. Write for proof, and tell us what you have for sale. Chartered Institute of American Inventors, Dept. 4-C, Washington, D. C.

**CASH** Daily with a route of nut and candy vendors. Small investment. Eamco, 350 Mulberry, Newark, N. J.

**MONEY** Making plans you won't regret. Satisfaction guaranteed. Hamilton, 1353 Hastings St., Chicago, Ill.

**I WANT** To send you proof of the wonderful pulling power of Popular Mechanics Magazine's classified pages. What's your proposition? Write me today. F. W. Johnson, Manager Classified Advertising, 200 E. Ontario St., Chicago, Ill.

**RUBBER** Molds easily made. 25c brings sample of liquid rubber, sample mold, and directions. Vosburg Laboratory, Austin, Texas.

**BIG** Money easily made in home or office. Business of your own; booklet describing 107 money making plans free. Chilton, Box 1105, Oakland, Calif.

**MAKE** More money vending. Successful operator shows how. Get surefire merchandising folio, \$1. Be tops in your town. Send today. Randa Vending Company, Des Moines, Iowa.



**AMAZING** New liquid plastic opens up an entirely new and very profitable field to the home manufacturer. Make costume jewelry, chessmen, advertising novelties, etc. right in your own home. No experience or expensive equipment needed. Simply pour new liquid plastic in rubber, plaster or metal mold. It sets in about 20 minutes at low temperature, transforming into a beautiful solid plastic. Tough, resilient, non-inflammable. You can do a big production business. But, don't delay. Get started immediately. "Complete plastic kit, everything you need to get started, only \$1.00 postpaid!" Mail your order today! Stewart's Studio, Dept. P4, 2927 Wilcox, Chicago.

**MAKE** Money home. Spare or full time. Amazing new proposition. Details free. Labey, Colorado Springs, Colo.

**\$150 INVESTMENT** Will increase your weekly income \$10 to \$20 without interfering with present position. No selling. Operators Supply Co., 4311 N. Lincoln Ave., Chicago, Ill.

**RECEIVE** Stacks of mail: Your name listed in 10,000 directories 25c. Liberty Sales Service-A, Sheboygan, Wisconsin.

**PLASTICS**, Complete kits, clocks, jewelry, etc. Free catalog. Carlson, 70 Fox, Buffalo, N. Y.

**LAWN Mower grinder** easily cheaply built. Plans \$1. Mowerservice, 222 Fourth, Janesville, Wis.

**"LEGITIMATE** Home business." New! Profitable! Your labels. You control repeat orders! Amazing system! No canvassing! Samples, dime. Particulars free. Gardena System, 128PB, Station "S," Los Angeles.

**OPPORTUNITIES** Aplenty! Money-makers that "click"! Latest offers free! Planagram, P-1079 Madison St., Brooklyn, N. Y.

**AFTERNOONS** Free for outdoors, shows, \$340 month home. Unique plans. No canvassing. Prepare for surprise. Polio-P, Station D, Los Angeles.

**START** Your own business. Make large profits. Sell new and used auction or bankrupt bargains in clothing and general merchandise. Experience unnecessary. Free wholesale catalog. Superior Jobbing, 1250-V Jefferson, Chicago.

**SOAP** Making. Learn at home. No machinery needed. Stamp. Posera, A-4545 Bartlett, Milwaukee, Wisconsin.

**SELL** By mail! Books; bargains. Big profits. Particulars free. Stamford, 3762-B Broadway, New York.

**PROFITABLE** Business. Full or spare time. Small investment. Free literature. Loidco, 1347-Wisconsin, Berwyn, Illinois.

**UNEMPLOYED?** We have the best dime seller on the market. Every housewife a sure prospect. 400% profit. Dime brings sample and wholesale prices. Tuesday, 2810-P2 Winfield, Canton, Ohio.

**EASY** Money at home. What you have been waiting for. Actual pleasure making beautiful flowers, look like natural. Free sample. Artcraft Series, Dept. 16, 2823 East Fourth Street, Los Angeles, Calif.

**280 WAYS** To independence, etc. \$1. Ralph Brooks, Arkansas, Wis.

**MAKE** Money in the mailorder business. Ystesund, 907 North 4th, Sheboygan, Wis.

**PENNIES** In Hamilton scales produce assured income without canvassing or selling. 1910 Vermont, Toledo, Ohio.

**SELL** By mail. "The Key to Business Opportunities" shows how. Particulars for stamp. Maples, 3418 South Marshfield, Chicago, Illinois.

**YOUR** Own dignified, permanent, highly profitable business easily built, without capital. Write. Business Service, Olympia Building, New Bedford, Mass.

**"NUGGETS** Of Knowledge." 42 page booklet, containing a gold mine of information, with money making plans and formulas, only 25 cents. Quandt, 2826 Winchester St., Baltimore, Md.

**CAPITAL**—How and where obtained for personal and business needs. Capital Service, Arlington, Va.

**COLOR** Concrete with chemicals. Benches. Washing-wells. Spin concrete pottery. Stucco-rock. Miniature castles, mills. Cold glaze, marbling. Sample 10c. Hollywood CementCraft, 8527 Wonderland, Hollywood, California.

**EARN** Steady income with "route" of peanut, gum and amusement machines. Small capital required. Robbins Co., 1141P DeKalb Avenue, Brooklyn, N. Y.

**MOLDEX** Makes best rubber molds, models, supplies, stamp. Pentucket Arts, Haverhill, Mass.

**MARBLELIKE** Concrete mixture—Chemically colored! Glazed! Resurface old buildings—Make terrazzo floors, statuary. "Spin" pottery. Particulars, miniature vase, samples 10c. Rapido Service, Edwardsville, Illinois.

**WHO'S** Who and what's new in "The Mail Order World." Monthly—10c. Pines, 583-A Monroe, Brooklyn, N. Y.

**START** Something. Prosperity books 10c. Dolsen, Pineapple, Brooklyn, New York.

**ALL** Ambitious persons wanting part time work. Send for free opportunity listings. George Hans, 428 South Halsted Street, Chicago, Ill.

**MAKE** Artificial marble, glazed tiles, uncanny. Tabletops, plaques, floors, hones, novelties. Hard, fireproof, inexpensive, cement secrets. Brilliant tile and liquid rubber samples 3c. John A. Payn, 945 Grande Vista Avenue, Los Angeles, Calif.

**HANDY** Men—Earn money home operating Community "Fix-It" Shop. Stafford, Makanda, Illinois.

**TESTED** Money making plans, ideas that produce. Literature free. Mayfair, 3921 Pinkney Road, Baltimore, Maryland.

**I EARN** \$200 monthly, making household necessity. Repeats steadily—good profits. Instructions \$1.00. Particulars 10c. Pring Laboratories, Kirkiand Lake, Ontario, Canada.

**WE** Start you in business at home, spare-time, earnings \$5-\$30 weekly, selling by mail. Wensel's Service, 327 Taylor Terrace, Chester, Penna.

**SELL** Guaranteed tires wholesale. Save users up to 70%. No experience necessary. Profits easy. Unlimited field. Details free. Auto Tire Company, 4502 S. Ashland, Chicago.

**SEEKAY** Collection 66 profitable home moneymaking plans, \$1.00. New! Tested! Sample, full information 10c. Seekay, Augusta, Maine.

**AMAZING** New household product. Make at home. Sell by mail. McK, received 647 orders from 1500 circulars. Big profit. Send \$1.00 for complete plans. Mailorder Institute, B-651 South State, Chicago.

**PROFIT** With new products. Make, sell, repeat. Analysis. Research. Guaranteed formulas. Biggest catalog free. Nominal prices. Gibson Laboratory, Chemists, BD-1142 Sunnyside, Chicago.

**MONEY** In Butterflies, moths. See Sinclair Display Advertisement on page 24A.

**MAKE** \$5-\$15 Daily with beautiful feather pictures. Free details. Samples 12c stamps. Marquez-PBG, Apartado 1176, Mexico City.

**WHOLESALE**R'S Guide to direct supply source. Lowest prices possible. \$1.00 postpaid. Hicks, Box 8, Brooklyn, N. Y.

**EARN** Extra money writing for publication. Simple method. Demand inexhaustible. Details free. Dona Veretts, 17 Grotton, Lowell, Mass.

**MAKE** Rubber molds for casting. Instruction and sample mold 25c, or beginners kit for \$2.50 containing everything needed to start you in the casting business. Progressive Mold Works, Box 461, Denver, Colo.

**"MONEY** By Mail" brings proven, tested money makers to start your own business. Sample copy 10c. Universal, Lacoochee, Florida.

**WORKABLE** Mail order plans. Particulars in booklet (useful premium included) 25 cents. J. E. Howe, Box 183, Evansville, Indiana.

**ARTIFICIAL** Marble sanitary flooring, instruction covering wood or cement flooring 1/2 inch thick, fireproof, all colors, low cost, ornamental casting, concrete, plaster, papier-mache, garden furniture, statuary, flexible molds, particulars free. Chris Mahler, Elmont, N. Y.

**DELAWARE** Charters: Complete service \$35. Submitted forms. Chas. G. Guyer, Inc., Wilmington, Del.

**107 WAYS** To make money, in home or office, business of your own. Full particulars free. Elite Co., 214 Grand St., New York.

**SELL** By mail. Books, novelties. Bargains! Big profits! Particulars free. E. Eifco, 438 N. Wells, Chicago.

**BE** Independent! Secrets of riches fascinatingly revealed. Details. Todd's Service, 262 Arlington, Youngstown, Ohio.

**ELITE** Collection of business plans, contains 107 tested plans and scores of formulas. Start own business; home, office. Particulars free. Elite Co., 214 Grand St., New York.

**PLASTEX** Industries offers industrious men an opportunity to start a business of their own, manufacturing art goods, novelties, souvenirs, etc., in Plastex and marble imitation. 5c material makes \$1 articles. Rubber moulds furnished for speed production. Small investment brings big returns. You are just in time for big wholesale season now starting. Write for interesting booklet mailed free. Plastex Industries, Dept. A, 1085 Washington Ave., New York.

**CHARTERS:** Delaware; best, cheapest; free forms. Colonial Charter Co., Wilmington, Del.

**GIANT** Mail, opportunities, added income, ideas, 52 page magazine. 10c. Katz, 4254 N. Kimball, Chicago.

**PROFITABLE** Home business. Legitimate. No canvassing. Maywood Publishers, P-923 Broadway, New York.

**WHERE** To buy at lowest wholesale prices. Information free. Yorena, Box P-312, Bayonne, N. J.

**100 PROFITABLE** Mail order and local plans. Gilbert Supply, 1107 Broadway, New York.

**MAIL** Order business is your opportunity. Many began small, now earn thousands yearly. No personal contact. Boundless opportunities. Have had over 30 years experience; will help you succeed. Send 25c for valuable booklets, none free. B. Brenner, 257 S. 21st, Philadelphia.

**HOW** And where to obtain capital fully explained, free particulars. Star Service, Wapakoneta, Ohio.

**WE** Help start you in business, furnishing outfits and instructions, operating "Specialty Candy Factory" home. Men and women, opportunity to earn \$20 to \$50 weekly, all or spare time. (Our 29th year.) Booklet free. W. Hillyer Ragsdale, Inc., Drawer 4, East Orange, N. J.

**LEARN** Arc welding. A growing industry with great opportunities. Consult your local school, or if there is none available write The Lincoln School of Welding, Dept. A, Box 5758, Cleveland, Ohio.

**MAN** In each town to plate auto parts, reflectors, bicycles, fixtures, mirrors, by late method. Simple plan of manufacturing at home starts you in good paying business. Free particulars and proofs. Gunmetal Co., Ave. H, Decatur, Ill.

**MANUFACTURE** From Phospholene. Cleaning fluid 1c gallon; bleach 2c gallon; hand soap 2c pound; and ten fast sellers. Sample 25c. Details free. Western, 6615 Denison Ave., Cleveland, O.

**WANT** More business? 2c daily, opens individual New York branch office requiring no room number on your stationery or advertisements. Co-operative Mail Service, 126 Lexington Avenue, New York.

**FINANCIAL** Independence obtainable by placing coin operated merchandise vending machines, out on percentage basis, no experience required, little capital needed, write for free details. Torr, 2047 1/2 South 68th Street, Philadelphia, Pennsylvania.

**BE** Your own boss. Customers everywhere. Amazing profits. Read our ad page 161A. Rogers Manufacturing Company.

#### MONEYMAKING OPPORTUNITIES

**YOU'LL** Like resilvering mirrors, auto-parts, reflectors, making chipped glass signs. Write. Sprinkle, Plater, 287, Marion, Indiana.

**CANDY.** Ten selected professional formulas. Fast sellers. \$1. A. Poirier, Dutton, Mont.

**SOIL-LESS** Vegetation. Latest chemical formula 50c. Dunn Co., Middletown, Ohio.

**RAISE** Earthworms for profit. Information free, stamp appreciated. Bureau Zoological Research, 106A Broadway, Peoria, Ill.

**SPLENDID** Opportunity collecting reptiles, frogs, toads for us. Our instructions make collecting easy. Contract and particulars dime. Biological Research Laboratories, Dept. M-10, Springfield, Mo.

**MAN** In each town to plate auto parts, reflectors, bicycles, fixtures, mirrors, by late method. Simple plan of manufacturing at home starts you in good paying business. Free particulars and proofs. Gunmetal Co., Ave. N, Decatur, Ill.

**MILLION** Articles. Buy wholesale. Valuable directory, dime. Ideal Service, D-4, Park Ridge, Ill.

**DOLLARS** By mail with "Dollarmor" choice opportunities. Sample dime. Lawn-dale Press, Franklin, N. H.

**YOUR** Opportunity. Moneymaking secrets. Cash in now. 25c refundable. Swaty, Mentone, California.



**THREE** Monthly mail order magazines, filled with money making opportunities 10c. George Fenner, 1618 Lucia, Louisville, Ky.

**A DOLLAR** a minute. Your own boss. No scheme, racket, formula, plan, process or selling. A good living in less than one hour daily. Details for dime (no stamps). No Oregon orders accepted. Mansion House, Box 513, Portland, Oregon.

**MAKE**—Sell your own goods. Details free. Pederson, 1609½ East 5th, Duluth, Minn.

**WHOLESALE** Sources, 500,000 articles. Free directory. Maywoode, 925 Broadway, New York.

**EARN** Money. New plan. Samples. Particulars 10c. Browne, Box 272-X, Duluth, Minn.

**CAN** You invent "upset-proof" ladder? Manufacturers pay cash for solution. New list 147 recently requested inventions. Just off press. Send 25c (coin). Meyl-Erie, 3204 N. Oakley, Chicago.

**BIG** Mail magazines. Moneymaking opportunities. Only 10c. Mickey Publisher, 2620 Stromberg, Pittsburgh, Penna.

**SELLS** For \$1.00—costs 15c. \$1.00 sample, details, 25c. Buckeye Products, Box 146, Piqua, Ohio.

**STOP** Squealing—Start crowing! Work mornings home—country drives or movies—afternoons! No canvassing! Folio-A, Station "D," Los Angeles.

**MILLIONS** Jobless! Supply satisfying employment information by mail. Keep dollars received! We fill your orders. Co-operative Service, 77 Swan, Buffalo, New York.

**"INCOME** Builder" makes you money-getter! Shows how, in spare time, at home, start, build, develop, prosperous business, your own. Send stamp quickly for money-saving, pre-publication gift offer. Become swift success! Westko, Plainview, Nebraska.

**FREE**—100 Wonderful business, mail-order and home work moneymaking offers. Lewis Co., 828-C Carpenter, Oak Park, Ill.

**WRITE** Quick. Wonderful new money-making proposition. Jay-Way, 26 Journal Square, Jersey City, N. J.

**RUG** Cleaner. 1c makes gallon. Formula 25c. (Formulas.) Tom Moore, Chemist, Waterloo, Iowa.

**YEAR'S** Subscription, plans, information, instructions, offers, etc., 25c. Sure Sales Magazine, Saint John, Kansas.

**THE** Knack of making money in any job, business or profession. Send stamp please. Imperial Service, 226 East 86, New York.

**SELL** By mail exceptional articles. Information free. Stamford, 3762-C Broadway, New York.

**HELPERS** Wanted! Big money introducing advertising necessity. Capital, experience unnecessary. Details stamp. Hurry! Johnston, P-257 North Washington, Tiffin, Ohio.

**"PORT** Of Opportunities" published monthly—offering latest self employment; ideas; plans; schemes. \$1.00 year, copy 10c. Farm & Home Industries, Gardenville, N. Y.

**BORROW** Recognized moneymaking books. Send for list. Anderson, Box 548, Muskogee, Okla.

**STEADY**, Amazingly large income. Angora wool rabbits. We buy wool. Instructions, marketing contract 10c. Logangora Industries, Logan, Utah.

**DOLLARS** In Fixit service. Particulars. Houligate, Station C, Pasadena, California.

**LEARN** Radio announcing! Big opportunities. Good wages. Instructionlet \$1.00. KPRO, Longview, Texas.

**NEW** 1939 Moneymaking opportunity. Particulars free. M. Benton, Liberty, N. Y.

**EXTRAORDINARY** Moneymaking opportunities! Mailorder and locally. Stamp. Raymond Schwarting, South Amana, Iowa.

**"SCHEMER"** Monthly, Alliance, Ohio, (41st year) publishes schemes, tips, opportunities, formulas; big producers: \$10,000-\$25,000 reported. Year, \$1.00. Now subscribe! Trial six months only 30c.

**TYPISTS** Earn extra money. Send 25c (coin) for "Twenty-one Ways to Make Money With the Typewriter." H. Robbins, Box 6048, Kansas City, Missouri.

**"PROSPERITY"** For home workers. 64 page magazine. Sample, dime. Sizemore, 4917N Kostner, Chicago.

**"OPPORTUNITIES** Everywhere for Everybody." Best offer on market. Particulars free. International Research Bureau, 1115 Sherman, Denver, Colorado.

**JOBLESS?** Get a job at once. Work easy; keeps dollars coming. Send dime for money making opportunities. Cap Waller, Black River Falls, Wisconsin.

**AGENTS**, Electric razors \$4.79. 3000 other articles. N. Lawrence, 46 Lincoln Terrace, Leominster, Mass.

**THE** Greatest depression buster and easiest profit producer you have ever met. Send quarter. Imperial Service, 226 East 86, New York.

**MAKE**, Use, sell, letter patterns. Instructions \$1.00. Harwell's, Byrdstown, Tenn.

**\$100** MONTH Up, business of your own. No canvassing, particulars free. George System, Box 4616, East Liberty Station, Pittsburgh, Penna.

**12** RED Hot, slickest, legitimate ways to make money quick. This is rare information. Write Dixon, Box 1403, Youngstown, Ohio.

**MAKE** Money mailing color postals. Sample free. Arkan Advertising Service, Arkansas City, Kans.

**\$10.00** DAILY In your home; plans 25c. Details free. Johnson, 414 McRae, Wilmington, N. C.

**HUNDREDS** Amazing new moneymaking secrets. No canvassing. Particulars, stamp. Herman's, 451 South, Massillon, Ohio.

**SELL** 36 \$1.00 Secrets, 25c. Costs 4c. "Imprints furnished." 25c sample copy 10c. Acme, 328-S Eastern, Los Angeles.

**MONEY!** Money! You can make money. Ten special money-making formulas for \$1. Roberts, 413 S. Main St., Jellico, Tenn.

**ANALYSIS**, Research. Newest guaranteed formulas. Biggest catalog free. Nominal prices. Gibson Laboratory, Chemists, CS-1142 Sunnyside, Chicago.

**MONEY** In butterflies, moths. See Sinclair Display Advertisement on page 24A.

**FREE** Copy "24 Ways to Make Money," formulas, etc., if you send name and 10c coin. We send you big mail for 3 months of latest money-making offers, catalogues, samples, etc. Cleveland's, Inc., Dept. P, Elkhart, Indiana.

**\$25.00** STAMPING Names per 100 key-checks. Sample 25c. Details furnished. Bohn Company, Box 86P, Wilkes Barre, Penna.

**MOULDS**, Guaranteed, for casting toy soldiers, Indians, trappers, warships, sinker moulds, 244 kinds. Send 5c for illustrated catalogue. Henry C. Schiercke, 645 Spencer, Ghent, N. Y.

**BIG** Money easily made: 107 test plans for your choice. Home, office. Descriptive booklet free. Elite Co., 214 Grand St., New York.

**FREE** Folio describes 2000 ways to make money. Marvin Studios, 203 South Dearborn, Chicago.

**YOUR** Name—5,000 mailing lists—25c. Get samples, opportunities galore from all over world. Pines, 583-A Monroe, Brooklyn, N. Y.

**BUY** Wholesale, million items, free information. Harris Service, 475 Powell St., Brooklyn, New York.

#### FORMULAS, PLANS, ETC.

**FORMULAS**—All kinds. Real moneymakers. Lowest prices. Catalog free. Clover Formulary, P-4, Niles Center, Ill.

**ESTABLISH** Steady income. Compound sales tested preparations. Sell garages, gas stations. 10 formulas \$1.00. Davis, 730 Howard, New Haven, Conn.

**THAXLY** Formulas for perfect products. Accurate analyses. Catalog free. B. Thaxly Company, Washington, D. C.

**10,000** FORMULAS Rock bottom prices. Furrate, Box 253, Ironton, Ohio.

**GUARANTEED** Formulas—New fast sellers. None better. Lowest prices. Catalog free. Kemico, 49M, Park Ridge, Ill.

**FORMULAS**, Latest money makers. Literature free. Belfort, 4042 N. Keeler, Chicago.

**DUPLICATION** Of branded and other products! Rare—"hard-to-obtain," formulas for all uses. Newest guaranteed formulas for latest best-selling goods in all lines. Write me your requirements and receive big. Monthly-Formula-Messenger subscription free! Miller, Chemist, 706-AF Miller Chemical Building, Tampa, Florida.

**GROW** Plants without soil year round. Home, cellar, apartment, outdoors. Complete kit, including seeds, definite directions, \$1.00 postpaid. Chemi-Culture, 4701-PM Sheridan, Chicago.

**"ANYTHING** In formulas?" Particulars free. "Research Bureau," 100 Chelsea, Charlestown, Massachusetts.

**NEW** Formulas, analysis, free information. Research-Development Laboratory, 449 So. Ionia Ave., Grand Rapids, Mich.

**SENSATIONAL!** 446 Latest moneymaking formulas compiled in large volume. Only \$1.00 prepaid. B. Eifen, 4916 Rorer, Philadelphia.

**FORMULAS** Originated, improved. Submit problem. Kent Mfg., 816 Bridge, Grand Rapids, Michigan.

**DANDRUFF** Compounds. Two tested formulas. Send quarter. Box-281, N. Park Sta., San Diego, Calif.

**FORMULAS** Free. Where to get and three moneymaking plans 25c. Box 116, Bluford, Ill.

**"1c** FORMULAS!" Literature; sample—3c! (Typewriter ribbons, three—\$1.00!) Galluzzo, 409P Trenton, Pittsburgh, Penna.

**ANALYSIS**, Research. Newest guaranteed formulas. Biggest catalog free. Nominal prices. Gibson Laboratory, Chemists, BD-1142 Sunnyside, Chicago.

**FOR** Those desiring home employment, 25 moneymaking formulas \$2.00. Write Eugene J. Sousa, 61 Union St., Nantucket, Mass.

**FORMULAS:** 15 Proven moneymaking formulas \$1.00. (Not stock-formula catalogue stuff), real unusual offers. List free. Marvel Laboratories, 6629 No. Maplewood, Chicago.

**ELITE** Formulas and plans; make and sell your own products. Descriptive booklet free. Elite Co., 214 Grand St., New York.

#### CHEMISTRY

**LABORATORY** Spectroscope for chemical analysis \$2.50. Kutting Sons, Campbell, California.

**BOOK** Of 320 chemical experiments \$1.00. Free catalog of microscopes, chemistry, mineralogy. Tracey Laboratory, Evanston, Illinois.

**LODESTONE** Magnetic, selected large specimens, 25c. Mineral Supply Co., 923 South Keeler, Chicago.

**CHEMICALS** In 5c quantities. Catalog 5c. Fleischer's Laboratories, Everett, Mass.

**CHEMICALS**, Laboratory, glassware, apparatus. Send 3c for catalog CP1. Biological Supply Company, 1176 Mt. Hope Avenue, Rochester, N. Y.

#### AGENTS WANTED

**MEN!** Women! Operate quick moneymaking route in choice localities or work right from your home. Excellent year round earnings. Just give away valuable premiums and samples with famous quality coffee, spices, soaps, flavorings—300 everyday necessities. Also \$500.00 yearly bonus and big display to all qualified dealers. Experience unnecessary. Part time workers welcome. Togstad Company, Dept. D-17, Kokomo, Indiana.

**DISTRIBUTORS**, New approved motor reconditioner; does what we claim. Sell to agents calling on automotive trade; we furnish leads. Send \$1.95 for trial box and full information. W. S. Anderson Products, 493 4th St., San Francisco, Calif.

**SEASON** Just starting. Up to \$20 daily demonstrating one-minute electric hot water heaters. Write for demonstrator and territory. P. O. Box 388, Minneapolis, Minn.

**AGENTS**, Sell toys, novelties, sinkers. Particulars free. W&W Toy Co., 12605 Craven, Cleveland, Ohio.

**WEAR** Fine hose I send without cost with outfit while taking orders for amazing new hosiery. Replacement guaranteed against holes, snags, and runs. Rush name and hose size. Wilknit, Desk D-37, Greenfield, Ohio.

**AMAZING** Three purpose cleaner. Germicide, deodorant, cleanser. Big profits. Write for particulars. Solvit Chemical Company, Madison, Wisconsin.

**NON-COMPETITIVE**, Amazing invention. Toilet flush regulator. Saves many times its cost. Every water user a prospect. Exclusive territory to distributors and agents. Hydrolator Company, 5609-M Chester Ave., Philadelphia.

**BUILDERS**, Contractors, handymen. Long range leveling device. Something new. A real necessity. Liberal commission. Prout Mfg. Co., Box 158-C, Elkhart, Ind.

**AGENT**—Manufacture specialties. Hire agents yourself. Particulars free. Tilford, Box 516, Louisville, Ky.



**DON'T** Be a job hunter—Start your own business on our capital. No hard times; no lay-offs; always your own boss. Hundreds average \$3,000 to \$5,000 annual sales year after year. Sales way up this year. We supply stocks, equipment on credit. 200 home necessities. Selling experience unnecessary. Wonderful opportunity to own pleasant, dignified, profitable business backed by world-wide industry. Write Rawleigh's, Dept. D-U-PPM, Freeport, Ill.

**SUPPLY** Friends with well-known, guaranteed coffee, spices, extracts, soaps, etc.; make up to \$32 in a week. Also get Ford car as bonus. Full particulars and trial offer mailed free. Zanol Products Co., 6044 Monmouth, Cincinnati, Ohio.

**MYSTERIOUS** Disc heats water instantly without coal, gas or oil. Pays up to 233% profit. New principle. No risk sample offer. Write Lux Co., Dept. H-1, Elkhart, Indiana.

**500% PROFIT** With new perfected (1939) quick-action, no flint, automatic gas lighter. Retail 25c. Sample 5c. New Method Co., Box PMG-76, Bradford, Penna.

**BEAUTIFUL** Bird pictures handmade with genuine feathers. Sell on sight! Large profits! Free particulars. Samples 10c stamps. Marquez-PG, Apartado 1176, Mexico City.

**MAKE** Money selling gadgets to close doors. Write Out West Awning Co., Colorado Springs, Colorado.

**AGENTS**, Men, women, part time workers, send for my propositions. J. J. Frank, 525A Palm, Rockford, Ill.

**MONOGRAMMING** Automobiles real money maker. Write for samples. International Co., Box 9360, Philadelphia, Pa.

**MAGAZINE** Agents—Increase your profit 30% by working for us. Write Publisher's Circulation Service, Inc., Dept. H, 407 South Dearborn, Chicago.

**SUCCEED** With your products. Make-sell. Formulas. Accurate analyses. Catalog free. B. Thaxly Company, Washington, D. C.

**SELL** Lucky Brown Hair Dressing to colored folks. \$5 day possible. Famous Co., 2243-YJ Indiana Avenue, Chicago, Illinois.

**BUSINESS** Proposition resilvering mirrors, autoparts, reflectors, making chipped glass signs. Write, Sprinkle, Plater, 128, Marion, Indiana.

**ATLAS** Window sign letters. Large sizes—penny each. Get beautiful samples. Atlas, 7941 Halsted, Chicago.

**ENGRAVED** Name plates, numbers, signs, etc., easily sold, profits large. Brett Bros., Winthrop, Mass.

**EARN** To \$25 weekly selling women's silk hosiery. Dept. P.M.A., Bon-Silk Hosiery, Albany, N. Y.

**AGENTS** For Rub-It-Liniment. Good repeater. A-M-Co., 4317 Altgeld, Chicago.

**YOU** Pay \$4. You sell for \$10 or more. 25c brings sample and details. Darmstaeter, 9312 Hayes, Detroit, Mich.

**300% PROFIT** Selling gold leaf letters for store windows; high grade letters 15c each. Free samples. Metallic Co., 438-B North Clark, Chicago.

**BLADES**—Double-edge unconditionally guaranteed. \$4.00 thousand. 1/2 deposit with order. Joe Segall, 2534 East 55th, Cleveland, Ohio.

**RELIABLE** Agents wanted to sell cast aluminum and bronze grave markers, \$5.00 up. Good commissions and bonus. Firestone Foundry, Dept. P, Ashland, Ohio.

**UNIQUE** Calling cards, samples dime. Creations, Box 944, Laredo, Texas.

**AGENTS!**—Mail our powerful literature. Big profits. Exceptional home business. Stamford, 3762-D Broadway, New York.

**1939 PRICE** List now ready. Write The Peripad Company, Indianapolis, Ind.

**SALESMEN** Work in new way, demonstrating to man or woman "Look-well Kit" (not toilet preparation). Work homes; offices; stores. All or part time. Sells \$1.25 most all profit. Gladly send details. Be quick. Le Cliff Distributing Co., Gold Street, Cedar Lake, Ind.

**SUCCESSFUL** Agents use successful methods. Details free. Sidney, Pottsville, Penna.

**SELL** Necessities, big profits. List samples 10c. Krueger, 5751 Justine, Chicago.

**MAN** To take up landscape work. Must be satisfied with \$35 in a week at start. No experience necessary. Handle orders for roses, evergreens, shrubs, fruit trees, berries, for old and new customers. Moore & Co., Dept. PM, Newark, New York.

**MONEY** In butterflies, moths. See Sinclair Display Advertisement on page 24A.

**FASTEST** Money maker selling reversible topcoats. Lifetime chance. Write Yale-Clothing, Meriden, Conn.

**BUY** Direct! Shirts, hosiery, specialties, etc. Big profits. Send for catalogue. Monarch Equipment, 2776 Jerome Ave., New York.

**CALLING** Cards, processed personal stationery. Liberal profits. Free outfit. Universal, Orange, Massachusetts.

**MAKE** Up to \$16 daily. Amazing new invention holds autos on hills without use of emergency. Makes driving safer. Every motorist needs. 10 second demonstration sells. Installed in 10 minutes. One model fits all cars and light trucks. Buell Mfg. Co., Dept. PM-4, 2975 Cottage Grove Ave., Chicago.

**FIRST** Offering. Genuine Liquid Bake-lite coating renews worn linoleum, furniture, floors, waterproofs damp cellars. Amazing results pyramid sales. 133% profit. Staminite Corp., Dept. 9, New Haven, Conn.

**AN** Unusual opportunity for a man in each city to sell a strictly non-competitive item highly endorsed by leading authorities. Eastman Co., 1304 Harper Ave., Detroit, Mich.

**EXCLUSIVE:** 3 Big moneymakers—Household products. James Bailey Company, Section 7, Chicago.

**PROFIT** With new products. Make, sell, repeat. Analysis. Research. Guaranteed formulas. Biggest catalog free. Nominal prices. Gibson Laboratory, Chemists, BD-1142 Sunnyside, Chicago.

**500% PROFIT.** Gold and silver colored sign letters. Offices, stores. Free samples. Modernistic, B-3000 Lincoln Ave., Chicago.

**MONUMENTS,** Markers. Guaranteed granites. Lowest prices. Lettered. Delivered. Free catalog. Mikelich Company, (Manufacturers), St. Cloud, Minnesota.

**EX-O-LENE.** New, red-hot, repeat auto product. Guaranteed. Millions waiting. To 500% profits. Information free. Thermo Exolene Works, Peoria, Ill.

**CARPENTERS:** Sell, install overhead garage door hardware. Paying business. Circular free. Wilkie, Independence, Mo.

**500% PROFIT!** Gold and colored sign letters for windows, offices, trucks, signs. Auto monograms. Easily applied by agent or customer. Neonite, Akron, Ohio.

**SELL** Social security plates. Sample 10c. Particulars free. Reliable Sales Co., 6 West 28th Street, New York City.

**BIG** Money taking orders; shirts, ties, hosiery, underwear, pants, uniforms, dresses, etc. Sales equipment free! Experience unnecessary. Write Nimrod, 4922-AN Lincoln, Chicago.

**200% PROFIT.** No investment, fast seller, field unlimited. Danna, Box 57, West New York, New Jersey.

**BIG** Money applying initials on automobiles. Easiest thing today. Free samples. Also, sideline salesmen for short order decalomania name plates. "Ralco," 1305 Washington, Boston, Mass.

**ELGIN,** Waltham, Hamilton watches. Make big money. \$3.95. Send for free jewelry catalog. Plymouth Jewelry Exchange, 163-B Canal St., New York.

**AGENTS:** Smash go prices! Santos coffee 12c lb. 4-oz. vanilla 8 1/2c. Razor blades 10 for 8 1/2c. 100 sticks chewing gum 12c. 150 other bargains. Premiums. Experience unnecessary. Carnation Company, PO, St. Louis, Mo.

**AGENTS**—Opportunity make money; book containing 107 successful business plans; home-office; send for free introductory booklet. Elite Co., 214 Grand St., New York.

**AGENTS** Make big profits on food products, bargain deals. Low wholesale prices. Rush name for trial outfit offer. Ho-Ro-Co, 2810-R Dodier, St. Louis, Mo.

**STARTLING** Invention—Pocket adding machine. Nationally advertised \$2.50. Whirlwind seller. Big profits. Baby Calculator Co., Box 1118, Chicago.

**REVOLUTIONARY** Window cleaning tool. Good Housekeeping approval. Only ten \$2.25 sales daily to housewives, factories, schools, stores will make you \$350.00 monthly. Carter Products Corp., 900 Front Ave., Cleveland, Ohio.

**BIG** Money applying initials on automobiles. Write for particulars and free samples. American Letter Company, Dept. 40, Dunellen, New Jersey.

**FREE** Sample—Amazing cleaner; sells homes, taverns, everywhere. Big profit—fast repeater. Betco, 5007 Irving Park, Chicago.

**AGENTS**—To mail our literature. Good profits. Home business. Maywood, 149 Fifth Ave., New York.

**MANUFACTURE** Specialties, hire agents yourself. Big money. Free literature. Gilbert Supply, 1107-P Broadway, New York.

**AGENTS:** Stamping names on pocket-key protectors. Sample check with your name, address, 25c. Stamping outfits. Emblem checks, check-fobs, name plates. Hart Mfg. Co., 303 Degraw St., Brooklyn, N. Y.

### HIGH-GRADE SALESMEN

**SALESMEN**—Take orders—New reflector lawn numbers. Instant appeal. Every home owner wants one. Big comm. daily. Write quick. Be first your territory. Charles Sherman & Co., Springfield, Ill.

**SPECIALTY** Salesmen—Big advance commissions selling our business building trade cards on coupons to retail concerns, business concerns, theaters. Easy sales. Steady repeats. Exclusive opportunity. Outfit free. New Process, 49 East 21st, Dept. F-1, New York.

**ADVERTISING** Book matches—Sell union label book matches. Fastest selling line in America. Large sales producing kit, sample matches, complete cut catalog, eight color combinations make selling easy. Commission in advance. Superior Match Co., 7530 Greenwood, Dept. M-4, Chicago.

**DID** You make \$50 last week? Does your job offer you real future? If not, why not start a wholesale business of your own? Start with little as \$2.50. Handle line 200 nationally advertised 5c-10c products. Show merchants new plan for increasing sales and profits. Handle everything from your home at start. Chance to operate one of our Silver Fleet service trucks. Facts free. World's Products Co., Dept. 10-D, Spencer, Ind.

**MAKE** More money with Red Comet Automatic Fire Extinguishers. Low price. Proved seven years. Splendid sales outfit free. Some good territory open. Exclusive. Write quick. 704 Red Comet Building, Littleton, Colo.

**SELL** Business cards, business stationery, book matches, gummed tape, paper towels, advertising pencils, salesbooks, rubber stamps, social security books, advertising specialties. 35% commission daily. Money making specials. Experience unnecessary. Free sales portfolio. Willens, 2130 Gladys, Dept. FB, Chicago.

**SPARE-TIME** Subscription representatives for leading magazines. Starting supplies free. Write Davies Company, Box 119, Chehalis, Wash.

**SPARKLING** Glo-Brite signs sell fast to stores, restaurants, taverns. Lasting gold finish. Religious mottoes. J. A. Baxter, Cambridge, Ohio.

**SALESMEN,** Distributors—Established company. New automotive system all car and fleet owners vitally need. Sells for \$2.95. Lloyds of London insurance up to \$5,000. Makes quick convincing demonstration. Large repeat business. New proven merchandising plan to dealers carries 100% insurance protection for you. Profits up to \$600 per month. Exclusive territories. Guaranteed sales or money back under Plan A. Write today for details of full-size test sample and all facts. No obligation. Craver-Jay Corporation, Dept. 110, Kansas City, Missouri.

**AMERICA'S** Biggest brush bargains. Bigger and better than ever. Catalogue. Frank-Lin Brushes, Bridgeport, Conn.

**ADVERTISING** Book matches—Fastest seller out! Big cash commission daily. Experience unnecessary. Factory direct. Peak quality at low prices assures quick repeats. Large outfit free. Write, American Match & Printing Co., 4822 South Trumbull Ave., Dept. 64, Chicago.

**FASCINATING** Home business. Sell stores, washing solution costs 2c sells 50c, rug cleaner, paint cleaner, polish, vanilla, etc. 25c brings sample and complete manufacturing course. HIDRO Company, St. Paul, Minn.

**SELL** Multi colored business cards. Illustrations printed five colors. No competition. Sells \$1.95 thousand—50c commission. Hundreds cuts. Beautiful pocket size portfolio. Write letter to Winkler Printing Company, 1612 Chicago Street, Omaha, Nebr.

**AMAZING** Seller. All weather coat guaranteed ten years, \$9.95. Commission \$3.00. Selling outfit free. Tenyear Raincoat Co., Dept. 25, Templeton, Mass.

**BIG** Commissions—Selling to stores celluloid pricing tickets, metal shelf moulding. To restaurants, menu covers, signs. F. Pricing Press, 124 White St., New York.



**SELL** America's largest line business necessities. Book matches, gummed labels, political items, restaurant supplies, sales-books, embossed stationery, shipping supplies, office supplies, advertising specialties, business stimulators, business stationery and forms. Hundreds fast sellers. New low prices. Commissions advanced daily. Experience unnecessary. Complete outfit free. Northwestern, AT-625 Jackson, Chicago.

**COCKROACHES** Killed new way. Food form in permanent container. Big profit. Repeat sales. Free starting offer and sample carton 25c. Gillies Products Company, 513-B South Tenth, Fargo, N. D.

**BRUSH** Salesmen. You want higher commission, 200 items, everybody uses, low prices, exclusive territory. Neway Brush Co., Hartford, Conn.

**PRINTED** Specialty salesmen. Send us your idea. We will print it for you at lowest prices. Springer Press, Miami, Oklahoma.

**75c SAVES** Motorists big repair bills. Full details to live salesmen. Repeater, sample 50c. Manufacturer, 2812 Gillham, Kansas City, Mo.

**DISTRIBUTORS.** Free sample world's best seller. Girard Mfg. Co., Washingtonville, Ohio.

**OPERADO**—Sensation. Fits any radio. No-cost sample. Esco-A, Kansas City, Mo.

**DISTRIBUTORS**—Supply revolutionary corn remover to stores. New sales plan results in landslide of orders. 150% profit. Exclusive franchise. Great Christopher Corp., Buffalo, New York.

**NEW** Specialty—Sells every business and professional man. Four \$15 sales daily pay \$280 weekly. Farrell cleared over \$1,000.00 monthly. Write, F. E. Armstrong, President, Dept. PM, Mobile, Ala.

**BLADES.** Finest quality. Factory prices, postpaid. Ace Blades, Buffalo, N. Y.

**EXCELLENT** Opportunity selling our complete line of brushes. Largest commissions. Write for sales plan. Wire Grip Sanitary Brush Company, 2300 5th Ave., New York.

#### HELP WANTED

**M. M. Earned** \$267, three weeks, raising mushrooms in cellar! Exceptional, but your cellar, shed perhaps suitable. We buy crops. Book free. United, 3848 Lincoln Ave., Dept. 65, Chicago.

**IF** You are ambitious you can make good money with a Rawleigh route. We help you get started. Sales way up this year. No experience needed. Steady work for right man. Write Rawleigh's, Box D-2-PPM, Freeport, Ill.

**MEN** Wanted for coffee routes. Earnings up to \$45 in a week. Automobile given producers as bonus. Write Zanol Products, 6038 Monmouth, Cincinnati, Ohio.

**\$30 WEEKLY** Or more earn. Grow mushrooms in cellar, shed. We buy 30c lb. Mr. B. earned \$270 in few weeks spare time. Write, free book. Mushrooms, Dept. 701, 2019 Second, Seattle, Wash.

**MAKE** Extra money sending us names. Details 3c. Richmond Service, 504 Broadway, Sterling, Ill.

**AMAZING** Magic crystals make powerful all purpose cleaner. Take orders everywhere. Pays up to 200% profit. Sample free. Write Emsee, Dept. 104, Monroe, Michigan.

**SALARIED** Positions—Let us find one for you. Write for valuable information. Executive's Promotion Service, (15), Washington, D. C.

**STEADY** Work—Good pay. Reliable man wanted to call on farmers. No experience or capital required. Pleasant work. Home every night. Make up to \$12 a day. Wonderful new proposition. Particulars free. Write McNess Co., Dept. 272, Freeport, Illinois.

**BIG** Money taking orders; shirts, ties, hosiery, underwear, pants, uniforms, dresses, etc. Sales equipment free! Experience unnecessary. Write Nimrod, 4922-BG Lincoln, Chicago.

#### EDUCATIONAL AND INSTRUCTION

**MASSAGE.** Hydrotherapy, dietetics, drugless therapeutics, chiropody, taught by mail. Evans Correspondence School, Montgomery, Ala.

**LEARN** To be a master mechanical optician. Master mechanical opticians earn \$25 to \$50 per week. Select a field that is not overcrowded. Big demand for skilled mechanics. Write for particulars. American Institute of Mechanical Optics, Box 427, Mount Vernon, Illinois.

**WANT A job?** Learn Diesel and auto mechanics. Pay later! Why worry with a low-pay job? Diesel and auto mechanics offer you real opportunity to earn more. Learn easily, quickly. Write either school for low tuition rates. Information free! Dept. 10-4, McSweeney Trade Schools, Detroit, Mich., Kansas City, Mo.

**BE A** master salesman. Double your income. Be sure of a job. Write American School of Salesmanship, P. O. Box 87, Clinton, Mass.

**LEARN** Watchmaking. Complete instructions \$3.00. Catalog wholesale tool, material, watches 5c. Stewart's, 721 Olive, St. Louis, Mo.

**FOR** An extremely profitable lifetime business, operate a collection-credit agency. Free folder. Cole Associates, Syracuse, N. Y.

**WATCH** Repairing is steady profitable work. Experts always in demand. You can learn watchmaking trade at home, spare time. New original instruction system. Script engraving course included. Write for free details today! Nelson Co., 2016 Manhattan Building, Chicago.

**SUMMER.** Winter hotel positions. Seashore, mountains. Home study courses. Placement service. Lee Hotel Institute, 161 Summer Street, Boston.

**STUDY** For degree in psychology, metaphysics, theology. Home study. Chartered college. Free catalog. College of Universal Truth, 1100 North Dearborn, Chicago.

**WORK** For "Uncle Sam." \$1260-\$2100. Try next examinations. List jobs and particulars telling how to qualify—free. Franklin Institute, Dept. J3, Rochester, N. Y.

**BECOME** Practical scientific investigator. Modern, illustrated course. Thorough training by former agent U. S. secret service. Particulars free. International Secret Service Institute, PM-49, Hoboken, N. J.

**SLIDE** Rule simplified by Richardson. 100 pages, 100 illustrations. Dollar, 4212 24th Place, Chicago.

**CARPENTERS**—Pope's Simplex Roof Chart. All cuts, lengths, all rafters. Any roof, pitch, guaranteed. \$1.00. Ed Pope, Box 23, Sayre, Oklahoma.

**LEARN** How to make money in real estate—a home-study course prepared by experts for beginners and experienced realtors. Write Morrison School of Real Estate, 100 No. LaSalle, Dept. 7, Chicago.

**EARN** Big pay. Learn Diesel engineering, electric, acetylene welding by world famous Sweeney System of practical experience. E. J. Sweeney announces removal of all his schools to Dallas, Texas. Write for special offer to Main Office Sweeney Engineering School, Dept. G, 2203 Commerce, Dallas, Texas.

**GROW** Plants without soil. Complete outfit \$1.00. Folder free. Gordon Laboratories, 509-L Fifth Ave., New York.

**MANUAL** Of Locksmithing. Send for application. Christison's, 1019 - 14th, Denver.

**SUCCESSFUL** Men are "realists." Treatise on realism sent free. Realist League, 45 Abbey Court, Brooklyn, N. Y.

**GOVERNMENT** Examinations. Professional assistant, investigator, supervising inspector, others. For free list opportunities write Pergande Publishers, D12, Milwaukee, Wisconsin.

**INVENTIVE** Minded can become independent. Explanation free! L-Higbee, Cantil, Calif.

**MONEY** In cartooning! See Raye Burns School advertisement on page 150A.

**HOW** To write business letters. Self instruction. Increase your success opportunities. \$3. Details free. Better Letters, 4416-18 Elston, Chicago.

**LEARN** Shorthand at home. John Woolven, Box 326, Augusta, Georgia.

**LEARN** The practical way—Decorating, paperhanging, graining, marbling, sign painting, card writing, pictorial painting. Catalogue free. Chicago Painting School, 437 North Clark Street, Chicago.

**LEARN** Auto mechanics, body, repairing, welding electricity, refrigeration. Diesel. Stevinson's, 2008A Main, Kansas City, Mo.

**GOV'T** Jobs start \$1260-\$2100 year. Men-women age 18-50. Former examiner's tested method helps qualify you. Particulars, list jobs free. Write today. Patterson School, 8C Mercantile Bldg., Rochester, N. Y.

**TELEGRAPHY** Taught thoroughly. Railroad retirement act creating opportunities for new operators. Expenses low. Catalog free. Dodge's Institute, Hiatt Ave., Valparaiso, Ind.

**SECRET** Investigation. Experience unnecessary. Detective particulars free. George Wagner, M-2640 Broadway, N. Y.

**CLAIM** Adjusting. Splendid salaries. Depression proof. Fascinating home study course. Free booklet tells how to qualify. Burns School, Keystone Bldg., Pittsburgh, Penna.

#### PLAYS, STORIES, MANUSCRIPTS

**SHORT** Stories, novels forcefully rewritten, typed for marketing. Welton Tinney, Winnsboro, Texas.

**CASH** For verses. "Rhyming For Cash" tells you how to rhyme your way to fortune. Send \$1.00. Ann Kellogg, Dept. T, Box 283, Hyannis, Massachusetts.

**ORIGINAL** Poems, songs wanted for publication, radio. Westmore Music Corporation, Dept. 33G, Portland, Ore.

#### CARTOONING, COMMERCIAL ART, SHOWCARD WRITING, SIGN PAINTING

**ANYONE** Can paint signs with Speedway Letter Patterns, all styles. Instructions with sample, 3 in. alphabet 10c. Display Letters Co., Dept. M, 8309 Third Ave., Brooklyn, N. Y.

**BE A** lettering artist! Learn how to letter headings for magazine and newspaper advertisements. Highly paid profession. Free booklet. Guild School of Lettering and Advertising Design, 324 Summit Avenue, Hackensack, N. J.

**GAGS!** Comic strip ideas! Supplied by Weldon Tinney, Winnsboro, Texas.

**LEARN** Cartooning—drawing, 46 lessons, over 650 illustrations, complete, including supplies—75c. Poplar Company, 3739 Poplar Ave., Brooklyn, N. Y.

**MGS** School of Cartooning. Send for details and free lesson. P. O. Box 893, Springfield, Mass.

**COMPLETE** Cartoon course, \$1.00. Sample lesson, 10c. E-Zee Cartoon, 126 Lexington Ave., New York.

**35c BRINGS** Success Art O'Grams Story of Cartoonists. Current issue free. Bart Supplies, 915 Marquette, Minneapolis, Minn.

**CARTOONISTS:** Complete course on "Drawing Heads." Over 200 illustrations 20c. Box 71, Mattapan, Mass.

**LEARN** Show card writing by mail. Individual instructions. Actual lettering demonstrations. No books. Materials furnished. Thirty years experience. Illustrated folder free. W. H. Long, 818 Wyandotte, Kansas City, Mo.

**CHALK** Talks. Laugh producing program. \$1.00. Catalog 10c. Balda, the Cartoonist, Oshkosh, Wisconsin.

**CARTOONING** Course: 30 illustrated lessons, over 500 drawings, pens and pencils. Sent complete postpaid for \$1.00. Scovell Studios, Box 748-P, Hollywood, Calif.

**CARTOONING,** Sketching, etc.—46 lessons, 600 illustrations, including drawing paper, pens, pencils, \$1.00 complete. Fraba Service, Cashton, Wisconsin.

**PEN** And ink illustrations for catalogue and general printing purposes at right prices. High grade work. Heraldic Studios, 1914 Oakdale Avenue, Chicago.

#### ADVERTISING AGENCIES, LETTER WRITERS, FOR ADVERTISERS

**SALES** Letters, folders, complete mail campaigns. 20 years experience. C. R. Switzer, 31-E Georgia, Indianapolis.

**INCREASE** Your sales through agents, mail order, stores. Newspaper, magazine, mailing-list ratebook free. Chicago Advertising Agency, 20P1 West Jackson, Chicago.

**SELL** Your product through agents, mail order. Inch advertisement 324 newspapers \$16.80. Martin Advertising Agency, 171M Madison Avenue, New York.

**LEARN** Advertising quickly at home. Easy practical plan. No text books. Common school education sufficient. Interesting booklet and requirements free. Page-Davis School of Advertising, 3601 Michigan Avenue, Dept. 3431, Chicago.

**DIRECT-MAIL** Advertising services. Sales letters that sell. Mailing lists. Omaha List & Letter Co., Box 2172, South Omaha, Nebr.

**ADVERTISING** Placed all magazines, newspapers, radio. Lowest rates. Free service. 54 page rate book free. Baker Advertising Agency, A-189 West Madison, Chicago. Successors to Ankrum. Established 28 years.



LETTERS Of all kinds properly written. Albert Schantz, Baden, St. Louis.

MAILING List of 1000 employed ladies, \$6.00. Genung, Box 250, Ithaca, N. Y.

INCH Display, 28 magazines, 3 months, \$3.00. Paramount Press, Atlanta, Missouri.

ADVERTISE. Rates, advice given. Bush Agency, 1472 Broadway, New York City.

FREE—New Advertisers Rate Guide, 44 pages. Includes everything. Lowest rates. E. H. Brown Advertising Agency, 140 S. Dearborn, Chicago.

ADVERTISE: 24 Words in 250 newspapers \$10. Lists free. Advertising Bureau, 4515-C Cottage Grove, Chicago.

### BUSINESS SERVICE

CHICAGO Mail address—Phone service, business, personal. Mail forwarded daily, \$5.00 monthly. Secretarial service if desired. Hanock Company, 43 East Ohio.

\$2.00 MONTHLY Maintains Brooklyn, New York address. 39 Pine Street.

New York, Times Square address, \$2 monthly. Diener, 1474 Broadway.

CHICAGO Mail address \$1 monthly. Your personal, business mail forwarded daily. Established 1919. General, 56 West Washington.

### RUBBER STAMPS AND OFFICE SUPPLIES

GUARANTEED Typewriter ribbons, 35c delivered; adding machine ribbons, 50c. Economy, 126 Kinzie, Chicago.

ORIGINAL, Cushion mounted. One, two lines, 25c; three 35c; four 45c. Stamp Works, 814 Bradley, Peoria, Ill.

2 LINES 25c, 3 Lines 35c. Stamp Works, Auburn, Nebr.

2 LINES 25c, 3—35c, cushion mounted. Stamp Works, Centerport, N. Y.

CUSHION Mounted one-two lines 25c; three 35c. Hauer Press, 1314 Ford, Youngstown, Ohio.

### TYPEWRITERS, DUPLICATORS, OFFICE DEVICES

INCREASE Business now. "Excelligraph" Rotary Stencil Printer reprints thousands everything you typewrite, hand-write, draw or trace. Colors, \$19.75 to \$44. Terms. Illustrated literature free to business or professional men. Pittsburgh Typewriter Supply, Department K-2, Pittsburgh, Penna.

NEW \$3.75 Automatic adding machine. Fully guaranteed. Bassett, Box 302-K, Altadena, California.

TYPEWRITERS, Adder, mimeograph, multigraph, addressograph. Send for free lists of machines that will help you at half price. Pruitt, 28 Pruitt Bldg., Chicago.

### PRINTING, MULTIGRAPHING, MIMEOGRAPHING, GUMMED LABELS

500 STATEMENTS \$1.50. Booklets, catalogues, etc. Roe Printing Co., Weidman, Mich.

150 LETTERHEADS, 125 Envelopes, both \$1.00. 500 stickers,  $\frac{3}{8} \times 2\frac{1}{2}$ , 25c. Gercke, 4600 Cottman Street, Philadelphia, Penna.

DE LUXE Letterheads—150, \$1.50; 500, \$2.50. Fred Meyer, Hobart, Ind.

500  $8\frac{1}{2} \times 11$  20 LB. Bond letterheads or  $6\frac{3}{4}$  envelopes \$1.25. Vicks Print, Exeter, N. H.

ENVELOPES, 500,  $6\frac{3}{4}$ , \$1.00. Morey Press, 87 Somerset, Springfield, Mass.

1,000  $2\frac{1}{2} \times 3$  LABELS \$1.25;  $1 \times 2\frac{1}{2}$ , 75c. K. Shearrow, Kalamazoo, Mich.

125  $8\frac{1}{2} \times 11$  BOND Letterheads and 125 envelopes \$1.00 postpaid. Letterheads, bill-headers, 300—\$1.00. Benneville, 907 West Roosevelt, Philadelphia.

QUALITY Printing. Reasonable. State your requirements. Paramount Press, Atlanta, Mo.

1000 STICKERS,  $\frac{3}{4} \times 2\frac{1}{2}$ , 45c. Envelopes, letterheads. Titworth, 754 Cornelia, Flint, Mich.

FREE Cardcase—500 quality business cards \$1.00 with order postpaid. Printing every description. Ace, 720 Wyandotte, Kansas City, Missouri.

1000—\$1.50. ENVELOPES, Circulars, noteheads. Eisen, 4511 - 4th Avenue, Brooklyn, N. Y.

MIMEOGRAPHING—500 Letter-size \$3.25. Nissen Letter Shop, Winston-Salem, N. C.

250 MODERN Letterheads \$1.35 postpaid. Belvidere Press, Belvidere, New Jersey.

SAMPLES Better printing, reasonable prices. Hildebrand's, 4554 North Uber Street, Philadelphia, Penna.

175 BOND Letterheads and envelopes \$1.00 postpaid. Village Press, Somerset, Mass.

125 LETTERHEADS, 100 28 lb. envelopes, both \$1.00 postpaid. Evansprint, Reading, Penna.

1000 CARDS 74c. Envelopes, letterheads \$2.19. Trowbridge, 7915 Parnell, Chicago.

WE Print for profit. Embossing, Fechner, 202 Ashland, River Forest, Ill.

LETTERHEADS In rich gold, silver, all colors, easily, cheaply, perfectly made. Outfit 60c moneyorder. U. Shumway, Painted Post, N. Y.

1000 LETTERHEADS, Envelopes or statements, \$2.69. You'll order again. Lewis, Malvern, Ohio.

1,000 TICKETS Or cards \$1.00. Harward, 780 University, Rochester, N. Y.

CIRCULARS, Labels, envelopes, stationery printing, salesbooks. Keelerprint, 4237-W Cermak, Chicago.

1000 KLEAN-KUT Business cards \$1.00, prepaid. Freeman's 242 Arcade, Atlanta, Georgia. (Agents wanted.)

PRINTING At lowest prices. Catalog free. Springer Press, Miami, Oklahoma.

BOOKLETS, Folders, low prices. Sample free. Miller Printshop, Lawrence, Kansas.

1000 BUSINESS Cards \$1.00. Vellum, free cut. Dixie Business Card Co., 189 Jefferson, Memphis, Tenn.

6x9 CIRCULARS, Letterheads, envelopes, postcards, \$2.75, 1000; 5000, \$7.50-\$9.45. Typewriter letters \$2.25. Folders, all printing low prices. Samples. Goodprint, Harrisonburg, Va.

\$1.89 THOUSAND—Quality envelopes, statements, letterheads. Prompt. (Established 1893). Salesmen wanted. Cameron Printing, Thompsettown, Penna.

PRINT Anything. Lowest prices. Samples free. Hamilton Press, 4341-P Meade, Chicago.

HARVEY Labels—Better values. Free samples. 6618K Quimby, Cleveland, Ohio.

MIMEOGRAPHING, Illustrated letters, circulars, samples. Bur-Wil, 24 Louisa, Binghamton, N. Y.

HAMMERMILL Letterheads, 300  $8\frac{1}{2} \times 11$ , any color paper and ink, \$1.48 postpaid. Free particulars. Woodruff's, 217A Lewis, Duluth, Minnesota.

125 LETTERHEADS,  $8\frac{1}{2} \times 11$ , and 125 envelopes,  $6\frac{3}{4}$ , printed, \$1.00, postpaid. Samples free. Pine Hill Printery, Freeman, South Dakota.

135  $8\frac{1}{2} \times 11$  BOND Letterheads and 135  $6\frac{3}{4}$  envelopes—only \$1.00! Postpaid. Beautiful work! Premier, 454 Christopher Avenue, Brooklyn, N. Y.

1000 STICKERS, Four lines, 50c. Fine labels. Cott's, Spickard, Missouri.

PRINTING? Get lowest prices. Churchill, 4316 South Salina, Syracuse, N. Y.

1939 PRICELIST, Portfolio of samples free. McCall Press, 1326 South 27th, Omaha, Nebr.

1000 BUSINESS Cards \$1.00 postpaid. Tucker, P.M. Box 65, Indianapolis.

500  $\frac{3}{4} \times 2\frac{1}{4}$  FOUR Line gummed stickers, 25c. Moritz Printing, Saginaw, Mich.

### PRINTING OUTFITS AND SUPPLIES

BARGAINS—Presses, type, supplies. Send stamp. 159 Harvard, Cambridge, Mass.

LONG Established printers warehouse. Big lists 3c. Landis, Richland, Penna.

HAND Presses, type and complete printers' supplies. Send stamp for catalog and new price list. P. Peiffer & Co., Newark, N. J.

PRINT Your own cards, stationery, circulars, advertising. Save money. Easy rules furnished. Print for others, big profits. Junior outfits \$9.00, senior outfits \$17.00 up. Details free. Kelsey Presses, D-11, Meriden, Conn.

TYPELESS Printer prints from post card size to  $8\frac{1}{2} \times 14$  inch sheet—low price, free details. Professional Products, Dept. 410, Silverton, Ohio.

SPECIAL—Twelve inches of new border and list of bargains, 25c. Econofoundry, 7137 Constance, Chicago.

PRESSES \$5.00. Type 50c. Cuts 10c. Complete bargain catalogs. Send stamp. Bradshaw, 3214-P Huron, Chicago.

NEW Type 29c font. Catalog dime. National Type Co., Jackson, Mich.

MAKE Photo-engraving outfit yourself! Particulars free. Nu-Ideas, Carrollton, Illinois.

USED Presses, type, supplies. Lists 3c. Turnbaugh Service, Loysville, Penna.

BARGAINS, Presses, type. List 3c. Exchange D-15, 22 Orient, Meriden, Conn.

### PATENT ATTORNEYS

INVENTORS: Send immediately for your copies of our new free books, "Patent Protection" and "Suggestions on Selling an Invention." Sixty-eight pages of interesting facts. They tell how Patent Laws protect you; kind of sketch or model needed; simple steps to take without cost; how successful inventors have secured financial assistance; show interesting inventions; illustrate important mechanical movements. With books we also send free Evidence of Invention form to help establish date of disclosure. Prompt service, reasonable fees, special deferred payment plan. Strictest secrecy. Forty-one years' experience. Highest references. Write us today. The facts in our books are worth money to the man with a good invention. Address: Victor J. Evans & Co., Registered Patent Attorneys, 113-D Victor Building, Washington, D. C.

PATENTS. Protect your idea by securing free "Proof of Invention" folder. Exceptional personal service. Established 1906. E. E. Vrooman, 671 Woodard Bldg., Washington, D. C.

INVENTORS—Time counts in applying for patents. Don't risk delay in protecting your invention. Send sketch or model for instructions or write for free book, "Patent Guide for the Inventor" and "Record of Invention" form. No charge on how to proceed. Prompt, careful, efficient service. Clarence A. O'Brien and Hyman Berman, Registered Patent Attorneys, 58-R Adams Building, Washington, D. C.

PATENT Your invention with this responsible firm of registered patent attorneys. Deferred payment plan. Over 64 years experience. Write for free books answering all the questions you want to know about your patent and its commercial possibilities—also "Certification of Invention" form. C. A. Snow & Co., 146 Snow Building, Washington, D. C.

PATENT Attorney-engineer. Confidential, personal service. Reasonable fees payable in installments. Preliminary information and advice free. Send sketch today. Don't delay. David Manly Heller, 127 North Dearborn, Chicago.

PATENTS—Trade marks. Preliminary advice, book and disclosure form free. Personal service. Irving L. McCathran, 1060 International Bldg., Washington, D. C. Registered Patent Attorney.

INVENTORS—Before disclosing your invention to anyone send for form "Evidence of Conception"; "Schedule of Government and Attorneys' Fees" and instructions. Sent free. Lancaster, Allwine & Rommel, 411 Bowen Building, Washington, D. C.

"INVENTOR'S Guide," 100 mechanical movements, free; advises on patenting, selling inventions. Frank Ledermann, Tribune Bldg., New York.

L. F. RANDOLPH, 302-B Victor Bldg., Washington, D. C. Low cost. Book and information free.

PATENTS. Booklet free. Highest references. Best results. Promptness assured. Watson E. Coleman, Patent Lawyer, 724 Ninth St., Washington, D. C.

INVENTORS—Send for free booklet "Patent-Sense." Information based on 64 years experience. Lacey & Lacey, Dept. 5A, 635 F St., Washington, D. C.

### FOR INVENTORS

INVENTORS—Time counts in applying for patents. Don't risk delay in protecting your invention. Send sketch or model for instructions or write for free book, "Patent Guide for the Inventor" and "Record of Invention" form. No charge on how to proceed. Prompt, careful, efficient service. Clarence A. O'Brien and Hyman Berman, Registered Patent Attorneys, 58-R Adams Building, Washington, D. C.

INVENTORS Advised safe economical method securing and selling patents. A. B. Edwards, Box 1585A, Little Rock, Ark.

INVENTOR'S Universal Educator; contains 900 mechanical movements; 50 perpetual motions; instruction on procuring and selling patents and selecting an attorney, etc. Suggests new ideas. Price \$1 postpaid in U.S.A. Address Albert E. Dietrich, 511-B Colorado Bldg., Washington, D. C.



**HAVE** You a sound, practical invention for sale, patented or unpatented? If so, write Chartered Institute of American Inventors, Dept. 4-A, Washington, D. C.

**WE** Locate buyers meritorious patented, unpatented inventions. If will sell, reply immediately. Descriptive booklet free. Invention Reporter, 5A-11236 South Fairfield, Chicago.

**INVENTIONS** Protected, illustrated, \$10.00. Details. Carland, 407 Mitchell Bldg., Milwaukee.

**FINANCIAL** Assistance for invention to be patented. Working models built. E. Worsham, Box 1356, Washington, D. C.

**PATENT** Procedure pulled to pieces. Hot stuff. Remedies proposed. Pamphlet 25c. Proctor, 349 Third, Long Beach, Calif.

**IDEAS** Developed into salable, practical products. Extensive experience. Roman Winograd, Consulting Engineer, 140 Nassau, New York.

**INVENTORS:** Profit by your invention. A practical talk to inventors by an experienced manufacturer. Our 68 page booklet "Mind vs. Matter" mailed upon receipt of 25c. Rex Engineering Co., Cincinnati, Ohio, Dept. D.

**INVENTORS:** "Making Inventions Pay," our 32-page illustrated book, mailed upon receipt of 3c postage. Crescent Tool Co., Dept. Z, Cincinnati, Ohio.

**PENDING** Patent applications can be brought before thousands of manufacturers, free of charge, through Invention Magazine. Write for details. Invention, Inc., 635 F Street, Washington, D. C.

**INVENTORS—**Send for 72-page book on patents. Reasonable terms. Conscientious treatment to inventors. L. F. Randolph, Registered Patent Attorney, 302-E Victor Bldg., Washington, D. C.

**I SELL** Patents. Established in 1900. Charles A. Scott, 773PM Garson Ave., Rochester, N. Y.

#### INVENTIONS WANTED

**NOVELTIES** Wanted for England. Manufacturers and inventors apply Frey, Hotel Astor, New York.

**PRACTICAL** Inventions wanted. Full protection guaranteed. Write for "4-Point Service" bulletin. R. & S. Engineering Company, 17 East 42nd Street, New York, N. Y., Dept. M4.

**PATENTED** Items suitable for chain stores purchased outright or royalty basis. Write full particulars. Chas. Harris, 90 No. Washington St., Boston, Mass.

**WE** Have clients looking for new items to manufacture on royalty. Electric goods, household items, automotive, airplane improvements, etc. Must be patented, engineering completed and ready to market. Will H. Wade & Co., Industrial Financing, 134 South LaSalle Street, Chicago, Illinois.

**WANTED—**Meritorious patented, unpatented inventions. Booklet free. Invention Reporter, 5B-11236 South Fairfield, Chicago.

**MANUFACTURER** Experienced in promoting small wood or metal specialties desires new items, preferably patented. Send details. R. Clague, 3040 N. Murray, Milwaukee, Wis.

**MANUFACTURER** Wants new products. Royalty or purchase. Joseph Becker, Stillwater, Minnesota.

**WE** Have a client who wants a lock nut to buy outright or manufacture on royalty, also we want a variable speed reducer. Must be patented and ready to market. Will H. Wade & Co., Industrial Financing, 134 So. LaSalle Street, Chicago.

**OUR** Client who sells variety stores 1,000,000 items annually wants another 20c seller on a royalty basis. Give full particulars for attention. Rel. 56 W. Washington, Chicago.

**I SOLD** 354 unpatented "ideas" last year. Free booklet, "Cashing In on Unpatented Ideas" shows you new roads to profits. Hendrickson, Argyle, Wisconsin.

**INVENTORS—**Products—New ideas wanted for development and promotion. Can arrange for manufacture and sale. Howard W. Frank, Product Engineer, 55 West 42nd Street, New York.

**SMALL** Inventions wanted by manufacturers. I'll help you sell your invention. Write for free circular. Stanley Hull, 7829-K Euclid Avenue, Cleveland, Ohio.

**SIMPLE,** Practical inventions wanted by manufacturers, patented or unpatented. For information write Chartered Institute of American Inventors, Dept. 4-D, Washington, D. C.

**CASH** For unpatented ideas. Stamp for particulars. Mr. Ball, 9441-A Pleasant, Chicago.

#### PATENTS FOR SALE

**METAL** Basket holds fruits or flowers. Inexpensive to make, any metal. Test shows sure market among grocers, dept. stores, florists, gift shops, etc. Royalty or outright. M. Cooper, 6757 Stony Island Ave., Chicago.

**UNPATENTED—**Two great envelope inventions. Scheetz, 98 Branch, Sellersville, Penna.

**PRACTICAL** Sanitary poultry holding rack for bloodtesting, vaccinating, worming, etc. C. Summers, Ethel, Mo.

**SELF-LEVELING** Measuring cup. Hilda Ellingson, 30-Morris Location, Hibbing, Minn.

**ROTARY** Compressor. Pat. 2,097,714. C. M. Ayre, 804 Danville, Arlington, Va.

**PATENTED.** Proper motor vehicle tire. Eliminates tire trouble and accidents. Non-collapsible. Greatest features. Guaranteed offer. George Craig, 311 S. Gridley St., Bloomington, Ill.

**SEVERAL** Unpatented inventions for sale. Interested parties write P. Clark, Box 690, Bromptonville, Quebec, Canada.

**BEST** Offer takes Armstrong electric flat tire signal. Patent number 2,108,187. Literature furnished. Walter Armstrong, Sr., 206 North Anthony Street, New Orleans, Louisiana.

**MANUFACTURERS:** For new products or profitable manufacturing opportunities, inquire. Invention Reporter, 5C-11236 So. Fairfield, Chicago.

**FOR** Sale. Handy utility trouble light. Rowland Villwock, Waupaca, Wisconsin.

**DIESEL** Oil carburetor. Patent No. 2,096,407. Box 936, Louisville, Ky.

**FOR** Sale. New educational game. Write. Homer Beene, Graysville, Tennessee.

**FOR** Sale—Royalty: unique \$5 scientific invention. Corrects leg, feet-trouble, chest, busts, shoulders, chin, wrinkles. Posture, reducing, building up. Pilates, 939 8th Ave., New York City.

**UNPATENTED** Steel post eliminating flood damage to fences. Harry Sutcliffe, Grainfield, Kansas.

**GAME** Manufacturers. Cash in on this timely novelty "Polatiks" (the presidential campaign game). Can be played by small or large groups. Will let on royalty basis. Investigate. C. D. Ballantyne, 505 Fifth Ave., New York City.

**BOW-FACING** Oars. Outright or royalties. Copeland, P. O. Box 456, Ketchikan, Alaska.

**PATENTABLE.** Copyrighted bob pin and hair pin holder. Time saver for beauty shops. Wilson Smyth, Call Box 10, Odessa, Texas.

**PATENT** No. 2133908 On alarm illuminator clock for sale. Harry Swanson, 2745 Elliott Ave., Minneapolis, Minn.

#### MANUFACTURING

**INVENTIONS** Manufactured in any quantities. Tools, dies, metal stampings; working models built; industrial designing. Complete blueprint and engineering service. Write for "4-Point Service" bulletin. R. & S. Engineering Company, 17 East 42nd Street, New York, N. Y., Dept. PM-4.

**COMPLETE** Manufacturing service—Metal articles developed, working models, novelties, dies, stampings, wire forms, spinning, plating, castings, screw machine products, spot welding, assembling, free warehousing. Southern Products, P49, Independence, Missouri.

**HAVE** You a product or invention made with small-sized metal tubing? Large manufacturer wants new specialty product to make and sell; any kind of manufactured product, but tubing must comprise 75% of manufacturing cost. Will purchase outright or pay royalty. Write Advertising Agency, 900 Donovan Bldg., Detroit, Mich.

**INVENTIONS—**Manufactured in any quantity at low cost by old established company. Stampings, metal specialties, dies, models, etc. Free estimates. Send for catalog. Crescent Tool Co., Dept. X, Cincinnati, Ohio.

**INVENTIONS** Manufactured by an experienced company, in any quantity at low cost. Metal specialties, novelties, stampings, dies, and models. Free estimates. Our booklet "Mind vs. Matter" sent upon receipt of 25c. Rex Engineering Co., Cincinnati, Ohio, Dept. C.

**LIGHT** Manufacturing, model making, dies, machine work. High Haven Machine Co., Reading, Mass.

#### MODELS AND MODEL SUPPLIES

**LIVE** Steam locomotives \$9.50 to \$200. Catalogue 25c. Steam Electric Co., Bloomfield, N. J.

**HOME**CRAFT And model supplies. 1939 catalog now ready 10c. Hobby Supply House, Box 2014, Pittsburgh, Penna.

**CATALOGUE** Of over 40 engines, castings, supplies. 25c. Refunded. Howard Co., A-2417 North Ashland, Chicago.

**BUILD** Casson-Craft. Sixteen models, galley, battleship, whaler, etc., 25c exhibition case included. Dealers also supplied. Catalog 3c. Fred Johnson, 559 Webster Avenue, New Rochelle, New York.

**MAKE** Better models faster with model-making machinery. Write William Roemer, 656M Winthrop Ave., New Haven, Conn.

**SPEED** Boat hulls, kits \$3.25 up. Literature. St. Louis Model Boat Co., 225 N. Meramec, Clayton, Mo.

**HAWK'S** New 1939 illustrated catalog showing railroad and airplane kits, parts and price list now available—10c. Hawk Model Co., 3521 Fullerton Ave., Chicago, Ill.

**SUBMARINE** 24" Kit to build \$1.00. Spotts, 3925 N. Broad, Philadelphia.

**MINIATURE** Boat and airplane supply catalog 5c. Selley, 1377 Gates Ave., Brooklyn, N. Y.

**MODELS—**Your ideas developed into practical working models. 30 years successful experience; thousands of satisfied customers. Confidential service guaranteed. Bank references. Send 3c postage for our large booklet—"Making Inventions Pay." Crescent Tool Co., Dept. Y, Cincinnati, Ohio.

**RAILWAY** Models. Catalog handbook 25c. Walthers, 247 E. Erie, Milwaukee.

**BUILD** Miniature gasoline motors. Fascinating, educational, profitable. Details, drawing, 10c. Wright Motor Works, 3256 Lake Park Ave., Chicago.

**MODEL** Railroad Shop, Dept. PM, Dunellen, New Jersey. New 24 page illustrated catalog 10c postpaid.

**SHIP** And yacht model fittings; construction sets; model yacht sails; illustrated catalog 20 cents. A. J. Fisher, 1002-1 Etowah Avenue, Royal Oak, Mich.

**MODEL** Supplies for the inventor. Send 3c stamp for catalog. Pierce Model Works, Tinley Park, Ill.

**MODELS—**Practical models put over your ideas. We develop models from the crude to perfect working devices. Your idea might have large commercial value. Services confidential. Bank references. Registered graduate engineers at your service. Send 25c for our 68 page booklet "Mind vs. Matter." Rex Engineering Co., Cincinnati, Ohio, Dept. B.

**STEAM** Locomotives!  $\frac{3}{4}$ " scale. Build one by "Easy Steps." Our illustrated catalog lists all needs, 25c. Little Engines, Box 15B, Wilmington, Calif.

**MODEL** Airplanes, boats, radios, supplies. Catalog 10c. Imperial, 416-K McDonald, Brooklyn, N. Y.

#### BLUEPRINTS AND PLANS

**BUILD** Efficient, tested air conditioner for yourself or resale for as low as \$20.00. Real moneymaker in your locality. Send \$1.00 for complete plans and instructions. Box 162, Freewater, Oregon.

**SIGNAL** Bell for driveway service. Essential for fruit stands, ice docks, service stations, etc. Build it yourself. Simple, inexpensive, construction. Plans \$1.00. Jay Maples, 2530½ N. W. 11th Street, Oklahoma City, Okla.

#### HOME CRAFTSMEN

**SQUAREKNOTTERS!** Make belts, handbags, etc. Quality cord samples with catalog, free. Beginners book, catalog and samples, 10c. Special! Regular \$1 book with 50c beginners outfit, all for \$1. P. C. Herwig Co., Dept. J-15, 121 Sands St., Brooklyn, N. Y.

**20** FULL Size lawn ornament patterns 25c. Wickman, 744 Brooklyn, Dept. 13, Dayton, Ohio.

**NEW** Manual for tool users free. Tells you how to use and care for your tools; how to sharpen your saws. Write Henry Disston & Sons, Inc., 411-C Tacony, Philadelphia, Penna.

**MAKE** Door mats from junk tires. Kowell, 5372 St. Clair, Detroit.



**UNPAINTED Furniture** saves dollars. Beds \$5.95. Dressers \$9.95. Chests \$6.95. Solid maple bedroom pieces \$11.95. Catalog 3c. Mayflower Manufacturing, 1551 Thomas, Chicago.

**DOES Your home work shop** cause radio interference? Build friction clutch, plans, castings, complete or partial kit. Stamped envelope brings information. Build Craft Engineer Co., Linden, N. J.

**MANUFACTURE Novelties, furniture.** Turn spare time into cash. Interesting illustrated thirty-six page catalog containing woodworking machinery, construction sets, projects, information, 10c. Woodcraft Service, Plainview, Minnesota.

**TRADE Present equipment for 1939 models.** Write. Craftsman's House, Avoca, Penna.

**BAND Saws \$1.00.** Up to nine feet long—any width. Best Swedish steel. Guaranteed. Send size of your saw and \$1.00 to Toledo Saw and Grinding, Toledo, Ohio.

**22 FULL Size lawn ornament patterns** 25c coin. Strother, Belington, West Virginia.

**20 LAWN Ornament patterns 30c.** 20 novelty patterns 30c. 14 silhouette patterns 30c. 15 lawn ornament patterns different from those above 30c. All for \$1.00. Modern Woodcraft, Saginaw, Michigan.

**BEAUTIFULLY Designed, easy to build;** bluebird, wren, robin, chickadee, nut-hatch, and flicker homes. Blueprints, details and specifications 35c each. Complete set \$1.50. Can furnish select package lumber reasonable. Write for prices. Hager Design, R.R. No. 3, Rockford, Ill.

**MAHOGANY, Pine, hardwood.** Save up to 60%. Metima Lumber Co., Box 83, Hillside, N. J.

**"MODERN Wood Sculpture."** Complete instruction book on carving statues \$1.00. Lee, Wood Art Studio, Centerville, Ia.

**CRAFTSMEN, Cape-chisel, flat, round-nose,** diamond-point, center-punch and five assorted pin punches, 3/16" x 3 1/4", \$1.00. Send dime for any 3/16" x 3 1/4" tool. Catalogue, instructions. Ace Tool Co., Johnson City, N. Y.

**FURNITURE From old auto seats, plans** \$1.00. W. Abbott, Bellmore, N. Y.

**LEATHERCRAFTSMEN—Write for free** instructions and price list of leather, tools, etc. Sample cards 5c. Wilder & Co., Dept. F, 1038 Crosby St., Chicago, Ill.

**PLYWOOD At wholesale.** Everything in plywood and veneers for the professional and amateur craftsman. Complete stock of foreign domestic woods at wholesale prices. Send 10c for new interesting catalog. Your dime refunded on first order. Beck Plywood & Veneer Co., 1312 N. Halsted St., Chicago, Ill.

### OLD GOLD, WATCHES, JEWELRY, PRECIOUS STONES

**5000 REBUILT Elgin, Waltham, Hamilton** watches. Also ladies, gents wrist watches. Make big money! 12 size, 7 jewel, Elgin or Waltham, \$4.75; 16 size, 17 jewel, \$7.50. Send for free watch and diamond catalogue. The New York Jobbers, Dept. M, 74 Bowery, New York, N. Y.

**AGATES, Gems, minerals.** 20 gemstones \$1.00. Pricelist free. Hill, Route 7, Salem, Oregon.

**WATCHMAKERS' Supplies, tools,** watches. Sold—purchased. Ben Segal Company, 5 So. Wabash, Chicago.

**WATCHMAKERS' Repair service.** Save half. Paul Jewelry Co., LaCrosse, Wis.

**AUSTRALIA'S Lovely opals.** Illustrated catalogue free. Good selection \$5. Norman Seward, Melbourne, Australia.

**HIGHEST Prices for old gold, teeth,** watches, jewelry. Full cash value mailed day shipment received. Satisfaction guaranteed or articles cheerfully returned. Information free, or ship today. Chicago Gold Smelting Co., 300-P Champlain Bldg., Chicago.

**GOLD \$35 Ounce.** Ship old gold teeth, crowns, jewelry, watches—receive cash by return mail. Satisfaction guaranteed. Free information. Dr. Weisberg's Gold Refining Co., 1500-Q Hennepin, Minneapolis, Minn.

### FOR THE HOME

**FIFTY Cents buys complete fire alarm** protection for your home! For details write. Seaver B. Cole, 7 Ferry Street, Bradford, Mass.

**MAKE Your windows puttyless.** Free sample. Metallic Glazer Co., Box 422, Warren, Ohio.

**SMELLY Shoes?** Send self addressed stamped envelope for information about shoe hygiene and free sample. Shu-Sweet, Santa Fe, New Mexico.

**REFINISHING Your furniture made** easy! Complete instructions 35c (coin). Todd's Service, 53 McGuffey, Youngstown, Ohio.

### OIL BURNERS

**GUN-TYPE, Over production sale, for** furnaces, water and steam plants. \$62.50 complete. Mechanical Arts Co., 1304 Washington, Chicago, Ill.

### TOBACCO

**GUARANTEED: Cigarette, pipe or chewing,** 5 lbs. \$1.00, ten \$1.75. Pay when received. Pipe and box cigars free. Rives Tobacco Co., Paducah, Ky.

**PREPAID Guaranteed 28 inch sweet,** juicy Redleaf chewing or mild smoking. 4 lbs. \$1.00. R. B. Jolley, Dresden, Tenn.

**SMOKE "Kool-Puff," the modern pipe.** Lockco, 1476, Washington, D. C.

### RAZORS—BLADES—SHARPENING

**80 DOUBLE Edge blue steel blades \$1.00.** Free blade sharpener. National Sales Agency, Box 446-A, Gainesville, Florida.

### SURVEYING INSTRUMENTS

**GUARANTEED Factory rebuilt transits** and levels for rent (with purchase option) or sale (cash or terms). Order now before prices advance. We will repair, trade in, or buy your old instruments. Ship prepaid for estimate and valuation. Write for List M-44 and complete information to Warren-Knight Co., 136 N. 12th St., Philadelphia, Penna.

### FOR SALE—MISCELLANEOUS

**BASE Ball night illumination set for** sale, will light any field or track. Portable, set up in two hours. Sun Portable Lights, 108-21 37th Drive, Corona, New York.

**FOR Sale.** My rubber stamp shop. Bargain. MacPatridge, Muncie, Ind.

### WANTED—MISCELLANEOUS

**CASH For used microscopes, binoculars,** cameras, slide rules, drawing sets, surveying, mechanical, and scientific instruments. Highest prices paid day shipment received. Satisfaction guaranteed or shipment promptly returned. Elman's, 2302 Van Buren, Chicago.

### PERSONAL

**GOOD Eyesight without glasses. No** drugs. Surprisingly simple treatment. Guaranteed. A. Jacobson, Upsala, Minn.

**EMBARRASSED By smelly shoes?** Shu-Sweet quickly removes the odor. Money-back guarantee. 25c postpaid. Shu-Sweet, Santa Fe, New Mexico.

**MAKE Friends think you are visiting** Boulder Dam. Surprise them. Mail scenic post cards or letters in your own handwriting. Send 25c coin for two scenic cards. Fill them out and we'll mail them free of charge. Francisco Blazzye, Box E, Boulder City, Nevada.

**SEND Me \$1.00 (no stamps) receive** ladies' gold plated "heirloom" bracelet. Fashion's immediate favorite. By applied science equal to jeweler's \$5.00 bracelet in appearance and durability. Treasured gift, friend or relative. Money back guarantee. Klugherz, 27 Market, Poughkeepsie, N. Y.

**UNUSUAL Gifts. Authentic beautiful** Indian dolls, native Guatemalan costumes, \$1.00 couple. Colorful handwoven bridge sets \$2.50. Belts \$1.25. Mayan Handicraft, 540 41st Street, Miami Beach, Florida.

**EXPERT Aid in crossword, movie scramble,** statement, etc., contests. Jones, 49-13 Vernon Boulevard, Queens, N. Y.

**WIN Prize money: Booklet—"Success-**ful Contesting"—shows how. 10c postpaid. Bulletin listing \$200,000.00 prizes included. World Publishers, 4515-B Cottage Grove, Chicago.

**EXCLUSIVE Photographs: Samples,** complete list 25c. Albert McGoldrick, Mansfield, Mass.

### MISCELLANEOUS

**SMELLY Shoes?** Shu-Sweet removes the odor and prevents further trouble. Simple to use and money-back guarantee. 25c postpaid. Shu-Sweet, Santa Fe, New Mexico.

**SOMETHING New.** Metal slat venetian blinds. Accurate Manufacturing Works, 2336-8 Milwaukee Ave., Chicago.

**TALKING Greeting cards.** They really talk. Sensationally new. Charley McCarthy and general cards say: Hello sweetheart, happy birthday, please get well, happy Easter, greetings mother dear, etc. 15c each plus 10c for mailing. Examiner, 728 W. Wisconsin, Milwaukee, Wis.

**WONDERFUL Free-hand wristlite.** Unbelievable adaptations 99c. Monroe Sales, Springfield, Ohio.

**BUSINESS Proposition resilvering mir-**rors, autographs, reflectors, making chipped glass signs. Write, Sprinkle, Plater, 288, Marion, Indiana.

**FOOL Your friends! Make believe you** are here. 20c stamps brings you 2 scenic postcards (\$1.00 for 20). Fill them your own handwriting and return for free mailing; we pay postage. Marquez-PMC, Apartado 1176, Mexico City.

**SWAPPER'S Friend, R4, Saline, Michi-**gan. Interests swappers, collectors. 50c year, sample 10c.

**TATTOOING Outfits, electrograver ma-**chines. List 3c. "Waters," 965 Putnam, Detroit.

**NERVOUSNESS—Fear! Afflicted? Free,** illuminating information. Jno. Englund, Ironwood, Michigan.

**WIN! Free contest bulletins, literature,** stamp. "Contesting," P. O. Box 9, Station P, Brooklyn, New York.

**IF Interested in buying freshly dried** California fruit direct from grower—or other products—write W. M. Black, 262A Santa Rita Ave., Palo Alto, Calif.

**1500 SWAP Offers in Traders Bulletin** Magazine 10c. Instruction course on swapping \$1.00. 234 West Lake, Chicago.

**MILK Goats. Literature, magazine, free.** Address Goat World, Vincennes, Ind.

**ABUNDA-GRO Performs planting mira-**cles, produces super-vegetables, flowers, plants in apartments, basements, or outdoors, with or without soil. Simple, profitable, fascinating, inexpensive to use. Satisfaction guaranteed; free information. Unique Gardening Club, Upsala, Minn.

**SWAP Or sell articles you don't need.** Get those you want. Send dime for Swapper's Guide, listing articles from all over United States. Dept. PM, Swapper's Guide, Delphos, Ohio.

**HOW To resilver mirrors, complete in-**structions \$1. Prewitt, Box 181, Danville, Ky.

**CRIPPLE Creek gold ore specimens 35c.** Indian arrowhead included free. Nankers Company, Box 884, Colorado Springs, Colorado.

**ASTROLOGY, Palmistry, explained, 192** pages, 50c; dreams explained, 192 pages, 50c; both 75c. Poplar Company, 3739 Poplar Ave., Brooklyn, N. Y.

**MEXICAN Scenic postcards: Two, 12c** stamps. Free remailing service. Marquez-PMC, Apartado 1176, Mexico City.

**BURIED Treasure and mineral ore can** be located. Sensational new Goldak Radioscope money back guaranteed to locate any metal. Write world's largest manufacturer of successful metal locators for interesting literature. (Postage stamp appreciated.) Dept. P4, The Goldak Co., 1031 South Broadway, Los Angeles, Calif.

**SUSPENDERS Or belt (give size) 50c.** You won't be disappointed. Northwestern Suspender Co., Des Moines, Iowa.

**AMATEUR Cartoonists, earn nice in-**come copying and duplicating cartoons for advertisers. 3-M Service, Argyle, Wis.

**GET Big laughs! Have three cartoons** 8x11 drawn from photograph of yourself or friends for only one dollar. Really laughproof! Send your order today stating 3 hobbies, also inclosing photograph (which will be returned) and \$1.00 to Salber Studio, 415 Des Moines St., Des Moines, Iowa.

**AMATEUR Tattooing outfits. Circular** free. Tatuco, 651-A South State, Chicago.

**MONEY In butterflies, moths. See Sin-**clair Display Advertisement on page 24A.

**COLLECTORS, Swappers, contest fans,** investigate free trading service. Exchange, Box 425, Detroit.

**COATS-OF-ARMS And crests correctly** rendered in colors or black and white. Highest grade. Estimates free. Heraldic Studios, 1914 Oakdale Ave., Chicago.

**MEN! Hand-made wristwatch straps,** guaranteed sweatproof, finest genuine calf leather, outlasts others 4 to 1. Regular \$2.00 value. Special introductory "Maker-to-You" Offer only \$1.00. Western Leathercrafters, Box 3493, Portland, Ore.



# Experimental Television

## INVITES PIONEERS

• Still in its infancy, no one doubts the future of television. Get in on the ground floor of a development that's bound to revolutionize American life—the I. C. S. Radio Course with Television will equip you to go ahead with it. Ask for details.

### INTERNATIONAL CORRESPONDENCE SCHOOLS

BOX 5546-J, SCRANTON, PENNA.

Explain fully about your course in the subject marked X:

- Radio       Sound Technicians  
 Experimental Television  
 Aviation Section of Radio Operating

Name \_\_\_\_\_ Age \_\_\_\_\_

Address \_\_\_\_\_

## DIESEL ENGINES AND DIESEL ELECTRIC POWER

Take advantage now of the opportunity offered by this fast growing industry. Send for your copy of this practical and easy to understand book, just published, covering in great detail every phase of the construction, adjustment, operation, care and repair of Diesel Engines—automotive—stationary—marine, tractor and locomotive. This valuable 300 page book, just published, contains over 200 illustrations, costs only \$2.50 and has a 5 day money back guarantee. Send for your copy NOW!

**FREE** Catalog of practical books on Painting; Decorating; Commercial Art; Sheet Metal; Welding; Radio; Electricity; Carpentry; Plumbing; Heating and Ventilation.

F. J. DRAKE & CO., 173 N. Michigan Ave., Chicago, Illinois

Drake's Books Sold at All Good Book Stores

## LEARN CARTOONING

CASH IN ON YOUR TALENT! CARTOONING, SKETCHING, LETTERING, ETC. All in one Practical, EASY LEARN AT HOME COURSE containing 40 lessons and over 600 illustrations. Included with course are Pens, Pencils and Drawing Paper. Entire course with material sent complete and postpaid for only \$1.00. Absolutely no further charges. FRABA SERVICE, Dept. 33-A, Cashton, Wisconsin.



## Begin NOW to be a STAR DRUMMER

Combine a money-making career with a barrel of fun, by beginning NOW,

while you can enjoy it best, to play a drum. The drum kings of tomorrow are among the thousands who are learning to play the drum today. It's easy! No complicated music lessons to learn. It's swell to keep time with a pair of sticks on a drum head. To start you off, we want to send you FREE, an interesting illustrated catalogue describing the famous GRETSCH DRUMS. Just write on a penny postcard: "I want a FREE drum catalogue", sign name and address and mail to Dept. P40.

**The FRED. GRETSCH Mfg. Co.**  
Musical Instrument Makers Since 1883  
60 BROADWAY, BROOKLYN, N. Y.

# LUSCOMBE

## SCHOOL OF AERONAUTICS

Limited student enrollment—specialized training in metal airplane engineering and construction including design, drafting and laboratory work. One year course. After first five months students are permitted part time apprentice work actually building planes of three different types now being used all over the world. Folder giving further information sent upon request.



LUSCOMBE SCHOOL OF AERONAUTICS

West Trenton, N. J.

MERCER AIRPORT Phone Trenton 6184



## Be a MONEY-MAKING RADIO EXPERT

I'll train you for a good job in Radio, Television, or a business of your own. My new, personalized sparetime home-study Course fits you quickly, easily. You get real Radio Equipment. I show you how to earn while you learn.

**FREE:** Write for complete details in new catalog "HOW TO MAKE MONEY IN RADIO" Sprayberry Academy of Radio, 210-D University Place, N. W. Washington, D. C.

## MONDELL GRADUATES RECEIVED DURING 1938. GOVERNMENT DRAFTING, SURVEYING, ENGINEERING INSPECTORS' JOBS AT SALARIES \$2000 TO \$3120 YEARLY.

Drafting, Architectural, Airplane, Mechanical, Electrical, Piping, Ship, Structural, Mathematics, Sciences, Blueprint Reading, Building Estimating, Preparation Engineers' Licenses, Civil Service, Engineering Exams, Jr. Engineer (Airplane, Civil, Mechanical, Structural, Concrete), Jr. Meteorologist, Days, Evenings and Home Study courses. MONDELL INSTITUTE. 230 WEST 41ST, NEW YORK

## TOOL & DIE MAKING DESIGNING

Machinists Trade. Not a correspondence course. Practical shop training in the world's Industrial center. Write today for full information.

NATIONAL SCHOOL OF MECHANICAL TRADES

Dept. 105

628 W. Lake St.

Chicago, Ill.

## Government Jobs

EXAMINATIONS SOON VALUABLE INFORMATION FREE  
COLUMBIAN CORRESPONDENCE COLLEGE  
WASHINGTON, D. C.

## BIG BUSINESS AT HOME With New Greaseless DOUGHNUT

Go into sensational new kind of food business! Start in your kitchen. Even without previous experience profits up to \$15 to \$30 in a day possible. Make and sell amazing GREASELESS DOUGHNUTS. We supply equipment and plans. Stores sell for you. Send postcard NOW for special quick-starting offer. Send no money.

BROWN BOBBY CO., 325 W. Huron St., Dept. D-184, Chicago, Ill.



**A AND N SUPPLY CO.**  
Bargains—Military, Sport Goods, Firearms, Clothes, Shoes, etc. Send 10¢ for new catalog, to be redeemed on first order.

EST. 1868

A & N Supply Co., 4772 Lester St., Richmond, Va.

In answering an advertisement with a coupon. Sometimes advertisers are unable to respond to inquiries due to lack of complete information.

## HOW TO PRINT SIGNS and SHOW CARDS

## EARN GOOD MONEY! SPACE OR FULL TIME!

Learn Sign Painting and Show Card business. Practical lessons in lettering, gilding, window, tin and paper signs, etc. How to mix paints. Over 200 latest alphabets, layouts and instruction charts. "HOW TO PAINT SIGNS AND SHOWCARDS" complete, only \$1.98. Order now. Money back if not satisfied. Send for FREE folder. ILLUSTRATED BOOK CO., 220-4th Ave., N. Y.

## WARNING TO INVENTORS

Don't sacrifice royalties or cash to invention racketeers. Know how to protect your ideas at every stage, where and how to finance or sell inventions, when and when not to patent, how much

to expect in royalties or outright sale. New book, IF YOU WANT TO INVENT, also suggests hundreds of immediate opportunities to cash in on inventions wanted for production. Send \$2.75 check or money-order. Return for full refund if not absolutely satisfied.

THE VANGUARD PRESS, Dept. 11, 424 Madison Ave., New York, N.Y.



# NOW YOU CAN PRESERVE YOUR POPULAR MECHANICS

## In This Handsome PERMANENT ART BINDER



**Specially Designed and Made for Popular Mechanics Readers. Has Self-Binding Feature**

Your Popular Mechanics Magazine will be doubly interesting and doubly valuable when preserved in one of these handsome art binders, which holds six issues. Heavy leather-grained finish, embossed and stamped in antique gold style. Covers open flat. Patented fasteners hold magazines in place and any issue may be inserted or removed easily and quickly.

**Only \$1** *postpaid*  
(\$1.25 Foreign or Canada)

**ORDER ON COUPON BELOW!**

Will make a beautiful addition to your reading table or personal library. Size  $10\frac{3}{8} \times 7\frac{1}{8} \times 3\frac{1}{4}$  inches. Specify whether wanted for January to June or July to December issues. Use these binders for your collection of back issues.

**POPULAR MECHANICS PRESS, Dept. PMB, 200 East Ontario Street, Chicago.**

I enclose \$\_\_\_\_\_ for which you may send me \_\_\_\_\_ Art Binders for Popular Mechanics Magazine.

PLEASE CHECK  January to June Issues.  July to December Issues.

Name \_\_\_\_\_  
Address \_\_\_\_\_  
City \_\_\_\_\_ State \_\_\_\_\_

*When writing please mention Popular Mechanics*



## There's MONEY IN ARC WELDING!

"No more tiresome work for me. I get a real thrill out of being an arc welder—and don't forget it, I'm getting more money than I ever earned on hit or miss jobs."

You, too, can become part of this great new industry! There's almost no limit to what welders can accomplish—they cut manufacturing costs way down. Because they know the "How and Why" of Welding, Metallurgy, Drawing, Blueprint Reading, Set-Up Work and Fabrication.

No wonder manufacturers all over the country are demanding practically trained School of Engineering Welding Operators, Welding Technicians, and Welding Engineers!

Don't be content with ordinary work at low pay—when in a short time you can become a thoroughly Trained Specialist in Welding.

**MILWAUKEE SCHOOL of ENGINEERING**  
*Institute of Electrotechnics*

Dept. PM-439 Broadway and E. State, Milwaukee, Wis.

Send Free Booklet "ARC WELDING, World-Wide Dawn of a Gigantic Industry." Also tell me how I can become an

Are Welding Operator in 3 1/2 months.... Gas Welding Operator (6 weeks).....  
Welding Technician (4 months)..... Welding Engineer (1 year).....  
Send details of Student Loan Plan..... Earn Part Expense Plan.....  
Name..... Age.....  
City..... State.....  
(If interested in other courses, check here, Refrigeration and Air Conditioning Technician (3 mo.)..... Radio and Television Service Man (6 Mo.).....  
Commercial Radio Engineer (1 Yr.)..... Electrical Engineer B.S. Degree (4 yrs.)..... PM-439

## Rosati ACCORDIONS

are as fine as human hands can make them. Perfect intonation, tone quality and amazing volume. Breath-takingly beautiful. **EASIEST OF ALL INSTRUMENTS TO LEARN.** Most dealers offer credit terms, as well as COMBINATION LESSON AND INSTRUMENT PURCHASE PLAN. Write for FREE CATALOG and name of nearest dealer.

Write for FREE ACCORDION INSTRUCTION BOOK

**A. ROSATI**  
48 East 20th St., N. Y. C.



## FREE BOOK CATALOG

We publish books on more than 100 practical, technical and scientific subjects—including air conditioning—automobiles—aviation—Diesel Engines—electricity—formulas—machinery—model making and other mechanical subjects. Sent on request.

YOU WILL BE INTERESTED in our HOUSE WIRING by Poppe. An up-to-date book that tells you how to do any building wiring job. Complete, revised edition, 225 Pages, 171 Illustrations, Price \$1.00. Sent to any address by The Norman P. Henley Publishing Company, 2 West 45th Street, New York City.

## LEARN CARTOONING

by the method that has developed hundreds successfully. Send name, address and age for free chart to test your ability.

THE LANDON SCHOOL, 1739 National Bldg., Cleveland, Ohio



## "I Want To Be An Automobile Expert"

AMERICAN TECHNICAL SOCIETY  
Dept. A419, Drexel Ave. at 58th St., Chicago, Ill.

If you think that your 7-Volume Self-Taught Auto Facts will help me to become an auto expert you may send them on approval. If after 15 days I find I am learning rapidly and decide to continue, I will send you \$2.00 and pay the balance at the rate of \$2.00 a month until \$24.80 is paid. Otherwise, I will return all material to you express charges collect.

Name \_\_\_\_\_  
Address \_\_\_\_\_  
City \_\_\_\_\_ State \_\_\_\_\_  
Attach letter stating age, occupation, and name and address of employer and of at least one other business man as reference.



# OL' JUDGE ROBBINS

## NEW YORK TRAFFIC LIGHTS

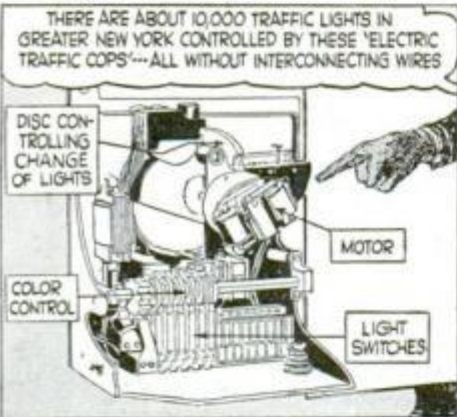

## FOR FULL-BODIED, "NO-BITE" SMOKING



### YOU SAY THE WORD ON THIS FAIR-SQUARE GUARANTEE

Smoke 20 fragrant pipefuls of Prince Albert. If you don't find it the mellowest, tastiest pipe tobacco you ever smoked, return the pocket tin with the rest of the tobacco in it to us at any time within a month from this date, and we will refund full purchase price, plus postage. (Signed) R. J. Reynolds Tobacco Company, Winston-Salem, N. C.

**50** pipefuls of fragrant tobacco in every 2-ounce tin of Prince Albert

# PRINCE ALBERT

THE NATIONAL JOY SMOKE



# Popular Mechanics Magazine

REGISTERED IN U. S. PATENT OFFICE AND CANADA

WRITTEN SO YOU CAN UNDERSTAND IT

Vol. 71

APRIL, 1939

No. 4

2133- Leggett

## WONDERS *of the* NEW YORK FAIR

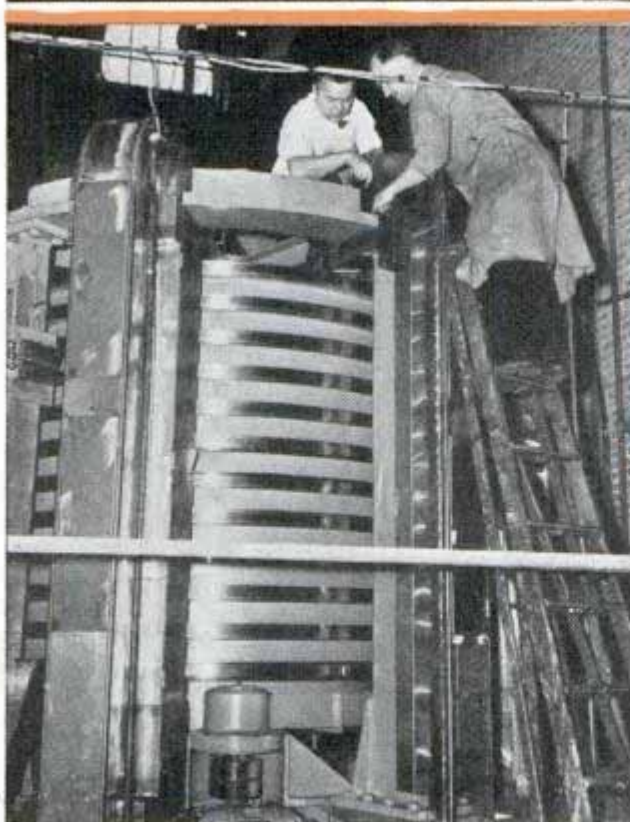

Top, "chemical statue" at du Pont building. Bottom, General Motors' multi-voice speaker unit

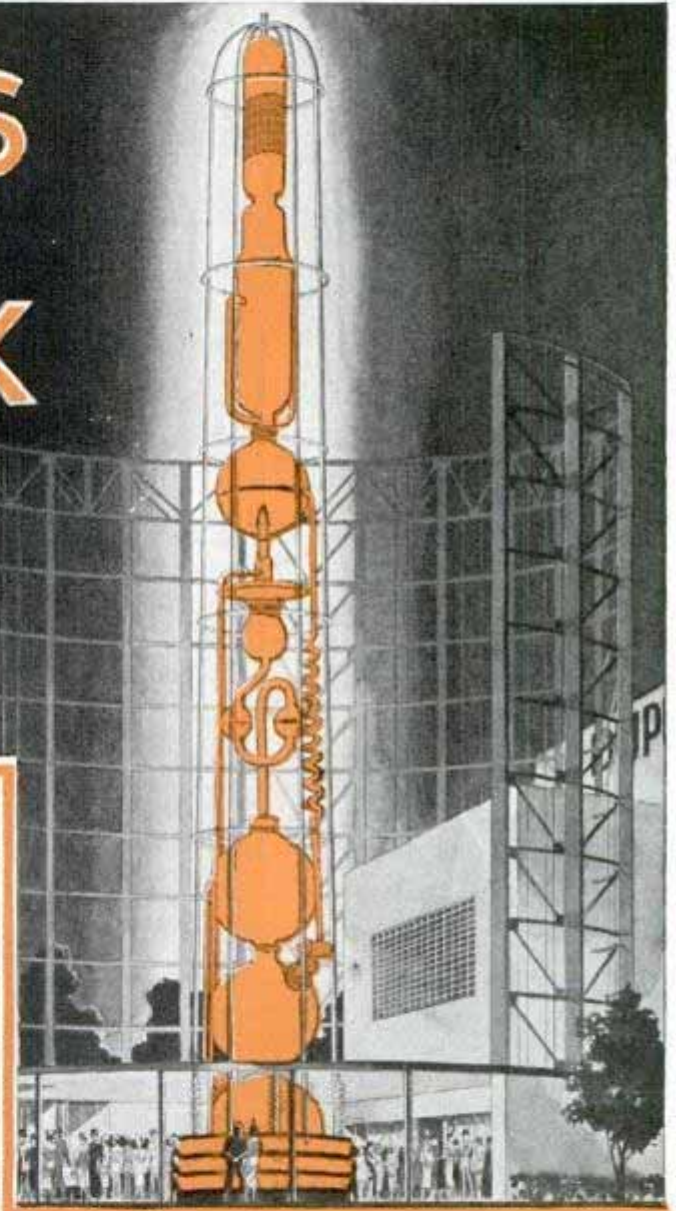

By Julian Leggett

WITH the aid of science and masters of modern showmanship, industry is ready to put on its most spectacular show of all time at the New York World's Fair.

A 10,000,000-volt generator will hurl giant bolts of lightning with sufficient force to split tree trunks while wide-eyed fairgoers watch from a safe distance. A 130-foot locomotive, the largest in the world,



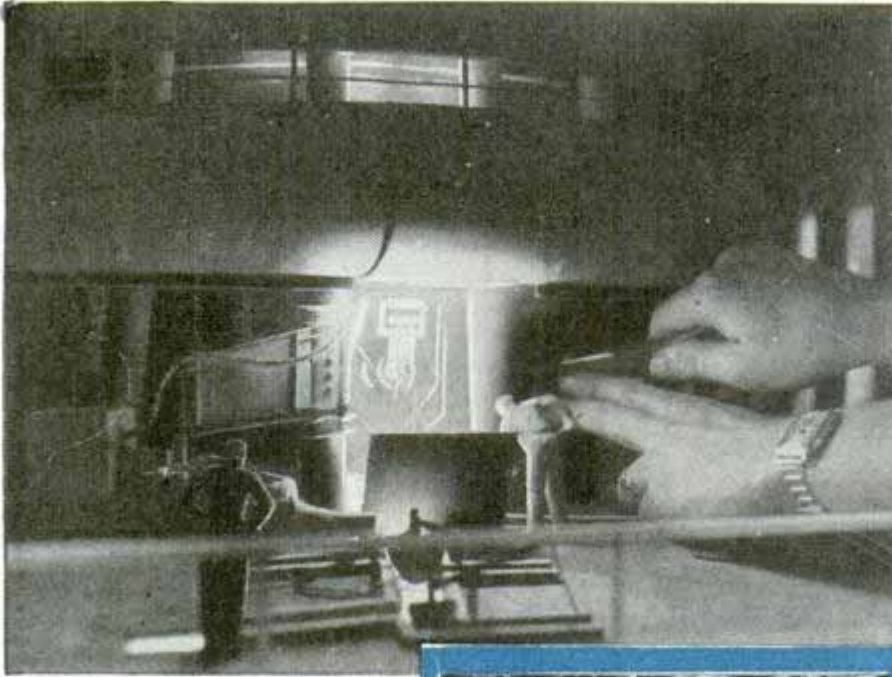

will run at full speed on a bed of masonry. Today's version of the fabled "magic carpet," chairs mounted on an escalator, will carry visitors on a thrilling ride during which they will seem to float hundreds of feet above the earth while watching a layout of highways of the future and listening to a 150-voiced, twenty-ton robot describe transportation facilities of tomorrow.

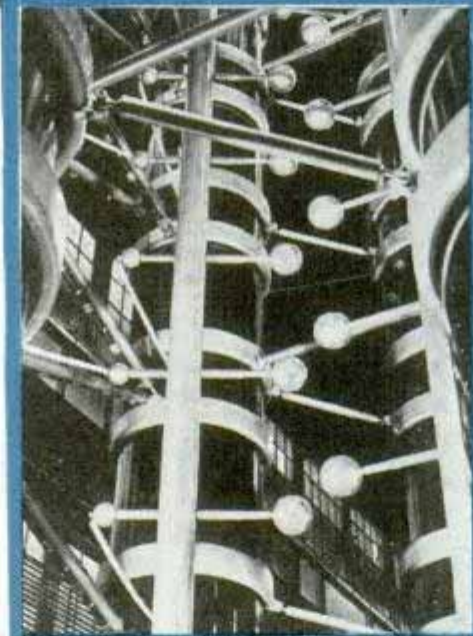

Slowly revolving on pontoons in a 20,000-gallon concealed moat, a turntable 100 feet in diameter will portray the automobile's cycle of production in moving displays mounted on its pyramid-like superstructure. With the aid of color and light, fluids will seem to circulate through giant vessels and retorts in a "chemical statue" towering 100 feet. Mysteries of television will be unfolded in a building resembling a giant radio tube. Full-sized automobiles will race up spiral ramps and circle the top of another huge building to give visitors an exciting ride on an elevated highway. A machine with an electric voice will create human speech as its operator presses keys and turns knobs.

United States Steel Corporation, literally bringing the mountain to Mohammed, will present a miniature steel plant—blast furnace, open-hearth furnace and roll-

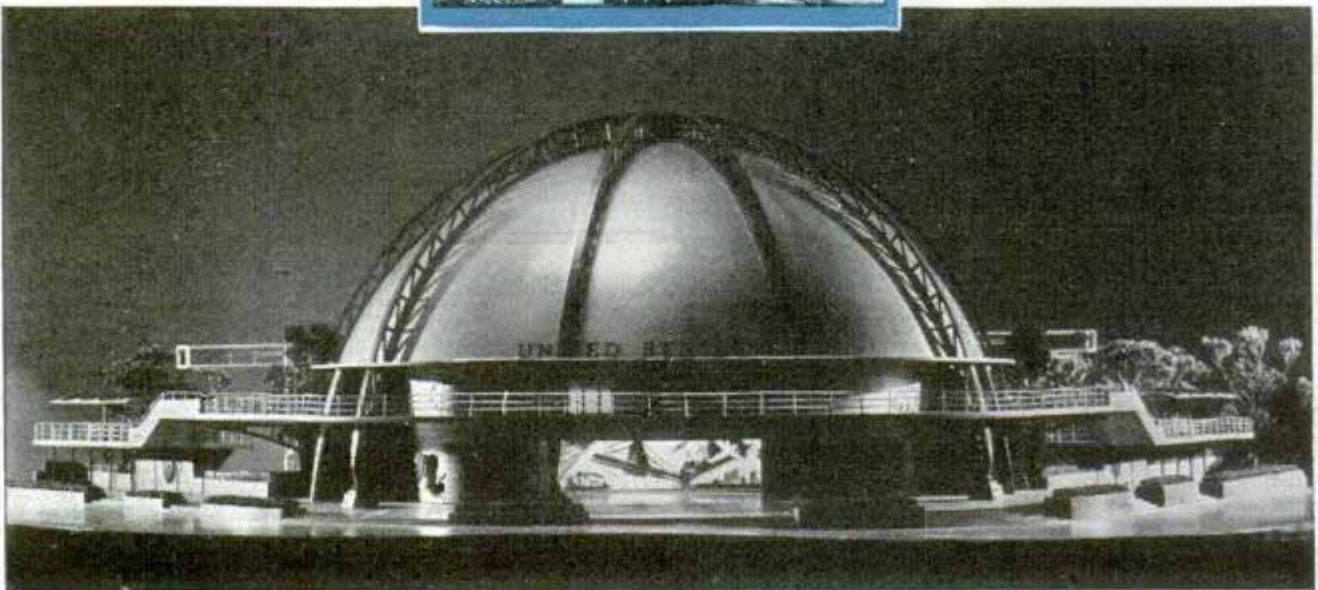

*Top, casting floor of U. S. Steel's blast furnace, with man's hands illustrating size. Center, looking upward at capacitors of General Electric's lightning maker. Bottom, U. S. Steel's "inside-out" building*



£183

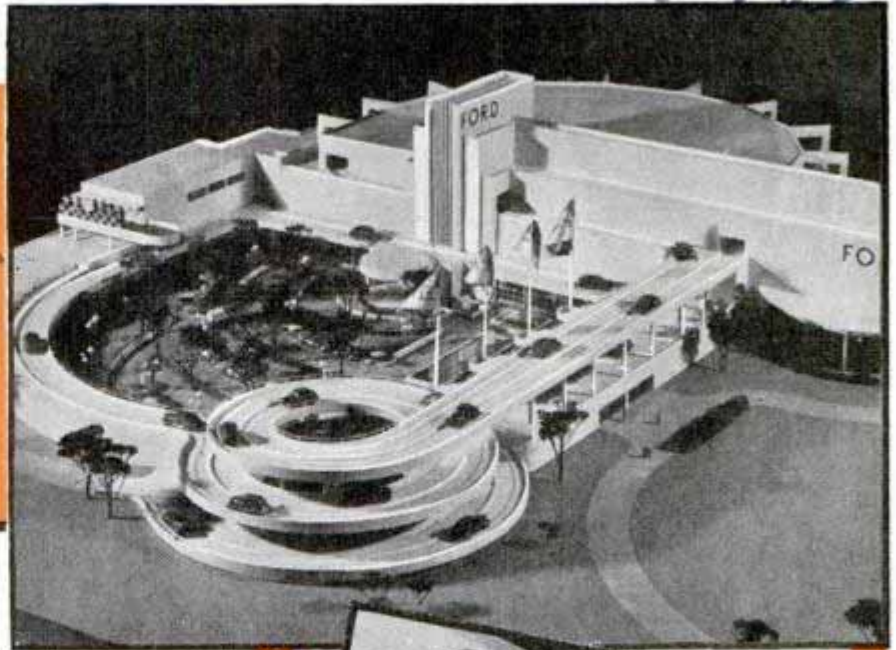

ing mill—to illustrate its operations. An ore-mining diorama also will be a part of the exhibit in an “inside-out” structure, the huge dome of which will be supported by external structural members. Visitors will be given a glimpse into the future by means of a large-scale cyclorama which will portray the possible evolution of the city, the farm, the factory, the highway and the home as built with steel. Anchored in concrete, ten steel trusses forming the “inside-out” supporting members curve upward, meeting at a point sixty-six

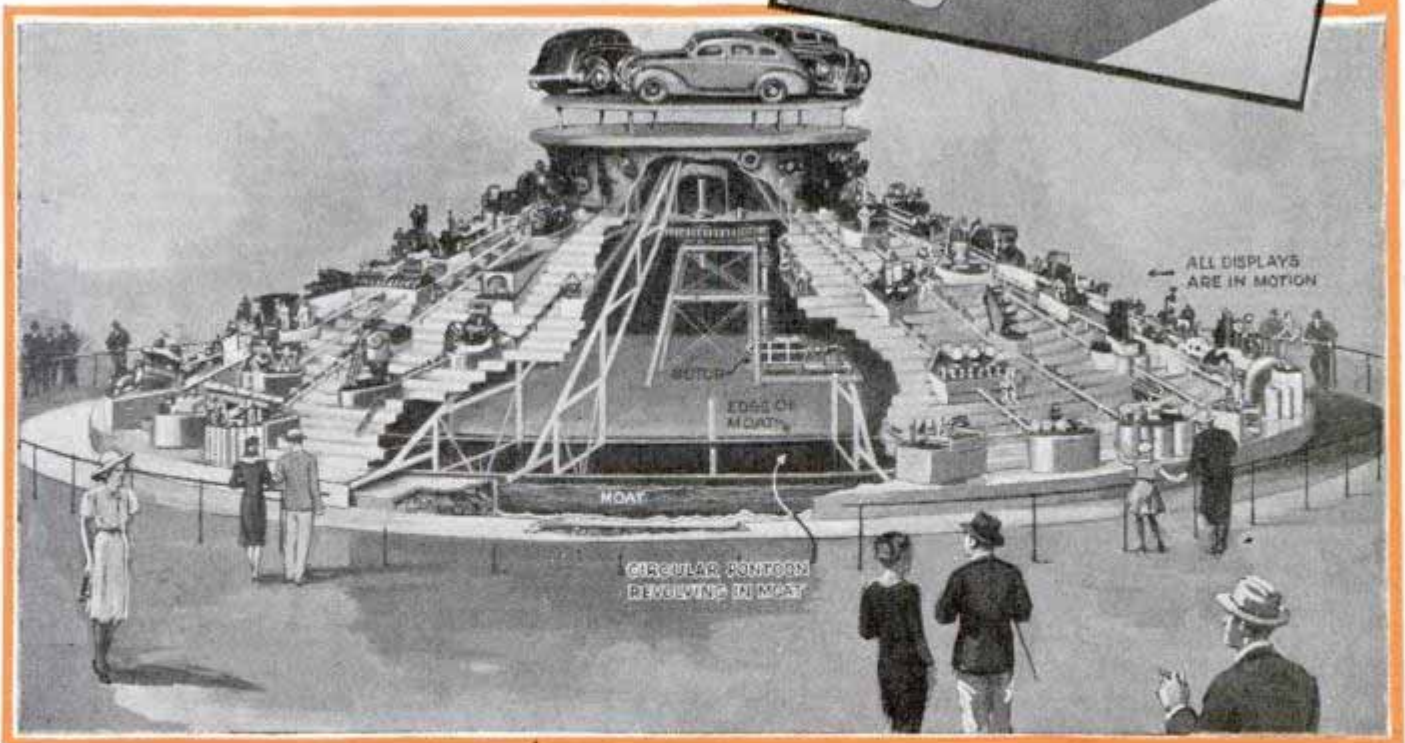

Top, left, statue of “Speed” by Joseph E. Renier at the fair. Right, Ford’s “Road of Tomorrow” runs over exhibit building. Center, novel figures used on Ford turntable. Bottom, the turntable, sketched to show moat and the small motor used to turn the giant exhibit



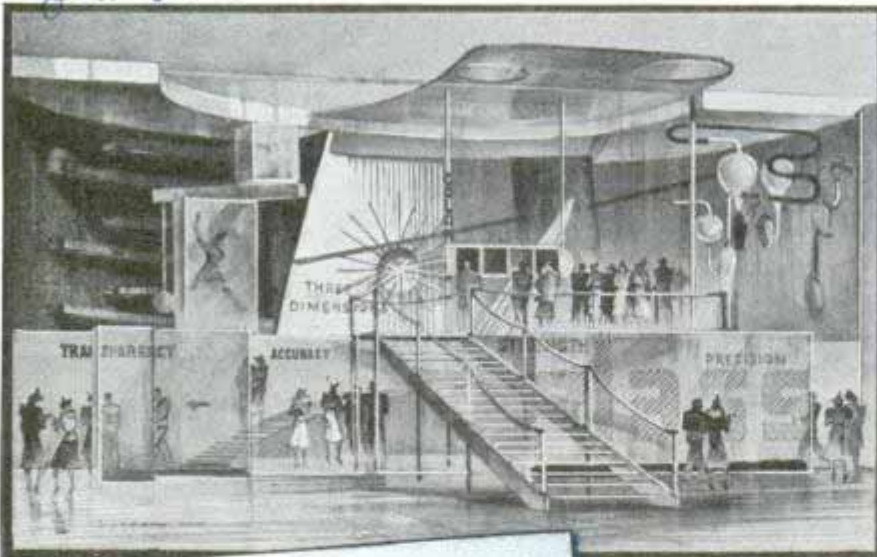

feet above the ground. This framework, weighing 350 tons, will conceal lighting fixtures to illuminate the polished stainless steel hemisphere covering the exhibit.

In addition to a giant lightning-maker, General Electric Company will present many recent spectacular developments in its "house of magic." The artificial lightning equipment consists of two generators, each with a capacity of five million volts. Each comprises six vertical stacks of capacitors piled up for thirty-four feet. Time for operating the unit is fifteen seconds, that is, for the voltage to reach its full value before discharging across a thirty-foot gap with a blinding flash.

In harmony with the "World of Tomorrow" keynote of the fair, the Ford Motor Company's exhibit will be climaxed by the "Road of Tomorrow," which circles the top of the building and over which visitors will ride in Ford and Lincoln-Zephyr cars to obtain an impression of the safety highways of the future. The Ford exhibit also includes the spectacular turntable on which is presented the "Cycle of

Production." Rising like a pyramid, the turntable will present eighty-seven individual displays, many of which will be in motion, and thirty-seven automobile parts. At its top will be three complete cars. Only a two-horsepower electric motor is required to rotate the 100-ton turntable and thirty-three tons of displays and automobiles. Manufacture of certain parts will be conducted on a platform near the turntable. On the platform will be a foundry, small steel rolling mill and other equipment for casting, stamping, drilling and machining the metal. An electric furnace will be used to melt the metal. The Ford exhibit was designed by Walter Dorwin Teague of New York.

(Continued to page 149A)

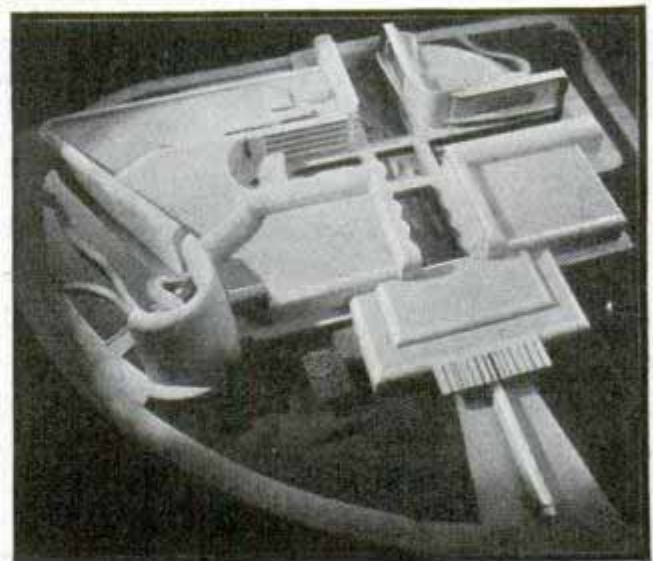

Top, part of Glass Center exhibit. Note the glass staircase. Center, loading coal into steamship, a part of "Railroads at Work" exhibit. Bottom, model of General Motors building showing highways of future







# Transparent Book Tells Tale on a Series of Plastic Pages



Arranging the transparent pages of a plastic book in proper sequence to tell the story of world evolution against a continuing background

Pictures that tell a story in sequence on the transparent pages of a plastic book offer a new medium to the teacher and the advertiser. The transparent book was invented by a Chicago dentist, originally as an aid in teaching technique at a dental school. Its covers and pages are of a glass-like plastic material, on which a given procedure or problem is built up in a picture sequence so that as each page is turned the new step is projected against a background of the accumulated preceding steps. When all the pages have been turned the entire story appears through the transparent covers as a complete unit. In one book, for example, the inventor demonstrated on successive pages the evolution of the world.

## Chlorophyll in Plants Measured by Absorption of Red Light

Science has found a way to measure the concentration of chlorophyll in plants with an accuracy of one part in ten million. Chlorophyll is that green pigment in leaves which acts as a catalyst, changing carbon dioxide from the air, with the addition of water and sunlight, into plant carbohydrates. To measure it, Dr. Earl S. Johnston of the Smithsonian Institution uses a thermocouple. First the chlorophyll is ex-

tracted from the plant with acetone, and through the green pigment held in solution a beam of filtered red-light waves is passed. The chlorophyll molecule absorbs this light, and the more pigment in the solution the less light passes through. What light does escape absorption falls on the thermocouple, and a minute electric current set up is measured with a galvanometer.

## Electric Beverage Mixer Bounces Drink in Glass

Bouncing faster than your hand could do it, an electric beverage mixer shakes the glass with rapid up-and-down movement that blends the ingredients thoroughly. The mechanism has no motor or bearings to wear out and is built for long use without servicing.



Ingredients of beverage are placed in glass, covered, then given a thorough mixing by the agitator

Mr. S. Theo Jones 10 W. Jackson  
see 158a March 14 29

System of  
Revolution and  
Evolution

Washington

Shaker

Chicago  
Kopf  
2112 N. Kedzie



J. 26

418 Wabton Place Chicago 487

# Elephants Get Painless Shave with Blowtorch

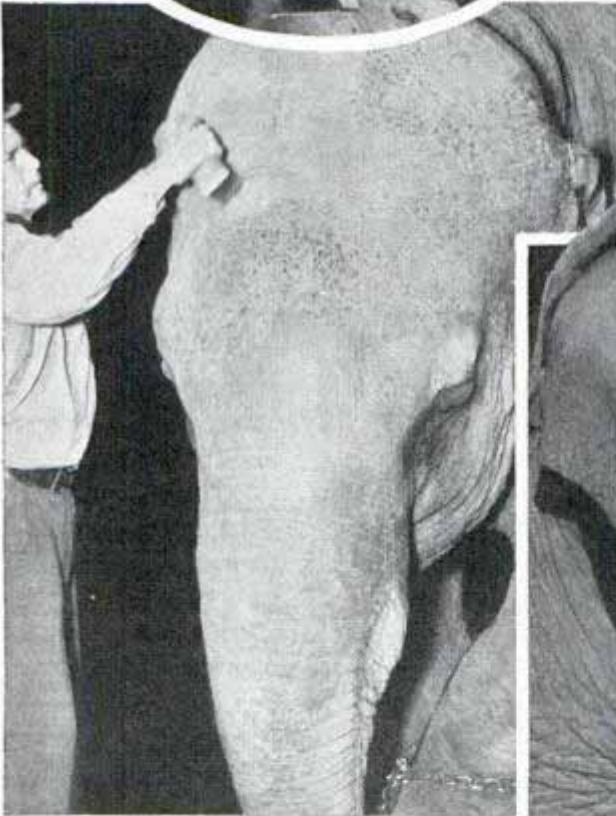
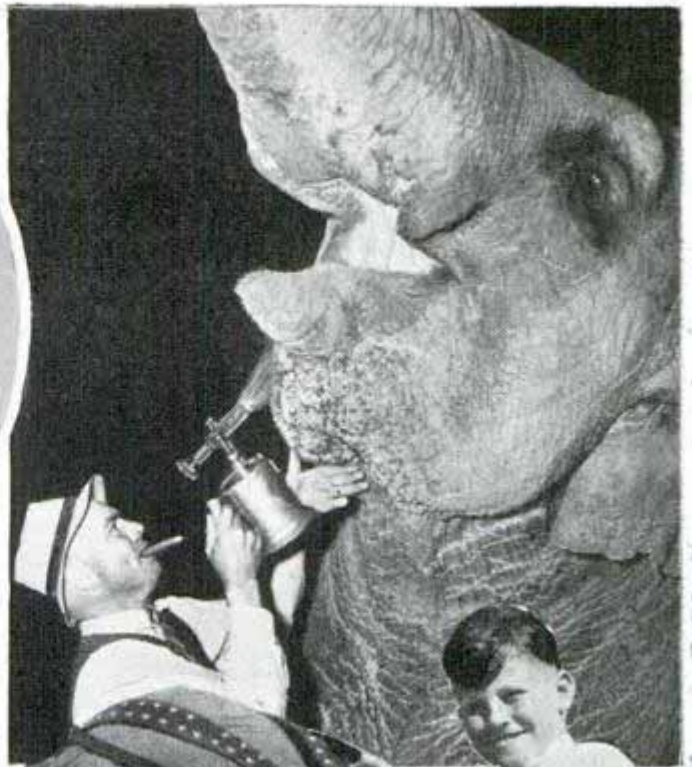

*Above, left, drawknife trims off excess hoof growth; right, hair is removed by blowtorch flame. Below, left, scrubbing hide with steel brush; right, elephant, after beauty treatment, appears before his public*

Circus elephants are given beauty treatments twice a year with a blowtorch to remove the slight coating of hair which covers them. The "shave" is painless for the hair is merely singed off by moving the torch rapidly over the hide. Following the singe, the hide is scrubbed clean with stiff steel brushes. Then one or two liberal coats of oil are applied, and when this soaks in the hide becomes pliable and less subject to sores. The huge feet, too, must

be trimmed down twice yearly. This is done first with a knife and then smoothed with a file. In its native state an elephant can rub off the growth of hair and keep its feet in trim, but easy circus and zoo life make beauty treatments necessary.

☐ Nearly a billion gallons of water are pumped every day through Chicago's mains—enough to flood the city's 213 square miles eight feet deep in a year.

Chicago Tribune. Jan 17 19 29

Vertical handwritten notes on the right margin, including "Chicago Tribune" and "Jan 17 19 29".



# TALKING



Left to right, railroad signals for: "cut 'er onto a stock track;" "stop 'er;" and "spot 'er on track 8." Center, left, signaling that the locomotive is running low on water and that he will take it to the tank. Bottom, signal meaning a switch or cross track



**S**IGN language is one of the oldest forms of speech. Before the white man came to North America, Indians talked to one another with gestures. And there is evidence to suggest that the Egyptians may have used sign language in building the pyramids.

In this day and age of scientific communication speech without words still exists. Sign language is employed by the deaf and is indispensable to industry, sport, transportation and entertainment. It is used in such widely separated fields as railroading, aviation, radio, motion pictures, the stage, orchestral conducting, traffic regulation, construction, surveying, auctioneering, football, baseball, and the army and navy!

The average man uses sign language much more than he realizes. He shakes hands in greeting, waves goodbye, scratches his head when puzzled, strokes his chin while thinking, holds his nose in disgust, and shakes his fist when angry. Sign language is truly a universal language.

The hand signals used in traffic are familiar to every motorist: forearm vertical for a right turn, forearm horizontal for a left turn, and forearm dropped at an angle for slowing down. While directing traffic, police officers raise their hands to signify "stop" and jerk the thumb or forefinger to denote "go."

In Los Angeles, Dr. G. H. Ferber preaches a silent sermon every Sunday at the Lutheran Pilgrim Church for the Deaf. The deaf use the sign language in two ways: first, using a one-handed alphabet to spell out words, and second, creating signs to denote a com-

#1500  
 Sold  
 Los Angeles  
 15 39  
 Aquilino  
 Dr. G. H. Ferber  
 Los Angeles  
 Cmt. Andrew



W. J. ...  
... 500

# WITHOUT WORDS

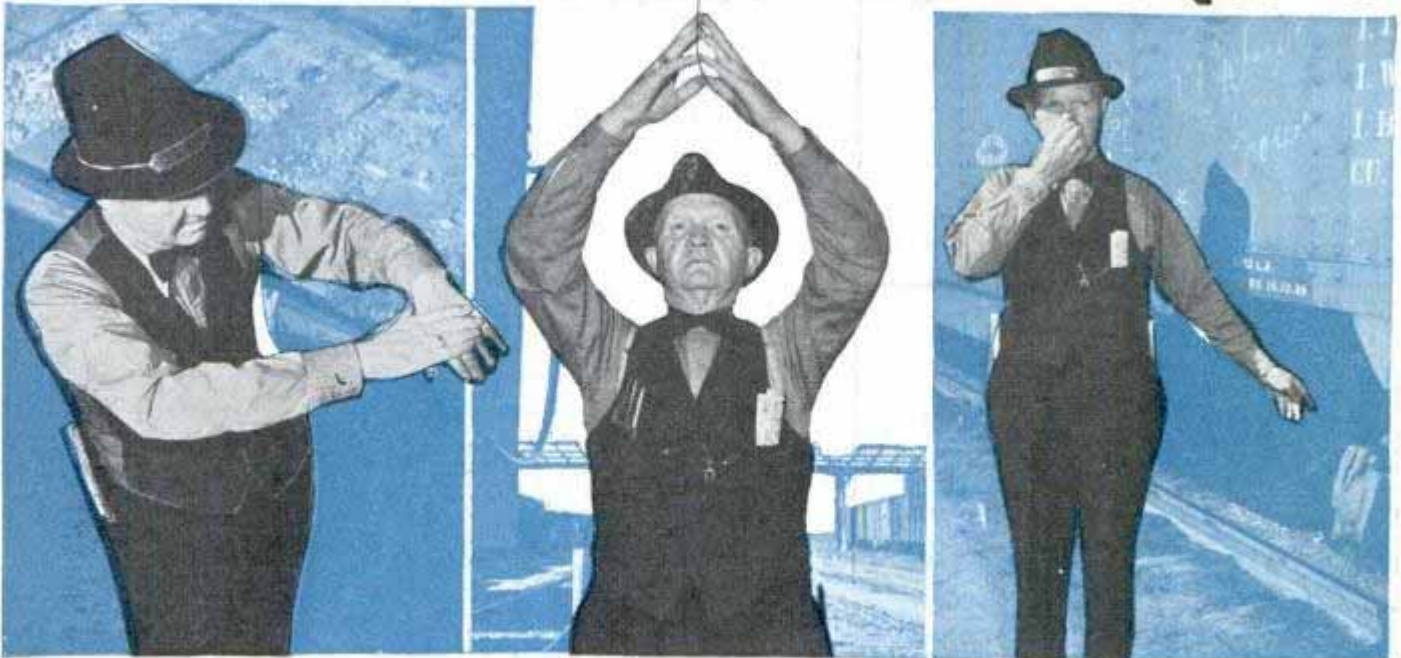

*Left to right, more railroad signals, meaning: "back up the train;" "take her to the roundhouse;" and "hot box." Center, right, air-line signal for "unload passengers at Gate 10." Bottom, "come to a complete stop"*

plete idea. In most cases, a deaf person uses a combination of both methods while "speaking."

The sign for "cat" is made by stroking an imaginary whisker. A bulging coat pocket becomes the symbol of a "rich man." The word "dog" is made by snapping the fingers as one does when calling a dog. To express jealousy, the signer bites his forefinger—possibly with the idea that a jealous person hurts only himself. Sometimes two signs are made to express an idea. "Coal" is "hard" and "black"; "neighbor" is "live" and "near."

The Indian sign language was used primarily by members of different tribes who could not speak one another's language. William Tomkins, of San Diego, Calif., has collected and recorded more than 800 Indian signs.

He says: "sign language is so faithful to nature and so natural in its expression that it is not probable that it will ever die. It may be used to advantage at a





Marvin Jones  
NBC  
Program Executive

14  
1500



distance which the eye can reach but not the ear, and still more frequently when silence or secrecy is desired."

Arm and hand signals have played an important part in the history of transportation. The pony express rider waved his arms to denote his approach and the need for a fresh horse. Bargemen once gave orders to mule drivers on the bank through a system of hand signals. Today, both railroading and aviation rely upon signals to convey important information.

The operating rule books of American railroads, based on the American Railway Association Standard Code of Rules, show seven hand signals. They are for stopping, starting, and regulating the speed of trains. Besides these seven signals, however, dozens more have come into everyday use among railroad engineers and switchmen. Each road and each section of the United States has evolved its own code of sig-

Strip, top to bottom, radio signals meaning: "on the nose," or timing is correct; "keep your chin up," an order to artists; "slow up," or stretch the program; and "o.k." Strip, left to right in center of page, football signals meaning: "unnecessary roughness;" "time out;" "flying block or tackle;" "crawling, pushing or helping runner," and "holding"



nals. For example, when the engineer of a Union Pacific train tips a closed fist to his mouth it means "stop for water." The switchman indicates which track the train is headed for by holding up a certain number of fingers. The "roundhouse" is indicated by both hands held over the head to form a gable. Hands held over the ears mean "ice track." A "stock car" is indicated by wiggling the hands while the thumbs are pressed against the ears; a "caboose" is indicated when the switchman scratches his ribs. Any railroadman knows that a "hot box" is denoted when the hand is held to the nose.

Aviation has also found hand signals helpful in guiding planes in and out of the airport. Pilots and air-field attendants "talk" with their hands above the deafening roar of 1,000-horsepower engines. The right arm extended ninety degrees from the body means "taxi to gate." Both hands extended above the head mean "unload passengers at this gate." Two fingers of the right hand



A1500

extended say "taxi out for a takeoff." When both arms are crossed in front of the face it means "come to a complete stop." Index finger and thumb of the right hand forming a circle say "arrived on time."

From almost the very beginning, radio was compelled to adopt a code of hand signals. At first mechanical devices were tried but they were soon abandoned in favor of arm and hand signals. Radio listeners are unaware of the continual flow of silent signals between producers, engineers, announcers, artists, and conductors while a program is on the air. The keyman of any radio show is the producer. He is responsible for the thousand and one details that must be taken care of before and during a



Strip in center of page, left to right, football signals for: "penalty refused" or "no good;" "off-side;" "illegal forward pass;" "player illegally in motion," and "interference with forward pass." Top, right, "it's a touchdown." Bottom, movie signal for "hold everything—airplane," thus saving sound film from interference while plane is flying overhead

radio program. He must see that the show opens the proper second, that the artists stand the proper distance from the microphone and that the timing is perfect. Where silence is golden, the radio producer uses a system of hand signals to prevent costly and embarrassing mistakes.

The orchestra conductor leads his musicians by means of hand signals. Some conductors have even abandoned the baton, believing that the hands can be more expressive than a slim stick of wood. Among the dance band conductors, B. A. Rolfe is one who does not use a baton; in the world of classical music, Leopold Stokowski of the Philadelphia Symphony is noted for the expressive hands by which he conducts.

(Continued to page 146A)



Handwritten notes in blue ink at the bottom of the page, including "2 Jan" and "The name of the..."



# Fanlike Megaphone Spreads Voice to Far Corners

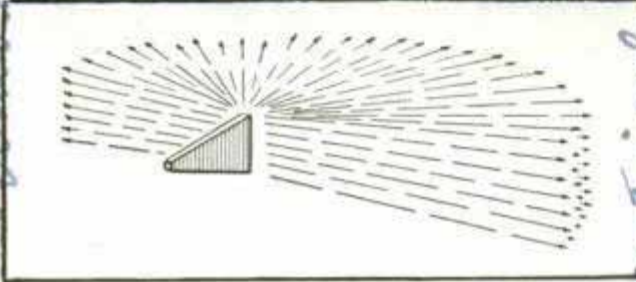

Megaphone is held with six-inch slot vertical. Below, diagram shows how slot spreads sound sidewise

The cone-shaped megaphone, indispensable to a cheer leader's equipment, has been redesigned. Instead of sending sound upward and downward, the new instrument spreads the voice sidewise at an angle of 180 degrees to far corners of the grandstand through a narrow vertical slot. Its flat sides are parallel, and two inches apart. The mouthpiece is two inches square and the outer opening is two by six inches. Tests with sizes from one to six feet long led to adoption of the smaller size. Thin wood or metal is used in its construction.

Designed by R. W. Watson

take that protrudes into the open. The other end of the hose fits on the tire valve. Making spares easier to service gives added insurance that they will have enough air when an emergency occurs.

# Sound Bounces Off Bald Heads but Velvet Dress Stops It

You may not care what kind of clothes the radio audience wears, but sound engineers say clothes make some difference in the tone quality of a concert orchestra. Stiff dress shirts worn by men cause sound waves to bounce back so tone values, especially in the higher frequencies, register with unusual sharpness. On the other hand, informal garb tends to prevent reverberation, and velvet dresses kill echoes more quickly than silk and taffeta. Bald-headed men make poor noise absorbers. The human body "soaks up" sound vibrations and transforms them into heat, but there is no likelihood of running a temperature since the heat thus acquired is so infinitesimal that it cannot be measured.

# Folding Bed Tucked into Chest Takes Up Little Space

Easily moved from room to room, a folding bed tucks away into an attractive chest that takes up very little space. In crowded apartments or small homes the bed fits neatly as an extra piece of furniture.



Bed in open position. When not in use bed is folded into chest and doors are closed, hiding it

American Furniture Mart Chicago

# Air Hose Saves Opening Trunk to Inflate Spare Tire

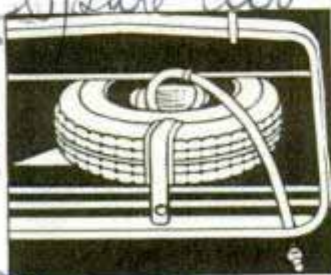

Spare tires carried in automobile trunks can be tested or inflated without opening the trunk cover, by attaching an air hose with in-

electronic much

Pioneer Specialty Co. | Pullman Couch Co.



# Bumps in Dark Avoided by Crossing Arms

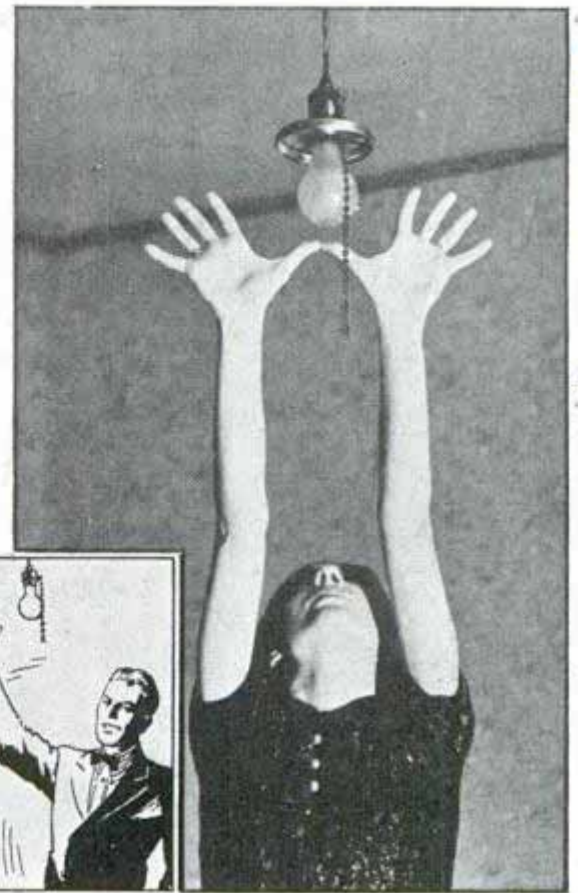

Left, with arms properly crossed you can't bump into open door. Right, finding light with hands spread. Insets show how improper methods fail

Did you ever bump into an open door while groping for it in the dark with outstretched arms? Next time cross your arms in front and the door cannot pass between them to come in contact with the face or head. Locating with one hand a drop cord or other small object overhead often seems

hopeless, but success comes in knowing how. Simply place the thumbs together and spread the fingers widely apart and see how easy it is to cover an area four times greater than when one hand is used.

# Image as Seen by Defective Eye Is Reproduced by Robot

What the defective eye sees when looking at an object is demonstrated by a "robot eye" completed recently. Virtually every visual defect can be reproduced. The device first produces a stereoscopic picture by means of two specially built and matched projectors. Then special lenses are inserted which distort the natural picture, making it possible to view the image as it actually would appear to a person with impaired eyesight. Work on the robot was started fifteen years ago in an attempt to show state officials how dangerous faulty vision could be to automobile drivers unable to read warning signs properly.



"Robot eye" imitates defective vision by distorting picture

Dr. Frederick Hamilton Distinguished Service Foundation of Ophthalmology



# 'Stop Light' on Golf Putter Signals Incorrect Swing

Prof. A. M. Low (Pentech)  
London, W. 4. Eng.



Red light on club helps golfer improve game by flashing signal when putter is swung incorrectly

Golfers who want to improve their putting now can practice with a club having a red light that flashes every time it is swung incorrectly. The putter, introduced in England, is used by professionals to teach golfers the proper use of this type of club.

Wm. A. Bess, chie.  
Revere, Mass.  
Chas. J. 103

## Stainless-Steel Cooking Utensil Has Copper-Clad Bottom

Stainless steel and copper are combined in a group of cooking utensils being introduced to housewives this spring. The body is of stainless steel for glass-like cleanliness, strength, beauty and resistance to food acids and alkalis. The base is cop-



Copper base of this utensil assures uniform heat

per-clad, the copper being one and one-half times as thick as the stainless steel. Copper assures uniform heat distribution.

## Illuminated Wall Switch Plate Easy to Find in the Dark

Rooms are made safer in the dark by an illuminated switch plate which costs nothing to use and does away with bumps and accidents suffered while groping for the light switch. Also walls can be kept free of finger marks. The luminous unit is at the top of the plate.



## Mileage Meter on Roller Skate Shows How Far It Glides

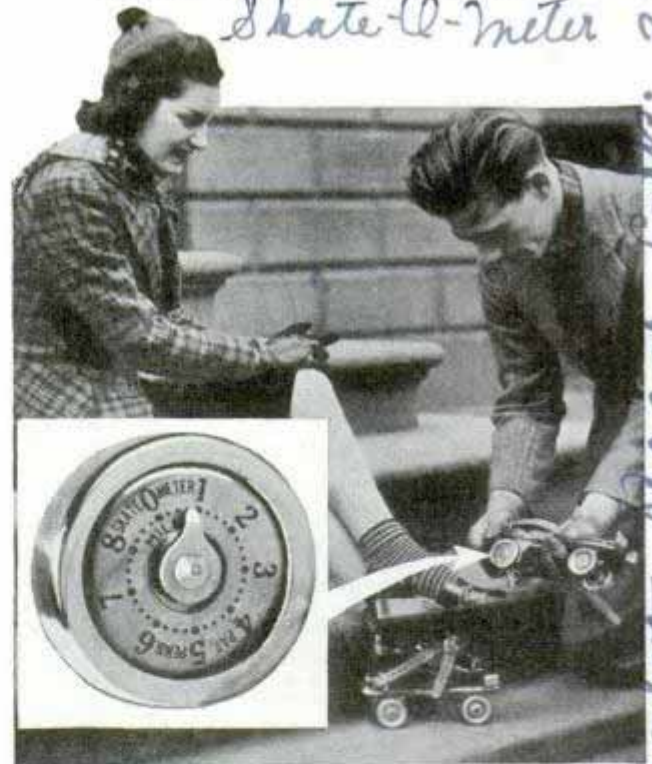

Inset, mileage meter built into roller skate wheel, which is mounted on skate as indicated by arrow

By equipping roller skates with a special wheel having a meter to count the number of miles covered, it is possible to take this form of exercise in measured quantities. A series of internal gears operate a pointer on the wheel to indicate the distance up to

261 Broadway  
Safety Razor Co.  
Legal

Handwritten notes at the bottom of the page, including '152 2nd St. Los Angeles' and 'The year's work'.



100

C. S. Robinson  
Robinson Aerial Surveys  
d. U. S. A. N.Y.

nine miles. Spinning of the wheel while off the ground is compensated for by the gear control. The mileage meter takes the place of a wheel on any regular roller skate, and it has an axle attached for easy installation. Roller skates, on which this meter is standard equipment, have adjustable clamps that conform to the shape of the shoe and are fastened without the usual "skate key."

### Periscope in Floor of Plane Lets Cameraman Pilot Ship

By thrusting an upside-down "periscope" through the floor of the plane, the photographer becomes master of flight on aerial mapping trips and the pilot merely flies "blind" on instruments. The pilot takes the ship up to the required altitude, levels off and sets his directional gyro as specified by the cameraman. Then he simply keeps the plane at constant speed and altitude and obeys right or left turn signals from the photographer, who, using the periscope, can see simultaneously the horizon ahead and the ground below just as his camera sees it. He directs the pilot by signal lights, and obtains exactly vertical pictures by means of a bubble level and automatic timer.

Swine Source 1/18/39

### Pneumatic Tool Mounts Tire without Damaging Its Walls



With tool hung from upper edge of rim, air pressure is applied and stretching arm snaps lower wall of tire in place on rim

Letting compressed air mount your tires on a drop-center rim not only saves time and effort but prevents any damage from pinching or hammering the tube and tire. A pneumatic tool just introduced consists of two air cylinders that apply power to a curved stretching arm. After the tire is partly mounted, the tool is hung from the upper edge of the rim and the stretching arm is fitted against the lower part of the tire. Air is applied and the tire snaps into place. Release valves assure safety.

Safe Way  
Ryan and Wheatley 521 W. 1st St. Los Angeles

### Army's Amphibian 'Duckling' to Aid Planes Down at Sea

"First aid" for landlubber army pilots forced down at sea is the duty of a fleet of short-range amphibians planned for air corps posts at coast and island stations.

Nicknamed the "duckling," the first of twenty-six of these twin-motored ships is undergoing tests by army air engineers. They are capable of better than 140 miles an hour, and have a cruising range of only 500 miles, carrying a crew of two and four passengers.



When army planes run into trouble at sea, this amphibian, now under test, can fly to the rescue at 140 miles an hour over a 500-mile range

There were 29,400,000 motor vehicles registered in the United States during 1938, representing sixty-eight per cent of the 42,900,000 registered around the world.

Summary: Aircraft Engineering  
Pub. Farmstead N.Y.

Auto Facts  
June 19 39



# Static-less Radio Promised by Short-Wave System



Giant tower of new ultra-high frequency station. Note the 150-foot crossarms

Radio programs without static is promised by the designer of an ultra-high frequency, short-wave system. A station for transmitting the programs has been constructed in New Jersey. It has a 400-foot tower with three 150-foot crossarms. Instead of conventional wires strung between two supports, the aerial consists of a series of copper-plated steel bars fastened to a boom suspended between the tower's crossarms. Waves sent out over these bars may be concentrated along the earth's surface, according to the inventor, Major Edwin H. Armstrong of Columbia University. Waves broadcast by the ordinary wire aerial go off in an arc in all directions. The station has been assigned a wave length of about seven meters. Even shorter wave lengths can be used effectively, it is claimed. The system will do away with the gain rider, who sits behind a soundproof glass panel in the conventional radio station watching the program and regulating

a dial controlling the frequency of the sound going out over the microphone. Major Armstrong's invention, because of the greatly increased dynamic range, which is the ability to reproduce both the loudest and softest tones with perfect fidelity and without noise, enables the sound being broadcast to remain even and natural without distortion due to compression. The new system differs from the old in that the wave frequency broadcast by this method is changed in accordance with the fluctuations of the voice, and not the intensity of the radiation. The new programs, at any given listening point within the range of the station, estimated at 100 miles, will have from one-hundredth to one one-thousandth the disturbance of programs broadcast by the present method, according to Major Armstrong. The receiver automatically rejects a signal that is too weak to be received satisfactorily, such as static noises, but receives all waves sent out from the high-powered transmitter. The system also can be used for multiple sending, four channels having been transmitted and received at the same time.

## Tiny Electric Stove for Office Cooks a Complete Meal

A complete meal can be cooked at school or in the office on a compact electric stove by simply plugging into a wall outlet. It has a drawer for frying and a regular electric burner on top. When the stove is not in use a lid conceals it from view.



Preparing meal on desk with electric stove. Steak is fried in drawer and coffee cooked over burner

Equipment designed by Armstrong - built by General Electric  
 Major Armstrong of Columbia University  
 9/1  
 251

Columbia Univ  
 New York

W 2 x m

water tank info

merchandise mark  
 Chicago

262  
 General Electric



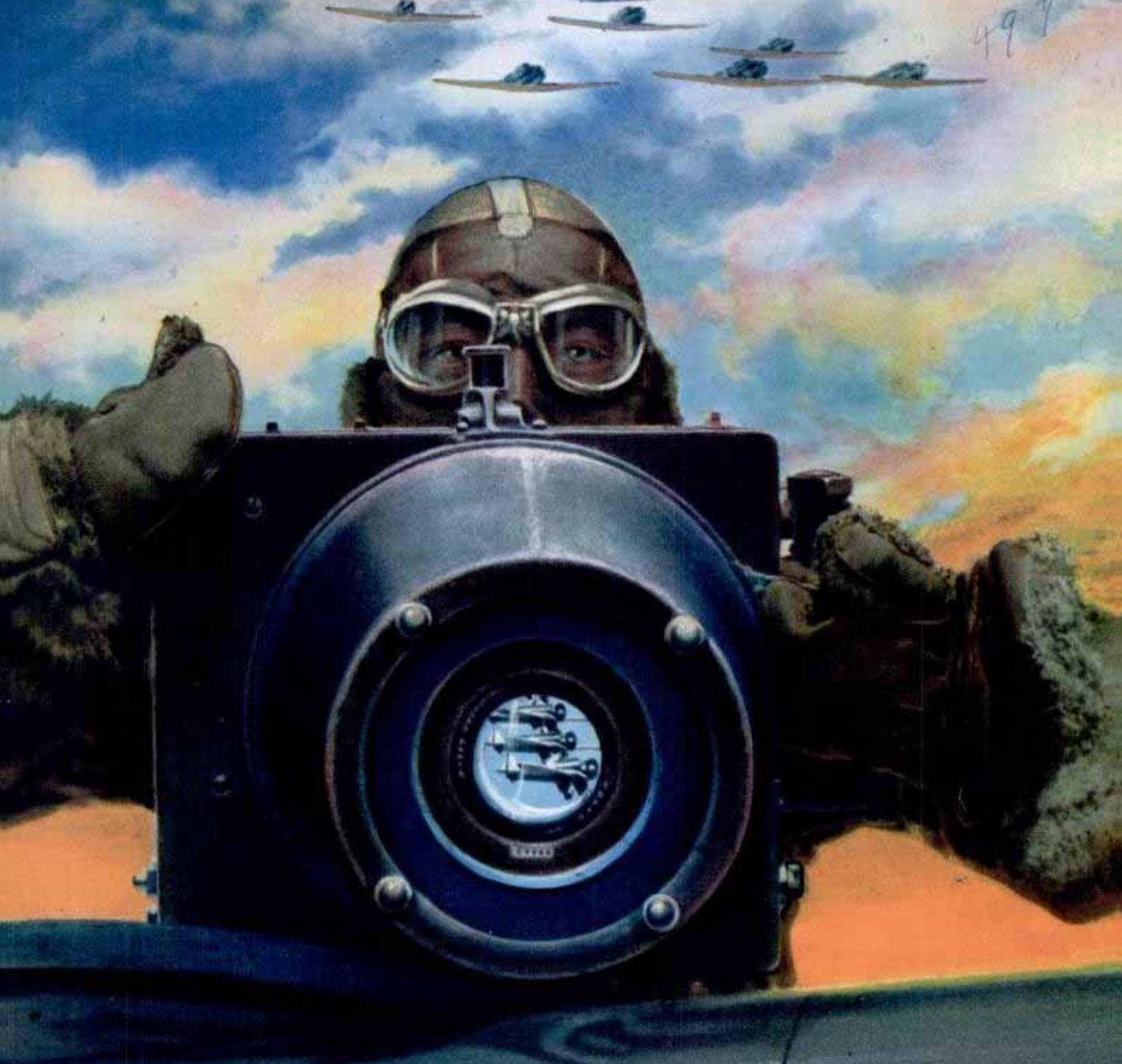

# COLOR "SPIES" *Join the* ARMY

**AERIAL** cameraman at work. The use of color films in military aerial photographic work has forced many changes in the art of camouflage since world war days.



1304

49



ARMY plane flying at 13,000 feet near Dayton, Ohio. Good color pictures can be taken from such altitudes.

*Boeing B-17*



that pictures could be taken only during the brightest hours on sunny days. With today's cameras and black-and-white film, a flying photographer can bring back pictures almost without regard to the time of day. Even hazy weather is hardly a handicap. Still, in spite of all its advances, black-and-white photography is far from perfect.

"The purpose of military aerial photography is to record exactly what the observer saw," one of the Wright Field technicians explains. "Black-and-white photographs have never been able to do that. Perfect color vision is one of the first requirements of a good observer. A color-blind observer would miss many important details and yet the black-and-white photographs we have depended upon in the past are almost completely color blind. Reds, blues and greens are reduced to virtually the same shade of grey. Objects that loom up from the ground because of color have no such emphasis in a drab photograph."

**C**OLOR photography is revolutionizing the art of military observation and today the clever camouflage that successfully concealed guns and troops in past wars is practically worthless.

So important is this new development that the photographic section of the Army Air Corps at Wright Field, Dayton, Ohio, is working night and day to adapt color photography for use in the field.

Aerial photography was in its infancy at the armistice. Films were so slow

*Com. Thomas E. Simons Jr.  
10555 97th Avenue  
Los Angeles, Calif.*

*Ref. Major George W. Isoddard,  
Wright Field, Dayton, Ohio*



#1304  
499

**T**YPE of photograph, right, taken with five-lens aerial camera. Cut branches of trees are no longer effective to conceal gun emplacements because the color camera spots the discolored foliage.

**A**ERIAL photograph of Washington, D. C., below, taken from an altitude of 15,000 feet. A color film such as this may disclose the color of taxicabs cruising in the streets below.



F-1A PHOTOGRAPHIC  
SHIP USED ON  
THE PROJECT

AREA COVERED  
PER EXPOSURE

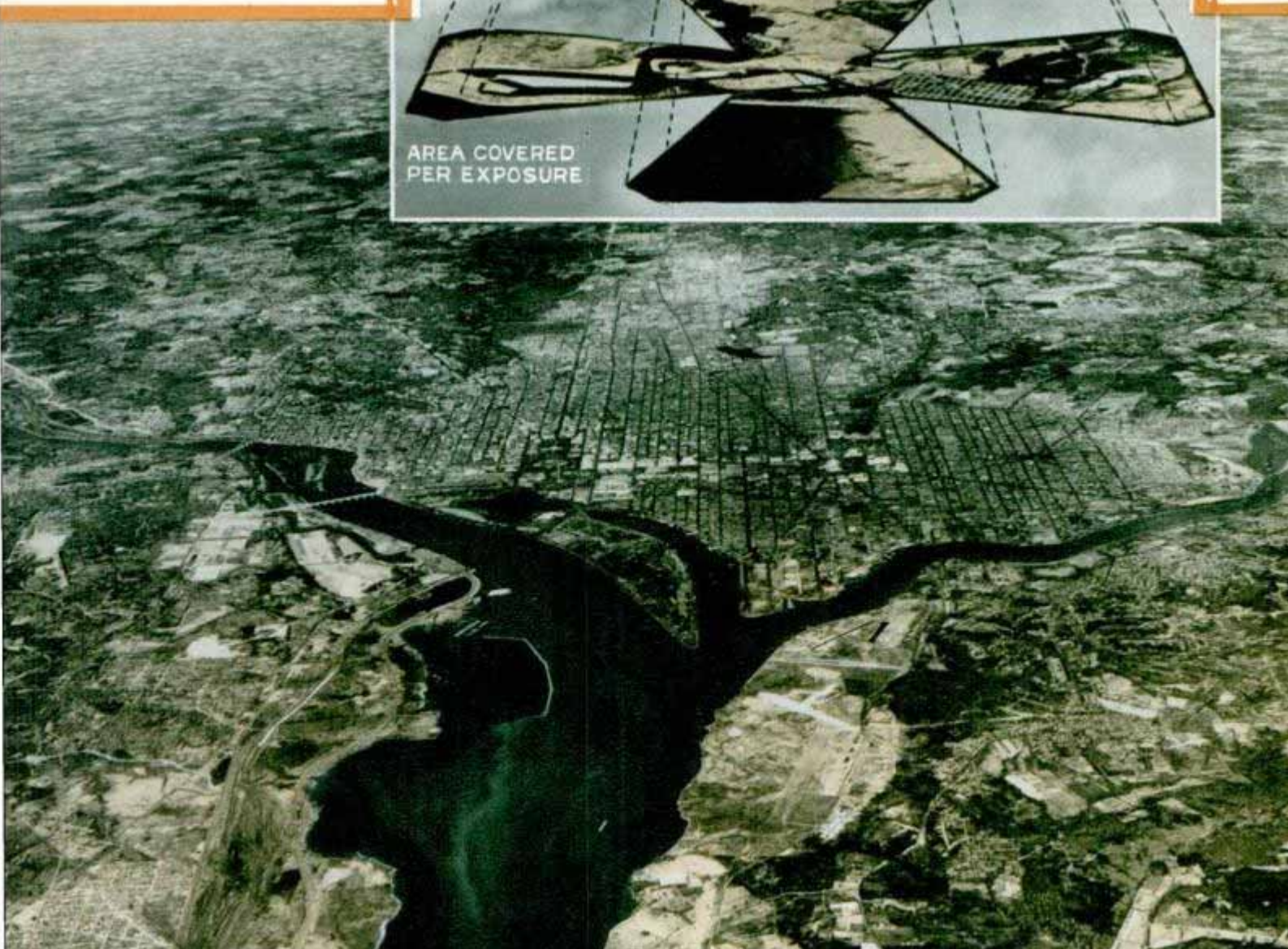



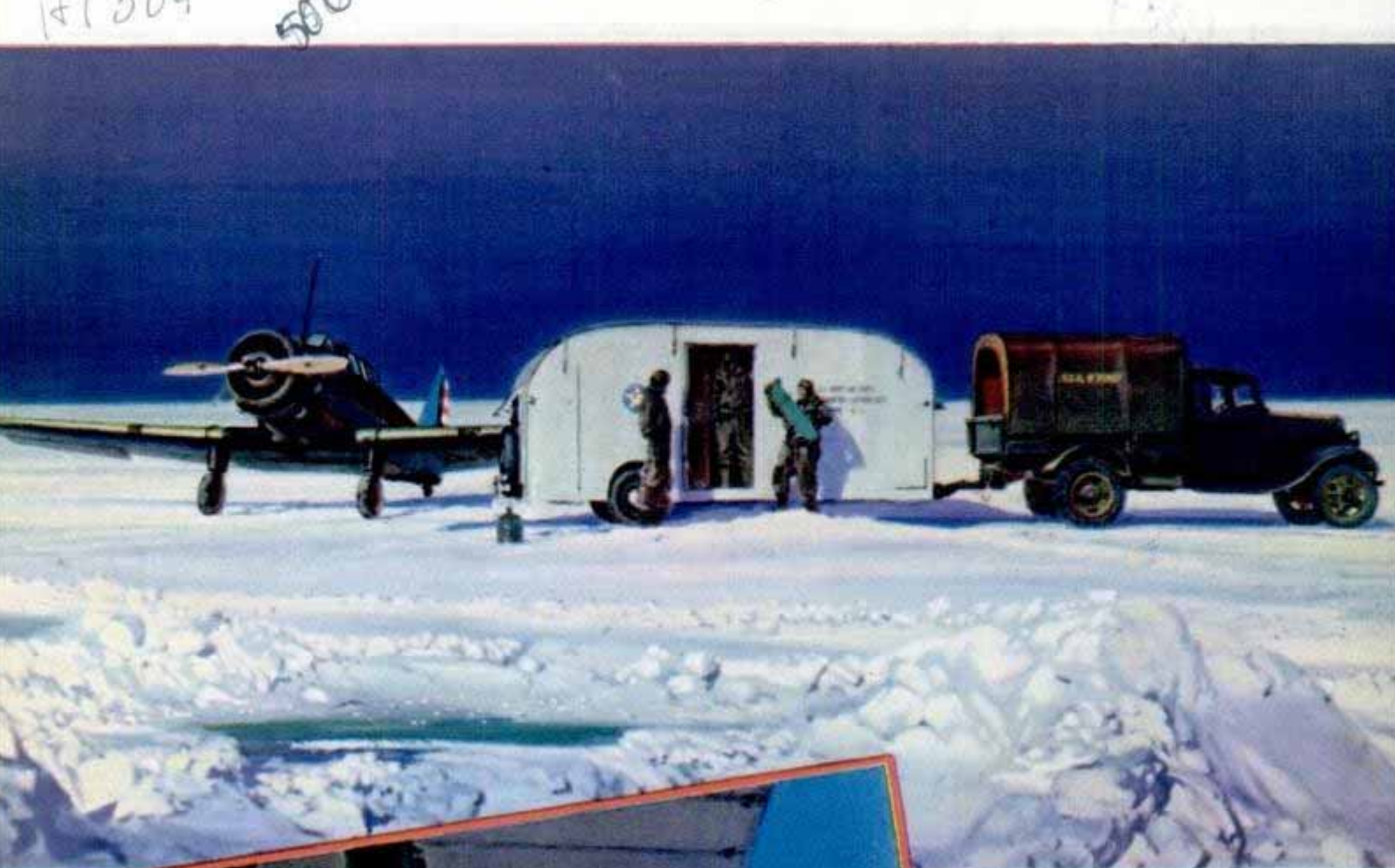

**PLANE** landing beside photographic laboratory trailer with negatives for rapid development. When developing and printing are finished in field unit, plane will deliver pictures to troops. Left, loading cameras in photographic plane.







501

Courtesy U. S. Army Air Corps

*Kodachrome*

**NATURAL** color photograph of army bombers flying in formation over mountainous country. The picture was taken from another plane.

“Color photography solves all such troubles. Using color film, a flying cameraman can bring back an identical record of what he saw, including things he may have forgotten or didn’t have time to notice. He doesn’t have to rely on his memory to explain his pictures. By projecting a color transparency on a motion-picture screen a group of staff officers can literally place themselves in the observer’s airplane and look down on the area he flew across. They see exactly what he saw with every shade and variation of color faithfully recorded.”

As a matter of fact, color photos are more accurate than the human eye. An observer at low altitudes can see objects on the ground in their true colors but the colors begin to fade when he climbs higher. Haze in the air obscures color more and more as he keeps climbing and at 12,000 feet the earth resembles a blueprint. When the Army Air Corps first experimented with color their pictures recorded exactly what the eye perceived,

but what they wanted were pictures that gave close-up colors no matter at what altitude the film is exposed. Today the photographers have special correcting filters that register objects in their true colors even though the camera is in a plane two miles high or more.

As an example of the fidelity of the new films and filters, a military camera plane flying high above New York City brought back pictures that revealed the exact colors of taxicabs cruising in the deep shadows of the streets between the tall buildings of the city, a detail that the cameramen themselves were unable to see. Much of the military research is leading to improvements in color photography which eventually may be made available to the commercial market although many developments are secret today.

Why, specifically, is color photography so important? For one thing, a color photograph reveals almost at once where foliage is being used to camouflage



14  
1304



**N**OSE of bomber painted with lamp black. The dull surface reflects virtually no light, making the plane invisible from the ground at night, even in the rays of powerful searchlights. Bottom, New York from an altitude of 26,000 feet.

502

a gun emplacement. It is estimated that ninety per cent of the camouflage used in the world war consisted of foliage cut and hung on wires or draped around objects that were to be hidden. Weeks would pass before the leaves faded enough to be apparent to the eye or the black-and-white camera. But with color film the slight changes in shade which occur a few hours after foliage is cut can be detected. Also, the scorching of trees in a forest, caused by the blasts of a con-



cealed field gun, is readily apparent in a color picture. Painted burlaps and nettings used to imitate natural backgrounds look entirely normal to the eye at a distance but are obviously artificial in a color picture.

The result is that camouflage experts are being forced to find new methods. Military camouflage, by one name or another, has been employed since the age of Caesar, when the masts of war galleys were paint-

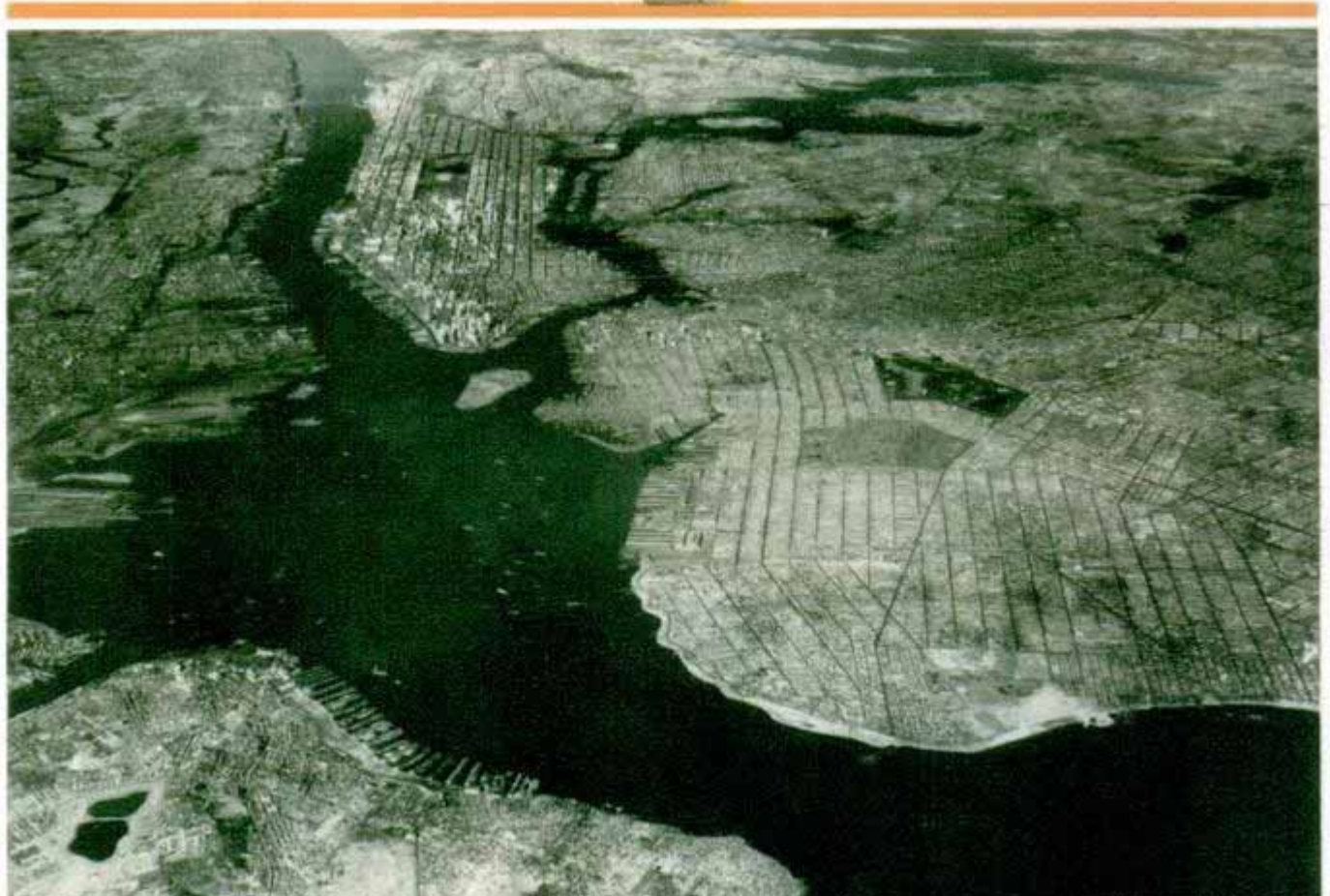



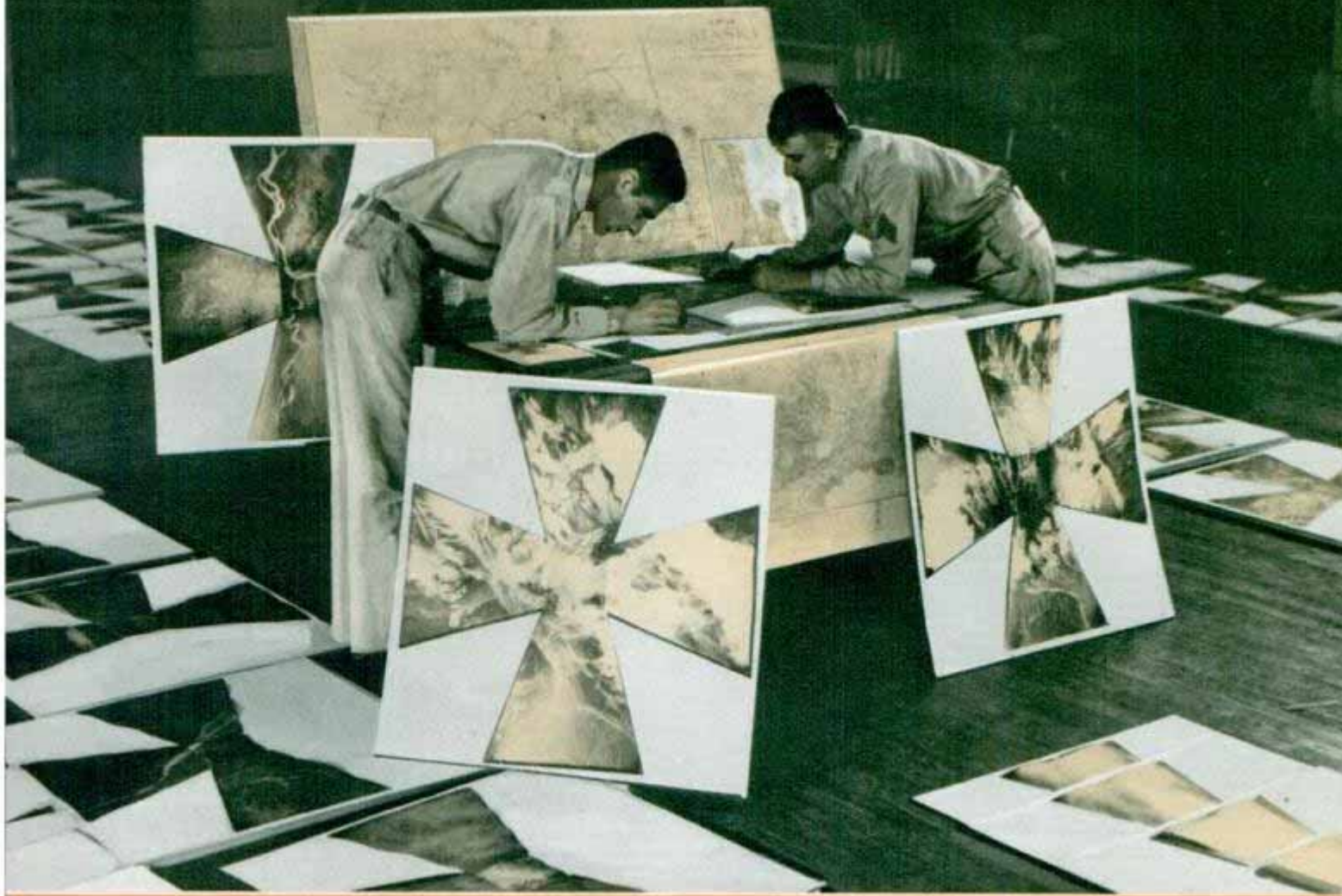

503

W1304

ed blue to blend with the sky. The art of "paintbrush warfare" ranges from color schemes designed to reduce visibility to the dazzle patterns often painted on ships that actually help an observer to spot them but tend to deceive him as to the ship's course, speed and range. One stunt, when complete concealment is impossible, is to hide an object by making it appear to be something else. At the war games at Fort Bragg, N. C., last year, anti-aircraft guns were concealed from aerial observers by erecting over each gun what appeared to be a typical mountaineer's log cabin, complete even to washing hung on an adjacent clothesline. The gun barrel projected up the chimney and the light frame "movie set" house could be collapsed in a few seconds when gun was to be fired.

Photography of any kind is



**CAMOUFLAGED** plane, in circle, as it appears when flying over grain field. It has been disguised to blend with the scenery below. Top, piecing together five-lens photographs.



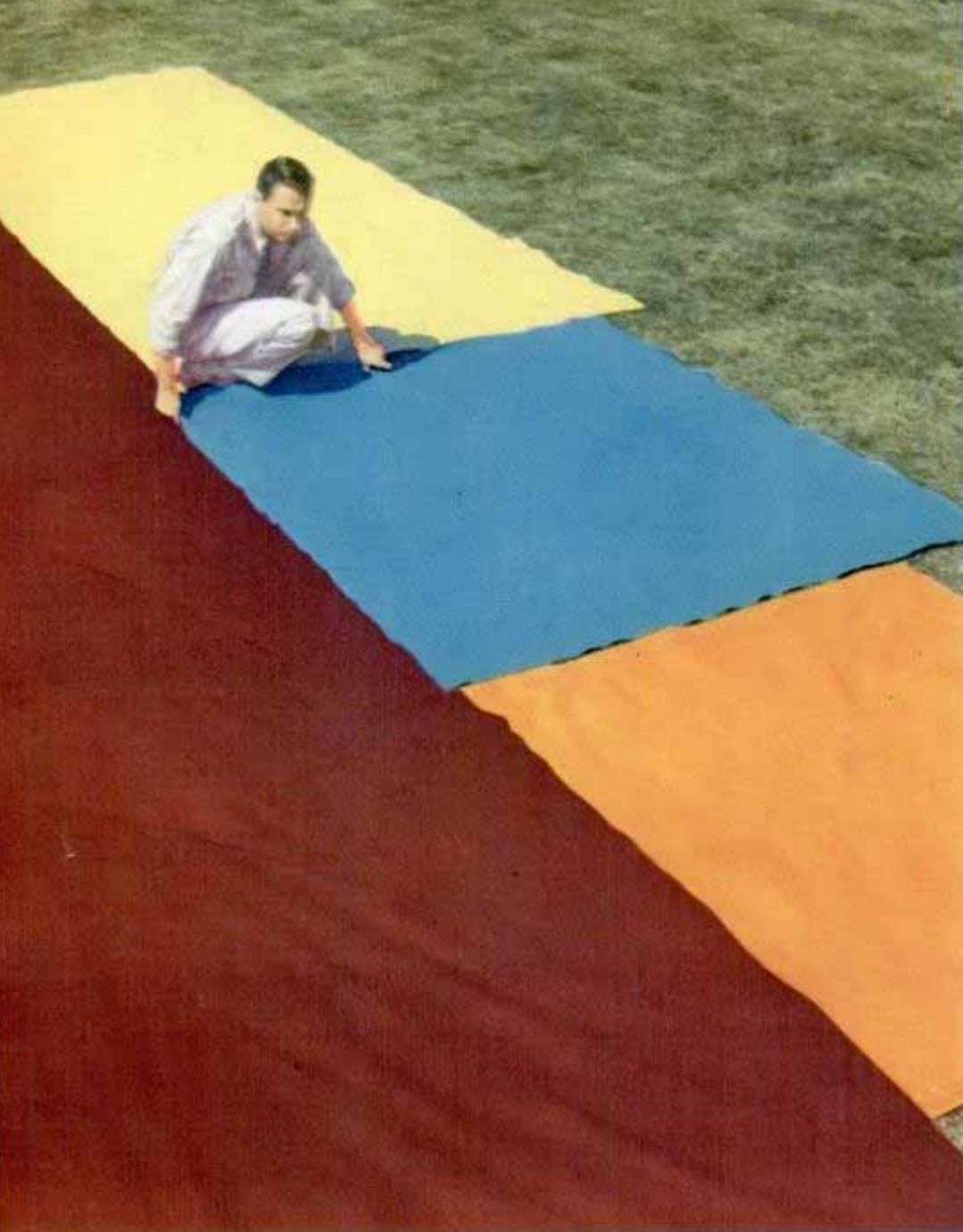

**ARRANGING** color panels on the ground so they may be photographed on color film from various altitudes. This is one method used to determine the best filters to employ at different altitudes.

**CAMERA** obscura used in bombing practice. The bomber signals by radio the exact time he would have released a bomb, while man inside camera obscura box plots bomber's position in air and determines whether theoretical hit has been scored.

141204

most valuable when the finished pictures can be delivered in a matter of minutes instead of hours or days after they have been taken. Traveling darkrooms mounted in truck trailers are being tried by the army and a quick-work process has been developed by which the photographer in a camera plane can develop his own black-and-white films while returning over the lines. The process requires from seven to ten minutes and the finished film, a negative by transmitted light and a positive by reflected light, is dropped in a message streamer to ground headquarters.

Processing of color film is so far a specialized laboratory job and takes longer. Part of the army's program is to simplify and speed up the technique so that  
*(Continued to page 128-A)*





# Photos Received by Wire on Sensitive Paper



Right, page proof of magazine sent by facsimile method. Bottom, receiving a photograph transmitted by Western Union's new service. Upper left, reproduction of photo from a David O. Selznick movie, as sent by facsimile system



tended for use of publishers, advertisers, police and others interested in the rapid transmission of pictorial matter. The system, which was demonstrated recently over telegraph lines between New York and Chicago, applies to picture transmission the advantages of the Western Union facsimile system in daily use since 1935 for the handling of facsimile telegrams, drawings and other matter.

With the aid of a special dry recording paper, photos may be transmitted and received by a telegraphic facsimile method announced recently by the Western Union Telegraph company. The paper, a carbon bearing, fibrous conducting type as sensitive to electricity as photographic paper is sensitive to light, makes it possible to receive positive prints which can be used immediately for reproduction purposes. Photo transmission by this method is in-

486  
**Television in Operating Room Shown to Student Surgeons**

Television is being tried out in the operating room of a New York hospital to permit medical students to observe surgical technique. An electric iconoscope camera, similar to that used in current television broadcasts, is mounted over the operating table and the viewing screens are located in the galleries.

60

Student newspaper

Installed by newspaper

I read June '10 the Cure by 4810-6



# Plane Speed Record Shattered in Power Dive

Breaking power dive speed records, a Curtiss Hawk ~~seventy-five~~ pursuit mono-plane recently tore through the air at a recorded speed of more than 575 miles per hour. The dive started at 22,000 feet and the plane, with motor wide open, was held in a vertical descent for 9,000 feet. Under this great speed the recording marker on the air-speed indicator went beyond the instrument's range and moved off the paper on which the graph is written. Although no accurate records of speeds attained in power dives are available, the highest hitherto reached is believed to be about 500 miles an hour. Federal aeronautics experts expressed the opinion that in the latest instance there may have been an error in the measuring device, since wind-tunnel tests have shown that as a modern plane approaches the 500-mile-an-hour speed a "shock wave" develops in the air, acting as a brake at one or more points of the ship, and effectively stops it or may, in some cases, even cause actual damage.

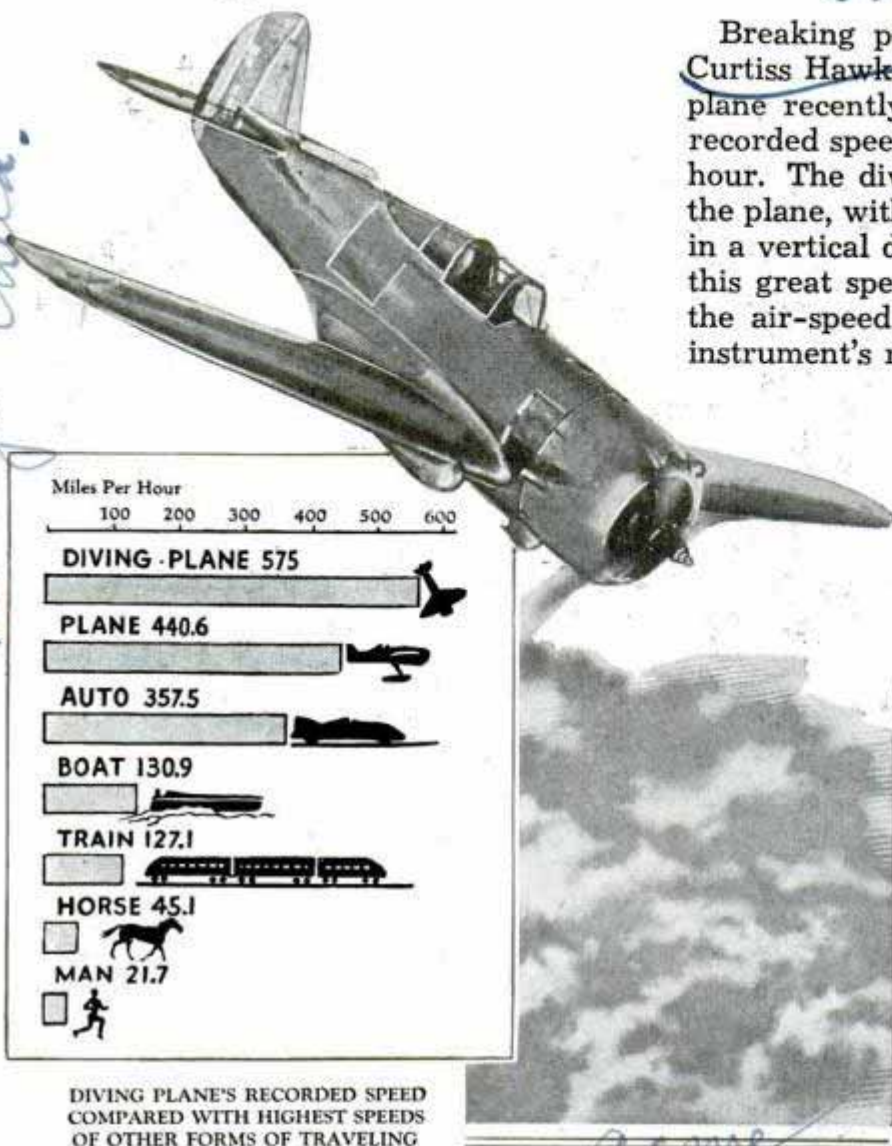

DIVING PLANE'S RECORDED SPEED COMPARED WITH HIGHEST SPEEDS OF OTHER FORMS OF TRAVELING

Curtiss Hawk single-seat fighting plane that broke power-dive record, and, below, speed records in other fields compared with airplane

# Fast Streamline Torpedo Boat Has No Mast or Funnel

Claimed to be the world's fastest warship, Britain's new seventy-foot torpedo boat, with three 1,000-horsepower engines, made fifty miles per hour during trial runs. Armor-plated and lacking both mast and funnels, the streamlined warship presents practically no "target silhouette." She carries four torpedo tubes, three guns, depth charges and smoke-screen apparatus.



Britain's high-speed streamline torpedo boat without mast or funnels, said to be world's fastest warship, made fifty miles an hour in trials. It is powered by three 1,000-horsepower engines

*Flung by Chief Test Pilot H. Lloyd Child.*

*Motor Cars  
Vulcan and Remore  
Buffalo N.Y.*

*Wide Walls*

*Miss Vesper, Ed. Parliament England*



# Piano Keys Play a Vacuum-Tube 'Orchestra'

Unlike any other musical instrument yet devised, the Novachord, latest invention of Laurens Hammond, is virtually an orchestra in itself. Its appearance and its seventy-two note keyboard are those of the spinet-type grand piano, yet at your

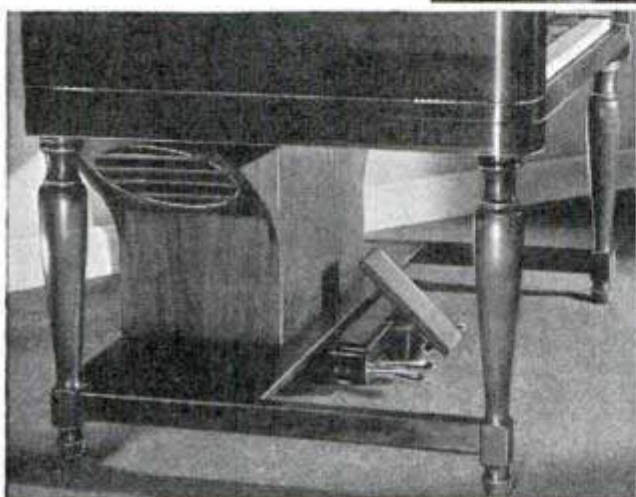

*Above, trying the Novachord's various tone qualities. Left, pedals, loud speaker and the manual controls*



fingertips are the sounds of the cello or French horn, the organ, piano, and many another instrument. Make a simple adjustment of the controls and you hear the singing strings of the Hawaiian steel guitar produced with remarkable fidelity. Secret of this versatile instrument is its new principle of tone generation, accomplished through vacuum tubes arranged in an ingenious electrical circuit. These tubes carry far less than their rated current and are guaranteed three years in home use. The Novachord plugs into an ordinary house circuit, and has no motors or rotating mechanisms. It consists of a keyboard, control panel, generator, amplifier, and loud speakers located on either side of the

foot pedals, which include an expression pedal, sustaining pedals operated by either foot and a sustaining pedal for the bass only. The fourteen controls on the face of the instrument have various functions of mixing and "coloring" the tones and varying the "attack," and in this way the sounds of traditional orchestral instruments, brass or string, may be simulated. Center control is the "Balancer," which suppresses or augments the volume of the lower half of the keyboard. Above it is a switch which varies the tone from bright to mellow. One control produces a sharp, percussive attack or a soft, slow tone that takes an appreciable time to gain full volume as the key is held down. At one extreme is heard the staccato note of the piano or harpsichord and at the other, the smooth singing of organ or strings. Yet there are no strings and hammers nor wind. Twelve vacuum-tube oscillators, one for each note of the musical scale, control the notes. They operate at the frequencies of the highest octave and supply the tones of that octave; other notes are obtained by a frequency divider system. Despite its versatility, the instrument can be played by anyone who plays a piano.



# SECRETS of

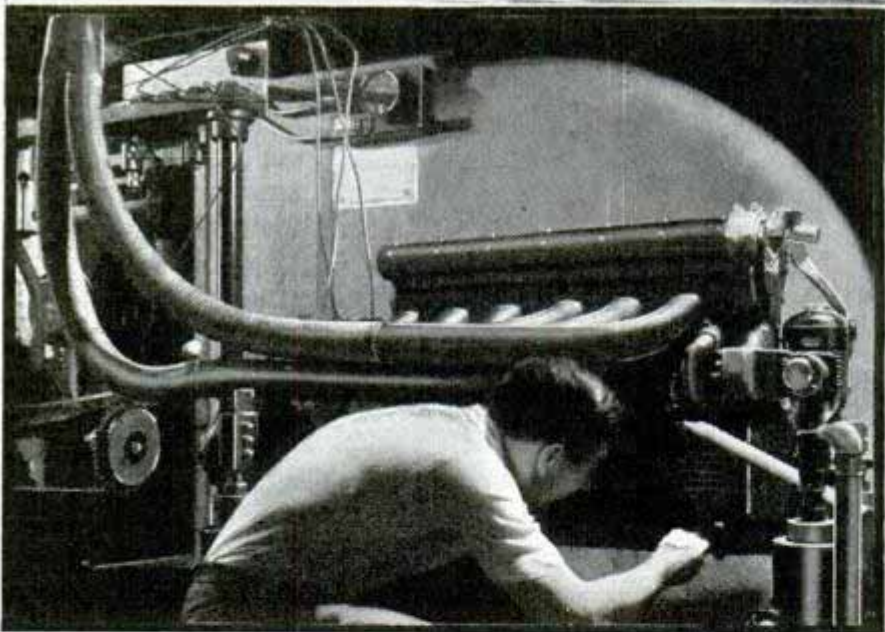
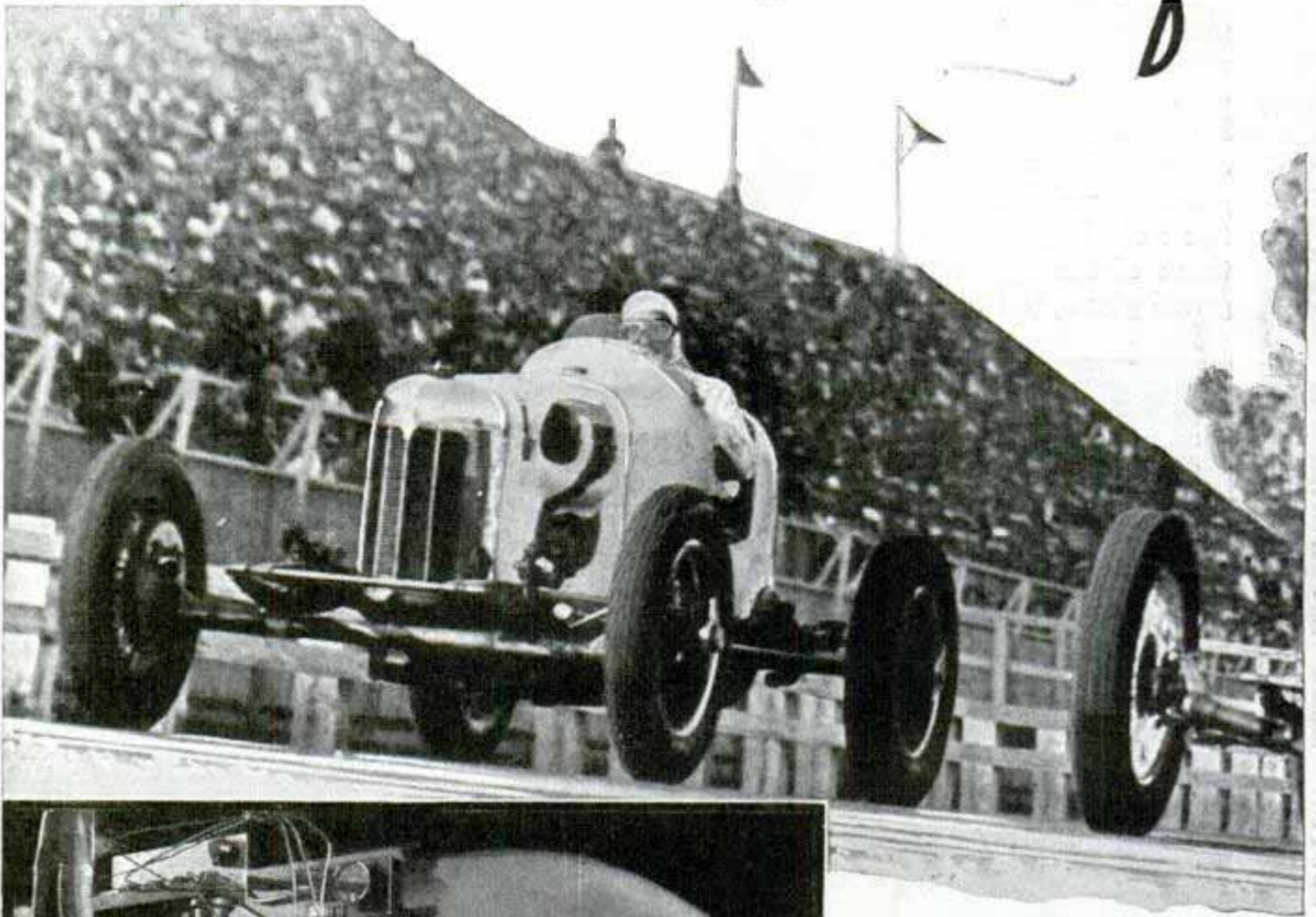

Above, roaring down the straightaway, with the car on the left passing the one next to the rail. Left, 550-horsepower engine on dynamometer stand for test.

*Thorne's 6-cyl.*

By

BOB SWANSON

*8904 - 7th Ave  
Los Angeles, Calif*

**T**HERE is a weird sound unlike any other in the world. It's the mighty throb of unleashed power when thirty-three drivers simultaneously press their accelerators to the floor at the start of the Indianapolis race.

The men in the lead hear only a dull rumble behind them. The tail-end drivers and the spectators get the benefit of the hair-raising song. But no matter what po-

sition a driver occupies, that sound marks the end of months of careful planning and the beginning of a four-hour duel.

Winning the big Memorial Day race is not mainly a matter of good driving, with the prizes going to the men who have the nerve to floorboard all the way. Instead nearly every action, every move on the track, is deliberately planned.

This is a 500-mile race, 200 times around



# BIG-TIME RACING

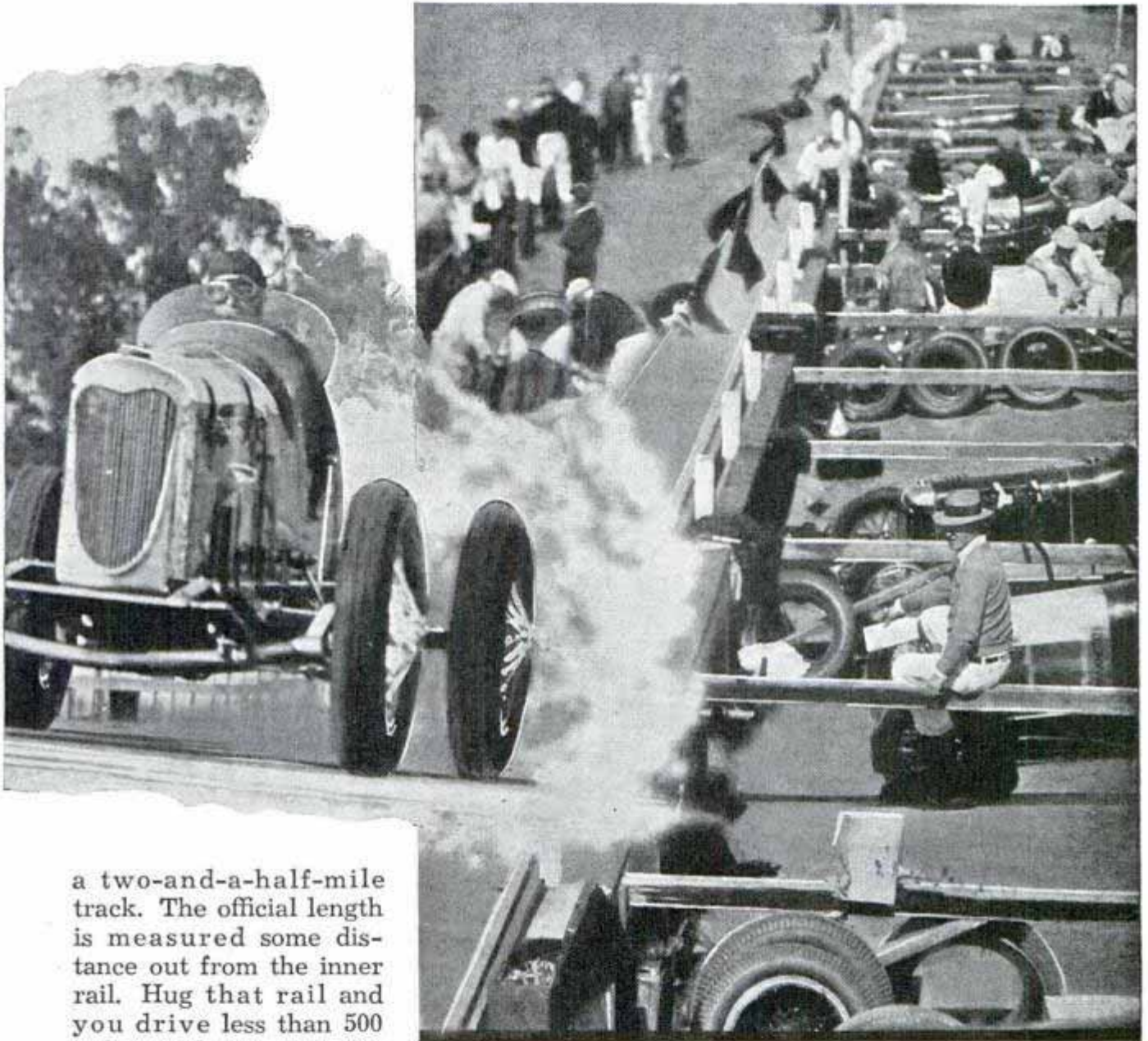

a two-and-a-half-mile track. The official length is measured some distance out from the inner rail. Hug that rail and you drive less than 500 miles to finish. But the men who drive farther out on the track in the speed groove will finish ahead of you. Roughly, this groove is high and close to the outer walls on the straightaways, and cuts down toward the rail coming out of each turn. Different cars handle differently and no two drivers follow exactly the same path.

Another important detail is the way the car handles. Balance, springing and the driver's own habits determine the "feel" of the car. The pit crew gets it exactly right, after a few trial runs, so the driver can hold the car with a sure hand without working too hard in the turns.

*Pit scene at paved track. Pit men keep sharp eyes on their cars so they can be prepared for quick servicing of the speedsters*

Most of the rest of the frantic pre-race preparation is the responsibility of the mechanics. They have to hit exactly the right combination of valve timing, carburetion, plugs, and fuel to produce the most power. Ordinarily the entire motor will be torn down two or three times in the process. Possibly pistons will be changed to obtain a different compression ratio and another fuel will be tried. Many of the cars, now that fuel restrictions have been lifted, are burning grain alcohol at \$4.00 per gallon, \$240 to fill a sixty-gallon tank.

As soon as the mechanics get the engine



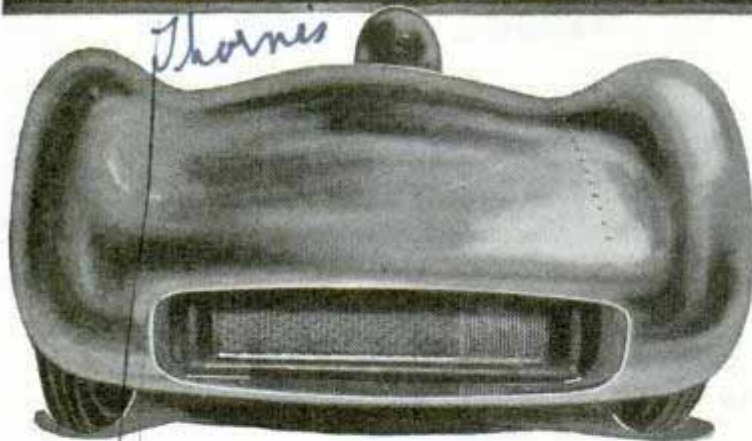
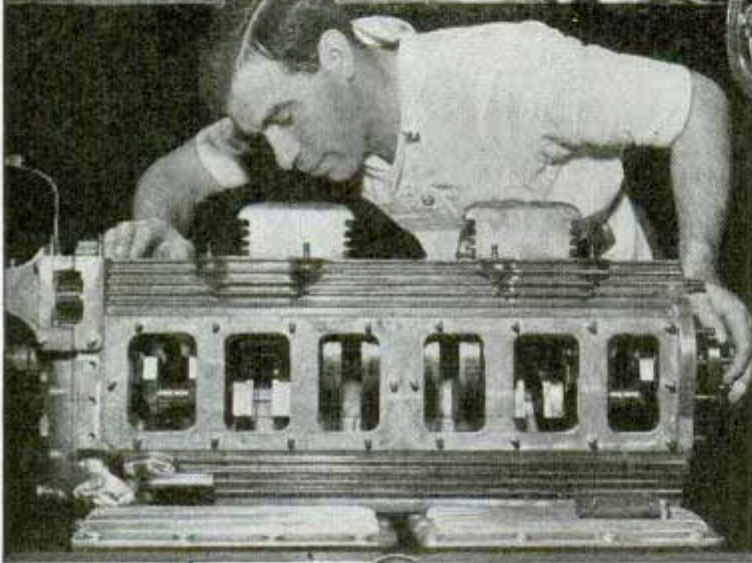
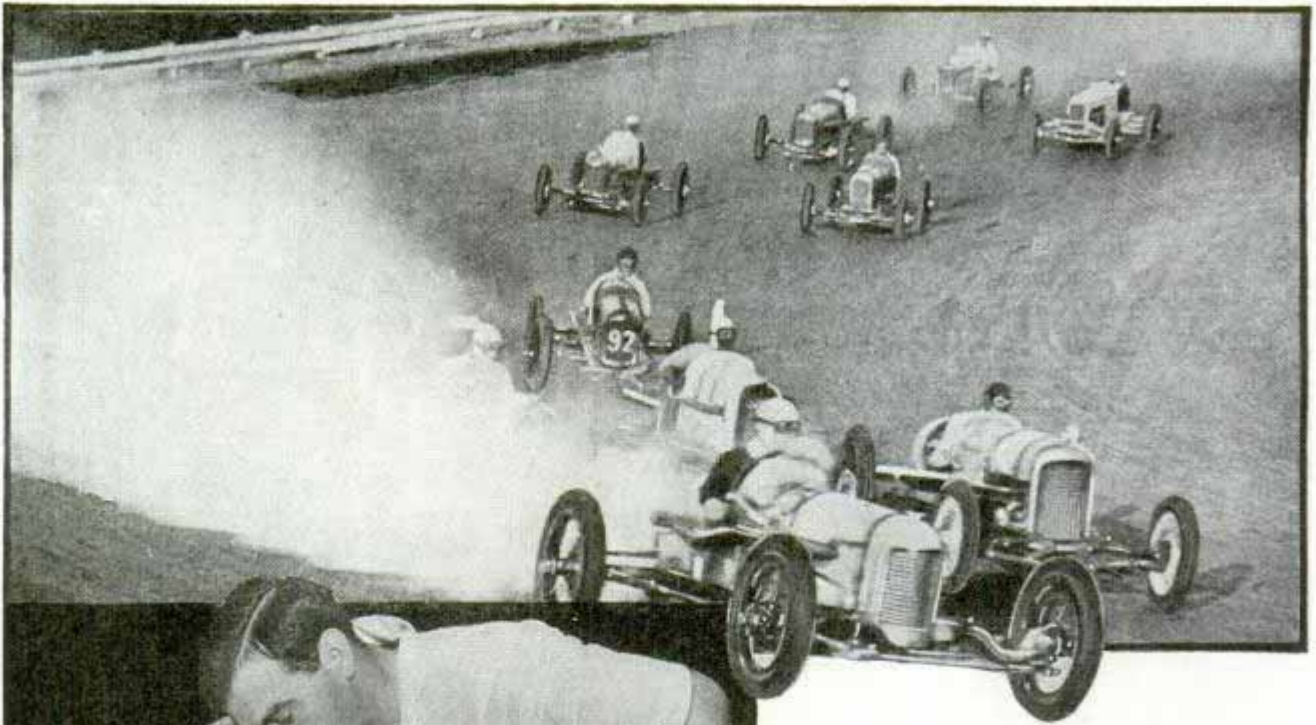

Top, cars bunched at turn on Los Angeles dirt track. Center, crankcase of racing engine. Bottom, nose of racing car has exposed radiator air-intake slot

tires. Racing tires are coated with a thin skin of rubber. The white breaker strip under the tread is our safety warning and when a driver sees that the breaker strip is beginning to show he knows he must stop for a tire change.

During the week or so before race day some drivers earn a few hundred dollars on the side by running tests of new or experimental tires for a tire company. Dual wheels are put on the car and the tires to be tested are mounted side by side with motorcycle tires that act as safeties in case the experimental fabrics blow up.

Veterans say there are thirty-two reasons why it's hard to win at Indianapolis, meaning the thirty-two other drivers in the race. That is only part of it. A car ahead may spin or blow a tire and involve you. Your car is apt to break down for any of a dozen reasons. Occasionally a car that has been

perfectly tuned the car is taken out on the track for a fuel test, checking on the miles per gallon to estimate the time for pit stops. Oil consumption is checked over and a trial on tires is apt to be run. Ordinarily one pit stop is planned, at about the 300-mile mark, to fill up with water, fuel, and oil, and to replace the two right-hand

groomed for weeks is wheeled to the starting line and then refuses to start. In the 1937 race I crept from twenty-third to fourth place in eleven laps and at fifty laps I was in third place. Then a bowl in the carburetor broke, putting me out of the race.

(Continued to page 116A)



*Marine Division*  
*Jersey City Police Dept.*  
*Capt. William M. McLaughlin*

# Police Emergency Car Launches Rescue Boat

Ready for any emergency along the Jersey City waterfront is a police truck fully equipped for rescue work and resuscitation, carrying a sixteen-foot motor launch that can be lowered from davits or rolled down on steel skids. Backing the truck to the water's edge, the police set up portable davits in a few seconds and launch boat and crew. Aboard the truck, the boat is mounted on a cradle with pneumatic tires, and if approach to the water is difficult the steel track is hauled from the rear of the car and the boat can be pulled easily to the river on its wheeled cradle. On each side of the truck are compartments containing life belts and vests, grappling hooks, rope ladder, inhalators, blankets and Thermos bottles, heat packs, hawsers and bilge pumps, and steel chains that can hoist sunken automobiles. At each corner is a 500-watt floodlight, and 400 feet of cable permit their use on portable tripods. The truck engine drives a 5,000-watt

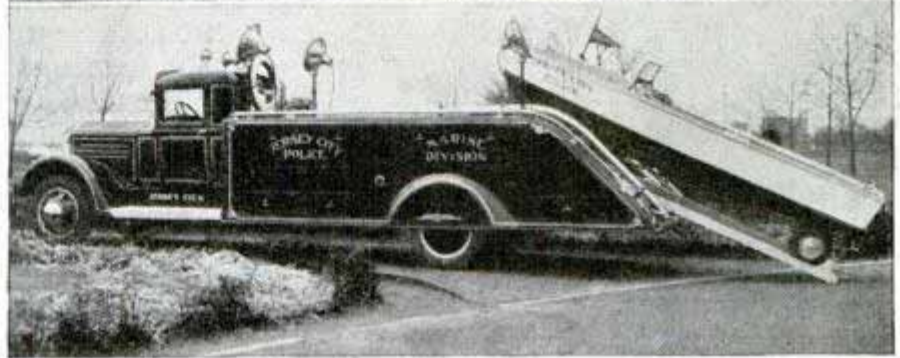

Launching rescue boat from police truck with davits, and on a steel track

generator for floodlights and power drills. A two-way radio keeps the squad in touch with headquarters. The rescue launch, driven by a seven-horsepower outboard engine, has two seats with cushions which could serve as life jackets.

*J 116*

# Fuselage for Plastic Airplane Is Molded in Two Hours

Plastic airplanes whose wings and fuselage could be molded in two hours offer a promise of low-cost mass production. One plane with plastic fuselage has flown more than 100 hours, but its wings are of ortho-

*Dakelite Corp. 249 Park Ave N.Y.*

dox construction. The material used was "Duramold," thin sheets of hardwood veneer bonded with a thermo-setting phenol resin to a thickness of about five thirty-seconds of an inch. It is waterproof, one-sixth as heavy as duralumin yet of tremendous strength. Two halves of the fuselage are molded in a great press, then sealed together without internal bracing. With its smooth exterior the plastic plane could cruise an estimated eight per cent faster than a similar ship with riveted surface.



Five-seat plane with molded plywood fuselage cruises 200 miles an hour

*Clark Aircraft*  
*200 w. 11th St. N.Y.*



# Airplane 'Drained' of Static by Wire Shot from Tail



Long wire which "drains" static from airplane is shot from socket in tail at touch of button in cockpit

No matter how bad the static conditions, normal reception of radio beam and voice signals on airplanes is assured by a static suppressor just developed. It has been installed on every transport ship of United Air Lines. The pilot releases the device from a socket in the plane's tail, by pressing an electric button in the cockpit. A wire shoots out from the socket and trails in the slipstream, and static electricity which otherwise would leak off various parts of the plane is discharged harmlessly through the suppressor. An extra wire is carried in a second socket. Engineers found that static was discharged from the sharpest points, so they used a steel wire smaller than the sharpest point on the plane, with a resistor to isolate the discharge from the vicinity of the plane.

## Non-Skid Paint for Floors Contains Steel Flakes

Non-skid paint intended to take the slipperiness out of concrete or steel floors and stair treads is available. The manufacturer

*United Laboratories  
Cleveland*

mixes eight pounds of stainless-steel flakes with every gallon of a varnish vehicle. Because it resists abrasion it is also used as a covering for conveyors and chutes.

## Vacuum Applies Brake Pedal When Throttle Is Released

Automatic brake control is provided by a vacuum-operated instrument that applies the brakes at the instant you withdraw your foot from the accelerator. It saves the time consumed in lifting the foot from the throttle and moving it over to the brake pedal—enough time, particularly in high-speed driving, to prevent many an accident. Gradual braking or emergency stops are made according to the suddenness of release of the accelerator. The device is located under the floorboards, and at the time of installation it can be adjusted in pressure to conform to your normal manner of driving. It does not replace the regular braking system, for the pedal can be used in the ordinary way, and the vacuum control can be disconnected by a button on the dashboard. It holds the car on hills while parked with the engine running.

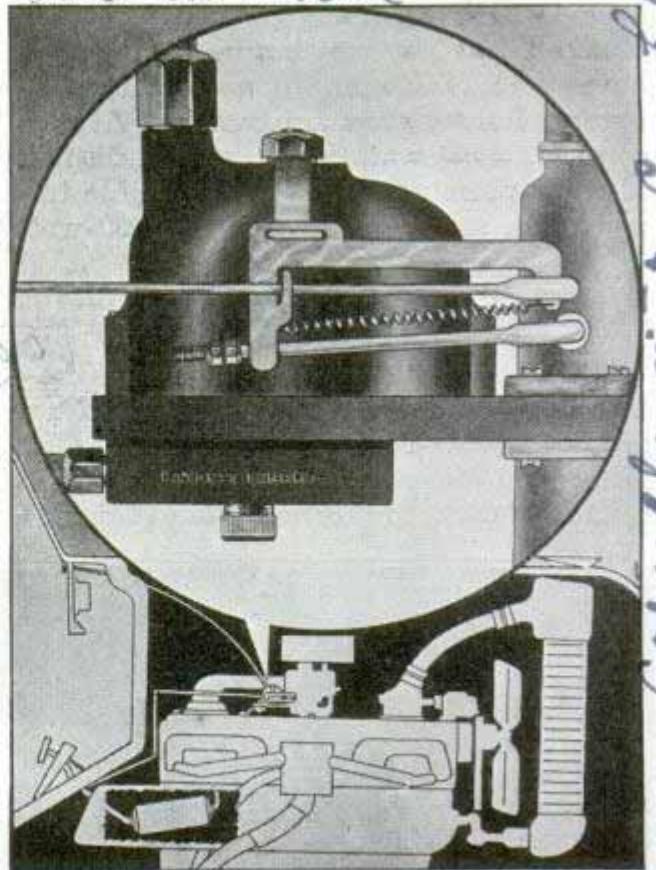

Diagram of automatic brake control installation on car, with the unit itself shown in circle

*608 25th  
Baltimore, Md. see letter  
Pender - Radio Corp.*

*Head of Research  
Laboratory*

*286.*

*Los Angeles  
500 W. 6th  
Vac. U. Matic  
Co. Ltd.*



# Fuel Laboratory on Wheels Traps Gas Cheaters

Making its appearance at gasoline filling stations without forewarning, a fuel-laboratory trailer operated by the state of Illinois catches gas cheaters. Apparatus in the mobile testing unit consists of an ice chest, sink, burners and a pair of cylinders containing gas, and a distillation outfit. Distillation of gasoline taken from the pumps discloses its ability to start a cold motor, its susceptibility to vapor lock, percentage which may be left behind to dilute crankcase oil, and whether or not lower-grade gasoline is blended with it. Flash and fire points of kerosene also are determined, and a distillation test ascertains the presence of ingredients which may tend to clog or crust the wick of a burner. There is also a Saybolt universal chromometer which makes a color comparison test of gasoline and kerosene, since color may indicate contamination if it varies from the original color at time of manufacture.

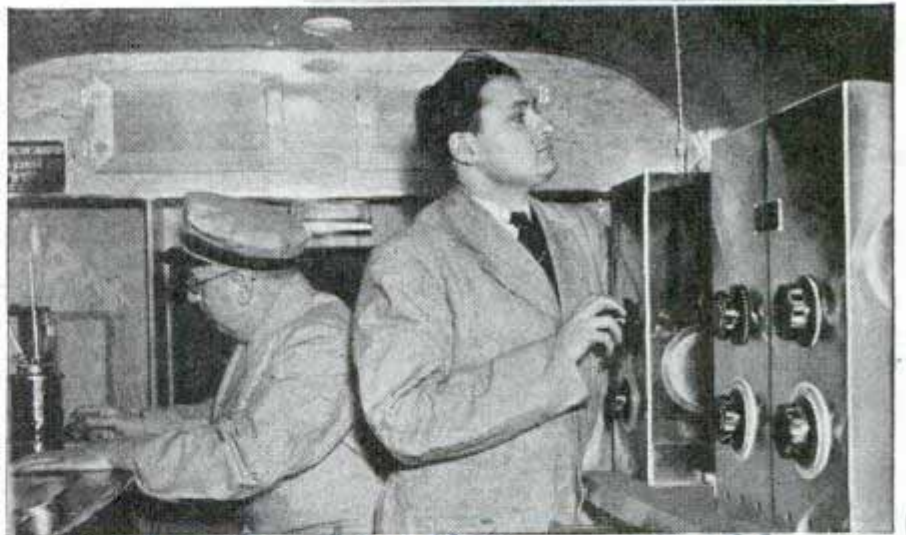

Top, inspector records type of gasoline taken from pump. Center, trailer laboratory. Bottom, making test of sample in laboratory

## Paintbrush with Curved Handle Reaches Inside Corners

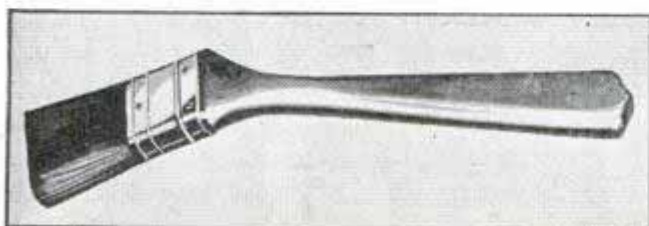

Unusual shape of this brush makes it easier to paint or clean inside corners and difficult places

Painting inside corners and in other difficult places is facilitated by a brush that has a curved shoulder. Besides its usefulness in painting cupboards, bookcases and the like it can be employed as a dusting brush for inaccessible parts of machinery.

There are about 3,450 miles of four-lane highways in the United States.

*Pittsburgh Superior and Steel Co. Pa.*

*Field Representative*



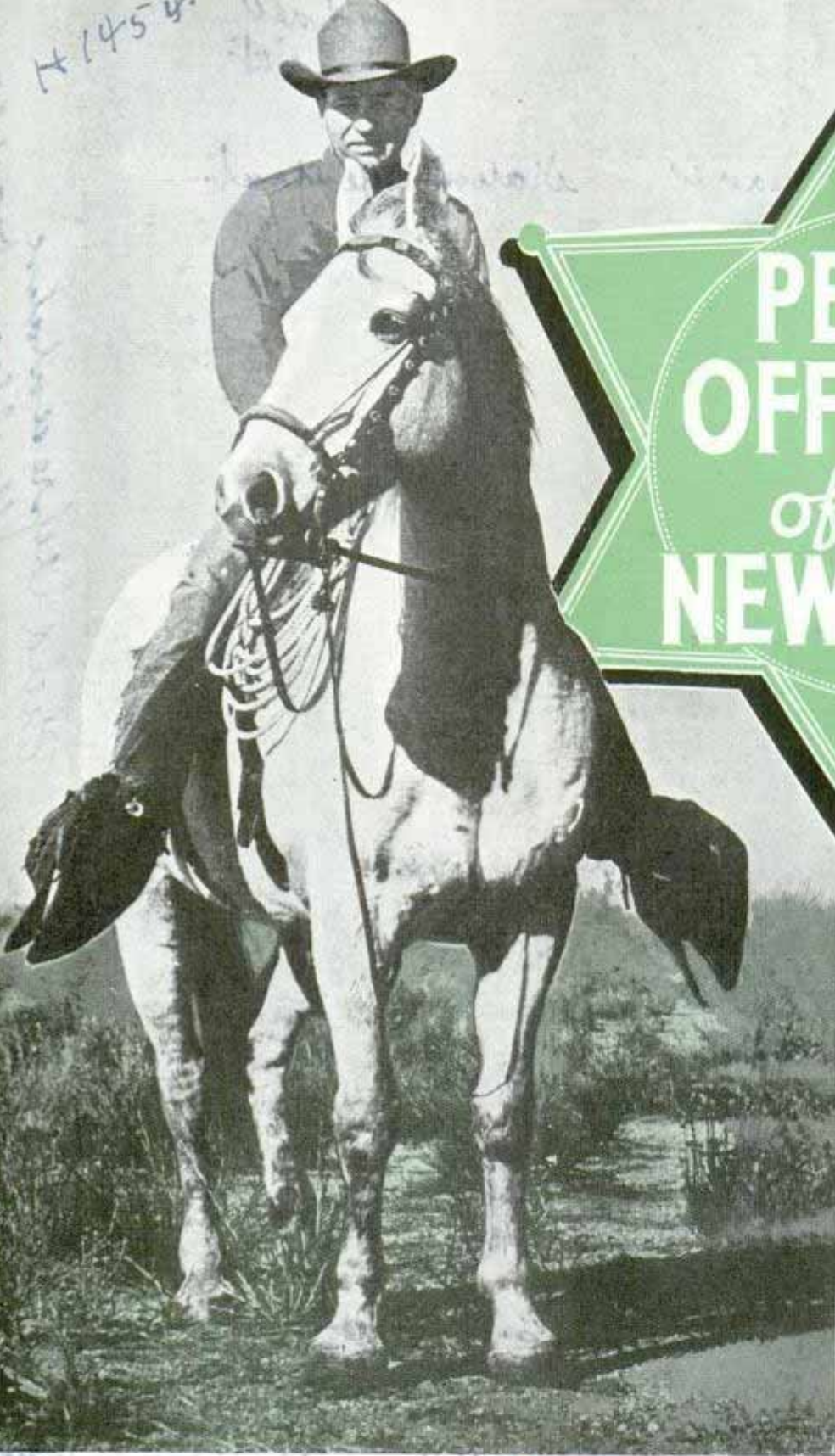

# PEACE OFFICERS *of the* NEW WEST

*Left, a mounted deputy sheriff on the range hunting for evidence in a cattle-rustling case*

was still in the field, moving from point to point to keep track of the racing flames. Zero humidity and a gale were sweeping the flames across thousands of acres of trees and brush. By radio the sheriff helped clear the way for fire-fighting trucks, supervised his deputies as they rushed ranchers and vacationists from dangerous areas, and kept the behind-the-scenes organization moving.

**T**HE sheriff parked his car on the mountain road to study the oncoming forest fire, then reached for the radio microphone and snapped on the generator switch.

"Car One to KSBC. Send Cars Six and Thirteen to Waterman Canyon to clear everyone out in a hurry. The fire is spreading that way. Car Three to the foot of the highway to stop traffic. All other deputies stand by."

At daybreak next morning the sheriff

An automobile with a two-way radio is a brand new mount for a western sheriff but he still must be the hard-riding, straight-shooting peace officer of tradition. He must ride a horse or drive a car equally well and he is as much at home with a couple of deputies around a camp fire as he is in his modern office. The old and the new live side by side on the western ranges. Indians on the rampage and automobile thieves, high graders and check



1055's

*Carl... Holman are  
Los Angeles Calif*



forgers, seem to belong to different centuries but peace officers have to contend with both.

Take some of the experiences of Emmett Shay, sheriff of the more than 20,000 square miles that make up San Bernardino county in California. He and sixteen active deputies—his entire staff including stenographers and radio men numbers only forty—enforce the law outside the towns in an area larger than Vermont and New Hampshire combined. His jurisdiction extends from the Nevada border and the Colorado river on the Arizona border to within fifty miles of the Pacific, three-quarters of the way across the state. Sometimes his men ride 300 miles to answer a call and a man on duty may drive more than 60,000 miles a year.

Inside his territory are mining towns, cattle ranches, mile-high timbered mountain ranges, stretches of arid desert, orange groves, and metropolitan commu-

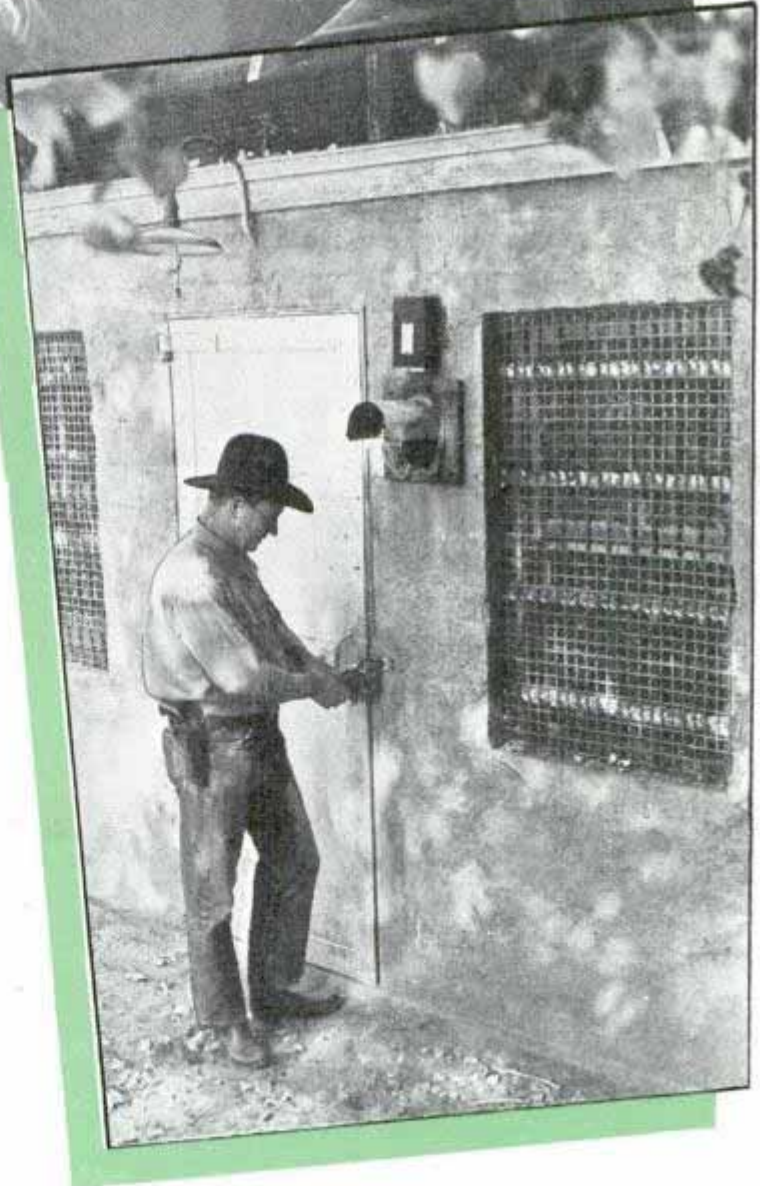

*Top, Sheriff Shay at microphone. Below, deputy locks up tiny desert jail. Notice screened ventilator over door*





*Top, sheriff with collection of weapons taken from prisoners; right, headquarters of "the law" in pioneer mining town. Bottom, deputy checking brands*

nities. The work of the deputies is just as varied as the geography. One day they may have to investigate a "wild west" shooting in a mining town and that night they may stake out in the sagebrush to put a stop to cattle-rustling activity. Possibly they will be called to fight a million-dollar forest fire in a mountain resort area, or check licenses in search of stolen cars.

Once thieves escaped with \$20,000 worth of jewelry from the Palm Springs resort and headed into Shay's county. That ended their freedom. Shay bottled up hundreds of miles of desert roads as quickly as if his men were surrounding a house. As soon as the warning came in over the inter-county teletype the radio central went to work, rousing men in one desert junction after another and sending them out to patrol the roads. There are few roads through the desert, still fewer highways and the thieves were easily trapped.

Not long ago two convicts escaped from San Quentin prison, kidnaped two guards and a car, and dodged through a dragnet laid to catch them. They reached San Bernardino and released the guards after saying they were

bound west. When Shay was notified he plugged the roads to the east instead, and an hour later two of his deputies caught up with the convicts and killed them after a running battle.

A dozen times a year or more there comes a call that hikers are lost in the mountains or a prospector has overstayed his leave in the waterless desert. Saddles and horses are loaded into trailers and towed to the end of a

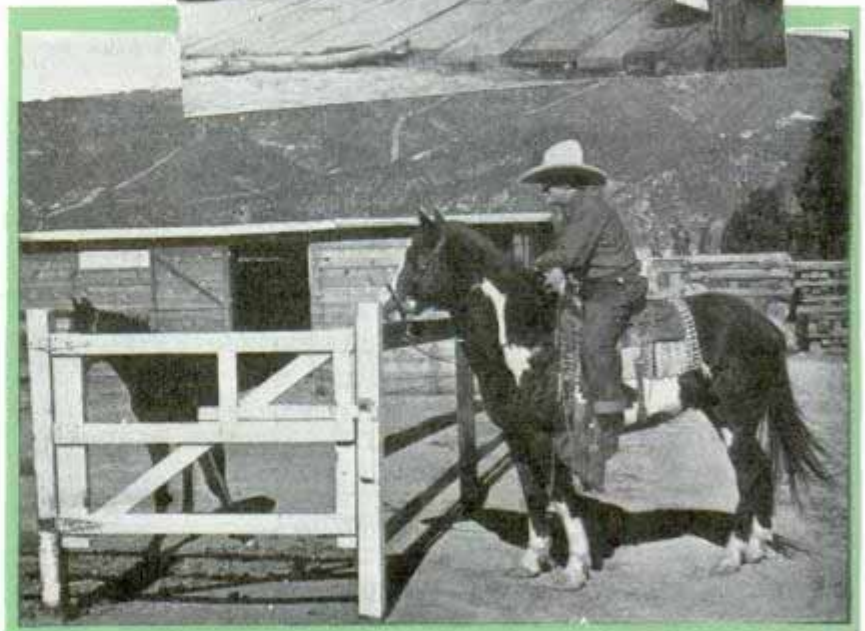
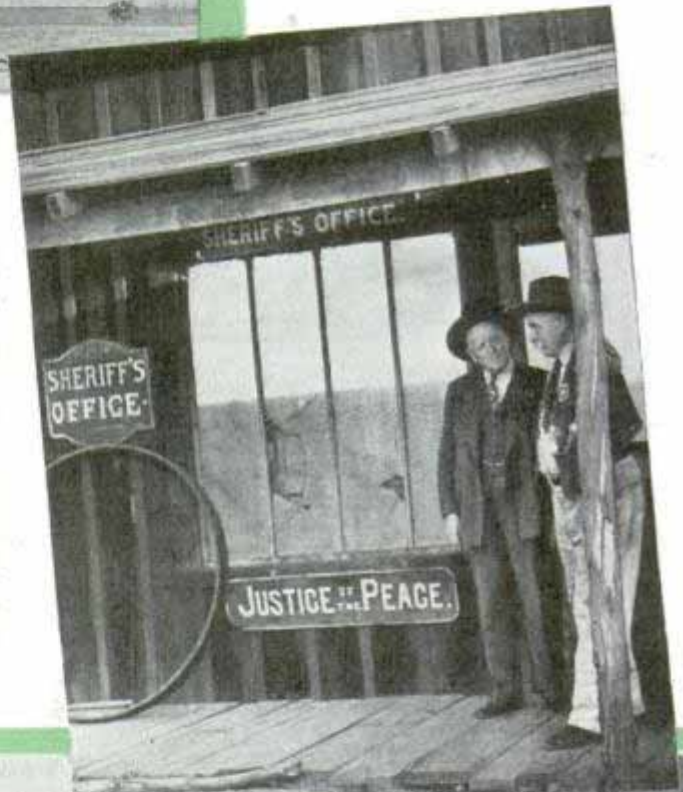





road and the men ride on into the region, taking their lead from Jesus Amarias, the aged Indian tracker who is one of the veterans of the force. Hikers usually stay close to the trails but great distances may have to be covered by a searching party on the desert. If the lost prospector is still alive and on the move he is usually

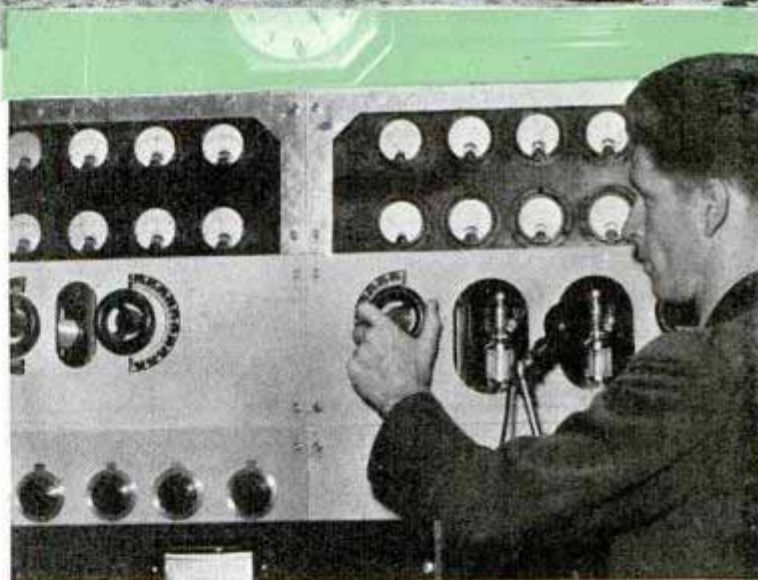

Top, deputy unloads horse from trailer to ride into hills. Right, sheriff's central radio transmitter. Below, "Oregon boot," formerly strapped on prisoner to prevent escape, and an 1867 reward poster



found, since one mounted man, sweeping the desert through glasses from the hills, can thoroughly cover many square miles in a day. Last summer deputies found the body of a man, with his watch still ticking; he had abandoned his car, stuck in the sand, and struggled only a few miles on foot through the desert heat.

In addition to his own deputies, the sheriff has an unofficial posse of fifty able riders, deputized and on call when needed.

City-trained police are handi-

(Continued to page 132A)



# 'Fingerprint' of Brain Wave Recorded on Paper Tape



Attaching electric terminals to ear and back of head to obtain "thought wave" record shown at bottom

No two persons think alike, and so your thought waves leave "fingerprints" as distinct and individual as the whorls of your thumbprint. From a five-year study of thought waves and their recording, Dr. Lee E. Travis, psychologist at the University of Southern California, has concluded that an electric graph can record various types of thought as well as thought waves distinct enough for personal identification. He places electric terminals on the ear and the back of the head of his subject, and the brain impulses—magnified 300,000 times—are registered in ink on a paper tape.

## Quick-Righting Fliers' Compass of Earth Inductor Type

Earth inductor compasses have been in use since 1921, but only recently the Washington Institute of Technology developed a compass adaptable for use on airplanes and ships. The new earth inductor overcomes the former inability to recover quickly from the rolling and pitching of a ship or the bank and dive of an airplane. It rights itself and gives a proper reading

within a half second after a disturbing motion. Advantages over other types of compass are that it does not spin wildly like the magnetic compass nor require frequent setting, as does the gyrocompass. On airplanes, the earth inductor compass may be air-driven, and on boats it is motor-driven.

## Diamond Set in Floor of Capitol Is Guarded by Piped Sound

Distances in Cuba are measured from a point marked by an \$8,000 diamond set in the floor of a room in the capitol. Although this diamond appears to be unguarded, it is watched by remote guards. They are not stationed in the room itself, but a metal tube beneath the diamond picks up any sound made near the gem and leads it to a point where men are always on watch. The slightest disturbance is amplified by the tube and brings guards on the run.

## "Robot" Breaks in Your Pipe by Siphoning Off Smoke

One way to break in your new pipe is to let the water faucet smoke it for you. This pipe-smoking "robot" consists of a few feet of rubber tubing and a glass "Y." The tubing is cut into three pieces, two of them a foot long and the third two or three times as long. One short length is attached to the pipe, the other becomes the exhaust, and the long tube connects the "Y" with the water faucet. The pipe must be supported at a level higher than the "Y." Fill the pipe

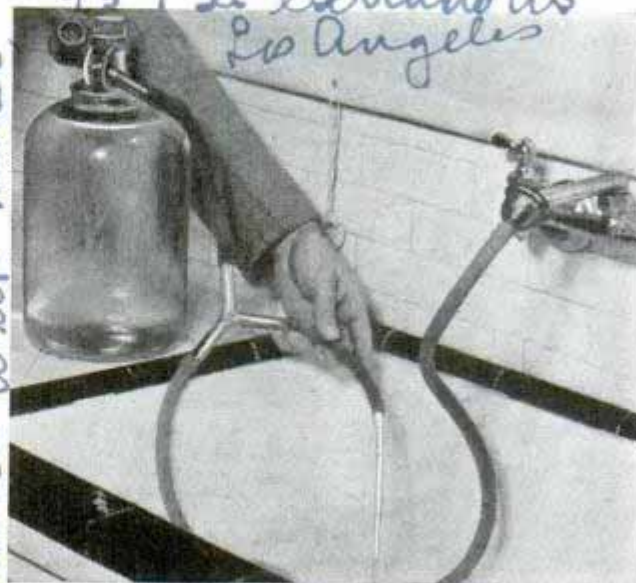

Handle of jar is used to hold pipe while water pressure draws air through pipe to keep it burning

*Dr. Travis*  
*H.S. Jaarden*  
*Shy. Track Sea-Track*  
*g-39*  
*Refer. American Express*  
*g 45*  
*Los Angeles Calif*  
*Los Angeles*  
*457 Serrano Ave Los Angeles*  
*Sum. Dr. Be With Miller*  
*Sumo Service 12/28/58*  
*San Francisco*  
*San Francisco*  
*San Francisco*



with tobacco, turn on the water and light the pipe; the smoke is siphoned out through the exhaust tube and enough draft is provided by the properly adjusted water pressure to keep the pipe burning.

**Six-Gun Bomber and Scout Plane Has Seven Tanks**

Called one of the most versatile military planes ever built, the new "Vultee" V-twelve bomber, equipped with complete camera installation, is useful for reconnaissance and observation as well as attacking and bombing. Driven by a single Wright 1,000-horsepower engine, the plane has a maximum speed of 243 miles per hour, a range of over 2,000 miles, and a top ceiling of 25,500 feet. Six machine guns are mounted in the ship, and it carries bombing loads up to 3,000 pounds. A crew of three operates the all-metal plane which has seven gasoline tanks, bringing remotest shores within range of a few hours.

**Land and Water Automobile Has Seats for Three People**



Amphibian auto carries three passengers on road. Below, more at home in water the craft nearly doubles its land speed

Not needing a truck or tow car to haul it to the water, an amphibian automobile invented in Germany has seats for three people. In tests on land the tub-like vehicle traveled seven and one-half miles per hour, and more than twelve miles an hour in the water. The propeller is raised above the road when the car trundles along on its small wheels.

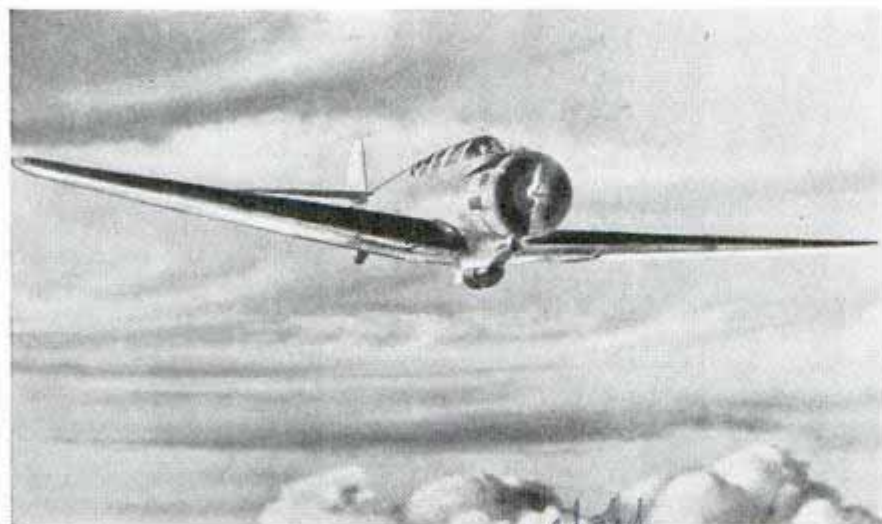

Carrying six machine guns and camera equipment, this high-speed bomber is effective as attack plane and useful for observation purposes

Vultee Aircraft Plant  
Glenn, Calif

Railway Age  
Jan 2 1939

by Ed. from Caney's  
Berlin



7 14 5 5

Ad. Emile O. Schwanbacher,  
D. Conrad O. E. G. Schwanbacher, Newark

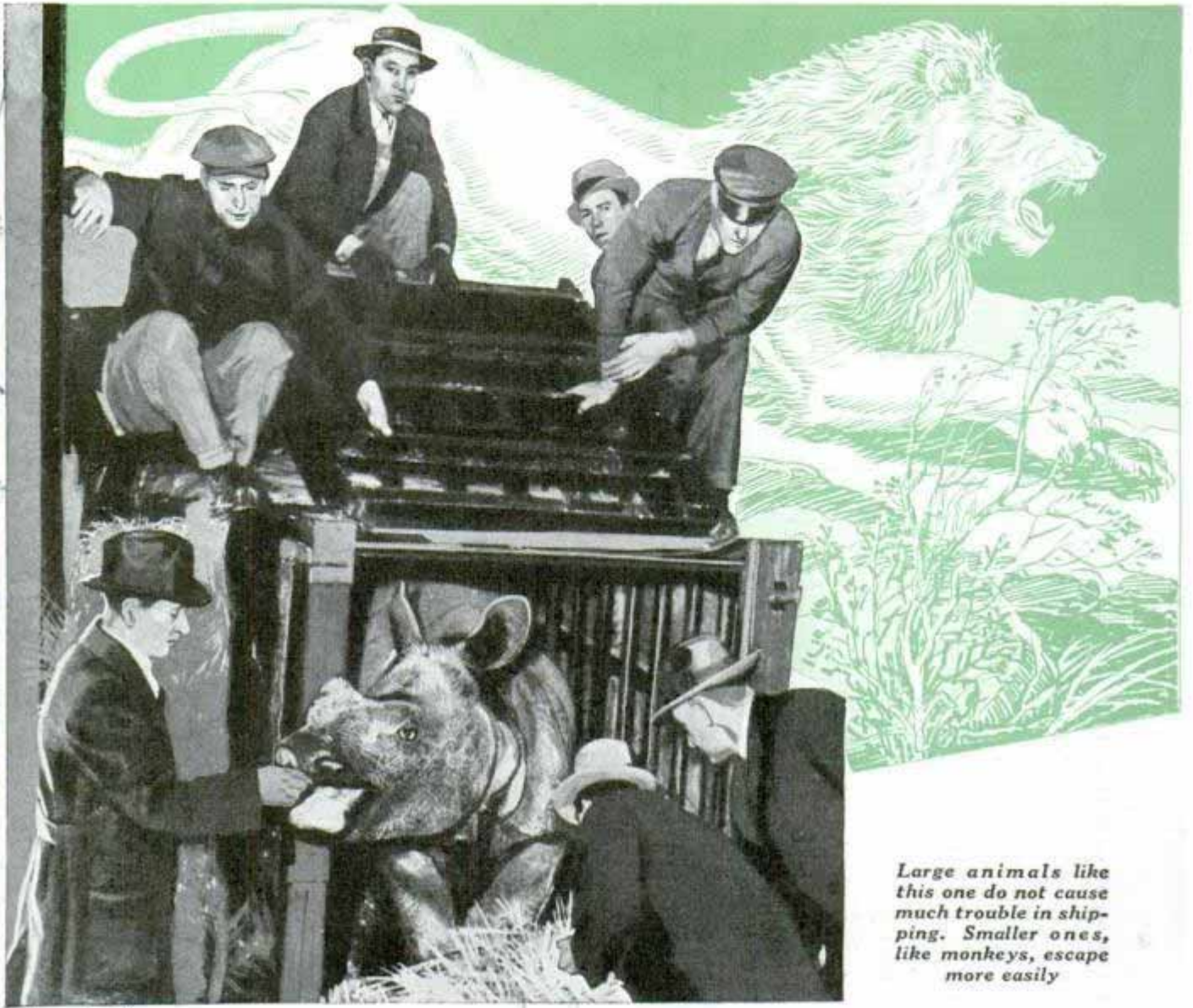

Large animals like this one do not cause much trouble in shipping. Smaller ones, like monkeys, escape more easily

# Hunting LIVE TREASURE

"RADIO Borneo to round up three pairs of black cassowaries. We've only one on hand. Better send Carroll back to Africa for another try at okapi. Call Vespermann at the Long Island station and find out when we can ship those Siberian camels to the coast. Their fifteen days of quarantine are up today."

Thus we hear Adolph Krone, manager of Louis Ruhe, Inc., the world's largest importers of wild animals, giving orders in the New York office which will send adventurous men into action in the far places of the earth in search of animal treasure.

It is a risky as well as a physically dangerous business. Not only is it difficult to

track down and capture rare specimens, but the many problems of what to do with them when they're caught have baffled many veteran explorers and made the collecting expeditions a science apart from exploration.

"After we've caught our specimens alive," says Mr. Krone, "we've got to bring them out of the jungles or the wilds in cages or crates to the nearest shipping port, a slow painstaking journey, particularly if the animal treasure happens to be in the form of a rhinoceros or other heavy animal. We've literally got to cut our own roads back.

"Then, when we get to the shipping port,



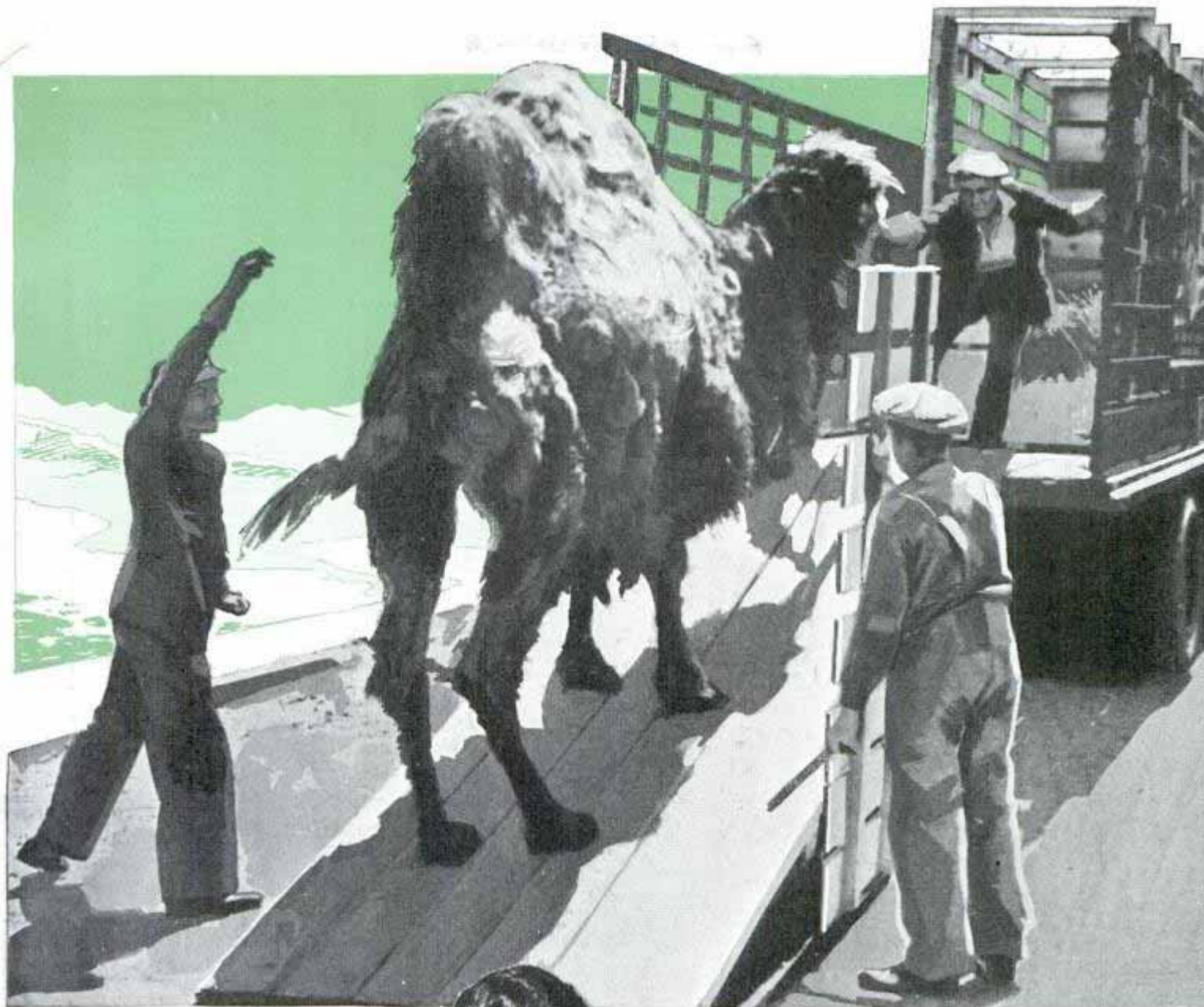

*in the*

# JUNGLE

we may have to keep our specimens in cages for several days so that they may get used to a 'captivity diet' which replaces food to which they've been accustomed. When they are placed on board a vessel for shipment to our station at Hanover, Germany, or Long Island, New York, pending their sales, they must be watched carefully to make sure that the change in climate does not kill



*Top, loading Siberian camel into truck. Bottom, baby gorilla finds drinking out of a cup exactly to his liking. It takes time to accustom wild animals to a captivity diet*



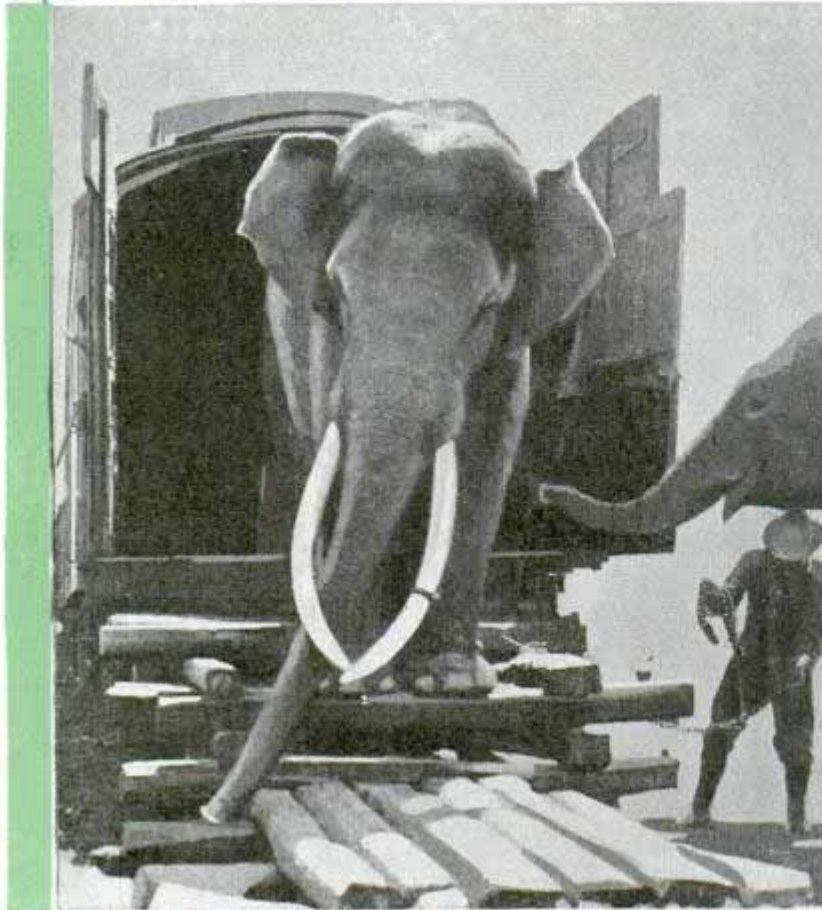

them. They must be nursed through seasickness—for nearly all wild animals get seasick when they're shipped by boat. They must be guarded carefully against escape from their shipping crates. When they do get to New York, if they happen to be cloven-hoofed animals, they must be quarantined for fifteen days. Thus it may take months to complete a transaction and fill an order."

Right now there is a standing order on the Ruhe books for okapi and several other types of rare animals. That okapi order has been there for years. Some day Mr. Krone will be able to fill it—and at a high price, unless some other collector brings back one or more ahead of him.



*Top, how an elephant is unloaded. Center, antelope on the run. Bottom, monkeys are shipped in this manner, but they must be watched carefully to prevent them from escaping. The little fellows are always getting into mischief*

"It is almost impossible to place a value on this wild treasure," says Mr. Krone. "Paradoxically, while we will spend a great deal of money to capture one specimen, if more are caught, the lower the value of each. Right now you probably could name your own price if you were lucky enough to have caught one of several rare species such as the South Russian saiga, the only antelope in Europe, a bongo, or African antelope, a rhinoceros from Nepal, India, an Abyssinian wild ass or a pigmy hippopotamus or pigmy elephant from Africa. If you managed to



# POPULAR MECHANICS

capture two of the same species, the value of each might be cut in half if you recoded value would be depreciated by a factor of two.

to be the largest for wild animals in the world of Siam. Ringling Bros. would sell as well as many other zoos. In the past however, the business has declined in the United States with it the demand for performing animals. On the other hand there has been a great increase in zoos throughout the

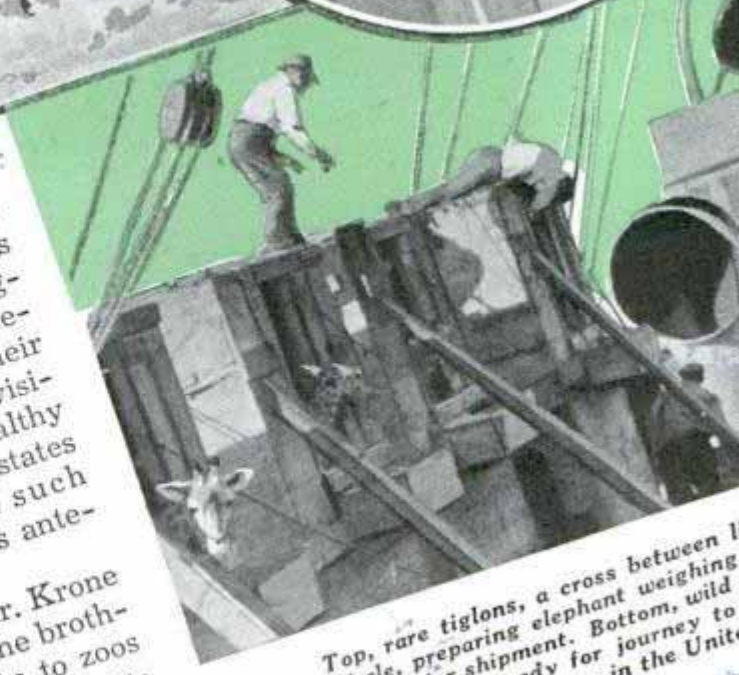
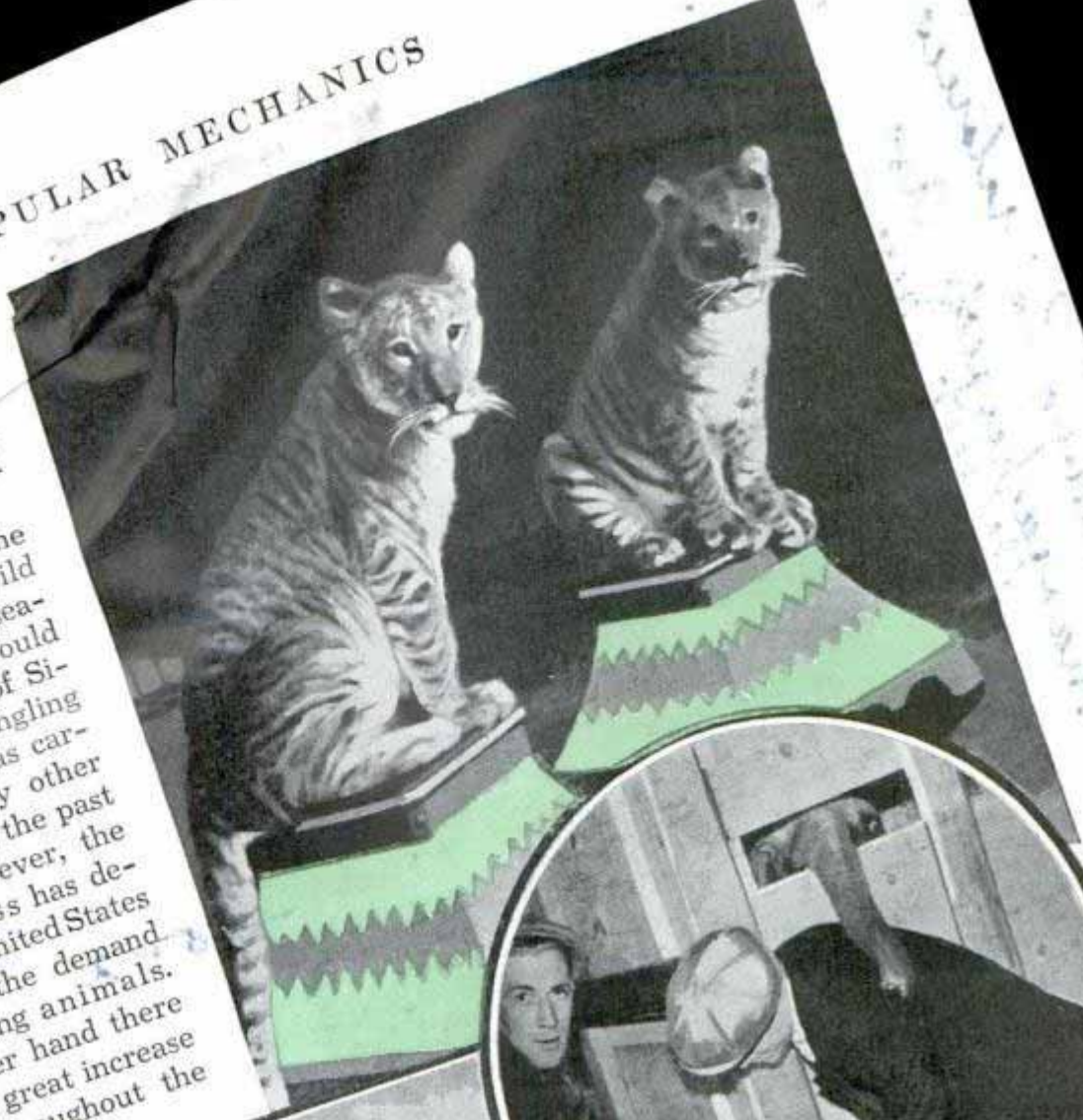

country and with it, a much brisker demand for rare "show" specimens which the larger zoological gardens need as special attractions for their thousands of daily visitors. In addition, wealthy people with large estates stock them with such show specimens as antelope and swans.

Each season Mr. Krone or one of the Ruhe brothers takes a trip to zoos making a survey of current requirements for wild animals. Based upon this survey, expeditions

Top, rare tigrons, a cross between tigers and lions. Middle, preparing elephant weighing platform for shipment. Bottom, wild animals, ready for journey to zoos in the United States.







capture two of the same species, the value of each might be a bit less, while if you rounded up half a dozen, the market value would be further depreciated."

Circuses used to be the biggest customers for wild treasure. In a single season the Ruhe firm would ship a whole herd of Siberian camels to Ringling Brothers, as well as carload lots of many other animals. During the past few years, however, the circus business has declined in the United States and with it the demand for performing animals. On the other hand there has been a great increase in zoos throughout the

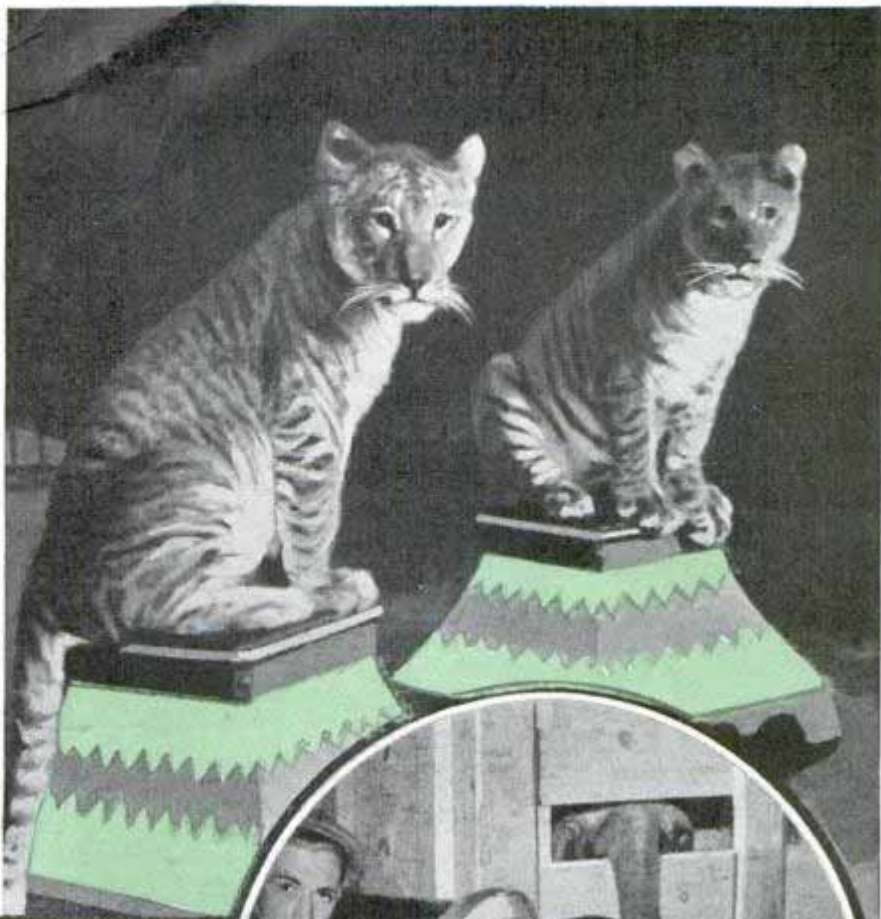

country and with it, a much brisker demand for rare "show" specimens which the larger zoological gardens need as special attractions for their thousands of daily visitors. In addition, wealthy people with large estates stock them with such show specimens as antelope and swans.

Each season Mr. Krone or one of the Ruhe brothers takes a trip to zoos making a survey of current requirements for wild animals. Based upon this survey, expeditions

(Continued to page 130A)

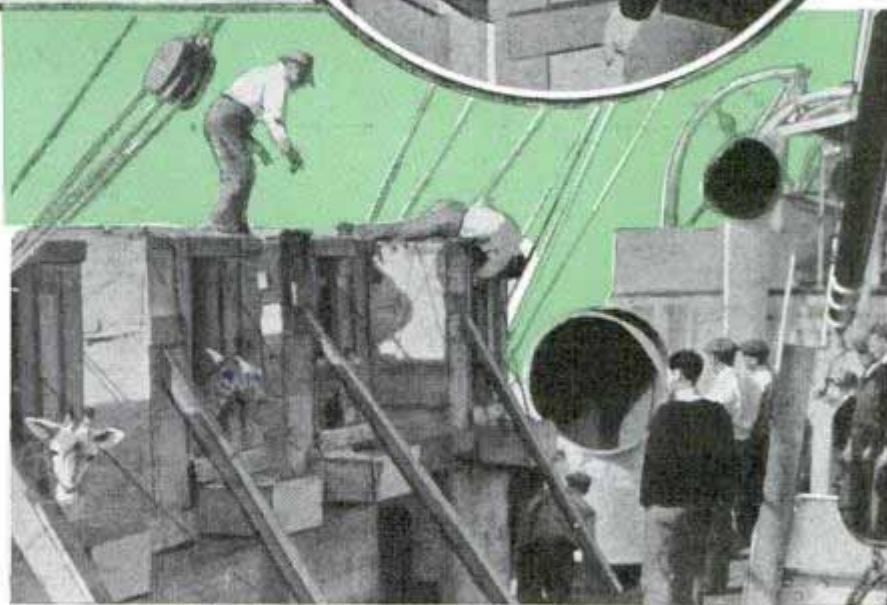

Top, rare tiglons, a cross between lions and tigers. Circle, preparing elephant weighing less than 1,000 pounds for shipment. Bottom, wild animals in crates aboard ship, ready for journey to new homes, perhaps in zoos, in the United States



8-19

# Dummy with Electric "Eyes" Tests Driver's Vision Area

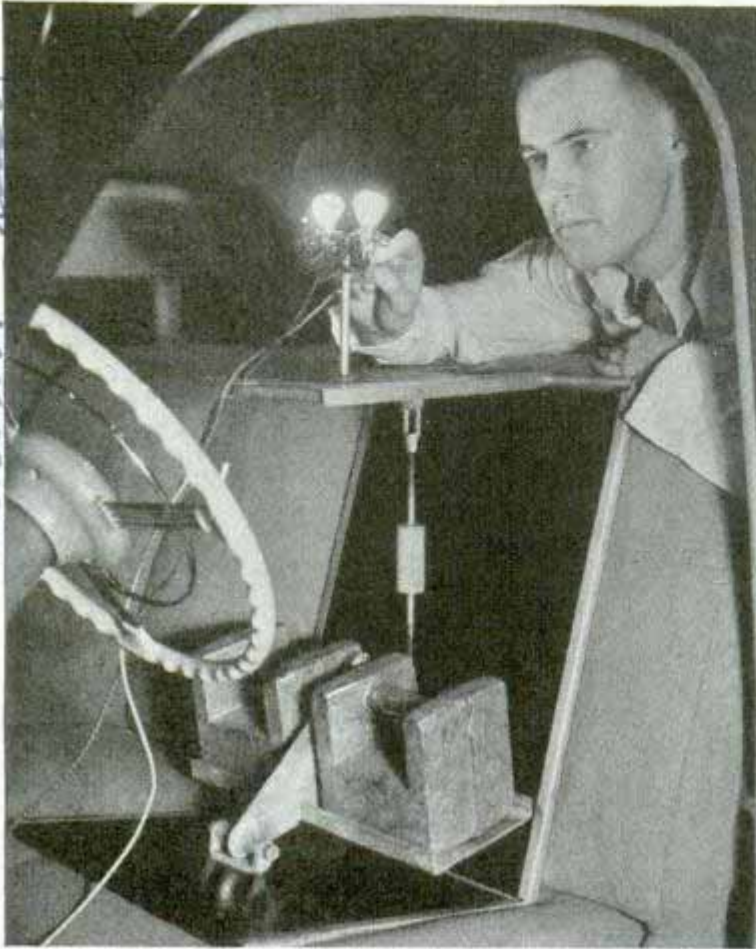

Weighted down with 150 pounds of lead, dummy's "eyes" are held in same relative position as those of average driver

Having electric-light bulbs in place of eyes, a dummy in the driver's seat of an automobile helps engineers determine the angle of visibility of windshields and side windows by throwing beams of light through them. Light from the bulbs is outlined on a huge white screen marked off in degrees, which is placed at a certain distance in front of the car. The splash of light reveals just how much the average driver can see through the windshield.

## Wood-Plastic Propeller Blades Save Engine's Power

Plastic-clad wooden propellers offer one solution of the problem put to aeronautical engineers by the ever-increasing size of airplanes, engines and "props." The growing weight of the propeller itself has threatened to set a limit to its size, because more and more of the engine's power was being devoted to turning the heavy

blades. By using blades of laminated spruce with a plastic cover for protection, as much as one-third of the weight can be saved in large propellers. An eight-foot propeller rated at 300 horsepower and weighing 41.5 pounds has been approved by the Civil Aeronautics Authority. Wood propellers ordinarily are not of the controllable-pitch type because of the difficulty of anchoring wooden, movable roots to the control mechanism. In the new type, however, the wooden blades merge into a root of hardwood impregnated with a phenol-formaldehyde resin, and this root can be screwed into a steel ferrule turned by the controllable-pitch mechanism.

H-1542

## Baby Rides Gasproof Pram Supplied with Filtered Air

Adults can wear gas masks, but no suitable protection for babies in air raids had been developed when the autumn war scare struck London. When this lack was discovered, an inventor in Kent built a perambulator with an airtight lid fitted with a window. At the rear is a rubber bulb which is squeezed periodically to drive out the stale air and send in a fresh supply of air through a gas filter.



Pressure of rubber bulb expels stale air and sends new supply of filtered air into gasproof pram

Chrysler Corp. Engineering Laboratories  
347 Massachusetts Ave  
Detroit, Mich

8-56

Reported by Fred E. Weick  
Engineering and Research

Desoto  
Chrysler  
Chrysler  
Chrysler

flexible  
flexible  
flexible  
flexible



*by Engineer Hans H. Koelmer  
Muschlerman*

# Engineer Visions Underground Torpedo-Train

Fast subterranean travel on torpedo-shaped monorail trains is envisioned by a German engineer, George Nuetzel, as the solution to surface transportation problems. These trains, with possible speeds of 250 miles per hour, would operate in tunnels constructed with ventilation and control channels to supply fresh air and to make for greater safety. While the trains would travel on a single rail, a second guiding rail would be provided for rollers attached to the trains in case balance should be disturbed. Air pressure would drive the trains. In order to reduce air resistance, the underground speedsters would be designed like torpedoes and would be streamlined to the greatest degree feasible. Passenger compartments would be sealed hermetically and proper air pressure would be maintained by oxygen machines. The engineer proposes to hold acceleration and braking within reasonable limits, to avoid ill effects on passengers.

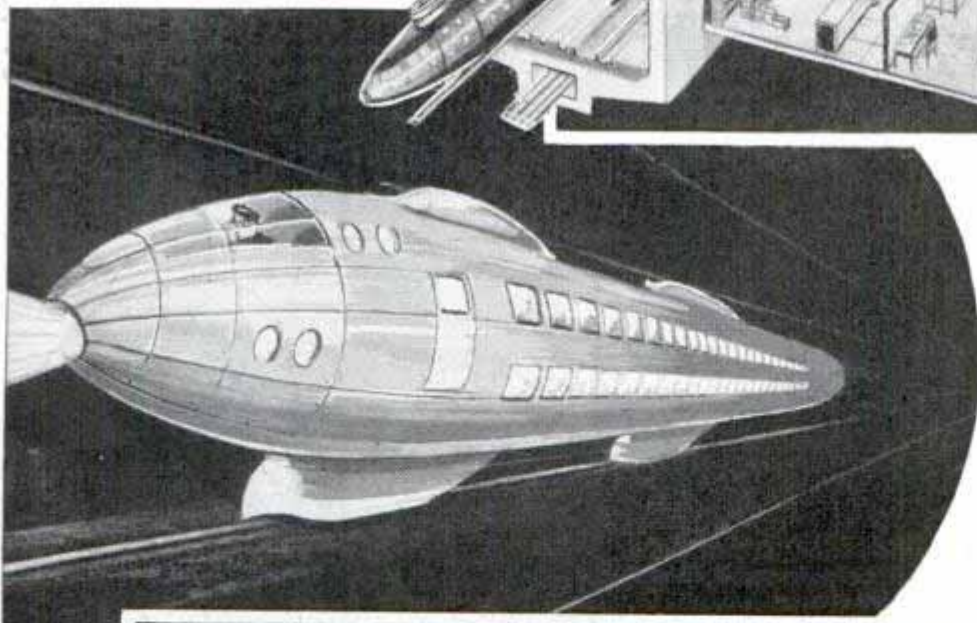
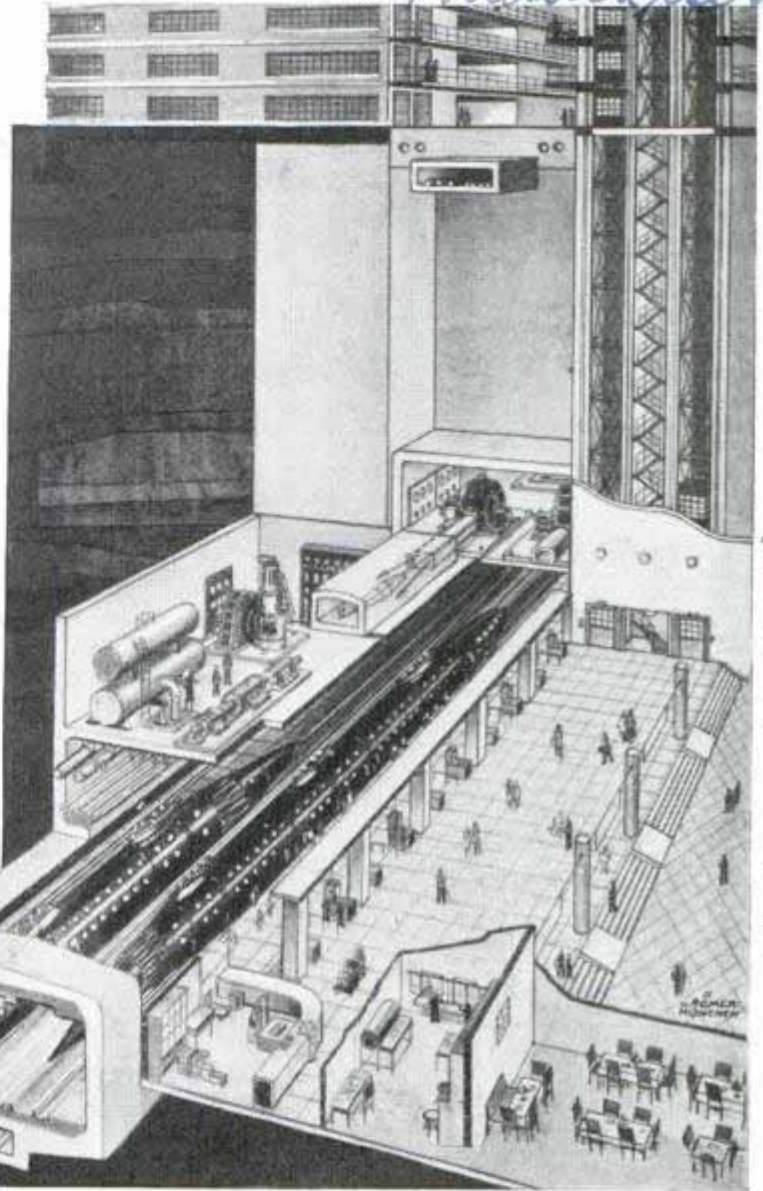

*Top, how terminal of proposed torpedo railway might appear. Left, artist's idea of the torpedo-train in operation. Bottom, side view showing guide rail above the underground streamliner*

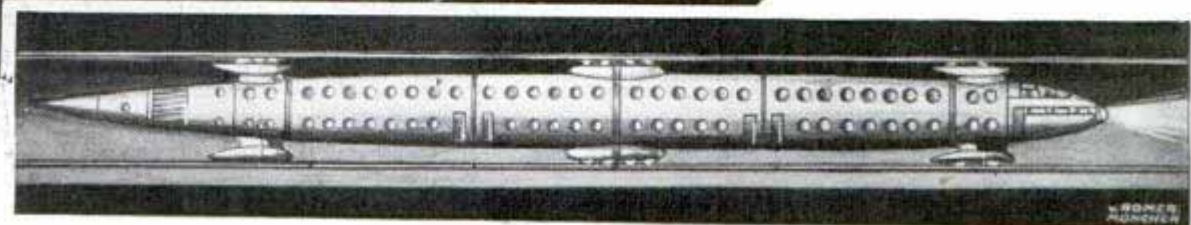



H 1571

# CHECK UP

Cont. max well Reid bargant. 541 1/2 Salendale  
Colod. See Angeles, Calif



Above, if half-filled milk bottle fails to upset when you jam brakes at twenty miles an hour, brakes need attention. Left, line up pencil with distant vertical object. Shut one eye. If pencil seems to shift, closed eye is "dominant" and other is loafing; pay special attention to traffic on side of weaker eye



Try the coin test, above, for reaction time. If you can't move toe fast enough to catch coin dropped thirty inches, you'd better drive slowly

Right, checking width of field of vision. Have a friend move pencil from side while you look him straight in eye. Point where you first detect pencil's approach marks limit of side vision; it should be at least eighty degrees from straight ahead



Some people should never be allowed to drive an automobile. Others have handicaps of which they are not aware—unbalanced vision, slow reaction time—handicaps whose risks could be minimized if the driver knew of them. There are a number of simple tests you can give yourself to check up on your capacity as a driver, most of them without even touching the wheel of the car. They tell you whether one eye is weaker than the other, demonstrate your "blind spots," warn if you are a bad judge of distance



11.5/11

# on Your DRIVING

To test your depth perception, try to thrust pencil through ring held on string, as at right. Looks easy? Try it with one eye shut. If you have difficulty with either eye closed, your judgment of distance is probably subnormal and you may have trouble scraping fenders and stopping at boulevards. The remedy: practice judging distance by size and position of objects and by shadows, as a one-eyed person must

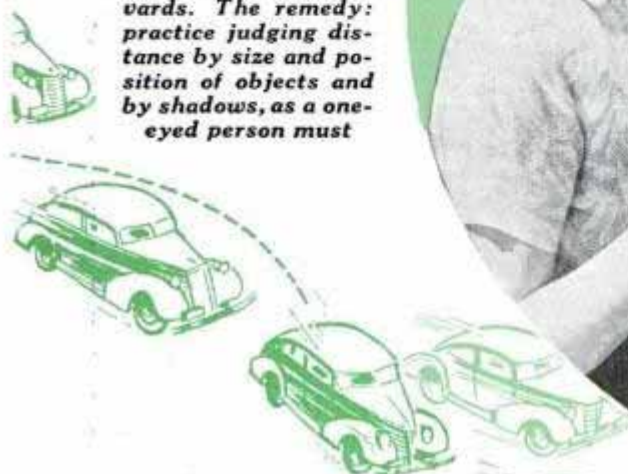

Below, doctor at school of optometry moves target on end of wand around visual field on blackboard while subject looks directly at small spot in center of board. When the target disappears, it indicates blind spot in subject's retina, marked here by small dotted circle on left side. Field of vision is indicated by large dotted circle

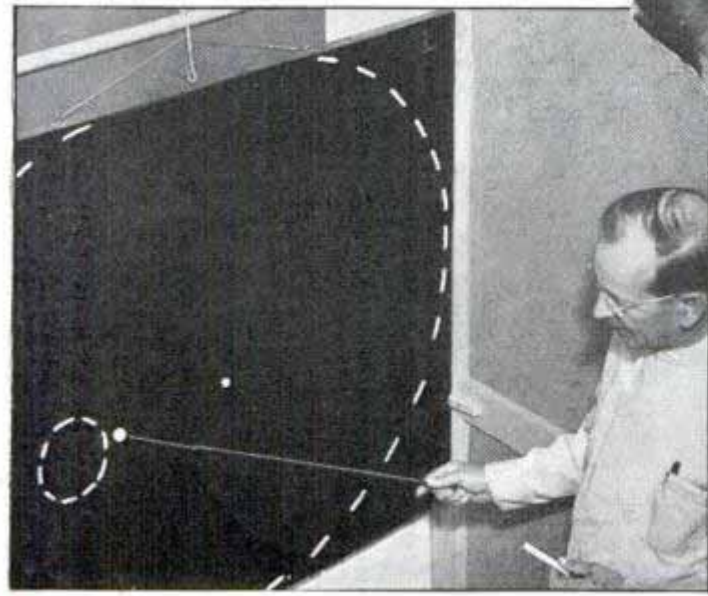

Every eye has a blind spot where optic nerve pierces retina. Find yours by moving paper marked with cross and circle across your field of vision until circle vanishes as it passes blind spot. This spot is big enough to hide a pedestrian or automobile some distance away. Avoid this risk by moving your head slightly as you drive



# Projector Casts Score Sheet on Screen over Bowling Alley

*Cover Score cast*



Photo shows official scorer at tallying desk with projector overhead. Sketch illustrates how it throws master score sheet on screen in full view

As the scorekeeper writes the bowling scores on his official board, an optical device just introduced projects the entire score sheet on a large screen over the alleys. With this enlargement of the master scoreboard always visible, duplicate and blackboard scorekeepers are unnecessary, and both players and spectators can follow the play and check the accuracy of the scoring.

tograph albums, the membrane simply being placed between the photograph or sign and the page or window, then ironed fast. The same procedure is followed in removing the picture from the page; re-heating it softens the adhesive and the photograph can be pulled free.

*1-15-78*

## Flexible Cover for Steam Cooker Locks Inside

Locking without clamps, the flexible cover of a steam cooker now on the market fits under the rim instead of on top. You squeeze the handles after inserting the cover and flip a hook to secure it in place. Cooking is done with steam pressures up to fifteen pounds, at which point a weight in the vent tube on top of the cover rises so surplus steam may escape. There is also an auxiliary pressure release which is easily replaced if blown off.

## Electric "Welder" Irons Photo in Album without Mucilage

*Photo-Film Photo-ukeler.*



Using a chemically treated membrane as a binder, photographs can be mounted neatly in an album with an electric "welder" that plugs in on

the house current. The membrane becomes adhesive when heated, and an ordinary flatiron can be used in place of the specially built welder if it is thermostatically controlled to prevent burning the paper. This method eliminates muss and saves labor. It is applicable to window signs and wall mountings as well as pho-



Cover for steam cooker is slipped under rim and locked in place by hook under lower handle

*Vischer Products Co  
merchandise mail*

*C. J. Wernersburg  
624  
1-15-78*

*38  
\$1.95  
\$0.95  
Snapshots  
hard*

*Seals Inc.  
Shelton Conn.*



# Short-Wave "Cannon" Shoots Heavy Atoms

From Cornell University laboratories comes the 1939 model atom smasher, an eight-foot glass vacuum tube in which radio short waves fire both light and heavy atoms at speeds of thousands of miles per second. Just put to work after three years of study and \$7,000 experimental costs, the apparatus is to be used in breaking down the atom and studying the nature of its nuclear force. The breech of this gun is a short metal tube, negatively charged, which attracts the positive particles toward itself. The barrel consists of seven more metal tubes arranged end to end, and linked to the radio apparatus so that each tube reverses its positive and negative ends 10,000,000 times every second. This keeps the positive atoms rushing forward toward the

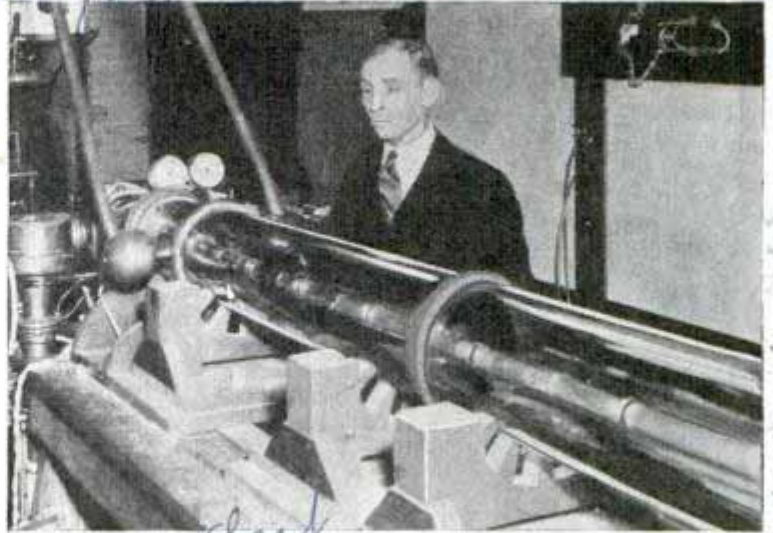

Swift-changing charge of metal tubes in eight-foot glass vacuum "barrel" sweeps positive atoms forward at terrific rate

negative end of the tube ahead with tremendous acceleration. Earlier atom smashers have been limited to lightweight atoms. The Cornell instrument can shoot atoms as heavy as mercury and lead.

# Protractor Tells Pilot's Position on Roller Map of Route

Rotating the transparent arms of a protractor in accordance with bearings taken on radio stations, an American Airlines pilot can plot his exact position on a roller



With protractor arms pointing to radio stations on which he has bearings, pilot finds his location

map of his route. Invented by an engineer of the line, this protractor was specially designed to aid aerial navigation. The map, scaled to twenty-four miles to the inch, is mounted on spools on a fourteen-inch square map board and is moved along as the flight progresses so that the area surrounding the plane is always visible to the pilot. The board always shows more than 100,000 square miles. The air route, radio ranges, broadcast stations, cities and important landmarks are included. After setting the inner dial of the protractor so that zero, or the nose of the plane, is opposite the outer scale reading which is the true heading of the ship, the pilot rotates the arms to loop azimuth readings on radio stations. Then he slides the protractor across the map until each arm passes over the station on which a reading was made. At this time the center of the protractor will be over the exact position of the plane when the bearings were taken.

Of the 228 locomotives ordered by American railways in 1938, thirty-six were steam engines, twenty-nine electric and 163 were Diesel-electric and other types.

Railway Age Jan 7 1939



# Parabolic Ceiling Reflector Distributes Light Evenly



Parabolic reflector distributes light evenly from flat ceiling. Inset shows path of light beams

Better distribution of light through the room is the function of a parabolic reflector unit for flat ceilings. The parabola provides even, controlled light, but heretofore it has been employed by curving the ceiling. The aluminum-painted reflector built for flat surfaces is said to increase illumination from twenty to fifty per cent.

# Photocell in Hot Furnace Wall Keeps "Eye" on Steelmaking

Microscopically thin, a film of rare metal that forms the "retina" of an electric eye watches over a 150-ton batch of steel in an open hearth, keeping the temperature more uniform and producing a better quality of metal. In bygone years the experienced eye of the operator was sufficient, but with present controlled grain size and tensile strength requirements, all guesswork had to be eliminated. The photoelectric control unit is installed in the walls of the open-hearth furnace so it "sees" only the light reflected from the roof interior. Should the inside temperature be too high, part of the fuel supply is

turned off automatically by the eye. Automatic control results in a higher average temperature, thus shortening the time required to produce a batch of steel, and it also extends the useful life of the refractory brick in the roof of the furnace.

# Plug "Bites" Through Insulation to Contact Electric Cord

Equipped with teeth that bite into the electric cord, a wall plug can be assembled without tools and without even stripping off the insulation. Wires are simply separated and inserted in grooves, then the screw top is drawn down tight to force the teeth through the insulation and into the wires, making a firm contact.

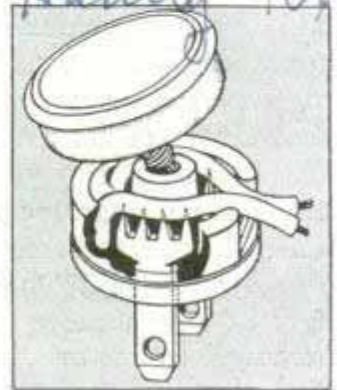

# Auto Keys Duplicated by Code with Portable Cutter

Any car key can be duplicated to code on a portable cutting machine operated either by hand or motor. A micrometer depth control guides the cutter. As new keys appear on the market, the manufacturer will issue new codes and guide keys to purchasers of the machine.

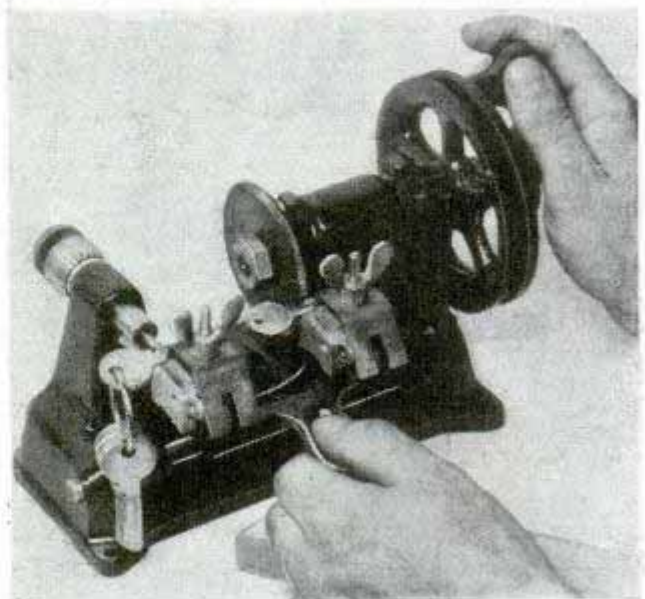

Hand-operated machine will duplicate any auto key to code. Note micrometer depth control on left

U.S. Steel Corp. Broadview  
New York  
Berger, wife, Mrs. Republic Steel Corp.  
1584  
341 Madison Ave  
New York

J-26  
J-34

Parabolume

J-20

Briggs and Stratton  
Carla 2711 2 12 ch



Glass Furniture Latest for the Modern Home

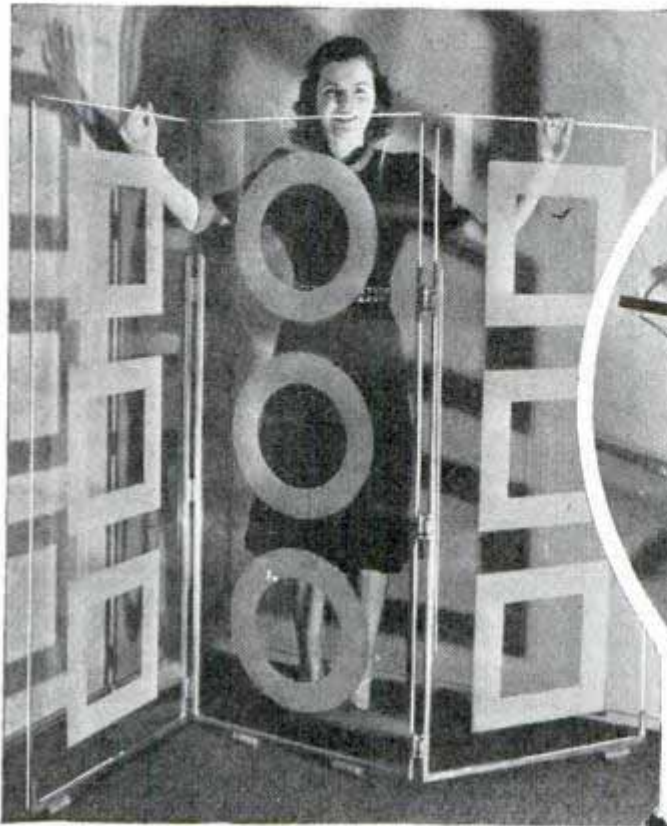

*Furniture made of glass is bringing new charm to the modern home and making possible new decorative effects. Top, left, an attractive glass screen with a simple geometric design of circles and squares*

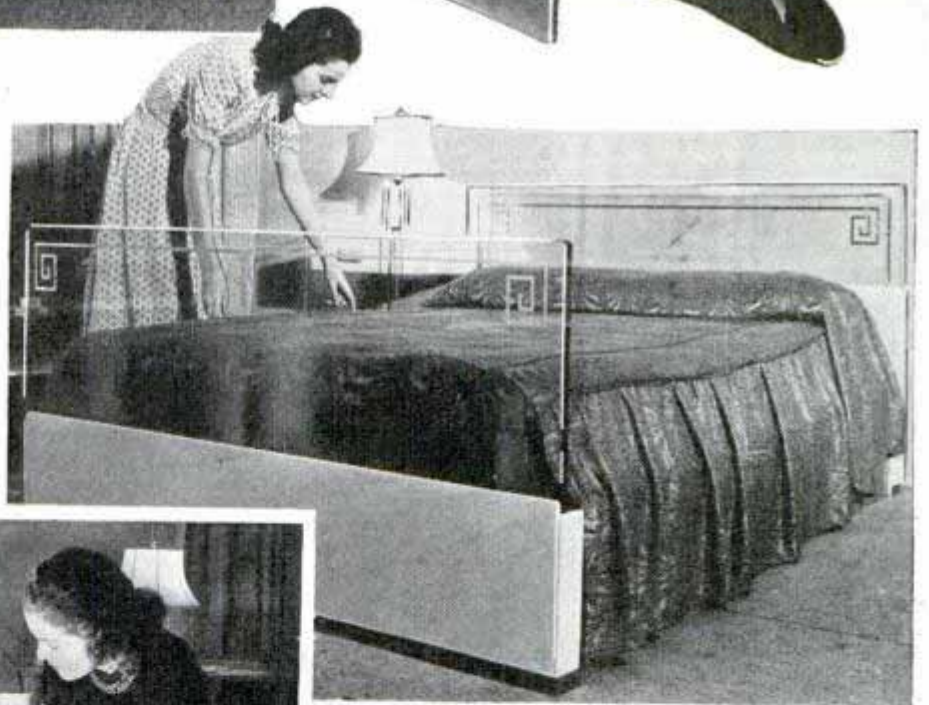

*Top, right, a glass bench of modern lines offers the homemaker a new means of attractive arrangement of furniture. Center, a double bed made of glass shows to best advantage its attractive spread. The bed is thoroughly durable, the head and foot "boards" being of extra heavy glass. Note the design worked into head and foot glasses. Left, a glass table, part of an exhibit in a New York department store, is highly decorative, as well as useful. Note the reinforcing metal ribs holding the "legs" of the table in place*



*Handwritten notes in blue ink at the top of the page include: 'Kisil rogan', 'High Point, N.C.', 'Shaw-Wal. Co. Attman Co', and 'Neyah'.*

*Handwritten notes at the bottom of the page include: 'No 11' and some illegible scribbles.*



# Million-Volt X-Ray "Pillbox" to Treat Cancer



Left, ready to lower transformer over million-volt X-ray tube, for which the transformer becomes an electrostatic shield. Hot cathode filament is at top of tube. Below, view of transformer without outer tank of steel, showing high-tension winding of flat coils of wire. With cover lifted, filament end of tube and part of control mechanism are exposed



In a "pillbox" not as tall as a man, scientists of the General Electric company have packed a million-volt X-ray machine whose radiation is equal to that of \$90,000,000 worth of radium. A giant in power but a pygmy in size, it was built for use in the cancer research laboratory of the new Memorial Hospital in New York. Weighing but two tons complete, and thus light enough to be portable on a truck, this X-ray could be used by industry as well as medical science, for it enables man to see through five-inch steel castings. The 800,000-volt machines designed only six years ago required special buildings to house them. Today's million-volt X-ray outfit is self-contained, operating at three milliamperes. Its transformer and an X-ray tube built in eleven sections are contained in a cylindrical steel tank of two sections, bolted together. The transformer operates on three-phase, sixty-cycle power and acts as an electrostatic shield around the tube. Its high-tension winding consists of more than 100 thin, flat coils of wire stacked inside the tank. The tube has its

target end at the bottom and grounded, and its hot cathode filament at the top. Of the total weight of 4,000 pounds, 1,000 pounds consist of lead for X-ray protection. Instead of oil, gas is used for insulation. It would have required 12,000 pounds of oil; 100 pounds of dichlorodifluoromethane gas sufficed. The grounded metal tank eliminates all shock hazard.

☐ The average price per pound of automobiles has dropped since 1920 from seventy-four cents to twenty-six cents.

Auto Facts - Jan 1939

Tribune Jan 3, 1939

Chicago  
Sept. 1938  
386



# Piano Has Two Keyboards Linked by a Pedal

Two keyboards would appear to double the difficulty of playing a piano, but Winifred Christie, appearing on the concert stage with the piano invented by her husband, says the double keyboard is easier to play than the standard piano. This is particularly true for children who have to stretch for wide chords on a single keyboard, she says. One of the keyboards is tuned an octave higher than the other and they may be played separately or together by means of a pedal coupler.



Demonstrating the dual-keyboard piano. One keyboard is tuned an octave above the other.

H 1586

# Disk Brakes for Streamliners Stop Fast Train Quickly

Since the birth of the railroads, trains have always been brought to a stop by braking force applied to the tread of the wheel. By manual power or compressed air a shoe was pressed against the rim or tread and dragged the car to a halt. But high-speed trains today are demanding more efficient braking methods, and the result is the appearance of a new system

in which the brake shoes exert their drag upon cast-iron disks instead of the wheel tread, and the wheel itself reverts to its original function of being just a wheel. Developed by the E. G. Budd Manufacturing company, the disk brakes have their first installation on a new Burlington railroad "Zephyr" streamliner now being built. Tests showed they could bring a train to a halt from 100 miles an hour in 2,000 feet without locking the wheels. The danger in braking at such speed has been the high temperature caused by friction, sometimes nearly melting the wheel and fusing the brake shoe with the tread. In the new brakes, air pressure forces two brake shoes against the surfaces of two disks. Small fins separating the two disks create a blast of air that fans away the heat of friction. Further cooling is provided by spaces between the seven segments into which the brake shoe is divided, and these spaces also reduce the area of braking contact enough to prevent locking. The brakes reduce pressure instantly and automatically if the wheel begins to slide.

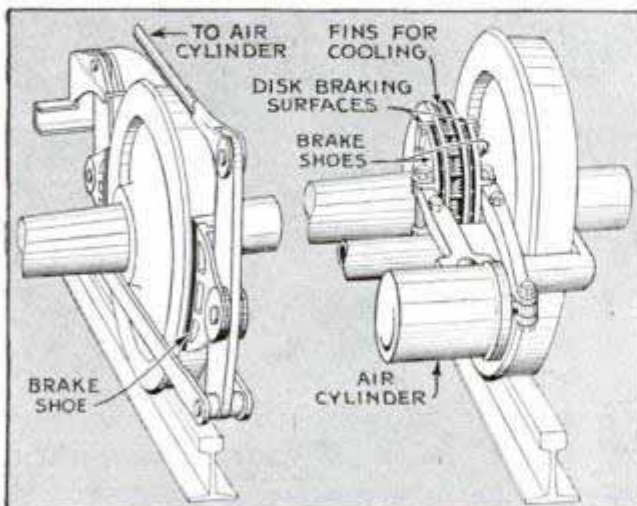

Left, a diagram of conventional air brake applying friction to wheel rim; right, the new disk brake

547 W. Jackson, Chicago



H 1513

Cont. Dr. Delbert Miller  
457 S. Serrano Ave.  
Los Angeles

Franklin D. Roosevelt  
1938

# CANARIES

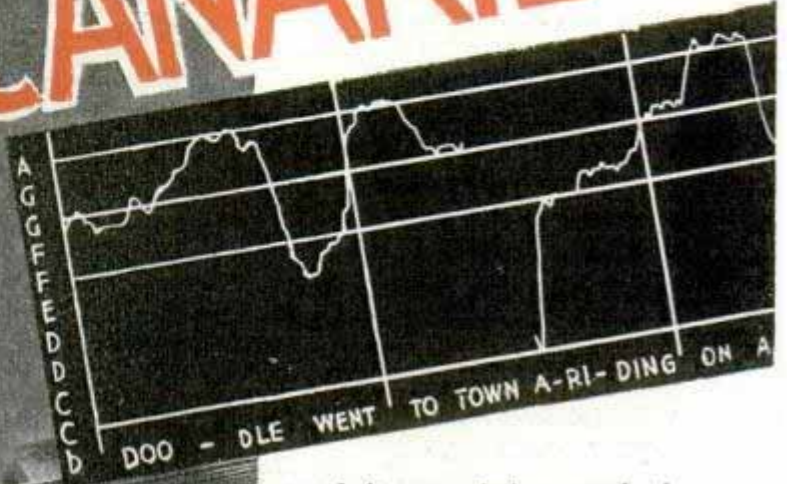
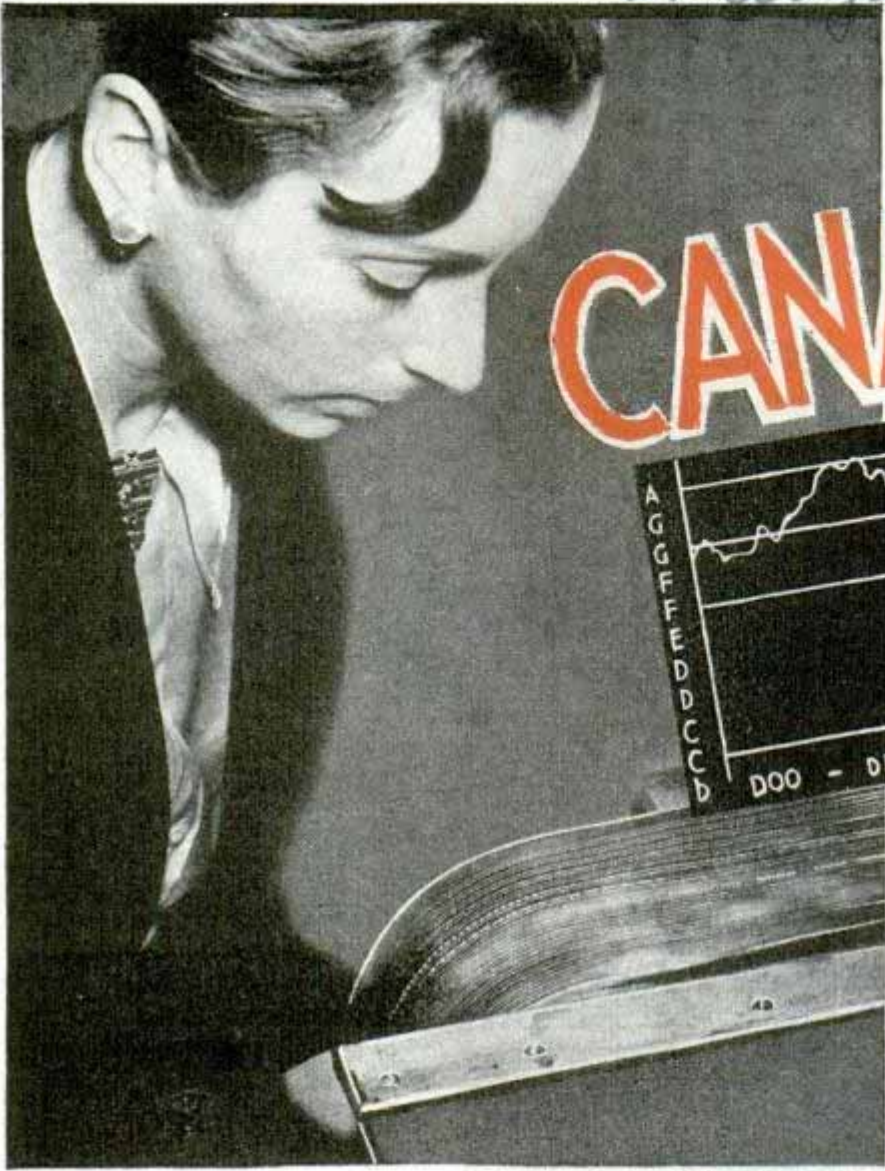

Left, examining graph of canary's song. Below, camera which records canaries' actions in their isolated cages. Above, graph of canary's song

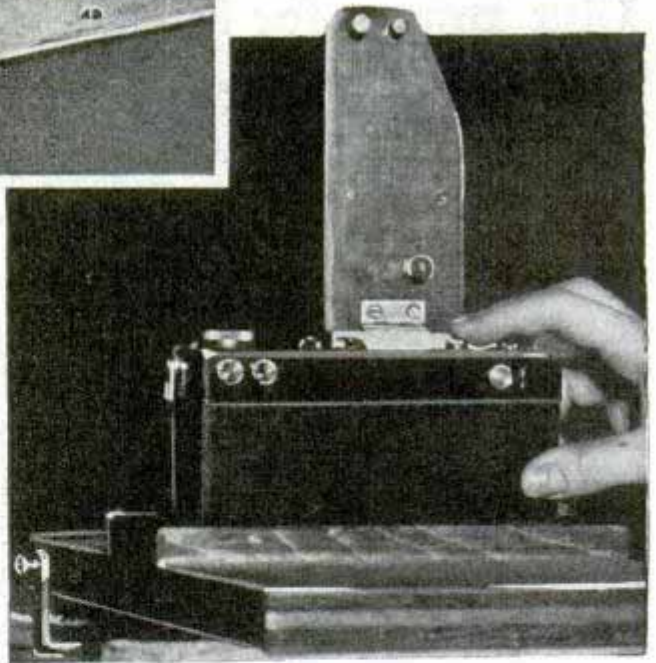

"MY CANARY can sing Yankee Doodle," the woman declared.

Psychologist Dr. Milton Metfessel of the University of Southern California was skeptical. *Los Angeles*

"I don't believe it," he said, "but I'll always make an experiment. Bring the bird into the laboratory and we'll make a phonograph record of whatever it sings."

Whereupon the bird sang Yankee Doodle through twice without a mistake. Dr. Metfessel was amazed. He promptly made arrangements to use the bird for future experiments, the results of which have altered science's conception of the old problem of heredity versus environment. For the first time, it has become possible to test an animal's reaction to what might be called "zero" environment.

During the experiments, which have gone on for three years, canaries have been kept in soundproof, air-conditioned

homes, in which, from the day of their birth, they were isolated from the outside world. From these "environmentless" homes they have broadcast through tiny microphones their self-taught songs, which songs have been recorded and graphed.

Dr. Metfessel reasoned that if a canary could learn to sing Yankee Doodle, it could



# SING *for* SCIENCE

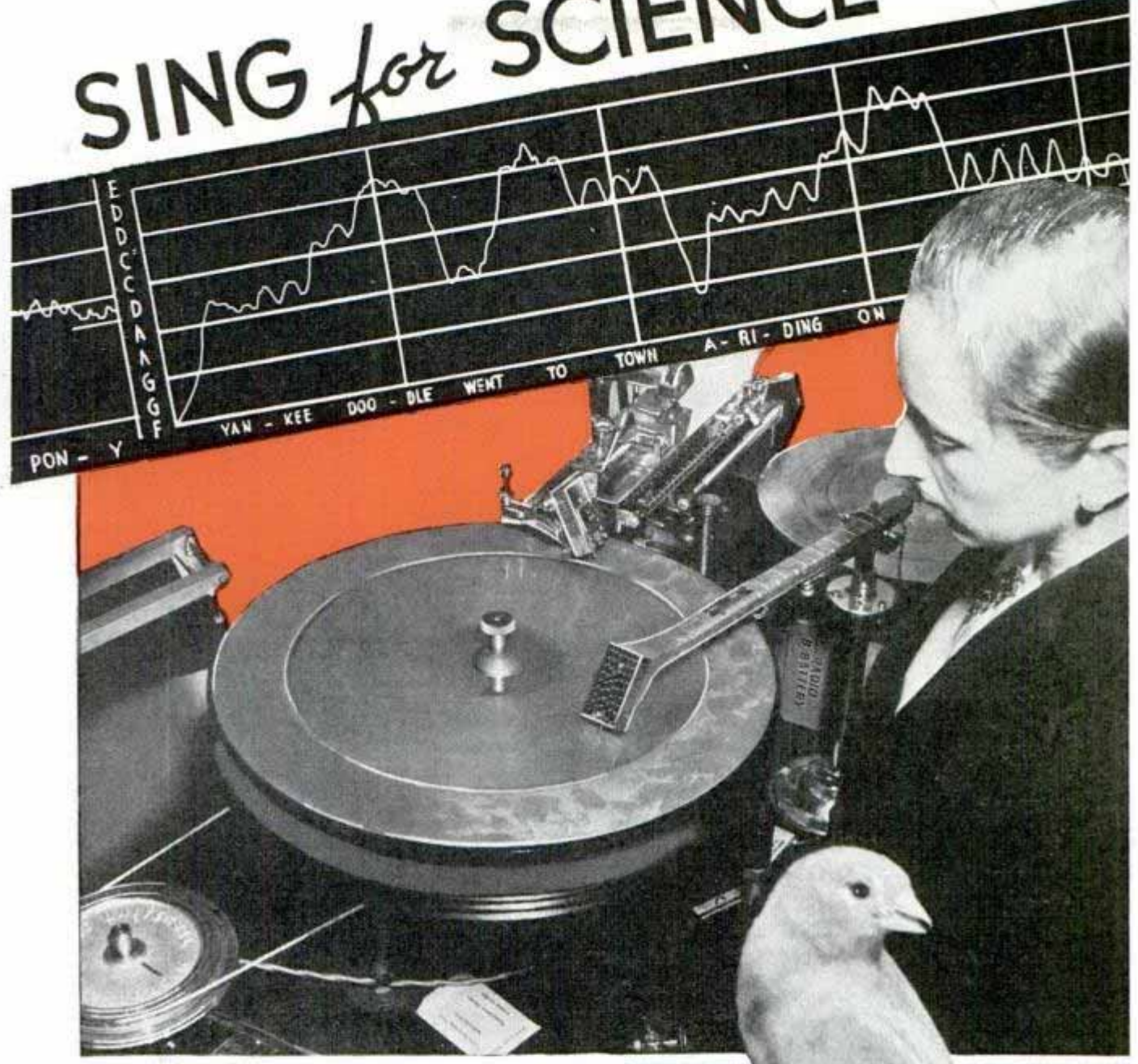

simulate at least one human characteristic. Moreover, as canaries sang naturally, there was an excellent opportunity for contrasting songs learned from heredity with those learned from environment.

To introduce the canary to the role of experimental subject, Dr. Metfessel built a series of "cells," which were soundproofed by several inches of porous insulating material outside of which was cotton padding. The cells, just large enough to take a normal size bird cage, were air conditioned and lighted with a forty-watt globe.

"We want our canaries to be happy," Dr. Metfessel explains. "As far as we can tell, they seem to enjoy it. After a year in the

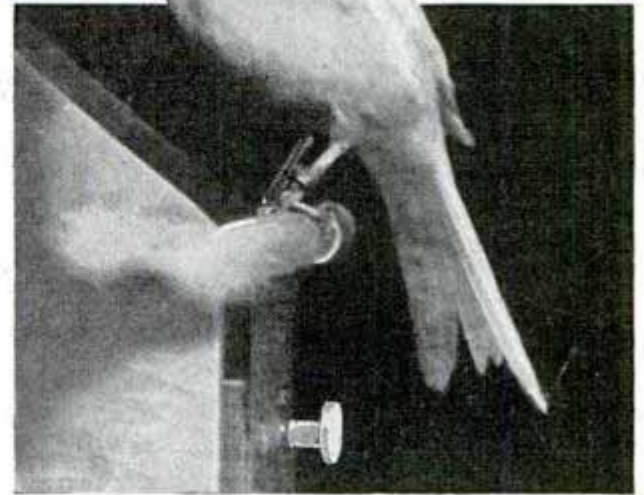

Center, apparatus for broadcasting "vibrato" into cage. Bottom, tiny experimental songster, the first to sing without ever hearing a sound





boxes, their job is finished, and they are taken out and allowed to begin a normal life."

To record the canaries' songs, tiny microphones were put in the boxes. These were connected, through a switchboard, with loud speakers in Dr. Metfessel's office. By means of the switchboard, any individual canary could be "put on the air."

To record the songs on graphs, a complicated bit of machinery was worked out. The songs are first recorded on standard aluminum phonograph records. Later these records are placed on the turntable of the "graphing machine." This device uses a phonograph pickup arm to take the sound impulses from the record. It then converts the sound impulses into electrical impulses, which move a pen across a ribbon of photographic paper. This paper is lined with a miniature scale, suited to the range of notes in a canary's song.

The photographic paper is next developed into a white-on-black positive, which gives in graphic form the song that the canary sang. That song might just as well have been sung on the dark side of the moon. For no outpost of the universe could



be more isolated than those padded boxes in Dr. Metfessel's laboratory.

After everything was ready, and the canaries had emerged from their eggs, and lived for several months in their isolated worlds, Dr. Metfessel and his assistants began to spend long hours with their heads practically inside the speakers, their fingers manipulating the switches, turning on the mike in one cage after another.

Would they sing, or would the experiment fail, and the canaries live out their year in silence? Did all canaries learn their songs from other canaries, and was the whole theory of heredity perhaps wrong?

Then an assistant flipped the switch labeled Experimental Bird Number 60, and a faint sound came from the speaker. Feeble and faltering

(Continued to page 144A)

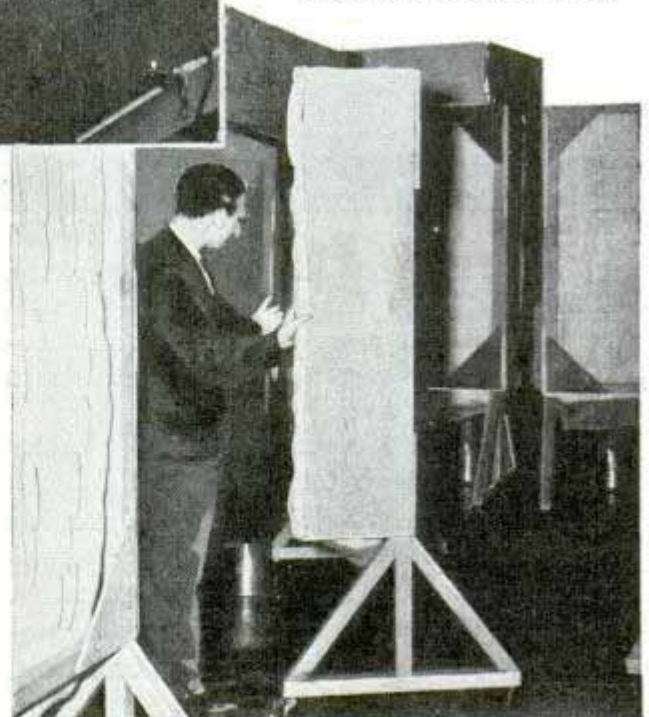

Top, listening to song from cage. Center, loud speakers broadcast the canary's trills. Bottom, swinging open padded walls inclosing canary cages



# Paper Tear-Gas Bomb Ends Peril of Wounds

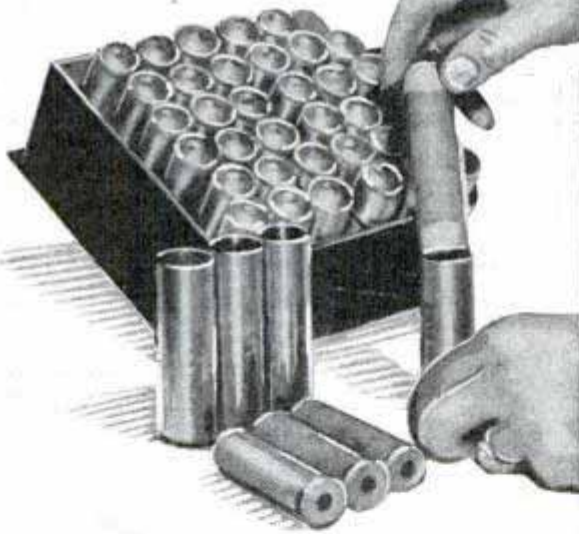

Top, scoring direct hit on human target, and inventor firing tear-gas machine gun. Below, placing projectile in shell, and, right, exploding safety bomb in pocket

Even if it makes a direct hit when fired at a person, a tear-gas bomb packed in paper will not cause wounds. Explosion of the bomb also involves less danger, since there are no flying fragments. The bomb can be exploded at any distance from 100 to 300 feet by adjusting a small fuse that is ignited in firing, and gunpowder spread through the center of the bomb furnishes heat and fire to turn the crystals into gas. A brass shell three and one-half inches

long and one inch in diameter serves as the cartridge, and eighteen paper bombs can be fired in quick succession with a special machine gun. Each one releases 16,000 cubic feet of gas.

☐ The most northerly railway in the world runs from coal mines to the harbor at King's Bay, Spitzbergen, only 750 miles from the North Pole, but inactivity of the mines recently has left the rails idle.

*Pullman Company News  
Jan. 21, 1939*

*Cart. my ...  
Caton a Box 124  
Toledo, Ohio  
C.W.C.A.  
Mauville  
Mauville  
My Corp.  
Pontiac,  
Mich.*



# Lighted Mirror and Vanity Kit Handy for the Woman Driver

*Callender's  
623 S. Wabash, Chicago  
All Feb 1941  
13/a*



Mary Pickford of movie fame finds mirror and makeup kit handy aids in motoring

Equipping the automobile with an illuminated mirror and a vanity kit is a boon to the woman driver. Vanity mirrors with neat electric lights are available for installation on the back of the sunshade, and kits containing lipstick, rouge, powder, cream and other makeup necessities can be obtained for attachment to the inside of the door on the glove compartment.

## Rubber Floor for Shower Stall Molded in One Piece



Made in one piece, a seamless rubber receptor for shower baths is ready for installation in the home just as it leaves the manufacturer. It

takes the place of the heavy lead pan usually used. The floor has a slipproof tread, and the rubber always remains flexible so it will not crack or leak. An asphaltum plate forms the base and gives the necessary pitch to the center for draining.

## Non-Reflecting Street Light Eliminates Sun Phantom

"Sun phantom," the confusing reflection of outside light from the surface of a traffic light, is eliminated in a signal lamp just brought out. Its reflector and lens are so designed that light from the outside is dissipated within the optical unit and not reflected. The bulb socket is made adjustable to permit moving the filament of the lamp to the most effective position.

## Screen Door Storm Panel Blocks Winter Drafts

Screen doors are quickly converted into storm doors for winter months by applying a lightweight panel fitting over the screen. A window gives visibility without opening the door. Both the panel and window are wind and water proof, keeping out drafts and also preserving the screen.



Panel with transparent window covers entire screen and converts ordinary screen door into storm door

*Chevrolet motor plus Admiral motor corp. Detroit Mich.*

*3950 job. mach. gen. Mich.*

*Detail lumber dealers only*

*St. Louis, Mo.*

*Central States Paper and Bag Co.*



300-Mile Railway to Carry Ships Is Planned

Right, ship entering lock to be raised to track. Center, as ship would appear on cross-country railroad. Bottom, position of ship in carrier is shown in outline. Inset, map of route

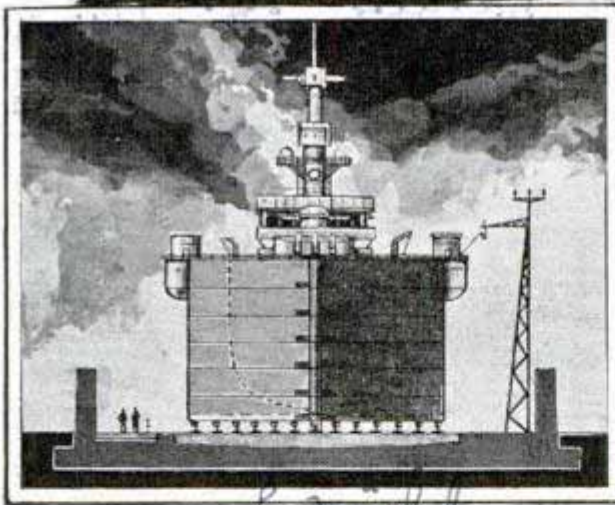
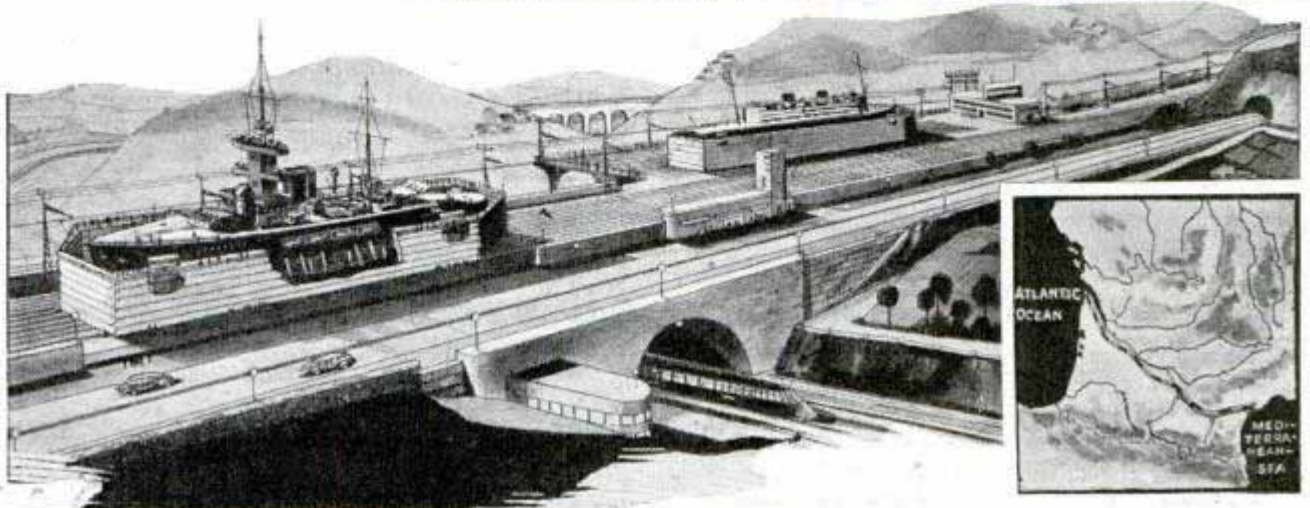
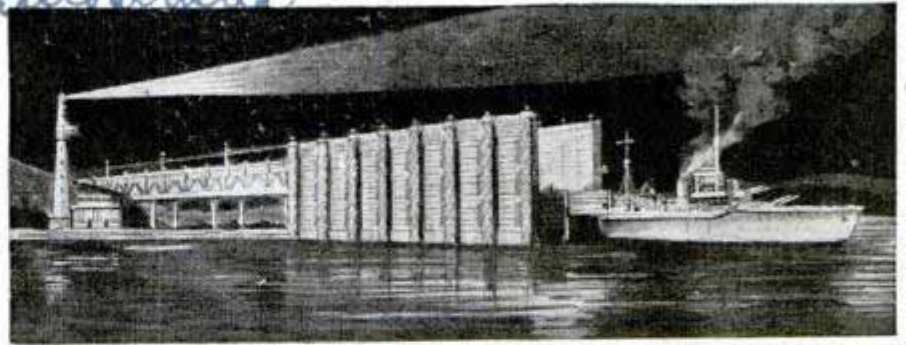

© Three Lions

means of electric power along a six-track railroad across the country. A regular railway for fast trains and two motor roads also would be part of the project. Captive balloon barricades are being considered as a means of defending the railway against enemy air raids. The balloons, spaced at 900 to 1,050 feet, would support steel nets at an altitude great enough to reduce the chance of successful bombing. The railway also could be used to speed up passage of trading ships from French ports to the Mediterranean.

French engineers are preparing plans for a ship-carrying railway, 300 miles long, between Port le Verdon and Beziers, linking the Atlantic and the Mediterranean. A similar line, but much shorter, already exists in East Prussia. The proposed railway, which would eliminate a 1,200-mile water trip from the Bay of Biscay to the Mediterranean, by way of Gibraltar, would enable the French Atlantic fleet to move quickly in emergencies. Rough drafts of the project call for a shipping port where ships would be put into movable docks, which then would roll by

U. S. Has 23,000 Aircraft Pilots and Half as Many Planes

Coincidental with the announcement of federal administration plans to train 20,000 aircraft pilots each year, the Civil Aeronautics Authority made known that there were 22,983 licensed pilots in the United States on January 1. Of these, 1,159 were air line pilots, 10,676 held private licenses and 6,834 commercial licenses. Women pilots numbered 675. The aircraft census showed 11,159 certified or uncertified planes, and 221 gliders with 172 licensed glider pilots.

Science Service  
1/9/39

Washington



### Desk Folds into a Suitcase with Portable Typewriter



Left, folding the desk into suitcase; right, desk in use, showing room for stationery and typewriter

Convenient for a typing job at home, on tour or in the field, a suitcase opens to form a desk holding a typewriter and compartments for stationery, carbon sheets and personal file. The case incloses the portable typewriter, too, and it takes but thirty seconds to unfold the table.

### Six-Cylinder Motorcycle Engine Gives Smooth Flow of Power

Desiring smoothness rather than high speed from his motorcycle, an enthusiast has built a six-cylinder motorcycle from a standard four-cylinder machine. It is capable of eighty-five miles an hour, and runs forty miles on a gallon of fuel. The

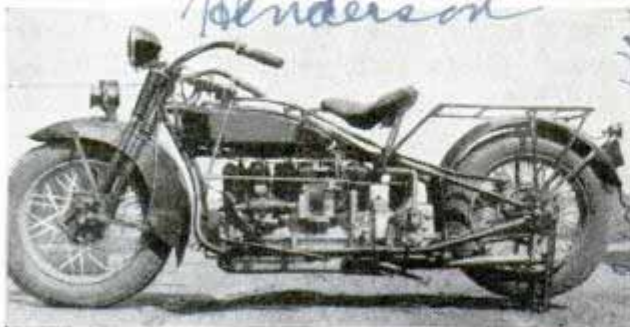

Lengthened to take two extra cylinders, motorcycle rewards builder by giving him smoother ride

frame was lengthened seven and three-quarters inches, and other parts were extended also to make room for two extra cylinders. The finished motorcycle sports a wheelbase of sixty-nine inches.

### Tiny Chemical Dose Stops Scale Forming in Water Pipes

Scale formation from the precipitation of calcium carbonate in water pipes and power plants can be prevented by adding a chemical dose so infinitesimal that it almost defies chemical analysis. The preventive material is sodium hexametaphosphate, named "Calgon" by its makers. It will not remove the calcium carbonate from the water, but holds it in solution so that it cannot form the troublesome scale. One or two parts of the chemical to a million parts of water has been found an effective dose.

### Water Power Runs Dishwasher That "Plugs In" on Faucet



Placing cover on dishwasher before turning on hot water, which sprays dishes by means of rotating arms

Water power alone runs an automatic dishwasher that cleans a full load of silver, glassware and dishes in three minutes. There are no electrical connections. Soap is not used. The tableware is stacked on wire racks in the pan, the cover is laid over it, and the hose "plugged in" on the hot-water faucet. Rotating arms in the base spray the hot water over the dishes and a drainage hole discharges used water into the sink.

Bennett Bros. Inc. 485 5th Ave. New York

Downman, Philadelphia Pa

Blenderson

miracle #24.50.92.69  
1457 21st Ave. Los Angeles Calif

Walter Thomas

Sterilaid Desinfector



H 1342.

Mr. Stanley Cross,  
Rudy Arnold Photos,  
Alfred Bennett airport

# FRONTIER GUARDS on the WING

Brooklyn, N.Y.



A TRIM, silver biplane taxied to a stop after a swift landing on a huge airport hugged by rough mesquite desert. A truck, with a few alert men standing by, pulled up to the plane. A door swung open, and two surly men shambled out of the ship to be herded into the truck and driven away.

To the casual observer, this meant nothing. To the men of the Air Patrol Detachment, a unit of the United States Coast Guard situated at El Paso, Tex., this meant that two more who had defied Uncle Sam's laws had been caught. The men were smugglers.

An area comprising the states of Texas, Arizona and New Mexico comes under the watchful and alert eyes of the "Border Patrol," as the Air Patrol Detachment is sometimes called. In addition, this unit takes care of the important task of aerial patrol of the international boundary line that divides the United States and Mexico. At present, this big task is performed by a compact unit operating five speedy airplanes equipped with a mass of paraphernalia ranging from hurricane warning message blocks to submachine guns and stretchers.

Smuggling attempts of all kinds are rife

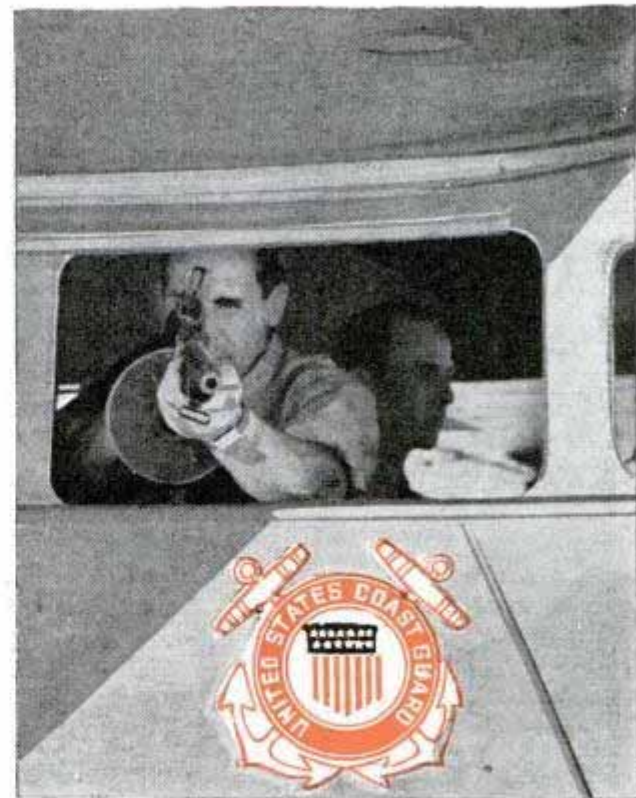

Top, unloading sick boy from Coast Guard plane. Bottom, machine gun is brought into play if smugglers ignore command to land their plane



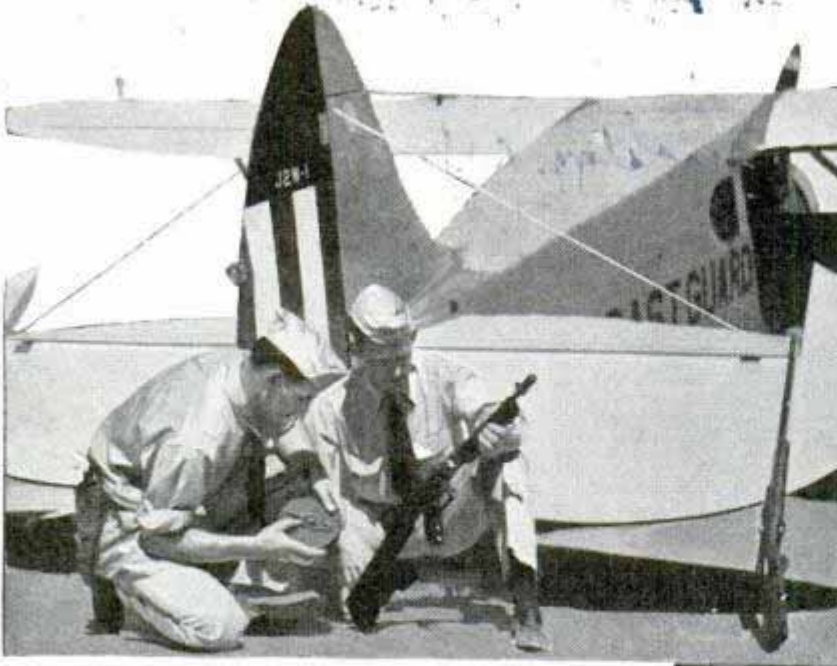

service-type guns and machine gun, is carefully checked over to see that it is in perfect working order. Along these lines, coast guardsmen indulge in periodical armament practice at rifle ranges to improve already excellent marksmanship. A usual crew is two men per plane, pilot and copilot who also is a capable mechanic and radioman. Constant communication is maintained with the home base all during the flight which may last only a few

in the international boundary line area, and there are many tricks employed by lawbreakers which the Border Patrol must be on constant guard to avert. Extremely lucrative, if they can get away with it, is the smuggling in of contraband Mexican gold and narcotics. These are the two most prevalent forms of smuggling by air. It is up to the Coast Guard to bend every effort to prevent such things.

Before each patrol flight, a careful plan is drawn up for each plane so that it will cover an extensive area. Emergency equipment, including armament consisting of



hours, or cover thousands of miles of territory that may take the plane long distances from the hangar. One advantage is the usual prevalence of extremely clear weather, for although distances are deceptive, a plane can be spotted easily. Every aerial traveler is overhauled and inspected thoroughly to ascertain its character. Any suspicious sign brings the Coast Guard's signal for the other ship to land. If signals do not suffice, the patrol pilot employs superior airmanship to force the suspicious aircraft down. Sometimes

Top, checking plane's armament. Center, border patrolmen at target practice. Bottom, loading plane with hurricane emergency equipment





such methods do not avail, and the more persuasive one of aiming a machine gun at the transgressor does the trick.

An airplane on the ground in these remote areas is also treated with suspicion, being thoroughly inspected through binoculars. If conditions seem to warrant, the Coast Guard plane lands and searches the grounded ship thoroughly.



The Coast Guard planes keep an especially watchful eye on that part of the boundary marked off by the Rio Grande river. While international law and courtesy forbid the planes from crossing over into Mexico, an adequate watch can be kept from the United States side. Flying low over the river, the plane may spot apparently innocent-look-

(Continued to page 141A)



Top, posed picture showing how smugglers are searched. Center, cargo of contraband being examined by Coast Guardsman. Bottom, Border Patrol plane riding herd on a suspicious aircraft



# Sliding Panels in Baby Crib Control Air Circulation



Sliding panels at foot of crib have been opened to provide circulation, leaving panels at head closed

Draftproof ventilation is "built into" the latest baby crib. Each side of the crib consists of two sliding panels so arranged that the side toward the wind or the electric fan can be closed off fully or partly. Side panels toward the head and the feet move independently, mounted on quiet rollers. The sides also lower to bed height.

# Double Slots in Airplane Wings for Safe Takeoff and Landing

Wing flaps with double slots are the latest safety device for aircraft. Single flaps are already in common use, but the new type has been found highly efficient in aiding a quick takeoff and a slow-speed landing. Since it is retractable, the double-slotted flap does not increase the drag of the wings at high speed.

# Auto Headlight Turned to Amber by Transparent Cover



For motorists who like amber lights for driving in fog, a flexible and transparent cover for automobile headlights is on the market.

Made of amber-colored material, the covers are slipped over the lenses and held by an elastic rim. When not in use they are carried in a small container.

# Radio Echoes Help Make Maps by Tracing Ground Contour

Radio echoes which tell an airplane pilot just how high he is above the ground promise to help make aerial maps. The terrain clearance indicator, hailed as one of the outstanding contributions to air safety in 1938, not only warns the pilot when he is approaching a mountain, but also traces the contour of the ground below. It sends a radio beam earthward and the time required for its round trip back to the instrument gives an exact measurement of its distance above the earth. Variations in the earth's contour computed from records obtained by the echo altimeter will be valuable in preparing aerial maps of the future.

# Automatic Lock Inside Keyhole Cannot Be Pried Out

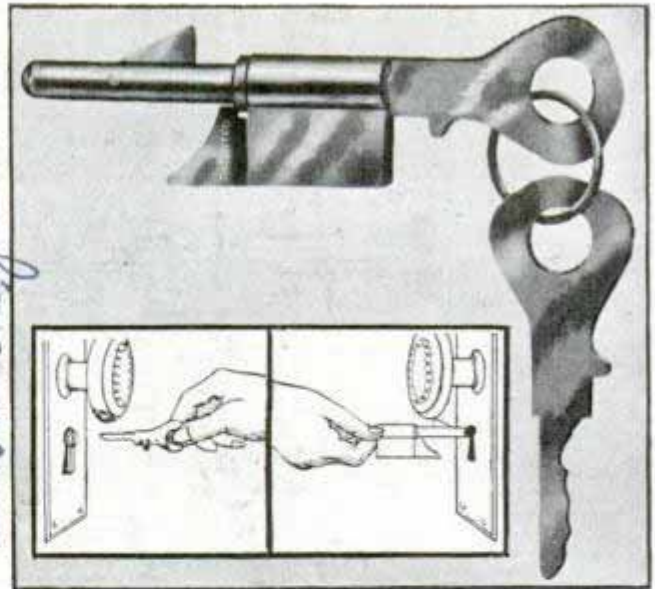

Keyhole lock and keys. Inset, key must be used in unlocking but is not needed for inserting lock

Double protection with a door lock can be obtained by an auxiliary lock that fits into the keyhole and locks automatically when inserted without the key. It cannot be pried out or opened with a skeleton key, but the key must be used for unlocking. The assembly converts any ordinary mortise lock into a pin tumbler cylinder lock.

Reported by Carl G. Wenger, engineer

Babyguard Crib No. 2247

9-45 Science Service

Household Paper Products Co. 100 2 E. 71st St. New York, N.Y.

Independent Lock Co. 71st St. New York, N.Y.

Pat. pend. \$15.00 \$36.00

Science Service 10/10/39

Engineers.



# Electric Detective Uncovers Secrets of Sleep

Most people sleep more than is necessary, and occasional loss of sleep is no cause for worry; persons who depend on an alarm clock wake up a half hour before the alarm actually sounds; daytime naps do not impair sleep at night; but regular habits are the best guarantee of sufficient sleep and efficiency during the waking hours. These conclusions are based on experiments with sleep at the University of Chicago. To obtain a record of changes that take place in the electrical resistance of the skin, a tube so sensitized that it has been successfully used as a lie detector is attached to the sleeper's arm. A box on his chest notes variations in breathing, and another device charts movement during sleep. How soundly the subject is sleeping can be determined by measuring the

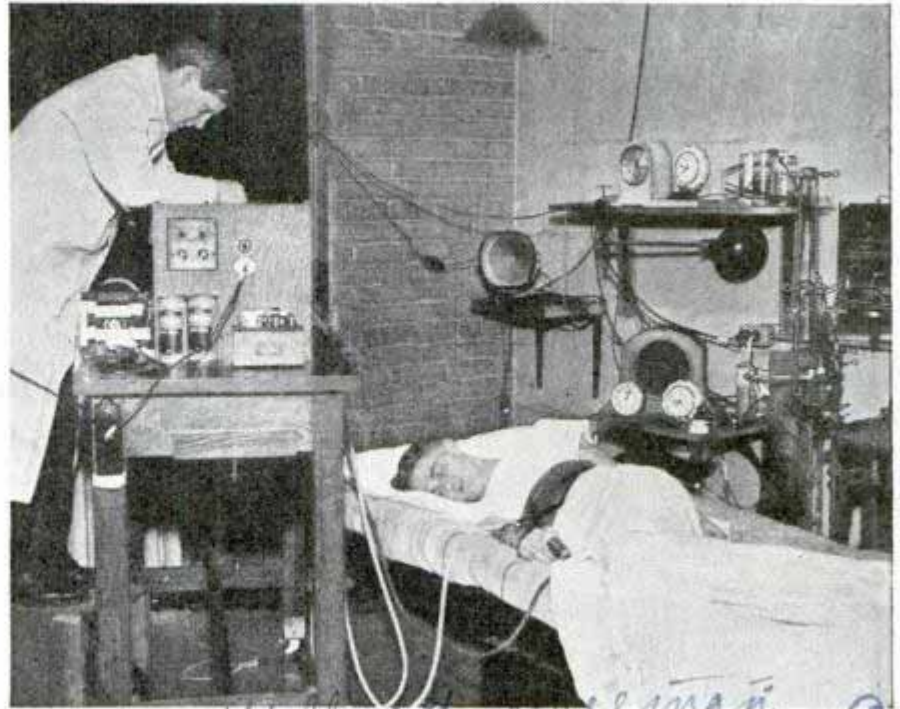

College student sleeps in the midst of assorted paraphernalia while a professor notes electrical resistance of various parts of his body

amount of noise required from a near-by loud speaker to awaken him. About 10,000 experiments have been conducted, using students of the university as subjects, to learn the effects of sleep on the body.

Emb. M.A. Bartlett, Bartlett Services

## "Elephant Trains" Carry Sightseers at Golden Gate Fair

Fantastic elephant-like trains, with the driver's cab replaced by a howdah, transport sightseers at Golden Gate International Exposition. Usually a train has three

trailers, each carrying twenty passengers. Seats are back to back, facing to the right and left of the train, and the conductor has an aisle between the seats. Trailers have

but two wheels at the extreme rear, and steel floor plates overlap at the couplings to form an articulated train of four separate units with only ten wheels. Easy to board, the trailers are built within six inches of the ground. The power unit is an eighty-five horsepower V-eight engine.

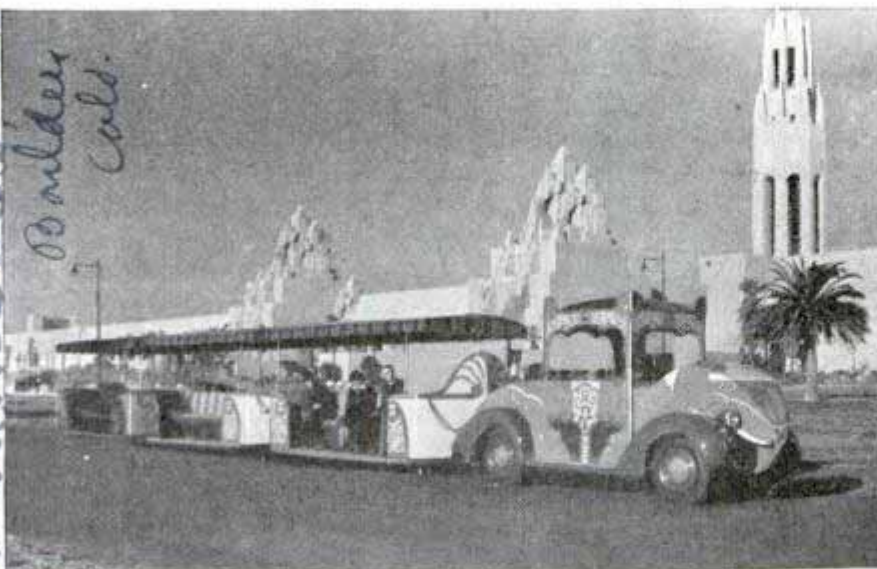

Dressed up to resemble a howdah mounted on the back of an elephant, this fantastic tractor pulls open-air trailers at the Golden Gate Exposition

¶ Six states—California, Texas, Florida, Michigan, Pennsylvania and Ohio—and Alaska have more than 100 airports and landing fields in each.

C.A.A. Report  
Jan 5 1939

Field

H 156

Wells and Helman

Acme



Snow machines turn 300-pound ice cakes into six-hour blizzard to coat ski slide in summery Los Angeles with a six-inch layer of fast ice



# PAINTING PICTURES

41423  
 emb. Maxwell Road  
 54 1/2 Glendale  
 Blvd. Los Angeles  
 ONE night about fifteen years ago, a young electrician named Otto K. Olesen dragged down the main street of Hollywood his most cherished possession—a huge searchlight bought at an auction of army equipment. He set it up in front of Grauman's Egyptian theater, where a new picture was having its premiere. Olesen thought that a giant pencil of blue light swinging back and forth across the evening sky might attract people's attention.

It did. Curiosity brought them swarming by thousands in automobiles from the suburbs and the beaches, clogging traffic for miles. Olesen found he had started a tremendous fad. Today nobody in Hollywood thinks of opening a new gasoline station, supermarket, or theater without a hillbilly band, a battery of floodlights, and a bank of Olesen's big sun-arc searchlights waving back and forth to lure curious people from miles around. Olesen not only

opens them in a blaze of glory—he sometimes closes them as well, his rented floodlights later illuminating the auction where the stock and fixtures of an unsuccessful business are sold under the sheriff's hammer. Practical jokers have been known to hire the "Big Bertha" searchlights, with their 325,000,000-candlepower beams, to give unsolicited publicity to an unsuspecting friend's wedding, and now and then a famous movie star comes home to find his house marked out by a circle of giant light beams while friends await to celebrate his birthday.

One night Olesen set up a semicircle of big arcs masked by gelatin filters and flung a great sunburst of color against the sky, adding sheets of pulsating rainbow tints to create a huge aurora borealis. The purpose was to advertise the opening of a new hotel, but people as far as sixty-five miles away flooded newspaper offices with re-

Otto K. Olesen  
 Illuminating Co. Ltd.

1560 N. Vine. Los Angeles





*with* LIGHT

ports that the "northern lights" of the arctic were visible in California.

If enemy bombers suddenly raided southern California, probably the first civilian called out by the army would be Olesen, for his platoon of mammoth sun arcs, mounted on trailers or big two-motored trucks with gasoline power plants able to pour 200 amperes across the flaming, chemically cored carbons, could quickly raise a curtain of light around vital areas. More than once his whole fleet has been drafted suddenly when an entire city went



*Top, battery of big sun arcs shines outside Hollywood theater where movie premiere is attracting celebrities. Below, head-high reflector cylinder of mobile 200-ampere arc projector which has a range of 100 miles*





© Otto K. Olesen

*Top, colored searchlight beams create "Aurora Borealis" visible for sixty-five miles. Below, unit to project messages on clouds or smoke*

black—during a disastrous cloudburst, for instance, when his crews of "juicers" sped to the stricken town of Montrose and laid down a barrage of light to aid searchers combing the ruins for survivors. At the time of the Long Beach earthquake his men dragged their cables into dark hospitals rocking with continued shocks, so that surgeons could care for the hundreds of victims being brought in by rescuers.

Only in Hollywood would you find a warehouse like Olesen's full of weird ap-

paratus ranging from baby spotlights you could put in a teacup, to giant projectors that paint pictures on the clouds; huge, thundering blizzard machines, and flame generators that lay down mock "fire" by the acre. His wind machines, often rented to the movies, have helped fight oil-well fires by laying down a protective screen of air under which men could walk up to the burning well and throttle its flow. Commercial photographers have used them to ripple the clothing and hair of "motorists" posing in studio set-ups for advertising pictures. Again, they have been hurried to a fire-damaged store where their powerful blasts quickly dried out merchandise wet by firemen's hoses.

When western ski jumpers wanted to hold a tournament in snowless Los Angeles, Olesen obliged by providing a six-hour blizzard. A tubular steel scaffold 160 feet high was built in the Memorial Coliseum and elevators hoisted a total of 6,500 big 300-pound ice cakes to two of Olesen's



snow machines, which spewed forth a powdery blast of sleet, coating the slide with a six-inch layer and making it one of the fastest ski jumps ever built. Again, during a Christmas celebration when strolling bands of musicians roamed Hollywood's main boulevard under a mile-long string of Olesen's floodlights, open-mouthed residents saw Santa's sleigh arrive in a blizzard composed, this time, of cornflakes which in the uptilted searchlights looked like real snow.

Trick effects are an Olesen specialty because few other firms are equipped to handle orders like the one, for instance, that called for "5,000 fireflies, an acre of fog, and a flame machine to put fire on the wings of fairies." That was for Max Reinhardt's performance of "Midsummer Night's Dream" in the Hollywood Bowl.

The fog was easy—a network of buried pipes releasing puffs of chemical mist, driven by controlled fans so it would drift naturally

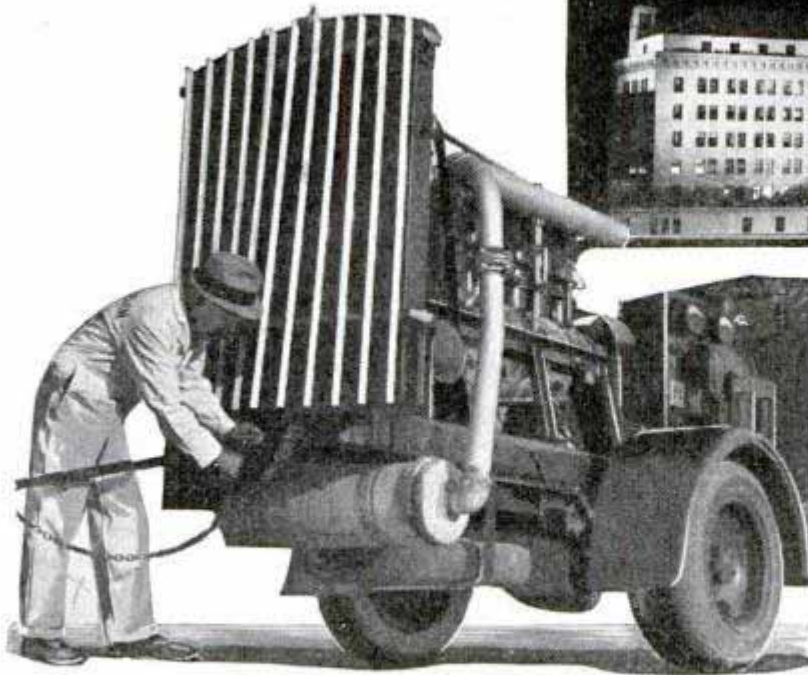
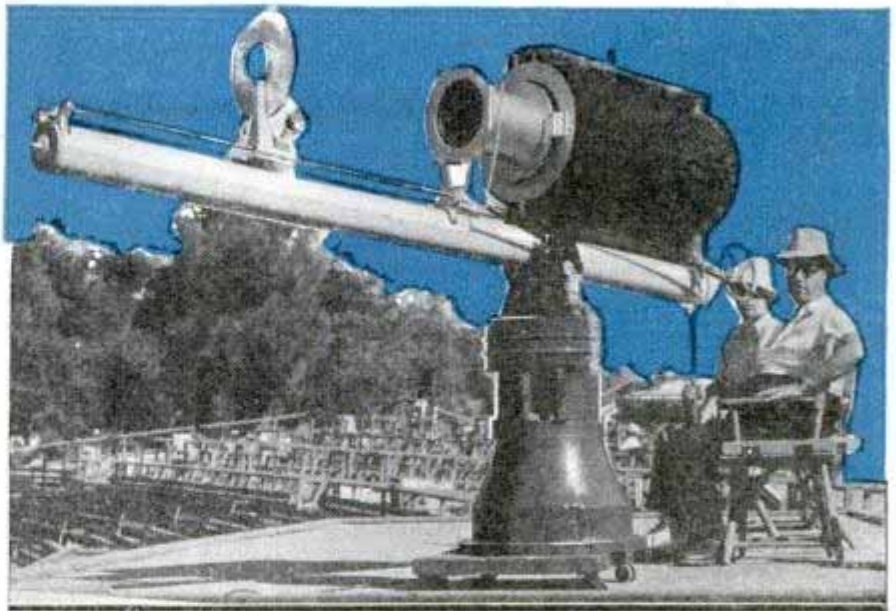

*"Cannon" at top throws twelve-inch spot of light on stage 1,500 feet away. Center, Los Angeles city hall transformed into "lighthouse." Bottom, two-motored truck generates power for searchlight*

across the "stage," a grassy, tree-covered hillside. The fireflies were a harder problem, for they had to seem actually in flight through the surrounding "forest." Among the sagebrush bushes covering the slopes of the forty-five-acre natural amphitheater, he wired 5,000 small, ten-watt bulbs painted a ghostly, pale greenish-blue to look phosphorescent. Motor-driven flashers timed them to

(Continued to page 124A)



H-424

# Film Record Guides Hand of 'Robot' Sculptor

Newport, Monmouthshire, England

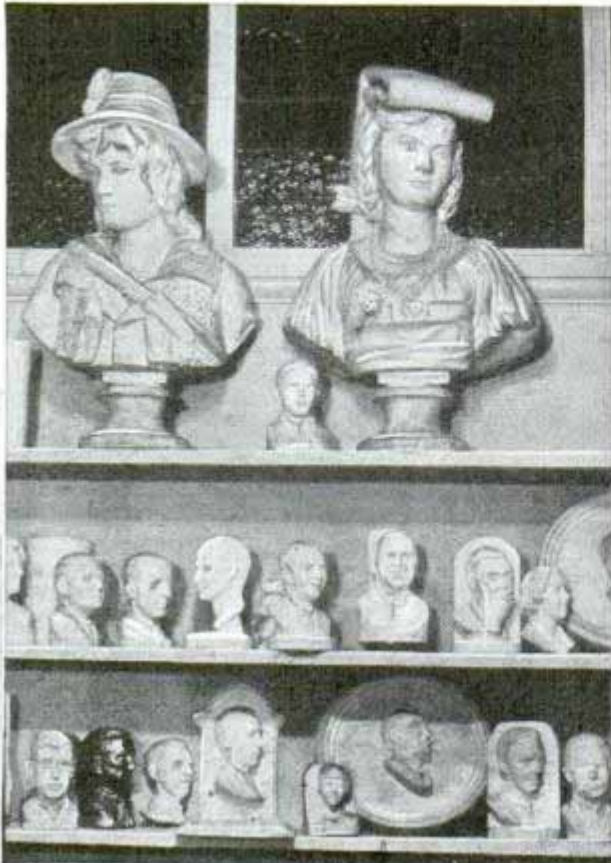

Above, S. T. Jeffreys, English originator of "photosculpture," with a mounted likeness of himself, and some of the busts and heads on his studio shelves. Right, vertical light beam scans face of the model as synchronized camera records contours. Below, automatic cutting tool, guided by film record of contours, carves out a bust from block of material



See next 5717/36



The camera long since has invaded the realm of the painter, and now it usurps the domain of the sculptor. An English inventor conceived the idea of photosculpture, in which the camera is made to guide automatic tools carving from stone or plastics the shape of the object photographed. In the first stage a narrow vertical beam of light is projected on the object, following its contours while a synchronized camera records them. The photographic record then is placed in a reproducing machine to guide the "robot" sculptor tools. You could "sit" for this camera and take home a bust of yourself within an hour



# Bone Tests Dog's Vision in Fitting "Specs"

Fitting a dog with glasses is a difficult problem. First you must

perform a sight test, then train the

dog to

cently he worked out a satisfactory

tory solution. For several successive

days he gave the dog a dry bone, covered with fat, to lick. The

animal became familiar with the shape of the bone. Then the bone,

made odorless, was suspended fifteen feet in front of the dog for a

"test-reading chart." Various lenses were placed in front of the

dog's eyes, and when proper corrective lenses were used the dog

observed the bone and tried to reach it. These lenses were installed

in a special frame.



Left, optician holds a bone in front of dog while trying various lenses. Right, the dog wearing his new "specs"

# Monsters of Old Are Modeled in Concrete from Fossils



© Charles d' Emery

Dinosaurs are once more making an appearance in the Black Hills of South Dakota where their fossil remains have been unearthed. The replicas made in cement resemble the real saurian species dug out of the surrounding shale. Several of the prehistoric monsters have been reproduced as part of Dinosaur park overlooking Rapid City.

Two dinosaurs appear ready to defend their domain against intruders

# Marsh Buggy 'Floats' on Seven-Foot Tires Made of Arc-Welded Steel

Leakproof tires seven feet in diameter and four feet wide, made of large arc-welded steel drums instead of the usual pneumatic rubber, help a ponderous all-steel "marsh buggy" keep afloat in marshy land. The unit weighs 10,000 pounds and is capable of carrying a 6,000-pound load. The "buggy" operates at two miles per hour in water, seven miles in marshes, and twelve on the highway. It is twenty-one feet long.

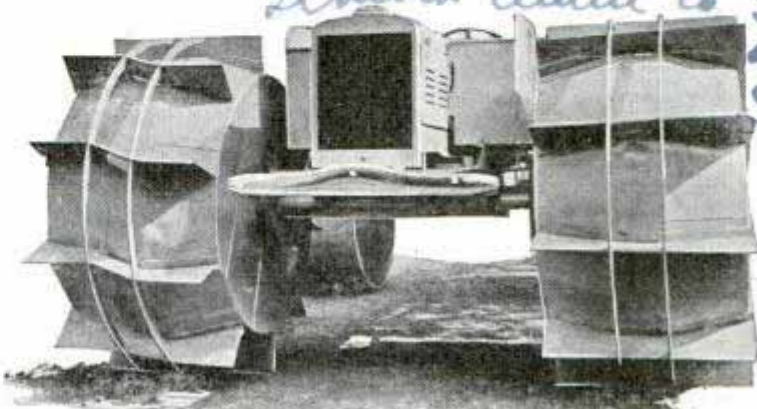

Fins on steel wheels help propel the vehicle through water

Constructed by Stanolind Steel and Iron Co. in an shop at



#1398. *Chick. L. ...*

# THIRTEEN SLAVES

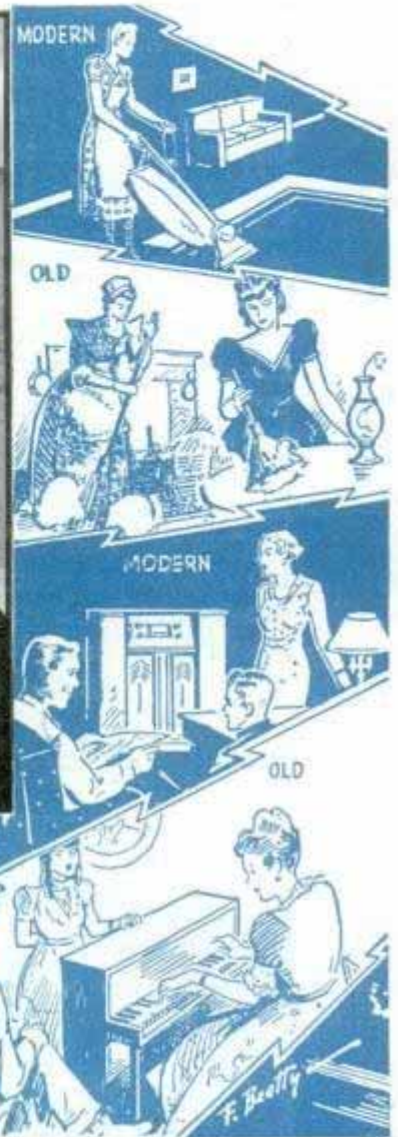

**Y**OU thought slavery was abolished long ago. You look back with a twinge of envy to Mount Vernon, and lament that the ease and splendor of that graceful period of American life are vanished forever.

Don't feel sorry for yourself. You're a bigger slave-owner than George Washington. True, the master of Mount Vernon did not have to pay wages to the scores of negroes, men, women and children, who tilled his fields and cooked his meals, hewed his firelogs and tended loom and spinning wheel, washhouse and stable. But he had to clothe them, house them, to deal out daily rations to them all.

Washington's slaves cost plenty more than yours. You do have to pay yours, but you don't feed nor clothe them, nor build them living quarters. And you probably pay less than two-fifths of a cent for every hard hour's work put in by any one of your husky, versatile and willing slaves. You really can't complain.

Your slaves are kilowatts. Put a kilowatt to work for one hour and it does the work of thirteen strong men. Flick the switch of your thousand-watt electric iron, use it to press clothes for sixty minutes and you have hired the labor of thirteen men for a nickel or less.



*Compare the back-breaking old way of ironing with modern way at top. Bottom, putting electrical slaves to work in a moth-prevention treatment of furniture*



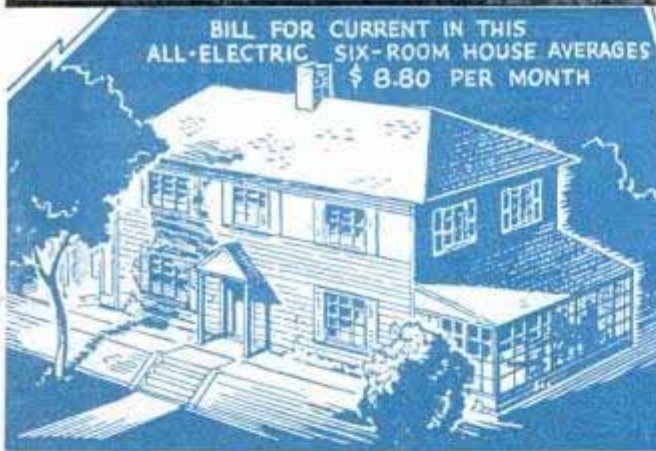

Meals at Mount Vernon came from separate cookhouse. You can prepare breakfast right on the table with electric toaster, griddle and coffee urn. Drawings contrast old and new way of doing household chores

George Washington, living in the height of eighteenth-century fashion, kept sixty-six slaves on his beautiful Mount Vernon estate. The average American family today has the equivalent of more than 400 slaves at its call. And, too, these slaves of yours are on duty night and day, without sick leave or vacation, uncomplaining, never slamming a door or gossiping with the next door help or talking back to you.

Of Washington's sixty-six, some were children, some were poor workers, and many were assigned to work in the fields and stables and other outside tasks that do

not concern you at all. Mount Vernon was really an independent economic unit, as much so as any medieval manor. It raised its own livestock, grain, gardenstuff, and tobacco. One man and four slave girls were busy at the spinning wheels constantly. In a year the Mount Vernon spinning wheels and looms turned out 815 yards of linen, 365 yards of woollens, 144 yards of linsey, forty yards of cotton.

Other slaves spent day after day in the washhouse—your own electric washer and ironer are busy perhaps two or three hours every week and cost you about thirty-five



Vol. 10, No. 10, 1938



cents a month in current; others were employed in the dairy at milking, skimming, churning, cheese-making; in the mills, the brick kilns, the carpenter shop, the smokehouse, the woods, the distillery. That left a relatively small number of the sixty-six to do the household tasks. And those are the very tasks to which your entire available staff of 400 servants is devoted. Of course, you can never use all that help. In an all-electric home you might use an average of twelve kilowatt-hours a day, the equivalent of thirteen hard-working servants putting in a twelve-hour day and charging you about 2.84 cents each for his day's work.



Let's take apart the average bill of an average family living in an all-electric home for the last year.

This householder actually averaged twelve kilowatt-hours a day throughout the year and paid \$105 for the year's electricity. He lived in an average city, where home electric rates started at six and one-fourth cents a kilowatt-hour and ranged down to one and one-half cents according to the amount used. He didn't have to think about assigning duties to his electrical slaves, but if he had, the twelve kilowatt-hours of 156 servant-hours a day would have been organized something like this:

Night shift: 11 p.m. to 6 a.m. Three man servants



Top, the 1939 kitchen with electric refrigerator, dishwasher, garbage disposal unit, food mixer and range. Center, old-time basement laundry. Below, up-to-date basement with automatic heating and air-conditioning plant, and washing machine in kitchen

Owner - Mrs. E. Clifford  
Westfield, N.J.



121398



At left and above, old and modern methods of scrubbing and polishing floor. The bicyclist, pedaling a "bike" harnessed to watt meter, at his best could "pump" only 240 watts for an instant and in six full days could generate fifteen kilowatts

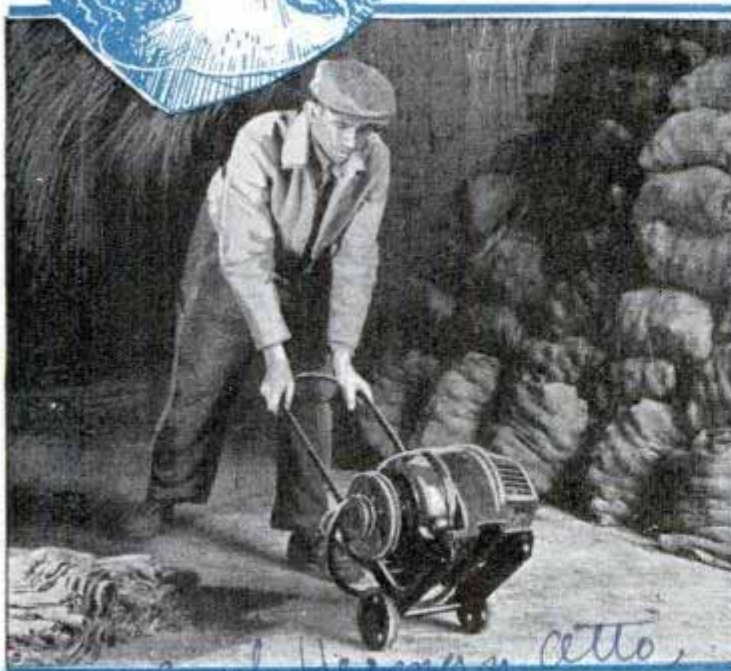

Electricity is moving to the farm. Here is a portable two-horsepower motor used to grind feed, shell corn and hoist hay on a Pennsylvania poultry farm.

tend the motor of the automatic furnace all night, keeping the house temperature at the desired level; they keep the tank full of hot water; they keep the refrigerator down to forty degrees; they keep fourteen small lights burning indoors and out to discourage burglars; they keep seven electric clocks running, one of them the alarm clock that wakes the head of the house at six; and they are on guard to sound alarms if fire breaks out or intruders break in.

Day shift: 6 a.m. to 7 p.m. Three more man servants take over the furnace, refrigerator and clocks, and provide ultraviolet sun baths, electric shaves and light. Meanwhile six maid servants are cooking breakfast, lunch and dinner on the electric range; they mix and grind food, polish the floors, vacuum rugs and furniture, and on washday an extra crew comes in to run the washer and ironer and to dry the clothes when weather requires it.

Evening shift: 7 p.m. to 11 p.m. Two maids spend just ten minutes washing the entire day's dishes in the electric washer and disposing of garbage. Four man servants operate the radio, lights, furnace, refrigerator and clocks.

It all adds up close to 156 servant-hours a day, and all for about thirty cents!

Whether they turned a fruit juicer or pumped oil into a furnace or rang the

(Continued to page 114A)

manager. Westinghouse Electric Poultry Raising



### Thermostat Valve for Radiator Saves and Controls Heat



Arrow indicates thermostatic air valve mounted on radiator. Below, left, is cutaway sketch of unit

Temperature in each room is controlled as desired by fitting radiators of one-pipe steam-heating systems with a newly developed thermostatic air valve. The thermostat replaces the ordinary air valve and is installed in a few minutes without making costly changes in the system. Any temperature between sixty and eighty degrees Fahrenheit can be maintained by setting the dial, and one room can be heated adequately without wasting heat in other rooms. According to the manufacturer, tests have indicated that savings up to thirty per cent in fuel are possible.

### Non-Icing Airplane Carburetor Works in Any Position

Using a diaphragm mechanism instead of the usual float to control fuel flow, a carburetor recently developed has solved two outstanding aircraft engine problems. It assures constant flow of fuel to the engine regardless of the plane's position, important particularly to military aircraft which frequently execute dives and loops. Also

icing in the new carburetor is prevented by keeping its metal surfaces out of the way of the expanding stream of fuel, which travels so fast it is out of the carburetor before it can reduce temperature in the carburetor markedly.

### Governor Drops Control on Hill to Allow Truck Full Power

Positive speed control on level roads but full power on hills is assured by a governor developed for truck operators. On uphill climbs the governor is taken out of operation entirely, but when the truck reaches level ground the governor goes back to its job of preventing excessive speed.

### Accordion File for Negatives Opens for Easy Inspection

Miniature films can be stored in a transparent "accordion" file which protects them from fingerprints, scratching and curling. There are twelve rows, each holding twelve negatives of the thirty-five-millimeter size. Unfolded, the file permits easy inspection of the strips.



Stretching open the accordion file, twelve rows of miniature negatives can be inspected against light

*Sullivan Valve and Engineering Co. 16 S. Arizona St. Pueblo, Colo. 9/16*  
*Vanoverman P.O. Box 1229 St. Louis, Mo. 4/8*  
*Science Service 1/9/39*  
*Holley*  
*Raygrain Corp. 425 4th Ave. New York*  
*W. J. Kuttler, Chief Engineer, Holley*

*Algonquin Airplane Products Co. 1718 N. Lamar, Chicago*  
*g-11*  
*g-55*  
*g-22*  
*E. J. View 304*



Capt. McGraw  
The Boat  
The Quartermaster

# Tender and Mailman to the Harbor Lights



If light buoy, above, needs "heavy" repairs it is taken aboard and reserve buoy is anchored in place. Right, quartermaster at wheel. Captain with glasses watches approach to lightship "Ambrose"

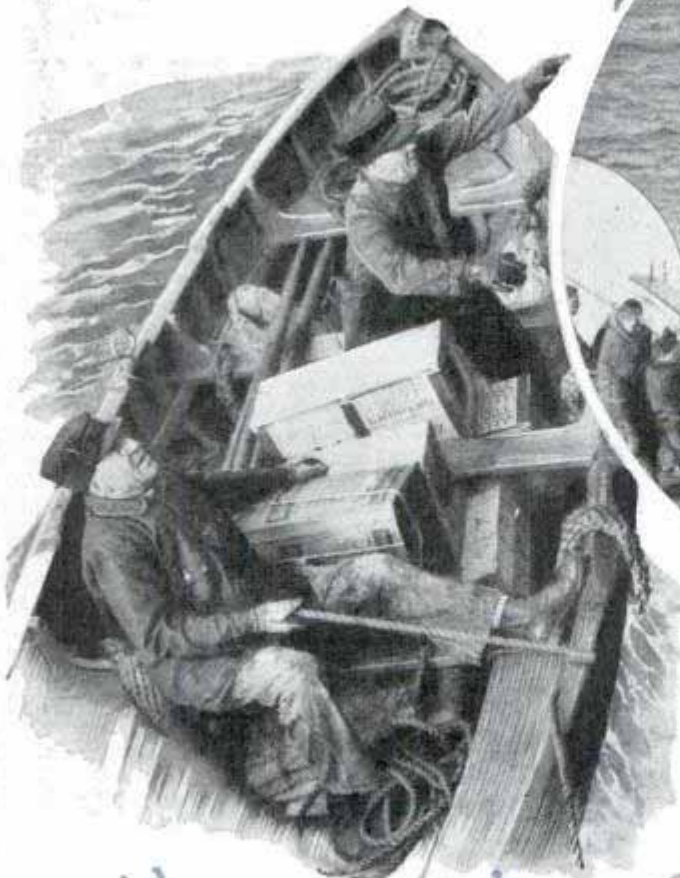
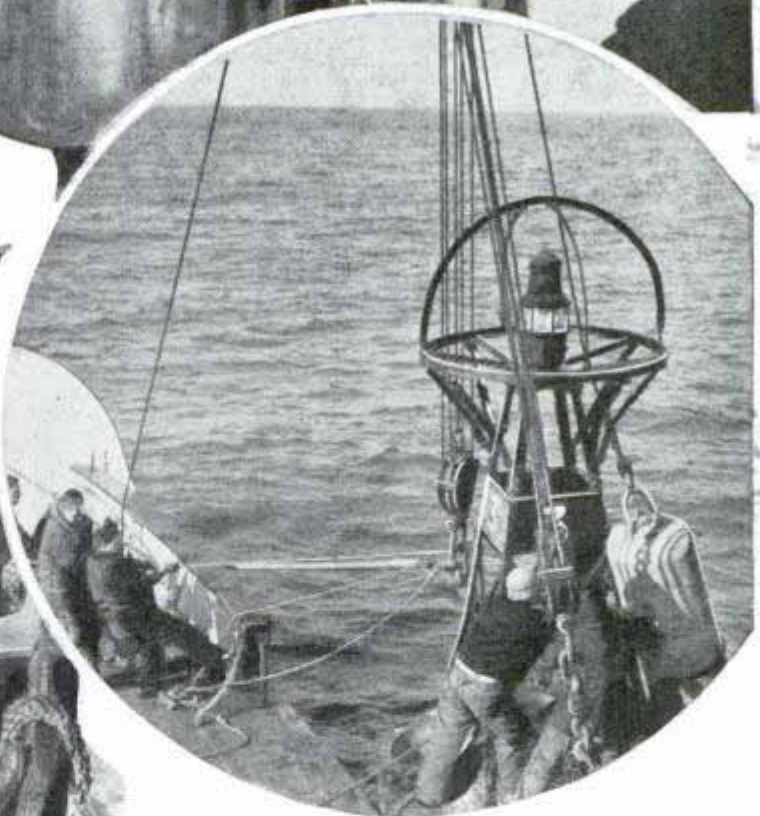

Three days each week, in sunshine, storm or fog, the U. S. lighthouse ship "Spruce" pushes out from Staten Island to tend the lighthouses and buoys of New York waters. Every light must be inspected, gas tanks exchanged or refilled, emergency repairs made by the crew of thirty, mail and supplies left at lighthouses or lightships. Left, boat pulls alongside for supplies. Above, removing tank from buoy in Ambrose channel

Raystone & New Co



# 1585

# HANDFULS of

Gordon A. Babb  
manager, Ace Model Shop  
East Colorado Blvd Pasadena  
Calif

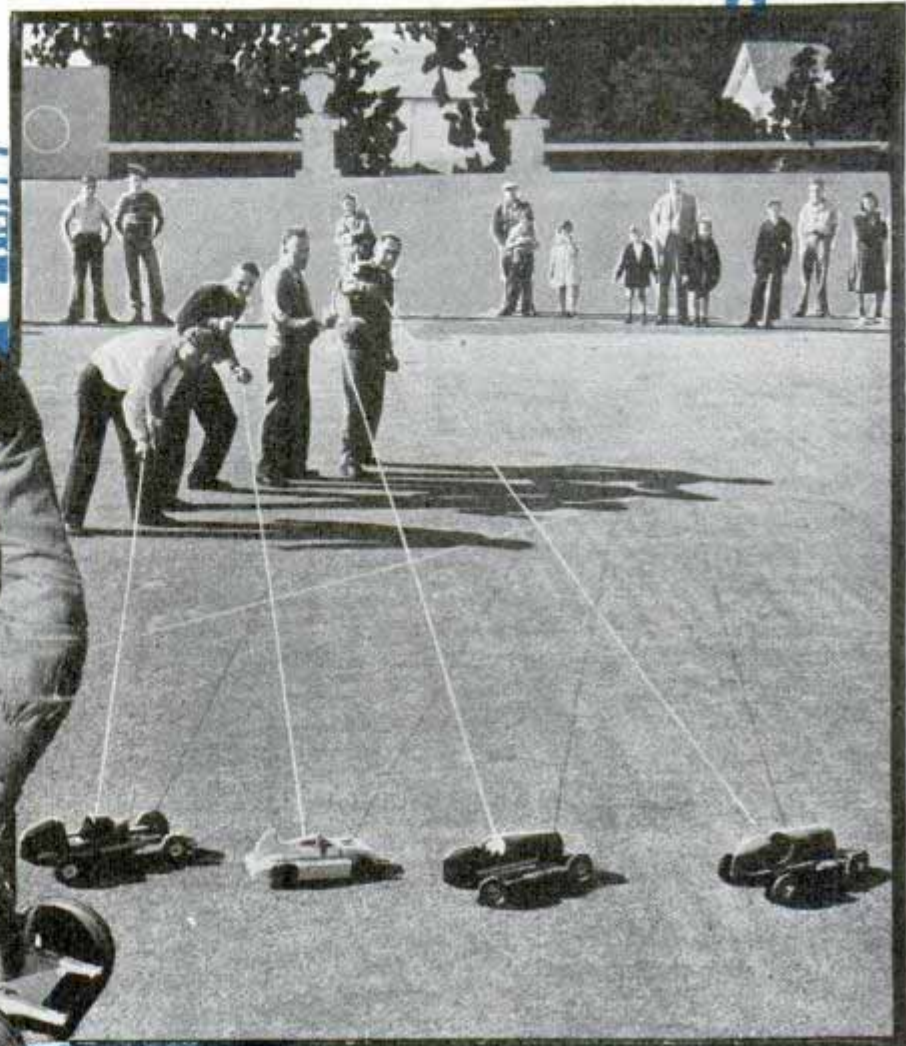

Above, Gordon A. Babb of Pasadena, designer, fills seventeen-inch racer's tank with two-ounce mixture of gasoline and oil. Right, "drivers" guide midgets in race on circular course by cords fastened to swivel joint on side of car. Below, underside of racer showing front-drive shaft and ignition batteries

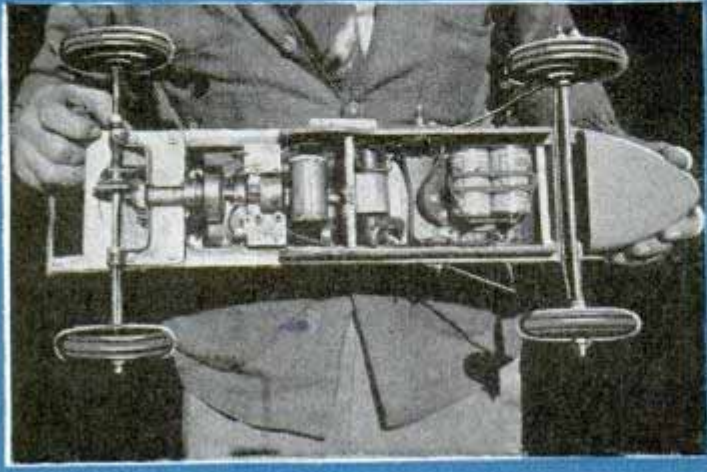

Racing meets for driverless automobiles that buzz around circular tracks at forty to fifty miles an hour on a dishful of gasoline are sweeping a model-builder's hobby into a racing sport of nationwide scope. Two hundred of these Lilliputian cars are competing in regular races in the southwest, where the hobby had its origin. Actually replicas in miniature of Indianapolis speedway and midget track champions, these cars carry only a two-ounce mixture of gasoline and light oil in their tiny tanks and develop engine revolutions as high as 7,500 and 9,000 per minute. Most of them have front-wheel drives, some driven by gears and others by friction. One of them set a distance record of three and one-half miles. The baby racers weigh around six and one-half pounds and are twenty-two inches long, over all. Frames and bodies usually are of wood, but the latest models are being built of metal with steel frames, incorporating nearly every feature found in a standard-size car of the major speedways. In order to race, the rear wheels are adjustable to an angle and are locked by braces from the rear axle to the frame. The "drivers" guide them from the "hub" of the track by long cords attached to the sides with a swivel joint. Spongy tires were used at first, but the strain of racing forced change to solid tires







# Coin-in-the-Slot Newsreels Viewed Like Penny Arcade



Inserting coin in slot. Right, interior of newsreel vendor showing how pictures are projected and relayed to view by reflector

Motion pictures showing the latest news events have been added to the long list of products sold by vending machines. A projector in a large cabinet is started by inserting a coin in a slot and the film is viewed through a window. The machines will be set up in railroad stations, hotel lobbies, and other public places. The newsreel vendor was shown recently at a display of coin-operated machines in Chicago.

## Changes in Auto Designs Urged to Stop Noises

Automobile designs must be re-planned to get rid of road noises, two General Motors engineers recently reported to the Society of Automotive Engineers. With the older but quieter cars of wood panel and steel construction equipped with more noisy engines, much road vibration was deadened and did not make a lot of difference. Since the introduction of today's all-steel bodies and

quieter motors motorists have been plagued by vibrations set up in the entire auto. Change in design is sought to prevent natural vibration frequencies of major parts from coinciding so they will not reinforce each other. Damper pads which have been tried did not prove successful.

## Huge Sugar-Cane Harvester Cuts Two Rows

Twelve feet high, twelve feet wide and sixteen feet long, a sugar-cane harvester plows through two rows at a time and cuts one and one-half acres—about thirty tons of cane—in an hour. Besides costing less than hand labor, operation of the harvester permits concentration of labor in the sugar mills, and in time of frost it may save a sugar-cane grower thousands of dollars. It was invented by S. C. Thompson of Labadieville, La.

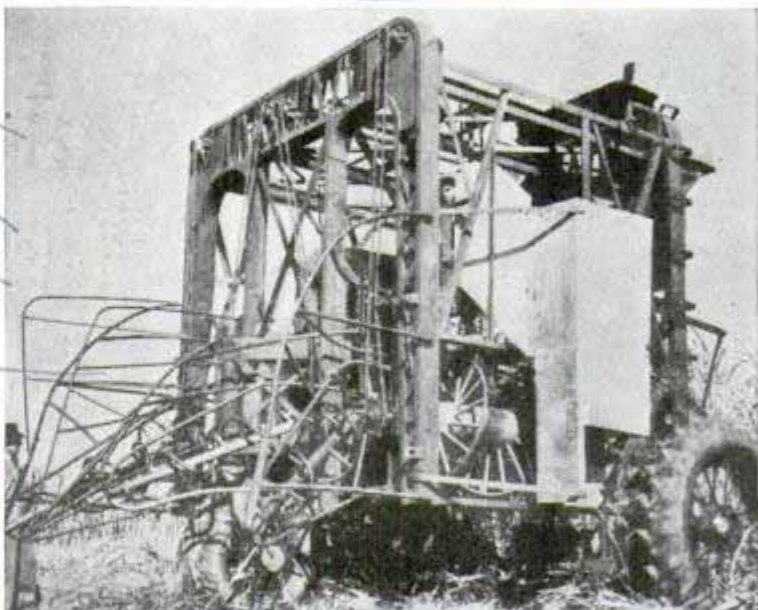

Bridgelike structure on wheels is sugar-cane harvester that cuts two rows and covers one and one-half acres an hour

*Ernest E. Wilson and Paul Huber*

*Pruning Island*

*4710 Fullerton Ave Chicago*

*1+1519*

*Acme*

*#1663*

*same series 1/10/39*



# Music from Mixing Bowls and Salvaged Junk

Marimbas from the junkyard, melodies from mixing bowls! Humble enough sources, yet L. L. Chamness of New Providence, Ia., produces good music from his homemade instruments. Scrap metal cut mathematically to musical keys over an octave and a half formed beautifully toned



Top, playing steel chimes made from scrap metal. Center, plate-glass marimba with tin can resonators. Left, a scale of matched mixing bowls played with potato mashers

steel chimes. No resonators were used, the bars being screwed to a sounding board and resting on rubber tubes. From thousands of mixing bowls Mr. Chamness chose several that were in exact pitch to make a perfect scale; played with old-fashioned potato mashers, the bowls have an exquisite tone. A plate-glass marimba was made entirely of salvaged junk. Tin cans were used for resonators, soldered together with ends removed except for the bottom, their

sizes varying to vary the pitch. Bars of plate glass recovered from windshields, desk tops or store windows rest on rubber weather-stripping shock absorbers, with knotted cords to hold each bar in place over its resonator. The tin cans are mounted on tin strips fitting into slits in the frame. The glass marimba produces two full octaves above the ordinary wooden or metal marimba, its lower notes rich and mellow, its upper notes bell-like.

## Mountain Top Blasted Away to Open Rich Copper Mine

Hidden in an Arizona mountain is a tremendous body of copper-bearing ore a mile square and 700 feet thick. Engineers are blasting off the top of the mountain to reach it—a five-year task that probably will cost \$30,000,000 before any copper can be mined. The project involves removing 400 feet from the peak, bringing it down from an altitude of 5,300 feet above sea

level to 4,900 feet and hauling 37,000,000 tons of rock and earth to be dumped in surrounding canyons. Phelps Dodge corporation engineers estimate the deposit contains 3,300,000,000 pounds of copper. In blasting off the peak, holes are drilled fifty-five feet deep and packed with dynamite. Fifty to 100 tons of explosive at each shot loosen 100,000 to 200,000 tons of earth.

*J-33 Phelps Dodge Copper Products*  
*corp 40 W. 11th St. New York*  
*Mountain Square Mine*  
*Morencio Arizona.*



W 1489.

Com. James McQuinn 421 W. 60th St. New York City



casting crew arriving there first gets the audience and that's the big prize in this thrill-packed business.

Earthquakes, floods, fires, air tragedies, mine disasters—radio must be at the ringside for all of them. Many assignments are cloyed with danger and hardship. Announcers and engineers have donned hip boots, raincoats, and hats in the manner of firemen and gone out for the spectacular, only to find upon their arrival in the stricken area that tragedy stalked. Here they have lent a willing hand in rescue in addition to their broadcasting chores. Brief, routine programs have lengthened into sleepless thirty-hour shifts in sleet and rain when throats become raw from broadcasting a ceaseless stream

# HEROES *of the*



**“WE INTERRUPT** this program to bring you a special bulletin—”

This prelude to hot news on the air means that on some national or foreign front, a new chapter, or perhaps just a footnote to the history of our times, is being written.

Already a mobile unit—a self-contained broadcasting studio—may be speeding there. If not, broadcasting equipment is being loaded into an airplane, blimp, or cutter. But no matter what the mode of transportation, you can be sure microphones are moving rapidly toward the news source to bring you the running story as it unfolds. The obstacles may be great and the competition keen, for the broad-

Left, radio hookup between American and European trains going ninety miles per hour. Right, broadcasting war maneuvers at Pine Camp, N. Y.



Circle, getting boy flood victim's story. Below, broadcasting the Easter parade. Note top-hat antenna and batteries beneath announcer's coat (right). Diagram of this micro-wave transmitter appears at bottom of page

*me  
Islands  
Bragg  
Security  
Hicks,  
N B C  
H 1489*

*Jacobs  
Reade*



# RADIO "FLASH" . .



of emergency calls and bulletins.

When the little town of Hatfield, Mo., was cut off from the outside world for almost a month by heavy snows, Larry Sherwood and Jimmy Gardner were dispatched there to conduct a network program. Borrowing two fur-lined flying suits, they started out in a motor car and were successful in getting

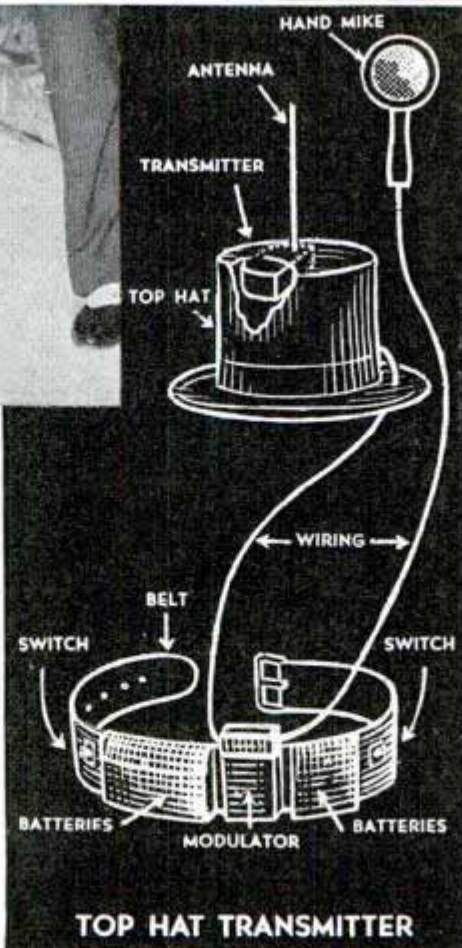

within ten miles of the town before running into snowdrifts twenty and thirty feet high. Their equipment was then loaded onto a sled, the men plowing along at the side of it. A heavy blizzard slapped at them throughout the remainder of the trip, the thermometer hovering around twenty-five degrees below zero. But they got a program on the air twenty-four hours before any supply train was able to get into town.

With the whole world for a studio, the special events men have brought war into the living room and, during an international crisis, have made it possible for us to eavesdrop on the world's council chambers.



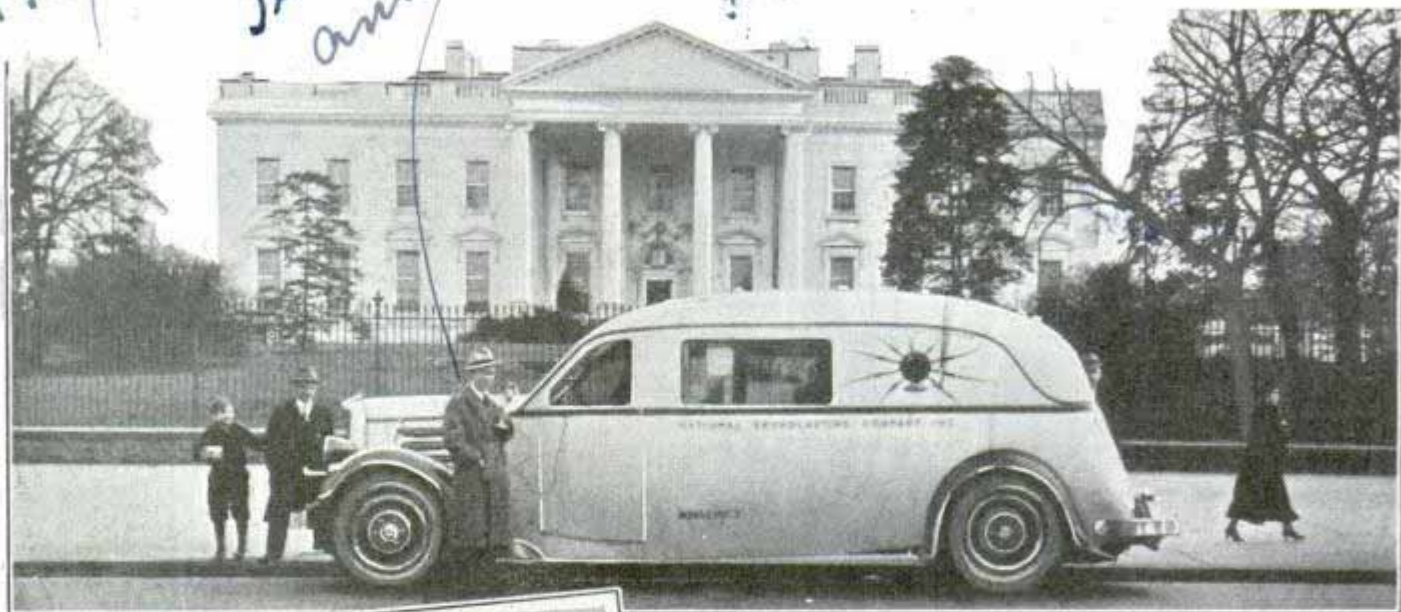

**Top, mobile unit transmits description of White House. Center, broadcasting facilities inside stratosphere balloon. Bottom, news bulletins coming in to be broadcast**

The widespread interest in foreign affairs has brought into prominence the foreign radio correspondent, the most glamorous job in the current broadcasting picture. When the world's peace hangs by the slender thread of diplomacy, NBC's Max Jordan and Edward Murrow, Columbia's continental representative, virtually live in the air, flying from one European capital to another, contacting foreign offices, arranging pickups of spot news and making summaries and translations of important events.

Floyd Gibbons first brought America an eye-witness account of a battle. Thousands of American loud speakers reverberated, not with studio sound effects but the actual machine-gun fire between Chinese and Japanese forces during an early skirmish in Shanghai. Since then, NBC has taken its listeners on a round-the-world tour of the wars, starting ironically enough at Geneva, and stopping at Madrid, Barcelona, Shanghai, and Tokyo where war correspondents and commentators described the situation, some of the comments being punctuated with the distant roar of cannons and bursting shells.

In normal times, the scramble for listeners is wide open and the special events departments of the chains are ever alert for novelties and features that will



attract listeners. First communication with the McGregor Expedition in Greenland, a visit with the Terry-Holden Expedition in the jungles of British Guiana, a trip inside the ancient pyramids of Giza, and a two-way hook-up between an American streamline train going ninety miles an hour and a European one traveling at the same rate are but a few of the dishes served up to excitement-hunting dialers.

American technicians like to recall the time they captured the rumble and hiss of Mount Vesuvius' boiling lava after continental radio men had passed up the idea on the ground of it being too dan-



*Above, diver being lowered into Lake Michigan for special broadcast. Left, special radio program from plane high in the air. Below, two special events broadcasters giving listeners the thrill of amusement park's water chutes*



gerous. In three days of experimenting, American radio men figured out a way of handling the program. Two fifteen-watt transmitters were lowered into the depths of the seething crater. Vesuvius roared and grumbled, at times nearly drowning out the voice of the announcer who spoke from another microphone at the edge of the crater.

The longest trip on record was taken by George Hicks and two crack engineers when they accompanied National Geographic

(Continued to page 124A)





# Magnifier Worn on Head Gives Binocular Vision



Both hands can be used for holding film before magnifier held on head by an adjustable band

For examination of miniature film negatives and enlargement projections for sharpness, a binocular magnifier fitted with an adjustable headband gives a three-dimensional view, showing objects in their true thickness and shape. An illumination attachment also is available, and the magnifier can be worn over spectacles.

## Micrometer with Automatic 'Feel' Reduces Chance of Error

Despite the apparent simplicity and precision of the micrometer caliper, measurements made with the instrument may vary



Strong hands will not upset the automatic "feel" because scribed lines show him when to stop

due to slight compression of the material being clamped or distortion of the instrument itself. These inaccuracies, resulting from differences in pressure with which the micrometer is operated, are avoided by substituting a helical spring ratchet mechanism for the ordinary ratchet used to transmit the torque of the operator's fingers. Thus the "feel" becomes automatic, removing the human element. The new ratchet also saves time in making adjustments, for this can be done while it is assembled on the micrometer by merely removing the cover. When the ratchet has been adjusted to give a definite torque, the operator needs only to turn a cylindrical cap at the end of the caliper until scribed lines on the cap and micrometer barrel are brought into alinement after the spindle contacts the work.

H 1440

## Fuel Saver Conserves Gasoline Lost by Power Jet on Car

There is one type of fuel waste that automobile governors are unable to stop. Fords and Chevrolets with certain makes of carburetors have mechanically operated

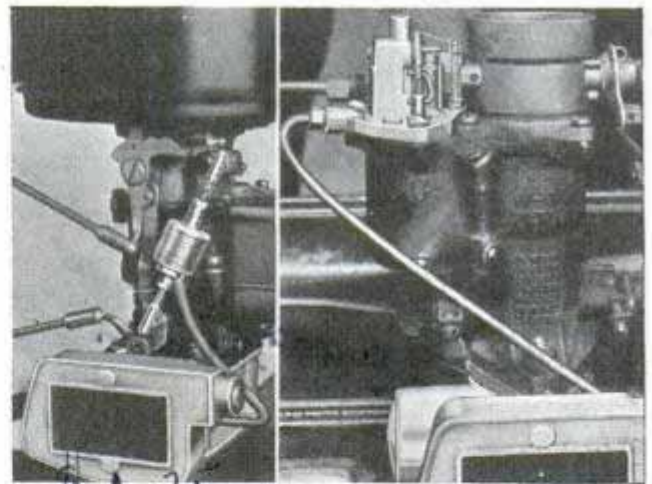

Left, fuel economizer assembly for Ford cars. Right, vacuum metering control for the Chevrolet

power jets which open every time the accelerators are fully depressed, resulting in a loss of fuel and dilution of crankcase oil. To remedy this condition, vacuum-controlled attachments may be installed to regulate the operation of the power jets. Where the vacuum piston is built in the governor, the pump lever arm to the governor may be removed and replaced by the economizer unit, while in other cases a vacuum metering control replaces the bowl

Hoaf Products Co  
1620 N. Franklin

Carl Zeiss, Inc 485-6th Ave New York  
H 1556  
H 1594  
Bell Telephone Laboratories 463 Walnut St. New York



cover of the carburetor. By automatically controlling the power jet with vacuum instead of by mechanical means, it operates only when the engine load requires, and the correct amount of gas will be used regardless of the position of the accelerator.

# Snow Shovel Swings Overhead to Dump Its Load into Truck

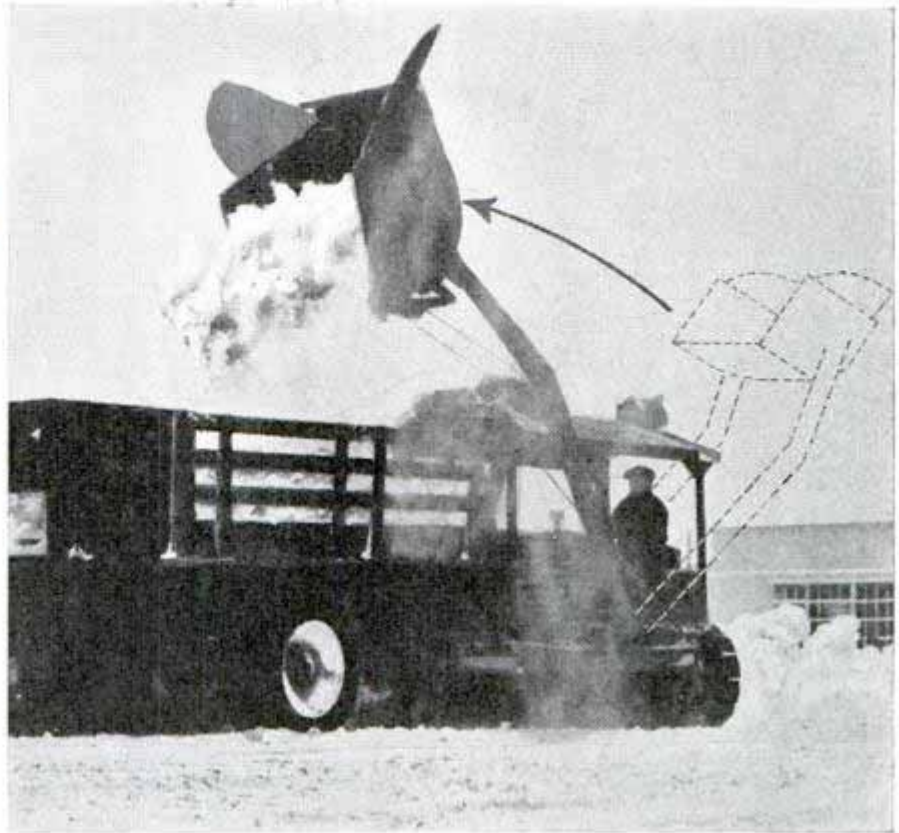

Backing its shovel into snow pile, tractor swings its load overhead to dump into truck ahead. Dotted lines and arrow indicate arc of swing

## Portable Hydraulic Pipe Bender Has Many Shop Uses

Light in weight and capable of working in limited space, a hydraulic pipe bender can do many jobs in the shop where lifting or pulling power is needed. Power is supplied by a hand-operated hydraulic pump developing ten tons of pressure. Detachable shoes mounted on extension bars and on the ram are forced against opposite sides of the pipe in the bending process. Besides bending pipe, conduit and rails, the unit has interchangeable parts to lift machinery, pull gears from shafts, and clamp parts for welding and assembling.

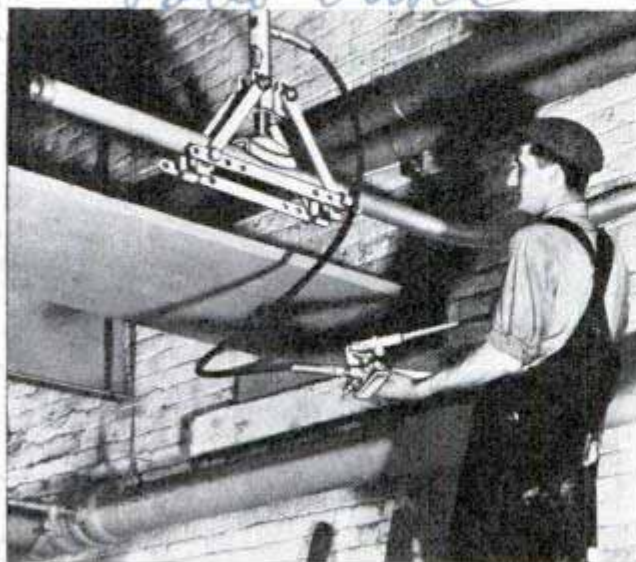

Hand-operated pump delivers ten-ton pressure to pipe bender that works in hard-to-get-at places

Any standard crawl-type tractor can be equipped with an overhead shovel just developed for loading snow or dirt into trucks. To pick up a load, the tractor backs the shovel into the bank or pile; then, without turning the tractor, the shovel rises in an arc and dumps its load into the truck from the front end of the tractor. It can be converted into a bulldozer with an up and down motion.

## Beater Has Two-Speed Gear for Heavy and Light Foods

You can mix heavy foods with no more effort than light ones by using a beater equipped with high and low speed gears. To change the speed of the mixer, a clutch moves upward or downward and engages the desired gear.



Blackhawk Mfg. Co. 5325 W. ...



# Target Towed by Toy Train Helps Make Good Marksmen



*Instructor fitting targets to the train. This method allows him more time to watch the shooting and help improve recruits' marksmanship*

Far from its usual berth as a plaything, the toy electric train has been assigned a place in the British army. On one shooting range a miniature locomotive pulls cardboard targets mounted on tiny trucks, bringing them into view for recruits to fire at. Instead of drawing the targets by means of a string, the sergeants now simply press a starting button. This gives instructors more time to help recruits improve their marksmanship.

## Nonmagnetic Ship Has No Steel in Framework or Hull

Sailors may be asked to use bronze instead of steel razors in the new British nonmagnetic ship "Research," as iron and steel would interfere with her research work in terrestrial magnetism and atmospheric electricity. Less than 700 pounds of iron and steel are used in essential parts of the dynamo and Diesel engines, while 300 tons of other metals have gone into her construction. The first duty of the ship

probably will be to finish the work of the "Carnegie" which blew up at Samoa in 1929. This ship was on her seventh trip in course of preparing charts showing the true and magnetic compass readings for many positions in all ocean waters between eighty degrees north and sixty-one degrees south latitude. For the "Research" all stores are to be packed in glass containers to avoid metal cans or nailed boxes. Paper clips will be brass.

## Hot Water and Air Pump Combine to Open Drain

Hot water and air pressure combine forces in a hand-operated drain cleaner being used to clear obstructions in plumbing. An attachment is connected to the hot-water faucet to clear grease stoppage in the pipe; then a hand pump builds up air pressure which is released by a trigger, forcing an opening. There is also an alcohol filling arrangement for thawing frozen pipes.

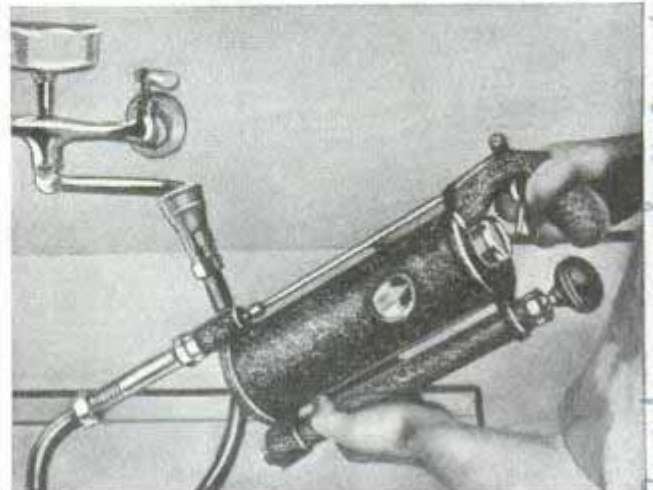

*Trigger sends shot of compressed air into drain after hot water from faucet has loosened grease*

*Used by Army in England*  
*1965*  
*London, Middlesex*  
*Acme*  
*© Planet News, Ltd.*  
*Carnegie is notable in Washington, D.C.*  
*Empire State Bldg.*  
*12/29/28*



# From Sirup to Yarn Flows the Story of Rayon



Viscose solution shoots through orifices of spinneret "shower bath" to form filaments which join to make rayon thread



*Rayon plant*

From pulp to sirup to filament to thread runs the story of rayon. Above, operator in Richmond, Va., plant of E. I. du Pont de Nemours & Company draws thread through guides to be reeled into skeins. Left, robot manikins model dresses of cellulose acetate rayon yarn in miniature fashion show, while synchronized voice which appears to come from manikin describes the gown shown

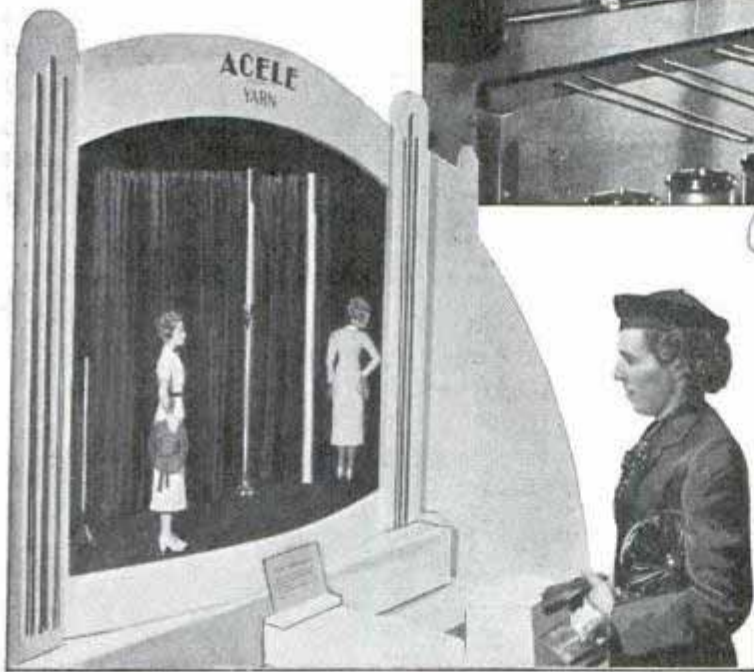

*Former du Pont has begun a minimum of 100 million*

Pulp used to manufacture viscose rayon is treated chemically and becomes red-dish-brown sirup. Below, worker picks up thread emerging from spinneret, passes it over spinning machine and guides it into buckets with stream of water

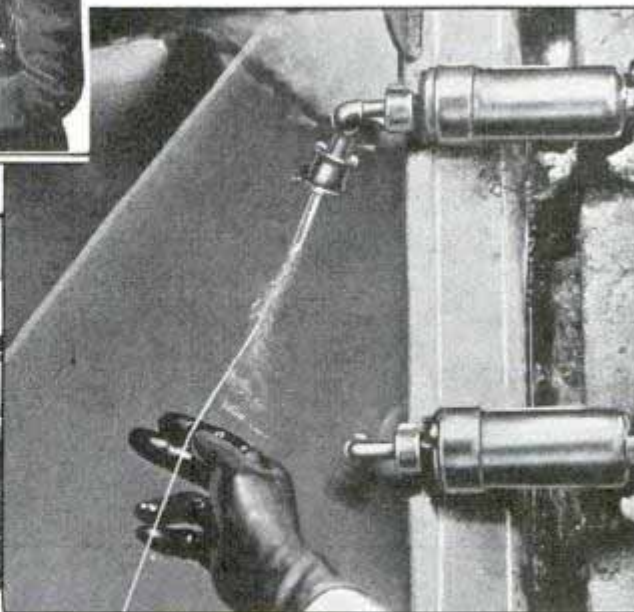
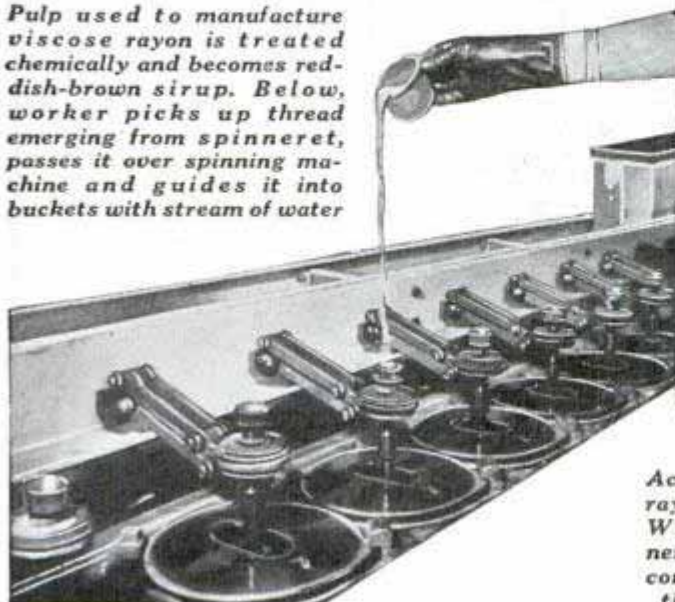

Actual chemical transformation of viscose liquid into rayon thread is shown for first time in photograph above. What appears to be a glass tube extending from spinneret is in reality many fine streams of liquid which are converted chemically into solid cellulose filaments and then become rayon thread seen in rubber-gloved hand



# Floating Ship in Dry Dock Replaces Launching

Danger of capsizing a ship or damaging the hull in launching is avoided, and many difficult engineering problems are eliminated with a dry dock which floats ships merely by pumping water into an enclosure. If a ship is to be launched, the keel is laid on a slanting slip of strong blocks requiring geometrical accuracy, and, of course, the ship must be floated on level

keel when she is ready for interior appointments and equipment. In the new dockyard, a large ocean steamer may be built from the start on level, dry ground, its floor being above water level. The dockyard consists of an enclosure 1,000 feet long and 400 feet wide, closed at both sides by strong walls. Gates at either end remain open for hauling material during the construction period. Along one side of the dock is a slip which provides an outlet to open water. When the ship is to be floated for finishing touches, the gates are closed and sealed, and water is pumped into the dry dock. Afloat, the boat is towed by windlass and ropes into the slip from where it is floated to open water after the levels are equalized. A huge crane, which can lift 240 tons, carries heavy parts and material to the ship while under construction.

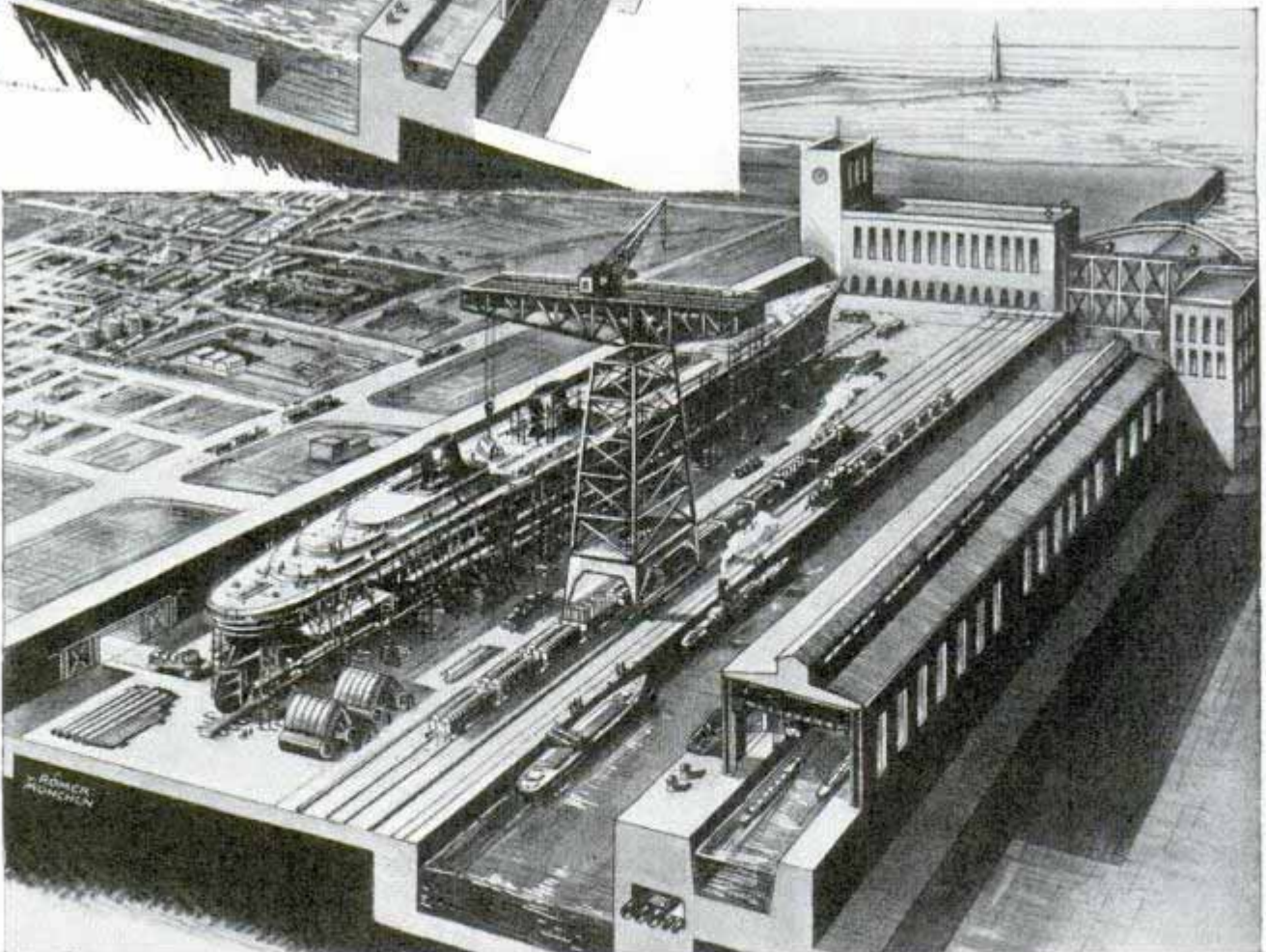
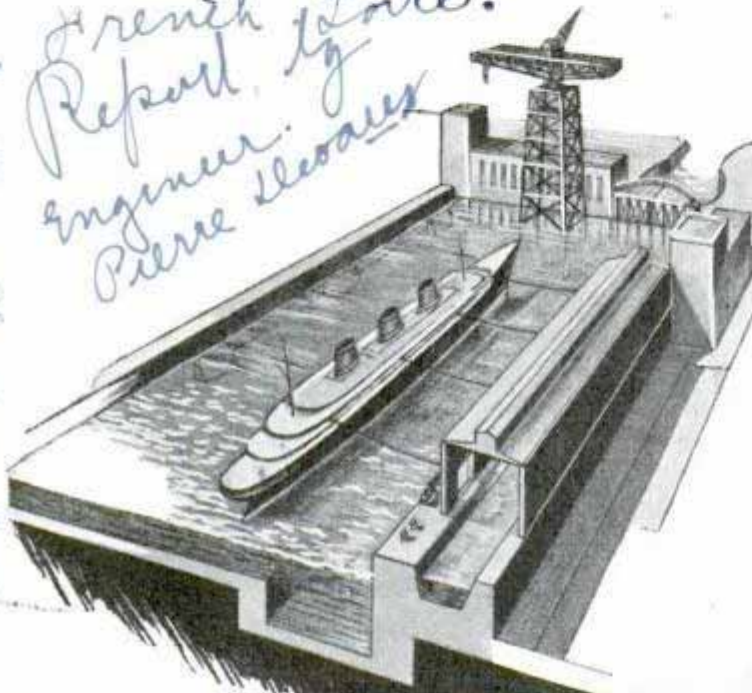

Ship under construction in the dry dock. When hull is completed and ready for interior finishing, the crane travels to the far end, as shown above, and water is pumped in so boat may be towed to slip at side



# Dog Dishes on Swivel Arms Simplify Feeding

Dogs are prevented from fighting and gormandizing by feeding them separately in cages at one of the largest fox-hound kennels. Each dog has his own pen, with an individual feeding dish suspended on a swivel. An attendant fills the dish outside the stall, and when mealtime arrives it is swung inside where the dog may eat unmolested.

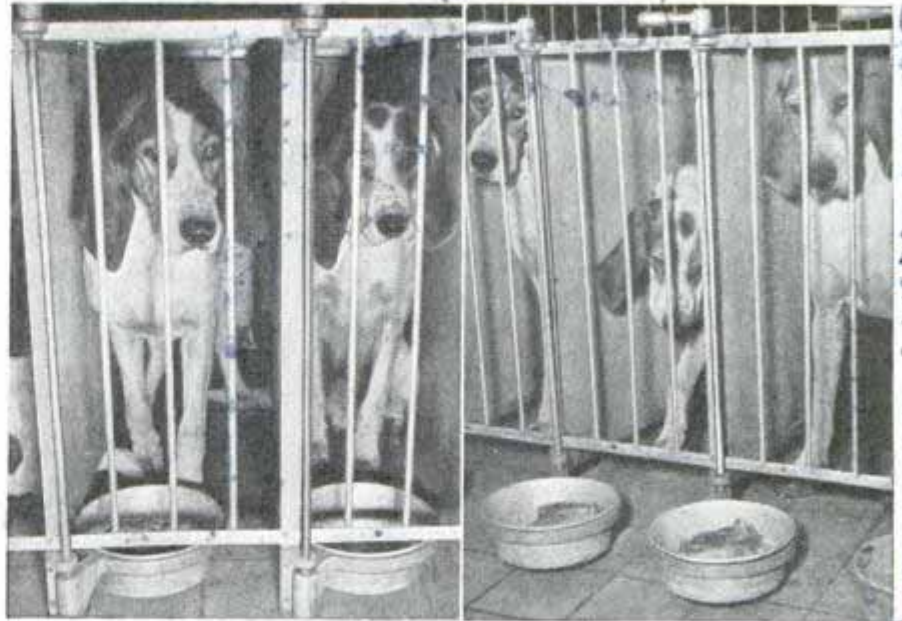

At mealtime food pan is swung into kennel by twisting handle at top of rod

# Legs "Telescope" into Washer to Fit under Table or Sink



Equipped with retractable legs, a small washing machine can be lowered for storing under the kitchen sink or table. Complete with wringer and ironer attachments, the washer is elevated by crank handle to the correct working height for any operator, and it is small enough for use in kitchen or even the bathroom. A pump drains the tub, and one motor supplies all the power.

Washing machine is raised to convenient height when in use and legs retract into body for storage under table as pointed out by arrow

# Tractor Vacuum Cleaner Sifts Beach Sands Like Huge Gold Washer

Beach sands are picked up by a huge vacuum cleaner and cleared of objects that make "sand bathing" unpleasant. The device, working like a dry gold washer, is a combination tractor, mechanical and magnetic picker, and vacuum cleaner built for the beaches of San Diego, Calif. Nails, broken glass, paper, chewing gum and sticks of wood are separated from the sand and stowed in its mechanical "stomach." At the close of a day's work the operator sometimes finds coins, rings, necklaces and watches. These are returned to their owners if possible.



Sand scooped up by tractor is run through vacuum cleaner and then returned to beach minus all refuse

*Designed by John... near City shops*

*Edgemont Delaware County*  
*Washing Machine Co. 54 W. 1st St. Lancaster Pa.*



# Grooves in Center of Road Force Cars to Right Side

Designed by Dr. Miller Mc Chintock, Director Traffic Research Bureau, Yale University, New Haven, Conn.  
1573  
Science Laboratories  
424 E. 4th St. Columbus, Ohio

Michigan State Highway Dept  
Mich



Safety grooves down middle of highway nudge car back to right side of road by gripping the wheels

Automobiles are gradually and safely forced back to the right side of the road by diagonal grooves installed down the middle of the pavement. The new barrier does not project above the surface, but consists of corrugated sheet steel having deep, slanting ruts which grip the left front wheel of the encroaching car and deflect it to the right. After the tire is caught in a rut, the wheels cannot be turned to the left. An installation near Lansing, Mich., has been effective in preventing head-on collisions. Centerline barriers are feasible only on wide highways where cars do not have to cross the middle of road in passing.

## "Daylight" from Mercury Bulb on Standard Lighting Unit



"Daylight" illumination is supplied by two auxiliary bulbs built into a lighting unit that fits into the regular socket and operates on standard current systems. The mercury

lamps, which operate without transformers, are used only where color-corrected light is essential to accuracy of work or for inspection and display of merchandise.

## Dustproof Film Drying Tube Holds Forty-Frame Roll

Photo negatives are carefully guarded from dust in an automatic drying tube that has a fan and heating unit at its base. It dries the film rapidly and uniformly. The tube is long enough to accommodate a forty-frame roll of thirty-five-millimeter film or a full-length roll of three-and-one-fourth-inch film.

## Turn Signal on Auto Gearshift Has Pilot-Light Reminder

Within easy reach of the driver, the switch for a directional signal fitting all automobiles and small trucks is mounted on the gearshift lever ball. To operate the signal, the driver flips the toggle switch to right or left, depending on the direction he

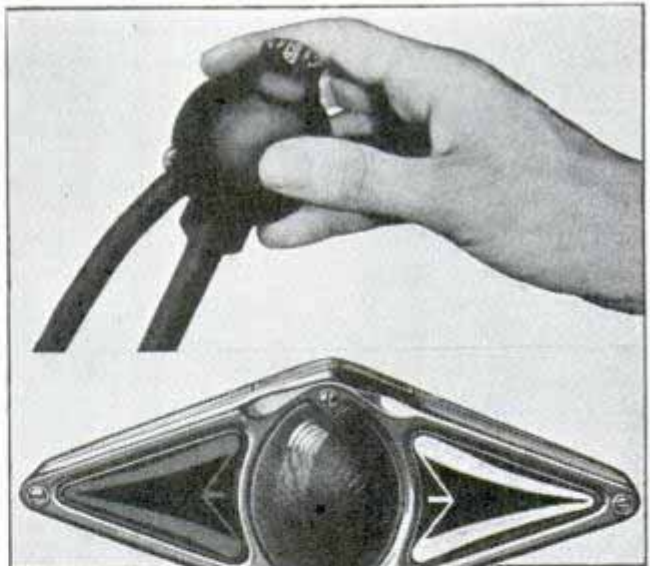

Switch and pilot light on ball of shifting lever, and, below, arrow indicating direction of turn

plans to turn. This illuminates an arrow at the rear of the car, visible for 125 feet in daylight, to warn other drivers. If the signal switch is not returned to neutral after turning, a pilot light on the gearshift ball serves as a reminder. The toggle switch may be mounted on the dash or steering-wheel post, if preferred, and the rear signal unit includes taillight and stop light.

3706  
Long Island City, N.Y.  
9-35  
model - 35 mm  
19.5 years  
H1522  
Teleoptic Co  
Whisper Wis



A 1427

# GUARDING *Your* GOLD

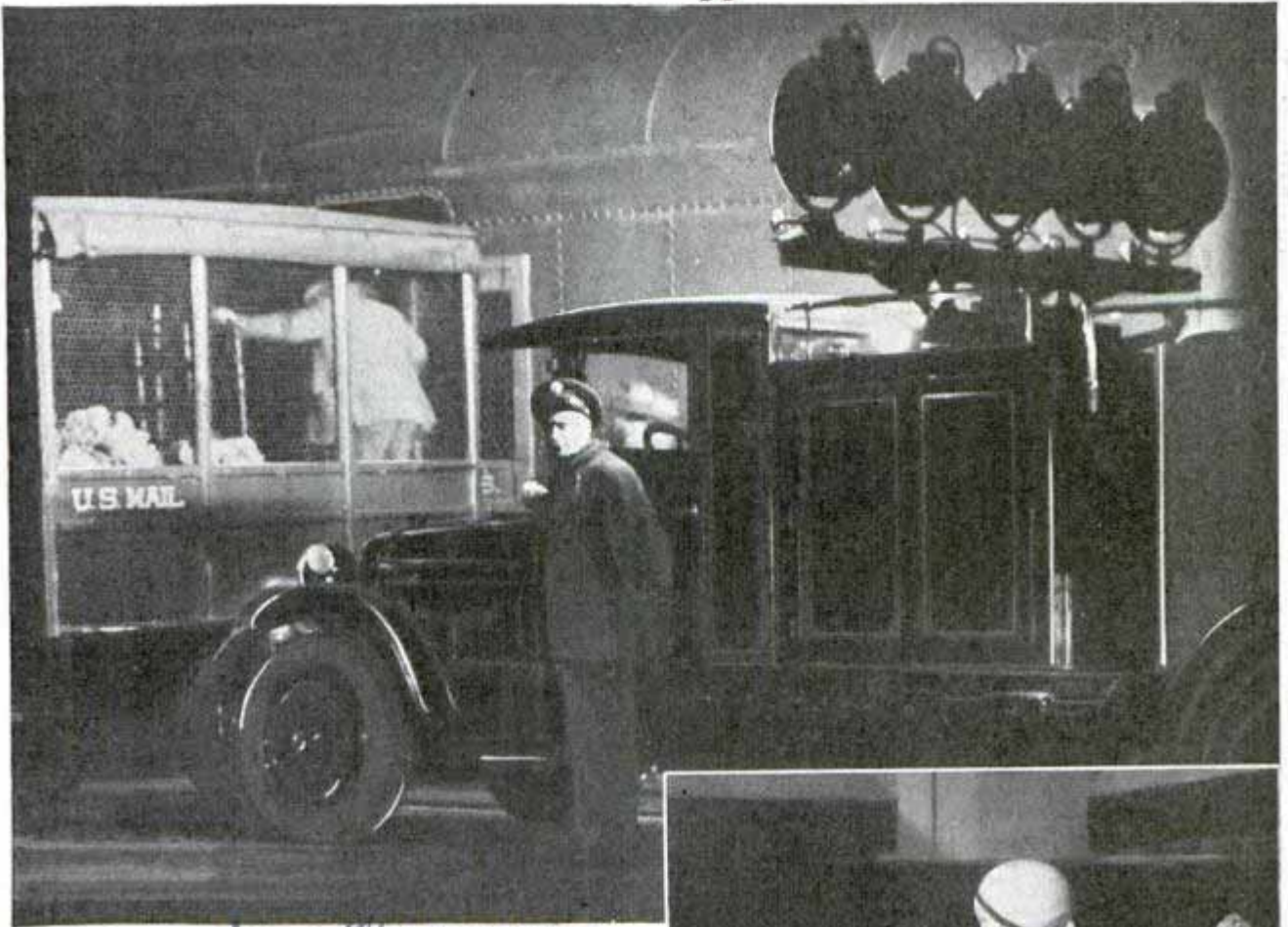

*San Francisco*

By Frank J. Taylor

*715 Market St.*

THE amazing five-year flood of gold to this country, unparalleled in history, casts Uncle Sam today in the role of a King Croesus, with so much wealth that he hardly knows what to do with it. The United States mint has on hand about 100 dollars worth of the precious metal for each man, woman and child. This totals up to the staggering sum of twelve billions in gold alone, not to mention a sizable mountain of silver. It is the greatest treasure of all time, amounting to more than half the world's entire monetary gold supply, four times that of the British Empire, six times that of France. And as the tide is still rolling in, what to do with the magnificent hoard is taxing its custodians no end.

Assaying, purifying and safely storing this treasure calls for the most ingenious schemes the scientific minds of the mint could devise. Only the mint may own and hoard monetary gold. Since there is one



*Top, fire department provides floodlights while gold is loaded from truck to train; below, fine gold anodes stacked in gold chloride room of mint refinery*



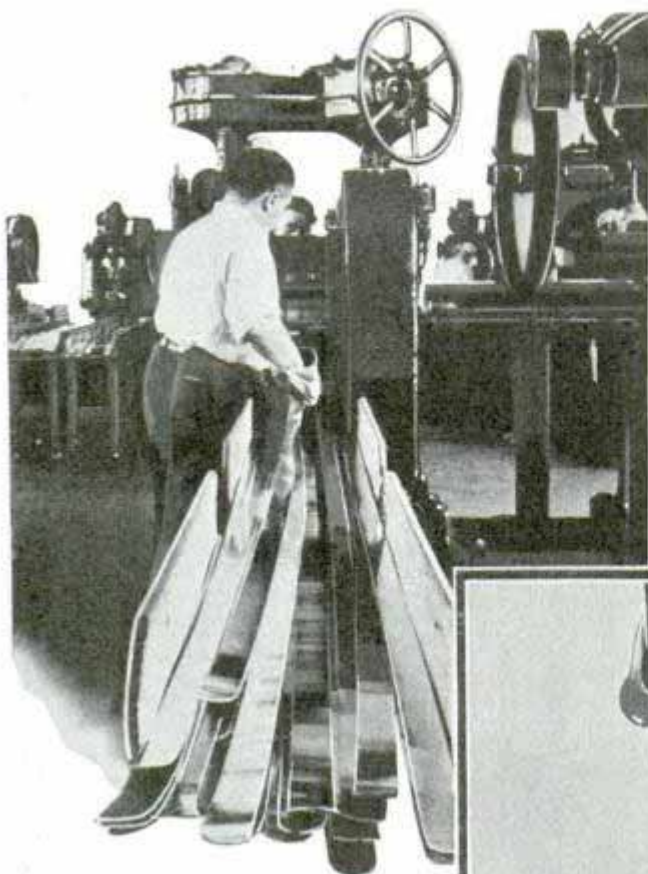

*Above, feeding silver bars into coin-stamping machine. Right, a bucket of new coins ready for "bath" to harden surfaces*

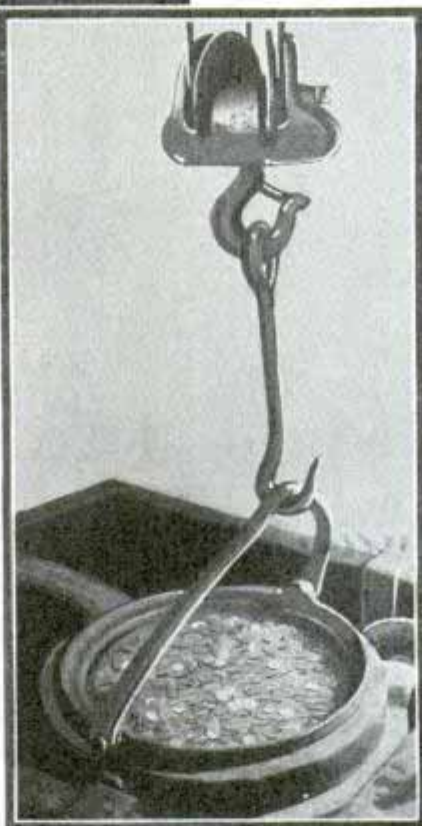

price, \$35 an ounce, at which new gold or "scrap" gold may be sold to the mint, and another price, only half that, at which hoarded gold coins may be turned in, the temptation to trick Uncle Sam's gold buyers is great. It seldom succeeds. Calling for even greater ingenuity is the task of safekeeping the nation's gold from possible raids by gangsters or envious foreign enemies.

The tremendous project of reorganizing the mint to meet its new obligations has fallen to its first woman director, Mrs. Nellie Tayloe Ross of Wyoming. The mint's work falls into two operations—money making, and guarding the treasure. When Director Ross took over management, all of the mints were doing a little of each job. Gold was flowing into the mints at Philadelphia, Denver and San Francisco and the assay offices in New York, New Orleans and Seattle. So was silver. Coinage was confined to Philadelphia, Denver and San Francisco. Shortly after Director Ross

assumed her duties, Superintendent Peter J. Haggerty of the San Francisco mint reported his vaults were so bulging with gold that he had to stack silver bars unprotected in the corridors. He had over two billions in gold on his hands, double that sum at today's \$35 per ounce valuation. Something had to be done.

The director launched the drastic reorganization that has made the United States mint system the most modern in the world. The plants at San Francisco and Philadelphia were designated as money factories for the manufacture of coins. These mints also purchase the precious metals from all who bring them in, as do the assay offices at New York, New Orleans and Seattle. The Denver mint, strategically located behind two mountain ranges, 800 miles from the nearest foreign boundary, became primarily a depository. Superintendent Haggerty was told to ease his congestion by shipping two billion dollars in gold by registered parcel post to Denver—up to that time the most spectacular movement of gold in history.

To relieve the situation in the New York assay of-

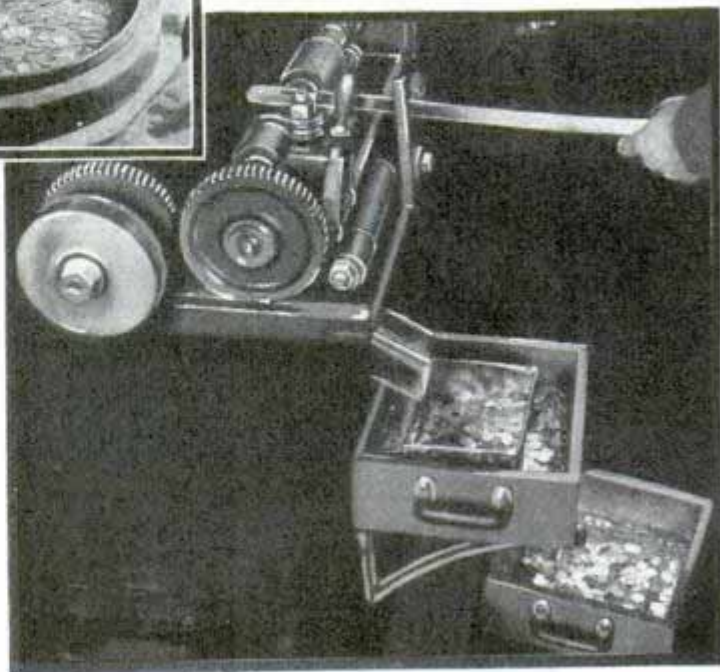

*New nickels are pouring out of this stamping machine at a rate of 600 per minute*



face, where an equal hoard of gold had accumulated, the director was authorized to build a "strongbox" far enough inland so that no invading army could endanger it. Most nations with large gold reserves have hidden treasure chests. Great Britain is supposed to have one under the Thames river, France under the Seine, both so ingeniously built that an invading army could never find the storage vaults, much less open them. No foreigner knows where the Swiss hide their two-billion-dollar gold hoard, fourth largest in the world, but it is supposed to be deep in the Alps.

Mrs. Ross and her experts decided against a secret hiding place for America's gold. Instead, they voted to build a strongbox in the open where any citizen could see how his hundred dollars worth of gold in the public treasury was being guarded. They settled upon Fort Knox Military Reservation in Kentucky as the logical spot, because it is far inland and was the post of a mechanized cavalry

(Continued to page 118A)

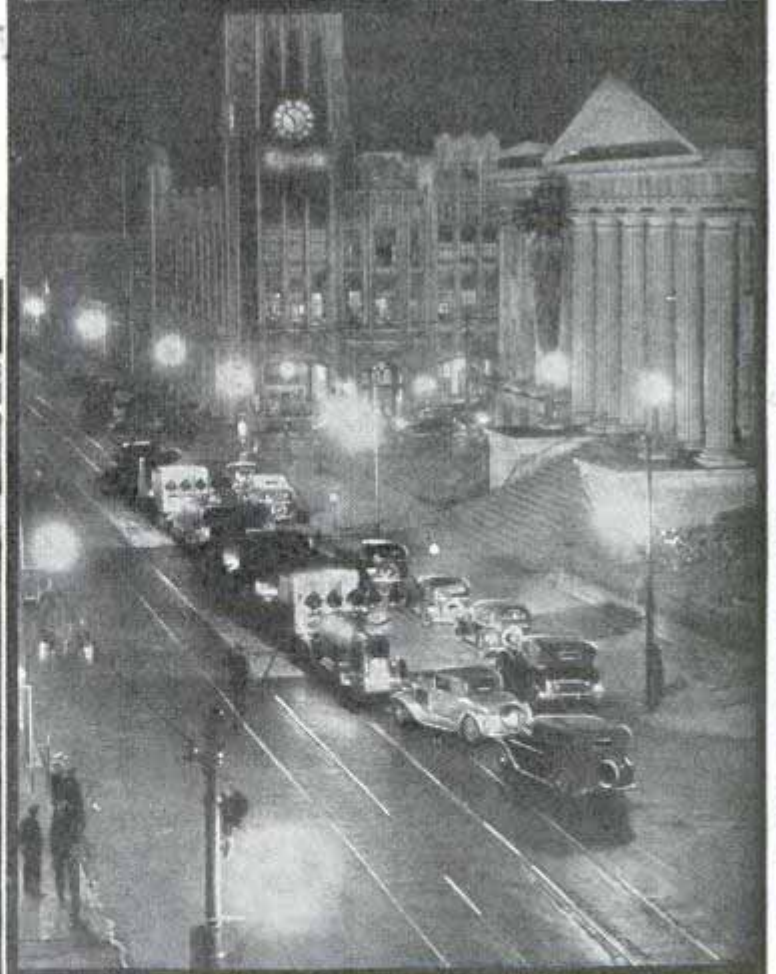

© Fred Bennett (lower right)

*Top, weighing gold bars on scales so sensitive they register the weight of your signature in ink on slip of paper. Below, at left, moving a million dollars in gold in mail pouches; right, gold convoy leaving San Francisco mint, the building at right. Notice floodlight trucks*



# Mirror Hung from the Neck Aids Makeup or Shaving

*U.S. - Back*



With the mirror suspended from the neck, two hands can be used in arranging the hair

Hung around the neck like a necklace, a mirror designed as a "makeup" aid leaves both hands free to arrange the hair. It could be used also as a man's shaving mirror. The neck piece forms a folding base when the mirror is set on the dresser.

# Hundreds of Floodlight Flashes from One Photo Bulb



Expense of taking pictures where floodlighting is needed has been reduced by the introduction of bulbs that flash hundreds of times at a cost of two cents or less per flash. One of the bulbs, shown in the picture, furnishes 200 flashes of 50,000 lumens, each lasting five seconds. Flash occurs about fifty seconds after the current is turned on. Another lamp gives 1,000 instantaneous flashes of 50,000 lumens last-

ing a few seconds each. The lamps operate on 110-120 volts a.c., and the glass bulbs are lined inside with silver reflectors. Besides supplying brilliant artificial sunlight of highest actinic value, both floodlamps are available with a special blue glass for making photographs in color.

# Casting Reel without Backlash Needs No Thumb Control

Backlash is eliminated in a fisherman's reel with controlled spool speed, and without previous experience you can cast the average five-eighths-ounce lure thirty-five to forty-five yards without using your thumb to check the spool. The speed is controlled by an oversize tail bearing and an adjustable head-end spool cap, the tail bearing being seven times larger than the head bearing.



# Neon Sign Identifies Police Car Setting Pace for Traffic

Instead of lurking at a dark corner to trap speeding motorists, a Chicago police squad car has been equipped with a neon sign identifying it plainly, and is under orders to tour the boulevards at the top legal speed limit to pace traffic. The letters are eight inches high and have a high visibility even in fog.



Clearly labeled by the neon sign, this police car tours Chicago boulevards at the legal speed limit

*James G. Kerr, Chicago Police*

*The Lynech Studios Los Angeles Calif. 741 N. Johnson*

*Handwritten notes and signatures on the right side of the page.*



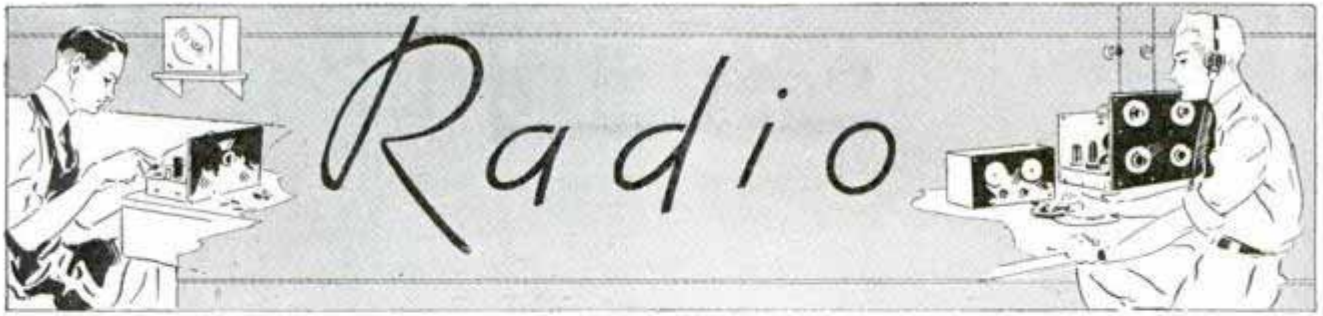

# COMBINATION PANEL *for* S-W RECEIVER

**I**F YOUR short-wave receiver is of the table type, with power-supply unit and speaker housed in separate cabinets, you probably have the power unit under the table and the speaker located in some inconvenient position. A simple solution for this problem is a rack and panel table-top assembly that any set owner can arrange to suit his particular requirements.

Most manufacturers of standard short-wave receivers supply notched relay-rack panels for their table-type sets, also panels for speaker and power-supply units. All of these panels are notched to fit ordinary relay racks thus making a compact well-

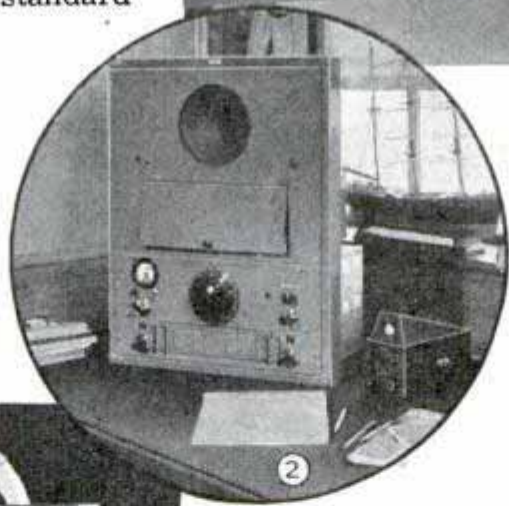

appointed receiver installation such as the one shown in the accompanying photos. In this particular 2-panel assembly the speaker and power-supply panel is a combination unit which also provides a spare-coil cabinet, fitted with a hinged door, as shown in Fig. 1. Door panels are also useful for

log and chart cabinets in case your receiver does not employ plug-in coils. The complete assembly appears in photo Fig. 2; this rack has a panel capacity of 24½ in. and takes up no more room on the operating table than the receiver would require in a table-type cabinet.

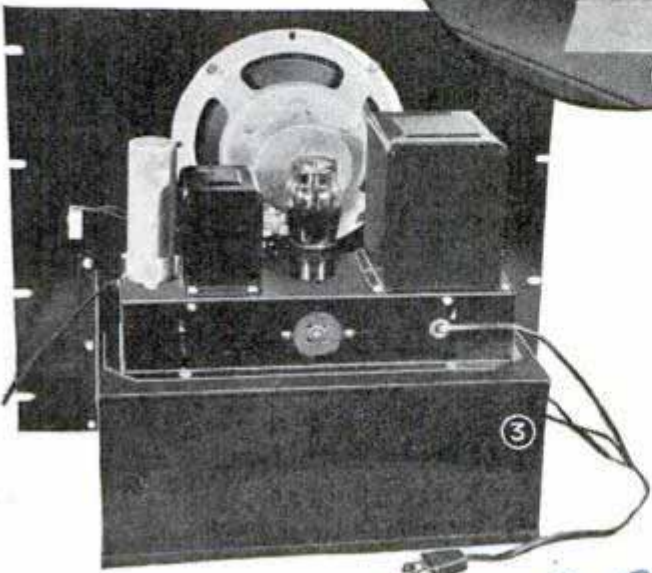

Photo Fig. 3 shows a rear view of the power-supply unit, speaker and coil cabinet, all of which are supported directly on the combination panel, the speaker being properly placed for best results.

*National Company, Inc.  
61 Sherman St. - Mass*



# LOW COST THREE-UNIT

By M. N. Beitman

## Part I

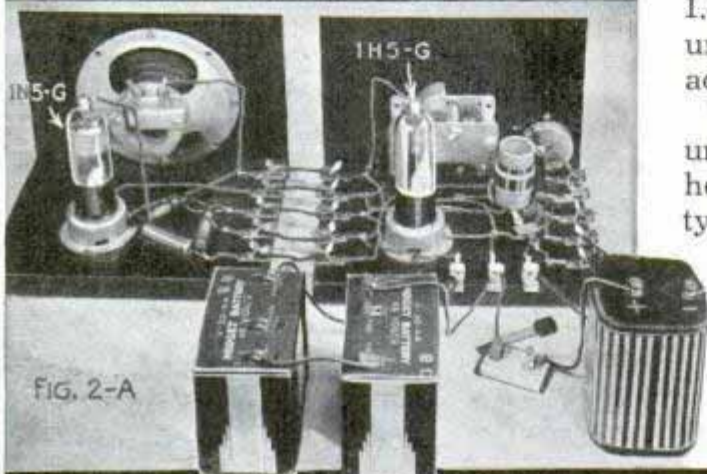
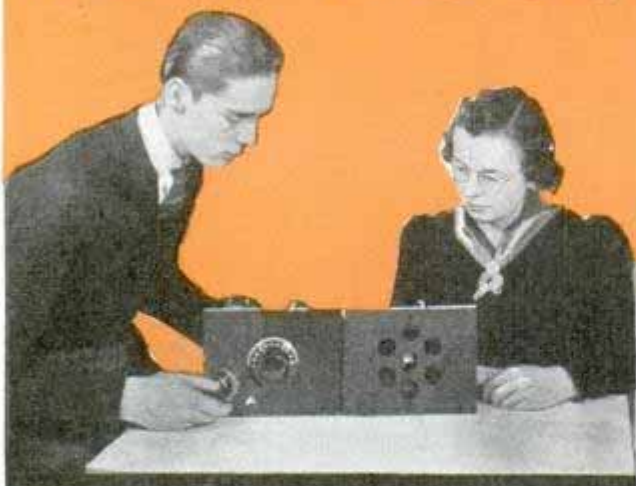

HERE is a beginner's receiver that is extremely simple to build and inexpensive to operate. It has several unusual features of special interest to students and beginners with limited pocketbooks who want to build an efficient broadcast receiver at the lowest possible cost consistent with good parts. Using the very latest 1.4-volt tubes, it consists of three separate units, two of which can be omitted and added any time the builder desires.

The detector is the necessary foundation unit, which is a complete battery-operated headphone receiver in itself. It employs a type 1H5-G tube and obtains its operating power from a single  $1\frac{1}{2}$ -volt dry cell and one or two small 45-volt B-batteries. These batteries also operate the audio amplifier and r.f. units which are

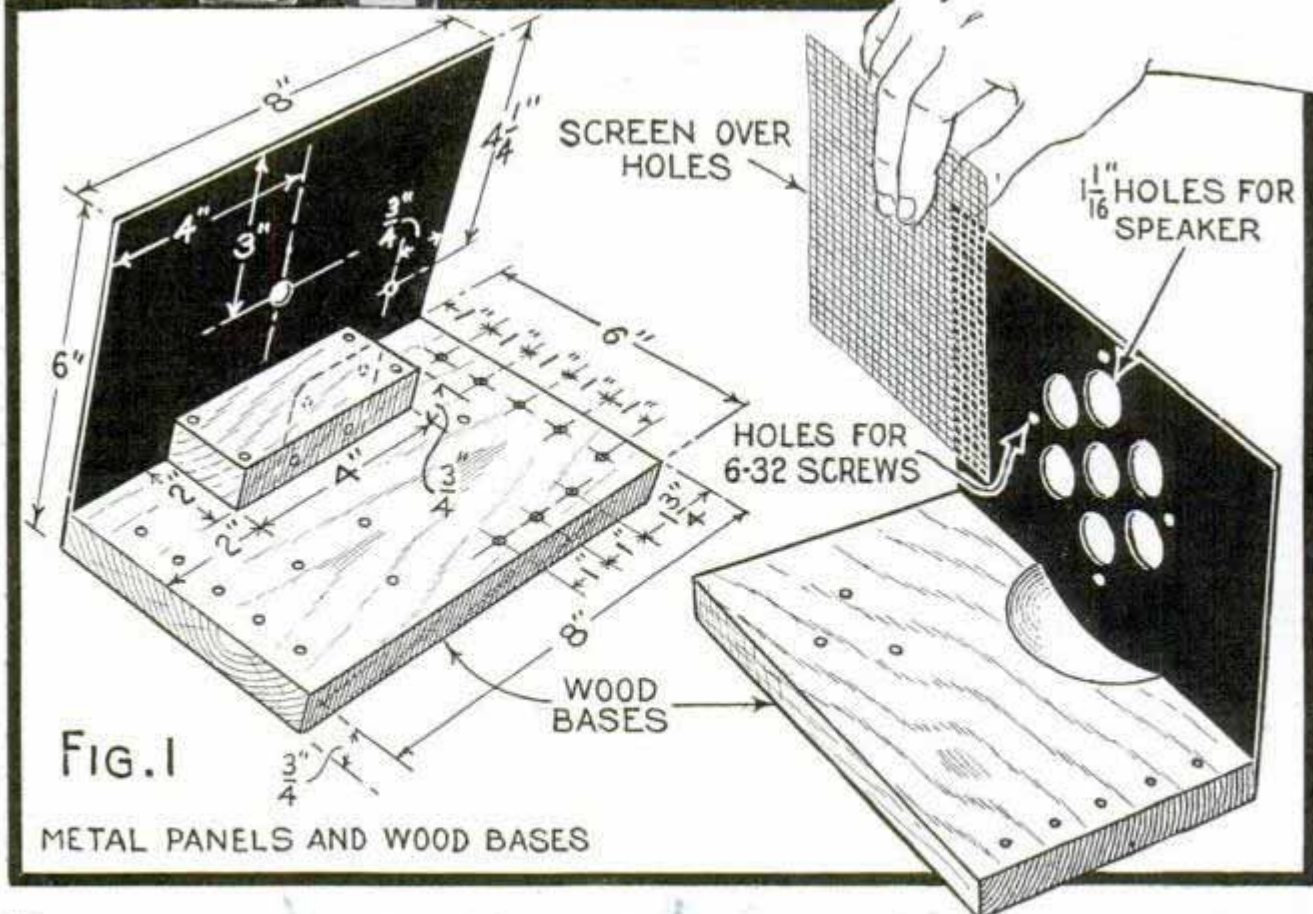

FIG. 1

METAL PANELS AND WOOD BASES



# BROADCAST SET *for beginners*

easily connected by means of short jumper wires and clips; the original battery connections to the detector unit are not disturbed. Good loud-speaker volume is available from local stations when the 1N5-G audio amplifier unit is added. The r.f. unit, to be described later, provides greater selectivity, extends the range for distant stations and completes the three-unit assembly.

Panel and base details for both the detector and audio amplifier units are given in Fig. 1. The wood bases and metal panels are the same size for all units; and the center hole in the detector panel should be large enough to clear the condenser shaft. Holes are cut in the



FIG. 2-B

speaker panel to form a grille which is backed with a piece of wire screen.

A simplified wiring diagram for the detector and audio amplifier units appears in Fig. 2. The small switch connected in series with the positive "A" battery lead is used to turn the set "on" and "off." Neg-

(Continued to page 138A)

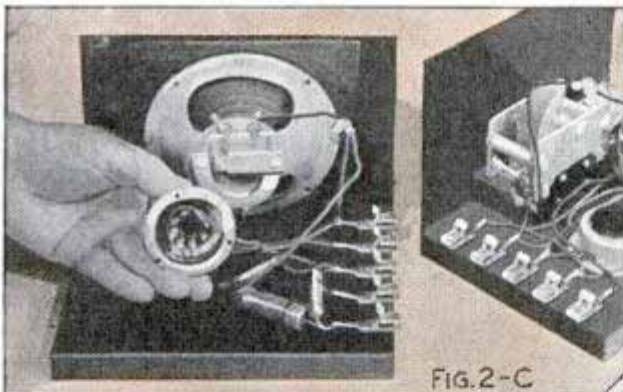
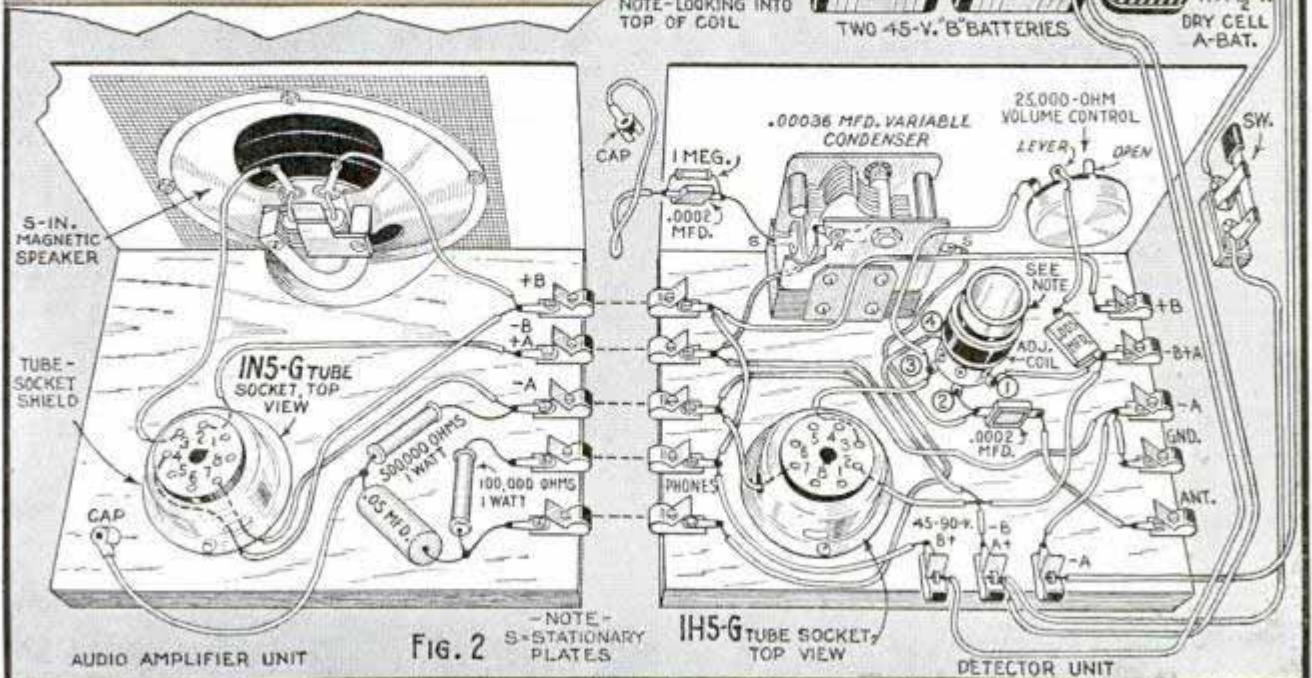

FIG. 2-C





# One All-Wave Antenna Serves Twenty Sets



Fig. 2

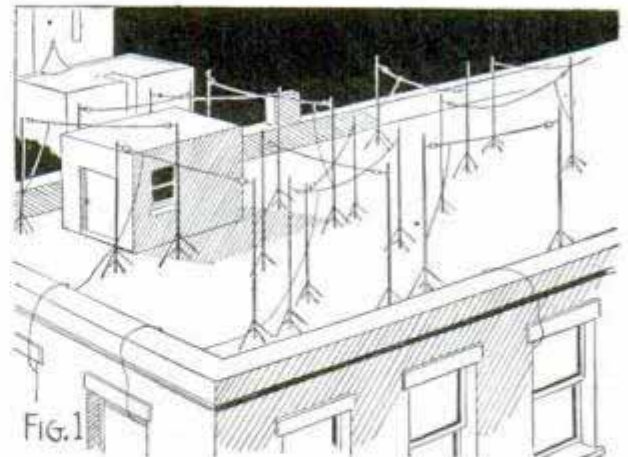

Fig. 1

**A**NTENNA jungles on the roofs of many modern apartment houses, hospitals, and private residences mar the appearance of such buildings as illustrated in Fig. 1, and do not provide efficient reception.

During the past few years a number of building owners installed uniform antennas on their buildings. However, in order to obtain good results, on both long and short waves, it was still necessary to have one antenna for each radio set.

An answer to this problem is to be found in the recent development of an all-wave antenna system which permits up to twenty radio receivers on a single antenna as shown in Fig. 2. No one set will interfere with any other on the same antenna. The sensitivity and range of the radio sets will not be affected appreciably, and all sets can be tuned to different broadcast and short-wave stations without interference.

While only one antenna transformer and lightning arrester are needed for each antenna system, one of the "multicoupler" units must be installed in each radio outlet. These General Electric units are the

(Continued to page 136A)

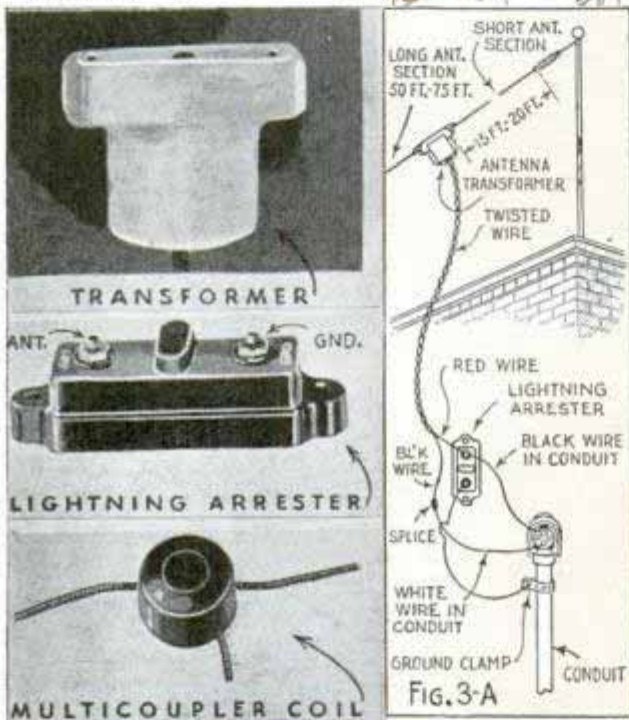

FIG. 3-A

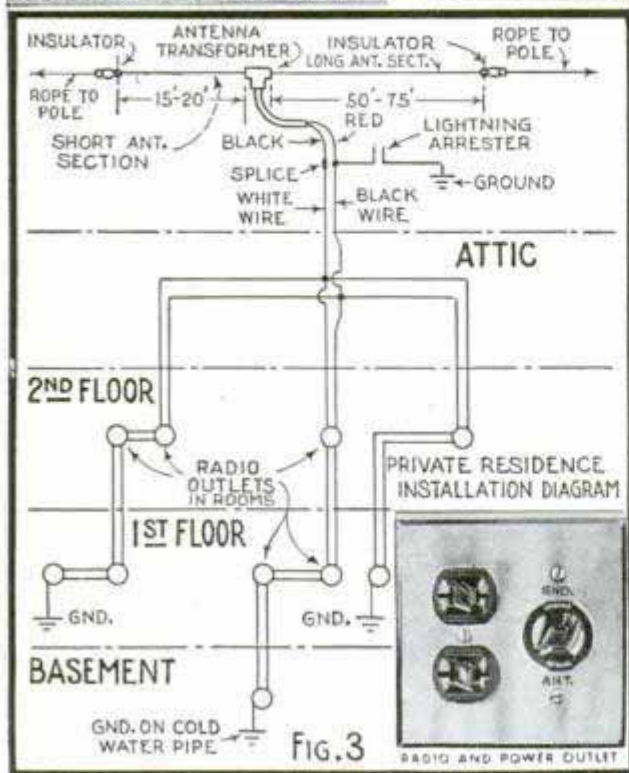

FIG. 3

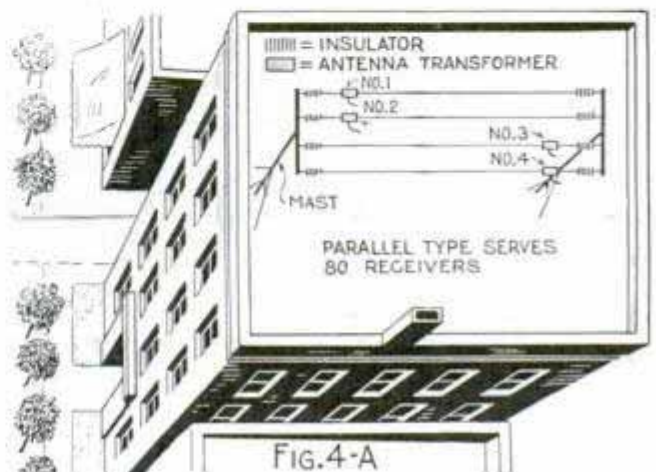
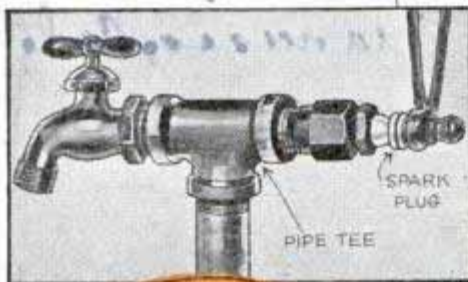

FIG. 4-A



# Practical RADIO SUGGESTIONS

Spark plug makes a good lightning arrester for your antenna when mounted and connected in the manner illustrated in the sketch, and photo below. Old model T Ford plugs screw into ordinary  $\frac{3}{4}$ -in. water-pipe fittings; a pipe tee can be added to a yard tap or a coupling may be placed on the end of a pipe driven into moist ground. Insulation is removed from the antenna lead-in wire at the point where it is fastened to the binding post; the electrodes in the end of the plug should be separated to form a  $\frac{1}{8}$ -in. gap. When used as direct ground connection push electrodes together



Left, plug-in type noise filter greatly reduces radio interference created by electric shaving devices. Lower left, inexpensive "vertical" breadboard arrangement for experimental receiver, amplifier or transmitter; for average requirements, end pieces are  $\frac{3}{4}$  by 10 by 26 in.; shelves  $\frac{3}{4}$  by 10 by 18 $\frac{1}{2}$  in.; space shelves 9 $\frac{1}{2}$  in. apart

Lower right, vertical antenna equipped with coaxial cable lead-in which transfers signal from noise-free area above building to radio receiver with minimum loss and no pick-up of man-made static where it passes through the poor-signal area. Photo "A" shows simple kit for making your own coaxial cable; assembly method is illustrated in diagram "B"

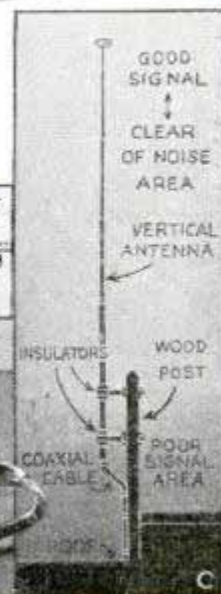
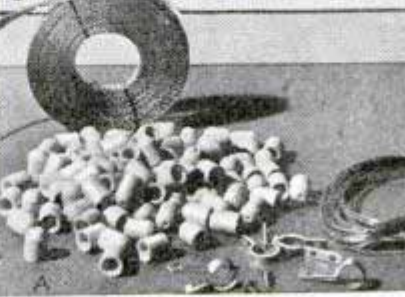
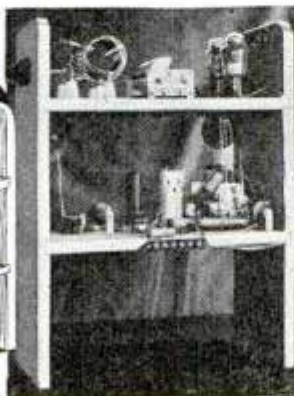

Jobe Electronics Corp  
 Springfield, Mass



*Radio Corp. Newark, N.J.*

### Long and Short Television Tubes



*Cathode-ray tubes, for students and experimenters, now available in 16-in. "stubby" bowl and 23-in. funnel shapes suitable for either horizontal or vertical mounting*

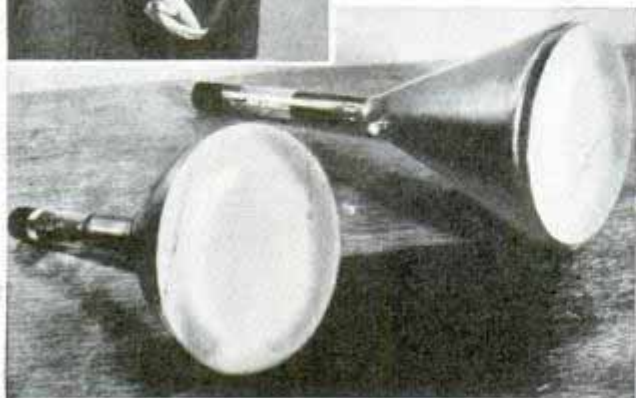

Both types of television tubes shown in the photos have 9-in. viewing screens. The "stubby" variety at lower left permits the use of more compact cabinets and direct off-the-screen viewing. The image is reproduced in black and white.

### Five and Ten-Meter Receiver

Designed exclusively for tuning in the ultra-high frequency range, this receiver follows the growing interest in high-fidelity broadcasts, 5 and 10-meter amateur bands and television sound-channel re-

*5-10 Skyorder*

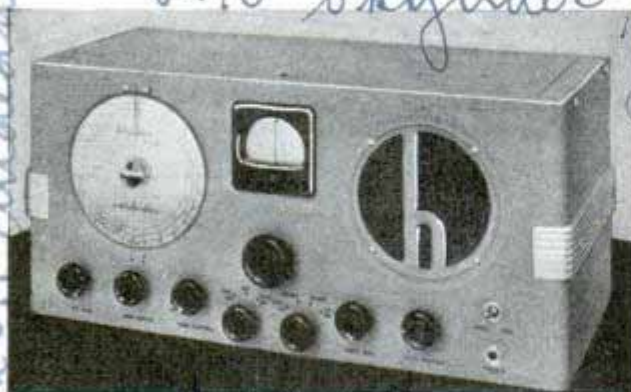

*\$ 69.50*

ception. It is an 8-tube super and operates on either a.c. or a 6-volt storage battery by means of an external vibrator supply. Thus the receiver is equally well adapted to home or portable mobile operation.

### Record Player and Amplifier

This portable electric record player has a built-in 3-tube amplifier, 6-in. speaker and crystal pickup. It is suitable for classroom, clubs, summer camps or similar use.



*Radio Corp. Chicago*

### Inter-Communication Unit

Serving both as a speaker and microphone, this secondary inter-communication unit can be placed on a desk or hung

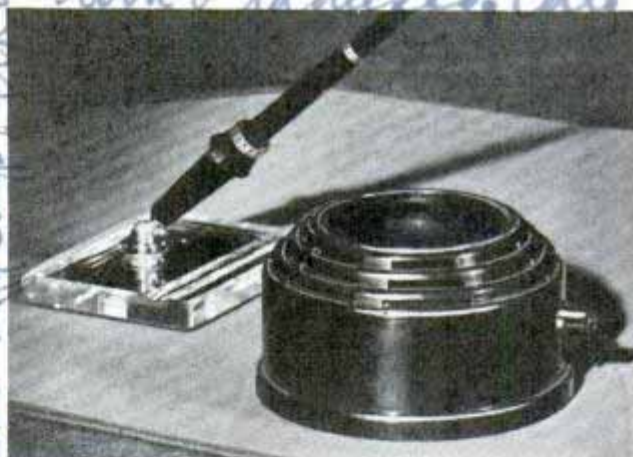

on the wall. A switch makes it possible for the operator to call the master station to which it is connected.

Blueprints covering radio construction articles in this and past issues are available for 25 cents each. Original material lists, with names of manufacturers and dealers, can be obtained from our Radio Department upon receipt of postage.

**NEXT MONTH—How to Build an On-a-Chair Cabinet for Your Midget Receiver.** This cabinet hangs conveniently right on the arm of your easy chair and is designed to hold any ordinary midget-type set in the proper position for handy tuning. Also—**Beginner's Low-Cost Three-Unit Receiver, Part II**

*Ballou Bros. Inc. Chicago*

*Remember into Carb. 19th at Baymont*

*San Francisco Calif*





# New FLOWER SHELVES and BRACKETS

*enhance your home*

HOW frequently have you looked at some "bare" spot about the outside of the house—a window or door, perhaps—and wondered what to do about it? Just what will be most effective depends on the surroundings and the architecture of the house, but usually a simple shelf, window box, or flowerpot bracket will be exactly the finishing touch needed. For example, see what happens to the corner window in Fig. 1 when the flower shelf with scrolled edging is added. You won't have any trouble making this with a handsaw and hammer and nails as in the detail, Fig. 2. Fig. 4 suggests a design suitable as a border feature for an open patio or flagstone landing, and Fig. 5 shows a simple wrought-iron bracket which can be made easily in dupli-

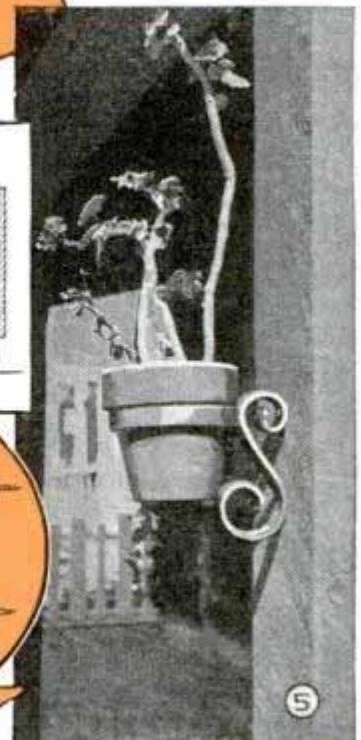
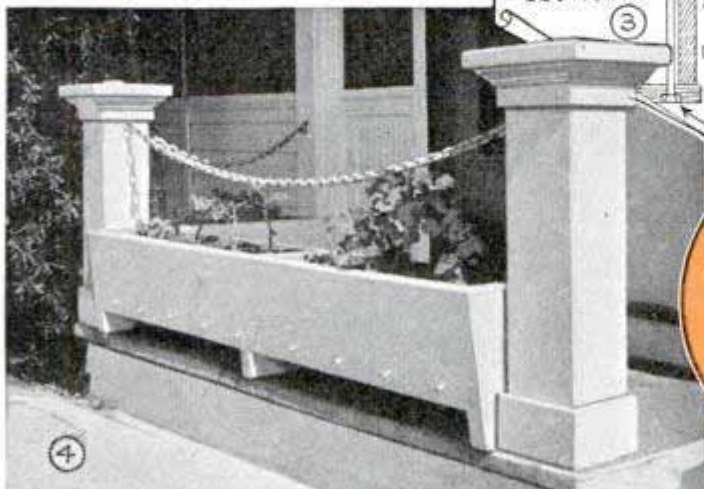
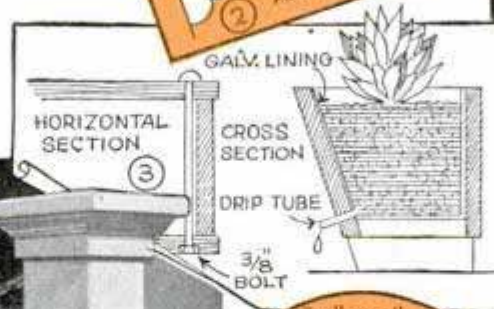
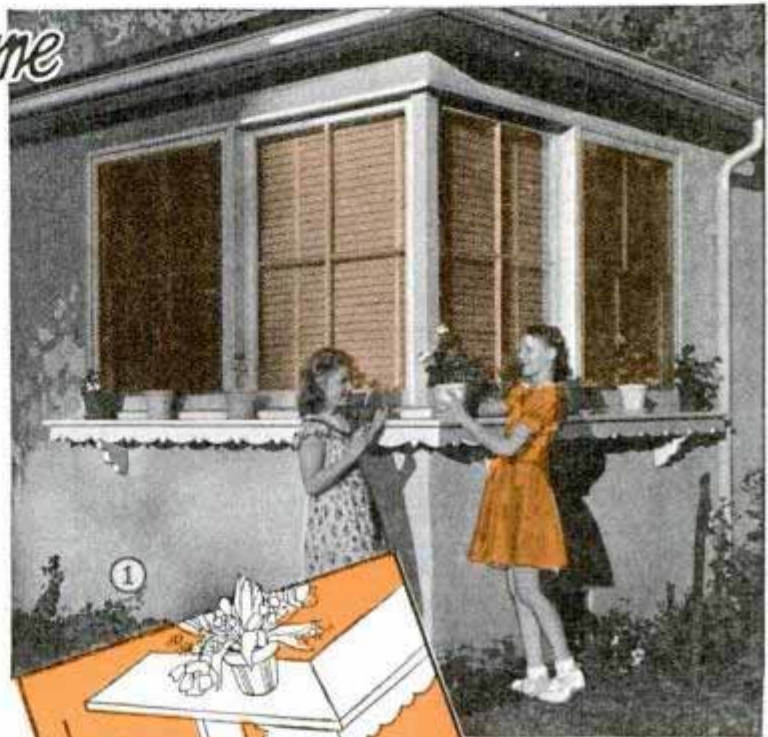



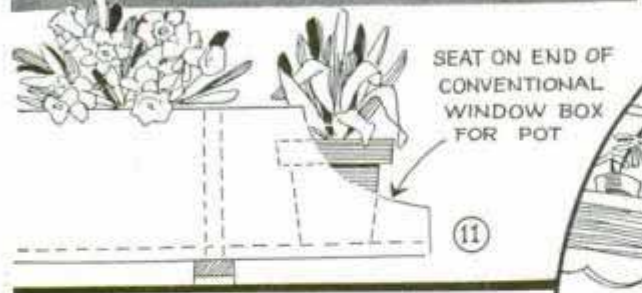
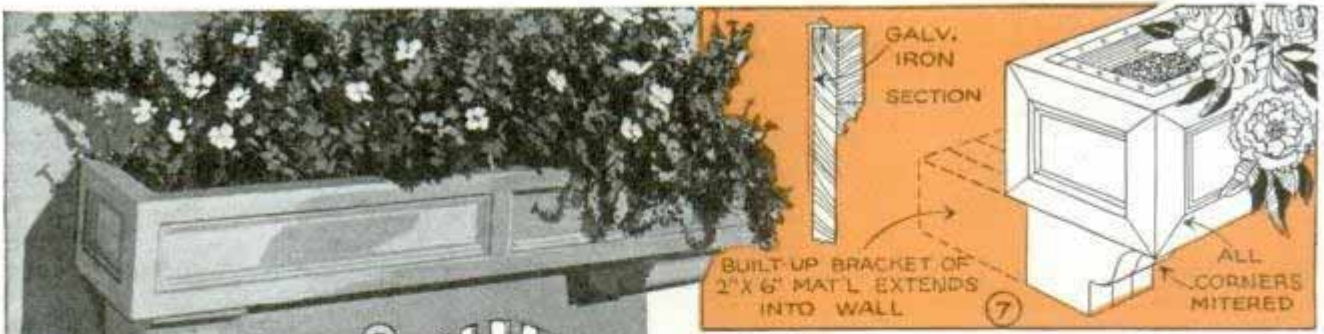

cate for mounting on the uprights of open trellises or gateways. The simple details of window-box construction are shown in Fig. 3 while Figs. 6, 7 and 12 suggest variations of design. One important feature of window-box construction is the fitting of sturdy brackets, strong enough to support the combined weight of the box and damp soil. Cypress is one of the best woods to use in making both the box and the brackets because of its resistance to rot.

A variation of the window-box idea is shown in Fig. 10. Round openings in the shelf are cut slightly smaller than the diameter of the flowerpots at the rim so that the pots are concealed from view when in place. Window and corner shelves are always attractive for small potted plants such as cactus, especially in the sun room. Suggestions for these are given in Figs. 9 and 13, the designs to be made either singly or in duplicate.

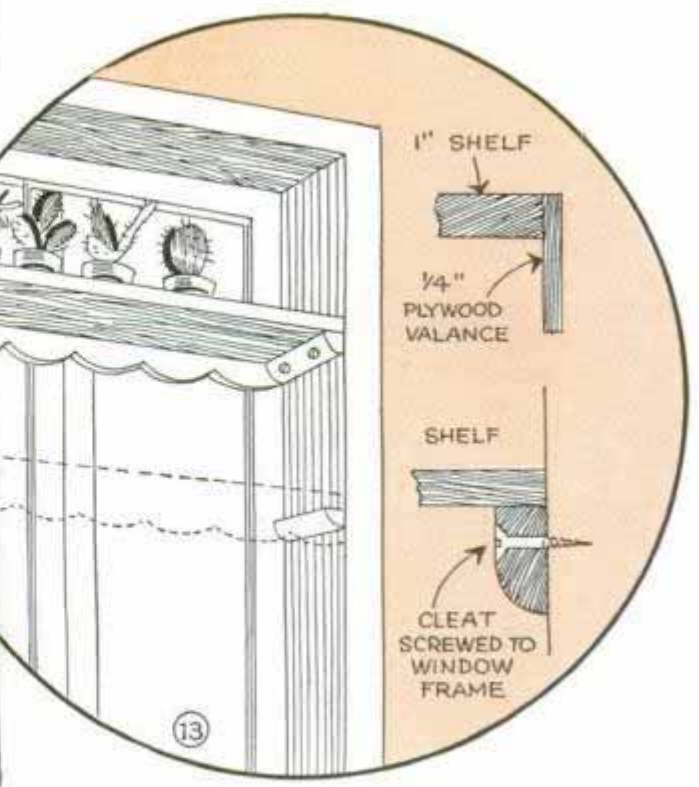



# Motorized Floor Polisher Saves Hand Rubbing

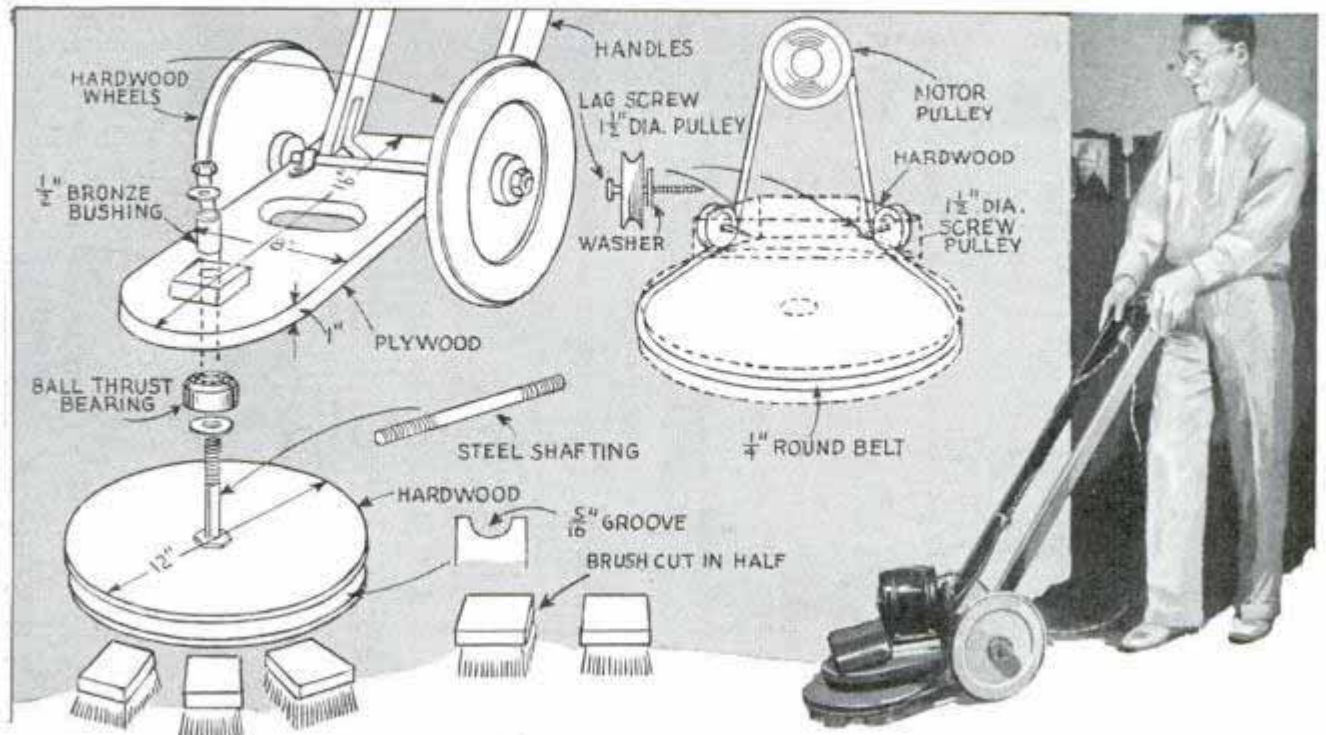

This homemade polisher takes the "rub" out of hand rubbing on waxed floors. All you have to do is push it slowly back and forth from a standing position. To make it, three ordinary scrub brushes are sawed in half as shown and each half is glued and screwed to a turned hardwood pulley 12 in. in diameter and grooved for a round belt. The brush halves must be spaced equally and located the same distance from the center of the pulley. Handles and two

rubber-tired wheels, coaster wheels will do, are fitted to a base on which the motor is mounted. Then the disk is attached to the base as indicated and driven with a round belt running over two idler pulleys. Note that the disk carrying the brushes bears against a ball thrust bearing and the vertical shaft turns in a bronze bushing fitted into a hardwood block screwed to the plywood base.

—C. E. Rogers, Manhattan, Kans.

## Overflow Water of Rain Barrel Is Drained from Bottom

If you have a summer cottage, which is used only occasionally, and depend on barrels set under the eave downspouts for your water supply, the idea of scavenging, or having the overflow water come from the bottom of the barrel, will improve the water. When water stands in a barrel for a length of time, it becomes more or less stagnant, and when the supply is replenished by rains, the stagnant water stays in the bottom of the barrel and the fresh water overflows when the barrel is full unless the method shown is used.

—August Menger, San Antonio, Tex.

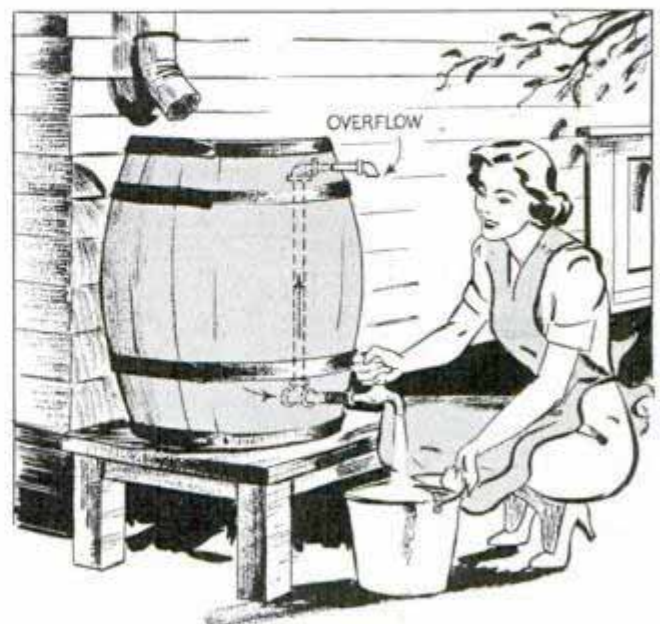

☞ When there is considerable gluing to be done, fill a small aluminum cake decorator with the glue and it can be applied quickly.



## Decorative Stands Hold Flowers in Front of Windows

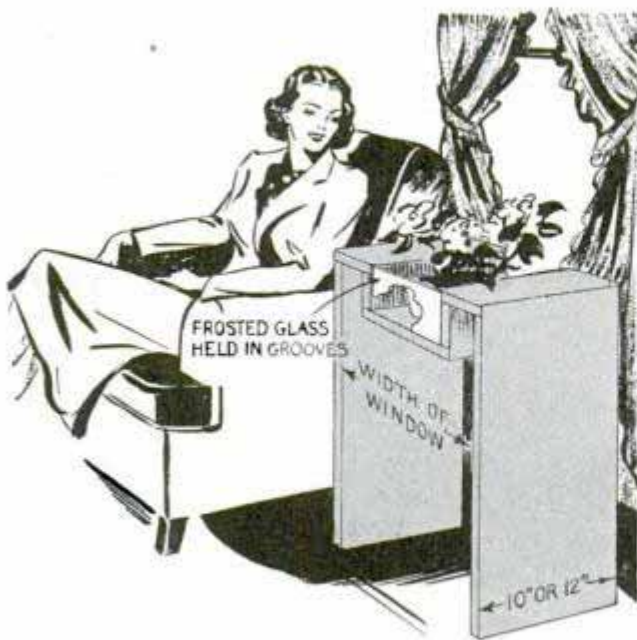

Neat flower stands with wells in the top to hold potted plants not only add a decoration to a room, but also help in filling blank spaces in front of windows where no other piece of furniture seems to fit in well. The tables can be any size desired, either extending above the window casement or coming flush with it. If you copy the table shown, miter the joints, and provide each one with a small angle brace for rigidity. The well should be of a size to take a sheet-metal tray, which can be slid out for watering and caring for the plants. To hide the tray, a piece of frosted glass can be put in front as indicated.

—Shirley Ware, Chicago.

## Metal Points Crimped on Arrows with Old Pair of Scissors

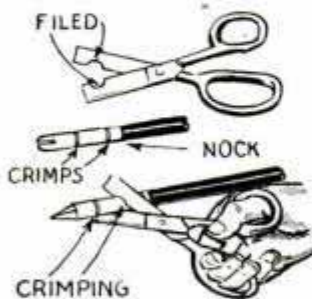

Amateur archers who make their own arrows and use metal nocks and tips, can make a handy tool for crimping them in place from an old pair of scissors.

Just break off the blades near the handles and file half-round notches, making the notches of a size to fit the work correctly. In use, slip the nock or point in place and crimp it as indicated in the lower detail.

Fine teeth made in the edges of the notches with a small file will indent the crimped portion of the metal into the wood arrow so that the nock is held firmly in place.

## False Bottom in Coat Pocket to Carry Valuables

A short, concealed pocket sewed to the lower end of your regular coat pocket, which has the bottom slit so that it can be closed with a hookless fastener, provides a secret place for carrying jewelry and other small articles of value. When the fastener is closed, the coat pocket serves its regular purpose, and anyone reaching into it is not likely to be aware of the extra pocket.

REGULAR COAT POCKET

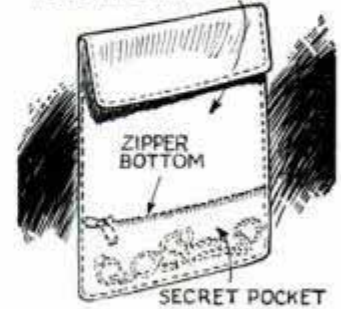

## Photo Prints Washed Rapidly



When preparing photos for newspapers, I have found that the prints could be washed rapidly by using a garden-hose spray nozzle

of the type shown in the photo. This is attached to the faucet in the darkroom, and the tray holding the print is set at an angle so that the water spray can be directed against it.

—R. M. Eadie, High River, Alberta, Can.

## Paper Sealer from Cork

A large cork with a highly polished furniture glide in the small end is a handy thing to have around when gluing paper or other material. The glide slides easily, avoids soiling the work and reduces finger strain.



—Frank Bentley, Clinton, Ia.



# Scenic Wall Rack to Hold Guns and Books

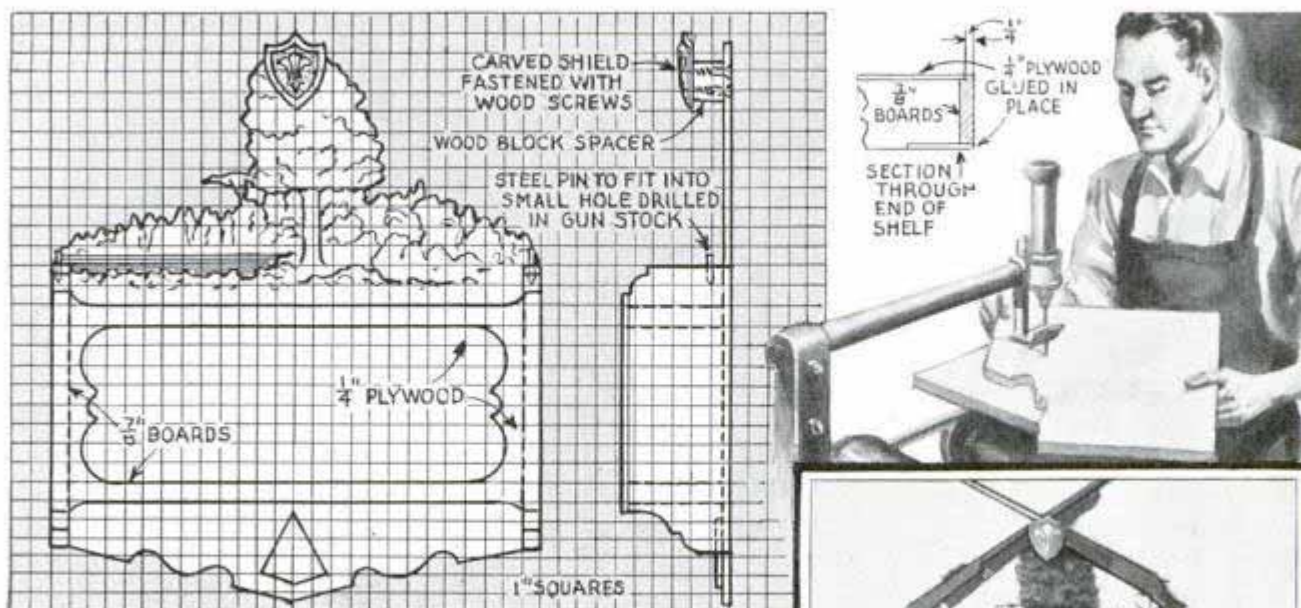

One sportsman who had rather limited wall space in his den for a gun rack and also a hanging bookshelf, combined the two into a single unit of unusual design. To fit in with its purpose, the scrollsawed top, painted to represent a woodland lake, lends additional "atmosphere." The view shown above may be duplicated by first sketching it on a large sheet crosshatched in 1-in. squares, then tracing the pattern on wood by means of carbon paper, and finally scrollsawing. If you are artistically inclined the job of painting the scene suitably will be simple, but if you are not inclined to do this, you can substitute a large photo of a similar appropriate scene. For this purpose you use an enlargement which is glued to the wood securely before scrollsawing along the edge of the treetops and horizon. Of course, the enlargement need not extend entirely across the width of the rack but it may be only about 12 in. wide and located centrally. In assembling the parts you can use glue and screws, countersinking the screw heads and concealing them effectively with crack filler.

## Greased Board Holds Tiny Parts

When repairing, dismantling or assembling articles that contain numerous tiny screws and other small pieces that are easily lost, lay the delicate parts on a smooth board that has been coated lightly with grease. The slight tackiness of the grease will prevent the parts from being brushed or blown away.

## Crosscut Saw Stiffened by Brace to Use It Single-Handed

The next time you want to use a two-man crosscut saw alone, string two wires between the handles and tighten them by slipping a notched stick between the wires. This will tend to stiffen the saw so that the handles will have less tendency to wobble from side to side.

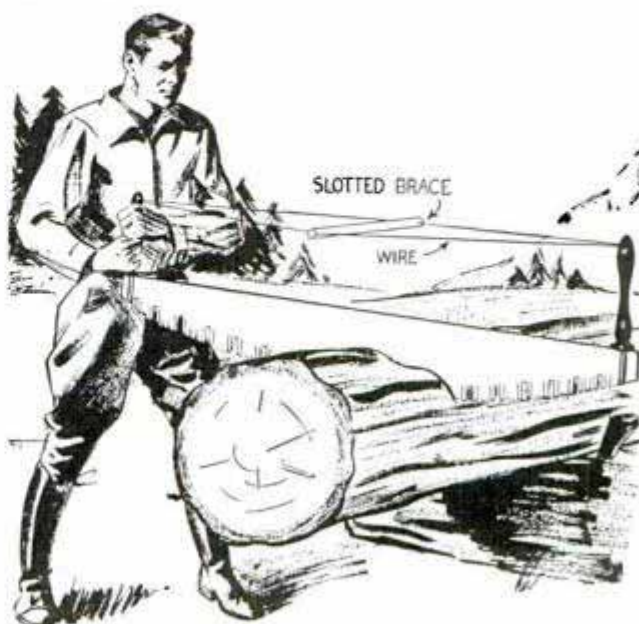







# in Walnut

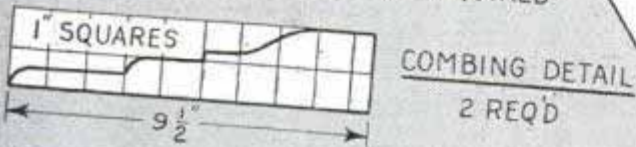
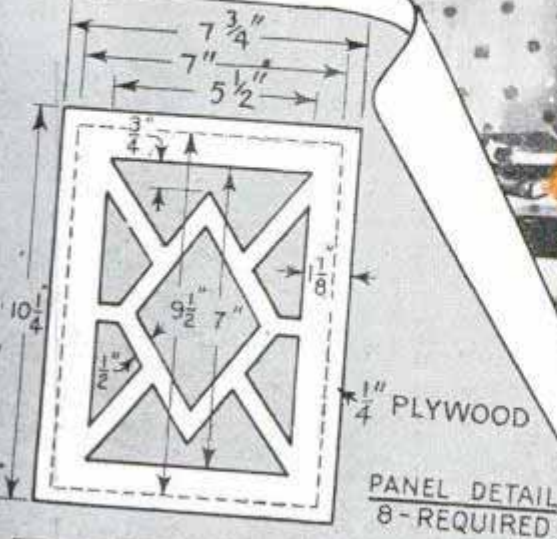

**PROCEDURE:** GROOVE AND RABBET POSTS, JOINT AND FIT RAILS, SCROLL-SAW PANELS, FIT IN GROOVES. THEN GLUE AND ASSEMBLE SIDES, LAY OUT DOWEL HOLES FOR COMBING AND FEET, ASSEMBLE SHELVES, TOP, BOTTOM, AND BACK IN ORDER NAMED. MATERIAL: BIRCH OR WALNUT

### MATERIAL LIST

- |  |   |
|--|---|
| 2 pieces for top and bottom,<br>3/4" x 10 1/2" x 20 1/2" | 8 panels, 1/4" x 7 3/4" x 10 1/4" plywood     |
| 4 side posts, 3/4" x 1 1/2" x 47 1/2"                    | 4 feet, 1 1/2" x 1 1/2" x 5"                  |
| 4 top and bottom rails,<br>3/4" x 1 3/4" x 7 3/4"        | 8 pieces for brackets, 3/8" x 3 1/2" x 3 1/2" |
| 6 inside rails, 3/4" x 2" x 7 3/4"                       | 1 piece for cleat, 1/2" x 1 1/2" x 18"        |
| 3 shelves, 1/2" x 9 1/2" x 18 3/4"                       | 2 pieces for combing, 1/4" x 2" x 9 1/2"      |
| 1 back, 1/4" x 18 1/2" x 47 3/4" plywood                 | 1 piece for combing, 1/4" x 2" x 19 1/2"      |
|  | 4 dowels for feet, 1/2" x 2 3/4"              |
|  | 9 dowels for combing, 1/8" x 1"               |

V-SHAPED VEINING CHISEL  
STOCK FOR FOUR FEET

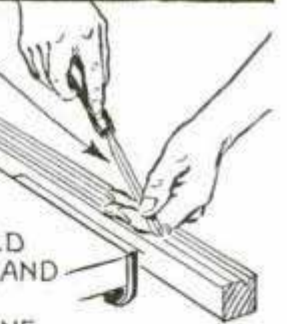

THE MOLDING MAY BE FORMED WITH A VEINER AND GOUGES OR UNIVERSAL PLANE

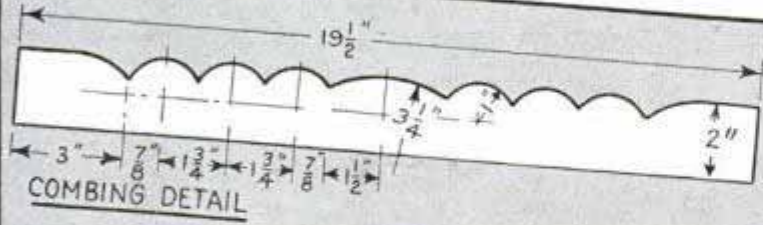

Elegantly styled in Chippendale, this four-shelf bookcase, with its attractive, scrollsawed panels inserted into the side framing, its grooved feet, and the neatly scalloped rail at the top, is a piece of furniture worthy of special place in any library or living room. The shelf space is designed to accommodate books of various sizes. Construction is simplified because of the number of duplicate parts. If you desire, the design may be altered to a two or three-shelf case by shortening it from the height given





## Warm Air from Heater Directed on Floor by Fan

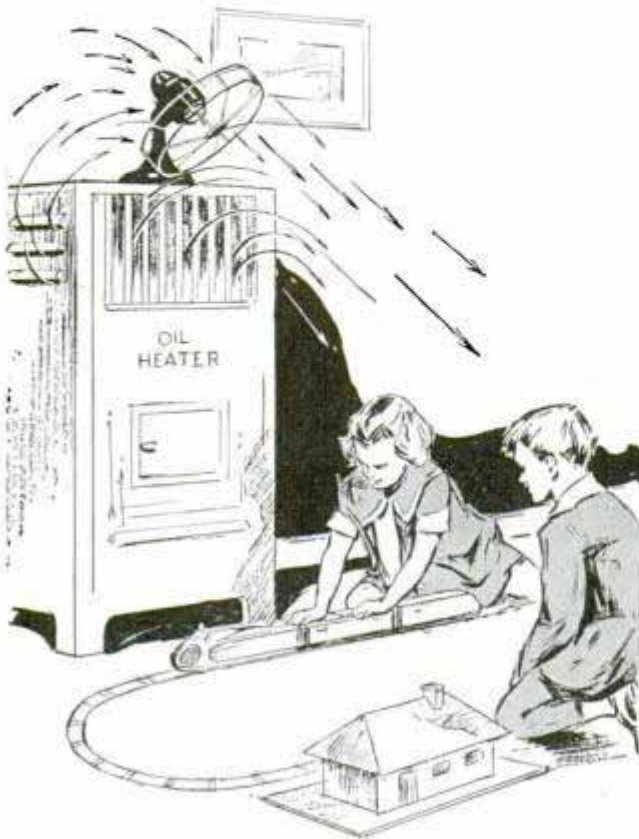

In homes where oil heaters are used and the floors have a tendency to be cold, an electric fan set on top of the heater and adjusted to direct the warm air downward will help. This is especially desired when small children are playing on the floor. Also, the fan helps to circulate air to adjoining rooms that might otherwise be difficult to heat on extremely cold days.

—Ray E. Kraft, Forest Park, Ill.

## Rubber Tire for Wheelbarrow

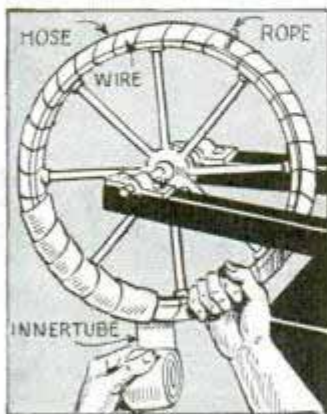

When using a wheelbarrow around the home or in the garden, you can make it push easier over soft ground and silence it when passing over sidewalks by putting a piece of garden hose around the rim of the wheel.

To do this, cut the hose to length and stuff it with rope. Then put it on the wheel and bind it in place with wire. Cover this with

a wrapping of rubber cut from an old inner tube, using rubber cement at the end of the strip, after the wrapping has been completed, to keep it from unwinding.

## Spring Clip on Spectacle Case Keeps It in Pocket

If you carry a spectacle case, rivet a spring clip to the lid so that it can be slipped over the edge of your pocket to keep the case from dropping out if you stoop. Almost any spring clip will serve the purpose. One taken from an old fountain pen or automatic pencil will do, or you can even cut off the ring part of a lead-pencil clip and use the straight portion.—Fred L. Fromme, Brooklyn, N. Y.



## Chisel Handle Is Protected by Door Bumper

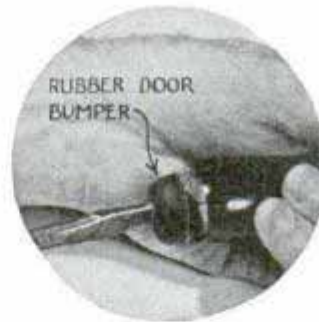

When the wood handle of a chisel becomes battered from use, it can be renewed by cutting off the tip and screwing a small rubber door bumper on the end. The repair is

permanent and enables you to use the chisel with either a hammer or mallet.

## Celluloid Ruler Easy to See with Red Strip in Center

Applied to the center of a celluloid ruler, a strip of red cellulose tape makes the ruler easy to see



when it is lying on a desk among papers and other work. Be sure to clean the surface of the ruler thoroughly so that the tape will adhere to it.



# New HOUSE NUMBERS

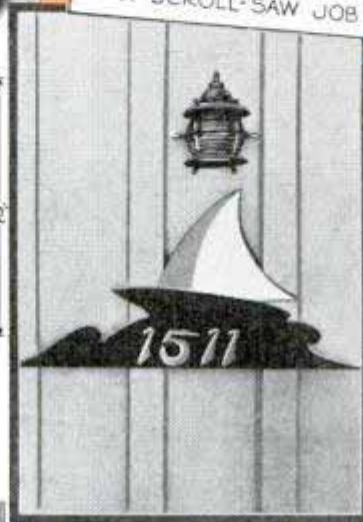
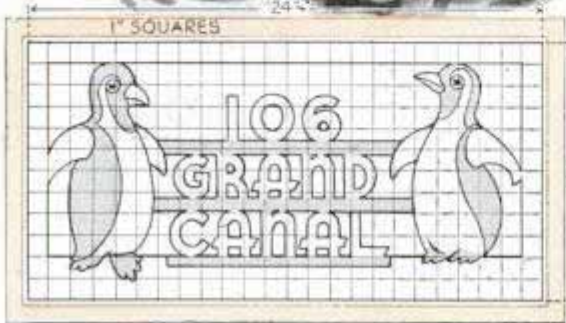
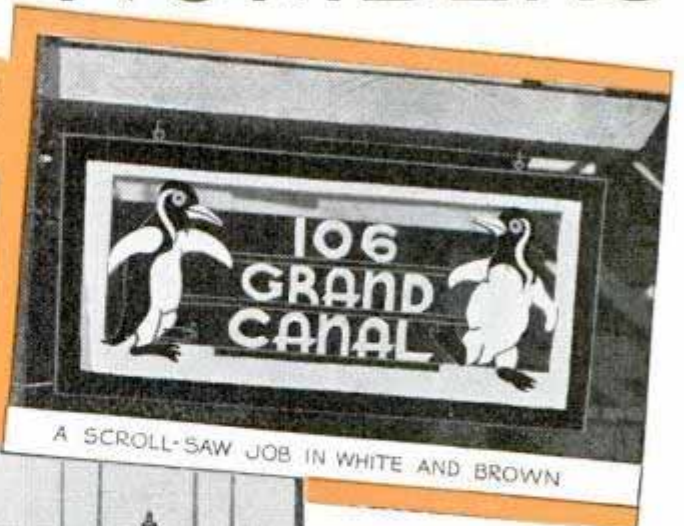
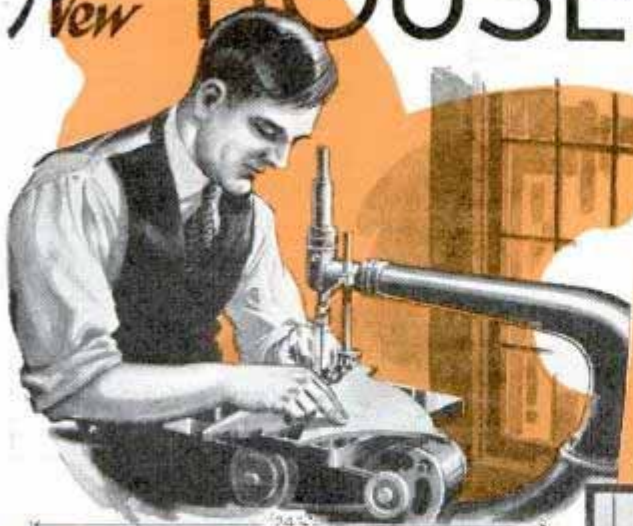

SCROLL-SAWED FROM  $\frac{1}{4}$ " PLYWOOD

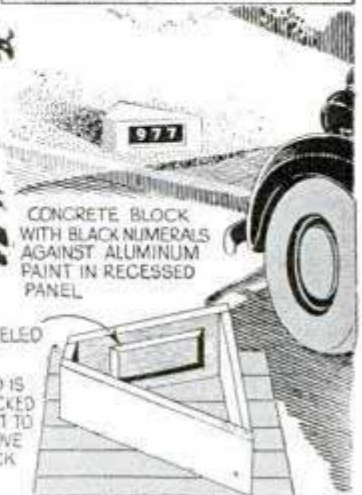
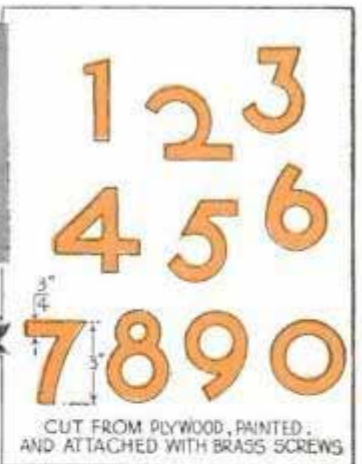
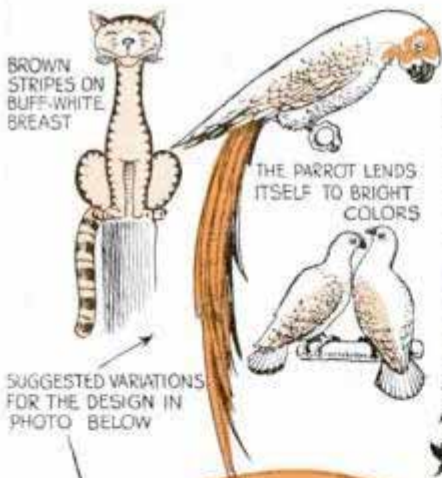

SPELLED-OUT NUMBERS ARE ATTRACTIVE



## Twin Propellers Double Flight Time of This Model Plane

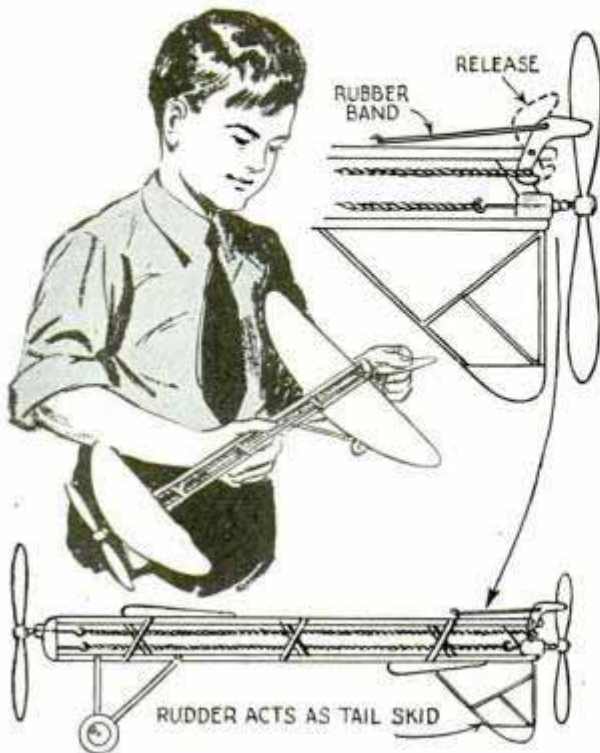

Here is something new in model airplanes; twin propellers arranged in tandem so that one runs and then the other, almost doubling the time that the plane will stay in the air. The plane is made in the regular way except that the rudder is on the underside so that it serves as a tailskid. The rubber band operating the front propeller is fastened to a pivoted L-shaped arm, which engages the rear propeller and prevents it from turning until the arm is pulled back. As the band untwists in driving the front propeller, the pull on the arm is gradually reduced and a short rubber band fastened to the upper end of the arm pulls the arm back, allowing the rear propeller to rotate.

—Kenneth Howard, French Lick, Ind.

## V-Notches in Hand Vise to Grip Round Stock

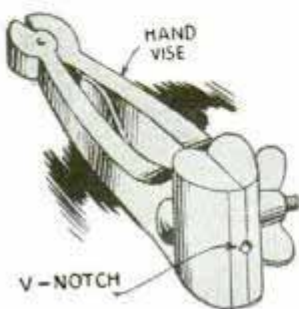

A hand vise can be made more versatile and efficient by filing a V-notch in each jaw so that small round stock can be gripped firmly. The notches must

be filed carefully and in alignment, their depth depending on the diameter of stock to be handled.

## Nail Held by Paint Brush for Driving

One workman who has tried many methods of holding nails to drive them in hard-to-reach places, claims that a small paint brush beats them all. The nail is inserted into the bristles, which hold it firmly, yet are pliable and permit the nail to be driven almost its full length before removing the brush.



## Mouse Trap Clamps Small Parts While Glue Sets

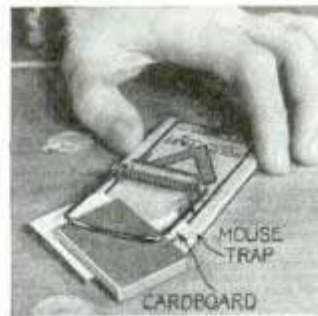

Model makers using cardboard or any thin, light stock will find that a common mouse trap serves as a handy clamp for gluing these materials. The pressure can be equalized

by placing a piece of plywood over the work.—J. P. Driscoll, Buffalo, N. Y.

## Marking Young Trees and Shrubs

Nurserymen and others who have a number of young trees and shrubs to mark can do it inexpensively as shown. With ink, write the data on strips of fairly heavy kraft paper and then dip each

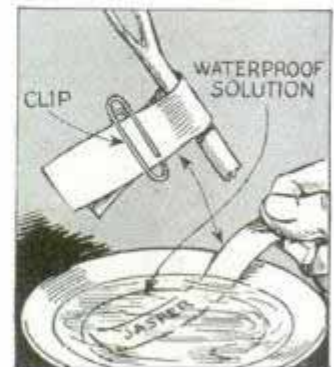

one in a waterproofing solution, such as hot paraffin or spar varnish diluted with linseed oil. Wire paper clips will do for attaching the slips to the shrubs or trees.



## "Crossed-Leg" Fireside Bench Is Upholstered

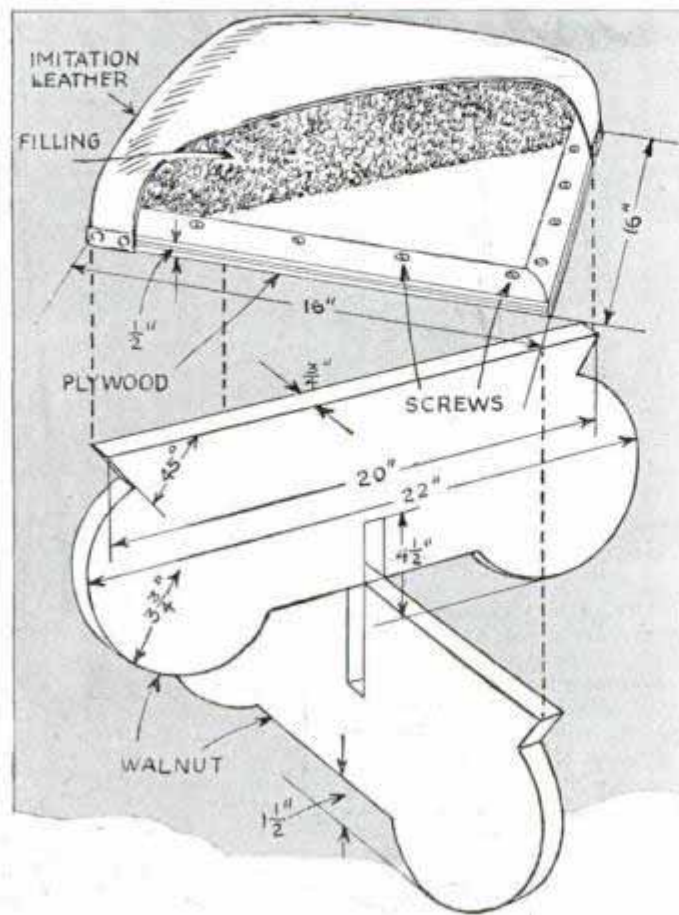

The "legs" of this bench are simply two boards sawed in duplicate from a simple pattern and halved together edgewise with the top edges flush as you see from the detail. Then the seat bottom fits cornerwise on this base as shown. Notice that strips of quarter-round are screwed to the edges of the seat bottom to round over the

covering and make a neater fit. A hair filling and an imitation-leather covering complete the job all except finishing the exposed wood, which should be sanded and filled, then shellacked and waxed in the natural color. As an alternative the covering can be in color and the wood base enameled to harmonize.

## Cutting Dowels in Half Lengthwise on Scroll or Band Saw

Used in conjunction with either a scroll or band saw, this jig enables you to do an accurate job of cutting dowels or plastic rods and tubes in half lengthwise. The jig consists mainly of a hardwood block bored so that the stock will be a snug sliding fit. A metal guide strip just as thick as the saw cut, is arranged to pass through the center of the hole at one end. This keeps the work from turning while pushing it through. A slot to take the saw blade is cut at the other end of the hole to be in line with the guide strip. In use, the jig is clamped tightly to the saw table after being carefully adjusted for position as shown, and the work is fed in slowly.

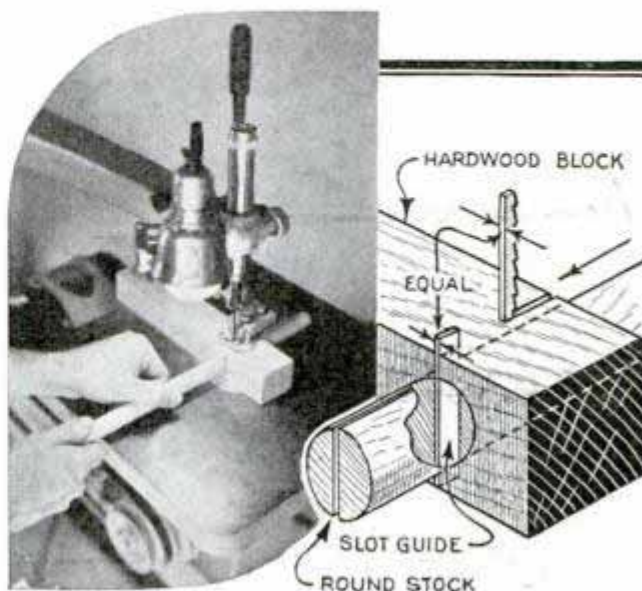



# Porch Mail

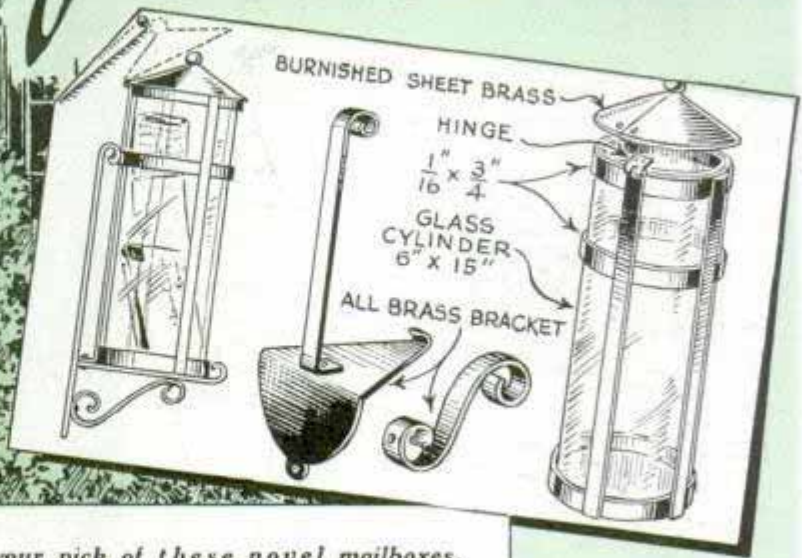

Take your pick of these novel mailboxes, which range in design from a glass tube supported in an attractive frame of brass to a wooden shoe. You can make up any one ready for use in a single evening. Brass parts should be burnished and given a coat of clear lacquer to protect the finish

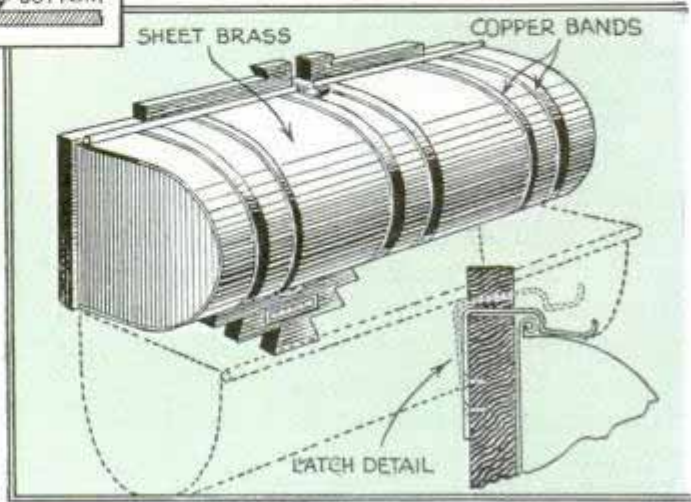
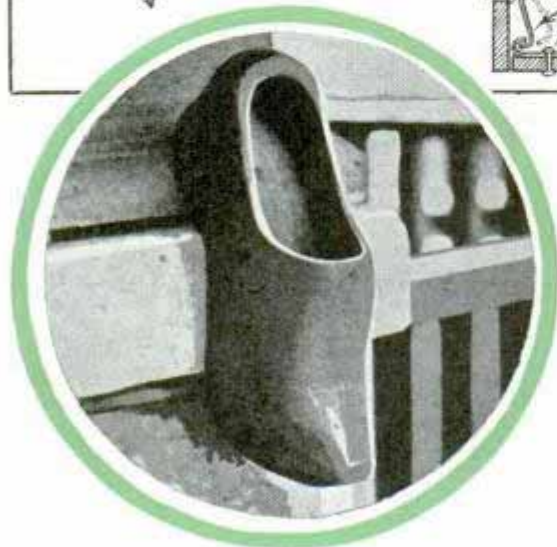
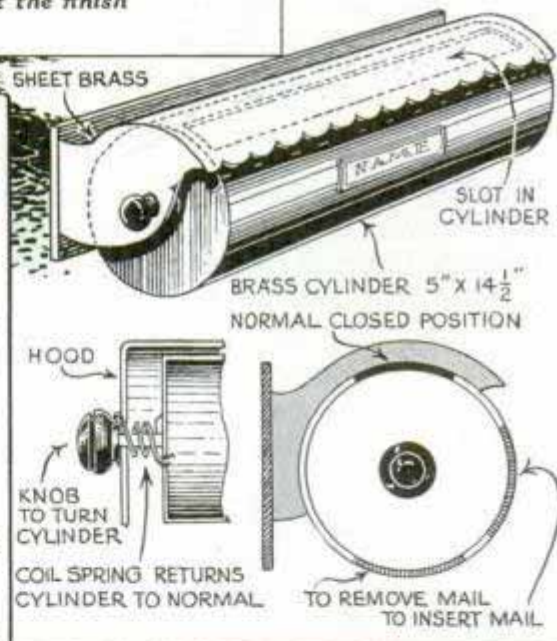
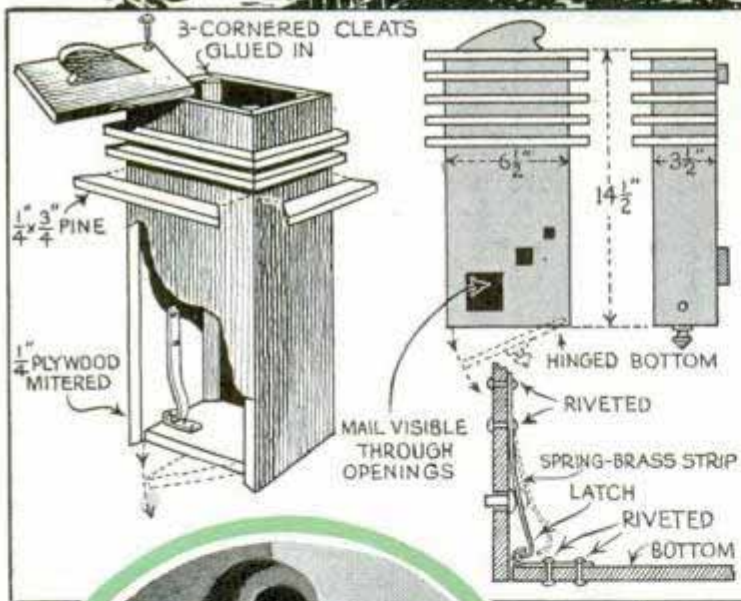



# Boxes

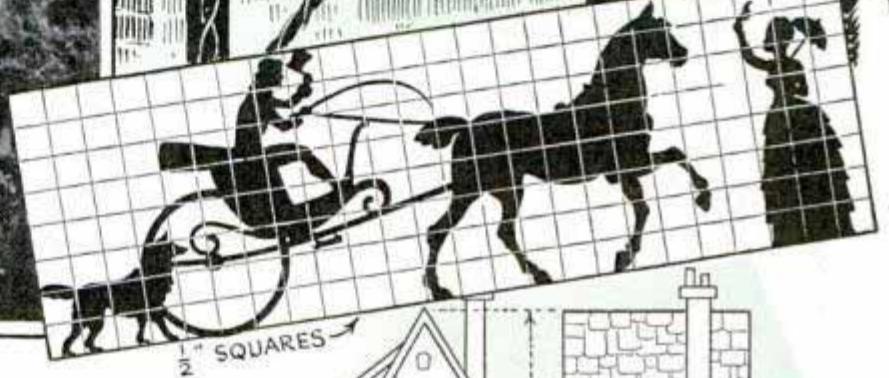
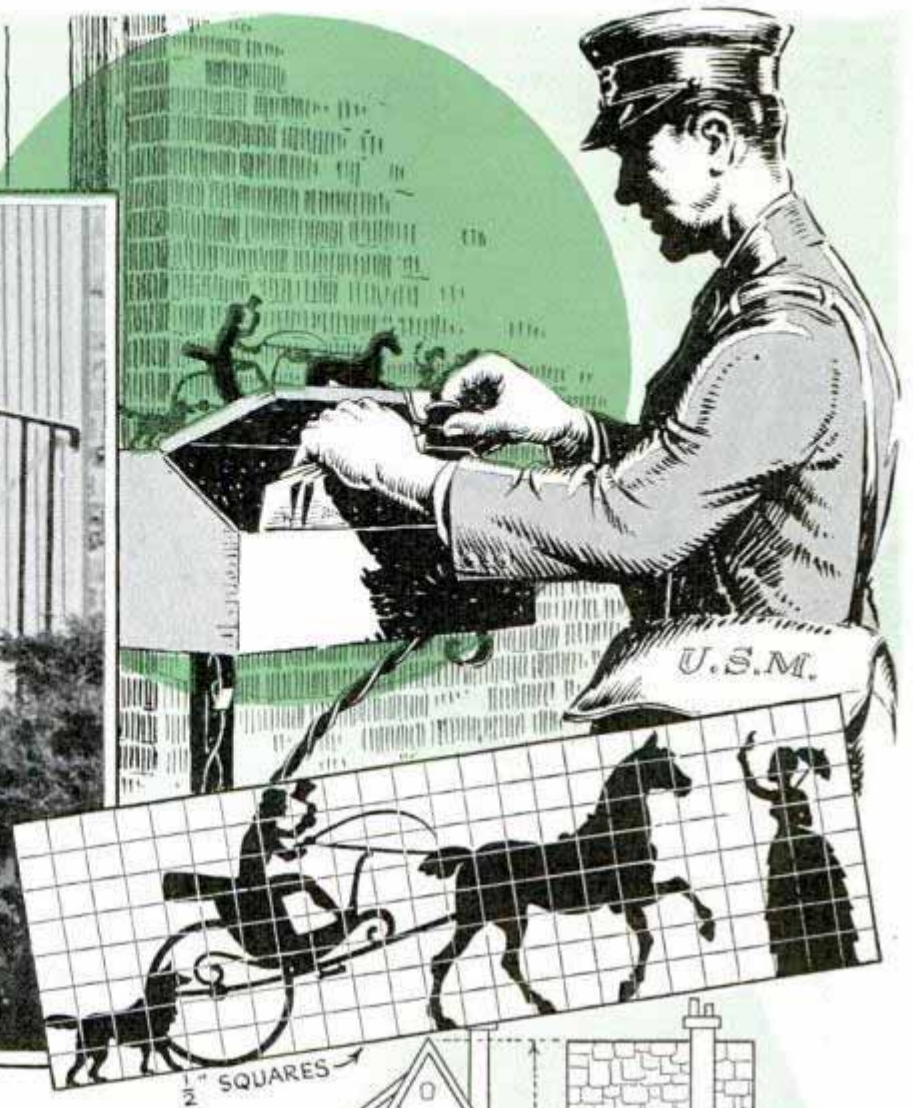
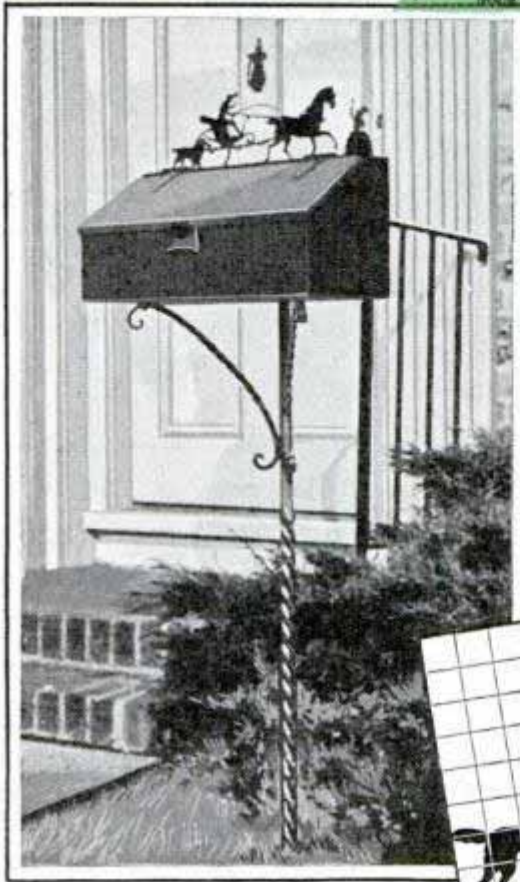

The appearance of a plain box type like the one above is improved considerably by adding a silhouette ornament scroll-sawed from brass or copper. Or if you care for one with a more dainty touch, take the fairy cottage at the right, which is very attractive when painted in bright colors. When the lid is lifted a mirror on the underside shows mail in the bottom. If you like to know when the postman arrives, the box below sounds a doorbell when it is opened. A push button located so the lid contacts it is wired into your doorbell circuit. Copper bands contrasting with brass box enhance the appearance

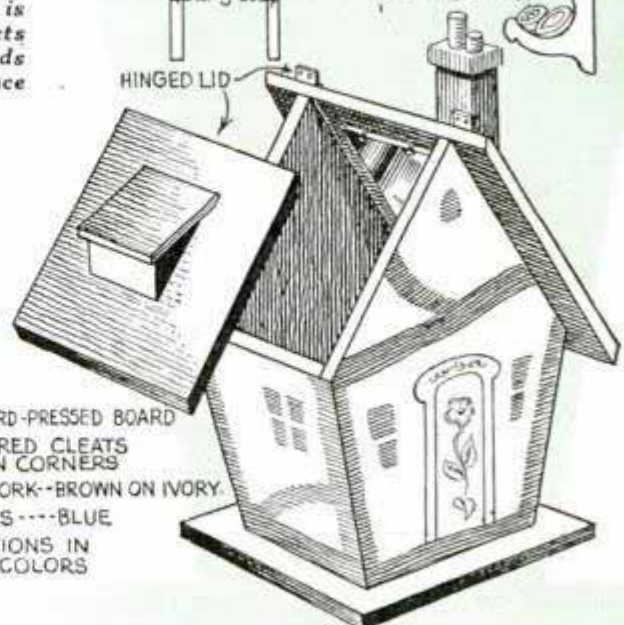
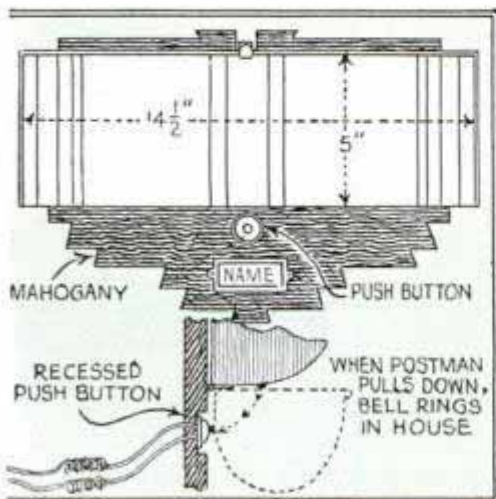
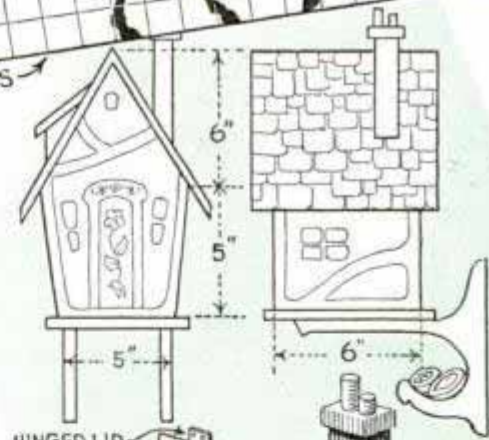

ALL  $\frac{1}{8}$ " HARD-PRESSED BOARD  
3-CORNERED CLEATS  
GLUED IN CORNERS  
TIMBER WORK--BROWN ON IVORY  
WINDOWS----BLUE  
DECORATIONS IN  
BRIGHT COLORS



## Obstruction in Underground Pipe Removed with Air Pressure



Here is a simple method of clearing a clogged underground pipe that saved one farmer many dollars by making it unnecessary to dig up the pipe. A tire valve was wound with friction tape to fit tightly inside a tee fitting in the pipe line on the dry side of the obstruction. The valves beyond the tee were closed tightly, after which air was forced into the pipe with a tire pump. After considerable pressure had been built up to loosen the obstruction, the valve was quickly removed from the pipe. The resulting sudden change in pressure at this side of the obstruction enabled the water pressure on the other side to force it on through the pipe.

## Nozzle of Shower Bath Taped to Control Spray

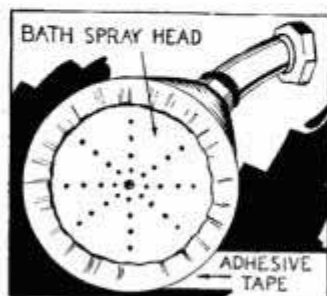

as indicated, will take care of the trouble. Usually a strip about  $\frac{3}{4}$  in. wide will do

If the spray from a shower-bath nozzle is a little too wide to stay within the proper bounds of the tub and curtain, a strip of adhesive tape put around the edge of the nozzle

the trick. The tape will wrinkle when applying it, due to the circular shape of the nozzle, but this will not hinder its effectiveness in plugging some of the holes.

## Cork Improves Cable Release

Drilled through the center and slipped over the cable release of a camera, a round cork of the type used on fishlines as a float provides a good hand grip. This is especially true when photographing children or taking other pictures where the subject must be watched so closely that you may inadvertently drop the slender release.—Daniel Reynolds, Pontiac, Mich.

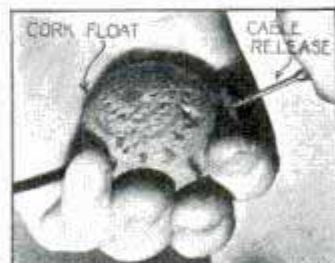

## Emergency Transplanting Tongs

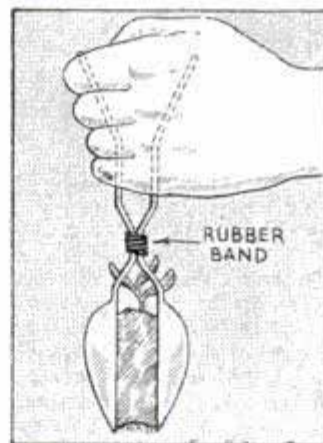

Two discarded tablespoons bent and tied together with rubber bands provide an emergency pair of transplanting tongs for small flowers and plants. It's a good idea to sharpen the ends of the spoons.

## Fisherman's Fly Is Protected by Hollow Rubber Ball

To protect a valuable fly when carrying a casting rod through weeds and brush, you can cut a slit in the side of a hollow rubber ball and slip it over the fly, letting it dangle from the tip of the rod. Another method is to impale the ball on the rod near the grip so that it always will be at hand for the same purpose.

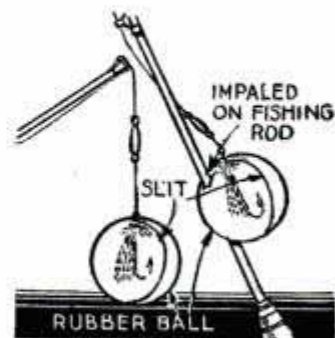



# WALL SCONCE

*in bow-and-arrow motif*

Pointing upward, the arrow projects through a stringless bow that carries two lamps. Turning the "feathered" end of the arrow operates the switch. The lamp is portable so that it can be hung up anywhere, and the cord is run to the nearest wall receptacle, which may be located behind the "shield" or at the baseboard

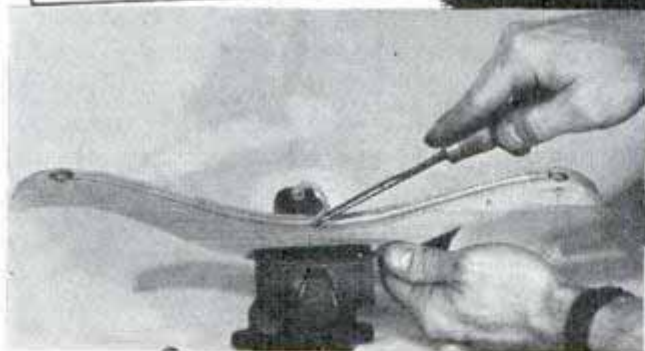
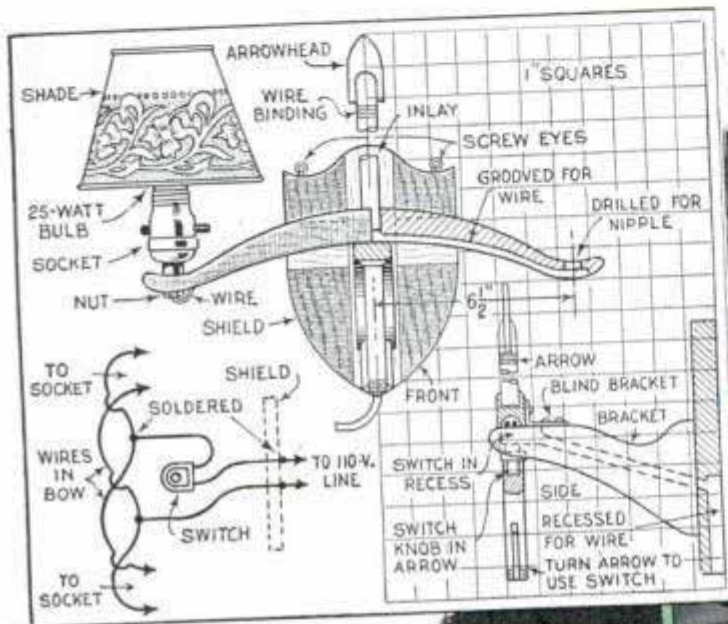

The shield, bracket, bow and the arrow shaft are made of selected mahogany. The arrow tip and the feathers are represented by parts shaped from maple, and the shield is inlaid with the same material. The stock for the shield should be inlaid before it is cut to shape. This procedure will assure neat joints. Before you cut stock, the bracket is drilled lengthwise and the shield is also drilled and recessed to conceal the wiring. The top half of the arrow fits in a hole drilled in the bow while the upper end of the lower half is drilled to fit snugly over the knurled turn button of a small 110-volt metal-shielded switch, which is mortised into the lower edge of the bracket as shown in the cross-hatched section above. After the holes for socket nipples are drilled in the ends of the bow and the groove cut in the bottom for the wiring, sand all edges round and assemble

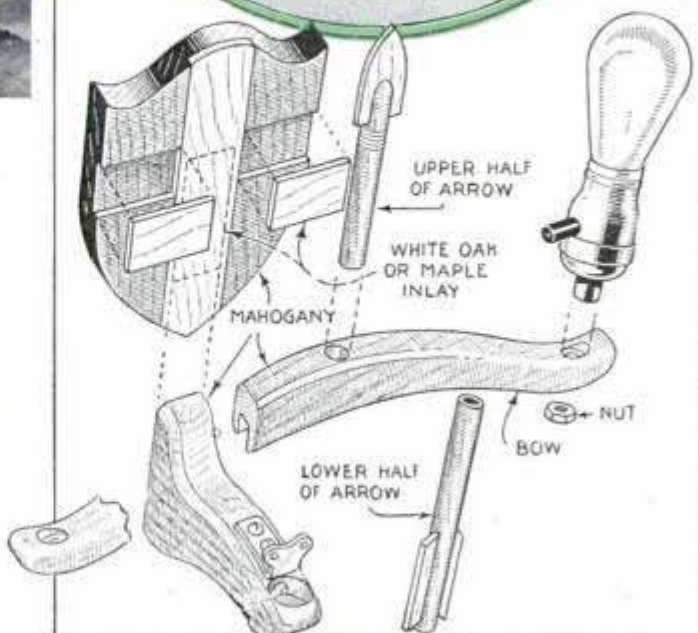



## Sulphur Locks Sagging Plaster on House Ceiling



Poured in strips 5 or 6 in. wide between the joists of a ceiling, melted sulphur will anchor plaster firmly that has been loosened because of jars, defective keying, etc. Engineers of the Bureau of Reclamation discovered this method at Grand Coulee dam where plaster in many of the houses had been loosened by blasting. On a test, a plastered surface a yard square that was sagging supported a weight of 240 lbs. per square foot after applying the sulphur. Before pouring on the melted sulphur, prop up the defective plaster carefully to avoid breaking it. Ceilings in a house at Coulee cost only \$25 to repair in this way, against about \$200 for complete replastering and redecorating.

—Henry W. Young, Portland, Ore.

## Brads Driven through Thin Wood without Splitting

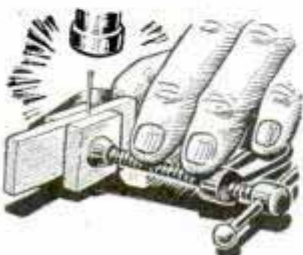

The need for driving small brads through thin stock edgewise usually means plenty of trouble unless you clamp

the strip between two thicker blocks in a C-clamp or vise. Be careful to start the brad straight, then drive it with light blows of the hammer.

—Paul H. Smith, Charlestown, Mass.

## Steel Clips over Coat Sleeves Keep Out Cold Air

When hunting or working outside during cold weather, slip a couple of bicycle trouser guards over the sleeves of your coat at the wrists. They will keep cold wind or snow from blowing up your sleeves, and when not needed take little space in your pocket.—J. W. Robinson, New York City.



## Sealing Wax Dissolved in Alcohol to Paint Soap Carvings

To brighten soap carvings or give them the appearance of metal, paint them with a solution made by dissolving sealing wax in alcohol. The wax is inexpensive and is available in a variety of colors. It will require two or three coats for a good job, and if the work is to be trimmed or outlined in colors, simply moisten the brush in alcohol, and draw it over the wax to pick up the color.





# *Simplified* GATE-LEG TABLE *folds into small unit*

By  
**WAYNE C. LECKEY**

**I**DEAL for limited space in the small apartment or home, this little drop-leaf table with its snug folding legs is very convenient, for it can be stored readily in a closet or behind a door, when not in use. Walnut for the top, finished natural, and any close-grained hardwood, finished bone white, for the understructure, are the two woods most suitable for construction and give a pleasing contrast.

Start the job by turning the two sets of legs from square stock, following the dimensions given in Fig. 1. While all four legs are turned to the same over-all length, one pair is altered from the center bead down to permit the connecting stretcher to pivot beneath the other. Both stretchers are turned to identical shape. The pivoted underframing of the top to which corresponding legs are doweled and glued flush, is shown in Fig. 5. While each member may be cut from a solid block, you can simplify the job by cutting four separate wedge-shaped pieces and gluing them, as shown, to a 2-in. piece. When pivoted at the center with a  $\frac{1}{2}$ -in. dowel, the two will fold compactly together. Screw pockets should be made in one member to permit fastening the top.

In assembling the pieces so far cut, you can glue and clamp one set of corresponding legs with stretcher and apron, as a single unit, Fig. 7, but the remaining pair have to be assembled after the apron and stretcher are pivoted. This makes it impossible for the two sections to come apart. These should be made to work freely. The

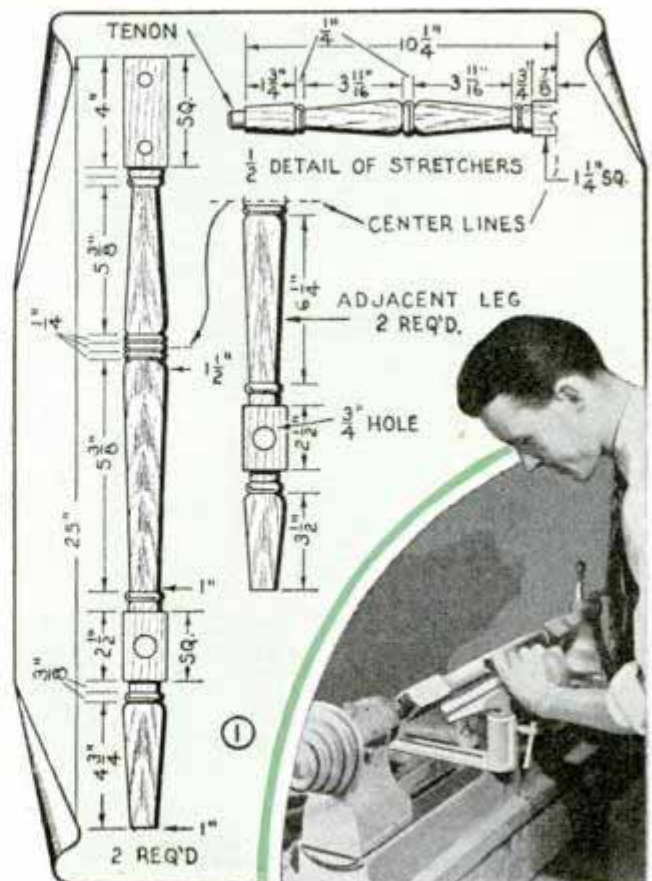



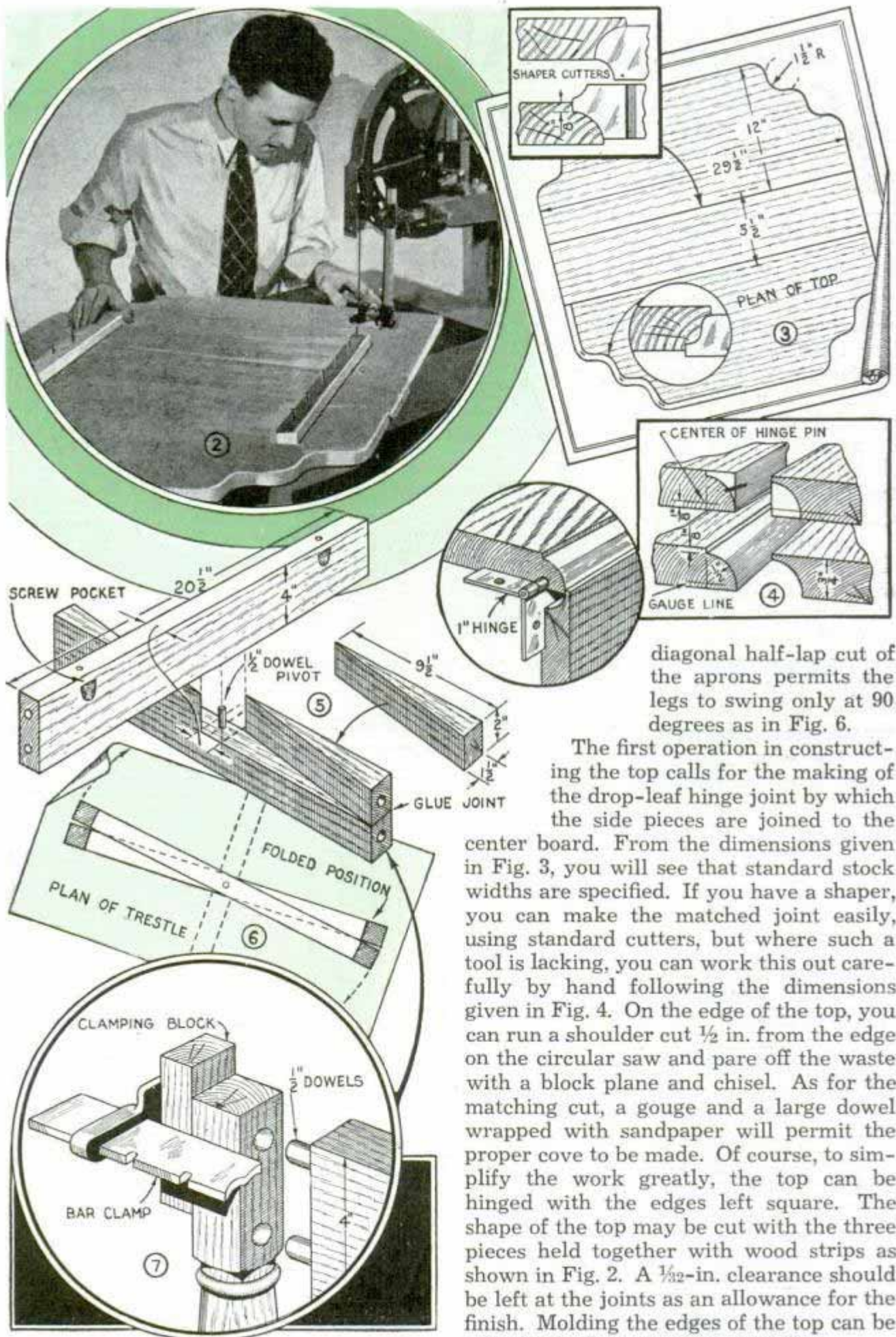

diagonal half-lap cut of the aprons permits the legs to swing only at 90 degrees as in Fig. 6.

The first operation in constructing the top calls for the making of the drop-leaf hinge joint by which the side pieces are joined to the center board. From the dimensions given in Fig. 3, you will see that standard stock widths are specified. If you have a shaper, you can make the matched joint easily, using standard cutters, but where such a tool is lacking, you can work this out carefully by hand following the dimensions given in Fig. 4. On the edge of the top, you can run a shoulder cut  $\frac{1}{2}$  in. from the edge on the circular saw and pare off the waste with a block plane and chisel. As for the matching cut, a gouge and a large dowel wrapped with sandpaper will permit the proper cove to be made. Of course, to simplify the work greatly, the top can be hinged with the edges left square. The shape of the top may be cut with the three pieces held together with wood strips as shown in Fig. 2. A  $\frac{1}{32}$ -in. clearance should be left at the joints as an allowance for the finish. Molding the edges of the top can be varied to suit your own equipment.



## Kitchenware Polisher Fitted on Fruit Juicer

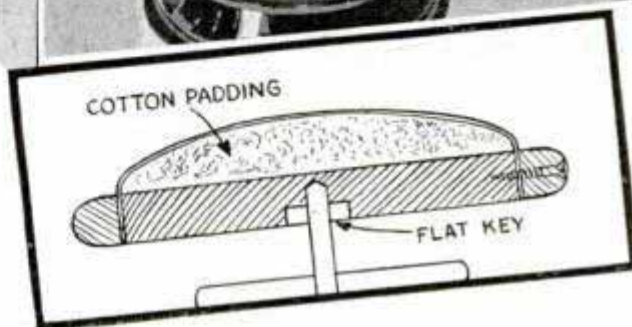
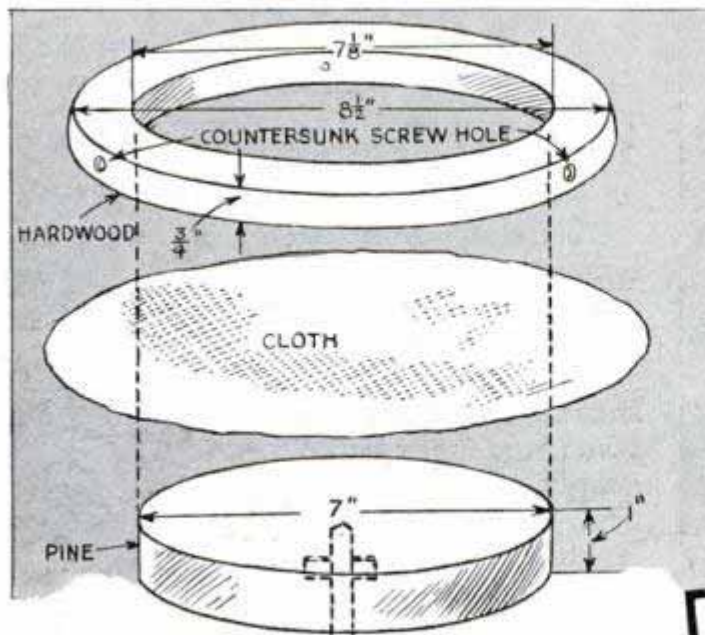

By merely fitting a cloth-faced disk on a motor-driven fruit juicer, you have a buffer which makes an easy job of polishing silverware, carving sets, or any small household utensils that are brightened ordinarily by hand rubbing. The disk is a two-part telescopic affair which stretches and holds a piece of cloth in the same manner as a pair of embroidery rings. Natu-

rally, the disk must be made carefully so that when it is assembled on the projecting shaft of the juicer motor, it will run true and without vibration.

## Block on Boat Transom Helps to Prevent Loss of Motor

Screw a hardwood block to your boat transom in the position indicated to prevent loss of the motor if the clamps are

loosened by vibration. Before doing this, however, be sure that the transom is strong enough to carry the motor under all conditions without breaking off. Use heavy screws in attaching the block and trim it to a width so that the clamp screws will just pass under it.

—Buzzy Eddins, Marlin, Tex.



## Fishhook Easily Removed from Clothing

To remove a fishhook from your clothing, without damage to the fabric, simply open the eye of the hook with a pocketknife and pull the shank through the cloth as indicated.

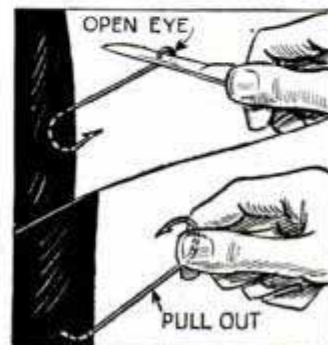



## Improving Circulation of Air Through House

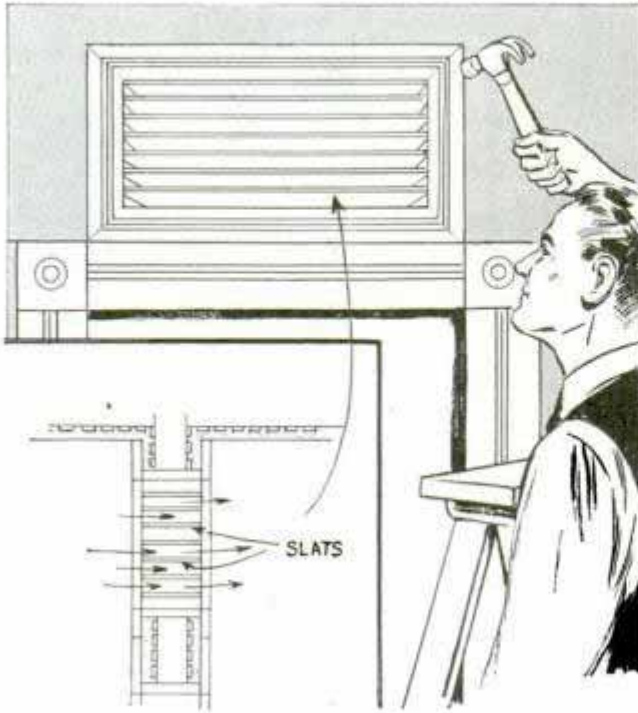

When visiting a friend, I noticed that his home seemed to be heated uniformly through the house, while our home, which was laid out similarly, had cold spots in it. He showed me grilles above some of the doors which permitted heated air to pass from room to room freely without forming pockets of dead air above the doorways. The grilles were made by cutting an opening in the wall above each door and fitting it with a frame similar to the woodwork in the home. Thin wood slats set in the frames completed the job.

—Robert H. Warfel, Lancaster, Pa.

## Increasing Capacity of Chuck on Your Lathe

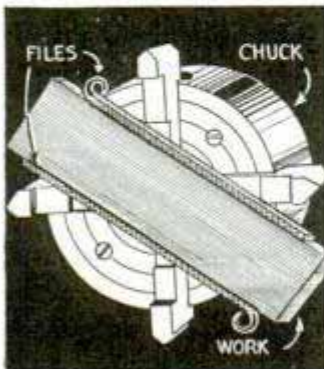

Small four-jaw chucks can be made to hold many jobs beyond their normal capacity by gripping the work across the jaws as shown. Those who have never tried this method may think

the grip would not be tight enough. However, it is possible to obtain a grip for any job if two old flat files are laid across the

jaws. If the file tangs are bent back, they will form handles to slide the files along when setting up the job.

—H. Moore, Kirkstall, Leeds, Eng.

## Rubber Band Holds Lantern in Boat Bow

To hold your lantern safely and securely in the bow of the boat, yet in position for instant release when necessary, simply stretch a rubber band lengthwise on the deck and tack it as shown. Placing the base of the lantern between the strips of rubber will prevent it sliding or tipping.

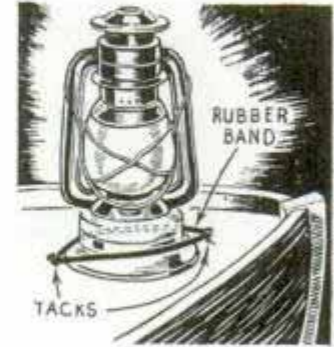

## Wire Music Rack Clips on Leg and Takes Little Space

When practicing music, especially on a stringed instrument, or when playing at parties or places where space is limited, this leg music rack is just the thing. It allows you to sit comfortably in a chair and doesn't take up space on the floor. Bent from wire, the rack is easily assembled, and solder can be used where it is necessary to join the wire. The leg clip should be bent from heavy spring wire, which can be covered with small rubber tubing.

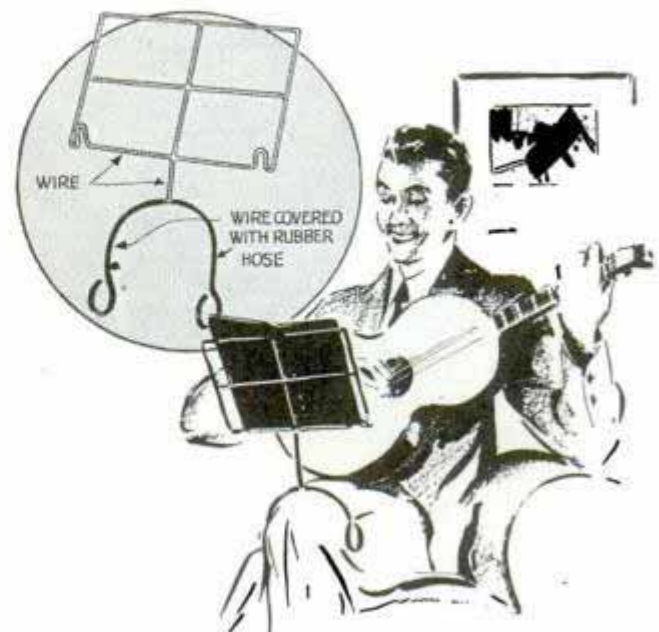



# Chained Dog on Pie Tin Forms Novel Sundial

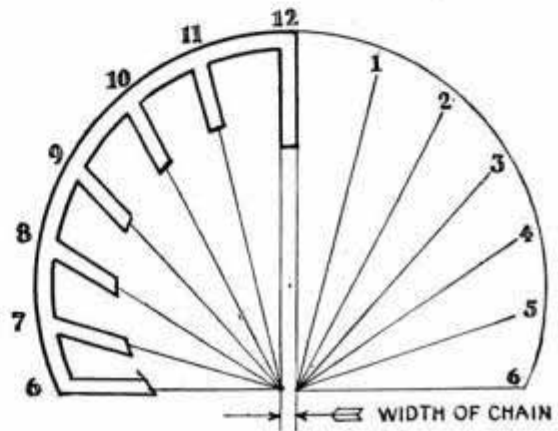
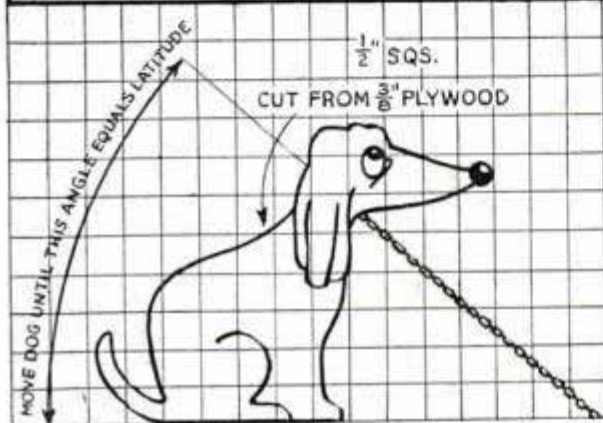
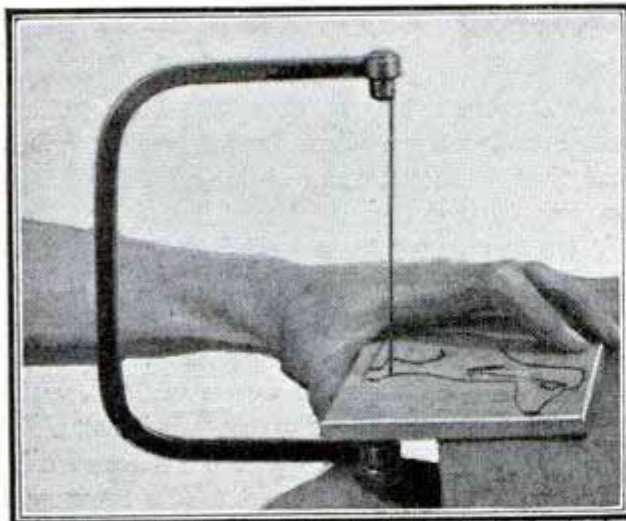

In this simple sundial, a scrollsawed dog is screwed to a large pie tin. A taut chain extends from the dog's neck to the pan, as shown, at an angle equal to the latitude of your home. This angle need not be exact; within a degree or two is close enough. You can find the latitude by looking at a map. Set the assembly in a sunny place so that the pan is level and the dog's tail points exactly north. Using your watch as

a guide, mark off the hour lines. All you have to do is mark the hours from one to five as seven to eleven are in the same relative positions on the opposite side of the chain, and twelve and six are always the same regardless of the latitude. The entire assembly must be well painted to protect it from the weather. Make the dog's body a light color and the features black.

—George B. Harran, Westfield, Mass.

## Fireplace Screen Hinged in Panels Folds Inside Opening

Here's a fireplace screen that is unusual in that it has four panels that can be folded flat against the inside walls of the fireplace when not in use. The opening is faced with a light steel frame to which the panels are hinged in pairs, each pair being hinged together so that one folds back flat over the other. The panels consist of brass screen wire stretched over steel frames.

—Floyd McCracken, Anaheim, Calif.

☐ A soft cloth dampened with alcohol will clean an ivory toilet set.

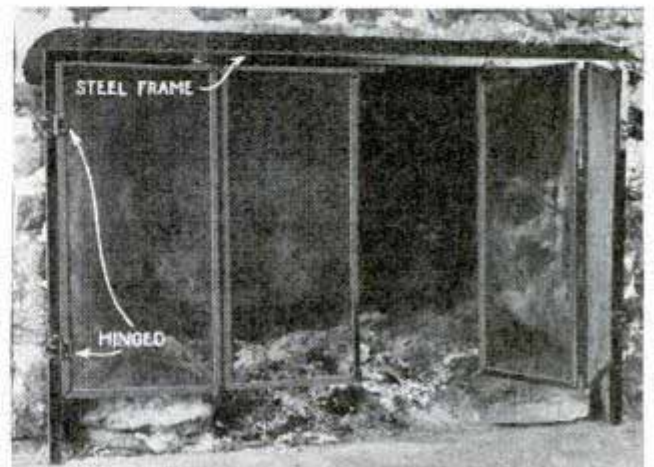



# "SKIPPER" - *Low-Cost*



The garboard is the first plank to be fitted on the bottom. All bottom planks must be set in seam composition or similar adhesive in order to make watertight joints

## PART II

AFTER turning "Skipper" upside down, there are two or three little jobs which must be done before the bottom planking can be fitted. The chine pieces and the rabbet along the keel must be faired up so that they are flush and on the same angle as the frames, as in Figs. 40 and 41. In fairing up the chines, carry the bevel forward to frame No. 1. At this point, take a pencil and draw lines on the chine similar to the markings shown in Fig. 43. Plane away the corner of the chine between these two lines. After fairing the keel rabbet on each side, take a wood chisel and knock out a V-cut on each side of each frame, next to the keel, as shown in Fig. 42. These notches are limber holes, and their purpose is to permit passage of bilge water so that it can be bailed out at some low spot.

Following the same construction as used on the sides, the bottom frames are beveled and then notched out to take battens. Battens are spaced on centers 5 in. apart, Fig. 47, this spacing being uniform from the stern to frame No. 4. From frame No. 4 forward, the spacing varies slightly, becoming less as the batten sweeps forward. Locate the proper positions by checking the batten for a fair sweep while approximating the positions shown in the photos. Figs. 44 and 45 show how the battens terminate against the chine. The single batten is

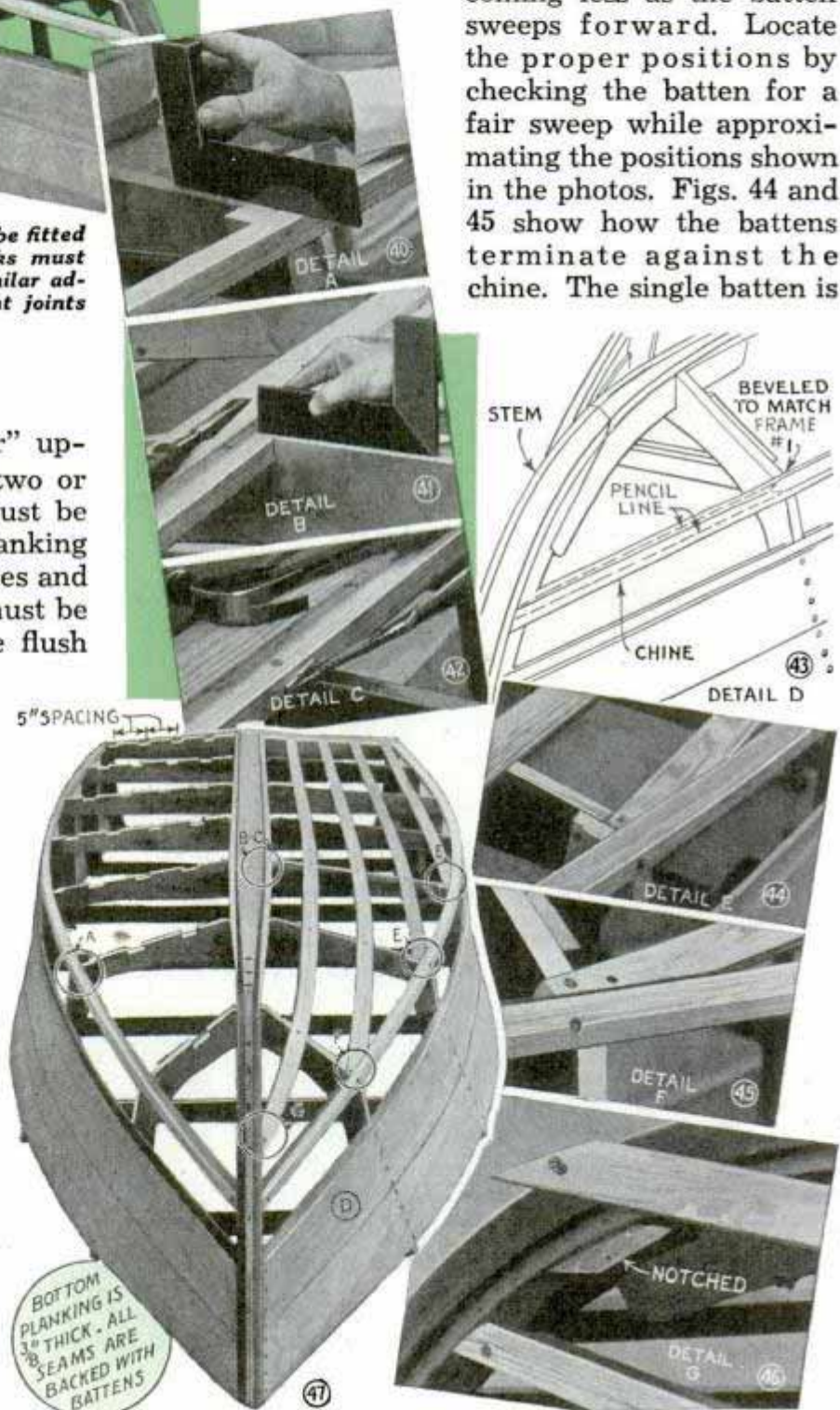



# OUTBOARD

fitted to the stem as shown in Fig. 46, rather than cutting the long bevel which otherwise would be required.

The first plank to be fitted is the garboard—next to the keel. The shape of this should be obtained by using the spiling board. The plank is screwed the full length along the keel and stem rabbets, using 1¼-in. No. 8 screws spaced 2½ or 3 in. apart. Fastenings into the batten are 1-in., No. 15 copper nails, spaced about 2½ in. apart. Fig. 39 shows the plank being fastened in place. It should be pulled up tightly into the rabbet. To get a tight boat, both the rabbet and the batten should be coated with seam composition or some other similar compound before the plank is put in place.

The second plank on the bottom is the hardest to fit of all the planks. Not only does it have to take the most difficult bend, but it also calls for careful fitting at the chine. Fig. 50 shows this plank

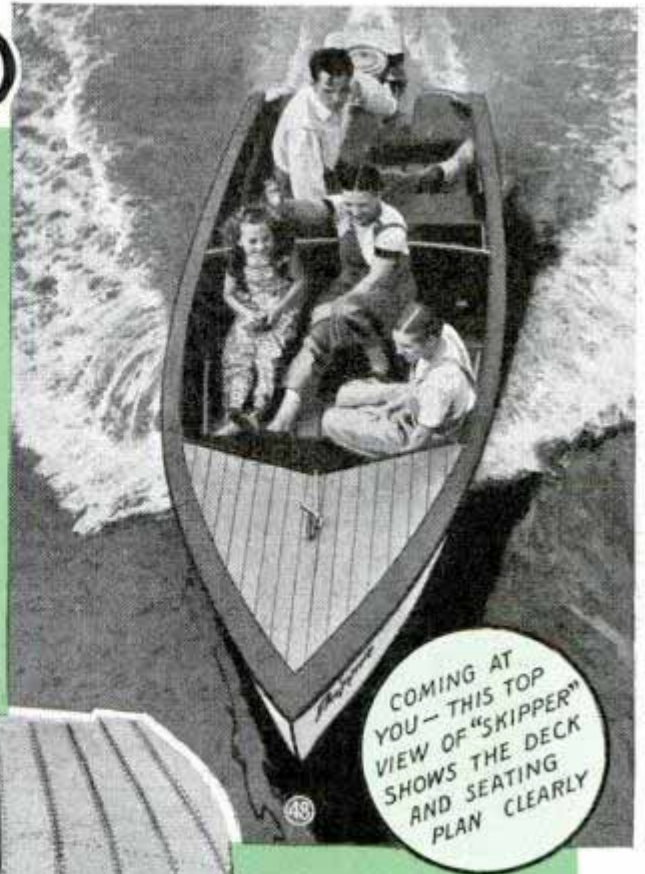

clamped in place ready for fastening. The bend can be made cold, but there will be less danger of splitting the plank if the end is first soaked for about one-half hour in boiling water. Be careful in fitting the screws into the chine

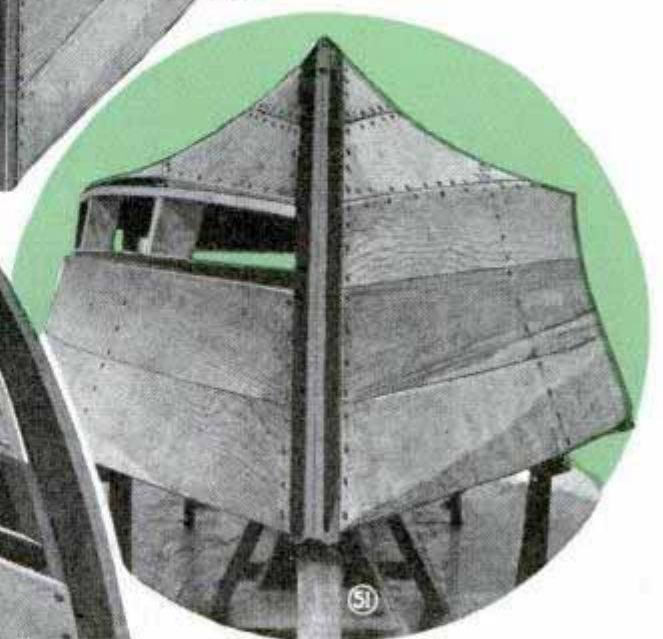
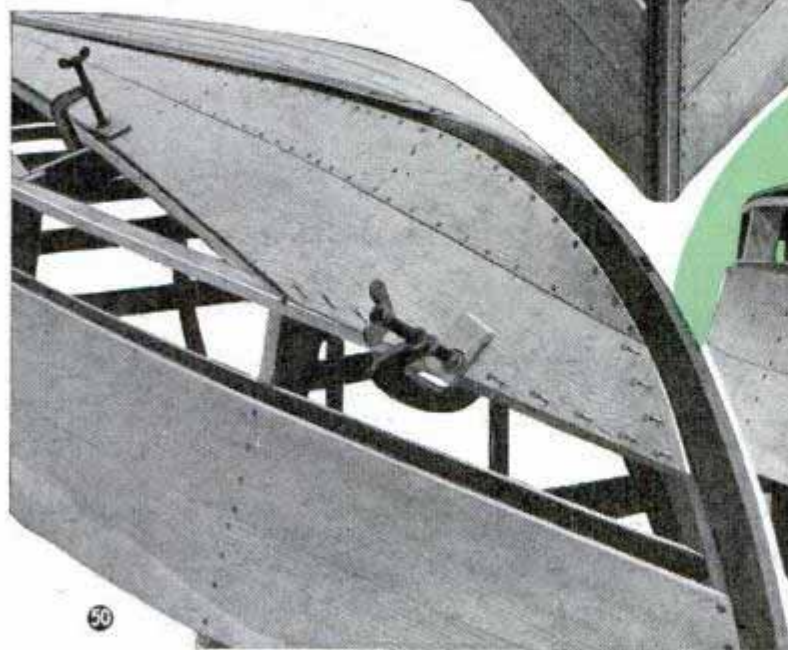





Above, seat risers and floor cleats in place. Photo at right shows flooring nailed in place

piece. The tendency is to get these screws too close to the edge, making it impossible to fit the final side plank in place. This second plank is not fitted tight—there should be about  $\frac{1}{16}$  in. of open seam between it and the garboard. Likewise, all succeeding planks are laid up with a uniform  $\frac{1}{16}$ -in. opening to allow for swelling.

Fig. 49 shows the bottom planking completed. The overlap at the chine is dressed off flush from the stern to frame No. 1. From frame No. 1 forward to the stem, the edge of the plank gradually rolls over, as can be seen in Figs. 49 and 51.

Fig. 51 shows the final plank—the shutter plank—fitted in place on one

Drawings at right give details of transom and transom knees. Photo below shows joint being treated

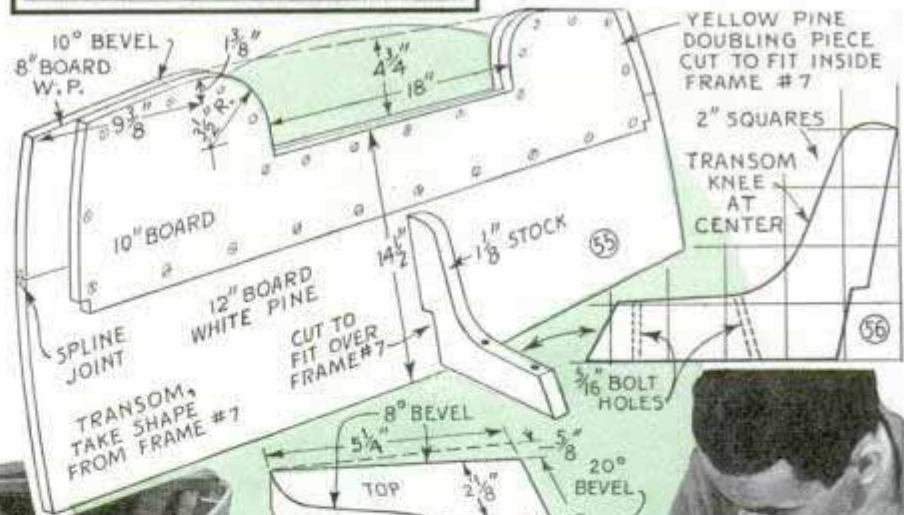
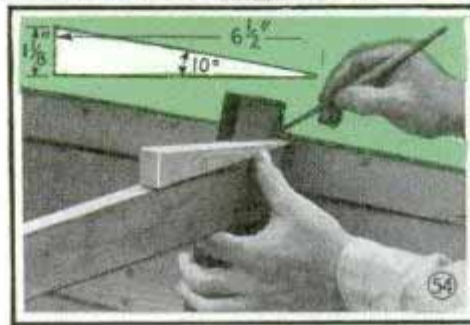

side. Here again, the edge of the plank is dressed off flush from the stern to frame No. 1, where the edge gradually rolls over to form a true-miter bevel joint with the second bottom plank at the stem. This joint is important for the appearance as well as the tightness of your boat.

The hull can be turned now right-side up, and should be painted on the inside immediately while everything is clean. The floor boards go in next. Notice in Fig. 52 how small cleats are fastened to the forward frames to take the plank ends. Flooring is  $\frac{5}{8}$  in. thick, each piece being about  $3\frac{1}{2}$  in. wide except the center plank which is 6 in. wide. A section of the center plank should be left loose so that it can be removed to get at the keel. Fig. 52 also shows

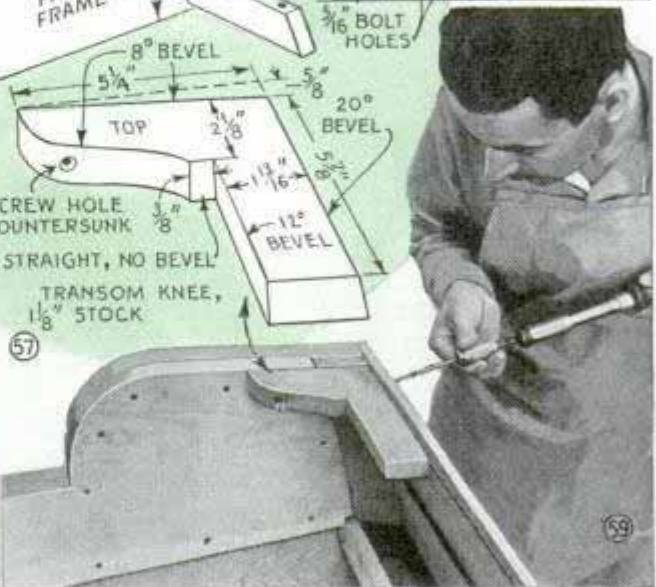









to the exact lines of frame No. 7 before the planking is applied. Before fitting the transom in place, tack about five strands of candle wicking in the joint, as in Fig. 58, and daub the whole surface plentifully with seam composition. There are three knees to be fitted in place at the stern. The one from transom to keel, Fig. 56, is easy to make and fit, but the two smaller ones at the top are a little tricky. However, if you are band-sawing and follow the bevels as marked, Fig. 57, you should be able to get a fair working fit on the first try. Going back to the transom itself, notice that the top is cut on a 10-degree bevel. This extends from the outside to about halfway down the curve where it gradually blends into a square cut. The straight section on which the motor rests is cut square. Use plenty of screws in fastening the transom—a double row from the back into the frame as well as a row from the outside of the planking. Fasten the knees securely, as shown in Fig. 59.

Fitting the deck, seats and other trim is easy going. Fig. 68 should give you a fair idea of the general layout. The deck beams are dimensioned in Fig. 60 and the breast hook in Fig. 62—a little oversize in length to allow for slight variations in the work. Fig. 61 shows the beams being fitted in place. The deck is crowned both ways, showing a slight curve fore-and-aft as well

as crosswise. The beam spanning frame No. 2 is cut out at the center to take the  $\frac{3}{4}$ -in. thick cleat piece, as shown in Fig. 63. The coaming plate is not set vertically, but is slightly inclined so that the top edge leans forward. Fit the covering board by first sawing the outside edge to the same sweep as the hull; then mark and cut the inside edge to the shape shown, using a flexible batten to get a fair curve in the forward part of the board. Join at frame No. 3 as

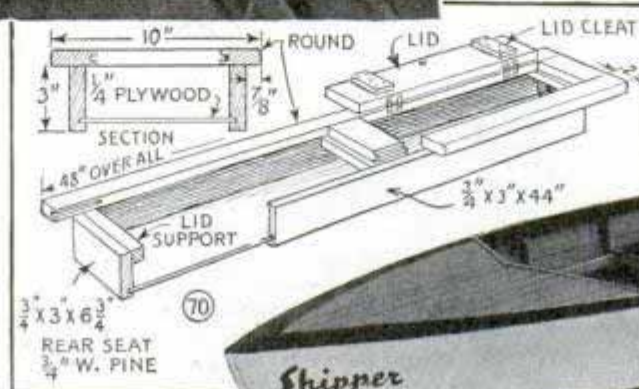

*One-inch-wide masking tape protects the black waterline while the red or white paint is sprayed or brushed on*

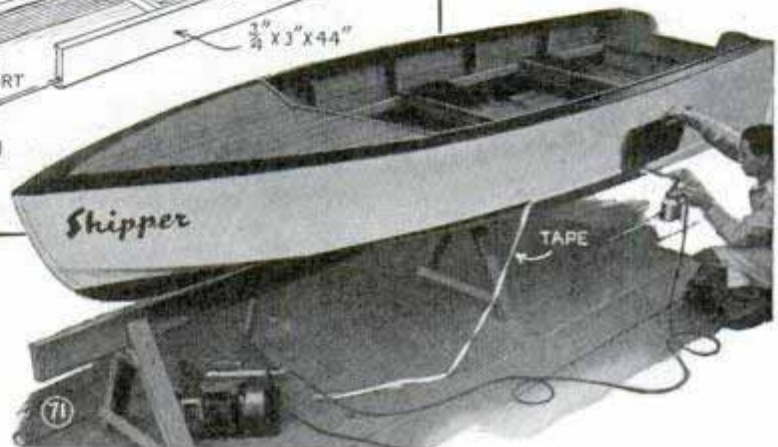

shown in Fig. 64 and fasten to the transom with screws as in Fig. 66.

All seats are  $\frac{3}{4}$ -in. stock. The forward and center seats should be saw-cut on the underside and cleated to prevent warping. The center seat is fitted with risers, these being fastened to the main seat risers with angle irons, as in Fig. 67. The hinged back for the center seat is cut from a 12-in. board, the top of which is crowned the same as the beam at frame No. 2. Stops for the back are provided by two doorstops, as can be seen in Fig. 65. Fig. 69 shows how narrow strips of  $\frac{3}{8}$ -in. wood are fitted below the covering boards to form a landing for the deck strips. Before fastening these, fit and cut all of the deck boards. These are  $2\frac{1}{2}$  in. wide, or 5 or  $7\frac{1}{2}$  in. wide boards can be used, the seams being marked with a saw-cut about  $\frac{1}{8}$  in. deep. Saw-cut or bevel the edges of all deck strips and also along the ends that butt against the covering boards in order to



bring out a pattern effect. The seams should be tight at the bottom, but should show a uniform grooved effect at the surface. Fig. 70 gives details on the locker-type rear seat. You can use a straight board if desired, but the locker space is handy for stowing small duffle and tools.

Painting is next. An effective scheme is red or green bottom, black waterline, white topsides, and darker red, green or buff on the deck. The waterline is found by measuring 5 in. up from the bottom of the keel at the center of the transom. This mark, carried level across the transom and then level along the sides, is where your boat will ride with a combined hull, motor and passenger weight of 725 lbs. This line is the underside of the 1-in.-wide black stripe. The line is easily put in by first running around the hull with a rough band of black, feathering the brush or gun edges. A strip of masking tape will then protect the actual black line while the white and red paint are being put on, as can be seen in Fig. 71.

### Extra Straps on Brief Case Carry Large Packages

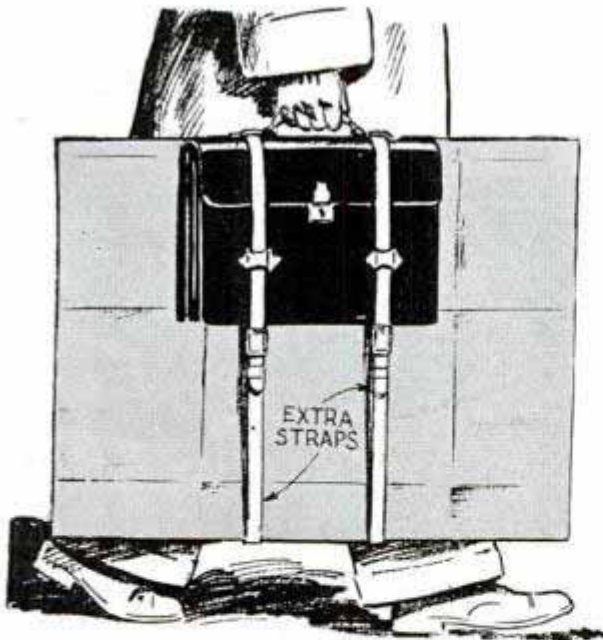

When it is necessary to carry a brief case as well as large packages or other objects such as drawings or photographs, two straps buckled to the ends of the straps of the case make a handy carrier. When not in use, the extra straps are coiled and carried inside the case.

—Bertram Brownold, Woodmere, N. Y.

### Walnut Meats Are Not Damaged When Cracked on V-Block

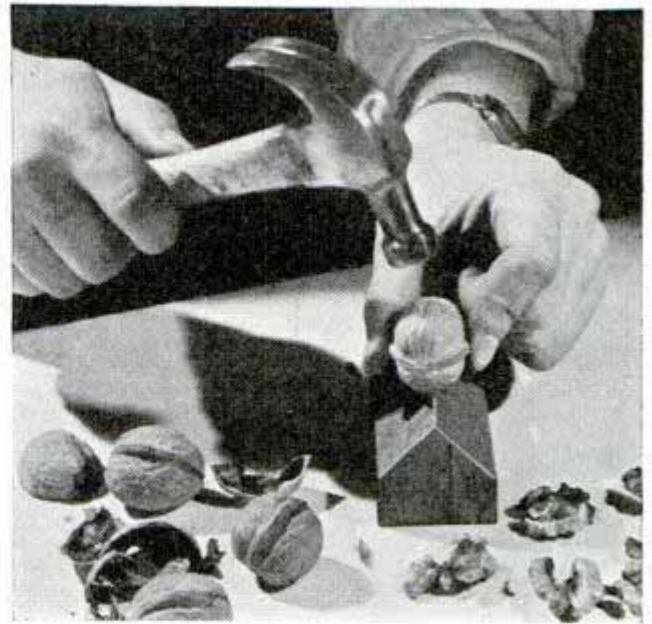

The next time you have a number of English walnuts to crack, and want the meats undamaged, use a V-shaped wood block as shown in the photo. Set the walnut on the block so that it rests midway between the two ridges, and tap it with a hammer.—D. Stratton, Lakeside, Wash.

### Faucet Handle Fits on Reamer

When looking for a handle to use on small reamers, gimlet bits, etc., to serve in cramped quarters, try a faucet handle. Most of these that fit square faucet stems will hold small tools. If a spare faucet handle is available, the opening may be filed to further conform with the shank.

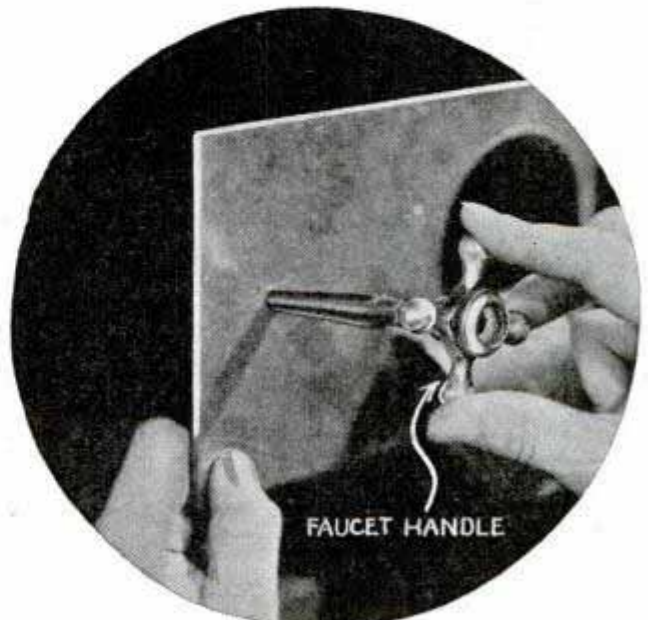



## Stops on Sawhorse Hold Board on Edge for Planing



To hold a board on edge while finishing the edge, one workman fitted his sawhorse with removable stops, which were spaced about 1 in. apart. The stops were lengths of maple dowels fitted snugly into holes drilled through the sawhorse so that they could be driven down out of the way when not being used.

—G. E. Hendrickson, Argyle, Wis.

## Auxiliary Jaws for Calipers Take Inside Measurements

When it is necessary to take an inside measurement behind a lip or shoulder on a piece of work, these auxiliary jaws for a micrometer or a pair of calipers will enable you to do the job accurately and quickly. The jaws are made from two pieces of steel bent to identical shapes and pivoted together exactly in the center. This work must be done carefully if the measurements are to be accurate. In use, the jaws are closed and slipped inside the

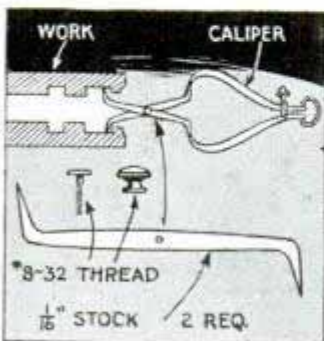

pers, or you can use a small bottle. Wires inserted through the stopper at one end as in Fig. 2 carry the current. Fig. 3 shows how the switch is attached to the angle with a clip. The wires should be well insulated and taped carefully where the ends enter the switch.—L. Schmitt, Chicago.

work and then opened against it, after which the calipers, or micrometer, are used on the projecting ends of the jaws as shown.—L. Malecki, Chicago.

## Light on Record-Playing Machine Controlled Automatically

A small lamp to illuminate the turntable of a machine for playing records is very handy, especially if it is turned on and off automatically when the lid is raised or lowered. In the original installation, the machine had an angle piece pivoted to one side which moved when the lid was raised as indicated in Fig. 1. A mercury switch fastened to one leg of the angle controlled the light. If your machine hasn't an angle of this type, one can be installed. The switch can be made easily, using a short glass tube with a little mercury inside and the ends plugged tightly with rubber stop-

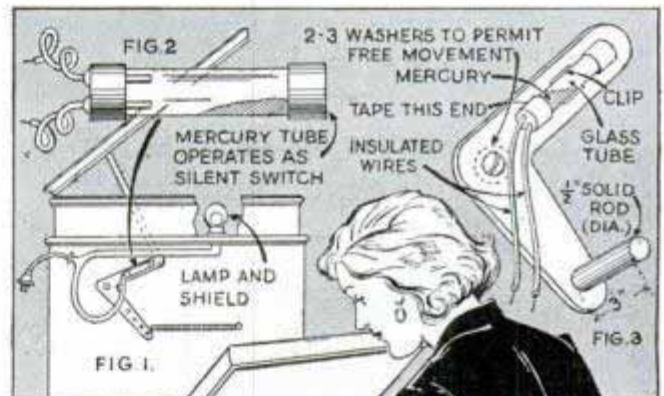

pers, or you can use a small bottle. Wires inserted through the stopper at one end as in Fig. 2 carry the current. Fig. 3 shows how the switch is attached to the angle with a clip. The wires should be well insulated and taped carefully where the ends enter the switch.—L. Schmitt, Chicago.

☞ Wrap surplus putty in wax paper so that it will remain soft until needed.



# This Coaster Has Drag Brake for Quick Stops

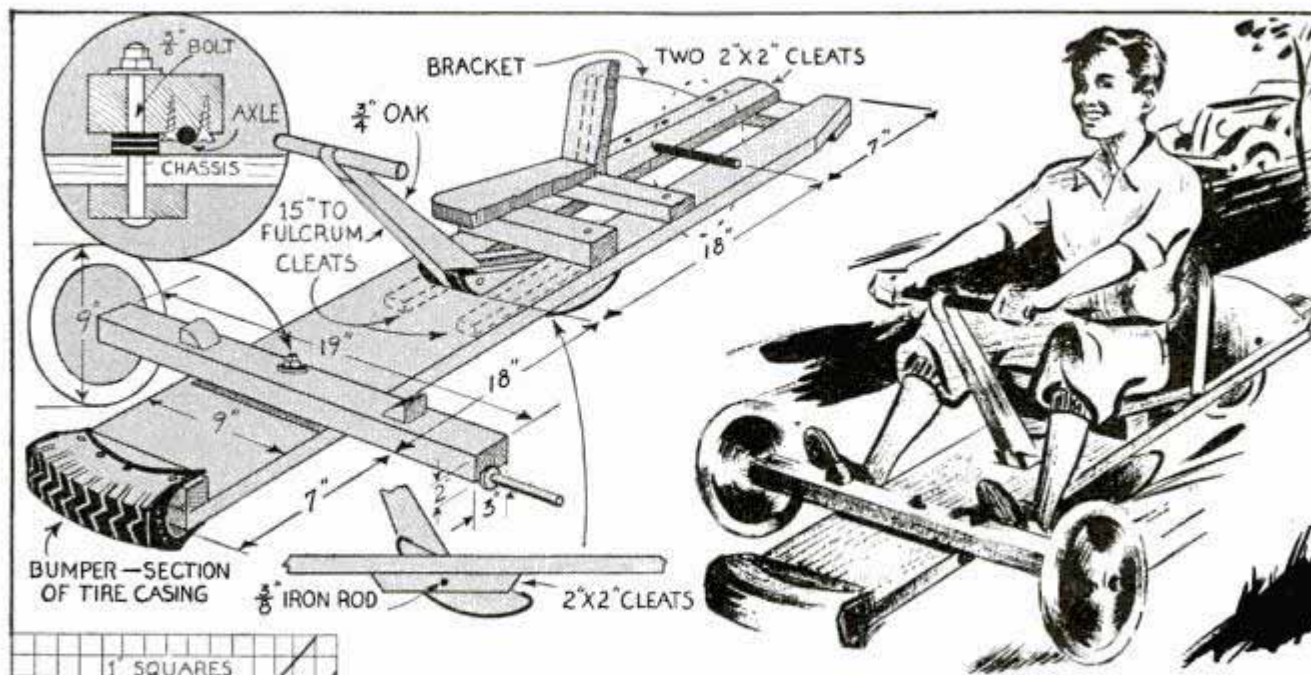

This coaster can be made with three wheels as shown or with four wheels. Its frame is underslung and balanced to carry the weight well forward. The brake is designed for quick, safe stops on steep grades. It consists of duplicate cam-shaped shoes brought into contact with the ground or sidewalk when you pull back on the hand lever.

## Non-Slip Feet for Ladder from Loose Strips of Inner Tube

Light ladders can be prevented from slipping on smooth surfaces by fitting folded strips of inner tube into slots cut in the lower ends so that they project a few inches as shown. Small brads or nails

driven through the wood into the slots will hold the rubber in place. The loose ends of the strips accommodate themselves to the slope of the surface and will hold the ladder more securely than similar rubber strips nailed smoothly over the ladder ends.



## Sun and Rain Proof Labels to Identify Plants

Plant labels that will last for several years can be made by writing with black ink or soft-lead pencil on strips of thin wood and then dipping them in spar varnish or shellac. Less conspicuous and more durable are labels made of zinc. This is cut into strips of the desired size and the data written on them with a mixture of hydrochloric acid, 1 liquid oz., and powdered antimony, 1 oz., the latter being stirred into the acid. A sharp-pointed wood skewer or pointed hardwood twig is used for a pen. The writing will turn black on the zinc and both writing and label will last indefinitely.

—John P. Thorn, Elizabeth, N. J.



# GROUND-GLASS FOCUSING

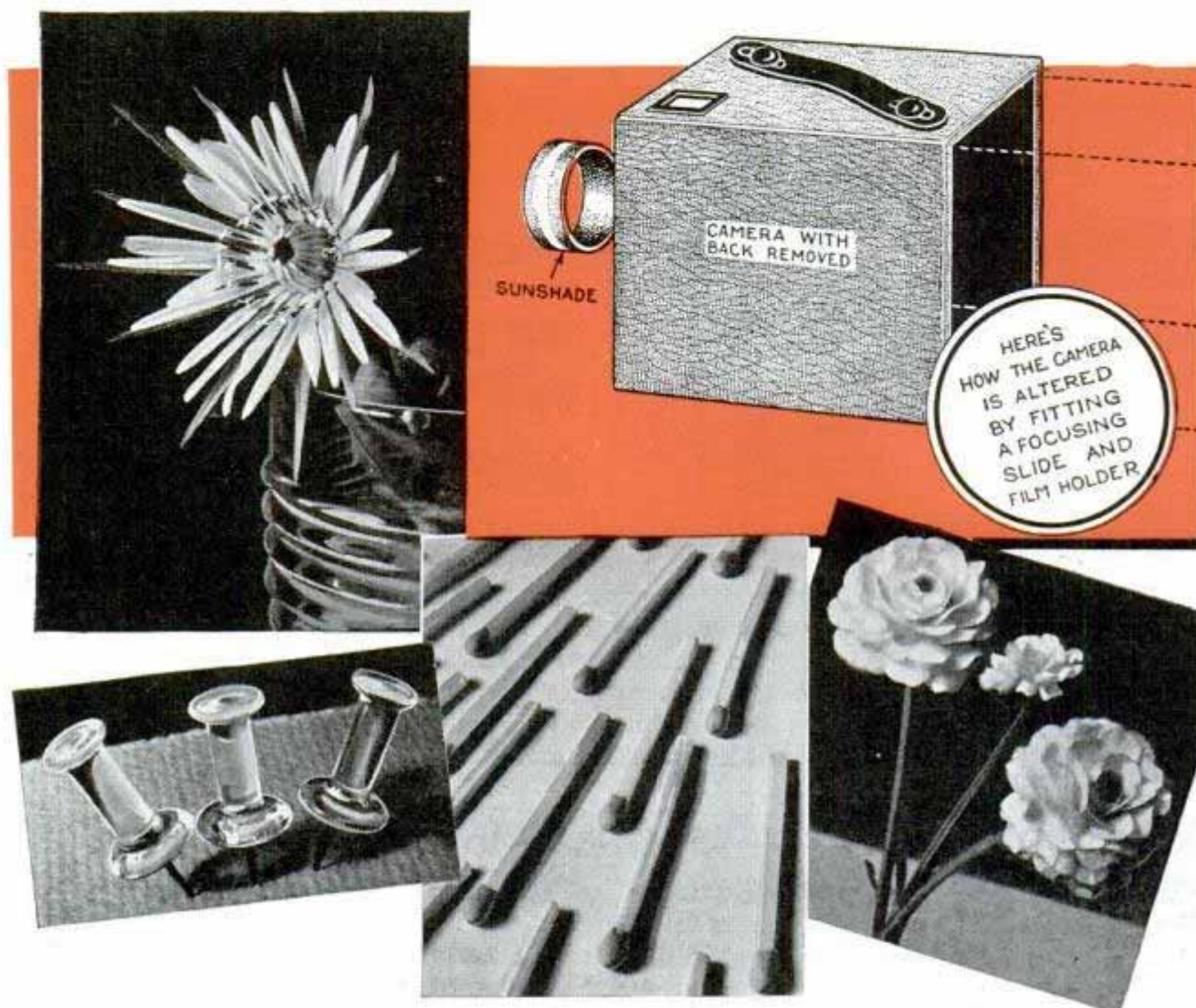

**C**LOSEUPS of small objects, portraits and delicate copy work are all possible with an inexpensive box camera. Notice the fine detail in the four shots shown above. All were taken with a box camera which was fitted out the same as in Figs. 1 and 2. These simple attachments provide ground-glass focusing, a long extension bellows for working close to the subject, a filter, a smooth-acting shutter with no jar whatever and a means of stopping down the lens—all the essential features of an expensive camera. For closeups you add to these a steady tilting base and the outfit is ready for use.

Since all dimensions depend upon the box camera used this should be obtained first. Parts that are dimensioned are suited to a popular make of box camera taking  $2\frac{1}{4}$  by  $3\frac{1}{4}$ -in. roll film. Dimensions of oth-

er parts are left to the builder, as different makes of these cameras may vary slightly in over-all sizes. The back and film carrier are removed from the camera and the focusing is done by racking the box "bellows" as in Fig. 2. The bellows is made of  $\frac{1}{4}$ -in. plywood assembled with brads and cellulose cement, and after assembly it must be sanded very carefully to assure an easy sliding fit inside the camera box. A supporting frame is attached to three sides of the box, A and C in the upper detail, Fig. 4. The remaining parts B, D, E, F and G make up the simple mechanism with which the bellows is racked in focusing on the ground glass. The latter is cemented to a removable holder and hood as in the lower detail, Fig. 4. The three pieces of the supporting frame extend  $\frac{1}{4}$  in. beyond the bellows to provide a light trap. The



# with a BOX CAMERA

By DANIEL REYNOLDS

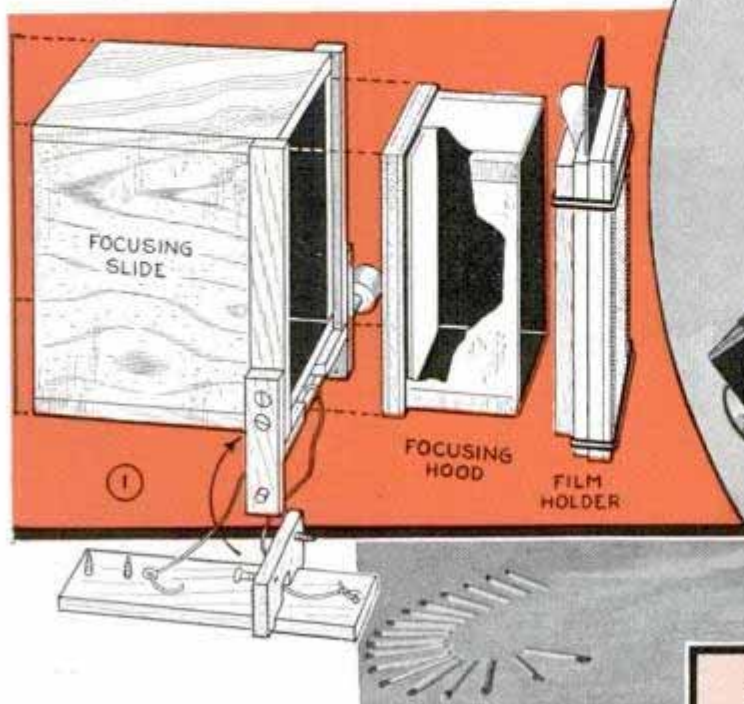

track, F, Fig. 4, is attached to the tilting base with screws and cement as indicated. The bellows is supported on the sliding member G, which is notched for a cord, the latter being attached to a screweye in the track, looped around the dowel E and tied onto a second screweye in the base, as shown by dotted lines in the upper detail, Fig. 4. To make a convenient knob, cut away the flanges of a large thread spool and force the center section over the end of the dowel as at D. Small wooden washers cemented to the dowel prevent its slipping out of place. All surfaces of the box are given a coat of flat black paint. The ground-glass frame can be assembled from solid stock, or you can make it from a piece of  $\frac{3}{4}$ -in. plywood of the same outside dimensions as the bellows. An opening the same size as the film is cut in the center. The focusing hood is made of heavy cardboard assembled with adhesive tape at all four corners, then cemented to the frame. The ground glass should be  $\frac{1}{4}$  in.

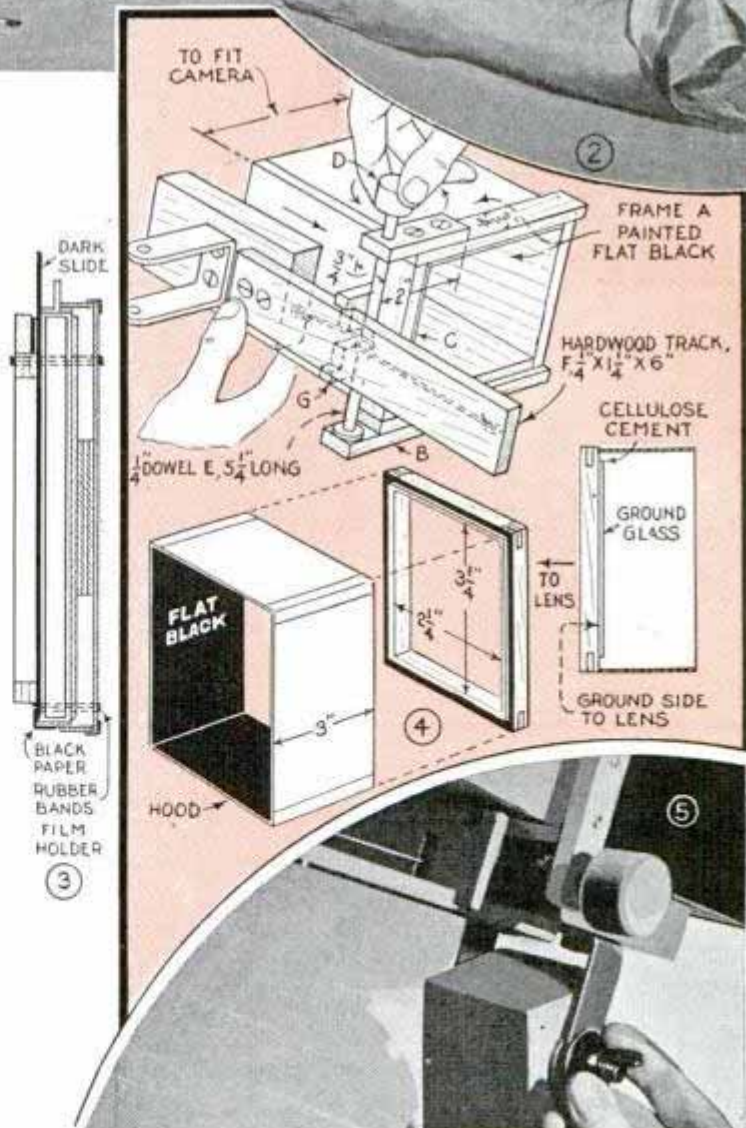



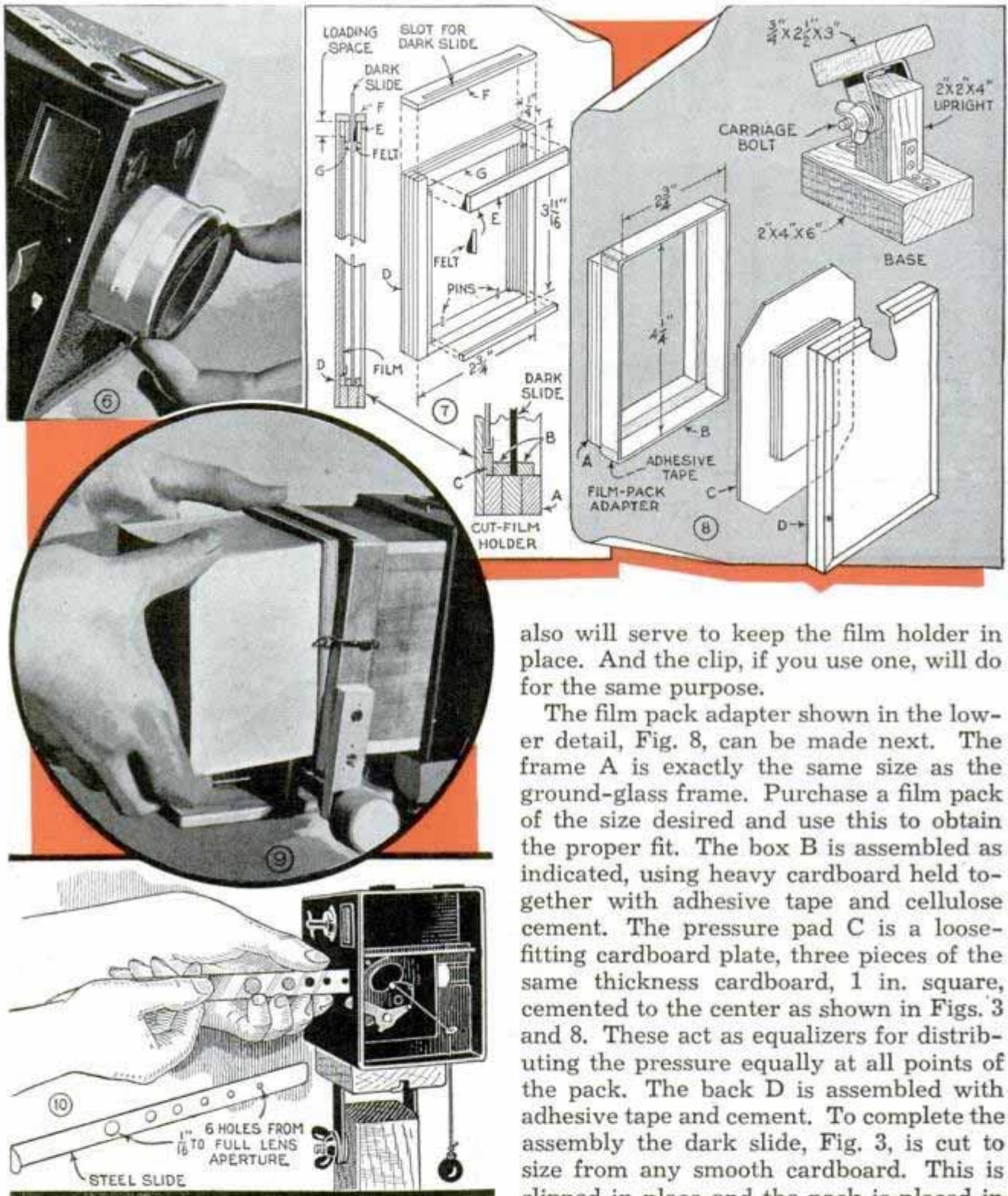

wider and longer than the opening to permit its being cemented in place. Now you can make up the base complete as in Figs. 5 and 8, and when you assemble you will have the construction to the stage shown in Fig. 2. The hood can be held in place with clips made of spring wire as in Fig. 9. Or a light rubber band looped over small wire hooks driven into each side of the bellows frame will serve to hold the hood while focusing. The same band doubled

also will serve to keep the film holder in place. And the clip, if you use one, will do for the same purpose.

The film pack adapter shown in the lower detail, Fig. 8, can be made next. The frame A is exactly the same size as the ground-glass frame. Purchase a film pack of the size desired and use this to obtain the proper fit. The box B is assembled as indicated, using heavy cardboard held together with adhesive tape and cellulose cement. The pressure pad C is a loose-fitting cardboard plate, three pieces of the same thickness cardboard, 1 in. square, cemented to the center as shown in Figs. 3 and 8. These act as equalizers for distributing the pressure equally at all points of the pack. The back D is assembled with adhesive tape and cement. To complete the assembly the dark slide, Fig. 3, is cut to size from any smooth cardboard. This is slipped in place and the pack is placed in position, followed by the pressure plate and the back. Rubber bands are then slipped around the entire assembly, a piece of cardboard faced with felt being glued to the frame A in contact with the dark slide. This acts as a light trap. After the glue has set, the entire assembly is taken down and given a coat of black waterproof ink. Paint should not be used, as it tends to warp the cardboard. When the dark slide is withdrawn the pack snaps forward into contact



with the frame A, Fig. 8. After the picture is taken, the insertion of the slide again forces it back.

The film and plate holder permits the use of emulsions not found in packs. A sheath of the proper size is first obtained together with cut film of the correct size. The assembly is shown in Fig. 7. Note here that there are duplicating key letters appearing on the sectional view. The frame A is the same as the ground-glass frame with the exception that the top is cut out. Part D is a piece of heavy cardboard cemented to part A. The sheath loaded with film is placed in position and parts C are cut to width and cemented in place. The space between strips C should be an easy fit for the loaded sheath. The two pins are then driven in place and cut to project  $\frac{1}{8}$  in. Strip G is then cemented to parts C as shown. The guides for the dark slide are glued to the sides of A, using the slide itself as a spacer. Part E is faced with felt and cemented to A. The top piece F is next cemented in place after locating and cutting the dark-slide slot. The entire assembly is then given a coat of black waterproof ink. The loading of these holders is very simple and may be done easily in total darkness.

The action of a box-camera shutter is not suitable for fine closeup work, so the arrangement shown in Fig. 10 is used. The thread with a large bead at the end pulls the single leaf of the shutter open and returns it without the slightest jar. For detail, the lens must be stopped down to the smallest opening that the lighting permits. Fig. 10 shows the steel slide which is substituted for that regularly furnished with the camera. This slide is made up from a strip of clock spring or any other steel strip which can be cut to fit the regular slide opening. The holes give a range of stops from  $\frac{1}{16}$  in. to full aperture, and, although no attempt has been made to calculate definite light value, they will be found adequate for most purposes. The filter, Fig. 6, is simply a lens of an inexpensive pair of sun glasses. The mounting was made of an adhesive-tape carton cemented in place as indicated. The filter factor will have to be arrived at through experiment. In using the camera the focusing is done with the lens wide open, and the shutter is set for a time exposure.

## Wood Soles Relieve Foot Strain When Standing on Ladder

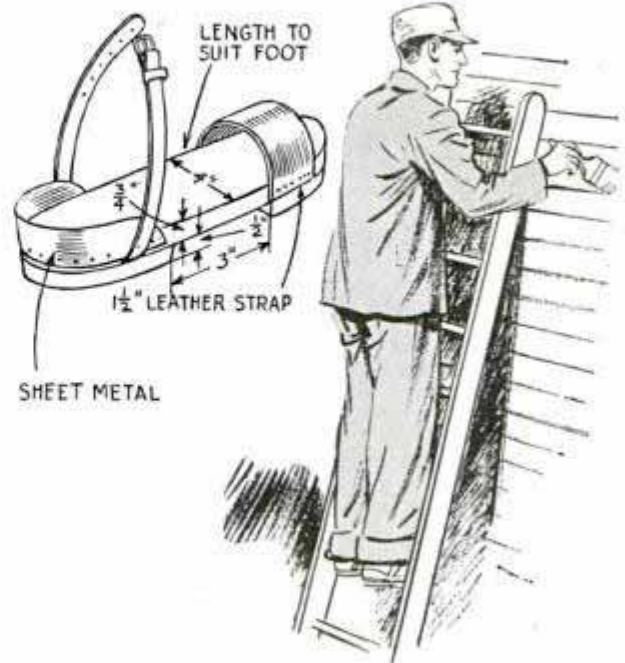

Workmen who must stand on ladders for long periods will find these soles just the thing. They are stiff and spread your weight in a natural manner over the soles of the feet. Heel and toe pieces on the underside tend to prevent slipping off the ladder rungs. Wide pieces of leather serve as toe straps and strips of sheet metal at the heels keep the feet from slipping back.

## Making Wood Brackets Easily

One of the easiest and most economical ways to make small brackets of the cove type, is first to cut a wood block perfectly square. Then bore or jig-saw a hole in the exact center, making the hole large enough to leave the wood about 1 in. wide at the centers of all four sides. Sawing the block in four equal parts gives you four brackets.

—John E. Hyler, Peoria, Ill.

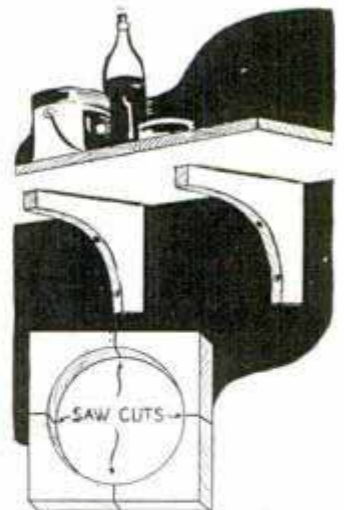

☛ For particular work, patching plaster may be screened through a flour sifter before mixing it with water.



## Sanding Large Floors by Hand without Squatting



Fitted with a long handle, a sandbag to weight the abrasive paper or cloth enables you to sand a floor by hand without getting down on your hands and knees. The forked handle is pivoted to opposite sides of the bag, pieces of heavy leather being riveted to the cloth at these points to reinforce it. Two pieces of abrasive paper should be glued together with the smooth sides facing. The rough surface of the upper piece keeps the bag from slipping.

—Axel E. Ogren, Chicago.

## Strike Plate of Lock Is Fitted with Aid of Carbon Paper

When installing a door lock, you can save time in locating the position of the strike plate by using a piece of carbon paper. Just hold the door closed tightly, slip the carbon between the lock and stile and turn the key several times to force the lock bolt against the paper. This will leave a clean

impression on the stile, accurately marking the location of the plate. If the stile is dark, coat it with white show-card paint in the

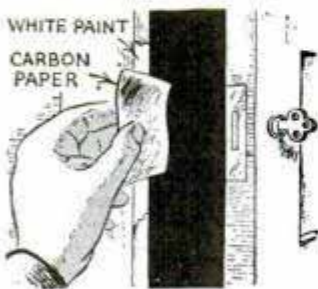

approximate position of the plate. The paint can be removed easily when the job has been finished.

## Rubber Balls on Porch Swing Protect Wall

Fastened to the back of a porch swing, sponge-rubber balls form resilient bumpers if the swing is close to a painted wall and there is likelihood of children swinging against it. It is a comparatively easy matter to punch holes through the balls and heavy cord is then threaded through them to permit quick attachment.

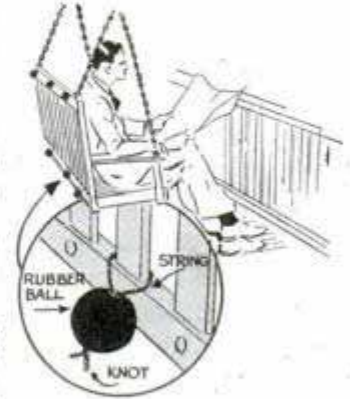

## Moldings Held in Miter Box by Improved "Clothespin"

Difficulty in keeping small molding from pulling or vibrating under the saw in a miter box, especially when sawing a long piece that is hard to hold with one hand, may be overcome by this improvised "clothespin." It is made from an oak block, which is slotted to straddle the back board of the miter box. The lower end of the pin is beveled to fit down over the molding strip, and the weight of the pin holds it in place under ordinary use.

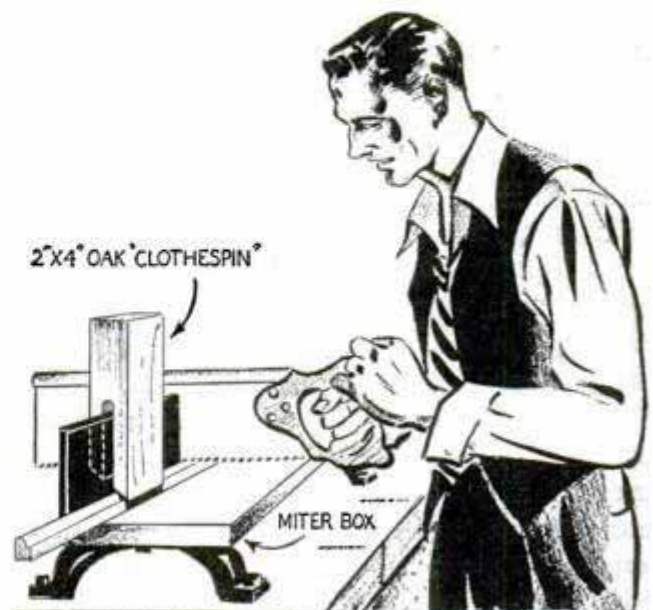



# Fluff-Rug Strands Woven on Simple "Loom"

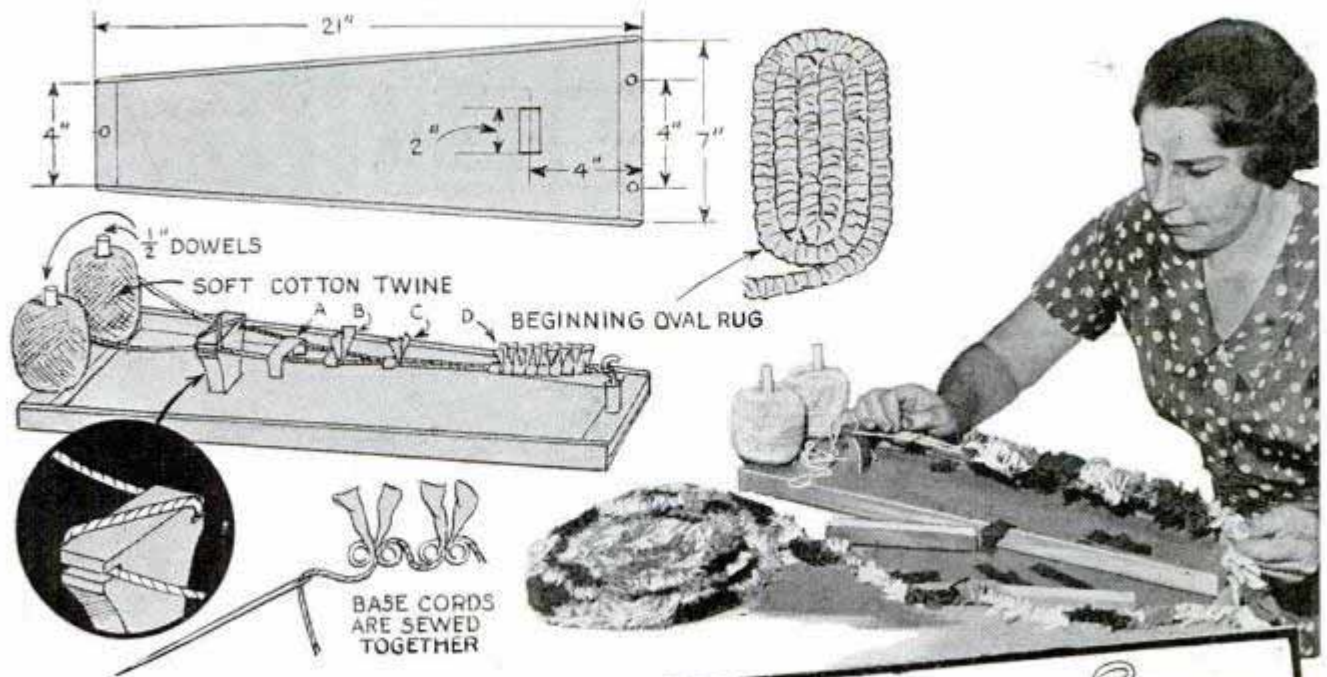

Here's a quick way to make strands for the popular fluff rugs. As you see from the details it's no trick to make up the "loom" ready for use. Begin with tearing suitable cloth or rags into  $\frac{3}{4}$ -in. strips and wind several turns around the cutting board as in the lower detail. Then run the shears down the slot, cut, and you have a number of short pieces of just the right length for tying onto the cords. This is done by laying the strip across the cords as at A in the detail above. Bring the ends under each cord and up as at B, knot as at C, and finally slide the knotted strips tightly together as at D. Continue this procedure until the space from A to D is filled. Then trim in

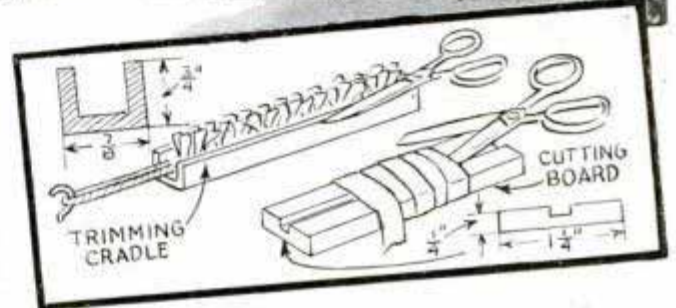

the cradle as shown in the lower-right detail. As the work progresses the finished end is removed from the hook and more cord is unwound from the balls. The same process continues until the strand is of the desired length for sewing into the rug. The upper-right detail shows the arrangement of strands when starting an oval rug.

## Cutting Large Pieces of Sheet Metal with Your Hack Saw

The next time you have a piece of sheet metal to cut and it is too wide to use a hack saw, try the following method: Mark off the line for the cut as usual, then run another line parallel to it, spacing the lines  $\frac{1}{2}$  in. or more apart so that when the strip between them is removed the opening will take the saw frame. Now saw on one line for a distance of an inch or so, then change and saw on the other line. By alternating the cuts and rolling up the narrow strip of metal in the center, you can cut any length of sheet metal. Cut off the strip at intervals if it's hard to handle.

—Vernon Tracey, Centreville, N. B., Can.

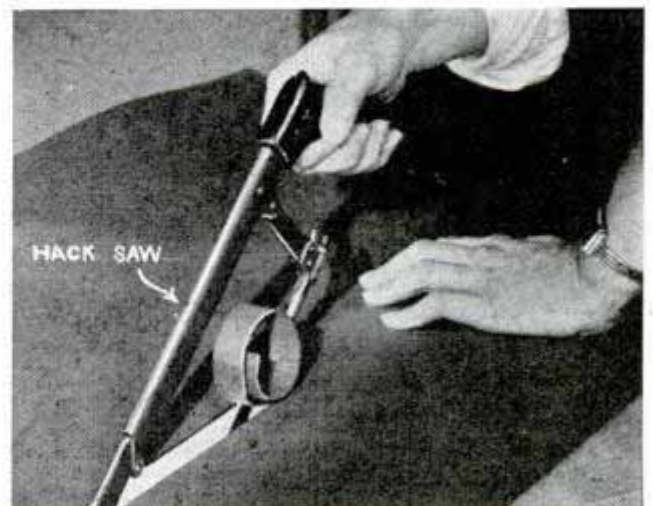



# Solving HOME



Two strips of spring steel bent as in 1 and tied together by soldering a small rod across them, provide a handy receptacle for paper bags when screwed to the back of a pantry door



2, You will find waxed bread wrappers handy for daily cleaning a gas stove. Heavy wire bent as in 3, and screwed across a paneled door, provides hat racks, while rugs and other articles too thick to fasten on a clothesline in the regular way can be held in place by clipping two sides together with a clothespin as in 4. A flashlight makes a good emergency darning as in 5, especially when working where the illumination is poor, as the light can be turned on to show through the cloth

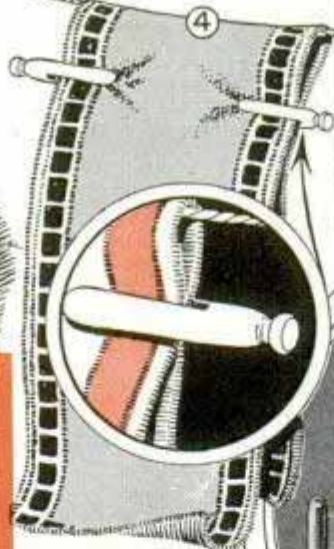
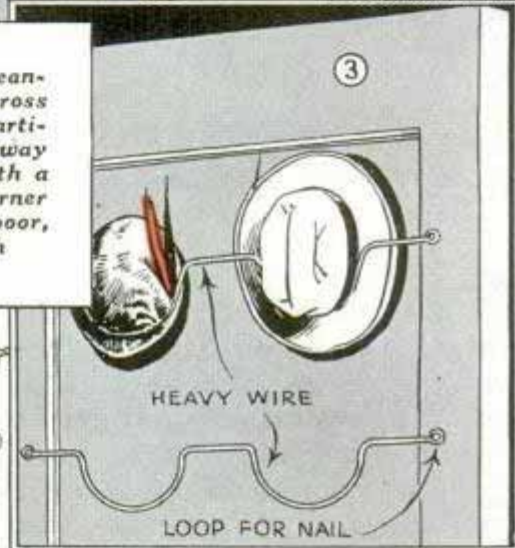

A hair-curling clip of the type shown in 6 is handy to prevent small rolls of gummed sealing paper from unrolling. Bend the legs of the pincer-like curler at right angles just below the pivot pin, set it on the roll and then bend the legs over the edge as indicated. A strip of adhesive tape stuck around the free roller of a clothes wringer as in 7, helps to keep it from slipping when running through a thick garment



# PROBLEMS

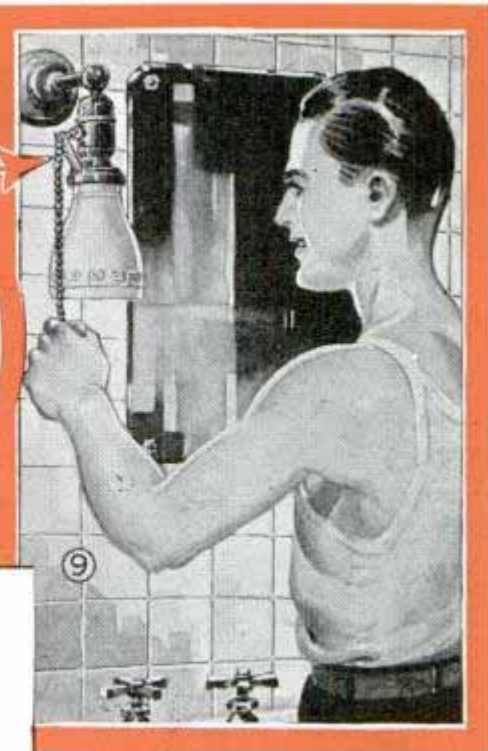
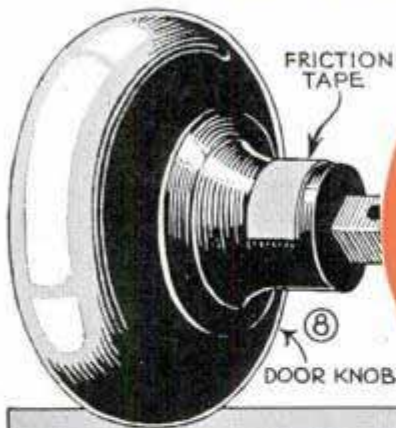

When a screw in a doorknob wears with long use and tends to work out, stick a piece of friction tape over the head as in 8, to keep it in place. A brass arm slotted at one end and pivoted to a lamp-shade holder to take the pull chain as in 9, keeps the latter away from the shade, gives a direct pull on the switch and makes it easy to grasp the chain

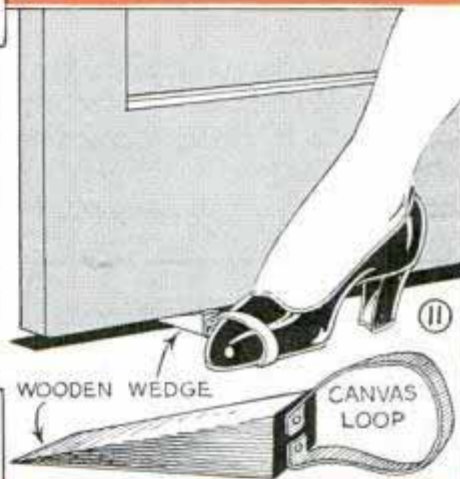
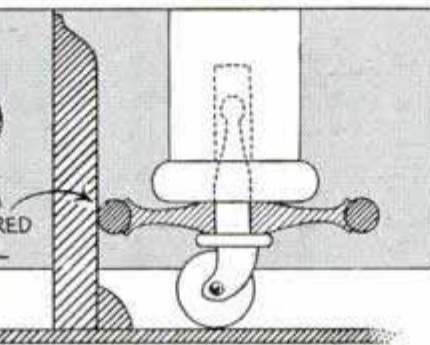
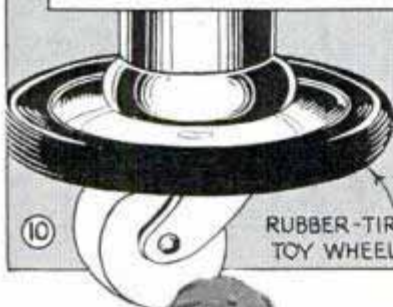

RUBBER-TIRED TOY WHEEL

WOODEN WEDGE

CANVAS LOOP

To avoid accidental marring of baseboards by a bed, slip rubber-tired toy wheels over the shanks of the casters as in 10. A strip of canvas tacked to a wedge-type doorstop as in 11, enables you to remove it with the foot

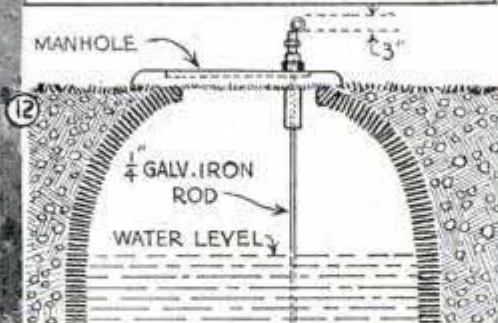

To read the cistern-water gauge in 12, which is similar to an auto oil gauge, just raise the rod, which shows the water level. A short piece of pipe through the cistern platform takes the rod, which has an eye on the upper end to provide a finger grip. Inverting a shade from a gasoline pressure lamp over the mantle-type kerosene lamp in 13 provided soft illumination similar to that of electric floor lamps of the indirect type



## Angle-Iron Straightedge to Mark Lines on Round Stock

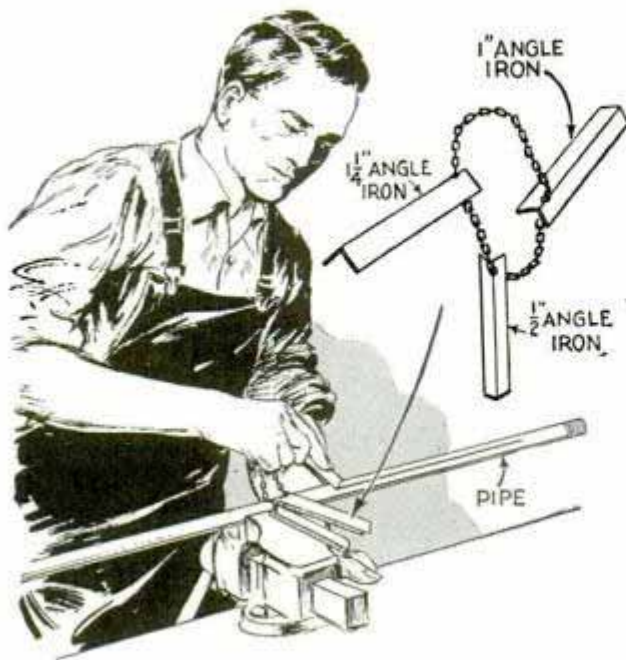

Home craftsmen and others who want to mark straight lines on pipe or round stock, as a guide in drilling a number of holes, will find lengths of angle iron handy for the purpose. If you have much of this work

to do, it's a good idea to get three to four lengths of angle iron of different sizes, chain them together as indicated and keep them in your toolbox so that they always will be at hand.

—M. M. Warren, Monterrey, N. L., Mexico.

## Tree Guard of Metal Lath

Metal lath provides an ideal guard for a small tree. It is stiff and durable, and when formed into a cylinder, the lower end can be filled with peat moss or mild fertilizer, which is kept confined within a small space. When sprinkled or wet by rain, chemicals

in the latter are carried down into the soil about the roots. To form the lath, it can be wrapped around a large pipe or small pole.

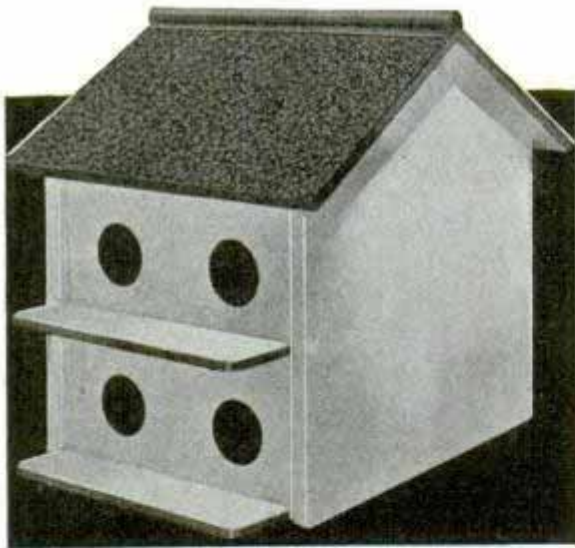
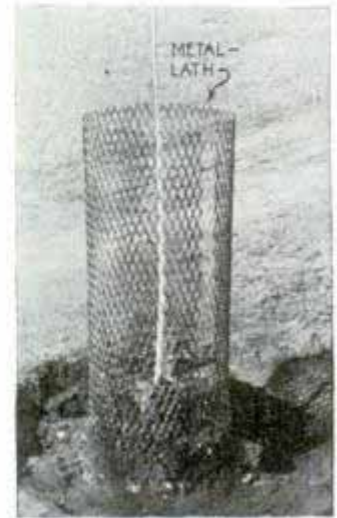

## Eight-Compartment MARTIN HOUSE

Closed to Sparrows

Hinged perches fold against the entrances so that sparrows can be kept out before the martins arrive. All compartments are easily accessible for cleaning by sliding down the two front panels, ordinarily held in place by turnbuttons.

Plywood is used for construction and the entire job can be done with a few ordinary tools in a couple of evenings. No skill in craftwork is required.

If you want to build this simple project just send the coupon and 10 cents for Craftplan No. 3004. This completely pictures all details of construction, assembly and mounting, and gives full instructions how to proceed step by step.

POPULAR MECHANICS MAGAZINE  
200 E. Ontario St. Chicago

Enclosed find 10 cents for Craftplan No. 3004 on  
8-Compartment Martin House

Use Pencil

Ap. MARTIN HOUSE—CRAFTPLAN No. 3004





# *Drill-Vise* MILLING UNIT *on small lathe*

Just mount it on the cross slide and do keyway cutting, end milling and surfacing

**T**HIS handy milling unit for small metal-turning lathes consists simply of a drill-press vise mounted on the cross slide of the carriage. The vise is mounted on a disk similar to the index disk of the compound rest, Figs. 1 and 2. Thus you utilize both the lateral and traverse feeds and the depth of the vise jaws gives a considerable range of vertical adjustment. Also the unit can be swiveled to any degree desired to handle angular work. Figs. 1 and 3 show typical operations on parts of small models. Milling cutters should be held in a collet chuck but if the lathe is not fitted with chuck and suitable collets, you can grip the cutters in a three-jaw scroll or center chuck and, by working carefully, get very good results on light work.

Figs. 4 and 5 show the base or pad on which the drill-press vise is mounted. It is turned from a single piece of cold-rolled steel and all the dimensions given adapt it to use on a well-known make of home workshop metal-turning lathe. Notice in Fig. 4 that the base is held in place with a hardened pointed setscrew bearing against the beveled projection on the underside of the disk. The setscrew lock is regular equipment on this particular lathe and the beveled projection on the vise mounting simply duplicates that on the regular compound supplied with the lathe as you see in Fig. 2, where the two parts are shown

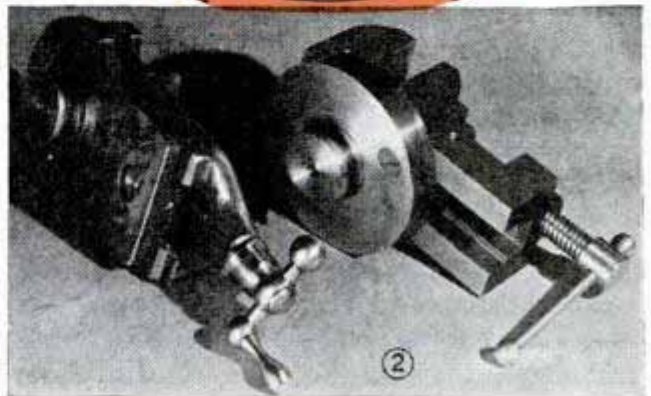
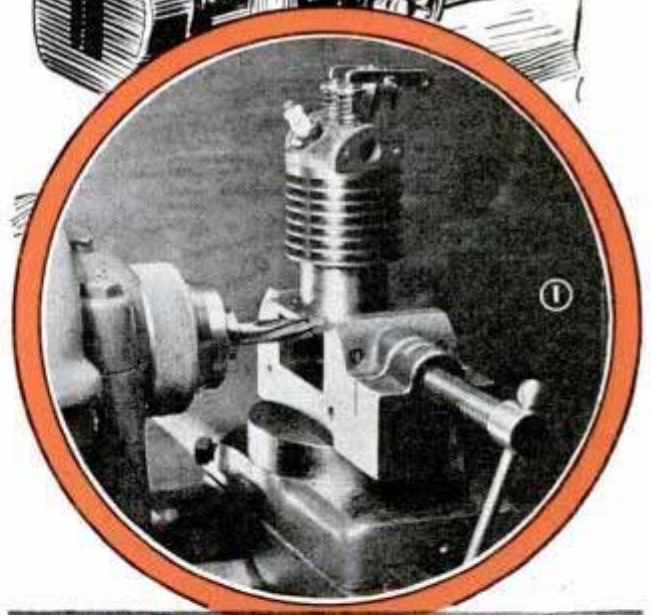



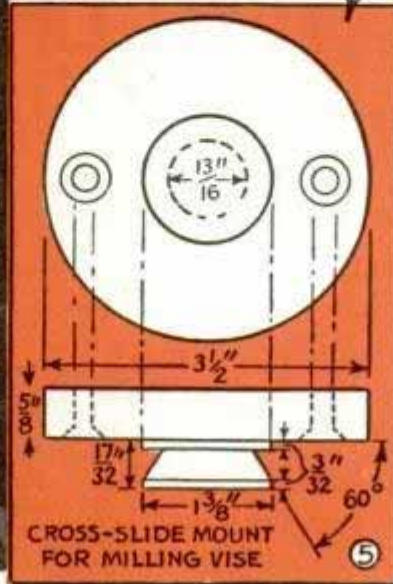
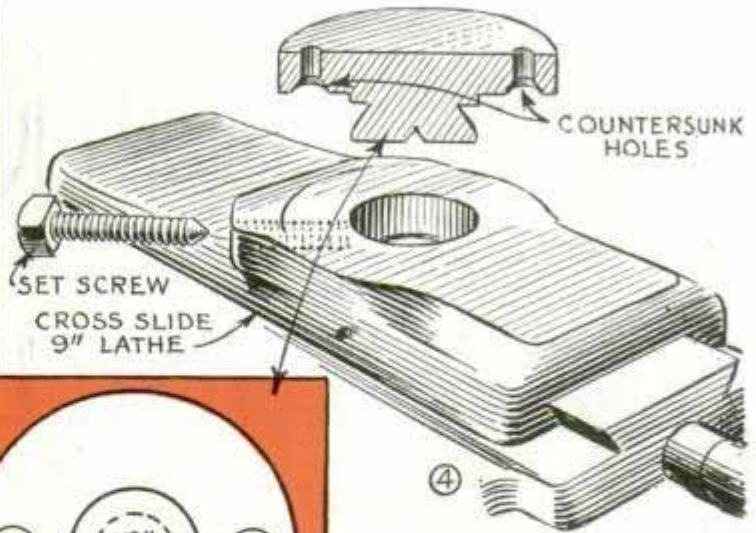
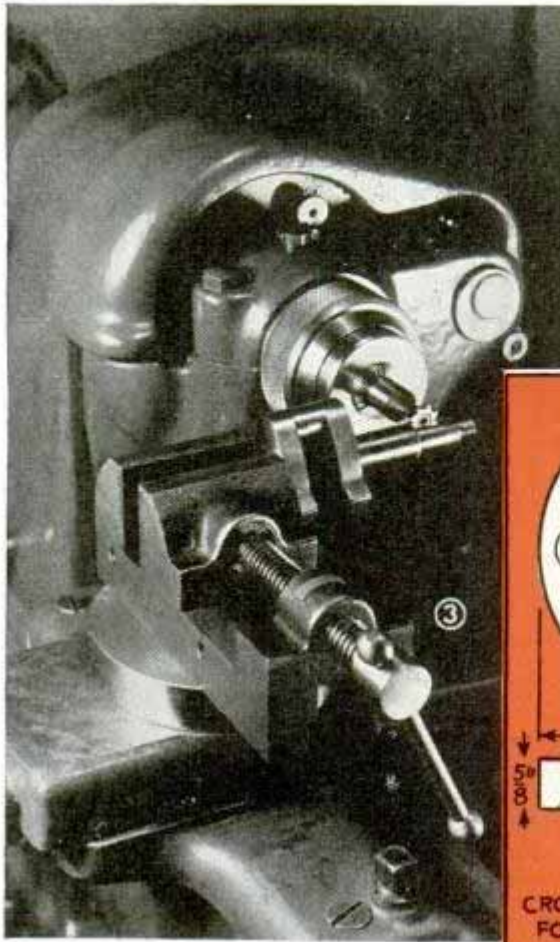

appearance tap holes in the vise are stopped, that is, not drilled clear through and are threaded with a bottom tap. To take full advantage of the accurately milled surfaces of the vise it is necessary to use care in machining the base so that it will furnish flat parallel surfaces, top and bottom.

for comparison. Mounting on any other small lathe will, of course, require some alteration in the size and shape of the duplicate.

The base is drilled for  $\frac{1}{4}$ -in. No. 20 flat-head screws, and registering holes are drilled and tapped in the vise. For neat

Then provide an assortment of blocks of varying thicknesses cut from steel bar stock for use in blocking work to the required height in the vise. With this equipment at hand you can handle most any milling job on model parts that does not require use of a vertical feed.

## Improved Underground Muffler for Light-Plant Engines

So efficient is this muffler for a lighting-plant or other small engine that it cannot be heard at a distance of 150 ft. Instead of a single large pipe running up from a sunken barrel, which is usually found on mufflers of this type, there are five small pipes, each allowing a small portion of the exhaust gases to escape with a noise not much louder than a sigh. The barrel is encased in concrete 4 in. thick, the concrete assuring a good muffler long after the thin sides of the barrel have rusted away.

When you want a smooth, polished finish on wood turnings such as tool handles, first sand them carefully and then hold an oiled strip of cloth or leather against the work as it rotates in the lathe.

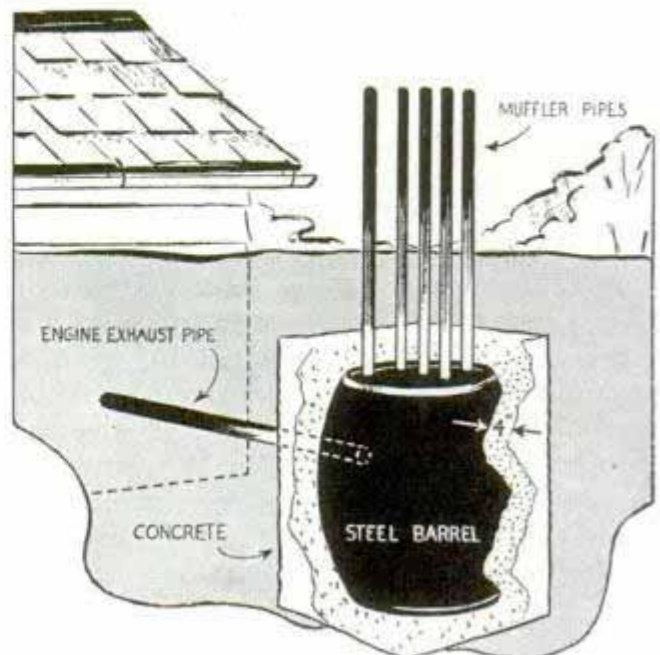



# Boring Tool Adjusts to Varying Diameters

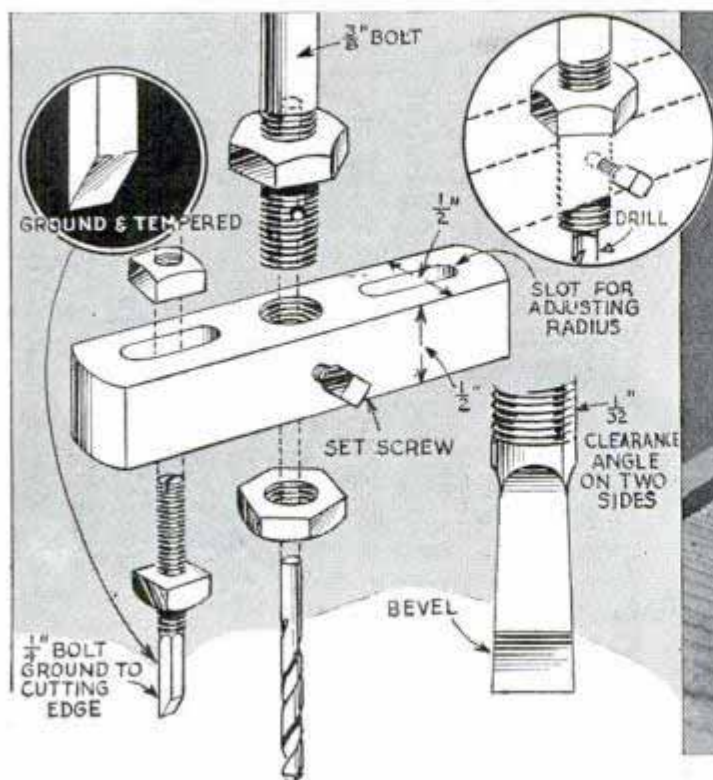

Originally designed to bore out wooden frames for magnifying lenses, as shown in the illustration, this boring tool has the distinct advantage of being adjustable for a 1-in. variation in diameter. There are two cutters, one running slightly deeper than

the other. They are simply machine bolts with the heads cut off and the ends ground with bevel and clearance angles as shown. Hardening and regrinding to a sharp edge will make them suitable for use in any wood and also very soft metals.

## Twine on Farm Dispensed from Bag to Prevent Tangling

To keep a ball of twine handy around the farm shop or granary, place it in a burlap bag, draw the end of the string through the side and hang the bag on a nail. The string may be pulled out and cut off as needed, or the bag can be carried about the farm where twine is required. A discarded section from a mowing-machine sickle driven into the wall of the building will provide a good string cutter.



## Hotel Communicating System

One owner of a small hotel where business did not warrant the installation of a complete inter-room telephone system operated from a central switchboard, installed a buzzer in each room and a loud speaker in the corridor on each floor. To communicate information to a guest, the clerk "buzzes" the room and then talks to the guest over the speaker.



## Splash Guard on Well Platform Protects Shoes and Clothes



Nailed to a well platform, a section of auto tire provides a good splash guard to avoid wetting the shoes or clothes when removing the tank supply pipe to fill a pail while the pump is in operation. The section of tire is placed on the well platform in the position shown and one side turned outward and nailed close to the bead.

## Drill Stiffener to Remove Taps

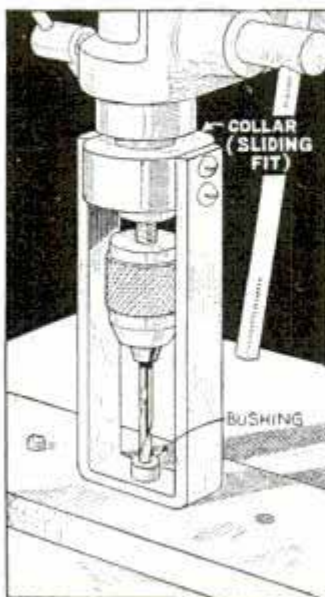

About the only way to remove some broken taps is to anneal them and drill them out, which is often difficult as they are apt to break off at an angle. Then an unguided drill end is deflected. A guide attached to the drill press as shown will usually overcome the trouble and the drill will run

straight. The guide is made from a piece of flat iron bent to a U-shape and attached to a collar which is a sliding fit on the drill-press spindle.

## Sliding Hose on Lantern Holds Bail Vertically

Finding it convenient to have the bails of his warning lanterns held vertically, a contractor provided each one with a short piece of rubber hose, which fit over the tubular frame so that it could be raised to hold the bail or moved down to let the bail drop. The hose was split along one side, and had a slot at the upper end to slip over the bail.

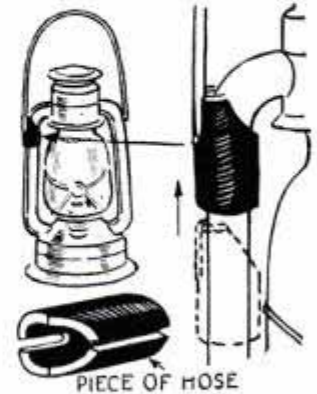

## Cement Anchors Put on Posts with Tin-Can Forms

Farmers who prefer steel fence posts anchored firmly with cement need not convey the cement, sand, gravel and tools to the field as it is possible to attach such anchor pieces before the posts are set. A number of posts are driven into the ground a few inches through large-size tin cans, after which the cement is poured.

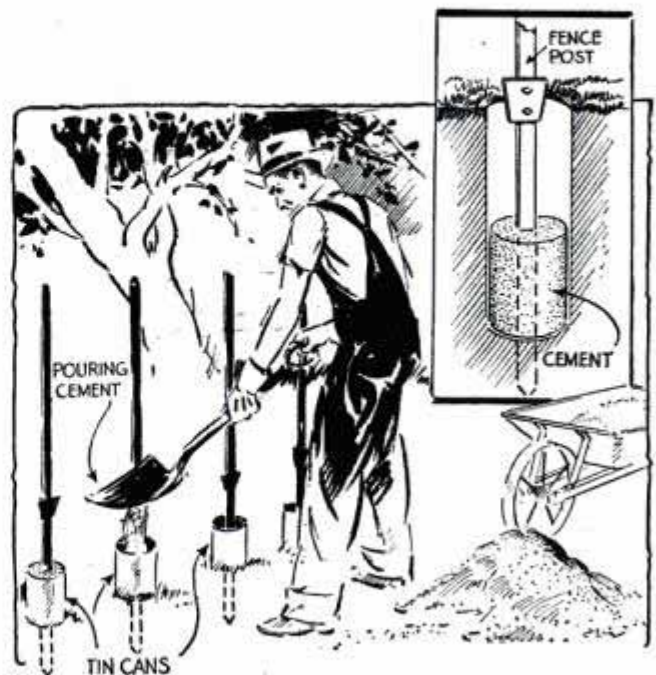



# WIRE LAMPSHADE FRAMES

*assembled quickly with these jigs*

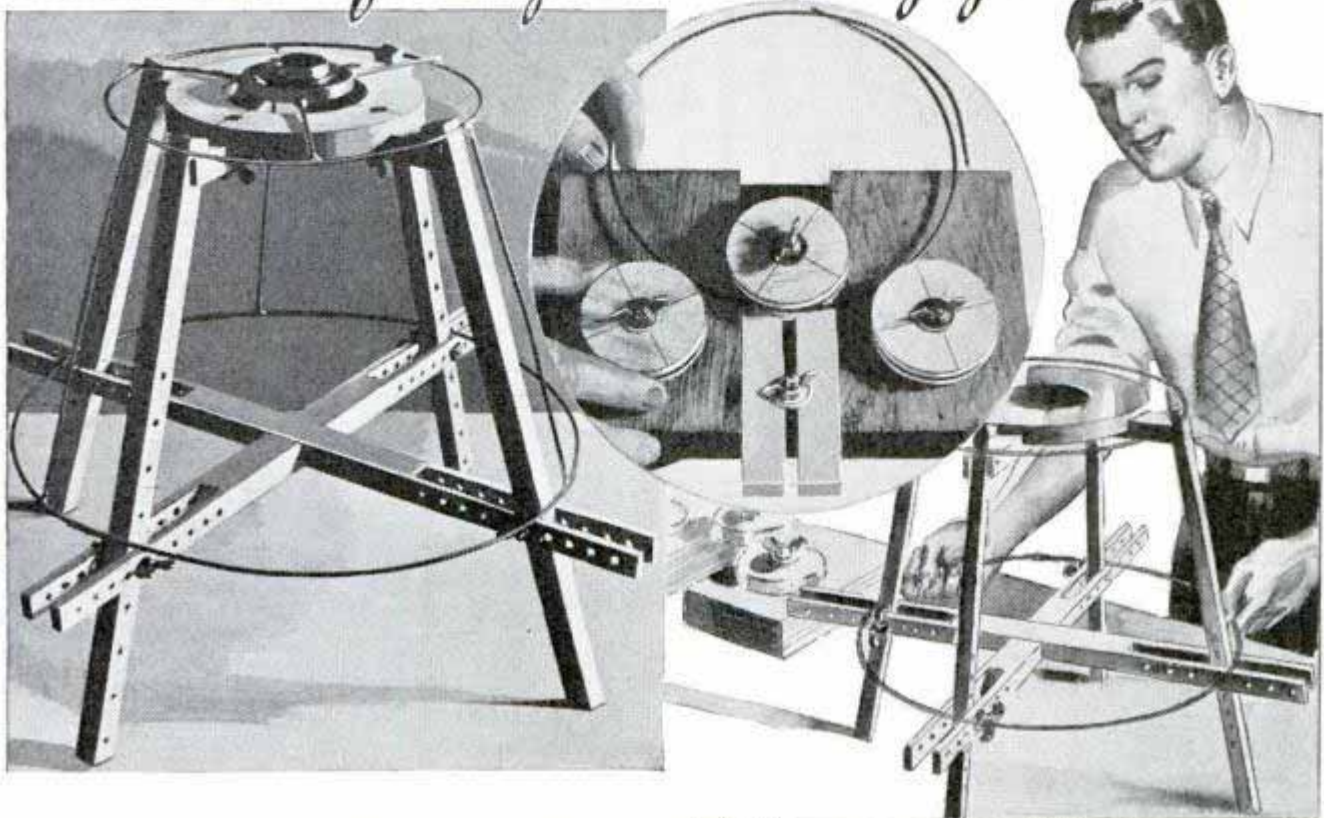

*These jigs are adjustable for any regular size of wire lampshade frame and make it easy to turn out a neat job in a fraction of the time required by other hand methods. To make time in assembling frames one should adopt a definite procedure, making up a pilot model first to get the exact size of the various wire parts, which are then cut to length. Run the stock for the rings through the bending jig, solder the meeting ends, and you're ready to finish each shade in turn on the assembly jig*

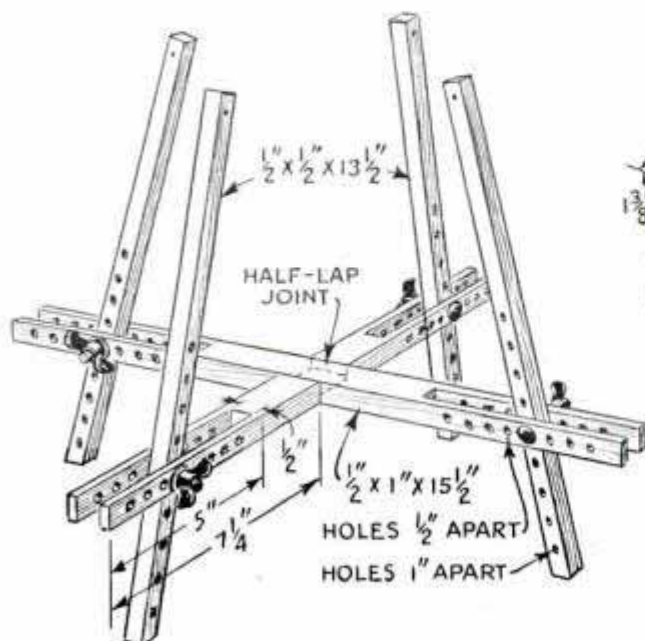
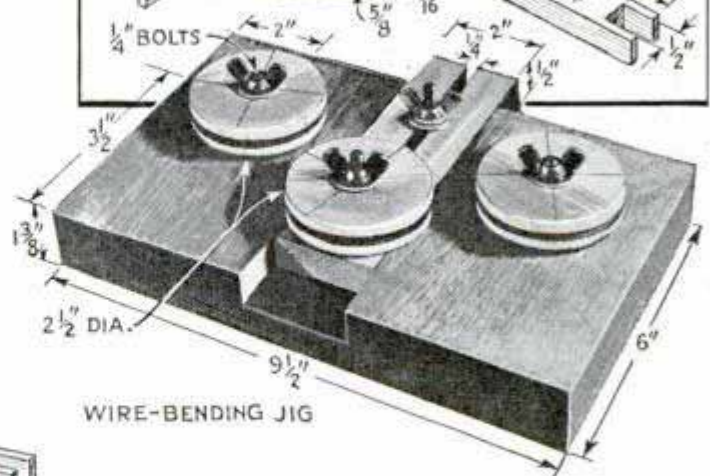
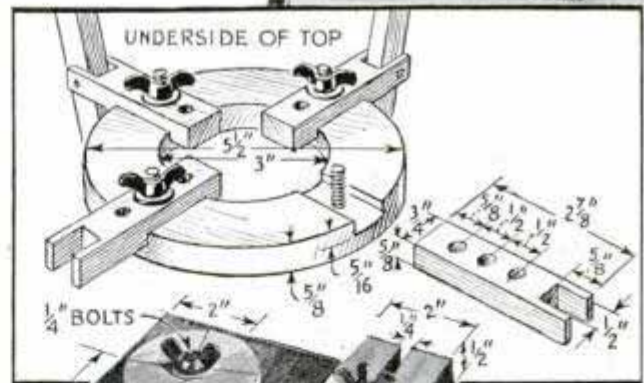

*Use hardwood for all parts of each jig and take special care to space the holes accurately in the vertical and horizontal members of the assembly jig. To make the top ring of the latter, cut right-angle grooves in a piece of stock 6 in. square, then saw to the inside and outside diameters given in the detail above*



## Vertical Tiles in Barn Foundation Avoid Dampness in Basement



Asked the cause of dampness in a barn basement, one contractor explained that the trouble was due to the fact that the underground tile of the foundation had been laid horizontally. If the lower tiles were placed vertically, moisture accumulating within them would have drained off quickly into the ground instead of seeping through the walls.

## Rubber Rollers on Roofing Ladder to Move It Easily

Workmen for one roofing company fitted their ladders with rollers near the lower

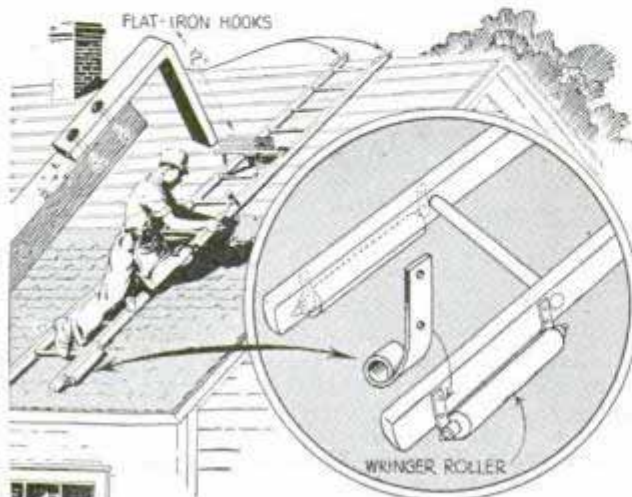

ends so that they could move them along a roof easily. The rollers were taken from old clothes wringers and were attached by pieces of flat iron with eyes formed in the lower ends to take the roller shafts. Lengths of heavy flat iron bent to the shape indicated in the small detail and screwed to the ladders at the top fit over the ridge of the roof.

—Bob Poulson, Los Angeles, Calif.

## Can Cover Forms Phone "Nest" on Workbench

To prevent your telephone from being accidentally pushed off a bench or table, cut one side from the rim of a large can cover and nail it to the bench to serve as a holder. Countersink the nail heads carefully so that they do not interfere with setting or sliding the telephone base into the cover.



## An Improved Bar Clamp

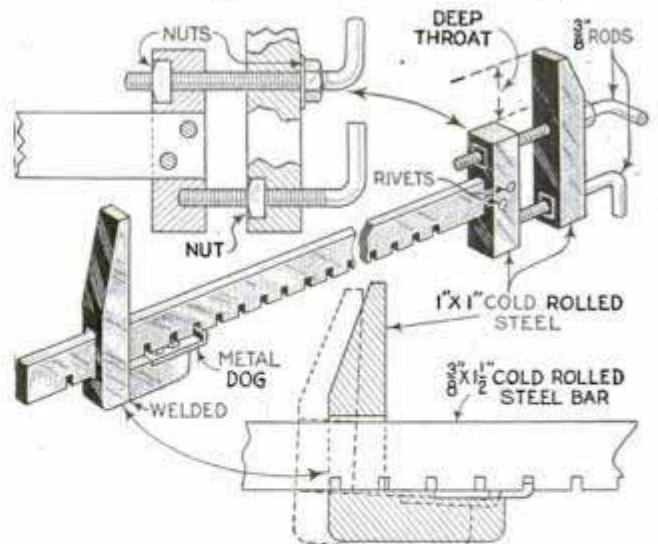

This clamp is constructed easily and combines the advantages of an adjustable bar clamp with a deep throat and double-screw adjustment. The screws are  $\frac{3}{8}$ -in. rods threaded and bent at the ends to form handles, the nuts being let into the stock as shown. Ordinary hand-screw clamps may be made in the same manner at a cost of a few cents for the screws.

—C. F. Blake, Oregon City, Ore.



# Building and Using a WATTMETER

Also how similarly constructed instruments can be used as ammeters and voltmeters

By C. A. CROWLEY

FOR accurately measuring current, voltage and wattage in electrical circuits and appliances, you can build and calibrate reliable instruments yourself if the details explained in this article are carefully followed.

Unlike the usual type of ammeter and voltmeter, which consist essentially of a permanent magnet and a movable coil, as shown in Figs. 2 and 3, the wattmeter to be described has two stationary coils and one movable coil as indicated in Fig. 5. While wattage of direct-current circuits and appliances can be measured by using a voltmeter and ammeter as in Fig. 4, multiplying the volts and amperes to get the watts, this method of determining wattage is not applicable on alternating-current circuits and therefore the wattmeter is necessary. It can be used on both direct and alternating circuits. The two stationary coils have a low resistance and the current, in passing through them, produces a magnetic field in which the movable coil is pivoted. Thus, instead of using a permanent magnet to exert influence on a movable coil, you have an air-core electromagnet. The movable coil, which is wound with fine wire to give it a high resistance, is connected in parallel with the circuit being measured. The magnetic field set up by this coil is proportional to the voltage across the circuit, and the repulsion between the two electromagnetic fields is proportional to the product of the effective current and voltage, which is the watts.

**Wattmeter Construction:** The complete wattmeter is shown in Figs. 1, 11 and 16. Fig. 6 shows general assembly views. The meter is mounted on a wood base, which is reinforced with two cleats. The frame on

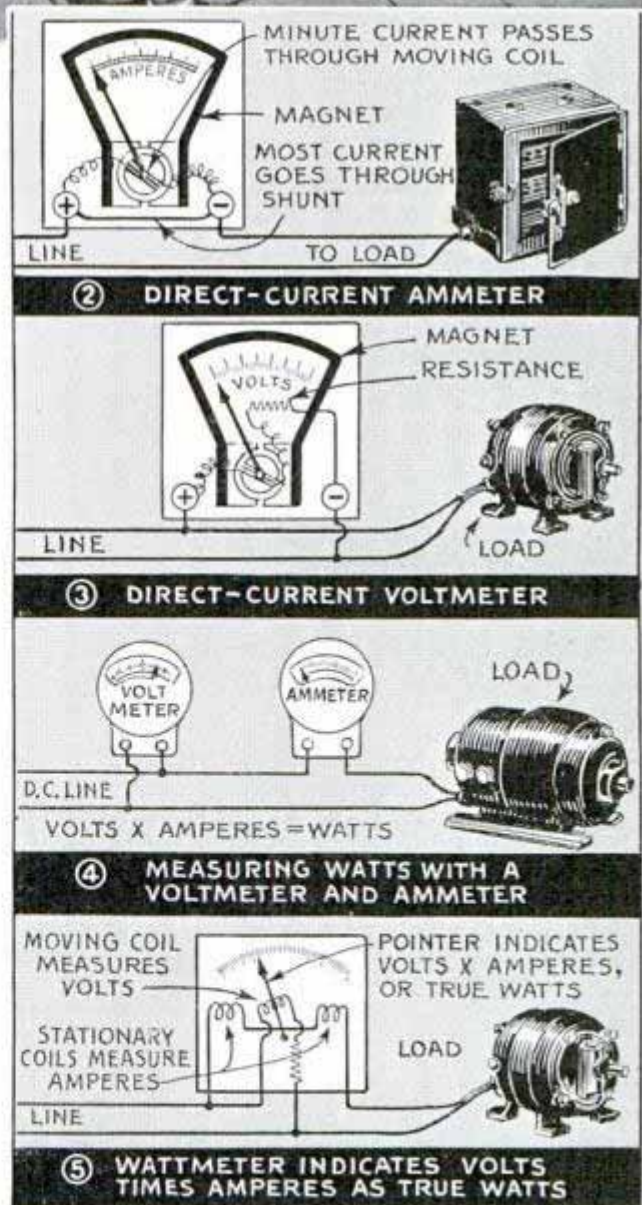
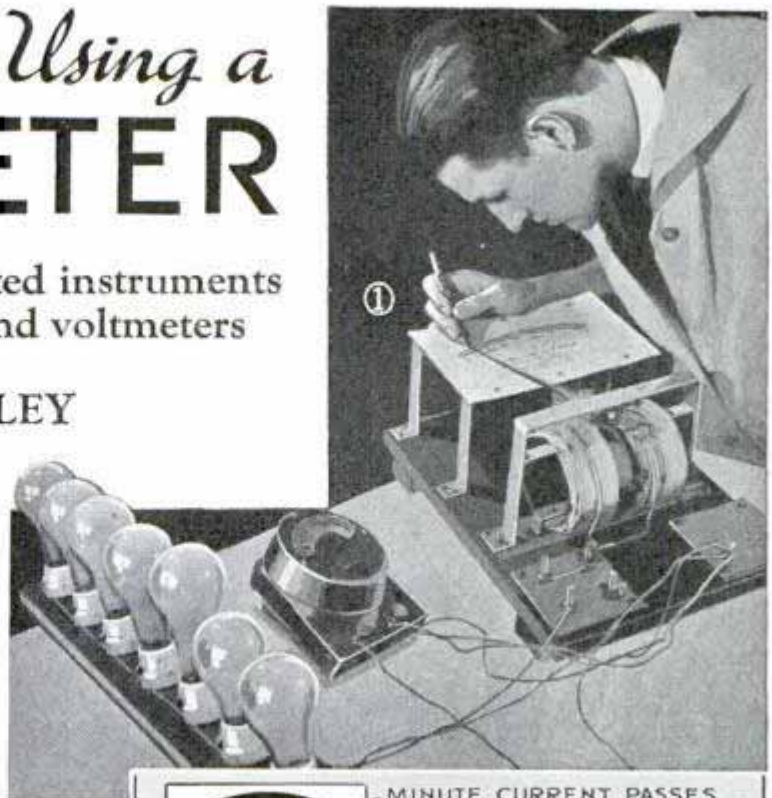



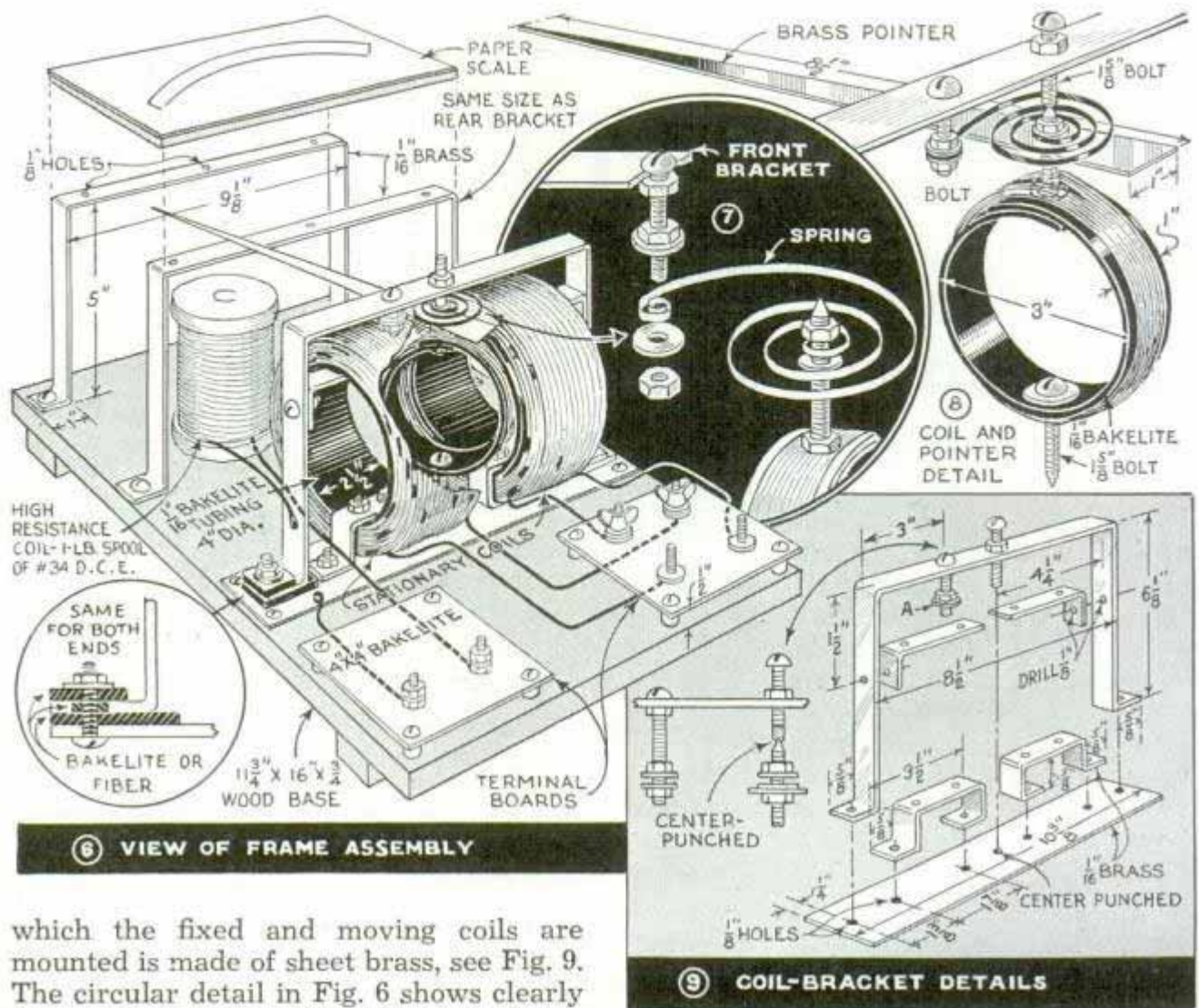

which the fixed and moving coils are mounted is made of sheet brass, see Fig. 9. The circular detail in Fig. 6 shows clearly the method of insulating the main frame piece from the brass base plate. Stock for the base plate is about 1 1/2 in. wide, while that used for the main frame is 1 in. wide and that for the brackets is 5/8 in. wide. The fixed coils are wound on 1/16-in. Bakelite tubing, 4 in. in diameter and 2 1/2 in. wide, and are fastened to the upper and lower brackets with No. 6-32 brass machine screws, the heads of which are covered with fiber insulation to prevent damaging the cotton wrapping of the wire. Brass machine screws of this size are used throughout the instrument. The coils are wound in a clockwise direction, using 2 lbs. of No. 14 B & S double-cotton-covered wire for each coil. In order to hold each layer of wire securely in place so that the coil will be wound neatly, you place strips of ordinary friction tape over a layer already wound, bringing the loose ends of the tape up over the next layer after it is wound, as illustrated in the detail below Fig. 11.

The movable coil and pointer assembly

is made next, as shown in Figs. 6, 7 and 8. The pointer is cut from brass or aluminum and the coil is wound on a Bakelite cylinder of dimensions indicated in Fig. 8. Two No. 6-32 brass machine screws with the ends pointed as shown serve as pivots. The coil is wound with 300 turns or more of No. 34 double-cotton enameled wire and the ends of the coil are soldered to the heads of the pivot screws. In winding, take care that none of the turns of wire are "shorted" on the pivot screws or nuts securing them to the Bakelite tubing. It may be best to use a strip of friction tape or some tough paper as a layer of insulation at these points. The pointer and the spiral springs are fastened to the upper pivot screw with two nuts. Then the coil is mounted in position, the lower pivot resting in the small depression made with a centerpunch directly below the upper bearing screw, and exactly in the center of the base plate, see Fig. 9. A No. 6-32 brass nut is soldered on top of the main frame



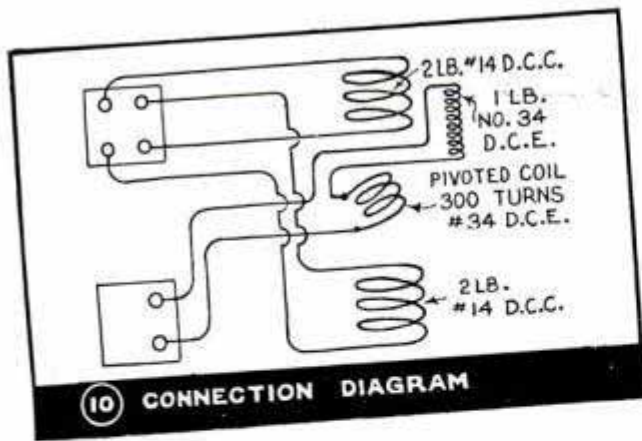

piece, exactly at the center, for the upper bearing, which is a No. 6-32 brass machine screw 1 in. long with the end center-punched. The free end of a light, phosphor-bronze or brass spiral spring is fastened to the main frame at A, Fig. 9. The tension on the spring can be adjusted by turning the screw, which is locked in position by tightening the top nut. The fixed coils are now fastened to the frame and the entire frame screwed to the wooden base. Details for the supports for the dial or scale of the instrument are shown in Fig. 6; they are 1 in. wide and support a brass or aluminum plate 6 by 9 $\frac{3}{4}$  in. in size, to which the paper dial is fastened with rubber cement.

A high-resistance coil, which is mounted under the dial is a 1-lb. spool of No. 34 double-cotton enameled wire wound from two separate spools as shown in Fig. 13. The number of turns must be adjusted in calibrating the instrument, directions for which will be given later. On each of the front corners of the instrument is a Bakelite panel, mounted  $\frac{1}{2}$  in. above the wooden base. On one of these are four binding posts, to which the leads from the field coils are attached as shown in Fig. 10. The connections are made on the underside of the panel. The manner of connecting the resistance coil and the moving coil to the posts on the other panel is also shown in Fig. 10. The connections to the moving coil are made by soldering one to the base plate and the other to the main frame piece as indicated in Fig. 6. These connections may be made with No. 14 d.c.c. wire. Because of minor differences in construction, the instrument must be calibrated individually by comparison with a good wattmeter, and therefore no scale can be given that will fit all instruments made from

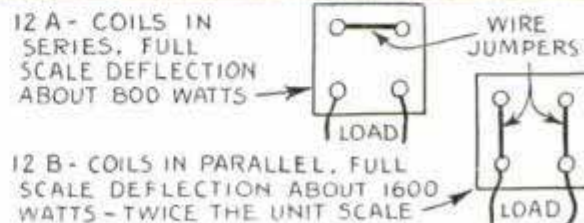
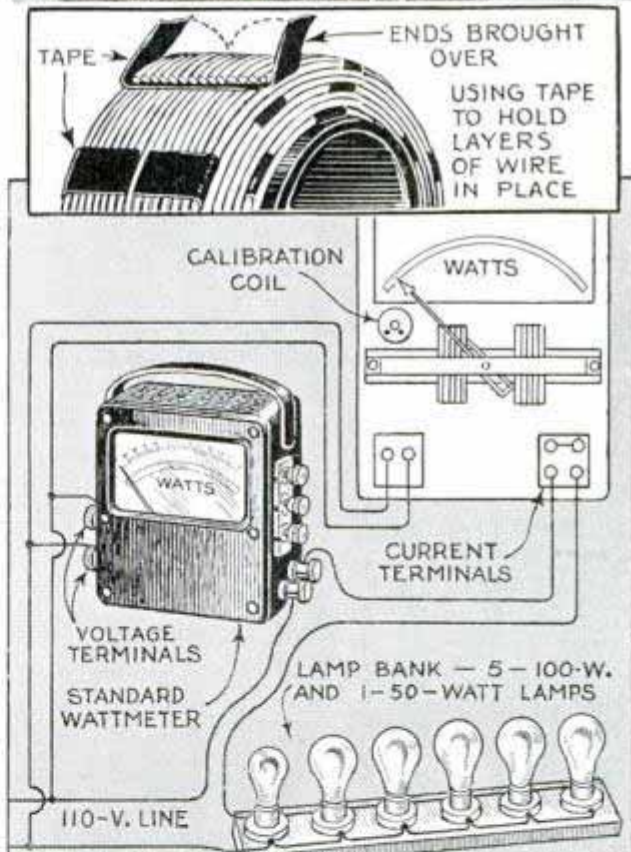
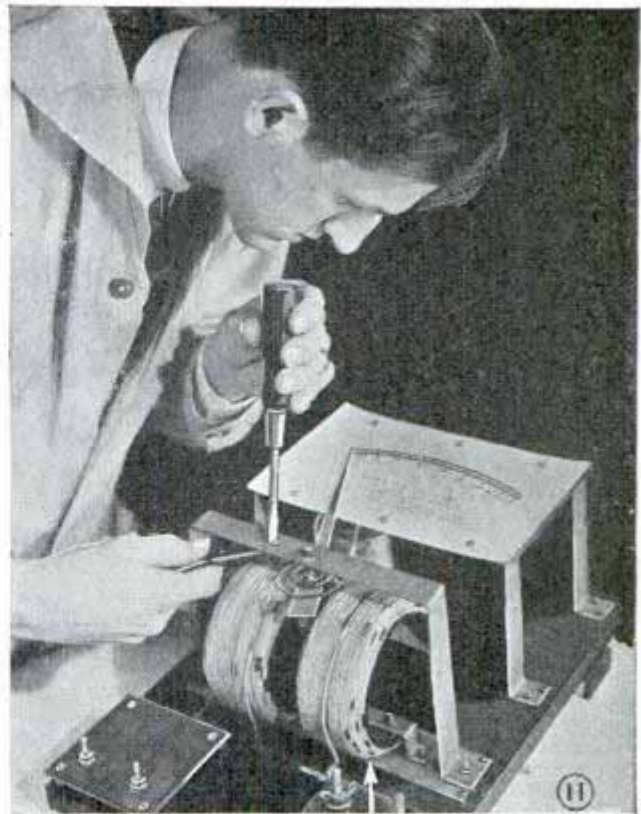



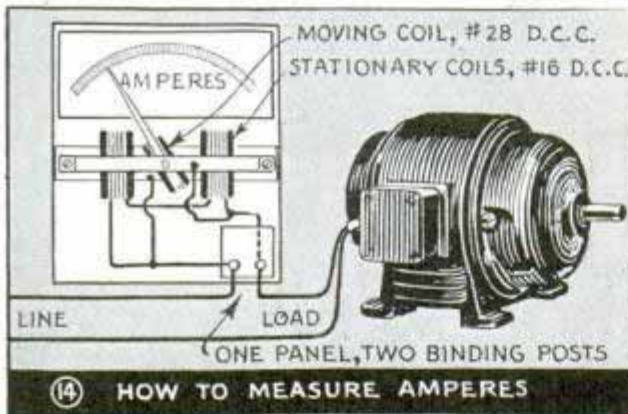

these instructions. If a standard wattmeter is not available, take your meter to a high school or college where you will doubtless find an interested student or instructor who will calibrate the instrument for you.

To calibrate the wattmeter, use the circuit shown in Fig. 12. Connections are made as shown to a lamp bank containing five 100-watt lamps and one 50-watt lamp. The field coils of your wattmeter are to be connected in series as shown in Fig. 12A. The standard wattmeter used to calibrate your meter should read to about 750 watts. The amount of wire in the resistance coil of the instrument is reduced until the deflection of the pointer is about three-fourths of the full scale. It is important that wire be removed from a full spool to calibrate rather than to start with an empty spool, as too little wire in this coil would cause the moving coil to burn out.

Then the coil is permanently fixed in place and the connections soldered. By varying the number and size of lamps in the lamp bank, different readings on the standard wattmeter can be obtained. The corresponding position of the pointer on your wattmeter should be marked in each case. From this data the scale for your meter can be drawn. The meter then can be used to measure the power in any a.c. or d.c. circuit within its range. In calibrating the instrument, the spring will have to be adjusted carefully so that a repeat test will always bring the pointer to the same value as marked on the scale. When trouble is encountered here, the movement or spring is incorrectly adjusted mechanically. Having calibrated the instrument, it can be made to measure power values twice as great by simply changing the jumper connections on the right-hand terminal board as shown in Fig. 12.

**Ammeter Construction:** An ammeter

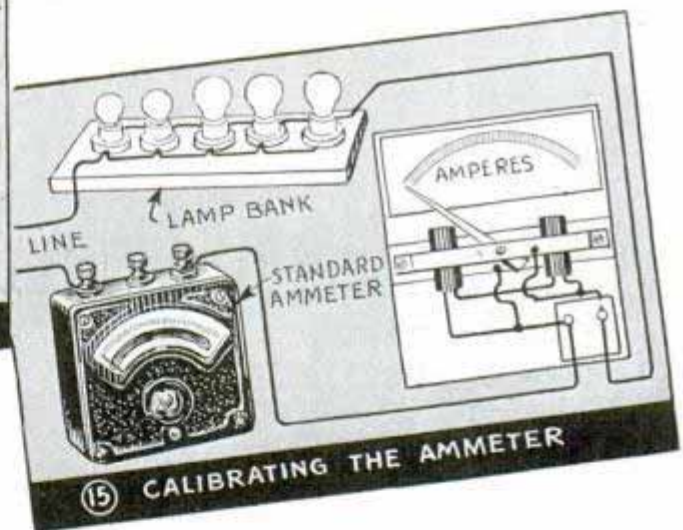

can be made by winding the stationary or field coils full with No. 16 d.c.c. wire and the moving coil full with No. 28 d.c.c. wire. All coils should be wound to the same thickness as the coils on the wattmeter. An extra resistance coil is not needed. Fig. 14 shows how the ammeter is connected in use and Fig. 15 shows the method of calibrating the instrument, by comparing it with a standard ammeter. The number and size of the lamps are varied, and the current corresponding to each deflection of your ammeter is read on the standard ammeter and marked on the new instrument scale.

**Making a Voltmeter:** To make a voltmeter, the moving coil may be the same as



for a wattmeter and the field coils wound full with No. 34 d.c.e. wire to the same specifications as the field coils of the wattmeter. The resistance coil may not be needed for a low-range meter, but for a high-range meter, the coil should be placed in series with the other coils. This coil should be wound also with No. 34 wire, as shown in Fig. 13, the amount to be determined by calibrating. The coils are all connected in series, as shown in Fig. 18. The method of calibration is shown in Figs. 16 and 17. The potentiometer should have a resistance of from 1,500 to 2,000 ohms and should be capable of carrying a current of 0.1 to 0.5 ampere. Starting with the sliding contact at the end marked A, move the contact toward B until the maximum voltage desired is read on the standard meter. Then reduce the amount of

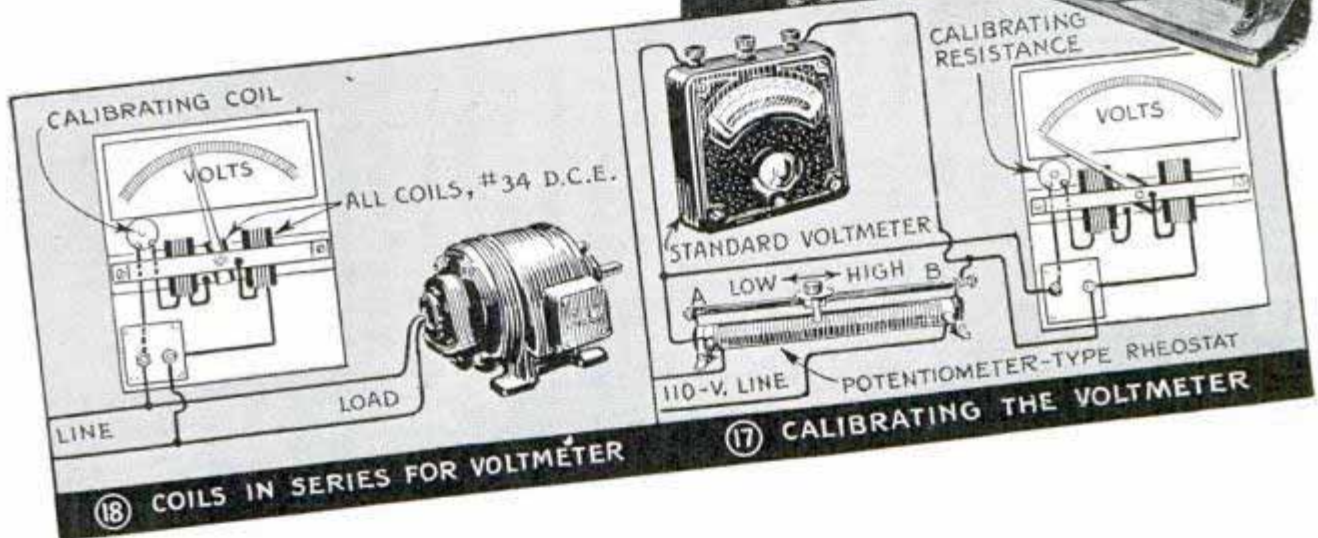

wire in the calibrating resistance coil until the pointer of your meter shows a full-scale deflection. For example, if the meter is to read up to 110 volts, adjust the potentiometer until the standard meter says 110 volts, and then adjust the coil until the pointer of your instrument also stands at full-scale deflection. In making this adjustment, readjust the potentiometer as required to keep the standard instrument reading 110 volts. Finally mount the coil permanently in position, and starting with the sliding contact at the low-voltage end, A, of the potentiometer, determine the scale by comparison with the readings of the other meter.

While the methods of assembling these instruments are simple, and careful work is certain to produce rugged meters which

can be used for hundreds of practical jobs, it is none the less of the greatest importance that the various details given be followed carefully. Poor insulation, imperfect mechanical alinement of parts or the use of iron or iron screws will cause innumerable troubles. Only brass, aluminum or copper parts and brass screws should be used. The springs are best coiled from phosphor-bronze wire; however, a section of clock hair spring can be used if it is carefully mounted.

☞ A writing fluid that dries almost instantly can be made by adding alcohol to ordinary ink. Where a good quality paper is used, equal quantities of ink and rubbing alcohol may be mixed, but for more absorbent paper, less alcohol should be added.



## Signboards Painted in Colors Without Time for Drying



Having a number of signboards to prepare with the lettering in one color and the background coat in another color, one workman did the job without losing time for the paint to dry. The lettering was laid out on the boards in faint pencil lines, and a tool made from a couple of razor blades mounted on a wooden handle, was used to "cut-in" the letter margins. With the outer grain of the wood severed, it was easy to fill in the letters and background without having the colors flow together.

## Electric Bell Detects Pipes Buried in Concrete

When it is necessary to drill holes in concrete floors and walls that contain buried electric conduit or other raceways, this signal will sound a warning the moment the chisel touches them. As all elec-

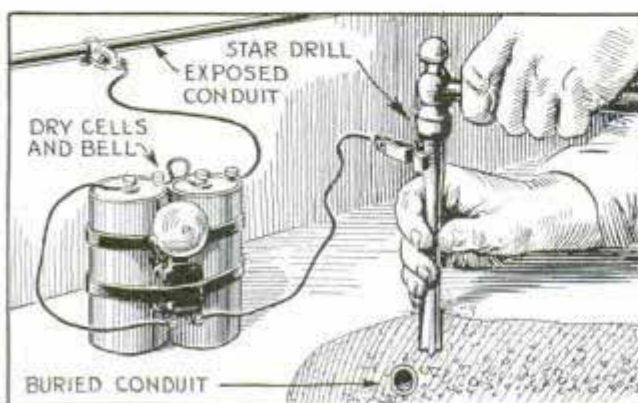

tric conduits are generally continuous and grounded, all you have to do is connect one side of the signal circuit to an exposed conduit and the other side to the chisel. Also, as most structural steel is riveted or welded into one continuous piece, the same idea can be used when drilling concrete that contains steel beams. The signal consists of two or three dry cells and a door-bell assembled and wired as shown.

## Sign Painter's Emergency Palette Made from Muffin Tin

When a palette is needed in a hurry and none is at hand, one can be improvised from a muffin tin. Just cut the bottom out of one of the corner molds and line it with rubber for a thumb hole. The colors can be mixed in the remaining molds.

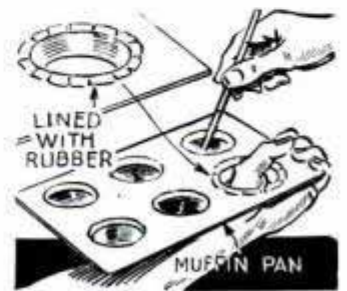

## Meat Cured in Barrel Smokehouse Does Not Get Hot

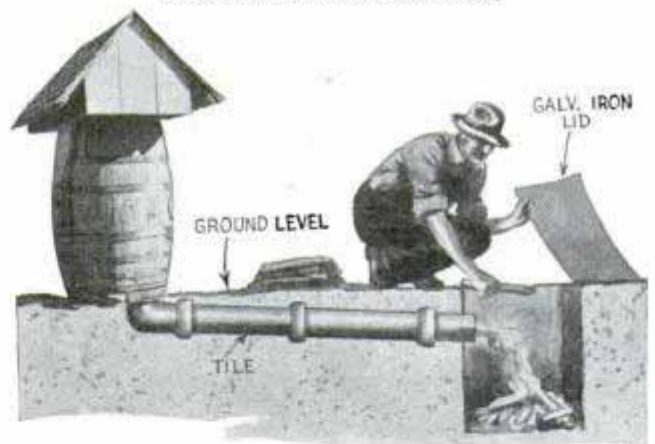

This smokehouse is claimed to be superior to the usual kind. A barrel was set in the ground and connected to a small fire pit by a line of sloping tile, after which a superstructure was built on the barrel. This had a shingle roof and crosspieces inside from which the meat was hung. Doors form one end to permit easy hanging and removal of the meat. During the smoking process the meat is kept cool and there is no dripping of fats, which is often the case when the fire is built directly under the meat. Control of the smoke is obtained by a piece of sheet iron laid over the hole.



## Wheel Guard for Hay Rake

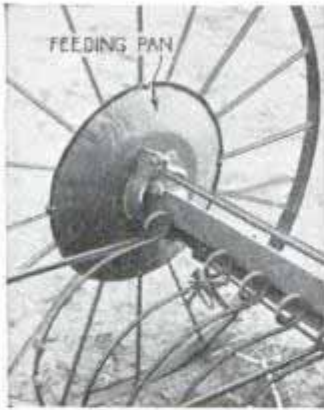

Circular pressed-steel feeding pans were put on the wheels of this hay rake to prevent hay from winding up on the axle and clogging the trip dogs. A hole was cut in the center of each pan to take the wheel hub,

and smaller holes were made near the rim for hook bolts which fasten the pans to the spokes.—Dale R. Van Horn, Lincoln, Nebr.

## Singeing Hand Rope on Elevator Removes Projecting Fibers

Workmen who operate elevators of the type that have hand ropes will find it a good idea to keep them smooth and free of projecting fibers. These can be removed easily and quickly with the flame of a blowtorch, which is passed rapidly along the rope, taking care not to burn it.



## Rubber Strip over Chopping Block Prevents Flying Pieces



When chopping wood on a block, the pieces have a tendency to fly upward when cut and may injure the face or eyes of the worker. This can be prevented by nailing a piece of garden hose over the block as indicated. The rubber is generally strong enough to hold its shape without stiffening. Two nails at each end will hold the hose in place.—C. A. Oldroyd, Barrow-in-Furness, Lancs., Eng.

## Battery Clip Holds Putty Can on Paint Pail



To carry a small can of putty where it will be at hand on a painting job for repairing windows, one workman uses a spring battery clip, with which the can is attached to the pail as shown. The fastener is secure and could be used for holding small cans of trimming paint in a handy position.

Chromium cleaner that is sold for use on auto parts will keep your shop tools shiny and free of rust.

## Red Lantern Gives Flasher Effect When Rotating in Wind

Realizing the effectiveness of a flashing light as a danger signal, a road contractor soldered tin wings to the sides of his red lanterns. When the latter were suspended by a cord, the wings caught the slightest breeze and rotated slowly, alternately hiding and exposing the light.





## Dividers Set to Given Radius Quickly on Indented Strip

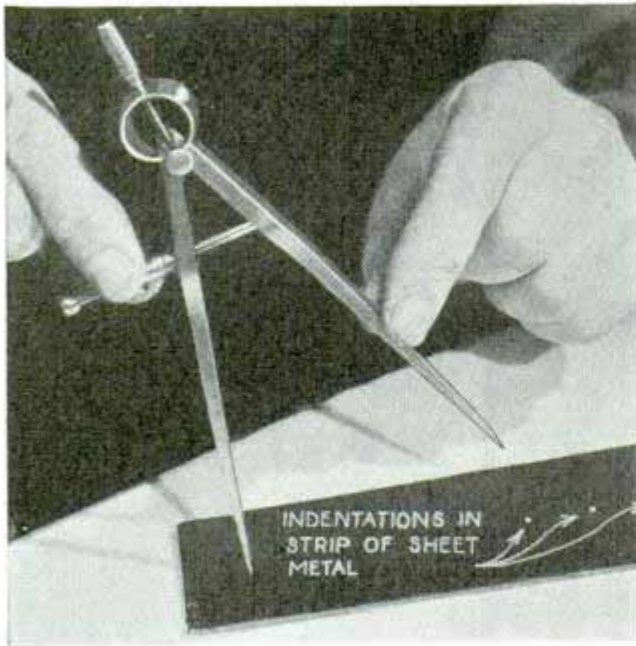

A tinsmith who often had jobs that required setting his dividers to the same various radii several times, especially when making up duplicate pieces, found that he could save time by using this simple measuring strip. It is a piece of sheet metal indented with a punch, the indentations being spaced to suit the most used radii. In use, one leg of the dividers is set in an indentation near the end of the strip, after which the other leg is adjusted to set in an indentation to give the desired radius.

## Scale at Edge of Drawing Board Has Many Uses

You won't have to stop work and look for a ruler that has been misplaced, if you set a scale in the surface of your drawing board near the edge as indicated.

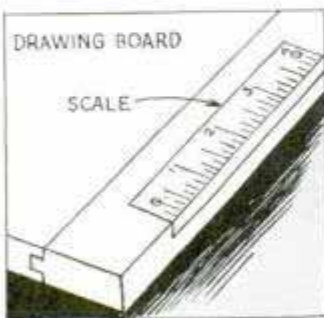

The scale can be any length desired within the limits of the board, and should be set flush with the surface. The recess for the scale should be cut carefully on the edge of the board that is used the least so that it does not interfere with use of the T-square.

—S. J. Gancher, Richmond Hill, N. Y.

## Seed Grain Treated for Disease in This Duster

Designed by M. B. Moore of the Minnesota College of Agriculture, this duster enables two men to treat 40 to 60 bu. of seed grain an hour with chemical disinfectants. The seed is spread in layers in the proportioning trough which drops it over a series of baffle boards located in the mixing chute.

In building the duster, first nail up the mixing chute, placing the clean-out door on either side. Then comes cutting and placing of the baffles which is very important. The upper edges of these are beveled to  $45^\circ$  to fit snugly against the inside of the chute, and the grain of the wood should run from top to bottom. A 2-in. hole is bored in each baffle 2 in. from the top and  $\frac{3}{4}$  in. from the right edge. Notice that there are three large baffles and two smaller ones which are placed alternately in the chute, first a large one and then a small one and so on. The top baffle is placed with its beveled edge running parallel to the proportioning trough and with the hole under the opening that will be made by raising the trough. The second baffle is turned  $\frac{1}{4}$  turn to the right so that part of the grain sliding from the first baffle will fall through the hole in the second. Each following baffle is also turned  $\frac{1}{4}$  turn to the right. When the mixing chute has been completed, assemble the proportioning trough and hinge it to the chute, pushing the trough clear into the front of the chute so that no opening is left unless the trough is raised. The free end of the trough is supported by a rope and pulley hung from the ceiling.

A bushel of seed is put into the trough and spread out evenly over the entire length. Over it is sprinkled the required amount of dust disinfectant, spread evenly in a line down the center of the trough from one end to the other. Next add the second bushel of grain and a second dose of disinfectant. Be sure that you have located the baffles correctly and fill the trough carefully as directed, as the effectiveness of the duster depends on these two points. Always clean the duster before treating a different variety of seed. Don't breathe the dust; all fungicides are more or less poisonous. It's best to wear a dust mask if treating much seed.



# SEED-GRAIN DUSTER

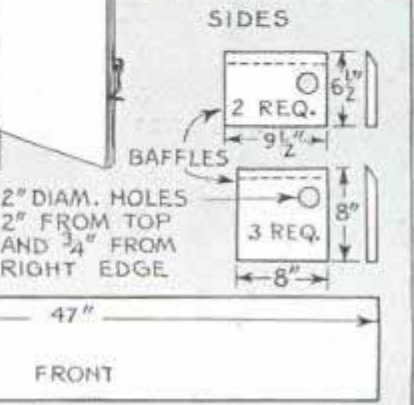
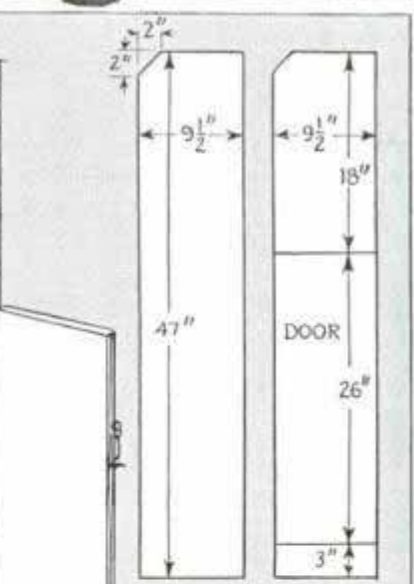
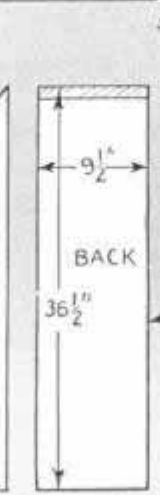
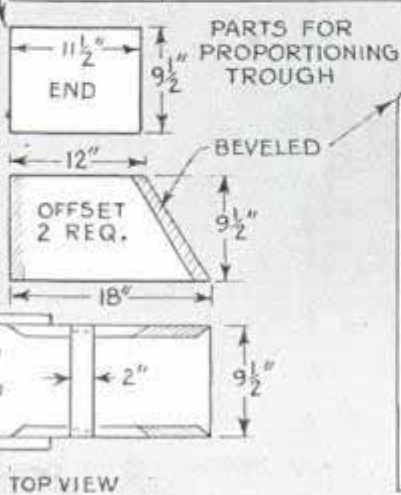
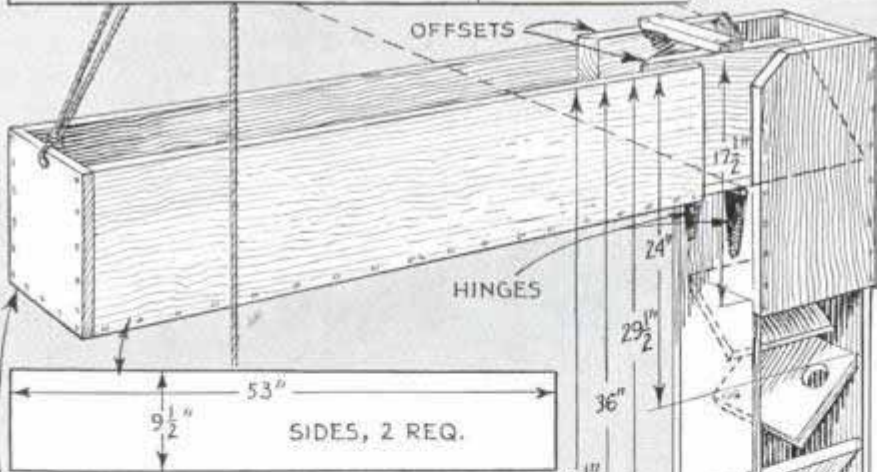
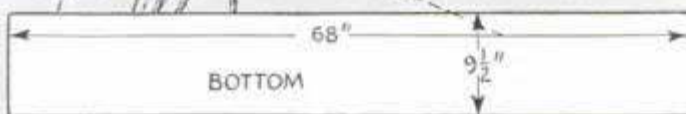
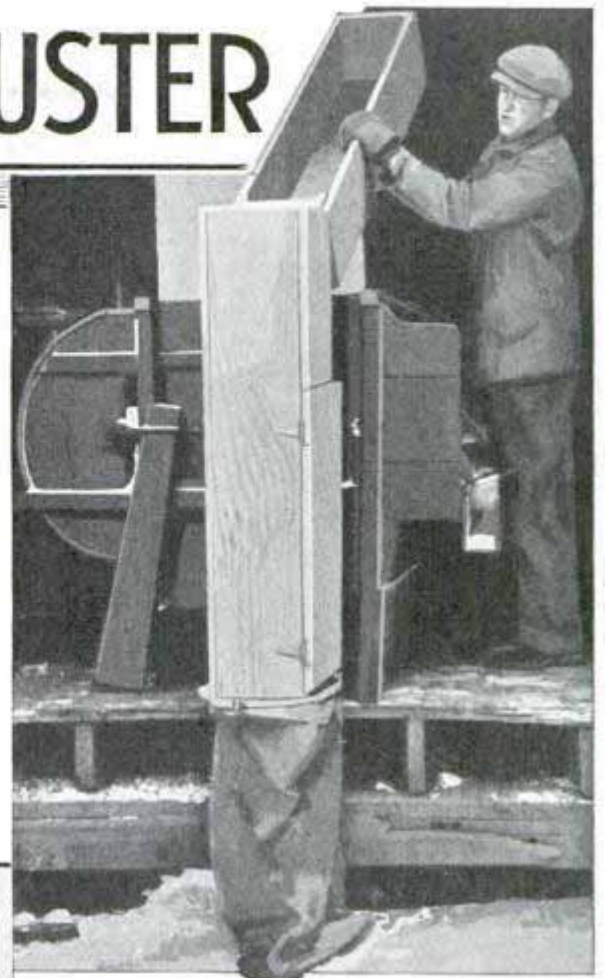
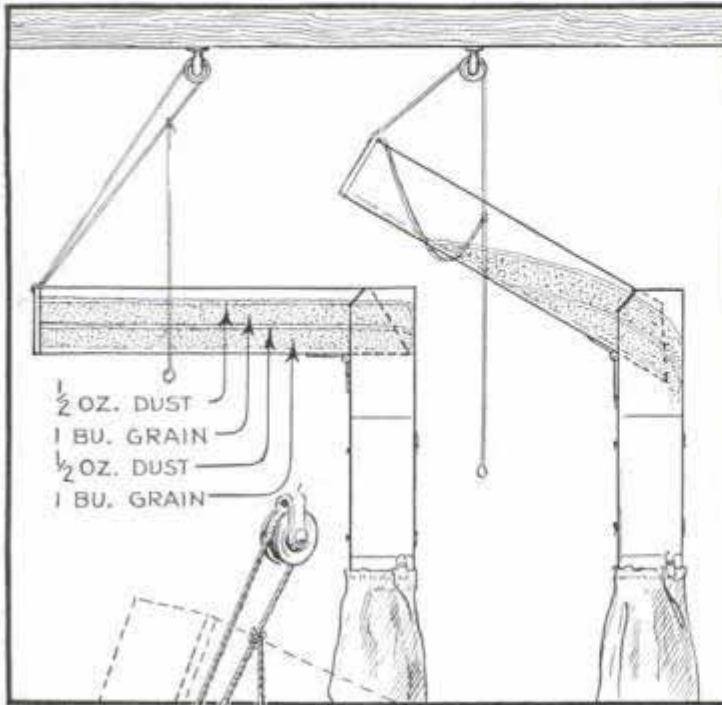



## Jig Clamps Mitered Angle Iron When Welding

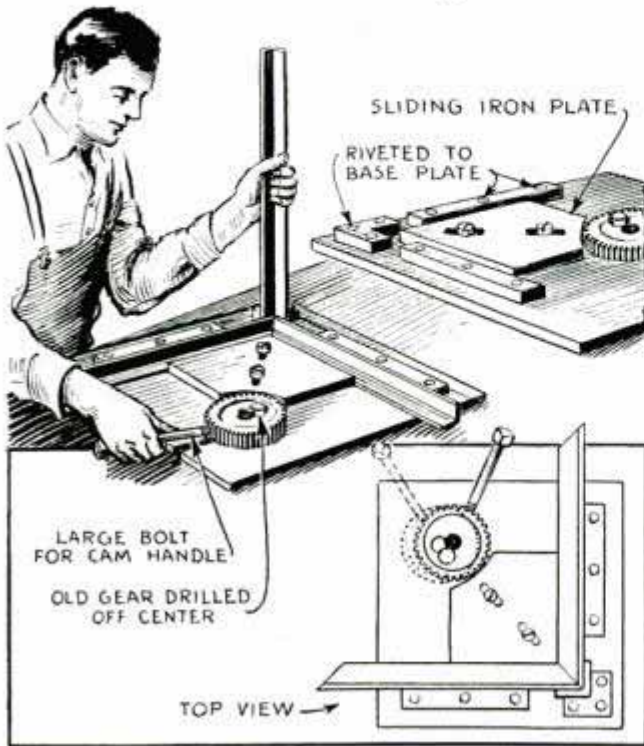

An efficient clamp to hold mitered angle iron, while welding or brazing together frames for benches and tables, is devised easily from plate steel and flat iron. The parts are drilled and assembled as shown. Dimensions depend largely on the material at hand, and the size of angle iron to be welded. In use, an old gear or metal disk pivoted eccentrically on the base provides a cam to hold the sliding shoe securely against the angle iron, which, in turn, rigidly clamps the upright corner piece in place. A small piece of asbestos placed beneath the corner, prevents damage to the jig.

—Anthony Wolchok, Toronto, Ont., Can.

## Connecting Pipe to Metal Tank

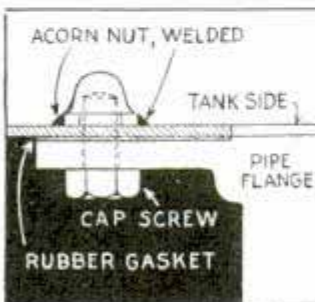

Here's a method of connecting pipes to sheet-metal tanks, which not only saves materials, but also assures a tight joint. Instead of using two each of pipe flanges, gaskets, pipe nuts and lead grommets, acorn nuts are welded to the inside surface of the tank over the holes drilled

to take the flange bolts. In connecting the pipe this way, cap screws are substituted for the flange bolts and are screwed into the acorn nuts. This makes it necessary to use only one flange, gasket and pipe nut on the outside.

—L. H. Georger, Buffalo, N. Y.

## Window Pocket Holds Tags on Shipping Case

A produce merchant who requests that egg-shipping cases be returned, provides each case with a tin pocket for the address tag, which is kept from slipping out of the pocket by a tack at one end. A window or opening is cut from the pocket to expose the name and address. The tags are printed with the shipper's address on one side and the receiver's on the other so that they can be removed and turned over to send the cases either way.



## Apron on Press Protects Work When Printing Cards

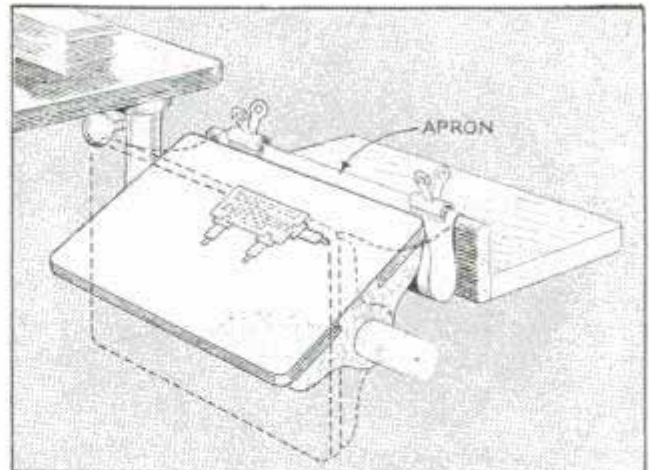

After a number of printed cards had been soiled by dropping between the platen and delivery board of a job press, one printer bridged the gap between them with a paper apron. One end of this is slipped under the draw-sheet clamp and the other end is attached to the delivery board with a couple of paper clamps.



Key remote & Motorized Garage Doors 145

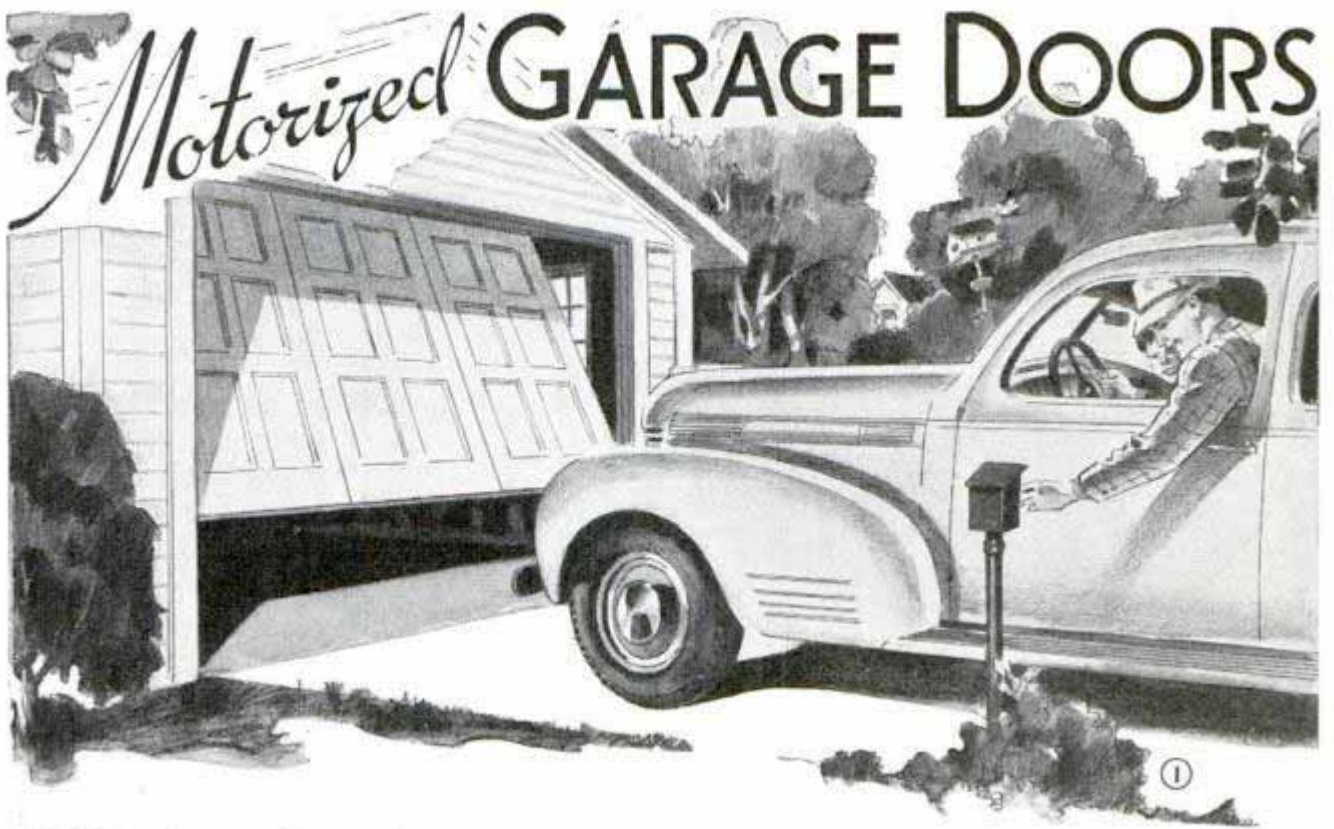

WITH this installation for operating garage doors automatically, you simply close a switch located at any convenient point as shown in Fig. 1, and the doors open or close as desired. Although not shown in the details, you can install in addition a solenoid-operated lock so that the doors cannot be opened by hand from the outside. The lock is wired into the circuit so that it operates when the control switch is closed. A key-type switch is preferable on outdoor installations such as this one so

that persons not in possession of the key will be unable to operate the switch. In addition to the control switch, limit switches are installed so that when the door is fully closed or opened, the motor will be cut out until the control switch is again closed. A motor, speed-reduction unit, switches and wiring material, some channel and angle iron, pulleys, shafting and spring steel tape besides the doors, of course, are the essentials required. By carefully studying over the details Figs. 2 and 3, you will see

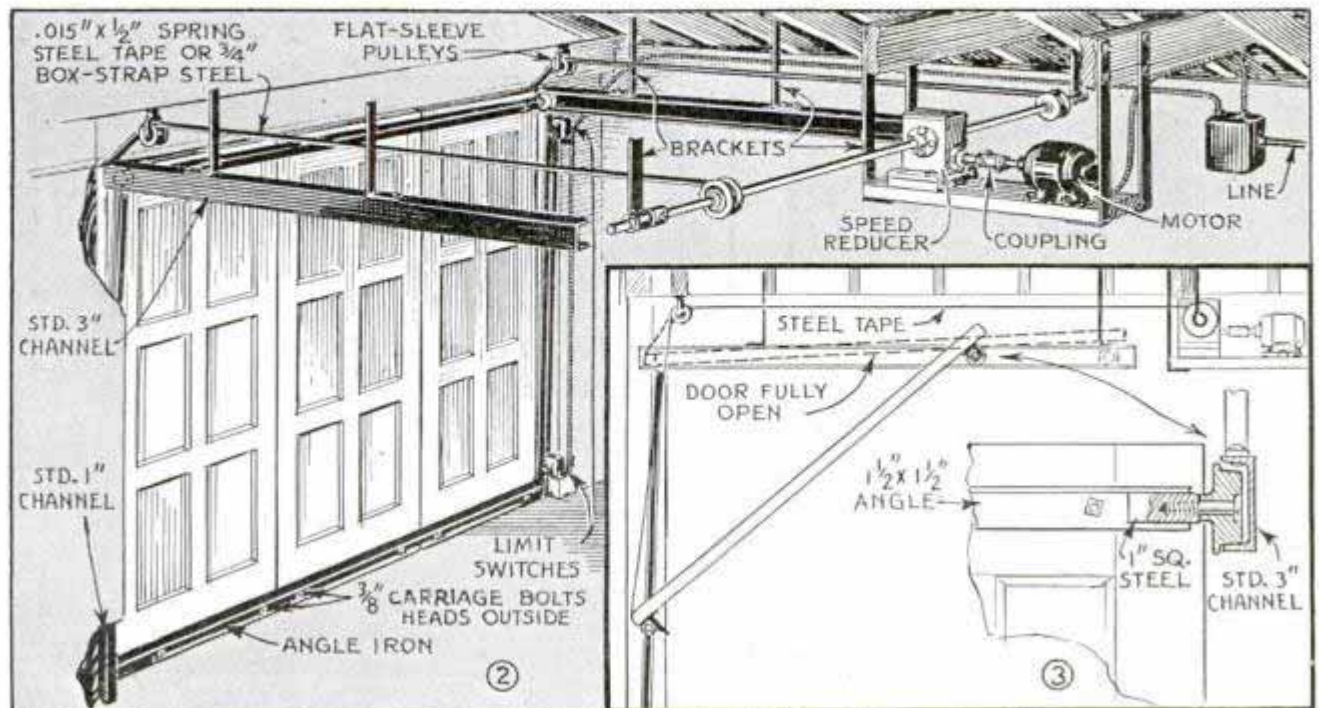



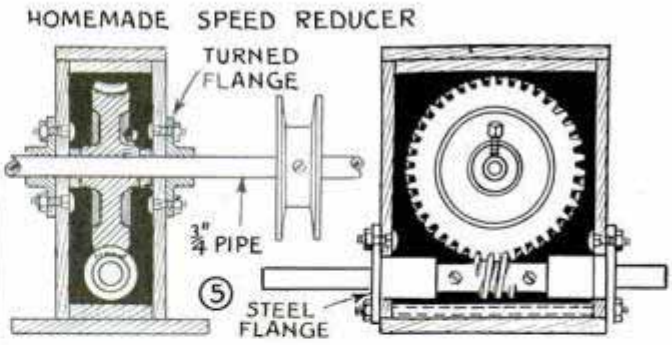
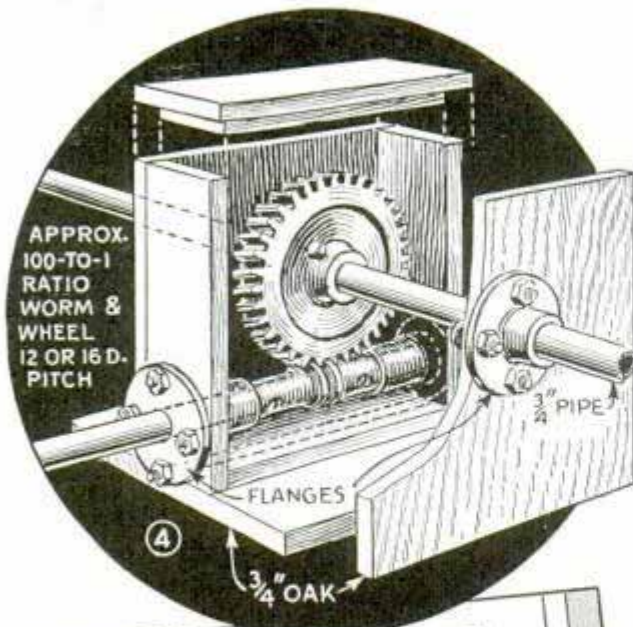

how the parts are assembled and how the doors are raised. If your garage is very short, check carefully to determine that the doors will not strike the car when swinging over at the angle shown in Fig. 3.

All parts are standard except the speed reducer shown in Figs. 4 and 5, which may be constructed easily if a small lathe is available. The unit is housed in a hardwood box. Standard 3/4-in. pipe is used for the sheave shaft, Figs. 2 and 4. The coupling to the motor may be made from a short piece of garden hose and a pair of hose clamps, Figs. 2 and 8. For a.c. operation use a 1/4 or 1/2-hp. split-phase motor, or series a.c. motor. Repulsion-induction motors cannot be used. On d.c., a series, shunt, or compound-wound motor is suitable.

Three ordinary house doors fastened together at top and bottom with angle iron and carriage bolts serve as the single large door. A square piece of steel welded into the ends of the angles at the top and bottom provides a bearing for the roller studs and bottom guide pins. The rails in which the flanged rollers run are standard 3-in. channel to which 3/8 by 1-in. supporting

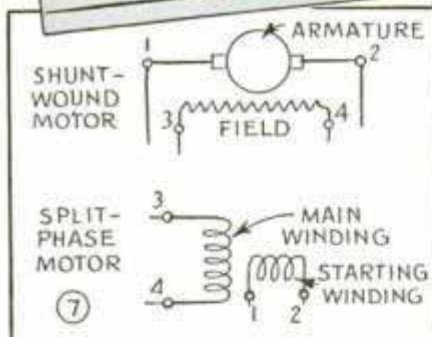
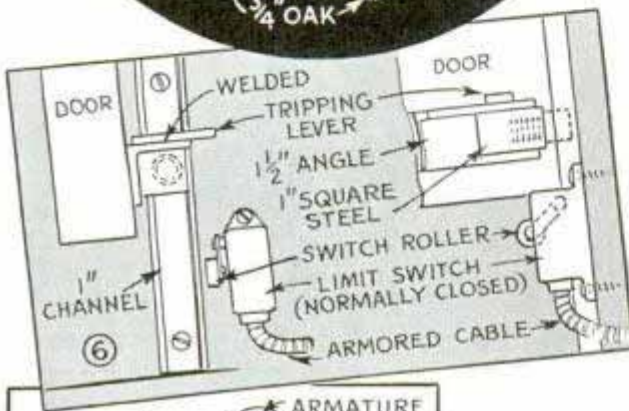

UPPER LIMIT SWITCH ALWAYS CLOSED UNLESS DOOR IS ALL THE WAY UP.

SPLIT-PHASE A.C. OR SHUNT-WOUND D.C. MOTOR.

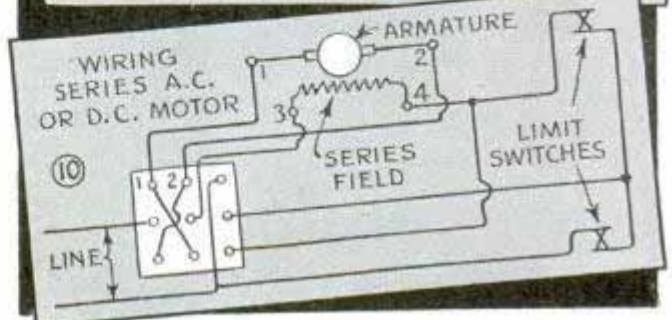
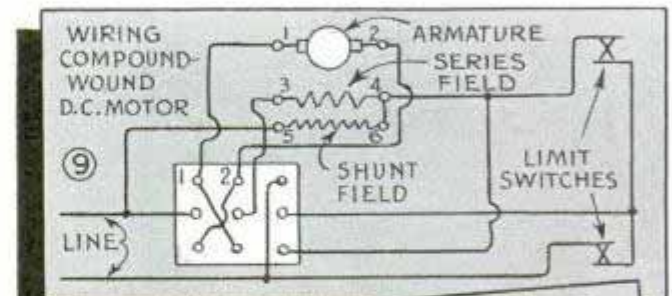
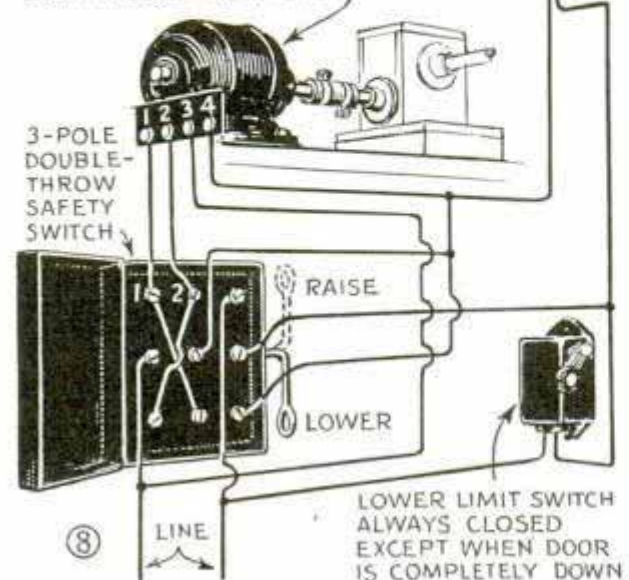



straps are welded. The channels must slant slightly toward the doorway. One-inch channels screwed to the door frame provide a track for the projecting pins which guide the bottom of the door, Fig. 2. Keep in mind that the door must clear these channels when opening. This means that the width of the door must be slightly less than the distance between the channels. Either  $\frac{1}{64}$  by  $\frac{1}{2}$ -in. spring steel or  $\frac{1}{64}$  by  $\frac{5}{8}$  or  $\frac{3}{4}$ -in. steel box straps may be used for pulling up the door, Fig. 2. The sheaves on which the straps are wound should be approximately 2 in. in diameter so that the danger of breaking the straps will be eliminated. The speed at which the door is raised can be regulated by the size of the sheaves.

The limit switches are placed at the top and bottom of the vertical track as shown in Fig. 2 and in the detail, Fig. 6. These are normally held closed by a spring but when the switch arm is depressed by the door they are opened. The switches are located as shown in Fig. 2 and a pawl is welded in the proper position to trip the switches when the door reaches the top or bottom of the track as shown in Fig. 6. An inclosed triple-pole double-throw safety switch is used to control operations. A wiring diagram for a split phase a.c. or a shunt-wound d.c. motor is given in Figs. 7 and 8. Wiring diagrams for series and compound wound d.c. motors are shown in Figs. 9 and 10. With connections made as indicated, and the switch thrown upward, the door will move up to the top, and when the switch is closed downward the door will move down. If the limit switches are located at the right points, it will stop when the end of the track is reached.

To test the system, close the switch for a moment only in either direction, to see in which direction the door moves. Open the switch immediately. If the door moves in the wrong direction, that is, if it moves up when the switch is closed down, it will be necessary to interchange the leads 1 and 2 in the wiring diagram. This change should be made at the safety switch.

☛ If you have a tire valve that leaks, examine the small prongs at the inner end; unless these are spread sufficiently, they will not bed on the ridge inside the stem and may bind on the valve spindle.

## Pivoted Step on Delivery Truck Out of Way When Driving



Constantly climbing in and out of a truck, when loading or unloading, is a simple matter if you pivot a step on the side as shown. It is merely a length of 2 by 6-in. stock notched as indicated and attached. When resting on the ground one side of each notch forms a tread. When not in use, the step is swung over against the box to rest on the fender.

## Overheating and Loss of Power Caused by Heat Regulator

When the motors of certain cars lack power and have a tendency to overheat, the trouble may be caused by the butterfly valve of the regulator, which directs hot exhaust gases around the

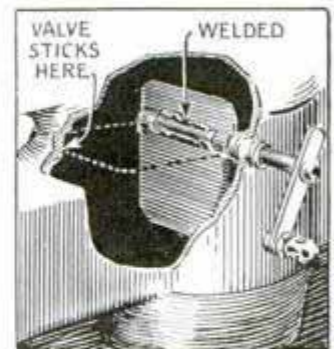

fuel passages. Sometimes the valve becomes loose on its shaft and works to the rear of the exhaust manifold where it sticks in the curved part and causes a strong back pressure against the motor. The only repair is to remove the manifold and weld the valve to its shaft in the correct position.—E. J. Novak, Omaha, Nebr.



## Battery Truck Is Assembled from Scrap Parts

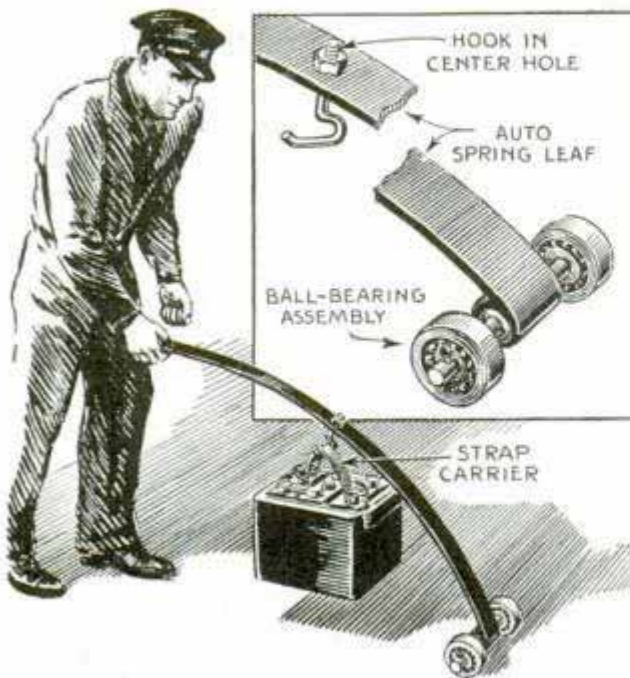

To move batteries easily about the shop, one mechanic made a truck from a spring leaf and two ball-bearing assemblies. A short shaft through the eye of the spring served as an axle for the bearings, which were held in place with cotter keys, and an

altered eye bolt through the center hole of the leaf provided a hook for a strap carrier which grips the battery terminals.

## Repairing Broken Crank Handle on Car Window

If you break off the crank that operates a window, it can be repaired with little trouble. Have someone hold the handle in place and drill through it into the broken end of the shaft. Then tap the hole to take a long stove bolt or machine screw, and drive the latter into place.—V. Robinson, St. Paul, Minn.

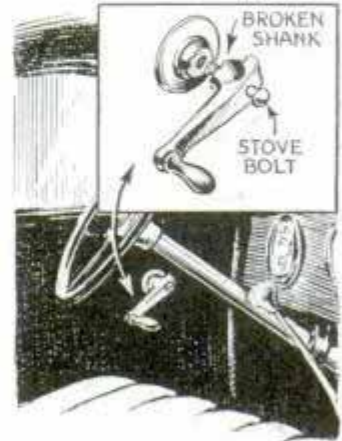

Always keep the gap between the ignition breaker points adjusted as recommended by the manufacturer; a gap too small or too large has the same effect as a spark that is timed too early or too late.

## "Skipper"—Low-Cost, 14-ft. Outboard Runabout



At an expenditure of only \$30 to \$40 you can build this trim, five-passenger runabout, which is powered by a 4 to 24-hp. outboard motor. Its speed ranges from 9 to 24 m.p.h. depending on the size motor used. The boat has a 54-in. beam, 15½-in. freeboard, 24-in. depth, a 5-in. draft at 725 lbs., and a weight of about 275 lbs. Six plans (Nos. 1018 to 1023 incl.) showing details of building besides sheets giving material list and outline of procedure will be sent postpaid on receipt of \$1.

### Other Boats You Can Build

- "Roamer"—765 to 770: Outboard cabin cruiser; two berths. Six prints \$1.00.
- "Sea Saucer"—893: 9½-ft. sail boat. Deck, bottom and sides are 3/16-in. plywood. 25c.
- 17-Ft. Kayak—928 and 929: Light framework covered with canvas. Two prints 50c.
- 12-Ft. Utility Rowboat—707: Flat bottom. Four seats. Sturdy design. 25c.
- 16-Ft. Canoe—811 and 812: Cedar planking covered with canvas. Two prints 50c.
- "Arrowhead" Sloop—944 to 951: Fast sailboat 21 ft. long, 5 ft. 11 in. beam. Set of 8 prints \$1.50.

Any six of these plans (not projects) will be sent upon receipt of \$1

### 400 Build-It-Yourself Plans

Every home workshop owner should have our illustrated catalogue for constant reference to get ideas on what to build. Shows nearly all projects as they look when finished. Includes modern and colonial furniture, home and garden improvements, workbenches, tool cabinets, motor-driven machines, models of all kinds, outdoor-sport devices, radio equipment, electrical devices, toys and novelties, juvenile articles, etc. The only cost to get this new catalogue is a three-cent stamp. Be sure to print your name and address carefully when ordering.

Address Plan Service, Popular Mechanics Magazine, 200 East Ontario St., Chicago



# SNAPSHOTS at NIGHT are simpler and surer than ever with EASTMAN'S NEW HIGH SPEED FILM

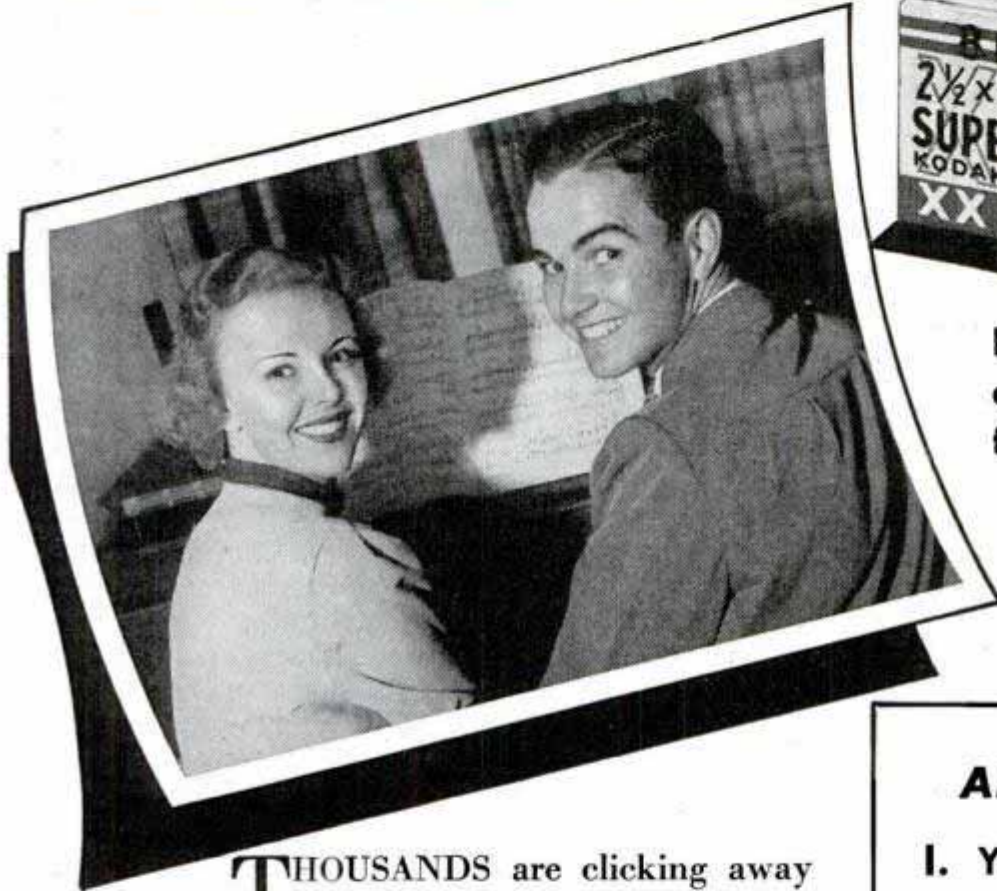

Kodak Super-XX is  
about four times as  
fast as ordinary film

**T**HOUSANDS are clicking away indoors these evenings, as confident of getting good snapshots as though they were taking pictures outdoors in the sunlight. That's how simple, how sure, nighttime picture taking has been made. With fussy posing out, even the inexperienced picture taker gets lively, informal, true-to-life snaps. You need less light indoors than ever before; and you use any camera that takes the new high speed film, Kodak Super-XX—even an inexpensive Brownie.

**FREE BOOKLET . . .** A single reading, and you're ready to make nighttime snapshots you'll be proud of. Non-technical text, interesting photographs, easy-to-understand diagrams, and light arrangements. At your dealer's . . . Eastman Kodak Company, Rochester, N. Y.

## ALL YOU NEED

1. Your present camera loaded with the new Kodak Super-XX Film
2. A couple of inexpensive Mazda Photoflood lamps in Kodak Handy Reflectors



*next week's advertisement*







"*Struck it rich*  
million dollar flavor  
in a half-a-dollar pipe  
..that's *VELVET*"

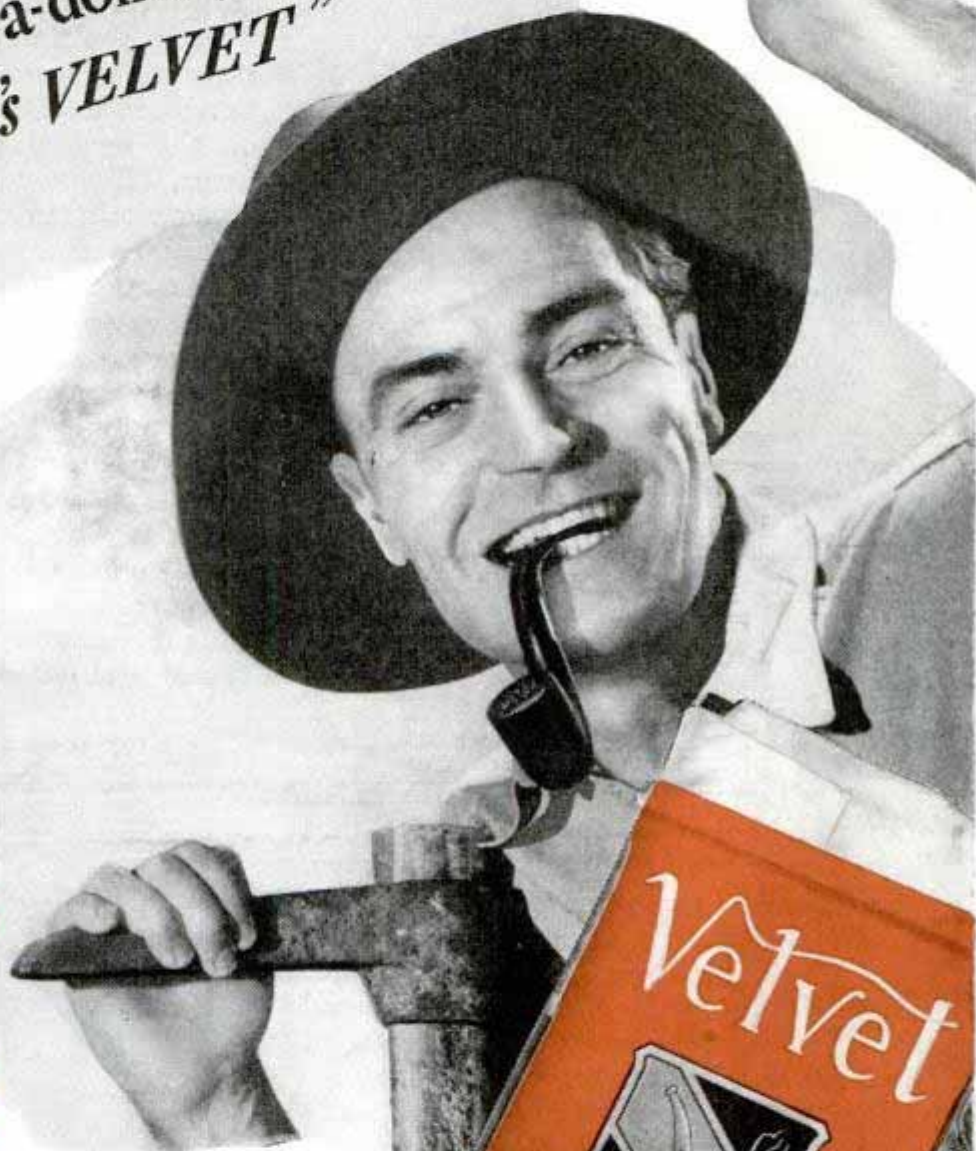

**V**elvet

- the *MILDNESS*  
of fine old  
Kentucky Burley  
aged in wood
- the *FLAVOR*  
of pure maple  
sugar for extra  
good taste

*Velvet packs easy in a pipe  
Rolls smooth in a cigarette  
Better tobacco  
for both*

*Better  
smoking  
tobacco*





# Secrets of Big-Time Racing

(Continued from page 510)

Driving through traffic at 150 miles per hour is not as different as you might think from ordinary traffic driving on a highway. Much of the time you are only a few feet away from another car and you pass to the right or the left depending on which

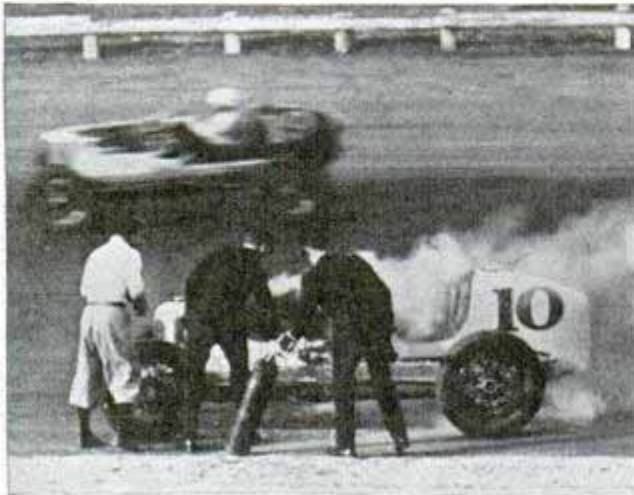

*Track firemen extinguishing flames on racing car. Note car whizzing by in background*

side looks best. You have a rear-vision mirror fastened on the cowl to see behind you.

Driving strategy changes as conditions change during a race but one of my final preparations is to map out a general idea of how I plan to drive. The qualifying speeds tell us what cars we have to watch out for and help us estimate the speed that the winner of the race will have to drive. Theoretically I can plan to get up to that speed and stay on it, saving my motor, yet I know that if a couple of the leaders get into a duel the whole pace will be stepped up and those who want to be up in front at the finish will have to drive accordingly.

Hanging back and waiting for the leaders to blow up is another technique, and getting in front and trying to stay there is a third. On different occasions each type of driving has won. There are defensive drivers and offensive drivers. Some work their way up near the lead and stay there, not trying to pass the leaders but fighting doggedly to prevent any one passing them. Other drivers take the offensive and fight as hard as they can to pass every car on the track.

This year I am going to have a pretty powerful car, using the 500-horsepower engine built by Frank Lockhart and owned

by Alden Sampson. It is being mounted in an "ultra super" streamline body. The power plant consists of two ninety-one-cubic-inch supercharged eight-cylinder blocks mounted on one crankcase, but employing two crankshafts geared to the single-drive shaft. The sixteen-cylinder engine ought to give me a fast and easily controlled car.

From the time I shift into high gear at sixty miles per hour I'll have a schedule to adhere to, 7,000 revolutions per minute on the long straightaways, 5,000 on the turns. I'll have memorized the exact point, going into a turn, where I'm to get off the throttle, and the proper point in the turn to put my foot down again. Some drivers don't vary half a second per lap all through the race, so well do they stick by their pre-race schedules.

The pit men keep track of the arithmetic. Sitting in the cockpit, lap after lap, you get tired of mathematics and it's easier to steal a look at your pit as you flash by. Some of the signals on the blackboard may have a secret meaning although nearly all drivers and pit crews use a few signals in common. The capital letter P followed by a number tells you your place. A large letter L with a number tells you your lap. An arrow



*Driver on right heads up toward rail to avoid car that has spun completely around in race*

pointing ahead or behind with a figure shows the speed that the driver ahead of you or astern is making.

Driving the Indianapolis classic is a punishing job. Your head rings and buzzes for a couple of days afterward and you can hardly hear a shout. Powder puffs inside the helmet help save your ears. If it turns

(Continued to page 118A)



## Front Wheels Aligned Before Car Is Built

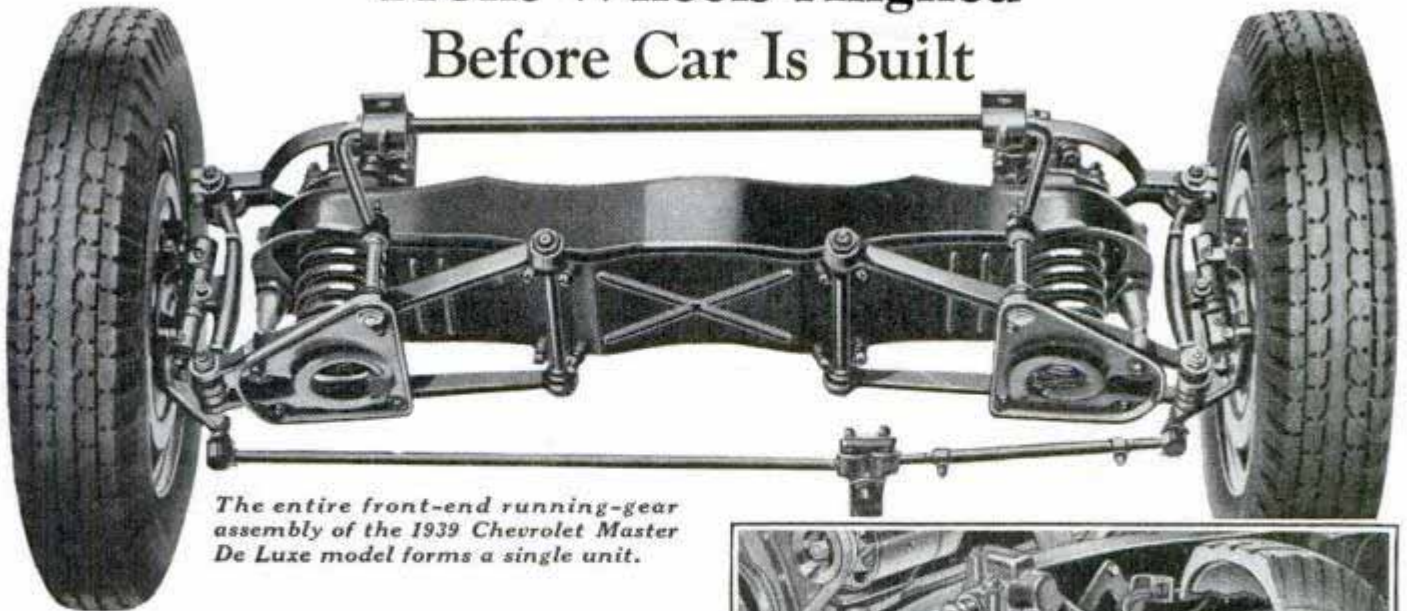

*The entire front-end running-gear assembly of the 1939 Chevrolet Master De Luxe model forms a single unit.*

With the adoption of a completely new design of Knee-Action for its 1939 Master De Luxe models, Chevrolet has put in effect a revolutionary improvement in motor car assembly systems. Instead of being added to the chassis piece by piece on the final assembly lines, the entire front end is assembled at the manufacturing plant at Detroit, and shipped as a unit, ready for bolting to the chassis frame at Chevrolet's assembly plants throughout the country. This system assures that every car will leave the line with its wheels aligned and its steering gear adjusted to the exact standards set up by the engineering department.

At the manufacturing plant in Detroit, each front-end unit is placed in an elaborate master jig which gauges every part and locates it accurately before the assembly is finally tightened up and its parts locked in permanent position. When the unit is bolted to the chassis frame at a car assembly plant, no further check is required to insure correct steering and wheel alignment. Ordinarily, these adjustments are made on the car assembly line, where variations in tires, tire pressures, front springs,

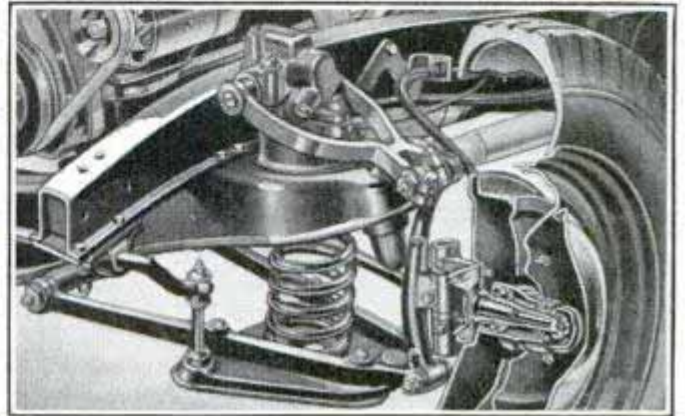

*Cutaway view shows the individual spring suspension, or Knee-Action, of the new 1939 Chevrolet Master De Luxe.*

etc., tend to prevent exact uniformity in the alignment and steering.

For service work, the entire front end—comprising the front cross-member, Knee-Action suspension, shock absorbers, torsional sway eliminator, king pins, steering knuckles and spindles, steering pitman arm extension and tie rods, hydraulic brakes and front wheels—may be removed as a unit without disturbing the original wheel alignment and steering adjustments.—Chevrolet Motor Division, General Motors Sales Corporation, Detroit, Mich.

**"CHEVROLET'S THE CHOICE"**

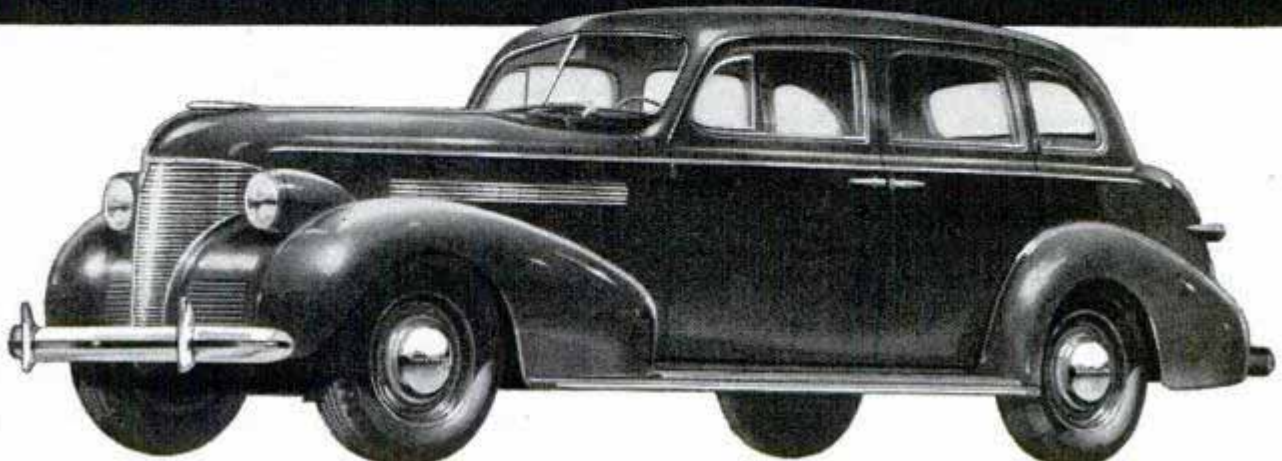

*When writing to advertisers please mention Popular Mechanics*



(Continued from page 116A)

out to be a hot day some of the drivers are going to be affected by the heat. They'll start to see things that they know are not on the track and they'll start to see spots in front of their eyes. That's the time to pull into the pits for a relief driver.

The last hour before the race is a long one. The nine o'clock bomb goes off and all cars are wheeled out on the track. From that time on the mechanics can't touch them for a last-minute adjustment or tune-up. There's not much for the drivers to do during the hour aside from having their group photograph taken.

Then, at a few minutes before ten, the mechanics come out with the oil and the battery cart. The oil supply has been heated to the bubbling point and it's poured in hot to save warm-up time. The mechanics plug the battery cart terminals into a socket to operate the flywheel starter. One

of them stows a vacuum jug full of ice water, with a long rubber tube, into the cockpit so that I can reach for a drink without taking my eyes off the track.

I climb into the seat, throw the switch, and touch the starter button. The motor fires, and I idle it at 1,500 revolutions per minute while I watch the oil-pressure-gauge needle come up to the mark. I watch the rest of the instruments, too, and I'm careful with the foot throttle until the whole motor has warmed up.

The pace car moves out in front and I fasten my helmet, tucking the goggles into place. All of the cars are rolling now but the race hasn't begun yet. One lap to go, with the pace car leading the way around the track. It pulls out of the lead as we start down the straightaway. The green flag drops, thirty-three throttles are kicked all the way down and the race is on!

## Guarding Your Gold

(Continued from page 575)

corps of the army. The Fort Knox Depository is probably the strongest, best guarded, least expensive, most sensible strongbox owned by any nation. In its vaults reposes over a fourth of the world's known monetary gold. Yet there are no secrets about it, and any modern Jesse James, any



Beyond the well-guarded gate lies Fort Knox Depository, "strongbox" for six billion dollars in gold

greedy gangster or envious foreign dictator can read all about it in public prints. Doing that, he would conclude it wasn't worth the risk trying to rob this vault even for six billions in bars of gold.

The Fort Knox Depository, which cost only \$560,000, is a squat structure tucked away in the hills. It is surrounded by an

iron fence and a moat crossed by a single drawbridge. Its ten-foot concrete base is so firmly imbedded in solid rock that not even an earthquake could jar it loose. The storage vault, about the size of a tennis court, is topped by a concrete bombproof roof and surrounded by every electrical and chemical safety device known. The steel I-beams imbedded in the concrete walls give off a deadly gas if touched with a blowtorch. The "pill boxes" are manned by guards with machine guns, gas guns and rapid-fire artillery rifles. The grounds are floodlighted all night, and in case of breakdown of its outside power source, the depository has a standby power plant of its own. The staff guarding the treasure could withstand a lengthy siege with their independent water source, kitchen and storeroom stocked with food. A corps of high-speed army tanks is detailed as the gold guard. In a pinch the vault can be completely flooded in such a way that invaders, if they ever did take this fortress, would find it impossible to get the gold for many days.

Since gold coinage ceased, all the twenties, tens and fives have been melted into \$14,000 bricks for storage. But silver coinage is booming. The record year in the

(Continued to page 120A)



# 4 ways You Save with Mobiloil



**Y**OU "ROB PETER TO PAY PAUL" when you use oil built to emphasize *one* or *two* good qualities! Engines are over 30% faster... 100° F. hotter... than a few years ago. They demand oil that resists wear, carbon, gum, "oil drag," *equally* well!

Mobiloil does that! It's distilled, refined, dewaxed, filtered, to give *Balanced Protection*.

**RESULT:** See the blackboard above. *Mobiloil* saves you money 4 ways! Socony-Vacuum Oil Co., Inc.

**MOBIL OIL** *For Balanced Protection*



(Continued from page 118A)

mint was 1919 when the stamping machines, each of which can knock out coins at ten a second, turned out 738,642,000 coins. Coinage dropped to 23,000,000 coins in 1933, last year was back to a half billion. The mint is now building a silver depository at West Point Military Reservation.

Finest money-making plant in the world today, is the mint completed within the last year in San Francisco. Laid out like an automobile factory, it is designed for manufacturing rather than storage, although it has two large vaults. The gold bars and "scrap"—fraternity pins, rings, lockets, watch cases, stick pins, dental fillings—that flow in through its receiving door keep on moving like an automobile on the assembly line. From the receiving room on the second floor, they move to the assaying rooms to be tested, into the melting and refining rooms for purification, and finally into the vaults for storage or, in the case of silver, for temporary safekeeping until they are rolled into long strips from which coins are stamped. People come in the front door, bullion at the rear. Both are protected by men and guns and gas. On the fourth floor is a precipitating system to settle the dust and catch fumes from the assaying and refining rooms, recovering each year about \$20,000 worth of precious metal.

The particular pride of the new mint is the shooting range on the top deck. When Mrs. Ross became head of the mint she discovered that not one employe in ten, even among the guards, was a good shot. She requires regular target practice with pistols and rifles for every guard and executive, and today the men who guard your gold are crack shots.

Although any citizen can walk in with a trinket containing an ounce or more of gold and sell it, the mint does not welcome sightseers. The director herself, arriving in San Francisco after hours one day, called at the old mint, gave her name to the guard and asked for admittance. He looked at her dubiously, shook his head and said:

"Madam, you may be the director, but I don't know you and I can't let you in."

So the boss had to go back to her hotel and make proper arrangements by phone.

It is an awesome experience to stand in the presence of two or three billion dollars worth of the glittering stuff. You see no

bags of eagles and double eagles, only bricks the size of small loaves of bread, stacked ceiling high on shelves. When you are permitted to lift a brick, you find it so hefty you would hate to carry one five blocks. In the old mint it was the practice to stack gold bars up like loaves of bread; however, when the bricks were slid into place, minute particles often scraped off. The gold must be accounted for in fractions of an ounce, each bar being weighed every time it is moved. These infinitesimal losses ran into enough to throw the accounting system off. Now each bar is stored in a wooden compartment by itself.

Moving such enormous quantities of gold from mint to mint taxes the ingenuity of mint officials, because obviously if some daring group of gangsters were going to stage a holdup, the time to do it would be when a shipment of 200 tons of gold bricks worth \$200,000,000 was in transit in city streets or on a train bound over the mountains. Although the mint passes the buck to the post office by shipping each brick in a separate mail bag by registered parcel post (which cost \$430,000 when the San Francisco gold was moved to Denver and even more when the New York supply went to Fort Knox), the mint, the army, police, postal inspectors and railroad detectives combine talents for discouraging crooks.

When the Fort Knox gold was moved, Superintendent Sigmund Solomon of the New York assay office had his men bring the bars one by one, each with a number corresponding to an entry in a registry book giving its weight, to a scale where it was weighed and checked into the hands of post-office employes. The latter slid each bar into a small mail bag and fastened it with a combination lock. The bags were stacked on dollies and rolled onto mail trucks. These traveled only at night, when the streets were empty, to the armored train where the dollies were pushed into mail cars. Through the streets of New York, the postal trucks were followed by fire department floodlight trucks and by army trucks bearing soldiers. At their side rode mounted police. The nine-car train in which were concealed crack machine gunners, sped over a secret route to Fort Knox, preceded by a dummy freight train. There the gold was met not only by mint

(Continued to page 122A)



# Flying Blind-4 FEET from DEATH

TROPIC DOWNPOUR BRINGS ADVENTURE TO ROUTINE FLIGHT



OLEN V. ANDREW

① "I had flown four friends over to Lihue, on the island of Kauai, for a weekend of camping on the beach," writes Olen V. Andrew, P. O. Box 3295, Honolulu, T. H.

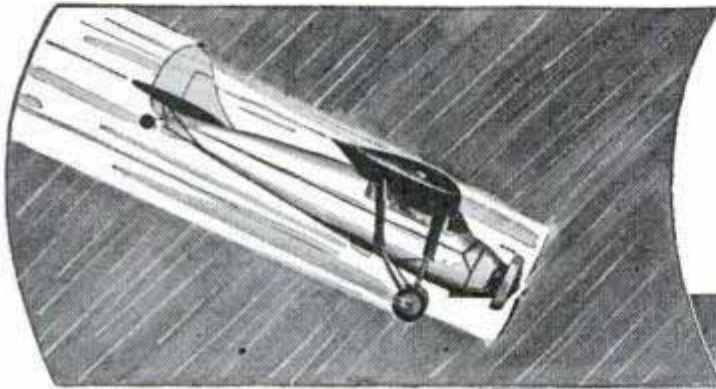
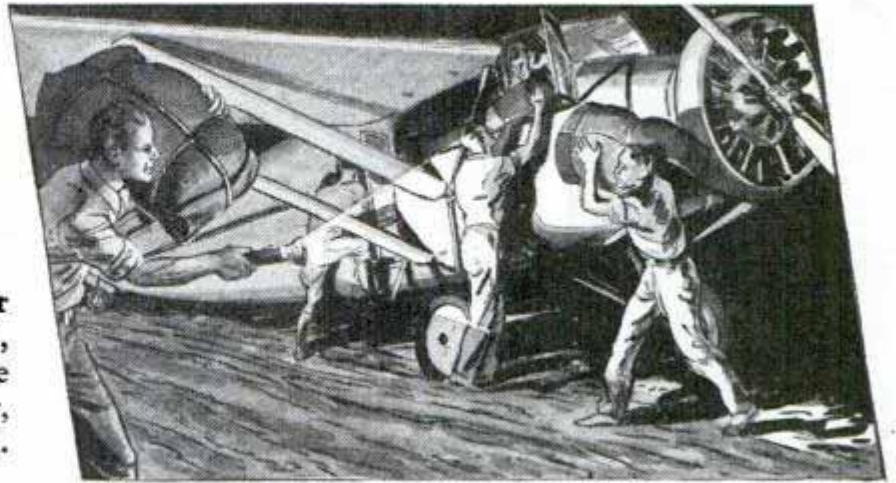

② "We broke camp at three o'clock Monday morning, packed our dunnage in the plane and crawled in for the 100-mile hop back to Honolulu, all of it being over water. There was no moon, but the night was clear when we started. Five minutes later..."

③ "... we ran into a driving rainstorm. I couldn't fly over it, I didn't have proper instruments for flying through it, so the only thing to do was to get down low and keep visual contact with the water. But it kept getting darker, the rain fell harder and harder, till we couldn't see the water below us. I handed my big 'Eveready' five-cell flashlight to the fellow in the co-pilot's seat, told him to hold it out the window and flash it below..."

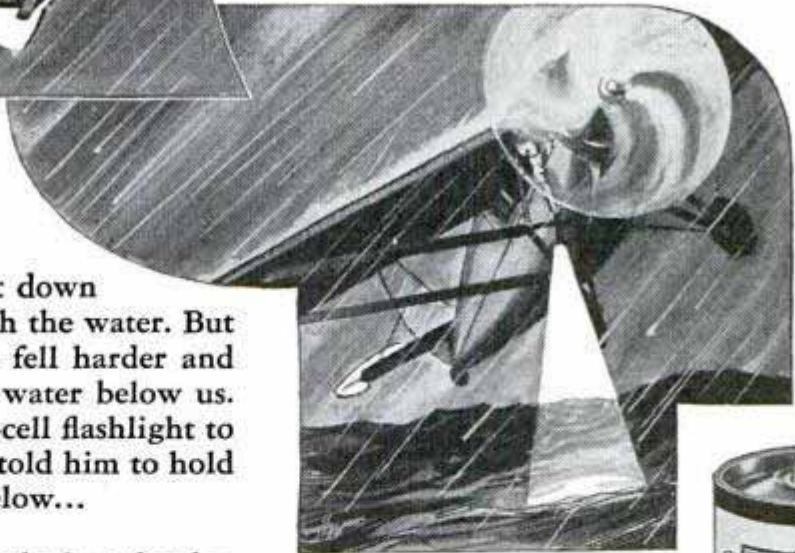

④ "... and there was the sea, only four feet below us! Those long Pacific rollers were almost lapping at the wheels! My heart skipped a beat to think how I had brought five people within inches of their doom! Certainly it was the power of those 'Eveready' fresh DATED batteries that saved us all, and that kept us safe above the sea for the next half hour till the storm lifted. You can take it from me, (Signed) Olen V. Andrew "I don't fly without 'em."

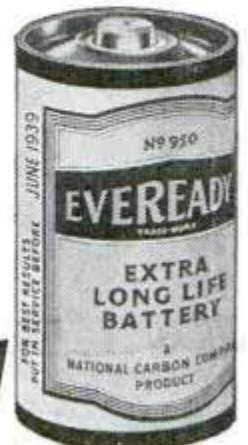

**FRESH BATTERIES LAST LONGER... Look for the DATE-LINE**

NATIONAL CARBON COMPANY, INC., 30 EAST 42nd STREET, NEW YORK, N. Y.

Unit of Union Carbide UCC and Carbon Corporation

When writing to advertisers please mention Popular Mechanics



H 1427

(Continued from page 120A)

# America's Greatest Movie Camera Value!



**NEW! FASTER  
f4.5 LENS!**

**NEW! Built-In  
VIEW-FINDER**

**\$15**

Prices Higher Outside U.S.A.

## USES 69¢ FILM!



Here's the new 1939 movie camera that gives you the simplicity of operation . . . the dependable performance . . . the thrilling life-like results you'd expect only from high-priced cameras.

So dependable is this new UniveX, with fast f4.5 lens and built-in optical view-finder, that we guarantee "satisfactory results, or a new roll of film free."

Movies are easy to take with the new UniveX . . . just as easy as taking snapshots! And with the 69¢ UniveX film roll, your movies actually cost less than snapshots!

It's America's greatest movie value, because UniveX makes more movie cameras than any other manufacturer. Ask your dealer today to show you the sensational, new 1939 UniveX with its sensational high-priced features. Many dealers now offer the new UniveX on convenient easy payment terms.

UNIVEX MOVIE CAMERA PRICES START AT

**\$9.95**

VIEW-FINDER



Features Like These Found Only In High Priced Models!

HINGED COVER



**Sensational New Guarantee Insures Your Movies!**  
"Satisfactory movies if instructions are followed or a new roll of film free."  
Your guarantee of perfect results with this \$15 camera.

UNIVERSAL CAMERA CORP. **FREE BOOKLET**  
Dept. C-2, New York City

Send me illustrated booklet which describes the New 1939 UniveX Cine "8" and its sensational guarantee.

Name

Address

City  State

**It's Smart To Own The  
NEW 1939 UniveX**

workers, but by a motorized cavalry brigade. Inside, each gold bar was stored in its individual cell, and the mail bags burned to recover any particles of gold that had scraped off onto the canvas.

Once in the world's greatest movement of gold a single bar was lost. It was the night of the first shipment. Figuring that Al Capone gangsters were in town (Capone had just moved to Alcatraz) and had outwitted them, the authorities prepared to ransack San Francisco. Then the driver of a mail truck drove up.

"Did you lose a bar of gold?" he asked. "One fell off the dolly and under my seat."

Old-timers in the mint can tell by the way it looks and feels where raw gold comes from. Regulations require that any seller of gold make affidavit where he got the metal. It is a temptation for anyone who has hoarded gold coins illegally to melt them for sale. The assay men quickly spot this gold and even tell raw gold from California, Australia, Alaska or New Guinea, after it has been melted. Some time ago a miner sent from Nevada several shipments of bars about which a San Francisco assay man was dubious.

"This doesn't look like Nevada gold to me," he insisted. "It's California gold."

Secret service men were asked to solve the mystery. They discovered that the miner panned his gold in California, but with a prospector's unwillingness to reveal his strike, he sent it to a friend in Nevada to be re-shipped to the mint.

The world's gold mines today yield about a billion dollars worth annually. A third of this comes from South Africa, another third from Russia, United States, and Canada, in the order named but in unequal quantities. Other countries combined produce the other third. But all the gold produced in the world this year will be less than a tenth of the treasure hoarded in the Fort Knox and Denver strongboxes, so ingeniously defended that about the only way they could be entered would be by an overthrow of the government.

Popular Mechanics Magazine can furnish the name and address of the maker of, or dealer in, any article described in its pages. If you wish this information, write to the Bureau of Information, inclosing a stamped, self-addressed envelope.



# HOW GOOD-LOOKING ARE *You* ON THE BEACH?

**SKINNY? HERE'S HOW  
THOUSANDS GAIN A NATURALLY  
ATTRACTIVE BUILD**

*Posed by  
professional  
models*



**THIN, TIRED, NERVOUS  
PEOPLE OFTEN GAIN  
10 TO 25 LBS., NEW PEP  
—QUICK**

**H**ERE'S the best news ever told for thousands of skinny, tired, washed-out men and women who are almost ashamed to be seen in a bathing suit—people who can hardly eat, sleep or work—people who are so weak and weedy-looking, so nervous and cranky they've almost lost all friends.

Now they can easily gain naturally attractive pounds, new pep and popularity often in just a few weeks—by taking these pleasant little Ironized Yeast tablets.

And it's easy to understand. Scientists have discovered that hosts of people are thin, rundown and nervous simply because they don't get enough Vitamin B and iron from their daily food. Without these vital substances you may lack appetite and not get the most body-building good out of what you eat.

But now you can get these exact missing substances in these easy-to-take little Ironized Yeast tablets. And the improvement they make in a short time is often astonishing. Thousands have gained 10 to 25 pounds of naturally good-looking flesh in just a few weeks. Their tired feeling and nervousness seem to have just flown away. They're full of pep, look like new persons, and are more popular and happy in every way.

### Make this money-back test

Get Ironized Yeast tablets from your druggist today. If with the first package you don't eat better and **FEEL** better, with much more strength and pep—if you're not convinced that Ironized Yeast will give you normally attractive flesh, new energy and life, the price of this first package will be promptly refunded.

Only be sure you get genuine Ironized Yeast, and not one of the cheap, inferior substitutes often offered which do not give the same results. Be sure to look for the letters "IY" stamped on each tablet.

### Special offer!

To start thousands building up their health right away, we make this special offer. Purchase a package of Ironized Yeast tablets at once, cut out the seal on the box and mail it to us with a clipping of this paragraph. We will send you a fascinating new book on health, "New Facts About Your Body." Remember, results with the first package—or money refunded. At all druggists, Ironized Yeast Co., Inc., Dept. 534, Atlanta, Ga.

**TUNE IN ON THE GOOD WILL HOUR**, every Sunday Evening. Your newspaper gives time and station.



ARE YOU  
LIKE THIS?

OR THIS?



# Painting Pictures with Light

(Continued from page 549)

flash here and there, instead of in unison, and automatic dimmers made their glow die away gently like real bugs. For the



*Powerful searchlights on shore miles away paint Golden Gate bridge with golden glow*

"fairy flames," Olesen designed a huge "cannon" projector with a barrel nearly ten feet long. A combination of lenses narrowed the beam down to a needle point so small that the operator, situated on a hilltop a block away, could play it on only the hands and arms of the actress, causing the "fairy wings" to gleam brightly against a darkened background.

The premiere of "In Old Chicago" naturally suggested a fire effect. Olesen rigged up two portable boilers, laid down a curtain of steam across the entire face of the theater building, and flooded it with red light. Motorists flocked to see the burning building and several fire alarms were turned by excitable neighbors. For the

opera "Die Walkure" in the Hollywood Bowl, his men shot burning butane gas, under high pressure, in jets forty feet high.

When the Golden Gate bridge at San Francisco was completed, Olesen got a hurry-up call to light its eight-mile span and approaches. With less than three days to get ready, he rushed in portable equipment—a huge battery of floodlights to light the guard rails and safety nets; clusters of high-powered beam projectors to push the light up 800 feet to the top of the tower; and at a point on the shore, a score of long-range searchlights with diverging lenses to lay a narrow sheet of light across the water and paint the bridge with a golden glow. During the preliminary testing, residents were amazed to see a perfect image



*Adjusting carbons of a huge sun arc. Notice the perfect reflection in mirror behind the arc*

of the bridge towers reflected upon the misty sky as twenty-four billion candlepower flooded the span.

# Heroes of the Radio "Flash"

(Continued from page 565)

scientists and U. S. navy experts some 8,000 miles to Canton Island in the South Seas. One fifteen-minute broadcast was made, but it was in connection with the longest eclipse in 1,200 years, so the radio officials thought the trip worth it.

Frequently, special events on the air are literal lifesavers. An ex-navy officer joined NBC's technical staff and, together with other technical men, spent a month in figuring out a way to broadcast a program

from a submerged submarine. It involved sending a coaxial cable up through the periscope of the submarine after it had submerged in order to get the antennas above the surface. The actual broadcast took only five minutes, but it foreshadowed the possibility of better communication with submarines sunk by accident.

The special events broadcasters cannot rehearse their programs and occasionally a

(Continued to page 127A)





Half an hour late **ALREADY!**

Replace your battery **BEFORE**  
it breaks down—**NOT AFTER**

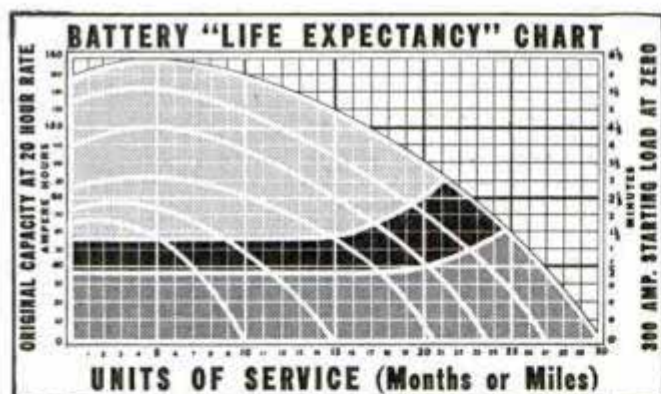

You know that feeling when you rush out to the car in a hurry to get to work—step on the starter—and nothing happens! Nearly everyone has experienced it at one time or another, because batteries *do wear out*. Developments and improvements during the last ten years have greatly extended their useful life, but the fact remains that no battery can last forever!

No one wants to waste money on a worthless battery, and no one wants to give up a battery that still has plenty of service left in it but is simply “run-down” because of improper generator adjustment or defective

wiring. The Delco Battery “Life Expectancy” Chart was prepared with this in mind. It provides a check on your battery that will save you money and inconvenience!

The Delco Battery “Life Expectancy” Chart shows you how many months of service are left in your battery, based on its original capacity and the units of service it has given. The information for this chart was obtained after extensive research to determine the average life of various capacity batteries. Ask any Delco dealer to show it to you, and let him demonstrate how it works with your own battery. If you are interested in studying this chart, he will give you a miniature edition for your own use.

*Unsolicited letters from car owners in every part of the country testify to the exceptional service received from Delco batteries. Outstanding dependability under all operating conditions explains why Delco batteries are standard on all General Motors cars and trucks.*



# Delco-Remy

ANDERSON, INDIANA

Delco battery sales and service requirements are available at United Motors Service Stations and dealers everywhere.



**World's Largest Manufacturer of Automotive Electrical Equipment**

*When writing to advertisers please mention Popular Mechanics*



**SEE WHAT Atlas ENGINEERS HAVE DONE FOR YOU**

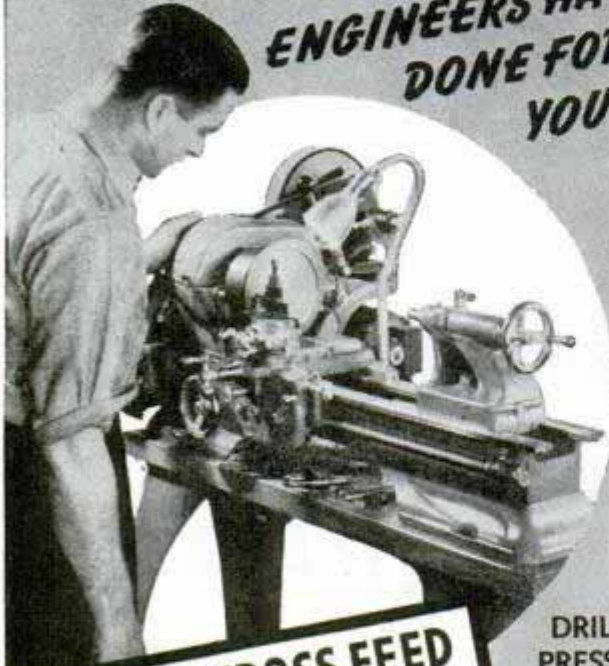

**POWER CROSS FEED NOW STANDARD EQUIPMENT**

DRILL PRESSES



SHAPERS

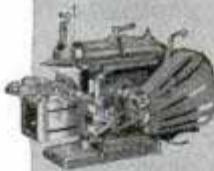

NEW 6" LATHE



1939 CATALOG



Your dealer has a big surprise in store for you—the new Atlas F-Series 10" Lathe—first low-cost precision lathe with power cross and longitudinal feeds as standard equipment!

It's the sweetest running lathe you've ever seen—complete V-belt drive, quick-change countershafts, compact controls, precision-ground bed ways, custom-built spindle bearings, back-gear power, and many other modern features. Prices, complete less motor, are \$104.75 for horizontal countershaft, \$99.75 for vertical countershaft. Ask your dealer to show it to you and explain the low monthly terms.

**FREE**

Send the coupon below today for the big new 72-page Atlas Shop Equipment Catalog.

**ATLAS PRESS CO.**  
443 N. Pitcher St.  
KALAMAZOO, MICHIGAN

ATLAS PRESS CO., 443 N. Pitcher St., Kalamazoo, Mich.  
Send me your 1939 Catalog describing:  New 10" Metal Lathes  New 6" Metal Lathe  New 7" Shaper  Drill Presses  Arbor Presses  Wood Lathes

Name .....

Address .....

City and State .....

When writing please mention Popular Mechanics

**Free Catalog**



Ready March 8

Fully illustrated, showing special footwear and clothing for fisherman and camper, also special fishing tackle.

L. L. BEAN, Inc., 33 Main Street, Freeport, Maine

**FISHERMEN prefer this NEW BAIT!**



Thousands know the WEEZEL Streamlined Feathered Minnow gets fish! Many exciting colors, 3 sizes: Casting; Fly Rod; Muscle-Saltwater. At all dealers. Folder Free—write THE WEEZEL BAIT CO., Dept. T, Disney St., Oakley, Cincinnati, O.

**WEEZEL LURES**



**DRIVE ANY ROUTE On the Map**

You can follow any directions with a Hull Auto Compass on your windshield. Drivers everywhere depend upon it to get them there on time, and by the shortest route. It shows your direction of travel at all times, in any weather. Only \$2.95 at your dealer. Two-piece model \$1.95. Write for circular.

HULL MFG. CO., P. O. Box 246-D12, WARREN, OHIO

**PIONEER NON SINKABLE BOATS**



13 Models—35 Sizes—\$25 to \$167.50  
Time tested for 28 years—America's outstanding values in Row Boats, Fishing, Hunting, Outboard and Inboard, Ice, Sail and Play Boats! Always ready to use! Endorsed by leading summer camps and resorts! Send post card for 24-page Catalog! It's FREE!  
PIONEER MFG. CO., 414 PERRY ST., MIDDLEBURY, IND.

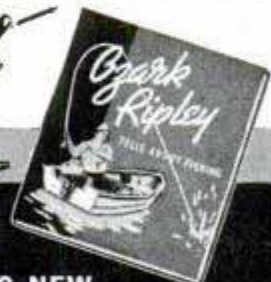

**FISHERMEN GET THIS THRILLING NEW BOOK ON FISHING Free!**

"Ozark Ripley Tells About Fishing." Page after page of thrills covering all types of angling—written by Ozark Ripley, master fisherman. Also valuable information on outboard motors and boats. Write for your copy. Free! JOHNSON MOTORS, 1211 Pershing Road, Waukegan, Ill.



(Continued from page 124A)

stunt does not work out as planned. From a point 420 feet below the surface of Lake Michigan—the greatest depth ever reached by a person clad in a flexible diving suit—Max Gene Nohl attempted to give the radio listeners a description of what he could see. The only hitch in the setup was that he could not see more than six inches in front of his helmet. He spoke through a microphone fastened in his helmet and connected to the deck of a cutter by telephone lines.

Scoops on international broadcasts are frequently made by the quick-thinking

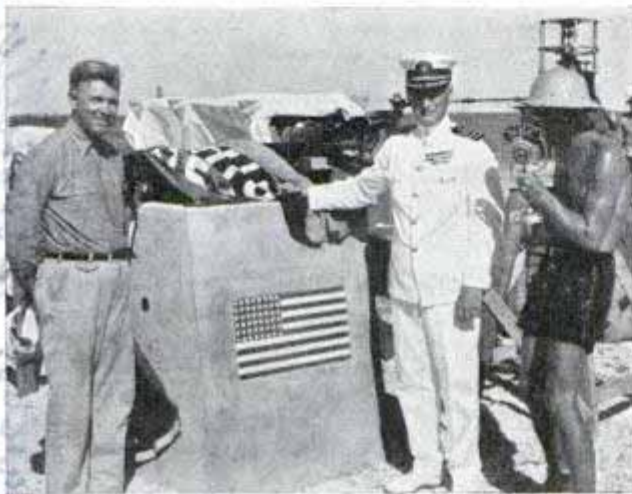

© National Geographic Society  
Special broadcast of eclipse being made from Canton Island in the South Seas

foreign correspondents. Foreseeing a certain development in a crisis, the newscaster will arrange his program. It will be sent out from a short-wave transmitting station in Europe over a directional beam aimed at the receiver in America. Although this program can be heard by other short-wavers, no one is permitted to rebroadcast it if the sender has arranged for a point-to-point service.

Since the days of the earliest transatlantic experiments, NBC engineers have kept world-wide charts and records of atmospheric conditions, variances in the magnetic field, effects of sunspots, of daylight and dark, and of the seasons of the year. So thorough has been their study that they are about ninety per cent accurate on their forecasts of good reception conditions.

The value of these records and experiments has been shown repeatedly. Many of the overseas broadcasts are handled with the smoothness of domestic programs and few are disturbed by static or made inaudible by fading.



... in  
the house



. around  
the car



. working  
outdoors

You'll find  
Scores of Uses for the  
NEW "HANDY" FILE



2 files  
in 1



The new Nicholson "Handy" File is safe to carry in your pocket . . . convenient to hang up in your garage or shop. One side is an 8" double-cut file for fast metal removal; the other side, an 8" single-cut file for tool sharpening and finishing jobs. Convenient brilliant orange self-handle, with handy hang-up hole. Cellophane-wrapped, at your hardware store. If your dealer hasn't one in stock, ask him to get you the new Nicholson "Handy" File—easily recognized by its brilliant orange self-handle. Nicholson File Company, Providence, Rhode Island, U. S. A.

A FILE FOR EVERY PURPOSE

**NICHOLSON**  
PIONEERS IN  
QUALITY PRODUCTION

75<sup>th</sup>  
ANNIVERSARY  
YEAR





# Color "Spies" Join the Army

(Continued from Coloroto Section)

photographers in the field can handle their own films. Another part of the experimental program is the development of new color films and filters even faster and of greater fidelity. In this program large felt panels, each dyed a different color, are laid on the ground and are photographed from the air at different altitudes by means of a multi-lens camera. The best filters to use at each altitude are determined in the laboratory by matching the finished color films with samples from the cloth panels.

Less than ever before can armies conceal their actions from the prying eyes of aerial photographers. If a commander is suspicious that enemy troops and supplies are being moved under cover of night, a photographer can make a flashlight picture from the air that will reveal any movement below. Instead of an ordinary flash bulb the photographer uses a giant flash bomb, the camera shutter automatically tripping after the bomb release has been pulled and the bomb, safely away from the plane, has exploded. Such a powerful charge of powder lights up the countryside and provides enough illumination for a clean-cut picture that reveals every detail of the ground.

Movements of an enemy fleet at sea, concealed in haze or fog, may be detected with infrared film that has the ability to obtain an image of objects hidden to the eye. Ships fifty miles away and invisible to the cameraman can be picked up on the film. A present difficulty is that infrared film is quite slow. It is expected that research will increase its sensitivity so that shorter camera exposures may be made.

Such developments are forcing the camouflage corps to seek new color schemes and patterns for concealing ground objects. Concealment without disturbing or adding to natural features on the ground is hard to achieve and the development of color photography has intensified the problem. Airports and batteries of large guns are harder to hide than ever and probably the best solution will be to have a number of alternative fields and gun positions so airplane servicing equipment or the guns may be moved to new positions frequently.

Hiding airplanes in the air is receiving a lot of study and in the army today there is

a continuous seesaw game between the air corps and the anti-aircraft units. Month after month, anti-aircraft guns and crews are sent to military airports for practice maneuvers, the idea being to learn whether bombers can conceal themselves from the ground and still achieve their mission, or whether modern anti-aircraft equipment can locate them in the air and beat them off. Right now, under some conditions, the bombers seem to be ahead. Burnishing the under surfaces of the wings and fuselage with silver polish helps make a bomber visible in the daytime or in the beam of a searchlight, but it also creates such a glare that it is difficult for a man at a range finder to learn the plane's altitude. Painting a bomber with dull lamp black makes it completely invisible from the ground at night even at normal bombing altitudes, and searchlight beams can sweep across the camouflaged plane time after time without detecting it. Exhausts are mounted above the wing on a bomber, instead of below, to hide exhaust flames from the ground.

Camouflaging for daylight operations is difficult and the present idea is that an airplane should be specially camouflaged for each flight, its altitude, the time of day, and other considerations determining just what sort of deceptive coating should be applied. In a general way an airplane is camouflaged like a fish, dark above and light below, so that no matter whether an observer is above or below the plane its outline will fade into the background.

## "Free-Wheeling" Plane Propeller Does Not Turn Dead Engine

When an airplane engine goes dead damage may be increased if it is turned by the windstream acting on the propeller. To meet such occurrences, a "free wheeling" propeller that can spin freely without turning the engine has been developed. It consists of a one-way drive designed so the propeller may be turned by the engine but cannot work the other way around.

Send return postage to our Bureau of Information to learn the name of the maker of any device described in this magazine.

1304

propeller engine  
part in New York City  
Calswell, Corp. 200  
J-2  
W. J. Rand  
United Aircraft





## THE AC HEAT RANGE SYSTEM: WHAT IT IS, HOW IT WORKS, AND HOW TO MAKE USE OF IT

To give good performance, spark plugs must operate within a certain temperature range. In relation to engine operating temperature, they must "run" neither too hot, nor too cool.



### If they run too Cool

—they will rapidly collect soot and carbon. These cause fouling and misfiring.

### If they run too Hot

—the insulator may become encrusted, the firing points may wear rapidly, or the overheated plug may cause habitual pre-ignition.



Through the AC Heat Range System, the temperature range of *any* AC plug can not only be predetermined but it can also be definitely charted. Once charted, that temperature range can also be designated. Thus, spark plug users can know, from the designation, the heat characteristics of one AC plug as compared with another. A shift to a cooler or hotter plug type becomes, consequently, a simple matter.



**77** What's behind the numbering system? It's very simple.

AC uses numerals to designate the temperature range—and uses them like the graduations on a thermometer. A type 75 is hotter than a 74; and cooler than a 77. A 28 is hotter than a 26. A 44 is cooler than a 47.

### The Basis of Heat Range

Spark plugs are cooled by radiation. The heat they take on travels up the insulator to the spark plug shell; from the shell to the cylinder block;

from the block to the water in the engine jacket.

The illustration tells the story. →

The short insulator cools faster because the heat travels a shorter distance to reach the spark plug shell. The long insulator cools slower because the heat travels a longer distance.

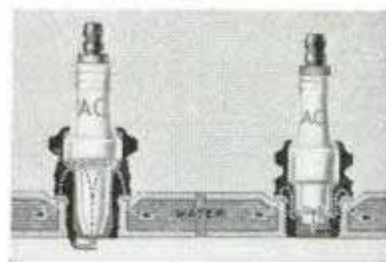

So, you can see that the heat range of an AC Spark Plug is mainly determined by the length of that part of the insulator up which the heat must travel.

### Here's the Important Point

Only AC Spark Plugs are made in a heat range which is *complete* for all sizes of plugs.

If you find that your plugs *foul*, or become encrusted, firing points wear quickly or pre-ignition develops, go to any Registered AC Plug Cleaning Station and have the attendant see that you have the right plug type. It won't take five minutes—and correction *will* give you the engine performance you want.

Have the Plug Type checked while you're getting your spark plugs cleaned (cleaning costs 5c a plug)





# Hunting Live Treasure

(Continued from page 523)

are sent out from New York and Hanover to trap animal treasure, and between twenty-five and thirty collectors are dispatched to the wild animal marts at Surabaya, Java, Singapore and elsewhere to purchase specimens caught by independent trappers and natives.

"Just how great the risks are may be judged by an expedition of eight collectors that we sent to Abyssinia a few years ago," said Mr. Krone. "They were to bring back a number of zebras and other fairly common wild animals as well as to try capturing a wild ass, which, of course, would



*Here's how the giraffe is crated for shipment so that its neck will not be cramped*

fetch a considerable price. Haile Selassie, then Emperor, sent an official representative along to expedite matters.

"The expedition went into what was regarded as safe territory, only to be caught between the lines of two warring tribes. Things got more and more dangerous and when the two tribes combined to exterminate our men, it was high time to call a halt to their activities. All that expedition brought back was one baby lion—and that cost us more than \$10,000."

One of the most skillful of the Ruhe collectors is Phillip Carroll, who is on a long trip to Africa to try to fill the order for the okapi of which there only three in captivity. Its quest is taking him to the nearly

inaccessible Ituri Forest in the Belgian Congo, but before he starts active trapping he must procure a capture permit from the Belgian government. This costs approximately \$1,200 and an export fee is \$600.

"Most governments charge high for tapping their jungle treasure chests," says Mr. Krone. "In some cases where very rare specimens are involved the collector may be prohibited from exporting the animal at any price. Such is the situation with the Indian rhinoceros of Nepal."

There is a ban on exporting the rare African white rhinoceros, even if a trapper should be fortunate enough to capture one, as it is estimated that there are only 200 of these in existence.

"There are difficulties to be encountered at every step from the first placing of the order to the final delivery to the customer," says Mr. Krone. "Whenever possible, we utilize the latest offerings of science adapted to our work, but science, unfortunately, hasn't been greatly interested in animal treasure—until after it has been trapped and is ready for exhibition.

"On this side of the Atlantic it's another story. On Long Island, almost a stone's throw from the city, we have a wild animal farm containing several acres of pens and cages, scientifically heated and hygienically cared for. On this farm, much of the animal treasure is boarded pending its shipment to zoos."

So matter of fact do the Ruhes regard this adventurous business that they even have a catalogue listing some of the numerous "open order" stock, popular sellers in the animal world, which they are ready to ship anywhere, f.o.b. New York, at short notice. Included in the catalogue are Tibetan sun bears, Tasmanian devils, Borneo cassowaries, Siberian tigers, gorillas and a great many other exotic beasts and birds.

Airplanes and even dirigibles have been used by the Ruhe firm to speed animals to their purchasers, in marked contrast to the slow, tedious journey from their jungle homes to the New York farm.

"A few years ago we had a European rush order for American antelope," says Mr. Krone. "We completed the transaction promptly by flying them from Wyoming to New York and then shipping them across the Atlantic on a Zeppelin."



## THE STRANGE CASE OF MR. L. D. ROGERS . . .

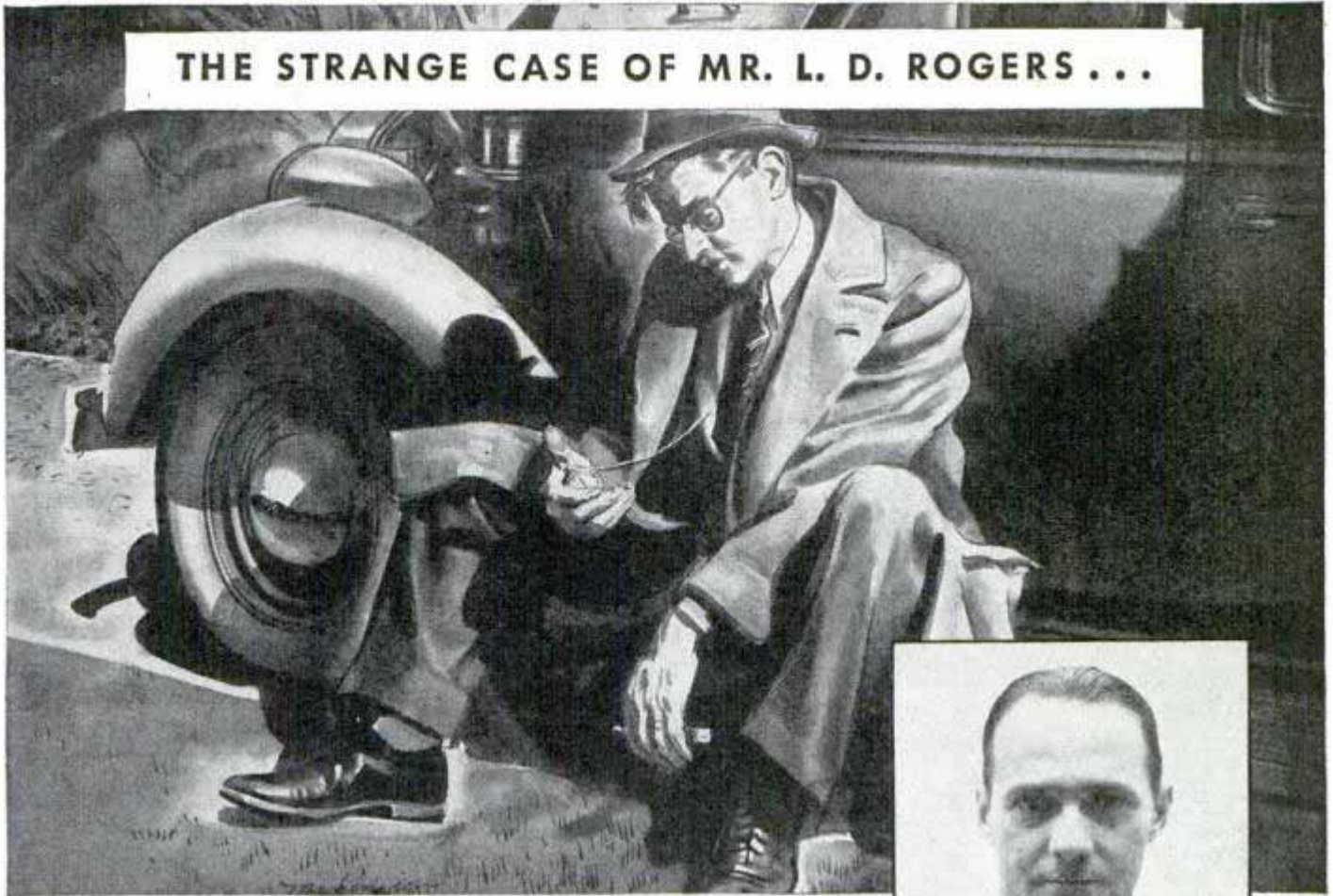

MR. L. D. ROGERS  
Monroe, La.

**"It always happened  
when I was in a hurry!"**

"Four months ago I began having starting trouble—and it *always* seemed to happen when I was in a hurry!

"I took my car to one garage after another. Each time they'd recharge the battery and tell me it was O. K. And each time I'd have another starting failure in less than two weeks. It seemed even the most experienced mechanics couldn't locate the REAL trouble.

"Finally, a friend told me about *Willard Starting Service*. Doubting but desperate, I agreed to try once more. I went to your Willard Dealer here.

"Believe it or not, in 15 minutes he checked the ENTIRE electrical system of my car...located the trouble (which wasn't in the battery at all) and fixed it so it stayed fixed. In my opinion you have made a real contribution to American motoring with this new *Willard Starting Service*. It's great!"

### Here's How It Can Protect You

Your Willard Dealer has a new instrument (called the *Willard Electrical Check*) that "x-rays" the entire starting system—under actual load condi-

tions. With it he can locate worn or undersize cables, loose connections, faulty wiring, voltage regulators and generators that need adjustment . . . the things that cause most starting failures.

*We offer you this Willard Starting Service, as our way of EARNING your patronage. It will save you money—save you trouble—and relieve you of worry . . . come in and try it.*

*Your Willard Dealer*

*You can identify our station  
by this sign.*



**STARTING  
Willard  
SERVICE**

If you are interested in the "why" and "how" of the instrument that makes this service possible, send a letter or postcard to Willard Storage Battery Company, Dept. M-4, Cleveland, Ohio.



H1454

# FREE NEW KIND of INFORMATION BOOK:

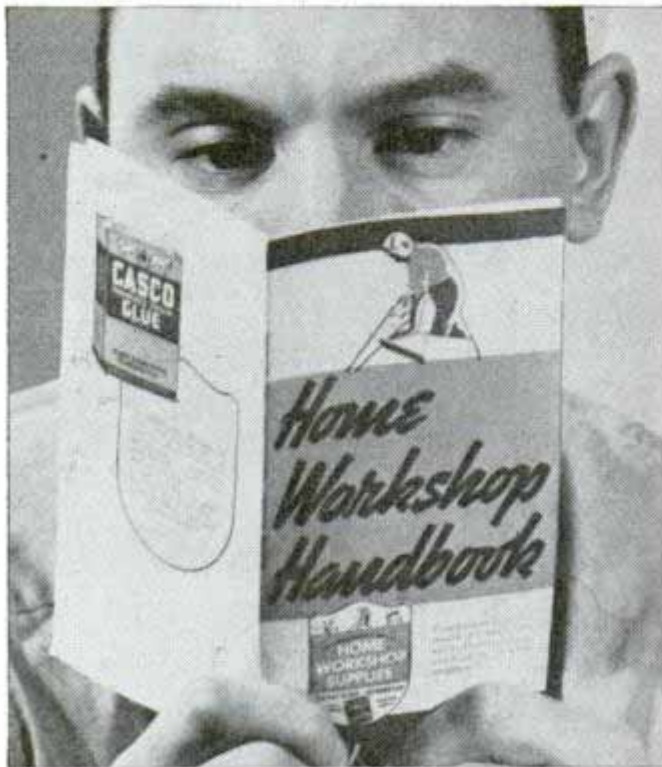

## Tells how, where to get expert advice on TOOLS, FREE PLANS, FINISHES, GLUING

It answers such questions as:

- What shall I make?
- Where can I get plans for making things?
- What useful booklets can I get on the use and care of hand tools?
- Where can I learn about fine cabinet woods and veneers and can they be bought in small quantities?
- Where can I get helpful hints on finishing my projects?
- How do I go about joining a home workshop club? Etc., etc., etc.

Here is the first handbook ever to contain all this information.  
Send for your copy today. Use coupon below.



The Home Workshop Handbook is sent  
you FREE with the compliments of

# CASCO

POWDERED CASEIN GLUE

10c to 65c at your Hardware,  
Paint or Lumber Dealer's.

Casein Company of America  
Dept. PM-439, 350 Madison Ave., New York, N. Y.  
Yes, I want a "Home Workshop Handbook".

Name.....

Address.....

-----SAVE 2c, stick coupon on penny postcard-----

## Peace Officers of the New West

(Continued from page 517)

capped in the mountains and desert and Shay's staff is hand-picked for the territory. Some of his men such as Art Manning, former rodeo champion, are ex-cowboys, others are veteran peace officers who have served since the '90s, while others are specialists of the police laboratory kind. Shay is the modern G-man type with a background of western justice, since he is following in the footsteps of his father and an uncle who were sheriffs in the same county while he was still a deputy.

Rough-riding and fast-shooting as the sheriff and his staff are, they have a reputation for scientific crime detection. Fourteen murderers were in jail at the same time a few years ago, and only two were later released. In 1937, not one major crime in the county went unsolved. In an unofficial national survey by a government body Sheriff Shay's office was given second highest honors in criminal detection and apprehension.

An unidentified corpse is difficult to trace back and hundreds are found and listed as "unknown" every year in the United States. Yet when a murdered man was found in the desert with every possible means of identification removed from his clothing the sheriff's office did not give up. No one resembling the corpse had been reported missing. A second minute search of the pockets, after every other attempt at identification had failed, revealed a scrap of paper twisted almost into pulp. Penciled marks on the paper were illegible, but in the laboratory the officers were able to decipher a few words that seemed to relate to the telegraphic transfer of money between two banks.

That started a long hunt. Every bank in the desert country was checked. Finally, in Salt Lake City, a banker said he had given advice on a money transfer to a young Englishman, en route from Detroit to Los Angeles as a passenger in a car driven by another man. One clue led to another. The money had been transferred to a Los Angeles bank and had since been withdrawn by a person answering the description of the driver. It was almost a perfect crime, but the driver was caught.

Another difficult identification case con-

(Continued to page 135A)





**BALL JOINT \$1.75**  
**AUTO TRAILER COUPLER**  
 Rocky Mt. States West, \$2.00. Postpaid  
**ADJUSTABLE \$1.35**  
**BUMPER HITCH**

This hitch can be put on, taken off, or adjusted to 6 different positions with a wrench. Postpaid. \$1.35 without ball. (Rocky Mt. States West \$1.50.) Write for catalog on trailer hardware and camping trailers.

**We Specialize in Trailer Axles—**  
 Either with or without Brakes



**ZAGELMEYER AUTO CAMP CO.**  
 1494 S. Henry St. Bay City, Mich.

**30¢ BUYS CLASS & CLUB PIN! RINGS!**

SMART, up-to-the-minute designs. Pins in 2 colors with any 3 or 4 letters and year. Handsome Sterling silver rings. Oldest, largest makers; famous for quality for 44 years. Clean cut work distinguishes Bastian Pins and Rings anywhere. Write for new catalog today!

**BASTIAN BROS. CO.**  
 Dept. 73 Rochester, N.Y. **\$1.40**

**RE-STRING RACKETS AT HOME**  
**EARN MONEY.**



It's pleasant, profitable work. No experience or skill required. Easy to learn. Full line of guaranteed Stringing Tools, Frames, Gut and Silk Strings. Every item high quality. Write for complete information.

**FREE** Write for our 1939 Catalog and instruction sheet.  
**W. A. BICKEL & CO., 137 N. Marion, Dept. A-49, Oak Park, Ill.**

**CASH IN QUICK**  
 ALL OR PART TIME—MEN AND WOMEN—MAKE EASY MONEY SELLING  
**GENUINE LEATHER TIES**

4-in-Hands and Bows, for Men and Boys. Beautiful patterns and colors. LOOK LIKE SILK. Won't wrinkle. Wear indefinitely. Cleaned with a damp cloth. Big profits; repeat orders. No sales ability needed. Big leader in necktie sales. Send 50 cents for sample kit. Information free.

**CENTURY TIE CO., Mfrs., 2345-P W. Grand Blvd. Detroit, Mich.**  
 (Originators of Leather Ties)

**PHOTO ENLARGEMENTS**  
**5¢ ANY SIZE**

Is Photography your hobby? Do you want a profitable spare business at home? Make **PHOTO ENLARGEMENTS** for yourself and others. Your cost 5¢ each and less. The Ideal Photo Enlarger is **AUTOMATIC**. No experience required. Also **COPIES** any picture. **\$5.94 COMPLETE**. Interesting circular **FREE**.

**IDEAL-O, 122 East 25th Street, New York City**

**KINKADE GARDEN TRACTOR**  
 and Power Lawnmower

A Practical Power Plow and Cultivator for Gardeners, Suburbanites, Florists, Truckers, Nurserymen, Fruit Growers

**Low Prices - Easy Terms**  
**American Farm Machine Co.**  
 1058 33rd Av. SE. Minneapolis, Minn.

Catalog free

**ENGINES**

A real money maker for farm or factory. Uses Cheap fuels. Pays for itself out of savings. Costs Less to Own—Less to Operate.

**LOG SAWS**

Make Money—Start a wood sawing business—turn spare timber into cash. Cash or Terms—Engine and Saw Catalog.

**WITTE ENGINE WORKS**  
 1744 OAKLAND AVE. KANSAS CITY, MO.

**A BUSINESS OF YOUR OWN WITH AN IDEAL LAWNMOWER SHARPENER**

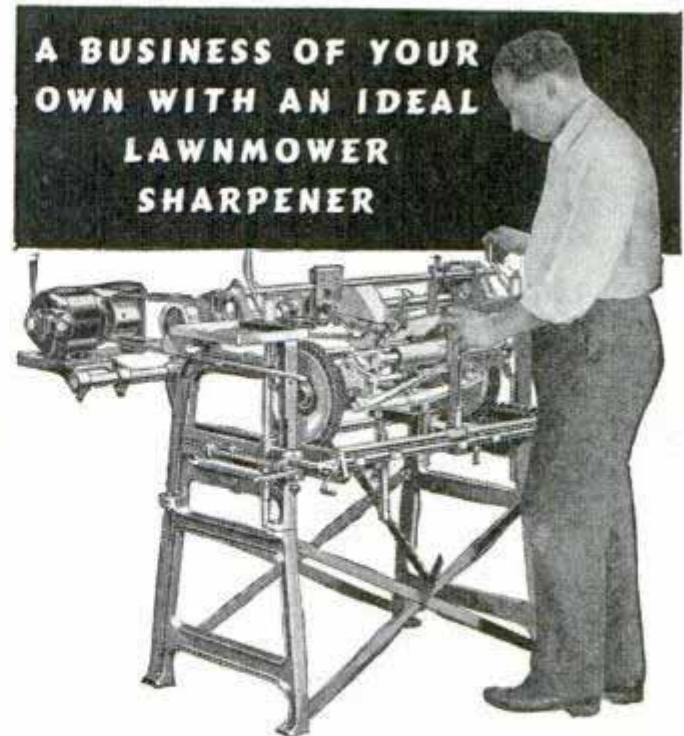

**Be Independent! Hundreds Now Have A Profitable Business of Their Own—So Can You!**

Our free plans show you how to build a successful business of your own sharpening lawnmowers. Most men earn up to \$25 a week. Roy F. Stier, Wis., writes "I paid for my Ideal Sharpener in exactly 36 days and have to-date sharpened 200 mowers at \$1.25 each. I live in a village of 500 people." Howard Hellen, Minn., writes, "I sharpened 745 lawnmowers, sold 60 used mowers and grossed \$1,100.00 from April 5 to Sept. 15." A. M. Larsen, Utah, writes, "We average 9 lawnmowers a day." Chas. H. Chism, Ohio, writes, "I have had as high as 30 mowers come into my shop in one day." P. G. Armour, Pasadena, Calif., writes "We get \$1.00 for small 4-blade machines, \$1.25 for 5-blades, \$1.50 for large mowers."

**EARN GOOD MONEY**  
 Full Time or Spare Time

Like magic, the Ideal Lawnmower Sharpener makes old, dull, badly worn mowers cut like new. Set the mower in the Ideal, make a few simple adjustments, and the machine does the rest. Sharpens any mower to a perfect edge in 15 to 20 minutes—usual charge \$1.00 to \$1.50. Customers come back year after year. Positively no experience necessary. Attach to light socket. Start in your basement or garage. Work in spare time only if you wish. Attachments for grinding skates, grass shears, hedge shears, sickles, scythes, and axes. **FREE CATALOG** tells complete story.

**FREE BOOK**  
*tells how*  
**TO MAKE UP TO \$25 PER WEEK EVEN IN SPARE TIME**

SEND POST CARD FOR FREE BOOK  
**The Fate-Root-Heath Co.**  
 449 Bell St., Plymouth, Ohio.

*make money--*  
**SHARPEN LAWNMOWERS!**





# WET CELLARS MADE DRY from the Inside!

**D**AMP musty cellars are unsanitary, a danger to health and a poor place to store valuable material.

Where water or moisture seep in through cracks or porous spots in the floor or walls, you can make and keep your cellar dry and sweet—a fit place to work, free from odor, mold and rust—by filling the cracks and coating the moist surface with Smooth-On No. 7.

This is the one practical waterproofing that you can apply yourself, easily, from the inside, to wet or dry surface and with every assurance of thorough water-tightness, even in the wettest seasons.

Excellent also for patching concrete floors, waterproofing garage, stable and washroom floors, brick walls, cisterns, septic tanks, water troughs, fountains, fish ponds, swimming pools, manure pits, etc.

About 25 pounds of Smooth-On No. 7 are required for each 100 square feet of surface covered, and no experience is necessary. Complete instructions on the package.

Sold in 5-pound cans and 25, 50 and 100-pound kegs.

## Mail Coupon for FREE HANDBOOK

This booklet explains all Smooth-On compositions and is filled with simple instructions and diagrams for making many household and automobile repairs—all with least effort, time loss and expense. Every professional repair man and home worker should have a copy for guidance in stopping leaks of water, steam, gas, etc., tightening stripped wood screws, loose nuts, etc., anchoring parts in metal, concrete or wood, and waterproofing and weatherproofing structural parts. Write for your copy, and keep a can of Smooth-On No. 1 ready for emergencies.

SMOOTH-ON MFG. CO., Dept. 37,  
574 Communipaw Ave., Jersey City, N. J.

Please send the free Smooth-On Handbook.

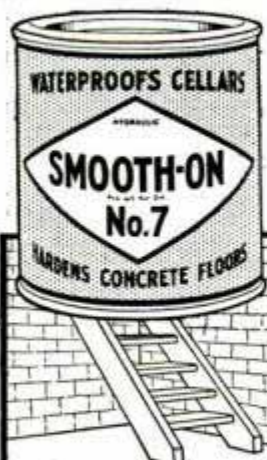

Name.....

Address.....

4-39.....



Do it with  
**SMOOTH-ON No. 7**

When writing please mention Popular Mechanics

DO IT BETTER and FASTER  
with a **DREMEL**  
**MOTO-TOOL**



weighs  
only  
6 ounces

If you like to make things, or do odd jobs around the house you will find hundreds of uses for this amazing, electric ALL PURPOSE tool. Make money or save money by fixing it yourself, 60 TIMES FASTER than by hand. Invaluable to professional mechanics. Universal motor. Powerful and Fast, 25,000 to 27,000 revolutions per minute. Perfectly balanced, long wearing and is operated with one hand. Beginners can match the work of experts. Use it on wood, steel, iron, brass, plastics, any material. Every home work shop, every factory should have one.

## Power Plus Speed

Dremel Moto-Tool will do hairline precision work or a power job. Designed and built in the only factory making hand moto-tools exclusively. Has self-aligning oilless bearings, built in thumb operated switch, universal collet chuck, and a great many more advantages over other tools. Underwriter approved. Only \$9.85. See it at your dealer's, order of us direct (we pay postage) or

Write for Free Booklet and Low Prices On  
**10 DAY TRIAL Combination Offer.**

Address Dept. 421

**DREMEL MANUFACTURING CO., RACINE, WIS.**

*Specialists in Motor-in-Hand tools*

## STANDARD GARDEN TRACTORS

**Plow** Powerful Gas Tractors for Small Farms.  
**Seed** Gardeners, Florists, Nurseries,  
**Cultivate** Fruit Growers, Poultrymen.

**Mow Hay** 1 & 2 Cylinders  
High Wheels. Rubber or  
and **Lawns** Steel Tires. Walk or Ride.  
Do Belt Work—Free Catalog

**STANDARD ENGINE CO.**  
Minneapolis, Minn. Philadelphia, Pa. New York, N. Y.  
3221 Como Ave. 2546 Market St. 290 Cedar St.



## Beautiful Bench Arbor

8' high, 5'-6" long, 2' wide. Easy to build. Detailed Blueprint 75c. Complete Knock-Down Bench Arbor \$42.50. TRELLISES—12 different designs. Blueprint of all 12 only 50c. CAPE COD LAWN CHAIRS—3 distinctive designs. Blueprints 50c ea. All 3 only \$1.00. For catalog send 10c.

• "Over 35,000 Satisfied Customers" •

**CRAFTSMAN'S MODEL CO., Dept. P-28,**  
2030 N. 41st St., MILWAUKEE, WIS.



## WORLD'S BEST LINE of TRAILER AXLES, HITCHES and PARTS

Send Only 50c Today for our Complete House Trailer Working Blue Prints. WRITE FOR FREE LITERATURE.

**HAMMER BLOW TOOL COMPANY, Dept. 104, Wausau, Wis.**

## EARN MONEY MAKE COLOR GLAZED CONCRETE PRODUCTS

MAKE 2,500 designs color-glazed concrete pottery without molds or costly tools. New, patent method. Use only sand, cement, cheap materials. Glazed tiles, walls, grave-stones, etc. Operators wanted. **MEN (only):** Write for **FREE** booklet, details of this money-making business.

**NATIONAL POTTERIES COMPANY**  
Room 6, 13 W. 26th St., Minneapolis, Minn.



## NEW BRUSH PLATING OUTFIT For AUTO PARTS

Connects to a battery with no tanks necessary. Plates on iron, steel, brass, copper, etc. Almost as simple as painting. Hundreds of car owners waiting for this low-cost plating. Improves appearance and value of the car. Your opportunity to make good income plating auto parts, bathroom fixtures, reflectors, mirrors, etc.

## FREE PROOF

Write quick—big season here. Get **FREE PROOF** and particulars that put you in a paying business of your own.

**GUNMETAL COMPANY**  
AVENUE M DECATUR, ILL.



(Continued from page 132A)

cerned a man burned beyond recognition in a wreck. Here again no apparent identification was left. No one was reported missing. Diligent survey revealed that a man with similar dental work had once served in the army in the Philippines. Fingerprints were available in army records but no fingerprints could be obtained from the corpse. Then O. W. Bottorff of the identification bureau tried an experiment. From the least-burned finger of the body he scraped away the charred surface and delicately removed the thin layer of inner skin. Using this as a photographic negative in the darkroom he obtained a print on sensitized paper that faintly indicated the whorls of the fingerprint. This record coincided with the army print and identification was complete.

Western justice is swifter than ever since the installation of KSBC, the 500-watt central transmitter in the county courthouse. Primarily serving the sheriff's office, the station also contacts police cars of the county seat, cars of the sheriff of adjoining Riverside county, and the mobile receivers of the forestry service. More than sixty cars are tied together by the station. Seventeen of the county cars are equipped with two-way sets. Transmission and reception are on different frequencies but the central radio station can divert an incoming message over its own transmitter when one car needs to contact another direct for two-way communication.

Shay's county is growing up. More and more people are moving into the rural sections. High grading a mine is not as common now as petty theft. Cattle rustling has gone modern with high-speed trucks and even these thefts are not as common as gasoline-station and drugstore hold-ups. But in a county the size of San Bernardino there are plenty of bad men in the old tradition still left, and Shay and his deputies have two kinds of crime to fight—the old and the new.

Our Bureau of Information keeps on file the names and addresses of makers of, and dealers in, all devices described in the pages of Popular Mechanics Magazine. We are glad to furnish this information to our readers upon request, accompanied by stamped, self-addressed envelope.

## Now a Quick and Easy Shaving Gillette Blade at $\frac{1}{2}$ Price



The new  
Thin Gillette  
Blade has edges of an  
improved type, hard  
enough to cut glass

Now Gillette announces a super-service razor blade of top quality to save you money. You get good-looking, comfortable shaves that protect your skin from the smart and burn caused by misfit blades. Gillette alone, with its world-renowned facilities, can produce a blade like this. And it sells at only 10c for four. The edges are of an entirely new kind—stand up where the going is tough. Get a package from your dealer today.

4 for 10c  
8 for 19c

You men who want utmost shaving  
luxury of course demand—

## The Gillette Blue Blade

AMONG men who demand ultra shaving comfort, the Gillette Blue Blade is first choice—largest selling of all brands. With this heavy-duty blade you get immaculate shaves—shaves that give you a feeling of well-being. Every man can afford this luxury—for it costs less than one cent a day. When you ask for these deluxe blades your dealer knows that you take pride in buying the best. Get a package of them today.



5 for 25c





**SERVICE MEN  
RADIO BUILDERS  
AMATEURS**

**GET ALLIED'S SPRING CATALOG JUST OUT!**

**SAVE on everything in RADIO**

**FREE SEND COUPON**

*Everything in Radio*  
**Allied Radio 1939**

**SETS ... AT NEW LOW PRICES**

Send for ALLIED'S Spring Catalog—just out! See the new 1939 KNIGHT sets with "Air-Magnet" built-in aerials, Push-Button Tuning, etc.—at new low prices; 62 new models, some as low as \$6.95—new AC, AC-DC, portable battery, 1½ volt, 6 volt and auto sets; new Phono-radios, phonographs, record players! Send coupon for ALLIED'S Super-Value Catalog!



**NEWEST KITS READY TO BUILD: SEND FOR FREE PARTS LISTS**



Dozens of new kits—new Meissner 1, 2, and 3 tubers, "Pee Wees", "Mystery" Phono and Mike kit, and many others. Write for free parts lists showing all parts required to build any kit. Just send name and date of issue of magazine. **BEGINNERS! SEND FOR ALLIED'S RADIO BUILDERS HANDBOOK.** A new and different type of book, planned especially for radio beginners. Tells how to select circuits, read diagrams, build radios, make chassis, wind coils, etc. Includes valuable short wave transmitting and receiving data. Send coupon with 10c for your copy. **Only 10c.**

**NEW SOUND SYSTEMS!**

Revolutionary new P.A. for every purpose from 8 to 65 watts. Standard and de luxe models—permanent, portable, and mobile—with Monitor Speakers and Remote Control. Also, Radio's biggest selection of recording equipment, discs, and accessories. Read all about the sensational new "Flex Disc."



**PARTS! HAM GEAR! TESTERS!**



ALLIED'S new Spring Catalog brings you **Everything in Radio at Lowest Prices!** Thousands of parts, new Amateur Receivers and transmitters, new test equipment, etc.

ALLIED Radio Corp.  
Dept. 5-D-9  
833 W. Jackson Blvd.  
Chicago, Ill.

**FREE Catalog**

- Send me your new Spring Catalog
- Enclosed find 10c (plus 3c postage) for Builder's Book
- Send me parts list for.....

Name.....  
Address.....  
City..... State.....

**All-Wave Antenna Serves 20 Sets**

(Continued from page 580)

only new or special parts required, all others are standard materials. The multicoupler unit consists of an assembly of coils small enough to be placed in an outlet or switch box, and is provided with color-coded leads for antenna, set and ground. Seven-strand No. 22 tinned copper wire is used for the antenna.

The transformer is installed directly in the antenna wire at the point indicated in Fig. 3 and, by means of it, the desired fea-

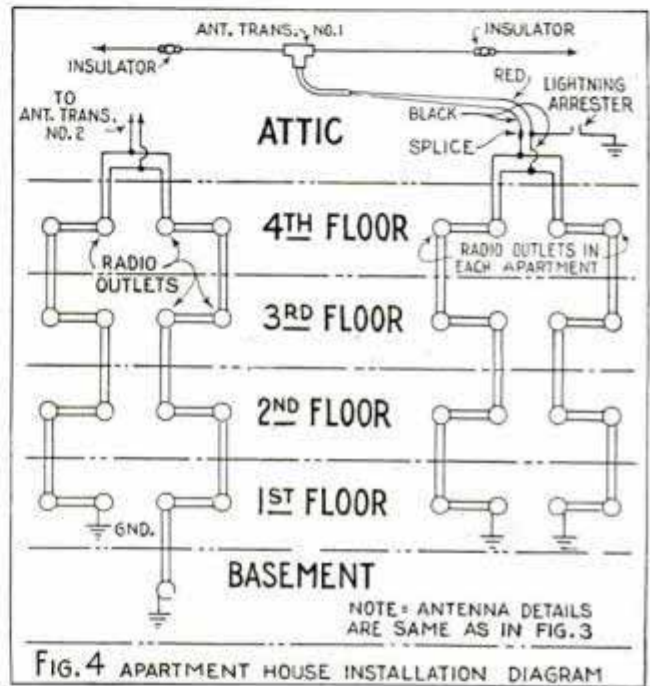

FIG. 4 APARTMENT HOUSE INSTALLATION DIAGRAM

tures of a doublet antenna for short-wave reception are combined with the high efficiency of a type-T system for broadcast programs on standard wavelengths. With this transformer, which is supported by the antenna itself, maximum results are assured by automatically selecting the doublet or "T" antenna according to the tuning band desired. Under no conditions should an antenna be installed under a slate roof or near steel supporting structures. Quite frequently, an inside antenna in the attic is specified by architects. No inside type can give results as satisfactory as an outside antenna.

Fig. 3-A shows all details for bringing the antenna leads into the building; Fig. 3 is a suggested installation diagram for a private residence, while Fig. 4 shows one-half of an apartment-house installation where four antennas may serve up to eighty receivers. In this case, as shown in Fig. 4-A, they are paralleled and spaced 4 ft. apart.



# TEST-O-LITE

**Tests Everything Electrical From 100 to 550 Volts**

A real necessity for electricians and home because it has 1001 uses. Equipped with a Neon light which tells instantly where trouble lies in electric circuits, fuses, cut-outs, motors, radios, all kinds of electric appliances, etc. Tells A. C. from D. C. Far superior to ordinary clumsy test bulb. Fountain pen size with clip for carrying in vest pocket. Lifetime guarantee.

**PATENTED**

**L. S. BRACH MFG. CORP.**  
55 Dickerson St., Newark, N. J.

**\$1.50** At Electrical Stores or Post-paid

APPLIANCES  
MOTORS  
FUSES

**BURN YOUR NAME ON TOOLS WITH THE ARKOGRAF**

**PROTECT YOUR TOOLS FROM THEFT**  
Write with electricity any name or design on the hardest and finest tools and instruments, or any metal, like writing on paper with pen or pencil. **Complete Outfit \$3.50**—Prepaid Anywhere. Interesting illustrated circular free. Write today. Agents wanted. **ARKOGRAF PEN CO., 3927 S.E. Stark St., Portland, Ore.**

**BUILD THE SCHOONER BLUENOSE**

**Complete Kit \$2.50 Post Paid**

Makes perfect building easy

**CARVED PINE HULL**  
Metal Anchor, Steering Wheel, Lifeboats, Anchor Chain, Casks, Masts, Dowels, Lacquer and Cement.

Send for complete catalog, 10c

**IDEAL AEROPLANE & SUPPLY COMPANY, INC.**  
26 West 19th Street, New York

## WHY DO WIVES Like Model Railroaders for Husbands?

• Because it keeps them home nights—and is *not expensive*—though many wrongly think it so! The whole thrilling story of this grand hobby is told in the new *Scale-Craft Catalog*—with charts, diagrams, illustrations—revealing its full fascination from the first steps to the latest developments. A joy to read! Invaluable for reference! Send 25c today for *your copy*, to Scale-Models, Inc., 1516 S. Wabash Ave., Dept. A Chicago, Illinois.

## The WISE ONES SAY

**"Keep a jar or tube of Lucky Tiger Ointment handy"**

Made to allay Itching and Burning Feet—Crusty Scalps—Ringworm—Rectal Irritations—Prickly Heat—Insect Bites—Stings—Itchy Scalp Irritations—Externally caused Pimples—Soothe fire and sunburns.

Get a jar at your drug or 10c store or applications at barber shop.

**ANTISEPTIC FOR** Inhibitory Use when in proper contact—as in bandage or dressing for simple Cuts, Wounds, and Scratches.

**FREE** 25c Trial Tube if you send us name of your druggist or barber.

**LUCKY TIGER MFG. CO.**  
Dept. 77 Kansas City, Mo.

# Alkalize with Alka-Seltzer

**UPSET STOMACH**  
**HEADACHE**  
**MORNING AFTER**

LET NOT EXCESS ACIDITY UPSET YOUR BILL OF FARE. LET ALKA-SELTZER SETTLE THINGS. ENJOY THE SPRING AIR.

BE READY WHEN A HEADACHE COMES, TO FREE YOURSELF FROM PAIN. WISE PEOPLE ALKA-SELTZER-IZE AND WHISTLE IN THE RAIN.

WHEN "MORNING AFTER" CLOUDS APPEAR, DON'T WASTE YOUR TIME A WHINING. LET ALKA-SELTZER LIFT THE FOG. YOU'LL FIND THE SUN STILL SHINING.

**Be Wise — Alkalize**

Tablet in a glass of water makes a sparkling pleasant-tasting solution. Drink it and it gives quick relief from Headaches, Sour Stomach, Distress after meals and other common ailments. Alka helps overcome excess acid condition so often associated with these troubles.

An Alka-Seltzer

**30¢ & 60¢ PKGS**  
OR BY THE GLASS AT DRUG STORE SODA FOUNTAINS

**TUNE IN THE NATIONAL BARN DANCE SATURDAY NIGHT NBC NETWORK**

## DO YOU WANT a new business profession of your own, with all the trade you can attend to? Then become a foot correctionist, and in a few weeks earn big income in service fees,—not medical nor chiropody—easy terms for home training, no further capital needed, no goods to buy, no agency. Established 1894. Address Stephenson Laboratory, 1 Back Bay, Boston, Mass.



**THIS YEAR YOU MAY BE THE ONE**



*this* **FREE BOOK** *helps to success*

Twice a year we put out a new edition of this radio book. And every year thousands of men (of every age) are started off on exciting new hobbies, profitable sidelines, swell new jobs—because of it. You'll hear it called the greatest catalog in radio, the guide to better buys, the one volume that has everything.

**BIGGER THAN EVER**

A complete new line of Lafayette Public Address from the tiny 5 watt restaurant order amplifier to a 70 watt unit for use at race tracks and ball parks. In addition to perfect engineering, we've streamlined the cabinets for more SELL! Over 60 radio models ranging in price from \$8.95 to \$175 . . . countless thousands of parts . . . ham equipment and a complete up-to-the-minute camera section. 188 ideapages beckoning the man who wants to get into Amateur Radio, into Public Address, into Photography—for fun or profit.



**KITS**

See this sensational build-it-yourself equipment. Nationally advertised lines such as Meissner . . . our own thrifty Lafayette kits, new this year. Easy to use—fun to work with. Get the thrill of building it yourself—and build your own future!

**SEND FOR FREE COPY**  
Discover how valuable this catalog is, what doors it opens to you, what savings are waiting on everything you buy. Tear off the coupon, paste on penny postcard and mail at once.

**LAFAYETTE RADIO CORP.**

AND **WHOLESALE RADIO SERVICE CO. INC.**  
NEW YORK, N. Y. CHICAGO, ILL. ATLANTA, GA.  
100 SIXTH AVENUE • 901 W. JACKSON BLVD. • 265 PEACHTREE ST.  
BOSTON, MASS. • BRONX, N. Y. • NEWARK, N. J. • JAMAICA, L. I.

Rush New **FREE** Radio Catalog No. 76.

**FREE!**  
Name..... PLEASE PRINT **THE WORLD'S**  
Address..... **FINEST**  
City..... State..... **RADIO**  
**LAFAYETTE RADIO CORP.**  
Dept. 7D9—100 Sixth Ave., New York, N. Y. **CATALOG**  
PASTE COUPON ON PENNY POSTCARD

**Unit Receiver for Beginners**

(Continued from page 579)

ative "B" remains connected when the set is off. However, when the "A" filament supply is switched off no current is drawn from the "B" battery.

Shielded tube sockets are employed; top views of the sockets are given in Fig. 2 and underside views in the schematic circuit diagrams Figs. 3 and 4. Photo Fig. 2-C shows a bottom view of the socket. The prongs of these "Amphenol" sockets are

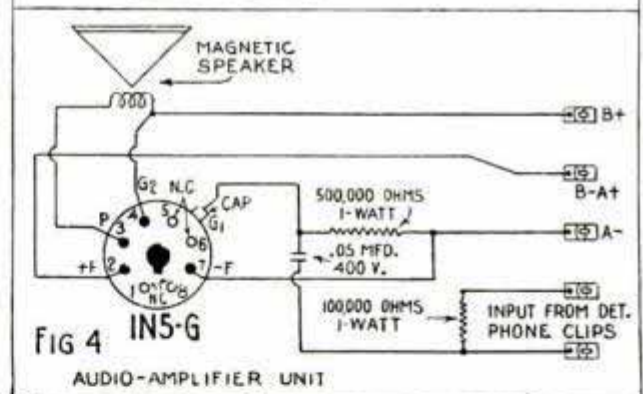
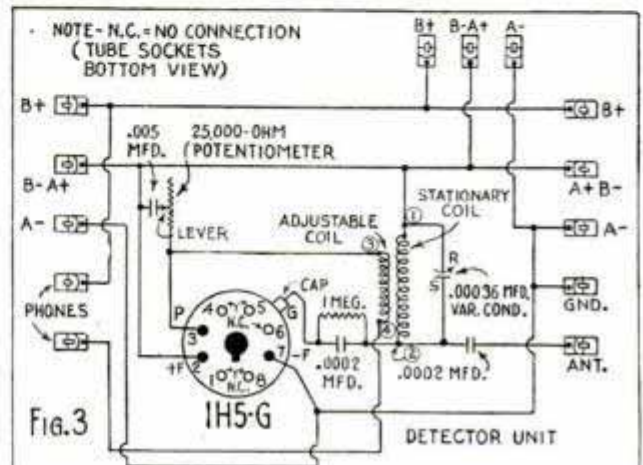

numbered on the underside. Please note that a small metal plate is used to hold the variable condenser in position. A list of the original materials used in all three units can be obtained from Popular Mechanics radio department without charge. Blueprint R-266 will not be available until Part II of this article appears in the May issue. To operate the detector unit alone, as shown in photo Fig. 2-B, merely connect a pair of headphones to the phone clips, and antenna and ground to the clips specified. No other clips are in use until required. When a station is tuned in, adjust the movable coil until the signal is loud and clear; it should not be necessary to readjust this coil.

(To be continued)



# Amazing Quick Relief For Acid Indigestion

**YES—TUMS** a remarkable discovery brings amazing quick relief from indigestion, heartburn, sour stomach, gas, and burning caused by excess acid. For TUMS work on the true basic principle. Act unbelievably fast to neutralize excess acid conditions. Acid pains are relieved almost at once. *TUMS are guaranteed to contain no soda. Are not laxative. Contain no harmful drugs. Over 2 billion TUMS already used—proving their amazing benefit. Try TUMS today. Only 10c for 12 TUMS at all drug-gists. Most economical relief. Chew like candy mints. Get a handy 10c roll today.*

You never know when or where



Tums are anti-acid—not laxative. When you need a laxative get—**Nature's Remedy** This all vegetable laxative brings such gentle, dependable relief for conditions due to constipation.

**RADIOS..SAVE UP TO 50%** YOUR AGENT'S COST PRICE

DEAL DIRECT...FACTORY PRICES! Many models to select from: AC-DC; All-Wave; armchair models; automatic tuning; car radios; Farmsets that operate like city radios! Send postcard for NEW Bargain Catalog FREE. 30-DAY TRIAL plan and agent-user proposition! GOLDENTONE RADIO CO. DEPT. 115 DEARBORN, MICHIGAN

**Free Catalog** \$4.95 ea. in Lots of 3

**30 DAY TRIAL \$6.98 UP**

**TRAILER BUILDERS · BUYERS · OWNERS** Send 25c for this Big Book Today

Over 100 pages! Beautifully Printed and Illustrated! Trailer Suggestions and Ideas colored Catalog shows America's greatest line of Trailer Parts and Equipment at lowest prices. Everything from wheels to top. Rush 25c today. Satisfaction positively guaranteed! TRAILER SUPPLY CO. Box 435-A WAUSAU, WIS.

**BUILD IT YOURSELF** The Jim Dandy Cabin Cruiser

The Trailer that has everything. Classy! Roomy! Easy to build in any size with my simplified Plans and Instructions—Price \$1.00. Rush dollar bill today to JIM DANDY Box 125-A WAUSAU, WIS.

**HOLD-E-ZEE AUTOMATIC GRIP SCREWDRIVERS**

Hold, start and set-up screws in unhandy places. Gripper instantly released by spring action, sliding by out of way when not in use. Finest materials throughout, chrome vanadium blades; many have transparent insulating, unbreakable handles. (Illustrated.)

No more expensive than ordinary screw drivers. Models for recessed-head screws. Handiest ever. Get one today. At auto-supply, hardware or electrical stores.

UPSON BROS., INC. 86 EXCHANGE ST. ROCHESTER, N. Y.

**PROUD OF YOUR TOOLS?** Then, like other machinists and toolmakers, keep them in a Gerstner Chest. Free catalog.

**GERSTNER TOOL CHESTS** 439 Columbia St. Dayton, Ohio

**NOW ONLY \$5.00 REAL ENGINE VALUE**

Over 7,000 GHQ Gas Engine Kits have been sold at \$8.50. Now is your chance to buy the New Improved kit for \$5.00. Absolutely complete with coil, plug, etc. For boats, planes, etc. All parts guaranteed. Send only \$1.—Shipped Express Collect for balance same day. Catalog 3c. DEALERS WRITE.

All parts finished. Only a screwdriver needed. 1/5 H.P. Average assembly time 30 minutes.

**GHQ MOTORS, 854B East 149 St., New York, N. Y.**

**HAVE YOUR DRAWING EQUIPMENT WITH YOU.. WHEREVER YOU GO!**

## AUTODRAFT PORTABLE DRAFTING MACHINE

The Autodraft drafting machine combines a drawing board, triangle, T-square, scale, protractor and thumb tacks all in one. A portable drafting machine no bigger than a briefcase and as easy to carry. No draftsman need be told the wonderful conveniences of a big drafting machine. Now—all those advantages are available in a portable drafting machine.

Every tool you need always at hand, where, when and how you want it.

You'll find a thousand uses and necessities for Autodraft. You'll draw more. It speeds and facilitates work. It's built strong, light and compact so you can carry and use Autodraft wherever and however you go, on calls, to construction camps, at home, on walking trips, by street car, auto or on foot. Salesmen, engineers, inventors, construction men, ama-

teur sketchers, students, artists, idea men find Autodraft **INVALUABLE**.

The combined T-square, triangle, ruler and protractor are permanently anchored to semi-universal arm that swings all over the board and always keeps the device in true. Angle adjustments made in a flash.

Two sizes, 9 x 12 and 13 x 18, for every practical purpose. Water-proof, non-warping "Presdwood" board (won't split). Alloy steel arm, anchor, protractor-L-square and paper clamps. Bake-lite protractor knob. Priced \$5.75 and \$8.00. Order from your dealer or direct from factory. Write for Free Catalog No. 389 of drafting supplies.

**EUGENE DIETZGEN CO.** Everything for drafting and surveying.

2425 N. Sheffield Ave., Chicago, Illinois

**THE NEW CORONA Zephyr**

**ONLY \$29.75**

All prices subject to revision. I. C. Smith & Corona Typewriters Inc. Desk 4, 723 E. Washington St., Syracuse, N. Y. Please send me free folder describing Corona Zephyr.

Name \_\_\_\_\_  
Address \_\_\_\_\_  
City \_\_\_\_\_ State \_\_\_\_\_



**IT'S A CINCH TO REPAIR WALLS WITH RUTLAND PATCHING PLASTER**

Just mix with water.. Rutland makes a perfect patch.. stays put.. costs only a few cents.

**RUTLAND PATCHING PLASTER**

FOR BREAKS IN PLASTERED WALLS

**COLUMBIAN METAL BOATS**

Light weight, durable, carefully built boats at remarkably low prices. Made of toughest galvanized copper bearing steel. Wood gun-wales. Heavy transoms for outboard motors. Two or more built-in air chambers for extra buoyancy in case of upset. Real wave riders; easy to handle. Never leak or warp. Always ready for use. Both round and flat bottom boats; all sizes and styles.

**Write For Free Boat Booklet** with description and prices of complete line of metal boats—knockabouts for fishermen, light weight livery boats for parks and resorts, heavy duty craft for outboard motors.

**Dealers Wanted—**who can develop volume sales.

**COLUMBIAN STEEL TANK COMPANY,**  
P. O. Box A-4226 Kansas City, Missouri

**FREE BOOK**

**FREE "BETTER RESULTS WITH GLUE"**

Send post card for booklet, "Better Results with Glue," containing many useful hints about mending, model making and home workshop jobs. Address: McCormick Sales Co., 402 Light St., Baltimore, Md.

**IRON GLUE 10¢** at hardware, drug and 10c stores; also in cans from 1/4-pint to 1 gallon

**SOCIAL SECURITY PLATES**

Operate your own business. We start you without one penny investment. Over 400% profit. New plan—hire your own agents. Sell thru stores and direct. Over 40 million buyers waiting for this beautiful bronze plate. Postcard brings **FREE OUTFIT.**

**U. S. NAME PLATE CO.,** Box 769, Dept. 324, Chicago

**YEARS AHEAD!**

**NOW** Exclusive twin aluminum cylinder block reduces weight of Johnson's famous all-purpose "LT" twin to 33 1/2 lbs.! Power increased to 5.0 N. O. A. certified brake h. p. at 4000 r. p. m.! All sinew—no "fat"! \$109.50. De luxe model with Ready Pull Starter \$129.50. (Shown here.)

Also see the new Miracle Motor—only 21 1/2 lbs.—ban-tam edition of the above. Only \$79.50! Other models as low as . . . **\$49.50**

All prices f. o. b. factory.

**Free Handy Chart**  
NEW! Sizes, specifications of the 10 great Sea-Horse motors for '39. New models. New features. Illustrated. Send for your copy!

**JOHNSON MOTORS**  
408 Pershing Road, Waukegan, Ill.

**JOHNSON GIVES YOU "ALL THREE!"**

1. Perfected Alternate Firing — backed by 10 years experience in building.
2. Quiet. Built-in Underwater Exhaust.
3. Reverse! With 3600 Steering!

**JOHNSON SEA-HORSES**

**COMET CLIPPER GAS MODEL**

**\$4.95**

**NEW 36 PAGE CATALOG**  
Hundreds of models, 10c up. Gas model kits, motors, accessories. Send 5c stamps to

Prize-winning, record-breaking, 6 ft. gas model. Removable power unit; detachable wing and tail; difficult parts finished. Kit with automatic timer, \$4.95; postage 25c, or buy from dealer.

**COMET, 2509 CERMAK ROAD, CHICAGO, ILL.** Dept. P-4

**OTTAWA LOG SAW \$39**

**BIG BOOK FREE**

PUTS THIS OTTAWA to work for you. MAKE MONEY! Wood is valuable. Does more than 10 men. Easily operated. Falls trees—saws limbs. Use 4-hp. engine for other work. Write for **FREE Book.**

**OTTAWA MFG. CO.**  
1827 Wood St., Ottawa, Kans.

SAW 10 TO 27 CORDS A DAY

**TRAILER PARTS**

Latest type heating stoves, window assemblies, couplers. Everything for the trailer. 40 page illustrated catalog. 10c.

**MARVEL TRAILER PARTS CO.**  
19020 Celestine Ave., Detroit, Mich.

**MONEY for MEN ALL FREE**

THE PLASTEX Industry needs manufacturers on small scale and for big production of Lamp and Clock Stands, Art Goods and Novelties in Plastex and Marble imitation. Experience unnecessary. 1/2c material makes regular 10c store sellers. Rubber moulds furnished for speed production. Small investment brings big returns. BIG CHAIN STORE orders now being placed by us. Ambitious men have chance for real prosperity. Our **FREE** booklet will interest and benefit you. **PLASTEX INDUSTRIES.** Dept. P, 1085 Washington Ave., New York, N. Y.



## Frontier Guards on the Wing

(Continued from page 543)

ing groups of people, some of whom appear to be fishing. Fishermen they may be, but they can be aliens attempting entry into our country along this comparatively unguarded section. Lone cars traveling along the border are also closely scrutinized, the plane swooping to get a quick glance at the vehicle and its occupants.

Another thing to be watched for is the smuggling of cattle, a profitable undertaking if the lawbreakers can get away with it, due to an export tax by Mexico and the usual import tariff imposed by the United States. Any activity of this nature is immediately reported by radio to the home base, and turned over to the proper authorities for immediate action. The Border Patrol works in close and impartial cooperation with the other federal agencies located in this area.

A "stagger" system of operations insures that the detachment can always have several planes ready for all emergencies. Unless something really big comes up, some of the planes are always in the hangar while the others are on patrol. Those at the airport receive careful and complete overhauls that cover the ship from tail light to wing tip. Auxiliary equipment, such as radio, instruments, parachutes, first-aid kits, rations, etc., receive their share of careful attention. Border Patrol men are experienced mechanics and know their share of radio and instrument technique.

Law-enforcement activities may also consist of unrelated duties such as the spotting of illicit "stills" from the air. Despite efforts at concealment, the sharp eyes of patrol pilots often discover the location of such distilleries, in remote mountain country. Upon returning to his base the pilot draws up a detailed "track chart" which will enable officers to locate the hide-out and seize the offenders. Considerable revenue, often mounting into hundreds of thousands of dollars, has been saved the government by the efforts of the Coast Guard Service.

Border Patrol planes may hit upon many forms of probable and actual distress that call for expert assistance. This may range from flying hundreds of miles to the low, swampy lands of the Gulf of Mexico region

(Continued to page 143A)

## THE SAW OF TODAY



Time, now, to enjoy ownership of a finer saw. The Disston D-23: Lightweight, straight back, narrow blade. True taper ground. Runs easy and cuts fast. Disston Steel. High polish, striped back, beautifully etched. Applewood handle, full carved, weather proof finish, 26" length . . . \$3.85 Also Disston D-8, "The Saw Most Carpenters Use." Skew back, 26" length . . . \$3.50 Also KEYSTONE made by DISSTON saws, 26" cross-cut \$1.00 up; Rip \$1.50 up

These prices apply only to United States; for others, write Henry Disston & Sons, Ltd., Toronto, Canada.

## and the Hint of the Month



To make a perfectly square end cut is easy, when the face of the board is marked square and a Disston try square used, as illustrated, to keep the saw in a vertical position.

## AND NEW EDITION

### FREE BOOK

Disston Saw, Tool and File Manual, radically revised. How to set and file saws. How to choose and use saws and tools. Many home workshop hints like one above, in its 48 pages of text and profuse illustrations.



## SEND COUPON!

Henry Disston & Sons, Inc.  
411 Tacony, Philadelphia, U.S.A.

Please send me FREE copy of the new Disston Saw, Tool and File Manual.

REMEMBER  
HARDWARE WEEK  
MAY 6-13

Name.....

Address.....



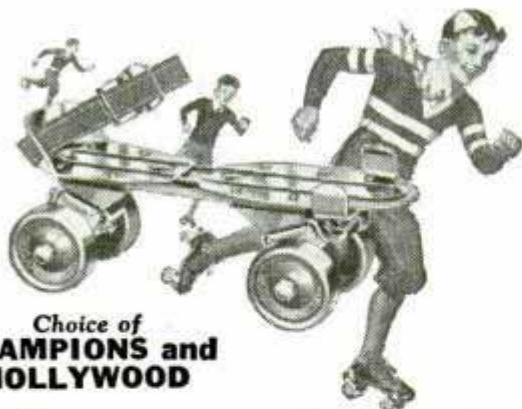

Choice of  
**CHAMPIONS and  
HOLLYWOOD**



**CHICAGO FLYING SCOUT**  
Roller Skates

**SPEEDY OVERSIZE BALL-BEARINGS** will give you Thrills with less Spills and more Miles.

Demand "CHICAGOS."  
Write for **BOOKLET**  
"How to Roller Skate"

**FREE SKATE PIN AND ANKLE PADS**

Send picture of "Our Gang" cut from wrapper around skates with 10c to cover mailing, and receive beautiful **Gold F. Skate Pin and Ankle Pads.**

**CHICAGO ROLLER SKATE CO.**

Quality Roller Skates for over 37 Years

4414 W. Lake St.

Chicago, Ill.



**DRINK to your HEALTH**  
with Fresh **VEGETABLE JUICES**  
**MADE IN YOUR OWN KITCHEN**  
with the **HEALTH-MINE**

You'll enjoy making carrot, spinach, pineapple, celery, and other fruit and vegetable juices—with the **HEALTH-MINE**, a vegetable juice extractor for home use. Just turn the handle—and out come the healthful juices. **FREE WITH EACH MACHINE**—valuable recipes for vegetable juice cocktails. Order a **HEALTH-MINE** today!

**MODERN HEALTH-MINE, c/o M. Koth**  
1428 N. 24th St. Milwaukee, Wis.

ONLY  
**\$3.95**  
(plus 20c postage)

**Go Places for Less**  
**Auto-Glide**  
for Sport, Business, Deliveries  
**1/3¢ Per Mile**

Think of it! Sensational **AUTO-GLIDE** takes you any place . . . fast, comfortably, at 1/3¢ per mile! Zip out for sports . . . to work or school. Take trips . . . make deliveries at 1/10 the cost of auto travel! Amazing 1 1/2 or 2 H.P. Cushman engine runs **125 MILES PER GALLON**, 35 miles per hour, with quick get-away and power to burn! Zips up steep hills. Most rugged machine built. Electric welded all-steel frame. Low slung, well balanced—rides better than a bike. Handles like car in traffic or on highway. Parks any place. Big brake for instant stops. Clutch (most models) for smooth starts, stops. Balloon Tires. Cushion seat big enough for two.



**\$92.45**  
**UP**

A **MODEL FOR EVERY PURPOSE!** Standard and De Luxe **AUTO-GLIDE** for sport, business, school, **KARI-PAC** and **SIDE-KAR** for delivery purposes.

**NEW!** 3-wheel delivery model, front carrier, hauls 400 lbs.! Real economy!  
**WRITE!** for photos, full details, very low prices. Send **NOW!**

**THE CUSHMAN MOTOR WORKS**  
Dept. D-4, Lincoln, Nebr.



Dealers! Get Now! Offer Now!



**Learn AVIATION**

**Come to LINCOLN** Be a Transport Pilot, an Airplane Mechanic or Aeronautical Engineer! Aviation pays Pilots up to \$6000 a year! Airplane Mechanics also get good pay! You can train at this **LINCOLN GOVERNMENT APPROVED SCHOOL** for a good-pay position in Aviation. Train here on fast modern airplanes; repair and overhaul aircraft motors; help design and build real airplanes. We teach you how and assist Graduates in locating positions. Part-time employment for board and room while training. **WRITE TODAY** for complete information.

**LINCOLN AIRPLANE & FLYING SCHOOL**  
551 Aircraft Building, Lincoln, Nebraska



**BIG PROFITS**  
**RESTRINGING RACKETS**  
AT HOME! WRITE US!

Earn big profits restringing tennis rackets at home. Easy work. Experience unnecessary. Save on your tennis, badminton, squash! Send for **FREE CATALOG** of Tennis Equipment—**Hurry!**  
H. E. Willis Co., 1047 W. 47th St. Dept. A-49 Chicago, U. S. A.

**Save On GUT!**  
—Buy Direct from Factory **SILK!**



**NEW SUPER-QUALITY KITZELMAN FENCE**

Heavier, amazingly improved galvanizing. Tougher, longer-lasting Copper-Bearing Steel. **Low Factory Prices. WE PAY FREIGHT.** 160 styles and heights Farm, Poultry and Lawn Fence; Steel Posts, Gates, Barb Wire, Paints, Roofing. Write today. **KITZELMAN BROTHERS** Dept. 94 Muncie, Indiana



**Wind Electric Plant**

**Build Your Own—We Show You How.** Easily made from old auto generator. Dime brings complete plans and Big **NEW** catalog of 500 electrical items. 100 other generator changes to 6, 12, 32, 110 volt Plants, Motors, Welders, Electrical Fencer. Write today. **LEJAY MFG., 1447 LeJay Bldg., Minneapolis, Minn.**



**YOUR OWN MOVIES! 10¢ A DAY!**

**NATIONALLY ADVERTISED SMM and 16MM** Movie camera, projectors. For home, business, church, school, club. **MONEY BACK 10 DAY TRIAL.** Payments as low as 10¢ A DAY. Satisfied customers throughout the world. **FREE** details. **WRITE TODAY.**  
Don Elder's Home Movies, Dept. A-4, 739 Boylston St., Boston, Mass.



**PRACTICAL MAGNIFIERS**

New type magnifier with swivel joints. Six sizes—1 1/2" dia. to 5" dia. lens. Prices, 50¢ to \$10. Send for **FREE** Catalog of these attractive, well-built instruments.  
**MAG-NI-LINE PRODUCTS,** Dept. 12, 3456 E. Jefferson, Detroit, Mich.



**AGENTS 300% Profit SIGN LETTERS**

For Store Fronts and Office Windows. Anyone can put them on. Free Samples. Liberal Offer to general agents.  
**METALLIC LETTER CO., 438 N. Clark St., Chicago**

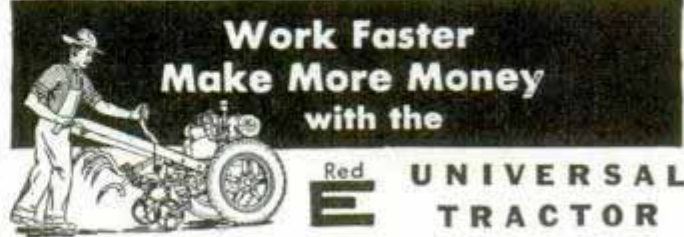

**Work Faster**  
**Make More Money**  
with the

**Red UNIVERSAL TRACTOR**

With this practical machine and attachments you can do all field and belt work hours faster at the low cost of 33¢ per day. Many units pay for themselves the first season. Unusually easy to handle and operate. Absolutely safe. Hundreds of users. Buy direct at low factory price. Two weeks' trial—satisfaction guaranteed. Write for colorful, free catalog.

**PIONEER MFG. CO. Dept. V-49 West Allis, Wis.**

When writing please mention Popular Mechanics



(Continued from page 141A)

to do hurricane warning work, to transporting ill or injured persons to medical attention.

During the summer and fall seasons the Border Patrol is on guard against hurricanes. Spare moments are engaged in the making of many hundreds of small wooden "message blocks" to which are attached long white or yellow streamers which are easily visible from the air when dropped to residents of villages and outlying settlements.

Notification by weather bureau officials that a hurricane is about to hit, or is on its way, unleashes the Coast Guard planes for this important duty. In addition to the message blocks, a cargo consisting of a stretcher, warm blankets, concentrated food supplies, first-aid and medicine kits is packed in. In cases of assistance after a storm, the planes spot isolated parties, make rescues whenever possible, and carry serums to combat outbreaks of disease.

The Border Patrol is used to receiving calls and requests from frantic friends of persons lost in the vast wastelands of the southwest. If their time of departure and probable course can be obtained, the Coast Guard goes out on search, and invariably finds them. From a vantage point in the air, the plane can easily pick up tracks of an auto or horse. Before going out on a search, each plane is assigned a certain area to cover. A cargo chute is placed on board, and the door nearest the co-pilot is taken off to facilitate throwing it out of the plane. Packed inside a large steel container are a ten-gallon canister of water, canned food, bread and fruit juices, first-aid kit, and snake-bite and tarantula-antidote medicine.

Once the lost party is sighted, the plane swoops low to ascertain the physical condition of the individuals, and the cargo chute is tossed overboard. A note is dropped giving the people instructions to stay where they are, so that the plane can radio an accurate position to the home base for a ground rescue crew. Hours, or maybe days later, they will be rescued and brought back to civilization.

☐ Thirty-one new lightweight streamline railroad trains were placed in operation during 1938 and four more will be introduced by June this year.

*Oranway Age*  
Jan. 7 1939

*New life for the old*  
**FAMILY ALBUM**  
*with indoor "snaps"*

**1. Fed up?** Are you tired of photo albums that are all "vacation shots?" Then, here's a suggestion to give new life to *your* album. Take some indoor snapshots with your camera and G-E MAZDA Photo lamps.



**2. For action,** natural as can be, you'll want G-E MAZDA Photoflash lamps. Their split-second flash helps you get crisp, clear photos like this. Each lamp gets one picture. Good for color, too.



**3. And for dozens of shots,** get G-E MAZDA Photoflood lamps. Their brighter, whiter, continuous light, used with new "super" type high speed film permits snapshots indoors, even with box cameras. Grand for home movies. Buy them where you buy film.

*To be sure of better pictures, be sure your photo lamps are "G-E"*



**New Lower Prices**  
G-E MAZDA Photoflood Lamps  
No. 1 (was 25c) now **20c** list  
No. 2 (was 50c) now **40c** list

**Action? Pets?**  
G-E MAZDA Photoflash Lamps  
No. 10 . . . . . **15c** list  
**Brand New**  
No. 21 (Synchro-Press) **20c** list

**GENERAL**  **ELECTRIC**  
**MAZDA PHOTO LAMPS**





I'm tooling along Main Street when I bump smack into Bill Jonson. "Hi!" says Bill. "Come on down and look at the Indians!" "What's up?" I want to know. "A Wild West show?" "I'm talking about the new Indian motorcycles," says Bill. "They just came in and I hear they're honeys."

Bill's a motorcycle fan from way back, and I'm thinking of getting one myself if I ever save some money, so I tag along to the Indian dealer's place. And boy, what 'honeys' those 1939 Indians are! Right away I'm crazy to own one. "How about this Indian Junior Scout?" I ask Bill.

"Just the machine for you," says Bill. "The Junior Scout's light and flexible—easy to handle as a bicycle. You don't want racing speed, but you'll breeze along at 40 to 60 m. p. h. with a reserve of power on top of that—and a gallon of gas will take you at least 70 miles. Beat that for economy!"

"And notice," Bill goes on, "this Junior Scout is no chug-chug one-lunger—it's a real TWIN-CYLINDER job with Indian's famous dry sump oiling system—like they use in airplane engines—knee action fork, distributor ignition—and plenty more. But all you need to know is, it's made by Indian—the biggest name in motorcycles. Come on and ride it. Mac—he's the owner of this shop, and one swell guy,—will let you give it a trial run."

So I swing into the saddle, give the starter a flick, and I'm off—and what a sweet running machine that Junior Scout is! When I see how easy she handles and rides, and feel the real lift of her zip and power, boy, I'm sold—only I don't know where I'm to get the million a machine like that ought to cost.

"Listen," says Bill, "the Indian Junior Scout will set you back just \$215, F. O. B. factory—and that's the lowest price for a 'twin' in the whole U. S."

"Even so," I protest, "a couple of hundred bucks is more than I carry around in my pocket." "That's all right," says Bill, "Mac'll let you pay for your Indian while you're riding it—a little each week."

So that's how the "Indians got me"—and am I glad they did! Take my advice, hop around to your Indian dealer's yourself. You'll see something!

**FREE!**

Or do this—mail the coupon below with 15c and the Indian people will send you their magazine "Indian News" for a year, also give you a Certificate that entitles you to a swell Indian Rider's Jersey FREE when you order your new motorcycle. I'll be seeing you on the road!



INDIAN MOTORCYCLE CO., Springfield, Mass.

Please send me items checked [ ] Indian News for one year (I enclose 15c in stamps to cover mailing cost). [ ] Certificate of Value entitling me to Indian Sport Jersey FREE when I order my new Indian motorcycle. [ ] Indian catalog.

Name .....

Address .....

PM49

Please be sure to check your age group  
[ ] 16-19 yrs. [ ] 20-30 yrs. [ ] 31 yrs. and up [ ] under 16 yrs.

INDIAN MOTORCYCLE CO., Springfield, Mass.

H1513

## Canaries Sing for Science

(Continued from page 536)

though it was, the sound was undoubtedly the beginning of a normal canary song. A few days later bird Number 60 was singing a complete song—a song almost indistinguishable from that of a normal canary. Records and graphs were made of the song and compared with graphs from the songs of prize-winning canaries. The graphs were almost indistinguishable. By heredity alone, the canaries had learned to sing the song of their kind.

Then Dr. Metfessel had another idea: "Let's see what the canaries would do if, instead of living in complete silence, they

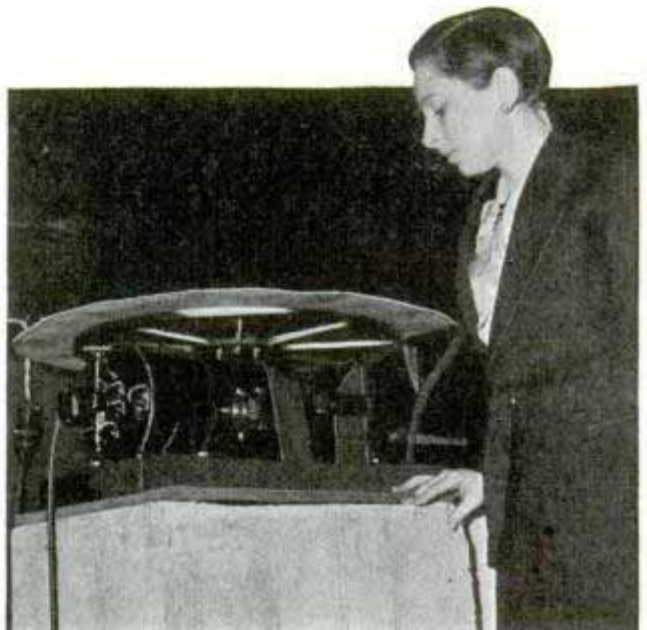

Phonograph recording of canary's song is made with this equipment in the laboratory

heard one note—a note canaries never sing. If they reproduced that note, it would be the result of environment only."

So bird Number 60—one of six birds which began to sing in a soundless world—was mated with a normal canary, and one of the chicks was placed in the isolation box as soon as it emerged from the egg. A tiny loud speaker was placed in the cage. When this bird came to the age when canaries begin to sing, a "vibrato" was broadcast daily into the canary's cage. The vibrato is a characteristically human note, a note which canaries never sing. Day after day that single note sounded in the otherwise silent little world.

A camera was rigged up in such a way that pictures could be taken of the canary



1513  
without the bird noting anything unusual, or hearing the click of the shutter. The camera was placed at the end of a dark tube, which was connected with a small observation window in the side of the cell. This observation window was kept closed until the camera was in place, and all light excluded with a black cloth. Then the window was opened and pictures were taken by the normal light in the cage.

The days dragged on. The vibrato sounded. Photographs of the canary often showed it seated with its head cocked on one side, as if listening intently.

Then one day, after the vibrato was turned off, a tiny bit of sound came from the speaker in the office. It lasted only an instant. Soon it was followed by another. They were uncertain, experimental sort of sounds that bore only a slight resemblance to the human vibrato. Days went by, until one afternoon the canary boldly broke forth in a sustained note—a note no canary had ever sung before—the human vibrato.

A canary had sung a note which no normal canary had ever sung, a note which was not even suited to its vocal organs. That song was produced by environment alone.

While Dr. Metfessel was drawing his conclusions, another strange fact was brought to his attention.

A second canary had "learned" to sing the vibrato. The vibrato was the same, but the method by which he learned to sing it was entirely different, and there were graphs to prove it. Both canaries had produced a certain note, but that note hadn't been produced automatically—for they had used different methods. In other words, they had worked it out in different ways—as two men will solve a puzzle by different systems. It appeared that the canaries actually might have thought about how to produce that sound. Dr. Metfessel believes, however, that many more experiments must be made before definite conclusions on the question of animal thinking can be drawn.

Our Bureau of Information keeps on file the names and addresses of makers of, and dealers in, all devices described in the pages of Popular Mechanics Magazine. We are glad to furnish this information to our readers upon request, accompanied by stamped, self-addressed envelope.

*"Make me One*  
—I'LL BE GLAD  
TO PAY YOU!"



**Enjoyable evenings with Driver Tools will put extra money in your pocket**

*"Mrs. F. begged me to make her a lantern like mine, and she paid a good price. The R's down the street wanted a weathervane . . . have turned out a corner cupboard for another family."*

That's typical of the way hundreds of Driver-equipped home shops are returning a profit as well as a lot of fun. You can do as well. The new 1939 Driver Tools will enable you to produce "professional" work that SELLS . . . so easily that you will enjoy every minute.

### THIS DRILL PRESS DOES 7 JOBS

A Driver Drill Press will handle routing, shaping, dovetailing, mortising, drum sanding and carving, as well as drilling. Choose from a range of models from \$17.50 to \$40.00 (motor and accessories extra). Model D925 shown has six-spline spindle, Jacobs Chuck, ample ball bearings, superior head, wide range of speeds, four inch spindle travel, chuck to table capacity of 12 inches. NEW CATALOG of Walker-Turner's big line of Power Tools and Accessories will help you establish a fine shop for little money. Also guides you in bringing your present equipment up to date. Send coupon or see local Walker-Turner dealer.



\$17.50 to  
\$40.00

**DRIVER** *Engineered* **POWERTOOLS**

Walker-Turner Co., Inc.  
149 South Avenue, Plainfield, N. J.

I am interested in . . . . . starting a home shop;  
. . . . . improving present shop. Send Catalog and  
proper helps.

Name . . . . .  
Address . . . . .



**SPRING IN THE AIR,  
AND SANI-FLUSH  
IN YOUR RADIATOR!**



**CLEAN OUT ANTI-FREEZE  
WITH SANI-FLUSH**

It's time to remove the anti-freeze from your car! Also a whole winter's accumulation of rust, scale, sludge and sediment! They clog the delicate veins of the radiator. The motor overheats. You waste power. You may find yourself with an expensive repair bill on your hands.

Don't take a chance. Clean out anti-freeze with Sani-Flush for 10c (25c for the largest trucks and tractors). Just pour it in. Run the engine, drain, flush and refill (*directions on the can*). Then your radiator is really clean. And your car runs cool. Do it yourself. Or, if you prefer, have your garage or service station do it for you. Insist on Sani-Flush. It cannot injure motor or fittings. You'll find Sani-Flush in most bathrooms for cleaning toilets. Sold by grocery, drug, hardware, and five-and-ten-cent stores. 25c and 10c sizes. The Hygienic Products Company, Canton, O.

**Sani-Flush** Safe NOT CAUSTIC  
KEEPS RADIATORS CLEAN

**HANDY TAPS and DIES . . .**  
Accurate—carefully hardened and tempered. Complete range of sizes at your local five and ten cent store

**HENRY L. HANSON, WORCESTER, MASS.**

**60 POWER TELESCOPE . . . \$219**  
VARIABLE EYEPIECE 20X—40X—60X

**NEW!** Three telescopes in one. 3 different magnifications. 20 power for ultra-bright images with 40 and 60 power for extra long range. Guaranteed to bring distant objects, people, sports events, ships, moon, stars, etc., 60 times as close.

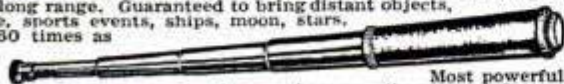

Most powerful made for anywhere near the money. Closes to one foot in length. Multiple lens system. 30 mm. objective lens. 5 sections. Directions included for using as a compound 4 lens microscope. American made. Prompt shipment guaranteed. We pay the postage. Only \$2.19.  
**BROWNSCOPE CO., Dept. 44, 5 W. 27th St., New York, N. Y.**

181500  
**Talking Without Words**

(Continued from page 491)

When the talkies hit Hollywood in 1927, directors who had been shouting their orders were compelled to learn sign language. So that costly film would not be ruined by verbal commands, actors, electricians, cameramen, and sound mixers also had to learn to "talk" without sound. With certain variations, many of their signals are similar to those used in radio.

Dogs, cats, horses and other animals that act before the Hollywood cameras are usually directed by hand signals. The trainer stands just out of range of the camera and commands his animal by hand and arm



Movie sound mixer on Paramount lot signals "No good," and scene must be retaken

code. Long months of training are required to make four-legged movie actors respond to hand movements.

In modern construction work hand signals play an important part. Surveyors, who sight across canyons and over mountain tops, use a system of arm signals when their voices will not carry to their assistants. In construction of skyscrapers and bridges, huge steel beams are hoisted or lowered in accordance with a well-defined system of signals. In tunnel construction, finger signals are used when thundering jackhammers make it impossible to talk.

From the days when the United States Army fought Indians it has retained the

(Continued to page 148A)



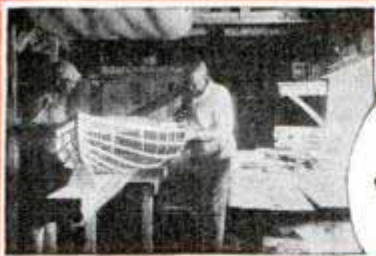

**Assembles His Ki-Yak In Canadian Wilds**  
**1** Mr. C. L. Chester receives his OK-2 OUTBOARD KI-YAK KIT and starts to assemble it in his summer Canadian cabin. The formed-to-shape aluminum ribs (an exclusive PATENTED Mead feature) insure a perfectly shaped hull. All wooden parts come cut-to-fit.

# BIG MONEY!

ASSEMBLING MEAD'S

## New PORTABLE KI-YAK

IN A FEW DAYS AT HOME!



**New PATENTED Type of Construction Guarantees Easy, Perfect, Low Cost Job!**

### 3 BOATS IN ONE!

Assemble your own beautiful, portable OK-2 Outboard MEAD KI-YAK in a few days at home from our Patented Cut-to-fit Construction Kit...and save nearly half the factory assembled cost! Also, earn Big Profits building, selling to others! Successful, quick assembly guaranteed! Experience unnecessary. 10 and 12 year old children have done fine jobs! All Parts Numbered! ALUMINUM Ribs Come Formed, Ready-To-Attach! Wooden Parts Accurately Cut-To-Shape! Then...take your "Mead" anywhere by hand or car for paddling, sailing, rowing, outboard motoring, touring, fishing, camping, hunting! Safe, Seaworthy, Leakproof, Durable. INEXPENSIVE. Thousands in use.



### NEW

### The 14-Foot 75-lb. OK-4 READY!

Carries 4 adults and duffel—the lightest, biggest, strongest boat of its kind!

**Light As A Feather—Strong As A Giant!**

"CK" models (Paddle & Sail) weigh only 20 to 45 lbs.! Mead's 3-Boats-in-One—The "OK-2" (oars, motor, sail) weighs just 50 lbs. The sensational NEW OK-4 takes motor up to 9 h.p.—weighs only 75 lbs! Astonishing strength assured by our entirely new, exclusive small-boat construction principle.

**Factory-to-You at Factory Prices!**

Because we sell direct to the user—we can offer you ROCK-BOTTOM PRICES and QUALITY!

Send coupon and 10c for full details this minute!

**\$6 PADDLE GIVEN**  
 with every "CK" KI-YAK —if you hurry!

### Mail This!

MEAD GLIDERS, 15 So. Market Dept. B-49, Chicago

GENTLEMEN: I enclose 10c as postage-handling charge. Please rush me your new illustrated KI-YAK Boat Circular, Money-Making Plan, Low Introductory Factory-to-You Prices, and Special Gift Offers.

NAME.....

St. & Number.....

CITY.....State.....

### OARS & Oarlocks GIVEN

With Your OK Ki-Yak—If You Hurry!



(Above) OK-2 as rowboat  
 (Below) CK-3 with sail rig.

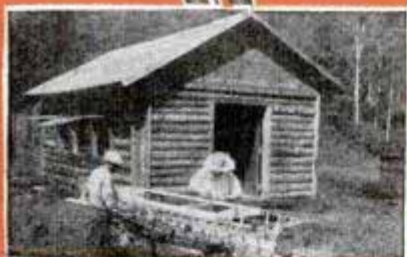

**2** Preparing to cover with canvas, dope and paint.



**3** Mrs. Chester off for a brisk run to the best fishing spot.



**4** Back with 4 Big Ones! Some fish... and SOME BOAT!

**MEAD GLIDERS**  
 15 S. MARKET ST. DEPT. B-49 CHICAGO, U.S.A.



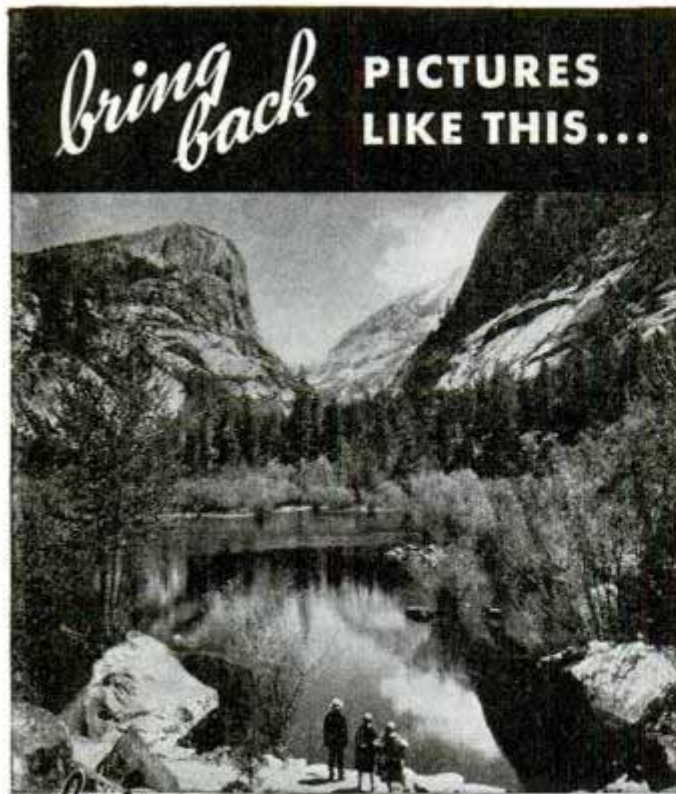

*when you* TAKE A WESTON ALONG

All the pictures you take with your camera will be just as good... rich in detail... if you take along a WESTON Exposure Meter. Simply point the tiny meter at any scene or subject you wish to photograph, and set your lens and shutter as indicated. That's all there is to it... nothing complicated or confusing even for beginners. But it *will* insure a perfect exposure *every time* you take a picture... give you pictures you'll be proud to show. Can be used with still or movie cameras. See this inexpensive meter at your dealer's, or write immediately for interesting literature.



Weston Electrical Instrument Corporation, 671 Frelinghuysen Avenue, Newark, New Jersey.

**WESTON**  
Exposure Meter

## SOIL CHEMISTRY

### Makes Your Garden Grow

#### Sudbury Soil Test Kit

For a better lawn and garden, study the chemistry of your soil with this new efficient Sudbury Soil Test Kit. Gives essential information to adjust soil to the needs of your plants and grasses. Club model (illustrated) makes 50 individual tests for nitrogen, phosphorus, potash and acidity. Cased in strong imitation leather. Complete instructions and data on plant needs. Order by mail, C.O.D., (or send \$4.75 with order and we will pay shipping charges).

**\$4.75**



**SUDBURY SOIL TESTING LABORATORY**  
P. O. BOX 691, SO. SUDBURY, MASS.

(Note: Home Gardener's Model, cardboard case, 20 individual tests, only \$2 postpaid.)

A 1500

(Continued from page 146A)

vestige of a sign language. A sweeping motion of the arm means "come on, let's go," and is used when soldiers go over the top. When the hand is circled above the head it signifies "everyone come here." Both hands flattened against the earth means "keep low." The semaphore signaling of the navy, now done with flags, is an outgrowth of hand and arm signaling.

Auctioneering depends upon a subtle system of unspoken signals. A wink of the eye, a tapping of a pencil, the opening of the mouth, or the raising of one finger may signify either "buy" or "sell." In the Chicago wheat pits, millions of dollars change hands with never a word being spoken.

The world of sports is familiar with sign language. Several years ago, football officials adopted a set of signals to let spectators, coaches, and sports writers know why certain penalties were assessed. When the quarterback opens his clenched fists, a center snaps the ball back. Coaches are sometimes warned against trying to signal from the bench.

Baseball also has its wigwag wireless. A low spreading motion of the umpire's hands means "safe," while a thumb jerked over one shoulder says plainer than words "you're out!"

In our complex, mechanical world, the use of sign language seems to be increasing rather than decreasing. Gestures and signals can express ideas quicker and more completely, in many cases, than the spoken word.

9-141. *make us know*  
Low-Cost Airplanes of Plywood Shaped around Formers

Under development in a New Jersey factory is a mass production system of building airplanes by wrapping flexible plywood around formers. Airplane wings, seaplane floats and other large body assemblies are shaped much as a tailor shapes a suit of clothes around a dummy. The method does away with expensive molds and dies and high costs of skilled labor. A thermoplastic resin is used in the plywood, making repairs easy since damaged parts could be reheated and remolded.

*Eugene L. Vidal Pres*  
[Send return postage to our Bureau of Information to learn the name of the maker of any device described in this magazine.

*Curry*  
*Research Corp. Bendix. n. of*  
*Aircraft Research Corp.*



## Wonders of the New York Fair

(Continued from page 484)

The giant locomotive operating at full speed is a part of the railroad exhibit, sponsored by twenty-seven eastern railroads. The engine, built especially for the fair, weighs 519 tons and develops 7,000 horsepower. Other features of the exhibit include "Railroads on Parade," a great stage presentation of the romance of transport development in America in the last hundred years; "Railroads at Work," a huge diorama showing for the first time the complete operation of a modern railroad

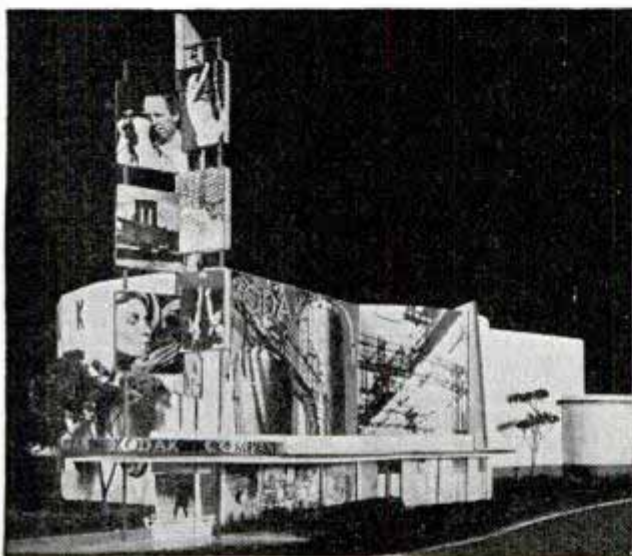

Huge photo-murals will draw attention of fair-goers to the Eastman Kodak building

system, and "Railroads in Building," another large-scale diorama showing the actual construction of railroads and equipment. In addition, there will be track exhibits of modern foreign and American locomotives and trains.

A conception of motor traffic facilities of tomorrow will be projected in the General Motors exhibit. Designed by Norman Bel Geddes, it includes the "magic carpet," chairs mounted on an escalator. Visitors thus will be transported over what will appear to be future express and feeder highway systems. At times the spectator will have the sensation of seeing these things from an altitude of hundreds of feet above the earth. Sound effects and the voice of a narrator will be heard only within the shell of the visitor's chair. The tour will be climaxed when the visitor emerges from his traveling chair into a full-sized street intersection in the "World

(Continued to page 151A)

## New $\frac{5}{16}$ " Utility Drill

ADAPTABLE TO  
DOZENS OF USES

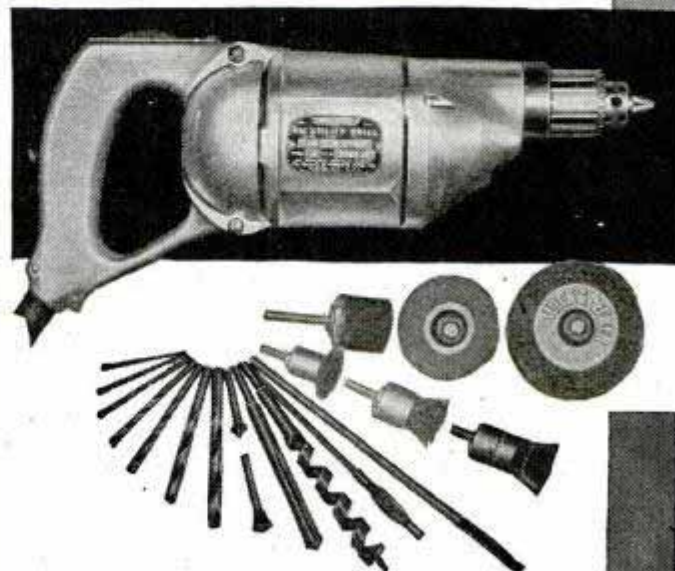

The new Black & Decker  $\frac{5}{16}$ " Utility Drill is versatile to the "nth" degree. The added chuck capacity and correct spindle speed of this remarkable tool permit the use of many varieties of bits, including twist drills for wood, metal and concrete, carbon bits, countersinking cutters, wire brushes, drum sanding attachments, grinding wheels and carbon-cleaning tools.

Can be used in production work, maintenance use, general shop use or in a bench drill stand for more accurate work. In short, here is the ideal, all-around service drill. Perfectly balanced, ruggedly built and highly powered. And because its versatility goes beyond other drills in the same price class, you can't afford to be without this  $\frac{5}{16}$ " Utility Drill. Sold by leading jobbers. Write for complete information on this new Drill today. The Black & Decker Mfg. Co., 604 Penna. Ave., Towson, Md.

# BLACK & DECKER

BLACK & DECKER

World's Largest Manufacturer of  
PORTABLE ELECTRIC TOOLS



# MEGOW MODEL KITS

have very important special features not possessed by others. For instance—the new ready-carved Leading Edge used on the PIPER CUB shown here—the latest Megow gas-powered model—a new, light weight size that avoids crackups. Wingspan 52 $\frac{3}{4}$ ". \$3.95. By mail, 20c extra.



**GIANT 50" FLYING MODELS.** Big, beautiful outline scale models with Motor Hum Device. Light weight, expertly engineered, with large clear plans, TAYLOR CUB, AERONCA K or FAIRCHILD RANGER, \$1.00. MONOCOUE, \$1.25. 60" STINSON RELIANT, \$1.50. WACO, \$2.00. By mail, 15c extra.

**NEW 30" FLYING MODELS.** Famous planes, interesting in design, remarkable in detail. Motor Hum Device. CESSNA C-34, RYAN SC, STINSON RELIANT, ARROW SPORT, AERONCA K, HOWARD DGAS, REARWIN SPEEDSTER. 50c plus 10c post.

**MEGOW MODEL SHIPS.** Carved Hulls on sizes \$2.00 and up. Many ready-made parts. HISPANIOLA (shown here), ARABELLA (Capt. Blood), XEBEC (Robinson Crusoe), BEAR OF OAKLAND, SEA BIRD, etc., \$2.00. SETH PARKER, \$1.00. By mail, 15c extra. MEGOW HO-GAUGE FREIGHT CARS, 50c plus 10c postage. Send 5c postage for 100-page illus. catalog of model kits, ready-made parts and supplies.

## MEGOW'S

Dept. PM., Howard & Oxf. Sts., Phila., Pa. or 217 N. Dearborn St., Chicago, Ill.

## PLANEFILM

### The Magic Covering

Light, tough, elastic, non-porous, smooth as glass, opaque, colorful. Stretches drum-like over irreg. curves. Easy to use. No glue, dope, finishing or stretching. Exclusive dists.

# HOW TO WORK IN Wood



In the 136 pages of this catalog you get the latest knacks in Wood Working, the up-to-date correct processes of finishing, complete directions for Craftsman's new art Inlay method (so easily learned), lists of extra-rare, fancy woods from Africa, Australia, East India and elsewhere—and how best used.

... Also, 235 (yes, 235!) brand new Scroll Saw patterns, (66 others; total 301)

Also, page after page of **bargain deals** in standard and rare woods, complete lists of all American Woods, cut to convenient sizes without waste at bargain prices, figured Veneers, Plywoods, legs, arms, ornaments, inlays and overlays, hardware and miscellany of all kinds, etc.—all this for only 10c.

Woodcraft quickly learned—start right in making beautiful furniture. Fascinating Hobby. Also Money Maker for Spare Time.

—TEAR OUT this ad NOW as reminder—

to get 1939 catalog No. 12. Mail 10c silver or stamps to CRAFTSMAN WOOD SERVICE CO. 2734 S. Mary St., Chicago

Your Name .....

Your Address .....

# Thompson BEATS the World on BOATS



## Better Built Lower Prices

Canoes \$64 and up

Rowboats \$42 and up

Outboards \$42 and up

Very fast utility model

## Only Boats With Full Length Spray Rails

Keep passengers perfectly dry—even at high speeds. Catalog also shows today's five most popular models of sailboats. Two big factories. Prompt shipment.

**CATALOG FREE** Write for your copy. State kind of boat in which you are interested.

**THOMPSON BROS. BOAT MFG. CO.** (87)  
213 Ann St., PESHIGO, WIS. (Write to either place) 113 Elm St., CORTLAND, N. Y.

## CATCH MORE FISH

### Send for FREE BAIT BOOK



This practical handbook, for fishermen, is a fascinating, reliable guide to better fishing! It tells how and why Creek Chub True-to-Nature Lures and Flies Catch More and Bigger Fish! Beautifully illustrated! Sent FREE upon request!

CREEK CHUB BAIT COMPANY  
414 Randolph St. Garrett, Ind.

## CARTOON YOUR WAY TO SUCCESS!



DON'T COPY - LEARN TO ORIGINATE!

RAYE BURNS will teach you HOW TO CREATE ORIGINAL CARTOONS at home that you can SELL! Course has 26 lessons and 600 illustrations. Send name and address for free details. Only... **\$2.85**

RAYE BURNS SCHOOL, Dept. M-B, Box 2194, CLEVELAND, OHIO

## ARC WELDER FROM OLD DODGE

For light or heavy work 75-200 amps. 35c brings complete plans and valuable catalogue listing 500 electrical items. Over 100 other generator changes. LEJAY MFG., 1347 Lejay Bldg. Minneapolis Minn.



## EASY PROFITS IN PAINT SPRAYING



Paint walls, ceilings, screens, furniture, radiators, machinery faster, better!  $\frac{1}{4}$  H. P. motor 110 Volt 60 Cycle AC, complete with Spray Gun, 15 ft. hose. Weighs only 44 lbs. Carry anywhere. FULLY GUARANTEED. Only \$31.15 f. o. b. Chicago. \$5 Deposit. Balance COD, or SEE YOUR DEALER. Circular FREE. Get started making money NOW!

Ideal Automatic Pump Co. Dept. PM-4, 801 Washington, Chicago **\$31.15** Complete



## GRANDFATHER'S CLOCK, LOWER PRICED

Our newest offering, at an unheard of price for a faithful reproduction of a real Grandfather's Clock. Scroll top, narrow waist, like picture. Shipped Knock Down. Cleverly designed. Easy to assemble. Others even cheaper. Plans 10c, Catalogue FREE. AMERICAN CHIME CLOCK CO. 1670 Ruffner St. (Established 1877) Philadelphia, Pa.

# PAYS Up To This MAGIC-DISC HEATS WATER INSTANTLY!

233% PROFIT  
60 second Demonstration

EVERY HOME CAN AFFORD THIS AMAZING LOW COST NEW IMPROVED ELECTRIC WATER HEATER.

Made by an OLD Reliable Company. Amazing New Principle Heats Water Instantly. Just plug in the light socket. SELLS FAST and Pays Agents up to 233% PROFIT. No Risk. SAMPLE OFFER. Write at once for details.

## THE LUX COMPANY

Dept. H-209 Elkhart, Ind.





(Continued from page 149A)

of Tomorrow." Extending for more than a city block in four directions, the spectacular intersection will present a living picture of the architecture, motor-traffic regulations and pedestrian facilities of the future.

Sound for the traveling chairs will be supplied by a twenty-ton system capable of delivering 150 different descriptive talks at the same time. The giant speaker is constructed on a steel drum, eight feet in diameter. The drum, rising twelve feet into the air from a circular base, revolves, carrying ribbons of sound film in front of

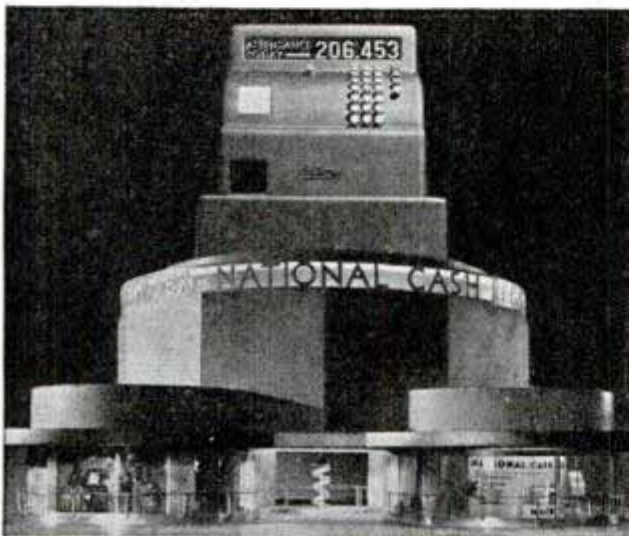

Giant revolving cash register tops exhibit building of National Cash Register company

tiny needles of light, whose variation is no greater than one-thousandth of an inch. From that point the sound is carried to 150 speakers.

A spectacular tower symbolizing chemical research stands before the exhibit building of E. I. du Pont de Nemours and Company. Ten feet in diameter and 100 feet high, the tower incloses within steel framework a greatly enlarged representation of the complex apparatus found in chemical research laboratories. Fluids will appear to circulate within the tower, while from the top a long plume of vapor will seem to rise. The du Pont exhibit is called the "Wonder World of Chemistry," designed by Walter Dorwin Teague. Among its features will be a demonstration of the new synthetic textile, nylon; a model nitrogen fixation plant; development of synthetic aromatic bases, used in perfumes, synthetic methanol, used in anti-freeze,

(Continued to page 152A)

## STANLEY CHISELS

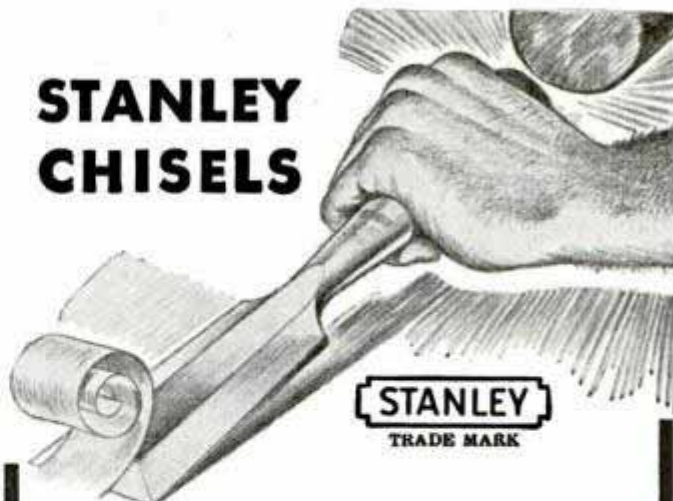

### HOLD THAT EDGE!

Because *Stanley knows chisels*; knows steel selection, forging, tempering, grinding. Stanley knows, too, how to design a handle that's comfortable and built for long, hard service. You have a wide choice in all sizes.



#### "STANLOID"

A finely balanced tool for the artisan. Handle of tough, non-metallic material, blade and tang forged from one piece of finest chisel steel.



#### "EVERLASTING"

Built for a lifetime of hard service. A one-piece forging from head to blade transmits hammer blows direct to cutting edge. Rubber composition handle. Tool steel blade.



#### SOCKET

A fine, moderate priced tool for general work. Blade and socket are forged in one piece. Selected straight grained hickory handles, capped with 3 leather washers.



Your hardware dealer will be happy to show you Stanley Chisels. Or write for Catalog 34 . . . your guide to good tools.

## STANLEY TOOLS

Division of The Stanley Works, 105 Elm St., New Britain, Conn.

### 26 NEW PLANS 50c FOR HOME CRAFTSMEN



Modern desk-pen holder! Night table! Magazine stand! Party tray—and 22 other useful things you'll want to build. Complete working drawings. Each plan on a separate sheet of tough paper. Send coin or stamps now for the new Stanley Plan Packet.



## Said little Red Riding Hood-



**"How handsome  
you look, grandpa, since you got  
a Barbasol Face"**

**W**HY not resolve right now to break with old-fashioned shaving methods that tend to dry, tighten and wrinkle the skin?

Why not get yourself a smoother, softer, younger-looking Barbasol Face?

For Barbasol is a lot more than a wonderful beard-softener that gives the quickest, cleanest shave you ever had. Barbasol also contains certain beneficial oils that protect the skin from irritation while you shave—that soothe the skin after you've shaved.

Try Barbasol for just ten days and we promise, you'll be pleased as Punch with the improvement in your skin—free from roughness and irritation, no half-cut stubble—a smoother, younger-looking face. Your druggist carries Barbasol in three sizes. Large tube, 25¢. Giant tube, 50¢. Family-size jar, 75¢. Scalpel-sharp Barbasol Blades, 5 for 15¢.

For Modern Shaving

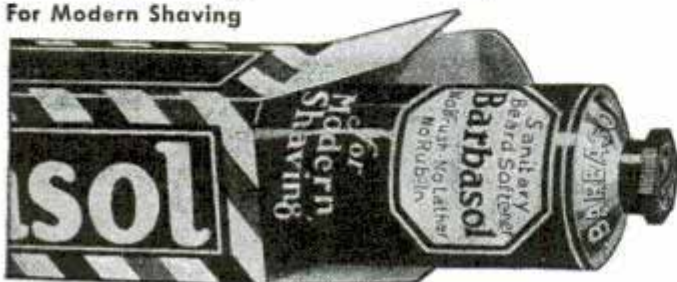

**No Brush • No Lather • No Rub-In**

(Continued from page 151A)

and "Nitramon," the explosive so safe to handle and use that it has removed all former transportation hazards. Another interesting display will be a pest-control laboratory, showing how fungicides and insecticides for the control of such pests as the housefly and the Japanese beetle are tested and developed.

One of the most brilliant spots at the fair will be the Glass Center, housing the combined exhibits of Corning Glass Works, Owens-Illinois Glass Company and Pittsburgh Plate Glass Company. Designed by Shreve, Lamb and Garmon, it will contain more than 20,000 square feet of plate glass, structural glass and glass block and will describe a huge semi-circle. Crowning the building will be a tower of glass blocks. A metal helix winding up the tower will be outlined in fluorescent tubing for illuminating the tower at night. Glass blowers in action, the spinning of glass filaments one twentieth the diameter of a human hair into fabrics and a panorama depicting the 5,000-year history of glassmaking will be among the exhibit's features.

Television is the central theme of the exhibit of Radio Corporation of America. In special viewing rooms the public will be shown pictures which have been flashed through the air. Many other unusual radio and electronic devices also will be shown in the main building, which is shaped like a radio tube. Near by will be a slender radio mast marking the RCA Communications exhibit, at which visitors may see how radio messages are transmitted to all parts of the world.

Automobiles careening over a huge field, crashing head-on into one another, turning somersaults and doing other perilous stunts will thrill visitors to the exhibit of the B. F. Goodrich Company. The object of this death-defying exhibition is to afford dramatic testing of anti-skid and other characteristics of tires. Grandstands will be provided for spectators. At the main entrance of the exhibition building will be a ninety-foot tower housing a "tire guillotine." Through its glass sides visitors will see a heavily weighted blade plunge downward from varying heights directly upon automobile, truck and airplane tires.

Westinghouse Electric and Manufacturing Company's exhibit will portray many

(Continued to page 154A)





# GET A ROYAL—THE PORTABLE WITH OFFICE TYPEWRITER FEATURES

**READ WHAT OWNERS SAY:**  
"Homework is neat, business-like now!" (Student) . . . "A real help to all of us." (Parent) . . . "Smooth, steady, grand to use." (Ex-secretary).

**SEND NO MONEY**—don't spend a cent—until you've seen right in your own home how easy a Royal makes writing—how its many "big machine" features and controls help you turn out a professional looking job easier and faster than by hand. Remember—the Royal Portable is made, tested, guaranteed by the Makers of World's No. 1 Typewriter for the office. Use the coupon for facts—all about the Royal Portable. Mail it today.

**FREE HOME TRIAL**



**A YEAR TO PAY!**

## ACT NOW! . . NO OBLIGATION

**FREE! INCLUDED**



Royal's Instant Typing Chart, shows you how to type RIGHT.



with every Royal Portable at no extra cost—a handsome, all-weather Carrying Case.

**ROYAL TYPEWRITER COMPANY, INC., DEPARTMENT D-77, 2 PARK AVE., NEW YORK CITY**  
Tell me how I can get a Royal Portable on **Free Home Trial**; also how I can own one on **Easy Monthly Terms**.

NAME \_\_\_\_\_  
STREET \_\_\_\_\_  
CITY \_\_\_\_\_ COUNTY \_\_\_\_\_ STATE \_\_\_\_\_

## CLAMPS

You can re-sharpen dull edges, can "set by" with mediocre tools in many places but your clamps must be right. The least slip or opening can ruin joints or set-ups, can ruin hours of painstaking work. That is why industry has standardized on "Jorgensen" Clamps—dependable lifetime tools engineered and manufactured by "The Clamp Folks."

**ADJUSTABLE CLAMP CO.**  
"The Clamp Folks"

421 N. Ashland Ave., Chicago, U.S.A.



Pony Miniatures 9 types—1" to 2 3/4" cap. Not toys but fine tools with 100 uses.

Pony "50" Fittings go on ordinary 3/4" pipe. Any length. Send \$3.00 plus postage (6 lbs.) for fittings for two "50" Clamps. Also "Pony" #52 Fittings for 1/2" pipe—2 sets for \$1.50 plus postage.

**Catalog FREE!**



Genuine "Jorgensen" Handcrews grip at all angles, never slip, split or loosen. All sizes. Send \$3.20 plus postage (7 lbs.) for 2 No. 1 Handcrews—openers.

## NEW BIG TRAILER PARTS CATALOG

Shows hundreds of house trailer items. Build your own trailer or re-condition the one you have. Wholesale prices. Quality merchandise. Prompt shipment. Send 10c for this money saving catalog today. C. M. Hoof Company, 1736 S. Michigan Ave., Dept. P-4, Chicago, Ill.

## Large Paint and Roofing Manufacturer

wants reliable men to sell direct to factories, stores, warehouses, schools, homes, and farmers, at factory prices on credit. Big demand. Good profits. District Manager's position open for right man. Reply:

**THE MADISON PAINT CO., DEPT. C-98, CLEVELAND, OHIO**



### — NEW — SENSATIONAL — KEYLESS — ELECTRIC GAS TANK LOCK

Cap unlocks—SNAPS open by pressing a button on your dash. Close the cap and it locks automatically. Fully guaranteed. Wonderful opportunity for Agents and Dealers. Write immediately for exclusive distributorship proposition. Territory going fast. SNAP-UP GAS CAP CO., DEPT. C. ASHLAND, KY.

## HANDEE Tool of 100 Uses

### A Whole Tool Shop In Your Hand

Smooth, steady power at your finger tips. Unmatched performance, with our own CUSTOM BUILT precision motor. For work on all materials.



Save Hours of Hand Work

Finest, Fastest, Most Powerful Tool for Its Weight

Uses 300 accessories, interchangeable in easy-working chuck to grind, drill, polish, engrave, sharpen, carve, sand, saw, rout, cut, etc. Set up shop anywhere; plug in AC or DC socket.

**STANDARD MODEL** (Shown above), 20,000 r.p.m. Wt. 16 oz. \$10.75 postpaid with 3 Accessories. **DE LUXE MODEL**, 25,000 r.p.m. Wt. 12 oz. \$18.50 postpaid with 6 Accessories.

**GET A DEMONSTRATION** at Hardware, Tool or Dept. Stores or order either model on 10-Days Money-back Trial.

### Free - 64-PAGE CATALOG

Complete information on Handee Products and their wide application in crafts work and industry all over the world.

**Chicago Wheel & Mfg. Co., 1101 W. Monroe St., Dept. PM, Chicago, Ill.**

Send Catalog  Standard  De Luxe  Send C.O.D.

Name.....

Address..... PM-4



# GREAT NEWS

FOR 6,901,587\* FISHERMEN . .



NEW EVINRUDE "MATE"



\*This is the number of fishing licenses issued in 1937.

GREAT NEWS for any fisherman who wants every precious hour on the water to yield him the biggest catches of fish and pleasure! Now Evinrude presents an outboard within the weight and the cost of a modestly equipped tackle kit . . . AND WHAT A MOTOR IT IS! Smooth as silk . . . quiet as a kitten's purr . . . a dream of starting ease and sureness! A genuine Evinrude . . . with Hooded Power, finger-tip controls, Co-Pilot steering and a cooling system that's permanently trouble-proof!

## SEND FOR FREE CATALOG!

Write today for free catalog of 1939 Evinrudes . . . 9 models to choose from . . . 9 certified power ratings . . . 9 speed ranges. Every model offers the greatest feature any outboard can give . . . the confidence and constant pleasure of easy, instant starting! With cata-



logs we'll send Boat Directory and handy Boat-and-Motor Selector—all free! Address, EVINRUDE MOTORS, 4079 North 27th Street, Milwaukee, Wisconsin.

Evinrude Motors of Canada, Peterboro, Canada.

# EVINRUDE

9 GREAT EVINRUDES TO CHOOSE FROM

WEIGHS ONLY  
**10 LBS.**

COSTS ONLY  
**\$34<sup>50</sup>**

RUNS 10 HRS.  
ON A SINGLE  
GALLON

AN *Elto*  
BUILT BY EVINRUDE  
NOW ONLY **\$29<sup>50</sup>**

(Continued from page 152A)

phases of that industry in technical and scientific displays. The American Institute Science and Engineering Club will be in operation, with boys and girls between twelve and eighteen working at benches producing useful products. The exhibit will contain a theater where an interesting short play will depict electricity as the universal servant.

In the Eastman Kodak building, visitors will find a swift, complete, vivid survey of photography today. Each phase will be included—amateur photography in color and black-and-white, photography in medicine and dentistry, X-rays, electrocardiography, photomicrography, visual education, home movies and others. A feature of the building will be a slender, sixty-eight foot tower on which lights will play in rhythmical progression. The tower will be triangular and from it will project ten fins on which twenty huge photomurals will be mounted, each eight feet wide and eleven feet high. At the base of the tower will be three revolving photomurals. Inside the building will be an enormous screen, twenty-two feet high and 187 feet long, on which will be flashed, in single panoramic views and in groups of pictures, the greatest show of color photography ever seen. On this screen, small full-color transparencies will appear at a magnification of 50,000 times the area of each. Giant projectors, each weighing nearly one ton, will provide illumination for showing the transparencies.

Full-scale manufacture of automobile tires and the portrayal of the story of rubber will feature the exhibit of Firestone Tire & Rubber Company. Unique in this display will be a full-sized reproduction of a thriving American farm, livestock, farm hands and all. This part of the exhibit will demonstrate how the American farm has become modernized by the adoption of pneumatic tires to every kind of wheeled farm implement. The tire plant will produce a finished tire every four minutes before the eyes of fair visitors.

Displaying the progress of time-telling from the prehistoric smoldering rope and the Egyptian slave gong to the timepiece of tomorrow, the "Chronicle of Time" will be presented by the Elgin Watch Company. The exhibit will be housed in a semi-cir-

(Continued to page 156A)



**WRITE TO Bass FOR HIS BOOK OF BARGAINS**

**ORDER FROM THIS LIST OF BASS-GUARANTEED BARGAINS**

- Candid Midget—Schneider F:2 lens, Rapid Compur, Eveready case, list \$81.75 ..... \$47.50
- 4x5 or 10x15 cm. ZEISS IKON SPEED DECKRULLO, 18 cm. Carl Zeiss Tessar F:4.5 f.p.a. for both sizes and double ebony plate holder. List \$225, at \$79.50
- New 6x6 cm. Voigtlander Super Miniature Reflex camera—Skopar F:3.5 lens ..... \$59.50
- 9x12 (3 1/4 x 4 1/4) Zeiss Volta—single ext. film pack and plate—Novar F:6.3 lens—f.p.a. and 2 holders; brand new ..... \$11.95
- New 2 1/4 x 3 1/4 Zeiss Miroflex-12 cm. F:3.5 Tessar—focal plane speeds to 1/2000 sec. f.p.a. and 3 holders—formerly \$275 ..... \$87.50

**BASS CAMERA COMPANY**  
179 W. Madison St. Dept. P Chicago, Ill.

**CAN YOU BEAT THESE POWER COSTS?**

Save up to **\$293<sup>80</sup>** Per Month on power costs

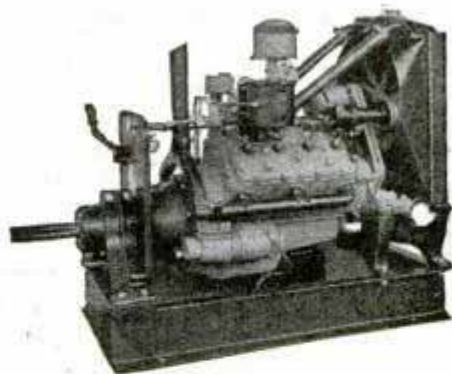

**with a KRW FORD V8 Unit**

50 H. P. with KRW V8 Unit using natural gas (1125 BTU) @ 30c per 1000 cu. ft. .... \$ 46.80 per month  
50 H. P. with KRW V8 Unit using gasoline @ 10c per gal. (no tax) ..... \$140.40 per month

Above figures show primary fuel costs (lubricating oil not included) for operating a KRW V8 Unit to develop 50 H. P. for 10 hours per day—26 days per month. Compare this with electricity @ 3c per KWH which amounts to \$340.60 per month. You can pay for a KRW Unit in a few short weeks out of actual savings!

KRW V8 Units are daily saving money for operators of air conditioning and refrigeration equipment, mills, factories, shops, welders, compressors, pumps, well-drilling outfits, contractors' equipment, etc. New KRW "GUARDIAN" automatically stops engine in case of cooling or lubrication failure.

Write for new bulletin just off the press—packed with useful information engineering data, etc. You can buy through your local Ford Dealer and benefit by local service and low-cost Ford engine replacement feature.

**K. R. WILSON 17 Lock St. BUFFALO, N.Y.**

Builders of Shop Equipment for Ford Dealers Since 1916  
West Coast Branch: 722 Mateo St., Los Angeles.  
Export Office: 90 West St., New York.

**BE AN EXPERT MARKSMAN!**

Have FUN



**Get a DAISY AIR RIFLE**

Get in on the big fun... get your heart set on a famous DAISY... go to your Dealer NOW and see the beautiful models selling from \$1.25 up. Or, write us today for Picture Circular showing all 7 Daisy Air Rifle models, enclosing thin dime for mailing-handling charge on Circular.

USE **BULLS EYE** copper-coated steel shot for accurate shooting... only shot Officially Approved **225 Shots 5c** for Daisys only

**DAISY MFG. CO., 1104 Union St., Plymouth, Mich.**

**Make Big Money The American Way**

Get into something for yourself where your income is practically unlimited—the AMERICAN ELECTRIC METHOD of floor surfacing gives you that opportunity. Large profits—work easy to get—no previous experience necessary. Start with as little as \$75 in this tried and proven money-making business. Write quickly—no cost or obligation.

**The American Floor Surfacing Machine Co.**  
523 South St. Clair Street • Toledo, Ohio

**BALCO** Ready! **BALCO'S 1939 CATALOG!**

THE CATALOG OF EVERYTHING IN POWER TOOLS, SPRAY EQUIPMENT, MODEL SUPPLIES, ELECTRIC MOTORS, Metal Lathes, accessories, spray guns, Elec. Bench Grinders, Grinding Wheels, Lathe Chucks, Micrometers, Pulleys, V Belts, Carving Tools, Compressors, BALCO'S complete stocks and fast service save you time. Send a 5c stamp today for your big new copy.

**BALCO ELECTRIC TOOL & SUPPLY CO.**  
605-A W. Washington Blvd., Chicago, Ill.

**CASH IN ON SPARE TIME**

**\$30 WEEKLY OR MORE EARN.** Grow mushrooms HOME. Cellar, shed suitable. We buy 30c lb. Year round business.  
**\$270** made by Mr. B. in few weeks SPARE TIME. Guaranteed materials. Established 1931.

Write for FREE BOOK  
**WASHINGTON MUSHROOM INDUSTRIES**  
Dept. 601, 2019 2nd Seattle, Wash.

**INVENTORS** Have you a good idea? Is it for sale?

Patent desirable but not necessary Is it registered?  
Write, Fluorescent Processes, Inc.  
1720 N. Damen Ave., Chicago, Ill. **WE ARE NOT ATTORNEYS**

**Class Pins 30¢ up FREE CATALOG**

Artistic pins, rings and emblems for classes and clubs. Attractive prices. Finest quality, gold plated, silver, etc. Over 300 designs.  
Write Dept. N, METAL ARTS CO., Inc., Rochester, N. Y.

**ITALIAN ACCORDIONS**

HAND MADE. Very best. Lowest prices. Direct from Factory Representative. Send your name and address for FREE catalog.  
**ITALIAN ACCORDION COMPANY**  
323 W. POLK ST., DEPT. P-10 CHICAGO, ILL.

**Syncho JIG SAW**

Faster! Safer! Cleaner! Real performance. Cuts with smooth, clean edges. No sanding required. Electric operation. No motor or reciprocating parts. Operates on 60 cycle, 110 volt A.C. Ideal for home craftsmen, and model makers. Two models.

7200 Strokes per minute **Only \$4.95** (East of Rockies)



Write Today for FREE LITERATURE  
Export Office: 40 Worth St., New York; Western Dist.: Federated Sales Co., 2437 W. Valley Blvd., Alhambra, Cal.

**SYNCHRO DEVICES, INC.,** 511 Boydell Bldg. Detroit, Mich.

When writing please mention Popular Mechanics



(Continued from page 154A)

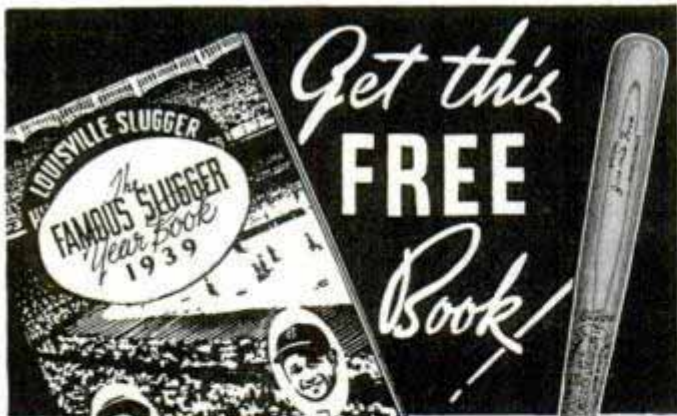

Get this  
**FREE**  
Book!

WHERE YOU  
**BUY YOUR SLUGGERS**

The 1939 Baseball Centennial edition of the Famous Slugger Year Book is now ready! Contains batting averages; the 1938 records of Big League players and what they have to say about their Louisville Sluggers. This enlarged edition includes everything you'll want to know about batting. Foot Now ready at your dealer's. If he cannot supply you, send 5c in stamps or coin to Dept. P-31, HILLERICH & BRADSBY CO., Louisville, Ky.

Genuine  
Autographed

**LOUISVILLE SLUGGER BATS**



HIT DAYS TO PLAY!

**NEW BENJAMIN AIR PISTOLS WITH MULTIPLE LEVER HAND PUMP FOR TARGET-SMALL GAME-CAMPING-ETC.**



Guaranteed-Accurate-Practical-Economical-Safe-Clean-Quiet. Adjustable Force-Amazing Maximum Velocity. No smoke or fumes. Bolt Action-Hammer Fire-Hair Trigger-Safety Lock-Hand Pump. Single Shot BB \$8.50; Ringie Shot cal. 177 or 22 with rifled barrel \$8.50; BB 8-Shot \$10.00; Holster \$2.00. Also a complete line of Benjamin Genuine Compressed Air Rifles for BB and cal. 177 or 22. No license required from dealer or factory. Ask for complete specifications and Free Targets. **BENJAMIN AIR RIFLE CO., 850 Marion St., St. Louis, Mo., U.S.A.**

WRITE TODAY!

**Free! PIPE CATALOG**  
**NEW! SAVES YOU MONEY**



508 different pipes, 91 high grade tobaccos, pouches, racks, humidors, and pipe gadgets from all over the world at bargain prices! Tells—How To Keep Your Pipe Sweet, How To Blend, etc., etc. 32 pages... hundreds of illustrations! We ship **POSTPAID** all over U S Thousands of pipe smokers save money—We are the largest pipe purveyors and tobacconists (strictly) in the world. Send for **FREE** Catalog now.—No obligation.

**WALLY FRANK LTD., 10 E. 45TH ST., NEW YORK Dept. 10**

**Saw-Filing**

Pays up to \$2 or \$3 an Hour in Spare Time

A FOLEY Automatic Saw Filer files hand, circular and band saws better than the best hand filer. Cash business, no canvassing, no eyestrain. No experience needed. Louis P. Wadovick, Ohio, says, "I have filed 764 saws in spare time and have earned \$850.00 in carpenter work due directly to my saw filing contracts." Send coupon for **FREE PLAN**, no obligation.



**FOLEY MFG. CO., 416-9 Foley Bldg., Minneapolis, Minn.**

Send Free Plan on Saw Filing business.

Name.....  
Address.....

cular hall. Also in the building will be an astronomical observatory in which will be demonstrated the method of determining correct time from the stars.

Contrast between the modern electric gearless elevator and the old steam elevator of the 1860s will be drawn in the exhibit of the Otis Elevator Company. Cabs of the two elevators will be displayed.

"The City of Light," a spectacle designed by Walter Dorwin Teague, will be presented by the Consolidated Edison Company of New York. Its central figure is a three-dimensional, animated architectural model of the New York metropolitan area, about one city block long and over three stories high. More than 4,000 buildings, studded with 130,000 windows, will be shown in this giant diorama. A complete model subway system, with trains designed for a run of 35,000 miles, will be a part of the exhibit.

*9-104*  
**Removable Tray for Bird Cage Is Easy to Service**

A removable tray for a bird cage can be serviced without putting the hands inside. Cups and feeding perches are bracketed to the tray, and all this equipment is slipped out easily by raising a section at one end of the cage. Two upper perches are taken out through the side, and the swing goes through the top. There is nothing to interfere with placing of paper mat on the bottom of the tray.

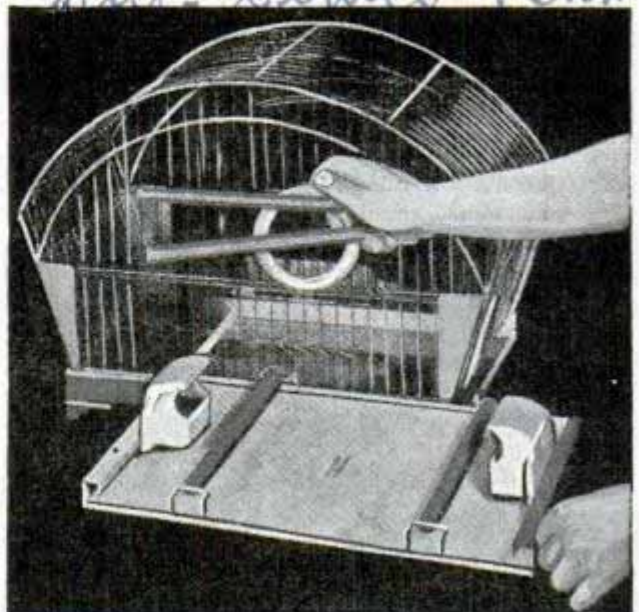

Perches, swing and tray with feeding and water cups are easily removed from bird cage for cleaning

*Address P. B. Bendy, New Haven, Conn.*



# ELECTRICITY

FROM YOUR OWN ELECTRIC PLANT  
WHEN POWER LINES FAIL

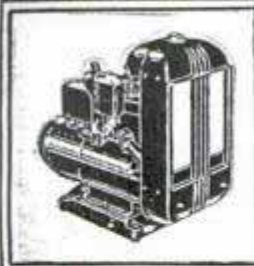

ONAN ELECTRIC PLANTS furnish 110 Volt, 60 Cycle, A.C. Current same as City Power Lines. Models for Farms, Camps, Construction Jobs and for Emergency Service in Hospitals, Schools, Theatres and Public Buildings. SAVE PROPERTY and even LIVES in case of Power Line Failure. Thousands in use in all parts of the World. Operate Lights, Radios, Water Systems, all Appliances. New Models 250 to 50,000 Watts, 12, 32 and 110 Volt, D.C.—110 and 220 Volt A.C. Also Combination A.C.-D.C. Units. Manual, Self-starting and Full-automatic Starting Types. \$29 and up. Shipped COMPLETE—READY TO RUN. Write for Details.

**D. W. ONAN & SONS**  
1032 Royalston Ave. Minneapolis, Minn.

## FLAME-GUN Destroys Weeds Does Work of 4 Men!



Hauk Kerosene Flame-Gun—2000° F. controlled heat—quickly, easily, economically destroys weeds (seeds and all), brush, other objectionable growths. Keeps roadways, fences, irrigation ditches, orchards, etc., clean. Hundred and one uses. Inexpensive—Safe—Easy to use. Pays for itself in time and money saved. 10 day Free Trial. Write for Free booklet and special introductory price.

Hauk Mfg. Co., 134 Tenth St., Brooklyn, N. Y.

MOW  
with  
ONE  
HAND.



Handiest power mower ever built—only one with easy one-hand control—cuts 18" swaths; mows large lawns in quarter of time for only 5c fuel cost. Quiet, easy starting 4-cycle motor; adjustable cutting heights; rubber tires. Easy terms. Model "D" \$110, Model "S" shown...\$79.50

FREE LITERATURE—

**EVINRUDE LAWN-BOY POWER MOWER**

Write EVINRUDE  
1763 W. Hope Ave.  
Milwaukee, Wis.

## WET BASEMENTS!

Amazing new Seal-Seep method, anyone can use. Applied to inner masonry wall and floor surfaces; no digging. Guaranteed permanently effective. Agents write for unusual earnings opportunity. Details FREE. National Seal-Seep Co., Dept. 492, Cincinnati, O.

Waterproof  
Your Own  
Save up to  
\$100 to \$150

## BUILD YOUR GRANDFATHER CLOCK

The Simple Sensible Red-Kut way as thousands have. DIME brings PLANS and sixty pictures "HOW" Book pricing many fine brass weight Westminster, tube chime, electric and battery movements showing nine beautiful colonial grandfather cases. WHY WAIT LONGER! KUEMPEL CHIME CLOCK CO., Bldg. 27, Guttenberg, Iowa.



## Print Your Own

Cards, stationery, circulars, tags, labels, advertising, etc. Save money. Print for Others; Big Profits; easy rules sent. Will do popular Raised Printing like Engraving. Junior outfit \$9. Senior outfit \$17 and up. Send for free catalog and all details. KELSEY PRESSES, E-37, MERIDEN, CONN.



## CATCH FISH!

minnows, eels, milk, muskrat, with our folding galvanized Steel Wire Traps. Walton's Automatic Hooks are so constructed that when a fish gives the slightest pull on the bait the upper hook reaches down and gets a hold that holds him. 3 for 50c. Write for descriptive catalog of Traps, Hooks, Lures, and other specialties. Walton Supply Co., 3507 Juniata Ave., St. Louis, Mo.

## New Accurate 10" Slide Rule

Enables you to do difficult calculations instantly without paper or pencil—multiplying, proportions, division, extracting roots, etc. Accurate, white composition face. Has Standard A, B, C, D, CI, and K scales. Made in U.S.A. **50¢**

Special magnifying indicator. For complete outfit, including slide rule, 16-page illustrated instruction book, carrying case, send 50c in coins or U. S. stamps (60c in Canada). Mailed postpaid. Satisfaction guaranteed or money refunded. (Schools and dealers: write for quantity price.) Send today for this great value. **LAWRENCE ENGINEERING SERVICE, 14 Smith St., PERU, INDIANA**



## For NEPTUNES are DEPENDABLE!

Don't let "Row, Row, Row Your Boat" be your sad fish story. Get a NEPTUNE! Swift, sturdy and dependable - t'will take you there and bring you back no matter what the weather.

Each NEPTUNE Outboard is precision-built for longer, worthier service - sure starting - smooth operation - plenty of power and speed. Choose the size you need, from 1.2 H.P. at \$35.50 to 16 H.P. at \$164.50. Send for free literature on the complete NEPTUNE line.

NEW NEPTUNE  
"FIVE"  
Alternate-Fire  
Twin

**MUNCIE GEAR WORKS, Inc.**  
Muncie, Indiana  
New York Office: 45 E. 17th St.,  
Gramercy 7-6310

From  
**\$35.50**  
UP

# NEPTUNE Motors

BUILT FOR SALT WATER AS WELL AS FRESH WATER



## Indianapolis Race Car Model Kit

This kit builds a Two-Man Race Car that looks like the real racing models used by famous racing drivers! Kit is complete to detail, all parts, nuts, full sized plans furnished. \$1.00 plus 15c postage or buy from dealer. 6 other models from 10c to \$2.95. Circular of models FREE. NORTHERN AIRCRAFT, PM-2, Manitowoc, Wis.

# TYPewriter 1/2 Price

Easy Terms  
Only 10c a Day  
Save over 1/2 on all standard office models. Also portables at reduced prices.



**SEND NO MONEY**  
All late models completely refinished like brand new. FULLY GUARANTEED. Big free catalog shows actual markings in full colors. Lowest prices. Send at once. Free course in typing included. **10-day Trial**  
**International Typewriter Exch.,** 231 W. Monroe St., Dept. 401, Chicago

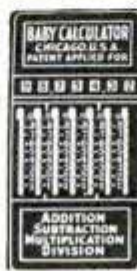

## WORLD'S LOWEST PRICED ADDING MACHINE

GUARANTEED ACCURATE. Not a toy. Operates with only a finger flick. Adds, subtracts, multiplies, divides. Counts up to a million. Pays for itself over and over. Ideal Gift—for Business, Income Tax and School use. **ONLY \$2.50**  
**MONEY BACK GUARANTEE.** Send name and address. Pay postman only \$2.50 plus postage. (Send full cash if outside U. S.) Money back in 10 days if not delighted. **AGENTS WRITE. CALCULATOR MACHINE COMPANY (Mfrs.), DEPT 104, P. O. BOX 1118, CHICAGO, ILLINOIS.**



**NEW PHOTO BOOK FREE!**



*save on everything you buy in photography!*

Here's a brand new camera book just off the press. It will prove extremely valuable to you. It's **FREE**. Send for a copy today. Do as thousands of thrifty camera fans are doing—let this book give you the "buy word" on everything you need in photography. Everything's here—cameras, all makes, all types—ranging in price from \$1 to \$100; complete equipment for developing, printing and enlarging—all at economy prices. *Tear off the coupon and mail NOW.*

**LAFAYETTE CAMERA CORP.**  
 Division of **WHOLESALE RADIO SERVICE CO. INC.**  
 NEW YORK, N. Y. CHICAGO, ILL. ATLANTA, GA.  
 100 SIXTH AVENUE • 901 W. JACKSON BLVD. • 265 PEACHTREE ST.  
 BOSTON, MASS. • BRONX, N. Y. • NEWARK, N. J. • JAMAICA, L. I.

Rush New FREE Catalog No. 76

Name.....  
 Address.....  
 City..... State.....



**LAFAYETTE CAMERA CORP. CATALOG**  
 Dept. 7DC9-100 Sixth Ave., New York, N. Y.  
**PASTE COUPON ON PENNY POSTCARD**

**WINDOW AND SCREEN for Cabin, Cottage and Camp**

Complete assembly of window and screen. All metal, welded construction. Insect-proof and weatherproof. Waterproof, sponge rubber seal. Easily opened, closed and locked. Handsome appearance.

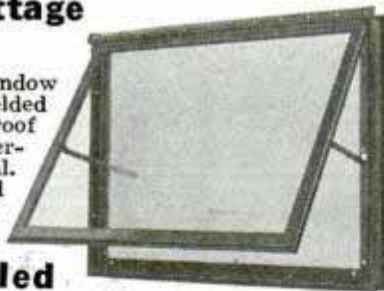

**Easily Installed**

Easy operation, with 3 different open positions. Fit snug and flush. Best materials and workmanship. Low prices for all sizes.

**Write Today for Free Folder and Prices**

**HERRON - ZIMMERS MOLDING CO.**  
 3902 E. Outer Drive Detroit, Mich.

**AT LAST! MAXIMUM PERFORMANCE**

**From Your Home Radio—With Verti-flex THE MODERN ANTENNA!**

A new type of antenna perfectly "tuned" to the new vertical radiators now in use by modern broadcasting stations.

**Only \$1.00 COMPLETE**

**Better Reception • Saves Power • Simple to Install**

Verti-flex, in three telescoping sections of rod aluminum, is 9 ft. high. Install it outside your window in ten minutes. Be first to show this new modern antenna! **Just enclose a dollar bill with this coupon!**

**Verti-flex** THE MODERN ANTENNA 2138-B No. Racine Ave. Chicago, Illinois Enclosed is \$... (cash or m. o.) for  Verti-flex antennas.

Name.....  
 Address.....  
 City..... State.....



*J-151*  
**Five-Foot Web of Welded Iron Is Home of Copper Spider**



*Novel product of a welder is this web of welded iron rods with a huge copper and bronze spider on it*

Little Miss Muffet might get the fright of her life from this grim-looking spider, but there's really no reason to be alarmed. The spider itself is made of copper and bronze, and it is at home on a five-foot web of welded iron bars. Architect and builder of this giant web is an Alhambra, Calif., man who makes novelties in iron. The legs of the spider are a foot long. The insects furnished for the spider's dinner are of iron, welded to the web, which is composed of 150 small bars.

*J-134*

**Remote Control for Sound Unit Carried in Palm of Hand**

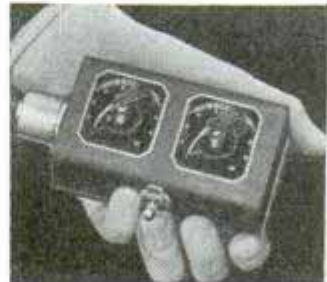

Remote control for a public-address system is provided by a unit small enough to fit in the palm of the hand. With it the operator can mix the sound from

two microphones and control the output of the amplifier, raising or lowering its volume as noise in the audience varies.

*Operadig Mfg Co.*



# HARD WORKERS! "REACH FOR HORSEHIDE HANDS!" THEY CAN TAKE IT!"

Pony-White  
Horseshide Driver's  
Slip-On Pattern  
No. 8565

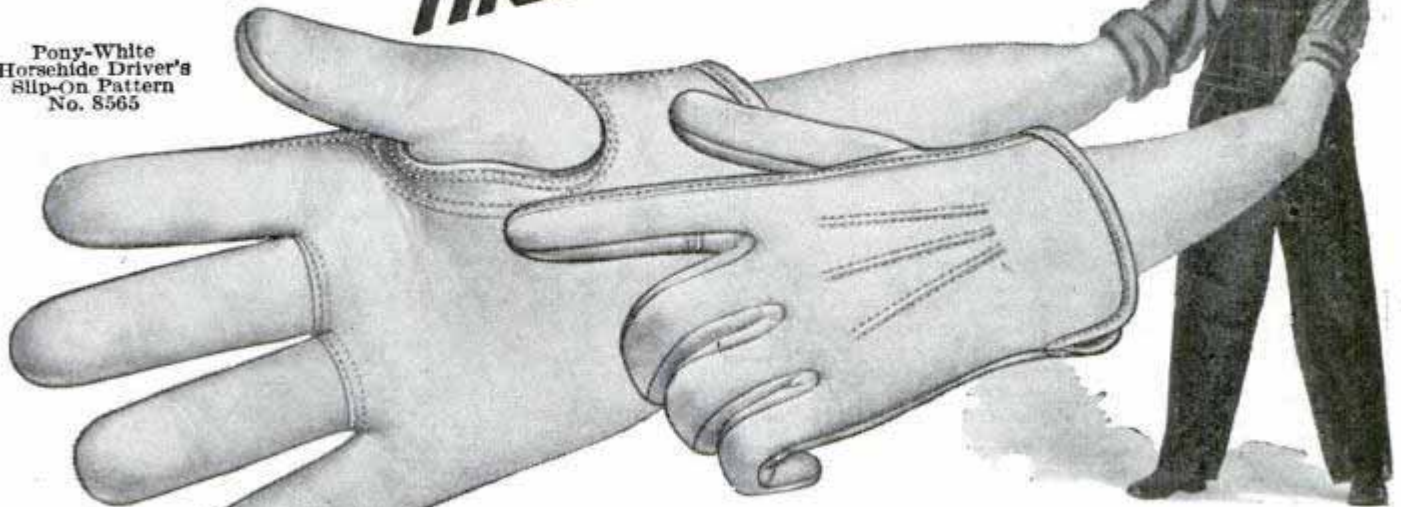

**DEALERS:**  
Offer customers  
genuine Wol-  
verine Full  
Grain Horseshide Work Gloves. Fast-selling, nation-  
ally advertised. Write for catalog and tested sales plan.

**M**ILLIONS of hard working hands reach for Wolverine  
Horseshide gloves every day! Tough as a piece of harness  
... soft as buckskin, they're tanned by a secret process so  
they always stay soft! Water-soaking won't harden them!  
Made by makers of Wolverine Shell Horseshide work shoes.  
If your dealer can't supply you, send us his name and 75c.  
We'll mail you a pair postpaid. Style No. 8565, Sizes 8 to 12.

## WOLVERINE HORSEHIDE WORK GLOVES

**WOLVERINE SHOE & TANNING CORP.**  
Dept. D-50  
Rockford, Mich.

**ACE**  
LATHE TOOL SET  
**\$14.50**

**ARMSTRONG BROS. TOOL CO.**  
"The Tool Holder People"  
368 N. Francisco Ave., CHICAGO, U.S.A.

Be permanently tooled-up  
for every operation on  
your Metal Cutting Lathe

The ACE Set is complete—there's nothing  
more to buy. Drop forged by the manufac-  
turers of cutting tools used by 96 per cent  
of the plants and shops in industry they  
are correctly designed, are of special  
steel, are finely finished, are  
stronger—will last a life-  
time. You can cut easier.  
Easier and more  
accurately with ACE  
TOOLS.

- 3 Turning Tools, 2 Cutting Tools, Knurling Tool, Boring Tool, Threading Tool, High Speed Steel Cutters and Blades, and 2 Wrenches in Fitted Steel Case.

## Sharpened over 2,000 lawn mowers last season

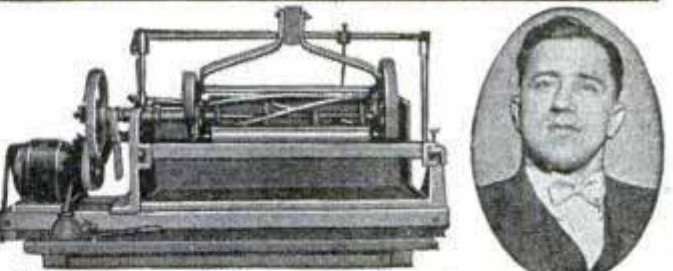

"I sharpened between 2,000 and 2,500 lawn mowers this season. I cover a territory of 50 miles around my home town and have all the work I can handle. With the Foley Lawn Mower Sharpener I can handle up to 40 mowers a day."—Ivan G. Long, Penn.

Many other men like Mr. Long are independent and making big money in the fine cash business of sharp-  
ening lawn mowers with the

### FOLEY LAWN MOWER SHARPENER

No experience required. Simply put mower in the machine—the Foley does a perfect job automatically, in 15 or 20 minutes. Sharpens all kinds and sizes by factory method. You get \$1.00 to \$2.00 each for hand mowers and \$4.00 to \$6.00 for power mowers. Invest-  
igate NOW!

**FREE** Attachment for grinding axes, hatchets, knives, etc., included FREE. Brings you business the year 'round. Small investment, easy payments. Best season just ahead! Write today for FREE business-starting plans—no obligation, no sales-  
men will call.

**FOLEY MFG. CO., 407-9 Foley Bldg., Minneapolis, Minn.**  
Send Free Plan for making money sharpening Lawn Mowers, and  
Special Offer on the Foley Lawn Mower Sharpener.

Name .....

Address .....

**ATLAS STICK-ON LETTERS**  
Beautiful Gold Colored. New Styles.  
5 Year Guarantee. Large Sizes.  
Penny Each. Tremendous Demand.  
Amazing Profits. Write for Samples  
and Starting Equipment. Hurry!  
**ATLAS Sign Works, 7943 Halsted, Chicago**

**WINDOW SIGNS**

I WISH I HAD SOME SPENDING MONEY

HERE'S MY CHANCE! I'LL MAKE THE COUPON!

BRING A MAGAZINE EVERY MONTH

NOW I HAVE MONEY AND A BICYCLE BESIDES!

**Boys' BIKE for YOU**

Flash down the street on this deluxe stream-  
lined motobike. Comes equipped with  
blast hornlite, balloon tires, coaster brake,  
and newest accessories. Earn it, a movie  
machine with film, and any of  
300 other prizes. Make MONEY,  
too. It's fun! It's easy! Just  
deliver our magazines to people  
whom you obtain as customers  
in your neighborhood. Many  
boys earn a prize the first day.  
You can, too. Do it in your spare time.  
To start, rush postal card to Jim Thayer,  
Dept. 877, The Crowell Publishing Co.,  
Springfield, Ohio. State age.

For You  
**MOVIE AND FILM**



*J-117*

**Fish Living Inside Milk Bottle  
Hauled Up in Seine Net**



*wide world*  
Bottled up alive when he ventured into his glass prison, this drumfish was caught in fishers' seine

Fishermen seining in Puget Sound hauled up what seemed to be just another net-load, but when it was dumped on deck they found a fish wedged in a milk bottle. Apparently the finny adventurer, after exploring the bottle, was trapped and could neither turn around nor back out. Failing in efforts to remove the drumfish, as it is called, from the bottle, the fishermen turned it over to the Seattle aquarium.

*J-155*

**Atom Explosion Frees Energy  
of 200,000,000 Volts**

Explosion of atoms with the terrific discharge of 200,000,000 volts of energy has been accomplished by a Berlin scientist. This tremendous force is thirty times as powerful as radium, and if harnessed for practical use might prove an invaluable weapon to medical science and a potent tool for industry. Attempts to duplicate the feat are being made at American universities, but it is expected that many years may pass before this atomic energy can be used practically, if ever.

*newyork Times  
1/29/39*

*Factory Finish*  
**SANDING**

*This*  
**EASY  
ELECTRIC  
WAY!**

You can always get a factory-standard finish with this handy portable belt sander, even without experience. GuildSander always leaves a straight grain finish without swirls or scratches. It's so perfectly balanced there is no tendency to tip or gouge. And it's so light (weighs only 9 lbs.) you can use it for hours without getting tired. "Don't understand how I got along without a small sander so long," is typical owner's comment on this freedom from sanding drudgery.



GuildSander works on wood, metal, wall-board, plastics and bone—on rounded and curved surfaces, both concave and convex. Ideal for sanding joints and miters. Plugs in nearest socket, AC or DC. Popular priced and economical to operate. Carries a written guarantee.

USE IT FOR SANDING,  
GRINDING, SHARPENING,  
POLISHING, REMOVING  
PAINT AND  
VARNISH



Let your hardware dealer show you what you can do with GuildSander, or write us today for full information.

SYRACUSE GUILD TOOL COMPANY  
1700-4C N. Salina Street  
Syracuse, N. Y.

**New GuildSander** PORTABLE  
ELECTRIC

**"Erie" Light Delivery**

**SOLVES THE PROBLEM OF  
CHEAP AND FAST DELIVERY**

Costs only 1/5 of a cent per mile. From 100 to 120 Miles per Gal. of gasoline. A powerful, high grade machine, with Sachs Motor, chain drive, 2-speeds and clutch, powerful brakes, balloon tires. SPEEDS UP TO 40 MILES per Hour. Big compartment for packages. Needed by everyone in etc., WRITE for special offer today.



delivery service, stores,  
Dealers Wanted.

**STREIFTHAU MFG. CO., Dept. 101, Middletown, Ohio**



*Fun WITH A*  
**TELESCOPE**



• Bring distant scenes close up in a jiffy. And for clear seeing be sure your telescope is an optically fine world-famous **Wollensak**, with money-back guarantee. 8-power (illustrated, wonderful value at \$3.75) to 45-power (\$47.50); at stores, or direct, postpaid (or C. O. D.)

• **WRITE FOR FREE BOOK!**

Wollensak Optical Co., 657 Hudson Ave., Rochester, New York

**WOLLENSAK**



# CIRCULAR SAW \$3 POST PAID

(Outside U. S. or C. O. D. \$3.95)



"The Ripmaker" saves hours of tedious hand sawing. Has 4" combination rip and crosscut blade, oilless bearings and 8" x 5 3/4" steel table adjustable so that pieces up to 1" thick may be cut (pieces up to 2" by turning stock). Base, saw support and table adjusting slide, heavy iron castings. Adjustable ripping fence.

**FREE CATALOG**

describing complete power tool line: Jig Saw, \$1.50; Shaper with oilless bearings, \$3; Drill Press, \$2.50; completely equipped Lathes, \$2 and \$4.90; Sander, \$1; etc. Order today or send card for Catalog.

J & H Metal Products Co. 5 Commercial St. Rochester, N. Y.

## FACTORY GUARANTEED

### NEW REMINGTON NOISELESS PORTABLE

AT LAST! The famous Remington NOISELESS Portable plus Carrying Case is yours for as little as ten cents a day. Brand new. Not rebuilt. Standard keyboard and every modern feature. Free typing instruction booklet. 10-Day free trial. You don't risk a penny. **WE PAY ALL SHIPPING CHARGES.** Act now! Remington Rand Inc. Dept. 152-4. 465 Washington St., Buffalo, N. Y.



AS LOW AS  
**10c A DAY**

**BE YOUR OWN BOSS**

Build A Business with

### ROGERS UNIVERSAL LAWN MOWER GRINDER

LATEST INVENTION Sharpens reel blades as well as leads face and edge of stationary blades without dismantling mower—makes mowers operate easier, cut smoother, stay sharper longer. Takes less time and effort. Every job perfect—Every customer satisfied. Tool grinding attachment FREE. Compare this Grinder with others. Write for descriptive literature.

ROGERS MANUFACTURING CO. LINDSEY, OHIO

## NOW YOU CAN GET A HEAVY DUTY INDUSTRIAL WELDER

Works Off 110-Volt Light Socket  
This marvelous DYNAMIC Power Welder will do the work of much higher priced types. It is easily portable. WELDS Cylinder, Block, Bumpers, Fenders, Tanks, Farm Machinery, and etc. Will also solder and braze in the lightest material. Works on iron, steel, tin, brass, copper and all other metals. Men without previous experience can make as much as \$5.00 on a one hour repair job. Go into business—Open a Welding Shop NOW. AGENTS—Make big profits selling to garages, factories, janitors and machine shops. Write TODAY for our 10-DAY TRIAL OFFER.

DYNAMIC WELDER COMPANY  
2226-GU Silverton Road Chicago, Illinois



for Only \$19.75  
RETAIL

A guaranteed outfit that does the work with least effort.



PAINT SPRAY OUTFIT \$6.95. This all-purpose spray outfit has a two valve air compressor adjustable safety air release valve, pressure type internal mix spray gun, extra nozzle and aluminum cup, air hose and connections, all mounting accessories and instructions. Uses a 1/4 H. P. motor, which is not included. The gun alone is worth more than we are asking for the entire outfit. Works equally well with lacquer, enamel, or insecticide. Spray your car, spray your furniture. Compressor can be used for vacuum or operate gas blow torch for welding.

Send \$1.00, balance C. O. D.  
**PHILADELPHIA MACHINERY CO.**  
603 Arch St., Philadelphia, Pa.

## SPARE TIME MONEY . . .

There's a big demand for the many hand-tooled articles you can make with the Easco Leathercraft Set. Easily learn to make good money in your spare time. Complete outfit including tools, leathers, patterns, etc., and full instructions, only \$2.00—on sale at leading Department Stores or order direct and pay postman on arrival. \$2.50 outside U. S.

### LEATHERCRAFT

Free When ordering direct, clip name of your Department Store to this ad, and we will include with your set, one extra free project. Illustrated Catalog 10c.

E. A. SWEET CO. Dept. A-23 Binghamton, N. Y.



RIDE with SHAW DU-ALL

to BIGGER PROFITS!

You can Ride or Walk with SHAW — Operates for Only 3c an Hour

DeLuxe riding attachment operates equally well with all plowing, cultivating, and mowing equipment. Creates greater demand than ever before.

With or without riding attachment the Shaw is one of greatest time, labor and money savers for users of tractor power. Does all field, road and belt work.

**IMPORTANT FEATURES**—Several Shaw tractor models—2 to 5 H.P. 5-horse model available with either single or twin-cylinder engine. 3 speeds forward and reverse. Special 6-speed gear optional—runs 1/4 to 15 mi. per hr. Shifts like car. Air-cooled engine. Gauge wheel. Power turn. Flexible plow hitch. Tool attachments for all uses.

### AGENTS

and dealers—liberal proposition for qualified men. Write for low prices, discounts, and terms.

**10-DAY TRIAL** —Use on your own work for 10 days without risk. Write for full details, low factory prices and big FREE book today.

SHAW MFG. CO.

4504 Front St., Galesburg, Kans.; 130-G West 42nd St., New York, N. Y.; 5812-G Magnolia Ave., Chicago, Ill.; 668-G No. 4th St., Columbus, Ohio.

WRITE FOR LOW FACTORY PRICES!

## HOT WATER SPEED KING



### From Any Electric Light Socket

MILLIONS of homes, stores and offices everywhere need **SPEED KING**—the new, amazing **Water Heater**—that heats water boiling hot so fast it takes your breath away. No muss! No waste of time or fuel! Just a simple "plug-in" at any 110-volt light socket—and presto... just the amount of hot water you need for the bath, for shaving, for dish-washing. **CHEAPER** because you don't have to heat gallons when you need only a few quarts. **FASTER** because the intense electric heat goes directly into the water. Sells fast on a 60-second demonstration. Small in size—fits the pocket, easy to carry. Anyone can afford it.



**60-SECOND Demonstration Amazes Housewives**

## SAMPLES for AGENTS

I WANT you to know the almost uncanny heating action of this speedy water-heating invention. Write quick—a postcard will do—for my **SAMPLE OFFER** that brings you an actual **Sample SPEED KING** for demonstration. You can make plenty of cash as my agent. **HURRY!** Big season starting now. **SPEED KING** solves the hot water problem when furnaces shut down. Act quick and I'll show you how to make the fastest money of your life. Send No Money!—Just your name.

**JUST SEND**

**NAME**  
WRITE your name and address in the margin, clip & mail this coupon or send penny postcard to Dept. 164.

Name .....  
Address .....  
City .....

**NU-WAY MFG. COMPANY**  
Dept. 164 Walnut Bldg., DES MOINES, IOWA



# MAKE BIG MONEY AT HOME!

## Electroplating by Brush!

### AMAZING NEW INVENTION!



**NO TANKS, LIQUIDS, GENERATORS** Only **\$685**  
**DOES SAME WORK AS BIG OUTFITS**  
 Sensational news! Marvelous new invention actually electroplates with electric brush. As easy as painting. Deposits heavy layer of actual metal—gold, silver, nickel, cadmium, copper, etc.—by electrolysis. Does same beautiful, PERMANENT work as big, costly tank outfits. Non-liquid. Anyone can use from dry cells, storage battery or household current. Complete outfit weighs only 3 lbs.—take it anywhere—ready for instant use.

**PLATE THOUSANDS OF ARTICLES SPARKLING NEW WITH STROKE OF BRUSH**  
**BIG EARNINGS REPORTED IN SHORT TIME**

Amazing low price and magic-like demonstration brings you thousands of orders for plating from garages, radio shops, bicycle shops, machine shops, home work shops, factories, offices, janitors, doctors, dentists, jewelers and farmers, homes, stores, etc.—with big profits for you! Schedule of plating charges furnished; also reports of big money users are making with the WARNER NU-WAY ELECTROPLATER.

**FREE SAMPLE PROVES ALL CLAIMS**

Send today for amazing profit details with this revolutionary electroplating invention. **FREE SAMPLE & BIG MONEY-MAKING PLAN.** Get started in a profitable business of your own. Full or spare time. Be the WARNER NU-WAY ELECTROPLATER IN YOUR TOWN. Simply mail post card with your address.

**WARNER ELECTRIC CO., Dept. H-5**  
 360 North Michigan Ave. Chicago, Ill.



## DOENUT WHEELS

DOENUTS, developed and patented by the originator of the air-wheel, absorb more surface obstructions and eliminate jolting. Protect wood and concrete floors. Do not sink in mud or soft ground. Cadmium plated disc wheel with adjustable ball bearings. Size 10"x2.75" with cap. of 225 lbs. per wheel and 12"x3.50" with load cap. of 325 lbs. per wheel. Ideal for wheelbarrows, painting rigs, spraying equipment, textile trucks, dish trucks, boat dollies, food carts, or most any portable unit that rolls. Handle same loads with less than half the labor. Send 10c postage to cover cost of mailing literature.

**MUSSELMAN PRODUCTS CO.**  
 6225-1 St. Clair Avenue, Cleveland, Ohio

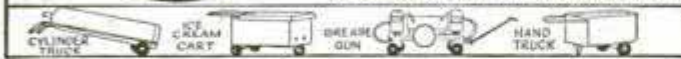

• Every fisherman will want this book! Written by Cal Johnson, noted angler. Tells tried ways, methods of night fishing for bass, wall-eyes, other fish. How, when to cast or troll after dark. Frogging. 72 pages of night fishing thrills. Shows the Powerlite and other Delta electric lanterns. Write for this book. Free!

**DELTA ELECTRIC COMPANY**  
 330 W. 33rd St. Marion, Indiana



Powerlite  
**\$3.35**  
 less battery

# Increase Your Earning Power

Apply time and labor-saving kinks to your work. Your efficiency will soon be recognized and you will be in line for advancement.

If you do machine shop work of any kind, sheet-metal work, painting, carpentry, auto repairing, farming, concrete work, plumbing, electrical work, welding, building-glass work, general repairing, tool-making, poultry raising, masonry or home repair work, get this

## LIBRARY OF 2400 TIME AND LABOR SAVING IDEAS FOR SHOPMEN AND HANDYMEN

JUST PUBLISHED

### SHOP NOTES for 1939

417 Articles  
 806 Illustrations  
 224 Pages  
 Price 50c  
 See partial list of contents below

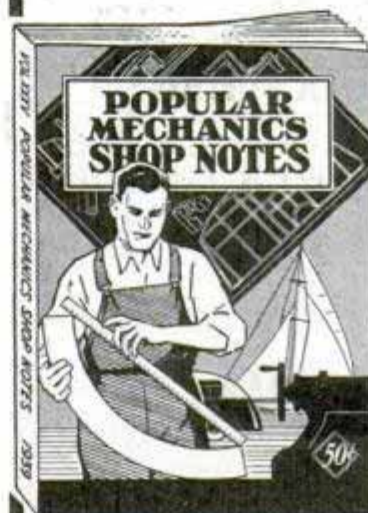

Including the new 1939 issue illustrated above, there are six volumes in the Shop Notes Library of 2400 easily understood short cuts to every-day jobs. Here are just a few of the subjects taken from the latest issue:

|                        |                       |                          |
|------------------------|-----------------------|--------------------------|
| Alabaster, Turning     | Grease Pit, Cover for | Printers, Hints for      |
| Auto Mechanics, Short  | Grinding              | Shaper, Homemade         |
| Cuts for               | Lathe Kinks           | Sheet Metal Work         |
| Carpentry Kinks        | Machinist's Helps     | Stainless Steel, Working |
| Drafting Room Helps    | Marble, Imitation     | Telescope Mount          |
| Electrician's Aids     | Metals, Buffing and   | Thread Cutting           |
| Electro Engraving      | Polishing             | Trailer Kinks            |
| Farm and Garden Helps  | Metals, Chemical      | Truck Driver, Helps for  |
| Fluting, Spiral        | Coloring of           | Welding                  |
| Gas Engine, Midget     | Motorist, Helps for   | Window Displays, Novel   |
| Generator, Wind-Driven | Paper Hanger's Helps  | Wood, Bending            |
| Charges Batteries      | Pattern Sanding       | Wood Lathe, Homemade     |
| Glass Blowing          | Photographic Kinks    | Wood Turning             |
|                        | Poultry Appliances    | Complete Guide to        |

Each volume contains approximately 400 articles and 600 illustrations and has 200 or more pages. This unrivaled library of shop helps may be secured for a limited time only. After the present supply of books is exhausted the offer must be withdrawn.

**\*Send No Money\***

**POPULAR MECHANICS PRESS,**  
 200 E. Ontario St., Room 439, Chicago, Ill.

Send me, as per your offer, the following books. I will pay postman price and small amount of postage. My money will be refunded if I am not satisfied. (Check what you want.)

- 1939 Shop Notes and Lathe Handbook (Metal Working), both for 98c.  
 Shop Notes Library (6 vols.) \$2.98.

Name.....

Street and No.....

City..... State.....

\*C. O. D. applies to U. S. and possessions only. If you reside elsewhere, remittance must accompany order.

When writing please mention Popular Mechanics



*Paul Armstrong*  
**Hand-Applied Dashboard Brake  
 Aids Starting on Hill**

*Master Card*

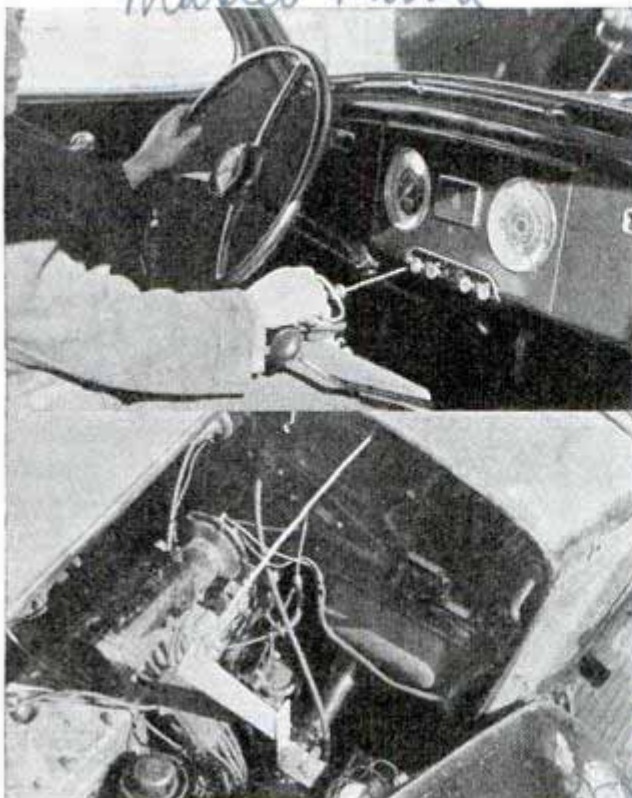

**Pulling ring on dashboard applies brakes. Lower view shows cable attached to brake lever under hood**

As an aid to drivers in starting a car on a grade and also to those handicapped by crippled or weak legs, a hand brake for the dashboard has been developed. A nickel-chrome pull ring on the instrument board is linked by cable to a lever arrangement under the hood; pulling the ring applies the brakes on all four wheels.

*2-143*  
**Adapter Lens for Closeup Shots  
 Will Fit Any Movie Camera**

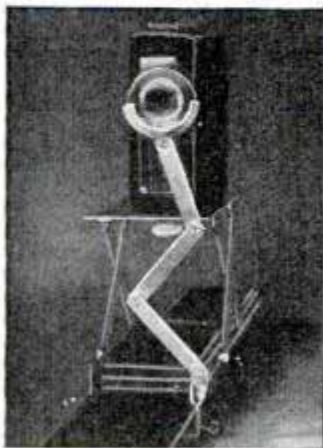

For closeup "takes" of small objects and for sharply focused titles, there is an adapter that fits all movie cameras. It can be used with either fixed or universal-focus lens, and fits any aperture. The adapter is adjustable for the height of the lens and a metal plane table is furnished to fasten the device to a tripod.

*Deshee Products Corp  
 Trenton, N.J.*

**TELLS TIME-SECONDS-DISTANCE-SPEED!**  
*The New Improved*  
**PIERCE CHRONOGRAPH**



**4  
 IN  
 1  
 W  
 A  
 T  
 C  
 H**

You must see this amazing watch to appreciate how invaluable it can be in your daily work and hobbies. Engineers, mechanics, aviators, sportsmen, radio workers, photographic enthusiasts constantly use the *new improved dust-proof* PIERCE CHRONOGRAPH

**Three Extra Features at No Extra Cost!**

1. ACCURATE, RELIABLE, TIME-PIECE.
2. A STOP-WATCH which checks off the time in fifths of seconds. Invaluable in photographic, electrical and similar work.
3. A TACHOMETER which gives correct speed of any traveling object. For telling ground and flying speed, as a simple converter and calculator.
4. A TELEMETER which tells how far away you are from any simultaneous source of light and sound.

If you have not as yet seen the Pierce Chronograph, do so today. Your jeweler, sporting goods, photographic or department store will be glad to show you this "4-in-1" watch. If he cannot supply you, order direct. Use coupon below!

**\$19.75**

Pierce Watch Company - Dep't. No. B  
 22 West 48th Street, New York, N. Y.

I am enclosing \$19.75  \$34.75 (for 17J yellow gold filled)  for which send Pierce Chronograph as described. Send descriptive circular

NAME \_\_\_\_\_  
 ADDRESS \_\_\_\_\_  
 CITY \_\_\_\_\_ STATE \_\_\_\_\_

**HEAR EASILY!**  
 even in group conversation

*Western Electric*  
**HEARING AID**  
 Ortho-technic Model

The Audiphone gives new hearing ease; it's based on advanced technique in hearing aid design, learned in Bell Telephone making. It should help you hear clearly in group conversation, at greater distances, in any position. Your dealer will recommend the Audiphone that best meets your needs—and there's a network of service stations in all principal cities.

**GRAYBAR ELECTRIC CO.,** Graybar Bldg., New York.

Please send details on Western Electric Audiphone (Ortho-technic Model) and name of nearest dealer. PM-44

Name \_\_\_\_\_  
 Address \_\_\_\_\_  
 City \_\_\_\_\_ State \_\_\_\_\_





**Stucco Spraying Machine**  
 Renew old buildings. Make new construction more permanent and attractive. Plastic Colorcrete is waterproofed. It fuses with any masonry surface. It fills cracks. It can be applied in any thickness and in 30 colors. Fully proven by over 13 years actual use under all conditions and every climate.

**OFFERS BIG EARNINGS**

Owners everywhere want to enhance present values. With this machine you can supply this big waiting market with permanent Colorcrete at amazingly low cost. Operators report cost of 2c and up per sq. ft. and sell up to 7c. Some have paid for their equipment from first few jobs. Machine capacity up to 1,000 sq. ft. per hour.

Get the facts. Send for books "Proven Business Opportunity". Write today. It offers you big extra income.

**COLORCRETE INDUSTRIES, INC.**  
 571 Ottawa Ave. Holland, Mich



**SOUTH BEND FISH-OBITE INSURED TO CATCH FISH**

Write today for free 128-page book on Fishing. Shows new sensational Fish-Obite bait, insured to catch fish. Policy with bait. Shows new Perfectoreno reel with "controlled spooling"—no back-lashes.

**50 FISH IN COLORS**  
 Over 50 fish identified in life colors in this book. Gives casting lessons—fishing hints. A book every angler wants! Write for your copy now! Sent Free!

**SOUTH BEND BAIT COMPANY**  
 507 HIGH STREET SOUTH BEND, INDIANA

**FREE! 128-PAGE BOOK ON FISHING**

**Calling all Cars**

**A MYSTERIOUS DISCOVERY SAVES UP TO 30% ON GASOLINE or Costs Nothing to Try**

Stop wasting Gas!—trim dollars off gas bills—get more power—quicker pickup—faster acceleration! **AUTO OWNERS everywhere praise VACU-MATIC!** Proven so efficient, it is guaranteed to satisfy, or the trial costs you nothing.

**Automatic Supercharge Principle**  
 Vacu-matic is entirely different! It operates on the supercharge principle by automatically adding a charge of extra oxygen, drawn free from the outer air into the heart of the gas mixture. It is entirely automatic and allows the motor to "breathe" at the correct time, opening and closing as required. Saves up to 30% on gas costs, with better motor performance.

**AGENTS Get Yours FREE**

**FITS ALL CARS**  
 Constructed of six parts fused into a single unit, adjusted and sealed at the factory. Easily and quickly installed by anyone in a few minutes.

**FOR INTRODUCING.** Here's a splendid opportunity for unusual sales and profits. Every car, truck, tractor owner a prospect. Send name and address now for big money making offer and how you can get yours Free. The Vacu-matic Co., 7617-431 W. State Street, Wauwatosa, Wis.

**QUICK CASH IN NEW POTATO CHIPS**

**START AT HOME**

Here's your chance—a money-making business of your own. Turn potatoes into cash by making new kind of Potato Chips with my improved outfit. Makes delicious, superior, "NON-GREASY" Chips at low cost. A few hours' practice does it. Begin anywhere—city, village, town. Potatoes cheap and plentiful. Wholesale or retail. Steady year-round business. Groceries, markets, restaurants, taverns, do the retailing for you. **WE HELP START YOU IN BUSINESS.** Great quantities of Chips are eaten daily. Profit large—unusually so. You can start this money-making business on a "next to nothing" outlay of cash. Write for Potato Chip Booklet.

**LONG-EAKINS COMPANY**  
 428-5 High St. Springfield, Ohio

**MYSTERIOUS DEVICE WELDS BRAZES AND SOLDERS ANYONE CAN OPERATE**

Now, an electric welding, brazing and soldering Torch, complete with power unit, goggles and supplies, **Works INSTANTLY off any light socket.** Does a thousand and one repair jobs at amazingly **LOW COST** on aluminum, iron, steel and other metals. **Indispensable** for Auto, Body and Fender Repairs, and home repairs—shop, factory, farm, engineer, janitor, sheet metal, radio and bicycle repairs. Anyone can handle without previous experience with our **sim-10-DAY HOME TRIAL** instructions. Write at once for Special Introductory Low Price Offer or get one free by helping to introduce it. **ELECTRO-TORCH CO., 2613-CU Michigan Ave., Chicago**

**ONE-MAN SAWMILL**

Makes lumber, shingles, lath, ties, crates, boxes, cots, all forms lumber

**TURN TREES INTO MONEY WITH A BELSAW**

Three capacities: 10, 14 and 20 ft. Accurate set works positive dogs. Hand or power feed. Runs on low power—Many owners use old auto engine. Pays for itself quickly—thousands in commercial service, everywhere. Write for free lumber handbook and catalog of mills, supplies, tools, saw tables, and woodworking equipment.

**Belsaw Machinery Co., 5119-X Davidson Bldg., Kansas City, Mo.**

**FARM MODEL \$49.00**

**CONSTRUCTA-SCOOT**

The Best Motor Scooter Value in America That Easily and Quickly Assembles from Fully Finished Factory Kits.

**AT BICYCLE COST!**  
**\$29.50** Less Motor **COMPLETE** with Motor **\$59.50**

F.O.B. Chicago, Ill.—Write for Literature  
**RENMOR MFG. CO., Not Inc. 2544 So. Wabash Av., Chicago, Ill.**

**COMB-A-TRIM** The New Quick Trimmer

Something New! Trim your hair without any experience. It's easy! The excess hair comes off smoothly and easily by just pulling trimmer through hair like an ordinary comb. Save on hair-cut bills. . . . Trim your own hair or the whole family's. Send 49c and your Comb-A-Trim will be sent at once, postpaid.

**49¢**

Comb-A-Trim Co., 510 Bell Block, Dept. P-1, Cincinnati, Ohio

**Earn Cash at Home!**

We paid M. M. \$1174 for exceptional "cellar crop" SNOW-KING mushrooms! Big free picture book tells if your cellar, shed, barn suitable. We furnish materials, buy all crops. Write today. Est. 1908.

**UNITED CO., 3848 Lincoln Ave., Dept. 308, Chicago.**

**Now BOAT BUILDING MADE EASY**

**Famous Boat Book Shows How**

Detailed instructions, plans, materials, methods for building 16 most popular power, sail and row boats. Get Popular Mechanics **BOAT BOOK** and build your own at low cost. Prepared for those with limited skill and few tools. Includes also—"What a boat enthusiast should know." Only \$3.00. Pay postman on delivery or write for descriptive circular.

**Popular Mechanics Press**  
 Room 439D  
 200 E. Ontario St. Chicago



## Pullman Car Names Tell a Story of What's Inside the Car

There's a system in the naming of Pullman sleepers and parlor cars, and if you know the system you can often tell what type of cars makes up the passing train. The well-traveled story that Pullman cars were given their fancy names by the late Mrs. Frank O. Lowden, who was Miss Florence Pullman, is not true. She never named a car. A committee of the Pullman Company is charged with selecting names, and one of its rules, often broken, is to name cars so as to indicate without reference to a catalogue the character of the car. For example, all names preceded by "Mt." or "Mountain" are used on observation cars containing sleeper sections. The "Lake," "Camp" and "Fort" cars all contain ten sections, drawingroom and two compartments. A series of "Saints" and "Mcs" have twelve sections and drawingroom. "Point Bonita," "Point Hope," "Point Pelee" and other "Points" have ten sections and two drawingrooms. Parlor cars on the Pennsylvania's "Congressional Limited" between New York and Washington bear names of signers of the Declaration of Independence and members of the Continental and Constitutional congresses—John Hancock, Benjamin Franklin, Gouverneur Morris, and the like. The "President" cars, named for Adams, Cleveland, Garfield, Grant, Harrison, Jackson, Jefferson, Lincoln, Roosevelt and Washington, indicate another type of compartment and drawingroom car with special finish. Some railroads requested special names, such as the "Great" series of the Great Northern's Oriental Limited: "Great Spirit," "Great Lakes," "Great Plains," etc., and the various "Sunset" cars of the Southern Pacific Sunset Limited. Indian names are favored on several western trains. One large group of cars bears names taken from Greek and Roman history. When the Pullman company absorbed the Wagner Sleeping Car company years ago there were 300 duplications of names, and overnight the Pullman people had to dig up new names for a wholesale rechristening; clerks at the Chicago Public Library ran through ancient history books to collect the Greek and Roman names. Eighty-four of Pullman's nearly 8,000 cars are named for flowers, from Ageratum to Zinnia.

# YOUR HAIR

**- IS IT GETTING THIN?  
- IS IT FALLING OUT?**

**Rent** A HOME MODEL  
**CROSLEY XERVAC**



If poor blood circulation of the scalp causes your trouble, try the XERVAC way to arrest it—

Scalp specialists know that good, rich blood circulating in the deep-seated blood vessels of the scalp nourishes the hair roots, aids in arresting abnormal loss of hair, helps to produce hair growth. . . It is known that VACUUM and PRESSURE around scalp, applied intermittently and properly controlled, is highly effective for forcing fresh, stimulating blood deep into these blood vessels. One way to do it has been found in the regular use of Crosley XERVAC—that popular hair and scalp device used so successfully in barber shops and clinics.

**Write for New Rental Plan**

Learn how you can RENT the new compact home model XERVAC and use it in your home for a small rental fee. Try it, watch results. Get the benefits of this amazing device on easiest possible terms. No obligation—just write

**THE CROSLEY CORPORATION**  
Dept. D10 CINCINNATI, OHIO

**HOME MODEL**  
SAME AS ORIGINAL PROFESSIONAL,  
ONLY MORE COMPACT..

## Start YOUR OWN BUSINESS Be An Electric Engraver



Engrave  
YOUR WAY  
TO PROFITS

Here is a quick and easy way to start a business of your own. You need no experience to learn. Amazing new invention, the ELECTROGRAVER, opens new profit field. As Easy to use as a pencil. Engraves beautifully on brass, steel, glass or bakelite. Sensational Ideal! Nothing else like it!

**BEGIN AT HOME IN SPARE TIME**

The Electrograver is ideal for engraving names on Social Security Plates, name plates, key checks, dog tags, jewelry, fountain pens, cigarette cases and tools. Will also duplicate actual signatures on metal or glass. Operates from AC light socket or battery. Outfit as low as \$13.50. Send \$13.50 today for complete outfit and receive 50 Goldtone Social Security Plates Free or write at once for details.

William Moore Mfg. Co., 653 S. State, Chicago

**STAR  
METAL  
BOATS**

★ ★ ★



**NON-SINKABLE • ECONOMICAL**  
Newly developed construction used in 60 models. Rowboats, outboards, sailboats, low priced in-board launches and a 50-lb. Dowmetal boat. Rubber cushioned—quiet performance. Save money, get better quality. No wood to caulk, leak or rot. Light, buoyant. Specials for resorts and liveries.

Send for FREE CATALOG  
**STAR METAL BOAT CO. BOX P GOSHEN, INDIANA The Winner**





## Stretch dimes into dollars with SPORS 4000 BARGAINS

260 Pages of Amazing Values Like These —

This new 1939 Wholesale Book for salesmen, dealers, etc., describes and offers you over 4000 Tested Fast Sellers; Money-Making Ideas; Sales Building Plans; office specialties, home necessities. Read about the customer whose orders total \$46,000 retail value in 5 months. Same opportunity for you. There is room here for only a few examples. This catalog costs about 25c and we are sending it to you for One Dime to cover the cost of mailing and packing etc. You get your dime back with your first order. Our money back guarantee protects you. Send the dime or stamps and see how you can turn dimes into dollars. Today! Now!



5 Yr. GUARANTEED FOUNTAIN PEN

No. R400. Features: plunger filler; visible ink supply; non-tarnishing size 4 point; guaranteed. Jet black color. When offered for 69c you make over 400% profit. (Full line of writing instruments in our catalog.) Sample 13c. Dozen \$1.40.

### ELGIN DRY SHAVER

No. E308. Precision motor chrome plated head; operates on 110 A.C. Ready to operate. 1 year guarantee with each shaver. Money back if not pleased. Sample 79c. Dozen 75c each. 6 dozen 69c each.



### HEAT-KWIK WATER HEATER

No. E541. Tested and approved by Automotive Test Laboratories of America. Heats water quickly from any 110 volt light socket. Every home, camp, office, store, farm are ready prospects. Money back if not pleased. Sample 85c. Dozen \$8.88.



### FOCUSING OPERA GLASS

No. V225. Has 17 ligne, non-achromatic lens. Metal body, covered with imitation mother-of-pearl. Brings distant objects closer to field of vision. You would expect to pay \$1.95 for it. Each in velvet-like bag. Satisfaction guaranteed or money back. Sample 20c. Dozen \$1.95.



## SEND WITH ONE DIME TO SPORS COMPANY

2-39 ELM ST., LE CENTER, MINN.

Dear Spors Co.: Yes I want your new 1939 Wholesale Catalog right away. Here's your dime. I want it back with my first order.

NAME .....

ADDRESS .....

CITY..... STATE.....



**SOLDERING IRON, ELECTRICAL**, neat regular heavy duty. Guaranteed 120 volt 60 Watt. Your price \$1.25, postpaid in U. S. A., regular price \$1.50. Illustrated circular free. Send for agents opportunities. **GREAT LAKES METAL SPEC. & MFG. CO., 1450 West North Avenue, Chicago, Illinois.**

World's Finest Clarinet ENDORSED BY

"PEE WEE" RUSSELL  
CHESTER HAZLETT



The new clarinet sensation. For the first time an American-made clarinet acknowledged to excel all others in intonation and perfection of scale. Amazing new bridge key protector, adjustable pivot screws, post lock plates. Other exclusive features; yet they cost no more. See your dealer or write us today for free book on clarinets or any other band instrument.

C. G. CONN, Ltd., 431 Conn Bldg., Elkhart, Ind.

Write FOR FREE BOOK



## SpeedWay

Real Quality Tools

Designed, manufactured and guaranteed by SpeedWay, for 30 years leading manufacturers of industrial drills, these are really fine tools, correctly designed, correct speeds, genuine high torque drill motors. Small, handy, powerful; 1000 RPM—drill handles to 1/4" in steel. Die cast handle and gear housing, \$7.95. Grinder operates at 20,000 RPM. (high speed is essential for good grinding). With collets for 1/8" and 3/32" arbors, \$6.95. No. 250 KIT, both drill and grinder with 5 accessories in steel carrying case \$14.95. Complete line of accessories and drill press stand. Write for Circular. Dealers Write SPEEDWAY MFG. CO., 1842 S. 52nd Ave., Cicero, Illinois

DRILL \$7.95

GRINDER \$5.95

SET \$14.95

## MAKE and mend things with DU PONT DUCO CEMENT. Transparent, flexible, waterproof. Holds permanently on just about everything.

### EMPIRE TORPEDO LEVEL

Will be the handiest tool in your kit. 9" long. Shows Plumb, Level, 45°, 1" and 2" pitch. Colored glasses. Grooved bottom

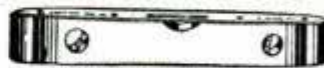

EMPIRE LEVEL MFG. CO.

Dept. P-1

717 S. Sixth St., Milwaukee, Wis.

for pipe work. Won't tear pocket. Satin finish. \$1.25 postpaid. Or from your dealer. Send 10c for catalog of 74 different levels.

### BUILD YOUR OWN AC. GENERATORS

You now can buy all parts ready for assembly to change old six volt auto generators to 110 volt AC. Make extra money at home building light plants. Send now for catalog of parts.

**CARMI TRANSFORMER WORKS**  
202 Staley St. Carmi, Ill.



**STEAM ENGINES** for small boat models. Two-cylinder power plants, ready to run, with boiler propeller and burner.

Model SE-1, oscillating type..... Price \$2.00

Postage extra, shipping wt. 3/4 lb.

Model SE-3, slide-valve type..... Price \$3.00

Postage extra, shipping wt. 1 1/4 lb.

Shawnee Engine Co., Box 162, Station D, Cincinnati, O.

## Get DYKE'S Famous

# AUTO Book



Learn to Test, Adjust and Repair all Cars.

If you want to make money in the automobile business today get the world's greatest authority to help you. Get DYKE'S AUTOMOBILE AND GASOLINE ENGINE ENCYCLOPEDIA. Now Ready—the 3rd printing of the new 18th edition. Right up to date and the biggest value ever offered in the 27 years of its publication.

You've heard of "DYKE'S". Hundreds of thousands of previous editions have been sold. Successful auto men, students, car owners, everywhere, swear by it. It contains more practical information on auto testing, adjusting and repair than anything else ever printed. Now up to date with all the newer automotive developments, including tune-up data for all 1938 cars. Weighs 6 pounds. Has 1434 pages and 4600 pictures.

### ORDER TODAY

Dyke's Famous Auto Book sent postpaid anywhere for \$6.00. If in U. S. or possessions order by postcard and pay postman price plus small C.O.D. fee on delivery. Safe delivery guaranteed.

Automotive Diesel Engines Included.

Tune-up Charts for 1938 Cars and Trucks.

All 1938 Car Specifications.

Carburetor and Ignition Data.

### POPULAR MECHANICS PRESS

Room 439, 200 East Ontario Street, Chicago



114 & 32 nd. Wisconsin  
 "Wireless" Neon Display Signs  
 Made of Separate Letters

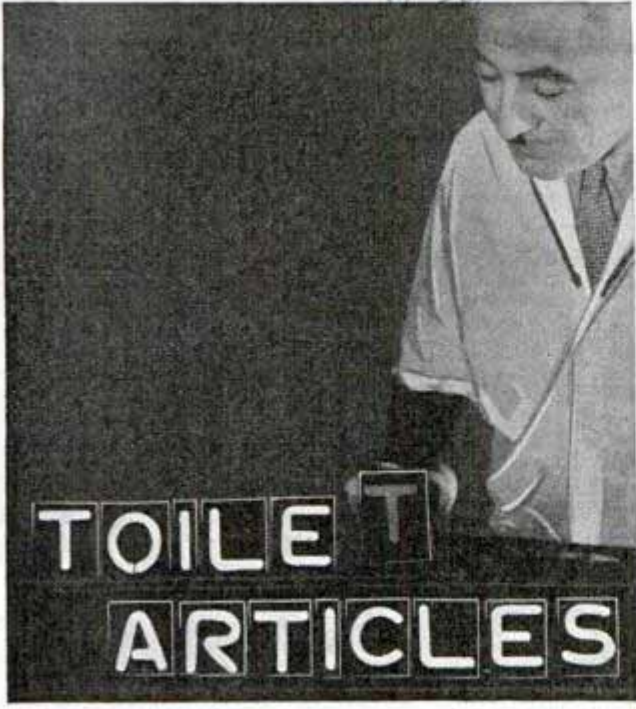

Separate neon-tube letters are spelled out on counter where electrically energized strip lights them

"Wireless" neon signs that can be changed as easily as writing with a pencil are making their appearance in display windows and on store counters. Each neon-tube letter is independent, and is set up without wires, plugs or sockets. The sign is simply spelled out above an electrically energized strip mounted in the top of the showcase or counter.

272  
**Theftproof Electric-Bulb Socket Locked by Magnetic Tool**

Loss of electric bulbs by stealing or loosening through jar and vibration is prevented by an adapter for lamp sockets. It screws into the standard socket, and the lamp can be released or locked into place only by a plier-like magnet.



Ⓞ About one-third of the world's glass production, valued at \$800,000,000 a year, is contributed by United States factories.

Compressed Air. Jan. 1939.  
 P-857

**Agents and Dealers WANTED to sell or rent the NEW Mead Ranger SCOOTER**

These sensational new, improved Ranger Scooters sell like hot cakes all over the country! Order your demonstrator while territory is still open—there's big money selling to all stores needing quick, cheap delivery... sell to messengers, mechanics, garages, canvassers, friends; or rent for easy hourly profits at bike shops, beaches, resorts, etc. Rush dime for illustrated circular, details. MEAD'S New Ranger Scooter for 1939 features: X-member 1-piece ALL STEEL frame, 2-speed transmission, etc. Solo models, tandem or delivery, also 3-wheel miniature car. **Hurry! Write!**

Retail Prices From **\$99.00** F. O. B. Chicago

EASY PAYMENT TERMS AVAILABLE IN MOST STATES. ... amazing mileage—120 miles per gallon. Go anywhere.



Send 10c for Folder, details

CYCLE CO  
**Mead**  
 Dept. OS-118, Chicago

**America's Smallest Radio ... WITH BIG SET FEATURES**

Small enough to carry in one hand (8 1/2" x 5" x 4 1/2") powerful enough to bring in stations strong. Dynamic speaker. 4 full size genuine RCA 60, tubes and aerial—ready to play. One year guarantee. **Free Home Trial.** Money back if not satisfied. **1939 CATALOG FREE** Models for homes, farms, cars. Console and table models. **Save up to 50%.** Silver Mfg. Co., Inc., Dept. P-4, 2868 Elston, Chicago

**\$6.94** in Walnut



**BIG NEWS FOR MODELBUILDERS & HOMECRAFTSMEN**

In the values and prices featured in the great new C-D Handbook Catalog—now ready! Bargains galore. Thousands of items—including 135 world-famous C-D flying model airplanes; also other makes, 10c up. Also O, CD, OO and HO gage model RR equipment, and toy trains at 20c up. Gas model airplanes, and all well known gas engines; hand tools, power machinery, ship kits—and all necessary supplies. Microscopes, etc. Nothing ever like it before. Edition limited. Act quick. Rush name, address and **10c**

Cleveland Model & Supply Co. Inc., 4500-C25 Lorain Ave., Cleveland, Ohio

**MACHINE SHOPS - GARAGES**



If you are rigging Trucks with Power Take-Offs or mounting Gasoline Engines for the operation of Corn Shellers; Feed Grinders; Saw Mills; Hoists; Air Compressors; Arc Welders; Electric Light Plants and Refrigerating Units, you need Governors for engine speed regulation, and should be a Pierce Dealer.

WRITE FOR OUR DEALER PROPOSITION

THE PIERCE GOVERNOR COMPANY  
 WORLD'S LARGEST GOVERNOR BUILDERS  
 1710 Ohio Ave. Anderson, Indiana

**PIERCE GOVERNORS**  
 MOST STABLE • MOST SENSITIVE GOVERNORS BUILT



**25 YEARS OF INDIAN FUN**

STEPHEN W. MEADER, author of many adventure books, at the stern blade of his Old Town.

I've paddled my "Gray Goose"—18-foot Old Town Guides' Model—since 1914. Twenty-five years of canoe pleasure have cost me less than a cent a day. "Gray Goose" is truly Indian in design, but far stancher, far steadier. —Stephen W. Meader

**FREE CATALOG** Own your own Old Town Canoe. Write for a free catalog that shows all kinds of canoes for paddling, sailing, and outboards. Also outboard boats, including big all-wood family boats, rowboats, dinghies. Write today. Address: Old Town Canoe Co., 534 Main Street, Old Town, Maine.

**"Old Town Canoes"**

**FREE TRAILER PARTS CATALOG**

We'll save you money on—axles, springs, wheels, couplers, windows, sinks, water pumps, brakes, refrigerators, beds, tanks, inside and out, 6V lamps, furniture, jacks—everything. Special discount to mfrs. **NATIONAL TRAILER EQUIPMENT CO.**—Successors to Kar-A-Van Industries, Inc. Dept. P. 714 W. Wisconsin Ave., Milwaukee, Wis.

Complete Plans and Building Instructions, 10¢

**LEARN Short-Method Arithmetic**

Simplified system used by "master minds" on stage, accountants, bankers, etc. Easy to learn. Add columns of figures short-cut method; multiply 4 figures by 4 figures without using old-fashioned multiplication; use eight method of proving addition, division, etc. Learn horsepower calculation, how to use slide rule, micrometer. Complete illustrated course only \$1.00, postpaid. Satisfaction or refund. Amaze your friends with your mental wizardry! Free details—mail coupon TODAY.

**NELSON CO., 300 Manhattan Bldg., Chicago, Ill.**

Send free details about "short-Method Mental Arithmetic" without obligation on my part.

Name .....

Address .....

City ..... State .....

**Decorative Decalcomania Transfers**

Imported Designs of all Sizes and Types—Flowers, Fruits, Figures, Silhouettes, Marguerite, Birds, Butterflies, Juvenile, Dogs, Horse Heads, Ships, Landscapes, Borders, Chinese, etc., for Furniture, Doors, Walls, Trays and what not.

Catalog with 800 illustrations in color sent for 25¢ in coin. Deductible on first dollar purchase.

**L. C. WELLS**  
Dept. PM-94, 25 E. 26th St., New York



**UNIVERSAL GRINDER DE LUXE \$495 COMPLETE**

New sensational high speed du-all model, grinds, carves, drills, sands, engraves, polishes electrically. Its reliable and remarkable performance produces better work plus saving you hours of time and labor. Our low price includes everything, grinder accurate collet chuck, cord plug and switch for 110 volt AC-DC and 30-piece arbor tool set of assorted grindstones, mandrels, carving and routing cutters, bristle brushes, polishing wheels and assorted sand paper discs of sand, emery and garnet.

Rush \$1.00—Balance C.O.D.

**PHILADELPHIA MACHINERY CO.**  
Dept. DU-ALL, 118 N. 6th St., Phila., Pa.

**50 PIECE UNIVERSAL ARBOR TOOL SET 95¢**

Indispensable to Jeweler, Laboratory, Model Maker and Home Craftsman. The ideal outfit for fine accurate grinding, sanding, routing or carving. Includes 12 grindstones with brass centers in assorted sizes, 5 bakelite cut-off wheels, 5 assorted engraving, routing or carving bits, 2 polishing buffs, 1 mounted point, 2 bristle polishing brushes, circular and cup shape, 3 mandrel arbors, 20 assorted sanding discs of emery, garnet, sand, fine, medium and coarse. Send coin or money order. Shipment prepaid.

**PHILADELPHIA MACHINERY CO., 118 N. 6th St., Phila., Pa.**

**Make \$35 a Week or More at Home—In Spare Time!**

**Every Worker a Prospect for this New Permanent Social Security Plate**

Neat Red, White and Blue also Gold effect metal plates, with name and Social Security number stamped in, sells on sight to working people everywhere. Stays clean. Big profit on each sale. Complete stamping outfits and accessories. Also make your own raised letter stationery with our unique Embosser.

**ROOVERS BROS., INC.**  
Dept. M4f, 258 Bway., N. Y., & 3611-14th Ave., Bklyn., N. Y.

**YACHT MODEL FITTINGS**

**50-800 Marblehead Class**

There's a saying that "fine feathers make fine birds"—we say, "Fine fittings help to make a fine model." Get your plans, assembly instructions for both planked and bread and butter hulls, all latest type fittings for the popular 50/800 Marblehead class and 36" sailing models. brochure \$.05.

Send \$.15 in coin or stamps for 8 1/2 x 11" catalogue with full page illustrations of 17 different models and a complete line of ship model fittings.

**MARINE MODEL CO., 174 Worth Street, Dept. 394, NEW YORK**

**TOYS—HOME FOUNDRY—SUPPLIES**

**WRITE FOR FREE CATALOG**

showing Casting, Pyrography, Sand Pen and Metal-Tap Sets; large sets, \$2. Also supplies. **HOME FOUNDRY MFG. CO., Dept. P4, 3122 Fifth Av. Chicago, Ill.**

**BOOKS—FOR TODAY'S BIG OPPORTUNITIES**

List sent free upon request

**Popular Mechanics Press, 200 E. Ontario St., Chicago**

**GROW PLANTS WITHOUT SOIL** Startling New Development

**Complete Directions for Small and Large Scale Growing**

Get the new book "Soilless Growth of Plants" and learn this new technique which everyone is talking about. Three methods described—Water Culture, Sand Culture, Sub-Irrigation. Explains all operations. Tells how to make containers and nutrient solutions from raw materials at small cost—how to grow flowers, vegetables and fruits without soil. A fine hobby and a money-saving investment for city dwellers. A source of new business for gardeners, nurserymen, etc. Only book of its kind. Order today "Soilless Growth of Plants." Sent postpaid for \$2.75.

**POPULAR MECHANICS PRESS Dept. 4398 200 E. Ontario St., Chicago**



**Tells How to Use—**

Concrete About the Home; Concrete in the Garden and Yard; Concrete About the Farm; Concrete Homes and Buildings; Making Recreation Devices; Concrete in the Workshop; Concrete Products for Manufacture; Concrete in Business and Industry, etc. Gives 146 Concrete Kinks.



The Book of the hour for the workshop fan, handy man and home owner.

**NEW Concrete BOOK**  
Makes Cement Work of All Kinds *Easy*

256 Pages — 16 Colored Plates, Hundreds of Pictures

Large book 7 x 10 inches. Handsome cloth binding. Sent postpaid for only \$5. Sent COD in U. S. if preferred. Order today. Make concrete work a fascinating hobby or a profitable business.

**Money Making Facts - Best Methods - Materials - New Colored Concrete - 146 Kinks**

"1001 Ways to Use Concrete" strips the mystery from the fascinating work of making useful articles and permanent improvements with concrete. This book, just published covers every known use of concrete for the home, farm, building, business and industry, plus newer uses in decoration and arts. Includes new fast setting and gloriously colored concrete and 146 valuable usable kinks. 1001 uses of concrete including homes, garden furniture, pools, statuary, etc., recreation devices, farm improvements, driveways, walks, etc. Describes all methods and materials. Shows how to do real professional type jobs.

POPULAR MECHANICS PRESS - 200 East Ontario St., Dept. 4390 - CHICAGO

**HOW TO FLY**  
only \$250

If you are interested in aviation in any way—if you want to find your wings—let Capt. Duncan, licensed pilot in three countries, show you the way in his latest book.



**AIRCRAFT FLIGHT INSTRUCTOR**

By Capt. Richard Duncan, M. C.

Just published. This amazing book contains the exact instruction the beginner or student needs to learn to fly. Thoroughly covers the basic principles of flight, ships, motors, use of instruments, etc., right through to advanced flying, aerobatics, inverted (up-side-down) and blind flying. Big 330-page book with 129 diagrams and pictures. Flexible leatherette binding. Sent postpaid anywhere in world for \$2.50. Or if in U. S. or possessions, order on postcard and pay price plus small C.O.D. fee to postman on delivery. Interesting too, for airline passengers. Get your copy today. Learn to fly with Capt. Duncan.

Popular Mechanics Press, Room 439, 200 E. Ontario St., Chicago

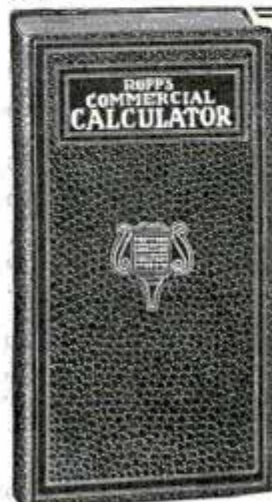

**Mathematics Made Easy by ROPP'S CALCULATOR AND SHORT-CUT ARITHMETIC**

Shows the Answer as Quickly as a Watch shows the Time to all Problems likely to occur in the Office, Store, Shop, Bank, Farm, or Factory.

Over 2,000,000 Sold  
Explains and simplifies every principle in Arithmetic, Mechanics, and Mensuration.

PRICES POSTPAID  
Desk Size, Flexible Keratol Binding.....\$2.00  
Pocket Size, Art Leather Binding.....\$1.00  
Pocket Size, Cloth Binding.....\$0.50

POPULAR MECHANICS PRESS  
Room P-4 200 E. Ontario St. CHICAGO

**HELP! HELP!** **I'LL FIX YOU STRONG AS EVER**

Fix up your crippled furniture, chipped veneers, splintered mouldings with Rogers Glue... they look like new... Stays put longer because it's stronger — 10c and up in tube, bottle and can at hardware stores or send 10c for full size bottle and free set of project plans.

ROGERS, Gloucester, Massachusetts!

**ROGERS**  
the best LIQUID FISH GLUE

SAYS GLUEKY

**NEW KIND OF MAN'S SHOE**

The new sensation in men's shoes — The Chippewa Clipper. It zips on and off in a "jiffy". Right now is the right time to get into a dignified and highly profitable shoe business of your own with this fast seller, and a complete line of almost 250 styles of dress, work and sports shoes. Prices as low as \$1.98 a pair. Free 10-second demonstrator sells super-comfort air-cushion shoes like magic.

Sales division of manufacturer established 36 years wants salesmen. No experience needed. Write for complete sales kit. It's free!

**CONSOLIDATED SHOE SYSTEM**  
Dept. M16, Chippewa Falls, Wis.

**ZIPS ON and OFF**

**SALESMEN WANTED BIG PAY EVERY DAY**

**Only 15c A Day**  
**Puts This All-Purpose ELECTRIC ARC WELDER IN YOUR SHOP**

**TEN-DAY TRIAL**  
**Guaranteed: 10 Months To Pay**

Now, it is EASY for every inventor, laboratory, home workshop owner, garage, repair shop, and factory to afford a complete welding service for manufacturing, maintenance, experimental, or repair work. Full size, heavy-duty Aladdin Electric Arc Welder—yours for only 15c a day! Has efficiency of machines costing far more. Welds all weldable metals and alloys. Handles everything from fenders and light sheet metal to motor blocks and heavy castings. Also fine for soldering and brazing.

**WORKS ON 110 OR 220-VOLT A. C.** Simply plug into 110 or 220-volt, 60-cycle A. C. electric outlet. Costs only few pennies an hour to operate. Anyone can use easily. Comes complete with helmet, electrode holder, welding rods, full instructions, etc. Nothing else to buy. Fully guaranteed.

**WRITE FOR 15c A DAY PLAN.** Stop throwing away profits! Do your own welding. Get sensational facts. Write today!

**COMMONWEALTH MFG. CORP.**  
Dept. W-51 4208 Davis Lane, Cincinnati, O.

**A Super Value 8" TABLE SAW**

PRICE ONLY \$11.95

Built to Duro high standards of quality and workmanship. It is the greatest value Saw that has ever been put on the market. High quality materials machined to close limits for accuracy—gray iron base, table bracket and table give rigidity and smoothness.

All Duro tools are designed for greater convenience of operation and made of quality materials for longer life. Send for new 1939 Duro Woodworking catalog illustrating America's finest and most complete line.

**★ 2 3/8" DEPTH CUT ★ TABLE 11" X 15"**  
**★ FREE VISION GUARD ★ PRICE INCLUDES MITRE GAUGE & RIP FENCE**

**DURO METAL PRODUCTS COMPANY**  
DEPT B3, 2649 N. KILDARE CHICAGO, ILL.



# New Candid Style Camera

\$2.00



—One of the greatest camera values in years! Handsome candid style "Traveler" equipped with new High-Speed Graf Lens, Eye-Level Magnifying View Finder, provision for snapshots or time exposure. Gives 16 exposures on V-127 or A-8 film. Looks like a \$10 value. Made of beautiful polished Tenite and measures 4½" x 2¼" x 2½" —all for only \$2.00! Written guarantee with each camera.

## SEND NO MONEY

Just send your name and address and pay postman \$2.00 on arrival, plus a few pennies postage—or send \$2.00 and Traveller will be shipped postage prepaid. Either way, satisfaction guaranteed or money refunded. (Sporty-looking Flexhyde Carrying Case with genuine leather strap only 50c extra).



R-W CAMERA MART, 3355 N. Halsted Street, Chicago, Illinois

# WORLD'S GREATEST all around ELECTRIC TOOL

## DRILLS — GRINDS — SANDS — SAWS POLISHES — SHARPENS — CARVES

The new WHIZ ELECTRIC TOOL is the handiest power tool ever made. Not a delicate instrument but a real rugged tool, equally effective for both power and precision work. Drills through ¼ inch iron plate in 42 seconds or engraves intricate designs on jewelry. Handles any material: Metals—Woods—Alloys—Plastics—Glass—Steel—etc. Saves time. Eliminates labor. Plug into any socket AC or DC, 110 volts. Chuck ¼ inch capacity. Ball bearing thrust. Powerful triple-gear motor. "Worth its weight in Gold." STANDARD MODEL with Normal Speed (uses 50 different accessories, instantly interchangeable.) Special Introductory Price for limited time, only \$6.95. Accessory outfit (Value \$2) includes set of drills, mounted 1½ inch grinder, sanding discs, cutting wheels, mounted brush, polishing wheel, carving bur, etc. FREE with each outfit ordered NOW. We pay postage. Will send C. O. D. if desired. 10-DAY TRIAL—MONEY BACK GUARANTEE.

ONLY \$6.95  
POSTPAID  
GUARANTEED FOR ONE YEAR

Special "2-SPEED" MODEL combines Normal Speed and High Speed in one outfit (uses 200 accessories) only \$8.95 complete, with same accessory outfit (value \$2) FREE.

Paramount Products Co., Dept. 4A, 48 West 48th St., New York

# ACT NOW \$59.60 F.O.B.

30 M.P.H. and 125 M. per gal. of gas. All steel construction, balloon tires, special molded sponge rubber seat, Briggs & Stratton 1 H.P. motor. Has light, clutch, and powerful brake. Two speeds for only \$5.00 extra. Easy to operate. All parts enclosed for driver's safety. Star Put-Puts have been made for years. Save 40% by buying direct. Write for complete, illustrated, literature.

STAR PUT-PUT COMPANY  
ROCHESTER INDIANA

# PRESTO! ANYONE CAN MASTER GLAZE

LEAVES HARD GLASS-LIKE FINISH  
SEALS THE PORES OF THE SURFACE  
EASY TO APPLY  
WILL NOT FINGER-MARK  
NO OILY FILM  
EASY TO KEEP CLEAN  
AS WITH POLISH  
NO SMEAR OR STREAKS AS WITH WAX  
LASTS SIX MONTHS TO A YEAR  
SAVES YOU MONEY

Car Owners! Meet Master Glaze—the sensationally different luster for new and used cars! Not a wax—not an oil polish—not a paint!—nothing that "smears" over the surface.

MASTER GLAZE is a unique discovery—a creamy liquid—quick and easy to apply! Gives a hard, glass-like surface. Even gasoline cannot dull it! Lasts six months to a year! Amazing luster—beautiful, sparkling clean and brilliant! Doesn't finger-mark—doesn't smear! A match box full glazes an entire car. Seals the pores—protects! NOTHING LIKE IT!

**AGENTS**  
An unusual opportunity!  
Quick, flashy demonstrator.  
Big profits.  
Good territory.  
Write today!

FREE Offer! Write now for FREE BOOK—LET and FREE TRIAL OFFER. Just send your name and address. Write

MASTER GLAZE CO., 7720-62 W. Harwood Ave., Milwaukee, Wis.

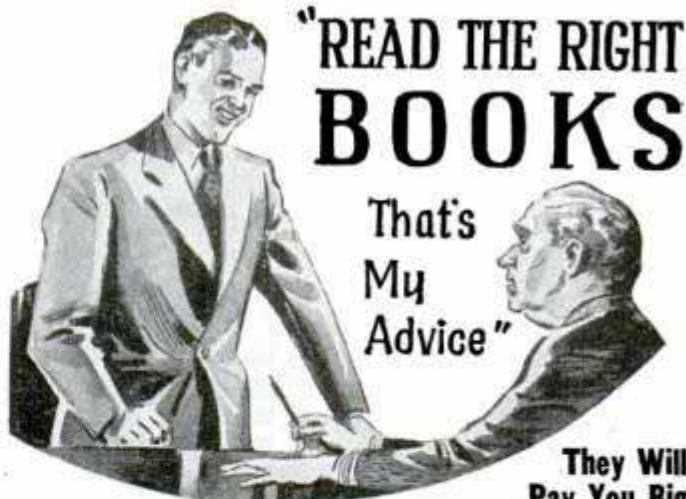

# "READ THE RIGHT BOOKS

That's My Advice"

They Will Pay You Big

Dividends for Little Effort  
To help you on your job; to prepare for a better job; to develop a spare-time extra money income—make use of these books. Thousands have profited by them.

## SELECT FROM THIS "HAND PICKED" LIST

- |   |   |
|---|---|
| <b>AIR CONDITIONING</b><br>Live Field; Great Future . . . . . \$4.00                        | <b>MACHINE SHOP WORK</b><br>Complete. 400 Pages. 444 Illustrations. . . . \$2.50            |
| <b>ALUMINUM WORKING</b><br>For School and Home Shops. Just Out 295 pp., illus. . . . \$3.00 | <b>MACHINE WOOD-WORKING</b><br>First Complete Book. \$3.25                                  |
| <b>AUTO ENCYCLOPEDIA</b><br>The Famous Dyke's Latest Edition . . . \$6.00                   | <b>MATHEMATICS</b><br>Easy Guide for the Practical Man. . . . \$1.50                        |
| <b>110-V. GENERATORS</b><br>Made From Old Auto Units. . . . . \$1.00                        | <b>MECHANICAL DRAWING</b><br>Learn Drafting; Good Salaries. . . . . \$1.00                  |
| <b>BIRD HOUSES</b><br>Build to Sell; Easy Designs. . . . . \$1.00                           | <b>MONEY MAKING IDEAS</b><br>1000 Ways to Make \$1000. . . . . \$2.50                       |
| <b>BLUEPRINT READING</b><br>For the Building Trades. . . . . \$1.25                         | <b>OFFICE MACHINES</b><br>All Makes. Care and Operation. . . . . \$2.50                     |
| <b>BOAT BOOK</b><br>Power, Sail, Rowing, Paddle Plans. . . . \$3.00                         | <b>OXYACETYLENE WELDING</b><br>Hard Surfacing, Lead Burning, Cutting New ed. . . . . \$1.25 |
| <b>BOY MECHANIC</b><br>Hundreds Things Boys Can Make. . . . . \$2.00                        | <b>PAINTING AND DECORATING</b><br>New book. \$1.50  |
| <b>CARPENTRY, PRACTICAL</b><br>Complete 436 pages. Revised Edition. . . \$2.00              | <b>PROSPECTORS' HANDBOOK</b><br>How to Mine, Appraise, Equip. . . . . \$3.00                |
| <b>CIVIL SERVICE</b><br>Home Study Courses Federal, State, City Positions. . . . . \$1.00   | <b>RADIO SERVICING</b><br>Profit by Knowing Costs, Kinks, Etc! . . . . \$4.00               |
| <b>CONCRETE</b><br>1001 Ideas for Using. New Popular Mechanics Book. . . \$5.00             | <b>REFRIGERATION</b><br>Electric, Gas. Be a Service Expert. . . \$5.00                      |
| <b>DIESEL ENGINES</b><br>For Land, Air and Water. . . . . \$4.00                            | <b>REWINDING ELECTRIC MOTORS</b><br>Fractional Sizes. . . \$2.50                            |
| <b>ELECTROPLATING</b><br>With Copper, Nickel and Chromium Technical bulletin. . . . \$1.00  | <b>SHIP MODEL</b><br>Entire Text, Famous "Sovereign" of 1637. . \$1.00                      |
| <b>FORMULAS</b><br>1059 Money Making. Start a Business. . \$1.25                            | <b>SOIL-LESS GROWTH OF PLANTS</b><br>Just out. . . . \$2.75                                 |
| <b>A.C. POWER WIRING</b><br>Covers all uses of a.c. for power. . . . . \$4.00               | <b>STEEL SQUARE</b><br>How to Figure Angles of Rafters, Roofs, Etc. . . . . \$1.00          |
| <b>FURNITURE MAKING</b><br>Tools, Materials, Design. . . . . \$2.50                         | <b>TOYS</b><br>For Amusement or Profit. Saleable Designs. . \$1.50                          |
| <b>HOUSE CONSTRUCTION</b><br>Details. Practical, Up-to-date. Complete. . . . . \$3.00       | <b>TRAILER BUILDING</b><br>New Book. . . . . \$1.00   |
| <b>HOUSES, SMALL</b><br>Book of, for Home Builders. . . . . \$2.00                          | <b>UPHOLSTERY</b><br>Always a Big Market. Start Own Business \$2.00                         |
|   | <b>WOOD FINISHING</b><br>Methods, Tools. . . . \$2.00                                       |

## Pay Postman BOOKS SENT C.O.D. to ANY ADDRESS in U. S.

Selected books will be sent to any address in U. S. or possessions and you can pay postman indicated prices plus small C. O. D. fee. We will pay postage to any address in the world if remittance accompanies order. Mail your order now and enjoy the extra advantages of extra knowledge.

POPULAR MECHANICS PRESS

Room 239A

200 East Ontario St., Chicago



# FOR YOUR SHOP - Handy Combination Unit



Every shop can use this combination Delta 10-inch saw and 6-inch Jointer! It enables you to rip stock to width and then joint it without moving a step. Men who use it say that with this combination they can perform 80% of all common wood-working operations at savings of from 25% to 50% in time. Absolutely **no interference** between saw and jointer—either machine may be used singly or both together. Both machines are driven from one motor mounted below. This makes for compactness, portability and low operating cost.

## Send for CATALOG

giving complete details, price on this Delta Combination Unit and on the entire line of Delta low-cost light power wood and metal-working tools, Dept. A439.

**DELTA MFG. CO.** 600-634 E. VIENNA AVENUE  
MILWAUKEE, WISCONSIN

## A PRECISION ELECTRIC FENCER

**PARMAK** NOW ONLY \$9.90  
Now the World's Largest Selling Electric Fencer—Single wire a tremendous saving. Five new models. Write today for 30 DAY TRIAL offer and free catalog. DEALER-AGENTS FREE wanted. Many valuable exclusive territories open. Catalog PARKER-McCRORY MFG. CO., 100-D, Kansas City, Mo.



## GIVE THAT PROFESSIONAL FINISH TO THE THINGS YOU MAKE

### MASTER STRIPING OUTFIT

It's easy to stripe! Adds beautiful effects—professional work accomplished almost immediately. Price includes: tool for making 3 most popular stripe widths; 2 material containers; guides; complete instructions. Money back guarantee. Send only \$1.00 with order—balance C.O.D.

ONLY \$4.50 Postpaid

WENDELL MFG. CO., 2500 N. Ashland Ave., Chicago, Ill.

## WINTER FARM RELIEF!



Here's farm relief no farmer can afford to be without—EN-AR-CO (Japanese style) OIL. Stimulates local circulation for the relief of pains of Neuralgia, Sprains, Sore Muscles, Fatigue and Exposure, also the discomfort of Head Colds and Bronchial Irritation. EN-AR-CO has been doing it for over 50 years. Best insurance against a crop of troubles. Get EN-AR-CO today and get your quick pain relief. All Druggists. NATIONAL REMEDY CO. MADE IN U.S.A. NEW YORK

## CAMERA BOOK FREE!



Explains latest inventions, methods of Photography and Home Movie Making, for fun and profits. Offers hundreds of amazing money-saving Bargains in still and movie Cameras, Lenses, Films, etc. Used equipment accepted in trade. Satisfaction guaranteed!

WRITE FOR FREE BARGAIN BOOK!

Central Camera Co., 230 S. Wabash, Dept. K-4, Chicago, U. S. A.

## EARN MONEY Stringing TENNIS RACKETS



Build up a business of your own stringing tennis rackets. It pays up to 140% profit PER RACKET. String YOUR OWN RACKET AND SAVE MONEY. No experience needed—we teach you how. Tennis players need new strings in their rackets two or three times yearly . . . every stringing means PROFIT for you. See how simple it is to get in this business. Costs practically nothing to start. Easy work! GET STARTED NOW!

FREE Write today and we will send you Free plan and special offer on strings and stringing equipment.

### THOMPSON MANUFACTURING CO.

4535 Packers Ave., Chicago, U. S. A.  
TOMGUT "Court-Tested" Tennis & Badminton Strings

## Earn \$150 to \$300 EXTRA PROFIT monthly with "Simplified" ARC WELDING



Yes, you can "Build Your Own." Save \$300 to \$500

Start a big pay business of your own now, with new 40 Volt Simplified Arc Welder. New low prices and easy pay-out-of-profit terms makes equipment available to everyone. Exclusive Hobart features guarantee easier, faster operation. Same machine as used by largest manufacturers. Extra earnings easily pay for it without expense to you.

### 30 DAYS TRIAL TO PROVE IT PAYS

Use this welder for 30 days on your work, at our risk. See for yourself how many profitable jobs it can do before you buy. Write today for complete details on 30 Days Trial and Easy Terms. No obligation.

HOBART BROS., Box M-49, TROY, OHIO



AS LITTLE AS \$20 Monthly puts it in your shop

Get your FREE Book on New Profits for Welding Shops



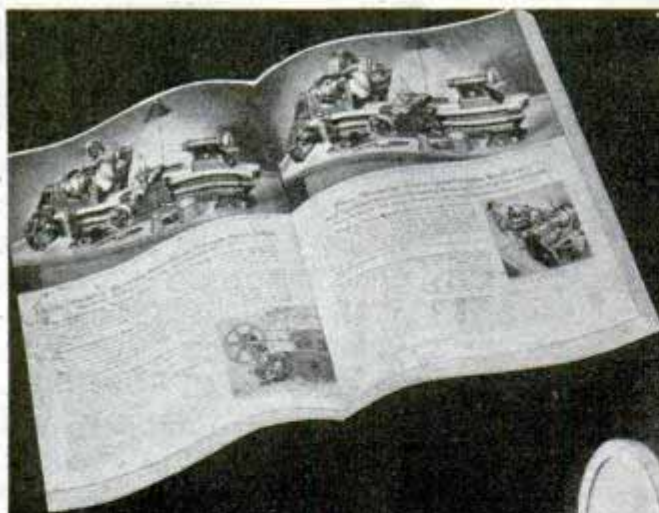

## WRITE FOR YOUR COPY OF THIS FREE 32 PAGE BOOK

### Showing The New 9" South Bend Workshop Precision Lathe . . . .

A Back-Geared, Screw Cutting Lathe of Highest Quality and Accuracy. Used by Leading Manufacturers for Doing All of These Metal Working Jobs:

Drilling, turning, boring, reaming, cutting screw threads, facing, milling, filing and chucking, in steel, iron, wood, plastics and all other machinable materials.

### Insist on These Important Precision Lathe Features

1. Hand-scraped V-ways on lathe bed
2. Precision Machine Cut Steel Gears
3. Precision Lead Screw Cuts Screw Threads 4 to 112 per Inch.
4. All Steel and Iron Construction
5. Ball Thrust Bearing on Spindle
6. Twin Gear Reverse for Right and Left Hand Threads and Feeds
7.  $\frac{1}{4}$ -inch Hole Through Headstock Spindle has Collet Capacity of  $\frac{1}{2}$ ".

### Send Coupon FOR THIS NEW BOOK

Illustrating, describing and pricing the new 9" Lathe in 3', 3 $\frac{1}{2}$ ', 4' and 4 $\frac{1}{2}$ ' bed lengths and 8 different drives. Shows 38 attachments for use with the lathe and gives in clear detail important features and construction.

**SOUTH BEND LATHE WORKS,**  
640 E. Madison St., South Bend, Ind., U.S.A.  
Please send me Free of charge, Postpaid, the new  
Catalog No. 46-B for Machinists and Mechanics  
and the South Bend Easy Payment Plan.

Class of Work.....  
Name.....  
Address..... State.....  
City.....

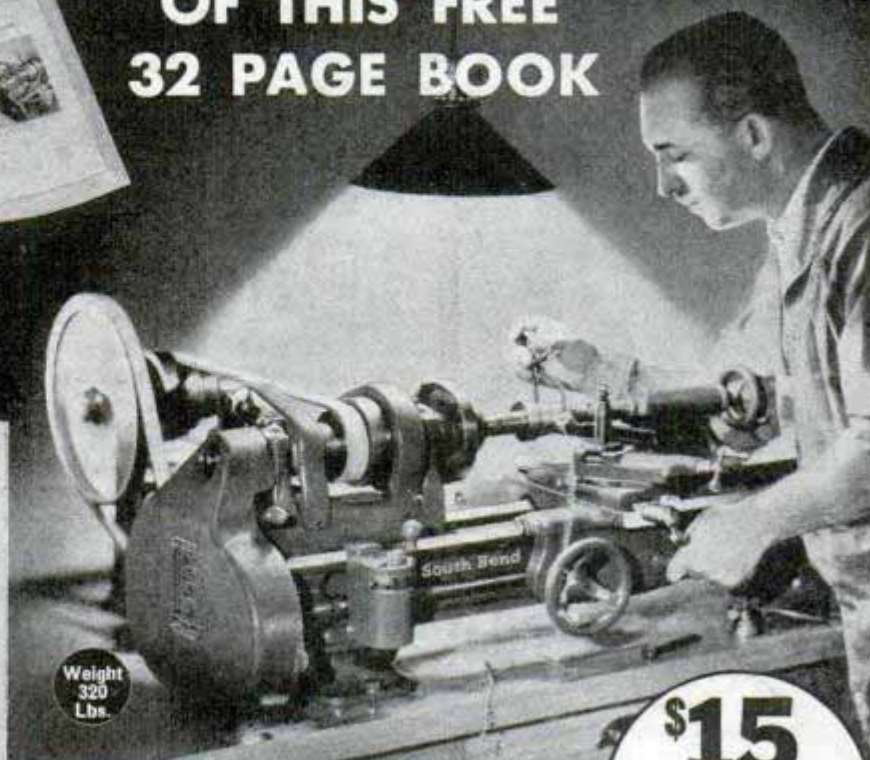

Weight  
320  
Lbs.

No. 415-YA, 9 $\frac{1}{4}$ " swing by 3' bed Workshop Bench Lathe with Horizontal Motor Drive,  $\frac{1}{4}$ " H. P. Reversing Motor, Switch, Belts, Change Gears and Adjustable Belt Tension Countershaft..... **\$117**

**\$15**

Down Payment  
**PLACES THIS LATHE  
IN YOUR SHOP**

Balance  
**\$6 Monthly**

**T**HIS new book shows the 9-inch precision lathe that is used by every class of industry for handling machining operations. Its important features and construction, illustrated and described in the book, are the reason for industry using this 9-inch South Bend Workshop Lathe so extensively in Manufacturing plants, Machine shops, Tool rooms, Laboratories, and Repair shops.

The 38 attachments available with the 9" lathe make it an all-purpose tool, and make any shop in which it is installed complete. Does milling, grinding, draw-in collet chuck work, taper work, and other operations.

Other important features include: automatic longitudinal screw feed to carriage,  $\frac{5}{8}$ " tailstock set-over for taper turning, micrometer graduations on compound rest and cross feed screws, adjustable gibs on compound rest and cross feed.

South Bend Precision Lathes are manufactured in five other sizes—9", 11", 13", 15" and 16" swing, in bed lengths 3' to 12', in Countershaft Drive and Motor Drive. Priced \$85 to \$1500.

### SOUTH BEND LATHE WORKS

640 East Madison St., South Bend, Ind., U.S.A.

**SOUTH BEND**  
*Precision* **LATHES**



# FISHER FACTS

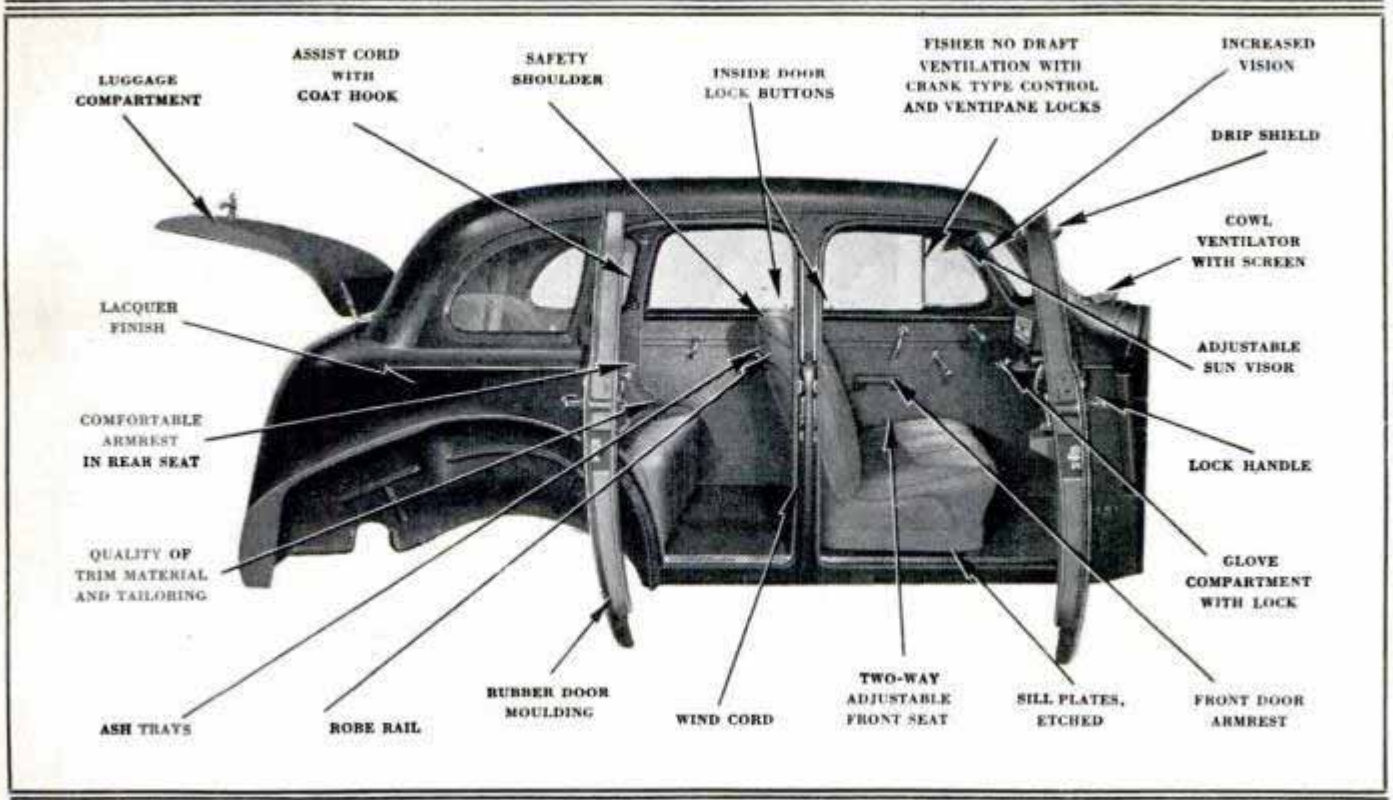

*They're saying, "Chevrolet's the Choice" in the low-price field—and the diagrammatic drawing above quickly shows that its Body by Fisher is one of the best reasons why.*

## NEW LIGHTS on LUXURY —in the new Body by Fisher

**L**UXURY starts back of the assembly line in the new Unisteel Body by Fisher — thanks to Fisher engineers.

For it is a luxury, indeed, to have a car body that is all in one substantial steel unit — from seamless steel Turret Top, through all the steel panels and reinforcements, right down to the solid steel floor.

But, of course, this inseparable unity of the Unisteel Body is only the beginning of the luxuries with which it adds so much extra value to the 1939 General Motors cars.

For instance, its steel Turret Top, all of its steel panels and even

its steel floor are scientifically insulated against heat, cold and noise.

Yes, luxurious comfort is as important in the new Body by Fisher as is its Unisteel resistance to wear, weaving, jolts and shocks. Just sit in its wider, more comfortable seats — look at all the fine new fabrics and jewel-like appointments that Fisher craftsmen have fashioned this year.

And just note the increased visibility they've provided for greater safety!

No wonder people are saying "For 1939 better buy the car with Body by Fisher."



## BODY BY FISHER

ON GENERAL MOTORS CARS ONLY: CHEVROLET • PONTIAC • OLDSMOBILE • BUICK • LA SALLE • CADILLAC



WITNESSED STATEMENT SERIES:

## "SOLD AMERICAN"

MEANS FINE TOBACCO FOR LUCKIES

F. E. McLAUGHLIN, auctioneer, has been "in tobacco" for 13 years. He says: "I've never yet seen Luckies buy anything but the best tobacco ...so I've smoked them since 1928."

## Have you tried a Lucky lately?

RECENT tobacco crops have been outstanding in quality. New methods, developed by the United States Government, have helped the farmer grow finer tobacco. As *independent* experts point out, Luckies have always bought the cream of the crop. Thoroughly aged, these fine tobaccos are now ready for you. And so Luckies are better than ever. Have you tried a Lucky lately? Try them for a week and know why ...

**With Men Who  
Know Tobacco Best-  
It's Luckies 2 to 1**

*Easy on Your Throat-  
Because "IT'S TOASTED"*

Copyright 1939, The American Tobacco Company