

HOTELS ON THE WING

POPULAR MECHANICS

MAGAZINE

WRITTEN SO YOU CAN UNDERSTAND IT

REG'D. TRADE MARK, GREAT BRITAIN, NO. 410428

REG. U.S. PAT. OFF.

MARCH
25 CENTS



SEE PAGE 398

RACING THE MIGHTY MIDGETS

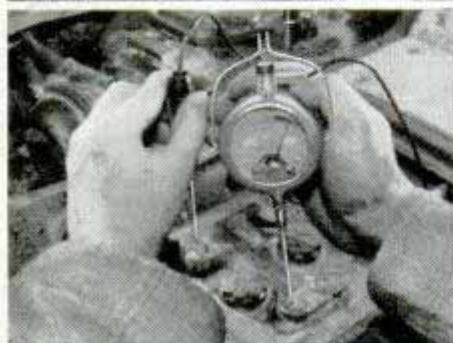

THAT a hydrometer reading of a battery is not the real indication of the battery's condition? This reveals only the chemical condition. To find the power available, it is necessary to check the battery under load with a low-reading voltmeter.

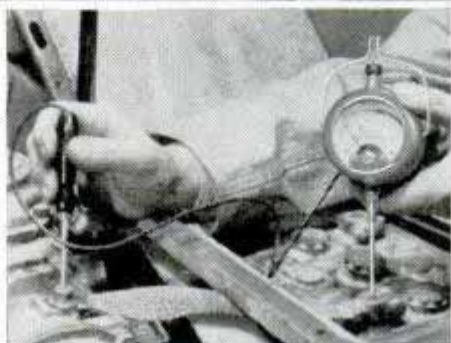

THAT voltage loss—caused by excessive resistance in cables, connections, or parts—may make the difference between a car that *will* start and a car that won't start? Battery cables and ground straps must be full size and free from corrosion.

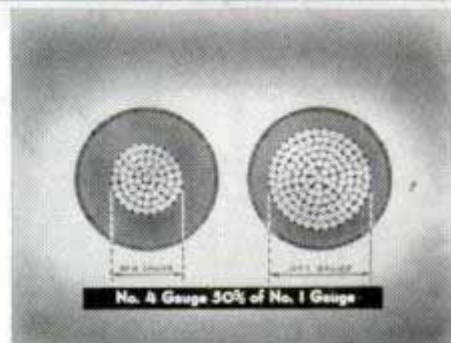

THAT some battery cables have only 50% as much copper in the core as the standard No. 1 gauge cable—and, therefore, have only 50% of the current-carrying capacity? All Packard battery cables are No. 1 or No. 0 gauge.

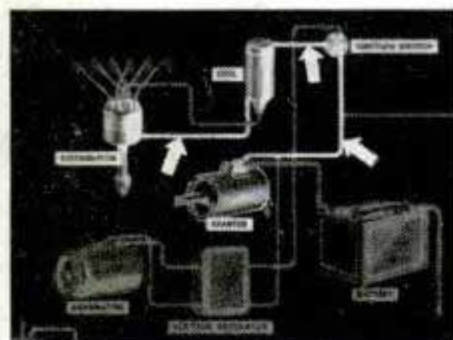

THAT a common cause of voltage loss and unsatisfactory performance in the primary ignition circuit is excessive resistance in the cables? New cables that are too small will not remedy this condition—they must be of proper size.

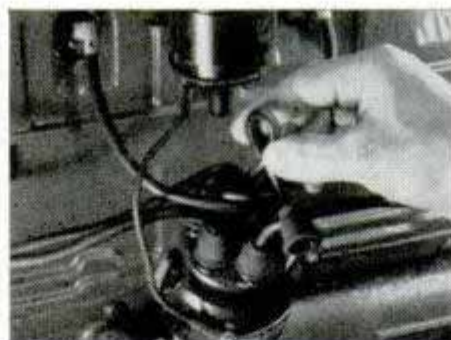

THAT cracked and oil-soaked insulation of the spark plug wires allows electricity to leak away and robs your car of pep, power and economy? Packard 440 ignition cable has a secret-formula protective sheath that seals in the high voltage.

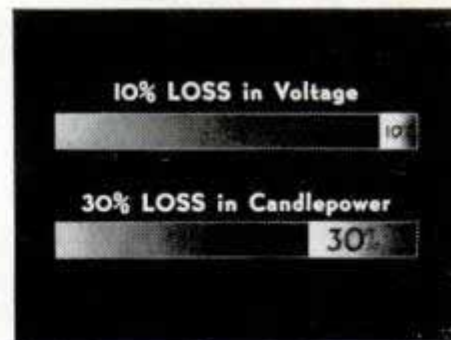

THAT a 10% loss in voltage in the lighting circuit causes a 30% loss in candlepower? Because of this—and because old, worn or undersized cables are a dangerous fire hazard—good wiring is a very important safety factor.

AND DO YOU KNOW THAT—?

Packard Electric is the only cable company that trains mechanics with a program of Service Films and Service Instruction Manuals on Re-Wiring. This means that when you drive into a service station or garage where Packard cable is used, you are sure of getting the highest quality cable,

installed by mechanics who know how. Packard Electric Division, General Motors Corporation, Warren, Ohio.

Packard
REG. U.S. PAT. OFF.
TRADE MARK

THE STANDARD WIRING EQUIPMENT OF THE AUTOMOTIVE INDUSTRY

It's Such a Big Car.

OF THE LEADING LOW-PRICED
CARS, PLYMOUTH IS
**6 INCHES LONGER THAN
ONE—5 INCHES LONGER
THAN THE OTHER!**

Now—You Get More Car For Less Money

1. Perfected Remote Control Gear Shifting.
2. Auto-Mesh Transmission.
3. Amola Steel Coil Springs.
4. New Safety Headlamps—better road lighting.
5. Revolutionary, New "Safety Signal" Speedometer.
6. Big Safety-Steel Body.
7. Time-Proven, Double-Action Hydraulic Brakes.
8. Functional Design—new trend in styling gives Plymouth glamorous new beauty.
9. All Plymouth models have the same big, 82-horsepower "L-head" engine, giving full power and economy.

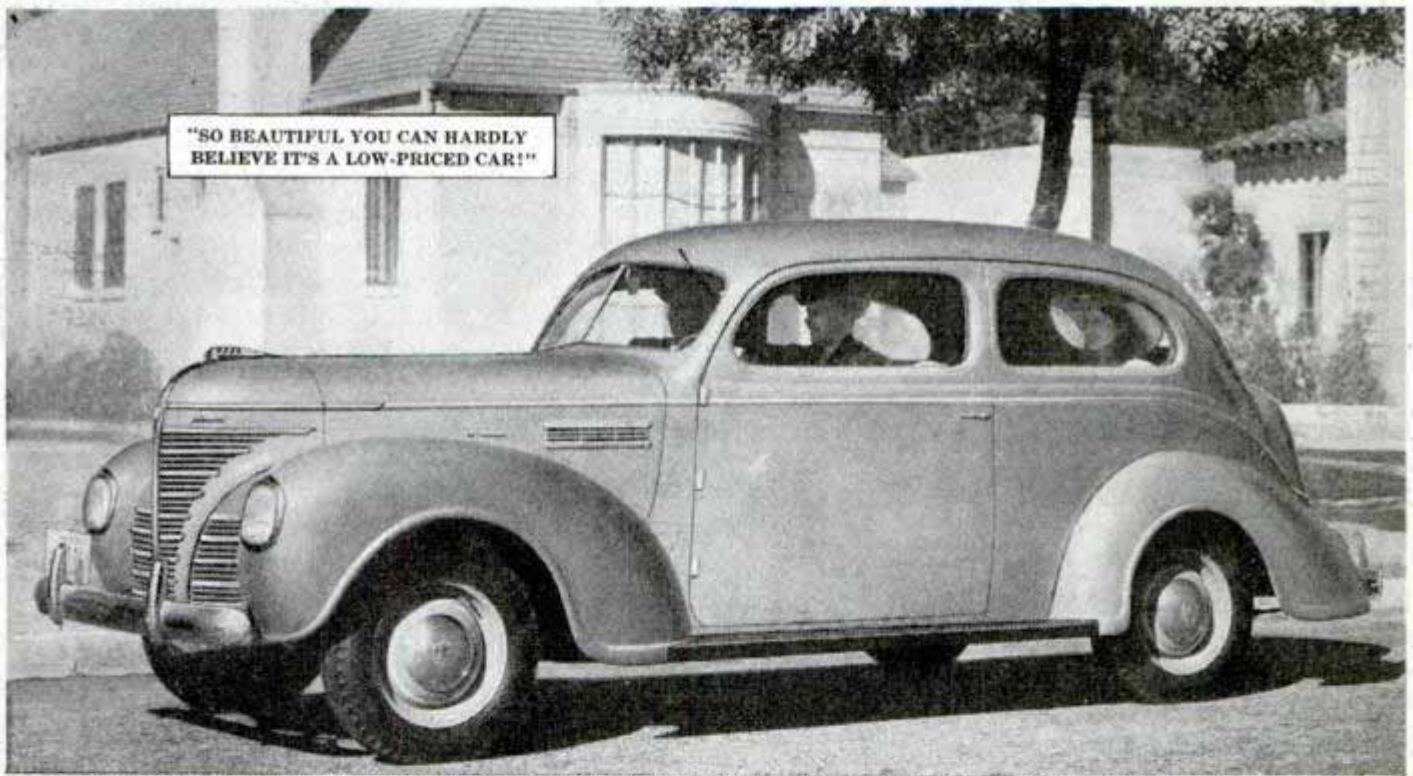

ALL PLYMOUTH MODELS—both "Roadking" and "De Luxe"—have a Safety-Steel body which is completely rust-proofed.

STANDARD EQUIPMENT on "De Luxe" models at no extra cost—Perfected Remote Control Gear Shifting with All-Silent Auto-Mesh Transmission. Marvelous new shifting ease. Nothing new to learn!



INCLUDED IN LOW PRICES:

"Detroit delivered prices" include front and rear bumpers, bumper guards, spare wheel, tire and tube, foot control for headlight beam with indicator on instrument panel, ash-tray in front and rear, sun visor, safety glass and big trunk space (19.6 cubic feet). Plymouth "Roadking" models start at \$645; "De Luxe" models slightly higher. Prices include all federal taxes. Transportation and state, local taxes, if any, not included. See your Plymouth dealer for local delivered prices. PLYMOUTH DIVISION OF CHRYSLER CORPORATION, Detroit, Michigan.

TUNE IN MAJOR BOWES' AMATEUR HOUR, C. B. S. NETWORK, THURS., 9-10 P. M., E. S. T.

**PLYMOUTH BUILDS
GREAT CARS** NEW "ROADKING"
NEW "DE LUXE"



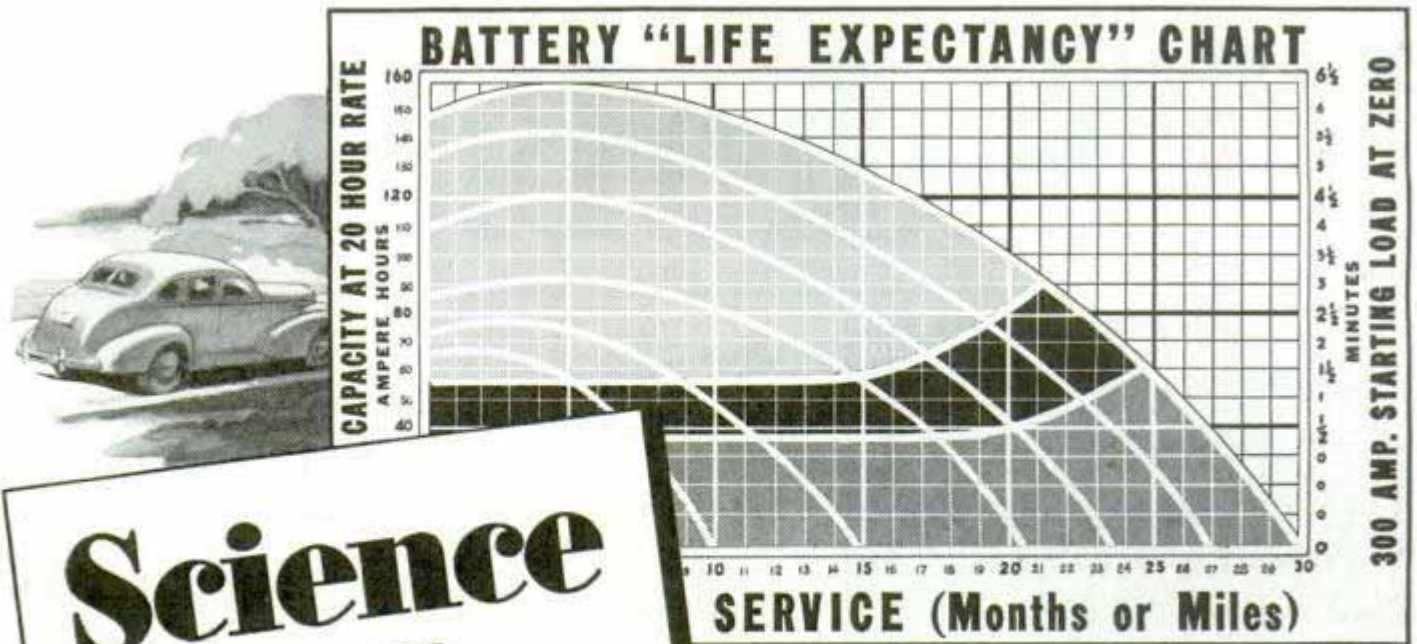

Science
comes
to the rescue

**Now You Don't Have to Guess
When Your Automobile Battery Is
Likely to Give Out—You Can Know
Beforehand When to Replace**

When to replace a battery? This has always been a major problem for car owners. Naturally, every driver hates to risk the inconvenience and annoyance of having a battery go dead, particularly since this seems to happen when time is short or help is hard to get. On the other hand, nobody wants to turn in a battery that still has plenty of life in it.

Now science provides the answer! Delco-Remy—manufacturer of Delco Batteries—conducted an intensive research program. Complete information was collected on the service given by thousands of batteries. This data was classified and grouped to establish the original Ampere Hour Capacity of each battery and to show the Units of service which each had given (in passenger car service a Unit equals one month, or 1000 miles).

These figures were then tabulated and plotted into curves, to form the Battery "Life Expectancy" Chart.

To determine the probable life of any battery, measured in terms of its ability to crank an engine at 0° F., all that is necessary is to know the original Ampere Hour Capacity of the battery. Find the curve of the particular battery on the chart and follow it until it is intersected by the line indicating the Units of service which the battery has given. That point shows the probable amount of life left in the battery, and when it should be replaced.

Stop in at your Delco Battery dealer's and let him demonstrate how the "Life Expectancy" Chart works. He will also supply you with a smaller copy of this chart if you are interested—just ask him for it.

Delco Batteries are known the world over for long, dependable, efficient service. That is why they are standard equipment on all General Motors cars and trucks. Make your next battery a Delco.



Delco-Remy

ANDERSON, INDIANA

Delco Battery sales and service requirements are available at United Motors Service Stations and dealers everywhere.



World's Largest Manufacturer of Automotive Electrical Equipment

When writing to advertisers please mention Popular Mechanics

Popular Mechanics Magazine

H. H. WINDSOR, Founder

H. H. WINDSOR, Jr., Editor and Publisher

March, 1939

Vol. 71, No. 3

Special Features

<u>The City of Tomorrow</u>	321
<u>Trapping Modern Cattle Rustlers</u>	328
<u>Miracle of New Color Movies</u>	Coloroto
<u>Paul Reverses of '39</u>	348
<u>"Hot Papa" to the Rescue</u>	354
<u>Grooming the Iron Horse</u>	360
<u>Air Line under Glass</u>	367
<u>Going Nature One Better</u>	371
<u>Hunting Lost Voices</u>	377
<u>Racing the Mighty Midgets</u>	386
<u>Making the Grade on Skis</u>	392
<u>Hotels on the Wing</u>	402
<u>Topsy-Turvy Weather Magicians</u>	410

(Continued on next page)

Guarding Your Gold

RUMOR has it that Britain's gold lies hidden in a secret vault beneath the Thames river, that France stores her monetary wealth under the Seine where no invading army could discover it. But Uncle Sam, hoarding the greatest treasure in all time—twelve billion dollars in gold alone and a mountain of silver besides—frankly tells you just where to find it and what obstacles face any desperate band that would risk death to crack the national safe. At Fort Knox, Ky., lies one-fourth the world's monetary gold supply, safer behind its iron fence, moat and drawbridge than a medieval castle; its ten-foot concrete base rests on solid rock, defying even an earthquake; its roof is bombproof, its steel beams "breathe" deadly gas at the touch of a blowtorch. Read in the April issue how Uncle Sam guards your staggering pile of riches.

Next Month

ONE of the most hazardous occupations in the world is that of the Ruhe family, who for seventy years have been combing the jungles and deserts and mountains around the globe for wild animals and birds. If you want an okapi or a black swan or an African bongo they'll get it for you, although it may involve trouble with native tribes and a lot of nursing for seasick animals. An article next month tells of the adventurous business of the Ruhe brothers.

Heroes on the Air

TUNE in on the radio news bulletin and you may be listening to a hero—for it takes heroics to cover mine disaster and hurricane, shipwreck and war. One radio reporter carries the microphone within sound of bursting shells at Barcelona, another brings you the sound of Vesuvius' boiling lava. Read the adventures of radio heroes in the April number.

Army Color "Spies"

CAMOUFLAGE that tricks the human eye cannot fool the color camera that sees through haze and shadow. Army cameramen have flown above New York City and snapped pictures revealing the color of taxicabs in the street "canyons" far below. How natural color photography is changing the game of war is told next month, illustrated with eight pages of Coloroto.

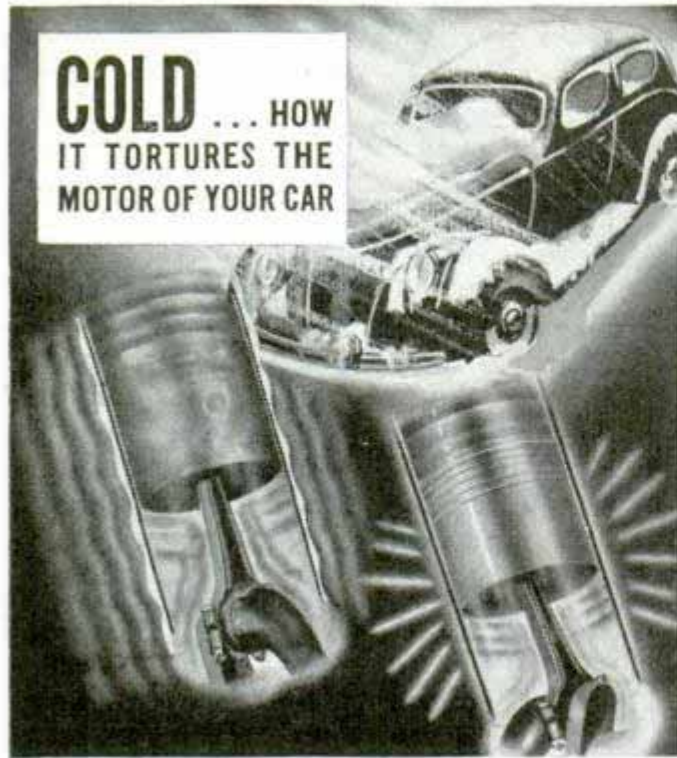

COLD ... HOW IT TORTURES THE MOTOR OF YOUR CAR

When you start your car in cold weather, pistons like this race INSTANTLY up and down, 1300 times per minute. Twenty-two times per second! Sluggish, half frozen oil, drained to the base, won't go to work that fast. Thirteen hundred blistering, scraping, metal wracking strokes take place without benefit of lubrication. Here is a main reason why your motor wears out. This is what depreciates your investment.

This piston, bearing and shaft are bathed in Pyroil. A protective lubricating film is provided that always stays on the metal in spite of heat or cold. The Pyroil film does not drain into the base. Pyroil is different from regular lubricating oil. It lubricates from the moment these parts go into action. There is no metal to metal clash and damage. No fierce, metal wearing friction. Battery drain is diminished. Your motor starts easier. Oil and fuel consumption are lessened. Here is what protects your motor and saves you money.

PYROIL WILL PROTECT IT

Pyroil is inexpensive to use. You merely add a few ounces to gasoline tank and to crankcase. It gives you increased power, easier starting, smoother performance, lowered operation costs. Many times it offsets costly repairs. Get away from hard starting, from cold weather torture and damage. Try Pyroil. Get some today at your service station or garage. Manufactured and guaranteed by Pyroil Company, W. V. Kidder, Founder, 53 Pyroil Bldg., La Crosse, Wisconsin, U. S. A.



NOTHING FINER FOR NON-ABRASIVE NEW CAR BREAK IN!

DISTRIBUTORS: CHECK AND MAIL COUPON FOR FRANCHISE FACTS.

SIMPLY ADD TO GAS & OIL

PYROIL COMPANY,
53 Pyroil Bldg., LaCrosse, Wis., U. S. A.
Please send Bulletin on the care of my car in winter.
 Also send details of your plan for Distributors.

Name.....
Address.....
City..... County..... State.....

(Contents—Continued)

AUTOMOTIVE

- Street barriers help control traffic 333
- X-ray exposes tire weaknesses to car owner 336
- Optical tester for headlights 359
- Cars passing at fifty require 1,000 feet 364
- Brake gauge "tailors" drum and shoe to size 368
- Overshoes built into tire treads 368
- Illuminated sign is turned by wind power 369
- Steel hook for straightening auto fenders 374
- Auto brake power booster 380
- Ambulance air conditioner 385
- Driver re-enacts crash on chart at "trial" 385
- Rubber-covered bumper pushes without marring 389
- Parabolic barriers add to highway safety 390
- Bike wheel attached to bus measures acceleration 400

AVIATION

- Radio "ear" for blind flying 358
- Target planes salvaged when hit by gunfire 365
- Autogiro tested for military observation 384
- Fabric fuel tank withstands vibration 384
- Pilot sits in tail of fighting plane 415

CONSTRUCTION

- Jack-in-the-box platform for workmen 370
- Two-mile traffic tunnel links river cities 389
- Air circulator in fireplace gives more heat 407

Wendell FARM sails 382

- Self-closing bumper gate for automobiles 374
- Twin-propeller windmill built by farmer 384
- Plants raised under artificial light 390
- Plants "analyze" their own soil 400

HOUSEHOLD

- Self-starting siphon lifts heavy liquids 332
- Electric shaver carries a headlight 358
- Pedal converts bathinette into dressing table 416
- Register fan circulates heat from furnace 120A

PHOTOGRAPHY

- Supersensitive exposure meter 336
- Soft metal frame binds film for projection 353
- Automatic home movie titler saves time 364
- Camera trick shows windmill arching in "wind" 368
- High-speed photo of perfect golf drive 383
- Pictures centered for mounting by three-way ruler 385
- "Fishing pole" lifts camera for odd angles 406
- Filter for camera lens provides five changes 407
- Automatic darkroom timer works like dial phone 416

RADIO AND ELECTRICITY

- Facsimile newspaper printed on home radio 333
- Refrigerator used as oven for heat tests 364
- Torpedo antenna for television 369
- Electric fence stops "ticks" carried by deer 374
- Four-in-one automatic fuse 414
- Set automatically tunes in your favorite programs 417
- How to build portable phono-radio 418
- Five-band preselector for short-wave receiver 420
- Practical radio hints 421
- All-purpose mobile sound system 422
- Line noise analyzer saves time 422
- Portable set is self-powered 422

SCIENCE AND INDUSTRY

- Fireproof eyeshield covers entire face 332
- Fume detector sees shadow cast by vapor 353
- Earth's death in fire visioned 376
- Anesthetic kills pain for three weeks 380
- Oil under pressure runs engine 390
- Doctors "pipe" cold light through curved rods 391
- Transparent film of rubber non-inflammable 401
- Quick-frozen food in sealed cans 408
- Electrons measure wear of metals 416

SPORTS

- Bowling and golf combine into new game 358
- Golf club penalizes incorrect swing 376
- Foot-and-hand cycle has streamline hood 390
- Outdoor ice rink enjoyed all summer 408
- Automatic timer for swimmers 409
- Bicyclist tours with trailer carrying his bed 409
- Starter's gun holds fire if runner lifts hand 414

(Continued to page 6A)

"WE'LL TAKE MOTORCYCLING

Every Time!"



EVERY minute is packed with fun and thrills — when you own a Harley-Davidson. You get a real kick out of meeting other happy riders — going on club runs — taking in hill-climbs, reliability runs, gypsy tours — and other exciting events in the world's greatest outdoor sport. You never have to wish for good times — there is always something doing for you and your Harley-Davidson.

See your Harley-Davidson dealer today. Let him tell you the whole amazing story of the fun of motorcycling. Learn how easy it is on your pocketbook. Take a Free ride. Ask about his Easy Pay Plans — and send in the coupon.

Winner 200-mile Pacific Coast Speedway Championship, Oakland, Calif., November 27, 1938. Former record lowered by 19 minutes 20-3/5 seconds. Harley-Davidson riders took first seven places.

HARLEY-DAVIDSON
 WORLD'S *Champion* MOTORCYCLE
DAVIDSON



MAIL COUPON Today!

HARLEY-DAVIDSON MOTOR
 Send Illustrated Literature
 Motorcycling Magazine.
 Name.....
 Address.....

This One



TAY1-971-FBTY

**NO WONDER HIS PATIENTS
LOST PATIENCE!**

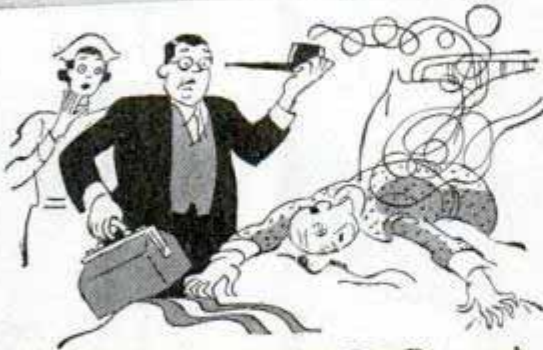

FAINTED DEAD AWAY! But Doc can't seem to figure *why*. Of course Doc doesn't think to blame that cut-throat *tobacco* in his briar. Get yourself a *milder* blend!

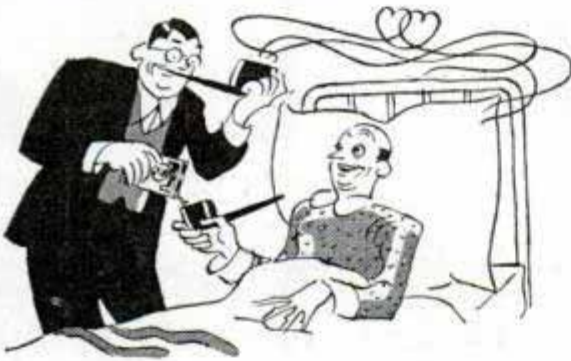

THE CURE! Doc switched to a 2-oz. tin of Sir Walter. Now his patients perk up and cheer. Know why? It's burley of A+ mildness . . . good-smellin' to *others*.

**IT SMOKES
AS SWEET
AS IT SMELLS**



HOW TO
TAKE CARE
of
YOUR PIPE

FREE BOOKLET tells how to make your old pipe taste better, sweeter; how to break in a new pipe. Write for your copy today. Brown & Williamson Tobacco Corporation, Louisville, Kentucky, Dept. P-93.

TUNE IN Tommy Dorsey and his orchestra. Every Wednesday night, coast-to-coast, NBC Red Network.

(Contents—Continued)

TOOLS

Two-hundred-pound wrench turns hinge nut.....	358
Power-driven saw cuts trees into logs.....	391
Lathe with power cross feed.....	408
Electric knife grinder in streamline case.....	414

MISCELLANEOUS

Rubber exhaust for motorboats is non-corrosive.....	332
Snowplow made from powered lawnmower.....	332
Barrow inside giant wheel carries big loads.....	359
Clamps for carpenter's horse holds without nailing.....	359
Lead foil in shoe aids X-ray fitting.....	364
Insulation sprayed on wall like paint.....	365
Electric lunch box heats meal for worker.....	370
Foot and hand powered tricycle.....	370
Ribbed hot-water bottle fits around arm.....	374
Old ships converted into fast ocean liners.....	375
Plastic splint easily shaped to fit arm.....	376
Permanent ink for writing on glass.....	380
Refrigerated locker under floor lifts out.....	380
Water-color mural air view of New York.....	381
Miniature village completes night and day cycle.....	383
Freak accidents spare some, kill others.....	396
Highway snowplow shovels and loads.....	396
Motorcycle daredevil smashes through barrels.....	396
Thousands of models in builder's collection.....	397
Magnetic rocks hooked like fish.....	400
Translucent plastic statues lighted inside.....	401
Allergy sufferers are smarter in tests.....	406
Motor-driven tutor teaches body swim strokes.....	407
Tandem bicycle float.....	416

(Craftsman and Shop Notes)

AUTOMOTIVE

Vacation shaving from a car battery.....	451
Helps for the motorist.....	477
Chalk locates cracks in axle.....	478
Flexible driveway markers.....	478
Improving toe accelerator.....	478
Pipe stakes on truck.....	478
Suspended skid chains move truck on inclines.....	478
Cleaner for battery posts.....	479
Duplicate patch balances inner tube.....	479
Flashlight to inspect batteries.....	479
Grease gun operated by carpenter's brace.....	479
Excessive tightening weakens connecting-rod bolts.....	480
Rollers on truck driver's skid.....	480

CHEMICAL AND CHEMISTRY

Crystals crushed with razor.....	432
Pneumatic trough and "beehive" for home chemists.....	438
Sand bath for chemists.....	448
Bottle stoppers from erasers.....	454
Pestle from doorknobs.....	475

FARM

Anchoring ends of woodpile.....	432
Gate latch from hinge.....	432
Draftless ventilation in dairy barns.....	462
Double slide in grain spout measures feed.....	472

FURNITURE

Pioneer footstool in maple.....	428
Re-caning saves old chair.....	434
Portable study desk.....	447
Sewing box has pivoted trays.....	455

HAND TOOLS

Clinching nails aided with file.....	432
Clamp to hold work while scrollsawing.....	439
Rack over bench has flexible pockets.....	448
Screw holder quickly bent from wire.....	448
Simple mandrel to wind springs.....	450
Using expansion bit in hardwood.....	455
Altering drills for sheet metal.....	466
Soap lubricant on metal punch.....	476

HOME WORKSHOP

Loosening tip of soldering iron.....	432
What you can do with two wheels.....	437
Anchoring hammer heads.....	476

(Continued to page 8A)

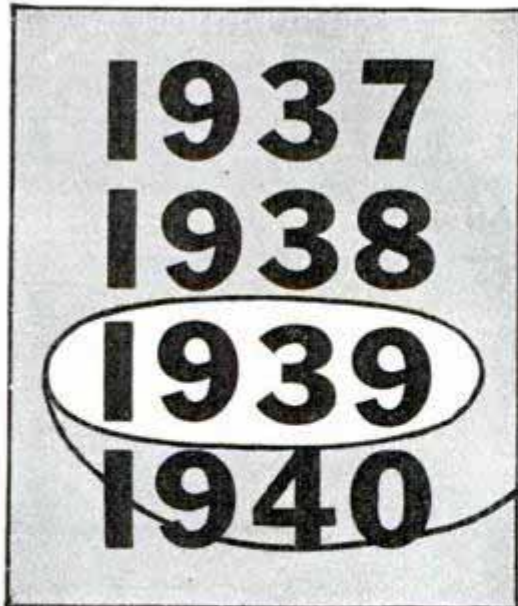

Now is the time!

Business is Searching for YOU, if

RIGHT now, in many lines, there is a search for really *good* men—managers, leaders—men who can take charge of departments, businesses, branch offices, and get things humming.

As always, there are not enough ordinary jobs to go 'round—but rarely before, in the history of American business, has there been so much room at the *top!* And new jobs are being created by the business pick-up in many lines—jobs that pay splendidly and that open the way to lifetime success.

Ordinarily, there would be plenty of men to fill these jobs—men in junior positions who had been studying in spare time. But most men have been letting their training slide during these dark years of depression . . . “What’s the use?”—You have heard them say. Perhaps there has been some excuse for sticking to any old kind of a job one could get the past few years—but the door is wide open for the man with ambition and ability *NOW!*

And don’t let anyone tell you that “Opportunity Only Knocks Once”—that’s one of the most untruthful sayings ever circulated. Op-

portunities flourish for *every* American every day of his life.

Far more to the point is to be ready—to be *prepared*—to make yourself *interesting* to the big-time employer—and LaSalle offers you a short-cut method of qualifying for opportunity jobs in accounting, law, traffic, executive management, and kindred occupations.

LaSalle Extension is 30 years old—averages over 30,000 enrollments a year—60 American firms each employ 500 or more LaSalle-trained men—surveys show that many LaSalle students attain 40% salary increase after graduation—10% of all C.P.A.’s in the U.S.A. are LaSalle-alumni.

Why not find out what LaSalle has done and is doing for men in *your* position? Send and get the facts; see what LaSalle can do for you, personally!

There’s no question about it—business is picking up—jobs are looking for *men*—the time has come for you to *qualify* for prosperity. Mail this coupon today!

LASALLE EXTENSION UNIVERSITY A CORRESPONDENCE INSTITUTION

4101 S. Michigan Ave., Dept. 364-R Chicago

I am in earnest about my success and I would like to have your special booklet—without any cost or obligation to me—about my opportunities and your success training in the business field I have checked:

- | | |
|--|--|
| <input type="checkbox"/> Business Management | <input type="checkbox"/> Industrial Management |
| <input type="checkbox"/> Higher Accountancy | <input type="checkbox"/> Modern Foremanship |
| <input type="checkbox"/> Traffic Management | <input type="checkbox"/> Business Correspondence |
| <input type="checkbox"/> Modern Salesmanship | <input type="checkbox"/> Business English |
| <input type="checkbox"/> Commercial Law | <input type="checkbox"/> Effective Speaking |
| <input type="checkbox"/> Law—Degree of LL.B. | <input type="checkbox"/> C. P. A. Coaching |
| <input type="checkbox"/> Expert Bookkeeping | <input type="checkbox"/> Stenotypy |

Name _____ Age _____

Position _____ Address _____

Ask for one of these booklets—or a similar one on your own field of business. They are free!



FIX IT!

with

“WOOD-IN-CANS”

Repair unsightly FLOOR CRACKS quickly and easily with PLASTIC WOOD! Handles like putty—hardens into wood that will take wax, paint or polishes as a part of the original floor. Get it at paint, hardware and 10¢ stores.

PLASTIC WOOD

HEAVY BODY 3-IN-ONE KEEPS ELECTRIC MOTORS ON-THE-RUN!

RIGHT for electric refrigerators and washing machines, too! Gives electric tools longer life. LUBRICATES. CLEANS. PREVENTS RUST.

At Hardware, Drug, Grocery, 10¢ Stores.

3-IN-ONE OIL

(Contents—Continued)

HOUSEHOLD

- New frames for your pictures423
- Neat pipe supports for clothesline426
- Folding tie racks and shelves439
- Solving home problems456

LAWN AND GARDEN

- Protecting seedlings in hotbeds and cold frames....426
- Slatted hotbed covers protect plants438
- Lawn roller from expansion tank.....450

OFFICE

- Replacing rubber typewriter feet450
- Applying drawing ink to pen466
- Drawing board held at angle with casement adjuster.475

PHOTOGRAPHY

- Periscope for taking photos in crowd425
- Homemade dispenser measures ferrotyping polish.426
- Pocket viewer for film.....438
- Signs produced by photography448
- Negative dryer has warm-air circulation463
- Lamp lights on plateholder depth gauge.....465

POWER TOOLS

- Changing jig-saw blades with block of wood427
- Tenon jig for circular saw433
- Protecting threads on chucked work438
- Saw miter gauge has auxiliary straightedge.....455
- Correct centering on lathe459
- Testing drill-press table for precision work466
- Tool post holds emery cloth for polishing.....471

STORE AND SHOP

- Shoe-shining kit slides under chair seat453
- Handle for stamp pad462
- Outdoor display stands on casters462
- Papers on scale safe in wind462
- Silent signal for waiters464
- Two-wheel trucks move heavy loads464
- Window panes protected by wire mesh464
- Shop-broom holder from hose471
- Springs grip wrapping paper471
- Linotype slugs held in galley by eraser472
- Cleaning rusted overhead shafts476

MISCELLANEOUS

- Cleaning empty paint pails425
- Small parts storage cans identified quickly.....426
- Foot bridge from car frames427
- Guides aid in manifold work on typewriter.....427
- Non-slip surfaces for ladder rungs430
- Shield keeps sleet from flag-pole pulley430
- Smoothing inside wood rings on belt sander.....430
- Turned "bird valet" holds pipe and cleaners.....430
- Design for time431
- Streamlined sidewalk scooter433
- Avoiding cracks in tops of hip boots439
- "Skipper"—low-cost outboard runabout440
- Locating leaks in wading boots448
- Ruled celluloid aids in making sketches.....449
- Building paper applied with scaffold in place.....450
- Pencil clip improvised from paper clip450
- Completing interrupted card deal452
- Rotating drawers save space453
- Celluloid shield under paper fasteners454
- Fire kindled with brick soaked in kerosene.....454
- Leg anvil from flatiron454
- "Tailored" tennis rackets454
- Auto casings protect children on seesaw458
- Fancy washers on bolt heads458
- Chalk substituted for showcard brush464
- Design transferred to linoleum block with ammonia.465
- Novelty finishes with brush and spray467
- Handles for carrying lengths of pipe472
- Tamper-proof air vent on gas tank472
- Cementing glass, metal and celluloid473
- Installing fuel tank on light plant476

IMPORTANT NOTICE

It is the intention of this magazine to provide its readers with information regarding the latest developments in the mechanical arts. We take no responsibility as to whether the disclosures contained in our articles are covered by patents and advise readers to investigate this subject before making, using, or selling any of the products, machines, or processes described, in order to avoid possible liability for patent infringement.



"SHOP PRACTICE & HOME STUDY - brother, they go together!"

• "I work in the shop every day. And a couple of hours every evening, I study. Study what? I don't mind telling you — an I. C. S. Course! Take it from me, shop practice and home study go together. When you combine them, you're headed for more pay and a brighter future!"

The International Correspondence Schools are proud that over 600 American schools, colleges and universities use textbooks prepared by the I. C. S.! And I. C. S. instruction is a *personal* relationship between student and instructor. The coupon will bring you detailed information.

INTERNATIONAL CORRESPONDENCE SCHOOLS

BOX 5542-J, SCRANTON, PENNA.

★ Without cost or obligation, please send me a copy of your booklet, "Who Wins and Why," and full particulars about the subject *before* which I have marked X: ★

TECHNICAL AND INDUSTRIAL COURSES

- | | | | |
|--|--|--|--|
| <input type="checkbox"/> Architect | <input type="checkbox"/> Sheet Metal Worker | <input type="checkbox"/> Commercial Refrigeration | <input type="checkbox"/> Surveying and Mapping |
| <input type="checkbox"/> Architectural Draftsman | <input type="checkbox"/> Boilermaker | <input type="checkbox"/> Plumbing <input type="checkbox"/> Steam Fitting | <input type="checkbox"/> Bridge Engineer |
| <input type="checkbox"/> Building Estimating | <input type="checkbox"/> Telegraph Engineer | <input type="checkbox"/> Heating <input type="checkbox"/> Ventilation | <input type="checkbox"/> Bridge and Building Foreman |
| <input type="checkbox"/> Contractor and Builder | <input type="checkbox"/> Telephone Work <input type="checkbox"/> Radio | <input type="checkbox"/> Air Conditioning and Cooling | <input type="checkbox"/> Chemistry <input type="checkbox"/> Pharmacy |
| <input type="checkbox"/> Structural Draftsman | <input type="checkbox"/> Mechanical Engineering | <input type="checkbox"/> Steam Engineer | <input type="checkbox"/> Coal Mining |
| <input type="checkbox"/> Structural Engineer | <input type="checkbox"/> Mechanical Draftsman | <input type="checkbox"/> Steam Electric Engineer | <input type="checkbox"/> Mine Foreman <input type="checkbox"/> Fire Bosses |
| <input type="checkbox"/> Management of Inventions | <input type="checkbox"/> Machinist <input type="checkbox"/> Toolmaker | <input type="checkbox"/> Marine Engineer | <input type="checkbox"/> Navigation |
| <input type="checkbox"/> Electrical Engineer | <input type="checkbox"/> Patternmaker | <input type="checkbox"/> R. R. Locomotives | <input type="checkbox"/> Cotton Manufacturing |
| <input type="checkbox"/> Electric Lighting | <input type="checkbox"/> Diesel Engines | <input type="checkbox"/> R. R. Section Foreman | <input type="checkbox"/> Woolen Manufacturing |
| <input type="checkbox"/> Welding, Electric and Gas | <input type="checkbox"/> Aviation Engines | <input type="checkbox"/> Air Brakes <input type="checkbox"/> R. R. Signalmen | <input type="checkbox"/> Agriculture |
| <input type="checkbox"/> Reading Shop Blueprints | <input type="checkbox"/> Auto Technician | <input type="checkbox"/> Highway Engineering | <input type="checkbox"/> Fruit Growing |
| <input type="checkbox"/> Heat Treatment of Metals | <input type="checkbox"/> Auto Electrical Technician | <input type="checkbox"/> Civil Engineering | <input type="checkbox"/> Poultry Farming |

BUSINESS TRAINING COURSES

- | | | | |
|--|---|--|--|
| <input type="checkbox"/> Business Management | <input type="checkbox"/> Bookkeeping | <input type="checkbox"/> Service Station Salesmanship | <input type="checkbox"/> Grade School Subjects |
| <input type="checkbox"/> Industrial Management | <input type="checkbox"/> Secretarial Work | <input type="checkbox"/> First Year College Subjects | <input type="checkbox"/> High School Subjects |
| <input type="checkbox"/> Traffic Management | <input type="checkbox"/> Spanish | <input type="checkbox"/> Business Correspondence | <input type="checkbox"/> College Preparatory |
| <input type="checkbox"/> Accountancy | <input type="checkbox"/> French | <input type="checkbox"/> Stenography and Typing | <input type="checkbox"/> Illustrating |
| <input type="checkbox"/> Cost Accountant | <input type="checkbox"/> Salesmanship | <input type="checkbox"/> Civil Service <input type="checkbox"/> Mail Carrier | <input type="checkbox"/> Cartooning |
| <input type="checkbox"/> C. P. Accountant | <input type="checkbox"/> Advertising | <input type="checkbox"/> Railway Mail Clerk | <input type="checkbox"/> Lettering Show Cards <input type="checkbox"/> Signs |

DOMESTIC SCIENCE COURSES

- | | | |
|---|---|--|
| <input type="checkbox"/> Home Dressmaking | <input type="checkbox"/> Advanced Dressmaking | <input type="checkbox"/> Foods and Cookery |
| <input type="checkbox"/> Professional Dressmaking and Designing | | <input type="checkbox"/> Tea Room and Cafeteria Management, Catering |

Name..... Age..... Address.....

City..... State..... Present Position.....

If you reside in Canada, send this coupon to the International Correspondence Schools Canadian, Limited, Montreal, Canada
If you reside in England, send coupon to I. C. S., 71 Kingsway, London, W. C. 2, England

Look at Yourself...

12,000 Planes Yearly Goal for U. S. Defense Orders Flooding Plane Builders Full Blast Output

AIRPLANE OUTPUT TO BE DOUBLED

Look at these Headlines

Plane Plants Will Expand Holds Sky Only Aviation Limit Backlogs

FLOOD OF ORDERS POURS INTO AIRCRAFT PLANTS

Air Defense Program Rushed; 24-Hour Shifts for Industry

Then LOOK AT THE GOOD JOBS IN AVIATION Back of these Headlines

Size up yourself! Size up your present line of work! Compare your chances for good pay and a big future with the chances of the man smart enough to get into Aviation. The headlines tell the story . . . but not the whole story . . . for Aviation is just in its infancy. It is a big industry already . . . is swiftly growing bigger and bigger. Prepare - NOW - for one of Aviation's good jobs . . . and write your own ticket for the future.

TAKE THIS QUICK, PROVED WAY TO AN AIRCRAFT CAREER

NEW BOOKLET tells you all about Aero I.T.I. Master Aircraft Mechanics and Aeronautical Engineering Courses. Through these exclusive courses hundreds of Aero I.T.I. graduates have already stepped into the industry. To find out how you, too, can start your aircraft career, send the coupon for free booklet.

READ THIS Feature IN THE NEWS

EXECUTIVE BOARD

C. A. VAN DUSEN Vice-Pres., Consolidated Aircraft Corporation	JOHN K. NORTHRUP formerly Pres., The Northrop Corp., and Vice-Pres., Douglas Aircraft Co., Inc.	ROBERT E. GROSS Pres., Lockheed Aircraft Corporation
---	---	--

Aero Industries Technical Institute
5253 West San Fernando Road, Los Angeles, Calif.
U. S. Civil Aeronautics Authority Approved School

Please send free booklet on Aviation opportunities and Aero I.T.I. training. (This information intended only for men over 17 and under 40).

NAME _____ AGE _____

ADDRESS _____

CITY _____ STATE _____ a-15-p

ELECTRICAL ENGINEERING

ONE YEAR Course Prepares For Technical Work In Electrical Field

Thorough training in principles, with practical applications in laboratory and shop. High placement record. Modern buildings, dormitory, dining hall. Campus. 47th year begins Sept. 27.

CATALOG on request.



BLISS ELECTRICAL SCHOOL
133 Takoma Avenue, Washington, D. C.

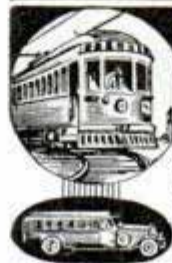

BE A RAILWAY WRITE TODAY

TRAFFIC INSPECTOR

OPPORTUNITIES FOR OUR TRAINED GRADUATES
Railway and Bus Lines use our trained Passenger Traffic Inspectors. Earn good pay to start and advance rapidly with experience. Short, home-study course prepares you and upon completion we help place you at up to \$135 per month, plus expenses, to start, or refund tuition. Interesting work; splendid opportunities. Write for details.

STANDARD BUSINESS TRAINING INSTITUTE,
Div. 203 Buffalo, N. Y.



Operator No. 38

FOLLOW THIS MAN

Secret Service Operator No. 38 is on the job! Running down dangerous Counterfeit Gang. Faint finger prints in murdered girl's room.

Free The Confidential Report Operator No. 38 made to his chief. Write for it.

Earn a Regular Monthly Salary
YOU can become a Finger Print Expert at home. In your spare time, at small cost. Write for confidential full report and details. Literature will be sent only to persons stating their age.

INSTITUTE OF APPLIED SCIENCE
1920 Sunnyside Ave. Chicago, Ill.
Dept. 1353



Learn to Write

Begin Today. Write for our Free Book, "How to Become a Good Penman." It contains specimens and tells how others learned to write in spare time. Your name elegantly written on a card if you enclose stamp for postage. Write today. The Tamblin School of Penmanship, 418 Ridge Bldg., Kansas City, Mo.

RADIO ENGINEERING, broadcasting, aviation and police radio, servicing, marine and Morse telegraphy taught thoroughly. 48 weeks' engineering course equivalent to three years' college radio work. School established 1874. All expenses low. Catalog free.

Dodge's Institute, Ada St., Valparaiso, Ind.

Photography

for



PLEASURE or PROFIT

Prepare for profitable business or fascinating hobby, at home under guidance of qualified instructors. No previous experience necessary, common school education sufficient. Many earn while learning. Our practical studio methods also qualify for well-paying positions upon graduation. Send coupon below at once for free booklet "Opportunities in Modern Photography", particulars and requirements.

AMERICAN SCHOOL OF PHOTOGRAPHY
3601 Michigan Avenue Dept. 1353 Chicago, Illinois

Send booklet, "Opportunities in Modern Photography", full particulars and requirements.

Name _____ Age _____

Address _____

City _____ State _____

On His Record— Which Man Would YOU Hire?

ELECTRICAL ENGINEERING		Book Sent	Exam. Ret'd	%
Wiring				
Batteries		14 35	5 2 35	87
Electrical Appliances		14 35	6 18 35	90
Meters		5 2 35	8 1 35	83
Principles of Motors and Gene		5 20 35	8 17 35	95
Maintenance of Motors and G		6 18 35	9 27 35	91
Armature Winding		1 35	11 9 35	89
Power Station and E			1 4 36	92
Diesel Electric Plants			2 10 36	82
Practical Mathematics			3 30 36	84
Mechanical Drawing			5 9 36	94
Electrical Layouts			8 29 36	88
Practical Physics		5 9 36	10 4 36	91
Elements of Electricity		* 8 29 36	11 30 36	80
First Year Algebra		10 4 36	12 3 36	94
Plane Geometry		11 20 36		86
Trigonometry			5 26 37	81
Industrial Electric		3 18 37	8 10 37	79
Alternating-Current Electricity		5 26 37	12 20 37	83
		8 10 37	3 22 38	85

Not Started (written over the left table)

Graduated (written over the right table)

You Are Hired on YOUR Record—

Employers Want to Know, Are YOU Prepared for Promotion

Your own ability to hold the better jobs depends entirely on the preparation you have made to accept the opportunities offered every month in the year in the active fields of today such as Air Conditioning, Diesel Engineering, Drafting and Design, etc. Men in these fields and others with preparation as accountants and in merchandising are being advanced into such openings as department heads, managers, foremen, superintendents, travelling auditors, etc.

Your opportunity today simply means being ready for the good jobs looking for good men—your chance for a worthwhile position depends on whether or not you will prepare to meet the demands of employers all over the country who are offering the big jobs to men who can handle them!

Without training a man is no more valuable at 40 than at 30, is old at 50. But the doctor at 40 or 50 is a better doctor than he was at 30—and it's the same with

men trained in other fields—executives, draftsmen, engineers, merchants, architects are young at 40, at 50—and still have many good pay years ahead. Promotion, increased pay, reward properly prepared men!

American School, an educational institution incorporated "not for profit," has used for over 40 years a direct and practical method for preparing men to handle the bigger jobs in business and industry.

American School graduates hold important positions as engineers, accountants, experts, draftsmen, managers, etc., or successfully operate their own business. Thousands of our High School graduates have entered colleges, universities, normal schools, etc., have attained success in business or industry.

Find out how American School can help YOU, the difference it may make in your entire future success and happiness! Mail coupon today for free Bulletin and early lesson in field of your choice. No obligation on your part.

American School, Dept. G345, Drexel Ave. at 58th St., Chicago

Cut Along This Line

Try a Lesson Yourself—No Obligation

American School, Dept. G345, Drexel Ave. at 58th St., Chicago

I have checked the line of work in which I would like a good job. Please send me without expense or obligation on my part a copy of your Bulletin and an early lesson in the field I have selected.

- | | | |
|--|---|---|
| <input type="checkbox"/> Air Conditioning | <input type="checkbox"/> Electrical Engineering | <input type="checkbox"/> Law |
| <input type="checkbox"/> Architecture | <input type="checkbox"/> Diesel Engineering | <input type="checkbox"/> Liberal Arts (College) |
| <input type="checkbox"/> Automotive Engineering | <input type="checkbox"/> Drafting and Designing | <input type="checkbox"/> Mechanical Engineering |
| <input type="checkbox"/> Automobile Repairing | <input type="checkbox"/> Electric Refrigeration | <input type="checkbox"/> Merchandising |
| <input type="checkbox"/> Bookkeeping and Cost Accounting | <input type="checkbox"/> Heating, Ventilating, Plumbing | <input type="checkbox"/> Private Secretary |
| <input type="checkbox"/> Business Management | <input type="checkbox"/> Professional Accounting | <input type="checkbox"/> Radio and Television |
| <input type="checkbox"/> Civil Engineering | <input type="checkbox"/> Incl. C. P. A. Coaching | <input type="checkbox"/> Salesmanship |
| <input type="checkbox"/> Aviation | <input type="checkbox"/> High School | <input type="checkbox"/> Shop Practice |
| <input type="checkbox"/> Contracting, Building | <input type="checkbox"/> Highway Engineering | <input type="checkbox"/> Shop Management |
| | | <input type="checkbox"/> Steam Engineering |

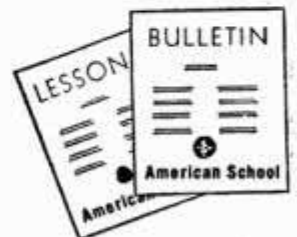

Name _____ Age _____ Occupation _____

Street _____ City _____ State _____



GOOD MONEY to be made in POULTRY

Many Earn Extra Spare-Time Profits — Or You May Build a Business of Your Own

Whether you want a job at good pay or a profitable business of your own, Poultry offers you many opportunities. Poultry meat and eggs are always in demand, and at times there is a shortage of trained poultrymen. My Home Study Course shows you how to succeed—how to save money and make money, either for yourself or for an employer.

CASH IN SPARE TIME or FULL TIME

No matter where you live or what you do now, my proved course will show you what to do with poultry right from the start. If you choose to start a business of your own, I'll show you how to make a small investment grow, show you how to expand. Send for the facts today.

FREE Book Shows the Way to Big Pay and Big Profits

Mail coupon below TODAY —for my Big NEW FREE Book, "How to Raise Poultry for Profit." My forty years of experience are yours. The poultry industry may need you, and therefore you need my free book. Get it—and get in line for the extra money that can be made in poultry!



Mail NOW for FREE Book

NATIONAL POULTRY INSTITUTE, Dept. 41-D
Adams Center, N. Y., Att'n: Harry M. Lamon, Pres.

Dear Mr. Lamon: Send me your FREE Book, "How to Raise Poultry for Profit". I want to know more about my opportunity to make extra money spare or full time.

Name.....
Address.....

Learn this Profitable Profession



in 90 Days at Home

Hundreds of men and women of all ages 18-50 make \$10.00 to \$20.00 in a single day giving scientific Swedish Massage and Hydro-Therapy treatments. There is a big demand from Hospitals, Sanitariums, Clubs, Doctors and private patients as well as opportunities for establishing your own office. Learn this interesting money-making profession in your own home by mail, through our home study course. Same instructors as in our NATIONALLY KNOWN resident school. A diploma is awarded upon completion of the course. Course can be completed in 3 to 4 months. High School training is not necessary. Many earn big money while learning.



Anatomy Charts & Booklet FREE

Enroll now and we will include uniform coat, medical dictionary, patented reducing roller and Hydro-Therapy supplies without extra cost. The reducing course alone may be worth many times the modest tuition fee.

Send coupon now for Anatomy Charts and booklet containing photographs and letters from successful graduates. These will all be sent postpaid—FREE.

The College of Swedish Massage (Successor to National College of Massage)
Dept. 364—30 E. Adams St., Chicago.

You may send me FREE and postpaid, Anatomy Charts, booklet containing photographs and letters from graduates, and complete details of your offer.

Name.....
Address.....
City..... State.....

When writing please mention Popular Mechanics

NOW EMPLOYS 8 MEN

A young tree surgeon read an advertisement like this and decided to take a home study course in landscape gardening. E.G.W., Wilmington, Del., tells his story: "I decided to become a Landscape Architect. My first jobs were small, done in spare time. I now employ 8 men. In 1937 I did over \$10,000 worth of business. The course has paid for itself many times over." Alert men want to get ahead. Ask us for "Success thru Landscape Training"—a free booklet that may open a new business for YOU. Course has been taken by thousands, lessons are simple. Investigate this opportunity!

American Landscape School, 6054 Grand Ave., Des Moines, Iowa



VOICE

100% Improvement Guaranteed

We build, strengthen the vocal organs—not with singing lessons—but by fundamentally sound and scientifically correct silent exercises... and absolutely guarantee to improve any singing or speaking voice at least 100%... Write for wonderful voice book—sent free. Learn WHY you can now have the voice you want. No literature sent to anyone under 17 years unless signed by parent.

PERFECT VOICE INSTITUTE, Studio 1353
64 E. Lake St., Chicago

LEARN AVIATION IN LOS ANGELES—Nation's Aviation Capital



Huge increases in Los Angeles aviation activity has insured good paying positions for California Flyers graduates. Only U. S. Government and industry approved school here in nation's aviation capital, offering airline piloting, engineering, mechanics, drafting, aircraft construction. Learn in America's most modernly equipped and strategically located school. Low tuition. Write for free catalog.

CALIFORNIA FLYERS
SCHOOL OF AVIATION—Dept. PM-3
LOS ANGELES MUNICIPAL AIRPORT, INGLEWOOD, CALIF.

Learn to MOUNT BIRDS

Tan SKINS, Make Up FURS

Be a Taxidermist. We teach you at Home. Mount Birds, Animals, Pets, common specimens. Save your hunting trophies; decorate home and den. Make genuine KROME LEATHER, tax and make up furs for sparetime profit. FREE BOOK 48 pages—tells all about it. Hunters, get this wonderful book. Its Now Free. Send postal card Today—This Minute! State your AGE.

N. W. School of Taxidermy, Dept. 9373, Omaha, Nebr.

KNOCK-EM-COLD!

THE BIGGER THEY ARE, THE HARDER THEY FALL. LEARN JIU JITSU!

36 secret knock-out blows without fists by 25c world famous Police Jiu Jitsu Instructor

A little jab with tip of fingers, or strike with edge of hand to right spot and tough guys go out like a light. Also many one fingered headlock breaks. Northwest "Mounties" use Jorgensen's system. G-Men must be Jiu Jitsu experts. He has personally taught many in U.S. Army, Navy, Marines, National Guard, Coast Guard, Immigration, Border Patrol, Police, etc. and performed for the Movies. Whether you are young or old, man or woman, send now for new illustrated course. Full Price 25c Size or strength mean nothing. Fear no man, gun, knife, club. S. J. JORGENSEN 797 Maritime Bldg., Seattle, Wash.



Minstrels

Unique First Parts for complete show with special songs and choruses. Make-up. Catalog Free.

T. S. Denison & Co., 203 N. Wabash, Dept. 19, Chicago



ENGINEERING DEGREE IN TWO YEARS

B.S. DEGREE courses in engineering: Electrical, Civil, Chem., Mechanical, Radio and Television, or Aeronautical. 1 yr. Mech. Drafting. Intense, practical, thorough program. Prep courses without extra charge. Earn while you learn in this industrial center. Low tuition. Enter March, June, Sept., Dec. Write for Catalog. 229 E. Washington Blvd., Fort Wayne, Ind.

INDIANA TECHNICAL COLLEGE

Who said: "Only College Men Can Get Good Jobs?"

THESE MEN DID NOT GO TO COLLEGE

Read about the jobs they got and the money they make

I WORK ON RADIO PART TIME ONLY. I HAVE AVERAGED ABOUT \$50 A MONTH.



JOHN B. MORRISSETTE
809 VALLEY STREET
MANCHESTER, N.H.



I AM NOW IN CHARGE OF THE RADIO DEPARTMENT OF AMERICAN AIRLINES AT CLEVELAND, OHIO.

WALTER B. MURRAY
MUNICIPAL AIRPORT
CLEVELAND, OHIO.

I MAKE \$50 TO \$60 A WEEK AND HAVE ALL THE RADIO WORK I CAN DO.



H.W. SPANGLER
126½ S. GAY STREET
KNOXVILLE, TENN.

I WAS WORKING IN A GARAGE WHEN I ENROLLED WITH N.R.I. I HAVE MADE AS HIGH AS \$400 A MONTH IN RADIO.



E.G. WOLFE
ROUTE 1
BRISTOL, IND.

I HAVE BEEN IN BUSINESS FOR MYSELF FOR 18 MONTHS MAKING \$200 TO \$300 A MONTH.



ARLIE J. FROEHNER
224 WEST TEXAS AVE.
GOOSE CREEK, TEXAS



I will Train You at Home in your spare time for a Good Job in RADIO

You have a chance. Don't pass it up. Many of my successful graduates, now making good money as Radio Experts, had only a grade school education or its equivalent.

Get Ready Now for Jobs Like These

Radio broadcasting stations employ engineers, operators, station managers and pay well for trained men. Fixing Radio sets in spare time pays many \$200 to \$500 a year—full time jobs with Radio jobbers, manufacturers and dealers as much as \$30, \$50, \$75 a week. Many Radio Experts open full or part time Radio sales and repair businesses. Radio manufacturers and jobbers employ testers, inspectors, foremen, engineers, servicemen, in good-pay jobs with opportunities for advancement. Automobile, police, aviation, commercial Radio, loudspeaker systems are newer fields offering good opportunities now and for the future. Television promises to open many good jobs soon. Men I trained had good jobs in these branches of Radio. Read how they got their jobs. Mail coupon.

Many Make \$5, \$10, \$15 a Week Extra in Spare Time While Learning

The day you enroll I start sending extra Money Job Sheets; show you how to do

Radio repair jobs. Throughout your training I send plans and directions that made good spare time money—\$200 to \$500—for hundreds, while learning. I send you special Radio equipment to conduct experiments and build circuits. This 50-50 method of training makes learning at home interesting, fascinating, practical. I ALSO GIVE YOU A MODERN, PROFESSIONAL ALL-WAVE, ALL-PURPOSE RADIO SET SERVICING INSTRUMENT to help you make good money fixing Radios while learning and equip you for full time jobs after graduation.

Find Out What Radio Offers You

Act Today. Mail the coupon now for "Rich Rewards in Radio." It's free to any fellow over 16 years old. It points out Radio's spare time and full time opportunities and those coming in Television; tells about my training in Radio and Television; shows you letters from men I trained, telling what they are doing and earning. Find out what Radio offers YOU! MAIL COUPON in an envelope, or paste on a postcard—NOW!

J. E. Smith, President
Dept. 9CP, National Radio Institute
Washington, D. C.

MAIL NOW • Get 64 page book FREE

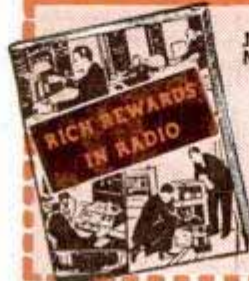

J. E. SMITH, President, Dept. 9CP,
National Radio Institute, Washington, D. C.

Dear Mr. Smith: Without obligating me, send "Rich Rewards in Radio," which points out the spare time and full time opportunities in Radio and explains how you train men at home in spare time to become Radio Experts. (Please Write Plainly.)

NAME _____ AGE _____

ADDRESS _____

CITY _____ STATE _____

HIGH SCHOOL

At Home!

Qualify for the better Commercial, Industrial and Civil Service positions by getting a High School education in spare time!

Prepare for College, Pre-Professional, Regents, State Equivalency Examinations, and Business and Industry

U. S. Govt. figures show High School graduates average \$2112 yearly. Many Finish in 2 Years!

No classes; no time wasted going to and from school. You make rapid progress by our methods. Thousands of ambitious men and women select the American School each year.

All books furnished. School est. over 40 years. Endorsed by educators. Small monthly payments.

American School, Dept. H345, Drexel Ave. at 58th St., Chicago

American School, Dept. H345, Drexel Ave. at 58th St., Chicago

Without obligation send me your free Bulletin and information about your High School course at home, or the field I have checked.

- | | | |
|--|--|---|
| <input type="checkbox"/> Air Conditioning | <input type="checkbox"/> High School | <input type="checkbox"/> Law |
| <input type="checkbox"/> Architecture | <input type="checkbox"/> Electrical Engineering | <input type="checkbox"/> Liberal Arts (College) |
| <input type="checkbox"/> Automotive Engineering | <input type="checkbox"/> Diesel Engineering | <input type="checkbox"/> Mechanical Engineering |
| <input type="checkbox"/> Automobile Repairing | <input type="checkbox"/> Drafting and Designing | <input type="checkbox"/> Merchandising |
| <input type="checkbox"/> Bookkeeping and Cost Accounting | <input type="checkbox"/> Electric Refrigeration | <input type="checkbox"/> Private Secretary |
| <input type="checkbox"/> Business Management | <input type="checkbox"/> Heating, Ventilating, Plumbing | <input type="checkbox"/> Radio and Television |
| <input type="checkbox"/> Civil Engineering | <input type="checkbox"/> Professional Accounting Incl. C. P. A. Coaching | <input type="checkbox"/> Salesmanship |
| <input type="checkbox"/> Aviation | <input type="checkbox"/> Highway Engineering | <input type="checkbox"/> Shop Practice |
| <input type="checkbox"/> Contracting, Building | | <input type="checkbox"/> Steam Engineering |
| | | <input type="checkbox"/> Shop Management |

Name..... Age..... Occupation.....
 Street..... City..... State.....

This MACHINISTS' Home-Study Course



helps men get ahead

Newly assembled—specially priced—these five recent books give you the practical facts on modern machines, up-to-date methods, you need to advance in machine shop work. Take advantage of the other man's experience as found in books, to solve your problems, increase your efficiency, with

The NEW AMERICAN MACHINISTS' LIBRARY

5 volumes—2014 pages—1853 illustrations

(A combined home-study course and reference library)

This library of machine shop practice was written for practical men. It gives you the best methods for every kind of machine shop work. It fully explains lathes, drills, and other machine tools and their operation, automatic screw machines, speeds and feeds, gear design and production, punch and die work, metal surfacing, etc., etc. Plainly written—completely illustrated—the best kind of help to the machine shop man who wants to advance himself.

No money down—special price—easy payments.

EXAMINATION COUPON

McGraw-Hill Book Co., 330 W. 42nd St., New York

Send me for ten days' examination the new American Machinists' Library. If satisfactory I will send you \$1.50 in 10 days and \$3.00 monthly until the price of \$16.50 is paid. If not wanted, I will return the books postpaid. (To insure prompt shipment write plainly and fill in all lines.)

Name.....
 Home Address.....
 City and State.....
 Position.....
 Name of Company..... PM-3-39

AVIATION APPRENTICES

GOOD PAY GOOD FUTURE
 AIRMINDED YOUNG MEN INTERESTED IN TRAINING FOR ENTERING THE WELL PAID FIELD OF AVIATION AS APPRENTICES—Write immediately, enclosing stamp.
MECHANIX UNIVERSAL AVIATION SERVICE CO.
 Wayne County Airport, Box 857, Dept. E, Detroit, Mich.

ENGINEERING

DEGREE IN TWO YEARS
 TECHNICAL AND APPLIED COURSES. Nonesentials omitted. TIME AND MONEY SAVED. Degree 2 yrs., diploma 1 yr. Electrical, Mechanical, Architectural, Structural, Civil, Aeronautical, Highway. All courses include Air Conditioning, Electric Refrigeration and Diesel. Short intensive courses 3 and 4 months in Electricity, Power Plant, Diesel-Electric, Air Conditioning, Electric Refrigeration, Drafting. Extensive modern equipment. LOW TUITION. Part-time work for room and board. Thousands of successful graduates in U. S. and foreign lands. Approved by Industry, endorsed by educators, recommended by alumni. One and two-year courses open in Sept., short courses open year round. 39th YEAR. Catalog free.
FINLAY ENGINEERING COLLEGE
 1001 Indiana Avenue Kansas City, Mo.

MECHANICAL DENTISTRY

Learn
 A profession offering unlimited opportunities. Most modern and complete course embracing every branch from Plate to Porcelain Work, which prepares you to work for Dentists or start your own business. Individual instruction—practical training in day or night school. No books—no classes. Catalog upon request
McCARRIE SCHOOL OF MECHANICAL DENTISTRY
 207 N. Broad St. Dept. 743 Philadelphia, Pa.

LEARN WATCH REPAIRING

AT HOME You can learn by our modern and original system of instruction every part of the Watch Repairing Trade at home. You can earn money while learning and prepare yourself for a well paying position or start in business after completing our course of instruction. Good watch repairers are in demand and generally earn very good salaries. For particulars apply to the **Wisconsin School of Watch Repairing**
 524 E. Mason St., MILWAUKEE, WIS.

Get your free copy "MARCH of DIESEL"

NEW ISSUE . . .
JUST OFF THE PRESS

COLORFUL
★
INTERESTING
★
HIGHLY
ILLUSTRATED



Tells about the many uses for Diesel engines, including some of the more recent applications in trains, trucks, buses, airplanes, and boats. Full of interesting pictures of Diesels at work and Hemphill Diesel students getting actual practice on many types of Diesel engines. For your free copy . . . send the coupon NOW.

HEMPHILL DIESEL SCHOOLS

*Diesel and Diesel-Electric - Full-Time Resident Courses
Or You Can Start Your Training at Home*

BOSTON.....114 Brookline Ave.
NEW YORK.....31-26 Queens Blvd., L. I. City
DETROIT.....2341 W. Lafayette Blvd.
CHICAGO.....2014 Larrabee St.

MEMPHIS.....417 Monroe Ave.
LOS ANGELES.....2120 San Fernando Road
SEATTLE.....501 Westlake North
VANCOUVER, B.C.....1363 Granville St.

Please send me my free copy
of "March of Diesel" book-
let and information on your
Diesel courses.

NAME _____ AGE _____

STREET ADDRESS
OR RURAL ROUTE _____

CITY _____ STATE _____ m-34-p

Send this coupon to nearest address shown above

DO YOU LIKE RADIO

DOES THE FUTURE OF TELEVISION

INTEREST YOU?



Send for your free copy

You men anxious to make good in radio and related industries want the true facts,—you want to know about employment opportunities and requirements. National Schools,—a million-dollar trade school,—will supply you with a sincerely honest statement of facts on what you should do to get into the profitable radio industry. No exaggerations,—no mis-statements. Mail coupon today. Send for your free copy. Real facts on radio employment requirements. You need real experience. National offers complete training with modern equipment.



NATIONAL SCHOOLS
Los Angeles

Request for **FREE BOOK** of DETAILS

NATIONAL SCHOOLS,
Dept. 3-PMR, 4000 S. Figueroa St., Los Angeles, Calif.

NAME _____ Age _____
ADDRESS _____
CITY _____ STATE _____

M ECHANICS-WELDERS - COLLISION MEN

GOOD JOBS and Mighty GOOD PAY

Do you want to earn big money? If so let us know which of the following trades you prefer. You learn by doing. Practical work. Expert teachers. Low tuition. Personal attention. It will pay you to investigate AT ONCE. Just check the courses you'd like to take and mail today. You will receive full information, absolutely without cost or obligation. But don't delay.

Check the Trade You'd Like to Learn

- Complete Auto Mechanics (including Diesel)
- Auto Collision
- Metal Finishing
- Electric Arc and Acetylene Welding
- Spray Painting
- Body and Fender Bumping

Ask about our "Pay After Graduation Plan"

Name
Address

Mail the above at once to

MICHIGAN TRADE SCHOOL
3758 Woodward Ave. Detroit, Mich.

Write for **FREE FOLDER**

GET IN THE SWING

with Slingerland . . . DRUMS GUITARS MANDOLINS



GENE KRUPA — World's Greatest Swing Drummer uses Slingerland

NOTHING CORNEY about Slingerland Instruments

Compare the value—tone and power in Slingerland "Radio King" drums, banjos, guitars, mandolins, marimbas or bugles—before you buy. Guaranteed more for your money. Acclaimed the tops in smooth

tone, easy playing, rich power by world's leading musicians. Easy payments. 5-days free trial. See at your dealers.

Cut this ad out—good for \$1.00 credit. Free special information on how to organize drum and bugle corps. Free Catalog—mention instrument wanted.

SLINGERLAND DRUM CO.
1330 Belden Avenue Chicago, Illinois



Air Become An Conditioning Engineer

Big fast-growing field for men trained in design, estimating, insulating, installing and servicing. Offers real opportunities in Air Conditioning new buildings and remodeling worth-while old buildings. Write today for method of how you can prepare for this thriving industry. No obligation.

American School, Dept. AC-345, Drexel at 58th, Chicago

U.S. GOV'T JOBS

Earn \$1260 to \$2100 at Start

Excellent opportunities for citizens 18 to 50. No special experience usually required. Railway Postal Clerks may earn \$155 first month; Customs Inspectors as high as \$3,000 a year. Send for **FREE BOOK "How to Secure a Government Position."** It tells about many good government positions and how our tested method will help you pass examinations. Write AT ONCE. **PATTERSON SCHOOL**, Arthur R. Patterson (former Gov't. Examiner), Principal, 83 Mercantile Bldg., Rochester, N. Y.

Learn Public Speaking

At home—in spare time. Many overcome "stage-fright," gain self-confidence and increase earning power, this easy way. Write for free booklet, *How to Work Wonders With Words* and requirements. North American Institute, Dept. 1353, 3601 Michigan Ave., Chicago, Illinois

MAIL FOR FREE INFORMATION

BROOKLYN YMCA TRADE SCHOOL

1117 Bedford Ave., Dept. PM-70 Brooklyn, New York City, N. Y.

- Diesel Engines
- Diesel Pre Engineering
- Aviation Mechanic
- Aeronautical Pre Engineering
- Auto Mechanic
- Refrigeration
- Radio and Television Mechanic
- Air Conditioning
- Architectural-Mechanical Drafting
- Electrical
- Armature Winding
- Oil Burner
- Welding
- Talking Pictures
- Machine Shop
- Window Display

Name.....
Address.....

IF YOU WENT TO COLLEGE you may have used I. C. S. TEXTBOOKS

Tribute to the educational soundness and worth of textbooks prepared and used by the International Correspondence Schools:
600 American schools, colleges and universities use them.

Among these institutions are:

Alabama Polytechnic Institute	Montana State College	University of Kentucky
Brown University	New York University	University of Maine
Bucknell University	Northwestern University	University of Michigan
California Institute of Technology	Ohio State University	University of Minnesota
Carnegie Institute of Technology	Oregon State Agricultural College	University of Missouri
Clemson College	Pasadena Junior College	University of Nebraska
College of the City of New York	Pennsylvania State College	University of Nevada
Columbia University	Rhode Island State College	University of New Mexico
Cornell University	Rose Polytechnic Institute	University of North Dakota
Dartmouth College	Rutgers University	University of Oklahoma
Duke University	South Dakota State College	University of Pennsylvania
George Washington University	Stanford University	University of Pittsburgh
Georgia School of Technology	Syracuse University	University of Southern California
Harvard University	The Citadel	University of Tennessee
Indiana University	Tulane University	University of Texas
Iowa State College	University of Alabama	University of Vermont
Johns Hopkins University	University of Arizona	University of Wisconsin
Kansas State Teachers College	University of Arkansas	University of Wyoming
Lehigh University	University of British Columbia	Utah Agricultural College
Louisiana State University	University of California	Virginia Polytechnic Institute
Marquette University	University of Chicago	Washington State College
Massachusetts Institute of Technology	University of Colorado	Wayne University
McGill University	University of Delaware	Yale University
Michigan State College	University of Florida	
Mississippi State College	University of Idaho	

• "I. C. S. makes effective a system of instruction designed to fit the needs of individuals unable to attend resident institutions, and also to fill the requirements of business and non-business organizations."

Ralph E. Weeks, President

A booklet, "The Business of Building Men," will be sent free on request



INTERNATIONAL SCHOOLS

SCRANTON, PENNSYLVANIA

New York • Chicago • Philadelphia • Washington • San Francisco • St. Louis
 Los Angeles • Boston • Montreal • London • Sydney • Wellington • Cairo
 Shanghai • Havana • Mexico City • Honolulu • Buenos Aires • Manila • Cape Town

INTERNATIONAL CORRESPONDENCE SCHOOLS

BOX 5543-J, SCRANTON, PENNA.

★ Without cost or obligation, please send me a copy of your booklet, "Who Wins and Why," and full particulars about the subject before which I have marked X: ★

TECHNICAL AND INDUSTRIAL COURSES

- | | | | |
|--|--|--|--|
| <input type="checkbox"/> Architect | <input type="checkbox"/> Sheet Metal Worker | <input type="checkbox"/> Commercial Refrigeration | <input type="checkbox"/> Surveying and Mapping |
| <input type="checkbox"/> Architectural Draftsman | <input type="checkbox"/> Boilermaker | <input type="checkbox"/> Plumbing <input type="checkbox"/> Steam Fitting | <input type="checkbox"/> Bridge Engineer |
| <input type="checkbox"/> Building Estimating | <input type="checkbox"/> Telegraph Engineer | <input type="checkbox"/> Heating <input type="checkbox"/> Ventilation | <input type="checkbox"/> Bridge and Building Foreman |
| <input type="checkbox"/> Contractor and Builder | <input type="checkbox"/> Telephone Work <input type="checkbox"/> Radio | <input type="checkbox"/> Air Conditioning and Cooling | <input type="checkbox"/> Chemistry <input type="checkbox"/> Pharmacy |
| <input type="checkbox"/> Structural Draftsman | <input type="checkbox"/> Mechanical Engineering | <input type="checkbox"/> Steam Engineer | <input type="checkbox"/> Coal Mining |
| <input type="checkbox"/> Structural Engineer | <input type="checkbox"/> Mechanical Draftsman | <input type="checkbox"/> Steam Electric Engineer | <input type="checkbox"/> Mine Foreman <input type="checkbox"/> Fire Bosses |
| <input type="checkbox"/> Management of Inventions | <input type="checkbox"/> Machinist <input type="checkbox"/> Toolmaker | <input type="checkbox"/> Marine Engineer | <input type="checkbox"/> Navigation |
| <input type="checkbox"/> Electrical Engineer | <input type="checkbox"/> Patternmaker | <input type="checkbox"/> R. R. Locomotives | <input type="checkbox"/> Cotton Manufacturing |
| <input type="checkbox"/> Electric Lighting | <input type="checkbox"/> Diesel Engines | <input type="checkbox"/> R. R. Section Foreman | <input type="checkbox"/> Woolen Manufacturing |
| <input type="checkbox"/> Welding, Electric and Gas | <input type="checkbox"/> Aviation Engines | <input type="checkbox"/> Air Brakes <input type="checkbox"/> R. R. Signalmen | <input type="checkbox"/> Agriculture |
| <input type="checkbox"/> Reading Shop Blueprints | <input type="checkbox"/> Auto Technician | <input type="checkbox"/> Highway Engineering | <input type="checkbox"/> Fruit Growing |
| <input type="checkbox"/> Heat Treatment of Metals | <input type="checkbox"/> Auto Electrical Technician | <input type="checkbox"/> Civil Engineering | <input type="checkbox"/> Poultry Farming |

BUSINESS TRAINING COURSES

- | | | | |
|--|---|--|--|
| <input type="checkbox"/> Business Management | <input type="checkbox"/> Bookkeeping | <input type="checkbox"/> Service Station Salesmanship | <input type="checkbox"/> Grade School Subjects |
| <input type="checkbox"/> Industrial Management | <input type="checkbox"/> Secretarial Work | <input type="checkbox"/> First Year College Subjects | <input type="checkbox"/> High School Subjects |
| <input type="checkbox"/> Traffic Management | <input type="checkbox"/> Spanish | <input type="checkbox"/> Business Correspondence | <input type="checkbox"/> College Preparatory |
| <input type="checkbox"/> Accountancy | <input type="checkbox"/> French | <input type="checkbox"/> Stenography and Typing | <input type="checkbox"/> Illustrating |
| <input type="checkbox"/> Cost Accountant | <input type="checkbox"/> Salesmanship | <input type="checkbox"/> Civil Service <input type="checkbox"/> Mail Carrier | <input type="checkbox"/> Cartooning |
| <input type="checkbox"/> C. P. Accountant | <input type="checkbox"/> Advertising | <input type="checkbox"/> Railway Mail Clerk | <input type="checkbox"/> Lettering Show Cards <input type="checkbox"/> Signs |

DOMESTIC SCIENCE COURSES

- | | | |
|---|---|--|
| <input type="checkbox"/> Home Dressmaking | <input type="checkbox"/> Advanced Dressmaking | <input type="checkbox"/> Foods and Cookery |
| <input type="checkbox"/> Professional Dressmaking and Designing | | <input type="checkbox"/> Tea Room and Cafeteria Management, Catering |

Name.....Age.....Address.....

City.....State.....Present Position.....

If you reside in Canada, send this coupon to the International Correspondence Schools Canadian, Limited, Montreal, Canada
 If you reside in England, send coupon to I. C. S., 71 Kingsway, London, W. C. 2, England

YOU CAN BECOME A MONEY-MAKING RADIO EXPERT
WITH THE New SPRAYBERRY
Personalized
HOME TRAINING in RADIO and TELEVISION



You Learn Easily in Your Spare Hours...By Doing Many Experiments with Up-To-Date Equipment

Here's a really fine, up-to-the-minute Radio and Television Training that's specially designed to give you quick results.

Training Prepares You For Good Radio Jobs... at Excellent Pay

My training starts right at the beginning of Radio... unfolds each subject in a simplified, logical, understandable style. You easily learn Television, Electronics, Facsimile Radio, Radio Set Repair and Installation Work, etc.

I Supply
146 RADIO PARTS
RADIO TOOLS
ALL PURPOSE ANALYZER

No Previous Experience Needed
 It makes no difference what your education has been. I can fit you for a good-paying Radio job. Your success is my full responsibility.

You Get Professional Test Equipment Plus Experimental Outfits
 ... Includes 146 Radio Parts (to build complete Receiver), Tools, All-Wave, All-Purpose Analyzer, and Experimental Outfits for conducting actual experiments with your own hands.

Earn While You Learn
 My **BUSINESS BUILDERS** show you how to put your Equipment to practical use in handling actual money-making Radio Service Jobs shortly after you begin training.

The Sprayberry Course is Sold Under a Money-back Agreement

RUSH COUPON for BIG FREE BOOK

Sprayberry Academy of Radio
 F. L. Sprayberry, President
 210-C University Place, N. W., Washington, D. C.
 Please rush me FREE copy of "HOW TO MAKE MONEY IN RADIO"

Name.....Age.....
 Address.....
 City.....State.....
 (Mail in envelope or paste coupon on penny postcard)

Let me put my Finger on YOUR **Mistakes in English**



SHERWIN CODY

ARE you worried about making embarrassing errors in spelling, grammar, pronunciation? My patented 100% self-correcting device gives you a confident command of English, teaches you to speak and write forcefully, entertainingly. No tiresome rules to study. My method has shown over 100,000 people how to make good English a daily habit.

FREE BOOK Send for free book, "How You Can Master Good English in 15 Minutes a Day."

SHERWIN CODY SCHOOL OF ENGLISH
 53 Searle Building
 Rochester, N. Y.

Learn To MOUNT BIRDS



TAN SKINS—MAKE UP FURS
 Be a Taxidermist. We teach you at Home. Mount Birds, Animals, Pets, Heads, Fish. Save your hunting trophies. Decorate home and den. Make Money. Mount and tan for others. Fun and Profits! Don't delay. WRITE TODAY—NOW—for **FREE BOOK** with 100 game pictures. Hunters, get your copy—It's Now Free. Send post card. State your AGE.
 N. W. SCHOOL OF TAXIDERMISTRY, Dept. 3373, Omaha, Nebr.

Get this Proven PAY-RAISING PLAN



LET ME TRAIN YOU IN DRAFTING UNTIL YOU GET A GOOD PAY JOB!



ENGINEER DOBE

Take a *short cut* to a Bigger Job, Better Pay and a REAL future. Learn Drafting! It's an easy way to get into your favorite work—Electricity, Aviation, Diesel, Air Conditioning, Automotive, Building, Machinery, Transportation, etc. I agree to train you until you get a good pay job.

Draftsmen Draw Good Pay
 I have trained thousands of men ages 16 to past 50 in spare time at home to qualify for Bigger Jobs at Better Pay. Let me train you quickly by same easy, low cost "Work-Job" Method. No experience needed. High School education not necessary.

All Working Tools Furnished
 You get complete Professional Draftsman's Tools and Drawing Table—sent without extra charge at once. Mail coupon for Free Book about my **PROVEN PAY RAISING PLAN**. Write TODAY!
ENGINEER DOBE, Div. 3373, Libertyville, Ill.

ENGINEER DOBE, Div. 3373, Libertyville, Ill.

Send me your Free Book "SUCCESSFUL DRAFTSMANSHIP." Explain how you assist your graduates to good positions as Draftsmen.

NAME.....AGE.....
 ADDRESS.....
 TOWN.....STATE.....

Successful DRAFTSMANSHIP

AVIATION SPARTAN OFFERS YOU—

Unequaled advantages "Oil Capitol of the World" finest flying weather and country. Government Approved. Factory affiliation advantages Commercial, Military All-Metal construction. Home of the DAWN PATROL. All courses Mechanical and Flight, Student Dormitories, Restaurant.

Write for Illustrated Catalog.
 J. D. GREEN, Director, Dept. PM 17, TULSA, OKLAHOMA

SPARTAN SCHOOL OF AVIATION

LEARN MECHANICAL DENTISTRY **SEND FOR FREE BOOK**



Special Tool Offer—Now!
 Don't waste the best years of your life. Learn this **money-making** business in a few months. Day or Evening, and become independent. Big demand. *Highly endorsed—oldest school*. Practical, individual training. Easy terms. Write NOW for free catalog P and trial offer.

New York School of Mechanical Dentistry,
 125-127 West 31st Street, Dept. 9, New York City

EARN A DEGREE AT HOME
From A Chartered Institution of Higher Learning

Home Study Courses leading to Degrees in Arts; Sciences; Philosophy; Education; Public Health; Psychology; Sociology; Physics; Chemistry; Pol. Science; Theology; Law; Business Training; Accounting; Statistics; Adv.; Agriculture; Sales; Electrical; Civil; Mechanical; Drafting; Architectural; Automotive; Steam; Diesel; Aeronautical; Radio; Structural; Industrial; Highway; Petroleum; Mining; Marine; Refrigeration; Air Conditioning; Chemical Engineering. Founded 1908. Chartered.
McKinley-Roosevelt Graduate College, 4213 Clarendon Ave., Chicago

MONEY-MAKING OPPORTUNITY

for men of character. Over \$1,600 per month earned by California man. Over \$400 a week by Georgia man. \$1,000 in a month by Delaware man. Exclusive franchises available for an invention expected to replace a multi-million dollar industry. Install on free trial. Sell itself. Repeats. Exclusive proposition. Write F. E. Armstrong, Dept. 1112-C. Mobile, Alabama.

KAR-NU BEAUTIFIES OLD CARS WITH SPARKLING NEW FINISH!



PAYS UP TO \$7 AN HOUR!

KAR-NU refinishes any color automobile easily, quickly and economically without polishing, waxing, rubbing or painting.

JUST WIPE IT ON WITH A CLOTH!
 Magic-like fluid covers old paint with tough, elastic coat. Absolutely transparent, self-leveling, self-polishing. Guaranteed. Lasts 8 to 12 months. As beautiful as a fine paint job—saves need for \$25 to \$75 refinishing expense. Write for **Free Sample** to prove our claims and Territory offer.

KAR-NU CO. Dept. R-30, Oakley Sta. Cincinnati, O.

Be An ARTIST



Learn to Draw at Home This Proven, Practical Way!

YOU have always longed for it—this fascinating ability to draw. Now it can really be yours! Illustrating, Rapid Sketching, Decorative Designing, Commercial Art, Cartooning—you can now learn all of this right in your own home. Many of our graduates never studied art before, yet today are successful artists with good incomes.

Our proven, practical method makes it fun to learn, in your spare time. And now, with just a few hours' pleasant practice each week, *you*, too, can see how to make drawings that have a real commercial value—just as these WSA graduates (shown below) have done! Get into this interesting, profitable field **NOW!** Mail coupon for **FREE BOOK**, "Art for Pleasure and Profit" at once!

Commercial Art, Cartooning and Designing, ALL in ONE Course!

It's like an enjoyable game when you learn to draw by the WSA method. You learn right at home, yet every bit of your artwork receives the individual attention and criticism of a real art teacher. You get a sound, complete all 'round art training based on our 24 years of successful teaching experience.

Free Book Gives Details

Our colorful **FREE BOOK** describes the latest developments and opportunities in this fascinating and profitable field—and gives full details of our course. Tells about our graduates—their successes—what they say—shows actual reproductions of their work—and tells how they earned good money. Mail coupon or post card **today**. (No salesman will call.) Please state age.



Can YOU do THIS?

Our method is easy to follow

Every step in our course is clear and practical. You start with a simple line framework and then advance gradually, as you learn, to the finished drawing. We have made it possible to teach Art to almost everyone by practical steps that the average person can follow. The above figures are reproduced from our Life Class Book included with the course.

\$25 for One Drawing

Mrs. G. A. Wemmer of Kansas, sold several pictures upon completing the course. One small one for \$25!



Paid for Course

Dr. Wm. R. Kent of New Jersey won enough in Art prizes and exhibits to pay for his course!

Got a Job right away

Clifford E. Conkell of Michigan, was called into the city's largest dept. store the very same month he received his WSA diploma!



Every student receives two large Artists' outfits that include everything he needs to start the W.S.A. course. The first outfit is sent immediately upon enrollment. Mail the coupon today, if interested.

TWO BIG ARTISTS OUTFITS INCLUDED



WASHINGTON SCHOOL OF ART,
Studio 123M, 1115—15th Street, N. W.
Washington, D. C.

Without obligation, please send me a **FREE** copy of your colorful, illustrated Book, "Art for Pleasure and Profit."

Name..... Age.....
Address

City..... State.....

1/24/35
NEW



INVENTIONS

FOR keeping brake drums cool in unusually warm weather or on runs through mountainous country, a new form of body construction for the automobile has been patented. Under a patent, a louver would be built into the side of the body, above the fender. A conduit, extending from the louver to the brake drum, would conduct a cooling current of air to the braking mechanism. This construction is intended for use on the rear brake drums.



A SUBSTITUTE for the chain-drive method of bicycle propulsion has been patented. It consists of a pedal on each side connected to the rear hub through gears. The rear hub has two reciprocating clutches through which the gears are connected to

the hub. The pedals are caused to rise alternately through the use of two ball-and-socket jointed links connected to a small lever on the underside of the bicycle frame. The revolving pedals of the conventional drive are replaced in this system by pedals of long leverage which oscillate through only a fraction of their circumference, thus making it possible to utilize most of the force applied. In the conventional drive, there is only about fifty per cent efficiency, since about one-half the force applied to the pedal goes to the hub



of the pedal and one-half to propulsion. When the new mechanism is used, the bicycle is equipped with a front wheel brake.

SOMETHING new in aviation is found in the extensible wing patented recently. The aircraft would have an elongated fuselage with fixed wings extending laterally from the forward portion, as in the conventional airplane. These wings would be hollow and open along their rear edges. An extensible and collapsible auxiliary wing would be housed in the fixed wing, on each side of the plane, but so arranged that it

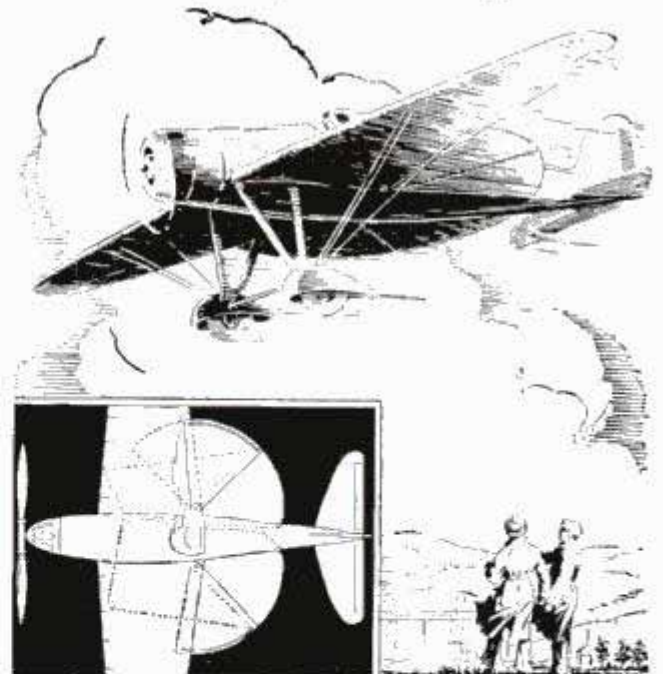

could be moved out of the open rear edge to form a sector-shaped wing extending from the fixed wing in a semicircle to the rear of the fuselage. Controls within the pilot's compartment would be used for manipulating the auxiliary wing. One advantage of such a wing would be that the plane might land at slower speed.

(Continued to page 33A)

TRAIN FOR **ELECTRICITY**

12 Weeks PRACTICAL SHOP WORK

IN THESE BIG CHICAGO COYNE SHOPS

ELEMENTARY DEPARTMENT
 ARMATURE WINDING-TESTING
 HOUSE WIRING
 MOTORS
 REFRIGERATION

PREPARE FOR OPPORTUNITIES LIKE THESE:

R. R. Signal Wiremen,
 Housewiring,
 Telephone Maintenance,
 Illumination Man,
 Armature Winding,
 Motor Repair Man,
 Power Plant Operator,
 Maintenance Electrician,
 Auto Ignition and Battery,
 Air Conditioning,
 Electric Refrigeration,
 and many others.

H. C. Lewis

I'LL FINANCE YOUR TRAINING

Send me the coupon below and I'll tell you all about my quick, easier way to train for your start towards a better pay job in electricity. Get your training **FIRST**—Then pay for it in easy monthly payments starting 60 days after your regular 12 weeks training period ends. Electricity offers to many the opportunity for a better job, more money and a real future. Get into a fascinating well-paid field where trained men make good money.

LEARN BY DOING ON REAL ELECTRICAL EQUIPMENT

In the Big Chicago Coyne Shops you "Learn-By-Doing" on real motors, dynamos, generators, etc. You learn to wind real armatures, wire houses, operate real switchboards. **FIRST**—You are told how to do a thing... Then—**YOU DO IT YOURSELF**. Can you imagine an easier or quicker way to Learn?

DIESEL, AIR CONDITIONING ELECTRIC REFRIGERATION

Training **NOW** included in these important branches of Electricity without extra cost. This valuable instruction should offer you more opportunities in the electrical field.

COYNE ELECTRICAL SCHOOL
 H. C. LEWIS, PRESIDENT
 500 S. Paulina St., Dept. 39-72, Chicago, Ill.

MANY EARN WHILE LEARNING EMPLOYMENT HELP AFTER GRADUATION

If you need part time work to help you pay living expenses while training, my Employment Department will help you find it. After you graduate, you get **FREE** Lifetime Employment Service. Send coupon today for full particulars.

GET THE FACTS

Don't let lack of money keep you from sending in the coupon **NOW**. My Big **FREE** Book is full of facts and photographs which tell you about Coyne Training. I will also send you the details of my "PAY-TUITION-AFTER-GRADUATION" plan, **SPARE TIME EMPLOYMENT OFFER, GRADUATE EMPLOYMENT SERVICE, LIFETIME PRIVILEGE OF REVIEW, AND OTHER ADVANTAGES.**

H. C. LEWIS, Pres.
COYNE Electrical School, 500 S. Paulina St. Dept. 39-72, Chicago, Ill.

Dear Sir: Please send me, absolutely free, your Big New Book and full particulars of your "PAY-TUITION-AFTER-GRADUATION" PLAN and all other details of your offer.

Name _____

Address _____

City _____ State _____

Mail in Envelope or Paste on Postcard.

MAIL THIS COUPON NOW!

INVENTORS

ACT NOW TO PROTECT YOUR INVENTION
WITH U.S. PATENT

OUR BIG BOOK TELLS YOU

The Importance of Quick Action

If you have a new idea that is patentable—and want to secure for yourself your inventor's sole right to profit from the idea—you can't afford to lose time in securing the protection of a U. S. Patent. Other inventors may be working on the same idea right now. Should

they develop this idea and file patent application before you do—the burden of establishing priority will be upon you. Our Big Book—"Patent Guide for the Inventor"—will tell you the quickest possible way to secure Patent Protection for your idea. SEND FOR IT TODAY!

THE FIRST IMPORTANT STEP IN SECURING A PATENT

is to obtain the services of a Registered Patent Attorney. Establish the date of your invention as explained in our Book and disclose your idea to him in correct form. He then makes a SEARCH of the Patent Office Records and reports to you on the existing U. S. Patents which might bear on your invention, giving his opinion on the advisability of proceeding and filing formal application. How this inexpensive

step can save you money, time and delay when Patenting your idea—how it tells you whether or not it is worth your while to file formal Application—all is explained in our Big Book—Send for it TODAY. If you have developed some improvement, something which adds to the usefulness of any product—whether this product is patented or not—you should protect your improvement with a Patent at once. Send for our Big Book which tells you how.



WHITNEY'S FIGHTING SPIRIT

Eli Whitney let go a law career to build a cotton gin. No mechanical contrivance existed to suggest the operations this device had to perform. Even the means for drawing wires were not at hand—he had to work them out himself. He overcame all obstacles by pressing himself to determined, tireless effort. After Thomas Jefferson, Secretary of State, granted his patent on March 4, 1794, Whitney had to get money

behind his invention. Phineas Miller consented to join him, financing the manufacture of Whitney's cotton gin.

ALSO FREE RECORD OF INVENTION

Use our FREE "Record of Invention" Form to assist you in recording the descriptive outline of your idea and to establish the date of your invention. With it you can make a rough sketch of your idea and have it witnessed in a manner of value to you, as evidence should occasion arise. Whether you plan to proceed immediately or not—get this Form, record your invention, and have it witnessed.

MAIL COUPON TODAY
FOR BIG

FREE

48 PAGE
FORM FOR RECORDING



**CLARENCE A. O'BRIEN
and HYMAN BERMAN**

70-W Adams Building Washington, D. C.
Registered Patent Attorneys Before U. S. Patent
Office

You Can PATENT

Small Ideas May Have Large Commercial Possibilities

Ideas do not have to be complicated to be profitable when Patented. The 5c and 10c stores flourish on simple Patented products which are commercially successful. The zipper, safety pin, thumb tack, paper clip, collar button—all are simple yet familiar inventions—brought their inventors rich rewards. If you have a Patentable idea—act to protect it. Send for our FREE 48-Page Book that tells you how.

NEW IDEAS FOR IMPROVEMENTS IN MACHINERY ARTICLES, DESIGNS, FORMULAS, ETC.

Every year thousands of Patents are granted. Very few, however, represent the discovery of entirely new principles. Most of them provide new methods of doing some every-day thing in a better way—changes for greater efficiency, usefulness, adaptability, or beauty in some previously Patented thing. These IMPROVEMENTS are patentable if new, and actually represent new invention. These improvement Patents offer large chances for profit if commercially useful. The business world wants improved products and services.

OUR SERVICES TO YOU

We are Registered Patent and Trade-Mark Attorneys, serving Inventors all over the United States and abroad. Our organization is complete. We have Draftsmen, experienced

Searchers and Attorneys to serve your interests. We can act as your legal adviser in all Patent Matters. Our complete service is described in our Big Book. Mail Coupon for it NOW.

IN CASE YOU FEEL THAT YOU HAVE NOT SUFFICIENT FUNDS AVAILABLE FOR PATENT FEES

Our Big Book tells you how to legally assign an interest in your invention before filing application—to some friend willing to aid you. Better to do this than to delay indefinitely and see another inventor develop your idea and Patent it before you do. Send Coupon NOW.

REASONABLE FEES—CONVENIENT TERMS

Don't worry about finances. Our fees are very reasonable—we can arrange convenient terms of payment. It is our custom to permit clients to pay for our services in installments as the application progresses in our office. See our Big Book for fees in obtaining Patent. It explains our arrangements clearly. Send for it NOW.

BOOK AND FREE YOUR INVENTION



SEND TO-DAY

CLARENCE A. O'BRIEN and HYMAN BERMAN

70-W Adams Bldg., Washington, D. C.
Registered Patent Attorneys Before U. S. Patent Office

Please send me at once your Big Free 48-Page Book "Patent Guide for the Inventor" and your Specially Prepared "Record of Invention" Form. This request does not obligate me.

REQUEST OUR BOOK — NOW!

Know exactly what you should do to secure a Patent—what must be done every step of the way—how the Patent Law protects you—what we, as Registered Patent Attorneys, can do for you. Mail the coupon NOW for our Big Booklet and "Record of Invention" Form.

CLARENCE A. O'BRIEN and HYMAN BERMAN

70-W Adams Building Washington, D. C.
Registered Patent Attorneys Before U. S. Patent Office

NAME.....

ADDRESS.....

CITY.....STATE.....

(Please write or print plainly)

FOR MEN WHO WANT TO LEARN A PROFITABLE TRADE

Complete DIESEL TRAINING

NO MATTER WHERE YOU ARE OR WHAT YOU DO — we have a training plan for YOU!

IF you are sincerely ambitious and interested in making good in the Diesel field, be sure to immediately investigate our flexible training plan that will fit your circumstances. A Plan for every Man. A Plan for those seeking immediate shop training as well as for those who cannot give up their present employment and income. For 34 years National Schools, a recognized leader in the field of trade education, has helped wide-awake men to success. This million-dollar trade school will supply you with a sincere, honest statement of facts of what you should do to quickly get into the profitable Diesel Industry. No exaggerations—no misstatements; and a definite plan to fit you.

Write Today for Full Details

Mail the coupon below. Find out how you can get the finest in Diesel training without delay. See how this great trade school operates and makes its facilities available to every ambitious man. Actual work in modern training shops, a part of every man's instruction. Shop methods time-tested for 34 years. Fascinating, efficient preparation. Get the facts.

WE ARE DEFINITELY INTERESTED IN HELPING MEN OF LIMITED INCOME AND "BLIND ALLEY" JOB HOLDERS.

NATIONAL SCHOOLS



FREE BOOK

Los Angeles

Request for Free Book

NATIONAL SCHOOLS (established 1905) Dept. 3-PMA
4000 South Figueroa Street, Los Angeles
Please send me, without obligation, your FREE BOOK and information regarding Diesel Employment Opportunities and Requirements.

NAME _____ AGE _____
ADDRESS _____ CITY _____ STATE _____

EASIEST to master!

THIS NEW P-A

● Such beautiful tone, and so easy to play! Just touch a key and blow normally; you can't miss. Nothing to compare with these new P-A Saxes, Clarinets, Trumpets, and other P-A instruments. Fully guaranteed; your success assured. See your music dealer or write direct for beautiful free book. No obligation. Easy terms. Greatest fun, easiest with P-A. Write today sure.

PAN-AMERICAN
303 P-A BUILDING ELKHART, INDIANA

SPARE TIME HOME TRAINING IN TELEVISION and RADIO

as Low as **\$39.50**

1939—TELEVISION YEAR!—Big opportunity for jobs. My amazing new training saves up to 80% usual cost. Covers Radio, Broadcasting, Public Address, Photo Electricity, and Latest Television Practices. Over 100 lessons, modern, thorough in scope. 10 months to pay.

FREE TRIAL—10 lessons sent at once on **FREE TRIAL** basis if you write today. See for yourself.

S. Q. NOEL, Pres., **UNIVERSAL TELEVISION SYSTEM**
616 Candier Building Kansas City, Missouri

AN AVIATION CAREER OFFERS YOU GREAT FUTURE!

Demand for trained aircraftsmen is increasing and already exceeds supply. Curtiss-Wright Tech, Aviation's foremost and oldest school, is located on Grand Central Air Terminal in heart of the aircraft industry and specializes in training **MASTER MECHANICS and AERONAUTICAL ENGINEERS**. (No flying involved.) Graduates are obtaining immediate employment. Write for details NOW. Dept. PM-3.

Curtiss-Wright Technical Institute, Glendale (Los Angeles) California

LAW STUDY AT HOME

Legally trained men win higher positions and bigger success in business and public life. Greater opportunities now than ever before. Big corporations are headed by men with legal training.

More Ability: More Prestige: More Money

We guide you step by step. You can train at home during spare time. Degree of L.L. B. Successful graduates in every section of the U. S. We furnish all text material, including 14-volume Law Library. Low cost, easy terms. Get our valuable 48-page "Law Training for Leadership" and "Evidence" books FREE. Send for them NOW.

LaSalle Extension University, Dept. 364-L, Chicago
A Correspondence Institution

Learn ADVERTISING at Home

Greater opportunities now in advertising. Learn easily and quickly in spare time. Practical work. No text books. Old established school. Low tuition—Easy terms. Send for free booklet and requirements.

Page-Davis School of Advertising
Dept. 1353, 3601 Mich. Av., Chicago

WHY NOT spend spring, summer, fall; gathering butterflies, insects. I buy hundreds of kinds for collections. Some worth \$1 to \$7 each. Simple outdoor work with my instructions, pictures, price list. Profit—pleasure. Send 10c (not stamps) for Illustrated Prospectus before sending butterflies.

MR. SINCLAIR, DEALER IN INSECTS
Dept. 6, Box 1830 San Diego, Calif.

MAKE MONEY AT HOME

RUBBER MOLDS *Low as 6¢ EA.*

Amazing rubber mold-making outfit makes perfect flexible molds of plaques, ash trays, book-ends, etc. Molds cost from 6c to 25c each. Each mold makes hundreds of novelties and gifts to sell up to \$1.00 apiece! No experience necessary. Quick and easy. Start profitable business in your home... sell to stores, gift shops, friends, resorts, road stands, by mail. Full or spare time. "Molders Handy Book" and list of buyers FREE. Write

SO-LO WORKS
Dept. R-827 Cincinnati, Ohio

Easy as A-B-C

DOESN'T IT LOOK SIMPLE?

Yet it's from the famous "Merry Widow" Waltz!

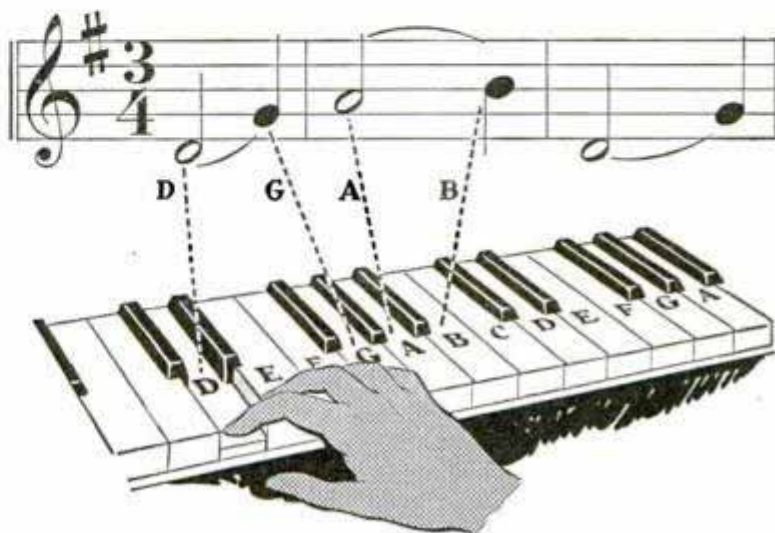
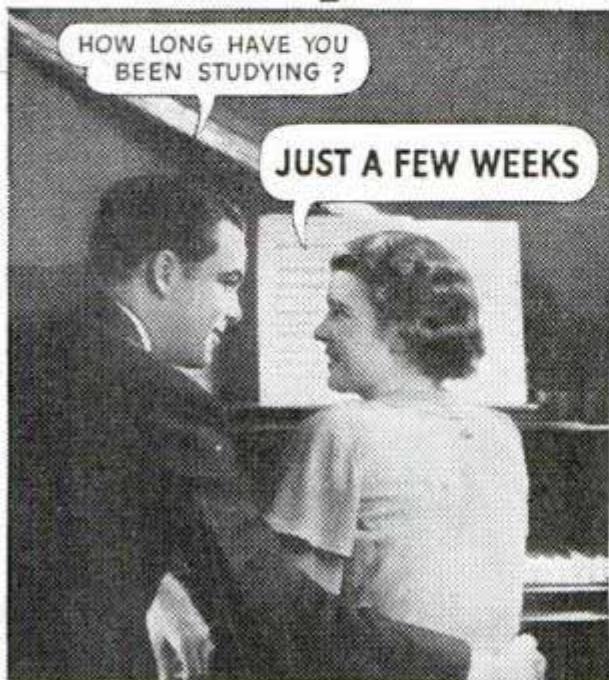

HERE'S PROOF THAT YOU, TOO, CAN LEARN TO PLAY THE PIANO OR ANY OTHER INSTRUMENT!

JUST strike the notes indicated above and you will actually be playing the opening bars of one of the world's favorite musical compositions! And it's just as easy to play other famous melodies, too, when you use the wonderful "Note-Finder."

This invention of the U. S. School of Music takes the mystery out of the piano keyboard, does away with tedious study and practice, enables anyone to play a real tune almost from the start. And that's the way this modern method works. You learn to play by *playing*. Soon you will be thrilled and delighted to find that you can pick up almost any piece of popular music and play it at sight. And that applies to the piano or violin, the saxophone or guitar, the accordion or whichever instrument you choose for your own!

FREE Demonstration Lesson

This demonstration lesson will give you the surprise of your life. It will show you, in black and white, how you can quickly realize your dreams of playing your favorite instrument. With the demonstration lesson, you will also receive a handsome illustrated booklet and details of the remarkable, money-saving offer that enables you to learn music at home for but a few cents a day. All this material will be sent to you by return mail, without cost or obligation. Simply mail the coupon or write, mentioning instrument that interests you. Do it *today*. Note: instruments supplied when needed, cash or credit. U. S. School of Music, 73 Brunswick Bldg., New York City, N. Y. (Forty-first year—Est. 1898.)

Takes Only Few Minutes a Day!

PICK YOUR INSTRUMENT

Piano	Guitar
Violin	Saxophone
Organ	Mandolin
Cornet	Ukulele
Trombone	Harp
Piccolo	Clarinet
Flute	Cello
Hawaiian Steel Guitar	Trumpet
Piano Accordion	
Plain Accordion	
Voice and Speech Culture	
Modern Elementary Harmony	
Drums and Traps	
Banjo (Plectrum 5-String or Tenor)	

Do you wonder that over 700,000 people all over the world have taken advantage of this easy way to learn music at home? Don't let old-fashioned ideas deprive you of the joys of playing any longer. You don't need special talent; you don't need any previous knowledge of music; you don't need to spend months on monotonous drills and exercises. It's fun to learn music this modern way; it's easy as A-B-C; it takes only a few minutes a day. But see for yourself! Simply send today for our

U. S. School of Music,
73 Brunswick Bldg., New York, N. Y.

Gentlemen: Please send me by return mail, FREE Demonstration Lesson, illustrated booklet and full details. I am interested in the following instrument:

.....

Name.....

Address.....

City..... State.....

Check here if you want our Instrument Catalog.

Here's the Kind
of NEW MEN
I Build!

Do YOU Want to Be One?

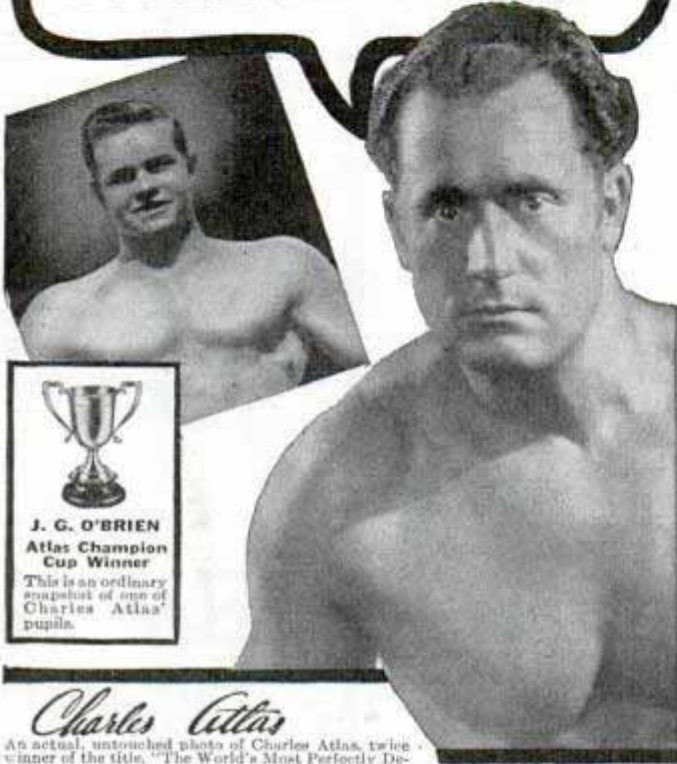

J. G. O'BRIEN
Atlas Champion
Cup Winner
This is an ordinary
snapshot of one of
Charles Atlas' pupils.

Charles Atlas

An actual, untouched photo of Charles Atlas, twice winner of the title, "The World's Most Perfectly Developed Man"—who offers you this amazing 7-DAY TRIAL OFFER.

**..And I'll PROVE in Just
7 DAYS
I Can Make YOU One!**

Men—meet J. G. O'Brien, of California, one of my Silver Cup Winners! Look at that strong neck—those broad, handsome shoulders—that muscled chest and stomach. Read what he says: "Look at me NOW! **Dynamic Tension** works like magic. Those 7 days certainly proved that you can make a fellow a NEW MAN!"

Do you want a prize-winning body like this? Are you fed up with having no strength, no vigor, being only HALF-ALIVE? Then listen—YOU'LL SEE AND FEEL RESULTS IN ONE WEEK! That's all I ask—SEVEN DAYS! In the FIRST WEEK I'll absolutely PROVE that I can give you, too, the kind of body men respect and women admire! I was once a skinny, timid weakling of only 97 lbs. I didn't know what real health or strength were. Then I discovered the amazing secret that changed me, like magic, into "The World's Most Perfectly Developed Man"! My secret is **Dynamic Tension**. It is the tested, natural method of developing you **inside and out!** It can give YOU the powerful, rippling muscles you want. It goes after ordinary constipation, pimples, indigestion, underweight and overweight.

Dynamic Tension will make a NEW MAN of you in double-quick time. I'm ready to PROVE it in a 7-day TRIAL OFFER. Results the first week—or it costs you NOTHING!

FREE BOOK Let me show you the amazing results produced for thousands! I'll send you FREE my famous book, "Everlasting Health and Strength." It shows actual photos. It tells exactly what I can do for your body! Write your name and address on coupon. Mail to me personally today. I'll rush your free copy to you AT ONCE! **Charles Atlas, Dept. 8-C, 115 East 23rd Street, New York, N. Y.**



CHARLES ATLAS,
Dept. 8-C, 115 East 23rd Street, New York, N. Y.

I want the proof that your system of **Dynamic Tension** will make a New Man of me—give me a healthy, husky body and big muscle development. Send me your FREE book "Everlasting Health and Strength" and full details about your 7-day TRIAL OFFER.

Name..... (Please print or write plainly)
Address.....
City..... State.....

You have
a future in

**RADIO
ENGINEERING**

One Year Course Prepares You for Technical Career

College calibre training in an intensive one-year course for high school graduates. Our own new building in the Nation's Capital. Completely equipped shops and laboratories—students enjoy actual "lab" experience under outstanding engineer-instructors. Graduates qualify for professional radio jobs. CREI men now in more than 275 radio stations. School year begins in Sept.—ends in June. Preparatory home-study training at no extra cost. Write now for free booklet: "A Tested Plan for a Future in Radio". State age.



CAPITOL RADIO ENGINEERING INSTITUTE
Dept. PO-3,3224 16th St., N.W., Wash., D.C.



TRI-STATE COLLEGE

B. S. Degree in 2 Years

World famous for technical 2-year courses in Civil, Electrical, Mechanical, Chemical, Radio, Aeronautical Engineering, Business Administration and Accounting. Special preparatory

department for those who lack required high school work. Short diploma courses (36 weeks) in Surveying, Drafting. Low tuition. Low living costs. Students from every state and many foreign countries. 56th year. Enter March, June, September, January. Write for catalog, 439 College Ave., ANGOLA, IND.

Regain Perfect Speech, If You

STAMMER

Send today for beautifully illustrated book entitled "DON'T STAMMER," which describes the Bogue Unit Method for the scientific correction of stammering and stuttering. Method successfully used at Bogue Institute for 38 years—since 1901. Endorsed by physicians. Full information concerning correction of stammering sent free. No obligation. **Benjamin N. Bogue, Dept. 1300 Circle Tower, Indianapolis, Indiana.**



**AIR CONDITIONING
AND REFRIGERATION
TRIAL LESSON**

Trained men needed. Good pay. Opportunities. Learn easily AT HOME in spare time (or at our Chicago School). Send for FREE TRIAL LESSON. No charge for this now or later. Write today.

CHICAGO TECHNICAL COLLEGE
C-303 Tech Bldg., 118 E. 26th St., Chicago, Ill.

**DENISON'S
PLAYS**

Musical Comedies, Operettas, Vaudeville Acts, Minstrels, Comedy Songs, Make-up Goods.

**60
YEARS
OF HITS**

T. S. Denison & Co., 203 N. Webash, Dept. 9, Chicago



LOOK! Baby Chicks

THOUSANDS WEEKLY ALL YEAR. Finest quality & Layers in 40 breeds. Hybrid Baby Pullets and Cockerels, B. W. D. Tested. Ducklings, Goslings, Baby Turkeys, Guineaes. In business 30 years. Catalog free. ORDER NOW. Make BIG money raising NABOB QUALITY CHICKS. **NABOB HATCHERIES, BOX M, GAMBIER, OHIO**

don't WORRY

Why put up with years of needless discomfort and worry? Try a Brooks Automatic Air Cushion. This marvelous appliance permits the opening to close, yet holds reducible rupture securely, comfortably—day and night. Thousands report amazing results. Light, neat-fitting. No hard pads or stiff springs to chafe or gouge. Made for men, women and children. Durable, cheap, **Sent on trial** to prove it. Never sold in stores. Beware of imitations. Write for Free Book on Rupture, no-risk trial order plan, and proof of results. All correspondence confidential. **BROOKS COMPANY, 457-A State St., Marshall, Mich.**



**ABOUT
RUPTURE**



RULES

This contest open only to amateurs, 16 years old or more. Professional commercial artists and Federal students are not eligible.

1. Make drawing of girl 6½ inches high, on paper 7 inches high. Draw only the girl, no lettering.

2. Use only pencil or pen.

3. We return no drawings.

4. Print your name, address, age, occupation on back of drawing.

5. All drawings must be received by February 28th, 1939. Prizes will be awarded for drawings best in proportion and neatness by Federal Schools Faculty.

DRAW ME!

TRY FOR A
Free Art Course

Copy this girl and send us your drawing — perhaps you'll win a COMPLETE FEDERAL COURSE FREE! This contest is for amateurs, so if you like to draw do not hesitate to enter.

Prizes for Five Best Drawings — FIVE COMPLETE ART COURSES FREE, including drawing outfits. (Value of each course, \$215.00.)

FREE! Each contestant whose drawing shows sufficient merit will receive a grading and advice as to whether he or she has, in our estimation, artistic talent worth developing.

Today design, color and illustrating influence the sale of most merchandise. Trained commercial artists have, therefore, become important in industry. They are in demand, — well paid — machines can never displace them. Artistic talent is comparatively scarce. If you can draw, why waste this rare gift? Train yourself to do work for which nature has fitted you and which few people can do. Success nowadays comes easier to those who develop natural ability. We have trained many young men and women now capable of earning up to \$5,000 yearly as artists. Use this opportunity to test your talent. Read the rules and send us your drawing.

◀ FEDERAL SCHOOLS ▶ INC ▶

Dept. 3139 Federal Schools Building, Minneapolis, Minnesota

When writing to advertisers please mention Popular Mechanics



**START
\$1260 to \$2100 YEAR
MANY 1939
APPOINTMENTS EXPECTED**

Railway Postal Clerks

Railway Postal Clerks get \$1,900 the first year regular, being paid on the first and fifteenth of each month. (\$79.17 each pay day.) Their pay is automatically increased yearly to \$2,450. Advance may be had to Chief Clerk at \$2,700 a year (\$112.50 each pay day.)

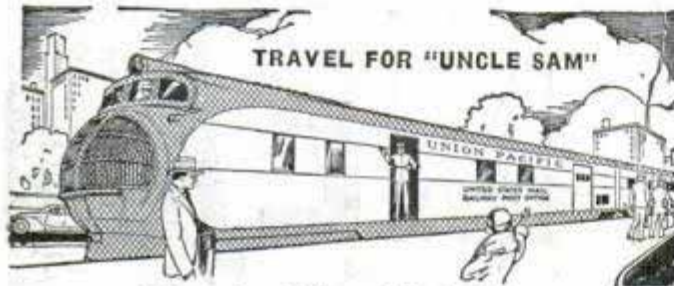

3 Days On—3 Days Off—Full Pay

Railway Postal Clerks on long runs usually work 3 days and have 3 days off duty or in the same proportion. During this off duty their pay continues just as though they were working. They travel on a pass when on business. When they grow old, they are retired with a pension.

City Mail Carriers, Post Office Clerks

Clerks and Carriers now get \$1,700 the first year on regular and automatically increase \$100 a year to \$2,100 and \$2,300.



Many Other Positions

Many other positions are obtainable. Those wishing these positions should qualify at once.

Get Free List of Positions

Fill out the following coupon. Tear it off and mail it today—now, at once.

This investment may result in your getting a big-paid government job.

FRANKLIN INSTITUTE, Dept. H-173, Rochester, N. Y.

Rush to me, entirely free of charge (1) a full description of U. S. Government Jobs; (2) Free copy of Illustrated 32-page book, "U. S. Government Positions and How to Get Them"; (3) List of U. S. Government Jobs; (4) Tell me how to qualify for one of these jobs.

Name.....

Address.....

Use This Coupon Before You Mislays It. Write or Print Plainly.

When writing please mention Popular Mechanics



Diesel Engines produce "LOW COST" power—the newer ones are unbelievably light in weight. High Speed trains, passenger busses; huge trucks and now airplanes have adopted **DIESEL POWER**. Think what that will mean in the way of opportunities for **DIESEL TRAINED MEN**.

Learn Diesel at Home

Get into this profitable field NOW—prepare for an ever increasing demand—know the answer to any Diesel problem. We train you at home in **SPARE TIME**. No need to waste a minute or interfere with work or pleasure. Prepare for advancement the Diesel way. Get in line for a Big Pay Job. Write for **FREE** bulletin—there is no cost or obligation.

AMERICAN SCHOOL

Dept. D345 Drexel at 58th Chicago

BE A CARTOONIST

AT HOME IN YOUR SPARE TIME UNDER personal supervision of the famous cartoonist **NORMAN MARSH** creator of "DAN DUNN" appearing every day in big papers. Success—Fame—Real Money may be Yours when you learn Marsh's easy simple methods and secrets. Send name and address for free details of **MARSH'S Personal course. ACT TODAY!**

MARSH CARTOON SCHOOL
4554 Broadway Dept. C-100 Chicago, Ill.

TRAIN FOR Radio IN 12 WEEKS

BY SHOP WORK
I'll Finance Your Training

Prepare for jobs in Broadcasting, Talking Pictures, Television, Wireles, etc., by 12 weeks practical shop training in Coyne Shops. Free Employment Service. Many earn while learning. You don't need previous experience or a lot of book learning. Write for **BIG FREE RADIO AND TELEVISION BOOK**, and my "Pay-Tuition-After-Graduation" Plan.

H. C. LEWIS, Pres., RADIO DIV., Coyne Electrical School
500 S. Paulina Street Dept. 39-3H Chicago, Illinois

JOBS in RADIO-TELEVISION

Extension and resident training in television, aviation and police radio. Let us tell you how we train men, fit them for good jobs, help them get jobs. Write for catalog. Affiliated with **KMBC**, major network station. Address **MIDLAND TELEVISION, Inc., 106-C Power & Light Bldg., Kansas City, Mo.**

do-it-with-squabs



Ready for market **ONLY 25 DAYS OLD**. Write a post-card, get **FREE EYE-OPENING Picture Book**. Why breed for ordinary trade when these great **luxury** national markets are **wide open** for all the **SQUABS** you can ship, every day in the year? Go after this desirable, profitable trade now.

RICE FARM, 636 H St., Melrose, Mass.



Best Poultry Paper 6 BIG ISSUES 10¢

Helps increase Poultry Profits. Send coin or stamps. 50 cents for 3 years or 10 cents for 6 months trial. Agents wanted. **American Poultry Journal**
632 So. Clark Street Chicago, Illinois



WINTER FARM RELIEF!



Here's farm relief no farmer can afford to be without—**EN-AR-CO** (Japanese style) OIL. Stimulates local circulation for the relief of pains of **Neuralgia, Sprains, Sore Muscles, Fatigue and Exposure**, also the discomfort of **Head Colds and Bronchial Irritation**. **EN-AR-CO** has been doing it for over 50 years. Best insurance against a crop of troubles. Get **EN-AR-CO** today and get your quick pain relief. All Druggists.

NATIONAL REMEDY CO. MADE IN U.S.A. NEW YORK

INVENTORS



Look Ahead

THIS is the time of year when ambitious, forward-thinking men look ahead, lay plans for the future that may mature into profitable reality. Last year the record-playing attachment for radios became a reality and sold like "hot cakes" at a low popular price. Women's clothes

were almost revolutionized by the introduction of the "house coat." The "electric nurse"—a guard against kidnappers—hit the market with a bang. Portable air-conditioners went up in value, down in price. The gearless hydraulic transmission has become a practicality. Farmers saved thousands of dollars with electric fencing.

Every year brings new inventions. There will be more in 1939. Smart men will plant the seeds of invention into the fields of industry, and reap the harvest when it is ripe. So do your spring "idea planting" early.

Where We Can Help

"Planting," as you know, is not all there is to it. It takes watering, weeding, thinning, and pruning to make things grow right. Here is where we can help you: Through more than forty years—good times and bad—this organization of experienced searchers, expert patent draftsmen, skilled patent attorneys, and faithful clerical employees has helped inventors at every step. Our prompt and skillful service has taken literally thousands of crude ideas—many of them sketched with a pencil stub by the light of an oil-lamp—and marched them through the final, formal grant of a United States Patent.

The minute your letter of inquiry, or coupon, comes to this office, a highly trained group of 40 men and women—occupying nearly the whole floor of a big office building—swings into action to serve you. Fees can be arranged.



Look Here

Many Small Ideas May Have Large Commercial Possibilities

The man who tinkers for years with a big industrial machine, costing thousands of dollars, isn't necessarily the most successful inventor. Think today of markets in the mass . . . of a hundred million people spending nickels and dimes for matches, safety pins, soap dishes, can openers and other household necessities. Think of something NEW and BETTER that the millions will want. **LOOK AROUND.** See what they're buying at Woolworth's, Kresge's, Walgreen's. Look around your own home, your own neighborhood. Often a small, practical invention is worth more than a complicated machine.

Get These FREE Books

These illustrated Free Books tell you real facts: How the patent laws protect you. Why you need the protection of a U. S. Patent. What a competent, registered patent attorney can do for you. What kind of sketch or model is needed. How to make a proper disclosure in order to establish your claims. How some successful inventors have secured financial assistance. They show 115 different mechanical principles. These books may help you. Send today. They come to you without cost or obligation.



Look Around



VICTOR J. EVANS & Co.

REGISTERED PATENT ATTORNEYS
MAIN OFFICE: 112-C, VICTOR BUILDING
WASHINGTON, D. C.

Other Offices: 514-N, Empire Building, Pittsburgh
405-N, Garfield Building, Los Angeles
1010-N, Hobart Building, San Francisco

Gentlemen: Yes! I'm looking ahead, going to look around, and I want to look at your Free Books at once. Please send them by return mail to—

Name

Street and No.

City or Town..... State.....

PATENTS

Booklet Free Highest References
Promptness Assured Best Results

Send drawing or model.

ALL BUSINESS GIVEN PROMPT AND PROPER ATTENTION

Listed Patent Lawyer in the latest editions of the Rand-McNally Directory of Bankers and Bank-Recommended Attorneys, published by Rand-McNally & Co., Chicago, Ill.; The Baggott & Ryall Directory of Guaranteed Attorneys, published by Legal Directory Corporation, Boston, Mass.; American Lawyers Annual, Cleveland, Ohio; Bankers Service Legal Directory, published by Bankers Service Co., Boston, Mass.; Eyre's Law List, 9 Park Place, New York City; Snow-Church Directory Co. Lawyers List, published in New York City, and the Central Guarantee Co., Bankers and Lawyers Directories, 630 Fifth Avenue, New York City.

WATSON E. COLEMAN, Victor Building, 724 Ninth Street, N. W.
REGISTERED PATENT LAWYER **WASHINGTON, D.C.**

INVENTORS PATENT YOUR IDEAS SEND FOR FREE BOOK



HOW TO OBTAIN A PATENT

Written by a Former Member of the Examining Corps (1922-24) of the U. S. Patent Office. If you want to profit by your idea, you should take steps to apply for a U. S. Patent at once. Your first step is to get this Free Book. This interesting illustrated book contains valuable information you should have. It tells you fully how to obtain a patent on your idea in the quickest way. With this Free Book you will also receive a "Record of Invention" form on which you can easily record your idea. Personal and Confidential Service: Your case will be personally handled only by a Registered Patent Attorney who is also a Former Member of the Examining Corps of the U. S. Patent Office. All communications confidential.

MAIL COUPON TODAY for FREE PATENT BOOK and RECORD OF INVENTION Form.

CARL MILLER

REGISTERED PATENT ATTORNEY
FORMER MEMBER EXAMINING CORPS U. S. PATENT OFFICE

Woolworth Bldg., 35th Floor, Dept. 39A, New York City
MILLER BUILDING, Dept. 39A, Washington, D. C.

Please send me your Free Book, "How to Obtain a Patent," and your "Record of Invention" form.

NAME.....

ADDRESS.....

New Ideas now Salable Before Patenting

Practical, useful inventions may now be safely marketed without patenting expense. Write for proof that we successfully sell both patented and unpatented inventions.

Chartered Institute of American Inventors
Dept. 4, Barrister Building, Washington, D. C.

PATENTS—TRADE MARKS

All cases submitted given personal attention
Form "Evidence of Conception" with instructions
for use and "Schedule of Government
and Attorneys' Fees"—FREE!

LANCASTER, ALLWINE & ROMMEL
Patent Law Offices

412 Bowen Bldg. Washington, D. C.



G E A R S

In Stock — Immediate Delivery

Gears, speed reducers, sprockets, thrust bearings, flexible couplings, pulleys, etc. A complete line is carried in our Chicago stock. Can also quote on special gears of any kind. Send us your blueprints and inquiries.

Send 10c for Complete Catalog No. 10

CHICAGO GEAR WORKS
769-773 W. Jackson Blvd. CHICAGO, ILL.

INVENTORS PROTECT & SELL

Your unpatented invention can be sold with positive safeguards under patent laws. New, low-cost procedure. Complete details, free.

AMERICAN PATENTS CORPORATION
Dept. 4-E Washington, D. C.

INVENTORS

who derive largest profits know and heed certain simple but vital facts before applying for patents. Our book, Patent-Sense, gives those facts; sent free. Trade Marks—Copyrights.

LACEY & LACEY, Est. 1869, 635 F St., N. W., Dept. 5, WASHINGTON, D. C.

ALBERT E. DIETERICH

THEODORE H. RUTLEY

REGISTERED PATENT LAWYERS
512 B Colorado Bldg. WASHINGTON, D. C.

Booklet on Patents sent free



Send for Catalog Today

BUCHSTEIN'S FIBRE LIMB

is soothing to your stump—strong, cool, neat, light. Easy payments. Braces for all deformities. Agents wanted.

D. BUCHSTEIN CO.
610 3rd Ave., So., MINNEAPOLIS, MINN.

RUPTURED?

Get Up-To-Date Relief

Why try to worry along with old-fashioned trusses that gouge your flesh—press heavily on hips and spine—enlarge opening—fail to hold rupture? You need the Cluthe. No leg-straps or harness. Automatic adjustable pad seals opening—follows every body movement with instant increased support in case of strain. Cannot slip. Holds rupture whether at work or play, easy to wear. Waterproof. Can be worn in bath. Send for amazing FREE 100-page, cloth-bound book "Advice To Ruptured" and details of liberal truthful 60-day trial offer. Also names of grateful patrons in your neighborhood. Write today. Cluthe Sons, Dept. 31, Bloomfield, New Jersey.

To PROTECT YOUR INVENTION Use this coupon, NOW

Delays are dangerous and may be very costly. My personal service assures prompt action, strict confidence, and a minimum of expense. I suggest that you send me a model or drawing, or sketch and description of your invention, and \$5.00. I will make a search and report

promptly as to its patentability and send you a copy of my 72-page booklet. Or, if you prefer to read my booklet first, mail the attached coupon at once. I will also send my "Record of Invention" form. (Over 38 years experience as a Registered Patent Attorney.)

L. F. Randolph, 302-D Victor Bldg.,
Washington, D. C.

Please send me at once, free of charge, your 72 page booklet and "Record of Invention" form.

Name.....

Address.....

A PERSONAL CONFIDENTIAL PATENT SERVICE

C. A. SNOW & CO. IS ONE OF AMERICA'S OLDEST PATENT ATTORNEY FIRMS

INVENTORS!

These **FREE BOOKS**
Give You Useful, Practical
PATENT FACTS

These books will save you time and money—and tell you:

If you have already constructed a device, or merely have an idea on paper . . . now is the time to give it the protection you have the right to enjoy. Your first step is to send for these free booklets. They contain pertinent information based on our 64 years of experience in obtaining patents for thousands of people everywhere. These books will be sent to you free of charge, and without obligation. They show you just how to proceed, and the value of a patent to protect you if other inventors are working on the same idea.

- How to obtain a patent . . .
- How you can commercialize your patent . . .
- Why you need a patent . . .
- Correct way to proceed and costs . . .

**Protect Before You Sell—
We Help You With Both!**

The entire organization of C. A. Snow & Co. is at your service—ready to give you immediate, confidential advice. Now is the time to find out IF your idea can be patented . . . if not, you save time and money in developing your idea. If our search reveals your idea is patentable—you should protect it at once. We also offer you suggestions on how you can sell your idea and realize a profit. Get these Patent Facts now . . . tear out and mail coupon.

C. A. SNOW & CO.

Registered Patent Attorneys Since 1875

139 Snow Building, Washington, D. C.

Yes!

Send me free copies of your books, "How We Protect You" and "Suggestions on How to Commercialize your Invention." Also send original "Certification of Invention" form.

Name.....
Address.....
City or Town.....
State.....

This is our 64th Year!



"BECOME A LIGHTNING TRICK CARTOONIST"
Make money Chalk Talking. Send \$1.00 for Laugh Producing Program of 23 Trick Chalk Stunts. Illustrated Catalog 10 cents.
BALDA ART SERVICE, Dept. T-2, Oshkosh, Wis.

EARN THE DEGREE
Doctor of Psychology (Ph.D.), Philosophy, Divinity. General Course—Arts, Secretarial, etc. A Correspondence Institution Chartered by State of Washington. Send for 32-page FREE Bulletin at once. No Obligation.
Temple Bar College, Dept. 3-R, 1620 Thirteenth Avenue
Seattle, Washington, U.S.A.

TRAVEL - for 'UNCLE SAM'

RAILWAY POSTAL CLERKS
Men 18 to 35
\$1900 First year regular
MANY OTHER GOVERNMENT JOBS
Common Education Usually Sufficient
\$1260 to \$2100 First Year
MEN—WOMEN
Mail Coupon immediately—today sure.

**GET A
U. S. GOVERNMENT
JOB**



COUPON

FRANKLIN INST., Dept. H195, Rochester, N. Y.
Gentlemen: Rush to me, without charge, 32 page book with list of U. S. Government big paid positions obtainable. Advise me also regarding salaries, hours, work, vacation, etc. Tell me how to qualify for a position.

Name.....
Address.....

Learn AVIATION

Come to **LINCOLN** Aviation is booming!



Huge expansion program calls for thousands more trained men. **GOOD SALARIES PAID.** Many make \$2000 to \$7000 a year. **Big-Pay opportunities open for more Lincoln Trained Men.**



TRAIN NOW AT THIS GOVERNMENT APPROVED AVIATION SCHOOL

Prepare here for your official Government Ratings and a good-pay position as Pilot, Mechanic or as Aeronautical Engineer. Learn to fly our fast, modern airplanes; to overhaul and rebuild airplanes and airplane engines; help design and build new, advanced-type airplanes.

HERE'S YOUR BIG OPPORTUNITY to get into Aviation. Our Graduates taking good positions. Part-time employment for board and room while in training. We assist Graduates in locating positions.

MAIL COUPON for complete information.

LINCOLN AIRPLANE & FLYING SCHOOL
563 Aircraft Bldg., Lincoln, Nebraska

I'd certainly like to get into Aviation! Please send me complete information about Lincoln Training.

Name..... Age.....
Address.....
City..... State.....

Diesel... the NEW POWER



The amazing performance of the Diesel powered Burlington Zephyr trains has opened a new era of power efficiency. Airplanes, automobiles, great industrial plants will soon be using these marvelously efficient engines. This means a new profession, a new trade for thousands of men. Learn Diesel operation, construction and repair NOW through our brand new quick reference encyclopedia, the only complete encyclopedia on Diesel Engineering.

6 Big Books Shipped FREE

for examination. If you want to get into the most promising new field of the century, the liveliest, most up-to-date, most talked of profession, send for these books on our amazingly free shipment offer. Over 2,000 pages profusely illustrated and right up to the minute. Examine these books, read them, test them and if not thoroughly satisfied return them at our expense and you won't owe us one cent.

Brand New 1939 Edition

This brand new 6 volume edition of Diesel Engineering is the last word in Diesel information. Brought right up-to-date by a group of prominent engineers, makes it the final authority for beginners and experts alike. Six large volumes, handsome, durable binding, 2500 pages, covers Diesels from theory to design, electricity and its application through diesel power, in fact, all related subjects to help you master this NEW, BIG PAY profession.

AMERICAN TECHNICAL SOCIETY,
Drexel at 58th Street, Dept. 0319, Chicago, Illinois.
You may send me the new 6 volumes on Diesel Engineering for ten days free examination. I will pay the few cents express only. Will examine the books and return them in ten days unless I decide to keep them, in which case I agree to send you \$2.00 in ten days and \$3.00 a month until the introductory price of only \$24.80 is paid.
Name.....
Address.....
City..... State.....
Please attach a letter giving age, occupation and the name and address of your employer and that of at least one business man as reference.



New LACO Oil Heater

Low as \$23.50

One of the best-heating, most durable oil heaters in LACO history! No basement needed, installs like a stove. Has self-coats and tank, easy heat-regulator. Featured with LACO's famous Two-Stage Double-Flue burner, capable of developing tremendous heat, and LACO's Inner-Heating Unit that utilizes utmost of the heat. Quiet. Beautiful.



At the right is LACO's Pressure-Type fuel oil burner. Designed by L. A. Cocklin, one of the industry's most successful builders. New simplicity, new fuel economy. Greatly improves the value of your home.

WRITE direct to factory for new illustrated booklet giving complete details, illustrations and unusually low dealer prices of LACO Heaters and Burners. Send NOW!



LACO OIL BURNER CO. 139 Union Ave. Griswold, Iowa

MAKE MONEY with your CAMERA

Thousands of publications buy MILLIONS of photos yearly from amateurs. We show you what to photograph, how to do it, where to sell for biggest profits. Learn at home to become a journalistic or press photographer. Use any camera in easy installments. Pay for course in FREE BOOK. Write for FREE BOOK. UNIVERSAL PHOTOGRAPHERS, Inc., Dept. 73, 10 W. 33rd St., N. Y. C.

FREE BOOK CATALOG

We publish books on more than 100 practical, technical and scientific subjects—including air conditioning—automobiles—aviation—Diesel Engines—electricity—formulas—machinery—model making and other mechanical subjects. Sent on request to any address by The Norman P. Henley Publishing Company, 2 West 45th Street, New York City, N. Y.

INVENTORS:

GET MY NEW FREE BOOK. Use my personal, confidential patent service. Send for free facts on patenting your invention. Also suggestions on financing a patent application. Reasonable fees. Deferred payments arranged. Write HUGH E. McMORROW, Registered Patent Attorney, Dept. 309-B, Barrister Building, Washington, D. C.

RADIO COURSE

PREPARED FOR HOME STUDY

The only low-priced home-study course in practical radio servicing. Prepares you quickly for a good pay job in Radio. Includes everything about radio, amplifiers, television, and transmitters. Practical data only, easy to understand, covers latest facts from fundamentals to advance work. More than 300 large 8 1/2" x 11" pages. Greatest value in Radio training. Limited quantity. Special price, \$1.95, postfree.

\$1.95
COMPLETE COURSE
300 Pages
400 Illustrations
Size: 8 1/2" x 11 in.
GUARANTEED

SUPREME PUBLICATIONS
3727 W. 13th St., Chicago, Ill.

CARTOONING

To those earnest students of this fascinating profession who realize the advantage of PERSONAL INSTRUCTION by a nationally known cartoonist, I offer a system of study recommended by America's foremost cartoonists. It's as near like private tutoring as is possible in a home study course. Write at once for free details.

DORMAN H. SMITH, Box C597, San Rafael, California

PHOTO-ENGRAVING TASOPE SINCE 1931

TASOPE, world's largest builders of complete Photo-Engraving Plants. We supply newspapers, printeries, studios, colleges, high schools and individuals with precision-built equipment, and give thorough training in Photo-Engraving and Photography, (home or residence)—all at one low cost! Cash in on popularity of pictures. Big money working full or part time for others, or open your own well-paying business. Amazingly small investment. Cash or terms. Catalogs free.

THE AURORA SCHOOL OF PHOTO-ENGRAVING
Dept. PM-2 Tasope Bldg. Aurora, Mo.

NEW INVENTIONS

(Continued from page 20A)

HANDY for the storage of food or liquid containers, an arrangement for building a cabinet into the back of the automobile's front seat has been patented.



The cabinet has doors for protection of the stored bottles and other containers. A large door, closing the central compartment, may be raised to horizontal position to form a table. Locked in this position, it may be used for serving a meal on the road, or perhaps for a game of cards, writing or similar purposes.

Greater control over the beam of a flashlight than in ordinary hand lamps is claimed by the inventor of an adjustable reflector. The reflector is supported by a U-shaped bracket, the supporting arms of which are adjustable longitudinally. Thus, the reflector may be adjusted from a position covering the lens of the flashlight to a position parallel to the light beam. Rays from the lamp may be directed by this means as the user desires.

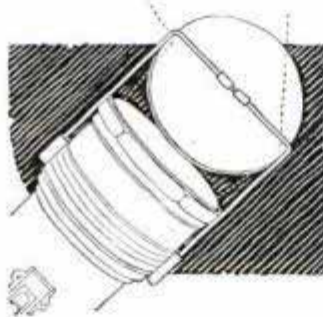

AMONG the additions to water sports equipment is an amusement device consisting of a flat float board which may be propelled by the user. The device is designed so that the user sits in a chair-like portion of the float, with his body below the water and his head extending above the surface through a hole in the board. Paddles by which the board is propelled are operated by levers worked by the hands.



(Continued to page 54A)

More **GOOD JOBS** in **DRAFTING** NOW!

Calls for Draftsmen Are Increasing! Want-ads prove it. Steel mills—railroads—buildings—all are "on the up" . . . all are calling for Draftsmen. New fields like Air Conditioning and Diesels join in the call—"Give us more trained DRAFTSMEN." Some who read this advertisement will do nothing. **Others, smart enough to realize this means Opportunity, will Send A Post Card or Mail the Coupon for Free Trial Lesson.**



This Complete Drawing Outfit, Tools and Table sent to Chicago Tech Home-Study students in Drafting.

The draftsman's work comes first. When business improves . . . and it is improving . . . there is new construction work, new buildings, new machines, repairs and reconstruction work. All these must first be laid out on paper. So the FIRST man that must be hired is the DRAFTSMAN.

Drafting is Well-Paid Work

Drafting is clean, interesting professional-type work. It pays well to start . . . offers real opportunities for promotion. You need no previous training or experience . . . no special talent—to learn Drafting. It is one of the steadiest employment fields. No machine ever did the Draftsman's work . . . and no machine can be invented. So your job is always secure.

Learn at Home in Spare Time

(or at the College in Chicago) by the fascinating, easy, step-by-step plan originated by this 35-year old school for Draftsmen. This is the way thousands of successful men started their careers. Begin yours without delay . . . terms are low . . . and we help you to a job when ready. Send now for

TRIAL LESSON in Free DRAFTING

Sample this easy-lesson system of learning Drafting. Send post card or this coupon. No charge now or later for this **FREE LESSON**. Prove to yourself how easy it is to learn Drafting by the C.T.C. Method.



C-200 Tech Bldg., 118 E. 26th Street, Chicago, Illinois.

Please send me **FREE Trial Lesson in DRAFTING** and show me how I can prepare for good positions in spare time **AT HOME**.

Name.....Age.....

Address.....

P. O.....State.....



DRAFTING

BOOKS SENT FREE!

ON APPROVAL

5 VOLUMES BRAND NEW EDITION

Only 15 minutes a day with these WONDER BOOKS can prepare you for a good drafting job in less than a year. Mechanical and architectural drafting from simple straight lines to important complex plans. *A step at a time!* Built especially for beginners, for men with only grammar schooling. Drafting room practice, PLUS ENGINEERING, made easy and clear. Includes complete information on blue print reading for building and machine trades.

Big Field Big Demand Big Pay

Competent draftsmen are urgently needed right now in all building and manufacturing lines at \$30.00 to \$75.00 a week. That's just the beginning—FOR DRAFTSMEN HAVE THE BEST CHANCES FOR ADVANCEMENT. Pleasant, fascinating work, easy to learn and do. Learn quickly with these books—send coupon for a set and see for yourself.

A year's consulting membership in the American Technical Society now given to all readers of this famous cyclopedia of drafting. Many say that it is worth more than the cost of the books.

Complete set of drawing instruments if you send for these drafting books NOW. These instruments are made of the finest of German silver, are absolutely accurate and are packed in velvet lined leatherette pocket case. Real \$10 value, but included with these books.

AMERICAN TECHNICAL SOCIETY
Dept. D319, Drexel at 58th St., Chicago, Ill.

For Beginners or Experts

Written, so you can understand every word, by 22 well known engineers and architects. De-Luxe flexible binding, nearly 2,000 pages, 1546 blueprints, charts and diagrams; prepares you for a good drafting job in mechanical or architectural lines. Sent for 10 days' free use if you mail coupon immediately.

These Instruments Included



American Technical Society, Dept. D319, Drexel at 58th St., Chicago, Ill. Send for 10 days' trial New 5 volume set of drafting. I will pay the few cents delivery charges. If I wish, I may return books in 10 days and owe you nothing but if I decide to keep them, I will send \$2.00 after 10 days, then only \$3.00 a month until \$24.80, the advertising price, is paid. Send latest edition and include drawing instruments and Membership Certificate.

Name.....
Address.....
Attach letter stating age, occupation, employer's name and address and that of at least one business man as a reference.

WIRING

VOL. VII AUDELS NEW ELECTRIC LIBRARY—A MASTER BOOK ON WIRING
728 PAGES, 1200 ILLUSTRATIONS. \$1.50

House and Power Wiring
Diagrams—Problems and Calculations

fully explained in clear practical language, easy to use and understand including helps and hints for all electrical workers that will save time, trouble and money.

AUDELS NEW ELECTRIC LIBRARY—
A progressive Home Study and Reference Course in applied electricity. Easy to understand. Questions and answers plainly written for a complete working knowledge of modern electrical practice, necessary to every electrician, engineer, mechanic and student.

LEARN THE AUDEL WAY! You ask the question—Audels New Electric Library gives the answer—3500 simplified outlines, graphic illustrations and precise explanations covering Construction, Operation and Machine Maintenance.

BOOK A MONTH PLAN—Order the volume that interests you—today! We will send that volume on 7 days' free trial. If the book helps you, send us \$1.50. If it does not help you, mail book back to us.

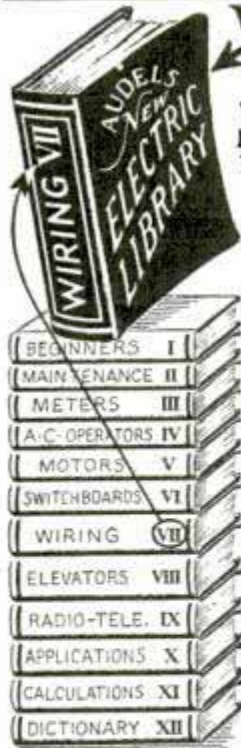

FREE EXAMINATION COUPON

Theo. Audel & Co., 49 W. 23rd St., New York City
Mail Vol. VII on 7 days free trial. If O.K. I will remit \$1.50 otherwise I will return it. Also please send further information about the Electric Library—no obligation unless I am satisfied.

Name.....
Address.....
Occupation.....
Reference..... PM

When writing please mention Popular Mechanics

PARKS AIR COLLEGE

PARKS AIRPORT EAST ST. LOUIS, ILL.

Offers YOU COLLEGE and PROFESSIONAL TRAINING
Majoring in AVIATION

Accredited by the Illinois Superintendent of Public Instruction. U.S. approved as a Commercial Ground and Flying School and Mechanics' School. Open to high school graduates.

FOUR courses lead to B.S. degrees in Professional Piloting, Aviation Operations, Maintenance Engineering, Aeronautical Engineering.

SIXTEEN TRAINING PLANES are used in professional flight training which prepares graduates for airline flight operations. 74% of graduates enter air transportation in North and South America. 69,000 hours flight training given, 650 hours being flown monthly.

FACULTY of 34 specialists in various fields of aviation. 1569 graduates. Enrollment limited to a total of 300. 100-acre airport, 14 buildings devoted to school purposes exclusively. Dormitories and dining hall at the College.

Spring Term March 27. Send postcard for new 60-page catalog.

12th YEAR REGISTRAR, DEPT. PM-3
PARKS AIR COLLEGE, East St. Louis, Ill.

SEVEN WONDERS of the WORLD

FREE

Pictured in FULL COLOR—Each 7 1/2 x 10 1/4". Send only 10c to cover mailing costs. The wonders you have longed to see, reconstructed from recent discoveries and painted by famous artists, so you can view them at the height of their glory and read their stories. 24 page booklet. Educational! Entertaining! Mail 10c to

WM. H. WISE & CO., Dept. 563, 57 West 47th Street, New York City.

New York Established 1902
Electrical
Ask for free booklet **School**
44 West 17th St., N. Y. C.

STUDY ENGINEERING AT HOME

From A Chartered Institution of Higher Learning

Home Study Courses leading to Degrees in Electrical, Civil, Mechanical, Drafting, Architectural, Automotive, Steam, Diesel, Aeronautical, Radio, Structural, Mining, Industrial, Highway, Petroleum, Marine, Refrigeration, Air Conditioning, Chemical Engineering; Arts; Sciences; Philosophy; Education; Public Health; Psychology; Sociology; Physics; Chemistry; Geology; Pol. Science; Theology; Law; Agriculture; Business Training; Accounting; Statistics; Adv.; Sales. Founded 1908. Chartered McKinley-Roosevelt Graduate Colleges, 4220 Clarendon Ave., Chicago

TOOL & DIE MAKING DESIGNING

Machinists Trade. Not a correspondence course. Practical shop training in the world's industrial center. Write today for full information.
NATIONAL SCHOOL OF MECHANICAL TRADES
Dept. 104 628 W. Lake St. Chicago, Ill.

Yes! YOU CAN MAKE BIG MONEY WITH HOOVER UNIFORMS!

Big earnings for ambitious men and women in new uncrowded field with famous nationally-advertised Hoover line of smart, exclusive Uniforms for restaurants, fountains, hotels, taverns, stores, offices, doctors, dentists, etc. Not house-to-house. No experience—no money needed to get into this new, big-income business. Mail postcard now for beautiful new Uniform Style presentation, actual samples and money-making equipment—sent FREE.

HOOVER 251 West 19th Street
Dept. BJ-9 New York

Own A Profitable Greaseless DOUGHNUT BAKESHOP Start In Your Kitchen!

Who else wants to enjoy profits from this amazing new business you can start in your own kitchen? New electrical invention turns out delicious, different Brown Bobby Doughnuts. Everybody wants them! Stores eager to sell for you. Big daily profits possible selling production of one machine at wholesale only. We supply equipment and tested money making plans. This is your chance. Send No Money. Rush postcard for FREE details.

BROWN BOBBY CO., 620 N. Michigan Ave., Dept. D-183 CHICAGO, ILL.



**John made \$42⁵⁰
in one day
in his NEW
Business**



● Get Into This Business Now —

a business which is so new that it is practically without competition. This alone should enable you to make really **BIG MONEY**. Hotels, homes, clubs, office buildings offer tremendous possibilities. Our new **DETERGER** washes upholstered furniture, electrically right in your customer's home, with a new soapless soap whipped into **DRY** suds. *No liquid touches the fabric*, therefore the furniture is ready for use soon after cleaning. We have helped hundreds of men get into business for themselves with our automatic equipment. The U. S. Government and many of the world's largest hotels use our machines.

Make Money the FIRST DAY

The Deterger is ready to use when you receive it, so you ought to be taking in big profits the first day. We want an honest, ambitious man in every locality. If you are that man we will help you get started for yourself in a business with tremendous possibilities.

No Rent to Pay You don't have to rent a shop. You don't have to hire a building, for you do the work right in your customer's home. You save the expense of carting furniture back and forth to a central plant; the owner's home is your workshop.

Want a Career in photography?

Big opportunities to make money! Train at Home or in our completely equipped studios. Commercial, News, Portrait, Advertising, Natural Color, Motion Picture and other branches of photography. Famous experts will be your teachers. 29th year. Send for Free booklet. **NEW YORK INSTITUTE OF PHOTOGRAPHY**
10 West 33 St. (Dept. 49) New York City

WANT A STEADY TOP PAY JOB?
I TRAIN YOU QUICKLY • PAY ME LATER!

Learn a trade Easily, Quickly: Auto, Aviation, Diesel Mechanics, Collision, Body, Fender Repair, Auto Painting, Gas, Arc Welding. Write At Once!

Why spend your life hunting low-pay jobs—**TRAIN** for a steady one with top wages and promotion opportunities! McSweeney expert, **PRACTICAL** training puts others on top—let it do the same for you. Low tuition rate, pay after learning.

FREE! Big, FREE book gives facts on quick way to big pay jobs. Write to nearest school **TODAY** Dept. 10-3.

McSWEENEY TRADE SCHOOLS
Detroit, Mich. or Kansas City, Mo.

CARTOON YOUR WAY TO SUCCESS!
DON'T COPY - LEARN TO ORIGINATE!

RAYE BURNS will teach you **HOW** to **CREATE ORIGINAL CARTOONS** at home that you can **SELL!** Course has 26 lessons and 600 illustrations. **\$2⁸⁵**
Send name and address for free details. Only...

RAYE BURNS SCHOOL, Dept. M, Box 2194, CLEVELAND, OHIO

Correspondence Courses in RADIO and ELECTRICAL ENGINEERING **LOW AS \$25**

ELECTRICAL ENGINEERING. Get good grasp of wide electrical field. Modern. Very understandable. Theory made easy.

RADIO ENGINEERING. Extra fine course in radio, public address, photo-electric work. Trains you to be super-service man, real vacuum tube technician. Tuition ONLY \$25, either course. Deferred payment plan. Experiment kits furnished.

Write for free copies of school catalogs, student magazines, etc.

FREE LINCOLN ENGINEERING SCHOOL, Box 931-P3, Lincoln, Nebr.

J. S. Corson says

"I cleaned seven living room sets and fourteen chairs, as well as twenty-five automobile interiors the very first month and made \$279.50." Berger Hanson wrote "My investment in your **DETERGER** was the wisest I have ever made. It is my most valued asset." Barrett says: "Made \$28.00 in eight hours, on another job made \$11.00 in two and one-half hours." Alex Gulkin's business expanded so fast that he already has **SIX DETERGERS** making money for him.



No liquid touches the fabric when cleaning with the **DETERGER**.

Pay as you Earn

Only a limited amount of money is needed for a down payment. The balance you send on easy terms. Most men find it possible to make far more than the cost of the machine before the payments come due. Every machine is fully **GUARANTEED** and satisfied customers send their friends to you.

Book sent FREE

Write today for copy of our booklet "Your Own Business, Profits Instead of Wages." Let us tell you how easy it is to get started in a year around business where you are your own Boss and can stop worrying about just a job. Write today—**NOW**.



VON SCHRADER MFG. CO., 553 Pl., Racine, Wis.

VON SCHRADER MFG. CO., 553 Pl., Racine, Wis.

Send me (without obligation) your free booklet telling me how I can own my own business and become financially independent and how I can pay for the **DETERGER** on easy terms.

Name.....
Address.....
City..... State.....

AVIATION Practical Aviation Instruction for the layman, and for the pilot, for the mechanic, and for the ground-school instructor. The transport license method of specialized aviation instruction, published since 1930. Write for **FREE** circular.

THOMPSON AVIATION PUBLISHERS
8326 Woodward Detroit, Mich.



The Hobby of Hobbies
for Young Men and Old Men----

Yes, the ace of hobbies for Young and Old. You will think so too, after you have finished your first piece of **WOODCRAFT** ...

It's an absorbing hobby. Throughout your life, you can make lovely livable furniture, also lamps, bookends, etc. Start with saw, plane, hammer or a \$1.98 scroll saw outfit.

1939 **10¢**

And a Money Maker

The 1939 Craftsman's new catalog No. 12 is a veritable storehouse of up-to-date facts for Woodworkers.

Write for this Book

EXPERTS: You **NEED** this catalog and buyers guide; keep posted and up-to-date!

BEGINNERS: special detailed directions on "How to Start."

CRAFTSMAN WOOD SERVICE CO., 2733A S. Mary Street, Chicago, Ill.

I enclose 10c (stamps or coin) for which please send new 1939 Bargain Catalog No. 12 for Woodworkers.

Name.....
Address.....

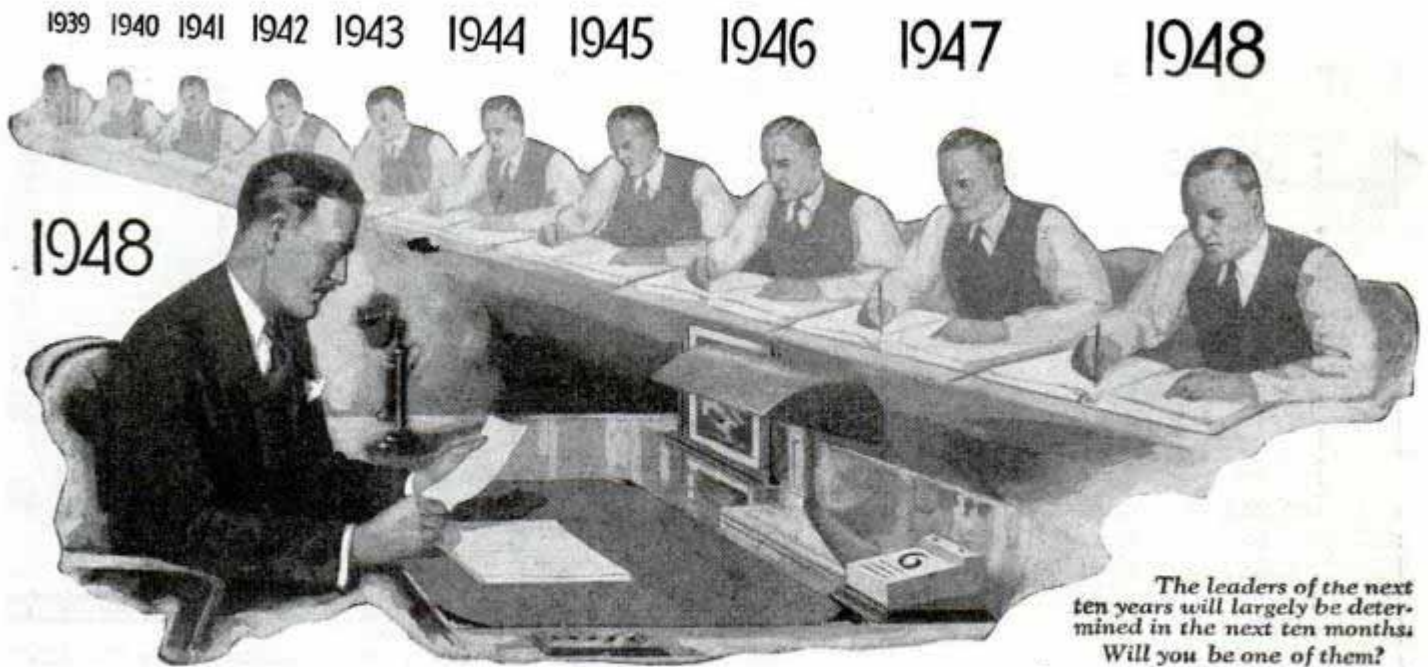

Will You Be Clerk or Manager Ten Years from Now?

"SURELY, this could never happen to me," you say—"that I should be sitting at the same desk—be doing the same work—for ten straight years!"

But wait a minute—

Exactly that same thing has happened to thousands upon thousands of men. It has probably happened to men right in the company you now are working for. And—unless you fit yourself for a better job—there is a very good chance that it may happen to you!

Unthinkable? That's what J. N. Dixon of Columbus, Ohio, said to himself. Yet lack of training kept him slaving away at low wages for a long time.

TRIPLES INCOME

Here is Mr. Dixon's own story—"Just after I returned from the war, one of your representatives found me plugging away at a bookkeeper's job in Marietta, Ohio. He performed a real service and explained to me the need of further training, and induced me to take the LaSalle training in Higher Accountancy. After a few months of study, I secured a position with the Trust Department of a National Bank. This was the stepping stone I needed to various responsible positions including handling of receiverships and other important duties. That quickly boosted my income several hundred percent."

ANOTHER AMAZING SUCCESS STORY

If you think Mr. Dixon's success story too unusual read what J. H. Krouse of Memphis, Tennessee, says. "When I decided to take your training in Higher Accountancy, I was a clerk. Today I am Chief Consultant Accountant for the U. S. Engineer's Office in Memphis, Tenn. Whatever success or recognition I have had, I owe to your training. I have had no other specialized training along this line. Your method of teaching is not only instructive but highly engaging. I have observed other courses, but firmly believe LaSalle has the best to be had anywhere."

Another bit of evidence is Mr. R. P. Barthalow's experience. Mr. Barthalow is Chief of the Sales Tax Section of the Tax Commission of Ohio, a department which handles over \$50,000,000 a year. Mr. Barthalow attributes much of his success to LaSalle training.

SEND FOR These Two Books and Start Toward Bigger Success

Need you hear more before you investigate the opportunities in Accountancy?

Or will you face the problem of your future NOW—and send to LaSalle and get further facts and particulars?

Without cost or obligation, the coupon will bring you two interesting books—one a 48-page book entitled "Accountancy, the Profession that Pays"; the other "Ten Years' Promotion in One."

How about those next ten years—will you wait or will you START TODAY to realize the tremendous opportunities that may lie ahead of you through sound and practical home-study business training?

Measure your grit and ambition by what you do with this coupon—NOW.

LaSalle Extension University A CORRESPONDENCE INSTITUTION

Dept. 364-HR CHICAGO

Opportunities in Accountancy—Check below and we will send you a copy of "Accountancy, the Profession that Pays," also copy of "Ten Years' Promotion in One," all without obligation.

Higher Accountancy: Leading to position as Auditor, Comptroller, Certified Public Accountant, Cost Accountant, etc.

Other LaSalle Opportunities: If more interested in one of the other fields of business indicated below, check that.

- Business Management
 Expert Bookkeeping
 C. P. A. Coaching
 Modern Salesmanship

- Traffic Management
 Law: Degree of LL. B.
 Industrial Management
 Modern Business Correspondence

- Stenotypy
 Business English
 Commercial Law
 Effective Speaking



Name Age

Present Position Address

**WORLD'S
BEST
WANT AD
MEDIUM**

CLASSIFIED Advertisements



Advertisements in this section, 35 cents per word, each insertion, minimum 10 words, payable in advance

To be inserted under proper classification in April issue, copy should be in our office February 8th

April issue on sale March 1st

Popular Mechanics Magazine, 200 East Ontario Street, Chicago, Illinois

YOU'LL PROFIT

By reading and answering the classified ads in this section. Hundreds of opportunities to make and save money.

Mr. F. W. Johnson,
Popular Mechanics,
Chicago, Illinois

Dear Mr. Johnson: I am enclosing another check for \$7.00 for my advertisement to run in the November, 1938 issue. Kindly run this same advertisement in every issue through the May issue. As an advertiser for the past 15 years, I find the cost per reply in the Popular Mechanics less than any other medium. Not only this, but the customers secured through your magazine are better "spenders."

Very truly yours,

W. B. KESSEL.

(Original letter on file in our office)

AUTOMOBILES—MIDGET CARS

CAN You test a used car? "Ingenious Used Car Tips" shows how. Send 50c to Box 49, Station Y, Brooklyn, New York.

AUTOMOBILE Mechanics who want business or earn extra money write for samples and details of nationally distributed self locking Triplex piston rings. Eliminate re-boring. Guaranteed life of car. Franchises valuable. Some territories open. Triplex, 2261 South Union, Dept. N, Chicago.

MOTORIST—New rings or rebore unnecessary. Motor Reconditioner Tablets does the work. Buy them from our authorized dealers. New dealers wanted everywhere. If no dealer is available, order yours direct, postpaid C.O.D. W. S. Anderson Products, Dept. A. 493, 4th St., San Francisco, Calif.

GARAGES Need tire repairman. Positions open. Profitable business. Six lessons home or shop teaching. Process Vulcanizing School, Eagle Pass, Texas.

GAS Saver—Wiper hose installation. Postpaid dime. Motor Specialties, Box 8849, Wilkensburg, Penna.

MIDGET Two-passenger autos, midget racers, midget motorcycles, motorscooters, motors, wheels, parts, plans. Handbook catalog, illustrations, 20c coin. Midwest, Box 1959, Chicago.

MIDGET Cars, parts, plans. Priced right. Catalog 20c. Derby Midgets, Woodstock, Illinois.

R & R Mfg. Co., Anderson, Indiana. Racing cars, midgets and speed equipment. Catalogue 25c.

1938 IGNITION Supercharger. Quick starting, wet or cold. Mileage, pep, power, less carbon. \$1.25. E. G. Sales Co., 321 Broadway, New York.

BUILD This powerful inexpensive supercharger for any car. Adds up to 8 horsepower. Complete plans 30c. Box 623, East San Diego, Calif.

ALUMINUM Alloy pistons, automotive, aviation, Diesel, industrial, marine, midget, model, motorcycle, outboard. Finished or semi. Judson Mfg. Co., Hedge and Gillingham, Philadelphia, Penna.

FORD V-8's, 1934-1938; gasoline saving device. \$1. Walert Co., 3429 No. 10th St., Milwaukee, Wisconsin.

MIDGET Plans, parts, kits. Catalog, 10c. Lists 100 used motors, midgets, parts, 20c. Details free. Shipp's Midgets, Box 543-H, Zanesville, Ohio.

TRIPLE Any car mileage performance. Up to \$15 day servicing. Send one dollar for easy guaranteed method. Carburetor Motor Company, Box 596, Wichita Falls, Texas.

AUTO TRAILERS

BUILD The famous, low-cost Jim Dandy Cabin Trailer. Complete plans and instructions 50c. Plans to build the beautiful, streamlined Jim Dandy Cabin Cruiser, \$1.00. Trailer Builders Manual and catalog of trailer parts, supplies and equipment—over 100 interesting, illustrated pages, 25c. Order today. Satisfaction guaranteed. Trailer Supply Co., 411-A Jackson St., Wausau, Wisconsin.

TRAILER Guide—Instructions, plans for building. Complete listing parts, supplies, showing prices. Send 25c today. A. J. Stephens, Kansas City, Mo.

POPULAR Mechanics "Family Trailer," complete illustrated plans for building in Shop Notes for 1937 only 50 cents postpaid. Popular Mechanics Press, Room (C38), 200 E. Ontario St., Chicago.

AUTO SUPPLIES AND EQUIPMENT

RE-REFINE Crankcase drainings, request information. Zebball, Mount Holly, N. J.

A STAMP And quarter for idea worth \$50.00 to garage and service stations. New Ideas, 407 Van Horne, Muscatine, Iowa.

BARGAINS—Compressors, welders, battery chargers, car washers, attractively priced. Terms, trial. Write for bargain list. Hobart Automotive Supply, Box M-395, Troy, Ohio.

FREE Wholesale bargain catalogue, auto supplies, equipment, tools, American, 1189 Bedford Ave., Brooklyn, N. Y.

BUILD Half inch drill from automobile starter. Plans one dollar. Imperial Garage, Clarkson, Ontario.

REFINE Used oil without cost. Particulars, F. Gerwin, Fairview, Oklahoma.

RECHARGE Batteries chemically without electricity. Harmless. Formula 50c. S. Dunn, Box 214, Middletown, Ohio.

PISTONS And rings for autos, trucks, tractors, motorcycles, airplanes, outboards, Diesel. Betterway Company, Minneapolis.

NEW! Your automobile stop light becomes a stop guide. Attach Seco behind your speedometer quickly. Makes your stop light flicker according to how fast or slow you stop. Introductory price \$1.00. State car and year. Smith Engineering Co., 197 Brunswick Blvd., Buffalo, N. Y.

PLATING Outfits for auto parts. Connect to a battery. No tanks used. Free particulars and proofs. Gunmetal Co., Ave. J, Decatur, Ill.

ACETYLENE Welding outfits, \$32.95; electric welders, \$74.95. Easy-payment plan. Box 331, Hamilton, Ohio.

MOTORCYCLES, BICYCLES, MOTOR SCOOTERS AND SUPPLIES

HARLEY-DAVIDSON Used parts for sale. Make us an offer. 514 E. Grand, Des Moines, Iowa.

SEND 15c For illustrated used motorcycle catalog. Bargains. Largest stock genuine Indian parts and motorcycles. Indian Motorcycle Sales, Kansas City, Mo.

MOTORCYCLE Bargains, lowest prices, bargain sheets for stamp. Motorcycle accessories. Rochester Harley Davidson Corp., 129 W. Main St., Rochester, N. Y.

HI-LIFE Bicycle generators operate lights direct or charge miniature Kie-O storage battery. Write Kimley, 1271 E. Ferry, Buffalo, N. Y.

NEW Revolutionary outboard motor for bicycles, small cars. Complete with hanger, pneumatic tire. Request literature. Richardson Company, Aurora, Missouri.

BUILD Power scooters, midget cars. We supply tires, wheels, motors. Lowest prices. Send 10c for plans, etc. Bild-Ur-Own Devices, 5238 Lake, Chicago.

3 WHEEL Gasoline scooter with 2 speed transmission. Blue prints \$1.25. R. Harter, New Castle, Indiana.

MOTORS, Tires, wheels, etc. for building scooters and midget cars. Low prices. Literature and motor scooter plans 10c. Honsaker, Masontown, Penna.

PARTS And accessories. Send 10c for Motorcycle Manual, Bootz, 622 East Grand, Des Moines, Iowa.

INSIDE Dealer prices. Overstocked, all models. Indians and Harleys. Rebuilt, guaranteed. Dime brings latest list. Crandall-Hicks, Boston, Mass.

ALLOY Pistons—Harley, Indian, Henderson, Excelsior, Cleveland. New and used parts for less. Cylinder grinding. Catalogue and wings pin 10c. Ballak, 1115 Chestnut, St. Louis, Mo.

RECONDITIONED Motorcycles. New—used parts for all makes. Authorized Harley-Davidson dealer. Whitman Motorcycle & Supply Co., 405-9 Southwest Blvd., Kansas City, Mo.

AVIATION

AVIATION Needs men. Pilots, mechanics, draftsmen, sheet metal, positions open. Learn now. Free catalog. California Flyers School of Aviation, Dept. PMC-3, Los Angeles Airport, Inglewood, California.

PROPELLERS For sleds, aircraft. Catalog 10c. Banks Propellers, Love Field, Dallas, Texas.

FLY In Chicago at the strategic center of the greatest flying activity. Primary and advanced instruction. Free booklet. Midwest Flying School, 4500 W. 83rd St., Chicago, Ill.

AVIATION Apprentices — Airminded young men interested in training for entering aviation as apprentices see ad on page 14A.

HOW To learn flying without money. Folder, dime. Corrigan, Box 391, Hempstead, N. Y.

100 AIRPLANES \$35 Up. Located everywhere. Terms, trades. Complete catalogue 25c. Used Aircraft Directory, Athens, Ohio.

PRACTICAL Course in flying. Twenty-nine chapters, illustrated, complete. Only \$1.00. Aircraft Directory, Athens, Ohio.

GET into aviation—Airline pilots get up to \$700 a month; mechanics, \$200; aeronautical engineers, \$400. Prepare now at this Government Approved School. Write for complete information. Lincoln Airplane & Flying School, 2004 Aircraft Bldg., Lincoln, Nebraska.

PROPELLERS For airplanes, sleds. Ice-lesed blueprints, supplies. Catalog dime. Lorenzen Propellers, Niles, Michigan.

GRADUATE Airplane mechanic. Ten weeks. \$1.00 week. Graduates with leading concerns. Free catalog. United Air School, Elgin, Ill.

PROPELLERS—All types, including latest three blade airliners. American Flea Special \$12.50 down. Universal Aircraft, Ft. Worth, Texas.

A. C. GENERATORS

PRACTICAL Changes for automobile generators. See our advertisement at bottom of page 124A. Autopower.

BATTERIES, GENERATORS, ETC.

PLATING Generators and motor generator sets. Write for information Hobart's new line electro plating equipment. Payments low as \$12.40 monthly. Quality machines, quick delivery guaranteed. Hobart Bros., Box M-392, Troy, Ohio.

LOOK! 32v 650 Watt "Electra" wind-chargers \$35. Super-efficient Aerodynamic propellers. "Electra" wind generators. Factory prices. Big electrification manual free. Kubat Mfg., St. Paul, Minnesota.

BUILD Your own windcharger. Cost 98c for material plus used car generator. Copyright instructions 10c. Wesco, 452 Terminal, Minneapolis, Minn.

PROFIT—Rebuilding batteries. Make your own plates. Information 25c (coin). Partico, Box 82, Glendale, Calif.

GENERATORS, Motors, alternating and direct current. Bargains. Electrical Surplus, 1885 Milwaukee Ave., Chicago.

EDISON Lifetime storage batteries for light and power. Eliminates acid battery diseases. Long guarantee. All kinds rebuilt generating plants, motors, and miscellaneous articles at bargain prices. Free interesting literature. T. Hawley Smith Co., Croton Falls, N. Y.

12 VOLT Heavy duty generators \$8.50. Save money on new, used automotive electrical parts; free catalog. State Ignition, 52 Cullerton, Chicago.

EDISON Storage batteries for light-power systems. Non-acid. Odorless, fifteen year life. Five year unconditional guarantee. Bargains in complete lighting systems. Low prices. Free illustrated literature. "Sec-Jay" Battery Co., 82 Sterling Ave., Yonkers, N. Y.

ELECTRICAL SUPPLIES—EQUIPMENT

BARGAINS—Arc welders, also motor generator. Write for new bargain list telling needs. Hobart Bros., Box M-397, Troy, Ohio.

ELECTRIC Eye \$1.00. Electric eye book 50c. Literature, catalog 10c. Photobell, Dept. 85, 96 Warren, New York.

EXHAUST Fans, new, 22" steel frame and shutter, \$50 value, complete \$22.50. Niederst Co., 700 E. 41 St., Chicago.

MAGNET, New alloy, lifts 50 times own weight \$1.00. Advance, 861-P4, Minneapolis, Minn.

ELECTRIC Engraver, engraves all metals deeply, dollar. Hudson Bros., East Syracuse, N. Y.

ULTRA Violet—Infra red. Dual ray health lamp. Two separate units in one. Promotes sun tan—vitamin "D". Automatic control. AC-DC current. \$3.90 postpaid. Details, Beyer Mfg. Co., 4515-P Cottage Grove, Chicago.

ELECTRO-SCRIBE: Electric pencil writes, engraves all metals. \$1.00 postpaid. Details, Beyer Mfg. Co., 4515-K Cottage Grove, Chicago.

WELDING AND SOLDERING

75-200 AMPERE Arc welders from Dodge generators. Complete plans 35c. 100 other generator changes. LeJay Manufacturing, 347 LeJay Building, Minneapolis, Minn.

DODGE Arc-welder, 25-125 amperes, 0-40 volts d.c. (Two Dodges 25-200) built from North-East 12 volt automobile generators without rewinding armature. Plans \$1.00. Welders Club of America, AB-3432 M-Mart, Chicago.

ALUMINUM Solder, guaranteed a genuine metal bar \$1.00. American Laboratories, Box 6, Chicago, Illinois.

ARC-WELDING Supplies — Wholesale prices. Agents wanted. Welders Club, AB-3432 M-Mart, Chicago.

DEMONSTRATORS, Electric arc welders. Money-saving prices. Used by the government. Trial and terms guaranteed. Hobart Welders, M-393, Troy, Ohio.

44 "LESSONS In Arc-welding" 50c. Welders Club, AB-3432 M-Mart, Chicago.

OXYACETYLENE Welding and cutting and 359 other informative articles in Shop Notes, Vol. 32, only 50c postpaid. Popular Mechanics Press, Room (C38), 200 E. Ontario St., Chicago.

ARC-WELDER 25-600 Amperes d.c., 0-75 volts, built from d.c. vehicle motors. (No rewinding). Plans \$1.00. Welders Club, AB-3432 M-Mart, Chicago. For sale: New and used d.c. vehicle motors.

REBUILT a.c. d.c. Arc welders, all sizes; engine governors, idlers. Terms. Low prices. Guaranteed. Service Co., 3732 Cedar Ave., Cleveland, Ohio.

DELCO Arc-welder, 25-200 amperes d.c., 0-75 volts, built from Delco 32 volt light plant. (No rewinding.) Plans \$1.00. Welders Club, AB-3432 M-Mart, Chicago.

BLUEPRINTS For powerful 110v. a.c. welder, \$1.50. Write for information. Marvelweld, Box 1156, San Francisco.

NEW Arc welder, Cheap. Free literature. Holgerson's Service, Canton, Kansas.

GENUINE Dodge arc-welder. (No rewinding.) Plans \$1.00. Welders Club, AB-3432 M-Mart, Chicago.

ENGINES, MOTORS, DYNAMOS

NEW Split phase 1/3 h.p. motor. Guaranteed two years. Double drive shaft. Built-in starting switch. New departure ball bearings. Every part is extra strong. 110-120 volt, 60 cycle ac., 1750 rpm. Only \$8.95 plus 65c postage. Address Dept. D93, Sears-Roebuck, Chicago.

BARGAINS—Plating generators, motor generator sets, also arc welders. New low prices for large and small shops. Trial—easy terms if desired. Hobart Bros., Box M-396, Troy, Ohio.

GOVERNORS For auto engines \$5 up. Candee-Smith, 445½ E. 3rd St., Los Angeles.

5 KVA Alternators \$125.00; also larger sizes. Motors, generators. Queen City Electric, 519 South California, Chicago.

BARGAIN—½ Hp. motors, 60 cycle, 1 phase, 110 volt, like new, guaranteed, \$7.40. Send check to Erie Electric Motor Co., 120 Church, Buffalo, N. Y.

300 MOTOR Diagrams and tables covering three phase; Star, Delta, nine lead, two and four speed; two phase; single phase; split phase, capacitor, repulsion induction, fan, armature windings, etc. Satisfaction guaranteed or money refunded. \$1.50 prepaid. Educational Advancement Company, Lakewood, New York.

REWIND Washing machine motors, auto generators, make a.c. welder. Each book \$1.00. 10c brings particulars, catalog winding materials. Ernest Knight, LaSalle, Ill.

MOTOR Winding lessons, illustrated. Send stamp for particulars. Also motor data for experienced winders, introductory selection \$1.00. Motor Data Company, Box 7631, Kansas City, Mo.

BARGAINS: Electric shaver \$1.48; ¼" drill \$3.67; candid type camera \$1.89; motors, grinders, radios, clocks, appliances. Pricelist free. Mailorder Electric Co., 713 So. Dearborn, Chicago.

SMALL Elect. motors with flexible shafts, rebuilt \$3.25 postpaid. McConnell, 1619 Edgewood Ave., Racine, Wis.

ALTERNATING, ½ Horse, 110 volt, induction motors. Rebuilt, guaranteed, \$7.50. Wilmot Auto Supply, 2247 St. Paul Ave., Chicago.

MACHINERY, TOOLS AND SUPPLIES

FOR 9" South-Bend lathes. Milling attachments, universal movement, \$9. Threading dial indicator \$3; 6" four jaw chucks, \$9.50. Unique Manufacturing Co., 4807 North 31st Ave., Omaha, Nebr.

TREMENDOUS Surplus of factory tools selling out. Drills, taps, files, hacksaws, etc. Send for free lists, include six cents postage. Travers Tool Co., 264 Jackson Ave., Long Island City, N. Y.

ATTENTION! Experimenters, craftsmen, inventors: You need this giant ten pound hardware kit. Big box full of screws, nuts, washers, gears, springs, rivets, brackets, etc. Over 1000 parts—price \$1.49—worth \$7.50. Guaranteed satisfaction. Manufacturers Screw, 221-B West Illinois, Chicago.

TAPER Attachment fits any So. Bend 9" lathe, \$10. Milling attachment for workshop lathes, \$9.00. Prepaid U.S.A. Circular free. Alexander Machinery Co., 1516 Webster St., Omaha, Nebr.

BARGAINS, Demonstrators, electric arc welders, guaranteed, 30 days trial and terms. Write Hobart Welder Exchange, Box M-394, Troy, Ohio.

COMPRESSORS, Single cylinder, 100 lb. \$6.00. Edison universal double shaft motors, \$2.00. Powerful G. E. 15 volt transformers, \$2.00. All sizes Edison storage batteries. Pioneer Air Compressor, 120 Chambers St., New York City.

250 POPULAR Sizes of cap and machine screws, stove bolts, nuts, washers, rivets, etc. Standard and S.A.E. threads. Assortment would cost \$2.50 retail. My price \$1.00 delivered in U.S.A. Money back if not satisfied. H. Sackmann, 76 W. Exchange St., Akron, Ohio.

AIR Compressors, new 1¼x1¼, \$6. 2x2 \$7. 2½x2 \$8. Guaranteed. Send check or money order. National, 560 Washington, Chicago, Ill.

PLASTICS, Brass, aluminum, monel, stainless steel, gears, etc. Catalog 10c. Hobby Supply House, Box 2014, Pittsburgh, Penna.

14" x 6" GREAVES Klusman cone head engine lathe, quick change, No. 0 Cincinnati miller, cheap. Write for particulars. Cincinnati Machinery & Supply Co., 221 E. Second St., Cincinnati, Ohio.

BOATS, OUTBOARD MOTORS, ETC.

USED Outboard motors, all makes. Stamp brings list. Used parts, propellers and accessories. 50% list price. Outboard Headquarters, 305 Atlantic Ave., Boston, Massachusetts.

ELECTRIC Outboard from old automobile generator operates with car battery. Smooth—quiet. Plans 10c. LeJay Manufacturing, 547 LeJay Building, Minneapolis, Minn.

BUILD Your favorite boat by the Welch System. Its inexpensive; interesting and profitable. Everything for building, equipping or repairing your boats. Use Welch Ready Cut Parts. Send 10c for catalog showing boats of many types; boat hardware; propellers; marine paints; sails; boat finishing materials and Welch White Cap marine motors. Welch Boat Company, Station K-1, Milwaukee, Wisconsin.

BUILD Your own boat with our pre-fabricated frames and materials. They're different. Save 2/3s and costly mistakes. Send requirements for quotations. Illustrated catalog 100 boats, 10c. Bay City Boats, Inc., Bay City, Mich., 1552 Adams St.

ASSEMBLE Your own boat. Our finished knock-down frames and materials save you 2/3 builder's cost. All types and sizes. Send 25c for big catalog. Brooks Boat Co., Inc., D4, Saginaw, Mich.

BOAT Blueprints and full size paper patterns, priced 50c up. Wide selection. Cruisers, runabouts, sloop, snipe, outboard boats, etc. Designed by leading naval architect. Rush 10c (coin) for illustrated catalog. Cleveland Boat Blueprint Co., Station A-66, Cleveland, Ohio.

OUTBOARD Motor. Assemble your own. We furnish complete kit with instructions for 1.2 h.p. \$27.50. Or any part separately. Parts list catalogue 10c. Guaranteed product for troll fishing or pleasure use. Outboard Headquarters, 305 Atlantic Ave., Boston, Massachusetts.

OUTBOARDS — Save ½. Good used parts, all makes and models. Bargains rebuilt motors. Crandall Hicks Co., 959 Commonwealth, Boston, Mass.

FORD Marine conversion parts and kits. Models A, B, V8 (domestic or foreign). Catalogue 25c (coin). Osmitson, 3644 No. Lawrence St., Philadelphia, Penna., U.S.A.

12 FOOT Flat bottom rowboat, complete plans 25c. Free boatbuilding catalog. The Rudder, 15 Murray St., New York.

FORD-ZEPHYR Marine conversions. Catalog 10c. Lehman Engineering Company, Dept. D, Newark, N. J.

BOAT Designers are highly paid professionals. Complete course by mail. Catalog. Westlawn, Montville, N. J.

FIELD GLASSES, TELESCOPES AND MICROSCOPES

POWERFUL Binoculars. Guaranteed quality. \$3.50 postpaid. Southern Electrical Specialties, Temple, Texas.

ASTRONOMICAL Telescopes, binoculars, cameras, microscopes, bought, sold, repaired. Send 10c for list of instruments desired. Rasmussen, Box 294, Amsterdam, N. Y.

TELESCOPES—New, used, \$5.00 up; amateur kits, aluminizing, parts, accessories, mounts, books, maps, microscopes, binoculars, scientific instruments. Send 10c for catalog, interesting articles. American Telescope Laboratories, Department 21, Hollywood, California.

TELESCOPES, Microscopes, binoculars; 1939 bargain catalog free. Brownscope Company, 5 West 27th Street, New York.

BUILD Reflecting telescopes. 6" kit, \$3.50; other kits—all abrasives, mirrors, eyepieces, diagonals, illustrated instructions, 10c. Catalogue free. Optical Development Corporation, Dept. G, 1560 Broadway, N. Y.

TELESCOPES, Microscopes, chemistry, mineralogy. Scientific catalog free. Tracey Laboratories, Evanston, Illinois.

FREE Instructions. Build powerful telescope. Jamer, Box 94, Manorville, N. Y.

SPORTING GOODS, GUNS, FISHING TACKLE, ARCHERY

FENCING Equipment. Foils, swords, masks, etc. Low prices. Free catalog. Industrial Products, Dept. 23, 48 West 48th Street, New York.

FREE Catalog fly tying materials. Our specialty helping beginners. Work Fly Company, Pueblo, Colo.

BARGAINS! Gun catalog 5c. Fishing catalog 5c. Ski catalog 5c. J. Warshal & Sons, First and Madison-PM, Seattle, Wash.

SINKER Molds for making your own sinkers. Free illustrated folder. Reading Instrument Co., Box 78, Reading, Penna.

ARCHERY Headquarters—617 South State, Chicago. Catalogue free. Complete instruction book 50c.

HUDSON Bay blankets, Indian pack baskets, camp stoves, knives, compasses, outdoor equipment. Free catalog. Howe Fur Co., Box P, Coopers Mills, Maine.

ANTIQUES, RELICS, INDIAN GOODS

ARROWHEADS—Glacial boulder beauties, rainbow variations. Don McKillop, Regina, Sask.

ARROWHEADS. 100 Good or 60 fine, \$3.00. Catalog. George Holder, Glenwood, Ark.

SWORDS, Rapiers, daggers, pistols, armor catalog 6c. Abels, 860A Lexington Avenue, New York.

MAKE Your own Indian arrowheads. Illustrated booklet "How to Make Arrowheads" of flint, glass, etc. \$1.00. Indian Lore Publications, Green River, Wyoming.

100 GOOD Arrowheads \$3. Catalog. 5c. H. Daniel, Hot Springs, Ark.

INDIAN Relics, beadwork, coins, curios, minerals, old glass. Catalog 6c. Indian Museum, Northbranch, Kansas.

TAXIDERMISTRY

MODERN Taxidermist Magazine, Greenfield Center, N. Y. Crammed full with valuable taxidermy information. Three sample copies 25c.

TAXIDERMISTRY Supplies—Quality artificial eyes, teeth, genuine Jonas head forms. Tools, materials, etc. Everything for the progressive taxidermist. Send 10c for big illustrated catalogue. Jonas Bros., 1049 Broadway, Denver, Colo.

DOGS, PETS, BIRDS

SELLING St. Bernard puppies! Good ones. Registered. Fine pictures, information free. Manitou Kennels, Watrous, Sask., Canada.

STANDARD Rabbit Journal, Milton, Penna. Year 50c, sample dime. Supplies.

BEAUTIFUL Pure white police dogs. Ansonia Kennels, Mose, N. Dak.

MINKS, Squirrels, raccoons, foxes, ferrets, muskrats, skunks, wolf pups. Tippman, Caledonia, Minn.

BIRDS? Get American Canary Magazine monthly. Year, \$1.00. 2839-P North Halsted, Chicago.

POULTRY AND FARM SUPPLIES

MORE Profit in your grain fed to poultry. Brightest prospects in 10 years. Write today for catalog, and complete price list on 21 breeds, chickens, turkey poults and ducks. Special—Day old Leghorn pullets before March 15th only \$12.40—100. Dubois County Hatchery, Box 912, Huntingburg, Ind.

IMMEDIATE Delivery on Reds, Barred, Buff, White Rocks, Wyandottes, Orpingtons, \$7.90—100. White, Buff, Brown Leghorns, Anconas \$7.45—100. Sexed chicks 90% accuracy guaranteed, \$3.50—100 and up. Write for complete low price list and catalog. Salem Hatchery, Box 81, Salem, Indiana.

GREENSBURG Bloodtested chicks for broilers and layers. Immediate delivery on Barred, White, Buff Rocks, Reds, Wyandottes, Orpingtons, \$7.45—100; White, Buff, Brown Leghorns, Anconas, \$6.95—100. Sexed chicks, heavy breed pullets, \$9.95—100; cockerels \$9.95—100. Leghorn pullets before March 15th, \$12.95—100; after March 15th, \$15.45—100; cockerels \$3.50. Greensburg Hatchery, Box 40, Greensburg, Indiana.

SEYMOUR Chicks for broilers and early layers. Our prices are always at rock bottom. Write us before you buy chicks. Get our free catalog, and prices on turkey poults and ducks. Special—Leghorn day-old pullets \$12.45—100 before March 15th. Heavy breed pullets or cockerels \$9.95—100. Seymour Hatchery, Box 36, Seymour, Indiana.

5 ALL-EXPENSE Trips to World's Poultry Congress. Write for contest rules and free catalog telling how to make money with Davis chicks. Tom Barron day old Leghorn pullets \$12.90—100 till March 15th. Unsexed Barred, Buff, White Rocks, Reds, Wyandottes, Orpingtons, Minorcas, \$8.45—100. Write for complete price list. Turkey poults and ducks. Davis Poultry Farm, Route 34, Ramsey, Indiana.

CUSTOMERS Report raising 95% Australwhite chicks, two pound broilers at seven weeks, laying pullets at four months, healthier, disease resistant, big money makers. Catalogue free. Parkin Hatchery, Box 85, Shawnee, Oklahoma.

FREE Sample poultry magazine. Twelve issues 25 cents. Unexcelled. Poultry Item, Sellersville, Penna.

SEXED And sex-linked chicks. 6 popular hybrids; 52 purebreds. Large new book free. Mrs. Berry's Farm, Route A, Clarinda, Iowa.

LOW Factory prices on electric brooders, batteries, parts, wire fabrics, etc. Free 76 page catalog. Bussey, 5151 West 65th, Chicago.

HEADQUARTERS—World champion layers. We imported 353 - 361 - 364 egg contest hens from Australia - New Zealand. Free educational catalog shows customers profits. Osborne Farm, Box 70, Holland, Michigan.

MAKE Money with poultry. Read America's leading poultry magazine for latest information. Three years \$1.00; nine months 25c. Poultry Tribune, Dept. E-93, Mount Morris, Ill.

CHICK Raisers make extra money selling our chicks to neighbors. Write Jackson County Hatchery, Box 19, Seymour, Ind.

TREES, SHRUBS, ROOTS, HERBS

MAMMOTH Canadian pansies. 100 seeds 25c. Box 342, Sherbrooke, Que.

JUST Out! World's greatest "Herbalist Almanac." Beautifully illustrated in natural colors. Contains over 200 old-fashioned herb medicine recipes for home use. 10c postpaid. Worth dollars! Botanic, 145 W. 112th St., Chicago.

GINSENG Growing instructions 10c, seeds reasonable. Truth about frogs 10c. Specialty Farm, Rockford, Minn.

FARMS AND FARM LANDS

FARMS That pay in the Great Northern Railway agricultural empire, Minnesota, North Dakota, Montana, Idaho, Washington, Oregon. Fertile black soil, high production crops, grain, fruit, vegetables, feed and livestock. Many kinds of farms for selection. Write for book on state you prefer. E. C. Leedy, Dept. 357, G. N. Ry., St. Paul, Minn.

CANADIAN Tax sale lands for a dollar an acre and up. Small monthly payments. Farms, timber, hunting and fishing camps, minerals. Limited number of properties. Write at once for free illustrated booklet. Tax Sale Service, Room 613, 72 Queen St. W., Toronto, Canada.

NEW! Strout's catalog—Farms, rural business opportunities; this great 100-page bargain list free. Write today. Strout Realty, 255-P 4th Ave., New York City.

GOOD Farms available. Washington, Minnesota, Idaho, western Montana, Oregon. Dependable crops, favorable climate. Write for impartial advice, literature and list of typical bargains. Specify state. J. W. Haw, 119 Northern Pacific Ry., St. Paul, Minn.

40 ACRES, Near White River, unimproved; poultry land. \$175, \$5 down, \$5 monthly. Free list and literature. Hubbard, 216 Grossman Bldg., Kansas City, Kans.

FARM MACHINERY AND SUPPLIES

ALL Purpose tractors at factory price. Shaw 2 to 5 horsepower, riding or walking types. Does plowing, discing, harrowing, cultivating; mows lawns, cuts weeds, does hauling; runs belt machinery. Air or steel tires. Three speeds forward and reverse. Thousands in use. Write for free catalog and 10 day trial offer. Shaw Mfg. Co., Dept. PM3, Galesburg, Kansas.

NEW And used tractor parts at tremendous savings. Write for free 1939 catalog. Central Tractor Wrecking, Co., Boone, Iowa.

PROFITABLE OCCUPATIONS

HOW To earn money at home! Big, free book tells inside story—how hundreds are earning cash raising mushrooms in cellars, sheds. Cash paid for all raised. Write today. United, 3848 Lincoln Ave., Dept. 62, Chicago.

RAISE Rabbits for us. We pay to \$7.00 each. Catalogues 10c. Rabbitries, Bowling Green, Kentucky.

RAISE Guinea pigs. Make money. Thousands needed. We supply breeders and buy the young. Free illustrated book. Research Supply, 2436 W. York Street, Philadelphia, Penna.

MEN—Women, operate "Specialty Candy Factory" home, all or spare time. Steady income. (Our 29th year.) Hillyer Ragsdale, Inc., Drawer 62, East Orange, N. J.

BROADCASTING Industry pays highest wages! 25c for proof sheet, information on getting employment. Kennison, Augusta, Maine.

GROW Vegetables, flowers in water with our dry chemicals. Directions, chemicals \$1.00. Holland Plant Chemicals, 1519 Eggert Rd., Eggertsville, N. Y.

BALLGAMES, Movies afternoons. Work mornings home. Your own business. Stamford, 3762-A Broadway, New York.

RAISE Rabbits and cavies for us. We buy at top prices. Complete details in catalog, contract and magazine. 10 cents. Stahl, Box 1, Holmes Park, Mo.

MINK, Bred females, April delivery. Dime for general information. Lomman's Fur Farm, Spangler, Penna.

COUNTRY Drives or movies afternoons! Work mornings home. No canvassing! Folio-H. Station D, Los Angeles.

POSITIONS At sea. Details free. No employment agency. Julius, Amarillo, Texas.

OLD BOOKS WANTED

WE Pay up to \$5000 each for old books, also high cash prices for old magazines, letters, newspapers. A single story book, school book, old Bible, travel book, almanac, etc., that looks worthless may bring you \$50, \$100 or \$500 in cash. Thousands wanted. Send 10c now for latest price list. American Book Mart, 140 S. Dearborn, Dept. 2613, Chicago.

BOOKS, PERIODICALS, PICTURES, POSTCARDS

READ Good books. Widest variety, world-famous books. Best prices. Dime brings complete catalog. The Garden Publishers, 1110 N. Euclid, Indianapolis.

SPARE-TIME Subscription representatives for all magazines. Instructions, complete starting supplies; free. Pines, 583-A Monroe, Brooklyn, N. Y.

GAMES—ENTERTAINMENT

BINGO Games, all sizes, lowest price catalog. Warnovco, Conimicut, R. I.

PLAYS, Operettas, musical comedies, complete minstrel first-parts with song programs, blackface skits, vaudeville acts, monologs, dialogues, recitations, juvenile plays and songs, musical readings, entertainments, make-up goods. Catalog free. T. S. Denison & Co., 203 N. Wabash, Dept. 11, Chicago.

MAGIC TRICKS, PUZZLES, JOKER NOVELTIES

FREE Tricks! Join Magicians' Fraternity! Monthly magazine, sample 10c. International Magicians, Mt. Morris, Illinois.

GIANT Surprise catalog of magic, jokes, tricks, puzzles, novelties 10c (coin). Lawson Vick Co., Dept. P5, Queens Village, N. Y.

CLEVER, Wholesome puzzles, tricks, magic. Stamp brings circular. Ihsen, Box 24, Fairview, Penna.

BE A magician. Large professional magic catalogue of latest tricks 25c. Cash paid for complete Tarbell Magic Courses. Write, Ireland, C-109 North Dearborn, Chicago.

LEARN Ventriloquism, 3c stamp brings particulars. Smith, 125 N. Jefferson, Peoria, Illinois.

EARN Money in any crowd. Call names of strangers, tell unspoken questions. Professional course mind reading, spirit writing, etc., \$1. Henderson, Box 341, San Bernardino, Calif.

MAGIC. Earn while learning. Particulars for stamp. Browne, Box 272, Duluth, Minn.

WORLD'S Largest magic shop professional catalog, 25c. Holden, 220 W. 42nd St., New York.

BECOME A magician and earn extra money in your spare time. Send 25c today for your copy of our 168 page catalogue. This book is full of tricks for everyone, from the beginner to the professional performer. Established 1910. Chicago Magic Company, 2300 North Mason Avenue, Chicago, Illinois.

OLD STAMPS WANTED

WILL Pay \$100.00 for 1924 1c green Franklin stamp, rotary perforated eleven (\$1,000.00 if unused). Send 6c today for large illustrated folder showing amazing prices paid. Vernon Baker, 444PM-3, Elyria, Ohio.

STAMP COLLECTING

WHOPPER Packet 5c. Jubilees, ships, triangles, map, diamond, airmail, boy king, Vatican, Jhind, Siam, Iran, Iraq, Peru, Iceland, etc. 33 dandy stamps, only 5c with approvals. Dominion Stamp Company, Dept. P, Arlington, Va.

CANNIBALAND! Immense Gilbert Ellice commemorative, \$5 United States, Lillibrian Bongo antelope, mystery British Colony triangle (thrilling surprise!), fantastic Manchukuo mausoleum, breathtaking beauty from Cayman Islands, etc. This astounding packet of bizarre and intriguing stamps absolutely free to approval applicants enclosing 3c postage. Viking Stamp Co., 1-Z Hanson Pl., Brooklyn, N. Y.

U. S. Postage dues, 1/2c to \$5.00—15c; 35 common, 15c. Pauls Stamps, 4550 P3 North Mobile, Chicago.

FREE Stamp catalogue. Latest issue. Giant fifty-page quarterly, listing albums, supplies, Canadians, Newfoundland, United States, new issues, foreigners and pictorials. Fully illustrated! Empire Stamp Co., Dept. PM, Toronto, Canada.

FREE—\$1 U. S. stamp with request for 52 page list of United States and foreign stamps. Stamps on approval. References necessary. 20 different nineteenth century U. S. 28 cts. New Hussman Stamp Co., 1122 Pine, St. Louis, Mo.

PRODIGIOUS Package! Banana airmail, Perak, Selangor, "Green Cross" charity, Wurttemberg, Siberia, tiniest airmail, etc. 5c with approvals! Saxon Company, 408a Jay Street, Brooklyn, N. Y.

ASK For my 1/2 cent approvals. Olivio Alvos, Guadalupe, Calif.

A REAL Bargain. 200 all different foreign and 60 different U. S. stamps—our pamphlet on "How to Make a Stamp Collection Properly" and our big bargain list of sets, packets and album—all for only 18c. Queen City Stamp & Coin Company, Room 36, 604 Race Street, Cincinnati, O.

GAMBLE. Huge auction purchase broken into \$1.00 lots. Enormous value. Worldwide testimonials. Hughes, Queens Rd., Bournemouth, England.

50 DIFFERENT U. S. commemoratives, airmails, 15c. Approvals. Motzer, 1022 Liberty, Cincinnati, Ohio.

FREE Collection. 12 different Yugoslavia for names and addresses of three active stamp collectors if you ask for approvals. Reimers, 600 Flatiron, Fort Worth, Texas.

GIANT Packet 200 all different, from Africa, South America, Asia, South Sea Islands, etc. Includes world's smallest stamp, triangle and diamond-shaped stamps, animal stamps, Nicaragua Olympic "baseball" commemorative; and many others. Also packet 17 different United States (cat. 65c)—all obsolete, including \$5 denomination, commemoratives, etc. Total catalog value nearly \$5.00! All for 5c to approval applicants. Write to-day! World-Wide Stamp Co., Box 600, Camden, New York.

SELL Stamps: Salesmen (12 years up) earn cash commissions. Everglades Stamp Company, Halcyon Arcade, Miami, Florida.

NICE Premium with my penny approvals. Box 462, Youngstown, Ohio.

U. S. Stamps on approval. Nothing over 1c each. Lincoln Exchange, 173 Columbia Ave., Irvington, N. J.

NYASSA'S Bicolored camels, giraffes, zebras and Gamma's flagship (12), 15c. Approvals. Ruclare Stamps, Bradburn, Rochester, New York.

1000 WORLDWIDE Stamp mixture 25c. Monjar, 1542 Waverly, Cincinnati, Ohio.

ITALY—100 Different commemoratives for \$1 bill. Bayer, Giuria 33, Torino, (Italy.)

40 CHINA, Japan, premiums, lists, approvals, 10c. Northeast, Box 6618, Kansas City, Mo.

PICTORIAL Stamp approvals. Lacombe, 1800 W. Payette, Syracuse, N. Y.

ABYSSINIA To Azerbaijan—A countries, 50 different stamps with approvals 10c. Swan Stamps, 694 Swan, Dunkirk, N. Y.

FREE! 101 Stamps to approval applicants sending postage. Quality Stamp Shop, Englewood, Colorado.

THREE Beautiful triangle sets, 25 different, 5c. Approvals. Warden, Box 1961, Amarillo, Texas.

CANADA 30 Diff., 3 cts. with approvals. F. Lambert, Box 156, Fort William, Ont., Canada.

EXCHANGE Duplicates cat. over 3c. for same value attractive foreign revenues. Park, 589 Beacon, Boston.

CANADIAN Dollar stamp 5c with approvals. Atkinson, 2273 Souvenir, Montreal, Canada.

100 DIFFERENT Stamps 6c. 300—20c. Gunning, 8606 Woodhaven Boulevard, Woodhaven, N. Y.

FREE! Hindenburg Zeppelin airmails complete. Approval applicants. Riedell, Greensburg, Penna.

APPROVALS For beginners. Write United, 219 First Street, Claremont, Calif.

GOYA Nude, 5c with approvals. Jack Millhiser, 7724 Abbott, Pittsburgh, Penna.

WHOLESALE—Canada, Newfoundland. Fifty page illustrated wholesale catalog, featuring Canadians, Newfoundland, British Colonials, United States, supplies. Free. Empire Stamp Company, Dept. 5, Toronto, Canada.

FREE—The Stamp Finder! Our new 20 page edition, fully illustrated, which will enable you to instantly identify all difficult stamps. Also fine packet of odd and unusual stamps from Bosnia-Herzegovina, Monaco, Patiala, Cyprus, etc., including maps, ships, animals and strange scenes. All free to approval applicants including 3c postage. Garcelon Stamp Co., Box 900, Calais, Maine.

5 DIFFERENT Stamp sets 15c. Paul, 2216 Clinton, Berwyn, Illinois.

UNUSUAL Airmail bargain! In ten years Australia has issued only 5 airmail stamps, one of which was for the first official flight from Australia to London. This is No. 304 which catalogs used 35c and is one of the few commemorative airmail stamps issued anywhere. So beautiful and distinctive is this stamp that we have given it a deserved place in our almanac, "Famous Stamps and Their Stories" of which we have just published a second, enlarged deluxe edition—fully illustrated with over 500 outstanding stamps. We will send Australia 304 and 10 other equally attractive airmails for only 10c to serious approval applicants and also include a free copy of the almanac, which critics have pronounced the best work of its kind, having no peer for entertaining and instructive reading. Approval Headquarters, Globus Stamp Company, 268 - 4th Ave., New York City, Dept. 201.

WHOLESALE Approvals. Extraordinary discounts. References. Fuld, Dickmann Building, St. Louis, Missouri.

CZECHOSLOVAKIA—100 Different 19c. Approvals. Niederstadt, 4727 West Beloit, Milwaukee, Wis.

150 GOOD Mixed foreign stamps, 5c coin. Stanton, Niantic, Conn.

FREE—125 U. S. commemoratives with 600 mixed U. S. containing airmails, specials, dues, obsoletes for 50c. Humphrey, 310 Cloverleaf, San Antonio, Texas.

10 COMPLETE Sets including airmails 10c with approvals. Midwest Stamp Mart, 2241 East 71st, Chicago.

125 BETTER U. S. 10c: 500, 30c. W. Sloat, Washington, Iowa.

25 DIFFERENT South-American 10c. no approvals. Burkhart Stamps, Sandwich, Ill.

FREE! Set cataloging \$2.25. Approvals. Gramatan, Box 302P, Mount Vernon, N. Y.

TRIANGLES Free, approval applicants, 3c postage. Abell, 200 Cherry, Chelsea, Mass.

SENSATIONAL Packet! Ascension, Fiji Basutoland, Tanganyika, etc. 6c with approvals. Doty, 5032 So. Gramercy, Los Angeles, Calif.

EGYPT 15 Different 3c with approvals. Thorff Stamp Co., Box 77, Marion, Ind.

FIFTY Different U. S. 10c with approvals. BenKen, 2439 South Ninth Street, Milwaukee, Wisconsin.

OFFICIAL Postcard views World's Fair and world's largest bridges, mailed opening day; 3 different 25c coin. Oroc, 12-B Geary, San Francisco.

1000 MIXED U. S. only 25c postpaid. W. J. Deachman, Plymouth, N. H.

PIRATE'S Treasure. 100 different Caribbean stamps \$1.00. Ana Gray, Kingshill, Virgin Islands.

CLEAN, Interesting approvals at 50 to 80% discount, splendid value. Write today. John Stamp, 79 Holton, Montreal.

CLIPPERS, 1319, 1320, 1321; 50 cents coin. Hanington, Babylon, N. Y.

WHENEVER You want attractive foreign approvals, 1c up, write Mitchell, Box 23, Jersey City, N. J.

HINDEBURG Zeppelin, Spain nude duchess, 5c approvals. Shultes, Berne, N. Y.

MONTHLY Stamp and coin magazine, six months and 25 foreign stamps, 25c. American Stamp Journal, Cedar Rapids, Iowa.

U. S. No. 340, 25c with fine U. S. or foreign approvals. Vanderbilt, 7-P Mountain Terrace, Upper Montclair, N. J.

100 DIFFERENT Hungary 7c, approvals. Hazett, 701P Fourth Baycity, Mich.

TRY "Cent-Hi" penny approvals. Ransom, 1333 Pontiac, Ann Arbor, Mich.

100 DIFFERENT Air mails, triangles, diamonds, etc. 20c with approvals. Hays, South Gate, Calif.

FREE Packet with approvals. Hawthorne Stamp Co., 3221 So. 53 Court, Cicero, Ill.

1/5 CATALOGUE! Clearing out many years' accumulation general foreign, cataloging 5c up, in lots \$1.00 net and up. British Colonials included. Only fine stamps, no junk, no approvals. Send no money, pay postman. Mail card telling amount desired. Guaranteed. C. E. Bockmer, Geneva, N. Y.

SPANISH Miniature sheet free—Approvals. Crown Stamps, 12702 Stoepele, Detroit, Michigan.

TRIANGLES, Airmails, commemoratives, pictorials for ten cents to approval applicants. Pioneer Stamp Shop, 224 Main, El Monte, California.

30 DIFFERENT Angola, Cape Verde, Guinea, Portugal, Mozambique, St. Thomas and Prince 5c. Approvals. Depraw, Ocean Park, Calif.

FREE. U. S. \$1, \$2, \$4 and \$5 stamps. Unbeatable U. S. approvals. Nelson, 78 E. 5th St., St. Paul, Minn.

U. S. Approvals! Rock-bottom prices! 4745 South Aldrich, Minneapolis, Minn.

1000 MIXED, 25c. Well worth sorting for values. Plaza Stamp Co., Box 1161, Santa Fe, N. Mex.

UNITED States approvals! Bargain prices! Service! P. O. Box 822, Minneapolis, Minn.

TIPEX Sheets—1 each mint and used—25c. U. S. Approvals with each order. Regal Stamp Co., 3505 Aldine St., Philadelphia, Penna.

300 DIFF. Stamps only two dimes to approval applicants. World Stamp Co., Flint, Mich.

U. S. Constitution stamp of Ecuador, gorgeous six-color stamp showing U. S. flag in natural colors and George Washington, also Marvel packet 33 different including new Cayman Islands, Gen. Franco Spanish Morocco "war stamp" 60 yr. old Luxemburg, "bull-fight" stamp, largest diamond, tropical triangle, Chinese "midget" stamp, etc., all for 5c with approvals. Potomac Stamp Co., Dept. 103-D, Washington, D. C.

25 DIFFERENT Canada only 5c to approval applicants. York Company, Toronto 9, Ontario.

UNEXCELLED! Free packet, including Guatemala map, many scenic commemoratives, and select free 5c from approvals. Send 3c. Far Seas Company, Box 2154, Houston, Texas.

APPROVALS Of large and fine stamps that please. Benson Stamp Exchange, 2606 No. 60 St., Omaha, Nebr.

UNITED States approval headquarters. Send wants. George Davis, Webster, Mass.

FINE Approvals, freshly filled books and sheets. Tell me what you want and I will send it. Milton Skinner, 306 East Fourth, Long Beach, Calif.

BE A sport, take a chance, send a dime, see the nice 100 stamps I am sending approval applicants. Dime refunded if not satisfied. A. Anderson, 367 Fulton, Brooklyn, New York.

NEVER Offered before. 21 French Colonies, pictorials, sets of 5 each (105) for 35c. French, 241 Euclid, Cleveland.

PENNY Approvals, that satisfy. Neil Gronberg, Box 5441-P, Philadelphia, Penna.

SCARCE Nova Scotia 15c with approvals. References. Clowes, 892 Home, Winnipeg, Canada.

47 DIFFERENT Czechoslovakia. 3c to approval applicants. Pearce, 2833 N. W. 13th, Oklahoma City, Okla.

WEIRD Azerbaijan issue! Value 53c, only 3c. Lucky, 5018 Pernod, St. Louis, Mo.

SPLENDID Approvals—United States, foreign. Discounts. Lincoln Stamp Co., Shelbyville, Illinois.

BUILD Collections new novel way. Complete details, plan, sample packets, dime. Pacific Exchange, 1911 1st West, Seattle, Wash.

1000 MIXED U. S., 15c. 150 different, 75c. Lee, Bridgeport, N. Y.

FREE—\$1 U. S. stamp with request for 52 page list of United States and foreign stamps. Stamps on approval. References necessary. 20 different nineteenth century U. S. 28 cts. New Hussman Stamp Co., 1122 Pine, St. Louis, Mo.

AIRMAILS And commemoratives, 25 different, including Columbians, Panama-Pacific, Edison, Zeppelin, etc., only 5c with exceptionally fine United States and foreign approvals. Marco Stamp Co., Box 888, San Francisco, Calif.

3 PHILIPPINES With approvals 3c postage. McLoughlin, North Avenue, Meriden, Conn.

75% DISCOUNT. Send 25c, 50c or \$1.00, receive four times amount in stamps cataloging 3c up. Globe Sales, Box 505, Pontiac, Mich.

\$10 STAMP Free to approval applicants. Foote, 309 Greeley, Webster Groves, Mo.

STAMPS. A superb selection sent on approval. Quality at low prices. Fred Herzberg, Box 91-P, Elmhurst, Ill.

1857—1938 STAMPS At 1c and 2c each. Catalogue up to 10 times my prices. Ledue, Saint Petersburg, Florida.

HEADQUARTERS For United States. Send 50 cents and two references for 50 different, including scarce 572 and 573. Approvals included. Price lists on request. R. M. Stamp Co., Box 230P, Port Chester, N. Y.

FREE! 25 Japanese, inclose postage, request approvals. Secrist, Muscatine, Iowa.

FIJI (Scarce) included forty country mixture—100 stamps, 10c; 300, 25c. No approvals. Elsea, Bowling Green, Ohio.

GIANT Diamond-shaped stamp! Big packet 105 all different including Alexandra (new country), Congo, Manchukuo, Ecuador constitution, Costa Rica triangle, air-mails, commemoratives; giant diamond-shaped stamp, \$5 United States; set United States telegraphs, cataloging 30c. Packet British colonies including Burma (new country), jubilee and coronations; scarce sets 2 Siberia, cataloging 50c. Illustrated lists. Everything for only 5c to approval applicants! Write to-day! Mystic Stamp Co., Dept. 80, Camden, New York.

PANAMA Triangle and 50 others free to approval applicants sending 3c postage. Tatham Stampco, Springfield-30, Mass.

U. S. Approvals? Parks, used, complete 19c. Hubers, Palace Building, Minneapolis.

SPLENDID Estonia collection, 25 different, pictorials, semipostals, scarce imperf, only 5c. Imperial Stamps, G.P.O. 130, New York.

FREE—From every continent, 155 different, airmails, triangle, commemoratives, pictorials, many U. S. and others, with 1c approvals. Send 5c for postage and handling. Ace Stamps, Colonial Arcade, Cleveland, Ohio.

UNITED States illustrated looseleaf catalog, \$1.00. Send postage for free United States price list, precancel list. Stanley Gibbons, 38-P Park Row, New York.

300 DIFFERENT Stamps 20c; 600, 50c; 1000, \$1; 2000, \$3; 3000, \$7. Fred Onken, 630 79th St., Brooklyn, N. Y.

FREE, 50 Stamps, Iraq, etc. Postage 1c. Album 3c. Bullard, 268 Northampton, Boston, Mass.

FREE! Triangle airmail! Diamond! Pictorials! British Colonies! Wonderful packet 61 different (no Europe) 5c to approval applicants. Bargain Co., Box 39P, Times Square Station, New York.

SOUNDS Impossible! 120 different—Afghanistan, Azerbaijan, Zanzibar, triangle, diamond stamps; United States commemoratives, Civil War issue, \$2, \$5 high denominations; everything—5c. Abell's, 1818 St. Paul, Baltimore, Md.

U. S., Canada, Newfoundland, Mexico: "Four Star approvals." Nothing like them! Write today. 312 mixed U. S. only 10c. Kessels, Tucson, Arizona.

BEAUTIFUL Irish girls. Second set of souvenir stamps issued by Irish Hospitals' Trust Limited, Dublin. Specimen sheet of 20 stamps supplied free of charge to all writing to Mr. J. O'Sheehan, Department PM, 28 Earlsfort Terrace, Dublin, Ireland.

SMALL Sheet of 4 different triangles 10c to approval applicants. Victoria Stamp Co., London 4, Canada.

UNBELIEVABLE! 62 Different, six triangles and diamonds; airmail, animal, war stamps—China, Japan, Manchukuo, insurgent Spain; Asia, Africa, South Seas. Everything, 5c! Crowder's, 127E North, Baltimore, Md.

CANNON! Set of stamps showing cannon, firing squad, cavalry charge and 200 other different stamps, only 10c to approval applicants. L. H. Reich Stamp Co., 4647 Kenmore, Chicago.

FREE! Two coronation sets. Postage 3c. Roberts, 312F Shearerbig, Bay City, Mich.

UNITED States—45 different, perforation gauge, hinges, bargain pricelist—all for 10c. Seidenberg, Baroda, Mich.

FREE! "United States and British North America"—our valuable, complete, illustrated, 64-page catalog quoting lowest prices. Big illustrated list of foreign stamps also included. H. E. Harris & Co., 137 Transit Building, Boston, Mass.

200 DIFFERENT 10c. Big 50% approvals. Covert Stamp, 39 State, Rochester, N. Y.

50 DIFFERENT, Fine U. S. including perforation gauge, 10c with approvals. The Stamp Shop, 809 Holland Bldg., St. Louis, Mo.

BRAZIL, 50 Different 10c with bargain approvals. Davis, Silver Lake, Ind.

ASK For our wonderful one cent approvals. Prospect Stamp Co., 225 Broadview, Toronto, Canada.

WHOLESALE Catalog for dealers. Illustrated. Postage 5c. Frank Co., 4900 Chalmers, Baltimore, Md.

STAMP Dealers, your ad here will bring wonderful returns. Ask me for proof. F. W. Johnson, Manager, Classified Advertising, Popular Mechanics Magazine, 200 E. Ontario St., Chicago.

APPROVAL Sheets. One to three cents. Frederick B. Driver, 2009 Finance Bldg., Philadelphia, Penna.

25 UNITED States, including \$4 and \$5 stamps free to approval applicants, 3c postage. Brownie Stamp Shop, Flint, Mich.

WEEKLY Stamp magazine, thirteen weeks, 10c. Stamp Journal, Kalamazoo, Mich.

RARE COINS

GOLD Coins wanted, 40% to 50% premium. A. French, Route 1, Troy, N. Y.

OLD Money wanted. Will pay \$100.00 for 1894 dime, S. mint, \$50.00 for 1913 Liberty head nickel (not buffalo). Big premiums paid for all rare coins. Send 4c for large coin folder. May mean much profit to you. Numismatic Co., Dept. 20, Fort Worth, Texas.

BARGAINS! Rare collection of coins for sale. Containing: United States large copper cent over 80 years old, Flying Eagle cent, copper nickel cent, bronze cent before 1866, rare 1922 cent, 2c piece, 3c piece, half dime, Civil War cent, old Confederate bill, 5 different foreign coins from 5 different countries and our complete large catalog, all for only \$1.00 postpaid. Don't wait! Send \$1.00 now for this rare collection. Money refunded if not satisfied. 10 1914S cents \$1.00, 18 large cents \$1.00, 5 1924D cents \$1.00, 6 1931S cents \$1.00. Worthy Coin Corporation, 184 Summer St., Dept. 32, Boston, Mass.

50,000 COINS, Medals, papermoney. Lists free. Coinshop, 8P South 18th, Philadelphia, Penna.

SCRIP Coins, 15 different 25c plus postage. Box 787, Beckley, W. Va.

WANTED: Certain late U. S. coins, Album, information 10c. Kathan, Cornelius, Oregon.

25 DATES Indian head cents \$1. Stamp brings selling price list. Ramsay, 882 E. Market, York, Penna.

BRILLIANT 1938-S Uncirculated cent and list 10c. 3 different 25c. Landon, Box 1733 Wilshire, Station, Los Angeles.

CASH Premiums paid for 1200 different U. S. coins. Complete buying list 15c. James Randall, 407 South Dearborn, Chicago.

CERTAIN Large cents worth \$750.00; small cents \$12.00; nickels \$250.00; dimes \$300.00. Send 15c for latest 1939 complete 36 page illustrated buying book. American Coin Co., Box 3507-A, Cleveland, Ohio.

25 COINS 25c, 44 Coins, bills, tokens, 25c. Otto Oddehon, 44 Overland, St. Louis, Mo.

55 COINS, Bills, tokens, Eagle cent, 25c, 20 coins, 25c. Bishoff, 500 E. 8th, Kansas City, Mo.

COINS Bought: Will pay \$5.00 each for certain Lincoln pennies; Indianheads \$100.00; dimes \$700.00. Catalogue 10c. Federal Coin Exchange, Columbus, Ohio.

CONFEDERATES, Russians, Mexicans, 3 sets 15 bills all different 60c, no stamps. International Exchange, 166 Jackson, Chicago.

ANCIENT Roman coins, five different, \$2.00; commemorative half dollars, five different, \$5.00. S. Koepfel, Merritt Bldg., Los Angeles, California.

UNITED States. Large cent, 2c bronze, 3c nickel and bargain list, 25c. Eleven dates large cents, \$1. George P. Coffin Co., Augusta, Maine.

COMMEMORATIVE Half dollars, Lincoln \$1.19; Cleveland \$1.19; Long Island \$1.19; Texas \$1.19; Boone \$1.29; Arkansas \$1.89; Elgin \$1.49; Wisconsin \$1.49; York \$1.49; Bridgeport \$1.99. Selling price list free. Bob Cohen, Box 3507-G, Cleveland, Ohio.

GET Profit and pleasure in collecting old coins. Send 10c for 56-page illustrated coin catalog. You'll be delighted with it. Send for it now. B. Max Mehl, 370 Mehl Bldg., Fort Worth, Texas. Largest rare coin establishment in U. S. Established 38 years.

BIG Prices paid for certain wanted coins. 1909 cent \$10.00, some silver dollars \$4000, 1864-1865 Indian head cents \$100.00 each, dimes before 1895, \$600; liberty head nickels before 1914, \$500; encased postage stamps; some large pennies \$2000; half cents, \$275.00; paper money, gold dollars \$1500, foreign coins \$165, some worth \$6000 each. You may have coins for which we pay big premiums. Therefore send 15c today for 1939 big illustrated coin book for certain wanted coins. National Coin Corporation (80), Daytona Beach, Florida.

FINE Foreign 1700 coin, 2 notes and catalog 10c. Geo. Best, Cedar Rapids, Iowa.

COMMEMORATIVE Half dollars, Lincoln, Stone Mountain, Oregon, Texas, Cleveland, Kentucky, San Diego, Long Island, \$1.50 each. Illustrated catalogue No. 14, 25c. Norman Shultz, Salt Lake, Utah.

FREE! Foreign coin, banknote, and large illustrated coin catalogue. Send 4c postage. Coin approvals sent. Tatham Coinco, Springfield-125, Mass.

\$5 TO \$500 Each paid for hundreds of old or odd coins. Keep all until posted. Many very valuable. Send 10 cents for illustrated Coin Value Book, 4x6. Guaranteed buying and selling prices. 31 years in business. Coin Exchange, Box 5, Le Roy, N. Y.

RARE U. S., foreign coins, war medals. Catalogue 10c. Mengelle, Colorado Springs, Colo.

HOBBIES AND COLLECTIONS

ASTRONOMY. The most fascinating hobby of all. Explore stars, planets, distant objects on earth. Build your own telescope. Amateur kits \$3.50 up. Full instructions. Send 10c for catalog, interesting articles. American Telescope Laboratories, Department 22, Hollywood, Calif.

PHOTO FINISHING

PHOTO Mill. Immediate service! No delay! Roll developed, carefully printed and choice of two beautiful 5x7 double weight professional enlargements, one tinted enlargement, or eight reprints—for 25c coin. Reprints 2c each. The Photo Mill, Box 629-12, Minneapolis, Minnesota.

MAIL Your rolls to film center of the world. Any 6 or 8 exposure roll developed and printed 25c coin. DeLuxe enlargement coupon free! Photo Finishing Shop, Est. 23 yrs., 411-EE Genesee Valley Trust Bldg., Rochester, N. Y. "The Camera City."

20 REPRINTS 25c. 100, \$1.00. Rolls developed, 16 sparkling Lifetone prints, 2 studio enlargements—25c. Lifetone Studios, B-8, Des Moines, Iowa.

AT Last! All your snapshots in natural colors. Roll developed, 8 natural color prints, only 25c. Reprints, 3c. Amazingly beautiful. Natural Color Photo, Janesville, Wisconsin.

OIL Coloring photographs a fascinating hobby or profitable business. Learn at home by easy simplified method. Previous experience unnecessary. Common school education sufficient. Send for free information and requirements. National Art School, 3601 Michigan Avenue, Dept. 3433, Chicago, Illinois.

THE Joy of really beautiful pictures is yours if you get Willard's clear, brilliant prints. Roll developed, 2 prints each negative, only 25c. Valuable enlargement coupon. Willard's, Box 3535-A, Cleveland, Ohio.

IDEAL Photos. Professional deckle-edge prints and free enlargement with each roll for only 25c. Ideal Photos, Box 2255, Paterson, N. J.

FREE Sample. Send negative. Streamline Studios, Box 5699-K1, Cleveland, Ohio.

THE Modern Finishers, St. Paul, Minnesota, are the outstanding finishers in America for low prices with quality pictures. Our modern methods give quick service and bright guaranteed neverfade pictures. Roll developed, 16 prints, 25c coin; 16 reprints, 25c. Enlargement coupons. Join our thousands of satisfied customers by sending us your next roll or reprint order. Modern Finishers, Box 3537, St. Paul, Minn.

DOLLARS For your best snapshots! Earn extra cash with camera! Instruction, one dime. Hippenstiel, Russell Ave., Bethlehem, Penna.

NOW! Embossed deckle-edged Velox prints. Roll 25c. Eight. "Southern," Edinburg, Va.

PHOTO Stamps from your photograph. Gummed, perforated, glossy finish. 25 for 50c; 50, 75c; 100, \$1.00. Universal Photo Stamps, 315-2 Washington, Elmira, N. Y.

MINIATURE Film, fine grain development, 2 1/2 x 3 1/2 enlargements. 35mm. \$1.00, bantam 25c. Film Capital Service, Box 504, Rochester, N. Y.

GET Clear, brilliant pictures the modern Artcraft way. Roll developed, 2 prints each negative only 25c. Valuable enlargement coupon. Artcraft, Box 1822-A, Washington, D. C.

35MM. 36 2 3/4 x 4 1/4 In. glossy enlargements. Film fine grain developed 95c. Photo Finishing Co., 2186 Broad St., Cranston, R. I.

NOTICE—The Artist's Photo Club, Lyons, Kansas, announces establishment new photo finishing department. Rolls developed 25c. 8 by 10 enlargement 35c, four \$1.00, Eastman Kodak Six 20 series 2 given for month's best photo. Grand prize given for year's best. Send your roll or a photo for eligibility. Photos returned.

TWENTY Reprints 25c. Roll developed and two prints each negative, 25c. Send for free mailing envelopes, price list. Star Photos, J-109 N. Dearborn, Chicago.

IMMEDIATE Service! Better pictures. Sixteen guaranteed prints from roll. 25c. one colored or two plain enlargements and 8 guaranteed prints 25c. Sixteen reprints only 25c coin. Candid rolls developed free! Prints enlarged to 3x4, only 4c each. One day service. Details and mailers free on request. American Studios, Box B, LaCrosse, Wis.

20 REPRINTS 25c. 100 Reprints, \$1.00. Films developed, 2 prints each negative, 25c. Mercury Studios, Box 822-B, Chicago.

PROMPT Service! Rolls developed, two Velox prints each negative 25c. Hench Studios, Harrisburg, Penna.

A PROFESSIONAL 4x6 enlargement of each exposure. Eight exposure rolls. Coin 25c. Wells, Box 5556M, Cleveland.

35MM. DEVELOPED and printed in strips of three nicely booked. 50c coin. Wells, Box 5556M, Cleveland.

ROLL Developed, 8 brilliant fadeproof Velox prints and two professional enlargements 25c. Overnight service. Young Photo Service, 405-C, Albany, N. Y.

ROLL Developed and 16 prints 25c. Reprints 20 for 25c, 50 for 50c coin. Queen City Service, Dept. C, Box 7, Niagara Square Station, Buffalo, N. Y.

EXPERT Miniature film developing. Very fine grain. Best 20 pictures 3x4 Kodabrom enlargements \$1.00. Reprints 4c. Regular rolls 8 prints, 2 enlargements 25c. Expert Studios, LaCrosse, Wis.

ROLLS Developed, printed, two 5x7 enlargements included—25c. Reagan, 406 Tenth North, Seattle, Wash.

LIFE Photo finishing lasts a life time. Roll developed, 8 prints, 2 enlargements 25c. Reprints 1 1/2c. Life Photos, Hutchinson, Kansas.

TWO Glossy enlargements. 1 colored with roll 25c. Arbor Service, 10, Joliet, Ill.

ROLL Developed, 16 guaranteed prints, two coupons on enlargements 25c. Smart Photo, Winona, Minnesota.

CANDID Special. 35mm. rolls enlarged to 3 1/4 x 4 1/2. \$1.00. 18mm. rolls 60c. 3 1/4 x 4 1/2 reprints 3c. Brown Photo Company, 1910-61 Emerson, Minneapolis, Minn.

16 PRINTS With roll 25c. 16 reprints 25c. Rex Photo, Ogden, Utah.

BEAUTITONE Enlargement, dime and negative. Giant Snapshots, Inc., Green Bay, Wis.

GUARANTEED. Roll developed, 16 prints 25c. 20 prints 25c. Quality Photo, Hutchinson, Kansas.

QUICK Service—Rolls developed, 8 guaranteed prints; 2 enlargements; 25c coin. OK Photo Service, Ottawa, Kansas.

ROLLS Developed and printed 10c. Trial. Quality Finishers, Maywood, Ill.

ROLLS Developed, 2 prints each and 2 free enlargement coupons, 25c; reprints, 2c each; 100 or more, 1c. Summer's Studio, Unionville, Mo.

ROLL Developed and 8 beautiful Velox glossy prints 25c coin or stamps. Reprints 3c each. Fotoprint Service, Box E, Roanoke, Va.

FINER Finishing. Rolls developed and printed, with one colored enlargement, or two professional enlargements. All for 25c (coin). Genuine, nationally known. Moentone superior quality. Moen Photo Service, La Crosse, Wis.

FOR The discriminating amateur, roll developed and carefully printed 25c, reprints 3c. Superior workmanship, same day service. Paramount Co., 327 E. 92nd St., New York.

PHOTO Mill. Immediate service! No delay! Roll developed, carefully printed and choice of two beautiful 5x7 double weight professional enlargements, one tinted enlargement, or eight reprints—for 25c coin. Reprints 2c each. The Photo Mill, Box 629-12, Minneapolis, Minnesota.

CAMERAS, PHOTO SUPPLIES

CAMERAS and supplies. Free illustrated catalog listing everything photographic—still and movie cameras, films, lenses—at tremendous savings. Hundreds of bargains, new and used. All guaranteed. We take your old camera or equipment in trade. Write now for your free copy of our newest money-saving bargain book—just out! Limited edition. Hurry! Central Camera Co., (Photographic Headquarters Since 1899), 230 South Wabash, Dept. 3-K, Chicago.

MAKE Money in photography. Learn quickly at home. Spare or full time. Easy plan. Previous experience unnecessary. Common school education sufficient. Interesting booklet and requirements free. American School of Photography, 3601 Michigan Ave., Dept. 3431, Chicago.

AMATEUR Photographers—Stop spending, make money in 1939. It can be done. Write now. Delmar Sales Company, Delmar, N. Y.

CLEAN-OUT Of Xmas trade-ins! What you want we have—at lowest clearance prices. Every type, still, movie cameras, projectors, accessories for small monthly payments. Trades accepted. Large 8-16mm. movie library. Free membership. Low rentals. Write for your copy of "Mogull Bargain News," 64 West 48th St., New York City.

\$50 WEEK With a kodak. Booklet describes 100 magazine markets 35c. S. George, 285 East Queen, Philadelphia, Penna.

MAKE Money selling snapshots. Dime brings 152-page book complete instructions, markets, real information. Lyons-Publishers, 3016-P Elgin Avenue, Baltimore, Md.

MAKE Powerful telephoto camera, trifling cost. Jamer, 94D, Manorville, N. Y.

PERSONAL Exposure record gummed labels. Your name imprinted. Attach to back of your photographs. Contains space for writing complete data about each photo. 500 labels, \$1.00, postpaid. Herald, Batavia, Illinois.

REPAIRING Cameras, all optical instruments. Specialize in designing special and intricate precision optics. American Telescope Laboratories, Department 23, Hollywood, California.

BASS Inventory clearance. Profit by these unusual bargains. 35 mm. candid midget, F:4.5 lens, \$12.75. Used Foth Derby, F:3.5, \$15.75. 2 1/4 x 3 1/4 Agfa Film Pack and plate, with F:6.3 lens, \$10.75. 9x12 or 3 1/4 x 4 1/4 Zeiss Ikon Film Pack and plate, single ext., F:6.3 lens, auto shutter, film adapter and holder, \$11.95. Used Argus, F:4.5 lens, \$7.75. New candid midget, Xenon F:2 lens, Rapid Compur and case, \$80.00 value, at \$54.75. Hundreds of other bargains in the great Bass Bargaingram and special bulletins. Your money back if unsatisfactory after 14 days trial. Write Bass Camera Company, Dept. AG, 179 W. Madison St., Chicago, Illinois.

ENLARGER \$1.59. Enlarges eight times size of small negatives. Fully guaranteed. Paramount Sales Company, 89 Dudley Street, Boston, Mass.

CAMERAS Films, paper 25% to 35% discount. Paramount Photo Division, 327 East 92nd St., New York.

CAMERAS—Shutters repaired. Leather bellows installed in folding and view cameras. Bellows made to order. United Camera, A-1515 Belmont, Chicago.

NO More wasted film or unnecessary expense. Take pictures you can be proud of. Sell to magazines and newspapers. Make good money wherever you live. Easy, low-cost home study course shows you how! Free catalog. Universal Photographers, Dept. 104, 10 W. 33 St., New York City.

HAVE You a camera? Send ten cents for recent number of our big magazine, showing how to make better pictures and earn money. American Photography, 116 Camera House, Boston, 17, Mass.

PHOTO Mill. Immediate service! No delay! Roll developed, carefully printed and choice of two beautiful 5x7 double weight professional enlargements, one tinted enlargement, or eight reprints—for 25c coin. Reprints 2c each. The Photo Mill, Box 629-31, Minneapolis, Minn.

If You go to Mexico ask first for prices and pamphlets of finest German quality miniature and other cameras, binoculars, movie cameras and projectors. Foto Mantel Sucr. R. Rudiger V. Carranza 11. P. O. Box 1459, Mexico City.-105. Branch store: Tijuana, Baja California. Branch store: Tijuana, Lower California. Hotel Comercial. Branch store: Monterrey, N. L., Morelos Oriente No. 557.

MOTION PICTURES AND SOUND EQUIPMENT

BRILLIANT Aluminum screen, 31x36 inches, washable, unmounted \$1.75. Improved Products Co., Roslyn Heights, New York.

MOVIE Title sets—500 embossed letters, 14 silhouettes, 10 backgrounds, masks. Price \$1.00. Kramark, Inc., 28 W. 19th St., New York City.

SOUND Features 35mm. \$5.00 up. Brommer, 1726 W. 68th, Los Angeles.

PENN-CRAFT Movie films. Save. Write. Pennsylvania Photo, Box 423-A, Williamsport, Pennsylvania.

EASIEST, Simplest titling outfit. Trace from script charts. \$2.00 complete. Samples 3c. Stein Studios, Flatiron Building, New York.

FREE Lists, 16mm., 8mm. films, cameras, projectors, accessories. Home Movies, Box 216, Easton, Pennsylvania.

35MM. FILMS. List 5c. Bedner, 5300 S. Talman, Chicago.

TALKIES, Silents, 35mm., sale, rent, UFD, 15903 St. Mary's, Detroit, Michigan.

CLEAN-OUT of Xmas trade-ins! What you want we have—at lowest clearance prices. Every type, still, movie cameras, projectors, accessories for small monthly payments. Trades accepted. Large 8-16mm. movie library. Free membership. Low rentals. Write for your copy of "Mogull Bargain News," 64 West 48th St., New York City.

BIG List! Silent 35mm. films. Demsey, 1223 Berkley, Youngstown, Ohio.

TALKIE \$15.00, Silents \$5.00. Projectors. Simpson, 1275 South Broadway, Dayton, Ohio.

8-16MM. FILMS. All subjects. Sold, exchanged, complete rental library, silent and sound. Films rented everywhere. Bargains in equipment. Trades accepted. Free illustrated catalogue (with sample film 10c). Garden Exchange, 317-A West 50th, New York.

15% TO 25% Discount on still or movie cameras. Free circular. Paramount Co., 327 E. 92nd St., New York City.

35MM. SILENT. Rented 50c weekly. Calderara, 5119 South St. Louis, Chicago.

BARGAINS—Complete 16mm-8mm. line. No-Wat-Ka, 151 Broadway, Paterson, N. J.

"THE World's Greatest Passion Play." Specify sound or silent. 8 reels, 16mm. rent and purchase. Superior than Oberammergau stage play. Write Hemenway Film Co., 37 Church St., Boston, Mass.

DIRECTORY of 1010 free films, classified, 16mm., 50c. Box 109, Ashtabula, Ohio.

35MM. SOUND Films and projectors. Oakley Film Exchange, Nelsonville, Ohio.

8mm., 16mm. FILMS. Cameras, projectors. Bargain list. Block, 1265 Broadway, New York.

PROJECTOR Film; sample, 10c; lists free. Goodwill Company, Jackson, Tenn.

PASSION Play, World's finest. Seven reels 16mm. silent. Regular price \$225. Special for this month \$125. Crown Film Corp., 42 Melrose St., Boston, Mass.

COMPLETE 16mm. And 8mm. film rental library. Attractions: "White Hell of Pitts Palau," "Lost World," "Pony Express." Free catalog. National Cinema, 3 West 29th, New York.

GENERA Film for all movie cameras, 100 ft. single 8mm., \$1.00; double 8mm., \$1.75; 16mm., \$1.35. Sample for stamp. Processing powders and outfits. Promaders, Davenport, Iowa.

35MM. ROLLS Fine grain developed free. 36 enlargements 3 1/2 x 5, \$1.00. Cartridge reloaded 35c. Photoshop, Linton, Ind.

COMEDIES, Westerns, 500 feet 75c. Jersey Films, 2075 Richland, Lakewood, Ohio.

BASS Wants to mail you without charge our new 52-page Cine Bargaingram No. 234—sound, silent, 8 mm., 16 mm., 35 mm. equipment, of the quality we can sell on our money back guarantee. Write for this valuable book at once. Full description of the RCA 16 mm. sound on film camera. Newsreel model is only \$250.00, and Bass is exclusive distributor. Dept. A, Bass Camera Company, 179 West Madison Street, Chicago, Illinois.

MOVIE Film. Develop yourself. Univex, Eastman, etc. Chemical samples 15c. Raw film wholesale. Lake Camera Exchange, Gary, Ind.

LEARN Motion picture theatre management, advertising, projection. Free catalog. Give age. Theatre Institute, Elmira, N. Y.

16-35MM. RENTED 50c Weekly; lists 3c. Hoffman Film Service, 57 Broad, Albany, N. Y.

BARGAINS! 8mm., 16mm., free literature. Elder, B-739 Boylston, Boston, Mass.

RELIGIOUS Pictures for rent or sale. 16mm. and 35mm. sound or silent. All-Sacred Film Co., 31 Melrose St., Boston, Mass.

RADIOS, SUPPLIES, INSTRUCTION

DYNAMIC And permanent magnet speakers. All sizes and types. Unbelievably low prices. Specify your needs and we will quote. Radio Parts Outlet Co., 5868 Magnolia Ave., Chicago, Ill.

RADIO Parts bargain, 5 different types of transformers and chokes, 1 variable condenser, 3 trimmer condensers, 12 assorted bi-pass condensers, 12 assorted resistors. Liberal assortment of knobs, screws, nuts, bolts, and other miscellaneous radio items. All brand new. Guaranteed retail value at least \$10.00. Only \$2.00 cash with order. Satisfaction guaranteed. Radio Parts Outlet Co., 5868 Magnolia Ave., Chicago, Ill.

SEND For free giant money saving radio and phonograph record catalogue. United Radio Company, 1000-M, Newark, N. J.

TRANSFORMERS—Design, build any size, type, frequency. Instructions, \$1.00. Translab, 2827 Third Ave. W., Hibbing, Minnesota.

BE A radio announcer! Good possibilities. Audition brochure 50c. KFRO, Longview, Texas.

DON'T Buy a radio. Get our catalog first listing over 400 nationally known standard make sets. Also 700 electric specialties for the home. Big special, 10 inch phonograph dance records, 12 for \$1. Write today. Modell's, 56 Cortlandt St., New York.

PLANS 18 Tested crystal sets, with "Radiobuilder"—25c year. Laboratories, 7700-C East 14th, Oakland, California.

RADIOS—\$9.95. All kinds. Save 50%. Catalog free. 30-day's trial. Marco-F, Kansas City, Mo.

RADIO Engineering, broadcasting, aviation and police radio, servicing, marine and Morse telegraphy taught thoroughly. All expenses low. Catalog free. Dodge's Institute, Ames St., Valparaiso, Ind.

MUSIC AND MUSICAL INSTRUMENTS

PLAY Piano by ear! Negro harmony, chimes, pretty chords, etc. Write "Piano Bill," 207 Ossington, Toronto, Canada.

LEARN Swing piano! Postal brings free folder. Christensen, 751 Kimball Hall, Chicago.

TUNE Your own piano. Easy method \$2.00 postpaid. J. Sullivan, Grant St., Irwin, Penna.

SONGWRITERS! Musicians! Singers! Teachers! Music Arranger, 6574 Gundry, Long Beach, California.

SONGWRITERS: Send us your poems, wonderful proposition. Keith-Downing Publications, Clearwater, Florida.

SONGS. Poems, bought, composed, arranged, published. Royalty contract, free information. Metro-Melody Publishers, 532A Geary, San Francisco.

ORIGINAL Poems, songs wanted for publication, radio. Westmore Music Corporation, Dept. 33H, Portland, Ore.

SONGWRITERS: Free! Valuable booklet. Interesting, instructive. Len Fleming, Wellsboro, Penna.

VIOLINS—Handmade masterpieces, best since Stradivarius. John Lehto, San Pedro, Calif.

SONGPOEMS Wanted for modern musical settings. Send for contract. Roy Allen, Kitchel, Ind.

SONGPOEMS, Melodies. Outstanding offer. Hibbeler, C-5, 2157 No. Avers, Chicago.

SEND \$1.00 To Piano Shorthand Music Company, Springfield, Illinois, for How to Play Piano by Ear.

MYSTERY Control for all record players. See advertisement page 139A.

ORIGINAL Music composed to your words, \$5. 200 printed copies \$10. Reginald Belcher, Chatham, New Jersey. 30 years church organist.

DANCE Orchestrations popular back numbers, 10—\$1.00. Silverman, 3305 Lawrence, Chicago.

MUSIC Composed to words. Rhyming pamphlet on request. Phonograph recording of completed songs. Send poem for consideration. Keenan's Studios, Dept. PM, Box 2140, Bridgeport, Conn.

SONGWRITERS! Send poems. Best price, service available. Variety Service, Salem, Indiana.

SONGS—Arranged, revised by arranger "Cherry Blossom Lane." "Gypsy Tea-room," others. Send for details. Harold Potter, Box 511, Miami, Florida.

SONGWRITERS—Get free the inside facts on successful songwriting by famous Broadway composer. Write today. Songwriters Institute, 1234-C Broadway, New York.

JAZZ Piano guaranteed by mail in 20 lessons. Erskine Studios, 810 East 14th St., Oakland, California.

SONG Poem writers wanted, our 50-50 plan has aided many songwriters. Russell Duke received \$150.00 advance on his song. Burl Bogg's song won a nationwide contest. We may be able to help you. Send poems or write for free booklet today. Indiana Song Bureau, Dept. 41, Salem, Ind.

DUO-FLEX Reeds for clarinets, and saxophones eliminate your reed troubles. Write for circular. Duo-Flex Reeds, 1204 1st Ave., Evansville, Ind.

SONG Poems wanted to be set to music. Free examination. Send poems to McNeil, Bachelor of Music, 4153-PM S. Van Ness, Los Angeles, Calif.

PIANO By ear. Free booklet. Day-V-Way, Woolworth Building, Dearborn, Michigan.

MUSIC Composed to words. Wonderful proposition. Bauer Bros., Oshkosh, Wis.

WRITE Songs. Big money and reputation. Write for information. J. Gordon Pub. Co., 201 N. Hoynes Ave., Chicago.

WANTED! Lyrics, melodies for songs. We arrange, publish, sell. Superior Song Studios, Passaic, N. J.

SONGWRITERS: Send your poem today for immediate consideration. Richard Brothers, 24 Woods Building, Chicago.

SONG Writers. Send for publishing agreement. McKinley Music Publishers, 1501 E. 55th St., Chicago.

BUSINESS OPPORTUNITIES

MAKE Money electroplating! Marvelous patented invention plates with electric brush—easy as painting. Does same beautiful, permanent electroplating—gold, silver, nickel, cadmium, etc.—as big tank outfits. No liquids—lightweight—portable. Anyone can use from battery or household current. Only \$6.85 complete. Write for details and sample of work done. Warner Electric Co., 360 N. Michigan, Dept. G-11, Chicago.

NATIONAL Baking Institute announces a new home study course covering all phases of commercial baking. Good field for ambitious men. Nearly a depression proof business. Common school education sufficient. Send for free booklet "Opportunities in the Baking Industry" and requirements. National Baking Institute, 3601 Michigan Ave., Dept. 3433, Chicago, U.S.A.

"**RUBBER** Molds." Make them yourself. Formulas, instructions 25c. Ideal Service, 179-R3, Park Ridge, Ill.

POPCORN Machines, caramelcrisp, crispettes, cheese coat, potato chips. Long Eakins, 2035-C High St., Springfield, Ohio.

STEADY Money in showcards, signs, window lettering. Easy. Amazing details free. Write Nelson Company, 2029 Manhattan Building, Chicago.

FORTUNES Are being built on waste. Used motor oil holds hidden wealth. Millions of gallons drained and thrown away yearly. Our Precision Refining Unit recovers a daily average of 40 gallons of high quality, rich bodied oil from a barrel of waste drainings. In use by U. S. gov't. Tremendous profits up to \$16.00 a day supplying consumers at 12c a quart. Average refining cost only 2c a quart. No training required. Modest investment offers you a profitable business, complete equipment and exclusive territory. Don't delay, write for complete details. Precision Engineering Sales Company, Dept. 102, 4300 Millcreek, Kansas City, Mo.

CASH In on big demand for Mexican novelties! Large profits! Particulars free. Samples 10c stamps. Marquez-PBF, Apartado, 1176, Mexico, City.

YOU'LL Like resilvering mirrors, auto-parts, reflectors, making chipped glass signs. Write, Sprinkle, Plater, 127, Marion, Indiana.

"MAKE Mirrors at home." Big profits. Little outlay. Also emboss, grind—foil, gold leaf, frost, chip and make imitation stained glass. Instruction course 50c. Ideal Service, M-3, Park Ridge, Ill.

M. M. earned \$267, three weeks, raising mushrooms in cellar! Exceptional, but your cellar, shed perhaps suitable. We buy crops. Book free. United, 3848 Lincoln Ave., Dept. 61, Chicago.

WANTED. Ambitious, reliable persons to help me contact advertisers. P. Pietran-tonio, 151 Fifth Ave., New York City.

REAL Moneymaking opportunities at home. Ystesund, 907 North 4th, Sheboygan, Wisconsin.

BE Rich. Make 900% profit bottle vanilla extract. Free labels. Tharp, 914 Lexington, Cumberland, Md.

START Business anywhere. Work mornings, home. Good pay. Dunn, Box 74, Ionia, Michigan.

MAKE Signs, print on glass, inscribe souvenirs, permanent as the pyramids. M. Swisher, Box 136, Clairton, Penna.

FREE List of 2556 occupations. Don't be a square peg in a round hole. Write today. No obligations. Vocational Guidance Bureau, 201 Park Ave., Dept. 2A, Baltimore, Maryland.

FORMULAS — Fast selling products. Guaranteed. Laboratory tested. Lowest prices. Catalog free. Kemico, 55K, Park Ridge, Ill.

REAL Opportunity. Recolor, waterproof, awnings, etc. Now offered first time, our own shop formulas with complete instructions, only \$1.25. Calvin Awning Products, 3930 Drysdale Ave., Los Angeles, Calif.

UTTERLY Amazing moneymaking possibilities back-yard gardening. Stamp brings information. Lightning Speede, Streator, Illinois.

INCORPORATE In Delaware. Liberal laws, low costs. Corporation Registration & Trust Company, 927 Market Street, Wilmington, Delaware.

LATEST Business opportunities, full or spare time. Regular 25c, yours for 10c while supply lasts. Edward Muse, 859 Crucible St., Wabash Sta., Pittsburgh, Penna.

BUSINESS Opportunities to have agents work for you. Free particulars. Tilford, Box 516, Louisville, Ky.

PAYING Mailorder business for you. Write Dixie Mailers, King, North Carolina.

WONDERFUL Opportunity. Exceptional profits. Read Woodcraft Service advertisement Home Craftsmen column.

1001 OPPORTUNITIES. Send 3c stamp for details. Mt. Hi. Engineering Chemical Co., Casper, Wyoming.

"MONEY By Mail" brings proven, tested money makers to start your own business. Sample copy 10c. Universal, Lacoochee, Florida.

WORKABLE Mail order plans. Particulars in booklet (useful premium included) 25 cents. J. E. Howe, Box 183, Evansville, Indiana.

SELL Quality health food products! Your labels! No canvassing! Samples, dime. Details free. Gardena System, 128CP, Station "S," Los Angeles.

MAKE Artificial marble, glazed tiles, uncanny. Tabletops, plaques, floors, hones, novelties. Hard, fireproof, inexpensive, cement secrets. Brilliant tile and liquid rubber samples 3c. John A. Payn, 945 Grande Vista Avenue, Los Angeles, Calif.

MAKE Bleach water formula 50c. Capotosto, 1707 Cranston St., Cranston, R. I.

UNEMPLOYED? We have the best dime seller on the market. Every housewife a sure prospect. 400% profit. Dime brings sample and wholesale prices. Tuesday, 2810-P Winfield, Canton, Ohio.

SOAP Making. Learn at home. No machinery needed. Stamp. Posera, H-4545 Bartlett, Milwaukee, Wisconsin.

GROW Plants without soil. Chemical crop culture. Formulas and bibliography, 35 cents. Formulas, instructions and bibliography, \$1. Hydroponics, Box 613, Guthrie, Ky.

MONEY Jobs yours. Tell others how get dollars in mail daily. No selling. Opportunity of lifetime. Stingley, Box 225, Bell, California.

HANDY Men—Earn money home operating community "Fix-It" shop. Stafford, Makanda, Illinois.

RUBBER Mold bargains. Stamp brings catalog. Colonial Art, Grove Street, Derry, N. H.

AMAZING Patented screw-holding screw drivers. No competition! Factories, hardware stores buy quantities. Big profits, repeats. Foreign territories open. Free trial! Toolco, 6002 Journal Bldg., Boston, Mass.

BE Successful in business. Learn elementary and guiding principles from expert. Don't lose time and money experimenting; study and win. Complete course reasonable. Free booklet. Gardner & Gardner, 212-A Eighth Ave., S. W., Cedar Rapids, Iowa.

"BINGO." New coin operated amusement game. Large income, operating "route." Small investment. Details free. Robbins, 1141P DeKalb Ave., Brooklyn, New York.

MAKE Money at home! Grow mushrooms in cellar or shed, with Ami U. S.-Patented Mushroom Spawn and step-by-step, easy-to-follow Manual of Instructions. Fascinating, profitable. Booklet free—write today. Anglo-American Mushroom Industries, Dept. 34, Toronto, Ont.

BE Your own boss. Customers everywhere. Amazing profits. Read our ad page 139A. Rogers Manufacturing Company.

OPPORTUNITIES Galore in Mail Magazine. Copy dime. Nixons, Stevens Point, Wis.

EXTRAORDINARY 1939 Profits! Manufacturing "Popular Branded Products." Stamp brings informative Formula Messenger telling how! Miller, Chemist, (Established 1897), 706-Mb, Tampa, Florida.

INVESTIGATE Proposition of merit. Send stamped envelope. Pipe Sterilizer Mfg. Co., Atlanta, Ga.

OPPORTUNITIES Aplenty! Moneymakers that "click"! Latest offers free! Plan-agram, P-1079 Madison St., Brooklyn, N. Y.

1500% PROFIT! "Free 32-page book" tells you how to make genuine rubber molds and manufacture fast-selling composition novelties! Write Stewart's Studio, Dept. P-2, 2927 Wilcox, Chicago.

RECAST Old batteries into new. Latest achievements. Battery Laboratories, St. Paul, Minn.

\$35 TO \$50 Week easily made with our plan. Work at home. Complete details, 25c. Atlas Promotion Service, Box 476, Red Lodge, Mont.

\$1.90 PROFIT On each \$2.00 order. Strictly legitimate. Particulars free. Pop-Director, Drawer 989, Edinburg, Texas.

MONEY In Butterflies, moths. See Sinclair Display Advertisement on page 24A.

OPERATE Paying mail order business in your own home. Nickell's, Rt. 1, Box 456, Bend, Oregon.

PROFIT With new products. Make, sell, repeat. Analysis. Research. Guaranteed formulas. Biggest catalog free. Nominal prices. Gibson Laboratory, Chemists, BD-1142 Sunnyside, Chicago.

\$1.00 BRINGS 120 Guaranteed business methods. Sam Graham, Warrenton, Virginia.

LEARN A big profit business. Small investment. Free literature. Loideco, 1347 Wisconsin, Berwyn, Ill.

COLOR Concrete with chemicals. Washing-wells. Spin concrete pottery. Stucco-rock. Miniature castles, mills, cold glaze, marbling. Sample 10c. Hollywood Cement Craft, 8527 Wonderland, Hollywood, Calif.

RUBBER Vulcanized, makes best molds. See samples showing artistic work. Dime brings samples. Novelty Company, Grayling, Michigan.

SELECTED Opportunities. Tested, guaranteed 10c. Hannes, 600 W. 164, New York.

MAILORDER Books and articles. Exceptional. Sell by mail. Use our powerful literature. Big profits. Particulars free. Stamford, 3762-B Broadway, New York.

ARTIFICIAL Marble sanitary flooring, instruction covering wood or cement flooring ½ inch thick, fireproof, all colors, low cost, ornamental casting, concrete, plaster, papier-mache, garden furniture, statuary, flexible molds, particulars free. Chris Mahler, Elmont, N. Y.

DELAWARE Charters: Complete service \$35. Submitted forms. Chas. G. Guyer, Inc., Wilmington, Del.

MAKE Color-Glazed concrete pottery, tiles, walls. New, patented method. Complete plants cost only \$35.00. Men (only). Write for free colorplate, details. National Potteries, 13 West 26th, Minneapolis, Minnesota.

IF It's cash you're after "Profit-Pointers" tells how. Free. Richer, 5 Kensington Sta., Brooklyn, N. Y.

107 WAYS To make money, in home or office, business of your own. Full particulars free. Elite Co., 214 Grand St., New York.

PLASTEX Industries offers industrious men an opportunity to start a business of their own, manufacturing art goods, novelties, souvenirs, etc., in Plastex and marble imitation. 5c material makes \$1 articles. Rubber moulds furnished for speed production. Small investment brings big returns. You are just in time for big wholesale season now starting. Write for interesting booklet mailed free. Plastex Industries, Dept. A, 1085 Washington Ave., New York.

SELL By mail. Books, novelties. Bargains! Big profits! Particulars free. E. Elco, 438 N. Wells, Chicago.

BE Independent! Secrets of riches fascinatingly revealed. Details. Todd's Service, 262 Arlington, Youngstown, Ohio.

ELITE Collection of business plans, contains 107 tested plans and scores of formulas. Start own business; home, office. Particulars free. Elite Co., 214 Grand St., New York.

"SCHEMER," Alliance, Ohio (41st year) prints schemes, tips, opportunities, formulas; big producers: \$10,000 to \$25,000 reported. Year, \$1.00. Get wise! Trial six months only 30c.

CHARTERS: Delaware; best, cheapest; free forms. Colonial Charter Co., Wilmington, Del.

GIANT Mail, opportunities, added income, ideas, 52 page magazine. 10c. Katz, 4254 N. Kimball, Chicago.

PROFITABLE Home business. Legitimate. No canvassing. Maywood Publishers, P-923 Broadway, New York.

WHERE To buy at lowest wholesale prices. Information free. Yorena, Box P-312, Bayonne, N. J.

100 PROFITABLE Mail order and local plans. Gilbert Supply, 1107 Broadway, New York.

EARN Extra money at home. You can increase your income quickly and easily at home. Wentworth supplies you with work and furnishes all materials. Write today for free booklet. Wentworth Pictorial Co., Ltd., Dept. 71, Hamilton, Ont.

LIQUID Marble—anyone can make! Colorful, glazed! Moulded, brushed, sprayed. Rubberlastic moulds. Composition flooring. Big money in these! Particulars free. Marbleizing Service, Edwardsville, Ill.

MAIL Order business is your opportunity. Many began small, now earn thousands yearly. No personal contact. Boundless opportunities. Have had over 30 years experience; will help you succeed. Send 25c for valuable booklets, none free. B. Brenner, 257 S. 21st, Philadelphia.

HOW And where to obtain capital fully explained, free particulars. Star Service, Wapakoneta, Ohio.

WE Help start you in business, furnishing outfits and instructions, operating "Specialty Candy Factory" home. Men and women, opportunity to earn \$20 to \$50 weekly, all or spare time. (Our 29th year.) Booklet free. W. Hillyer Ragsdale, Inc., Drawer 4, East Orange, N. J.

LEARN Arc welding. A growing industry with great opportunities. Consult your local school, or if there is none available write The Lincoln School of Welding, Dept. A, Box 5758, Cleveland, Ohio.

SUCCEED With your products. Make-sell them. Formulas, Processes. Accurate analyses. Catalog free. B. Thaxly Co., Washington, D. C.

MAN In each town to plate auto parts, reflectors, bicycles, fixtures, mirrors, by late method. Simple plan of manufacturing at home starts you in good paying business. Free particulars and proofs. Gunmetal Co., Ave. H. Decatur, Ill.

AFTERNOONS Free for outdoors, shows. \$340 month home. Unique plans. No canvassing. Prepare for surprise. Folio-P, Station D, Los Angeles.

MANUFACTURE From Phospholene. Cleaning fluid 1c gallon; bleach 2c gallon; hand soap 2c pound; and ten fast sellers. Sample 25c. Details free. Western, 6615 Denison Ave., Cleveland, O.

INVENTORS—We successfully sell inventions, patented and unpatented. Write for proof, and tell us what you have for sale. Chartered Institute of American Inventors, Dept. 4-C, Washington, D. C.

WANT More business? 2c daily, opens individual New York branch office requiring no room number on your stationery or advertisements. Co-operative Mail Service, 126 Lexington Avenue, New York.

PRIZE Contest money! You can win plenty! Stamp brings opportunity! National Contest Bulletin, (Dept. P.), Box 130, Grand Central Station, New York City.

I WANT To send you proof of the wonderful pulling power of Popular Mechanics Magazine's classified pages. What's your proposition? Write me today. F. W. Johnson, Manager Classified Advertising, 200 E. Ontario St., Chicago, Ill.

MONEYMAKING OPPORTUNITIES

YOU'LL Like resilvering mirrors, autoparts, reflectors, making chipped glass signs. Write, Sprinkle, Plater, 287, Marion, Indiana.

3 MONTHLY Mail order magazines, filled with money making opportunities 10c. George Penner, 1618 Lucia, Louisville, Ky.

MILLION Articles. Buy wholesale. Valuable directory dime. Ideal Service, D-3, Park Ridge, Ill.

WITHOUT Soil grow flowers, vegetables in chemical solution. Formula 50c. S. Dunn, Box 214, Middletown, Ohio.

FOUR New 1939 moneymaking opportunities. Literature free. M. Benton, Liberty, N. Y.

MONEY Making ideas. "Key to Business Opportunities." Particulars, 10 cents none free. Maples, 3418 South Marshfield, Chicago, Illinois.

\$50 WEEKLY Introducing advertising necessity. Johnston, P-257 North Washington, Tiffin, Ohio.

ABUNDA-GRO Is new. It produces amazing flowers, plants, vegetables without soil in apartment, parlor, or basement. Using Abunda-gro is simple, fascinating, inexpensive, profitable. Satisfaction guaranteed. Details free. Unique Garden Club, Upsala, Minnesota.

"PORT Of Opportunities" published monthly—offering latest self employment; ideas; plans; schemes. \$1.00 year, copy 10c. Farm & Home Industries, Gardenville, N. Y.

MAKE Extra money. Dime brings dozens of moneymaking propositions including copy of "Sparetime Moneymaking Magazine." Tuesday, 2810-P Winfield, Canton, Ohio.

BORROW Recognized moneymaking books, folios by mail 10c each. Send for details and list. Anderson, Box 548, Muskogee, Okla.

FREE—100 Wonderful business, mailorder and home work moneymaking offers. Lewis Co., 828-C Carpenter, Oak Park, Illinois.

MONEY! Money! Yes you can make money. Ten special money-making formulas for one dollar. Reeve, Box 3012, Knoxville, Tenn.

MARVELOUS Beauty plan 25c. Edcoes Service, 39 Pine, Brooklyn, N. Y.

MILLIONS Jobless! Supply satisfying employment information by mail. Keep dollars received! We fill your orders. Details, stamp. Co-Operative Service, 77 Swan, Buffalo, New York.

START Profitable, permanent business, making distinctive, raised-letter stationery; home, spare time. Sells quickly to homes, offices. New, simple, amazing process; no experience or printing equipment required. Get sample sheet, information quick! Home Embossers, 1071 Niagara, Buffalo, New York.

MONEY In butterflies, moths. See Sinclair Display Advertisement on page 24A.

\$25.00 STAMPING Names per 100 key-checks. Sample 25c. Details furnished. Bohn Company, Box 86P, Wilkes Barre, Penna.

"OPPORTUNITIES Everywhere for Everybody." Best offer on market. Particulars free. International Research Bureau, 1115 Sherman, Denver, Colorado.

TYPISTS Earn extra money. Quarter brings "Twenty-One Way to Make Money With the Typewriter." H. Robbins, Box 6048, Kansas City, Missouri.

EARN Extra money writing for publication. Simple method. Demand inexhaustible. Details free. Dona Veretts, 17 Grotton, Lowell, Mass.

MONEY Makers for ambitious people—a 32-page "gold mine." Stamp brings everything. Lone Star Service, Box 772, Dallas, Texas.

ANALYSIS. Research. Newest guaranteed formulas. Biggest catalog free. Nominal prices. Gibson Laboratory, Chemists, CS-1142 Sunnyside, Chicago.

MONEY From honey. Good, steady income from small investment. Information how you can determine whether you can put bees to work making money for you. Send 25c. Box 885, Boston, Mass.

INCREASE Earnings. Information quarter. Service Sales, Box 115, Cleveland, Tenn.

MOULDS. Guaranteed, for casting toy soldiers, Indians, trappers, warships, sinker moulds, 244 kinds. Send 5c for illustrated catalogue. Henry C. Schlercke, 645 Spencer, Ghent, N. Y.

WHERE To buy exceptional articles at lowest wholesale. Information free. Stamford, 3762-C Broadway, New York.

BIG Money easily made; 107 test plans for your choice. Home, office. Descriptive booklet free. Elite Co., 214 Grand St., New York.

FREE Folio describes 2000 ways to make money. Marvin Studios, 203 South Dearborn, Chicago.

GROW Plants without soil. Folder free. Gordon Laboratories, 509-H Fifth Ave., New York.

UP To \$60 weekly! Spare or full time. Capital and experience unnecessary. Your own advertising service. Something new. Your services always in big demand by everyone in business. Complete working plans, \$1.00. No other investment. Universal, Box 1461, San Antonio, Texas.

YOUR Name—5,000 mailing lists—25c. Get samples, opportunities galore from all over world. Pines, 583-A Monroe, Brooklyn, N. Y.

MAILORDER Opportunities, plans, formulas, information. Circulars free. Harvey Teeple, Decatur, Indiana.

STOP Squealing—Start crowing! Work mornings home—country drives or movies—afternoons! No canvassing! Folio-A, Station "D," Los Angeles.

MAN In each town to plate auto parts, reflectors, bicycles, fixtures, mirrors, by late method. Simple plan of manufacturing at home starts you in good paying business. Free particulars and proofs. Gunmetal Co., Ave. N. Decatur, Ill.

RAISE Earthworms for profit. Information free, stamp appreciated. Bureau Zoological Research, 106A Broadway, Peoria, Ill.

WHOLESALE Sources, 500,000 articles. Free directory. Maywoode, 925 Broadway, New York.

FORMULAS, PLANS, ETC.

PICTURE Transferring compound, grease paint, spot remover, disappearing ink, invisible ink. Instructions with 26 others, all for dollar bill. Rousseau, 415 6th St. N. W., Grand Rapids, Mich.

FOR Those desiring home employment. 25 moneymaking formulas \$2.00. Write Eugene J. Sousa, 61 Union St., Nantucket, Mass.

SELF Vulcanizing cement. 50c to Formula Agency, 490 Western Ave., Lynn, Mass. Typed formula.

GUARANTEED Formulas—New fast sellers. None better. Lowest prices. Catalog free. Kemico, 49M, Park Ridge, Ill.

REFINE Used oil without cost. Particulars. F. Gerwin, Fairview, Okla.

FORMULAS: 15 Proven moneymaking formulas \$1.00. (Not stock-formula catalogue stuff), real unusual offers. List free. Marvel Laboratories, 6629 No. Maplewood, Chicago.

FORMULAS—All kinds. Real moneymakers. Lowest prices. Catalog free. Clover Formulary, P-3, Niles Center, Ill.

NEW Formulas. Analysis. Free literature. Research Development Laboratory, 449 So. Ionia, Grand Rapids, Mich.

MAKE More money! Manufacturing "Popular Branded Products." Stamp brings informative Formula Messenger telling how! Miller, Chemist, (Established 1897), 706-Mf. Tampa, Florida.

GROW Plants without soil. You can do it. Home apartment, cellar or outdoors. Remarkable growth year round. 25 gallons season supply chemicals, directions, bibliography, \$1.00 postpaid. Chemi-Culture, 4701-N Sheridan, Chicago.

FORMULAS 1c Each! Literature; sample formula 3c! Galluzzo, Wilkinsburg, Pennsylvania.

ANALYSIS. Research. Newest guaranteed formulas. Biggest catalog free. Nominal prices. Gibson Laboratory, Chemists, BD-1142 Sunnyside, Chicago.

FORMULAS Free. Where to get and three money making plans 25c. Box 116, Bluford, Ill.

NEW Confection, resembles potato chips. Easily made. May Lee, 1829 Kennett, St. Louis, Mo.

ELITE Formulas and plans; make and sell your own products. Descriptive booklet free. Elite Co., 214 Grand St., New York.

THAXLY Formulas for perfect products. Accurate analysis assured. Resultful research. Catalog free. B. Thaxly Co., Washington, D. C.

FORMULAS. Latest money makers. Literature free. Belfort, 4042 N. Keeler, Chicago.

CHEMISTRY

HANDBOOK For chemical experimenters, illustrated, hundreds of experiments, postpaid 50c. Experiment booklet 15c. Catalogue, 5c. Reading Scientific Company, Reading, Penna.

GENERAL Chemistry simplified. 35c pamphlet. Joray, 2731 Vine, Cincinnati, Ohio.

CHEMICALS In 5c quantities. Catalog 5c. Fleischer's Laboratories, Everett, Mass.

CHEMICALS, Laboratory, glassware, apparatus. Send 3c for catalog CPI. Biological Supply Company, 1176 Mt. Hope Avenue, Rochester, N. Y.

FREE Chemistry catalog. Supplies at 5c! Equip complete laboratory. Send 3c for postage. Kemkit Scientific Corp., 397P Bridge St., Brooklyn, N. Y.

TELESCOPES. Microscopes, chemistry, mineralogy. Scientific catalog free. Tracey Laboratories, Evanston, Illinois.

AGENTS WANTED

AGENTS—Fast selling, patented hair cutter, simple, easily used. Converts safety razors into hair cutters. Send 30c for sample and details. Universal Converter Company, 305a Dime Building, Allentown, Penna.

AMAZING Profits selling new lotionized cleaner. Something different. Whirlwind seller to housewives. Write immediately. Clean-O, 1323 Elm St., Denver, Colo.

PERMANENT Representative wanted for Hoover uniforms to call on restaurants, hotels, beauty parlors, doctors, nurses, others. Excellent immediate income. Leads furnished. Valuable equipment free. Hoover, Dept. BJ-B, 251 W. 19th, New York.

212% PROFIT Selling amazing new liquid mender. Fixes most anything; unlimited demand. Write for free sample proof. Indiana Laboratories, Dept. T-39, Elkhart, Ind.

BEAUTIFUL Bird pictures handmade with genuine feathers. Sell on sight! Large profits! Free particulars. Samples 10c stamps. Marquez-PH, Apartado 1176, Mexico City.

500% PROFIT With new perfected (1939) quick-action, no flint, automatic gas lighter. Retail 25c. Sample 5c. New Method Co., Box PMG-75, Bradford, Penna.

BUSINESS Proposition resilvering mirrors, autoparts, reflectors, making chipped glass signs. Write, Sprinkle, Plater, 128, Marion, Indiana.

SELL Signs, mottoes. Write Schaffner, 1336 West Rush, Philadelphia, Penna.

WANTED—Purchasing agents, no experience or money required, write and mail 3c stamps for application to Purchasing Mgr., 176 N. Halsted St., Chicago.

WORLD'S Fastest money maker. Sell 50c packs of razor blades for 5c. Tharp, 914 Lexington, Cumberland, Md.

500% PROFIT! Gold and colored sign letters for windows, offices, trucks, signs. Auto monograms. Easily applied by agent or customer. Neonite, Akron, Ohio.

AGENTS Wanted. Fast selling smoker's novelty, ejector cigarette case. Write Campbell, 47 E. Ohio, Chicago.

UP TO \$6.00 an hour. Amazing Kar-Nu beautifies old cars with sparkling new finish—without rubbing, polishing, waxing, painting. Costs little. Wipes on with cloth. Lasts 8-12 months. Free sample. Kar-Nu, Dept. R-8, Cincinnati, Ohio.

MAN And wife—to run local coffee agency. Earnings up to \$240 in a month. New Ford sedan given you as bonus. I send complete outfit. You don't risk a penny. Details free. E. J. Mills, 3208 Monmouth, Cincinnati, Ohio.

MAGIC Clothes brush. Revolutionary invention. "Erases" dirt like magic. Saves drycleaning. Sensational seller. Samples sent on trial. Rush name. Kristee, 103, Akron, Ohio.

START Making money selling new exclusive flat pencils with note books for pocket and purse. Sample 50c guaranteed. Harris Products, Orange, Mass.

SELL Social security plates. Sample 10c. Particulars free. Reliable Sales Co., 6 West 28th Street, New York City.

BIG Money taking orders; shirts, ties, hosiery, underwear, pants, uniforms, dresses, etc. Sales equipment free! Experience unnecessary. Write Nimrod, 4922-AN Lincoln, Chicago.

AGENTS—Salesmen—District managers—New \$1.00 auto necessity. Every auto owner needs. Season on. Over 100% profit. Details free. Hylite Laboratories, PM-2007 Grand Ave., Chicago.

YOUR Own local shoe business. Free outfit starts you! Bonus shoes given. 173 styles. Big advance commissions. Experience unnecessary. Tanners Shoes, 953 Boston, Mass.

200% PROFIT. No investment, fast seller, field unlimited. Danna, Box 57, West New York, New Jersey.

TOOTH-BRUSH Cabinets. New, sanitary. Liberal commissions. Sample 50c. B & C Woodshop, 2812 Roosevelt Road, Chicago, Illinois.

INITIAL Automobiles. Big profits. Outfit \$2.00. Samples 3c stamp. Money-back guarantee. Evans Products, Midian Avenue, Windsor, Conn.

AMAZING. Speedy self-selling, "one-call" proposition; every day your pay day! New, sensational, money-saving 7-Purpose Beauty-Lotion Concentrate. \$24 profit possible from dollar investment! Write quick; territory going fast. Ermadon, 301 Emslie, Buffalo, New York.

GALVANIC Roofing paint. Dependable weather proofing guaranteed. Add 5, 20 years to roofing. Particulars. Agents. Galvanic Products Co., Vanderbilt, Penna.

\$1 STARTS You in business selling complete line ties, Slyde-ons, bows and novelties. Over 100% profit. Write today for descriptive wholesale catalog, prices and free sample materials. Philip's Neckwear, 20 West 22nd, Dept. P-1, New York.

YOUR Name on the label and all repeat business must come to you. Cosmetics, toilet articles, food products, medicines, flavoring extracts, household specialties. 200% to 400% profit. Build a real business of your own. We print your name on the labels at no extra charge. Send ten cents for complete details and prices. National Scientific Co., Box 5269, Richmond, Va.

NECESSITIES Always in demand! Experience unnecessary to earn steady income selling shirts and sportswear factory to wearer. Gigantic variety; one year guarantee; customized fit (90 sizes). Half price offer creates amazing values. World's largest concern of its kind. Our sales force earns \$100,000.00 yearly. Get your share! Simply write orders. We deliver and collect. Postcard brings you complete money-making outfit free. Write Dept. 206, Rose-cliff-Quaker, 1239 Broadway, New York.

AGENTS. Sell all purpose cleaners to hotels, dairies, banks, taverns, hospitals, housewives. Distributors name on each box. Kleanwell Products, Box 1324, Youngstown, Ohio.

DON'T Be a job hunter—Start your own business on our capital. No hard times; no lay-offs; always your own boss. Hundreds average \$3,000 to \$5,000 annual sales year after year. We supply stocks, equipment on credit. 200 home necessities. Selling experience unnecessary. Wonderful opportunity to own pleasant, dignified, profitable business backed by world-wide industry. Write Rawleigh's, Dept. C-U-PPM, Freeport, Ill.

STA-WELD Permanently seals leaky radiators, cracked cylinder blocks, etc. Big repeating money maker. Factory, 2812 Gillham, Kansas City, Mo.

GRANITE Monuments. \$9.90 up. Delivered. Lettered. Catalog. Mikelich Company, St. Cloud, Minnesota.

MONEY In butterflies, moths. See Sinclair Display Advertisement on page 24A.

FRONT Money at once. Sells for 98c. Profit as much as 78%. New item. Sells like hotcakes. Territories going fast. Act quick! Details free. Ajax Tool & Die Co., Dept. 35, Racine, Wis.

PROFIT With new products. Make, sell, repeat. Analysis. Research. Guaranteed formulas. Biggest catalog free. Nominal prices. Gibson Laboratory, Chemists, BD-1142 Sunnyside, Chicago.

EX-O-LENE. New, red-hot, repeat auto product. Guaranteed. Millions waiting. To 500% profits. Information free. Thermo Exolene Works, Peoria, Ill.

AMAZING Zipper clothesline. Instant demonstration. Sells on sight. Dunn Mfg., Hempstead, N. Y.

BIG Money applying initials on automobiles. Easiest thing today. Free samples. Also, sideline salesmen for short order decalomania name plates. "Ralco," 1305 Washington, Boston, Mass.

ELGIN, Waltham, Hamilton watches. Make big money. \$3.95. Send for free jewelry catalog. Plymouth Jewelry Exchange, 163-B Canal St., New York.

MILLIONS Of prospects! Buyers everywhere! Sensational lifetime gold colored deluxe social security plates; case! Tremendous value! Fast seller! Big profits! Complete selling outfit free! Union Specialty, 1775-J Broadway, New York.

SELL Calling cards. Liberal profits. Outfit free. Universal, Orange, Mass.

SELL Our vest pocket size illustrated comic booklets. Send quarter for 10 different samples. None free. Reepsac Sales, 96 - 5th Ave., New York.

NEW Invention rids premises of roaches, ants, waterbugs, for a year. Homes, hotels, stores buy hundreds. Big profits. Write for distributor's trial offer. Rid-A-Tor Co., Dept. 39, Kansas City, Mo.

AMAZING Opportunity—Give away valuable premiums and samples with famous quality coffee, spices, 400 other necessities. Steady work—excellent pay. \$500.00 yearly bonus and free samples to all qualified dealers. Experience unnecessary. Part time workers welcome. Togstad Company, Dept. C-16, Kokomo, Indiana.

AGENTS! Big profits, mailing our literature. Home business. Stamford, 3762-D Broadway, New York.

DO You want agents for your proposition? Your ad in this space will place your message before hundreds of men seeking fast-selling products. My folder "How to Secure Agents" is filled with proof. I'll gladly send you a copy free. P. W. Johnson, Manager Classified Advertising, Popular Mechanics Magazine, 200 E. Ontario St., Chicago.

GUARANTEED Gold leaf letters for store and office windows. 300% profit. Free samples. Metallic Co., 438-B N. Clark, Chicago.

SAMPLE To smokers. Mail 6c in stamps—Sweet Tobac, rich flowery tropical mix with a delicate aroma. Distributors wanted. Specialty Forum, 9441 Pleasant Ave., Chicago.

SELL Artistic oil painted personal portraits! Portraiture, 826 Noble, Chicago.

HIGH Grade window letters 1 1/2c each. Free samples. Metallic Co., 438-A North Clark, Chicago.

FREE Sample world's best seller. G. Mfg. Co., Washingtonville, Ohio.

SELL Stores, taverns, gas stations 1939 sparkling 25c Gem signs. Cost 5c. Gem, 4327-M Harrison, Chicago.

500% PROFIT. Modernistic guaranteed Stick-on letters for windows, offices, trucks. Large sizes 1c. Easily applied. Free samples. Modernistic, B-3000 Lincoln, Chicago.

AGENTS: Smash go prices! Santos coffee 12c lb. 4-oz. vanilla 8 1/2c. Razor blades 10 for 8 1/2c. 100 sticks chewing gum 12c. 150 other bargains. Premiums. Experience unnecessary. Carnation Company, PO, St. Louis, Mo.

AGENTS—Opportunity make money; book containing 107 successful business plans; home-office; send for free introductory booklet. Elite Co., 214 Grand St., New York.

AGENTS Make big profits on food products, bargain deals. Low wholesale prices. Rush name for trial outfit offer. Ho-Ro-Co, 2810-R Dodier, St. Louis, Mo.

SUCCEED With your products. Make-sell them. Formulas. Processes. Accurate analyses. Catalog free. B. Thaxly Co., Washington, D. C.

STARTLING Invention—Pocket adding machine. Nationally advertised \$2.50. Whirlwind seller. Big profits. Baby Calculator Co., Box 1118, Chicago.

BIG Money applying initials on automobiles. Write for particulars and free samples. American Letter Company, Dept. 40, Dunellen, New Jersey.

AGENTS—To mail our literature. Good profits. Home business. Maywood, 149 Fifth Ave., New York.

FREE Sample—Amazing cleaner; sells homes, taverns, everywhere. Big profit—fast repeater. Betco, 5007 Irving Park, Chicago.

MANUFACTURE Specialties, hire agents yourself. Big money. Free literature. Gilbert Supply, 1107-P Broadway, New York.

AGENTS: Stamping names on pocket-key protectors. Sample check with your name, address, 25c. Stamping outfits. Emblem checks, check-fobs, name plates. Hart Mfg. Co., 303 Degraw St., Brooklyn, N. Y.

ENGRAVED Name plates, numbers, signs, etc., easily sold, profits large. Brett Bros., Winthrop, Mass.

REVOLUTIONARY Window cleaning tool. Good Housekeeping approval. Only ten \$2.25 sales daily to housewives, factories, schools, stores will make you \$350.00 monthly. Carter Products Corp., 900 Front Ave., Cleveland, Ohio.

ATLAS Window sign letters. Large sizes, penny each. Beautiful free samples. Atlas, 7941 Halsted, Chicago.

"1,000 WAYS To Make \$1,000." You can do it—others have. This amazing book will startle you. 475 pages, only \$2.50. Popular Mechanics Press, Room (C38), 200 E. Ontario St., Chicago.

HIGH-GRADE SALESMEN

CITY And rural salesmen. Two for southern manufacturer rated at half million. Monthly earnings up to \$400 to \$800. Take orders for roof coating with the aid of numerous powerful, visual demonstrations. Used on warehouses, schools, garages, public buildings, etc. Also full line of paints. Credit plan gives buyer long trial before paying a penny. Earnings advanced. Experience in our line not required but sales ability and intelligence absolutely necessary. We start you at our expense. Write immediately for complete details. The Zone Company, Box 4313, Dept. A, Fort Worth, Texas.

DID You make \$50 last week? Does your job offer you real future? If not, why not start a wholesale business of your own? Start with little as \$2.50. Handle line 200 nationally advertised 5c-10c products. Show merchants new plan for increasing sales and profits. Handle everything from your home at start. Chance to operate one of our Silver Fleet service trucks. Facts free. World's Products Co., Dept. 10-C, Spencer, Ind.

SELL Business cards \$1.50 thousand. Business stationery, book matches, gummed tape, paper towels, advertising pencils, sales-books, rubber stamps, advertising specialties. Free sales portfolio. 35% comm. daily. Money making specials. David Lionel Press, 312 So. Hamilton, Dept. DO, Chicago.

MAKE More money with Red Comet Automatic Fire Extinguishers. Low price. Proved seven years. Splendid sales outfit free. Some good territory open. Exclusive. Write quick. 704 Red Comet Bldg., Littleton, Colo.

DISTRIBUTORS—Supply revolutionary corn remover to stores. New sales plan results in landslide of orders. 150% profit. Exclusive franchise. Great Christopher Corp., Buffalo, New York.

THIS Ad directed to salesmen with sales ability. Application solicited for roof coating, paint, oil and grease proposition sold on long trial credit terms; no down payment. Earnings up to \$400 to \$800 per month. (Sworn statement.) Earnings advanced. No experience in our line needed, but intelligence and ambition are needed. Otherwise, please do not waste your time or ours. Panther Oil & Grease Mfg. Co., Box 4306, Dept. 106, Fort Worth, Texas.

POSITION Open paying salary and expenses based on small sales quota with nationally known manufacturer of standardized maintenance products. We want a salesman qualified to call on industrial plants, institutions, municipalities, school boards, real estate, insurance companies and large property owners. Protected territory. Old accounts given. Rapid advancement assured right man. American Asbestos Products Co., Dept. B, Cleveland, Ohio.

SALESMEN. Distributors—200 items brushes, mops. Marvelous magnetic brush excels vacuum cleaner. Big profits. Newway Brush Company, Hartford, Conn.

MORE Money in 1939 selling advertising book matches. Cash commission. Full or part time. Experience unnecessary. New outfit free. Gem Match, 72-PM West Washington, Chicago.

ADVERTISING. Specialty salesmen! Sensational advertising pencil deal. Every business a prospect. Striking color assortment. Lowest prices. Big commissions. North American, D-554 Adams, Chicago.

INVESTIGATE New profitable industry. California Earthworm Farms, Highland Park, Los Angeles, California.

BIG Commissions—selling to stores celluloid pricing tickets, metal shelf moulding. To restaurants, menu covers, signs. P. Pricing Press, 124 White St., New York.

AMAZING Seller. All weather coat guaranteed ten years, \$9.95. Commission \$3.00. Selling outfit free. Tenyear Raincoat Co., Dept. 20, Templeton, Mass.

FREE Samples—Red hot specialties. Jackson's, P-105, Kansas City, Mo.

RAWLEIGH Men make good money. Supply everyday household necessities to Rawleigh routes of 800 family users. Ambitious men can make good earnings at start. We furnish everything but the car. Write today. Rawleigh's, Dept. C-A-PPM, Freeport, Ill.

ADVERTISING Book matches—Sell union label book matches. Fastest selling line in America. Large sales producing kit, sample matches, complete cut catalog, eight color combinations make selling easy. Commission in advance. Superior Match Co., 7530 Greenwood, Dept. M-3, Chicago.

YOUR Own suits free. Other attractive bonuses and free shirt offer plus big cash profits for selling your friends quality tailored-to-individual measure suits. Five popular new low price ranges. Exclusive sport and swing styles no extra charge. Prices defy competition. Elaborate selection spring and summer new shades and patterns. Satisfaction or money back guaranteed by reliable thirty year old tailoring firm. No experience needed. Sample outfit free. Jay Rose & Co., Dept. P-3, 330 So. Wells, Chicago.

ADVERTISING Book match business now booming. Experience unnecessary. Big cash commission daily. Factory direct. Low prices and top quality assure repeats. Big sales kit free. Match Corporation of America, Dept. E-3, 3433 - 48th Place, Chicago.

LIVE Energetic salesmen to sell complete line of motor oils and greases. Shipment direct from refineries in Ohio, Pennsylvania, Wisconsin and other states. Roberts Coal Company, Memphis, Tenn.

NEW Specialty—Sells every business and professional man. Four \$15 sales daily pay \$280 weekly. Farrell cleared over \$1,000.00 monthly. Write, F. E. Armstrong, President, Dept. PM, Mobile, Ala.

BLADES. Finest quality. Factory prices, postpaid. Ace Blades, Buffalo, N. Y.

EXCELLENT Opportunity selling our complete line of brushes, largest commissions. Write for sales plan. Wire Grip Sanitary Brush Company, 2300 5th Ave., New York.

EARN Money in your spare time taking subscriptions to Popular Mechanics. Unlimited possibilities, every family a prospect. Easy to sell. Bonus paid in addition to liberal commission. Send postcard for further details today. Circulation Dept., Popular Mechanics Magazine, 200 E. Ontario St., Chicago.

HELP WANTED

STEADY Work—Good pay. Reliable man wanted to call on farmers. No experience or capital required. Pleasant work. Home every night. Make up to \$12 a day. Wonderful new proposition. Particulars free. Write McNess Co., Dept. 272, Freeport, Illinois.

WEAR Fine hose I send without cost with outfit while taking orders for amazing new hosery. Replacement guaranteed against holes, snags, and runs. Rush name and hose size. Wilknit, Desk C-37, Greenfield, Ohio.

MEN! Earn \$5 daily extra. Retain your position. Sell beautiful etched metal social security plate and double cellophane leather case. 70% commission. Send your S. S. No. and 10c for agent's equipment. Wm. Hamant, 665 W. Lexington St., Baltimore, Md.

M. M. Earned \$267, three weeks, raising mushrooms in cellar! Exceptional, but your cellar, shed perhaps suitable. We buy crops. Book free. United, 3848 Lincoln Ave., Dept. 63, Chicago.

BIG Money taking orders; shirts, ties, hosery underwear, pants, uniforms, dresses etc. Sales equipment free! Experience unnecessary. Write Nimrod, 4922-BG Lincoln, Chicago.

EDUCATIONAL AND INSTRUCTION

LEARN Shorthand at home. John Woolven, Box 326, Augusta, Georgia.

FOR An extremely profitable lifetime business, operate a collection-credit agency. Free folder. Cole Associates, Syracuse, N. Y.

BECOME Practical scientific investigator. Modern, illustrated course. Thorough training by former agent U. S. secret service. Particulars free. International Secret Service Institute, PM-39, Hoboken, N. J.

1939 GOVERNMENT Jobs. Commence \$105-\$175 monthly. Prepare immediately at home, for examinations. Experience usually unnecessary. Full particulars—list positions, free. Write today. Franklin Institute, Dept. H3, Rochester, N. Y.

WATCH Repairing is steady profitable work. Experts always in demand. You can learn watchmaking trade at home, spare time. New original instruction system. Script engraving course included. Write for free details today! Nelson Co., 2015 Manhattan Building, Chicago.

CARPENTERS—Pope's Simplex Roof Chart. All cuts, lengths, all rafters. Any roof, pitch. Guaranteed. \$1.00. Ed. Pope, Box 23, Sayre, Oklahoma.

INVENTIVE Minded can become independent! Explanation free. I. Higbee, Cantil, Calif.

STAMMERS—A new, practical, easy way to cure your stammering at home. Very small cost. Not a school. Write for free literature. Carl, Box 771, Detroit, Mich.

KNOW Your mental strength. Invaluable information on mental powers, concentration, control, memory, etc. "Dynamental" twelve studies postpaid \$1.00. Dynamental, 9304 Amesbury, Cleveland, Ohio.

CIVIL Service arithmetic, 662 tricky problems, solutions, \$2; 667 mental questions, \$2; customs, meat inspector, storekeeper-gauger, postal, many others, \$1 each. List jobs free. Pergande Publishers, D11, Milwaukee.

GOVERNMENT Jobs available. Act immediately. Free information. Cooper, 210A Colorado Building, Washington, D. C.

MANUAL Of locksmithing. Send for application. Christison's, 1019 - 14th, Denver.

PROFESSIONAL Slide rule. Prepaid, 25c. Gold Shield Products, 350-M Greenwich St., New York.

PROSPERITY For you. Revolutionize your life. Dime brings actual lessons in "Creative Procedure." Gardiner's, Box 6048, Kansas City, Missouri.

LEARN Linotype operating, photo-engraving, printing. Particulars free. Nu-Ideas, Carrollton, Illinois.

LEARN The practical way—Decorating, paperhanging, graining, marbling, sign painting, card writing, pictorial painting. Catalogue free. Chicago Painting School, 437 North Clark Street, Chicago.

LEARN Auto mechanics, body, repairing, welding electricity, refrigeration. Diesel. Stevinson's, 2008A Main, Kansas City, Mo.

LEARN Watchmaking. Complete instructions \$1.90. Catalog wholesale tool, material, watches 5c. Stewart's, 721 Olive, St. Louis, Mo.

TELEGRAPHY Taught thoroughly. Railroad retirement act creating opportunities for new operators. Expenses low. Catalog free. Dodge's Institute, Hiatt Ave., Valparaiso, Ind.

BOOKKEEPING Taught for as low as 40c weekly. Other home-study courses. Write for particulars. Institute of Business, Box 1055, Sacramento, Calif.

GOV'T Jobs start \$1260-\$2100 year. Men-women age 18-50. Former examiner's tested method helps qualify you. Particulars, list jobs free. Write today. Patterson School, 8C Mercantile Bldg., Rochester, N. Y.

HELP Yourself to success—good books put you on higher plane. Catalog—chemical and technical books for stamp. Kraftsmen's Press, Cos Cob, Conn.

SECRET Investigation. Experience unnecessary. Detective particulars free. George Wagner, M-2640 Broadway, N. Y.

MASSAGE. Hydrotherapy, dietetics, drugless therapeutics, chiropody, taught by mail. Evans Correspondence School, Montgomery, Ala.

PLAYS, STORIES, MANUSCRIPTS

WRITERS. Turn your rejected stories into cash! Our pattern outline for radio play \$1 per story. Stories revised, typed, marketed. Barrett-Keenan Literary Service, 302 Fifth Ave., New York.

ORIGINAL Poems, songs wanted for publication, radio. Westmore Music Corporation, Dept. 33G, Portland, Ore.

SHORT Stories, novels forcefully revised, typed for marketing. Welton Tinney, Winnsboro, Texas.

CARTOONING, COMMERCIAL ART, SHOWCARD WRITING, SIGN PAINTING

MONEY Making plans—Market guide—25c. Cartoon Studios, LaCrosse, Wis.

CHALK Talks. Laugh producing program, \$1.00. Catalog 10c. Balda, the Cartoonist, Oshkosh, Wisconsin.

CARTOONING Course: 30 illustrated lessons, over 500 drawings, pens and pencils. Sent complete postpaid for \$1.00. Scovell Studios, Box 748-P, Hollywood, Calif.

CARTOONING, Sketching, etc.—46 lessons, 600 illustrations, including drawing paper, pens, pencils, \$1.00 complete. Fraba Service, Cashton, Wisconsin.

PEN And ink illustrations for catalogue and general printing purposes at right prices. High grade work. Heraldic Studios, 1914 Oakdale Avenue, Chicago.

BE A lettering artist! Learn how to letter headings for magazine and newspaper advertisements. Highly paid profession. Free booklet. Guild School of Lettering and Advertising Design, 324 Summit Avenue, Hackensack, N. J.

ADVERTISING AGENCIES, LETTER WRITERS, FOR ADVERTISERS

ADVERTISING Placed all magazines, newspapers, radio. Lowest rates. Free service. 54 page rate book free. Baker Advertising Agency, A-189 West Madison, Chicago. Successors to Ankrum. Established 28 years.

LEARN Advertising quickly at home. Easy practical plan. No text books. Common school education sufficient. Interesting booklet and requirements free. Page-Davis School of Advertising, 3601 Michigan Avenue, Dept. 3431, Chicago.

EFFICIENT Advertising prepared for any business. 38 years experience. Newspaper, magazine, mailing-list free. Chicago Advertising Agency, 20-PE West Jackson, Chicago.

FREE—New Advertisers Rate Guide, 44 pages. Includes everything. Lowest rates. E. H. Brown Advertising Agency, 140 S. Dearborn, Chicago.

ADVERTISE: 24 Words in 250 newspapers \$10. Lists free. Advertising Bureau, 4515-C Cottage Grove, Chicago.

DIRECT-MAIL Advertising services. Sales letters that sell. Mailing lists. Omaha List & Letter Co., Box 2172, South Omaha, Nebr.

BUSINESS SERVICE

LOS ANGELES Mail address \$2 monthly. Dickey, 628 W 9th.

\$1.00 MONTHLY Maintains Detroit mailing address. Harry Wells, Baseline, Michigan.

CHICAGO Mail address \$1 monthly. Your personal, business mail forwarded daily. Established 1919. General, 56 West Washington.

WASHINGTON, D. C., reliable, permanent, mailing, forwarding, branch office address. Hawkins Mail Service, 817 Fourteenth.

RUBBER STAMPS AND OFFICE SUPPLIES

ORIGINAL. Cushion mounted. One, two lines, 25c; three 35c; four 45c. Stamp Works, 814 Bradley, Peoria, Ill.

2 LINES 25c, 3 Lines 35c. Stamp Works, Auburn, Nebr.

2 LINES 25c, 3-35c, cushion mounted. Stamp Works, Centerport, N. Y.

CUSHION Mounted one-two lines 25c; three 35c. Hauer Press, 1314 Ford, Youngstown, Ohio.

TYPEWRITERS, DUPLICATORS, OFFICE DEVICES

INCREASE Business now. "Excelsograph" Rotary Stencil Printer reprints thousands everything you typewrite, handwrite, draw or trace. Colors, \$19.75 to \$44. Terms. Illustrated literature free to business or professional men. Pittsburgh Typewriter Supply, Department K-2, Pittsburgh, Penna.

NEW \$3.75 Automatic adding machine. Fully guaranteed. Bassett, Box 302-K, Altadena, California.

TYPEWRITERS, Adder, mimeograph, multigraph, addressograph. Send for free lists of machines that will help you at half price. Pruitt, 28 Pruitt Bldg., Chicago.

PRINTING, MULTIGRAPHING, MIMEOGRAPHING, GUMMED LABELS

1000 LETTERHEADS, Envelopes, statements—\$2.75 delivered. Lackawanna Print, Lackawanna, N. Y.

BUSINESS Stationery \$2.40 1,000. Samples. LaPorte Printing, 3461 Vernon, Astoria, N. Y.

200 THREE-LINE Stickers, 10c; 500, 20c. Times, Warrensburg, Ill.

POSTPAID—125 8½x11 Bond letterheads and 125 envelopes \$1.00; letterheads, billheads, 300—\$1.00. Benneville, 907 West Roosevelt, Philadelphia.

MIMEOGRAPHING, Illustrated letters, circulars, samples. Bur-Wil, 24 Louisa, Binghamton, N. Y.

HAMMERMILL Letterheads, 300 8½x11, any color paper and ink, \$1.48 postpaid. Free particulars. Woodruff's, 217A Lewis, Duluth, Minnesota.

125 LETTERHEADS, 8½x11, and 125 envelopes, 6¾, printed, \$1.00, postpaid. Samples free. Pine Hill Printery, Freeman, South Dakota.

STATEMENTS, 500, \$1.15. (Samples.) J. P. Printing, 2617 Ann, Philadelphia, Pennsylvania.

EXTRA Quality! 1000 letterheads, statements or envelopes \$2.75. Kelly's Print Shop, Columbia, Mo.

135 8½x11 BOND Letterheads and 135 6¾ envelopes—only \$1.00! Postpaid. Beautiful work! Premier, 454 Christopher Avenue, Brooklyn, N. Y.

1000 STICKERS, ¾x2½. Four lines 45c. Titsworth, Cornelia St., Flint, Mich.

HARVEY Labels. Not cheapest, but better values. 6618A Quimby, Cleveland, Ohio.

QUALITY Envelopes, 500—\$1.50; 1000—\$2.50. Sullivan's, Fairport, New York.

250—\$1.00 POSTPAID. Letterheads, envelopes, statements, cards. Press, 209 South Upper, Lexington, Kentucky.

EMBOSSED Stationery at ordinary printing prices. Fechner, 202 Ashland, River Forest, Ill.

PRINTING. Lowest prices in America. Samples free. Pitz, Middle, Iowa.

1000 BUSINESS Cards 75c; 3x6 circulars 45c. Barjenco, 22 Fox, Worcester, Mass.

\$2.25—1000; LETTERHEADS, Envelopes, statements, circulars. Samples. Midwest Printing, 514P Huron, Minneapolis, Minn.

LABELS: All kinds. Write, samples. JBSCO, Box 93, Holyoke, Mass.

1000 6¾ PRINTED Envelopes \$1.40. James, Box 1436, Long Beach, Calif.

BORDER And ornament font 50c. Catalog 10c. Daemicke, 6452 Kenwood, Chicago.

FREE Samples: low priced, high quality mimeographed work, our specialty. Gottwirt, 1169 Lincoln Place, Brooklyn, N. Y.

1000 BUSINESS Cards \$1.00 post paid. Superba Print, 912 Towne, Los Angeles, Calif.

\$1.50—1000 ENVELOPES, Statements, circulars, 100 cards 25c. 503 - 46th Street, Brooklyn, N. Y.

DELUXE Letterheads—150, \$1.50; 1000, \$4.50. F. C. Meyer, Hobart, Indiana.

PERSONAL Book matches are distinctive; enhance prestige and dignity of your name. 100 books \$1.00. Sanderson Match Co., Ottawa, Ill.

ENVELOPES, 500, 6¾, \$1.00. Morey Press, 87 Somerset, Springfield, Mass.

1000 6x9 CIRCULARS, Letterheads, envelopes, postcards, \$2.75; 5000, \$9.45. All printing reasonable. Samples. Goodprint, Harrisonburg, Va.

1000 GOOD Business cards \$1.00, prepaid, cash. Sullivan Printing Company, Memphis, Tenn.

1000 STICKERS, Four lines, 50c. Fine labels. Cott's, Spickard, Missouri.

PRINTING? Get lowest prices. Churchill, 4316 South Salina, Syracuse, N. Y.

1939 PRICELIST, Portfolio of samples free. McCall Press, 1326 South 27th, Omaha, Nebr.

1000 BUSINESS Cards \$1.00 postpaid. Tucker, P.M. Box 65, Indianapolis.

500 ¾x2¼ FOUR Line gummed stickers, 25c. Moritz Printery, Saginaw, Mich.

PRINTING OUTFITS AND SUPPLIES

NEW Type 25c per font. Wolverine Type & Paper Co., Weidman, Mich.

PRESSES \$7.00 Up. Type, supplies, lists 3c. Landis, Richland, Penna.

USED Presses, type, supplies. Lists 3c. Turnbaugh Service, Loysville, Penna.

PRINT Your own cards, stationery, circulars, advertising. Save money. Easy rules furnished. Print for others, big profits. Junior outfits \$9.00, senior outfits \$17.00 up. Details free. Kelsey Presses, E-11, Meriden, Conn.

COMPLETE Font 12 point Stymie type \$1.00. (New.) Econofoundry, 7137 Constance, Chicago.

12 COLORS Printing inks \$1.00. Sample 20c. 503 - 46th Street, Brooklyn, N. Y.

PRESSES \$5.00. Type 50c. Cuts 10c. Shops bought, sold. Complete bargain catalogs. Send stamp. Bradshaw, 3214-P Huron, Chicago.

INGENIOUS Rotary press. Furnished complete with sliding rubber type and equipment—at \$2.50. Prints pictures and several sizes of type. Free circular. Superior Type, 3942 Ravenswood, Chicago.

HAND Press, type and complete printers' supplies. Advise equipment you need and we quote prices; or send stamp for catalog. P. Peiffer, 14-C; 6 Columbia St., Newark, N. J.

BARGAINS, Presses, type. List 3c. Exchange D-15. 22 Orient, Meriden, Conn.

BARGAINS — Presses, type, supplies. Send stamp. 159 Harvard, Cambridge, Mass.

PATENT ATTORNEYS

INVENTORS: Send immediately for your copies of our new free books, "Patent Protection" and "Suggestions on Selling an Invention." Sixty-eight pages of interesting facts. They tell how Patent Laws protect you; kind of sketch or model needed; simple steps to take without cost; how successful inventors have secured financial assistance; show interesting inventions; illustrate important mechanical movements. With books we also send free Evidence of Invention form to help establish date of disclosure. Prompt service, reasonable fees, special deferred payment plan. Strictest secrecy. Forty-one years' experience. Highest references. Write us today. The facts in our books are worth money to the man with a good invention. Address: Victor J. Evans & Co., Registered Patent Attorneys, 113-C Victor Building, Washington, D. C.

PATENTS—Before too heavy an outlay of time or money is made on an invention, a search of the Patent Office records should be made to determine as nearly as possible whether or not the same idea has been patented before. The cost of this search is small, while the value of the facts it uncovers is often considerable. We offer inventors and manufacturers a thorough prompt, confidential search service—plus experienced counsel and assistance in every phase of Patent and Trade-Mark practice. Write for our new free book containing valuable information relating to patent procedure. Clarence A. O'Brien and Hyman Berman, Registered Patent Attorneys, 58-P Adams Bldg., Washington, D. C.

FREE Books tell all! What to do with your invention? Patent facts clearly explained. 64 years' experience at your immediate service on easy budget payment plan. Write today for free copies of interesting booklets and "Certification of Invention" form. C. A. Snow & Co., 136 Snow Building, Washington, D. C.

PATENTS. Protect your idea by securing free "Proof of Invention" folder. Exceptional personal service. Established 1906. E. E. Vrooman, 871 Woodard Bldg., Washington, D. C.

INVENTORS: Use my personal, confidential patent service. Send for free facts on patenting your invention. Also suggestions on financing a patent application. Reasonable fees. Deferred payments arranged. Write Hugh E. McMorrow, Registered Patent Attorney, Dept. 309-W, Barister Building, Washington, D. C.

PATENTS—Trade marks. Preliminary advice, book and disclosure form free. Personal service. Irving L. McCathran, 1060 International Bldg., Washington, D. C. Registered Patent Attorney.

PATENTS—Any country. Reasonable rates. Free information. Ramsay Company, 273 Bank St., Ottawa, Canada.

INVENTORS—Before disclosing your invention to anyone send for form "Evidence of Conception"; "Schedule of Government and Attorneys' Fees" and instructions. Sent free. Lancaster, Allwine & Rommel, 411 Bowen Building, Washington, D. C.

"INVENTOR'S Guide," 100 mechanical movements, free; advises on patenting, selling inventions. Frank Ledermann, Tribune Bldg., New York.

L. F. RANDOLPH, 302-B Victor Bldg., Washington, D. C. Low cost. Book and information free.

PATENTS. Booklet free. Highest references. Best results. Promptness assured. Watson E. Coleman, Patent Lawyer, 724 Ninth St., Washington, D. C.

INVENTORS—Send for free booklet "Patent-Sense." Information based on 64 years experience. Lacey & Lacey, Dept. 5A, 635 F St., Washington, D. C.

FOR INVENTORS

PATENTS—Before too heavy an outlay of time or money is made on an invention, a search of the Patent Office records should be made to determine as nearly as possible whether or not the same idea has been patented before. The cost of this search is small, while the value of the facts it uncovers is often considerable. We offer inventors and manufacturers a thorough prompt, confidential search service—plus experienced counsel and assistance in every phase of Patent and Trade-Mark practice. Write for our new free book containing valuable information relating to patent procedure. Clarence A. O'Brien and Hyman Berman, Registered Patent Attorneys, 58-P Adams Bldg., Washington, D. C.

IDEAS Developed into salable, practical products. Extensive experience. Roman Winograd, Consulting Engineer, 140 Nassau, New York.

SAFEGUARD Your unpatented invention before submitting drawings to others. Quick inexpensive method. Upheld by highest courts. Instructions \$1.00. S. Dunn, Box 214, Middletown, Ohio.

I FINANCE Inventions; market specialties; create distribution; build sales organizations; originate sales presentations; give expert marketing advice. James Maratta, Marketing Consultant, 185-A Madison Ave., New York.

WHETHER Patented or unpatented, profit by voice of experience. Private secretary to inventor for fifteen years offers surprising truths in thousand words of vital information! Dollar bill to Box 65, Clinton, Illinois, brings inside facts that may be worth thousands.

WE Locate buyers meritorious patented, unpatented inventions. If will sell, reply immediately. Descriptive booklet free. Invention Reporter, 5A-11236 South Fairfield, Chicago.

ENGINEERING Drawings from your sketches. Blueprints. Country's lowest fees. Postal. Draftsman, 127 Lewisburg, Ohio.

IF You are looking for new roads to profits, write for my free booklet, "Cashing in on Unpatented Ideas." Stamp appreciated. Hendrickson, Argyle, Wisconsin.

HAVE You a sound, practical invention for sale, patented or unpatented? If so, write Chartered Institute of American Inventors. Dept. 4-A, Washington, D. C.

INVENTORS: Profit by your invention. A practical talk to inventors by an experienced manufacturer. Our 68 page booklet "Mind vs. Matter" mailed upon receipt of 25c. Rex Engineering Co., Cincinnati, Ohio, Dept. D.

INVENTORS: "Making Inventions Pay," our 32-page illustrated book, mailed upon receipt of 3c postage. Crescent Tool Co., Dept. Z, Cincinnati, Ohio.

PENDING Patent applications can be brought before thousands of manufacturers, free of charge, through Invention Magazine. Write for details. Invention, Inc., 635 F Street, Washington, D. C.

INVENTORS—Send for 72-page book on patents. Reasonable terms. Conscientious treatment to inventors. L. F. Randolph, Registered Patent Attorney, 302-E Victor Bldg., Washington, D. C.

I SELL Patents. Established in 1900. Charles A. Scott, 773PM Garson Ave., Rochester, N. Y.

INVENTIONS WANTED

PRACTICAL Inventions wanted. Full protection guaranteed. Write for "4-Point Service" bulletin. R. & S. Engineering Company, 17 East 42nd Street, New York, N. Y., Dept. M3.

WANTED—Meritorious patented, unpatented inventions. Booklet free. Invention Reporter, 5B-11236 South Fairfield, Chicago.

I SOLD 354 unpatented "ideas" last year. My free booklet tells you how to sell yours. G. Hendrickson, Argyle, Wisconsin.

WANTED. Patented, unpatented inventions for immediate exploitation to 5000 manufacturers. P. O. Box 443, Salem, Indiana.

CASH For unpatented ideas. Stamp for particulars. Mr. Ball, 9441-A Pleasant, Chicago.

SMALL Inventions wanted by manufacturers. I'll help you sell your invention. Write for free circular. Stanley Hull, 7829-K Euclid Avenue, Cleveland, Ohio.

SIMPLE. Practical inventions wanted by manufacturers, patented or unpatented. For information write Chartered Institute of American Inventors, Dept. 4-D, Washington, D. C.

PATENTS FOR SALE

PATENTED Gasoline barrel locking device. Patent No. 2,032,223. Investigate this. Albert Ostgaard, Cadogan, Alta., Canada.

FOR Sale. Patented multiple switch, one light to a thousand. Write Harry White, 352½ Laveta Terrace, Los Angeles, California.

WANTED—Party finance manufacture, market—Royalty—New improved patented lawn mower. Thoroughly tested and proved most practical, dependable, useful mower ever built. Decidedly different—Proved merit—Has wonderful exclusive outstanding selling features everybody wants. Economically produced. Money maker. Investigate. C. Fricker, 1321½ Broad, Newcastle, Indiana.

SELL Your patent through a small classified ad in Popular Mechanics. Many inventors have found buyers in this way. Ask me for proof—I'll gladly send it to you. F. W. Johnson, Manager Classified Advertising, 200 E. Ontario St., Chicago.

COLLAPSIBLE Sand-rake for golfers. Outright or royalty basis. K. Muranaka, 96 Puiwa Lane, Honolulu, Oahu, Hawaii.

MANUFACTURERS: For new products or profitable manufacturing opportunities, inquire, Invention Reporter, 5C-11236 So. Fairfield, Chicago.

ABSOLUTELY New wind charger, built in governing. Member of Chartered Institute. John W. Smith, Decatur, Ga.

FLEXIBLE Glass window screen roller slides with window. Violet ray effect. Patent pending. Write William Gorgay, 500 West 124 Street, New York, N. Y.

MANUFACTURING

INVENTIONS Perfected, dies, stamping quantity production, brasswork, mould-making, bicycle sprocket lubricator. Catalog 3c. Baum's Metal Specialties, Kansas City, Mo.

INVENTIONS—Manufactured in any quantity at low cost by old established company. Stampings, metal specialties, dies, models, etc. Free estimates. Send for catalog. Crescent Tool Co., Dept. X, Cincinnati, Ohio.

INVENTIONS Manufactured in any quantities. Tools, dies, metal stampings; working models built; industrial designing. Complete blueprint and engineering service. Write for "4-Point Service" bulletin. R. & S. Engineering Company, 17 East 42nd Street, New York, N. Y., Dept. PM-3.

COMPLETE Manufacturing service—Metal articles developed, working models made, dies, stampings, wire forms, spinning, plating, castings, screw machine products, baked enameling, assembling, free warehousing. Southern Products, P39, Independence, Mo.

INVENTIONS Manufactured by an experienced company, in any quantity at low cost. Metal specialties, novelties, stampings, dies, and models. Free estimates. Our booklet "Mind vs. Matter" sent upon receipt of 25c. Rex Engineering Co., Cincinnati, Ohio, Dept. C.

MODELS AND MODEL SUPPLIES

SHIP Model kits, fittings. Catalog 5c. Polk's, 429 Seventh Ave., New York.

SUBMARINE 24" Kit to build \$1.00. Spotts, 3925 N. Broad, Philadelphia.

MINIATURE Boat and airplane supply catalog 5c. Selley, 1377 Gates Ave., Brooklyn, N. Y.

MODELS—Your ideas developed into practical working models. 30 years successful experience; thousands of satisfied customers. Confidential service guaranteed. Bank references. Send 3c postage for our large booklet—"Making Inventions Pay." Crescent Tool Co., Dept. Y, Cincinnati, Ohio.

SHIP Model—American merchantman, 28" long, completely and correctly rigged. Captain A. C. Stott, U.S.N., 90 Church St., New York.

BUILD 18 Inch model cabin cruiser or speedboat or electric outboard. Send dime for information. Sykes Motors Company, Lakewood, Ohio.

MODEL Gas engine castings, face plate and angle plate castings, brass, steel, etc. Stamp for catalog. Louis Terek, 1000 N. Lamont, Chicago.

CATALOGUE Of over 40 engines, castings, supplies, 25c. Refunded. Howard Co., A-2417 North Ashland, Chicago.

MODEL Racer kit 35c. 8 airplane kits \$1.00. List 5c. Northern Aircraft, Manitowoc, Wisconsin.

RAILWAY Models. Catalog handbook 25c. Walthers, 247 E. Erie, Milwaukee.

BUILD Miniature gasoline motors. Fascinating, educational, profitable. Details, drawing, 10c. Wright Motor Works, 3256 Lake Park Ave., Chicago.

POWER Models, steam locomotives, electric railways, gasoline, steam engines, ship machinery, accessories. 84 page catalog 35c. Chas. Cole, Ventura, Calif.

RACING Hulls, kits \$3.50 up. St. Louis Model Boat Co., 225 N. Meramec, Clayton, Mo.

MODEL Railroad Shop, Dept. PM, Dunellen, New Jersey. New 24 page illustrated catalog 10c postpaid.

SHIP And yacht model fittings; construction sets; model yacht sails; illustrated catalog 20 cents. A. J. Fisher, 1002-1 Etowah Avenue, Royal Oak, Mich.

MODEL Supplies for the inventor. Send 3c stamp for catalog. Pierce Model Works, Tinley Park, Ill.

MODELS—Practical models put over your ideas. We develop models from the crude to perfect working devices. Your idea might have large commercial value. Services confidential. Bank references. Registered graduate engineers at your service. Send 25c for our 68 page booklet "Mind vs. Matter." Rex Engineering Co., Cincinnati, Ohio, Dept. B.

STEAM Locomotives! ¾" scale. Build one by "Easy Steps." Our illustrated catalog lists all needs. 25c. Little Engines, Box 15B, Wilmington, Calif.

MODEL Airplanes, boats, radios, supplies. Catalog 10c. Imperial, 416-K McDonald, Brooklyn, N. Y.

HOME CRAFTSMEN

DOES Your home work shop cause radio interference? Build friction clutch, plans, castings, complete or partial kit. Stamped envelope brings information. Build Craft Engineering Co., Linden, N. Y.

20 FULL Size lawn ornament patterns 25c. Wickman, 744 Brooklyn, Dept. 12, Dayton, Ohio.

NEW Manual for tool users free. Tells you how to use and care for your tools; how to sharpen your saws. Write Henry Disston & Sons, Inc., 311-C Tacony, Philadelphia, Penna.

PROFITABLE Job for your workshop. Write. Kowell, 5372 St. Clair, Detroit.

WONDERFUL Opportunity. Exceptional profits. Manufacture novelties. Turn workshop into factory. Spare time into cash. Fifty assorted, popular woodworking projects with complete working drawings, instructions, \$1.25 postpaid. Interesting catalog containing supplies, construction sets, projects, books, credit coupon and valuable information, 10c. Woodcraft Service, Plainview, Minnesota.

20 BIRDS And animals, lawn ornament patterns 30c. Modern Woodcraft, Saginaw, Michigan.

LAWN Ornament patterns. Set of 5 for 25c. M. O. Sales Service, Atkinson, Nebraska.

BUILD This comfortable level riding gliding chair. Blueprints \$1.00. Superior Designers, 628 N. Skinker, St. Louis, Mo.

TRADE Present equipment for 1939 models. Details. Write now. Craftsman's House, 62, Avoca, Penna.

"MODERN Wood Sculpture." Complete instruction book on carving statues \$1.00. Lee Wood Art Studio, Centerville, Iowa.

LEATHERCRAFTSMEN—Write for free instructions and price list of leather, tools, etc. Sample cards 5c. Wilder & Co., Dept. F, 1038 Crosby St., Chicago, Ill.

PLYWOOD At wholesale. Everything in plywood and veneers for the professional and amateur craftsman. Complete stock of foreign domestic woods at wholesale prices. Send 10c for new interesting catalog. Your dime refunded on first order. Beck Plywood & Veneer Co., 1312 N. Halsted St., Chicago, Ill.

OLD GOLD, WATCHES, JEWELRY, PRECIOUS STONES

NEW 7 Jewel wrist watches \$8.00 up. Reasonable watch repairing. Hammond, 120 W. Susquehanna, Philadelphia, Penna.

SEMIPRECIOUS Stones, how to cut them book \$1.00. Stamp for information. Home Lapidary Shop, Madera, California.

WATCHMAKERS' Repair service. Save half. Paul Jewelry Co., LaCrosse, Wis.

WATCHMAKERS' Supplies, tools, watches. Sold, purchased. Ben Segal, 5 South Wabash, Chicago.

AUSTRALIA'S Lovely opals. Illustrated catalogue free. Good selection \$5. Norman Seward, Melbourne, Australia.

HIGHEST Prices for old gold, teeth, watches, jewelry. Full cash value mailed day shipment received. Satisfaction guaranteed or articles cheerfully returned. Information free, or ship today. Chicago Gold Smelting Co., 300-P Champlain Bldg., Chicago.

GOLD \$35 Ounce. Ship old gold teeth, crowns, jewelry, watches—receive cash by return mail. Satisfaction guaranteed. Free information. Dr. Weisberg's Gold Refining Co., 1500-Q Hennepin, Minneapolis, Minn.

FOR THE HOME

KEEP Cellar free of Fly Ash when filling ash can. Photo, instructions 25c. P. O. Box 451, Cincinnati, Ohio.

BEAUTIFY Your old furniture! Refinishing now made easy. Complete instructions 35c. Todd's Service, 262 Arlington, Youngstown, Ohio.

THE \$17.50 Fuel Savers for \$2.50 advertised last month are going fast. Send for information now. H. Trebert, Canandaigua, N. Y.

OIL BURNERS

GUN-TYPE. Over production sale, for furnaces, water and steam plants. \$62.50 complete. Mechanical Arts Co., 1304 Washington, Chicago, Ill.

TOBACCO

GUARANTEED: Cigarette, pipe or chewing. 5 lbs. \$1.00, ten \$1.75. Pay when received. Pipe and box cigars free. Rives Tobacco Co., Paducah, Ky.

RAZORS—BLADES—SHARPENING

SHARPEN Your old blades, easily, quickly. No expense. Directions 10c silver. C. G. Blair, Box 696, Atlanta, Ga.

ELECTRIC DRY shaver, with double-edge shaving-head for quick, close shaves. Fully guaranteed against defects. \$1.98 postpaid, or C.O.D. plus postage. Bargain catalog other items free. Hackard, 3816-M Belmont, Chicago.

WANTED—MISCELLANEOUS

CASH For used microscopes, binoculars, cameras, slide rules, drawing sets, surveying, mechanical, scientific, and musical instruments. Highest prices paid day shipment received. Satisfaction guaranteed or shipment promptly returned. Elman's, 2302 Van Buren, Chicago.

PERSONAL

SHU-SWEET Will save those smelly shoes. It chases odor! 25c postpaid. Shu-Sweet, Box 1066, Santa Fe, New Mexico.

ARE You deaf? Abell's artificial ear drums are recommended. Write now for free booklet. Dr. Abell, Slavin Bldg., Pasadena, Calif.

CORRESPONDENCE—Coaxers bring letters. 25c dozen. Gwynn, Main, Adrian, Michigan.

WIN Prize money: Booklet—"Successful Contesting"—shows how. 10c postpaid. Bulletin listing \$200,000.00 prizes included. World Publishers, 4515-B Cottage Grove, Chicago.

EXCLUSIVE Photographs: Samples, complete list 25c. Albert McGoldrick, Mansfield, Mass.

NERVOUS? Fears? Depressed? Afflicted? Free helpful information. Norman Ferngold, Psychologist, Office 15, 22 Amherst St., Worcester, Mass.

BOOKKEEPING. Home, personal, business. \$2.25. Popular Mechanics, 200 E. Ontario St., Chicago.

MISCELLANEOUS

GET Informed: Latest bulletin fluorescent and other high priced rocks and minerals; interesting, profitable. 15c stamps. Brandex Laboratories, Box 180, Oakland, California.

FOOL Your friends! Make believe you are here. 20c stamps brings you 2 scenic postcards (\$1.00 for 20). Fill them your own handwriting and return for free mailing; we pay postage. Marquez-PMB, Apartado 1176, Mexico City.

WIN. Maintain, regain happiness. Science of Happiness, one dollar. Chas. L. Cart, Blanchester, Ohio.

BUSINESS Proposition resilvering mirrors, autopaarts, reflectors, making chipped glass signs. Write, Sprinkle, Plater, 288, Marion, Indiana.

NERVOUSNESS—Fear! Afflicted? Free, illuminating information. Jno. Englund, Ironwood, Michigan.

C-CLEAR Polishes, and prevents steaming on windshields, also eye-glasses. Medium size 25c. Send coin or money order to Strand Optical Co., 77 Washington St., Providence, R. I.

INSTANT Defroster for windshields, eye-glasses, storewindows. Liberal cake, instructions 10c postpaid. J. Rahn's, Ellsworth, Minnesota.

MEXICAN Bridge tally cards with beautiful feathered birds. Send 20c stamps for samples. Paez, Apartado 754, Monterrey, Mexico.

DO Fear, worry and unrest plague your life? Send quarter for my method. Not a cult—not a religion. Simply common sense. Box 378, Ashland, Wisconsin.

BANISHES Foot odors, tired aching feet in 20 minutes. Price 10c. Ferdinand's Foot Tablets, Ferdinand's Laboratories, Indianapolis, Ind.

MONEY In butterflies, moths. See Sinclair Display Advertisement on page 24A.

NEON Signs. Get lowest wholesale prices, \$11.50 up. Midwest Neon, Council Bluffs, Iowa.

SWAP Or sell articles you don't need for those you want. Send dime for Swappers Guide listing articles from all over United States. Dept. PM, Swapper's Guide, Delphos, Ohio.

I'M Never out of work. My plan brings me \$95.00 monthly average, best plan out. Guaranteed. Details 25c. Shupitz, White-law, Wisconsin.

AMATEUR Tattooing outfits. Free circular. Tatuco, 651 South State, Chicago.

LAM-A-FAB. The cloth cement, acid and waterproof. Permanently repairs anything made of cloth. Sails, hunting equipment and suits, football suits and athletic equipment, rugs, canvas chairs and work clothing. S. J. Russell Co., P. O. Box 187, Peoria, Ill.

MONUMENTS. Low prices. Lettered. Delivered. Guaranteed. Reliable Marble-Granite Company, A17, Oneco, Florida.

COLLECTORS. Swappers, contest fans, investigate free trading service. Exchange, Box 425, Detroit.

NEW Calculator, lightning speed. Invaluable to anyone. \$1.00. Rock Shallow, 516 W. Dominick St., Rome, N. Y.

TATTOOING Outfits, supplies, illustrated list free. "Waters," 965 Put-nam, Detroit.

COATS-OF-ARMS And crests correctly rendered in colors or black and white. Highest grade. Estimates free. Heraldic Studios, 1914 Oakdale Ave., Chicago.

SWAPPER'S Friend, R4, Saline, Michigan. Interests swappers, collectors. 50c year, sample 10c.

HOW To identify and determine value of old precious metals. Where to buy. To whom to sell. Reliable and up-to-date information. Complete instructions only \$1 postpaid. Popular Mechanics Press, Room (C38), 200 E. Ontario St., Chicago.

AUDELS Carpenters and Builders Guides 4 vols. \$6



Inside Trade Information for Carpenters, Builders, Joiners, Building Mechanics and all Woodworkers. These Guides give you the short-cut instructions that you want—including new methods, ideas, solutions, plans, systems and money saving suggestions. An easy progressive course for the apprentice and student. A practical daily helper and Quick Reference for the master worker. Carpenters everywhere are using these Guides as a Helping Hand to Easier Work, Better Work and Better Pay. To get this assistance for yourself, simply fill in and mail the FREE COUPON below.

Inside Trade Information On:

How to use the steel square—How to file and set saws—How to build furniture—How to use a mitre box—How to use the chalk line—How to use rules and scales—How to make joints—Carpenters arithmetic—Solving mensuration problems—Estimating strength of timbers—How to set girders and sills—How to frame houses and roofs—How to estimate costs—How to build houses, barns, garages, bungalows, etc.—How to read and draw plans—Drawing up specifications—How to excavate—How to use settings 12, 13 and 17 on the steel square—How to build hoists and scaffolds—skylights—How to build stairs—How to put on interior trim—How to hang doors—How to lath-lay floors—How to paint.



THEO. AUDEL & CO., 49 W. 23rd St., New York City

Mail Audels Carpenters and Builders Guides, 4 vols., on 7 days' free trial. If O.K. I will remit \$1 in 7 days, and \$1 monthly until \$6 is paid. Otherwise I will return them. No obligation unless I am satisfied.

Name.....
 Address.....
 Occupation.....
 Reference..... P.M.

When writing please mention Popular Mechanics

AIR CONDITIONING AND ELECTRIC REFRIGERATION INDUSTRY NEEDS TRAINED MEN

34 year-old organization now receiving applications of men to prepare for positions in Air Conditioning and Electric Refrigeration. Qualify in 3 months for Estimating, Installation, Service, Maintenance and Sales positions. No experience needed—We train you under actual working conditions in our own air conditioned laboratories. Free employment service. Get illustrated book "Step Up to Success"—it's free! Write



MILWAUKEE SCHOOL of ENGINEERING
 Institute of Electrotechnics
 Dept. PM-339 Broadway and E. State, Milwaukee, Wis.



CARTOONING

FREE TRIAL LESSON! Cash in on your sense of humor—AT HOME—BY MAIL. Have fun! Make money! No experience needed to start. Write today for FREE LESSON, mailed postpaid. No obligation. Moon Gag-Cartoon School, Dept. A, Fall Creek, Wis.

BIG PROFITS in DRY-CLEANING!

Good times or bad, dry-cleaning and redyeing stores prosper. Good-paying opportunities in even smallest towns. Easy to learn at home—requires no capital. Training costs but a few cents a day. Not a get-rich-quick scheme, but a substantial, well-paying field that can mean a steady income, your own home, car and all the other things that make life worthwhile. **FREE** book gives details. Write TODAY to **HUBBARD DRY CLEANING & REDYEING SCHOOL, SILVER SPRING, MD.** Dept. AE-101.

LAW

STUDY AT HOME for Personal Success and Larger Earnings. 28 years of successful student guidance assures expert instruction. LL.B. Degree awarded. All text material furnished. Easy payment plan. Send for **FREE BOOK—"Law and Executive Guidance,"** at ONCE.

AMERICAN EXTENSION SCHOOL OF LAW
 Dept. T, 737 N. Michigan Ave., Chicago, Ill.

NOW YOU CAN LEARN ANIMATED CARTOONING



AT HOME IN YOUR SPARE TIME

ANIMATORS MAKE GOOD PAY... Train for this fascinating profession by new, simplified methods. Complete course includes 33 lessons, charts, diagrams prepared by former Walt Disney and Max Fleischer Animator. Learn to develop characters like Popeye, Mickey Mouse, Donald Duck. Learn to plan and time action; with dialog, music. Learn to build stories, plots, gags. Good money-making opportunities in movies, entertainment, newspaper, advertising and business fields. No previous art training needed.

ACT NOW
SEND \$4.95 (CASH, CHECK OR MONEY ORDER) TO...

SCREEN CARTOON STUDIOS
SUITE 900 1426 G ST. N. W. WASHINGTON, D. C.



"Whatever my question, I always look first in the NEW MERRIAM-WEBSTER..."

because it offers me the greatest amount of information ever presented in one volume!

Not only "The Supreme Authority" on words—their spelling, pronunciation, definition, etymology—but a KNOWLEDGE BOOK of general information that is amazing in its comprehensiveness and scope. Its type matter is equivalent to an 18-volume encyclopedia. 600,000 entries—122,000 more than in any other dictionary.

WEBSTER'S NEW INTERNATIONAL DICTIONARY - Second Edition

See it today. Any bookdealer will be glad to show it to you. Look for the Circular Trade-Mark and the "NW" Monogram stamped on the cover.



Write for **FREE BOOKLET:**

"The New Merriam-Webster; What It Will Do For You." G. & C. Merriam Co., Dept. 221, Springfield, Massachusetts.

Copyright, 1939, by G. & C. Merriam Co.

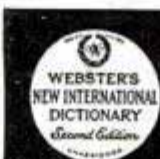

NEW! COMPLETE and Up-to-the Minute Book on HOUSE WIRING

Covers, in great detail, all phases of practical wiring for homes, garages, farm buildings, etc. Written in the simplest language; describes and illustrates fuses, circuits, switches, installation plans; also wiring diagrams; over 200 illustrations; cloth binding \$1.50 postpaid. 5-day money-back guarantee.

FREE Catalog of practical books on Painting; Decorating; Commercial Art; Sheet Metal; Welding; Radio; Electricity; Diesel Engines; Carpentry; Plumbing; Heating and Ventilating.

DRAKE & CO., 177 N. Michigan Av., Chicago
Drake's Books Sold at All Good Book Stores

Auto-Diesel

Master a real trade. Auto Mechanics, Diesel Mechanics, Arc Welding, Acetylene Welding, etc. Let us train you to be an expert Auto-Diesel Mechanic and help you get a good job. The cost to you is reasonable. Learn on modern equipment with tools under experienced instructors. Real shop work. Steam heated buildings. Room and board in our steam heated dormitory. We pay your fare to Nashville. For free catalog write

Nashville Auto-Diesel School, Dept. 75, Nashville, Tenn.

DRAFTING'S the JOB for YOU!

LEARN AT HOME

Here is a fine way to make a living and to fit yourself for a **BIGGER and BETTER** job. Draftsmen are needed everywhere buildings, roads, bridges, tools or machines are built, for these all start on the drafting board. The billions being spent in public works, alone call for **thousands of draftsmen** to prepare the plans. Learn to be a draftsman in spare time at home. Write for **FREE** bulletin—no obligation.

American School Dept. DD345 Drexel at 58th, Chicago

PLUMBERS & STEAM FITTERS

Audels Plumbers and Steamfitters Guides

4 Vols. \$6

A practical, illustrated, Reference Library and Study-Course for Master Plumbers, Journeymen and Apprentice Steamfitters, Gas Fitters and Helpers, Sheet Metal Workers, Draughtsmen, Master Builders, Engineers and all Building Trade Students. This valuable set of handy, pocket-size Guides explains in practical concise language and well-done illustrations all the principles, advances and short cuts of the Plumbing and Heating trade—based on modern practice. Contains careful, detailed instructions on how to figure and estimate various jobs. Use **FREE COUPON** below to examine, without obligation, this valuable work.

INSIDE TRADE INFORMATION ON:
Soldering, tinning, joint wiping, bending, beating. Pipe—iron—steel, threading. Mathematics, tables, physics. Materials—iron, steel, copper, brass, lead, tin, antimony, etc. Sheet metal—galvanized—plate. Sanitation, syphonage, tanks. Drainage, sewage, purification. Fixtures—bath—kitchen. Pipe fittings, soil pipe, tools. Laying out work. Roughing. Screwed fittings, flanges, joints. Pipe bending, examples. Elbows. Heating, ventilation, air conditioning, refrigeration. Water supply, mains, wells, tanks. Gas-fittings. Sheet metal work, problems, methods. Brazing, heating, lead burning. Welding, various welds, methods. Blacksmithing, forges, tools. **Air Conditioning.**

THEO. AUDEL & CO., 49 W. 23rd St., New York City

Mail Audels Plumbers Guides, 4 vols., on 7 days' free trial. If O. K. I will remit \$1 in 7 days, and \$1 monthly until \$6 is paid. Otherwise I will return them. No obligation unless I am satisfied.

Name.....

Address.....

Occupation.....

Reference..... P. M.



When writing please mention Popular Mechanics

YOU CAN!

CONTROL YOUR FATE

Only one power controls your destiny—a strange force sleeping in your mind. Awaken it! Command it to obey you! Push obstacles aside and attain your fondest hopes and ideals. The Rosicrucians know how.

WRITE FOR FREE BOOKLET

Learn why great masters through the ages were Rosicrucians. Free booklet tells the fascinating story of this age old Fraternity and how to obtain its priceless teachings. Write to: Scribe D. X. X.

THE ROSICRUCIANS (AMORC)
SAN JOSE, CALIFORNIA



Know Electricity as Experts Know It—and Get an Expert's Pay!

What about your future? Who is safe today? Surely not the man who is contented to stand still! Know your job thoroughly—prepare yourself for jobs ahead. To do just this thousands of men have used

The Croft Library of Practical Electricity

The Croft Library is a complete electrical educator. It is founded on practice—on 20 years of shirt-sleeve experience—on work as it is actually done. It is jammed from cover to cover with the kind of hard-headed facts you want. Written so that the beginner can easily understand it, yet so sound, so thorough, that it is the daily guide of 50,000 highly paid electrical workers and engineers. Croft tells you the things you need to know about: motors, generators, armatures, commutators, transformers, circuits, switchboards, distribution systems—electrical machinery of every type—wiring for light and power—wiring of finished buildings—underwriters and municipal requirements—illumination in its every phase—the most improved methods of lighting—lamps and lamp effects, etc.—how to do a complete job, from estimating it, to completion.

No money down—easy payments

Fill in and mail the coupon attached and we will send you the entire set of seven volumes for ten days' examination on approval. We take all the risk—you assume no obligation. If you decide to keep the books, send \$1.50 in ten days and the balance at the rate of \$2.00 a month. Send the coupon NOW and see the books for yourself.

EXAMINATION COUPON

McGRAW-HILL BOOK CO., 330 W. 42nd St., New York

Send me for ten days' examination on approval the Croft Library of Practical Electricity. If satisfactory I will send you \$1.50 in 10 days and \$2.00 monthly until the price of \$19.95 is paid. If not wanted, I will return the books postpaid. (To insure prompt shipment write plainly and fill in all lines.)

Name.....
 Home Address.....
 City and State.....
 Position.....
 Name of Company..... PM-3-30

MIDWEST FACTORY SALE!



SAVE UP TO 50% NEW!

PUT THIS NEW WORLD WIDE CHASSIS IN YOUR CABINET
Only \$19.95 COMPLETE
 WITH TUBES AND SPEAKER

It's easy to put this big new 14-tube world-wide Midwest chassis in your cabinet and get exciting world-wide reception. Midwest makes a radio to suit every purse... 6-tube to 17-tube, 5-band models. Prices start as low as \$10.95.

As Much As

\$40 TRADE-IN ALLOWANCE

... on the beautiful 17-tube, 5-band Model "D" shown on left. Money-back guarantee. Write for new FREE 1939 catalog.

EASY TERMS Dept. 15-JJ, MIDWEST RADIO CORPORATION, Cin'ti., O.

PASTE COUPON ON 1" POSTCARD...OR WRITE TODAY!

MIDWEST RADIO CORPORATION Dept. 15-JJ Cincinnati, Ohio
 Name.....
 Address.....
 Town..... State.....
 User-Agents Make Easy Extra Money. Check here () for details.

BOEING SCHOOL STARTS AVIATION CAREERS



The air industry looks to Boeing School for men trained to make good in aviation. Jack Knight, 2,400,000-mile ace pilot, says: "IF YOU WANT TO GET BEYOND FIRST BASE IN AVIATION, I RECOMMEND BOEING SCHOOL." United Air Lines founded Boeing School, closely supervises all Boeing courses. School buildings adjoin United's hangars at A-1-A Oakland Airport. Boeing School classes are kept small. Equipment is complete, modern. At Boeing School you're inside aviation! Write today for FREE 1939 BOEING SCHOOL BULLETIN. Describes Pilot, Ground, and Engineering courses. Gives lines of promotion. Tells opportunity for high school graduates. Address: BOEING SCHOOL OF AERONAUTICS, Dept. E-16, Airport, Oakland, California.

A DIVISION OF UNITED AIR LINES



WANT A GOOD-PAY JOB?

Trained Tool and Die Makers, precision machinists, automatic screw machine men earn as much as \$50-\$60 per week. Train at one of America's best equipped shops. Training work supervised by experts. Day-Evening classes. Low fee, employment help. Write NOW for free booklet "Practical Machine Shop Training." Allied Screw Machine Co., Inc. (School Division) Dept. PM3 603-9 Lake St. Chicago, Ill.

CARTOONING

PAYS WELL Turn your talent into dollars. Develop your ability with personal instruction from an internationally-known cartoonist. His exclusive, successful method of drawing and creating ideas makes it easy to learn. Write for Free Booklet explaining details of this exceptional home-study course. National School of Cartooning, 437 Penton Building, Cleveland, Ohio

DIESEL

Get BETTER training. Realize Adcox advantages. Located in Pacific Northwest, a Diesel center. Established 28 years. Modern equipment, expert instructors. Close cooperation for YOUR success. Earn room and board while learning. Send for FREE big 40-page Diesel School Catalog No. 18. Home Study and Resident Course. L. L. ADCOX TRADE SCHOOL Portland Oregon

PIANO — HAWAIIAN (STEEL) GUITAR SPANISH GUITAR...easily learned at home

Become a skilled musician by our simple, short-cut note method. Play songs almost instantly. COST LESS THAN 2c a DAY! Money back guarantee. Write for free details. HAMANN INSTITUTE, 3016 N. 24th Place, Dept. R-3, Milwaukee, Wis.

I WANT MEN Coffee Routes paying up to \$60.00 in a week. 350 more men needed throughout U. S. on local routes. Operate on credit. Ford Sedans or \$500 cash given producers as bonus. Rush postcard for free facts. E. J. Mills, 9375 Monmouth, Cincinnati, Ohio.



Earn Cash at Home!

We paid M. M. \$1174 for exceptional cellar crop Snow-King mushrooms! We furnish materials; buy all crops. Big FREE picture book tells if your cellar, shed, barn, suitable. Est. 1908. Write today. United Co., 3848 Lincoln Av., Dept. 305, Chicago

Government Jobs

EXAMINATIONS SOON VALUABLE INFORMATION FREE
 COLUMBIAN CORRESPONDENCE COLLEGE WASHINGTON, D. C.

GET INTO THE BAKING BUSINESS!

National Baking Institute announces a new home study course in commercial baking. Baking now America's fifth industry in wages. Nearly a depression-proof business. Good field for ambitious men. Common school education sufficient. Send for free booklet "Opportunities in Commercial Baking" and requirements. National Baking Institute 3601 Michigan Ave. Dept. 1353 Chicago, U. S. A.



EASY TO PLAY —EASY TO OWN



You've always wanted to play this fascinating instrument. Now there is no reason to delay. Now you may thrill family and friends, with a chance to earn extra cash at dances, entertainments and on the radio. For now there is a genuine DEAGAN Marimba (including complete, easy lessons) at the lowest price in history. . . . To write for details TO-DAY may easily mean a LIFE-TIME of pleasure, profit and popularity!

J. C. DEAGAN, Inc., 3453 Deagan Building, CHICAGO

Send for my book how to develop

STRONG ARMS and BROAD SHOULDERS

with 20 full pages of illustrations, showing and fully describing exercises that will quickly develop, beautify and make you gain great strength in your Shoulders, Arms, Wrists, Hands and Fingers. Without any apparatus. This is really a remarkable course of Physical Culture exercises. Don't fail to send for it NOW. 25c coin or 30c U. S. Stamps.

ANTHONY BARKER

1235 6th Ave.

Studio P.

New York City



LEARN CARTOONING

by the method that has developed hundreds successfully. Send name, address and age for free chart to test your ability.

THE LONDON SCHOOL, 1739 National Bldg., Cleveland, Ohio



MONDELL GRADUATES RECEIVED DURING 1938, GOVERNMENT DRAFTING, SURVEYING, ENGINEERING INSPECTORS' JOBS AT SALARIES \$2000 TO \$3120 YEARLY.

Drafting, Architectural, Airplane, Mechanical, Electrical, Piping, Ship, Structural, Mathematics, Sciences, Blueprint Reading, Building Estimating, Preparation Engineers' Licenses, Civil Service, Engineering Exams, Jr. Engineer (Airplane, Civil, Mechanical, Structural, Concrete), Jr. Meteorologist, Days, Evenings and Home Study courses. MONDELL INSTITUTE, 230 WEST 41ST, NEW YORK

Know! YOUR CAR

ASK TO SEE IT!

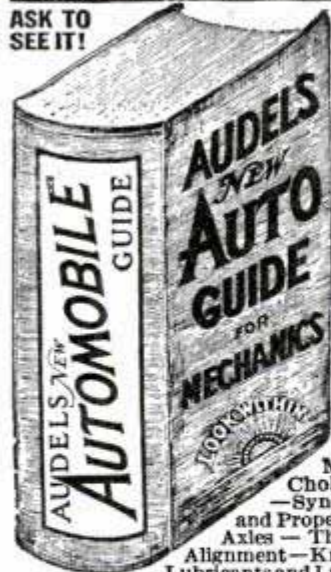

GOOD NEWS—JUST OUT

AUDELS NEW AUTOMOBILE GUIDES NEW from cover to cover. Explaining the Theory, Construction and Servicing of modern motor cars, trucks and buses; and the application of auto type Diesel Engines. . . . PRACTICAL INFORMATION IN HANDY FORM, 1540 PAGES COVERING . . .

AUTO REPAIRS & SERVICE HELPS

All the Parts of an Automobile—Automotive Physics—The Gas Engine—How a Gas Engine Works—Gas Engine Principles—Multi-Cylinder Engines—Horse Power—Automobile Engines—Engines; Stationary Parts—Engines; Moving Parts—Pistons—Piston Rings—Connecting Rods—Crank Shafts—The Valves—The Valve Gear—Cams and Cam Action—Valve Timing—Cooling Systems—Gasoline—Fuel Feed Systems—The Mixture—Carburetors—Automatic Choke—Super-Chargers—Transmissions—Synchro-Mesh—Clutches—Universals and Propeller Shafts—The Differential—Rear Axles—The Running Gear—Brakes—Wheel Alignment—Knee Action—Steering Gear—Tires—Lubricants and Lubrication—Automotive Electricity

—Ignition Systems—Magnet Ignition—Spark Plugs—Ignition Coils—Distributors—Automatic Spark Control—Ignition Timing—Generators—Starters—Generator and Starter Testing—Lighting Systems—Storage Batteries—Battery Charging—Battery Testing Troubles. Automotive Diesel Engines. Inside Views of all Automobile Parts Fully Illustrated. To Get This Assistance for Yourself Simply Fill In and Mail Coupon Today.

\$4 COMPLETE • PAY ONLY \$1. A MONTH ←

THEO. AUDEL & CO., 49 WEST 23rd STREET, NEW YORK
Please send me postpaid AUDELS NEW AUTOMOBILE GUIDE (\$4) for free examination. If I decide to keep it, I will send you \$1 within 7 days; then remit \$1 monthly until purchase price of \$4 is paid. Otherwise, I will return it to you promptly.

Name

Address

Occupation

Reference

HOW TO PAINT SIGNS

and SHOW CARDS

EARN GOOD MONEY!

—SPARE OR FULL TIME ■

Signs and Showcards are always in demand—in every community, everywhere! Anyone who can write can learn to make signs—and earn a tidy sum every week. This marvelous book shows you how! **HOW TO PAINT SIGNS AND SHOW CARDS** gives you instruction in gold window lettering, pen and brush sign painting, silk process work, etc. etc. Every practical detail is covered thoroughly. All instruction is in very simple language, illustrated by numerous actual applications. Almost 300 pages, 7 inches wide, nearly a foot high. Printed on heavy coated stock for perfect legibility. Bound in durable, luxurious imitation leather and stamped in gold.

FULL PRICE: ONLY \$1.98

PRACTICAL LESSONS in

- LETTERING • GILDING
- SHOW CARDS • SIGN LAYOUTS
- COMPOSITION • BANNERS
- WINDOW SIGNS
- TIN AND PAPER SIGNS
- HOW TO MIX PAINTS
- BOARD AND WALL SIGNS

And Many Other Subjects

ALL COMPLETE IN THIS BOOK!



OVER 200 ALPHABETS and SIGN INSTRUCTION LAYOUTS

All standard types of letters—every modern alphabet—the very latest sign layouts—you get all this within the covers of this one book. **HOW TO PAINT SIGNS AND LAYOUTS** provides beginners with a perfect instruction manual to start them immediately on the road to success in the sign business; it provides professional sign makers with a real reference volume of the best types, layouts, etc., used today. With this book in your studio you will never be at a loss for ideas, you will always be able to produce striking layouts, powerful, modern lettering that will increase demand for YOUR work.

SEND NO MONEY

Don't miss this opportunity to enter a very profitable, pleasant and interesting vocation. See for yourself what this book, **HOW TO PAINT SIGNS AND SHOW CARDS**, can do for you. Get a copy on approval. There is no obligation to keep it. You decide for yourself in your own way whether the book is worth the small price of \$1.98. Send no money now—just mail the coupon. Pay the postman on delivery—\$1.98, plus postage. If not more than satisfied, return the book in 5 days and receive full refund.

MAIL THIS COUPON AT ONCE!

ILLUSTRATED EDITIONS CO., Dept. 71, 220-4th Ave., N.Y.C.
Send me for approval a copy of "HOW TO PAINT SIGNS and SHOW CARDS." I will pay postman \$1.98 (plus postage) on delivery with the understanding that if I am not more than satisfied with the book I may send it back to you in 5 days and you will refund my payment in full. (☐ Check here if you wish life-time, im. leather DeLux binding, \$2.98).

NAME

ADDRESS

CITY..... STATE.....

If you enclose \$1.98 with this order, we will pay postage.

Im. leather, life-time DeLux binding, \$2.98. Same approval and refund privilege.

When writing please mention Popular Mechanics

NEW INVENTIONS

(Continued from page 33A)

IN TENDED to reduce the work of erecting telegraph, telephone and other wire-supporting poles, a device for attachment to the front of trucks has just been patented. It consists of a pair of standards

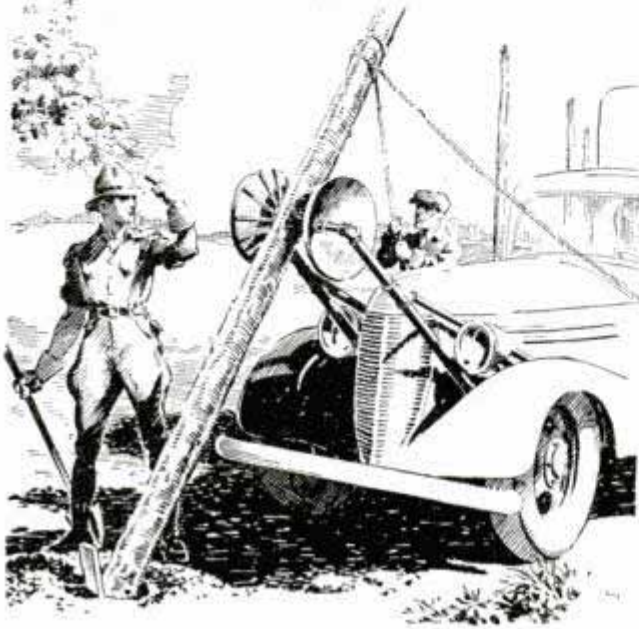

between which is mounted a roller. One end of the telegraph pole is set into the hole, at an angle, and the other is placed on the roller. By moving the truck forward, the pole is raised and set into the hole.

AIR conditioning for the home is provided under a patent issued recently.



One phase of the invention is that of dehumidification of air, that is removal of moisture in the summer months. The system involves the use of a substantially hygroscopic substance and includes the steps of passing a current of air periodically over the substance while cooling the substance to cause it to absorb moisture from the air. Then the air thus dried is conveyed to the room to be conditioned. The system also calls for alternately regenerating the substance while it remains in operable position by exposing it to the sun. The heat of the sun causes the moisture to evaporate from the substance into the air.

BAKING biscuits and bread is too common to be of much interest to most people, but one inventor has found a new way of doing it. A recent patent covers a portable oven consisting of an upper and lower section. The upper section has internal reflecting surfaces parabolic in right cross section and the lower has an internal reflecting surface elliptic in right cross section. Rays from a heating element are radiated to the baking tray by reflection from the oddly arranged surfaces.

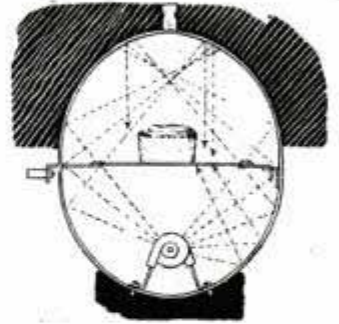

TAKING pictures at night is made easy by a combination flash lamp and camera patented recently.

Batteries are stored in the handle. The head of the flashlight is enlarged to house two lamps, complete with reflectors and lenses to produce concentrated light beams. Located between the electric bulbs is the lens of the camera.



SERVING the double purpose of beach hat and fan, a novelty costume article has been patented recently. It consists of a single sheet of flexible material transversely pleated from one end to the other. When the two ends are joined by suitable means, the sheet forms a hat which may be secured to the head by means of ribbons.



Due to the fact that many of the devices described in this department are still in the patent office stage and are not on the market, Popular Mechanics Magazine cannot undertake to supply further information regarding them.

Look!...it's
HUCKLEBERRY FINN

Remember? The freckle-faced, barefooted kid who took that crazy ride down the Mississippi on a raft...with black Jim and two of the worst rascals in fiction, the Duke of Bilgewater and the Lost Dauphin.

Mickey Rooney plays Huck Finn as if he were *born* to be Huck Finn. He splits open a catfish the same way Huck did, tells the same whoppers and runs into the same hair-raising adventures that Huck did in the book. You surely want to see this picture—it's great!

Mark Twain's
HUCKLEBERRY FINN

STARRING
MICKEY ROONEY

with WALTER CONNOLLY
 WILLIAM FRAWLEY • REX INGRAM
 LYNN CARVER • JO ANN SAYERS

Screen Play by Hugo Butler

A Metro-Goldwyn-Mayer Picture

Directed by Richard Thorpe

Produced by Joseph L. Mankiewicz

"The Wizard of Oz" (in Technicolor) now in production at the Metro-Goldwyn-Mayer Studios



OL' JUDGE ROBBINS

AT THE
RADIO CITY
SKATING RINK



JUST IMAGINE-- AN OUTDOOR SKATING RINK RIGHT IN THE MIDDLE OF THESE TALL BUILDINGS

WHAT WILL THEY THINK OF NEXT?



HA HA! YOU KNOW, I THINK I SLIPPED!

WELL, YOU'VE GOT COMPANY, CHUBBINS-- THERE GOES ANOTHER SPILL, OVER THERE



HERE ARE YOUR HAT, GLASSES, AND PIPE, SIR. I THINK THAT'S ALL YOU DROPPED

GOODNESS, NO! YOU'VE MISSED THE MOST IMPORTANT



HERE IT IS, SIR-- YOUR PRINCE ALBERT. I KNOW HOW YOU'D FEEL TO LOSE IT



WELL, NOW I FEEL BETTER! THERE'S NOTHING LIKE A PIPE-LOAD OF PRINCE ALBERT TO SET A SMOKER RIGHT WITH THE WORLD

THAT'S BECAUSE P.A. IS MADE TO GIVE PIPE-SMOKERS EXACTLY WHAT THEY WANT-- RICH, TASTY SMOKING WITHOUT BITE!

Smother Smoking to YOU

THOSE P.A. FOLKS PUT **EXTRA JOY** IN SMOKING BY REMOVING THE BITE. PRINCE ALBERT SMOKES **EXTRA MILD, FULL-BODIED**



EVERY TIN OF P. A. BACKED BY THIS GUARANTEE

Smoke 20 fragrant pipefuls of Prince Albert. If you don't find it the mellowest, tastiest pipe tobacco you ever smoked, return the pocket tin with the rest of the tobacco in it to us at any time within a month from this date, and we will refund full purchase price, plus postage.

(Signed) R. J. Reynolds Tobacco Company, Winston-Salem, N. C.

50 pipefuls of fragrant tobacco in every 2-oz. tin of Prince Albert



AND P.A.'S THE TICKET, TOO, FOR RICH-TASTING 'MAKIN'S' CIGARETTES THAT ROLL UP **FASTER, SMOKE SLOWER, COOLER**

PRINCE ALBERT THE NATIONAL JOY SMOKE

Popular Mechanics Magazine

REGISTERED IN U. S. PATENT OFFICE AND CANADA

WRITTEN SO YOU CAN UNDERSTAND IT

Vol. 71

MARCH, 1939

No. 3

H 1524

The CITY of TOMORROW

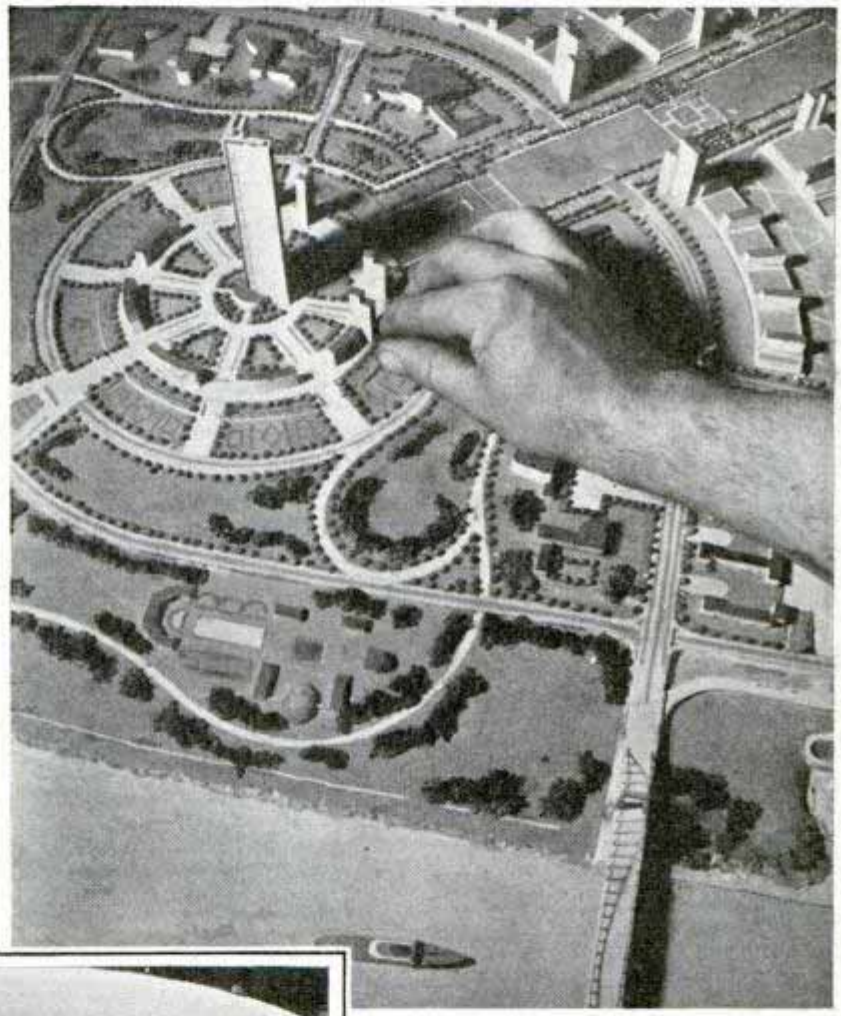

501 Madison Av. New York



Views of model from which Democracy is being constructed in 200-foot Perisphere at New York World's Fair

By Henry Dreyfuss
Industrial Designer

As Told to Julian Leggett

THE city of tomorrow is going to stretch and take a deep breath and be a healthier and happier community because of that. It will be composed of a central town or "brain center" surrounded by satellite towns containing factories.

People who work in these factory towns are going to live close to their

141524

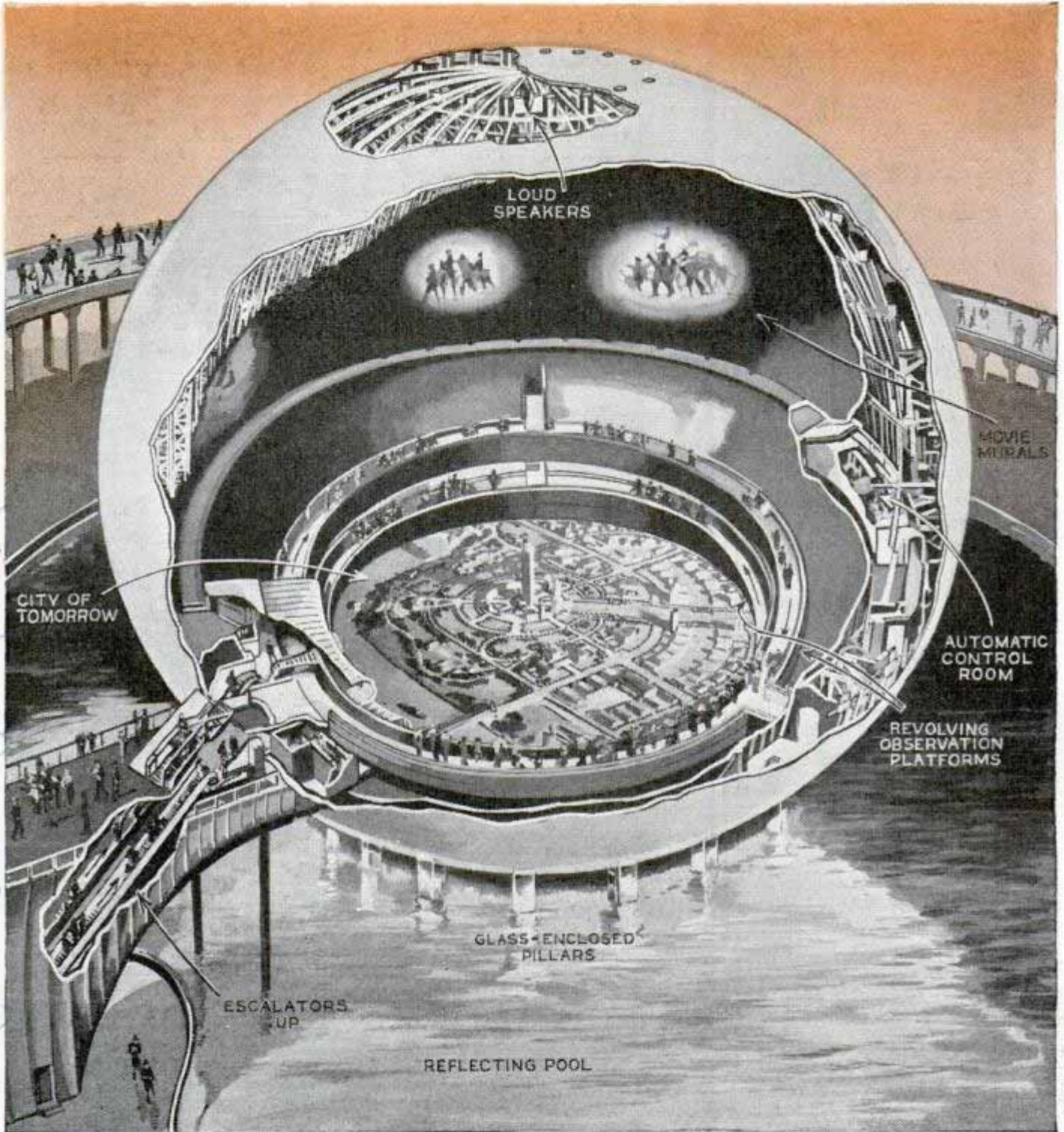

Drawing of Perisphere with photo of 200-foot model of Democracy as it will appear to World's Fair visitors. Henry Dreyfuss is creator of the fair's theme exhibit, the central feature of which is Democracy, planned community of tomorrow

work. They will have a school and a movie. The resident of the satellite town will get up in the morning in a house pleasantly surrounded by green. He can walk to work and his children can walk to school in complete safety because they will never cross a vehicular street. When his wife goes to market, she can walk if she wishes, through a park, and she will shop in a park, since the stores will be situated around pleasant

green belts. She might drive, but she never would run the risk of killing anyone because no one will cross the highways.

If this couple wants to hear the latest theatrical production, they will drive forty miles to the hub—to Democracy—over pleasant highways and right to the theater without a single traffic jam, because the city is planned for that very thing. They will park under the theater, see the per-

H/529

formance in air-conditioned comfort, then return home.

Their home, in the satellite town, will have a living room, bedroom and dining room facing a park, and a kitchen facing a highway. It will be painted in attractive colors—an individual house that will resemble no others on the street. The park facing the home will have a place to swim, and playgrounds for the children.

In the satellite town there will be a public market where the farmers living in the green belt will bring their produce. People will not eat concentrated food capsules; they will eat fresh green foods direct from the gardens. They won't have artificial flowers because they will get fresh ones from the garden. The family will develop good taste because they will be surrounded by good things—music, trees and other cultural advantages.

A man will be loyal to his employer because he makes this city possible. Today a man leads two lives—the life of his work and the life of his family. Tomorrow's city is

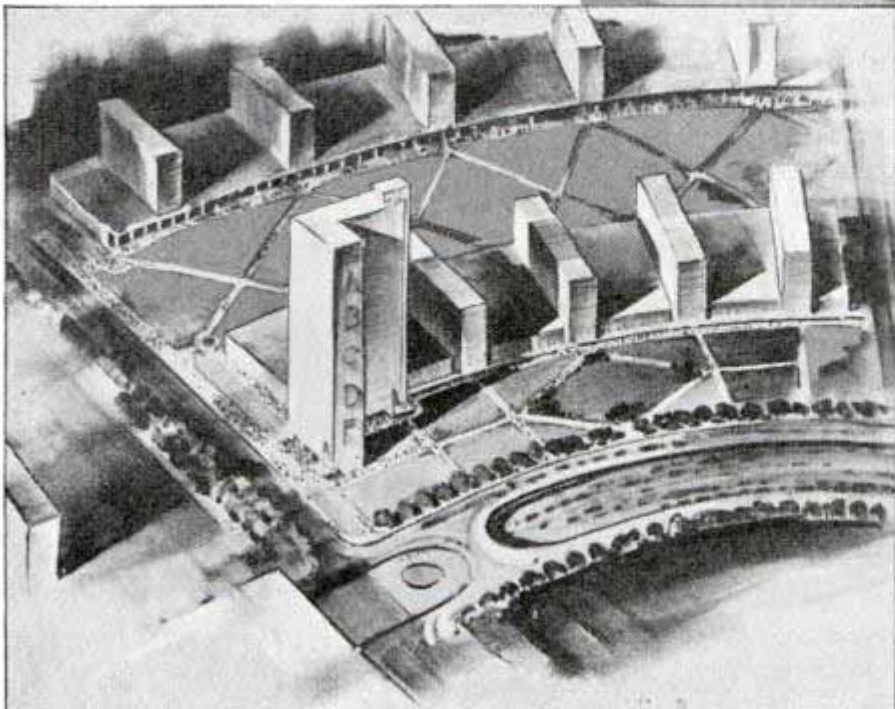
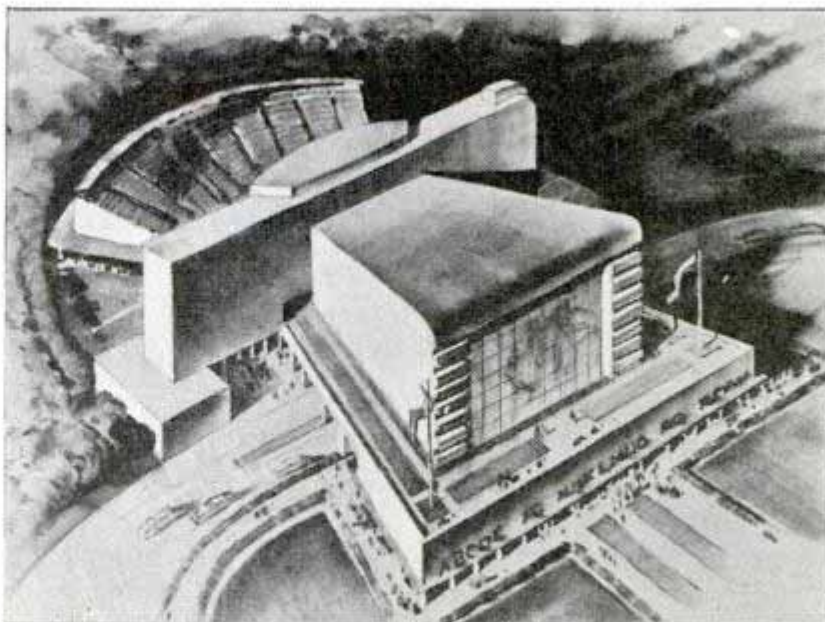

Top, Democracy's opera house, designed by Henry Dreyfuss, has reversible stage facing open-air amphitheater in summer and interior of theater in winter. Center, model of open-air restaurant. Bottom, shopping center of Democracy, as sketched by Theodore Kautzky

going to inject a third stage, which is playtime to improve his mind and body. The man of the future will be sufficiently educated so that he won't turn off the radio when he tunes in a symphony orchestra—he is going to appreciate that music. Perhaps he will have a shop in his home where he can do wood carving or some other form of handicraft. In fact, hobby shops may be run by the city.

(Continued to page 148A)

Handwritten notes at the bottom of the page, including the word "document" and some illegible scribbles.

Chicago Tribune

12927/38

1553

141561

Glass Made Invisible as Air Does Not Reflect Light

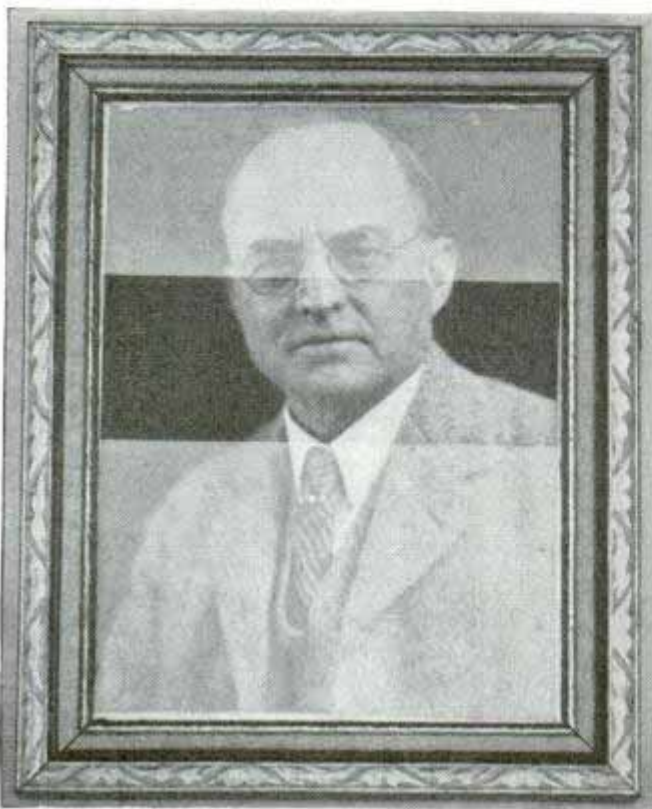

Clear strip across middle of portrait compares non-reflecting glass with untreated glass above and below

Ordinary thicknesses of glass are made as invisible as air by stopping all reflection of light with a coating of oily film. Glass usually does not pass all of the light, but reflects about eight per cent from the surface, creating the glare you see from pictures framed in glass, display windows and clock faces. By applying to the surface of glass a very thin chemical film about four millionths of an inch in thickness, or exactly one-quarter of the wave length of light, Dr. Katharine B. Blodgett of General Electric's research laboratories has been able to remove all glare and reflection. Light rays reflected from both the outer and inner surfaces of the oily film are caused to counteract one another, since rays coming from the outer surface are equal in intensity and opposite in phase to those reflected from the inner surface. Discovery that a film of insoluble soap one molecule thick can be spread on the surface of water furnished the key to the secret. Glass is treated by dipping it through this floating film and the dippings are continued until about forty-four layers are built up. Light transmission of a piece of

glass was increased from ninety-two to 99.2 per cent with this treatment. Although not yet commercially available, the process can be applied to lenses in cameras and telescopes. In showcases, display windows and clocks the glass would be invisible and eyeglasses would not reflect light beams from the sides or behind the wearer.

1553

Two-Wheeled Submarine Auto Explores the Ocean Floor

Believing the ocean floor is the next frontier for the prospector in search of mineral and marine wealth, Simon Lake has built a two-wheeled electric automobile for submarine exploration. Inventor of the first successful open-sea submarine, Mr. Lake designed his latest deep-water vehicle for peaceable commercial use. It is operated by a crew of four. Propeller and wheels are driven by electricity drawn through cables from a surface ship. Mr. Lake anticipates the submersible car will be used to hunt oil and gold on the ocean floor, to locate sunken ships and "farm" oyster and sponge beds and to carry cargo on new trade routes in the arctic.

Pat. # 2,125,301

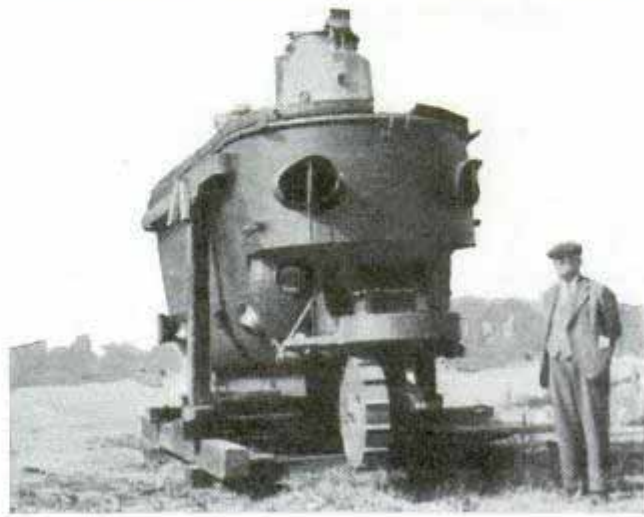
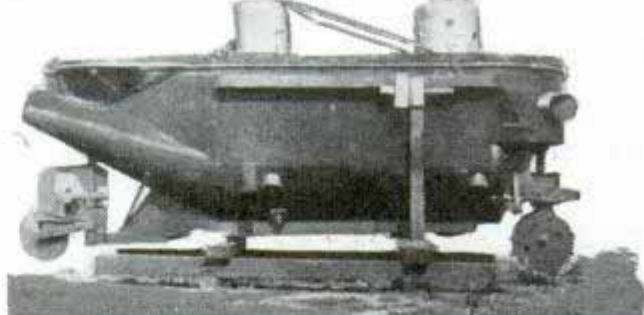

Notice the observation windows, the propeller and fore and aft wheels in two views of submarine auto

Simon Lake, New York

see mar. 1940 - 129a

Schenectady, N.Y.

R 15 36
General Electric Co
Schenectady, NY

2

MILES
A
MINUTE!

TURBINE *ON* WHEELS



CARRYING its own steam-turbine power plant and capable of doing twice the work of the conventional locomotive for each pound of fuel, a new type of streamline electric locomotive built for the Union Pacific railroad is rated at better than two miles per minute. Using a steam turbine to generate electricity for its six driving motors, the new rail giant develops 5,000 horsepower. It operates on a low grade of "bunker" oil, even cheaper than that used by Diesel engines, because the fuel is burned in a firebox instead of in an internal-combustion engine. Turbines and the turbo-electric drive are not new, but this is the first time in this country that either has been applied successfully to rail-traction purposes. The engine has two cabs. The boiler uses forced circulation of the water through the tubes surrounding the furnace. Forty-five thousand pounds of steam are generated an hour to a pressure of 1,500 pounds at a temperature of 920 degrees Fahrenheit. The steam, after passing through the turbine, is condensed and used



Top, steam-electric locomotive. Bottom, engineer in cab of streamline giant. Note the automobile-like windshield and windshield wiper

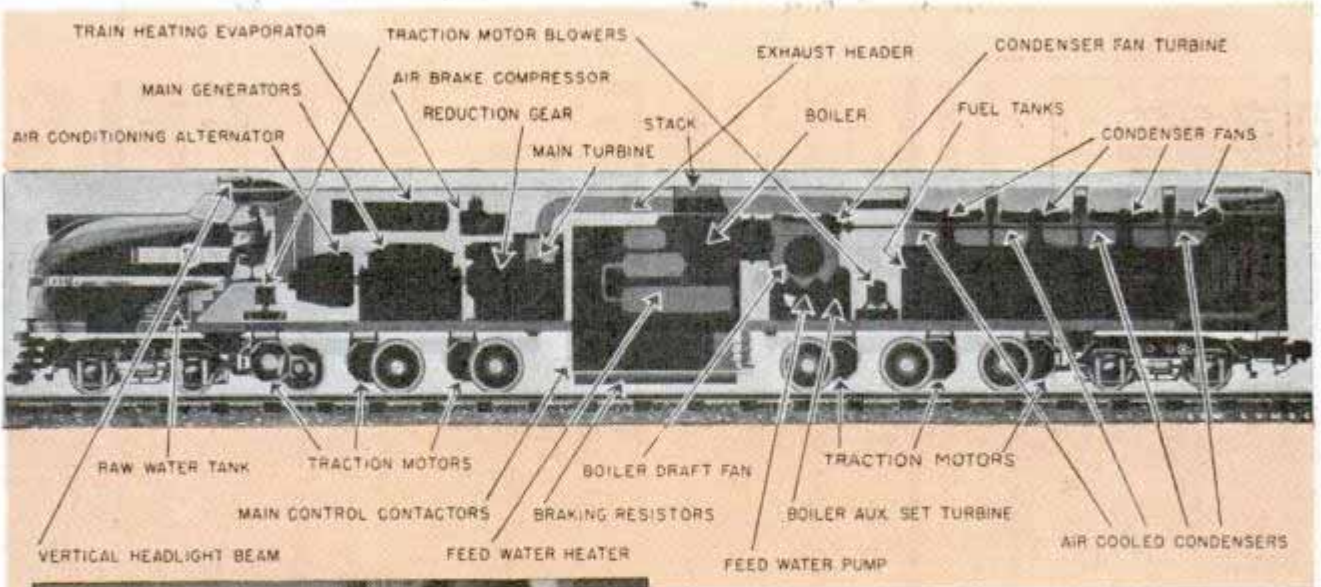

Above, sketch showing principal parts of "turbine on wheels." Left, interior of cab showing control equipment. Below, turbine and gear with cover removed from top half

motors act as generators when the train is coasting, is employed, enabling the engineer to glide to smooth, easy stops. This type of braking reduces wear on brake shoes and eliminates disagreeable grinding of brakes. This locomotive is powerful enough to handle the heaviest standard train equipment from Chicago to the Pacific coast without a change of engines and without a helper on mountain grades of the Union Pacific line. It is designed to operate at 110 miles per hour for long periods. Economical use of fuel and water will permit runs of 500 to 700 miles without stops. Mechanical and electric parts were made by General Electric company.

Schenectady, N.Y.

again and again, thus requiring no additional water for running the locomotive. Additional water is necessary, however, for heating passenger coaches. A feature of the equipment is introduction of completely automatic operation. When the engineer increases power and speed in the cab, the flow of fuel to the boiler also increases. Only a few minutes are required to raise the pressure from zero to full steam pressure, thus avoiding long delays in putting the locomotive into service. Control of electrical equipment also is automatic. Electric braking, whereby the driving

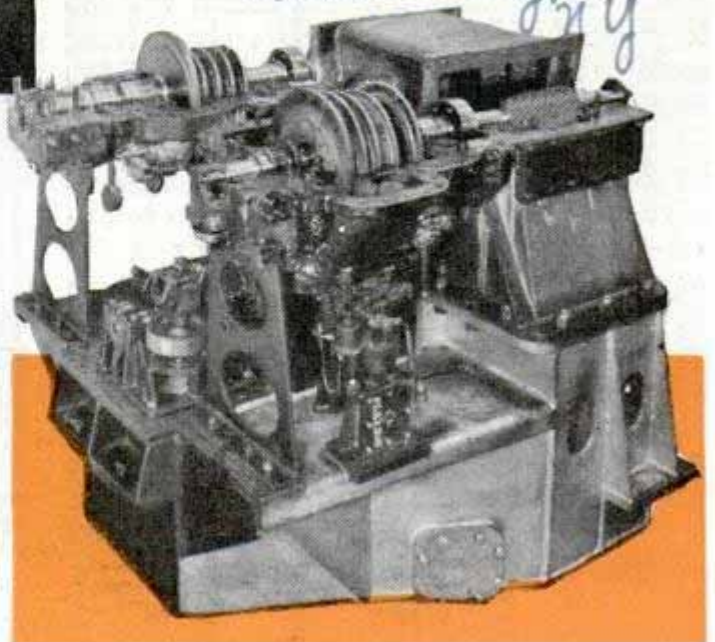

141465

Deep Sea Diving School Washington 327

School for Sea Divers Has Classroom in Tank

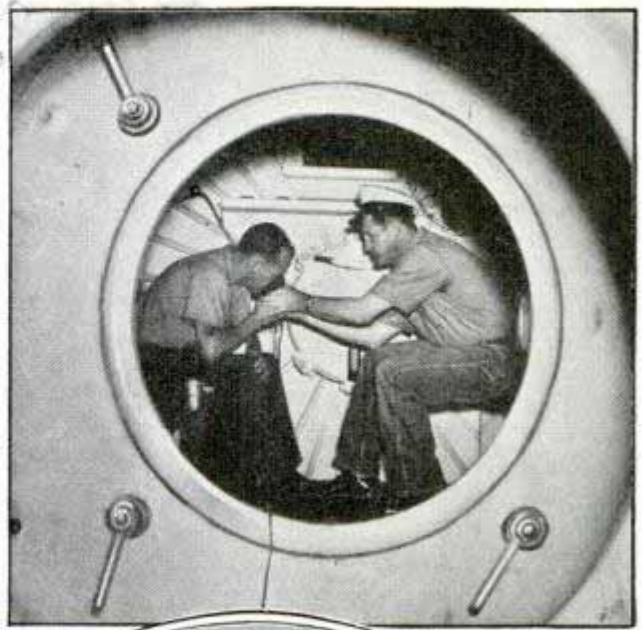
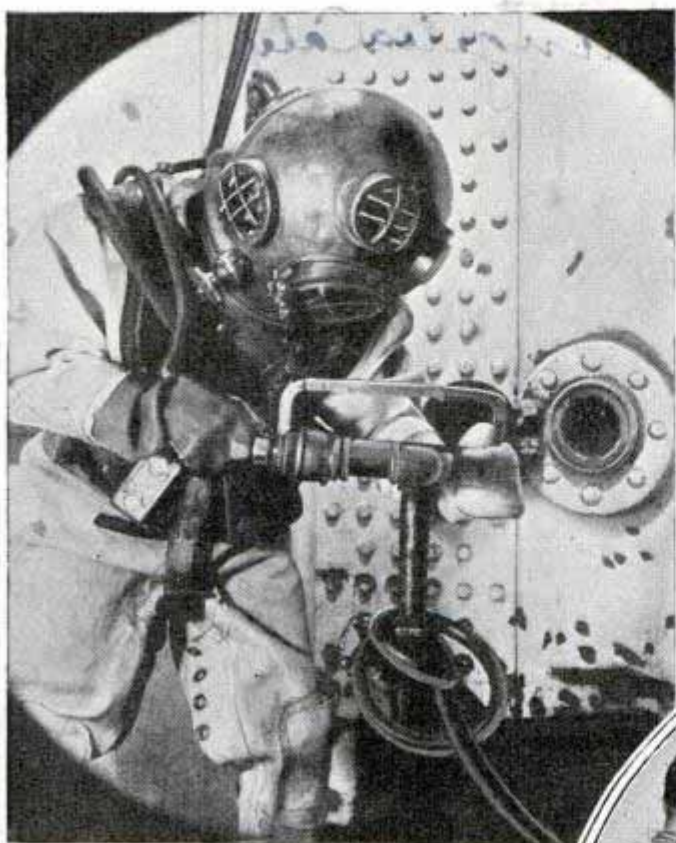

Deep-sea divers of the U. S. navy are sent to school before attempting salvage work. They work in a tank under pressures corresponding to 300 feet under water. Above, left, diver inside tank learning to use a hacksaw on a pipe line. Right, instructor and student undergoing decompression to avoid the "bends" after a dive in the tank

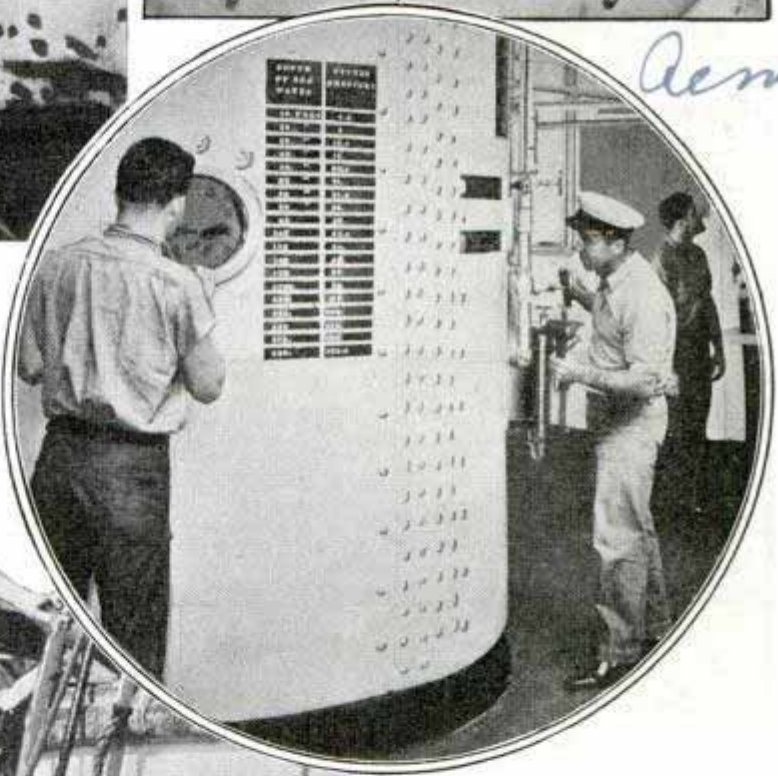

Acme



Above, through portholes instructors watch divers at work in a large tank and talk to them by telephone. Left, after twenty-six weeks of indoor training the diver is given practical lessons in underwater flange fitting, also oxyhydrogen and electric arc welding. Classes are selected from among petty officers for the school, and graduates are designated "divers, first class." Skilled divers go down to recover documents from sunken U. S. vessels to keep them from enemy hands; also secret signal and code books are sought from sunken enemy ships in time of war

17 140
Cmt Thomas & Stevenson, Jr.
10555
Trapping MODERN
Los Angeles, Calif

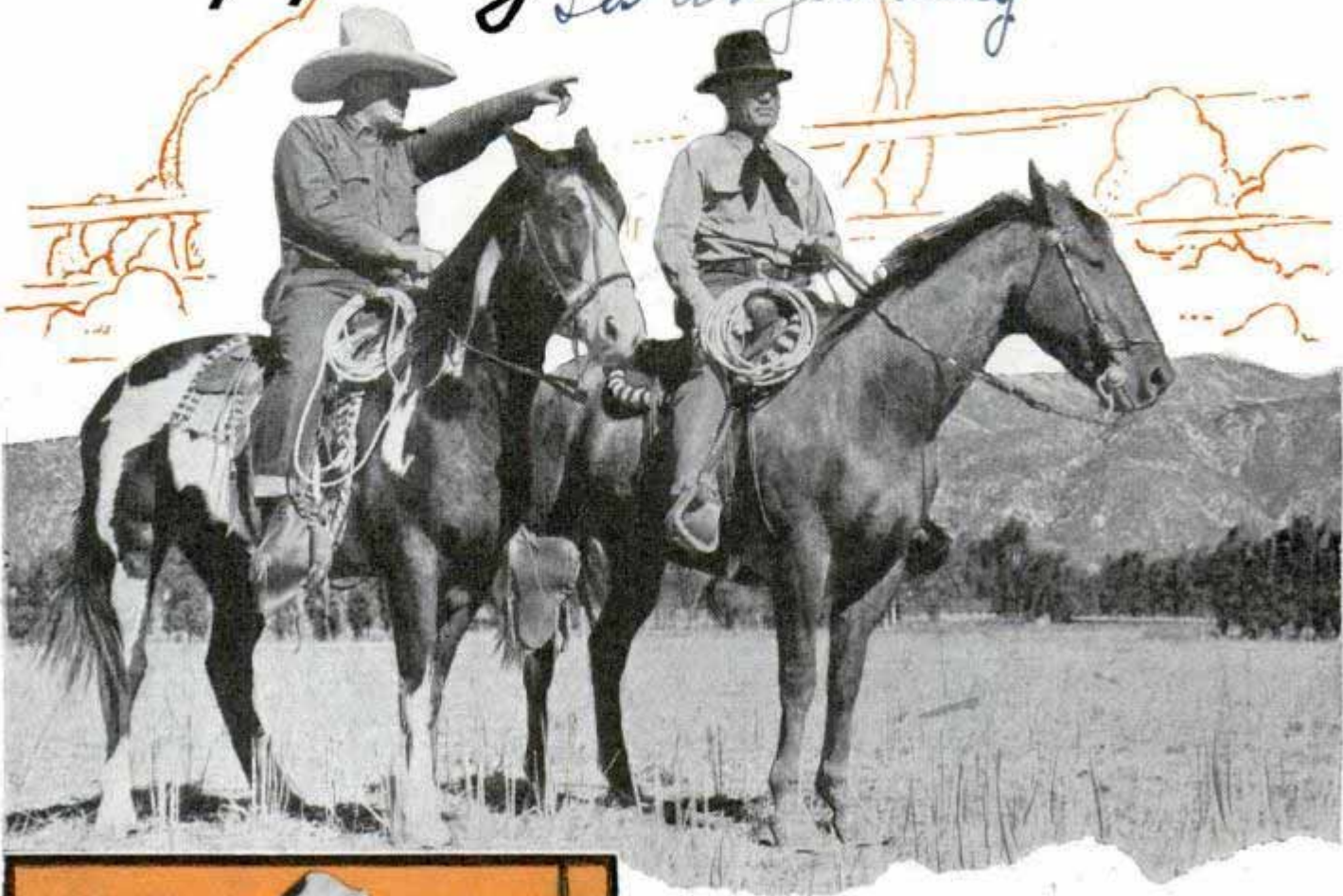

Top, deputies searching for evidence. Bottom, examining collection of branding irons

CALVES were being stolen from the range, the stock detectives felt certain, but they couldn't prove it. The only evidence was the constant bawling of some of the cows, indicating that their calves had disappeared. Occasionally a spot was found that looked as though a calf had been butchered, but there were no tire marks or footprints or even a suggestion that footprints had been brushed out.

The detectives were fighting in the dark but they got their man. The range was too big for adequate patrols and it was impossible to investigate every rancher for 100 miles around on mere suspicion, so they tried another way. They decided who was the most logical suspect, waited until he started on a truck trip and then searched his camp. Not a single bit of suspicious evidence was found until one of the detectives curiously turned over a pair of large shoes. That was all they needed. On the bottom of each shoe was attached a wooden plate carved to the shape of a

CATTLE RUSTLERS

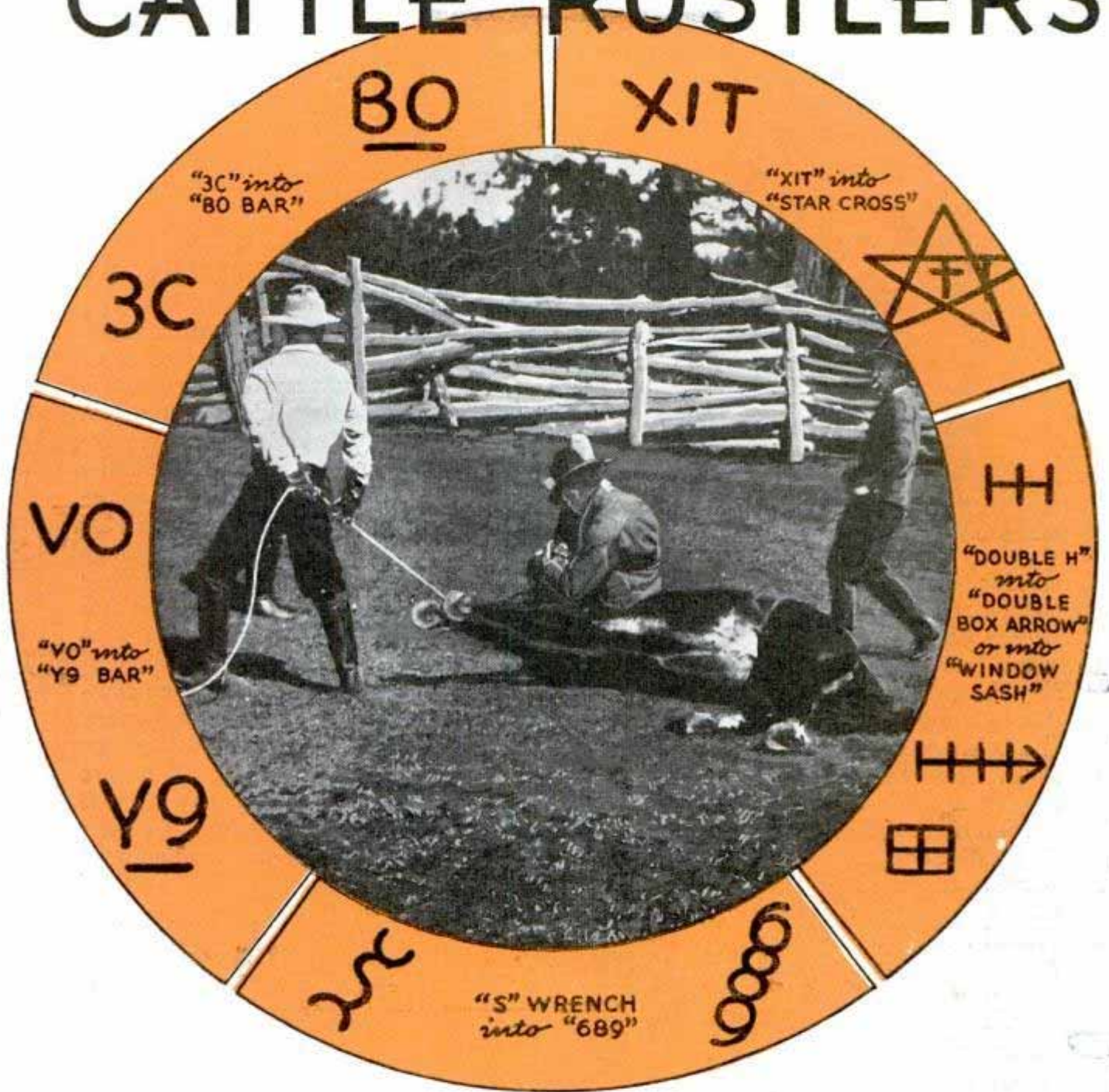

Cow punchers preparing to brand saddle horse. The border illustrates how brands may be altered by rustlers to conceal cattle thefts. Note how the "VO" brand (left) is changed to "Y9"

cow's hoof. The rustler had been parking his truck along a road and walking into the range and out again leaving tracks just like a cow's.

Cattle rustling is about as prevalent in most parts of the west today as it ever was. Modern Hereford range cattle are worth more than the stringy long-horn animals of the past and in addition they have become used to the presence of men and automobiles, making it easier to capture them. Losses have been estimated as high

as a million dollars a year in the cattle states, although an exact figure is difficult to reach, since a ranch owner may not discover a theft for weeks or months after some of his cattle have been stolen, or he may never learn of the theft. That is because, with thousands of animals spread out over a range that measures several hundred square miles, an owner may not count his cattle more than once a year.

Once inspectors at the Los Angeles stock yards sent a wire to an Arizona cattlemen's

...into a double h...

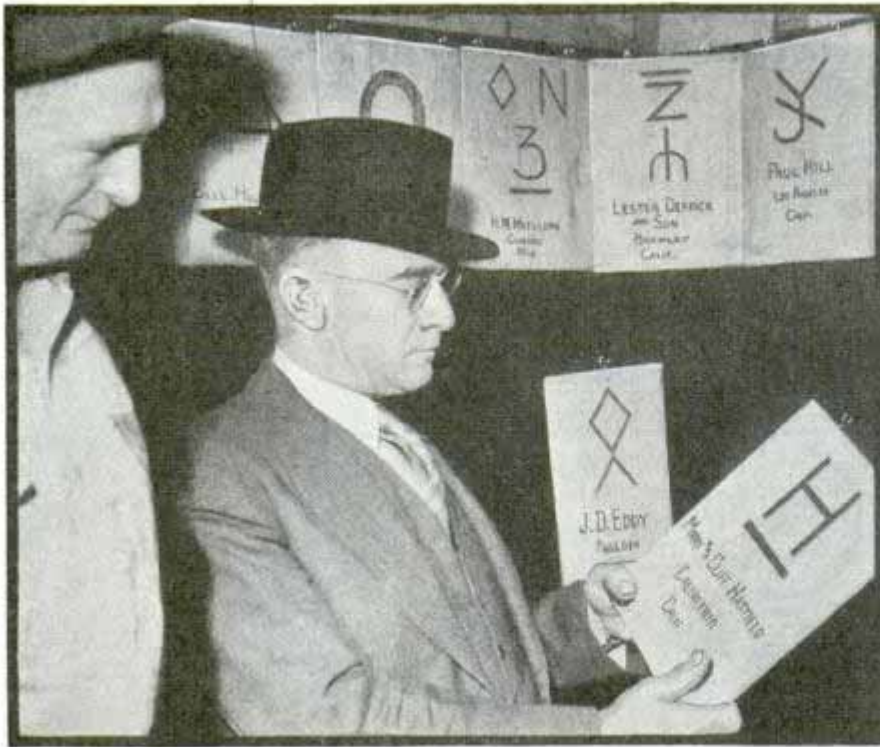

"The 1939 cattle thief is apt to have a fast truck and trailer into which he can load thirty head of stock and speed off at forty miles per hour," Capt. Mace remarks. "The next morning he unloads at some point several hundred miles away. The night's work may represent a haul of \$1,500. The rustler may live in a city and thus be hard to trace. He may butcher cows or calves on the range, burying their hides on the spot to eliminate the identifying brands, and peddle the meat to unscrupulous retailers. He may rework the brands on animals, chang-

ing the original brands to a symbol he has registered himself. He has a sleeve full of tricks but the peace officers and vigilante associations have just as many."

In some parts of the west "gasoline cowboys" ride the highways, stopping every truck that carries cattle to see that the shipment papers are in order. There are standing rewards for catching cattle thieves. Gun duels are still fought on the range. A county sheriff may have an area

association, advising them that they were suspicious of a recent shipment of 300 cattle, worth \$10,000, and representing nine different brands. The inspectors were holding the cattle in Los Angeles and they wanted to know whether the shipment was bonafide. Then the telegraph wires started to sizzle. The owners of the animals had thought their cattle were safe on the home ranges and none of them knew of the shipment. Rustlers had rounded up the stock, stolen some Arizona brand inspection slips, filled them in, and used them to bluff the railroad into carrying the cattle to the coast. All of the law-breakers were caught.

Cattle stealing the modern way is far different from old-time rustling on the range. Veteran stock detectives like Capt. C. E. Mace, supervising inspector of the Livestock Identification Service in the southern part of California, have seen the rustler abandon his horse and his practice of cutting out a band of cattle from a herd and running them off through the night in favor of more up-to-date methods. In twenty years as a stock detective Mace has arrested scores of rustlers.



Top, examining brand marks of different herds. Bottom, cowhands reading notice of \$200 reward for arrest of cattle thieves

New Stock yards. Los Angeles.

as large as Massachusetts under his jurisdiction with only a few deputies to uphold the law and he welcomes the assistance of ranchers who are ready to use their guns freely. The radio, teletype, and telephone help prevent the escape of cattle thieves after they have been detected, and the modern roads that help the rustlers also help the law-enforcement officers.

In California, where stock raising in all its

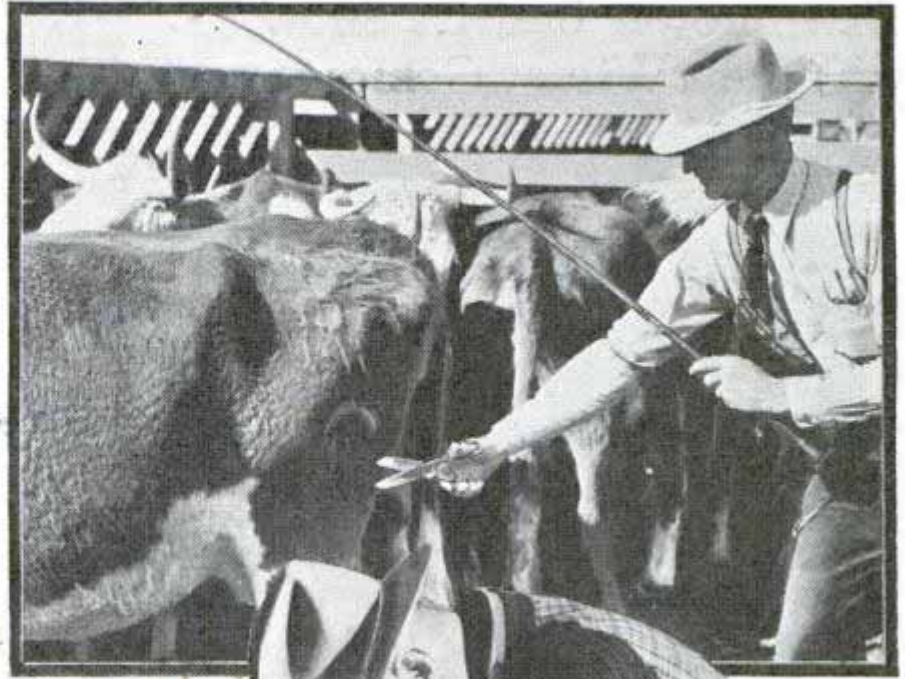

Top, snipping hair to inspect brand. Center, examining tire tracks after cattle theft. Bottom, deputy broadcasting message to officers on the range

branches is one of the most important industries, cattle rustling is on the wane. Vigilant stock owners and detectives have made it difficult to steal cattle and harder still to sell them. Taking the profit out of the old-time practice is putting a stop to it. The state-operated Livestock Identification Service arrested more than seventy people for cattle stealing last year, mostly in cases that represented only one or two animals instead of the wholesale thefts of the past.

Taking the profit out of rustling is ac-

(Continued to page 145A)

Lawnmower Shovels Snow When Winter Comes



Snow removal is easy with this gasoline-driven plow which will go back to cutting grass next summer

Double service is obtained from the gasoline-driven lawnmower by making it plow snow in winter. Mechanics in the park department of Duluth, Minn., removed cutting blades from the machine and substituted fiber brushes, which are set diagonally to throw the snow off to one side. The snowplow has cleared sidewalks of snow several inches deep.

Self-Starting Pressure Siphon Lifts Heavy Liquids



Air pressure and vacuum alternating in a self-starting siphon causes liquid to begin flowing by lifting it in the tube when a rubber bulb is squeezed and released. The siphon removes thick cream for whipping without pick-

ing up the milk, and it will transfer jelly from the cooking pot to glasses. Where different kinds of liquids separate themselves in the container, the top one may be drawn off without disturbing the others. Fruit juices, acids, chemicals, ink or aquarium water thus are easily siphoned, leaving the pulp or sediment untouched.

Rubber Exhaust for Motorboats Eliminates Corrosion

To avoid the corrosion that attacks metal exhaust pipes in the water, an exhaust hose made of rubber and duck is offered for motorboats. When unburned fuel mixes with water in an exhaust pipe, a weak solution of sulphuric acid forms, resulting in corrosion of the metal pipe. The flexible hose, its inner tube made of heat-resistant rubber, its outer cover oil-resistant, is unaffected by acid or salt water.

Full-Vision Fireproof Eyeshield Guards Entire Face

Protection for the face and clear vision in all directions are combined in a transparent eyeshield for industrial workers. Made of flexible and fireproof material, the guard sheds hot metal. An adjustable headband holding the shield is equipped with a removable sweatband to keep perspiration out of the eyes. The shield does not interfere with spectacles.



Flying particles and hot metal will glance or roll off this eyeshield which does not obstruct vision

G.A. Smith, 2008 Cleveland Ave Chicago

Co, Raybestos. Manhattan Co Passaic NJ
H1546
Coldor.
H1521
Jackson Electrode Holder 15/22 mach. shop

Facsimile Newspaper Printed on Home Radio

Radio took over the newsboy's job recently when the St. Louis Post-Dispatch began regular broadcasting of a specially prepared facsimile newspaper, which was received on a home "scanning" set of tabletop size. At a rate of fifteen minutes per page, the receiver unrolled duplicate pages of news, sports, photographs, cartoons, radio programs and gossip, and financial news. The broadcasts were experimental, to test the practicability of transmitting



Wide World
Top, transmitter scans "master" copy of newspaper; left, reading facsimile as it comes from home receiving set

newspapers on ultra-high-frequency waves; receiving sets were placed in fifteen homes. The original printed copy of the four-column, eight-and-one-half inch newspaper is placed, a page at a time, on a cylinder in the transmitter. As it revolves seventy-five times per minute, it is scanned by a photoelectric "eye" and the variations

of light reflected from the black and white pages vary the outgoing radio waves. The process is reversed in the receiver. Continuous rolls of paper and carbon paper pass over a metal cylinder from which a small stylus projects. Pressure, varied by the radio waves, is exerted on a metal bar parallel to the cylinder, and the black and white of the original printed page is duplicated. There are no dials or adjustments for the reader to operate. A clock turns on the receiver for the broadcast and stops it at the conclusion.

Street Barriers Slow Up Automobiles to Control Traffic

Giving the government full control of traffic entering Jerusalem and other Palestine cities, concrete blocks are erected at strategic points along the highways to slow down all cars, which must thread their way through in a zigzag course. It is impossible for an automobile to make any sudden advance or to speed past the guards stationed in the concrete tower at the roadside.



Wide World
Autos slow down for inspection when they meet these barriers

FLUID DRIVE

gives smoother ride

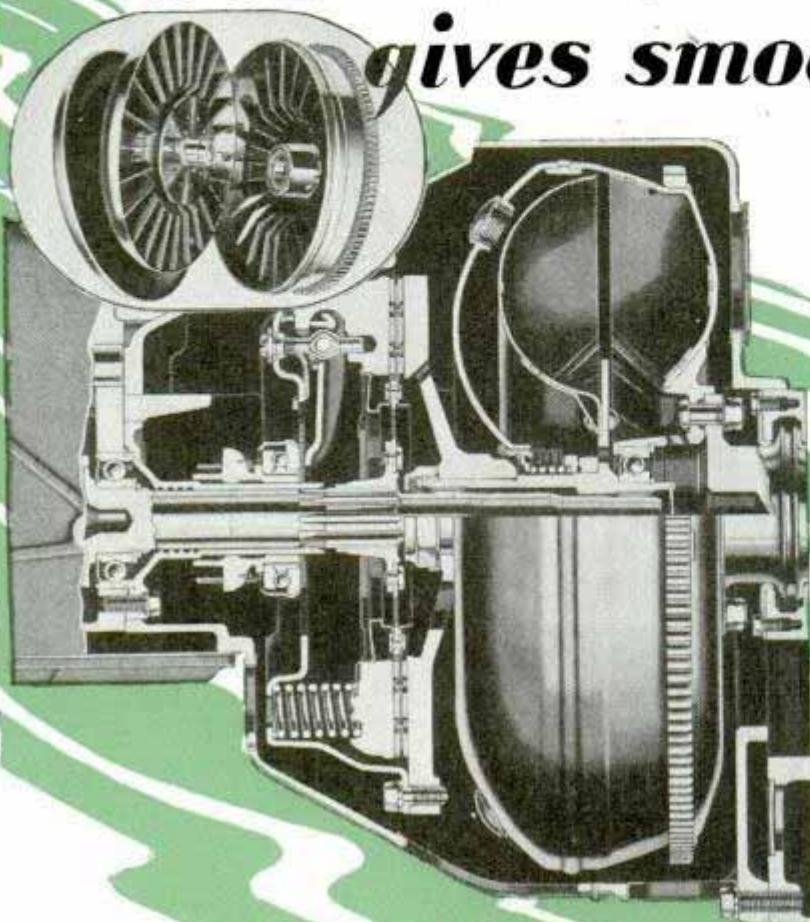

Left, cutaway showing driver and runner paddles. Inset, drive housing open to show fins. Center, electric fans and hand-turned paddles illustrate principle of drive. Bottom, outline showing position of drive between engine and drive train

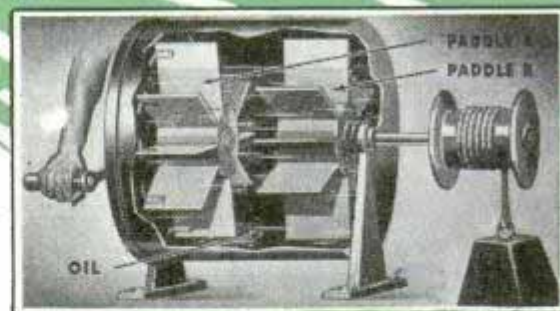
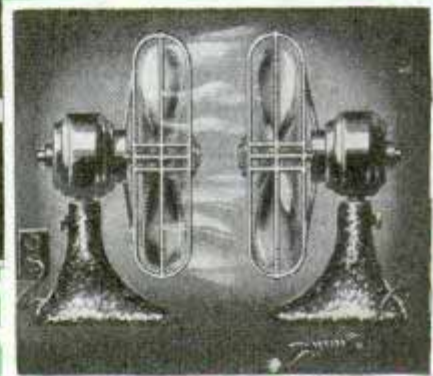

IMPARTING to the gasoline-driven automobile the smoothness of a steam or electric-powered vehicle, a "fluid drive" is standard equipment on the 1939 Chrysler custom imperial line. It is a device for transmitting power from the engine to the rear wheels. Under ordinary conditions it permits driving the automobile without using clutch or gear-shift lever. The principle is similar to that in which one electric fan starts another facing it by means of the air blast from the first fan striking the blades of the second fan. In the case of the fluid drive, oil is employed instead of air. To hold the oil in, both fans are inclosed in a steel housing,



Chrysler Corp. 341 Maggachyette Ave Detroit Mich

which is nearly full of the fluid. One of the fans, which now becomes a paddle since it is moving oil, is attached to the crankshaft of the engine. Facing this paddle, called the driver, is a second paddle, called the runner, which is connected to the rear wheels through a suitable drive train of conventional type. Hence, in operation, the engine turns the first paddle, or driver, which pumps oil through the blades of the second paddle, or runner. The moving oil causes the runner to turn, thus turning the rear wheels. There is no mechanical connection between the driver and the runner, hence none between the engine and rear wheels. This is what makes operations of the fluid-drive car so smooth, since no shocks are transmitted through the oil. The driver, which is attached to the engine, always turns a little faster than the runner, attached to the rear wheels. This difference in speed between the two members is called slip. In driving on a level road at normal speeds, the slip is very low, about one per cent. But under heavy loads at low speeds the slip becomes greater and reaches its maximum when the car is left in gear while the engine is running and the car is stopped. This does not kill the engine, as in the ordinary automobile when brought to rest in gear without releasing the clutch. The fluid-drive car may be started smoothly from a standstill in high gear simply by releasing the brake and stepping on the accelerator. Gear shifting is unnecessary. Declutching when stopping also is unnecessary because the engine will not stall. Thus unskilled drivers have less difficulty in operating this type of car, particularly in making smooth starts. The fluid drive damps out all torsional vibrations originating in the engine, thus reducing shock and wear and tear on the whole driving train from engine to rear wheels. The car may be driven as slowly as desired in high gear without declutching and there will be no engine bucking. When starting the engine it is unnecessary to shift out of gear or declutch. When slowing down, the engine may be used as a brake, just as in the standard car.

41367
**Truck Loaded with Giraffes
 Avoids Low-Bridge Highways**



Giraffes, thrusting their heads out of covered truck at one stop on the transcontinental trip to their new home

When two giraffes were transported across the United States recently by truck, a special route was selected to avoid low bridges and overhanging electric wires. The giraffes were shipped from New Jersey to the San Diego, Calif., zoo.

41530
**Push-Button "Freezes" Needle
 on Cop's Speedometer**

Disputes about a traffic violator's speed are quickly settled if the policeman's motorcycle is equipped with a push-button speedometer. A "high-speed needle" in the instrument, stopped by thumb button control while the officer is chasing the speeder, substantiates the policeman's word by recording the speed at the time of contact.



Pressing button with thumb "freezes" speedometer needle to keep record of traffic violator's speed

used by Evanson

quarantine at Dept. of Animal Husbandry, N.J.

H 1541.

X-Ray Exposes Tire Flaws and Hidden Nails to Driver

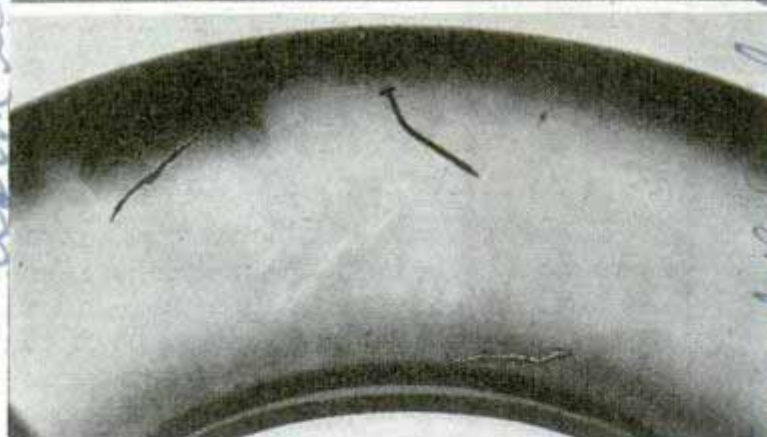

Top, motorist examines tire through window of X-ray "inspector." Below, shadow of nail and tire cut seen in machine

Automobile owners may look directly through their tires with the aid of an X-ray inspection machine announced recently. Nails, broken cords, glass and bruises stand out clearly as smudges and cracks on the X-ray window, thus revealing weaknesses that not even a tire expert could detect. In one test of the tires on 100 automobiles, the machine revealed that ninety-nine per cent of these cars carried one or more hidden tire dangers. Another investigation of 2,000 worn tires produced 2,049 nails and tacks, 2,099 pieces of glass and 2,197 pieces of rock and small stones which had become

lodged either in the tread or deeper in the body of the tire. In addition, a number of tires showed breaks in the cords, as well as other defects that eventually would have resulted in a flat, or possibly a blowout. Detection of these hazards takes only a few minutes. After the car is jacked up, the tire X-ray is rolled under one wheel. Protective flaps confine the rays to the section of the tire being inspected. The operator turns a crank to rotate the wheel. When any foreign object or defective section of cord is revealed, it is immediately spotted, automatically marked, and the inspection continues. Once located, the foreign objects may be extracted quickly with special tools. In addition to its value as a safety factor, the tire X-ray is a money saver. Firestone engineers say that tires given this inspection have a mileage life well beyond the normal expectancy of a tire that does not receive such attention. They point out that the machine should play a part in the reduction of the forty million flats which occur in this country every year, at the same time preventing many an accident.

Supersensitive Photo Meter Has Full Minute Range

So highly sensitive that it can be used in dim indoor light as well as in the brightest sunlight, an exposure meter for photographers has an extremely wide range, running from 1/2000 second to a full minute. No reading is taken while aiming the meter, but a simple ring adjustment is made. This lines up all possible combinations of film speed and exposure time on the dial. The meter is operated by a cobalt steel magnet and a photocell.



Firestone Tire and Rubber Co. 4000 ...

... 4000 ...
\$1533
Cleveland, Ohio

Co 10514

... Baker-Nichols ...

Mr. James H. Sullivan
431 W. 60th Terrace
Kansas City, Mo.

MIRACLE *of* NEW COLOR MOVIES



DOROTHY LAMOUR and Ray Milland, wearing shiny "elephant" hat, as shooting begins on "Her Jungle Love," new Technicolor romance of the tropics made by Paramount Studios.



Paramount
ART staff, above, preparing sketches for color motion picture, "Men with Wings." Left, set sketch by Lyle Wheeler of interior of the royal hunting lodge in "The Prisoner of Zenda," a production of Selznick International Pictures.

COLOR moving pictures are a miracle in mechanical ingenuity. Mistakes of the pioneering days have been forgotten and one by one the major studios have rejoined the march toward an all-color screen.

Just when that objective will be reached is a question. Enthusiastic producers say it will be within a few years, others believe its general adoption will not come until television begins making inroads on the popularity of moving pictures.

One thing is certain: color movies are here to stay. Modern Technicolor is true color. There are no compromises in the spectrum and the color camera is now capable of reproducing whatever is placed in front of it not only as to color but also as to light and shade.

Technicolor's engineers, in collabora-

tion with Eastman's research staff, are working on a multi-layer or monopack process which can be operated through a regular black-and-white camera. It will be at least another year before the new film emerges from the laboratory, but when it does, engineers predict black-and-white films gradually will disappear.

In the present color camera, a system of prismatic mirrors and light filters shunts red, green, and blue rays of light to three different negatives as they are exposed simultaneously through a single lens. The result is three films recording in black and white the intensities of these colors.

By means of a special photographic process, positive matrix films of gelatin are prepared from these negatives. These three gelatin reliefs are then dyed with their complementary colors. The dye

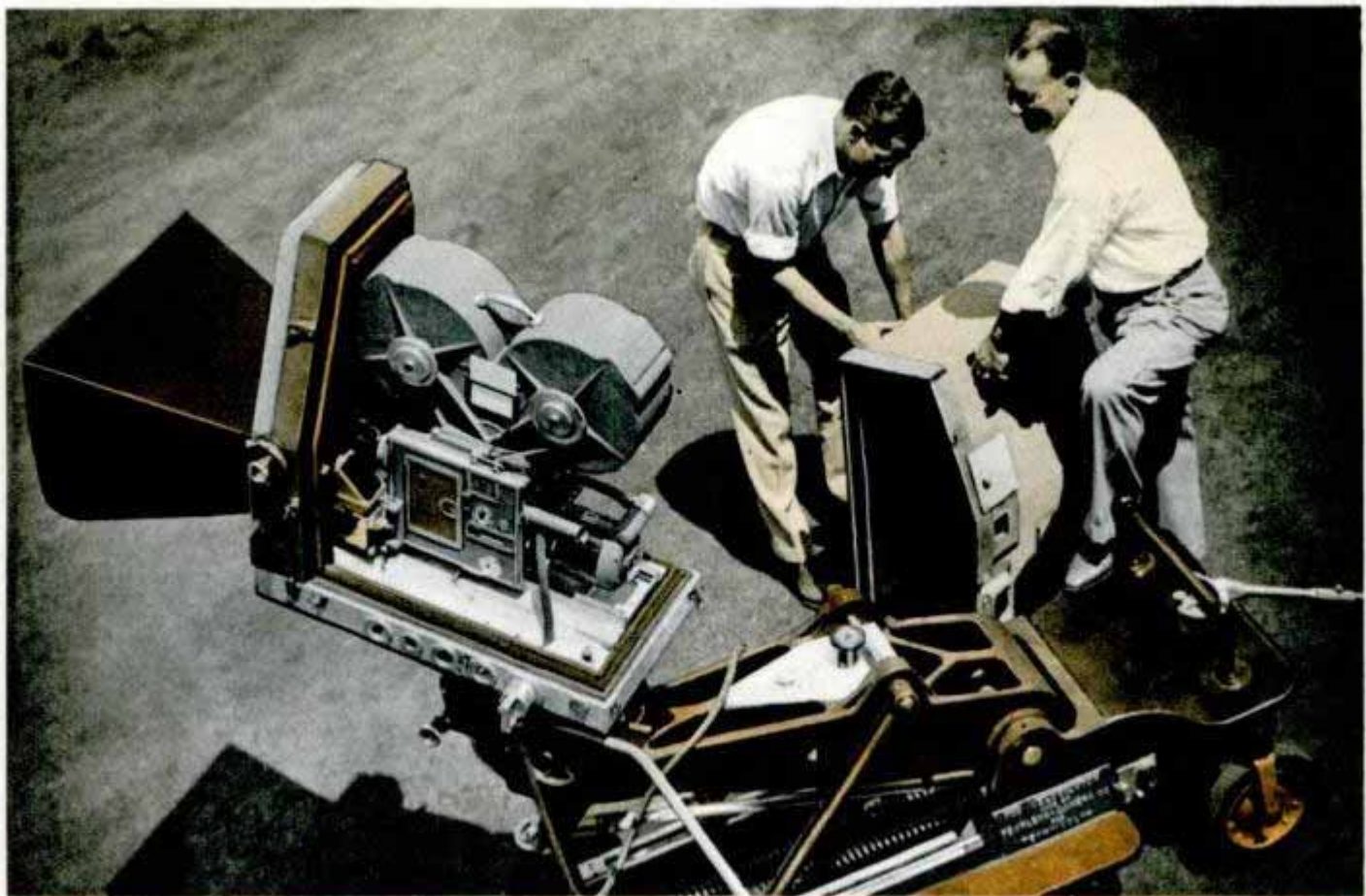

PICTURE of camera used in making Technicolor motion pictures. Right, sketch which shows how the color camera operates.

next is transferred onto another film strip which receives its images one above the other and contains a faint key image in gray silver to aid in definition and registration. The finished product is a series of colored pictures, blended in every hue, like a fine job of color printing.

The monopack film will convert Hollywood's black-and-white equipment into color cameras. It also will simplify the taking of color pictures so film shooting schedules and cost sheets may be drastically cut. An immense amount of work on the monopack process was done by the late Dr. Leonard T. Troland. His findings indicate two methods of how the monopack might be applied to Technicolor's requirements.

The more important one calls for a film with an emulsion sensitized in strata to each of the primary colors. At the outset, the entire depth of the emulsion is sensitized to a single primary color. Two-thirds of the depth subsequently is relieved of its color

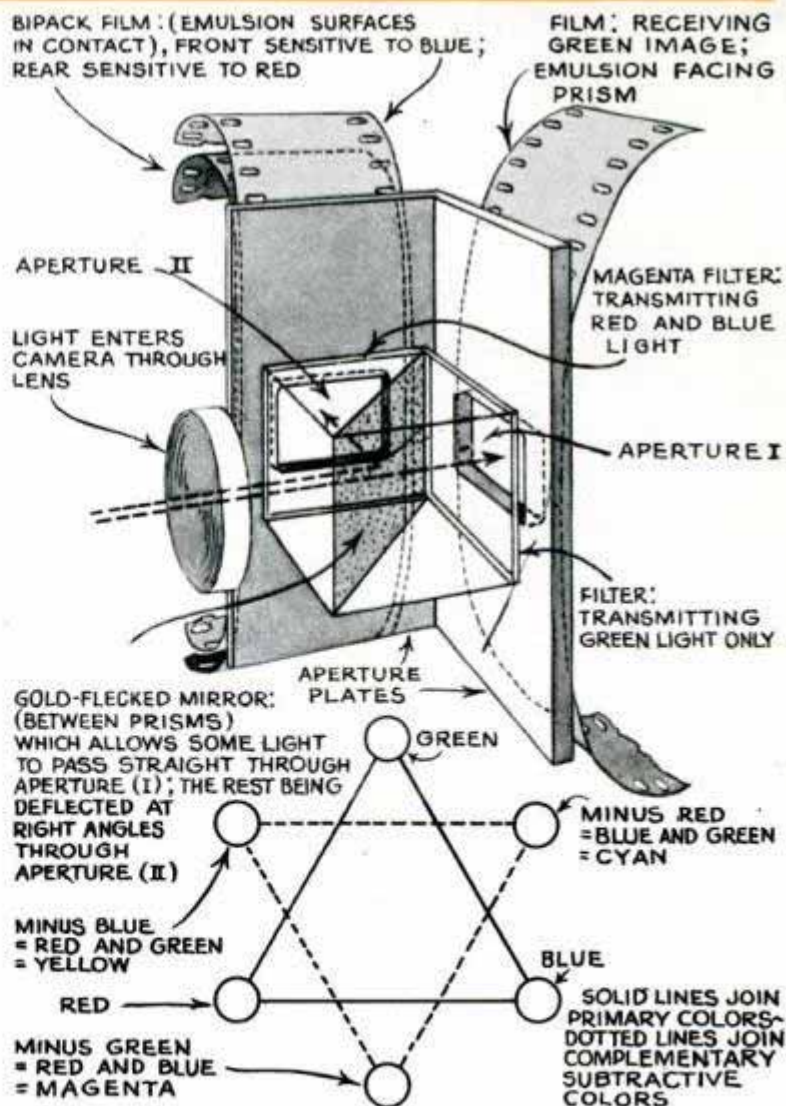

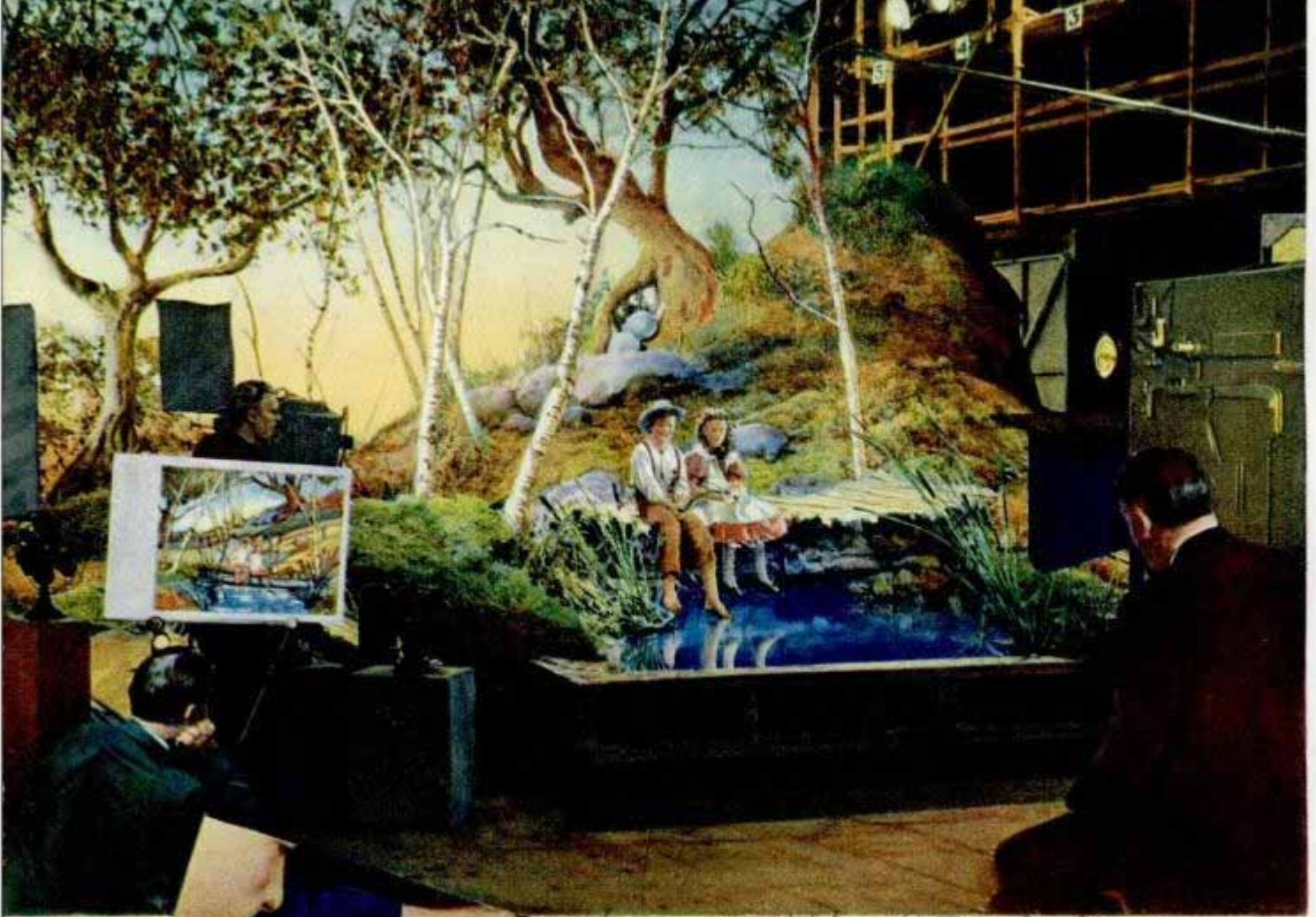

Tommy Kelly - Artist

SHOOTING scene in Technicolor picture, "The Adventures of Tom Sawyer." Left, watercolor sketch from which set was built. Bottom, strip running onto next page, record of each color, with the dyed transfer next to it. The transfer is made to a blank ribbon of positive film and the colors, printed one after the other, blend and give every possible color combination.

161056



sensitivity and the remainder is then dyed to the second primary color. Here again the dye is removed from one-half of the remaining two-thirds of the emulsion so this portion may be sensitized in the same manner as the other two levels to a third primary.

After being exposed and developed, the entire negative is bleached in a tanning bath, changing it from an opaque negative to a transparent film and at the same time hardening that

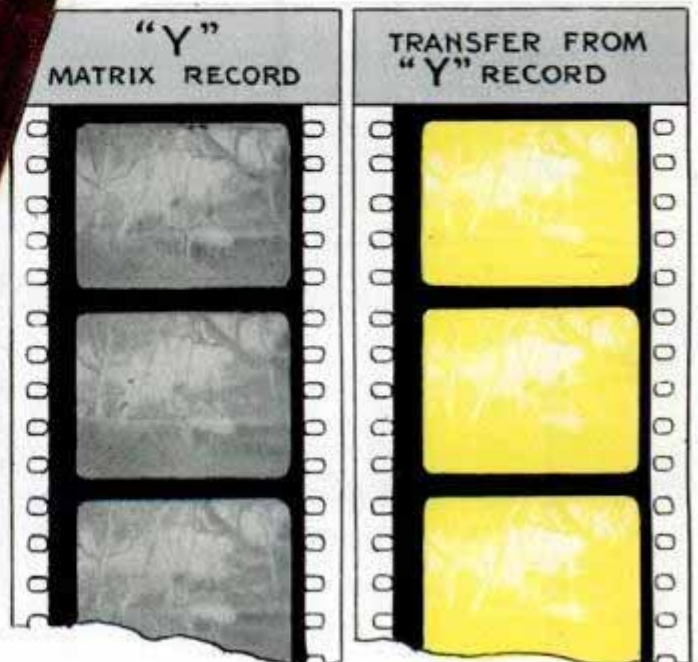

12705

HERE is the finished print, obtained from the blending of colors in the manner shown at bottom of page. This is the same scene, now imprinted on color film, as that shown in the process of being photographed (on opposite page) with aid of the water-color sketch just to left of the set.



portion of the gelatin that is in contact with the silver grains. The gelatin not containing silver grains remains soft while that of the middle tones toughens in proportion to the amount of silver it contains. In other words, a film is produced with a coating of gelatin that contains three strata of hard and soft areas.

There are certain types of dyes that will color soft gelatin strongly without affecting hard gelatin, and the next step is to stain the tanned film strongly with one of these dyes that is a non-actinic color, that is, one that will permit only those rays of light to pass that will not expose a photographic film. When completed, this results in a positive of all three color impressions.

The dye is removed from the top two layers, leaving a positive of the bottom

layer in a non-actinic color. From this positive is printed a negative and, having accomplished one-third of the objective, the positive is freed of dye.

The film is again stained non-actinic, only this time the dye is stopped when it has penetrated through the second layer. When the dye is extracted from the top stratum, a positive of the middle-layer impression is obtained. A negative is made from this section of the film. Again the dye is taken out of the original film and the remainder is dyed non-actinic for the third and last time. A negative also is made of this layer, thus making one for each of the primary colors. From these negatives, which accomplish the same purpose as the three exposed in the present Technicolor camera, gelatin matrices can be made and

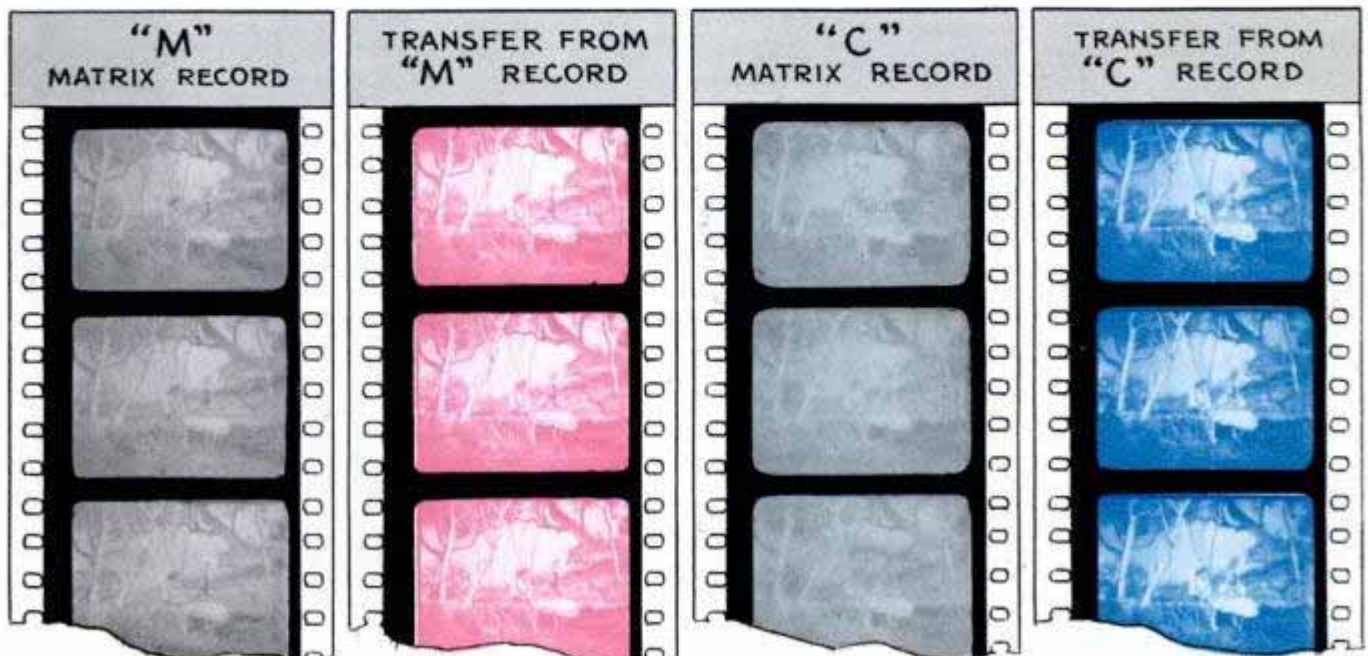

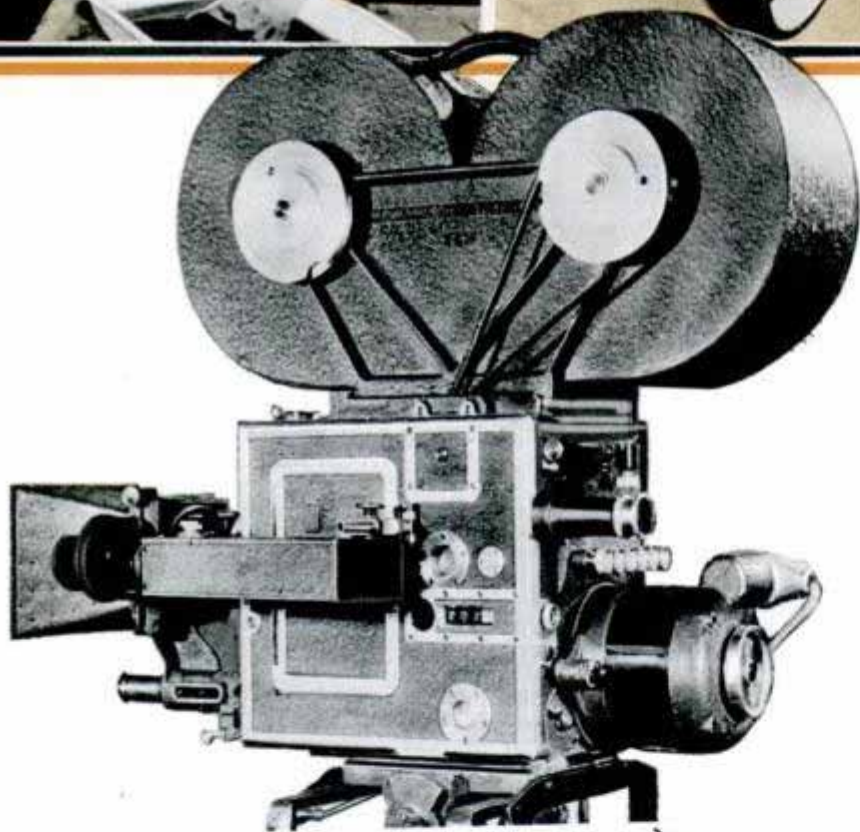

prints turned out by usual laboratory procedure.

The second way of obtaining a monopack is with a film similar to Kodachrome in that three layers of emulsion are combined into one.

Through a judicious use of color values, unusual depth can be given a picture. This is traceable to the fact that a cool color can recede, while a warm color can advance. For backgrounds, neutrals, buffs, tans, and grays and grayed-out tones of cool colors are used. Then by using combinations of warm and cool colors in the costume and set dressing, the characters stand away from the background and are given modeling and relief not possible in black and white. This same technique also serves to concentrate attention on the principals since it is only necessary to reverse this pro-

Lyn Payne Paramount Studios
F. E. IVES, top, left, pioneer in color photography. Center, craftsman preparing color set. Right, Artist Groesbeck executing "visualizations" of pictures to serve as guide for composition and lighting. Below, closeup of Technicolor camera through which three film negatives run at same time. Bottom, and extending on opposite page, diagram of process by which colors are applied to film by sensitizing the emulsion to one color at a time.

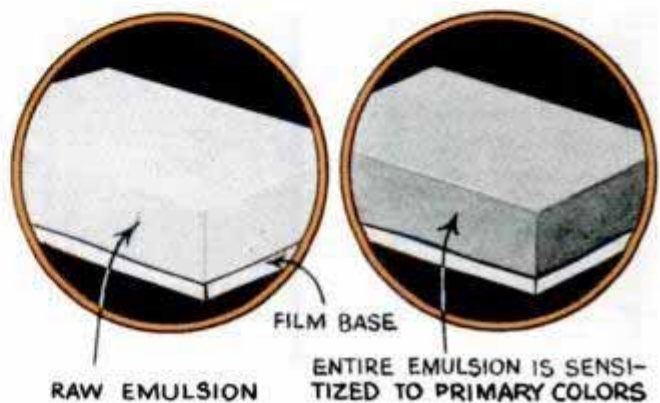



STEPHEN GOOSSON, art chief at Columbia Studios, conferring with Paul Murphy and Lionel Banks on plans for a new motion picture.

cedure to keep secondary and extra players unobtrusive.

"The color of a motion picture," explains Natalie M. Kalmus, ace colorist of the film capital, "is presented to audiences in a highly concentrated manner on the small area of a theater screen where values not obvious to the glance of a casual observer in everyday life become vastly more pronounced. It falls to the colorist to simplify and diminish in intensity the small distracting areas of color not important to the story or to the characters. Also, the colors in a

particular scene must harmonize with those in the scenes preceding and following it."

Color balance also must be maintained in each individual scene. Color values of walls, properties, and set dressing are carefully planned to be complementary to the important players in the scene as well as being in harmony with each other. Not only are certain materials tested for color but texture as well because certain window drapes, for instance, will absorb too much light while others will reflect too much.

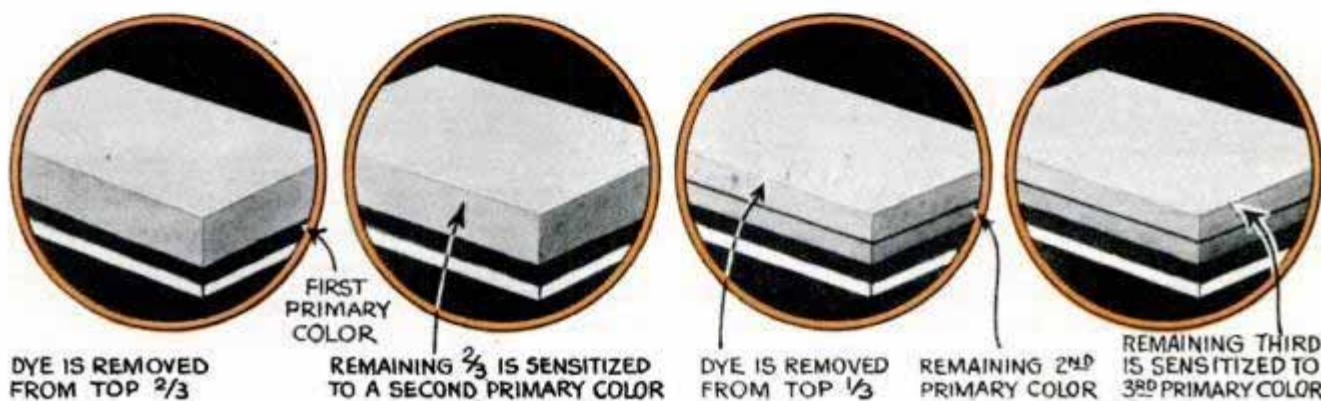



Robert Louis Stevenson

TECHNICIANS, top, preparing for single scene in Paramount's "Ebb Tide," a Technicolor production. Bottom, Artist Flannery of the Paramount staff prepares a sketch for Technicolor film, "Men with Wings." Every step in a color movie must be planned carefully and executed with the utmost precision.

When a story is ready to be put into production, the first step is to determine its color key, that is, the proper colors that fit the story and the people who are to play in it. If it happens to be a light musicale, pastel shades such as hydrangea blues, daffodil yellows, and pinks may be used as these suggest gaiety and laughter. But for something more serious, say, an adventure story, sepias, marrons, olive and bottle-green shades fit the mood.

Color combinations are worked out so they build toward a climax. Scripts are scanned, too, for big moments, possible color highlights, where color goes beyond its normal function to supply a dramatic wallop.

Such a highspot occurred in "The Adventures of Robin Hood" when King Richard and his followers threw off their somber black cloaks and hoods, revealing the red and white Crusaders' tunics and
(Continued to page 128A)

Electric Voice with a Keyboard Really Talks

Eleanor

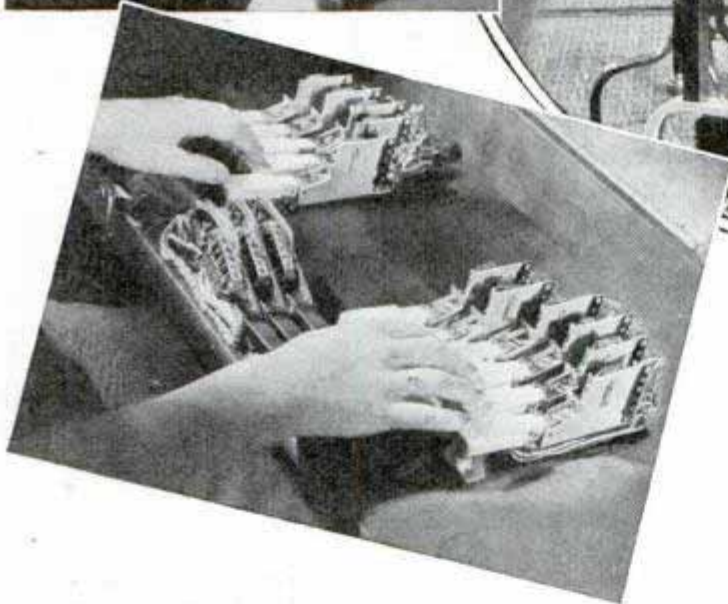
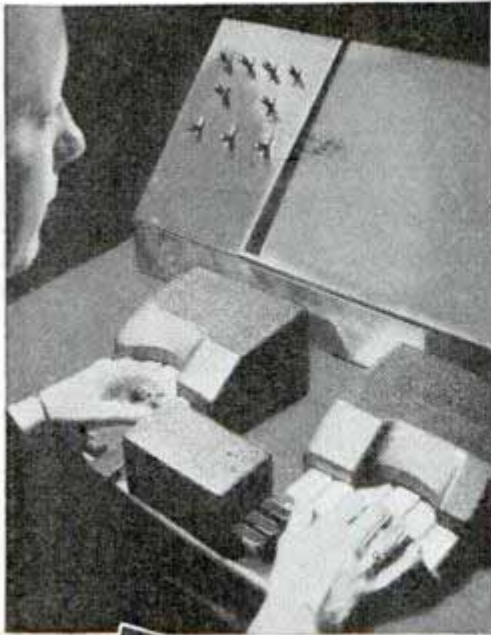

Left, two views of keyboard, covered and exposed. Above, the talking machine

First machine in the world to create speech, an electrical device demonstrated recently is operated by pressing keys somewhat like those on an old-fashioned parlor organ. A skilled operator, by pressing the keys singly or in combination, can make the machine carry on a conversation, stating facts, asking questions or emphasizing words. Built of apparatus used in everyday telephone service, the machine is provided with equipment corresponding to the two kinds of speech sound. One kind of sound is made by forcing the breath through the mouth, past tongue, teeth and lips, a sort of hissing employed in pronouncing s, th and f. In the machine there is an electrical hiss, and with some of the keys the operator can control its quality to make those sounds. Other keys make

the "stop consonants" like d, k and p. Another kind of sound, that used in the vowels, like a, e and o, comes from the vocal cords and is very complex and somewhat musical. In the talking machine is an electrical source of sound corresponding to the vocal cords. A pedal permits changing its pitch and giving it a rising or falling inflection. When the operator wants the sounds made by the vocal cords, instead of whispered sounds or consonants, an arm-rest switch is depressed. Then the particular parts of this vocalized sound which are wanted are created by playing the proper keys. The source for this sound is the "relaxation oscillator" which gives a saw-toothed sound wave in contrast to the smoothly rounded wave of a pure musical note. The machine, which is called the Voder by its creators, Bell Telephone engineers, produces tones of a woman or a man at the turn of a knob. Bleating of sheep, lowing of cattle, grunting of pigs and even the rat-a-tat of the woodpecker also can be produced by the Voder.

Laboratories, 111 / New York

On the "Bridge" of the Greatest Sky Clipper

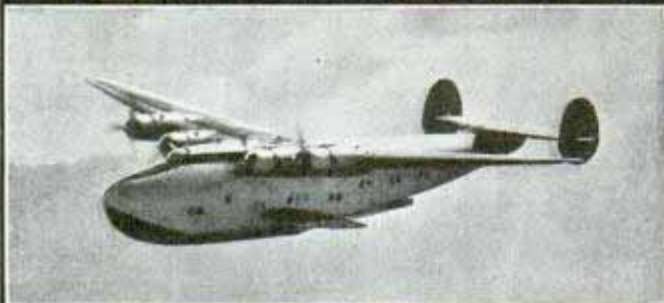

Top, radio operator and flight engineer; below, forward view of roomy supercockpit. Left, sky clipper in flight and diagram of control room

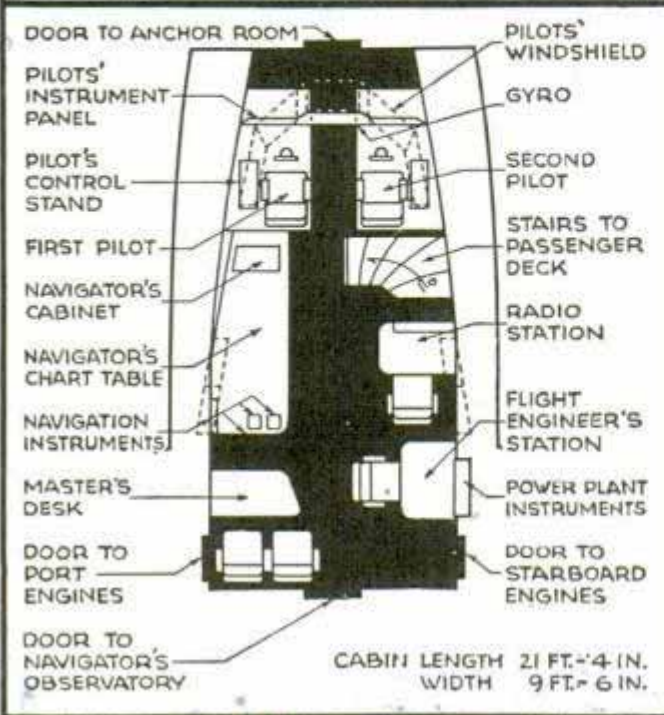

On the "bridge" of the greatest of flying boats, Boeing's seventy-four-passenger clipper, six officers are intent upon the maze of controls and instruments that surround them. It is a maze to you, but in reality it is simple, for the pilots have been relieved by navigator, radio officer and flight engineer of all but manipulation of the flight controls. Efficient yet roomy, this supercockpit is twenty-one feet long and nine and one-half feet wide; soundproofed, carpeted, comfortably furnished to avoid fatigue. First and second pilot sit forward, with dual controls and instruments: altimeter, air-speed dial, rate of climb indicator, turn and bank indicator, artificial horizon and directional gyro. Between these are the gyropilot, tachometers, manifold pressure gauges, compasses, outside air thermometer,

Boeing Aircraft Co, Everett, Wash. Station Seattle

12/15/49

clock, flap position indicator, gyropilot pressure gauges and instrument vacuum gauge. At the navigator's station are a seven-foot chart table, cabinet and instruments. There is an overhead turret for celestial observations and two drift sight stations under the wings. Opposite the navigator sits the radio operator, with three transmitters, three receivers and the radio direction finder. Just back of him is the flight engineer, responsible for the power plants and the calculation of power and fuel required for the flight. Facing the engineer is a panel carrying twenty-six instruments—tachometers, fuel quantity and flow indicators, oil temperature and pressure dials, air-fuel ratio indicators, a potentiometer showing temperature at two cylinder heads and cylinder bases of each engine; and, among others, an indicator which would detect presence of carbon monoxide in the heating system and shut it off automatically. In addition, the engineer has individual engine and propeller controls, mixtures and pressure regulators and hand-operated emergency fuel pumps. One dial shows up water in the fuel tanks, and there is a power-operated fire extinguishing system. An important safety factor is easy access to every motor during flight. Final authority is the master, who sits behind the navigator, correlating the crew's functions and directing the flight.

Lifelike Radio Robot Speaks, Walks and Lights Cigarette

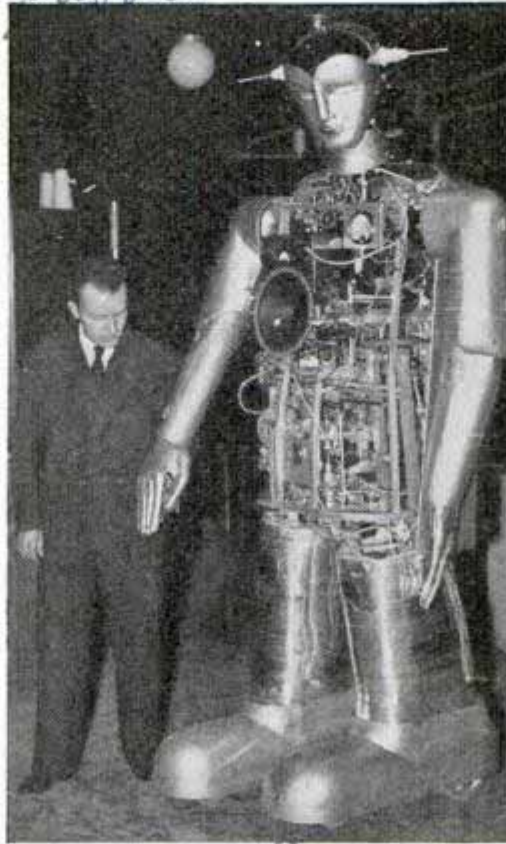

© Planet News, Ltd.

Left, "Sabor's" jacket is removed to show the complexity of its mechanism. Right, the robot lighting a cigarette for its inventor.

After ten years of work, a Swiss inventor has completed a lifelike robot seven feet tall and weighing 400 pounds. Controlled by radio, "Sabor," as the robot is christened, walks forward, backward or sidewise, and forms words correctly with its lips in speaking. The mechanical man will answer questions and can light its master's cigar.

Shock-Absorbing Ice Crusher Protects Glass Tumbler

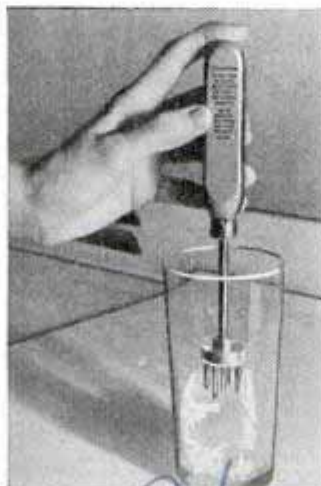

Chopping ice cubes in a glass tumbler without chipping or breaking it, a five-pronged crusher absorbs all jar with aid of a bronze spring inside its wooden handle. The prongs are first embedded in the ice, then the handle containing a hammer is moved up and down gently, driving the prongs through to crush the cube. Tension of the spring placed between hammer and prongs dampens the shock and prevents injury to the glass.

Apex Products Corp

H 1482.

Com. Co. de West Hill
457 S. Serrano Ave.
Los Angeles, Calif

PAUL REVERES of '39



Night rider, left, speeds through citrus groves and telephones temperature reports to central office. Right, lighting smudge pot to save fruit from frost damage

AS THE man runs between the trees, the beam of his flashlight cuts through the darkness. The finger of light searches for a moment, finds what it wants, and stops. The man swings open a small box, glances at a thermometer within, then moves on, running for a telephone pole silhouetted against the moonlit sky.

He jerks from its case a transmitter, climbs up the pole and plugs in.

"Jones calling from station forty-five. Temperature twenty-eight and still falling." Then he climbs down, runs to his car, and speeds away.

He is a modern Paul Revere, awakening the countryside to war—a war to save 50,000,000 dollars from the specter of the dropping thermometer. Throughout hundreds of square miles around his speeding car are row on row of some of the world's finest citrus trees, their branches heavy with green fruit—fruit that may be blight-

ed before the first ray of sunlight breaks the grip of the cold.

This is the story of an organization whose job it is to awaken 10,000 men within two hours and send them stumbling into the night, their sleepy eyes searching for smudge pots while their numb fingers fumble with flaming torches.

From early November until the end of May the danger of a killing frost is always present in the southern California citrus belt. In 1935 alone a single frost caused \$60,000,000 damage.

To prevent such disasters, growers were forced to stay awake night after night, watching thermometers and listening to frost warnings over the radio. On the majority of these nights no frost occurred, with the result that the grower wasted the entire night and was unable to work the following day.

The situation needed a man with an idea.

BATTLE FROST



The man's name was Paul Smith. Working with the growers, he organized the Central Citrus Protective Association, which covers the entire San Gabriel valley.

That warning message phoned in by the rider was picked up on one of a bank of phones in the office of the Protective Association. In that little, crowded room twenty men and girls sit around a "U" table, headphones clamped to their ears. In the center of the "U" is Paul Smith. The message from the rider comes to him. Almost before the message is completed, Smith turns to one of the girls at the table.

"Call numbers 106, 107 and 109," he says, "and tell them it's twenty-eight and to get out of bed and start firing—and do it quick."

As the girl calls the growers corresponding to those numbers, Smith turns back to his phone to take a message from another rider. All along the table tense voices are making and answering calls. One grower



Top, frost fighters gather around flaming smudge pot for a moment's relaxation. Below, arousing orchardmen with telephone warning of freezing temperature



Above, filling smudge pot from oil truck. Center, flaming smokeless heater on guard in orange grove. Bottom, taking dew point and temperature at weather station

is informed that the temperature in his vicinity is still safe, and that he can go back to sleep; another is brought from his bed with a cheery:

"Hello, Anderson, frost warning calling. Better get up, it's down around twenty-eight at your grove. Sure I know you were up last night, but that's not going to do any good tonight. Come on, get your pots going."

In another office a man bends over a map across which runs a maze of circles and wavy lines. He is a meteorologist. It's his job to calculate the all-important relation between temperature and dew point and to predict whether a wind will blow away the frost or a sud-

den temperature rise will make smudging unnecessary. He makes a final check of his map, and reaches for his overcoat and gloves. Two miles away in the center of a grove is a "key station" where a recording thermometer, a barograph, and a wet-bulb thermometer will give data for his next prediction.

Before he leaves the room, he snaps on the short-wave radio. From the regional offices of the U. S. Weather Bureau come the latest data collected by stations strung over an area of half a million square miles, from ships at sea, and lonely observers on mountain tops. An observation made on a tramp steamer in the Pacific and that made in a grove are both part of the same vast organization with which human ingenuity is fighting the icy fingers of frost that reach for those billions of lemons, oranges and grapefruit.

At the key station, the weather man notes the reading and plugs in a phone.

He is instantly connected with the central office.

"Cole calling from key station number four. Looks bad. Dew point is still around twenty-five. There's some wind due from the north, but it won't be here before dawn. It looks like a whole night of it."

Smith turns to the operators around the table.

"It's everybody out



Top, Paul Smith at "nerve center" of modern Paul Reveres, where two dozen telephones speed frost warnings to citrus growers. Below, taking one of thousands of nightly thermometer readings, and an avenue of flaming smudge pots



again tonight," he says. "And the cold won't break until morning."

The buzzers sound even faster now. There are no longer cheery remarks to the men called from their beds. There is no time for that. Two thousand growers must be contacted, and no call must be delayed when the mercury is falling to the point which means ruin and poverty.

The riders speed through the groves. The tocsins from that office go out unceasingly. The hours drag on. The temperature falls. The dew point is unchanged. If the dew point rises, the



frost danger is less, for when dew forms, heat is released and the temperature decline is retarded. But when the dew point is below the frost point, the release of heat comes too late.

Coffee is served to the group around the table. They reach for the cups without looking away from the lists before them. Out in the groves women are serving coffee to men whose faces are

(Continued to page 132A)



High-Wing Transport Plane Has Visibility for Sightseers

Douglas Ill. 5

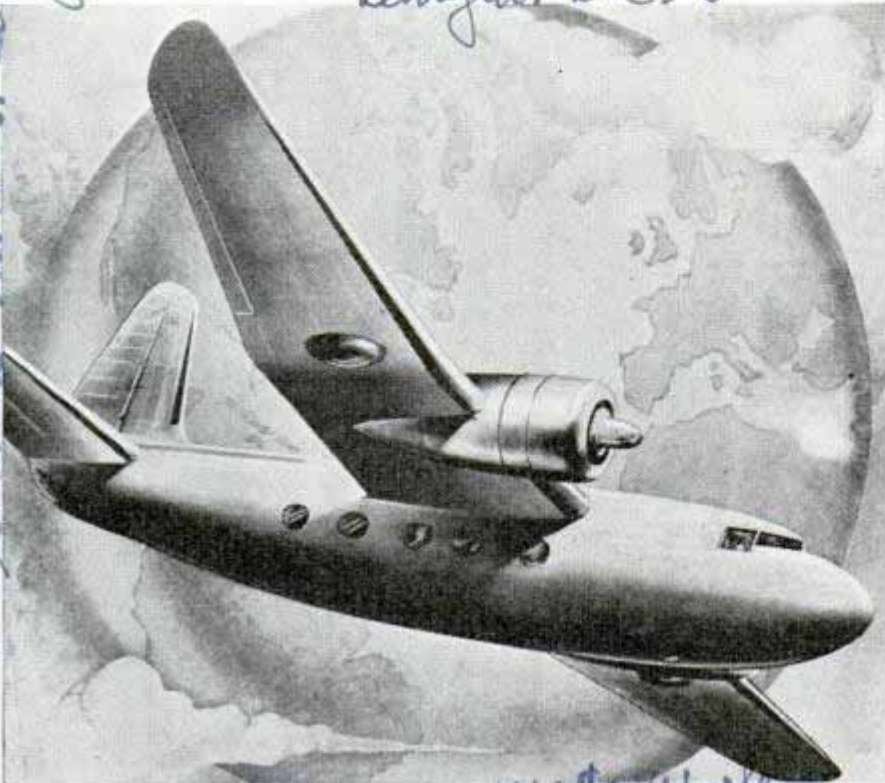

Windows of air liner below its high wing give passengers an unobstructed view of ground, and tricycle gear keeps plane on level keel when it lands

Affording better visibility for sightseeing, a high-wing airplane announced by Douglas carries sixteen passengers. It is equipped with the tricycle landing gear, adapted from its bigger brother, the "DC-4." With a strong keel along the bottom of the ship, it can land without its wheels in an emergency with safety. It is sixty feet long and has a wingspread of seventy-eight feet. On two 850-horsepower engines, the "DC-5" can cruise 169 miles an hour.

Radios for Power-Line Trucks Speed Up Trouble Shooting

name not given

Short-wave radio is helping trouble shooters, those minutemen of the power lines, to speed up answers to emergency calls. One power company is operating thirty-five trucks equipped with radio sets receiving orders sent over a 150-watt transmitter. Another company uses a fifty-watt transmitter to contact trucks and cars. As soon as an emergency is reported to the service station a dispatcher notifies the truck closest to the trouble and instructs the crew to proceed to the scene. Two supervisors' cars also have transmitters, and in case of serious breakdown, the super-

refer to Publicity Dept.

visor answering the call reports progress being made and also orders any additional equipment needed. The extension of short-wave radio to trouble shooters is possible under the recent allocation of ultra-high frequencies by the Federal Communications commission to organizations established for relief purposes, persons in remote locations, and public utilities.

#1526

Single-Runner Sled Adds Ski Thrills to Coasting

More speed and greater thrills are possible with a sled riding on a single ski instead of the usual double runners. It is steered by rolling the body to the left or right. Rails on the sides of the platform give the rider constant control. Weighing only fourteen pounds, the sled is easily handled.

Hand mono-ski



Hand rails give a strong safety grip for balancing the single-runner sled on a fast ride downhill

Tiherl Products Co.

Buffalo, N.Y.

*Douglas Aircraft Co
Santa Monica, Calif*

*General Electric Radio
Dec. 1938*

#1576

*Mr. Carl S. Johnson,
Invention of Radiation
and Organisms*

Plants Grown without Sun or Soil Test Light

Mysteries of the effect of light on plant growth are being unraveled by "incubator tomatoes" raised from seeds without sun or soil. In the experiments, which are being conducted at Smithsonian Institution, chemically treated solutions and artificial light take the place of soil and sun to "pick to pieces" that which we know as light. The plants are submitted to tests under lights rich in different colors, some red, some blue, and so on.

H 1446

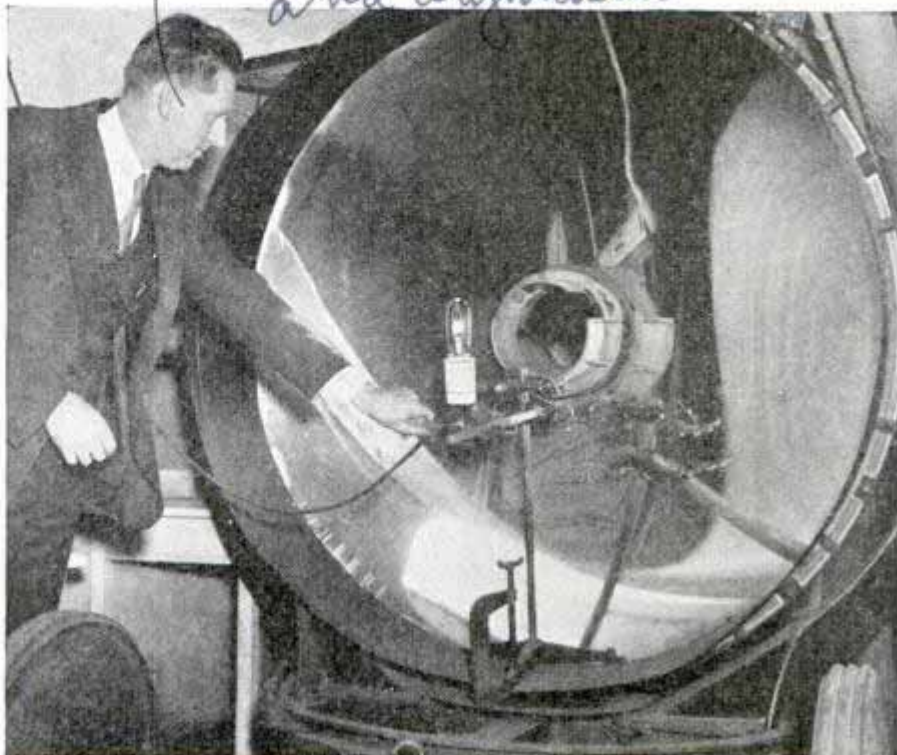

Fume Detector Sees Shadow Cast by Poison Vapor

So sensitive that it can "see" one part of mercury vapor in one billion parts of air, a fume detector just developed reacts instantly to the "shadow" of the poisonous vapor. Mercury emits a blue and ultraviolet light. A lamp in the detector emits these same rays, and when samples of air being tested are sucked into the unit, any mercury vapor in the air will absorb the light and cast a shadow on a photoelectric tube. Since the amount of mercury in the air is proportional to the shadow, the apparatus can measure the vapor.

H 1478



Top, lighting a 500-watt lamp in an apparatus that gives various intensities for the growing plants; bottom, examining some tomato plants

Soft Metal Frames Bind Miniature Film for Projection on Screen



Tape and adhesives are eliminated in the use of soft metal frames for binding thirty-five-millimeter negatives for projection. The film is simply sandwiched between the two glass plates and the aluminum edges of the frame are folded over with the fingers. These frames can be used repeatedly to bind other negatives, folding again and again without cracking the metal.

Minora American Corp

General Electric Co. Schenectady, N.Y.

Comp. of ...

"Hot Papa"



towerman frequently averts such a threatened crash. Sometimes, though, when the pilot has his radio snapped off or when his wheels remain folded in spite of his efforts, the plane comes in and skids and plows its way to a stop. Occasionally it crashes, its motor tears loose, and the lightened plane bounces as high as the hangars, somersaulting in the air before landing on its back.

Military flying is far more hazardous than civil aeronautics but accidents are surprisingly few in view of the tremendous number of hours that pilots spend in the

Left, demonstrating how fire ax is used for breaking into engine compartment. Below, "crash wagon" drawing up in front of bombing plane in fire practice drill

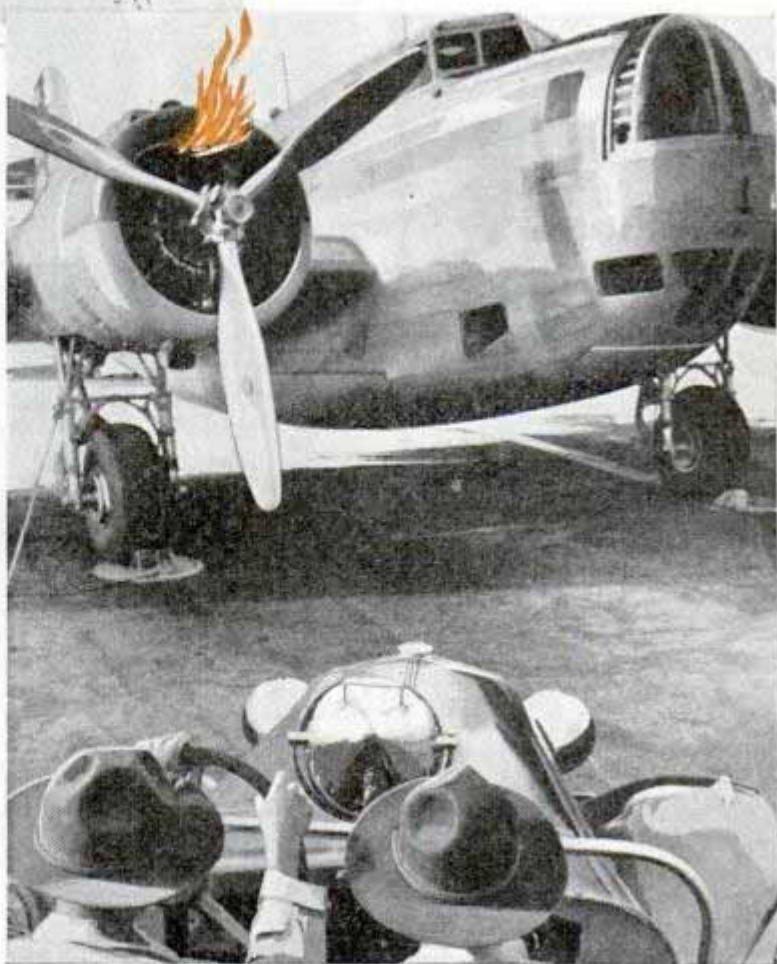

WITH one sharp look at the plane settling for a landing the dispatcher in the airdrome's control tower hastily reached for his radio phone.

"Johnson in BC-1! Get your wheels down! Your wheels are up! Get your wheels down before landing!"

The oncoming plane faltered and then zoomed upward as the voice of its pilot came in over the loud speaker. "The wheel gear must be stuck. It's wound down and the indicator shows the wheels are down. I'll try it again a couple of times. Check me as I fly over the tower."

Watching, the dispatcher saw the wheels finally unfold from the wing and lock in position. Then he cleared the plane for its landing. From his position high above the military airport the vigilant

Cent. Thomas & Stinson Jr. 10655 Tolman dr. Los Angeles

... ..

Stevens
County Calif

to the RESCUE

Public Relations
Office

air. At such an airdrome as March Field in California where bombers, observation planes, and attack planes engage in daily maneuvers there are several hundred flights every day with the total sometimes rising to 600 take-offs and landings in twenty-four hours.

Often as not when an accident happens at the field the towerman sees it coming. If it is at a far corner of the great airport he will be on the phone, ringing for the "crash wagon" and ambulance to get out to the scene, even before the plane hits the ground. That's because the men on tower duty, used to judging landing speeds and angles, can sense something wrong before a crash takes place. If a plane loses flying speed too high above the landing mat and its wings start to wobble, there is not



Directing bombing plane to parking place. Bottom of page, crash crew member in "hot papa" suit demonstrating use of spear for ripping away skin of plane fuselage to rescue fliers

much chance that the pilot will be able to pull out safely.

Even if the pilot is uninjured he barely has time to unsnap his safety belt before the crash wagon slides to a stop beside the wreck. Equipped with every kind of fire-fighting device and with emergency tools





Left, "hot papa" holding carbon-dioxide thrower for quenching flames. Below, attaching disabled plane to truck before hauling the ship off the field

for smashing into closed cockpits, the red eighty-five-mile per hour truck stands parked at the side of the field night and day. Its crew of two trained men may do nothing for weeks except keep the engine hot for instant starting and an eagle eye on the planes maneuvering around the field, or they may respond to several crashes in one day.

The worst kind of crash is one with a fire and with an injured man inside the plane. Then one of the crash crew pulls on the "hot papa" suit, asbestos clothing inside of which he can walk through the hottest gasoline flames to rescue a disabled flier. Flares and ammunition inside the plane are apt to explode from the heat yet rescue work must be done calmly. There is no time to waste fumbling with a jammed cockpit cowling and the rescue man may rush in on the plane, rip the dural sheathing away with a special lance, and fight his way to the pilot. A burning plane is fought down-wind, a blanket of freezing carbon dioxide being laid down first, followed by foamite solution to prevent a flashback.

Once an observation plane was getting up to flying speed on the take-off when one of its landing flares broke loose and caught in the tail skid. On fire, the fiercely burning flare enveloped the tail group in flames. The pilot knew that the fire would spread forward as soon as he slowed down, yet it would be suicide for him to take off. Using the brakes as hard as he dared, he slowed to a stop. By then the flames were eating forward and he barely had time to jump away. The crash wagon arrived just as he hit the ground and the crash

crew saved the motor, lower wings, and fuel supply.

The gasoline supply does not always catch afire in a crash. When an attack plane turned over because





its wheels locked as it was landing, streams of gasoline started pouring down the sides of the plane and one of the crash crew was saturated with the fuel as he tore away at the cowling to rescue the men inside. Fire might have started any second and the other crash man stood by with the carbon-dioxide thrower in his hands, ready to smother the first leap of flames.

Many bad crashes happen away from the field in mountainous areas where there are no landing places. If engine failure disables a plane its crew may have to jump for their lives. Right now there are a number of wrecked military planes high in the mountains, too far from trails or roads to be salvaged. All that the salvage crew can do in such a case is to rescue the machine guns and ammunition and then completely hide the wreck with brush so that it won't be sighted from the air and reported as another crash.

March Field's ponderous six-wheel-drive salvage truck can be driven into surprisingly difficult spots to salvage a plane or repair it so that it can fly again. On one trip the truck may be driven into Utah and then across twenty miles or more of open desert to reach the scene of a forced landing. Another time the truck may be able to crawl to within half a mile of a wreck high in the Sierra Nevada mountains. Trees are cut down to open a pathway and then the plane is hauled down over the snowbanks to the truck with a long block and tackle.

When his motor conked out too far from

an airport one pilot made a perfect landing in a city dump. He got down all right but he couldn't get up again and the salvage truck made a 100-mile trip to the spot to remove the wings and tow the fuselage out to a field large enough for a take-off. Another time two fliers lost in a snowstorm at night thought they spotted an emergency field alongside an airways beacon and they landed in what turned out to

(Continued to page 126A)

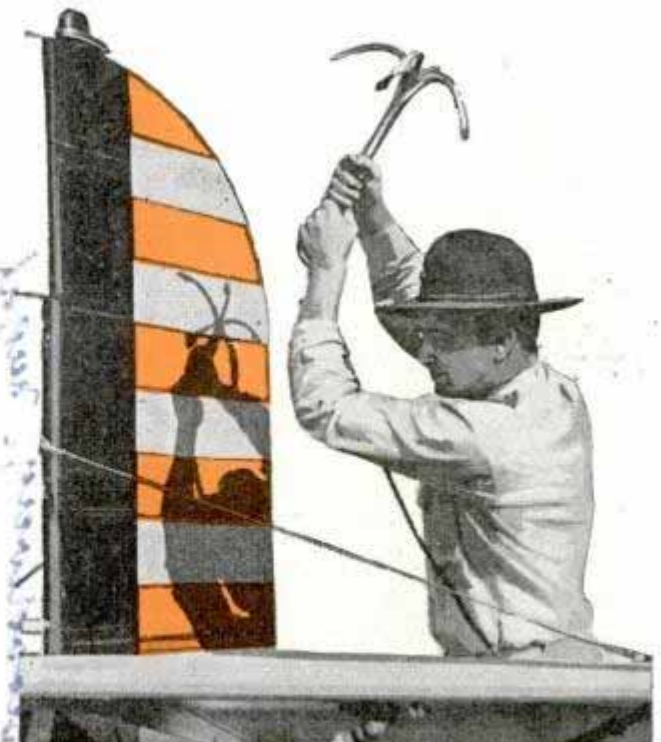

Top, crash wagon ready for rescue work. Bottom, grapple hook that may be slammed into airplane wing or tail when plane must be moved quickly in emergency. A truck hooked to the grapple can drag the plane away, thus aiding in rescue of the fliers

Jack 358
72 Gardner

250. Part 10

1462.

POPULAR MECHANICS
St. Allston, Mass
New York

Bowling and Golf Joined to Make Indoor Game

Bowl. Golf.

maker. Paul and Lewis, 37 Federal, Boston, Mass.

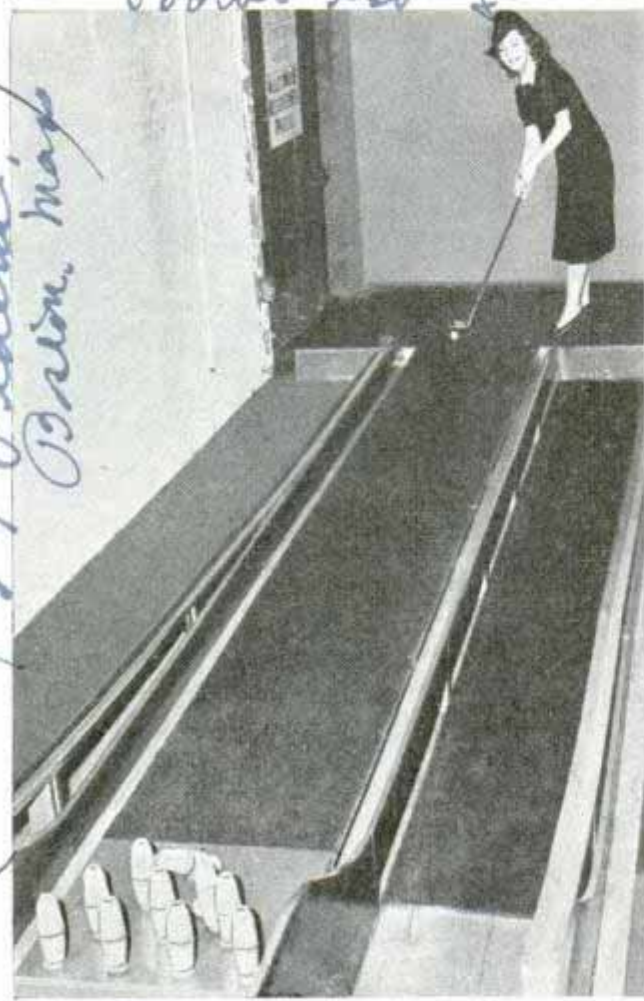

Making long putt on carpeted alley of new bowl-golf game, with head pin instead of a cup as target

Golf clubs swing all winter on green-carpeted bowling alleys in a recently introduced game in which the golf ball replaces the bowling ball, and featherweight pins are toppled by accurate putts. Scores are made the same as in bowling.

1444

Radio "Ear" for Blind Flying Tells Pilot His Position

With the newly developed "marker receiver" installed in his cockpit, an air pilot is given a tone or visual signal that tells him his position over one of the beacon stations on his route. The signal is automatic, and in effect creates a trail of radio "landmarks" that orient the pilot when flying blind. These beacon stations transmit "marker" signals in fan or cone-shaped pattern directly overhead, on a frequency of seventy-five million cycles per second.

Western Electric Co
Operation Radio

As the plane carrying a marker receiver enters the field of this pattern, the receiver emits a characteristic tone identifying the station below. It is also equipped to operate lamp signals in the cockpit.

1407

Light for Electric Shaver Attaches to Any Make

Headlights for electric razors are the latest convenience for the man in the family. A small electric lamp that "rides" the shaver throws a bright beam of light just where it is needed, directly in the path of the cutting head. The lamp plugs in between the shaver and its connecting cord.

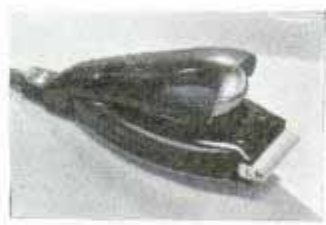

1463

Two-Hundred-Pound Wrench Turns Huge Hinge Nut

When a machinist is called to tighten one of the big hinge nuts for Chicago's new lock gates, he takes along a giant end wrench weighing about 200 pounds. The lock, in appearance resembling a canal

Sanitary District Canal



Wide World

A wrench taller than himself presents a problem to the workman who moves it from one job to another

jutting out into a harbor in Lake Michigan, is being built to control diversion of water from the lake into the Chicago river, and will also seal the harbor so the river does not reverse after a storm and pollute the city's source of drinking water.

H 1406
**Barrow Inside Giant Wheel
Carries Large Loads Easily**



no information
Sept 10
Hauling heavy load in barrow as it rolls easily on the inside track of big wheel. The barrow always remains right side up

H 1499
**Eye Tester for Auto
Headlights Runs
on a Trestle**

Automobiles must have good "eyes," and to make certain the new cars go out with efficient headlights one car manufacturer uses an optical test system. The tester is mounted on a 100-foot trestle operated by pull chains. Rays of the headlights of each new car are focused through a condenser lens upon individual screens bearing an "x" for centering the light.

Plymouth and Chrysler

Rolling on the inside rim as a giant easy-rolling wheel turns, a container capable of carrying big loads forms a new kind of wheelbarrow. The container always stays right side up. Handles attached to the barrow make the vehicle easy to operate, one man being able to push it fully loaded.



Pulling the optical tester on its hundred-foot trestle into position for focusing car headlights

H 1430
**Clamps for Carpenter's Horse
Hold without Nailing**

Nails are not needed to assemble two-by-fours into a sawhorse if the carpenter is equipped with a clamp just introduced. After being cut to proper length, the uprights are simply placed in the clamp. The cross-piece is added to complete the assembly by adjusting a bolt, and the horse may be dismantled quickly when the job is finished. Teeth in the clamp jaws insure a tight grip.



Send return postage to our Bureau of Information to learn the name of the maker of any device described in this magazine.

New York 37 W. Broadway

*Anchor Mfg Co 210 S. Chicago
Christiana Ave. Chicago*

1041
Grant

GROOMING

By

Roderick M. Grant

INTO the Chicago terminal glides the stainless steel Aeolus, dusty and panting from its 441-mile sprint from the Twin Cities at an average of sixty-six miles an hour. A long haul and a fast one for any iron horse.

The engineer leans from the cab to get his orders.

"Take her out to the yards for a quick turn," he is told. "She is pulling the 'Zephyr' on a test run to Denver tonight."

One hour to clean the firebox, take on fuel, water, sand. A quick inspection. Then back to the Union Station and off for Denver at a mile a

Left, shoveling cinders from under the stack at the end of a night's run. Below, shaking and raking the firebox clean

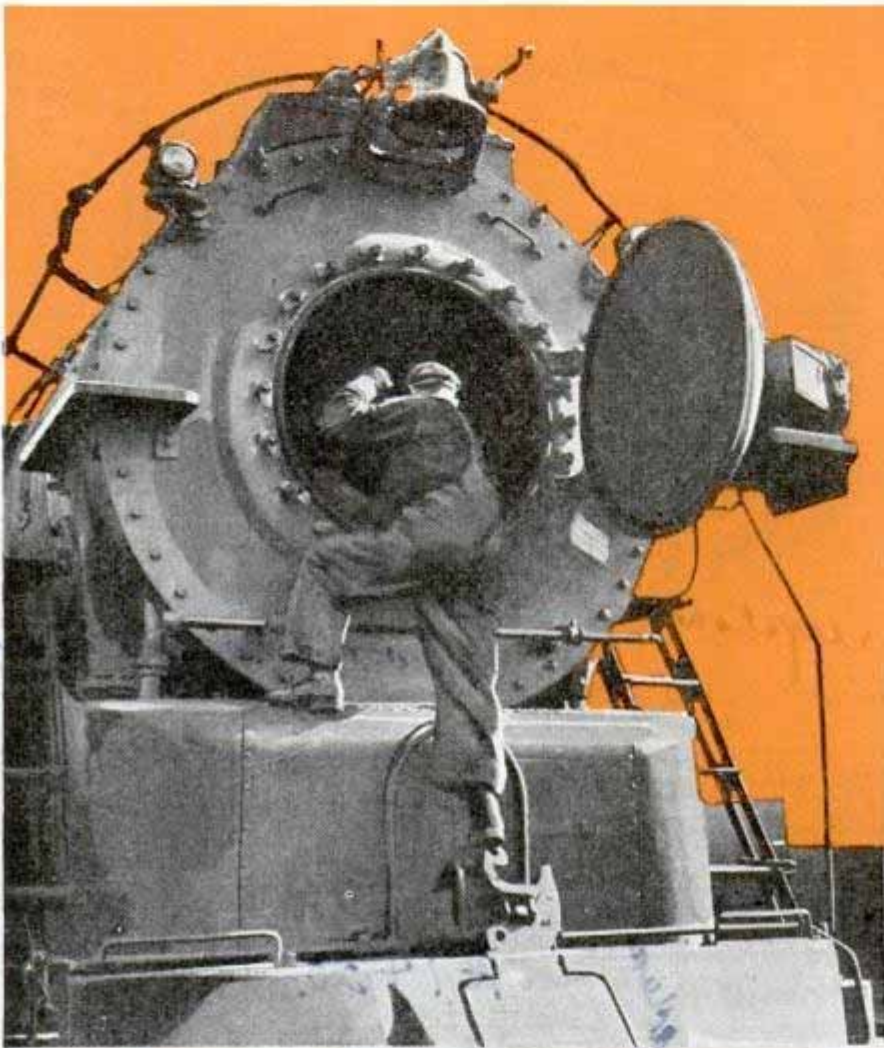

the IRON HORSE



Just in from Minneapolis, No. 5624 submits to thorough inspection by electricians and mechanics in Chicago yard while fire is "pulled." Note ash buckets in adjoining track

minute. Nine hundred sixty minutes to go 1,039 miles. Minneapolis to Chicago to Denver, 1,480 miles with one hour's rest.

Ten years ago they'd have told you it was impossible. No steam engine could do it. Why, it took two or three changes of engines between Chicago and Denver.

Well, the Aeolus did it. How? The foreman of the roundhouse in Chicago's Burlington railroad yards explains:

"They could have done it years ago. They just didn't have the nerve. The steam locomotive has always had plenty of speed and power. But I'll tell you what keeps it pounding the rails on longer runs today—roller bearings and packed lubrication."

The old picture of the grimy engineer poking the two-foot spout of an oilcan into the elbows of his engine is now obsolete. They don't do it that way. The streamline

Aeolus, much the same old horse under its stainless-steel shrouding, could go 1,475 miles without seeing an oilcan. But don't think for a minute that locomotives ramble along day after day with no more than a trip to the coal chute and water tower and an occasional dumping of the ashpan. There's a daily ritual of inspection and testing and cleaning that involves hundreds of operations.

Any ordinary horse could expect a night's rest after a day on the milk-wagon route. But not the iron horse. From the moment No. 5624 eases under the coal tower in the Western avenue yard at Chicago after her overnight trip from Minneapolis until she emerges sleek and snorting under a 250-pound head of steam to start the north-bound run with the nineteen cars of the North Coast Limited, there's never a pause.

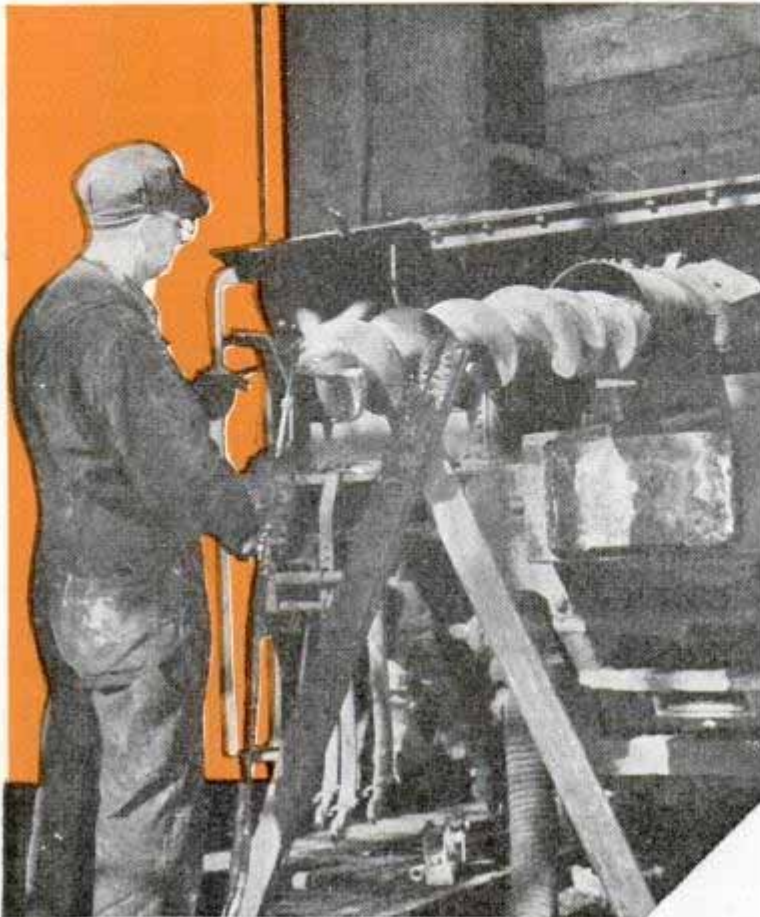

"Heavy" repairs occasionally include torch work on the stoker screw, which delivers coal from tender to locomotive firebox

No. 5624 is last in the morning parade to the Burlington railroad's roundhouse. At the water tower the engineer clammers down, takes a final look around for parts needing repairs and makes out his report of engine condition while the hostler takes over the locomotive. From the engineer's report and subsequent findings of engine inspectors, the roundhouse foreman determines what repairs are needed beyond the regular daily regimen.

Down the inspection track the procession moves like cars on a production line. No. 4002 of the "Blackhawk," in from the early trip from Minneapolis; No. 3001, the "Fast Mail"; No. 3012, which brought the "Ak-Sar-Ben" from Omaha; No. 7016 of the "Empire Builder," from the Twin Cities, and finally No. 5624 of the North Coast Limited. The hostler fills the 18,000-gallon water tank in the tender, then moves her along to the next tower for sand and coal. Twenty-four tons of bituminous

stoker coal are carried, and the chute drops a bit of coarse coal at the last for hand-firing to start the fire.

A few yards down the track a lever on the side of the engine is thrown and the ashpan is dumped into huge buckets in the pit between the rails. Shaker and poker clean out every remnant of fire from the firebox and a hose flushes the pan and drenches the ashpit.

On down the line the washers take over. From spray guns carried over the shoulder they shoot a mixture of light oil and hot water and air under pressure, washing the grit and dust of the road from the engine, from stack to coupler. Meanwhile steam and water are blown from the bottom of the boiler, carrying out any sediment that may have settled. The amber headlight gets a good polishing, then the nose of the locomotive is swung open and any soot and cinders that have settled under the stack are shoveled out.

All spic and span, the engine ambles another few yards nearer the stable and submits to the thump test. The hostler levels off the rods on one side of the engine to "dead center"; on the other side an inspector holds a caliper at various points on the driving rod and crank arm to measure



Before entering roundhouse, entire locomotive is bathed with mixture of hot water, light oil and air shot from spray gun

the jump when the hostler, setting brakes hard, gives it a "thump" of steam. If the caliper shows more than $\frac{3}{32}$ -inch slack, there's shop work to be done. Today, for example, No. 5624 shows too much wear on the shoe that carries the main rod, and the inspector jots an order on the report to remove the shoe for tinning.

At last No. 5624 is ready for a rest. She glides down to the turntable and noses into her stall in the roundhouse. Here it is eleven o'clock, she had her last bite of coal before she pulled into the downtown depot, two hours ago; the fire has long since been dumped, yet she still has steam up. How long can she keep up a working head? Five

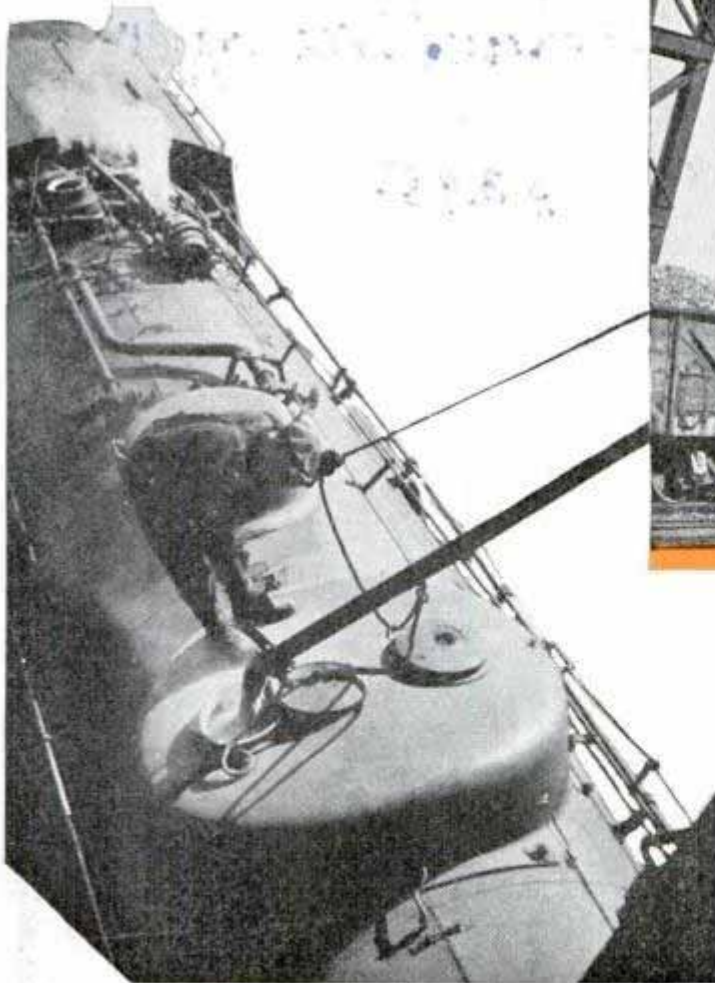
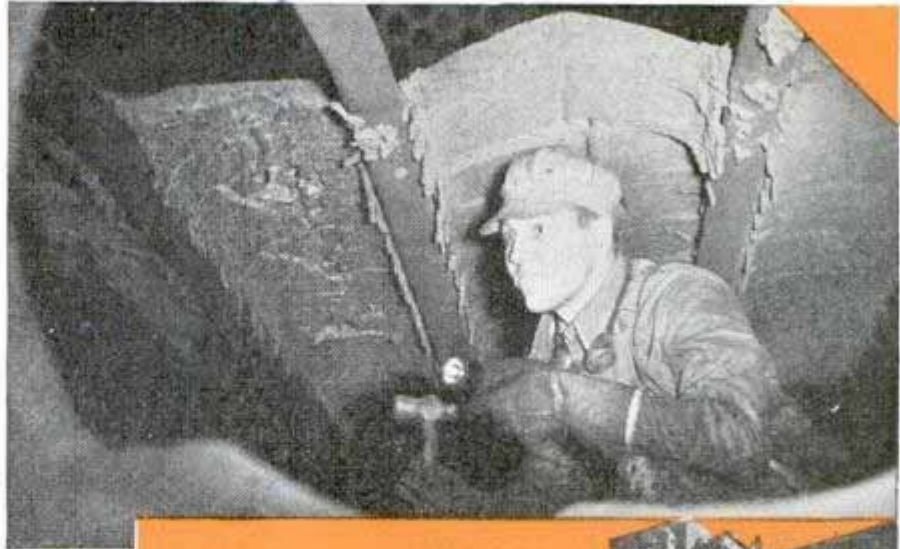

With the fire out but the temperature still 210 degrees, inspector takes a look inside firebox, top. Right, gantry crane empties ash bucket from track pit. Left, taking on a fresh supply of sand

hours, if not overworked. In cold weather, however, the pressure may drop too low for work within an hour and a half.

Now for "the works." An electrician tests dynamo, lights, everything electrical, and changes the tapes on which a continuous log of the engine's speed has been recorded. A boiler washer blows her down, and inspectors go over every valve and connection for steam leaks, they inspect the gauge cock and water glass and clean them out, they dive into the pit to make any necessary repairs from below. Ham-

(Continued to page 130A)

Refrigerator Used as Oven for Heat-Treatment Tests

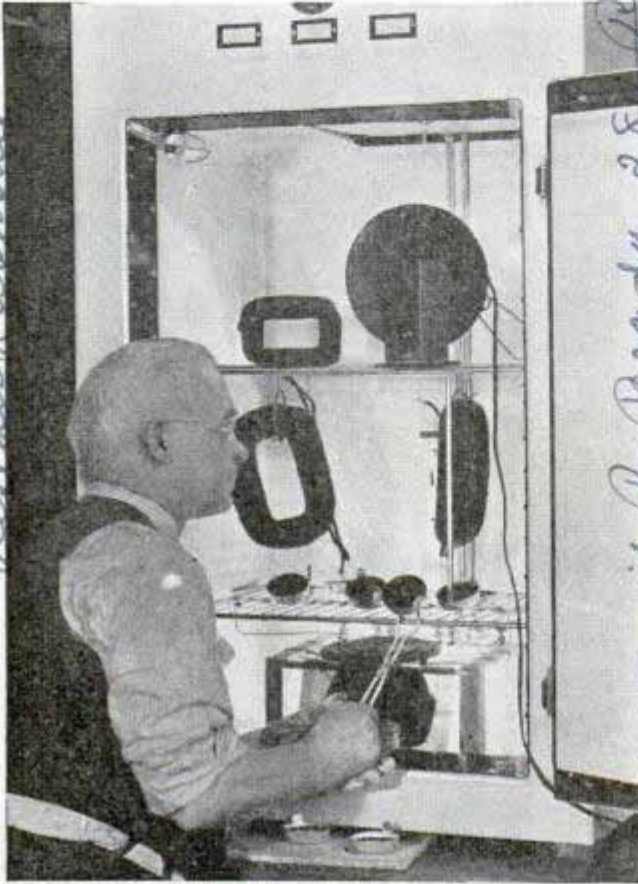

Using an electric refrigerator for an oven in putting electric coils and insulation to heat tests

If a refrigerator keeps heat out, it should also keep heat in. On that basis several discontinued models of electric refrigerators have been converted into automatic temperature-regulating ovens in the Westinghouse Research Laboratories to test varnishes and insulating materials under high temperatures. Electric coils and windings are put in the "refrigerator ovens" for accelerated aging tests.

Cars Passing at Fifty Require 1,000 Feet and Ten Seconds

Average drivers need 1,000 feet of road distance and ten seconds in time to pass the car ahead, traveling at fifty miles per hour. At thirty miles, cars require from 450 to 650 feet. This was learned in tests made by Yale University scientists to determine proper sight distances which will help engineers in designing highways of the future. With cameras and a stop watch, passing cars were photographed to measure distances, and the time taken for pass-

ing was recorded. Tests included flying passes, where the vehicle traveled at constant speed throughout the maneuver, and accelerative passes, in which the passing driver started at the same speed as the vehicle ahead of him. Forced and voluntary returns to the right-hand side of the road also were checked.

Lead Foil Built into Toe of Shoe Aids in X-Ray Fitting

To assure accurate and comfortable fitting of shoes, an inventor has patented a method of building a small piece of lead foil into the shoe to cast a shadow in the X-ray fitting machine. The lead foil is placed across the toe of the shoe, and if the wearer's toes extend beyond the oblong shadow seen over the X-ray, the shoe is too short.



Automatic Home-Movie Titler Saves Time, Ends Splicing

Eliminating printed titles and the burdensome job of setting up individual letters and numerals, an automatic titling machine for amateur movie makers is on the market. It is capable of setting up three rows of letters of twelve characters each. Thirty-six small wheels, each operating a



Title, shown inset, as written by automatic machine useful to home movie makers

Universal Camera Corp

Mr. H. C. G. Weber, Chemist Research Division

Dr. David R. Brady, 28 Rippon St. H 1474

Science Service 11/26/38

W. H. Allen shoe received - genuine shoes

Scherer Hill Hazen Pa

L. W. Forbes

J. M. Watson and Eugene M. Suedlaff Research H 1428

ribbon of forty-two characters, afford a total of 1,512 letters that fall into place automatically at the touch of the finger. On each ribbon a complete alphabet, numbers from zero to nine and all punctuation marks, stand out in brilliant white against a dead-black background. The titler is pocket size and can be used with any make of movie camera, eight or sixteen millimeter machines. Important also is the fact that the usual splicing and film rearranging are eliminated, since the movie maker, having finished shooting a scene, sets up an appropriate title on the spot, photographs it by holding the camera in one hand and the automatic titler in the other. The title is recorded at once in its proper position in the film.

1402

Insulation Is Sprayed on Wall Like Paint

Sprayed on like paint, a new insulating material builds a "blanket" on the wall to give protection against cold or heat. Made in dry flake form, which is fire-proof, the insulation unites with an atomized adhesive as it leaves the spray gun. It can be applied to any surface such as wood, metal or concrete, in any thickness.

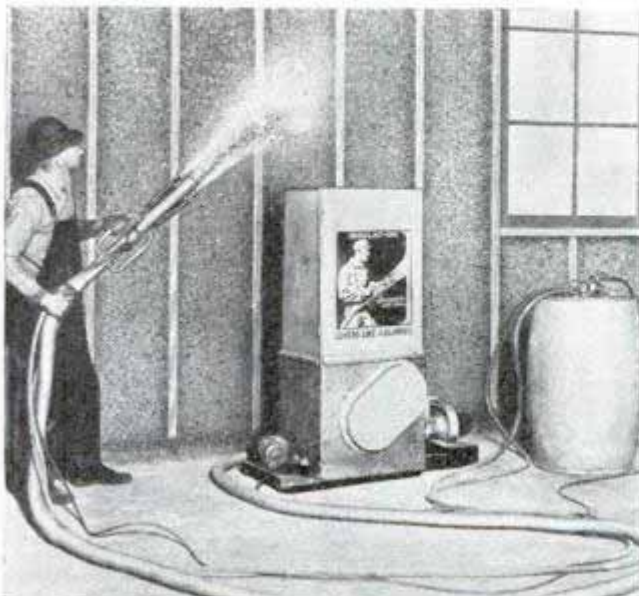

Spraying insulating material with special gun. Atomized adhesive holds it on the wall

Sprays. Flake. Co. 1 Road

Target Planes Saved from Sea When Hit by Navy Gunners

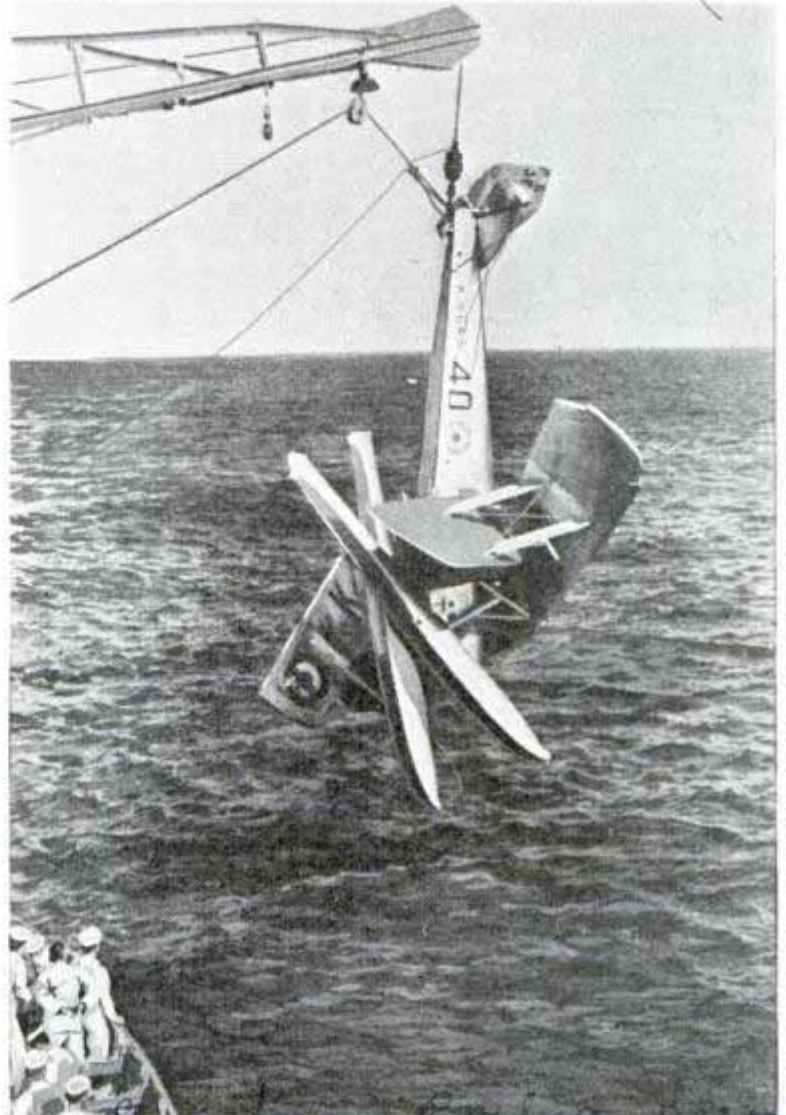

European Pacific Service
With wings and pontoons twisted by crashing into the water, target plane is saved from a watery grave by rescue ship

Small seaplanes, called "queen bees" by the British Royal Air Force, are used as targets for anti-aircraft gunners of the British navy. They carry no pilots, being catapulted from the "mother" ship and controlled by wireless when in the air. Their motions, simulating actual conditions of an air attack, make them ideal for gun practice. Since the target plane carries costly wireless equipment and motors, a rescue ship is always ready to pick it up when it is brought down.

Names and addresses of manufacturers and dealers in articles described in this magazine will be furnished by our Bureau of Information upon request accompanied by stamped, self-addressed envelope.

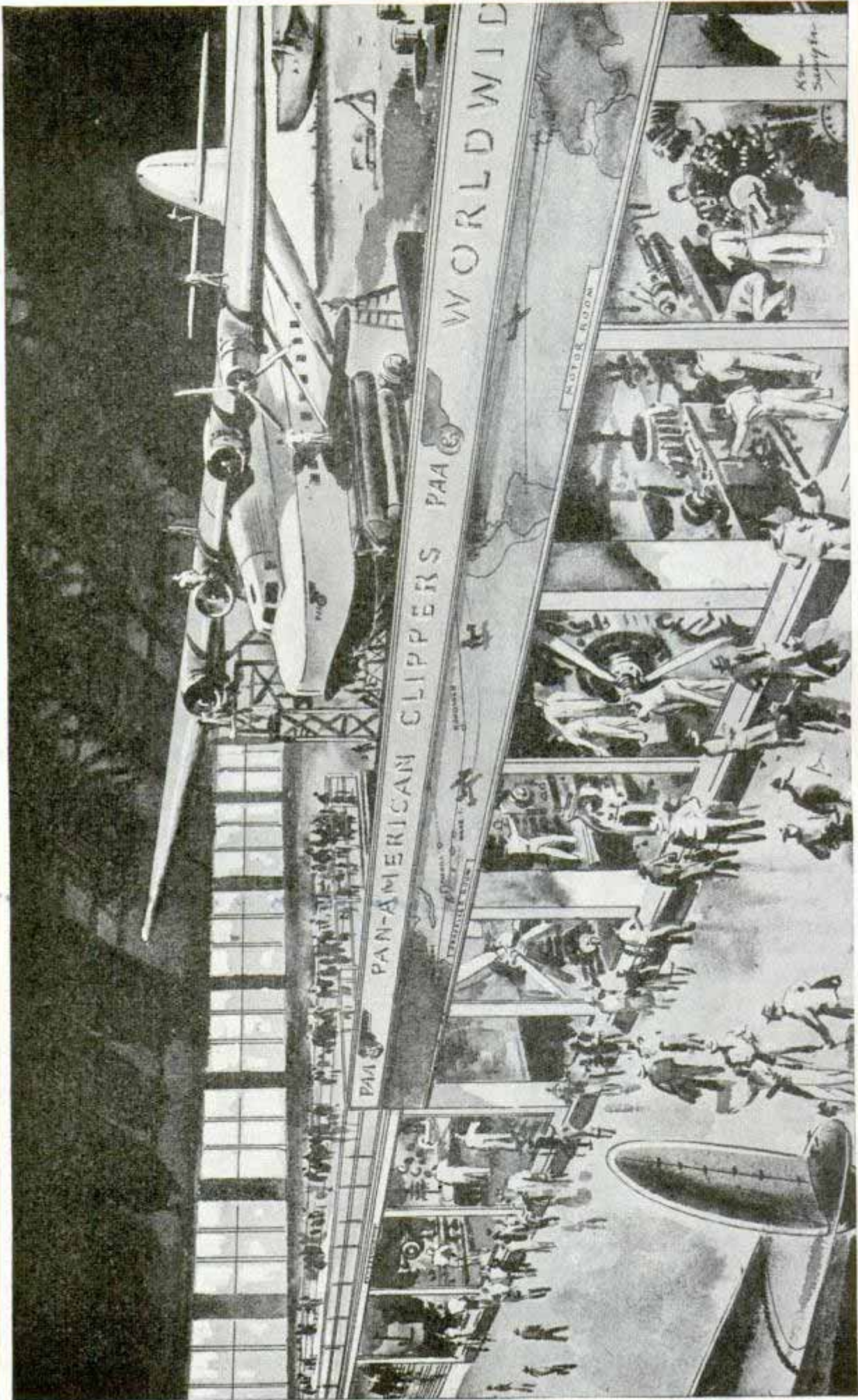

Here is how the "air line under glass" will appear to the visitors at the Golden Gate Exposition on San Francisco bay. Clipper planes will land and take off in the lee of Treasure Island and receive overhauls in this Hall of Air Transportation. Spectators will view all operations through glass panels, as shown here

AIR LINE *under* GLASS

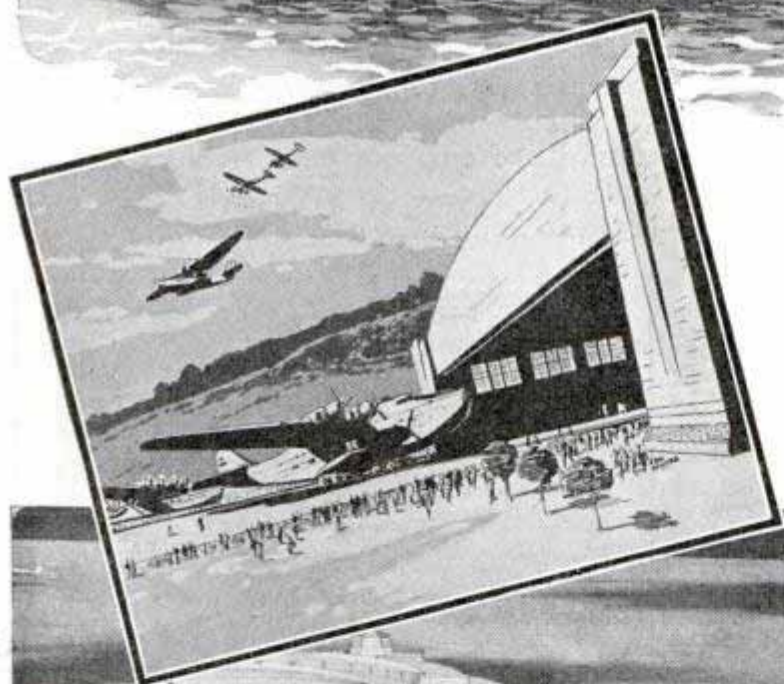

Above, Philippine clipper taxiing off Treasure Island against a background of Golden Gate Exposition buildings. Clipper ships of Pan American Airways will base here during the exposition. Left, Hall of Air Transportation where Pan American will put its entire trans-pacific air base under glass. This drawing shows a clipper being hauled out of the water on a cradle for its overhaul in the building

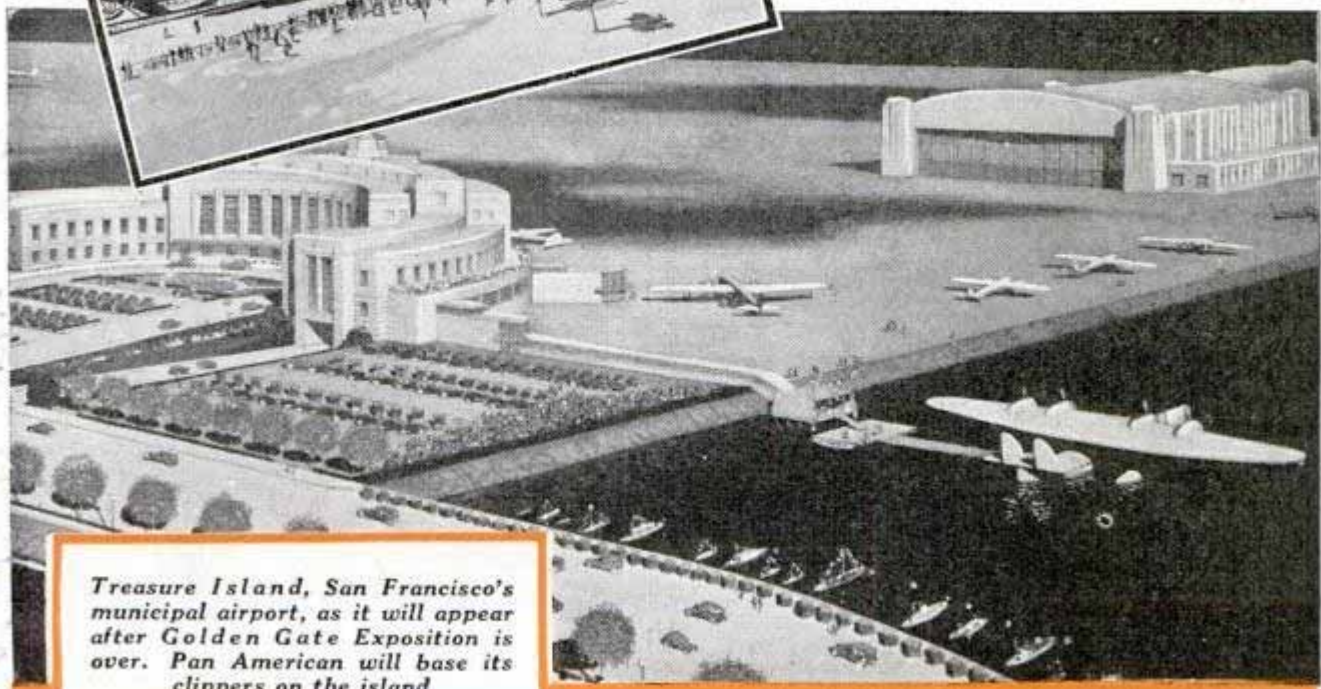

Treasure Island, San Francisco's municipal airport, as it will appear after Golden Gate Exposition is over. Pan American will base its clippers on the island

H 1452

Windmill Goes for 'Swing' but It's a Camera Trick

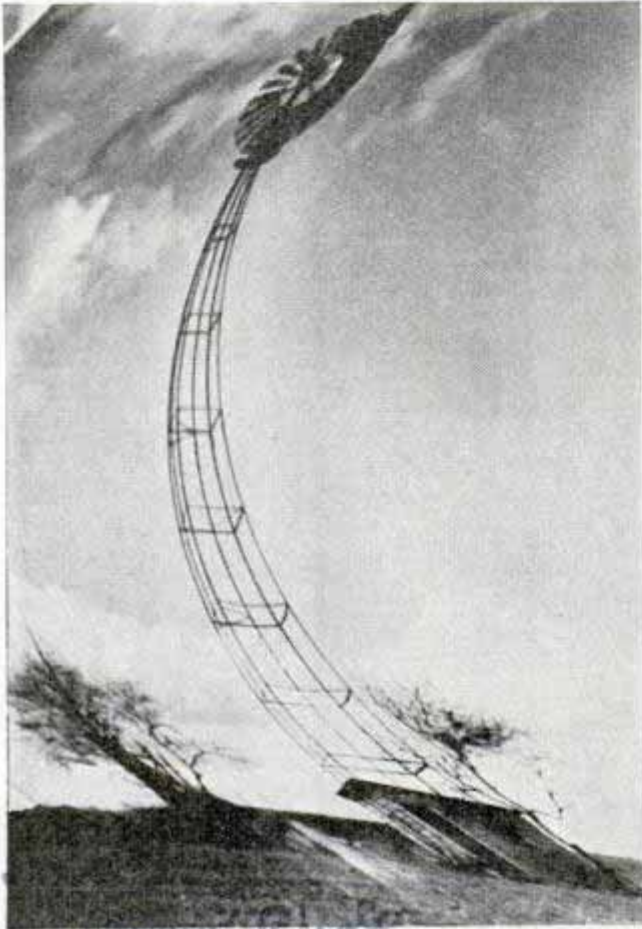

Bending the enlarging paper during exposure produced this "windy" picture of a New Jersey windmill

Looks like a stiff wind blowing over this New Jersey farm, doesn't it? But this isn't one of those hurricane pictures. It was a nice day, and the backbone of that windmill was perfectly straight. The trick is done in the photographer's darkroom, simply by holding the enlarging paper in a curved position while exposing it.

but are built into the treads. They consist of hundreds of deep, sharp, rubber winter-traction lugs which provide safe driving by gripping into slush and snow just as a tractor does. In the spring, the tires are taken to the dealer, who buffs off the lugs, leaving a brand new tread that has never touched the ground. This new tread, however, is not intended to replace the cleated-type of passenger-car tire for regular driving on soft, unpaved roads.

H 1410

Brake Gauge "Tailors" Drum and Shoe to Exact Size

Brake-drum gauge, shoe gauge and grinder are combined in a precision tool just introduced to the garage trade. Operating on direct or alternating current, it tailors the lining to the exact drum size while the brake shoes are in position on the car. Its micrometer gauge checks the wear on different parts of the brake and permits adjustments directly on the axle. The drum micrometer, calibrated in thousandths of an inch, first takes its reading and then is transferred to the grinding unit, locked to the correct size.

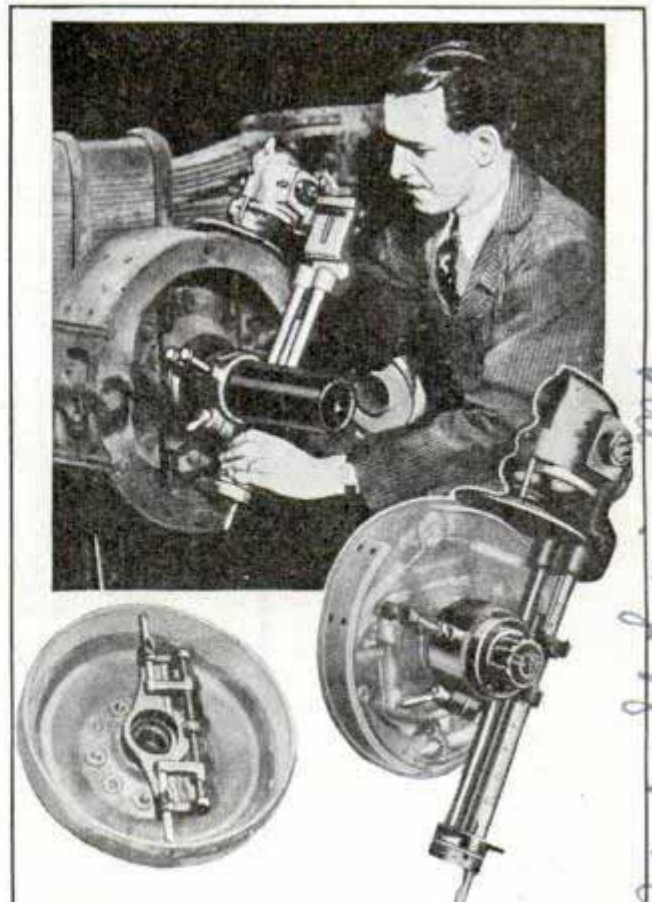

Measuring brake drum, below, and grinding to exact size with the combination gauge and grinder

Patent, St. Louis, Mo.

General Tire & Rubber Co. H 1435

Safety Overshoes on Auto Tires Are Removed in Spring

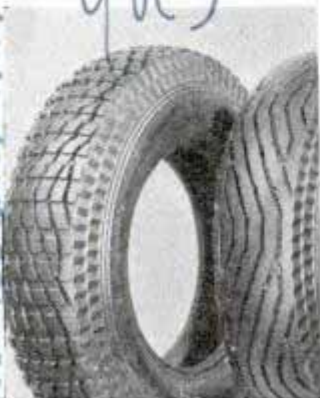

Like many folks, automobile tires are wearing overshoes for safety in winter. When spring comes, these encumbrances are unwanted and unnecessary. The overshoes are not slipped over tires,

Stiles-Barrett Corp

Torpedo Antenna "Sprays" Television Picture

From a unique dual antenna atop the Empire State building, 1,200 feet above the streets of New York, go pictures and sound to the television audience of the metropolitan area. The scenes are "sprayed" from torpedo-like objects pointing in four directions; words and music emanate from a newly designed type of doublet which doubles back on itself, four together forming a loop above the torpedo antennas. This equipment was engineered to fill the need for antennas capable of transmitting television signals "flat," or without peaks, over a thirty-megacycle band. Actually it can accommodate six times the band width necessary for present television standards. Its electrical measurements as precise as the specifications of a fine watch, the torpedo-and-loop antenna must withstand the rigors of weather on its high perch, and the installation includes both a lightning rod and heating units to prevent ice formation.

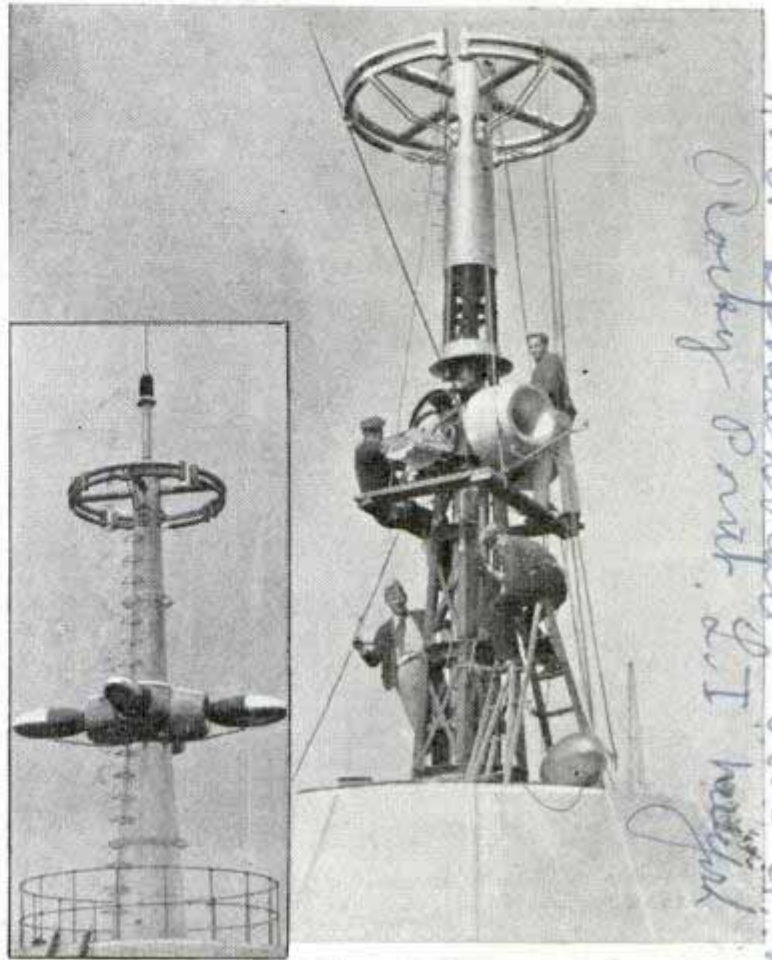

Installing television antenna on Empire State building, and finished unit. Sound radiates from loop, pictures from "torpedoes"

Lighted Motion Sign on Automobile Uses Wind Power

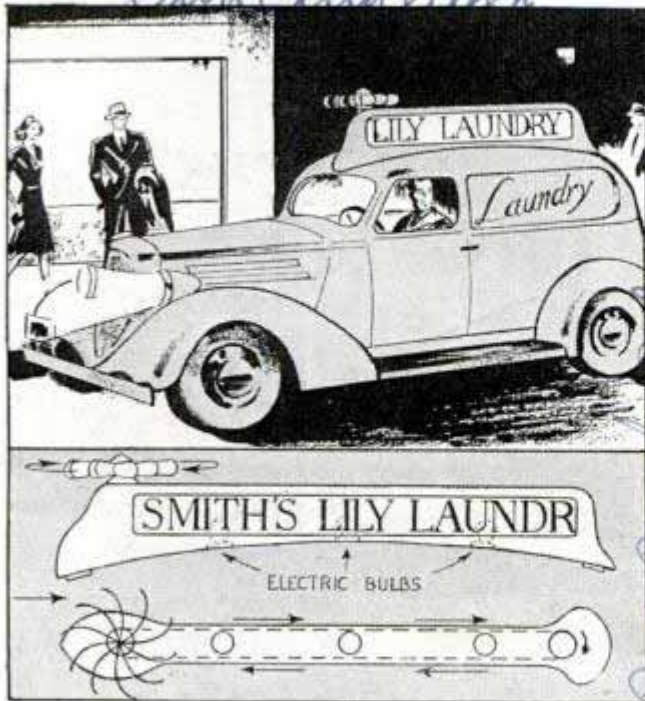

Moving sign mounted on auto and two views showing the three lights and how air-wheel turns the belt

Kept in motion by an air-wheel operated by the wind, an illuminated sign has been developed for use on the top of delivery vehicles. The sign is painted on an endless strip of translucent celluloid about eight inches wide, and is carried on two vertical rollers about two inches in diameter. An air-wheel twelve inches across catches the slightest breeze and converts it into rotary motion to drive the forward roller. Thus an ever changing message is presented on either side of the automobile. Three electric lights in the base of the sign, placed between opposite sides of the endless belt, give all the illumination needed both night and day. All moving parts have anti-friction bearings.

☐ If all the energy in a gallon of gasoline were converted into work it could lift a 460-million-pound building two and one-half inches.

Developed by Research group at MIT
 9-13-36
 Handwritten notes on right margin

Ava McHarg

Is m.c. Chemistry and wheels

"Crank-and-Pedal" Tricycle Has Standing Room Only



Treading on pedal boards drives this unique tricycle, and there is an extra pull in hand-turned crank

You ride standing up on the novel three-wheeled vehicle invented by a Statesville, N. C., man. Either foot or hand power, or both, can be used to propel this tricycle. As the rider shifts his weight from one pedal board to the other, a ratchet attached to the single front wheel pulls the wheel over. Meanwhile the other pedal is allowed to rise, and a spring winds the opposite ratchet back on the wheel. There is reserve power in the hand-turned sprocket connected by chain to the front wheel.

Electric Lunch Box for Worker Heats in Fifteen Minutes

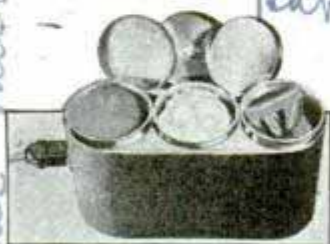

In a thermostatically controlled electric lunch box a workman can carry a full meal to be heated at noon by plugging in on any convenient circuit. It takes about fifteen minutes to warm up a complete luncheon. The top unit has three removable aluminum cups

for food. The bottom unit, which is not heated and is insulated from the upper section, can be used for food and utensils. There are optional heating elements for 110-volt, twelve-volt and six-volt circuits, and chemical heat is also available.

Electric Jack-in-Box Platform Lifts Workmen into Dome

Maintenance and repair work on the lofty Rotunda of the Ford Motor company, at Dearborn, Mich., posed a difficult problem which has been solved by a "jack-in-the-box" platform for workmen. The telescoping platform, consisting of eight aluminum frames, rises by electric power from a base height of eight feet nine inches to a top forty-six feet above the floor. The motor, mounted at the base, is controlled by push buttons on the railing of the working stage, which extends outward to give easy access to the murals and electric lights around the wall. Originally the Ford building at Chicago's Century of Progress Exposition, the Rotunda was moved to its present permanent location.

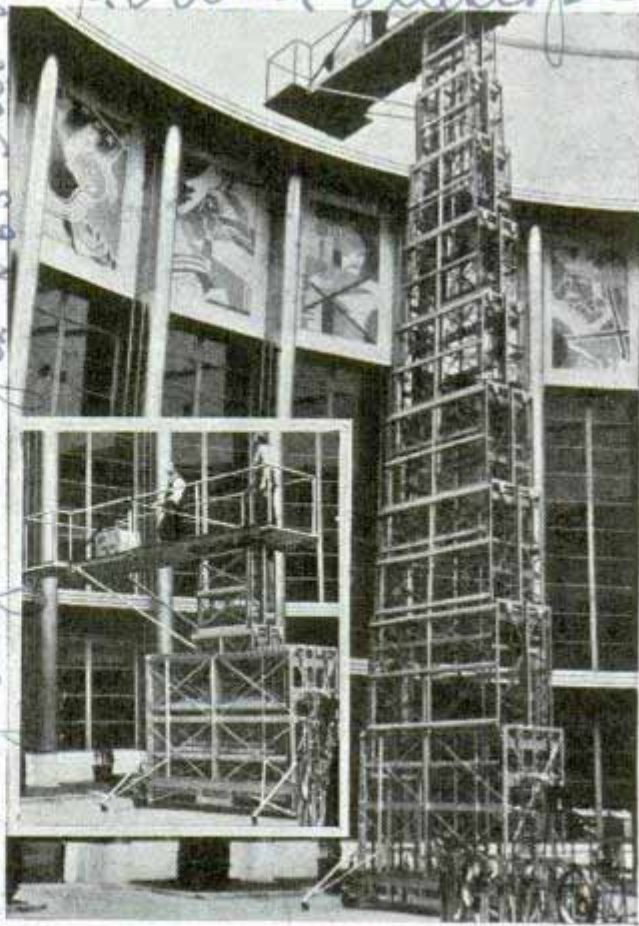

Electric platform extended to full height for cleaning Ford Rotunda, and, inset, retracted into base

A. P. Steele
Electric Lunch Box Co
Alameda Mich.
1472

Van Buren, Chicago
Engineering Co 265 3rd

1447

W. Atlee Burpee
Burpee Seed Co. Phila.

Going NATURE ONE BETTER

OUT in California, where the huge W. Atlee Burpee Floradale seed farm offers in midsummer the breath-taking spectacle of a thousand acres of flowers bursting into bloom at once, two-score men and women in overalls crawled on their hands and knees up and down the rows of forty acres of marigolds. As each crawler came to a new plant, he plucked a leaf, crushed it and sniffed, then tossed it aside.

These antics continued for almost two days, when one young worker dashed for the farmhouse, waving a sprig of marigold leaves and shouting, "I've found it, a marigold without odor."

The occasion goes down in seedmen's annals as the "great Burpee smelling bee." It was inspired by David Burpee, head of the seed house, whose ambition was to trick nature into originating a marigold without the rancid odor offen-

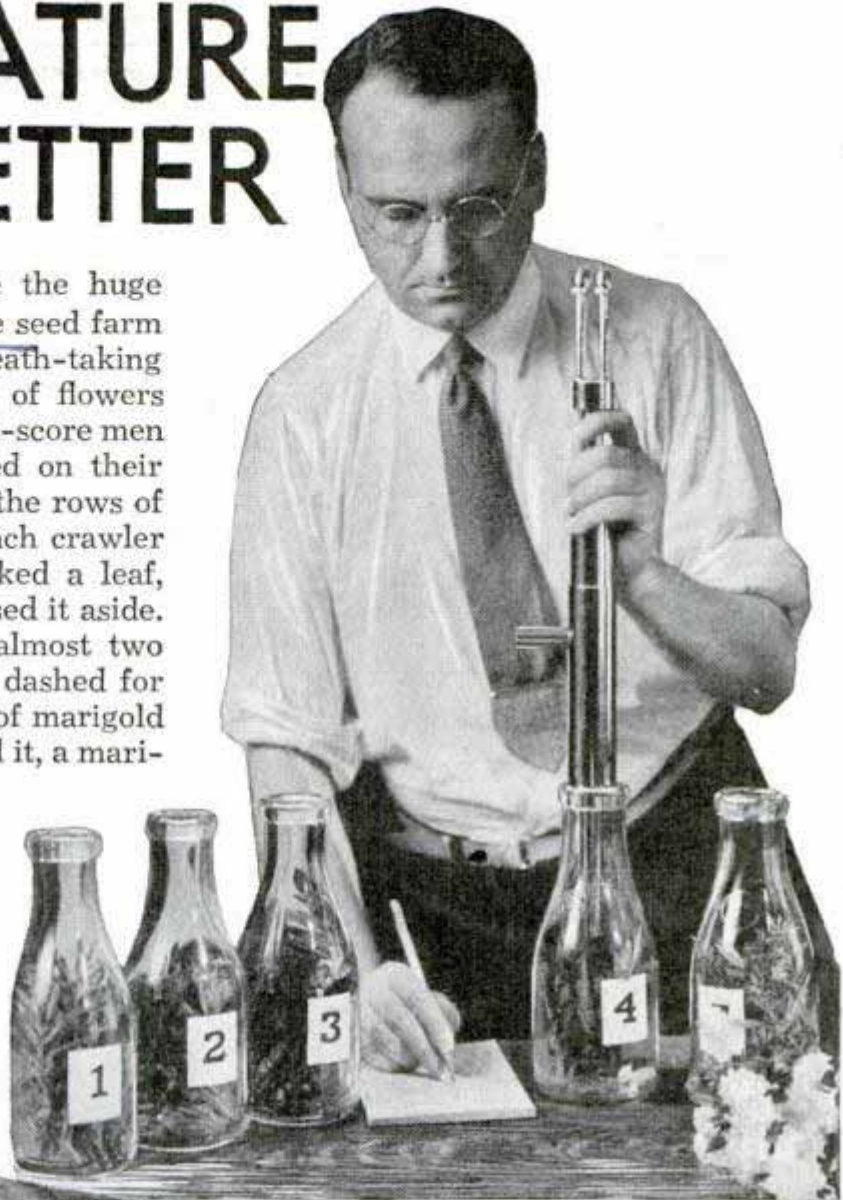

David Burpee, above, using osmoscope to detect faintest odor, if any, in foliage of marigolds. Bottom, experimental work with flowers involves hooding promising plants to prevent cross-pollination

Ed. J. ...
El Monte, Calif



Top, sweet peas almost shoulder high. Right, "Pinkie blood" strain of sweet pea compared with ordinary variety



sive to so many people. Mr. Burpee knew that if he could find one odorless marigold plant among the 600,000 on his farm, he could breed an entirely new strain. But he had to have the one plant, a sport or mutation, without the little white oil glands in the leaves. Only nature could give him that, and he knew that only once in 900,000 plants did nature throw a mutation. This explains the rejoicing when the odorless marigold was discovered. Before long, the joy was doubled. A missionary in the interior of China sent Mr. Burpee two dozen seeds of a new marigold he had discovered. It, too, was entirely odorless. Thus the hybridizers had two chances to rebuild the marigold, and in five years, they and breeders of four other flower seed farms, who availed themselves of the new stock, changed the marigold from a social outcast in the garden to a reigning favorite.

These two events, the finding of a mutation in a seedman's garden, and the discovery of the amateur seed hunter, illustrate two of three main methods by which science is constantly outwitting nature to improve flowers and vegetables. Na-

ture is careless, and the highly bred plants upon which we depend for color and fragrance or for food have a tendency to revert to type. It is a never-ending struggle to build them up. Until recently plant builders were dependent upon seed safaris for breeding stock with which to work. Within the last five years they have discovered new methods of "shocking" plants to change their chromosome set-up, thereby increasing the probability of mutations a thousandfold. Some of the tricks they play on nature read like magic.

For decades, seed hunters sought a nasturtium with a better smell. Finally, to his amazement, "Uncle John" Bodger, head of the Bodger seed farms, discovered a bouquet of double, yellow, sweet-scented nasturtiums on the table in his niece's home at El Monte, Calif. His niece said a Mexican woman had given them to her.

The Mexican woman said she had received the seeds from a friend who got them in a garden in a town in Mexico. Mr. Bodger caught the first train for the town. But



Muslin cages inclose calendula plants, the seed of which will be saved and grown for future inspection



the garden was neglected and all the plants had died. The family that grew the nasturtiums had moved away and no one knew where they had gone.

But in the meantime, another niece, Elizabeth Bodger, one of the out-

standing plant breeders of the country, had gathered a handful of seed of the double golden sweet-scented nasturtium in the Mexican woman's garden. From these the Bodgers grew the first "Golden Gleams," which later gave their doubleness and their sweet odor to nasturtiums of all colors.

The Bodgers and the Burpees are great rivals. When the Bodgers scooped the world on the first "Golden Glean" nasturtiums, the Burpees looked for ways to even the score. Before long their gar-

(Continued to page 118A)

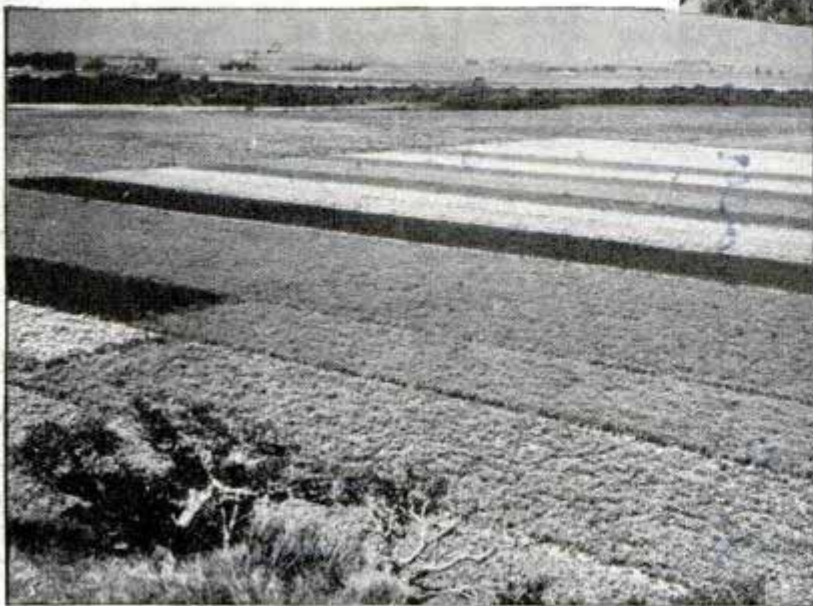

Top, hand-pollinating giant petunias. Center, treating plants with chemical extract. Bottom, growing sweet peas for seed

Burpee & Burpee Seed Co.

Self-Closing Bumper Gates Swing on "Maypole"

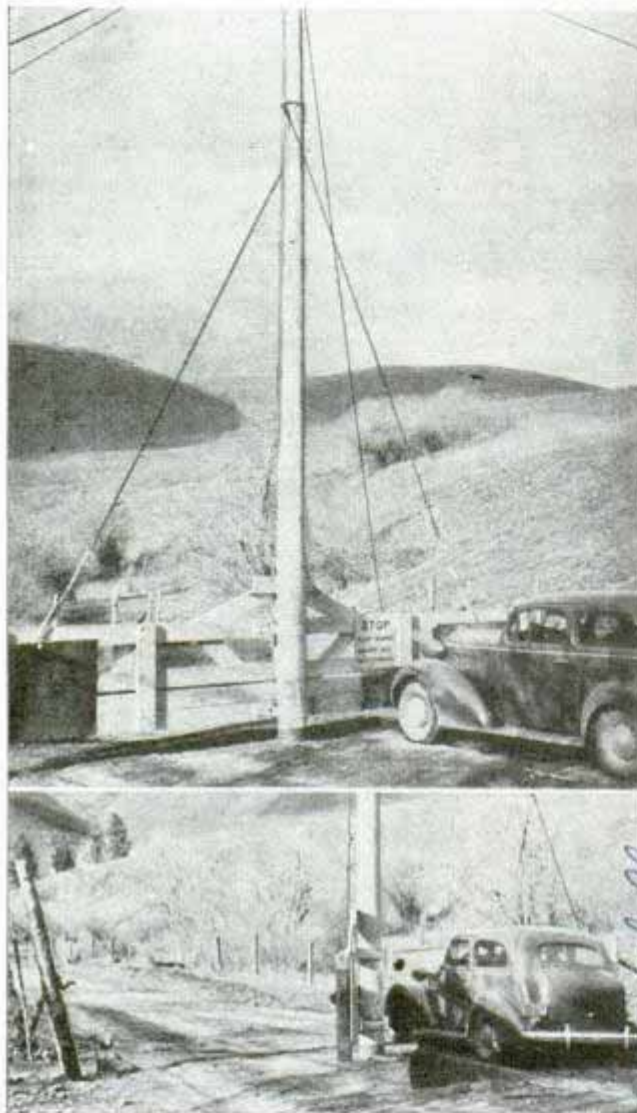

Ranch gate swings open when nudged by car, then cables swing it shut by their own torque

Farmers in the stock-raising regions of the northwest are installing automobile gates that swing shut of their own weight after the car passes. A center post twenty-five to thirty-five feet high supports the gate. The motorist edges the bumper against the gate, nudges it open and the steel supporting cables wrap themselves around the post like ribbons on a maypole, and by their own torque pull the gate closed. The gate is built heavy enough to prevent farm animals from pushing it open.

Electric Fence Guards Cattle from Tick-Infested Deer

Eighty miles of electric fence erected in Florida helped cattle raisers win a skirmish with fever ticks and at the same time

Miller Rubber & Co. Inc. - 124 High St. Jackson, Miss.

saved the guilty deer "carriers" from slaughter. A recent check of cattle in one area freed of ticks by dipping and rigid quarantine, showed they had been re-infested, and investigation proved that wild deer were the smugglers. As a humane alternative to killing the deer, an electric fence was stretched from Bonita Springs on the Gulf of Mexico to the Everglades. Quarantine guards watch the gaps where roads cut through. One contact with the fence keeps a deer away from the area.

H 1493

Ribbed Hot-Water Bottle Fits Curved Surfaces

Three interior partitions running lengthwise permit wrapping a ribbed hot-water bottle around curved surfaces such as arms and shoulders. This type of construction prevents bulging and strengthens the bag. The bottle is twenty inches long.

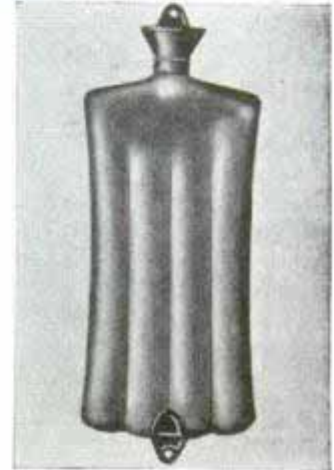

H 1496

Steel Hook for Auto Repairman Straightens Fender or Body

Bent fenders and running boards, dented aprons and car bodies can be straightened with an adjustable metal hook just introduced. The hook is mounted on a shaft for lever action, both shaft and hook being of strong steel. Rubber cushions protect the finish of the automobile and provide a grip.

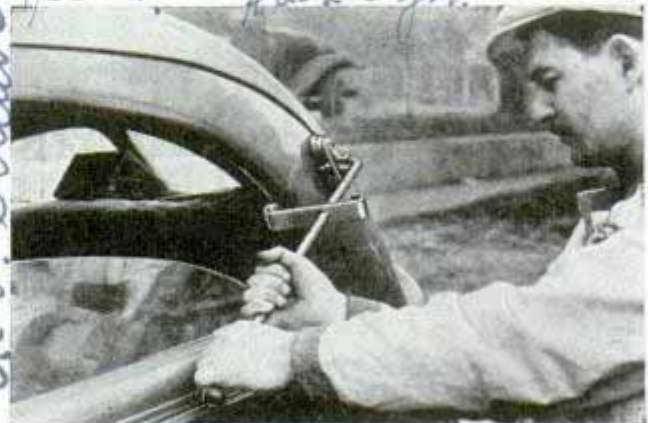

Applying leverage to steel hook to straighten car body. Notice the rubber cushions to protect finish

Cent. Kenneth W. Carlson Pendleton, Ore.

141523

Cent. Milton B. Sackett Post 2, Portland, Ore.

A. F. Strasser, Wash. D. C.

Old Ships Converted into Fast Ocean Liners

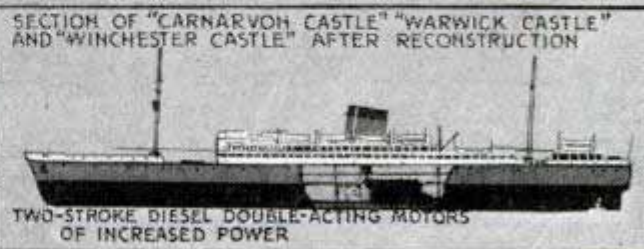
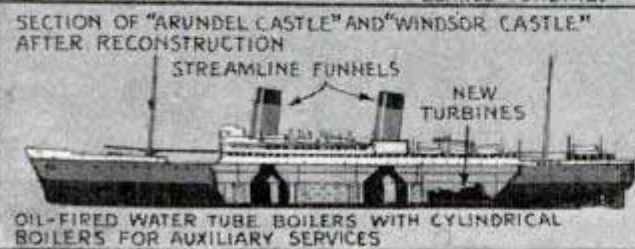
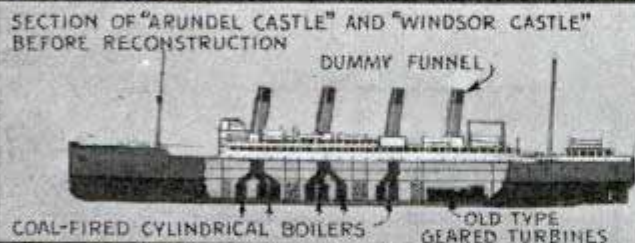
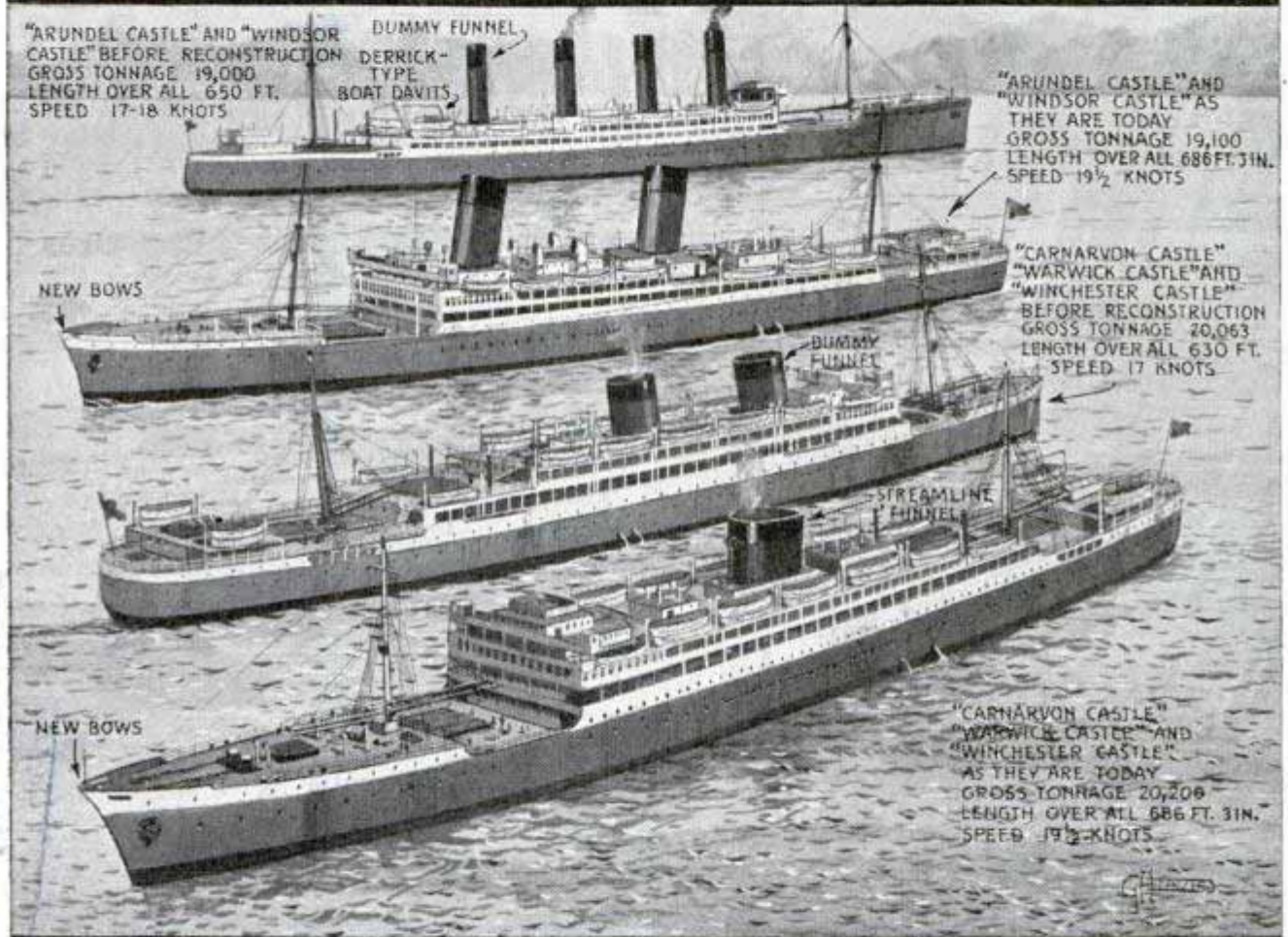
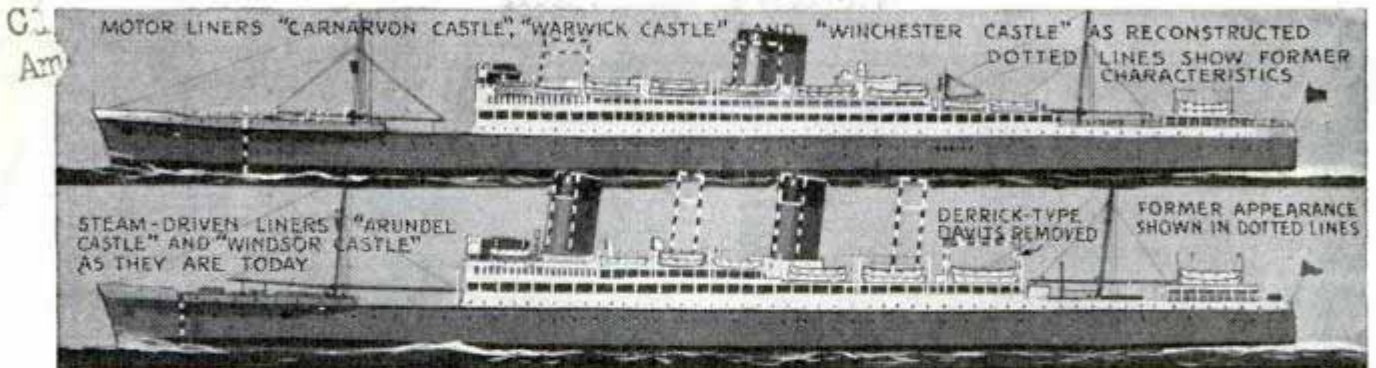

To speed up ocean travel, an English shipping company has converted five old ships into fast liners. Two four-funnel steamships were lengthened and fitted with new engines and boilers. Three motorships were lengthened and equipped with the latest Diesel motors

G.C. du... 626 Schuyler Av. Arlington, N.J.

Transparent Plastic Splint Is Used Many Times

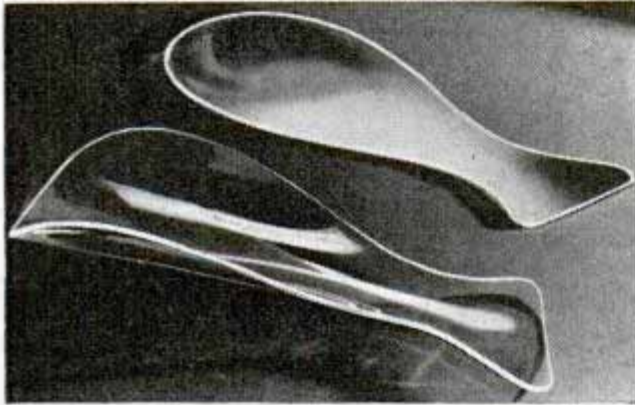

Splint is molded quickly to fit curved surfaces of the arm, and holds broken member rigid upon cooling

Made of transparent plastic material, a surgical splint is shaped easily to fit the arm by dipping in hot water. It can be cleaned and reshaped by heating for repeated use. Light in weight, the splint is comfortable and the transparency permits taking X-ray pictures or examination of a wound without removing it.

H 1548

Earth's Death in Fire Visioned in Latest Solar Theory

As the sun cools, the earth—many millions of years hence—ultimately will become a frozen orb as have other stellar bodies. But scientists now believe that death will first come to the earth in flames as it melts under a sun 100 times as bright and hot as it is today. This is the conclusion from the theory of Prof. Hans A. Bethe of Cornell University that carbon in the sun acts as a transmuting catalyst to

Science Service 12/19/38

d. Thaca, ny

change hydrogen into helium atoms and thus release a tremendous store of nuclear energy that keeps the sun shining on and on through the ages. It is his belief that hydrogen in the sun is used up in the process, while the carbon content remains virtually unchanged. In studies of the evolution of stars, Prof. George Gamow of George Washington University found the main result of a constantly decreasing hydrogen content was to increase the luminosity of the stars and their output of energy. Professor Gamow estimates that the sun at present is about sixty per cent hydrogen, and that it will be 100 times brighter when its hydrogen content drops only a few per cent. However, any alarms over the imminence of the earth's end may be deferred for millions of years, for there has been no evidence of any climatic change due to increase in the sun's luminosity since the beginning of history.

H 1499

Practice Golf Club "Breaks" If Player Swings Wrong

Improper swings are penalized by the bending of a "swing corrector" golf club. Just below the grip a spring breaks open if the player makes a false move in his drive. In this way each error is discovered and can be corrected.



Arrow points to spring that breaks open to tell the golfer he has committed an error in his swing

John... Club, 10... 100... 100...

John... 100... 100...

% Health Centre, Inc. 100... 100...

H. H. ...
Cm. ...
108 E. 66th St
New York City

Hunting LOST VOICES

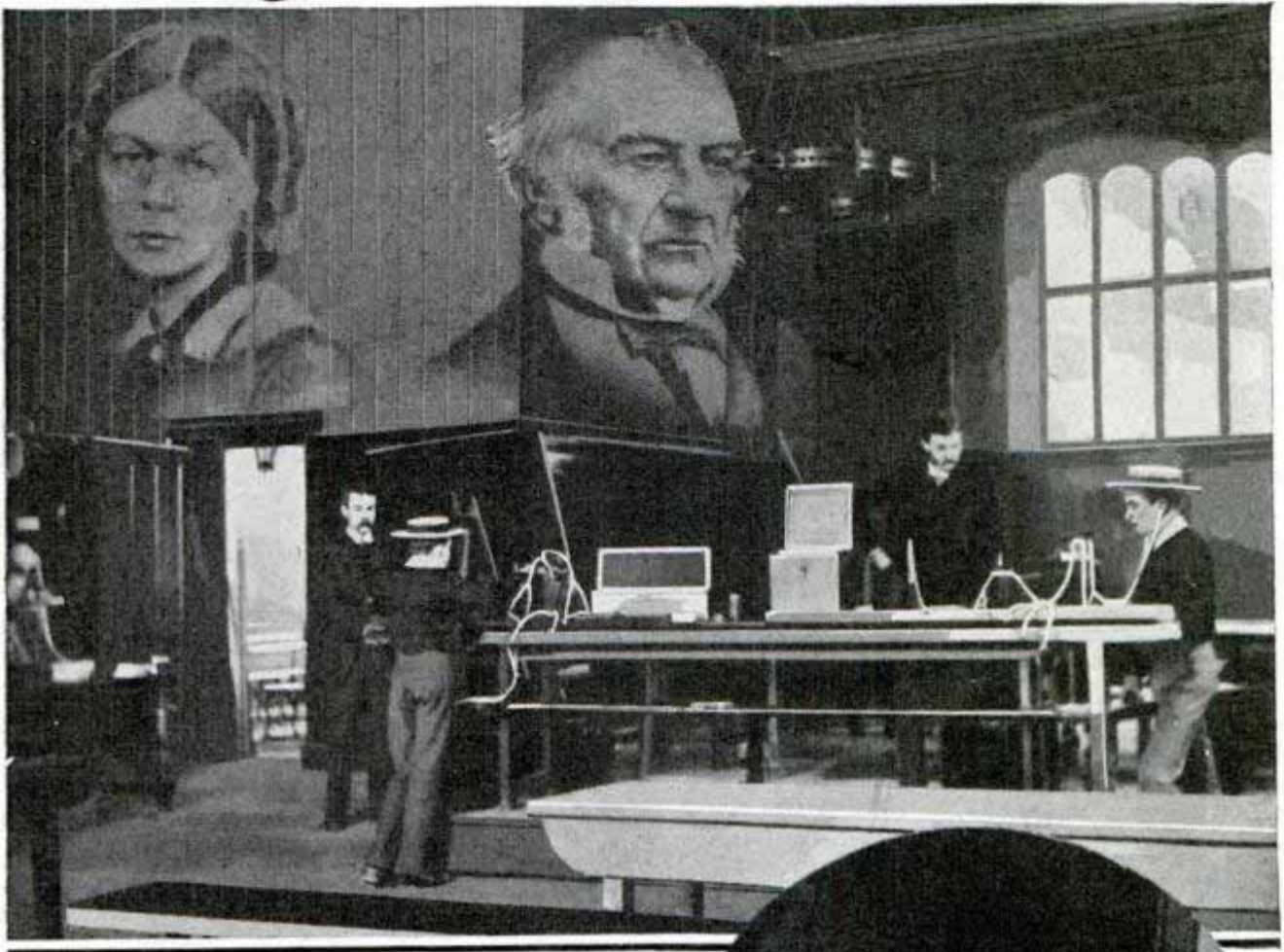

WHAT was there in the voice of Napoleon which inspired thousands of men to die for him on the field of battle? Was there something in the way George Washington spoke which gave the American colonists courage to continue their disheartening fight for independence? What about the voice of Lincoln and other famous men of an earlier day whose voices are now stilled forever? Did they speak with the calm assurance of President Roosevelt, the thundering impressiveness of Benito Mussolini or the hysterical earnestness of Adolph Hitler, present-day leaders who have stirred millions by their oratory?

Because of the importance which historians, educators and others are attaching to the human voice as indicative of the individual and the period during which he lived, scientists are preserving the voices of the modern great and near great for posterity and hunting for famous lost voices of



Top, London studio where voices of Gladstone and Florence Nightingale were recorded. Below, examining wax cylinders found by "voice hunters"

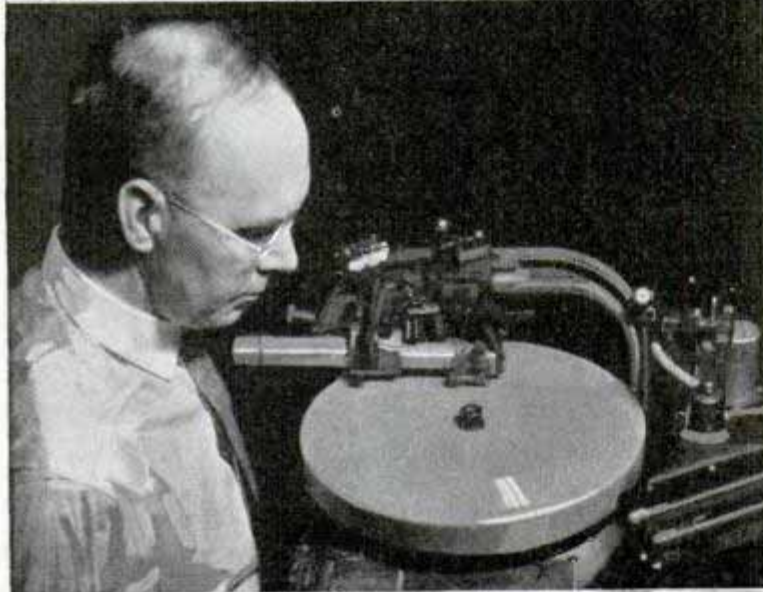

the past, some of which go as far back as 1878, the year Thomas Alva Edison invented the phonograph.

With the rapid development of perfect sound-recording on motion-picture film and phonograph records the voices of present-day leaders and statesmen are being preserved for all time. When the president of the United States speaks over a nation wide radio hook-up, every intonation and inflection of his voice is captured on a phonograph disk by sound engineers, perhaps hundreds of miles away, who simply set up their recording apparatus near the loud speaker of a receiving set. And when a famous statesman or celebrity is photographed "in sound" by the newsreel cameraman, his voice is recorded for posterity by technicians in a laboratory while the film is being projected.

Realizing the importance of the human voice as an aid to the printed word in recording history for future generations, the United States Library of Congress last year started its "voice archives," supplementing an earlier one

In taking off "lost voice" from fragile original record with aid of delicately cut sapphire, cylinder is played through amplifier to modern master disk, top. Center, record taken to R.C.A. laboratory is recorded on wax disk. Bottom, modern record on which voice is reproduced for posterity, and, right, Victor record just pressed and still retaining excess "dough" on edges



which Prof. George Hibbet of Columbia University began in 1926. But in listing the names of great men of the present and the immediate past, scientists pointed out that it was also possible to resurrect some of the voices of celebrities of the late nineteenth century, people who were still living in the early days of the phonograph.

Thus there is now under way a tedious search of world-wide proportions for the voices of some of the great who have passed on.

Leading this hunt is a sound engineer, scientist and former friend of Edison, Robert Vincent of New York, who has already ferreted out such famous voices as Premier Gladstone of England, Florence Nightingale, William Jennings Bryan, P. T. Barnum, Henry M. Stanley, the African explorer, and others. He has succeeded in

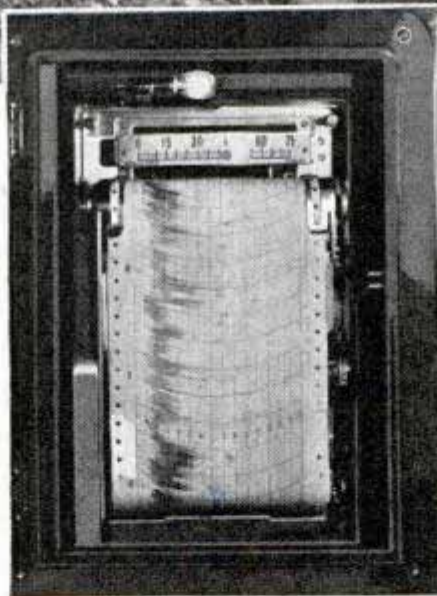

President Wilson's voice speaking from record to Indians. Below, oscillograph makes picture of voice

transferring their voices to modern phonograph disks.

Thus Mr. Vincent is carrying on one of Thomas Alva Edison's most cherished wishes. In 1878 when the great inventor patented the phonograph he said: "It will henceforth be possible to preserve for future generations the voices as well as the words of our Washingtons, our Lincolns and our Gladstones and to have them give us their greatest efforts in every town and hamlet in the country."

Mr. Vincent points out that in the early days of the phonograph it was not possible to make duplicates of phonograph records, as it is today, so that the crude wax recordings were the only ones in existence of the voices of the speakers. The wax cylinders were apt to crack and were very fragile. When Mr.

(Continued to page 143A)

Handwritten notes:
 4/0
 Edison Co.
 New York

#1366

Lancaster, Pa.

Refrigerated Chest in Floor Lifts Out for Easy Access

Polar Chest Locker



Cold-storage locker is hoisted by overhead lift from refrigeration chamber into warm room for customer

To allow customers access to their refrigerated lockers without bundling up to enter a low-temperature room, the lockers are being installed under the floor and raised when needed. When a patron calls, the tier of lockers is hoisted by an overhead lift into a room at normal temperature, and it can be held at any desired distance above floor level. These lockers are made for use in meat, grocery and other stores where customers buy products in season and store them in six-cubic-foot refrigerated compartments until needed.

#1517

Pain Vanishes for Three Weeks under "Slow" Anesthetic

Slowing down the pace of a local anesthetic has resulted in killing pain for three weeks by one injection. The pain killer, a mixture of procaine, two other chemicals

and refined French almond oil, is named neothesol and was developed at the College of Physicians and Surgeons in New York. Long insensibility to pain is achieved by the oil, which holds and releases the anesthetic gradually into the tissues.

#1492. 130W. 168th

Ink for Writing on Glass

S. O. Brand
Resists Acid and Fire

Ink that can be applied permanently to glass, porcelain or china is put on with a pen or fine brush, and its permanency is increased by gently warming the object. Non-inflammable and unaffected by strong solvents like alcohol and turpentine, the ink under tests resisted the corrosive action of hot sulphuric and other acids as well as strong alkalis.

#1475

Brake Booster to Help Driver Fits on Steering Post

Attached directly to the brake pedal, a power booster now on the market raises slight pressure of the foot to 200 pounds. Installation is made with ordinary tools, requiring no change in the braking system whether it is hydraulic or mechanical. The unit fits any make of car and does not interfere with engine performance.

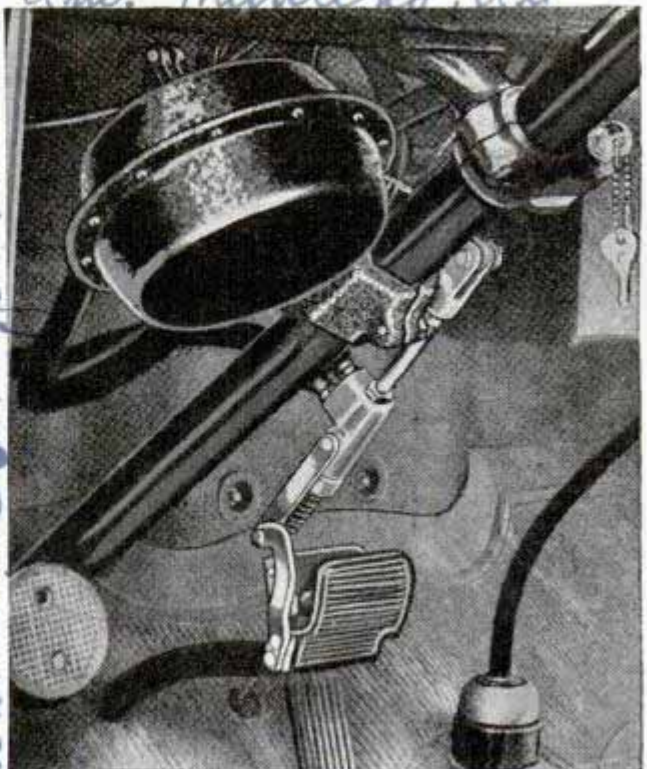

Air-brake performance is obtained from this power booster acting like a giant's foot on the pedal

see March 1941 - 326

Change Int. 12/13/38

Automobile Improvement

Stewart Research W. 315-22nd St.

Dr. G. O. Burt and ...

Giant Mural Depicts Air View of New York

At right, Carl Roters working on Manhattan-Bronx section of giant mural water-color painting for World's Fair. Below, notice the large brushes he employs; to right, fitting a section into mural



Occupying nearly 1,000 square feet at the New York World's Fair, a giant water-color mural painted by Carl Roters will show the New York metropolitan area as seen from the air. Described as the first large water-color mural ever attempted, it was executed by means of a new technique that resulted in a painting with the fidelity of a map and the fire of a stained-glass window. The artist used brushes twenty times as large as those ordinarily required by water-colorists. He painted, in eight sections, a quarter-scale color model of the mural, then produced the giant mural. The work was done with the aid of a full-scale working sketch of the map of the area, in chalk on detail paper, with land areas colored red, the river, sound and ocean areas in blue. The final work was in 114 sections which were assembled in checkerboard fashion. Each section of linen-backed water-color paper embraced an area of nine square feet, the largest size offering full

brush control. The mural will be lighted with a high-intensity direct light by a row of sixty-four elliptical aluminum reflectors, each containing a 150-watt incandescent lamp. The reflectors are so focused that the most intense light falls on those brilliantly colored areas accentuated by the artist in the painting. The exhibit will be in the World's Fair building of the Consolidated Edison company of New York.

4 drawing Place

155 n. Clark
Room 428
H/1520

12/23/38

382

Self-Cleaning Filter Fits Any Type Faucet

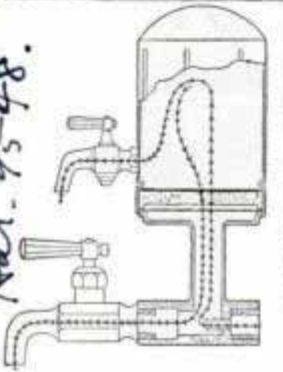
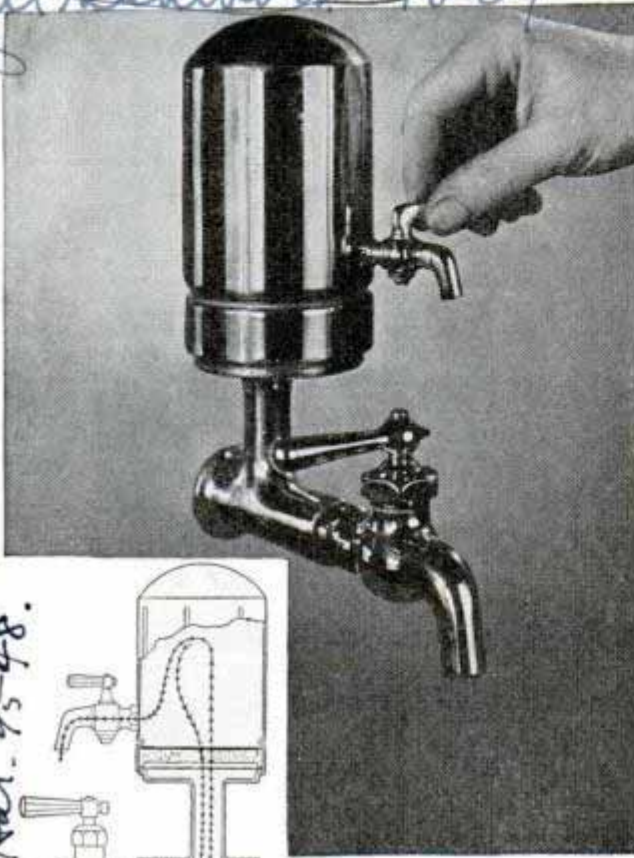

Filter, with user turning cleaning faucet. Inset, drawing shows principle of filter

Easy to install on any faucet, single or double, a self-cleaning stainless-steel water filter is ready for the market. It does not interfere with the flow of hot or cold water for washing purposes and it takes no space on the sink. Operating on the reverse-flow siphon principle, the filter cleans itself by flushing impurities out and into the sink each time the cold-water faucet is opened.

Air Records Are Nearing Limit Set for Today's Planes

Airmen who seek to break existing speed, distance and altitude records are beset by theoretical limits of the airplane as we know it today, according to Prof. William E. Durand of Stanford university. Airplanes, as we now know them, will not climb much beyond 60,000 feet, he predicts, about 4,000 feet above the present altitude record. The limit of speed is estimated at 500 miles per hour, and, for distance, from

8,000 to 9,000 miles. A speed record of 440.8 miles an hour has been made by an Italian seaplane which sacrificed everything to its engine, leaving only room enough for the pilot and a few gallons of fuel. This leaves a margin of sixty miles for later speed record attempts. Two British bombers recently flew more than 7,000 miles to set up a new distance mark, which, comparatively, does not come as near the limit as the established speed and altitude marks. However, this larger margin between actual and ideal performance is not surprising when we realize the remote chance of an absence of adverse weather conditions and the continuous functioning of all working parts during sixty to eighty hours required for the flight.

Three-Mile Breeze Turns Mill with 'Sails' Instead of Blades

Breezes as light as three miles an hour will operate a windmill that uses "sails" instead of the conventional rotating blades. It always starts with a downstroke of the pump, and over a given period can pump more water than the rotary type. A direction vane keeps the working parts toward the wind. Pressure of the wind against the sails exerts a lift like that on the wing

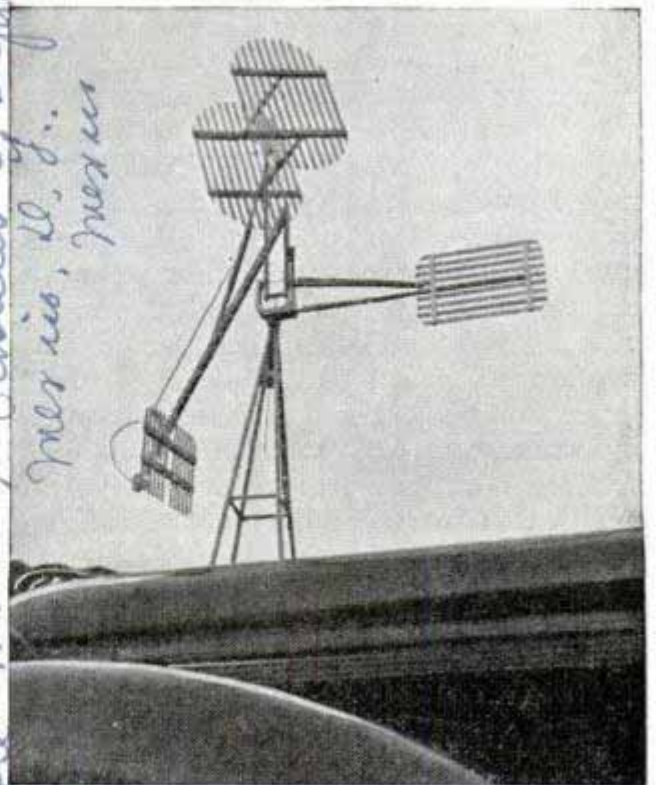

Wind lifts sails at top until gravity flips them around to give wind a new angle of attack

Harrison Specialties, Inc.
22 E. Van Dieren, Chicago
Tel. 95-48.
R. H. Walley
Stanford P. O. 15
Caled
Alto moras, Rosales y Refl.
Mexico, D. F., Mexico

Science Service 12/19/38

Science Service 12/19/38

'Shell Burst' Built on Truck Trains Military Observers



Seen from the air this cloth-draped auto resembles the explosion of a shell and is used in testing the work and equipment of army observers

Autogiros are undergoing tests by the field artillery to determine their value for military observation work. If successful they will either replace or supplement airplanes and balloons now being used. To simulate warfare, a mobile truck unit was covered with black and white cloth, appearing to airmen like the explosion of a fifty-five millimeter shrapnel shell. The autogiro hovering over this noiseless blast reports its observation back to the lines.

Fabric Fuel Tank for Airplanes Is Vibration-Proof

Fabric fuel tanks to withstand severe vibration on airplanes are announced by the Glenn L. Martin company, makers of flying boats and bombing planes. In tests made with the Mareng-fuel cell, as the bag

is known, it was still gas-tight after 700 hours of violent vibration, whereas twenty-five hours usually would be acceptable for metal tanks. The fabric, impregnated with synthetic rubber not dissolved by gasoline, tends to slow up loss of fuel through leaks caused by bullets, for example, and the leaks are repaired as easily as those in a tire's inner tube.

Windmill with Twin Propellers Pumps Water on Farm

Twin propellers pump all the water needed on a farm in northern Minnesota. The windmill was built by the farmer himself, using two disks of twelve metal blades each, mounted on the ends of a discarded differential shaft. The blades are three feet long. A metal arrow keeps the propellers turned to the wind however light.

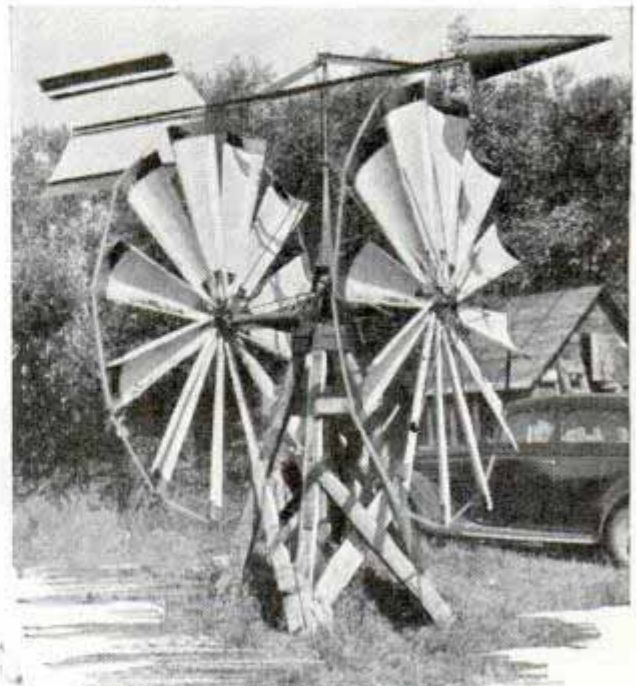

Twin disks are mounted on old differential shaft

Built by John Harvo

708th. Used at Ft. Bliss, W. Va. by the 1st Aero. Serv. Co. 12/19/38

Baltimore Md

Driver Re-Enacts Crash on Chart at "Trial"

Truck drivers for a Chicago department store are placed on trial before a jury of fellow employes whenever they are involved in a traffic accident, and the plan has reduced the accident rate remarkably. A large graph showing various typical street intersections is used to "re-enact" the crash. Dummy trucks of celluloid are placed on the chart to represent traffic at the time of the accident. Two "attorneys" question the driver, and the jury renders a verdict charging him with a degree of responsibility varying from none to 100 per cent. The driver's no-accident bonus is at stake.

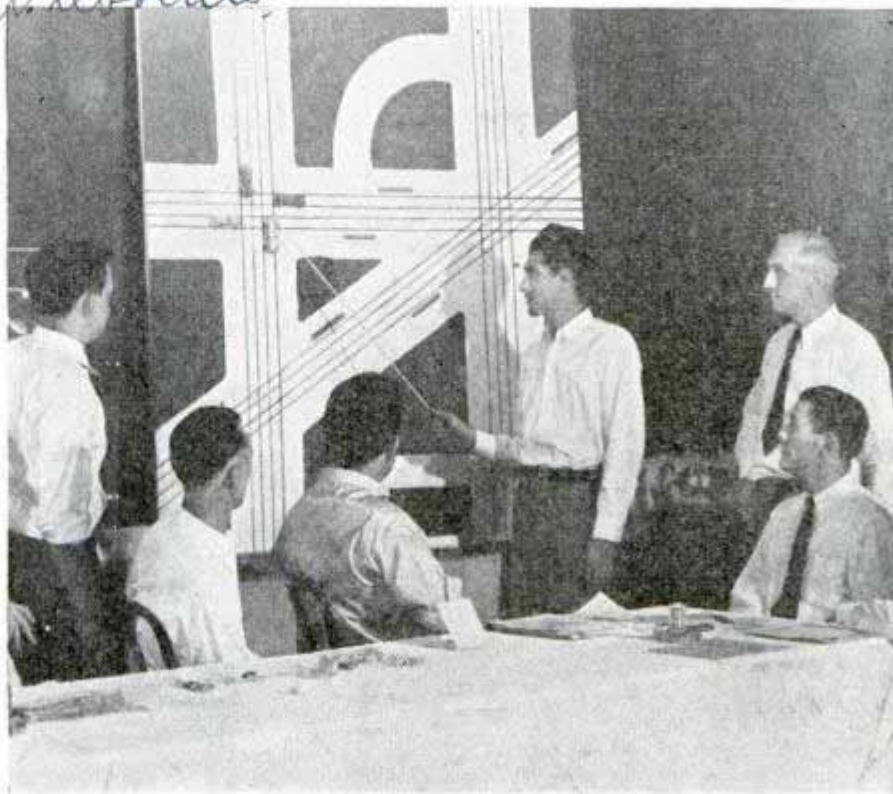

Ready-made chart with examples of various street intersections is used to "re-enact" traffic accident at truck driver's trial by company jury

H1426.

Air Conditioner for Ambulance Is Installed under Floor

Comforts of air conditioning have reached the ambulance. A compact mechanical unit, which is set beneath the floor in a space normally required by the gasoline tank, draws fresh air from the outside through a grille. filters, cools and dehumid-

ifies it, and then passes it through a radiator into the ambulance interior. Temperature is automatically controlled by a thermostat. Power is supplied by a one-horsepower electric motor and an evaporative type of condenser is used.

H1413

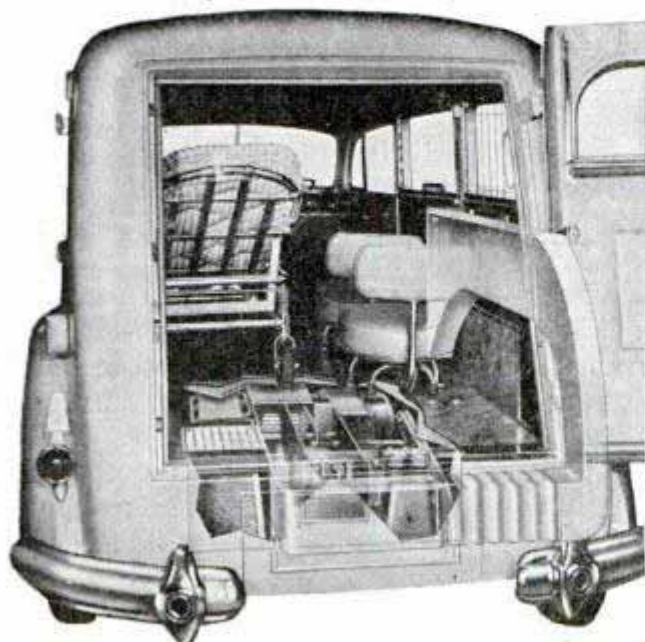

Cut-away section shows how air-conditioning unit is placed without taking up floor space in ambulance

Pictures Centered for Mounting by Three-Way Ruler

Three simple measurements with a metal "H" ruler will center a photograph for mounting in much less time than you take to figure the center with pencil and ordinary ruler. The mount is placed in the center clip so that the same figure reads on the upper scale on both edges. Then the vertical members are set to the width of the picture, and adjusted so that their scale gives the measurement of the bottom border.

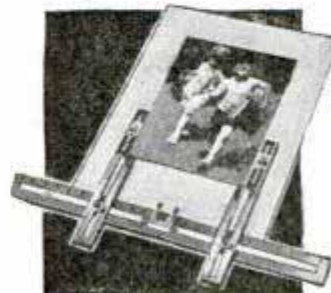

The Crane Co.

Denny Barber
4824 51st Ave New York



RACING

Drivers of midget speedsters in huddle before a race as track rules are reviewed for them

see March 1937
394

MIDGET automobile racing, which looked like a flash-in-the-pan sport a few years ago, is beginning to replace the big car races in popularity.

Spectators at the short quarter-of-a-mile tracks sit only a few feet away from the roaring cars, now being driven at speeds approaching big-car performance. The 100 or more midget tracks in the United States have been rebuilt for faster driving and soon board speedways, banked up to forty degrees on the turns, are going to permit faster speeds than ever.

The baby race cars are small, but they are true racing machines. The most powerful of the miniature engines are only twenty-two inches long, yet they develop up to 100 horsepower, permitting wide-open straightaway speeds of up to 120 miles per hour. Cars have averaged 100 miles

per hour in 150-mile championship races around one-mile tracks.

The latest trend in the midgets is toward more complete streamlining, with smaller radiator cores in front and with high fish-tail sterns that seem to provide better control for the skidding and broadsliding in the turns and that are a real protection if a driver happens to roll over in a crash. Quick-change wheels and quick-change rear-end gears are being adopted so that drivers can groom their cars to fit the conditions of each individual race.

At the present high speeds a spill that was hardly dangerous a few years ago is apt to be quite serious. Accidents are bound to happen when half a dozen cars or more are packed in a tight bunch sliding around a turn, with every driver trying to steal the lead.

Carl Thomas
10.5.5
Stinson
Solomon
L. J. ...

H1343

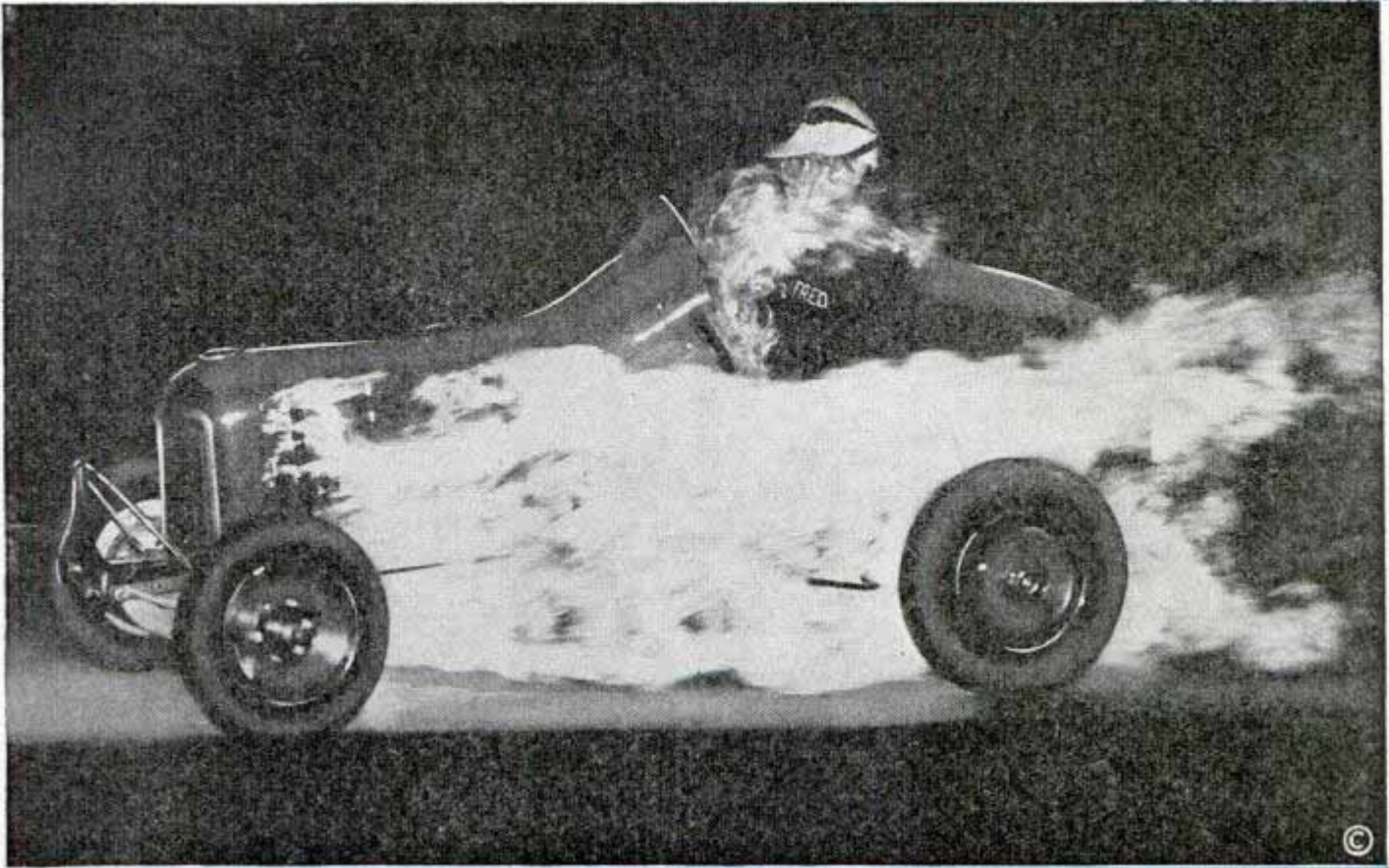
Reference: *W. M. ...*
Midget Association
3814 1/2 Crawford St.
Los Angeles

the MIGHTY MIDGETS

One spectacular accident at a night speedway happened recently when a car's fuel line broke and gasoline under heavy pressure started to squirt over the hot motor block. The driver, aware only that his engine had stopped, pushed the clutch down and coasted for a few yards while pumping up the pressure on his fuel tank. Then he let the clutch out again to see if the engine would start. Instantly a spark ignited the quarts of fuel that had spilled over the engine compartment and the car was transformed into a flaming fifty-mile-per-hour comet. The driver slowed down quickly and jumped out but he spent weeks in the hospital.



Top photo © Carroll Photo Service

Top, spectacular photo of midget car that burst into flames at fifty miles per hour when fuel line broke. Bottom, driver overhauling steering assembly in preparation for another race

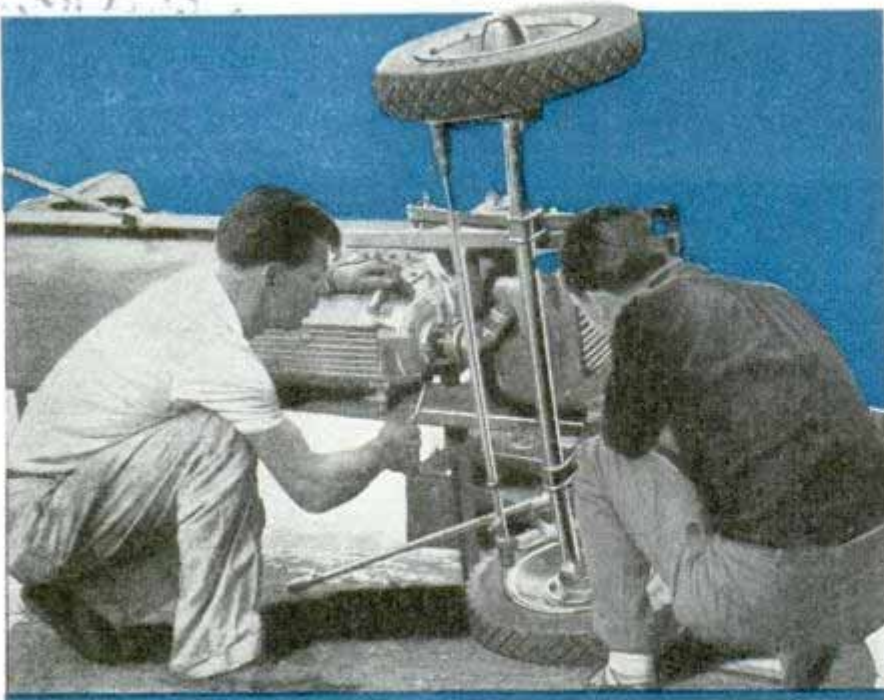

supply kit, his experience telling him which set to use after he judges the weather at the track.

The practice laps that a driver makes before a race program starts are really for testing out his motor instead of for getting used to the track. After a few laps he removes a spark plug and holds it against his palm, the degree of dampness of the plug telling him a great deal about his car-



Top, midget car turned on its side to facilitate work on engine. Center, "broadsliding" around turn on short dirt track. Bottom, cars in pit, ready to be pushed out on track and warmed up for race

More than any other kind of racing, midget races are won in the pits. Leading drivers such as Ronnie Householder, Bob Swanson, Fred Friday and Paul Russell drive brilliant races, but just as important as their skill in competition is the ability of themselves and their pit crews to tune their engines. No more than three or four cars out of a dozen in a typical race may be tuned to peak performance. This is because the tiny motors are so sensitive that even minor changes in atmospheric conditions may affect their power.

There are more than a dozen different grades of spark plugs and a good driver may carry as many as eight grades in his



buretion and valve timing. The sound of his exhaust is another key to valve timing and he tightens or slacks off on valve-spring tension if necessary. Fuel adjustments may have to be made after each minor change. Most drivers use their own

(Continued to page 116A)

Two-Mile Traffic Tunnel Links River Cities

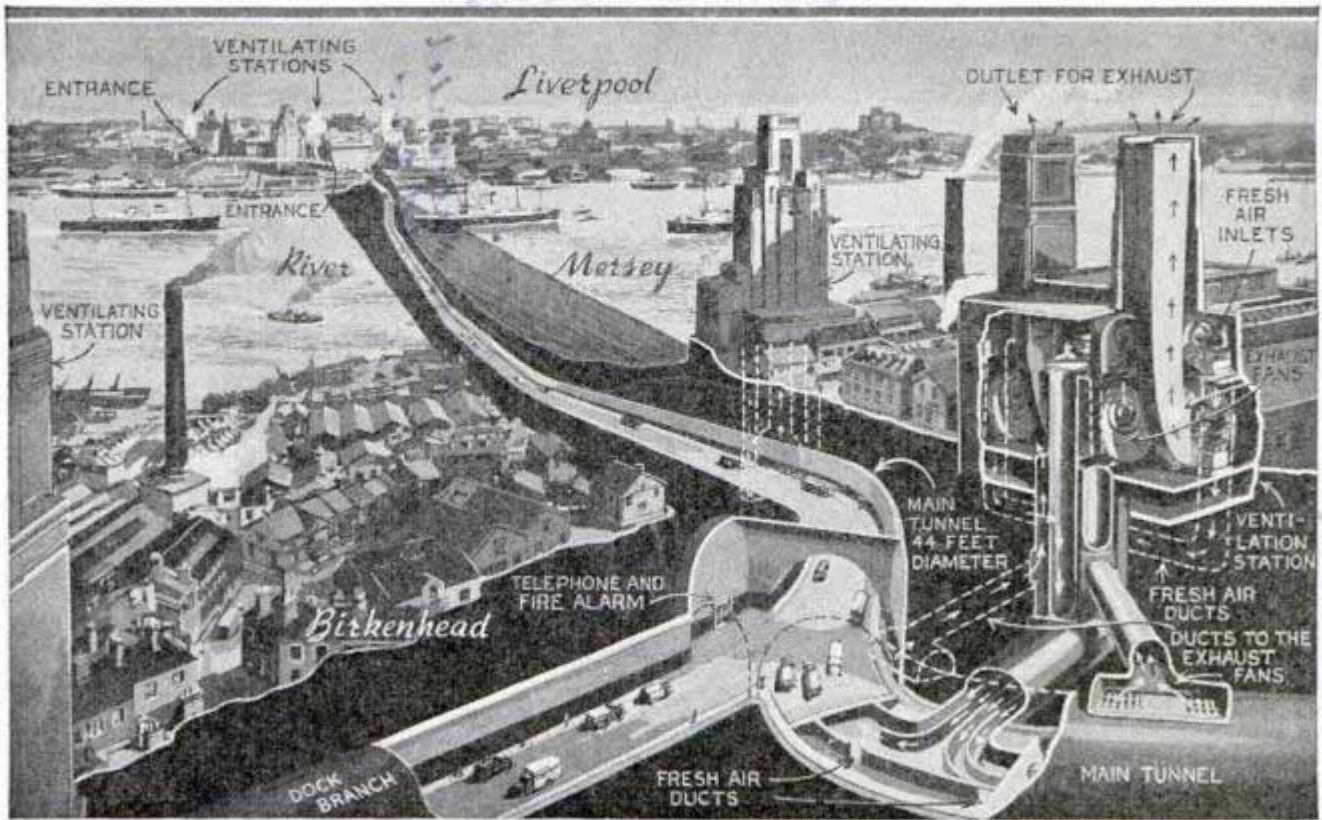

Above, diagram of Mersey river tunnel and ventilating stations. Right, excavating Liverpool approach

Connecting Liverpool and Birkenhead with a traffic tunnel under the River Mersey was one of the outstanding engineering feats of recent years. The main bore is 2.13 miles long, and to ventilate it properly required several stations on each shore, where powerful fans exhaust the stale air and drive a fresh supply through ducts. The tunnel has a diameter of forty-four feet.

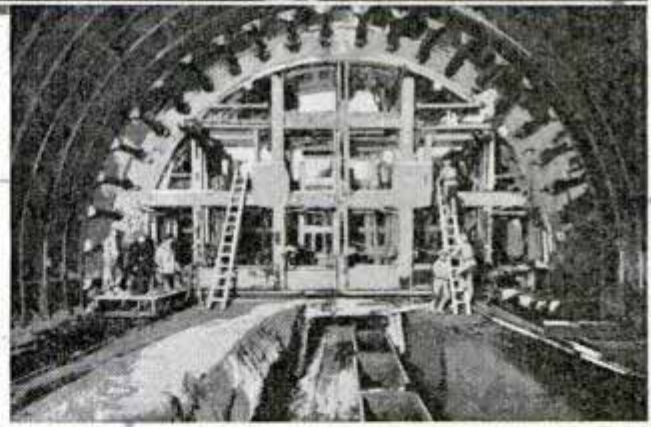

Rubber-Covered Bumper Pushes Car without a Scratch

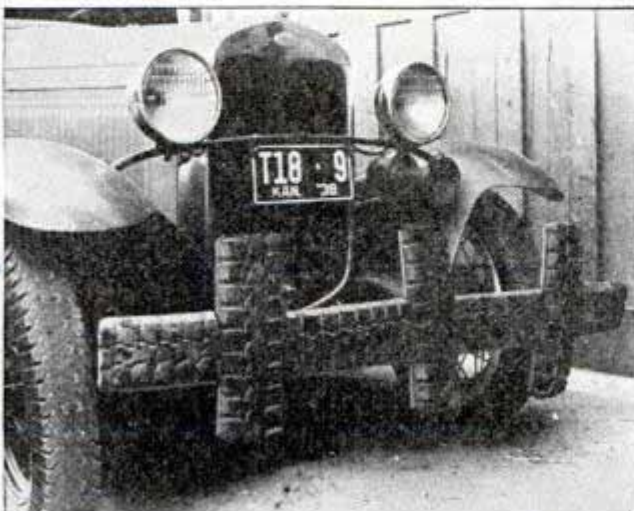

This bumper gives cars a push without a scratch

To protect the customer's automobile from bumps and scratches, a Kansas garage owner has covered the bumper of his service car with old tires from which the bead and part of the sidewall have been cut. This eliminates the risk of damage from different bumper heights and from scraping bumper against bumper when giving a stalled car a "boost." The three vertical pieces are made of heavy strap iron. The tire pieces are bolted to the iron.

When an auto travels seventy miles an hour, air rushes through its carburetor at a rate as high as 250 miles an hour.

Handwritten note: Cont. See the Automobile

Vertical handwritten note: See page 150-151

Foot-and-Hand Cycle Has Streamline Hood

Propelled by pedals, like a bicycle, and by hand levers, worked by alternate movements of the arms, a new cycle fitted with a streamline canvas hood has been demonstrated in France. The hood, which has a light metal framework, fits down over the rider's shoulders, cutting down air resistance at high speeds. The seat of the vehicle is only about eighteen inches above the ground and virtually in the same plane as the wheel hubs. The pedals or stirrups are connected to the hub of the front wheel and the rider pushes straight ahead.

Left, preparing for speed run with bicycle hood. Note double drive on the bike. Below, cycling at high speed as hood reduces wind resistance

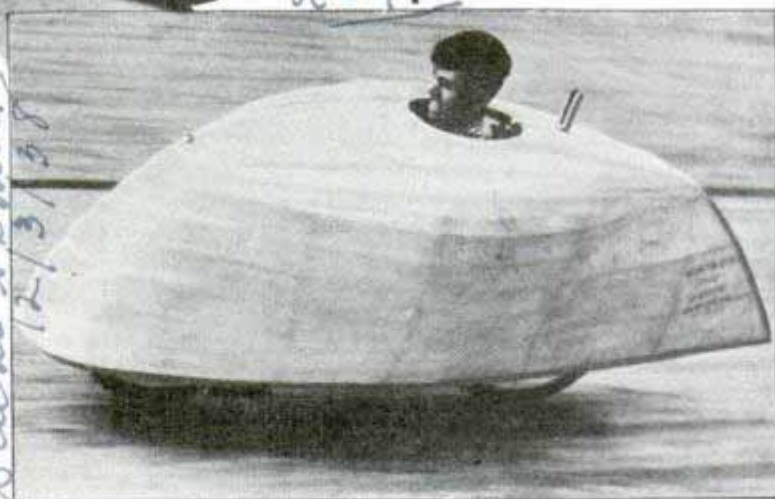

Oil Pressure Runs Engine

Engineers have turned to oil under pressure to drive motors at high speed, thus adding another power source for tools. They describe its essential principle as resembling that of the steam turbine, except that oil makes things move, not steam. The oil serves a double purpose, being the source of power, and also the lubricant.

Highways Made Safer by Wall Developed from Roller-Coaster Idea

Out of the thrilling curves of giant roller coasters has come an idea for increasing highway safety. Cars of amusement rides negotiate turns so sharp that neither the wheel flanges nor super-elevation of the curve would normally keep them on the track. The trick is achieved by mounting rollers on the side of the car so an addi-

tional restoring force is obtained. Adapting this idea for a central highway barrier wall, Yale university traffic experts devised a sloping metal surface whose profile is a parabolic curve. As the front tire of a car starts to ride up this surface it gradually reaches a point where the side walls of the tire press against the barrier

*Uchero, chue
1402 Cahman
Deloit.*

*Julio Rossi.
Paris. no street
address*

*U. R. Ideman,
Deloit head.
12/3/38*

*Bureau of Street Traffic Research
Yale University
Dr. Miller No. Chintock*

Doctors "Pipe" Cold Light through Curved Plastic Rods

14171
wall. This creates a restoring force which re-directs the car away from the barrier and back onto the roadway. No part of the car except the sides of the tires touches the wall, and the action is gentle if the driver allows the car to guide itself for the instant it is on the barrier. A full size parabolic deflector is four and one-half feet high and four feet wide at its base. Extensive tests indicate that the barrier is effective with cars and trucks at speeds up to sixty miles per hour.

1421

Power-Driven Saw Fells Trees and Cuts Up Logs

Taking power from a portable air compressor, a crosscut saw fells trees and cuts them into logs or firewood lengths. The saw blade, driven by a piston, will cut through a hardwood log twenty-six inches in diameter in three minutes. If it becomes jammed the blade is readily detached from the frame so it can be released from the log.

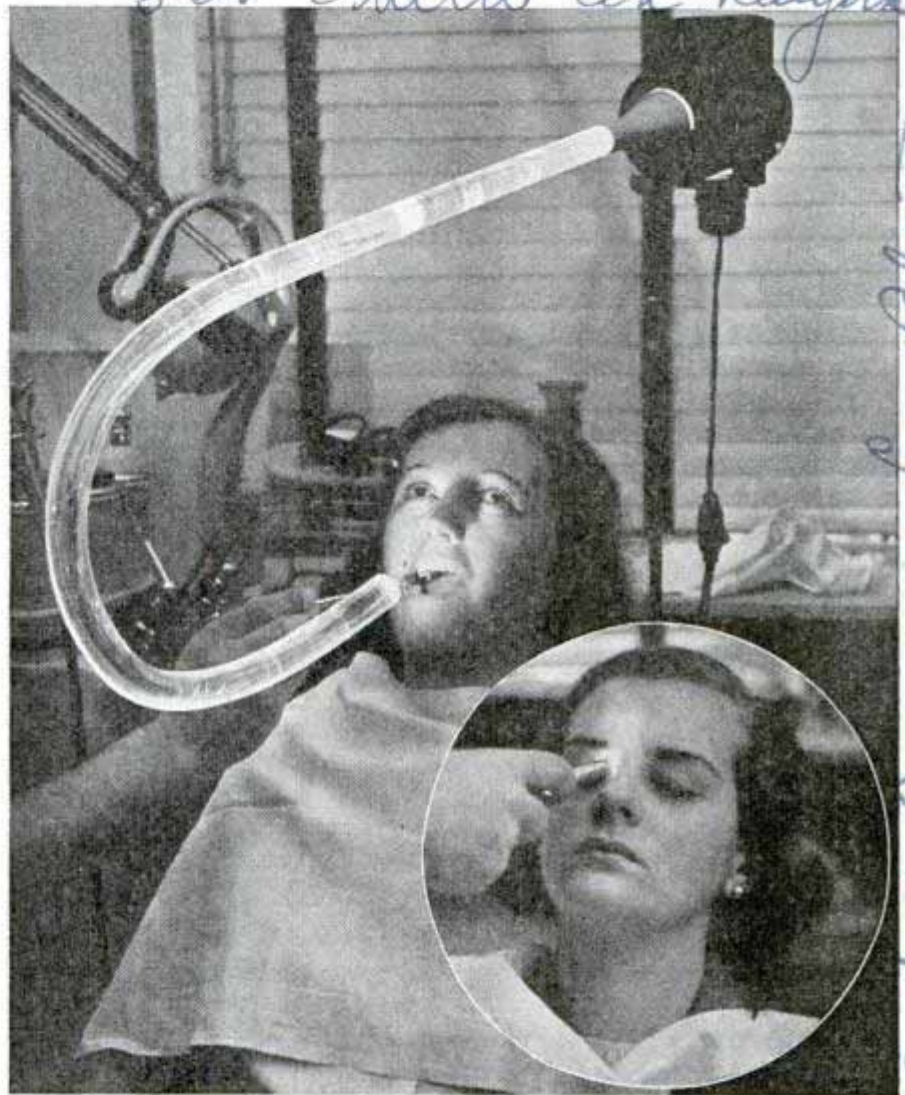

Light travels around curve of plastic rod to patient's mouth while dentist uses both hands for work. Inset, examining sinuses with cold light

Chemistry has put new tools in the hands of the doctor, surgeon and dentist—curved instruments that bend the light and focus it just where it is needed. For the dentist and throat specialist there is a combined tongue depressor and flashlight that leaves the operator's hands more free for work. The surgeon can use a lighted retractor that illuminates the site of operation while holding back the tissues. Transilluminators "pipe" light needed for examination of the sinuses. Curved rods ten feet long can be connected to a hospital ceiling or a portable stand. All these instruments are made of "Lucite," a plastic which has the property of bending light like quartz, so that light rays can travel from the bulb at the base to the tip without creating any glare along the walls.



Two men grip the saw frame as the blade, reciprocated by an air compressor, cuts through a big log

The Hardy Compressor Co

14171
Caroline Sales Co.
569 Third Ave. New York
E. D. du Pont de Nemours & Co. Charles Keefe, N.J.
Industrial Div. Wilmington

MAKING *the* GRADE



Turning a corner on skis calls for special technique. Hans Hauser, thrice Austrian ski champion, shows two pupils at Sun Valley, Ida., the "kick turn," one of the first steps to learn

IF YOU can walk, you can ski! To start, you need only a little self-confidence—and a pair of skis. In fact, you'll probably need more confidence that first day when a gentle hillside that looks like a mountain to you starts sliding under your wobbly legs than on the day, weeks hence, when you streak down a precipitous jump and soar out into space for your first solo.

But skiing is easy to learn; you can take that from Hans Hauser, three-time open ski champion of Austria and now head of the ski school at Sun Valley, winter resort in the Sawtooth mountains of Idaho. Here's what he tells his "freshman" class before he lets them touch snow:

"Don't be afraid to look awkward or un-gainly; listen to your instructor, remember what he says and you're on the road to becoming a skier."

Hauser tells you to begin your skiing at home.

"After the first few steps, it's all a matter of practice," he says, "but those first steps should be in the home, where the novice can put the shiny new skis on his feet and get the feel of them. During those first steps, the beginner should be sure the skis fit perfectly, especially the boots; for a great deal of his future success is going to depend on the skis feeling just right. Then comes the first try at the snow, when the beginner's confidence is important, even though an instructor is present to point out any mistakes."

The first precaution the skier must take is to see that all snow is removed from the ski boots. Then the toe should be thrust firmly into the toe-binding, so that the strap fits snugly. It is important to remember that the foot must be parallel to the ski and not loose.

Let yourself go. Tenseness is one of the beginner's troubles. As in many other

on SKIS



Overhead, a jumper takes off with the greatest of ease from a rocky mountain slope; below, a party of skiers rides the Sun Valley "snow tank" to the top of a run

sports, the novice should relax and spend at least several hours of his first day walking. He should be equipped, of course, with the two ski poles, both placed in the snow vertically, the points about even with the skier's toes.

As you thrust your left foot forward, push with the left ski pole. At the same time the right ski pole should be thrust ahead to a position two feet in front of the

left foot. The second step is the reverse of the first, and when grade and snow permit, the skier should take advantage of his glide between steps. After thrusting forward the left ski, relax and glide before pushing your right ski forward.

The second item to learn is the kick turn, the easiest way to reverse direction. From



*Left, fast action on a turn!
Above, skiing under arches
to learn the downhill crouch
position, knees bent and
weight carried forward*

normal position, skis and ski poles resting in the snow even with the toes, the skier puts his right pole one foot in back of his feet and his left pole one foot forward, putting plenty of weight on the poles.

Now lift the right ski, point upward until its back end rests in the snow by the tip of the left ski. Then swing the right ski down and back so that it rests at right angles with the left ski—its point resting in the snow near the rear end of the left ski.

With your weight placed heavily on the ski poles, the left ski is now brought around to face the same direction as the right ski. At this point the ski poles are both on the left side of the skier—the op-

posite side to the direction which the kick turn was made. The entire procedure is reversed when a kick turn to the left is made.

So far, so good. You've learned to manipulate your skis, but you aren't getting anywhere. Coach Hauser suggests that you're ready for promotion, and the next lesson is to try a straightaway on those slippery slats.

"It is best to pick a very gentle slope," the ski champion advises.

"The skis should be parallel, about two or three inches apart. One ski should be forward about half the length of your ski boot. Ski poles are about six inches in back of your boots. Always rest the poles

Here is where the fun comes in. Skijoring provides plenty of thrills; the rider below has towed the skier past a snow-bank for a jump. Don't try that your first day on skis!



A 14.31



in back of you, never forward, and grasp them tightly.

"Move either the left or right foot forward in a slow glide. Give yourself a slight push with the poles. Then bring the other foot forward, a little behind the starting foot. If the slope is gentle enough you won't gather too much speed.

(Continued to page 134A)

Top, Hans Hauser teaching pupils the "crouch," and a skier plowing snow on a downhill turn. Right, the ambition of all skiers—soaring out into space from a high jump. Notice the body perfectly balanced. Bottom, beginners learning the position for hill-climbing

Photos courtesy
Union Pacific railroad

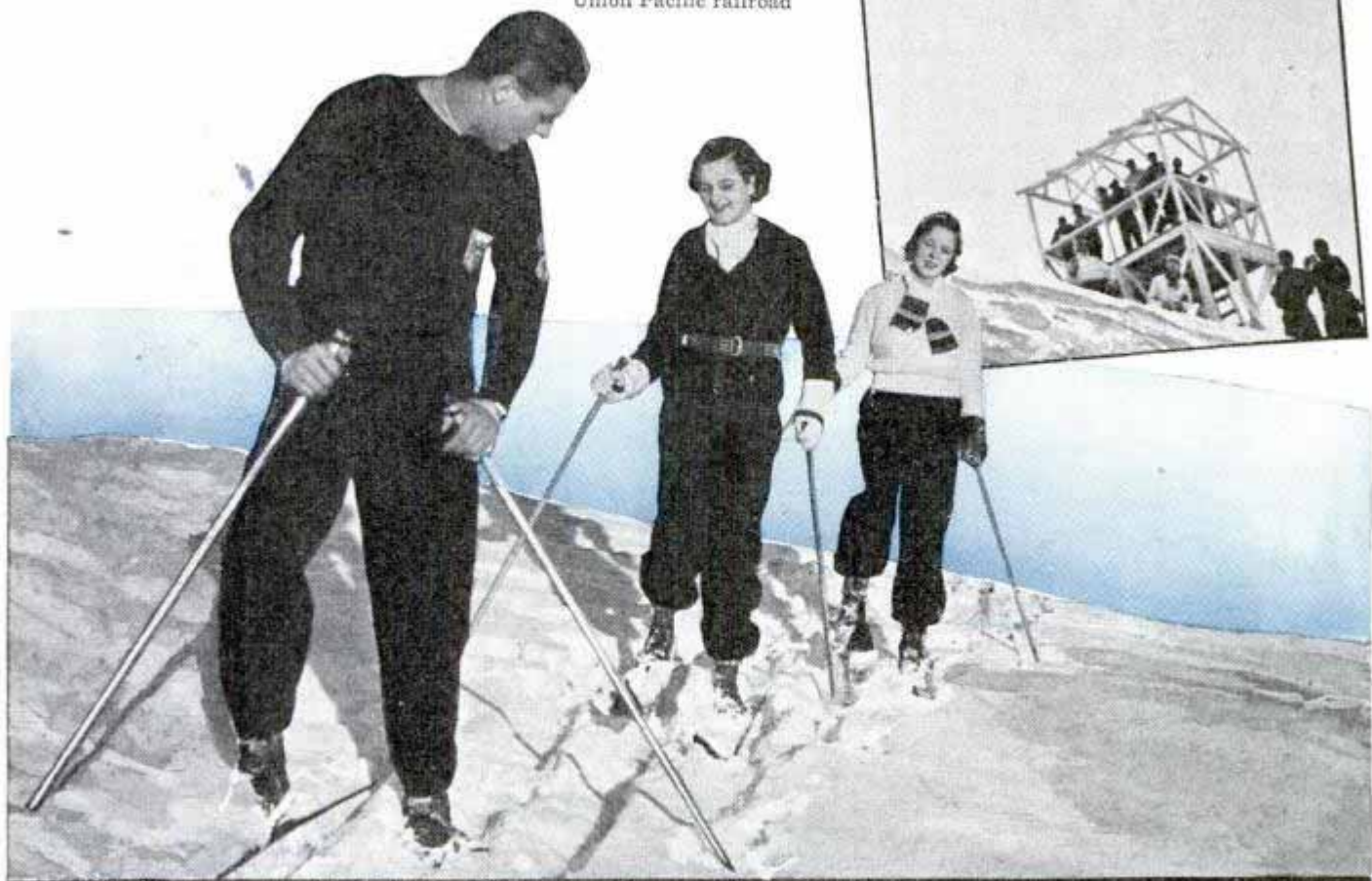
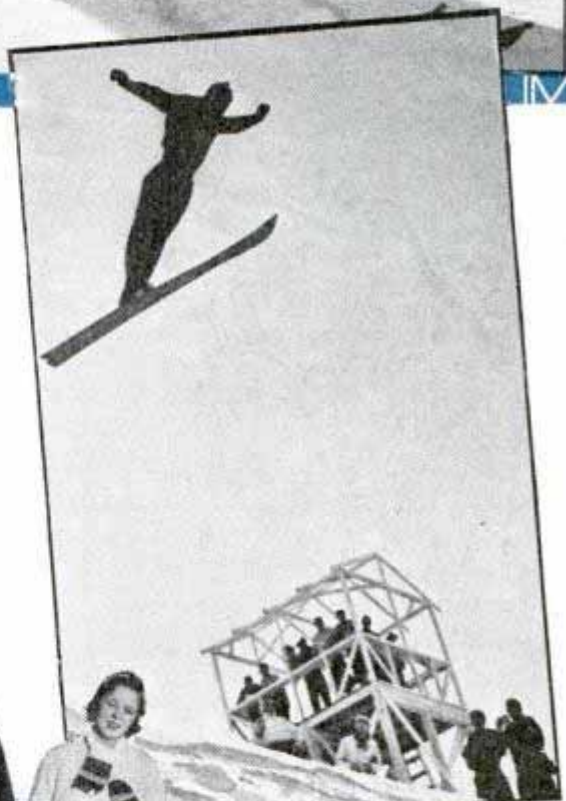

Highway Snowplow Shovels and Loads in Single Operation



Truck follows alongside or behind to receive snow and ice picked up by scraper and elevated to long conveyor on top

Picking up snow and ice as it moves along the road, a motor-driven plow loads trucks at a top speed of ten cubic yards per minute. Arms on the scraper feed snow to the conveyor where it is lifted for discharge into a truck. By means of controlling levers the operator, seated high in the cab, can swing the conveyor to the rear or to either side, and also make vertical adjustments of the gathering head. In addition to snow and ice, the loader will handle ashes, coal and cinders.

Freak Accidents Spare Some, Kill Others

Fate took it out on many an individual last year in highly unusual ways and spared others in fashions equally surprising, according to the National Safety Council. Three oil workers were at work atop a storage tank, when an explosion shot flames around it and also blew away their only avenue of escape, a ladder. A second blast set the ladder back in place, and the men clambered down. A hurrying fireman slid

down the firehouse pole with such speed that matches in his pocket caught fire. An automobile moving over a bridge as a train passed below swerved to avoid another car, then skidded through a six-foot iron rail, plunging down and landing on its wheels upon a coach of the passing train. But no one was hurt. The automobile bounced safely off the coach. At the Chicago municipal airport an Air Corps Reserve private climbed on the fuselage of a plane to service it. The pilot, unaware of his presence, took off, but someone saw the "cowboy" and the plane was called back. A two-year-old girl suffered only a slight cut on the chin when struck by a 250-ton locomotive and catapulted in the air whereas an eighteen-months-old boy was electrocuted as he chewed the cord of a bridge lamp.

Daredevil Cyclist Smashes through Wall of Barrels

Reducing barrels to hoops and staves is the business of Cary Lofton, movie-stunt daredevil, but he does it the hard way. His specialty is riding his motorcycle through a wall of barrels.

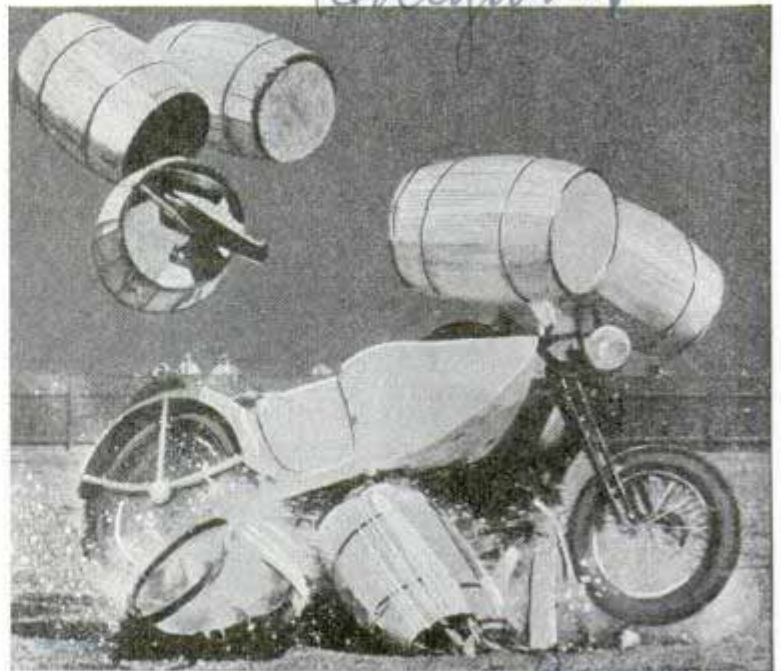

Motorcycle stunt rider smashing through a stack of barrels at top speed. Splinters fly, but he comes through unscathed

207 Wacker Drive Chicago

1470

121422 Joy May Co.

Scene Scene 2/3/38

Thousands of Models Carved by One Man



Miniatures of nearly everything ever built by man form part of a huge collection of models created by Lawson Diggett, hobbyist extraordinary, who started whittling a quarter of a century ago. Hurrying home from work this model builder dons overalls and spends several hours each evening in the home workshop. Besides automobiles and airplanes, he has constructed several tiny cities. His first city grew bigger and bigger until, tiring of moving it about, the maker doomed it for destruction. An "air raid party" followed, in which bombs fell upon the miniature to end the vacant-lot sized project. Now his cities are kept small enough to fit a table top. White pine is the

Tiny auto wheel being carved from white pine. Top, 500 scale models form only a small part of the total

basic material for most of the creations, although aluminum pie plates, broken round glass from toothbrush containers for windshields, and pins with the heads clipped are employed in automobiles. A saw, tack hammer, wood rasp, pliers, tinsnip and jackknife are his only tools. He requires about three evenings to carve an average automobile. Cars in his collection representing those which have established world records are among the favorites.

At a speed of sixty miles an hour, an average size automobile tire revolves 43,000 times every hour and, during a day's driving, may flex 360,000 times.

12 1/2 N Beach St.

Models made by B. J. Woodruff Co. Akron, Ohio



spreading stream of projectiles considerably reduces the likelihood of the enemy's escape. In addition, each destroyer is provided with depth charges for war against enemy submarines. Two depth-throwers are located to port and starboard and a discharger or depth-charge dropper is fitted at the stern. After the hostile submarine has been located by the air-bubble streak, the destroyer proceeds at full speed over him and starts to discharge its depth charges. The throwing mechanism hurls the 300-pound explosives 120 feet to port and starboard and dead astern, literally blanketing the submarine below. Since the charges are set to explode at varying depths, the chance of a hit is even greater. The water pressure created by the explosions is sufficient to cause heavy leakage in the hull of the most stoutly constructed

underwater craft. Additional armament of the new destroyers includes six 4.7-inch guns in pairs and multiple pom-poms firing two-pound shells with machine-gun rapidity for defense against aircraft. High-speed operation is another feature of these "sea hornets." Although they have only one streamline funnel, their boilers are very efficient, when compared with those used in warcraft up to this time. The boilers are of the water-tube, high-pressure type and are housed in inclosed stokeholds. Turbines developing 40,000 horsepower give a speed in excess of thirty-five knots. This type of destroyer is the first ever designed for the British fleet with only one funnel. Length of the craft is 348 feet at the waterline and the displacement is 1,690 tons. Each of these powerful warcraft is manned by a crew of 218.

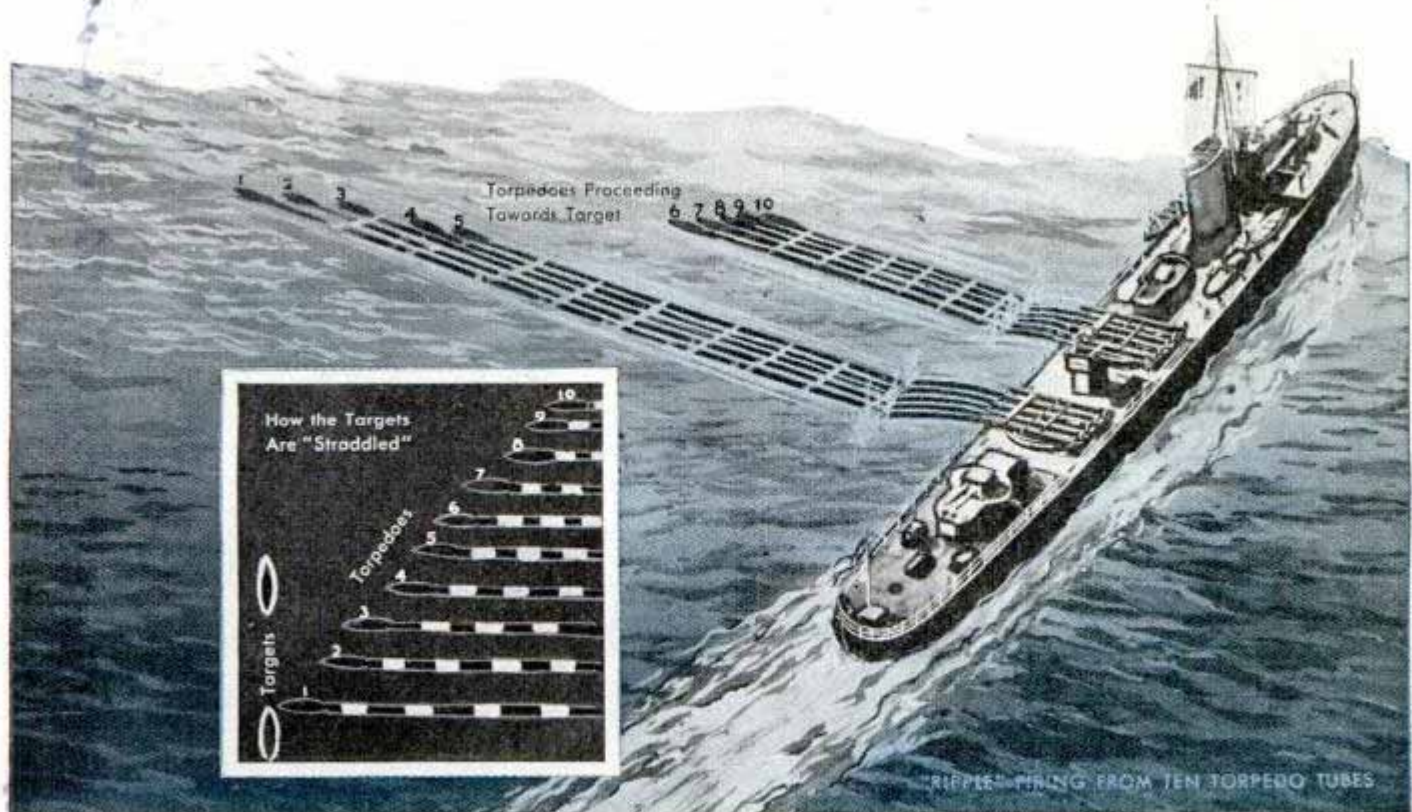

Top, view of the speedy one-funnel boat. Bottom, how ten torpedoes are fired from the quintuple tubes in a ripple at enemy ship. Inset, method of firing which increases the chance of hitting an enemy ship as it speeds along the surface

Magnetic Rocks Are 'Hooked' Like Fish with Pole and Line



This rock weighs 150 pounds and is attracting a needle at the end of its thread. It also holds hairpins and a horseshoe

Prospectors who seek magnetic meteorites and chunks of magnetic ore in the Colorado desert of southern California use as regular equipment a fishpole and a long line with a heavy iron nail instead of a hook. Flipping his nail from rock to rock as he slowly strolls across the desert, the prospector depends upon the magnetic pull of a magnetized rock to hold the iron nail. Such rocks are sold as specimens.

1509

Plants "Analyze" Their Own Soil by Symptoms of Hunger

Chemists can analyze soils to determine whether they provide all the chemical foods necessary for plant growth, but the plants themselves can do the job better. The skilled botanist can read telltale symptoms of diet deficiencies in the leaves of the plant. Using tobacco as a "test-tube" plant, Dr. J. E. McMurtrey of the U. S. De-

partment of Agriculture has found that lack of nitrogen in the soil shows up in paler green leaves, the lower leaves turning yellow and drying out to a light brown. If the soil lacks phosphorus, he says, the leaves are darker green and narrow, and the plant remains immature. Iron starvation is indicated when the leaves fail to develop any green color except along the veins.

1480

'Bike' Wheel on Motor Bus Measures Acceleration

Before a passenger bus is placed in service it must meet an acceleration test administered by a bicycle wheel attached to the front step. A flexible shaft and gearing arrangement connect the wheel to registering apparatus inside the bus. The distance traveled in feet per second and in miles per hour is recorded on a moving tape and also tabulated on meters. The "bike" wheel is mounted to rise and fall with road irregularities, and to make the test accurate the bus must travel its trial runs in two directions on the same course.

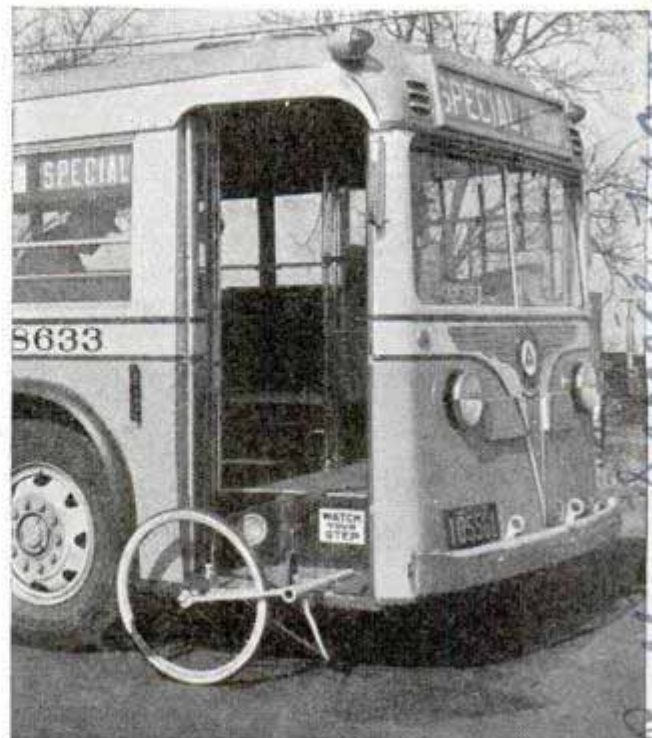

Flexible shaft from bicycle wheel to recording apparatus tells story of accelerating ability of bus

Vertical handwritten notes on the left margin: 'Pony Express Museum, Arcadia, Calif.', 'Crime Service, 1248/38', and 'Thomas G. Dunham Jr. 10555 Holman Ave'.

Vertical handwritten notes on the right margin: 'Washington D.C.', 'To Park Place', 'Price of machine', and 'Newark, N.J.'.

Ralph Mancuso, all Marine Corps
 Woodside, Cal. Original
 27-01 Bridge Plaza Hall
 Long Island City
 H 75 03
Translucent Plastic Statues Lighted on Inside

Translucent figures of heroic size, cast in synthetic plastic material and illuminated from within, will feature the exhibit of the United States government at the New York World's Fair. Edward Heckler Burdick designed the exhibit, which is divided into twelve parts, representing the twelve functions of government as they affect the average citizen. In each section the central figure is a sculptured mass of cast plastic, nine and one-half feet high, resting on a base four feet and two inches high and weighing 1,500 pounds. The figure, lighted from within, symbolizes the function of government depicted by the section. From a height of thirty-five feet, a highly colored moving mural appears to flow down into the plastic figure, telling the history of the governmental function which each section represents. On either side of the lighted figure is a series of miniature displays, or dioramas. To give the visitor the effect of going from darkness into light, the exhibition hall will be unlighted except for the illumination given off by the exhibits.



Here is how the plastic statues will look. Illumination comes from lights located inside the figure and base

The giant figures were cast by a new technique involving the use of rubber molds and certain periods of curing.

H 1460
Transparent Film of Rubber Will Resist Water and Fire



Transparent umbrella made from new material

Rubber in the form of transparent sheets is introducing virtually a new industry with products ranging from raincoats to oxygen tents. Called Pliofilm, the material is based on a hydrochloride of rubber and is inherently waterproof and non-inflammable. It neither shrinks nor expands, and forms an odorless wrapping film unaffected by weather, mold, insects, oils, or by weak acids or alkalis, and so may be used as packaging material in direct contact with foods. It is also in demand for transparent curtains, umbrellas, aprons, garment bags, tobacco pouches and the like. The material is produced in five thicknesses.

Send return postage to our Bureau of Information to learn the name of the maker of any device described in this magazine.

Magee

N 1229



HOTELS



Above, looking from tip of Boeing clipper's right wing to tip of left wing, 152 feet. Below, artist's sketch of 100-passenger ship expected to be the Clipper of Tomorrow. It would be about twice as large as today's modern transports

LOCOMOTIVE power and all the services and conveniences of the modern hotel have been incorporated into new giants of the airways which are ready to speed the American traveler over land or sea in safety once considered impossible to achieve in aviation.

Steam heating, air-conditioning, hot and cold running water, artistic decorations, individual service from carefully trained attendants, electrically operated kitchen and home appliances, telephones, luxurious berths and even bridal suites—these

are a few of the features of the latest aircraft intended for use on regular runs.

Of three super-airliners which have been completed and tested successfully, two either are in service or soon will be flying scheduled routes.

Largest of the three is the Boeing "314," Pan American Airways clipper, a seventy-four passenger cruiser that is the first commercial airplane capable of carrying a sizable load of passengers and cargo across either the Atlantic or Pacific ocean.

Weighing 82,500 pounds and driven by four 1,500-horsepower engines, any two of which are able to keep the giant craft in the air while work is being done on the others, the "314" has twice as much power as the average railroad locomotive and a range of 4,000 miles with forty passengers aboard. Its top speed is approximately 200 miles per hour. Catwalks through the wings lead to the engine nacelles, each roomy enough for several men to work. Full feathering propellers permit the stop-

Boeing Aircraft Co

Handwritten notes in the left margin, including "N 1229" and other illegible scribbles.

Handwritten notes in the right margin, including "Seats" and "Boeing Aircraft Co".

H 1229



on the WING

ping of engines completely during flight so that mechanics may service or repair the huge motors.

This "Queen Mary of the air" is the first airplane with two full decks, connected by a spiral staircase. It has eighteen separate rooms within the hull proper, not counting the four "engine rooms." The ship measures 109 feet long and has a wing span of 152 feet, nearly one-half the length of a city block. The hull has an inside volume equal to that of a five-room house including basement, and the craft's thermostatically controlled system produces nearly five times as much heat as the heating plant of a modern seven-room house. Fuel tanks hold enough gasoline to



Above, Douglas "DC-4" climbing on only two engines. Note that two propellers are idle. Below, conferring in "mock-up" of the Boeing "Stratoliner's" pilots' compartment

Douglas Aircraft Co. Inc. California

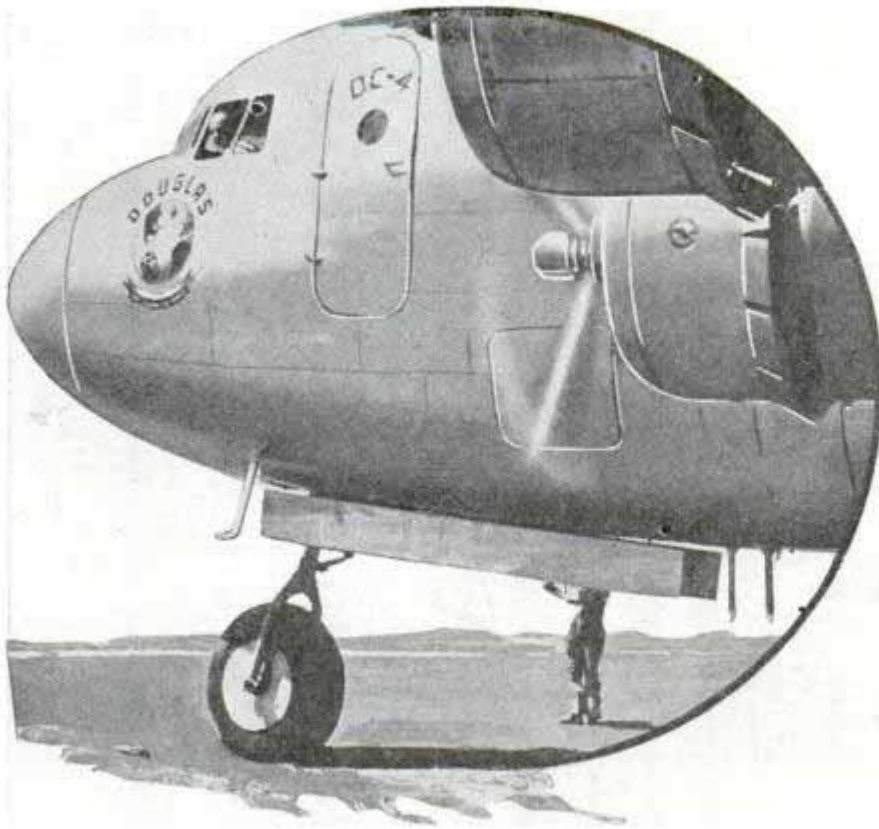

drive an automobile two and one-half times around the world, 4,300 gallons, and the cargo holds have a capacity of 10,000 pounds of mail and air express. There are approximately 50,000 different parts in the clipper, assembled with 15,200 bolts and 1,000,000 rivets. The electrical system contains eleven and one-half miles of wiring, installed in 400 runs of conduit, and outlets for 160 light bulbs.

On the passenger deck are nine separate sections, including five standard compartments accommodating ten passengers each and a half-size compartment for four. The central section is a large room that may be used as lounge or dining saloon and the aftmost section is a de luxe compartment which may be used as a bridal suite.

Berths are six feet three inches long and thirty-two inches wide, with thirty-five inches of headroom. Handsomely styled furniture in the rooms is built with light aluminum frames and is cushioned with a newly developed pillowy substance made of curled horsehair impregnated with liquid rubber. Color schemes of the upholstery, wall and ceiling lining, deep carpets and trimmings vary in different compartments. Double windows in each compartment are fitted with Venetian blinds.

The bridal suite is attractively furnished with a triple seat, davenport type convertible into upper and lower berth, built-in settee, dressing table, two end tables, mirrors, washstand and cabinet and an overstuffed chair. Modern tables between casually arranged overstuffed chairs offer accommodations for fourteen passengers at a time in the dining saloon. The

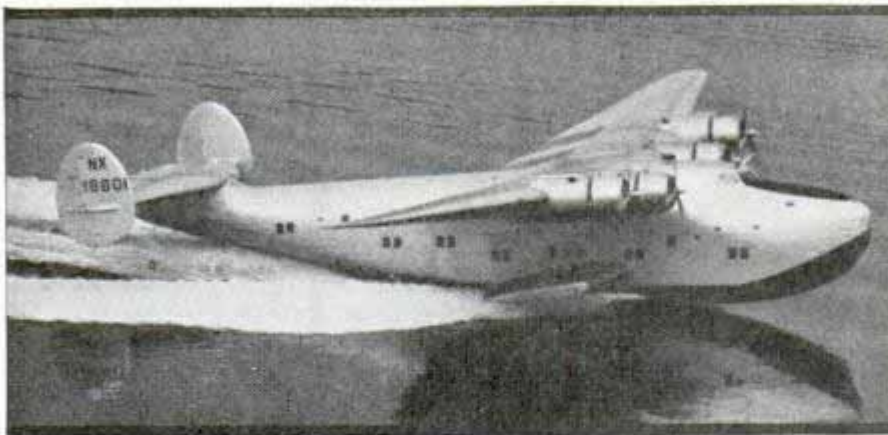

Top, Douglas "DC-4" has nose wheel for safe landing. It retracts when the ship is in the air. Center, Boeing clipper taking off. Bottom, cutaway view of Boeing clipper shows passengers' comfortable quarters on the main deck

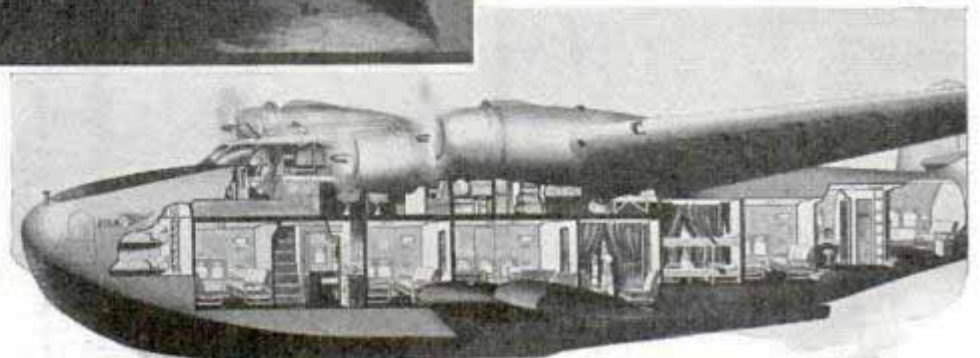

Boeing at Lake Washington Seattle.

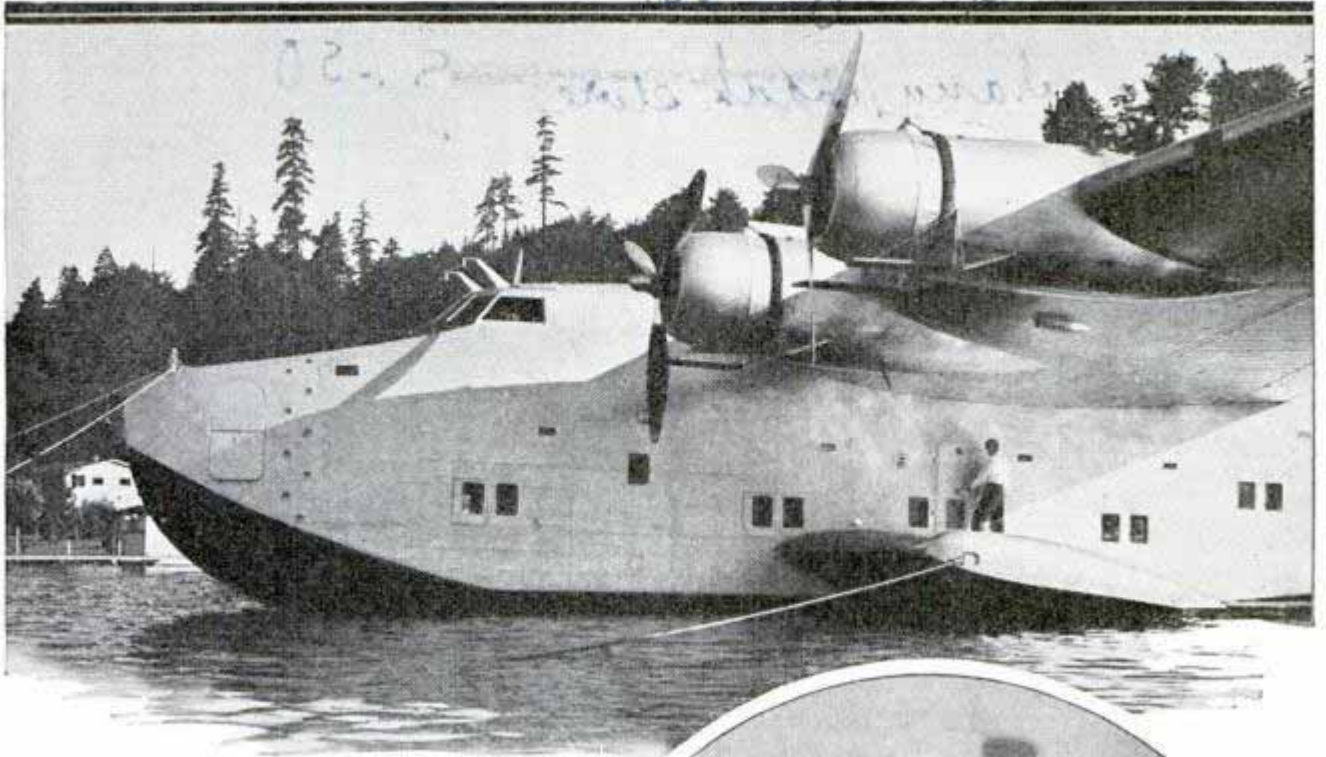

galley is equipped with cupboards, serving tables, drawers and thermos containers for serving meals to the plane's seventy-four passengers and crew of eight. Between meals it may be converted into a bar.

The clipper's control deck provides liberal working space for the flight crew of six. At the forward end are the pilot's and co-pilot's stations and behind the pilot is the navigator's station, with a broad table for full-sized nautical charts. Across from the navigator is the radio operator's desk, with complete equipment including radio direction finder, three transmitters and four receivers. Behind the navigator is the master's desk and

(Continued to page 114A)



Boeing

Top, clipper at its moorings. Circle, officials test passenger compartment. Bottom, clipper landing after test flight. Note wing flaps in lowered position to decrease speed



Boeing Pan American Clipper

Boeing Pan American Clipper

"Fishing Pole" Lifts Camera for Odd Angles

many Kodak store

\$1.50



© Three Lions

Top, right, taking picture from overhead with "fishing-pole" camera, and, left, the result. Below, camera on tilting head with string running through screw eye to shutter release



Unusual picture angles can be obtained easily by mounting the camera on a long pole to extend over the heads of bystanders. A photographer adopted this idea after falling out of a tree in an unsuccessful attempt to obtain a picture. With four sections, each four feet long, he made a sixteen-foot pole. At the top is an ordinary tilting-top bracket on which the camera is mounted. This allows the camera to be set at any angle and the shutter is operated by a string running down the rod through screw eyes. With this arrangement the photographer can snap parades from behind the lines, or even picture himself from an odd angle.

Allergic People Prove to Be Smarter in Tests Given College Freshmen

If you suffer with sniffles and wheezes you are likely to have above average intelligence. That is the conclusion drawn from a survey made by the University of Michigan health service, in which freshmen entering the university from 1931 to 1935

were classified into five groups according to their symptoms and family history of allergy, the strange disease which makes individuals sensitive to certain substances. The five groups ranged from students known to have some type of allergy, to in-

Dr. Boneventura

148

Ann Arbor, Mich

Air Circulation in Fireplace Sends More Heat into Room

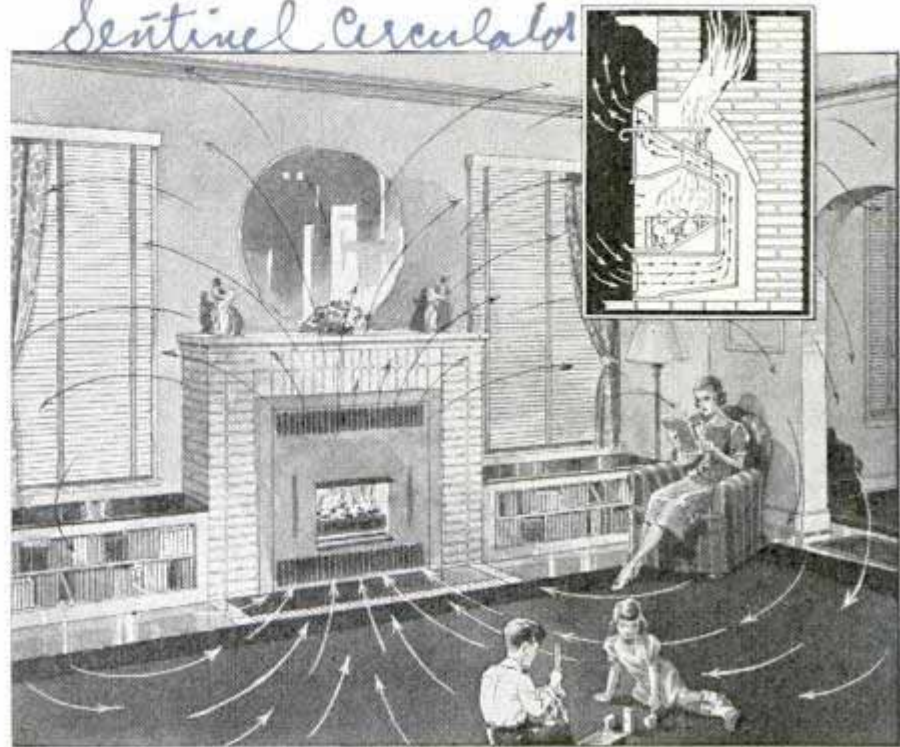

Heated air is distributed in room as indicated by black and white arrows. Inset shows chamber around circulator where air is heated

Cold, drafty air from the floor is drawn into a fireplace circulator, heated in the air chamber, and distributed evenly to all parts of the room. The entire unit is constructed to fit into any fireplace, being installed without making changes or alterations in the original equipment. Having an opening twenty inches long, the circulator is of ample size for burning sixteen-inch firewood, and the grate is so designed that hard fuel also may be used. Setting the damper is simple; it is readily adjusted for a large or small fire or closed tight when not in use. Large air passages permit rapid circulation of warmth at all times. The grate is removable for cleaning.

Sliding Filter for Camera Lens Provides Five Changes

Mounted in a series of five in a sliding panel, filters for movie cameras are instantly interchangeable to meet varying conditions. The panel mount also provides a lens shade.

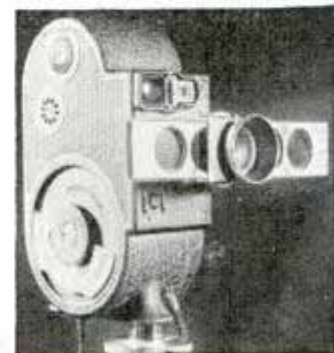

dividuals with no symptoms and no family history of sensitiveness to the ailment. In almost every case the allergy groups had fewer failures in the entrance examinations and more students in the upper bracket of the intelligence test ratings, than did the members of the group who had no symptoms of allergy.

4/466

Motor-Driven Tutor Teaches Body Swim Strokes

First lessons in swimming are given by an electric instructor that puts the pupil's body through the proper strokes. The beginner lies prone on the apparatus, and his arms, leg, head and body are taken through the motions by a series of five cams operated by an electric motor. Several lessons accustom the limbs to the strokes and it becomes automatic when tried in the pool.

3640 Elder St. Phila.



Beginner "memorizes" swim strokes taught by robot

James B. Anderson

Photographic Specialist, Inc. 1123 Broadway, New York

Skaters Enjoy Summer Ice under Blazing Sun

1605 S. Norton Ave Los Angeles



Ice skating rinks like this, where skaters can glide on hottest summer days, may be built in some of the country's largest cities. On the right of the stage can be seen part of the large orchestra stand

Tropical Ice Gardens, Westwood, Calif.

Blazing sunshine does not melt the ice of an outdoor skating rink recently completed in Los Angeles, and skaters may enjoy their sport all summer long. The skating area, 210 by 100 feet, has a one and one-half inch water ice floor kept solid by the circulation of 24,000 gallons of brine that moves along patented corrugations in a

white enameled steel floor below the ice. A spectator's gallery seating 7,000 people, a stage, and other buildings around the rink block off warm winds which otherwise would remove the blanket of cold air above the ice and permit melting. New design of freezing equipment solidifies fifty tons of water in about four hours.

Lathe Has Power Cross-Feed and Is Quick-Reversing

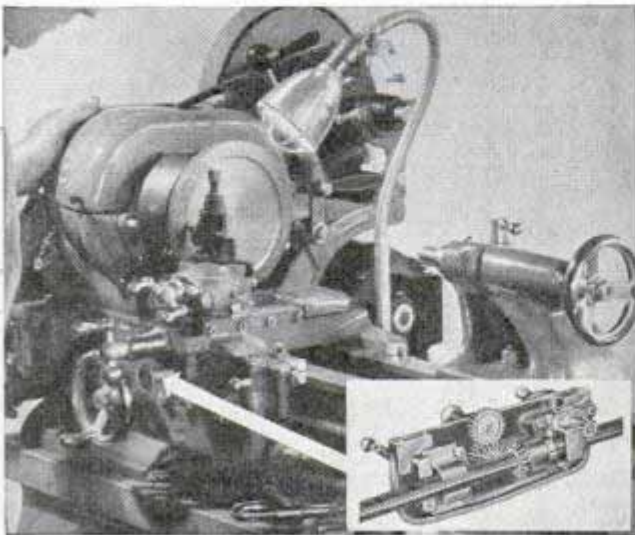

Inset shows bevel gearing arrangement of power cross-feed on latest type bench lathe

Just made available to machine-tool users is a bench lathe equipped with power cross-feed. Longitudinal and cross-feeds are instantly reversible. This lathe has a V-belt drive, a wide speed range, and compact controls. Pushing a knob on the front of the apron engages the cross slide screw.

Quick-Frozen Food in Cans Sealed to Prevent Drying

Ripe fruits and vegetables may be purchased in the can because of a process for continuous quick-freezing under production-line methods which has been developed for canneries. Among foods already

(Capt. Herman Vetter Refrigeration Engineer)

Vertical text on the left margin, possibly a name or address.

Vertical text on the right margin, possibly a name or address.

Atlas Press Co.

Food Machinery Corp.

successfully frozen in cans are orange and lemon juice; pulps of apricot, nectarine, plum and youngberry; avacado slices and pulp; milk, cream, eggs, peas, asparagus, string beans and lima beans. The vegetables are handled both as a dry pack and with brine. Since cans are hermetically sealed with a vacuum closer, dehydration is eliminated and the original quality of fresh food is protected from deterioration.

H 1406.

426 Washington Ave. H 14171
**Automatic Timer Sets Pace
 and Counts Swimmers' Laps**

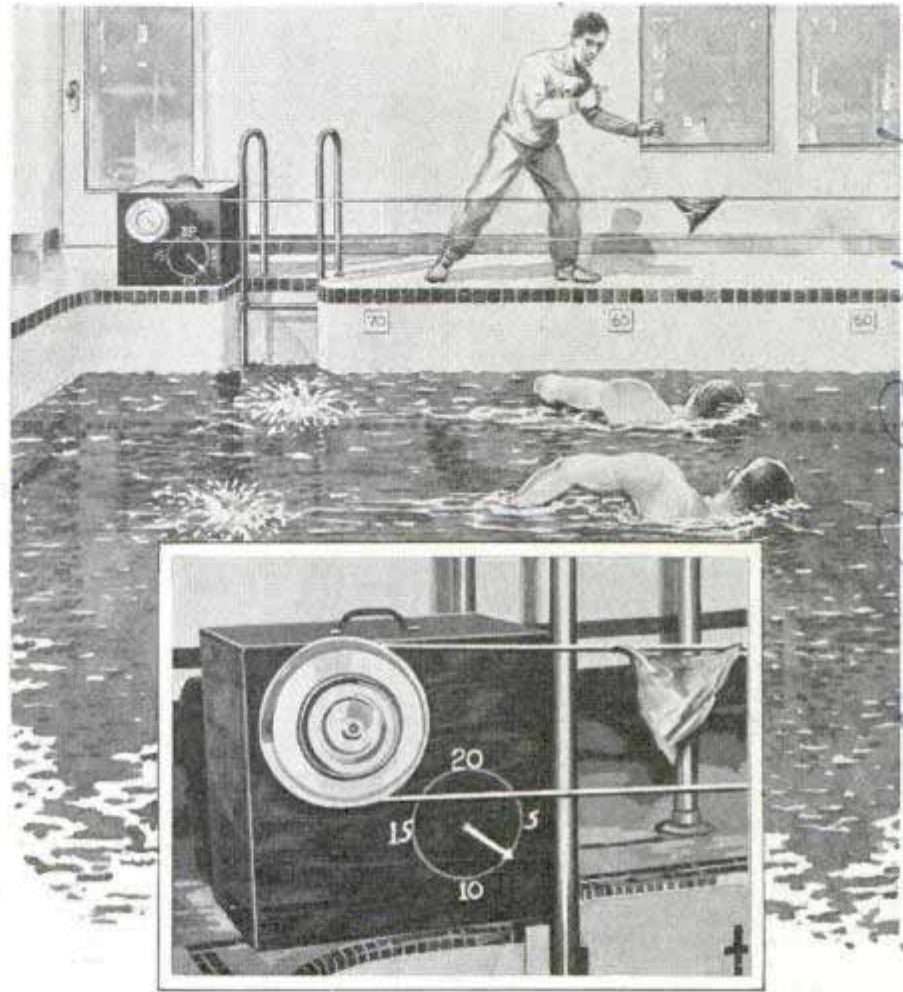

Flag traveling on line paces swimmers at any speed desired, relieving coach of need for stop watch. Numbered dial counts laps in distance swim

**Bicyclist Tours with
 Trailer Carrying
 Built-In Bed**

Towing his bedroom behind him in a streamline trailer, a California bicyclist is at home wherever he stops for the night. The eight-foot trailer offers ample room to stretch out in comfort on its built-in bed. It is thirty-eight inches high and thirty-six inches wide. Bob McCulley, who built it, plans a tour from California to Florida.



more world
 Bicycle tourist is at home wherever he stops, with a comfortable bed built inside eight-foot trailer which, fully equipped, weighs 135 pounds

Operating on pulleys stationed at each end of the pool, an automatic timer for swimmers sets the pace with a flag traveling at any desired rate and at the same time records the number of lengths completed. It relieves the coach of his stop watch, and precludes guesswork by showing the exact pace at every stroke. The timing mechanism, electrically operated, may be set at speeds from fifty seconds for 100 yards to two minutes and forty seconds for 100 yards. It is adjustable to a tenth of a second for any distance within that range. Extremely slow speeds are used in training to teach rhythm and relaxation.

Ed and Amy J. Bond, Swimming Coach, State College, Pullman, Wash.

431 60 60 to Denver
Cancer City

TOPSY-TURVY

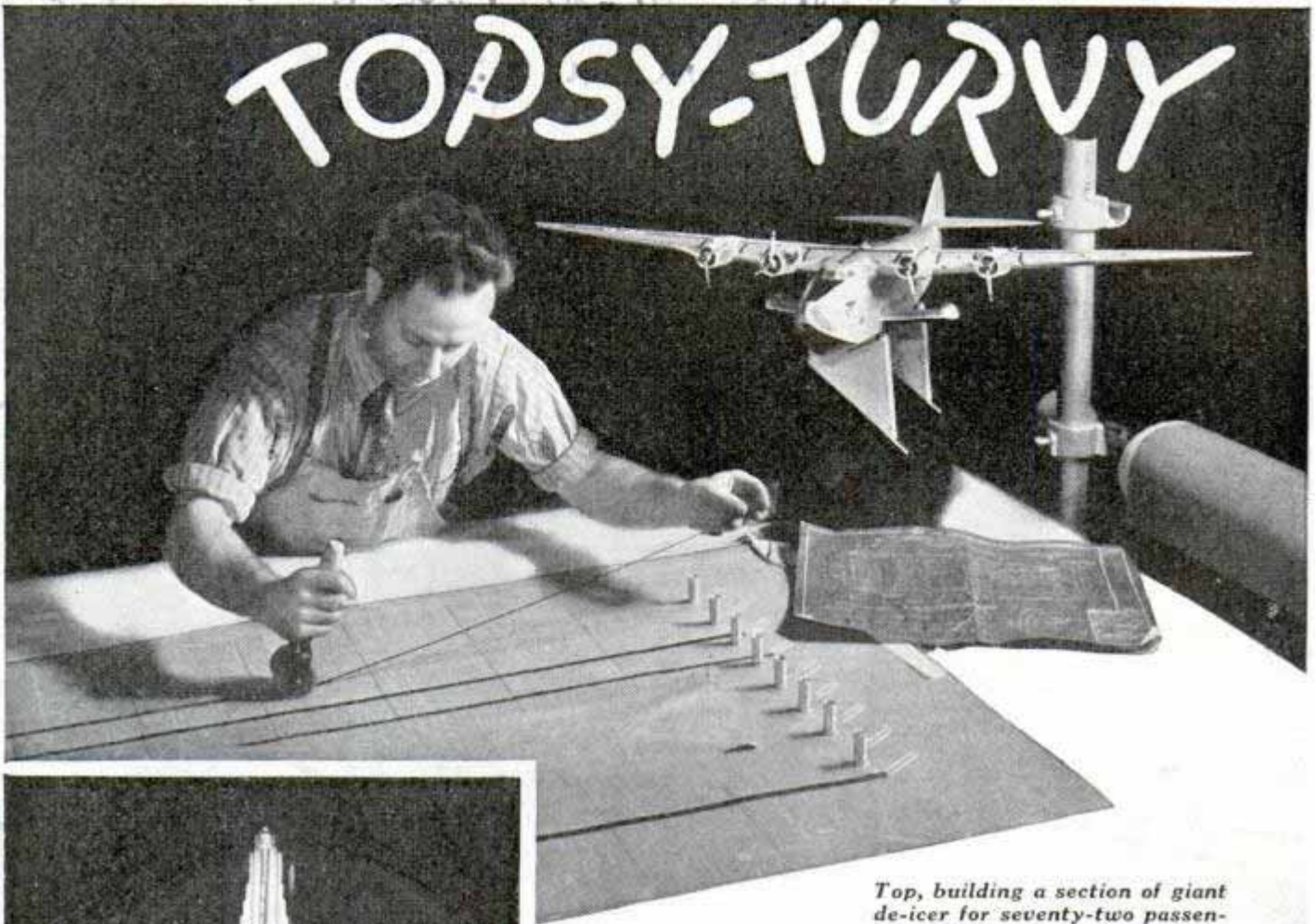

Top, building a section of giant de-icer for seventy-two passenger Boeing ocean flying boat. Left, model of Empire State building in ten-foot wind tunnel

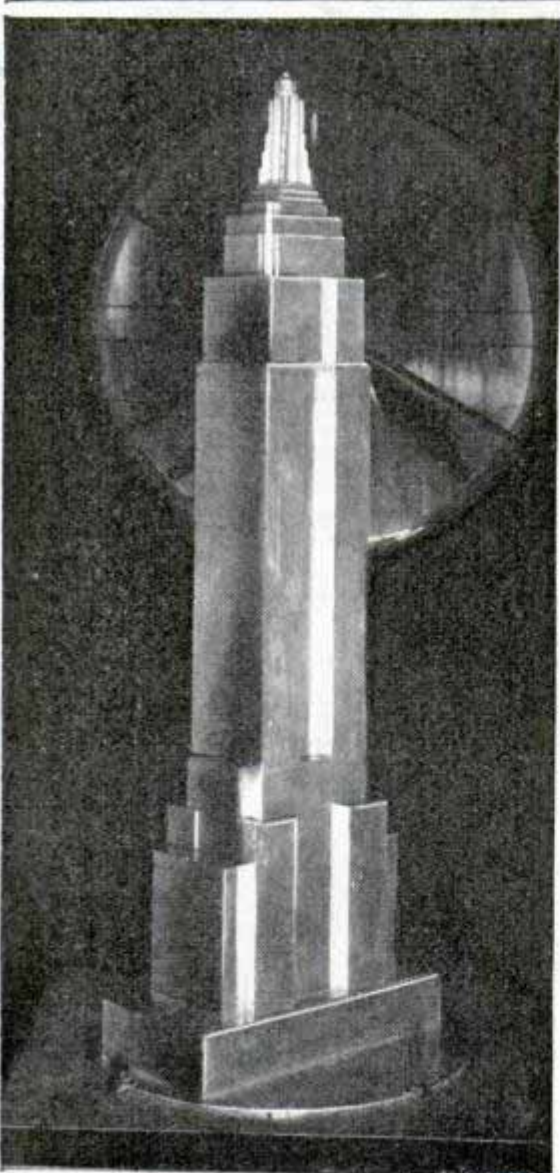

BLIZZARDS in August and heat waves in dead of winter; raging floods in lands stifled by drought; earthquakes and tidal waves that never find their way into headlines—

These are but a few of the topsy-turvy weather conditions created by modern Vulcans and Thors by the flip of a switch or the turn of a dial. They can simulate the furies and caprices of the elements on the moment's notice. Their magic makes possible the manufacture of better motorcars, safer airplanes and sturdier buildings, as well as enhancing our safety and comfort.

"Tailor-made" weather has been developed by research workers to determine the value of a given material or construction for a specific service. If automobiles are to meet extremes in weather conditions throughout their lives, they must prove their fitness in the cold rooms of motorcar builders' engineering departments. Temperatures as low as thirty degrees below zero and sixty-mile gales can be reproduced in Studebaker's weather plant. Checks on thermostatic heat and water controls, engines running under sub-zero conditions, and carburetion and ignition tests are made regularly, in addition to

41320

Weather **MAGICIANS**

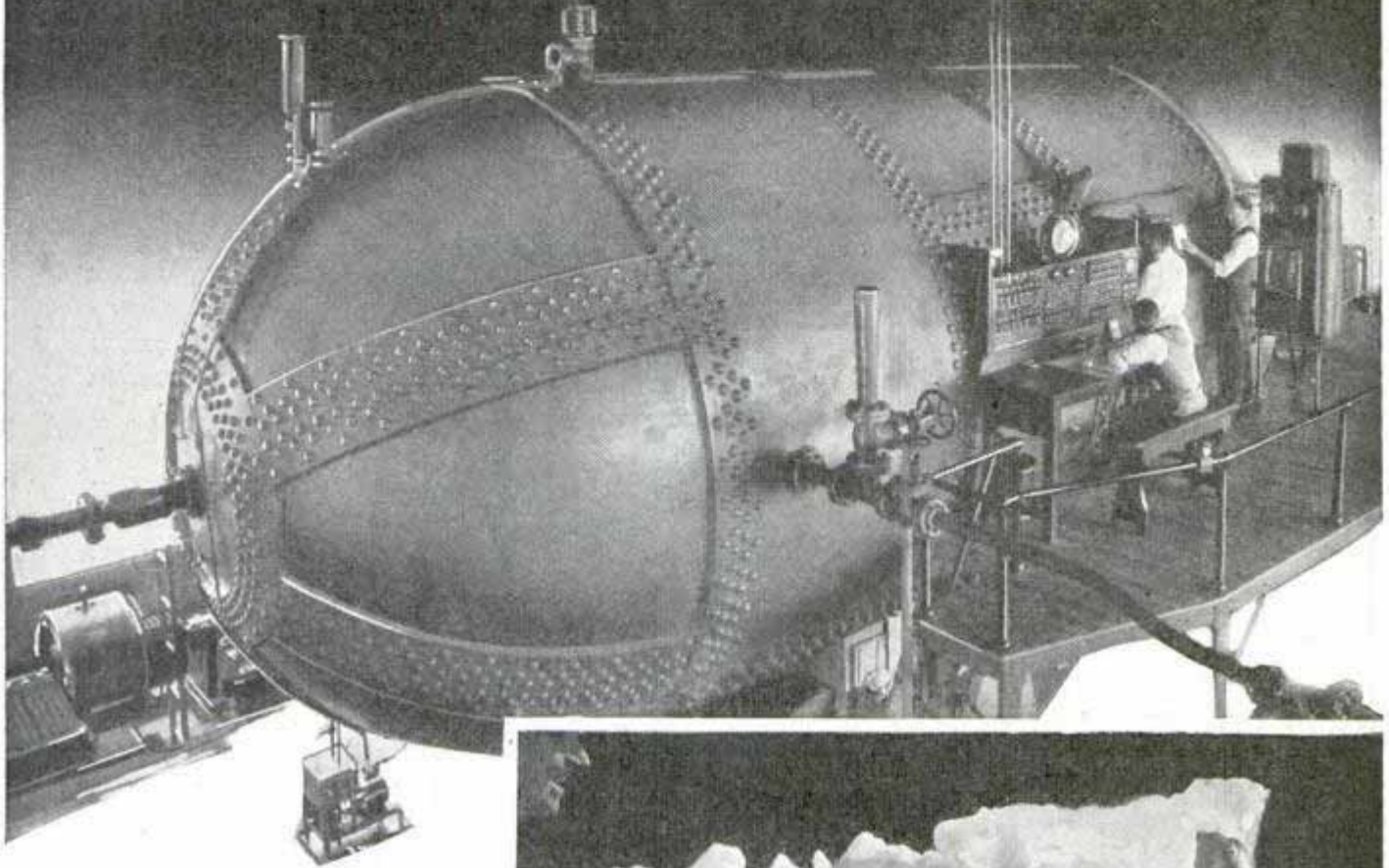

studies on such developments as the car's new air-conditioning and heating unit.

Remember the airplane of a dozen years ago? It was a crude, boxlike contraption with peculiar landing gear, square wing tips and a wealth of brace wire. The location and power of the engine were a mere guess, as was the design of the propeller.

Contrast such a ship with a modern Boeing, Douglas, or Lockheed.

What is responsible for the great gap between them? Is it the combined experience of pilots, air-line operators, chemists, engine builders, gained from the millions of commercial flying miles piled up since the early twenties? That's part of it, but the real reason may be summed up in one word, research. And aeronautical research calls for plenty of test-tube weather.



Top, variable density wind tunnel where research engineers study performance of scale models. Below, automobile frozen in block of ice

Ice formation on aircraft has given the air industry its biggest headaches. The danger lies partly in increased weight, but chiefly in the deformation of aerodynamic shapes; since it is from the wings' contour that the lifting factor is derived, it can be seen readily what a menace the ice film can become.

In all the years spent in developing

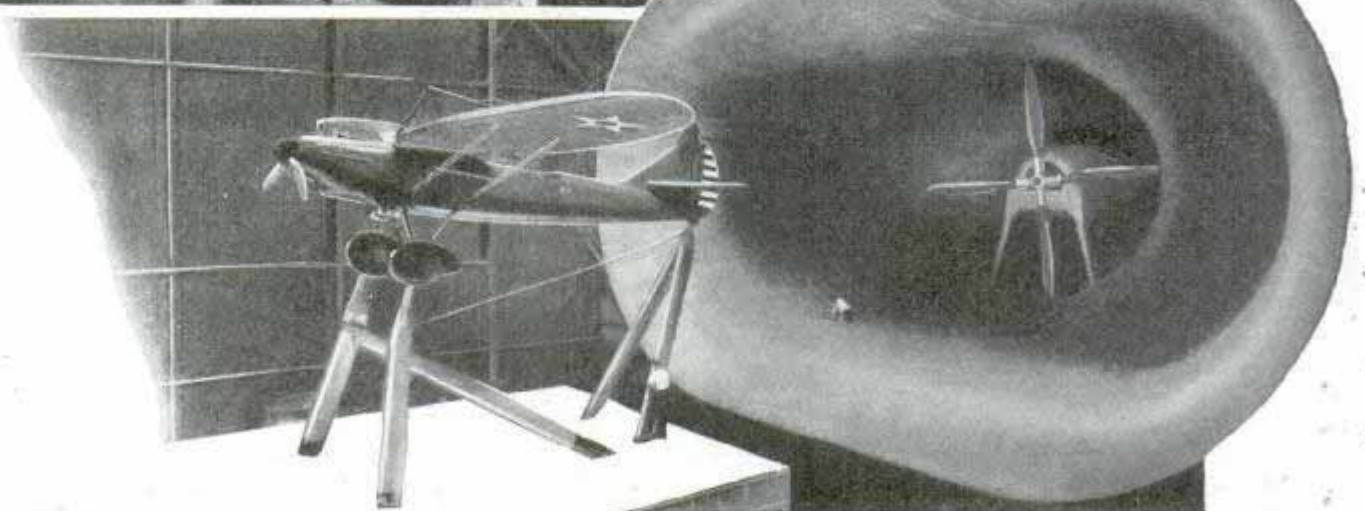
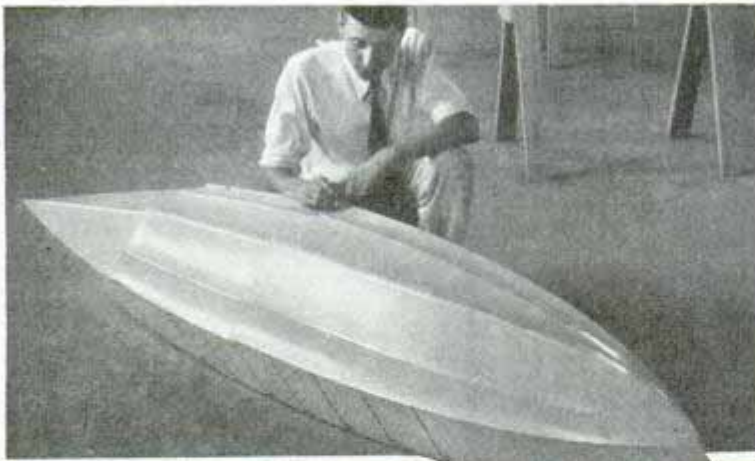

de-icing equipment, the engineers have had to manufacture their own weather for research. The biggest rubber de-icers ever made were put on Pan American's giant "Boeing 314," the seventy-two-passenger Atlantic clipper; but before 310 square feet of rubber could be converted into overshoes, model planes spent months bucking gales in a test chamber.

In Goodrich's storm room, largest of its kind in the country, water sprays, a cooling plant and blowers join forces to furnish tempests similar to those Pan American will have to cope with across the North Atlantic. The rubber mittens, standard equipment on commercial air lines, line the leading edge of wing and tail surfaces. Connected with a compressed-air pump, they expand and contract with regular pulsations, cracking the ice so the wind can strip it off. A wide variety of de-icers have been tested in this plant, each being subjected to different types of ice, from watery slush to hard rime ice of white crystalline structure. It has been found that the most violent breaking action is effected by a three-tube shoe, inflating first the center and then the two outer tubes.

Seaplane hull models in upper two pictures are towed at high speed in experimental basin to determine water resistance. Below, watching "superflood" pass over model of Tygart dam spillway. Bottom, army plane ready for test in full-scale wind tunnel at Langley Field.

naca wind tunnel

Vergines

H73'20
Massachusetts Institute of Technology

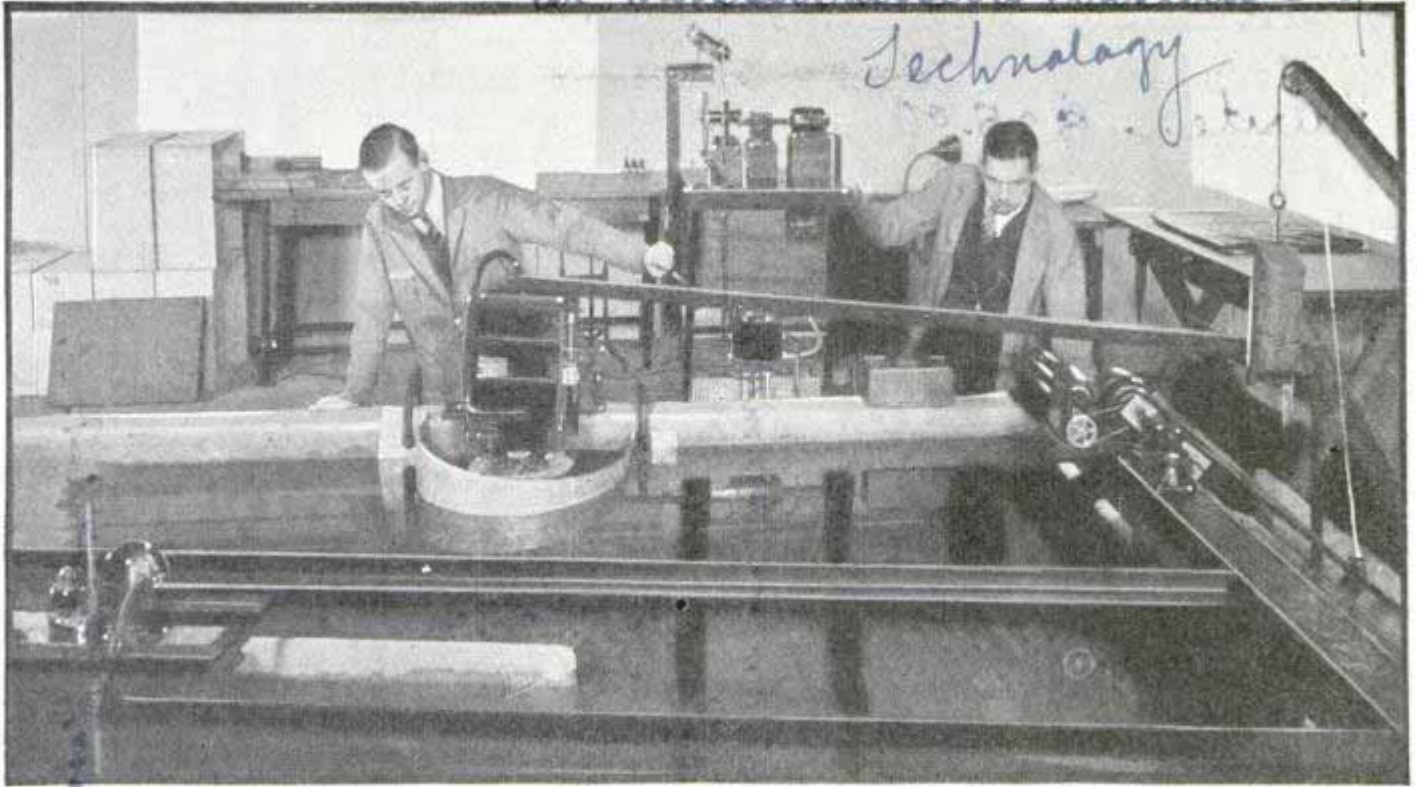

The collective nightmares of air-line pilots could not churn up the variegated weather on tap at the laboratories of the National Committee for Aeronautics at Langley Field, Va. Its variable-density air tunnel is one of the outstanding scientific pieces of equipment in the world. Only in this type of wind tunnel is it possible to use small models for obtaining full-scale results. The tunnel is constructed within a steel tank and compressed air is used to test the miniature. If, for example, a one-twentieth scale model airplane is tested, the air is compressed to twenty times normal density, or 300 pounds per square inch.

Kingpin among the fifteen wind tunnels at Langley Field is 434 feet long, 222 feet wide and ninety-seven feet high. The air stream is thirty by sixty feet with a velocity from twenty-five to 118 miles an hour. The diameter of the propellers is thirty-five feet five inches.

Ask the average person what he knows about the science of seismology and he will tell you it is concerned solely with the

recording of earthquake motions. Registering wave motions is indispensable to earthquake study, but it is only a means to an end. The geophysicist uses seismographs to find out what he can about the interior of the earth and the causes of earthquakes; the engineering seismologist studies seismograms to learn the effects of earthquakes on buildings.

The scientist working in this latter branch, instead of recording the motions of an earthquake, takes a record of an actual earthquake shock, then reproduces it

(Continued to page 122A)

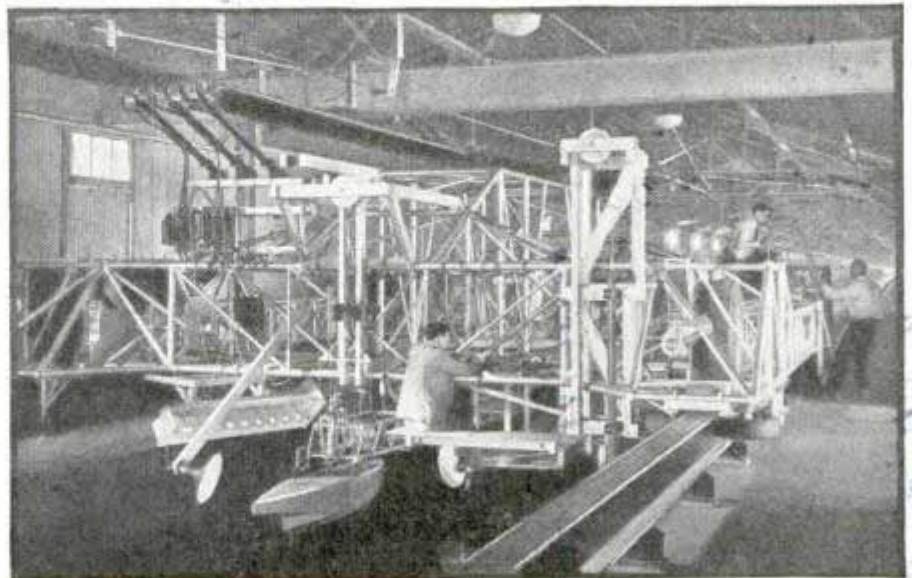

Top, electrical tide-maker in model of Cape Cod canal. Bottom, view of experimental tank with miniature flying-boat hull mounted for test tow

Electric Grinder for Knives Gives Uniform Edge



It takes little time to keep knives sharp with this electric grinder that puts on a keen edge quickly

Flip a switch, pass a knife through the slot, and an electric grinder puts a keen, convex edge on the blade regardless of how the knife is inserted. Entirely enclosed in a streamline hood, the power unit drives four abrasive blades that grind at a speed of 10,000 strokes per minute, giving a uniformly sharp edge the full length of the blade. The grinder will not burn or weaken the temper of the knife.

Four-in-One Safety Fuse Plug Changes Automatically

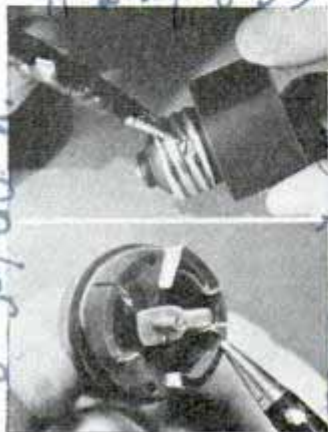

If you blow a safety fuse with an automatic changer, another takes its place in five seconds. If a defective electric appliance has caused the trouble, this five-second lapse allows time to pull it out before the

lights come on again. The new safety fuse will change automatically three times in the same manner, and when the fourth fuse burns out the lights flicker on and off to indicate that the unit should be replaced. In the event of a severe short circuit, however, the flickering also will cease. Inside the unit a contacting pin, mounted on a shaft rotated by a coil spring, engages the fuse metal. When the first fuse burns out, this pin by-passes it and turns to the next one. After the fourth has burned, the contacting pin meets the flicker fuse which will not blow out unless there is a severe short in the system. The lapse of time between fuse changes is controlled by the tension or a binder pin against the shaft.

Runner Cannot "Jump the Gun" Equipped with Ground Plate

Jumping the starting gun in a foot race is impossible with an electrical apparatus demonstrated at the Amateur Athletic Union convention. If the runner lifts his hand prematurely from the pad, electrical contact with the gun is broken, preventing it from being fired.



Gun will not fire if the runner breaks the electric contact by lifting his hand from the pad too soon

3-19-41
Lucille
8:30
12 na St Milwaukee Wis
1454
Kretzschmar \$25.00
Mr. No longer listed.
Very Gracious American Olympic Committee
H 1464
Lawson Robinson Olympic Track Coach
Judge Sam
Charles Penney
Manager, I and Amena
District
H 1467
H 229 833
Harry A. Johnson
309 50 N
Sacramento, Calif
John J. Magee
Disc in hands

Mr. ... Hillside Road, Guildford, Surrey, England.

Pilots Sit in Tails of Latest Fighting Planes

Airspeed Factory Tests on ...

Delanné ...

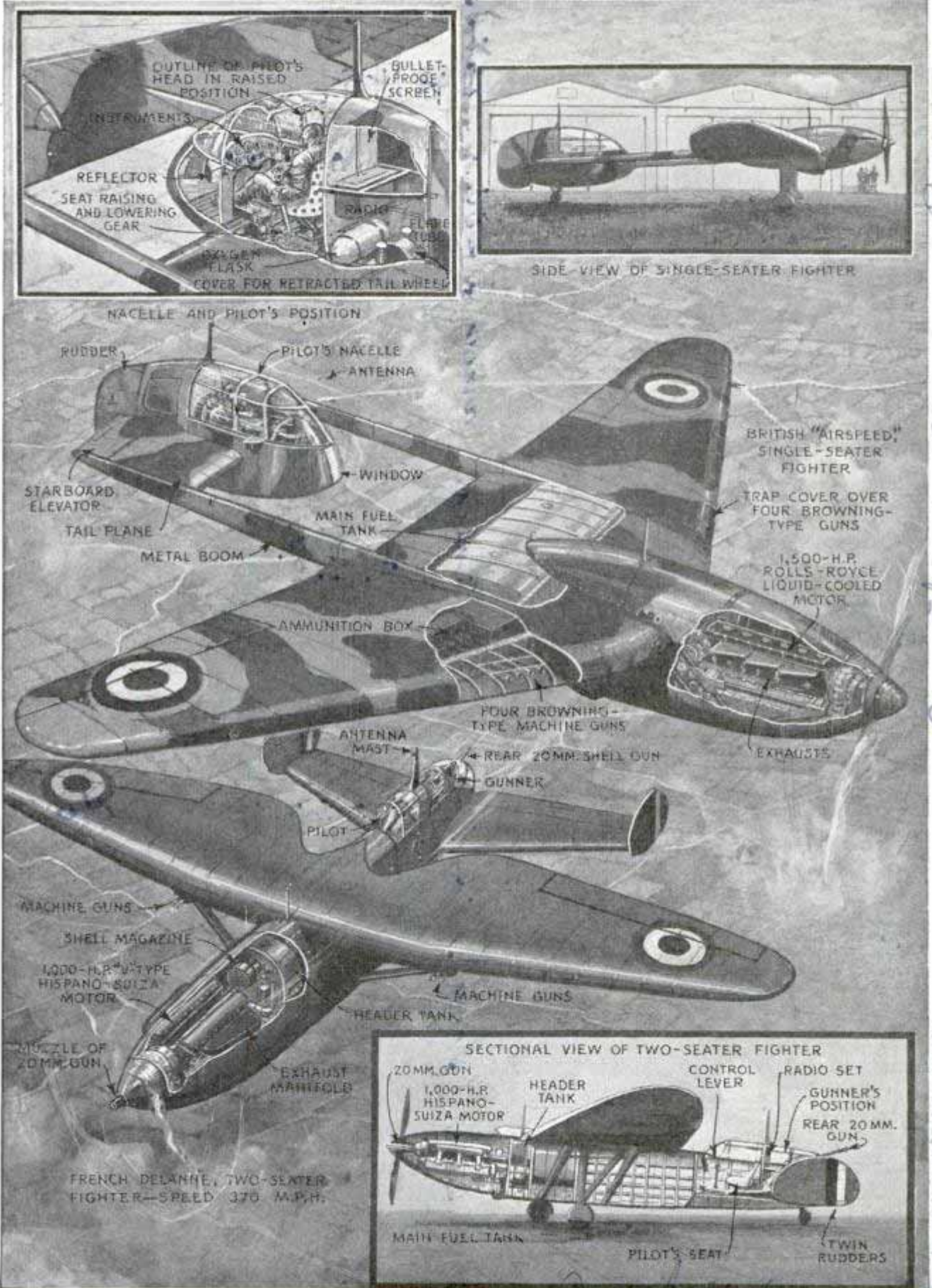

Here are two of the latest fighting aircraft. Top, the British single-seater has wide visibility and its pilot sits in the tail. Below, the French two-seater has pilot and gunner sitting in the tail. Its armament includes shell-firing cannon. Both ships are fast, the French plane being rated above 370 miles per hour

Delanné ...

Tandem Bikes Are Coupled Making Striking Float



Four of the riders supply all the power needed to propel this float made by combining two tandems

Two tandem bicycles have been coupled together to form an easily maneuvered float for use in parades. Mounted on a bracket between them is a single bike to carry an extra rider. Motive power is supplied by four persons astride the tandems. Fully loaded with riders, radio and decorations, the float weighs about 800 pounds.

Electrons Bouncing Off Metal Predict Surface Wear

Long sought because of its importance in almost every phase of engineering, an electronic method of predicting the wear of metals in rails, bearings and other machine parts has been found by research engineers of Westinghouse Electric and Manufacturing company. The electron is well adapted to studies of mechanical wear, because, unlike X-rays, it is easily deflected by the atoms in any material it strikes and penetration is limited to the surface layers. In practice a beam of electrons moving at a speed about half that of light is bounced

off the surface under examination, and the direction of the diffracted rays leaving the surface is recorded photographically. The structure of the surface may be determined from this pattern.

Automatic Timer for Darkroom Works Like Dial Phone

Both hands are left free for "dodging" and careful control of the printing when a photographer uses an automatic darkroom timer that dials the number of seconds



exposure. Operated like a dial telephone, this timer is cut in on the light circuit of the enlarger. After focusing, you dial the number of seconds and the light is automatically turned on for the proper interval.

Pedal Converts the Bathinette into Baby's Dressing Table

Converting the baby's portable bath into a dressing table is done by a foot pedal on the latest models. Without taking her hands from the baby, the mother steps on the pedal and a canvas frame is drawn over the rubber tub and locked in place.



Stepping on foot pedal brings canvas table over baby's bathtub and locks it in that position

R. E. Knorr, Lynnwood, Calif.

Central Camera Co. 200. X. Wabash Chicago

Dr. J. C. Tschirsky, Research engineer

Dr. J. C. Tschirsky

#1461

#10-00

#1418

#1510, 576 etc

Baby Bathinette Corp.

RADIO



SET "REMEMBERS" TO TUNE IN

NOW you can "pre-select," hours in advance, as many different programs as you wish, and then go away and forget your radio. This receiver automatically turns itself "on" and "off" and changes stations on the hour, half hour or quarter hour. You can also leave the same station on for several hours at a time if you so wish.

The time-tuning dial is shown in photo Fig. 1. This dial is combined with a self-regulating electric clock which changes each station all day long and "remembers" to tune in the



programs you wish to hear. If the set is operating it can be turned off by merely pressing a button; to cancel all previous station settings it is only necessary to swing the clock finger dial to the left. The set can be operated directly by pushing buttons on the dial, and the clock does the very same thing by closing switches inside.

Referring to the list of programs in her daily newspaper, the young lady is "pre-setting" her radio for the entire day. A small red indicator, or pointer, on the time scale is turned to the time the desired station is to be tuned in; the station is then dialed much in the same manner as you would use a dial telephone. Settings for all listed programs are thus made. Photo Fig. 3 shows the mechanism back of the clock face.



1939 LITTLE GIANT *Portable*

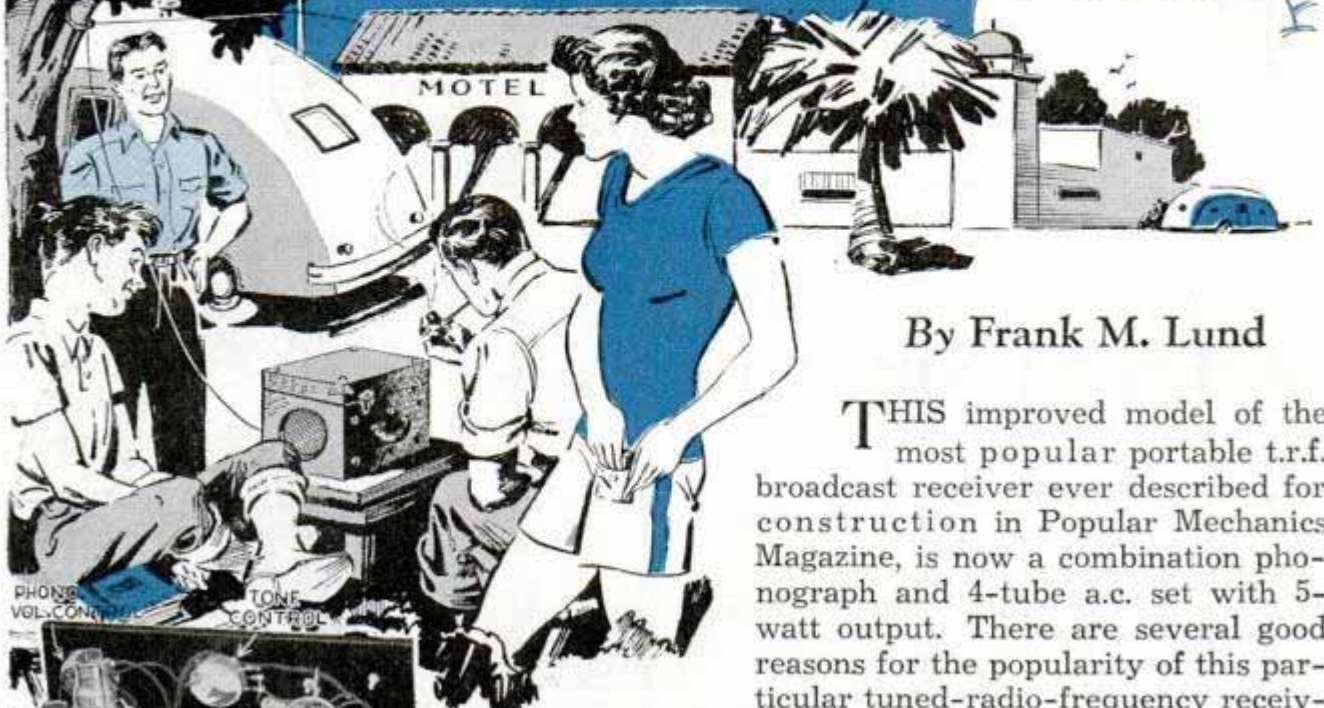

By Frank M. Lund

THIS improved model of the most popular portable t.r.f. broadcast receiver ever described for construction in Popular Mechanics Magazine, is now a combination phono-graph and 4-tube a.c. set with 5-watt output. There are several good reasons for the popularity of this particular tuned-radio-frequency receiver circuit;

it makes an excellent inexpensive general-purpose portable broadcast set that is easy to build, has distance-getting ability, adjustable tone control and surprising volume. A beam-power tube in the final stage of the new model provides ample output for a 6-in. dynamic speaker and the volume is all that could be desired for both radio and phonograph-record reproduction.

Easily portable and all a.c. in operation, it can be used wherever a 110-volt, 50 to 60-cycle line supply is available. The phono-radio combination provides entertainment and dance

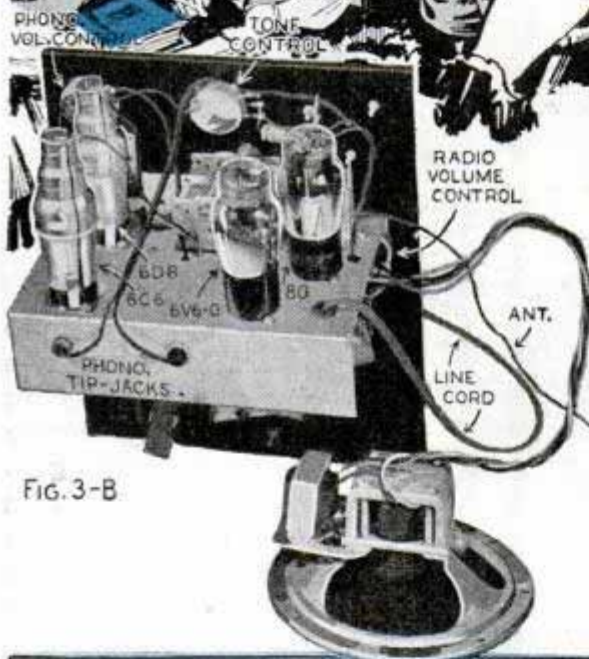

FIG. 3-B

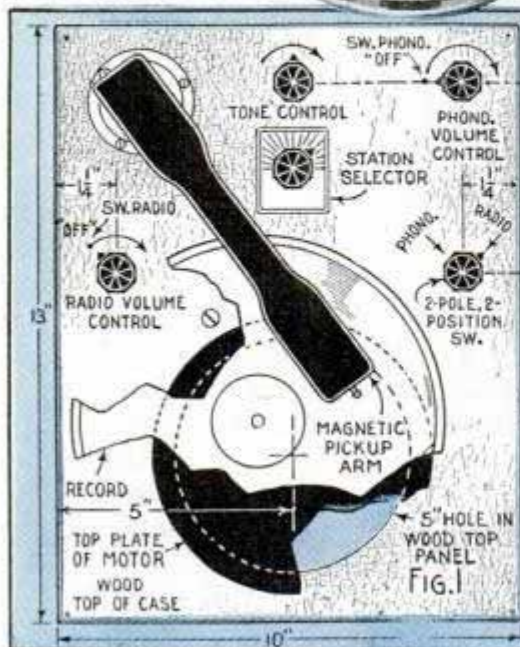
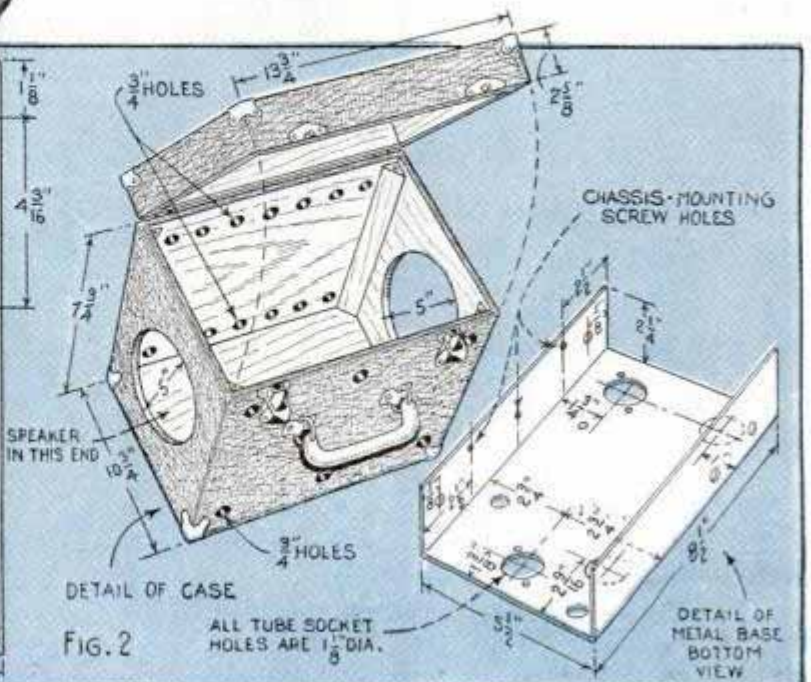

FIG. 1



DETAIL OF CASE

FIG. 2

ALL TUBE SOCKET HOLES ARE 1/8" DIA.

T.R.F. PHONO-RADIO

music for small groups in locations where large receivers would not be practical, and phonograph records may be played and amplified when broadcasting stations leave the air. Complete in every detail, it weighs only 16 lbs., and operates on a 20-ft. antenna.

Readers who built former models of the receiver will note that the same types of antenna and r.f. coils are employed, the main changes being in the output stage and the power transformer which replaces the line-cord resistor. This transformer furnishes power for the self-starting induction-type phono motor and the radio set. The phono motor is provided with an 8-in. felt-covered turntable, which turns at a constant speed of 78 revolutions per minute, and plays all sizes of commonly used records.

(Continued to page 136A)



FIG. 3-C

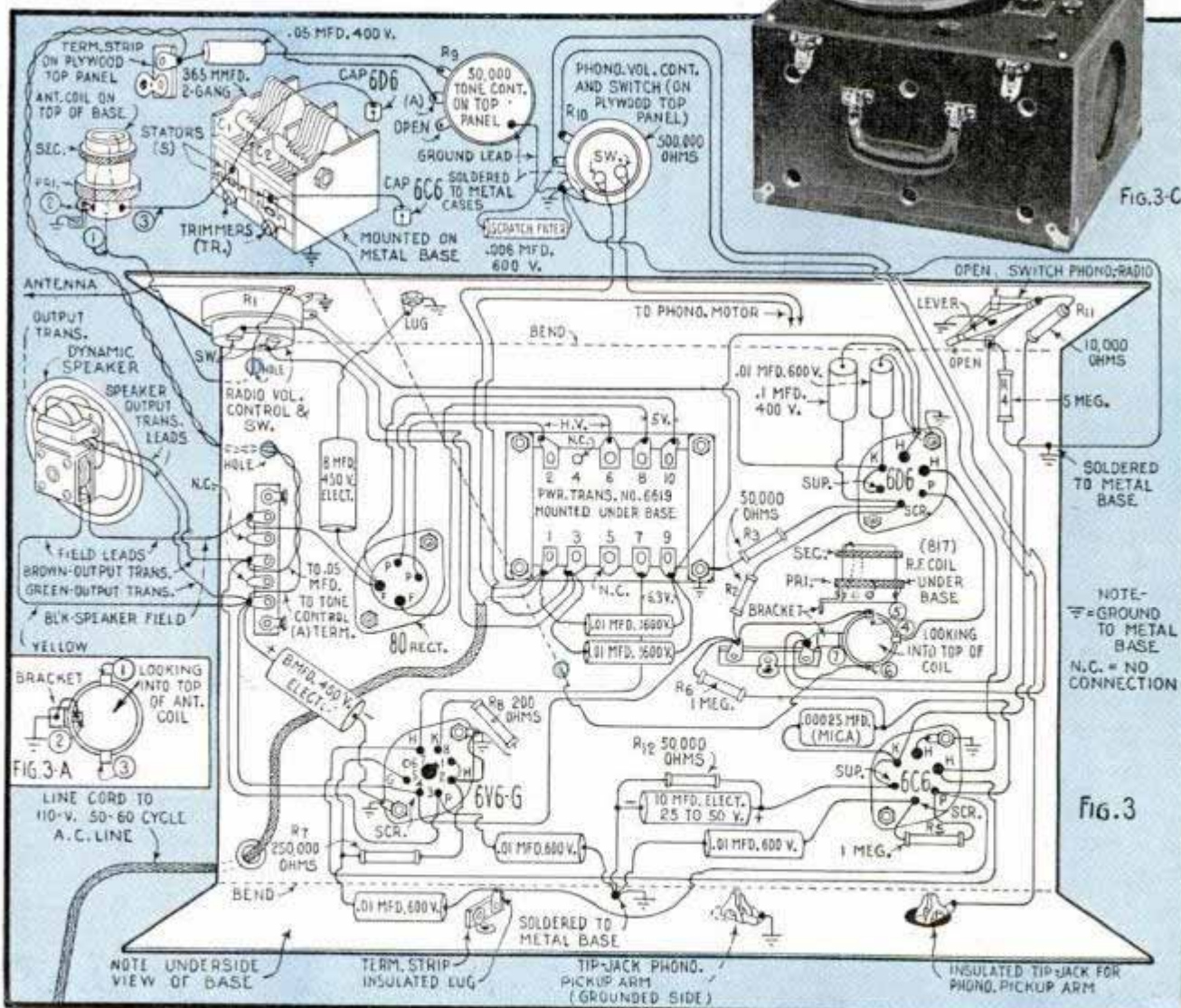

Preselector Unit for Any Short-Wave Receiver



YOU can separate and bring in those hard-to-get stations with this preselector which employs a Browning 5-H foundation tuner unit and a Raytheon-1851 high-gain television-type tube, in a simple regenerative circuit that requires only a handful of parts.

The tuner unit is designed to cover the 10, 20, 40, 80 and 160-meter bands and each coil has its own band-setting trimmer condenser. A two-deck switch permits band selection at will. The 35-mmfd. condenser is common for all coils. It is necessary to adjust the band-setting trimmers (C_2) for the length of antenna used. Only one of the five coils supplied is

shown in the schematic circuit diagram, Fig. 1. Those having supers with a wide 20-meter band, can use this preselector for 10-meter operation, provided the intermediate frequency is not higher than 500 kc.

Only four soldered connections are necessary to connect the tuner unit in the simplified hookup shown in Fig. 2. These connections are all completed in the photo at lower left. The value of the 20,000-ohm resistor may have to be increased or decreased for smooth regeneration control on all five bands.

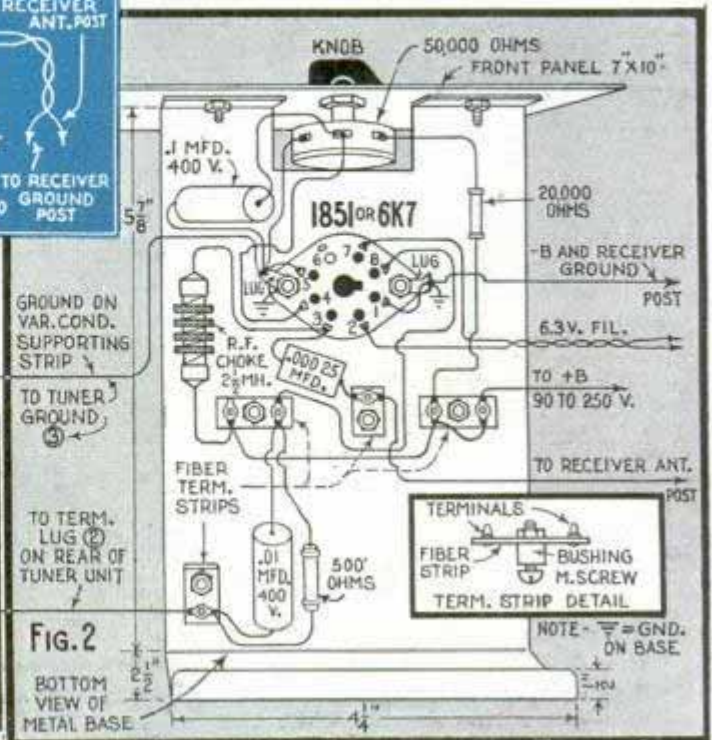
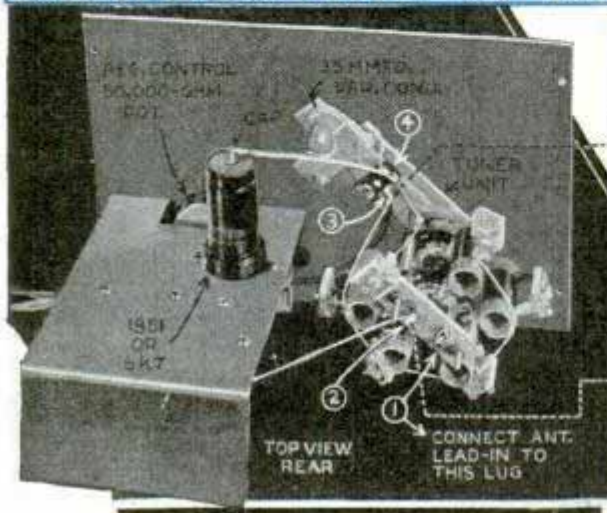
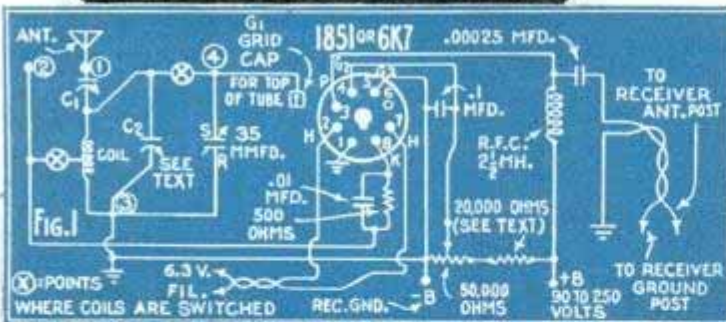
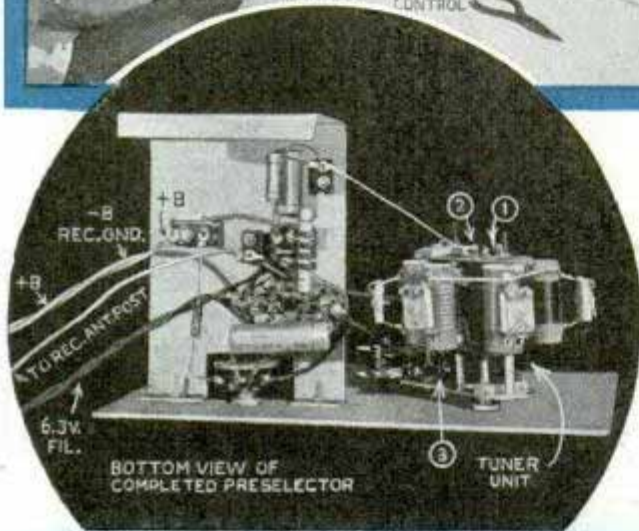

*Natural Company
 One 61 Sherman
 Malden Mass*

Practical RADIO HINTS



Extension speaker of "universal" type installed in kitchen by means of an insulated single-wire line from plate terminals of output-tube sockets in receiver; circuit is completed by connecting ground post of set, and extension speaker to a cold-water pipe. Speaker-housing details in Figs. 1 and 1-A. Fig. 2, hookup for single tube

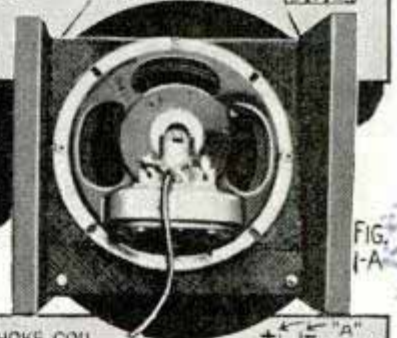
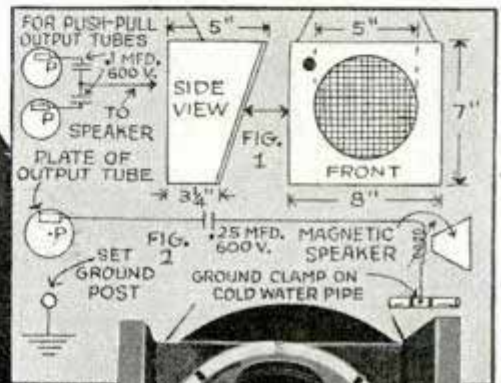
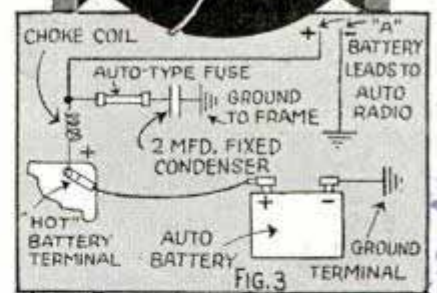
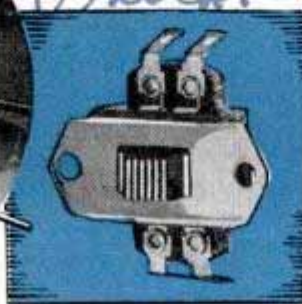
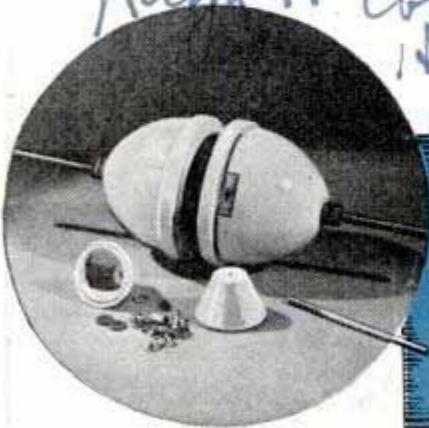

Diagram Fig. 3 is an effective method for eliminating ignition interference in an auto set when all other means such as shielding and suppressors fail. Choke is made by winding from 25 to 50 turns of No. 14 double-cotton-covered wire on a form 1/2 in. in diameter and about 3 in. long. Fuse prevents shorting battery if blocking condenser fails. Lower left, Steatite bushings for bringing high-frequency voltage through partitions; small ones are also used to support coils. Right, slide switch useful for tone controls or change-over circuits. Fig. 4 illustrates a safe method for grounding receivers of the a.c.-d.c. type which have no ground posts or provision for a chassis ground. A .5 mfd. paper-type condenser is connected in series with a lead fastened under a screw on the chassis base, the other side of the condenser being attached to a ground clamp on a cold-water pipe



*Arch H Eby, Inc. 2066
 Downing Park Ave.
 Phila.*



Portable Set Is Self-Powered



No antenna or ground wires are required for this self-powered battery-operated receiver as the antenna wire is built into the set itself. The dry-cell "A" battery will serve for 250 playing hours before replacement is necessary. Broadcast receivers of this description are suitable for sportsmen, vacationers and travelers away from power lines.

Line Noise Analyzer Saves Time

Connected between the noise-producing electrically operated appliance and power line, or between the radio receiver and

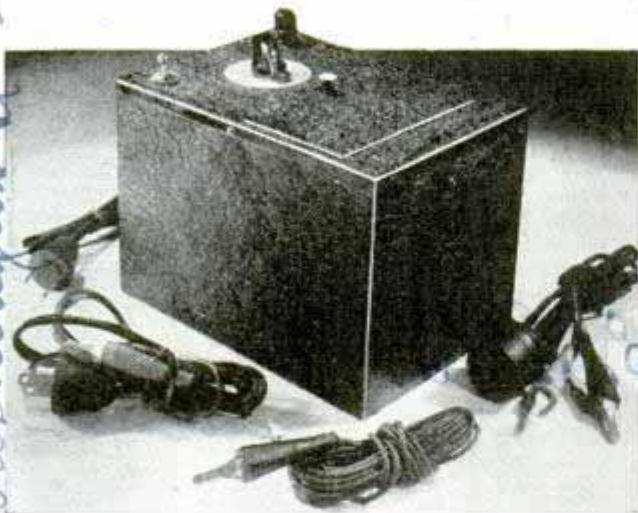

line, various forms of noise-filter arrangements can be tried out quickly by merely rotating a selector switch on this compact portable device. Attachment cords and connectors provide for test connections and grounds. When noise is reduced to a minimum, the analyzer indicates the standard type noise filter to use in duplicating the same setup, thus eliminating guesswork and loss of time.

All-Purpose Mobile Sound System

Operating either from a 110-volt a.c. line or a car battery, this versatile public-address system is suitable for street-corner, mobile or indoor applications; its 30-watt normal output is ample for good-sized crowds. It consists of a 9-tube ampli-



fier in a steel carrying case and two 12-inch permanent-magnet loud speakers with aluminum dome baffles. The unit includes a phonograph turntable and pickup, generator for battery operation and receptacles for speaker, microphone and power plugs.

Blueprints covering radio construction articles in this and past issues are available for 25 cents each; original material lists and additional information can be obtained from our Radio Department without charge upon receipt of postage.

NEXT MONTH—How to Build a Low-Cost Progressive Three-Unit Broadcast Receiver. Designed especially for student beginners; employs three of the latest 1.4-volt tubes; works on one No. 6 dry cell and two 45-volt midget B-batteries. Also—**How to Operate Up to Twenty Receivers on a Single All-Wave Antenna**

Philco Radios & Television Corp.
 3701 N. Broad Philadelphia
 Aerovox Corp. 70
 Washington D.C.

Ignorance repairs
 Service Co. Inc.
 100. 6th Ave New York

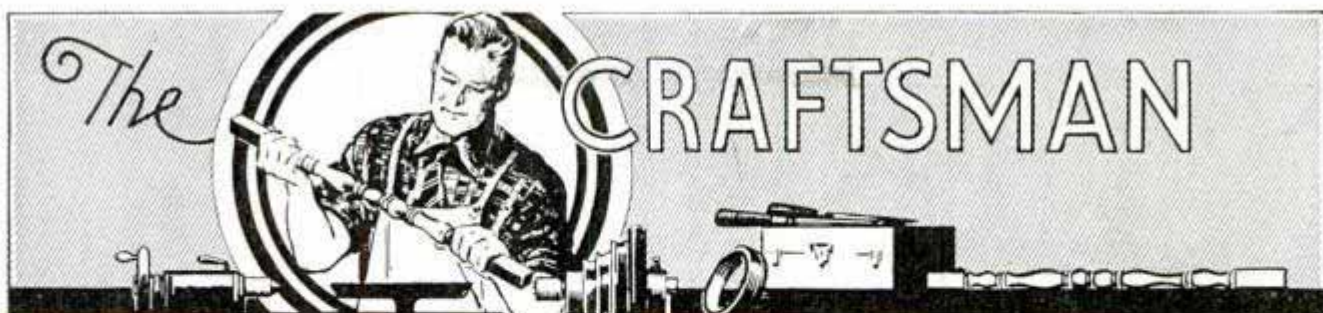

NEW FRAMES

for your pictures

Two types—one raises the picture in relief out from the wall while the second, having mirrored sides, gives sunken effect

By W. C. LECKEY

MOUNTED in either of these two stunning frames your pictures will stand out strikingly among modern furnishings. The molding for the frame pictured in Fig. 2 is cut and assembled as shown in Figs. 3 and 4, from strips of white pine. The saw groove for the glass inserts, which is cut at a 60° angle, and the rabbeted edge for the picture glass are cut before gluing and nailing to the beaded side pieces. Then the molding is mitered to corresponding lengths, after which it is glued and nailed together at the corners. If equipment is not at hand to run the 1/4-in. beads around the outside of the frame, Fig. 4, you can leave this plain. For the inserts, you can select either silver, blue or black mirror glass. You can make the latter from clear glass as follows: After the glass has been cut to size,

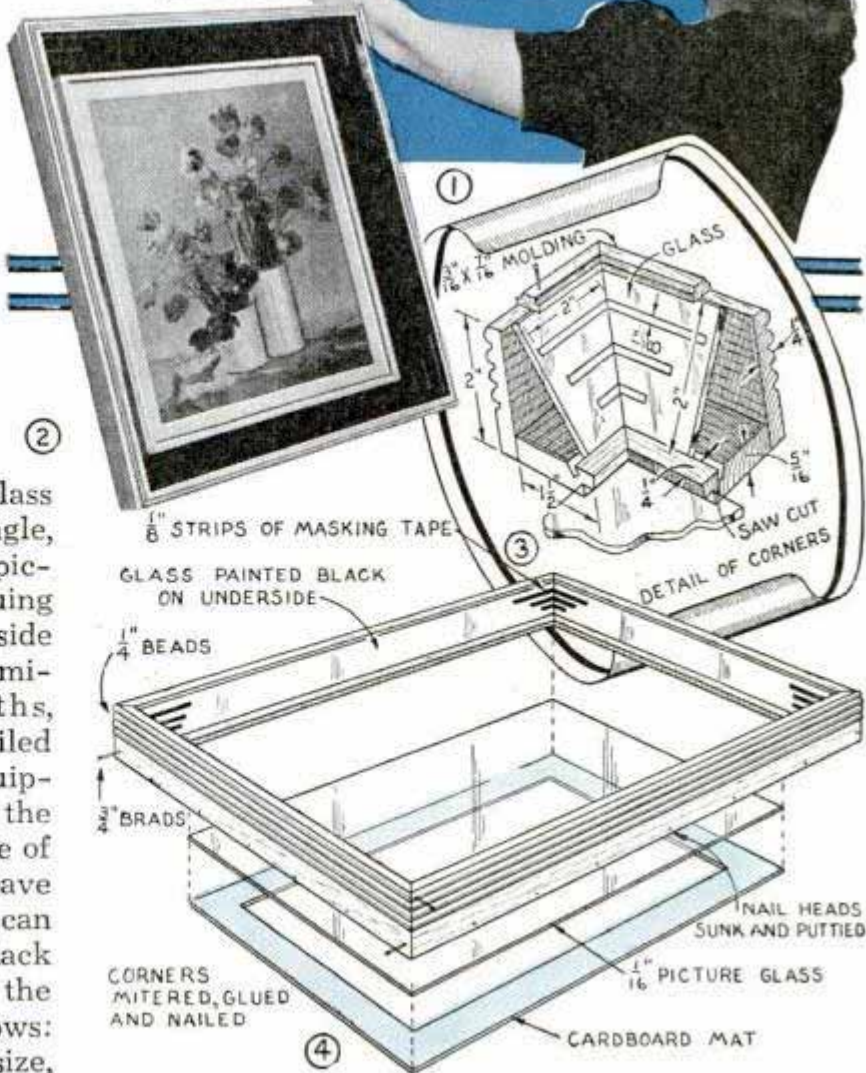

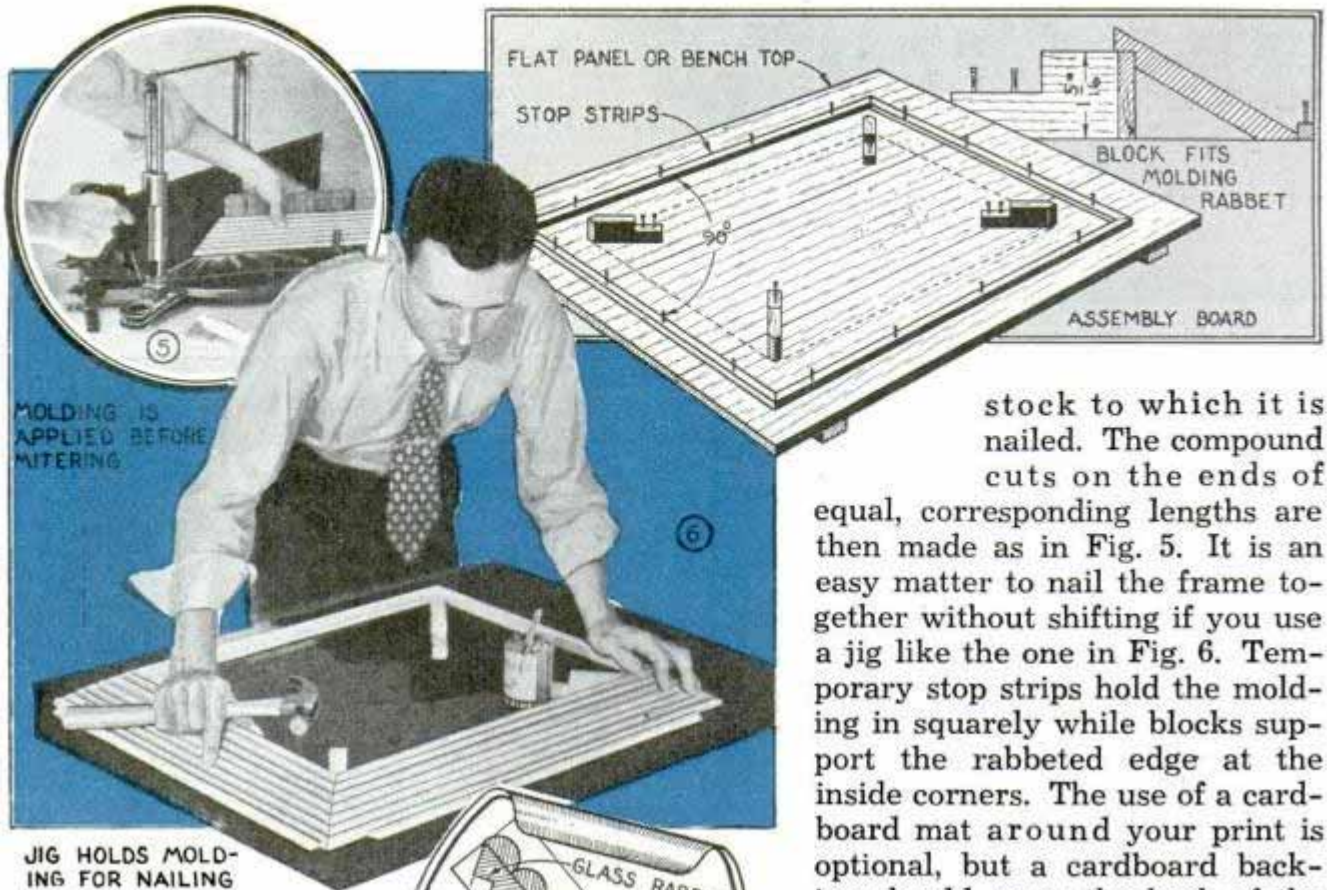

JIG HOLDS MOLDING FOR NAILING

apply strips of masking tape to corners on the underside as in the suggested pattern. Then give the underside two coats of black enamel. When dry, cut around the masking tape carefully with a razor blade, remove the tape and fill in with gold paint. A template of cardboard will be helpful in cutting the glass to butt together accurately at the corners. An overhanging strip of narrow molding glued to the top edges of the frame keeps the glass in place. Two coats of bone-white enamel are then applied.

The frame pictured in Fig. 1 can, of course, be made larger than dimensions indicated in Fig. 7. Essentially, this frame is made up by gluing strips of 1/2-in. half-round molding to a 1/2-in. underframing. You will note in the detail above Fig. 7 that seven strips of molding laid side by side equal the width of the

stock to which it is nailed. The compound cuts on the ends of equal, corresponding lengths are then made as in Fig. 5. It is an easy matter to nail the frame together without shifting if you use a jig like the one in Fig. 6. Temporary stop strips hold the molding in squarely while blocks support the rabbeted edge at the inside corners. The use of a cardboard mat around your print is optional, but a cardboard backing should cover the back of the frame as in Fig. 8, to keep out dust and moisture.

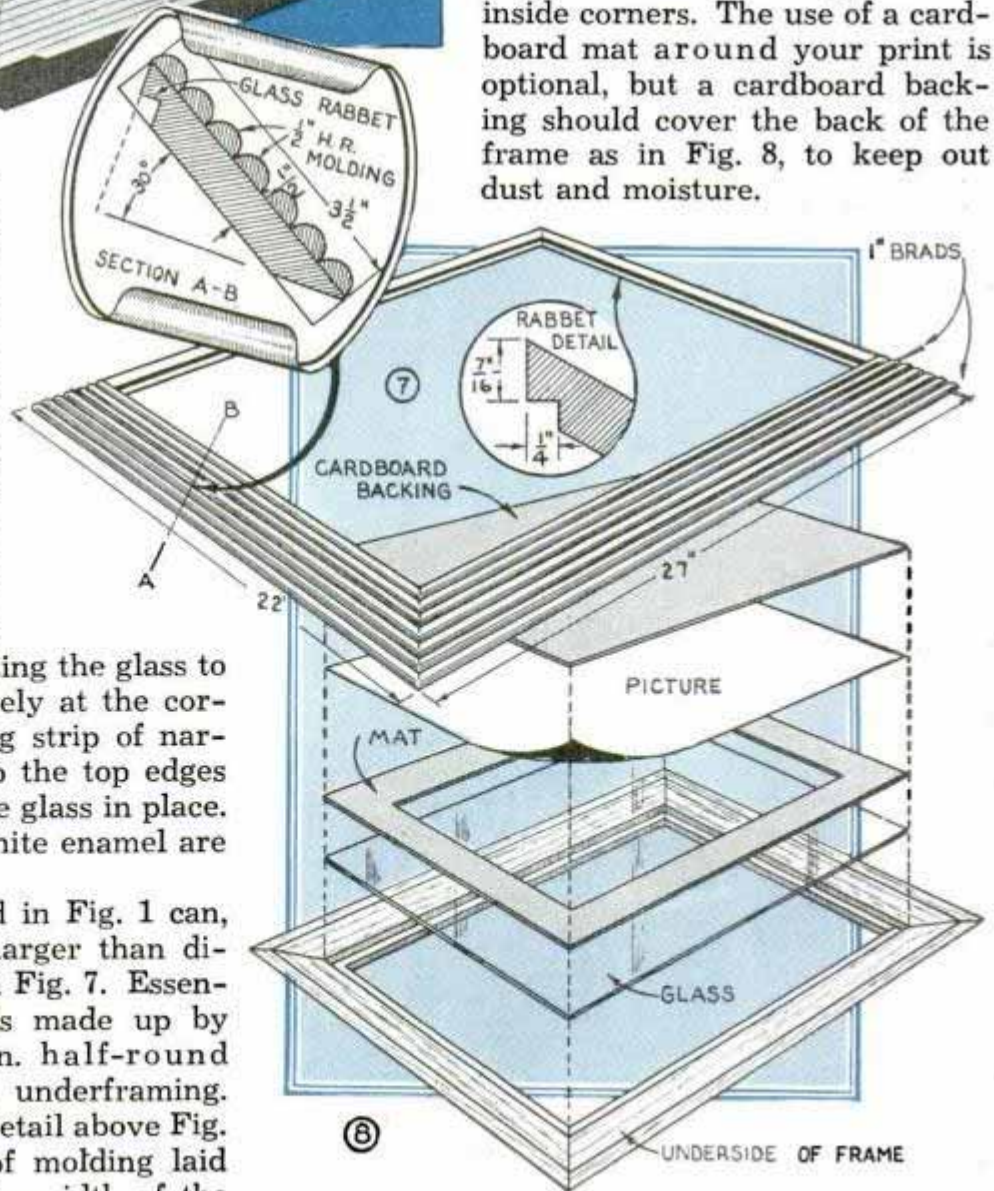

⑧

Camera Elevated Above Crowds by Periscope

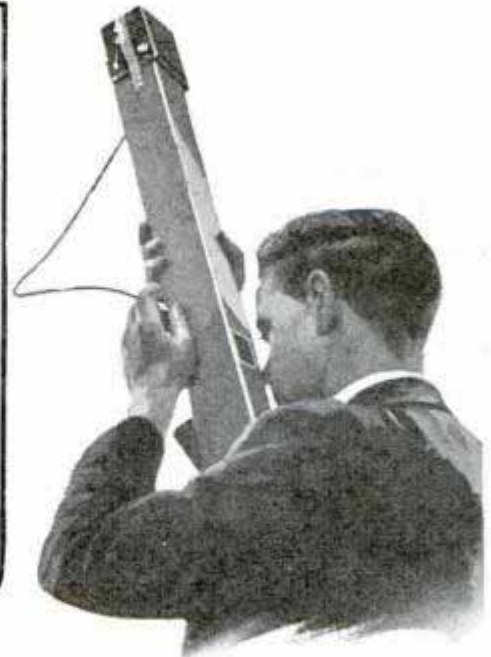
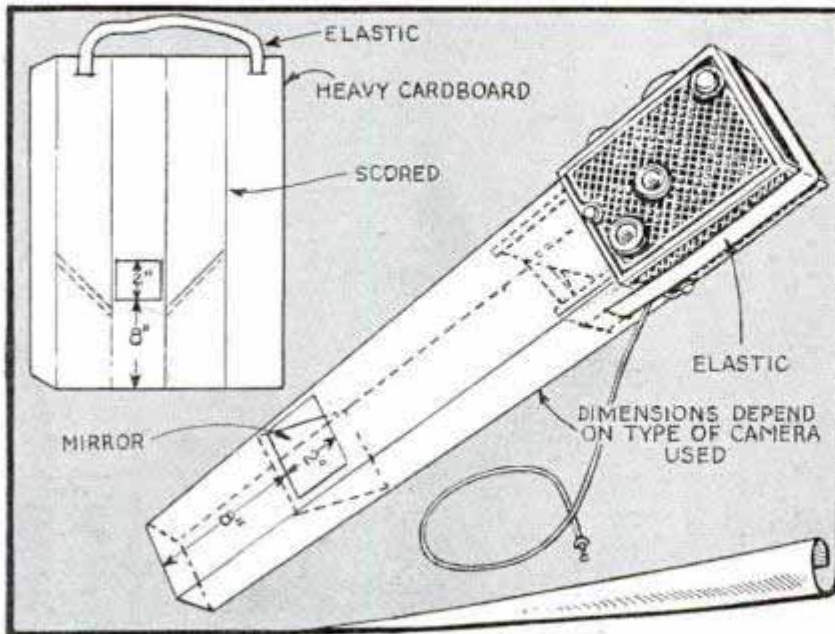

Photographers who favor small reflex cameras, which are of little use in a crowd or other places where objects interfere with waist-high aiming of the lens, will find that this simple periscope solves the problem. It consists of a rectangular tube and a small mirror. Heavy cardboard or other suitable rigid material may be used for making the tube. The upper end fits the camera focusing hood snugly to exclude light, and the tube tapers slightly

toward the lower end. About 8 in. from this end, a small mirror is set at a 45° angle behind a 2-in. opening in one side of the tube. Small wood strips glued to the inside support the mirror. Any object showing on the camera ground glass is visible on the mirror through the opening. An elastic band fastened to the tube holds the camera in place. The shutter can be operated with a string, although a 2-ft. cable release is preferable.

Paint Burned Out of Empty Pail Without Damaging Metal

Large paint pails, which are often made of steel, provide handy containers around the farm or shop when cleaned inside thoroughly. To do this easily, first scrape the inside to remove as much paint as possible. Then set the pail in a tub of water with a weight in the bottom to hold it down, and drop a lighted newspaper inside. The paint residue will ignite and burn away entirely without melting soldered joints. Water surrounding the pail protects it against excessive heat.

White-shoe cleaning paste of the type that comes in tubes is a good substitute for white poster paint; when thinned with water, it is efficient and is less expensive than regular poster paint, especially when used in large quantities, or to cover large surfaces.



Clothesline Support of Pipe Is Neater Than Wood



Disliking the appearance of a heavy wooden post to support a clothesline, I made some supports from $\frac{3}{4}$ -in. pipe. Each one consists of three pipes assembled in a triangular shape and fitted together at the top by means of elbows, tees and nipples. The bottom of each support is set in a sunken nail keg, which is filled with concrete to anchor the pipes.

—C. M. Lyman, New Hartford, N. Y.

Dispenser Measures Polish



To obtain uniformity in polishing ferrotypes, a photographer uses a bottle which automatically measures the exact quantity of polish required each time. A glass tube, such as a sipper, is cut off so that it holds ex-

actly the amount of polish required for each tin. Then the tube is bent at the lower end and inserted into the bottle stopper so that it just clears the bottom of the bottle. When the latter is tipped up, the amount of liquid contained in the sipper is poured onto the ferrotypes.

Tin Cans Containing Small Parts Easily Identified

As cans used for storing small parts, nails and screws in the workshop are not transparent like glass jars often used for this purpose, one worker attached a sample of the contents on the outside. Some small items were fastened directly to the can with a drop of solder while larger items such as bolts were slipped through wire bent to form loops and soldered to the can. The samples can be removed readily, are easy to see and measure quickly, and the arrangement saves considerable time.

—Arthur M. Chester, San Diego, Calif.



Seedlings in Hotbed Shielded from Drip and Chill

In glass-covered hotbeds and cold frames, delicate seedlings are often beaten down or rotted by the constant drip water caused by moisture condensing on the underside of the glass. The use of a separate

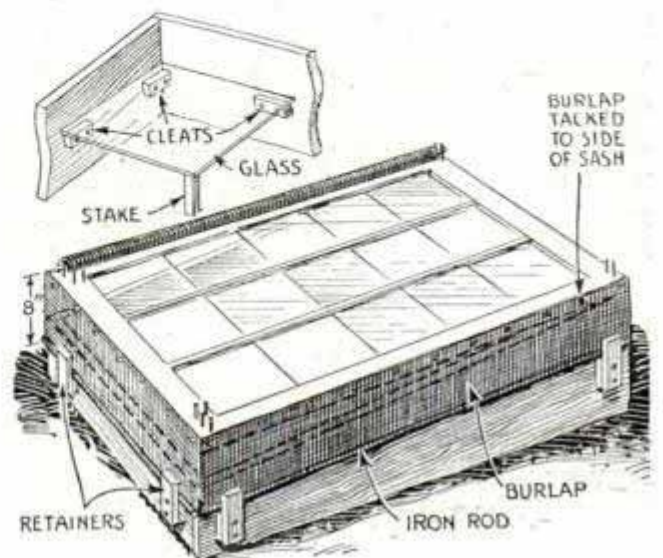

pane of glass mounted inside the frame, as shown in the upper detail, ends the nuisance. The inner glass remains at the same temperature as the confined air and will not sweat. As ventilating glass-covered frames are not always practical during cold or windy days, due to sudden chilling of seedlings, the sash may be raised from one to several inches, by using a burlap curtain as shown in the lower detail. Then the escape of warm air and entrance of cooler air are retarded, thus bringing to the seedlings a gradual change of temperature. The top edge of the curtain is tacked to the sash and a hem at the lower edge of the curtain incloses a rod or pipe to serve as a weight. Cleats on the frame keep the curtain in position.

—Robert Stahler, Portsmouth, Ohio.

Bridge from Old Car Frames

A pedestrian bridge in a Nebraska state park is supported on old car frames, which have been stripped down and placed on end. The cross member of each carries steel rails, which support the bridge planks. The frames extend well above the walk proper so that guard rails are installed easily.

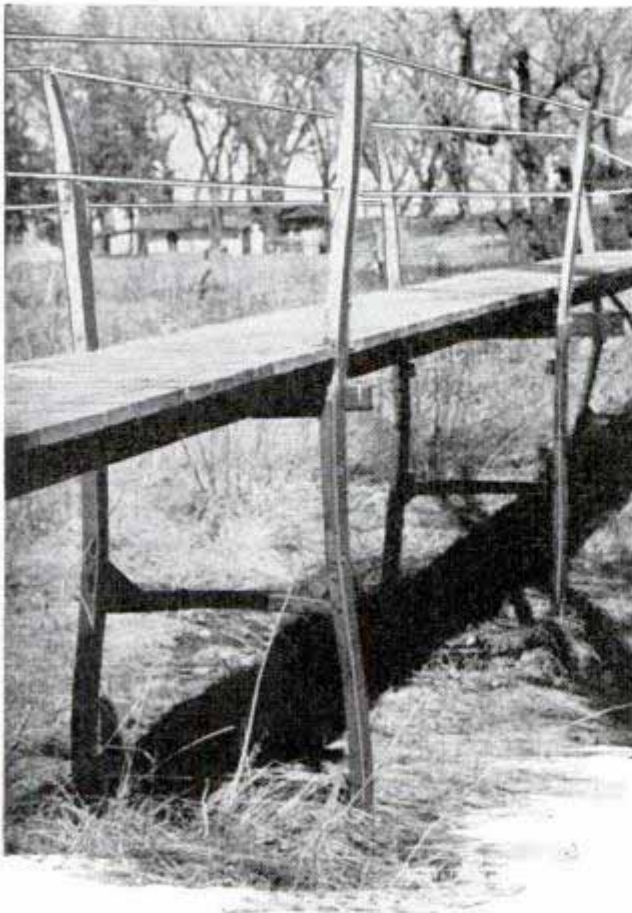

Changing Jig-Saw Blade Is Easy with Block of Wood

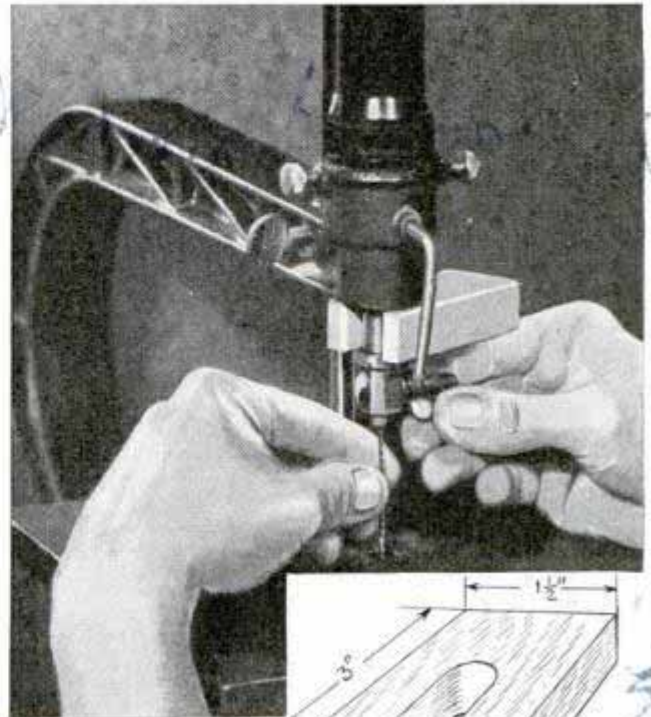

THICKNESS FOR DESIRED BLADE TENSION

TO FIT SHAFT

Users of jig saws who have wished for an extra hand when changing a blade, will find that a block cut as indicated will hold down the spring-loaded shaft, leaving both hands to insert the blade and tighten the locking screw. Thickness of the block will depend on how far the shaft must be lowered to get the required tension on the blade.—Ralph T. Moore, Lakewood, Ohio.

Paper Tape Guides on Typewriter Aid in Manifold Work

Difficulty in typing a number of sheets of paper with carbons between them caused me to experiment with guides of gummed-paper tape stuck to the typewriter roller as indicated.

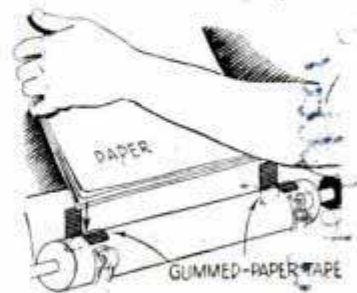

The tape was folded and creased so that half the length of each piece was free, forming a V into which the sheets and carbons were dropped before turning the roller to bring them into typing position.

—G. E. Hendrickson, Argyle, Wis.

A Pioneer FOOTSTOOL

*W.A. Ranch Co
410 S. Market Chicago*

*Wholesale of Thurston Supply Co
Anoka, Minn.
supplies small order*

ALL JOINTS ARE MADE WITH SCREWS & GLUE

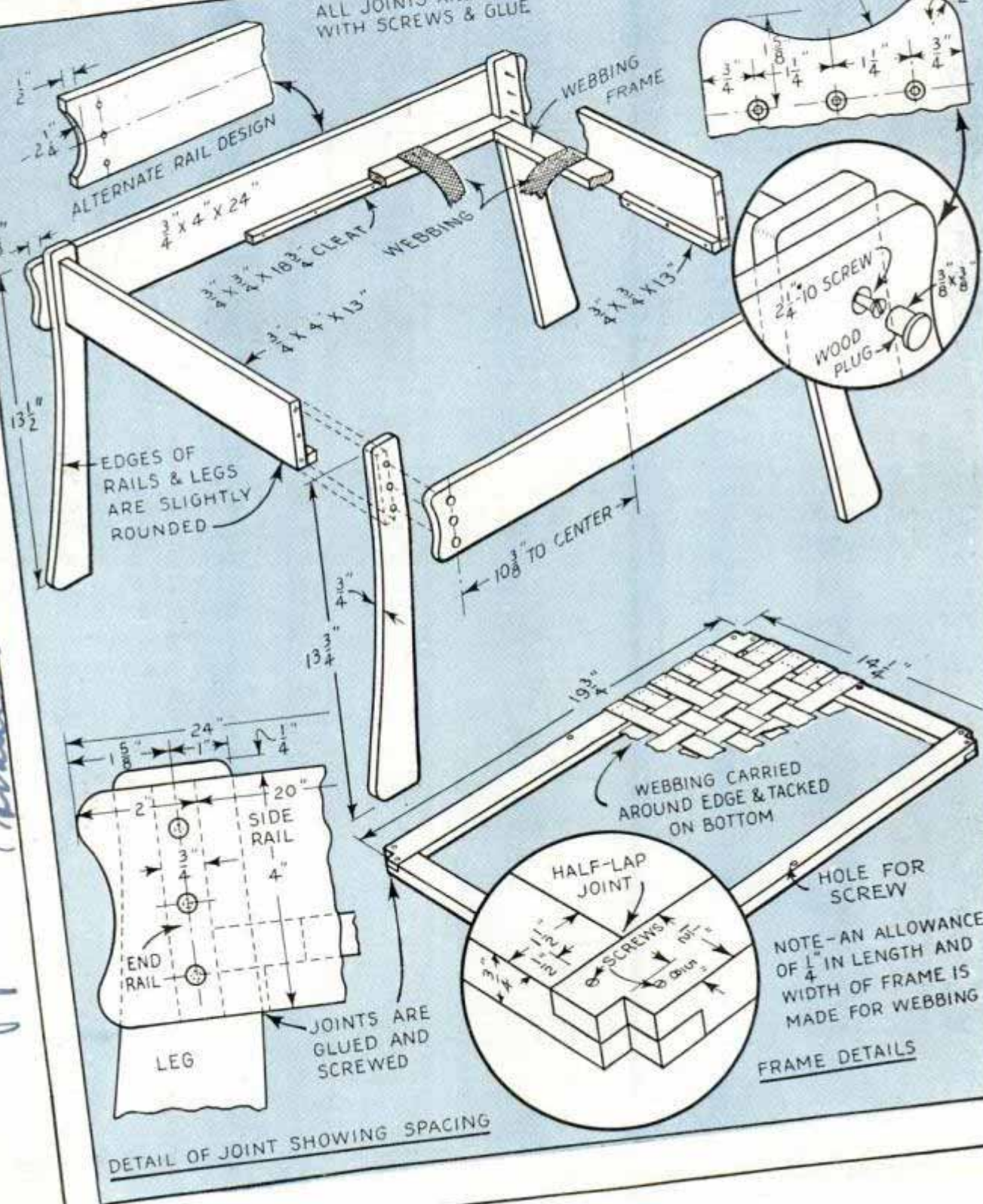

in Maple

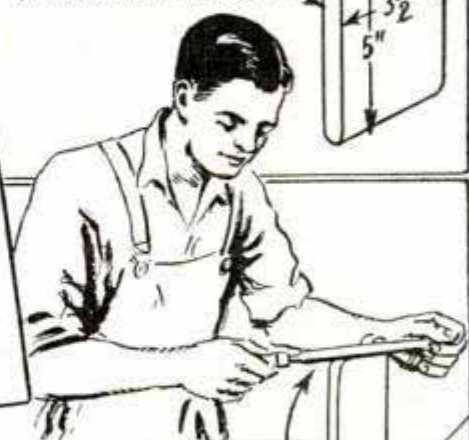
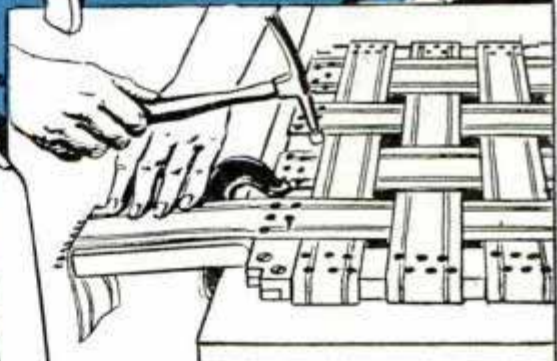
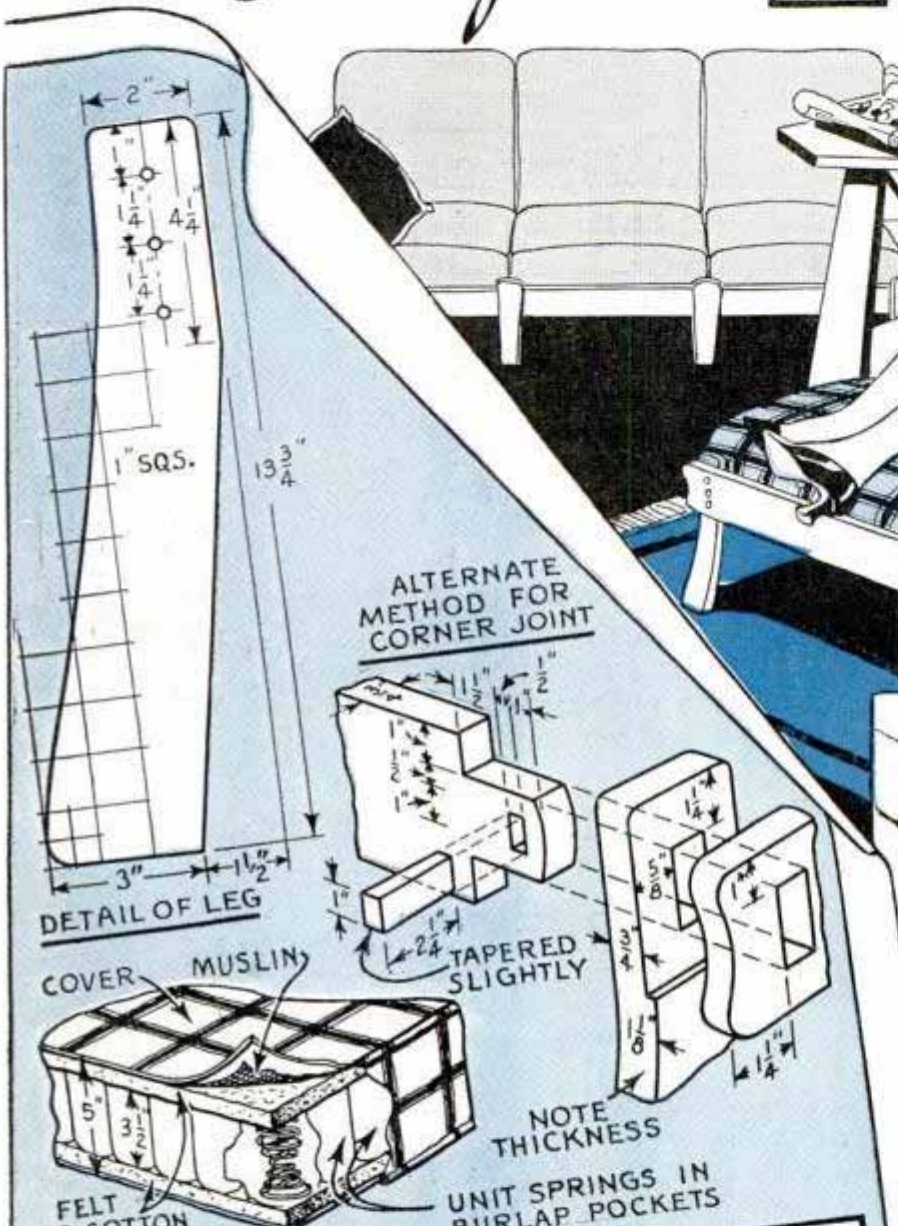

HALF-ROUND FILE

END DESIGN IS SAWED, THEN SMOOTHED WITH HALF-ROUND FILE

- LIST OF MATERIAL**
- 4 PCS. FOR LEGS 3/4 BY 4 1/2 BY 13 3/4 IN.—MAPLE
 - 2 PCS. FOR SIDE RAILS 3/4 BY 4 BY 24 IN.—MAPLE
 - 2 PCS. FOR END RAILS 3/4 BY 4 BY 13 IN.—MAPLE
 - 2 PCS. FOR CLEATS 3/4 BY 3/4 BY 18 3/4 IN.—SOFT WOOD
 - 2 PCS. FOR CLEATS 3/4 BY 3/4 BY 13 IN.—SOFT WOOD
 - 2 PCS. FOR FRAME 3/4 BY 1 1/2 BY 14 1/4 IN.—SOFT WOOD
 - 2 PCS. FOR FRAME 3/4 BY 1 1/2 BY 19 3/4 IN.—SOFT WOOD

Styled in a fashion so much in vogue at present, this footstool is the ideal companion piece for a wing chair. It's comfortable too, when used individually as a fireside seat, or as a radio bench. Simplicity of construction makes it an easy job for the craftsman who has only a few tools and limited spare time. The cushion spring unit can be obtained ready-made at a nominal cost and the work of covering it to make an attractive, removable cushion is a simple upholstery job

Non-Slip Surface for Rungs on Ladder

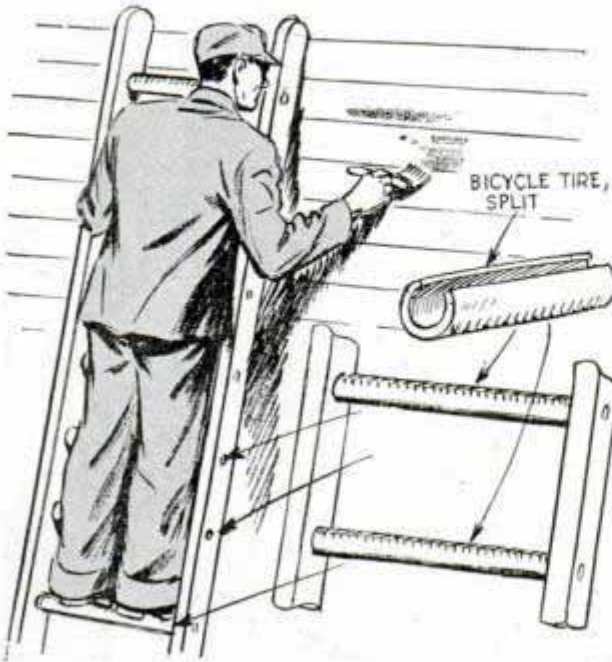

Danger of slipping while standing on a ladder, when your shoe soles are wet or muddy, can be reduced to a minimum by covering the rungs with pieces of old bicycle tires. Just slit the pieces on the underside and slip them in place. If the diameter of the tire is too large for the rungs, cut a strip from the underside.

—R. Moffatt, Brooklyn, N. Y.

Smoothing Inside of Wood Rings on Belt Sander

To sand inside surfaces of large wood rings on a belt sander set the ring on the belt, hold sandpaper against the inside surface of the ring, as shown, and start the machine. This rotates the ring, with the



inner surface receiving the abrasive action. By holding the sandpaper in a cup form in your hand, a wood ball can be sanded in the same manner. Care must be taken to hold the sandpaper to the side and top of the ball to avoid tendency of the ball to jump off the sander.

Rubber Disk Slipped on Flag Pole Shields Pulley Against Sleet

To keep ice and sleet out of the slot and pulley of a flag pole, one school janitor provided a shield cut from a piece of inner tube. When this was fitted snugly over the top of the pole to rest just above the pulley slot, it formed a cone-shaped shield which was found highly effective.

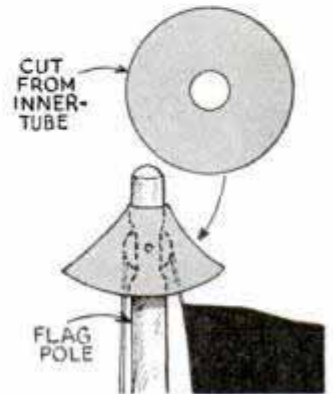

Turned "Bird Valet" Holds Pipe and Cleaners

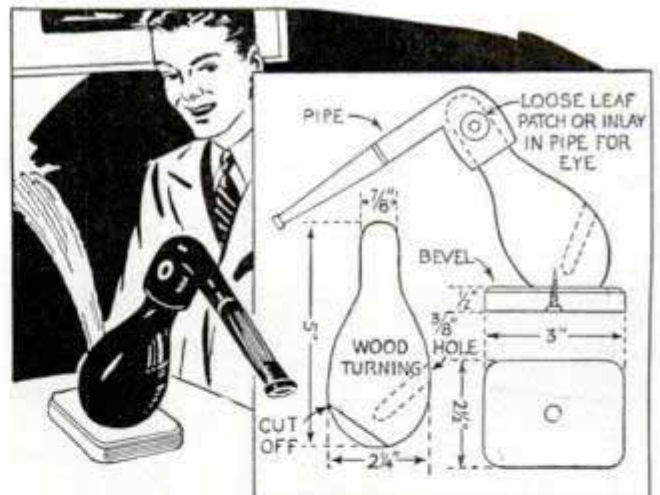

It takes both the pipe and the cleaners to complete this droll bird valet for without them he looks like nothing more than a miniature bowling pin. The pipe adds his head and bill, and the cleaners provide a tail. It takes only a few minutes to turn the body from hardwood on the lathe, drill the hole for the pipe cleaners, and mount on a base as shown. The latter can be enameled white and the body black. A linen loose-leaf patch or an inlay on each side of the pipe bowl forms the eyes.

Thurston Supply Co. Krenmpel Co. Sutterberg, Calif.

Design for TIME

WITH its red dial backed by a crystal ring, this colorful clock case is assembled from plastics, and makes a distinctive mantel piece. After jigsawing the figures in the dial, it is trued up on a disk sander, using a pivot pin as shown in the photos below, and cemented to the ring. The base of the case is a length of red plastic tube drilled to take two plastic rods as indicated, then cut in half and slotted to take the edge of the ring. The slot must be cut carefully to get a good fit. The clock is a small electric movement, which can be obtained from any clock dealer at a nominal cost. If specified when ordered, the hands that come with the clock will be of the proper length. If you already have a movement the hands can be shortened or lengthened easily with little trouble.

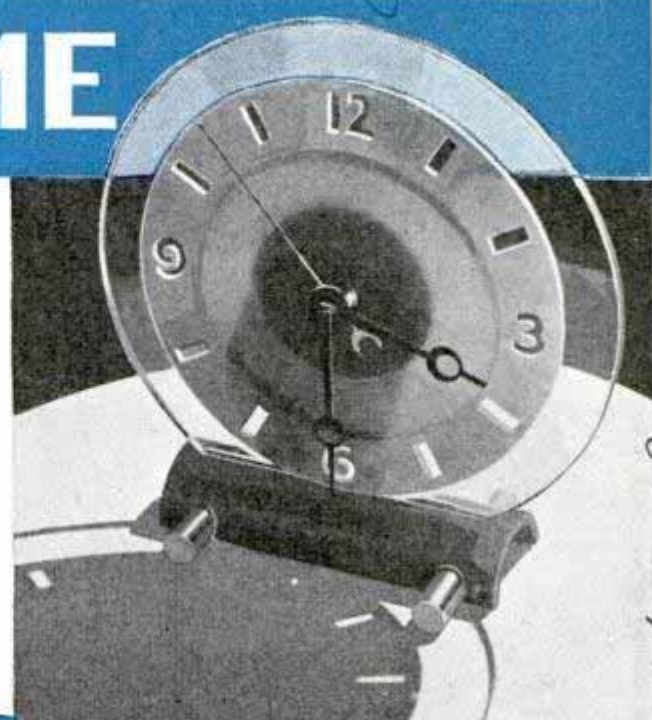

A SMART CLOCK IN COLORFUL RED & CRYSTAL PLASTIC

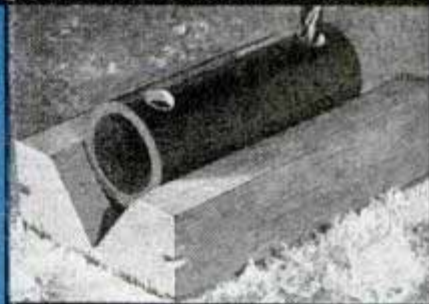
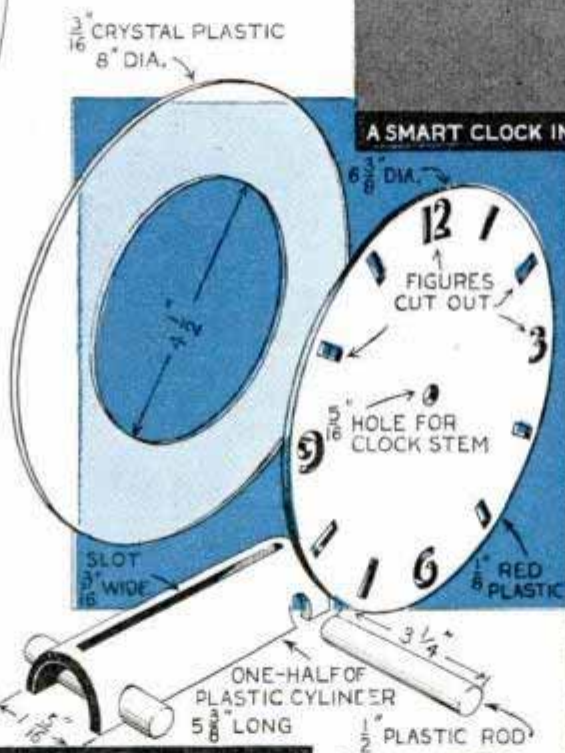

DRILLING HOLES FOR RODS

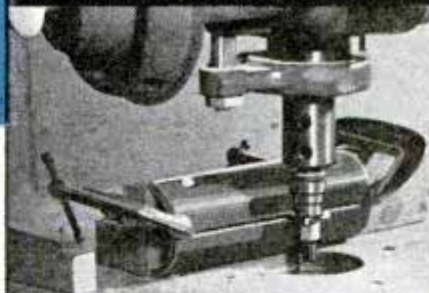

CUTTING GROOVE FOR CRYSTAL DISK

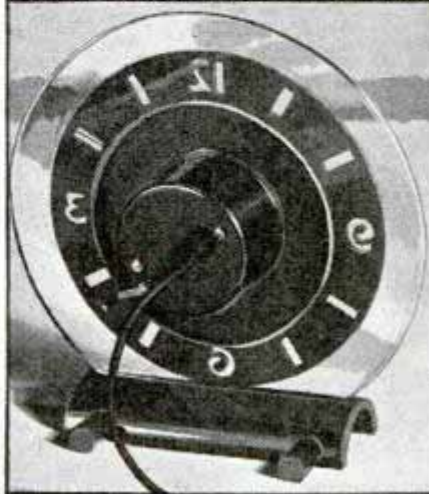
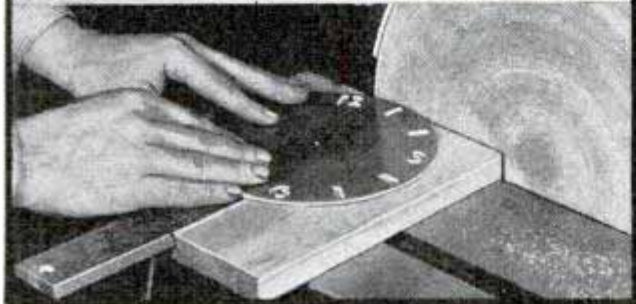
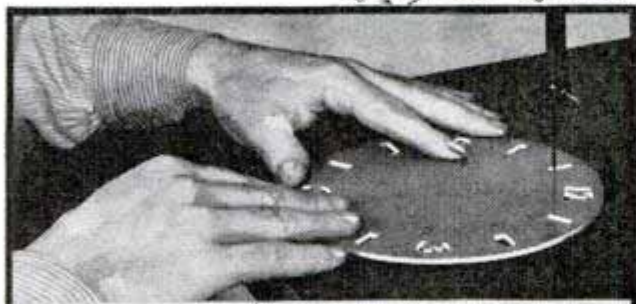

REAR VIEW SHOWING CLOCK

Caddy balls. Sutterberg? Krenmpel

Nails Clinched over Old File Can't Tear Clothing

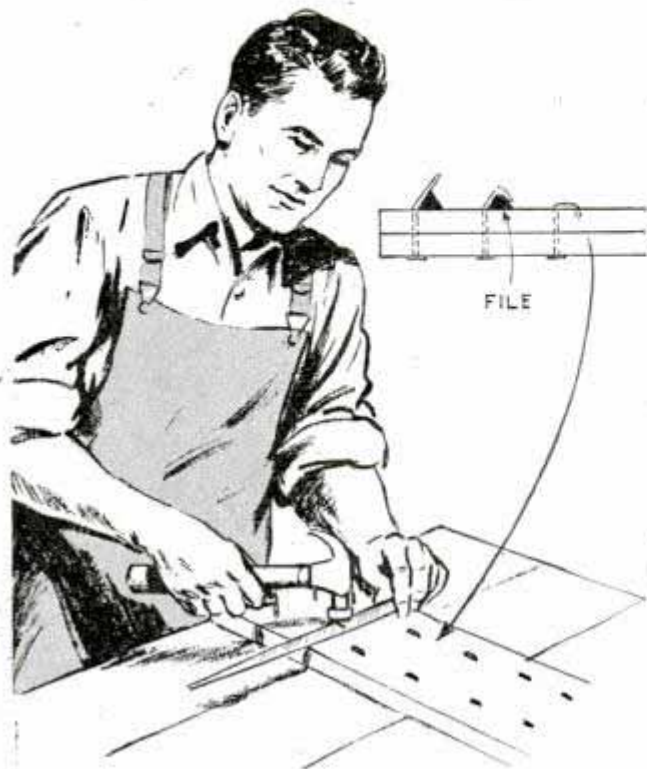

Nails clinched in the ordinary way on boxes, crates or doors which must be handled, frequently tear clothing or cause injury due to the projecting points. To prevent this and at the same time clinch the nail more tightly, bend the projecting point over an old three-cornered file and then drive the point into the wood.

Tip of Electric Soldering Iron Removed without Damage

Tight-fitting tips on electric soldering irons are frequently hard to remove without damage when the head is clamped in the vise and the tip is loosened with pliers or pipe wrench. To hold the tip immovable while unscrewing it, get a 12-point socket wrench head of suitable size and mount it on a wooden base by means of a short carriage bolt. Or, simply grip it in a vise. In use, you insert the tip into the wrench opening and, pushing down firmly to prevent the tip from slipping upward, turn it by the handle. The

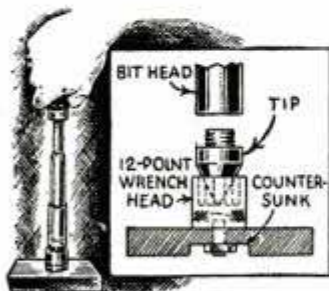

weight of the wood on the saplings will keep the anchor thus formed in position.

wrench head makes contact with all four corners of the tip. Do not use a hexagon wrench head as it will not fit properly.

—W. C. Wilhite, Carlinville, Ill.

Chemical Crystals Are Crushed with Safety Razor

Amateur chemists and photographers who have occasion to crush chemical crystals will find that the frame of a discarded safety razor serves nicely for the purpose.

The curved face of the razor permits it to be pressed down on the crystals with a rocking motion, thus doing a quick and effective crushing job.



Self-Latching Gate Fastener from Strap Hinge

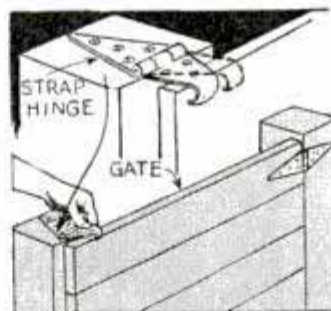

With one end bent over to form a hook, a strap hinge provides a good latch for a small wooden gate. When the latter is closed the latch automatically holds it. It's best to saw off the gate post flush with the top of the gate to support the hinge, or a block can be nailed to the side of the post.

Firm Anchor on Woodpile

There's no need to drive stakes in frozen ground to support piles of cordwood. Forked saplings are stuck between layers of wood and stout sticks are slipped through the ends as shown in the drawing. The weight of the wood on the saplings will keep the anchor thus formed in position.

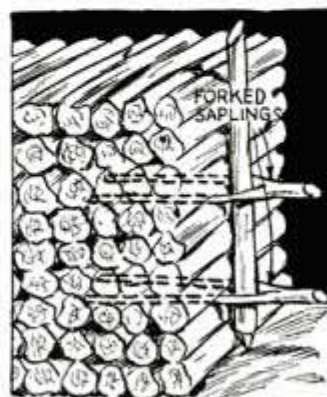

Streamlining Adds Snap to Sidewalk Scooter

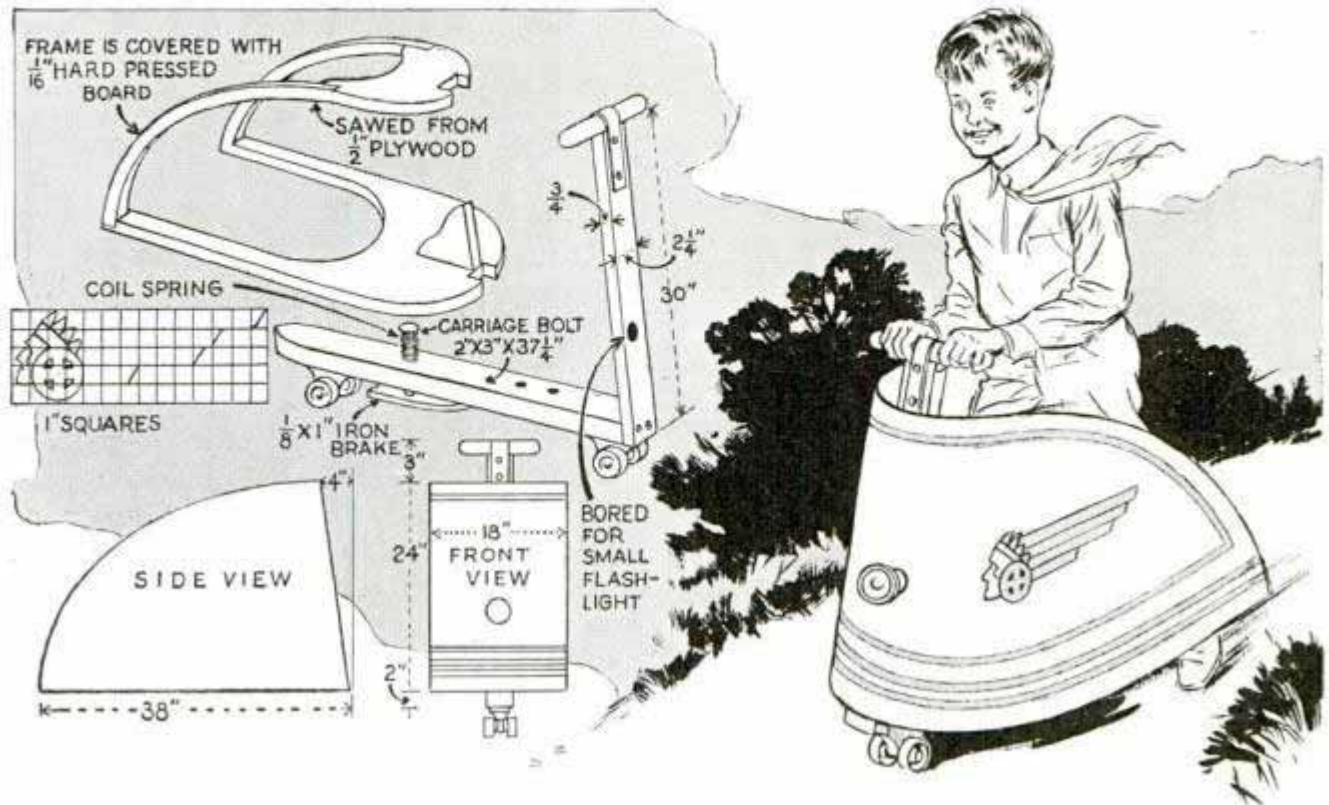

Patterned after modern streamline locomotives, this sidewalk scooter is sturdy, yet comparatively light in weight and the construction is possible with hand tools. The chassis is made from any available stock, and skate wheels are attached in the usual manner. An effective brake consists of an 18 to 22-in. length of lightweight flat iron, bent as shown and bolted to the underside of the chassis. A hole drilled through the chassis directly over the free end of the brake shoe is fitted with a bush-

ing in which the carriage bolt will slide easily. A coil spring is also provided to raise the bolt when foot pressure is released. The frame for the shield consists of two horizontal U-pieces notched to fit the steering post to which they are attached. Then a piece of $\frac{1}{16}$ -in. hard-pressed board is cut and attached to the frame. A small flashlight can be set in a hole bored in the steering post and the shield is then given a snappy paint job in orange, with a red-and-white emblem.

This Simple Jig for Cutting Tenons Fits Any Circular Saw

Here's a jig for safely cutting tenons on your circular saw. It consists of three blocks; one is the base and the other two are fastened together at right angles as indicated. The underside of the base is slotted for an oak runner, which slides in the miter-gauge groove of the saw table. The upper surface of the base and the lower surface of the horizontal block that fits on the base, are each grooved at right angles to the first groove, to fit a runner which permits lateral adjustment. The horizontal block is fastened to the base with bolts which slide in slots to permit adjusting the jig for cutting tenons of different thicknesses. A C-clamp will hold the work.

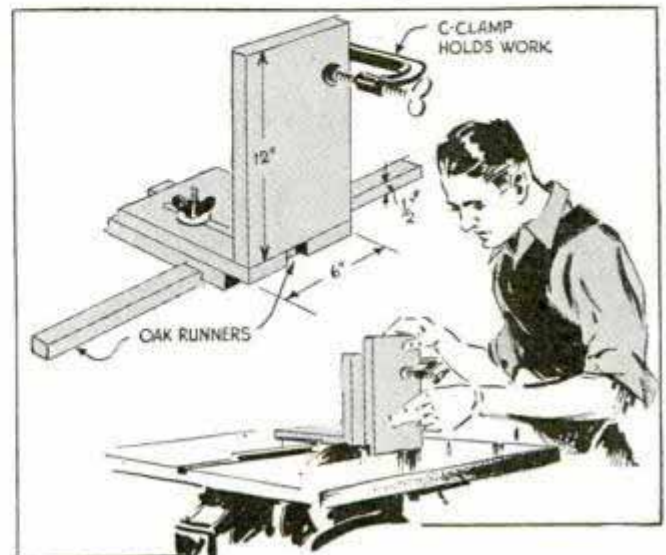

RE-CANING

Easily mastered by any beginner. All you buy is the cane as no tools except wood pegs are needed

WHY not get out that old rocker from the attic if all it needs is a new seat? Once you have acquired the knack of weaving cane, there's no trouble at all in doing this work and it's a possibility for making some spare-time profits.

Size of Cane: First you take a piece of cane from the broken seat and go to your furniture dealer so that new cane of the same size can be obtained. If the worn-out seat has been removed, you determine the correct size of cane to get by the size of the holes in the seat frame and the distance they are spaced apart. If the holes are $\frac{3}{16}$ in. in diameter and $\frac{3}{8}$ in. apart, use a size termed as superfine. When they measure $\frac{1}{2}$ in. apart, use fine fine; when $\frac{5}{8}$ in. apart, use fine. Quarter-inch holes $\frac{3}{4}$ in. apart require medium and $\frac{5}{16}$ -in. holes, $\frac{7}{8}$ in. apart take common. The two sizes generally used are fine and medium. Cane comes in bundles of 1,000 ft. or half bundles of

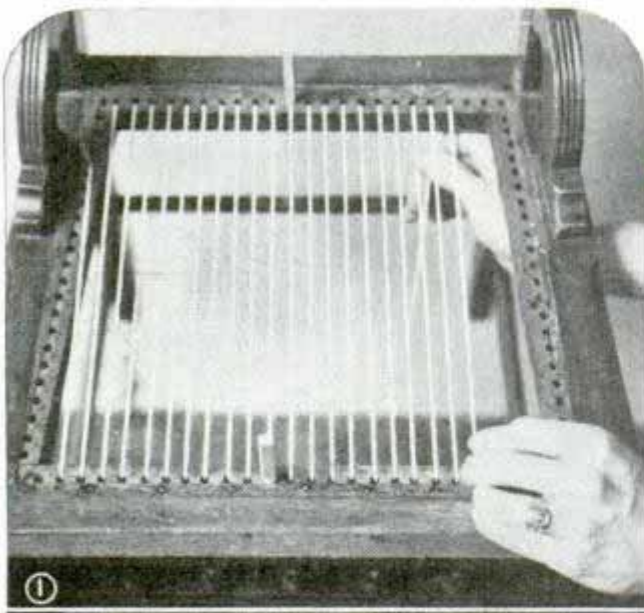

①

BEGIN STRINGING FROM THE FRONT CENTER HOLE

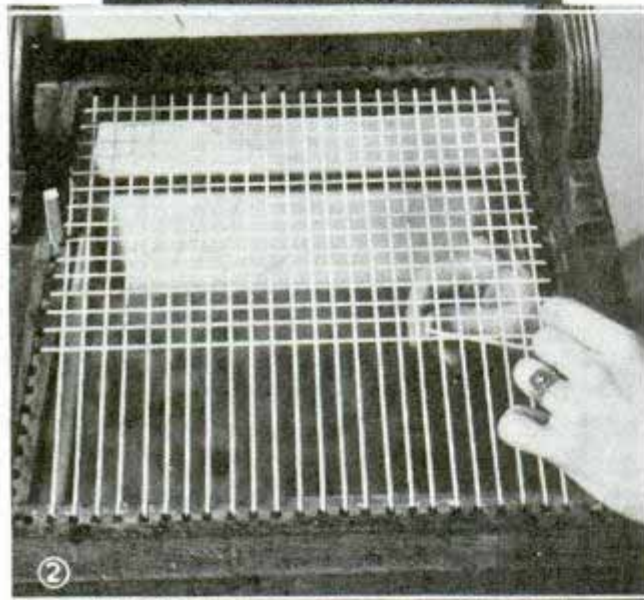

②

CROSS STRANDS ARE STRETCHED FROM LEFT TO RIGHT

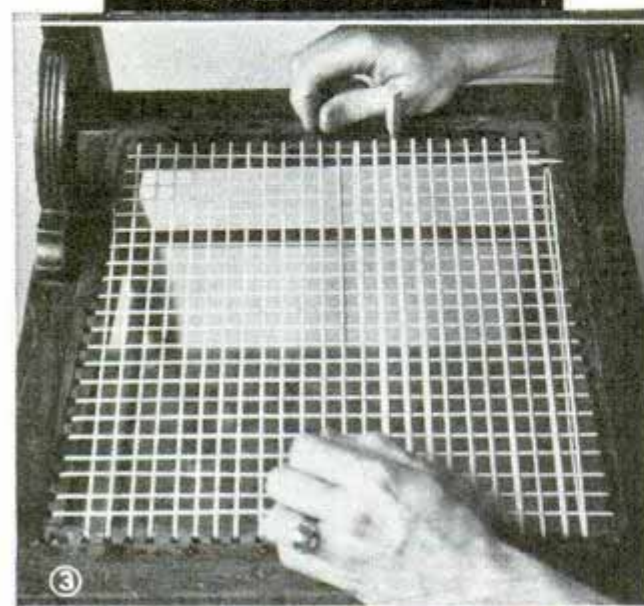

③

ANOTHER LAYER OF STRANDS GOES OVER THE FIRST ONE

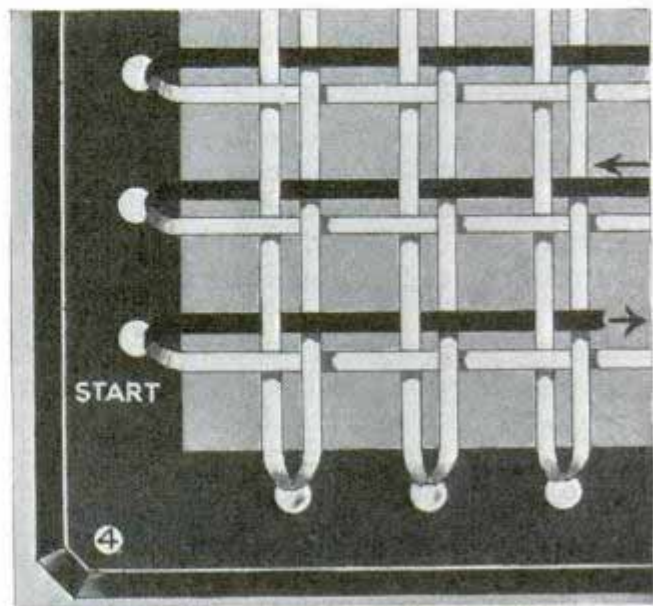

④

THE WEAVING BEGINS - UNDER ONE STRAND AND OVER THE NEXT

*Cane (material) supply to
Anoka, Minn.
J. L. Hammett Co., Kendall
Square, Cambridge
Mass.*

saves that old chair

500 ft. A full bundle will reseat three or four chairs of average size. If you wish to purchase just enough material for a single seat, keep in mind that sixteen single strands will do a seat measuring about 14 in. square.

Cane Is Kept Moist: Remove the old cane seat and clean out the holes in the frame. For tools you need only five or six tapered wood pegs. If the holes are not too large, golf tees will serve for pegs. Each time you are ready to use a new strand of cane, it should be immersed in water for a few moments. This makes it somewhat pliable and easier to work. However, too much soaking makes the cane too limp for easy working. Your hand dipped in water occasionally while handling will keep it sufficiently moist.

Square Seats Easiest: A square or rectangular seat is easier to weave than a round one. When weaving a round seat, you must skip several holes so that the strands will run parallel. The first step in weaving a square seat is to run the strands vertically from front to back. Start with the center hole in the front rail as in Fig. 1. Insert the strand, letting the end extend about 3 in. below, and hold in place with a peg. Run the entire strand between the thumb and forefinger to keep it from twisting so that the glazed surface will be on top. From the center front hole pass the strand through the center back hole, drawing it firmly but not too taut to break, and fasten with a peg. Bring the end up through the adjacent hole on one side, shift the peg to this hole, and, running the cane through your fingers as before, draw it back to the front rail, parallel to the previous strand, then insert into the hole and fasten with a peg. This procedure is continued until all vertical strands are in place, omitting the corner holes.

The second step is merely a repetition of the first step except that the strands run across the first ones as in Fig. 2. When a strand is nearly used up and is too short to reach across again, peg the end and start



HERE'S A FINISHED JOB -- BOTH SEAT AND BACK ARE RECANED. VARNISHING WILL MAKE THIS CHAIR AS GOOD AS NEW.

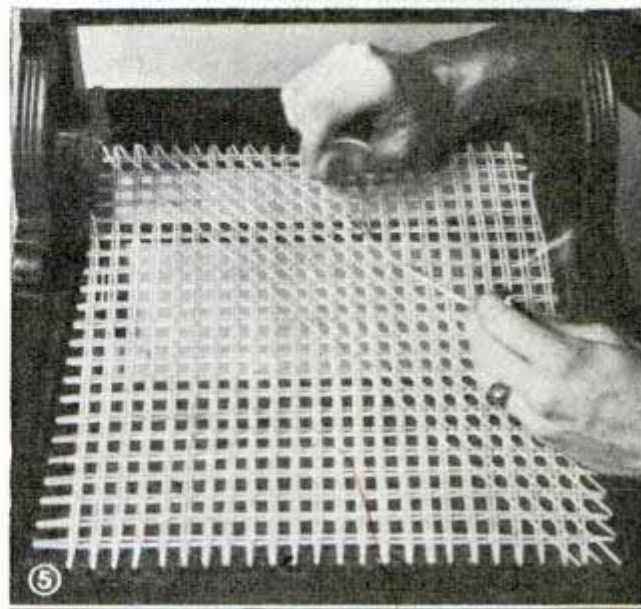

START THE DIAGONAL STRANDS IN ONE DIRECTION.

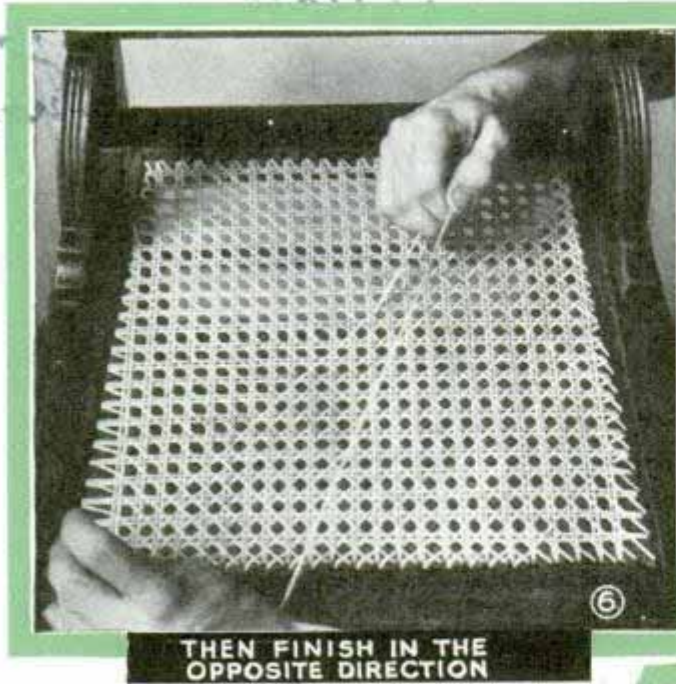

THEN FINISH IN THE
OPPOSITE DIRECTION

with a new strand. You do not join strands. When all horizontal strands are laced over the vertical ones, you are ready for the next step.

Fastening Loose Ends: Before starting the third step, you can fasten the free ends of the strands thus far in place by tying to the underside. To do this, wet the end of each strand thoroughly, pass it under one of the loops of cane between the holes and bring it around in a knot. If necessary, a knife blade will aid in slipping the strand under the loop. The third step is a repetition of step one, a second layer of vertical strands being laced over the horizontals as in Fig. 3.

Actual Weaving Begins: With the next step, Fig. 4, you begin actual weaving. Weaving from left to right, each horizontal strand, indicated in black, is passed under one vertical and over the next adjacent one. Each time you say to yourself "under and over," for each pair of verticals, until you reach clear across. After passing the strand down through the hole and up the next, you are ready to make a return trip from right to left, but this time weaving over and under instead of under and over. In weaving, frequently draw the entire strand up taut.

The Pattern Takes Shape: Next is the fifth step—the diagonals, Fig. 5. Starting at the left front corner hole, work a strand under the double row of horizontals and over the double row of verticals, continuing in a like manner also on the return trip.

By studying a sample taken from the old seat you will be able to correct yourself if you have difficulty. In step six, Fig. 6, you make a diagonal weave in the opposite direction. You use a reverse procedure for this, passing over the horizontals and under the verticals. When this weave is completed, all loose ends are tied to the underside.

Applying the Binding: The binding, Fig. 7, covers the holes around the border of the seat and provides a neat, finished edge. Use a wide strand known as binder.

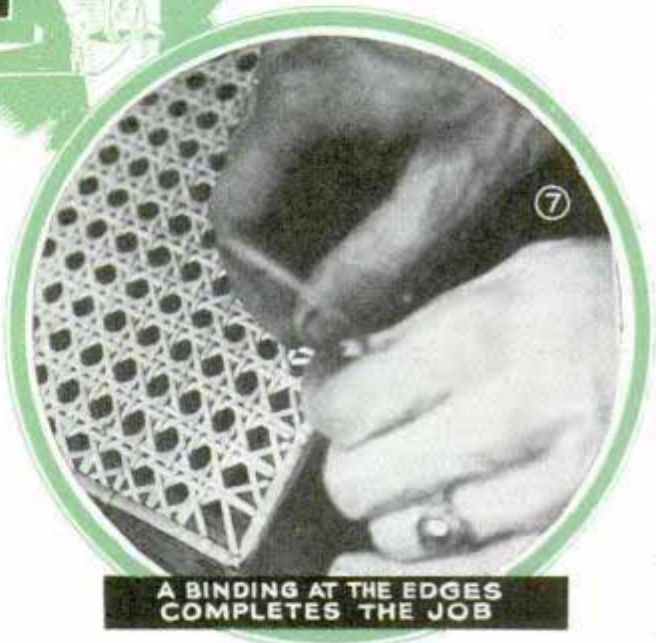

A BINDING AT THE EDGES
COMPLETES THE JOB

To fasten this over the holes, you use a strand of the same size cane as you have been using for weaving. Skipping every other hole, pass the end up through the hole from the bottom, lay the binder over the row of holes and form a loop around the binder with the cane as you again pass the strand down through the same hole. This method is continued around the entire border of the seat. If you find it difficult to pass the strand through some of the holes, you can enlarge the opening by working a nail around in the hole. If the seat, after it has dried thoroughly, rings when struck sharply by the hand, you have done a good job. A coat of clear varnish or lacquer on the cane will make it impervious to moisture and ready for a long period of usage.

Viewing Motion-Picture Films on Pen-Type Flashlight

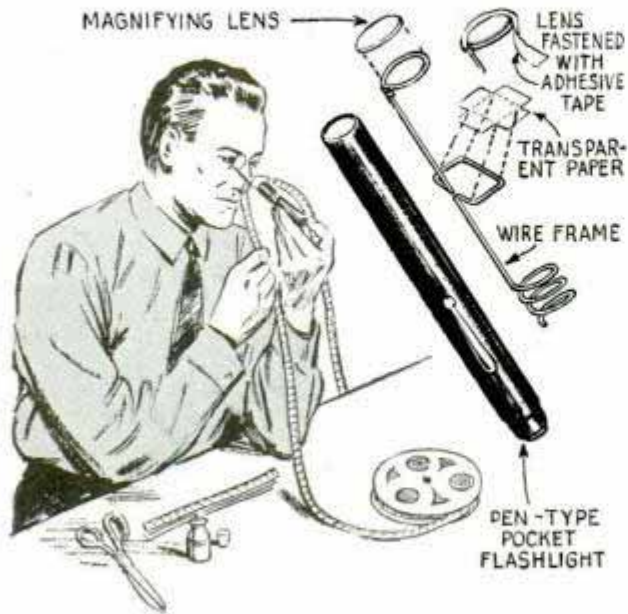

This pocket film viewer is handy and useful when editing your motion-picture films. It consists of wire bent to grip a pen-type flashlight and a small magnifying glass fastened to the frame with adhesive tape. A piece of transparent paper is glued in place as illustrated to diffuse the light from the flashlight. The film is placed directly over the paper. Such a viewer is especially helpful when splicing in titles, as they may be read directly from either the small 8-mm. or the 16-mm. size film.

Pneumatic Trough and 'Beehive' for Chemical Experiments

Home chemists who desire to experiment with the collection of gases will find that an ordinary bread tin having an overflow pipe soldered onto one side near the top, will serve very well as a pneumatic trough, while a small flower pot, altered as shown in the sketch, makes a good "beehive." A

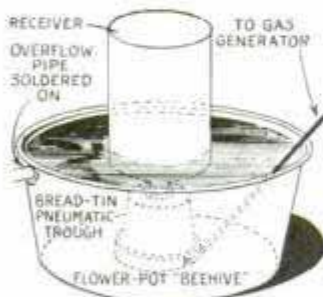

large bottle in which the gas is collected is set in an inverted position over the hole in the bottom of the flower pot, the latter, of course, being submerged below the surface of the water. The rim of the flower pot is notched with a file to take the tube

from the gas generator. In use, the bottle and pan are filled with water. Then the bottle is turned upside down and placed over the flower-pot hole. As the gas comes in, water will run out and be replaced with gas until the bottle is filled.

Slats Across Top of Hotbed Give Partial Shade

These slats over hotbeds permit ample sunlight to reach the seedlings on bright days, yet allow individual plants to benefit from intervals of shade during the heat of midday, as at this time each slat casts a "traveling" shadow. The slats are sawed quickly and a single small nail through each holds them in place. This method is excellent for tender plants which are apt to suffer from continuous hot sunshine.

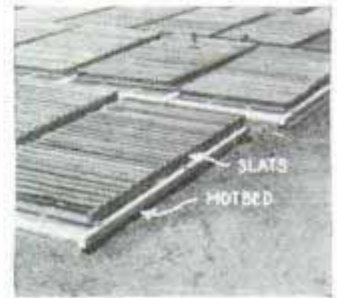

Wire Wound on Threaded Work Protects It in Chuck

When it is necessary to chuck threaded work in a lathe, you can protect the threads by winding copper wire in them. It should be of a size large enough to project beyond the height of the threads. You'll find the wire better than a split brass or copper tube.—C. W. Woodson, East Aurora, N. Y.

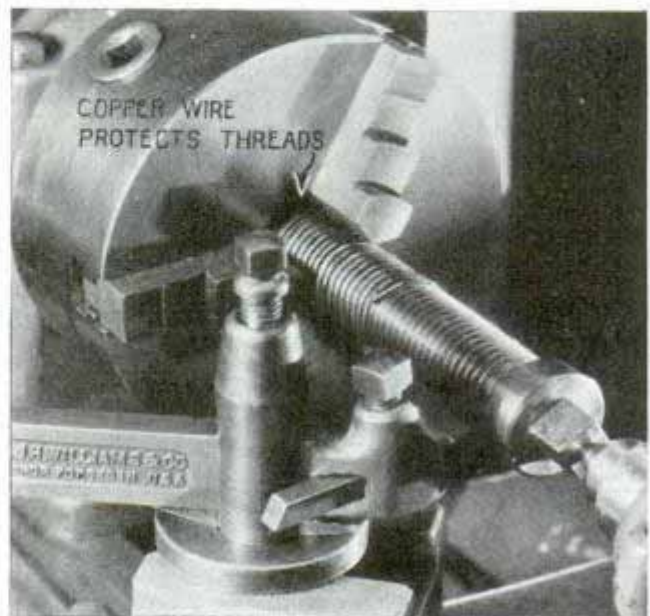

One-Piece Tie Racks and Shelves Fold Flat

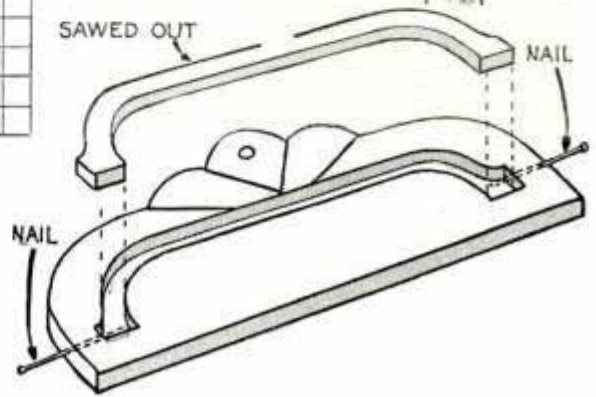
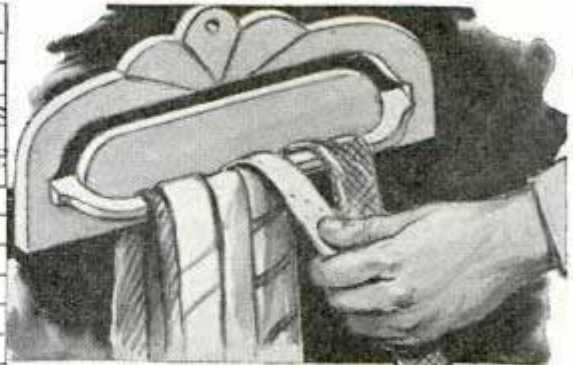
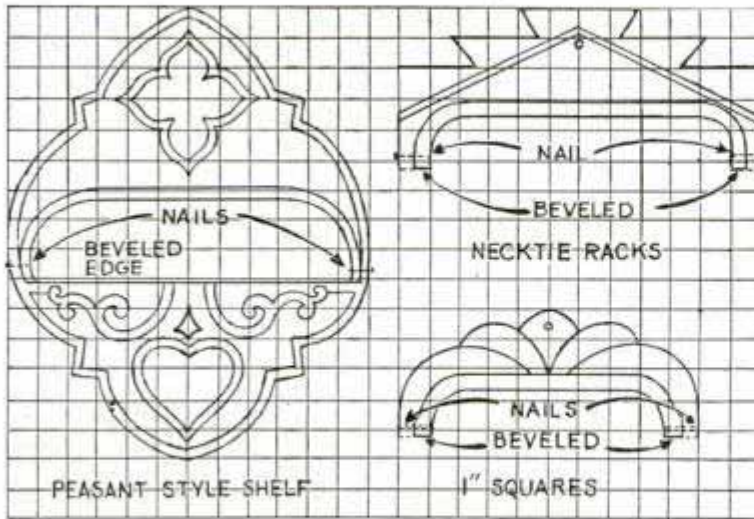

Scrollsawed from single pieces of plywood or other suitable stock, these necktie racks and small wall shelves pivot to the backs, and when folded, fit in the space from which they were cut. Brads or finishing nails form pivots. After cutting out the parts, the front lower edge of the pivoted member of such a shelf or rack must be beveled slightly in order to provide sufficient clearance to prevent binding. While a few suggestions are given here, anyone can elaborate on the ideas and produce an endless variation of designs

This Quick-Acting Clamp Holds Work While Scrollsawing

Here's a clamp that disposes of the problem of holding work for intricate cutting with a hand scrollsaw or coping saw. It

consists of a base, a sliding arm and a cam, all made from scrap hardwood stock. Exact sizes are of no importance. You can make it up to suit your work. The arm is faced with a square piece of rubber cut from a stair tread to prevent marring the stock, and the small end slides between a couple of angle-iron brackets to permit adjustment. Also, the cam is pivoted between the brackets. A coil spring fitting tightly in a hole drilled partly through the arm from the underside raises the latter when the cam is released.

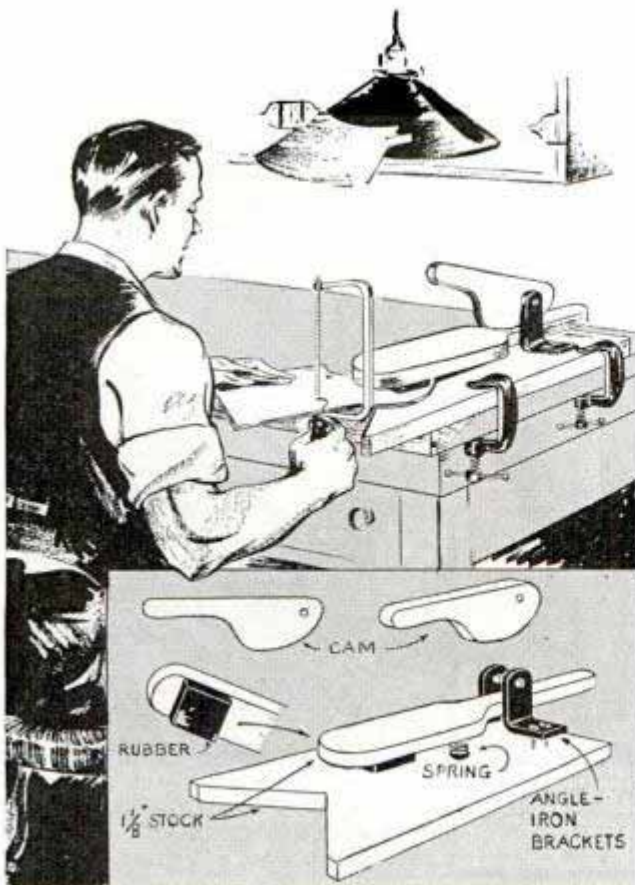

Hip-Boot Tops Held by Clothespin to Avoid Cracking Uppers

When you set hip boots in a closet, clip the tops together with a spring-type clothespin as indicated. This keeps them from folding over, which will cause the rubber to crack if the boots are left in this position for any length of time.



"SKIPPER"—Low-Cost

PART I

IDEAL for river or lake use, yet big enough to ride rough water, "Skipper" is a smart little craft combining graceful lines with low-cost, simplified construction. Cost of materials will vary between \$30 and \$40. You can get an idea of "Skipper's" performance from Fig. 1 and photos below it, also Fig. 5. Figs. 2, 3, and 4 show construction.

Begin work by making up a full-size pattern of each frame, as shown in Fig. 6. Draw one side only, then fold the paper on the centerline and with carbon paper, facing up, duplicate the outline on the opposite side of the centerline.



①



PLENTY OF ROOM

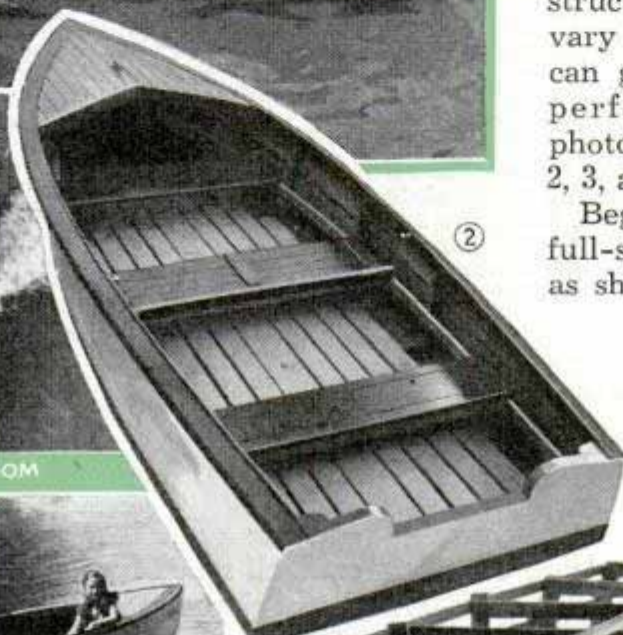

②



SUITABLE FOR SMALL MOTORS



HAS A V-BOTTOM



SPEED WITH SAFETY

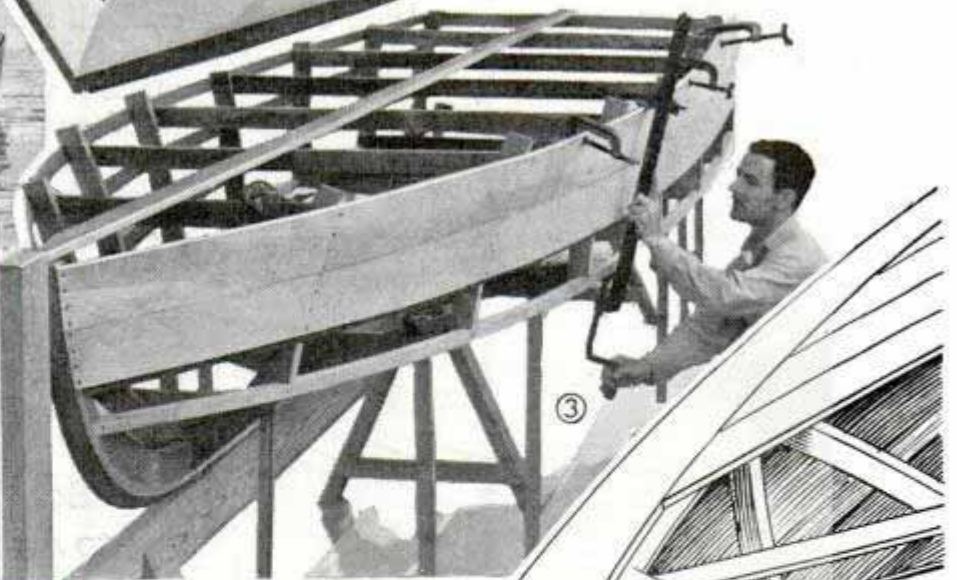

③

BREAST HOOK

"SKIPPER"	
LENGTH	— 14 FT.
BEAM	— 54 IN.
FREEBOARD	— 15½ IN.
DEPTH	— 24 IN.
DRAFT	— 5 IN. @ 725#
WEIGHT	— 275 LB.
PASSENGERS	— 5
MOTORS	— SUITABLE FOR MOTORS FROM 4 TO 24 HP.
SPEED	— 9 TO 25 M.P.H. DEPENDING ON MOTOR

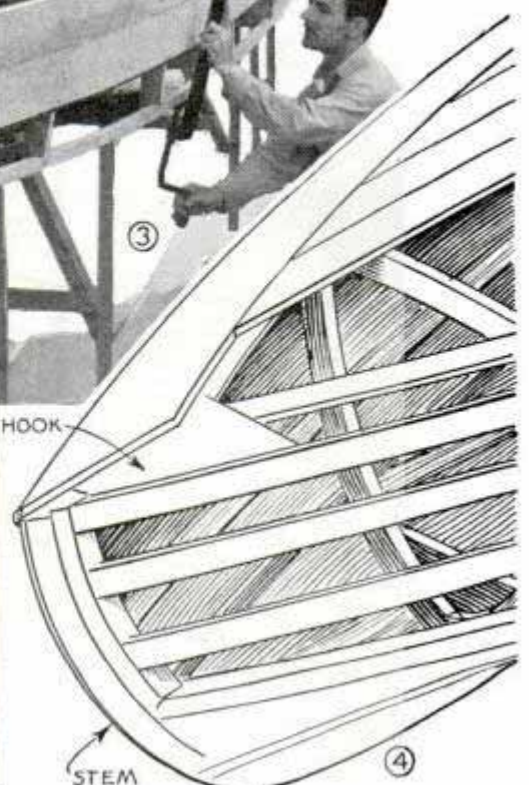

④

STEM

Outboard Runabout

Fig. 6 shows the general frame shape, while Fig. 7 gives the dimensions for each frame at the points indicated.

After making the paper patterns, transfer the outlines to the $\frac{3}{4}$ -in. frame stock and saw out on the bandsaw. Each frame has two side members, and these should be nailed together and sawed in one operation. The chine notches can be cut at the same time, with the exception of frame No. 1, which is beveled and best fitted after the frames are set up. The chine stock is 1 by 1 in., and a short section of the stock should be used to locate the position of the notch on the paper patterns and later on the frame stock. Fig. 8 shows how the chine fits into the corner of each frame—

one edge even with the edge of the side frame. At frame No. 1, the location is as shown in the inset, Fig. 8.

The parts of each frame are assembled over the paper pattern, as shown in Fig. 10. The pieces are first nailed together, then fastened with screws. The joint is a simple butt joint except at frame No. 7, which is half-lapped, as shown in Fig. 9. Note also in this drawing that the bottom piece of frame No. 9 is beveled at 12 degrees. This bevel applies to the top and bottom edges, also the top of the keel notch and the top of the chine notch. All other frames are cut square across. Be sure to mark the centerline on each frame across the temporary crossbar before removing it from

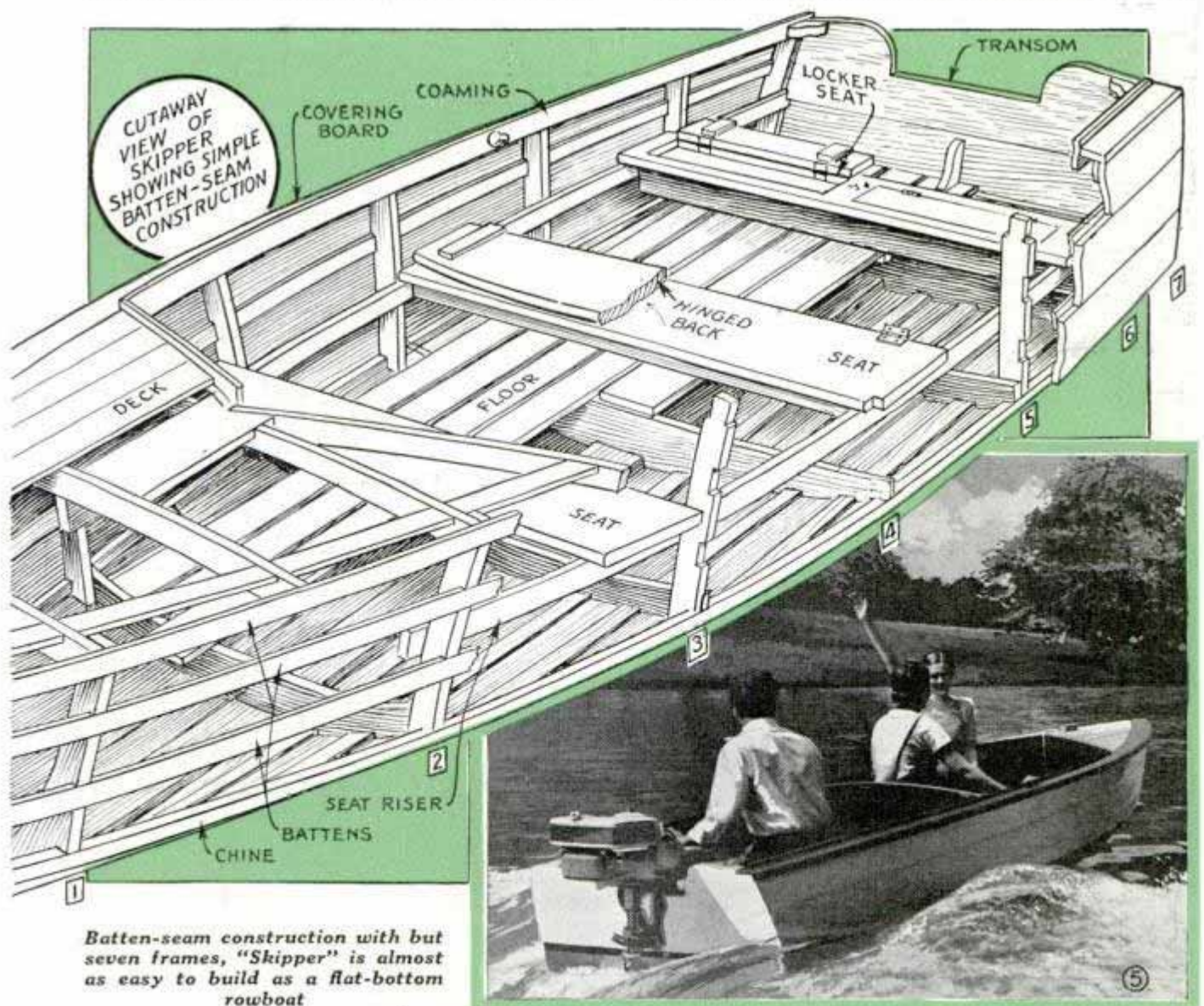

Batten-seam construction with but seven frames, "Skipper" is almost as easy to build as a flat-bottom rowboat

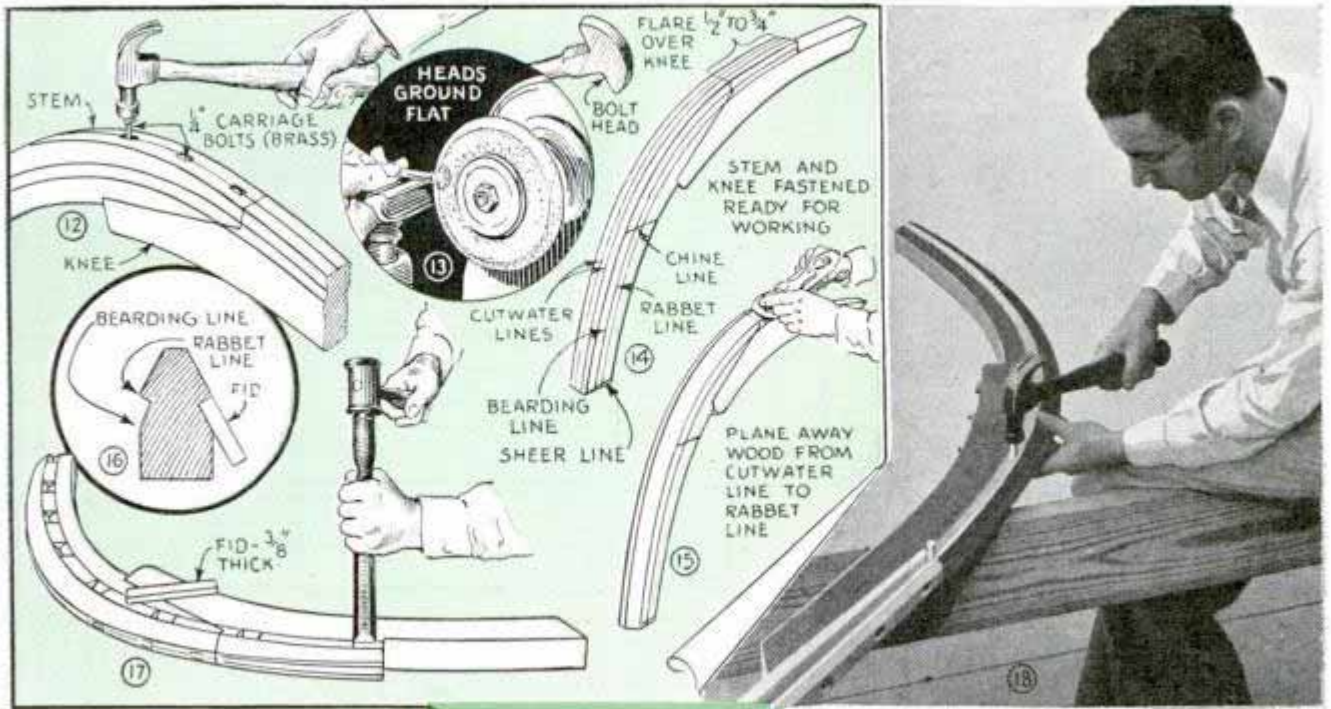

notches to make one continuous rabbet, as shown in Fig. 19.

The keel is cut from 1½-in. yellow pine or white oak, 4½ in. wide. Square up the end which butts against the stem, and then lay off the station marks, as shown in



Fig. 23. Cut the keel to exact length, and make the step at the stern end as shown in the drawing. Now, on the circular saw, Fig. 24, cut a rabbet along each edge of the bottom of the keel, starting at the stern and stopping at station No. 3. Shape the forward part of the keel to the dimensions given in Fig. 23. Now pick up the saw-cut rabbet, Fig. 20, at station No. 3, and continue it at the same depth but tapering in width until it becomes zero at the end of the keel. This taper cut is not the true rabbet. Before the

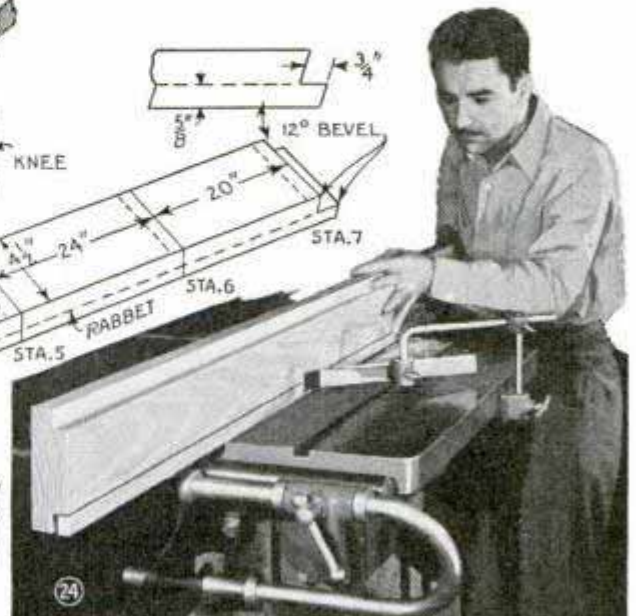
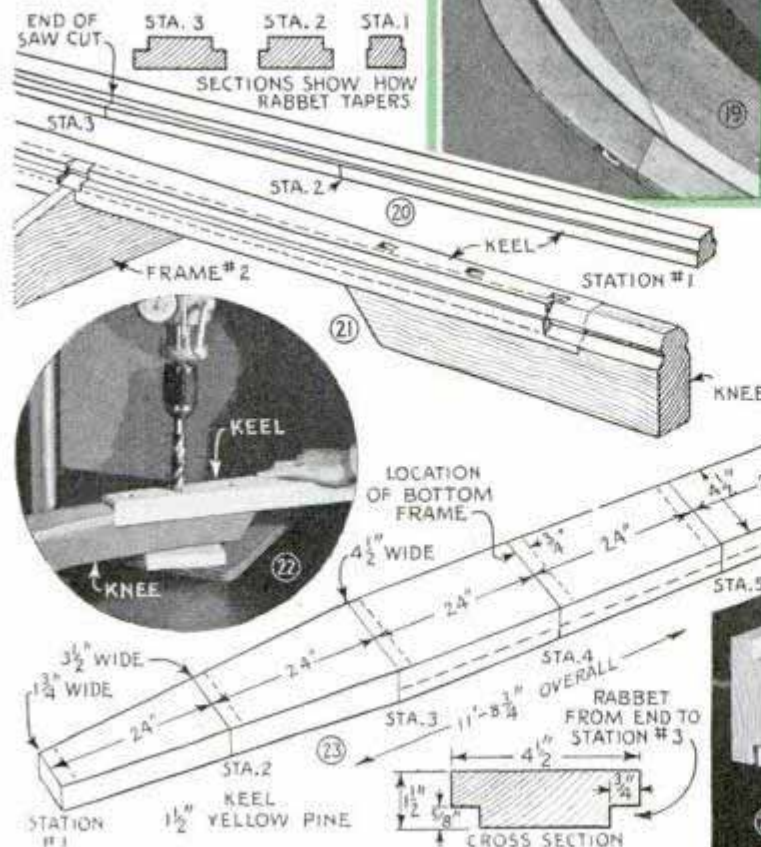



THE KEEL IS FASTENED TO THE KEEL SUPPORT WITH LAG SCREWS

"Skipper" is built on a keel support of 2 by 6 in. yellow pine. Small blocks of wood fastened to the support give the proper curvature to the keel

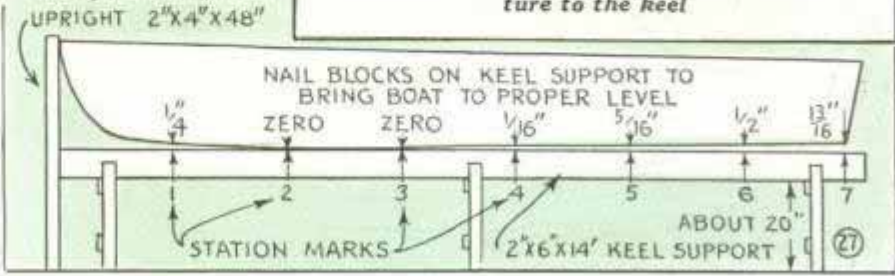

latter can be cut, the keel must be fastened to the stem, using three carriage bolts. The heads are left round, and are countersunk a little over $\frac{1}{4}$ in., as shown in Fig. 22. Projection of the keel beyond the stem should be faired off with a plane, carrying the curve about 12 to 15 in. along the keel. You can now spot in the rabbet at the end of the keel, as shown in Fig. 21, making the cut the same as at the end of the stem. Then, setting frame No. 2 in place and using the fid,

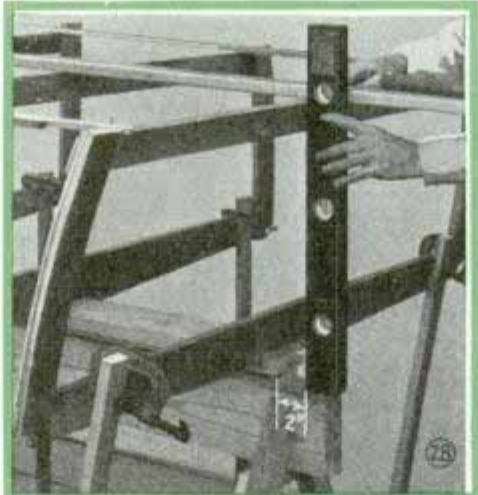

you can spot in the rabbet at station No. 2. Draw a fair line between these two cuts and cut the rabbet. Fig. 18 shows the final step of driving $\frac{3}{8}$ -in. softwood dowels into the rabbet where the joints cross it. These stopwaters go right through from side to side, and are trimmed off flush.

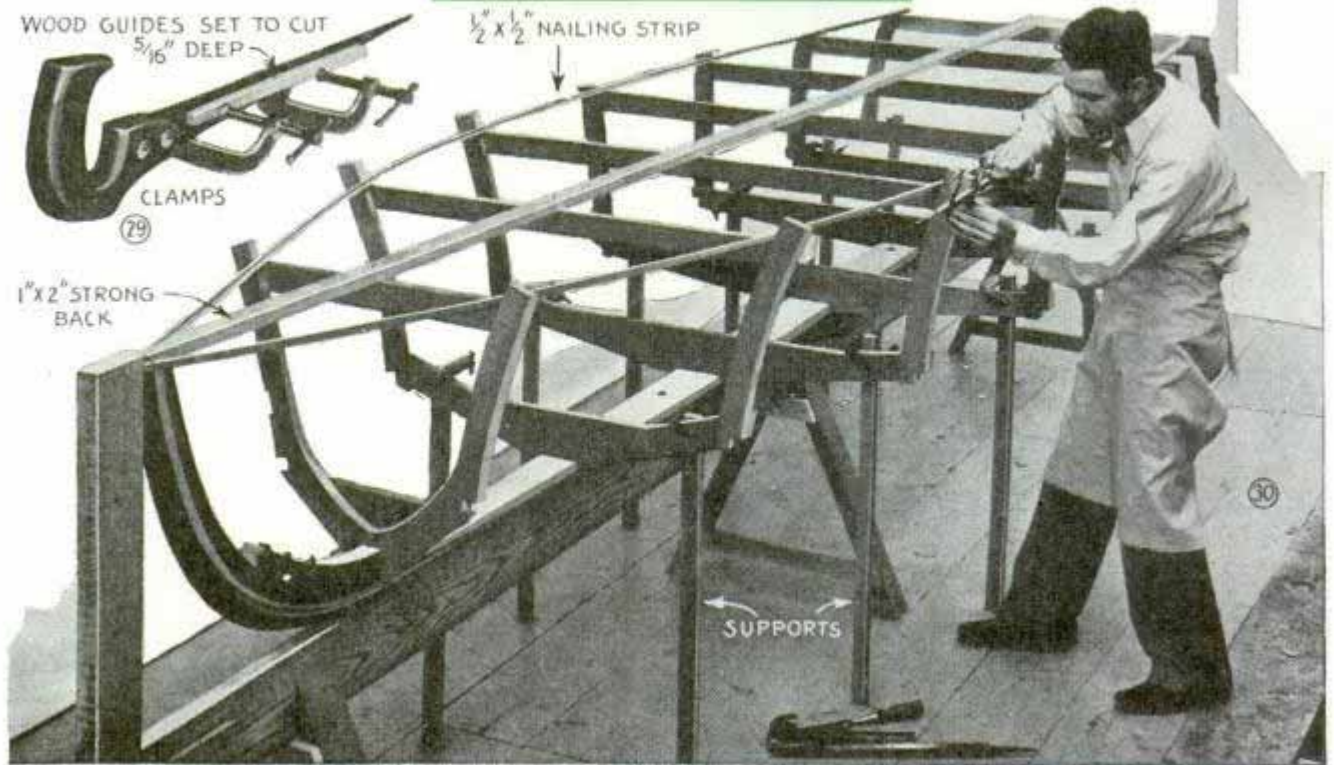

WOOD GUIDES SET TO CUT $\frac{5}{16}$ " DEEP
CLAMPS

$\frac{1}{2}$ x $\frac{1}{2}$ " NAILING STRIP

1" x 2" STRONG BACK

SUPPORTS

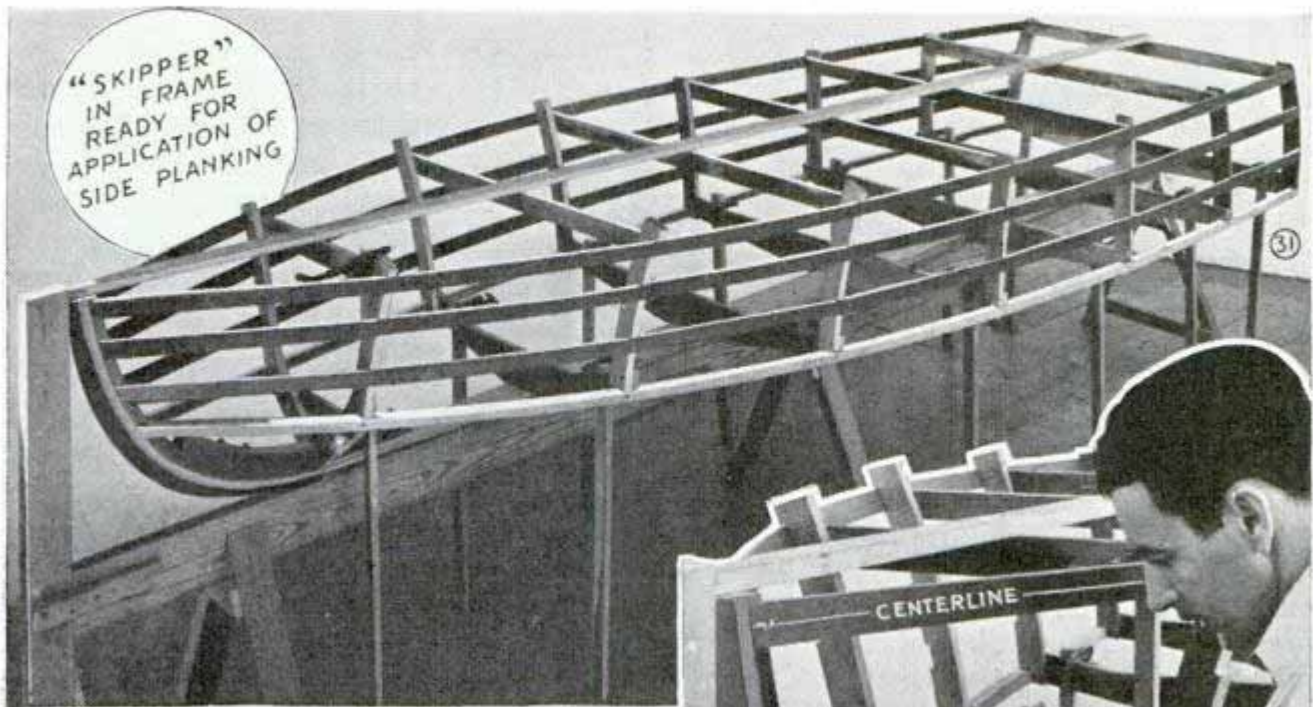

The building trestle, Figs. 26 and 27, is a 2x6-in. plank, 14 ft. long, supported on trestle legs as shown. The top edge of the plank must be straight, and it must be set with a spirit level. This is important. Place the keel and stem assembly on the keel support, and, under each of the station marks on the keel, locate and tack small blocks of wood of the thickness shown in Fig. 27. Fasten the keel to the keel support with three lag screws, Fig. 26. These will be

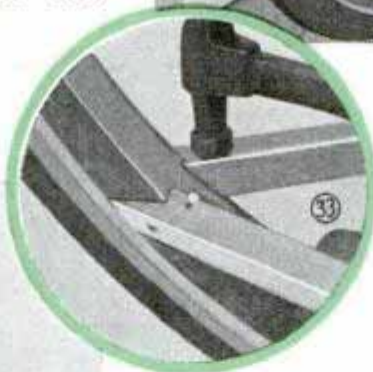

removed later and the holes plugged. The 2 by 4-in. end support should be plumbed vertical, the stem being toe-nailed to the top.

Now the frames are set in place at the points previously marked on the keel. Each frame is fastened at right angles to the keel centerline with 2 in. No. 10 screws, one on each side from the underside of the rabbet, Fig. 25. Countersink the screw heads $\frac{1}{8}$ in. One other point of importance can be seen in Fig. 30—frames Nos. 1, 2, 3, and 4 are placed so that the side frames face the front. Sides of frames 5 and 6 face aft. The last frame, No. 7, is raked as in Fig. 28.

Fig. 30 shows all the frames set up. The strongback is nailed in place first, each frame being leveled vertically before nailing. Support sticks hold each frame level crosswise, while the nailing strips keep the frames spaced equally.

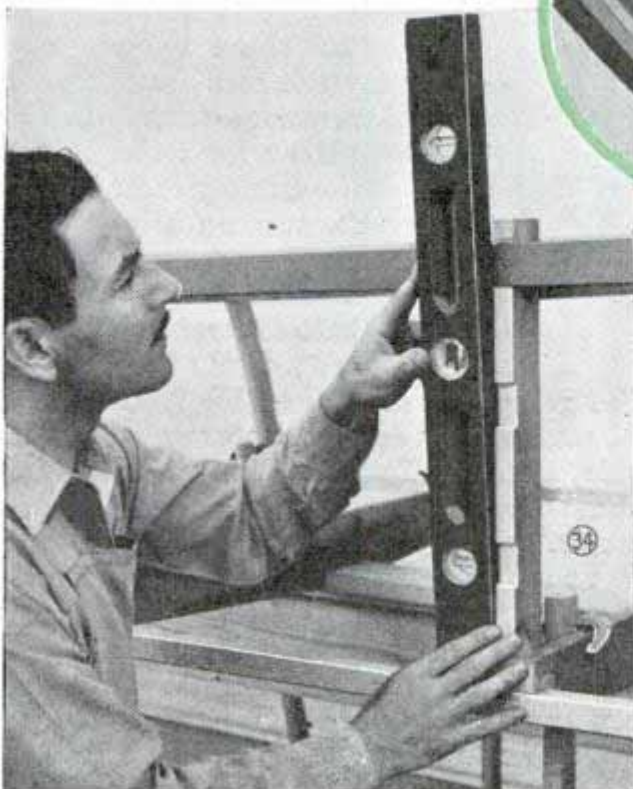



The edges of the side frames now must be beveled to carry out the contour of the boat. The proper bevel can be determined easily by springing a light strip of wood across the frames. After beveling, cut the batten notches, taking the spacing from the dimensions given in Fig. 7. Check the marks by nailing a batten in place. Batten notches are easily cut by clamping guide strips to the saw, as in Fig. 29. Clean out the waste with a wood chisel and then smooth up with a rasp.

Fig. 31 shows "Skip-



PLANKS ARE FITTED FROM BATTEN CENTERLINE TO BATTEN CENTERLINE, THE SHAPE BEING DETERMINED BY SPILING

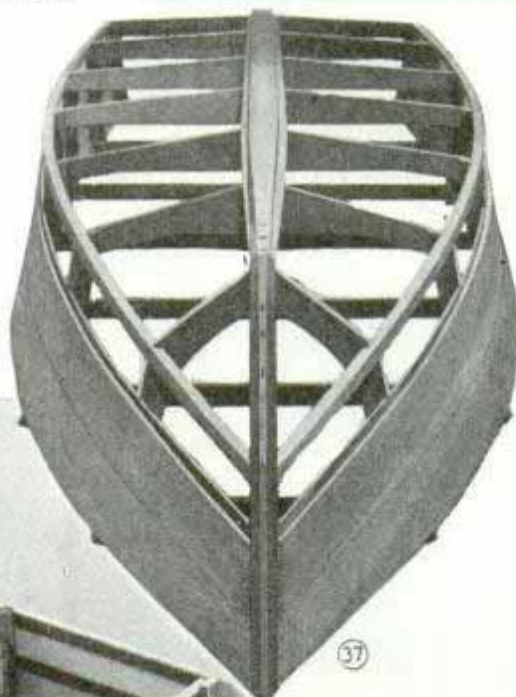

to lie immediately behind the bearding line. The chine is similarly beveled and is also notched to fit around the stem, as in Fig. 32, being fastened with one screw from the side and one nail from the top, as in Fig. 33. At the frames, the chine is fastened with one 2-in. No. 10 screw countersunk to allow later shaping of the chine pieces. Before fastening the chine, check each frame with a level, as in Fig. 34. All battens and the chines are sawed off flush with

the rear face of frame No. 7. The first planks to go on are the center ones on each side, Fig. 35. To determine the shape of these and other planks, you will need a $\frac{3}{16}$ -in. "spiling" board sawed out roughly so as to fit between the batten centerlines. Do not force the spiling board—let it make its own curve and tack it lightly in place. Fig. 36 shows the operation of spiling, using a small block of wood with one corner cut off as an index. The block is placed so that one edge touches the batten centerline

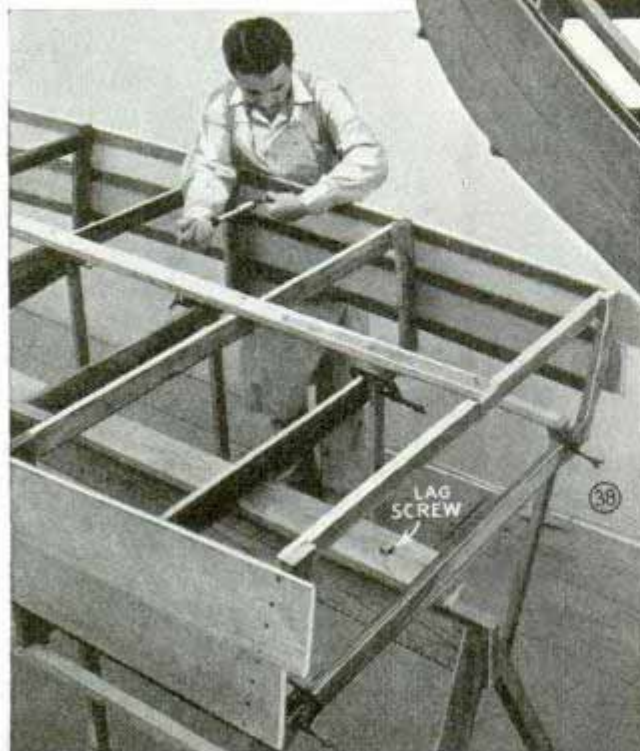

This cutaway view of "Skipper" shows all principal parts, which are keyed and dimensioned in the table below. The approximate number of board feet in each piece of lumber is listed so that the cost of any piece can be determined by multiplying by local costs per board foot of the selected wood

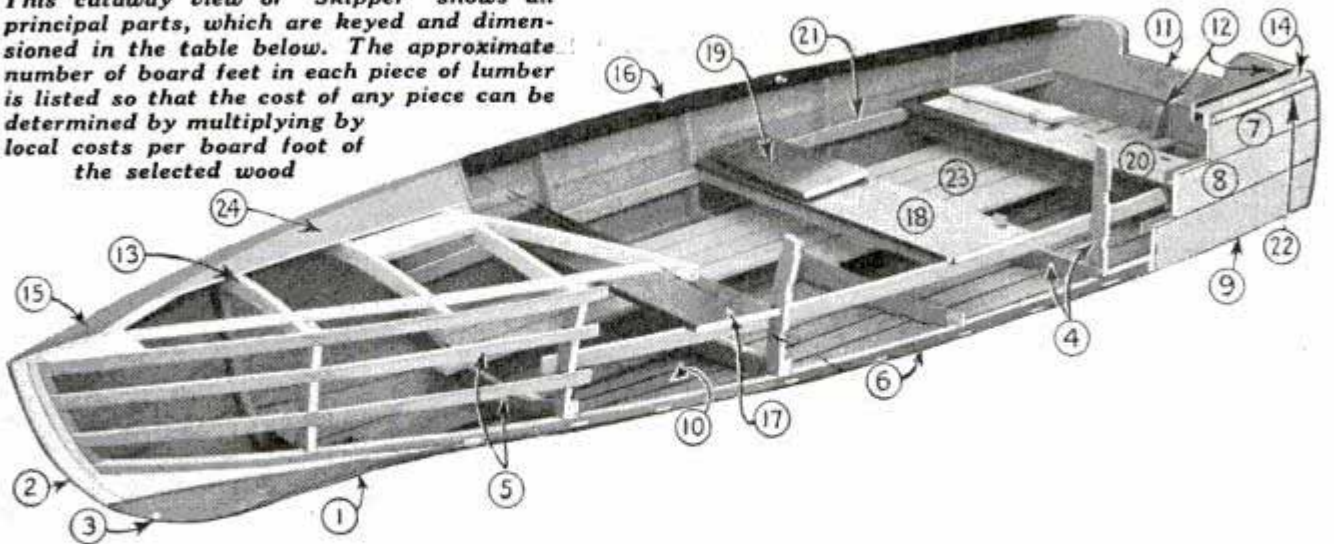

Key No.	LUMBER Part and Size Sizes in inches except where marked in feet	Board Ft.
1	† Keel—1 piece 1½ net x 4½ net x 12 ft. yellow pine	12
2	Stem—1 piece 1¾ net x 6 x 5 ft. white oak	5
3	Knee—included in Item 2	00
4	Frames—2 pieces 1 x 8 x 10 ft. poplar	14
5	Battens—5/16 net x 1½ net—3 pieces 16 ft., 6 pieces 14 ft., 2 pieces 12 ft., 2 pieces 10 ft.	14
6	Chine—2 pieces 1 net x 1 net x 16 ft. yellow pine	5
7	Sheer Plank—2 pieces ¾ net x 10 x 16 ft. white pine	28*
8	Center Plank—2 pieces ¾ net x 8 x 16 ft. white pine	22*
9	Shutter Plank—2 pieces ¾ net x 8 x 14 ft. white pine	20*
10	Bottom Planking—	
	Garboard—2 pieces ¾ net x 8 x 14 ft. white pine	20*
	Bottom 2—2 pieces ¾ net x 8 x 14 ft. white pine	20*
	Bottom 3—2 pieces ¾ net x 8 x 12 ft. white pine	16*
	Bottom 4 and 5—2 pieces ¾ net x 10 x 10 ft. white pine	18*
11	Transom—1 piece 1 x 12 x 4 ft. white pine	4
	1 piece 1 x 8 x 4 ft. white pine	3
	1 piece 1 x 10 x 4 ft. yellow pine	3
12	Transom Knees—1 piece 1½ net x 10 x 2 ft. white oak	2
13	Deck Beams—1 piece 1 x 8 x 4 ft. white pine	3
14	Covering Board—cut from sheer plank scrap	00
15	‡ Covering Board—1 piece 1 x 8 x 16 ft. white pine	11
16	Coaming—2 pieces ¾ net x 3 x 12 ft. white pine	6*
17	Front Seat—1 piece 1 x 10 x 4 ft. white pine	4
18	Center Seat—1 piece 1 x 14 x 4 ft. white pine	5
19	Seat Back—1 piece 1 x 12 x 4 ft. white pine	4
20	Rear Seat—1 piece 1 x 6 x 4 ft. white pine	2
21	Seat Riser—2 pieces ¾ net x 1¾ net x 10 ft. yellow pine	3
22	Sheer Molding—2 pieces 1 in. half round, 16 ft.	4
23	Floor—6 pieces ¾ net x 4 x 10 ft. No. 1 white pine	20
	2 pieces ¾ net x 4 x 8 ft. No. 1 white pine	6
	1 piece ¾ net x 6 x 10 ft. No. 1 white pine	5
24	Deck—scrap plank stock	
	Keel Form—1 piece 2 x 6 x 14 ft. No. 1 yellow pine	14
	Frame Cross Bars—30 ft. lin. 1 x 2 shingle lath	5
	Strongback—1 piece 1 x 2 x 16 ft. white pine	3
	Nailing Strips—2 pieces ½ net x ½ net x 16 ft.	3
	Supports—scrap	00
	Coaming Plate—included in frame lumber	00

† Actual finished sizes are marked "net." All others standard mill sizes.
‡ Resaw ¾ in. thick for covering board; ¾ in. thick for spiling board.
* Board footage of 1-in. stock, required for dressing ¾ in. net.

FASTENINGS	
§ Planking—1¼ in. No. 6 or 8 F. H. screws	6 gross
Planking—¾ in. No. 6 F. H. screws	3 gross
Planking—1 in. No. 15 copper nails	2 lb.
Chines and Frames—2 in. No. 10 screws	3 doz.
Frames—1½ in. No. 8 screws	4 doz.
Battens—1¼ in. No. 6 screws	1 gross
Covering Board and Coaming—1 in. No. 6 screws	1 gross
Deck Beams—1½ in. No. 8 screws	3 doz.
Keel Form—¾ x 2½ in. lag screws	3
Keel and Stem—5/16 in. carriage bolts	5, 4½ in., 3, 3½ in.
§ 1 gross allowed for miscellaneous fastenings.	

Miscellaneous small items include brads, string, ½ gal. seam composition, candle wicking, tacks, hinges, 30 in. of ¼-in. brass half oval for stem band, 2 doorstops for center seat back, one 6-in. cleat, and paint totaling 1½ gal. of colors selected.

and a pencil mark is drawn around the part of the block that rests on the spiling board. This is repeated at intervals of about 10 in. When the spiling board is removed and tacked to a length of the planking stock, the block is used to relocate the exact shape of the plank. Tack two planks together and saw as one, or, you can use 1½-in. (net) lumber, cutting the plank in the solid and resawing to make two ¾-in. thick planks. Each plank is fastened with four 1¼-in. No. 6 screws at each frame and at the stem. Fastenings along the battens consist of ⅝-in. No. 6 screws, inserted in pairs at about 4-in. intervals, as shown in Fig. 38. Plank No. 2—the sheer plank—is fitted and fastened in the same way. In spiling this plank, the spiling board will lift above the batten and it will be necessary to use a larger marking block. After these two side planks have been fitted, Fig. 37, the boat can be turned over in readiness for application of the bottom planking.

(To be continued)

Hand-Tool Rack over Bench Has Flexible Pockets

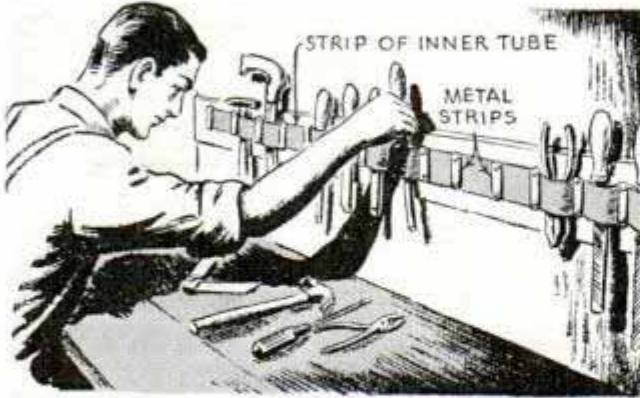

When a number of hand tools are used at the bench, time will be saved and each tool can be kept out of the way without looking for the pocket made for it, if you use this flexible tool holder. It consists of a long strip of rubber about 3 in. wide, which can be cut from an old inner tube and fastened to a 6-in. board, on the wall back of the bench, with strips of metal or wood spaced about 4 in. apart. These are tacked or screwed in place.

—L. Schmitt, Chicago.

Attractive Signs and Name Plates Produced by Photorelief

Have you seen the new photographic prints on which the characters appear to have been carved in low relief? Here's a method which produces similar results for cards, name plates, etc. Once you have the

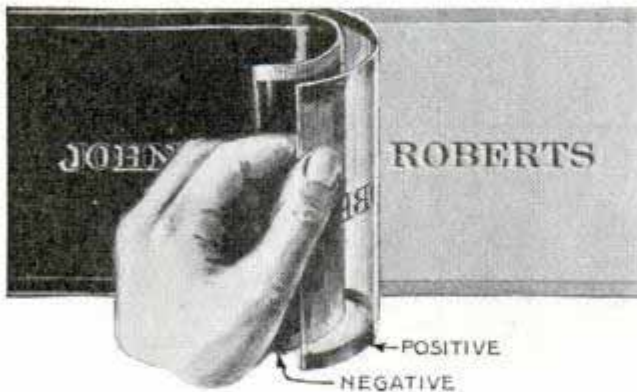

desired text—letters or pictures—photograph it and develop the film in strong developer for contrast. When the negative is dry make a contact print on another film to get a positive. Then develop the latter in regular developing solution. When dry, place the two negatives face to face and

there you have the subject in relief. Hold the negatives in position with adhesive tape so they cannot shift and make prints either by contact or projection.

—John G. Roberts, Chicago.

Screw Holder of Stiff Wire Saves Time

The next time you have to start a screw in a place that is hard to reach, just take a minute to bend this holder from a piece of stiff wire. Slip it under the head of the screw and you can guide it into the hole with little trouble.—Opie Read, Jr., Chicago.

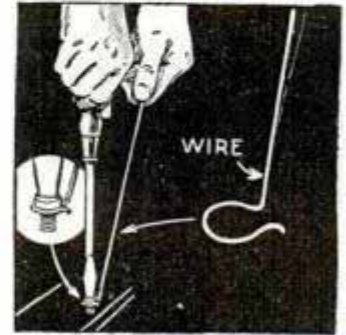

Simple Sand Bath for Chemists



Here's a sand bath, for heating vessels indirectly, that any amateur can make at practically no cost. It consists of a cigarette tin fitted with legs of flat iron to raise it high enough to slip a Bunsen

burner under it. The legs can be fastened to the bottom of the tin with rivets.

Locating Leaks in Wading Boots

When wading boots develop pin-hole leaks that are hard to locate, moisten the rubber over the suspected area with soap-suds. Then roll the upper leg of the boot on a broomstick to compress

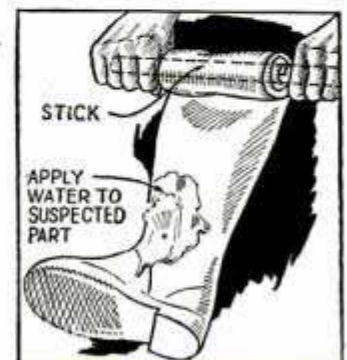

the air. The pressure will cause small bubbles to appear over the leaking spots which then may be marked for repairs.

Portable Study Desk Is Stored Behind a Door

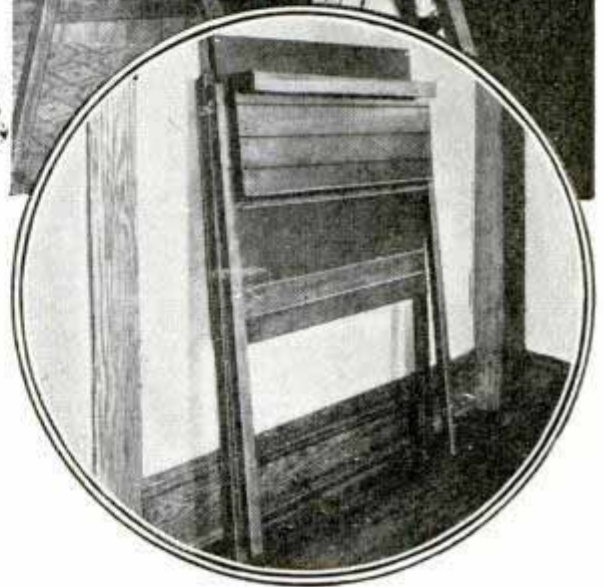
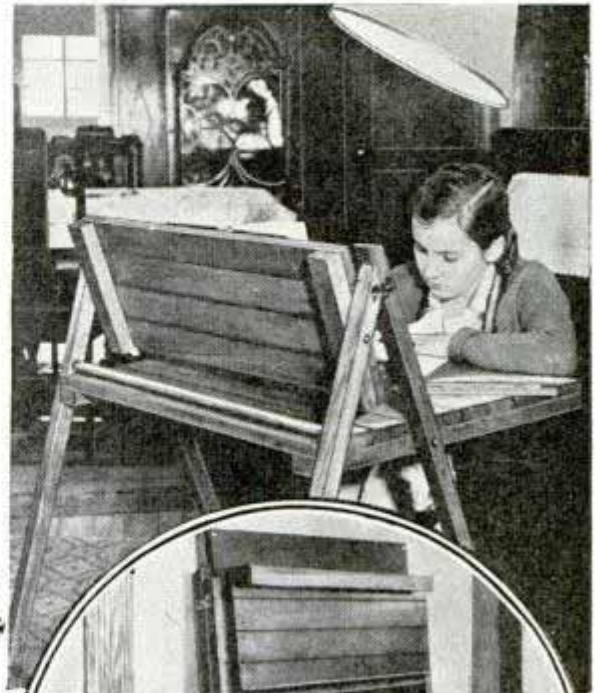
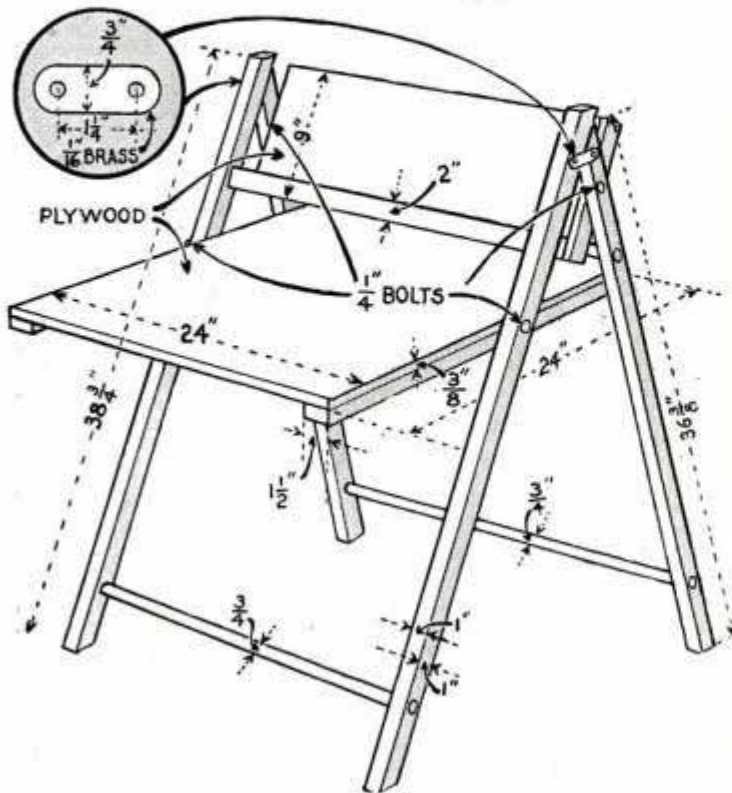

For use with almost any chair, this sturdy, folding student's desk can be tucked away in a jiffy. It has a bookrack with a ledge high enough to hold a book open and to accommodate pencils. There is sufficient space between the rack and the desk top to permit papers to slide to the rear, out of the way, when not in use. The top, made of plywood, bears up against a dowel crosspiece between the rear legs. To fold the desk, the bookrack is turned over so that the ledge is uppermost, after which the desk top is turned and the legs brought together.

Sketch Photos or Drawings with Aid of Ruled Celluloid

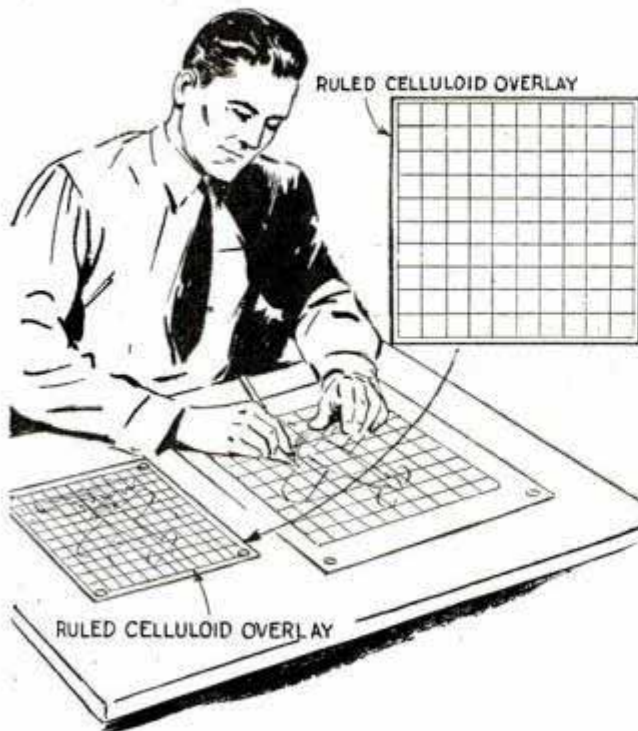

It is a simple job to copy a picture the same size or larger than the original, if you use a piece of celluloid ruled off in squares. This is placed over the picture to be copied, after which the sheet of paper on which the sketch is to be made is also ruled off in squares. However, the size of these is determined by the amount of enlargement. For instance, if the celluloid is ruled off in 1/2-in. squares and the picture is to be reproduced twice the original size, the paper should be ruled off in 1-in. squares. Then, you proceed in sketching, and the ruling will serve to locate accurately the lines to be drawn.

—M. G. Winterton, Ft. Lewis, Wash.

☐ Paper on the backs of pictures, to keep out dust, should be renewed as soon as it has become torn.

Hot-Water Expansion Tank Makes Handy Lawn Roller

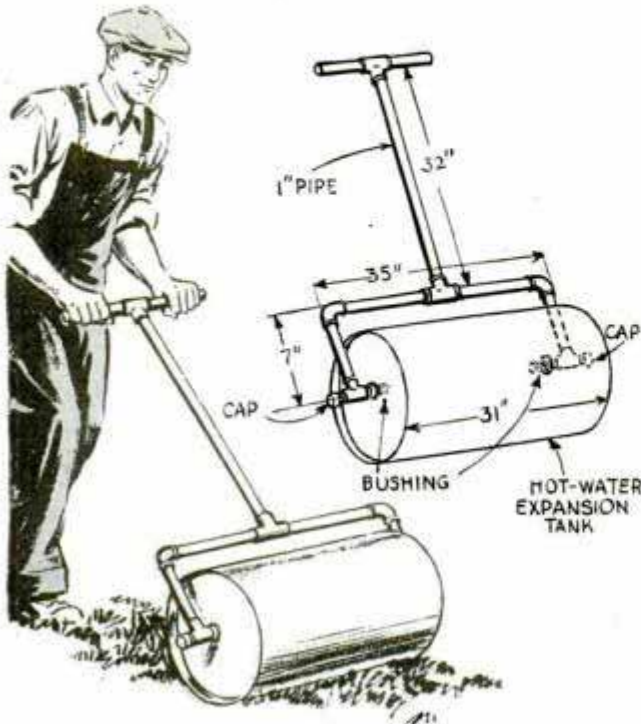

Using a few pieces of 1-in. pipe, four tees and a discarded expansion tank you can easily make up an efficient lawn roller. A screw bushing is turned into each end of the tank, using pipe-thread compound to prevent leakage of water. Tees slipped over the bushings act as bearings for the handle. To fill the tank you simply remove either one of the caps on the bushings and insert the hose. Any small holes in the tank can be plugged with copper wire and soldered.—I. D. Linehan, Chicago.

Simple Mandrel to Wind Springs

For winding a number of springs I use a simple crank shaped from an iron rod. This is placed between two soft-wood blocks clamped in a vise, after which the end of the wire from which the springs are to be wound is inserted into a hole in the end of the crank. Then, the latter is rotated slowly to wind the spring, taking care to space the wire turns correctly. As the work progresses, the wire cuts tiny grooves in the blocks like threads. Duplicate springs then

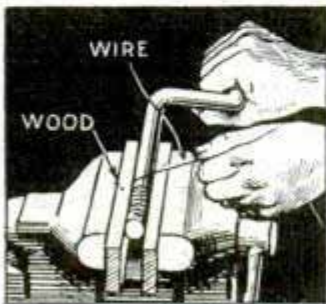

can be wound rapidly, as the grooves in the blocks guide the wire and space it automatically as the crank is turned slowly.

—J. F. Dockar, Vancouver, B. C., Can.

Building Paper Applied Easily with Scaffolding in Place

Instead of loosening scaffolding braces from the side of a building when applying paper, leave the scaffolding in place and cut a slit in the paper to slip over the braces as shown. When the scaffolding is removed, the flap can be tacked down.

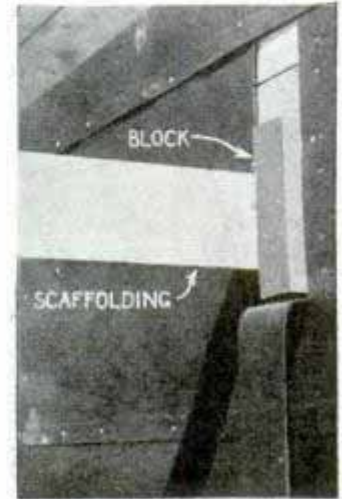

Replacing Typewriter Cushions

Old, hardened rubber cushions on the feet of a typewriter can be replaced with ordinary fuller balls obtainable at a local variety or plumbing store. Cut off tops as indicated and insert screw bolts in the holes. Upon tightening the screws, the heads will become deeply sunk into the rubber, thereby providing neat and durable cushions. —Morris Clayton, Nowata, Okla.

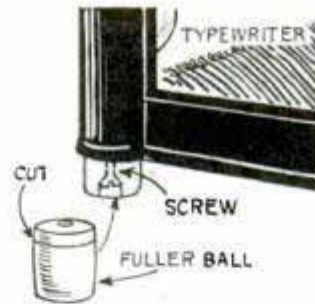

Emergency Lead-Pencil Clip

An emergency pencil clip is quickly improvised by fitting the pencil with a common "socket" eraser and slipping a wire paper clip under it as shown. If the lower end of the wire is bent upward slightly, it will slide over the edge of a pocket easily.

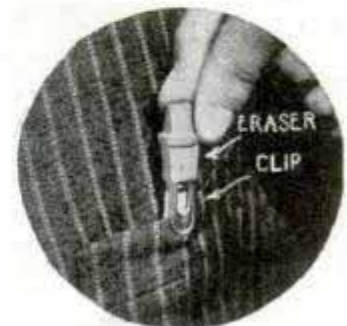

VACATION SHAVING

from a car battery

WITH this compact and easily built outfit, tourists, "trailerites," and traveling men can operate their 110-volt electric razors from the 6-volt car storage battery at a current not exceeding 6 amps. All you need is a couple of door buzzers, a bell transformer, which you rewind, a few condensers, switch, plug outlet and wire. The parts are mounted on a panel which is slid into a box, the top of which has a plug outlet and switch. Cables from the unit to the battery pass through holes in the side of the box or they may attach to binding posts on a small Bakelite panel on the side of the box.

The transformer core is taken from a doorbell transformer. The cores for most transformers of this kind are $\frac{5}{8}$ by $\frac{7}{16}$ in. in cross-sectional area and have a winding space $1\frac{1}{4}$ in. long, and the values given for rewinding are based on these figures; however, any bell-ringing transformer will do, provided the same number of turns are used and the wire sizes specified are adhered to. After the case has been removed from the transformer, all of the old windings are stripped off.

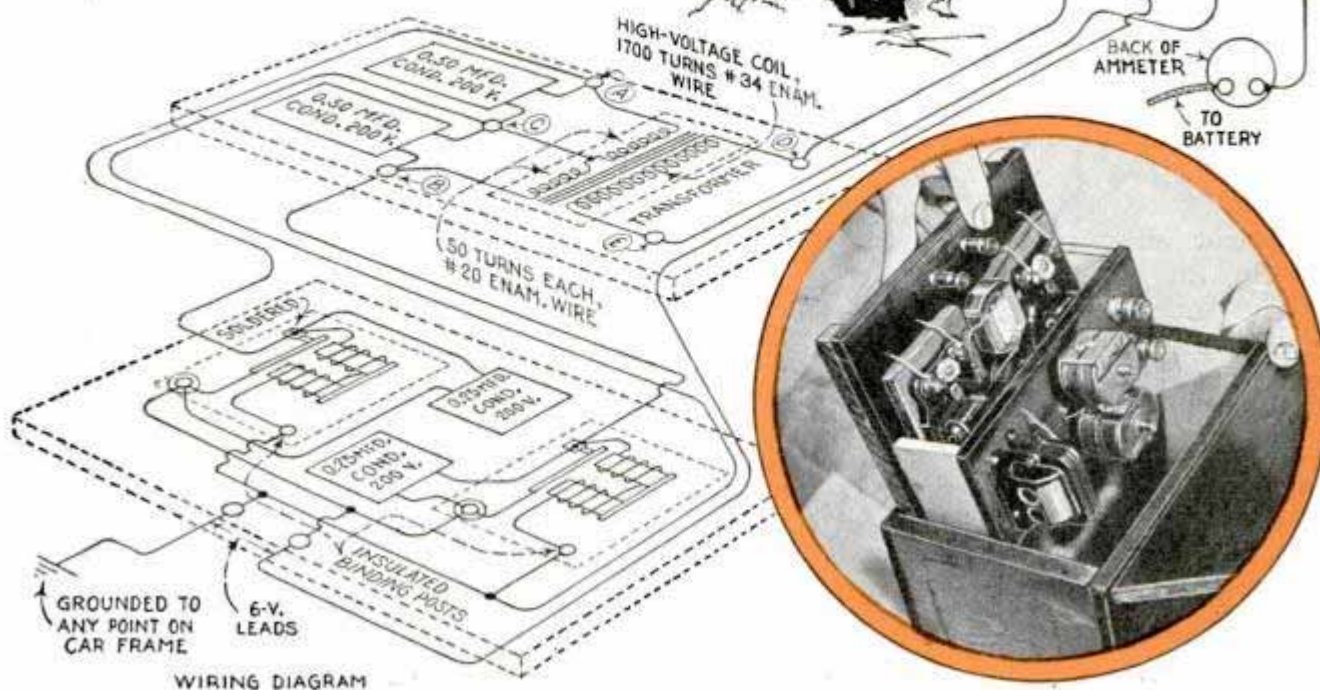

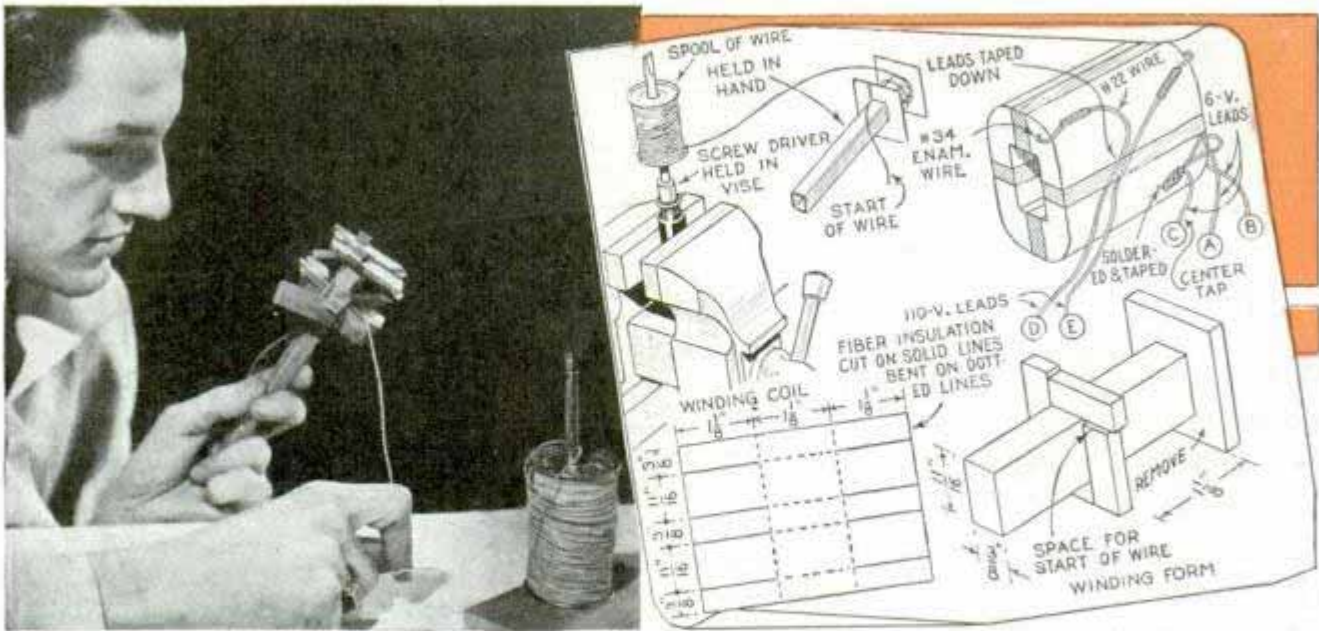

A winding form having dimensions to suit the core and 8 or 10 in. long is made from wood. Strips of cotton tape are laid lengthwise along the form and covered with a piece of fiber or heavy brown paper cut to the shape shown in one of the details. This is held in place with a single band of friction tape. The 110-volt coil is wound with 1,700 turns of No. 34 enameled wire evenly distributed. Cotton-covered wire cannot be used as there is not enough space. Under no circumstances can smaller (larger gauge number) than No. 34 be used for this coil. No insulation is needed between layers. When the coil is finished, a 12-in. length of wire should be left for connections, and the coil covered with a layer of brown paper. Then the low-voltage coil is wound over the 110-volt winding with No. 20 enameled wire, two coils of fifty turns each being required. These can be wound at the same time from two spools of wire. The start and finish ends of each coil must be marked carefully so that they can be connected properly after winding.

When these coils have been wound, the ends of the cotton tapes are tied over the coil unit to hold it together, and it is slipped off the form. A single turn of friction tape is wrapped around each of the four sides of the coil to hold it together permanently. The ends of the high-voltage coil should be soldered to lengths of No. 22 or No. 20 cotton-covered wire to prevent possible breakage of the fine wire. The joint must be made close to the coil, and

then the connection should be insulated and taped down to the coil to prevent any sudden jerk from snapping the wire. The finish end of one of the low-voltage coils and the start end of the other low-voltage coil should be soldered together and a sufficient length of wire left to facilitate connections. This center-tap should be marked "C" for identification. The other ends of the low-voltage coils are marked "A" and "B." It makes no difference which is marked "A" and which "B." The laminations are slipped into the coil alternately from the two ends exactly as they were originally, and the transformer case is put around the transformer and bolted tightly. The five leads to the coils should be brought out through the porcelain bushings which were used on the original transformer.

The parts of the unit can be mounted very compactly as shown. Bakelite is used for the panels. The condensers shown are 200-volt radio condensers of the capacities indicated. The buzzers are mounted on sponge rubber to cut down the noise as much as possible.

Completing Interrupted Card Deal

If you are interrupted while dealing cards, and forget where you stopped, try the following method to complete the deal correctly. Begin with yourself and deal out the balance of the deck, going around the table in the opposite direction and taking the cards from the bottom of the deck.

Shoe-Shining Box Slides under Chair Seat

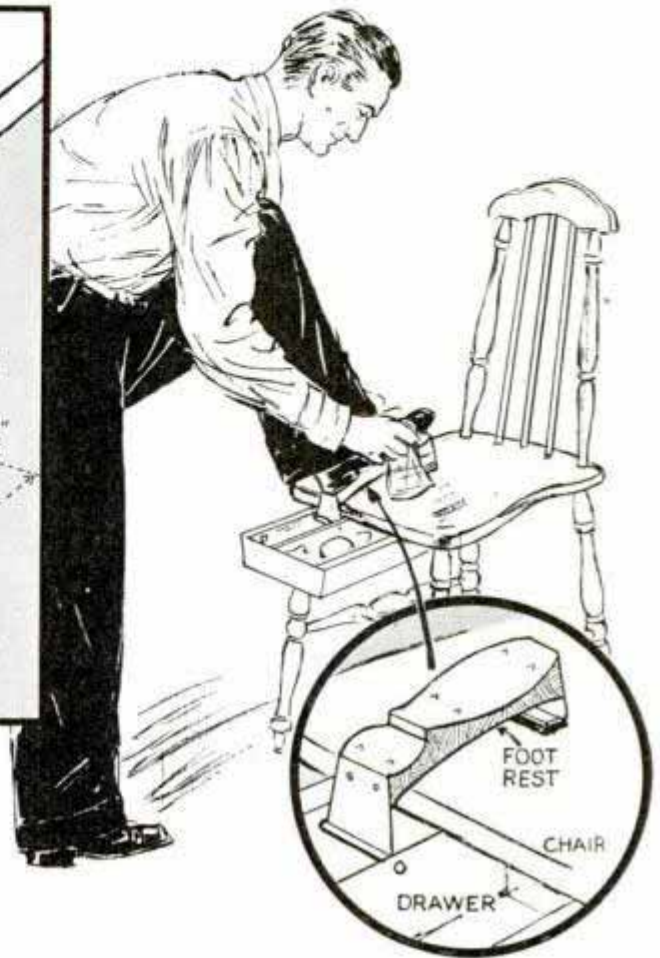
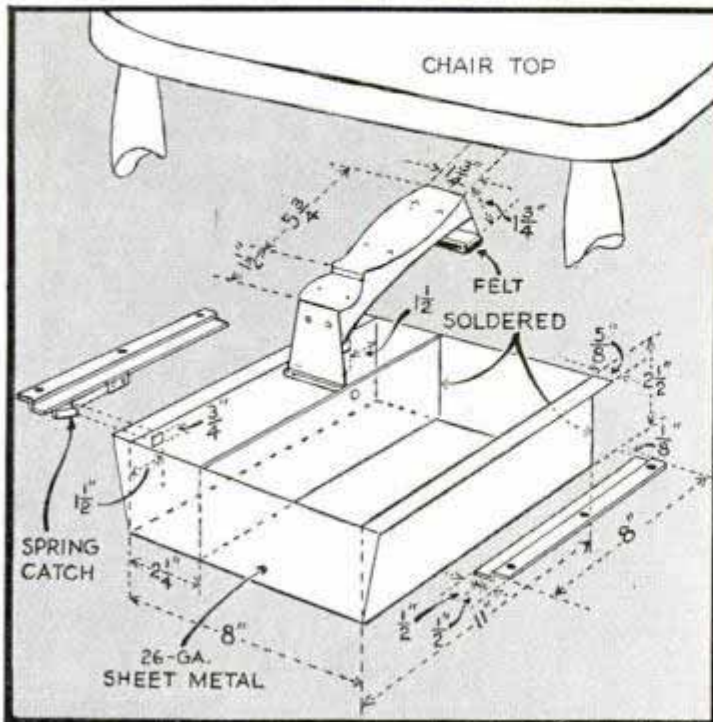

Sliding in two rails screwed to the underside of a chair, this box slides forward for ready access to the contents when needed, and a wooden footrest then can be swung over on the chair seat. The footrest is pivoted between one side and a partition of the box and has a piece of felt on the end that contacts the chair seat to avoid marring it. The tray can be made up of sheet metal or wood as desired. One of

the slides is provided with a spring catch to keep the tray in the closed position, and a stop may be added to prevent it from sliding out and dropping on the floor.

Rotating Drawers Save Space Underneath the Workbench

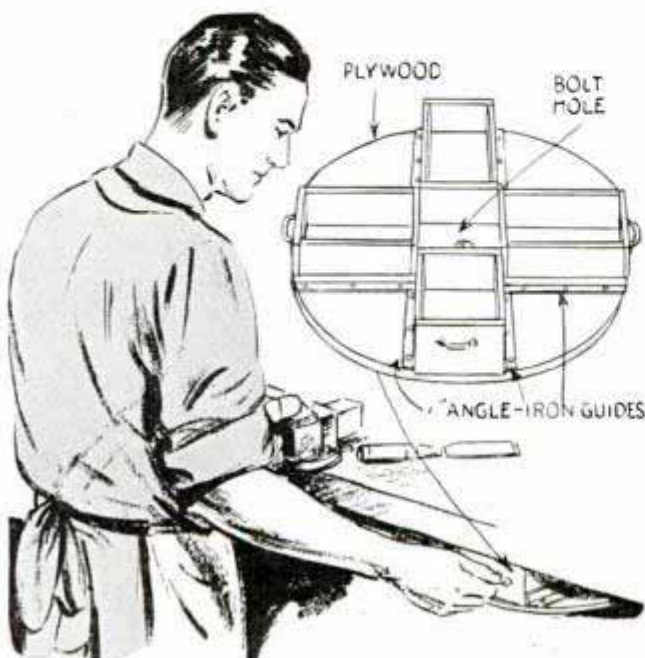

When space is limited under a workbench these rotating drawers will help solve the problem. Also, they can be reached from either side by turning them to bring the one desired in front. The drawers are assembled on a large plywood disk having a diameter approximately equal to the width of the bench. The disk is pivoted in place with a strong bolt and washers, and the drawers slide between angle-iron guides screwed to it. If the disk tends to tip due to unequal loading, an X-frame of light stock can be suspended from the bench underneath it to provide the necessary support on the heavy sides.

—Lowell C. Ferguson, Spokane, Wash.

☛ Screw a metal broom holder to the top of your ladder for holding a screwdriver.

Small Anvil from Flatiron Clamps to Leg



A handy little anvil, that may be held securely on one's leg, is made by attaching a discarded flatiron to a short section of auto casing. The flatiron is drilled and tapped to receive two small stud bolts or large machine screws, the heads of which will sink into the fabric of the casing as they are tightened.

Tennis Rackets Are "Tailored" to Measure

Unless the handle of your tennis racket fits your hand and has the proper "feel," you are not likely to play your best game.

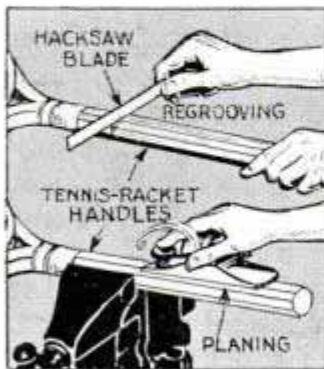

Usually the handle is too large which causes muscular strain and slows you down. This does not mean faulty manufacture, as the sizes must be standardized. The handle of a man's racket usually measures $4\frac{3}{4}$ in. in circumference at the butt and you can reduce this safely by careful planing to $4\frac{1}{2}$ in. or any size in between that fits your hand. The feel of the racket must be determined by trial during the planing op-

eration. When it's just right, you duplicate the original grooved surfaces by drawing a hacksaw blade over the flat surfaces with the grain.—D. J. Gaul, Bridgeport, Conn.

Brick Soaked in Kerosene Kindles Fire

You'll have no trouble starting a fire at camp, in a stove or in your fireplace, if a soft brick soaked in kerosene is used. It's best to split the brick in half and wrap it with heavy wire to provide a handle.

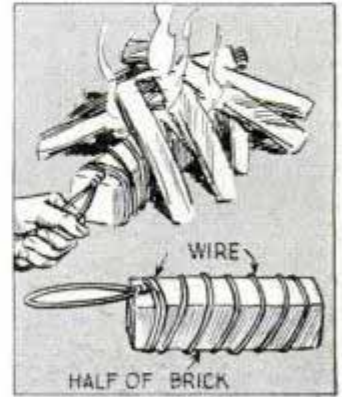

Shields under Paper Fasteners Prevent Ragged Holes



Punched holes in papers held together with small brass fasteners are prone to become worn and ragged, especially those in the top and bottom sheets, so that the papers finally tear

loose. This trouble can be avoided easily by folding a $\frac{1}{2}$ -in. strip of celluloid or tough cardboard over the paper before punching each hole.

Bottle Stoppers from Erasers

Rubber corks for small chemical bottles in the laboratory may be had by using pencil erasers of the type shown. The hollow end compresses easily to slip into the mouth of a bottle.

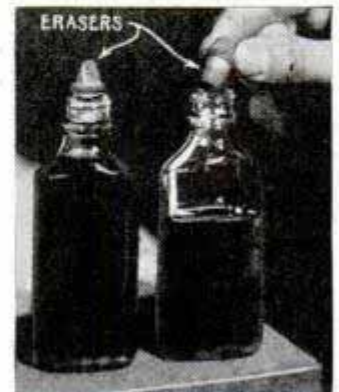

☐ Poached eggs will not stick to a saucepan if the bottom has been rubbed with oil.

Pivoted Trays on Sewing Box Show Contents

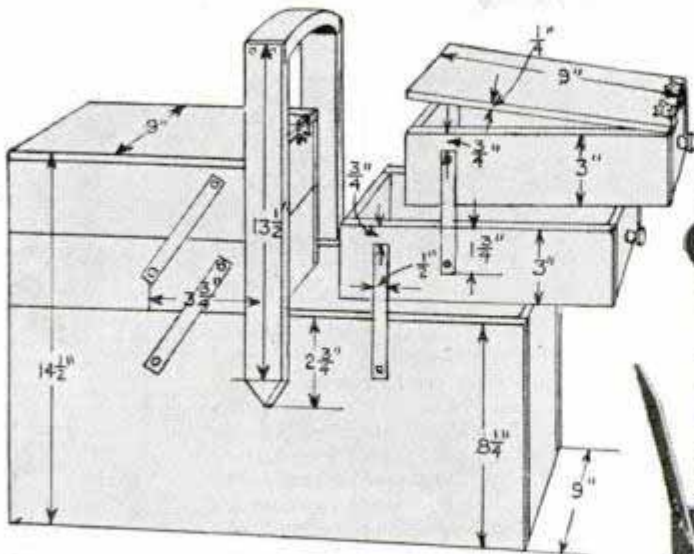

Swinging the pivoted trays of this sewing box outward makes everything readily accessible to the home seamstress. Plywood is used throughout except for the handle and the strips of metal on which the trays pivot. The strips, all of the same length and drilled identically at the ends for screws, must be located at an angle and parallel to each other, as shown when the trays are in the closed position, so the trays will not bind when moving them over to rest snugly together when in the open position.



Auxiliary Straightedge on Miter Gauge of Circular Saw

Quickly attached or removed at will from the saw miter gauge by means of metal clips as shown, this auxiliary straightedge has a convenient scale by which to set an adjustable stop block. A

length of $\frac{3}{4}$ -in. stock, preferably plywood, is cut to fit flush with the top of the face of the gauge and is slotted to receive the tongue of the stop block. The block is held securely at the desired position by a wing nut conveniently located on the back side of the beam.

—Wayne C. Leckey, Aurora, Ill.

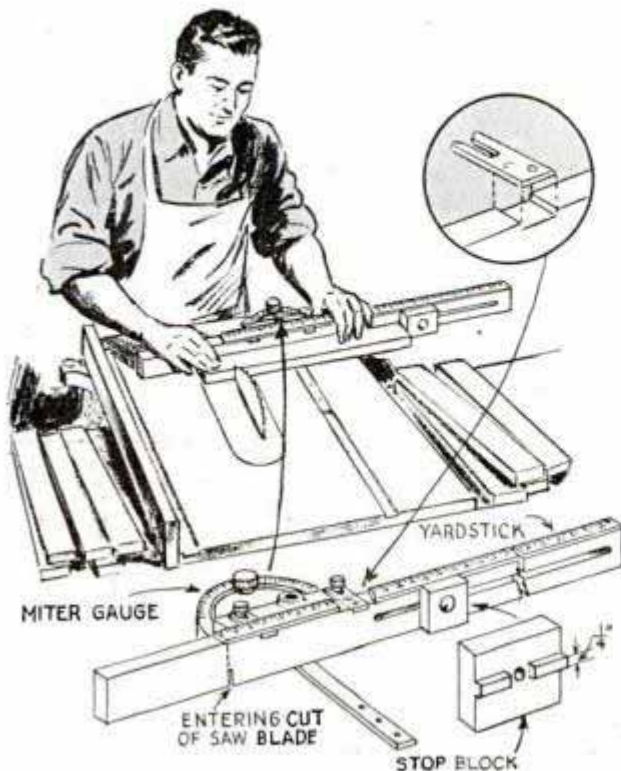

Using Expansion Bit in Hardwood

You can ease the strain on an expansion bit when boring hardwood if you first remove some of the waste stock. To do this, drill a tiny pilot hole in the work for the screw of the expansion bit. Then run in the latter until the outer cutting lip outlines the hole to be bored. Next bore four holes inside the circle formed by the bit as indicated in the drawing.

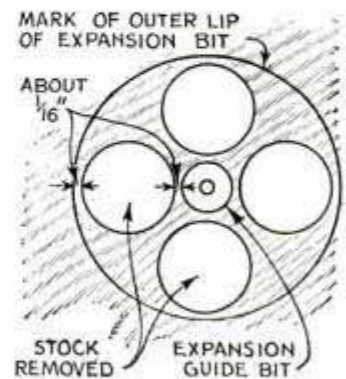

—Donald B. McElroy, Bloomington, Ind.

Solving HOME

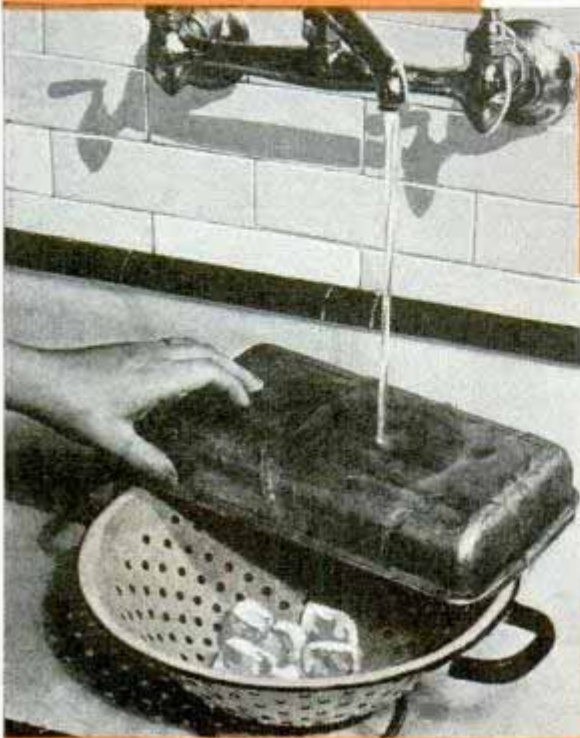

While running hot water over inverted ice-cube tray, use a colander to receive the cubes, which keeps them all together, washed and drained. Umbrellas are stored in fabric bags by one housewife; each bag has a tie cord and is tacked to the wall. Below, strip of cloth tape sewed to center of tablecloth is pinched between table leaves to prevent children or pets from pulling cloth off

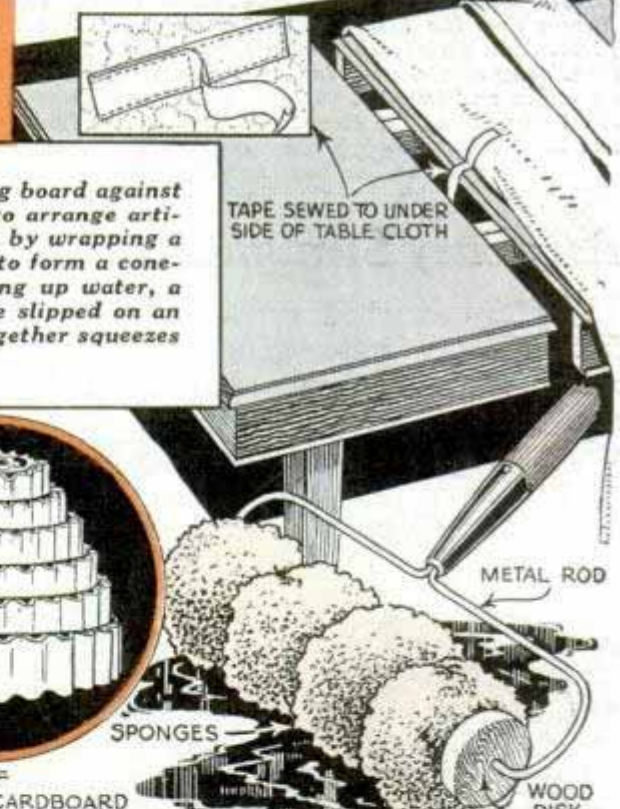

TAPE SEWED TO UNDER SIDE OF TABLE CLOTH

METAL ROD

SPONGES

WOOD DISK

Left, broom clamp holds ironing board against wall in crowded closet. Frog to arrange artificial flowers is quickly formed by wrapping a strip of corrugated cardboard to form a cone-shaped roll. Right, for mopping up water, a few sponges and two disks are slipped on an iron rod. Pushing the disks together squeezes out the water

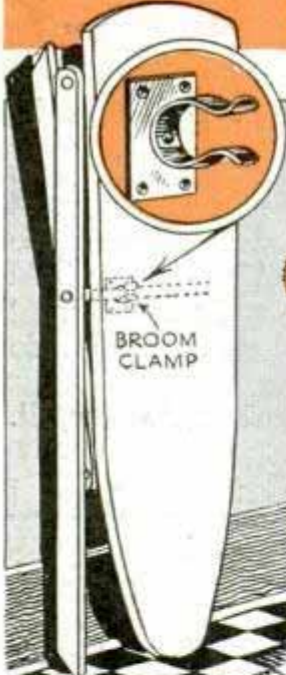

BROOM CLAMP



1" STRIP OF CORRUGATED CARDBOARD



Lemons in tightly sealed jar in refrigerator do not dry out quickly

Tiny stiff brush on handle of whisk broom aids spot removal



STIFF BRUSH



A little starch in window wash water helps produce luster

Keeping tumblers from overturning on card table

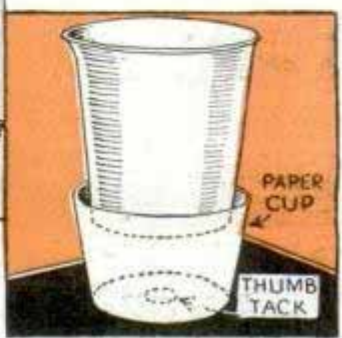

PAPER CUP

THUMB TACK

PROBLEMS

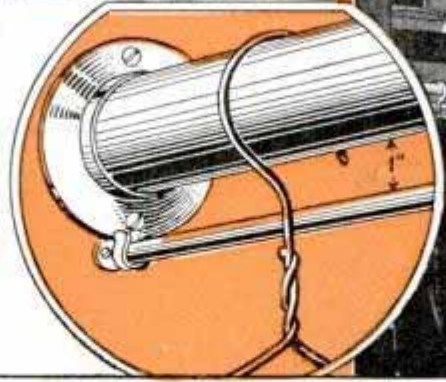

Lowering of stubborn upper sash eased by two hand grips. Rod under clothes-hanger pole prevents hangers from swinging off when clothes are removed quickly. As an aid in squeezing out contents of small tubes, try a clothespin

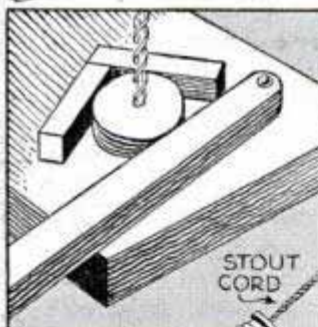

Right, recess in front of coal door confines dust when delivering. "Snake" on the left to keep sink drain pipes clean consists of $\frac{3}{8}$ -in. disks cut from broomstick, drilled off center and strung on stout cord; it scrapes the entire inside surface of the pipe

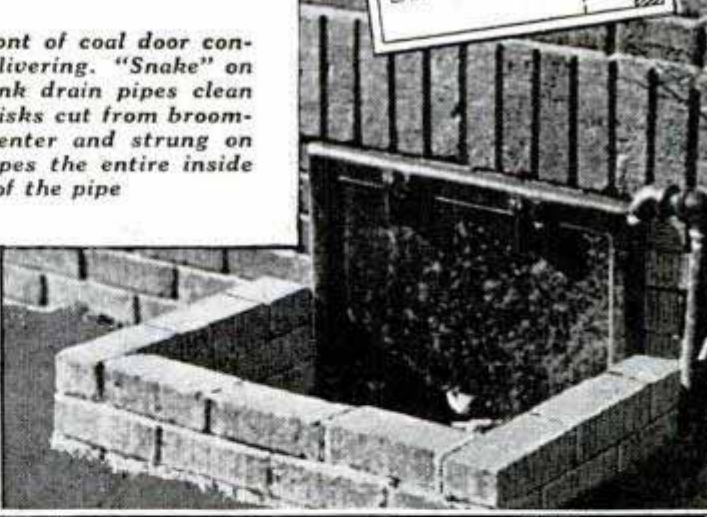
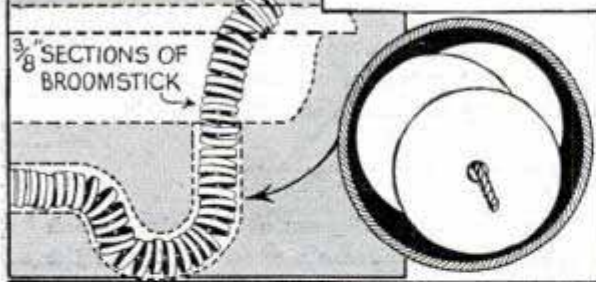
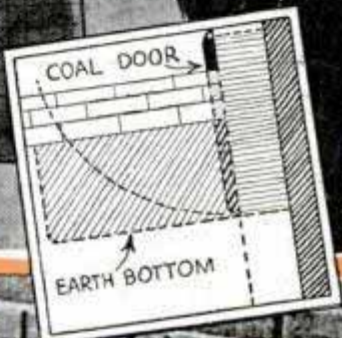

Piece of auto casing supports wood on chopping block

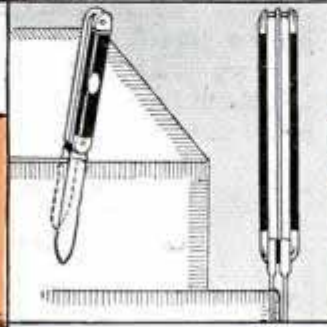
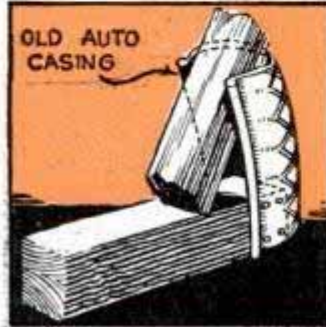

One knife blade guides other to cut along edge of paper box

Valve stems stuck in hose to form scraper for furnace flues

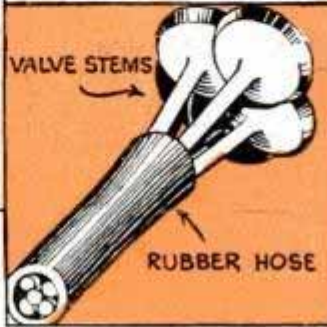

Asphalt shingle under ladder avoids slipping on smooth floor

Auto-Casing Bumpers on Seesaw Protect Children's Legs



As an aid in sitting on a seesaw, children often bring their legs well under it with the result that they are sometimes injured when the ends of the seesaw strike the ground. To avoid this, an old auto casing

can be set into the ground under each end of the board at an angle as indicated. The casings also absorb the shock.

Neat Washers on Bolt Heads

As a means of ornamenting exposed bolt heads on display cabinets and the like, fancy looking washers can be provided simply by drilling furniture glides through their centers. Where a smooth headed bolt is used, the glide may be soldered to it as shown. This will keep the bolt from turning when drawing it up, as the prongs will imbed in the surface of the work.

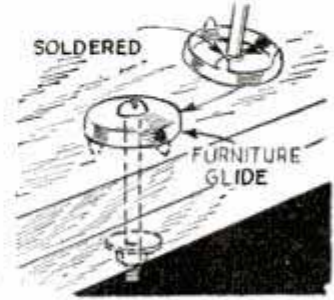

Colonial Footstool *adds to arm-chair comfort*

Readymade, removable cushion attached with snaps. Easy enough for beginners in handicraft, yet attractive enough for advanced woodworkers. Only a few hand tools required. Complete information, plans and photos for only ten cents



Four short, tapered legs glued and keyed into a top to which a comfortable cushion is fitted

EASY TO MAKE

All there is to the construction and assembly is the attachment of four tapered legs to the top, rounded ends of the legs being glued and keyed with a wedge in four slanting holes, bored with the aid of a simple jig. Finishing is no trouble at all and the completed stool is a worthwhile and extremely practical article for the average home that any craftsman will enjoy making.

DETACHABLE CUSHION

A standard cushion of your own choice, which you purchase, is the same size as the top of the stool. Straps sewed on the underside of the cushion are passed through slots in the top of the stool and are tacked or snap-fastened to the underside to keep it in place, yet permit quick removal when necessary for cleaning.

CRAFTPLAN SHOWS HOW

Just send ten cents to get a Craftplan for making this project, which gives dimensioned drawings and details, includes photos picturing several steps, and explains just how to go about the work, step by step. Use the coupon so you will get the Craftplan promptly.

POPULAR MECHANICS MAGAZINE
200 E. Ontario St. Chicago

Enclosed find 10 cents for Craftplan No. 3002 on
Colonial Footstool

Use pencil

Mh. Colonial Footstool—Craftplan No. 3002



SHOP NOTES

CORRECT CENTERING

What every lathe owner should know about using calipers, center square, surface gauge and bell punch to locate centers

ACCURATE turning of both round and square work begins with proper centering. Tool steel and cast iron in particular must be centered accurately, the former to assure that the decarbonized surface layer is removed completely so that the steel can be hardened properly, and the latter so the tool will cut through the scale and not be dulled by this hard surface layer.

Methods of Locating Centers: While a centering machine is generally used in large shops, small shops must use hand methods. Where great accuracy is not required

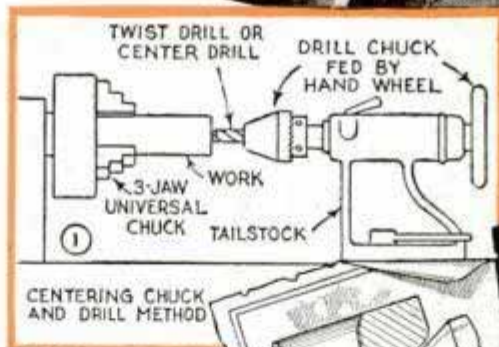

2 BEARING SURFACE TOO LARGE

3 BEARING SURFACE TOO SMALL

4 WORK SCRIBER

5 POOR SUPPORT AND EXCESSIVE WEAR

6 CORRECT PROPORTIONS

7 CENTER FOUND BY DRAWING DIAGONALS

8 LOCATING CENTER OF RECTANGULAR STOCK

9 COATING WORK WITH COPPER FOR MARKING

10 LOCATING CENTER WITH HERMAPHRODITE CALIPER

Labels in diagrams include: STRAIGHTEDGE, INTERSECTION OF DIAGONAL IS CENTER OF WORK, COPPER-SULPHATE SOLUTION, WAD OF COTTON, END OF PIECE, ARCS DRAWN WITH CALIPERS, LOCATING CENTER, and HERMAPHRODITE CALIPER.

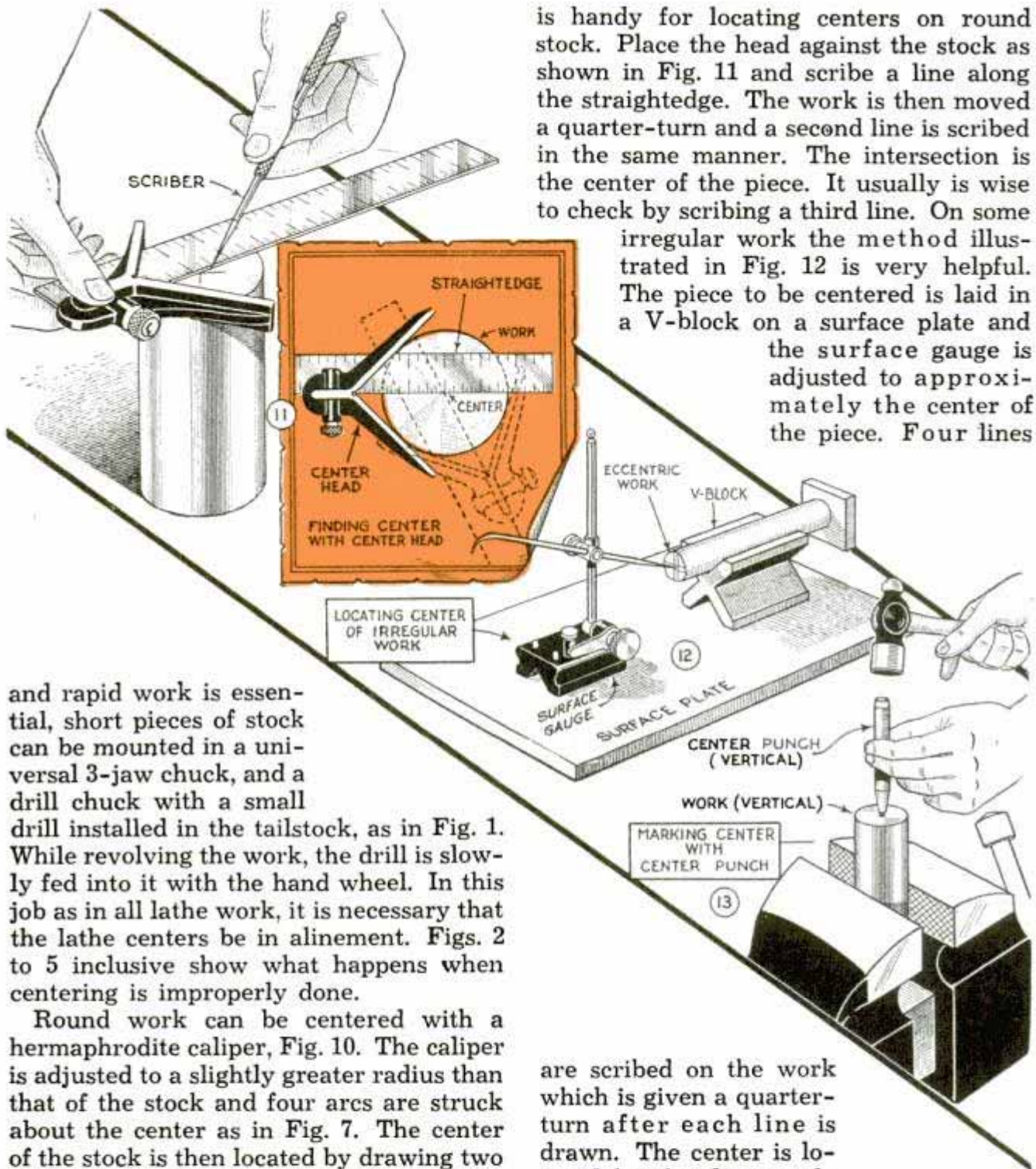

is handy for locating centers on round stock. Place the head against the stock as shown in Fig. 11 and scribe a line along the straightedge. The work is then moved a quarter-turn and a second line is scribed in the same manner. The intersection is the center of the piece. It usually is wise to check by scribing a third line. On some irregular work the method illustrated in Fig. 12 is very helpful. The piece to be centered is laid in a V-block on a surface plate and the surface gauge is adjusted to approximately the center of the piece. Four lines

and rapid work is essential, short pieces of stock can be mounted in a universal 3-jaw chuck, and a drill chuck with a small drill installed in the tailstock, as in Fig. 1. While revolving the work, the drill is slowly fed into it with the hand wheel. In this job as in all lathe work, it is necessary that the lathe centers be in alignment. Figs. 2 to 5 inclusive show what happens when centering is improperly done.

Round work can be centered with a hermaphrodite caliper, Fig. 10. The caliper is adjusted to a slightly greater radius than that of the stock and four arcs are struck about the center as in Fig. 7. The center of the stock is then located by drawing two diagonals cutting the intersections of the arcs, Fig. 7. In order that fine scribed lines can be seen clearly, a solution of copper sulphate in water is applied to the steel with a wad of cotton or a rag, as shown in Fig. 9, until a copper coating forms. Clear lines can be scribed on this surface with very little pressure. Another method is to coat the end of the stock with chalk. The center of rectangular stock is located by drawing two diagonals across the end, as shown in Fig. 8. The intersection of these lines is the center of the piece.

The center head of a combination square

are scribed on the work which is given a quarter-turn after each line is drawn. The center is located by the diagonal-line method, and the center of the other end is found in the same way.

Center Punching: After the center has been located, the work is clamped in a vise and the center is marked with a center punch and a hammer, as shown in Fig. 13. After both centers have been center-punched, the work is placed in the lathe and turned by hand, marking any high spots at either end with chalk, as shown in Fig. 17. The piece is replaced in the vise and tapped again with the center punch, which is driven toward the high spot to

"drift" the mark to the central point, as shown in Fig. 16. Finish the indentation by driving the punch vertically. Test again between centers and repeat if necessary until tests show that the indentation is truly centered. Unless extreme accuracy is required, use a bell center punch, Fig. 18. This tool will locate centers on round stock in one operation with sufficient accuracy for ordinary work. Simply place it over the end of the stock and strike the plunger lightly with a hammer.

Drilling the Centers: The center can be formed in one operation with the center drill shown in Fig. 14, or in two steps with a drill and reamer. Three types of centering tools are shown in Fig. 19. The upper detail shows the combination center drill while the lower-right detail shows two types of center reamers. Drill and reamer sizes for work of various sizes are given in Fig. 15. The centering tool or reamer should match the center being used, that is, a 60° reamer for the regular 60° lathe center. To use the combination center drill, mount the work as in Fig. 14 with the centering tool chucked in the live spindle of

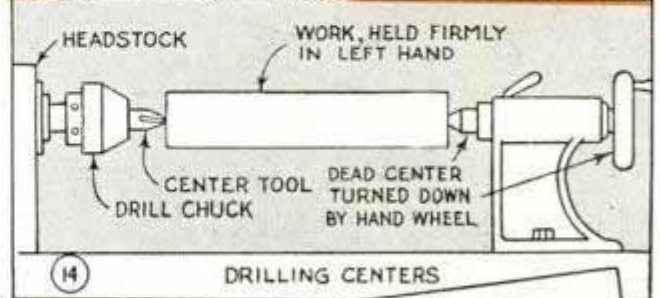
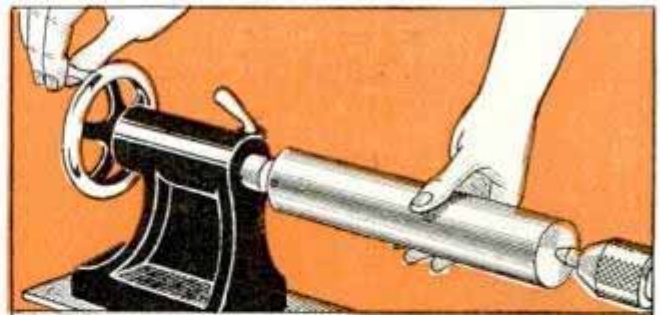

SIZES OF CENTERS

Diameter of Work in Inches	Diameter of Center (Countersunk) in Inches	Diameter of Center Drill in Inches
3/16 - 5/16	1/8	1/16
3/8 - 1	3/16	3/32
1-1/4 - 2	1/4	1/8
2-1/4 - 4	5/16	5/32

15

the lathe. Feed with the tailstock while the lathe is running at its highest speed, holding the work as shown to prevent its turning. The drilled hole always should be from 1/3 to 1/2 the diameter of the reamed hole, as indicated at d in Fig. 6. For steel or wrought iron, lard oil or a cutting compound should be used to lubricate the drill. Cast iron is always drilled dry. If a drill and reamer are used to form the centers, the operation is the same, except that it is performed in two steps. A lead hole of the proper size, Fig. 15, is drilled first. Then it is reamed to the proper diameter using a center reamer of suitable size.

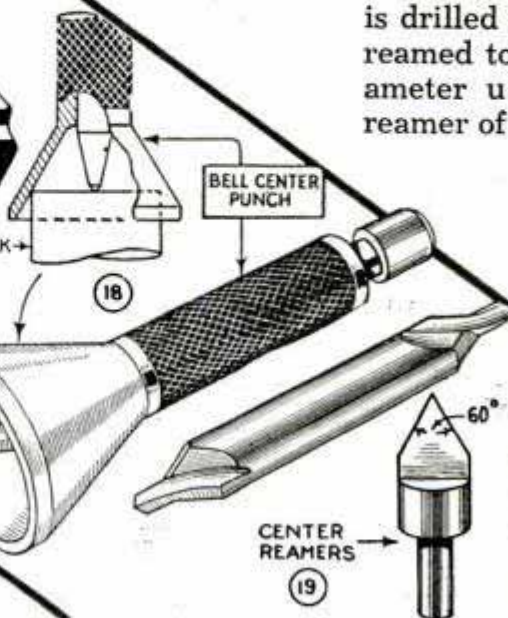
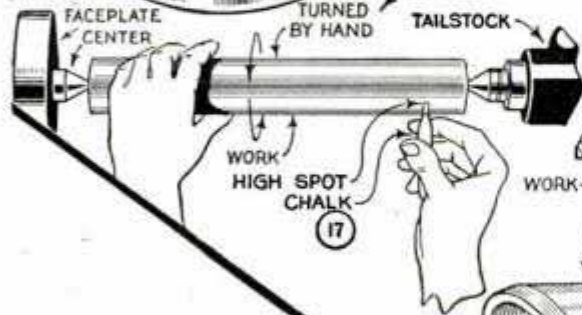
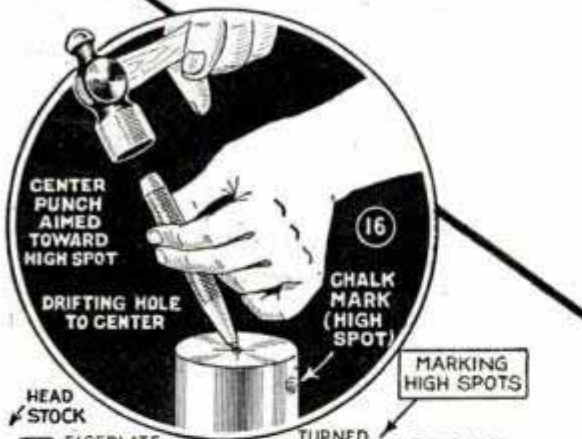

The bell center punch at the right offers the quickest means of centering small round stock where precision is not required. It will center-punch stock of varying diameters

Wheeled Stands Display Goods in Front of Store



The problem of moving stands of merchandise from the front of the store to the inside at the end of the day, or in case of sudden rains, is solved by providing the stands with casters. The large rubber-wheel type is best for this purpose. Or, small cart wheels on axles attached to the bottom of the stands, will serve the purpose, although they do not give as much flexibility of movement as casters.

Weigh Slips on Outside Scales Held Safely in Wind

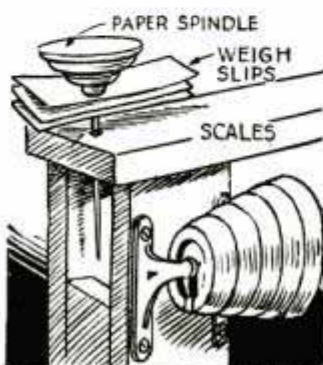

Instead of the usual method of setting a spindle paper file on the arm of a scale, one produce buyer drilled a hole through the arm to receive the spike of a paper

spindle, as shown. The slips impaled on the spindle are thus held against any possible loss by wind, and the spindle is easily removed for further additions.

Handle on Rubber Stamp Pad

To simplify opening a rubber stamp pad, cut the wooden handle from a discarded stamp block and attach it to the center of the pad cover. This allows the pad cover to be lifted easily and saves time and trouble when you are in a hurry.



Draftless Ventilation in Barns

Draftless ventilation in some dairy barns near Lincoln, Nebr., is obtained by pulling the windows inward against sheet-metal triangles inverted and attached to the side frames of the windows. As illustrated, one

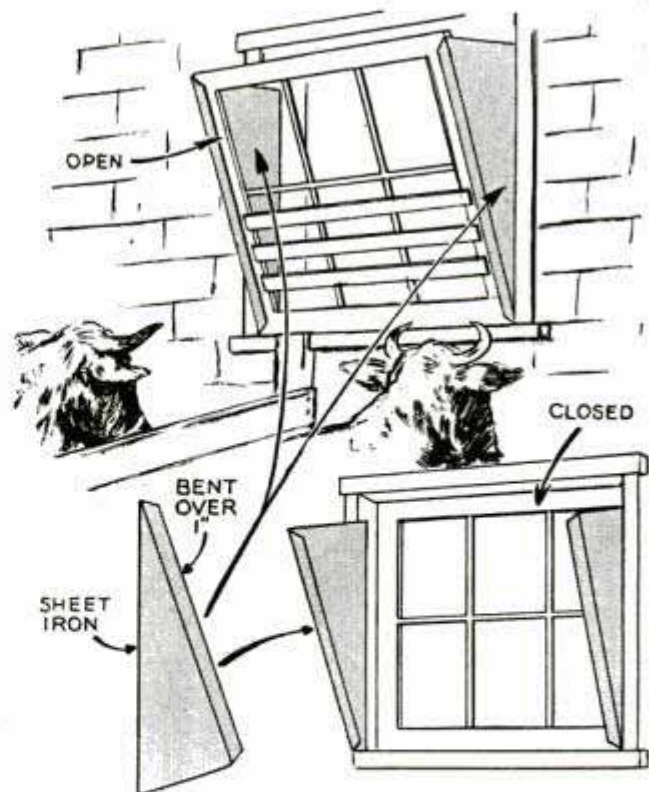

side of each triangle is bent over at right angles to serve as a stop for the windows. The incoming air flows against the windows and is deflected upward. Turnbuttons hold the windows closed.

This **NEGATIVE DRYER** has warm-air circulation

FOR quickly drying negatives and ferrotyped prints, this dryer takes little space. Air is forced through a U-shaped passage and may be warmed by an electric-heater element which may be turned on or off while the fan is running.

Plywood is used for construction. Sides adjacent the heating element are protected by asbestos paper. A piece of $\frac{1}{8}$ -in. hard-pressed board or sheet metal is bent to deflect the air around the center partition and up through the other side. Crosspieces hold ferrotype tins vertically. Cut films are suspended from spring clothespins attached to dowels, which are merely set across the crosspieces. A hinged frame covered with wire mesh is provided to catch the glossy prints. It is swung down to permit a 36-in. roll of film to hang from the top of the cabinet. The lower switch, which includes a ruby lamp, connects to the heating element. A thermometer is mounted beneath this lamp and extends into the cabinet.

—Myron Levee, Chicago.

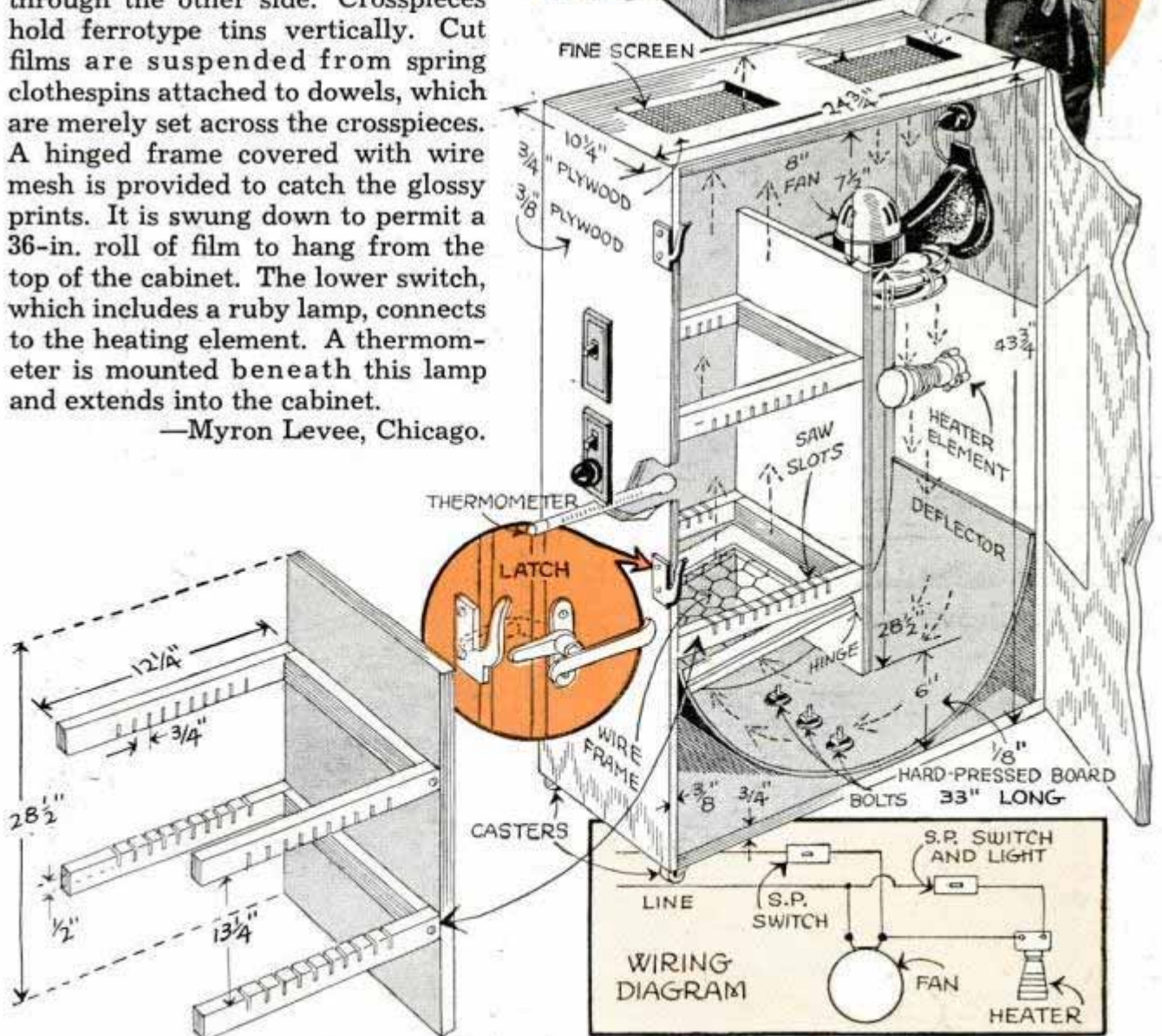
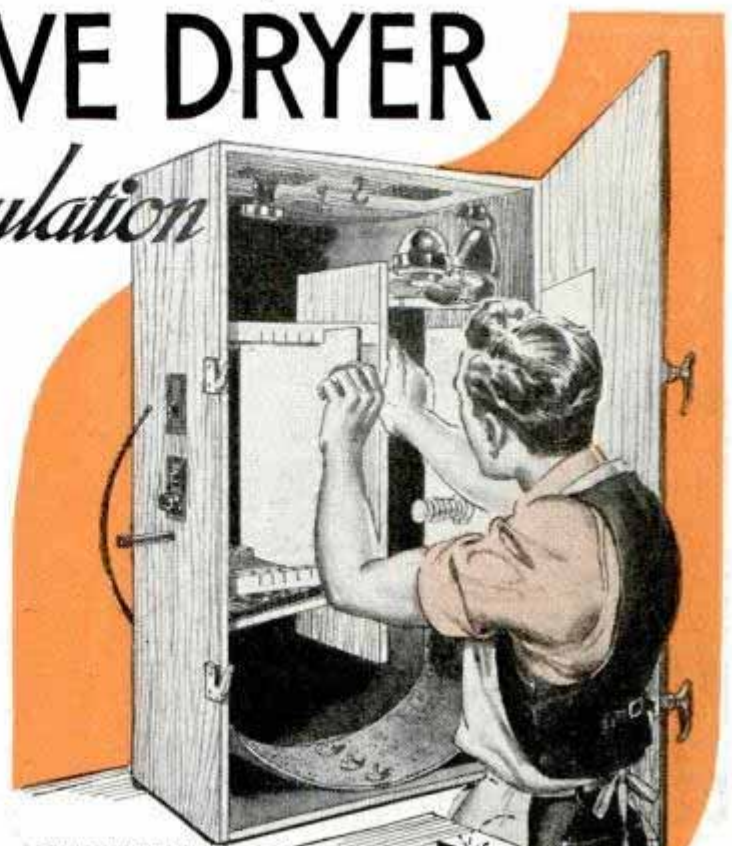

Colored Lamps Summon Waiters to Restaurant Tables

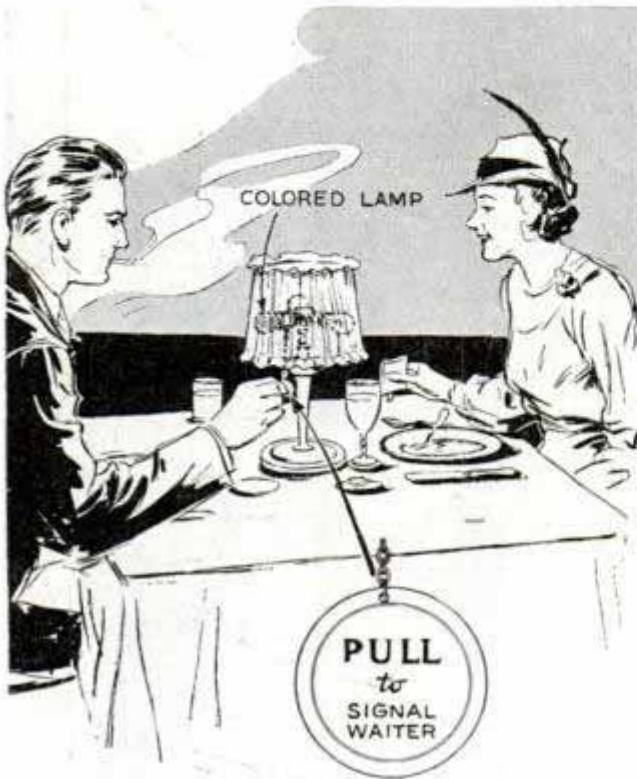

Noticing that some of his patrons were annoyed at the delay in trying to catch the eye of a waiter, the manager of a large restaurant used a colored bulb in the cluster of each table fixture. The bulb was wired independently of the white ones and was operated by a pull chain from which a printed tag was suspended directing the patron to its use. It was an easy matter for the waiters to glance over the dining room and determine where their services were required. After answering the call, the waiter extinguished the lamp.

Chalk Substituted for Brush in Showcard Painting



Showcard writers who have large paper posters to letter on short notice and who do not wish to take time to mix liquid colors, can turn out work of similar character and appearance by using colored crayons dipped in al-

cohol. Crayons so treated will work on almost any surface and the job may be accomplished in much less time. Water was also found effective but not as satisfactory as alcohol.

Wire Protects Factory Windows Against Breakage from Inside

In one manufacturing plant breakage made it necessary to protect certain windows from the inside. This was done by stretching medium wire mesh over light wooden frames. The latter were made removable by driving screw eyes into the window frames and registering L-hooks into the screens as in the detail.

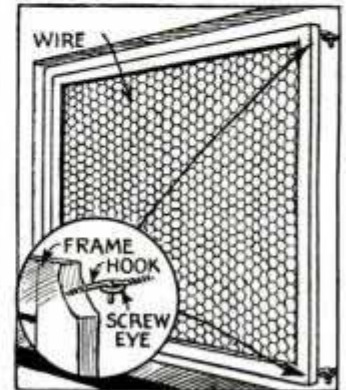

Heavy Cases on Loading Platform Moved on Two Push Trucks

Moving of heavy cases by means of two-wheeled push trucks saves time on one loading platform. The case is first rocked in the usual manner to get the edge of one truck under it, after which the other truck is slipped under the opposite end. Two persons can wheel the load and shift it around where desired.

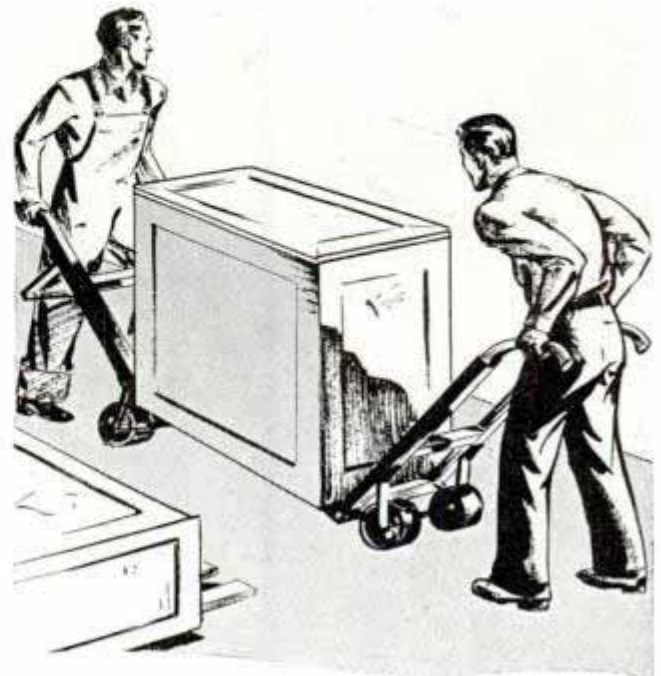

Lamp Lights on Plateholder Depth Gauge

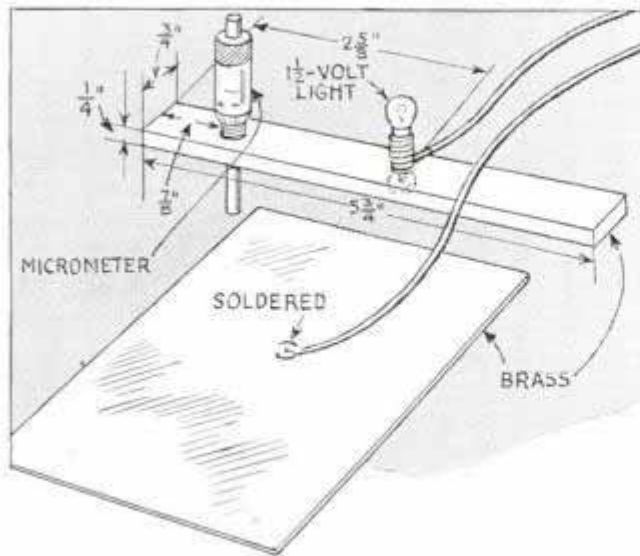

FOR the color photographer who measures the depth of his plate and film holders, this homemade micrometer depth gauge with a flashlight indicator is accurate and saves considerable time. Whether the three-color negatives are exposed in sequence or simultaneously in a one-shot three-color camera, the plate or film holders must have exactly equal depth in order to assure images of the same size. Holders used in ordinary black-and-white photography are seldom accurate for color work. Hence when purchasing holders for color photography, the depth from the face of the plateholder to the surface of the plate must be measured accurately at all four corners, and holders are then selected in groups of three so that their respective faults will be similar.

To make this micrometer depth gauge, you get a piece of No. 16-gauge engravers' brass cut to the same size as the photographic plate, a strip of flat brass long enough to fit across the plateholder, a dry cell, 1½-volt flashlight bulb, some wire and a cheap micrometer. The drawing shows the assembly. After cutting off the arm of the micrometer, the shank is filed round, and the end of the shank is threaded to fit a tapped hole in the brass strip. A flashlight lamp is then attached to the brass strip so that one contact connects with the strip and the other one to an insulated lead which goes to the dry cell. Another lead from the dry cell is soldered to the brass plate. In use, the brass strip is laid across the plateholder as shown in the photo and the micrometer turned down



until the lamp lights. Naturally this visual method of indicating with a lamp when the micrometer touches the metal is more accurate than feeling with the fingers when the micrometer touches it.

—T. M. Hamilton, Chicago.

Ammonia to Transfer Pictures to Linoleum Blocks

When a picture is to be transferred from a newspaper to a linoleum block to make a printing cut, moisten the picture with ammonia, lay it face down on the linoleum and weight it with an iron, so that the picture will be applied smoothly over the surface. Leave the weight in place for not more than 5 min., then remove carefully and dry the block. The picture thus transferred to the linoleum will be the reverse of the original and will print a duplicate of the original picture.

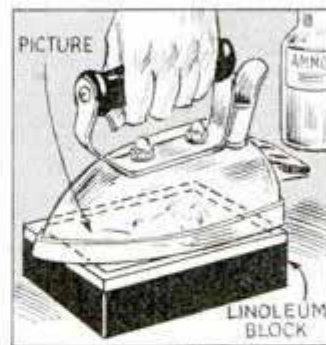

☞ Stains caused by butter, fats and oils, can be removed easily from unwashable materials by sponging the spots with carbon tetrachloride.

Drawing Ink Applied to Pen from Bottle

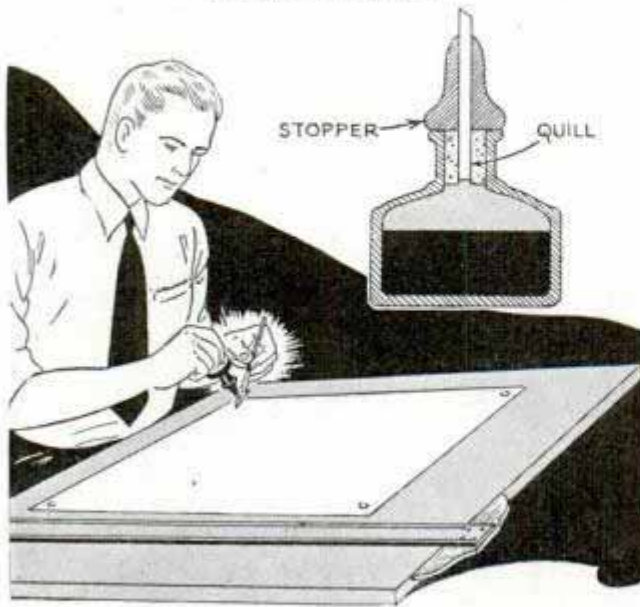

One draftsman found that by reversing the quill in the ordinary drawing-ink bottle the ink can be fed to the liner pen a single drop at a time, without flooding or spilling. To do this he removed the quill and drilled a hole through the hard-rubber stopper so that the quill could be reversed. It should be a snug fit and may be glued in place. To prevent evaporation of the ink, a rubber stopper, such as a small pencil eraser, or a wooden plug, is inserted in the open end of the quill.

—Ellsworth Davis, Geneva, Ohio.

Altered Drills Cut Smooth Holes in Thin Sheet Metal

By simply changing the angle of the cutting edges of old drill bits, one mechanic found that he could cut clean, round holes in thin sheet metal. The trick in re-grind-

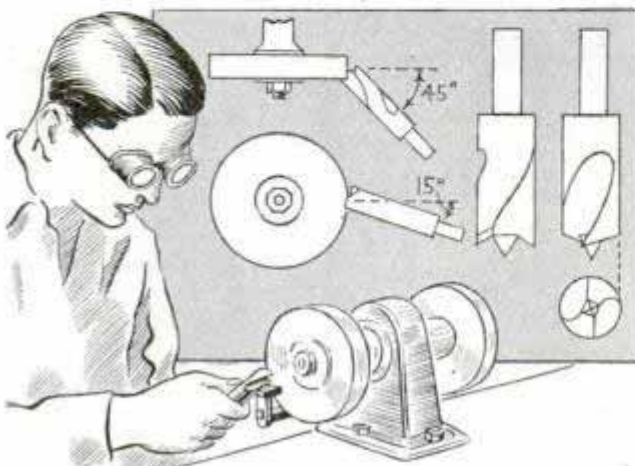

ing the drill is to produce a tapering center point with square sharp corners, the point being exactly on the axis of the drill. This point acts as a pilot in the same way as the small pilot drill on a hole saw, preventing the bit from running off-center and enlarging the hole. Holding the drill on the corner of the grinding wheel at the angles indicated produces both the center point and the cutting edges required. Check the accuracy of the grinding by measuring from the center point to the cutting edge on both sides.

—A. W. Hansen, Maywood, Ill

Testing Your Drill-Press Table for Precision Work

Use of a dial indicator will show up any inaccuracy of a drill-press table when preparing for precision work. A short piece of cold-rolled steel is drilled to receive an ordinary lathe mandrel on one end and the dial indicator shaft on the other. Insert the mandrel in the drill chuck and bring

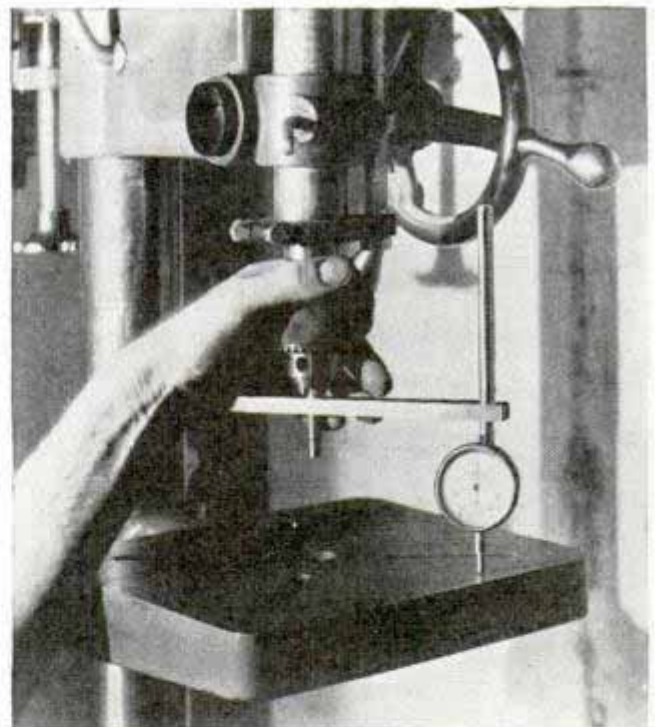

the spindle down till the indicator point touches the table. Then lock the spindle. Turn the indicator and chuck by hand slowly while watching the indicator hand. It is surprising how much spring there is to a sturdy drill-press table. For this reason the table should be one or two thousandths of an inch high at the front

Rep. Painting, Finishing & Repairing

catalog on request

296 Philadelphia Soleda Ohio

NOVELTY FINISHES

with Brush and Spray

Crackle, crystal, spatter and veiled finishes, as well as wrinkling, shading, smutting and many others applied to furniture and novelties

NOVELTY finishes of interesting textures and color combinations can be used to advantage in the home or professional shop. They are smart and distinctive, cost little if any more to apply than the usual smooth finish of one color, and can be applied readily without previous experience. Most of the effects require a spray gun for successful application, although some can be brushed or dipped.

Crackle: Crackle enamel is available either clear or in standard colors, and is applied over a lacquer undercoat.



A CRACKLE FINISH IS EASILY APPLIED



It dries almost instantly and cannot hold its original overall coverage, but instead cracks into numerous small sections, as can be seen in

Figs. 1 and 2. Red crackle over black lacquer is commonly used to produce a Spanish vargueno or oriental effect. Other good combinations are brown over ivory, green over gold and blue over gray. After the under coat has dried, the crackle coat is sprayed on. The lighter this is applied, the smaller the cracks will

be. Some experience is required in order to get a uniform surface. For pleasing, transparent effects on polished metal, colored glass, or parchment mix clear crackle enamel, about 10 parts, to the desired color, 1 part. The base coat should be clear lacquer or a rich, yellow gold. In all cases, the crackle coat should be protected, when dry, with a coat of clear lacquer.

Wrinkling: One of the most popular finishes on all kinds of metal work is wrin-

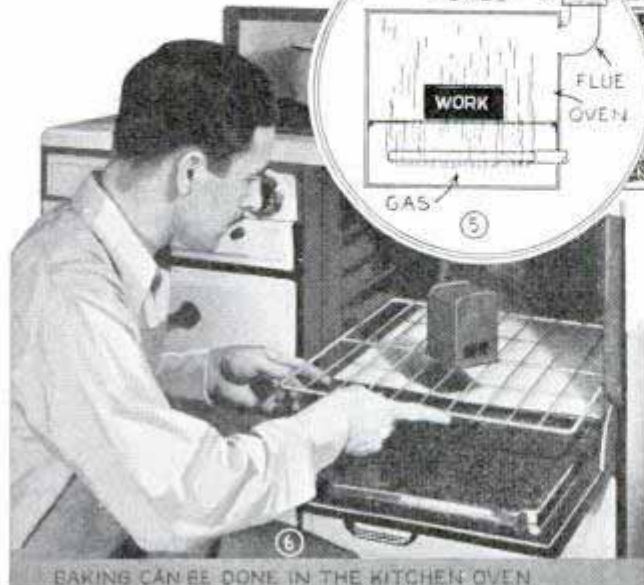
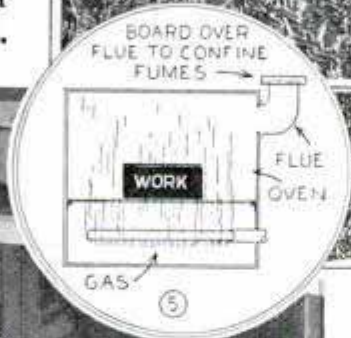

BAKING CAN BE DONE IN THE KITCHEN OVEN



ling. The lacquer used is somewhat heavier than the average spraying lacquer. It is also sprayed, being applied best with pressure feed. Like most texture finishes, a thick coat gives a heavy, pronounced pattern, while a thin coat gives a fine-textured effect. A medium heavy coat works best. After spraying, the work is placed in an oven to bake. The temperature should be between 180 and 220 degrees Fahr. Fig. 3 shows the appearance of the wrinkling lacquer coat after baking. The baking time runs about 2 hrs. at 220 degrees.

Crystal: Crystal or crystallizing lacquer is another baked-on finish. It comes in black and clear only. The general effect

can be seen in Fig. 4, and consists of very small crystals. A light coat gives best results. Like wrinkling lacquer it is sprayed direct without undercoats of any kind. In baking crystallizing lacquer, it is necessary to confine the products of combustion inside the oven, as shown in Fig. 5. Baking time is about 30 minutes at 150° Fahr., Fig. 6.

Shading: Shading or two-toning offers one of the simplest methods of securing a novelty effect on small furniture pieces, kitchen sets and the like. It is done by first applying a base coat, and then shading various parts of the work with a gun, as shown in Fig. 7. In a natural finish with clear lacquer, a special brown shading lacquer is used to secure the desired effect. Color shading can be done with lacquer enamels or with paste pigments ground in japan. The fluid should be of very light body so that it can be applied in a fine mist coat. Effective color combinations include black on light green or red, gold on black, tan on ivory, green on natural light wood, dark blue on light blue, etc.

Jack Frost: "Jack-Frost" lacquers come in all colors, both opaque and transparent. The fluid is applied directly to bare wood, metal or glass. A fairly heavy coat works best. The texture starts forming about 2 min. after application and appears somewhat as shown in Fig. 12 although the exact pattern may vary considerably. The transparent finishes are especially effective on polished metals, glass



COAT WITH BLACK OR OTHER COLOR PAINT; THEN WIPE OFF WITH A CLEAN CLOTH



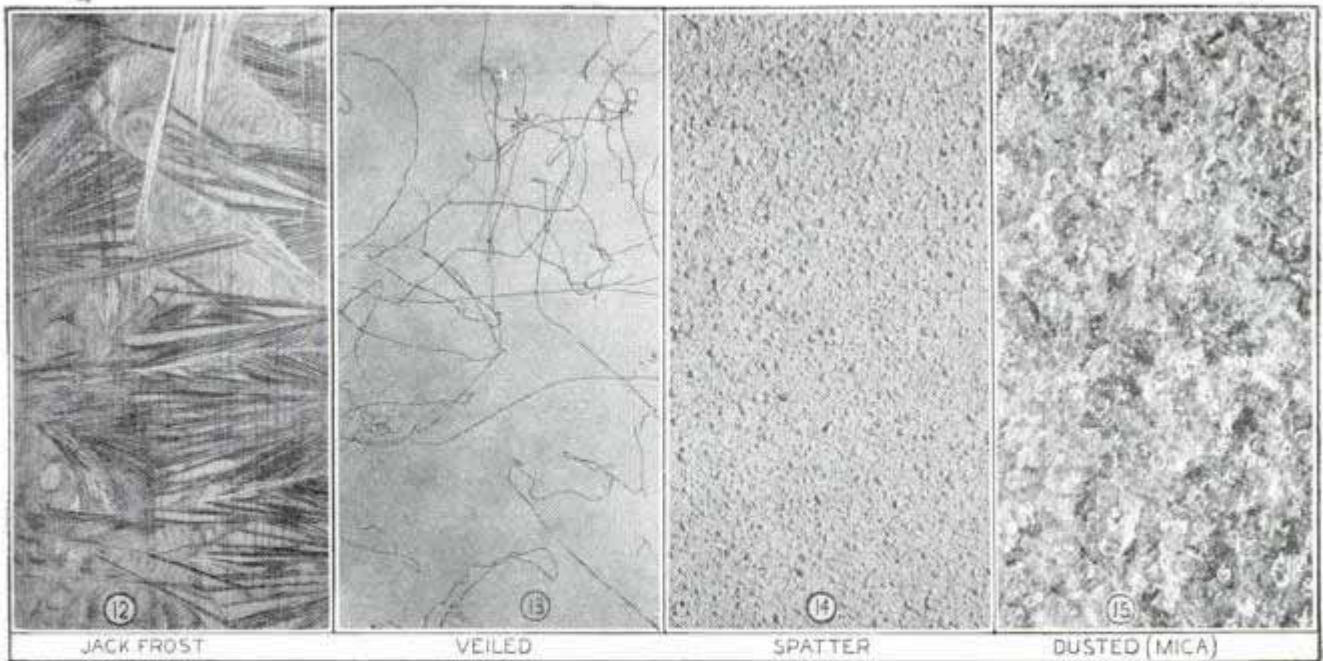

bottles, Fig. 8, light bulbs and lighting fixtures.

Side Shading: An interesting effect on any raised finish is applied by spraying a contrasting color with the gun held almost parallel to the surface, as shown in Fig. 9. The job being worked in this picture is a wrinkle finish in bright green. The top color being applied is red, and, because of the position of the gun, the red color is deposited only on the sides of the wrinkles. The finished job appears green when viewed from one side and red when viewed from the opposite side.

Smutting: To add color and depth, smutting is commonly employed. A typical example is shown in Figs. 10 and 11. The project being finished is a cigarette box, which has been coated

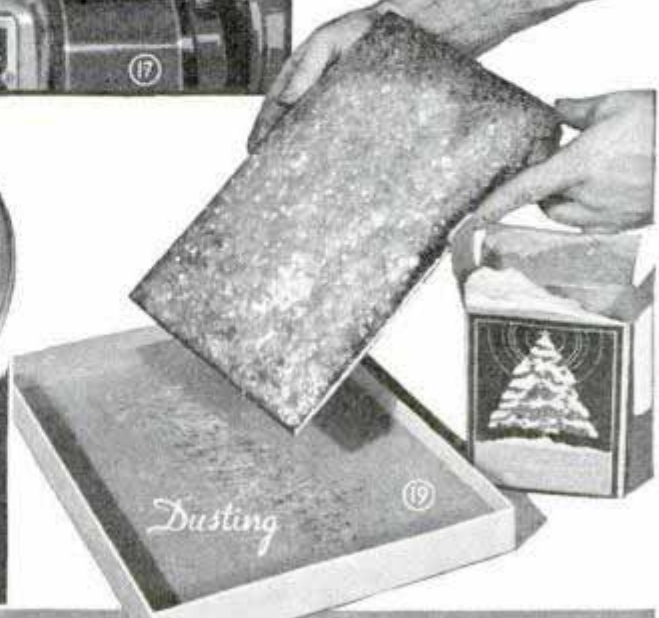
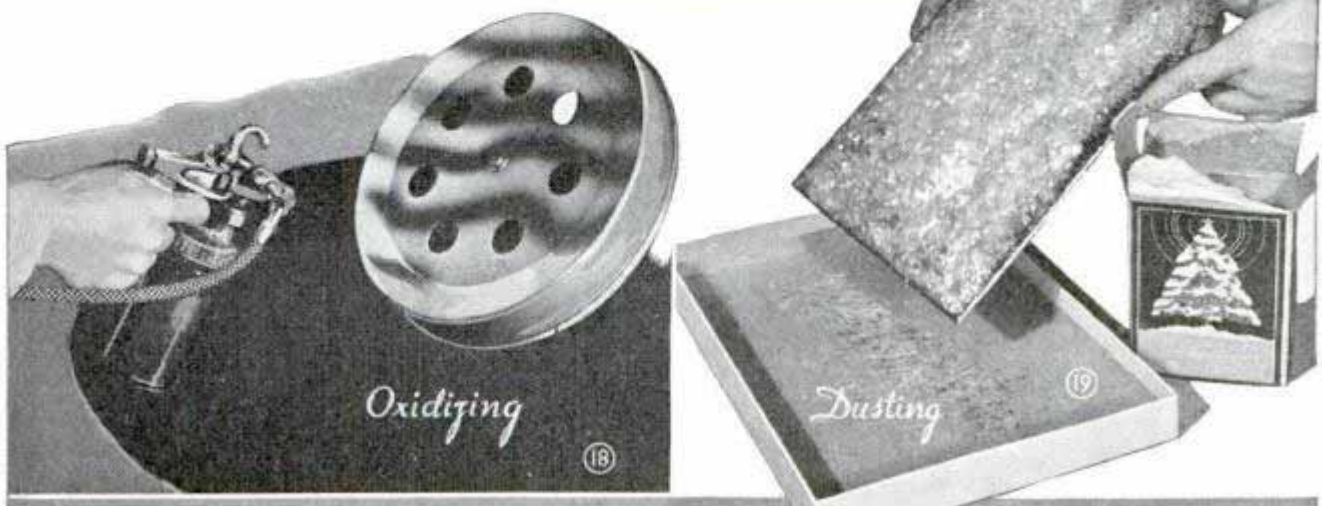
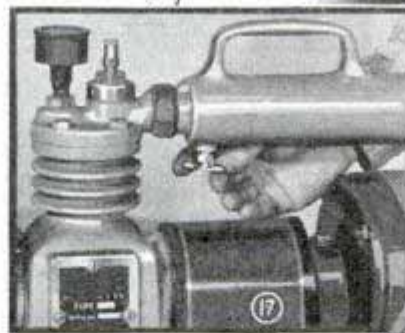

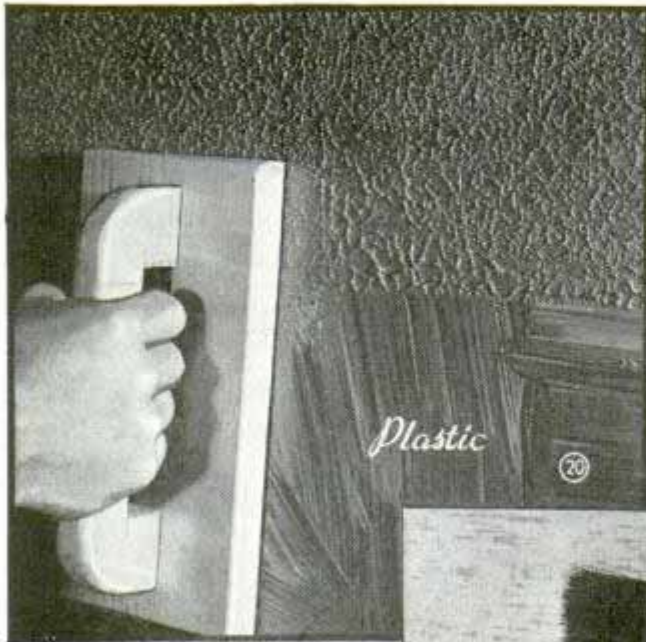

Many interesting effects in wall treatment are possible with the use of plastic paint

with red Jack-Frost lacquer. After this has dried, a smut is made by mixing paste pigments with japan or oil. Ordinary paint or enamel also can be used. A coat of the smutting color is applied, as shown in Fig. 10, and then immediately wiped off with a clean rag, as in Fig. 11, leaving the smut color in the depressed portions of the design.

Spatter: The familiar spatter effect is easily obtained by loading a large brush with the desired color and then striking it sharply against the hand to spatter the drops of color, as shown in Figs. 14 and 16. Similar effects can be obtained with a spray gun. For best results with a spray gun, pressure feed should be used. The paint should be of fairly heavy body, and the air pressure should be reduced greatly. On small spraying outfits, the reduction in pressure can be made by releasing the valve on the expansion chamber, as in Fig. 17. Contrasting color effects should be used on small areas, never for walls or other large surfaces.

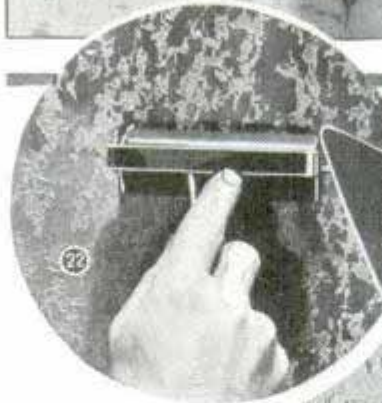

Oxidizing: Imitation oxidizing, extensively used on metal products, is done by spraying black lacquer on polished metal, as shown in Fig. 18. A round spray pattern is required. Novelty effects using bronze powders mixed with bronzing liquid or clear or colored lacquers can be obtained easily. Where bronze powders are mixed with colored lacquers to secure a metallic effect, the proportions should be about one tablespoonful of powder to a pint of lacquer.

Dusting: In this process, the work is first coated with varnish. After the varnish has dried to a "tacky" stage, the top coating of bronze powder, pulverized felt, colored ground glass, etc., is sifted or dusted on. Figs. 15 and 19 show mica crystals being applied in this manner. Finish with a top coat of clear varnish.

Veiling: Giving the appearance of a string of color looped again and again on the surface of the work, veiling lacquers give an interesting effect, as shown in Fig. 13. Professional application requires a spe-

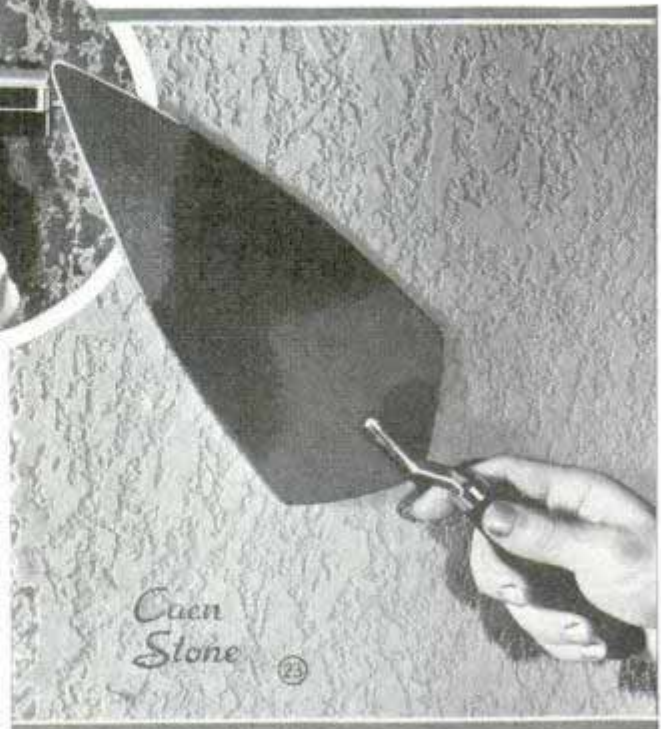

cial spray-gun nozzle, but a good novelty effect similar to spatter but with comet-like tails can be obtained by using this material in an ordinary spray gun.

Plastics: Plastic paint is commonly used for wall surfaces, but can be applied to flower boxes, vases and other products where a rough texture is desired. It is of heavy body, and is best applied with a brush. After it has set up slightly, the material can be worked in a number of different ways to secure the desired texture. One method commonly employed is to use a wooden float, pressing this into the finish and then pulling straight out, as shown in Fig. 20. Other textures can be obtained with a stiff brush, crumpled newspapers or with a towel.

Spread-Spatter: An effective variation of spatter work is obtained by using plastic or other paint. This is spattered in the usual manner and when slightly set up is brushed lightly, as shown in Fig. 21. The example shows a two-tone spatter effect of light red and green over cream, the two colors being spread at right angles.

Caen-Stone: As shown in Figs. 22 and 23, Caen-stone effect is a popular wall finish secured by using plastic paint. It is applied over a smooth base coat. The top coat of the same or a contrasting color is applied by knifing the plastic in place, then leveling it smooth with a trowel. Two-tone effects in this and other troweled finishes can be obtained by applying the color coat of pigment with a rubber roller.

Emery Cloth Grippped in Tool Post to Polish Lathe Work

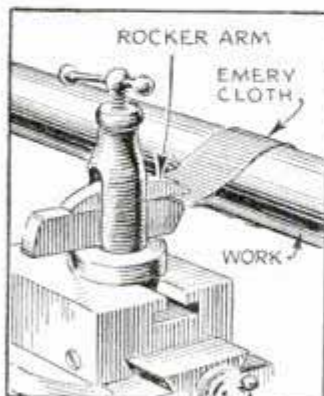

There's no need for tired fingers occasioned by holding a strip of emery cloth on metal-turning work, when polishing it, as the job can be done just as efficiently in most cases by using the tool post.

The end of the strip is inserted and tightened to the desired degree by the fine adjustment knob on the carriage.

—Don Heller, Pasadena, Calif.

Springs Grip Wrapping Paper on Shipper's Table

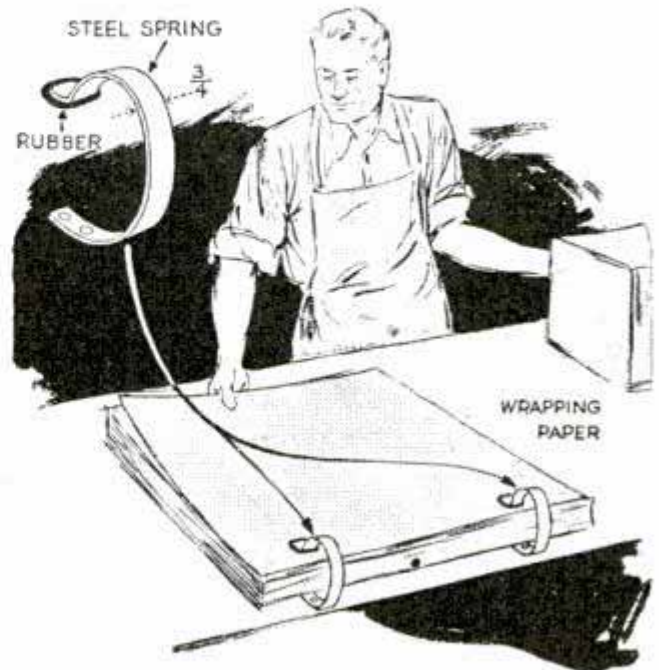

Stacks of wrapping paper are kept in orderly arrangement by the moderate pressure of two spring clips, which are screwed to the table top. Whether a full stack or only a few sheets, the pressure applied is always practically the same. If you can't find suitable springs for this purpose, they can be made from $\frac{3}{4}$ -in. spring steel of a gauge to obtain the desired pressure. Pieces of sheet rubber are cemented to the tips of the springs as shown or sections of rubber tubing may be forced over the ends.

Shop Broom Held in Hose

A serviceable holder for your shop broom can be made by cutting a section of discarded radiator hose as shown and tacking it to a wall at an angle. When the broom handle is inserted and lowered to a vertical position, the twisted hose section grips it at opposite sides and holds it securely.

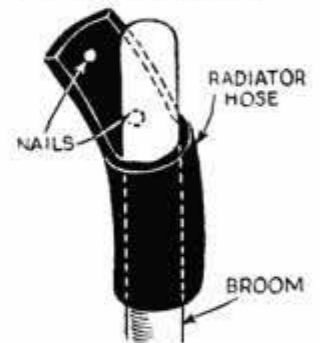

☐ When you are in a hurry to defrost a mechanical refrigerator, turn it off, empty the ice-cube trays, fill with boiling water and replace them in the freezing unit.

Double Slide in Grain Spout Measures Feed

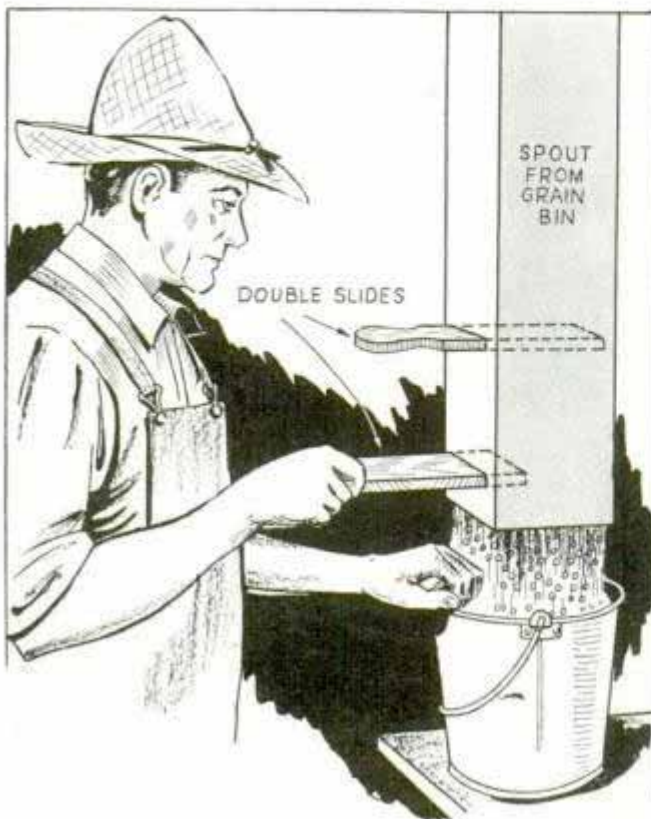

To measure out a peck of grain each time, without wasting it by overflowing the feed pail, one farmer employs a double slide on the spout that leads from the grain bin. In use, the bottom slide is closed and the upper one is opened. Then the upper slide is closed and the lower opened to allow the grain to flow into the receptacle.

Tamper-Proof Air Vent

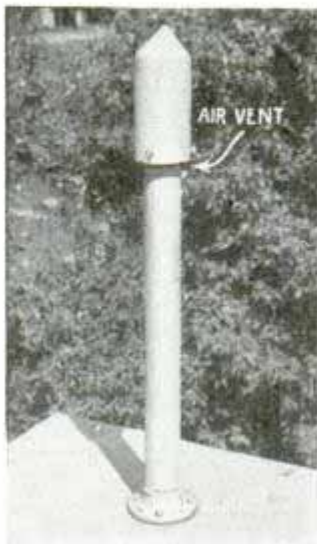

Allowing for expansion and contraction of gas and liquid in a storage tank, this tamper-proof vent with storm shield was made from a short length of pipe which forms a cap over a smaller pipe providing about $\frac{1}{2}$ in. clearance all around. The top of the smaller pipe was slotted and

the four segments were bent in and then welded together. Bolts were turned through threaded holes in the lower end of

the cap so that their ends bear tightly against the smaller pipe to keep the cover centered and to prevent removal by youngsters. The smaller pipe was attached to a flange which was then fastened to bolts imbedded in the concrete tank top.

Eraser Holds Linotype Slugs in Galley

One printer keeps linotype slugs from falling when moved about in a galley by using large rubber erasers, which are cut partly through

the center to fit over the edge of the galley, as indicated. The holder may be moved back and forth when inserting or removing part of the contents.

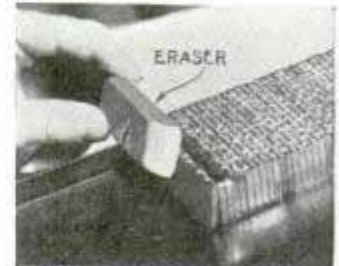

Handles to Carry Lengths of Pipe Reduce Finger Strain

When carrying lengths of pipe, iron rods and bars that are tiresome to grip with the hands, a pair of these plywood or hardwood handles will help. They are bored to take the work and a hand hole is cut as shown, the sharp edges of the latter being rounded with a file.



CEMENTING

glass, metal and celluloid

WHILE library paste is perfectly satisfactory for use on paper, no one would try to use it for a permanent joint on steel. Yet all of us have from time to time tried to use a cement which was no more fitted for the work in hand than library paste is for use on steel. Metal, glass and celluloid require special adhesives.

General Procedure: The first requisite for a strong joint is that the surface be free from dirt, dust, grease, rust and corrosion, Figs. 2 to 7 inclusive. The surfaces can be washed well and dipped in hot-lye solution to remove grease. Rust can be removed from iron or steel by repeated dipping in a solution made by pouring slowly sulphuric acid, 1 lb., in water, 1 gal., in a stoneware crock. As sulphuric acid will produce severe burns if gotten on the skin and will also damage cloth, it should be handled carefully, using rubber gloves. Between dips the surface should be scoured well with steel wool. The work should be rinsed well in hot and then in cold running water, and dried carefully. The edges to be joined should not be touched again with the hands. Any old cement or glue should be removed by soaking, scraping, or with a suitable solvent. Materials such as aluminum, which cannot be dipped in strong alkali, may be freed from grease by washing with naphtha, carbon tetrachloride, or similar grease solvents.

The adhesive must be brought into intimate contact with the parts to be joined. It is gen-

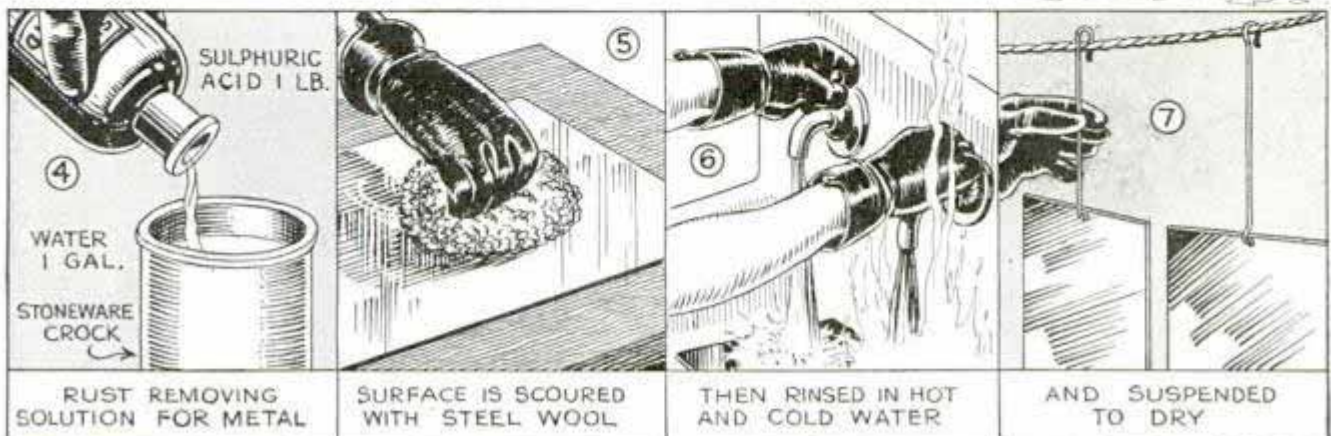

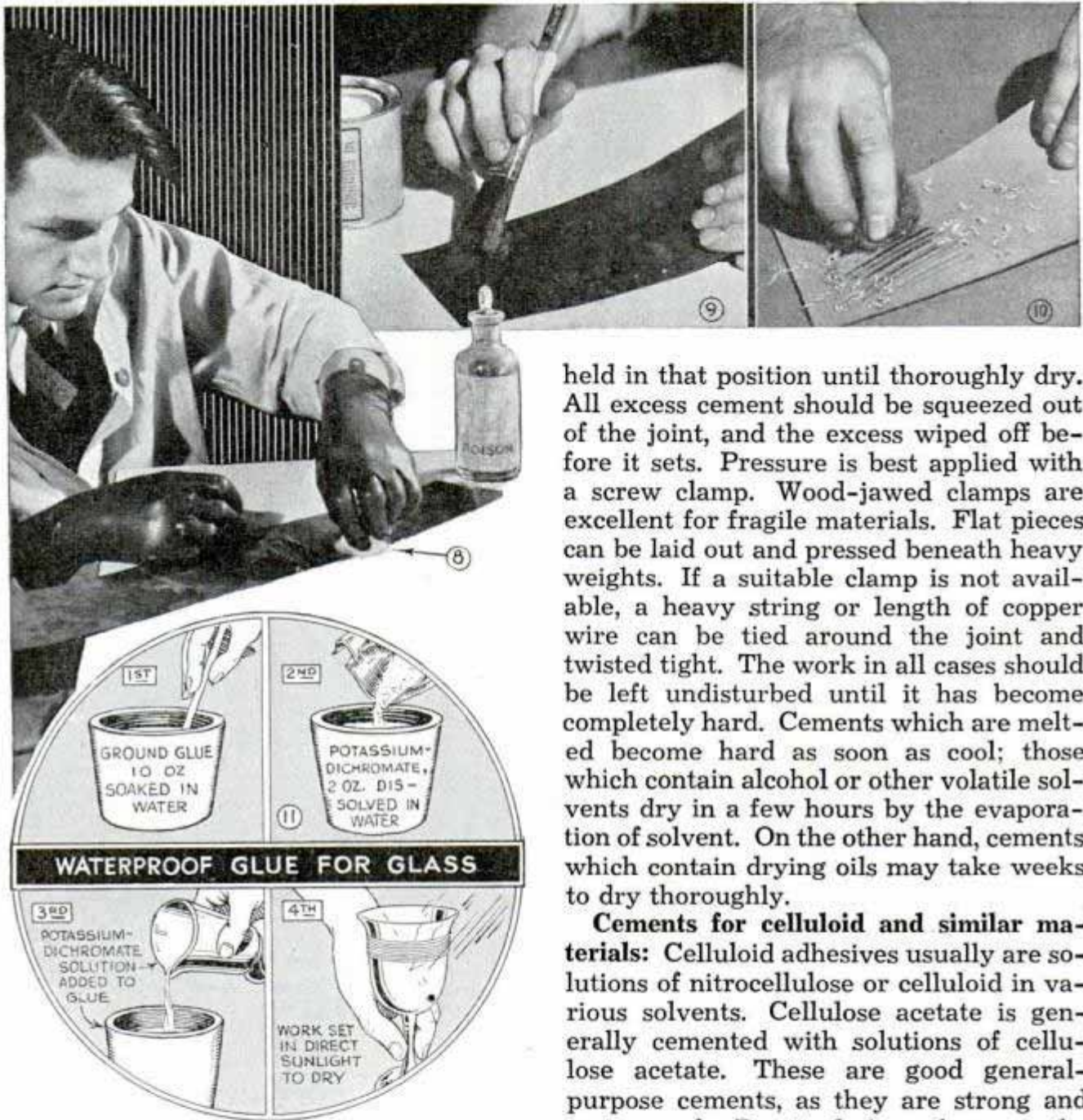

erally a good idea to roughen the surface slightly, using sandpaper or other abrasive, as in Fig. 1. Metal surfaces can be etched lightly with dilute hydrochloric acid, applied with a wad of cotton, Fig. 8. This roughening gives the adhesive a chance to grip the surface firmly. Adhesion also can be improved by brushing the cement on to the surface, Fig. 9, or, if the surface is porous, the cement can be rubbed into the pores. In the case of cements which must be heated, it is helpful and usually necessary to heat the work to the same temperature as the cement.

When the cement has been applied, the joint should be pressed firmly together and

held in that position until thoroughly dry. All excess cement should be squeezed out of the joint, and the excess wiped off before it sets. Pressure is best applied with a screw clamp. Wood-jawed clamps are excellent for fragile materials. Flat pieces can be laid out and pressed beneath heavy weights. If a suitable clamp is not available, a heavy string or length of copper wire can be tied around the joint and twisted tight. The work in all cases should be left undisturbed until it has become completely hard. Cements which are melted become hard as soon as cool; those which contain alcohol or other volatile solvents dry in a few hours by the evaporation of solvent. On the other hand, cements which contain drying oils may take weeks to dry thoroughly.

Cements for celluloid and similar materials: Celluloid adhesives usually are solutions of nitrocellulose or celluloid in various solvents. Cellulose acetate is generally cemented with solutions of cellulose acetate. These are good general-purpose cements, as they are strong and waterproof. Practical formulas are the following, all percentages by weight: (1) Scrap film or other celluloid 20, acetone 80. (2) Celluloid 20, ethyl acetate 60, alcohol 20. (3) Celluloid 16, ethyl acetanilide 10, acetone 74. (4) Cellulose acetate 12, tricresyl phosphate 8, methyl (wood) alcohol 20, ethyl acetate 30, methyl acetate 30. To these may be added 10 or 15 per cent filler if desired. Cellulose acetate can be substituted for celluloid in these formulas, and vice versa. The celluloid or cellulose acetate should be cut fine, and if scrap photo film is used, the gelatin should be removed by scraping or by scouring with steel wool, as shown in Fig. 10. The solvents used are very volatile and inflammable, and the ce-

ments must be kept in tightly corked containers until needed.

Celluloid can be "welded" also without heat if the edges to be joined are softened with a mixture of alcohol, 3 parts, and ether, 4 parts, and pressed firmly together. These solvents are volatile and the vapor of ether is highly explosive; therefore, this solution should be used away from all flames and sparks, and where there is adequate ventilation.

Cellophane can be cemented with a mixture of gum arabic, 2 lbs. 3 oz., water, 3 qts. 9 oz., and glycerin, 3 lbs. 12 oz., to which $\frac{1}{8}$ oz. formaldehyde is added.

Cements for glass: A waterproof glue can be made by soaking ground glue, 10 oz., in sufficient water to bring it to the usual consistency, Fig. 11. Potassium dichromate, 2 oz., is dissolved in a little water and added to the glue. The glue mixture must be kept away from light. After the glue has been applied and the joint clamped, it is set in direct sunlight until thoroughly dried. This joint is completely waterproof after a thorough exposure to light.

An acidproof cement for glass and stoneware can be made by melting together equal parts of pitch, rosin, and plaster of paris, and applying the mixture while molten. Equal parts of gutta-percha and gum shellac melted together make a cement which is strong and waterproof. Casein mixed to a paste with a saturated solution of borax, or with waterglass, makes a strong cement.

Cements for metals: Metal surfaces can be cemented together, or metal can be cemented to stone with a cement made by mixing litharge and glycerin to a paste of suitable consistency. It must be mixed just before use as it sets rapidly. Addition of whiting, silica, or iron oxide will retard the setting time. Metal also can be cemented in stone or marble with a mixture of iron filings, 1 lb., and plaster of paris, 3 lbs., made into a paste with water.

Iron articles can be cemented with a mixture of iron filings and waterglass. Another cement for iron is made by mixing ammonium chloride, 1 lb., sulphur, $\frac{1}{2}$ lb., and iron filings, $\frac{3}{4}$ lb., and adding water just before using.

☞ Liquid wax applied to oilcloth will keep it from cracking and peeling.

Door Knobs Serve as Pestle in Emergency



Amateur chemists who need a pestle for crushing crystals of various kinds, will find that a pair of discarded door knobs and a strong bowl serve the purpose. A little friction tape wrapped around the knob held in the hand will improve the grip.

Drawing Board Held at Angle with Casement Adjuster

If you use a drawing board on a desk or table, a convenient working angle can be maintained by using a casement adjuster of the type shown. Attached near the rear of both table and board, it provides an ideal arrangement for tilting the board.

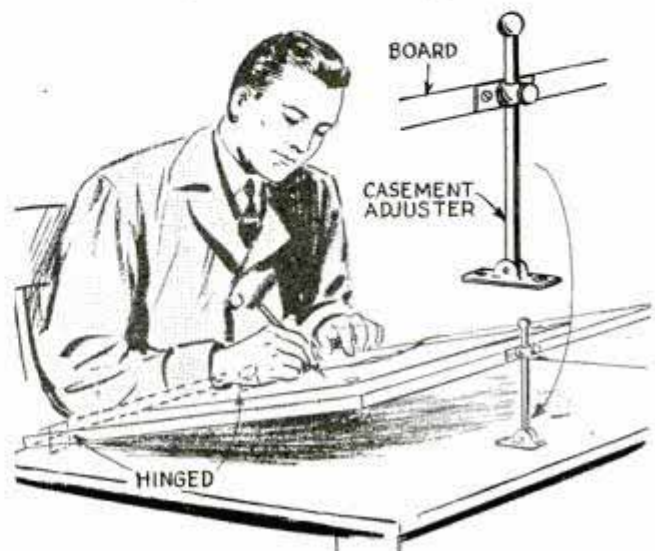

Installing a Large Fuel Tank on Your Light Plant

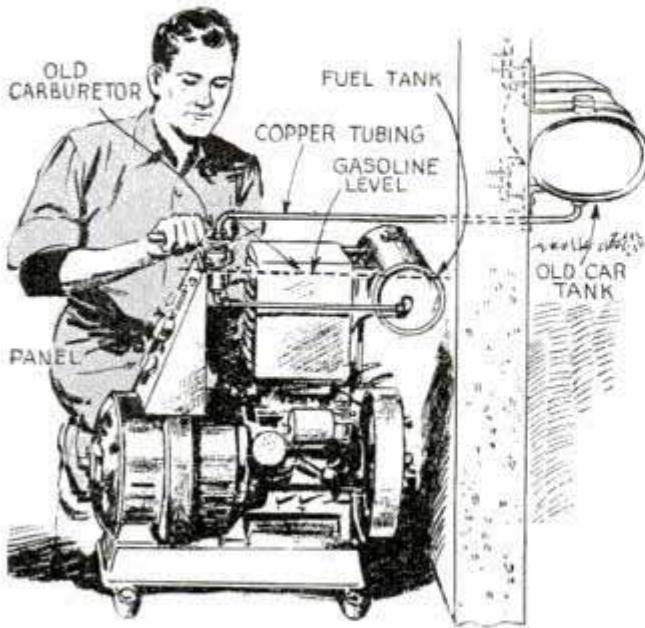

Instead of filling the small gas tank on your farm-lighting plant every couple of days, why not save time by installing a large auto gas tank, which needs only an occasional filling? Mount the large tank outside the building so that it is slightly above the small one. Then run small pipe or copper tubing to the inlet of an old car carburetor, mounted so that the bottom of the bowl is at the same level as that desired for the fuel in the small tank. Remove the drain cock from the bottom of the carburetor and run a pipe from it to the small tank. The carburetor float keeps the fuel level in the small tank constant.

—G. W. White, Severn Park, Ont., Can.

Anchoring Hammer Heads

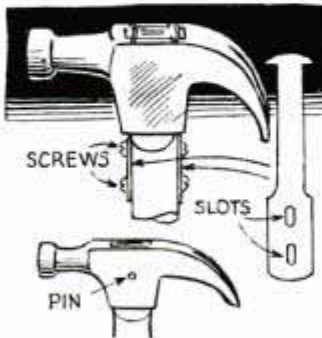

Where changing conditions of humidity allow heads on hammers to loosen, safety from danger of the head flying into space when least expected, is possible if you provide a

couple of T-shaped anchors. These are cut from $\frac{1}{16}$ -in. metal and are passed through the hole in the head when it is driven on the handle so that the ends of the anchors can be screwed to the top and bottom of the handle. Slots are suggested instead of

holes in order to permit takeup. Another method of pinning the head to the handle is shown in the lower detail.

Soap Lubricant Speeds Punching of Sheet Metal

Annoyance of a metal punch sticking in the sheet metal when a number of holes are punched may be minimized by keeping a bar of soap at hand and pushing the point of the punch into the soap at frequent intervals. In this way sufficient lubrication is provided to ease withdrawing the punch.

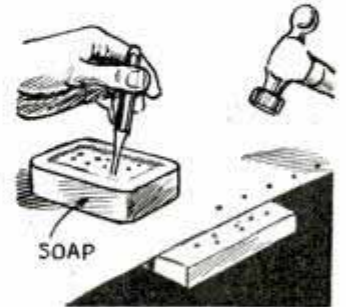

Overhead Shafts Polished Easily with Long-Handled Tool

To clean and polish overhead shafting that had rusted while the plant was idle, one foreman used the tool shown. It consists of a split length of garden hose tacked to the end of a suitable pole. Emery powder, sprinkled in the rubber trough formed by the hose, facilitated the cleaning.

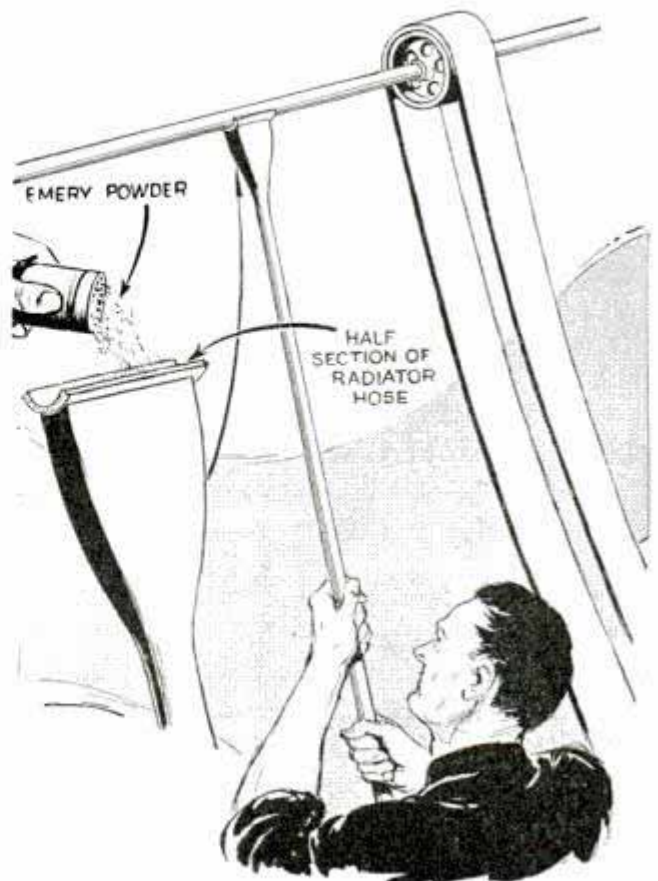

Helps for the MOTORIST



1: Heat developed by rubbing a door handle briskly with a cloth will often thaw a little ice in the keyhole. 2: Before inserting a bulb in a head or tail lamp, coat the base of the bulb with flake graphite so that it will not corrode and stick in the socket. 3: Some motorists claim that springs of older motor cars can be improved by inserting pieces of oiled rubber between the leaves at the ends

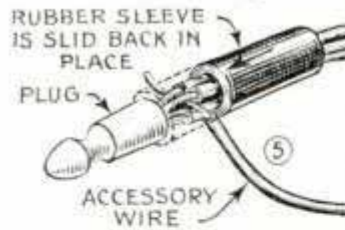

Piece of radiator hose fastened to a wall as in 4, provides a handy holder for a hydrometer. When connecting electrical accessories on a car that has plug-type connectors as in 5, slide back the insulating rubber sleeve and insert the bared end of the accessory wire between the wires of the plug. It's best to apply a little solder to make a good connection, although a temporary one can be made by moving the sleeve back against the plug to hold the wire in place

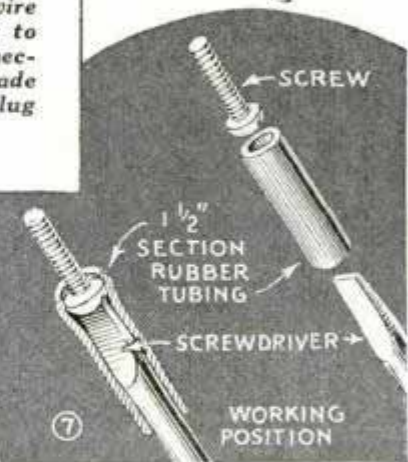
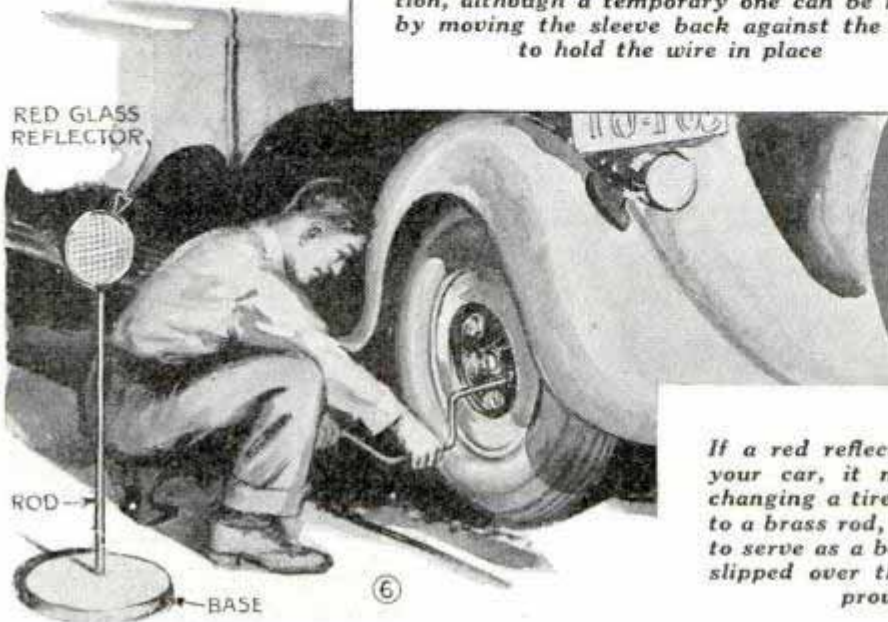
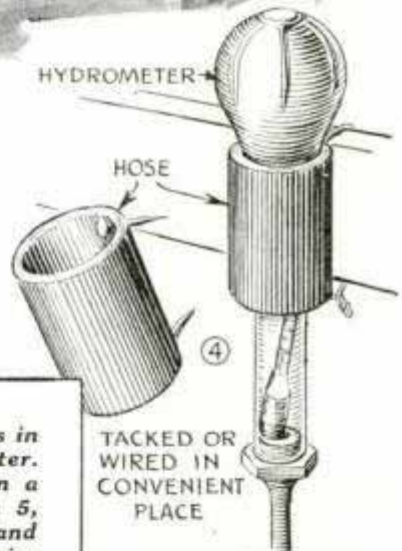

If a red reflector like the one in 6 is carried in your car, it may help avoid an accident when changing a tire at night. The reflector is soldered to a brass rod, which is stuck in a small wood disk to serve as a base. A piece of small rubber tubing slipped over the blade of a screwdriver as in 7, provides a good screw holder

Floor Flanges Hold Pipe Stakes on Truck

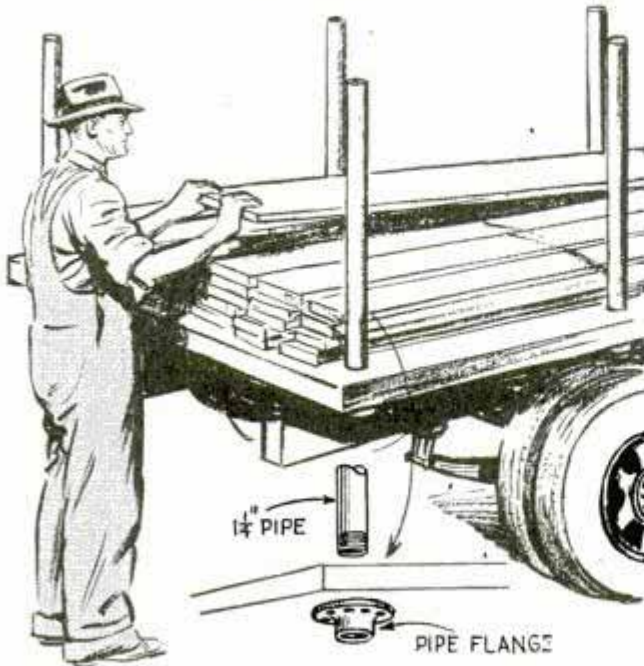

Pipe stakes on a truck can be attached securely by means of floor flanges screwed to the underside of the floor, in line with the holes in which the stakes are to be inserted. This method permits quick insertion or removal of the stakes and there is little possibility of them becoming loosened accidentally and lost.

This Rubber Driveway Marker Does Not Break Off

As the driveway to one neighbor's house entered the highway at a sharp right angle,

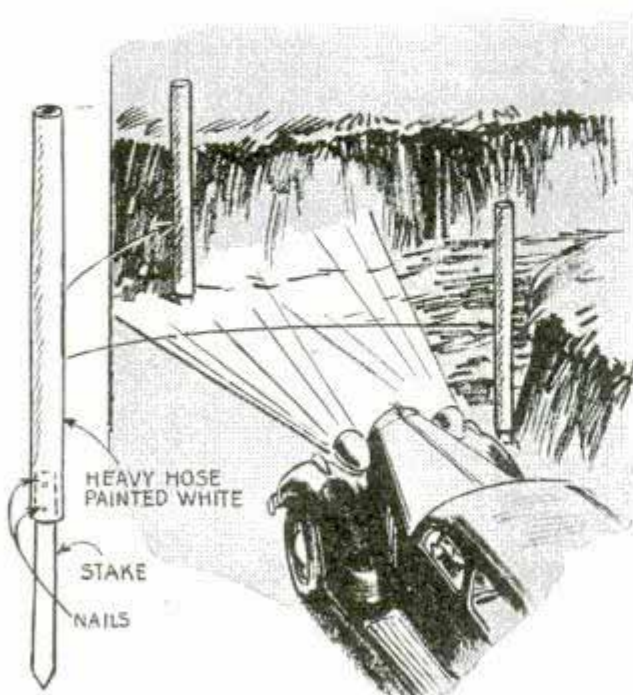

with high banks on each side, and wooden marking posts were repeatedly broken by motorists turning too short, lengths of stiff water hose were substituted. These were attached to wooden stakes extending 3 or 4 in. above the ground. The hose was painted white for visibility at night.

—James Vick, Winterpeck, Va.

Improving Toe Accelerator

A mechanic, servicing a number of trucks which were provided with ordinary toe-type accelerators, learned that many of the drivers were complaining of foot strain on long trips. To

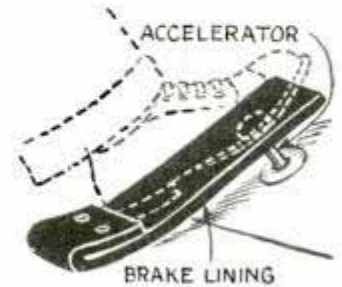

avoid this, he mounted pieces of heavy brake lining over the accelerator buttons to provide foot and heel rests.

Chalk Locates Crack in Axle

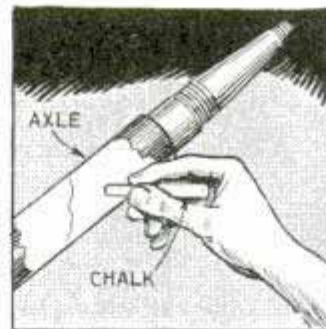

Axles or drive shafts of automobiles sometimes develop cracks that cannot be seen with the naked eye. If the shaft is cleaned thoroughly and given a coating of

chalk, oil or grease that remains in the crack will seep through the whitening to reveal the crack in a dark line.

Skid Chains Suspended from Body to Move Truck on Inclines

A rural truck driver who needed skid chains in bad weather at a few of his stops, which were on inclines, but did not need them elsewhere, solved the problem by fastening the chains to the truck body behind each rear wheel.

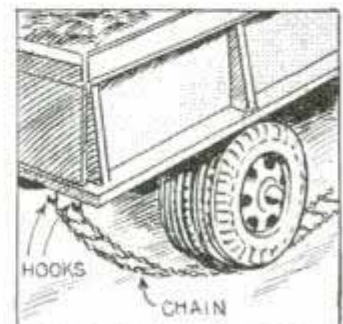

When a stop was made where

the chains were needed, the wheels were allowed to roll back on the chains, which afforded the traction necessary to start the load moving. Hooks were provided so that the chains could be removed readily.

Bottle Stopper and Files Clean Battery Posts

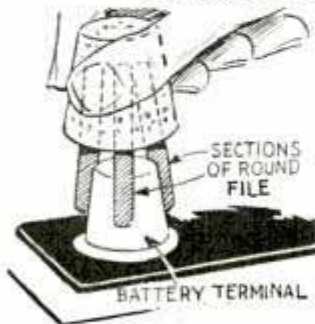

One garage mechanic improvised an effective tool for cleaning storage-battery posts quickly by inserting three pieces of a round file into holes drilled in a large rubber stopper.

The files adjust themselves to fit any variation in diameters of the posts.

Flashlight Hangs on Rubber Cable to Inspect Batteries

Observing the danger involved in lighting matches when inspecting batteries on a charging line, one garageman strung a stout wire above the line and from this suspended a flashlight with a steel ring and rubber cable. This so simplified the use of the light for close examination of the batteries that the danger was completely eliminated.



Grease Gun Is Turned by Brace to Loosen Clogged Bearings

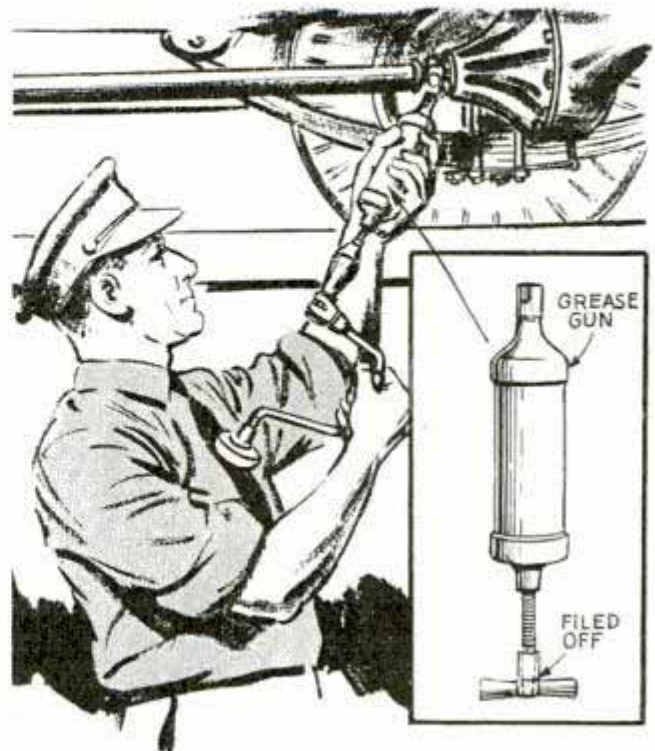

Forcing grease into "frozen" fittings with a hand grease gun of the screw type can be accomplished usually with little effort if you use a carpenter's brace. To do this the handle of the grease gun must be cut off and the end of the shaft squared so that it will fit into the brace.

Duplicate Patch on Inner Tube Keeps Wheel Balanced

A Wisconsin garageman claims that steering troubles often can be traced to uneven balance of one of the front wheels, caused by a heavy patch on the inner tube. In such cases he balances the tube by placing a duplicate patch on the opposite side. The same care is even more essential in placing large repair boots in casings.

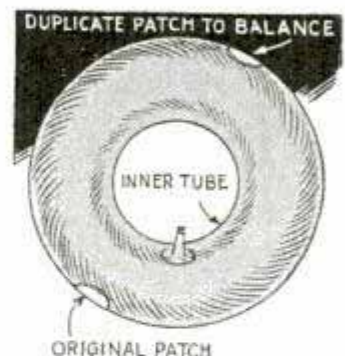

☐ A little vaseline placed in the joint between the rim and body of a headlamp will make it easier to remove the lens and also helps keep out water.

Rollers Fitted on Truck Skid to Load Heavy Objects



To push heavy boxes single-handed into a truck, one driver put removable rollers on his unloading skid. They are turned from hardwood to a diameter of 1 in. great-

er than the width of the side members of the skid. The rollers are drilled lengthwise for heavy steel rods, which are a sliding fit so they can be removed. Holes in the side members of the skid serve as bearings. When the skid is used for unloading, the rollers are removed.

Connecting-Rod Bolts Weakened by Excessive Tightening

While it is important that nuts on connecting-rod bearings be drawn up snugly to avoid looseness of the bearing caps, excessive tightening may stretch the bolts and weaken them appreciably. Or, the threads may be damaged so that strain on the bearings, when the motor is in operation, tends to loosen the nuts, making it necessary to install new bolts. In some cases, it may not be noticed that the threads or bolts are damaged, and the bearings tightened only to have them loosen again.

Latest Plan Catalogue for Home Craftsmen

Hundreds of useful and attractive things to make in your workshop

Profusely illustrated to show just what the articles listed look like when finished

Includes

MODERN AND COLONIAL FURNITURE of all kinds such as tables, chairs, stands, magazine baskets, cupboards, cabinets, chests, sewing baskets, etc.

HOME AND GARDEN IMPROVEMENTS comprising items like Venetian blinds, shutters, trellises, arbors, fireplaces, bird houses, Dutch windmills, etc.

WORKBENCHES, TOOL CABINETS, MOTOR-DRIVEN MACHINES such as drill presses, scroll saws, circular saws, belt, drum and spindle sanders, shapers.

MODELS OF ALL KINDS, both scale-type historic models and tournament-type model racing yachts.

OUTDOOR-SPORT DEVICES, rowboats, motorboats, canoes, kayaks, iceboats, skis, bobsleds, kites.

ELECTRICAL DEVICES, soldering irons, spot welders.

RADIO EQUIPMENT, receivers, transmitters, amplifiers.

TOYS AND NOVELTIES for gifts or resale purposes.

JUVENILE ARTICLES such as midget auto, doll house.



The only cost to get this new catalogue is a three-cent stamp. When ordering be sure to print or write your name and address carefully

POPULAR MECHANICS PLAN SERVICE, 200 E. Ontario St., Chicago, Illinois

EASTMAN'S NEW HIGH SPEED FILM

**MAKES NIGHT SNAPSHOTS
EASY EVEN FOR A \$1 BROWNIE**



ONCE it took an expert—and an expensive camera—to make snapshots at night. Now the most inexperienced of picture takers are shooting happily away after dark. You need less light indoors than ever before; and you use any camera that takes the new high speed film, Kodak Super-XX—even an inexpensive Brownie. And what pictures you get! Taken instantaneously, with a film four times as fast as ordinary film, they're unposed, informal, full of life.

FREE BOOKLET. . . This little booklet introduces you to one of picture taking's biggest thrills—snapshots at night. A single reading, and you're ready to make nighttime snapshots you'll be proud of. Non-technical text, interesting photographs, easy-to-understand diagrams, and light arrangements. At your dealer's . . . Eastman Kodak Company, Rochester, N.Y.

ALL YOU NEED

1. Your present camera loaded with the new Kodak Super-XX Film
2. A couple of inexpensive Mazda Photoflood lamps in Kodak Handy Reflectors



Hotels on the Wing

(Continued from page 405)

overstuffed chair, while the rearmost station is the flight engineer's quarters, with desk and expansive instrument and control panels. The engineer handles fuel valves, mixture controls, temperature controls, propeller adjustment controls and engine synchronization.

Second of the new air giants is the Douglas "DC-4," largest commercial land plane in the world. Truly a hotel on wings with accommodations for forty-two guests by day or thirty by night, it has a top speed of four miles per minute. A crew of five operates the huge ship.

Its steam-heating system automatically maintains a temperature of seventy degrees inside the cabin. Air, individually regulated by each passenger, is forced into the cabin at the rate of 1,250 cubic feet per minute. Two auxiliary engines, working independently of four giant motors generating a total of 5,600 horsepower, supply electricity to light the ship, cook food or operate hair curlers and electric shavers.

The "DC-4" has a comfortable ladies' lounge and men's dressing room and even a private compartment which may be used as a bridal suite. There are telephones for the crew and a dictaphone for businessmen who want to work while traveling.

The "DC-4" was built to the order of United Air Lines, Transcontinental and Western Air, American Airlines, Pan-American Airways and Eastern Air Lines. All production models will have supercharged cabins for substratosphere travel. This ship has a "tricycle" landing gear, which incorporates a nose wheel to permit shorter and safer take-offs and landings and prevent nosing over if brakes are applied suddenly or the wheels strike an obstruction. The gear is ideal for "blind landings."

"Upper level" flying becomes more than a dream with introduction of another Boeing ship, known as the "Stratoliner." This craft is designed to carry thirty-three passengers by day or twenty-five in luxurious night accommodations at speeds above four miles per minute through the smooth, rarefied atmosphere found at 14,000 to 20,000 feet.

The "Stratoliner's" path lies below the true stratosphere but above the heavy air belt that brews surface weather conditions.

At 20,000 feet winds are considerably more constant than at normal flight levels and the air is virtually free from the turbulence that sometimes gives airplanes a "rough ride" on lower levels. Storm clouds and icing conditions, both flying hazards, usually lie below this flight belt. And the air is so rarefied that high speeds at normal cruising power are practical.

While the "Stratoliner" is propelled by four engines, each providing 1,100 horsepower for take-off, only 2,500 horsepower is necessary to drive it 240 miles per hour at 20,000 feet. So great is the amount of reserve power, complete loss of power of one engine during take-off creates no danger. In fact, any two of the four engines can maintain an altitude of 10,000 feet and speeds up to 170 miles per hour, with the air liner fully loaded.

Natural low-level atmospheric conditions for "upper level" passengers are created by automatic temperature and pressure-regulating devices within the sealed cabin. The pressure controls make it possible to bring the ship from 15,000 feet to sea level at 565 feet per minute without discomfort to passengers.

Fresh air, drawn through the leading edge of each wing, is compressed by two engine-driven superchargers and circulated through the cabin after being heated by freeze-proof steam radiators, and then is discharged through an exhaust chamber.

The right-hand side of the passenger cabin is divided into four compartments, each containing davenport-type seats for six passengers. Along the left side are nine reclining chairs. At night, each compartment makes up into two sets of upper and lower berths, each of which is six feet seven inches long. Windows, fresh-air inlets, reading lights and call buttons are placed in both upper and lower berths. The ship also offers the conveniences of women's and men's dressing rooms with every facility for the toilet. A galley permits the serving of hot meals in flight.

In addition to hotel-like comfort and luxury, each of the super-airliners offers one or more of these new safety features: Four-engine power, pressure cabins for high flying, inclusion of flight engineer in the crew to relieve pilots of engineer duties, and the tricycle landing gear.

*that old
Velvet flavor
sure keeps
a pipe
in tune*



Velvet

- the **MILDNESS**
of fine old
Kentucky Burley
aged in wood
- the **FLAVOR**
of pure maple
sugar for extra
good taste

*Velvet packs easy in a pipe
Rolls smooth in a cigarette
Better tobacco
for both*

*Better
smoking
tobacco*

Racing the Mighty Midgets

(Continued from page 388)

secret blends consisting of a white gasoline base to which lead and benzol are added in varying amounts, or else some high octane aviation fuel that is made even more anti-



Inner tube protects driver's throttle foot in car that has developed an oil leak

knock by additions of lead compound. Some drivers use one carburetor per cylinder although one driver, for some reason he can't explain, seems to get the best results out of his four-cylinder engine by using three carburetors.

Most midget tracks are banked dirt tracks with a surface of clay and decomposed granite, packed down and sprinkled before each race program. The condition of the surface and the changes made in it by the pounding cars have their effect on speed, and a good driver carries several sets of tires to use at different times. Grooved tires are usually mounted in front for good steering, knobbed tires in the rear when the track is slick, smooth rear tires when the track is heavy, and rear tires with some standard tread when the track is in just the proper intermediate condition for fast driving.

Likewise a good driver changes his rear end gear ratio according to the track and

weather conditions. As many as twenty or twenty-five different gear combinations may be carried by a shrewd driver and he can change gears in a few minutes between races through a plate in the rear end.

Rules of the American Midget Association restrict the engines to 105-cubic-inch displacement, or sixty-five cubic inches with a supercharger. The cars must weigh between 550 and 950 pounds dry, most drivers finding that a car weighing between 700 and 750 pounds seems to handle easiest. Above that weight a car is sluggish while below 700 pounds the great power in the rear end tends to jump the car off the ground if it happens to hit a hole. A few drivers are now trying out front-wheel and four-wheel drives.

Outboard marine engines, re-built automobile engines, and various built-up engines were used when midget racing got its start and many of them are still in use today. Most of the consistent winning drivers, however, are using a special racing motor that costs more than \$1,000. This Offenhauser engine is a four-cylinder double overhead valve motor that develops 100 horsepower at 6,500 revolutions per minute.

Prizes at the best tracks range from \$1,500 to \$2,500 per night of racing with the

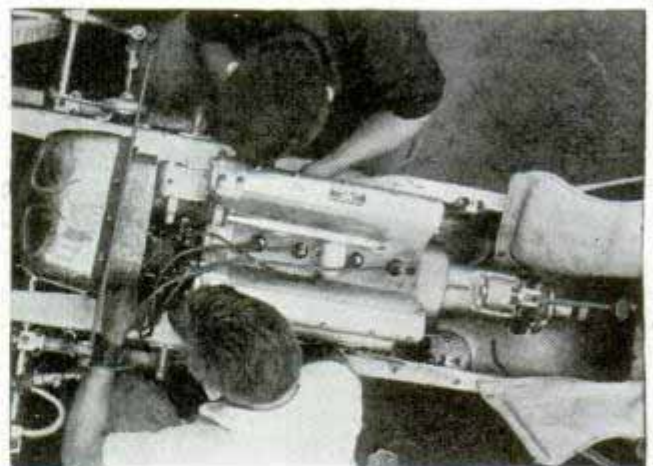

Putting finishing touches on tiny engine that develops up to 100 horsepower

purse being split up among the winners of several races. An important midget track such as the Gilmore Stadium at Los Angeles, holding thirty-two race meets during a season, may attract a total attendance of half a million people during that time.

3814 12 Crawford St. Los Angeles Calif

1962 midget racing

NOW! YOU CAN ENJOY THE SPORT OF

SPORTS!

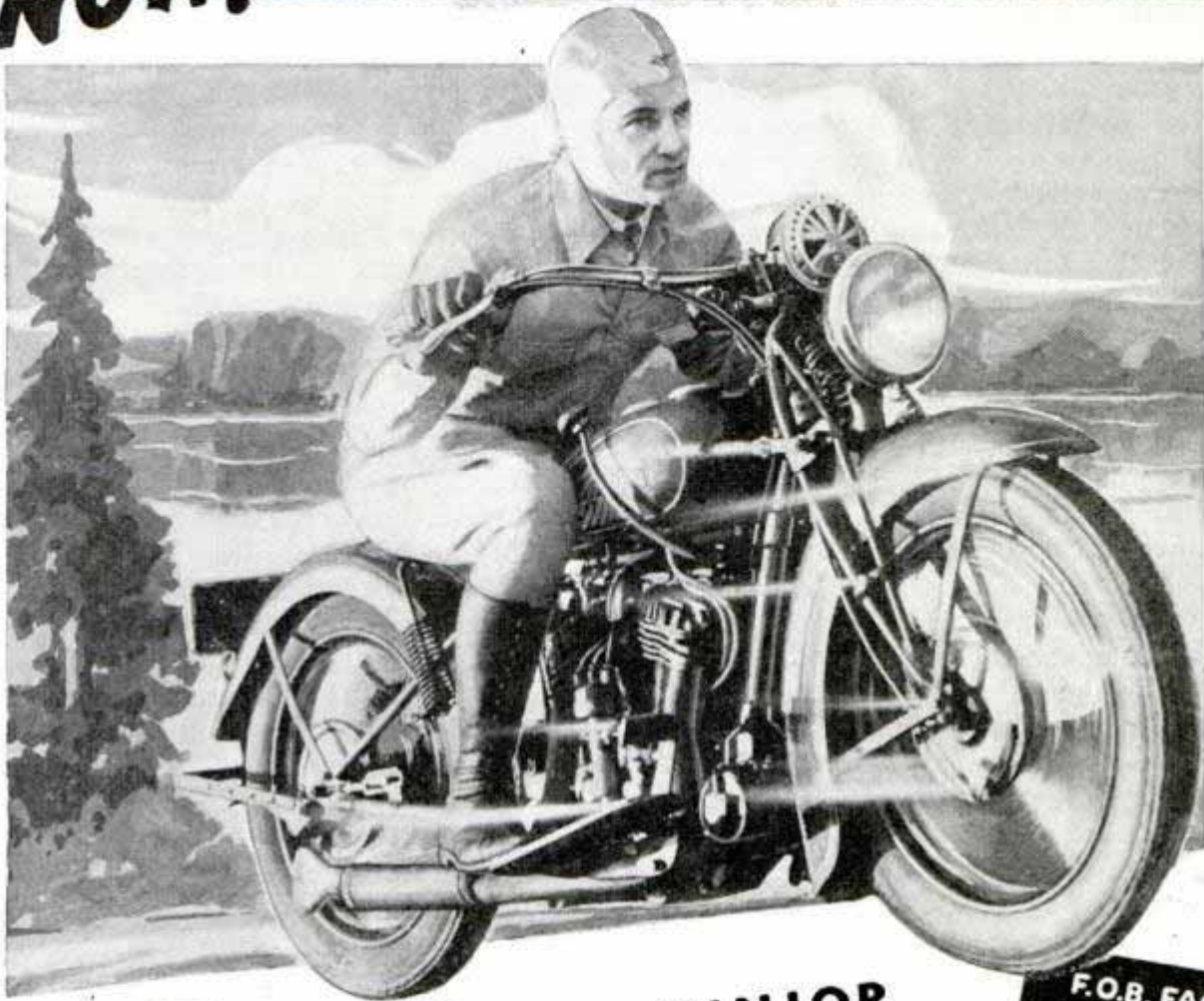

Indian JUNIOR SCOUT

THE LOWEST PRICE "TWIN" IN AMERICA

JAMPAK VACATION HOURS with sport, adventure, thrilling fun! Indian makes it possible with its phenomenally low price for a genuine twin cylinder motorcycle—an engineering triumph with peppy pickup and punchy power, easy to handle and a miracle of economy to operate. More than thirty-five new improvements make the 1939 Indians—Junior Scout, Sport Scout, De Luxe 4, Chief 74—America's greatest motorcycle value. Ask your Indian dealer today about his pay-as-you-ride plan.

INDIAN IS AMERICA'S FASTEST STOCK MOTORCYCLE!

MAIL COUPON TODAY

A year's subscription to Indian News, containing news, pictures, thrills of motorcycle-dom—yours for the cost of mailing! Mail the coupon for this and your Certificate of Value entitling you to a handsome, useful Indian Sport Jersey, absolutely FREE, when you order your new Indian motorcycle.

FREE!



F.O.B. FACTORY
\$215.
FULLY
EQUIPPED



INDIAN MOTORCYCLE CO., Springfield, Mass.

Please send me items checked Indian News for one year (I enclose 15c in stamps to cover mailing cost). Certificate of Value entitling me to Indian Sport Jersey FREE when I order my new Indian motorcycle. Indian catalog.

Name

Address

PM39

Please be sure to check your age group
[] 16-19 yrs. [] 20-30 yrs. [] 31 yrs. and up [] under 16 yrs.

INDIAN MOTORCYCLE CO., Springfield, Mass.

Going Nature One Better

(Continued from page 373)

deners were planting rows of the double yellow nasturtium seed, purchased from the Bodgers, alongside rows of the old-fashioned single nasturtiums in all colors. When the plants blossomed, a hundred girls with camel's-hair brushes went down the rows, tickling first a single, then a double flower. Thus by hand pollination, they crossed the doubleness and the sweet odor of the new type with the multi-colors of the singles. It was a tremendous undertaking but they made 40,000 crosses that summer.

Other seed growers were doing the same thing, but on a smaller scale. Ordinarily, it is a three to five year job to cross two varieties, creating a new type by relentlessly weeding out the off-plants, then growing enough seed to supply the market. That fall, when other growers gathered their seed of the first generation crosses, and stored it in moisture-proof warehouses to await spring, the Burpees proceeded in a most unorthodox manner. They packed their double nasturtiums in airy boxes, even before the seed was dry, and shipped it by air to South America, Cuba, and Florida. Other packages went to Australia. Some they planted at Chula Vista near San Diego. The Burpee greenhouses at Fordhook were cleared of all other flowers and planted to nasturtiums. There the plants thrived under artificial light and steam heat.

By midwinter, the Burpees had "rogued" out all the plants bearing double flowers, much to the consternation of their gardeners. However, David Burpee anticipated that the nasturtiums were recessive in the second and third generations. Those that were double in the second would produce singles in the third. Those that were single in the second would become double in the third. By early spring, Mr. Burpee had accumulated more than 100,000 seeds which he could count upon safely to produce doubles in a variety of colors, and so great was the demand at ten cents per seed that he had to grow quantities of plants from cuttings.

This discovery that three generations of a new plant in the making could be kaleidoscoped into one year is one of the most revolutionary innovations in outwitting

nature developed in the past decade. The Burpee hybridizers maintain a winter farm regularly at Chula Vista, and not only nasturtiums, but petunias, marigolds, zinnias and other flowers have been given the speed-up in the modeling process. Other breeders have followed suit. Just as designers in other fields have their ideas of what the public wants, so flower builders have to guess from three to five years ahead and create not only the right color or the right flower, but also build up a sufficient stock of seed to supply the demand.

One of the most revered flower originators is Frank Cuthbertson, executive of the Ferry-Morse company. Mr. Cuthbertson is a builder of vegetables as well as flowers, but his fame comes mainly from what he calls his "sweet pea workshop." It is a two-acre garden at Salinas, Calif., where he has undertaken to remodel the sweet pea, which has been driven from southern, midwestern and eastern gardens by the hot summers. The sweet pea, as developed for gardens of a quarter of a century ago, just couldn't take heat.

Like other plant breeders, Mr. Cuthbertson needed a mutation to start. He scoured the world for one and even sent to Sicily, where the first sweet pea, a scrawny but hardy plant with a little purplish flower, was discovered two centuries ago, and started again at scratch with this same rugged forebear. While he was working, Dame Nature, in a generous mood, handed him a gift, a sport with foliage twice as sturdy and luxuriant as any other plant in his garden. It bore huge pink blossoms and soon became known as "Pinkie." It was most astonishing for this to happen right in his sweet pea workshop, because seed hunters had scoured the world, looking in vain for this very phenomenon. Mr. Cuthbertson knew he had something. In succeeding years, he crossed the giant with sweet peas of every other color, and once more, as the result of "Pinkie blood" in their veins, sweet peas are returning to the gardens of regions with hot summers.

The elder W. Atlee Burpee, credited with having introduced more new flowers and vegetables into the gardens of this country than any other individual, used to travel

(Continued to page 120A)

NO SKINNY MAN HAS AN OUNCE OF SEX APPEAL

BUT SCIENCE HAS PROVED THAT THOUSANDS DON'T HAVE TO BE **SKINNY**



Posed by professional models



THOUSANDS OF THIN, TIRED, NERVOUS PEOPLE GAIN 10 TO 25 LBS. . . NEW STRENGTH QUICK

— with Ironized Yeast Tablets

Gains 14 lbs. Popular Now



Don Russo

"I had lost weight, had no pep, looked so bad I was ashamed to go out. With Ironized Yeast in 3 months I gained 14 lbs. My new huskiness and pep has brought me lots of new friends, too."

Don Russo, Phila., Pa.

Admired Since He Gained 12 lbs.

"Was losing weight and pep. Nothing helped until I got Ironized Yeast. In 6 weeks I gained 12 lbs. and am full of pep. Everybody admires my physique, too."

Ralph Loeffler
Arlington, Wash.



R. Loeffler

IMPORTANT

Beware of Substitutes

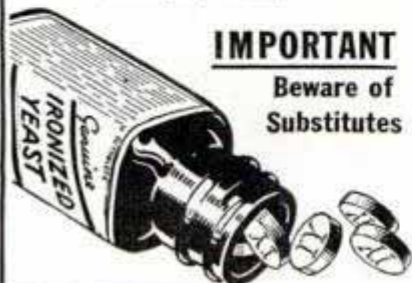

THOUSANDS of skinny, rundown people who never could gain before have quickly put on pounds of solid, naturally attractive flesh, with these remarkable scientifically tested little Ironized Yeast tablets. What's more, instead of that terrible tired feeling and jittery nerves, they now have wonderful new strength and energy, eat well, sleep soundly and with improved looks and new pep have won new friends and popularity.

Why they build up quick

You see, scientists have discovered that many people are underweight and rundown, often tired and nervous, simply because they don't get enough Vitamin B and iron from their daily food. Without these vital substances you may lack appetite and not get the real body-building good out of what you eat.

Now you get these exact missing substances in these amazing little Ironized Yeast tablets. The improvement they bring in a short time to those who need Vitamin B and iron is often astonishing. Thousands report gains of 10 to 25 lbs., wonderful new pep—a new natural attractiveness that wins friends everywhere.

Try them without risking a cent

Get Ironized Yeast tablets from your druggist today. If with the first package you don't eat better and FEEL better, with much more strength and pep—if you're not convinced that Ironized Yeast will give you the normally attractive flesh, new energy and life you have longed for, the price of this first package promptly refunded.

Only be sure you get the genuine Ironized Yeast, and not one of the cheap, inferior substitutes often offered which do not give the same results. Look for the letters "IY" stamped on each tablet. You don't want inferior substitutes.

Special offer!

To start thousands building up their health right away, we make this special offer. Purchase a package of Ironized Yeast tablets at once, cut out the seal on the box and mail it to us with a clipping of this paragraph. We will send you a fascinating new book on health, "New Facts About Your Body." Remember, results with the first package—or money refunded. At all druggists, Ironized Yeast Co., Inc., Dept. 533, Atlanta, Ga.

TUNE IN ON THE GOOD WILL HOUR, every Sunday Evening. See your local paper for time and station.

H1250

(Continued from page 118A)

30,000 miles each year, scouting for bigger, better varieties. He sought better plants ready made, the "pick-up" method of improving strains.

Today, the seed hunter scarcely hopes to find a new plant in perfect condition. He is looking for traits. A few years ago a federal seed hunter scouting in the interior of India discovered a tough and unattractive little musk melon, practically unedible, but able to resist a blight which had suddenly descended upon the great winter gardens of this country. The resistance of this insignificant India melon, bred into American varieties, soon produced a new strain which revived a waning industry.

Uncle Sam's seed hunters are now rounding up vegetables with useful characteristics from every land and acclimating them on half a dozen farms operated by the Department of Agriculture. They also furnish breeding stocks to experimental farms operated by the agricultural colleges of the states. With this start, scientists are inducing nature to create tomatoes that ripen in the short northern summers, corn that flourishes despite the cool nights of the Pacific coast and a host of other useful garden products.

The evolution of hybrid corn is an outstanding example of outwitting nature. Sweet corn has suffered from blights, and in several experimental stations, the hybridizers tried inbreeding to make the stock more true. Several generations of inbreeding invariably resulted in plants of smaller stature, as might be expected, but to the amazement of scientists doing the work at the Connecticut experiment station and at Purdue university, the resulting progeny when these pigmy strains were crossed turned out to be giants. Today, virtually all sweet corn grown in the country is "corn that went to college," one or another of the hybrid strains produced by planting two inbred varieties side by side and de-tasseling the female parent.

A hybrid plant, combining the best characteristics of two parents, is just making its appearance among flowers. It is the new red marigold, developed by the Burpee hybridizers. It combines the velvety red color of the little French marigold with the luxuriant round head of the big African. Combining these was a feat, because the little French male parent has more chro-

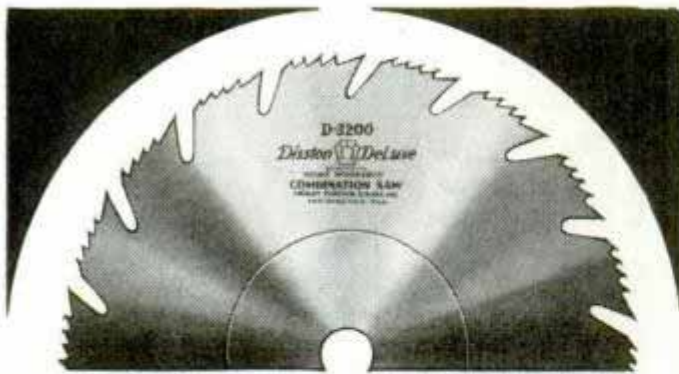

Saws of Craftsmanship

Let Disston Steel, Disston workmanship, smooth finish, accurate fitting, sharp teeth that hold their cutting edge, prove how these circular saws can help you do better work . . . even on the most intricate jobs. Ask for "Disston De Luxe" at your dealer's.

Cross-cut; Rip; Combination

6" (1/2" hole) \$2.70 8" (1/2", 5/8", 3/4" hole) \$3.50
7" (1/2" hole) \$3.10 10" (5/8", 3/4" hole) \$4.50

Hollow Ground Combination

6" (1/2" hole) \$4.30 8" (1/2", 5/8", 3/4" hole) \$5.40
7" (1/2" hole) \$4.90 10" (5/8", 3/4" hole) \$6.90

These prices apply only to United States; for others, write Henry Disston & Sons, Ltd., Toronto, Canada.

and the Hint of the Month

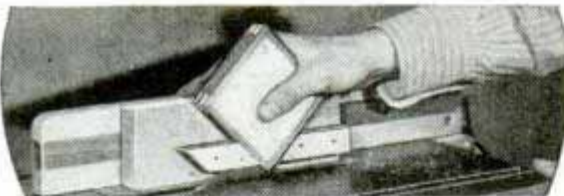

Jig for cutting mortise slots in mitred corners for inserting veneer strips to make feather joint. Holds work at correct angle and gives cut of proper depth. Temporary block inside frame lets you hold work firmly.

and a New Edition

FREE BOOK

New Disston Saw, Tool and File Manual, better than ever! 48 pages; hints like one above; also tells how to joint, set and sharpen saws, how to choose and use all kinds of saws and tools.



—MAIL COUPON—

Henry Disston & Sons, Inc.
311 Tacony
Philadelphia, U. S. A.

Name

Address

H 1250

mosomes than the big African female parent. This unequal balance has defied the efforts of hybridizers for years, and even now the resulting hybrid is sterile. As a consequence, if red marigolds are to exist, the plant builders must hybridize them to order each year for next summer's gardens. The marigolds can't reproduce themselves by natural means.

However, science has one more trick to play. Plant builders have discovered that when nature spurns their efforts at crosses because one parent has more chromosomes than the other, by certain "shock" treatments, they can change the chromosome balance. One method is to immerse the small plant in colchicine, a chemical extract from the autumn-blooming crocus, or the substance may be sprayed on leaves and buds. Another is to X-ray the seeds. A third is to heat them almost to the point of cooking, then cool them rapidly before life is destroyed. The theory is that these "shocks" reproduce the possible conditions under which nature springs mutations. For example, a hot day followed by a cold night.

At any rate the shock treatment increases the mutation percentage many fold. Hybridizers have such high hopes for outwitting nature by the method that, where the elder W. Atlee Burpee spent many months each year hunting "pick-ups" in plants, his son, David Burpee, who succeeds him, carries on seed safaris in laboratories and greenhouses where skilled scientists spend their time tricking nature into producing bigger, better flowers and vegetables for your garden.

H 1439

Furnace-Heat Circulator Fan Warms Cold Rooms

Hot air is drawn from the furnace and recirculated in the hard-to-heat room by a newly developed fan which is designed for attachment to the floor or wall register. Adjustable to fit any size register, it can be applied in five minutes with a screwdriver.

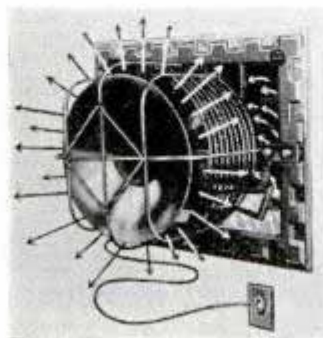

Applied in five minutes with a screwdriver.

Kesco Co. Chicago

OWN THIS SET OF 12 FINE TOOLS

For Model Makers, "Railroaders",
Everyone With Delicate Filing Jobs

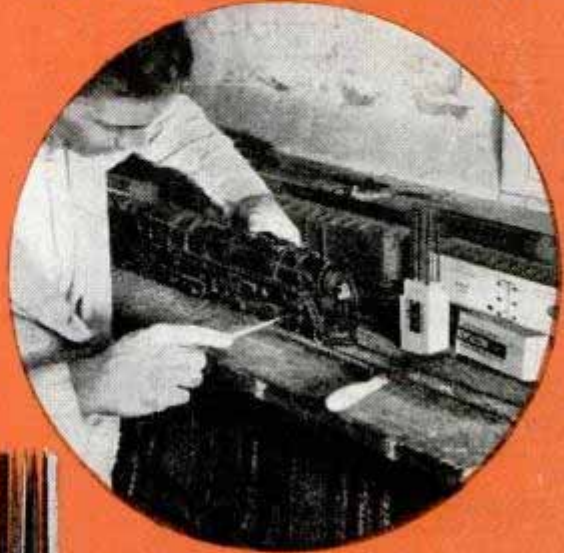

**12 DIFFERENT NICHOLSON
X. F. KNURLED HANDLE
NEEDLE FILES
In a Wooden Box
That Becomes A
Bench Stand**

Whether you're a fine die-maker in a jewelry manufacturing plant, or a home craftsman with a love of precision, these Nicholson X. F. Needle Files will suit you "to a T". What's your most delicate filing job? . . . fashioning a tiny capstan for a ship model? . . . a slide-valve for a scale locomotive? . . . in this box is the right shape Needle File to do it to perfection!

These sets are supplied with 12 files in your choice of any one of the following lengths: 4", 4 3/4", 5 1/2", and 6 1/4", and in your choice of any one of the following cuts: Nos. 0, 2, 4, and 6 (No. 6 is finest cut). 6 1/4" length in No. 2 cut is most popular for general use. If your hardware dealer cannot supply you, write us. Be sure to specify length and cut you wish. Nicholson File Company, 22 Acorn Street, Providence, R. I., U. S. A.



A FILE FOR EVERY PURPOSE

NICHOLSON
PIONEERS IN
QUALITY PRODUCTION

**75th
ANNIVERSARY
YEAR**

St. Louis, Mo

1320

Topsy-Turvy Weather Magicians

(Continued from page 413)

so he can study the resistance of models.

The latest machine, developed by Arthur C. Ruge of Massachusetts Institute of Technology in cooperation with Dr. Vannevar Bush, solves this difficulty in a more efficient and practical way than the old-style shaking tables. A shadowgraph—optical cam—is made from an actual earthquake record by cutting the record out along the wavy line which represents the quake. The shadowgraph then is passed before the "electric eye" of the machine. An electric analyzing device, coupled to

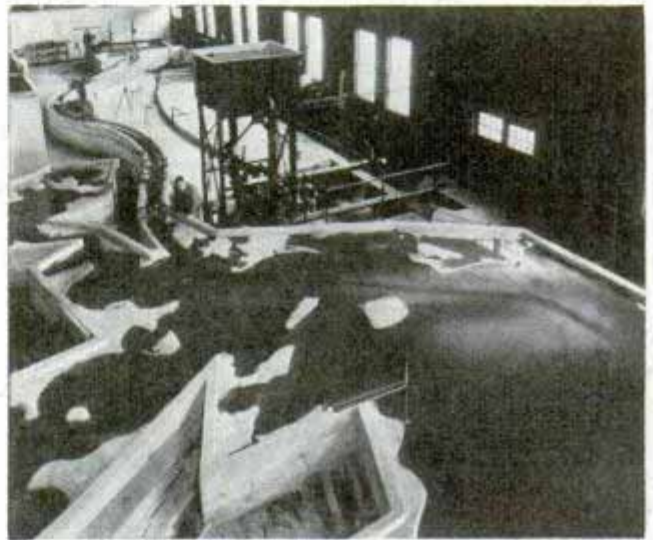

Small-scale reproduction of Cape Cod canal built to study effect of tidal currents

the eye, performs the function of a brain, controlling the machine in such a way that it is forced to follow the wavy line as the shadowgraph moves along.

The primary driving power of the earthquake machine is obtained from oil under pressure working against a piston connected to a platform which is free to move in any direction. The electric analyzing device controls a valve which feeds the oil into the piston chamber. This valve is moved in exactly the same way a radio receiver moves the diaphragm of a dynamic loud speaker, only the force available can reach a maximum of nearly fifty pounds and consequently can move very fast.

With the possible exception of hurricanes and tornadoes, floods are our most deadly natural enemies and, in seeking improved techniques for subduing them, engineers have turned to hydraulic laboratories. At the United States Waterways

(Continued to page 125A)

TO GET A STRONG HOLD OR TIGHTEN LOOSE PARTS

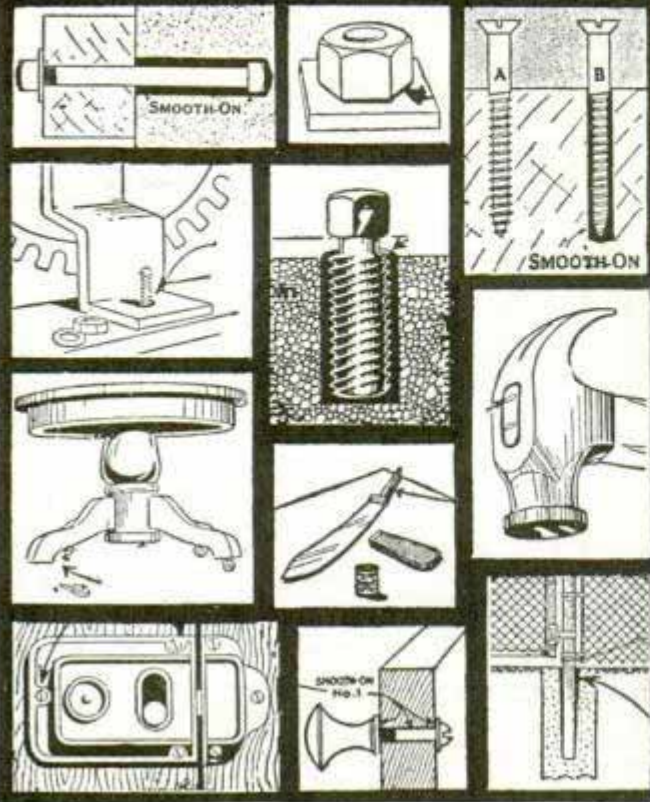

SMOOTH-ON No. 1 restores full usefulness of household fixtures, utensils and tools that would otherwise have to be discarded.

Try it for tightening loose parts and stopping leaks of water, steam, gas, etc., at joints and cracks. Use it also on your car for stopping leaks in the radiator, hose connections, gas tank, oil and exhaust lines, for patching cracked water jackets, for tightening loose hub caps, mud guards, lamp and tire supports, etc.

Smooth-On No. 1 is simple to apply and hardens to everlasting tightness. Merely follow directions in the Smooth-On Book which is sent free if you return the coupon.

Buy in 7-oz., 1-lb. or 5-lb. can from your nearest hardware store.

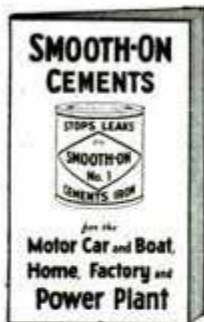

Mail Coupon for FREE BOOK

SMOOTH-ON MFG. CO., Dept. 37, 574 Communipaw Ave., Jersey City, N. J.

Please send the free Smooth-On Repair Book.

Name.....

Address.....

3-39.....



Do it with **SMOOTH-ON**

BIG MONEY!

ASSEMBLING MEAD'S

New PORTABLE KI-YAK

IN A FEW DAYS AT HOME!



FACTORY-TO-YOU at Low Factory Prices!

Assemble your own beautiful, portable MEAD KI-YAK in a few days at home and save nearly half the factory assembled cost! Also—earn Big Profits building, selling to others! Mead's perfected, PATENTED, exclusive "Home Assembly" Method using Cut-To-Fit-Construction Kit GUARANTEES successful, quick assembly. Experience unnecessary. 10 and 12 year old children have done fine jobs! All Parts Numbered! ALUMINUM Ribs Come Formed Ready-to-Attach! Wooden Parts Cut-to-Shape! Then . . . take your "Mead" anywhere by hand or car for paddling, sailing, rowing, outboard motoring, touring, fishing, camping, hunting! Safe. Seaworthy. Leakproof. Durable. INEXPENSIVE. Snappiest boat afloat.



The popular Double-End Cockpit "O K-2," as a motor-boat. Takes 4 1/2 h. p. or less.



Get started on your own!



Here's the OK-2 as a row-boat. Uses sail-rig test!



C K-3 with sail-rig . . . probably the fastest boat of its size ever built! Length: 16 ft. Wt.: 45 lbs.



MEAD'S NEW 14-FOOT, 75-POUND PORTABLE OUTBOARD KI-YAK

Uses Paddle, Oars, Sail or Motor Up to 9 h. p.

Each model in the "CK" KI-YAK series is convertible in 10 minutes from paddle boat to SAIL-BOAT complete with rudder, tiller, lee-boards, outrigger floats! The "CK" KI-YAKS are really 3 boats in one being immediately convertible into row-boat, sail-boat or motor-boat. Mead KI-YAKS are the fastest boats for their weight whether you use wind, muscles or motor BECAUSE Mead Ki-Yaks are:

Light as a Feather — Strong as a Giant!

Our entirely new and exclusive small-boat construction principle gives astonishing strength. Ribs can't break, rot, warp. And IMAGINE! CK-1 weighs only 20 lbs. . . . CK-2 only 30 lbs. . . . CK-3 only 45 lbs.! OK-2 weighs only 50 lbs., and the new 14-foot OK-4 only 75 lbs. THAT'S PORTABILITY! Nothing else like them! MEAD KI-YAKS are unsurpassed. This is the kind of boat you have always wanted. NOW is the time to start building one—find out all the fascinating details! Send dime and coupon now for Giant-size Picture Circular, Low Introductory Factory Prices, Gift Offers on Oars and Paddle!

MEAD GLIDERS

15 South Market—Dept. B-39—Chicago
MAIL COUPON NOW!

GENTLEMEN:

I enclose 10c as postage-handling charge. Please rush me your new Illustrated KI-YAK Circulars, Money-Making Plan, Low Introductory Prices, and details of your \$6 Gift Paddle and Gift Oars Offers.

NAME

St. & Number

CITY State

RUSH ME WITH 10c TO:

MEAD GLIDERS
15 S. MARKET ST. DEPT. B-39 CHICAGO, U.S.A.

\$6 PADDLE GIVEN
with your CK Ki-Yak—if you hurry!

Mail Coupon NOW!

Hurry—Before Prices Go Up!
The Cost of Living is going up—and MEAD KI-YAK prices may have to be raised. Send coupon now while prices are still rock-bottom. This may be your Last Chance to buy at present low prices! Hurry!

CAN YOU BEAT THESE POWER COSTS?

Save up to **\$293⁸⁰** Per Month on power costs

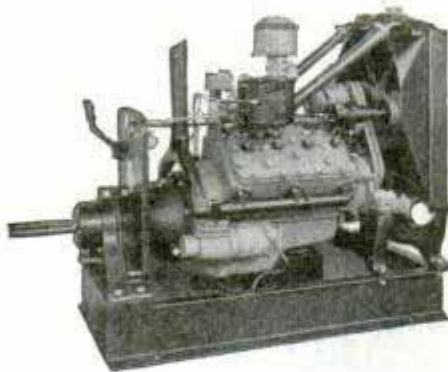

with a KRW FORD V8 Unit

50 H. P. with KRW V8 Unit using natural gas (1125 BTU) @ 30c per 1000 cu. ft. \$ 46.80 per month
 50 H. P. with KRW V8 Unit using gasoline @ 10c per gal. (no tax) \$140.40 per month

Above figures show primary fuel costs (lubricating oil not included) for operating a KRW V8 Unit to develop 50 H. P. for 10 hours per day—26 days per month. Compare this with electricity @ 3c per KWH which amounts to \$340.60 per month. You can pay for a KRW Unit in a few short weeks **out of actual savings!**

KRW V8 Units are daily saving money for operators of air conditioning and refrigeration equipment, mills, factories, shops, welders, compressors, pumps, well-drilling outfits, contractors' equipment, etc. New KRW "GUARDIAN" automatically stops engine in case of cooling or lubrication failure.

Write for new bulletin just off the press—packed with useful information, engineering data, etc. You can buy through your local Ford Dealer and benefit by local service and low-cost Ford engine replacement feature.

K. R. WILSON 17 Lock St. **BUFFALO, N. Y.**
 Builders of Shop Equipment for Ford Dealers Since 1916
 West Coast Branch: 722 Mateo St., Los Angeles.
 Export Office: 90 West St., New York.

NEW BRUSH PLATING OUTFIT For AUTO PARTS



Connects to a battery with no tanks necessary. Plates on iron, steel, brass, copper, etc. Almost as simple as painting. Hundreds of car owners waiting for this low-cost plating. Improves appearance and value of the car. Your opportunity to make good income plating auto parts, bathroom fixtures, reflectors, mirrors, etc.

FREE PROOF

Write quick—big season here. Get **FREE PROOF** and particulars that put you in a paying business of your own.

GUNMETAL COMPANY

AVENUE M DECATUR, ILL.

ONE-MAN SAWMILL

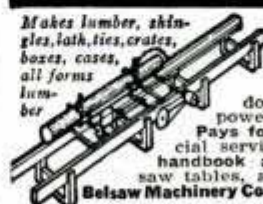

TURN TREES INTO MONEY WITH A BELSAW **\$49⁰⁰**
 Three capacities: 10, 14 and 20 ft. Accurate set works positive dogs. Hand or power feed. Runs on low power—Many owners use old auto engine. Pays for itself quickly—thousands in commercial service, everywhere. Write for free lumber handbook and catalog of mills, supplies, tools, saw tables, and wood-working equipment.
Belsaw Machinery Co., 8110-W Davidson Bldg., Kansas City, Mo.



PHOTO ENLARGEMENTS 5¢ ANY SIZE

Is Photography your hobby? Do you want a profitable easy business at home? Make **PHOTO ENLARGEMENTS** for yourself and others. Your cost 5c each and less. The Ideal Photo Enlarger is **AUTOMATIC**. No experience required. Also **COPIES** any picture. **\$5.94 COMPLETE**. Interesting circular **FREE**.
IDEAL-O, 122 East 25th Street, New York City

CAMERA CATALOG

FREE

See the whole photographic show, pick out what you need. Take advantage of our money-saving prices, wide selections, money-back guarantee. Mail penny postcard **NOW** for your **FREE** copy of this sensational Camera Catalog No. 72.

WHOLESALE RADIO SERVICE CO., Inc.
 Dept. 7CC9—100 Sixth Ave., New York, N. Y.

KINKADE GARDEN TRACTOR

and Power Lawnmower
 A Practical Power Plow and Cultivator for Gardeners, Suburbanites, Florists, Truckers, Nurserymen, Fruit Growers
Low Prices - Easy Terms
American Farm Machine Co.
 1058 33rd Av. SE. Minneapolis, Minn. **Catalog Free**



Print Your Own

Cards, stationery, circulars, tags, labels, advertising, etc. Save money. **Print for Others; Big Profits;** easy rules sent. Will do popular Raised Printing like Engraving. Junior outfit \$9. Senior outfits \$17 and up. Send for free catalog and all details.
KELSEY PRESSES, E-37, MERIDEN, CONN.



CLAUSING MFG. CO. OTTUMWA, IOWA

CATCH MORE FISH

Send for **FREE BAIT BOOK**

This practical handbook, for fishermen, is a fascinating, reliable guide to better fishing! It tells how and why Creek Chub, True-to-Nature Lures and Flies Catch More and Bigger Fish! Beautifully illustrated! Sent **FREE** upon request!
CREEK CHUB BAIT COMPANY
 413 Randolph St. Garrett, Ind.

Thompson BEATS the World on BOATS

Better Built Lower Prices

- Canoes \$64 and up
- Rowboats \$42 and up
- Outboards \$42 and up

Very fast utility model

Only Boats With Full Length Spray Rails
 Keep passengers perfectly dry—even at high speeds. Catalog also shows today's five most popular models of sailboats. Two big factories. Prompt shipment.
CATALOG FREE
 Write for your copy. State kind of boat in which you are interested.
THOMPSON BROS. BOAT MFG. CO. (87)
 213 Ann St. PESHIGO, WIS. Write to (either place) 113 Elm St., CORTLAND, N. Y.



TURN SCRAP INTO MONEY

AUTOPOWER tells you how in plain, easy, simple and illustrated instructions that anyone can follow. Change auto generators into useful, practical A C and D C generators and motors with voltage from 2 to 1,000 volts, for power, light, welding, radio, sound, etc. No previous experience nor special tools needed. Generators can be driven by wind, water, fan belt, etc. **INSTRUCTIONS FOR BUILDING AND A WELDER THAT ACTUALLY WORKS UP TO A 3/16" ROD. ALSO COMPLETE PLANS FOR WIND AND WATER POWER PLANTS.** Send for your copy of "AUTOPOWER." Already used and endorsed by thousands. Only \$1.00 postpaid.
S. W. DUNCAN, Publisher.
 410 S. Hoyne Ave., Chicago



1320

(Continued from page 122A)

Experiment station at Vicksburg, Miss., between 300 and 400 persons are constructing models of sections of important rivers so engineers can work out flood-control measures. On the 245-acre tract, approximately twenty-five "floods" are rampaging at once, accurately predicting surface elevations, slopes, velocities, eddies, current directions, and other factors.

Before a spade of dirt was turned on the Tygart river dam, one of a series planned to protect Pittsburgh from floods, Harold H. Thomas, head of the hydraulic staff at Carnegie Tech, and army engineers spent

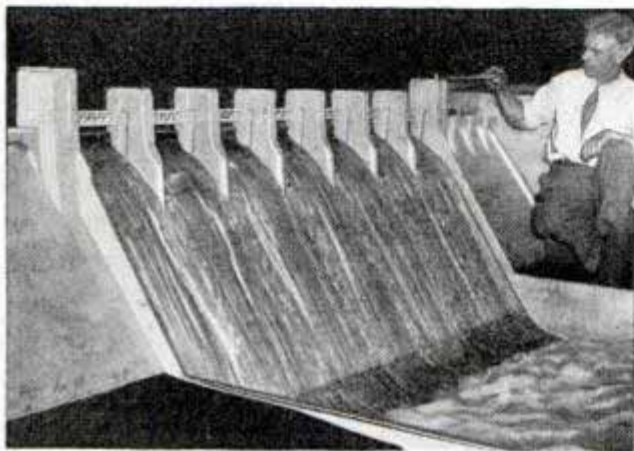

Carnegie Institute engineer points to figure of six-foot man in proper scale on Tygart dam model

three years studying models of the giant faucet that is to hold back a potential of 327,500 acre-feet of water.

When details of the dam had been decided upon tentatively, the question came up as to what might happen if there were an overflow. The model indicated a hole would be gouged out below the dam wall that would weaken and possibly cause the \$18,000,000 structure to give way. The engineers turned again to the miniature and it furnished the answer—the building of a spillway apron and cushion pool.

Atlantic storms, which annually cause millions of dollars worth of damage to property and land, are created in vest-pocket sizes so experts can study the designing of protective sea walls. A plunger in a basin sends miniature storm waves breaking against an experimental sea wall, tossing spray to a height comparable in nature to more than forty feet.

No matter what the weather outside may be, the prediction for test chambers will be high winds, sleet and ice, rain, with earthquakes and floods over wide areas!

HAPPY BIRTHDAY

with INDOOR "SNAPS"

(They're easy to take with G-E Photofloods)

"LOOK at my swell birthday pictures," says Molly. "And Daddy's so proud... says he's going to take lots of indoor snaps now that he's found how easy it is with G-E Photofloods."



1. "When Mummy brought in my cake I forgot all about Daddy's camera and how bright the room was. Maybe that's what makes these snapshots look so natural."

2. "I did hear several clicks as I began to blow. But after all, a cake is more serious business for a gal with a birthday."



3. "Daddy's tickled pink with this picture. And Mummy says she's so glad he thought to take indoor snapshots. I say, 'Happy Birthday!'"

BIRTHDAY COMING? Take indoor "snaps" with your camera. Go to your film dealer for G-E MAZDA Photoflood lamps and new "super" type film that make it easy.



New Lower Prices
G-E MAZDA Photoflood Lamps

No. 1 (was 25c) now 20c list

No. 2 (was 50c) now 40c list

Action? Pets?
G-E MAZDA Photoflash Lamps

No. 10 15c list

Brand New
No. 21 (Synchro-Press) 20c list

GENERAL  ELECTRIC
MAZDA PHOTO LAMPS

When your
Stomach
feels upset

Turn it
RIGHT SIDE UP
with
Alka-Seltzer

● See how a bubbling glass of Alka-Seltzer will quickly help put you "right side up" when an upset stomach, attack of Acid Indigestion or a Headache makes you feel miserable.

● Alka-Seltzer is **DOUBLY** effective because it offers relief in **TWO** ways. Its analgesic action relieves pain and discomfort promptly and its alkalizing qualities help to neutralize any existing excess acid condition. Get a **30c** or **60c** package at any Drug Store.



DO YOU

WANT a new business profession of your own, with all the trade you can attend to? Then **become a foot correctionist**, and in a few weeks earn big income in service fees,—not medical nor chiropody—easy terms for home training, no further capital needed, no goods to buy, no agency. Established 1894. Address Stephenson Laboratory, 1 Back Bay, Boston, Mass.

12/11/65
"Hot Papa" to the Rescue

(Continued from page 357)

be a rocky gulley. They didn't hurt themselves or the plane but it was impossible to fly out again. The fliers were marooned for a day until searching planes sighted them and dropped food. Later on the salvage squad disassembled the plane and trucked it out to a field.

Occasionally the salvage truck hauls a new engine or wing out to a plane that had to make a forced landing. On one such occasion the salvage squad had to do their repair work during an intense sandstorm on the desert, one trouble they had being that tools were hidden in the drifting sand almost as soon as they were laid down. Mechanics who reached around for a wrench they dropped a moment before had a hard time finding it.

Each accident to a military plane, no matter how unimportant it seems, calls for an investigation because the army wants to know exactly what caused the trouble. Mechanical failures of any kind are rigorously inspected so that improvements can be made to new equipment.

With half a dozen or more scouting and bombing missions scheduled on a typical day, the dispatcher at March Field uses a radio airdrome control system to keep track of the scores of planes taking part. Each pilot or squadron leader calls the dispatching office by radio while he is still warming up his engine in the parking area. He reports his destination and mission and other data and receives permission to taxi out to the runway. On the runway, he again phones in and receives permission to leave the ground. Dispatching is handled very much like the dispatching at a busy commercial airport.

On his way back to the field, a returning pilot calls in while still several miles away, requesting landing instructions. He may be told to circle at 4,000 feet for five minutes while a group of twenty-eight planes ahead of him complete their landings, or he may be told that the field is clear, no traffic reported, and that he is free to land immediately. Then the dispatcher adds his final instructions to the pilot: "Get your wheels down!"

☐ Send return postage to our Bureau of Information to learn the name of the maker of any device described in this magazine.

\$200 My First Week



... Now in my OWN Business.

Would you, too, like to own a business where you could take in \$200 your first week as did L. A. Eagles in Madison, Wisconsin?

We want a reputable, honest man in each locality. This man need not have any special experience or more than ordinary ability, but he must be honest and courteous.

Such a man we will start in business for himself. You can make far above average profits in the rug-washing business—a high-grade business all your own. Many earn \$125 to \$200 per week—some considerably more.

NO SHOP NECESSARY

The rug-washer finishes rugs like new on the customer's floor. Anyone can run it. Electricity does the work. A quick, thorough and highly-efficient method that restores the natural beauty of floor coverings.

There are hundreds of customers—in your vicinity and nearby towns. The business grows steadily. Simply wash a few rugs or carpets. These customers tell others and also give you their future work. Soon you will have a prosperous year-around business. Send coupon for booklet explaining everything.

"Profits Pay for Home"

Harry Hill built and paid for a home from rug-washer profits. His first day's business was \$86. Another man writes, "Made \$70 in 13 hours." A. L. Miller says, "Have had rug-washer 6 years—have earned as high as \$92 a day." M. O. Malmin earned 3 times the cost of his machine the first two months. You, too, can enjoy a large income.

VON SCHRADER MFG. CO., 103 PL., RACINE, WIS.

Free Book!
MAIL COUPON now

VON SCHRADER MFG. CO.
103 Pl., Racine, Wis.

Send at once (no obligation) your free booklet illustrating rug-washer and telling how I can own my own permanent business: how I can earn large profits at prices below other methods: how I can become financially independent in a short time: and how I can pay on easy terms.

Name.....

Address.....

City.....State.....

"Never a Complaint"

C. J. White says: "\$100 business in six days—never a complaint." That is the nicest part of this business—every customer is more than satisfied. Stains and blotches disappear and vivid colorings and freshness in faded floor coverings come back.

EVERY MACHINE GUARANTEED

You take no risk. These machines have been manufactured since 1918 and are used by the United States Government and by many of the world's largest hotels. They are fully GUARANTEED.

EASY TERMS

The complete equipment is inexpensive. A reasonable down payment brings everything to you and the balance is paid monthly. From the start, you have your own business—one that is profitable and of which you can be proud.



MAIL COUPON Today

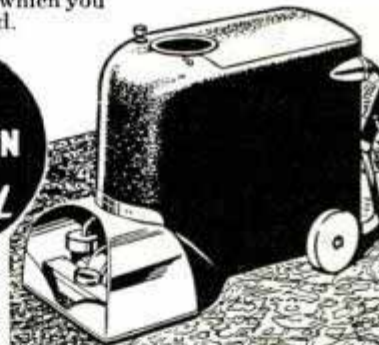

EARN MONEY MAKE COLOR GLAZED CONCRETE PRODUCTS



MAKE Color-glazed concrete pottery, tiles, walls. New method. No molds. Use only sand, cement, cheap materials. U. S. and Canada patents. Complete licensed plants low as \$35. MEN (only): Write for FREE booklet, colorplate, details of this new money-making business.

NATIONAL POTTERIES COMPANY

Room 6, 13 W. 26th St., Minneapolis, Minn.

EASY PROFITS IN PAINT SPRAYING



Paint walls, ceilings, screens, furniture, radiators, machinery faster, better! 1/4 H. P. motor 110 Volt 60 Cycle AC, complete with Spray Gun, 15 ft. hose. Weighs only 44 lbs. Carry anywhere. FULLY GUARANTEED. Only \$31.15 f. o. b. Chicago. \$5 Deposit, Balance COD, or SEE YOUR DEALER. Circular FREE. Get started making money NOW!

Ideal Automatic Pump Co., Dept. PM-3, 801 Washington, Chicago \$31.15 Complete



DRIVE ANY ROUTE On the Map

You can follow any directions with a Hull Auto Compass on your windshield. Drivers everywhere depend upon it to get them there on time, and by the shortest route. It shows your direction of travel at all times, in any weather. Only \$2.95 at your dealer. Two-piece model \$1.95. Write for circular.

HULL MFG. CO., P. O. Box 246-D11, WARREN, OHIO

HANDY TAPS and DIES...

Accurate—carefully hardened and tempered. Complete range of sizes at your local five and ten cent store

HENRY L. HANSON, WORCESTER, MASS.

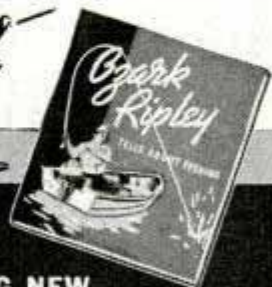

FISHERMEN GET THIS THRILLING NEW BOOK ON FISHING Free!

"Ozark Ripley Tells About Fishing." Page after page of thrills covering all types of angling—written by Ozark Ripley, master fisherman. Also valuable information on outboard motors and boats. Write for your copy. Free! JOHNSON MOTORS, 1211 Pershing Road, Waukegan, Ill.

*You're out
in the Cold-*



... till you get a Barbasol Face

If you think women don't notice, just shave with Barbasol for 10 days or so and see how your wife or sweetheart warms up to the improvement in your face.

Here's why:

A Barbasol Face is a smoother, younger-looking face because Barbasol does a whole lot more than give you the sweetest shave you ever had—

Its beneficial oils help to prevent razor-irritation, while you shave—and leave your skin soft and smooth and supple, after you've shaved.

Why keep on torturing your skin with old-fashioned methods that bite and burn, tending to roughen and wrinkle your skin? Why be content with other methods that leave a half-cut stubble?

Turn to Barbasol today and know the thrill of the quickest, smoothest shave in the world, plus fine protection for your skin.

Your druggist sells three sizes, large tube, 25¢; giant tube, 50¢; family jar, 75¢. Barbasol Blades, 5 for 15¢.

For Modern Shaving

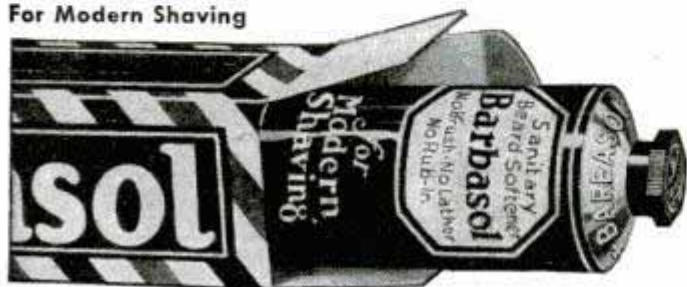

No Brush • No Lather • No Rub-In

H 1056
Miracle of New Color Movies

(Continued from Coloroto Section)

shining armor. The emotional stimulus was heightened here by the change from a somber to a brilliant color, and the attendant symbolism from despair to courage, hope and faith.

White-flame carbon arcs generally are used for color photography on interior sets and sunlight or sunlight with carbon arc-light mixed, for exteriors. The white-flame carbon arclight matches the color of daylight which permits the mixing of these two light sources. Illuminating engineers working with Technicolor have recently produced color-corrected incandescent lamps using special color-correcting filters so this type of equipment can be used on color photography.

High-speed camera shots, matt and painting shots, miniatures, glass shots and projection background scenes are being used more and more in Technicolor, permitting studios to save on production costs in color as they do in black and white.

Naturalness is the big aim in make-up and only a small amount is used. In fact, Ray Rennahan, color cameraman, believes many a film star could step before the color camera and work without any make-up whatever.

Experiments with color pictures began fifty years ago when Frederick E. Ives demonstrated the additive process for reproducing natural colors. He took three photographs, one through a red, one through a green and one through a blue solution. Positives were made from these negatives on lantern slides, and then they were projected, one on top of another, by three lanterns, each through its original taking solution.

Later, Charles Urban advanced the idea of substituting successive for simultaneous projection of the different colored partial pictures on the theory that the persistence of retinal impressions applies to color as well as form. His work was utilized by Albert G. Smith in a process known as Kinemacolor. He simplified operations by reducing the three primary color sensations to two, dividing the spectrum so the colors in each half corresponded to red-orange and blue-green.

In Kinemacolor, the negatives were made on a single film alternating through the red-orange and green-blue halves of a

141056
 disk rotating with the proper velocity between film and lens. A positive was made from this and projected with the aid of a similar device. The colors of the successive pictures, modified by a special fixed color screen, were combined by the persistence of retinal impressions and approximately reproduced the natural tints of a scene.

Although some excellent results were accredited to the additive methods, their chief drawbacks were that camera shutter and projecting machine had to run at twice the speed of silent black-and-white film, and there was likely to be fuzziness in the projected images.

Technicolor engineers first used an additive process. They wanted to get away from any system that called for special projection equipment so they began working with a two-component subtractive process in which two gelatin reliefs, produced on thin celluloid, were glued together, back to back, and dyed in complementary colors. The big trouble here was that the double-coated stock curled in either direction, instead of only one direction, and this upset the focus.

By 1928, Technicolor engineers devised a process which called for the transfer of the dye from a gelatin relief or matrix to a gelatin film. Color made a big splash on the screen for a year or so, then went into an eclipse until the birth of the three-component process now in use.

141560
**License Number Easier to Read
 When Letter Is Added**

Using a letter with four or five numerals makes the automobile license plate easier to read than when figures or letters alone are used, it was found recently in tests made by Lehigh university psychologists. In a state like Pennsylvania where more than 1,000,000 cars are registered, plates can be identified with a maximum of only five digits, as Z99999. If numerals are used entirely the number would reach seven digits, which are not easily recognized or remembered.

Names and addresses of manufacturers and dealers in articles described in this magazine will be furnished by our Bureau of Information upon request accompanied by stamped, self-addressed envelope.

That's Gold

— in my
cellar - shop!

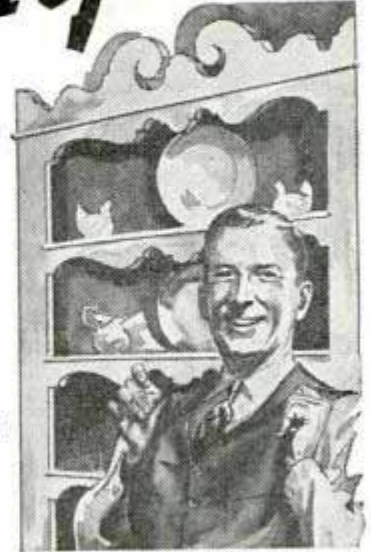

**Hundreds of
 Driver - equipped
 home shops
 return a nice profit
 as well as a lot of fun!**

It's a cinch to make money on your investment in Driver Power Tools. All around you are folks who want things made . . . who'll be glad to pay for the furniture, knick-knacks, etc., you enjoy making. Try it! The new 1939 Driver Tools will prepare you for BUSINESS . . . enable you to turn out "professional" work that SELLS. Enable you to do it so easily that your "Business" will remain FUN for you.

You'll want this NEW 14" BAND SAW—

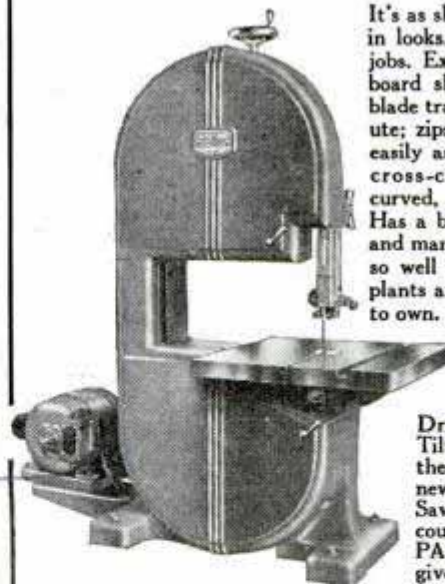

It's as slick in operation as it is in looks. Does a multitude of jobs. Example is the corner cupboard shown above. Its keen blade travels 2535 feet per minute; zips through heavy oak as easily as a light panel. Rips, cross-cuts, makes accurate curved, angle and mitre cuts. Has a big 16"x16" tilting table and many other features. Built so well that big wood-working plants are using it. Costs little to own.

Your local Walker-Turner dealer will demonstrate this tool, also the new Driver 10" Geared Power Tilting Arbor Saw . . . the new 6" Jointer . . . new Metal-working Band Saw and others. Use the coupon to get the NEW 48-PAGE CATALOG which gives the details you want.

DRIVER *Engineered* POWER TOOLS

Walker-Turner Co., Inc.,
 139 South Ave., Plainfield, N. J.

I want your new 1939 Catalog of Driver Tools, accessories and motors.

Name.....
 Address.....

Service Service 12/24/38

Grooming the Iron Horse

(Continued from page 363)

mers rap steel while expert eyes and ears look and listen for flaws. One fellow climbs into the still hot firebox for a quick, thorough inspection with flashlight, watching

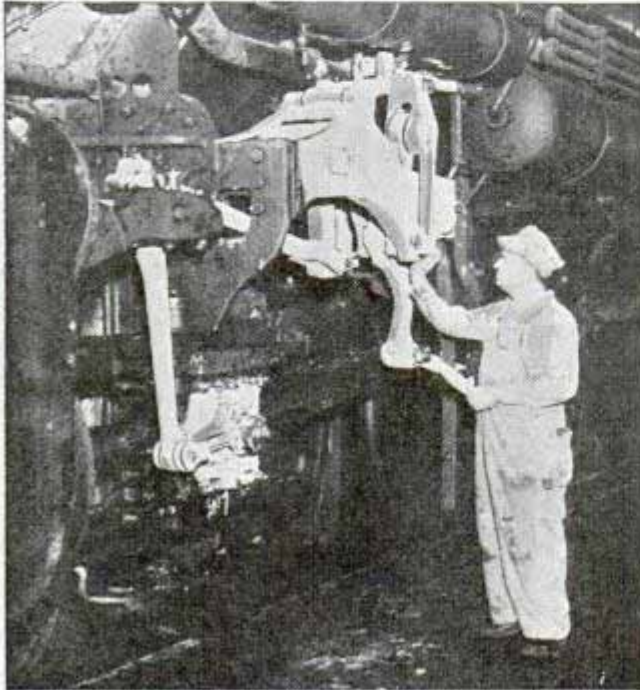

Monthly inspection includes whitewashing all moving parts to show up any tiny flaws in steel

for loose rivets and cracks. He stays there about five minutes, at 210 degrees.

Then come the washing and refilling of the boiler, the blowing of flues, filling of grease cups on the rods and application of a grease gun much like that used on your automobile. One man spends an hour starting a new fire, four men spend fifteen minutes giving the locomotive a final bath, a supplyman sees that all essential tools and supplies are aboard and by three p.m. the locomotive should be ready for inspection on the outbound track. It has taken thirteen man-hours to put No. 5624 through her servicing routine. Probably she could have omitted most of it, run right back to Minnesota with a mere shake of the ashpan and a quick "once over." The Aeolus did. But the railroads play safe. When a load of lives is riding at seventy miles an hour behind a million pounds of steel, every pound of that iron horse must be fit.

If she keeps her health for a month without a day off, the engine may roll up 15,000 miles. Then one day every month she must go to the shops for monthly inspection: cylinders and valve heads are re-

moved and all moving parts whitewashed to show up any minute flaws in the steel. The tank is washed, hose inspected, staybolts hammer-tested, and superheater coils examined under high water pressure.

Add to the daily and monthly routine a quarterly checkup which includes the replacement of all gauges, tests of water pump and lubricator, whitewash inspection of drawbar and safety bar, valve stems and piston rods and examination of rod bushings, and to this a semi-annual inspection of air-brake equipment. Add to all this an annual program of removing, washing and hammer-testing air drums, a hydrostatic pressure test to drums, boiler and tubes, removing safety valve and dome cap, and cleaning all water columns. And still you have a general overhauling of every locomotive every two to five years, as its general health demands.

It's more than 100 years old now, but the iron horse still thrills as it roars down the track at seventy, eighty, ninety miles an



Measuring slack in driving rods with caliper while hostler sends "thump" of steam against set brakes

hour. Smooth, efficient, powerful, it is a symbol of might. But it is the grooming in the stables, day after day, that keeps the iron horse mighty—and mighty safe.

84 feet 5 inches. 100-1000?

THE STRANGE CASE OF MR. SLAVIN . . .



**"No one—it seemed—
could find the answer"**



BERNARD SLAVIN
Chicago, Illinois

"Last September—three months after I had spent \$12.00 for a well known battery—I began having starting trouble! During the winter I had to be pushed at least 15 times! And each time I got madder. Battery dealers would look my battery over—test it—recharge it again . . . and in a week or so I'd be in trouble again. *No one could find the real answer!*

"Finally someone told me about *Willard Starting Service*. I went to a Willard Dealer and in a few minutes he found the cause of the trouble, *which wasn't in the battery at all!*

"He showed me why most run-down batteries are caused by little things you never see—worn or undersize cables, loose connections, faulty wiring, and voltage regulators that need adjustment. He showed me how he can locate these hidden flaws quickly with the *new Willard Electrical Check*.

"Believe me, if you want freedom from trouble—get acquainted with *Willard Starting Service*."

Ask Your Willard Dealer About It!

You should know about this new kind of *positive* protection against Starting failure. By keeping you out of trouble we hope to merit your business, and *Willard Starting Service* is our way of EARNING your patronage. Come in and try it.

Your Willard Dealer

You can identify our station by this sign.



If you are interested in the "why" and "how" of the instrument that makes this service possible, send a letter or postcard to Willard Storage Battery Company, Dept. M-3, Cleveland, Ohio.



Here's the steel tape engineers prefer. It's hard to kink, hard to curl. **BLACK-ON-WHITE** means easy reading, fewer errors. Bonded white surface protects steel from rust and is easy to clean. 25, 50, 75, 100 ft. lengths. Good for a long life of tough use. Mail coupon today for free sample of tape and illustrated folder showing new, popular-priced models.



K&E FAVORITE WYTEFACE
MADE IN U.S.A. PAT. OFF. TRADE MARK
STEEL MEASURING TAPES

KEUFFEL & ESSER CO. . . Est. 1867 . . Dept. 29, Hoboken, N. J.

Name: _____
 Address: _____
 City: _____ State: _____

HOLD-E-ZEE

Automatic Grip Screwdrivers

Hold, start and set-up screws in unhandy places. Gripper instantly released by spring action, sliding up out of way when not in use. Finest materials throughout, chrome vanadium blades; many have transparent, insulating, unbreakable handles. Models for recessed-head screws. No more expense live than ordinary screwdrivers. At auto-supply, hardware or electrical stores.

UPSON BROS., INC.
 86 Exchange St.
 Rochester, N. Y.

Patented

NEW! ALADDIN READI-CUT
WORLD'S LOWEST-PRICED
QUALITY HOMES!

\$495 UP
WE PAY FREIGHT



BUY DIRECT—SAVE UP TO 30%

Yours! . . . a beautiful, new Aladdin home at up to \$800 saving by buying direct from our big mills NOW! Your choice of 98 designs, 4 to 10 rooms. Aladdin Read-i-cut Method saves 18% material waste, 30% labor—prices include all lumber Read-i-cut, siding, millwork, windows, doors, interior woodwork, flooring, roofing, hardware, nails, paints, stains, varnish—and we pay freight!

NEW CATALOG! Packed with full-color illustrated home values (that comply with F. H. A. loan requirements). Summer Cottages \$300 up. Send 25¢ for this big new catalog No. 326 TODAY! Write nearest mill.



ALADDIN CO. BAY CITY, MICHIGAN
 Portland, Ore.; Toronto, Can.

Paul Reveres of '39 Battle Frost

(Continued from page 351)

black with oil. A few belated tankers roar down the roads, bringing oil for those pots which were not filled the day before. Giant tanks, scattered throughout the groves, loom against the sky—4,000,000 gallons of oil stored against just such an hour of need. A pot burns nine hours—then there must be more oil—or else.

And slowly the columns of mercury in 10,000 thermometers begin to rise. Twenty-seven—twenty-seven and a half—twenty-eight—twenty-nine—and there it holds. Every phone in the central office is busy. The riders no longer pause to light cigarettes.

Then at last the eastern sky begins to pale, the trees begin to take shape. A bit of a breeze stirs the leaves. Then a long ray of light struggles through the murk.

Sunlight—and men drop where they are, while endless miles of flaming pots form a strange pattern among the trees.

And in the central office weary hands pull off head sets, and tired voices give the last report.

"It's all right now. The bureau says it'll be warmer tomorrow night—tell the boys to come home and sleep."

The strange organization has done its job—so that you and I can have our glass of orange juice—and a great industry can continue to live.

1567

Eyes Indicate Length of Life of Middle-Aged Persons

Changes in eyesight form a basis for predicting the span of life that may be left for middle-aged persons, according to studies of 8,000 cases by Prof. Felix Bernstein of New York university. The ability of the eye to change focus to see near and distant objects, called the accommodating power, is affected by hardening of the lens of the eye, which follows closely other bodily changes accompanying the ageing process. Most persons become aware of changes in their eyes at forty-five or later, and turn to glasses. If this process, known as presbyopia, takes place early in life, Prof. Bernstein says the individual will be overtaken by old age quickly, whereas a ripe old age may be expected by one unaffected by presbyopia until late in life.

fellow service 12123

I'M GLAD I BOUGHT AN IDEAL LAWNMOWER SHARPENER AND WENT INTO BUSINESS FOR MYSELF . . .

YOU, TOO, CAN HAVE A PROFITABLE BUSINESS OF YOUR OWN . . .

Our free plans show you how to build a successful business of your own sharpening lawnmowers. Most men earn up to \$25 a week, even in spare time. Howard Hellen, Minn., writes, "I sharpened 745 lawnmowers, sold 60 used mowers and grossed \$1100.00 from April 5 to Sept. 15." Roy F. Stier, Wisc., writes, "I paid for my Ideal Sharpener in exactly 36 days." Like magic, the Ideal Lawnmower Sharpener makes old, dull, badly worn mowers cut like new. Simply set the mower in the Ideal, make a few simple adjustments and the machine does the rest. Sharpens any mower to perfect edge in 15 to 20 minutes—usual charge \$1.00 to \$1.50. Attach to light socket. Start in your basement or garage. Work spare time or full time. Attachments for grinding skates, grass shears, hedge shears, sickles, scythes and axes. FREE CATALOG tells complete story.

THE FATE-ROOT-HEATH CO.
349 Bell St. Plymouth, Ohio



Make Money! SHARPEN LAWNMOWERS THE "IDEAL" WAY!

RE-STRING RACKETS AT HOME • EARN MONEY.



It's pleasant, profitable work. No experience or skill required. Easy to learn. Full line of guaranteed Stringing Tools, Frames, Gut and Silk Strings. Every item high quality. Write for complete information.

FREE Write for our 1939 Catalog and Instruction sheet.
W. A. BICKEL & CO., 137 N. Marion, Dept. A-39, Oak Park, Ill.

BURN YOUR NAME ON TOOLS WITH THE ARKOGRAF

PROTECT YOUR TOOLS FROM THEFT
Write with electricity any name or design on the hardest and finest tools and instruments, or any metal, like writing on paper with pen or pencil.
Complete Outfit \$3.50—Prepaid Anywhere
Interesting illustrated circular free. Write today.
Agents wanted.
ARKOGRAF PEN CO., 3927 S.E. Stark St., Portland, Ore.

OTTAWA LOG SAW \$39

BIG BOOK FREE

PUTS THIS OTTAWA to work for you. MAKE MONEY! Wood is valuable. Does more than 10 men. Easily operated. Falls trees—saws limbs. Use 4-hp. engine for other work. Write for FREE Book.
OTTAWA MFG. CO.
1727 Wood St., Ottawa, Kans.

TRAILER BUILDERS • BUYERS • OWNERS TRAILER

Send 25c for this Big Book Today

Over 100 pages! Beautifully Printed and Illustrated! Trailer Suggestions and Ideas galore! Catalog shows America's greatest line of Trailer Parts and Equipment at lowest prices. Everything from wheels to top. Rush 25c today. Satisfaction positively guaranteed!
TRAILER SUPPLY CO. Box 438-A WAUSAU, WIS.

BUILD IT YOURSELF

The Jim Dandy Cabin Cruiser
The Trailer that has everything. Classy! Roomy! Easy to build in any size with my simplified Plans and Instructions—Price \$1.00. Rush dollar bill today to
JIM DANDY Box 125-A WAUSAU, WIS.

Agents and Dealers WANTED to sell or rent the NEW Mead Ranger SCOOTER

These sensational new, improved Ranger Scooters sell like hot cakes all over the country! Order your demonstrator while territory is still open—there's big money selling to all stores needing quick, cheap delivery . . . sell to messengers, mechanics, garages, canvassers, friends; or rent for easy hourly profits at bike shops, beaches, resorts, etc. Rush post-card for illustrated circular, details. MEAD'S New Ranger Scooter for 1939 features: X-member 1-piece ALL STEEL frame, 2-speed transmission, etc. Solo models, tandem or delivery, also 3-wheel miniature car. Hurry! Write!

Retail Prices \$99.00 F.O.B. Chicago

Amazing low prices . . . amazing low cost—6 miles for 1c . . . amazing mileage 129 miles per gallon. Go anywhere.



WRITE TODAY FOR FREE FOLDER

CYCLE CO. Mead

17 South Market, Dept. MS-118, CHICAGO

CASCO HINTS for

Better Gluing



MIXING—CASCO mixes easily. No heating... no lumping. Just add water and stir. At first, chemical action thickens CASCO... so let mix stand for 15 minutes. Now creamy and smooth, CASCO is tacky, ready for use.

SPREADING—CASCO is easily mixed to suit the job. Heavy mix for hard woods—difficult gluing. Thin mix for easy gluing... soft wood, cardboard, etc.

SETTING—When clamps are impractical, the quick gripping power of heavy CASCO mix insures strong bonds even with moderate pressure.

FREE! CASCO GLUING GUIDE

Detailed directions for mixing and using CASCO. Hints for home repairs, woodworking, making water-resistant paint, tile cement, etc. Send your name and address to—

CASEIN COMPANY OF AMERICA
350 Madison Ave., Dept. PM-339A, New York, N. Y.

FOR BETTER WORK GET THE RIGHT SAW FOR EVERY JOB

ATKINS Silver Steel SAWS

See your hardware dealer. Send for FREE Work-At-Home Book.
E. C. ATKINS AND COMPANY, 426 S. Illinois St., Indianapolis, Ind.

ENGINES

A real money maker for farm or factory. Uses Cheap fuels. Pays for itself out of savings. Costs Less to Own—Less to Operate.



LOG SAWS

Make Money—Start a wood sawing business—turn spare timber into cash. Cash or Terms—Engine and Saw Catalog.

WITTE ENGINE WORKS 2743 OAKLAND AVE. KANSAS CITY, MO.

RIDE THE ERIE MOTOR BIKE



OVER 100 MILES TO THE GALLON: A powerful, high grade machine with Sachs Motor; 2-speeds, and clutch, chain drive, powerful brakes, balloon tires. World's outstanding low-priced pleasure and utility motor-bike. Thousands in daily use. Speeds up to 40 miles per hour.

WRITE for Special offer today. Rider Agents wanted.
STREIFTHAU MFG. CO., Dept. 100, Middletown, Ohio

H (43)

Making the Grade on Skis

(Continued from page 395)

"Position is very important. The arms are close to the body, the knees slightly bent, so that they are in line with the tips of your boots. For perfect balance the upper part of the body is brought slightly forward. Thus the shoulders, knees and tips of the ski boots are in perfect aline-



Clearing a ridge high in the Sawtooth mountains. Notice ski poles held ready for braking and steering

ment. Now that you are in motion, try it several times over, until you gain confidence in yourself."

Ready for a climb now? Let's have a try. The chief precaution in climbing is not to exhaust your energy too quickly. First the diagonal climb. With skis parallel, move forward up an easy slope, not straight up but on a diagonal line. Use the kick turn you have already learned when you wish to change direction. Take it easy and don't get too tired.

A half day or so at this and you are ready for the herringbone, the maneuver which takes you straight uphill. The ends of the skis are placed together and the points apart, V-shape. The weight should rest on the inside edges of both skis. The knees are still straight and apart. Move either foot about a foot forward. Then bring the other ski up, off the ground. The body is forward, weight resting slightly on the poles. Repeat the maneuver. Look backward after a while and you will see a perfect herringbone pattern in the snow.

Now you are ready for the most important and fundamental turn in skiing, the

← (43)
 snowplow turn. Start off at the top of a gentle slope as you did before. The ends of the skis are apart and the points together, the opposite of the herringbone start uphill. As you move slowly down, to turn to the right bring your left ski slightly forward. Put more weight on your left (or bottom) ski, turn your left (or outside) shoulder forward, swing your hips to the right and if you keep the same position you will find yourself making an easy, confident turn to the right. In other words, keep the snowplow position and with your body swinging, you will automatically turn. But wait a minute, beginner—don't go too fast or make a complete turn at first!

For a left snowplow, the right ski is brought forward and the weight is transferred to the right ski. Spend plenty of time on this turn. If you learn this one right, all your other turns will be right.

While learning these turns, keep up your exercises in downhill sliding and climbing. The key to skiing with skill is to practice and practice and practice. When you are well advanced you can learn the more involved turns, the stem turn, the stem Christiana, the parallel Christiana and the



Hauser shows beginners the position for a snowplow turn, the skis forming a wedge or "V"

jump turn. But it is better to know the primary maneuvers well before you graduate into such advanced skiing. Learning these first steps will keep you busy for a long time.

Our Bureau of Information keeps on file the names and addresses of makers of, and dealers in, all devices described in the pages of Popular Mechanics Magazine. We are glad to furnish this information to our readers upon request, accompanied by stamped, self-addressed envelope.

Brand New 3/16" Hornet Drill Perfect for "Tight Spots"



This sensational new Black & Decker HORNET is the smallest, sturdiest 3/16" drill available today. Remarkably compact (only 6" over-all), light in weight (only 34 ounces), yet ruggedly built and highly powered. With its comfortable "Pistol Grip" and minimum spindle offset, this high-speed "vest pocket" drill permits steady, one-hand production operations in cramped quarters without fatigue.

Powerfully motored, perfectly balanced, and chockful of all the traditional quality that has made Black & Decker famous for fine tools. The 3/16" HORNET is a perfect companion to the 1/4" HOLGUN, another compact, more powerful, slower speed drill. Get full details about these two drills today. Sold by leading Jobbers. The Black & Decker Mfg. Co., 603 Pennsylvania Ave., Towson, Maryland.

BLACK & DECKER

BLACK & DECKER

World's Largest Manufacturer of
 PORTABLE ELECTRIC TOOLS



SERVICE MEN
RADIO BUILDERS
AMATEURS

Get this book that
SAVES
on everything
in **RADIO!**

Send for ALLIED's free 1939 Catalog today! 180 pages of values—new Knight Radios for every requirement; Build-Your-Own Kits for beginners and advanced experimenters; P. A. systems from 8 to 65 watts; complete lines of Amateur transmitters and receivers; all leading test equipment brands; 14,000 exact duplicate and replacement parts; books, tools, etc.

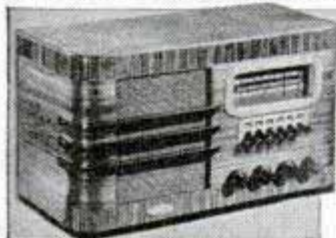

Knight SETS

62 new models at new low prices as low as \$6.95. 4 to 16 tube sets for AC, AC-DC, 1½ Volt, 6 Volt and 32 Volt models. See the new "Tiny Knights", phonographs, phono-radio combinations, record players, all in ALLIED's 1939 Catalog!

62 NEW MODELS

KITS

FREE PARTS LISTS

We can supply free parts lists for any kit shown in any radio magazine or handbook construction article. Write!

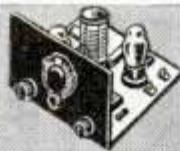

BEGINNERS! SEND FOR ALLIED'S RADIO BUILDER'S HANDBOOK!

A new and different type of book, planned especially for radio beginners. Tells how to select circuits, read diagrams, make chassis, solder, wind coils, etc. Packed with valuable receiving and transmitting data. Send coupon with 10c for your copy.

EVERY RADIO NEED AT MONEY-SAVING PRICES!

No matter what your radio need is, you'll find it fully answered in ALLIED's great 1939 Catalog. Here's Everything in Radio at Radio's lowest prices. Thousands of money-saving, profit-making items ready for instant shipment so that you get what you want when you want it. Send for ALLIED's Catalog today—you'll profit on every order!



ALLIED Radio Corp.,
Dept. 5-C-9
833 W. Jackson Blvd., Chicago, Ill.

- Send me your Free 1939 Catalog.
- Enclosed find 10c (plus 3c postage) for Radio Builder's Book.
- Send me parts list for.....

Name.....

Address.....

FREE
Catalog

1939 Little Giant Phono-Radio

(Continued from page 419)

Although not especially designed for beginners, this portable phono-radio unit is not difficult to build and may be adapted for installation in an old console or large table-type cabinet if the builder does not wish to use it for portable purposes. The electric phonograph feature just about doubles the cost of parts used in the construction of former models of this midget receiver.

The arrangement of the various controls is clearly given in Fig. 1; these controls, receiver chassis and phono motor are all

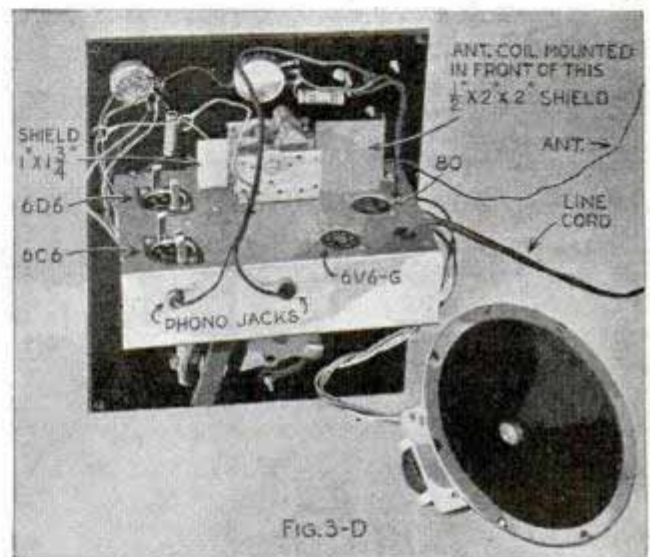

assembled directly on the back of the ¼-in. plywood panel which is covered with imitation leather. The magnetic pickup arm is an "Upco" type having an impedance of 10,000 ohms. This panel and the phono motor should be mounted on soft para rubber grommets and screwed loosely in position to prevent microphonic vibration. Carrying case and metal chassis base details are shown in Fig. 2; the same plywood stock and covering material are used for the case, which is provided with pull-apart hinges. The sheet-metal base is easily formed; however, it is available formed and drilled to the specifications given, if desired. A number of holes drilled in the case provide air circulation and further aid in eliminating vibration when loud volume is desired. Two 5-in. holes are cut in each end of the case, the speaker being mounted in the left end; all holes are backed with ordinary gold grille cloth.

A simplified wiring diagram of the com-

(Continued to page 138A)



JOHNSON'S NEW MIRACLE MOTOR

WORLD'S SMALLEST ALTERNATE FIRING TWIN!

Only 21½ pounds...
Underwater Exhaust
Reverse... 2.5 h. p.*

WITH SYNCHRO CONTROL,
PATENTED CO-PILOT, DUAL
INTAKE, ALROK TREATMENT
(CORROSION RESISTANT)
—12 OTHER BIG FEATURES!

FOR ONLY \$79.50
F.O.B. FACTORY

*N.O.A. Certified Brake H.P. at 4000 R.P.M.



● Reverse! Underwater Exhaust! Perfected Alternate Firing! These are the "big three" of outboard motoring — and you get all of them in a Johnson!

There are 10 great Sea-Horses for '39 — from the famous low priced, 17 lb. Bantam Single at \$49.50 (f.o.b. factory) to the big Super-Powered Twin developing 22.0 h. p.* Streamlined enclosed power heads and Johnson's famous Ready-Pull Starter available on Single and Light Twins.

See your Johnson dealer for a demonstration. You'll find his name listed under "Outboard Motors" in your classified telephone directory.

JOHNSON MOTORS
400 Pershing Rd., Waukegan, Ill.
Johnson Motors of Canada,
Peterboro, Canada

JOHNSON Sea-horse OUTBOARD MOTORS

With Johnson Alternate Firing, perfected through ten years of development and experience. Smoother! Better!



FREE! Beautiful new 1939 Sea-Horse Handy Chart. New Models. New features. Illustrated. Write today!

JOHNSON MOTORS, 400 Pershing Rd., Waukegan, Illinois.
Gentlemen: Please send me the new 1939 Sea-Horse Handy Chart.

Name _____
Address _____
City _____
State _____

BUILD THE SCHOONER BLUENOSE 22" MODEL

Complete Kit
\$2.50
P. P.

Makes perfect building easy



Carved Pine Hull, Metal Anchor, Steering Wheel, Lifeboats, Anchor Chain, Casks, Masts, Dowels, Lacquer and Cement.

Send for complete catalog, 10c.
IDEAL AEROPLANE & SUPPLY COMPANY, INC.
26 West 19th Street, New York

Write with Electricity



USE THE ELECTROGRAF

Writes easily on the hardest metals or alloys. Positively indelible. Your tools, protects against theft. Absolutely permanent. Requires few seconds only—anyone can operate. Pays for itself.

\$1.98
POSTPAID
Send No Money—Pay Postman \$1.98 plus postage. If M.O. or check accompanies order, we pay postage. AGENTS: Write today for our proposition.

NATIONAL LABORATORIES, Portland, Ore.

New Adding Machine Fits Vest Pocket!

Adds, subtracts and multiplies up to one billion. Weighs only 4 ounces. Not a toy—strong guarantee. Absolutely accurate, very fast. Sells to offices, stores, homes—wherever figures are used. Write quick for **FREE AGENTS** sample offer and Money-Making Plan.
VE-PO-AD, Dept. 177, 303 W. Monroe St., Chicago



STANDARD GARDEN TRACTORS

Plow Seed Cultivate Mow Hay and Lawns

Powerful Gas Tractors for Small Farms, Gardeners, Florists, Nurseries, Fruit Growers, Poultrymen.

1 & 2 Cylinders
High Wheels. Rubber or Steel Tires. Walk or Ride.
Do Belt Work—**Free Catalog**

STANDARD ENGINE CO.
Minneapolis, Minn. Philadelphia, Pa. New York, N. Y.
3221 Como Ave. 2546 Market St. 290 Cedar St.



HANDEE Tool of 1001 Uses

A Whole Tool Shop In Your Hand

Smooth, steady power at your finger tips. Unmatched performance, with our own CUSTOM BUILT precision motor. For work on all materials. Uses 200 accessories,



Save Hours of Hand Work

Finest, Fastest, Most Powerful Tool for Its Weight



interchangeable in easy-working chuck to grind, drill, polish, engrave, sharpen, carve, sand, saw, rout, cut, etc. Set up shop anywhere; plug in AC or DC socket.

STANDARD MODEL (Shown above), 20,000 r.p.m. Wt. 16 oz. **\$10.75** postpaid with 3 Accessories. **DE LUXE MODEL**, 25,000 r.p.m. Wt. 12 oz. **\$18.50** postpaid with 6 Accessories.

GET A DEMONSTRATION at Hardware, Tool or Dept. Stores or order either model on 10-Days Money-back Trial.

Free - 64-PAGE CATALOG

Complete information on Handee Products and their wide application in crafts work and industry all over the world.

Chicago Wheel & Mfg. Co., 1101 W. Monroe St., Dept. PM, Chicago, Ill.

Send Catalog Standard De Luxe Send C.O.D.

Name.....

Address..... PM-3

BUILD A RADIO that really does things



It costs you less! And you can have a radio that IS a radio. No piece of furniture, but a real professional receiver. Now you can be among the first to hear what's happening around the world. Send for great FREE catalog of build-it-yourself kits, parts, tools, etc. Here in one handy 188-page volume is everything you will need to build—at low money-saving prices.

Here's a book for you FREE



Send for your copy today! It's cram-jam full of great values—in radio equipment, in Public Address, in home appliances, plus a new camera section. Use it as your buying guide. Save time and money. Mail coupon now!

WHOLESALE RADIO SERVICE CO. INC.
 NEW YORK, N.Y. • CHICAGO, ILL. • ATLANTA, GA.
 100 SIXTH AVENUE • 901 W. JACKSON BLVD. • 262 PEACHTREE STREET
 BOSTON, MASS. • BRONX, N.Y. • NEWARK, N.J. • JAMAICA, L.I.

WHOLESALE RADIO SERVICE CO., Inc.
 Dept. 7C9—100 Sixth Ave., New York, N. Y.
 Rush FREE 1939 Radio Catalog No. 73

188 PAGE CATALOG FREE

Name.....
 Address.....
 City..... State.....

PASTE COUPON ON PENNY POSTCARD

60 POWER TELESCOPE... \$2.19

VARIABLE EYEPIECE 20X—40X—60X
NEW! Three telescopes in one. 3 different magnifications. 20 power for ultra-bright images with 40 and 60 power for extra long range. Guaranteed to bring distant objects, people, sports events, ships, moon, stars, etc., 60 times as close.
 Most powerful made for anywhere near the money. Closes to one foot in length. Multiple lens system. 30 mm. objective lens. 5 sections. Directions included for using as a compound 4 lens microscope. American made. Prompt shipment guaranteed. We pay the postage. Only \$2.19.
BROWNSCOPE CO., Dept. 43, 5 W. 27th St., New York, N. Y.



NEW BENJAMIN AIR PISTOLS WITH MULTIPLE LEVER HAND PUMP FOR TARGET-SMALL GAME-CAMPING-ETC.

Guaranteed—Accurate—Practical—Economic—Safe—Clean—Quiet. Adjustable Force—Amazing Maximum Velocity. No smoke or fumes. Bolt Action—Hammer Fire—Hair Trigger—Safety Lock—Hand Pump. Single Shot BB \$8.50; Single Shot cal. 177 or 22 with rifled barrel \$8.50; BB 8-Shot \$10.00; Holster \$2.00. Also a complete line of Benjamin Genuine Compressed Air Rifles for BB and cal. 177 or 22. No license required from dealer or factory. Ask for complete specifications and Free Targets. **BENJAMIN AIR RIFLE CO., 890 Marion St., St. Louis, Mo., U.S.A.**



EARN MONEY Stringing TENNIS RACKETS

Build up a business of your own stringing tennis rackets. It pays up to 140% profit per racket. String your own racket and save money. No experience necessary—we teach you how. Tennis players need new strings in their rackets two or three times yearly... every stringing means profit for you. See how simple it is to get in this business. Costs practically nothing to start. Easy work! Get started NOW!



FREE Write today and we will send you FREE plans and special offer on strings and stringing equipment.

THOMPSON MFG. CO., 4535 Packers Ave., CHICAGO, U. S. A.
 Makers of TOMGUT "Court-Tested" Tennis Strings & Restringing Equipment

(Continued from page 136A)

plete combination unit appears in Fig. 3. This shows all parts above and below the base and the various controls mounted on the wood panel. Speaker-cable connections are all made direct to a terminal strip mounted on the underside of the base. Please note that the power transformer is a half-shell type; the top cover is temporarily removed and drilled for short machine screws which are used to fasten it to the underside of the metal base in the position shown. Fig. 3-A shows detailed antenna coil connections, and photos Figs. 3-B, 3-C, 3-D and 3-E give various views

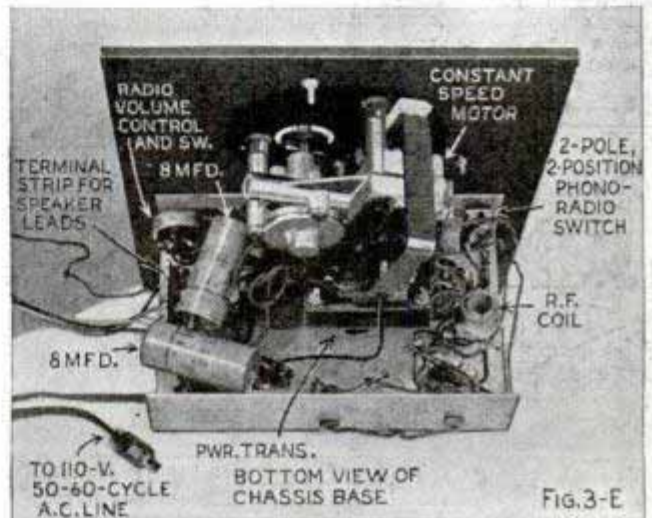

FIG. 3-E

of the completed assembly. The speaker cable should be 20 in. long to permit instrument panel removal for tube change or inspection. A schematic circuit diagram is given in Fig. 4.

When wiring the set, the electrolytic condensers should be kept well away from the power transformer so that heat will not damage them. Also keep phono pickup leads as far as possible from the transformer and a.c. line or excessive hum will result. The shields shown in photo Fig. 3-D must be mounted between the sections of the variable condenser in the positions indicated. The dynamic speaker and its output transformer provide for a 1,000-ohm field, hum-bucking coil and 2,000-ohm impedance to match the type 6V6-G beam-power output tube. A list of the original parts used in the model can be obtained from Popular Mechanics radio department without charge.

When using the radio receiver, turn the "radio" volume control "on" and adjust

(Continued to page 141A)

BIG OPPORTUNITIES

MANUFACTURING MATERIALS FOR LOW COST BUILDING



OPPORTUNITY COMPLETE, READY-MADE FOR YOU IN YOUR LOCALITY—One that is proven—ready for you to cash in big on the great building up-turn under way. It includes all the essentials upon which sound and successful business enterprises are established.

SUPERIOR PRODUCT, LOW COST PRODUCTION—You will produce a material nearly 20% lighter in weight—A product capable of meeting all known building requirements—One accepted by Government and City Building Departments—Requiring 20% less material—Made by line production machines. Raw materials will enter at one end and your finished products will emerge from the other end—reducing costs to lowest minimum.

EARNING POWER AND FUTURE—Present DUNKIRK-DUNSTONE Manufacturers already point the way for you. Some are selling output at 100% over cost. Others show earnings of more than \$1,000 per month right from the start—others are rapidly expanding from earnings.

WE EQUIP YOU WITH LINE PRODUCTION MACHINERY—Large production—only one or two men—high standard quality. Equipment costs but fraction of other processes of equal capacity. Franchise granted covering your locality—protecting your market, business and future.

INVESTIGATE NOW—Send for "4 Keys to Success." It tells the complete story—How present manufacturers are making outstanding progress in this new industry—One that offers unlimited opportunity for growth, expansion and profit. Write today.



INDUSTRY WAITING FOR BETTER MATERIAL AT LOWER COST

Countless numbers of new homes, apartments and structures for business and industrial purposes are needed today. Government, industry, financial institutions are helping to stimulate building and to hasten prosperity—actually preparing the way for the man equipped to supply this tremendous demand. Your product will be permanent, fire and termite proof—in a full range of beautiful colors, shades and textures. Improved design cuts construction costs to the level of frame; and with factory-to-job delivery, offers new standard of service to building trade in your community.

W. E. DUNN MFG. CO. 600 W. 24TH ST., HOLLAND, MICHIGAN



CASH IN QUICK

ALL OR PART TIME—MEN AND WOMEN—MAKE EASY MONEY SELLING

GENUINE LEATHER TIES

4-in-Hands and Bows, for Men and Boys. Beautiful patterns and colors. LOOK LIKE SILK. Won't wrinkle. Wear indefinitely. Cleaned with a damp cloth. Big profits; repeat orders. No sales ability needed. Big leader in necktie sales. Send 50 cents for sample kit. Information free.

CENTURY TIE CO., Mfrs., 2345-P W. Grand Blvd. Detroit, Mich. (Originators of Leather Ties)

BE YOUR OWN BOSS

Sharpen Lawn Mowers with ROGERS UNIVERSAL LAWN MOWER GRINDER

LATEST INVENTION Sharpens reel blades as well as inside face and edge of stationary blade without dismantling mower—makes mowers operate easier, cut smoother, stay sharp longer. Every job perfect—Every customer satisfied. Tool grinding attachment FREE. Compare this Grinder with others. Write for "Building a Business."

ROGERS MANUFACTURING CO. LINDSEY, OHIO

UTILITOR TRACTORS

for PLOWING, DISCING, CULTIVATING, PLANTING, MOWING, HAULING, Etc.

Thousands in Use for 15 to 20 Years
Riding and Walking Models 3 to 12 H.P.

WRITE FOR FREE CATALOG

UTILITOR CO. MIAMISBURG, OHIO DEPT. A

MYSTERY CONTROL FOR RECORD PLAYERS

New! Be first with better reproduction. Plugs in any outlet. Plays records through one or a dozen radios in any part of your home. No wire connections. Improves tone, volume, less needle scratch. Works on any Record Player, through any make radio. Details Free. Money back guarantee. Order today Postpaid \$4.95.

PHONO-RADIO LABORATORIES, UPPER MONTCLAIR, N. J.

BIG MONEY IN FLOCKING

Get PRO KIT on 10-Day Free-of-Risk Offer!

Be independent, make steady income from fascinating new business. Apply colorful water-proof pulverized fibers (cotton, wool, rayon, silk) to any surface. Produces beautiful soft finishes for shoes, purses, hats, boxes, tables, bottles, picture frames and 1001 other articles. Simply apply binder, then spray or flock with Jordan Flocking gun.

10-Day Trial Offer. Try it on your own work at our risk. Details of offer and money-making plans sent without obligation. Write today.

JORDAN AIR PUMP CO. Dept. P4, Bryant Bldg. Kansas City, Mo., U.S.A.

Only \$3.30 Complete (With Complete Instructions)
Unit consists of flocking gun, three large boxes of flocking (three colors), binder and applicator. Sent postpaid when cash with order. Sent C.O.D., plus postage and small C.O.D. fee. 10-Day Trial Offer either way.

How to work in Wood



1939 Catalog 10c Only.....

Experts' catalog; also: **GUIDE** for beginners. Shows how to start right in with the simplest tools making beautiful furniture. Wonderful hobby. Profit maker, for spare or full time. See catalog No. 12!

In the 136 pages of this catalog you get the latest knacks in Wood Working, the up-to-date correct processes of finishing, complete directions for Craftsman's new art Inlay method (so easily learned), lists of extra rare, fancy woods from Africa, Australia, East India and elsewhere and how best used.

Also, 235 brand new scroll saw patterns,—yes, 235 (66 others; total 301).

Also, page after page of real **BARGAINS** in extra-rare foreign woods, complete lists of all standard American Woods, cut to convenient sizes without waste, figured Veneers, Plywoods, legs, arms, ornaments, inlays and overlays, hardware and miscellany of all kinds, etc.

WOODWORKERS: Be sure to study this remarkable 136 page 1939 catalog No. 12. You need it. Yet it's only 10c. Write today.

CRAFTSMAN WOOD SERVICE CO., 2733B S. Mary St., Chicago

"IT TAUGHT THE OLD DOG A NEW TRICK"



"Junior showed us your ad," writes W. W. B. "Said he had to have a Royal Portable for homework."

"Your 'Free Home Trial' sounded good to us. So we sent in the coupon that very night."

"Immediately Junior started doing homework easier and faster. And that gave me an idea . . ."



"Typing's a cinch—with a Royal. Now I work out ideas on it. Already I've gotten one raise."

You Can Get This BIG FAMILY HELP ON FREE HOME TRIAL

A Royal Portable helps you write faster, think faster. It's an opportunity for a better, brighter future—a chance for you, your whole family, to do more, be more!

SEE IT . . . TRY IT in your own home! Know all about a Royal before you risk a penny. See exactly how a Royal will help you whatever your job. Then—own it on your own terms.

Take your choice—pay cash or pay in easy monthly terms with small carrying charge. The easy, modern way to own a Royal. Your choice of models—all factory-new, reasonably priced.

ACT NOW! Mail coupon today for full details of Royal's offer—all about models, prices, terms—everything. No obligation.



OWN A ROYAL PORTABLE ON YOUR OWN TERMS

FREE!

Royal's Instant Typing Chart shows you how to type RIGHT.

INCLUDED with every Royal Portable at no extra cost—a handsome, all-weather Carrying Case.

ROYAL TYPEWRITER COMPANY, Inc., Dept. D-26, 2 Park Ave., New York, N. Y. Tell me how I can own—on Easy Monthly Terms—a latest model Royal Portable—with FREE HOME TRIAL.

Name _____ Street _____
City _____ State _____

FACTORY TO YOU
WRITE for FREE CATALOG

NEW SUPER-QUALITY KITSELMAN FENCE

Heavier, amazingly improved galvanizing. Tougher, longer-lasting Copper-Bearing Steel. Low Factory Prices. **WE PAY FREIGHT.** 169 styles and heights Farm, Poultry and Lawn Fence; Steel Posts, Gates, Barb Wire, Paints, Roofing. Write today. **KITSELMAN BROTHERS** Dept. 94 Muncie, Indiana

DO IT BETTER and FASTER with a DREMEL MOTO-TOOL

weighs only 6 ounces

If you like to make things, or do odd jobs around the house you will find hundreds of uses for this amazing, electric ALL PURPOSE tool. Make money or save money by fixing it yourself. 60 TIMES FASTER than by hand. Invaluable to professional mechanics. Universal motor. Powerful and Fast. 25,000 to 27,000 revolutions per minute. Perfectly balanced, long wearing and is operated with one hand. Beginners can match the work of experts. Use it on wood, steel, iron, brass, plastics, any material. Every home work shop, every factory should have one.

Power Plus Speed

Dremel Moto-Tool will do hairline precision work or a power job. Designed and built in the only factory making hand moto-tools exclusively. Has self-aligning oilless bearings, built in thumb operated switch, universal collet chuck, and a great many more advantages over other tools. Underwriter approved. Only \$9.85. See it at your dealer's, order of us direct (we pay postage) or

Write for Free Booklet and Low Prices On 10 DAY TRIAL Combination Offer. Address Dept. P.28

DREMEL MANUFACTURING CO., RACINE, WIS.
Specialists in Motor-in-Hand tools

30¢ BUYS CLASS & CLUB PIN!

SMART, up-to-the-minute designs. Pins in 2 colors with any 3 or 4 letters and year. Handsome Sterling silver rings. Oldest, largest makers; famous for quality for 44 years. Clean cut work distinguishes Bastian Pins and Rings anywhere. Write for new catalog today!

BASTIAN BROS. CO.
Dept. 72 Rochester, N.Y. \$1.49

GRANDFATHER'S CLOCK, LOWER PRICED

Our newest offering, at an unheard of price for a faithful reproduction of a real Grandfather's Clock. Scroll top, narrow waist, like picture. Shipped Knock Down. Cleverly designed. Easy to assemble. Others even cheaper. Plans 10c. Catalogue FREE.

AMERICAN CHIME CLOCK CO.
1679 Ruffner St. (Established 1877) Philadelphia, Pa.

TRAILER PARTS

Latest type heating stoves, window assemblies, couplers. Everything for the trailer. 40 page illustrated catalog, 10c.

MARVEL TRAILER PARTS CO.
19020 Celestine Ave., Detroit, Mich.

ELECTRIC LIGHTS FROM WIND

Easy to have lights, radio, power for washing machine, etc. Dime brings complete plans and Big NEW 1939 catalog of remarkable values. 100 other changes for old generators to 6-12-32-110V plants, motors, welders, elec. fence, etc.

LEJAY MFG., 1447 LeJay Bldg., Minneapolis, Minn.

COMET CLIPPER GAS MODEL

NEW 36 PAGE CATALOG

Hundreds of models, 10¢ up. Gas model kits, motors, accessories. Send 6¢ stamps to

Prize-winning, record-breaking, 6 ft. gas model. Removable power unit; detachable wing and tail; difficult parts finished. Kit with automatic timer. \$4.95; postage 25c, or buy from dealer.

COMET, 2509 CERMAK ROAD, CHICAGO, ILL. Dept. P-3

\$4.95

When writing please mention Popular Mechanics

(Continued from page 138A)

volume to satisfactory operation. To use the phonograph, turn down the "radio" volume control, but do not turn it "off"; now turn the phono-radio switch to "phono" and place record on turntable. Insert a good needle in the pickup arm, and turn on "phono" volume control and adjust the volume to suit. A variable tone control is provided and this can be used with ei-

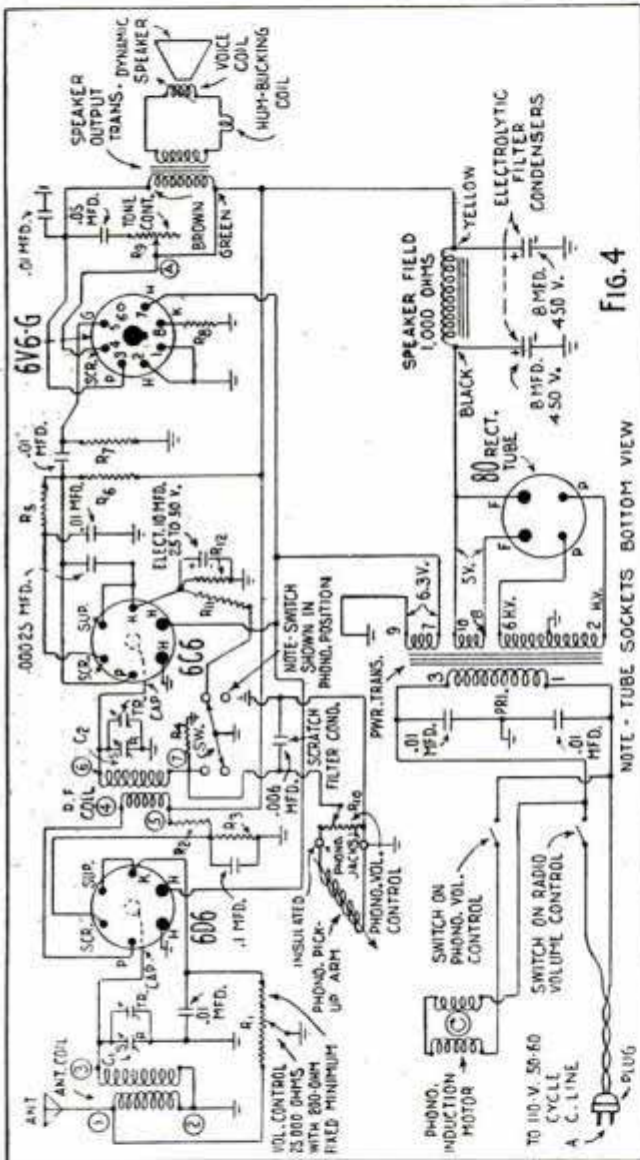

FIG. 4

ther phonograph or radio; please note that an efficient needle-scratch filter is built into the circuit.

To balance the radio receiver, turn the variable condenser about seven-eighths open and adjust the two trimmer condensers (TR) with a small screwdriver, for maximum noise. No external ground connection is necessary for this set. A 20-ft. antenna of the flexible, roll-up type may be used for local stations; for distant reception the antenna should be from 50 to 75 feet long for maximum results. Blueprint number of this article is R-265.

A PUBLIC ADDRESS SOUND SYSTEM

Complete Outfits for

- ORCHESTRAS
- AUDITORIUMS
- ATHLETIC FIELDS
- LECTURE HALLS
- SCHOOLS
- HOSPITALS
- CLUB ROOMS
- CAFES BALLROOMS
- SOUND TRUCKS

for Every **INSTALLATION**

- Indoors or outdoors, any size crowd may be fully and properly covered with the use of Radolek sound amplifying equipment. Speaker talks only in natural tone and every person in the audience can hear distinctly.
- Radolek offers Public Address equipment for every type of installation—permanent, portable or mobile. Choose your sound system from the Radolek line to exactly fit your own requirements. Easily installed by anyone.
- Complete selection of high gain, high fidelity amplifiers with outputs from 10 to 100 watts. Full line of P.A. accessories.
- Radolek equipment is attractively designed and quality constructed. Big Savings in costs are assured. Deferred payments if desired. Send for illustrated book. Address Dept. PM 27.

601 W. RANDOLPH ST. **THE RADOLEK CO.** CHICAGO, ILL.

DOENUT WHEELS

DOENUTS, developed and patented by the originator of the air-wheel, absorb more surface obstructions and eliminate jolting. Protect wood and concrete floors. Do not sink in sand or soft ground. Cadmium plated disc wheel with adjustable ball bearings. Size 10"x12.75" with cap. of 225 lbs. per wheel and 12"x3.50 with load cap. of 325 lbs. per wheel. Ideal for wheelbarrows, painting rigs, spraying equipment, textile trucks, dish trucks, boat dollies, food carts, or most any portable unit that rolls. **Handle same loads with less than half the labor.** Send 10c postage to cover cost of mailing literature.

MUSSELMAN PRODUCTS CO.
6225-H St. Clair Avenue, Cleveland, Ohio

Free! 72 PAGE BOOK ON NIGHT FISHING

• Every fisherman will want this book! Written by Cal Johnson, noted angler. Tells tried ways, methods of night fishing for bass, wall-eyes, other fish. How, when to cast or troll after dark. Frogging. 72 pages of night fishing thrills. Shows the Powerlite and other Delta electric lanterns. **Write for this book. Free!**

DELTA ELECTRIC COMPANY
300 W. 33rd St. Marion, Indiana

Powerlite \$3.95 less battery

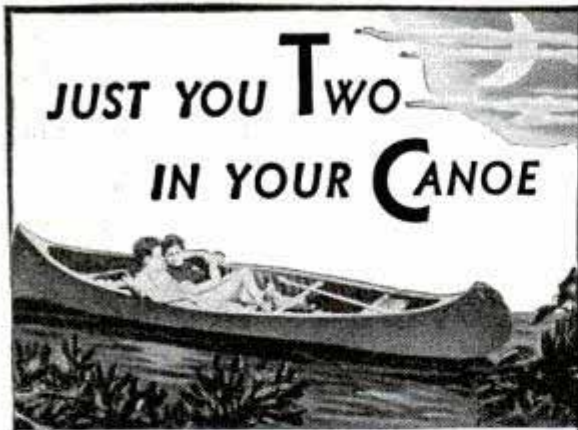

• THE rustle of leaves in a whispering breeze, with the light of a moon for your mood. An Old Town Canoe is a world of your own . . . your passage to peace and contentment.

The dip, dip, dip of a Redskin's paddle takes you through quiet enchantment. Paddling or resting, it's steady and strong. It's sturdy and easy to own.

FREE CATALOG shows all kinds of Canoes for paddling, sailing or outboards. Also Outboard Boats, including big all-wood family boats. Rowboats. Dinghies. Write today. Address Old Town Canoe Company, 533 Main Street, Old Town, Maine.

"Old Town Canoes"

WRITE TO **Bass** **FOR HIS BOOK OF BARGAINS**

ORDER FROM THIS LIST OF BASS-GUARANTEED BARGAINS

- Candid Midget—Schneider F:2 lens, Rapid Compur, Eveready case, list \$84.75 **\$54.75**
- 4x5 or 10x15 cm. ZEISS IKON SPEED DECKBULLO, 18 cm. Carl Zeiss Tessar F:4.5 f.p.a for both sizes and double ebony plate holder. List \$225, at \$79.50
- Korelle Reflex—with Victor F:3.5 lens demonstrator. List \$62.50 **\$46.50**
- 9x12 (3 1/4 x 4 1/4) Zeiss Volta—single ext. film pack and plate—Novar F:6.3 lens—f.n.a. and holder; brand new. \$11.95
- New Beira Voran—8 or 16 shots on 120 film. Radionar F:4.5 lens, Prontor II shutter. \$19.75

BASS CAMERA COMPANY
179 W. Madison St. Dept. P Chicago, Ill.

NEW POWER TOOLS for Home, Shop and Industry



Delta tools are portable, rugged, efficient—yet astonishingly low priced. Ideal for small shops, home shops, and factories. Many new features and improvements. Complete DELTA line includes: Circular Saws, Scroll Saws, Lathes Jointers, Shapers, Band Saws, Grinders, Drill Presses—and full line of accessories. Send today for big 48 page FREE Catalog.

DELTA MFG. CO. (Dept. A339)
600 E. Vienna Ave., Milwaukee, Wis.

CLAMPS

You can re-sharpen dull edges, can get by with mediocre tools in many places but your clamps must be right. The least slip or opening can ruin joints or set-ups, can ruin hours of painstaking work. That is why industry has standardized on "Jorgensen" Clamps—dependable lifetime tools engineered and manufactured by "The Clamp Folks."

ADJUSTABLE CLAMP CO.

"The Clamp Folks"

421 N. Ashland Ave., Chicago, U.S.A.



Pony Miniatures
3 types—1" to
2 1/4" cap. Not
too a hot line
tools with 100
uses.

Pony "50" Fittings go on ordinary 1/4" pipe.
Any length. Send \$3.00 plus postage (6 lbs.)
for fittings for two "50" Clamps. Also
"Pony" 752 Fittings for 3/8" pipe—2
sets for \$1.50 plus postage.

Catalog FREE!



Jorgensen Handcrews

Genuine "Jorgensen" Handcrews grip at all angles, never slip, split or loosen. All sizes. Send \$3.20 plus postage (7 lbs. for 3 No. 1 Handcrews—open 6".

NOW ONLY \$5.00 **REAL ENGINE VALUE**

Over 7,000 GHQ Gas Engine Kits have been sold at \$8.50. Now is your chance to buy the *New Improved* kit for \$5.00. Absolutely complete with coil, plug, etc. For boats, planes etc. All parts guaranteed. Send only \$1.—Shipped Express Collect for balance same day. Catalog 3c. **DEALERS WRITE.**

All parts finished. Only a screwdriver needed. 1/5 H.P. Average assembly time 30 minutes.

GHQ MOTORS, 854B East 149 St., New York, N. Y.

RADIOS..SAVE UP TO 50% **YOUR AGENT'S COST PRICE**

DEAL DIRECT...FACTORY PRICES! Many models to select from: A.C. D.C. All Wave; armchair models; automatic tuning; car radios; Farmsets that operate like city radios! Send postcard for NEW Bargain Catalog FREE. 30-DAY TRIAL plan and agent-user proposition!

GOLDENTONE RADIO CO., DEPT. 102, DEARBORN, MICHIGAN

Free Catalog **\$4.95 ca.** in Lots!

30 DAY TRIAL \$6.98 UP

BOAT & CABINET LUMBER

Oak, Mahogany and Spruce in finished sizes for boat construction. Thoroughly kiln dried stock in Manual Training and Cabinet Lumber—Walnut, Cherry, Poplar, Gum, Birch, Maple, Basswood, Butternut, Cedar, Ash, etc.

MAISEY & DION LBR. CO., 2349 S. LOOMIS ST., CHICAGO, ILL.

PINS 30¢ RINGS \$1.50 up **FREE CATALOG**

Finest quality. Over 300 artistic designs. Write for our attractive free catalog and select a beautiful pin or ring for your class or club.

Dept. N, METAL ARTS CO., Inc., Rochester, N. Y.

NEW BIG TRAILER PARTS CATALOG

Shows hundreds of house trailer items. Build your own trailer or re-condition the one you have. Wholesale prices. Quality merchandise. Prompt shipment. Send 10c for this money saving catalog today.

C. M. Hoof Company, 1736 S. Michigan Ave., Dept. P-3, Chicago, Ill.

YOUR OWN MOVIES! 10¢ A DAY!

NATIONALLY ADVERTISED 8MM and 16MM Movie camera, projectors. For home, business, church, school, club. **MONEY BACK 10 DAY TRIAL.** Payments as low as 10¢ A DAY. Satisfied customers throughout the world. FREE details. **WRITE TODAY.**

Don Elder's Home Movies, Dept. A-3, 739 Boylston St., Boston, Mass.

GERSTNER TOOL CHESTS

Have life-long friends among machinists and tool-makers everywhere. Free catalog.

GERSTNER TOOL CHESTS
439 Columbia St. Dayton, Ohio

SOFT WATER

MAGIC WORDS—that are bringing big profits to Webb Salesmen!

The Webb Portable Water Softener gives every housewife, soft water in an endless flow for washing dishes, laundry, bath, shampoo and every home purpose. Softens hardest water instantly at the turn of the faucet. Provides healthful drinking water equal to many expensive bottled waters.

Distributors Salesmen FREE SALES PLAN

100% profit—simple home demonstration sells it easily. Leads to larger sales. Write today for free literature and full details of the Webb **NO RISK TEST OFFER** and **FREE Sales Plan.**

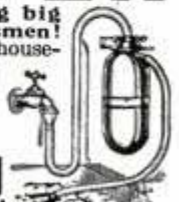

NO RISK TRIAL OFFER!

WEBB MFG. CO., Dept. P-39, 1813 Baltimore Ave., Kansas City, Mo.

Hunting Lost Voices

(Continued from page 379)

Vincent unearthed them, more than half a century later, from moldy cellars, cluttered attics and other places where they had lain neglected, it was necessary to handle them with the greatest of care. A single jar or a scratch on a delicate wax groove would have ruined the possibility of resurrecting the voices of such personages as the late President Wilson or Theodore Roosevelt, of Sarah Bernhardt, A. Conan Doyle, Sir Henry Irving, Admiral Robert Peary and many others.

"Re-recording these voices of long ago presented unusual and delicate problems in sound engineering," says Mr. Vincent. "There could be no second attempt on any one of them, if we were to record them on master records so that duplicates for modern phonographs could be made for official archives, for schools, colleges and historical libraries.

"The early phonograph which Mr. Edison and his men had used to record these lost voices, of course, was spring driven, and the spring did not work evenly. They were so faint in sound that it was necessary to use earphones. Besides, the speed of various wax cylinders varied. Some, for example, had one hundred grooves to the inch. Others had one hundred and fifty.

"We secured one of these early phonographs, and in the laboratory replaced its spring-driven motor with an electrical one. A delicate sapphire, which exactly fitted the grooves was cut by Frank Capps, who had been associated with Mr. Edison.

"This was one of the most important operations in the process, for, if the sapphire was not absolutely precise, the grooves would have been shaved and the voice ruined. This work, which was done under the microscope, had to be repeated tediously as wax cylinders whose grooves were of varying widths were reproduced through an amplifier to a master record on the turntable of the latest in scientific sound-recording apparatus.

"As may be imagined, hunting lost voices has a great many thrills. To hear someone speak out of the past, a human voice that has been stilled for half a century and which would be lost forever except for a fragile wax cylinder, is an experience which now may be shared by millions.

(Continued to page 144A)

NOW YOU CAN HAVE

A Complete
**WOODWORKING
SHOP**

At Unbelievably
Low Cost!

**7 POWER
MACHINES
IN ONE**

**35 Different
Operations**
Quietly
Swiftly
Smoothly



Awarded
Gold Medal
New York
Power Show

**10
MONTHS TO PAY**
Easy
Terms!

- Complete Planing Mill
- Saw Table
- 14 Inch Band Saw
- Reversible Shaper
- Speed Spindle
- Mortiser
- 36 Inch Lathe

**Carpenters, Home Crafts-
men, Builders!**

Now you can finish every job completely on one machine! No time wasting handwork! No other cutting tools needed! No other combination machine ever built can equal its fine accurate work and cut full-size lumber in so little floor space.

The **Electric Carpenter** fits space 4 x 6 ft. Weighs 520 lbs. Does more work than 5 tons of old-fashioned single purpose machinery.

Easily Handles the Hardest Woods

Makes every cut necessary in building a house. Does the finest cabinet precision work. Saves on millwork. Turns odds and ends of lumber into profit. Finishes the job completely in one-third the usual time! Everyone marvels at the **Electric Carpenter's** speed, accuracy, and power.

If it's made of wood, you can make it with the **Electric Carpenter!** Remember the **Electric Carpenter** does 35 different woodworking jobs perfectly.

Safe, Easy To Operate

One piece solid ribbed frame, accurately machined all over. Precision ground table tops. Ball bearing throughout, all metal, all direct drive.

Runs from light socket. Choice 1/2 H. P. and 1 H. P. electric motor, or 1 H. P. Gasoline Motor and all special types.

A remarkable machine! A great time saver! A great money maker! Hundreds of carpenters and cabinet makers swear by the **Electric Carpenter!** With it the home craftsman can rival the workmanship of professionals. Fully guaranteed. Write today for free illustrated folder.

Exclusive National Distributor

NATIONAL TARGET & SUPPLY CO.

Dept. P-102 1255 25th St. N.W. WASHINGTON, D. C.

FREE "BETTER RESULTS WITH GLUE"



Send post card for booklet, "Better Results with Glue," containing many useful hints about mending, model making and home workshop jobs. Address: McCormick Sales Co., 402 Light St., Baltimore, Md.

at hardware, drug and 10c stores; also in cans from 1/4-pint to 1 gallon

MACHINE SHOPS - GARAGES



If you are rigging Trucks with Power Take-Offs or mounting Gasoline Engines for the operation of Corn Shellers; Feed Grinders; Saw Mills; Hoists; Air Compressors; Arc Welders; Electric Light Plants and Refrigerating Units, you need Governors for engine speed regulation, and should be a Pierce Dealer.

WRITE FOR OUR DEALER PROPOSITION

THE PIERCE GOVERNOR COMPANY
WORLD'S LARGEST GOVERNOR BUILDERS
1710 Ohio Ave. Anderson, Indiana

PIERCE GOVERNORS
MOST STABLE • MOST SENSITIVE GOVERNORS BUILT

121403

(Continued from page 143A)

PLAY LATEST HITS!
Even If You Can't Read a Note!



It's America's newest musical sensation! For solos, duets, novelty effects, and for playing with piano and other instruments, it is without equal. So easy to play you can learn by yourself in just a few minutes. Music teachers endorse it as ideal pre-band instrument. **Send No Money!** Simply send name and address, and upon delivery pay postman one dollar and a few cents postage. Be the first in your group to play this keen new instrument. **TONETTE COMPANY, Dept. PM-3, 30 East Adams Street, Chicago, Illinois.**

\$1 TONETTE
ANYONE CAN PLAY IT

PIONEER
 NON SINKABLE BOATS



13 Models—35 Sizes—\$25 to \$167.50
 Time tested for 28 years—America's outstanding values in Row Boats, Fishing, Hunting, Outboard and Inboard, Ice, Sail and Play Boats! Always ready to use! Endorsed by leading summer camps and resorts! Send post card for 24-page Catalog! It's FREE!
PIONEER MFG. CO., 413 PERRY ST., MIDDLEBURY, IND.

Join the thousands who now go places for less!

Auto-Glide
 CUSHMAN-Powered



Now, all aboard for a wonderful Glide Ride!—the most economical you ever enjoyed! Thousands from coast to coast get 125 MILES PER GALLON, 35 miles per hour. Ideal for work, school, deliveries—any place you'd use a car! Husky 1½ or 2 H.P. engine has fast get-away, zips up hills. Powerful brakes stop machine on a dime. Handles like car in traffic. Easy to park. Extra rugged construction. Safe on all roads. Clutch (most models) makes starts, stops, easy. 2-speed transmission (optional). Big, comfortable cushion, room for two!

5 NEW MODELS! Standard, (above) newest low-priced 2-wheel model for business, sport. DeLuxe model, streamlined, electric lights, for youngsters, office workers. **KARI-PAC**, big rear carrier for deliveries, school, etc. **SIDE-KAR**, attaches to above models, makes 3-wheel unit. **3-WHEEL DELIVERY MODEL** (left) has 400 lb. capacity.

125 Mi. PER GAL.

35 Mi. PER HR.

\$92⁴⁵ UP

WRITE! Or see your dealer for Free book showing all models. Send NOW!

THE CUSHMAN MOTOR WORKS
 Dept. T-3, Lincoln, Nebr.

Dealers: Get Spl. Offer Now!

"In this connection my greatest thrill was when I heard what few other living people had heard, the sound of the bugle which blew the call for the charge of the Light Brigade at Balaklava in 1854.

"Here was one of the crudest of wax cylinders, reinforced from the inside with twine. One whole night in 1937 my associates and myself spent in experimenting, changing sapphires and adding new equipment in order to reproduce the sound of that amazing old recording. It must have been about three o'clock in the morning when we finally heard with astounding clarity and volume the content of that record. The three of us in the laboratory felt a chill run down our spines when we heard the notes of that old bugle, which was first sounded by J. Edwards of Lord Edward Somerset's Household Troops who were fighting under Wellington against Napoleon at the Battle of Waterloo. The bugle was kept as an heirloom by the British army and was not used again until the Crimean war in which it sounded the call for the charge of the Light Brigade, famous British regiment."

In 1890 the trumpeter, an old man, was invited to re-sound the actual charge for recording on the newly invented phonograph. The record is introduced by the clear voice of a woman announcing: "Record made at Edison House, Van Cumberland Avenue, London, August the 2nd, 1890."

This is followed by the voice of the trumpeter who says: "I am Trumpeter Landfrey, one of the surviving trumpeters of the Charge of the Light Brigade at Balaklava. I am now going to sound the bugle that was sounded at Waterloo and sound the charge that was sounded at Balaklava on that very same bugle the twenty-fifth of October, 1854."

The question of who really discovered the North Pole, Peary or Cook, has been brought up many times. On a wax cylinder recently recovered by Mr. Vincent and re-recorded, Admiral Peary is heard making a speech to the Peary Arctic Club in 1909 giving facts and figures in proof that he was the real discoverer.

Present-day historians credit President Franklin D. Roosevelt with having originated the "fireside talks" but an old record preserved by Mr. Vincent proves that President Woodrow Wilson started this

custom in 1915. President Wilson had his voice recorded in the White House and the records were sent, together with a phonograph, to Indian reservations throughout the United States so that the voice of the Great White Father could be heard.

In addition to recording the voices of the great and near great so that millions may listen to them, science is now interested also in "photographing" these voices on diagrams called oscillograms. By this means the voice chart of a famous man may be compared to that of another's and the pauses, intonation and other tricks of oratory studied.

When the present Duke of Windsor renounced his throne, his memorable broadcast was not only recorded for posterity as he literally changed history, but by means of the delicate oscillograph, a dramatic chart was made of the emotion in his voice. President Roosevelt, Hitler, Mussolini and many other prominent present-day figures are also having their voices recorded and photographed by scientists so that they will not be lost to future generations.

Trapping Modern Cattle Rustlers

(Continued from page 331)

complished by checking the ownership and sales papers of cattle at all sales points and stock yards. Animals may be spirited from their home range and moved half a dozen states away, yet the brand inspectors, tracing back on the shipment, finally catch up with the rustlers. In California all packing houses and stock yards are bonded and any temptation to deal with outlaws is removed. Inspectors make the rounds of butcher shops and retail establishments all through the state, checking each side of beef for the official stamp that can be affixed only by a government inspector at a licensed slaughter house.

In spite of these precautions rustlers would still get away with some sales if it were not for the fact that stock detectives have trained themselves to recognize stolen animals at a glance.

"That may sound like a boast," Capt. Mace says, "but it's just about the truth. A good stock detective can sit on his horse alongside a runway and tell from one look whether some of the animals were stolen,

(Continued to page 147A)

**THE BIG NEWS
MOTOR OF THE YEAR!**

**THE EVINRUDE
Mate**

**WEIGHS ONLY
10 LBS.**

**RUNS 10 HRS.
ON A SINGLE
GALLON**

**COSTS ONLY
\$34.50**

All prices f.o.b. factory

**AN Elto
BUILT BY EVINRUDE
NOW ONLY \$29.50**

NOW Evinrude gives you the latest, greatest light motor achievement . . . a motor so miraculously light that your tackle kit seems heavy in comparison! *Amazingly economical* . . . 10 miles of smooth performance for 5 cents! A dream of starting ease . . . a true Evinrude at a price that brings Evinrude ownership within the means of every sportsman! Nine great Evinrudes give widest choice of motors—from the *lightest*, handiest to the *swiftest*, most powerful! Each gives all of Evinrude's outstanding features—Hooded Power—exceptional starting ease—Co-Pilot steering—utmost ease of control—a cooling system that can never fail!

FROM THE LIGHTEST—



WRITE FOR FREE CATALOGS!

Write today for 1939 Evinrude and Elto catalogs, Boat Directory and handy Boat-and-Motor Selector. **ALL FREE**, address **EVINRUDE MOTORS**, 5570 N. 27th St., Milwaukee, Wis.

Evinrude Motors of Canada, Peterboro, Canada

EVINRUDE
9 GREAT EVINRUDES TO CHOOSE FROM

FLASH! Craftsman - BOICE-CRANE
10" TILTING ARBOR SAWS
COST LESS!

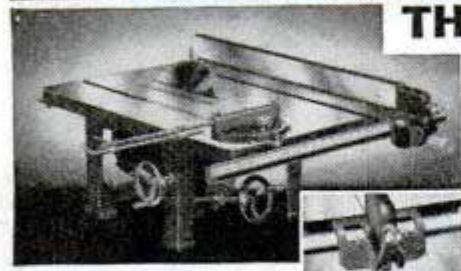

THIS BIG 10" TILT-ARBOR

only \$65⁹⁵

- Uses "standard" low cost motors too!
- Needs 1 motor only for saw-jointer combination unit.
- Lower upkeep. Motors out of dust. No gears to replace.
- Floor base if wanted.

New! SINGLE CONTROL RIP FENCE

Brand new exclusive feature! ONE control all that's needed to *micro-set, fast feed, and lock* rip fence. Faster, handier, more accurate. No gear. Nothing to get out of order. Boice-Crane's no-lag fence feature further perfected!

New "HELMET-HEAD" DRILL PRESS

A new kind of Drill Press. Loaded with features. Handsome "designed-in" belt guard at no extra cost. Only Drill Press with self-centering, 6 tooth, involute-type spline. A more powerful, longer wearing, smoother running kind of spline. Bigger bearings. Bigger base. Heavier duty. Ultra-modern design. Drills, routs, shapes, mortises, sands.



SEND FOR 1939 CATALOG

BOICE-CRANE CO., Dept. 239, Toledo, O.

Catalog FREE. Spinning Handbook 10c.

Name _____
No. _____
City _____ State _____



"FIRST CHOICE"

-in KNIVES

Byrd, Peary, Lindbergh and other famous names top the list of explorers and sportsmen who know that--



MARBLES Knives give the utmost in service and satisfaction. No. 49-4 1/2 in. blade, \$2.00; No. 60-4 in. blade, \$1.50. Prices include sheath. At Dealers or direct. Write for catalog. (A-149)

Marble Arms & Mfg. Co. 578 Delta Avenue Gladstone, Mich., U.S.A.

DEALERS WANTED

Make YOUR CAR Produce Some Real \$\$\$\$



WAKE UP! GET BUSY! STOP WORRIES!
DO LIKE HUNDREDS OF OTHERS ARE DOING

Men over 30 make your car produce some real earnings. Investigate the County Dealer plan and get started with nation-wide organization. Be like John Lehman, who says: "This plan has provided me with a steady income for 8 years." Nationally advertised products. No capital required for store, fixtures, or stock of merchandise. Checks on Fridays for all profits due. Special plan for spare-time workers. Write details of experience and we will rush free inside facts on new plan.
FYR-FYTER CO., Office 90-39, Dayton, O.

U. S. REVENUE CUTTER "JOE LANE"



Complete with precision shaped and hollowed hull, accurate full size plans, assembly instructions, all deck and spar material, all FINISHED FITTINGS, and complete history of the "JOE LANE"—\$7.00.

Send 15c in coins or stamps for complete 8 1/2 x 11 catalogue with full page illustrations of the latest innovations in marine models.

MARINE MODEL COMPANY
174 Worth St. Dept. 303 New York, N. Y.

New Accurate 10" Slide Rule

Enables you to do difficult calculations instantly without paper or pencil—multiplying, proportions, division, extracting roots, etc. Accurate, white composition face. Has Standard A, B, C, D, CI, and K scales.

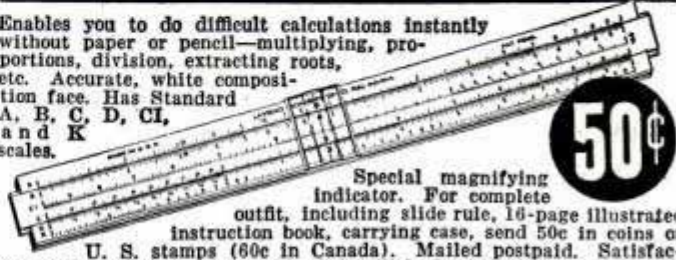

50¢

Special magnifying indicator. For complete outfit, including slide rule, 16-page illustrated instruction book, carrying case, send 50c in coins or U. S. stamps (60c in Canada). Mailed postpaid. Satisfaction guaranteed or money refunded. (Schools and dealers: write for quantity prices.) **BOX 13.**

LAWRENCE ENGINEERING SERVICE, PERU, INDIANA



BIG PROFITS RESTRINGING RACKETS

AT HOME! WRITE US!
Earn big profits restringing tennis rackets at home. Easy work. Experience unnecessary. Save on your tennis, badminton, squash! Send for FREE CATALOG of Tennis Equipment—Hurry!
H. E. Willis Co., 1047 W. 47th St. Dept. A-39 Chicago, U. S. A.

Save On GUT!
—Buy Direct from Factory SILK!

FREE TRAILER PARTS CATALOG

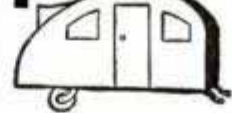

We'll save you money on—axles, springs, wheels, couplers, windows, sinks, water pumps, brakes, refrigerator, beds, lamps, inside and out, 6V lamps, furniture, jacks—everything. Special discount to mfrs. Building plans & instructions, 10c. Successors to Kar-A-Van Industries, Inc.

NATIONAL TRAILER EQUIPMENT CO.
Dept. P, 714 W. Wisconsin Ave. Milwaukee, Wis.

Handicraft

Basketry, Beadcraft, Claycraft, Raffia, Leathercraft, Metalcraft, Weaving, Kindergarten and Elementary Pastimes.

Send 10c for Catalog
AMERICAN REEDCRAFT CORPORATION
Dept. P, 130 Beekman Street New York City

YOU'LL LIKE RESILVERING MIRRORS, REFINISHING

Plated articles, Autoparts, Reflectors, Tableware. Making Chipped Glass Name Plates. Signs. Experience Unnecessary. Write. **SPRINKLE, Plater, 129, Marion, Indiana**

NOW YOU CAN GET A HEAVY DUTY INDUSTRIAL WELDER

Works Off 110-Volt Light Socket
This marvelous DYNAMIC Power Welder will do the work of much higher priced types. It is easily portable. **WELDS** Cylinder Blocks, Bumpers, Fenders, Tanks, Farm Machinery, and etc. Will also solder and braze on the lightest material. Works on iron, steel, tin, brass, copper and all other metals. Men without previous experience can make as much as \$5.00 on a one hour repair job. Go into business—Open a Welding Shop NOW.
AGENTS—Make big profits selling to garage, factories, janitors and machine shops. Write TODAY for our 10-DAY TRIAL OFFER.
DYNAMIC WELDER COMPANY
2226-GN Silverton Road Chicago, Illinois

for Only \$195
RETAIL



When writing please mention Popular Mechanics

(Continued from page 145A)

even if he isn't looking for stolen animals at the time.

"Not only that, without looking at the brands or the ownership papers a brand inspector can usually tell at once from what part of the country an animal came. Turn a couple of dozen cattle from all parts of the west into a corral and the inspector usually can name the home state of each animal. Half the time he will be able to name the owner, simply by the appearance of the animal. It's entirely a matter of experience and he judges an animal's home range by its appearance and quality. Even the length of the hair, depending upon the time of year, helps form his judgment."

Not long ago an inspector overseeing a movement of cattle to the chutes ordered fifteen of them turned out into a vacant corral. To an untrained eye they looked practically the same as their companions but to the practiced eye of the inspector they were vastly different. He simply noticed that the fifteen head were "feeders," cattle that hadn't yet been brought up to the prime condition that would bring the owner the best price. No owner, he knew, would normally sell cattle when he could get a much better price by fattening them for a few weeks more. The inspector was right, and it was another case of an owner having been robbed without his knowledge. Four men went to jail.

One of the queerest cases in Mace's records is the one in which some cattle rustlers were arrested on the high seas. Some of the islands off the California coast are used as cattle ranches and on one occasion some fishermen went ashore on one of the islands, shot a cow, and hauled it aboard their boat. A cowboy who heard the shot investigated and saw the fishing boat heading out to sea. From his description the boat was boarded and the slaughtered beef was found.

In some cases rustlers have increased the size of their own herds by selecting brands based on the brands of neighboring herds, imprinting their own brand over the original. In Canada the Royal Canadian Mounted Police has suggested that cattle be "nose printed" similar to the fingerprinting of humans as a positive check of their identity, since it is claimed that all noseprints of cattle differ.

EASY PAYMENT AUTO INSURANCE SAVES YOU MONEY

Motorists Save THOUSANDS through ALLSTATE INSURANCE COMPANY

Make repairs, buy tires or licenses on your savings—as others say they do by insuring in ALLSTATE.

EASY PAYMENTS

All Forms of Coverage — Prompt Claim Service

This company, organized by Sears, Roebuck and Co., is wholly independent and offers Bodily Injury or Property Damage Liability, Collision, Fire, Theft, Glass Damage and other protection at rates substantially lower than most other old line stock insurance companies. All allowed claims settled WITHOUT DELAY.

More than \$4,869,000 in Assets!

With assets of more than \$4,869,000 and liabilities of \$3,282,000 ALLSTATE has \$3.00 for every \$2.00 it owes. **GET THE FACTS—** Learn about EASY PAYMENTS with FULL protection while paying. No need to wait! FREE booklet and rates on request.

ALLSTATE INSURANCE COMPANY (Organized by Sears, Roebuck and Co.)

—SAVE MONEY—MAIL COUPON TODAY—

ALLSTATE INSURANCE CO., 20 N. Wacker Drive, Chicago, Ill.

Please send information regarding Automobile Insurance.

MAV

Name _____

Residence _____

Address _____

Post _____

Office _____

County _____ State _____

Make _____ Type _____

of Car _____ of Body _____

Model _____ Year _____

Name, Number or Series _____ of Model _____

Car _____ Purchased _____

Cost Me _____ New or Used

My present insurance expires _____

Participating policies written at standard rates in New York, New Hampshire, Virginia, Oklahoma and Texas.

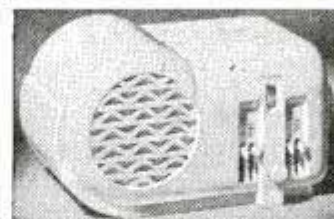

Silver Superhet Radio WITH AUTOMATIC TUNING

Push a button and there's your station—instantly and accurately. Beautiful platoon cabinet, size 13" x 7 1/2" x 6 3/4". 5 genuine RCA inc. tubes. 5" DYNAMIC speaker. Gets standard broadcasts and police short wave. Operates on 110 volt current, 60 cycle. One year guarantee. **FREE HOME TRIAL.** Money back if not satisfied. Send \$2 dep. bal. c.o.d. (Ivory \$1.50 extra.) Walnut... **\$10.94**

FREE 1939 Catalog — Models for farms, homes, cars.

SILVER MFG. CO., 2868 Elston Ave. Dept. P-3, CHICAGO, ILL., U.S.A.

WORLD'S GREATEST all around ELECTRIC TOOL

DRILLS — GRINDS — SANDS — SAWS
POLISHES — SHARPENS — CARVES

The new WHIZ ELECTRIC TOOL is the handiest power tool ever made. Not a delicate instrument but a real rugged tool, equally effective for both power and precision work. Drills through 1/4 inch iron plate in 42 seconds or engraves intricate designs on jewelry. Handles any material: Metals—Woods—Alloys—Plastics—Glass—Steel—etc. Saves time. Eliminates labor. Plug into any socket AC or DC, 110 volts. Chuck 1/4 inch capacity. Ball bearing thrust. Powerful, triple-gear motor. "Worth its weight in Gold." STANDARD MODEL with Normal Speed (uses 60 different accessories, instantly interchangeable.) Special Introductory Price for limited time, only \$6.95. **FREE** Accessory outfit (Value \$2) includes set of drills, mounted 1 1/2 inch grinder, sanding disc, cutting wheel, mounted brush, polishing wheel, carving bar, etc. **FREE** with each outfit ordered NOW. We pay postage. Will send C. O. D. if desired. **10-DAY TRIAL—MONEY BACK GUARANTEE.**

ONLY
6.95
POSTPAID
GUARANTEED
FOR ONE YEAR

Special "2-SPEED" MODEL combines Normal Speed and High Speed in one outfit (uses 200 accessories) only \$8.95 complete, with same accessory outfit (value \$2) FREE.

Paramount Products Co., Dept. 3A, 48 West 48th St., New York

N 1524

The City of Tomorrow

(Continued from page 323)

I think there is going to be something to take the place of the poolroom—a glorified Leisure House where people may have social contact with others. Most of the objectionable forms of recreation today are merely forms of escape. The idea of haste will be removed. Today we are rushing to do something. We will temper all that with leisure, therefore nervous diseases will be

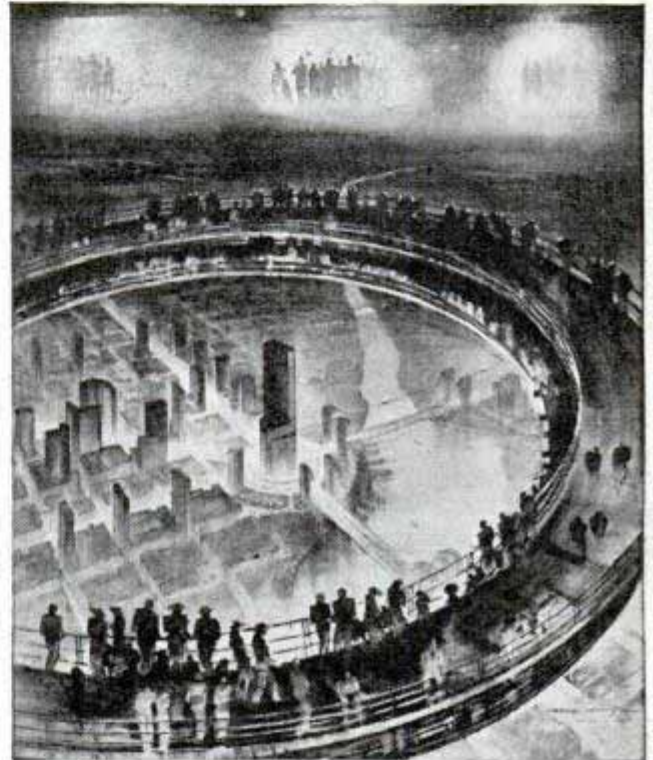

Artist's sketch of Perisphere's interior shows visitors on revolving platform, with Democracy below. This is a night view

eliminated to a large extent. We will be happier and healthier because of our surroundings.

Our satellite town will take care of elementary education, then the children will go to the hub to complete their schooling in a fine university, with museums, excellent libraries and other advantages near by.

New clothes, rather than new clothing, will be designed for the future. We will accept the human body and make every attempt to bring out its good points. The man will plug his suit into an electric-light socket, then set a meter at the temperature which will keep him comfortable all day, either hot or cool days. The suit will have properties to retain that temperature. Clothes will be far less expensive and more colorful. In the future city

(Continued to page 150A)

SEE THE NEW **CORONA** *Zephyr*



THE 9 lb. WONDER OF PORTABLE TYPEWRITERS!

SWINGING SHIFT

BACK SPACER

84 CHARACTER FULL STANDARD KEYBOARD

TUCKS AWAY IN A DESK DRAWER

ONLY **\$29⁷⁵**

L C SMITH & CORONA TYPEWRITERS INC Desk 3
723 E. Washington Street,
Syracuse, N. Y.

Please send free folder describing Corona Zephyr.

Name.....

Address.....

City..... State.....

YOU ARE NOT GETTING MAXIMUM PERFORMANCE FROM YOUR HOME RADIO

—unless you have the proper antenna!

Whether your radio is new or old, its performance can be improved with the proper antenna installation. Verti-flex, the new vertical antenna, is perfectly "tuned" to the new, vertical radiators now in use by most modern broadcasters. Try this new Verti-flex with your radio.

- Better Reception
- Saves on Power
- Simple to Install
- Smartly Styled
- Costs Only \$1.00

Verti-flex is 9 ft. high over all. Made in three telescoping sections of rod aluminum, it is light, durable and weather proof. You can use it most conveniently on your window ledge. Just ten minutes to install it—then forget all about it!

The complete kit with antenna, base, bracket, screws, special flat lead-in strip and directions comes to you postpaid for only \$1.00. Be first in your neighborhood to show this smart new streamlined antenna.



Just enclose a dollar bill or money order with this coupon!

Verti-flex Division
2138 No. Racine Ave.
Chicago, Illinois

Please rush me postpaid—
Verti-flex antennas: \$.....
(m.o.-cash) enclosed as payment
in full.

NAME.....
ADDRESS.....
CITY..... STATE.....

KILL RATS WITHOUT POISON

YOUR MONEY BACK IF RATS DON'T DIE



K-R-O won't kill Livestock, Pets or Poultry; Gets Rats Every Time. K-R-O is made from *Red Squill*, a raticide recommended by U.S. Dept. Agr. (Bul. 1533). Ready-Mixed, for homes, 35¢ and \$1.00; Powder, for farms, 75¢. All Drug and Seed Stores. Damage each rat does costs you \$2.00 a year. K-R-O Co., Springfield, O.

K-R-O KILLS RATS ONLY

BUILD DUTCH WINDMILLS

LIGHTHOUSES, LAWN FIGURES, LAWN CHAIRS, TRELLISES, ETC., BEAUTIFY YOUR GARDEN

Model B-30 Windmill 24" high. 50¢
 Wings operate farmer at bucksaw. Blueprint 75¢
 Model H-10 Windmill hexagon style, 40" high overall. 75¢
 A beautiful model. Blueprint 75¢
 Model H-10 Lighthouse, 40" high. Blueprint 50¢
 Comfortable, Sturdy Cape Cod Lawn Chair. Blueprint 50¢
 12 Artistic Trellises. Blueprint all 12 only 50¢

Special All Blueprints mentioned above for only \$2.00. Send 10¢ for Illustrated Catalog. "Over 35,000 Satisfied Customers"

CRAFTSMAN'S MODEL CO.,
 2030 N. 41st St., Dept. P-27, Milwaukee, Wis.



Most MARVELOUS INVENTION

since cars were made, known as Knee accelerator operated inside of Knee direct to carburetor, indorsed by all Commercial Travelers Who wishes to make time with ease and Safety.

4 Orders taken on a 20 minute demonstration, send PO Money Order \$3.00 for 1 accelerator, let us know territory wanted.

KNEE ACCELERATOR MFG. CO., 531 Main, Deadwood, S. Dak.

ACE LATHE TOOL SET

\$1450

Be permanently tooled-up for every operation on your Metal Cutting Lathe

The ACE Set is complete—there's nothing more to buy. Drop forged by the manufacturers of cutting tools used by 90 per cent of the plants and shops in industry; they are correctly designed, are of special steel, are finely finished, are stronger—will last a lifetime. You can cut easier, faster and more accurately with ACE TOOLS.

At your Hardware Store—Circular FREE.

ARMSTRONG BROS TOOL CO.
 "The Tool Holder People"
 368 N. Francisco Ave., CHICAGO, U.S.A.



3 Turning Tools, 2 Cutting-off Tools, Knurling Tool, Boring Tool, Threading Tool, High Speed Steel Cutters and Blades, and 2 Wrenches in Filled Steel Case.

Stoves

AT FACTORY PRICES!



SALE CATALOG—FREE

Nearly 200 Styles and Sizes of Heaters, Ranges, Furnaces at **FACTORY PRICES.** Easy Terms. Write today for **FREE CATALOG.** New styles, new features—24-hour shipments.

Kalamazoo Stove & Furnace Co.,
 391 Rochester Avenue
 Kalamazoo Michigan
 Over 1,300,000 Satisfied Users
 39 Years in Business

"A Kalamazoo Direct to You"
Trade Mark Registered

Write for **FREE CATALOG**

Now!
Goodbye to SANDING Drudgery!

Guild Sander

PORTABLE ELECTRIC

This handy portable belt sander does better work in a few minutes than you can do by hand in several tiresome hours. Driven by a powerful motor, the endless abrasive belt skims over any surface, flat or rounded, and leaves it clean and smooth. Always works with the grain—can't scratch or leave ugly, circular swirls. It works on wood, wall board, metal, slate, marble, bone and plastics. You'll discover scores of uses for Guild-Sander around the house and in the shop. Popular priced and fully guaranteed in writing. Weighs only nine pounds. Works on AC or DC. Try it at your hardware dealer's or write direct for details.

SANDS
 GRINDS
 POLISHES
 BUFFS
 SHARPENS
 REMOVES PAINT
 VARNISH
 RUST

SYRACUSE GUILD TOOL COMPANY
 1700-3C No. Salina St. Syracuse, N. Y.

Write TODAY



MADE \$102500

in 9 Months with the

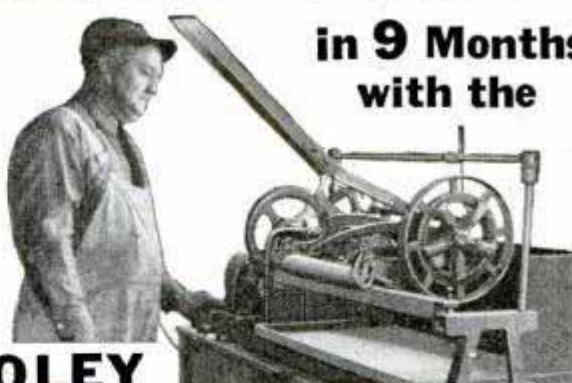

FOLEY LAWN MOWER SHARPENER

"A substantial increase in grind jobs each year proves beyond any doubt that Foley Grinders do very satisfactory work. We have ground 723 mowers since February 1 to date, November 9. Our total receipts on lawn mower service alone during that period has grossed us \$1,025.00. The prevailing price of grinding and adjusting service is \$1.00 and \$1.25—repairs and parts extra."—W. A. Tulp, Phoenix, Ariz.

You Too Can Make Big Money

Free plan tells you how to start. The Foley Lawn Mower Sharpener turns out perfect work quickly and easily, no experience needed. Simply put the mower in the machine and turn on the power. Uses same system as lawn mower factories. Sharpens all sizes and types in 15 or 20 minutes.

Special Offer: Attachment for grinding axes, hatchets, knives, etc., included FREE with Foley Lawn Mower Sharpener on our Special Offer, brings you business the year around. Send coupon today.

FOLEY MFG. CO. 307-9 Foley Bldg., Minneapolis, Minn.

Send Free Plan for making money sharpening lawn mowers, and Special Offer on the Foley Lawn Mower Sharpener.

Name

Address

(Continued from page 148A)

**REAL TIRE ENGINEERS
PRODUCE**

Gillette

BICYCLE TIRES



If you should take a Gillette Bicycle Tire apart, you would find that those snappy, modern non-skid treads are extra deep and made of real live rubber. Underneath the tread, you'd find extra layers of strong, latex-dipped, cord fabric. They are built by Gillette craftsmen who developed the most important improvements in tire history—not only in bicycle tires, but in auto, truck and tractor tires. When you purchase a new bicycle or replace the tires on your present bicycle, see the Gillette dealer and examine the tire that leads the Nation in sales. The extra quality costs no more.

Gillette Tires are also made for juvenile toys of all kinds.

Gillette Rubber Co.
EAU CLAIRE, WISCONSIN

HARD-TO-GET MATERIALS

Just out—Our twenty-fourth annual catalog of Hard-to-Get Materials for Homecrafters, Schools, Institutions, Antique, Novelty and Cabinet Shops. Most complete list in entire country on this class of supplies. Send 10c in cash or stamps today. (Partial list) Chest hardware, locks, hinges, supports, casters, copper trim, etc. also midgets, overlays, etc. Finishing materials, glue, stains, varnish, wax, Blint and garnet papers, rubber sanding blocks, stick shells, burning-in knives, etc. Upholstering supplies and coverings. Complete line of electrical findings for lamp manufacture, also cluster and indirect fixtures. Chair cane, woven and in strands, aplise, reeds, fibre cord, etc. Trays for smoking stands and glass liners. Large line electric and spring clock movements, with and without dials. Complete line Venetian Blind hardware, tapes and cords. Table slides and leg supports. Toy wagon wheels and casters. Wood dowels, also dowed screws, dowed centers, wood screw hole buttons. Excellent line card table leg supports. Bed hardware of every description. Desk pens, complete with funnel and fastening, without base. Water transfers, inlays, small mouldings, etc. Furniture glides and casters, office chair spiders, wood legs and K. D. chair frames. Small box hardware of every description. Large selection pulls, knobs, handles, hinges, locks, catches, etc. Perforated steel panels, chair braces, revolving chair fixtures, rocker springs, candlestick sockets, bill board clamps, banquet table equipment, many size braces, corner irons, lunger bolts, Step ladder braces, plaster strips, sliding track and abscureus. Typewriter desk hardware, bin swings, mirrors, nut bowl hardware, Bar pins for novelties. Catalin Plastics.

THURSTON SUPPLY CO.

Department P. M.

Anoka, Minnesota

**SEND TODAY FOR DURO'S
BIG 1939 CATALOG....**

Featuring America's Finest

**TABLE SAWS · BAND SAWS
CARVERS · HAND GRINDERS
SHAPERS · ROUTERS · LATHES
SANDERS · SCROLL SAWS
DRILLS · JOINTERS
AND ACCESSORIES**

Dept. B 4

**DURO METAL
PRODUCTS CO.**

2657 N. KILDARE, CHICAGO.

**POWER DRIVEN
MACHINERY**



you need not be exposed to inclement weather, but clothes will be provided for people who want to walk in the rain because of the health-giving properties. I think that clothes will be designed as the city is designed—for the convenience of the people who live in it and they will wear clothes in which they will be comfortable, thus creating style around comfort, convenience and health.

The green belt, or parkways, of the future will be important because the green always gives off health and because it prevents people from congregating in large crowds. There won't be many tall buildings, and thus no man-made canyons where people will be forced to work by electric lights. There will be sunlight and daylight in offices. Buildings and rooms will be painted in colors which will be restful and relieve eyestrain. We will not have windowless buildings, for we want the workers to look out of the windows and rest their eyes on the greenery of the parkways. The purpose of the window will be to let in light; it will not be opened.

Our city of the future will have no traffic lights. In order to make turns there will be clover-leaf roads and all sorts of rotary traffic. Vehicles will be moving constantly—you will never have to stop. There will be no need for a horn—no tooting horn or grinding brakes. You will run no danger of being run over. Within the satellite town will be certain streets which have free-flowing traffic for the use of town people going to and from their work. Traffic from one community to another will not pass through the shopping center of our town, thus the congested streets of today will be eliminated.

There will be only one tall building in the hub. This is a city of low buildings and our only reason for putting in a tall building is a dramatic reason—an architectural accent which points up the city. It will house the government for Democracy. It will have office space and the courts will be there.

The use of light will transform the city into another place at night. Buildings will glow with colored light and white light. Fountains will be illuminated, statues will be lighted.

Few people will live in the hub, but there

(Continued to page 153A)

NOW YOU CAN PRESERVE YOUR POPULAR MECHANICS In This Handsome PERMANENT ART BINDER

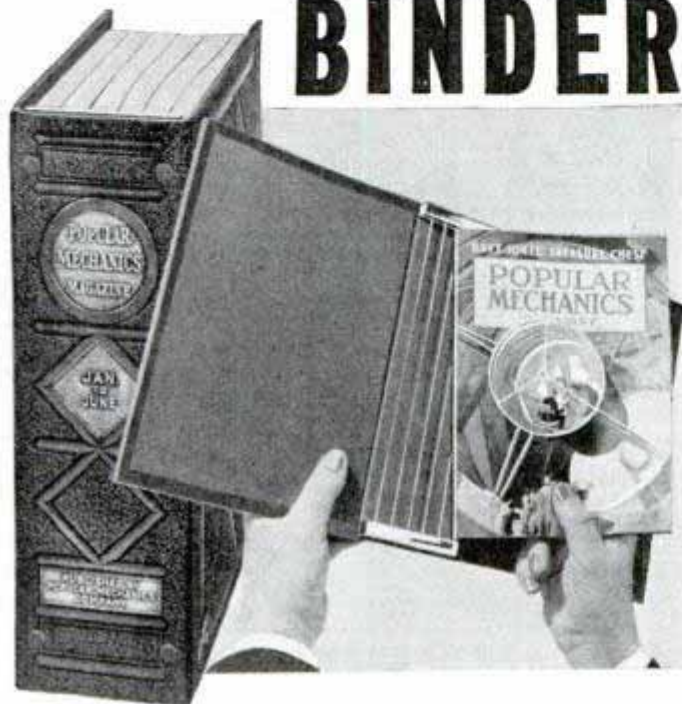

**Specially Designed and Made for Popular Mechanics
Readers. Has Self-Binding Feature**

Your Popular Mechanics Magazine will be doubly interesting and doubly valuable when preserved in one of these handsome art binders, which holds six issues. Heavy leather-grained finish, embossed and stamped in antique gold style. Covers open flat. Patented fasteners hold magazines in place and any issue may be inserted or removed easily and quickly.

**Only
\$1** *Postpaid*

(\$1.25 Foreign
or Canada)

**ORDER ON
COUPON
BELOW!**

Will make a beautiful addition to your reading table or personal library. Size $10\frac{3}{8} \times 7\frac{1}{8} \times 3\frac{1}{4}$ inches. Specify whether wanted for January to June or July to December issues. Use these binders for your collection of back issues.

**POPULAR MECHANICS PRESS,
Dept. PMB, 200 East Ontario Street, Chicago.**

I enclose \$_____ for which you may send me _____
Art Binders for Popular Mechanics Magazine.

PLEASE CHECK January to June Issues.
 July to December Issues.

Name _____

Address _____

City _____ State _____

When writing please mention Popular Mechanics

*Make your
FISH STORIES
come true!*

With a NEPTUNE, brother, you'll have time to fish! Vacation seems twice as long. Go in a hurry where the big 'uns lurk, fish the whole lake and speed home with your catch.

NEPTUNES cost less but give more dependable service. Smooth trolling; plenty of power and speed when you want it. Any size YOU need, from 1.2 H.P. at \$35.50 up to 16 H.P. at \$164.50. Send for free literature.

Muncie Gear Works, Inc.
Muncie - Indiana
New York Office:
45 E. 17th St., Gramercy 7-6310

**NEW NEPTUNE
"FIVE"
Alternate-Fire
Twin**

from
**\$35.50
UP**

NEPTUNE
Motors
BUILT FOR SALT WATER AS WELL AS FRESH WATER

VENETIAN BLINDS Make your own at low wholesale cost. It's easy under our unique plan. All materials supplied. Send 10c coin for samples of ladder tape, cord and slat, 15 color samples of tape and color chart.

VENETIAN BLIND MFG. & SUPPLY CO.

Dept. 2B, 1760 Lunt Ave., Chicago, Ill.

**MEGOW MODEL
KITS**

Many exclusive special features. For instance—the new ready-carved LEADING EDGE used on the Piper Cub shown here.

PIPER CUB—latest Megow gas-powered model, sensational new light-weight. Small size that avoids crackups. Easy to build and fly. Wingspan 52 $\frac{3}{4}$ ". Takes any $\frac{3}{8}$ " motor. \$3.95. By mail 20c extra.

Big, handsome 50" flying outline scale models. **TAYLOR CUB**, **AERONCA**, **FAIRCHILD RANGER**, \$1.00. By mail 15c extra.

30" Flying models, interesting in design and detail. **CESSNA 34**, **RYAN SC**, **STINSON**, **ARROW SPORT**, **AERONCA K**, **HOWARD DGAS**, and others. 50c. By mail, 10c extra.

MODEL SHIPS—**HISPANIOLA**, **ARABELLA**, **XEBEC**, and others. \$2.00 with carved hulls. **SETH PARKER**, \$1.00. By mail, 15c extra.

MEGOW HO-GAUGE Freight Cars 50c. By mail, 10c extra.

Send 5c for 100-page catalog.

MEGOW'S

Dept. PM., Howard & Oxf. Sts., Phila., Pa.,
or 217 N. Desplaines St., Chicago, Ill.

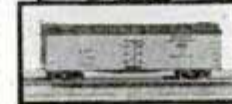

READY CUT HOMES

\$416 and up . . . Freight Paid. Save \$500 or more. 75 home plans to select from. Including 10 new feature 1939 designs. All modern, practical, distinctive, complete. Simple plans for easy assembly. Includes all lumber, insulation, roofing, bronze weather stripping, built-in features, attractive one-panel doors, latest hardware, nails, lath, paint, varnish. Also, summer cottages, garages, tourist cabins, etc. Information and plans for F. H. A. Financing requirements on request. For new 1939 full color catalog, with floor plans, send 25-cents to cover mailing.

NEW COLOR CATALOG FOR ONLY 25¢

INTERNATIONAL MILL and TIMBER CO.
Dept. P-39, Bay City, Mich.



BE AN EXPERT MARKSMAN!

Have FUN

Get a DAISY AIR RIFLE



Get in on the big fun . . . get your heart set on a famous DAISY . . . go to your Dealer NOW and see the beautiful models selling from \$1.25 up. Or, write us today for Picture Circular showing all 7 Daisy Air Rifle models, enclosing thin dime for mailing-handling charge on Circular.

USE BULLS EYE
copper-coated steel shot for accurate shooting . . . only shot Officially Approved **225 Shots 5¢** for Daisys

DAISY MFG. CO., 1103 Union St., Plymouth, Mich.

Wood WORKERS

Here it is!



Here is Harold Hunt's latest edition 1939 buyers guide and catalog. Nothing like it ever before published in the history of woodworking—136 pages of vital FACTS including new designs, new hints on finishing, many new ideas for experts (AND a new supplementary service showing beginners how to make beautiful furniture the first week) — Experts and Amateurs:

Get this book NOW

Be posted and up-to-date. Read the latest price quotations. See the lists of all Standard American Woods, of ultra-rare foreign woods, the new style of ornaments and inlays AND note the many astounding bargain deals! — Send only 10¢ (silver or stamps) to

CRAFTSMAN WOOD SERVICE CO.
2733C Mary Street Chicago, Ill.

only 10¢

Saw-Filing

Pays up to \$2 or \$3 an Hour in Spare Time

A FOLEY Automatic Saw Filer files hand, circular and band saws better than the best hand filer. Cash business, no canvassing, no eyestrain. No experience needed. Louis P. Wadwick, Ohio, says, "I have filed 764 saws in spare time and have earned \$850.00 in carpenter work due directly to my saw filing contracts." Send coupon for FREE PLAN, no obligation.



FOLEY MFG. CO., 316-9 Foley Bldg., Minneapolis, Minn.

Send Free Plan on Saw Filing business.

Name.....
Address.....

YOUR DOG LISTLESS?



Worms can cause it! Use **GLOVER'S Worm Medicine** (capsules or liquid). Popular for over 60 years! **FREE Dog Book**—write GLOVER'S, 462 Fourth Avenue, New York City.

GLOVER'S DOG MEDICINES

A KNOCKOUT SELLER



Millions waiting to buy. Retail 35¢. Every worker in shop, office, factory, salesroom—men and women everywhere buy quick. 100 sales daily easily possible. No experience. Tremendous profit daily plus monthly bonus. No investment. Nothing to carry. We deliver. Full or part time. Send postcard for Free Sample.

PRESIDENT, 435 N. Clark St., Dept. 121, CHICAGO.

Work Faster Make More Money with the



Red UNIVERSAL TRACTOR

With this practical machine and attachments you can do all field and belt work hours faster at the low cost of 33¢ per day. Many units pay for themselves the first season. Unusually easy to handle and operate. Absolutely safe. Hundreds of users. Buy direct at low factory price. Two weeks' trial—satisfaction guaranteed. Write for colorful, free catalog.

PIONEER MFG. CO. Dept. V-39 West Allis, Wis.

BUILD YOUR GRANDFATHER CLOCK



The Simple Sensible Red-i-Kut way as thousands have. DIME brings PLANS and sixty pictures "HOW" Book pricing many fine brass weight Westminster, tube chime, electric and battery movements showing nine beautiful colonial grandfather cases. **WHY WAIT LONGER?**

KUEMPEL CHIME CLOCK CO., Bldg. 26, Guttenberg, Iowa.

STEAM ENGINES for small boat models. Two-cylinder power plants, ready to run, with boiler propeller and burner.

Model SE-1, oscillating type Price \$2.00
Postage extra, shipping wt. 3/4 lb.

Model SE-3, slide-valve type Price \$3.00
Postage extra, shipping wt. 1 1/2 lb.

Shawnee Engine Co., Box 152, Station D, Cincinnati, O.

CATCH FISH!



minnows, eels, mink, muskrat, with our folding galvanized Steel Wire Traps. Walton's Automatic Hooks are so constructed that when a fish gives the slightest pull on the bait the upper hook reaches down and gets a hold that lands him. 3 for 50¢. Write for descriptive catalog of Traps, Hooks, Lures, and other specialties. **Walton Supply Co., 3507 Juniata Ave., St. Louis, Mo.**

Monuments \$9. Up

WE PAY FREIGHT

Best Quality Marble and Granite. Big Saving. Free Lettering. Guaranteed. Erected if desired. Write for Catalog and samples.

U. S. MARBLE & GRANITE CO., A-18, Oneco, Fla.

AGENTS ~300% Profit SIGN LETTERS

For Store Fronts and Office Windows. Anyone can put them on. Free Samples. Liberal Offer to general agents.

METALLIC LETTER CO., 438 N. Clark St., Chicago

WET BASEMENTS!

Waterproof Your Own Save up to \$100 to \$150

Amazing new Seal-Seep method, anyone can use. Applied to inner masonry wall and floor surfaces; no digging. Guaranteed permanently effective. Agents write for unusual earnings opportunity. Details FREE.

National Seal-Seep Co., Dept. 392, Cincinnati, O.

When writing please mention Popular Mechanics

(Continued from page 150A)

will be hotels and apartment houses along the edge of the city. Rooms will all face the green parks outside. People also will have country places on land not adaptable to farming and along the edge of the rivers. Too, there will be suburban towns that are completely residential.

Tomorrow's city will have a terminal center to which passenger traffic by air and by rail, bus and ship will come. Freight also would come to this terminal.

All highways will be illuminated to eliminate the glare of passing cars. There will be headlights on cars, but they won't be the brilliant kind. Also there will be the use of polarizing materials. Automobiles will have glass roofs so that their occupants may look out above, as well as to the sides, front and back. The traffic force in our city will be cut to a minimum. We see no great amount of crime in tomorrow's city because everybody is so happy, thus we will have a police force of only 100 men. Slums develop criminals, but we will have no slums. Instead of policemen we will have service monitors whose functions will be to assist the citizens rather than to correct them in the parking of cars. There will be only a small fire-fighting force because our city will be fireproof and because you will be able to extinguish flames by pushing a button that controls acid-shooting apparatus. The mailman will be replaced in the central city by automatic tubes which will speed a letter to the post office or to your office. The post office will be located over the transportation terminal.

All homes will be piped for sound and probably for motion-picture programs from a central station. Power will come from a generating plant located on the river near Democracy.

All these things will be possible through planning. To create the "City of Tomorrow," which is the theme exhibit at the 1939 New York World's Fair, has been a tremendous task. It has meant research into the projects of city planners. We have worked with experts in every phase of modern life, and incorporated the best features that each had to offer in this city. The result is a community which, if the funds were available, could be built tomorrow. This is no visionary city of the future; it is a practical suggestion of how we should be living today.

DOES TWO JOBS AT ONCE



NEW
SPEEDY
WAX

(LIQUID)

MADE BY DUPONT

Cleans the Car...and
gives a wax polish



Putting a wax polish on your car isn't the long tough job it used to be. Far from it! Now, with the marvelous new Du Pont Speedy Wax, you can clean the finish and give it a wax polish in one easy operation. You do *both* jobs at the same time—easily and quickly. And what a long-lasting lustre you get! Speedy Wax is fine for all types of car finishes. Try it.

Sample for you . . . We'll gladly send you a generous sample of Speedy Wax—enough for fenders and hood. Just send 6¢, to help cover postage, to Du Pont, Dept. MP-1, Wilmington, Delaware.



SCRATCHED FENDERS are repaired easily with Du Pont TOUCH-UP BLACK. It is easy to apply—use the brush in the can.

25 2/15 19 9

SEE WHAT *Atlas* ENGINEERS HAVE DONE FOR YOU

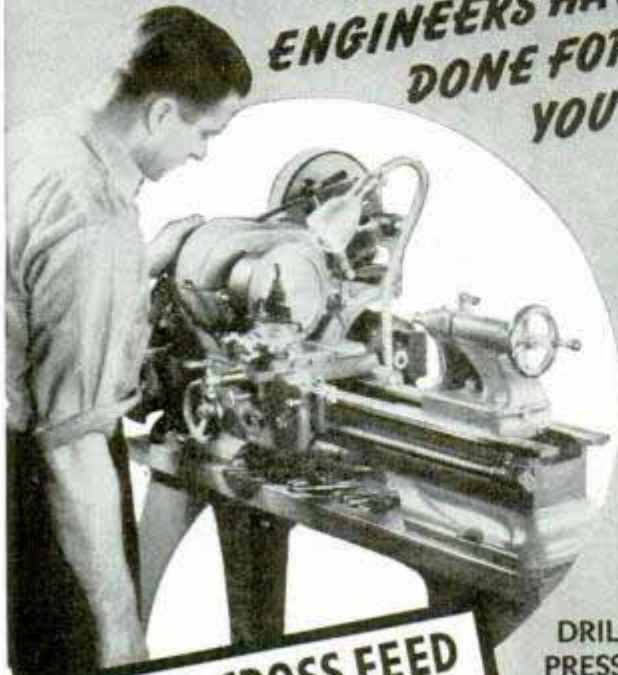

POWER CROSS FEED NOW STANDARD EQUIPMENT

Your dealer has a big surprise in store for you—the new Atlas F-Series 10" Lathe—first low-cost precision lathe with power cross and longitudinal feeds as standard equipment!

It's the sweetest running lathe you've ever seen—complete V-belt drive, quick-change countershafts, compact controls, precision-ground bed ways, custom-built spindle bearings, back-gear power, and many other modern features. Prices, complete less motor, are \$104.75 for horizontal countershaft, \$99.75 for vertical countershaft. Ask your dealer to show it to you and explain the low monthly terms.

FREE

Send the coupon below today for the big new 72-page Atlas Shop Equipment Catalog.

ATLAS PRESS CO.
343 N. Pitcher St.
KALAMAZOO, MICHIGAN

DRILL PRESSES



SHAPERS



NEW 6" LATHE



1939 CATALOG



ATLAS PRESS CO., 343 N. Pitcher St., Kalamazoo, Mich.
Send me your 1939 Catalog describing: New 10" Metal Lathes New 6" Metal Lathe New 7" Shaper Drill Presses Arbor Presses Wood Lathes

Name (Please print plainly)

Address

City and State

Fully Armored Football Player Defies Injury in Practice



This grotesque ball carrier wearing various types of drill armor would play a safe but not fast game

Completely padded with protective armor from head to foot, the best dressed football player can defy injury in blocking and tackling during practice games. A helmet and face mask resemble a man from Mars, and thick pads on his body and legs absorb whatever severe buffeting he may endure. Separations at the hips and knees permit free use of the player's limbs.

Shield for Cleaning White Shoes Keeps Polish from Spreading



Your white shoes can be cleaned without smearing whitening over the sole edges if you use a patented metal shield to keep colors from spreading. It is held between the sole and upper portion of the shoe.

Thomas C. Crowley, 24 47 7 3 11 11

marly. submer, Schuman & Co. U.S.

Julianm! edge, my

QUICK CASH IN NEW POTATO CHIPS

START AT HOME

Here's your chance—a money-making business of your own. Turn potatoes into cash by making new kind of Potato Chips with my improved outfit. Makes delicious, superior, "NON-GREASY" Chips at low cost. A few hours' practice does it. Begin anywhere—city, village, town. Potatoes cheap and plentiful. Wholesale or retail. Steady year 'round business.



Groceries, markets, restaurants, taverns, do the retailing for you. **WE HELP START YOU IN BUSINESS.** Great quantities of Chips are eaten daily. Profit large—unusually so. You can start this money-making business on a "next to nothing" outlay of cash. Write for Potato Chip Booklet. **LONG-EAKINS COMPANY**
328-5 High St. Springfield, Ohio



COMPLETE ELECTRIC PLANTS

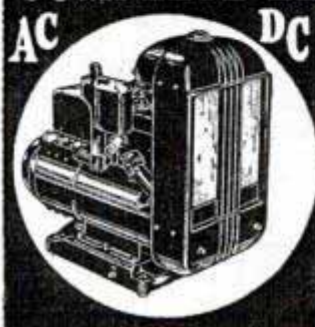

Onan A.C. plants furnish same current as city lines, 110 Volt, 60 Cy. For farms, camps, construction jobs. Operate radios, water systems, all appliances. New models, 350 to 5000 watts, 6, 12, 32 and 110 volt D.C. Models \$57.50 and up. Also combination A.C.-D.C. units. Shipped complete, ready to run. Write for details. **D. W. ONAN & SONS**
1031 Royalston Ave. Minneapolis Minnesota

PRACTICAL MAGNIFIERS



New type magnifier with swivel joints. Six sizes—1 1/2" dia. to 5" dia. lens. Prices, 50c to \$10. Send for FREE Catalog of these attractive, well-built instruments.

MAG-NI-LINE PRODUCTS,

Dept. 12, 3456 E. Jefferson, Detroit, Mich.

PAY POSTMAN

Sent C. O. D. Anywhere in the U.S.A.

ery, price plus small C.O.D. fee. Or remit with order and books will be sent postpaid anywhere in the world.



EXTRA MONEY BOOKS

Select

FROM THIS LIST

- AIR CONDITIONING**
Furnaces, Unit Heaters \$3.00
- AIRPLANE SERVICING**
Manual, New, 1000 Pages, Illus. \$6.00
- AUTO RACING**
Build Midget and Other Racers \$1.00
- AUTO REFINISHING**
Duco With Spray Gun \$1.50
- AUTO SERVICE SHOP**
Management, Money-making Ideas \$1.50
- BLUEPRINT READING**
For Machine Trades \$1.50
- BRICKLAYING**
Plain and Fancy \$1.50
- BUSINESS CORRESPONDENCE**
and Office Management \$1.75
- CARBURETORS (All Makes)**
New, Revised Edition \$3.00
- CHEVROLET SIX**
Car, Truck, Operation Repair \$2.50
- COLONIAL FURNITURE**
Making, 95 Pieces \$3.50
- DANCE**
Learn at Home Without Music or a Partner \$2.00

- FOUNDRY WORK**
Molding, Casting, etc. \$2.00
- HIGH-SPEED DIESELS**
New, practical, non-technical \$2.50
- HOME GROUNDS**
Furnishing \$0.80
- LEATHER MAKING**
and Tanning \$1.00
- METAL SPINNING**
Practical New Book \$1.00
- METALLURGY**
New Metals, Alloys In Use To-Day \$1.50
- MONEY-MAKING FORMULAS**
10,000 Practical \$4.00
- OIL HEATER HANDBOOK**
Manufacture, Distribution, Installation, etc. \$3.50
- PLASTERING**
Best Instruction Manual \$1.25
- RADIO PHYSICS COURSE**
New edition. Everything about Radio \$4.00
- SHEET METAL**
Construction Work \$2.50
- STEAM ENGINEER'S LICENSE**
How to Obtain \$2.00
- WOOD TURNING**
Course In \$1.50
- WROUGHT IRON WORK**
Practical \$1.35

POPULAR MECHANICS PRESS

Room 339E

200 East Ontario St., Chicago

EASY to play

With an easy playing Conn band instrument, you can be ready for band or orchestra in 4 to 6 weeks. A sure road to popularity if you start on a Conn. Choice of the world's greatest artists. Magnificent tone. Many exclusive features—yet they cost no more. Ask to see the marvelous new models now being displayed by Conn dealers.

WRITE FOR THIS NEW FREE BOOK

Home trial. Easy payments. Write us for free book on whichever instrument interests you most. Mention instrument.

C. G. CONN, LTD., 331 CONN BLDG. ELKHART, IND.

CONN

BAND INSTRUMENTS

HOT WATER SPEED KING



From Any Electric Light Socket

MILLIONS of homes, stores and offices everywhere need **SPEED KING**—the new, amazing **Water Heater**—that heats water boiling hot so fast it takes your breath away. No mess! No waste of time or fuel! Just a simple "plug-in" at any 110-volt light socket—and presto... just the amount of hot water you need for the bath, for shaving, for dish-washing, **CHEAPER** because you don't have to heat gallons when you need only a few quarts. **FASTER** because the intense electric heat goes directly into the water. Sells fast on a 60-second demonstration. Small in size—fits the pocket, easy to carry. Anyone can afford it.

60-SECOND Demonstration
Amazes Housewives

SAMPLES for AGENTS

I WANT you to know the almost uncanny heating action of this speedy water-heating invention. Write quick—a postcard will do—for my **SAMPLE OFFER** that brings you an actual **SAMPLE SPEED KING** for demonstration. You can make plenty of cash as my agent. **HURRY!** Big season starting now. **SPEED KING** solves the hot water problem when furnaces shut down. Act quick and I'll show you how to make the fastest money of your life. Send No Money!—Just your name.

JUST SEND

NAME

WRITE your name and address in the margin, clip & mail this coupon or send penny postcard to Dept. 163.

Name

Address

City

NU-WAY MFG. COMPANY,
Dept. 163 Walnut Bldg., DES MOINES, IOWA

MAKE BIG MONEY AT HOME! Electroplating by Brush! AMAZING NEW INVENTION



NO TANKS, LIQUIDS, GENERATORS Only **\$685**
DOES SAME WORK AS BIG OUTFITS
Sensational news! Marvelous new invention actually electroplates with electric brush. As easy as painting. Deposits heavy layer of actual metal—gold, silver, nickel, cadmium, copper, etc.—by electrolysis. Does same beautiful, PERMANENT work as big, costly tank outfits. Non-liquid. Anyone can use from dry cells, storage battery or household current. Complete outfit weighs only 3 lbs.—take it anywhere—ready for instant use.

PLATE THOUSANDS OF ARTICLES SPARKLING NEW WITH STROKE OF BRUSH
BIG EARNINGS REPORTED IN SHORT TIME
Amazing low price and magic-like demonstration brings you thousands of orders for plating from garages, radio shops, bicycle shops, machine shops, home work shops, factories, offices, janitors, doctors, dentists, jewelers and farmers, homes, stores, etc.—with big profits for you! Schedule of plating charges furnished; also reports of big money users are making with the **WARNER NU-WAY ELECTROPLATER**.

FREE SAMPLE PROVES ALL CLAIMS
Send today for amazing profit details with this revolutionary electroplating invention. **FREE SAMPLE & BIG MONEY-MAKING PLAN.** Get started in a profitable business of your own, full or spare time. Be the **WARNER NU-WAY ELECTROPLATER IN YOUR TOWN.** Simply mail post card with your address.
WARNER ELECTRIC CO., Dept. G-5
360 North Michigan Ave. Chicago, Ill.

Get BOBBY BERGER'S (INTERNATIONAL CHAMPION) OWN PLANS For Building

SOAPBOX DERBY STREAMLINER—Now it is easy to build your own Soap Box Derby Streamliner like the one Bobby Berger raced to the International Championship. Learn how he met world-famous people; won a 4 year college scholarship. Now, you can have Bobby Berger's own secrets to success. No special tools needed to build this streamliner coaster wagon in your own basement or garage. Write today for complete plans, specifications, and 20 page profusely illustrated book; also easy-to-understand building instructions. Complete Book, blue prints, and all details, now sent at special price of only 25c. Send stamps or coin. Mail request for your book today, so you can have fastest coaster wagon in your city. Write
BOBBY BERGER, c/o Boyscraft
P. O. Box 1244, Dept. E, Lincoln, Nebr.

Build this Smith Compressor



We will furnish complete instructions with a **Smith Compressor Head and Accessories**
With a Ford Motor and shop facilities you can easily assemble a Smith Air Compressor. You'll have a smooth performing, efficient compressor. Sixty cubic feet a minute capacity—all the power you'll need to operate rock drills and paving breakers. Here's a way to save money. Write for complete information.
Address Department D
GORDON SMITH & CO., Inc., Bowling Green, Ky.

TYPEWRITER Brand NEW!

Only **\$19.95** and up

10-Day Trial—Easy Terms
Guaranteed Brand New latest REMINGTON-GALET model only \$19.95 during this sensational sale. Also Royal, Corona and famous Featherweight Portables at real money-saving prices. Also standard full size office models rebuilt and fully guaranteed at 1/3 saving.
231 W. Monroe St. Dept. 301, Chicago

MYSTERIOUS DEVICE WELDS BRAZES AND SOLDERS

ANYONE CAN OPERATE

Now, an electric welding, brazing and soldering Torch, complete with power unit, goggles and supplies. **Works INSTANTLY off any light socket.** Does a thousand and one repair jobs at amazingly **LOW COST** on aluminum, iron, steel and other metals. **Indispensable** for Auto, Body and Fender Repairs, and home repairs—shop, factory, farm, engineer, janitor, sheet metal, radio and bicycle repairs. Anyone can handle without previous experience with our simple **10-DAY HOME TRIAL** instructions. Write at once for Special Introductory Low Price Offer. Try 3 in 1 Electric Torch for 10 days at our risk, or get one free by helping to introduce it. **ELECTRO-TORCH CO., 2613-CP Michigan Ave., Chicago**

50c BRINGS YOU 26 PRIZE -winning plans for shop projects in new Stanley Plan Packet. Each on separate 8 1/2" x 11" sheet. Postpaid anywhere in U. S. Write **STANLEY TOOLS, 105 Elm St., New Britain, Conn.**

Calling all Cars

MYSTERIOUS DISCOVERY SAVES UP TO 30% on GASOLINE or Costs Nothing to Try!

Stop wasting Gas!—trim dollars off gas bills—get more power—quicker pickup—faster acceleration! **AUTO OWNERS everywhere praise VACU-MATIC!** Proven so efficient, it is guaranteed to satisfy, or the trial costs you nothing.
Automatic Supercharge Principle
Vacu-matic is entirely different! It operates on the supercharge principle by automatically adding a charge of extra oxygen, drawn free from the outer air into the heart of the gas mixture. It is entirely automatic and allows the motor to "breathe" at the correct time, opening and closing as required. Saves up to 30% on gas costs, with better motor performance.
AGENTS Get Yours FREE
FOR INTRODUCING. Here's a splendid opportunity for unusual sales and profits. Every car, truck, tractor owner a prospect. Send name and address now for big money making offer and how you can get yours Free.
The Vacu-matic Co., 7617-417 W. State Street, Wauwatosa, Wis.

LIKE TO FISH?

Then Get This **FREE BOOK!**

Tells you how, when, and where to fish—how to bait and fly cast, the knots, etc. Special advice by Tony Accetta on how to balance your tackle for greater skill and more thrill.

SPECIAL OFFER

- SPORTSMAN'S LIGHTER — sure-fire in wind and rain — \$2.00 postpaid. (limited supply).
- FREE 66 pg. Fishing Guide and Catalog. Write today.

SHAKESPEARE COMPANY
486 N. PITCHER ST., KALAMAZOO, MICH.

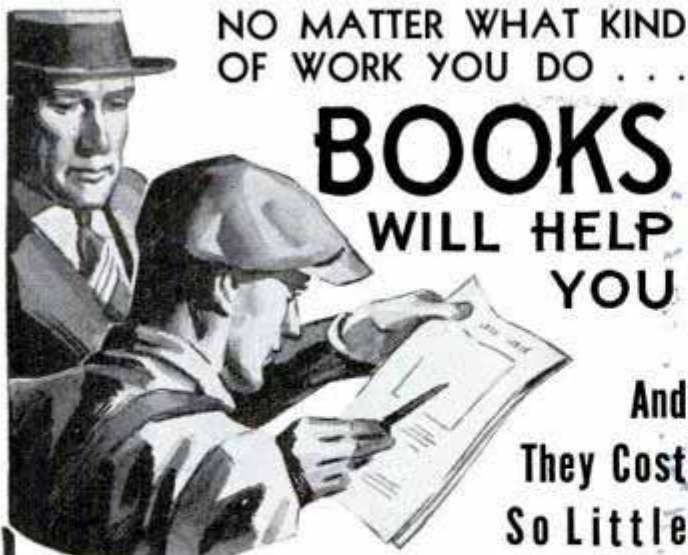

NO MATTER WHAT KIND
OF WORK YOU DO . . .

BOOKS WILL HELP YOU

And
They Cost
So Little

Select from
this List

Here are books that will help you—on your job—to advance to a better job—to earn extra money in spare time—to develop a hobby. Choose from this list and order today.

- AIR CONDITIONING**
Live Field; Great Future . . . \$4.00
- ALUMINUM WORKING**
For School and Home Shops. Just Out 295 pp., illus. . . \$3.00
- AUTO ENCYCLOPEDIA**
The Famous Dyke's Latest Edition . . . \$6.00
- 110-V. GENERATORS**
Made From Old Auto Units . . . \$1.00
- BIRD HOUSES**
Build to Sell; Easy Designs . . . \$1.00
- BLUEPRINT READING**
for the Building Trades . . . \$1.25
- BOAT BOOK**
Power, Sail, Rowing, Paddle Plans . . . \$3.00
- BOY MECHANIC**
Hundreds Things Boys Can Make . . . \$2.00
- CARPENTRY, PRACTICAL**
Complete 436 pages. Revised Edition . . . \$2.00
- CIVIL SERVICE**
Home Study Courses Federal, State, City Positions . . . \$1.00
- CONCRETE**
1001 Ideas for Using. New Popular Mechanics Book . . . \$5.00
- DIESEL HANDBOOK**
New! Latest Information . . . \$5.00
- ELECTROPLATING**
With Copper, Nickel and Chromium Technical bulletin . . . \$1.00
- FORD V-8 CARS, TRUCKS**
New, 700 Pages. Includes Details 1937 Cars . . . \$2.50
- FORMULAS**
1059 Money Making. Start a Business . . . \$1.25
- FURNITURE MAKING**
Tools, Materials, Design . . . \$2.50
- HOUSES, SMALL**
Book of, for Home Builders . . . \$2.00
- HYPNOTISM**
How to Become an Expert . . . \$2.00

- MACHINE SHOP WORK**
Complete. 400 Pages. 444 Illustrations . . . \$2.50
- MACHINE WOODWORKING**
First Complete Book . . . \$3.25
- MATHEMATICS**
Easy Guide for the Practical Man . . . \$1.50
- MECHANICAL DRAWING**
Learn Drafting; Good Salaries . . . \$1.00
- MONEY MAKING IDEAS**
1000 Ways to Make \$1000 . . . \$2.50
- OXYACETYLENE WELDING**
Hard Surfacing, Lead Burning, Cutting New ed. . . \$1.25
- PAINTING AND DECORATING**. New book . \$1.50
- PLUMBING**
500 Facts Every Homeowner Should Know . . . \$1.50
- PROSPECTORS' HANDBOOK**
How to Mine, Appraise, Equip. . . \$3.00
- RADIO SERVICING**
Profit by Knowing Costs, Kinks, Etc! . . . \$4.00
- REFRIGERATION**
Electric, Gas. Be a Service Expert . . . \$5.00
- REWINDING ELECTRIC MOTORS**
Fractional Sizes . . . \$2.50
- SHIP MODEL**
Entire Text, Famous "Sovereign" of 1637 . . . \$1.00
- SOIL-LESS GROWTH OF PLANTS**. Just out. \$2.75
- STEEL SQUARE**
How to Figure Angles of Rafters, Roofs, Etc . . . \$1.00
- TOYS**
For Amusement or Profit, Saleable Designs . . . \$1.50
- TRAILER BUILDING**
New Book . . . \$1.00
- UPHOLSTERY**
Always a Big Market. Start Own Business \$2.00
- WOOD FINISHING**
Methods, Tools . . . \$2.00

Use this advertisement as an order blank. Check books wanted. Add name and address and mail. Just pay postman price plus small C.O.D. fee. (In U.S. and possessions.) Or remit with order and books will be sent postpaid anywhere in the world.

Send No Money

POPULAR MECHANICS PRESS

Room 339A

200 East Ontario St., Chicago

When writing to advertisers please mention Popular Mechanics

POWER

for "100 USES"
at Only 3¢ an Hour

AMAZING
MONEY MAKER

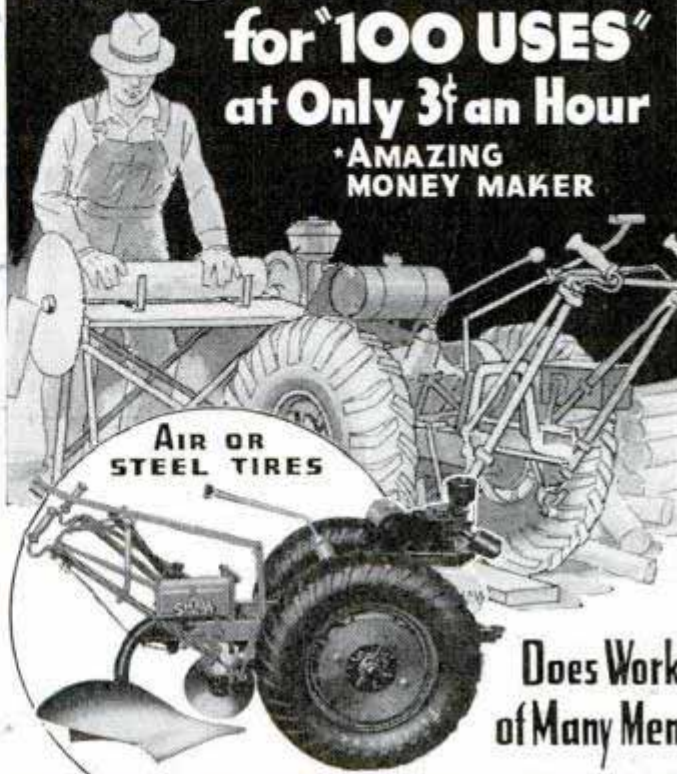

AIR OR
STEEL TIRES

Does Work
of Many Men

SHAW TRACTOR

DU-ALL

LOW FACTORY PRICE

Get year 'round speed and power with DU-ALL at amazingly low FACTORY PRICE. Does work of many men and several horses. Greatest time, labor and money saver made for farms, ranches, truck gardens, nurseries, orchards, poultry ranches, estates and suburban homes, golf courses and parks.

MANY USES —DU-ALL does all field, road, belt work. Plows, discs, harrows, furrows, seeds, cultivates, harvests, digs potatoes, mows, rakes, sprays, cuts weeds and hauls. It runs feed grinders, corn shellers, buzz saws, concrete mixers, onion graders, water pumps, lathes and other belt machinery.

ALL-PURPOSE RIDING ATTACHMENT—Revolutionary development puts Du-All years ahead. Automatically steered. Equally practical, for plowing, cultivating, etc. Air or steel tires.



Gear Shift—3 speeds forward (6, if desired) and reverse. Runs ¼ mi. to 15 mi. per hr. with 6 speed gear. Has power turn; powerful 4-cycle, air-cooled motor; improved tool control. **Four models**, 2 to 5 H.P. 5-horse model available with either single or twin cylinder engine.

10-DAY TRIAL — Mail coupon for details of this generous offer. Enables you to use DU-ALL 10 days on your own work at our risk.

FREE CATALOG —Big, illustrated. Pictures and describes all models. Quotes low factory prices. Costs you nothing. Send coupon now!

THE SHAW MFG. CO. (Address nearest office)

4503 Front St., Galesburg, Kans.; 5812-G Magnolia Ave., Chicago, Ill.; 130-G West 42nd St., New York, N. Y.; 668-G No. 4th St., Columbus, Ohio

Rush FREE information about the Shaw DU-ALL Tractor as checked below:

FREE Book and Low FACTORY PRICES 10-Day Trial Offer Liberal Agents' Proposition

NAME

ADDRESS

TOWN STATE

#1550.

Spinning Disk Spreads Sand on Forty-Foot Road



Sand-spreading trailer showing disk resting on rubber-tired wheel, and the hopper above

Sand is thrown from a spreader by its rotating disk at sufficient velocity to cover a swath forty feet wide. Men shovel sand into a hopper at the rear of a truck, from where it falls to a rotating disk equipped with six curved paddles. Riding on the pavement a rubber-tired wheel rotates the disk at high speed. The unit, mounted on the truck by two hinges, can be removed easily and hung on the tail gate when not in use, and as it lacks gears, chains or belts there are no mechanical parts that can clog.

"Transparent Book" Builds Up Picture to Tell Story

Pictures in a transparent book recently demonstrated are built up page by page until a complete story has been told. The book consists of covers and pages made of transparent plastic material, each containing one step in the procedure. As pages are turned each new step in the picture sequence is projected against a background of the preceding ones. When all pages have been turned, the entire story appears through the transparent covers as a complete unit. The viewing process can be reversed by turning pages from back to front, thus taking the picture apart instead of building it up. This type of book, it is said, is adaptable to a variety of fields including the schoolroom, business, industry and professions.

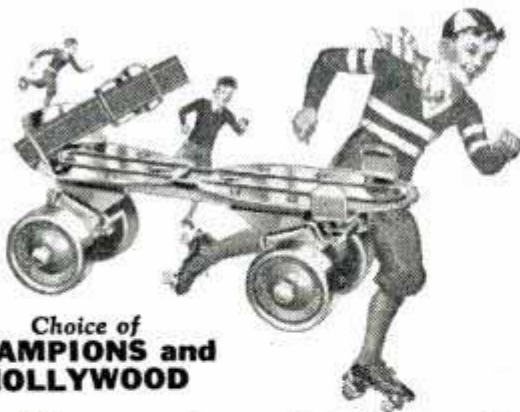

Choice of **CHAMPIONS and HOLLYWOOD**



CHICAGO FLYING SCOUT Roller Skates

For Speed—For Strength—for Economy
"CHICAGO" WHEELS HAVE 3 LIVES
 Extra quality features add health and greater pleasure. Demand **"CHICAGOS."**

Write for **BOOKLET "How to Roller Skate"**

FREE SKATE PIN AND ANKLE PADS
 Send picture of "Our Gang" cut from wrapper with 10c to cover mailing, and receive beautiful **Gold F. Skate Pin and Ankle Pads.**

CHICAGO ROLLER SKATE CO.
 Quality Roller Skates for over 37 Years
 4414 W. Lake St. Chicago, Ill.



FLEXIBLE...

transparent, waterproof

● Holds permanently on china, glass, wood, metal, leather, paper, fabrics. Not affected by heat, cold, moisture. Dries quickly. Ideal for model making, as well as for mending.



DUPONT DUCO CEMENT

World's Best Line of **TRAILER AXLES, HITCHES and PARTS**



New \$3.00 House Trailer Blue Prints Free With Axle Assembly.

WRITE FOR FREE LITERATURE

Special limited offer. **Send Only 50c Today** for the above mentioned genuine working blue prints and building specifications.

HAMMER BLOW TOOL COMPANY
 DEPT. 103 WAUSAU, WIS.



AUTO ENGINE SPEED CONTROL GOVERNORS

\$5.00 UP, 445 E. 3rd St., Los Angeles, Cal.



WORLD'S LOWEST PRICED ADDING MACHINE

GUARANTEED ACCURATE. Not a toy. Operates with only a finger flick. Adds, subtracts, multiplies, divides. Counts up to a million. Pays for itself over and over. Ideal Gift—for Business, Income Tax and School use. **MONEY BACK GUARANTEE.** Send name and address. Pay postman only \$2.50 plus postage. (Send full cash if outside U. S.) **Money back in 10 days if not delighted. AGENTS WRITE. CALCULATOR MACHINE COMPANY (Mfrs.), DEPT. 103, P. O. BOX 1118, CHICAGO, ILLINOIS.**

made by James H. Walker, Inc.

School of mechanical engineering low prices

Mr. S. Fred Jones



BIG OPPORTUNITY STUCCO SPRAYING

Renew old buildings. Make new construction more permanent and attractive. Plastic Colorcrete is waterproofed. It fuses with any masonry surface. It fills all cracks. It can be applied in any thickness and in 30 colors. Fully proven by over 12 years actual use under all conditions and every climate.

OFFERS BIG EARNINGS

Owners everywhere want to enhance present values. With this machine you can supply this big waiting market with permanent Colorcrete at amazingly low cost. Operators report cost of 2c and up per sq. ft. and sell up to 7c. Some have paid for their equipment from first few jobs. Machine capacity up to 1,000 sq. ft. per hour. Get the facts. Send for the books, "Proven Business Opportunity." Write today. It offers you big extra income.

COLORCRETE INDUSTRIES, INC.
570 Ottawa Ave. Holland, Mich.



BUILD ELECTRIC FENCE FROM OLD FORD COIL

Costs nothing to build—Dime brings complete Plans (formerly 35c) and Big NEW T COIL catalog listing over 550 electrical items at new low money saving prices. Send 10c to **LEJAY MFG., 1947 LeJay Bldg., Minneapolis, Minn.**

BERRY'S New POULTRY BOOK

52 BREEDS BERRY'S Hand-Picked CHICKS, also SEXED, STARTED. 52 Breeds. 5 HYBRIDS, World-Famous Money Makers. All Iowa Inspected, Pullorum Tested. Fowls, Turkey Poults. 40 years' Service. **LOW PRICES, Beautiful POULTRY BOOK FREE**, stamps appreciated. **BERRY'S POULTRY FARM, Box 29, CLARINDA, IOWA**

A AND N SUPPLY CO.

Bargains—Military, Sport Goods, Firearms, Clothes, Shoes, etc. Send 10¢ for new catalog, to be redeemed on first order.

EST. 1868 **A & N Supply Co., 4772 Lester St., Richmond, Va.**

Earn Cash at Home!

We paid M. M. \$1174 for exceptional cellar crop Snow-King mushrooms! We furnish materials; buy all crops. Big FREE picture book tells if your cellar, shed, barn, suitable. Est. 1908. Write today. United Co., 3848 Lincoln Av., Dept. 306, Chicago

ATLAS Stick-On Letter & WINDOW SIGNS

Beautiful GOLD Colored. New Styles. 5 year Guarantee. Large Sizes—Penny each. Tremendous Demand. Amazing Profits. Write for FREE SAMPLES and Starting Equipment. HURRY! **ATLAS Sign Works, 7943 Halsted, Chicago**

5c TIRE MAKES \$2.00 MAT

Make springy, long-wearing Rubber Mats out of old auto tires. Any length or width. BIG sale to schools, factories, stores, homes. Think of the profit. Brand new business. Field untouched. Reasonable investment and simple hand machine starts your local plant. Write quick for free information. Don't lose a minute—this is BIG!

FABRIX, INC. Dept. A-73 620 No. Michigan Ave., Chicago, Ill.

JIG SAW \$1.50

COD or outside U.S.A. \$1.25

POST PAID

Including 12 assorted blades, Adapters, Manual, and roller Saw Guide formerly found on expensive machines only. All metal, 15" long, 8" high, 6 1/2" table. A swift and easy cutter—best ever made for the money.

FREE CATALOG describing \$150 prize contest (1st prize, \$25; 2nd, \$15; 3rd, \$10; 66 other cash and merchandise prizes). Cat. illustr. complete power tool line: Shaper, Circular Saw with oilless bearings, \$3 each; Drill Press, \$2.50; completely equipped Lathes, \$2 and \$4.90; Sander, \$1, etc. Order today or send card for Catalog.

J & H Metal Products Co. 5 Commercial St. Rochester, N. Y.

FREE TRIAL OFFER

NEW REMINGTON NOISELESS PORTABLE

AS LOW AS

10¢ A DAY



The famous Remington Deluxe Noiseless Portable that speaks in a whisper is yours for a small initial deposit and terms as low as 10c a day! Brand new; standard

keyboard; automatic ribbon reverse; variable line spacer; PLUS the famous Remington NOISELESS feature.

YOU DON'T RISK A PENNY. Try the famous Remington Deluxe Noiseless Portable for 10 days. If you are not satisfied, send it back. We pay all shipping charges and refund your good will deposit at once.

FREE Typing Booklet, SPECIAL Carrying Case. With your purchase of a Remington Deluxe Noiseless Portable, you will receive free of charge, an instruction book on touch typing. Also, a sturdy carrying case is included in this price. You will incur no obligation. Send coupon now.

Remington Rand Inc., Department 152-3
465 Washington St., Buffalo, N. Y.

Tell me without obligation how to get a free trial on the new Remington Deluxe Noiseless Portable, including the carrying case and free typing booklet, for as little as 10c a day. Send catalog.

Name.....
Address.....
City..... State.....

Start YOUR OWN BUSINESS Be An Electric Engraver

Here is a quick and easy way to start a business of your own. You need no experience to learn. Amazing new invention, the **ELECTROGRAVER**, opens new profit field. As Easy to use as a pencil. Engraves beautifully on brass, steel, glass or bakelite. Sensational Idea! Nothing else like it!

BEGIN AT HOME IN SPARE TIME

The Electrograver is ideal for engraving names on Social Security Plates, name plates, key checks, dog tags, jewelry, fountain pens, cigarette cases and tools. Will also duplicate actual signatures on metal or glass. Operates from AC light socket or battery. Outfit as low as \$13.50. Send \$13.50 today for complete outfit and receive 50 Goldtone Social Security Plates Free or write at once for details.

William Moore Mfg. Co., 653 S. State, Chicago

Sani-Flush **SAFE, NOT CAUSTIC**

KEEPS AUTOMOBILE RADIATORS CLEAN

The WISE ONES SAY

"Keep a jar or tube of Lucky Tiger Ointment handy"

Made to allay Itching and Burning Feet—Crusty Scaps—Ringworm—Rectal Irritations—Prickly Heat—Insect Bites—Stings—Itchy Scalp Irritations—Externally caused Pimples—Soothe fire and sunburns.

Get a jar at your drug or 10c store or applications at barber shop.

ANTISEPTIC FOR Inhibitory Use when in proper contact—as in bandage or dressing for simple Cuts, Wounds, and Scratches.

FREE 25c Trial Tube if you send us name of your druggist or barber.

LUCKY TIGER MFG. CO.
Dept. 77 Kansas City, Mo.



FREE WHOLESALE CATALOG

For Salesmen

Shows 4000 World Wide Bargains. 260 pages of Big Values. 15 selling plans. This fascinating book of Opportunity is FREE. Write for a copy today.

GUVERNOR PENS & PENCILS

No. R400 Plunger filler fountain pen. Fills and empties in one operation. Fitted with non-tarnishing, size 4 durium point. Transparent barrel shows when to refill. An astounding value, offered at a price so you can make a long profit. Jet black color.

Sample 13c Dozen \$1.40
Gross \$16.70

No. R405 Mechanical pencil to match above pen. Has repel and impel movement. Compartment for leads.

Sample 8c Dozen 90c
Gross \$10.80

No. E308 Elgin quick shave electric shaver. Features: precision motor; operates on A. C.; chrome plated head. Compare with high priced electric shaver performance. Ready to operate. (Sales coupons 85c per 1000).

Sample 85c Dozen 80c each 6 Doz. 79c each

SPORS CO.

COSTS YOU

85c
ELGIN



BUILD YOUR OWN AC. GENERATORS

You now can buy all parts ready for assembly to change old six volt auto generators to 110 volt A.C. Make extra money at home building light plants. Send now for catalog of parts.

CARMI TRANSFORMER WORKS
202 Staley St. Carmi, Ill.

GROW PLANTS WITHOUT SOIL Startling New Development

Complete Directions for Small and Large Scale Growing

Get the new book "Soilless Growth of Plants" and learn this new

technique which everyone is talking about. Three methods described—Water Culture, Sand Culture, Sub-Irrigation. Explains all operations. Tells how to make containers and nutrient solutions from raw materials at small cost—how to grow flowers, vegetables and fruits without soil. A fine hobby and a money-saving investment for city dwellers. A source of new business for gardeners, nurserymen, etc. Only book of its kind. Order today "Soilless Growth of Plants." Sent postpaid for \$2.75.

POPULAR MECHANICS PRESS Dept. 339B 200 E. Ontario St., Chicago

PHOTOGRAPHY—Catalog of over 200 recommended books on ever phase of the art. Sent free on request.
POPULAR MECHANICS PRESS, 200 E. Ontario St., Chicago

BOOKS—OPPORTUNITIES
List sent free upon request
Popular Mechanics Press, 200 E. Ontario St., Chicago

BUILD a BOAT AT HOME

FOR PLEASURE OR PROFIT

Now you can have just the boat you've always wanted—power, sail, or rowboat—and at rock bottom cost, plus the fun of building. Make a nice profit if you want to sell. Get the

BOAT BOOK—New Edition

Have Your Own Boat This Year or Build Them to Sell

This famous book with 6 new boats added, shows exactly how to build 15 different popular boats. Step-by-step instructions with hundreds of pictures. Gives all plans, methods and materials. Includes racing, hydroplane, inboards, outboards, sailing and sectional boat to carry on car. Also old Ford motor for marine use and all boating terms, pilot rules, boat links, navigation rules, etc. You can't go wrong. Specially prepared for those with limited tools and skill. Price only \$3. Write for descriptive folder or order now and pay postman on delivery.



Popular Mechanics Press
Room 339B
200 East Ontario Street
CHICAGO



SNAP-UP Electrically operated GAS TANK LOCK

At last—An amazing invention makes possible this remarkable Electric Gas Cap. NO KEYS—To operate just press a handy button on your dash—cap unlocks and SNAPS open. Close the cap and it locks automatically. Fully guaranteed. THE COMING THING—Wonderful opportunity for Agents and Dealers. Write immediately for exclusive distributorship proposition.

SNAP-UP GAS CAP CO., INCORPORATED

ASHLAND, KY.

DECORATIVE Decalcomania Transfers

Imported Designs of all Sizes and Types—Flowers, etc.—for Furniture, Walls, Trays, and what not. Catalog with 800 illustrations in Color sent for 25c. Deductible on first purchase of \$1.00 or more.

L. C. WELLS, Dept. P. M. 93, 25 East 26th Street, New York

SPARE TIME MONEY . . .

There's a big demand for the many hand-tooled articles you can make with the Easco Leathercraft Set. Easily learn to make good money in your spare time. Complete outfit including tools, leathers, patterns, etc., and full instructions, only \$2.00—on sale at leading Department Stores or order direct and pay postman on arrival. \$2.50 outside U. S.

LEATHERCRAFT

Free When ordering direct, clip name of your Department Store to this ad, and we will include with your set, one extra free project. Sample Project 10c.
E. A. SWEET CO. Dept. A-22 Binghamton, N. Y.

Get this Book Now!

MONEY MAKING FORMULAS
1059 PRICELESS FORMULAS ALL IN ONE BOOK FOR \$1.25

FORTUNES MADE WITH FORMULAS LIKE THESE

- Cosmetics
- Remedies
- Beverages
- Paints
- Glues
- Polishes
- Inks
- Soaps
- Fertilizers
- Preservatives
- Lubricants
- Auto Products
- Food Products
- Metal Products
- Etc.

Hundreds of big selling products—earning millions in profits—grew from a simple formula. Your own product may bring you fame and fortune. Get this big 200 page book with 1059 formulas, and start a spare or full time business of your own. Everything explained—what to make—how to make it—where to get materials. This is the book that lifts the veil of secrecy from a profitable and fascinating business. Get your copy now. Only \$1.25 postpaid.

Popular Mechanics Press, Dept. 339-B, 200 East Ontario St., Chicago

HELP! HELP! **I'LL FIX YOU STRONG AS EVER**

Fix up your crippled furniture, chipped veneers, splintered mouldings with Rogers Glue . . . they look like new. . . . Stays put longer because it's stronger — 10c and up in tube, bottle and can at hardware stores or send 10c for full size bottle and free set of project plans.

ROGERS, Gloucester, Massachusetts



ROGERS
the best LIQUID FISH GLUE

ROGERS
SAYS GLUEKY

ROPP'S COMMERCIAL CALCULATOR

Mathematics Made Easy by ROPP'S CALCULATOR AND SHORT-CUT ARITHMETIC

Shows the Answer as Quickly as a Watch shows the Time to all Problems likely to occur in the Office, Store, Shop, Bank, Farm, or Factory.

Over 2,000,000 Sold
Explains and simplifies every principle in Arithmetic, Mechanics, and Mensuration.

PRICES POSTPAID

Desk Size, Flexible Keratol Binding. \$2.00
Pocket Size, Art Leather Binding. \$1.00
Pocket Size, Cloth Binding, \$0.50

POPULAR MECHANICS PRESS
Room P.3 200 E. Ontario St. CHICAGO

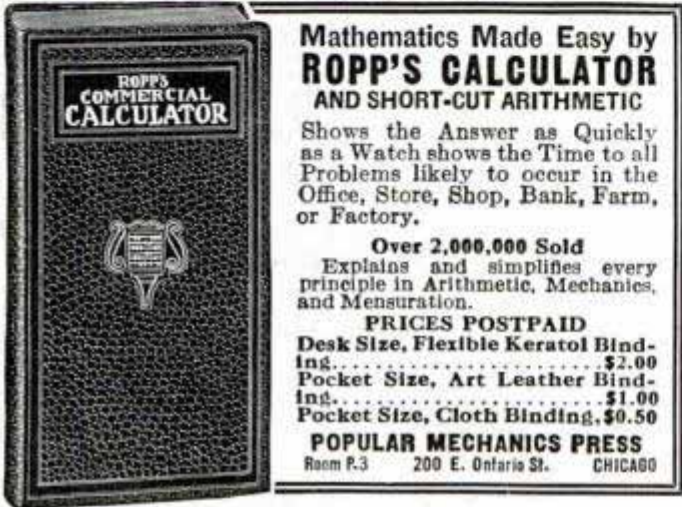

In answering an advertisement with a coupon, be sure to write name and complete address clearly. Sometimes advertisers are unable to respond to inquiries due to lack of complete information.

HAND SIZE MACHINE SHOP... Anyone Can Operate AT HOME

ALL-PURPOSE TOOL EVEREADY



The "EVEREADY" precision-built, power tool gives unsurpassed performance. Accurate—perfect balance—powerful—easy to handle. Ideal for delicate or heavy work. A real hand-size machine shop for drilling, grinding, cutting, polishing, engraving, routing, cleaning, sanding and sawing any material. Uses over 200 different standard size accessories, instantly interchangeable. Useful to hobbyists for sculpturing, etching, engraving, wood carving—ideal for pattern makers, laboratories, dentists, sportsmen, etc.

10 DAY NO RISK TRIAL

14⁹⁵ VALUE



DE LUXE HEAVY DUTY MODEL

Powerful, precision-built full ball bearing motor to stand steady, exacting work. Operates on 110 Volts AC or DC any cycle current. Weight 16 ounces, speed 22000 RPM.

Price complete with 5 accessories, packed in handy wooden case, only \$8.95 postpaid, or sent C.O.D. for \$1.00 deposit.

10 DAY MONEY-BACK GUARANTEE TRIAL. Send for your "EVEREADY" today!



DE LUXE MFG. CO., 173 W. Madison St., Dept. A, Chicago, Illinois

"You can earn \$150 to \$300 extra profit monthly with this HOBART WELDER"

30 Days Trial
in your shop on your own work to prove it
SEND for complete details



Get Into Arc Welding With Dependable, Long Life HOBART 40-Volt Equipment

You can now build a big paying business of your own with a new "Simplified" Hobart Arc Welder. Prices are the lowest in arc welding history . . . low enough to allow even the smallest shops to own one of these new welders. Extra profits will pay for it in a short time. And remember, there must be a good reason why Hobart is the fastest selling arc welder on the market today. Arc welding is today's profit opportunity . . . don't miss it!

Remote Control This is an important feature you get at no extra cost with Hobart. It lets you control your welder from any working point. Saves time, temper and eliminates the need for a helper on overhead or concealed work.

Easy to Operate Hobart Welders have "Simplified" operation. This means faster welding—with the right current for every job. Hobart is simplified, so any of your men can weld easily and successfully. The mystery and uncertainty of obtaining correct welding current settings are removed.

60% Extra Capacity Over old style 25-Volt Welders . . . necessary for welding with the new coated rods. Automatic reactance lets you handle light welder work without losing the arc. Users don't understand how they got along with old style welders after trying this new Hobart. Furnished in ELECTRIC DRIVE, GASOLINE ENGINE DRIVE, or GENERATOR ONLY.

"Pays-for-Itself" Terms You have 30 days trial at our risk to prove that extra earnings and savings obtainable with this improved welder makes it easy for you to own a Hobart with practically no cash outlay.

"Build Your Own" Let us tell you how you can build your own portable electric welder by using Hobart generator and coupling to your own engine and chassis. This equipment lets you operate any place, especially on the profitable outside jobs. Check coupon for detailed information.

HOBART One of the World's largest builders of Arc Welders

HOBART BROS. CO., Box M-39, Troy, Ohio

- Tell me more about—
- Building My Own Portable Welder
 - Complete Gas Engine Drive
 - Electric Drive Welder
 - Send FREE Book on "New Profits in Arc Welding"

Name

Address

Interested in 30 DAYS TRIAL EASY TERMS

Own this PROFIT MAKER for only \$20 MONTHLY

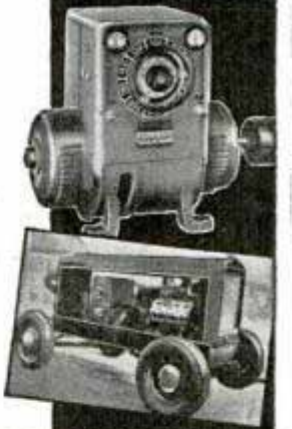

Build Your Own Arc Welder with above Hobart unit SAVES YOU \$300 TO \$500

Use this Coupon to get FREE Arc Welding Book



When writing please mention Popular Mechanics

NEW KIND OF PIPE



ELIMINATES "GOO" BY PREVENTING CONDENSATION OF MOISTURE

CLEANS LIKE A GUN

A sensational and entirely new pipe invention—Dr. Shotton's SANATON! No condensation of moisture to form "goo." Cleans like a gun—straight through from END TO END! Has FULL FREE OPEN straight draft! STAYS LIT! Stem never needs removing!

UP TO 150% PROFIT FOR AGENTS

What an opportunity for salesmen! One minute, startling demonstration sells it. Popular priced. Patented in United States, Canada and England. Not sold in stores—no competition. One distributor in one city has already sold over 9000 pipes. Rush name and address for SAMPLE OFFER and complete information. Territory allotments now being made.

FOSTER PRODUCTS, INC., DEPT. C-50
1965 E. 66th St. CLEVELAND, OHIO

FENCING

WORLD'S FINEST SPORT HARMLESS-EXCITING FUN
Develops strong body and alert mind. HARMLESS. The spring-steel 3-foot-long foils (swords) are equipped with rubber buttons. Aluminum cup-shaped hand guards. Our De Luxe foils are built for hard usage. Complete set of two foils (swords) and free instruction booklet, only \$1.98. We pay postage. ORDER NOW.
ALL-AMERICAN FENCERS GUILD, Dept. 3PM, 48 W. 48th St., New York

Make Big Money The American Way

Get into something for yourself where your income is practically unlimited—the AMERICAN ELECTRIC METHOD of floor surfacing gives you that opportunity. Large profits—work easy to get—no previous experience necessary. Start with as little as \$75 in this tried and proven money-making business. Write quickly—no cost or obligation.

The American Floor Surfacing Machine Co.
523 South St. Clair Street • Toledo, Ohio

SHELDON

Back Geared Screw Cutting PRECISION LATHES \$98 F. O. B. CHICAGO

The SHELDON "METALWORKER" is a sturdy, full sized, full weight, back geared, screw cutting, 10" precision lathe, built to industrial standards with hob-cut change gears, hardened and ground spindle, hand scraped V-way, etc., etc. 10 1/4" swing, 1 1/16" hole thru spindle, 20" center distance, 38" bed, complete with compound rest, tool post, change gears, face plate, centers and wrenches (as illustrated) less motor drive \$98.00 F. O. B. Chicago.

Write for FREE Bulletin on Sheldon Lathes, drives, attachments and tools. Easy Payment Plan and names of local distributor.



SHELDON MACHINE CO. INC.
3265 South Cottage Grove Chicago, U.S.A.
Write for Catalog

Only 15c A Day
Puts This All-Purpose ELECTRIC ARC WELDER IN YOUR SHOP

TEN-DAY TRIAL

Guaranteed: 10 Months To Pay

Now, for first time, it is EASY for every inventor, laboratory, home workshop owner, garage, repair shop, and factory to afford a complete welding service for manufacturing, maintenance, experimental, or repair work. Full size, heavy-duty Aladdin Electric Arc Welder—yours for only 15c a day! Has efficiency of machines costing \$250.00 to \$1,000.00. Welds all metals and alloys. Handles everything from fenders and light sheet metal to motor blocks and heavy castings. Also fine for soldering and brazing.

WORKS ON 110 OR 220-VOLT A. C. Simply plug into 110 or 220-volt, 60-cycle A. C. electric socket. Costs only few pennies an hour to operate. Anyone can use easily. Comes complete with helmet, electrode holder, welding rods, full instructions, etc. Nothing else to buy. Fully guaranteed.

WRITE FOR 15c A DAY PLAN. Stop throwing away profits! Do your own welding. Get sensational facts about Aladdin Arc Welder and 15c-a-day plan. Write today!

COMMONWEALTH MFG. CORP.
Dept. U-51 4208 Davis Lane, Cincinnati, O.

Why Is MODEL RAILROADING A Favorite Hobby Of SUCCESSFUL MEN?



Because it's a fascinating pastime (not expensive) and it keeps their faculties keenly alert! The whole thrilling story of this grand hobby is told in the new Scale-Craft Catalog—with charts, diagrams, illustrations—revealing its full fascination. A joy to read! Invaluable for reference! Send 25c today for your copy to SCALE-MODELS, INC., 1516 S. Wabash Ave., Dept. A, Chicago, Illinois.

RESOLE SHOES

FOR ONLY 4¢ EACH

SO-LO mends holes, worn spots in rubber, leather, cloth. Spreads like butter. Dries tough overnight. Flexible, non-skid, waterproof. Won't come off—guaranteed! 25c (25 repairs). At all 10c and hardware stores.

PRESTO! ANYONE CAN MASTER GLAZE

LEAVES HARD GLASS-LIKE FINISH
EASY TO APPLY
PROTECTS THE SURFACE
NO SMEAR OR STREAKS AS WITH WAX
LASTS SIX MONTHS TO A YEAR
SEALS THE PORES OF THE SURFACE
WILL NOT FINGER-MARK
NO DILY FILM AS WITH POLISH
EASY TO KEEP CLEAN
SAVES YOU MONEY

Car Owners! Meet Master Glaze—the sensationally different luster for new and used cars! Not a wax—not an oil polish—not a paint!—nothing that "smears" over the surface.

MASTER GLAZE is a unique discovery—a creamy liquid—quick and easy to apply! Gives a hard, glass-like surface. Even gasoline cannot dull it! Lasts six months to a year! Amazing luster—beautiful, sparkling clean and brilliant! Doesn't finger-mark—doesn't smear! A match box full glazes an entire car. Seals the pores—protects! NOTHING LIKE IT!
FREE Write now for FREE BOOKLET and **FREE SAMPLE OFFER, FREE TRIAL OFFER.** Just send your name and address. Write **MASTER GLAZE CO., 7720-45 W. Harwood Ave., Milwaukee, Wis.**

SpeedWay

Real Quality Tools

Designed, manufactured and guaranteed by SpeedWay, for 30 years leading manufacturers of industrial drills, these are really fine tools, correctly designed, correct speeds, genuine high torque drill motors. Small, handy, powerful; 1000 RPM—drill handles to 1/4" in steel. Die cast handle and gear housing. \$7.95. Grinder operates at 29,000 RPM. (high speed is essential for good grinding). With collets for 1/8" and 3/32" arbors, \$2.95. No. 200 KIT, both drill and grinder with 5 accessories in steel carrying case \$14.95. Complete line of accessories and drill press stands. Write for Circular. Dealers Write **SPEEDWAY MFG. CO. 1822 S. 52nd Ave., Cicero, Illinois**

DRILL \$7.95

GRINDER \$5.95

SET \$14.95

NEW KIND OF MAN'S SHOE

The new sensation in men's shoes — The Chippewa Clipper. It zips on and off in a "jiffy". Right now is the right time to get into a dignified and highly profitable shoe business of your own with this fast seller, and a complete line of almost 250 styles of dress, work and sports shoes. Prices as low as \$1.98 a pair. Free 10-second demonstrator sells super-comfort air-cushion shoes like magic.

Manufacturer established 35 years wants salesmen. No experience needed. Write for complete sales kit. It's free!

MASON SHOE MANUFACTURING CO.
Dept. 8-14 Chippewa Falls, Wisconsin

ZIPS ON and OFF

SALESMEN WANTED BIG PAY EVERY DAY



HAVE DEPENDABLE FORD BRAKES

Your Ford Car is listed in the so-called lower priced class but has more brake lining area and larger drums than the others, in fact as much or more brake area than all but the higher priced cars. You can have safe, sure, unfailing mechanical brakes. Install easily yourself our Simplex Floating Wedges to center the shoes for mechanical assurance with hydraulic performance. A set of four, one for each wheel, all for \$1.75. All models 1928 to 1938—Send for circular.

SIMPLEX WEDGE EXCHANGE, Dept. PM-11, 613 Jefferson St., Ottawa, Ill.



A PRECISION ELECTRIC FENCER

PARMAK

NOW ONLY \$9.90

Now the World's Largest Selling Electric Fencer

More than 50,000 farmers saving millions of dollars with PARMAK. One wire on light stakes costs only a small fraction of ordinary barbed or woven wire fence. A harmless electric sting holds all livestock like steel and concrete. Five new precision models. 30 DAY TRIAL OFFER proves that PARMAK is superior.

SEND FOR FREE CATALOG

DEALERS—Agents—Distributors—wanted. Big profits on fencing season just starting. Many valuable EXCLUSIVE territories open for immediate acceptance. (Est. 1923)

Parker-McCrory Mfg. Co., 100-C, Kansas City, Mo.



Amazing Invention REMOVES FILTHY DIRT FROM DRINKING WATER

Every home that is faced with the problem of filthy drinking water will welcome the new **AUTOMATIC Water Filter** which instantly delivers clear sparkling water — clear as regular spring water — by filtering it through cellulose fibers right at the faucet as needed. It is so convenient and inexpensive that every home can afford this Water Filter.

AUTOMATIC WATER FILTER, 600 S. High St., Dept. 175, Akron, Ohio

MILLIONS of people who are drinking water can now have crystal clear water with the **AUTOMATIC Water Filter**.

AGENTS! Make \$9.00 a Day — easy for taking only 8 orders from housewives who buy on five minute demonstration. Get yours FREE for introducing it.

When writing please mention Popular Mechanics



FREE!

Home Workshop Handbook



● Helps woodworkers from beginner to Master Craftsman. Contains a list of free and low-cost booklets offered you by leading experts on Tools, Finishes, Sharpeners, Cabinet Woods and Veneers, Project Plans and Workshop Clubs. First book with *all* this information. Mail coupon *now* for your copy. (Save 2c—stick coupon on penny postcard.)

CASCO POWDERED CASEIN GLUE

10c TO 65c AT HARDWARE STORES

CASEIN COMPANY OF AMERICA
350 Madison Avenue, Dept. PM-339, New York, N. Y.

Yes, send me your free "Home Workshop Handbook"

Name _____

Address _____

Syncro JIG SAW

Faster! Safer! Cleaner! Real performance. Cuts with smooth, clean edges. No sanding required. Electric operation. No motor or reciprocating parts. Operates on 60 cycle, 110 volt A.C. Ideal for home craftsmen, and model makers. Two models.

Write Today for **FREE LITERATURE**

Export Office: 40 Worth St., New York; Western Dist.: Federated Sales Co., 2437 W. Valley Blvd., Alhambra, Cal.

7200 Strokes per minute

Only \$4.95 (East of Rockies)



511 Boydell Bldg. Detroit, Mich.

FREE CAMERA BOOK!

Illustrates latest developments in photography and Home Movie Making, for fun and profit. Offers hundreds of new and used still, movie cameras, lenses, films, exposure meters, enlargers, darkroom supplies—everything photographic. All guaranteed — many at big savings. Central offers you America's most complete, varied stock of foreign and domestic merchandise from world's leading makers: Eastman Kodak, Zeiss, Bell & Howell, Graflex, Gevaert, Korona, Bausch & Lomb, etc. **SAVE at Central!** Satisfaction guaranteed or money back. We take your old camera and equipment in trade. Write for Free camera book!

CENTRAL CAMERA CO., 230 S. WABASH Dept. K-3, CHICAGO, U.S.A.

PHOTOGRAPHIC HEADQUARTERS since 1899



**WRITE FOR YOUR COPY
OF THIS FREE
32 PAGE BOOK**



Showing The New 9" South Bend Workshop Precision Lathe . . .

A Back-Geared; Screw Cutting Lathe of Highest Quality and Accuracy. Used by Leading Manufacturers for Doing All of These Metal Working Jobs:

Drilling, turning, boring, reaming, cutting screw threads, facing, milling, filing and chucking, in steel, iron, wood, plastics and all other machinable materials.

Insist on These Important Precision Lathe Features

1. Hand-scraped V-ways on lathe bed
2. Precision Machine Cut Steel Gears
3. Precision Lead Screw Cuts Screw Threads 4 to 112 per Inch.
4. All Steel and Iron Construction
5. Ball Thrust Bearing on Spindle
6. Twin Gear Reverse for Right and Left Hand Threads and Feeds
7. 3/4-inch Hole Through Headstock Spindle has Collet Capacity of 1/2".

Send Coupon FOR THIS NEW BOOK

Illustrating, describing and pricing the new 9" Lathe in 3', 3 1/2', 4' and 4 1/2' bed lengths and 8 different drives. Shows 38 attachments for use with the lathe and gives in clear detail important features and construction.

SOUTH BEND LATHE WORKS, 639 E. Madison St., South Bend, Ind., U.S.A.
 Please send me Free of charge, Postpaid, the new Catalog No. 46-B for Machinists and Mechanics and the South Bend Easy Payment Plan.

Class of Work.....
 Name.....
 Address.....
 City..... State.....

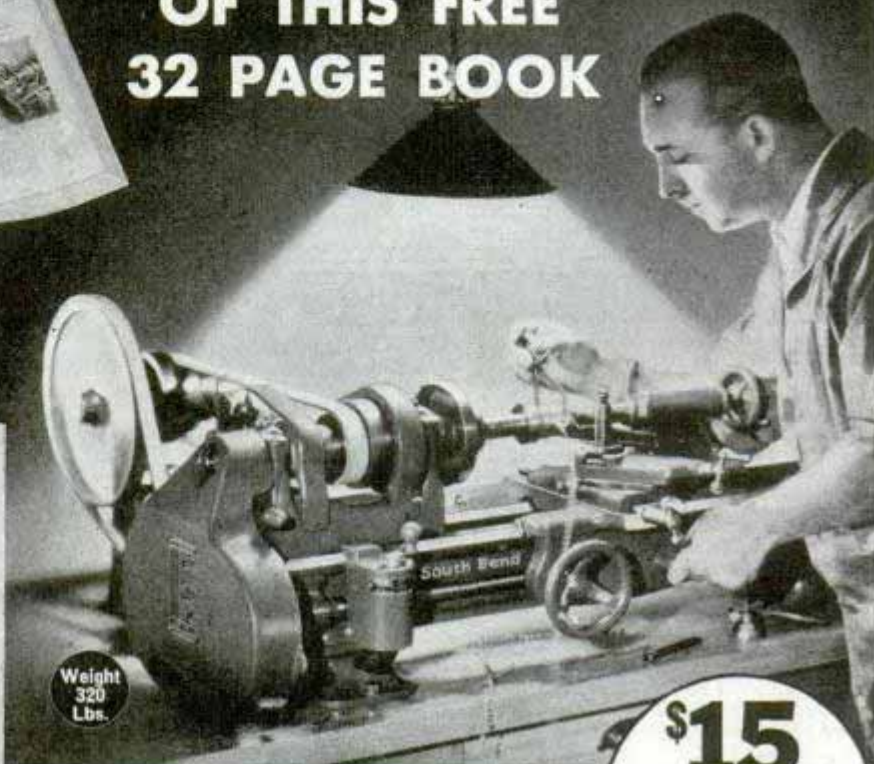

Weight 320 Lbs.

No. 415-YA, 9 1/4" swing by 3' bed Workshop Bench Lathe with Horizontal Motor Drive, 3/4 H.P. Reversing Motor, Switch, Belts, Change Gears and Adjustable Belt Tension **\$117**
 Countershaft.....

\$15
 Down Payment
PLACES THIS LATHE IN YOUR SHOP
 Balance \$6 Monthly

THIS new book shows the 9-inch precision lathe that is used by every class of industry for handling machining operations. Its important features and construction, illustrated and described in the book, are the reason for industry using this 9-inch South Bend Workshop Lathe so extensively in Manufacturing plants, Machine shops, Tool rooms, Laboratories, and Repair shops.

The 38 attachments available with the 9" lathe make it an all-purpose tool, and make any shop in which it is installed complete. Does milling, grinding, draw-in collet chuck work, taper work, and other operations.

Other important features include: automatic longitudinal screw feed to carriage, 5/8" tailstock set-over for taper turning, micrometer graduations on compound rest and cross feed screws, adjustable gibs on compound rest and cross feed.

South Bend Precision Lathes are manufactured in five other sizes—9", 11", 13", 15" and 16" swing, in bed lengths 3' to 12', in Countershaft Drive and Motor Drive. Priced \$85 to \$1500.

SOUTH BEND LATHE WORKS
 639 East Madison St., South Bend, Ind., U.S.A.

SOUTH BEND
Precision **LATHES**

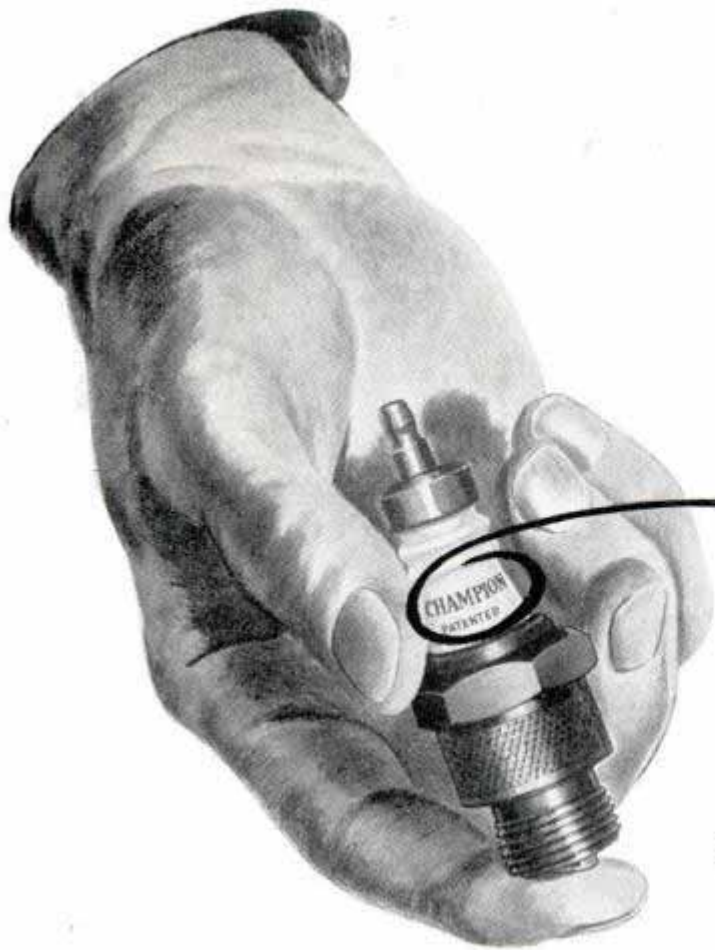

This is the spark plug **Champions**

use!

The best spark plugs for your car are those that are outstanding in open competition. In racing, Champion Spark Plugs are the choice of racing champions. Because of the better performance they bring to every engine, Champions have for fifteen consecutive years equipped the vast majority of all victorious racing engines everywhere.



IT IS THRIFTY TO INSTALL NEW SPARK PLUGS — DEMAND CHAMPIONS

WATCH
YOUR
NERVES

LET UP LIGHT UP A CAMEL

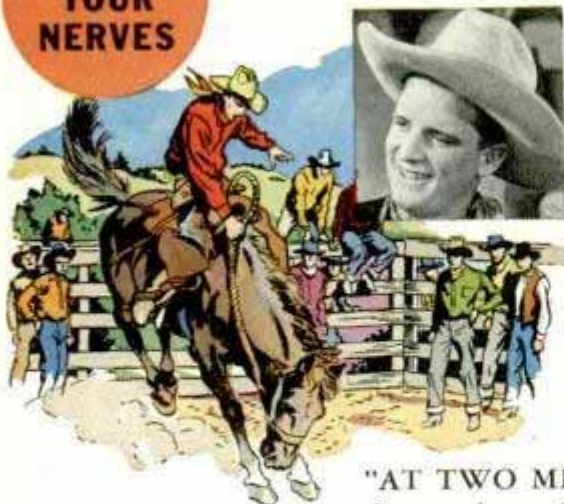

BAREBACK RIDING TITLES fall to rodeo star Carl Dossey (left) because of his splendid muscular control and the fact that he keeps his mind one jump ahead of the "bronc." But that means plenty of good old-fashioned nerve strain for Carl. "It's tough, exciting work," says he, "that would soon get my nerves jittery if I didn't ease off regularly. It's a rule with me to let up—light up a Camel every time I get a chance. Camels are mighty comforting. Most cow-punchers I know go for Camels."

"AT TWO MILES A MINUTE on a dirt track anything can happen!" says Ernest Gesell, Jr. (right), who won a National Circuit Championship in midget auto-racing. "Skids, crashes put a big strain on my nerves." Naturally, Ernie values steady nerves. And it's a rule with him to give his nerves frequent rests—to let up—light up a Camel.



In hazardous jobs —
in every-day "grinds"
— smokers say
**"CAMELS ARE SOOTHING
TO THE NERVES"**



JOAN NELLIGAN is a proof-reader. Like so many other people in every-day occupations, she doesn't live a hazardous life, but there's plenty of nerve strain in the kind of close work she does. She concentrates intensely to keep mistakes from getting into print. Her rule for resting her nerves is this: "When I feel 'nerve fag' coming on," she says, "I let up—light up a Camel. Camels soothe my nerves. I can smoke as many as I please. Camels are so mild. They never tire my taste!"



TWO AND ONE-HALF MILLION miles of flying without an accident! Meet Captain "Jack" Knight, United Air Lines. "I make it a firm rule to keep my nerves from getting strained and jumpy," says Captain Knight. "Every opportunity, in the air or aground, I let up—light up a Camel. Camels are really soothing—a grand smoke!"



Smoke 6 packs
of Camels and find
out why they are the
**LARGEST-SELLING
CIGARETTE
IN AMERICA**

COSTLIER TOBACCOS

Copyright, 1939, R. J. Reynolds
Tobacco Co., Winston-Salem, N.C.