

DAVY JONES' TREASURE CHEST

# POPULAR MECHANICS

MAGAZINE



WRITTEN SO

YOU CAN UNDERSTAND IT

REG. TRADE MARK, GREAT BRITAIN, U.S. PAT. OFF.

REG. U.S. PAT. OFF.

**FEB.  
25 CENTS**

**SEE COLOROTO  
SECTION**





# IF I FAILED...WE WERE ALL DEAD MEN



LASHED TO SHROUDS  
OF SINKING,  
BURNING SCHOONER,  
SAILORS SEE HOPE  
OF RESCUE FADE

① "The dream of my life, for which I had saved since I first went to sea at twelve, had come true!" writes Capt. Hans Milton of 610 West 111th St., New York City. "I was making my first voyage as master and owner of my own vessel, the two-masted topsail schooner 'Pioneer,' when the hurricane of last September caught us 400 miles off Nantucket.



② "We were pumping to keep afloat when we passed into the windless vortex of the storm where the waves were leaping and jumping crazily and where they crashed in our companion ways and filled the ship beyond hope of saving her.

The five of us and the cat scrambled aloft for our lives. Our deck-load of lumber kept us afloat and without fresh water and with almost no food we lived, lashed to the rigging, for three endless days and nights.

③ "Once a steamer hove in sight—but failing to see our distress signals, went her way. At 3 a.m. on the fourth morning steamer lights showed momentarily over the wild sea. We rigged a huge ball of sails and blankets, soaked it with gasoline, touched it off and hoisted it aloft.



④ "But the steamer did not change her course. She thought we were fishing. The wind blew burning fragments back on the ship setting her afire in various places. I could see the stern light of the steamer going away from us. *If I couldn't stop her, we were all dead men!* I climbed to the fore-top and in desperation pulled my flashlight from my back pocket and in Morse code signalled 'Sinking... SOS... Help!'

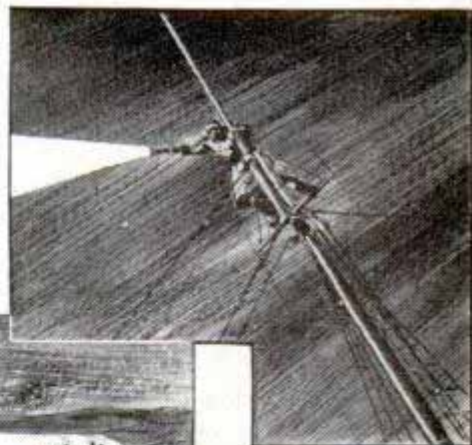

⑤ "Slowly, I saw the ship turn! In her last hour afloat, all of us and the cat were saved from the sinking, burning 'Pioneer' by those fine seamen of the United States Liner 'American Banker' and by the power of two tiny 'Eveready' fresh DATED batteries that stood by us in the blackest hour of our lives!

(Signed) *Captain Hans Milton*

**FRESH BATTERIES LAST LONGER... Look for the DATE-LINE**



NATIONAL CARBON COMPANY, INC., 30 EAST 42nd STREET, NEW YORK, N. Y.

Unit of Union Carbide  and Carbon Corporation



# A Better Built Car In Every Way

**YET PRICES  
ARE LOWER**



STANDARD EQUIPMENT on "De Luxe" models at no extra cost—Perfected Remote Control Shifting with Auto-Mesh Transmission.

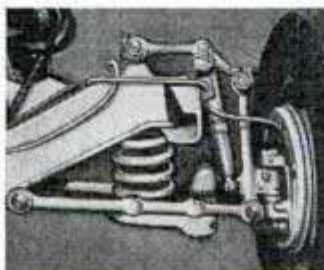

NEW AMOLA STEEL Coil Springs, finest design known, give Plymouth a wonderful new ride. Amola Steel is the new marvel of metallurgy.

## You See Finer Quality in Every Detail!

1. 114-inch Wheelbase.
  2. Thrilling High-Torque Engine Performance with New Economy.
  3. Perfected Remote Control Gear Shifting.
  4. Amola Steel Coil Springs.
  5. Ingenious new "Safety Signal" Speedometer.
  6. New Streamlined Safety Headlamps—greatly increased road lighting.
  7. Time-Proven, Double-Action Hydraulic Brakes.
- EASY TO OWN**... your present car will probably represent a large proportion of Plymouth's low delivered price... balance in low monthly instalments.

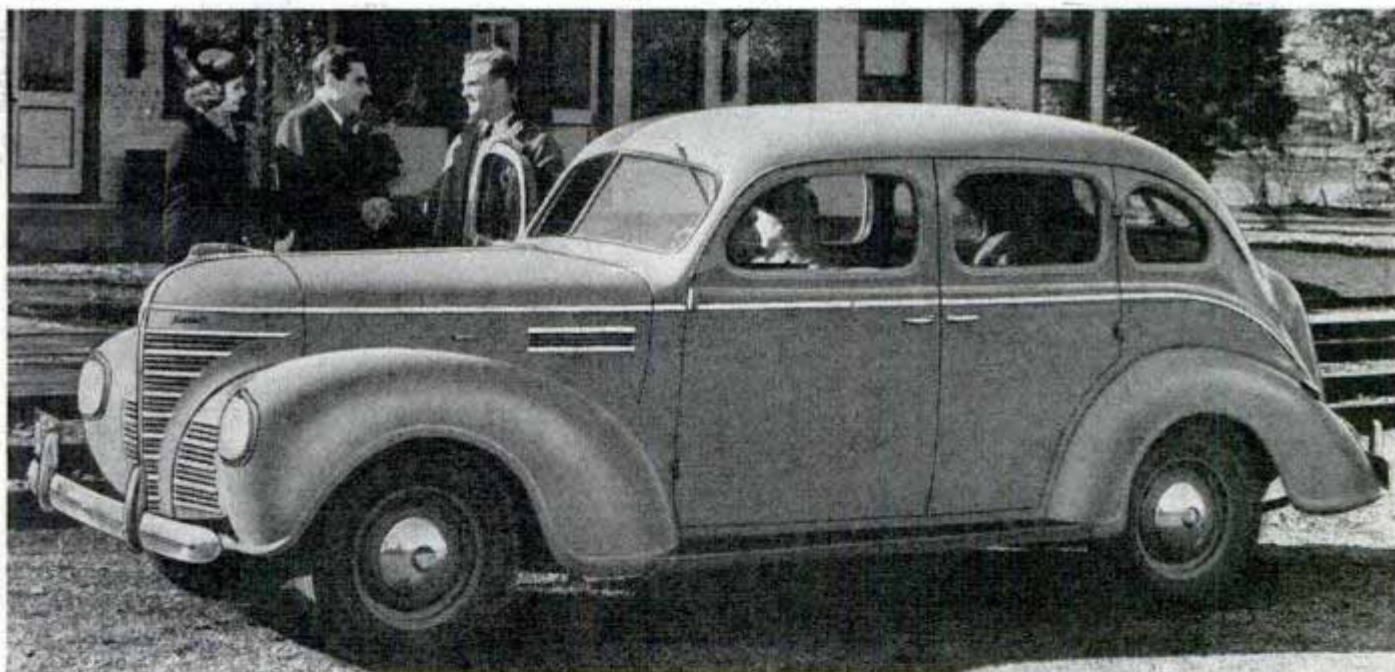

THE GREAT NEW 1939 PLYMOUTH "DE LUXE" Four-Door Touring Sedan...with completely rust-proofed Safety-Steel body.

**EASY TO BUY** "Detroit delivered prices" include front and rear bumpers, bumper guards, spare wheel, tire and tube, foot control for headlight beam with indicator on instrument panel, ash-tray in front and rear, sun visor, safety glass and big trunk space (19.6 cubic feet). Plymouth "Roadking" models start at \$645; "De Luxe" models slightly higher. Prices include all federal taxes.

Transportation and state, local taxes, if any, not included. See your Plymouth dealer for local delivered prices. PLYMOUTH DIVISION OF CHRYSLER CORPORATION, Detroit, Michigan.

**TUNE IN MAJOR BOWES' ORIGINAL AMATEUR HOUR, COLUMBIA NETWORK, THURS., 9 TO 10 P. M., EASTERN STANDARD TIME**

# PLYMOUTH BUILDS GREAT CARS

NEW "ROADKING"  
NEW "DE LUXE"





# *Yours for Good Service*



The people use the telephone—in this country nearly everybody.

The people operate the telephone—about 300,000 of them in the Bell System.

The people own the telephone business. There are about 750,000 owners of Bell System securities.

All of this works together to give you the best telephone service in the world at the lowest possible cost.

**BELL TELEPHONE  
SYSTEM**



*When writing to advertisers please mention Popular Mechanics*



# Popular Mechanics Magazine

H. H. WINDSOR, Founder

H. H. WINDSOR, Jr., Editor and Publisher

February, 1939

Vol. 71, No. 2

## Special Features

<u>Riding the Iron Cavalry</u>	<u>161</u>
<u>Fighting Noise with Light</u>	<u>166</u>
<u>Taming Death Valley</u>	<u>169</u>
<u>The Wonders of Astronomy</u>	<u>Coloroto</u>
<u>Tapping Davy Jones' Treasure Chest</u>	<u>188</u>
<u>Trapping Fish Pirates from the Air</u>	<u>194</u>
<u>Harnessing America's Wildest River</u>	<u>200</u>
<u>Check and Double-Check</u>	<u>210</u>
<u>What Your Nose Knows</u>	<u>217</u>
<u>Human Moles Battle a Mountain</u>	<u>226</u>
<u>Super-Safety Goes to Sea</u>	<u>232</u>
<u>Brains Against Flames in the Forest</u>	<u>242</u>
<u>Setting Bugs to Catch Bugs</u>	<u>251</u>

(Continued on next page)

## Going Nature One Better

SEED catalogues could tell amazing stories of plant wizards who produce big-eared corn from pygmy parents, who rob the marigold of its rancid odor and give it a chance for popularity, who tour the world in quest of a sweet pea that can keep its chin up through a hot midwestern summer. Seed men have learned new ways of tricking nature into producing lovelier flowers and tastier, blight-resistant fruits and vegetables. "Shock treatments" create new varieties by forcing a change in the chromosome balance; seeds are treated with X-rays, heated to the point of cooking and then quickly cooled. Small plants are drugged with an extract from the autumn-blooming crocus to shock them into new life forms. An article in the March issue will tell you how seed scientists on safari and in the laboratory are "Going Nature One Better."

## Next Month

SHOOTING a Technicolor movie is not just a matter of pointing a big camera and filming what color is there. Hollywood has to choose its colors first to create the right mood—pastels, hydrangea blues, daffodil yellows for the gay musical play or romance; sepia, maroon, olive for the serious dramas, bold colors for exciting high spots. An article next month, with eight pages of Coloroto photographs, tells how color pictures are made.

## Cattle Rustlers of '39

RUSTLERS were getting away with calves and leaving no clue—not even a tireprint or footprint. It was all very baffling until detectives raided a suspect's camp and found a man's shoe with a wooden plate on the sole carved in the shape of a cow's hoof. Cattle rustlers still do a million-dollar business, but they still get caught, as you will find in a story in the March issue.

## "Hot Papa"

LANDING gear snarled, an army plane tumbles across the runway in flames, trapping the pilot in the cockpit. But the airport control tower was looking for trouble and "Hot Papa" is right there wading through the fire in his asbestos overalls. Follow the thrills of the airport crash wagon in "Hot Papa to the Rescue," appearing in the next issue.





It's safer to drive through winter's ravages with a Pyroil treated car. New car or old, engine failures, break downs, freeze ups are far less likely. Because Pyroil shields and safeguards each vital engine part that undergoes great strain. Every Pyroil-sheathed bearing, shaft, cylinder wall, piston, valve and allied part works better. Operation is smoother. Power greater. Your engine gets the "break" it deserves when winter tosses on its overload.

Pyroil gives you easier starting, too. Parts spin quickly through sluggish or frozen grease and oil. Saves your battery from excessive drain. Here's an extra advantage you'll greatly appreciate!

And Pyroil is economical. A few ounces in gas tank and crankcase reach the whole engine interior. Costs but a few cents. Often saves you the tragedy of costly repairs.

Be safe this winter. Be economical. Get Pyroil in your car, at once. Sold everywhere at service stations or your garage. Manufactured and Guaranteed by Pyroil Company, W. V. Kidder, Founder, 52 Pyroil Bldg., La Crosse, Wisconsin, U. S. A.



**SIMPLY ADD TO GAS & OIL**

**NOTHING FINER FOR NON-ABRASIVE NEW CAR BREAK IN!**

**DISTRIBUTORS: CHECK AND MAIL COUPON FOR FRANCHISE FACTS.**

**PYROIL COMPANY,**  
52 Pyroil Bldg., LaCrosse, Wis., U. S. A.

Please send Bulletin on the care of my car in winter.  
 Also send details of your plan for Distributors.

Name.....  
 Address.....  
 City..... County..... State.....

(Contents—Continued)

**AUTOMOTIVE**

Tourist tent in trailer on caster wheels ..... 173  
 Tractor on two giant wheels pulls scraper..... 193  
 Built-in bumps "torture" autos on track..... 197  
 Gas-saving changes in engines suggested ..... 198  
 Automatic auto top operated by pressing button... 205  
 Ignorance intensifies menace of one-eyed driver... 214  
 Light built in battery tester..... 214  
 Truck body door rolls up like window shade..... 220  
 School bus rolls if it overturns ..... 222  
 Car resembling a plane has rocket-power vents..... 224  
 Filter on radiator takes sediment from water..... 224  
 Increased demand for gasoline forecast for 1939.... 225  
 Tractor plows lake bottom to improve beach..... 225  
 Hydraulic brakes given added safety factor..... 230  
 Hooded "dolphin" motorcycle hits record clip..... 236  
 "Air-pocket" cap prevents flooding storage battery. 240  
 Mirror helps show parts under auto ..... 240  
 Anti-aircraft tank fires cannon while speeding.... 241  
 Tractor built from junk parts ..... 246  
 Propeller shaft safety brake ..... 256

**AVIATION**

Bombers fly 7,162 miles for nonstop record..... 172  
 "Eyebrows" for planes speed recovery from stalling. 193  
 High-flying pursuit plane retracts landing gear.... 225  
 Shark-like nose on plane houses bombing sight... 236  
 Plane tubes like doughnuts tested for safety..... 237  
 Pilot sets altitude record near eleven miles..... 241  
 Dog keeps seaplane base clear of driftwood..... 247  
 Billiard-ball trick in plane ..... 256

**BOATS**

Wheels along dock guard boat from chafing..... 220  
 Swabbing decks with Dry Ice ..... 247  
 Forty years from "Intelligent Whale" to "R-10".... 249

**HOUSEHOLD**

Coffee temperature regulated by heat control plug.. 173  
 Wall bracket nut cracker ..... 186  
 Non-tipping food dish for baby ..... 208  
 Automatic electric teapot stops when brew is ready. 222  
 Door lens lets you see caller unseen ..... 230  
 Light globe is insect trap ..... 230  
 Automatic primer stops backflow of sewer gas.... 237  
 Safety rest for the flatiron ..... 240  
 Glass teakettle ..... 248  
 Measuring cap for bottle or can..... 248  
 Bread goes through toaster on small conveyor.... 250  
 Floor polisher run by air from vacuum cleaner.... 256

**MODELS**

Modeling museum creates "more real than life".... 174  
 Model planetarium demonstrates solar system..... 197  
 Sculptor finishes sand image with paintbrush..... 220  
 Model guns of balsa latest in hobbies..... 231  
 One-ounce motor drives a two-ounce plane..... 254  
 Ten-foot ship model cut from cardboard ..... 254

**PHOTOGRAPHY**

Enlarger focusing made easy by microscope easel... 176  
 Vise tapes and binds negatives into slides..... 186  
 Camera snaps hooked fish leaping from water.... 208  
 Enlarger is film viewer and retouching stand..... 214  
 Monsters in fish bowl stage camera thriller..... 215  
 Cold light for enlarging cuts exposure time..... 224  
 Ten-step light control for photographer ..... 230  
 Trigger tripod for one-hand picture shooting.... 246  
 Safelight "built into" photo paper ..... 246

**RADIO AND ELECTRICITY**

Tests on street speed coming of television..... 199  
 Radio antennas strung on fishing outriggers..... 205  
 Voice leveler equalizes roar and whisper..... 236  
 "Mike" in policeman's megaphone ..... 248  
 Radio directs switching operations in railway yard.. 248  
 Radio "mystery control" runs household devices... 250  
 Grand Coulee develops watts by the billion ..... 255  
 Television receiver kit for experimenters..... 257  
 How to build a simple inexpensive tube tester.... 258  
 Crystal-controlled CW transmitter for beginners... 260  
 Practical radio suggestions ..... 261  
 A.C.-D.C. volt-ohm milliammeter fits pocket.... 262  
 Automatic antenna for car or boat..... 262  
 Records transmitted by radio ..... 262  
 World time indicator for short-wave listeners.... 262

**SCIENCE AND INDUSTRY**

Quick-freezing process makes cell life stand still.. 172  
 Balloon train takes cosmic-ray census ..... 176

(Continued to page 6A)



## Vacuum Booster Creates Finger-Flip Gearshifting

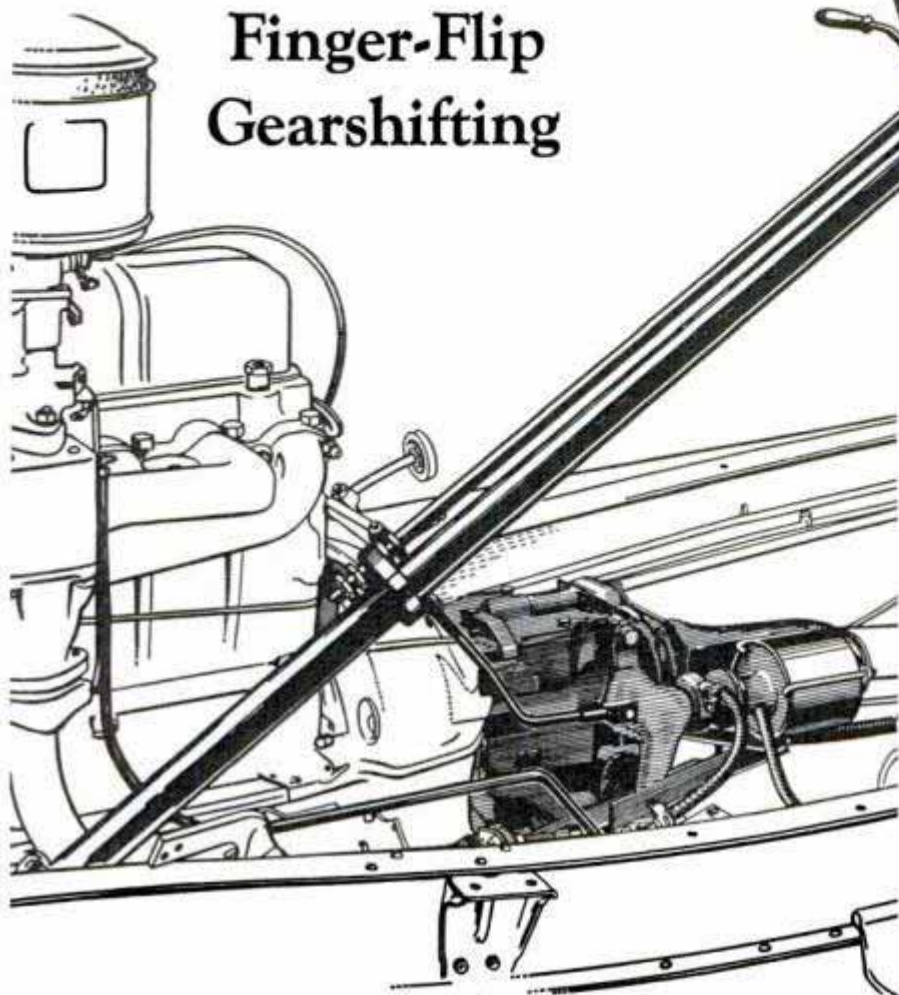

*Gears are shifted by a piston within the vacuum cylinder, mounted at the rear of the transmission. The short shifting-lever at the steering wheel controls the travel of the piston. Shafts and rigid links, instead of flexible cables, transmit movements of the shift lever to the vacuum control valve.*



A steering-column gearshift that uses the power of a vacuum cylinder to shift the transmission gears is one of the outstanding motor car improvements for 1939 introduced by Chevrolet, and available on all models at slight extra cost.

The vacuum shift is controlled by a short lever directly under the steering wheel, within finger reach. Because the vacuum cylinder supplies 80 per cent of the energy required, the driver can shift gears at a touch of his fingers.

A slide-valve within the

vacuum cylinder controls the shifting mechanism. The action is so exact that the driver is always in complete control of the shift; in fact, he can "feel" each stage of a shift, as with the floor-board lever.

The hook-up between the shift lever and the transmission is so solid that gears can be shifted entirely by hand power when the engine is not running and there is no vacuum.—Chevrolet Motor Division, General Motors Sales Corporation, Detroit, Mich.

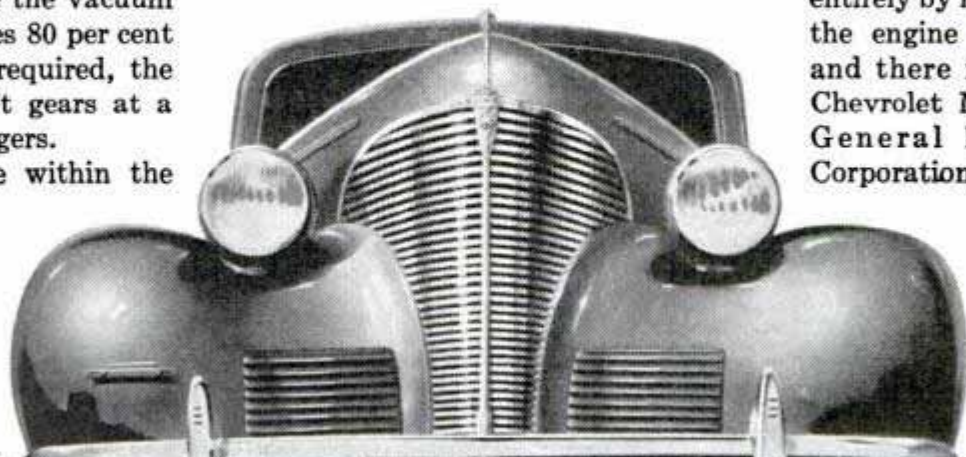

# "CHEVROLET'S THE CHOICE"





## THE SAW OF AMAZING VALUE

Amazing values in circular saws for your home workshop—KEYSTONE made by DISSTON! True running, long-lived. They fit your machine, suit your work. Designed for fine craftsmanship at low cost. Ask your dealer for Keystone Home Workshop Circular Saws—Made by Disston.

### Cross-cut; Combination

6" ( $\frac{1}{2}$ " hole) . . .	\$1.70
7" ( $\frac{1}{2}$ " hole) . . .	1.80
8" ( $\frac{1}{2}$ ", $\frac{5}{8}$ ", $\frac{3}{4}$ " hole)	2.00
10" ( $\frac{5}{8}$ ", $\frac{3}{4}$ " hole)	2.40

(Rip saws slightly lower)  
Also Hollow Ground,  
\$3.00 to \$5.00

These prices apply only to United States; for others, write Henry Disston & Sons, Ltd., Toronto, Canada

## and the Hint of the Month

Trimming inlay picture with "square board" made of  $\frac{5}{32}$ " plywood, with a strip to fit table slot clinch-tacked to bottom, and with cross pieces squared to saw.



## New edition—FREE BOOK



## SEND COUPON!

Completely revised Disston Saw, Tool and File Manual. 48 pages, contains a number of hints like the one above. Tells how to choose saws; to joint, set and sharpen saws; and uses of other kinds of tools. Many illustrations.

Henry Disston & Sons, Inc.  
211 Tacony, Philadelphia

Name.....

Address.....

## (Contents—Continued)

Rayon spun faster by whirling reels . . . . .	205
One-man cab on shovel lets boom clear . . . . .	209
Shivering alloy turns on heat if temperature drops . . . . .	223
Bacteria change sugars to valuable chemicals . . . . .	231
Atom smasher aids research in many fields . . . . .	238
Gasoline without by-products by catalytic process . . . . .	240

### SPORTS

Robot sparring mate hits with compressed air . . . . .	173
Vegetable "sculptor" makes amusing figures . . . . .	185
Tunnel target range built beneath back yard . . . . .	187
Landing net has built-in scale . . . . .	208
Wooden shoes for skates protect blade and floor . . . . .	222

### TOOLS

Lawn mower grinder whets without dismantling . . . . .	198
Thread file . . . . .	208
Portable oil drill mounted on rubber tires . . . . .	209
Portable gas-driven tool for drilling or grinding . . . . .	224

### MISCELLANEOUS

Risking death to build man's mightiest work . . . . .	175
Clamp-on light for the shop . . . . .	186
Swinging sun dial adjusted to avoid time errors . . . . .	186
Manhole lid stays down despite gas explosion . . . . .	187
Army's deadly weapons fight tanks and planes . . . . .	192
Clock opens dog's lunch pan . . . . .	192
Non-waste poultry feeder is adjustable, sanitary . . . . .	192
Tin horseman and steed made by soldering . . . . .	205
Mechanical cow chews and moos . . . . .	214
Polishing up a skyscraper while city sleeps . . . . .	216
Robot weathermen log sun and winds . . . . .	221
Nut cracker uses internal combustion . . . . .	222
Office "mike" helps direct distant job . . . . .	223
Conveyor belt delivers coal from truck to bin . . . . .	231
Asbestos lid clapped on incendiary fire . . . . .	237
Card index on wheel for quick reference . . . . .	239
Multiple-arch dam holds back irrigation lake . . . . .	239
Wax bath defeathers poultry for oven . . . . .	246
Reversible wrist watch . . . . .	249
"Danger meter" tells risk of forest fire . . . . .	254
Inverted vision glasses . . . . .	255

## (Craftsman and Shop Notes)

### AUTOMOTIVE

Building a two-car garage . . . . .	310
Hints for auto mechanics . . . . .	317
Dry Ice tests shock absorbers . . . . .	318
Puller for small bearings . . . . .	318
Repair for stripped threads in aluminum crankcase . . . . .	318
Shielding motorcycle control cable . . . . .	318
Welding-rod holder insulated . . . . .	318
Motorcycle housed in cloth "garage" . . . . .	319
Tool to pull transmissions . . . . .	319
Truck tire rack lowers to receive wheel . . . . .	319
Wheeled rack to display tires . . . . .	319
Chart shows feet required to stop . . . . .	320
Trailer has built-in level . . . . .	320

### FARM

Brush easily grubbed with iron bar and horse . . . . .	302
Watering tank used as feed trough . . . . .	302
Changeable roadside signs . . . . .	306
Roost to keep small chicks from smothering . . . . .	306
Slip stick binds hay on wagon . . . . .	308
Detachable dividers for hog trough . . . . .	315
Latch operates sectional barn doors as unit . . . . .	316

### HAND TOOLS

Hand pencil sharpener has shaving container . . . . .	266
Glue spread with fine comb . . . . .	267
Wire tightener from bolt . . . . .	277
Emergency wrench from bolt . . . . .	278
Pin drills kept in pocket case . . . . .	278
V-block from angle irons . . . . .	278
tubing plugged to saw off piece . . . . .	286
Altered wedge holds hammer on handle . . . . .	290
Blowtorch set on flanged plate cannot tip . . . . .	290
Marking gauge from clothespin . . . . .	290
Soldering iron has metal scraper attached . . . . .	294
Decorative hammer rack . . . . .	295
Lathe tool bits from broken drills . . . . .	301
Clamp ring on micrometer to adjust it . . . . .	308
Surface gauge glass holder . . . . .	308
Drills carried in cardboard holder . . . . .	315
Magnetic rack for tools . . . . .	315
Magnifying glass attached to centerpunch . . . . .	316

(Continued to page 10A)





# Plan Your Future

## Choose Your Field NOW For Success

Will you master fate or will fate master you? That's a question deserving your honest answer...right now! Actually it is largely up to you. You can do with Life almost what you will. LaSalle will help you establish yourself for real success by providing you with the comprehensive, specialized training for which it is so famous. Choose your field...now! Check the coupon below for the free booklet you want us to send you. It can be your first step toward assured success.

### Opportunities in Traffic Management

The field of Traffic Management offers real opportunity only to the man who knows. Spare time study and the will to succeed have pushed scores of Traffic employees up the ladder to financial success. Many LaSalle-trained traffic managers—in the railroad, truck and industrial field—now command salaries of \$3,000.00 to \$5,000.00 a year—and better. Investigate. Find out how you can qualify for these higher positions through LaSalle home-study and guidance.

### Law for Business Success

And it isn't necessary to practice law to get this Success. In fact probably most of the men who study law today have no idea of taking the bar examination or becoming lawyers—they want law training to help them master men and situations in business. You know that—

- (1) the man with legal training is a leader—not a follower.
- (2) legal training keens your mind—clears away the problems that stump the ordinary fellow and makes you master instead of man.
- (3) knowledge of law simplifies the complications of executive work.
- (4) Many top executive places are filled by men who have studied law.

No matter whether you are in a big corporation or a small business—in a city or a little town—a practical knowledge of law can hardly fail to be of real and vital help to you in making a more successful career.

In every state in the union you'll find law-trained men who came up through LaSalle. What others have done, you can do.

And LaSalle offers either a full law course leading to LL. B. or a shorter business law training—whichever you prefer. All text material, including valuable 14-volume Law Library. Training comprises the most effective features of modern law instruction.

### Executive Training

Executives who are efficient managers command responsible positions and good incomes. And the need for

trained executives is growing rapidly. We train you thoroughly at home in your spare time for every type of executive work—teach you the principles and practices used by our most successful business leaders and help you develop your management capacity—by a training built with the aid of outstanding executives.

### Become an Expert Accountant The Profession That Pays

The demand for skilled accountants—men who really know their business—is increasing rapidly. New state and federal legislation requires much more, and more efficient accounting from business—big and small. Corporations are in constant need of expert counsel in matters relating to Auditing, Cost Accounting, Business Law, Organization, Management, Finance. Men who prove their qualifications in this important branch of business are rapidly promoted to responsible executive positions—given an opportunity to earn real salaries. The range is from \$2,000.00 to \$10,000.00 a year—even to higher income figures.

Under the LaSalle Problem Method you can at home acquire a thoro understanding of Higher Accountancy, master its fundamental principles, become expert in the practical application of these principles—this without losing an hour of work or a dollar of pay.

Your training will be under the direct supervision of a staff of legal, organization and management specialists, business efficiency engineers and Certified Public Accountants.

Preliminary knowledge of bookkeeping is unnecessary. We train you from the ground up, or from where you now are, according to your individual needs.

### Mr. Salesman: What's Wrong?

Why aren't you making more sales—more money? Is it you—or your proposition? Check up first on yourself. Other men—no better than you—have found their earnings jump and stay up when they trained with LaSalle. Literally thousands of men—many of them years at the game—have increased their sales volume and earnings through home study with LaSalle guidance. Sound—practical—usable—right from field experience. Train for top-notch production with LaSalle.

## LASALLE EXTENSION UNIVERSITY A CORRESPONDENCE INSTITUTION Dept. 264-R, Chicago

I would like to have your special booklet—without any cost or obligation to me—about my opportunities and your success training in the business field I have checked.

- |   |  |   |
|---|--|---|
| <input type="checkbox"/> Higher Accountancy   | <input type="checkbox"/> Commercial Law        | <input type="checkbox"/> Business English |
| <input type="checkbox"/> Law: Degree of LL.B. | <input type="checkbox"/> Expert Bookkeeping    | <input type="checkbox"/> Business Corr.   |
| <input type="checkbox"/> Traffic Management   | <input type="checkbox"/> C. P. A. Coaching     | <input type="checkbox"/> Effective Sp     |
| <input type="checkbox"/> Modern Salesmanship  | <input type="checkbox"/> Industrial Management | <input type="checkbox"/> Stenotypy        |
| <input type="checkbox"/> Business Management  | <input type="checkbox"/> Modern Foremanship    |   |

This One



UPAW-4FP-CCJ5

Name.....Age.....

Position.....Address.....



# "IT WAS LIGHT IN A WILDERNESS

"I was stuck. A wife and three kiddies — and the same old pay envelope. I couldn't see a thing ahead except the same old grind. Then one day I read an I. C. S. ad. The coupon fascinated me. A new idea struck home — it was light in a wilderness of darkness to me! Today, because I mailed that coupon two years ago, I am a trained man — making a trained man's pay!"

Nearly fifty years ago, the International Correspondence Schools were established to provide sound educational facilities to men unable to attend resident schools. Over five million dollars have been spent in preparing textbooks and keeping them up-to-date. Today, you'll find I. C. S. graduates holding leading positions in every field of business and industry.

## 12 INTERESTING FACTS ABOUT THE WORLD'S LARGEST EDUCATIONAL SYSTEM

First student enrolled,  
October 16, 1891

### TOTAL ENROLMENTS

December 31, 1891.....	115
December 31, 1895.....	10,105
December 31, 1900.....	251,310
December 31, 1920.....	2,271,193
December 31, 1937.....	4,332,364

20,000 pieces of mail leave the I. C. S. daily.

Average daily postage bill on outgoing mail, \$500.

More than \$5,000,000 has been expended in preparing and improving I. C. S. textbooks.

More than 60,000,000 pages of printed study text are issued to students each year.

More than 500 colleges, universities and other resident schools have purchased and are using I. C. S. textbooks.

287 railroad companies and 2550 commercial and industrial estab-

lishments have made agreements with the I. C. S. for educating employees.

Colorado. Though confined to my bed through injury, I took the Colorado State Highway Dept. civil service examination and passed with marks sufficiently high to secure an appointment. I attribute this to I. C. S. training.  
Robert P. Owens, Pueblo, Colo.

Oregon. I consider the training given by I. C. S. to be of the very best and recommend the I. C. S. method to any one desiring an education or wishing to review school or college subjects.  
Oscar Cutler, Salem, Oregon

New Hampshire. I found the I. C. S. Salesmanship Course interesting and practical. It helped me derive the greatest benefit from 12 years' practical experience.  
Arthur Fekas, Nashua, N. H.

Maryland. While studying your courses I advanced rapidly, and at present I am Industrial Engineer in the Baltimore plant of the Mutual Chemical Company of America in charge of methods and cost control.  
H. L. Shipley, Baltimore, Md.

Missouri. Shortly after I enrolled with the I. C. S., I advanced to Layerout Foreman, then Chief Layerout, and at present I am Production Control man.  
Lawrence E. Foster, St. Louis, Mo.

California. My I. C. S. training, plus experience, qualified me to plan larger building projects. The interior design of some of the larger rooms of the remodeled S. S. City of Honolulu was one of these.  
J. Raymond Wyatt, Los Angeles, Calif.

# ICS



# OF DARKNESS TO ME"

Moine, My I. C. S. Course enabled me to hold a day job and also to retain my seniority rights. I thank my I. C. S. Instructors for their prompt and helpful interest.  
Harry F. Adams, Portland, Me.

Florida, I am more capable of carrying on my responsible duties as a result of my Traffic Management Course.  
Charles C. Barlow, Caryville, Fla

Texas, I. C. S. home study and promotion go hand in hand. My own case proves it. I am in the testing laboratory of the biggest oil company in the U. S. I thank you for the help you've given me.  
James Robert Hicks, Jr., Houston, Texas

Kansas, The I. C. S. Course on C. P. A. Problems and Higher Accounting has paid me big dividends - especially the section on Federal Tax Accounting.  
Maxwell Wright, Wichita, Kan.

## INTERNATIONAL CORRESPONDENCE SCHOOLS

BOX 5541-J, SCRANTON, PENNA.



Without cost or obligation, please send me a copy of your booklet, "Who Wins and Why," and full particulars about the subject *before* which I have marked X:



### TECHNICAL AND INDUSTRIAL COURSES

- |  |  |  |  |
|--|--|--|--|
| <input type="checkbox"/> Architect                 | <input type="checkbox"/> Sheet Metal Worker                            | <input type="checkbox"/> Commercial Refrigeration                            | <input type="checkbox"/> Surveying and Mapping                             |
| <input type="checkbox"/> Architectural Draftsman   | <input type="checkbox"/> Boilermaker                                   | <input type="checkbox"/> Plumbing <input type="checkbox"/> Steam Fitting     | <input type="checkbox"/> Bridge Engineer                                   |
| <input type="checkbox"/> Building Estimating       | <input type="checkbox"/> Telegraph Engineer                            | <input type="checkbox"/> Heating <input type="checkbox"/> Ventilation        | <input type="checkbox"/> Bridge and Building Foreman                       |
| <input type="checkbox"/> Contractor and Builder    | <input type="checkbox"/> Telephone Work <input type="checkbox"/> Radio | <input type="checkbox"/> Air Conditioning and Cooling                        | <input type="checkbox"/> Chemistry <input type="checkbox"/> Pharmacy       |
| <input type="checkbox"/> Structural Draftsman      | <input type="checkbox"/> Mechanical Engineering                        | <input type="checkbox"/> Steam Engineer                                      | <input type="checkbox"/> Coal Mining                                       |
| <input type="checkbox"/> Structural Engineer       | <input type="checkbox"/> Mechanical Draftsman                          | <input type="checkbox"/> Steam Electric Engineer                             | <input type="checkbox"/> Mine Foreman <input type="checkbox"/> Fire Bosses |
| <input type="checkbox"/> Management of Inventions  | <input type="checkbox"/> Machinist <input type="checkbox"/> Toolmaker  | <input type="checkbox"/> Marine Engineer                                     | <input type="checkbox"/> Navigation  |
| <input type="checkbox"/> Electrical Engineer       | <input type="checkbox"/> Patternmaker                                  | <input type="checkbox"/> R. R. Locomotives                                   | <input type="checkbox"/> Cotton Manufacturing                              |
| <input type="checkbox"/> Electric Lighting         | <input type="checkbox"/> Diesel Engines                                | <input type="checkbox"/> R. R. Section Foreman                               | <input type="checkbox"/> Woolen Manufacturing                              |
| <input type="checkbox"/> Welding, Electric and Gas | <input type="checkbox"/> Aviation Engines                              | <input type="checkbox"/> Air Brakes <input type="checkbox"/> R. R. Signalmen | <input type="checkbox"/> Agriculture                                       |
| <input type="checkbox"/> Reading Shop Blueprints   | <input type="checkbox"/> Auto Technician                               | <input type="checkbox"/> Highway Engineering                                 | <input type="checkbox"/> Fruit Growing                                     |
| <input type="checkbox"/> Heat Treatment of Metals  | <input type="checkbox"/> Auto Electrical Technician                    | <input type="checkbox"/> Civil Engineering                                   | <input type="checkbox"/> Poultry Farming                                   |

### BUSINESS TRAINING COURSES

- |  |   |  |  |
|--|---|--|--|
| <input type="checkbox"/> Business Management   | <input type="checkbox"/> Bookkeeping      | <input type="checkbox"/> Service Station Salesmanship                        | <input type="checkbox"/> Grade School Subjects                               |
| <input type="checkbox"/> Industrial Management | <input type="checkbox"/> Secretarial Work | <input type="checkbox"/> First Year College Subjects                         | <input type="checkbox"/> High School Subjects                                |
| <input type="checkbox"/> Traffic Management    | <input type="checkbox"/> Spanish          | <input type="checkbox"/> Business Correspondence                             | <input type="checkbox"/> College Preparatory                                 |
| <input type="checkbox"/> Accountancy           | <input type="checkbox"/> French           | <input type="checkbox"/> Stenography and Typing                              | <input type="checkbox"/> Illustrating  |
| <input type="checkbox"/> Cost Accountant       | <input type="checkbox"/> Salesmanship     | <input type="checkbox"/> Civil Service <input type="checkbox"/> Mail Carrier | <input type="checkbox"/> Cartooning  |
| <input type="checkbox"/> C. P. Accountant      | <input type="checkbox"/> Advertising      | <input type="checkbox"/> Railway Mail Clerk                                  | <input type="checkbox"/> Lettering Show Cards <input type="checkbox"/> Signs |

### DOMESTIC SCIENCE COURSES

- |   |   |  |
|---|---|--|
| <input type="checkbox"/> Home Dressmaking                       | <input type="checkbox"/> Advanced Dressmaking | <input type="checkbox"/> Foods and Cookery                           |
| <input type="checkbox"/> Professional Dressmaking and Designing |   | <input type="checkbox"/> Tea Room and Cafeteria Management, Catering |

Name.....Age.....Address.....

City.....State.....Present Position.....

If you reside in Canada, send this coupon to the International Correspondence Schools Canadian, Limited, Montreal, Canada  
If you reside in England, send coupon to I. C. S., 71 Kingsway, London, W. C. 2, England

When writing to advertisers please mention Popular Mechanics



**Now Ready—SENT FREE!**

NEW EDITION—25% more diagrams  
and information—a veritable  
encyclopedia of good repair  
practice

## SMOOTH-ON CEMENTS



for the  
**Motor Car and Boat,  
Home, Factory and  
Power Plant**

**T**HIS Handbook enables anyone to make countless home and auto repairs quickly, easily and with assured success. By following its instructions and diagrams, you can stop leaks of water, steam, gas, etc., tighten loose parts or stripped screws or nuts, anchor parts in wood, metal or masonry, make wet cellars dry from the inside, make water and weatherproof joints, etc.

For over 40 years the Smooth-On Cements have been used for many repair and construction purposes in power plants, factories and homes. The Smooth-On Cements are being constantly improved by laboratory experimentation. For example, the hardness, strength and working time of Smooth-On No. 1 have recently been doubled. Easy to apply. Just mix with water.

The new Handbook is up-to-date with new uses found by test and from the experiences of the many Smooth-On users.

MAIL THE COUPON for YOUR COPY and get Smooth-On from your hardware store.

SMOOTH-ON MFG. CO., Dept. 37.  
574 Communipaw Ave., Jersey City, N. J.

Please send the 1939 Smooth-On Handbook.

Name.....

Address.....

2-39.....



*Do it with* **SMOOTH-ON**

## (Contents—Continued)

### HOUSEHOLD

Swinging platforms conceal garbage cans.....	273
Initialed handles personalize sewing bag.....	277
Stretcher holds articles taut while drying.....	285
New cages for canaries.....	287
Solving home problems.....	296

### PHOTOGRAPHY

Pepper on negative imitates falling snow.....	267
Two-way desk frames for photos.....	271
Printing mask cut from Cellophane.....	272
Ferrotypes plates aid in producing artistic photos.....	273
Blackening objects for photographing.....	274
Spring improves tripod brace.....	278
Roll-film washer on paper clip.....	279
Jig to tape edges of lantern slides.....	286
Extension wire finder assures sharp focus.....	289
Safelight for inspecting prints in darkroom.....	290
Photos stored between cardboard to prevent curling.....	294

### POWER TOOLS

Special rip fence for cutting bevels.....	266
Auto starter switch controls lathe motor.....	274
Fifteen minutes to build electric motor.....	275
Inexpensive cutoff saw from car axle.....	294
Tap and die holders speed hand work.....	299
Stop assures accurate miter cuts.....	307
Quick measurements on your circular saw.....	309

### STORES AND SHOPS

Egg candler from desk lamp.....	285
Movable bin on counter keeps dry goods clean.....	301
Fowl held over barrel to remove feathers.....	316
Papers of powder folded to seal them.....	316

### TOYS AND NOVELTIES

Photographic place cards.....	265
Walking penguin is amusing toy.....	289
Hanging aquarium.....	295

### MISCELLANEOUS

Celluloid compass for laying out colored designs.....	265
Pivot mounting for bird feeder.....	266
Vacuum cup clip holds drawing on board.....	266
Canoe cradle from auto casing.....	267
Glasses held in pocket by rubber band.....	267
Distinctive coffee table in Roman styling.....	268
Easy way to use pantograph.....	270
Roof cement applied through slit in can.....	270
Rope aids in climbing hills on skis.....	270
Small spring keeps cork in vacuum bottle.....	270
Attaching newspaper clippings together.....	272
Cotter key lifts pendulum of clock.....	272
Lamp to find lost articles in theater.....	272
Drip catcher on end of umbrella.....	274
Non-skid bottom for file cabinet drawers.....	274
Bicycle ramp on porch steps.....	277
Removable handles for oil-drum containers.....	278
Ice-fishing semaphores.....	279
Faster than the wind in an iceboat.....	280
Graphite helps when setting rubber type.....	285
Picture frames from tongue-and-groove stock.....	285
Insulating terminal posts on motor.....	286
Non-slip guide for glass cutting.....	286
Stakes driven without splitting.....	288
Legs of dividers protected by pencil ferrules.....	290
Vanity gives four combinations of furniture.....	291
Keeping hair off flesh while dressing rabbit.....	294
Microscope slides on straws easy to pick up.....	298
Removing broken pipe from fittings.....	298
Pipe door handles to exert strong pull.....	301
Clamping T-square to drawing board.....	302
Firemen's helmet has size painted on brim.....	302
Split-second print timing.....	303
Pigeon perches from cans.....	304
Clutch and cable operate linotype pi stacker.....	305
Large machine screws removed with punch.....	306
Sunken oil drum keeps milk for route men.....	306
Drawing-paper dispenser has knife.....	307
Rubber mat on locomotive steps reduces slipping.....	308
Fence-wire supports to keep out trespassers.....	309
Skinning small animals with compressed air.....	314

### IMPORTANT NOTICE

It is the intention of this magazine to provide its readers with information regarding the latest developments in the mechanical arts. We take no responsibility as to whether the disclosures contained in our articles are covered by patents and advise readers to investigate this subject before making, using, or selling any of the products, machines, or processes described, in order to avoid possible liability for patent infringement.



# You Ask Me What I Am Doing?



## I Am Getting Ready to Earn More Money ... Preparing for a Bigger Job

I am a student of the American School, Chicago. A little more than half way through my course—already my increased knowledge has brought me promotion as a result of the hour or so a day I have been spending getting acquainted with the principles of the work I enjoy. I use only part of my spare time, so it doesn't interfere with my home and social life, and certainly helps me on the job.

I have been surprised at the practical manner in which even advanced work is explained. It is a lot easier than I had expected. I only wish I had started this plan of getting ahead a few years earlier. But when I was 18 to 20 I felt pretty sure of myself. I didn't take enough stock in what more experienced people told me about the importance of being thoroughly trained for the job I wanted.

**You Can't Win If You Don't Try**  
**American School, Dept. G245, Drexel Ave. at 58th St., Chicago**

CUT ALONG THIS LINE

## Try a Lesson Yourself—No Obligation

**American School, Dept. G245, Drexel Ave. at 58th St., Chicago**

I have checked the line of work in which I would like a good job. Please send me without expense or obligation on my part a copy of your Bulletin and an early lesson in the field I have selected.

- |  |   |   |
|--|---|---|
| <input type="checkbox"/> Air Conditioning                | <input type="checkbox"/> Electrical Engineering         | <input type="checkbox"/> Law                    |
| <input type="checkbox"/> Architecture                    | <input type="checkbox"/> Diesel Engineering             | <input type="checkbox"/> Liberal Arts (College) |
| <input type="checkbox"/> Automotive Engineering          | <input type="checkbox"/> Drafting and Designing         | <input type="checkbox"/> Mechanical Engineering |
| <input type="checkbox"/> Automobile Repairing            | <input type="checkbox"/> Electric Refrigeration         | <input type="checkbox"/> Merchandising          |
| <input type="checkbox"/> Bookkeeping and Cost Accounting | <input type="checkbox"/> Heating, Ventilating, Plumbing | <input type="checkbox"/> Private Secretary      |
| <input type="checkbox"/> Business Management             | <input type="checkbox"/> Professional Accounting        | <input type="checkbox"/> Radio and Television   |
| <input type="checkbox"/> Civil Engineering               | <input type="checkbox"/> Incl. C. P. A. Coaching        | <input type="checkbox"/> Salesmanship           |
| <input type="checkbox"/> Aviation                        | <input type="checkbox"/> High School                    | <input type="checkbox"/> Shop Practice          |
| <input type="checkbox"/> Contracting, Building           | <input type="checkbox"/> Highway Engineering            | <input type="checkbox"/> Steam Engineering      |

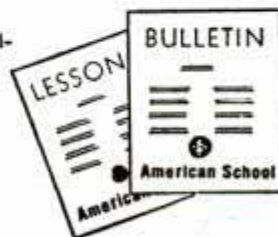

Name.....Age.....Occupation.....

Street.....City.....State.....



# HOW A "TIP" GOT TOM A GOOD JOB



J. E. Smith, President,  
National Radio Institute  
Established 1914

He has directed the home study training of more men for the Radio Industry than any other man in America.

## I will train **YOU** too at Home in Spare Time for Good Jobs in Radio

### HERE'S PROOF THAT MY TRAINING PAYS



#### \$50 Monthly in Spare Time

"I work on Radio part time, still holding my regular job. Since enrolling seven years ago, I have averaged around \$50 every month." JOHN B. MORISSETTE, 809 Valley Street, Manchester, N. H.

#### Makes \$50 to \$60 a Week

"I am making between \$50 and \$60 a week after all expenses are paid and I am getting all the Radio work I can take care of, thanks to N. R. I." H. W. SPANGLER, 126 1/2 S. Gay St., Knoxville, Tenn.



#### Operates Public Address System

"I have a position with the Los Angeles Civil Service, operating the Public Address System in the City Hall Council. My salary is \$170 a month." R. H. ROOD, R. 136, City Hall, Los Angeles, Calif.

Radio offers you many opportunities for well-paying spare time and full time jobs. You don't have to give up your present job, leave home or spend a lot of money to become a Radio Expert. I'm so sure I can train you at home for a good Radio job that I agree in writing to refund every penny you pay me if you are not satisfied with my training when you finish.

#### Get Ready Now for Jobs Like These

Radio broadcasting stations employ engineers, operators, station managers and pay up to \$5,000 a year. Fixing Radio sets in spare time pays many \$200 to \$500 a year—full time jobs with Radio jobbers, manufacturers and dealers as much as \$30, \$50, \$75 a week. Many Radio Experts open full or part time Radio sales and repair businesses. Radio manufacturers and jobbers employ testers, inspectors, foremen, engineers, servicemen, and pay up to \$6,000 a year. Automobile, police, aviation, commercial Radio, loud speaker systems are newer fields offering good opportunities now and for the future. Television promises to open many good jobs soon. Men I trained have good jobs in these branches of Radio. Read how they got their jobs. Mail coupon.

#### Why Many Radio Experts Make \$30, \$50, \$75 a Week

Radio is young—yet it's one of our large industries. More than 28,000,000 homes have one or more Radios. There are more Radios than telephones. Every year millions of Radios get out of date and are replaced. Millions more need new tubes, repairs. Over \$50,000,000 are spent every year for Radio repairs alone. Over 5,000,000 auto Radios are in use; more are being sold every day, offering more profit-making opportunities for Radio experts. And RADIO IS STILL YOUNG, GROWING, expanding into new fields. The few hundred \$30, \$50, \$75 a week jobs of 20 years ago have grown to thousands. Yes, Radio offers opportunities—now and for the future!

Get Facts about **THE TESTED**



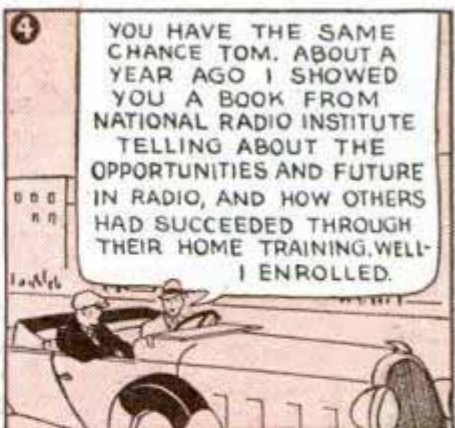

**Many Make \$5, \$10, \$15 a Week Extra in Spare Time While Learning**

The day you enroll, in addition to our regular Course, I start sending Extra Money Job Sheets, show you how to do Radio repair jobs. Throughout your training I send plans and directions that made good spare time money—\$200 to \$500—for hundreds, while learning. I send you special Radio equipment to conduct experiments, build circuits. This 50-50 method of training makes learning at home easy, fascinating, practical.

**I Also Give You This Professional Servicing Instrument**

Here is the instrument every Radio expert needs and wants—an All-Wave, All-Purpose, Set Servicing Instrument. It contains everything necessary to measure A.C. and D.C. voltages

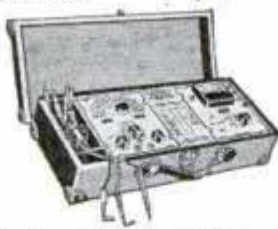

and current; to test tubes; resistance; adjust and align any set, old or new. It satisfies your needs for professional servicing after you graduate—can help you make extra money fixing sets while training.

**Find Out What Radio Offers You**

Act Today. Mail the coupon now for "Rich Rewards in Radio." It's free to any fellow over 16 years old. It points out Radio's spare time and full time opportunities and those coming in Television; tells about my training in Radio and Television; shows you letters from men I trained, telling what they are doing and earning. Find out what Radio offers YOU! MAIL COUPON in an envelope, or paste on a postcard—NOW!

J. E. SMITH, President  
Dept. 9BP  
National Radio Institute  
Washington, D. C.



**THIS FREE BOOK HAS HELPED HUNDREDS OF MEN MAKE MORE MONEY**



**This Coupon is Good for One FREE Copy of My Book**

J. E. SMITH, President, Dept. 9BP  
National Radio Institute, Washington, D. C.

Dear Mr. Smith: Without obligating me, send "Rich Rewards in Radio," which points out the spare time and full time opportunities in Radio and explains your 50-50 method of training men at home in spare time to become Radio Experts. (Please Write Plainly.)

NAME..... AGE.....  
ADDRESS.....  
CITY..... STATE.....

**WAY TO BETTER PAY**



*I'll Train You in*  
**DRAFTING**  
*until You Get a*  
**GOOD PAY JOB**



*Prepare NOW!*  
**YOUR TIME IS WORTH MONEY**

Let me train you as an expert Draftsman until you are holding a good-paying position. Trained Draftsmen command good salaries. I'll prepare you on practical work to get required experience as I have many hundreds of successful students.

**Drafting Offers Big O-P-P-O-R-T-U-N-I-T-Y**

Drafting is a profession that offers you BIG opportunities and MANY of them. When you become an expert Draftsman, hundreds of industries will be open to you to enter. You will have opportunities to get into **ELECTRICITY, AVIATION, TRANSPORTATION, AUTOMOTIVE WORK, BUILDING CONSTRUCTION, MACHINERY** and many other fields. Almost every industry offers chances for a better job at better pay and shorter hours.

**Learn At Home from an Engineer**

I'll train you at home in your spare time in a few months by my proven-practical "Work-Job" Method, at low cost and on easy terms. You don't need any previous experience. I give you actual working experience by my individual training method. Lack of higher education need be no drawback. High School education is not needed to start.

**ALL Working Tools Furnished**

Mail the coupon below today for FREE book, "Successful Draftsmanship" and full details of my practical Training Offer that includes Professional Drawing Instruments, Drawing Table and supplies all without extra cost. Now is the time to prepare. Don't wait another day. Send the coupon NOW for FREE Book.

SEND FOR **FREE BOOK**



Get My Proven Pay Raising Plan

*These TOOLS and Other EQUIPMENT Given When You Start*

**ENGINEER DOBE, Div. 3372, Libertyville, Ill.**

Send me your free book, "Successful Draftsmanship." Please explain how you assist your graduates to good positions as draftsmen.

Name.....Age.....

Address.....

Town.....State.....

**ELECTRICAL ENGINEERING**

ONE YEAR Course Prepares For Technical Work In Electrical Field

Thorough training in principles, with practical applications in laboratory and shop. High placement record.

Modern buildings, dormitory, dining hall. Campus. 46th year.

CATALOG on request.



**BLISS ELECTRICAL SCHOOL**

132 Takoma Avenue, Washington, D. C.

**BE A PASSENGER Traffic Inspector**

Our Easy, Home-Study Course Prepares You Men, 19 to 50—can qualify as Railway and Bus



Passenger Traffic Inspectors in a few weeks' spare time. We help place graduates upon completion at up to \$135 per month, plus expenses to start, or refund tuition. Splendid opportunities for advancement. Free Booklet. **STANDARD BUSINESS TRAINING INSTITUTE** Div. 202 Buffalo, N. Y.



Operator No. 38

**FOLLOW THIS MAN**

Secret Service Operator No. 38 is on the job! Running down dangerous Counterfeit Gang. Tell-tale finger prints in murdered girl's room.

**Free** The Confidential Report Operator No. 38 made to his chief. Write for it.

Earn a Regular Monthly Salary

YOU can become a Finger Print Expert at home, in your spare time, at small cost. Write for confidential full report and details. Literature will be sent only to persons stating their age.

**INSTITUTE OF APPLIED SCIENCE**

Dept. 1352 1520 Sunnyside Ave. Chicago, Ill.

**DENISON'S PLAYS**

Musical Comedies, Operettas, Vaudeville Acts, Minstrels, Comedy Songs, Make-up Goods.

**60 YEARS OF HITS**

Catalog Free

T. S. Denison & Co., 203 N. Wabash, Dept. 9, Chicago

**Come to WASHINGTON**



Train for a Fine Hotel Position Graduates Earning Substantial Salaries Good positions for trained men and women in hotel, restaurant and institutional field. Qualify in 4 months—learn on real hotel equipment. Placement Service FREE of extra charge. New day classes start Feb., Sept., Oct. Catalog FREE! **LEWIS HOTEL TRAINING SCHOOLS** Division RTC-398 Washington, D. C.

**TRAIN FOR Radio in 12 WEEKS**  
**I WILL FINANCE YOUR TRAINING IF YOU ARE SHORT OF MONEY**

Prepare for opportunities in Radio Broadcast, Talking pictures, Television, by 12 weeks of practical shop work in the great Coyne Radio Shops, on real RADIO and Sound equipment. You don't need advanced education or experience. Free Employment Service for life. Many earn while learning. Electric Refrigeration included. Mail coupon today for free book which tells you how hundreds have become successful Radio Men after taking our training. **H. C. LEWIS, Pres., RADIO DIV., Coyne Electrical School** 500 S. Paulina St., Dept. 29-3H, Chicago, Illinois

Send Free Radio Book and facts. Tell me about your "Pay-Tuition-After-Graduation" Plan.

NAME.....AGE.....

ADDRESS.....

CITY.....STATE.....





**GET AHEAD ~  
MAKE MORE MONEY**

**Be a DIESEL ENGINEER**

**TOOK TRAINING  
Now Chief Engineer**

"...Since leaving your school I have been constantly employed in the Diesel field, advancing from my first job as ordinary operator, several steps ahead to my present job as Chief Engineer of The New Mexico Gold Producers Corp."  
(signed) R. E. Lee

## HEMPHILL DIESEL SCHOOLS

America's original exclusively Diesel training institution... fully equipped to thoroughly train you as a Diesel Engineer.

BOSTON, 114 Brookline Ave.; NEW YORK, 31-26 Queens Blvd., L. I. C.; DETROIT, 2341 W. Lafayette Blvd.; CHICAGO, 2014 Larrabee St.; MEMPHIS, 417 Monroe Ave.; LOS ANGELES, 2120 San Fernando Rd.; SEATTLE, 501 Westlake North.; VANCOUVER, 1363 Granville St.

Located only in the above named cities and not connected with any other Diesel schools.

Already booming, Diesel is repeating the spectacular growth of the automobile industry right over again -- thousands of "top" men are there because they "got in on the ground floor" ... when that industry was new and growing by leaps and bounds. Now it is the Diesel industry that offers YOU exactly the same kind of an opportunity.

### WHAT ARE YOU GOING TO DO ABOUT YOUR DIESEL CAREER?

Get full information on a training plan designed to fit you to get ahead and make money as a Diesel engineer ... training you can get -- no matter where you live. Send the coupon NOW.

Please send me free new issue of "March of Diesel" booklet and information on Hemphill Diesel training. (This information intended only for men between 18 and 45).

NAME \_\_\_\_\_ AGE \_\_\_\_\_

STREET \_\_\_\_\_

CITY \_\_\_\_\_ STATE \_\_\_\_\_ m-33-p

Send This Coupon to Nearest Address Shown At Left





## High School Course at Home

### Many Finish in 2 Years

You can complete this simplified High School Course as rapidly as your time and abilities permit. Equivalent to resident school work—prepares you for entrance to college. Standard H. S. texts supplied—Diploma. Credit for H. S. subjects already completed. Single subjects if desired. High School education is very important for advancement in business and industry and socially.

### College Entrance

During the past 14 years, our High School graduates have been admitted to 531 different Universities, Colleges, Junior Colleges and Normal Schools—80% of them without entrance examination. Course also prepares for teachers' certificate and pre-professional examinations.

### Business—Industry

To get and hold a good position in Business today you must be able to write clear, accurate letters and reports—do figuring involving Algebra and Geometry—talk intelligently on matters requiring a knowledge of Geography, History, and Economics.

In Industry—Mechanical and Engineering lines—you must have at least an elementary knowledge of Physics and Chemistry—be able to figure quickly and accurately—know something of Mechanical Drawing and blueprints—and be able to talk and write accurately and clearly on both your work and ordinary topics of conversation.

Our High School course meets the preparatory educational requirements for Business and Industry.

### An Educational Institution

The American School was chartered in 1897 as an educational institution, not for profit—and is exempt from paying Federal income tax, like the best resident colleges and universities.

### Don't Be Handicapped—Complete Your Training Now

Be a High School Graduate! Prepare yourself for promotion in Business and Industry—for the Professions, College Entrance and social success. No matter what line you may select, High School training will prove invaluable to you!

### 20 Other Courses

Over 150 noted Educators, Engineers, and Business Men helped prepare our special instruction material, which is used by many resident schools and colleges, U. S. Navy, and Province of Manitoba, Canada. We offer you quality training at home for the best-paying lines of Industry and Business, as listed in the coupon.

Our moderate fees cover all instruction, standard textbooks and Diploma. Easy monthly terms. Get ahead in life. Start your training NOW!

Mail coupon for information about line that interests you  
**American School, Drexel at 58th, Chicago**

**American School, Dept. H-245, Drexel at 58th, Chicago**  
 Tell me how to train for success in line checked. No obligation.

- |  |  |
|--|--|
| <input type="checkbox"/> Accounting & Auditing   | <input type="checkbox"/> Diesel Engineering    |
| <input type="checkbox"/> Architecture & B'lding  | <input type="checkbox"/> Drafting & Design     |
| <input type="checkbox"/> Automotive Engin'ring   | <input type="checkbox"/> Liberal Arts          |
| <input type="checkbox"/> Business Management     | <input type="checkbox"/> Private Secretary     |
| <input type="checkbox"/> Com'ercial Aeronautics  | <input type="checkbox"/> H'per Ac't'g.(C.P.A.) |
| <input type="checkbox"/> Electrical Engineering  | <input type="checkbox"/> Highway Engin'rg      |
| <input type="checkbox"/> Electrical Refrigerat'n | <input type="checkbox"/> Mechanical Eng'r'g    |
| <input type="checkbox"/> Air Conditioning        | <input type="checkbox"/> Radio & Television    |
| <input type="checkbox"/> Civil Engineering       | <input type="checkbox"/> Salesmanship          |
| <input type="checkbox"/> Complete Law            | <input type="checkbox"/> Steam Engineering     |

Name.....  
 Address.....

When writing please mention Popular Mechanics

# EASY

## SOPRANI AMPLIPHONIC

### Simplifies Playing



Frank Pappie, N.B.C., with his Soprani ● **Lighter, easier to play, less bellowsing, plus more beautiful tone and volume, — that's how Soprani's exclusive Ampliphonic feature has simplified this accordion. Assures rapid progress. Home trial. Easy terms. See your music dealer or send for beautiful free book. Write today.**

**SOPRANI, INC.** Dept. 229, 630 S. Wabash Ave. CHICAGO, ILLINOIS

## Your VOICE!

### 100% Improvement Guaranteed or Tuition Refunded!

You to be sole judge! Strengthen and master your voice—not with singing lessons—but by scientific silent exercises, successfully taught for over a century. **Marvelous success with DEFECTIVE Voices.** Write for Free Voice Book. Learn WHY and HOW you can now have the voice you want. If under 17, we require parent's signature. With 100% improvement guaranteed—will you faithfully follow instructions? If so, WRITE: **Perfect Voice Institute, Studio 1352, 64 E. Lake St., Chicago**

# ENGINEERING

**DEGREE IN TWO YEARS**

TECHNICAL AND APPLIED COURSES. Nonessentials omitted. TIME AND MONEY SAVED. Degree 2 yrs., diploma 1 yr. Electrical, Mechanical, Architectural, Structural, Civil, Aeronautical, Highway. All courses include Air Conditioning, Electric Refrigeration and Diesel. Short intensive courses 3 and 4 months in Electricity, Power Plant, Diesel-Electric, Air Conditioning, Electric Refrigeration, Drafting. Extensive modern equipment. **LOW TUITION.** Part-time work for room and board. Thousands of successful graduates in U. S. and foreign lands. Approved by Industry, endorsed by educators, recommended by alumni. One and two-year courses open in Sept., short courses open year round. 39th YEAR. Catalog free.

**FINLAY ENGINEERING COLLEGE**  
 1921 Indiana Avenue Kansas City, Mo.



*Learn to Write*  
 Begin Today. Write for our Free Book, "How to Become a Good Penman." It contains specimens and tells how others learned to write in spare time. Your name elegantly written on a card if you enclose stamp for postage. Write today. The Tamblin School of Penmanship, 418 Ridge Bldg., Kansas City, Mo.



**WHY NOT** spend spring, summer, fall, gathering butterflies, insects. I buy hundreds of kinds for collections. Some worth \$1 to \$7 each. Simple outdoor work with my instructions, pictures, price list. Profit—pleasure. Send 10c (not stamps) for Illustrated Prospectus before sending butterflies.  
**MR. SINCLAIR, DEALER IN INSECTS**  
 Dept. 6, Box 1830 San Diego, Calif.

# Photography

## for



**PLEASURE or PROFIT**  
 Prepare for profitable business or fascinating hobby, at home under guidance of qualified instructors. No previous experience necessary, common school education sufficient. Many earn while learning. Our practical studio methods also qualify for well-paying positions upon graduation. Send coupon below at once for free booklet "Opportunities in Modern Photography", particulars and requirements.

**AMERICAN SCHOOL OF PHOTOGRAPHY**  
 3601 Michigan Avenue Dept. 1352 Chicago, Illinois  
 Send booklet, "Opportunities in Modern Photography", full particulars and requirements.  
 Name..... Age.....  
 Address.....  
 City..... State.....



# PREPARE NOW FOR A BETTER JOB IN ELECTRICITY OR RADIO

## BY 12 WEEKS TRAINING IN THE BIG COYNE SHOPS

Get into a real live, money making field where thousands of men make \$30, \$40, \$50 and up a week in the fascinating field of electricity. Prepare today for your start in a field that is full of opportunities for the trained man.

### Learn by Doing — in 12 Weeks

on real motors, generators, engines, and real Radio equipment and sets. The remarkable "Learn by Doing" method used in the great Coyne Shops trains you in Electricity and its many branches in 12 weeks. Actual shop work — not a correspondence course — you don't have to recite. Instead you are trained by actual work in wonderful, modern daylight shops on the finest kind of Electrical and Radio equipment, under personal supervision of expert instructors. That's why Coyne Training prepares you for your start in this field, in a short time.

### You Don't Need Previous Experience or a Lot of Book Learning

Many of our successful graduates have not even completed common school. At Coyne you learn by actual experience on a wide variety of up-to-date generators, motors, dynamos, batteries, automotive and aviation engines, electric signs, etc.

On Jobs Like These—No Correspondence  
Real Work on Modern Electrical Equipment

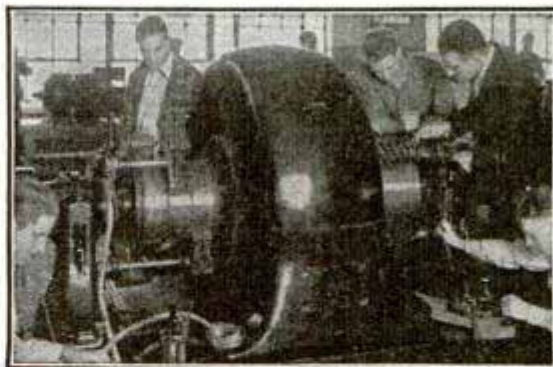

Working on Real Electrical Equipment at Coyne

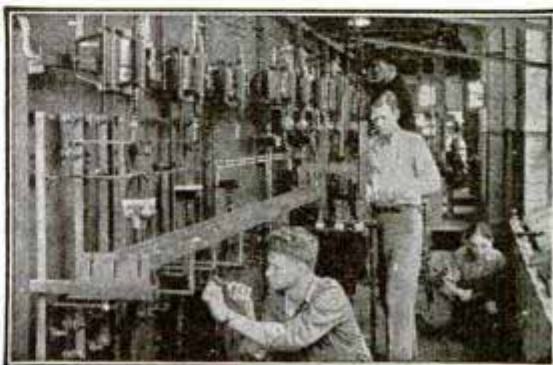

A Real Switchboard in the Coyne Shops

## Astounding Offer! PAY COST OF TRAINING AFTER YOU GRADUATE Over a Year to Pay in Small Monthly Payments

Get your training first—then pay back tuition in easy monthly payments starting 5 months from the date you start school, or 2 months after the required training period is over. And

you'll have 12 months to complete your payments. Mail the coupon now and I will send you, without obligation, full details of this astounding offer!

### EARN LIVING Expenses While You're Training!

Many of my students work part time to help pay their living expenses while they are training.

### EMPLOYMENT Help For You After Graduation

My Graduate Employment Service will give you employment help after graduation. You are also entitled as a graduate to free consultation service any time you need it.

### RADIO COURSE INCLUDED

Right now I am including, at no extra cost, a special Radio course, which you can take, at no extra charge, after you have completed your electrical course. Send coupon today and I'll send you all details of this offer.



### ELECTRIC REFRIGERATION AIR CONDITIONING

My electrical course includes training in these 2 fast growing branches of Electricity.

**MAIL  
Coupon  
NOW!**

### GET THIS FREE BOOK

Get the new "Coyne Opportunity Book," giving all facts about Coyne Training. Photographs of Shops showing students at work on modern electric equipment under the personal supervision of Coyne Expert Instructors. Also details of my Spare Time Employment Offer, Pay After Graduation Plan and Graduate Employment Service. Yours without cost. Simply Mail the coupon.



H. C. Lewis, President  
Coyne Electrical School, Dept. 29-72  
500 S. Paulina St., Chicago, Ill.

Send me your big FREE Book about Coyne Training and give me all details regarding your "Spare Time Employment Offer", "Pay After Graduation Plan" and Your Radio Course.

H. C. LEWIS, Pres.

Founded 1899

**COYNE ELECTRICAL SCHOOL**  
500 S. Paulina St., Dept. 29-72, Chicago, Ill.

NAME.....AGE....

ADDRESS.....

CITY.....STATE.....



# AIRCRAFT CAREERS

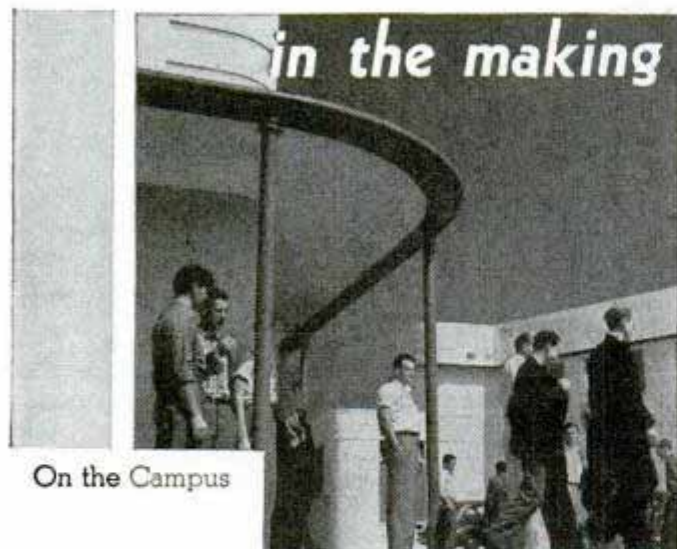

On the Campus

## PICTURE Yourself



HERE AT  
AERO I.T.I.

In Class

In the  
Shops



## Starting YOUR CAREER

... in a great industry that needs thousands of trained men RIGHT NOW ... that offers you an unlimited future in the fascinating work of creating and building tomorrow's bigger, better planes. Picture yourself at Aero I. T. I. starting such an ideal career ... following a *Master Aircraft Mechanics* or *Aeronautical Engineering* course. Find out why there is such a big demand for Aero I. T. I.-trained men ... why they advance so much faster. Get the whole story in a free new booklet. Send the coupon NOW.

### EXECUTIVE BOARD

<b>C. A. VAN DUSEN</b> Vice-Pres. Consolidated Aircraft Corporation	<b>JOHN K. NORTHROP</b> formerly Pres., The Northrop Corp. and Vice-Pres. Douglas Aircraft Company, Inc.	<b>ROBERT E. GROSS</b> President Lockheed Aircraft Corporation
---	--	--

**Aero Industries Technical Institute**  
5253 West San Fernando Rd., Los Angeles, Calif.  
*America's Finest Aircraft Training Institution*

Please send free booklet and complete information on Aero I.T.I. training for aircraft careers. (This information intended only for men over 17 and under 40.)

NAME \_\_\_\_\_ AGE \_\_\_\_\_  
ADDRESS \_\_\_\_\_  
CITY \_\_\_\_\_ STATE \_\_\_\_\_ a-14-p

# Air Become An Conditioning Engineer

Big fast-growing field for men trained in design, estimating, insulating, installing and servicing. Offers real opportunities in Air Conditioning new buildings and remodeling worth-while old buildings. Write today for method of how you can prepare for this thriving industry. No obligation.

American School, Dept. AC-245, Drexel at 58th, Chicago I

## Want a Career in photography?

Big opportunities to make money! Train at Home or in our completely equipped studios. Commercial, News, Portrait, Advertising, Natural Color, Motion Picture and other branches of photography. Famous experts will be your teachers. Free booklet.

NEW YORK INSTITUTE OF PHOTOGRAPHY  
10 West 33 St. (Dept. 49) New York City



## CARTOONISTS

Learn to draw original Cartoons. Send one dollar for my book, *FIRST STEPS TO A CARTOON CAREER*. Written and illustrated by a nationally known cartoonist. 22 lessons based on 20 years experience as cartoonist on great metropolitan dailies. Printed on strong paper. Spiral binding.

**\$1**

DORMAN H. SMITH, Box C597, San Rafael, California



## LOOK! Baby Chicks

THOUSANDS WEEKLY ALL YEAR. Finest quality & Layers in 40 breeds. Hybrid Baby Pullets and Cockerels, B. W. D. Tested. Ducklings, Goslings, Baby Turkeys, Guineas. In business 30 years. Catalog free. AGENTS! Big money made selling Nabob Chicks. Write! NABOB HATCHERIES, BOX M, GAMBIER, OHIO

## AUDELS Carpenters and Builders Guides

4 vols. \$6



Inside Trade Information for Carpenters, Builders, Joiners, Building Mechanics and all Woodworkers. These Guides give you the short-cut instructions that you want—including new methods, ideas, solutions, plans, systems and money saving suggestions. An easy progressive course for the apprentice and student. A practical daily helper and Quick Reference for the master worker. Carpenters everywhere are using these Guides as a Helping Hand to Easier Work, Better Work and Better Pay. To get this assistance for yourself, simply fill in and mail the FREE COUPON below.

### Inside Trade Information On:

How to use the steel square—How to file and set saws—How to build furniture—How to use a mitre box—How to use the chalk line—How to use rules and scales—How to make joints—Carpenters arithmetic—Solving mensuration problems—Estimating strength of timbers—How to set girders and sills—How to frame houses and roofs—How to estimate costs—How to build houses, barns, garages, bungalows, etc.—How to read and draw plans—Drawing up specifications—How to excavate—How to use settings 12, 13 and 17 on the steel square—How to build hoists and scaffolds—skylights—How to build stairs—How to put on interior trim—How to hang doors—How to lath-lay floors—How to paint.



**THEO. AUDEL & CO., 49 W. 23rd St., New York City**

Mail Audels Carpenters and Builders Guides, 4 vols., on 7 days' free trial. If O.K. I will remit \$1 in 7 days, and \$1 monthly until \$6 is paid. Otherwise I will return them. No obligation unless I am satisfied.

Name.....  
Address.....  
Occupation.....  
Reference..... P.M.



# MAKE MONEY

## in POULTRY



*"I'll show you how to have a fine spare-time or full-time business"*

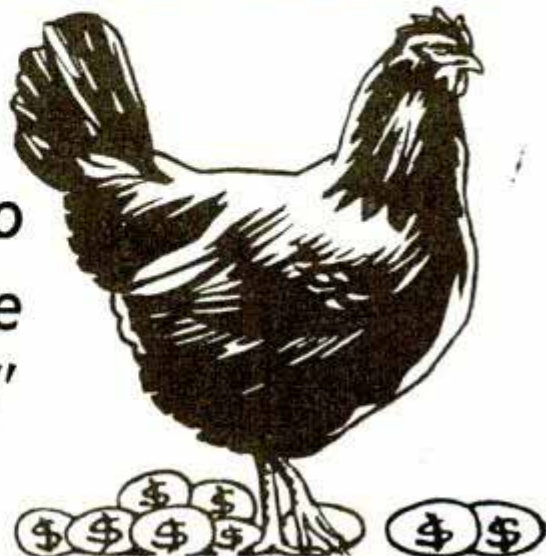

### No Experience Needed

Chickens grow naturally. They lay eggs naturally. But their growth can be speeded up. Their egg production increased. Modern methods of breeding, feeding, and marketing give the trained poultryman an advantage. My home-study course shows you and gives you an important dollars and cents advantage. For example, I show you how to increase yields, reduce losses, save time, tell when to buy, how to sell. Also, my students can save 10% to 25% on all equipment through my purchasing department. Get into this fascinating business and see for yourself. You'll be surprised to learn that really BIG money can be made.

**R**IGHT outside of Washington, D. C., on the road to Rockville, Md., near the big estates of many prominent people, there is a new restaurant, rapidly becoming famous, simply because it specializes in battery-produced broilers.

### Battery Brooding Helped in This Case

"Battery" brooding is the latest and most scientific method of raising delicious chickens for the market, with a minimum of cost and waste, and a maximum of profit. Every year it is attracting more and more men and women who want to make a nice income in a fascinating business. So simple you can do it in your garage or basement.

### Poultry for Pleasure and Profit

Years ago every farm had a flock of chickens, just to supply family needs, with a small supply of eggs and birds left over for the market. But few people thought of poultry either as a hobby or a business. Today all that is changed. Just as the restaurant, which I mentioned above, is making a big thing of birds produced the new way, so are thousands of individual operators: In all parts of the country, on the farm and in the suburbs, ambitious men and women are applying the latest methods, as taught through my famous home-study course, and cashing-in handsomely on poultry meat and eggs.

### Get my FREE BOOK on How to Raise Poultry for Profit

This is a year 'round business, ideal for either men or women, and even the children find it fascinating to help. You, too, may learn to use my modern methods and enjoy success right at home. But find out for yourself. See what it may mean to you and your family. Read my interesting 32-page illustrated FREE BOOK, "How to Raise Poultry for Profit"—just mail me this coupon TODAY.

## \$ RESULTS COUNT \$

**MONEY AHEAD**  
Says F. R. Ostrowski

F. R. Ostrowski of Chicago, recently wrote: "I have found that training pays in the poultry business as in any other business. Since finishing I have received offers to manage several Commercial Poultry Farms."



**Course Best Investment**  
Says Zimmerman

"I congratulate you on your practical and thorough Poultry Farming Course. Anyone interested in poultry will find your course the very best investment for success. I can highly recommend your training and personal service."  
Geo. E. Zimmerman, Union, N. J.



## SUCCESS COUPON

**HARRY M. LAMON, President,**  
National Poultry Institute,  
Dept. 40-D, Adams Center, N. Y.

I want to know how to make big money raising poultry. Send me your FREE book explaining your home-study course and PROVED methods.

Name.....

Address.....

City..... State.....







**S**PECTACULAR aerial advertising, in which an airplane and a parachute are employed, has been patented.



The parachute, with long advertising sign attached, is towed to high altitudes by the plane, then released. When the 'chute opens, it gently descends with the sign floating below it. One unusual feature is that the pilot follows the parachute down, circling not far above it, and just before it lands,

he picks it up by an attachment on the plane. Then he climbs again into the upper air to repeat the performance.

**P**ROTECTION of banks and theaters from holdups is the purpose of a newly patented alarm.

It consists of a body-girdling belt that fits around the chest of a guard or other employe and it includes an oscillation generating device adapted to transmit signals strong enough to be picked up by a receiving apparatus in another part of the bank or other building. The generator is actuated when the wearer of the alarm belt expands his chest abnormally, that is, more than that necessary in ordinary breathing.



Thus, the guard may send midget signals that will warn other guards or employes that a holdup is in progress, bringing help immediately to the scene.

**S**ERVING the double purpose of bumper guard and hitch connection for towing

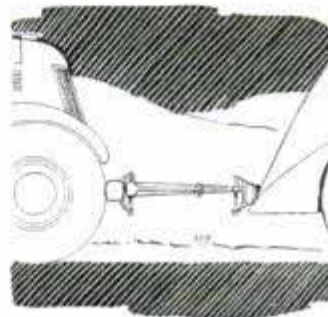

another car, a handy attachment for the automobile has been patented recently. An elongated plate secured to a bumper rod has a rib projecting forward.

At the free end of the rib is a bead. The hitch is made with the aid of a drawbar having a head provided with an opening to receive the bead and a slot at one side of the opening to accommodate the rib.

**M**AKING displays more attractive and more visible to the passerby is the

purpose of a newly patented non-reflecting window. It includes a curved transparent glass plate constituting a portion of an ellipse. A light-absorbing screen is used with the curved glass so that when the glass is mounted in the window opening, the foci of the ellipse will be represented by a point on the light-absorbing screen and a point located at the eye level of the normal observer. Thus, reflections are eliminated, increasing visibility of the window display.

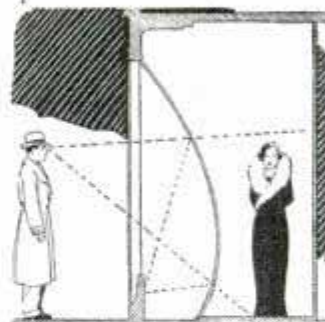

(Continued to page 33A)



# DOESN'T IT LOOK EASY?

Yet it's from the famous "Merry Widow" Waltz!

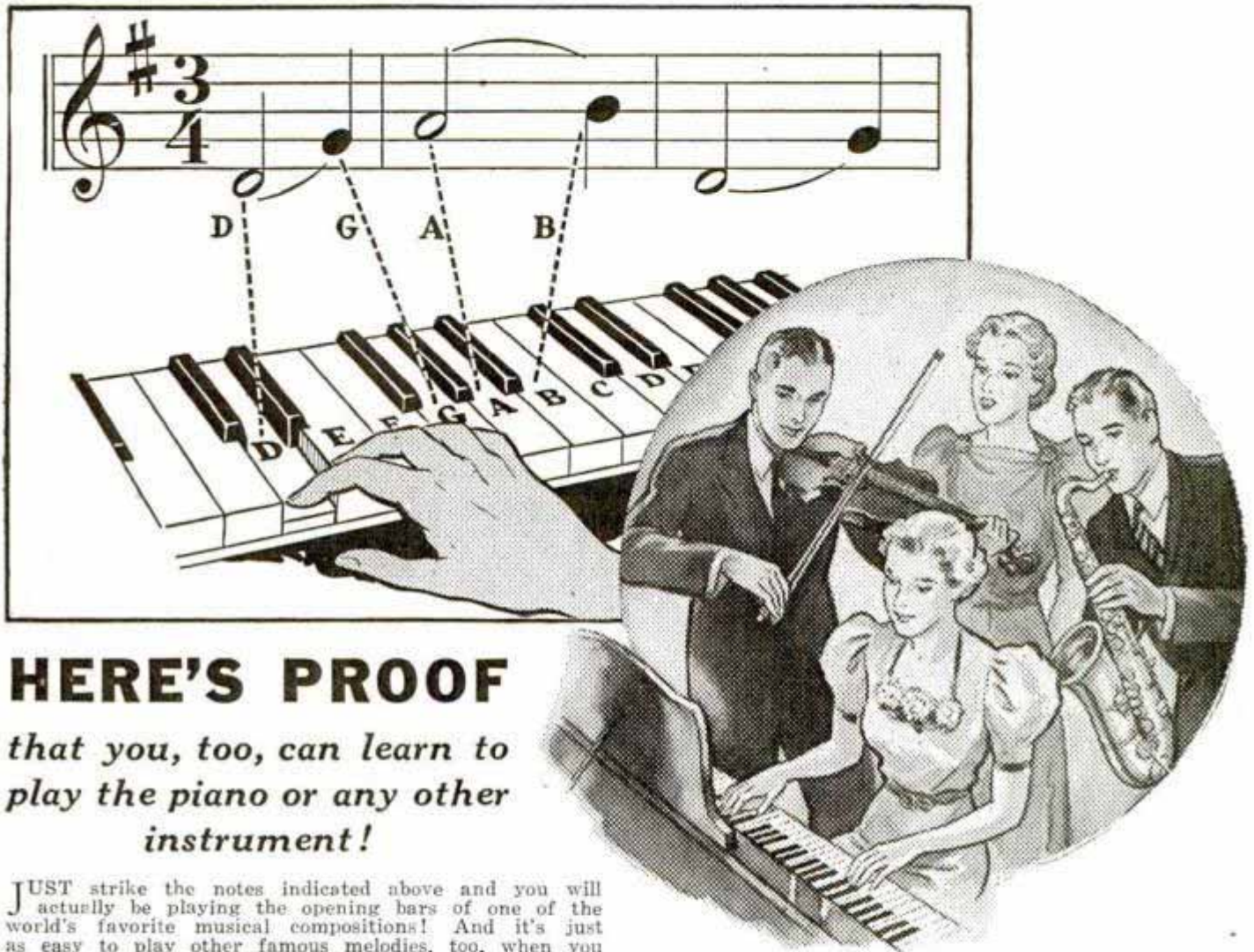

## HERE'S PROOF

*that you, too, can learn to play the piano or any other instrument!*

JUST strike the notes indicated above and you will actually be playing the opening bars of one of the world's favorite musical compositions! And it's just as easy to play other famous melodies, too, when you use the wonderful "Note-Finder".

This invention of the U. S. School of Music takes the mystery out of the piano keyboard, does away with tedious study and practice, enables anyone to play a real tune almost from the start. And that's the way this modern method works. You learn to play by *playing*. Soon you will be thrilled and delighted to find that you can pick up almost any piece of popular music and play it at sight. And that applies to the piano or violin, the saxophone or guitar, the accordion or whichever instrument you choose for your own!

### Takes Only Few Minutes a Day!

#### PICK YOUR INSTRUMENT

Piano  
Violin  
Organ  
Cornet  
Trombone  
Piccolo  
Flute  
Hawaiian Steel Guitar  
Trumpet  
Piano Accordion  
Plain Accordion  
Voice and Speech Culture  
Modern Elementary Harmony  
Drums and Traps  
Banjo (Plectrum  
5-String or Tenor)

Guitar  
Saxophone  
Mandolin  
Ukulele  
Harp  
Clarinet  
Cello

Do you wonder that over 700,000 people all over the world have taken advantage of this easy way to learn music at home? Don't let old-fashioned ideas deprive you of the joys of playing any longer. You don't need special talent; you don't need any previous knowledge of music; you don't need to spend months on monotonous drills and exercises. It's fun to learn music this modern way; it's easy as A-B-C; it takes only a few minutes a day. But see for yourself! Simply send today for our

### FREE Demonstration Lesson

This demonstration lesson will give you the surprise of your life. It will show you, in black and white, how you can quickly realize your dreams of playing your favorite instrument. With the demonstration lesson, you will also receive a handsome illustrated booklet and details of the remarkable, money-saving offer that enables you to learn music at home for but a few cents a day. All this material will be sent to you by return mail, without cost or obligation. Simply mail the coupon or write, mentioning instrument that interests you. Do it *today*. Note: instruments supplied when needed, cash or credit. U. S. School of Music, 72 Brunswick Bldg., New York City, N. Y. (Est. 1898)

U. S. School of Music,  
72 Brunswick Bldg., New York, N. Y.

Gentlemen: Please send me by return mail, FREE Demonstration Lesson, illustrated booklet and full details. I am interested in the following instrument:

Name.....

Address.....

City..... State.....

Check here if you want our Instrument Catalog.

*When writing to advertisers please mention Popular Mechanics*



# INVENTORS

ACT NOW TO PROTECT YOUR INVENTION  
WITH U. S. PATENT

## OUR BIG BOOK TELLS YOU

*The Importance of Quick Action*

If you have a new idea that is patentable—and want to secure for yourself your inventor's sole right to profit from the idea—you can't afford to lose time in securing the protection of a U. S. Patent. Other inventors may be working on the same idea right now. Should

they develop this idea and file patent application before you do—the burden of establishing priority will be upon you. Our Big Book—"Patent Guide for the Inventor"—will tell you the quickest possible way to secure Patent Protection for your idea. SEND FOR IT TODAY!

## THE FIRST IMPORTANT STEP IN SECURING A PATENT

is to obtain the services of a Registered Patent Attorney. Establish the date of your invention as explained in our Book and disclose your idea to him in correct form. He then makes a SEARCH of the Patent Office Records and reports to you on the existing U. S. Patents which might bear on your invention, giving his opinion on the advisability of proceeding and filing formal application. How this inexpensive

step can save you money, time and delay when Patenting your idea—how it tells you whether or not it is worth your while to file formal Application—all is explained in our Big Book—Send for it TODAY. If you have developed some improvement, something which adds to the usefulness of any product—whether this product is Patented or not—you should protect your improvement with a Patent at once. Send for our Big Book which tells you how.



### BLANCHARD TOILS TO TRIUMPH

The inventor of the lathe was a farmer's son. There was no one to show Thomas Blanchard how to do the things his mechanical bent inclined him to try. He started by making an apple-parer while at school. Working in his brother's tack factory, at West Milbury, Massachusetts, Blanchard determined to make tacks by machine, instead of by hand. His own brother belittled the idea. Tom persisted in working at it after his day in the factory. One day, after six years of experiment, he showed his tack-making

brother how to turn out 12,000 an hour with a wonderful machine, patent on which brought Blanchard \$5000.00.

### ALSO FREE RECORD OF INVENTION

Use our FREE "Record of Invention" Form to assist you in recording the descriptive outline of your idea and to establish the date of your invention. With it you can make a rough sketch of your idea and have it witnessed in a manner of value to you, as evidence should occasion arise. Whether you plan to proceed immediately or not—get this Form, record your Invention, and have it witnessed.

**CLARENCE A. O'BRIEN  
and HYMAN BERMAN**

78-V Adams Building Washington, D. C.  
Registered Patent Attorneys Before U. S. Patent  
Office

MAIL COUPON TODAY  
FOR BIG

**FREE**

48 PAGE  
FORM FOR RECORDING

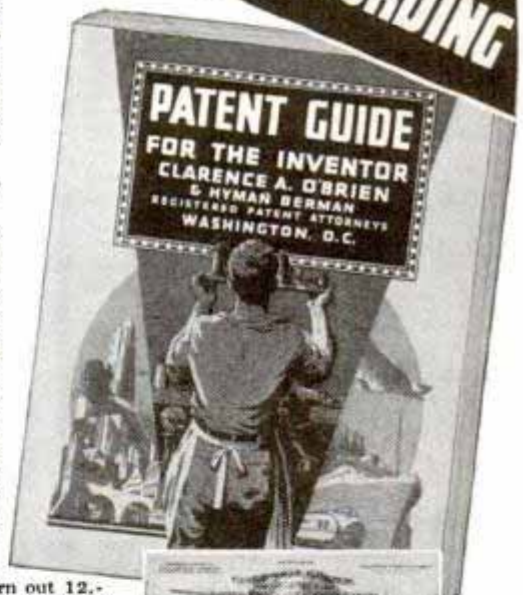



# You Can PATENT

## Small Ideas May Have Large Commercial Possibilities

Ideas do not have to be complicated to be profitable when Patented. The 5c and 10c stores flourish on simple Patented products which are commercially successful. The zipper, safety pin, thumb tack, paper clip, collar button—all are simple yet familiar inventions—brought their inventors rich rewards. If you have a Patentable idea—act to protect it. Send for our FREE 48-Page Book that tells you how.

## NEW IDEAS FOR IMPROVEMENTS IN MACHINERY ARTICLES, DESIGNS, FORMULAS, ETC.

Every year thousands of Patents are granted. Very few, however, represent the discovery of entirely new principles. Most of them provide new methods of doing some every-day thing in a better way—changes for greater efficiency, usefulness, adaptability, or beauty in some previously Patented thing. These IMPROVEMENTS are patentable if new, and actually represent new invention. These improvement Patents offer large chances for profit if commercially useful. The business world wants improved products and services.

## OUR SERVICES TO YOU

We are Registered Patent and Trade-Mark Attorneys, serving Inventors all over the United States and abroad. Our organization is complete. We have Draftsmen, experienced

Searchers and Attorneys to serve your interests. We can act as your legal adviser in all Patent Matters. Our complete service is described in our Big Book. Mail Coupon for it NOW.

## IN CASE YOU FEEL THAT YOU HAVE NOT SUFFICIENT FUNDS AVAILABLE FOR PATENT FEES

Our Big Book tells you how to legally assign an interest in your invention before filing application—to some friend willing to aid you. Better to do this than to delay indefinitely and see another inventor develop your idea and Patent it before you do. Send Coupon NOW.

## REASONABLE FEES—CONVENIENT TERMS

Don't worry about finances. Our fees are very reasonable—we can arrange convenient terms of payment. It is our custom to permit clients to pay for our services in installments as the application progresses in our office. See our Big Book for fees in obtaining Patent. It explains our arrangements clearly. Send for it NOW.

**BOOK AND FREE  
YOUR INVENTION**

*for quick  
action!*

## REQUEST OUR BOOK — NOW!

Know exactly what you should do to secure a Patent—what must be done every step of the way—how the Patent Law protects you—what we, as Registered Patent Attorneys, can do for you. Mail the coupon NOW for our Big Booklet and "Record of Invention" Form.

**SEND  
TO-DAY**

**CLARENCE A. O'BRIEN  
and HYMAN BERMAN**

**70-V Adams Bldg., Washington, D. C.**  
Registered Patent Attorneys Before U. S.  
Patent Office

Please send me at once your Big Free 48-Page Book "Patent Guide for the Inventor" and your Specially Prepared "Record of Invention" Form. This request does not obligate me.

**CLARENCE A. O'BRIEN  
and HYMAN BERMAN**

**70-V Adams Building Washington, D. C.**  
Registered Patent Attorneys Before U. S. Patent Office

NAME.....

ADDRESS.....

CITY.....STATE.....

(Please write or print plainly)



**FOR MEN WHO WANT TO LEARN A PROFITABLE TRADE**

*Complete*

# DIESEL TRAINING

**NO MATTER WHERE YOU ARE OR WHAT YOU DO — we have a training plan for YOU!**

IF you are sincerely ambitious and interested in making good in the Diesel field, be sure to immediately investigate our flexible training plan that will fit your circumstances. A Plan for every Man. A Plan for those seeking immediate shop training as well as for those who cannot give up their present employment and income. For 34 years National Schools, a recognized leader in the field of trade education, has helped wide-awake men to success. This million-dollar trade school will supply you with a sincere, honest statement of facts of what you should do to quickly get into the profitable Diesel Industry. No exaggerations—no misstatements; and a definite plan to fit you.

**Write Today for Full Details**

Mail the coupon below. Find out how you can get the finest in Diesel training without delay. See how this great trade school operates and makes its facilities available to every ambitious man. Actual work in modern training shops, a part of every man's instruction. Shop methods time-tested for 34 years. Fascinating, efficient preparation. Get the facts.

**WE ARE DEFINITELY INTERESTED IN HELPING MEN OF LIMITED INCOME AND "BLIND ALLEY" JOB HOLDERS.**

**NATIONAL SCHOOLS**



**FREE BOOK**

*Los Angeles*

*Request for Free Book*

NATIONAL SCHOOLS (established 1905) Dept. 2-PMA  
4000 South Figueroa Street, Los Angeles  
Please send me, without obligation, your FREE BOOK and information regarding Diesel Employment Opportunities and Requirements.

NAME \_\_\_\_\_ AGE \_\_\_\_\_

ADDRESS \_\_\_\_\_ CITY \_\_\_\_\_ STATE \_\_\_\_\_

**GET IN THE SWING**  
*with Slingerland . . . DRUMS*  
**GUITARS**  
**MANDOLINS**



**GENE KRUPA — World's Greatest Swing Drummer uses Slingerland**

**NOTHING CORNEY**  
about Slingerland Instruments

Compare the value—tone and power in Slingerland "Radio King" drums, banjos, guitars, mandolins, marimbas or bugles—before you buy. Guaranteed more for your money. Acclaimed the tops in smooth

tone, easy playing, rich power by world's leading musicians. Easy payments. 5-days free trial. See at your dealers.

Cut this ad out—good for \$1.00 credit. Free special information on how to organize drum and bugle corps. Free Catalog—mention instrument wanted.



**SLINGERLAND DRUM CO.**  
1330 Belden Avenue Chicago, Illinois

**BE A CARTOONIST**



AT HOME IN YOUR SPARE TIME UNDER personal supervision of the famous cartoonist NORMAN MARSH creator of "DAN DUNN" appearing every day in big papers. **Success—Fame—Real Money** may be Yours when you learn Marsh's easy simple methods and secrets. Send name and address for free details of MARSH'S Personal course. **ACT TODAY!**

4554 Broadway Dept. B-100 Chicago, Ill.

**LEARN AVIATION IN LOS ANGELES**



Huge increases in aviation activity creating good paying positions. Rapid advancement for California Flyers graduates. Only U. S. Government approved Los Angeles school offering flying mechanics drafting and aircraft construction. Most modern equipped and strategically located school in America. Low tuition. Free transportation to L.A. Write for Catalog.

**CALIFORNIA FLYERS SCHOOL OF AVIATION—Dept. PM 2**  
LOS ANGELES MUNICIPAL AIRPORT, INGLEWOOD CALIF.

**WILL YOU WEAR THIS SUIT**  
**and Make up to \$12 in a Day!**



Let me send you a fine all-wool union tailored suit **FREE OF ONE PENNY COST.** Just follow my easy plan and show the suit to your friends. Make up to \$12 in a day easily. No experience—no house-to-house canvassing necessary.

**Send for Samples — FREE OF COST**  
Write today for FREE details. ACTUAL SAMPLES and "sure-fire" money-making plans. Send no money.  
H. J. Collin, **PROGRESS TAILORING CO., Dept. P-216,**  
500 South Throon Street, Chicago, Illinois.

**MAIL FOR FREE INFORMATION**

**BROOKLYN**  
**YMCA**  
**TRADE SCHOOL**

- 117 Bedford Ave., Dept. PM-69  
Brooklyn, New York City, N. Y.
- Diesel Engines  Oil Burner
  - Diesel Pre Engineering
  - Aviation Mechanic  Welding
  - Aeronautical Pre Engineering
  - Auto Mechanic  Talking Pictures
  - Refrigeration  Machine Shop
  - Radio and Television Mechanic
  - Air Conditioning
  - Architectural-Mechanical Drafting
  - Electrical  Window Display
  - Armature Winding

Name.....

Address.....



**TIRE PUNCTURED 27 TIMES..**

**LEAKS NO AIR**

**1001 Repairs in Home. Auto, Farm For Only**

New plastinoid "putty"—**SO-LO**—fills cracks, holes in tires, shoes, boots—anything of rubber, leather or cloth. Spreads on like butter. Dries tough. Waterproof, flexible, non-skid. Won't come off—guaranteed! 25c package (25 repairs) shows many uses. At any 10c or hardware store.

**1c EACH**

**So-Lo**

**TRI-STATE COLLEGE**

World famous for technical 2-year courses in Civil, Electrical, Mechanical, Chemical, Radio, Aeronautical Engineering, Business Administration and Accounting. Special preparatory department for those who lack required high school work. Short diploma courses (36 weeks) in Surveying, Drafting. Low tuition. Low living costs. Students from every state and many foreign countries. 56th year. Enter March, June, September, January. Write for catalog. 429 College Ave., ANGOLA, IND.

**LEARN WATCH REPAIRING**

**AT HOME** You can learn by our modern and original system of instruction every part of the Watch Repairing Trade at home. You can earn money while learning and prepare yourself for a well paying position or start in business after completing our course of instruction. Good watch repairers are in demand and generally earn very good salaries. For particulars apply to the Wisconsin School of Watch Repairing 524 E. Mason St., MILWAUKEE, WIS.

**Regain Perfect Speech, If You STAMMER**

Send today for beautifully illustrated book entitled "DON'T STAMMER," which describes the Bogue Unit Method for the scientific correction of stammering and stuttering. Method successfully used at Bogue Institute for 38 years—since 1901. Endorsed by physicians. Full information concerning correction of stammering sent free. No obligation. Benjamin N. Bogue, Dept. 199 Circle Tower, Indianapolis, Indiana.

**Learn MECHANICAL DENTISTRY AT HOME!**

To make Crowns, Plates, Bridgework, etc., for Dentists. Easy practical way to learn mechanical dentistry at home in spare time. FULL EQUIPMENT OF TOOLS AND MATERIALS INCLUDED WITH COURSE. Low tuition. Easy terms. Write for FREE BOOK about this money making profession that is not affected by machine age. McCARRIE SCHOOL OF MECHANICAL DENTISTRY 207 N. Broad St., Dept. 742, Philadelphia, Pa.

**Minstrels** Comedy Skits & Plays Songs

Unique First Parts for complete show with special songs and choruses. Make-up. Catalog Free.

T. S. Denison & Co., 203 N. Wabash, Dept. 19, Chicago

**JOBS in RADIO-TELEVISION**

Extension and resident training in television, aviation and police radio. Let us tell you how we train men, fit them for good jobs, help them get jobs. Write for catalog. Affiliated with KMBC, major network station. Address MIDLAND TELEVISION, Inc., 106-B Power & Light Bldg., Kansas City, Mo.

**I WANT MEN**

**FORDS GIVEN** TEA & COFFEE ROUTES PAYING UP TO \$45

Million dollar company needs more men at once to make regular calls on local routes. No experience needed. Earnings start at IN A WEEK once. Ford Tudor Sedans given producers as bonus. Full particulars mailed free. Just send postcard. E. J. MILLS, 9291 Monmouth Ave., Cincinnati, Ohio

**Prepare at Home for JOBS in DRAFTING**

With this expert drawing outfit—drafting table, drawing board, superior drawing instruments . . . all sent without additional cost, you are all set to learn DRAFTING AT HOME. FREE TRIAL LESSON shows how easy. Mail coupon.

**THIS DRAWING OUTFIT YOURS**

The draftsman's work comes first. When business improves . . . and it is improving . . . there is new construction work, new buildings, new machines, repairs and reconstruction work. All these must first be laid out on paper. So the FIRST man that must be hired is the DRAFTSMAN.

**Drafting Is Well-Paid Work**

Drafting is clean, interesting professional-type work. It pays well to start . . . offers real opportunities for promotion. You need no previous training or experience . . . no special talent—to learn Drafting. It is one of the steadiest employment fields. No machine ever did the Draftsman's work . . . and no machine can be invented. So your job is always secure.

**Learn AT HOME**

in your spare time (or at the College in Chicago) by the fascinating, easy, step-by-step plan originated by this 35-year old school for Draftsmen.

**FREE TRIAL LESSON**

**free TRIAL LESSON**

Sample this easy-lesson system of learning Drafting. Send postal card or this coupon. No charge now or later for this FREE LESSON. Prove to yourself how easy it is to learn Drafting by the C. T. C. method in your spare time right in your OWN HOME.

**CHICAGO TECHNICAL COLLEGE**

B200 Tech Bldg., 118 E. 26th Street, Chicago, Illinois.

Please send me **FREE Trial Lesson** in DRAFTING and show me how I can prepare for good positions in spare time AT HOME.

Name..... Age.....

Address.....

P. O..... State.....

When writing please mention Popular Mechanics



**"I'll prove in only 7 days I can make YOU a NEW MAN"**

No other Physical Instructor has ever **DARED** make such an offer

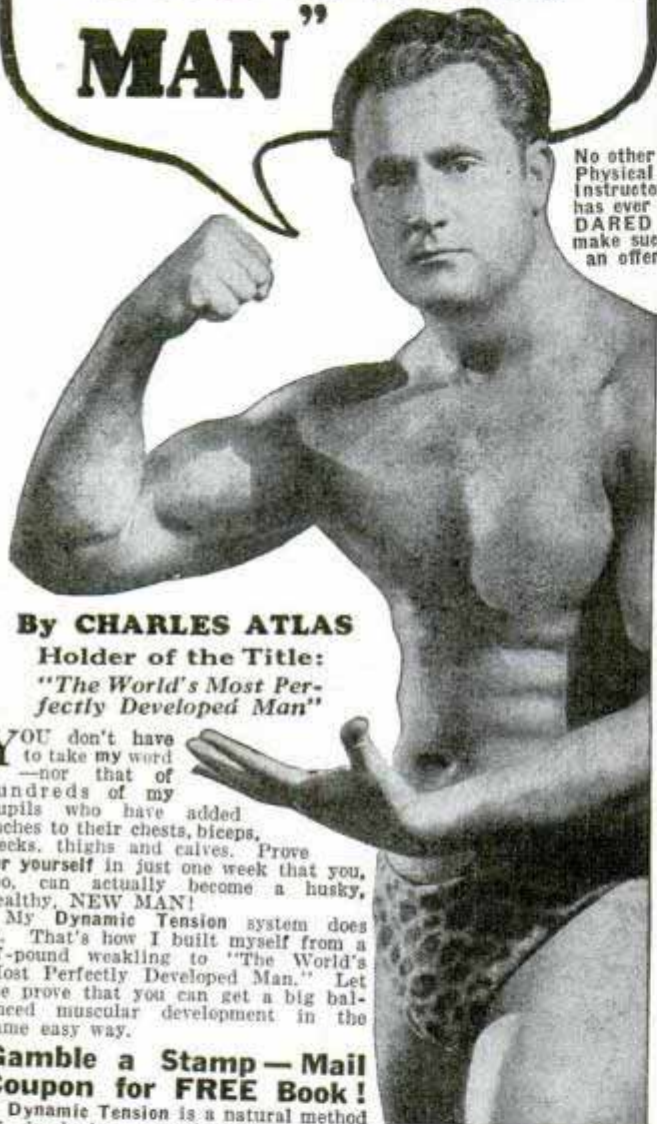

**By CHARLES ATLAS**  
Holder of the Title:  
"The World's Most Perfectly Developed Man"

**YOU** don't have to take my word—nor that of hundreds of my pupils who have added inches to their chests, biceps, necks, thighs and calves. Prove for yourself in just one week that you, too, can actually become a husky, healthy, **NEW MAN!**

My Dynamic Tension system does it. That's how I built myself from a 97-pound weakling to "The World's Most Perfectly Developed Man." Let me prove that you can get a big balanced muscular development in the same easy way.

**Gamble a Stamp—Mail Coupon for FREE Book!**

Dynamic Tension is a natural method of developing you, inside and out—without using any pills, unnatural dieting, or tricky weights or pulleys that may strain your heart or other vital organs. It goes after such ailments as constipation, pimples, skin blotches, and other conditions that keep you from really enjoying life.

Gamble a stamp today. Mail coupon for a free copy of my new illustrated book, "Everlasting Health and Strength." It shows you, from actual photos, how I have developed my pupils to the same perfectly balanced proportions of my own physique.

Write your name and address down on the coupon. Send it to me personally, **CHARLES ATLAS**, Dept. 8B, 115 East 23rd Street, New York, N. Y.

**CHARLES ATLAS**, Dept. 8B,  
115 East 23rd Street, New York, N. Y.

I want the proof that your system of Dynamic Tension will make a New Man of me—give me a healthy, husky body, and big muscle development. Send me your free book, "Everlasting Health and Strength"—and full details of your 7-DAY trial offer.

Name .....  
(Please print or write plainly)

Address .....

City..... State.....

When writing please mention Popular Mechanics



**STERLING SILVER CUP BEING GIVEN AWAY**  
This valuable cup stands about 14" high on a black mahogany base. I will award it to my pupil who makes the most improvement in his development within the next three months.

"Everlasting Health and Strength"

*No Wonder*  
**DIESEL**  
*PAYS SO BIG!*



Diesel Engines produce "LOW COST" power—the newer ones are unbelievably light in weight. High Speed trains, passenger busses; huge trucks and now airplanes have adopted **DIESEL POWER**. Think what that will mean in the way of opportunities for **DIESEL TRAINED MEN**.

**Learn Diesel at Home**

Get into this profitable field **NOW**—prepare for an ever increasing demand—know the answer to any Diesel problem. We train you at home in **SPARE TIME**. No need to waste a minute or interfere with work or pleasure. Prepare for advancement the Diesel way. Get in line for a Big Pay Job. Write for **FREE** bulletin—there is no cost or obligation.

**AMERICAN SCHOOL**

Dept. D245 Drexel at 58th Chicago

**WIN YOUR DAWN WITH THE PATROL**

Unequaled advantages in location for all year flying, finest equipment, highest Government approval for obtaining license in Transport, Limited Commercial, Private Flying, Radio, Sheet Metal, Mechanical Courses. For complete illustrated catalog, write—



J. D. GREEN, Director, Dept. PM 16, TULSA, OKLAHOMA

**SPARTAN SCHOOL OF AVIATION**

**ENGINEERING DEGREE IN TWO YEARS**

B.S. DEGREE courses in engineering: Electrical, Civil, Chem., Mechanical, Radio and Television, or Aeronautical. 1 yr. Mech. Drafting. Intense, practical, thorough program. Prep courses without extra charge. Earn while you learn in this industrial center. Low tuition. Enter March, June, Sept., Dec. Write for Catalog. 229 E. Washington Blvd., Fort Wayne, Ind.

**INDIANA TECHNICAL COLLEGE**

**CARTOONING**

**PAYS WELL** Turn your talent into dollars  
Develop your ability with personal instruction from an internationally-known cartoonist. His exclusive, successful method of drawing and creating ideas makes it easy to learn. Write for Free Booklet explaining details of this exceptional home-study course. National School of Cartooning, 437 Penton Building, Cleveland, Ohio

**Is Your Rupture HERE?**

Why delay proper palliative treatment? If you suffer from rupture—and your doctor advises the use of a proper-fitting support—send for the facts about our perfected truss invention—the Brooks Appliance for reducible rupture—with the **AUTOMATIC AIR-CUSHION SUPPORT**. Thousands bought by doctors for themselves and patients.

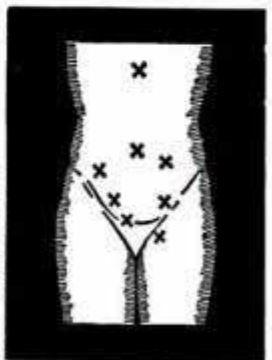

**Sent on Trial**—Made-to-measure, individual fitting for man, woman or child. Low-priced, sanitary, durable. No obnoxious springs or hard pads; no metal girdle to rust. Safe and comfortable. Helps Nature get results. Not sold through stores—beware of imitations. Write today for full information sent free in plain sealed envelope.

**BROOKS APPLIANCE CO.** 457 State St. Marshall, Mich.





**EASIEST**  
to master!

**THIS NEW P-A**

Such beautiful tone, and so easy to play! Just touch a key and blow normally; you can't miss. Nothing to compare with these new P-A Saxes, Clarinets, Trumpets, and other P-A instruments. Fully guaranteed; your success assured. See your music dealer or write direct for beautiful free book. No obligation. Easy terms. Greatest fun, easiest with P-A. Write today sure.

**PAN-AMERICAN**  
203 P-A BUILDING ELKHART, INDIANA

**LAW**

**STUDY AT HOME**

Legally trained men win higher positions and bigger success in business and public life. Greater opportunities now than ever before. Big corporations are headed by men with legal training.

**More Ability: More Prestige: More Money**

We guide you step by step. You can train at home during spare time. Degree of LL. B. Successful graduates in every section of the U. S. We furnish all text material, including 14-volume Law Library. Low cost, easy terms. Get our valuable 48-page "Law Training for Leadership" and "Evidence" books FREE. Send for them NOW.  
LaSalle Extension University, Dept. 264-L, Chicago

**Free AIR CONDITIONING AND REFRIGERATION TRIAL LESSON**

Trained men needed. Good pay. Opportunities. Learn easily AT HOME in spare time (or at our Chicago School). Send for FREE TRIAL LESSON. No charge for this now or later. Write today.

CHICAGO TECHNICAL COLLEGE  
B-303 Tech Bldg., 118 E. 26th St., Chicago, Ill.

**CRIME DETECTION SECRET SERVICE AND FINGER PRINTS**

**SECRET SERVICE BOOK FREE**

For 30 Days Reading  
No Money Down—Actual Crime Cases—  
If You Act Quick! We will send you this stirring book on Crime Detection, Secret Service and Identification. Work for 30 days free reading. Send no money. If you decide to keep it, then send me only \$1.00. If not, return it. WRITE TODAY. Literature will be sent only to persons stating their name.

T. G. COOKE, Dept. 1352, 1920 Sunnyside Ave., Chicago, Ill.

**CARTOON YOUR WAY TO SUCCESS!**

**DON'T COPY - LEARN TO ORIGINATE!**  
RAYE BURNS will teach you HOW to CREATE ORIGINAL CARTOONS at home that you can SELL! Course has 26 lessons and 600 illustrations.

Send name and address for free details. Only... **\$2.85**  
RAYE BURNS SCHOOL, Dept. M, Box 2194, CLEVELAND, OHIO

**DON'T CHOOSE YOUR LIFE WORK BLINDLY**

**USE THE "INDIVIDUAL VOCATIONAL SURVEY"**

... to determine the occupation in which your NATURAL abilities, personality, and characteristics should bring your greatest success. You can take this proven scientific step toward a better job and a brighter future, at small cost. Write for FREE BOOKLET No. A-12.  
Vocational Guidance Institute—Greenway Station, Tucson, Arizona

**STAMMERERS**

Before deciding, let us send you our free helpful leaflet "SPEECH" and Guild list of ethical, dependable schools which correct all speech defects. Most advanced methods. Personal individual instruction. Write today. No obligation.  
STAMMERERS ADVISORY GUILD, 1236 Maccabees Bldg., Detroit, Michigan

**MONEY-MAKING OPPORTUNITY**

For men of character. Over \$1,600 per month earned by California man. Over \$400 a week by Georgia man. \$1,000 in a month by Delaware man. Exclusive franchises available for an invention expected to replace a multi-million dollar industry. Install on free trial. Sells itself. Repeats. Exclusive proposition. Write F. E. Armstrong, Dept. 1112-B, Mobile, Alabama.

**Old Line Legal Reserve LIFE INSURANCE ONLY 77¢ PER MONTH PER \$1000 OF INSURANCE (at Age 21)\***

HERE ARE LOW RATES AT YOUR AGE FOR

Monthly Premium less the 9 1/2% Guaranteed Dividend (at age nearest birthday), per \$1,000	
Age	Age
21 \$ .77	30 \$ .97
22 .79	31 1.00
23 .81	32 1.03
24 .83	33 1.06
25 .85	34 1.09
26 .87	35 1.13
27 .90	36 1.16
28 .92	37 1.21
29 .95	38 1.25
39 \$ 1.29	48 \$ 1.87
40 1.35	49 1.95
41 1.39	50 2.04
42 1.45	51 2.15
43 1.51	52 2.27
44 1.57	53 2.39
45 1.64	54 2.53
46 1.70	55 2.66
47 1.79	

A further saving is made by paying premium annually or semi-annually.

\*Owing to low rates at which this policy is offered, the minimum amounts issued are: ages 21 to 45, \$1,500; 46 to 55, \$1,000. Rates shown are one-half permanent rates beginning fifth year.

**POSTAL'S FAMOUS "MODIFIED '4'" POLICY**  
Cash and loan values; guarantee 9 1/2% dividends; automatic premium payment clause and all standard provisions.

Send coupon for full details

POSTAL LIFE OF NEW YORK has paid out more than \$48,000,000.00 to its policy holders and beneficiaries during thirty-three successful years. If this policy does not fit your needs, Postal issues other standard forms, men or women, ages 10 to 60.

Postal Life Insurance Company, 511 Fifth Ave., Dept. M-483, New York, N. Y.

Send me without obligation complete information about your low-cost Modified "4" policy at my age.

Date of Birth .....

Occupation .....

Name .....

Street .....

City..... State.....



**WIRING**

**VOL. VII AUDELS NEW ELECTRIC LIBRARY—A MASTER BOOK ON WIRING**  
728 PAGES, 1200 ILLUSTRATIONS. \$1.50  
House and Power Wiring  
Diagrams—Problems and Calculations

fully explained in clear practical language, easy to use and understand including helps and hints for all electrical workers that will save time, trouble and money.

**AUDELS NEW ELECTRIC LIBRARY—**  
A progressive Home Study and Reference Course in applied electricity. Easy to understand. Questions and answers plainly written for a complete working knowledge of modern electrical practice, necessary to every electrician, engineer, mechanic and student.

**LEARN THE AUDEL WAY!** You ask the question—Audels New Electric Library gives the answer—9500 simplified outlines, graphic illustrations and precise explanations covering Construction, Operation and Machine Maintenance.

**BOOK A MONTH PLAN—**Order the volume that interests you—today! We will send that volume on 7 days' free trial. If the book helps you, send us \$1.50. If it does not help you, mail book back to us.

Stack of books: BEGINNERS I, MAINTENANCE II, METERS III, A-C OPERATORS IV, MOTORS V, SWITCHBOARDS VI, WIRING VII, ELEVATORS VIII, RADIO-TELE. IX, APPLICATIONS X, CALCULATIONS XI, DICTIONARY XII.

**FREE EXAMINATION COUPON**

Theo. Audel & Co., 49 W. 23rd St., New York City  
Mail Vol. VII on 7 days free trial. If O.K. I will remit \$1.50 otherwise I will return it. Also please send further information about the Electric Library—no obligation unless I am satisfied.

Name.....

Address.....

Occupation.....

Reference..... PM



*David  
Sarnoff  
says:*

David Sarnoff, once a poor lad and now the famous President of the Radio Corporation of America, in an article in Liberty Magazine states: "Civilization means elimination of unnecessary labor. The sewing machine and the vacuum cleaner save millions of women from backbreaking toil. The tractor makes the farmer's life bearable. The automobile lends wings to us all. The airplane is our magic carpet. It would be madness to slow up invention because our trouble is not that mechanical science moves too speedily, but that the governmental and social sciences move too slowly. . . . In a world reorganized to vibrate within certain wave bands, human intelligence will be able to distribute equitably nature's bounties from above and below, and make princes of paupers."

# INVENTORS

Send for Valuable Facts *about*



## Since the "Horseless Buggy" Days, We Have Helped Inventors

Perhaps you have already heard about our firm, because one client tells another—and we have served men in every state in the Union, and in nearly every foreign country. We have been working with inventors since 1898. If you have a good invention—or an idea for one—and don't know what Victor J. Evans & Co. can do for you, NOW is the time to find out.

## How We Can Help You

Both the Patent Office and the U. S. Supreme Court have made it clear that the inventor needs the assistance of a competent patent lawyer when it comes to protecting an invention. It is one thing to think up a good invention—it is another to get effective patent protection on it.

For more than a third of a century—it has been our business to give sound advice and counsel to inventors. Our free books (described on the opposite page) tell what steps to take first, how to protect yourself, how the laws protect you, what you must do, when to offer your invention for sale, how others have succeeded, and much more. You need this information.



## Simple Inventions May Have Excellent Commercial Possibilities

Frequently inventors confuse the size or the complication of a device with the question of commercial value and patentability. These two factors, of course, have no relation to each other. Most of our present-day complicated machines represent a process of evolution, a series of inventions. On the other hand, every so often some inventor comes along with a very simple "gadget" which possesses the elements of broad utility and is patentable. Some of the most profitable inventions have been of this latter class. Shown above are a few such examples. Whether a device is simple or complex, if it represents a forward step to save manufacturing costs, to save labor, or to add enjoyment to human life, it may prove patentable and profitable. This subject is more fully discussed in the booklet entitled "Patent Protection" shown on the opposite page.

1939						
SUN	MON	TUE	WED	THU	FRI	SAT
	1	2	3	4	5	6
7	8	9	10	11	12	13
14	15	16	17	18	19	20
21	22	23	24	25	26	27
28	29	30	31			

## What Will Be Next?

Ever since George Washington signed the first patent, America has led the world in inventions. It may be said that not a year has gone by without some important inventions being patented and commercialized. David Sarnoff, President of the Radio Corporation of America, sees a big future ahead for science and invention. Just as sure as the sunrise 1939 will see new inventions come out—new wealth made from patents. Your idea may be one of them. You never can tell. For this reason you should send for our books today and get the facts about patents and inventions.



# These FREE Books Tell You

Get the answers to your questions: How can I protect my invention? When can I show my invention to manufacturers? When can I offer it for sale? How should I go about selling it? Can I get protection without a patent? What are my employer's rights? These and other important questions are fully answered.

## Learn How Our Patent Laws Protect You . . . . .

The U. S. has liberal patent laws, and much of our national wealth is based on patents. In fact, a commission from a large foreign country decided that American progress was mainly due to our patent laws. These laws are made to protect you. Find out about them now. This is for your own good.

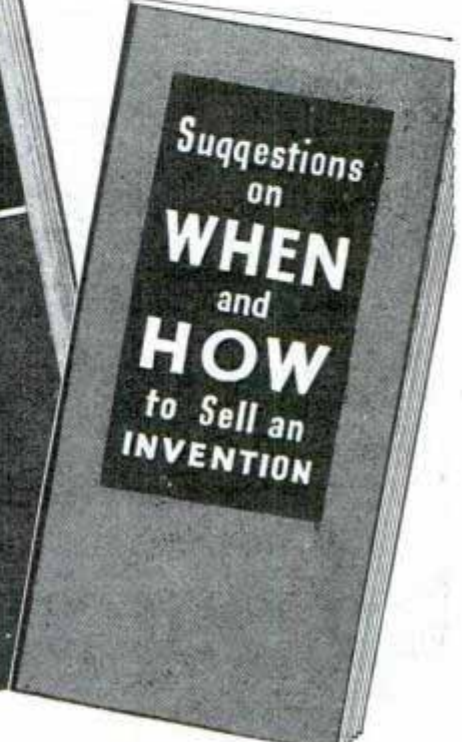

# PATENTS and Selling Inventions

### Mail Coupon Today

Delays are dangerous. If you have a good invention you should get protection for it just as soon as possible. Don't turn this page until you have clipped and mailed this coupon—you will hear from us by return mail.



### 115 Mechanical Principles Shown

Request the book "Patent Protection" (sent free to inventors). Not only does it tell you what to do for protection, and how to do it—it also shows you 115 different mechanical movements that you may use in developing your own inventions. Inventors tell us they have found these useful.

## VICTOR J. EVANS & Co.

REGISTERED PATENT ATTORNEYS

MAIN OFFICE: 112-B, VICTOR BUILDING  
WASHINGTON, D. C.

Other Offices: 405-N, Garfield Bldg., Los Angeles  
1010-N, Hobart Bldg., San Francisco  
514-N, Empire Bldg., Pittsburgh

Send me FREE copies of your books, "Patent Protection" and "When and How to Sell an Invention." (Note: Same books supplied by any of branch offices listed above.)

Name .....

Street and No. ....

City or Town ..... State .....



# PATENTS

**Booklet Free**      **Highest References**  
**Promptness Assured**      **Best Results**

Send drawing or model.

## ALL BUSINESS GIVEN PROMPT AND PROPER ATTENTION

Listed Patent Lawyer in the latest editions of the Rand-McNally Directory of Bankers and Bank-Recommended Attorneys, published by Rand-McNally & Co., Chicago, Ill.; The Baggott & Ryall Directory of Guaranteed Attorneys, published by Legal Directory Corporation, Boston, Mass.; American Lawyers Annual, Cleveland, Ohio; Bankers Service Legal Directory, published by Bankers Service Co., Boston, Mass.; Eyre's Law List, 9 Park Place, New York City; Snow-Church Directory Co. Lawyers List, published in New York City, and the Central Guarantee Co., Bankers and Lawyers Directories, 630 Fifth Avenue, New York City.

**WATSON E. COLEMAN,**      **Victor Building, 724 Ninth Street, N. W.**  
**REGISTERED PATENT LAWYER**      **WASHINGTON, D. C.**

## INVENTORS PATENT YOUR IDEAS SEND FOR FREE BOOK



### HOW TO OBTAIN A PATENT

Written by a Former Member of the Examining Corps (1922-24) of the U.S. Patent Office. If you want to profit by your idea, you should take steps to apply for a U. S. Patent at once. Your first step is to get this Free Book. This interesting illustrated book contains valuable information you should have. It tells you fully how to obtain a patent on your idea in the quickest way. With this Free Book you will also receive a "Record of Invention" form on which you can easily record your idea. Personal and Confidential Service: Your case will be personally handled only by a Registered Patent Attorney who is also a Former Member of the Examining Corps of the U. S. Patent Office. All communications confidential.

MAIL COUPON TODAY for FREE PATENT BOOK and RECORD OF INVENTION Form.

**CARL MILLER**  
 REGISTERED PATENT ATTORNEY  
 FORMER MEMBER EXAMINING CORPS U. S. PATENT OFFICE

Woolworth Bldg., 35th Floor, Dept. 29A, New York City  
 MILLER BUILDING, Dept. 29A, Washington, D. C.  
 Please send me your Free Book, "How to Obtain a Patent," and your "Record of Invention" form.

NAME.....  
 ADDRESS.....



## G E A R S

In Stock — Immediate Delivery

Gears, speed reducers, sprockets, thrust bearings, flexible couplings, pulleys, etc. A complete line is carried in our Chicago stock. Can also quote on special gears of any kind. Send us your blueprints and inquiries.  
 Send 10c for Complete Catalog No. 10  
**CHICAGO GEAR WORKS**  
 765-773 W. Jackson Blvd.      CHICAGO, ILL.

## Inventions Wanted Patented or Unpatented

We have been successfully selling inventions, patented and unpatented, since 1924. Write for proof, and tell us what you have for sale.  
**Chartered Institute of American Inventors**  
 Dept. 4, Barrister Building, Washington, D. C.

## PATENTS—TRADE MARKS

All cases submitted given personal attention  
 Form "Evidence of Conception" with instructions for use and "Schedule of Government and Attorneys' Fees"—FREE!

**LANCASTER, ALLWINE & ROMMEL**

Patent Law Offices

412 Bowen Bldg.

Washington, D. C.

## INVENTORS PROTECT & SELL

Your unpatented invention can be sold with positive safeguards under patent laws. New, low-cost procedure. Complete details, free.  
**AMERICAN PATENTS CORPORATION**  
 Dept. 4-E      Washington, D. C.

**INVENTORS** who derive largest profits know and heed certain simple but vital facts before applying for patents. Our book, Patent-Sense, gives those facts; sent free. Trade Marks—Copyrights.  
**LACEY & LACEY, Est. 1869, 635 F St., N. W., Dept. 5, WASHINGTON, D. C.**

## RUPTURED?

Get Up-To-Date Relief

Why try to worry along with old-fashioned trusses that gouge your flesh—press heavily on hips and spine—enlarge opening—fail to hold rupture? You need the Cluthe. No leg-straps or harness. Automatic adjustable pad seals opening—follows every body movement with instant increased support in case of strain. Cannot slip. Holds rupture whether at work or play, easy to wear. Waterproof. Can be worn in bath. Send for amazing **FREE** 100-page, cloth-bound book "Advice To Ruptured" and details of liberal truthful 60-day trial offer. Also names of grateful patrons in your neighborhood. Write today. Cluthe Sons, Dept. 31, Bloomfield, New Jersey.

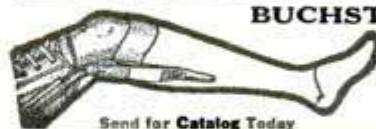

### BUCHSTEIN'S FIBRE LIMB

is soothing to your stump—strong, cool, neat, light. Easy payments. Braces for all deformities. Agents wanted.  
**D. BUCHSTEIN CO.**  
 610 3rd Ave., So., MINNEAPOLIS, MINN.

Send for Catalog Today



## Earn Cash at Home!

We paid M. M. \$1174 for exceptional "cellar crop" SNOW-KING mushrooms! Big free picture book tells if your cellar, shed, barn suitable. We furnish materials, buy all crops. Write today. Est. 1908.  
**UNITED CO., 3848 Lincoln Ave., Dept. 303, Chicago.**

## To PROTECT Your INVENTION — Use this coupon, NOW

Delays are dangerous and may be very costly. My personal service assures prompt action, strict confidence, and a minimum of expense. I suggest that you send me a model or drawing, or sketch and description of your invention, and \$5.00. I will make a search and report

promptly as to its patentability and send you a copy of my 72-page booklet. Or, if you prefer to read my booklet first, mail the attached coupon at once. I will also send my "Record of Invention" form. (Over 38 years experience as a Registered Patent Attorney.)

**L. F. Randolph,** 302-D Victor Bldg., Washington, D.C.

Please send me at once, free of charge, your 72 page booklet and "Record of Invention" form.

Name.....

Address.....

## A PERSONAL CONFIDENTIAL PATENT SERVICE



C. A. SNOW & CO. IS ONE OF AMERICA'S OLDEST PATENT ATTORNEY FIRMS

# INVENTORS!

*These FREE BOOKS*  
Give You Useful, Practical  
**PATENT FACTS**

**These books will save you time and money—and tell you:**

If you have already constructed a device, or merely have an idea on paper... now is the time to give it the protection you have the right to enjoy. Your first step is to send for these free booklets. They contain pertinent information based on our 64 years of experience in obtaining patents for thousands of people everywhere. These books will be sent to you free of charge, and without obligation. They show you just how to proceed, and the value of a patent to protect you if other inventors are working on the same idea.

- How to obtain a patent . . .
- How you can commercialize your patent . . .
- Why you need a patent . . .
- Correct way to proceed and costs . . .

**Protect Before You Sell—  
We Help You With Both!**

The entire organization of C. A. Snow & Co. is at your service—ready to give you immediate, confidential advice. Now is the time to find out IF your idea can be patented... if not, you save time and money in developing your idea. If our search reveals your idea is patentable—you should protect it at once. We also offer you suggestions on how you can sell your idea and realize a profit. Get these Patent Facts now.. tear out and mail coupon.

**C. A. SNOW & CO.**  
*Registered Patent Attorneys Since 1875*

129 Snow Building, Washington, D. C.

**Yes!** Send me free copies of your books, "How We Protect You" and "Suggestions on How to Commercialize your Invention." Also send original "Certification of Invention" form.

Name.....  
Address.....  
City or Town.....  
State.....

**This is our 64th Year!**



**"BECOME A LIGHTNING TRICK CARTOONIST"**

Make money Chalk Talking. Send \$1.00 for Laugh Producing Program of 23 Trick Chalk Stunts. Illustrated Catalog 10 cents. BALDA ART SERVICE, Dept. T-2, Oshkosh, Wis.

**EARN THE DEGREE**

Doctor of Psychology (Ph.D.), Philosophy, Divinity. General Courses—Arts, Secretarial, etc. A Correspondence Institution Chartered by State of Washington. Send for 32-page FREE Bulletin at once. No Obligation. Temple Bar College, Dept. 2-R, 1620 Thirteenth Avenue Seattle, Washington, U.S.A.

★ **Would You Like to Qualify for** ★

## U. S. CIVIL SERVICE EXAMINATIONS?

**SALARIES**  
\$1260-\$2100 a year TO START

CUSTOMS  
IMMIGRATION  
BORDER PATROL  
ALL TYPES CLERKS  
CUSTODIAL-GUARD  
STENOGRAPHERS  
TYPISTS  
RAILWAY-POSTAL  
RURAL CARRIER  
MESSENGERS  
(at \$1080)  
and many others

Common School Education  
Usually Sufficient

**MEN AND WOMEN Age 18-50 WHO ARE SERIOUS MINDED AND WISH INFORMATION ON "HOW TO SECURE A GOVERNMENT POSITION" WRITE TODAY! CHOOSE A CAREER AND PREPARE WITHOUT DELAY!**

**Personal Guidance Individual Coaching**

Why not work for Uncle Sam, the biggest employer of men and women in the world? Be ready for next examinations called! Sending for this FREE BOOK may result in your obtaining a fine Government position. Mail coupon now.

Patterson School,  
82 Mercantile Bldg., Rochester, N. Y.

RUSH, absolutely free, your descriptive book "How to Secure a Government Position," 1st cities where examinations are held; how I may qualify for a Government position.

Name..... Age.....  
Address..... City..... State.....

When writing to advertisers please mention Popular Mechanics





**I'm Getting Into AVIATION Why Don't YOU!**

Aviation is booming! Airlines expanding; Airplane Factories crowded with orders for new airplanes. Increased activity calls for MORE trained men. NOW is the time to prepare at . .

# LINCOLN

**A GOVERNMENT APPROVED AVIATION SCHOOL**

**BE A TRANSPORT PILOT** Earn a pilot's good pay! Learn here to fly fast modern airplanes. Get cross-country, night and blind flying experience. Earn your Government Pilot Rating. 16 Training Planes.

**BE AN AIRPLANE MECHANIC or AERONAUTICAL ENGINEER.** Learn here to overhaul and rebuild modern airplanes and airplane engines. Assist in designing and building new advanced-type airplanes.

**NOW IS THE TIME TO TRAIN AT LINCOLN.** Our Graduates taking good positions. We assist our Graduates in locating employment. **MAIL COUPON TODAY** for complete information.

**LINCOLN AIRPLANE & FLYING SCHOOL**  
562 Aircraft Bldg., Lincoln, Nebraska

I'd certainly like to get into Aviation! Please send me complete information about Lincoln Training.

Name: ..... Age: .....  
Address: .....  
City: ..... State: .....

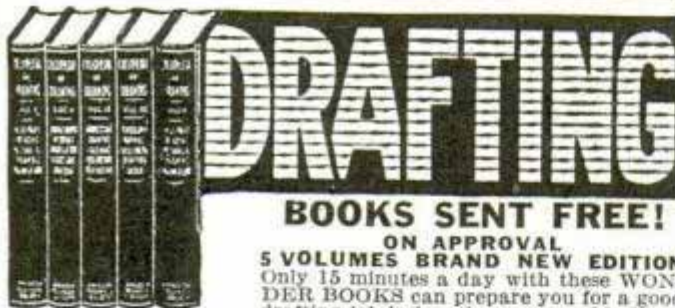

**BOOKS SENT FREE!**

**ON APPROVAL**  
**5 VOLUMES BRAND NEW EDITION**  
Only 15 minutes a day with these **WONDER BOOKS** can prepare you for a good drafting job in less than a year. Mechanical and architectural drafting from simple straight lines to important complex plans. *A step at a time!* Built especially for beginners, for men with only grammar schooling. Drafting room practice. **PLUS ENGINEERING**, made easy and clear. **Includes complete information on blue print reading for building and machine trades.**

**Big Field Big Demand Big Pay**  
Competent draftsmen are urgently needed right now in all building and manufacturing lines at \$30.00 to \$75.00 a week. That's just the beginning—**FOR DRAFTSMEN HAVE THE BEST CHANCES FOR ADVANCEMENT.** Pleasant, fascinating work, easy to learn and do. Learn quickly with these books—send coupon for a set and see for yourself.

*A year's consulting membership in the American Technical Society now given to all readers of this famous cyclopedia of drafting. Many say that it is worth more than the cost of the books.*

Complete set of drawing instruments if you send for these drafting books NOW. These instruments are made of the finest of German silver, are absolutely accurate and are packed in velvet lined leatherette pocket case. Real \$10 value, but included with these books.

**AMERICAN TECHNICAL SOCIETY**  
Dept. D219, Drexel at 58th St., Chicago, Ill.

American Technical Society, Dept. D219, Drexel at 58th St., Chicago, Ill.  
Send for 10 days' trial New 5 volume set of drafting. I will pay the few cents delivery charges. If I wish, I may return books in 10 days and owe you nothing but if I decide to keep them, I will send \$2.00 after 10 days, then only \$3.00 a month until \$24.80, the advertising price, is paid. Send latest edition and include drawing instruments and Membership Certificate.

Name: .....  
Address: .....  
Attach letter stating age, occupation, employer's name and address and that of at least one business man as a reference.



**THOUGHTS HAVE WINGS**  
*You Can Influence Others With Your Thinking*

**TRY IT SOME TIME.** Concentrate intently upon another person seated in a room with you, without his noticing it. Observe him gradually become restless and finally turn and look in your direction. Simple—yet it is a *positive demonstration* that thought generates a mental energy which can be projected from your mind to the consciousness of another. Do you realize how much of your success and happiness in life depend upon your influencing others? Is it not important to you to have others understand your point of view—to be receptive to your proposals?

How many times have you wished there were some way you could impress another favorably—*get across to him or her your ideas?* That thoughts can be transmitted, received, and understood by others is *now* scientifically demonstrable.

## This FREE Book Points the Way

The tales of miraculous accomplishments of mind by the ancients are now known to be fact—not fable. The method whereby these things can be **INTENTIONALLY**, not accidentally, accomplished has been a secret long cherished by the Rosicrucians—one of the schools of ancient wisdom existing throughout the world. Write for the free copy of the fascinating sealed book, "THE SECRET HERITAGE," which explains how you may receive this unique wisdom and benefit by its application. Address: Scribe H.M.T.

## The ROSICRUCIANS

(AMORC)

San Jose, California

(NOT A RELIGIOUS ORGANIZATION)

**Correspondence Courses in**  
**RADIO and ELECTRICAL ENGINEERING** **LOW AS \$25**

**ELECTRICAL ENGINEERING.** Get good grasp of wide electrical field. Modern. Very understandable. Theory made easy.  
**RADIO ENGINEERING.** Extra fine course in radio, public address, photo-electric work. Trains you to be super-service man, real vacuum tube technician. Tuition ONLY \$25, either course. Deferred payment plan. Experiment kits furnished.  
**FREE** Write for free copies of school catalogs, student magazines, etc.  
**FREE LINCOLN ENGINEERING SCHOOL, Box 931-P2, Lincoln, Nebr.**

## WANT A STEADY TOP PAY JOB?

I TRAIN YOU QUICKLY • PAY ME LATER!

Learn a Trade Easily, Quickly:  
Auto, Aviation, Diesel Mechanics, Collision, Body, Fender Repair, Auto Painting, Gas, Arc Welding, Write At Once!

Why spend your life hunting low-pay jobs—**TRAIN** for a steady one with top wages and promotion opportunities! McSweeney expert, **PRACTICAL** training puts others on top—let it do the same for you. Low tuition rate, pay after learning.  
**FREE!** Big, FREE book gives facts on quick way to big pay jobs. Write to nearest school TO DAY Dept. 10-3.  
**McSWEENEY TRADE SCHOOLS**  
Detroit, Mich. or Kansas City, Mo.

When writing please mention Popular Mechanics



## NEW INVENTIONS

(Continued from page 20A)

**B**EACH outings next summer might be more pleasurable if a newly patented shelter were on the market. The shelter is made of fabric, supported



at four corners by stakes in the manner of a tent. It has a roof to protect the user against sunburn.

Ordinarily the shelter would be erected with three sides in place, the fourth open toward the water, but this fourth side may be raised to permit changing from clothing to bathing suit in privacy. The shelter is easily portable.

**E**ASILY attachable to the windshield, a small defrosting unit for the automobile has been patented. It consists

of a small housing containing a motor, which drives a compressor. Extending from the housing along the lower edge of the windshield, in front of the driver, is a small metal cylinder with openings toward the windshield. Through these openings air is forced by the compressor, thus keeping the glass clear of frost in cold weather.

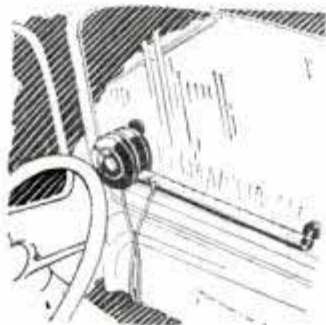

**I**NCREASED safety for the hunter is provided by an illuminated indicator that

shows when the gun is ready for firing. The device consists of a light bulb set into the wood on which the barrel rests and a battery located in the gunstock. An electrical circuit is arranged so that when the gun is ready for firing, the circuit is closed and the bulb lights to warn the hunter. A small switch controls the circuit.

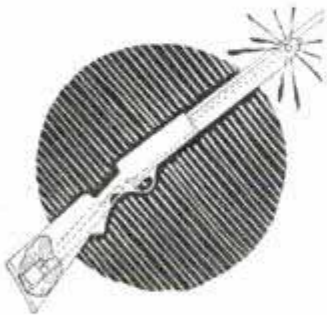

(Continued to page 51A)

"I aint"

"He don't"

"It's me!"

"You was?"

"Can't hardly"



## What Are YOUR Mistakes in English?

*They may offend others, as much as these offend you*

**I**F some one you met for the first time made the mistakes in English shown above, what would you think of him? Would he inspire your respect? Would you be inclined to make a friend of him? Would you care to introduce him to others as a close friend of yours?

These errors are easy for you to see. Perhaps, however, you make other mistakes which offend other people as much as these would offend you. How do you know that you do not mispronounce certain words? Are you always sure that the things you say and write are grammatically correct? To you they may seem correct, but others may know they are wrong.

Unfortunately, people will not correct you when you make mistakes; all they do is to make a mental reservation about you. "He is ignorant and uncultured," they think. So you really have no way of telling when your English offends others.

### FREE — Book on English

Sherwin Cody, perhaps the best known teacher of practical English, has perfected and patented a remarkable device which will quickly find and correct mistakes you unconsciously make. Correct English soon becomes a HABIT.

Mr. Cody's remarkable new invention, the 100% Self-Correcting Method, has already improved the English of more than 100,000 people. No useless rules, no tedious copying, no hard study. Only 15 minutes a day required. You learn by creating the HABIT of using correct English. Nothing like Mr. Cody's method has ever been used before!

A new book, "How You Can Master Good English in 15 Minutes a Day," is ready. It explains Mr. Cody's surprisingly easy method. Get a copy free and learn how to stop making embarrassing errors. You do not want others to judge you unfairly. Merely mail the coupon or a postal card, SHERWIN CODY SCHOOL OF ENGLISH, 52 Searle Building, Rochester, N. Y.

SHERWIN CODY SCHOOL OF ENGLISH  
52 Searle Building, Rochester, N. Y.

Please send me your free book, "How You Can Master Good English in 15 Minutes a Day."

Name.....

Address.....

If 18 years or under, check here for Booklet A.



# How Big Is YOUR PAY-CHECK?

*If you earn under \$3,000,  
Higher Accountancy may  
be the answer for you*

"THE size of my pay-check? What business is it of yours?" Perhaps that's the first reply that comes to your mind.

But—stop a moment. It really *is* our business—to help men just like you. In fact, it's been our business here at LaSalle for 30 years.

If your pay-check isn't all that you'd like it to be, why not consider accountancy? Why not become a member of this well-paid and respected field? Why not, in short, prepare yourself to earn real money—insure a good home for your family—a new car—an education for the growing youngsters—a bank account for a rainy day . . . these and many more of the precious things in life?

Maybe you're one of those ever hoping for "breaks" that will give you a higher standard of living. Yet that's precisely what most of 30,000,000 other employees in this country are doing.

Not all of them, of course. Here and there you find ambitious men who aren't depending on luck to carry them ahead. They're following a tested path to increased earnings—leaving nothing to mere chance. They're *training* themselves for better jobs—every week spending a few hours in serious but interesting study at home.

Some day, as expert bookkeepers and later as accountants, these determined men will have standing and a considerably larger income—in a profession that pays and pays well.

Why don't *you* do as they are doing—take advantage of LaSalle training? Even though you do not know the fundamentals of bookkeeping now—you nevertheless may have an excellent opportunity to master accountancy. Many others have done it.

Perhaps you're asking yourself, "But don't these others possess natural ability that I lack? Don't I need a special talent for all this?"

Ask rather, "If I do my part, won't *I* get results, too?"

You will! For all it takes is intelligence, serious study and work—not genius. Under the LaSalle system you solve problems by simple steps . . . from day to day, as an expert accountant does. You use the same basic principles. And when these problems become difficult and puzzle you, you get counsel that could be matched only through personal coaching by a battery of experts in a big accounting house.

In a comparatively short time, you train yourself in *Elements of Accounting, Principles of Account-*



ing, Auditing, Cost Accounting, Business Law, Organization, Management and Finance. The training—complete and intensive all the way—takes you right into C.P.A. coaching if you desire.

Later, when you're an accountant, it may be possible to go into business for yourself as a public accountant and be independent. Or, if you choose to work for someone else as an executive accountant, it well may be for a salary several times that which you draw now.

### Write for this FREE book

If you're tired of pinching pennies, investigate accountancy and LaSalle training. There isn't a faster, less expensive or more convenient method to master accountancy. Fill in the coupon and mail. We'll send you our 64-page book, "Accountancy, The Profession That Pays."

Then, when you read all the facts, you yourself will be able to judge best whether you have the will to study and apply your best efforts—toward a more secure future.

## LaSalle Extension University

A Correspondence Institution

Dept. 264-HR

Chicago, Ill.

I want to earn a bigger salary—through accountancy training. Send me, without cost or obligation, your 64-page book, "Accountancy, The Profession That Pays."

Name .....

Present Position ..... Age .....

Address ..... City .....





# CLASSIFIED

## Advertisements



Advertisements in this section, 35 cents per word, each insertion, minimum 10 words, payable in advance

To be inserted under proper classification in March issue, copy should be in our office January 8th

March issue on sale February 1st

Popular Mechanics Magazine, 200 East Ontario Street, Chicago, Illinois

## YOU'LL PROFIT

By reading and answering the classified ads in this section. Hundreds of opportunities to make and save money.

Popular Mechanics Magazine,  
200 E. Ontario St., Chicago, Ill.

Dear Mr. Johnson: We have used the classified section of your valued magazine for some years past and all that we can say is that we wish that there were a few more magazines in the country which had a "pulling" power like Popular Mechanics classified section. Have written our advertising agency repeatedly asking if there was not some other magazine that would compare favorably with yours and the answer has always been if there is such a magazine we have never heard of it, or words to that effect. Thanking you for all favors and wishing you continued success, we are

Yours most sincerely,

NEW METHOD MFG. CO.

(Original letter on file in our office)

### AUTOMOBILES—MIDGET CARS

**ALUMINUM** Alloy pistons, automotive, aviation, Diesel, industrial, marine, midget, model, motorcycle, outboard. Finished or semi. Judson Mfg. Co., Hedge and Gillingham, Philadelphia, Penna.

**FORD V-8's**, 1934-1938; gasoline saving device. \$1. Walert Co., 3429 No. 10th St., Milwaukee, Wisconsin.

**MIDGET** Plans, parts, kits. Catalog, 10c. Lists 100 used motors, midgets, parts, 20c. Details free. Shipps Midgets, Box 543-H, Zanesville, Ohio.

**MIDGET** Two-passenger autos, midget racers, midget motorcycles, motor scooters, motors, wheels, parts, plans. Handbook catalog, illustrations, 20c coin. Midwest, Box 1959, Chicago.

**MIDGET** Racing book; facts for fans, builders, drivers; track sizes, regulations; pictures, specifications, working drawings. \$1.00 postpaid, \$1.15 C.O.D. Ray Kuns, Department 34, Madisonville, Cincinnati, Ohio.

**1938 IGNITION** Supercharger. Quick starting, mileage, pep, less carbon, \$1.25. E. G. Sales Co., New York.

**MIDGET** Cars, parts, plans. Priced right. Catalog 20c. Derby Midget Cars, Woodstock, Illinois.

**"SCRAPE-ZIT"** New utility tool. Sales everywhere, motorists, merchants, offices, homes. No competition. Distributors wanted. Fred M. Giddings, Galesburg, Illinois.

**BE First**—Positive, outstanding, summer starting in winter pays. Practical plans, technique, expert instructions on good starting without "gadgets." With "gadgets." The latest device "Starting Ignition." How to build, avoid timer troubles and get 3/4 inch blue white starting sparks. This information cost \$9,000. Yours for \$1.00. Illustrations, working drawings, etc. Weston Laboratory, Elginburgh, Ontario, Canada. If you doubt write.

**AMAZING** New gas saver. Increased speed, power, compression. Price \$2.00. Economy Gasaver Co., Webster City, Iowa.

**TRIPLE** Any car mileage performance. Up to \$15 day servicing. Send one dollar for easy guaranteed method. Carburetor Motor Company, Box 596, Wichita Falls, Texas.

### AUTO TRAILERS

**BUILD** The famous, low-cost Jim Dandy Cabin Trailer. Complete plans and instructions 50c. Plans to build the beautiful, streamlined Jim Dandy Cabin Cruiser, \$1.00. Trailer Builders Manual and catalog of trailer parts, supplies and equipment—over 100 interesting, illustrated pages, 25c. Order today. Satisfaction guaranteed. Trailer Supply Co., 411-A Jackson St., Wausau, Wisconsin.

**TRAILER** Guide—Instructions, plans for building. Complete listing parts, supplies, showing prices. Send 25c today. A. J. Stephens, Kansas City, Mo.

### AUTO SUPPLIES AND EQUIPMENT

**REFINE** Used oil without cost. Samples. F. Gerwin, Fairview, Oklahoma.

**SAVE Half!** Guaranteed reconditioned truck and auto parts. All parts—all models, makes. Catalog free. General Auto, 7008-AA Cottage Grove, Chicago.

**PLATING** Outfits for auto parts. Connect to a battery. No tanks used. Free particulars and proofs. Gunmetal Co., Ave. J, Decatur, Ill.

**EMERGENCY** Device. Fits any car. Boon to night driving. 35c. Norman Dunn, Holland, Michigan.

**INEXPENSIVE** Guaranteed protective puncture seal. Airlock Laboratory, 1460 Hollywood, Chicago.

### MOTORCYCLES, BICYCLES, MOTOR SCOOTERS AND SUPPLIES

**PARTS** And accessories. Send 10c for Motorcycle Manual. Bootz, 622 East Grand, Des Moines, Iowa.

**MOTORCYCLE** Bargains, lowest prices, bargain sheets for stamp. Motorcycle accessories. Rochester Harley Davidson Corp., 129 W. Main St., Rochester, N. Y.

**INSIDE** Dealer prices. Overstocked, all models. Indians and Harleys. Rebuilt, guaranteed. Dime brings latest list. Crandall-Hicks, Boston, Mass.

**NEW** And used motorcycle parts, lists, 10 cents. Elmer Nelson, LaMoille, Illinois.

**SEND** 15c For illustrated used motorcycle catalog. Bargains. Largest stock genuine Indian parts and motorcycles. Indian Motorcycle Sales, Kansas City, Mo.

**THOUSANDS** Building own motor scooters. We supply parts. Literature dime. Drawings free. Comet Cycle Company, Box 3032, Madison, Wisconsin.

**ALLOY** Pistons—Harley, Indian, Henderson, Excelsior, Cleveland. New and used parts for less. Cylinder grinding. Catalogue and wings pin 10c. Ballak, 1115 Chestnut, St. Louis, Mo.

**RECONDITIONED** Motorcycles. New—used parts for all makes. Authorized Harley-Davidson dealer. Whitman Motorcycle & Supply Co., 405-9 Southwest Blvd., Kansas City, Mo.

### AVIATION

**AVIATION** Needs men. Pilots, mechanics, draftsmen, sheet metal, positions open. Learn now. Free catalog. California Flyers School of Aviation, Dept. PMC-2, Los Angeles Airport, Inglewood, California.

**GET** Into aviation—Airline pilots get up to \$700 a month; mechanics, \$200; aeronautical engineers, \$400. Prepare now at this Government Approved School. Write for complete information. Lincoln Airplane & Flying School, 2004 Aircraft Bldg., Lincoln, Nebraska.

**PROPELLERS** For sleds, airplanes; countershafts, hubs. Catalog 5c. Banks Propellers, Love Field, Dallas, Texas.

**AEROSLED** Motors, 80 h.p., aircooled, nine cylinders, new, weight 285. Price \$75. Free illustrated circular, suggestions. Allison Aircraft, Lawrence, Kansas.

**AVIATION** Apprentices — Airminded young men interested in training for entering aviation as apprentices see ad on page 55A.

**AIRPLANE** Mechanic's home-study license course \$1.25. Engine mechanic's \$1.25. Both courses \$2.00. Prepares for exams. Meyer Engineering, Box 8, Hempstead, N. Y.

**PRACTICAL** Course in flying—Only \$1.00 complete, postpaid. Satisfaction guaranteed. Aircraft Directory, Athens, Ohio.

**AVIATION**, "How to get into." Circular, dime. Corregan, Box 391, Hempstead, N. Y.

**100 AIRPLANES** \$40 Up. Terms. Motors, salvage, crackups. Complete catalogue 25c. Used Aircraft Directory, Athens, Ohio.

**PROPELLERS** For airplanes, sleds. Iced-sled blueprints, supplies. Catalog dime. Lorenzen Propellers, Niles, Michigan.

**POR** Sale: Surplus stock of metal tipped hardwood propellers. Tractor types only suitable for auto engines, airplane quality finish, \$5.00 to \$10.00, while they last. Write us your needs. Sensenich Bros., Lititz, Penna.

**GRADUATE** Airplane mechanic. Ten weeks. \$1.00 week. Graduates with leading concerns. Free catalog. United Air School, Elgin, Ill.

**PROPELLERS**—All types, including latest three blade airliners. American Flea Special \$12.50 down. Universal Aircraft, Ft. Worth, Texas.

### BATTERIES, GENERATORS, ETC.

**EDISON** Lifetime storage batteries for light and power. Eliminates acid battery diseases. Long guarantee. All kinds rebuilt generating plants, motors, and miscellaneous articles at bargain prices. Free interesting literature. T. Hawley Smith Co., Croton Falls, N. Y.

**PLATING** Generators and motor generator sets. Write for information Hobart's new line electro plating equipment. Payments low as \$12.40 monthly. Quality machines, quick delivery guaranteed. Hobart Bros., Box M-282, Troy, Ohio.



12 VOLT Heavy duty generators \$8.50. Save money on new, used automotive electrical parts; free catalog. State Ignition, 52 Cullerton, Chicago.

FREE Electricity—Lights, radio, battery charging. Wind power propeller and slow speed Ford generator \$5.95, with instructions for putting up. Wesco, 451 Terminal, Minneapolis, Minn.

EDISON Storage batteries for light-power systems. Non-acid. Odorless, fifteen year life. Five year unconditional guarantee. Bargains in complete lighting systems. Low prices. Free illustrated literature. "See-Jay" Battery Co., 82 Sterling Ave., Yonkers, N. Y.

LOOK! \$25.00 Builds complete 32v., 800 watt gasplant or windcharger. No rewiring. Detailed methods free. Kubat Mfg., St. Paul, Minnesota.

RECAST Old batteries into new. Latest achievements. Battery Laboratories, St. Paul, Minn.

AERODYNAMIC Windcharger propellers produce 10 to 30% more electricity. Factory prices. Kubat Mfg., St. Paul, Minn.

#### ELECTRICAL SUPPLIES—EQUIPMENT

MAGNET New alloy lifts 50 times own weight \$1.00. Advance, 861-P3, Minneapolis, Minn.

HEARING Aids, rechargeable batteries. Complete line, bargains. On approval. Dynamic Ear, 363 N. E. 76 St., Miami, Fla.

ELECTRIC Engraver, engraves all metals deeply, dollar. Hudson Bros., East Syracuse, N. Y.

ULTRA Violet—Infra red. Dual ray health lamp. Two separate units in one. Promotes sun tan—vitamin "D". Automatic control. AC-DC current. \$3.90 postpaid. Details. Beyer Mfg. Co., 4515-P Cottage Grove, Chicago.

ELECTRO-SCRIBE: Electric pencil writes, engraves all metals. \$1.00 postpaid. Details. Beyer Mfg. Co., 4515-K Cottage Grove, Chicago.

#### ELECTRIC FENCING

MAKE Electric fencer from old automobile coil. Complete plans 10c. No extras to buy. LeJay Manufacturing, 947 LeJay Building, Minneapolis, Minn.

#### WELDING AND SOLDERING

REBUILT a.c. d.c. Arc welders, all sizes; engine governors, idlers. Terms. Low prices. Guaranteed. Service Co., 3732 Cedar Ave., Cleveland, Ohio.

ONE Dodge arc-welder, 25-125 amperes, 0-40 volts, d.c. (Two Dodges: 25-200.) Build your own from North-East Dodge 12 volt generator without rewinding armature. Easy method. Guaranteed instructions. Plans \$1.00. Welders Club of America, AB-3432 M-Mart, Chicago.

POWERFUL 110-220 Volt a.c. welder constructed for less than \$5.00 uses starter coils. No winding. Plans \$1.00. Information time. Welders Supply Co., Box 132, Bellefontaine, Ohio.

ACETYLENE Welding outfits, \$32.95; electric welders, \$74.95. Easy-payment plan. Box 331, Hamilton, Ohio.

DELCO Arc-welder, 25-200 amperes, d.c., 0-75 volts. Build your own from 32 volt Delco light plant. No rewinding. Guaranteed instructive plans \$1.00. Welders Club of America, AB-3432 M-Mart, Chicago.

SPOT Welding, immense possibilities, \$16.50, \$40.00. Gale Hollinger, Glen Ellyn, Ill.

BLUEPRINTS For powerful 110v. a.c. welder, \$1.50. Write for information. Marvelweld, Box 1156, San Francisco.

NEW Arc welder. Cheap. Free literature. Holgeron's Service, Canton, Kansas.

APOLLO 110 Volt electric torch. Produces 3 inch flame similar to acetylene. Welds, brazes, solders all metals including aluminum. Works on ordinary house current. Complete \$12.50 prepaid. Apollo Mfg. Co., 634 Union Ave., Memphis, Tenn.

DEMONSTRATORS, Electric arc welders. Money-saving prices. Used by the government. Trial and terms guaranteed. Hobart Welders, M-283, Troy, Ohio.

ARC-WELDER, 25-600 Amperes, d.c., 0-75 volts. Build your own from d.c. vehicle motors. No rewinding. Guaranteed instructive plans \$1.00. Welders Club of America, AB-3432 M-Mart, Chicago. For sale: New and used d.c. vehicle motors.

#### ENGINES, MOTORS, DYNAMOS

BARGAIN— $\frac{1}{2}$  Hp. motors, 60 cycle, 1 phase, 110 volt, like new, guaranteed, \$7.40. Send check to Erie Electric Motor Co., 120 Church, Buffalo, N. Y.

NEW Split phase 1/3 h.p. motor. Guaranteed two years. Double drive shaft. Built-in starting switch. New departure ball bearings. Every part is extra strong. 110-120 volt, 60 cycle ac., 1750 rpm. Only \$8.95 plus 65c postage. Address Dept. D92, Sears-Roebuck, Chicago.

NEW Displacement motor runs without fuel absolutely. Read my copyright booklet, see for yourself. Send fifty cents. Money order. Herbert Ponsford, 1624 Camosun, Victoria, British Columbia.

300 MOTOR Diagrams and tables covering three phase; Star, Delta, nine lead, two and four speed; two phase; single phase; split phase, capacitor, repulsion induction, fan, armature windings, etc. Satisfaction guaranteed or money refunded. \$1.50 prepaid. Educational Advancement Company, Lakewood, New York.

REWIND Washing machine motors, auto generators, make a.c. welder. Each book \$1.00. 10c brings particulars, catalog winding materials. Ernest Knight, LaSalle, Ill.

ONLY \$7.50 Postpaid. Make automobile engines controlled power units for welders, sawing, etc. "Pepy" governors sold with money back guarantee. Harris Machinery, Minneapolis, Minnesota.

MOTOR Winding lessons, illustrated. Send stamp for particulars. Also motor data for experienced winders, introductory selection \$1.00. Motor Data Company, Box 7631, Kansas City, Mo.

BARGAINS: Electric shaver \$1.48;  $\frac{1}{4}$ " drill \$3.67; candid type camera \$1.89; motors, grinders, radios, clocks, appliances. Pricelist free. Mailorder Electric Co., 713 So. Dearborn, Chicago.

SMALL Elect. motors with flexible shafts, rebuilt \$3.25 postpaid. McConnell, 1619 Edgewood Ave., Racine, Wis.

ALTERNATING,  $\frac{1}{2}$  Horse, 110 volt, induction motors. Rebuilt, guaranteed, \$7.50. Wilmot Auto Supply, 2247 St. Paul Ave., Chicago.

#### MACHINERY, TOOLS AND SUPPLIES

KELLOGG Air compressors, \$6.00. Electric refrigerators, \$25.00. Vacuum pumps, Taylor, 105 East 102nd Street, New York.

AIR Compressors, new  $1\frac{1}{4}$ x $1\frac{1}{4}$ , \$6. 2x2 \$7. 2 $\frac{1}{2}$ x2 \$8. Guaranteed. Send check or money order. National, 560 Washington, Chicago, Ill.

ATTENTION! Experimenters, craftsmen, inventors: You need this giant ten pound hardware kit. Big box full of screws, nuts, washers, gears, springs, rivets, brackets, etc. Over 1000 parts—price \$1.49—worth \$7.50. Guaranteed satisfaction. Manufacturers Screw, 215-M West Illinois, Chicago.

PLASTICS, Brass, aluminum, monel, stainless steel, gears, etc. Catalog 10c. Hobby Supply House, Box 2014, Pittsburgh, Penna.

SOUTH Bend workshop 9" lathe, taper attachment \$10, milling attachment \$9, prepaid U.S.A. Money back guarantee. Free circular. Alexander Machinery Co., 1516 Webster St., Omaha, Nebr.

BARGAINS, Demonstrators, electric arc welders, guaranteed, 30 days trial and terms. Write Hobart Welder Exchange, Box M-284, Troy, Ohio.

14" x 6' GREAVES Klusman cone head engine lathe, quick change. No. 0 Cincinnati miller, cheap. Write for particulars. Cincinnati Machinery & Supply Co., 221 E. Second St., Cincinnati, Ohio.

CONCRETE Building block machines and molds. Easy payments. Catalog free. Concrete Machine Co., 5129 South Compton Ave., St. Louis, Mo.

#### BOATS, OUTBOARD MOTORS, ETC.

ASSEMBLE Your own boat. Our finished knock-down frames and materials save you 2/3 builder's cost. All types and sizes. Send 25c for big catalog. Brooks Boat Co., Inc., D4, Saginaw, Mich.

BOAT Blueprints and full size paper patterns, priced 50c up. Wide selection. Cruisers, runabouts, sloop, snipe, outboard boats, etc. Designed by leading naval architect. Rush 10c (coin) for illustrated catalog. Cleveland Boat Blueprint Co., Station A-66, Cleveland, Ohio.

OUTBOARD Motor. Assemble your own. We furnish complete kit with instructions for 1.2 h.p. \$27.50. Or any part separately. Parts list catalogue 10c. Guaranteed product for troll fishing or pleasure use. Outboard Headquarters, 305 Atlantic Ave., Boston, Massachusetts.

ELECTRIC Outboard from old automobile generator. Operates with car battery. Smooth, quiet. Plans 10c. LeJay Manufacturing, 547 LeJay Building, Minneapolis, Minn.

OUTBOARDS — Save  $\frac{1}{2}$ . Good used parts, all makes and models. Bargains rebuilt motors. Crandall Hicks Co., 959 Commonwealth, Boston, Mass.

FORD Marine conversion parts and kits. Models A, B, V8 (domestic or foreign). Catalogue 25c (coin). Osmithson, 3644 No. Lawrence St., Philadelphia, Penna., U.S.A.

NEWEST Thing in boat plans. 20 foot cabin cruiser, complete blue print \$1.00. Abbot Boats, Bellmore, New York.

12 FOOT Flat bottom rowboat, complete plans 25c. Free boatbuilding catalog. The Rudder, 15 Murray St., New York.

FORD-ZEPHYR Marine conversions. Catalog 10c. Lehman Engineering Company, Dept. D, Newark, N. J.

BUILD Your favorite boat—Save on the cost. The Welch System of Boat Building makes this possible. Send 10c for 32 page catalog showing Welch designs. White Cap motors, boat equipment. The Welch System completely explained in this interesting book. Use Welch Ready Cut parts and build your boat at home. Welch Boat Company, Station K-1, Milwaukee, Wis.

COMPLETE Your own boat with our pre-fabricated frames and materials. They're different. Save 2/3s and costly mistakes. Send requirements for quotations. Illustrated catalog 100 boats, 10c. Bay City Boats, Inc., Bay City, Mich., 1552 Adams St.

BOAT Designers are highly paid professionals. Complete course by mail. Catalog. Westlawn, Montville, N. J.

#### FIELD GLASSES, TELESCOPES AND MICROSCOPES

TELESCOPES, Microscopes, binoculars; 1939 bargain catalog free. Brownscope Company, 5 West 27th Street, New York.

TELESCOPES, New, used \$5.00 up; also amateur kits, books, maps. American Telescope Laboratories, Hollywood, California.

BUILD Reflecting telescopes, 6" kit, \$3.50; other kits—all abrasives, mirrors, eyepieces, diagonals, illustrated instructions, 10c. Catalogue free. Optical Development Corporation, Dept. G, 1560 Broadway, N. Y.

TELESCOPES, Microscopes, chemistry, mineralogy. Scientific catalog free. Tracey Laboratories, Evanston, Illinois.

FREE Instructions. Build powerful telescope. Jamer, Box 94, Manorville, N. Y.

USED Microscopes, binoculars, astronomical telescopes, surveying instruments—bought, sold, repaired. Send 10c for list. Rasmussen, P. O. Box 294, Amsterdam, N. Y.

MICROTOME, \$3.00 Postpaid. Satisfaction guaranteed. Circular. Malcolm Goodwin, 1422 Rorer, Roanoke, Va.

#### SPORTING GOODS, GUNS, FISHING TACKLE, ARCHERY

BARGAINS! Gun catalog 5c. Fishing catalog 5c. Ski catalog 5c. J. Warshal & Sons, First and Madison-PM, Seattle, Wash.

FENCING Equipment. Foils, swords, masks, etc. Low prices. Free catalog. Industrial Products, Dept. 22, 48 West 48th Street, New York.

RIFLES, Shotguns, S&W. Colts, target pistols, air rifles, hunting knives, binoculars, telescopes, police goods, badges, holsters, etc. Bargain catalog 3c. Lee Sales, (Dept. W), 35 West 32nd St., New York.

GOLF Clubs. Five club matched set \$2.50. Lincoln Surplus, 123 Galena, Freeport, Ill.

TREASURE Finders? Read Goldak advertisement on page 133A.

LEARN Gunsmithing at home. Repair your own and neighborhood's firearms. Free catalog describing 20 books on firearms and gunsmithing. Samworth, Marines, North Carolina.

SINKER Molds for making your own sinkers. Free illustrated folder. Reading Instrument Co., Box 78, Reading, Penna.



**ARCHERY** Headquarters—617 South State, Chicago. Catalogue free. Complete instruction book 50c.

**HUDSON** Bay blankets, Indian pack baskets, camp stoves, knives, compasses, outdoor equipment. Free catalog. Howe Fur Co., Box P, Coopers Mills, Maine.

### ANTIQUES, RELICS, INDIAN GOODS

**SWORDS**, Rapiers, daggers, armor list. Send stamp. Abels, 860A Lexington Ave., New York.

**DOLLS**, Antique, bought for cash. Write Kimport Dolls, Independence, Mo.

100 **GOOD** Or 60 fine arrowheads, \$3.00. George Holder, Glenwood, Ark.

**MAKE** Your own Indian arrowheads. Illustrated booklet "How to Make Arrowheads" of flint, glass, etc., \$1.00. Indian Lore Publications, Green River, Wyoming.

100 **GOOD** Arrowheads \$3. Catalog. 5c. H. Daniel, Hot Springs, Ark.

**INDIAN** Relics, beadwork, coins, curios, minerals, old glass. Catalog 6c. Indian Museum, Northbranch, Kansas.

### TAXIDERMISTRY

**PRICES** Slashed! New 36-page 1939 supply catalogue free. New items. New ideas. Postcard brings yours. Taxidermic Manufacturers, Memphis, Tenn.

**LEARN** By mail to mount birds and animals, tan skins, make leather. Old reliable school teaches, easily, quickly, at low cost. Over 250,000 students. Rush postal for free 48 page book. Northwestern School of Taxidermy, 775 Elwood Bldg., Omaha, Nebr.

**GLASS** Eyes, taxidermists', furriers' supplies. Big catalog free. Elwood Company, 222 Smith Bldg., Omaha, Nebr.

**TAXIDERMISTRY** Supplies—Quality artificial eyes, teeth, genuine Jonas head forms. Tools, materials, etc. Everything for the progressive taxidermist. Send 10c for big illustrated catalogue. Jonas Bros., 1049 Broadway, Denver, Colo.

### DOGS, PETS, BIRDS

\$15.00 **BUYS** Trained coon hound. Opossum, fox, rabbit and bird dogs cheap. List free. Ramsey Farm Kennels, Ramsey, Ill.

**MAMMOTH** Great Danes. Marvelous guards, companions. Pups \$25.00. Write for pictures. Kaimar Danery, Stone Mountain, Ga.

**BIG** Profits breeding Bostons! Circulars, dime. "Sentree." Royal Oak, Michigan.

**BIRDS?** Get American Canary Magazine monthly. Year \$1.00. 2839-P North Halsted, Chicago.

**BEAUTIFUL** Pure white police dogs. Ansonia Kennels, Mose, N. Dak.

**SPORTSMEN:** 200 Pointers, setters, straight cooners, combination hunters, rabbit and fox hounds. Reasonable. List free. Ramsey Creek Kennels, Ramsey, Illinois.

**REAL** St. Bernard puppies—cheap too! Royal Kennels, Chazy, N. Y.

### POULTRY AND FARM SUPPLIES

**SEXED** And sex-linked chicks. 6 popular hybrids; 52 purebreds. Large new book free. Mrs. Berry's Farm, Route A, Clarinda, Iowa.

**MORE** Profit in your grain fed to broilers. Poultry prospects bright. Write today for catalog, early order and quantity discounts. Dubois County Hatchery, Box 912, Huntingburg, Indiana.

**LOW** Factory prices on electric brooders, batteries, parts, wire fabrics, etc. Free 76 page catalog. Bussey, 5151 West 65th, Chicago.

**HEADQUARTERS**—World champion layers. We imported 353 - 361 - 364 egg contest hens from Australia - New Zealand. Free educational catalog shows customers profits. Osborne Farm, Box 70, Holland, Michigan.

10 **CASH** Prizes weekly for ten weeks. Also in addition to cash prizes, 5 all-expense trips to World's Poultry Congress. Write for contest rules and free catalog telling how to make money with Davis chicks. 21 breeds. Sexed chicks \$4.50—100 and up. Davis Poultry Farm, Route 34, Ramsey, Indiana.

**MAKE** Money with poultry. Read America's leading poultry magazine for latest information. Three years \$1.00; nine months 25c. Poultry Tribune, Dept. E-93, Mount Morris, Ill.

**GREENSBURG** Bloodtested chicks for broilers. Immediate delivery on Barred, White, Buff Rocks, Reds, also Leghorns \$4.50 up. Write for catalog, early order and quantity discounts. Greensburg Hatchery, Box 40, Greensburg, Indiana.

**CHICKS** For broilers. Immediate delivery on Reds, Barred, Buff, White Rocks, Wyandottes, Orpingtons, Leghorns. Sexed chicks 90% accuracy guaranteed on pullets. Write for low prices, quantity and advance order discounts. Salem Hatchery, Box 81, Salem, Indiana.

**SEYMOUR** Chicks for broilers and early layers. Our prices are always at rock bottom. Write us before you buy chicks. Get our free catalog, early order and quantity discounts. Seymour Hatchery, Box 36, Seymour, Indiana.

**CHICK** Raisers make extra money selling our chicks to neighbors. Write Jackson County Hatchery, Box 19, Seymour, Ind.

### TREES, SHRUBS, ROOTS, HERBS

**JUST** Out! World's greatest "Herbalist Almanac." Beautifully illustrated in natural colors. Contains over 200 old-fashioned herb medicine recipes for home use. 10c postpaid. Worth dollars! Botanicals, 145 W. 112th St., Chicago.

### FARMS AND FARM LANDS

**FARMS** That pay in the Great Northern Railway agricultural empire, Minnesota, North Dakota, Montana, Idaho, Washington, Oregon. Fertile black soil, high production crops, grain, fruit, vegetables, feed and livestock. Many kinds of farms for selection. Write for book on state you prefer. E. C. Leedy, Dept. 257, G. N. Ry., St. Paul, Minn.

**JUST** Out! Strouts catalog—Farms, country homes, rural business opportunities; nearly 2000 bargains described in states east of the Mississippi; write today for this money-saving time-saving guide. Free. Strout Realty, 255-P 4th Ave., New York City.

**GOVERNMENT** Lands ten cents acre up. Information all states twenty-five cents. National Tax Service, 600A Majestic Bldg., Detroit, Mich.

**CALIFORNIA** Irrigated dairy farms. Almond or walnut groves, fruit orchards and cattle ranches. For full particulars, write Bomberger Bros., Modesto, Calif.

**GOOD** Farms available. Washington, Minnesota, Idaho, western Montana, Oregon. Dependable crops, favorable climate. Write for impartial advice, literature and list of typical bargains. Specify state. J. W. Haw, 119 Northern Pacific Ry., St. Paul, Minn.

40 **ACRES**, Near White River, unimproved; poultry land. \$175, \$5 down, \$5 monthly. Free list and literature. Hubbard, 216 Grossman Bldg., Kansas City, Kans.

**CANADIAN** Tax sale lands for a dollar an acre and up. Small monthly payments. Farms, timber, hunting and fishing camps, minerals. Limited number of properties. Write at once for free illustrated booklet. Tax Sale Service, Room 613, 62 Queen St. W., Toronto, Canada.

### FARM MACHINERY AND SUPPLIES

**ALL** Purpose tractors at factory price. Shaw 2 to 5 horsepower, riding or walking types. Does plowing, discing, harrowing, cultivating; mows lawns, cuts weeds, does hauling; runs belt machinery. Air or steel tires. Three speeds forward and reverse. Thousands in use. Write for free catalog and 10 day trial offer. Shaw Mfg. Co., Dept. PM2, Galesburg, Kansas.

**NEW** And used tractor parts at tremendous savings. Write for free 1939 catalog. Central Tractor Wrecking, Co., Boone, Iowa.

### PROFITABLE OCCUPATIONS

**RAISE** Rabbits and cavies for us. We buy at top prices. Complete details in catalog, contract and magazine. 10 cents. Stahl, Box 1, Holmes Park, Mo.

**REGROOVING** Smooth tires is profitable. Your own business. Write today. L-219 N. 63rd Street, Philadelphia.

**MEN**—Women, operate "Specialty Candy Factory" home, all or spare time. We furnish outfits and instruction. Opportunity to earn steady income. (Our 29th year.) Booklet free. W. Hillyer Ragdale, Inc., Drawer 62, East Orange, N. J.

M. M. earned \$267, three weeks, raising mushrooms in cellar! Exceptional, but your cellar, shed perhaps suitable. We buy crops. Book free. United, 3848 Lincoln Ave., Dept. 59, Chicago.

**BIG** Money raising Angora Wool rabbits! Easy, fascinating. Wool brings \$3 to \$6 lb. Catalogue wool samples 10c. Clay's Farm, Sharon, Wash.

**BALLGAMES**, Movies afternoons. Work mornings home. Your own business. Stamford, 3762-A Broadway, New York.

**MINK**, Bred females, April delivery. Dime for general information. Lomman's Fur Farm, Spangler, Penna.

**COUNTRY** Drives or movies afternoons! Work mornings home. No canvassing! Folio-H, Station D, Los Angeles.

**TREASURE** Finders? Read Goldak advertisement on page 133A.

**RAISE** Guinea pigs, make money. Thousands needed. We supply breeders and buy the young. Free illustrated book. Research Supply, 2436 W. York Street, Philadelphia, Penna.

**POSITIONS** At sea. Details free. No employment agency. Julius, Amarillo, Texas.

**MAKE** Door mats from junk tires with ordinary home workshop equipment. Complete instructions \$3.00. Thomas Kowell, 5372 St. Clair, Detroit, Michigan.

**MINK** Easily raised. Highly profitable. Free booklet. Banks Minks, Framingham, Mass.

### OLD BOOKS WANTED

**WE** Pay up to \$5000 each for old books, also high cash prices for old magazines, letters, newspapers. A single story book, school book, old Bible, travel book, almanac, etc., that looks worthless may bring you \$50, \$100 or \$500 in cash. Thousands wanted. Send 10c now for latest price list. American Book Mart, 140 S. Dearborn, Dept. 2513, Chicago.

### BOOKS, PERIODICALS, PICTURES, POSTCARDS

**SEND** 10c For trial subscription, American Freeman, questions and answers magazine. Haldeman-Julius, Girard, Kansas.

**EXCLUSIVE** N. Y. world's fair photos. Information, samples 10c. Forman, 882 Lorimer, Brooklyn, N. Y.

**SPARE-TIME** Subscription representatives for all magazines. Instructions, complete starting supplies; free. Pines, 583-A Monroe, Brooklyn, N. Y.

**YOUR** Favorite magazines—Half price. Catalog, 10c. Magazine Exchange, Base-line, San Bernardino, Calif.

### GAMES—ENTERTAINMENT

**BINGO** Games, all sizes, lowest price catalog. Warnovco, Conimicut, R. I.

**PLAYS**, Operettas, musical comedies, complete minstrel first-parts with song programs, blackface skits, vaudeville acts, monologs, dialogs, recitations, juvenile plays and songs, musical readings, entertainments, make-up goods. Catalog free. T. S. Denison & Co., 203 N. Wabash, Dept. 11, Chicago.

### MAGIC TRICKS, PUZZLES, JOKER NOVELTIES

**MYSTIFYING** Tricks, 1½c each! Get yours. 1008 Commercial, Waterloo, Iowa.

**LEARN** Ventriloquism, 3c stamp brings particulars. Smith, 125 N. Jefferson, Peoria, Illinois.

**LOOK!** New 1939 catalog professional stage magic only 10c. Big new catalog 500 pocket-parlor tricks 10c. Each different—get both. Lyle Douglas, Station A-5, Dallas, Texas.

**EARN** Money in any crowd. Call names of strangers, tell unspoken questions. Professional course mind reading, spirit writing, etc., \$1. Henderson, Box 341, San Bernardino, Calif.

**GIANT** Surprise catalog of jokes, tricks, magic, puzzles, novelties, curiosities rushed for 25c. Free mystery trick included. Lawson Vick Co., Dept. P4, Queens Village, N. Y.

**MAGIC**. Earn while learning. Particulars for stamp. Browne, Box 272, Duluth, Minn.

**HAVE** Fun! Fool your friends! Latest trick jokes. 10c brings illustrated catalog and snappy free trick! Broadway Novelty Co., Box 75, Pelham, New York.



BE A magician. Large professional magic catalogue of latest tricks 25c. Cash paid for complete Tarbell Magic Courses. Write, Ireland, C-109 North Dearborn, Chicago.

THE Lyle Douglas catalogs are bigger and better than ever. Lyle Douglas, Station A-5, Dallas, Texas.

MAGIC; Books, occult; novelties. Catalog 10c. Eastern City Sales, 8-E Randolph, Chicago.

SVENGALI Magic decks. Bridge size, new style. Demonstrators sell them for one dollar. Dozen \$3.25. Sample post-paid thirty-five cents. Catalog 300 jokes and magics free. Adams Company, Asbury Park, N. J.

WORLD'S Largest magic shop professional catalog. 25c. Holden, 220 W. 42nd St., New York.

BECOME A magician and earn extra money in your spare time. Send 25c today for your copy of our 168 page catalogue. This book is full of tricks for everyone, from the beginner to the professional performer. Established 1910. Chicago Magic Company, 2300 North Mason Avenue, Chicago, Illinois.

#### RARE COINS

ANCIENT Roman coins, five different, \$2.00; commemorative half dollars, five different, \$5.00. S. Koeppl, Merritt Bldg., Los Angeles, California.

UNITED States. Large cent, 2c bronze, 3c nickel and bargain list, 25c. Eleven dates large cents, \$1. George P. Coffin Co., Augusta, Maine.

GENUINE Roman coin 25c; Flying Eagle, 3c nickel and list 25c. Maurice Gould, Box 73, Brighton, Mass.

COINS Bought: Will pay \$5.00 each for certain Lincoln pennies; Indian heads \$100.00; dimes \$500.00. Catalogue 10c. Federal Coin Exchange, 40 S-Mill, Columbus, Ohio.

COIN Cards, large stiff cardboard 11x14 in., cutout for Indian or Lincoln cents, liberty or buffalo nickels. Each 50c post-paid. Foreign postage extra. Lohmer Co., 825 Lima, Burbank, Calif.

OLD Money wanted. Do you know that coin collectors pay up to \$100.00 for certain U. S. cents? And high premiums for all rare coins? We buy all kinds. Send 4c for large coin folder. May mean much profit to you. Numismatic Co., Dept. 20, Fort Worth, Texas.

COMMEMORATIVE Half dollars, Lincoln \$1.19; Cleveland \$1.19; Long Island \$1.19; Texas \$1.19; Boone \$1.29; Arkansas \$1.89; Elgin \$1.49; Wisconsin \$1.49; York \$1.49; Bridgeport \$1.99. Selling price list free. Bob Cohen, Box 3507-G, Cleveland, Ohio.

44 COINS, Bills, tokens, 25c. Otto Oddehon, Overland Station, St. Louis, Mo.

PREMIUMS Paid for 1200 different U. S. coins in circulated condition including Indian and Lincoln pennies, standing Liberty quarters, etc. Complete buying list 15c. James Randall, 407 South Dearborn Street, Chicago.

INDIAN Cents, 10 different, 25c; 40 coins, bills, tokens, 25c; 20 coins, 25c. Bishoff, 500 E. 8th, Kansas City, Mo.

UNCIRCULATED San Francisco mint cent and list 10c. 3 different 25c. Landon, Box 1733, Wilshire Station, Los Angeles.

BIG Prices paid for certain wanted coins, 1909 cent \$10.00, some silver dollars \$4000, 1864-1865 Indian head cents \$100.00 each, dimes before 1895, \$600; liberty head nickels before 1914, \$500; encased postage stamps; some large pennies \$2000; half cents, \$275.00; paper money, gold dollars \$1500, foreign coins \$165, some worth \$6000 each. You may have coins for which we pay big premiums. Therefore send 15c today for 1939 big illustrated coin book for certain wanted coins. National Coin Corporation (80), Daytona Beach, Florida.

GET Profit and pleasure in collecting old coins. Send 10c for 56-page illustrated coin catalog. You'll be delighted with it. Send for it now. B. Max Mehl, 370 Mehl Bldg., Fort Worth, Texas. Largest rare coin establishment in U. S. Established 38 years.

FINE Foreign 1700 coin, 2 notes and catalog 10c. Geo. Best, Cedar Rapids, Iowa.

COMMEMORATIVE Half dollars, Lincoln, Stone Mountain, Oregon, Texas, Cleveland, Kentucky, San Diego, Long Island, \$1.50 each. Illustrated catalogue No. 14, 25c. Norman Shultz, Salt Lake, Utah.

FREE! Foreign coin, banknote, and large illustrated coin catalogue. Send 4c postage. Coin approvals sent. Tatham Coinco, Springfield-125, Mass.

\$5 TO \$500 Each paid for hundreds of old or odd coins. Keep all until posted. Many very valuable. Send 10 cents for illustrated Coin Value Book, 4x6. Guaranteed buying and selling prices. 31 years in business. Coin Exchange, Box 5, Le Roy, N. Y.

RARE U. S., foreign coins, war medals. Catalogue 10c. Mengelle, Colorado Springs, Colo.

#### OLD STAMPS WANTED

WILL Pay \$100.00 for 1924 1c green Franklin stamp, rotary perforated eleven (\$1,000.00 if unused). Send 6c today for large illustrated folder showing amazing prices paid. Vernon Baker, 444PM-1, Elyria, Ohio.

BUYING List with 333 illustrations, 10c. Liberty Stamp Co., St. Louis.

#### STAMP COLLECTING

BRITISH Solomon Islands—Land of cannibals and head hunters! Immense Solomon Islands commemorative, \$5. United States, Liberian Bongo antelope, mystery British Colony triangle (a thrilling surprise!), fantastic Manchukuo mausoleum, breathtaking beauty from Cayman Islands, etc. This astounding packet of bizarre and intriguing stamps absolutely free to approval applicants enclosing 3c postage. Viking Stamp Company, 1-Z Hanson Place, Brooklyn, N. Y.

WHOLESALE — Canada, Newfoundland. Fifty page illustrated wholesale catalogue, featuring Canadians, Newfoundland, British Colonials, United States, supplies. Free. Empire Stamp Company, Dept. 5, Toronto, Canada.

81 DIFFERENT Including Costa Rica triangles, Egyptian airmail; set Kouang Tchou; 25 British Colonies, etc. All for 10c with approvals. Arden Page, Hornell, New York.

MAMMOTH Free packet. Savage princess, exotic scenes, weird natives, maps, boats, animals, 3c postage. Approvals. Smith, 693 Clifford, Rochester, N. Y.

GIANT Packet 200 all different, from Africa, South America, Asia, South Sea Islands, etc. Includes world's smallest stamp, triangle and diamond-shaped stamps, animal stamps, Nicaragua Olympic "baseball" commemorative; and many others. Also packet 17 different United States (cat. 65c)—all obsolete, including \$5 denomination, commemoratives, etc. Total catalog value nearly \$5.00! All for 5c to approval applicants. Write to-day! World-Wide Stamp Co., Box 600, Camden, New York.

PRODIGIOUS Anniversary package! Bicolored banana airmail, Perak, savage Selangor, unique "green cross" charity, Wurttemberg, Kiwi bird, world's tiniest airmail, Sembilan, Portuguese commemorative, Siberia, striking pictorials. Only 5c with approvals! Saxon Company, 408a Jay Street, Brooklyn, N. Y.

AIRMAILS And commemoratives, 25 different, including Columbians, Panama-Pacific, Edison, Zeppelin, etc., only 5c with exceptionally fine United States and foreign approvals. Marco Stamp Co., Box 888, San Francisco, Calif.

50 BRITISH Colonials, premiums, lists, approvals, 10c. Northeast, Box 6618, Kansas City, Mo.

3 PHILIPPINES With approvals 3c postage. McLoughlin, North Avenue, Meriden, Conn.

GENEROUS Offer! Three triangles, Tanganyika, Newfoundland commemorative, giant map, U. S. \$5, scarce Manchukuo—29 pictorials. Extra! Spanish insurgent commemoratives. Everything 10c offered approval applicants. Tru-Value, Box P1412, Hartford, Connecticut.

FREE—22 Different Japan, also free hinges to approval applicants sending postage. Excel, Box 1315, Chicago.

UNITED States stamps on approval. Ranneger's, Box 134, Pittsburg, Kansas.

EARN Cash-stamps, sell my approval books. Nickel packets. Ellison, 2841 West 37th St., Brooklyn, New York.

FREE Collection 20 different Portugal for names and addresses of three active stamp collectors if approvals requested. Reimers, 500 Flatiron, Fort Worth, Texas.

FREE! 25 Different United States. Send 10c for 2 each Alexandrette, Bahrain, Nejd. (Approvals.) Arnosti, 465 Lexington, New York.

BIG Package stamps. Over 250 mixed with British Colonials. Only 5c to approval applicants. Washburn, Dept. D, 2224 Montana, El Paso, Texas.

50 VARIETIES Silver jubilee \$4.50. 100 coronations \$5.00. 100 George 6th \$2.00. Lists free all countries. Ontario Stamp Co., Box 444, Toronto, Canada.

WONDERFUL Bargain — Coronations, Sierra Leone, Nigeria, New Mozambique, and 100 different others. Everything 10c to approval applicants. Dusenberry, 300 West 23 St., New York.

OVER 150 All different United States, Canada, Newfoundland only, including commems., free premiums, 30 cents, coin, stamps. L'Hernault, 204 West 76th Street, New York City.

APPROVALS As you like them. Superb, attractive, cheap. Ref. Bartolo, 23 Inguanez, Rabato, Malta.

5 DIFFERENT Stamp sets 15c. Paul, 2216 Clinton, Berwyn, Illinois.

HUGE! Seven colors! Four varieties Ecuador-United States constitution stamps with packet 50 others, 5c to approval applicants. Livingston, 216B, St. Ignace, Mich.

1000 GOOD Mixed foreign, 25c. Mission Mart, Brookland, D. C.

APPROVALS Half cent and up. Andersen, 1341 Franklin, Milwaukee, Wis.

FREE—World's only octagonal (eight-sided) set to approval applicants. Charles Cleveland, 806 North Humphrey, Oak Park, Illinois.

100 DIFFERENT Including attractive triangle only 5c to approval applicants. Crystal Stamp Co., 3512 Leavenworth, Omaha, Nebr.

111 DIFFERENT Stamps 10c with approvals. Barclay & Sons, 407 S. Jackson, Kansas City, Mo.

33 DIFFERENT U. S. with approvals 6c. Reynolds Stamps, Flint, Mich.

THE World in a packet. An outstanding value! 100 stamps from 100 different countries, including Abyssinia, Afghanistan, Brunei, Falkland, Samoa and others from Africa, Asia, South America, West Indies, etc. Our pamphlet, which tells "How to Make a Stamp Collection Properly," together with our large bargain list of albums, packets, sets, etc. All for only 20c. Queen City Stamp Co., 604 Race St., Room 36, Cincinnati, Ohio.

100 U. S. 25c. Approvals, References. Napp, 1100 Euclid, Beloit, Wis.

ALL THE world—Approvals one cent and up. Dee Taylor, Rocky Mount, N. C.

ZEPELIN Hindenburg complete set 5c, approvals. French, 241 Euclid, Cleveland.

TRIANGLES! Triangles! Triangles! Triangles! Count them. Four! With famous Rivera nude stamp. Only 3c to approval applicants. Cactus Junior, Tucson, Arizona.

FINE Approvals, freshly filled books and sheets. Tell me what you want and I will send it. Milton Skinner, 306 East Fourth, Long Beach, Calif.

75% DISCOUNT. Send 25c, 50c or \$1.00, receive four times amount in stamps cataloging 3c up. Globe Sales, Box 505, Pontiac, Mich.

UNITED States approvals! Reasonable! Serious collectors! Box 822, Minneapolis, Minn.

ILLUSTRATED 2 Color letterheads, envelopes, 100 each \$1.00 postpaid. Professional Stationery, Nashville, Mich.

\$10 STAMP Free to approval applicants. Foote, 309 Greeley, Webster Groves, Mo.

FREE. Canada \$1 stamp to approval applicants. Munday, 1052 Manning Avenue, Verdun, Que.

30 DIFFERENT Canada 5c with approvals. Union Stamps, Kitchener, Ontario.

CLIPPERS, 1319; 1320; 1321; 50 Cents coin. Hanington, Babylon, N. Y.

105 STAMPS Including triangle, airmails, etc. 10c. Lufbery, Middletown, Connecticut.

STAMPS. A superb selection sent on approval. Quality at low prices. Fred Herzberg, Box 91-P, Elmhurst, Ill.

FREE. \$5.00 Stamp with approvals. Perley D. Porter, Wellesley, Mass.

UNPICKED! 100 U. S. revenues on documents—10c! (1000—60c.) 500 different world—35c! Vanvoorhis, Hyndman, Penna.



U. S.—63 different (commemoratives, airmail, etc.) with approvals 9c. 50 diff. commemoratives 1893 to date 25c. Moseley, 4932 Forestpark, St. Louis, Mo.

CASH For precancelled and bicentennials. Judd, 661 Platt, Toledo, Ohio.

FREE. Treasure packet, 3c please. Oromocto Stamps, Kitchener, Ontario, Can.

CASH For stamp collections, accumulations. Jennie Graves, Phoenix Building, Holyoke, Mass.

PICTORIAL Exchange. Send 25 different stamps and 10c; receive 25 different foreign pictorials. Waldo, Box 266, Dallas, Texas.

NEWFOUNDLAND—15 Different including coronation, 10c to approval applicants. "Crescent Stamps." London, Canada.

30 FINE Stamps cataloging \$5.00, only 30c with approvals. Fort Pitt, 1711 Howard, Pittsburgh 12, Penna.

WORLD'S Small airmail, also world's largest diamond stamp, free stamp magazine! \$2.00 U. S. stamp, commemoratives, special issues, scarce stamps from 25 countries. 5c with approvals. Capital Stamps, Dept. PM, Little Rock, Arkansas.

5 DIAMOND Stamps 5c. Barcus, 1631 S. Lincoln, Denver, Colorado.

FREE. 21 Diff. pictorials, jubilees, coronation, new issues. No junk. 3c postage. Approvals. James Stamps, Stone St., New Bedford, Mass.

OVER 800 Obsolete U. S. stamps! Satisfaction guaranteed or money refunded. \$1.50 postpaid. George Wentz, Brownsville, Texas.

HUNGARY, 100, 6c. 25 Coins 20c. Mails Rubin, 11 Pitt St., New York City.

8mm., 16mm. FILMS, Cameras, projectors. Bargain list. Block, 1265 Broadway, New York.

114 DIFF. Stamps 10c with approvals. Dietze, 9711 117 St., Richmond Hill, N. Y.

U. S. Specials—1000 mixed, 15c. 150 different. \$1.00. 30 different commemoratives. 10c. Lee, Bridgeport, N. Y.

1857—1938 STAMPS At 1c and 2c each. Catalogue up to 10 times my prices. Leduc, Saint Petersburg, Florida.

PRECANCEL Approvals, 35 different for 3c to applicants. Gierhart, Baltimore, Ohio.

HEADQUARTERS For United States. Send 50 cents and two references for 50 different, including scarce 572 and 573. Approvals included. Price lists on request. R. M. Stamp Co., Box 230P, Port Chester, N. Y.

STAMP Approvals. Fine sea shell. Coins, want list solicited. Hobbies, 126 Narcissus, W. Palm Beach, Fla.

BARGAIN Fine sets cheap. Write. Sweeper, 101 Monmouth, Newark, N. J.

FREE! 25 Japanese, inclose postage, request approvals. Secrist, Muscatine, Iowa.

CZECHOSLOVAKIA—50 Different 10c; 100, 34c; 200, \$1.60. Fuld, Dickmann Building, Saint Louis, Missouri.

FIJI (Scarce) included forty country mixture—100 stamps, 10c; 300, 25c. No approvals. Eisea, Bowling Green, Ohio.

75 STAMPS From 75 countries only 10c to approval applicants. Maynard Sundman, D123, Bristol, Conn.

110 DIFFERENT, Caledonia, South American, Guinea, etc., 3c to approval applicants. Extra—Two scarce airmails added free! Hunziker Philatelic Service, Box 225-M, Minneapolis, Minn.

FREE, Looseleaf commemorative album with 4 pound mission mixture for \$2.00. LaGrange Park Stamps, LaGrange, Illinois.

GIANT Diamond-shaped stamp! Big packet 105 all different including Alexandretta (new country), Congo, Manchukuo, Ecuador constitution, Costa Rica triangle, air-mails, commemoratives; giant diamond-shaped stamp, \$5 United States; set United States telegraphs, cataloging 30c. Packet British colonies including Burma (new country), jubilee and coronations; scarce sets 2 Siberia, cataloging 50c. Illustrated lists. Everything for only 5c to approval applicants! Write to-day! Mystic Stamp Co., Dept. 80, Camden, New York.

PANAMA Triangle and 50 others free to approval applicants sending 3c postage. Tatham Stampco, Springfield-30, Mass.

1939 ANNUAL Free—Features Canadians, Newfoundland, United States, colonials, foreigners, supplies. Sixty pages with hundreds of illustrations. Sent free. Gray Stamp Company, Dept. PM, Toronto, Canada.

WORLDWIDE Mixture (40 countries), South America, Orient, Africa, etc., including airmails and pictorials, 1,000, 35c; 3,000 (greater variety), \$1.00. 1,000 U. S. commemoratives (50 varieties, assorted) \$1.85; 500 (40 varieties) \$1.00. Wholesale Stamp Mart, 245 Broadway, New York.

EXCHANGE Stamps, postcards. Universe. "Exchangers," Bry 226 pres, Paris, France. Particulars free.

"ALL Pictorial" approval selections of medium priced air mails, commemoratives and new issues. Popular since 1929. Try us at least once. Norton Brothers, 2357 North 58th Street, Milwaukee, Wisconsin.

THE Panama constitution completes the entire U. S. constitution series. The flags of the United States and Panama in natural colors, the Statue of Liberty and the mottoes of each country make the Panama U. S. constitution stamps the most beautiful of the entire series. The U. S. constitution stamps issued by 13 different countries are now complete and getting scarce. We still have them all and will send them "on approval." The Panama set (2 values) will be sent for 10c to approval applicants. Approval Headquarters, Globus Stamp Company, 268 Fourth Ave., New York City, Dept. 201.

100 DIFFERENT U. S. 53c. Album Company, Box 344, Ft. Worth, Texas.

150 GOOD Mixed foreign stamps. 5c coin. Stanton, Niantic, Conn.

FREE 55 Different with approvals. Try our quality merchandise. Klipp, 2404 West Cherry, Milwaukee, Wis.

U. S. Approvals? Parks, used, complete 19c. Hubers, Palace Building, Minneapolis.

WORLDWIDE Mixture. Packet containing 1000, 25c. Plaza Stamp Co., Box 1161, Santa Fe, N. Mex.

30 COMMEMORATIVES 3c. Approvals. Story Service, 27½ Exchange Street, Gloucester, Massachusetts.

MAGNIFYING Glass. Powerful. Ground polished American lens. Unbreakable. 30 cents prepaid. Adams Sales, 317 State Tower, Syracuse, N. Y.

FREE Price list ten popular countries. Superb Stamp, 128 Market, Newark, N. J.

50 DIFFERENT U. S. stamps 15c. Siegel, Box 1710, Milwaukee, Wis.

25 DIFF. Obsolete U. S., catalog over \$1.25—25c. Omar, 436 Virginia Ave., Hagerstown, Md.

U. S. Mint Sullivan, Pitcher, Clark, Steuben, Edison—35c. with Connecticut free. McClay, Altadena, California.

UNITED States approvals! Sensible prices! 4745 South Aldrich, Minneapolis, Minn.

200 DIFFERENT United States stamps, all different, fine condition. \$1.50. Walton Millman, Rockford, Michigan.

SPLENDID Estonia collection, 25 different, pictorials, semipostals, scarce imperf. only 5c. Imperial Stamps, G.P.O. 130, New York.

UNITED States commemorative approvals. Send wants. George Davis, Webster, Mass.

CHOOSE Your premium from numbered (accurately) foreign approvals. 10c worth for 3c. Cowan, 16152 Snowden, Detroit.

FREE—From every continent, 155 different, airmails, triangle, commemoratives, pictorials, many U. S. and others, with 1c approvals. Send 5c for postage and handling. Ace Stamps, Colonial Arcade, Cleveland, Ohio.

PACKET Roumania. Dime with approvals. Notro, 4909 North Seeley, Chicago.

LOOK! 5 Costa Rica triangles, 25 different Japan, Vatican, Italian Africa, stamp wallet and perforation gauge. All for 10c to approval applicants. Wunsch, Box 410, Houston, Texas.

UNITED States illustrated looseleaf catalog. \$1.00. Send postage for free United States price list, precancel list. Stanley Gibbons, 38-P Park Row, New York.

300 DIFFERENT Stamps 20c; 600, 50c; 1000, \$1; 2000, \$3; 3000, \$7. Fred Onken, 630 79th St., Brooklyn, N. Y.

INDIAN Native stamps, 100 different, dollar bill. Cruz, Post Box 10, Lahore, India.

POSTAGE Stamp collections bought and sold. Philatelic Headquarters, Trenton, New Jersey.

THREE Triangles; 3 diamonds; 3 coronations; 3 airmails! 3 jubilees and 3 Bermuda pictorials 25c. Approvals. Eulalia Turner, Azusa, Calif.

U. S. Constitution stamp of Ecuador, gorgeous six-color stamp showing U. S. flag in natural colors and George Washington, also Marvel packet 33 different including new Cayman Islands, Gen. Franco Spanish Morocco "war stamp" 60 yr. old Luxemburg, "bull-fight" stamp, largest diamond, tropical triangle, Chinese "mid-let" stamp, etc., all for 5c with approvals. Potomac Stamp Co., Dept. 102-D, Washington, D. C.

WRITE For list remarkable stamp offers. Stamp Finance, Box 1028, Vancouver, Canada.

FREE—50 Different stamps to approval applicants, 3c postage. World Stamp Co., Flint, Mich.

BIG Packet unusual stamps (no cheap Europeans.) including scarce Zeppelin; world's smallest triangle; Indo-China airmail; Liberia; Eastern Roumelia; Canada coronation, silver jubilee; Italian East Africa; giant diamond-shaped stamp. Also Holy Lands packet (Palestine, Lebanon, Iraq, etc.); many others. Only 5c to approval applicants! Frederick Fitts, Framingham, Massachusetts.

FREE—The Stamp Finder! Our new 20 page edition, fully illustrated, which will enable you to instantly identify all difficult stamps. Also fine packet of odd and unusual stamps from Bosnia-Herzegovina, Monaco, Patiala, Cyprus, etc., including maps, ships, animals and strange scenes. All free to approval applicants inclosing 3c postage. Garcelon Stamp Co., Box 900, Calais, Maine.

FREE. U. S. \$1, \$2, \$4 and \$5 stamps. Unbeatable U. S. approvals. Nelson, 78 E. 5th St., St. Paul, Minn.

SELL Stamps: Salesman (12 years up) earn cash commissions. Write for outfit. Everglades Stamp Company, Halcyon Arcade, Miami, Florida.

WONDER Collection: Packet odd countries, two airmail sets, United States commemoratives, mint British Colonies, triangles, diamonds, 15 Asia, 10 Africa, packet nineteenth century—everything, 5c. Wright's, 2527 Guilford, Baltimore, Md.

ILLUSTRATED Album. Spaces 4000 stamps; with penny approvals 20c. Swan Stamps, 604 Swan, Dunkirk, N. Y.

FREE, 50 Stamps, Iraq, etc. Postage 1c. Album 3c. Bullard, 268 Northampton, Boston, Mass.

10,000 VARIETIES 1c Each! Gordon Davison, Box a568, Manchester, N. H.

FREE! Triangle airmail! Diamond! Pictorials! British Colonies! Wonderful packet 61 different (no Europe) 5c to approval applicants. Bargain Co., Box 39P, Times Square Station, New York.

MONTHLY Stamp and coin magazine, six months and 25 foreign stamps, 25c. American Stamp Journal, Cedar Rapids, Iowa.

SOUNDS Impossible! 120 different—Afghanistan, Azerbaijan, Zanzibar, triangle, diamond stamps; United States commemoratives, Civil War issue, \$2, \$5 high denominations; everything—5c. Abell's, 1818 St. Paul, Baltimore, Md.

U. S., Canada, Newfoundland, Mexico: "Four Star approvals." Nothing like them! Write today. 312 mixed U. S. only 10c. Kessels, Tucson, Arizona.

BEAUTIFUL Irish girls. Second set of souvenir stamps issued by Irish Hospitals' Trust Limited, Dublin. Specimen sheet of 20 stamps supplied free of charge to all writing to Mr. J. O'Sheehan, Department PM, 28 Earlsfort Terrace, Dublin, Ireland.

SMALL Sheet of 4 different triangles 10c to approval applicants. Victoria Stamp Co., London 4, Canada.

UNBELIEVABLE! 62 Different, six triangles and diamonds; airmail, animal, war stamps—China, Japan, Manchukuo, insurgent Spain; Asia, Africa, South Seas. Everything, 5c! Crowder's, 127E North, Baltimore, Md.

CANNON! Set of stamps showing cannon, firing squad, cavalry charge and 200 other different stamps, only 10c to approval applicants. L. H. Reich Stamp Co., 4647 Kenmore, Chicago.

FREE! Two coronation sets. Postage 3c. Roberts, 312F Shearerbldg, Bay City, Mich.

UNITED States—45 different, perforation gauge, hinges, bargain pricelist—all for 10c. Seidenberg, Baroda, Mich.

FREE! "United States and British North America"—our valuable, complete, illustrated, 64-page catalog quoting lowest prices. Big illustrated list of foreign stamps also included. H. E. Harris & Co., 137 Transit Building, Boston, Mass.



200 DIFFERENT 10c. Big 50% approvals. Covert Stamp, 39 State, Rochester, N. Y.

50 DIFFERENT, Fine U. S. including perforation gauge, 10c with approvals. The Stamp Shop, 809 Holland Bldg., St. Louis, Mo.

BRAZIL, 50 Different 10c with bargain approvals. Davis, Silver Lake, Ind.

ASK For our wonderful one cent approvals. Prospect Stamp Co., 225 Broadview, Toronto, Canada.

WHOLESALE Catalog for dealers. Illustrated. Postage 5c. Frank Co., 4900 Chalmers, Baltimore, Md.

PENNY Approvals, that satisfy. Neil Gronberg, Box 5441-P, Philadelphia, Penna.

30 DIFFERENT Angola, Cape Verde, Guinea, Portugal, Mozambique, St. Thomas and Prince 5c. Approvals. Depraw, Ocean Park, Calif.

STAMP Dealers, your ad here will bring wonderful returns. Ask me for proof. F. W. Johnson, Manager, Classified Advertising, Popular Mechanics Magazine, 200 E. Ontario St., Chicago.

APPROVAL Sheets. One to three cents. Frederick B. Driver, 2009 Finance Bldg., Philadelphia, Penna.

25 UNITED States, including 5¢ and 5¢ stamps free to approval applicants. 3c postage. Brownie Stamp Shop, Flint, Mich.

WEEKLY Stamp magazine, thirteen weeks, 10c. Stamp Journal, Kalamazoo, Mich.

SCRUTINIZE This—100 different stamps, 25 British Colonials, all 10c. Approvals. Parkway, Box 96-P, Kensington Station, Brooklyn, N. Y.

#### HOBBIES AND COLLECTIONS

HOBBYISTS! Swappers! Hundreds of fans, refund coupon. Dime. McCampbell, Calexico, Calif.

ALBUMS. Holds 600 match book covers, \$1.10 prepaid. Adams Sales, 317 State Tower, Syracuse, N. Y.

UNUSED Book match covers, 100 all different. \$1.00. Free list. Charles Edelman, 1311C East 84, Cleveland, Ohio.

EXPLORING Spectacular, mysterious limestone caverns is my fascinating hobby. Nature lovers interested in details or joining central Pennsylvania expedition send \$1.00 for personal letter. Box 627, Buffalo, N. Y.

BOY Mechanic—Famous library of 3 volumes covers the building of almost everything a boy might want to make. Actually covers 3,000 different articles. Each volume 460 pages, fully illustrated. Cloth. Price \$2 each or set of 3 vols.—\$5 postpaid. Popular Mechanics Press, Room (C38), 200 E. Ontario St., Chicago.

#### PHOTO FINISHING

TWENTY Reprints 25c. Roll developed and two prints each negative, 25c. Send for free mailing envelopes, price list. Star Photos, J-109 N. Dearborn, Chicago.

MATCHLESS Prints—Roll developed, 16 guaranteed Never-Fade Velox prints, 25c. Reprints 2c. Fast service. Lundstrom, 234 - 13th, Richmond, Calif.

IMMEDIATE Service! Better pictures. Sixteen guaranteed prints from roll, 25c. one colored or two plain enlargements and 8 guaranteed prints 25c. Sixteen reprints only 25c coin. Candid rolls developed free! Prints enlarged to 3x4, only 4c each. One day service. Details and mailers free on request. American Studios, Box B, LaCrosse, Wis.

MAIL Your rolls to film center of the world. Any 6 or 8 exposure roll developed and printed 25c coin. DeLuxe enlargement coupon free! Photo Finishing Shop, Est. 23 yrs., 411-DD Genesee Valley Trust Bldg., Rochester, N. Y. "The Camera City."

35MM ROLLS Supertone fine grain developed, 36 enlargements 3 1/2 x 5, \$1.00. 2 5x7s free. Texas Studios, M12, Sweetwater, Texas.

FREE Sample streamline snapshot. Send negative. Reprints 3c. Streamline Studios, Box 5699L, Cleveland, Ohio.

PHOTOGRAPHY For pleasure and profit. Prepare for profitable business or fascinating hobby at home. Previous experience unnecessary. Common school education sufficient. Write for information and requirements. American School of Photography, 3601 Michigan Ave., Dept. 3459, Chicago.

ROLL Developed 2 prints each 25c. Reprints 3c each. Ramsdell Photo Service, P.O. Box 5, Portland, Maine.

20 REPRINTS 25c. 100 Reprints, \$1.00. Films developed, 2 prints each negative, 25c. Mercury Studios, Box 822-B, Chicago.

PROMPT Service! Rolls developed, two Velox prints each negative 25c. Hench Studios, Harrisburg, Penna.

20 REPRINTS 25c. 100 Reprints \$1. Roll developed with 16 prints 25c. Newtowne, 4, Maywood, Ill.

GENUINE Velox fadeless prints. 20 reprints 25c. Roll developed, 2 sets prints and 2 professional enlargements 25c. Four 5x7 enlargements 25c. Filmshop, PM2, Sweetwater, Texas.

ROLL Developed, 8 brilliant fadeproof Velox prints and two professional enlargements 25c. Overnight service. Young Photo Service, 405-C, Albany, N. Y.

LESCAULT Studio quality enlargements. 5x7 colored, framed 50c. Rockland, Mass.

A PROFESSIONAL 4x6 enlargement of each exposure. Eight exposure rolls. Coin 25c. Wells, Box 5556M, Cleveland.

YOU Can do 'em yourself. "Photo Finishing Simplified," for beginners, make own outfit. Illustrated booklet 25c. Catalog—chemical and technical books for stamp. Kraftmen's Press, Cos Cob, Conn.

ROLLS Developed 2 glossy clear prints from each shot 25c. California Photo, P.O. Box 71, Warm Springs, Calif.

35MM. DEVELOPED And printed in strips of three nicely booked. 50c coin. Wells, Box 5556M, Cleveland.

PROFESSIONAL Quality service. Rolls developed, 8 prints and 2 enlargements 25c. The Film Capital Service, Box 504, Rochester, N. Y.

ROLL Developed and 16 prints 25c. Reprints 20 for 25c, 50 for 50c coin. Queen City Service, Dept. C, Box 7, Niagara Square Station, Buffalo, N. Y.

EXPERT Miniature film developing. Very fine grain. Best 20 pictures 3x4 Kodabrom enlargements \$1.00. Reprints 4c. Regular rolls 8 prints, 2 enlargements 25c. Expert Studios, LaCrosse, Wis.

ROLLS Developed, printed, two 5x7 enlargements included—25c. Reagan, 406 Tenth North, Seattle, Wash.

LIFE Photo finishing lasts a life time. Roll developed, 8 prints, 2 enlargements 25c. Reprints 1 1/2c. Life Photos, Hutchinson, Kansas.

TWO Glossy enlargements. 1 colored with roll 25c. Arbor Service, 10, Joliet, Ill.

ROLL Developed, 16 guaranteed prints, two coupons on enlargements 25c. Smart Photo, Winona, Minnesota.

ANY MM. fine grain film developed with 3 1/4 x 4 1/2 prints at 4c per print. 10 or more 3c each, 25 or more 2 1/2c each. Skrudlands Candid Dept., D-6444 Diversey, Chicago, Ill.

THREE Prints each good negative in roll 25c. Trial. Reprints 3c. Fred D. Eastman, Bode, Iowa.

EXCITING Photographic pastime. Collect genuine picture stars photos with roll developed including two prints each exposure—25c. Colorcraft, Box 2510-P, Hollywood, California.

CANDID Special. 35mm. rolls enlarged to 3 1/4 x 4 1/2, \$1.00. 18mm. rolls 60c. 3 1/4 x 4 1/2 reprints 3c. Brown Photo Company, 1910-61 Emerson, Minneapolis, Minn.

16 PRINTS With roll 25c. 16 reprints 25c. Rex Photo, Ogden, Utah.

MILLIONS Now know "Hollytints Means Better Prints." Two professional enlargements with trial roll—25c. Fascinating premiums. Unequaled service. Hollytints, P-1350, Hollywood, California.

BEAUTITONE Enlargement, dime and negative. Giant Snapshots, Inc., Green Bay, Wis.

GUARANTEED. Roll developed, 16 prints 25c. 20 prints 25c. Quality Photo, Hutchinson, Kansas.

QUICK Service—Rolls developed, 8 guaranteed prints; 2 enlargements; 25c coin. OK Photo Service, Ottawa, Kansas.

ROLLS Developed and printed 10c. Trial. Quality Finishers, Maywood, Ill.

WILLARD'S Gives your pictures a beauty treatment—they're clear, brilliant, full of life. Roll developed, 2 prints each negative 25c. Enlargement coupon. Willard's, Box 3535-A, Cleveland Heights, Ohio.

MAKE Photography Pay. New book. \$1.00. Popular Mechanics, 200 E. Ontario St., Chicago.

ROLLS Developed, 2 prints each and 2 free enlargement coupons, 25c; reprints, 2c each; 100 or more, 1c. Summer's Studio, Unionville, Mo.

ROLL Developed and 8 beautiful Velox glossy prints 25c coin or stamps. Reprints 3c each. Fotoprint Service, Box E, Roanoke, Va.

FINER Finishing. Rolls developed and printed, with one colored enlargement, or two professional enlargements. All for 25c (coin). Genuine, nationally known, Moentone superior quality. Moen Photo Service, La Crosse, Wis.

FOR The discriminating amateur, roll developed and carefully printed 25c, reprints 3c. Superior workmanship, same day service. Paramount Co., 327 E. 92nd St., New York.

#### CAMERAS, PHOTO SUPPLIES

CAMERA Set, take pictures, develop them yourself, complete outfit includes camera, films, fixing and developing powders, glass top printer, clip, printing paper, lamp, instructions, all sent postpaid for \$1 cash or money order. Imperial Photo Supply, Box 43, Station Y, New York City.

BASS Inventory clearance. Profit by these unusual bargains. 35 mm. candid midget, F:4.5 lens, \$12.75. Used Foth Derby, F:3.5, \$15.75. 2 1/4 x 3 1/4 Agfa Film Pack and plate, with F:6.3 lens, \$10.75. 9x12 or 3 1/4 x 4 1/4 Zeiss Ikon Film Pack and plate, single ext., F:6.3 lens, auto shutter, film adapter and holder, \$11.95. Used Argus, F:4.5 lens, \$7.75. New candid midget, Xenon F:2 lens, Rapid Compur and case, \$80.00 value, at \$54.75. Hundreds of other bargains in the great Bass Bargaingram and special bulletins. Your money back if unsatisfactory after 14 days trial. Write Bass Camera Company, Dept. AG, 179 W. Madison St., Chicago, Illinois.

MAKE Money in photography. Learn quickly at home. Spare or full time. Easy plan. Previous experience unnecessary. Common school education sufficient. Interesting booklet and requirements free. American School of Photography, 3601 Michigan Ave., Dept. 3431, Chicago.

ENLARGER \$1.59. Enlarges eight times size of small negatives. Fully guaranteed. Paramount Sales Company, 89 Dudley Street, Boston, Mass.

PHOTO Stamps 1c each from your favorite photograph. Gummed, perforated, glossy finish. Minimum order \$1.00. Universal Photo Stamps, 315-2 Washington, Elmira, N. Y.

EXPERTS And amateurs try Carminol. Latest red-chalk, blue-black toner. Excellent for portraits, \$1.00 postpaid. Free circular. Alvin Lohnes Company, 452 Parker Street, Boston, Massachusetts.

CAMERAS And supplies. Free illustrated catalog listing everything photographic—still and movie cameras, films, lenses—at tremendous savings. Hundreds of bargains, new and used. All guaranteed. We take your old camera or equipment in trade. Write now for your free copy of our newest money-saving bargain book—just out! Limited edition. Hurry! Central Camera Co., (Photographic Headquarters Since 1899), 230 South Wabash, Dept. 2-K, Chicago.

WE Process 16mm. movie (negative-positive) and miniature camera film. Complete printing and enlarging service. Ask for information. Impe, 157 West Santa Barbara, Los Angeles, Calif.

REPAIRING—Cameras, shutters. Leather bellows. Free estimate. Work guaranteed. Camera Shop, 105 East First, Wichita, Kansas.

CAMERAS Films, paper 25% to 35% discount. Paramount Photo Division, 327 East 92nd St., New York.

TREASURE Finders? Read Goldak advertisement on page 133A.

MIN Larger, today's best enlarger value; 35mm. to 4x5; \$17.50 to \$85.00. Models for Argus C, Contax, Foth Derby, Korelle, Leica, Speed Graphic lenses. Circular free. Leonard Westphalen, 75 East Wacker Drive, Chicago.

MAKE Your own telephoto, portrait, trick attachments. Instructions 25c. Photographer, 1342 N. 10, Fargo, N. D.

CASH For used cameras, lenses; describe. Miller Photo Service, Avoca, New York.

CAMERAS—Shutters repaired. Leather bellows installed in folding and view cameras. Bellows made to order. United Camera, A-1515 Belmont, Chicago.



IF You go to Mexico ask first for prices and pamphlets of finest German quality miniature and other cameras, binoculars, movie cameras and projectors. Foto Mantel Sucr. R. Rudiger V. Carranza 11. P. O. Box 1459, Mexico City.-105. Branch store: Tijuana, Baja, California. Branch store: Tijuana, Lower California, Hotel Comercial. Branch store: Monterrey, N. L., Morelos Oriente No. 557.

NO More wasted film or unnecessary expense. Take pictures you can be proud of. Sell to magazines and newspapers. Make good money wherever you live. Easy, low-cost home study course shows you how! Free catalog. Universal Photographers, Dept. 104, 10 W. 33 St., New York City.

HAVE You a camera? Send ten cents for recent number of our big magazine, showing how to make better pictures and earn money. American Photography, 116 Camera House, Boston, 17, Mass.

PHOTOGRAPHY Pays big profits. Make money with your camera. Over 200 recommended books on all branches of photography. Catalog free. Popular Mechanics Press, 200 E. Ontario St., Chicago.

### MOTION PICTURES AND SOUND EQUIPMENT

NEW England hurricane, 16mm., 100 ft. \$3; 360 ft. \$8.75. 8mm. 50 ft. \$1.75. 180 ft. \$5. Also cartoons, comedies, westerns, travelogs. Free list. Crown Film Corp., 42 Melrose, Boston, Mass.

MOGULL'S "Slightly-used" bargains. Victor 16mm. sound film projection outfit \$125.00. 16mm. sound film \$10.00 each, dramas, westerns, news reels, cartoons. Silents \$4.00. 36x48" beaded screen \$4.39. Kodascope \$55.00 model, special \$18.25. DeVry 35mm. \$675.00 sound film projector, amplifier, speaker \$185.00. Simplex theatre sound projector, complete \$655.00. Keystone \$55.00 projector. 16mm. \$31.00. Bell & Howell "129" 1600' 16mm. projector, case, \$138.00. B&H 8mm. camera \$28.00. Univex camera, spring driven \$6.00. projector \$9.25. Trades accepted. Castle films. Film rentals sent anywhere. Bargain bulletin, rental catalogues, free. Mogull's, 68 West 48th, New York.

BARGAINS! Silent 35mm. films. Projectors. Demsey, 1223 Berkley, Youngstown, Ohio.

16MM. 100 FEET. Outdoor \$1.75. Panchromatic \$3.50. Superior panchromatic \$4.50. Processed, postage paid. Criterion Films, P. O. Box 1233, Paterson, N. J.

8-16MM. All subjects, silent and sound, sold, rented and exchanged. Films, rented everywhere. Free illustrated catalogue (with sample film 10c). Garden Exchange, 317-A West 50th, New York.

ENLARGEMENTS From 16mm. 2 1/2 x 3 1/2. 35c. Garth Cinema, 1766 Gleason, Bronx, N. Y.

COMPLETE 16mm. And 8mm. film rental library. Attractions: "White Hell of Pitts Palau," "Lost World," "Pony Express." Free catalog. National Cinema, 3 West 29th, New York.

GENERA Film for all movie cameras. 100 ft. single 8mm., \$1.00; double 8mm., \$1.75; 16mm., \$1.35. Sample for stamp. Processing powders and outfits. Fromaders, Davenport, Iowa.

FILM For projectors, all kinds; sample, 10c; lists free. Goodwill Company, Jackson, Tennessee.

35MM. ROLLS Fine grain developed free. 36 enlargements 3 1/2 x 5, \$1.00. Cartridge reloaded 35c. Photoshop, Linton, Ind.

35MM. FILMS. List 5c. Bedner, 5300 S. Talman, Chicago.

FREE 16mm., 8mm. Films, cameras, projectors, accessories lists. Home Movies, Box 216, Easton, Penna.

FOREIGN Language 16mm. sound, sale. Garrison Films, 1600 Broadway, New York City.

35MM. SILENT Bargains. Films, projectors. Calderara, 5119 South St. Louis, Chicago.

35MM. ODD 75c. 16mm. \$1.50 complete. Savarese, Woodcliff Lake, N. J.

TALKIES—35mm. Rentals. \$1.00 per reel per week. With projector \$22.50. Lists 5c. Motion Picture Exhibitors, 3865 West 25th Street, Cleveland, Ohio.

16MM. MUSICAL Shorts, brand new, \$12.50 each. Shermco, 6101 Orchard Grove Ave., Cleveland, Ohio.

EXCLUSIVE Photographs: Samples, complete list 25c. Albert McGoldrick, Mansfield, Mass.

MOVIE Film. Develop yourself. Univex, Eastman, etc. Chemical samples 15c. Raw film wholesale. Lake Camera Exchange, Gary, Ind.

BASS Wants to mail you without charge our new 52-page Cine Bargaingram No. 234—sound, silent, 8 mm., 16 mm., 35 mm. equipment, of the quality we can sell on our money back guarantee. Write for this valuable book at once. Full description of the RCA 16 mm. sound on film camera. Newsreel model is only \$250.00, and Bass is exclusive distributor. Dept. A, Bass Camera Company, 179 West Madison Street, Chicago, Illinois.

HOLLYWOOD Titles made easy. Trace, artistic titling charts, \$2.00 complete. Samples, 3c. Stein Studios, Flatiron Building, New York.

COMEDIES, Westerns. 500 feet 75c. Jersey Films, 2075 Richland, Lakewood, Ohio.

LEARN Motion picture theatre management, advertising, projection. Free catalog. Give age. Theatre Institute, Elmira, N. Y.

"THE World's Greatest Passion Play." Sound or silent. 8 reels, 16mm., rent and purchase. Superior than Oberammergau stage play. Write Hemenway Film Co., 37 Church St., Boston, Mass.

16-35MM. RENTED 50c Weekly; lists 3c. Hoffman Film Service, 57 Broad, Albany, N. Y.

BARGAINS! 8mm., 16mm., free literature. Elder, B-739 Boylston, Boston, Mass.

15% TO 25% Discount on still or movie cameras. Free circular. Paramount Co., 327 E. 92nd St., New York City.

RELIGIOUS Pictures for rent or sale. 16mm. and 35mm. sound or silent. All-Sacred Film Co., 31 Melrose St., Boston, Mass.

### RADIOS, SUPPLIES, INSTRUCTION

TRANSFORMERS — Design, build any size, type, frequency. Instructions \$1.00. Translab, 2827 Third Ave. W., Hibbing, Minnesota.

RADIOS—\$9.95. All kinds. Save 50%. Catalog free. 30-day's trial. Marco-F, Kansas City, Mo.

GET Those new tubes! Spare set! All numbers, popular brands, 50c each, guaranteed perfect. Clinton, 4002-6 Ave., Brooklyn, N. Y.

PLANS 18 Record-breaking crystal sets, with "Radiobuilder"—year, 25c. Laboratories, 7700-C East 14th, Oakland, Calif.

RADIO Engineering, broadcasting, aviation and police radio, servicing, marine and Morse telegraphy taught thoroughly. All expenses low. Catalog free. Dodge's Institute, Ames St., Valparaiso, Ind.

DON'T Buy a radio. Get our catalog first listing over 400 nationally known standard make sets. Also 700 electric specialties for the home. Big special, 10 inch phonograph dance records, 12 for \$1. Write today. Modell's, 56 Cortlandt St., New York.

### MUSIC AND MUSICAL INSTRUMENTS

MUSIC Composed to words. Rhyming pamphlet on request. Phonograph recording of completed songs. Send poem for consideration. Keenan's Studios, Dept. PM, Box 2140, Bridgeport, Conn.

SONGWRITERS! Send poems. Best price, service available. Variety Service, Salem, Indiana.

BAND Instruments, cornet gold lacquer case \$25.00; wood clarinets case \$30.00, all new guaranteed, many others. Write Swains Music House, Mansfield, Penna.

SONGWRITERS! Outstanding, convincing offer. Hibbler, C-5, 2157 N. Avers, Chicago.

HIGH-CLASS. Low-cost song service. Len Fleming, Wellsboro, Penna.

SONGPOEMS Wanted for modern musical settings and commercial advancement. Roy Allen, Kitchel, Ind.

SONGS—Arranged, revised by arranger "Cherry Blossom Lane." "Gypsy Tearoom," others. Send for details, Harold Potter, Box 511, Miami, Florida.

SONG Poems wanted. New York Music Mart, Box 507, Church Street Annex, New York.

MUSIC Composing and printing. Request prices. Illinois Music Press, Nashville, Illinois.

SONGS Or lyrics wanted for "Musical Night Court" radio show and publication. Write to Judge Spencer, 145 West 45th, New York. Studio PM. Enclose large, stamped, self-addressed envelope for full particulars. Do not send songs. Write first.

WE Teach music by mail. Piano, violin, guitar, voice. Simple as abc. Particulars free. Paramount Conservatory of Music, Vancouver, Canada.

COMPLETE Orchestration—sheet music. 15—\$1.00. Silverman, 3303 Lawrence, Chicago.

SEND One dollar to Piano Shorthand Music Co., Springfield, Illinois, for How to Play Piano by Ear.

RADIO Wand. Changes slowest music into swing. Only \$1.25 postpaid. Fisher-Schmidt, Inc., 5013 Vermont Ave., Detroit, Michigan.

ORIGINAL Poems, songs wanted immediately for publication. Westmore Music Corporation, Dept. 33G, Portland, Ore.

SONGWRITERS—Get free the inside facts on successful songwriting by famous Broadway composer. Write today. Songwriters Institute, 1234-C Broadway, New York.

JAZZ Piano guaranteed by mail in 20 lessons. Erskine Studios, 810 East 14th St., Oakland, California.

SONG Poem writers wanted, our 50-50 plan has aided many songwriters. Russell Duke received \$150.00 advance on his song. Burl Bog's song won a nationwide contest. We may be able to help you. Send poems or write for free booklet today. Indiana Song Bureau, Dept. 41, Salem, Ind.

DUO-FLEX Reeds for clarinets, and saxophones eliminate your reed troubles. Write for circular. Duo-Flex Reeds, 1204 1st Ave., Evansville, Ind.

SONGWRITERS — Agents, new sales plan. National Music-D, 532 Sixteenth, Oakland, Calif.

SONG Poems wanted to be set to music. Free examination. Send poems to McNeil, Bachelor of Music, 4153-PM S. Van Ness, Los Angeles, Calif.

PIANO By ear. Free booklet. Day-V-Way, Woolworth Building, Dearborn, Michigan.

MUSIC Composed to words. Wonderful proposition. Bauer Bros., Oshkosh, Wis.

WRITE Songs. Big money and reputation. Write for information. J. Gordon Pub. Co., 201 N. Hoyne Ave., Chicago.

WANTED! Lyrics, melodies for songs. We arrange, publish, sell. Superior Song Studios, Passaic, N. J.

LEARN Sing piano! Postal brings free folder. Christensen, 751 Kimball Hall, Chicago.

SONGWRITERS: Send your poem today for immediate consideration. Richard Brothers, 24 Woods Building, Chicago.

SONG Writers. Send for publishing agreement. McKinley Music Publishers, 1501 E. 55th St., Chicago.

PIANO, Self Instruction. Play within an hour. \$1.00. Popular Mechanics, 200 E. Ontario St., Chicago.

### BUSINESS OPPORTUNITIES

HONEST Men wanted to own lifetime business. \$2.00-\$5.00 hourly profit. Prestige, cooperation national organization individually-owned businesses. Clean, rejuvenate, mothproof upholstery, carpets, clothing in homes, hotels, institutions. Certified service. "Earned \$90.00 one day"—Andersen. "Working 12 hours daily"—Lookiebill. "Work advertises itself"—McCoy. "Repeat orders building business"—Hargrave. Portable electric machines, materials, demonstrators, advertising furnished. Little as \$88 establishes business. Write while territories open. Home Service, 162-Pl, Deerfield, Illinois.

ARTIFICIAL Marble sanitary flooring, instruction covering wood or cement flooring 1/2 inch thick, fireproof, all colors, low cost, ornamental casting, concrete, plaster, papier-mache, garden furniture, statuary, flexible molds, particulars free. Chris Mahler, Elmont, N. Y.

DELAWARE Charters: Complete service \$35. Submitted forms. Chas. G. Guyer, Inc., Wilmington, Del.

M. M. earned \$267, three weeks, raising mushroom in cellar! Exceptional, but your cellar, shed perhaps suitable. We buy crops. Book free. United, 3848 Lincoln Ave., Dept. 70, Chicago.



**FORMULAS** — Fast selling products. Guaranteed. Laboratory tested. Lowest prices. Catalog free. Kemico, 55K, Park Ridge, Ill.

**MAKE Money at home!** Grow mushrooms in cellar or shed, with Ami U. S. Patented Mushroom Spawn and step-by-step, easy-to-follow manual of instructions. Fascinating, profitable. Booklet free—write today. Anglo-American Mushroom Industries, Dept. 32, Toronto, Ont.

**LOOK**—Ambitious men and women. You who desire to forge ahead of the crowd, achieve money success and really live; write now for free descriptive success literature that means accomplishment if properly followed. It is waiting for you. Ross C. McKiernan, P.O. Box 26, Galesburg, Illinois.

**YOU'LL Like** resilvering mirrors, auto-parts, reflectors, making chipped glass signs. Write. Sprinkle, Plater, 127, Marion, Indiana.

**MAKE Color-Glazed** concrete pottery, tiles, walls. New, patented method. Complete plants cost only \$35.00. Men (only). Write for free colorplate, details. National Potteries, 13 West 26th, Minneapolis, Minnesota.

**"RUBBER Molds."** Make them yourself. Formulas, instructions 25c. Ideal Service, 179RM, Park Ridge, Ill.

**FREE List** of 2556 occupations. Don't be a square peg in a round hole. Write today. No obligations. Vocational Guidance Bureau, 201 Park Ave., Dept. 2A, Baltimore, Maryland.

**WORKABLE** Mail order plans. Particulars in booklet 25 cents. J. E. Howe, Box 183, Evansville, Indiana.

**MANUFACTURE** Polishpuffs. Amazing proposition 10c. Particulars free. Hickorydell, Glenbeulah, Wis.

**107 WAYS** To make money, in home or office, business of your own. Full particulars free. Elite Co., 214 Grand St., New York.

**BUY 2c Lb.**, sell 50c to \$4.00 lb. Details 25c postpaid. Money-back guarantee. McArthur, Drawer 339-5, Butte, Montana.

**A NEW Industry** is born! Veg-O-Mat extracts delicious vegetable juices containing all minerals, vitamins. Highly recommended by physicians. Profitable repeat business. Particulars. Domestic Electric, 118 E. 28, New York City.

**CAPITAL**—Any purpose, how and where obtained, explained by nationally known expert. Particulars free. Capital Service, Arlington, Va.

**MONEY** In butterflies, moths. See Sinclair Display Advertisement on page 16A.

**PLASTEX** Industries offers industrious men an opportunity to start a business of their own, manufacturing art goods, novelties, souvenirs, etc., in Plastex and marble imitation. 5c material makes \$1 articles. Rubber moulds furnished for speed production. Small investment brings big returns. You are just in time for big wholesale season now starting. Write for interesting booklet mailed free. Plastex Industries, Dept. A, 1085 Washington Ave., New York.

**STEADY** Money in showcards, signs, window lettering. Easy. Amazing details free. Write Nelson Company, 2028 Manhattan Building, Chicago.

**POPCORN** Machines, caramels, crisp-ettes, cheese coat, potato chips. Long Eakins, 2035-B High St., Springfield, Ohio.

**CASH** In on big demand for Mexican novelties! Large profits! Particulars free. Samples 10c stamps. Marquez-PBE, Apartado, 1176, Mexico, City.

**SELL** By mail. Books, novelties. Bargains! Big profits! Particulars free. E. Elfeo, 438 N. Wells, Chicago.

**BE Independent!** Secrets of riches fascinatingly revealed. Details. Todd's Service, 262 Arlington, Youngstown, Ohio.

**ELITE** Collection of business plans, contains 107 tested plans and scores of formulas. Start own business; home, office. Particulars free. Elite Co., 214 Grand St., New York.

**"MAKE Mirrors** at home." Big profits. Little outlay. Also emboss, grind—foil, gold leaf, frost, chip and make imitation stained glass. Instruction course \$1.00. Ideal Service, Park Ridge, Ill.

**1500% PROFIT!** "Free 32-page book" tells you how to make genuine rubber molds and manufacture fast-selling composition novelties! Write Stewart's Studio, Dept. P-1, 2927 Wilcox, Chicago.

**SOUTHERN** Mineral deposits such as gold, copper, chromium, manganese, known to an experienced mining engineer, who wishes connection with parties interested in exploring and developing, or exploiting them. Address Mining Engineer, Box 1012, Hendersonville, North Carolina.

**"SCHEMER,"** Alliance, Ohio (41st year) prints schemes, tips, opportunities, formulas; big producers: \$10,000 to \$25,000 reported. Year, \$1.00. Get wise! Trial six months only 30c.

**MAKE Artificial** marble, glazed tiles, uncanny. Tabletops, plaques, floors, hones, novelties. Hard, fireproof, inexpensive, cement secrets. Brilliant tile and liquid rubber samples 3c. John A. Payn, 945 Grande Vista Avenue, Los Angeles, Calif.

**START** Your own business. Make large profits. Sell new and used auction or bankrupt bargains in clothing and general merchandise. Experience unnecessary. Free wholesale catalog. Superior Jobbing, 1250-S Jefferson, Chicago.

**"BINGO,"** New coin operated amusement game. Large income, operating "route." Small investment. Details free. Robbins, 141P DeKalb Ave., Brooklyn, N. Y.

**\$1.50 STARTS** Your business. Stamp brings catalog. Colonial Arts, Derry, N. H.

**CHARTERS:** Delaware; best, cheapest; free forms. Colonial Charter Co., Wilmington, Del.

**BRAND** New unusual business opportunities. Free information. Research Development Laboratory, 449 South Ionia, Grand Rapids, Mich.

**GIANT** Mail, opportunities, added income, ideas, 52 page magazine. 10c. Katz, 4254 N. Kimball, Chicago.

**BUSINESS** Opportunities to have agents work for you. Free particulars. Tilford, Box 516, Louisville, Ky.

**HANDY** Men—Earn money home operating community "Fix-It" shop. Stafford, Makanda, Illinois.

**START** Business anywhere. Work mornings, home. God pay. Dunn, Box 74, Ionia, Michigan.

**REAL** Moneymaking opportunities at home. Big profits. Write John Yatesund, Sheboygan, Wisconsin.

**INVESTIGATE** Proposition of merit. Tremendous possibilities. \$10.00 required. American, 320 Drake Bldg., Irvington, N. J.

**COLORFUL** Novelties, big demand. Sample, prices, dime. Creations, Box 944, Laredo, Texas.

**START** Something! Prosperity books 10 cents. Dolsen, 89-91 Pineapple, Brooklyn, New York.

**MAKE** Money mailing and distributing circulars. Geiger, 6538 North Maplewood, Chicago.

**PROFITABLE** Home business. Legitimate. No canvassing. Maywood Publishers, P-923 Broadway, New York.

**MAKE** Your own molds. Use vulcanize Rubberite, our marbelike cement equals polished marble. Dime brings assorted samples. Novelty Supply Co., Grayling, Michigan.

**SIGNS** And showcards. Easily painted with letter patterns. Samples with instruction booklet mailed 10c. John Rahn, D1330 Central Ave., Chicago.

**SOMETHING** New! Mail order, local business selling vegetable concentrates. Finest quality! Your labels. Samples, dime. Details free. Gardena System, 128BP Station "S," Los Angeles.

**WHERE** To buy at lowest wholesale prices. Information free. Yorena, Box P-312, Bayonne, N. J.

**6 MAIL** Order magazines including all you should know about mail order business, 25c. Armand Cartier, 31 Cumberland St., Woonsocket, R. I.

**DIME** Brings money making plan. Chas. Hyde, 537 Ritter, Reading, Penna.

**OPPORTUNITIES.** Plans, income ideas, magazine 10c. Ready-2149, Jackson, Chicago.

**AGENTS**—Big profits, mailing our literature. Home business. Stamford, 3762-B Broadway, New York.

**NOW 10c** Copy. Prize contesting pays thousands. Facsimile Contest Journal, Box 335, Atlanta, Georgia. Amateur writers wanted. Details for stamp.

**CAPITALIZE** On your ideas. Send self-addressed stamped envelope for information. Allison-Items, Box 81, Bound Brook, N. J.

**SUGGESTIONS:** How and what to sell by mail. 3c brings details. Popto-Director, Drawer 989, Edinburg, Texas.

**START 1939** Right! Manufacturing "Popular Branded Products." Stamp brings informative Formula Messenger telling how! Miller, Chemist, (Established 1897), 706-FB, Tampa, Florida.

**PLEASANT,** Profitable homework: Guarantees you income or double money back! Investigate now! Stamp brings particulars. Keep Working Industries, 5309 Forest, Dept. E, Kansas City, Missouri.

**RECEIVE** Stacks of mail: Your name listed in 10,000 directories 25c. Liberty Sales Service-A, Sheboygan, Wisconsin.

**100 PROFITABLE** Mail order and local plans. Gilbert Supply, 1107 Broadway, New York.

**OPPORTUNITIES** Aplenty! Moneymakers that "click"! Unusual "idea" service! Copyrighted dollar folio 10c. Planagram, P-1079 Madison St., Brooklyn, N. Y.

**MOLDEX.** Makes best rubber molds. Models, supplies. Pentucket Arts, Haverhill, Mass.

**TIPS.** Schemes, formulas. Sell your ideas. "Tipsheet" free with formula 25c. "SunShine," Box 912, Binghamton, N. Y.

**TREASURE** Finders? Read Goldak advertisement on page 133A.

**PROFIT** With new products. Make, sell, repeat. Analysis. Research. Guaranteed formulas. Biggest catalog free. Nominal prices. Gibson Laboratory, Chemists, BD-1142 Sunnyside, Chicago.

**FINANCIAL** Independence obtainable by placing coin operated merchandise vending machines, out on percentage basis, no experience required, little capital needed, write for free details. Torr, 2047½ South 68th Street, Philadelphia, Pennsylvania.

**MAKE** Extra money. Buy old gold. 25c coin brings book detailing how to test weight without scales, what to pay, where to sell. Metal Research, Box 1959, Chicago.

**"HOW** To Hire Hundreds of Agents by Mail," secrets of three highly successful plans, 25c. McKean, 6220 Valley Rd., Kansas City, Mo.

**START** Profitable home mail business. Plan, samples, big magazine; dime. Coates, 77 Millet, Dorchester, Mass.

**CAPITAL** Seekers—Put your project before 260 key-men. Cost trifling. Details free. Amster Leonard, Fox Theater Building, Detroit, Michigan.

**NEW** Mail order plan for new product. Going over big. Write quick. Phelps, 1900-C Euclid Ave., Cleveland, Ohio.

**EARN** Up to \$500.00 back yard gardening. Stamp brings information. Lightning Speeds, Streator, Illinois.

**\$1.90 PROFIT** On each \$2.00 mail order. Guaranteed legitimate. Particulars free. Pop-Director, Drawer 989, Edinburg, Tex.

**"1939 BUSINESS** Folio." Send for free copy. Hutchison, 314 North Fourth, Camden, N. J.

**DOLLARS** In doughnuts. Plans for making 20 kinds \$2.00. Cook, Box 31, Swampscott, Mass.

**EARN** Extra money at home. You can increase your income quickly and easily at home. Wentworth supplies you with work and furnishes all materials. Write today for free booklet. Wentworth Pictorial Co., Ltd., Dept. 71, Hamilton, Ont.

**MAKE** Money electroplating! Marvelous patented invention plates with electric brush—easy as painting. Does same beautiful, permanent electroplating—gold, silver, nickel, cadmium, etc.—as big tank outfits. No liquids—lightweight—portable. Anyone can use from battery or household current. Only \$6.85 complete. Write for details and sample of work done. Warner Electric Co., 360 N. Michigan, Dept. D-11, Chicago.

**SELL** By mail. "The Key to Business Opportunities" shows how. Particulars for stamp. Maples, 3418 South Marshfield, Chicago, Illinois.

**LIQUID** Marble—anyone can make! Colorful, glazed! Moulded, brushed, sprayed. Rubberlastic moulds. Composition flooring. Big money in these! Particulars free. Marbleizing Service, Edwardsville, Ill.

**MAIL** Order business is your opportunity. Many began small, now earn thousands yearly. No personal contact. Boundless opportunities. Have had over 30 years experience; will help you succeed. Send 25c for valuable booklets, none free. B. Breniser, 257 S. 21st, Philadelphia.



**HOW** And where to obtain capital fully explained, free particulars. Star Service, Wapakoneta, Ohio.

**WE** Help start you in business, furnishing outfits and instructions, operating "Specialty Candy Factory" home. Men and women, opportunity to earn \$20 to \$50 weekly, all or spare time. (Our 29th year.) Booklet free. W. Hillyer Ragsdale, Inc., Drawer 4, East Orange, N. J.

**LEARN** Arc welding. A growing industry with great opportunities. Consult your local school, or if there is none available write The Lincoln School of Welding, Dept. A, Box 5758, Cleveland, Ohio.

**SUCCEED** With your products. Make-sell them. Formulas, Processes. Accurate analyses. Catalog free. B. Thaxly Co., Washington, D. C.

**MAN** In each town to plate auto parts, reflectors, bicycles, fixtures, mirrors, by late method. Simple plan of manufacturing at home starts you in good paying business. Free particulars and proofs. Gunmetal Co., Ave. H, Decatur, Ill.

**AFTERNOONS** Free for outdoors, shows. \$340 month home. Unique plans. No canvassing. Prepare for surprise. Folio-F, Station D, Los Angeles.

**MANUFACTURE** From Phospholene. Cleaning fluid 1c gallon; bleach 2c gallon; hand soap 2c pound; and ten fast sellers. Sample 25c. Details free. Western, 6615 Denison Ave., Cleveland, O.

**LIKE** To draw? Earn steady income tracing and duplicating advertising cartoons. Ad-Service, Argyle, Wis.

**INVENTORS**—We successfully sell inventions, patented and unpatented. Write for proof, and tell us what you have for sale. Chartered Institute of American Inventors, Dept. 4-C, Washington, D. C.

**WANT** More business? 2c daily, opens individual New York branch office requiring no room number on your stationery or advertisements. Co-operative Mail Service, 126 Lexington Avenue, New York.

**PRIZE** Contest money! You can win plenty! Stamp brings opportunity! National Contest Bulletin, (Dept. P.), Box 130, Grand Central Station, New York City.

**I WANT** To send you proof of the wonderful pulling power of Popular Mechanics Magazine's classified pages. What's your proposition? Write me today. F. W. Johnson, Manager Classified Advertising, 200 E. Ontario St., Chicago, Ill.

### MONEYMAKING OPPORTUNITIES

**GROW** Flowers, plants, vegetables, year around, without soil. Simple, fascinating, inexpensive, profitable. Satisfaction guaranteed. Details free. Unique Gardening Club, Upsala, Minnesota.

**BORROW** Recognized moneymaking books. Folios by mail 10c each. Send for details and list. Anderson, Box 548, Muskogee, Okla.

**RESULT** Getter magazine, 1618 Lucia, Louisville, Ky., publishes money making opportunities, copy 10c.

**YOU'LL** Like resilvering mirrors, auto-parts, reflectors, making chipped glass signs. Write. Sprinkle, Plater, 287, Marion, Indiana.

**25c BRINGS** 24 Proven formulas. First-Ade Mart, E-300 North Cuyler, Oak Park, Ill.

**MONEY** In butterflies, moths. See Sinclair Display Advertisement on page 16A.

**MAILORDER** Plans, imprints, formulas, names. Davis, 337 River, Orange, Calif.

**BIG** Money easily made; 107 test plans for your choice. Home, office. Descriptive booklet free. Elite Co., 214 Grand St., New York.

**MILLION** Articles. Buy wholesale. Valuable directory dime. Ideal Service, Park Ridge, Ill.

**EASY** To make money with imprint circulars. Booklet of instructions and samples, 25c. Atlas Service, Box 476, Red Lodge, Mont.

**FREE**—200 Big Moneymaking ideas. Kay's, 2445 1/2 Brooklyn, Los Angeles.

**MONEYMAKING** Mail order proposition, details free. Lung, 328 E. Dewald, Ft. Wayne, Ind.

**DIME** Brings big package. Plans, formulas, envelopes, photo. William Co., Box 766, Wilmington, Delaware.

**FREE** Folio describes 2000 ways to make money. Marvin Studios, 203 South Dearborn, Chicago.

**MONEY** Jobs yours. Tell others how get dollars in mail daily. No selling. Opportunity of lifetime. Stingley, Box 225, Bell, California.

**NAPOLEON**, Bismarck, Foxie Grandpa and several other fast selling cakes and pastries will swell your bank account. Directions \$2.00. Cook, Box 31, Swampscott, Mass.

**EMPLOYMENT** Information. Individual service to fit your particular need. No books or gadgets to sell. Box 1646, Jacksonville, Florida.

**WATERCULTURE**. Grow flowers, vegetables, without soil, indoors, year round. Water and common chemicals used. Copyrighted, formula 25c. Hydroculture, Trenton, N. J.

**MAKE** Money mailing letters. 75c profit possible on each letter. McCants, Weslaco, Texas.

**FREE** Copy "24 Ways to Make Money," formulas, etc. Send name and 25c coin. We list you in "Opportunity Seekers Directory." Manufacturers, etc., will send you latest money making offers, catalogs, samples, etc. "Opportunities," Box 174-P, Elkhart, Indiana.

**I WANT** Ambitious, reliable persons to work with me contacting advertisers. Pietrantonio, 151 Fifth Ave., New York City.

**ADDRESS** Letters for us; big profits. Malonite, Bayside, New York.

**WHERE** To buy exceptional articles at lowest wholesale. Information free. Stamford, 3762-C Broadway, New York.

**FREE**—100 Wonderful business, mailorder and home work moneymaking offers. Lewis Co., 828-C Carpenter, Oak Park, Illinois.

**MILLIONS** Jobless! Get dollars in mail for satisfying employment information. Keep dollars! We fill your orders. Details for stamp. Co-operative Service, 77 Swan, Buffalo, New York.

**GROW** Plants without soil. Folder free. Gordon Laboratories, 509-H Fifth Ave., New York.

**EARN** Extra money writing for publication. Simple method. Demand inexhaustible. Details free. Dona-Veretts, 17 Groton, Lowell, Mass.

**\$25.00 STAMPING** Names per 100 keychecks. Sample 25c. Outfits furnished. Bohn Company, Box 86P, Wilkes Barre, Penna.

**TREASURE** Finders? Read Goldak advertisement on page 133A.

**ANALYSIS**. Research. Newest guaranteed formulas. Biggest catalog free. Nominal prices. Gibson Laboratory, Chemists, CS-1142 Sunnyside, Chicago.

**UP** To \$60 weekly! Spare or full time. Capital and experience unnecessary. Your own advertising service. Something new. Your services always in big demand by everyone in business. Complete working plans, \$1.00. No other investment. Universal, Box 1461, San Antonio, Texas.

**EARN** Money at home. Adult or child. No canvassing. Details for stamp. Richmond Service, 504 Broadway, Sterling, Ill.

**MOST** Complete practical sensible legitimate mail order plan \$1.00. Hutchinson, Box 2025, Atlanta.

**INTERESTED** In making money? 3c stamp brings you amazing information. Universal Press Syndicate, Sarasota, Fla.

**PROSPERITY** For home workers. 52 page magazine. Sample, dime. Sizemore, 4917 N. Kostner, Chicago.

**YOUR** Name—5,000 mailing lists—25c. Get samples, opportunities galore from all over world. Pines, 583-A Monroe, Brooklyn, N. Y.

**300 MONEYMAKING** Plans 25c. Literature 3c. Morrelle, 159-N State, Chicago.

**TYPISTS** Earn extra money. Send 25c (coin) for "Twenty-one Ways to Make Money With the Typewriter." H. Robbins, Box 6048, Kansas City, Missouri.

**MAILORDER** Opportunities, plans, formulas, information. Circulars free. Harvey Teeple, Decatur, Indiana.

**STOP** Squealing—Start crowing! Work mornings home—country drives or movies afternoons! No canvassing! Folio-A, Station "D," Los Angeles.

**MAN** In each town to plate auto parts, reflectors, bicycles, fixtures, mirrors, by late method. Simple plan of manufacturing at home starts you in good paying business. Free particulars and proofs. Gunmetal Co., Ave. N, Decatur, Ill.

**RAISE** Earthworms for profit. Information free, stamp appreciated. Bureau Zoological Research, 106A Broadway, Peoria, Ill.

**WHOLESALE** Sources, 500,000 articles. Free directory. Maywoode, 925 Broadway, New York.

### FORMULAS, PLANS, ETC.

**NEW** Confection, resembles potato chips. Easily made. May Lee, 1829 Kennett, St. Louis, Mo.

**ANALYSIS**—Duplication guaranteed. Valuable formulas. Consultation. Associated Chemists, Indianapolis, Indiana.

**GUARANTEED** Formulas—New fast sellers. None better. Lowest prices. Catalog free. Kemico, 49K, Park Ridge, Ill.

**ELITE** Formulas and plans; make and sell your own products. Descriptive booklet free. Elite Co., 214 Grand St., New York.

**FORMULAS**—All kinds. Real moneymakers. Lowest prices. Catalog free. Clover Formulary, Niles Center, Ill.

**ANALYSIS**. Research. Newest guaranteed formulas. Biggest catalog free. Nominal prices. Gibson Laboratory, Chemists, BD-1142 Sunnyside, Chicago.

**BOOKLET** Containing 40 auto specialty formulas, \$1.00. Excelsior Press, Box 182, Mar Vista, California.

**GROW** At home fruits, flowers, vegetables, without soil. New revolutionary method produces faster, less work. Season's supply chemicals, directions, formula, bibliography, all \$1.00 postpaid. Chemiculture, 4701-P Sheridan, Chicago.

**10 LABORATORY-TESTED** Formulas. Including waterless hand cleaner, \$1.00. Beach, Box 156, Groton, Conn.

**200 GUARANTEED** Tested formulas 25c. Box 67, Columbus, Indiana.

**ANTI-FOG**. Anti-frost (windshield). Formulas 25c. Tom Moore, Chemist, Waterloo, Iowa.

**SENSATIONAL!** Modern formulas 1c each! Literature free! Galluzzo, Wilkesburg, Pennsylvania.

**"ANYTHING** In formulas." Particulars free. "Research Bureau," 100 Chelsea, Charlestown, Massachusetts.

**MAKE** More money! Manufacturing "Popular Branded Products." Stamp brings informative Formula Messenger telling how! Miller, Chemist, (Established 1897), 706-Pf, Tampa, Florida.

**ANY** Formula 25c, six \$1.00. Chloro Chemical Co., Box 478, Salina, Kansas.

**200 TESTED** Formulas \$1.00. Joseph Saieg, 633 Collins, Joliet, Illinois.

**JUST** Name it! Any formula 25c or money back. Satisfaction guaranteed! Worl's Formula Bureau, Tampa, Florida.

**VALUABLE** 48 page formula book of 110 sure winners 50c. Bielefeld Co., New Knoxville, Ohio.

**FORMULAS**—Moneymaking, fast selling products. Literature free. J. Watson Company, Stockyards Station, Kansas City, Mo.

**THAXLY** Formulas for perfect products. Accurate analysis assured. Resultful research. Catalog free. B. Thaxly Co., Washington, D. C.

**FORMULAS**: 15 Proven moneymaking formulas \$1.00. (Not stock-formula catalogue stuff), real unusual offers. List free. Marvel Laboratories, 6629 No. Maplewood, Chicago.

**FORMULAS**. Latest money makers. Literature free. Belfort, 4042 N. Keeler, Chicago.

### CHEMISTRY

**CHEMICALS** In 5c quantities. Catalog 5c. Fleischer's Laboratories, Everett, Mass.

**FREE**—40 page catalog of chemical and laboratory supplies for amateur chemists. Wollensak microscopes and supplies, scientific books at big discount. J. D. Winn, 124 West 23 Street, New York City.

**CHEMICALS**. Laboratory, glassware, apparatus. Send 3c for catalog CPI. Biological Supply Company, 1176 Mt. Hope Avenue, Rochester, N. Y.

**FREE** Chemistry catalog. Supplies at 5c! Equip complete laboratory. Send 3c for postage. Kemkit Scientific Corp., 397P Bridge St., Brooklyn, N. Y.

**TELESCOPES**. Microscopes, chemistry, mineralogy. Scientific catalog free. Tracey Laboratories, Evanston, Illinois.



## AGENTS WANTED

**MEN! Women!** Operate quick money-making route in choice localities or work right from your home. Excellent year round earnings. Just give away valuable premiums and samples with famous quality coffee, spices, soaps, flavorings—300 everyday necessities. Also \$500.00 yearly bonus and big display to all qualified dealers. Experience unnecessary. Part time workers welcome. Togstad Company, Dept. B-16, Kokomo, Indiana.

**PERMANENT Representative** wanted for Hoover uniforms to call on restaurants, hotels, beauty parlors, doctors, nurses, others. Excellent immediate income. Leads furnished. Valuable equipment free. Hoover, Dept. AJ-B, 251 W. 19th, New York.

**GUARANTEED Gold leaf letters** for store and office windows. 300% profit. Free samples. Metallic Co., 438-B N. Clark, Chicago.

**LET Me send you \$6.00 worth actual sample food products and household necessities free.** Finest quality. Look after coffee and tea route. No experience. No investment. Bright future. Blair, Dept. 31-E, Lynchburg, Va.

**500% PROFIT With new perfected (1939) quick-action, no flint, automatic gas lighter.** Retail 25c. Sample 5c. New Method Co., Box PMG-74, Bradford, Penna.

**DISTRIBUTORS—Supply revolutionary corn remover to stores.** New sales plan results in landslide of orders. 150% profit. Exclusive franchise. Great Christopher Corp., Buffalo, New York.

**SAMPLE To smokers.** Mail 6c in stamps—Sweet Tobac, rich flowery tropical mix with a delicate aroma. Distributors wanted. Specialty Forum, 9441 Pleasant Ave., Chicago.

**UP To \$6.00 an hour.** Amazing Kar-Nu beautifies old cars with sparkling new finish—without rubbing, polishing, waxing, painting. Costs little. Wipes on with cloth. Lasts 8-12 months. Free sample. Kar-Nu, Dept. P-8, Cincinnati, Ohio.

**HOME Service repairmen:** Sell, install overhead garage door hardware. Pays well. Circular free. Wilkie, Independence, Mo.

**IF Earnings up to \$45 first week will satisfy you,** I'll send complete outfit to run home-operated grocery agency. Absolutely no money risk. Details sent free. Write Albert Mills, 3207 Monmouth, Cincinnati, Ohio.

**212% PROFIT Selling amazing new liquid mender.** Fixes most anything; unlimited demand. Write for free sample proof. Indiana Laboratories, Dept. T-29, Elkhart, Ind.

**SELL Artistic oil painted personal portraits!** Portraiture, 826 Noble, Chicago.

**MONEY In butterflies, moths.** See Sinclair Display Advertisement on page 16A.

**FASTEST Money maker selling reversible topcoats.** Lifetime chance. Write Yale-Clothing, Meriden, Conn.

**BUSINESS Proposition resilvering mirrors, autoparts, reflectors, making chipped glass signs.** Write, Sprinkle, Plater, 128, Marion, Indiana.

**MYSTERY Invention, carried in pocket, keeps hands, feet, ears, body warm on coldest days.** Lasts years. Everybody buys—workmen, housewives, schoolboys, farmers, others. Low priced—big profits. Write quick. Kumfy Warmer, Dept. T-2301, Cincinnati, O.

**HIGH Grade window letters 1 1/2c each.** Free samples. Metallic Co., 438-A North Clark, Chicago.

**YOUR Own shoes free as bonus, quick cash commissions showing complete shoe line.** Experience unnecessary. Selling outfit free. Tanners Shoe Co., 907 Boston, Mass.

**AMAZING! Free whipcord caps to hat customers.** Easy orders, big profits with exciting offer! Sample outfit free. Taylor, 15 Sixth, Dept. E-22, Cincinnati, Ohio.

**GRANITE Monuments \$9.00 up lettered, delivered.** Catalog, Mikelich Company, Saint Cloud, Minnesota.

**FREE Catalog—Sell foods.** Repeats. Write immediately. Saphore, Manager, 170 1/2 Monticello, Jersey City, N. J.

**PARING Knife.** New sensational peeler. 200% profit. Sample 10c. Three other household necessities. Apex Co., 400 Dakota Bldg., St. Paul, Minn.

**BEAUTIFUL Bird pictures handmade with genuine feathers.** Sell on sight! Large profits! Free particulars. Samples 10c stamps. Marquez-PG, Apartado 1176, Mexico City.

**SENSATIONAL New desk type pinning machine for semi-permanent fastenings.** A really new item which finds ready acceptance in industrial concerns, offices and stores. Not competitive with stapling machines and protected by basic patents. Excellent commissions and a real repeat business on pin refills. Young, intelligent men, age 23-30, wanted as selling agents in all cities over 10,000 population. Write immediately for complete details. Box No. 111, 56 W. Washington St., Chicago, Ill.

**NEW Register shield; protects walls, humidifies, traps dust.** Sample 35c. Paramount Produx, 18834 Marx, Detroit.

**AGENTS—Big profits, mailing our literature.** Home business. Stamford, 3762-D Broadway, New York.

**SEND (Ten cents) for samples of prunes, dates, figs, and nuts.** Agent proposition. Prunade Growers Association, Hollywood, Calif.

**EXTRAORDINARY 1939 Profits! Manufacturing "Popular Branded Products."** Stamp brings informative Formula Messenger telling how! Miller, Chemist, (Established 1897), 706-Pa, Tampa, Florida.

**FREE Sample world's best seller.** G. Mfg. Co., Washingtonville, Ohio.

**SELL Stores, taverns, gas stations 1939 sparkling 25c Gem signs.** Cost 5c. Gem, 4327-M Harrison, Chicago.

**500% PROFIT.** Modernistic guaranteed Stick-on letters for windows, offices, trucks. Large sizes 1c. Easily applied. Free samples. Modernistic, B-3000 Lincoln, Chicago.

**EX-O-LENE.** New, red-hot, repeat auto product. Guaranteed. Millions waiting. To 500% profits. Information free. Thermo Exolene Works, Peoria, Ill.

**PROFIT With new products.** Make, sell, repeat. Analysis. Research. Guaranteed formulas. Biggest catalog free. Nominal prices. Gibson Laboratory, Chemists, BD-1142 Sunnyside, Chicago.

**STRANGE Chemical sponge cleans wall-paper like magic.** Banishes housecleaning drudgery. Sensational demonstration. Samples sent on trial. Rush name. Kristee 102, Akron, Ohio.

**MILLIONS Of prospects! Buyers everywhere!** Sensational social security plates! Tremendous value! Fast seller! Big profits! Complete selling outfit free! Union Specialty, 1775-A Broadway, New York.

**CREW Managers and distributors wanted.** All-year-round seller. Free sample. Klean-Well Products, Box 1324, Youngstown, Ohio.

**AGENTS: Smash go prices!** Santos coffee 12c lb. 4-oz. vanilla 8 1/2c. Razor blades 10 for 8 1/2c. 100 sticks chewing gum 12c. 150 other bargains. Premiums. Experience unnecessary. Carnation Company, PO, St. Louis, Mo.

**SALESMEN Wanted.** Sell business cards, commission. Willmar Press, 674 Main St., Pawtucket, R. I.

**PROFIT 100% Selling calling cards.** Bonus, prizes to workers. Outfit free. Universal, Orange, Massachusetts.

**AGENTS—Opportunity make money; book containing 107 successful business plans; home-office; send for free introductory booklet.** Elite Co., 214 Grand St., New York.

**AGENTS Make big profits on food products, bargain deals.** Low wholesale prices. Rush name for trial outfit offer. Ho-Ro-Co, 2810-R Dodier, St. Louis, Mo.

**SUCCEED With your products.** Make-sell them. Formulas, Processes. Accurate analyses. Catalog free. B. Thaxly Co., Washington, D. C.

**STARTLING Invention—Pocket adding machine.** Nationally advertised \$2.50. Whirlwind seller. Big profits. Baby Calculator Co., Box 1118, Chicago.

**BIG Money applying initials on automobiles.** Write for particulars and free samples. American Letter Company, Dept. 40, Dunellen, New Jersey.

**AGENTS—To mail our literature.** Good profits. Home business. Maywood, 149 Fifth Ave., New York.

**FREE Sample—Amazing cleaner; sells homes, taverns, everywhere.** Big profit—fast repeater. Betco, 5007 Irving Park, Chicago.

**MANUFACTURE Specialties, hire agents yourself.** Big money. Free literature. Gilbert Supply, 1107-P Broadway, New York.

**AGENTS: Stamping names on pocket-key protectors.** Sample check with your name, address, 25c. Stamping outfits. Emblem checks, check-fobs, name plates. Hart Mfg. Co., 303 Degraw St., Brooklyn, N. Y.

**ENGRAVED Name plates, numbers, signs, etc., easily sold, profits large.** Brett Bros., Winthrop, Mass.

**REVOLUTIONARY Window cleaning tool.** Good Housekeeping approval. Only ten \$2.25 sales daily to housewives, factories, schools, stores will make you \$350.00 monthly. Carter Products Corp., 900 Front Ave., Cleveland, Ohio.

**ATLAS Window sign letters.** Large sizes, penny each. Beautiful free samples. Atlas, 7941 Halsted, Chicago.

**INFORMATION Of 1000 cards 50c.** Envelopes \$1.25, letterheads \$1.50, every printing—\$100. Weekly mailing—290 varied enrichers (stamp). Harris's, 210 E. Adams, Phoenix, Ariz.

## HIGH-GRADE SALESMEN

**MAKE Big daily profits selling Top Quality Advertising Book Matches.** Low prices. Experience unnecessary. Full time profits unlimited. Free sales kit. Zipper case offer. Match Corporation of America, Dept. E-2, 3433 West 48th Place, Chicago.

**SELL Business cards \$1.50 thousand.** Business stationery, book matches, advertising tape, paper towels, pencils, sales-books, rubber stamps, tags, menu covers. Free sales portfolio. 35% commission daily. Money making specials. Willens, 2130 Gladys, Dept. DB, Chicago.

**DON'T Be a job hunter.** Start your own business on our capital. No hard times; no lay-offs; always your own boss. Hundreds average \$3,000 to \$5,000 annual sales year after year. We supply stocks, equipment on credit. 200 home necessities. Selling experience unnecessary. Wonderful opportunity to own pleasant, dignified, profitable business backed by world-wide industry. Write Rawleigh's, Dept. B-U-PPM, Freeport, Ill.

**BIG Money applying initials on automobiles.** Easiest thing today. Free samples. Also, sideline salesmen for short order decalcomania name plates. "Ralco," 1305 Washington, Boston, Mass.

**NEW Specialty—Sells every business and professional man.** Four \$15 sales daily pay \$280 weekly. Farrell cleared over \$1,000.00 monthly. Write F. E. Armstrong, President, Dept. PM, Mobile, Ala.

**BIG Commission selling celluloid pricing tickets, metal shelf moulding, menu covers, changeable signs, celluloid advertising buttons.** P. Pricing Press, 124 White St., New York.

**BLADES.** Finest quality. Factory prices, postpaid. Ace Blades, Buffalo, N. Y.

**CARDED Merchandise, attractive displays.** Priced low. Free goods. Prepaid. Aspercol Products, Oakland, Calif.

**SPARE-TIME Subscription representatives for leading magazines.** Commission and bonus. Write Davies Company, Box 119, Chehalis, Wash.

**LARGE, Well rated firm needs representatives to call on schools, stores, business houses, with excellent patented product of unusual appeal.** Protected territory. Excellent factory cooperation. Permanent, profitable connection for a sincere, responsible man. Write Sales Manager, 532 North 22nd Street, Milwaukee, Wisconsin.

**AMAZING Seller.** Exclusive process all-weather coat guaranteed ten years, \$9.95—commission \$3.00. Established 1924. Selling outfit free. Nothing to invest. Tenyear Raincoat Company, Department 13, Templeton, Massachusetts.

**SELL Amazing Glove-X.** Big commission. Write, Zimel Laboratories, Port Chester, New York.

**SOCIAL Security plates, key checks, etc., up to 500% profit.** Operate own business. Thompson Co., 1734 Lawrence, Denver.

**KEYHOLE Illuminator, battery or transformer operated, instant seller.** Sample \$1.50. Babco Products, Denver, Colorado; Davenport, Iowa.

**400% PROFIT.** Amazing new appliance. Used in every home. Quick turnover. Sample free. Mil-der Mfg. Co., Valparaiso, Ind.

**MAKE \$20 Each sale; sensational new vacuum cleaners; sells itself on a 10 day trial; no salesmanship necessary; particulars free.** Hub Vacuum, 2762 Third Ave., New York City.

**NEWLY Invented door knob lights key hole.** Install in one minute. Earn big profits. Sample \$1.00. Jaxon, 329 N. Front, Grand Rapids, Michigan.

**YOUR Name monogrammed on 40 book matches, includes selling kit \$1.00.** Ellis Products, Hollywood, California.



**SELL** The new auto license ad plate, personalized with car owners initials, to auto dealers. A quick and easy sale, top commissions. Capital Advertising Spec. Co., 12803 Greiner Ave., Detroit.

**YOUR Own suits free.** Other attractive bonuses and free shirt offer plus big cash profits for selling your friends quality tailored-to-individual measure suits. Five popular new low price ranges. Exclusive sport and swing styles no extra charge. Prices defy competition. Elaborate selection spring and summer new shades and patterns. Satisfaction or money back guaranteed by reliable thirty year old tailoring firm. No experience needed. Sample outfit free. Jay Rose & Co., Dept. P-2, 330 So. Wells, Chicago.

**SALESMEN:** Bowling and billiard supplies, equipment; side line; big commissions. Write details. American Bowling & Billiard Corp., 50 West 17 Street, New York City.

**TERRITORY Open** on "certified" all-wood bridge furniture and novelties, displayed at Space 644 Furniture Mart, Chicago. Liberal commissions. Write or see us for details. Ermet Products Company, Indianapolis, Ind., 2050 Blvd. Ave.

**CALENDAR Salesman wanted:** Liberal commission on a new, unusual commercial calendar line—adaptable for every business. Plus our famous embossed calendars for funeral directors. State experience, age and territory desired. Write Budget Press, Salem, Ohio.

**EXCELLENT Opportunity** selling our complete line of brushes, largest commissions. Write for sales plan. Wire Grip Sanitary Brush Company, 2300 5th Ave., New York.

**SALESMEN—New money-making sensation** for garages, service stations, no competition, fine repeater. Automotive Laboratories, 1555 Hanchett Court, San Jose, Calif.

**MAKE More money with Red Comet Automatic Fire Extinguishers.** Low price. Proved seven years. Splendid sales outfit free. Some good territory open. Exclusive. Write quick. 704 Red Comet Bldg., Littleton, Colo.

**50 YEAR Established manufacturer** of the widely known Mendenhall's Cough Syrup and other household remedies wants salesmen-distributors selling to drug, grocery, and general store trade. Deliver and collect. Liberal commissions. J. C. Mendenhall Medicine Co., Inc., Dept. 81, Evansville, Ind.

**EARN Money in your spare time** taking subscriptions to Popular Mechanics. Unlimited possibilities, every family a prospect. Easy to sell. Bonus paid in addition to liberal commission. Send postcard for further details today. Circulation Dept., Popular Mechanics Magazine, 200 E. Ontario St., Chicago.

#### HELP WANTED

**WEAR Fine hose I send without cost** with outfit while taking orders for amazing new hosiery. Replacement guaranteed against holes, snags, and runs. Rush name and hose size. Wilknit, Desk B-37, Greenfield, Ohio.

**LOCAL Agents wanted to wear and demonstrate suits to friends.** No canvassers. Up to \$12 in a day easy. Experience unnecessary. Valuable demonstrating equipment, actual samples free. H. J. Graves, 1300 Harrison, Dept. P-817, Chicago.

**DO You want a job? If you are honest and really want a job, I'll send you a proven method of getting one.** Send 35c cash now and balance 65c only after this instruction has helped you get steady work. If you don't get your job in 30 days don't pay balance. Vocational Advisor, P.O. Box 1897, Seattle, Washington.

**OBTAIN Employment!** Try unusual methods, including homework ideas, 50 cents. Money-back guaranteed. Particulars free. New Idea Service, 126-B Lexington Ave., New York.

#### EDUCATIONAL AND INSTRUCTION

**TELEGRAPHY Taught thoroughly.** Railroad retirement act creating opportunities for new operators. Expenses low. Catalog free. Dodge's Institute, Hiatt Ave., Valparaiso, Ind.

**LEARN Watchmaking.** Trial lessons, model, tools \$1.00. Wholesale tool, material, watch catalog 5c. Stewart's, 721 Olive, St. Louis, Mo.

**BOOKKEEPING Taught for as low as 40c weekly.** Other home-study courses. Write for particulars. Institute of Business, Box 1055, Sacramento, Calif.

**WATCH Repairing is steady profitable work.** Experts always in demand. You can learn watchmaking trade at home, spare time. New original instruction system. Script engraving course included. Write for free details today! Nelson Co., 2014 Manhattan Building, Chicago.

**GOV'T Jobs start \$1260-\$2100 year.** Men-women age 18-50. Former examiner's tested method helps qualify you. Particulars, list jobs free. Write today. Patterson School, 8C Mercantile Bldg., Rochester, N. Y.

**BECOME Practical scientific investigator.** Modern, illustrated course. Thorough training by former agent U. S. secret service. Particulars free. International Secret Service, Institute, PM-29, Hoboken, N. J.

**CHESS.** Instruction, books, supplies. Interesting information. Particulars free. Chess Thoughts, Pearl River, N. Y.

**MEN—Women.** Get 1939 U. S. government jobs. Commence \$105-\$175 month. Prepare immediately for next examinations. Experience usually unnecessary. Particulars—list positions, free. Franklin Institute, Dept. G3, Rochester, N. Y.

**FREE Teaching tire vulcanizing.** Anybody can learn at home. 9 cents brings details. Box 156, Eagle Pass, Texas.

**BUSINESS English aids success.** Write English Institute, 425 DeBaliviere, St. Louis.

**FOR An extremely profitable lifetime business,** operate a collection-credit agency. Free folder. Cole Associates, Syracuse, N. Y.

**LOCKSMITH Instructions.** Key fitting, lock picking, etc. \$1 prepaid. Locksmith, Canadian, Texas.

**MEN—Women,** drafting pays better, learn easily at home in spare time. We train you until you get a job, particulars free. Write Monroe Institute, 1217D Garfield, Kansas City, Kansas.

**LEARN Fire eating, ventriloquism, torture acts.** Manly, 1315 Ferris, Los Angeles.

**If You like to draw, sketch or paint—write for talent test (no fee.)** Give age and occupation. Federal Schools, Inc., Dept. PM 19, Minneapolis, Minn.

**INVENTIVE Minded can become independent.** Explanation free! G-Higbee, Cantil, Calif.

**LEARN Photo-engraving; interesting, profitable.** Personal instruction. Box 510-M, Effingham, Illinois.

**PROSPERITY For you.** Revolutionize your life. Dime brings actual lessons in "Creative Procedure." Gardiner's, Box 6048, Kansas City, Missouri.

**STUDY Chemistry at home.** 35c. Joray, 2731 Vine, Cincinnati, Ohio.

**STUDY For degree in psychology, metaphysics, theology.** Home study. Chartered college. Free catalog. College of Universal Truth, 1100 North Dearborn, Chicago.

**HELP Yourself to success—good books put you on higher plane.** Catalog—chemical and technical books for stamp. Kraftsmen's Press, Cos Cob, Conn.

**CIVIL Service arithmetic, 662 special problems, solutions, \$2; 667 mental test questions, \$2; customs, meat inspector, storekeeper-gauger, postal, many others, \$1 each.** Valuable information free. Pergande Publishers, D11, Milwaukee, Wisconsin.

**BOOKKEEPERS: \$60.00 Monthly beginning January; 40 hours sparetime, your locality.** Send \$1 deposit for instructions, refunded if not accepted. State experience, age. Five Minute Systems, 16 E. Tupper, Buffalo, New York.

**BE A radio announcer.** Good possibilities. Audition booklet 25c. KFRO, Longview, Texas.

**LEARN In a few weeks high class decorating, paperhanging, graining, marbling, sign painting.** Catalogue No. 4 free. Chicago Painting School, 437 North Clark St., Chicago. Established 1902.

**BLUEPRINT Reading taught by mail.** Write Blueprint Reading Institute, Dept. A, Box 5662 Metropolitan Sta., Los Angeles.

**SECRET Investigation.** Experience unnecessary. Detective particulars free. George Wagner, M-2640 Broadway, N. Y.

**LEARN Auto mechanics, body, repairing, welding, electricity, refrigeration, Diesel.** Stevinson's, 2008A Main, Kansas City, Mo.

**MASSAGE, Hydrotherapy, dietetics, drugless therapeutics, chiropody,** taught by mail. Evans Correspondence School, Montgomery, Ala.

**MATHEMATICS, Sciences, drafting, blueprint reading, surveying, preparation civil service, engineering examinations.** Mondell, 230 West 41st St., New York.

**LEARN Air conditioning—America's next big industry.** Thousands of opportunities. Get your start with complete book by E. W. Riesbeck, \$3.50 postpaid. Popular Mechanics Press, Room (C38), 200 E. Ontario St., Chicago.

#### PLAYS, STORIES, MANUSCRIPTS

**ORIGINAL Poems, songs** wanted immediately for publication. Westmore Music Corporation, Dept. 33H, Portland, Ore.

#### CARTOONING, COMMERCIAL ART, SHOWCARD WRITING, SIGN PAINTING

**EARN Big money.** Commercial art, sign painting, lettering, showcard writing, cartooning. Complete self-instruction books sent on approval. Write immediately for free illustrated folders. Illustrated Editions Co., 220 - 4th Ave., New York.

**PAINT Signs for profit.** Fine lettering fast with Speedway Patterns. Modern styles, many sizes. Free samples, literature. For 3 in. alphabet enclose nickel. Display Letters Co., 8309 Third Ave., Brooklyn, New York. Dept. M.

**25c ART Magazine free while samples last.** Send 9c postage. Artist, 320 Doty, Madison, Wisconsin.

**CARTOONING Course: 30 illustrated lessons, over 500 drawings, pens and pencils.** Sent complete postpaid for \$1.00. Scovell Studios, Box 748-P, Hollywood, Calif.

**CARTOONING, Sketching, etc.—46 lessons, 600 illustrations, including drawing paper, pens, pencils, \$1.00 complete.** Fraba Service, Cashton, Wisconsin.

**NOW You can chalk talk.** Many learn one evening. Particulars free. Hendrixon, Argyle, Wisconsin.

**PEN And ink illustrations for catalogue and general printing purposes** at right prices. High grade work. Heraldic Studios, 1914 Oakdale Avenue, Chicago.

**BE A lettering artist!** Learn how to letter headings for magazine and newspaper advertisements. Highly paid profession. Free booklet. Guild School of Lettering and Advertising Design, 324 Summit Avenue, Hackensack, N. J.

**EARN cash income, copying and duplicating simple cartoons for advertisers.** 3-M Service, Argyle, Wis.

**MORGUE—Artists ready reference.** Compact collection helpful drawing aids, money-making tips. Extremely valuable to students, beginners, professionals. First series over 200 drawings, hands, arms. Send 50c coin. Metro Studios, Box 473-P, South Bend, Ind.

#### ADVERTISING AGENCIES, LETTER WRITERS, FOR ADVERTISERS

**FREE—New Advertisers Rate Guide, 44 pages.** Includes everything. Lowest rates. E. H. Brown Advertising Agency, 140 S. Dearborn, Chicago.

**LEARN Advertising quickly at home.** Easy practical plan. No text books. Common school education sufficient. Interesting booklet and requirements free. Page-Davis School of Advertising, 3601 Michigan Avenue, Dept. 3431, Chicago.

**INCH Display, 28 magazines, 3 months, \$3.00.** Paramount Press, Atlanta, Missouri.

**INCH Display advertisement 30 magazines year \$24.** Wood's Popular Services, Atlantic City, (N. J.)

**YOUR 25 Word ad 3 months \$1.50.** Plans, 89-91 Pineapple, Brooklyn, New York.

**ADVERTISE: 24 Words in 250 newspapers \$10.** Lists free. Advertising Bureau, 4515-C Cottage Grove, Chicago.

**SALES And collection letters that bring results.** Paul Muchnick, 5176 Penway, Philadelphia.

**ADVERTISING Placed all magazines, newspapers, radio.** Lowest rates. Free service. 54 page rate book free. Baker Advertising Agency, A-189 West Madison, Chicago. Successors to Ankrum. Established 28 years.



**MAIL-ORDER** Ad reaching 1,500,000 families throughout United States \$15.40 inch. Newspaper, magazine, ratebook free. Chicago Union Agency, 20-P West Jackson, Chicago.

**DIRECT-MAIL** Advertising services. Sales letters that sell. Mailing lists. Omaha List & Letter Co., Box 2172, South Omaha, Nebr.

#### BUSINESS SERVICE

**LOS ANGELES** Mail address \$2.00 monthly. Dickey, 628 W. 9th.

**WASHINGTON, D. C.** mail address, business, personal. Your mail reforwarded daily. Hawkins Mail Service, 817 Fourteenth.

**CANADIAN** Mailing address \$1.00 monthly. Canadian Enterprises, 1183 Bloor, Toronto Canada.

#### RUBBER STAMPS AND OFFICE SUPPLIES

**NAME, Address, 2 lines 25c; 3 lines 35c.** Stamp Works, Auburn, Nebr.

**CUSHIONED 3 Lines 45c.** Rubber Stamps, 32 East Dennick, Youngstown, Ohio.

**3 LINE 25c; 5M 4½x6 Circulars \$3.50** postpaid. Advance, Pewaukee, Wisconsin.

**ORIGINAL, Cushion mounted.** One, two lines 25c; three 35c; four 45c. Rotary press, type, prints postcards, \$2.50, literature. Stamp Works, 814 Bradley, Peoria, Ill.

**CUSHION Mounted one-two lines 25c; three 35c.** Hauer Press, 1314 Ford, Youngstown, Ohio.

**2 LINES 25c, 3 Lines 35c.** Stamp Works, Centerport, N. Y.

#### TYPEWRITERS, DUPLICATORS, OFFICE DEVICES

**INCREASE Business now.** "Excelligraph" Rotary Stencil Printer reprints thousands everything you typewrite, handwrite, draw or trace. Colors. \$19.75 to \$44. Terms. Illustrated literature free to business or professional men. Pittsburgh Typewriter Supply, Department K-2, Pittsburgh, Penna.

**NEW \$3.75 Automatic adding machine.** Fully guaranteed. Bassett, Box 302-K, Altadena, California.

**TYPEWRITERS, Adder, mimeograph, multigraph, addressograph.** Send for free lists of machines that will help you at half price. Pruitt, 28 Pruitt Bldg., Chicago.

#### PRINTING, MULTIGRAPHING, MIMEOGRAPHING, GUMMED LABELS

**HAMMERMILL Letterheads, 300 8½x11,** any color paper and ink, \$1.48 postpaid. Free particulars. Woodruffs', 217A Lewis, Duluth, Minn.

**ENVELOPES, 500, 6¼, \$1.00.** Morey Press, 87 Somerset, Springfield, Mass.

**1000 6x9 CIRCULARS, Letterheads, envelopes, postcards, \$2.75; 5000, \$9.45.** All printing reasonable. Samples. Goodprint, Harrisonburg, Va.

**125 8½x11 BOND Letterheads and 125 envelopes, both printed—\$1.00 postpaid.** Benneville, 907 West Roosevelt, Philadelphia.

**1000 6¼ ENVELOPES \$2.75.** Fairview Press, West 204th, Fairview Village, Ohio.

**CIRCULAR Printing.** Prompt. Price list free. Keelerprint, 4237-W Cermak, Chicago.

**1000 LETTERHEADS, Envelopes, bills \$2.40; 5000 \$8.50.** Samples. Laporte, 3461 Vernon, Astoria, N. Y.

**\$1.50 THOUSAND, 2½x4 Labels, 3x6 circulars.** Paramount Press, Atlanta, Missouri.

**1000 GOOD Business cards \$1.00, prepaid, cash.** Sullivan Printing Company, Memphis, Tenn.

**EXTRA Quality! 1000 letterheads, statements or envelopes \$2.75.** Kelly's Print Shop, Columbia, Mo.

**1000 STICKERS, Four lines, 50c.** Fine labels. Cott's, Spickard, Missouri.

**500 STATEMENTS \$1.50.** Booklets, catalogs, etc. Roe Printing Co., Weidman, Mich.

**FREE Catalog and samples.** Backus, 209-B South Laurel, Richmond, Virginia.

**PRINTING? Get lowest prices.** Churchill, 4316 South Salina, Syracuse, N. Y.

**SENSATIONALLY Low printing prices.** Stamp brings catalog. Nixons' Stevens Point, Wisconsin.

**175 BOND Letterheads and envelopes \$1.00 postpaid.** Village Press, Somerset, Mass.

**1939 PRICELIST, Portfolio of samples free.** McCall Press, 1326 South 27th, Omaha, Nebr.

**250 GUMMED Shipping labels 35c.** Ad-Man, 301-N New Jersey, Indianapolis, Ind.

**1000 BUSINESS Cards \$1.00 postpaid.** Tucker, P.M. Box 65, Indianapolis.

**1000 BUSINESS Cards, postpaid, \$1.00.** Superba Print, 912 Towne, Los Angeles.

**500 ¾x2¼ FOUR Line gummed stickers, 25c.** Moritz Printery, Saginaw, Mich.

**1000—6¼ BOND Envelopes \$1.95.** Samples. Feld, Elmwood Place, Ohio.

#### PRINTING OUTFITS AND SUPPLIES

**BUY—Sell used hand printing presses, type, etc.** Stines, 1154 West Wayne, Lima, Ohio.

**PRINT Your own cards, stationery, circulars, advertising.** Save money. Easy rules furnished. Print for others, big profits. Junior outfits \$9.00, senior outfits \$17.00 up. Details free. Kelsey Presses, D-11, Meriden, Conn.

**BUSINESS Getting cuts 7c in quantities.** Stereotype casters \$6.50. Mats, supplies. Economy, B351, Pontiac, Mich.

**TYPESETTING For amateur and professional printers.** Oakdale Composition, North Philadelphia, Penna.

**\$2.05 THOUSAND—Plain; print yourself.** VanDorn's Book Matches, Ottawa, Illinois.

**BORDER And ornament font 50c.** Catalog 10c. Daemicke, 6452 Kenwood, Chicago.

**NEW Type, rule, etc., rebuilt equipment.** Bargain prices. Anchor, Medford, Wis.

**ZINC Line cuts, 2x3", \$1.00.** Halftones, \$1.50. Printwell, Wyoming, Penna.

**STAMP Cuts, 25c up.** Attractive sample and catalog, 10c. Novateur Line, Box 55, Jackson, Michigan.

**ROTARY Printing press.** Guaranteed efficient. Complete with rubber type, \$2.50. Photo Shop, Linton, Ind.

**INGENIOUS Rotary press.** Furnished complete with sliding rubber type and equipment—at \$2.50. Prints pictures and several sizes of type. Free circular. Superior Type, 3942 Ravenswood, Chicago.

**PRESSES \$7.00 Up.** Type, supplies. Lists 3c. Landis, Richland, Penna.

**HAND Press, type and complete printers' supplies.** Advise equipment you need and we quote prices; or send stamp for catalog. P. Peffer, 14-C; 6 Columbia St., Newark, N. J.

**BARGAINS, Presses, type, List 3c.** Exchange D-15, 22 Orient, Meriden, Conn.

**BARGAINS — Presses, type, supplies.** Send stamp. 159 Harvard, Cambridge, Mass.

#### PATENT ATTORNEYS

**INVENTORS: Prompt, confidential, personal patent service at reasonable cost.** William H. Holzinger, Registered Patent Attorney, 3504A Southport, Chicago.

**INVENTORS: Send immediately for your copies of our new free books, "Patent Protection" and "Suggestions on Selling an Invention."** Sixty-eight pages of interesting facts. They tell how Patent Laws protect you; kind of sketch or model needed; simple steps to take without cost; how successful inventors have secured financial assistance; show interesting inventions; illustrate important mechanical movements. With books we also send free Evidence of Invention form to help establish date of disclosure. Prompt service, reasonable fees, special deferred payment plan. Strictest secrecy. Forty-one years' experience. Highest references. Write us today. The facts in our books are worth money to the man with a good invention. Address: Victor J. Evans & Co., Registered Patent Attorneys, 113-B Victor Building, Washington, D. C.

**HOW To protect and capitalize on your invention.** Write for free books answering all the questions you want to know about your patent and its commercial possibilities. Over 64 years' experience. Deferred payment plan. Write for free books today. C. A. Snow & Co., 126 Snow Building, Washington, D. C.

**PATENTS—Before too heavy an outlay of time or money is made on an invention, a search of the Patent Office records should be made to determine as nearly as possible whether or not the same idea has been patented before.** The cost of this search is small, while the value of the facts it uncovers is often considerable. We offer inventors and manufacturers a thorough prompt, confidential search service—plus experienced counsel and assistance in every phase of Patent and Trade-Mark practice. Write for our new free book containing valuable information relating to patent procedure. Clarence A. O'Brien and Hyman Berman, Registered Patent Attorneys, 58-M Adams Bldg., Washington, D. C.

**PATENTS—Trade marks.** Preliminary advice, book and disclosure form free. Personal service. Irving L. McCathran, 1060 International Bldg., Washington, D. C. Registered Patent Attorney.

**PATENTS—Any country.** Reasonable rates. Free information. Ramsay Company, 273 Bank St., Ottawa, Canada.

**PATENTS.** Send sketch, photos or model and description of your invention for preliminary search and patentability report. Total expenses, including search fee, for preparing, filing and prosecuting your application quoted before you proceed. Rates reasonable. Prompt and efficient services. Lynwood B. James, Registered Patent Attorney, Established 1913, Suite 843-A National Press Building, Washington, D. C.

**INVENTORS—Before disclosing your invention to anyone send for form "Evidence of Conception"; "Schedule of Government and Attorneys' Fees" and instructions.** Sent free. Lancaster, Allwine & Rommel, 411 Bowen Building, Washington, D. C.

**"INVENTOR'S Guide," 100 mechanical movements, free; advises on patenting, selling inventions.** Frank Ledermann, Tribune Bldg., New York.

**L. F. RANDOLPH, 302-B Victor Bldg.,** Washington, D. C. Low cost. Book and information free.

**PATENTS. Booklet free. Highest references. Best results. Promptness assured.** Watson E. Coleman, Patent Lawyer, 724 Ninth St., Washington, D. C.

**INVENTORS—Send for free booklet "Patent-Sense." Information based on 64 years experience.** Lacey & Lacey, Dept. 5A, 635 F St., Washington, D. C.

**PATENTS. Protect your idea by securing free "Proof of Invention" folder.** Exceptional personal service. Established 1906. E. E. Vrooman, 871 Woodard Bldg., Washington, D. C.

#### FOR INVENTORS

**PATENTS—Before too heavy an outlay of time or money is made on an invention, a search of the Patent Office records should be made to determine as nearly as possible whether or not the same idea has been patented before.** The cost of this search is small, while the value of the facts it uncovers is often considerable. We offer inventors and manufacturers a thorough prompt, confidential search service—plus experienced counsel and assistance in every phase of Patent and Trade-Mark practice. Write for our new free book containing valuable information relating to patent procedure. Clarence A. O'Brien and Hyman Berman, Registered Patent Attorneys, 58-M Adams Bldg., Washington, D. C.

**WE Locate buyers meritorious patented, unpatented inventions.** If will sell, reply immediately. Descriptive booklet free. Invention Reporter, 5A-11236 South Fairfield, Chicago.

**INVENTORS—Complete service, engineering, sales, patent protection.** Starck, 333 Wells Bldg., Milwaukee.

**BLUEPRINT And patent drawings prepared.** Write for free circular. Ormax Drafting Company, Bank Building, Bethesda Branch, Washington, D. C.

**INVENTOR'S Universal Educator; contains 900 mechanical movements; 50 perpetual motions; instruction on procuring and selling patents and selecting an attorney, etc.** Suggests new ideas. Price \$1 postpaid in U.S.A. Address Albert E. Dietrich, 511-B Colorado Bldg., Washington, D. C.

**INVENTORS Advised safe, economical method securing and selling patents.** A. B. Edwards, Box 1585, Little Rock, Arkansas.

**WARNINGS, Guidance, instructions.** Write to C-62, P.O. Box 458, Chicago.



**INVENTORS**—Your patented, unpatented inventions brought before 5000 manufacturers. Guaranteed exploitation and protection. Ideas developed, sold; 50-50 plan. Investigate this, write; P.O. Box 443, Salem, Indiana.

**IDEAS**, Inventions developed, promoted and financed. International Ideas Syndicate, 505 5th Avenue, New York City, Dept. 2M.

**WHETHER** Patented or unpatented, profit by voice of experience. Private secretary to inventor for fifteen years offers surprising truths in thousand words of vital information! Dollar bill to Box 65, Clinton, Illinois, brings inside facts that may be worth thousands.

**HAVE** You a sound, practical invention for sale, patented or unpatented? If so, write Chartered Institute of American Inventors, Dept. 4-A, Washington, D. C.

**INVENTORS**: Profit by your invention. A practical talk to inventors by an experienced manufacturer. Our 68 page booklet "Mind vs. Matter" mailed upon receipt of 25c. Rex Engineering Co., Cincinnati, Ohio, Dept. D.

**INVENTIONS** Bought, sold. Patented, unpatented. James Wallace, Homer, N. Y.

**INVENTORS**: "Making Inventions Pay," our 32-page illustrated book, mailed upon receipt of 3c postage. Crescent Tool Co., Dept. Z, Cincinnati, Ohio.

**PENDING** Patent applications can be brought before thousands of manufacturers, free of charge, through Invention Magazine. Write for details. Invention, Inc., 635 F Street, Washington, D. C.

**INVENTORS**—Send for 72-page book on patents. Reasonable terms. Conscientious treatment to inventors. L. F. Randolph, Registered Patent Attorney, 302-E Victor Bldg., Washington, D. C.

**I SELL** Patents. Established in 1900. Charles A. Scott, 773PM Garson Ave., Rochester, N. Y.

**INVENTIONS WANTED**

**SMALL** Inventions wanted by manufacturers. I'll help you sell your invention. Write for free circular. Stanley Hull, 7829-K Euclid Avenue, Cleveland, Ohio.

**WANTED**—Meritorious patented, unpatented inventions. Booklet free. Invention Reporter, 5B-11236 South Fairfield, Chicago.

**CASH** For unpatented ideas. Stamp for particulars. Mr. Ball, 9441-A Pleasant, Chicago.

**PRACTICAL** Inventions wanted. Full protection guaranteed. Write for "4-Point Service" bulletin. R. & S. Engineering Company, 17 East 42nd Street, New York, N. Y., Dept. D-2.

**SMALL** Inventions wanted by manufacturers. I'll help you sell your invention. Write for free circular. Stanley Hull, 7829-K Euclid Avenue, Cleveland, Ohio.

**SIMPLE**, Practical inventions wanted by manufacturers, patented or unpatented. For information write Chartered Institute of American Inventors, Dept. 4-D, Washington, D. C.

**PATENTS FOR SALE**

**UNPATENTED** Puzzle made from flat steel. Chas. Boch, Baden, Penna.

**MANUFACTURERS**: For new products or profitable manufacturing opportunities, inquire. Invention Reporter, 5C-11236 So. Fairfield, Chicago.

**MANUFACTURERS**. Patented animal trap. Humane. Swivelly constructed. Telescopically housed. Animal can't tangle up, break leg, twist out, escape. Tested three years. Simple. Easy to set. Sheet metal. Costs seven cents, retails 35 cents. Millions old style sold annually. Allen McMullen, Number Four, N. Y.

**SELL** Your patent through a small classified ad in Popular Mechanics. Many inventors have found buyers in this way. Ask me for proof—I'll gladly send it to you. F. W. Johnson, Manager Classified Advertising, 200 E. Ontario St., Chicago.

**MANUFACTURING**

**LET** Us manufacture and market your invention on a royalty basis. Toledo Saw and Grinding Company, Toledo, Ohio.

**INVENTIONS** Manufactured in any quantity at low cost. Stampings, dies, models, etc. Estimates and free catalog. Crescent Tool Co., Dept. X, Cincinnati, Ohio.

**DIES**, Stamping models and special machinery. Pierce Model Works, Tinley Park, Ill.

**INVENTIONS** Manufactured in any quantities. Tools, dies, metal stampings; working models built; industrial designing. Complete blueprint and engineering service. Write for "4-Point Service" bulletin. R. & S. Engineering Company, 17 East 42nd Street, New York, N. Y., Dept. DM-2.

**DIES**, Stampings, complete manufacturing, wire forms. Southern Products, Independence, Missouri.

**INVENTIONS** Manufactured by an experienced company, in any quantity at low cost. Metal specialties, novelties, stampings, dies, and models. Free estimates. Our booklet "Mind vs. Matter" sent upon receipt of 25c. Rex Engineering Co., Cincinnati, Ohio, Dept. C.

**MODELS AND MODEL SUPPLIES**

**RAILWAY** Models. Catalog handbook 25c. Walthers, 247 E. Erie, Milwaukee.

**CATALOGUE** Over 40 engines, supplies—25c. Refunded. Specialize in experimental or patent work. Howardco, A-2417 North Ashland, Chicago.

**LIVE** Steam locomotives \$9.50 to \$200.00. Pulling power limited only by wheels slipping. Catalogue 25c. Fourteen inch illustration of Hudson locomotive with parts to cut out, assemble, operate to study valve motion, etc., 50c. Steam Electric Co., Bloomfield, N. J.

**MODEL** Airplanes. 24" span, 4 kits, \$1.00. List 5c. Northern Aircraft, Manitowoc, Wis.

**PLANETARIUM** That really works. Information free. Zade, 558P LaJolla, Calif.

**BUILD** Miniature gasoline motors. Fascinating, educational, profitable. Details, drawing, 10c. Wright Motor Works, 3256 Lake Park Ave., Chicago.

**POWER** Models, steam locomotives, electric railways, gasoline, steam engines, ship machinery, accessories, 84 page catalog 35c. Chas. Cole, Ventura, Calif.

**RACING** Hulls, kits \$3.50 up. St. Louis Model Boat Co., 225 N. Meramec, Clayton, Mo.

**MODEL** Railroad Shop. Dept. 3M, Dunellen, New Jersey. New 24 page illustrated catalog 10c postpaid.

**SHIP** And yacht model fittings; construction sets; model yacht sails; illustrated catalog 20 cents. A. J. Fisher, 1002-1 Etowah Avenue, Royal Oak, Mich.

**MODEL** Supplies for the inventor. Send 3c stamp for catalog. Pierce Model Works, Tinley Park, Ill.

**STEAM** Locomotives! 3/4" scale. Build one by "Easy Steps." Our illustrated catalog lists all needs, 25c. Little Engines, Box 15B, Wilmington, Calif.

**MODEL** Airplanes, boats, radios, supplies. Catalog 10c. Imperial, 416-K McDonald, Brooklyn, N. Y.

**MODELS**—Practical models put over your ideas. We develop models from the crude to perfect working devices. Your idea might have large commercial value. Services confidential. Bank references. Registered graduate engineers at your service. Send 25c for our 68 page booklet "Mind vs. Matter." Rex Engineering Co., Cincinnati, Ohio, Dept. B.

**MODELS**—Your ideas developed into practical working models. 30 years' successful experience; thousands of satisfied customers. Confidential service guaranteed. Bank references. Send 3c postage for 32-page book—"Making Inventions Pay." Crescent Tool Co., Dept. Y, Cincinnati, Ohio.

**PRECISION** Engine for model builders, two dollars. Write for description. Pruett Novelty Works, 1828 West 43rd Place, Apt. 5, Los Angeles, California.

**HOME CRAFTSMEN**

**MANUFACTURE** Novelties. Turn workshop into factory. Spare time into cash. Small investment. Exceptional profits. Fifty assorted, illustrated, popular wood-working projects with complete working drawings, instructions, \$1.25 postpaid. Interesting home manufacturer's catalog listing supplies, machinery, tools, construction sets, projects, valuable information 10c. Satisfaction guaranteed. Woodcraft Service, Plainview, Minnesota.

**LEATHERCRAFTSMEN**—Write for free instructions and price list of leather, tools, etc. Sample cards 5c. Wilder & Co., Dept. F, 1038 Crosby St., Chicago, Ill.

**NEW** Manual for tool users free. Tells you how to use and care for your tools; how to sharpen your saws. Write Henry Disston & Sons, Inc., 211-C Tacony, Philadelphia, Penna.

**SAVE** Money on band saw and scroll saw blades. Master Saw & Machine, 200 Lumber Exchange, Minneapolis, Minn.

**20** FULL Size lawn ornament patterns 25c. Wickman, 744 Brooklyn, Dept. 11, Dayton, Ohio.

**SQUAREKNOTTERS!** Make belts, handbags, etc. Quality cord samples with catalog, free. Beginners book, catalog and samples, 10c. Special! Regular \$1 book with 50c beginners outfit, all for \$1. P. C. Herwig Co., Dept. J-13, 121 Sands St., Brooklyn, N. Y.

**PLYWOOD** At wholesale. Everything in plywood and veneers for the professional and amateur craftsman. Complete stock of foreign domestic woods at wholesale prices. Send 10c for new interesting catalog. Your dime refunded on first order. Beck Plywood & Veneer Co., 1312 N. Halsted St., Chicago, Ill.

**BUILD** Big money making, Giant Kettle Power Pop Corn Machines, in home shop, with our plans. Sell or operate. Details free. Earl Taylor, Malcom, Iowa.

**KNOCKDOWN** Furniture, supplies. Free circular. Geiser Brothers, 323 Cherry, Dover, Ohio.

**WANTED**. We have many customers waiting for used machinery and equipment needed by home craftsman. Immediate cash. Must be good condition and reasonable. Send details now. Craftsman's House, 52, Avoca, Penna.

**UNPAINTED** Furniture saves dollars. Beds \$5.95. Dressers \$9.95. Chests \$6.95. Solid maple breakfast sets \$10.95. Catalog 3c. Mayflower Manufacturing, 1551 Thomas, Chicago.

**GLASS** Jars. Round, 2" x 2", metal caps, 55c doz, 3 1/2 lbs. Two doz. \$1.00 6 lbs. Add postage. Midwest Shop Supply, Box 425, Chariton, Iowa.

**TURN** Alabaster! 4 butts, \$1.00, 100 lbs., \$5.00 f.o.b. quarries. Demonstrators, 1741 Harrison, Chicago.

**FOR THE HOME**

**IRON** Lining. Stove, furnace. Will fit any and all. Circulars free. W. R. Benjamin Co., Granate City, Ill.

**BUILD** Automatic electric humidifier for healthful winter living. Plans \$1. Information, photo 10c coin. Chas. Campbell, 340 Broad, Menasha, Wis.

**FUEL** Saver, furnace or boiler, anthracite, bituminous, coke. Have a few hundred of them I took to settle an account. Regular price \$17.50. My price \$2.50. Never wear out or need attention. Really worth investigating. Money refunded if not satisfied. For details address H. Trebert, Canandaigua, N. Y.

**BEAUTIFY** Your old furniture! Refinishing now made easy. Complete instructions 35c. Todd's Service, 262 Arlington, Youngstown, Ohio.

**BLUEPRINTS AND PLANS**

**FAMOUS** English high speed racing motors. Blueprint, pricelist on parts 25c. Kietzer, 6502 Adelphia, Pittsburgh, Penna.

**TWELVE** Inch horse and buggy. Complete instructions, photograph free. Clary Miniatures, Colorado Springs, Colorado, 1115 Institute.

**3** WHEEL Gasoline scooter with 2 speed transmission. Blue prints \$1.25. R. Harter, New Castle, Indiana.

**OLD GOLD, WATCHES, JEWELRY, PRECIOUS STONES**

**BRACELETS**, Silver filigree, latest fashion's demand, send \$2.00 for satisfactory sample or money back. Flores, Vallarta 1994, Guadalajara, Jalisco, Mexico.

**5000** REBUILT Elgin, Waltham, Hamilton watches. Also ladies, gents wrist watches. Make big money! 12 size, 7 jewel, Elgin or Waltham, \$4.75; 16 size, 17 jewel, \$7.50. Send for free watch and diamond catalogue. The New York Jobbers, Dept. M, 74 Bowery, New York, N. Y.

**WATCHMAKERS'** Supplies, tools, watches. Sold, purchased. Ben Segal, 5 South Wabash, Chicago.

**AUSTRALIA'S** Lovely opals. Illustrated catalogue free. Good selection \$5. Norman Seward, Melbourne, Australia.



**HIGHEST** Prices for old gold, teeth, watches, jewelry. Full cash value mailed day shipment received. Satisfaction guaranteed or articles cheerfully returned. Information free, or ship today. Chicago Gold Smelting Co., 300-P Champlain Bldg., Chicago.

**GOLD \$35 Ounce.** Ship old gold teeth, crowns, jewelry, watches—receive cash by return mail. Satisfaction guaranteed. Free information. Dr. Weisberg's Gold Refining Co., 1500-Q Hennepin, Minneapolis, Minn.

#### RAZORS—BLADES—SHARPENING

100 SINGLE Edge blades \$1., U. S. only. Brandt, Markle, Indiana.

**ELGIN** Advertised electric razor—\$1.75 postpaid. DMH Sales, Box 225, Ambridge, Penna.

**SENSATIONAL** Electric dry shaver \$2.25 postpaid. Latest dual type cutting head. Closes shaves. Unconditionally guaranteed. Western Dry Shaver, Wichita, Kans.

#### SURVEYING INSTRUMENTS

**GUARANTEED** Factory rebuilt transits and levels for rent (with purchase option) or sale (cash or terms). Order now before prices advance. We will repair, trade in, or buy your old instruments. Ship prepaid for estimate and valuation. Write for List M-314 and complete information to Warren-Knight Co., 136 N. 12th St., Philadelphia, Penna.

#### FOR SALE OR EXCHANGE

**PAINT!** 10,000 Gals. Buy! Sell! 80c gal. Dawson, 408 Broadway, Newark, N. J.

#### WANTED—MISCELLANEOUS

**CASH** For used microscopes, binoculars, cameras, slide rules, drawing sets, surveying, mechanical, scientific, and musical instruments. Highest prices paid day shipment received. Satisfaction guaranteed or shipment promptly returned. Elman's, 2302 Van Buren, Chicago.

#### TOBACCO

**GUARANTEED:** Cigarette, pipe or chewing, 5 lbs. \$1.00, ten \$1.75. Pay when received. Pipe and box cigars free. Rives Tobacco Co., Paducah, Ky.

#### PERSONAL

**FOOT-REM** For athletes foot. Powerful germicide and antiseptic. Money back guarantee. \$1.00 postpaid. Klee Products, 39th and McGee, Kansas City, Missouri.

**TREASURE Finders?** Read Goldak advertisement on page 133A.

**ORIGINAL** Poems, songs wanted immediately for publication. Westmore Music Corporation, Dept. 33J, Portland, Ore.

**NERVOUS?** Fears? Depressed? Afflicted? Free helpful information. Norman Ferngold, Psychologist, Office 15, 22 Amherst St., Worcester, Mass.

**WIN** Prize money: Booklet—"Successful Contesting"—shows how. 10c postpaid. Bulletin listing \$200,000.00 prizes included. World Publishers, 4515-B Cottage Grove, Chicago.

#### MISCELLANEOUS

**LAM-A-FAB**, The cloth cement, acid and waterproof. Permanently repairs anything made of cloth. Sails, hunting equipment and suits, football suits and athletic equipment, rugs, canvas chairs and work clothing. S. J. Russell Co., P. O. Box 187, Peoria, Ill.

**BUSINESS** Proposition resilvering mirrors, autoparts, reflectors, making chipped glass signs. Write, Sprinkle, Plater, 288, Marion, Indiana.

**MONEY** In butterflies, moths. See Sinclair Display Advertisement on page 16A.

**GOOD** Eyesight without glasses. No drugs. Results guaranteed. Representatives wanted. Arthur Jacobson, Upsala, Minnesota.

**MANUAL** Of locksmithing. Send for application. Christison's, 1019 - 14th, Denver.

**FITTINGS** Make oil drum wood stoves—homes, brooders, camps, garages, shops. Wilkie, Independence, Missouri.

**MONUMENTS.** Low prices. Lettered. Delivered. Guaranteed. Reliable Marble-Granite Company, A17, Oneco, Florida.

**SIGNATURE** Engraved on copper plate, mounted on beautiful desk fixture. \$1.00. Edward Karl, 75 Newell, Painesville, Ohio.

**MEXICAN** Bridge cards, with feathered birds. Send 20c stamps for samples. Paez, Apartado 754, Monterrey, Mexico.

**SHINE** By night, luminous paint, three colors, glass made reflectable. Quarter brings instructions. D. Kirk, Box 208, Grove City, Penna.

**YOUR** Social security card exact duplicate. Attractive lifetime bronze plate with leather holder, 25c postpaid. Craft, 230 West 21, New York.

**BUSINESS** Encyclopedia, valuable formulas, other priceless information, \$1.00 postpaid. Circular free. Bodnar, Box 403, Northfork, W. Va.

**COPROLITES**, Jasper, opalized wood, agates, 25 to 75 cents each. Box 808, Tacoma, Washington.

**COLLECTORS**, Swappers, contest fans, investigate free trading service. Exchange, Box 425, Detroit.

**POOL** Your friends! Make believe you are here. 20c stamps brings you 2 scenic postcards (\$1.00 for 20). Fill them your own handwriting and return for free mailing; we pay postage. Marquez-PMA, Apartado 1176, Mexico City.

**TREASURE Finders?** Read Goldak advertisement on page 133A.

**NEW** Calculator, lightning speed. Invaluable to anyone. \$1.00. Rock Shallow, 516 W. Dominick St., Rome, N. Y.

**TATTOOING** Outfits, supplies, illustrated list free. "Waters," 965 Putnam, Detroit.

**COATS-OF-ARMS** And crests correctly rendered in colors or black and white. Highest grade. Estimates free. Heraldic Studios, 1914 Oakdale Ave., Chicago.

**SWAPER'S** Friend, R4, Saline, Michigan. Interests swappers, collectors. 50c year, sample 10c.

**Turn JUNK IN TO Cash!** **TIRES START AT HOME**

The Most Sensational Business Opportunity Since 1929

Like turning lead into gold, here is a bus ness with a gran tic possibilities. Factories, Clubs, Stores, Schools, Homes, spend millions every year for rubber mats. Think of your profit when a

**HAND MACHINE and**

**5¢ TIRE MAKES \$2.00 MAT**

Brand new. Few men already started report unprecedented success. Wm. Eagle writes: "Can't make mats fast enough. First week brought over 200 orders for \$1.00 to \$10.00 each." Flash from Harris says: "Orders enough to keep 15 men busy all the time." Gunter got big order from County Commissioners and now reports: "Just signed up order for all Grade Schools and High Schools." No wonder responsible men are throwing everything else aside to establish local FABRIX factories.

**COSTS NOTHING** to get complete facts. Just send name and address. We'll send description of simple hand machine that quickly slices old tires into strips; show you how new method forms strips into thick, springy, long-wearing FABRIX Mats—how five cents worth of Junk Tires make a \$2.00 Mat; how you can start on a reasonable investment and build a business so big, so fast, that it will take your breath away. Don't delay a minute. Write or wire today. All information is free. **FABRIX, Inc., 620 N. Michigan Ave., Dept. A-72, Chicago, Ill.**



**There's MONEY IN ARC WELDING!**

"No more tiresome work for me. I get a real thrill out of being an arc welder—and don't forget it. I'm getting more money than I ever earned on hit or miss jobs."

You, too, can become part of this great new industry! There's almost no limit to what welders can accomplish—they cut manufacturing costs way down. Because they know the "How and Why" of Welding, Metallurgy, Drawing, Blueprint Reading, Set-Up Work and Fabrication.

No wonder manufacturers all over the country are demanding practically trained School of Engineering Welding Operators, Welding Technicians, and Welding Engineers!

Don't be content with ordinary work at low pay—when in a short time you can become a thoroughly Trained Specialist in Welding.

**MILWAUKEE SCHOOL of ENGINEERING**  
Institute of Electrotechnics

Dept. PM-239 Broadway and E. State, Milwaukee, Wis.

Send Free Booklet "ARC WELDING, World-Wide Dawn of a Gigantic Industry." Also tell me how I can become an

Arc Welding Operator in 3½ months..... Gas Welding Operator (6 weeks).....  
Welding Technician (4 months)..... Welding Engineer (1 year).....  
Send details of Student Loan Plan..... Earn Part Expense Plan.....  
Name..... Age.....  
City..... State.....  
If interested in other courses, check here: Refrigeration and Air Conditioning Technician (3 mo.)..... Radio and Television Service Man (6 Mo.).....  
Commercial Radio Engineer (1 Yr.)..... Electrical Engineer B.S. Degree (4 yrs.).....

PM-239



## PARKS AIR COLLEGE

PARKS AIRPORT EAST ST. LOUIS, ILL.

Offers YOU COLLEGE and PROFESSIONAL TRAINING  
Majoring in AVIATION

Accredited by the Illinois Superintendent of Public Instruction, U.S. approved as a Commercial Ground and Flying School and Mechanics' School. Open to high school graduates.

FOUR courses lead to B.S. degrees in Professional Piloting, Aviation Operations, Maintenance Engineering, Aeronautical Engineering.

FIFTEEN TRAINING PLANES are used in professional flight training which prepares graduates for airline flight operations. 74% of graduates enter air transportation in North and South America. 69,000 hours flight training given, 650 hours being flown monthly.

FACULTY of 34 specialists in various fields of aviation.

1569 graduates. Enrollment limited to a total of 300.

100-acre airport, 14 buildings devoted to school purposes exclusively. Dormitories and dining hall at the College.

Spring Term March 27. Send postcard for new 60-page catalog.

12th YEAR Registrar, Dept. PM-2  
PARKS AIR COLLEGE, East St. Louis, Ill.

## DRAFTING'S the JOB for YOU!

LEARN AT HOME

Here is a fine way to make a living and to fit yourself for a BIGGER and BETTER job. Draftsmen are needed everywhere buildings, roads, bridges, tools or machines are built, for these all start on the drafting board. The billions being spent in public works, none call for thousands of draftsmen to prepare the plans. Learn to be a draftsman in spare time at home. Write for FREE bulletin—no obligation.

American School Dept. DD245 Drexel at 58th, Chicago

# LAW

STUDY AT HOME for Personal Success and Larger Earnings. 28 years of successful student guidance assures expert instruction. LL.B. Degree awarded. All text material furnished. Easy payment plan. Send for FREE BOOK—"Law and Executive Guidance," at ONCE.

AMERICAN EXTENSION SCHOOL OF LAW  
Dept. S, 737 N. Michigan Ave., Chicago, Ill.

## EARN A DEGREE AT HOME

Home Study Courses leading to Degrees in Arts; Sciences; Philosophy; Education; Public Health; Psychology; Sociology; Physics; Chemistry; Geology; Pol. Science; Theology; Law; Business Training; Accounting; Statistics; Adv.; Agriculture; Sales; Electrical, Civil, Mechanical, Drafting, Architectural, Automotive, Steam, Diesel, Aeronautical, Radio, Structural, Industrial, Highway, Petroleum, Mining, Marine, Refrigeration, Air Conditioning, Chemical Engineering. Founded 1908. Chartered. McKinley-Roosevelt Graduate College, 4213 Clarendon Ave., Chicago

## Learn ADVERTISING at Home

Greater opportunities now in advertising. Learn easily and quickly in spare time. Practical work. No text books. Old established school. Low tuition—Easy terms. Send for free booklet and requirements.

Page-Davis School of Advertising  
Dept. 1352, 3601 Mich. Av., Chicago

## PIANO — HAWAIIAN (STEEL) GUITAR SPANISH GUITAR...easily learned at home

Become a skilled musician by our simple, short-cut note method. Play songs almost instantly. COST LESS THAN 2¢ A DAY! Money back guarantee. Write for free details. HAMANN INSTITUTE, 3016 N. 24th Place, Dept. R-2, Milwaukee, Wis.

## Original POEMS—SONGS WANTED FOR PUBLICATION

WESTMORE MUSIC CORP.

Dept. 33F

Portland, Ore.

## Yes! YOU CAN MAKE BIG MONEY WITH HOOVER UNIFORMS!



Big earnings for ambitious men and women in new uncrowded field with famous nationally-advertised Hoover line of smart, exclusive uniforms for restaurants, hotels, taverns, stores, offices, doctors, dentists, etc. Not house-to-house. No experience—no money needed to get into this new, big-income business. Mail postcard now for beautiful new Uniform Style presentation, actual samples and money-making equipment—sent FREE.

HOOVER 251 West 19th Street  
Dept. AJ-9 New York

# START DRAWING BIG MONEY!



LEARN TO DRAW AT HOME

MAKE \$30-\$50-\$75 A WEEK

Be an Artist and be your "own boss." You can learn AT HOME in your spare time this practical way—famous since 1914. There's a real future in this fascinating and profitable field for both men and women. If you have the desire to be an Artist, our training should give you the ability to earn good money.

## COMMERCIAL ART CARTOONING and DESIGN

All in ONE practical course



### PICTURE BRINGS \$25

—Miss G. A. Hill of Cedar Vale, Kans., has sold several paintings. One small picture for \$25.

### \$500 IN SPARE TIME

—E. Gandre of Sheboygan, Wis., average that amount in a year for spare time Art work.

### THANKS WSA FOR JOB!

—J. BEARD of Columbus, Ga., credits our course as sole reason for job as Art Director in advertising agency.

## This is the way you learn to BE AN ARTIST!

Our proven method of home instruction includes all of the important branches of Commercial Art. Your drawings are corrected and criticized by experienced Art instructors. You start by drawing straight lines and in advancing from lesson to lesson you receive all the personal constructive help you need.

## Mail coupon today for FREE BOOK

This colorful, illustrated book explains our course in detail and describes the TWO ARTISTS' OUTFITS given at no extra cost! They include everything you need to get started.



## FREE BOOK gives details!

WASHINGTON SCHOOL OF ART  
Studio 122M, 1115—15th Street, N. W.  
Washington, D. C.

Without obligation, please send me your Free Book, "Art for Pleasure and Profit."

Name..... Age.....

Address.....

City..... State.....



# Know! YOUR CAR

ASK TO SEE IT!

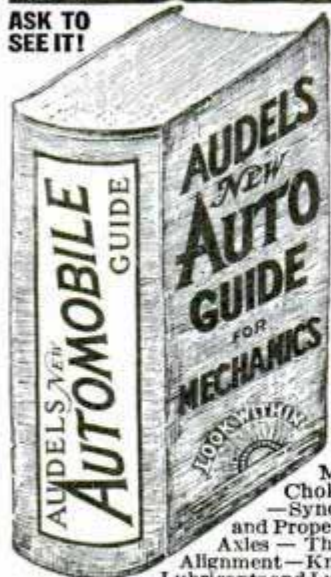

**GOOD NEWS—JUST OUT**  
**AUDELS NEW AUTOMOBILE GUIDE** is NEW from cover to cover. Explaining the Theory, Construction and Servicing of modern motor cars, trucks and buses; and the application of auto type Diesel Engines. . . . **PRACTICAL INFORMATION IN HANDY FORM, 1540 PAGES COVERING . . .**

**AUTO REPAIRS & SERVICE HELPS**  
 All the Parts of an Automobile—Automotive Physics—The Gas Engine—How a Gas Engine Works—Gas Engine Principles—Multi-Cylinder Engines—Horse Power—Automobile Engines—Engines; Stationary Parts—Engines; Moving Parts—Pistons—Piston Rings—Connecting Rods—Crank Shafts—The Valves—The Valve Gear—Cams and Cam Action—Valve Timing—Cooling Systems—Gasoline—Fuel Feed Systems—The Mixture—Carburetors—Automatic Choke—Super-Chargers—Transmissions—Synchro-Mesh—Clutches—Universals and Propeller Shafts—The Differential—Rear Axles—The Running Gear—Brakes—Wheel Alignment—Knee Action—Steering Gear—Tires—Lubricants and Lubrication—Automotive Electricity—Ignition Systems—Magneto Ignition—Spark Plugs—Ignition Coils—Distributors—Automatic Spark Control—Ignition Timing—Generators—Starters—Generator and Starter Testing—Lighting Systems—Storage Batteries—Battery Charging—Battery Testing Troubles. **Automotive Diesel Engines. Inside Views of all Automobile Parts Fully Illustrated. To Get This Assistance for Yourself! Simply Fill In and Mail Coupon Today.**

**\$4 COMPLETE • PAY ONLY \$1. A MONTH**

**THEO. AUDEL & CO., 49 WEST 23rd STREET, NEW YORK**  
 Please send me postpaid AUDELS NEW AUTOMOBILE GUIDE (\$4) for free examination. If I decide to keep it, I will send you \$1 within 7 days; then remit \$1 monthly until purchase price of \$4 is paid. Otherwise, I will return it to you promptly.

Name \_\_\_\_\_  
 Address \_\_\_\_\_  
 Occupation \_\_\_\_\_  
 Reference \_\_\_\_\_ -PM



## Fascinating, Profitable Profession NOW OPEN to More Men & Women

If you are looking for a **NEW** and **BETTER** way to make a living, take up Swedish Massage, for now you can learn at home. This interesting big pay profession was for years available only to a few. Its secrets were guarded jealously and fabulous prices were paid for instruction. This same instruction is now available to you at a mere fraction of the former price and you need not leave your present work until you have qualified as an expert and can command an expert's pay. The demand for **BOTH MEN AND WOMEN** has shown a steady increase and few, if any, have ever lacked employment.

**LEARN IN 90 DAYS AT HOME**  
 Use spare time at home to master a profession which has made thousands of dollars for ambitious men and women. Many graduates have completed their training in three months but you can take your own time, it need not interfere with either work or pleasure. All instruction has been prepared by the teachers in our famous resident school—the same material is used and a **DIPLOMA** is awarded upon graduation.

**ANATOMY CHARTS AND BOOKLET FREE**  
**No Obligation Of Any Kind SEND COUPON**

**THE COLLEGE OF SWEDISH MASSAGE** (Successor to National College of Massage), Dept. 264—1601 Warren Boulevard, Chicago.  
 You may send me **FREE** and postpaid, Anatomy Charts, booklet containing photographs and letters from graduates and complete details of your offer.

Name \_\_\_\_\_  
 Address \_\_\_\_\_  
 City \_\_\_\_\_ State \_\_\_\_\_

When writing please mention Popular Mechanics

# EASY TO PLAY — EASY TO OWN



You've always wanted to play this fascinating instrument. Now there is no reason to delay. Now you may thrill family and friends, with a chance to earn extra cash at dances, entertainments and on the radio. For now there is a genuine **DEAGAN Marimba** (including complete, easy lessons) at the lowest price in history. . . . To write for details **TODAY** may easily mean a **LIFETIME** of pleasure, profit and popularity!

**J. C. DEAGAN, Inc., 3452 Deagan Building, CHICAGO**

## MAKE MONEY with your CAMERA

Thousands of publications buy **MILLIONS** of photos yearly from amateurs. We show you what to photograph, how to do it, where to sell for biggest profits. Learn at home to become a journalistic or press photographer. Use any camera. Write for **FREE BOOK** course in easy installments. **UNIVERSAL PHOTOGRAPHERS, Inc., Dept. 72, 10 W. 33rd St., N. Y. C.**

## do-it-with-squabs

Ready for market **ONLY 25 DAYS OLD**. Write a post-card, get **FREE EYE-OPENING Picture Book**. Why breed for ordinary trade when these great luxury national markets are wide open for all the **SQUABS** you can ship, every day in the year? Go after this desirable, profitable trade now.

**RICE FARM, 636 H St., Melrose, Mass.**

## Best Poultry Paper 6 BIG ISSUES 10¢

Helps increase Poultry Profits. Send coin or stamps, 50 cents for 3 years or 10 cents for 6 months trial. Agents wanted. **American Poultry Journal** 632 So. Clark Street Chicago, Illinois

## ARTISTS MAKE MONEY

Find out your ability. Send name, age, occupation and address for Free Vocational Art Test.  
**Federal Schools, Inc., 2139 Federal Schools Bldg., Minneapolis, Minn.**

## Learn Public Speaking

At home—in spare time. Many overcome "stage-fright," gain self-confidence and increase earning power, this easy way. Write for free booklet, *How to Work Wonders With Words* and requirements.  
**North American Institute, Dept. 1352, 3601 Michigan Ave., Chicago, Illinois**

## POPULAR PLATFORM POEMS

Choice collection of poems ever assembled under one cover—a necessity for the accomplished platform speaker. Dramatic narratives, gems of humor. 70 poems by famous authors including Service, Cooke, Gillilan and Guest. Postpaid \$1.25.  
**T. S. DENISON & CO., 203 N. Wabash, Dept. 24, Chicago, Ill.**

## AGENTS 300% Profit SIGN LETTERS

For Store Fronts and Office Windows. Anyone can put them on. Free Samples. Liberal Offer to general agents.  
**METALLIC LETTER CO., 438 N. Clark St., Chicago**

## Own A Profitable Greaseless DOUGHNUT BAKESHOP Start In Your Kitchen!

Who else wants to enjoy profits from this amazing new business you can start in your own kitchen? New electrical invention turns out delicious, different Brown Bobby Doughnuts. Everybody wants them! Stores eager to sell for you. Big daily profits possible selling production of one machine at wholesale only. We supply equipment and tested money making plans. This is your chance. Send No Money. Rush postcard for **FREE** details.  
**BROWN BOBBY CO., 620 N. Michigan Ave., Dept. D-182, CHICAGO, ILL.**





NEW INVENTIONS K1323

(Continued from page 33A)

SOMETHING new in hair-waving devices has just been patented. It consists

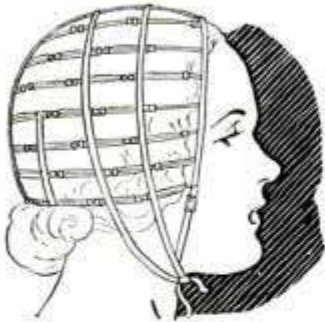

of a netlike flexible webbing adapted to be secured to the head. It incorporates a number of parallel strands with a series of combs that slide on the strands. Each comb has a

number of teeth for holding the hair in position to produce the wave effect. Sliding the combs along the strands aids in training the hair in the direction desired. The entire device is worn like a cap while the hair is being waved.

FOR the use of amateur or professional, a handy wrench has been patented. It

consists of a hollow handle with openings on one side and slots on the other. To the handle, at the top, is attached a flexible metal band. The free end of the band is shaped to engage the slots. The wrench is operated by fastening the band around a nut or bolt and securing the free end in one of the slots. Round screw caps also may be turned by this means.



ANY housewife who has used the various types of glass coffee makers now on the market knows how difficult it is to prevent breakage of top or bottom bowls. A patent for a coffee-maker safety guard has been issued. It consists of

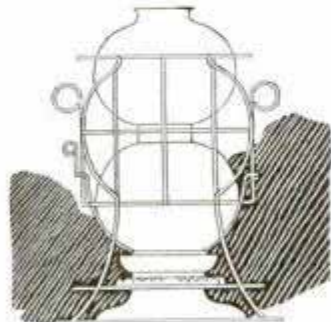

an openwork cage-like frame supported on the base of the coffee maker. The frame holds the glass bowls firmly enough to prevent tipping or dropping.

(Continued to page 58A)

CHIEF ENGINEER • ASSISTANT ENGINEER  
SALES ENGINEER • SERVICE MANAGER • DESIGNER

WILL You  
HOLD ONE OF  
THESE Good  
Jobs?

INSTALLATION FOREMAN  
SHOP SUPERVISOR  
SERVICE ENGINEER  
SHOP FOREMAN  
LAYOUT MAN

### Prepare Yourself For a Good Job

...in an industry *actually looking* for good men. Cinch your future! Take Thermo Institute's unmatched training in Air Conditioning and Refrigeration. Your practical training prepares you to step right into practical work. And it takes just a few months of *this* kind of training for a lifetime of real earning

power and job security. Courses to fit your personal circumstances...either at one of the three Thermo Institute laboratories or right in your own home.

**SEND COUPON FOR FULL DETAILS**

**THERMO AIR CONDITIONING INSTITUTE**

1755-A Broadway, New York, New York  
125-A W. Hubbard Street, Chicago, Illinois  
182 So. Alvarado Street, Los Angeles, Calif.

Please send complete information on Thermo Institute training for Air Conditioning and Refrigeration opportunities.

NAME \_\_\_\_\_ AGE \_\_\_\_\_

ADDRESS \_\_\_\_\_

CITY \_\_\_\_\_ STATE \_\_\_\_\_ 1-14-p

Send this Coupon to Thermo Institute address nearest you.



# This MACHINISTS' Home-Study Course



## helps men get ahead

Newly assembled—specially priced—these five recent books give you the practical facts on modern machines, up-to-date methods, you need to advance in machine shop work. Take advantage of the other man's experience as found in books, to solve your problems, increase your efficiency, with

### The NEW AMERICAN MACHINISTS' LIBRARY

5 volumes—2014 pages—1853 illustrations

(A combined home-study course and reference library)

This library of machine shop practice was written for practical men. It gives you the best methods for every kind of machine shop work. It fully explains lathes, drills, and other machine tools and their operation, automatic screw machines, speeds and feeds, gear design and production, punch and die work, metal surfacing, etc., etc. Plainly written—completely illustrated—the best kind of help to the machine shop man who wants to advance himself.

No money down—special price—easy payments.

#### EXAMINATION COUPON

McGRAW-HILL BOOK CO., 330 W. 42nd St., New York

Send me for ten days' examination the new American Machinists' Library. If satisfactory I will send you \$1.50 in 10 days and \$3.00 monthly until the price of \$16.50 is paid. If not wanted, I will return the books postpaid. (To insure prompt shipment write plainly and fill in all lines.)

Name.....  
 Home Address.....  
 City and State.....  
 Position.....  
 Name of Company..... PM 2-39

# M ECHANICS-WELDERS - COLLISION MEN

## GOOD JOBS and Mighty GOOD PAY

Do you want to earn big money? If so let us know which of the following trades you prefer. You learn by doing. Practical work. Expert teachers. Low tuition. Personal attention. It will pay you to investigate AT ONCE. Just check the courses you'd like to take and mail today. You will receive full information, absolutely without cost or obligation. But don't delay.

#### Check the Trade You'd Like to Learn

- |   |   |
|---|---|
| <input type="checkbox"/> Complete Auto Mechanics (including Diesel) | <input type="checkbox"/> Electric Arc and Acetylene Welding |
| <input type="checkbox"/> Auto Collision                             | <input type="checkbox"/> Spray Painting                     |
| <input type="checkbox"/> Metal Finishing                            | <input type="checkbox"/> Body and Fender Bumping            |

Ask about our "Pay After Graduation Plan"

Name.....  
 Address.....

Mail the above at once to

**MICHIGAN TRADE SCHOOL** **Write for FREE FOLDER**  
 3758 Woodward Ave. Detroit, Mich.

When writing please mention Popular Mechanics

### NEW! COMPLETE and Up-to-the Minute Book on HOUSE WIRING

Covers, in great detail, all phases of practical wiring for homes, garages, farm buildings, etc. Written in the simplest language; describes and illustrates fuses, circuits, switches, installation plans; also wiring diagrams; over 200 illustrations; cloth binding \$1.50 postpaid. 5-day money-back guarantee.

**FREE** Catalog of practical books on Painting; Decorating; Commercial Art; Sheet Metal; Welding; Radio; Electricity; Diesel Engines; Carpentry; Plumbing; Heating and Ventilating.

**FRED'K J. DRAKE & CO., 129 N. Michigan Av., Chicago**  
 Drake's Books Sold at All Good Book Stores

### AN AVIATION CAREER OFFERS YOU GREAT FUTURE!

Demand for trained aircraftsmen is increasing and already exceeds supply. Curtiss-Wright Tech, Aviation's foremost and oldest school, is located on Grand Central Air Terminal in heart of the aircraft industry and specializes in training **MASTER MECHANICS and AERONAUTICAL ENGINEERS.** (No flying involved.) Graduates are obtaining immediate employment. Write for details NOW. Dept. P.M.-2.

**Curtiss-Wright Technical Institute, Glendale (Los Angeles) California**

### Industry Needs MECHANICAL ENGINEERS

Big opportunities for men with Engineering training. Promote yourself by preparing for jobs as Engineer, Superintendent, Master Mech., Factory Eng., Chief Draftsman, Gen'l Foreman. You mechanically employed men don't have to change lines to win promotion, but do have to get ready for jobs ahead. Write today for method for preparing for this well-paying profession. No obligation.

**American School, Dept. M245, Drexel at 58th, Chicago**

### STUDY ENGINEERING AT HOME

Home Study Courses leading to Degrees in Electrical, Civil, Mechanical, Drafting, Architectural, Automotive, Steam, Diesel, Aeronautical, Radio, Structural, Mining, Industrial, Highway, Petroleum, Marine, Refrigeration, Air Conditioning, Chemical Engineering; Arts; Sciences; Philosophy; Education; Public Health; Psychology; Sociology; Physics; Chemistry; Geology; Pol. Science; Theology; Law; Agriculture; Business Training; Accounting; Statistics; Adv.; Sales. Founded 1908. Chartered McKinley-Roosevelt Graduate Colleges, 4220 Clarendon Ave., Chicago

### LEARN CARTOONING

by the method that has developed hundreds successfully. Send name, address and age for free chart to test your ability.

**THE LONDON SCHOOL, 1739 National Bldg., Cleveland, Ohio**

### MAGIC EASILY LEARNED

Amaze your friends with sleight-of-hand tricks! Easy to learn—completely baffling. No special apparatus required. Written by well-known magician, profusely illustrated, including patter for each trick. 24 tricks, \$1.00 postpaid.

**T. S. DENISON & CO.**  
 203 N. Wabash. Dept. 23, Chicago, Ill.

### NEW YORK SCHOOL OF MECHANICAL DENTISTRY

Earn big money in a few months. We show you how. Real Laboratory Training. OLDEST school. Day, Eve. Easy terms. Ask for free Catalog P and tool offer.

**N. Y. SCHOOL OF MECHANICAL DENTISTRY, 125 W. 31 St., N. Y. C.**

### RADIO ENGINEERING

broadcasting, aviation and police radio, servicing, marine and Morse telegraphy taught thoroughly. 48 weeks' engineering course equivalent to three years' college radio work. School established 1874. All expenses low. Catalog free.

**Dodge's Institute, Ada St., Valparaiso, Ind.**

### KAR-NU BEAUTIFIES OLD CARS WITH SPARKLING NEW FINISH!

**PAYS UP TO \$7 IN AN HOUR!**

KAR-NU refinishes any color automobile easily, quickly and economically without polishing, waxing, rubbing or painting.

**JUST WIPE IT ON WITH A CLOTH!**  
 Magic-like fluid covers old paint with tough, elastic coat. Absolutely transparent, self-leveling, self-polishing. Guaranteed. Lasts 8 to 12 months. As beautiful as a fine paint job—saves need for \$25 to \$75 refinishing expense. Write for Free Sample to prove our claims and Territory offer.

**KAR-NU CO. Dept. P-30, Oakley Sta. Cincinnati, O.**



**BE a RADIO TELEVISION EXPERT**  
**TRAIN AT HOME FOR GOOD JOB** → *In Spare Time at Low Cost!*



No Question about it—Television here in a big way—leading companies now selling home television sets. Many new stations starting. 1939 to be a Big Boom Year.

**TRAIN for TELEVISION and RADIO, TOO for Jobs Now and in Future**

MY NEW EASY TRAINING SYSTEM at Low Cost opens Quick Way to pleasant jobs at good pay and **YOU SAVE UP TO 80%** on usual cost. Over 100 lessons. Get

in ahead of others and "build up" with the world's next Billion Dollar Industry. Get ready NOW to **CASH IN BIG** as Television sweeps the country.

**10 LESSONS SENT YOU ON FREE TRIAL** Send No Money Pay No C. O. D.

Write today for 10 FREE TRIAL Lessons (fully illustrated) sent immediately and postpaid for 5 days Free Trial. Examine them, study them, learn all these 10 lessons teach you—then, if not delighted, return the lessons and

pay nothing. You have everything to gain, nothing to lose. Find out what radio-television offers you. Hundreds of men NOW SUCCESSFUL in Good Pay Jobs after training under my direction. Write immediately to

**S. Q. NOEL, President UNIVERSAL TELEVISION SYSTEM of Training, Box 601-G, Kansas City, Mo.**

**SEVEN WONDERS of the WORLD FREE**

Pictured in FULL COLOR—Each 7 1/2 x 10 1/4". Send only 10c to cover mailing costs. The wonders you have longed to see, reconstructed from recent discoveries and painted by famous artists, so you can view them at the height of their glory and read their stories. 24 page booklet. Educational! Entertaining! Mail 10c to

**WM. H. WISE & CO., Dept. 562, 57 West 47th Street, New York City.**

Send for my book how to develop

**STRONG ARMS and BROAD SHOULDERS**

with 20 full pages of illustrations, showing and fully describing exercises that will quickly develop, beautify and make you gain great strength in your Shoulders, Arms, Wrists, Hands and Fingers. Without any apparatus. This is really a remarkable course of Physical Culture exercises. Don't fail to send for it NOW. 25c coin or 30c U. S. Stamps.

**ANTHONY BARKER**  
 1235 6th Ave. Studio P. New York City

**PHOTO-ENGRAVING** TASOPE' SINCE 1931

TASOPE', world's largest builders of complete Photo-Engraving Plants. We supply newspapers, printeries, studios, colleges, high schools and individuals with precision-built equipment, and give thorough training in Photo-Engraving and Photography, (home or residence)—all at one low cost! Cash in on popularity of pictures. Big money working full or part time for others, or open your own well-paying business. Amazingly small investment. Cash or terms. Catalogs free.

**THE AURORA SCHOOL OF PHOTO-ENGRAVING**  
 Dept. PM-1 Tasope' Bldg. Aurora, Mo.

Ask for FREE Catalog

**... ITALIAN ... ACCORDIONS**

Latest Models — Buy direct from factory representative at lowest **WHOLESALE PRICES**. Save One Half. Used musical instruments taken in trade. Write now.

**ITALIAN ACCORDION MFG. CO., 323 W. Polk St., Dept. P-9 Chicago**

**NOW YOU CAN GET A HEAVY DUTY INDUSTRIAL WELDER**

Works Off 110-Volt Light Socket

This marvelous DYNAMIC Power Welder will do the work of much higher priced types. It is easily portable, **WELDS** Cylinder Blocks, Bumpers, Fenders, Tanks, Farm Machinery, and etc. Will also solder and braze on the lightest material. Works on iron, steel, tin, brass, copper and all other metals. Men without previous experience can make as much as \$5.00 on a one hour repair job. Go into business—Open a Welding Shop NOW. **AGENTS**—Make big profits selling to garages, factories, janitors and machine shops. Write TODAY for our 10-DAY TRIAL OFFER.

**DYNAMIC WELDER COMPANY**  
 2226-GG Silvertown Road Chicago, Illinois

for Only \$195 RETAIL



RAILWAY MAIL CLERK GOVERNMENT CLERK MAIL CARRIER POSTOFFICE CLERK

**DO YOU WANT \$36.50 A WEEK?**

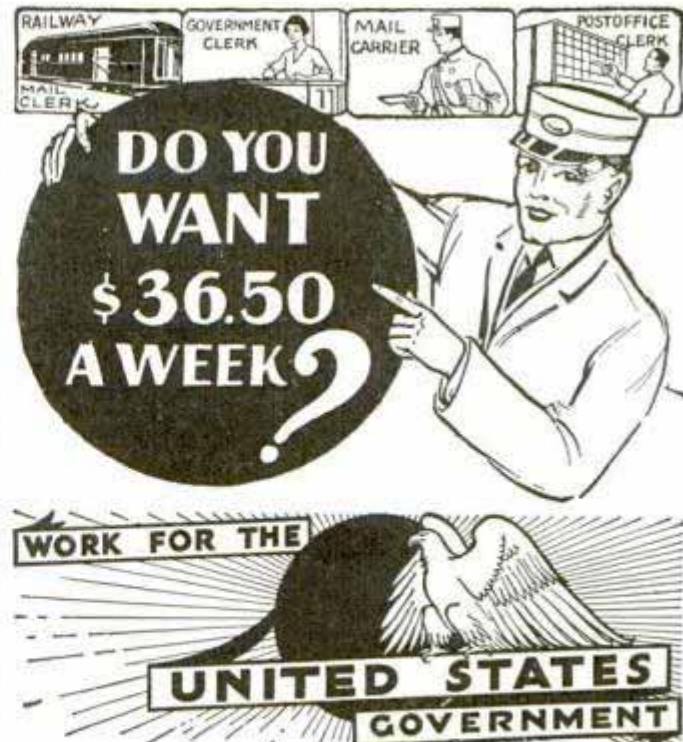

**WORK FOR THE UNITED STATES GOVERNMENT**

**START \$1260 to \$2100 YEAR MANY 1939 APPOINTMENTS EXPECTED**

Railway Postal Clerks get \$1,900 the first year regular, being paid on the first and fifteenth of each month. (\$79.17 each pay day.) Their pay is automatically increased yearly to \$2,450. Advance may be had to Chief Clerk at \$2,700 a year. (\$112.50 each pay day.)

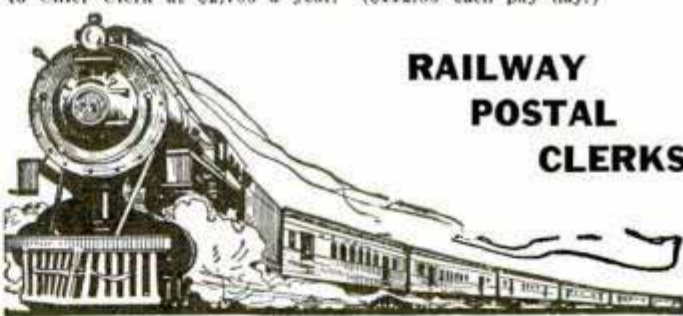

**RAILWAY POSTAL CLERKS**

**3 Days On—3 Days Off—Full Pay**

Railway Postal Clerks on long runs usually work 3 days and have 3 days off duty in the same proportion. During this off duty their pay continues just as though they were working. They travel on a pass when on business. When they grow old, they are retired with a pension.

**City Mail Carriers, Post Office Clerks**

Clerks and Carriers now get \$1,700 the first year on regular and automatically increase \$100 a year to \$2,100 and \$2,300.

**File Clerk—Clerk**

Open to Men—Women 18 to 50. Entrance salary \$1,260—\$1,440 a year. Appointments as File Clerks and Clerks in the Departments at Washington, D. C., are made from this examination.

**Many Other Positions**

Many other positions are obtainable. Those wishing these positions should qualify at once.

**Get Free List of Positions**

Fill out the following coupon. Tear it off and mail it today—now, at once. This investment may result in your getting a big-paid government job.

**FRANKLIN INSTITUTE, Dept. G173, Rochester, N. Y.**

Rush to me, entirely free of charge (1) a full description of U. S. Government Jobs, (2) Free copy of illustrated 32-page book, "U. S. Government Positions and How to Get Them"; (3) List of U. S. Government Jobs; (4) Tell me what to do to qualify for one of these.

Name .....

Address .....

Use This Coupon Before You Mislay It. Write or Print Plainly

When writing please mention Popular Mechanics



# Warning!

When You Say "Webster's Dictionary"  
You MEAN the MERRIAM-Webster



Accept Nothing Less Than  
the "SUPREME Authority"

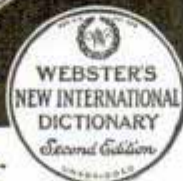

Look for the Merriam-Webster circular trademark on the cover. The New Second Edition of Webster's New International (unabridged) is 20 years newer, contains 122,000 more entries than any similar dictionary. Provides information in all branches of knowledge. The authority in courts, colleges, newspaper offices. Prepared by 207 of the world's foremost experts. 600,000 entries; 3,350 pages. 12,000 terms illustrated. Ask your bookdealer, or write for free illustrated pamphlet.

G. & C. MERRIAM CO., DEPT. 220, SPRINGFIELD, MASS.



## AUTO BOOKS SENT FREE

on approval. Just mail the coupon and we'll send you a set of these remarkable auto books, just off the press. Whether you are a mechanic or helper, expert or apprentice, auto owner or driver, if you're interested in knowing all about automobile mechanics, take advantage of this FREE OFFER.



### CAN YOU FIX IT?

These wonder books tell step by step HOW to take out "play" in differential - to kill the shimmy in steering - to set TIMING - how to put your finger instantly on engine trouble and then the quick expert way to FIX it. Newest improvements fully covered. Equal to a complete trade course at less than a fourth the cost.

6 BIG VOLUMES  
Brand New Edition  
2500 pages, 2000 illustrations, wiring diagrams, etc., including Marine Engines, Aviation Motors, Diesel engines, etc. De Luxe edition, gold-stamped flexible binding.

### GET A BETTER JOB

A better job—in the gigantic auto industry. BIGGER PAY—a chance to go into business for yourself and get a share of the huge profits, are waiting for any man who even half tries to improve himself. Learn auto engineering with these wonder books a new way—without studying or memorizing. Simply use the JIFFY INDEX to look up the answer to any auto problem. Built by eleven of America's greatest automobile engineers, and written in simple language so you can understand it. Very newest cars, all covered.

**FREE Privilege of consulting Automobile Engineers of American Technical Society for one year without cost if you mail coupon immediately**

Send NOW and we will include an EXTRA volume full of up-to-date diagrams.

AMERICAN TECHNICAL SOCIETY,  
Drexel Ave. & 58th St., Dept. A219, Chicago, Ill.  
I would like to see the new 6-volume edition of your AUTO BOOKS. I will pay the few cents delivery charges only, but if I choose to, I may return them express collect. If after 10 days use I prefer to keep them, I will send you \$2 and pay the balance at the rate of only \$3 a month, until \$24.80 is paid. Please include free membership and extra Volume 7, as per your offer above.

Name.....  
Address.....  
City..... State.....  
Attach letter stating age, occupation and name and address of employer and that of at least one business man as reference.

# Sensational New Business



BRINGS  
STARTLING  
PROFITS

Here's a chance for independence and quick success. Own a store like this—an easy, pleasant, dignified business you can be proud to operate. Greatest success in years. Takes but little money to start.

*Carmelcrisp*

## CARAMEL POPCORN STORES

Make and sell the world's most delicious popcorn confection—plump, tender, healthful popcorn coated with flavory, tasty caramel candy. Made under special, time-tested secret success formula. Different from any other—more savory, more delicious, more successful. No experience needed. We help start you—supply equipment, formulas, plans, guide you to success.

### FREE—"Golden Kernels of Profit"

FREE book tells how others are making big money and how you can do it. Brings positive proof of sensational earnings and gives you chance to get in a real business of your own—quickly—easily—while it's new and best. Write for facts. No obligation.



LONG-EAKINS CO., 228 High St., Springfield, Ohio

# WINTER FARM RELIEF!



Here's farm relief no farmer can afford to be without—EN-AR-CO (Japanese style) OIL. Stimulates local circulation for the relief of pains of Neuralgia, Sprains, Sore Muscles, Fatigue and Exposure, also the discomfort of Head Colds and Bronchial Irritation. EN-AR-CO has been doing it for over 50 years. Best Insurance against a crop of troubles. Get EN-AR-CO today and get your quick pain relief. All Drugists.

NATIONAL REMEDY CO. MADE IN U.S.A. NEW YORK



## Selected HELPFUL BOOKS

SEND NO MONEY—Sent C. O. D. Anywhere in U. S.

<b>AIR CONDITIONING</b> Furnaces, Unit Heaters. \$3.00	<b>HIGH-SPEED DIESELS</b> New, practical, non-technical. \$2.50
<b>AIRPLANE SERVICING</b> Manual, New, 1000 Pages, Illus. \$6.00	<b>HOME GROUNDS</b> Furnishing. \$0.80
<b>AUTO RACING</b> Build Midget and Other Racers. \$1.00	<b>LEATHER MAKING</b> and Tanning. \$1.00
<b>AUTO REFINISHING</b> Duco With Spray Gun. \$1.50	<b>METAL SPINNING</b> Practical New Book. \$1.00
<b>AUTO SERVICE SHOP</b> Management, Money-making ideas. \$1.50	<b>METALLURGY</b> New, Metals, Alloys In Use To-Day. \$1.50
<b>BLUEPRINT READING</b> For Machine Trades. \$1.50	<b>MONEY-MAKING FORMULAS</b> 10,000 Practical. \$4.00
<b>BRICKLAYING</b> Plain and Fancy. \$1.50	<b>OIL HEATER HANDBOOK</b> Manufacture, Distribution, Installation, etc. \$3.50
<b>BUSINESS CORRESPONDENCE</b> and Office Management. \$1.75	<b>PLASTERING</b> Best Instruction Manual. \$1.25
<b>CARBURETORS (All Makes)</b> New, Revised Edition. \$3.00	<b>RADIO PHYSICS COURSE</b> New edition. Everything about Radio. \$4.00
<b>CHEVROLET SIX</b> Car, Truck, Operation Repair. \$2.50	<b>SHEET METAL</b> Construction Work. \$2.50
<b>COLONIAL FURNITURE</b> Making, 95 Pieces. \$3.50	<b>STEAM ENGINEER'S LICENSE</b> How to Obtain. \$2.00
<b>DANCE</b> Learn at Home Without Music or a Partner. \$2.00	<b>WOOD TURNING</b> Course In. \$1.50
<b>FOUNDRY WORK</b> Molding, Casting, etc. \$2.00	<b>WROUGHT IRON WORK</b> Practical. \$1.35

These famous Pay-Raising, Extra-Money Books have helped thousands of others. Let them help you too. Check this list and mail with your name and address. Pay postman on delivery, price plus small C.O.D. fee. Or remit with order and books will be sent postpaid anywhere in the world.

POPULAR MECHANICS PRESS  
Room 239B, 200 East Ontario St., Chicago





**FREE BOOK TELLS HOW YOU CAN LEARN TO**

**MOUNT BIRDS and ANIMALS**

**BE A TAXIDERMIST—Learn by Mail**

Easy home lessons teach you quickly how to MOUNT BIRDS, ANIMALS, GAME-HEADS, FISH—to TAN LEATHER, FURS. Save your hunting trophies. Have a home museum. It's thrilling! Taxidermy is wonderful, FUN, A PLEASURE HOBBY AND A MONEY MAKER.—Investigate! Get this strange FREE BOOK. **EXTRA MONEY:**—Earn in your spare time. Sell your mounts; and do work for other sportsmen. Students report \$30 to \$75 and more per month. Big demand. Fine prices. If you want REAL PROFIT from spare time WRITE TODAY. **FREE BOOK**—with 100 photos of wild game. Tells about Taxidermy and how YOU can learn, easily, quickly. Old reliable school. 275,000 students. — STOP this minute and TEAR OUT THIS AD NOW as a reminder; then write; get the free book. You will be delighted, AMAZED. RUSH postpaid or letter and learn how to have more FUN, FASCINATION, PROFIT. State your AGE. Northwestern School of Taxidermy, Dept. 3372 Omaha, Neb.

Game is growing scarcer—every specimen valuable!

**Succeed in Landscaping**

**Get Started in an Interesting Profession**



You like to plan and plant a garden; you have ideas how a home should be landscaped. Whether or not they conform to the dictates of Landscape Architects, they are your plans, your ideas. Why not practice landscaping as a Landscape Expert? You can study at home, at moderate cost—and perhaps earn money while studying!

"On completion of your course I received a raise of \$17.50 a month."—E. D., Ala. "The course paid for itself many times in my spare time work."—E. H., Conn. "I have earned all the way from \$5 to \$400 for single jobs."—A. M. H., Minn. Other graduates speak in like enthusiasm.

Our landscape home study course of training has helped hundreds of men and women become trained Landscape Architects. Lessons are enjoyable, course is thorough. Ask today for details of our course and its money-making opportunities.

**American LANDSCAPE School**

6039 GRAND AVE. DES MOINES, IA.

Please send me your free illustrated booklet, "Success through Landscape Training."

Name .....

Address .....

Age..... Occupation.....

**AVIATION APPRENTICES**



**GOOD PAY GOOD FUTURE**  
AIRMINDED YOUNG MEN INTERESTED IN TRAINING FOR ENTERING THE WELL PAID FIELD OF AVIATION AS APPRENTICES—Write immediately, enclosing stamp.  
**MECHANIX UNIVERSAL AVIATION SERVICE CO.**  
Wayne County Airport, Box 857, Dept. E, Detroit, Mich.

**New York Electrical School** Established 1902  
Ask for free booklet  
44 West 17th St., N. Y. C.

**CARTOONING**  
FREE TRIAL LESSON! Cash in on your sense of humor—AT HOME—BY MAIL. Have fun! Make money! No experience needed to start. Write today for FREE LESSON, mailed postpaid. No obligation.  
Moon Gag-Cartoon School, Dept. A, Fall Creek, Wis.

**TOMBSTONES \$9.00 UP FREIGHT PAID OR ERECTED**  
Marble or Granite of Best Quality. Lettered. Guaranteed. Thousands sold. Write for Free Catalog and samples.  
U. S. MARBLE & GRANITE CO., Dept. A-18, Oneco, Florida

**MAKE MONEY AT HOME RUBBER MOLDS** Low as 6¢ EA.  
Amazing rubber mold-making outfit makes perfect flexible molds of plaques, ash trays, book-ends, etc. Molds cost from 6c to 25c each. Each mold makes hundreds of novelties and gifts to sell up to \$1.00 apiece! No experience necessary. Quick and easy. Start profitable business in your home... sell to stores, gift shops, friends, resorts, road stands, by mail. Full or spare time. "Molders Handy Book" and list of buyers FREE. Write  
**SO-LO WORKS**  
Dept. P-827 Cincinnati, Ohio

When writing please mention Popular Mechanics



**Know Electricity as Experts Know It—and Get an Expert's Pay!**

Recovery has begun! The months ahead are charged with significance and expectation. What will you do to get the jump on the other fellow?  
Thousands of men have used

**The Croft Library of Practical Electricity**

The Croft Library is a complete electrical educator. It is founded on practice—on 20 years of shirt-sleeve experience—on work as it is actually done. It is jammed from cover to cover with the kind of hard-headed facts you want. Written so that the beginner can easily understand it, yet so sound, so thorough, that it is the daily guide of 50,000 highly paid electrical workers and engineers. Croft tells you the things you need to know about motors, generators, armatures, commutators, transformers, circuits, switchboards, distribution systems—electrical machinery of every type—wiring for light and power—wiring of finished buildings—underwriters and municipal requirements—illumination in its every phase—the most improved methods of lighting—lamps and lamp effects, etc.—how to do a complete job, from estimating it, to completion.

**No money down—easy payments**

Fill in and mail the coupon attached and we will send you the entire set of seven volumes for ten days' examination on approval. We take all the risk—you assume no obligation. If you decide to keep the books, send \$1.50 in ten days and the balance at the rate of \$2.00 a month. Send the coupon NOW and see the books for yourself.

**EXAMINATION COUPON**  
**McGraw-Hill Book Co., 330 W. 42nd St., New York**  
Send me for ten days' examination on approval the Croft Library of Practical Electricity. If satisfactory I will send you \$1.50 in 10 days and \$2.00 monthly until the price of \$19.50 is paid. If not wanted, I will return the books postpaid. (To insure prompt shipment write plainly and fill in all lines.)  
Name.....  
Home Address.....  
City and State.....  
Position.....  
Name of Company..... PM-2-39



# Start a POTATO CHIP BUSINESS

IN YOUR KITCHEN *and*  
MAKE MONEY!

Buy Potatoes  
for **2c A POUND**  
Sell Them as  
Vita-Seald Chips for  
**35c A POUND**

**T**HERE'S big money in potato chips for any man or woman who wants a business capable of paying big daily profits from the very start. Just think of it. You can install the wonderful new machine in your kitchen—just manufacture and sack a sensational new kind of "Greaseless" Potato Chip—and let the stores sell them for you. Only \$2.50 invested in raw materials brings back \$10.00 in cash.



**EVERYTHING FURNISHED** You don't have to have a lot of money to start this business. A small investment in the machine puts you in a big profit business of your own. I send you everything including speed-slicer, cooker, oil-extractor (for making new "GREASELESS" chips), a big supply of printed bags and free advertising material. No experience is needed as I send complete, simple instructions showing how to make a profit the first day. Prices, pictures, and complete plans will be sent free for the asking.

**DON'T BUY ANYTHING** Just send your name and address on a post-card for all this free information including the "Secret of Making Greaseless Potato Chips." No obligation, but hurry and you may become independent as so many others have done with these fast selling new "Greaseless" Chips. Address your card to

G. H. Hardt, 620 N. Michigan Ave., Dept. E-52, Chicago, Illinois

## DO YOU LIKE RADIO DOES THE FUTURE OF TELEVISION INTEREST YOU?

Send for  
your  
free copy

You men anxious to make good in radio and related industries want the true facts,—you want to know about employment opportunities and requirements. National Schools,—a million-dollar trade school,—will supply you with a sincerely honest statement of facts on what you should do to get into the profitable radio industry. No exaggerations,—no misstatements. Mail coupon today. I send for your free copy. Real facts on radio employment requirements. If you need real experience. National offers complete training with modern equipment.

**NATIONAL  
SCHOOLS**  
*Los Angeles*

Request for **FREE BOOK** of DETAILS

**NATIONAL SCHOOLS,**  
Dept. 2-PMR, 4000 S. Figueroa St., Los Angeles, Calif.

NAME \_\_\_\_\_ Age \_\_\_\_\_

ADDRESS \_\_\_\_\_

CITY \_\_\_\_\_ STATE \_\_\_\_\_

## BOEING SCHOOL STARTS AVIATION CAREERS



The air industry looks to Boeing School for men trained to make good in aviation. Jack Knight, 2,400,000-mile ace pilot, says: "IF YOU WANT TO GET BEYOND FIRST BASE IN AVIATION, I RECOMMEND BOEING SCHOOL." United Air Lines founded Boeing School, closely supervises all Boeing courses. School buildings adjoin United's hangars at A-1-A Oakland Airport. Boeing School classes are kept small. Equipment is complete, modern. At Boeing School you're inside aviation! Write today for FREE 1939 BOEING SCHOOL BULLETIN. Describes Pilot, Ground, and Engineering courses. Gives lines of promotion. Tells opportunity for high school graduates. Address: BOEING SCHOOL OF AERONAUTICS, Dept. E-13, Airport, Oakland, California.

A DIVISION OF UNITED AIR LINES

## Rosati ACCORDIONS

are as fine as human hands can make them. Perfect intonation, tone quality and amazing volume. Breath-takingly beautiful. EASIEST OF ALL INSTRUMENTS TO LEARN. Most dealers offer credit terms, as well as COMBINATION LESSON AND INSTRUMENT PURCHASE PLAN. Write for FREE CATALOG and name of nearest dealer.

A. ROSATI, 42 East 20th St., N. Y. C.



## Auto-Diesel

Master a real trade. Auto Mechanics, Diesel Mechanics, Arc Welding, Acetylene Welding, etc. Let us train you to be an expert Auto-Diesel Mechanic and help you get a good job. The cost to you is reasonable. Learn on modern equipment with tools under experienced instructors. Real shop work. Steam heated buildings. Room and board in our steam heated dormitory. We pay your fare to Nashville. For free catalog write

Nashville Auto-Diesel School, Dept. 75. Nashville, Tenn.

## BOOKS — FOR TODAY'S BIG OPPORTUNITIES

List Sent Free Upon Request

POPULAR MECHANICS PRESS-200 E. ONTARIO ST. CHICAGO

## SECRETS THAT MAKE MONEY

1059 Money Making Formulas in  
Book Form. While Supply Lasts, \$1.25

Start a spare-time or full-time business of your own making products that sell. A good formula has made fortunes for others—may bring fame and fortune to you. Get this big 200-page book—tells what to make—how to make it—where to get materials. Nothing else like it. Order Money Making Formulas today. Postpaid Only \$1.25.

Popular Mechanics Press, Dept. 239A, 200 E. Ontario St., Chicago

## GROW PLANTS WITHOUT SOIL Startling New Development

Complete  
Directions  
for Small  
and Large  
Scale Growing

Get the new book "Soilless Growth of Plants" and learn this new technique which everyone is talking about. Three methods described—Water Culture, Sand Culture, Sub-irrigation. Explains all operations. Tells how to make containers and nutrient solutions from raw materials at small cost—how to grow flowers, vegetables and fruits without soil. A fine hobby and a money-saving investment for city dwellers. A source of new business for gardeners, nurserymen, etc. Only book of its kind. Order today "Soilless Growth of Plants." Sent postpaid for \$2.75.

POPULAR MECHANICS PRESS Dept. 239 200 E. Ontario St., Chicago



# U. S. GOVERNMENT JOBS!

## \$1140 TO \$2100 FIRST YEAR MANY 1939 APPOINTMENTS EXPECTED

Many Government examinations include Mental Tests. Try yourself. Answer the following problems and mail at once. Our examiners will correct your work, rate, and return it. The result should tell you the possibility of a high rating on the U. S. Government examination.

### MENTAL TEST

- How much is the interest on \$8,700 for half a year at three per cent?  
Answer.....
- An Implement is—(1) A false accusation; (2) A reminder; (3) A tool.  
Give number of correct answer.....
- Double entry means—(1) A punishable offense; (2) A method of indexing; (3) A system of bookkeeping; (4) A stub record of checks issued.  
Answer.....
- Technical means—(1) Mysterious; (2) Drawn in ink; (3) Scientific.  
Answer.....
- If you were earning \$50 an hour, how much would you receive for 34 days, working 7 hours a day?  
Answer.....

- Albany is to New York as Augusta is to—(a) Michigan; (b) Maine; (c) Wisconsin.  
Answer.....

**FRANKLIN INSTITUTE, DEPT. G195, Rochester, N. Y.**  
I send you my work on Mental Test No. 2. Kindly have your examiners correct this work and return to me with my rating, and at no cost to me. Kindly send 32 page book "How to Get U. S. Government Job" and full information regarding Government Jobs. Send list of Jobs and tell me how to qualify for one.

Name.....  
Address.....  
Age.....

### WANT A GOOD-PAY JOB?



Trained Tool and Die Makers, precision machinists, automatic screw machine men earn as much as \$50-\$60 per week. Train at one of America's best equipped shops. Training work supervised by experts. Day-Evening classes. Low fee, employment help. Write NOW for free booklet "Practical Machine Shop Training."

**Allied Screw Machine Co. Inc.**  
(School Division)  
Dept. PM2 603-9 Lake St. Chicago, Ill.

### LEARN to DRAW-



beautiful girls' heads and figures from large photos of artists' models. Be an artist. Turn your talent into dollars. Simple method makes it easy. No experience necessary.

### FREE SAMPLE CHARTS AND PICTURES

Send your name and address today, and only 10c to cover mailing cost. TRY IT FREE without obligation.

**TOWERTOWN STUDIOS, Dept. 236**  
520 NORTH MICHIGAN AVENUE, CHICAGO, ILLINOIS

### New LACO Oil Heater

Low as **\$23<sup>50</sup>**



One of the best-heating, most durable oil heaters in LACO history! No basement needed, installs like a stove. Has self-contained tank, easy heat-regulator. Featured with LACO's famous Two-Stage Double-Fine burner, capable of developing tremendous heat, and LACO's Inner-Heating Unit that utilizes utmost of the heat. Quiet. Beautiful.

At the right is LACO's Pressure-Type fuel oil burner. Designed by L. A. Cocklin, one of the industry's most successful builders. New simplicity, new fuel economy. Greatly improves the value of your home.

**WRITE** direct to factory for new illustrated booklet giving complete details, illustrations and unusually low dealer prices of LACO Heaters and Burners. Send NOW!



**LACO OIL BURNER CO. 129 Union Ave. Griswold, Iowa**

# PLUMBERS & STEAM FITTERS

## Audels Plumbers and Steamfitters Guides

4 Vols. \$6



A practical, illustrated, Reference Library and Study-Course for Master Plumbers, Journeymen and Apprentice Steamfitters, Gas Fitters and Helpers, Sheet Metal Workers, Draughtsmen, Master Builders, Engineers and all Building Trade Students. This valuable set of handy, pocket-size Guides explains in practical concise language and well-done illustrations all the principles, advances and short cuts of the Plumbing and Heating trade—based on modern practice. Contains careful, detailed instructions

on how to figure and estimate various jobs. Use FREE COUPON below to examine, without obligation, this valuable work.

### INSIDE TRADE INFORMATION ON:

Soldering, tinning. Joint wiping, bending, beating. Pipe—iron—steel, threading. Mathematics, tables, physics. Materials—iron, steel, copper, brass, lead, tin, antimony, etc. Sheet metal—galvanized—plate. Sanitation, syphonage, tanks. Drainage, sewage, purification. Fixtures—bath—kitchen. Pipe fittings, soil pipe, tools. Laying out work. Roughing. Screwed fittings, flanges, joints. Pipe bending, examples. Elbows. Heating, ventilation, air conditioning, refrigeration. Water supply, mains, wells, tanks. Gas-fittings. Sheet metal work, problems, methods. Brazing, heating, lead burning. Welding, various welds, methods. Blacksmithing, forges, tools. **Air Conditioning.**

**THEO. AUDEL & CO., 49 W. 23rd St., New York City**

Mail Audels Plumbers Guides, 4 vols., on 7 days' free trial. H. O. K. I will remit \$1 in 7 days, and \$1 monthly until \$6 is paid. Otherwise I will return them. No obligation unless I am satisfied.

Name.....  
Address.....  
Occupation.....  
Reference..... P. M.



When writing please mention Popular Mechanics



**Be a Civil Engineer!**  
Learn—Quick Reference Way

**It's Paying Big Right NOW**



**Cyclopedia of Civil Engineering**  
7 great volumes.  
2,800 pages.  
1,600 illustrations.  
New revised edition by twelve of America's greatest engineers.

Includes: Surveying, bridges, railroads, steel structures, municipal engineering, water supply, road building, etc.  
Spanish Grain Flexible Covers Gold Stamped

**Shipped Free**

For Examination **Slide Rule**

Be prompt and we will include a brand new, circular slide rule to carry in coat pocket. Invaluable in solving all kinds of engineering problems.

**Earn \$3000 with the help of these books**

**A Year — and Up!**

"Civil engineers are wanted NOW. Enormous amounts are being spent in all kinds of public works and not a dime is spent until the Engineer has prepared plans. Then He must direct the work. It's a big job and there are not enough men to go around. Everywhere you go, you see road work going on—water and sewer systems being built—vast projects of all kinds. Here is Your Opportunity to get the necessary training right at home. These books are complete and simply written so anyone can understand them. Start now on our FREE examination plan. Mail the coupon without obligation.

**American Technical Society**  
Dept. C219 Drexel at 58th St., Chicago

**American Technical Society**  
Drexel at 58th St., Dept. C219, Chicago  
I want to examine the CIVIL ENGINEERING Cyclopedia for 10 days FREE. I will gladly pay the few cents express, but I am to pay nothing for the 7 big volumes if I return them within 10 days. If I wish to keep them I will send you \$2 after the 10 days, then \$3 a month until advertising price, \$29.80 is paid. Send latest Edition and Slide Rule.

Name.....  
Address.....  
(Attach letter stating age, occupation, employer's name and address and that of at least one business man as reference.)

Get BETTER training. Realize Adcox advantages located in Pacific Northwest, a Diesel center. Established 28 years. Modern equipment, expert instructors. Close cooperation for YOUR success. Earn room and board while learning. Send for FREE big 40-page Diesel School Catalog No. 18. Home Study and Resident Courses.

**L. L. ADCOX TRADE SCHOOL**

Portland Oregon

**NEW INVENTIONS**

(Continued from page 51A)

**EVIDENTLY** designed to overcome the lack of space in an ordinary trailer, an

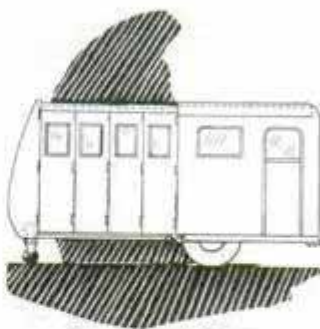

extensible camping vehicle has been patented. The front section is built rigidly for living purposes, while the rear section is arranged to align with the outer contours of the

front section when the trailer is closed, the two sections telescoping. The roof of the back section slides into a pocket in the roof of the front section when not in use.

**EFFICIENT** and fast cleansing of the teeth, with minimum effort, is the

purpose of an electric toothbrush patented a short time ago. A small motor drives a spindle fitted with bristles, taking all the work out of brushing the teeth.



**HANDY** for the housewife is a new kitchen tool, an easily operated egg separator. It consists of a funnel, a cup on the bottom of the funnel and a spring grip with one portion attached to the funnel and the other to the cup. Closing the spring grip

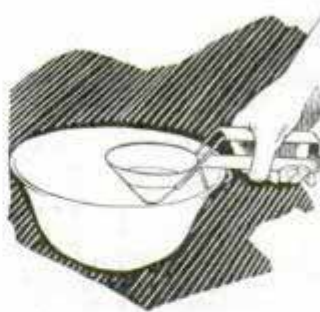

moves the cup away from the funnel, thus allowing the white portion of the egg to escape but retaining the yolk. The separator has a clamp for fastening on the rim of a bowl.

Due to the fact that many of the devices described in this department are still in the patent office stage and are not on the market, Popular Mechanics Magazine cannot undertake to supply further information regarding them.

**HOW TO GO AHEAD FROM 40**

**FREE OFFER** shows you how to find your way out of the rut to bigger success, more money, real importance—greater popularity.



Research discloses that any man of average intelligence has the ability to progress much farther than his present status. Undiscovered powers worth real money lie within him, ready to push him ahead to greater success the instant they are released. Self-analysis Chart sent FREE gives you the clue to easiest, quickest way to get bigger pay, become more important in business, gain new social popularity, have more perfect home life. If you are dissatisfied . . . if you are discouraged . . . if you are not making progress . . . if you want to quickly make more money in your chosen work . . . mail coupon at once for FREE Self-analysis Chart, at no cost or obligation to you.

Self-Study Foundation, Inc.,  
30 North Michigan Ave., Dept. A-36  
Chicago, Illinois

Please send me, free of charge, instructions for analysis of my capabilities and how you can help me "Get Set for Success." I understand this places me under no obligation.

Name.....  
Address.....  
City..... State.....





**NEW models  
EASIER TO PLAY**

Find out about these sensational new Conn Band Instruments. Many wonderful, exclusive features! Today, *more than ever*, Conns are the "choice of the artists." You'll advance faster and take more pride in a *genuine* Conn—made by the world's largest manufacturer. See your dealer or write us for Home Trial, Easy Payment offer. Mention instrument.

**C. G. CONN, LTD.**  
231 Conn Bldg., Elkhart, Ind.

**WRITE FOR FREE BOOK**

**CONN**  
BAND INSTRUMENTS

**in DRY-CLEANING!** **BIG PROFITS**

Good times or bad, dry-cleaning and redyeing stores prosper. Good-paying opportunities in even smallest towns. Easy to learn at home—requires no capital. Training costs but a few cents a day. Not a get-rich-quick scheme, but a substantial, well-paying field that can mean a steady income, your own home, car and all the other things that make life worthwhile. **FREE** book gives details. Write **TODAY** to **HUBBARD DRY CLEANING & REDYEING SCHOOL, SILVER SPRING, MD.** Dept. AC-101.

**MIDWEST SALE  
FACTORY-TO-YOU!**

**PUT THIS NEW CHASSIS  
IN YOUR CABINET**

**14-TUBES**

WORLD-WIDE CHASSIS

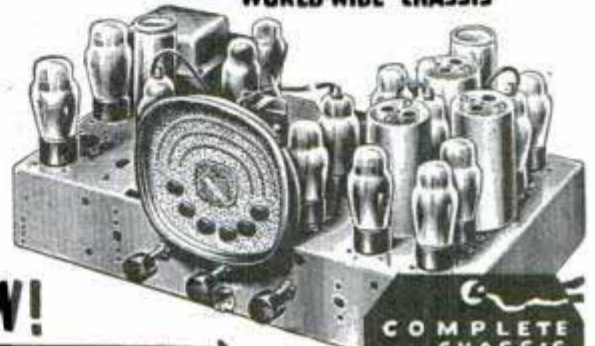

**NEW!**

**SAVE UP TO 50%**

COMPLETE CHASSIS  
Only \$19.95  
WITH TUBES AND SPEAKER

HERE it is—the greatest radio value we have ever offered. A big, powerful, new 14-tube world-wide Midwest. Why be content with an 8 or 10-tube set . . . when it is so easy to install this big, new, powerful 14-tube chassis in your own cabinet for the same price! For a little more than the cost of new tubes, you can modernize your old radio and get exciting world-wide reception — during this special sale!

**30  
DAYS  
TRIAL**

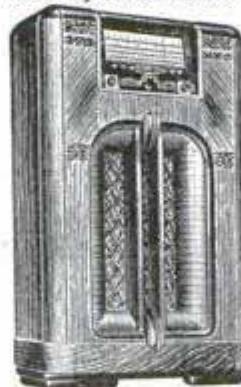

**LIBERAL TRADE-IN  
ALLOWANCE UP TO  
\$40 ON YOUR  
OLD RADIO**

. . . when you trade it in on the beautiful 17-tube 5-band Model "D" console shown here. Tell us the make and age of your present radio, so we can determine how much to allow you on it. New Time-Payment Plan makes it easier than ever before to own a Midwest. Midwest makes a radio to suit every purse . . . 6-tube to 17-tube 5-band models . . . and prices start as low as \$10.95. Absolute satisfaction guaranteed on a money-back basis. Write for **FREE** 1939 catalog.

**EASY TERMS**

Dept. 15-HH, **MIDWEST RADIO CORPORATION, Cincinnati, O.**

**PASTE COUPON ON 1c POST CARD . . . OR WRITE TODAY!**

**MIDWEST RADIO CORPORATION**  
Dept. 15-HH  
Cincinnati, Ohio  
Send me your new **FREE** catalog, complete details of your liberal 30-day **FREE** Trial offer, factory-to-you, wholesale prices and big **TRADE-IN** offer.

Name . . . . .  
Address . . . . .  
Town . . . . . State . . . . .  
User-Agents Make Easy Extra Money. Check here ( ) for details.

**MYSTERY INVENTION  
KEEPS HANDS, FEET, BODY  
WARM**

Even in Below-Zero Weather, Outdoors



**KUMFY WARMER**—carried in pocket, glove, sock, stocking, shoe or boot, or hung inside clothing, keeps you comfortably warm outdoors even on coldest days. Heats itself in 10 seconds—**STAYS WARM 12 HOURS** at a time. Lasts years. **ABSOLUTELY SAFE—NO FLAME.** Low-priced. **GUARANTEED.**

**AGENTS**—Make up to 205 percent profit. Everybody buys—workmen, housewives, drivers, sportsmen, spectators, farmers, others. Reserve your territory now for big winter profits. Write quick. **KUMFY WARMER, Dept. T-2300, Cincinnati, Ohio.**

**TOOL & DIE MAKING  
DESIGNING**

Machinists Trade. Not a correspondence course. Practical shop training in the world's Industrial center. Write today for full information, **NATIONAL SCHOOL OF MECHANICAL TRADES**  
Dept. 103 628 W. Lake St. Chicago, Ill.

**Government Jobs**  
EXAMINATIONS SOON VALUABLE INFORMATION FREE  
COLUMBIAN CORRESPONDENCE COLLEGE  
WASHINGTON, D. C.

**AVIATION** If you want to be an expert airplane pilot or mechanic, get off to a flying start by mastering a knowledge of atmospheric conditions, action of airstreams, stability in flight, balance of forces, etc. Our textbook "Practical Aerodynamics" makes it all very easy to learn. Send for it today—\$3 postpaid. Or write for circular on six practical aviation texts. **Thompson Aviation Pubrs., 8326 Woodward, Detroit, Mich.**



**LIVE BODIES FOR SALE**

Oh boy! Wouldn't that be swell—I'll tell you what I will do though. I will take that scrawny body of yours and whip it into shape just like I have done for myself and so many others. Do you want big muscles and a huge robust body? My book "Puissant Body Building" is absolutely **FREE**. **TOMMY LOUGHRAN, Dept. 5, 4 S. 15th St., Philadelphia, Pa.**

**PHOTOGRAPHY**—Catalog of over 200 recommended books on ever phase of the art. Sent free on request. **POPULAR MECHANICS PRESS, 200 E. Ontario St., Chicago**

*The World's Biggest*

Get Shop Notes for 1939! Only 50 cents. May easily be best investment of your entire lifetime. Contains 417 money-making, time-saving ideas, kinks, short cuts for mechanics, farmers, home workshop fans, handymen—for everyone who uses tools. 224 pages, 417 articles, 806 illustrations. Get 1938 Shop Notes too. Only 50c. **POPULAR MECHANICS PRESS Room 329-C, 200 E. Ontario St., Chicago**

**50¢ WORTH**

**SHOP NOTES FOR 1939**

When writing please mention Popular Mechanics



# OL' JUDGE ROBBINS

AT THE METROPOLITAN OPERA HOUSE IN NEW YORK CITY



THIS SEEMS LIKE OLD TIMES TO ME, CHUBBINS. YOUR MOTHER AND I ALWAYS TOOK IN THE OPERA ON OUR TRIPS TO NEW YORK.



THERE'S OUR FRIEND, THE MUSIC CRITIC—WE'RE SITTING WITH HIM, YOU KNOW.

HELLO, JUDGE!



YOU CAN WRITE HOME THAT YOU SAT IN THE FAMOUS 'DIAMOND HORSESHOE'.

AND WHAT A GRAND EXPERIENCE IT IS!



I DIDN'T QUITE HEAR WHAT YOU WHISPERED—SOMETHING ABOUT THAT CHARACTER BEING SO HAPPY AND CONTENTED SMOKING HIS PIPE.

YES, JUDGE, I SAID YOU OR I COULD PLAY THAT PART TO PERFECTION, ENJOYING PRINCE ALBERT AS WE DO.



THERE'S NO OTHER TOBACCO LIKE PRINCE ALBERT.

PRINCE ALBERT IS EASY ON THE POCKET-BOOK, TOO. THERE'S A LOT OF HAPPY SMOKING IN THAT BIG P.A. TIN.

*An Invitation To Real Smoking Joy!*

THE BIG 2 OUNCE RED TIN



PRINCE ALBERT'S NO-BITE PROCESS CERTAINLY TAKES OUT HARSHNESS, LEAVES IN FULL, RICH BODY!

**"MAKIN'S" SMOKERS!** Prince Albert has the **mildness** and **coolness** you want, too—plus **good, rich taste**. P.A. "makin's" cigarettes shape up **faster, firmer** because P.A.'S famous "crimp cut" makes it nestle in the paper right!

**50** pipefuls of fragrant tobacco in every 2-ounce tin of Prince Albert

**SO MILD**

Smoke 20 fragrant pipefuls of Prince Albert. If you don't find it the mellowest, tastiest pipe tobacco you ever smoked, return the pocket tin with the rest of the tobacco in it to us at any time within a month from this date, and we will refund full purchase price, plus postage. (Signed) R. J. Reynolds Tobacco Co., Winston-Salem, N.C.

# PRINCE ALBERT

THE NATIONAL JOY SMOKE

Copyright, 1938, R. J. Reynolds Tob. Co.

When writing to advertisers please mention Popular Mechanics



# Popular Mechanics Magazine

REGISTERED IN U. S. PATENT OFFICE AND CANADA

WRITTEN SO YOU CAN UNDERSTAND IT

Vol. 71

FEBRUARY, 1939

No. 2

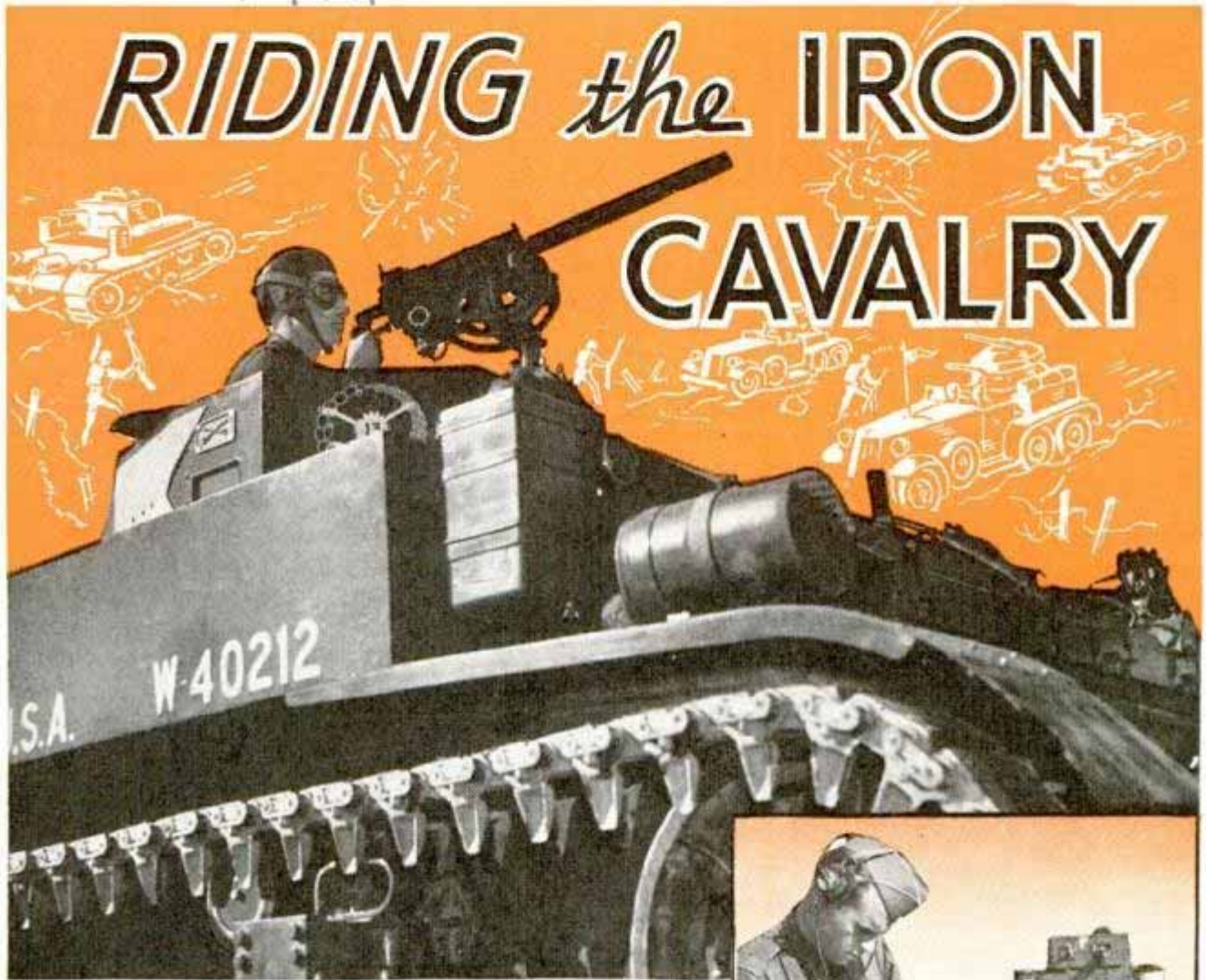

**P**UT on your helmet, adjust your dust goggles—you're going for a ride with Uncle Sam's new streamline fighting unit, the mechanized cavalry.

And it's not just a spin around the parade grounds, either, but a 750-mile trip to maneuvers. The schedule calls for 150 miles a day with road speeds of twenty and thirty miles an hour—no easy pace for 648 tanks, armored cars, trucks and motorcycles to maintain. They want to find if the new war machines can take it.

Before the Seventh Cavalry brigade, as the unit is called, starts rolling, let's look at some of the sleek iron horses. First, the scout cars, armored on the front, sides and rear but open at the top. These machines are for reconnaissance, or information seeking, and travel ahead of the column. Each of the



Top, anti-aircraft gun in rear of turret of combat car. Below, taking radio message while iron cavalry is rolling

Cent James Mc Queeny  
1131  
Kansas City, Mo





seventy-four cars has a .30-caliber and a .50 machine gun. A railing around the top of each vehicle serves as a track for the guns, permitting anti-aircraft as well as all-direction firing.

Nineteen heavier cars also are used in scouting work. They are completely enclosed and have six wheels with a four-wheel drive. There is little difference in the armaments of the two. The real backbone of this fighting force is the combat car, much like the light infantry tank.

The squat, turreted machine has both maneuverability and speed. The motor, located in the rear, has cylinders set in a circle around the drive shaft like an airplane radial engine. Rolling on rubber-coated "Caterpillar" treads, the combat car can do fifty-five miles an hour. There are 112 of them and their guns would fill an arsenal. The standard equipment includes a .30-caliber cowl machine gun; a .30 and a .50 turret gun, and at the rear of the tower, a .30 anti-aircraft gun.

When Italy's tanks were campaigning in Ethiopia natives hopped on some and with heavy stones put the protruding machine guns on the blink. That couldn't happen to this outfit—the crews are armed with Tommy guns and pistols fired through special portholes.

Formidable in appearance and important in battle are twelve 4.6-inch chemical mortars mounted on trucks, designed to throw twenty-five-pound smoke shells to screen off the brigade's movements from hostile eyes. There are also seventy-four trucks with half tracks, used to transport machine guns and crews employed in ground sup-



Part of an encampment made by the Seventh Cavalry Brigade while on a 750-mile trip between Fort Knox, Ky., and Fort Riley, Kans. Above, armored scout car used in reconnaissance work



#1411  
163

port, and for other personnel of the command. Sixteen of the brigade's 172 trucks are assigned to tow seventy-five-millimeter field guns used in action for artillery preparation before a general brigade attack. Others are for ammunition and artillery supplies. Also some of the trucks comprise a squadron supply train; others are employed in maintaining military vehicles, gasoline trucks and field kitchen equipment.

Lined up on the highway, the cavalry presents a vivid picture of rolling might. The column is twenty miles long. Everything is on wheels and when the mechanized cavalry arrives at its destination, there is no delay—its full fighting strength can take off its coat and go to work.

Your pulse quickens as you climb into a combat car. There is a clatter

(Continued to page 150A)

Right, headgear worn by tank riders. Below, the iron cavalry on the march. Bottom, four-wheel drive armored car

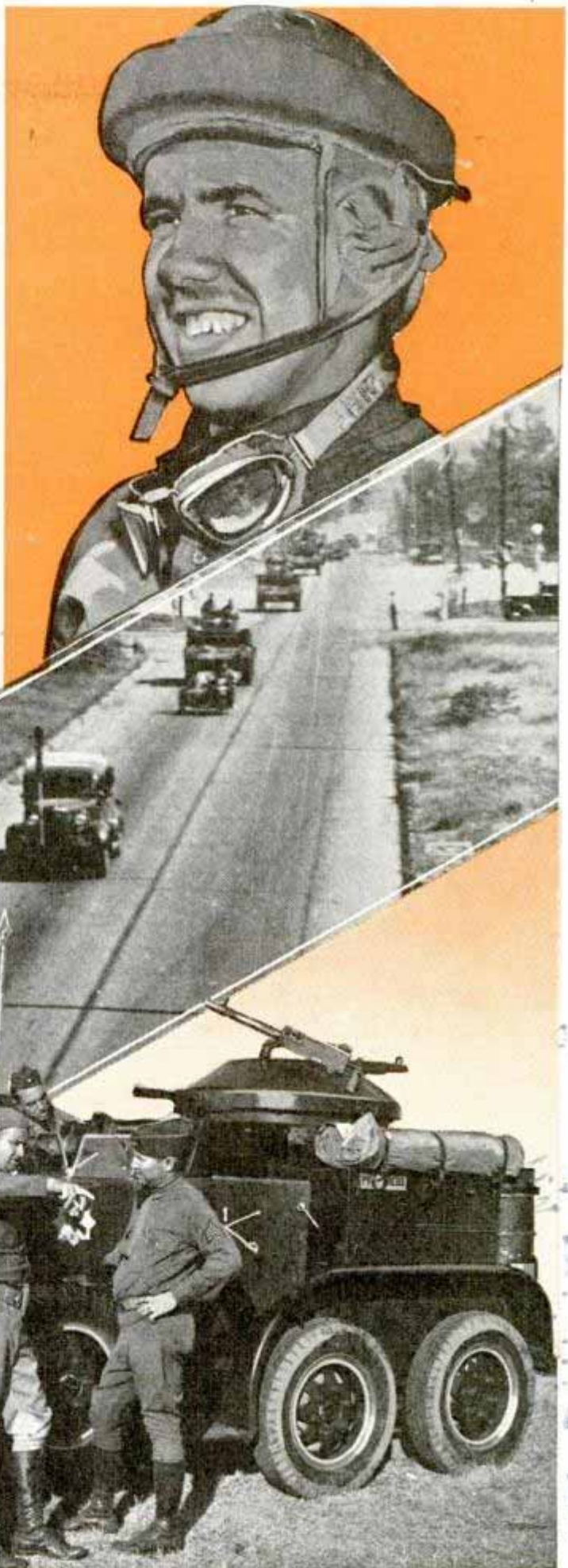

Vertical handwritten notes on the left margin, including "Cavalry" and "Iron Cavalry".

Vertical handwritten notes on the right margin, including "Cavalry" and "Iron Cavalry".



# Thirteen-Ton Air Streamliner Has Seats for Twenty-Two



Nose of the new British streamline ship. Note flowing lines of engine nacelles and the front of passenger compartment

Described as the nearest approach to a completely streamline plane, a thirteen-ton transport has just been added to Imperial Airways' fleet. It will be used in European service. The big streamliner, which is seventy-one and one-half feet long, has a wing span of 105 feet and accommodations for twenty-two passengers.

## Ink Sketches Made from Photos with Aid of Simple Kit

Anyone can make pen-and-ink drawings from photographs with the aid of a simple

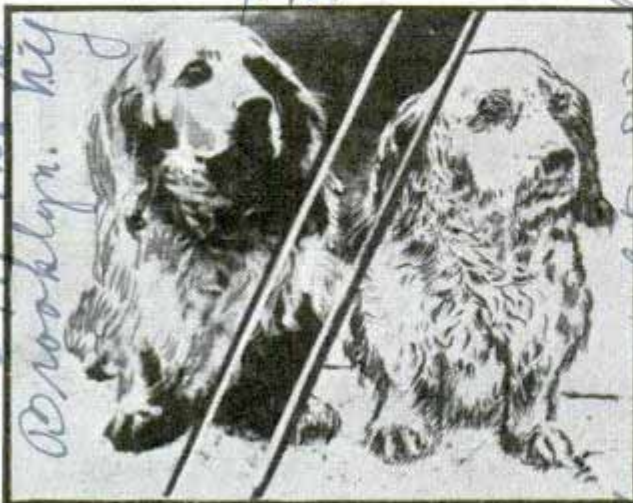

Left photograph from which ink sketch (right) was made with simple outfit

kit now on the market. First, the user goes over the outline of the drawing with a pen and waterproof ink, filling in the shadows of the photograph and then, with a simple solution of chemicals supplied in the outfit, bleaches out the photograph, leaving the pen-and-ink drawing intact. There are numerous practical applications of photo sketching in addition to the appeal it has for photographers, hobbyists, artists and children. Artists use the process to make drawings from which line cuts can be made, instead of expensive half tones which a photograph necessitates.

## Lifelike Mechanical Elephant Can Run, Walk and Dance

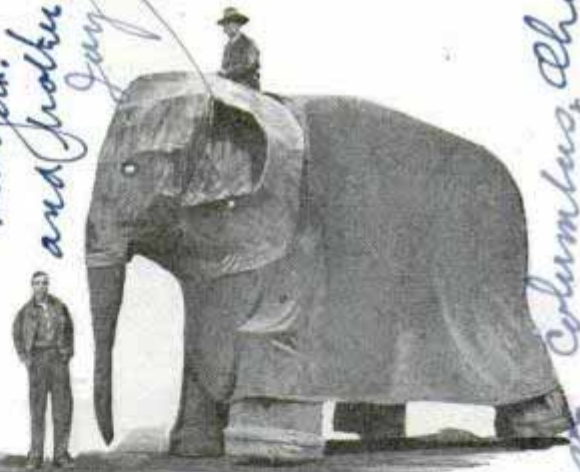

From his seat atop the neck, the driver can make this mechanical elephant run, walk or dance

When an elephant turns down a bale of hay for a bucket of gasoline, it's news. Jumbo is that kind of an elephant. Motor-driven, it walks, runs and dances, with natural leg movements simulated by an over-running clutch. Jumbo averages twenty miles to the gallon. With the driver atop its neck, the elephant has toured 15,000 miles on an advertising campaign. Several more are being built to carry passengers and advertising at the New York world's fair. The frame is of wood and chicken wire.

Handwritten notes in the left margin: #1382, #1370, Chas. M. Higgins & Co. Inc. 291-9th St. Brooklyn, N.Y.

Handwritten notes in the right margin: #1404, Columbus Chamber of Commerce, D. O. Higgins, New York, and Hoboken, N.J., Guy, and Leonard Hutten, 1156 Mt. Vernon, Permenan.

Handwritten note at the bottom: Built by George and Leonard Hutten.



# Stratosphere 'Diving Suit' Carries Bottled Air

Closely resembling a deep-sea diver's suit, a stratosphere dress was tested recently in the high altitudes by a parachute jumper who leaped from an airplane at 30,000 feet. Instead of the diver's air-feed hose, the suit is equipped with oxygen bottles which supply air, making the wearer completely independent of the thin mixture found high above the earth. The suit also protects the airman from low pressure found in the stratosphere and sub-stratosphere.

1450

## Bombproof Panama Canal Will Look Streamlined

Panama canal will take on a more streamline appearance when the "bombproofing" now contemplated is put into effect. While the locks themselves cannot be armored effectively to withstand powerful explosives, the canal walls can be strengthened and many structures vital to operation may be bombproofed in the literal sense. Electric power stations, fuel oil tanks, garages for the towing locomotives or "electric mules," operating stations, machine shops, administrative offices, living quarters for the operating force and barracks for the garrison, all can be put deep underground and thickly shielded with concrete. This will remove exposed moving parts to points where they will be protected against flying fragments. Power for the "electric mules" already is drawn

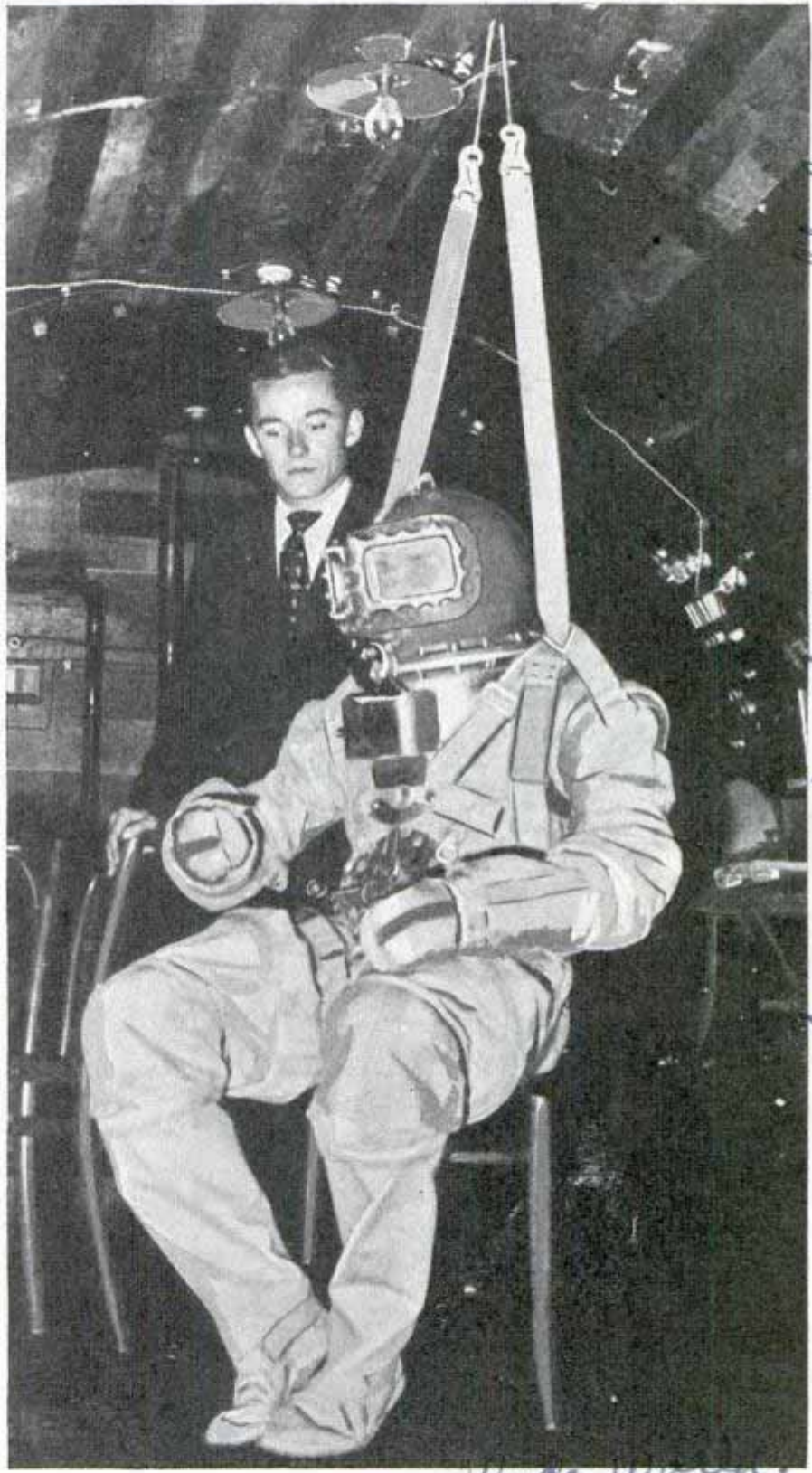

When you make a 30,000-foot parachute jump, here's your uniform. It seals you against low pressure, and you carry your air in bottles

from an underground trolley. A thick shell of armor could be worked in over the subterranean carrier of electricity. Removing many structures now on the surface will give the canal a more streamline aspect.

Tested at Villeneuve - St. George  
 and some of air is provided by French air

Subsea Service 11/29/38



H1353

Womans Hospital  
U. of Pittsburgh Medical Center

# Fighting



Left, alternating-current arc welding enables builders to erect a hospital next door to three other hospitals without noise. Below, using noise meter to measure sound created by high-voltage discharge between power line and insulator atop crossarm

Photographs courtesy Westinghouse Electric and Manufacturing company

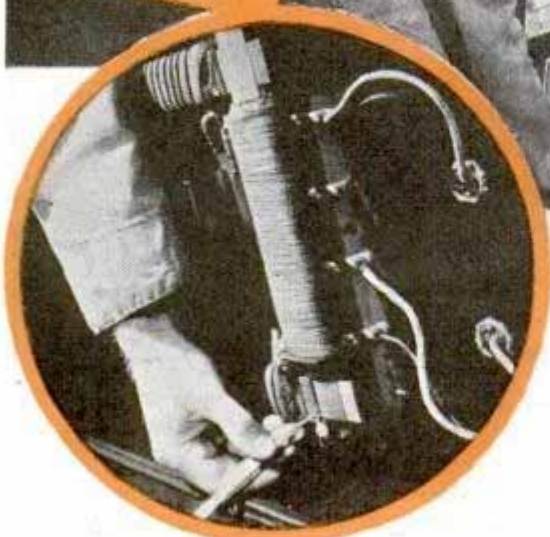
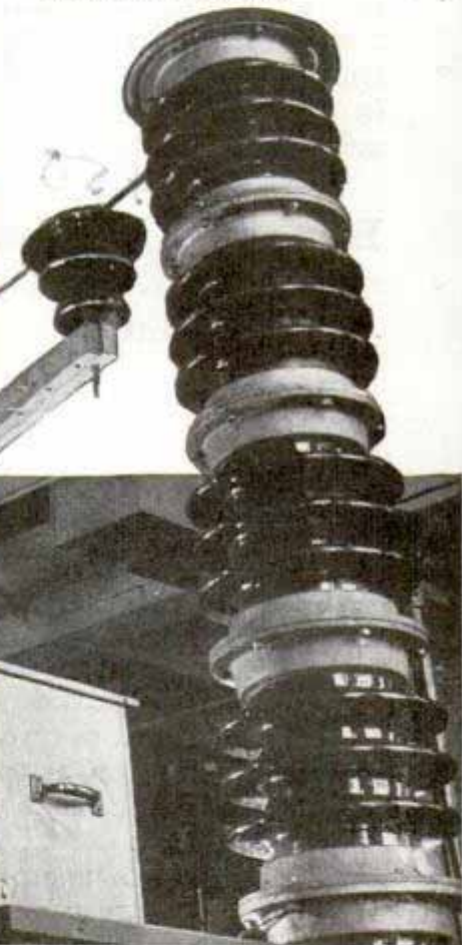

Here a tiny mirror is being used to reflect a light beam into photoelectric cells to measure stretch of steel caused by magnetostriction

STRIVING to make the world of tomorrow a quieter place than that of today, scientists are employing light as an anti-noise weapon. Sharp, tiny beams and pale, flickering rays are being directed on metals in industry's attempt to silence the clatter of machinery.

An "electric eye" is being used to measure the growth of metals under the pounding of a noise-maker called magnetostriction. Research engineers of Westinghouse Electric and Manufacturing company describe magnetostriction as

E. Pittsburgh, Pa.

Engineer C. O. Aggers



# Noise with Light

the property of magnetic metals, such as iron, to lengthen or shorten in an electromagnetic field. The lengthening and shortening of the metal set up vibrations which create midget pressure waves in the air. These little air waves not only cause vibrations in electrical machines, but make themselves heard as a buzzing or humming sound.

Because of the minuteness of these metallic changes, engineers have been handicapped, in fact, almost completely baffled, in their efforts to stop them, or even measure them. S. L. Burgwin of Westinghouse, in cooperation

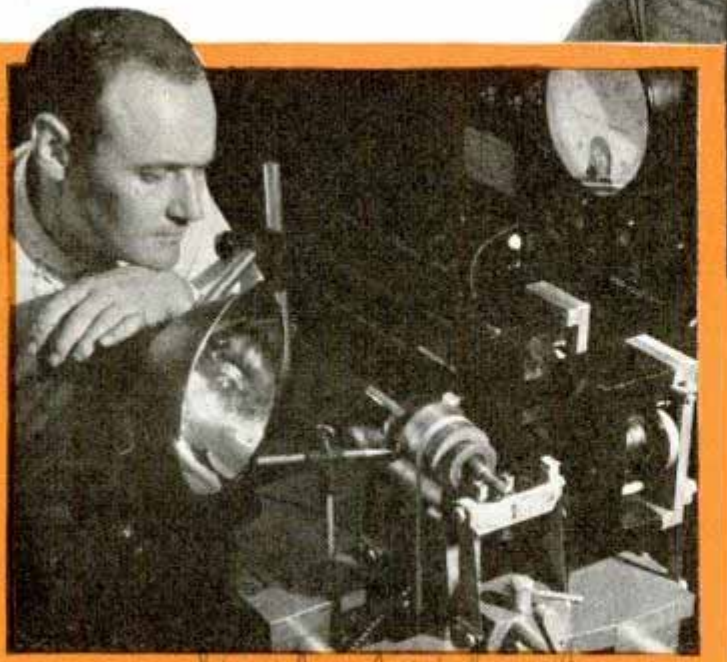

Top, apparatus using light beams to measure lengthening effect of magnetostriction, a noise-maker. Center, diagnosing noise inside motor coach. Bottom, using balancing machine to test rotor

with metallurgists seeking to produce a noise-free metal for electrical machine construction, has developed an electric-eye yardstick, using direct current to measure the simple change in length of steel test strips, detecting improvements and failures in the new metals.

Interference of friction has been overcome by a system of ball bearings on a supporting brass bar on which the test strip rests while being measured. By placing another heavy brass bar on top of

(Continued to page 127A)

W. O. Cleburn Research Engineer

J. C. Beach research



# Projecting Three-Dimension Pictures in Color

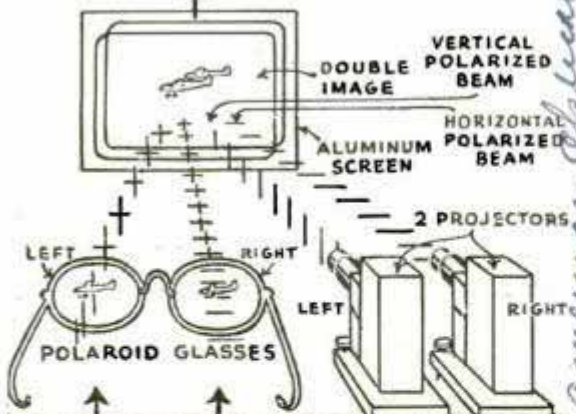
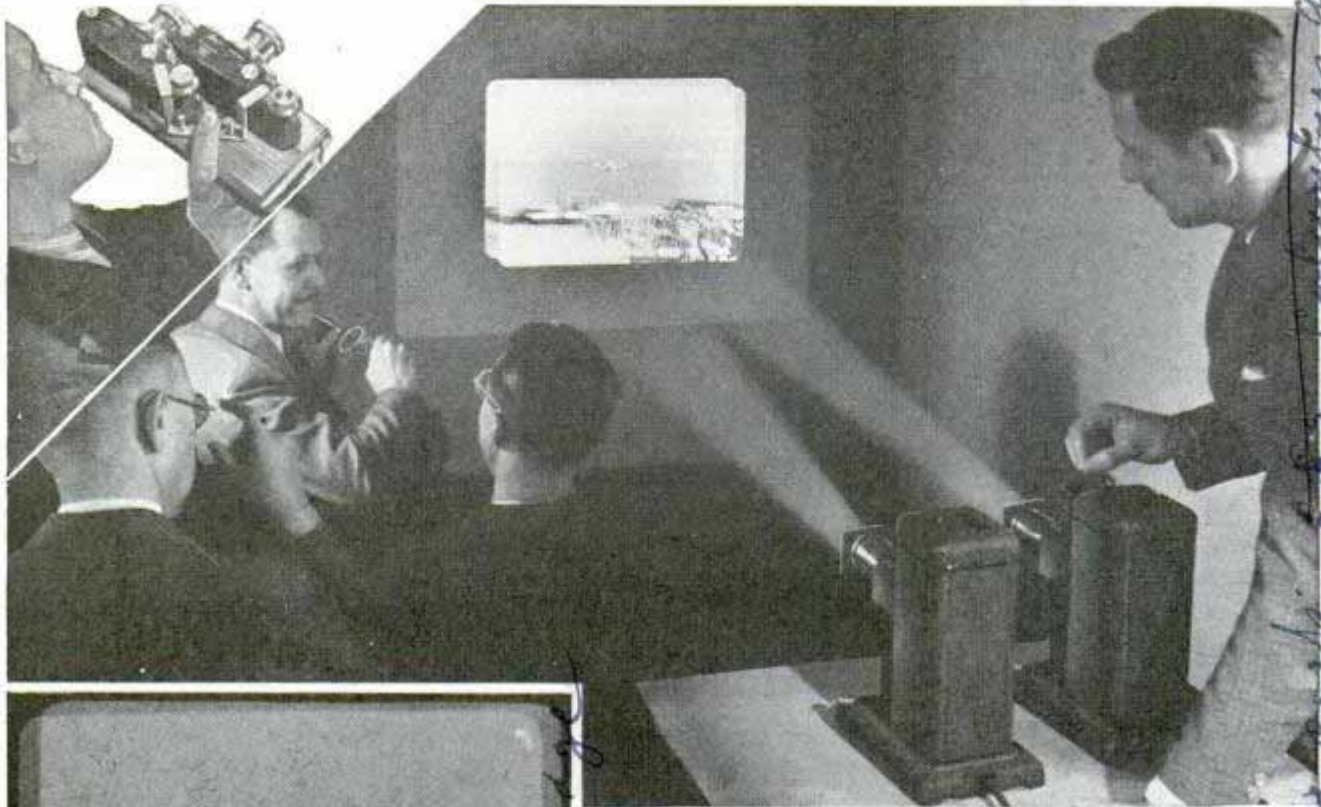

Top, snapping three-dimension picture with twin cameras and projecting twin slides for audience wearing Polaroid glasses; below, projectors with polarized filters. Left, overlapping image seen on screen with naked eye and, below, with glasses. Diagram shows how filters bring separate image to each eye

Third-dimension pictures in natural color, breath-taking in their effect of space and distance, can be projected on your home screen. Polaroid glass makes possible this magic effect. The first step is to snap twin pictures simultaneously with two cameras eye-distance apart. Mount the color slides and project them with two projectors, side by side, with opposite Polaroid filters over their lenses. The slightly overlapping pictures on the screen appear as a sharply defined three-dimension scene when Polaroid glasses are worn, the polarization of the right eye glass matching that of the filter on the right projector.



*Mr. Atkin - Carl Skipt.*

*1405*

*730*  
*730*  
*730*

*American Optical Co. Mass.*

*for H. S. Carver & Pressman*

*1935*



R1074 Cont. Thomas G. Swinson, jr.  
10555 Holman Ave  
Los Angeles, Calif

# Taming DEATH VALLEY



Over Death Valley's modern highway, above, moves a twenty-mule team reminiscent of pioneer days. Below, a Shoshone squaw with rugs and basket for tourist trade

**D**EATH Valley, one of the hottest and most awesome regions on earth, today is being transformed into a pleasant winter resort. Last year thousands of people visited the barren area in which scores perished from heat and thirst in the past.

Taming the desert, into which few people ever had the courage to venture and from which fewer returned, has been accomplished by building a few hundred miles of oiled automobile roads, developing the few water holes in the mountains, and making water available at other points. Today the tourist can drive at his ease through the Funeral and Panamint mountains, to Furnace Creek, the Devil's Golf Course, and through country that only Indians and hardy prospectors had visited before.



Defunct - Death Valley National Cemetery monument, Death Valley



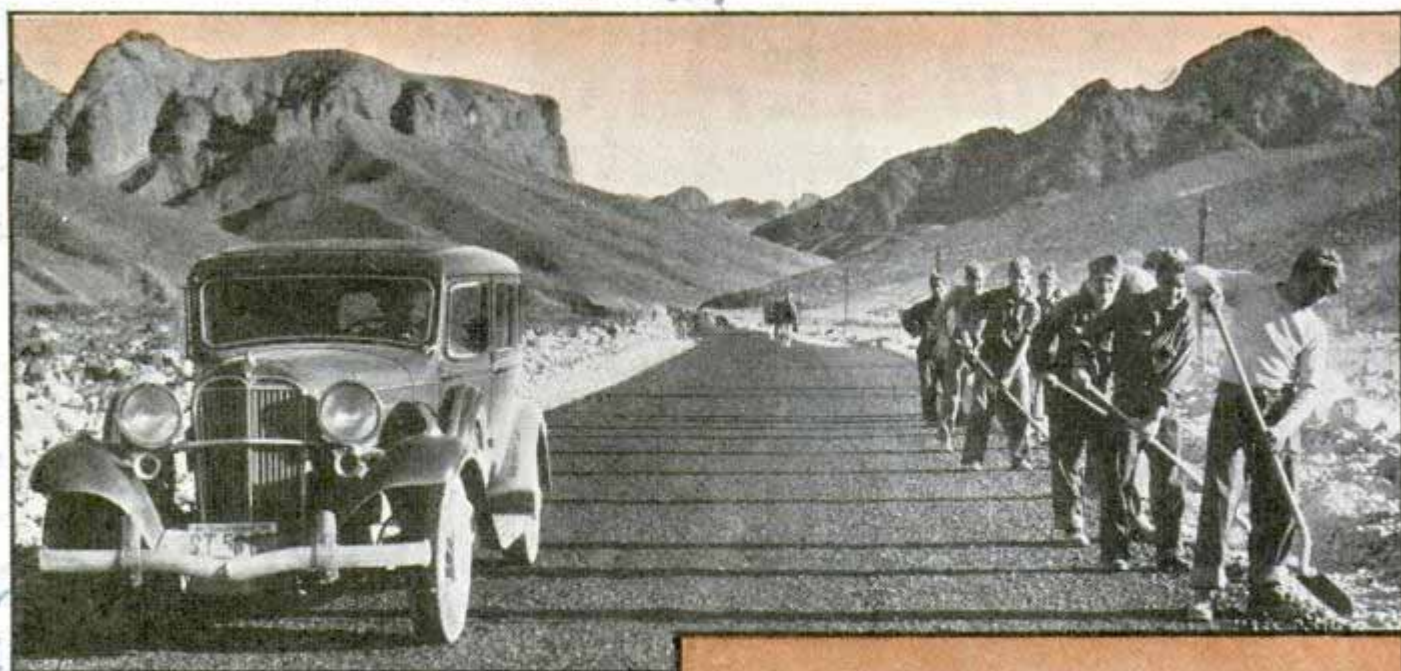

This sinister region in the Mojave desert in eastern California is a weird and fantastic geological wonderland, a mineral museum containing everything from potash and borax to copper and gold. In one part, a short walk takes you across adjoining deposits of copper, silver, turquoise, asbestos and silica. Death Valley itself is a narrow rift 140 miles long and from four to sixteen miles wide separating two sheer mile-high mountain ranges. All the colors of the rainbow are visible on the canyon walls. Pools of concentrated brine and fields of rough rock salt are found on the valley floor. More than 500 square miles of the valley are below sea

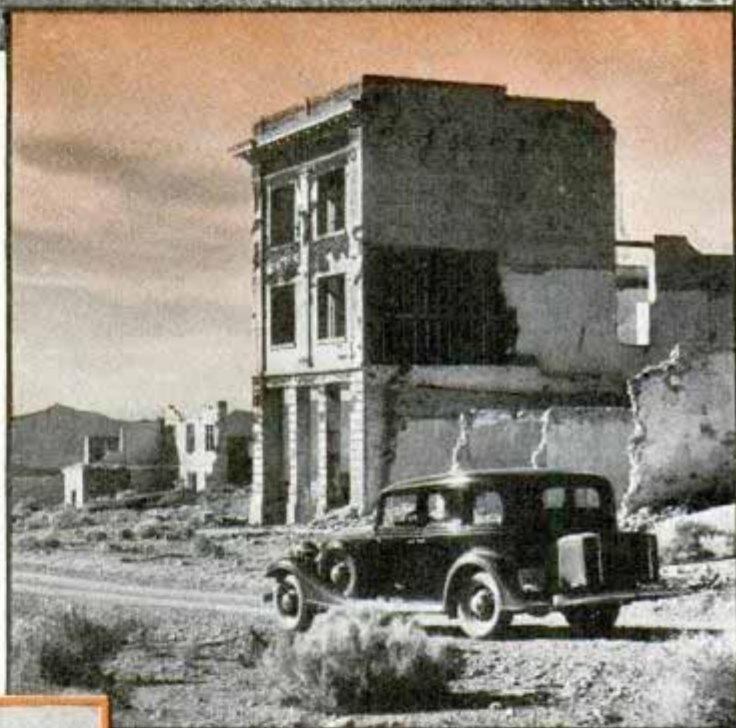

Photo by Auto Club of So. California

Top, building Death Valley's highway; right, crumbling office buildings and stores of ghost city of Rhyolite. Bottom, pool of brine at Badwater marks lowest point in western hemisphere

level and Badwater, 280 feet below sea level, is the lowest point in the western hemisphere. The valley is now a national monument administered by the National Park Service.

Tons of dates now are harvested each year on a ranch at Furnace Creek, Death Valley Scotty lives in a fabulous million-dollar castle overlooking the northern end of the valley, resort hotels have been built at scenic spots and tourists swim in marble pools, explore side canyons on horseback and play golf on a grass course on the valley floor. Tourist camps and camping





places are available but all this civilization exists only from October to April. During the rest of the year the valley lies abandoned in the terrible heat.

Even today hardly a summer goes by without a few being caught in the desert and dying from heat and thirst. A flat tire or a radiator leak may bring on a tragedy. Temperatures as high as 134 degrees have been recorded in the shade of a standard thermometer shelter at Furnace Creek and it gets hotter still on the salt beds around Badwater. Men have burned their hands holding the steering wheels of closed cars on short drives. Walking more than a few blocks is almost impossible in the simmering atmosphere.

Death Valley, known as "ground afire" to the Indians, got its modern name when it was discovered by a party of people on the way to the gold fields in 1849. Several members of the party died in the region from lack of water although the desert was crossed during the winter. Heavy snow falls each winter on 11,000-foot-high Telescope peak that overlooks the valley but the average annual rainfall on the valley floor is only one and one-quarter inches.

(Continued to page 154A)



© Frashers

*Vacationers now enjoy resort hotels, as at upper left, in what was once a valley of death. Above, picking dates at Furnace Creek ranch. Left, Pete Aguerreberry, famous old prospector, pans gold from his mine*



# Long-Distance Planes Lift Twice Their Weight

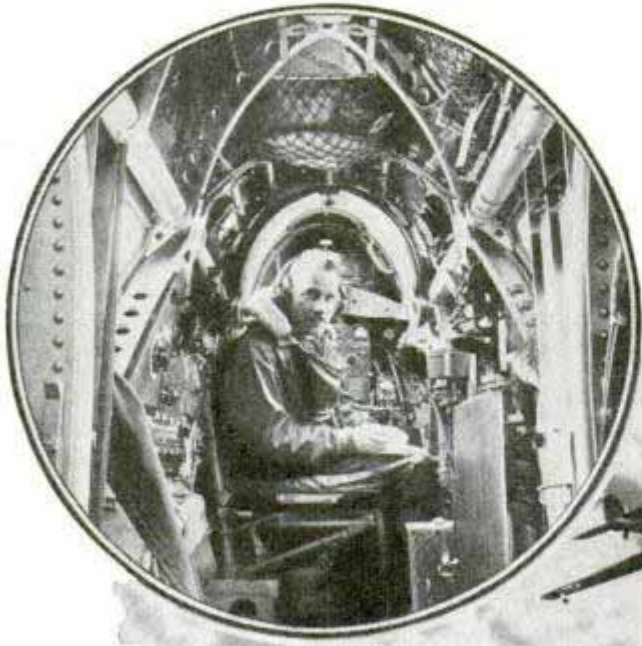

Below, Britain's three "Wellesley" bombers on their 7,162-mile flight to Australia that set a new nonstop record. Left, the radio operator, and at bottom, an interior view looking forward toward cockpit



Ordinarily an airplane can carry a load amounting to a little less than its own empty weight. When the British "Wellesley" bombers hoisted away from an Egyptian field for their record-making nonstop flight of 7,162 miles to Australia they lifted nearly twice their own weight. Empty, a Vickers Wellesley weighs 6,520 pounds. On the takeoff at Ismailia, Egypt, the gross weight of each plane was over 18,300 pounds. The single-engined, low-wing monoplanes covered the seven thousand miles in forty-seven hours and five minutes. Each was manned by a crew of three—pilot, radio operator and mechanic. The planes are built on a construction scheme described as "geodetic," without bulkheads or spars in hull or wings; the structural loads are supported by a lattice-work of aluminum alloy tubes. The wing span is seventy-four feet, the length thirty-nine feet. The nine-cylinder, air-cooled

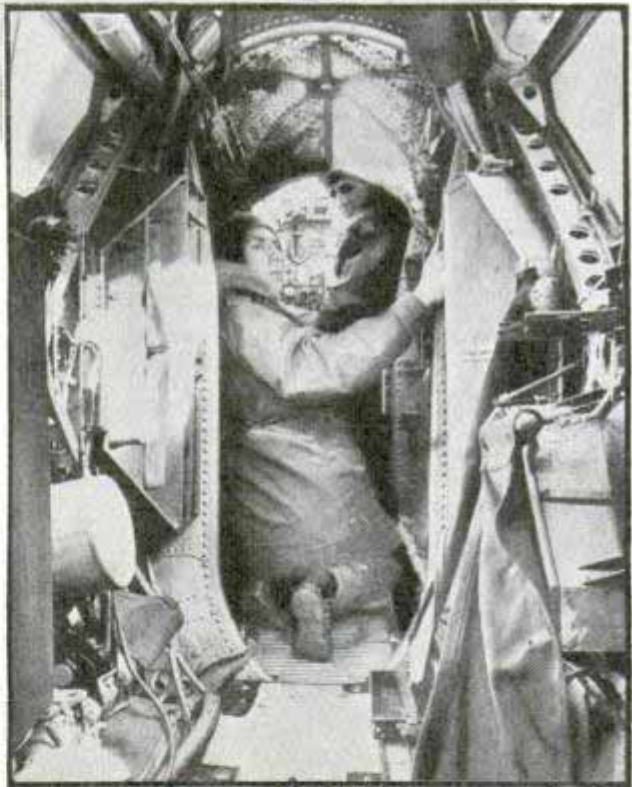

"Bristol Pegasus" radial engine of 900 horsepower turned a new type controllable-pitch propeller with wooden blades.

## Cell Life Made to Stand Still by Quick-Freezing Process

By freezing small living organisms at terrific speed life is made to stand still in a latent state for thousands of years. According to Prof. Alexander Goetz, physicist of the California Institute of Technology and inventor of the new process, the secret

of halting animation lies in a method of extremely quick cooling, followed later by rapid thawing to bring again a state of normal life. Living organisms, at present limited to yeast cells and bacteria, are plunged quickly into liquid hydrogen hav-

Pasadena, Calif.

H 1420  
NY Times  
11/20/38

H 1355

Royal Air Force



ing a temperature of minus 252 degrees centigrade, or about twenty-one degrees above absolute zero. Freezing takes place in one two-hundredth of a second which does not allow time for a change in the exact geometrical pattern of the cell's form. If frozen at a slower rate, the molecules in the cell could rearrange themselves and assume a crystalline form, forever losing life's characteristic pattern. In this new state of being, a minute of normal life can be stretched out over 10,000 years.

H/1409  
**Boxer's Robot Sparring Mate**  
**Fights with Compressed Air**

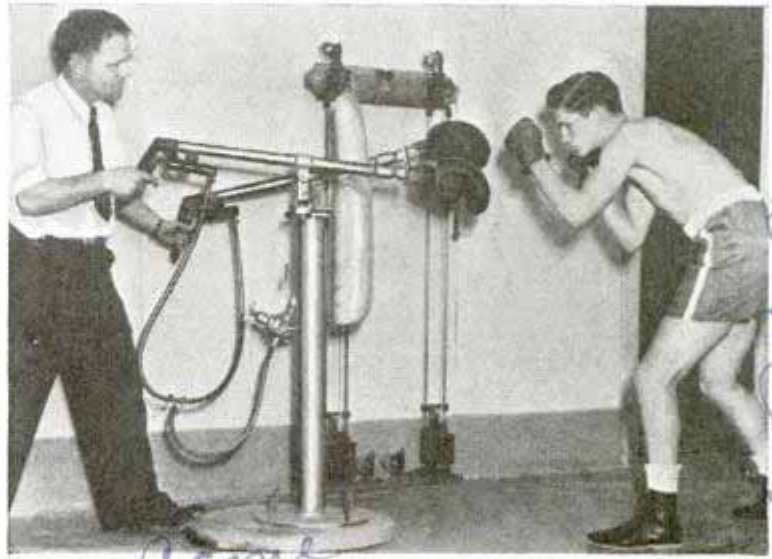

Compressed air is behind every blow this robot boxer strikes, and it takes quick dodging to evade its thrusts

H/1408  
**Tourist Tent in a Trailer**  
**Mounted on Casters**

For the motor tourist who prefers tent life, a small trailer has been developed which forms a roomy camp home. It has sleeping and dining facilities, and the partly raised trailer top supports the front of the tent roof at a height affording plenty of head room for campers standing inside. The trailer has a double-arm coupler which can be attached to any automobile without wrenches or special tools, and, with its caster-type wheels, rides smoothly and can be parked and backed without trouble.

Here's a sparring mate with plenty of punch, and one that can't be hurt. It is a two-fisted mechanical boxer built to teach footwork and alertness in dodging and blocking blows. The fighter tries to connect with a dummy, and meanwhile dodges the trigger-operated flying fists which are shot at him by compressed air.

H/1369  
**Coffee Temperature Regulated**  
**by Heat Control Plug**

Coffee can be kept at any desired temperature in an electric urn by means of a variable heat control plug. Built into the plug is a knob switch readily changed from high to low temperature. Although designed specifically for use with electric coffee makers, the plug can be used with many other appliances.

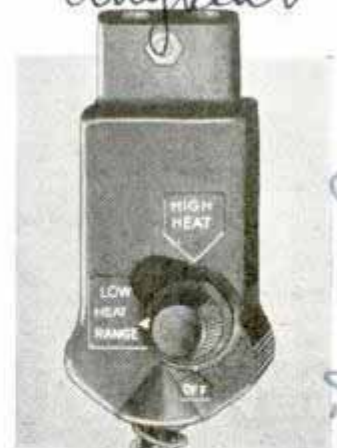

Double-arm coupler on this trailer, shown packed and with tent raised, is easily attached to any car

From the exhaust of automobiles in the United States comes 17,500,000,000 gallons of new water yearly, enough to fill a canal twenty-five feet wide and six feet deep from New York to San Francisco.

Fabriform Steel Products Co

General Motors Corp  
 "Chemistry and Wheels"

Designed by Fred. Frederick  
 Westchester, C. Y. O. Detroit  
 Siles, Co. Hartford, Conn.  
 Leary, Conn.



*Staff Taxidermist. Leon L. Walters.*

# Creatures Modeled to Appear Natural as Life

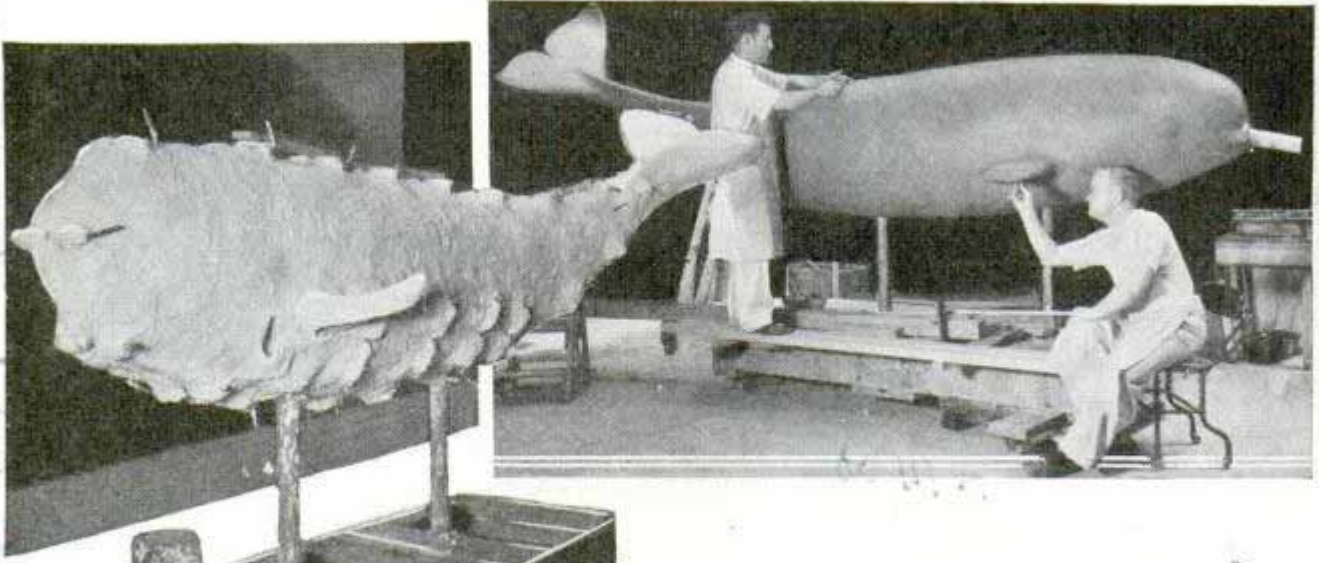

Here an arctic narwhal, close relative of the whale, is reproduced for Field Museum of Natural History. It begins with clay model, upper right; left, mold of plaster of paris is allowed to set over model, then removed a section at a time



Above, painting artificial "skin" of mammal inside plaster mold. Skin is a patented cellulose-acetate material. Left, wire-mesh and composition backing is applied to add structural strength, then sections of mold are fastened together

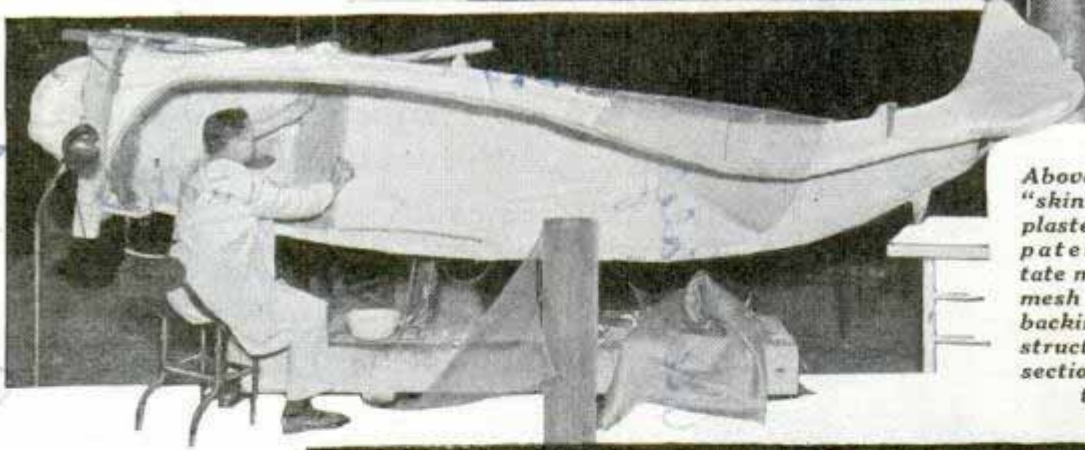

Strange synthetic creatures with skins of cellulose acetate—the material of which photographic film is made—are fashioned to appear as natural as life at the Field Museum of Natural History in Chicago. After sculpturing clay model and making plaster cast, taxidermists mix cellulose acetate with oil colors and reproduce skin pattern over entire mold. Later, mold is soaked and broken away, right, leaving exact copy of original

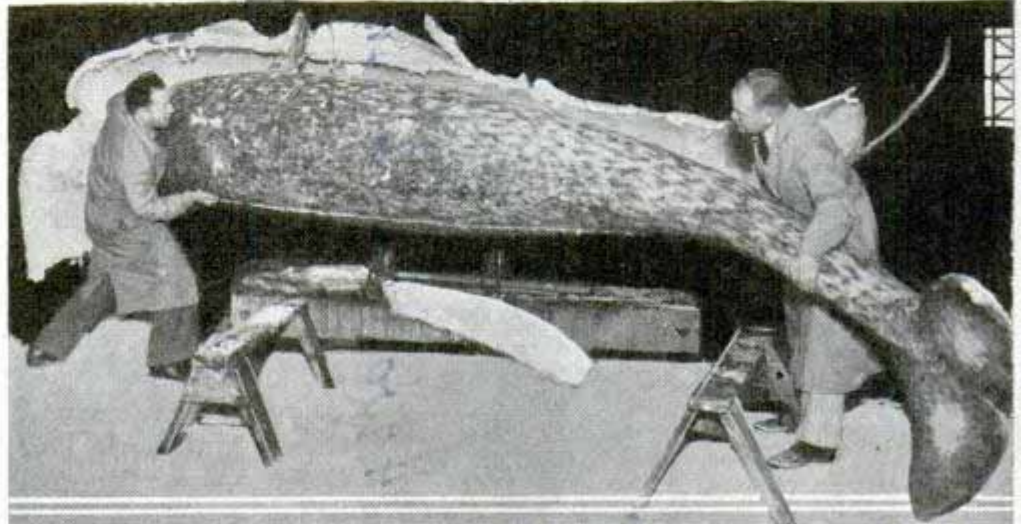

#1570. Process invented by -  
 Staff Taxidermist. Leon L. Walters.  
 Comb. John W. Meyer, Staff Taxidermist.

Strange synthetic creatures with skins of cellulose acetate—the material of which photographic film is made—are fashioned to appear as natural as life at the Field Museum of Natural History in Chicago. After sculpturing clay model and making plaster cast, taxidermists mix cellulose acetate with oil colors and reproduce skin pattern over entire mold. Later, mold is soaked and broken away, right, leaving exact copy of original



H 1349  
model

# Risking Death to Build Man's Mightiest Work

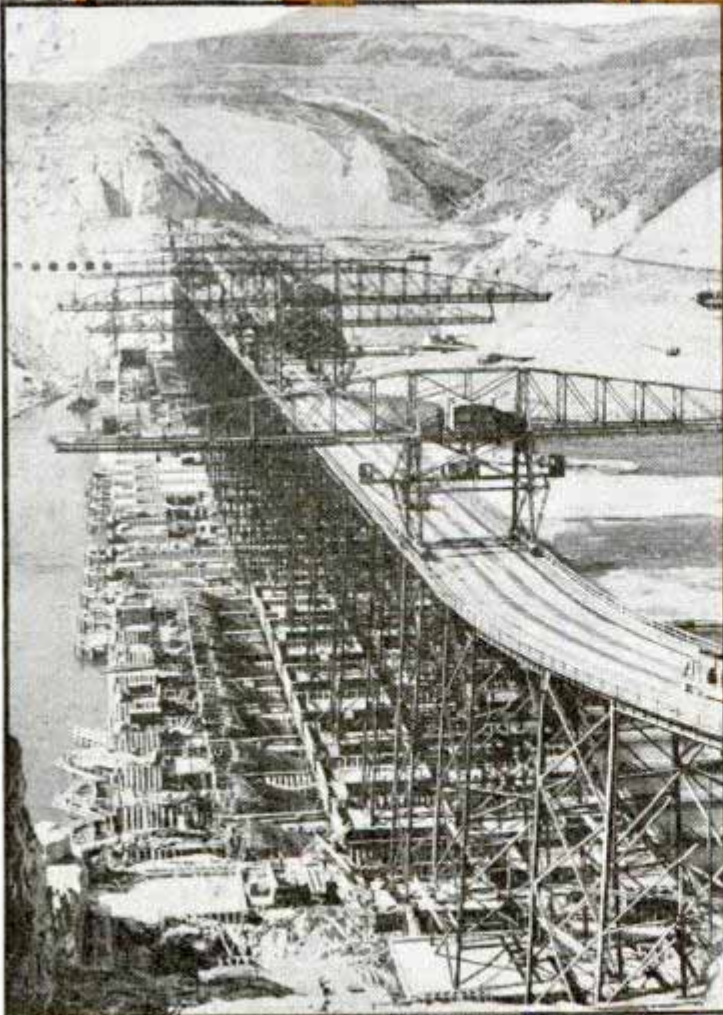

When Grand Coulee dam is completed it will be man's mightiest structure, a monument to engineers and workmen who risked life every day on dizzy heights of its skeleton. Its 550-foot wall will back up a lake 151 miles long, nearly a mile wide, developing 2,520,000 horsepower and irrigating 1,200,000 acres. At left, top, workman attaches a line to compressed-air "main"; right, crane swings men over foamy water to base of dam. Bottom, latest view of dam, and welder on penstock

Acme



171392

# Balloon Train Takes Cosmic-Ray "Census"

Into the stratosphere by train went six pounds of delicate instruments recently. It

was a train of balloons, hauling a Cellophane-wrapped radio station that sent back signals from nearly fifteen miles above the earth. Six bags filled with hydrogen were tied together in a line 100 feet long and released from the roof of the Franklin Institute at Philadelphia. For two and one-half hours the research staff below received signals from which they could read the temperature and cosmic-ray density at the various altitude levels up to 78,000 feet.

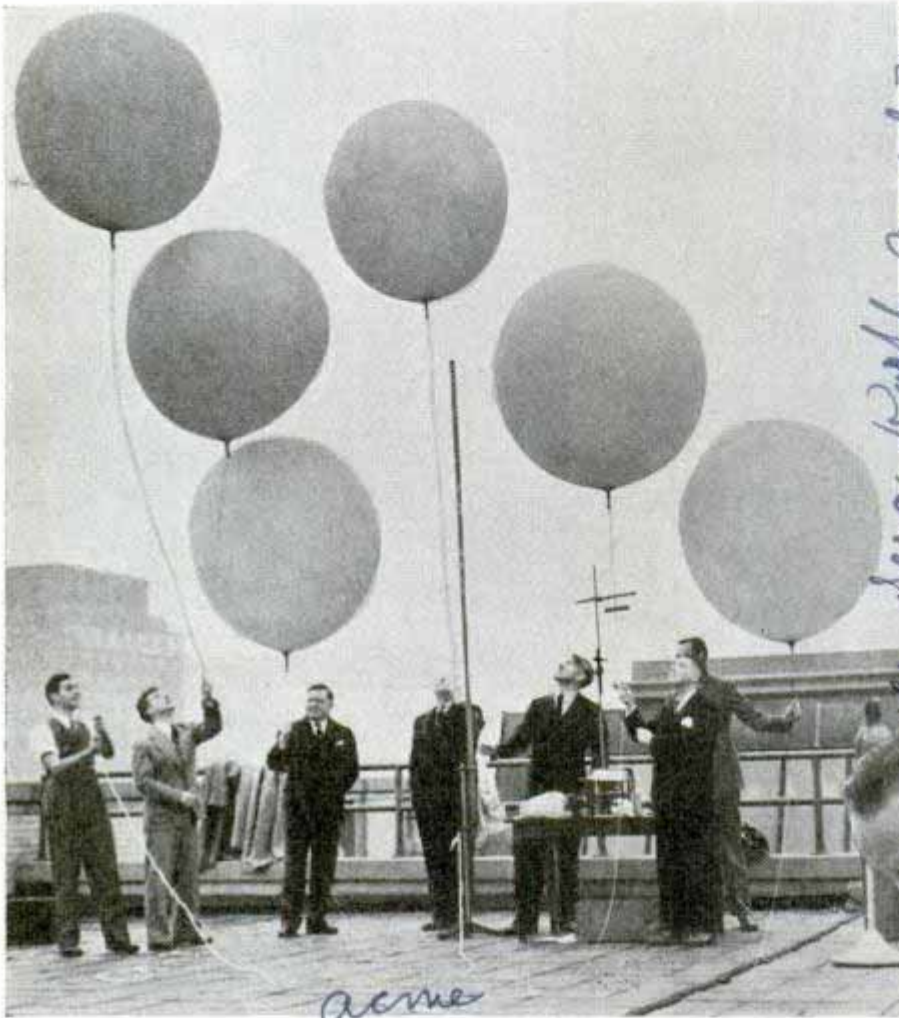

Top, six balloons ready to carry cosmic-ray instruments and radio transmitter to substratosphere. Below, wrapping radio set in Cellophane bag

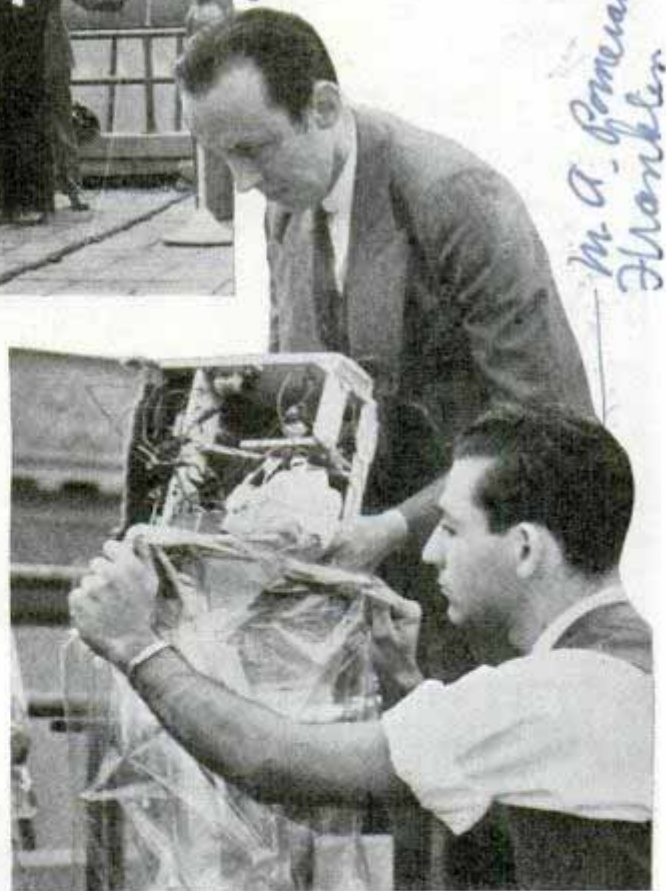

## Enlarger Focusing Made Easy by Microscope Easel

More accurate means of obtaining critical focus of photo enlargers is offered by a new framing easel. The device makes use of a microscope through which the actual grain of the emulsion is seen. When the grain of the film becomes sharply visible, the image is automatically brought into the most critical focus on the surface of the printing paper. The system gives the operator a control over the amount of grain that is to appear in the final print. Inasmuch as the actual grain of the film is in view when focusing, it is possible to defocus slightly until the grain has just about disappeared without any



great loss in print definition, actual sharpness of the image being unaffected. The easel, which is of metal construction, has quick adjusting paper stops which permit the border to be varied to any width.

171398  
International Research Corp., Ann Arbor, Mich

Dr. Serge Koff, Bartol Foundation

Mr. A. Pomeroy Franklin

acme

encl



689

London, W.C. 2, England.  
Modern Wonder. 5/28/38.  
Story from S. Thompson.

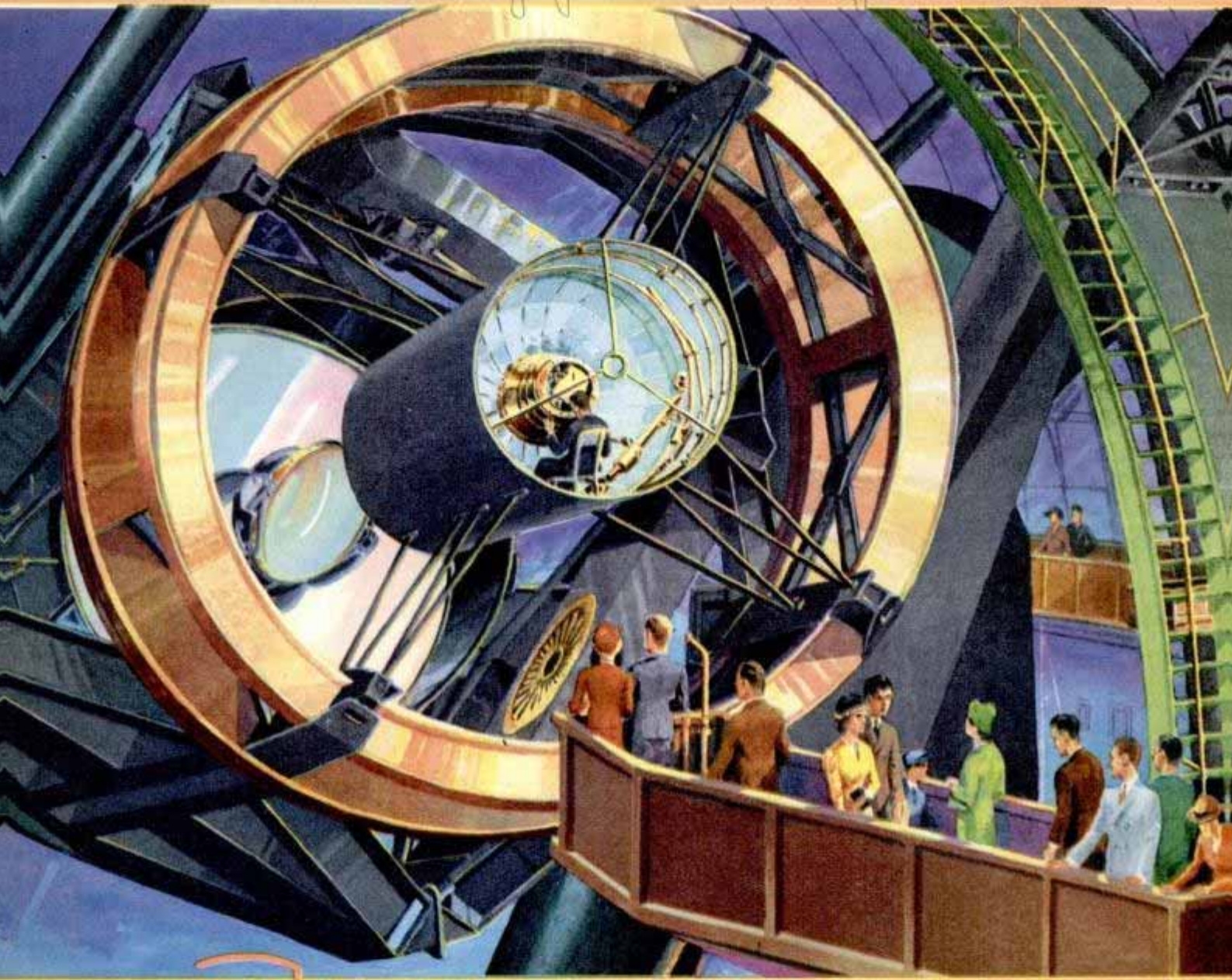

VISITORS on the "bridge" examine the mightiest of all telescopes, Mt. Palomar's 200-inch eye. (77)

The

# WONDERS of ASTRONOMY

Reference - Astro. Physics Dept.  
California Institute of  
Technology,  
Pasadena Calif.





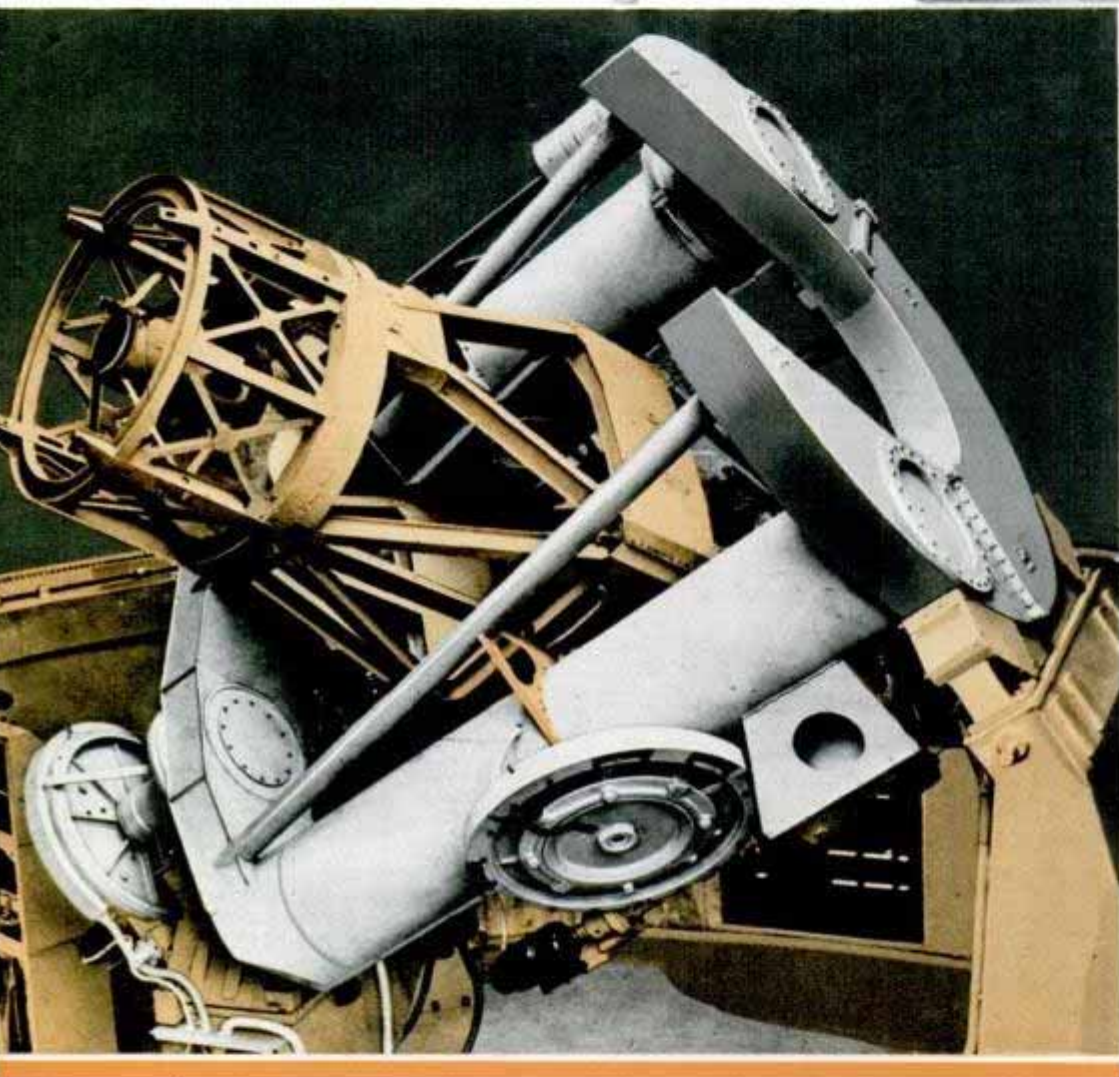
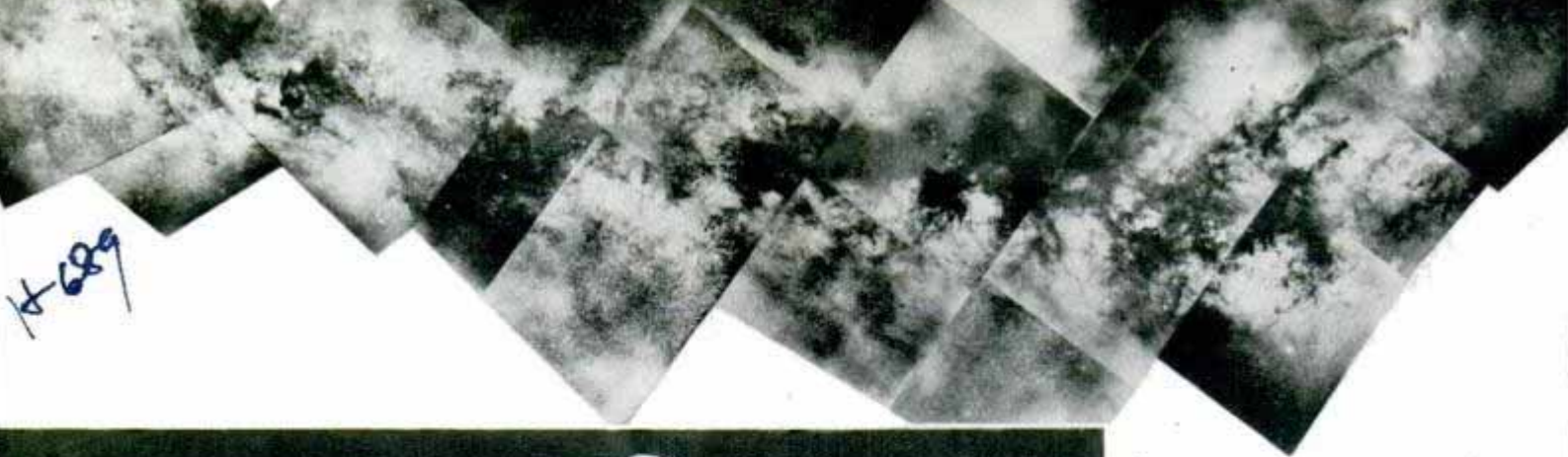

14-689

**MOSAIC** chart of Milky Way at top was photographed with six-inch lens. Astronomers expect to discover ten billion other star systems, each as large as the Milky Way, when the new mirror starts sweeping the skies. One-tenth the size of the giant telescope, the scale model at left is exact copy complete to electric drives and is itself an efficient instrument, already in use at Pasadena.

198

**W**ITHIN a year the mightiest telescope ever dreamed of, a \$6,000,000 giant that "couldn't be built," will be sweeping the skies for new contributions to man's knowledge. The great 200-inch reflecting telescope of the California Institute of Technology will start its career late in 1939 or early in 1940, considerably ahead of schedule.

Today, completing touches are being put on the big steel dome, fourteen stories high, that will house the instrument on the top of Palomar Mountain, ninety miles southwest of Pasadena. The telescope itself, complete except for the

delicate optical parts, will be finished this winter.

Gathering four times as much light as the largest instrument existing today, the Palomar telescope will see twice as far as any other telescope in the world. It will have twice the focal length of the next largest telescope and will be used for studying objects in the sky too faint to be perceived by present instruments.

Astronomers expect that they will discover some ten thousand million star systems each the size of our Milky Way and that they will be able to push the borders of the known universe to one bil-



lion light-years away. A light-year is nearly six trillion miles, the distance that light travels during a year's time.

The heart of the new telescope will be the 200-inch concave mirror, actually 201 inches in diameter, which is now receiving its final polishing and figuring. Some two tons of glass have been ground away to achieve the curve in the surface and another handful of glass will be removed during the twelve months that the final polishing will require. The mirror surface will be polished to an accuracy of one millionth of



199  
SPIRAL nebulae of Ursa Major, top, photographed by seven-and-one-half hour exposure. Above, studying spectral lines of stars to measure their elements. Below, under Mt. Palomar's dome.

an inch and a reflecting surface of aluminum, only a few molecules thick, will be deposited on the mirror in a special vacuum chamber.

This telescope will look like no other ever built and it will be far more versatile than most instruments. The new style of mounting permits it to cover the entire visible sky from the North Pole down to the southern horizon. Its optical parts can be hooked up in different ways to facilitate particular lines of research.

Direct observations, made by exposing photographic plates to the





1587

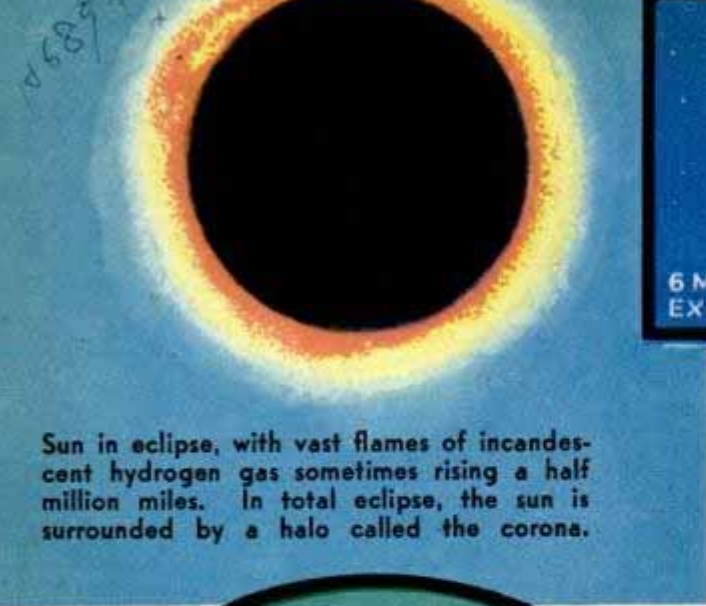

Sun in eclipse, with vast flames of incandescent hydrogen gas sometimes rising a half million miles. In total eclipse, the sun is surrounded by a halo called the corona.

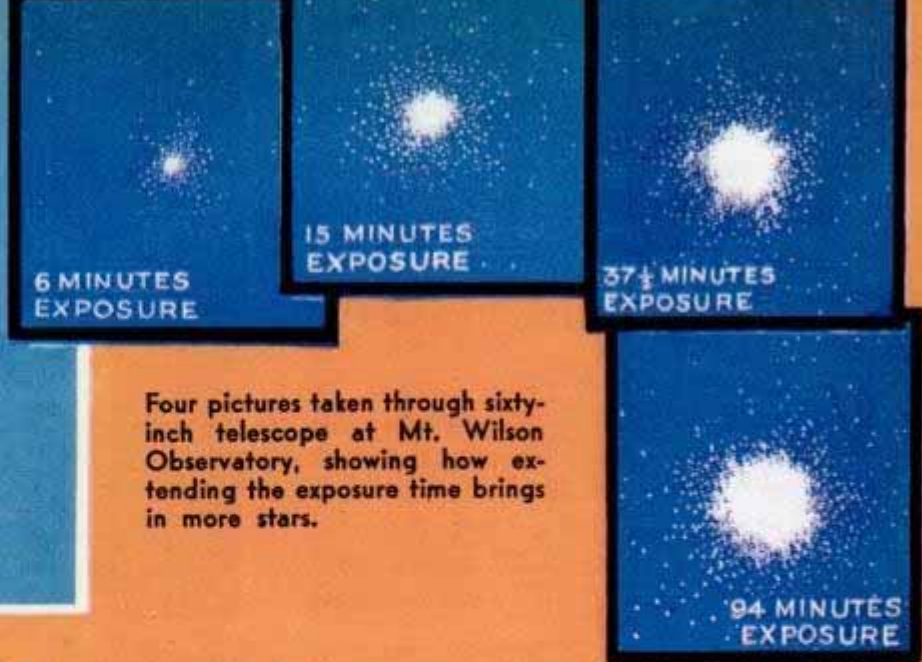

Four pictures taken through sixty-inch telescope at Mt. Wilson Observatory, showing how extending the exposure time brings in more stars.

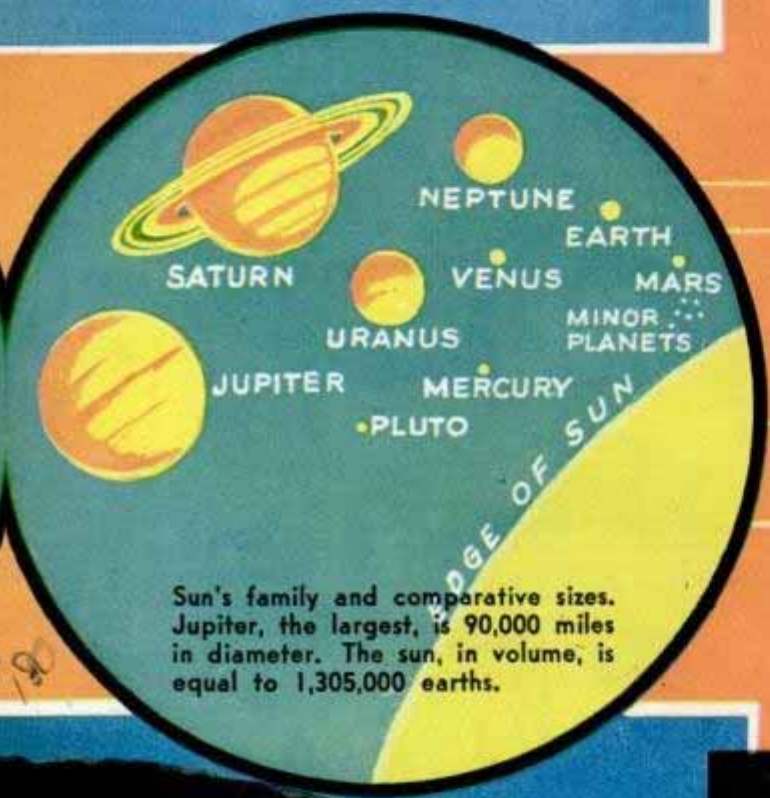

Sun's family and comparative sizes. Jupiter, the largest, is 90,000 miles in diameter. The sun, in volume, is equal to 1,305,000 earths.

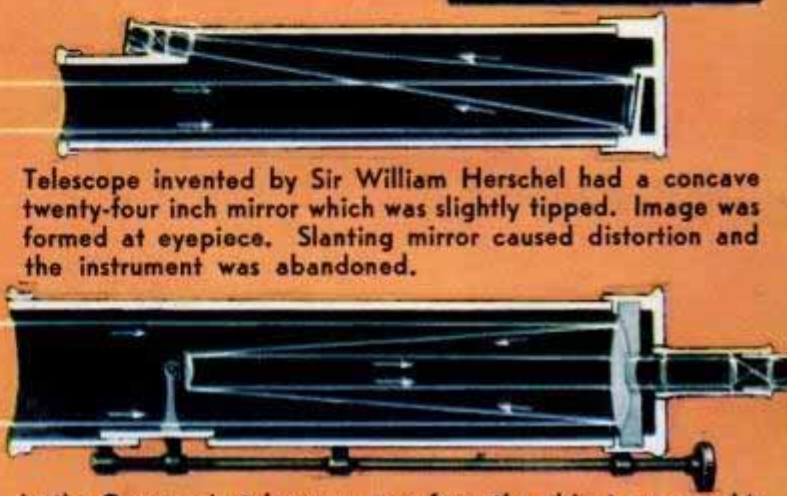

Telescope invented by Sir William Herschel had a concave twenty-four inch mirror which was slightly tipped. Image was formed at eyepiece. Slanting mirror caused distortion and the instrument was abandoned.

In the Cassegrain telescope, rays from the object are caught by large concave mirror near eyepiece and reflected to small convex mirror, which reflects them through hole in mirror to observer's eyepiece.

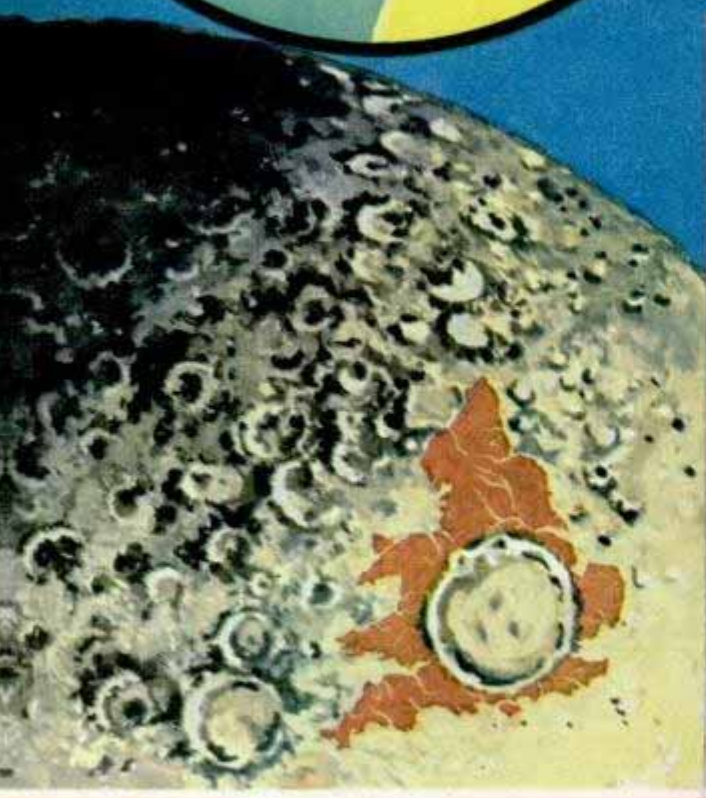

Moon as seen through 100-inch telescope at Mt. Wilson observatory. Size of craters is shown by map of England drawn to same scale.



Eighteen-inch Schmidt telescope in use on Mt. Palomar, Calif., as an exploring telescope for finding mysterious super novae stars.



and 7,000 miles wide.

Strange white spot which was discovered on Saturn in 1933.



Without astronomy, it would be impossible to keep time accurately, nor would the mariner be able to navigate or the airplane pilot to find his way. Astronomers discovered helium.

Remarkable tower telescope at Mt. Wilson Observatory, Calif., is 150 feet high and extends 75 feet into the ground. Sun's image is reflected downward to spectroscope in pit. Note the winding stairs.

Ordinary terrestrial telescope presents image right side up, unlike astronomical telescope from which lenses are omitted to obtain more light.

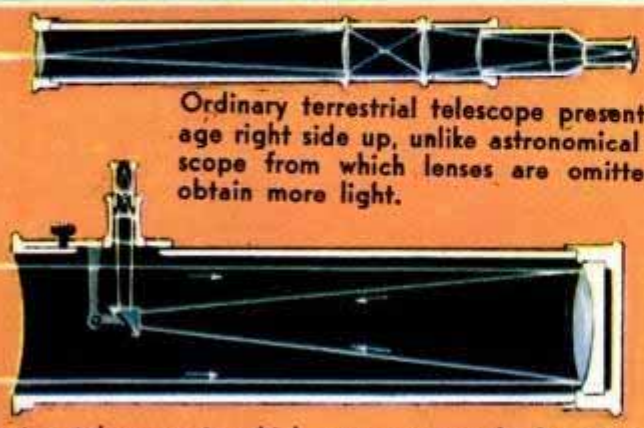

Newton telescope in which rays are caught by concave mirror, reflected back to prism which then reflects them at right angles. Eyepiece is at side.

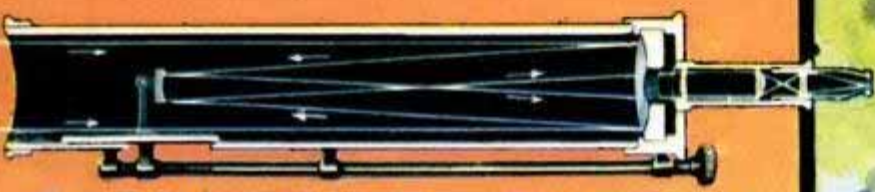

Gregorian telescope is like Cassegrainian except that image is reflected back to concave mirror instead of convex.



Visitors from space approaching the earth, with large meteor at bottom and comet at top right.



150 FT

75 FT

COATING OF ALUMINUM

11 FT RADIUS 16'8"

WEIGHT SAVING RECESSES

BASE PLATE

HOLE FOR EYE-PIECE

Largest piece of glass ever cast, 200-inch mirror for new telescope. It weighs twenty tons and smoothing its surface to one millionth of an inch will take two years.



New 200-inch telescope may reveal whether these are roads or canals on map of Mars drawn by the late Prof. P. Lowell.



14689

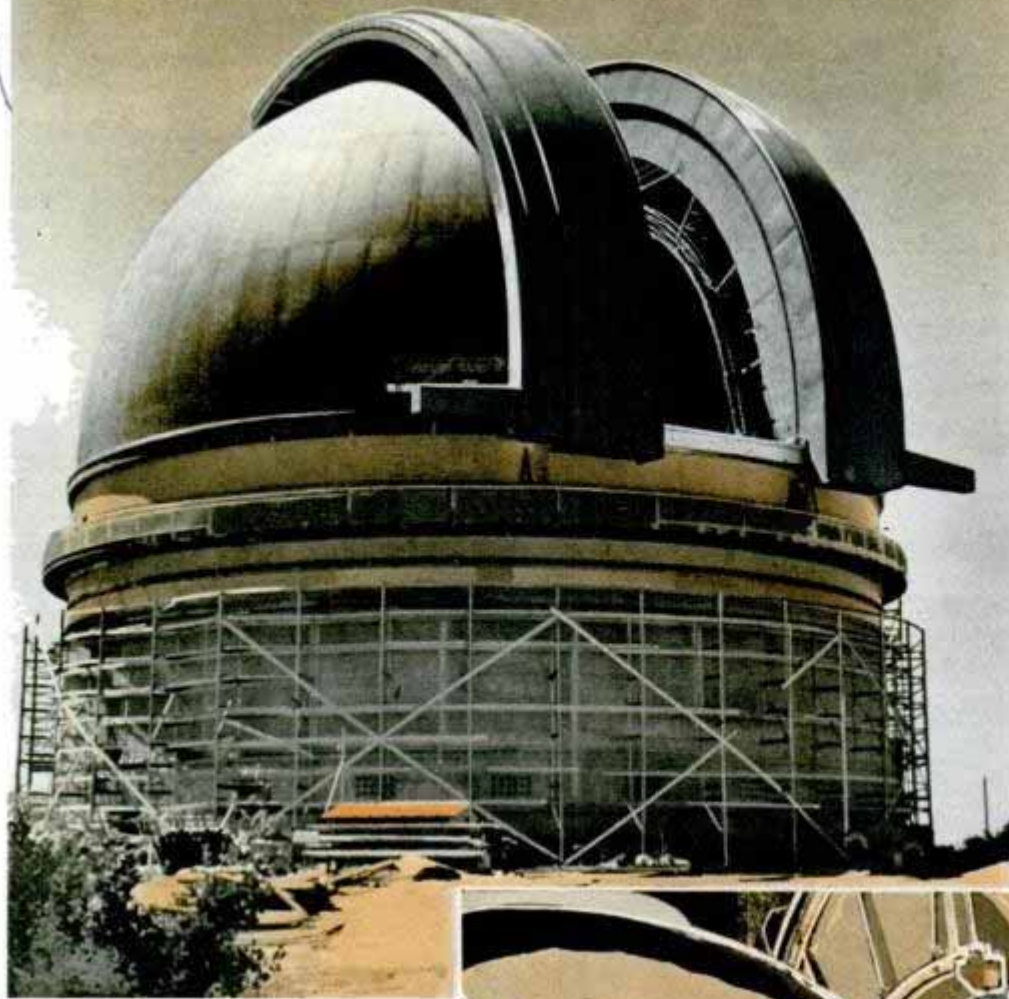

FOURTEEN stories high, the two-million-pound dome is really a dome within a dome, each coated with aluminum and separated by a four-foot air space for insulation. It revolves on thirty-two four-wheel trucks of railroad type which roll on a track around the wall. Below, cutaway drawing of declination trunnion. Bottom, twelve exposures of Saturn made at Mt. Wilson observatory.

182

concentrated light from the mirror, will be made at the prime focus, the point above the mirror where the reflected light is brought to a focus by the mirror's curve. The observer will be stationed inside a small bullet-shaped house suspended inside the skeleton barrel at that point. The house reduces the amount of starlight falling on the mirror down below but the astronomers estimate that this method will be more efficient than the diagonal mirror usually placed at the prime focus to reflect the rays out of the barrel to an observation point.

By substituting a mirror for the observer's cage at the prime focus and reflecting the gathered light back down through a hole in the center of the 200-inch mirror to an observation point below, a different optical effect is achieved. This Cassegranian focus will be used for

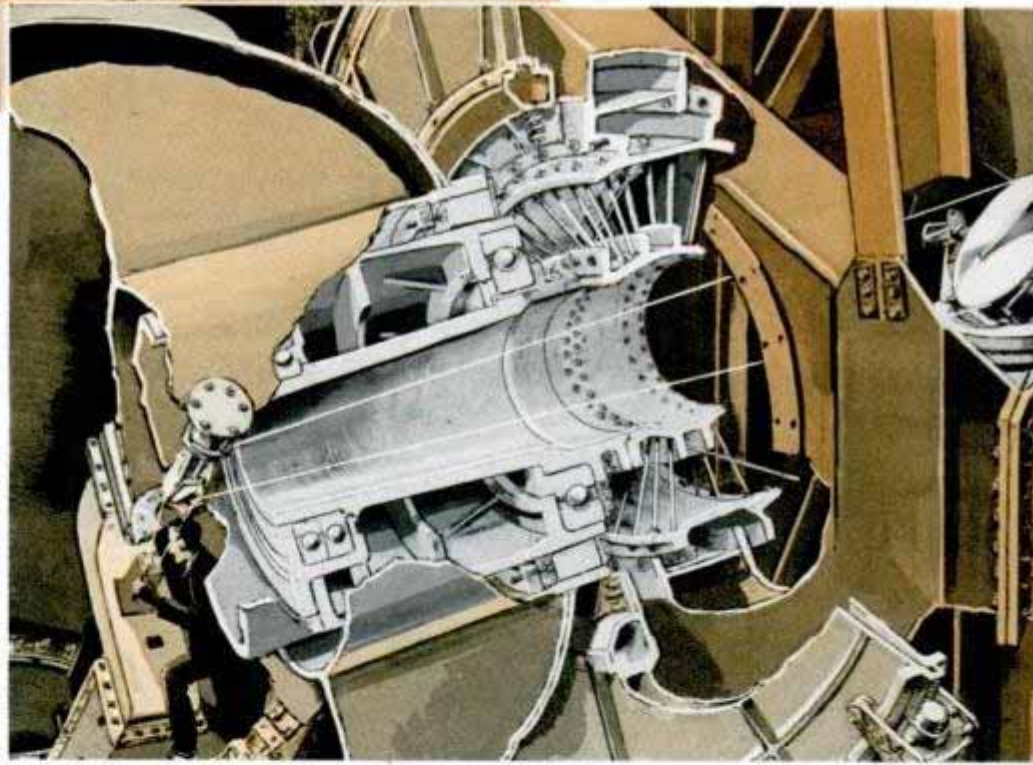

spectrographic and photographic observations. In still another hook-up, known as the coudé, the light is reflected from the prime focus back to a diagonal mirror suspended above the giant eye and is "piped" by several other mirrors to a constant temperature vault where special spectrographic work will be conducted. In this setup the light will be reflected from as many as five mirrors in the optical train. A jib crane, oper-





ated by electric motors, is being mounted on the great telescope for moving the optical parts.

Astronomers estimate that for many kinds of observations the telescope will be twice as powerful as was first planned simply because of the great improvements that have been made to auxiliary instruments since the telescope was first projected. Photoelectric equipment, correcting lenses, and the sensitivity of photographic emulsions all have been improved vastly, increasing the scope of all astronomical telescopes.

One of the great strides is a new superthermometer invented by Dr. John Strong of the Institute's astro-physics staff. This instrument, called a radiation pyrometer, resembles a small telescope and is equipped with rock-salt and quartz lenses that screen out all except infrared radiations. These red rays fall on two thin gold leaves attached to the wires of a tiny galvanometer. Aside from its astronomical importance the instrument can take the temperature of a person several miles away and measure the surface heat of clouds or balloons.

New ideas, new materials, and new methods were all necessary in building the titan of telescopes. Accuracies never before attempted on a large scale were imperative. Pointing the huge instrument on a star and holding the image still during the star's slow movement across the night sky is comparable to keeping a gun trained continuously on a target two inches in diameter that is eight miles away and that moves at a speed of three feet per second. To stay on the star the telescope must move on two axes at the same time and the great dome above it must also revolve so that the telescope always points through the open slot in the roof. The different

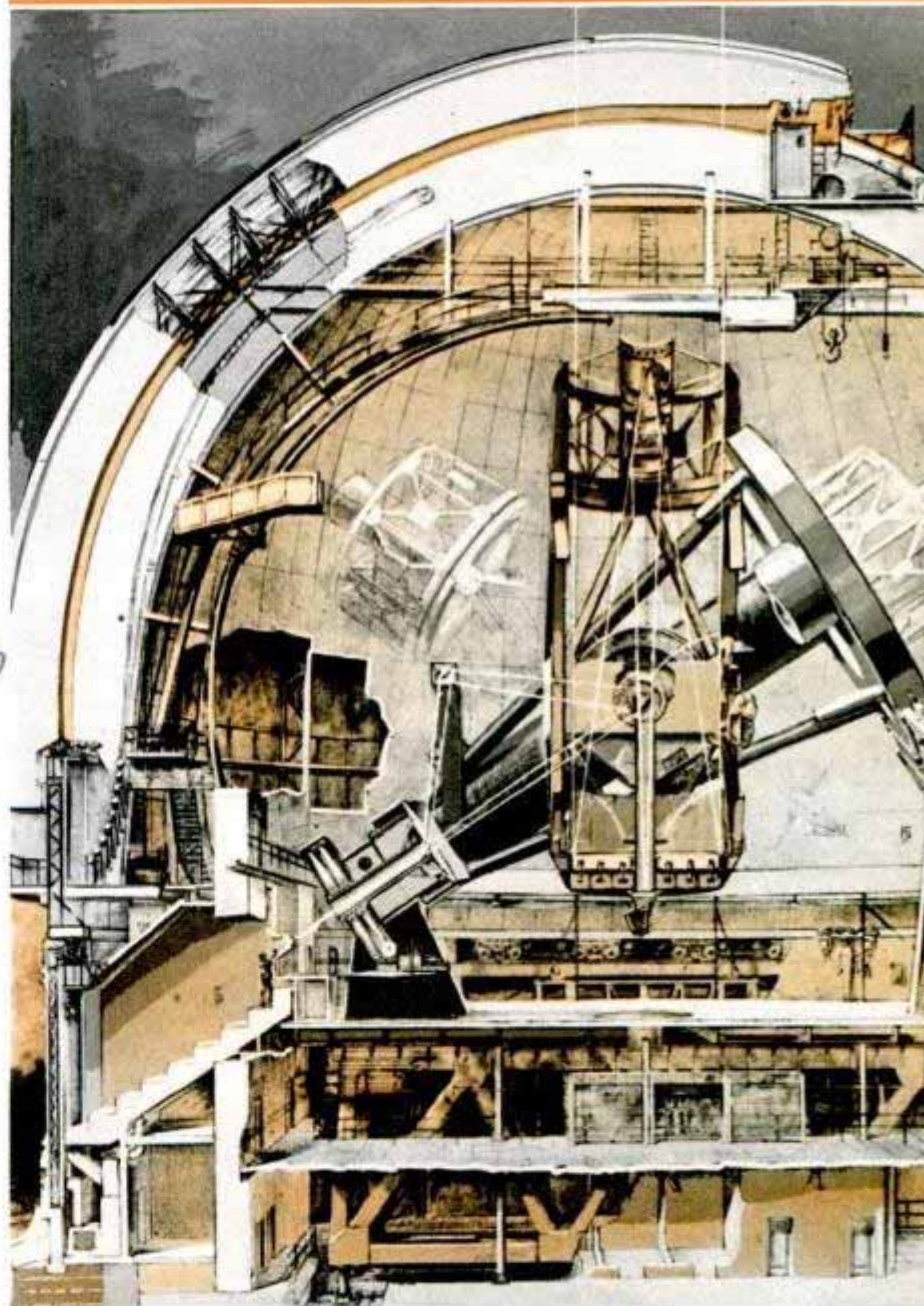
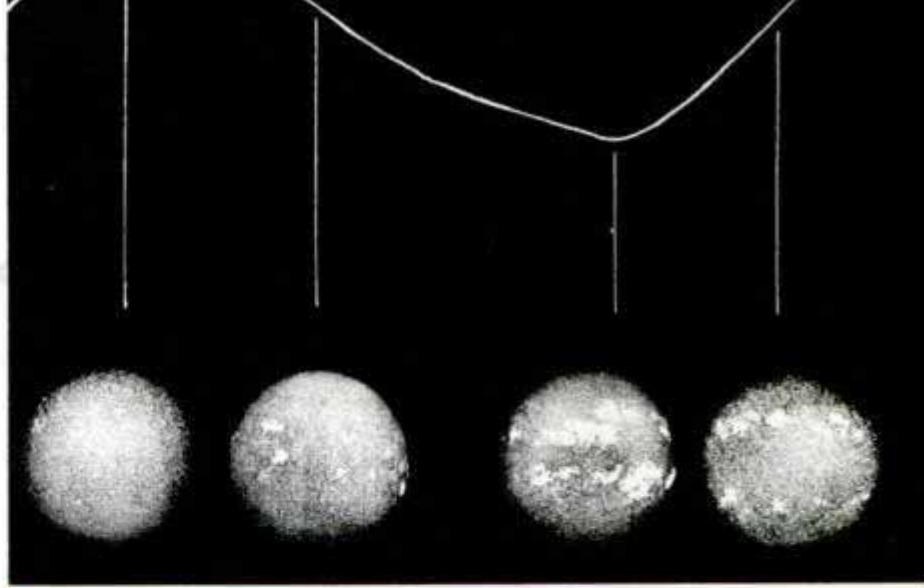

CURVE of single sun-spot cycle is shown at top with four calcium spectroheliograms showing appearance of sun at phases of cycle, observed at Mt. Wilson. Phantom drawing below gives impressive glimpse of immensity and intricacy of Mt. Palomar telescope.



14689

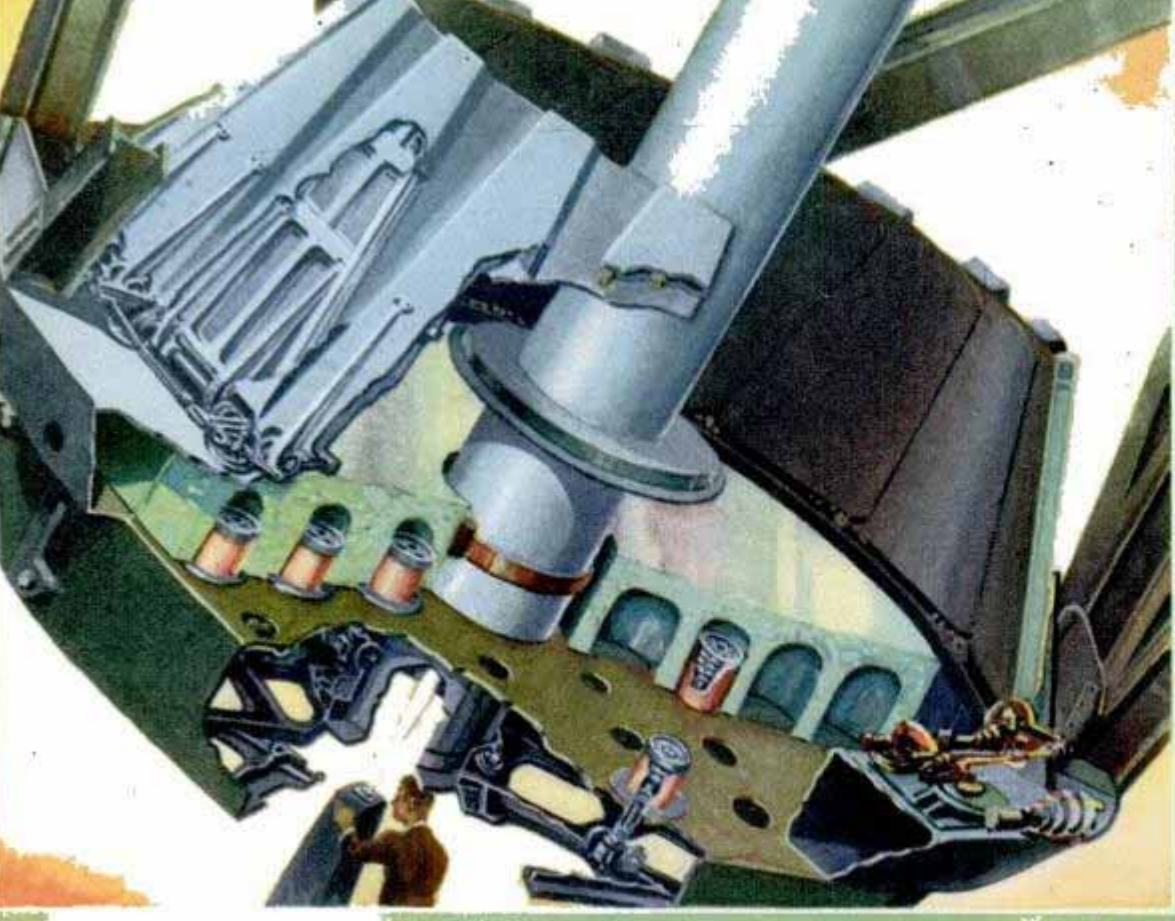

**MIRROR**, cell, support and cover are seen in cutaway drawing at left. Below, an astronomer inspects the small polished mirror which is used to reflect light from the stars to a spectrograph, where the scientist reads the thin spectral lines to learn the elements of which stars are made.

moving parts weigh hundreds of tons each and yet the slightest vibration would cancel the value of the telescope. For some kinds of research the image of a star, picked up by the great light-gathering eye, must pass through a slit one thousandth of an inch wide. Any vibration would throw the image off. Once, during an observation at another observatory, the vibration from a one and one-half-horsepower concrete mixer several blocks away was enough to disturb the instruments.

One of the most difficult feats was to arrange a smooth way of turning the big 2,000,000-pound dome. Even a slight vibration such as would barely ripple a glass of water would be too much. The problem was solved by a new type of drive developed by Edmund G. Grant, associate engineer of the project. The dome is supported by thirty-two four-wheeled railroad-type trucks that travel on a track around the circular wall. Instead of using the conventional rack and pinion to turn the dome Grant created a new kind of friction drive, using four electric motors of seven and one-half horsepower geared vertically to huge rubber-tired motor-truck wheels that press against the dome.

*(Continued to page 128A)*

184

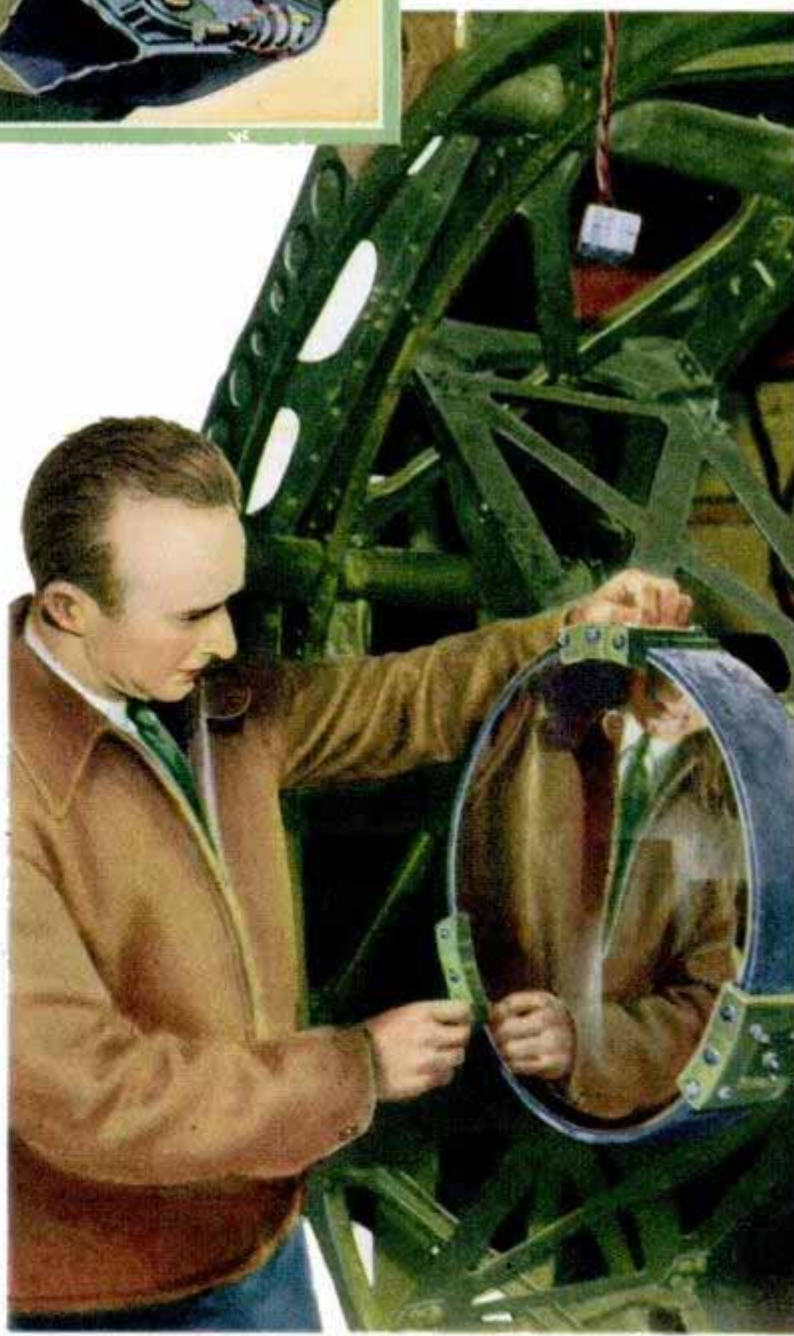



## Vegetable "Sculptor" Makes Amusing Figures

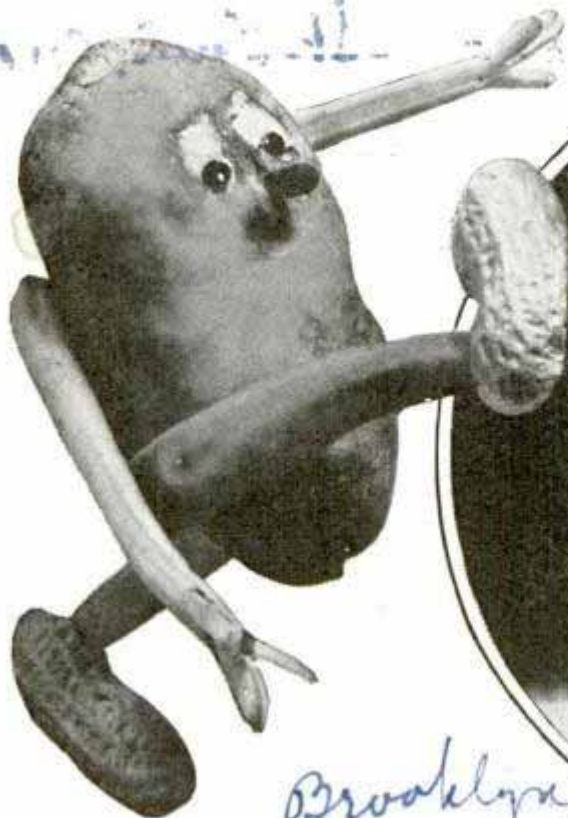

Brooklyn  
N.Y.

Talented ten-year-old Harold Brown, right, has developed an unusual hobby by assembling the ordinary run of vegetables, fruit and other items from the table into odd sport characters. Above, the big feet of this high-kicking football player are made of peanuts attached to string-bean legs; the body is made by carving a large potato, and stalks of celery swing at the sides to form arms

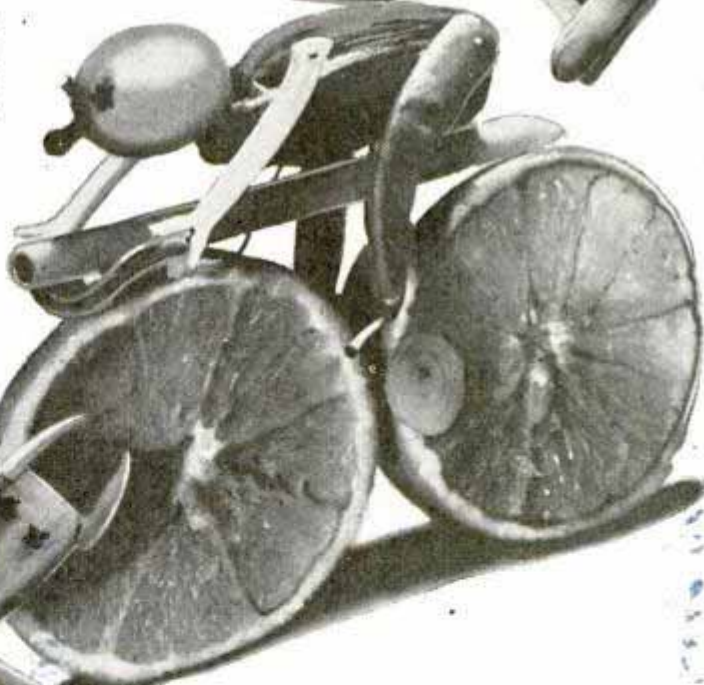

Above, with every muscle strained to win a sprint, the onion-head six-day bike rider points his spice nose into the wind; eyes made of cloves are wide open for every advantage, as the string-bean legs pedal away to drive wheels of orange slices. Left, with a carrot and string-bean body, and a celery tail, the horse watches his polo-player rider swing wickedly at a pea. The collection represents nearly every sport

16 26 W 7 St N



# Clamp-On Light for Shop Is Handy for Repairman

*Personality*



At top, spotlight is clamped to pipe in workshop and focused on center of operations

Particularly useful for repair work where a steady light is required at different angles, a new clamp-on light is on the market. The clamp, of the rubber-covered spring type, clamps readily and quickly to almost any support. The light from the lamp is projected in a glareless, concentrated beam. A ball and socket swivel joint permits tilting in any direction, increasing its uses in shop or factory.

## Vise Tapes and Binds Negatives to Make Lantern Slides

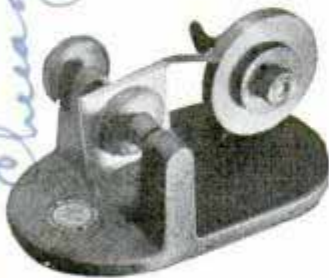

Acting as a vise, a new photographic aid tapes and binds miniature negatives into slides for projection. Ball-thrust bearings in each jaw allow the slide to revolve freely when pressure is applied and the glasses remain in exact position as it turns, assuring neatly applied binding. The jaws are faced with

*Warne and Carter*

rubber to insure a firm grip on the slides. Being heavy and having a sponge-rubber base, the unit will not slip while in use.

*St. Louis, Mo*

## "Gearshift" Nut Cracker Fits on Wall Bracket

Made to fit in a kitchen wall bracket, a handy nut cracker is operated by a small lever resembling an automobile gearshift, with a knob grip. A shift of the lever cracks the shell neatly and the meat can be removed unbroken. The bracket is a standard one made to hold various tools.



*A1385*

## Swinging Sun Dial Adjusted to Avoid Time Errors

Swinging in a vertical position, a new-type sun dial keeps more accurate time than the old-style stationary dial. The plane of the dial is adjusted by a notched arc designed to keep the stylus always at right angles with the sun at noon, thus reducing the margin of error common in horizontal dials during the various seasons.

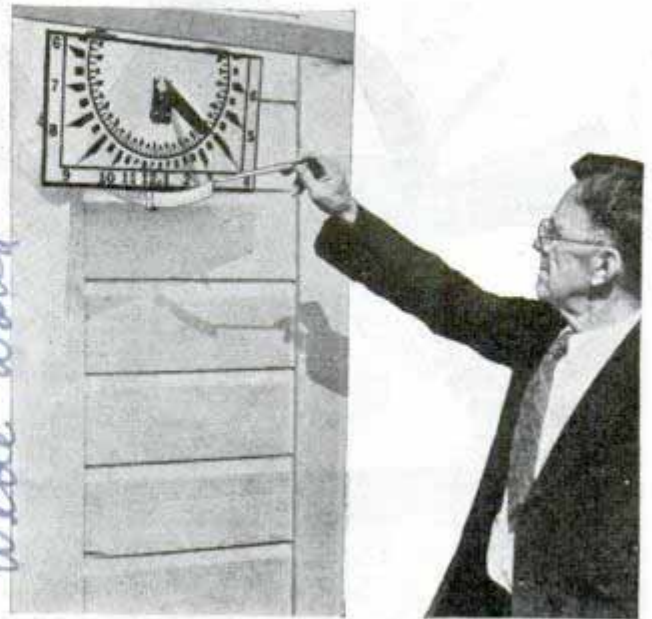

Notched arc under swinging sun dial is used to correct seasonal errors common in horizontal dials

*W. S. Brown, Salisbury N.C.*

*Brown Electric Co. Rochester N.Y.*  
*Central Camera Co. 230 S. Wabash. Chicago*  
*Wide World*



# Pistol Range Built in Tunnel under Back Yard

Shaped like a barrel, a fifty-foot target range built under the back yard permits shooting practice without disturbing the neighbors. Targets are carried through the tunnel on a wire and can be brought back to the basement by means of a pulley arrangement. The target is lighted at the end of the tunnel by reflected light. At twenty-five feet, midway of the tunnel, is another spot where targets may be placed. The range has electric fans to carry off smoke and fumes of burnt powder. A manhole in the yard permits access to the target end of the tunnel. Sound of gunfire is deadened by noise-absorbing material with which the basement is lined. A telescope at one side of the tunnel makes it possible for the gunner to check his shots. The tunnel range is used by Fred MacMurray, motion-picture actor.

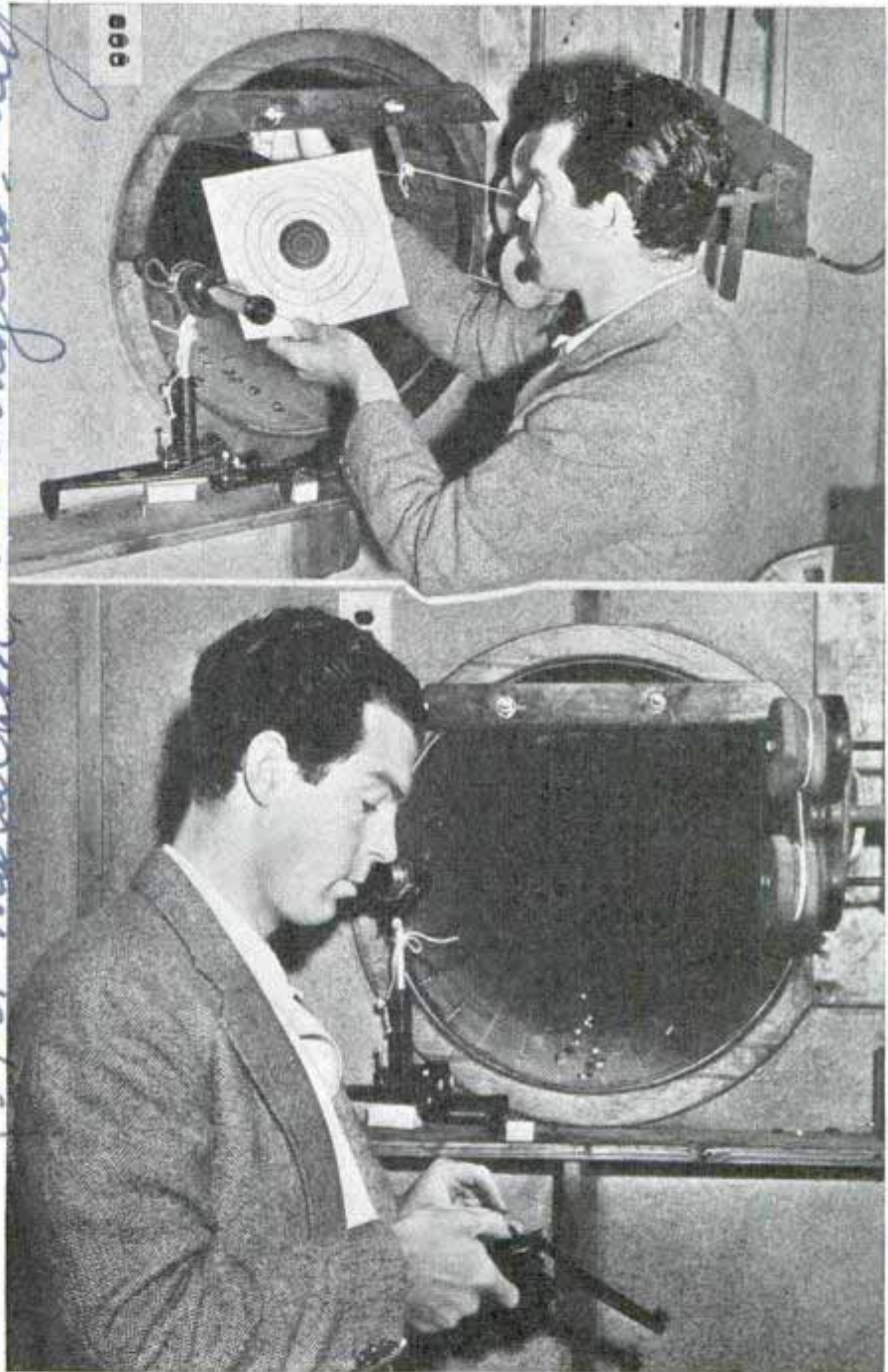

© Paramount Pictures, Inc.  
**Top, Fred MacMurray, film star, starts fresh target to end of tunnel on carrier wire. Below, loading for target practice on underground range**

61396

# Manhole Lid Remains in Place Despite Sewer-Gas Blast

When two Springfield, Ohio, men read newspaper reports of a sewer-gas explosion that flipped manhole lids high in the air and killed several persons, they went to work on a safety lid. The result is a manhole cover that will let gas escape but cannot

be flipped off by explosion or dislodged by traffic. It consists of two hinged lids connected to a center beam, although without any actual hinge, the connection being similar to that of a wheel on an axle. The lids would fly open in event of an explosion, but immediately drop back in position. The center beam is dropped through notches in the manhole rim and then given a quarter turn to anchor it. Once the cover is locked in place it cannot be dislodged or tilted by wheel traffic.



Co. inventors: Martin Swensen and Frank L. Patterson

273 Selwyn Road  
 Springfield, Ohio



# Tapping DAVY JONES'

Cont. Thomas E. Atkinson, Jr. Los Angeles  
 10555 Holmwood Ave. called



Lowering bottle for taking samples of deep-sea water. Left, "snapper" sampler with jaws which close automatically and bite out sample when bottom is touched



TREMENDOUS fortunes in undeveloped mineral wealth lie at the bottom of the sea and today the world is beginning to consider ways of extracting these hidden treasures. Natural deposits of phosphates, oils and other minerals that are buried under the oceans probably would be worth billions of dollars if they could be recovered.

Mining the bottom of the sea today is receiving close scientific study. "It is very probable that in the next generation a great deal of wealth will be taken from the sea bottom," says Dr. Francis P. Shepard of the University of Illinois, one of the sub-sea explorers. "Difficulties that seemed insurmountable before are being overcome. Oil wells off both the California and Gulf coasts are already extracting thousands of barrels of oil at sea."

The present off-shore wells, tapping underground pools that extend past beach lines, were drilled in shallow water or protected lagoons. Surveys indicate that the oil resources of Texas and Louisiana probably extend 100 miles out to sea. More than forty salt domes, along the sides of which large quantities of oil are commonly found, have been charted on the sea bottom in that area in depths of 200 feet of water or more. Most of these salt domes

Urbana



# TREASURE CHEST

are found at the edge of the continental shelf, from the Mississippi delta to the Mexican border. There are likewise possible submarine oil pools off the west coast of the United States, and areas considered worth exploring extend as far as 150 miles to sea in water depths up to 500 feet.

Petroleum engineers think it feasible with our present knowledge to drill for oil two or three miles off

*Current meter for measuring velocity and direction of deep-sea currents. Bottom, sediment trap which catches matter drifted along by sub-sea currents*

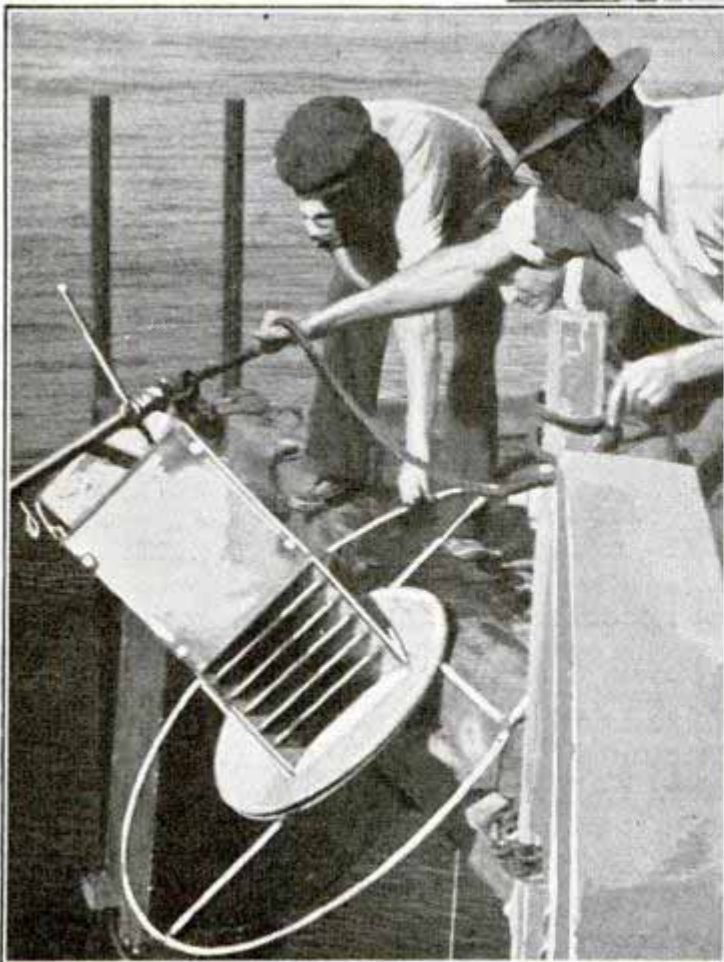

shore although costs might be considerably more than drilling on land. As deep-sea drilling technique improves wells might be drilled at much greater distances from shore, with pipe lines laid along the bottom of the ocean to the wells. One suggestion for drilling is that it could be done from barges moored to minimize wave motion. Present drill pipe is quite flexible and arrangements could be made to seal the work so it could be left safely during storm periods.

The shallow Malay seas are adjacent to oil territory, there may be vast oil possibilities in the wide submarine shelf off the north and east coasts of Siberia and salt domes have been charted in the shallow Persian gulf. One complication that might arise is the question of ownership of undersea resources, the high seas until now having been regarded as outside the jurisdiction of any country although interna-





*Examining sections of ten-foot core of sea-bottom samples. Right, relief map showing contours of submarine canyon off California coast near La Jolla. Contours at upper part represent hills ashore*

tional fishing treaties usually concede a country a prior interest in adjacent waters.

So far oil seems to be the most promising undersea treasure although evidence of other deposits has been found. Great masses of rock phosphate lie off Pacific coast beaches in depths of from 300 to 4,000 feet, some of which might be recovered by enormous dredges.

Gold dust has been reported in samples of the sea bottom taken from deep Alaskan fiords and there is the possibility that great deposits of placer gold may lie in the submarine canyons off the coast of California. Such deposits, if they exist, would be found concentrated in small areas due to the natural sorting action of the canyon currents. Fine placer gold frequently is found on California and Oregon beaches after winter storms.

Three-quarters of the world's surface lies under water and has never been explored adequately. One-tenth of this area consists of shoal continental shelves and

shallow seas covered with 600 feet of water or less. It is these shallow areas that have exploitation possibilities. Scientists formerly supposed the continental shelves were mere accumulations of debris swept off the continents by erosion. But, using "snappers" for bringing up samples of the bottom, and dredges for hoisting larger pieces, investigators are learning that the continental shelves are integral parts of the continents. As such they are likely to contain veins of valuable ores.

Today sub-sea scientists are exploring canyons more spectacular than the Grand Canyon, ancient lakes buried under a mile of water and

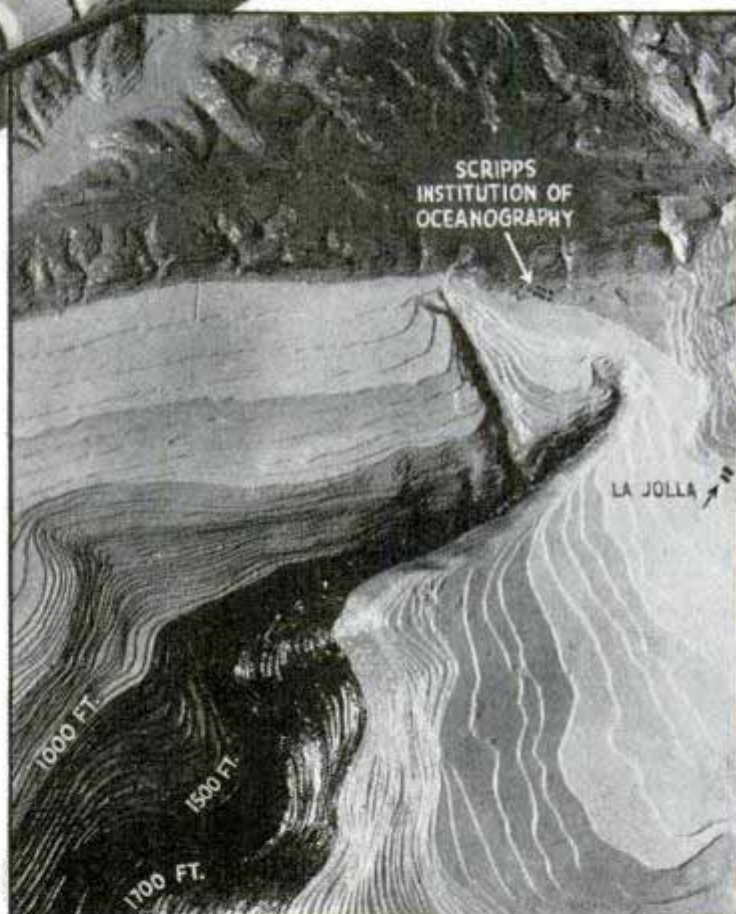

submarine volcanoes that may or may not still be active. During the last year, Dr. Shepard, with the cooperation of the Geological Society of America and the Scripps Institute of Oceanography at La Jolla, has been exploring the continental "borderland" off southern California. From the deck of the sturdy exploration schooner, "E. W. Scripps," he has surveyed the greatest known gorge in the world, a submarine canyon one wall of which rises 7,000 feet

*Dr. Shepard*



above its floor and which extends for more than seventy miles to sea off Monterey. This great canyon has nearly twice the height and length of the vast rift 100 miles off the coast of New York which was surveyed a few years ago.

There are fifty or more such submarine canyons along the west coast, most of them characterized by steep walls, winding beds and tributary branches that suggest they were once natural river channels at a time when the sea's level was much lower than at present. Typical river gravels have been

*The deep-sea exploring schooner, "E. W. Scripps." Right, adjusting deep-sea corer so it will trip automatically when dropped to bottom. Below, lowering trap to catch minute animal life*

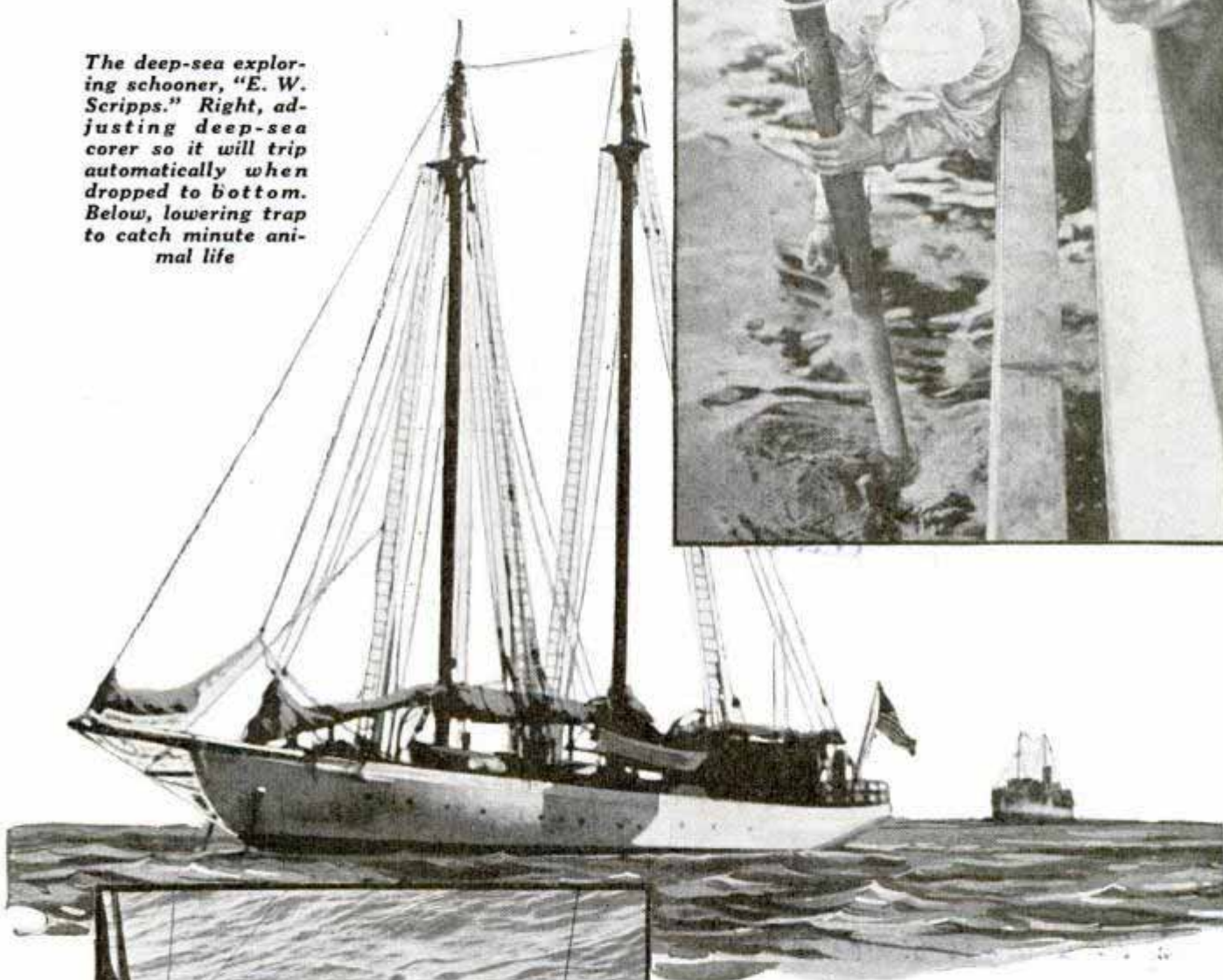
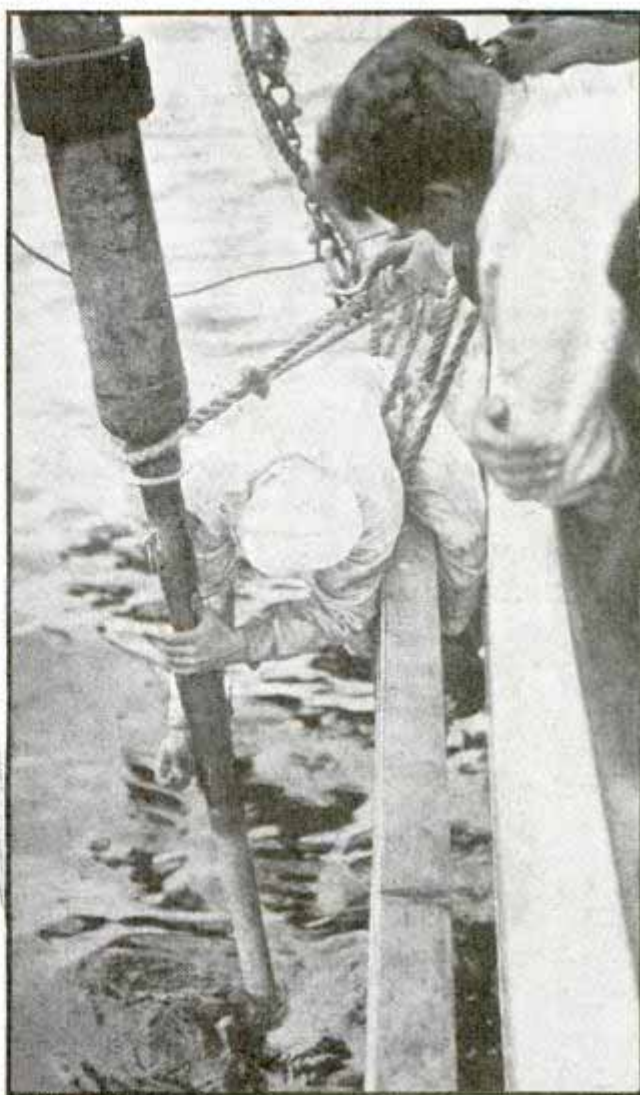

dredged up from the bottoms. Last summer Dr. Shepard reported a tremendous landslide in a submarine canyon off La Jolla. Being adjacent to the research laboratories, the walls of this canyon are checked by soundings every two months, and one set of soundings revealed that at one point the canyon cross section had changed since the last soundings, large

(Continued to page 147A)



*Western Specialty Club Association Dog Show*

### Clock Opens Dog's Lunch When Owner Is Absent



After patiently watching the clock, the pup is rewarded when the "alarm" opens the lunch bowl at six

Your dog can have his dinner right on the dot even if you don't come home until late. An automatic feeding pan that opens at any hour set on an alarm clock lets the pup eat at the proper time. Dogs quickly learn to be on hand when the lid pops open.

### Non-Waste Poultry Feeder Is Adjustable, Sanitary

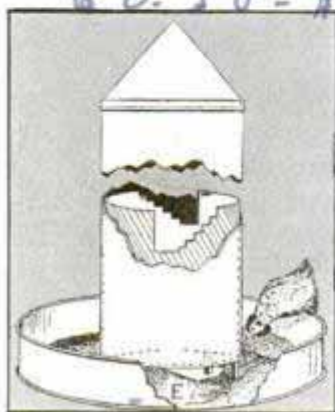

Made of galvanized steel, a self-feeder for poultry prevents waste. Flow of feed into the trough may be regulated, more coming down from a storage compartment as that in the trough is eaten. The feeder

is designed to keep the poultry from sitting on the edge of the trough, resulting in better sanitation. The feeder is made in two sizes. One model serves twenty-five to thirty hens at a time and the other has a capacity of 125 to 175 hens.

### Army's Latest Deadly Weapons Fight Tanks and Planes

Two new and highly effective weapons, one designed to combat aircraft and the other to fight tanks, have been adopted by the U. S. Army. The anti-aircraft gun is a thirty-seven-millimeter, automatic weapon, mounted on an all-around fire, four-wheel trailer which may be towed by a light truck at high speed. The unit has a wheelbase of 120 inches, with a fifty-eight-inch tread. It weighs 5,000 pounds. The anti-tank gun, of the same caliber, is mounted on a carriage capable of being towed behind fast trucks or being hauled short distances by man power. The gun crew is protected by armor. In action, one member of the crew loads the gun and the other aims and fires it.

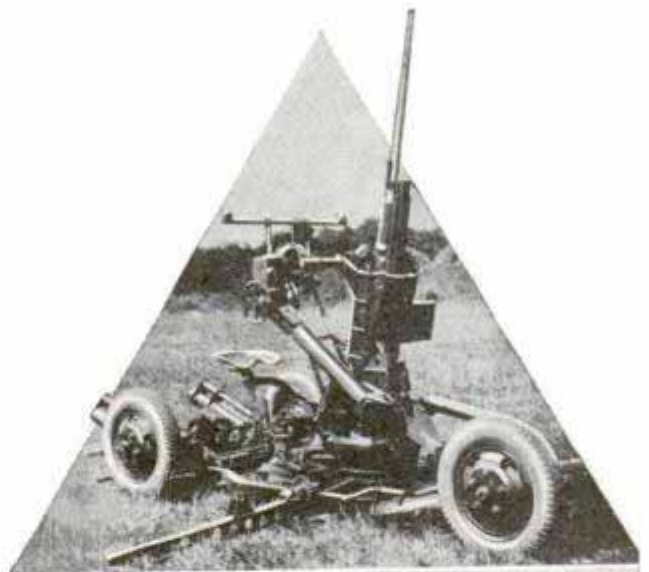

Top, automatic anti-aircraft gun; below, anti-tank gun with armor protection for its two-man crew

*Mrs. Alberta Macdonnell 2275 Broadway San Francisco Calif*

*#1384*

*82.50-85.00*

*Morrison Inc. 8335 Anchorage Circle Los Angeles Calif*



# Tractor on Two Giant Wheels Pulls Scraper

Mounted on two driving wheels which have pneumatic tires six feet eight inches high, a new tractor combines with a scraper to form an excavating machine for use on flood-control and dam-building projects. The tractor is powered by a Diesel motor developing 160 horsepower. Also mounted on two wheels, the scraper has a heaped-load capacity of thirty-eight cubic yards. Coupled together, the two vehicles form a forty-foot unit. The combination machine is speeding up operations on Hansen dam in California.



Above, the two-wheeled power unit. Note that the tires are man-size. Left, tractor hooked to a two-wheeled scraper, forming a forty-foot earth-working unit. The scraper has a capacity of thirty-eight cubic yards of dirt and it is useful in flood-control and dam-building operations. A Diesel engine develops 160 horsepower to drive the unit

## "Eyebrows" for Planes Speed Recovery from Stalling

Designed to aid in recovery from stalling and spinning, "eyebrow slots" are being installed on training planes at Randolph Field, the "West Point of the Air." The slot is a fixed installation on the leading edge of the wing. It causes a smooth flow of air to pass over the ailerons at slow speed, resulting in faster recovery from stalls and spins.



Pilot pointing to "eyebrow slot," a new safety device used on training plane to speed up recovery from stalling and spinning

There are 37,666,666 radio receiving sets in the United States, 290 for every 1,000 population.

*Handwritten notes:*  
 H1315  
 W.P. ...  
 Capt. Roger M. ...  
 Hugh M. Beville  
 Chief ...  
 Rockefeller Plaza



# Trapping FISH PIRATES

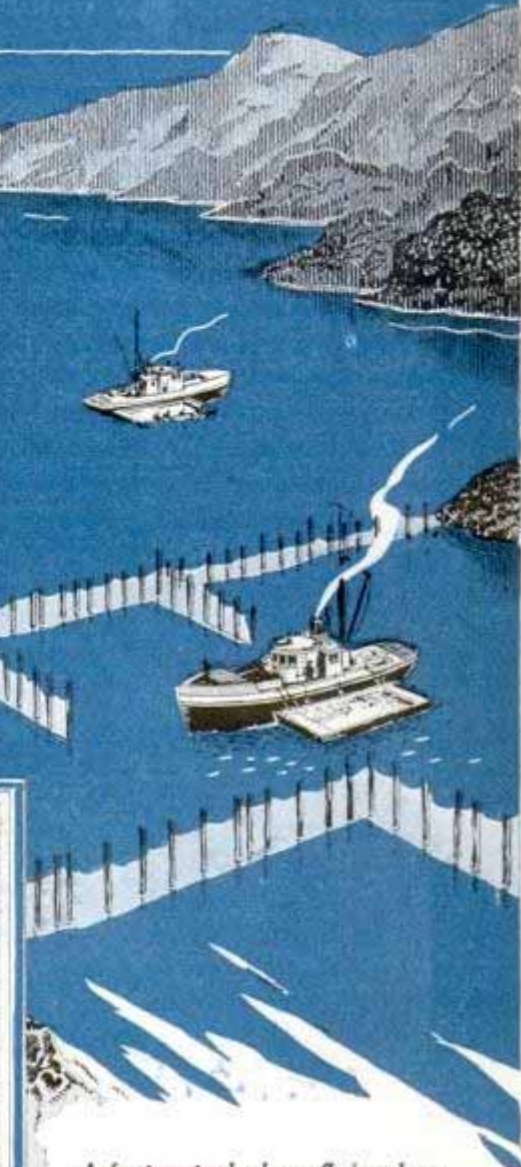

A fast patrol plane flying low over salmon traps. If the pilot decides those in the near-by boats are fish pirates, he notifies the authorities and the freebooters are usually caught before they can get away in their slow boats. Left, hand hauling a fish-trap lift net full of salmon.

A SLEEK blue monoplane flashed westward under the broken clouds of an Alaskan sky. Her pilot, Capt. Ansel C. Eckmann, scanned the glimmering water below as he pressed the right rudder bar to give a wide berth to the lofty peaks that rise sheer from the shore of Chichagoff island.

Ahead and around a tree-studded promontory, a heavy cannery tender plodded eastward, a group of light-hearted fisher-

men clustered around the wheel on the pilothouse roof. They laughed and joked, shouting to make themselves heard above the deep throb of the gasoline engine.

It was July 3, and they were heading for Juneau to celebrate the Fourth. Their fish traps, scattered for miles in isolated coves, had been deserted for the duration of the festivities.

Presently the plane rounded the point and Capt. Eckmann's sharp eyes spotted

Capt. Ross L. Cunningham  
 4516 W. Washington  
 Seattle, Wash.

Areas of sland  
 Wash.



R 1126  
Captain Eckmann may be reached at Orcas Island, Wash.

## from the AIR



*Lifting the silver horde from the trap to a scow for the ride to the cannery.*

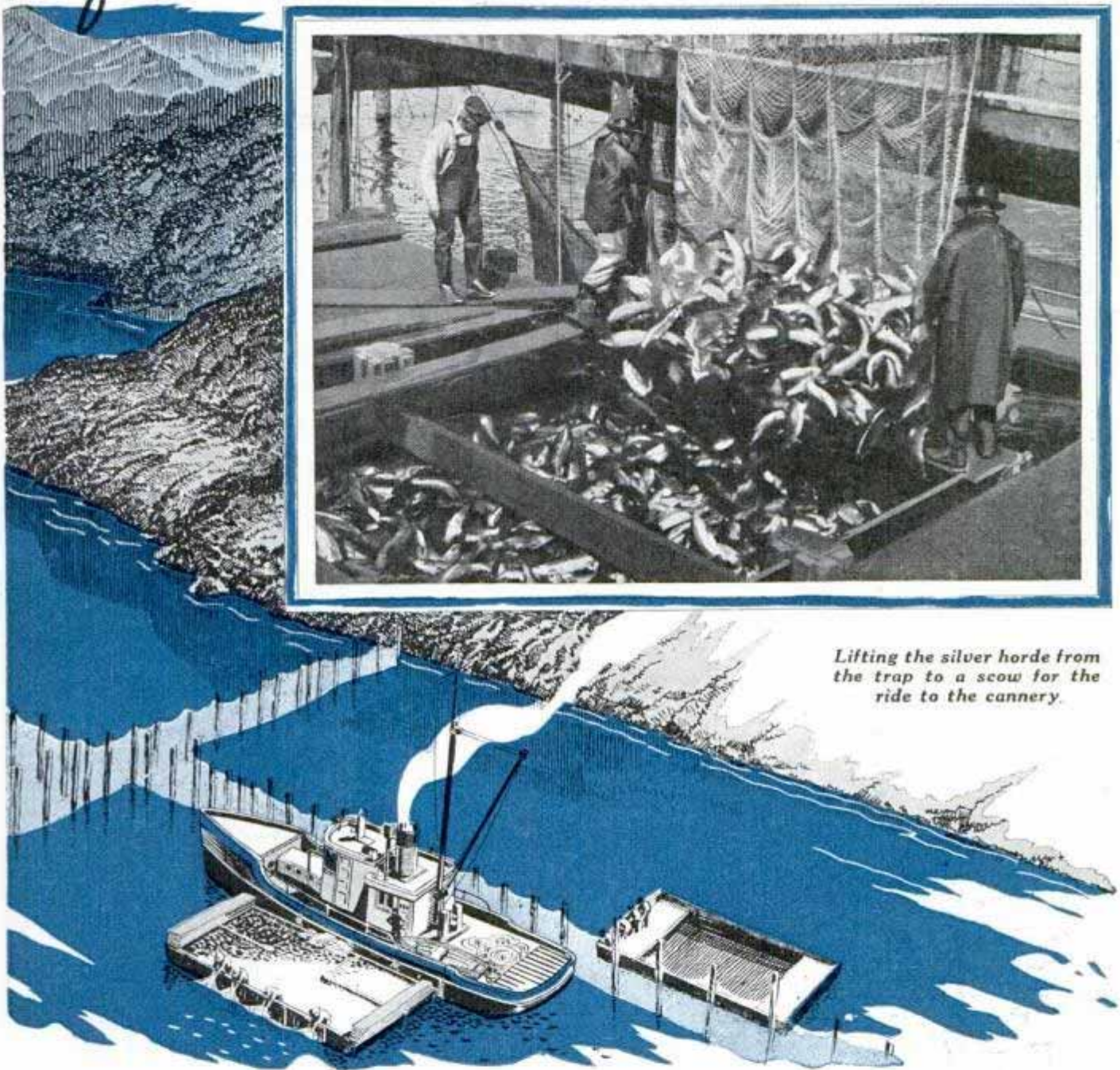

the surface boat. The plane's elevators lowered and the ship zoomed down to the cannery tender. Skimming so low over the water that the pontoons nearly touched, Capt. Eckmann's mechanic, Frank Hatcher, slid open a window and hurled a corked bottle into the water a few feet from the fishing boat.

The tender stopped and hands callused from hauling heavy fish nets scooped the bottle aboard. The cork was removed and a paper fluttered to the deck.

"Return to your traps," the note ordered. "The fish pirates are planning a big haul

over the Fourth. All leaves of absence are cancelled." The order bore the signature of the fishermen's superior.

The cannery tender swung about, pointing her bow westward. Rifles were broken out and loadings inspected. The fishermen were on their way back to guard their traps and their valuable catches of salmon.

Capt. Eckmann's plane was miles away within a few moments, dropping a similar message to another cannery tender. Then another and another until every crew was turned back.

This was ten years ago and the event



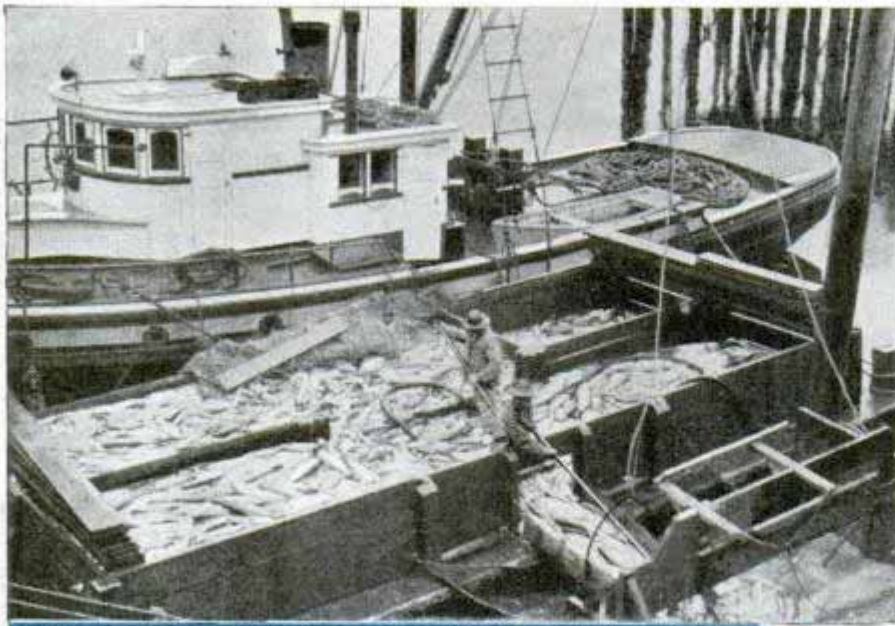

The Alaska fish traps attracted a new type of buccaneer from the hordes of men who followed the golden rainbow north in 1898 and were disappointed at not finding the beaches heaped with the precious metal. But they found something that paid nearly as well, and much easier to get—the silver horde that swam the cold waters of the Pacific ocean.

Thousands of the gold seekers turned to the fishing grounds to wrest fortunes from the millions of salmon which each year return to their birth streams to spawn and die.



marked the introduction of fast seaplanes to combat freebooters as gay and impudent as those ancients who pillaged the high-sterned galleons of Spain on the Caribbean sea. Almost overnight the fish thieves learned that the reckless genius by which they had looted salmon packers of hundreds of thousands of dollars annually could not cope with these darting patrol ships that swooped from behind mountains and clouds.

Salmon in Alaska are almost as liquid a medium of exchange as gold, silver or currency. They can be traded for supplies and services, or sold for cash-over-the-dock at any of the scores of canneries. Salmon can't be branded like an Oklahoma bull. All salmon look alike and possession is as valid as a warranty deed filed in the county courthouse. The man who delivers the fish to the cannery is the man who takes the cash.



*Top, tender bringing scow of salmon to cannery. Center, one of salmon patrol planes. Bottom, an Alaska glacier from the air, the daily sight of flyers who patrol the salmon grounds*

The fishermen spread seines, trolled and erected traps, selling their catches to the many canneries that sprang up quickly.

Traps are long rows of piling, extending sometimes a quarter of a mile from shore in channels where the salmon schools swim. Twine or wire nets are hung from them to trap the fish as they enter. One of the strangest characteristics of the salmon

(Continued to page 114A)



# Built-In Bumps 'Torture' Autos on Test Track

Automobiles are subjected to real torture on a new body-twisting stretch of test track at the Ford Motor company. The track, made of concrete, has mounds six inches high and as wide as the automobile. These mounds are staggered, one on one side of the track and another on the other. When a car is driven over the track on either side, the wheels pass over only one mound at the time. Another test calls for the car's right front wheel to pass over a mound at the same time



Auto "hitting the high spots" while being given a body-twisting test on new track. Note humps in the pavement

that its left rear wheel goes over the mound on the other side of the track, thus subjecting the body to a wracking twist. The punishment is all the more severe when the car is given the test at twenty to twenty-five miles per hour. So hard is the car

shaken that a test driver must fight to retain control. After several runs up and down the track, the car is taken to the laboratory and its body, springs, steering apparatus and other parts are examined carefully for signs of damage or failure.

H 1249

# Tiny Planets Move Around Midget Sun on Electric Model

Complete almost to the smallest detail, a model planetarium demonstrates the solar system when a button is pressed, the tiny planets moving in accurate paths about a midget sun

by a red light bulb, in exactly the relative time it takes the real planets to make a revolution. Every sixteen minutes, representing a year of 365 days, the "earth" around the sun. An

Francis Winkley resides at 112 Elm St. Madison, Wis.

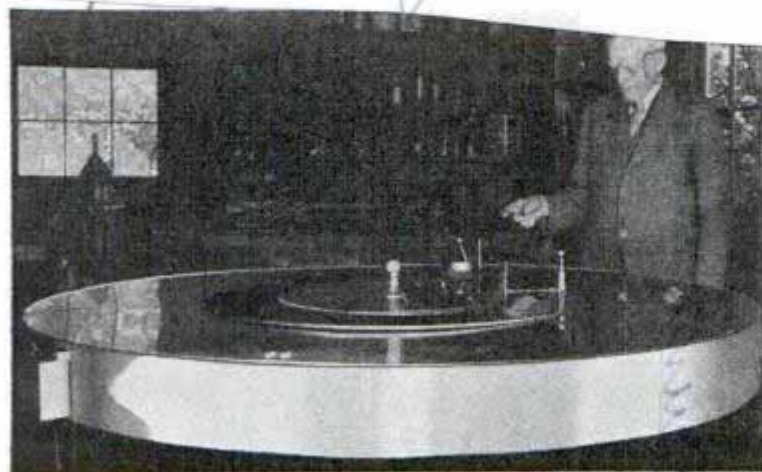

Electrically operated model of solar system. Tiny balls on top represent sun, moon, earth, Mercury and Venus

MOON TO MAKE ONE... about the miniature earth. At all times, the midget earth holds its relative position to the sun, while the moon and Venus vary from the horizontal plane in their proper movements. Earth and moon, on the model, are constructed to a scale of one-eighth of an inch to 1,000 miles, making the earth fifteen-sixteenths inch in diameter. Thirty-two gears, each with the correct number of teeth carefully computed, move the planets.

Cont. Evan A. Cohen 1950 2  
20th Century

Winkley  
112 Elm St  
Madison Wis  
Francis Winkley



1297.

# Tin Horseman and Steed Made by Soldering



This unusual figure of a tin horseman decorates the front of a Minnesota shop

Standard tin parts have been soldered to make the figures of a tin horse and rider that decorate the front of a Minnesota tin-smith's shop. The horse and rider are both depicted in lifelike pose, lending an artistic touch to the advertising device.

## Gas-Saving Changes in Engines Suggested to Car Makers

Slight changes in automobile engines that would make them more economical have been suggested to the automotive industry by A. J. Blackwood, C. B. Kass and O. G. Lewis of the Standard Oil Development company. These changes would reduce the octane rating of the gasoline used in the automobile, thus resulting in a saving. Reduction in the variations of distributor-cam contours, which determine when the fuel in each cylinder is fired, and reduction of the variation of the fuel and air mixture from cylinder to cylinder would make this possible. Some experts recommend that manufacturing practices should result in a decrease of several points in octane-number requirement (of the fuel),

which in turn could be utilized in future designs to permit of higher compression ratio and increased efficiency. A study on a typical engine reveals that there is wide variation in the mixture being fed to the different cylinders and in the timing of the ignition spark, with resultant detonation in some cylinders and an increase in the octane number of the fuel to make the entire engine operate well. Fuel octane number requirements vary from cylinder to cylinder and the engine as a whole needs the highest rated fuel required by the poorest functioning cylinder.

H 1346

## Dual Grinder for Lawn Mower Whets without Dismantling

Both the rotating blades and the stationary knife of a lawn mower can be sharpened by a power grinder which does its work without dismantling the mower. It takes but a few minutes to clamp the mower in position, perfectly alined for grinding. The reel blades are sharpened to the proper cutting clearance with relation to the stationary blade.

\$125.00

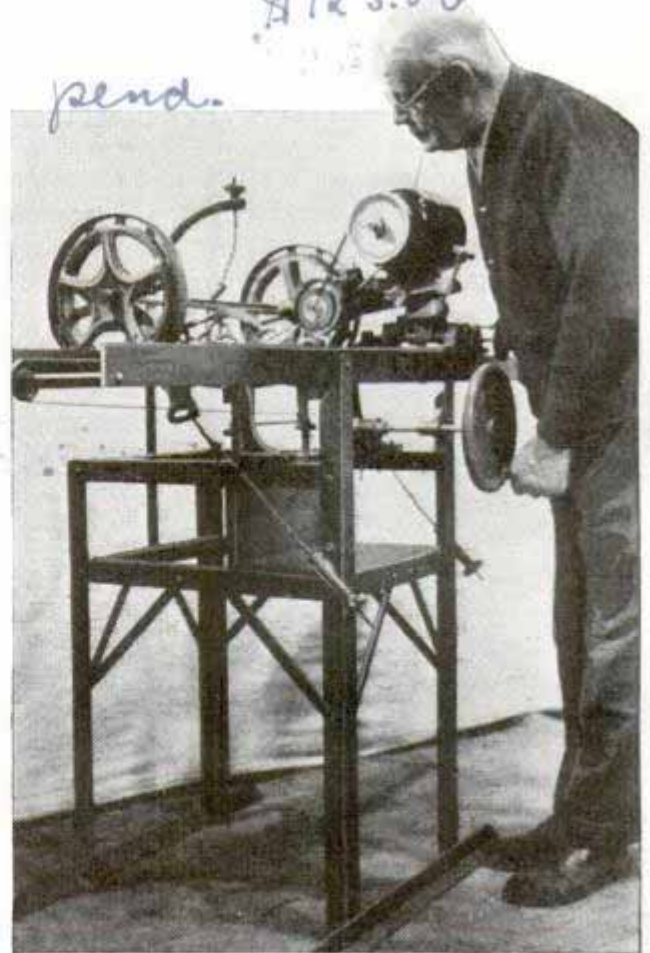

Once the mower is clamped in position, this grinder sharpens both stationary and reel blades

26 Broadway, New York City

Austin

pend.

Be / 9/11 / 178 / 36

Rogers Manufacturing



## Tests on Street Speed Coming of Television

**D**UE to mechanical difficulties, such as the laying of expensive cables for transmission, and to the lack of some means of paying for programs, television is not yet ready for general use in this country. But extensive experiments, aimed at improvement of apparatus, are being conducted in New York, and elsewhere, with such good results that an entirely satisfactory performance may be expected when television is introduced on a large scale. Since the transmission of pictures of news events as they happen will be an important feature of television, tests include work with a portable outfit. The iconoscope camera is trained on some person or object and the transmitter flashes pictures of the scene to receivers before which sit engineers to view the finished product and to suggest means for improvement. Just recently the portable unit caught pictures of a new model automobile arriving at the curb and discharging passengers. The unit transmitted the scene to a receiving set high up in a building near by, with what engineers described as satisfactory results. While the television pictures seen on the screen of the receiving set were not nearly as distinct as photographs of the same scene, they were clear enough for identification of persons within reasonable distance of the iconoscope camera.

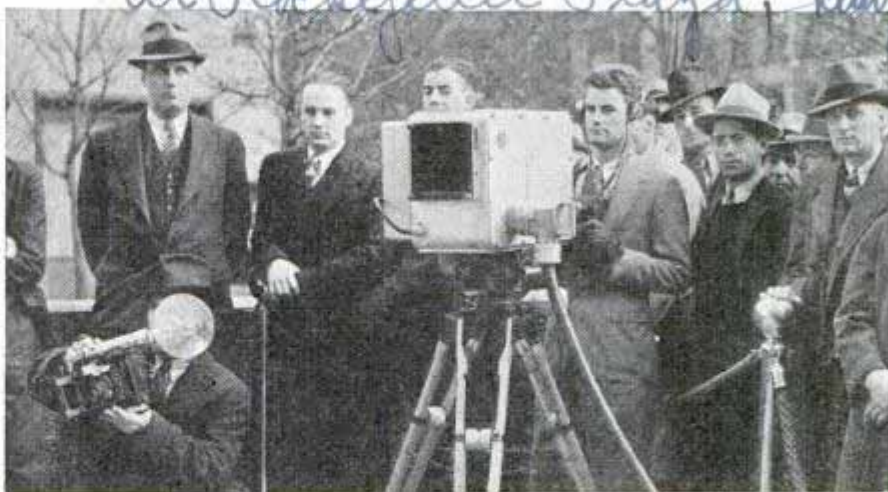

Iconoscope camera (top) being trained on automobile (center). Bottom, same scene on receiving set. Comparison with regular photo at center shows how far television has advanced in this country



H 1258

(magee)

# Harnessing AMERICA'S Wildest



One of the switchboards in the control room at Boulder dam from which the flow of power is regulated



FOR generations the raging Colorado, rushing through its mile-deep canyons, enjoyed the evil distinction of being America's most unruly river. In the spring it descended on fertile desert lowlands as a roaring torrent. In the summer when this parched soil cried out for water, the surly stream dwindled to a sluggish creek.

Today this renegade among rivers has been tamed. Imprisoned behind the massive concrete and steel wall of Boulder dam, the once ungovernable stream has become so docile that its former wasteful and destructive energy has been harnessed to do monumental tasks—to turn the wheels of industry hundreds of miles distant, to augment the water supply of the Los Angeles metropolitan area and to irrigate the rich farmlands along the river below the dam and in the Imperial valley.

In fact, so thoroughly has the Colorado been conquered that the puny hands of a few score of men, backed by the mighty strength of the dam, now direct the almost limitless force of this 1,700-mile river and control the flow of billions of gallons of water almost as easily as you control the flow of water at your kitchen faucet.

In the kitchen you turn a little valve and a jet of water under a few pounds pressure gushes out. At Boulder dam there are more than 21,500,000 pounds of gates and valves, a few weighing as much as 500,000 pounds. Opening such valves releases a veritable Niagara under pressures of hundreds or even thousands of pounds. Yet little more effort is required to open a



INTAKE TOWERS  
395 FT. HIGH

# RIVER

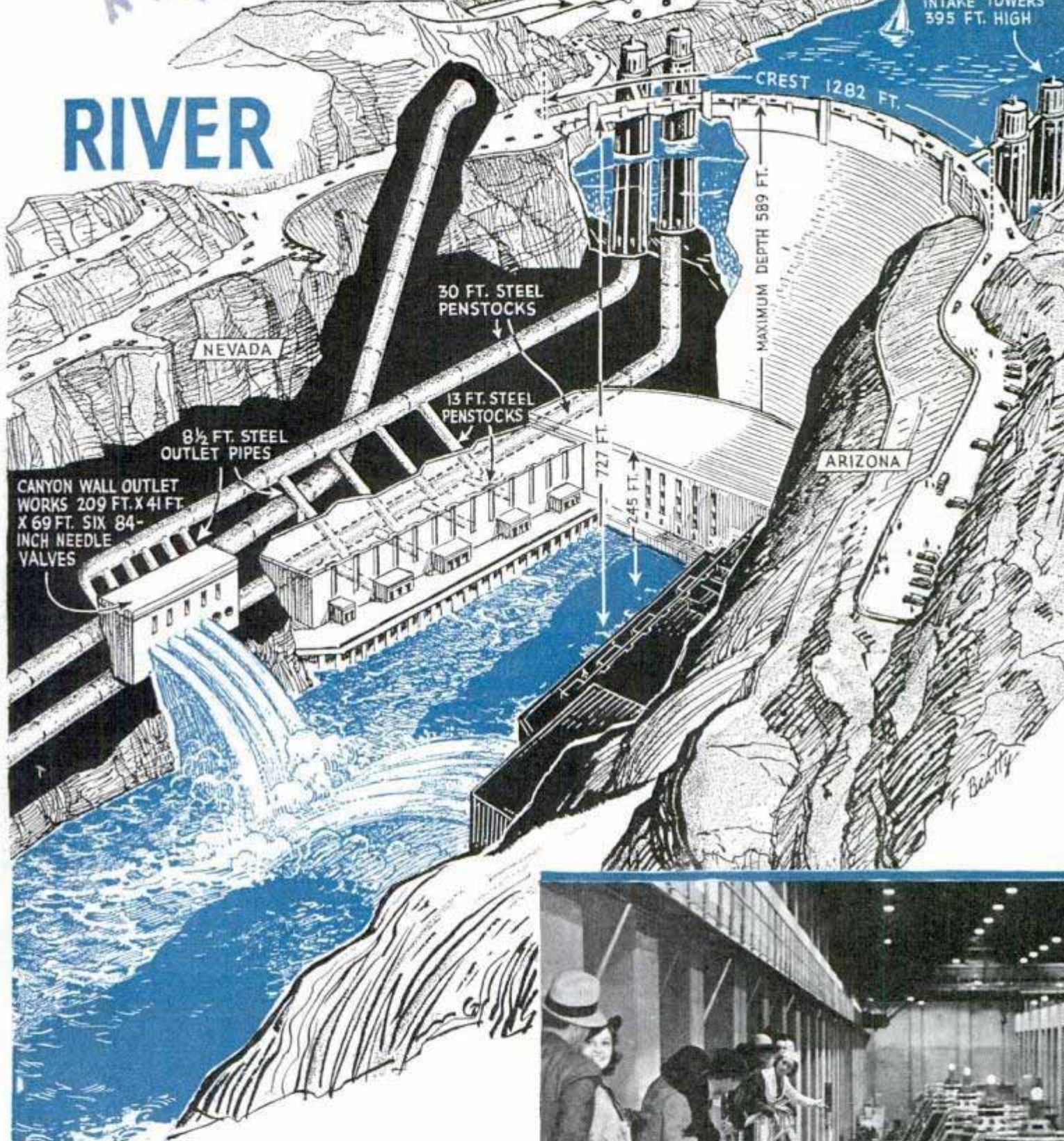

valve weighing several tons than is needed to turn the steering wheel of your car, because the water does most of the work. In fact, operating some of the valves and gates requires no manual effort at all. They work automatically.

The nerve center from which the flow of water for all purposes is directed is the water master's office. No water will ever flow over this dam. Instead it is carried through huge steel penstocks from eight and one-half to thirty feet in diameter. The water enters through gates in each of

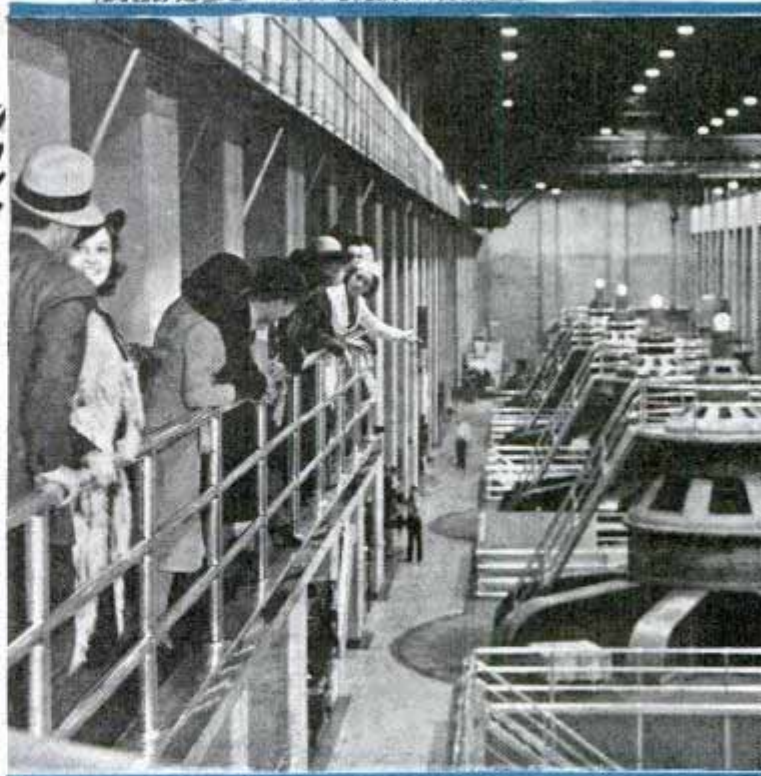

Some of the huge Boulder dam generators and, above, drawing showing how Nevada side of Boulder dam works. The Arizona side has a similar layout





four 375-foot intake towers above the dam, the tower gates being operated from a control tower in each unit although they can be closed in an emergency from the water master's office.

Through thirty-foot penstocks the water passes to smaller penstocks leading to the turbines in the powerhouse below the dam or, by operating needle valves, the water master's office can divert the flow through an outlet works emptying into the river below the dam. If, for example, an order is received from the Yuma project office which

collects the orders from each project along the river, for 10,000 cubic feet of water per second for irrigation purposes, and 7,500 cubic feet per second is being used by the turbines, the other 2,500 cubic feet is made up by releasing that amount through the outlet works.

When the reservoir above the dam is filled in another year or so, excess water can be diverted through two monster spillways, one on each side of the dam and each large enough to accommodate a battleship. These spillways, 650 feet long, 150 feet wide and 170 feet deep, empty into tunnels

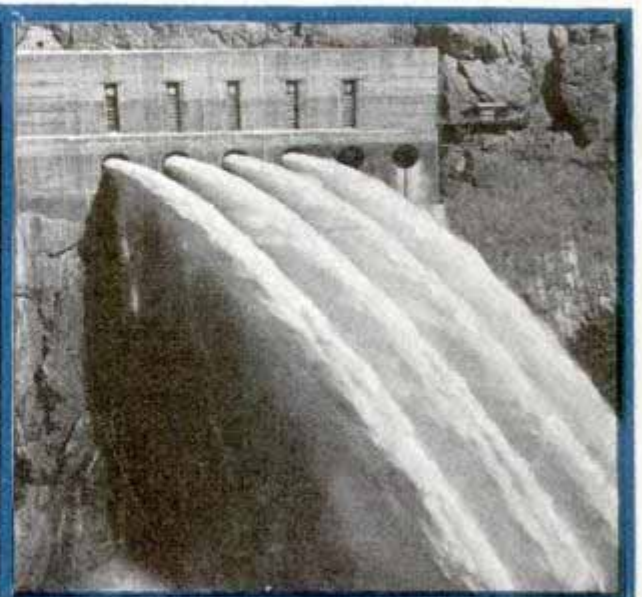
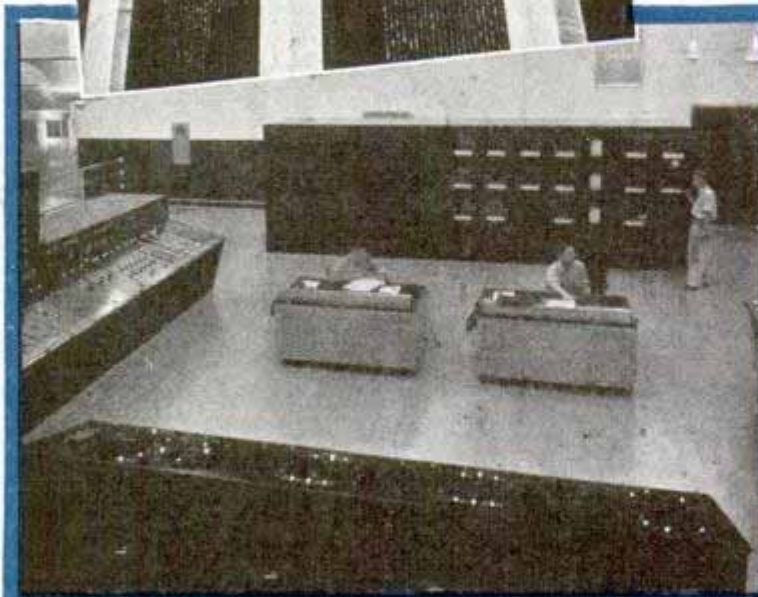

*Top, aerial view of dam and one of the great intake towers. Bottom, main power control room and, right, 9,000 cubic feet of water per second pouring from Arizona outlet works*



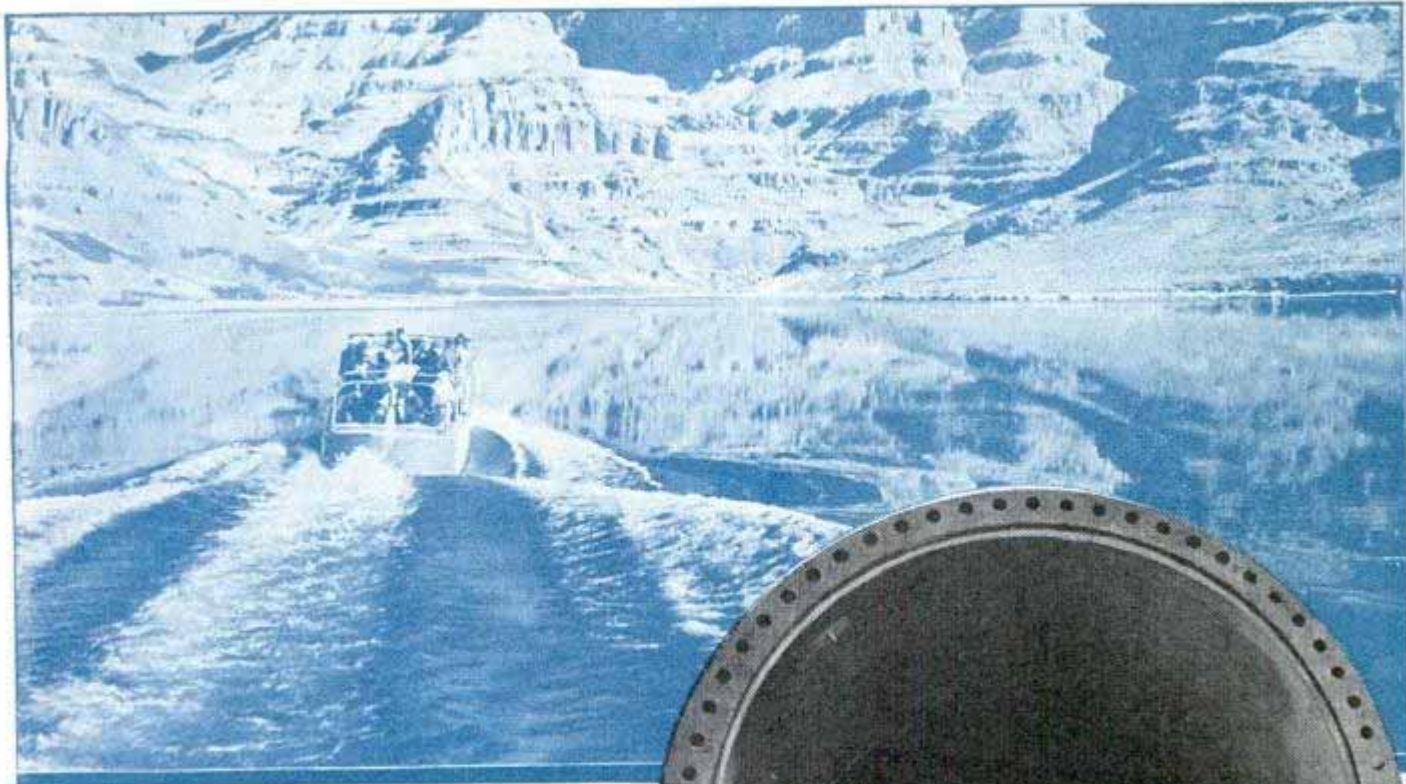

Photo courtesy

Transcontinental & Western Air, Inc.

*Boating on upper end of Lake Mead. Right, one of the Boulder dam penstocks. Bottom, operating needle valve in canyon wall outlet works*

fifty feet in diameter and 2,200 feet long. Steel gates atop the spillways can be set to operate automatically and in an emergency will rise sixteen feet, adding that much to the crest of the reservoir in case of a serious flood.

Should a big enough flood occur, more than 500,000 cubic feet of water per second could be emptied through spillways, valves and power plants. If both spillways were to discharge at their capacity of 200,000 cubic feet per second each, the energy of the falling water would be about 25,000,000 horsepower, and the flow over each spillway would be about the same as the flow over Niagara Falls, but the total drop would be more than three times as great! It is expected, however, that the flow of water through all outlets can be limited to a maximum of 75,000 cubic feet per second.

The fact that only a handful of men are required to operate a project as huge as Boulder dam is all the more remarkable when the

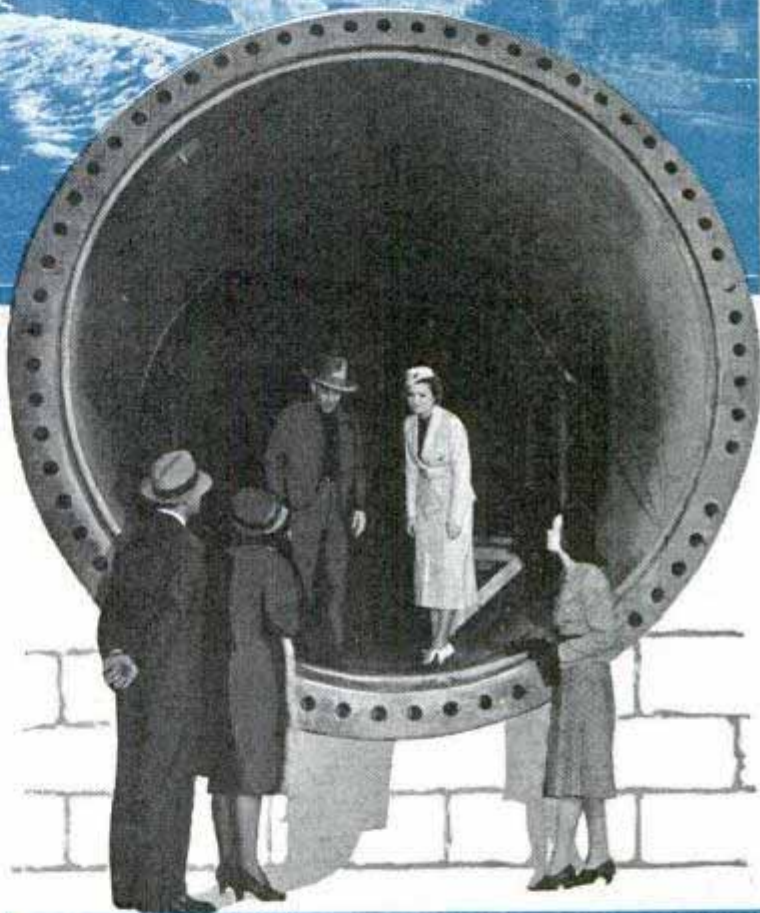



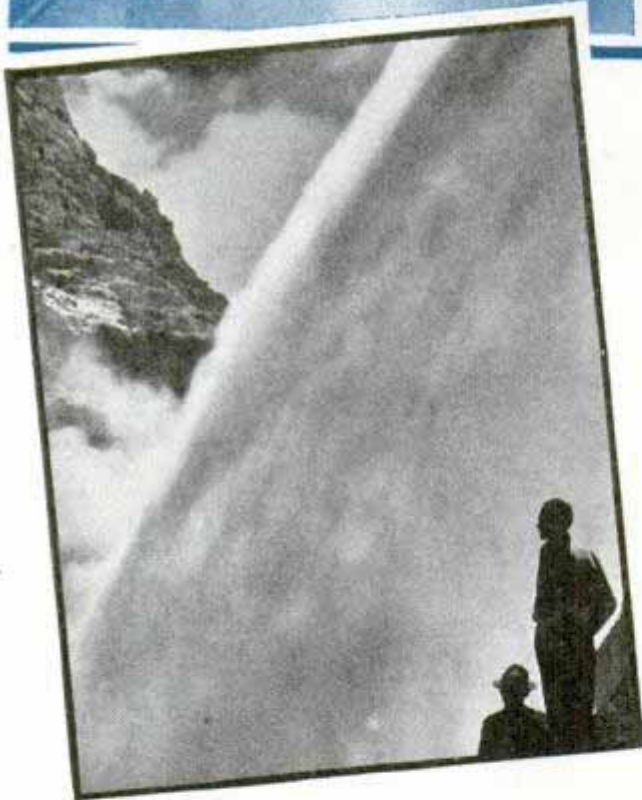
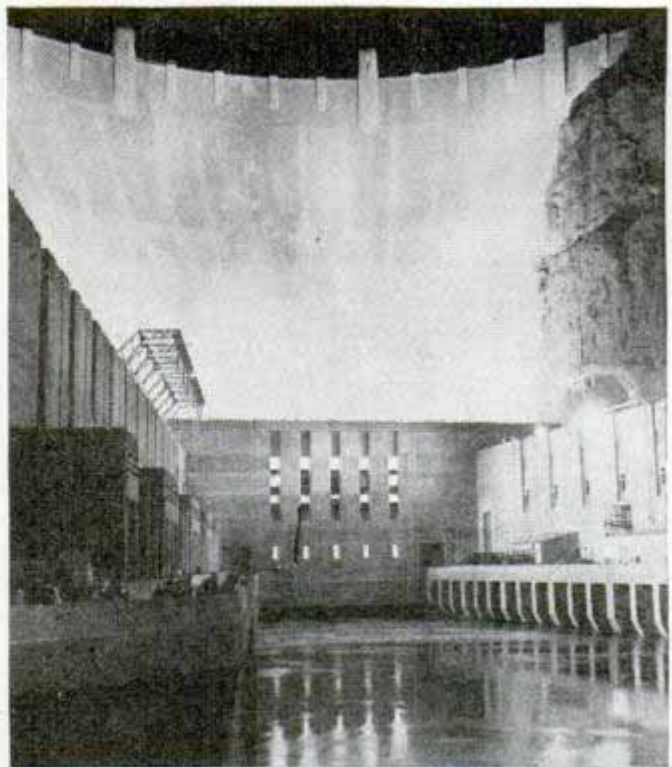

*Top, tiled corridor inside the dam itself and a night view of the dam. Bottom, water pouring from the canyon wall outlet works drops 180 feet—thirteen feet more than Niagara*

size of the dam and the volume of water it holds in check are fully realized. This dam, 727 feet high, 660 feet thick at the bottom and forty-five feet at the top, contains enough concrete to build a monument 100 feet square and more than two miles high, plus more than 50,000,000 pounds of reinforcing steel bars and rails.

With one sturdy shoulder against the

Arizona wall of Black canyon and the other pressing into the Nevada side, it holds in leash a larger volume of water than is contained in Lake Erie. Lake Mead, the reservoir above the dam and the largest man-made lake, is more than 100 miles long, has a maximum depth of nearly 600 feet, a maximum width of eight miles and covers more than 145,000 acres.

Eventually there will be enough water in this lake in the middle of an arid desert to supply every person on earth with 5,000 gallons. So heavy is this tremendous volume of water that it has "dented" the surface of the earth above the dam and it exerts a maximum pressure at the base of the dam of 45,000 pounds per square foot. Yet man controls its flow almost to the gallon by opening and closing the valves and gates which form a part of the dam.

Nestled at the toe of the dam is a U-shaped structure which is dwarfed by the great wall above it. This is the powerhouse which is as tall as a twenty-story building, each wing being 650 feet long. In this building are the great turbines and generators which produce the electric power for Los Angeles and other districts hundreds of miles distant. Eventually there will be installed in this structure fifteen 115,000-horsepower and two 55,000-horsepower vertical hydraulic turbines, a

(Continued to page 118A)



# Radio Antenna Strung on Fishing Outriggers

By stringing his radio antennas on the fishing outriggers, a Long Island yachtsman more than doubled his reception range. The forty-foot sport cruiser "Julieanna," of Freeport, L. I., is equipped with a single-frequency radio telephone set which normally has a range of sixty or seventy miles. When the fishing outriggers are spread out, and the antennas strung on them the telephone has a 150-mile range.

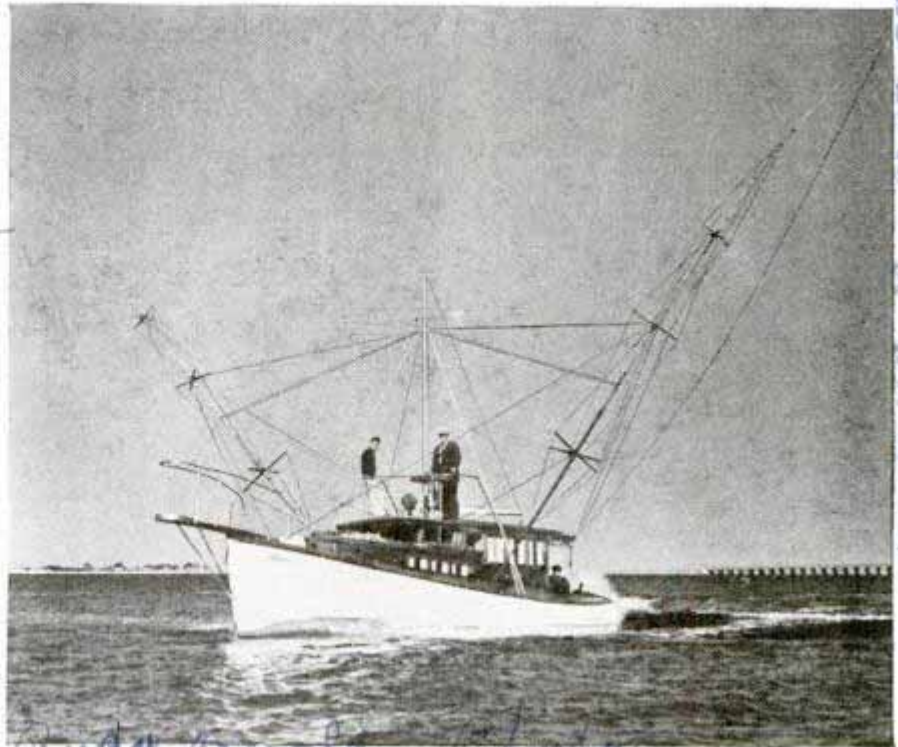

Radio telephone on this fishing boat has 150-mile range when its outriggers are spread to carry the antennas

# Automatic Auto Top Is Put Up or Down by Pushbutton

When you push a button on the dash of one new model automobile, the convertible top flies up or down, as you desire. Vacuum power operates the top. The rapidity



Cameraman catches top folding as driver operates control on the instrument panel

of raising or lowering the canvas seems almost magical when it is remembered that car tops of only a short time ago required the combined efforts of driver and passengers to get them up or down.

# Rayon Spun 800 Times Faster by Whirling "Bakelite" Reels

It used to take ninety hours to put molasses-like viscose through the various processing baths that transformed it into rayon. Today a new plant at Painesville, O., is being equipped to do the same job in six and one-half minutes. The secret of this speed is a patented spinning reel. These reels, resembling big talking-machine records, actually are cylindrical groups of Bakelite fingers that coil and uncoil the viscose strands and drop them downward at 200 feet a minute through baths to the driers and bobbins which wind the threads for the weaver. Pressure ejectors start the tiny streams of viscose on their way from the top. Speeding the manufacture of rayon 800 times faster than the traditional method, the continuous-spinning process is expected to do for rayon what the continuous-strip mill has done for steel manufacture.

*Phymyth dlv. Plymuth Corp. Massachusetts*  
*Industrial Rayon*



# TREASURE ISLAND

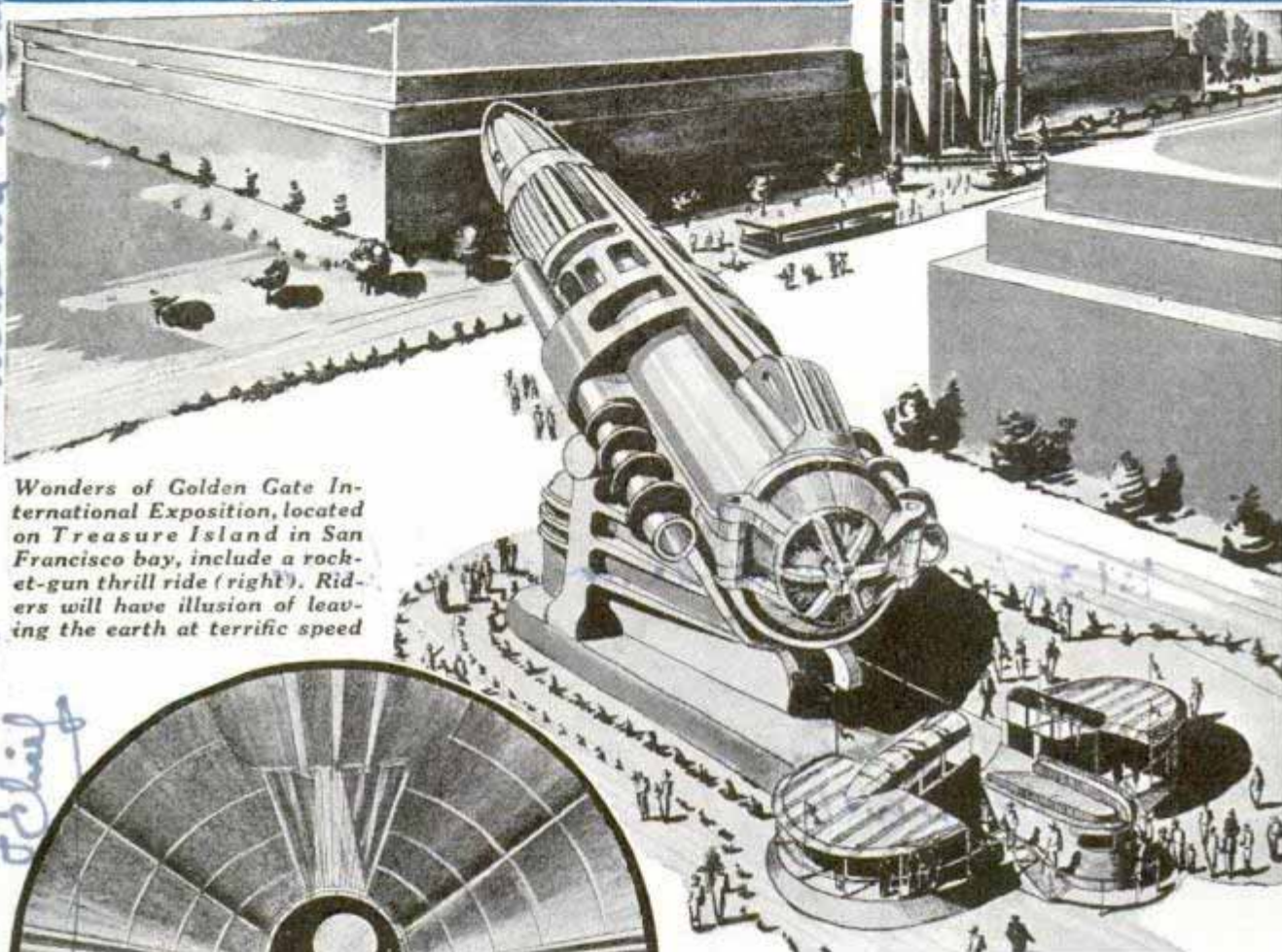

Wonders of Golden Gate International Exposition, located on Treasure Island in San Francisco bay, include a rocket-gun thrill ride (right). Riders will have illusion of leaving the earth at terrific speed



Left, view of 250-passenger compartment of rocket-gun ride. The "ship" is ninety feet long, equipped with portholes through which passengers apparently will see the earth receding. Below, 400-foot "Tower of The Sun" (center of photo), flanked by the main exhibit palaces

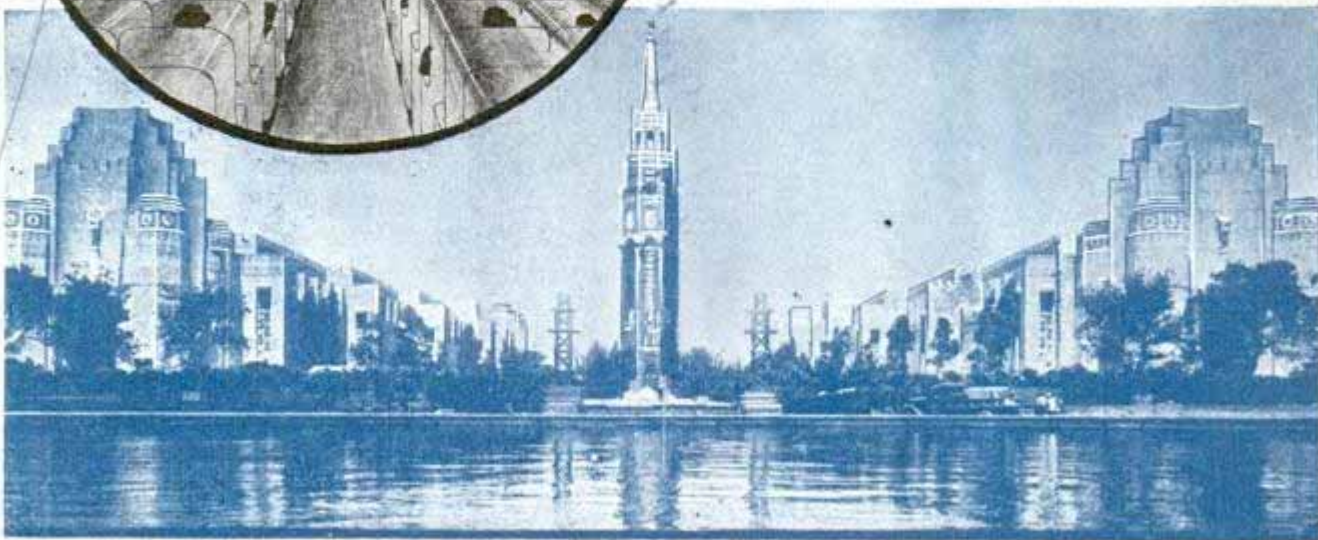

*Handwritten notes:*  
 H 126  
 Golden Gate International Exposition  
 585 Bush St San Francisco, Calif  
 "Pai Lou" Memorial Archway  
 Entrance to Chateau  
 Designed by  
 Walter K. Dillby architect  
 of  
 Dimension of  
 Amusement



# THRILLERS

dr. Edmund  
S. Martine

Right, another wonder of the exposition will be a steel diving bell which will take visitors into forty feet of shark-infested water. Operated vertically on a steel shaft, the bell will hold ten to fourteen passengers. The illusion of descent to great depths will be obtained through the use of a submarine garden. Built in a salt-water tank, the bell will be forced to the bottom under pressure. Release of pressure will allow the bell to bob to the landing pier on the surface.

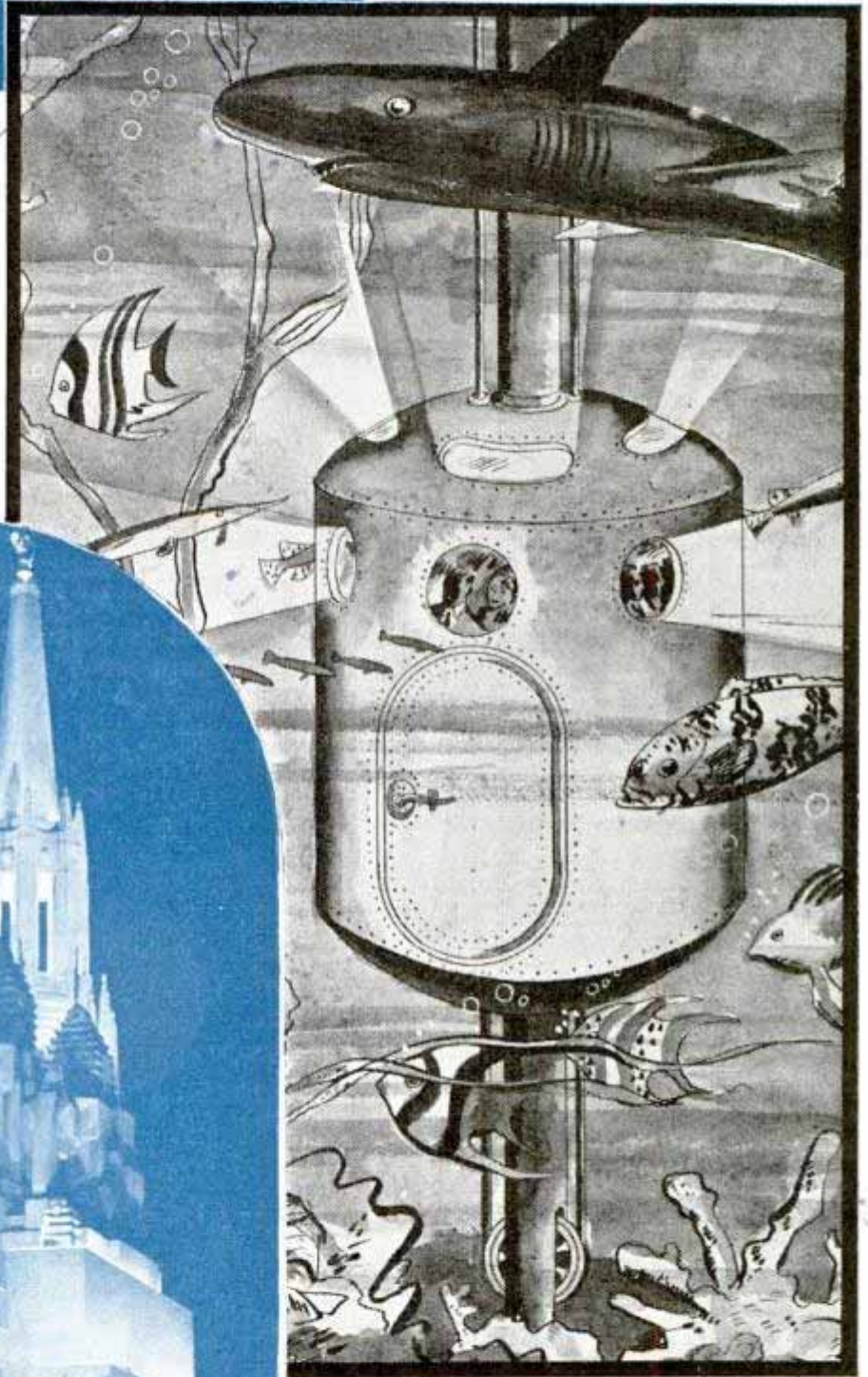

Left, night view of the "Tower of The Sun" in preliminary tests of \$1,000,000 illumination equipment. Spectacular lighting will make Treasure Island appear as a magic city floating in San Francisco bay. Treasure Island is 5,520 feet long, 3,400 feet wide and stands thirteen feet above sea level. It is located just north of Yerba Buena island, which is midpoint of the \$77,000,000 San Francisco-Oakland Bay bridge. The bridge gives access to the exposition by motor. The exposition is built in the form of a walled city, with a new "Pacific" type of architecture blending old Mayan, Incan, Malayan and Cambodian forms



# Camera Catches Big Fish Leaping from Water



Unusual photo of hooked fish leaping in the air caught by alert cameraman

When a hooked fish leaped from the water off Ocracoke island, N. C., recently, it jumped right into focus of a camera near by. The surprised photographer pushed the button and caught an unusual picture. The fish was a cabio, a rare salt-water fighter that usually jumps clear of the water after being hooked. It was landed after a battle of almost an hour.

standard threads exactly. Coarse or fine, standard threads all have the same sixty-degree angle. The double-edge file is handy for cleaning out dirty, mashed and tight-fitting threads.

# Landing Net Weighs the Fish as It Comes from Water

Enabling the fisherman to weigh his catch as it is taken from the water, a new landing net has a built-in scale. A standard spring scale set into the handle of the net functions by means of a release catch operated by the hand that holds the net. The net is made of strong linen mesh and is supported by a metal frame.

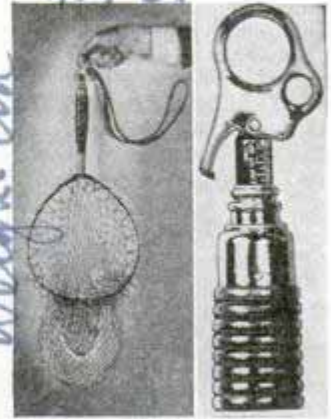

# Non-Tipping Food Dish for Baby Has Suction-Cup Feet



Held fast by suction cups, this dish cannot be overturned by children

Held firmly in place by three rubber suction cups, a non-tipping food dish for baby will adhere to any smooth surface. The dish cannot be upset. It is manufactured in bright pastel shades of pink, green and red plastic. The suction-cup feet are replaceable at small cost.

# Two-Edged Rethreading File Fits All Standard Threads

Two sharp, tapered edges of a steel file for repairing threads are made to fit all

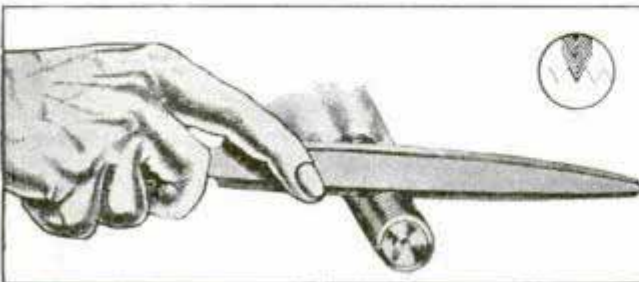

Repairing damaged threads with the double-edged steel file which cuts the standard sixty-degree angle

*Penick-Med. Lorraine  
Inc., 16 Hudson St.*

*Walbridge & Co.  
Penobscot Bldg.*

*Woods Co.*



Portable Oil Drill Mounted on Rubber Tires

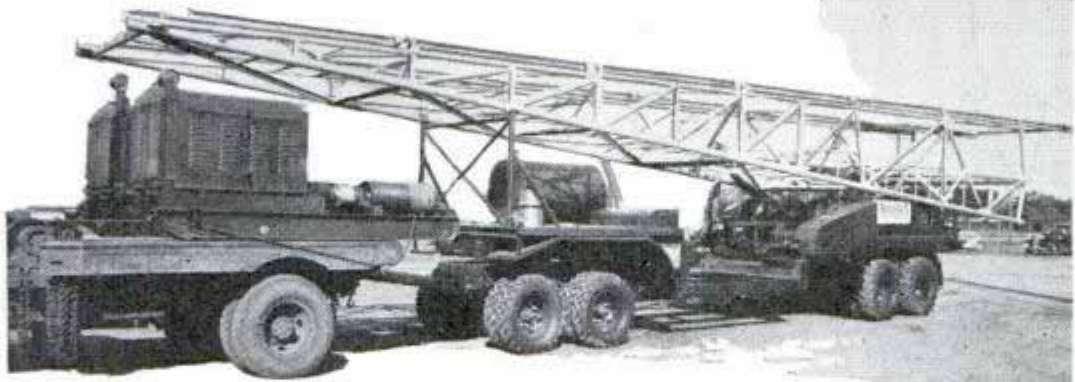

Top, the sixteen-wheel trailer carrying folded derrick to oil-well site. Right, portable drilling outfit set up ready for work

Self-contained and powered by two Diesel motors, a portable oil-well drilling outfit mounted on sixteen large pneumatic-tired wheels is now in use. Of the rotary type, the unit can drill 6,000 feet, at the rate of about 100 feet in twenty-four hours. When the unit is to be moved to another drill site, its derrick folds. The derrick will stack 5,000 feet of three and one-half inch drill pipe. Rotary drills of this type not only drill faster and deeper than the older "standard" type, but make it possible to take a sample core of earth at any depth, to show what formations are being encountered.

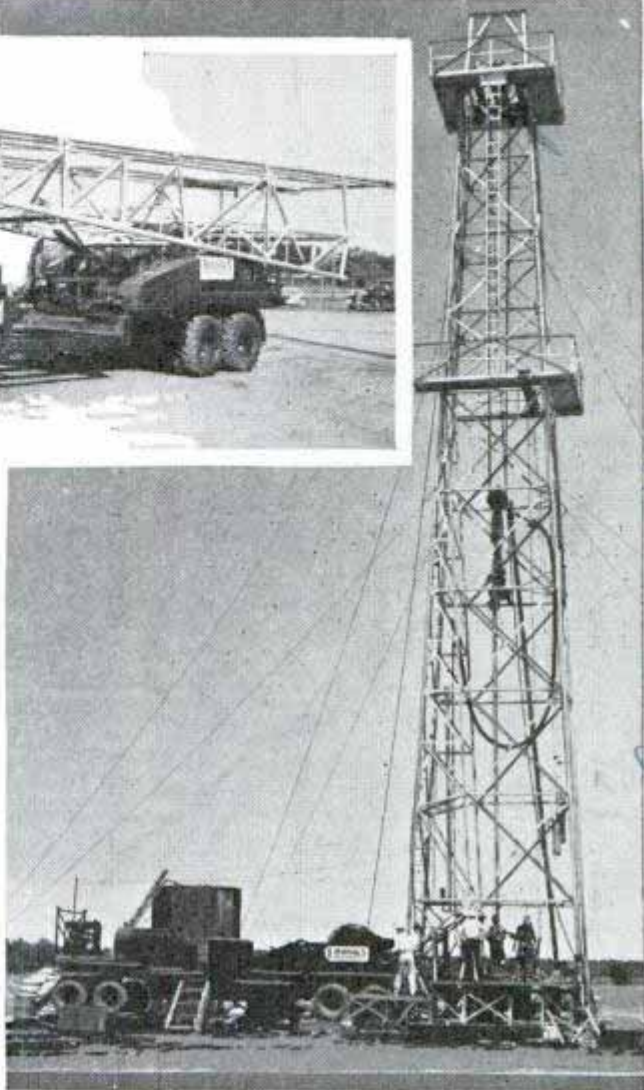

One-Man Cab on Shovel Truck Lets Boom Swing Clear



Notice the single-seat cab on this truck. It is made narrow so that the shovel boom can swing without interference

Mounted on a truck with a specially built cab, a shovel or crane can be transported easily to the job. A lightweight mounting makes it possible to install the shovel permanently on the truck, and its one-man cab leaves plenty of room for the boom to clear as it swings to dump its load. The shovel is gasoline-operated and has a seventy-five gallon tank alongside the driver's compartment.

Popular Mechanics Magazine can furnish the name and address of the maker of, or dealer in, any article described in its pages. If you wish this information, write to the Bureau of Information, enclosing return postage.

Hanson excavator  
Works 224  
Muskogee

Clayton Road  
Tulsa, Okla.  
149 B  
New York



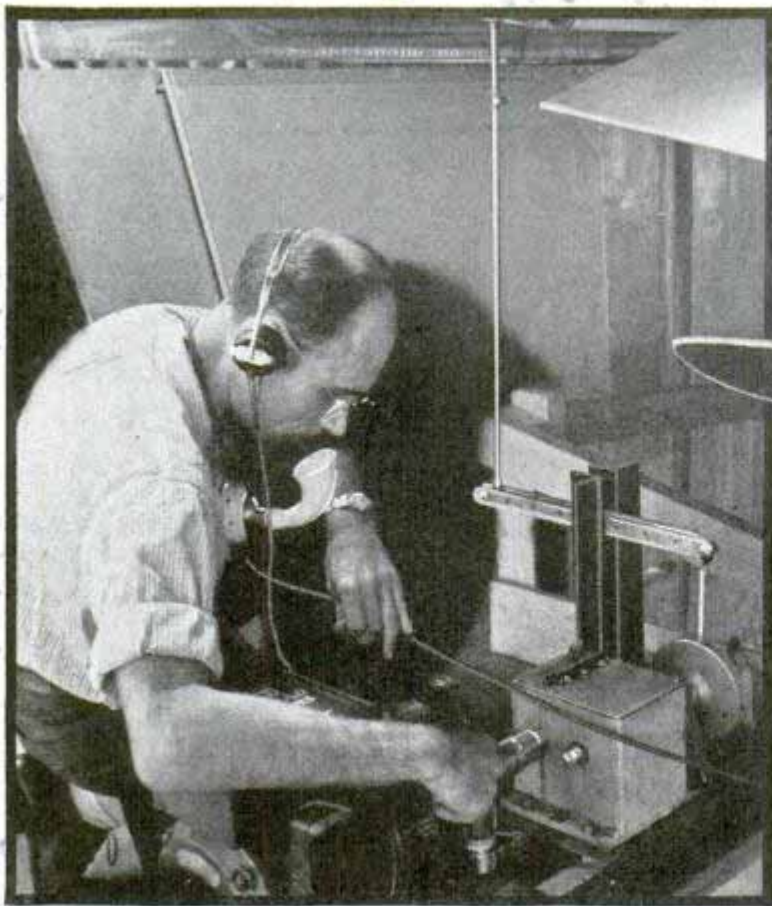

# CHECK

*Adjusting mechanism which produced artificial "air-quakes" on tail surfaces of "DC-4." Bottom, disk on propeller hub aided in measuring propeller vibration*

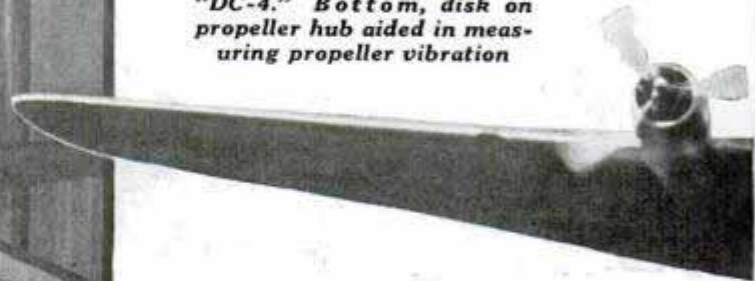

There is nothing spectacular, dashing or heroic about test-flying a new airplane, at least there isn't if the test crew knows its business. In fact, truth compels the blushing admission that the average test flight in the "DC-4" is about as exciting as a game of solitaire. That's the whole idea of testing—to make it a prosaic business; to put the ship through its paces

safely, to go the limit without taking chances.

Someone once described an engineer as a highly trained man who has to have everything proved to him. The test pilot does the proving. But if the engineer wants to determine the stalling characteristics of a new plane, the test pilot doesn't take the ship aloft, point her nose up and await de-

**By Benny Howard**

Research Test Pilot, United Air Lines

A TEST pilot, most people seem to think, is a foolhardy fellow destined to live a short but exciting life, a reckless chap who whisks an unproved plane into the sky and zips, zooms, rolls, dives, slips, spins and stalls in an earnest effort to dislodge an engine or snap a wing. If he succeeds, according to popular belief, he abandons ship, parachutes blithely down and then loaf until someone builds another airplane for him to murder.

This conception of a test pilot's job, I am happy to report, is just about 100 per cent wrong. United Air Lines which I represent in the tests of the largest land plane ever built on this continent was not looking for a stunt man. If I went up in the Douglas "DC-4" which represents an investment to date of almost two million dollars and the combined engineering of Douglas, United, TWA, American, Eastern and Pan American air lines, and started any impromptu aerial acrobatics, another pilot with no flying circus leanings soon would sit at the controls of this forty-two passenger, 65,000-pound sky liner.

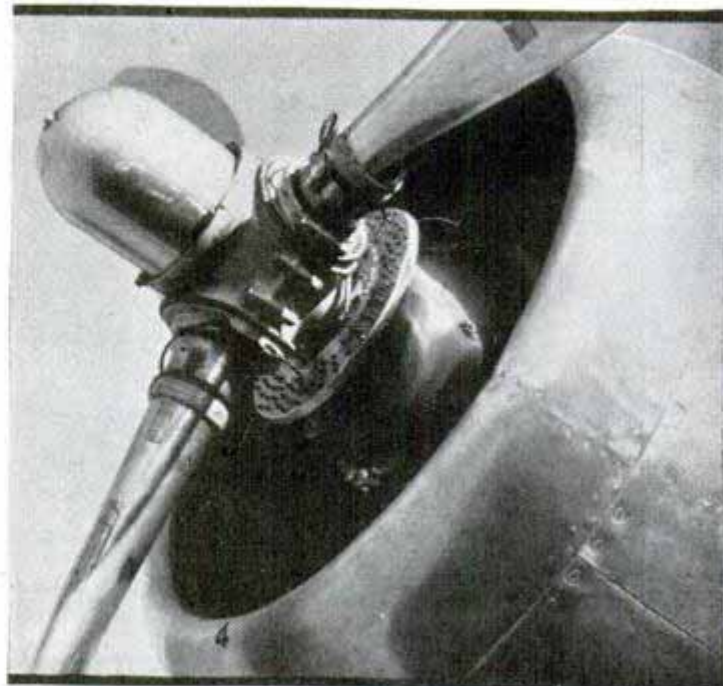

Douglas Aircraft Co. - Torrance, Calif. - Santa



7/12/50

# *and* DOUBLE-CHECK



velopments. He finds out in advance what will happen by sneaking up on the stall.

He bides his time. He waits until weather conditions are right. He finds out what the ship will do under each condition leading up to a stall. He is patient, slow, cautious, methodical, perhaps to the engineer he seems just a bit stupid. But when he finally stalls the ship, he knows exactly what it is going to do. He has crept up on his objective by taking a step at a time and testing his footing with each



*Two views of the great Douglas "DC-4" whose four motors develop 5,600 horsepower and, center, engineers reading instruments and recording data in cabin during flight tests*





our destination the proving ground in the sky. There are a score of engineers and observers aboard. With me in the cockpit is a flight engineer, a pilot for the Douglas company and another representing the Civil Aeronautics Authority. In the cabin engineers and observers sit on comfortable benches in front of large desks containing amazing arrays of instruments. An engineering chart has been prepared outlining every test for the flight, and even the position of each observer. All of us are equipped with parachutes.

As we thunder down the runway to the hum of

cautious step. Thus he executes a potentially dangerous maneuver without taking chances. That's test flying—a patient, methodical approach to each problem, taking nothing for granted, never accepting the obvious until it's proved.

Few realize the tremendous amount of data which must be obtained, the hundreds of performance figures which must be checked and correlated in testing a new plane such as the "DC-4." While in the test stage, this sky liner is actually a huge flying laboratory, its cabin filled with more than 2,000 pounds of test instruments and 6,000 pounds of wooden framework, seats and boxes for housing the crew, the scores of instruments and the ballast. The instruments in this winged technical institute record everything from the fuel required to take off to the temperature of the brake linings during a landing.

Let's make a typical test flight,

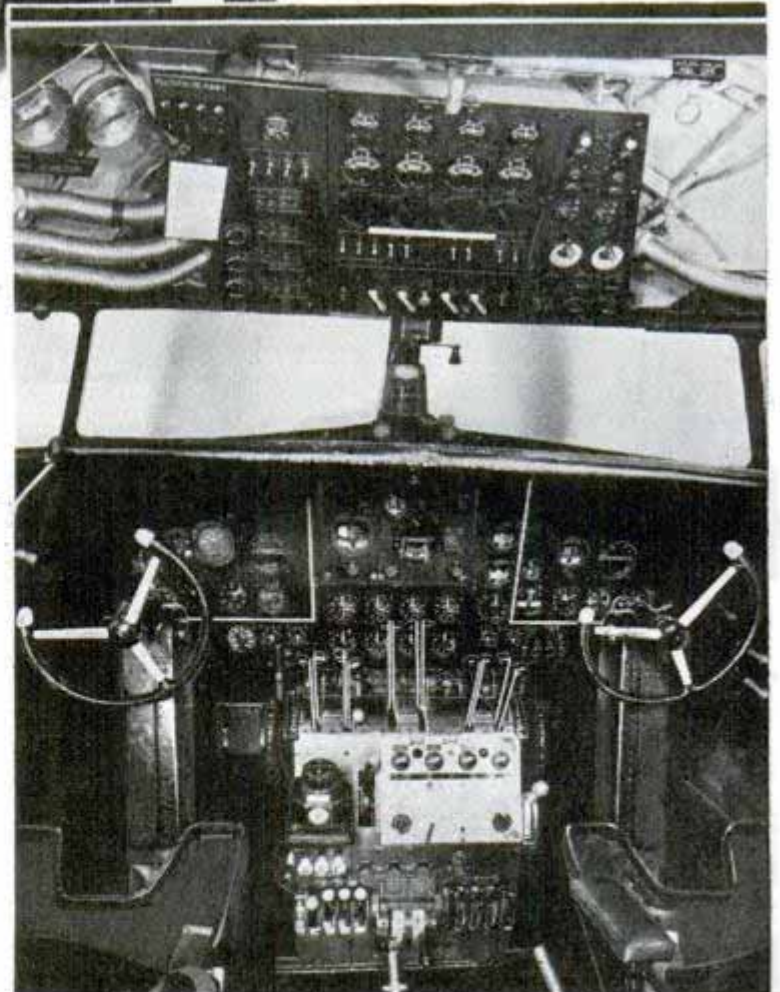

*Pilot's compartment of "DC-4" filled with flight and test instruments and, above, engineer in cabin watching "movies" of propeller vibrations during test flight*



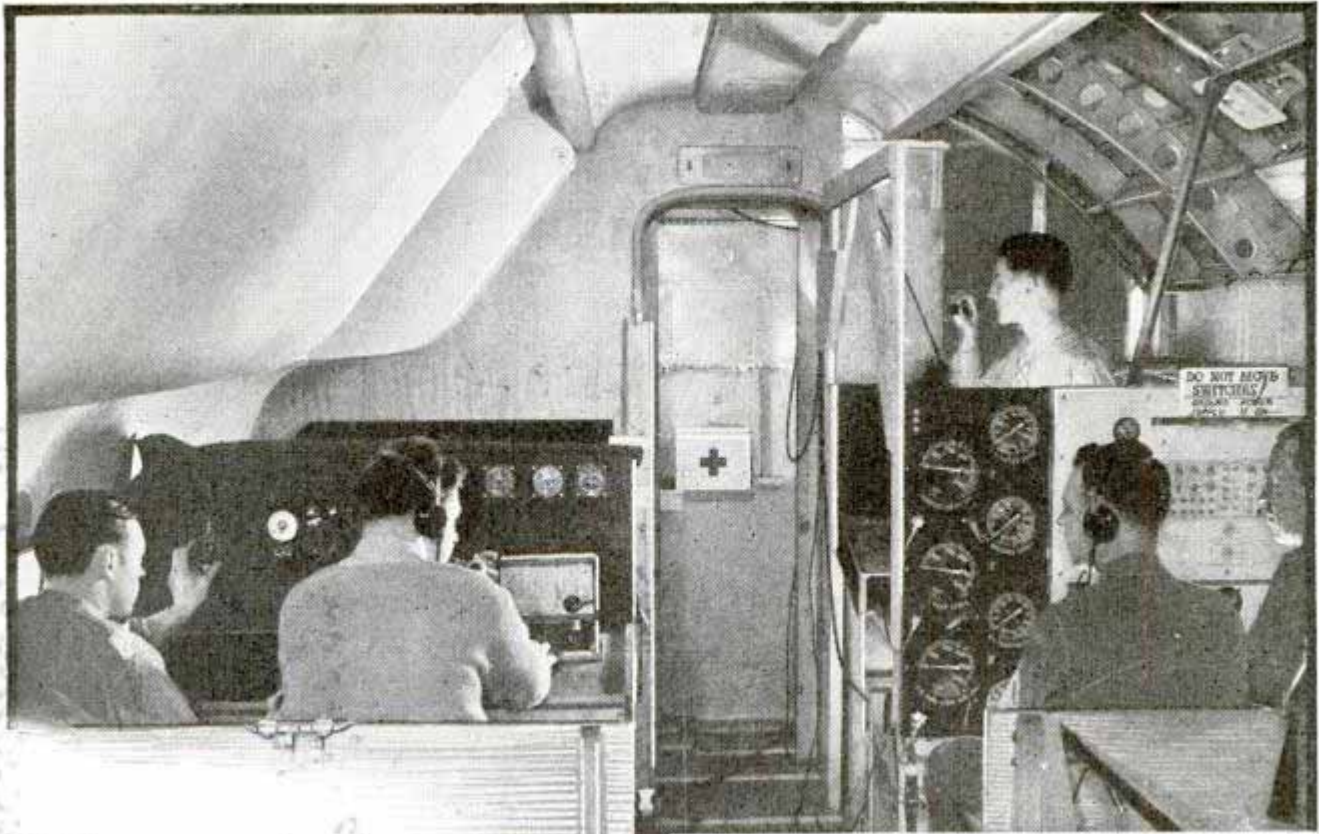

5,600 horsepower developed by the four engines, the flight engineer speaks rapidly into a dictating machine, recording his impression of the takeoff as he watches the dials and gauges. The ship's inter-phone system also connects the flight engineer with the pilots and with the engineers and observers in the cabin so data can be correlated as rapidly as it is gathered. During the progress of the flight, this engineer at my elbow continues to dictate so that when the trip is finished we have a complete record of everything which has occurred. This is important because everything that occurs on a test flight may be significant and nothing must be forgotten or we may have to do the entire test again.

Back in the cabin engineers and observers watch tons of instruments as they blink and whirl their thrilling story. Engine performance, the electrical system—big enough to illuminate an office building—the hydraulic system, vibrations and deflections in structural members—all are being checked and double-checked. On blueprint blanks, the engineers make detailed notes as the ship speeds high above the clouds. Engine pressures and temperatures, for example, require blanks with 110 lines, each of which must be filled out carefully during a flight. If just one person slips up and fails to get his share of the



*The author peering from cockpit of the "DC-4" and, above, engineers at their stations in the cabin during a test flight*

data, we may have to do the whole thing over.

After each flight, all the results are checked and transcribed. Eventually thick volumes of reports thus are accumulated, adding valuable information to the science of aeronautics. In this manner engine temperatures, on the ground and in the air,

(Continued to page 129A)



# Enlarger Is a Film Viewer and Retouching Stand



Top, inserting paper for enlarging; below, using ground-glass window for viewing strip of film

Four purposes are served by a photo printer designed for the miniature-camera enthusiast. It will make contact prints of any size negative up to three and one-fourth by four and one-fourth inches, and will enlarge to that maximum size a thirty-five millimeter or half vest-pocket negative. The printing method is simple. There is a slot for the film, and a ground-glass platen for centering. Closing the ground-glass door turns on the light and exposes the paper. The glass door also serves as a retouching stand and film viewer.

## Maybe You're a One-Eyed Driver and Don't Even Know It

In every hundred automobile drivers there are one or two who are completely blind in one eye. But three Yale investi-

gators report that twenty to forty drivers in every hundred have defective vision in one eye that handicaps them in driving—and these are especially dangerous on the road because they are ignorant of the danger. Once these drivers can be made aware of their deficient sight, they can be taught to drive with their heads at an angle or to keep turning from side to side to make the best use of the good eye.

## Light Built in Battery Tester Makes Scale Easy to Read

Pressing the rubber bulb of the latest battery tester causes a built-in light to illuminate the scale, making it easy to read. A check valve prevents acid from dripping on the clothing, allowing it to run into the barrel where it is kept until released.



## Mechanical Cow Chews and Moos to Attract Customers

Wagging its tail, wiggling its ears, chewing and even mooing, a mechanical cow is a novel advertising device used by stores. It contains motor and rods which provide action of the tail, ears, eyes, mouth and head. The mooing sound is produced by a bellows. Doors in the cow's side open to expose the mechanism.

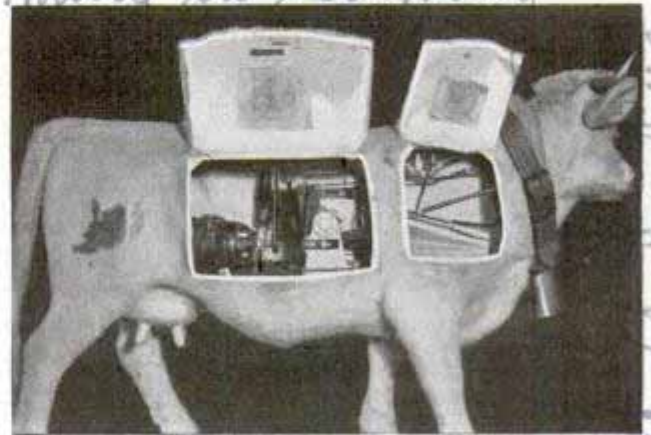

Doors in side of animated cow lift open to show mechanism that makes it move and moo

American Photo Laboratories 3017 Canoll Ave  
Chicago  
mini printer

Blindness, 50% 50%  
needed

Delmann  
Bellows  
It lights up

Ar. Becomes. Pa.  
made in Iserman  
Cm. A. G. I. Bank

#1412

Science Service  
1121138



# Monsters in Fish Bowl Stage Camera Thriller

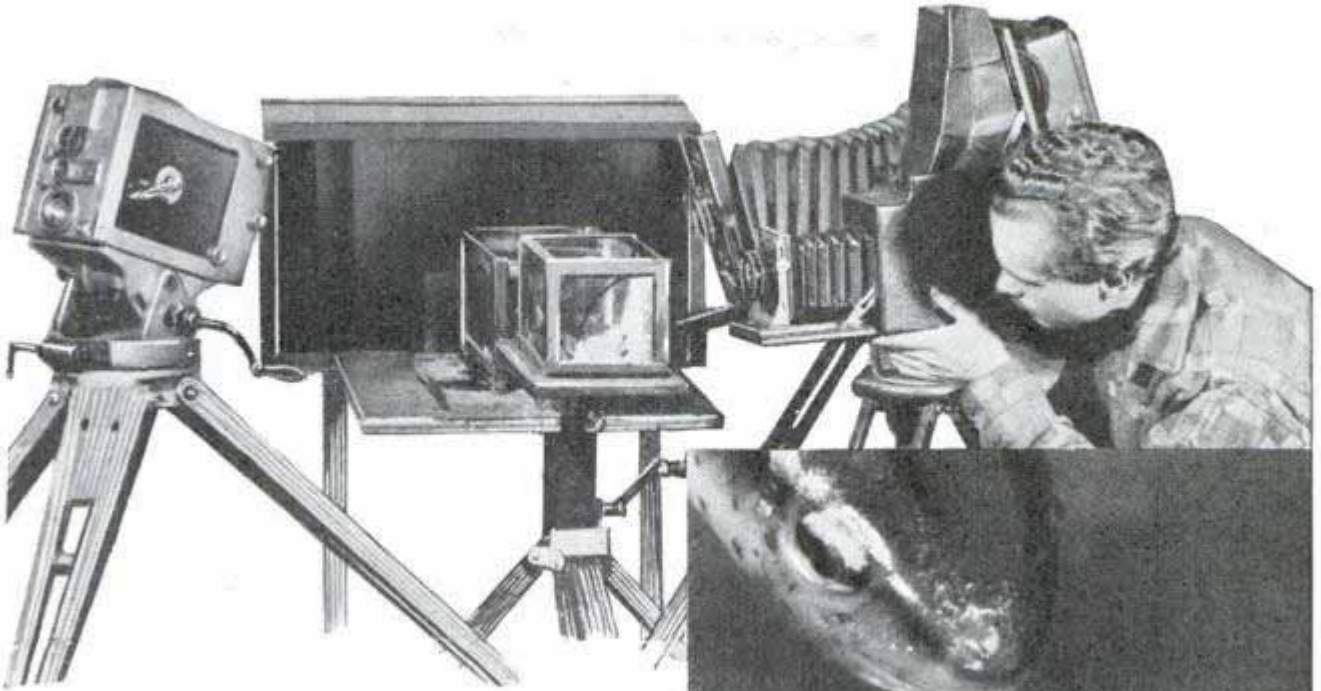

Three cameras are kept focused on small aquariums, ready to record exciting action. That fearful, pop-eyed creature below is just a small, harmless fish



There's hair-raising drama in a parlor fish bowl. Horrible beasts inhabit it, fighting among themselves for life. Lynwood M. Chace of Swansea, Mass., obtains thrilling pictures by training cameras on bowls peopled with fresh-water pond creatures. Proper lighting and lenses that permit extremely closeup focusing are the secrets of his striking photographs. That deadly creature at the right with tweezerlike claws in its lip is a tiny nymph that will become a dragonfly

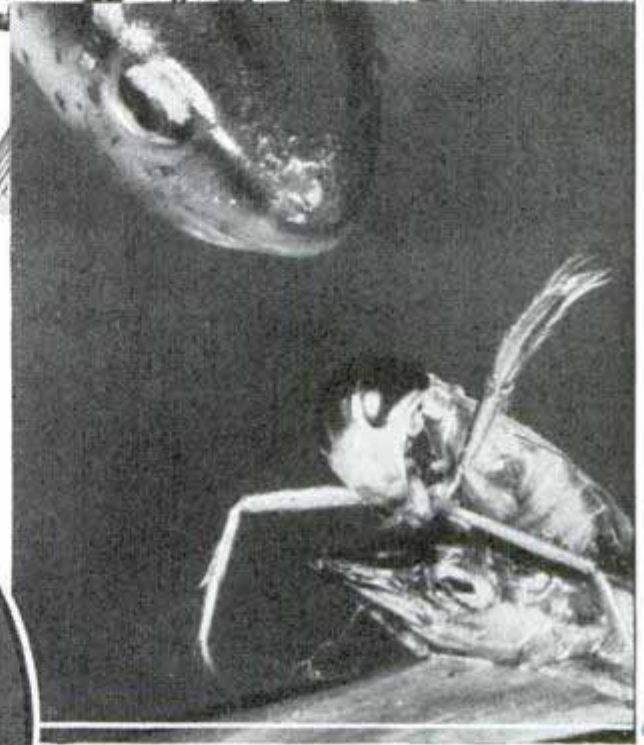

"Water boatman," above, is too busy eating dead fish to see newt swimming down to attack

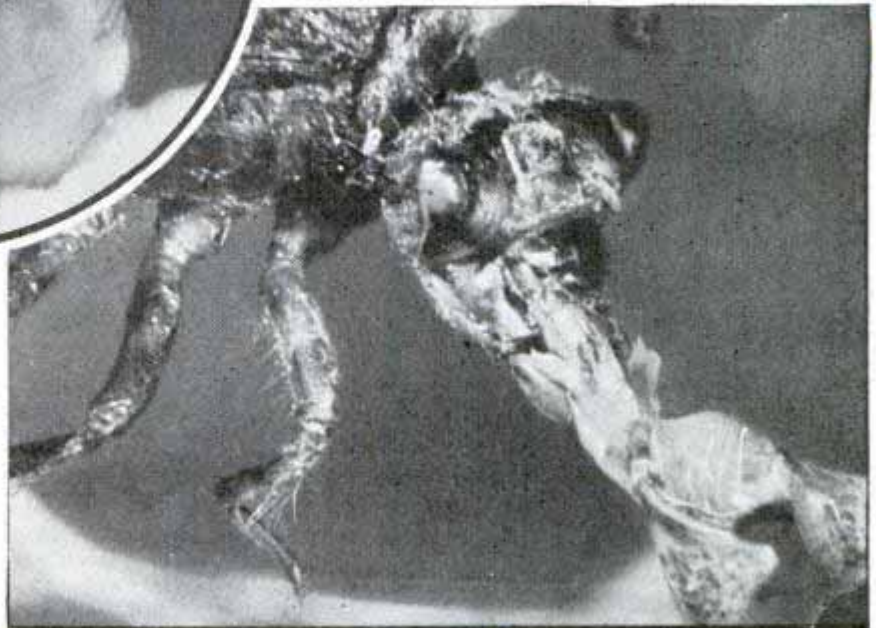

*come*

*10/16/1935*



*James O'Leary*  
*James O'Leary*  
*New York*

# Polishing Up a Skyscraper While City Sleeps

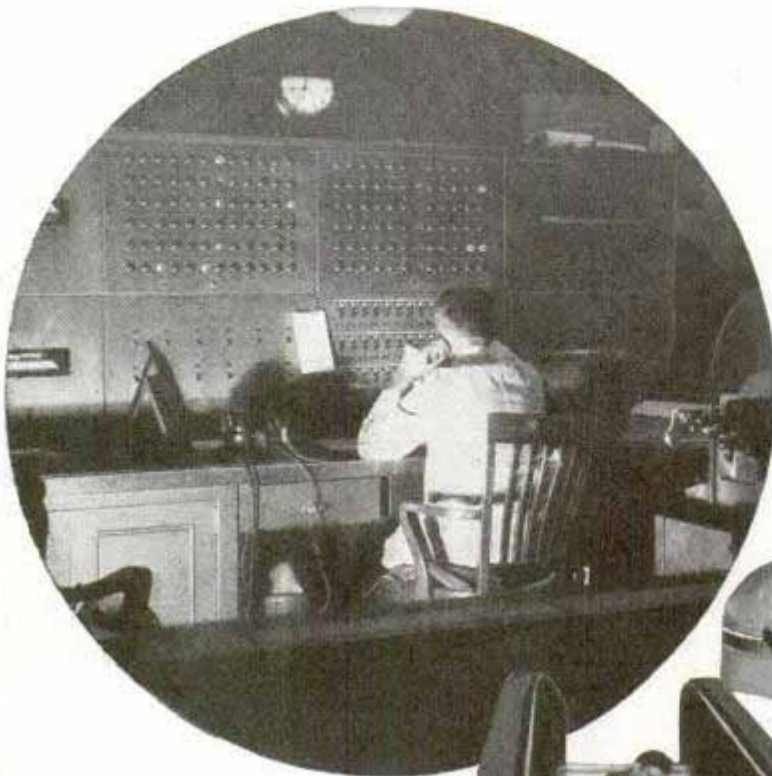

To keep a modern skyscraper shining, a huge staff is constantly at work in the small hours of the morning, earning its living while the city sleeps. Above, key man in the crew gets watchmen's reports, knows who goes in and out and why, and the location of all workers in the building

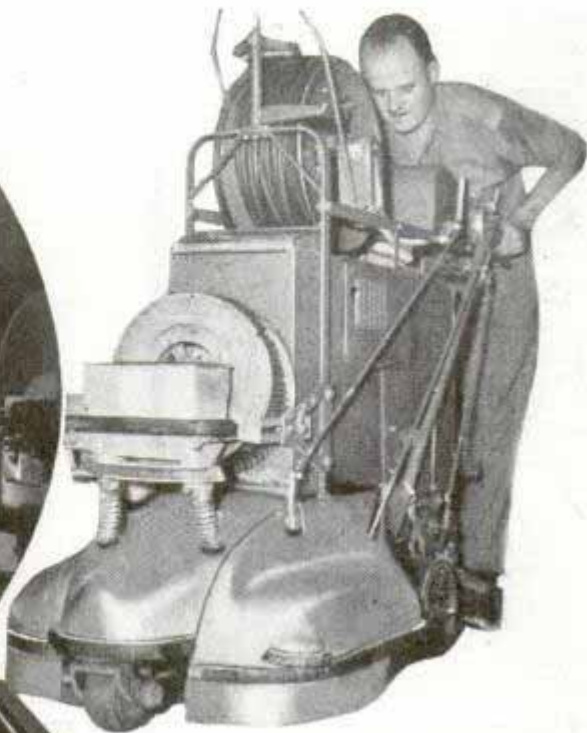

Above, operating big floor-polishing machine which keeps the skyscraper's terrazzo floors like gleaming mirrors. Left, digging chewing gum out of escalator treads gives this night worker a full-time job



*RCA Bldg.*

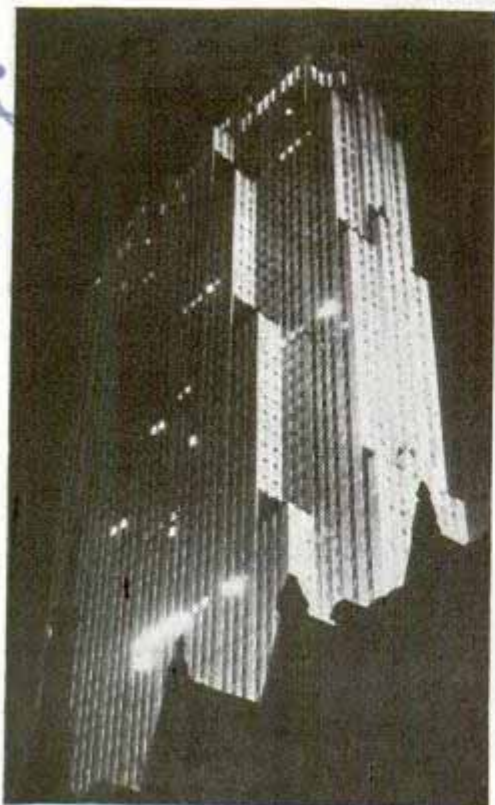

Left, scattered spots of light in the huge RCA building in New York show where hard-working women are scrubbing offices, another task in the process of keeping the skyscraper polished. Right, bronze cleaner, wearing mask, uses electric gun to spray on polishing fluid. The mask protects his lungs against fumes





# WHAT *Your* NOSE KNOWS

SENSORY EPITHELIUM

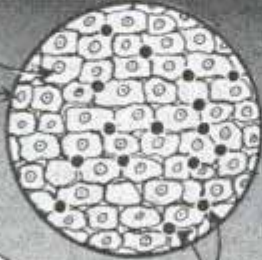

OLFACTORY NERVE ENDINGS

INTERIOR OF NASAL CAVITY

NASAL NERVES LEADING TO THE OLFACTORY LOBE OF THE BRAIN

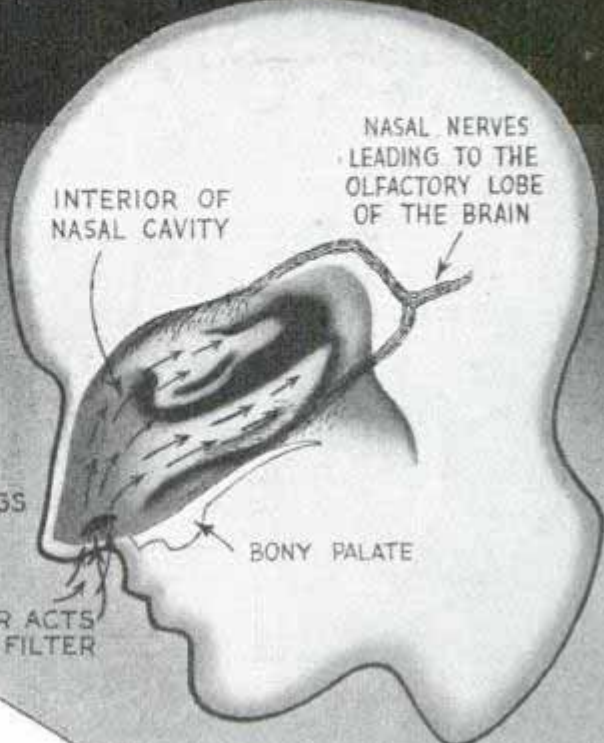

BONY PALATE

HAIR ACTS AS FILTER

**A**RE we losing our sense of smell? Such a belief is widespread, but it does not have fact as its basis, according to Dr. Ernest M. Seydell, who has spent many years in probing the mysteries of this little-understood sense.

In modern man, he says, olfaction is not a decadent sense but a primitive one. We have allowed it to remain in its original state while developing our sight and hearing to remarkable degrees.

As an analytical instrument, however, the human nose is more delicate than the spectroscope. Not one of our other senses is so acute, so extensively connected with the brain centers. And it plays a greater part in determining our behavior than we realize.

"Our innate objection to bad odors," Doctor Seydell states, "preceded many of the great scientific discoveries, which, in turn, removed the unhygienic factors responsible for these odors and also has succeeded in protecting us from many of our infectious diseases. In fact, the degree of advancement of a civilization according to our standards may be measured roughly by the absence of objectionable odors."

In our world, few things are



Sketch of human olfactory system, showing how odor sensations reach brain by way of nasal nerves. Below, chemical breath smeller helps to determine whether motorist has been using intoxicants

1023-1st national bank bldg. Wichita

developed by Dr. Rollo H. Harwar, Prof. Biochemistry, Colorado State University  
 4.31 W. 60th Terrace  
 Kansas City, Mo.

Doc Ba







malnutrition and mental unbalance. "One investigator," comments Doctor Seydell, "reported the case of a physician to whom violets had the odor of phosphorus. Another person who took a headache remedy smelled a continuous odor of cinnamon."

Much of what we think of as taste is actually smell. Paradoxically enough, most substances we smell do not taste. For proof, just close your nose and try to tell the difference between a slice of apple and one of onion by your sense of taste.

There is also a quantitative difference, Doctor Seydell explains. "We taste only relatively strong solutions," he says, "we smell very dilute ones. This can be demonstrated best by substances we can both taste and smell."

"Because of their qualitative difference, the two are used in a very unlike way. In

(Continued to page 144A)



Blindfolded and with nose closed, the man at left finds it impossible to tell difference between apple and onion solely by the sense of taste. The sense of smell quickly reveals the difference

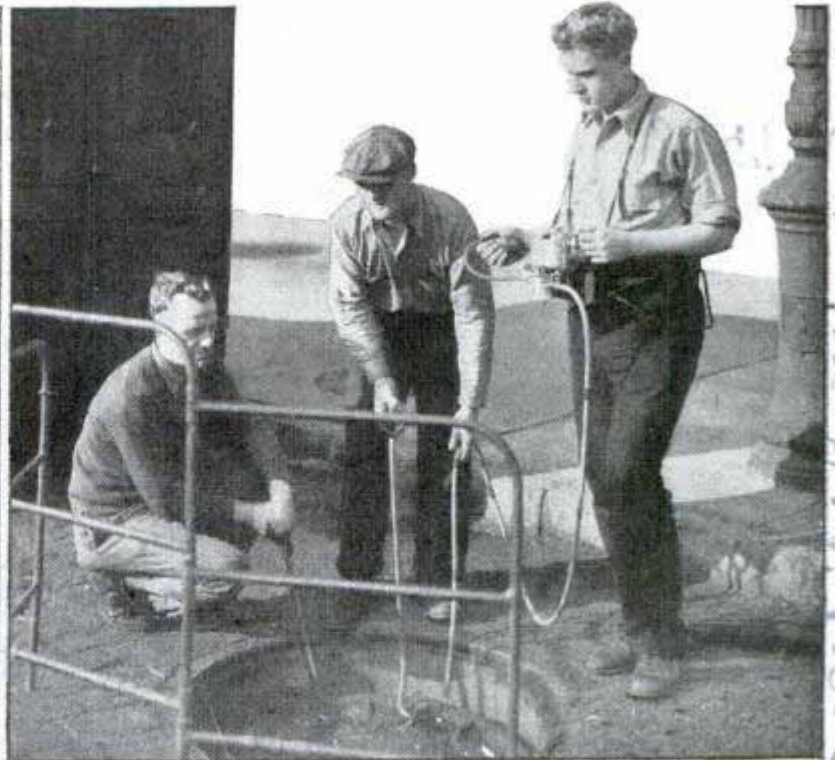

Left, sampling air at working face of mine with detector to find if gas is present. Right, sampling line and mechanical nose in use to discover gaseous condition in manhole

*the old water...  
 must Safety  
 Appliances Co. Praddock*



# Monster Shaped from Sand Made Real by Coat of Paint



© Hamlin of Brighton

Sand sculptor at English seaside resort finishes image of monster by applying a paintbrush. The paint produces an extremely realistic effect

It's only sand, this simian monster snarling from behind a tree stump. Visitors to an English seaside resort are occasionally startled at the appearance of a prehistoric monster or wild animal on the bathing beach. The creatures are the work of a sand sculptor, who after shaping them heightens the realistic effect by adding a coat of paint.

and after the boat is made fast, vertical wheels on hinged arms are swung out, projecting slightly beyond the horizontal wheels and letting the boat ride easily against them while moored. The tires are kept partly inflated and are covered with canvas to prevent marking the boat.

## Truck Body Door Rolls Up Like a Window Shade

Made of flexible steel, a new type of door for the rear end of trucks rolls up like a window shade. It travels in a groove and disappears under the roof of the truck. The door automatically stays in any position, making it possible for the driver to open it only part way to remove a single parcel. Trucks equipped with the door can back closer to the loading platform than those with swinging doors.



Opening like a roll-top desk, this flexible steel door makes it easy to load and unload truck

## Wheels Along Dock Guard Boat from Chafing While Moored

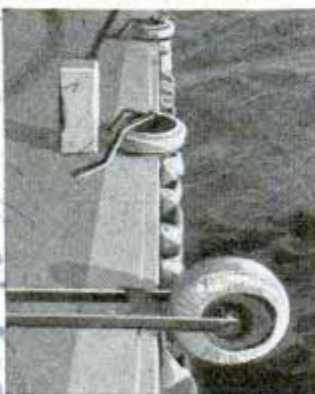

Discarded automobile wheels mounted along the edge of a dock form "roller bearings" for mooring a boat, preventing any scraping or rubbing of paint. California yachtsmen use balloon-tired car wheels or wheelbarrow wheels to protect their boats. Tires mounted horizontally let the boat slide in to the dock without touching it,

Em: Johnson & Johnson's Island, Calif  
Box 109 Pullman

E. Y. (et. successful)

H1397

Weymouth

H1389

Metropolitan Body  
Dodgechassis



# Robot "Weathermen" Log Sun and Winds

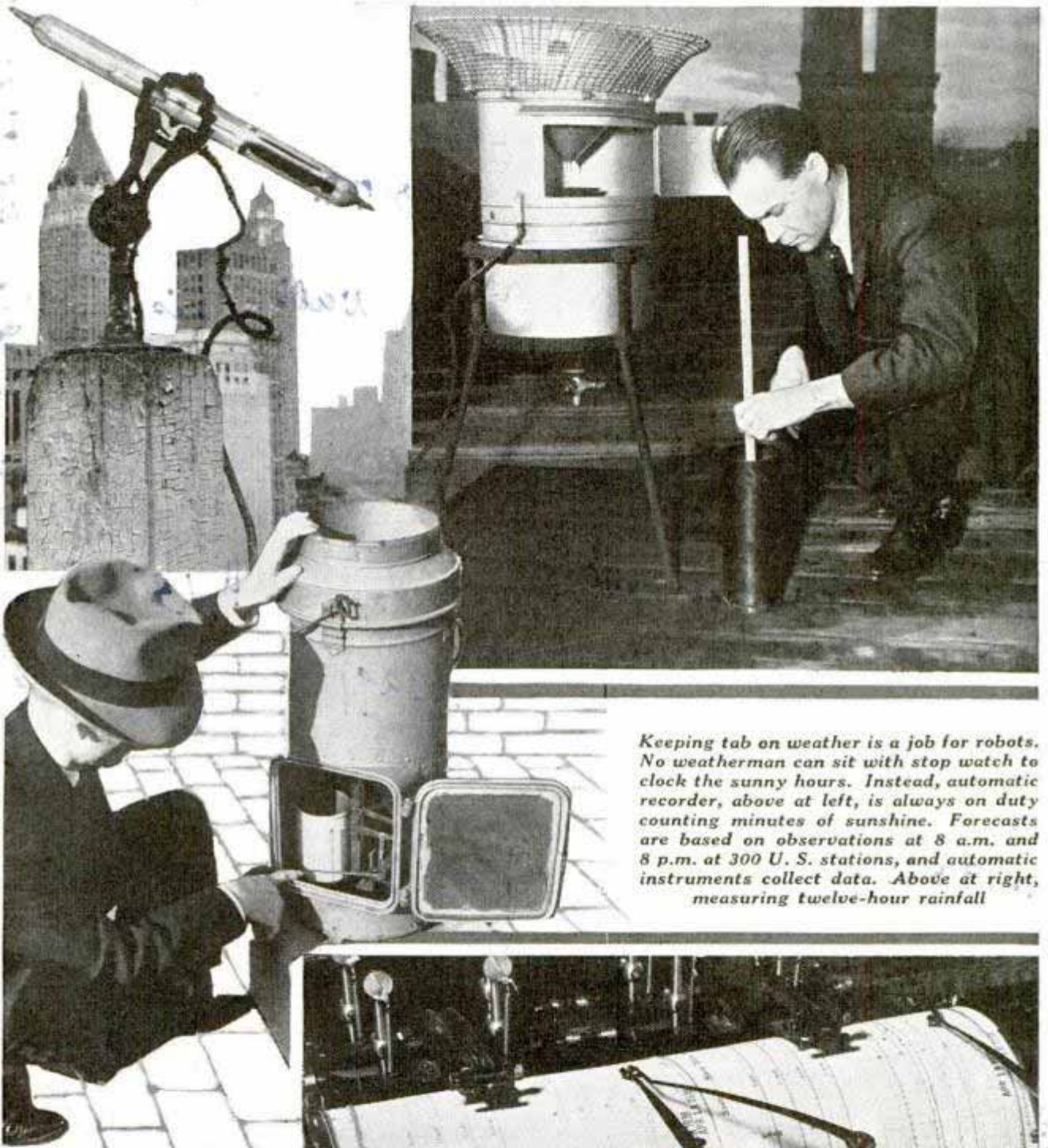

Keeping tab on weather is a job for robots. No weatherman can sit with stop watch to clock the sunny hours. Instead, automatic recorder, above at left, is always on duty counting minutes of sunshine. Forecasts are based on observations at 8 a.m. and 8 p.m. at 300 U. S. stations, and automatic instruments collect data. Above at right, measuring twelve-hour rainfall

Snow gauge, above, is accurate to one-hundredth inch. Triple register at right records wind direction and velocity, sunshine and rainfall. Each meteorologist reports twice daily the maximum, minimum and current temperatures, air pressure, precipitation, wind conditions and state of weather

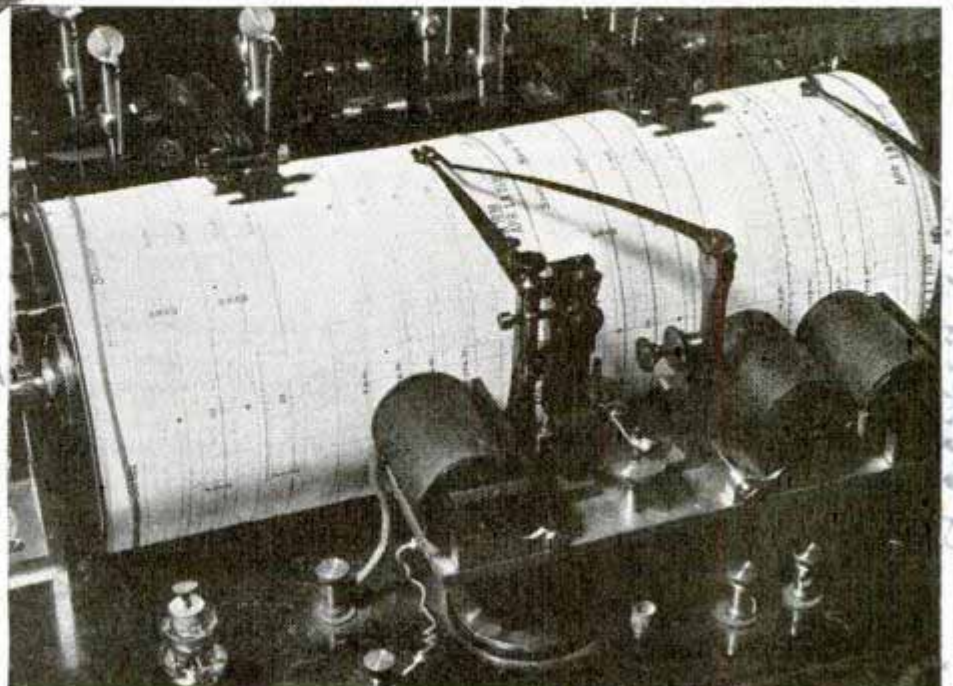

Acme



### Automatic Electric Teapot Stops When Brew Is Ready



Water boils up into spout of electric kettle and shuts off current when tea is brewed

Shutting off the current when the brew is ready, an electric teapot is the latest thing for the home. When the water boils, it automatically passes up through the curved spout into the warm teapot. The tea is brewed and when the teapot is filled, the pot shuts itself off automatically.

### Nut Cracker Blasts Off Shells with Internal Explosion

Now comes the "internal combustion" nut cracker. When you crack a nut shell from the outside, there is always some loss from broken meats. To produce perfect

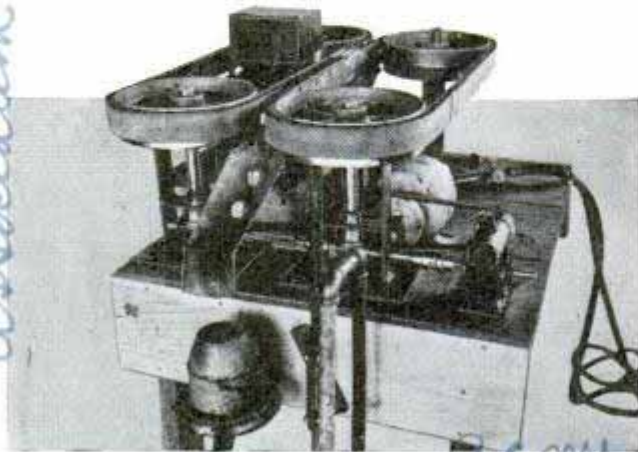

After receiving injection of gas, nuts slide down chute into burner where explosion blasts off shells

meats, the college of agriculture at the University of California has contrived a way to blast from within. Nuts are fed into a machine and pass over a circular saw which cuts a slot in the shell. Then jets inject into each nut a bit of non-poisonous explosive gas. As the nuts drop into a circular burner, the gas blows up, cracks off the shells and blows them away.

### Wooden Shoes for Ice Skates Protect Blades and Floor

Wooden shoes are being introduced to ice skaters. There is an oil-treated groove down the center of the shoe to hold the skate in place. You step into the groove, lock the shoe to the skate with a snap-on strap, then walk on the rug or the porch without marring either.

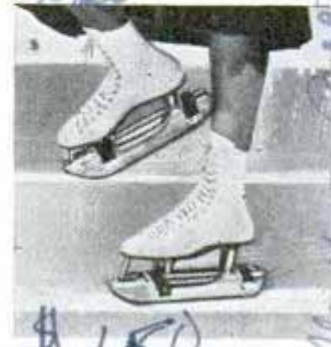

### School Bus Like Metal Cylinder Rolls If It Overturns



Youngsters riding in this school bus are safer, since it would roll over instead of taking flat crash

Made with a metal circular body so that it rolls if it overturns, a new school bus offers greater safety for its occupants. Since the vehicle would roll, instead of hitting flat, it is said to resist smashing more than the conventional-type bus. The windows are set into the side of the bus as an added safety factor.

English - maker unknown

California Walnut Growers Association

Flavis Calif

Jackson 55.15  
Colbert & Corby, 55.15  
Chicago

H 1378

Walk this

\$ 1.50

H 1291

Welder, J. Kirk  
Harris Sentinel Ala



# Office 'Mike' Helps Direct Distant Building Job

Microphones, loud speakers and field telephones have been combined in an independent communications system for directing construction of a \$2,000,000 apartment development in New Jersey. A radio microphone in the central office is connected to five loud speakers installed in trees on the twenty-six-acre tract where the construction is under way. Telephone handsets also are attached



Bottom, issuing building order over the office "mike." Circle, loud speaker in tree carries message to all workers on the job. Top, field engineer calls back on tree 'phone for further instructions

to the trees for communication with the office. Thus, an order spoken into the "mike" at the office reaches all of the more than 300 workers on the job, the five loud speakers broadcasting the message simultaneously. Should an engineer require still

further instruction or clarification of the order, he calls the office on the tree 'phone. The central office then locates the plans of the section about which the engineer is calling and complete details are broadcast over the loud-speaker system.

## 'Shivering' Alloy Turns on Heat at Drop in Temperature

Alloys that "shiver" at a change in temperature and can be made to operate electric switches automatically are the latest discovery of the metallurgist. The alloys are various mixtures of iron, nickel, chromium and silicon; by varying the proportions, the metal can be made to "shiver" or lose its magnetism at any desired temper-

ature from 150 below zero to 1,100 degrees above. It could be arranged to turn a heating plant on and off or to turn on a fan, sound a fire alarm or control refrigeration and air-conditioning machinery. The development is based on the knowledge that different magnetic metals lose their magnetism at varying temperatures.

Unnamed by L. O. Jackson and Russell Parrell

Chicago daily news 1/13/39

Memorandum distributed Columbus Ohio

Meadowbrook Village  
Plainfield, N.J.



mount Vernon NY

# Fast Car Resembling a Plane Has Vents for Rocket Power

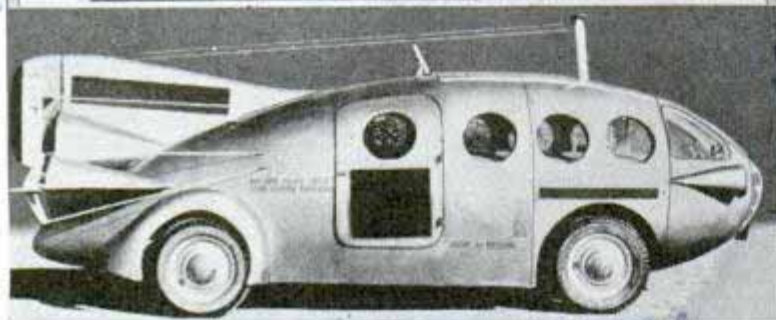
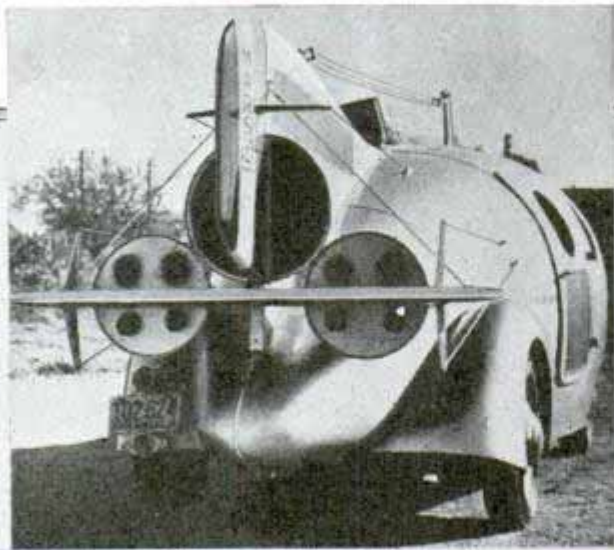

Notice the "rocket tubes" in rear of this car, which looks like a wingless airplane. It is driven by a supercharged motor

Closely resembling a small airplane without wings, a streamline automobile built recently has a speed of 115 miles per hour. Its eight-cylinder motor is equipped with a supercharger. Vents for rockets are provided at the rear of the speedster, indicating that its maker may be contemplating experiments with rocket power. Made of aluminum, the car cost \$16,000.

## Filter for Car Radiator Hose

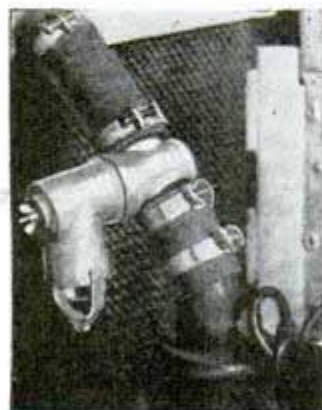

Overheating of the automobile engine may be reduced considerably through the use of a water filter mounted directly on the radiator hose. This filter removes foreign substances from the water, helping

to prevent clogging of the small passages in the radiator core. Water from the motor

is thrown against a screen in the filter. The mesh of this screen is smaller than the radiator core. The shape of the filter gives the water a whirling action which deposits sediment in a glass bowl offset from the water line.

## Cold Light for Enlarging Reduces Exposure Time

Mercury vapor and argon gas are combined in a tube light for photo enlarging that cuts down the exposure time. The light from this filamentless bulb is largely blue, with some green but no yellow, red or heat rays. Photo printing papers of the chloride, bromide and chloro-bromide types are highly sensitive to blue light but not to red, so the mercury-argon lamp is efficient for these papers. Another advantage is that it is a cold light and there is no danger of heat damage to the negative.

## Portable Gas-Driven Tool for Drilling or Grinding

Powered by a small gasoline motor, a portable tool for grinding, drilling and concrete surfacing is handy where no electricity is available. It operates at 3,500 revolutions per minute, top speed. Attachments for sanding, polishing and cleaning may be obtained.



Finishing a concrete surface with hand tool driven by a portable gasoline engine

built by Peter Vacco  
no street address

1414/4  
H1257

Ultra Violet Products, Inc. Glendale, N.Y.  
6158  
Holly wood, Calif.

With access \$163.75

Mall Tool Co  
77140th Chicago Ave



# Latest Pursuit Plane Retracts Landing Gear

P-40



Aerial view of new pursuit ship. Note that landing gear has been retracted

acme

Powered by a liquid-cooled engine, the U. S. Army Air Corps' latest pursuit plane has two machine guns synchronized to fire through the propeller. The craft has retractable landing gear. Oxygen apparatus

permits its operation at extremely high altitudes. The ship's radio is co-ordinated with an anti-aircraft alert net, so that it may be guided from ground posts to intercept hostile bombing planes.

Allison Single

# Tractor Plows Up Bottom of Lake to Improve Beach

H 1330

Pelican Lake

Two acres of lake bottom in Minnesota have been converted into a clean, sandy beach by a sea-going tractor and gang plow. Equipped with ground-gripping tires that had sufficient flotation on the oozing lake floor to keep it from sinking, the tractor pulled the plow back and forth over

the grass and thistle-filled muck bottom. Disking and harrowing followed, resulting in a clean beach on which nothing was left to injure the feet of bathers. The work extended as far from shore as the operator could go without getting water into the tractor motor. Much of the job was done with the tractor's front wheels submerged.

with the tractor's front wheels submerged.

H 1357

## Greater Demand for Gasoline Forecast

Oil men anticipate a four-per-cent increase in gasoline consumption this year as compared with 1938 because of the upswing in new car sales and other encouraging business signs. The American Petroleum Institute forecast the minimum need of the nation at 80,000,000 barrels.

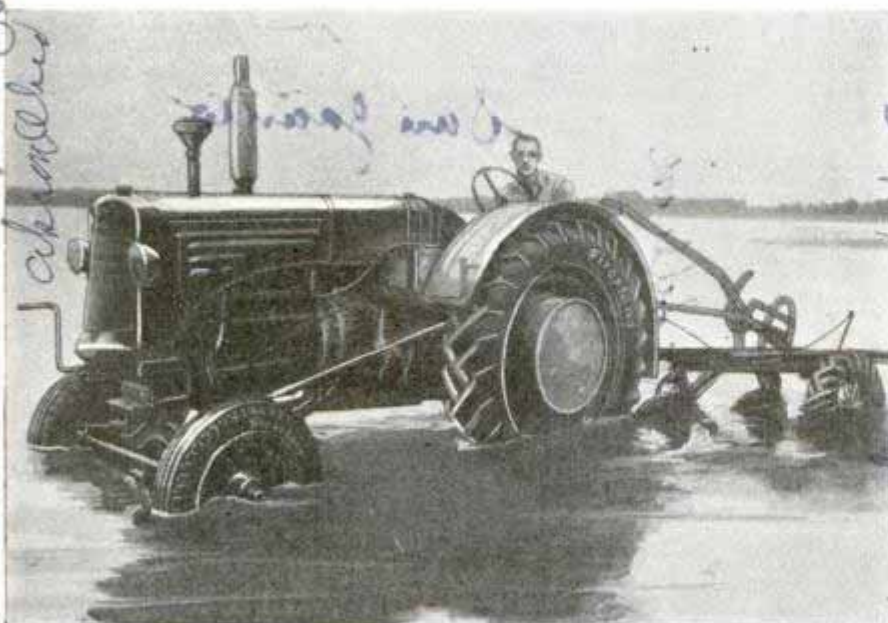

Plowing lake bottom with sea-going tractor to provide smooth beach near shore. The tractor's front wheels were often submerged

Gerry. Neth. Albany

50 w/50 k h h  
needed.

Tom Fineston  
New Jersey  
abraham

Dec 10/11  
see in same







1539 S. Beverly Blvd.  
West Los Angeles, Calif

# MOLES *Battle a* MOUNTAIN

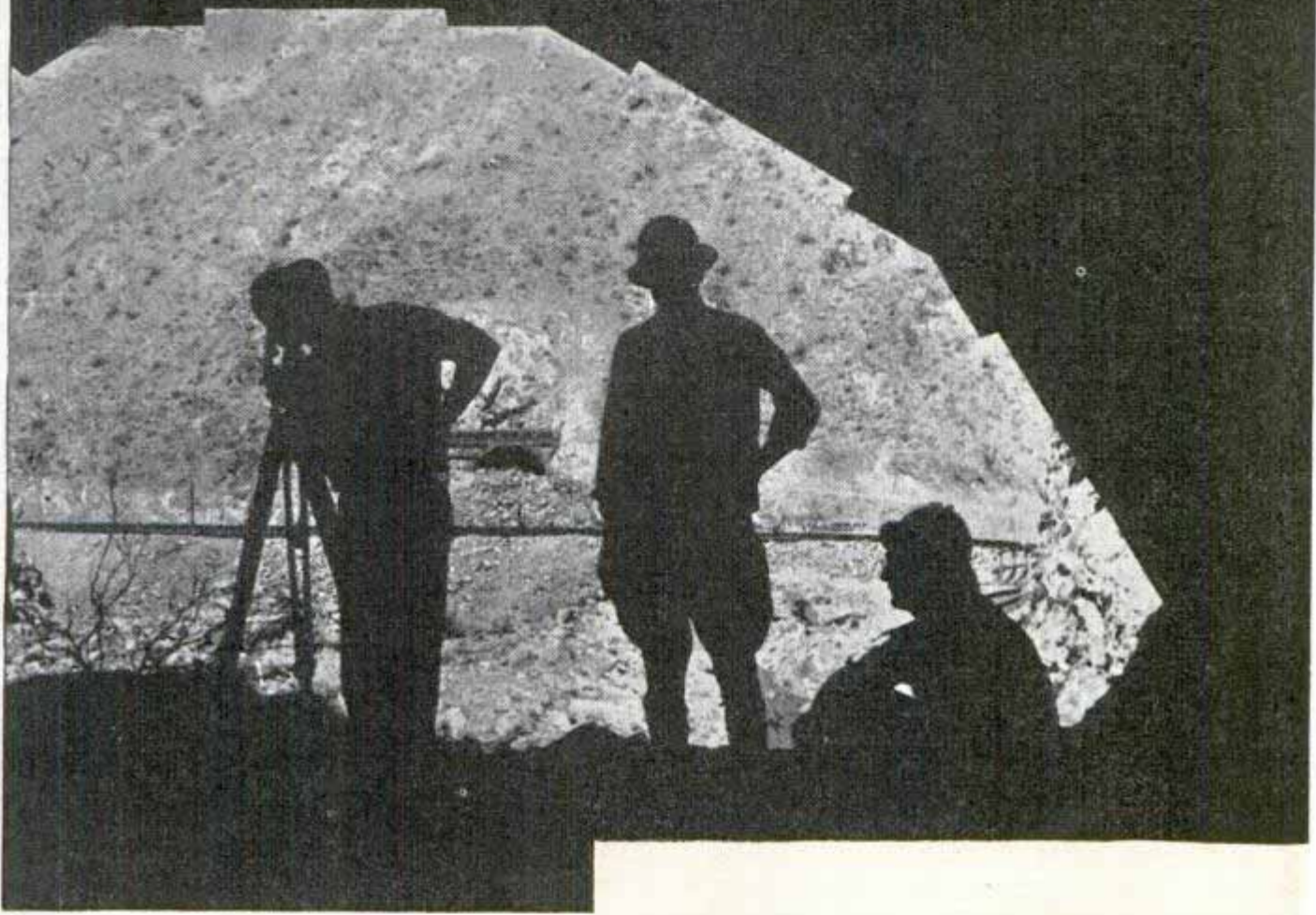

and 155 miles of distributing lines have been constructed. Much of the \$220,000,000 aqueduct system was built without strenuous opposition from nature. All the other thirty-seven tunnels were completed on schedule and below estimated cost, but at San Jacinto nature concentrated her fury. For her most effective weapon she chose the very thing that man will carry through the mountain—water.

For months two crews had worked toward one another—inch by inch. Finally the drills of one crew chattered through the last thin rock partition. The slim holes were loaded with explosives and the crews retreated to safety. "Mike" Leadbetter closed the elec-

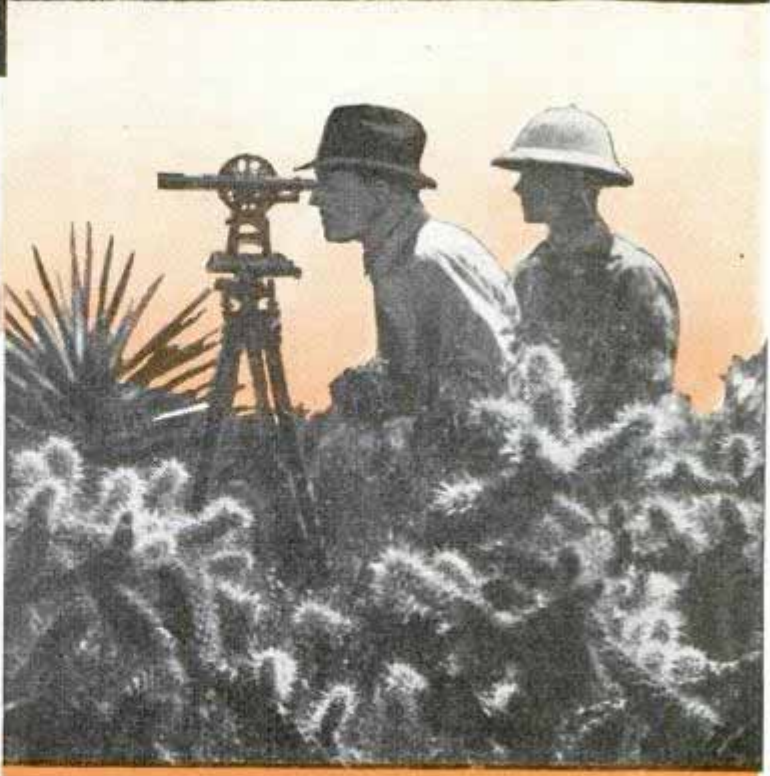

Surveyors at work on job which showed that the best route for the Metropolitan Aqueduct lay across deserts and through mountains. San Jacinto presented the toughest problems



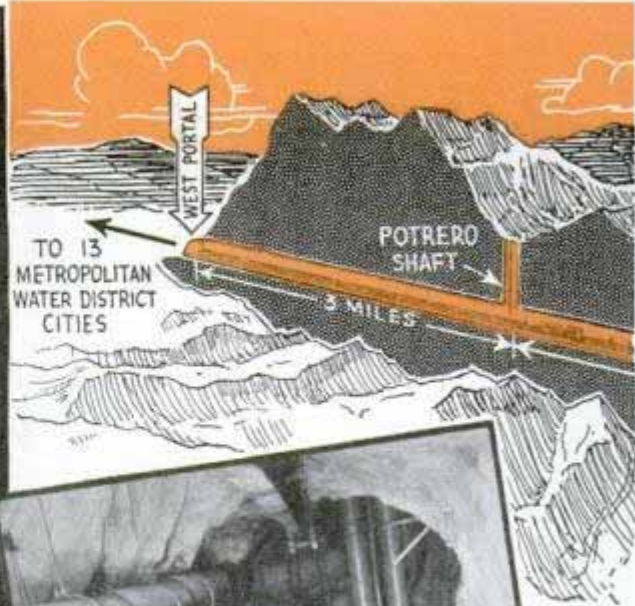
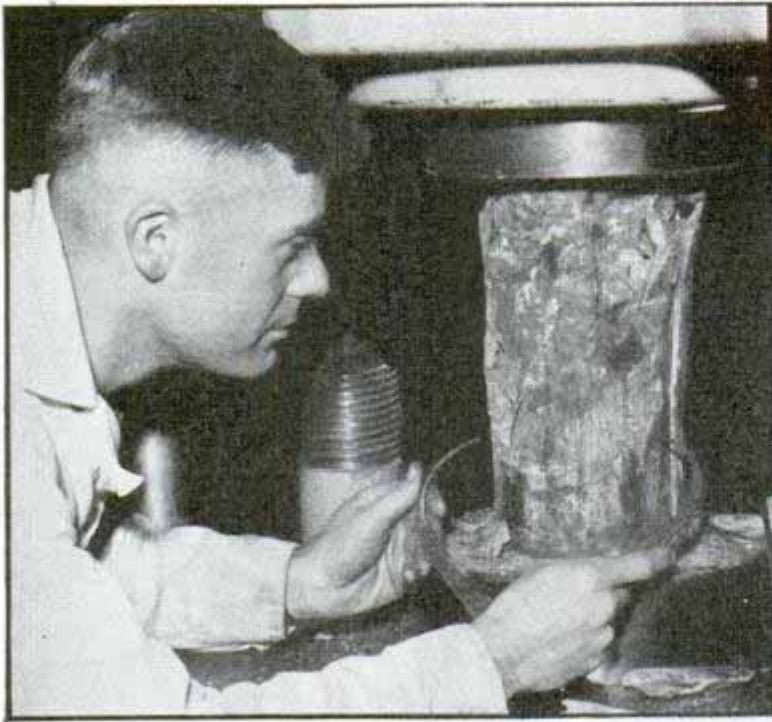

tric switch to fire the charge. First, a low rumble and then a surge of sound shook the mountain.

"She's holed through!"

From the throats of half a hundred men burst that cry as the two gangs raced to see which could get through the jagged hole first.

And the two shafts met exactly. Modern science and engineering had cooperated to bring two holes together deep in the heart of the mountain. Surveyors had kept a constant check on the progress of the tunnel to see that it varied not a fraction of an inch. Working with precision instruments, they could detect the slightest deviation in grade or angle.

The "battle" of San Jacinto was begun May 13, 1933. Preliminary surveys showed that the best route for the aqueduct lay under one shoulder of the mountain, which towers 10,805 feet. To have

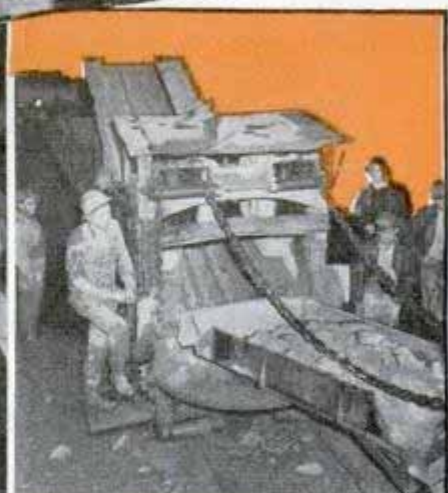
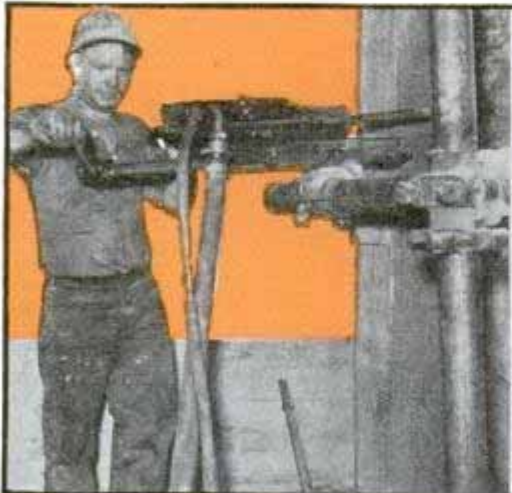

Top, left, testing concrete plug in laboratory. Center, one of the huge batteries of pumps used in tunnel. Bottom, left, machine-miner setting drill. Center, water pouring from ceiling and sides of bore. Right, mucking machine carrying away shattered rock after blast

Metropolitan Water District



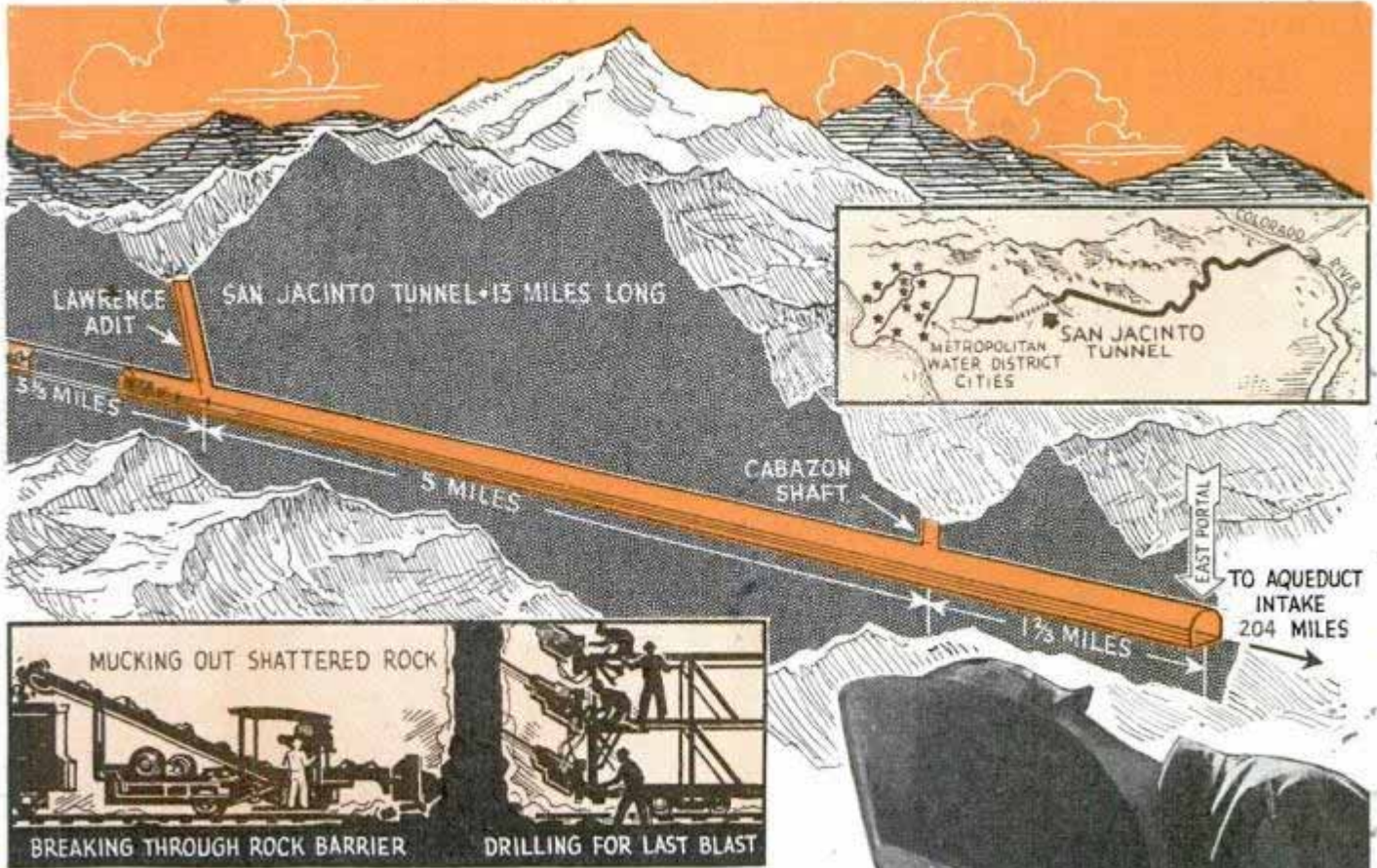

driven the tunnel straight through the mountain, from east to west, would have taken about twenty years. So, instead of excavating only from the east and west portals, it was decided to sink two vertical shafts and a slope adit along the route of the tunnel. With drilling crews working both ways from these auxiliary entrances, it was possible for eight crews to attack the mountain instead of two.

Here is what you would have seen if you had visited the tunnel before it was "holed through":

First you put on a "hard hat" for an excursion into the bore with Superintendent Leadbetter. The hat is made of pressed paper as tough as steel. Underground work is in progress twenty-four hours a day, seven days a week, with electricity illuminating the scene.

The air is fresh, being pumped into the tunnel, and the temperature is about that of rock temper-

(Continued to page 122A)

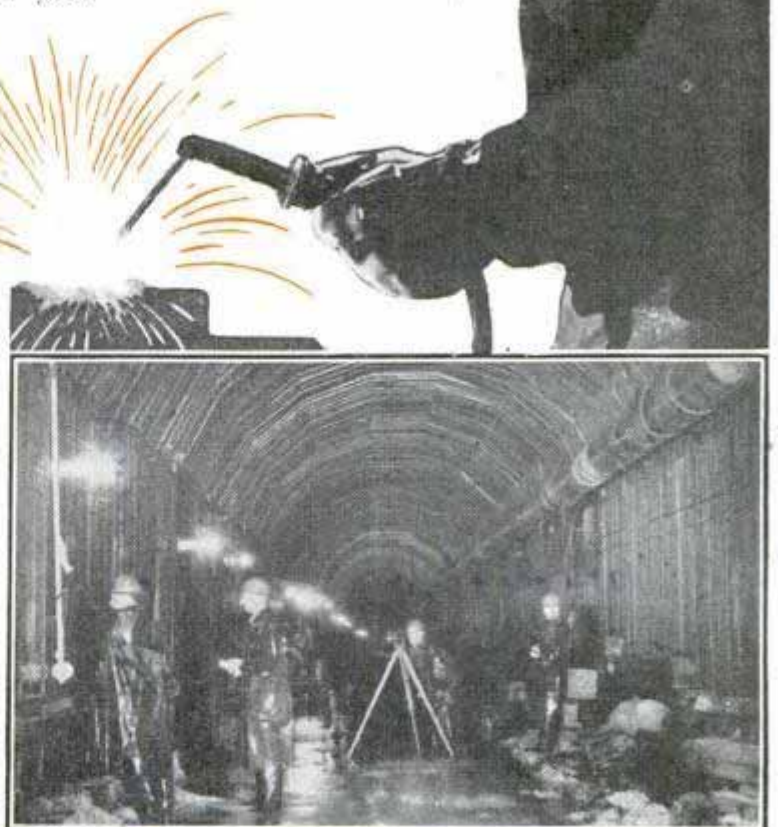

Top, map of the system, showing San Jacinto. Center, welder repairing drilling equipment. Bottom, "heavy ground" section where huge timbers are placed close together to prevent cave-ins



# Door Lens Reveals Caller But He Can't See In

*Protector-Scope \$6.50*



Housewife answering doorbell can see caller in two-inch lens, but the visitor cannot see inside

By means of a one-way "eye" in the front door, visitors can be seen before they are admitted to the house. Instead of the usual "peephole" which lets the caller look in, this device is a two-inch hand-ground lens. Outside, there is only a tiny hole visible. From the inside, the reducing lens shows clearly who is ringing the doorbell. It can be mounted high at an angle so that children can glance up and see outside.

## Ten-Step Photo-Light Control Varies from Dim to Flood



Ordinary electric bulbs can be varied from dim light to a brilliant flood by a ten-step control switch offered for photographing, printing and enlarging. While arranging

and focusing for an indoor scene, the cameraman can turn the control to normal or less, then adjust it to full floodlight for the brief moment required for exposure. Similarly, the switch permits positive control during printing and enlarging, allowing adjustment of the light according to density of the negative.

## Light Globe Is an Insect Trap with Removable Base

Attractive as a light fixture and attractive to insects as well, a ceiling globe of diffused glass has three funnel slots to lead moths and other insects to their destruction. Light invites the moths in, the superheated air kills them and they drop to the removable base which is easily emptied. The globe is designed for kitchens, porches and stores.



## "Eyes" Guard Hydraulic Brake and Warn of Leak in Line

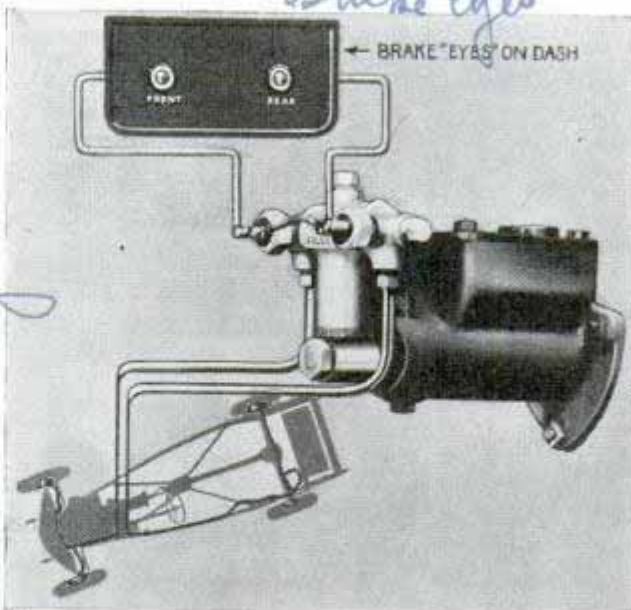

Diagram of protective system for hydraulic brakes, which shuts off defective line and warns driver

Hydraulic brakes are given an added safety factor by an automatic "sentry" just developed, a unit that stands guard over

*Distinctive Creations  
10 W. 47th St. New York*

*10 W. 47th St. New York*

*American Photo-Adapt Products Co.  
162 N. Franklin*



the hydraulic system and seals off the defective line whenever a break occurs, at the same time warning the driver. Loss of even a small amount of brake fluid through leakage causes failure of the system and leaves the driver without brakes. But this automatic device assures him at least two brakes. It consists of a unit attached to the master hydraulic cylinder and a dash signal. Whenever a break occurs in one of the lines, a balanced Neoprene ball is forced by the hydraulic pressure into a seat leading to the defective line and seals it off without further loss of fluid. Front and rear brakes are fed by separate lines so that if the Neoprene ball goes into action to shut off the front brake system due to a leak, the rear brakes are still in operating condition. On the dashboard, two red "eyes" marked "front" and "rear" flash every time the brakes are applied, but when a leak occurs the lamp representing the inoperative section fails to light.

### Bacteria Change Wood Sugars into Valuable Chemicals

Chemists have put bacteria to useful work in transforming sugar made from wood into valuable chemicals. Sugars already are being produced commercially from such trees as hemlock, beech, maple and birch. At the University of Wisconsin, these sugars were fermented experimentally by the agency of bacteria, and the products were butyl and ethyl alcohol, acetone and isopropyl alcohol.

### Conveyor Belt Delivers Coal Direct from Truck to Bin



Conveyor belt delivering coal at right angle from rear of truck to window of bin

### Model Guns of Balsa Wood Latest in Hobbies

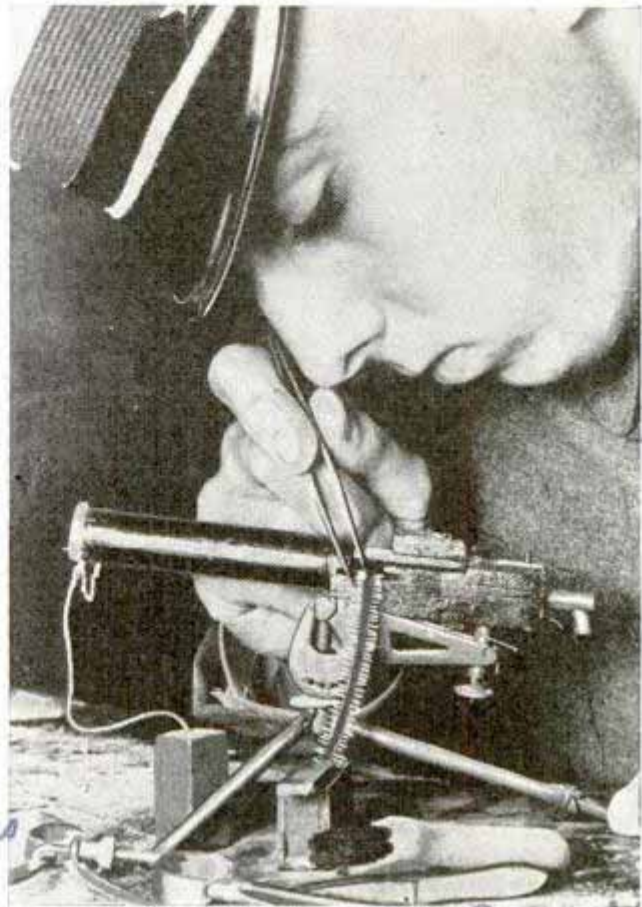

Model-maker working on his miniature machine gun with pair of tweezers

Creating balsa wood miniatures of destructive military equipment is the hobby of one military academy cadet. His model of a Browning machine gun captured top honors at a recent hobby show. The tiny weapons are complete in every detail.

Delivering coal directly from truck to bin, an endless conveyor belt eliminates shoveling and wheeling and so reduces delivery costs. The belt is eight inches wide, of heavy-duty rubber, mounted on two aluminum pulleys and driven by the truck motor. The conveyor will unload coal or other commodities into an elevated opening, and in combination with an auxiliary chute it will carry over a fence, hedge or terrace.

Inquiries as to makers of articles described in Popular Mechanics, will be answered by our Bureau of Information upon receipt of return postage.

191 760 m 200 see 11/10/38

H135

H1356

Truckveyor

Isar Wood Industries, Inc. / Detroit  
 Wash and Body Dies /

Cadet R. A. Hill Jr. Military Academy Valley Forge, Pa.



# SUPER-SAFETY *Goes*



and boat drills were held simply because the law demanded them. Passengers were inconvenienced as little as possible and in some cases the drills were slack. Today the whole merchant marine is determined that there will never be a repetition of the "Morro Castle" disaster. Training in emergency work is conducted continuously and thoroughly because emergency gear worth hundreds of thousands of dollars is worthless unless the men know how to use it.

No one ever knows when fire will break out on a ship. Likewise few men know when a fire drill will be held. At a quiet word from the captain or chief officer a man goes down to a cabin or cargo hold and operates the alarm apparatus. The first warning comes in on the

**S**EVEN short hoarse blasts and a long one on the whistle throw the normal routine of a great passenger liner into turmoil. Vibrating all through the ship, the "all hands on deck" signal sends crew members struggling into life belts and jumping to their boat stations.

On deck, life-jacketed men swing out the boats and ease them down to the rail. Inspectors stand by, watches in hand, while squads of men scramble into the swaying boats and are lowered away. Down on the water, the ship's motorboat casts off from its falls and moves away while the crews of the other boats break out their oars and follow. On the motorboat the radio operator descends into his watertight compartment and calls a station fifty miles away. The drill ends when blasts from the whistle recall the boats to the ship.

Passenger-liner crews play the game of "abandon ship" every week and they play it in grim earnest. The game has to be played exactly as if an emergency existed. Every man has to be letter-perfect in his duty. A decade ago fire



*Above, servicing whistles of big liner. Below, emergency crew equipped with stretchers, fire hose and breathing and lifesaving equipment*

*Capt Thomas G. Stearns Jr.  
10565 P.O. Angeles, Calif.*

*James Vial*



# to SEA

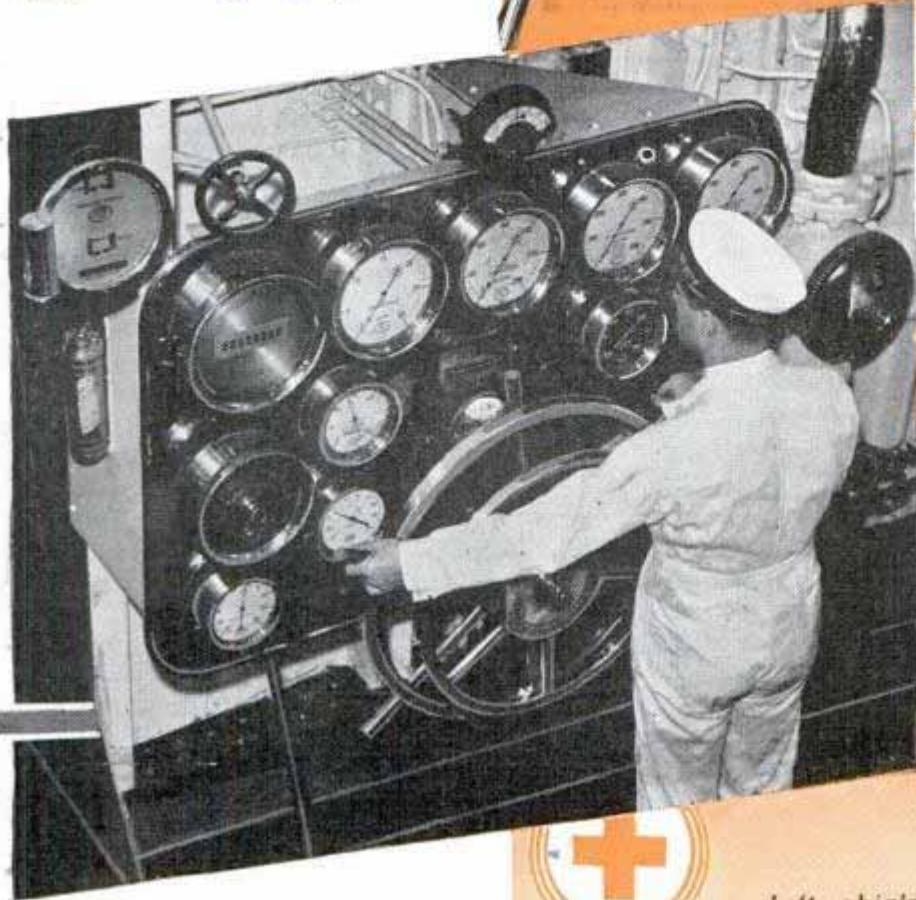

Left, ship's engine controls. Right, rescue-squad man. Bottom, inspecting motor lifeboat. Radio and engine are carried in watertight compartment

automatic alarm system on the bridge. Then general alarm bells all through the ship begin to sound. A man is sent up on the flying bridge to strike rapidly on the ship's bell. The officer on watch steps over to a smoke-detecting cabinet to see if smoke is coming up from the location of the alarm. A puff of cigarette smoke blown into a tube by the man who operated the alarm can be detected on the bridge.

Meanwhile, the ship's special emergency squad has been assembling. An officer leads the way to the scene of the alarm signal. Water lines are unrolled, hose is connected to the nearest high-pressure fire-fighting water mains, and men in



Reference: Bureau of Marine (Inspection and Maintenance) Washington





asbestos suits and breathing apparatus go through the actual work that they would if a real fire was being fought. Up on the bridge, a valve is turned to close all watertight doors and fire screens. A master switch shuts down every air-conditioning and air-circulating motor on the ship. Hand pumps and fire pumps all over the ship are tested, the men directing the big streams of water out over the rails. As part of the drill a man presumed to be disabled in the fire is fastened in a basket stretcher and carried up to the boat deck. Officers with check lists in their hands move rapidly from deck to deck, noting the operation of each piece of equipment and the ability of the men.

Thorough fire and boat drills are usually held in port but supplementary drills are held at sea. At least once each voyage passengers are assembled at their boat stations and rehearsed in fastening on life belts while the master of the ship ad-

dresses them over the loud speakers, giving instructions as to what they should do in a real emergency. Once a week, also, comes a "man overboard" drill. A boat is swung out over the side ready for lowering and the ship steams around or stops and goes astern just as if a man were to be picked up from the water.

Seeking greater safety on the sea, the Department of Commerce has tightened up its regulations in the last couple of years. Approved types of fire-fighting apparatus, more fire-resistant materials and bulkheads, and loud-speaker systems leading to the crew's quarters, public spaces and decks have been ordered installed on ocean-going passenger ships. Some vessels were held in port until the improvements were made. Exam-

inations for seamen and officers have been made more stringent. Greater care in avoiding accidents is part of the campaign. Officers and seamen are being better qual-

*Left, cadet-quartermaster at wheel and officer on bridge of S.S. "Matsonia." Right, removing plate from condenser for inspection. Bottom, boats ready for lowering in "abandon ship" drill*



ified to keep their ships out of danger. Hourly patrols are supplementing fire-alarm apparatus. Operating gear, such as the engine-room telegraph and the steering apparatus, is duplicated so that the stand-by system can be used if failure occurs.

The bridge is its brains and the center of a ship's nervous system. On the bridge the officer of the watch commands the speed and maneuvering of the vessel. Telephones connect him with the look-out in the bow and with the engine room. On another phone system he can call any station on the ship. Alongside the fire-alarm panels on the bulkhead are deck plans showing the location of all fire and emergency apparatus on board, the position of hydrants, extinguishers, Foamite outlets, escape manholes, and fire doors. He operates the general alarm system by pulling a switch, and closes all the watertight doors on the ship by pulling another. The ship's whistle and siren levers are under his hand, as are the controls of a high-intensity searchlight. He can address every person on board from the loud-speaker

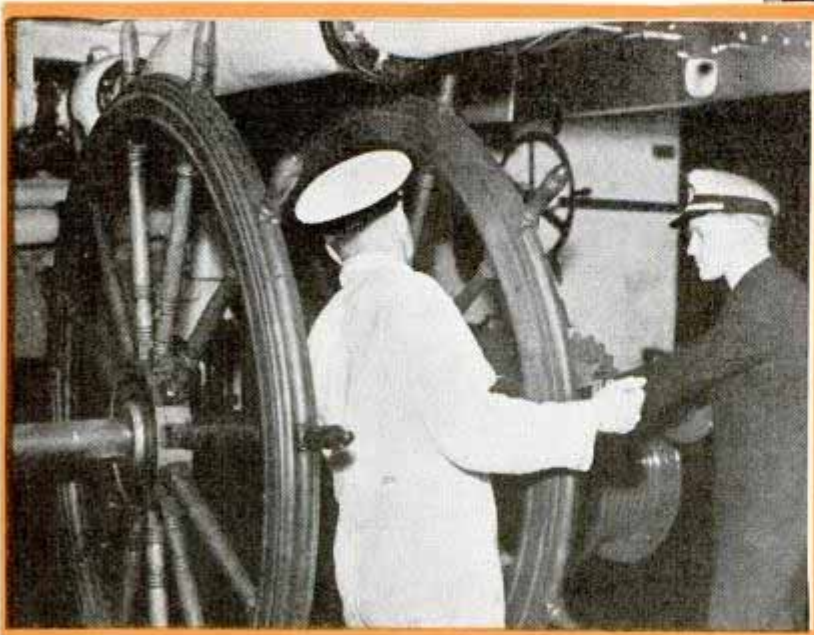

*Top, crew members at lifeboat oars. Center, operator at panel of ship-to shore radiophone system. Bottom, emergency steering gear down in stern of ship*

panel and by throwing a switch he can convert the speaker system into an emergency telephone to talk back and forth with some one at one of the speaker outlets.

Two quartermasters, a junior officer, and the officer of the watch usually occupy the bridge, with one of the quartermasters standing guard over the "metal mike" automatic steering gear that keeps the vessel on its course. If the device should break down he can steer the

(Continued to page 141A)



Bell Laboratories, New York  
463 West Newton

# Shark Nose on Bombing Plane Is Aid in Sighting



Designed to permit use of a new bombing sight, this plane's nose accidentally assumed the shape of a hungry shark

Giving it the appearance of a hungry shark, an odd-shaped nose on the latest Army Air Corps bombing plane permits use of a new and secret bomb sight. This device automatically figures out the speed of the plane and its altitude in relation to the target in order that a bomb may be dropped at the exact second necessary to score a hit. The bomber is powered by two engines.

# Roar and Whisper Equaled by Radio Voice Leveler

Whether you bellow in oratorical voice or speak in feminine whisper, the "vogad" will level your voice to normal volume over the radio telephone. A monotonous voice that accents strong and weak syllables equally may seem

tiresome to the listener, but a monotone is best for radio reception. The "vogad" is designed to level off the hills and valleys of shouts and soft words emanating from the transmitter; it reduces strong syllables quickly enough to avoid overloading the transmitter, and boosts weak syllables to prevent the listener from missing them. The name of the instrument is a coined word made up of the first letters of the words: "volume-operated gain-adjusting device."

# Fish-Like Motorcycle Hood Helps Set Speed Record

Over the same Utah salt flats where Eyston and Cobb recently drove their monster automobiles at nearly six miles a minute, a hooded motorcycle has set a new American record of 137.40 miles an hour. Like a roaring dolphin the two-wheeler flashed over the measured mile, its rider completely encased in the streamline shell, the rear section of which slides backward to admit the rider. The covering is of balsa wood laid over a framework of airplane tubing, with fabric glued over all. Vents in the nose admit air to cool the engine, the air escaping through louvers in the sides of the tail. The driver peers through a synthetic glass window slotted into the foretop of the shell. There are two recessed landing wheels that

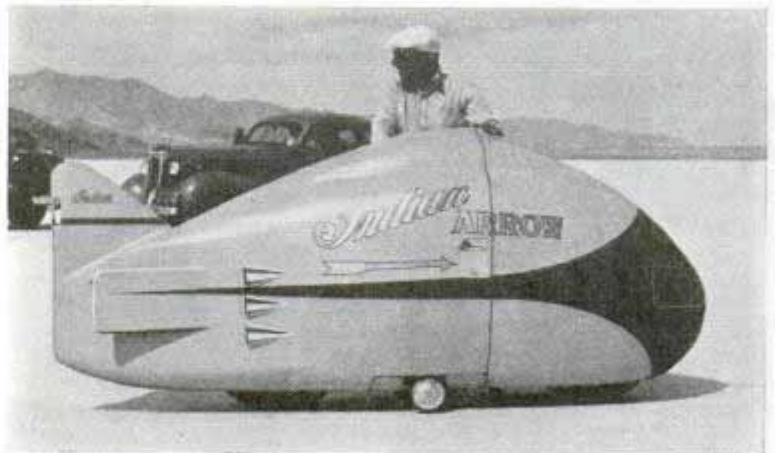

Rear section of "dolphin" shell slides back to admit driver, who sights through window in front. Notice "landing" wheel

Fred Ludlow, Pasadena police officer

Reference: Public Relations Office, March Field, Riverside County Calif.

7-13

Science Service

Bulder - 2 Haps Algeria  
Oakland, Calif



*Harrison*  
*Cincinnati*  
*1316*  
*Rubber & Akron, Ohio.*

## Plane Tubes Like Doughnuts in Water Test for Leakage

are dropped when the motorcycle approaches a stop. Built by "Hap" Alzina at Oakland, Calif., from a stock model, the "dolphin" has mammoth flywheels, crankpins, connecting rods and wristpins turned out of light alloy metals.



*Like so many giant doughnuts, tubes for airplane tires are tested for leakage in water vat, thus assuring passengers of more safety*

Looking like a huge cooking utensil holding giant doughnuts, a testing device subjects airplane tire tubes to submersion in a search for leaks. The inflated tubes are submerged in a tank. If the tube is leaking, a stream of air bubbles betrays the flaw and the tube is discarded. While few tubes are found defective, the test is conducted as a matter of safety to the air traveler, since a flat tire might result in the overturning of the plane.

*The Imperial Brass Mfg Co, 1200 W.*  
*1368*  
*6-00*

## Asbestos Lid Clapped on Fire Smothers Incendiary Bomb



*Acme*  
*no information*  
Asbestos-clad fireman drops dome to smother flames started by incendiary bomb. The demonstration was a part of air defense drill in England

*London*  
One of the special fire-protection devices introduced in England by air-raid defense authorities is an asbestos cap to be clapped over any small fire started by an incendiary bomb. The dome-like lid is carried on the end of a pole. For his own protection the fire fighter wears a special helmet, gloves and apron.

There are 22,500,000 electrically wired homes in the United States.

*Natl Safety News*  
*Nov. 1938. et.*







the nuclei of target atoms and if they happen to lodge therein, they create overweight bodies that begin radiating beta and gamma rays. Hence the atom is temporarily radio-active. So strong is the attraction of the super-magnet that a nail held in the field can be bent but not moved by the hand. Liquid oxygen, having magnetic properties, swirls toward the magnet instead of falling straight to the floor when poured into the air. The magnet even attempts to unwind coiled filaments of heating elements placed between its poles. Striking the machine's oscillator with a copper bar sets off an arc that will burn like a flame, more than a foot high, for as long as desired. Watches are stopped and sometimes damaged if exposed to the powerful magnetic forces of the cyclotron.

## Multiple-Arch Dam to Hold Vast Irrigation Lake in Check



Nearing completion, Bartlett dam will be the highest multiple-arch dam in the world, storing 200,000 acre-feet of water for irrigation

Thrusting high its battery of arches across the Verde river in Arizona, the Bartlett dam will create a vast lake to serve the irrigation needs of the Salt river reclamation project. This will be the tallest multiple-arch dam in the world. It will hold back a reservoir of 200,000 acre-feet capacity.

## Card Index Rotating on Wheel Permits Quick Reference

Rotating file wheels that accommodate cards are the latest accessory for efficient office bookkeeping. A spin of the wheel, which revolves in a vertical plane, brings the desired card to the top quickly, within easy reach and visibility. There are removable segments for transfer of records and division of work, and individual cards can be removed or replaced with one hand. Another file wheel rotates in a horizontal plane on a tabletop.



As many as 7,000 reference cards can be kept on this rotating-wheel file. A quick spin brings the desired card to the top

Lighting experts predict the average American home which used 425 kilowatts in 1926 will use 1,300 kilowatts in 1947.

with safety  
newer  
Chicago  
Mr. S. L. Gillingham  
Westinghouse







# Pilot Lifts Altitude Record above Ten Miles

Beating his own world's altitude record by nearly a mile, Col. Mario Pezzi of Italy recently established a new high mark for heavier-than-air craft of nearly eleven miles above sea level. Wearing protective garb that resembled a diver's suit more than an airman's uniform, the famous flier took his single-engined Caproni up to a ceiling of 56,017, according to his instruments. His former record, set in May, 1937, was 51,361 feet. On his latest ascent he rode in an air-conditioned, hermetically sealed cabin.



Col. Mario Pezzi of Italy is buckled into high-altitude suit for a venture into stratosphere. He reached 56,017 feet

14 1295

# Speedy Anti-Aircraft Tank Fires Cannon at 114-Mile Clip

Armed "to the teeth" with anti-aircraft guns, a tank that can chase airplanes at a 114-mile-an-hour pace on paved highways is being demonstrated to army engineers.

On rough terrain this armored dreadnaught can travel seventy-eight miles an hour. Its turret carries a thirty-seven millimeter anti-aircraft automatic cannon capable of firing 120 shots per minute, and in addition it carries three machine guns firing through slots in the front and sides. A driver, cannoner and machine gunner comprise the crew, who are protected by three-inch bullet-resistant glass. The tank weighs 10,000 pounds, a ton lighter than medium tanks now in army use.



Camouflaged tank capable of nearly two miles a minute on highway. Notice anti-aircraft guns in windshield and roof

Preston Tucker, Ned

Although traffic accidents have increased in numbers, the death rate based on mileage has decreased seventeen per cent since 1925.

General Motors Corp  
Publicity Bureau



at  
national  
forest  
in 1927

# BRAINS Against FLAMES

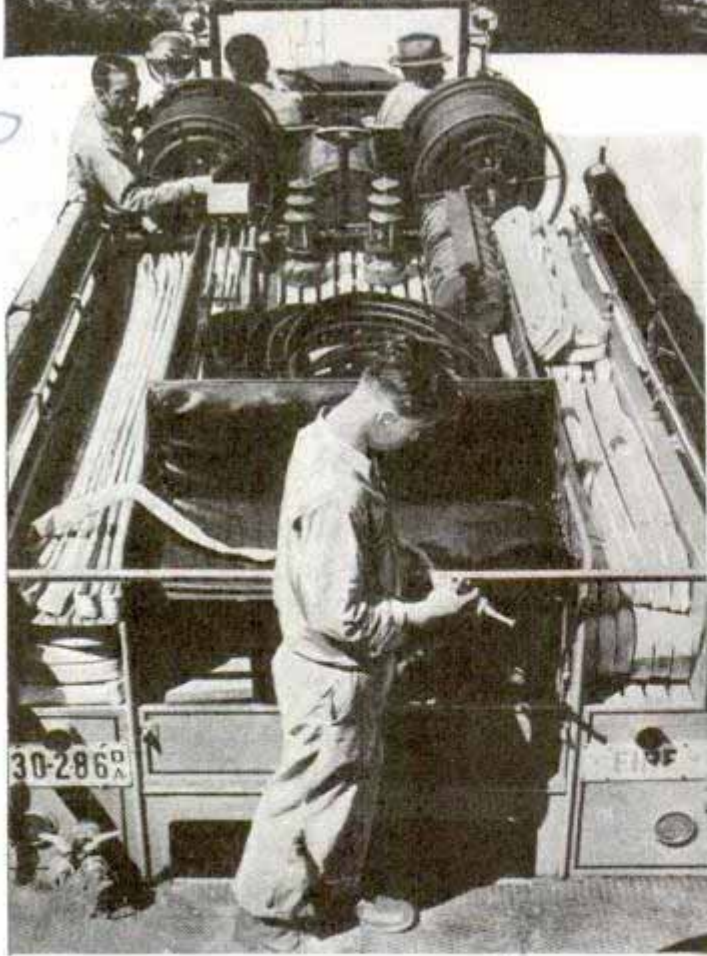

**C**HOKING smoke hung over field headquarters although the advancing flames of the forest fire were still ten miles away. An operator hurried from the mobile radio central to the conference table where the fire boss was holding a board-of-strategy meeting.

"Johnson says he's got to have three or four hundred more men right away," the operator reported. "The fire is running away toward the settlement and he can't hold it. It'll reach the first houses in a couple of hours!"

The commander-in-chief of the fire fighters picked up the latest weather map that the meteorologist had drawn and issued his order: "Tell Johnson he won't need another man. The wind is going to shift inside of an hour and he can start spreading his men out now for cleaning up. The settlement is safe."

He turned again to the blackboard. "This shift in wind, gentlemen," he resumed, "means that we can hold the ridge east of Oak Creek if we get up there by six o'clock. We'll have a bulldozer widen the firebreak. A cou-

Top, fire fighters pushing into heart of flames behind powerful stream of water. Bottom, modern forest-service fire truck that carries 250 gallons of water, hose and other flame-fighting equipment

1x  
-080  
Coul. Thomas E. Stinson Jr. 10565 Holman  
Ave. Los Angeles, Calif

the  
wells



47000  
California  
Fire Dispatchers, U.S. Forest  
Service, Post Office Building  
Pasadena, Calif.

*in the*

# FOREST

ple of tank wagons can stand by. We can pull half the men away from the head of the fire safely and concentrate on stopping it at the ridge.

Five minutes later the new orders were being dispatched to 3,000 men on the fire lines. Zone leaders were contacted by short-wave radio. Scouts carried other orders to isolated groups. The last tanker truck lumbered up the forest-service road to the new battlefield. An airplane roared away with the fire boss as passenger for a survey by which he might judge if the new strategy would halt the fire.

Fighting a forest fire the modern way is like a problem in military tactics. Thousands of men



*Left, fire fighters equipped with portable water tanks, slashing knives and electric headlights. Right, starting backfire to burn an area over which the main fire cannot pass*





have to be thrown into a forest within a few hours. A housing and feeding organization that didn't exist in the morning must be working smoothly by afternoon. Communication systems covering hundreds of square miles must get into operation at once.

Like the army with its zero hour, the forest service is organized ahead of time for efficiency. Speed is the essence of success in fighting a forest fire. It may take 100 men or more at headquarters and the camps to plan the campaign, move men to new positions, and keep them supplied with tools and food.

At headquarters the fire boss leaves most of the detail work to his chief of staff. The fire boss is the district ranger, the general behind the lines who pores over maps, considers slopes, types of cover and wind directions as he lays out the campaign. The chief of staff contacts crews and issues orders for him. Other staff members are a liaison officer for coordinating state, county, and fire-fighting crews from logging camps, a chief supply officer who checks everything from bread and blankets to

gasoline, a chief of transportation in charge of trucks and bulldozers, and a communications chief in command of the telephone, teletype, and radio circuits.

Attached to headquarters, along with the mobile central radio station, is a weather bureau on a special truck. A separate radio receiver allows the meteorologist to pick up the latest weather reports from the areas he wants. Combined with the observations he makes with his own instruments, these reports enable him to make new forecasts every half hour.

What the weather is going to do may affect the whole plan of battle. Knowing ahead of time that the wind is going to shift, the fire boss can get the jump on the flames by attacking them from a new position. Sometimes he may start a backfire or get "hot spot" crews ready to slash down the brush and fight the fire with portable back tanks.

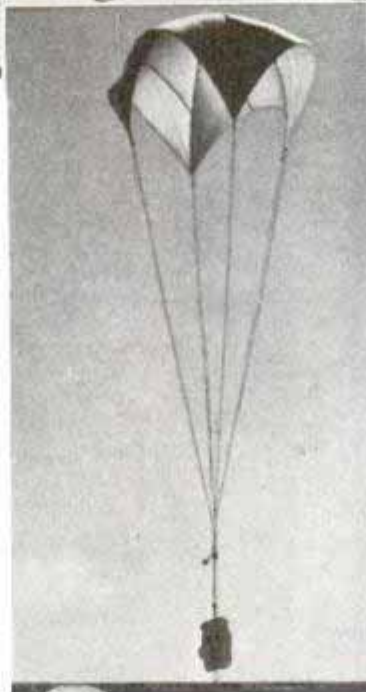

Top, mobile radio station. Center, food dropped from plane by parachute. Bottom, scene at field headquarters during a forest fire



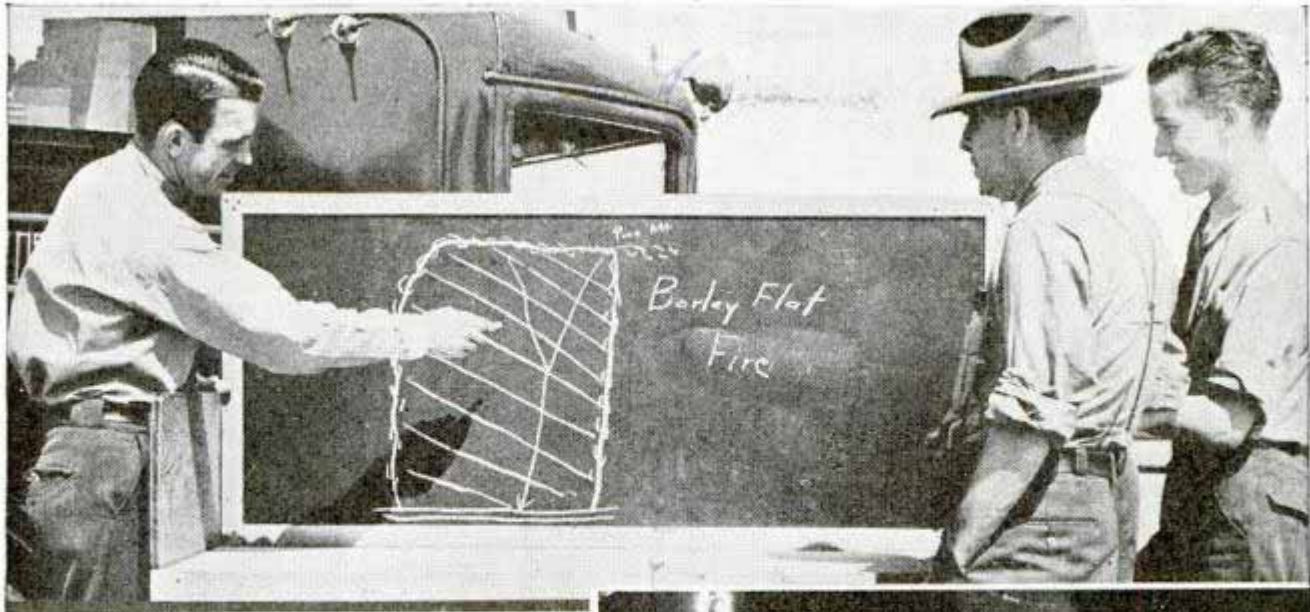

*Fire boss outlining progress of campaign against flames to staff members.*

Crown fires that race through the tree tops ahead of the main body of fire that eats its way from trunk to trunk are the hardest to fight. In coniferous forests the fire boss tries to cut the head off the fire, stopping its forward run, while in other cases he may decide that a flanking attack is best.

The first objective of the campaign is to try to corral the fire by ten o'clock in the morning following the day of discovery. It takes time to get men in to the fire lines and some of the most effective work can be done



Photos by U. S. Forest Service

*Center, night view of flames roaring through forest. Bottom, extinguishing small fire with a pack pump*

after dark. Normally there are up-canyon winds during the day that carry the fire toward the ridges but after dark the winds usually reverse, slowing down the flame front. Ten o'clock in the morning is the deadline because if the fire hasn't been beaten by then it is apt to burn all day, helped by heat of the sun and the lowered humidity. Sometimes the "boil up" at about that hour is like an explosion and flames suddenly race ahead as the right conditions of temperature and dryness occur.

(Continued to page 116A)

*Lassen National*



# 'Safelight' PhotoPrint Paper Developed in Lighted Room



"Safelight paper" containing orange dye is placed with negative in flexible frame and exposed to light

Development of photographic prints in a room lighted by a 100-watt lamp is made possible by the use of a sensitized paper with "built-in" safelight. This safelight consists of an orange dye. Negative and paper are placed in a special flexible frame that can be bent to conform with the shape of the bulb, assuring uniform illumination of all parts of the negative. After a short exposure, the print is placed in the developer, stop bath and hypo, where the orange dye is dissolved completely, leaving the finished print clear.

## Feathers Removed from Poultry with Aid of Wax Bath

Turkeys, chickens and other poultry are now prepared for your dinner table on a "production line" that includes a bath in hot wax to remove the feathers. It takes fifty-three minutes to go through this line but as many as 300 cleaned turkeys can be dressed for the oven at once. As the birds start on the conveyor, larger feathers are

removed by hand. Next they enter a drying tunnel, and then are dipped into vats of wax. A cold-water spray hardens the wax, and when it is stripped off the feathers come off too. The wax is reclaimed by reheating and separating feathers from wax by centrifugal force in a rotator.

## Trigger Tripod for Camera "Shoots" over Crowd

Snapshotting with one hand is as easy as firing a revolver when the camera is mounted on a pistol-grip tripod with trigger release. It is built to fit any camera having standard tripod threads and cable release for its shutter. The grip makes it especially easy to hold the camera at arm's length above the head, aim and "fire" at a subject over a crowd.



## Tractor Built from Junk Parts Does Farm and Road Work

Constructed from junk automobiles, truck and tractor parts, a homemade tractor built by a North Dakota farmer pulls



Farmer driving the three-wheeled tractor built from discarded automotive vehicles

two plows at four miles per hour. The task required 200 hours of spare time. The tractor also is used on roads.

*The Stanley Co. Des Moines, Iowa  
Reproduction Equipment Division  
Des Moines, Iowa  
Sawm Service  
Northwest Poultry and Dairy Products Co.*

*H1301  
H1303  
H1311  
H1336  
Photo Stitches, 1000 2nd Street, N.W., Wash. D.C.*



# Dog Keeps Seaplane Base Clear of Driftwood

Because of the activities of a dog, seaplane pilots landing at a New York river base breathe easier. This dog, a three and one-half year old German boxer, keeps the river around the base clear of driftwood which might damage the pontoons of incoming planes. Each morning the dog takes up his watch on the seaplane ramp. Upon sighting a piece of driftwood, he plunges in and drags it ashore. Sometimes the driftwood is so large that the dog must have help in dragging it out.

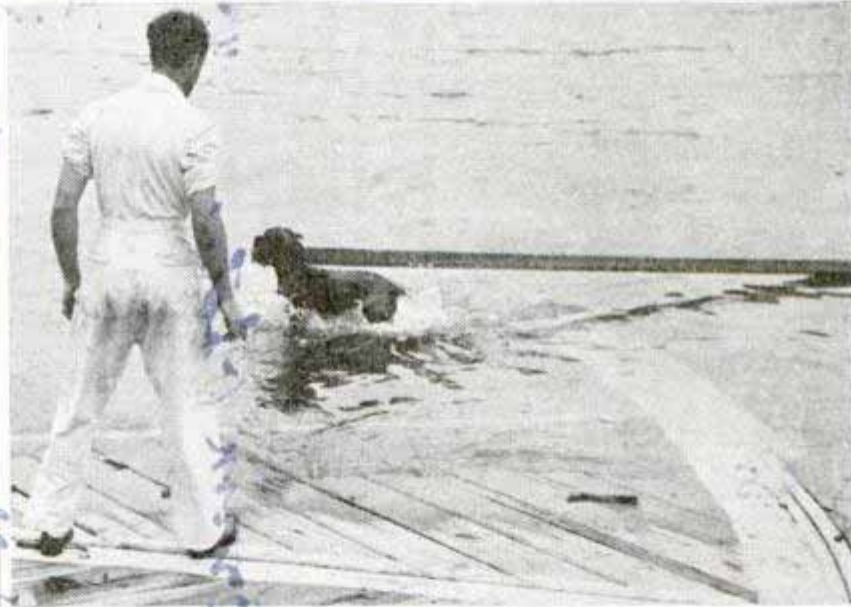

## Sailors Use 'Dry Ice' to Lighten Job of Swabbing Deck

Swabbing the decks is still the drudgery it has always been, but now it seems that Dry Ice may make the life of a sailor a bit easier. Technical advances have lightened other jobs, but nothing until now has replaced "elbow grease" in scrubbing away the tar that oozes from the seams on a ship's deck, especially in tropical waters. Lieut. L. F. Blodgett, commanding the U.S.S. "Whippoorwill" at Pearl Harbor, Hawaii, tried freezing the ooze by applying Dry Ice to the decks. After this treatment the tar was chipped off easily.

Eleven cable-operated streetcar lines remain in this country—seven in San Francisco, three in Seattle, one in Tacoma.

Top, dog leaps into river. Center, dragging heavy timber from the water. Bottom, enlisting help to complete the job

*Wall Street - Downtown Skyport*

*Legion owned by Carl Evans, local pilot who owns seaplane charter service.*

*1938*  
*Trained in...*

*Right says this has no...*  
*Photo by Arnold Photos*  
*1938*



# Heat-Resisting Glass Kettle for Table or Icebox



Transparent teakettle can be used for table service, for storing water in refrigerator or for boiling

Equally useful for table service and for storing water in the refrigerator, a glass teakettle has a locking lid for convenience when pouring. Water heats quickly in this transparent kettle of heat-resistant glass, and the amount of water in it can be seen at a glance as it boils.

# Pouring Cap for Bottle or Can Measures Out One Ounce

One-ounce doses of top-lubricating oil for your automobile engine or one-ounce portions of fruit juices and beverages can be dealt out handily with a dispensing cap which fits on bottle or can. Pressed or



Pressing the plunger of dispensing cap measures out exactly one ounce of fluid from bottle

screwed on the container, it acts as a seal and can be left on until the can is empty. To measure out an ounce, you simply tip the bottle or can, hesitate a second to let the cap fill, then press the plunger to pour.

# Radio in Cab of Freight Engine Directs Switching in Yard

Switching operations in a Swedish railway freight yard are directed by radio signals. The yard foreman operates a transmitter sending signals and telephonic orders on wave lengths between 1,000 and 2,000 meters, using varying tone frequencies for each separate switching signal. In the engine cab is a receiver with loud-speaker. The trolley wire for the electric locomotives serves as an antenna.

# "Mike" in Officer's Megaphone Raises Voice above Traffic

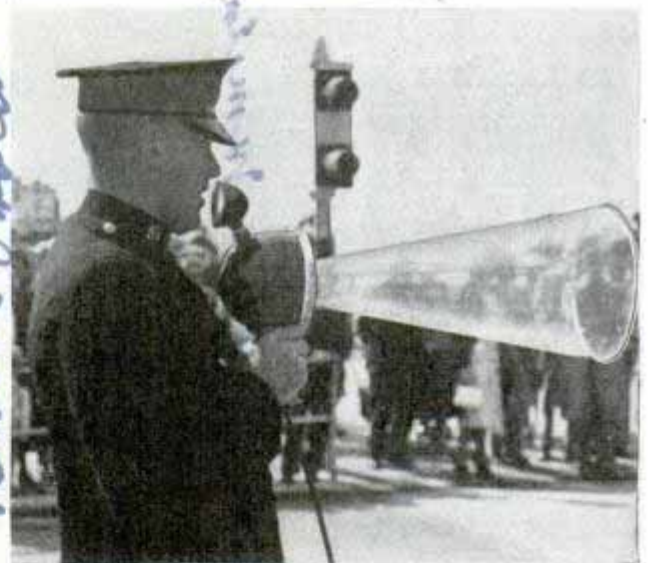

Traffic officer at Brighton, England, gets attention by talking into megaphone with "built-in" mike

When a policeman is trying to control traffic by voice, no ordinary megaphone will do. In Brighton, England, the police use a double-acting megaphone—it encloses a microphone. The constable speaks in normal voice, yet the sound is amplified many times and it seems that he is shouting. The amplifying apparatus is in a small case usually carried over the shoulder.

There are 11,163,000 horses and mules on farms in the United States today, only half as many as in 1915.

Corning Glass Works  
Corning, N.Y.  
Giffy Jigger Products Co.  
Pat. # 2,106,649

Department of Commerce  
Brom Photo

Route 10, Box 264-13, Ap. Ex. Daily News  
Melville, N.Y.  
10/31/38



# "Intelligent Whale" Grows into Modern Sub

Streamlines were not unknown in the nineteenth century. In fact the lines of the "Intelligent Whale," that daring submersible of 1897 which failed to gain an enlistment in active service, are cleaner than those of the modern "R-10" of the U. S. Navy with its bulky conning tower projecting from the hull amidships. But submarines have traveled far in forty years. The hand-driven "whale" of '97, which could carry a ten-man crew was never adopted for service by the navy and remains a curiosity on dry land for visitors at the Brooklyn Navy Yard to inspect. The Diesel-electric submarines of today are a powerful fighting arm of the sea forces.

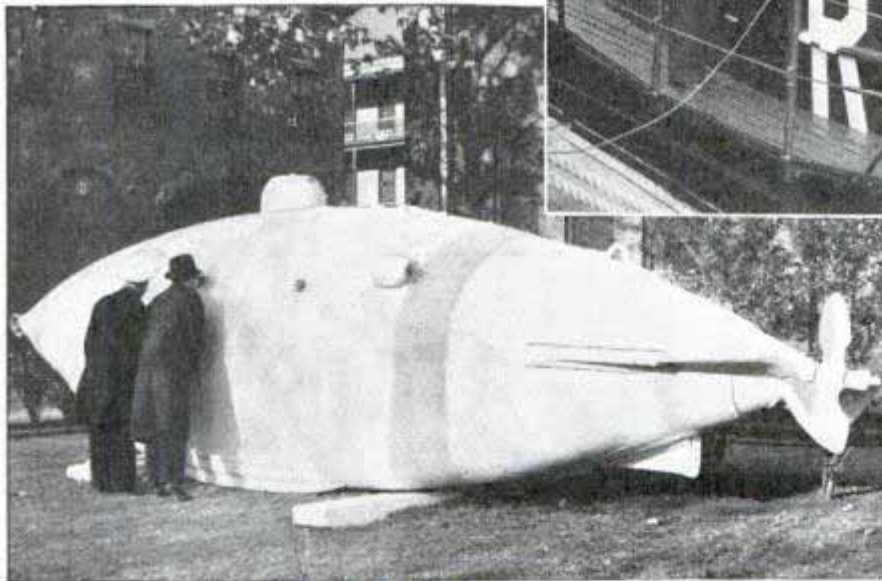

*Above, the conning tower of the "R-10," modern U. S. navy submarine. Left, the "Intelligent Whale," ten-man submarine of 1897 which the navy never adopted for service*

## Wrist Watch Does "About Face" to Protect Its Crystal

To protect its face from injury, a wrist watch just placed on the market is reversible. A slight pressure on one side and a flip of the finger turns the watch "about face" and locks it, dial and crystal toward your wrist and the monogrammed or decorated back facing outward.

Names and addresses of manufacturers and dealers in articles described in this magazine will be furnished by our Bureau of Information upon request accompanied by stamped, self-addressed envelope.

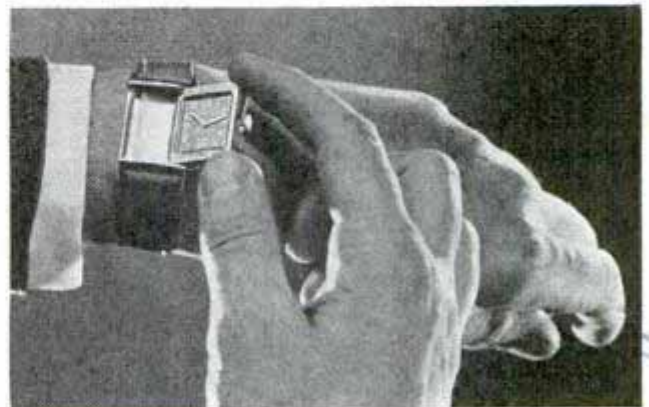

*Flipping the reversible wrist watch "about face" turns dial and crystal toward wrist for protection*

*Hamilton Watch Co  
800 Columbus Ave  
Cincinnati, Ohio*



2047 N Park St  
Phila

# Mystery Box Runs Household by Controlling Appliances

system. This is made to operate standard relays controlling such household devices as the coffee percolator, egg cooker, oven, ventilating system, or, if you please, a motor rocking the baby's cradle.

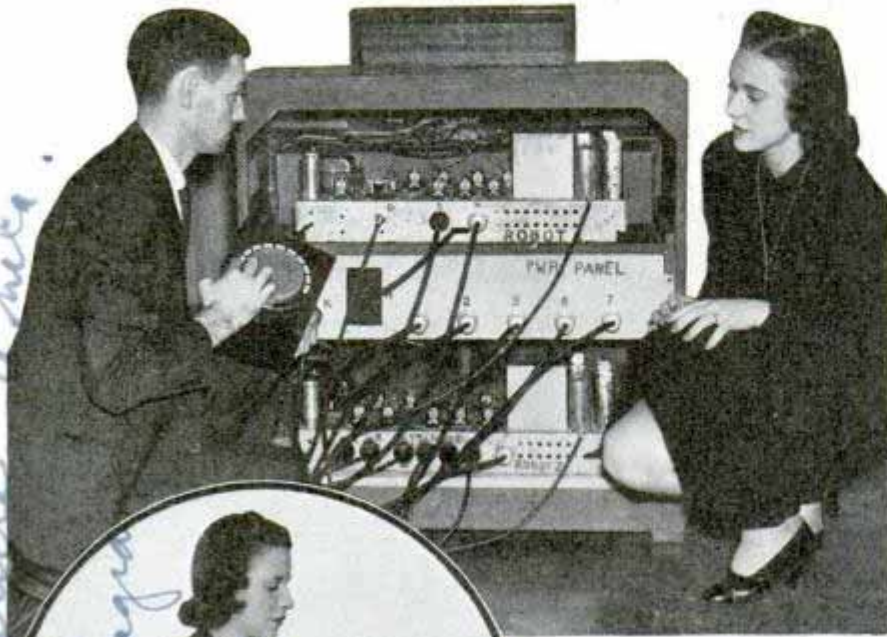

## Slices of Bread Ride Through Toaster

Riding through on a small conveyor, bread is toasted as it travels in a new automatic electric toaster. Each slice is carried past the heating elements on the conveyor at just the right speed for browning. The toaster's speed equals that of a two-slice toaster of the conventional type, since it is continuous and three slices can be browning at the same time, one finishing its trip, the second in the middle of the toaster and the third just starting through. The slices are dropped from the toaster when finished, eliminating watching. Current consumption is 700 watts. A special set-screw permits setting the toaster for the exact voltage of the house current. The base is air-cooled so the appliance may be handled while in operation.

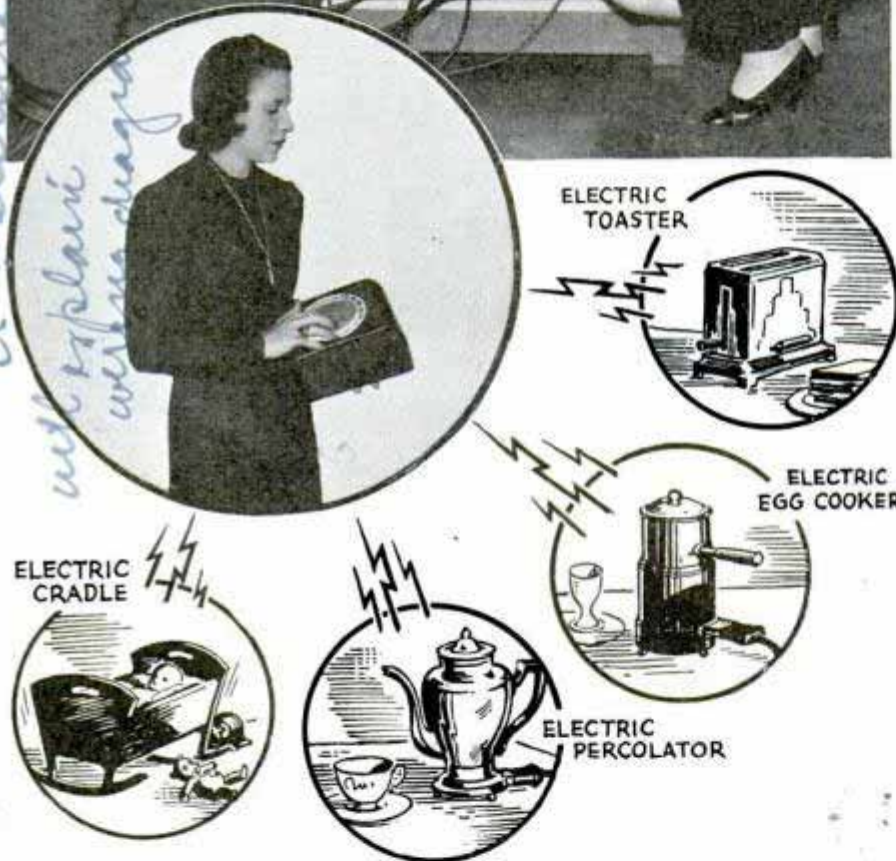

Top, keying "mystery box" to control electrical appliances. Circle, controlling appliances with the box is like using a dial telephone

Running a household by radio is no longer an idle dream. With the aid of a small transmitter, a little box with a dial, many home appliances can be operated from a distance. All things electrical in the household can be put under remote control by the magic of this "mystery" control box which is already used for tuning in and varying volume of radio programs. The box itself is a small portable transmitter which, taken to any part of the house, induces a current in the receiving end of the control

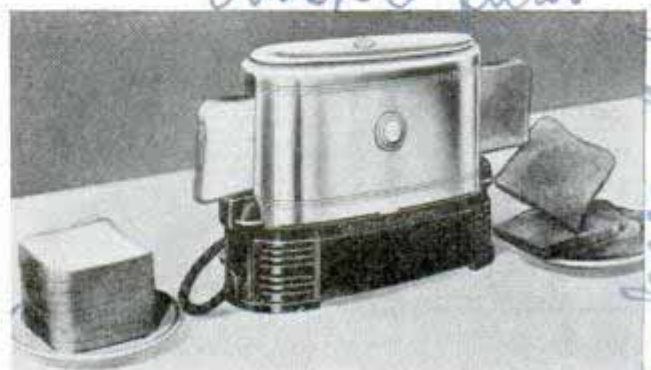

"Production line" method of making toast

Crocker Wheeler  
Electric

W. Parmler West, The Franklin Institute, Philadelphia

#1302

Toast-O-Lator

Ampere, N.Y.



41250. Mr. Morrill M. Hamilton.  
1539 S. Beverly Glen Blvd  
West Los Angeles, Calif.

# Setting BUGS to CATCH BUGS

ON THE asphalt apron of a Los Angeles airport, a silvery transport warms up for cross-country flight. The pilot awaits his signal from the dispatching tower.

"Hold up a minute," he is warned, "here comes a special rush order of "soldiers" for New Jersey. . ."

A field attendant sprints to the plane, and gives the co-pilot a cardboard package. Then the plane slips into the air and heads east.

Thus, thousands of tiny soldiers are flown each week from their California barracks to a far-flung battle-

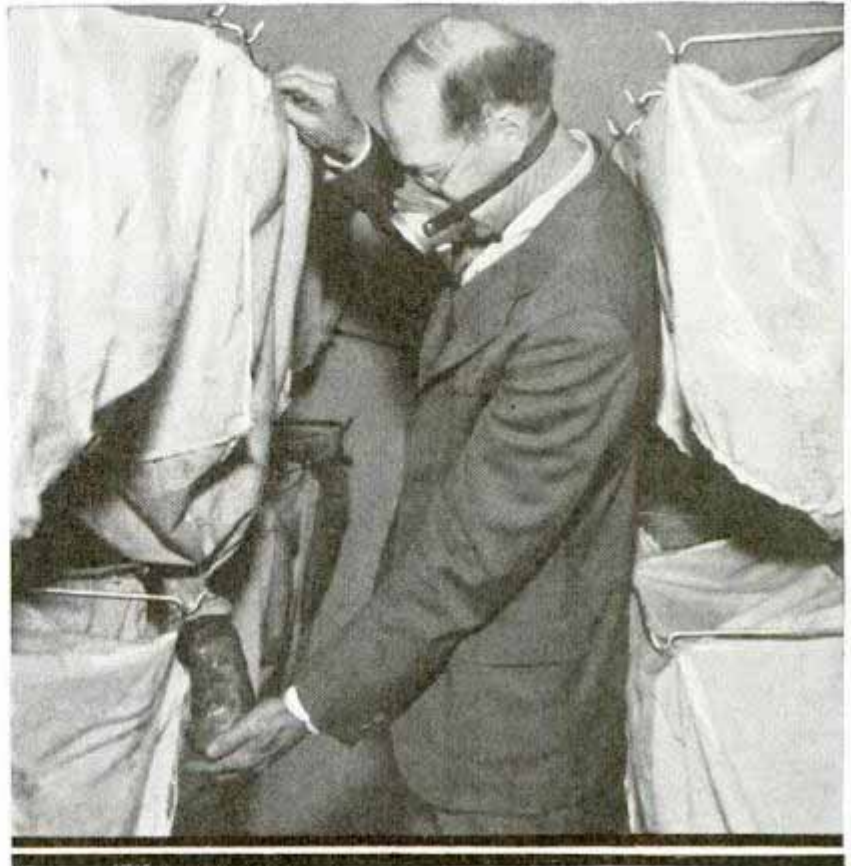

Top, Dr. Morrill wears gas mask in showing how eggs of grain moth are collected from cloth sacks. Bottom, examining egg card to determine whether *Trichogramma* is at work

field that extends from the peach orchards of Connecticut to the sugar-cane brakes of Puerto Rico. They are hurried eastward to help the American farmer in his never-ending war on insect pests that destroy a \$1,000,000,000 crop every year!

The Lilliputian soldiers are insects too—tiny wasps and beetles that massacre their destructive cousins of the field and forest. Entomologists call them parasites and predators. "Setting a bug to catch a bug" is a well-established practice known as biological control.

The Los Angeles laboratory of Dr. A. W. Morrill breeds parasites and predators on a commercial scale. Annually he ships between 40,000,000 and 50,000,000 eggs and insects to all parts of the United States by air express.

Islandale, Calif.  
251





*Top, packing parasitized eggs. Center, eggs are carded by being sprinkled over paper covered with squares of paste. Bottom, potato room where ladybird beetles are raised*

His customers are farmers, orchardists, nurserymen, agricultural experiment stations, and universities.

Insects comprise one of the largest living groups of creatures in the world. Of the 500,000 known species, however, only about 300 are actually injurious to man. The parasitic and predatory insects are important in checking the birth rate of their destructive relatives. They maintain a balance, without which the world would soon be overrun by legions of insects. Parasites usually deposit their eggs in their enemy's body, while predators kill outright by stinging.

One of the best known insect parasites is the *Trichogramma*—sometimes called the

"winged atom." This little fellow measures only one-fiftieth of an inch in length and can hardly be seen with the naked eye. Under the microscope it appears to be a tiny wasp. The *Trichogramma* is especially effective in destroying the eggs of the sugar-cane moth borer, the alfalfa butterfly, the greenhouse leaf tier, the tomato hawk moth, the corn-ear worm, the Oriental fruit moth, and many other pests. The *Trichogramma* female deposits her eggs in the eggs of the host insect, and when the wasp larvae hatch, they literally eat up the host insect's egg.

A close relative of the *Trichogramma* is a little wasp which carries the scientific name of *Microbracon hebetor*. This tiny parasite destroys the eggs and larvae of the Indian-meal moth which is a pest of stored food

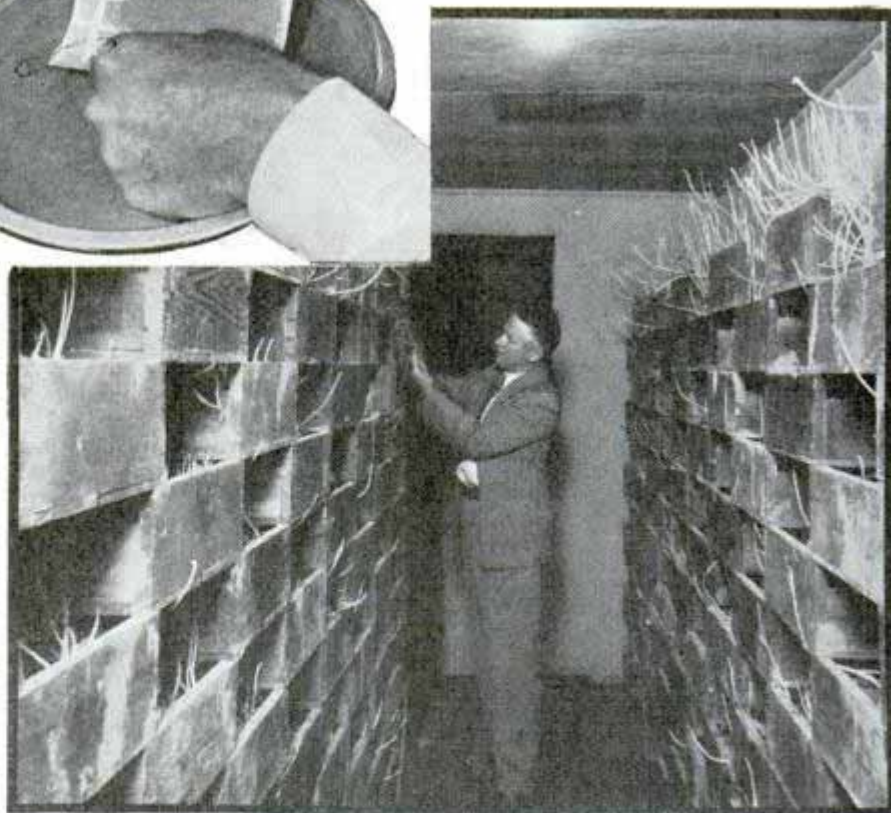

products—peanuts, raisins, beans, and cereals. If 100 of these little wasps are liberated in a warehouse, they will eliminate the Indian-meal moths in a very short time.



Another doughty little insect fighter is the ladybird beetle—of which there are dozens of varieties. The *Cryptolaemus* is well known and is often called "America's No. 1 Beneficial Insect." It is black and red and about one-eighth of an inch long. Southern California fruit growers sing the praises of this helpful little beetle. About thirty years ago the citrus industry was facing complete destruction by the mealy bug. *Cryptolaemus*

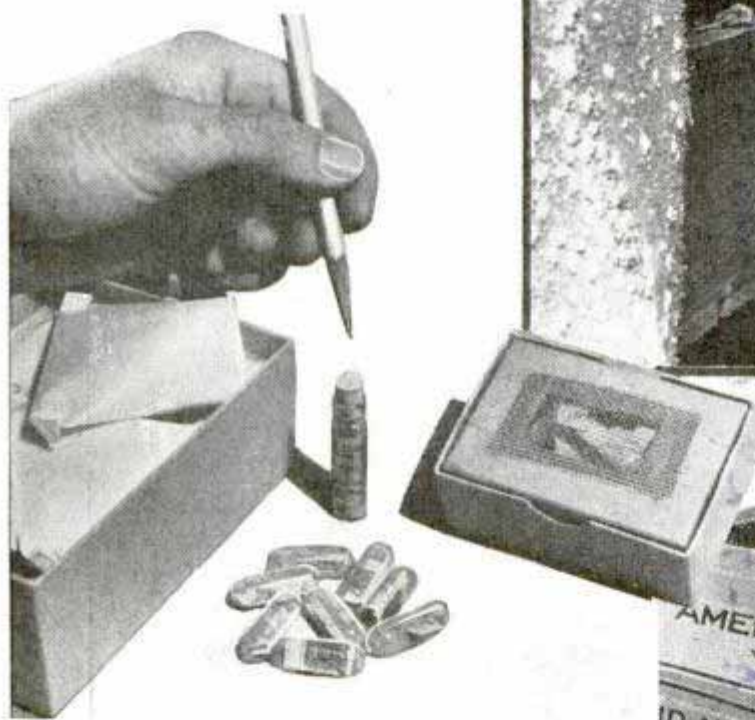
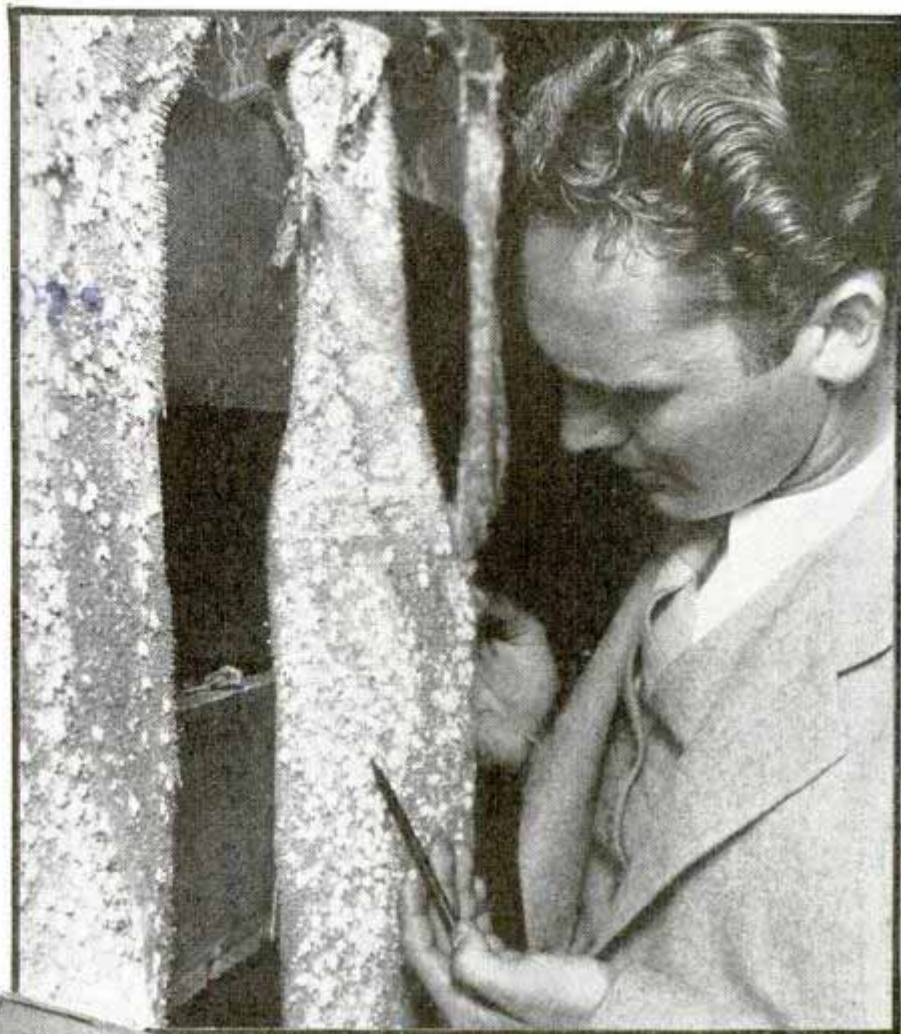

Top, mealy bugs on burlap. Left, four means of shipping. Bottom, placing shipments of parasitic insects and eggs aboard air liner.

was introduced from Australia and the mealy bug threat disappeared in short order. Orange and lemon associations in southern California still raise this beetle for distribution to members.

Dr. Morrill ships ladybird beetles by air to many parts of the United States where they are set against mealy bugs, thrips, aphids, and red spiders. He once saved a New York florist's stock of hothouse poinsettias by sending him *Cryptolaemus*. And once he received an order for 15,000,000 beetles!

(Continued to page 134A)





# Ten-Foot Cardboard Ship Cut Out with Scissors

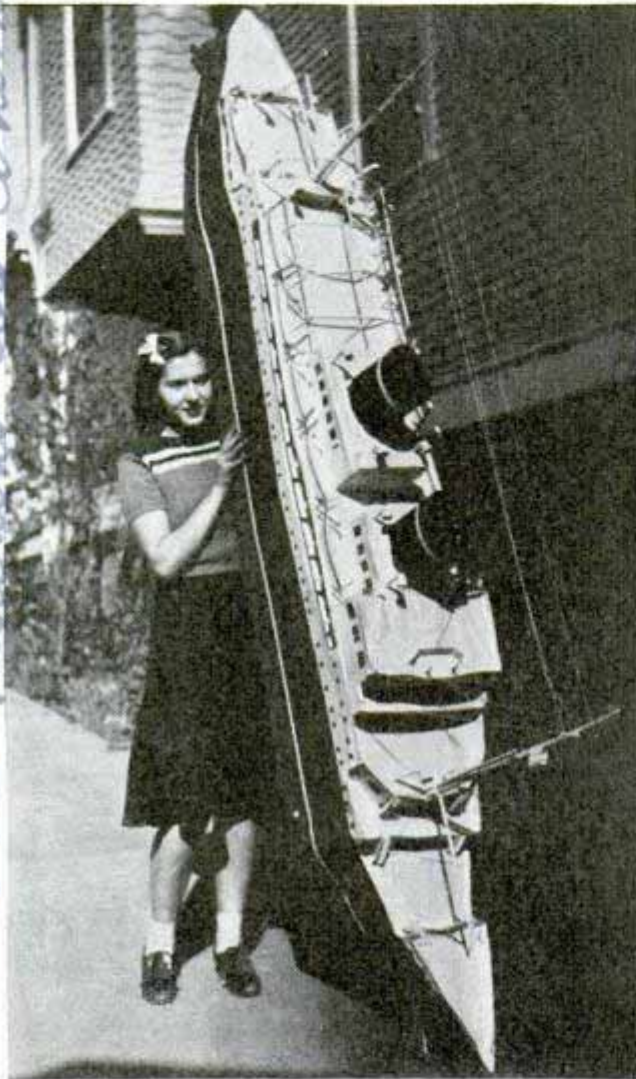

*It's made of cardboard! More than ten feet from stem to stern, the model was cut out with scissors*

With a pair of scissors for tools, a Cincinnati man has built a model ship more than ten feet long. It is a two-funnel steamer made of cardboard and paper, fashioned in great detail with masts, rigging and antennas. The same modelmaker has also cut out two ship models so tiny he carries them in a matchbox.

## "Danger Meter" Plots the Risk of Forest-Fire Outbreak

Forest patrols can calculate the immediate danger of fire with an instrument they call the "fire danger meter." There are six factors used in figuring the hazard: season of year, fuel moisture, relative humidity, wind velocity, visibility, and activity of fire-starting agencies. These factors can

be estimated or measured by instruments, and the resulting figures are applied to the "danger meter" which automatically gives the fire risk a numerical rating on a scale of seven. A danger rating of one is regarded as negligible; four would call for average season precautions, and seven requires measures to meet extreme danger.

## One-Ounce Motor Drives Plane Weighing Only Two Ounces

Among the smallest power plants in the world are the miniature engines built by a Los Angeles hobbyist. One of his tiny motors, two and one-fourth inches high and weighing only an ounce, turns the propeller of a model airplane weighing two ounces. The plane has a two-foot wing spread. At 10,000 revolutions per minute this midget motor develops about one-twenty-fifth horsepower. The same engine builder developed a two-cylinder opposed motor that is only six inches long, weighs six ounces and is rated at one-fifth horsepower. It has a speed of 9,500 revolutions per minute.

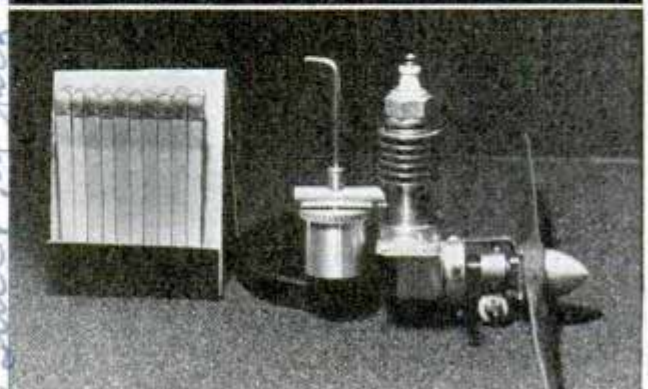
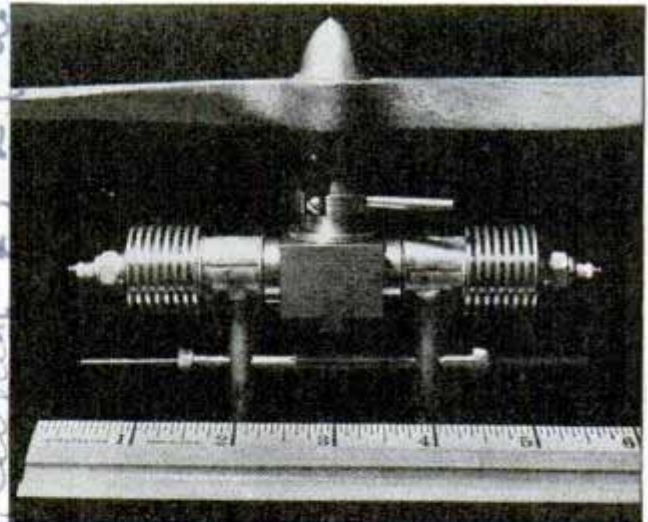

*Above, six-inch opposed-cylinder motor; below, one-ounce engine for a two-ounce model airplane*

*Built by Morris Holtzgraves Cincinnati 10/27/38 U.S. Forest Service Washington D.C.*

*1295*

*1258*

*Built by Jack Palmer 2-29-46 Washington D.C.*



# Grand Coulee to Develop Watts by the Billion

Construction of the first three gigantic generators for Grand Coulee dam—three units capable by themselves of lighting Chicago and New York or supplying all the electrical needs of a city of 650,000—has begun at the East Pittsburgh plant of Westinghouse Electric & Manufacturing company. These three will have an output of 324,000,000 watts, yet they are but the first of nine main and three local generators in the west power station. The east station will have nine more main generators. Rated at 108,000 kilovolt-amperes each, thirty per cent more powerful than the largest existing generators, this initial trio will require 4,500,000 pounds of steel, nearly 300 miles of copper wire and a million man-hours of work. One hundred and forty-one tons of water per second will pass through the eighteen-foot penstock leading to the water wheels which will spin million-pound steel rotors of the generators 120 times per minute. More

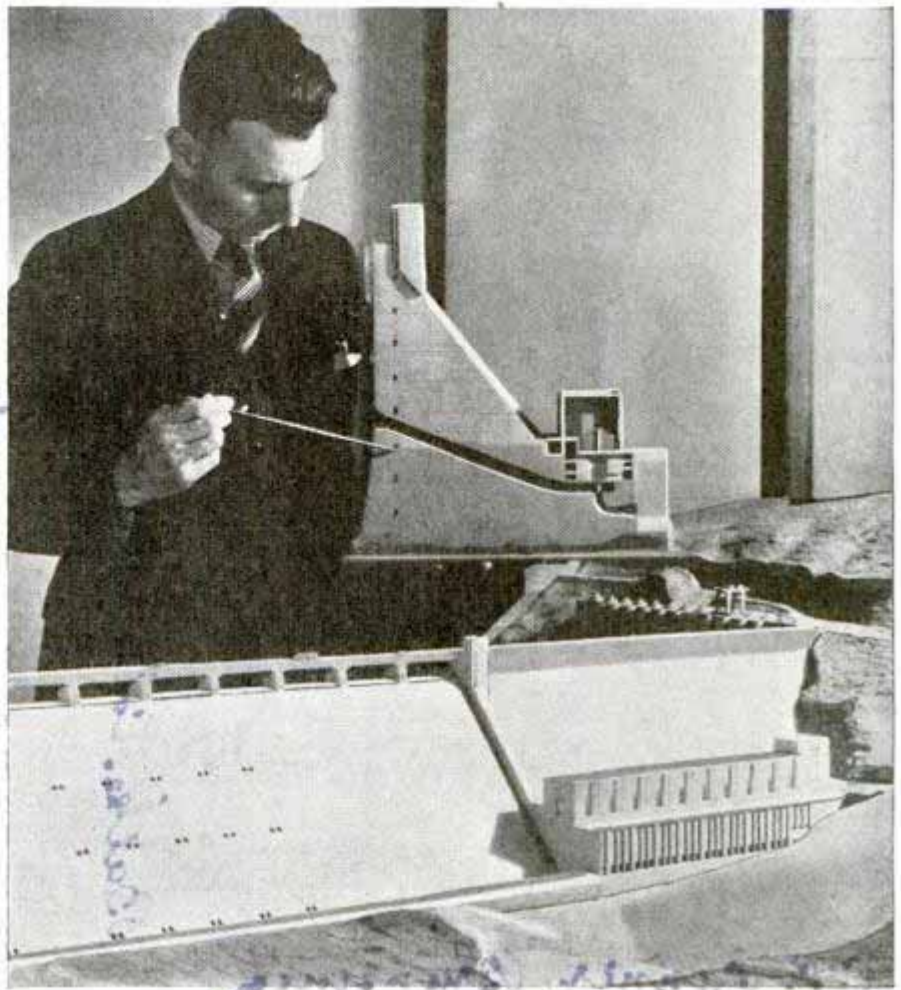

Model of Grand Coulee dam and a cross section showing the eighteen-foot penstock through which 141 tons of water per second will pass

than forty years ago George Westinghouse built the first hydro-generator at Niagara Falls, then a giant developing 5,000 horsepower. Each of Grand Coulee's main generators will develop 145,000 horsepower.

## Seeing World Upside Down Aids Space Perception Class

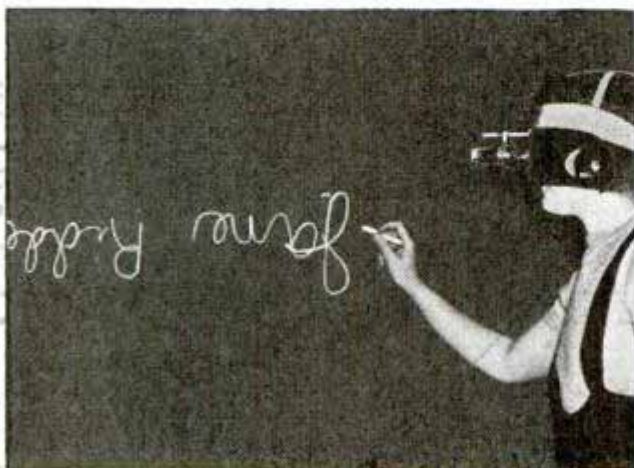

Student demonstrates how you write while wearing inverted vision glasses

Everything appears upside down to the student wearing inverted vision glasses in one university's psychology classes. The experiments with the phenomenon of inverted vision are used to teach more about space perception. Students find that one of the most difficult feats of getting about while wearing the glasses is that of walking downstairs. Stairs that lead down appear to lead up, so the wearer raises his foot to meet a downward step. A bowl looks convex instead of concave.

☐ The United States and Canada produce seventy-nine per cent of the world's autos.



# Billiard-Ball Trick in Plane Proves Flight Smoothness



Champion trick-shot artist balances one billiard ball on top of two others in plane flying 200 miles an hour at 10,000 feet

Here's a double-balancing act for you! It's quite a feat in itself to balance one billiard ball on top of two others. Charles Peterson, world champion billiard shot, executed the stunt in a United Air Lines plane flying at 200 miles an hour 10,000 feet above Chicago. A small billiard table was installed in the transport ship for the trick. Peterson demonstrated a number of shots requiring perfect balance of the balls and smooth vibrationless, balanced flight.

## Propeller Shaft Safety Brake Grips Both Sides of Drum

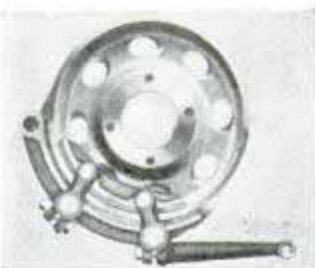

New safety for heavy trucks and buses is provided by a propeller shaft brake that grips both sides of the brake drum, instead of only the external or internal surface as do most brakes of this type. When the brake lever is applied, in-

ner and outer shoes are thrown toward each other simultaneously, gripping the drum on both interior and exterior surfaces, resulting in greater braking power with less effort and with smaller drum area. Because two-thirds of the drum is exposed to the air, rapid dissipation of heat is a feature of the brake. This results in greater efficiency and in longer life for the lining. The brake can be relined in twenty minutes.

## Floor Polisher Run by Air from Vacuum Cleaner

Utilizing the air pressure created by a vacuum cleaner, a new floor polisher makes easy the task of waxing floors. The floor brush is rotated by an aluminum turbine operated by the air pressure. The polisher is attached by detaching the bag from the cleaner and installing the polisher hose. Light enough to be carried easily, the polisher develops 2,200 to 3,300 revolutions per minute.

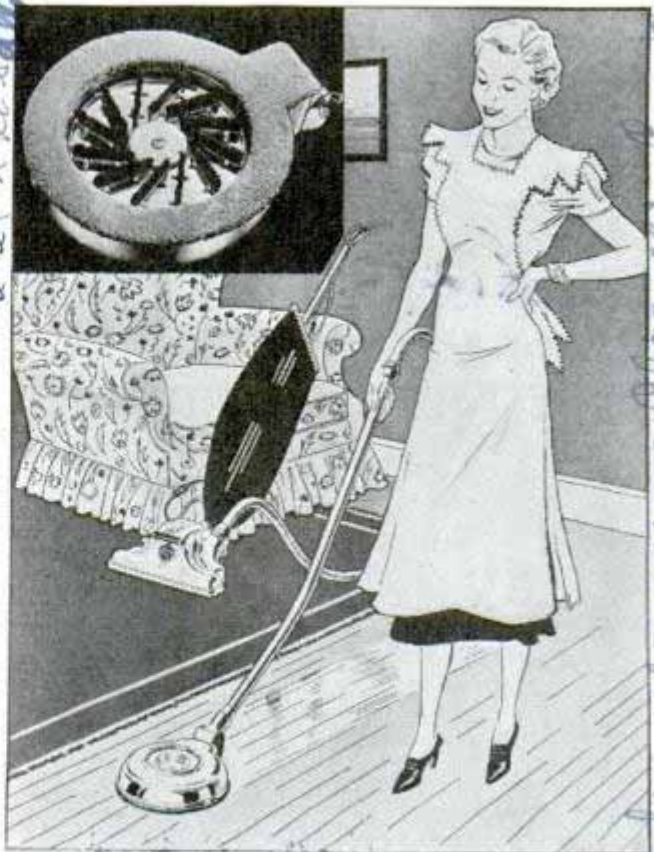

Drawing of polisher in use and connected to vacuum cleaner. Inset, underside of machine

Vertical handwritten notes on the left margin: "4734 Bellows Co", "Detroit, Mich.", "Heat-imp Brake Co", "C.P. Dinner, Brunswick", "181310", "Bach's Callender's", "Stewardess O' Bingham Allen", "H1319", "H1300", "Curbak Vacuum Cleaner Co. patent. Much Detroit."



*duplicate page*

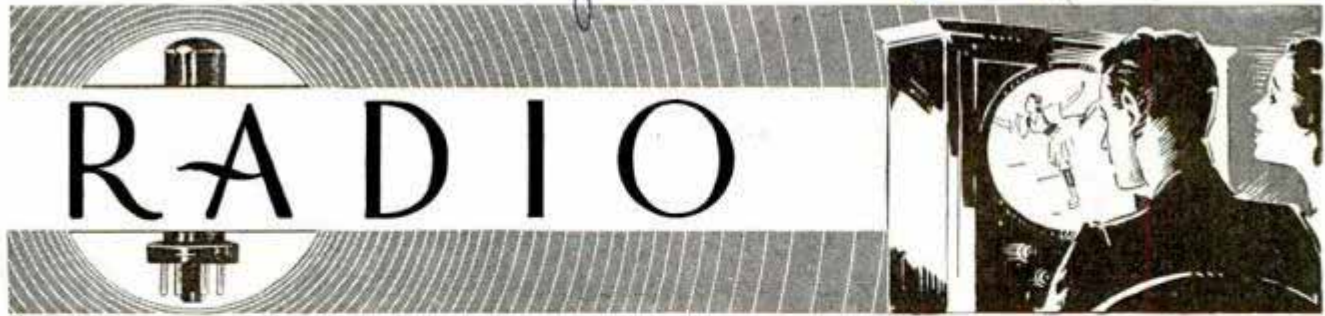

# TELEVISION RECEIVER KIT *for students*

ALTHOUGH television programs are experimental and the effective range is limited to the immediate vicinity of a few large cities at the present time, many schools are adding television courses.

The video, or television, receiver and power unit shown in photo Fig. 1 was recently demonstrated by a New York radio manufacturer and is available in kit form to

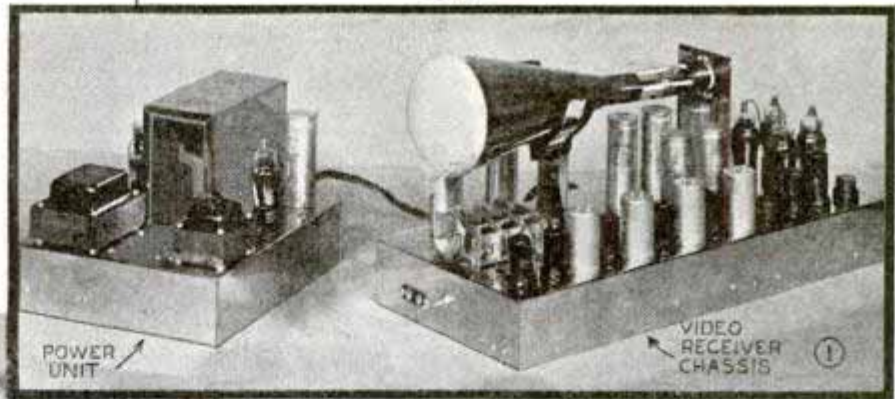

students and home experimenters. It is designed for the standards of the NBC Empire State Building transmitter and the forthcoming CBS Chrysler Building station, using 441-line scanning. It is anticipated that these standards will be adhered to in other sections of the country.

In demonstrating the receiver, engineer Barnet S. Trott revealed that the set uses 15 tubes in addition to the 5-in. cathode-ray tube. The use of electrostatic instead of electromagnetic deflection in the cathode-ray tube greatly simplifies construction. The cabinet installation illustrated in photo Fig. 2 offers a suggestion for housing combined sight and sound receivers. In the opinion of the designers, this low-cost video receiver can be built easily by the average radio experimenter.



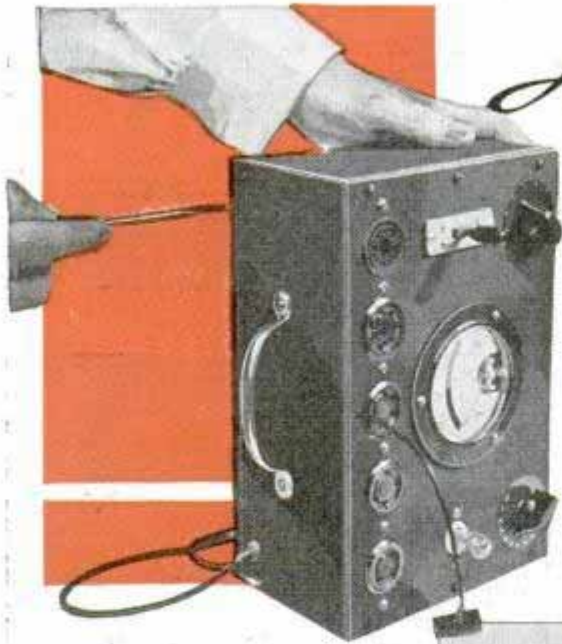

# How to build a

By M. N. Beitman

HERE is that inexpensive tube tester that you have been waiting for. No costly parts or complicated wiring will be found in this efficient homemade tube checker which will test over 120 types of modern radio tubes. Following common practice in tube-tester design, the unit operates on the emission principle and will detect a faulty tube in practically every case. The sensitive short-tester checks leakage between cathode and filament where leakage is most apt to occur.

The meter is an ordinary 0 to 1 ma. d.c. milliammeter provided with a new scale, reading half way "Bad-Good"; this scale may be hand drawn on cardboard as shown in the

CHART FOR TUBES COMMONLY USED

Tube	Fil. Switch Taps	Load Setting	Tube	Fil. Switch Taps	Load Setting
1A4	2	6.5	25A6	9	2.5
1A6	2	7.	25B6	9	2.5
1B4	2	7.	25A7	9	2.5
1F4	2	6.	25L6	9	2.5
2A3	3	2.5	25Z6	9	1.
2A5	3	3.5	19	2	7.
2A6	3	3.5	26	1	7.
2A7	3	4.	27	3	4.
2B7	3	6.	30	2	7.
5Z3	5	5.	31	2	7.5
6A6	6	2.	32	2	7.5
6A7	6	4.	33	2	6.
6A8	6	4.	34	2	7.5
6B5	6	6.5	35	3	5.5
6B7	6	6.	36	6	3.5
6C5	6	4.	37	6	5.
6C6	6	3.5	38	6	6.
6D6	6	4.	41	6	3.5
6E5	6	2.5	42	6	3.5
6F6	6	3.5	43	9	2.5
6F7	6	6.	45	3	4.
6H6	6	2.5	46	3	5.5
6J7	6	3.5	47	3	5.5
6K7	6	3.5	49	2	6.5
6L6	6	2.5	55	3	6.5
6L7	6	2.5	56	3	4.
6N7	6	2.	57	3	3.5
6Q7	6	3.	58	3	4.
6R7	6	3.	77	6	3.5
6V6	6	3.	78	6	4.
12A7	8	1.5	80	5	3.5
24A	3	5.5	83	5	5.5

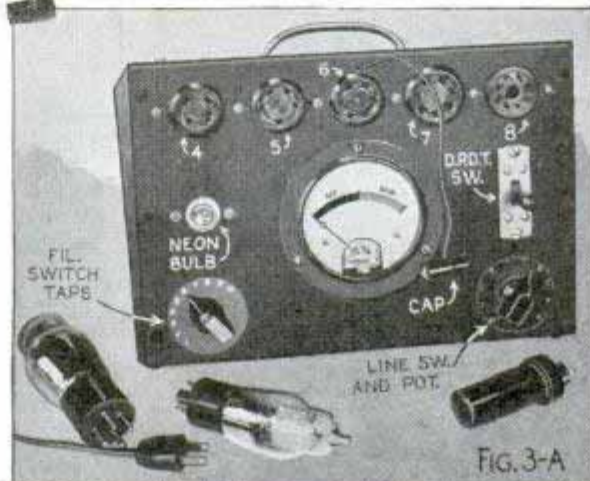

FIG. 3-A

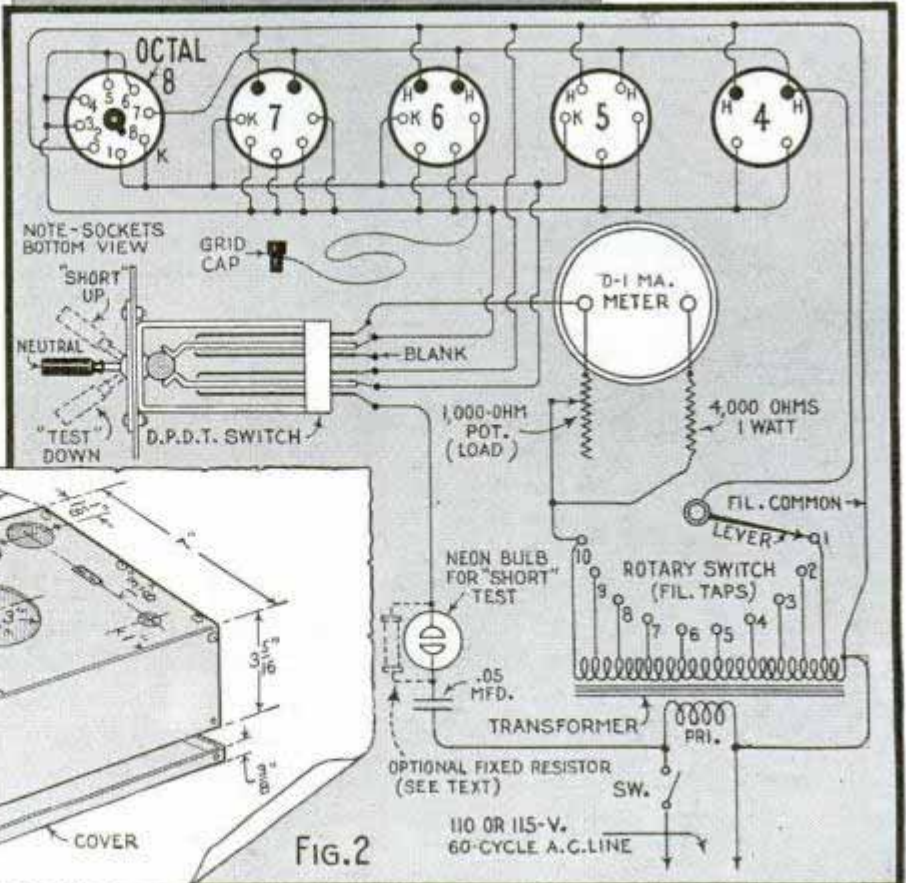

FIG. 2

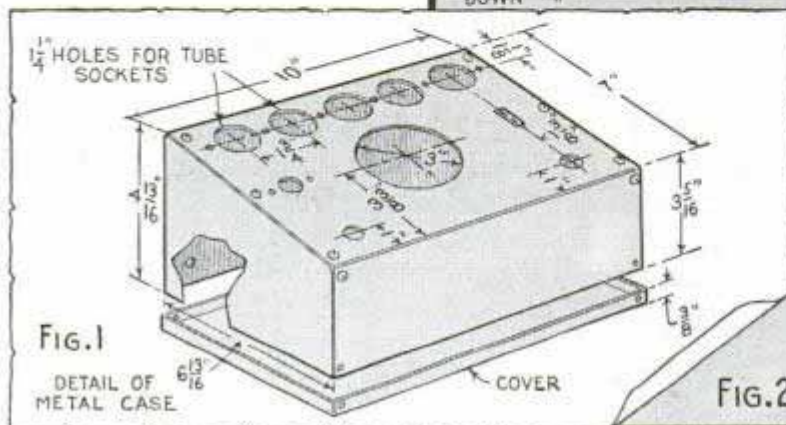

FIG. 1

DETAIL OF METAL CASE



*Amphibole*

*Amphibole*

# SIMPLIFIED TUBE TESTER

model, the "Bad" half being inked in red and the "Good" in green. This full scale length is, of course, the same as the original scale on the meter. Use the original scale as a template for cutting the new one, making sure that the holes are in the same position. Many of the parts for this tube checker can be found in the average radio experimenter's junk box, the only unusual part being the tube-testing transformer which is a standard unit and easily obtained. The unit may be operated on any 105 to 120-volt, 50 to 60-cycle a.c. line and is not critical in adjustment.

A sheet-metal case is detailed in Fig. 1; this is available formed and drilled, or any wood or metal case of similar dimensions may be used. The schematic circuit diagram is given in Fig. 2 and the simplified wiring diagram appears in Fig. 3. All parts in the underside view are shown in their relative positions; sockets of the "Amphenol" type are provided for 4, 5, 6 and 7 small and medium prong, and



FIG.3B

(Continued to page 136A)

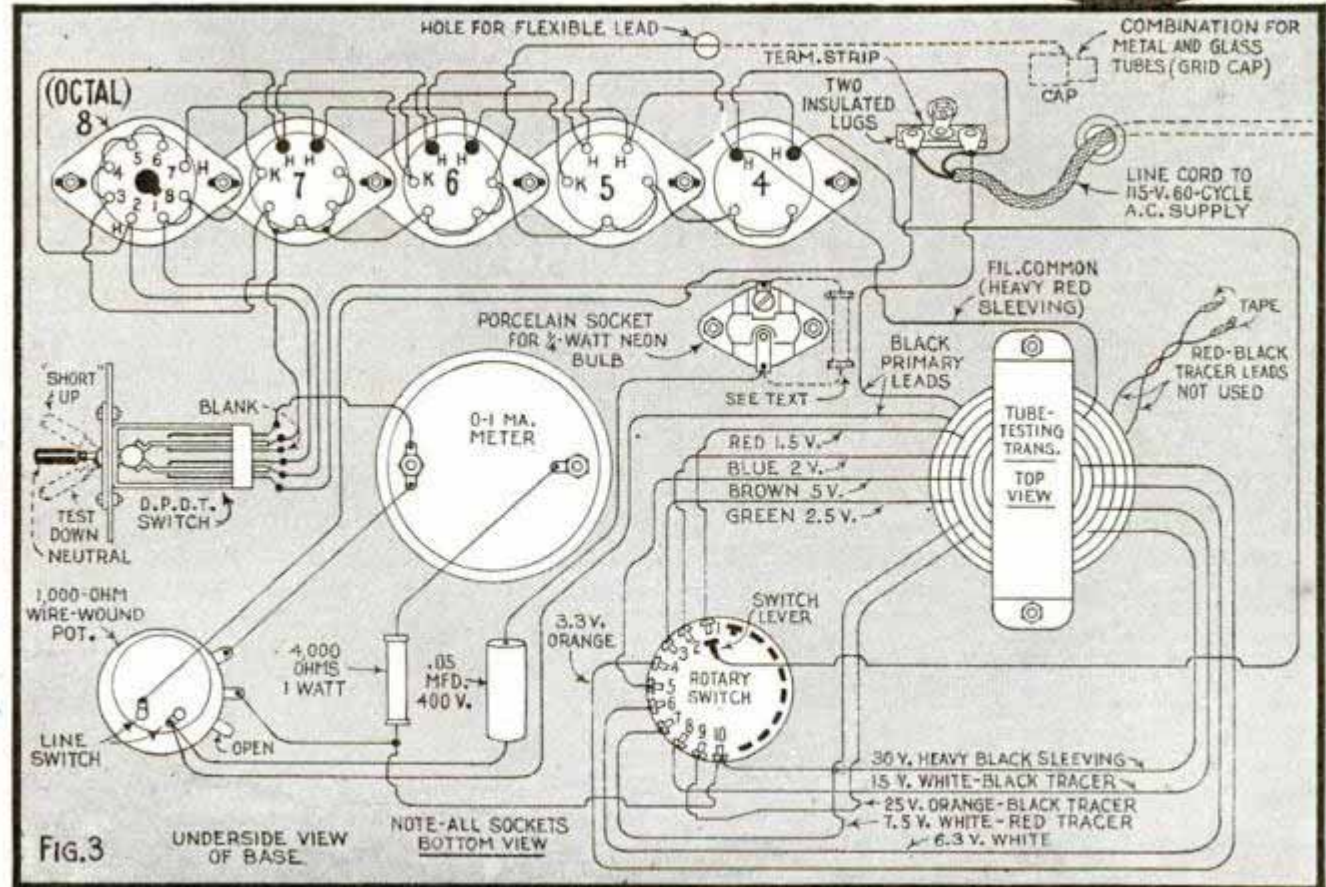

FIG.3

UNDERSIDE VIEW OF BASE

NOTE-ALL SOCKETS BOTTOM VIEW



# Beginner's Crystal-Controlled Transmitter



**T**HIS simple low-power unit is designed to aid the beginner, and enables him to go on the air with an economical crystal-controlled cw transmitter that can be assembled and wired in a few hours. A type 6L6-G tube is employed in the crystal oscillator stage and a type-80 rectifier tube in the self-contained power supply.

All parts are standard and available in a complete kit which includes a Bliley crystal and coil for operation in the 40-meter cw band. With additional plug-in coils the transmitter will operate on 20 and 10 meters without changing crystals. To work on 80 and 160 meters, appropriate coils and crystals are required. The chassis base is 11 in. long, 5 in. wide and 3 in. high.

Although the input is limited to 25 watts in the form shown, this unit also makes an excellent little exciter stage if the builder wishes to add a 110-watt r.f. final amplifier at a later date. A schematic circuit diagram is given in Fig. 1 and an underside view of the wired unit appears in photo Fig. 2; complete layout diagrams are supplied with the kit of parts. The finished transmitter is shown with an ordinary key, in photo Fig. 3.

A portable kit of similar description, for operation on a 6-volt battery, is also available for motor boats, autos and trailers for mobile and emergency use. This battery-operated vibrator type has a current drain of only 9 amps., fully loaded with key down, and 1.4 amps. at standby. Operating on cw in all 5 bands in the same manner as the a.c. type described, the battery unit is a complete transmitter with built-in power supply all on a single small chassis. Metal tubes are employed in the portable battery model to withstand rough handling.

In case of accident on the farm or in rural communities where lights may go out from flood or sleet storm, or in districts where a.c. current is not available, this small battery-operated transmitter is very useful as a means of amateur emergency communication.

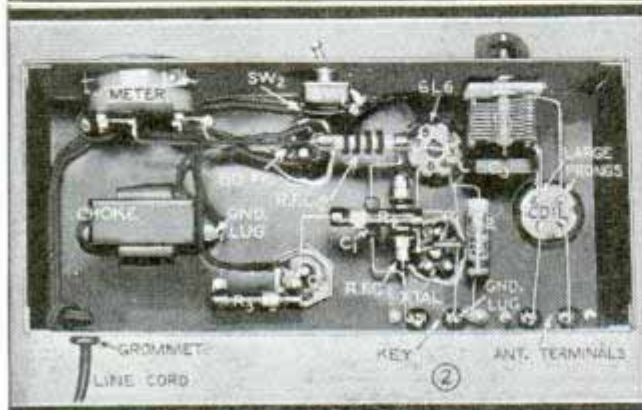
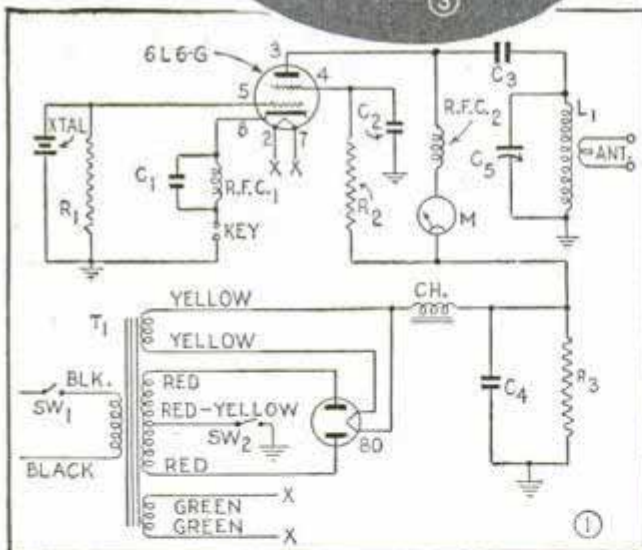



*Stephane* *Stephane*

# Practical RADIO SUGGESTIONS



Wireless control is now available for use with any radio receiver regardless of make, size or type; merely plug this portable tuning unit into the a.c. or d.c. electrical outlet in any room in your home and tune in stations. No wiring is necessary; features include push-button tuning, remote volume control and wireless manual tuning for every broadcast station. You still can operate your set in the usual manner



Left, vacuum-type 100-watt dummy antenna has resistance of 73 ohms to match twisted-pair lines. Enables amateurs to adjust transmitters without causing interference



Below, left, code teacher for beginners; slots forming code letters are cut in cardboard placed over copper sheet fastened to wood base. Signals are heard as metal pointer is passed over dot and dash slots. Below, center, sealed resistors for use in marine and tropical locations; right, car body acts as reflector for directional 5-meter antenna; spacing 18 in.

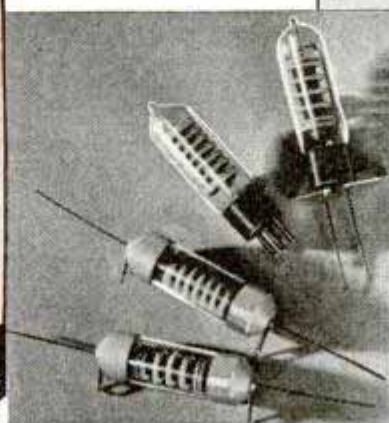
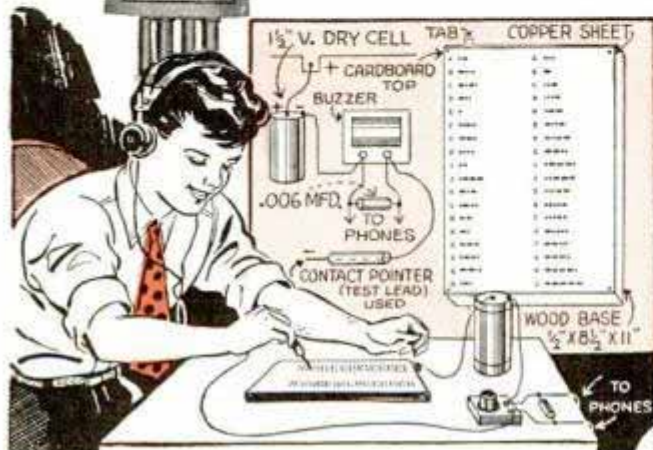
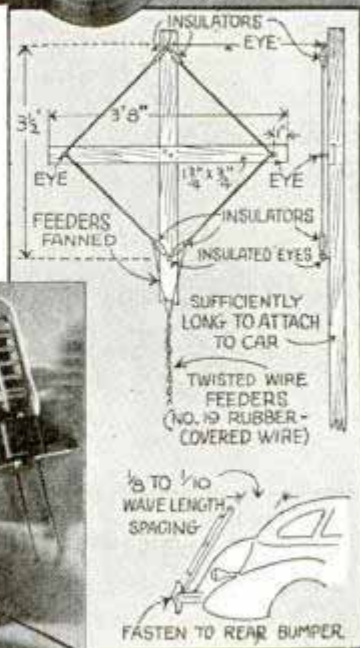



## Automatic Telescoping Antenna

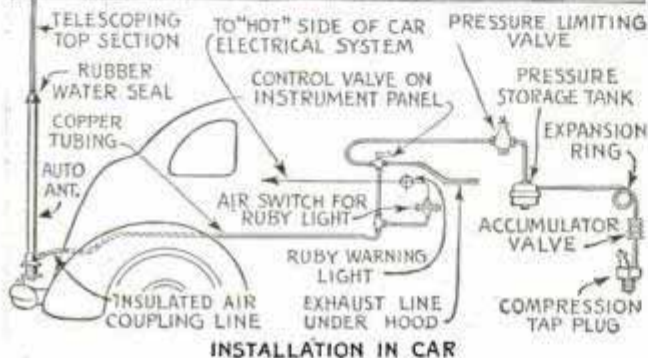

By means of compressed air, the operator of a car or boat equipped for two-way radio, can now raise or lower the antenna to any predetermined height by merely manipulating an air valve from the driving position, thus eliminating the danger of striking obstructions.

## A.C.-D.C. Test Meter Fits Pocket



Small enough to carry in your pocket, this unusually compact volt-ohm milliammeter includes all of the essential ranges for modern a.c. and d.c. set testing.

## Radio World Time Indicator

By turning this simple dial, short-wave listeners can now tell just when and where to tune for any foreign or domestic radio program. It also indicates the number of hours difference between given cities, and between local time and Greenwich mean time. A log of foreign short-wave stations is included.

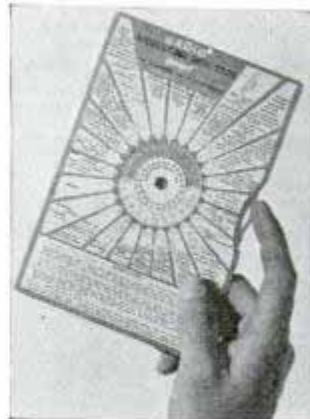

## Records Transmitted by Radio

You can play phonograph records through your radio set by means of this record player, located up to 20 ft. away and not connected to the receiver in any manner. A built-in oscillator "transmits" the signal.



Blueprints covering radio construction articles in past issues are available for 25 cents each; original material lists and additional information can be obtained from our Radio Department without charge upon receipt of postage.

**NEXT MONTH—How to Build the Little Giant Portable A.C. Phono-Radio.** The 1939 improved model of this popular midget broadcast receiver is a combination phonograph and 4-tube set with 5 watts output, built into a compact carrying case.

Also—A Regenerative Preselector which will add zip to your present receiver





# Ship's-Wheel BOOK END

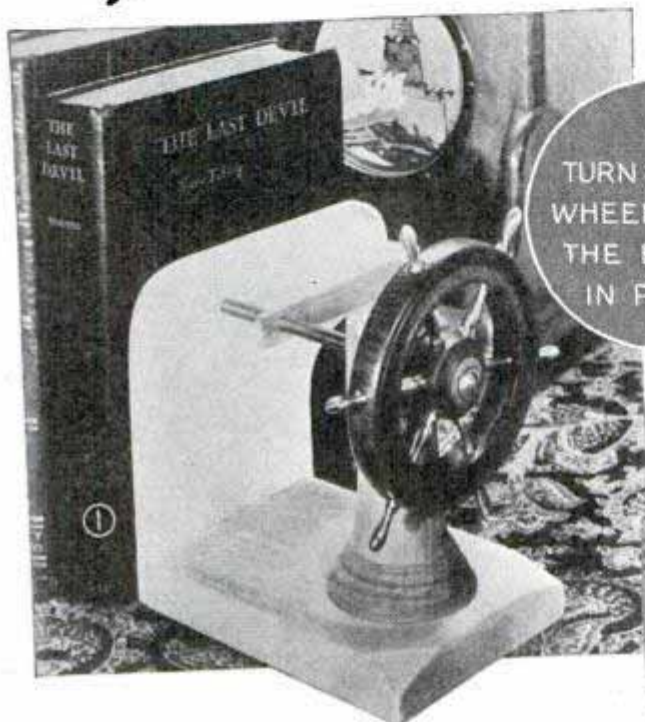

TURN the wheel of this nautical book end and a brass arm, working on a screw, slides in or out to grip or release the books. The construction is a combination of wood, metal and plastic, as you see in Figs. 1 and 2. The pedestal is sawed and turned from a short square of hardwood, and the top end is sawed to the hexagon shape required as in Fig. 3. To avoid a noticeable offset between the turned and sawed portions you have to be very careful in centering the piece, Fig. 4. The design and size of the turned section can be taken from Fig. 6. The  $\frac{3}{16}$  by  $4\frac{13}{16}$ -in. brass bolt will probably have to be threaded in the shop. It is grooved in the center of the portion that passes through the pedestal. A pin is fitted through the pedestal to engage the groove, thus holding the bolt in place.

The spokes of the wheel are turned from brass rod while the hub and rim of the wheel are turned separately from hardwood and indexed for six holes each. Ends of the spokes are threaded to turn into the hub. Notice in Fig. 6 that one of the spokes is longer and is used to lock the wheel in place. Now, in Fig. 5 you



CUT TO HEXAGON SHAPE

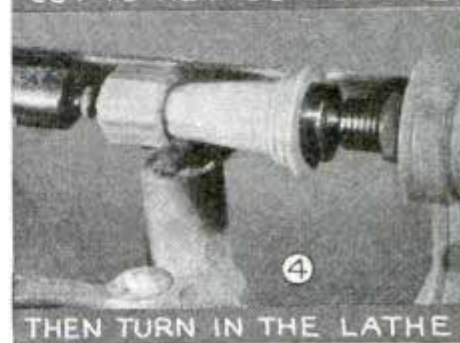

THEN TURN IN THE LATHE



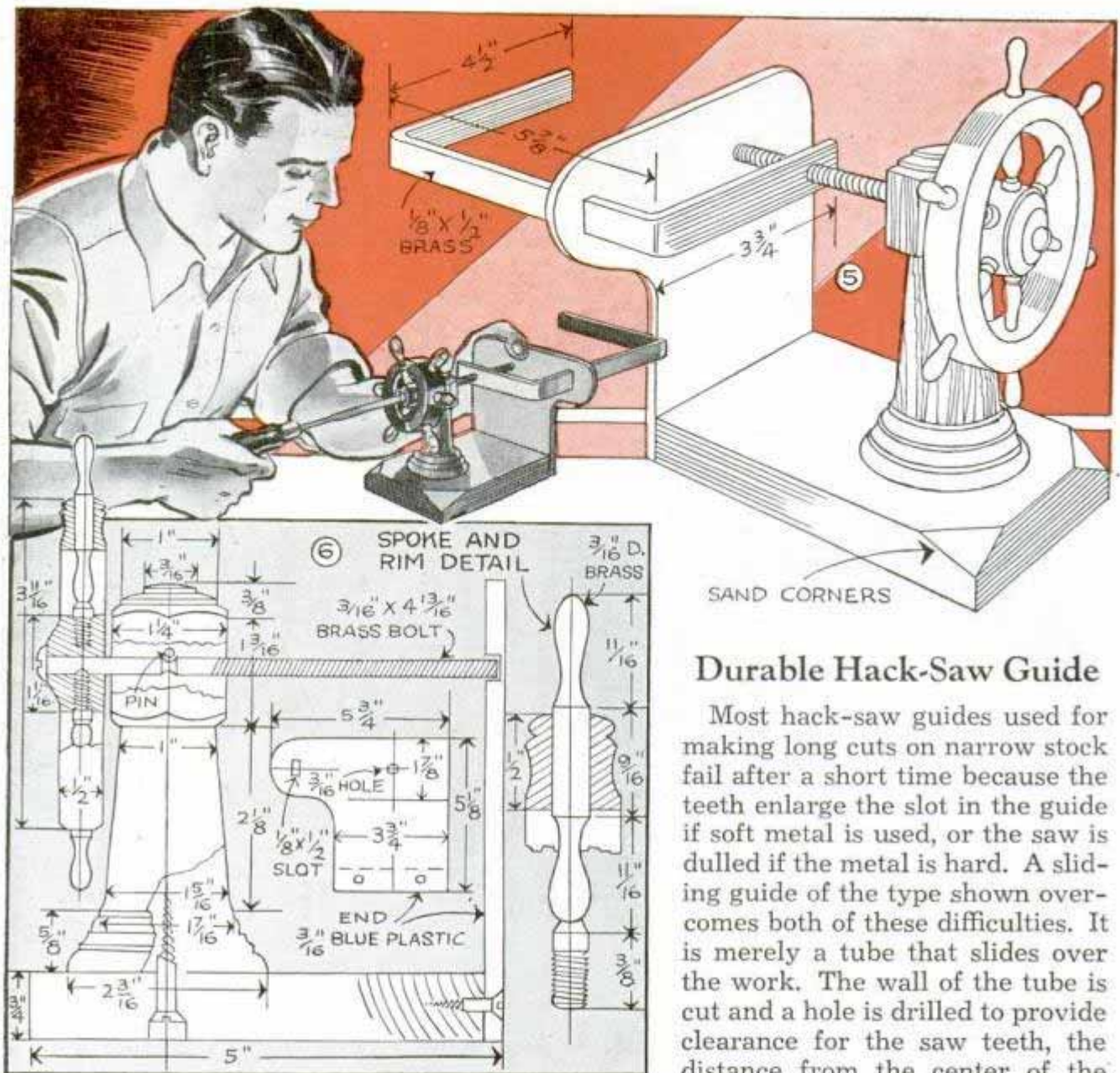

## Durable Hack-Saw Guide

Most hack-saw guides used for making long cuts on narrow stock fail after a short time because the teeth enlarge the slot in the guide if soft metal is used, or the saw is dulled if the metal is hard. A sliding guide of the type shown overcomes both of these difficulties. It is merely a tube that slides over the work. The wall of the tube is cut and a hole is drilled to provide clearance for the saw teeth, the distance from the center of the hole to the bottom of the slot being

equal to the width of the saw blade. In use, the tube is slipped over the blade and the cut is started. Then the lower end of the tube slides down on the work, while the cut progresses. The guide effectively holds the blade in the correct position and the teeth never contact the guide. Of course, for each size stock, a different guide is required. Several guides of different sizes can be made and kept on hand.

will see that one end of the clamp arm is drilled and tapped to run on the threaded bolt and that the arm is moved in or out by merely turning the wheel. Of course, the arm must be bent to shape neatly and should be polished carefully and coated with clear lacquer to prevent tarnishing. After sawing the plastic to shape as in Fig. 5 the edges should be rounded and smoothed with progressively finer grades of sandpaper. The base, pedestal, and the wheel rim and hub should be hardwood such as selected mahogany, walnut or maple finished in the natural color.

☐ If cut flowers are put into lukewarm water as soon as they come from the florist during winter months, they will last much longer.

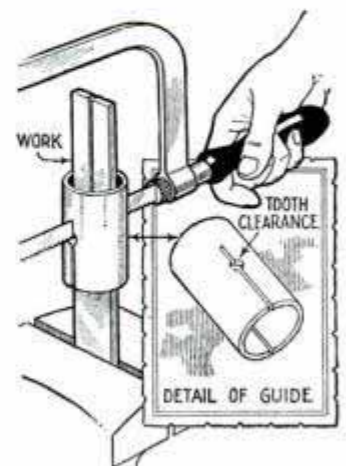



# These Amusing Place Cards Are Photo Prints

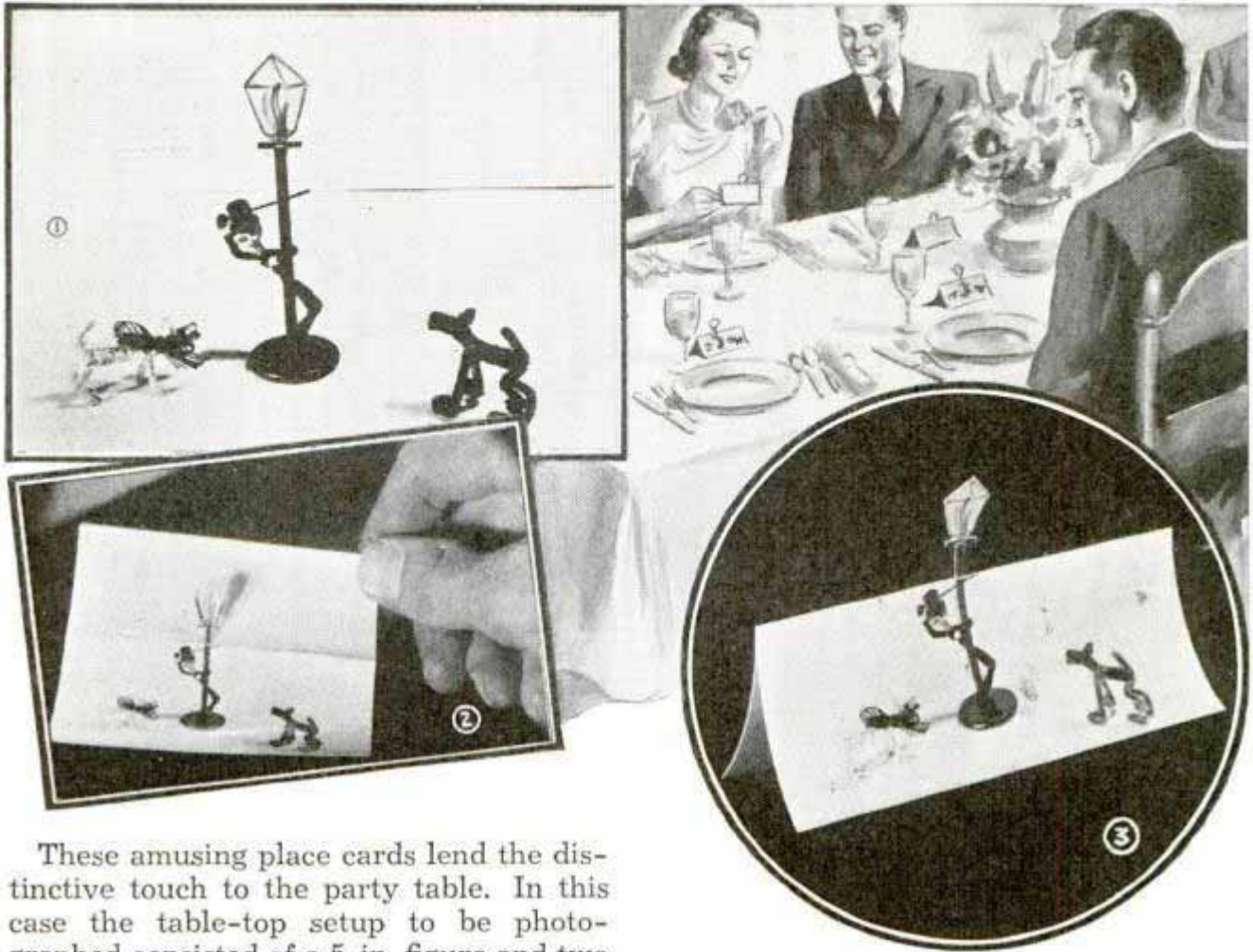

These amusing place cards lend the distinctive touch to the party table. In this case the table-top setup to be photographed consisted of a 5-in. figure and two dogs bent from pipe cleaners placed in appropriate poses on a white background as in Fig. 1. After this setup was photographed and prints made, the white borders of the prints were trimmed off and the top portion of the lamp post was cut out with a

sharp knife so that it would project when the print was folded as in Fig. 2, and set on the table as in Fig. 3. Of course, the variations in the table-top setups are practically without limit.

—Ormal I. Sprungman, Minneapolis, Minn.

## Transparent Beam Compass for Laying Out Colored Designs

Those who lay out designs involving circles scribed in different colors, will find this compass of  $\frac{1}{32}$ -in. celluloid a timesaver. You just use a needle as a pivot at one end and a sharp-pointed pencil at the other to draw the lines. There's no changing of leads for each colored line as is necessary when using an ordinary compass; just use separate colored pencils. Drilling a number of holes in a spiral at the outer end of the compass was found to permit very close adjustment.—D. Reynolds, Pontiac, Mich.

Ⓢ Small linoleum plugs or disks can be used to fill dowel and countersunk holes in a decorative manner.

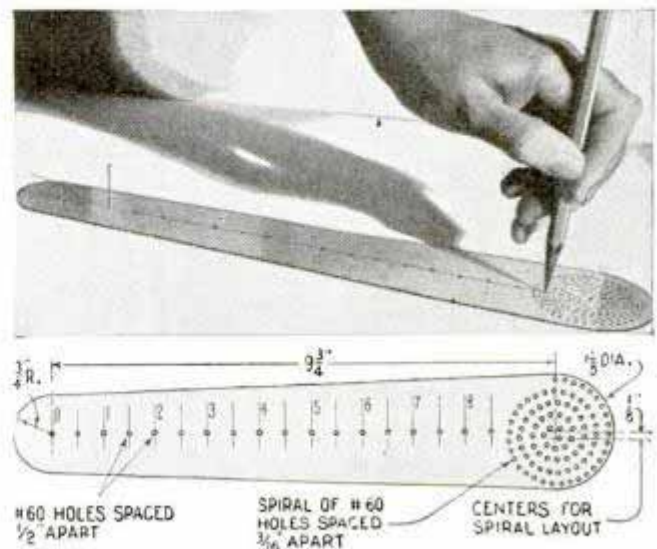



## Artist Uses Vacuum Cup and Clip to Hold Paper on Drawing Board

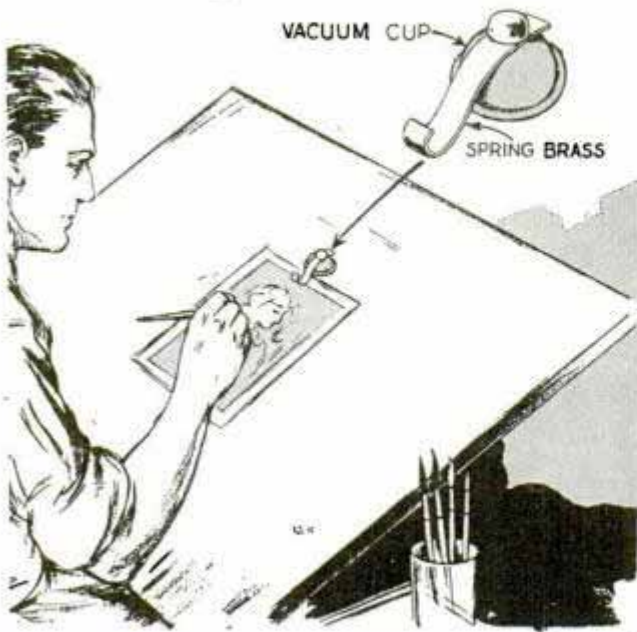

Artists and photo retouchers who often have work on their drawing boards where it is not advisable to use thumbtacks, because of the danger in marring the work, will find that this combination vacuum cup and clip solves their problem. A short piece of spring brass is bent to the shape indicated and fastened to the vacuum cup, which should be of the type that is fitted with a stove bolt in the upper end. The clip can be located any place on the board to hold the work without damaging it.

## Pivot Mounting for Bird Feeder Has "Needle-Point" Bearing

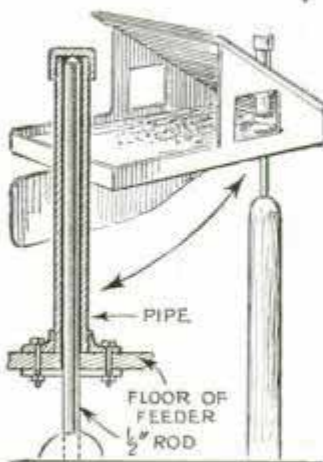

and a length of  $\frac{1}{2}$ -in. pipe with a cap on one end and a floor flange on the other. The rod projects through a hole in the floor into the pipe where the point seats in

This pivoted mounting for your bird feeder is practically self-lubricating and turns easily so that the feeder always heads into the wind to keep out snow and rain. The mounting consists of a length of  $\frac{1}{2}$ -in. steel rod pointed at one end

a tiny depression made in the cap with a small drill. A steel plate to take the bolts is placed on the underside of the floor to give rigidity. Heavy cup or fiber grease pressed into the pipe cap takes care of lubrication.

—W. J. Oldroyd, Waterbury, Conn.

## Improved Hand Pencil Sharpener

A common hand pencil sharpener may be provided with its own container for shavings. The sharpener is sweat-soldered to a can lid, which is cut away at one point to admit the pencil, a corresponding hole being made in the top part of the can. The lid is then fastened underneath the drawing board with wood screws as indicated.

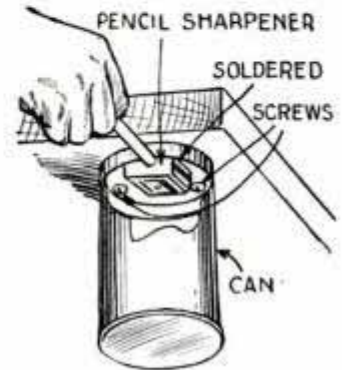

—S. J. Gancher, Richmond Hill, N. Y.

## Special Rip Fence to Saw Bevels

Where stock must be ripped at a bevel on both edges, this fence on a circular saw prevents damage to the thin beveled edge already cut, while cutting the other. Also, it prevents possible twisting and conse-

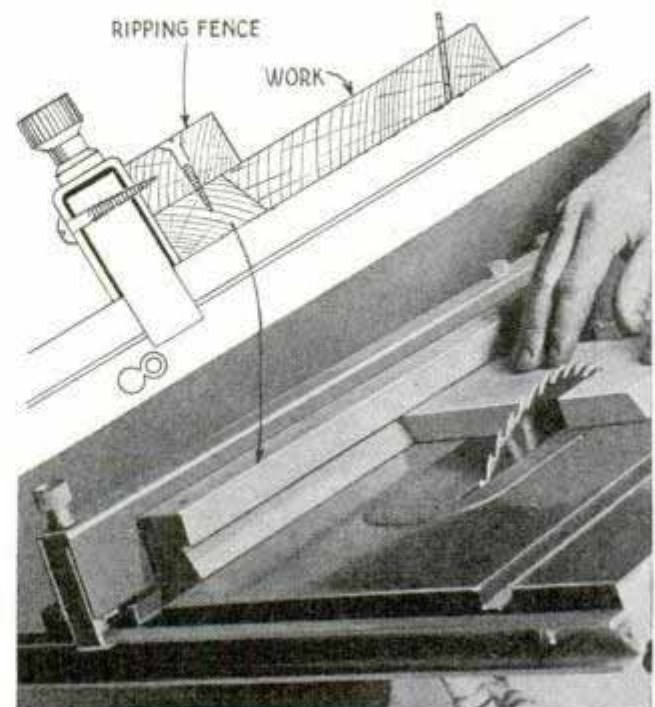



quent inaccurate cutting of stock that cannot be held down firmly between the fence and saw. The fence is assembled from two strips of wood as indicated, and is screwed to the regular saw fence. The outer edge of the lower strip is beveled at the same angle as the piece being sawed, permitting the edges of both stock and fence to contact each other fully. The lower strip of the fence must be the same thickness as the work.—H. R. Heydorf, Missoula, Mont.

### Glasses Held Securely in Pocket by Rubber Band

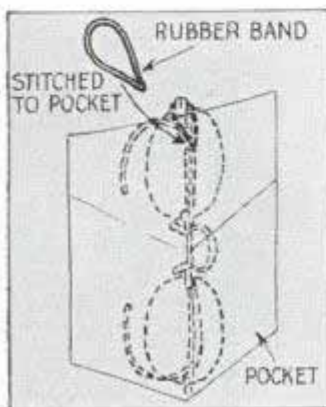

If you are in the habit of removing your glasses and dropping them in your shirt or coat pocket momentarily, try using a rubber band to keep them from slipping out when you stoop. Just stitch the band to

the upper inside surface of the pocket, and slip it over the temple hinge at one end of the lens as indicated.

—G. E. Hendrickson, Argyle, Wis.

### Canoe Cradle from Auto Casing

Half sections of an auto casing nailed to planks or blocks, provide a good cradle for storing a canoe. If desired, the blocks carrying the casings can be fastened together

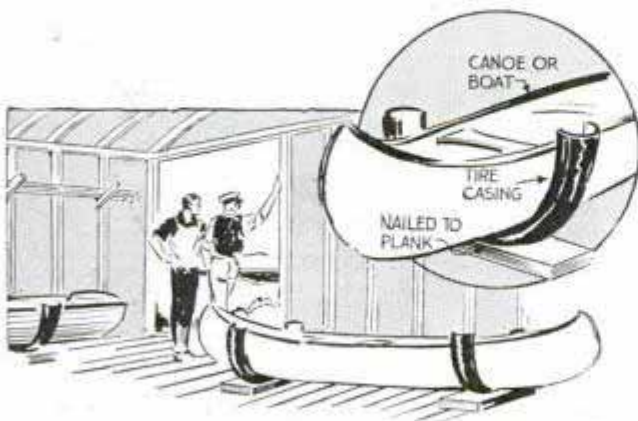

by means of a wood frame so that the entire assembly can be suspended from the ceiling or rafters of an outbuilding, or the cradle can rest on the floor.

### Falling Snow Imitated in Photo with Pepper on Negative



Snow scenes "shot" after the storm is over can have a touch of realism added when making the prints. With the printing frame in the horizontal position, pepper is sprinkled lightly on the negative. As snow would be visible right up to the camera, there is no need of eliminating any of the pepper from the film unless sheltered spots are included in the picture. The print is made in the usual way, care being used when placing the paper on the negative not to disturb the pepper. Stormy effects may be created by swirling the snow around buildings or other objects in the picture.

### Glue Spread with Fine Comb

To apply a thin coat of glue uniformly over a large surface quickly, use a fine comb as a spreader. The comb is especially handy when working on large pieces of veneer.









# in Roman Styling

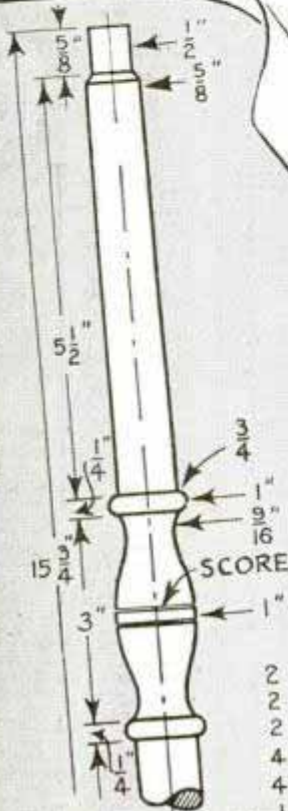

STRETCHER DETAIL

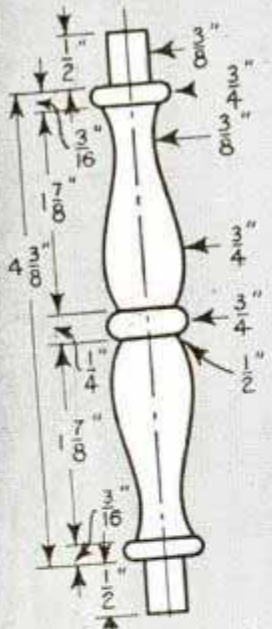

SPINDLE - 8 REQ'D

## MATERIAL LIST

- 2 PC. FOR FRAME - 1 1/2 X 1 1/2 X 28 IN.
- 2 PC. FOR FRAME - 1 1/2 X 1 1/2 X 16 IN.
- 2 PC. FOR RAILS - 3/4 X 1 1/2 X 17 IN.
- 4 PC. FOR QR. RDS - 3/4 X 2 1/2 X 8 IN.
- 4 PC. FOR LEGS - 3/4 X 7 X 10 IN.
- 1 PC. FOR MOLDING - 1 1/2 X 1 1/2 IN. BY 8 FT.
- 1 PC. FOR GLASS STRIP - 1/4 X 3/4 IN. BY 8 FT.
- 8 PC. FOR SPINDLES - 7/8 X 8 X 6 IN.
- 2 PC. FOR STRETCHERS - 1 1/8 X 1 1/8 X 16 IN.
- 2 PC. FOR PANELS - 1/4 X 4 8 X 7 IN. PLYW'D
- 1 PC. PLATE GLASS - 1/4 X 13 3/4 X 25 3/4 IN.

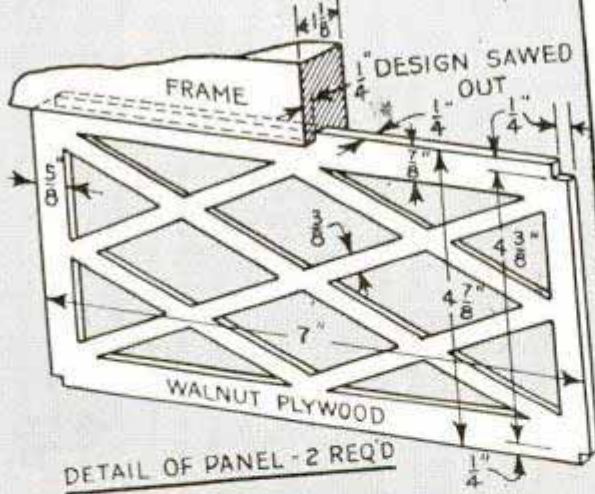

DETAIL OF PANEL - 2 REQ'D

**PROCEDURE :** ALL JOINTS ARE MADE WITH DOWELS & GLUE - FELT STRIPS ARE USED TO CUSHION GLASS WHICH IS INSTALLED FROM BELOW AFTER FINISHING - THE FRAME IS MITERED & SPLINED - SIDE ASSEMBLIES ARE GLUED UP COMPLETE BEFORE GLUING TO FRAME - WALNUT IS USED THROUGHOUT - FINISHED NATURAL WITH BOILED LINSEED OIL

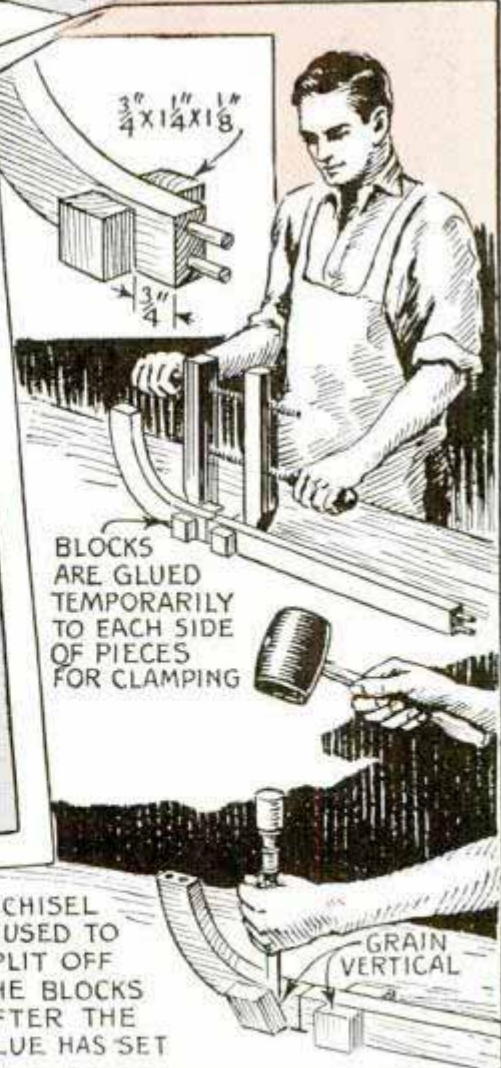

A CHISEL IS USED TO SPLIT OFF THE BLOCKS AFTER THE GLUE HAS SET



## Hill Climbing on Skis Less Tiring if Hand Ropes Are Used



Many years ago when I had a job of packing mail through a hilly country in the west, I used the method shown to aid in climbing the hills on skis. Two lengths of  $\frac{3}{8}$  or  $\frac{7}{16}$ -in. rope were looped and fastened around the skis by one of the two ways indicated in the drawing. The looped ropes were about 40 in. long and the upper ends of both loops were held in one hand, leaving the other to carry a ski pole. The ropes alone provided good traction except when the snow was very fluffy, at which time the short stick was used.

—James D. Boylan, Ann Arbor, Mich.

## Spring in Vacuum-Bottle Top Keeps Cork Tight

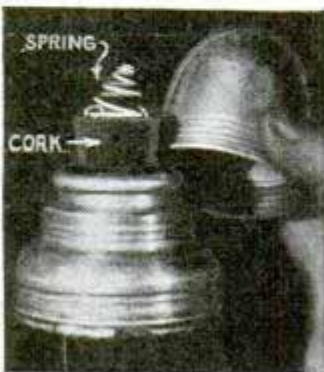

The tendency of air inside a hot vacuum bottle to expand and force out the cork is overcome by using a spring on top of the cork to press against the bottle cap when the latter is screwed in place. If pressure inside the bottle should be great enough to loosen the cork, the spring will force it back into place after

the pressure has been relieved, thus avoiding excessive leakage. The spring should be of the small spiral type and can be fastened to the cork with a couple of small staples.—W. C. Wilhite, Carlinville, Ill.

## Roof-Cement Can Has Slit in Top to Apply Contents

Instead of applying cement to the seams of rolled roofing with a brush, which is usually a messy job, try cutting a slit in the can top so that the cement will flow out in the shape of a thin ribbon. With a little practice, you will find you can do a good job with less work than is necessary when a brush is used.

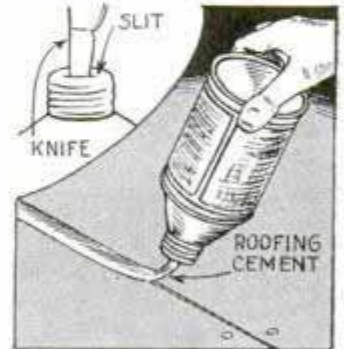

## Try This When Using Pantograph

The next time you have occasion to use a pantograph you'll find it will operate much more smoothly and accurately if a rubber band is stretched between the tracer point and the lead point of the arms. The tension formed by the rubber band eliminates the "jerky" motion and also prevents wobbling once the pivot joints have become worn.

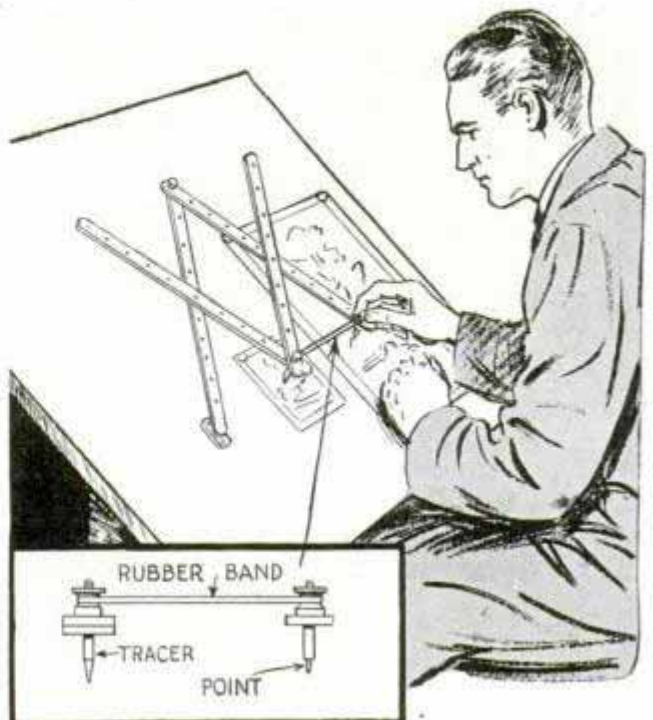



# Two-Way DESK FRAMES for your Photos

Easily made from colorful plastic or selected cabinet woods, these attractive desk frames offer a distinctive touch to "home portraits." Two panes of single-strength glass are used, the two pictures being fitted between them, back to back. The frame which holds the glass is rabbeted. Where round columns are being worked, the job is simplified by cutting the plastic rod oversize so that it can be nailed to the edge of a wood block, as shown in the drawing below. Crystal plastic,  $\frac{1}{8}$  in. thick, makes a good glass substitute, especially for circles or intricate shapes

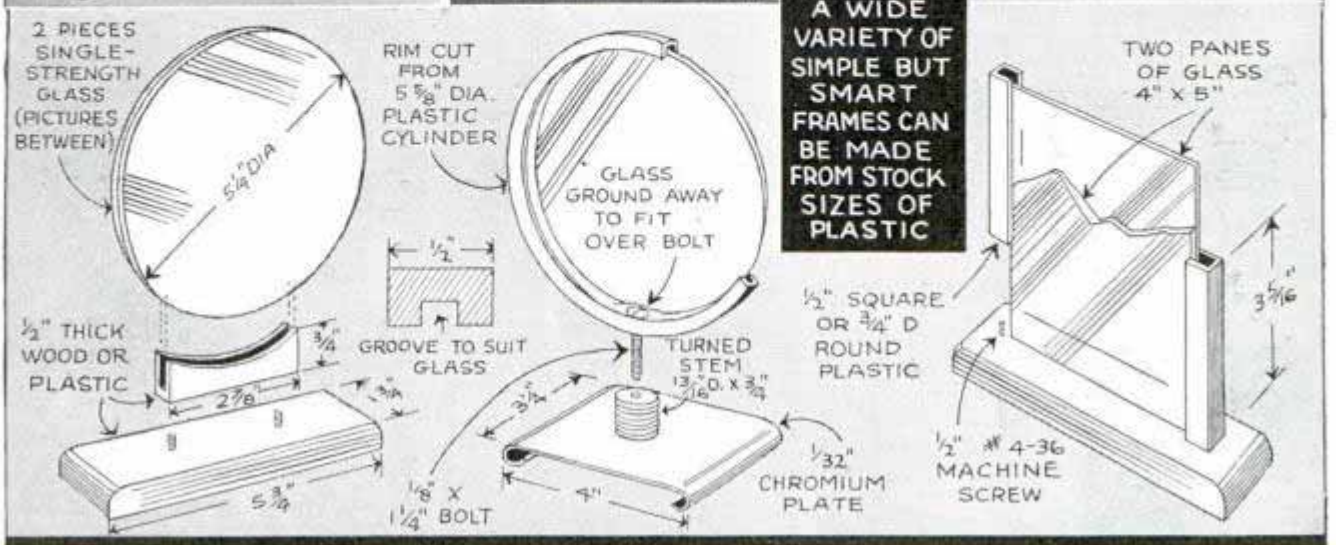
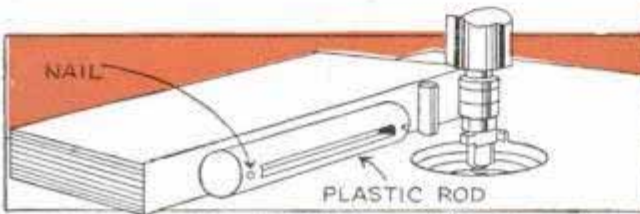



## Usher's Flashlight on End of Cane Handy to Locate Lost Articles

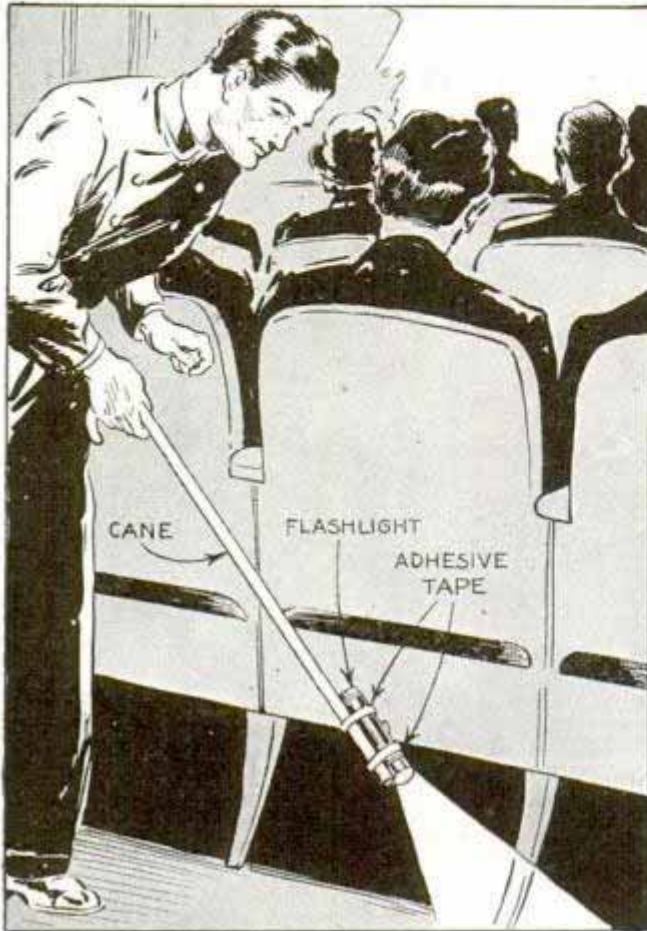

An usher in a theater who often has to retrieve articles lost or misplaced under the seats by patrons, taped a flashlight to a cane so that he can throw the beam of light on the floor between and under the seats without unduly disturbing the occupants. In this way, maximum illumination is obtained where needed and it requires only a few minutes to make a search.

## Cotter Key Lifts Pendulum to Renew Life of Clock

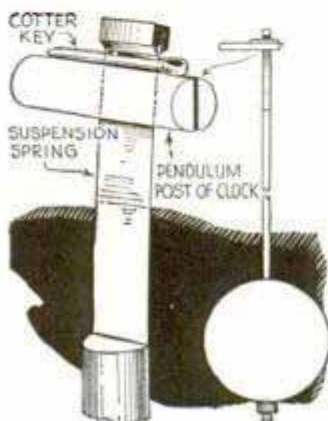

When a pendulum clock ceases to function properly for no apparent reason except age, it is possible that its usefulness may be renewed by raising the pendulum spring in the split post from which it is sus-

ended. The bend of the spring, when the pendulum is in motion, is thus applied to a stiffer portion of the metal. The lifting and fastening of the pendulum may be accomplished quickly by merely slipping a small cotter key over the spring between the split post and the attached stop.

## Clippings Fastened Together without Paste or Glue

Two newspaper clippings can be fastened together without the use of paste by following this method:

Leave a good margin at the bottom of one clipping and at the top of the other. Slit the first at the center near the bottom and then cut in from the edges of the second to make a couple of flaps. Fold these over, slip them through the slit and then unfold them, which locks the clippings together.—Don W. Sigler, Lincoln, Nebr.

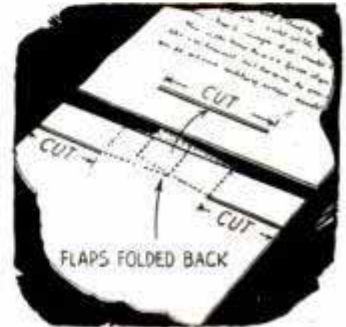

## Printing Masks of "Cellophane" a Cure for Fuzzy Edges

If the edges of your photos are fuzzy, the trouble is probably caused by using a heavy mask which prevents good contact between the paper and negative at the edges. This may be eliminated by using masks made of red Cellophane. It is sand-

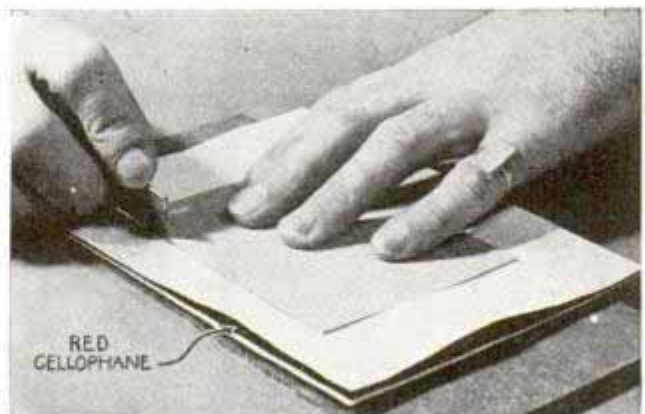

wiched between two sheets of paper and an opening of the desired size cut with a razor blade, using a piece of cardboard or a ruler as a guide.



# Swinging Platforms Conceal Garbage Cans

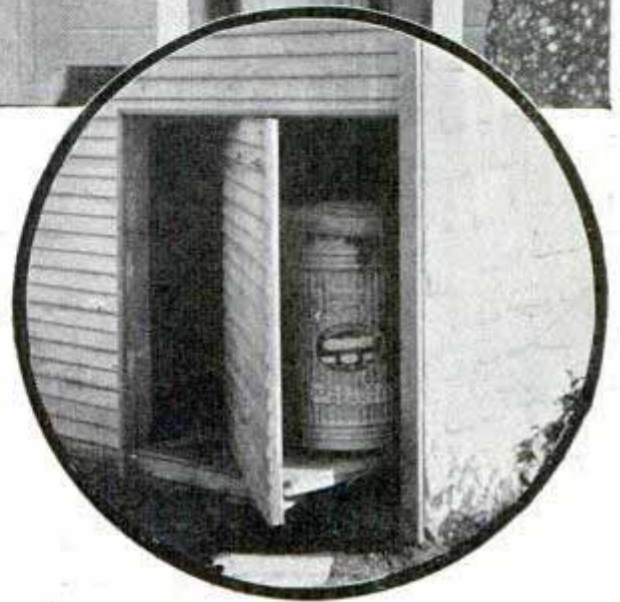
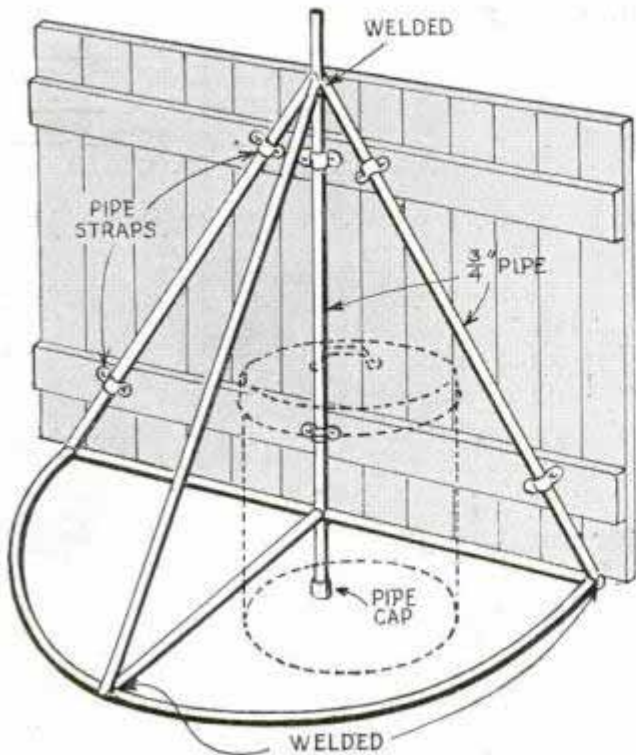

Besides effectively concealing unsightly garbage cans from view, which often detract from the appearance of a neat back yard or garden, the provision of a swinging platform and a dummy wall section enables the home owner to keep the cans where dogs cannot get at them. You can build a small shed against the house or garage for this purpose, and make the platform large enough to hold two cans. Or, in some cases the space under a high porch might be utilized

## Ferrotypes Plates to Produce Good Reflections in Photos

Instead of setting a small object on a mirror to photograph it for novel reflection effects, I use either a chromium or black ferrotypes plate. The chromium plates are preferable as they have a tendency to eliminate undesirable reflections of other objects in the room. Also, when the plates are used for this purpose no space will show between the object and its reflection, as is often the case when a mirror is used, owing to the thickness of glass between the top surface of the mirror and its undercoating of silver. It is necessary, of course, that the plates be free of scratches and thoroughly clean and dry.

—Arthur Trauffer, Davenport, Iowa.

☛ If the yolk of an egg breaks when separating it from the white and mixes with the latter, you can remove it with a cloth dipped in cold water; the yolk will stick to the cloth.

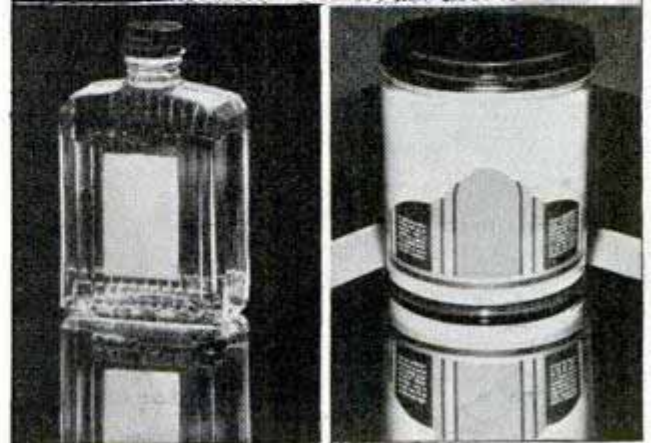
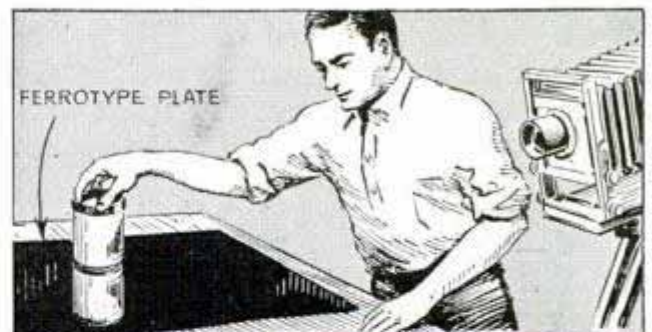



## Foot-Operated Switch Controls Electrically Driven Tools



Good use can be made of an auto starter switch in controlling electric motors on lathes and other tools where frequent starting and stopping are necessary. The switch is cut in one wire of the extension cord on the motor and operates the machine as long as it is held down with your foot. A metal block is best for housing the switch, although a wood block bored as indicated in the detail can be used, if the opening to take the switch is lined with sheet asbestos or thin sheet metal. Also, it's a good idea to use a fiber or metal sleeve where the wire enters the block.

—Harry R. Carr, New Milford, N. J.

## Suspension Wires in Photo Work Smoked to Avoid Showing

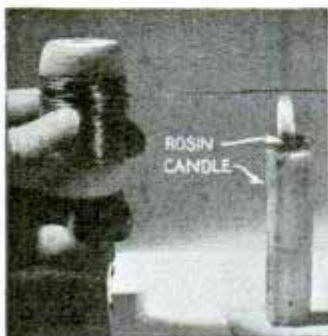

Wishing to suspend an object from wires against a dark background, one photographer covered them with black soot so that they would not show in the photo. This is

better than using paint, as the smoked surface does not reflect light and can be removed easily with a cloth. Small pieces of rosin placed at the base of a candle flame produce black smoke that adheres to the wires.

## Drip Catcher on Umbrella

No matter how much you shake an umbrella, after folding it when you come in out of the rain, there are always a few drops that run down on the floor. This water can be collected in the catcher shown, which is nothing more than a rubber spark-plug protector slipped over the end of the umbrella shaft.

—Frank Bentley, Clinton, Iowa.

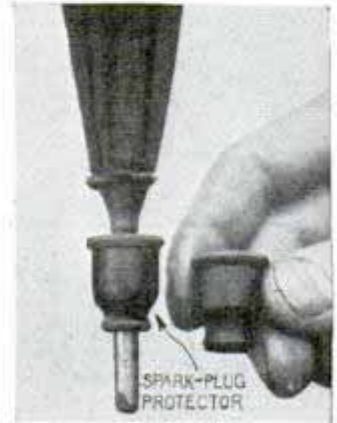

## Non-Skid Bottom in File Tray Keeps Folders in Position

Placed in the bottom of a file tray or file-cabinet drawer, a piece of corrugated cardboard will keep the folders from sliding along the bottom. You will find this idea especially handy in long file trays or cabinet drawers where folders tend to slip out of a vertical position.

—Ronald Eyrich, Milwaukee, Wis.

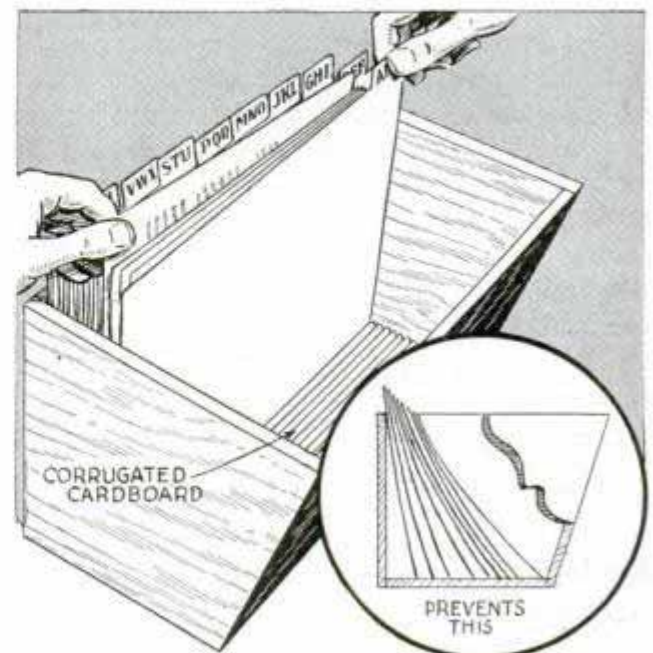



# *Fifteen Minutes to Build* **this ELECTRIC MOTOR**

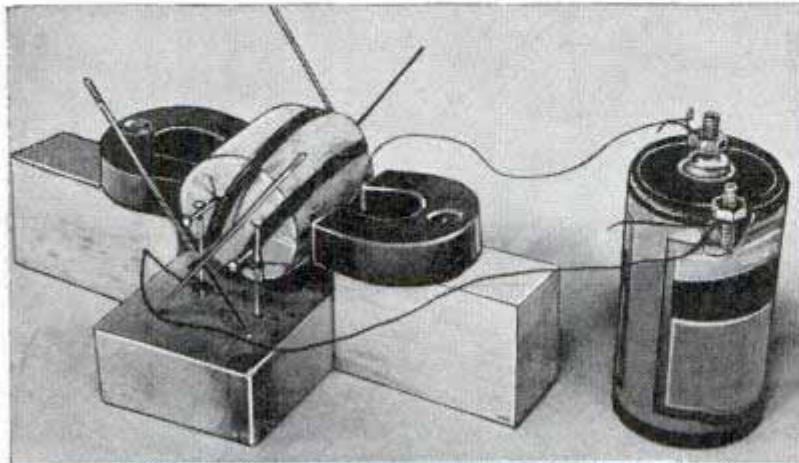

All ready to go! With horseshoe magnets acting as field coils a flashlight dry cell turns the armature at considerable speed.



By J. P. DRISCOLL

**Y**OU can make this tiny, simple motor from material available almost anywhere. If the motor has been properly assembled, a small dry cell of the flashlight type will provide sufficient current to run it at considerable speed. And, although the motor does not provide enough power to operate other toys, it is instructive to the junior electrician as it demonstrates basic laws of motor operation and will afford hours of fascinating play.

All you need is a large straight cork for the armature, two small horseshoe magnets to serve as the field poles, five darning needles for the shaft and shaft bearings, four pins to form a simplified commutator and brushes, twenty feet of No. 30 enameled magnet wire and three small wooden blocks.

The first step is to drive two pins into the end of the cork diametrically opposite each other on a line marked on the end through the exact center. These pins must be located the same distance from the edge of the cork to keep the latter balanced as much as possible. When the motor runs, the pins on the armature revolve in the space between two pins driven vertically into a block, and must lightly wipe against the latter to permit electric current to be

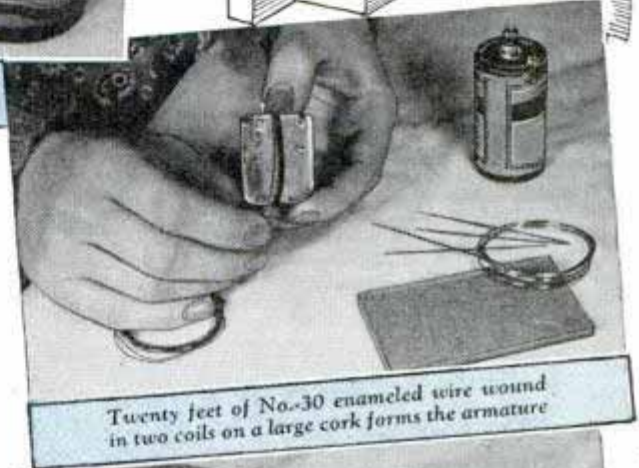

Twenty feet of No.-30 enameled wire wound in two coils on a large cork forms the armature



Here you see the two pins forced into one end of the cork to act as the commutator

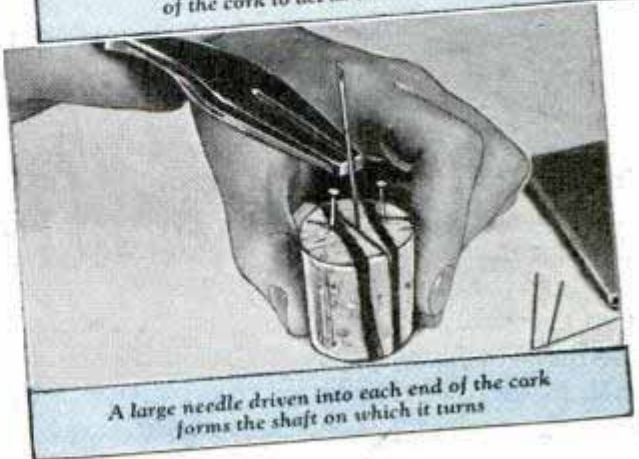

A large needle driven into each end of the cork forms the shaft on which it turns



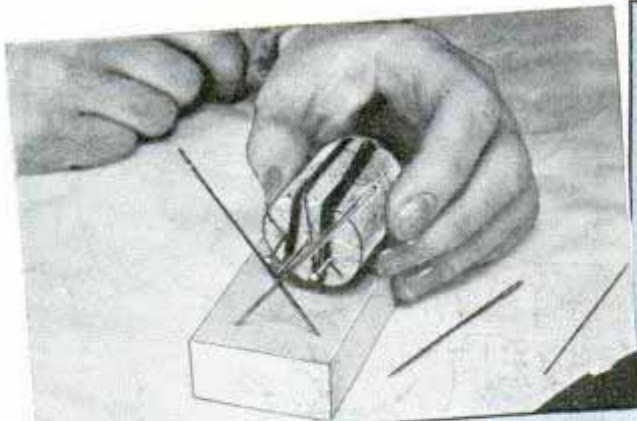

Simple non-friction bearings are made by driving two needles into the wood base at an angle

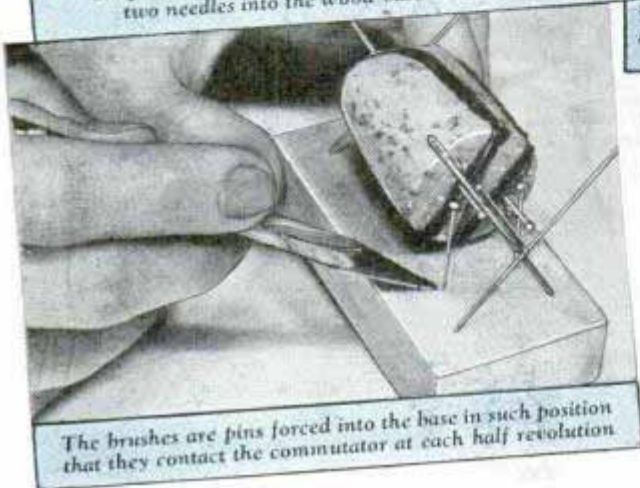

The brushes are pins forced into the base in such position that they contact the commutator at each half revolution

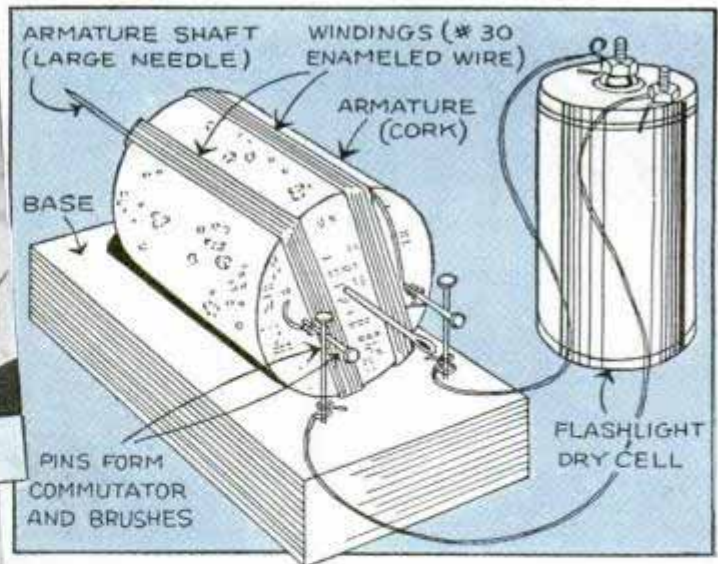

conducted to the armature winding, which is next wound on the cork in the position shown. Half of the wire is wound to form one coil, the wire is then crossed over and the winding continued in the same direction to form the second coil. It is important to get the same number of turns in each coil and to space the coils the same distance from the center of the cork in order to maintain balance. You can facilitate matters in this respect if you use a pencil and a ruler to lay off the location of the coils on both ends of the cork, just inside of the pins. Before winding, the end of the wire is scraped carefully for a distance of about one inch to remove all traces of the enameled covering. The cleaned end is wound around one pin to obtain good electrical contact and the winding is then started. Pushing a darning needle through the exact center of the cork as indicated, which can be done with a pair of pliers, provides the shaft and completes the armature assembly. Then two pairs of darning needles are forced into the armature support block to form bearings, each pair of needles crossing each other, making a crotch in which the armature shaft rotates.

The motor is now practically completed. You may snap a rubber band around the center of the cork to hold the coils in place as these might shift on account of centrifugal force when the armature rotates fast. Field poles are two small horseshoe magnets placed on wooden blocks set on each side of the armature. The pole faces of each magnet should line up parallel to the shaft and should be stationed as closely as possible to the side of the cork, allowing very little gap.

Before connecting the dry cell to the motor, you will have to examine and adjust the commutator and brushes. Only a slight wiping contact is required, and it is best to drive the brush pins lightly into the block so that there will be a little "give" when the commutator pins contact them. One dry cell is sufficient but greater speed is possible if two dry cells are connected in series. Direction of rotation is changed by reversing the connections to the dry cell.

## Locking Machine Screws in Place

A countersunk machine screw can be locked in place by forcing some of the surrounding metal into both ends of the slot with a sharp punch. You'll find this method more reliable than the conventional one of punching around the head of the screw.

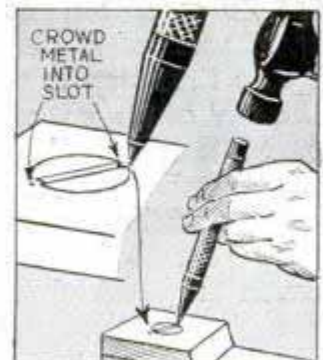



## Initialed Handles to Personalize Sewing Bags

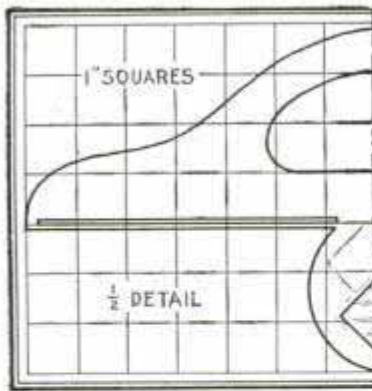

SUGGESTED DESIGNS

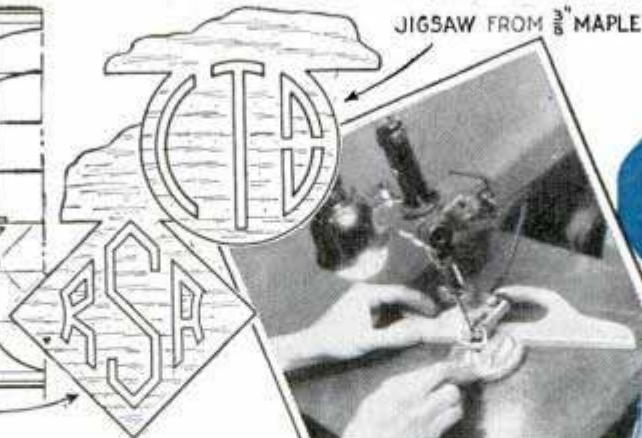

Your monogram or initials attractively jig-sawed in the handle of a sewing bag gives it a smart, personal touch besides making the bag more artistic in appearance. Although two suggestions on design are given, each combination of initials is different and must be worked out carefully on paper to suit the purpose and your particular fancy. Hardwood such as maple is preferred for the handle to give strength to the open letters. The fabric makes the initials stand out prominently.



## Bicycle Ramp above Porch Steps Is Swung Out of the Way

Where bicycles are kept on a porch, children will find it easy to take them up or down the stairs if a plank is provided to serve as a ramp, which reaches from the

porch floor to the sidewalk. It is pivoted at the upper end by means of an L-shaped rod, which fits in a pipe bearing fastened to the underside of the board by means of pipe cleats as shown in the circular detail. The other end of the rod pivots in a cleat fastened to the side of the porch just below the floor boards. This arrangement allows the assembly to be swung against a porch post, out of the way.



## Wire Tightened with a Bolt

To tighten a strand of wire when no tool is at hand, run a couple of nuts on a long bolt, so that the space between them will be a little wider than the diameter of the wire to be tightened. In use, set the nuts astraddle the wire and give the bolt a twist to one side.

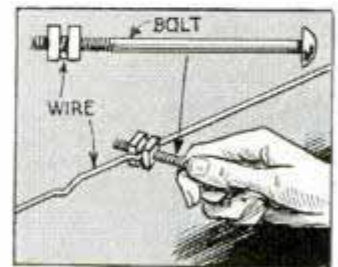



## C-Clamp Handles Easily Applied to Empty Oil Drums

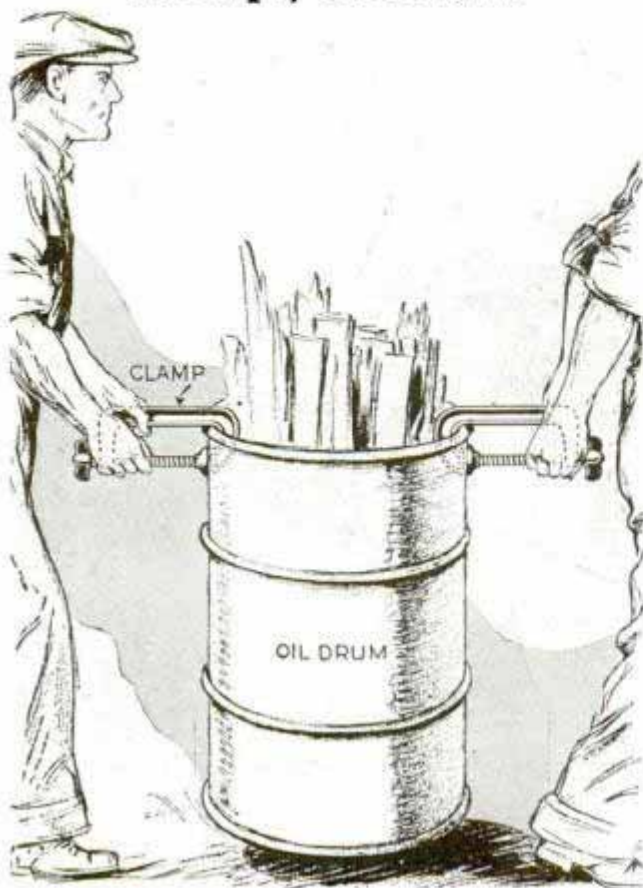

When using an empty oil drum to carry wood and other materials around the home, I apply a couple of large C-clamps to serve as handles so that two men can carry it conveniently. The clamps are fitted over opposite sides of the drum as indicated. This method, of course, is only suitable when the weight of the drum is not heavy enough to spring the clamps.

—Roger W. Lindemann, Chicago, Ill.

## V-Blocks from Angle Irons

Amateur craftsmen and others who have need of V-blocks, and accuracy is not critical, can assemble inexpensive ones from

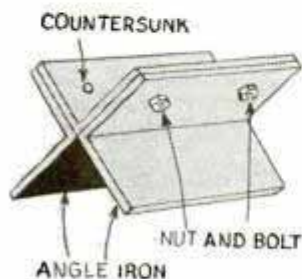

angle iron. Three pieces are needed for each block, which can be made any length desired. Assembled with small bolts, the irons are fastened together so that their vertices come together as indicated, the screw heads being countersunk. If the fillet of

the angle iron is too pronounced, as is usually the case, use the vee formed by the junction of the three pieces.

the angle iron is too pronounced, as is usually the case, use the vee formed by the junction of the three pieces.

## Tripod Support Made Rigid with Spring

Here's a simple way to improve tripods that have friction braces, which often slip out of place when the tripod is moved slightly. A small coil spring is fastened to the brace

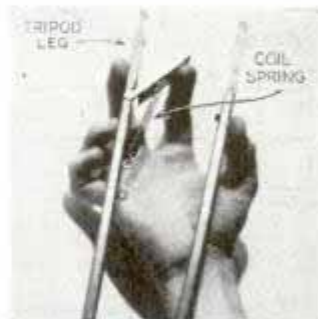

at one end and to the tripod leg by means of a screw eye at the other as indicated in the photo. This idea is especially handy for newspaper photographers who keep their tripods assembled most of the time.

## Pocket Case for Pin Drills

Small pin drills that are likely to be lost can be stored in an empty lipstick container, which permits them to be

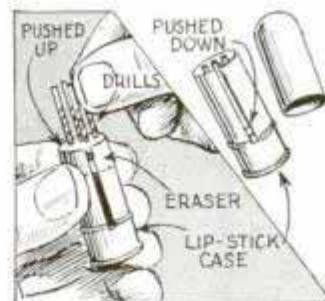

carried in the pocket if desired. The sliding cup inside of the container is fitted with a piece of soft eraser. Pushing up the cup to the top

of the container allows you to select any drill, after which you drop the cup back and apply the cap.

—Arnold Rauschwald, New York, N. Y.

## Emergency Wrench from Bolt

A wrench for small nuts may be made by bending the threaded end of a bolt as shown. If the wrench is to be used any length of time, run the threads well back toward the head and then flatten the end.





# Roll Film Is Gripped in Jaws of This Washer

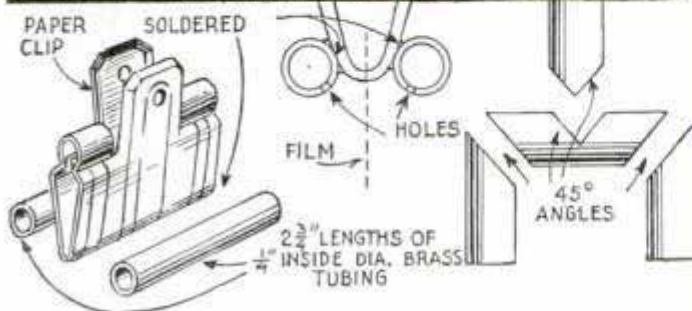
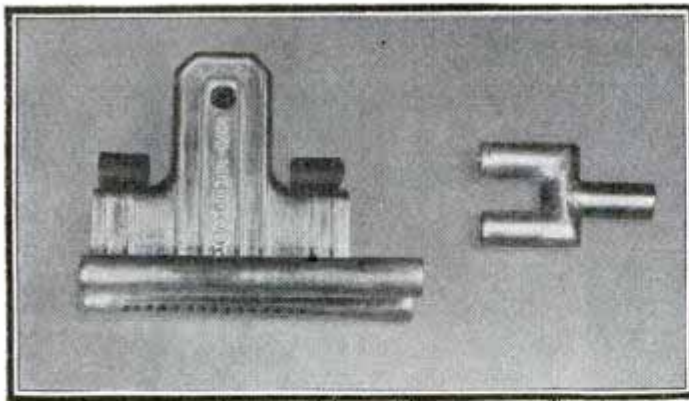

Gripping the film between its spring jaws, this washer is very handy, especially for the smaller sizes of film. Perforated with a row of  $\frac{1}{16}$ -in. holes spaced about  $\frac{1}{16}$  in. apart, two spray nozzles on the jaws direct a smooth sheet of water down each side of the film. A rubber tube connects to a near-by water faucet by means of an

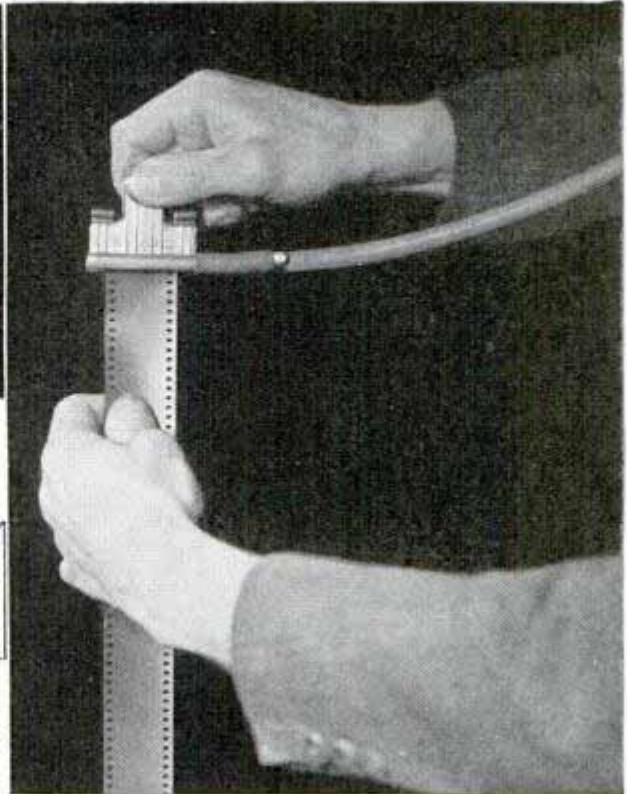

adapter. In this particular case the spray nozzles were connected to a Y-fitting with short lengths of rubber tubing. Besides being portable, this washer takes very little space when it has to be stored.

## Ice-Fishing Semaphore Shifts Balance When Line Is Pulled

Many ice-fishing signals move or wag only when the fish jerks at the line and

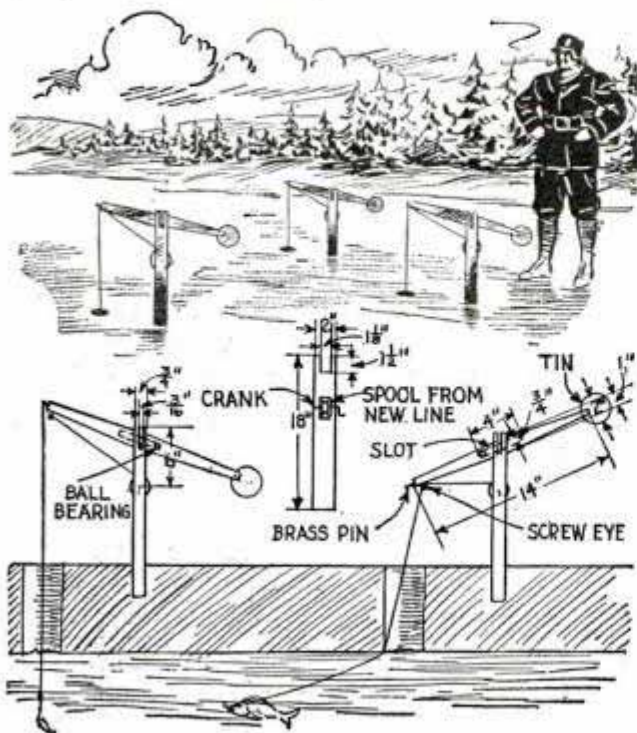

then return to their normal position. This one, however, continues to show that there has been a bite, even after the line has again become slack. A 1-in. crossarm having a numbered tin-can lid at one end, is pivoted in a balanced position on a vertical support, which is driven into the ice. A slot is cut in the center of the crossarm to take a steel ball, which should be free to roll in the slot after two pieces of sheet metal are tacked on either side to retain it. A spool to wind up the line is fitted in a cutout in the vertical piece, and the line is threaded through screw eyes as shown. When the fin end of the crossarm is pushed down, the ball rolls toward this end and its weight keeps the crossarm in this position. When a fish tugs at the line, the other end of the arm goes down so that the ball rolls toward the latter end and keeps the crossarm in this position.

—Cedric A. Wells, W. Allis, Wis.



# Faster than the Wind



All set!

By  
THOMAS P. LAKE

**E**IGHTY miles an hour with a 20-mile breeze is almost commonplace in an iceboat with only 75 sq. ft. of sail—little more than a sailing canoe might carry. It is only the resistance of the air on mast, rigging, sail and hull that prevents even greater speeds. Yet the craft is not at all difficult to handle if you know the methods used by veteran iceboaters.

Assume that the iceboat, Fig. 1, has been assembled and rigged. Your first job will be to hoist sail, taking care to obtain the correct tension on both luff (the edge of the sail adjacent to the mast) and foot (the edge adjacent to the boom). Sufficient pressure is placed on the halliard (the rope by which the sail is hoisted) just to bring out a few vertical wrinkles in the canvas near the mast. This slight stretching is essential, for it will be

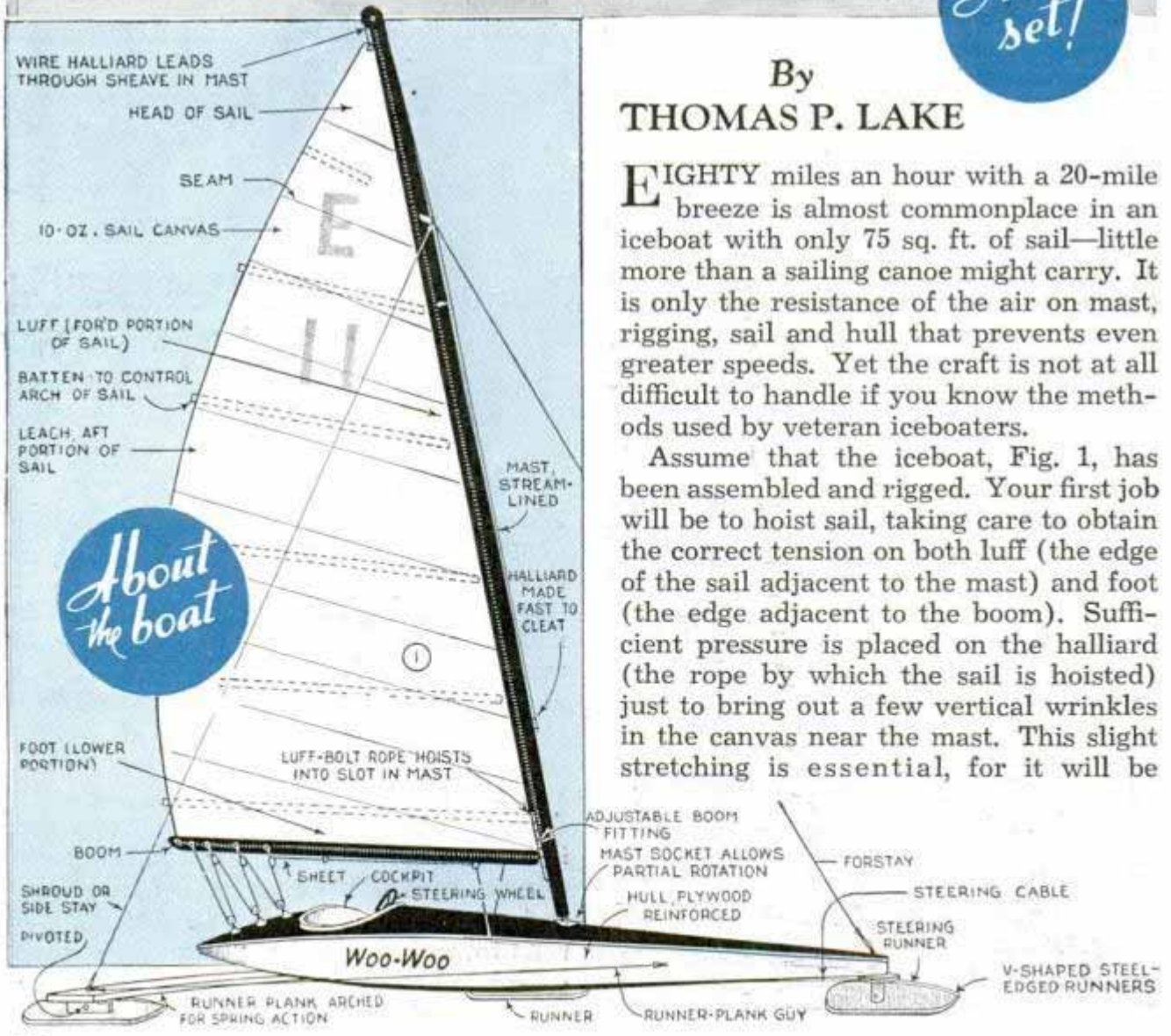

About the boat



# in an ICEBOAT!

Easy-to-follow technique on sailing an iceboat told "in a nutshell" so anyone can become adept — how to hoist sail, take off, tack, gybe, control sail for speed, stop and other maneuvers

equaled later in the opposite direction by the effect of the wind, and the sail then will be smooth. The foot of the sail should be similarly stretched for the same reason. However, care should be taken to avoid overstretching.

Before you hoist sail make sure that the boat is headed directly into the wind, Figs. 2, 3 and 4, and the sheet (the rope used to control the sail) is slack so that the sail can swing back and forth as the puffs of wind vary in direction. This will prevent the boat from sailing away with no one on board. Having hoisted sail, you are ready to go. Assume that in this case the breeze is from the north and blowing about 10 m.p.h., the



ice is smooth and free from snow, and you are to make the first run to the west, directly across the wind. Take hold of the steering wheel, or lever and push the boat forward, at the same time turning it to head west as in Fig. 6. Holding the sheet in one hand, you now take this in until the sail makes an angle of about 15 degrees with the boat. Then push against the cowlings, run a few steps, and, when the boat is moving briskly, jump into the cockpit as in Fig. 5.

The boat immediately picks up speed and is soon moving at about 20 m.p.h. You will discover that it takes very little effort to keep the boat headed in a straight line. The sail makes a smooth curve from the boom to the masthead. If you let a foot of the sheet slide slowly out, the boom moves out correspondingly. The sail makes a deeper curve, and at the same time the speed of the iceboat is reduced noticeably. If you take in the same amount of sheet the boat



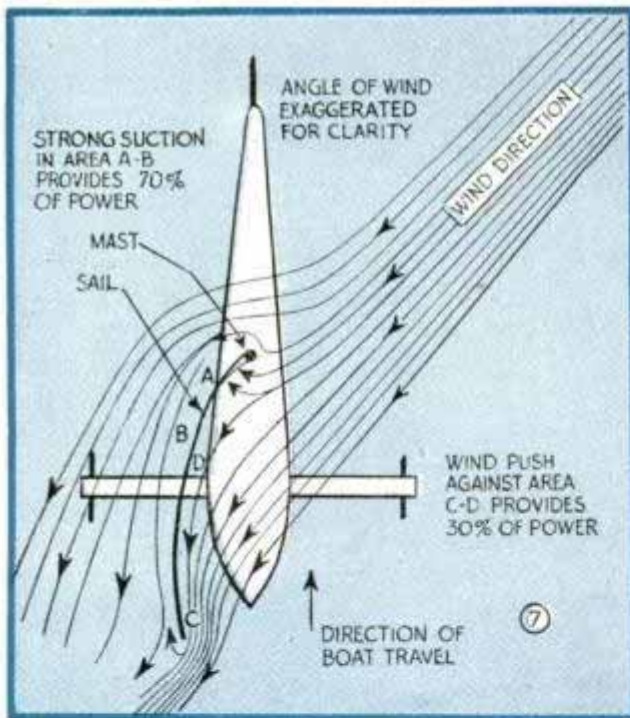
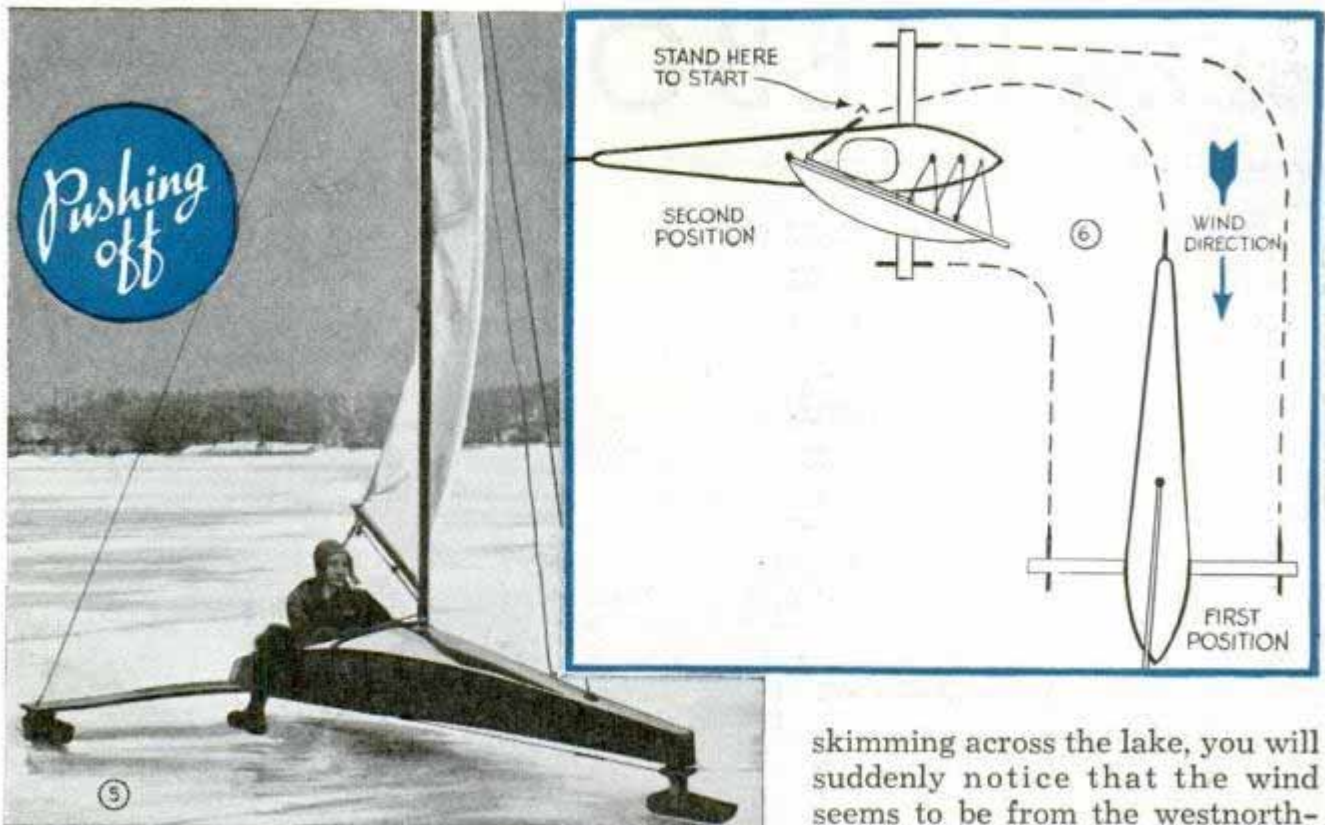

immediately regains its original speed and if the sail is additionally trimmed by taking in several more feet of sheet it becomes noticeably flatter, and the speed will increase to about 30 m.p.h., Fig. 7. From this it would appear that trimming the sail makes the boat go faster, but when you take in the sheet still more the speed immediately decreases, which proves that the sail can be too flat, as well as too slack. The trick is to keep the sail at the point of greatest driving power. While you're

skimming across the lake, you will suddenly notice that the wind seems to be from the westnorthwest, some 65 degrees west of north. This is what sailors term the "apparent" wind as distinguished from the true wind, Fig. 9, and is due wholly to the speed of the craft.

Now, just about the time you settle back to enjoy the thrills, there is a sudden acceleration of speed and the windward runner lifts off the ice as in Fig. 12. A puff of wind has struck the sail, tipping the craft to leeward. While this is disconcerting to the novice, it's an old story to the veteran. He simply lets a few inches of sheet slide through his hand, thus decreasing the power in the sail, and the runner settles back to the ice. Then he re-trims his sail.

By this time you are probably approaching the far side of the lake and you want to make a 180-degree turn and head back toward the starting point. This may be done in either of two ways, Fig. 10: turning into the wind, called tacking, or turning away from the wind, called gybing. We tack by turning the wheel until the boat begins a gradual turn into the wind and by holding the wheel in this position until the turn is completed. When the boat is headed into the wind, the sail shakes violently for a moment, as it is then in the position of a flag in a strong wind.

Having made a turn by tacking, you will want to try one by gybing. Turn the boat so as to make a curve downwind and then



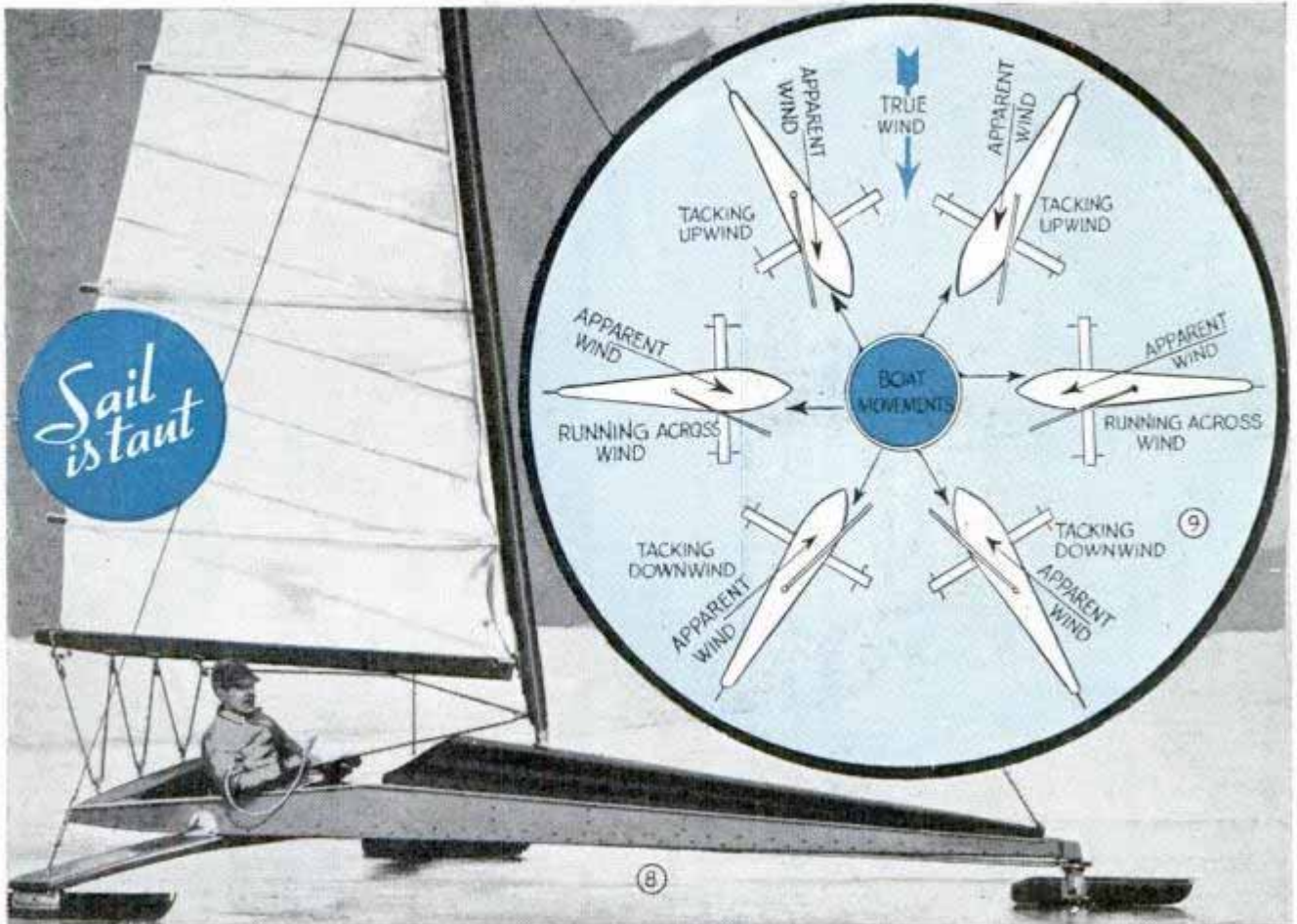

hold the steering wheel in this position. When the boat has swung 90 degrees, and is momentarily headed directly downwind, the sail shakes less than when tacking. This is because the speed of the wind is subtracted from the speed of the boat, instead of added to it as when tacking. Continue the turn, and when the wind strikes the sail on the other side, the speed lost during the turn will be regained rapidly.

About this time it will occur to you that sooner or later you will want to stop. Fig. 11 shows what to do. Recalling what happened when tacking you again turn the steering wheel and head the boat into the wind. When the sail flaps, indicating that it is not effective as a driving power, simply straighten the steering wheel and the boat will coast easily to a stop right into the wind.

Now that you can start, stop and sail across the wind, the next problem is how to sail the iceboat to a point that lies directly upwind. The ten-mile breeze is still blowing from the north, and the place to which you want to go is several miles directly north. As before, push off across

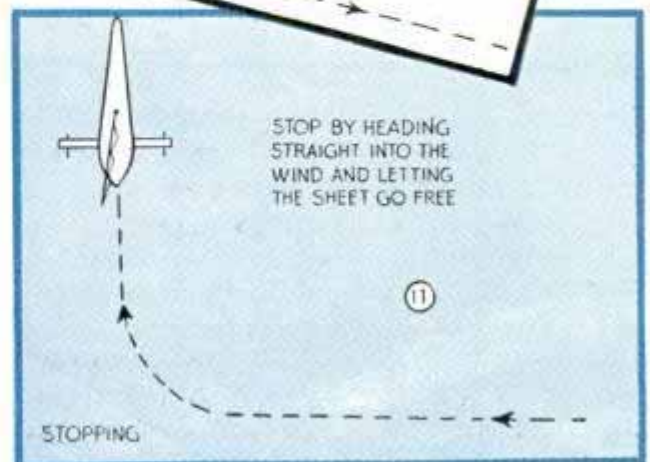
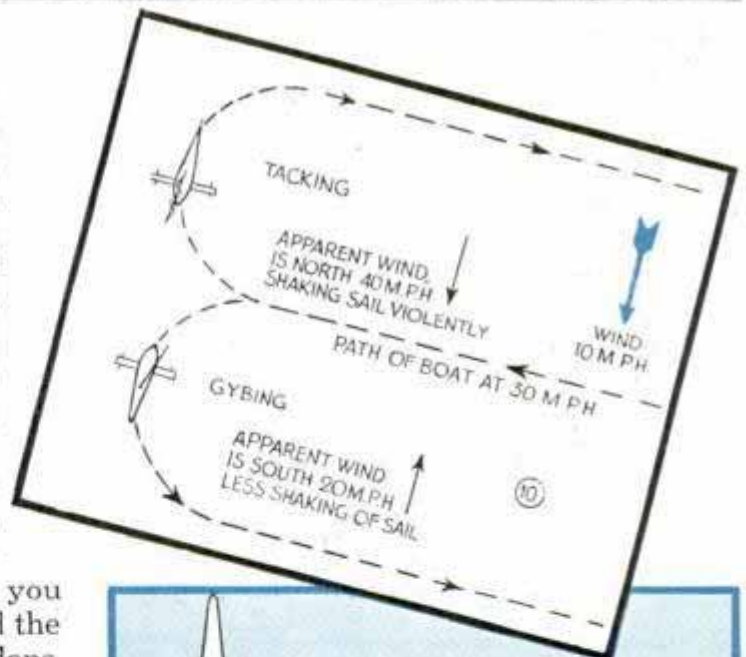



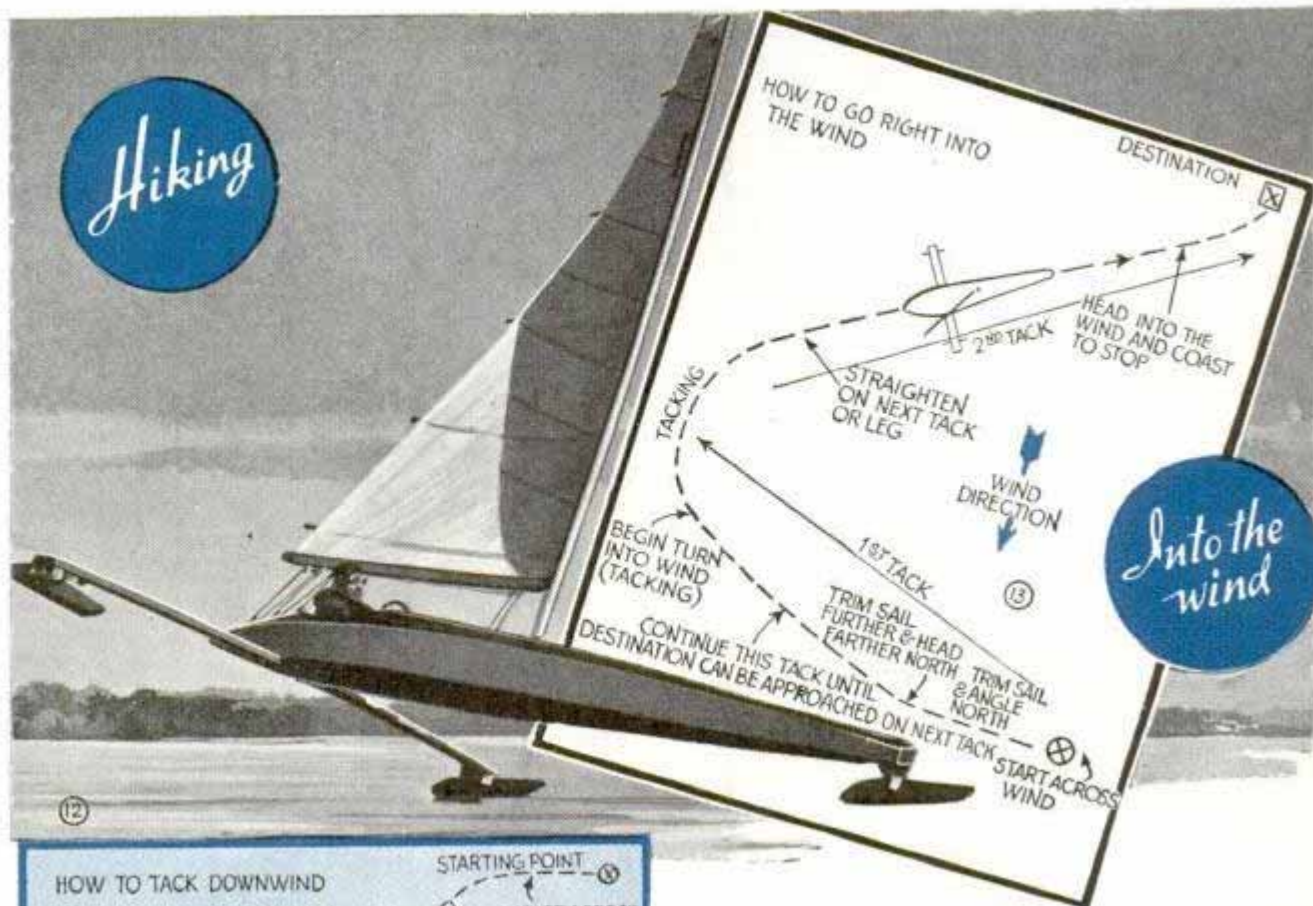

the wind, Fig. 13, but this time, instead of sailing due west, let the boat gain speed and then trim the sail flatter by stages to bring the boat closer and closer to the wind. By the time you near the end of the first tack, the boat should be headed nearly due northwest and traveling almost as fast as when going across the wind. Now turn or tack ship as indicated in Fig. 13, and take the wind on the other side of the sail. In this case only two tacks or legs are nec-

essary to arrive at the destination, but often it is necessary to tack several times in order to reach a given point.

Having arrived at the windward destination, you will want to return down wind, Fig. 14. Start out across the wind to get up speed. A rather common error, that of heading directly downwind, is also shown in Fig. 14. Even though you let out the sheet until the sail is at right angles the boat will drift along at a slow, dragging pace. Obviously this is not the way to get to leeward (in the direction in which the wind is blowing). To correct the error, head the boat across the wind again and trim in the sheet to gather way on the diagonal course. After getting up speed, change the course about 15 degrees toward the south, or a total of 105 degrees from the true wind. Immediately you do this there will be a quick but smooth acceleration in speed for you are now on the point of fastest sailing for iceboats. Covering a mile will be a matter of seconds. To make the best southerly progress, head 30 degrees farther south, or a total of 135 degrees from the true wind. Should an unusually strong puff of wind strike the sail, and the windward runner lift several feet from the ice, you can ease



the boat back to an even keel by changing the course a little more downwind. As you run out of the puff, the speed will again fall off unless you come back on the original course. Having run to a point nearly opposite the downward destination, you gybe, take the wind on the other side of the sail for a stretch, then turn left, right into the wind and coast to a stop. There you have the rudiments of sailing an iceboat. Of course, practice will develop skill in the finer points necessary in competitive sailing and winning races.

### Graphite on Rubber Type to Set It Easily

If your work requires the use of a grooved wooden block in which to set up rubber type, or if you have a rubber stamp on which the date must be changed daily, and you have trouble inserting the type during damp weather, a little flake graphite may solve the problem. Keep a small amount of it handy and when you pick up the type with tweezers, just dip it in the graphite and you will find that it slips into the holder without any trouble.

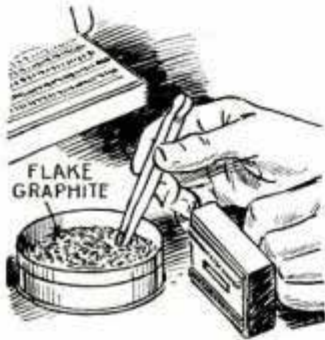

### Stretcher Holds Articles Taut While Drying

Belts for dresses, and various other articles that must be held taut while drying, can be handled to good advantage in this simple stretcher. Two mousetraps are screwed to a base and the articles to be dried are attached to the spring jaws of the traps as indicated in the photo.

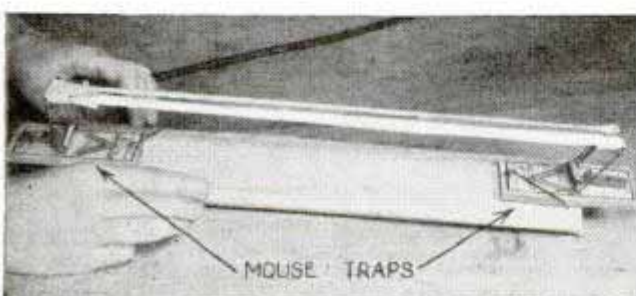

### Egg Tester Made from Lamp with Hole in Shade

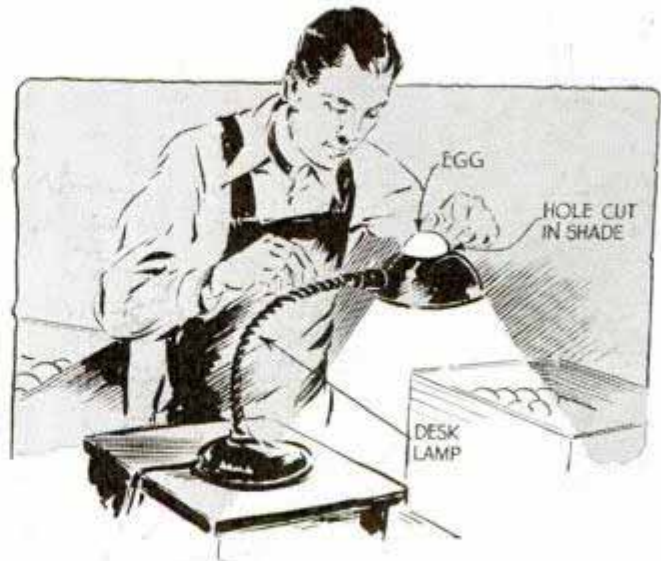

To test eggs in his produce room, and at the same time have sufficient light for packing, labeling, etc., one merchant employs a desk lamp with a suitable hole cut in the center of the shade. The eggs are passed over the opening in the reflector for rapid candling.

### Pictures and Paintings Framed with Tongue-and-Groove Stock

Needing frames for some paintings that I had just finished, I assembled them from tongue-and-groove stock. After ripping the stock through the center, the parts of each frame were mitered and sanded. The piece of stock containing the tongue was used for one frame as in Fig. 1, the tongue serving as a molding against which the painting was placed. On the piece containing the groove, one side of the latter was cut away, after which it was mitered and assembled as shown in Fig. 2, the cut-away portion of the groove being used as a molding to hold the painting in place in the frame.

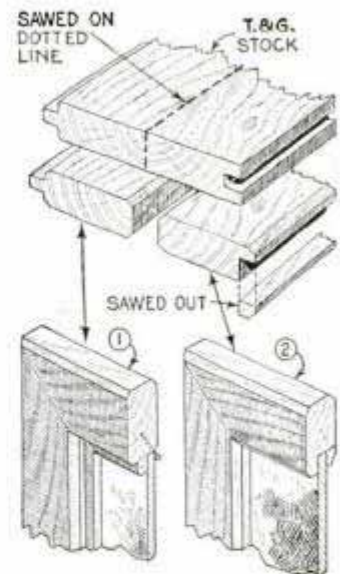

—A. Jorgensen, Berkeley, Calif.



## Non-Slip Guide for Glass Cutting Has Rubber-Coated Surface



Keeping a ruler or straightedge in place when cutting glass for picture frames, windowpanes, etc., is a simple matter if the back of the straightedge is given a coating of rubber cement. One coat of cement is sufficient and only occasional applications are necessary as the cement, slightly tacky, remains on the surface under continued usage unless it is rubbed off.

## Jig to Tape Lantern Slides

Both amateur and professional photographers who have a number of lantern slides to tape will find this jig a timesaver. Just pull out the tape onto the base of the jig, set the slide on top of the tape and roll it forward until all four sides are covered, pulling the thumb and index finger along the edge of the slide as it is rotated, to press the tape into place. The jig consists of a base on which is mounted a bathroom paper holder carrying two rollers, one at

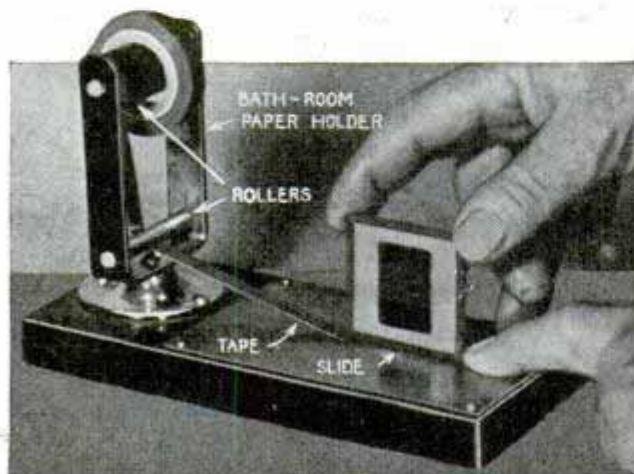

the top to hold the tape roll and a smaller one near the bottom under which the tape is fed. If a paper holder is not handy, one can be made by bending a piece of flat iron to a U-shape and fitting it with a couple of rollers. The working surface of the base is covered with a piece of glass or sheet metal which is screwed, nailed or cemented in place.—Clifford B. Paul, Moline, Ill.

## Tubing Sawed Off Neatly When End Is Plugged

The next time you have a piece of tubing to saw off, drive a dowel or a piece of round wood tightly into the end as indicated. This will help prevent the teeth of the saw from catching on the thin edges of the tubing. Also, the wood plug aids in cutting straight across the tube. If the plug is long enough to reach beyond the jaws of the vise in which the tube is held, it will tend to prevent crushing by too much pressure on the vise jaws.

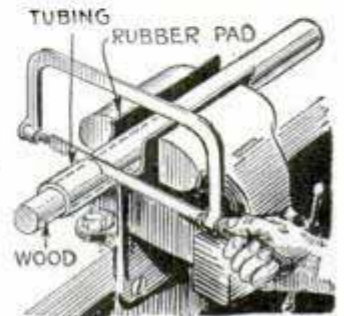

## Insulating Terminal Posts on Electric Motor

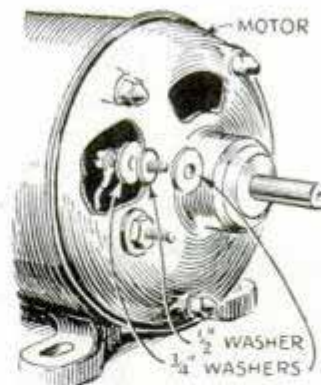

Faced with the problem of effectively insulating terminal posts installed on an electric motor, the job was done as follows: Two 1/2-in. holes were drilled through the housing to take fiber faucet washers, after the brass machine screws with fiber washers under their heads were passed through them. Similar washers on the outside completed the assembly as indicated. The spacing washers must be somewhat thinner than the wall of the motor housing to permit tightening.

Indelible-pencil stains should be rubbed with denatured alcohol, then after about five minutes, rinsed in a mild soapsuds.



# NEW CAGES *for* CANARIES

OF THESE four new designs in canary cages, there may be something to suit your fancy; your choice may be the small one at the right, which has pleasing curves at top and bottom, or it may be a larger one that fits a bay window or can be built on a porch, and really makes quite a display of your pets. In this one which is shown below, the effect of confinement, which is to some extent objectionable, is greatly minimized by using fine piano wire. Other cages of an especial novel nature are the cylindrical type, and the one mounted on a shelf with space for a potted plant on each side. Both are shown on the next page.

The first cage, as you see, is mounted flat against a wall and is made of wood except the top and bottom, which is sheet metal. The front and ends consist of dowels set in a frame which is attached to a plywood back and floor. A scalloped sheet-metal skirt is tacked around the edge of the floor. A paper floor covering can be inserted or removed from one end.

The cage below is large and accommodates a number of birds. There's easy access to the inside through two glass doors. The piano wire over the curved center section is strung through holes drilled in lengths of angle iron or brass at the top and bottom. To maintain uniform tension on the wire regardless of temperature changes, it is brought over short pieces of iron rod laid on the top angle iron, and is

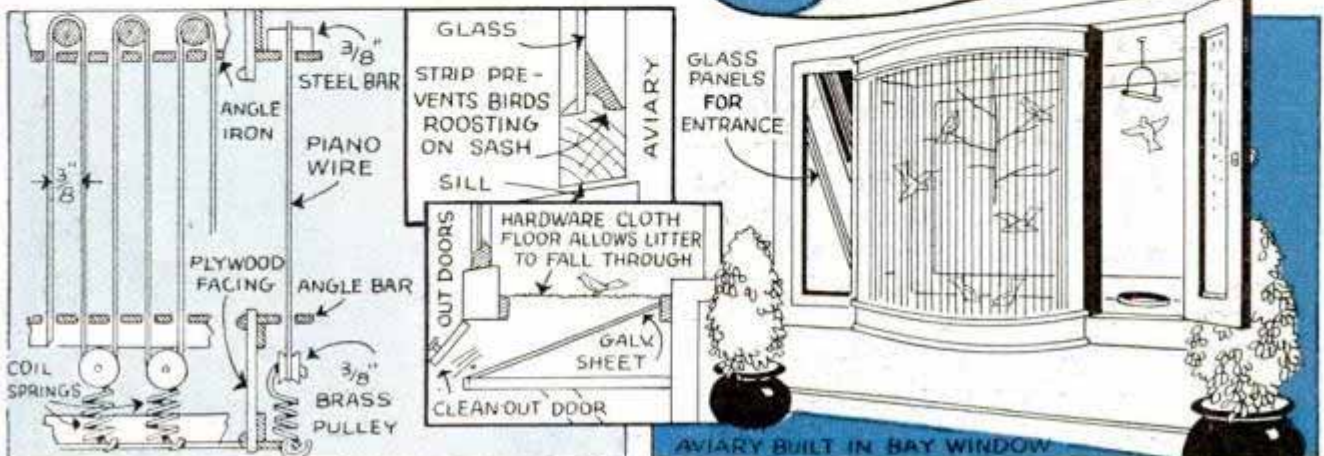
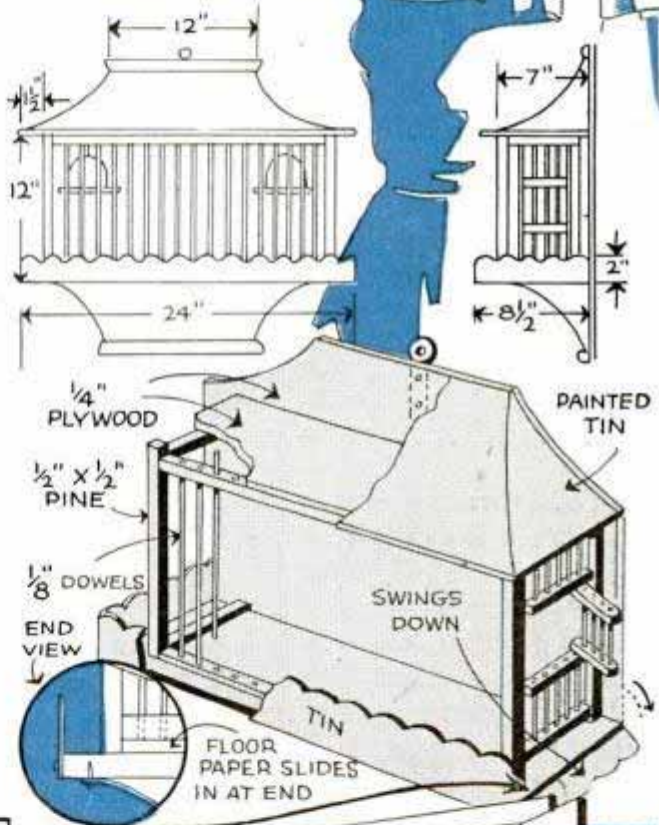



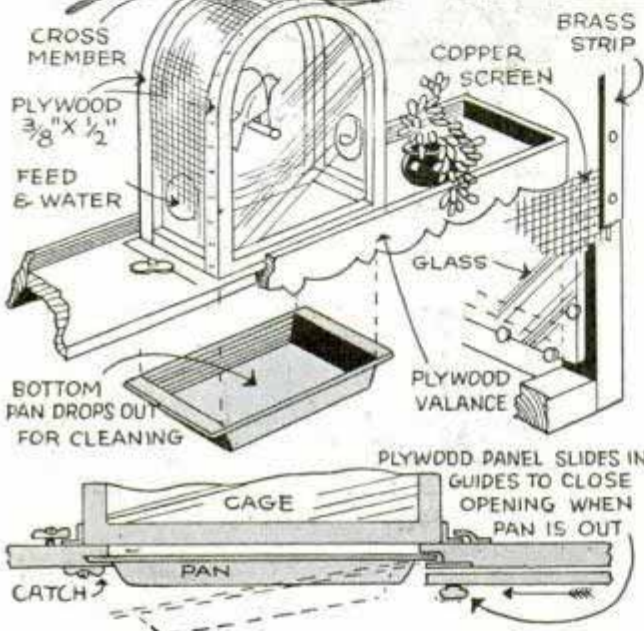
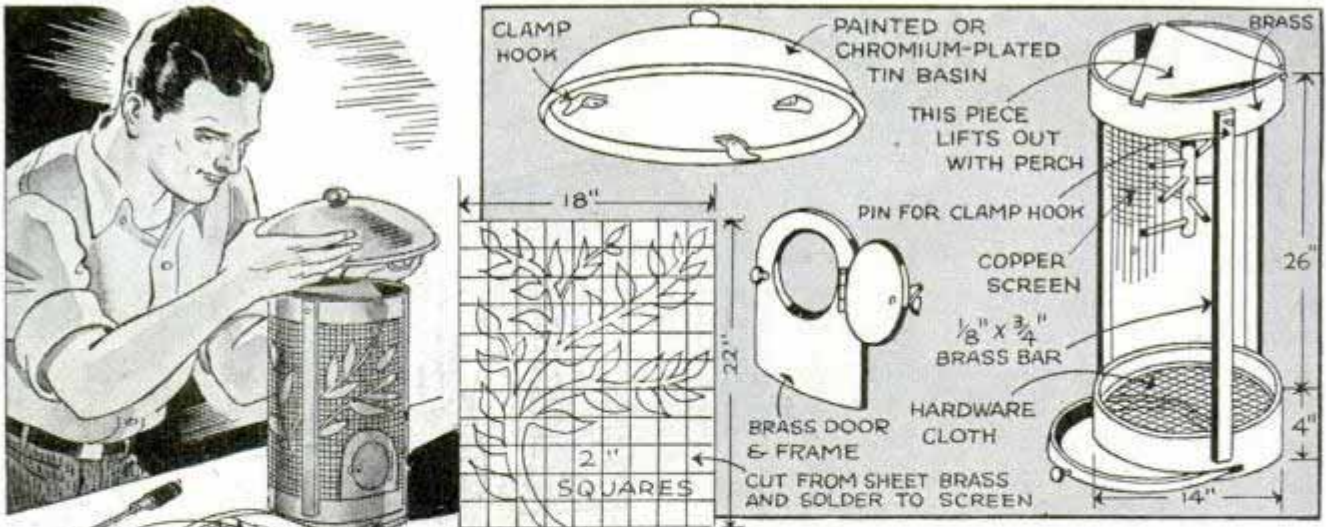

an attractive scalloped edge puts the finishing touch on the shelf. The lower detail shows how a removable pan is set into the bottom to catch the litter. A small plywood panel is provided to cover the opening while the pan is removed for emptying and cleaning. The detail also shows how both the cage and pan are attached to the bottom by means of L-shaped brackets and small turnbuttons.

**Stakes Driven without Splitting**

Splitting tent stakes when driving them can be overcome if you use a piece of hose, notched as shown, as a bumper. A piece of auto-radiator hose, which can be picked up at almost any filling station, is tough and will withstand considerable hammering.

threaded through small pulleys attached to short springs at the bottom. A hardware-cloth floor permits litter to drop through onto a sloping galvanized sheet from which it can be removed.

Finished in burnished brass and copper, and with some chromium-plating, the cylindrical cage is a striking piece of work. The frame is made entirely of metal over which copper screen wire is stretched. A removable metal dome sets off the top in a pleasing manner. The bottom of the cage is covered with hardware cloth, under which is a sliding tray so that litter can be removed without unduly disturbing the birds. The tray slides in a slot cut halfway through the circular frame member of the bottom.

The fourth cage is mounted in the center of a shelf providing space on either side for plants. The cage has a glass front, and screen-wire sides which converge into a rounded top. A plywood valance having





# Wood Penguin Waddles in Lifelike Manner

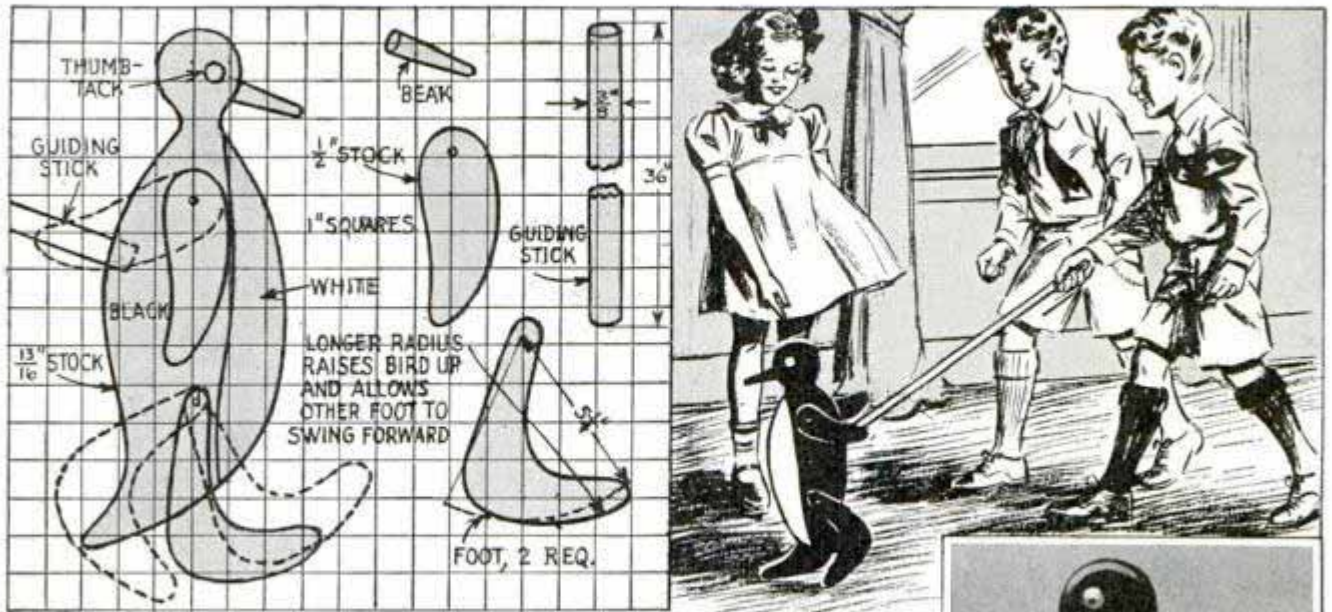

Although he's remarkably realistic in color, size and also in his manner of getting about, this penguin is made of wood and is pushed with a stick. Body and head are shaped from one piece of  $\frac{13}{16}$ -in. plywood while the wings and legs, or feet, are separate parts cut from  $\frac{1}{2}$ -in. material and pivoted to the body. The curve of the feet is the important thing as it is this curve which allows the penguin to walk in a lifelike manner. Of course, the feet must be pivoted so that they swing freely. This is done by drilling an oversize hole in each leg for a round-headed screw. A thin washer is placed over the screw between the leg and the body and also under the screw head. The wings can be pivoted in the same way.

—Dick Hutchinson, Ithaca, N. Y.



## Extension Wire Finder Assures Sharp Focus for Close-Ups

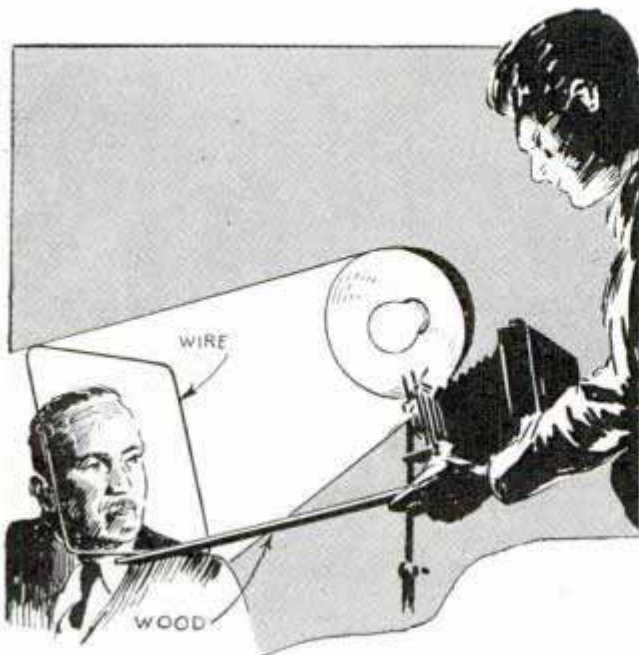

Here's a quick way to focus sharp when taking close-ups with a folding camera which is not fitted with a ground glass. The camera must be mounted on a tripod and the latter provided with a screw long enough to pass through a strip of  $\frac{1}{4}$ -in. pine and turn into the threaded camera socket. Then a wire finder, the dimensions of which are proportional to the size of the film, is mounted on a  $\frac{1}{4}$  by 2 by 36-in. length of pine. Camera and finder are now mounted on the tripod, and a strip of waxed paper is stretched over the opening at the back of the camera. After bringing the wire finder into sharp focus the tripod screw is tightened. In use, the frame is placed about the subject, the points at which the sharpest focus is desired being in exactly the same plane as the wire frame.



## Safelight to Inspect Photo Prints in Your Darkroom



Suspended above the hypo tray, this safelight will enable you to inspect immersed prints without removing them from the trays and carrying them outside if it is not desired to turn on other lights in the darkroom. Two telescoping cardboard tubes comprise the shade, which has a wood ring screwed or bradded into one end of the smaller tube. The ring fits over a two-piece porcelain receptacle, and a thin fiber or Bakelite ring, screwed to the wood one, fits between the parts of the receptacle. A feed-through switch is fitted just above the lamp.

## Marking Gauge Improvised from Clothespin

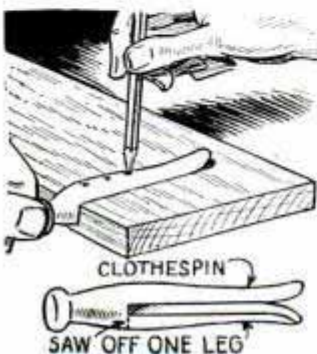

When a marking gauge was needed and none was at hand, I improvised one from a common clothespin. One leg was cut off to form a shoulder to ride against the edge of

the work, and holes were drilled at predetermined distances to take the point of a lead pencil.

—Wayne C. Leckey, Aurora, Ill.

## Split Wedge on Hammer Handle Holds Securely

Before driving a steel wedge into the end of a hammer handle cut it with a hack saw as indicated. Then the edges will flare out when the wedge is forced into the wood so that there will be little chance of it working out of the handle.

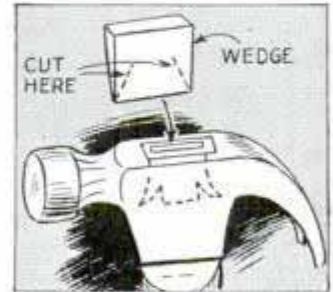

## Blowtorch Set on Flanged Plate Cannot Tip

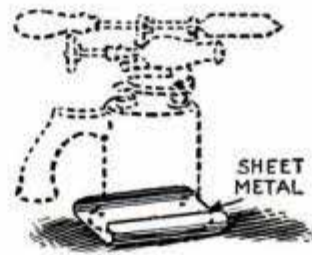

When placing heavy soldering irons on a blowtorch, and it has a tendency to tip, just tack a small plate of sheet metal with flanged edges to the bench top. Pushing the blowtorch base under the flanges will serve to anchor it securely and avoid mishaps.

## Legs of Dividers Protected by Pencil Ferrules

Ferrules removed from old lead pencils, after the rubber eraser has been worn down to the metal, provide handy protectors for the ends of dividers and compasses. The pointed ends of the legs are pushed into the rubber as shown.

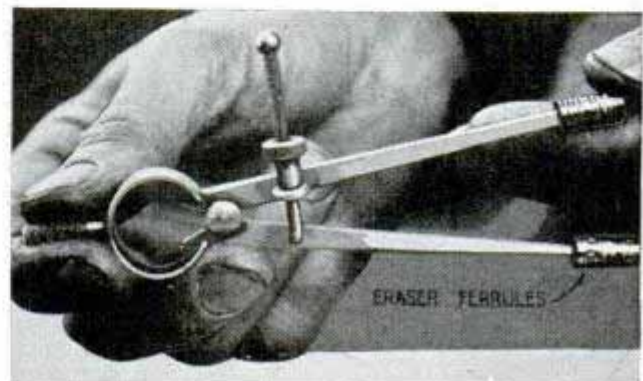



*Stebbins Hardware  
15 W Van Buren  
Chicago*

# This modern VANITY gives four combinations

By WALTER T. WARDE

THE charm of this combination vanity lies not only in its smart modern lines, but also in the fact that at a moment's notice it can be changed to four different pieces of furniture as you see in Figs. 1, 2, 5 and 6. By loosening the clasps on the back, the vanity can be altered to a chest of drawers and a low table or to a pair of bedside cabinets and a table. To the woman who likes to change the appearance of the room occasionally, such an advantage will make a definite appeal. Colored plastics are used for the tops of tables and cabinets and for the handles. Polished

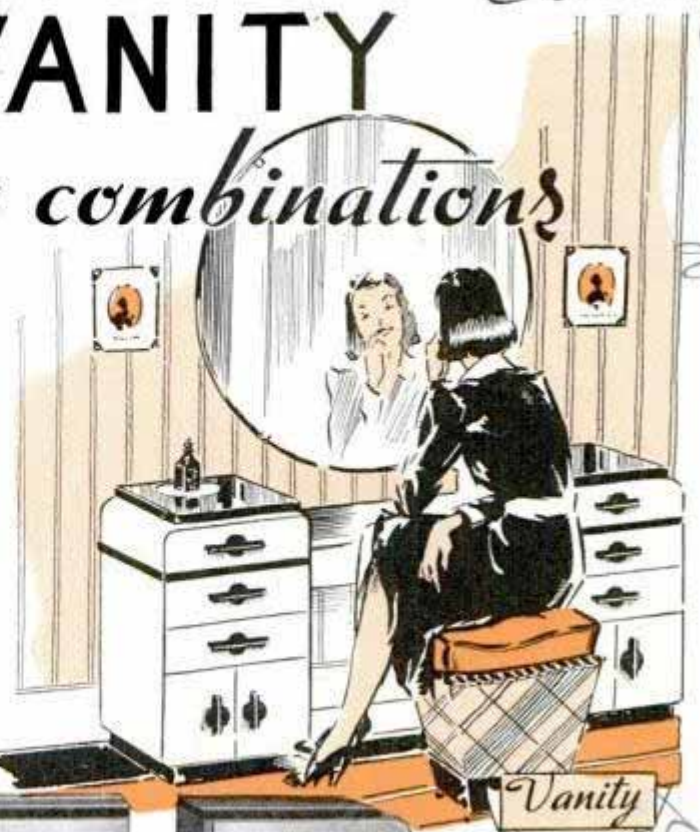

Vanity ①



Bedside Tables ②

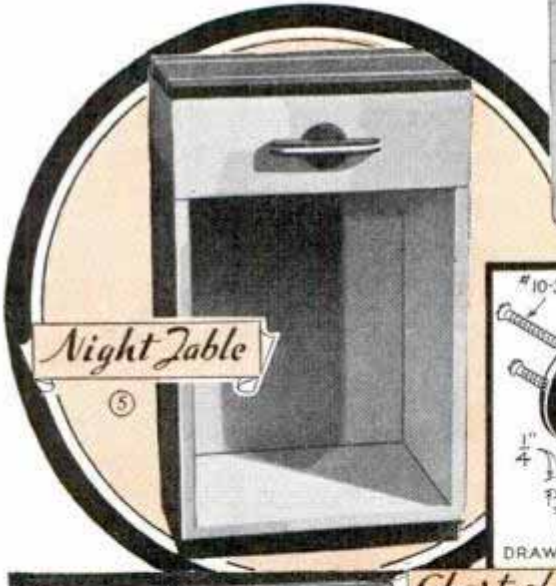

Night Table ⑤

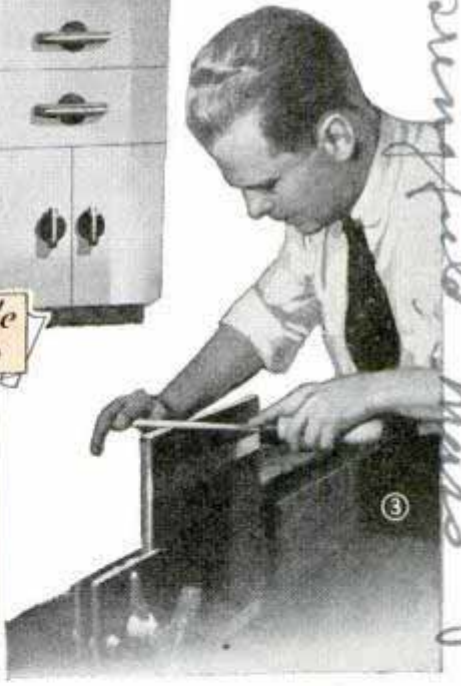
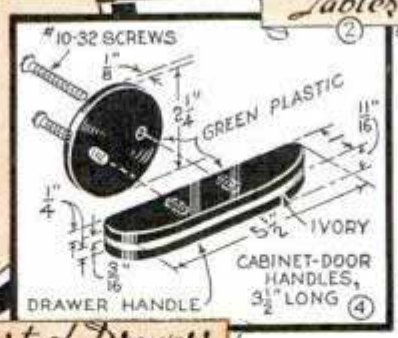

③



Chest of Drawers ⑥

aluminum bar makes an attractive overlay trim. The color scheme is ivory and jade green. Plastics used on the tops are green with an inlay of ivory. The same combination forms the handles, the colors being laminated together as in Fig. 4.

The cabinets are made first of 1/2-in. pine or birch plywood, glued and screwed together. As you will see from Figs. 7, 8 and 10 these are of very simple construction. All parts of the cabinets are first cut to dimensions, Fig. 8, and the sides grooved to ac-

*Stebbins Hardware, 15 W Van Buren, Chicago*





commodate the drawer runners, Fig. 9. Center guides also must be installed as in Fig. 10. Finally the top and bottom corners are rounded and then sanded smooth as in the lower-right detail, Fig. 8. Any imperfections in the wood and all nail holes are

filled with plastic wood and again sanded smooth. The next job is the base which is also of 1/2-in. plywood. It is glued and screwed to the cabinet. Furniture glides or sliding casters are attached to the base. Additional wood fillets are then glued back of the rounded corners to strengthen the joint, Fig. 8. This done, you nail on the 1/4-in. plywood back, which is not rabbeted in but cut roughly to shape, nailed in position, and the edges filed flush.

Before starting the duplicate work on the drawers, it's a good idea to build up the center table. Although this is really little more than a box, it should be assembled carefully. Note that the edges of the sides are cut away to allow the drawer front to fit flush when closed. The table is backed with 1/4-in. plywood nailed in place. This done, you are ready for the cabinet doors and drawers. Doors are of 1/2-in. plywood hinged to the sides. The rounded corner of each outside door is filed and sanded to a perfect fit after the door has been hinged in place. Small bullet catches hold the doors closed. The drawers are constructed with 3/8-in. sides, 1/4-in. plywood bottoms and 1/2-in. fronts fastened to 3/8-in. inside fronts. The fronts and backs are rabbeted to take the sides and the bottoms are set in grooves. Next fit the drawer guides in position and with the drawers tightly

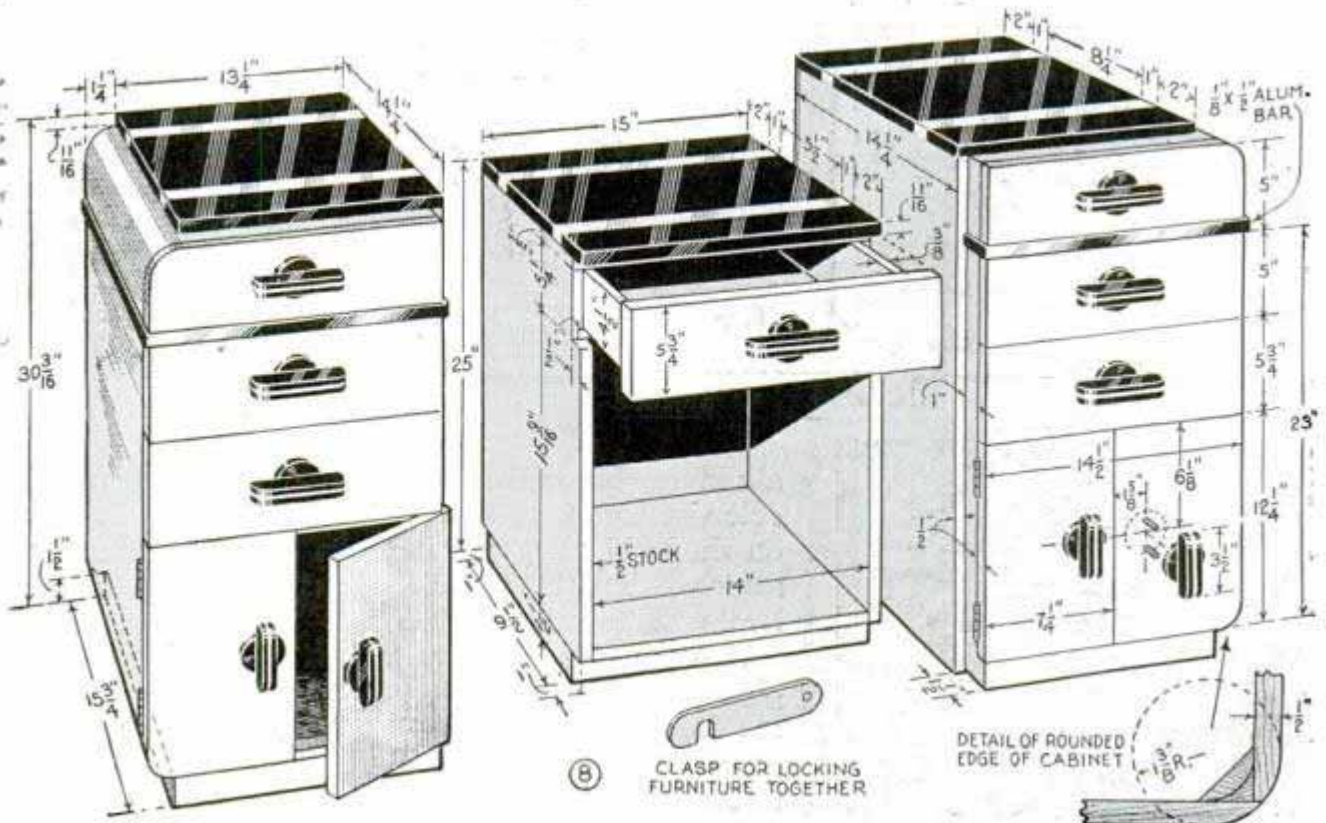

8 CLASP FOR LOCKING FURNITURE TOGETHER

DETAIL OF ROUNDED EDGE OF CABINET



closed, file and sand the fronts flush with the cabinet. The drawers and the inside of the cabinets are stained as in Fig. 7. The exterior is now gone over with fine sandpaper, then given one application of undercoater and when thoroughly dry, two coats of high-grade ivory enamel, sanding carefully between each coat. The clasps which lock the pieces together are cut and filed from  $\frac{1}{2}$  by  $\frac{1}{8}$ -in. aluminum bar, Fig. 8. These are screwed to the backs of each cabinet and hook over screws turned into the back of the table.

Finally come the drawer pulls and door handles. These are made of plastic in three pieces, two of  $\frac{1}{4}$ -in. thick green and one of  $\frac{1}{8}$ -in. thick ivory, laminated. The sheets are first cemented together with special plastic-to-plastic cement, Fig. 12, and afterward cut and filed to shape and polished, Fig. 11. The circular disks are cut from  $\frac{1}{8}$ -in. green plastic and cemented to the handle. Handles are then fastened to the drawer fronts with machine screws as in Fig. 4. The  $\frac{3}{16}$ -in. plastic for the tops is cut oversize and cemented to  $\frac{1}{2}$ -in. plywood with casein glue. When the glue has hardened, the edges are filed flush and slightly rounded, Fig. 3, the whole piece

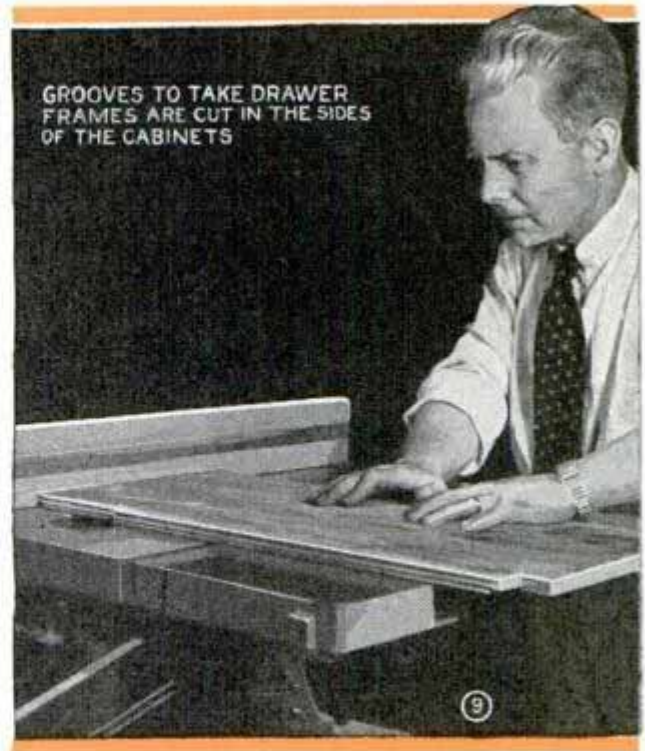

GROOVES TO TAKE DRAWER FRAMES ARE CUT IN THE SIDES OF THE CABINETS

9

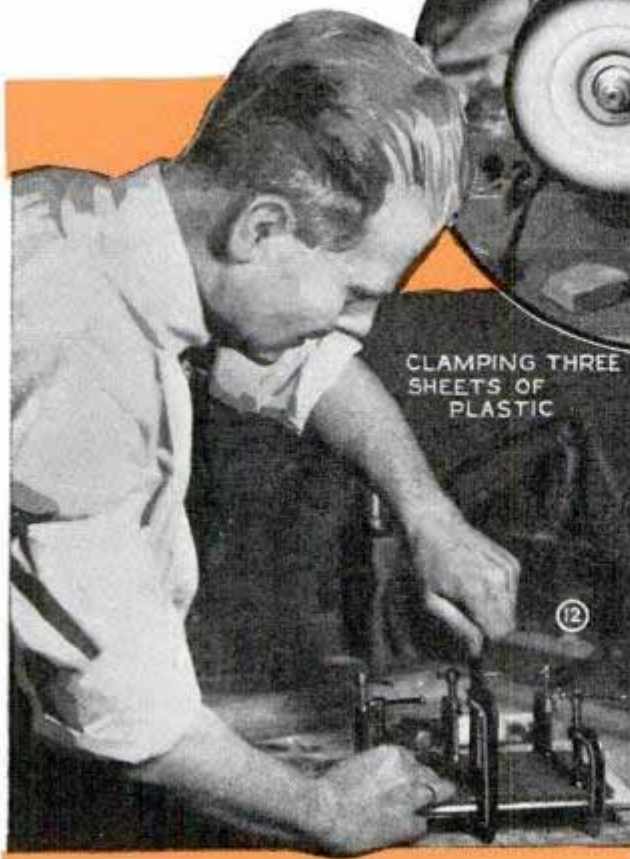
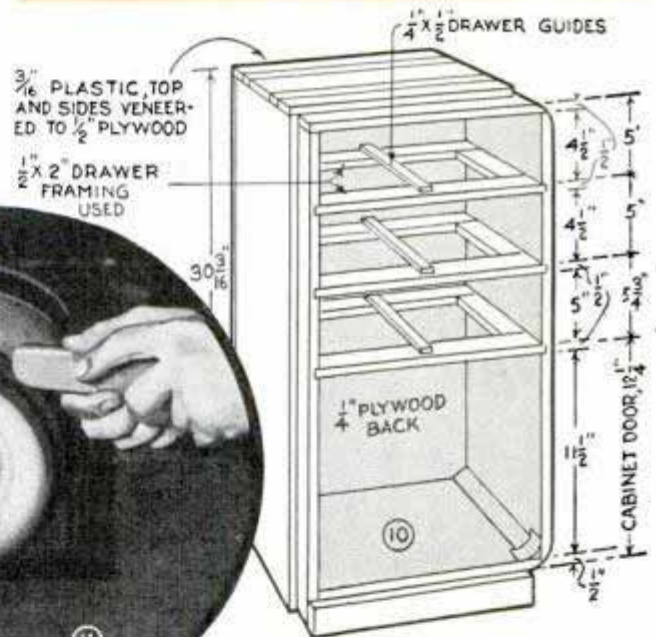

CLAMPING THREE SHEETS OF PLASTIC

12

then being highly polished on the buffing wheel with special plastic polishing compound. Then the tops are glued in position and screwed tight from the underside. The last step is the gluing on of the aluminum bar trim. This is first roughed on the gluing side and the outer face and edges are polished on the buffer. After coating with casein glue the strips are laid in position and held tightly with strips of cellulose tape till the glue is dry. Where the corners overlap, they are filed down flush and given a final polish, using a buffing wheel on the flexible shaft.



## Cutoff Saw Hung from Ceiling Pivots for Various Cuts



Here's a simple cutoff saw that anyone can assemble. The novelty of this setup is that the front axle of an old car is used. This is suspended from the ceiling or basement joists. The saw mandrel is attached to the lower end of the axle and the motor is mounted on a shelf supported by a flat-iron bracket near the upper end of the assembly. Loosening the axle nut at the ceiling permits the saw to be turned for making a cut at almost any angle across the work without moving the latter.

—W. A. Pierce, Fort Ann, N. Y.

## Metal Scraper on Soldering Iron

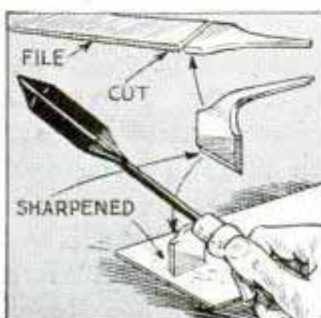

Bent from the tang end of a file as indicated and attached to a soldering iron by slipping the tang into the ferrule of the iron handle, a metal scraper is

always at hand for cleaning surfaces before soldering them. The end of the scraper should be ground to a chisel edge to provide a good scraping surface.

## Keeping Hair Off Rabbit Flesh When Dressing It

You can skin a rabbit without getting much of the hair on the carcass by dipping the animal in cold water before dressing it. The water causes the hair to mat and cling together so that, with ordinary precaution, the carcass will be clean. If several rabbits are to be dressed, change water frequently.



## Photo Prints Between Cardboard Will Not Curl

When you have a number of photographs to file or store away, and you don't want them to curl, as they usually do when placed loosely in drawers, put them in a folder made from two pieces of corrugated cardboard. Strips of adhesive or gummed-paper tape serve as hinges, while a couple strips at the front edge and one at each end will hold the two pieces of cardboard firmly against the prints.

—John G. Roberts, Chicago, Ill.

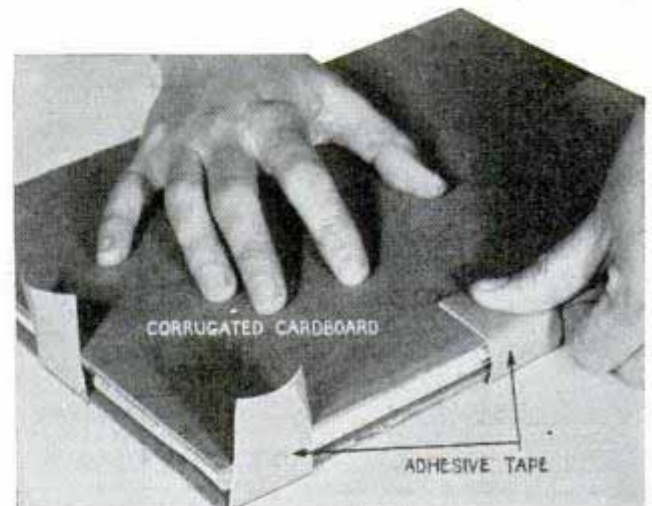



## Hanging Aquarium Adds Novelty to Room

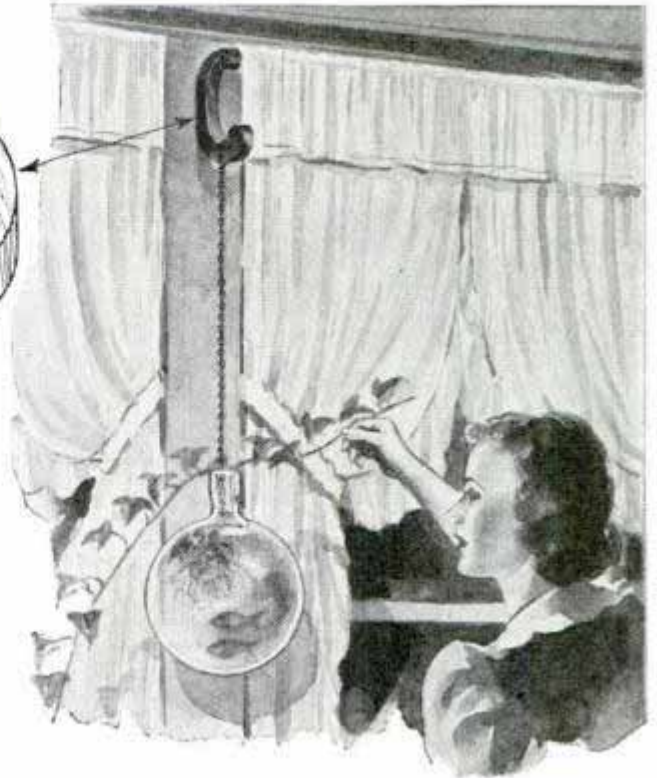
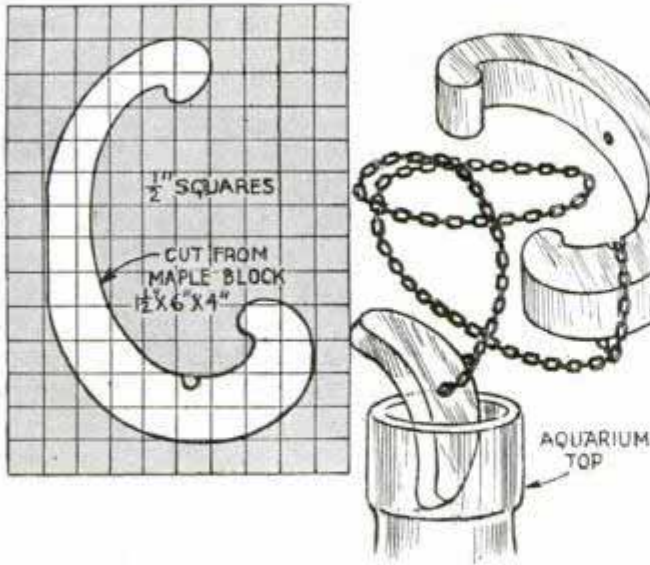

This aquarium is simply a round glass bowl or bottle with a short neck of the type used on some coffee makers. It is suspended from a scrolled hardwood bracket by means of a brass chain, the lower end of which is attached to a crescent-shaped piece of hardwood of such size that it can be slipped through the neck of the bottle. This piece can also be cut from soft metal such as  $\frac{1}{8}$ -in. aluminum. Although the bracket may be shaped from solid stock

it will be less likely to split if it is cut from two pieces of thin stock glued together with the grain running at an angle. The suspension chain should be rustproof.

—Dale R. Van Horn, Lincoln, Nebr.

## This Wall Rack Holds Your Hammers for Quick Selection

Fastened to the wall above or near your workbench, this rack keeps your hammers within easy reach. The backboard may be scroll-sawed at the top and bottom for appearance, after which two side pieces notched to take the hammer handles are screwed on. Spacing of the notches should be planned carefully so that the heads of the hammers will not interfere with each other and so that they can be arranged in order according to types and size.

—C. W. Woodson, East Aurora, N. Y.

## Wax Protects Wood Carving

Wood carvers who find that their work often cracks due to exposing the unseasoned center portion of the wood to the air, as the work progresses, can avoid this trouble by keeping the exposed surfaces coated with wax, a waxed cloth being kept handy to rub on the work each time it is laid away.

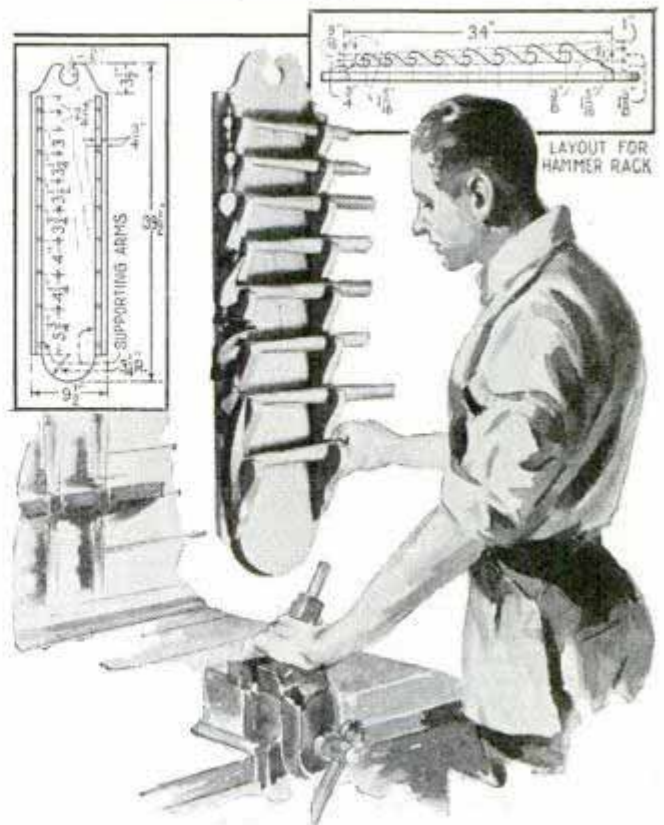



# Solving HOME

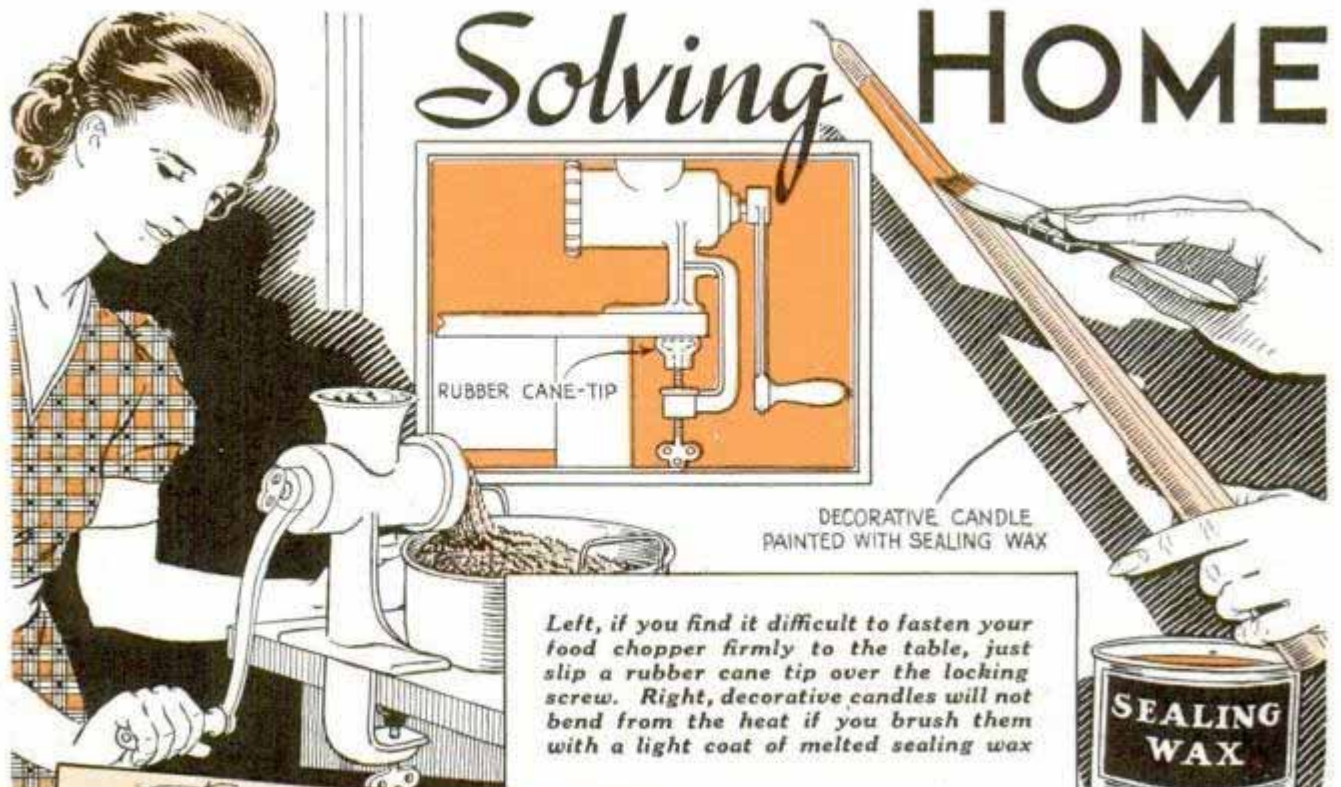

Left, if you find it difficult to fasten your food chopper firmly to the table, just slip a rubber cane tip over the locking screw. Right, decorative candles will not bend from the heat if you brush them with a light coat of melted sealing wax

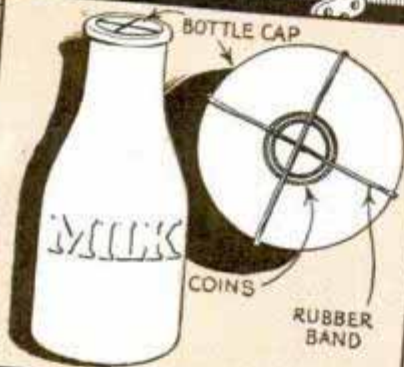

Instead of exposing coins in a bottle, snap a rubber band over the cap and slip them under it

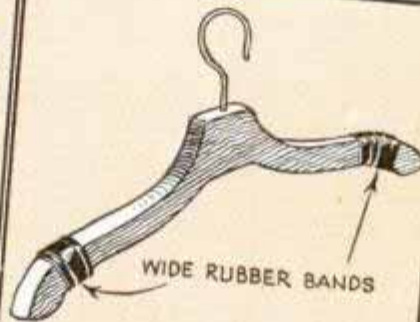

Rubber bands near the ends of a wood coat hanger will prevent garments sliding off on the floor

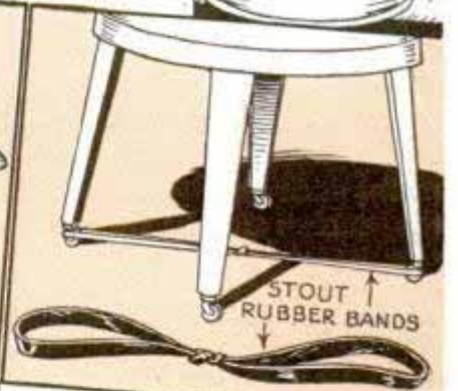

A band cut from inner tube and stretched over two casters prevents the washer from "creeping"

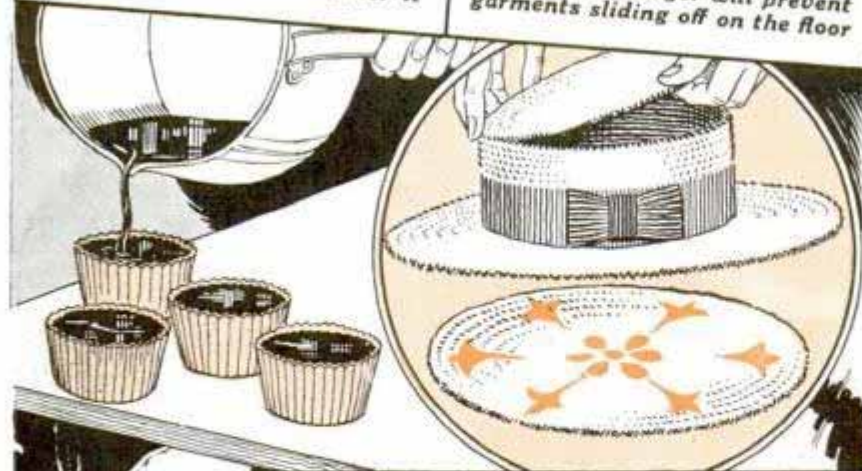

Left, to minimize dishwashing use paper cups to mold gelatin for desserts and salads. Dip in hot water to remove. In circle, the top of a discarded straw-hat crown makes a good hot-dish mat. The straw can be painted or dyed. Right, a file basket fitted with hooks made from wire hangers is just right for washing lettuce or vegetables



# PROBLEMS

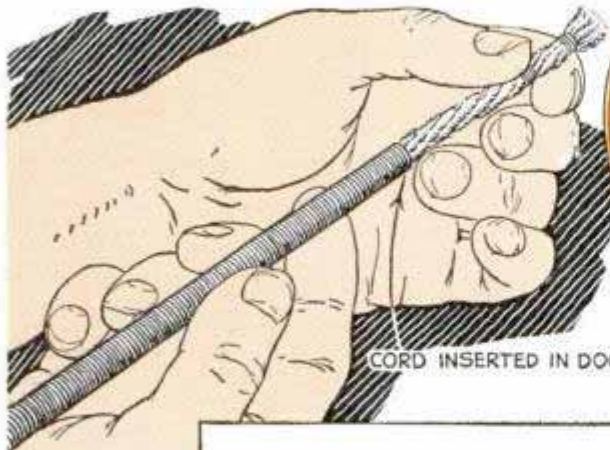

CORD INSERTED IN DOOR SPRING

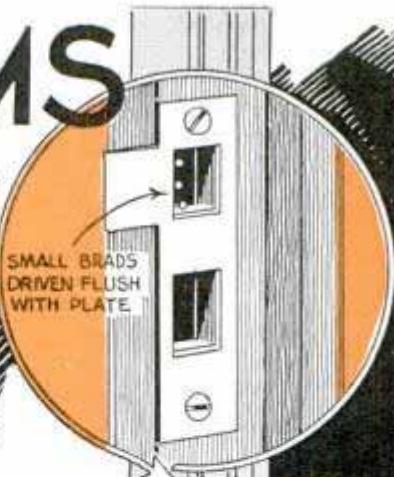

SMALL BRADS DRIVEN FLUSH WITH PLATE



Above, a creaking storm or screen-door spring can be silenced effectively by pulling a length of light rope through it. The rope can be pulled through the spring with a short length of wire and should be a fairly tight fit. Right, the rattling of a door can be stopped by driving small brads into the wood through the latch opening of the striker plate as shown in the circle

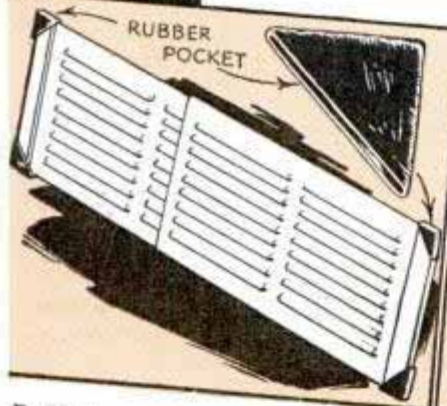

RUBBER POCKET

Rubber corner pads cemented on a metal window ventilator will prevent marring of the sill



A snap-on lamp shade turned upside down will eliminate glare from ceiling lights



A piece of cardboard cut and bent as shown holds a hat in suitcase without crushing

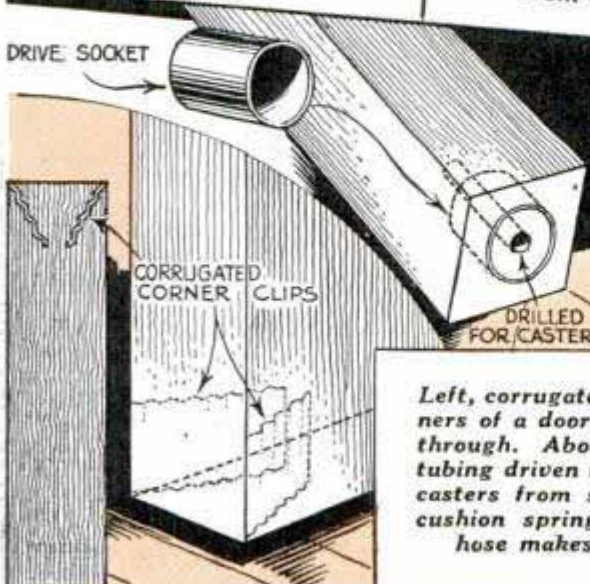

DRIVE SOCKET

CORRUGATED CORNER CLIPS

DRILLED FOR CASTER

Left, corrugated nails driven into the corners of a door will prevent mice gnawing through. Above, a short length of thin tubing driven into furniture legs prevents casters from splitting them. Right, a cushion spring attached to a length of hose makes a good furnace cleaner

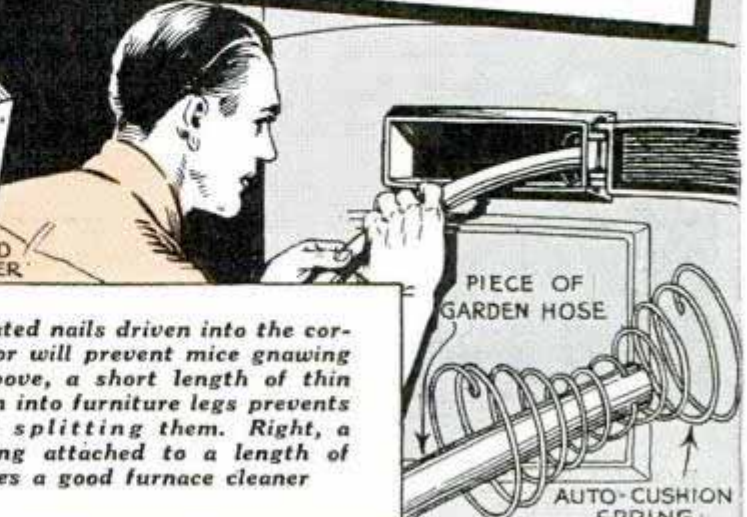

PIECE OF GARDEN HOSE

AUTO-CUSHION SPRING



## Microscope Slides Supported by Soda Straws

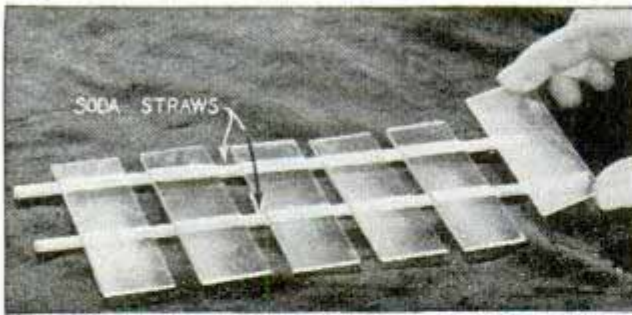

When using a microscope, place a couple of soda straws on a bench near by so that you can lay the slides on top of them as shown in the photograph. This not only protects the specimens on the slides against damage when laid down, but also enables you to pick the slides up easily.

☛ A soda straw slipped over the spout of an oilcan provides a good extension.

## Removing Broken Pipe Ends from Fittings

The next time the threaded end of a piece of pipe breaks off inside a tee, elbow or other fitting, try the following method of removing it: Drill a tiny hole close to the outer end of the fitting so that it just breaks through to the pipe. Then bend down the broken piece of pipe by driving a small punch through the hole in the fitting. After this has been done, you can usually turn out the broken piece easily. When the fitting is used again, there is little possibility of it leaking because there are several threads between the hole and the end of the pipe inside the fitting.

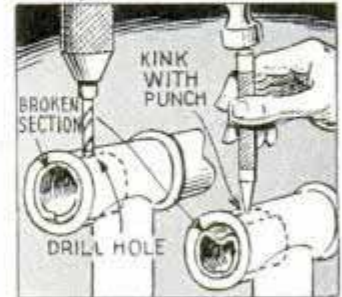

## Latest Plan Catalogue for Home Craftsmen

*Hundreds of useful and attractive things to make in your workshop*

Profusely illustrated to show just what the articles listed look like when finished

### Includes

**MODERN AND COLONIAL FURNITURE** of all kinds such as tables, chairs, stands, magazine baskets, cupboards, cabinets, chests, sewing baskets, etc.

**HOME AND GARDEN IMPROVEMENTS** comprising items like Venetian blinds, shutters, trellises, arbors, fireplaces, bird houses, Dutch windmills, etc.

**WORKBENCHES, TOOL CABINETS, MOTOR-DRIVEN MACHINES** such as drill presses, scroll saws, circular saws, belt, drum and spindle sanders, shapers.

**MODELS OF ALL KINDS**, both scale-type historic models and tournament-type model racing yachts.

**OUTDOOR-SPORT DEVICES**, rowboats, motorboats, canoes, kayaks, iceboats, skis, bobsleds, kites.

**ELECTRICAL DEVICES**, soldering irons, spot welders.

**RADIO EQUIPMENT**, receivers, transmitters, amplifiers.

**TOYS AND NOVELTIES** for gifts or resale purposes.

**JUVENILE ARTICLES** such as midget auto, doll house.

*The only cost to get this new catalogue is a three-cent stamp. When ordering be sure to print or write your name and address carefully*



**POPULAR MECHANICS PLAN SERVICE, 200 E. Ontario St., Chicago, Illinois**





# Tap and Die. HOLDERS

*speed up hand work*

**T**APPING and threading of work by hand or in a lathe is simplified, and the job is more accurate if these holders are used. Modelmakers in particular will find the combination tap wrench shown in Fig. 1 helpful. A length of brass bar stock, about 3 in. long, is drilled at the center to take the shank of the desired tap tightly. Two taps of the same size can be held in this manner, one being ground off at the end as a bottom tap, or two commonly used taps can be kept at hand, ready for use.

A wrench that will take various sizes of small taps is shown in Figs. 2 and 3. The jaws are shaped from  $\frac{1}{4}$  by  $\frac{1}{4}$ -in. steel bar stock, and the handles are made from drill rod. One end of each handle is turned

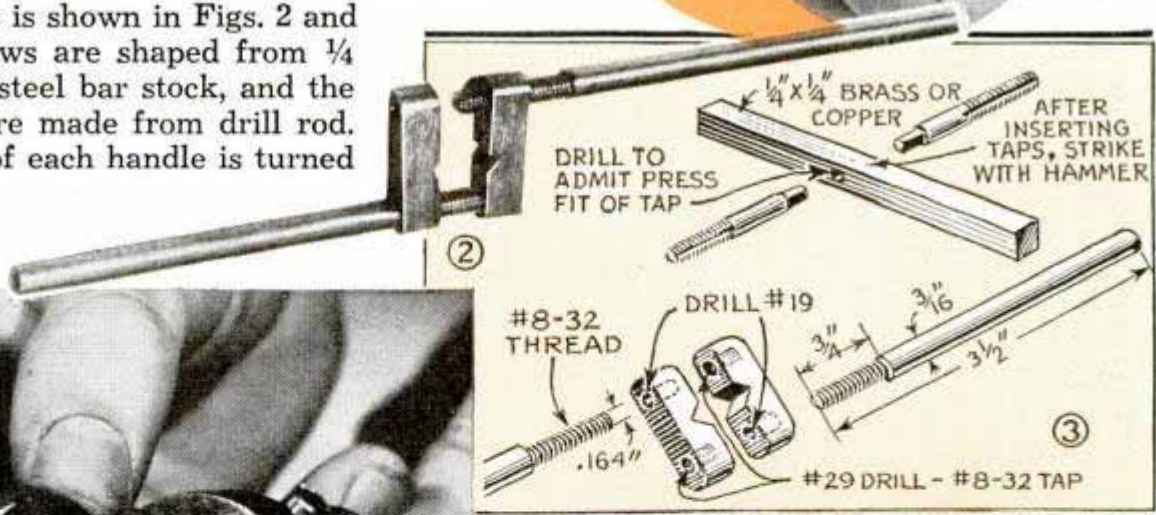
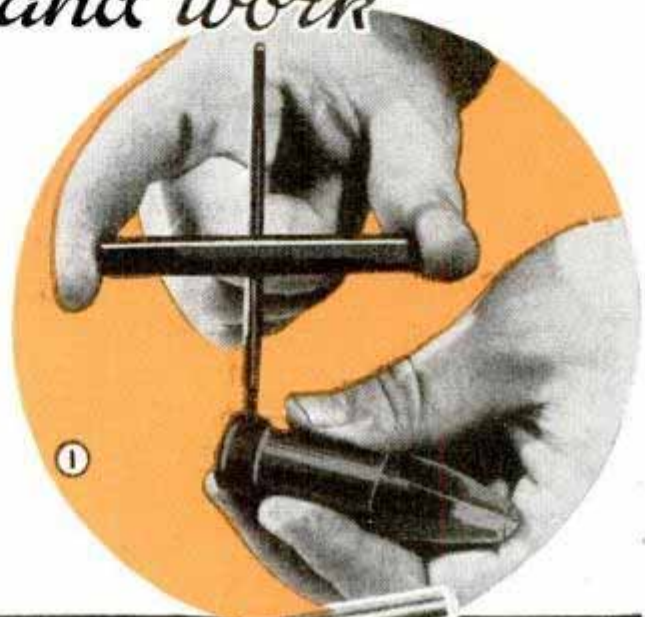

down and threaded to screw into the jaws as indicated. It is, of course, a job of only a few minutes to make larger wrenches of the same type to suit any job.

Another type of tap wrench is shown in Fig. 6. The handles are drilled, sawed and filed out as indicated, after which holes are drilled slightly smaller than the taps for which the wrench is intended. The holes



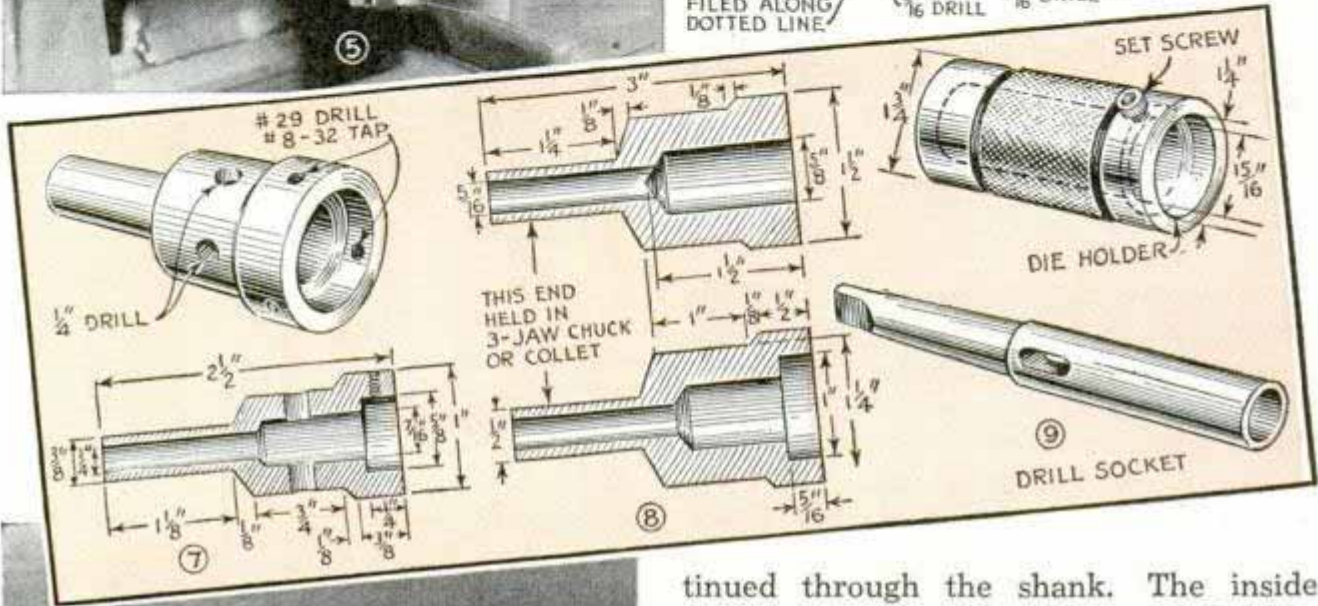
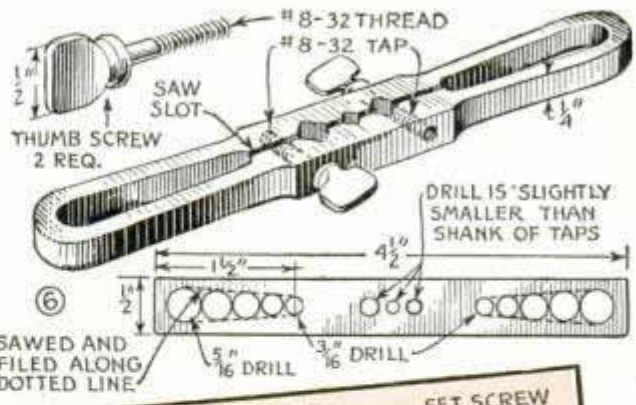
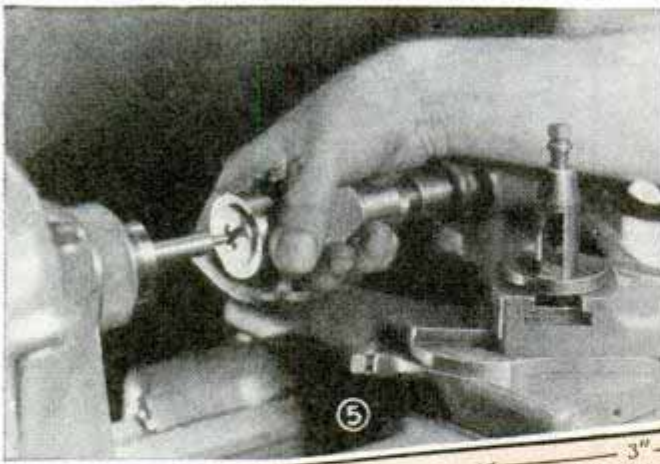

for the thumbscrews are also drilled at this time. Next a hacksaw slot is cut right down the center, from the opening in one end to that in the other. To accomplish this the blade is installed after inserting it into the shaped-out slot in one of the handle ends. The openings for the taps are then shaped to the desired size, with square files, and the holes for the thumbscrews are counterbored and tapped.

Useful attachments for threading work in a lathe are shown in Figs. 4, 5, 8, 9, and 10. They can be made in other sizes to hold all standard dies. Details of construction are shown in Fig. 8. These tools are made from cold-rolled steel. The outside is turned first, then the center is drilled out, and the central hole is con-

tinued through the shank. The inside shoulder is turned with the work held in a chuck or collet by the shank. Finally holes are drilled through the body and the collar is drilled and tapped for three setscrews. In use, the holder, with the proper size of die, is clamped in the headstock of the lathe, and the work is fed in by hand. A small pipe wrench or pair of pliers may be used to prevent it from turning. Because of the hollow construction of the die holder, long rods can be threaded for short distances or from end to end.

### Spur Link in Chain of Hoist Prevents Slipping

To keep logs, timbers and other work from slipping out of the chain when hoisting them on a bridge job, one contractor put a spur link of the type shown in the chain where it contacted the work. The "teeth" of the link bit into the wood when a pull was exerted on the chain.

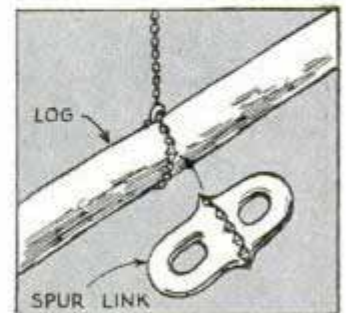



# Good Lathe Tools from Discarded Drill Bits

Owners of small machine shops can reduce lathe-tool costs by utilizing broken, high-speed drill bits. A little grinding converts them into excellent tools for light jobs of boring, turning, threading, key-seating, etc. They can be gripped in most regular tool holders as indicated in the four upper details. The side views of the bits in the lower details show how the ends are shaped for three different tools, while the top views indicate how the bits are ground off on one side to give proper clearance. Of course, care must be taken in grinding to get the correct angles on the cutting edge. The overhang should not exceed that normally allowed.

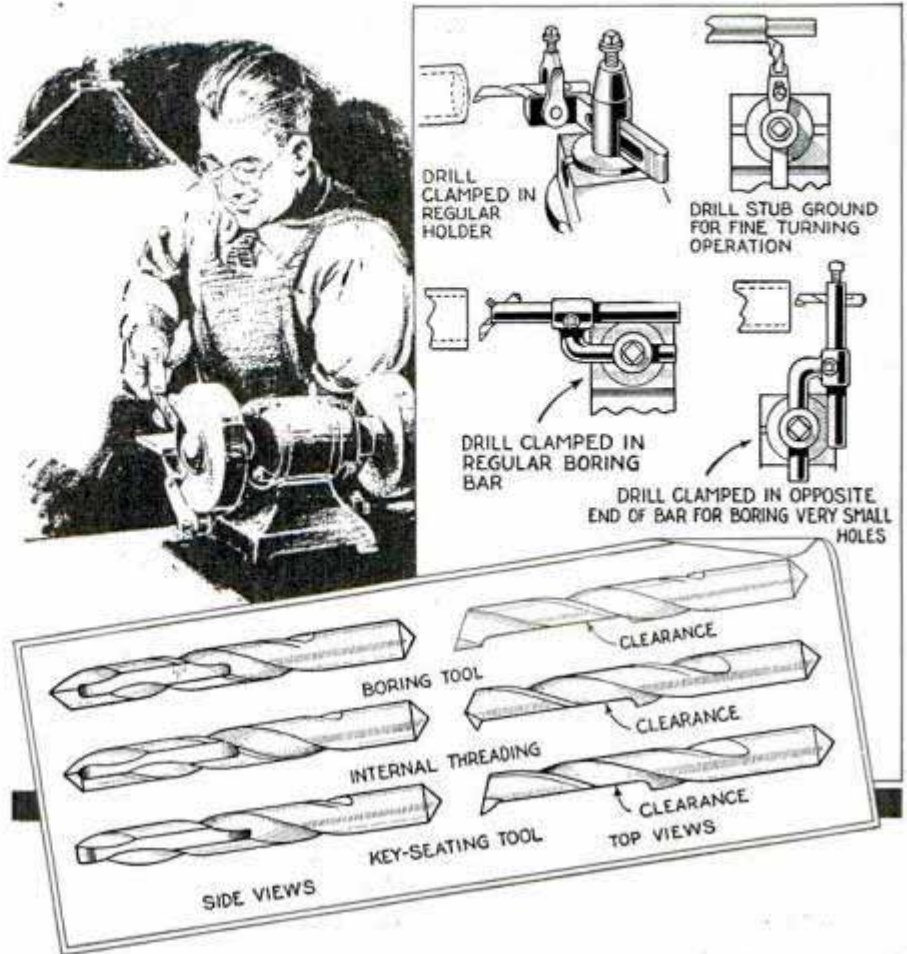

## Bin Protects Bolt Goods in Store When Taking Inventory

During inventory time when every bolt of material in a store must be measured, the unwound portion can be kept clean by running it into a bin attached to the counter as indicated. Two flat-iron hooks fit

into holes drilled into the counter, and as these are evenly spaced, the bin can be moved along from place to place.

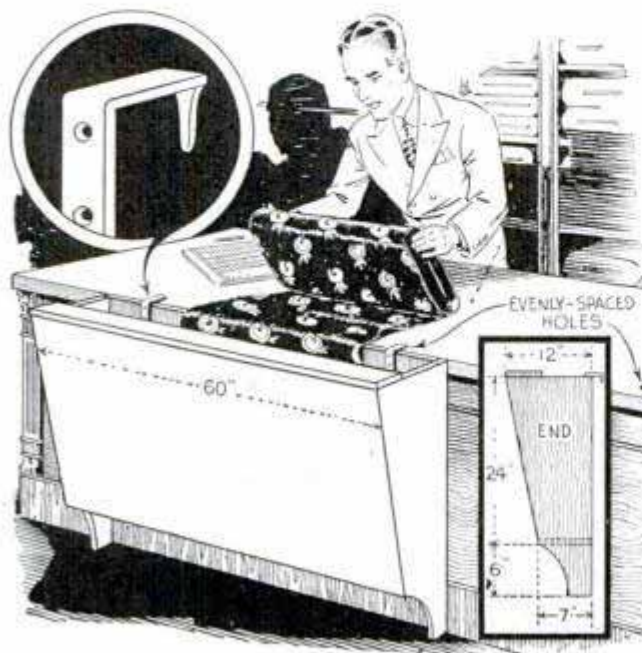

## Pipe Handles Open Heavy Doors

For opening heavy sliding doors, you will find handles assembled from pipe superior to the common type as they permit both hands to be used to exert a strong pull. The handles are about 20 in. long, and have elbows and floor flanges on the ends, the flanges being mounted on the inside surface of the doors with the elbows projecting through holes to the outside.

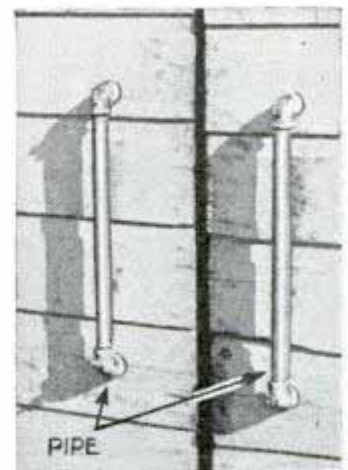



## Water Tanks Emptied in Winter Serve as Feed Troughs



During winter, when some watering tanks are not used because of the danger of freezing, they can be converted to feed troughs. They are set in a fence as indicated, and three or four wood strips running from the top of the fence to the edge of each tank allow the animals to feed, yet prevent them from throwing out the contents. If desired, a swinging panel can be suspended above the tank to close the opening in the fence.

## Clamp on T-Square to Grip Edge of Drawing Board

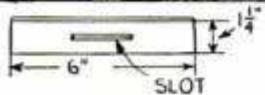
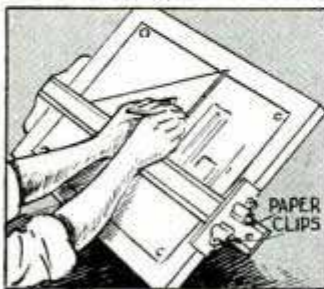

a strip about  $1\frac{1}{4}$  in. wide and 6 in. long. In the center of this, make a slot to slip over

Draftsmen, artists and others will welcome this method of holding a T-square head to the edge of the board while working with triangles. From a piece of heavy cardboard or thin wood, cut

the T-square snugly. In use, place the T-square on the drawing board in the desired position, slip the piece of cardboard or thin wood over it, pulling it snugly against the edge of the drawing board. Then slip two large paper clips of the clamp type over the edges of the T-square to hold the cardboard snugly against the edge of the board.

## Sizes of Firemen's Helmets on Brim Help Avoid Confusion

At the fire station of one small town, where the helmets were worn by various men at different times, the chief had the sizes of the helmets painted on the underside of the brims.

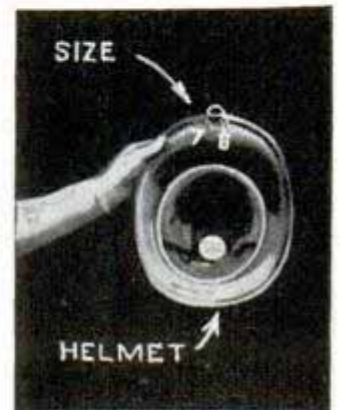

This enabled the men to pick instantly helmets that would fit without wasting time trying them.

## Pointed Bar to Pull Brush with Horse or Tractor

If you have land to clear of small brush, you can do it easily with this tool and a horse or tractor. The tool is a 1-in. iron bar 6 ft. long and pointed at one end. It has an iron ring welded about 10 in. from the pointed end to take a chain to which the horse or tractor is hitched. In use, stick the bar into the ground on one side of the brush and hook the chain in the ring.

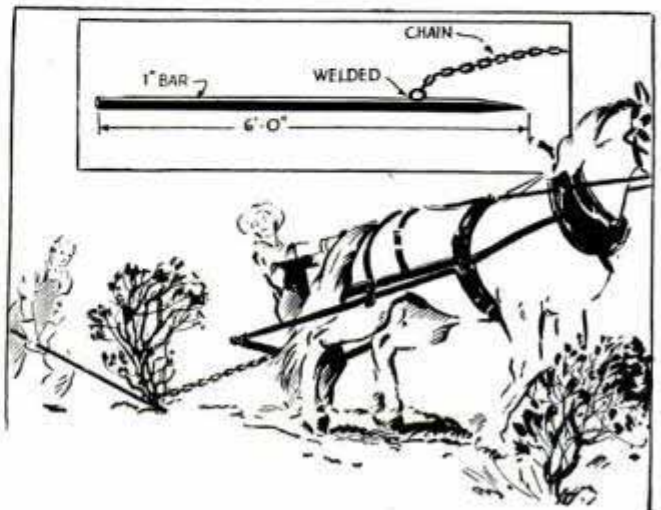



# Split-Second PRINT TIMING

By C. A. CROWLEY

WITH this timer you can expose photo prints exactly to a predetermined timing within fractions of a second and thus eliminate variations beyond control when employing the usual type of manually operated electric printer. Thus slight under and over-exposures can be avoided, once you know the correct time for negative and paper. With the calibrated dial set for the time you wish to expose a print, Fig. 1, you merely close the printer lid, and press the button switch of the timer. That's all there is to it because the light of the printer will be turned off automatically. All duplicate prints will be the same if the dial setting is left unaltered. While the timer is of great help to the photographer, its usefulness also can be extended to operate other electrical devices for predetermined short intervals.

The unit makes use of a relay, a radio power transformer, a type-80 rectifier tube and a type-45 power amplifier tube. In addition, two condensers, one 16 mfd., (100-volt rating) and the other 2 mfd., (400-volt

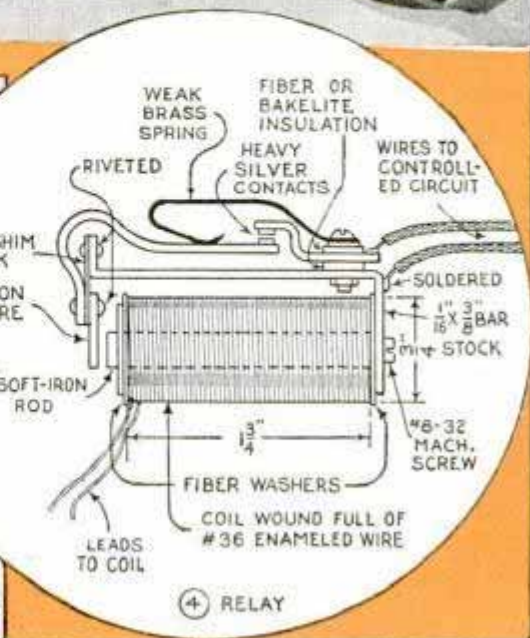
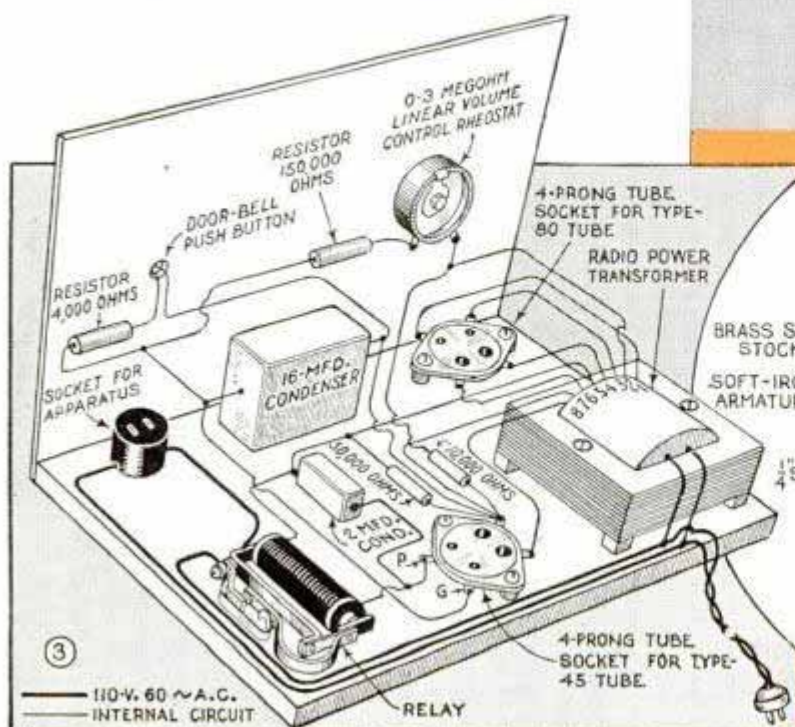
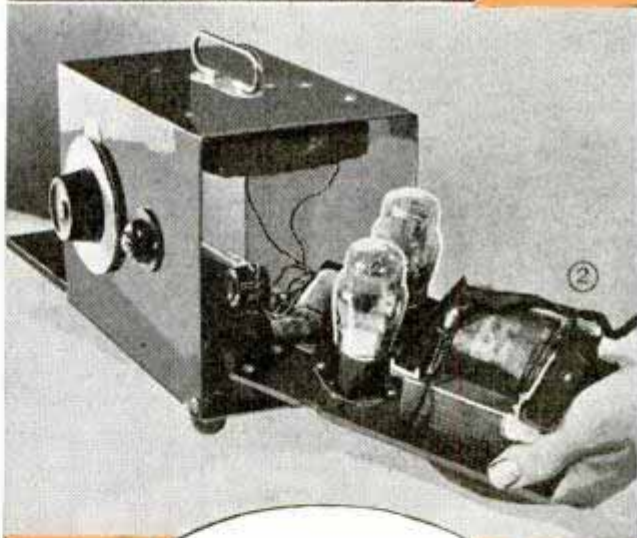



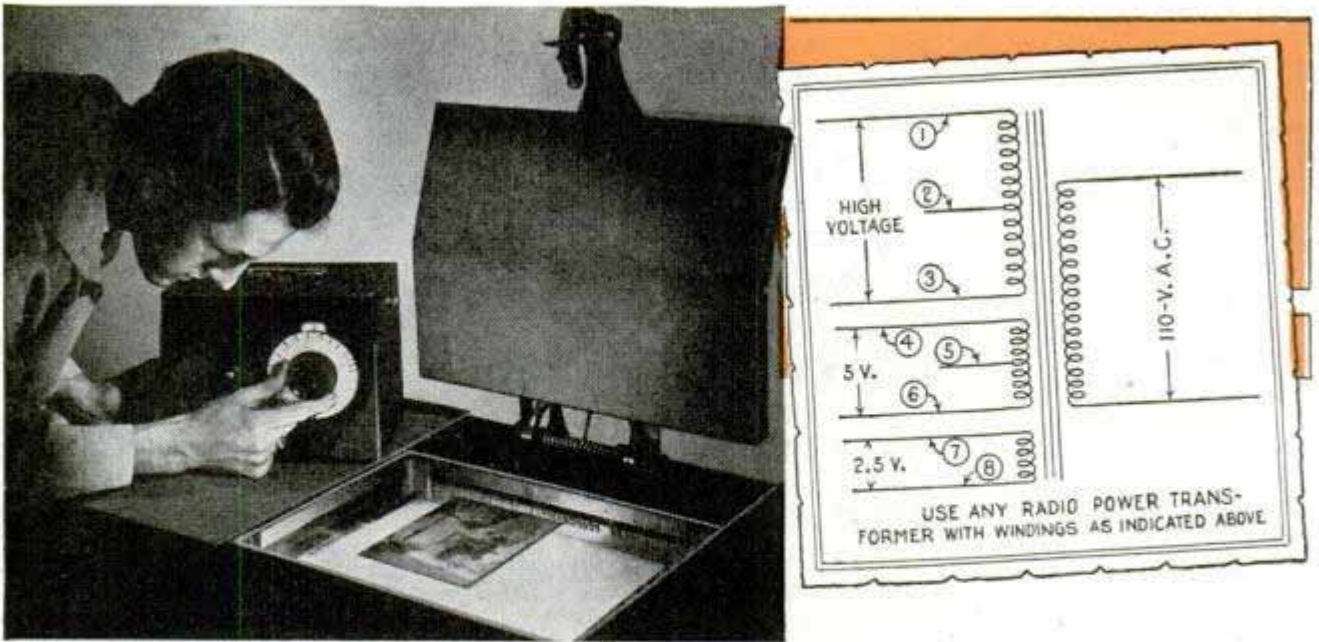

rating) and a few resistors are required. The parts are mounted in breadboard fashion as shown in Fig. 3, or they can be arranged inside a box, as shown in Fig. 2, which may involve a slightly different grouping of the parts. The transformer can be any radio power transformer suitable for the voltage and frequency available, which has three secondaries, including one center-tapped high-voltage coil, one center-tapped 5 volt winding, and a  $1\frac{1}{2}$ -volt winding. This is indicated in the last diagram, where the leads from the secondary taps of the transformer are numbered to correspond with those on the transformer in Fig. 1. The condensers used must be paper condensers; electrolytic condensers are unsuitable in this case. It may be necessary to connect a number of 1 or 2-mfd. condensers to make up the large condenser. The 0 to 3-megohm volume control is used to vary the interval during which the current is on, and it is important that a linear volume control be used. Many volume-control rheostats are so arranged that most of the resistance is at one end, which would make it more difficult to calibrate and adjust.

The relay, which you will have to make, is illustrated in Fig. 4. The core is  $\frac{1}{4}$ -in. soft-iron rod, and the coil, which consists of No. 36 enameled wire, should be wound to a diameter of  $\frac{3}{4}$  in. and a length of  $1\frac{3}{4}$  in. The winding can be random instead of in exact layers. The spring is very important, as its function is to put a very slight tension on the armature, causing it to

break the contact rapidly and without chattering. It will require some careful adjustment by bending this spring to get the relay to operate satisfactorily.

When everything is ready, plug into the line and connect to the printer. Depressing the push button momentarily resets the relay, which will then hold the circuit closed for a certain interval, depending on the adjustment of the volume-control rheostat. By setting the dial at various points and timing the lamp with a watch, it will be an easy matter to calibrate the dial in terms of time. The timer can be adjusted from a fraction of a second to several minutes. If longer time intervals are required, a larger capacity condenser or a higher resistance volume control is used.

### Pigeon Perches from Cans

By cutting a couple of V-slots in a tin can, it may be converted into a perch for your pigeon pen. The slots allow the can to be anchored firmly on two nails or screws, which are driven into the wall to leave the heads projecting slightly. Such metal perches do not harbor insect pests and are easy to remove for cleaning.





# Pi Stacker Operated by Clutch and Cable

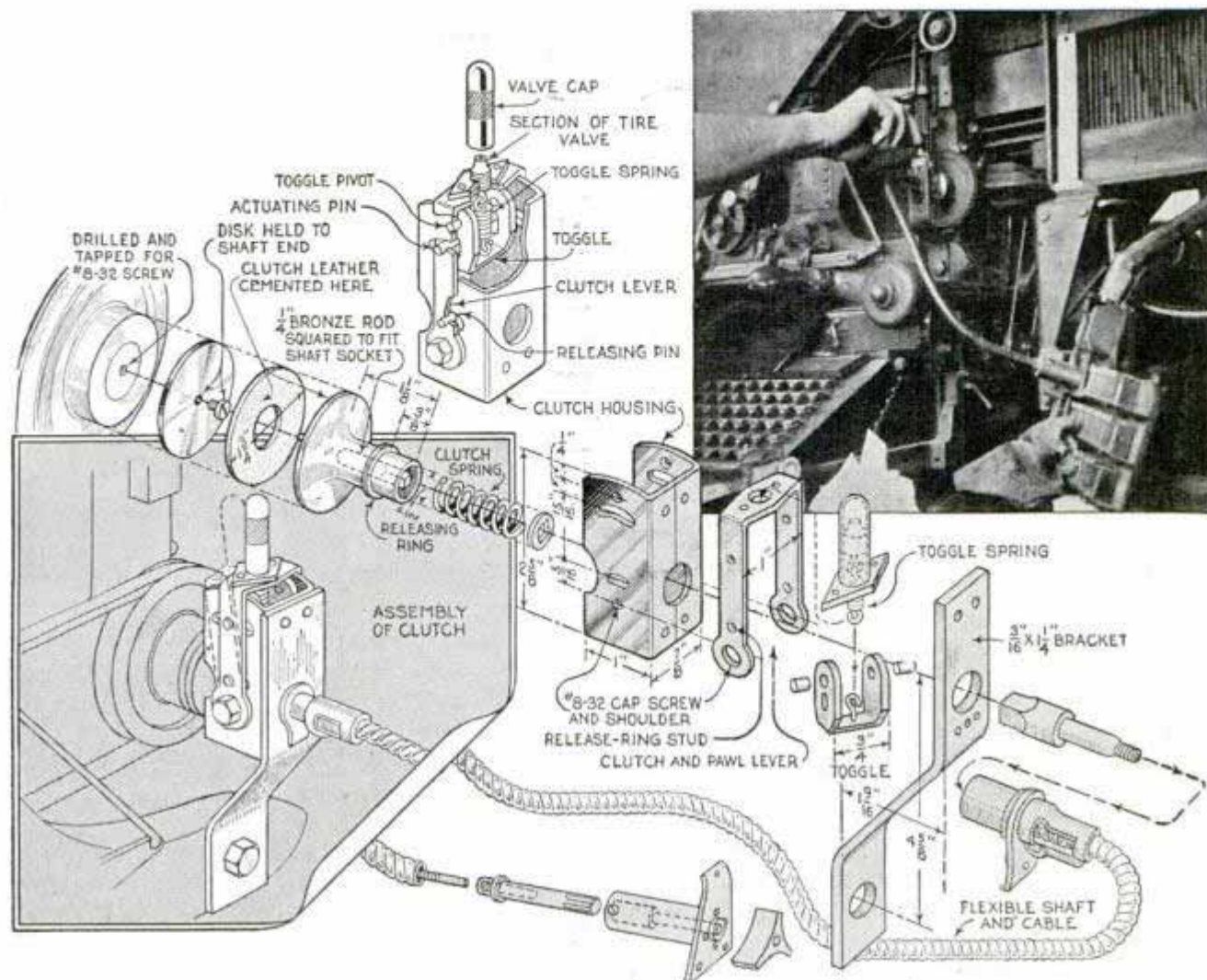

This flexible-cable drive eliminates the complicated belt arrangement on the pi stacker of some typesetting machines. The toggle throw-off makes it possible to disengage the clutch quickly, stopping the star wheel, if mats jam in the stacker. Even if this is not done immediately, the clutch will slip harmlessly until the operator flips the lever. The end of the shaft used as a source of power is rounded, but it can be squared easily with a file while the shaft is rotating under power. The center is found with a prick punch, also while the shaft is rotating, and a hole is drilled and tapped for the screw which holds the sheet-metal disk. The other disk, to which the clutch leather is cemented, is soldered to a section of tubing that holds the clutch spring. The releasing ring is a washer soldered to the tubing as indicated. A piece of  $\frac{1}{4}$ -in. bronze rod, squared at one end to engage a socket on the end of the cable, is soldered in a hole in the cen-

ter of this disk. Both disks are made of 16-ga. sheet metal. The clutch housing consists of two identical pieces of 16-ga. sheet metal. These can be scribed, drilled and filed to shape while clamped together in a vise. The toggle, levers and pawl also are 16-ga. sheet metal. The bearing for the extended star-wheel shaft is made from a  $\frac{1}{2}$ -in. collar partially filled with lead and drilled to fit the shaft. One end of the shaft is drilled to take the flexible cable and a washer is soldered on to act as a retainer. The spring in the clutch should be just strong enough to cause the star wheel to turn steadily, so the clutch can slip easily when a pileup of mats occurs. The spring in the toggle should be a small, stiff one to hold the clutch disks about  $\frac{1}{16}$  in. apart when the toggle is in the "off" position.

☐ A good dead-black paint can be made by thinning lampblack, of the type ground in linseed oil, with turpentine.



## Changeable Roadside Signs Slip Between Two Steel Posts

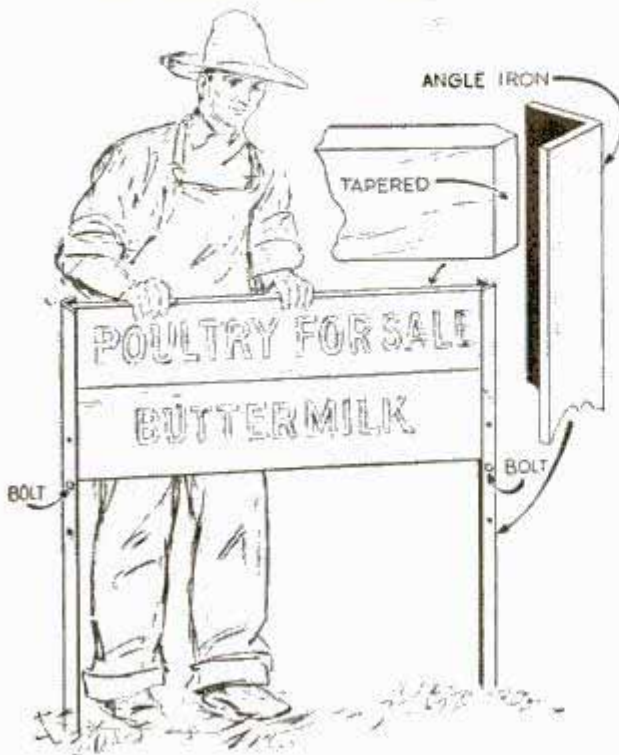

Farmers and gardeners who wish to advertise produce along a highway will find this changeable sign convenient. It consists of two angle-steel posts, which are spaced apart a suitable distance to accommodate the sign boards required. Each board is tapered at the ends to fit easily into the V-shaped sides of the posts. Small bolts or pins are run through the posts to support the boards at the height desired.

## Wire-Mesh Roosts for Chicks to Prevent Smothering

To train young chicks to roost and to prevent them from huddling together in a corner, which sometimes causes one or more of them to smother, try this wire-mesh roost. One end is shaped like a ramp enabling them to walk up to the roosts on which they will sit in preference to the

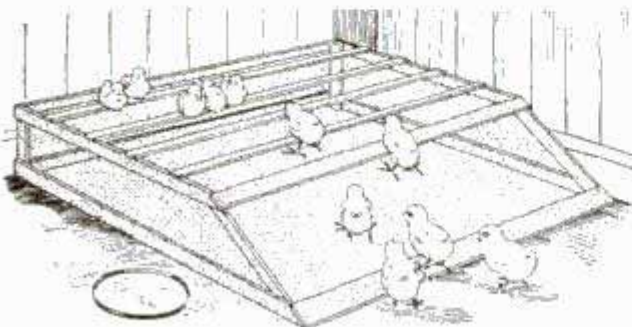

wire. If regular roosts are placed above these frames, the young chicks will later fly up to them.

—Stanley Russell, Vincennes, Ind.

## Large Machine Screws Loosened with a Punch

Before using large machine screws on a job where it may be necessary to remove them later, file a notch in the head of the screw, as indicated. Then if the screw should stick so tightly

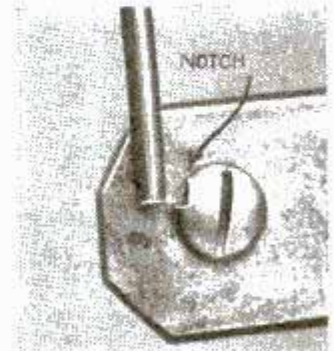

that it cannot be removed with a screwdriver, you can set a punch in the notch and loosen the screw by tapping the punch lightly with a hammer.

## Sunken Oil Drum Keeps Milk Safe for Route Man

Patrons of a milk and cream route in Wisconsin have found that their product reaches the market in better condition if it is protected from heat in summer or

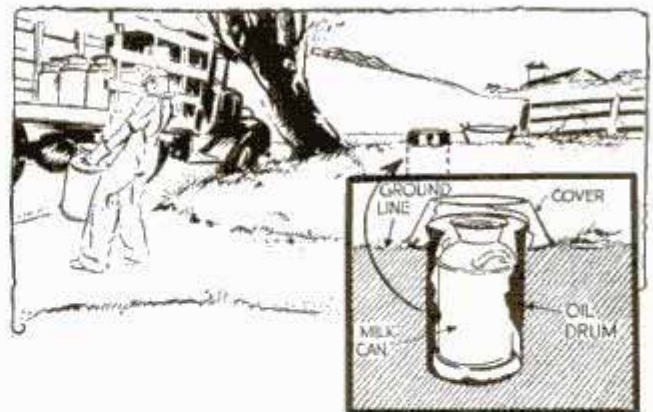

freezing in winter, by being stored in half buried oil drums at the roadside. The drums are covered with tubs, or other drum sections, to keep out rain or snow.

☞ To protect paint on your window sills, give it a coat of clear shellac. When dry, apply liquid wax. Renew the latter treatment occasionally and the paint will retain its luster indefinitely.



# Adjustable Stop Assures Accurate Miter Cuts

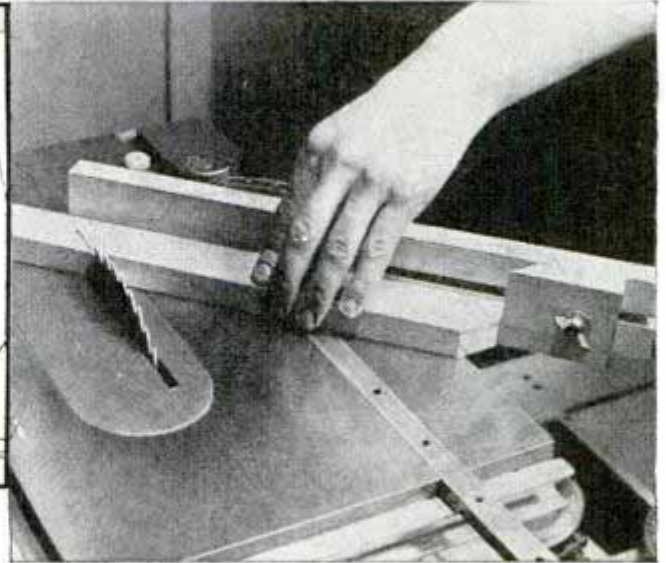
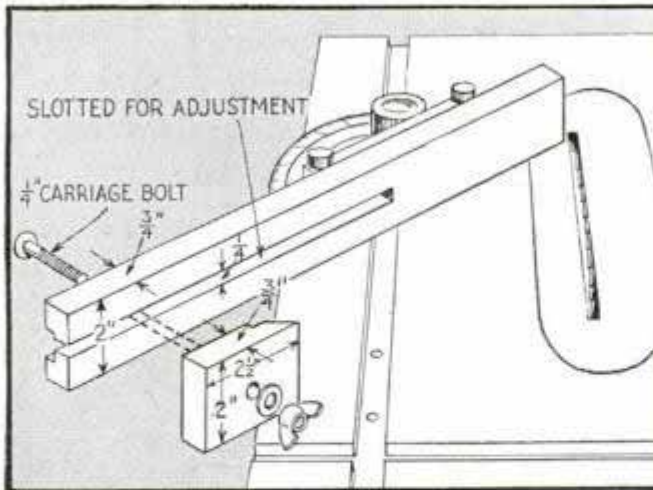

The next time you have a number of strips to miter to exactly the same length, take a few minutes to make this simple stop which will save you considerable work besides assuring accuracy. After the stop has been adjusted, any number of pieces can be run over the saw and they will all be the same length. The stop consists of a strip of  $\frac{3}{4}$ -in. hardwood slotted as shown. Then a sliding block of the same stock is clamped to the strip with a carriage bolt and wing nut. One end of the

block is mitered. Note especially that a shallow groove is run down the inner edge of the miter cut. This is very important since it prevents wedging of chips or sawdust which might result in inaccuracy. To use the jig, run a miter cut on one end of each of the strips, then set the stop to give the length you want. Once the stop is set you can run the second cut on all of the pieces without changing it.

## Drawing-Paper Dispenser Has Knife to Tear Off Sheets

You'll find this cabinet handy for dispensing drawing paper because you just pull out the paper and tear off the required size sheet. The loose end of the paper does not turn back on the roll and you don't have to use weights. There's room for four rolls inside the cabinet, two mounted ready for unrolling and two spare ones. The cabinet is a rectangular box fitted with a lid, the front edge of which is beveled to a  $30^\circ$  angle and has a steel strip fastened to it for cutting the paper.

### Machining Thin Metal Strips

When machining a thin strip of metal, tin one side and sweat-solder it to the tinned side of a thicker piece. Then the work can be machined extremely thin, tapered or shaped as desired because the extra piece gives a rigid backing. When the work has been finished, apply heat to the solder and separate the work from the backing piece.—E. Olson, Philadelphia, Pa.

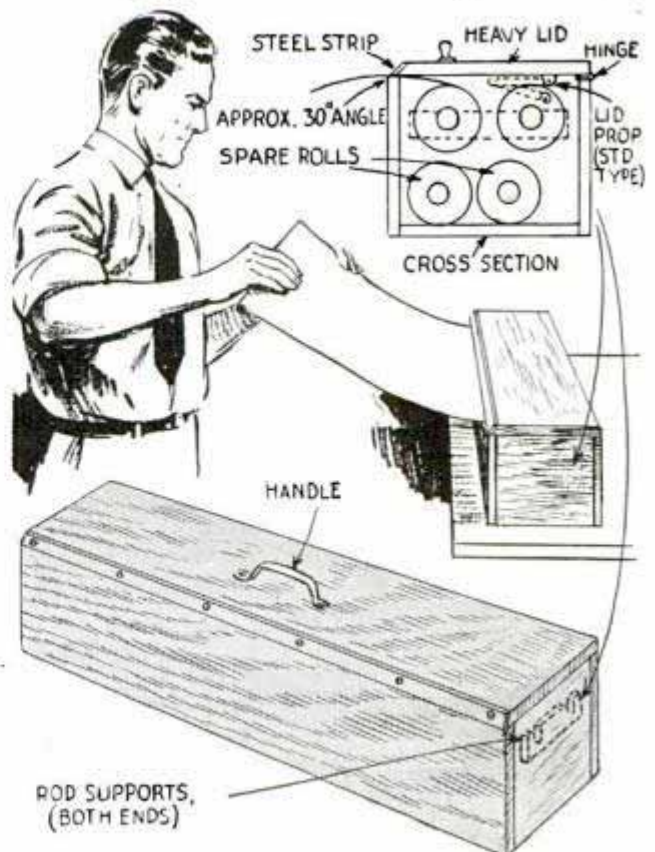



## Rope and Slip Stick Substituted for Boom Pole on Hay Load

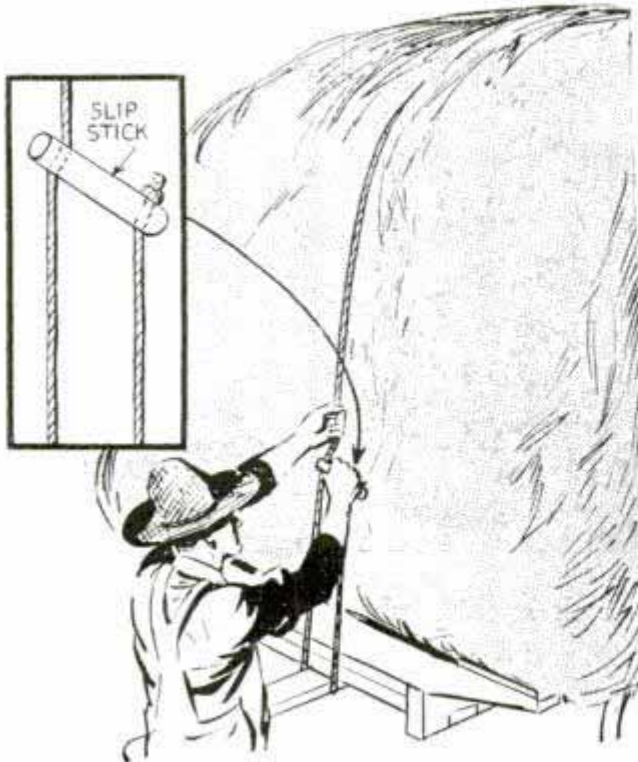

To secure a load of hay on a wagon, without using a heavy boom pole and knotted rope, one farmer uses a rope and slip stick. The rope is tied to the front of the rack, passed over the hay and fastened to the rear end of the rack. A slip stick, similar to those employed in adjusting tent ropes, is used to tighten the rope as indicated in the drawing.

## Clamp Holds Magnifying Glass on Surface Gauge

To set a surface gauge accurately to fine dimensions, it is best to use a magnifying glass. To overcome the awkwardness of holding the glass and setting the gauge at the same time, use this holder which clamps the glass to the surface-gauge scribe. The holder is a piece of flat steel bent to a U-shape, one end being drilled to take a thumb-screw and the other end being tapped for the same purpose. The U-piece is also

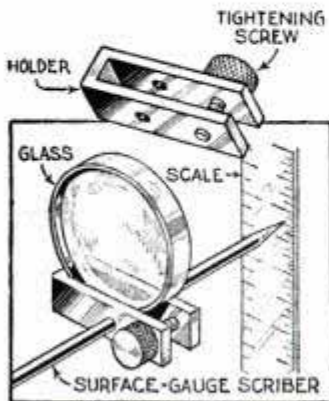

drilled to take the scriber as indicated. Inserting the rim of the glass into the piece and tightening the thumbscrew clamps it tightly to the scriber.

## Clamp Ring on Micrometer to Adjust It

When using a large micrometer to measure work held in one hand, this ring on the spindle will enable you to adjust it easily with the fingers. The ring is a steel disk with a hole through the center, the hole being slightly smaller than the diameter of the micrometer spindle.

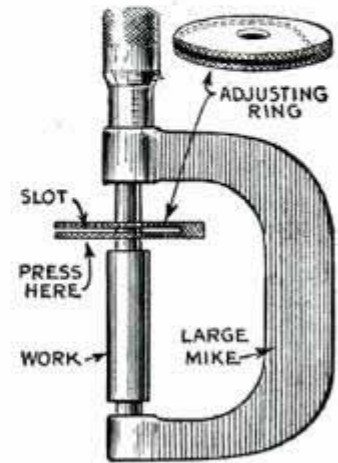

It is slotted transversely as indicated by the dotted lines on the detail. To slip the ring over the spindle, compress the slotted portion with the fingers. When released, the ring will grip the spindle tightly.

## Rubber Mat on Locomotive Steps Reduces Slipping

To prevent wood steps on the front ends of some switch engines from becoming slick when wet, just tack or cement strips of corrugated rubber to the steps. This provides a good footing, even when wet.

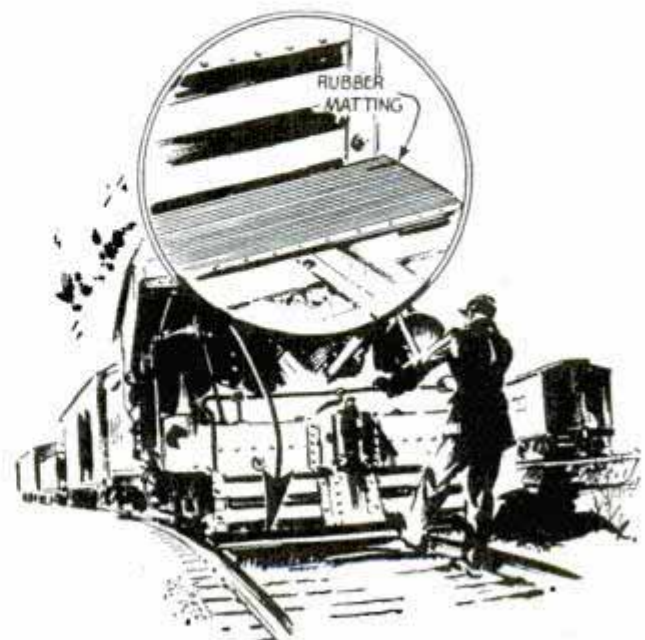



# Quick Measurements on Your Circular Saw

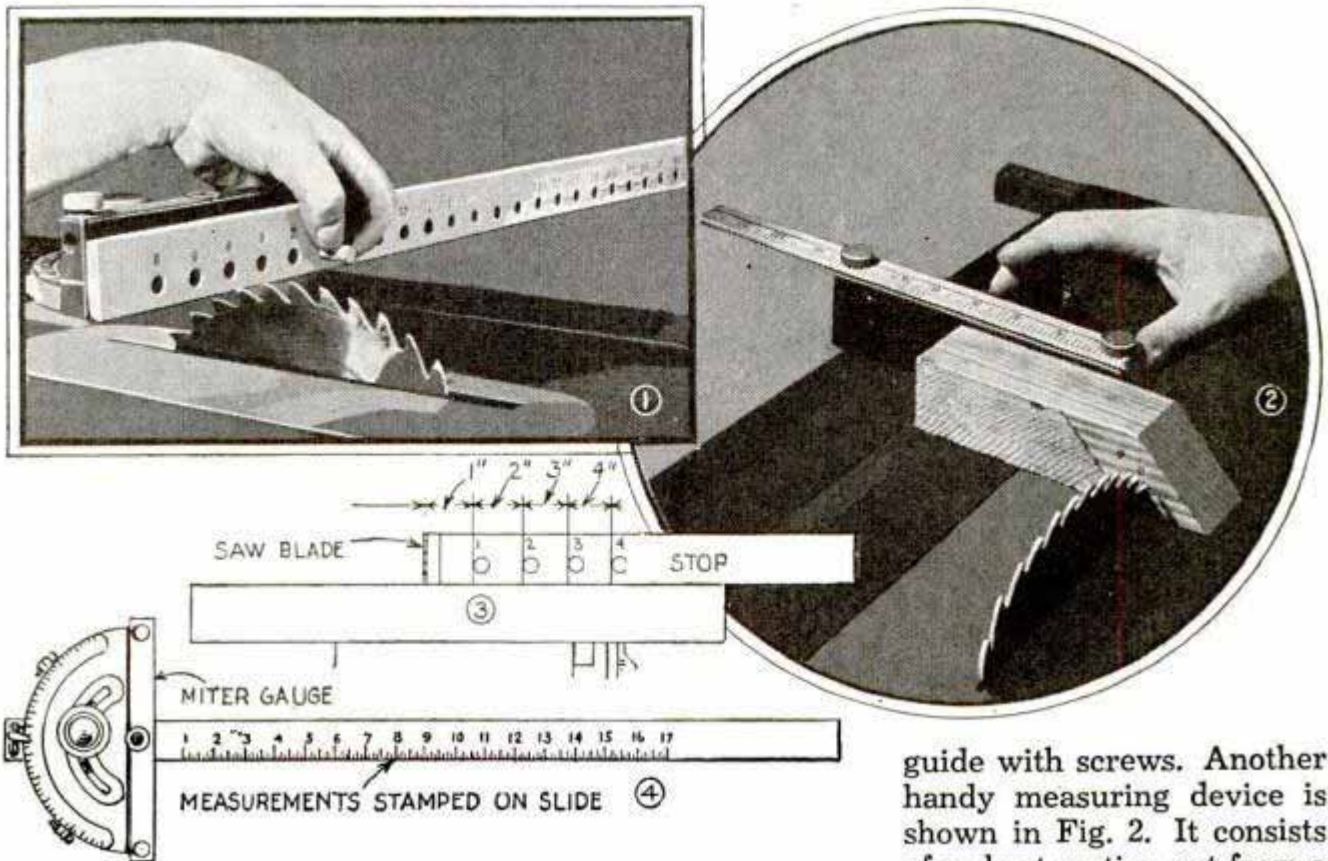

When you want to cut a number of pieces to exactly the same length, a stop like that shown in Figs. 1 and 3 will speed the job considerably as it is not necessary to measure and mark the stock before sawing. The arm attached to the crosscut guide may be of either  $\frac{3}{8}$  or  $\frac{1}{2}$ -in. hardwood with  $\frac{3}{8}$ -in. holes drilled 1 in. apart along the length. A  $\frac{3}{8}$ -in. dowel acts as a stop for the stock being cut. Fasten the arm to the crosscut

guide with screws. Another handy measuring device is shown in Fig. 2. It consists of a short section cut from a ruler or yardstick and screwed to the top of the crosscut guide. Bringing the end of the stock flush with any one of the graduations shows the exact distance from the side of the blade and also the length in inches of the piece when the cut has been made. Graduations on the arm of the crosscut guide are useful in checking width of the stock being sawed, Fig. 4. The graduations are easily stamped in the metal.

## Wires Supported on Car Springs Keep Out Trespassers

A property owner, whose grounds adjoined a public park, was much annoyed by trespassers who would climb the fence in spite of warning signs. To avoid building the fence higher, he obtained several main leaves from discarded auto springs and attached one of these to each alternate post along the fence. Strands of barbed wire through the eyes in the ends of the springs were sufficient to discourage the climbers under ordinary circumstances.

☐ The glass shield of a bench grinder can be made shatterproof by attaching a sheet of celluloid to the upper surface with cellulose cement.





# You can build this



concrete, and should have two under-car drains. While the original garage was 20 ft. square, a larger one can be built, following the same method of construction. The walls are covered with "Colonial" style siding over heavy building paper and the walls and ceiling are covered on the inside with plywood. A chimney is provided for heat in the winter. The roof is steep to help prevent snow from collecting on it, and the eaves are flush with the sides of the building for economy, and to facilitate closing up the rafter ends. Windows are the tight-closing, check-rail type, and are decorated on the outside with attractive shutters.

A service door is provided, and the front doors are the easy-acting, roll-up type shown in Fig. 1. They can be arranged to open either by a key or electrically. Lights can be controlled from the front or service doors.

Construction as shown in Fig. 2 starts, of course, with the concrete foundation and floor. Any good contractor will lay it or you may do the work yourself. Wall framing is spaced 16 in. on centers with double

**H**ERE'S a garage that is not only neat in appearance, but is so well constructed that it will stand indefinitely if mounted on a good foundation, which can be of the "slab" type or of the wall type. If the latter is used, it should extend well below the frost line in your particular locality. The floor, of course, should be

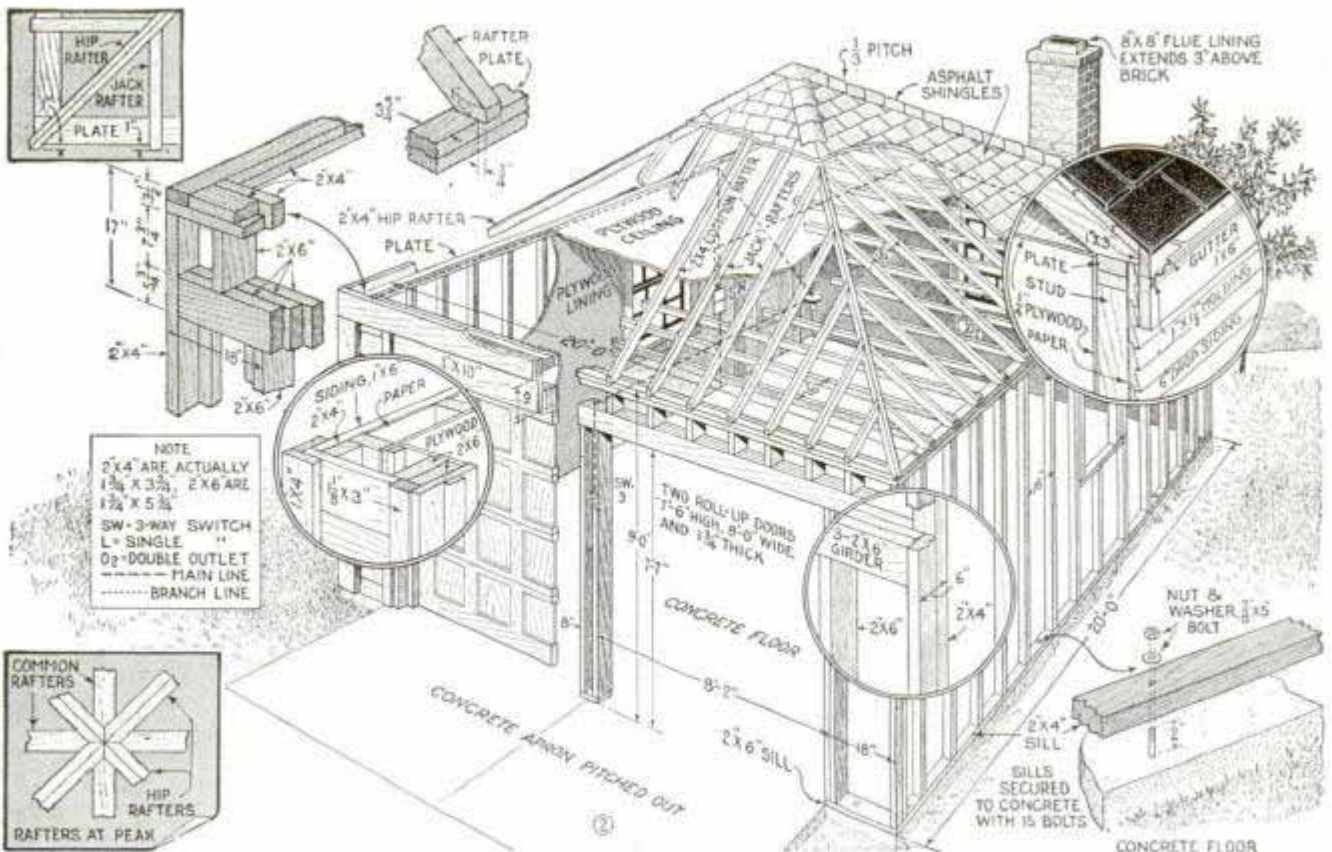



# TWO-CAR GARAGE



plates, headers and triple framing around the front doors, to secure a rigid, well built structure. First lay out and cut the pieces for the sills, as the holes for the bolts which fasten them to the concrete footing must be located and drilled. Then cut the plates and lay the lower ones next to the sills for marking out the centers of the studs on both pieces. Fig. 4 shows the location and size of the various openings.

The sills are bolted into place, the corner members erected and held plumb with stay lath and a temporary crosspiece nailed on the outside between corners, against which the studs may be set. The lower plates, supported by one or two studs, are next installed, after which the rest of the studs may be spiked into place. Considerable waste can be avoided if the studs at the door and window openings are omitted when setting up the wall framing, and later cut to size before installing. The common practice is to install them all and then cut out the openings later. Installing the top plate completes the wall framing.

Fig. 14 shows a typical window and door framing. Note that the rough or stud openings are made about 1 in. larger all around than the size of the frames to allow for squaring and setting plumb. The special

framing around the large doors is shown in detail in Fig. 2.

Before putting on the siding, a strip of heavy tar paper is stretched across the studding and secured temporarily with pieces of lath. Standard drop siding in a design to simulate bevel siding is used. The siding is started at the bottom, working up and adding paper as required. This material is inexpensive and makes a reasonably tight joint when used with paper. The corner joints of the siding are covered with corner boards as shown in Fig. 9. By lapping the siding at the corners as shown, the nails are placed a safe distance in from the ends of the boards.

The hip roof has four equal sides so the framing is simplified because of duplicate parts. The pitch of the roof is  $\frac{1}{3}$ , or for every 12 in. of run there are 8 in. of rise. So for 10 ft. of run there is a rise of 6 ft. 8 in. at the peak, as shown in Fig. 5. There are three types of rafters in this roof. These are shown in Fig. 8 together with the cuts on the ends. To obtain the length of the common rafters, with the tail and seat cuts, place the square along the piece as shown in Fig. 5. However, as the rafter is mitered at the top, as shown in the detail of the peak in Fig. 2, a deduction of



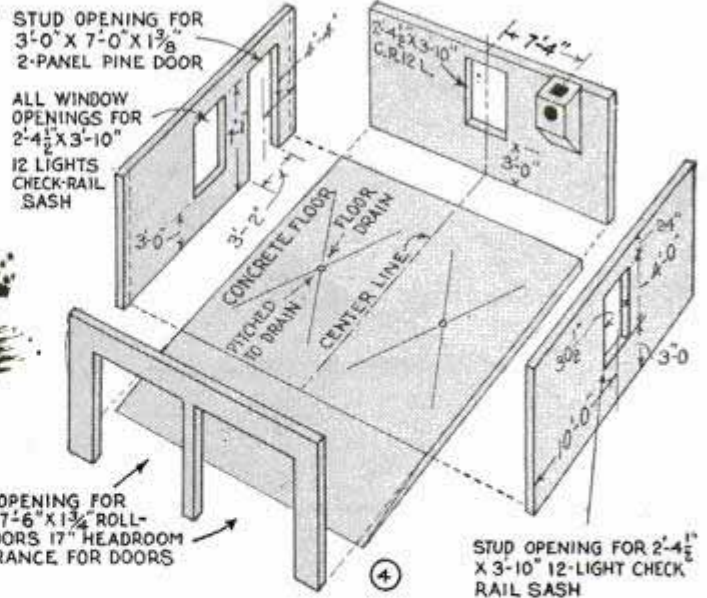

1 1/4 in. from the length must be made. Fig. 8 shows by dotted lines the length and shape of the rafter before making this deduction. Notice that the cheek cut remains at the same angle.

As the hip rafters run diagonally to the common rafters, we use the diagonal of 12 in. or 17 in. as our unit of run. Setting the square at 17 and 8 you proceed just as for the common rafters in obtaining the length of the hips. The seat cut is the same also, but the tail and top cuts are mitered. In order to provide a level surface on which the roof boards may be nailed, bevel or "back" the edges of the hip rafters as indicated. The lines are located on the ends with a square then carried along the sides for sawing.

Perhaps the easiest way for the novice to determine the lengths of the jack rafters is by actual measurement of one set after the hip and common rafters are in place. The tail and seat cuts are made on six pieces of various lengths and these pieces held in position and marked, after which they may be used as patterns for the other seven sets. The miter cut at the upper end, by which they are fitted against the hip rafters, is determined in the following manner: First lay off the plumb cut A, B, just as for a common rafter. Now measure

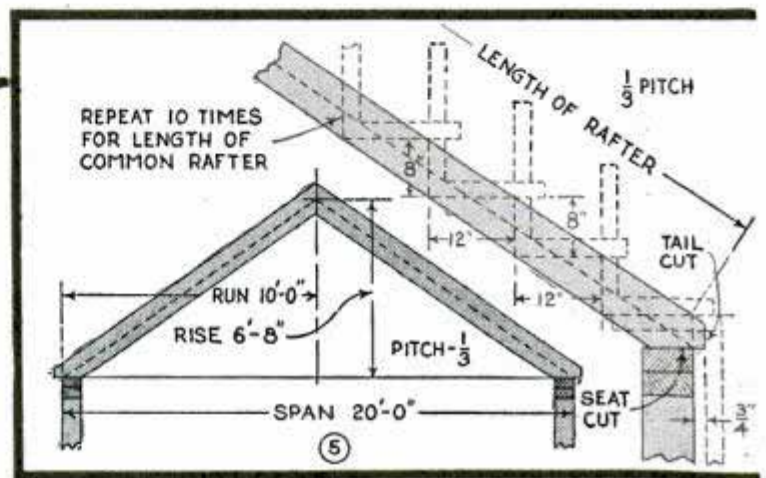

the thickness of the rafter and draw the parallel line C, D. Square across the top to point F. A line drawn from F to A and A to B will indicate the line of the miter.

After all of the rafters have been installed, the ceiling joists should be fitted and securely spiked to both the plates and the sides of the rafters. To lay the roof boards, start at the bottom, nailing two or three boards into place then sawing off the waste stock at an angle so that the end is flush with the adjacent side of the roof, as shown by the first cut in the detail of Fig. 7. Proceed in this way to the peak. Now start the adjacent side in a similar manner, lapping the ends of the first side and sawing at the angle shown as the second cut in the detail. Follow around the roof, taking care that all joints occur over rafters as in Fig. 6. Either square-edge or tongue-and-groove boards may be used but the latter are generally considered preferable. A good grade of individual shingle, laid 4 in. to the weather, Fig. 10, completes the roof.

A molded metal gutter is used all around



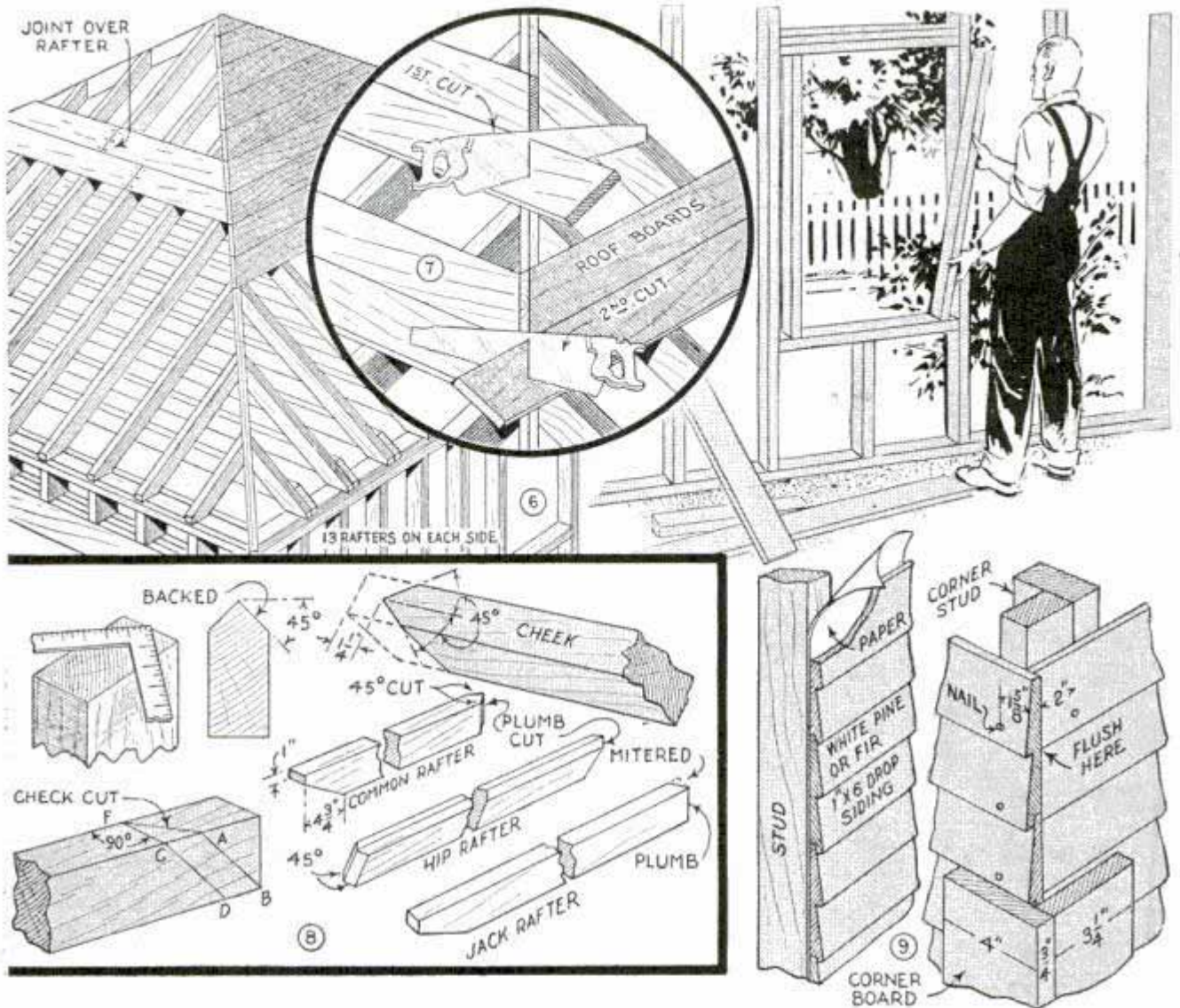

the roof to finish off the edges. A slight pitch should be given to the gutters so that they drain toward the back corner where a down spout is provided to empty into the drain. Standard window and door frames, sash and doors are used throughout. The shutters, however, are of special design, with fixed louvers, as shown in the detail of Fig. 11. Figs. 12 and 13 show the details of the chimney and the bracket upon which it rests. Any good coal, oil or gas-fired heater of suitable size will keep this well-constructed garage at a proper temperature in the coldest weather.

Overhead doors are perhaps the greatest advance in garage equipment in recent years. There are several rather similar makes on the market, any of which is entirely satisfactory. All of these doors are divided into sections horizontally and operate on a track. Because of a counterbalancing device, they operate so easily that even a small child can open or close them. All of them can be unlocked from

either side and if properly installed, according to the manufacturer's directions, should last for the life of the garage. The two essentials for the use of these doors is sufficient head-room and rigid door and ceiling framing, Fig. 2, so that the tracks will stay in line. Both are well provided for in this design.

There are also available several types of electric operators for over-head doors which are practical and very convenient as they may be operated from a distance and thus make it unnecessary to get out of your car to open or close the doors.

The proper installation of electric lights and control switches adds greatly to the convenience of a garage. A suggestion is given in Fig. 2. The usual center light should be controlled by three-way switches at both the center column, between the large doors, and also at some point near the service door. Another convenience is an outside light near the corner so that it will light both front and



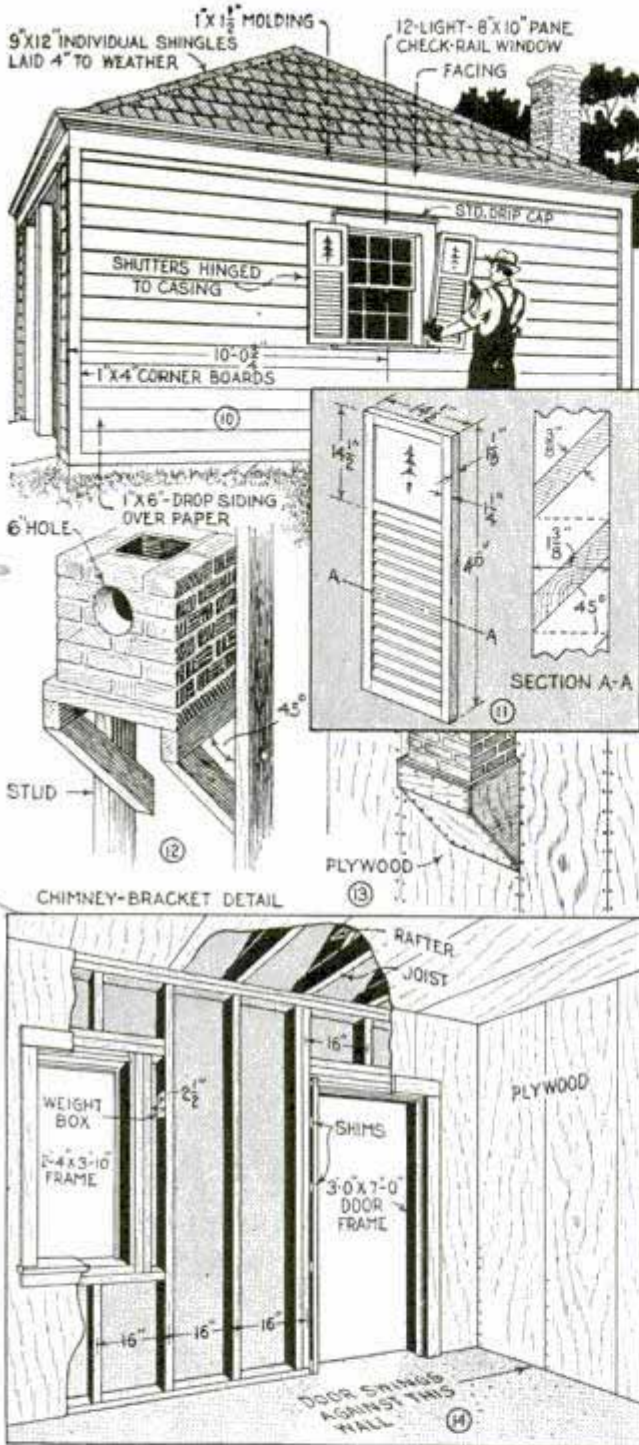

service doors. This light should be controlled by two switches, one in the house and the other located near the service door. In addition you will want outlets near the front of each car stall for trouble lamps or other appliances.

A water line in the garage is also a convenience that should be considered. This consists of an underground line from the house which is brought up near the center of the rear wall.

### MATERIAL LIST

- 60 pcs. yellow pine 2 x 4 in. by 10 ft. (for studs and corners)
- 10 pcs. yellow pine 2 x 4 in. by 16 ft. for plates
- 3 pcs. yellow pine 2 x 6 in. by 20 ft. for girder
- 9 pcs. yellow pine 2 x 6 in. by 8 ft. (for door studs, sills, etc.)
- 3 pcs. yellow pine 2 x 4 in. by 20 ft. for sills
- 15 pcs. yellow pine 2 x 4 in. by 20 ft. (for ceiling joists)
- 4 pcs. yellow pine 2 x 4 in. by 18 ft. (for hip rafters)
- 16 pcs. yellow pine 2 x 4 in. by 14 ft. (for common jack rafters)
- 18 pcs. yellow pine 2 x 4 in. by 12 ft. (for jack rafters)
- 4 pcs. fir or white pine 1 x 3 in. by 20 ft. (for cornice)
- 4 pcs. fir or white pine 1 x 6 in. by 20 ft. (for facing board)
- 6 pcs. fir or white pine 1 x 6 in. by 8 ft. (for door casings)
- 2 pcs. fir or white pine 1 x 3 in. by 8 ft. (for door trim)
- 1 pc. fir or white pine 1 x 8 in. by 8 ft. (for door division panel)
- 720 sq. ft. yellow pine matched roofing, 1 x 6 in.
- 720 sq. ft. fir or white pine drop siding, 1 x 6 in.
- 20 fir plywood panels,  $\frac{1}{4}$  x 48 in. by 10 ft. (for walls and ceiling)
- 2 roll-up doors  $1\frac{3}{4}$  in. by 8 x 7 ft. 6 in.
- 1 two-panel fir service door  $1\frac{3}{4}$  in. by 3 x 7 ft. complete with frame, trim and hardware
- 3 check-rail windows with 12 lights, 2 ft.  $4\frac{1}{2}$  in. by 3 ft. 10 in. complete with frames, trim, etc.
- 600 sq. ft. asphalt shingles
- 80 linear ft. molded gutter with downspouts
- 600 sq. ft. building paper

## Skinning of Small Animals Simplified by Compressed Air

Trappers and taxidermists can use this novel and practical method of skinning small animals. Instead of beginning the job with a sharp knife as is usually done, you first inflate the skin with compressed air, thus breaking loose the tissues that hold it to the carcass. This is done with an ordinary tire pump and a hypodermic needle, the latter being soldered to a valve stem and the assembly in turn screwed to the hose attached to the pump. Care must be taken to insert the point of the needle just

under the skin and close to an incision which will be made later in removing the hide. If the pelt is to be open-skinned, the needle can be inserted through the hide at some point along the underside of the belly. Where the pelt is to be skinned by the cased method, insert the needle on the underside of the hind leg. Do not inflate the skin more than necessary to break the tissues. After inflating and making the incisions, the pelt can be removed easily.

—J. R. Stafford, Hayden, Colo.

Fire inspector object to this.



## This Magnetic Rack Holds Small Hand Tools

The usual array of small tools that clutter a bench when you are working, can be stored efficiently on this magnetic rack. It will support pliers, screwdrivers, compasses, chisels, small wrenches, etc. Just place them against two iron strips which contact the faces of several magnets. Model-T Ford magnets are well suited for the purpose. They are placed in a rack made as indicated and the iron strips are screwed to the front of the rack at the top and bottom. It is important that like poles of the magnets be matched throughout, otherwise the pull will be lessened greatly. The poles can be matched by holding two magnets together as indicated in the center photo. If they show no attraction for each other when held together in this position, the like poles are together, but if they cling to each other, one of the magnets must be turned over.

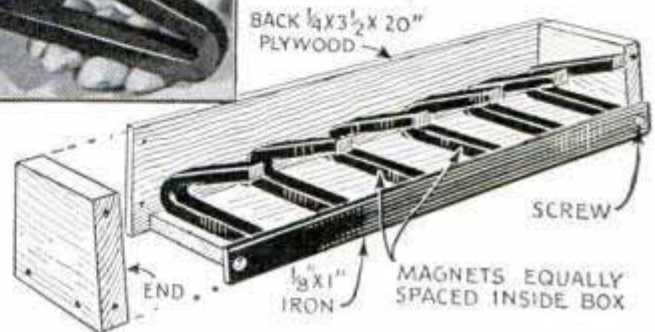
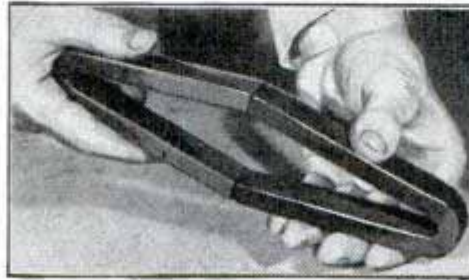
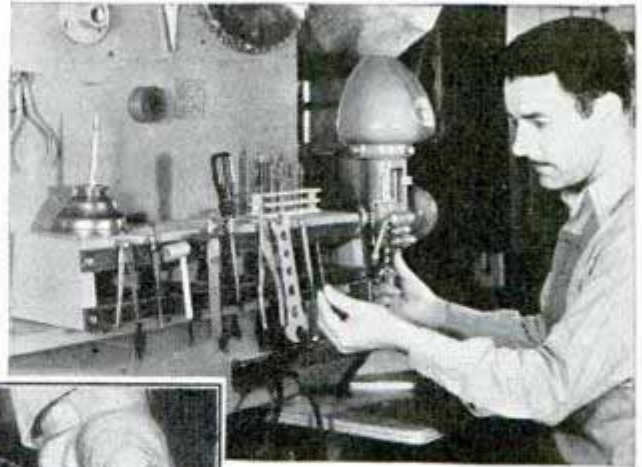

## Detachable Dividers for Hog Trough from Auto Skid Chains

To keep hogs from fighting over feed in a trough, one farmer uses old car or truck skid chains instead of wood cleats, which usually make it difficult to clean the trough properly. The chains are stretched taut and are fastened by screweyes, which are driven into the ends and sides of the trough and run through links of the chain.

Turning the heads at right angles to the links keeps the latter from slipping off the screws. When the screw heads are turned back parallel with the links, the chain can be lifted and removed for cleaning.

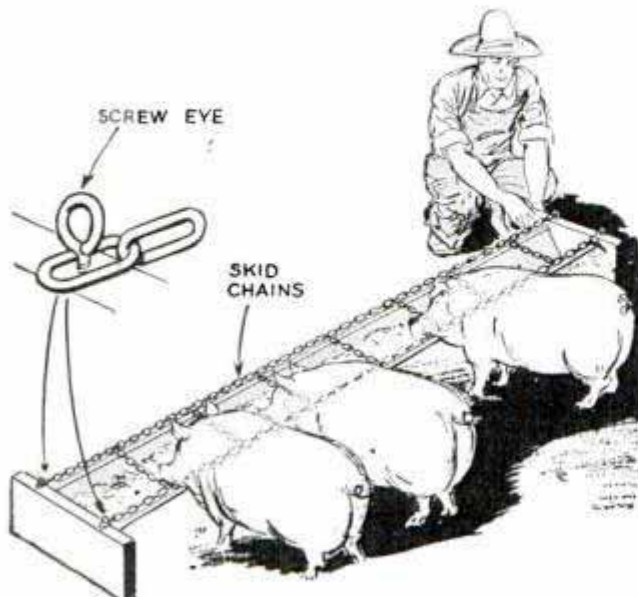

## Cardboard Holder for Drills Carried in Pocket

Finding it convenient to carry small drills in his pocket while working on a job away from his shop, a carpenter made this holder from a piece of corrugated cardboard. After cutting the cardboard

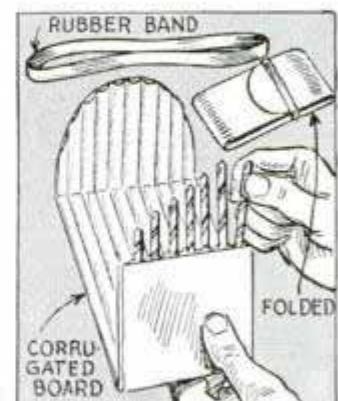

to the proper shape and folding it as shown, the drills are inserted into the corrugations, the flap of the holder being held in place by a rubber band.



## Chicken Is Held over a Barrel When Plucking Feathers



To hold fowls conveniently for plucking, one produce merchant uses a simple, detachable wire clip and hook which support the birds over an open barrel, in which the feathers drop. The clip is pushed between the barrel hoop and staves to engage the bird's feet, while the hook is attached to a rubber band anchored on the side of the barrel. The hook engages the neck and stretches the carcass across the opening. The hook and clip are made of heavy wire.

## Physician Folds Papers of Powder to Seal Them

When filling a prescription that contains different powders, one physician puts them in small pieces of paper, which are then folded to seal them tightly. To do this, the paper is folded as indicated by the dotted

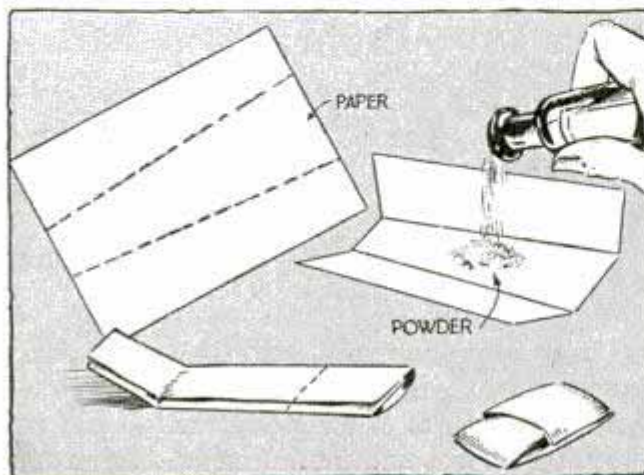

lines so that it tapers toward one end. Then both ends are folded over and the smaller one is inserted into the opening of the larger end.

## Magnifying Glass on Centerpunch Assures Accuracy

If you are using a centerpunch on work where accuracy is necessary, a magnifying glass attached to the punch as indicated will be helpful. The glass is of the type inclosed in a metal band to which strips of metal are soldered so that the assembly can be clamped to the punch as shown.



—Michael F. Wolf, Minneapolis, Minn.

## Sectional Stable Doors Operated as One Unit with Latch

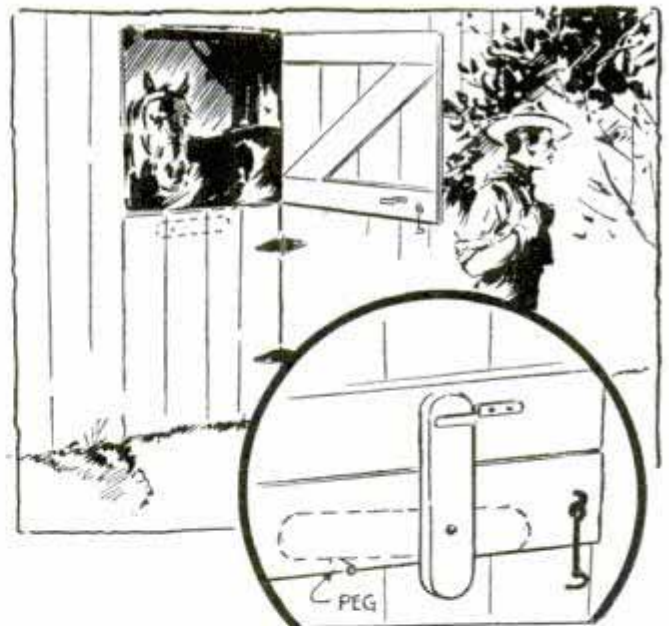

Barn doors of the two-section type may be operated as a single unit by use of the pivoted latch shown in the circular detail. To do this, attach a wooden pivot latch to the upper crosspiece of the lower door to engage a flat-iron hook on the lower crosspiece of the upper door. When not in use the latch rests on a peg or nail which supports it in a horizontal position out of the way, allowing the door to open separately.



# Hints for AUTO MECHANICS

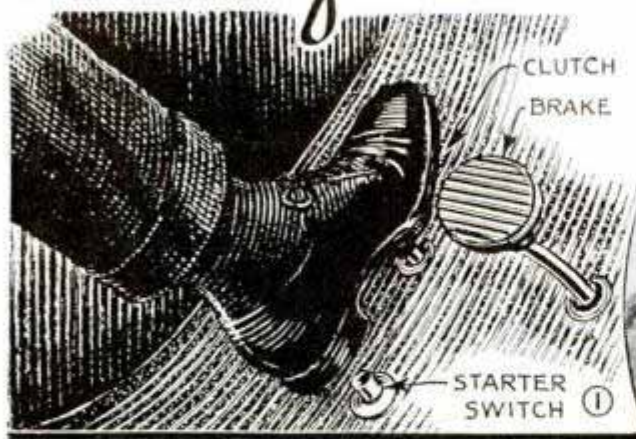

1, You can release a Ford V-8 clutch for cold-weather starting and close the starter switch with one foot by turning the latter sideways so that the heel touches the switch button. 2, an asbestos shield attached to clothespins with screws protects the tire and wheel when welding a damaged fender. The clothespins are clipped over the fender edge

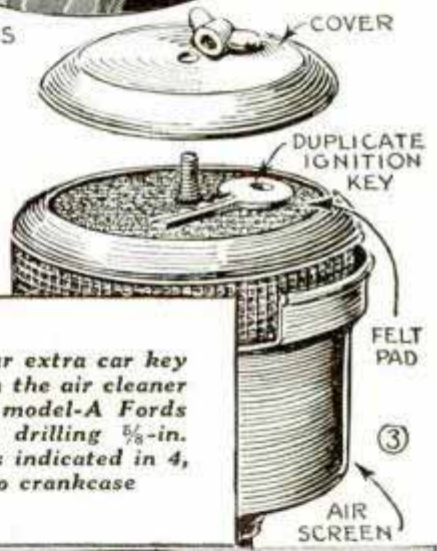
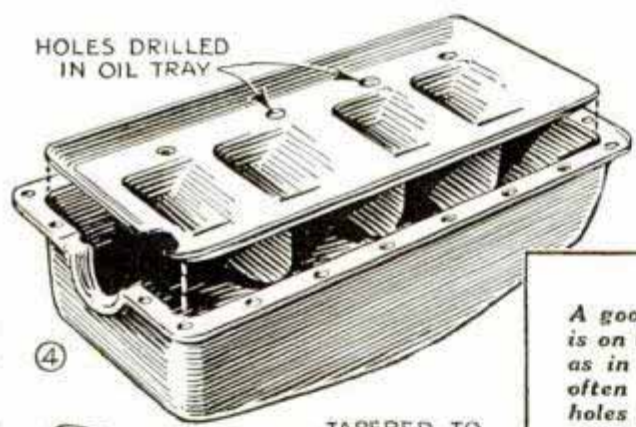

A good place to carry your extra car key is on top of the felt pad in the air cleaner as in 3. Oil pumping of model-A Fords often can be reduced by drilling  $\frac{3}{8}$ -in. holes in the splash tray as indicated in 4, to drain excess oil into crankcase

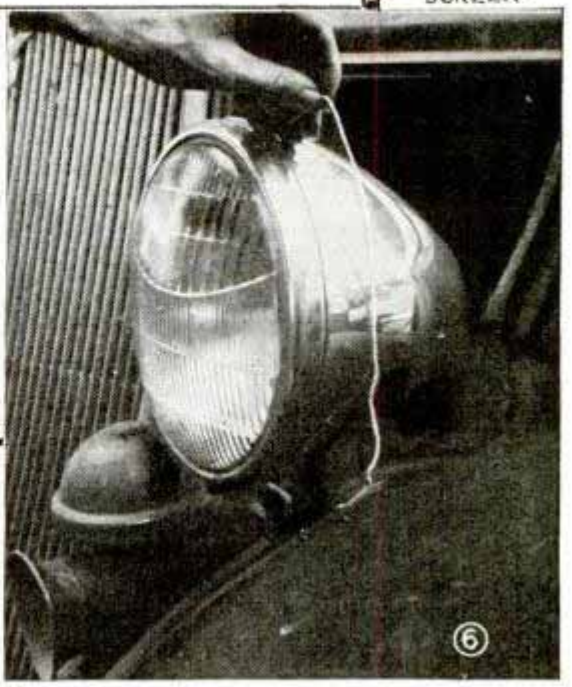
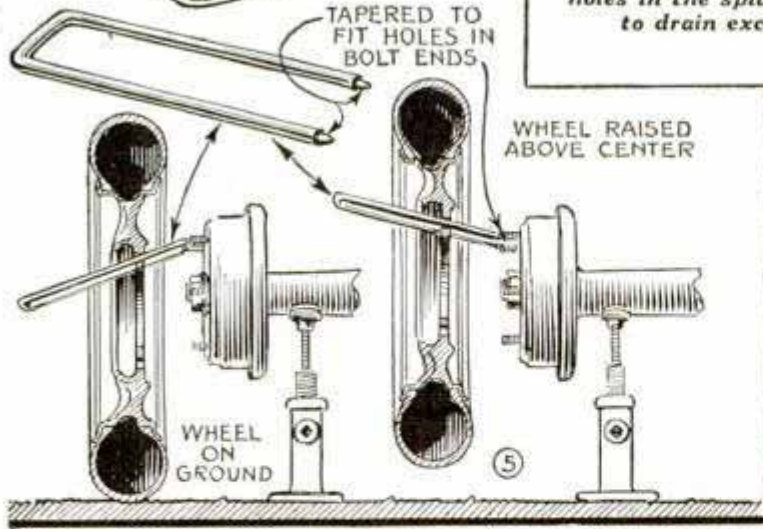

The tool in 5 will help slip a heavy wheel over the bolts of the brake drum. Drill holes in the ends of two adjacent bolts, bend an iron rod to a U-shape and point the ends. Slip the tool through the holes in the wheel and work as indicated. To help keep moisture out of your headlamps, press a paraffin-coated string into the joint between the lens rim and the lamp housing as indicated in 6. Use a string large enough to fill the joint



## Small Bearings Removed Quickly with Improved Puller

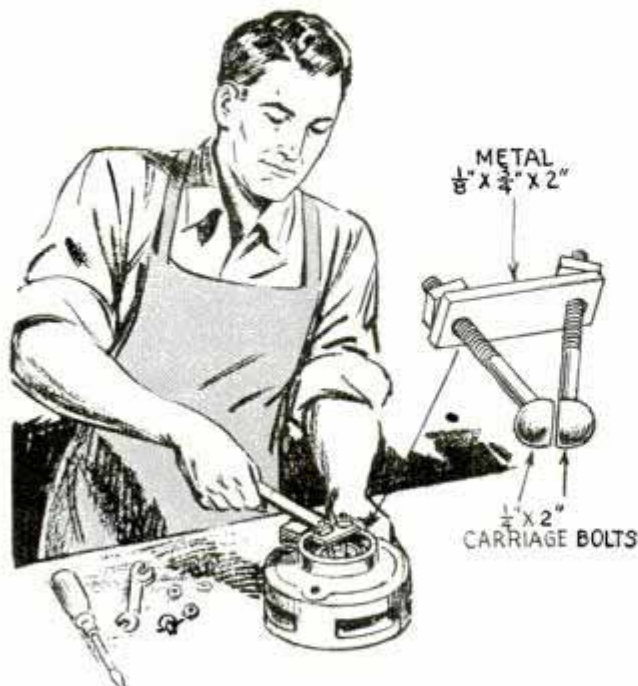

Removing starter, generator and other small bearings is easy with this improvised puller, which is assembled from a short piece of flat iron and a couple of carriage bolts. On most jobs it is not even necessary to take the generator apart; just slide the armature shaft out of the bearing far enough to let the bolt heads slip over the rear side of the race. In some cases, it may be necessary to insert the bolts separately and then slip the bar over the threaded ends. A pry under the bar will pull the bearing. For larger bearings use a heavier bar and larger bolts.

—M. W. Mutschler, Lincoln, Nebr.

## Use Larger Stud in Crankcase When Threads Are Stripped

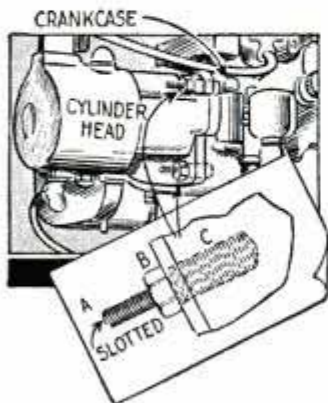

If you strip the threads of a hole in an aluminum crankcase, a repair can be made by reaming out the hole and tapping it to take a larger stud. The portion of the stud that projects from the case should be turned down to the same diameter as the one used first and then threaded. A screw-

driver slot sawed in the projecting end of the new stud will enable you to drive it into the hole.

—Karl Melvin, Halifax, N. S., Can.

## Protecting Control Cables

To protect motorcycle control cables from chafing where they rub against parts of the machine or where they pass through holes in the handlebars or other tubing, it is a good idea to cut suitable strips from a tobacco tin and wrap these around the cable at the point where the chafing occurs. The tin guards can be soldered in place or fastened with a strip of friction tape.

## Welding-Rod Holder Insulated When Repairing Motor Block

In order to weld a crack in the water jacket around a cylinder, the electrode of an electric welder had to be inserted through the small water openings in the

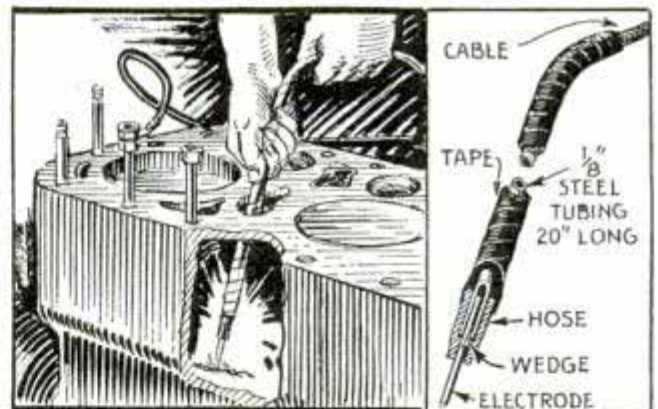

top of the block as shown. To do this without causing a short circuit, the welding cable was attached to a piece of small steel tubing in which the electrode was wedged. A piece of rubber hose was slipped over the joint between the electrode and tubing, after which the entire assembly was wrapped with tape. In one instance a weld was made through a 1-in. hole while the worker watched the job through another hole.—Jos. C. Coyle, Yuma, Ariz.

## "Dry-Ice" Tests Shock Absorbers

As shock absorbers of the hydraulic variety wear they become less effective. In some instances, heavier fluid will give the ride desired, but it is not easy to drain, re-



fill and try heavier fluid. A piece of Dry-Ice wrapped to each shock absorber with a rag will give the same effect. The lower viscosity resulting from chilling the shock absorber will give the effect of riding with heavier fluid. Then if the effect is what is wanted, the units can be drained and filled with heavier fluid.—C. E. Packer, Chicago.

### Cheap Garage for a Motorcycle

Motorcyclists who use a waterproof sheet to protect their machines when not in use, will find the following tip useful: Take two sleeves from an old jacket or coat and sew them into the sheet so that they can be slipped over the handlebars to prevent the sheet from blowing off.

### Heavy Transmissions Installed or Removed Easily

Here's a simple tool that will enable you to remove or install heavy transmissions single-handed. Also, it is handy for supporting them while installing or repairing a clutch. The tool consists of an L-shaped lever with a telescoping handle which can be adjusted for length. The short end of the lever is pivoted to an improvised clamp, which can be fastened to the instrument panel to provide an anchorage. A length of round stock bent to a V-shape and flattened at the ends slips over the handle and is fastened to cap screws or studs in the transmission to lift the latter.  
—Otto Seeliger, Chicago.

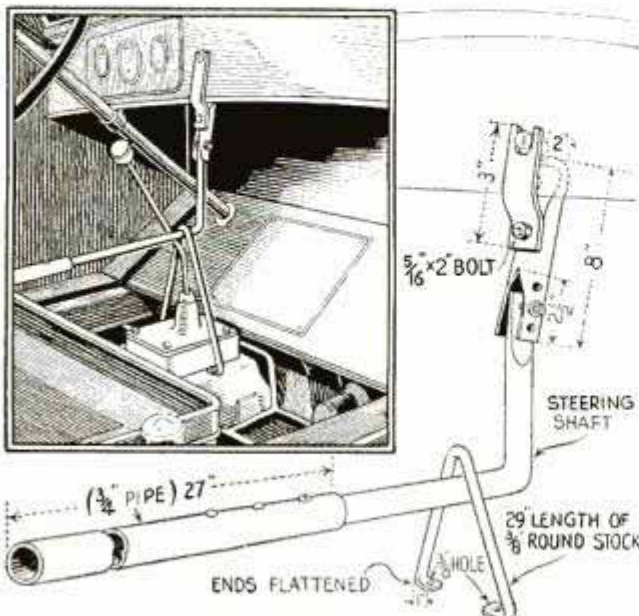

### Wheeled Rack to Display Tires Moved Inside at Night

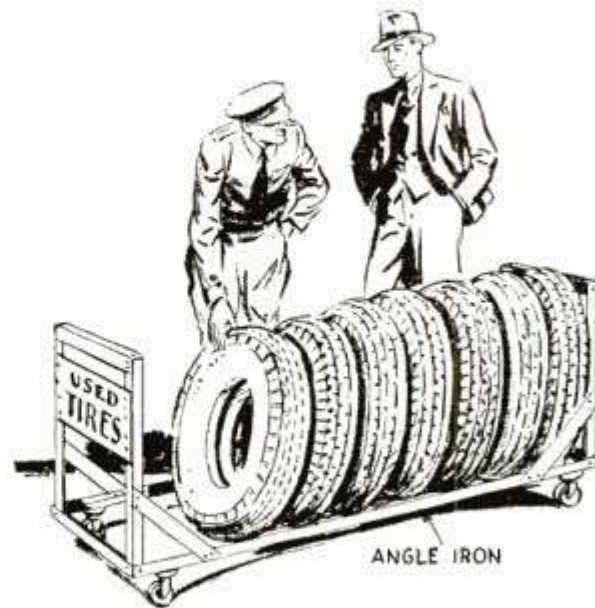

Service-station owners who handle used tires will find this wheeled display rack a labor saver as it can be loaded and moved to any spot on the premises and then moved inside the building at night without handling the tires. The rack is assembled from angle iron, which is riveted together, the wheels being heavy trunk casters mounted at each corner.

—Hugh Lineback, Siloam Springs, Ark.

### Spare-Tire Rack on Truck Lowers to Receive Extra Wheel

Instead of lifting a heavy tire and wheel to slide it into the spare-tire rack underneath the body of a truck, one driver altered the rack so that one of the supports could be lowered with a lever. This saved considerable labor in removing or replacing the wheel.—Don Smith, Chehalis, Wash.

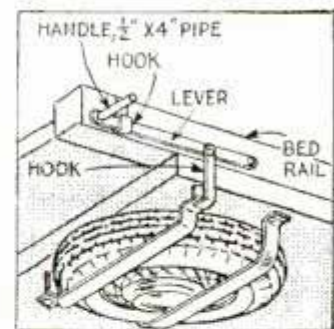

☐ If you have an idea that might be used for a short article in these pages, send it to the Homecraft Editor. Inclose a snapshot or drawing and give all the necessary information in as few words as possible. To be accepted, material must be of general interest and different from any we have published previously.



## Chart of Feet Required to Stop Aids Car Driver

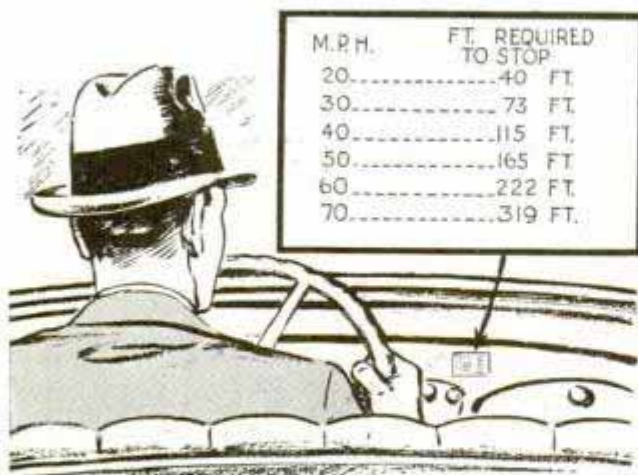

Finding that younger members of his family who drove did not realize the distance required to stop a car safely at a

certain speed, one motorist made up the chart shown and fastened it to the instrument panel in plain sight. After showing the drivers how to approximate distance by sight, they were able to stop safely without sliding the wheels, the chart giving them the required distance at a glance. Also, it served as a reminder to keep the speed down.

## Trailer Has Built-In Level

Two small spirit levels fastened to window of a trailer will prove a timesaver. They may be placed in different locations if desired, but they must be set at right angles to each other in order to read correctly for lateral and longitudinal leveling of the trailer.

—A. H. Vance, McNaughton, Wis.

## Plan-of-the-Month—A New Service

*How to get a collection of plans designed by leaders in craftwork*

Complete, easy-to-follow plans, including photos, material list and full instructions on building simplified but worth-while articles with generally used hand tools. No previous experience necessary

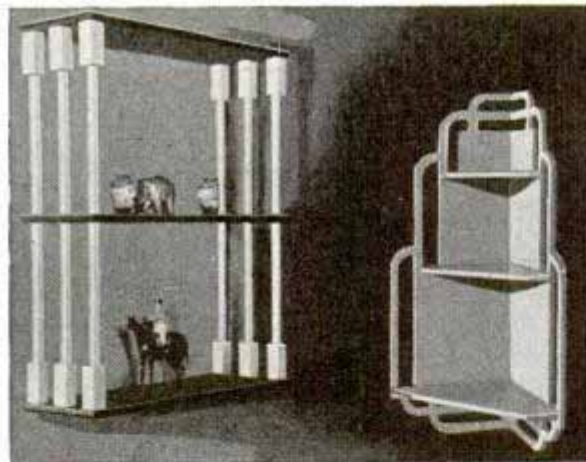

*Every home needs something like this to add an artful, delicate touch to large expanses of bare walls, or to add charm to uninviting corners*

### Send coupon and 10 cents for Craftplan of Wall and Corner Shelves

for bric-a-brac and whatnots in the home. Either one of these can be put together and attractively finished in an evening or two at the handicraft bench.

#### SIMPLE TO MAKE

All you need to make these shelves is some plywood, a few dowels and a length of square stock. The work can be done entirely with hand tools.

#### ALL DETAILS GIVEN

Craftplan shows and describes every detail and process of assembling step by step. New, simplified method of illustrating followed. Contains full-size patterns for scroll-sawing which you can trace directly on the wood. Also suggestions to obtain beautiful, pleasing finish.

#### START A HOME WORKSHOP

Why not get into home woodcraft? For the novice, such subjects as these shelves are just right as a starter. Besides getting the benefit of recreation, the useful things produced often can be sold at a profit.

POPULAR MECHANICS MAGAZINE  
200 E. Ontario St. Chicago

Enclosed find 10 cents for Craftplan No. 3003 on  
Small Wall and Corner Shelves

Use Pencil

FE. WALL SHELVES—CRAFTPLAN No. 3003



# With Eastman's new HIGH SPEED FILM any camera takes NIGHT SNAPSHOTS in its stride



About four  
times as fast  
as ordinary film



## ALL YOU NEED

1. Your present camera loaded with the new Kodak Super-XX Film
2. A couple of inexpensive Mazda Photoflood lamps in Kodak Handy Reflectors



**E**ASTMAN'S new four-times-as-fast film enables every one to make snapshots at night, regardless of his equipment. You need less light indoors than ever before; you use any camera that takes the new Kodak Super-XX Film—even an inexpensive Brownie. The pictures you get are not stiff and posed, but the same informal, spontaneous, true-to-life shots you snap outdoors.

**FREE BOOKLET . . .** This little booklet introduces you to one of picture taking's biggest thrills—snapshots at night. A single reading, and you're ready to make nighttime snapshots you'll be proud of. Interesting photographs, easy-to-understand diagrams, and light arrangements. At your dealer's . . . Eastman Kodak Company, Rochester, N. Y.



Eastman's  
**THREE**  
NEW FILMS  
meet every  
picture-taking  
need



**HIGH SPEED  
AND FINE GRAIN**

**KODAK PLUS-X FILM**, in miniature sizes only . . . Combining both increased speed and fine grain, the ideal all-round film for miniature camera use.



**EXTREME SPEED**

**KODAK SUPER-XX FILM**, in miniature and other popular amateur sizes. Yields good negatives under trying light conditions. Ideal for snapshots at night.



**EXTREME  
FINENESS OF GRAIN**

**KODAK PANATOMIC-X FILM**, in miniature sizes. Enlargements that are many times the original negative size still show no appreciable graininess.



# Trapping Fish Pirates from the Air

(Continued from page 196)

is that they will not retrace their course, even to fight free of nets.

These traps, necessarily, are scattered in wide areas. Often a single operator owns a dozen or more. The operators' cannery tenders visit the traps at intervals to load the fish aboard and carry them to the canneries to be marketed. During the interval, the trap often is left with a lone watchman. Among the hundreds of fishermen owning their own boats, but unable to finance traps or procure good locations, there developed the reckless individuals



An Alaska plane pausing at the foot of Taku Glacier

who chose the easy way to grasp a bountiful supply of fish by helping themselves in other people's traps.

These were the pirates, the rustlers of the north, who reaped the silver riches at the constant risk of prison or even death from the bullets of a watchman or an irate trap owner who happened along while the wholesale theft of salmon was in progress. Often the watchmen worked hand in hand with the freebooters. The trap owner, being absent, had no method of measuring the extent of his catch. Corrupted by the offer of the pirate to share in the proceeds of the raid, the unscrupulous watchman allowed and even helped the pirate to load his boat from the trap.

Watchmen who could not be corrupted

often were strongarmed, bound and tossed into a corner of the cabin while the salmon buccaneers helped themselves from the trap. Marketing the fish was so simple that it was not even a problem. Cannery owners had no method of determining the source of the salmon offered for sale, especially since the pirate passed off as a respectable fisherman. The freebooters did considerable legitimate fishing to establish themselves as regulars. A few cannery owners, of course, asked none too many questions, especially if the price was right.

The long series of depredations, extending over a quarter of a century, often had grim aspects as rifles spat bullets from both sides. The old Alaskan was wont to take law enforcement into his own hands in his desperate effort to protect his property.

Today the airplane, first introduced by Capt. Eckmann ten years ago, has made the life of the salmon freebooter unhealthy. It no longer is possible for the buccaneer to slip up to a trap in his boat, corrupt or overpower a watchman and make off with hundreds of dollars in fish because the trap owners employ planes extensively to chart the approach of the salmon and at the same time keep a law-enforcing eye on the traps. The planes speed in a few minutes over a shoreline that formerly took hours to cover in surface boats.

The sight of an unauthorized fishing boat at a trap will cause the plane to drop down out of the sky while the pilot and crew find out just what is going on. And if salmon are being stolen, it is but a matter of an hour or so before the plane will return with authorities empowered to handle the situation.

The pirate's boat cannot travel fast enough to leave the vicinity before the plane returns and once seen from the air, escape is impossible as the pilot can see the marauding vessel, no matter where she flees and hence is able to bring the freebooters to justice.

Names and addresses of manufacturers and dealers in articles described in this magazine will be furnished by our Bureau of Information upon request accompanied by stamped, self-addressed envelope.



"THIS SPORT *Tops*  
EVERYTHING!"



YOU can't beat motorcycling for plenty of excitement and fun. Takes you where thrills come thick and fast. You make lots of new friends — go on club runs and gypsy tours — attend hillclimbs, reliability runs, tourist trophy races — pal with other happy riders. See your Harley-Davidson dealer. Hear the fun-packed story of motorcycle club good times. Take a ride on a snappy new 1939 Harley-Davidson. Get the "feel" of motorcycling—greatest of all outdoor sports. Ask your dealer about his Easy Pay Plans—and send in the coupon NOW!

**TOURIST TROPHY CHAMPION**

Winner for the 4th consecutive time of the 45" and 80" National Tourist Trophy Championships.

**HARLEY-*Champion* MOTORCYCLE  
DAVIDSON**



**MAIL  
COUPON  
Now!**

HARLEY-DAVIDSON MOTOR CO., Dept. P-239, Milwaukee, Wisconsin  
Send illustrated literature and FREE copy of "ENTHUSIAST,"  
Motorcycling Magazine. Stamp is enclosed for mailing cost.

Name.....

Address.....



# Brains Against Flames

(Continued from page 245)

On the fire maps that are constantly being drawn and redrawn at headquarters the first is divided into zones with a zone boss in charge of each. Having 1,000 or more men under him, the zone boss has a staff resembling the one at headquarters for contacting the two or three divisions under his command. Each division breaks down into sectors of from fifty to 100 men with a second boss at the head of each, and each sector in turn is made up of a number of basic crews consisting of ten men each.

This military organization fights the fire while another staff takes care of the camps.



Interior of forest-service "firebox" shows equipment for fighting the flames

Each temporary camp, housing 500 men, has a staff of cooks, clerks, timekeepers, tool tenders, and helpers. The men work twelve-hour shifts and hot food and blankets, canteens of water, electric lights on headbands for working after dark must all be ready when needed. A big power grinder for sharpening shovels and axes and that can be unbolted for carrying on mules in rough country, is set up at each camp. In a distant town, the fire dispatcher of the forest district keeps in touch with the field headquarters and sends extra men and supplies to the scene as they are needed.

Professional forest rangers form the trained skeleton of the fire-fighting army. Each crew leader has to know the country and its possibilities. Before he leads his men into position he has to consider a way

of getting them out safely. Caught in tight quarters near a stream, crews have saved themselves by lying down in the water, gulping the air close to the surface until the flames have passed. Depending upon the type of timber and the breaks in the forest, a crew leader may successfully lead his trapped men on a dash through the flames, escaping over the burned area. This is a desperate, dangerous final resort and many fire fighters, blistered and burned, have saved their lives that way.

Forest-fire fighting is being widely mechanized. Networks of truck trails have been built in many forests so that big water trucks, carrying 250 gallons of water and equipped with one-inch lines for knocking down the flames, can join in the battle. A super-truck carrying 2,400 gallons of water is being tried out for wetting down areas in the path of a fire. Just as valuable as the new trucks are the bulldozers that scrape out new firebreaks and cut out lanes in front of the flames.

Last summer the airplane, in use for years for spotting and scouting fires, came into its own. Thousands of pounds of food and tools were dropped to isolated bands of fighters. In big fires transport planes may be chartered to fly crews into locations that would require days of travel to reach on foot.

The latest ideas in aerial fire fighting are being tried out with an airplane recently bought by the forest service. Equipped with a cargo compartment and with gear for lowering supplies by parachute, the plane is also being rigged with a powerful loud speaker by which orders can be issued to fire fighters on the ground below. Experiments are also progressing with bomb sights and releasing gear for bombing out small spot fires in the mountains with chemical foam. Packages of water, powders, and chemicals are being used as bombs. The experiments suggest that this may become a regular part of forest-fire fighting technique in the future.

Names and addresses of manufacturers and dealers in articles described in this magazine will be furnished by our Bureau of Information upon request accompanied by stamped, self-addressed envelope.



# HOW DO YOU LOOK IN YOUR BATHING SUIT?

**SKINNY?  
THOUSANDS GAIN  
10 TO 25 POUNDS  
THIS QUICK EASY WAY**



**Read how thin, tired-out, nervous,  
rundown people have gained health  
and strength—quick!**

ARE you ashamed to be seen in a bathing suit, because you're too skinny and scrawny-looking? Are you often tired, nervous—unable to eat and sleep properly?

Then here's wonderful news! Thousands of skinny, rundown men and women have gained 10 to 25 pounds, new pep, new popularity—with this scientific vitamin-rich formula, Ironized Yeast.

## Why it builds up so quick

Scientists have discovered that countless people are thin and rundown—tired, cranky, washed-out—only because they don't get enough Vitamin B and iron from their daily food. Without enough of these vital elements you may lack appetite and not get the most body-building good out of what you eat.

Now you get these exact missing elements in these marvelous little Ironized Yeast tablets. No wonder, then, that they have helped thousands of people who needed these elements to gain new naturally attractive pounds, new health and pep, new popularity and success—often in just a few weeks!

## Try them without risking a cent

Get Ironized Yeast tablets from your druggist today. If with the first package you don't eat better and FEEL better, with much more strength and pep—if you're not convinced that Ironized Yeast will give you the new pounds, new energy and life you've longed for, the price of this first package promptly refunded.

But just one warning! Due to the success of

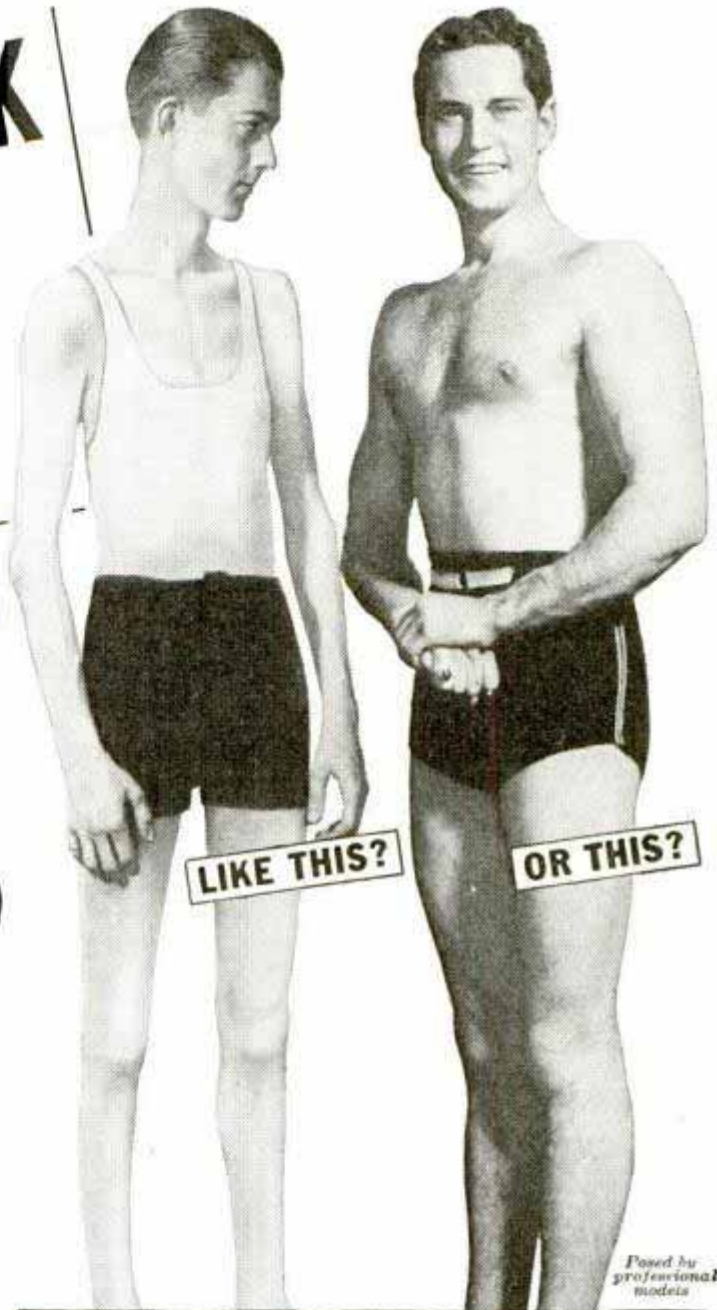

*Posed by  
professional  
models*

Ironized Yeast, a number of cheap, inferior substitutes have sprung up. Of course inferior substitutes do not give the same results. So insist on genuine Ironized Yeast. Look for the letters IY stamped on each tablet.

## Special offer!

To start thousands building up their health right away, we make this special offer. Purchase a package of Ironized Yeast tablets at once, cut out the seal on the box and mail it to us with a clipping of this paragraph. We will send you a fascinating new book on health, "New Facts About Your Body." Remember, results with the first package—or money refunded. At all druggists. Ironized Yeast Co., Inc., Dept. 532, Atlanta, Ga.

**TUNE IN ON THE GOOD WILL HOUR**, every Sunday Evening. See your local paper for time and station.



**Irvin Echard**

"I was so skinny I didn't want to go out. Finally, I tried IRONIZED YEAST. In five weeks I gained 14 lbs. Now I go out regularly, have good times."

**Irvin Echard, Barberton, O.**



**R. Loeffler**

"Was losing weight and pep. Then I got Ironized Yeast. In 6 weeks I gained 12 lbs. and am full of pep. Everybody admires my physique, too."

**Ralph Loeffler  
Arlington, Wash.**

**Gains 14 lbs.  
in 5 Weeks**

**Gains 12 lbs.,  
admired now**



H 1258

## Harnessing America's Wildest River

(Continued from page 204)

total of 1,835,000 horsepower, and the electrical energy generated yearly will amount to about 4,330,000,000 kilowatt-hours.

At present four turbines have been installed, their generators supplying power which is transmitted to Los Angeles over one of the most wonderful power lines in the world, since it is virtually automatic in operation throughout its distance of nearly

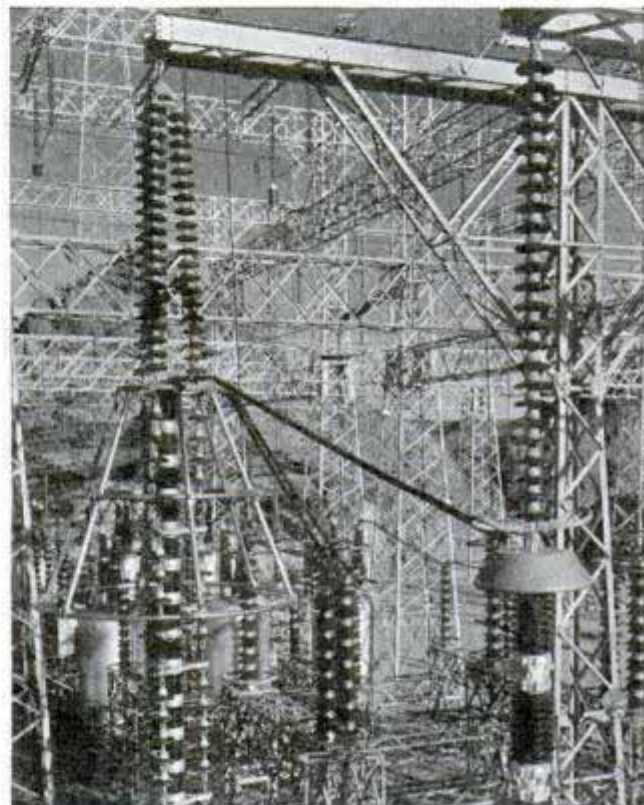

The "switchyard" at Boulder dam from which power is routed to Los Angeles

300 miles. Circuit breakers operate instantly in case of trouble, shunting the load from a damaged line to an undamaged one.

The power transmission is directed from a main control room where two or three men check an array of dials and instruments. A remote-control board in this room connects with the main power units and the men in this office are in contact with the receiving station in Los Angeles and with the "electrical cowboys" riding herd on the transmission line.

Two high-speed elevators descend 528 feet from the roadway at the crest of the dam to the powerhouse. Power-plant machinery is lowered from the rim of the canyon to the powerhouse by means of an

**Be Wise - Alkalize**



An Alka-Seltzer Tablet in a glass of water makes a sparkling pleasant-tasting solution. Drink it and it gives quick relief from Headaches, Sour Stomach, Distress after meals and other common ailments. It also helps overcome excess acid condition so often associated with these troubles.

TUNE IN  
THE NATIONAL  
BARN DANCE  
SATURDAY NIGHT  
NBC • NETWORK

**Alkalize with Alka-Seltzer**

AT ALL DRUGGISTS

30¢ & 50¢ PKGS.  
OR BY THE GLASS  
AT DRUG STORE  
SODA FOUNTAINS



**DO YOU** WANT a new business profession of your own, with all the trade you can attend to? Then become a foot correctionist, and in a few weeks earn big income in service fees,—not medical nor chiropody—easy terms for home training, no further capital needed, no goods to buy, no agency. Established 1894. A *dress* Stephenson Laboratory, 1 Back Bay, Boston, Mass.



H1258  
 electrically operated cableway 1,200 feet long and with a capacity of 150 tons. The cableway can be operated by remote control from any one of five stations.

The dam and powerhouse are operated much like any large industrial plant and office building. More than 800 men are at present employed there but over 500 of them are engaged in construction and maintenance work and in installing additional machinery. Of about 300 others, seventy-five or more are employed in the power generating department reading dials, checking the flow of oil and watching the generators and turbines.

The powerhouse contains more than ten acres of floor space and janitors inside and outside the structure keep it spotlessly clean. There are elevator operators, guides, maintenance men and electricians, pump operators, pipe fitters, a crew of painters constantly at work renewing the paint on the hundreds of miles of pipes and fittings and, last but not least, three rangers to maintain order.

While only a few hundred men actually are employed at the dam, and only a handful of men are needed in the actual control of the water itself, Boulder dam has created jobs for thousands of men and in the future will create work for many others. Below the dam lie some of the world's most forbidding desert areas, lands drier than the Sahara. Without irrigation the areas have been useless. With irrigation, their rich soil and the warm climate make them very productive.

Part of this area of 1,900,000 acres is now irrigated. Eventually the irrigation will be extended greatly and hundreds of people will find homes and rich farmlands where now is arid desert. The All-American canal, extending from the Colorado river near Yuma, Ariz., some 300 miles below the dam, along the international boundary some eighty miles to the west, will give to the great Imperial valley an adequate and reliable water supply, the water coming from the almost limitless store hoarded by Boulder dam.

This dam will also assure cities and towns of southern California a safe and reliable domestic water supply. A \$220,000,000 aqueduct will tap the Colorado river at Parker dam, 150 miles below Boul-

(Continued to page 121A)

## YOU'LL FIND Dozens of Uses for this 1/4" Junior Drill

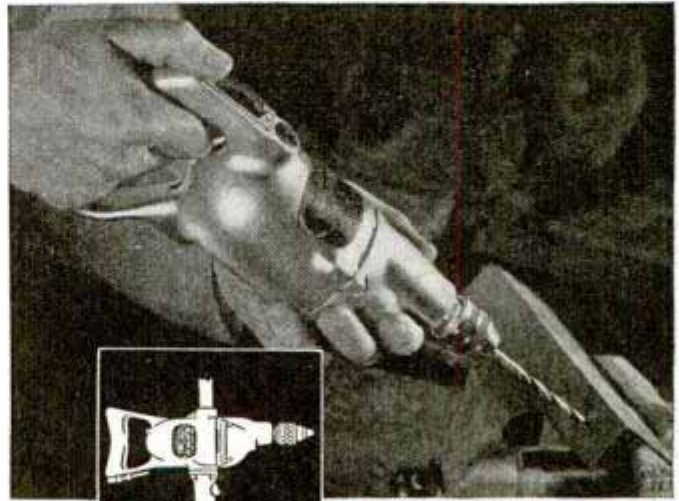

With the same fine qualities as the 1/4" Junior, but with greater power and capacity is the 1/2" Junior illustrated at left.

The Black & Decker 1/4" Junior drill has been definitely designed for the man who needs an "all-around" drill—and it's priced so reasonably that you can't afford to be without it. Here is a ruggedly built, powerfully motored, perfectly balanced drill that can be used in any metal or wood, that will drive various accessories, that can be picked up at any time for odd job use, or that can be used in a bench drill stand for more accurate work. And to top it off the 1/4" Junior is chockful of all the traditional quality that has made Black & Decker famous for fine tools. Get full details about this remarkable drill today—and its larger brother—the 1/2" Junior. Sold through leading jobbers. The Black & Decker Mfg. Co., 602 Pennsylvania Ave., Towson, Maryland.

# BLACK & DECKER

BLACK & DECKER

World's Largest Manufacturer of  
 PORTABLE ELECTRIC TOOLS



# HOW TO WORK IN Wood



New  
**1939**  
EDITION

136 PAGES

Only **10¢**

New  
1939  
Edition

Our last previous catalog No. 10 was in such demand that we were unable to supply delayed inquiries.—To make sure of getting this latest 1939 edition catalog No. 11, better write at once!

Tired businessmen: get back to this absorbing hobby; it beats golf; you know it does.

## Write *for this* Book

Harold Hunt, President  
CRAFTSMAN WOOD SERVICE CO.,  
2732 S. Mary Street, Chicago, Ill.

I enclose 10c (stamps or coin) for which please send new 136-page Catalog No. 11, latest 1939 edition.

Name.....

Street and No.....

Town..... State.....

Besides listing ALL the standard American woods and 35 rare imported woods, including the choicest, hard-to-find, fancy woods, many of these at astoundingly low prices and besides

Showing page upon page of carvings, trimmings, tools and hardware while posting you always on present best prices,

Besides all these thousands of quotations, this catalog contains a series of "deals," some 20 to 25 simply baffling bargains in lumber, veneers, and inlays; for example:

Deal No. 101A—Complete quality scroll saw outfit. . . **\$1.98**

Deal No. 102A—Outfit No. 1 of beginners tools. . . . . **\$5.25**

Deal No. 21—3 pieces each, 6 sq. ft. 1/8", 1/4" and 3/8" (choice of black walnut or mahogany) **\$3.20**

Deal No. 35, 4 pieces, each piece 3 sq. ft., 1/8": Vermillion (East India) Lacewood (Australia) Benin (West Africa) Black Walnut (America), All 4 pieces, total 12 square feet **\$3.00**

Here is Harold Hunt's remarkable NEW 1939 catalog and guide for woodworkers.

## NEW IDEAS FOR THE EXPERT

Page upon page of the latest up-to-date information; new patterns, novel designs, new devices.

Six new pages on wood finishing, the knacks, the little secrets, correct processes of finishing.

Extra facile method of inlaying; even a beginner can do it.

235(!) brand new scroll and fret patterns; choice new designs for trimmings; also new types of hardware. And so on and so on.

## A GUIDE FOR THE AMATEUR

Complete, detailed directions—so that the merest beginner can start right in with nothing but a hammer, saw and plane (or with a scroll saw) making beautiful furniture. You should see how absolutely clear everything is made for you in this Catalog:

1) Just what tools you need,

beginning with only the three or four everyday tools probably now in your basement.

2) Just what lumber to buy and in what sizes and exactly what hardware and miscellany for the things you decide to make.

3) Then precise, detailed directions with the pattern you pick.

## Bargains, too!

Deal Set No. 4—20 pieces, 2 1/2" x 5" x 1/4" of 20 different kinds of American woods, each piece labeled. In neat box. Invaluable for reference. All 20 at the nominal price of only **\$1.00**

Deal No. 14—100 sq. ft. Craftsman Special Veneer A grade, 1/28, size about 12" x 30", 7 kinds. Superbly beautiful, marvelous bargain. For detailed description see catalog. **\$6.25**

Deal Set No. 3—25 superb imported woods—2 1/2" x 5" x 1/2" all labeled, in neat box. All 25 for. . . . **\$3.50**

Deal No. 109A—Rare fancy woods for marquetry and inlaying; 5 sq. ft., maximum length 35". **\$4.50**

Choice of 1) British Guiana purple Amaranth, or 2) West African light brown Iroko, or 3) Australian silky brown Lacewood, or 4) East and West Indies light yellow striped Satinwood.

Several "deals" on inlays, overlays, and trimmings; also various special hardware bargains. To get the right idea of all these values you must see the new 1939 catalog No. 11.

All prices are F. O. B. Chicago.

Remember: Everything we list in our catalog we keep in our stock. We ship the day we get your order. Mail coupon.

For additional bargain (and for right prices on every kind of woodworkers supplies) read 1939 catalog.—See coupon at left.



H12 58

(Continued from page 119A)

der dam, and will carry the precious water 250 miles across the desert, through tunnels and over mountains to the coast cities.

While the dam has made of the Colorado river a friend instead of a menace to the people of the southwest, it has also opened up a great new recreational area to the people of all the country, an area established for the purpose by the government because in many ways it is expected to rival the most popular national park as an attraction for tourists and sportsmen.

Lake Mead, the desert sea, provides easy access now to stretches of the Colorado river which had been visited by only a few daring expeditions before the dam was built. The lake now extends for some thirty-nine miles up into the Grand Canyon and opens amazing vistas of colorful and impressive cliffs rising overhead nearly a mile at some points along the lake.

The lake and dam have already become popular with vacationists and are visited by nearly 500,000 each year. The lake was stocked with fish, then it was found to be teeming with large-mouthed black bass which are present by the thousands and have come from no one knows where. At any rate, this lake in a desert has become known as a fisherman's paradise.

Thus harnessing America's wildest river has done more than prevent devastating floods and equally devastating periods of drouth. The Colorado today not only is no longer a flood menace; it supplies a reliable source of water for domestic and irrigation purposes 250 miles distant, it produces a steady flow of electric power for the southwest and it has transformed a barren, arid, inaccessible area of this country into a new American playground.

H-14 36.

### Plenty of Red on Your Bait Will Catch More Fish

When you prepare to go fishing, put plenty of red on your bait. Fish have a yen for red, with green the second choice. In recent tests at Northwestern University, bass in white electrically wired basins were fed by medicine droppers tinted in various colors. Each fish had a certain color dropper, and if the wrong color was approached the fish received an electric shock. Gradually each fish learned its particular training color, red being most popular.

Sumner Service

transmission

Dr. Frank A. Brown, Jr.  
Assistant Prof. Zoology

# FREE NEW KIND of INFORMATION BOOK:



## Tells how, where to get expert advice on TOOLS, FREE PLANS, FINISHES, GLUING

It answers such questions as:

- What shall I make?
- Where can I get plans for making things?
- What useful booklets can I get on the use and care of hand tools?
- Where can I learn about fine cabinet woods and veneers and can they be bought in small quantities?
- Where can I get helpful hints on finishing my projects?
- How do I go about joining a home workshop club? Etc., etc., etc.

Here is the first handbook ever to contain all this information. Send for your copy today. Use coupon below.



The Home Workshop Handbook is sent you FREE with the compliments of

# CASCO

WEATHERPROOF  
POWDERED CASEIN GLUE

10c to 65c at your Hardware, Paint or Lumber Dealer's.

Casein Company of America  
Dept. PM2-39, 350 Madison Ave., New York, N. Y.  
Yes, I want a "Home Workshop Handbook"

Name.....

Address.....

-----SAVE 2c, stick coupon on penny postcard-----



141151



**FASTER  
FINER, EASIER  
WORK with the  
All-Purpose  
MOTO-  
TOOL**

**FUN OR PROFIT**

for home craftsmen, model builders or professional artisans.

No other electric, motor-in-hand tool gives you all the advantages of the MOTO-TOOL. **25-27,000 R.P.M. and easily handled.** Its lightness, perfect balance and convenient shape, gives you delicate precision control, yet does heavier work in amazingly quick time.

A variety of accessories available with the MOTO-TOOL makes you master of many jobs—cutting, carving, sawing, grinding, drilling, engraving, routing, sanding, shaping—any material. Thousands in use. These sturdy MOTO - TOOLS are built for long, trouble-free service. Has Bakelite, shock-proof housing. Integral finger grip close to chuck . . . self-releasing chuck lock . . . convenient snap switch and other exclusive features. Plugs into any A. C. or D. C. socket. At your dealers or direct by mail. **FREE booklet** on request.



Model 1, with one 1/8 inch Collet . . . \$9.85  
Model 2, with one 1/8 in. Collet . . . \$16.50

**MODERN CRAFTSMAN'S KITS**  
in handsome hardwood cases  
for light work. Model 1, with 23 accessories \$17.50  
for heavier work. Model 2, with 23 accessories. \$23.50

**10-DAY MONEY-BACK TRIAL**

**DREMEL MANUFACTURING CO.**  
Dept. A-1 Racine, Wis.

**30¢ BUYS CLASS OF CLUB PIN! RINGS**

SMART, up-to-the-minute designs. Pins in 2 colors with any 3 or 4 letters and year. Handsome Sterling silver rings. Oldest, largest maker; famous for quality for 44 years. Clean cut work distinguishes Bastian Pins and Rings anywhere. Write for new catalog today!

**BASTIAN BROS. CO.**  
Dept. 71 Rochester, N.Y. \$1.49

**WITH QUIK-TRIK RUST REMOVER**

MAKE A RAID ON RUST

Save Your Tools and Metal Parts from Destruction—Remove Stains from Tile and Porcelain.

So quick, so easy, so complete that you'll tell your friends. Money back if it's not the best you've ever used. Send 50 cents in stamps or coins.

**Big 1/2 pound Jar**

**BRAVO PRODUCTS COMPANY**  
Department A, 6432 Cass Avenue, Detroit, Michigan

**Thompson BEATS the World on BOATS**

**Better Built Lower Prices**

Only Boats With Full Length Spray Rails

Keep passengers perfectly dry—even at high speeds. Catalog also shows today's five most popular models of sailboats. Two big factories. Prompt shipment.

**CATALOG FREE**  
Write for your copy. State kind of boat in which you are interested.

**THOMPSON BROS. BOAT MFG. CO. (87)**  
213 Ann St., PESHTIGO, Wis. (Write to either place) 113 Elm St., CORTLAND, N. Y.

Canoes \$64 and up  
Rowboats \$42 and up  
Outboards \$42 and up  
Very fast utility model

**Human Moles Battle a Mountain**

(Continued from page 229)

ature, sixty-eight degrees. All the tunnel workers wear hard hats to protect their heads from falling rock. In addition, men working in the wet sections are clad in rubber hip boots and firemen's rubber coats, the finest that money could buy, yet constantly being replaced because of contact with sharp rock and pouring water.

Powerful little storage-battery locomotives rumble past on narrow-gauge tracks. These little electric engines cost \$6,000 each, of which \$3,000 is the cost of the battery. Some locomotives use a combination of battery and electric trolley. Each hauls from five to ten loaded cars, with four square yards of rock in each car. The rock



Engineer marking contour of tunnel as guide to drillers in preparing blast holes

is carried from the tunnel headings to the elevator or "skip" and lifted to the surface.

The bore is horseshoe-shaped, with the open end of the horseshoe for the floor. Sixteen feet in diameter, it could accommodate a standard-size American railroad train. The bore is built in this shape, engineers tell you, because it is more practical, from a construction standpoint, than a cylindrical tunnel, through which water might pass with less friction. Sides of the tunnel are coated with a special water-resisting concrete twelve inches thick.

Leaving the "tailor-made" part of the tunnel, Superintendent Leadbetter and his visitor plunge into a rocky hole where the scars of battle are still visible on the naked granite. This is what engineers call "good rock," because it stands without bracing. Next comes an area that is heavily timbered, with walls and roof support-

(Continued to page 124A)



# "HEAP BIG NEW BOAT READY!"

**HOLD 'UM 4 BIG PALEFACES! CARRY HIM ON SHOULDER! USE 'UM BANG/BANG! MOTOR UP TO 9 PONY-POWER! OARS & SAIL!**

*—Chief Eaglebeak*

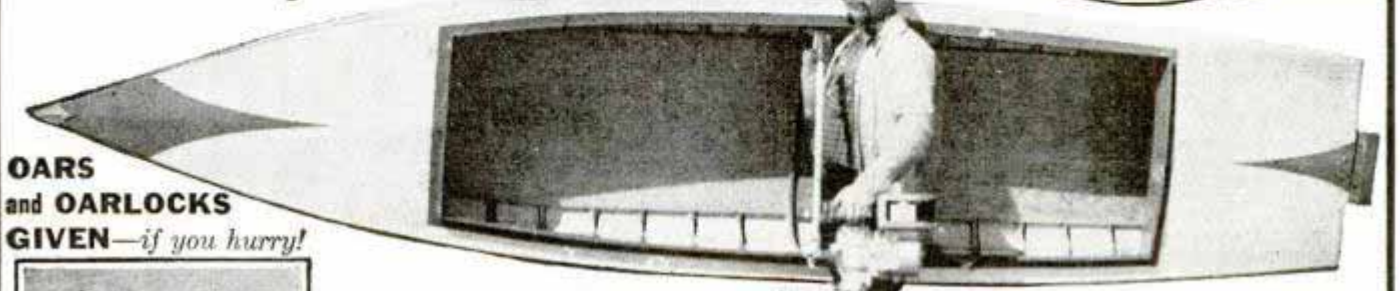
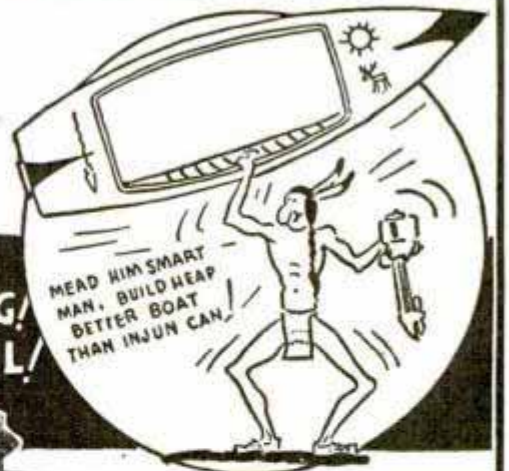

**OARS and OARLOCKS GIVEN**—if you hurry!



OK-4 is ideal for Sportsmen! Light, long, strong and roomy!



Even with 4 passengers, a light weight motor gives plenty of power!



Here's OK-4 speeding along with a 9 horsepower motor.



The new 69 lb. OK-4 easily lifted to car-top. Portable!



Two girls easily launch this sensational 14 footer!

**The Biggest, Lightest and Strongest Boat of Its Kind!**

**BIG MONEY ASSEMBLING NEW OK-4!**  
**IN A FEW EVENINGS AT HOME!**

Everybody—even grumpy old Chief Eaglebeak—is mighty excited over Mead's big, new 14-foot portable Outboard KI-YAK! Think of it!—ANYONE, without previous experience, can build OK-4 at home in a few evenings and save nearly HALF the factory-built cost—or sell to others at Big Profit! And get these startling OK-4 features: Carries 4 adults comfortably, and duffel—takes motors 9 h.p. or less, oars and sail—weighs only about 69 pounds for easy portability on shoulder or car-top for fishing, camping, touring, hunting. Seaworthy. Leakproof. Durable. Double canvas bottom for double-safety! The biggest, lightest, strongest boat of its kind—AND—made only by MEAD—in knock-down kits for quick home-assembly, or factory-built, ready for the water. Rush dime for Chief Eaglebeak's Circular, amazing Low Introductory Factory Prices! Oars and oarlocks GIVEN with your OK-4—if you hurry!



## 4 OTHER GREAT KI-YAKS

A Mead for every need! Paddle-and-sail models: The baby "CK-1", 10 footer, 20 pounder! The Sportsman's 30 lb. CK-2! The "Big bad CK-3" with 90 square feet of sail on 45 pounds of boat—the sailor's delight! Then there's the 50 pound "OK-2"—Spitfire Of The Fleet—takes up to 4 1/2 h.p. motor, oars, sail! and REMEMBER—Mead is America's largest Ki-Yak manufacturer—so buy your Ki-Yak from HEADQUARTERS. Rush Coupon and dime now!

**\$6 PADDLE GIVEN**  
with your CK Ki-Yak—if you hurry!



3 1/2 Year Old Carries CK-1

← CK-3

CK-2 →



The 50 Lb. OK-2—Uses Oars, Motor, Sail Rig.

## "MAIL 'UM COUPON!"

To: CHIEF EAGLEBEAK, c/o Mead Gliders, 15 So. Market, Dept. B-29, CHICAGO, U. S. A.

Rush 'um new KI-YAK Boat Circulars! Me much interested in heap low Factory Prices. Send 'um details on Free Oars and Paddle Offers. I enclose 10c postage, packing charge! (Please PRINT plainly.)

NAME.....  
St. and No.....  
City.....State.....

**MEAD GLIDERS**  
15 S. MARKET ST. DEPT. B-29 CHICAGO, U.S.A.



141159

# CAN YOU BEAT THESE POWER COSTS?

(Continued from page 122A)

Save up to \$293<sup>80</sup> Per Month on power costs

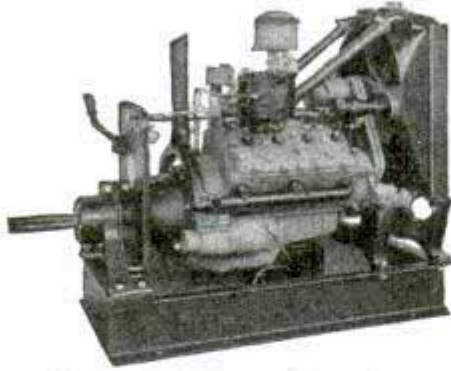

## with a KRW FORD V8 Unit

50 H. P. with KRW V8 Unit using natural gas (1125 BTU) @ 30c per 1000 cu. ft. . . . . \$ 46.80 per month  
50 H. P. with KRW V8 Unit using gasoline @ 10c per gal. (no tax) . . . . . \$140.40 per month

Above figures show primary fuel costs (lubricating oil not included) for operating a KRW V8 Unit to develop 50 H. P. for 10 hours per day—26 days per month. Compare this with electricity @ 3c per KWH which amounts to \$340.60 per month. You can pay for a KRW Unit in a few short weeks out of actual savings!

KRW V8 Units are daily saving money for operators of air conditioning and refrigeration equipment, mills, factories, shops, welders, compressors, pumps, well-drilling outfits, contractors' equipment, etc. New KRW "GUARDIAN" automatically stops engine in case of cooling or lubrication failure.

Write for new bulletin just off the press—packed with useful information—engineering data, etc. You can buy through your local Ford Dealer and benefit by local service and low-cost Ford engine replacement feature.

### K. R. WILSON 17 Lock St. BUFFALO, N. Y.

Builders of Shop Equipment for Ford Dealers Since 1916

West Coast Branch: 722 Mateo St., Los Angeles.  
Export Office: 90 West St., New York.

**HOLD-E-ZEE AUTOMATIC GRIP SCREWDRIVERS**

Hold, start and set-up screws in unhandy places. Gripper instantly released by spring action, sliding up out of way when not in use. Finest materials thru-out, chrome vanadium blades; many have transparent insulating, unbreakable handles. (Illustrated.)

No more expensive than ordinary screw drivers. Models for recessed-head screws. Handiest ever. Get one today. At auto-supply, hardware or electrical stores.

UPSON BROS., INC. 86 EXCHANGE ST. ROCHESTER, N. Y.

**NEW BENJAMIN AIR PISTOLS WITH MULTIPLE LEVER HAND PUMP FOR TARGET-SMALL GAME-CAMPING-ETC.**

Guaranteed—Accurate—Practical—Economic—Safe—Clean—Quiet. Adjustable Force—Amazing Maximum Velocity. No smoke or fumes. Bolt Action—Hammer Fire—Hair Trigger—Safety Lock—Hand Pump. Single Shot BB \$8.50; Single Shot cal. 177 or 22 with rifled barrel \$8.50; BB 8-Shot \$10.00; Diometer \$2.00. Also a complete line of Benjamin Genuine Compressed Air Rifles for BB and cal. 177 or 22. No license required—from dealer or factory. Ask for complete specifications and Free Targets. BENJAMIN AIR RIFLE CO., 890 Marion St., St. Louis, Mo., U.S.A.

**WRITE TODAY!**

**TEST-O-LITE**

Tests Everything Electrical From 100 to 550 Volts

A real necessity for electricians and home because it has 1001 uses. Equipped with a Neon light which tells instantly where trouble lies in electric circuits, fuses, cut-outs, motors, radios, all kinds of electric appliances, etc. Tells A. C. from D. C. Far superior to ordinary clumsy test bulb. Fountain pen size with clip for carrying in vest pocket. Lifetime guarantee.

APPLIANCES  
MOTORS  
FUSES

Patented

L. S. BRACH MFG. CORP.  
55 Dickerson St., Newark, N. J.

\$1.50 At Electrical Stores or Post-paid

ed by sixteen-by-sixteen Douglas fir logs. So tightly jammed together are the supports that the rock and sand above can hardly be seen. Here is the "heavy ground" where the granite has been crushed and faulted.

"This crushed rock is man-killer stuff," the superintendent tells you. "Even when we've timbered as heavily as possible, the sand sometimes lets go. Just "whoosh" before you know what's happening. One day about six months ago it came down. No warning at all. One of the boys got caught in it, but we were lucky enough to drag him out alive."

Leadbetter explains that the wet areas also are faulted and that water runs through the cracks. In one section the water came through so heavily that the drillers could make only nine feet progress in ninety days.

"In high-pressure water—which will knock a 200-pound man flat on his back—four to eight men may be required to handle a drill," the engineer says. "Holes at the bottom of the face must be drilled under water. Sticks of dynamite are strapped to poles and the poles wedged into drill holes so the powder will stay in place long enough to be fired."

Last spring a veritable torrent of water was encountered when it reached a peak of 15,800 gallons per minute. But then, as if "old man mountain" had found that this would not stop the drilling crews, the heading advanced almost immediately into a dry section. So abrupt was this change that the front of the drill jumbo was completely dry, while the rear end was being doused with about 10,000 gallons of water a minute.

To remove this water, batteries of giant pumps were installed in the tunnel. Large, bottle-shaped chambers were cut in the solid rock adjacent to the shaft. These chambers could be closed off with heavy steel bulkheads. Pumps with a capacity of as high as 29,600 gallons per minute were installed. These fed huge steel pipes that carried the water through the tunnel and out the portals.

The electric train on which you ride with the superintendent jolts to a stop. Up front can be seen the end of the shaft which the hard-rockers call the heading.

(Continued to page 126A)



# \$200 My First Week



## ... Now in my OWN Business.

Would you, too, like to own a business where you could take in \$200 your first week as did L. A. Eagles in Madison, Wisconsin?

We want a reputable, honest man in each county. This man need not have any special experience or more than ordinary ability, but he must be honest and courteous.

Such a man we will start in business for himself. You can make far above average profits in the rug-washing business—a high-grade business all your own. Many earn \$125 to \$200 per week—some considerably more.

### NO SHOP NECESSARY

The rug-washer finishes rugs like new on the customer's floor. Anyone can run it. Electricity does the work. A quick, thorough and highly-efficient method that restores the natural beauty of floor coverings.

There are hundreds of customers—in your vicinity and nearby towns. The business grows steadily. Simply wash a few rugs or carpets. These customers tell others and also give you their future work. Soon you will have a prosperous year-around business. Send coupon for booklet explaining everything.

### "Profits Pay for Home"

Harry Hill built and paid for a home from rug-washer profits. His first day's business was \$86. Another man writes, "Made \$70 in 13 hours." A. L. Miller says, "Have had rug-washer 6 years—have earned as high as \$92 a day." M. O. Malmin earned 3 times the cost of his machine the first two months. You, too, can enjoy a large income.

**VON SCHRADER MFG. CO., 102 PL., RACINE, WIS.**

*Free Book!*  
**MAIL COUPON now**

VON SCHRADER MFG. CO.  
102 Pl., Racine, Wis.

Send at once (no obligation) your free booklet illustrating rug-washer and telling how I can own my own permanent business; how I can earn large profits at prices below other methods; how I can become financially independent in a short time; and how I can pay on easy terms.

Name.....  
Address.....  
City.....State.....

### "Never a Complaint"

C. J. White says: "\$100 business in six days—never a complaint." That is the nicest part of this business—every customer is more than satisfied. Stains and blotches disappear and vivid colorings and freshness in faded floor coverings come back.

### EVERY MACHINE GUARANTEED

You take no risk. These machines have been manufactured since 1918 and are used by the United States Government and by many of the world's largest hotels. They are fully GUARANTEED.

### EASY TERMS

The complete equipment is inexpensive. A reasonable down payment brings everything to you and the balance is paid monthly. From the start, you have your own business—one that is profitable and of which you can be proud.

**MAIL COUPON Today**



## TRAILER BUILDERS·BUYERS·OWNERS

Over 100 pages! Beautifully Printed and Illustrated! Trailer Suggestions and Ideas galore! Catalog shows America's greatest line of Trailer Parts and Equipment at lowest prices. Everything from wheels to top. Rush 25c today. Satisfaction positively guaranteed!  
TRAILER SUPPLY CO. Box 438-A WAUSAU, WIS.

### BUILD IT YOURSELF

**The Jim Dandy Cabin Cruiser**  
The Trailer that has everything. Classy! Roomy. Easy to build in any size with my simplified Plans and Instructions—Price \$1.00. Rush dollar bill today to JIM DANDY Box 125-A WAUSAU, WIS.

## EARN MONEY MAKE COLOR GLAZED CONCRETE PRODUCTS

MAKE Color-glazed concrete, pottery, tiles, walls. New method. No molds. Use only sand, cement, cheap materials. U. S. and Canada patents. Complete licensed plants low as \$35. MEN (only): Write for FREE booklet, colorplate, details of this new money-making business.  
**NATIONAL POTTERIES COMPANY**  
Room 6, 13 W. 26th St., Minneapolis, Minn.

## BURN YOUR NAME ON TOOLS WITH THE ARKOGRAF

**PROTECT YOUR TOOLS FROM THEFT**  
Write with electricity any name or design on the hardest and finest tools and instruments, or any metal, like writing on paper with pen or pencil.  
**Complete Outfit \$3.50—Prepaid Anywhere**  
Interesting illustrated circular free. Write today. Agents wanted.  
**ARKOGRAF PEN CO., 3927 S.E. Stark St., Portland, Ore.**

## DRIVE ANY ROUTE On the Map

You can follow any directions with a Hull Auto Compass on your windshield. Drivers everywhere depend upon it to get them there on time, and by the shortest route. It shows your direction of travel at all times, in any weather. Only \$2.95 at your dealer. Two-piece model \$1.95. Write for circular.  
**HULL MFG. CO., P. O. Box 246-D10, WARREN, OHIO**

\$7.50 EACH POSTPAID

## Most Unusual MOVIE OFFER EVER MADE

GET BOTH CAMERA & PROJECTOR for Only \$13.50 Complete and Postpaid

Everything to take and show real 16 mm. movies at less cost than taking snapshots.  
CAMERA—Spring Motor drive—Automatic Release Button—Footage Indicator—50 foot capacity. No adjustments necessary.  
PROJECTOR—Quiet, smooth and flickerless—Motor driven—sturdily built. Uses standard 16 mm. film.  
Write NOW for Big FREE Catalogue of Movie Supplies and Film Subjects. We are never undersold.  
**PARAMOUNT MFG. CO., DEPT. G-97 BOX 224, BACK BAY, BOSTON, MASS.**

**FREE 50 FOOT PROJECTOR FILM with each \$13.50 COMBINATION.**



1159

# Can You Equal This Home for 795

Shipped Direct from Our Mill



Save 30% to 40% on Your New Home..

**WE PAY FREIGHT**

Don't pay several hundred dollars more than necessary when you build a home! Buy it direct from our mill at our low factory price. We ship you the materials—lumber cut-to-fit, ready to erect. Paint, glass, hardware, nails, etc., all included in the price—no extra charges. We pay the freight. Plans furnished—also complete building instructions. No wonder our customers write us that we save them 30% to 40%, compared with builders' prices. Easy terms—monthly payments.

Send for FREE BOOK of Liberty Homes

## Handsome Big CATALOGUE FREE

Pictures wonderful homes in colors at money-saving prices. Designs to suit everyone. Write for your catalogue today. LEWIS MANUFACTURING CO. Dept. 1292 Bay City, Michigan

## SPRAY UNIT \$25.00 as shown 22.50 less gun \$19.00 Less Motor

A low priced quality power sprayer that will spray lacquers, enamels, varnishes, dyes, cold water paints to any surface. It is compact, portable, simple to operate, built to stand hard use and economical to use. Complete unit is equipped with 3 cubic foot Piston type compressor, latest type pressure feed spray gun with fan and round caps, 15 feet hose, air gauge, 1/4 H.P., 110V, 60 cycle, AC motor. Send \$3.00 with order balance express C.O.D. Specify No. 150A. A 3 cent stamp will bring you No. 9 catalog listing this and 600 other items.



BALKO ELEC. MOTOR & SUP. CO. A2-605 Washington Bl. Chicago, Ill.

## STANDARD GARDEN TRACTORS

Plow Seed Cultivate Mow Hay and Lawns Powerful Gas Tractors for Small Farms, Gardeners, Florists, Nurseries, Fruit Growers, Poultrymen.

1 & 2 Cylinders

High Wheels. Rubber or Steel Tires. Walk or Ride.

Do Belt Work—Free Catalog

STANDARD ENGINE CO.

Minneapolis, Minn. Philadelphia, Pa. New York, N. Y. 3221 Como Ave. 2546 Market St. 290 Cedar St.



## NEW SUPER-QUALITY KITSELMAN FENCE

Heavier, amazingly improved galvanizing. Tougher, longer-lasting Copper-Bearing Steel. Low Factory Prices.

WE PAY FREIGHT. 160 styles and heights Farm, Poultry and Lawn Fence; Steel Posts, Gates, Barb Wire, Paints, Roofing. Write today.

KITSELMAN BROTHERS

Dept. 94 Muncie, Indiana



FACTORY TO YOU WRITE for FREE CATALOG

## "GIFTMAKER, SR."

(Outside U.S.A. & C.O.D. \$5.15)

\$150 PRIZE CONTEST

## New 24" LATHE \$490

Free Catalog:

A heavy duty, smooth running wood lathe at a remarkable price. 32" long, 7" high. Turns pieces 4 1/2" in diameter by 24". Fully adjustable. 2-speed. Weighs 10 lbs. Long and short tool rests. OILLESS bushings. Satisfaction guaranteed or money back.

Free Catalog describing \$150 prize contest (1st prize, \$25; 2nd, \$15; 3rd, \$10; 66 other cash and merchandise prizes). Cat. illustr. complete power tool line: Jig Saw, \$1.50; Shaper, Circular Saw with oilless bearings, \$3 each; Drill Press, \$2.50; 9 1/2" Lathe, \$2; Sander, \$1; etc. Order today or send card for Catalog.

J & H Metal Products Co. 5 Commercial St. Rochester, N. Y.

(Continued from page 124A)

The jumbo—a monster of a machine on which the drillers operate—looms ahead.

Leadbetter explains that the process of excavating a tunnel with modern engineering skill consists of three mechanical steps repeated over and over again—drilling, blasting, and mucking. On the jumbo are located the two-man crews with their powerful compressed-air drills.

In "good rock," when the tunnel was being driven "full face," as many as eleven drills sometimes were operating simultaneously. From twenty to sixty holes were drilled before being filled with dynamite. There was keen competition among the drillers to see which crew could get its quota of holes drilled first. When all eleven drills started chattering at the same time—each making more noise than a machine gun—you ceased to hear the ear-splitting racket. You felt it shuddering up and down your spine.

The second step, following the drilling, was loading and blasting. The holes had been drilled from eight to ten feet in length and three inches wide. These were carefully loaded with dynamite and black powder. When the holes were fully loaded, the hard-rockers withdrew 2,000 feet as required by safety regulations. An electric spark set off the blast.

The third step was "mucking" or clearing away the broken rock fragments shattered by the force of the explosion. With long iron bars, the miners pried loose slabs of rock clinging to roofs and wall. Then the mucking machine went to work. This is a \$10,000, electrically driven monster that scoops up huge loads of rock, lets it slide down its throat onto a moving belt, and dumps it into a waiting car.

Down in the tunnel were complete shops for keeping the pumps, the locomotives, the drills, and the electrical equipment in good repair. Drill steel must be sharpened after each drilling operation, and the "drill doctor" had an endless job. In addition to the repairmen, a regular first-aid crew stood ready at all times to put adhesive tape on a scratched finger or to resuscitate a man overcome by suffocation.

Men working on the tunnel were paid good wages. For example: a "gandy dancer" or track workman earned \$6 a day; a driller's helper received \$7.50; a driller \$8; and the operator of a mucking machine \$10.



## Fighting Noise with Light

(Continued from page 167)

the test strip, engineers have minimized the effect of temperature changes by absorbing heat before it reaches the steel. The earth's magnetic force and other strong magnetic fields are neutralized by a special coil and the application of three additional metal strips to form a complete magnetic circuit.

The measuring machine consists principally of a tiny roller, about the size of a darning needle, on the end of which is fastened a mirror about half the size of a dime. A divided photoelectrical cell and a light beam complete the setup. When a test strip is placed on the roller and magnetized by direct current, it lengthens. The light beam focused on the mirror is reflected to the photocell, registering the amount that the roller turns, determining the elongation of the strip. As the light beam moves, one part of the photocell gradually records more light than the other, tracing the deflection of the light beam, which may be as small as four ten-thousandths of an inch at a distance of about thirty-nine inches from the source of the light beam. By actuating a galvanometer, which measures a small electric current by movements of a magnetic needle, the photo-cell magnifies this deflection 100 times, making it readable.

Another machine developed for the battle against noise is the dynetric balancing device, an electrical brain designed to take vibrations out of rotors, the whirling parts of motors and generators. This machine feels and sees the rotor unbalance, which is sometimes as heavy as fifteen pounds in large machines or as minute as a drop of water in small motors, such as those used in vacuum cleaners. The balancer makes rapid-fire calculations which save hours of search for the cause of off-center weight.

Electric networks, magnetic currents and light from a Stroboglow provide the brain of the machine. The magnets and electric circuit "pick up" vibrations as slight as two one-hundred thousandths of an inch, and translate them into electric currents. Relayed to an amplifier, these vibration messages are analyzed and the "brain" calculates where the rotor is unbalanced and prescribes the amount of weight required to restore its balance.

# THRILLS OF THE OPEN ROAD ARE YOURS!

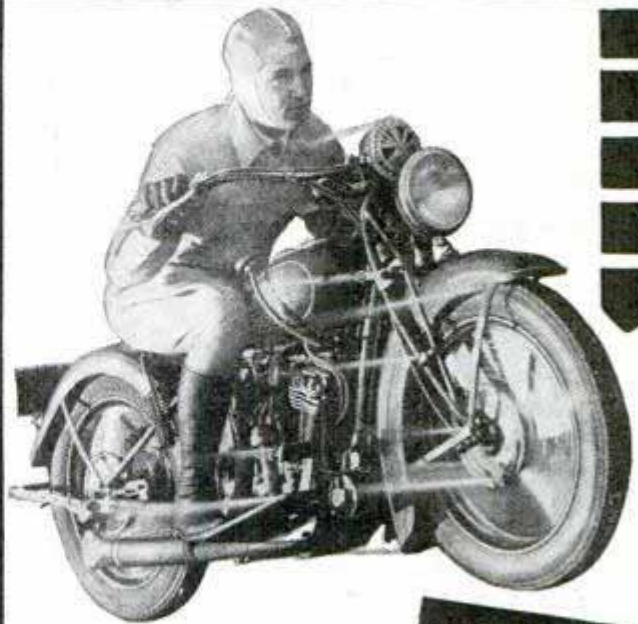

**Indian**  
JUNIOR SCOUT

F.O.B. FACTORY  
**\$215.**  
FULLY  
EQUIPPED

### AMERICA'S LOWEST PRICED "TWIN"

A mighty motorcycle at a midget price to bring you sport, adventure, fun! Junior Scout's easy handling, flashy getaway, zooming power and economy of operation make it America's greatest motorcycle "buy." With three other famous Indian models, refined and improved for 1939. Your Indian dealer has a pay-as-you-ride plan. See him today!

**INDIAN — America's fastest stock motorcycle!**

A year's subscription to thrilling Indian News for the price of mailing. Handsome Indian Sport Jersey when you order your new Indian motorcycle. Mail coupon today!

**FREE!**



INDIAN MOTORCYCLE CO., Springfield, Mass.

Please send me items checked [ ] Indian News for one year (I enclose 15c in stamps to cover mailing cost). [ ] Certificate of Value entitling me to Indian Sport Jersey FREE when I order my new Indian motorcycle. [ ] Indian catalog.

Name .....

Address .....

PM29

Please be sure to check your age group  
[ ] 16-19 yrs. [ ] 20-30 yrs. [ ] 31 yrs. and up [ ] Under 16 yrs.

INDIAN MOTORCYCLE CO., Springfield, Mass.



# NEW STANLEY PLAN PACKET

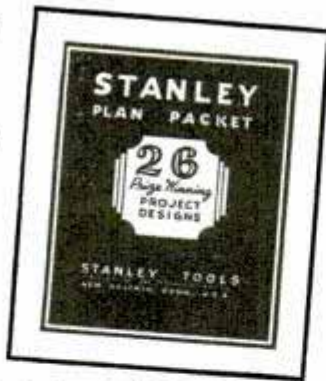

## ONLY 50¢

26 prize-winning plans for every man who enjoys working with tools and wood! You'll want to make every project, whether your shop is large or small. Important feature—each drawing is on a separate 8½ x 11" sheet of tough paper. Write today for the Stanley Plan Packet; only 50¢ postpaid anywhere in the U. S.

## STANLEY TOOLS

Division of The Stanley Works

105 Elm Street, New Britain, Conn.

## "Erie" Light Delivery

### SOLVES THE PROBLEM OF CHEAP AND FAST DELIVERY

Costs only 1/5 of a cent per mile. From 100 to 120 Miles per Gal. of gasoline. A powerful, high grade machine, with Sachs Motor, chain drive, 2-speeds and clutch, powerful brakes, balloon tires. SPEEDS UP TO 40 MILES per Hour. Big compartment for packages. Needed by everyone in etc., WRITE for special offer today.



delivery service, stores,  
Dealers Wanted.

STREIFTHAU MFG. CO., Dept. 99, Middletown, Ohio



## AUTO ENGINE SPEED CONTROL GOVERNORS

445 E. 3rd St. Los Angeles, Calif.

## Stoves AT FACTORY PRICES!



Write for  
FREE CATALOG

### SALE CATALOG—FREE

Nearly 200 Styles and Sizes of Heaters, Ranges, Furnaces at FACTORY PRICES. Easy Terms. Write today for FREE CATALOG. New styles, new features—24-hour shipments.  
Kalamazoo Stove & Furnace Co.,  
391 Rochester Avenue  
Kalamazoo Michigan  
Over 1,300,000 Satisfied Users  
39 Years in Business

**"A Kalamazoo  
Direct to You"**

## The Wonders of Astronomy

(Continued from Coloroto Section)

Thirty horsepower does the work as the truck tires tread against the inner wall of the dome. Huge springs keep the tires in contact with the dome under 85,000 pounds pressure and each motor and truck tire is mounted on rubber vibration absorbers. The system operates so smoothly that it is impossible to tell when the motors are running. Arc welding instead of riveting was used throughout the construction of the telescope and dome.

Insulating the big mirror against changing temperatures is extremely important because the slightest change in shape of the concave surface might destroy its effectiveness. The dome really consists of two domes, one supported inside the outer shell with a four-foot insulating air space between. The exterior is to be painted aluminum to reflect the sun's rays and the inner dome is also sheathed with a protective aluminum coat. It is estimated that the temperature rise inside the dome on the hottest days will never be more than five degrees. When not in use the 200-inch mirror at the base of the telescope will be protected by thermally insulated overlapping metal sheets hinged to fold over the glass like flower petals. A special motor is used for swinging them open.

To find out ahead of time how their sky giant would work and to correct any possible errors in engineering, the scientists built a scale model of the instrument and mounted it, complete to electric drives and an insulated dome, on the roof of the astro-physics building on the Pasadena campus of the institute. One-tenth actual size, the model has a 20-inch mirror and is an efficient, useful telescope.

With the use of the big telescope still a year away the Palomar observatory is already making history because the world's largest Schmidt telescope, a special photographic exploring instrument using a twenty-four-inch mirror and an eighteen-inch aperture, is now in use there. With this instrument one of the most puzzling phenomena in the universe is receiving close study in cooperation with the big telescopes of the Mount Wilson observatory of the Carnegie Institute. The astronomers are studying the super novae, stars of ordinary or minor brilliance that suddenly



burst into tremendous luminosity for no apparent reason. One of these stars may rise from almost invisibility to a brilliance equaling 100,000,000 times the brilliancy of our sun, although, of course, such super novae are so far away that the estimates can be made only with telescopes. The explosion may require a month to reach its peak, after which the star that has suddenly gone wild begins to fade again.

In studying the super novae the astronomers are right on the brink of the unknown because the spectra of these bursting stars are unlike the spectra of any other known objects. Apparently the elements in these stars are in such a chaotic physical state that they can't be recognized or compared to the elements we know. Instead of the thin spectral lines by which the elements in stars can be recognized the lines of the super novae resemble broad bands.

Study of the remarkable character of the spectrum and of the sudden luminosity and tremendous release of energy found in a super nova, it is thought, may lead to much new knowledge. But today practically everything about them is a mystery.

In any system such as the galaxy of which the sun is a member, a super nova may occur only once in from 600 to 1,000 years. The importance of the Schmidt telescope lies in its ability to search out such exploding stars as they occur, so that other instruments may be trained on them for close study. The present Schmidt telescope is being duplicated in an even larger instrument, with a seventy-two-inch mirror, on Palomar mountain.

H1230  
**Check and Double-Check**

(Continued from page 213)

fuel consumption under varying conditions, vibrations in single parts of the ship and in groups of parts, load distributions, air-flow characteristics over the airplane in different attitudes, speeds and operating conditions, and scores of other equally important matters are checked with an accuracy never before possible in actual flight.

Among the instruments carried for recording test data are an air-speed trailing bomb, potentiometer for recording temperatures, differential pressure gauges, hydraulic pressure gauges, accelerometers,

(Continued to page 130A)

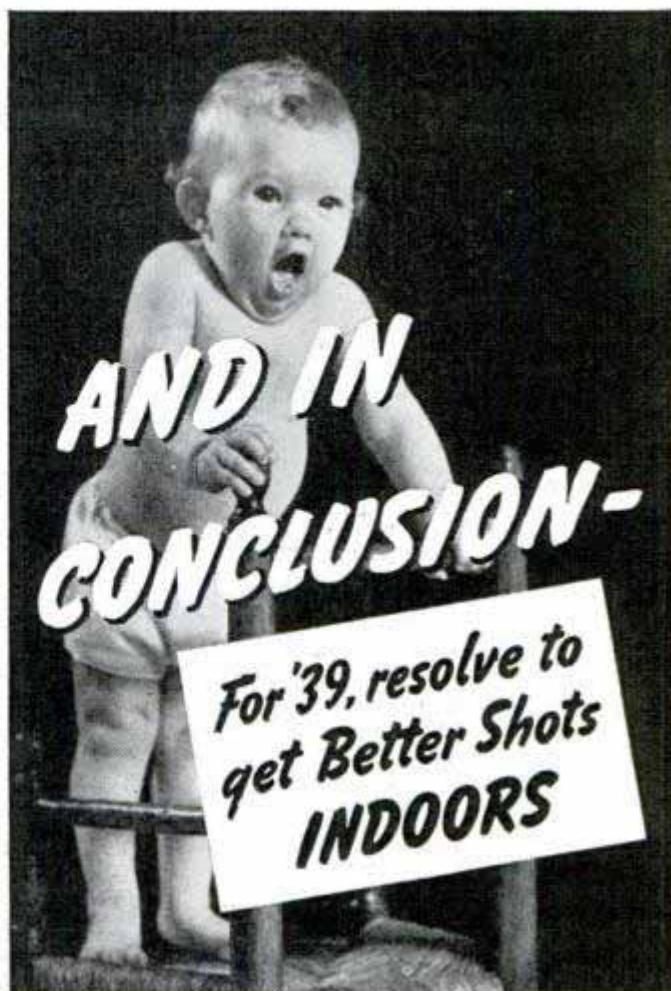

**G-E Photo lamps make it easy**

1. **PLENTY OF LIGHT** from G-E MAZDA Photoflood or Photoflash lamps for good clear pictures. (Follow directions on package.)
2. **IT'S THE RIGHT KIND** of light for better photos with modern film.



**New low prices on G-E Photofloods**

... the lamp for dozens of indoor shots with new "super" type high speed film

No. 1 . . . now **20<sup>c</sup>** LIST      No. 2 . . . now **40<sup>c</sup>** LIST

**NEWS! A new G-E Photoflash lamp for better, synchronized flash shots**

No. 21 . . . **20<sup>c</sup>** LIST

New longer flash  
New smaller bulb size  
More total light (than No. 20)

More uniform results  
Better negative density  
Better synchronization (with between-the-lens shutters)

**GENERAL  ELECTRIC**  
**MAZDA PHOTO LAMPS**



(Continued from page 129A)

# PLAY RECORDS

through your radio anywhere in the house!

## SENSATIONAL NEW MYSTERY RECORD PLAYER

**NEEDS NO CONNECTIONS!**



AK 21965

Now—listen to your favorite recordings where and when you choose! Lafayette's amazing new **Mystery Record Player** operates through any radio (regardless of age, make or type). No wires to attach. Simply plug into 110-volt a.c. outlet anywhere in the house. Has Hi-Fidelity Crystal Pick-up, plays 10" or 12" records. Connection for toy "mike". Your radio controls tone and volume. Portable walnut finished case. Lafayette's new thrill sensation is a gift at only **\$14.75**

**FREE CATALOG**  
Send for it today—NOW! The big 188 page **FREE** catalog. Here are radios, build-your-own kits, cameras, equipment—all at money-saving prices.

**MAIL COUPON NOW**  
Send money order, check or C.O.D. instructions with coupon for **Mystery Record Player**.

WHOLESALE RADIO SERVICE CO., Inc., 100 SIXTH AVE., NEW YORK, N. Y.

**WHOLESALE RADIO SERVICE CO., Inc.**  
Dept. 7BA9—100 Sixth Ave., New York, N. Y.

Enclosed \$..... Send **Mystery Record Player**   
Rush **FREE 1939 Radio Catalog No. 73**

Name..... PLEASE PRINT  
Address.....  
City..... State.....

**188 PAGE CATALOG FREE**

PASTE COUPON ON PENNY POSTCARD

# U. S. REVENUE CUTTER

## "JOE LANE"



Complete with precision shaped and hollowed hull, accurate full size plans, assembly instructions, all deck and spar material, all **FINISHED FITTINGS**, and complete history of the "JOE LANE"—\$7.00.

Send 15c in coins or stamps for complete 8 1/2 x 11 catalog with full page illustrations of the latest innovations in marine models.

**MARINE MODEL COMPANY**  
174 Worth St. Dept. 302 New York, N. Y.

**NOW ONLY \$5.00**

### REAL ENGINE VALUE

Over 7,000 GHQ Gas Engine Kits have been sold at \$8.50. Now is your chance to buy the **New Improved kit for \$5.00**. Absolutely complete with coil, plug, etc. For boats, planes etc. All parts guaranteed. Send only \$1.—Shipped **Express Collect** for balance same day. **Catalog 3c. DEALERS WRITE.**

A screwdriver is the only tool needed. 1 1/2 H.P.  
Average assembly time 30 minutes.

**GHQ MOTORS, 854B East 149 St., New York, N. Y.**

**BABY CALCULATOR**  
CHICAGO ILL. PATENT APPLIED FOR



**WORLD'S LOWEST PRICED ADDING MACHINE** VEST POCKET SIZE FREE TRIAL

GUARANTEED ACCURATE. Not a toy. Operates with only a finger flick. Adds, subtracts, multiplies, divides. Counts up to a million. Pays for itself over and over. **IDEAL GIFT—** for Business, Income Tax and School use. **MONEY BACK GUARANTEE.** Send name and address. Pay postman only \$2.50 plus postage. (Send full cash if outside U. S.) **MONEY BACK IN 10 DAYS** if not delighted. **AGENTS WRITE. CALCULATOR MACHINE COMPANY (Mfrs.), DEPT 102, P. O. BOX 1118, CHICAGO, ILLINOIS.**

propeller stress-measuring apparatus, photographic equipment for recording flying characteristics, and boundary layer and wake measuring instruments.

A pitot static tube on an airplane is used normally to measure air speed, and the air-speed trailing bomb is simply a ballasted and finned pitot static tube on the end of a long cable. By trailing the bomb in a region unaffected by the airplane and its wake, the total and static pressures at the pitot on the bomb may be compared with the pressures from the pitot static tube on the ship.

Until recently the actual power developed by an airplane engine in flight was unknown although an approximation was made by extending the test stand performance of an engine to altitude by theoretical means. On the "DC-4" we have a device which indicates the actual crankshaft torque developed by any of the four engines at any time. The external stationary gear of the planetary gear reduction is balanced by means of hydraulic pressure within two cylinders. This hydraulic pressure is easily recorded in flight and is translated into actual engine torque. This, with the tachometer which gives engine speed, yields an accurate measurement of brake-horsepower developed.

Potentiometers measure the temperature of every cylinder, oil temperatures throughout the entire oil system, the temperatures of various accessories and of two thirty-horsepower auxiliary power plants, and brake-drum temperatures during taxiing and landings. A survey of the pressure distribution of the fuselage is also being made to determine the best design for the sealed cabin. Long rubber tubes to various points, a bank of typewriter-like selector valves and a differential pressure gauge are used for this purpose and enable an operator to take readings as rapidly as he can press the buttons.

Propeller blades are exposed to centrifugal and thrust loads and also to engine-torque impulse loads and vibrational loads. Because of their fatiguing effect, the last two are very important and the magnitudes of these loads are measured at several points on the propeller blades with the aid of carbon elements cemented to the blades, the resistance of which varies with the deformation. By means of wires run



along the blades to brushes and from rings on the nose case of the engine to an oscillograph, a photographic recording of stress variations is obtained.

A movie camera also makes a record of the force applied on all the controls and the direction, the movement of the controls in degrees, the accelerations of the plane and the attitude of the plane in every dimension. The camera is trained on a set of normal flight instruments, including turn-and-bank indicator, artificial horizon, directional gyro and air-speed indicator to record the attitude and flight condition. At the same time the camera makes a record of the readings of separate instruments which indicate the force applied to the controls and the movement of these controls. There are instruments on this ship which measure the energy lost when forcing the wing through the viscous medium, air, and there are others which show the force the pilot applies to the elevator control which is equipped with a hydraulic booster. There is even a carbon-monoxide indicator and a complete system for oxygen distribution to members of the test crew, since the cabin is not yet pressurized.

All this may seem a bit complicated—and it is. It's so complicated that it may take twenty engineers and observers to glean all the information which all these test instruments deliver on a single flight. If I so much as bat an eye in the cockpit, an instrument somewhere on the ship will record the fact for posterity—and probably measure the energy I required to do it.

After a few months at the controls of the "DC-4," I no longer need speculate on my flying skill. It has been analyzed for me by scores of sensitive instruments which faithfully record everything I do and every move I make from the time I climb into the cockpit in the morning until I climb out at night.

The real "miracle men" of aviation today are not the test crews who, with the aid of a truckload of instruments, test the performance of a new plane after it is built. The wonder boys are the fellows who doped out all the performance characteristics before the ship was built. These wizards of the slide rule and power curve set down the performance specifications for the "DC-4" some three years ago while the raw materials for the plane were still

(Continued to page 132A)

## HERE'S WHY MARIA WAS MAD AT HIS BRIAR!

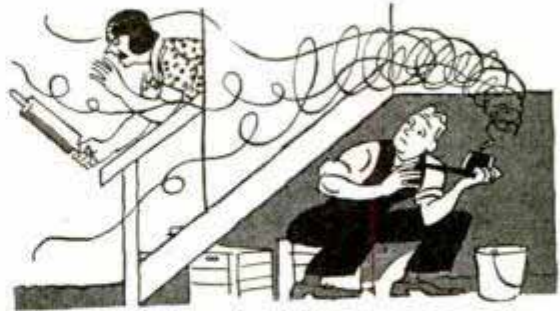

**HAVE A HEART** on your husband, ma'am — don't bawl him out for smoking. After all, it isn't his *pipe* that smells bad, it's that hot-and-heavy *tobacco* he always buys.



**NO MORE FIGHTS.** Some friend switched him to Sir Walter—two ounces of cool-smokin' burley—so mild it *never* bites the tongue—and a wife-winner for *aroma!*

**IT SMOKES  
AS SWEET  
AS IT SMELLS**



HOW TO  
TAKE CARE  
of  
YOUR PIPE

**FREE BOOKLET** tells how to make your old pipe taste better, sweeter; how to break in a new pipe. Write for your copy today. Brown & Williamson Tobacco Corporation, Louisville, Kentucky, Dept. P-92.

**TUNE IN** Tommy Dorsey and his orchestra. Every Wednesday night, coast-to-coast, NBC Red Network.



AN OPPORTUNITY FOR BIG EARNINGS WITH

## Amazing New WARNING SIGNAL

... Sells Every Motorist and Truck Driver

A BRAND NEW—RINGING—FLASHING—BACK-UP SIGNAL, that sounds a continuous warning when car moves in reverse. IT LIGHTS—IT RINGS—IT WARNS—and gives those in the path of danger a chance to get out of YOUR way before being HIT.

### NO COMPETITION

### Low Priced—Fully Guaranteed

Every Auto and Truck—30,000,000 of them in the U.S.A. are prospects. Attaches to any rear bumper bracket in a jiffy. Sells on sight . . . to 7 out of 10 on demonstration. BIG COMMISSIONS—steady repeat wholesale business from gas stations, new and used car dealers, and many other outlets. For distributing proposition WIRE at once to

### FEDERAL BACK-UP SIGNAL CO.

603 New Center Bldg.,  
Detroit, Michigan



## 60 POWER TELESCOPE . . . \$219

VARIABLE EYEPIECE 20X—40X—60X

**NEW!** Three telescopes in one. 3 different magnifications. 20 power for ultra-bright images with 40 and 60 power for extra long range. Guaranteed to bring distant objects, people, sports events, ships, moon, stars, etc., 60 times as close.



Most powerful made for anywhere near the money. Closes to less than a foot in length. Multiple lens system. 30 mm. objective lens. 5 sections. Directions included for using as a compound 4 lens microscope. American made. Prompt shipment guaranteed. We pay the postage. Only \$2.19. **BROWSCOPE CO., Dept. 42, 5 W. 27th St., New York, N. Y.**

## COMET CLIPPER GAS MODEL



4.95

### NEW 36 PAGE CATALOG

Hundreds of models, 10c up. Gas model kits, motors, accessories. Send 5c stamps to

Prize-winning, record-breaking, 6 ft. gas model. Removable power unit; detachable wing and tail; difficult parts finished. Kit with automatic timer, \$4.95; postage 25c, or buy from dealer.

**COMET, 2509 CERMAK ROAD, CHICAGO, ILL. Dept. P2**

PLAIN RING	SEALED WITH CUPPED 4-PIECE RING	SAVE OIL WITHOUT REBORING RESTORE POWER
OIL		HALING'S FOUR PIECE PISTON RINGS
COMPARE		Cup seals worn groove, saves oil. Distributors wanted. Piston Expanders, Steel Vented Rings, Segment and Plain Rings. Get circular and users testimonials.
		HALING CO. Dept. P Rochester, Minn.

## A Super Value 8" TABLE SAW



PRICE ONLY \$11.95

Built to Duro high standards of quality and workmanship.

It is the greatest value Saw that has ever been put on the market. High quality materials machined to close limits for accuracy—gray iron base, table bracket and table give rigidity and smoothness.

All Duro tools are designed for greater convenience of operation and made of quality materials for longer life. Send for new 1939 Duro Woodworking catalog illustrating America's finest and most complete line.

★ 2 3/8" DEPTH CUT ★ TABLE 11" X 15"  
★ FREE VISION GUARD ★ PRICE INCLUDES MITRE GAUGE & RIP FENCE

**DURO METAL PRODUCTS COMPANY**  
DEPT 83, 2649 N. KILDARE CHICAGO, ILL.

(Continued from page 131A)

in the earth. They doped out top speed, rate of climb, takeoff and landing speeds and hundreds of other factors. And their dope was correct.

The test flying in which we now are engaged is the "proof of the pudding" but it is only one phase of the tests to which the "DC-4" has been subjected. This ship was tested for months before it left its hangar. Every critical condition of taxiing, flying and landing was reproduced in ground experiments while the plane was being built. Reduced to mileage, the "indoor flights" of the ship, as recorded in load applications and vibration tests, were sufficient in force and duration to have taken the "DC-4" nearly three times around the world before it left the ground.

To accomplish these things without taking the ship outside its construction hangar required 100,000 hours of shop and engineering labor, 175,000 pounds of structural steel and scores of tons of equipment such as hydraulic jacks, blocks and tackles, chains and special rigging. More than 200 points on the ship were subjected to deflection readings as successive loads were applied and some tests were made to load factors three and one-third times the gross weight of the plane.

Small wonder, after such accurate planning and such rigid preliminary testing, that the pilot who puts this leviathan of the skyways through its preliminary paces has a pretty soft snap—even if his ego is deflated once in a while by a few tons of snooping instruments which jot down every wobble he makes.

Soon the testing will be finished. Then the heavy timbers which hold the pig-lead bars in place during flights will come out. Out also will come a truckload of test equipment. In will go luxurious fittings, curtains, berths, reading lamps, carpeting. Then the Douglas "DC-4" will become not only the largest land plane ever built in this country but probably the safest ship ever constructed—safe because it will have been more thoroughly tested than any other airplane. In this task of checking and double-checking tomorrow's sky liner, I am proud to have had a humble part.

☐ Send return postage to our Bureau of Information to learn the name of the maker of any device described in this magazine.



# OWN A ROYAL



Believes Royal helped him get ahead!

"The day I got my Royal I started typing my reports. The boss liked it. Soon I had a larger territory. Now I have 5 men under me."

# PORTABLE ON



Glad they picked a Royal

"All of us use our Royal Portable—Junior for his homework—I to work out assignments for a correspondence course which I'm taking."

# YOUR OWN TERMS



Ideas typed on Royal bring raise

"Ideas count where I work. Since I got my Royal, I've typed mine out. Already I've had one raise, and I expect another."

Only a Few Cents a Day

# FREE HOME TRIAL FOR EVERY

**MEMBER OF THE FAMILY!** A Royal Portable will help you write faster, think faster. A practical, modern necessity—it's an opportunity for a better, brighter future! A chance to do more, *be more!*

Without risking a penny prove—right in your own home—that a Royal will help you—whatever your business or profession—help you to set down your ideas and reports *legibly, impressively*. Prove too, that it will help the children with their homework . . . *help every member of your family with their writing!*

**READ WHAT ROYAL GIVES YOU!** Standard, full-sized keyboard. Easy, effortless action, Touch Control, Finger Comfort Keys, Genuine Dust Protection, Automatic Paper Lock, Touch-set Tabulator and many other office typewriter features. Tested, proved, guaranteed!

**FREE!** Royal's Instant Typing Chart, shows you how to type **RIGHT**. INCLUDED with every Royal Portable at no extra cost—a handsome, all-weather, triple-convertible Carrying Case.

**SEE** what a Royal will do! Then own it on your own terms—cash or *only a few cents a day!* Mail coupon today for full details of Royal's offer—prices, terms, Free Home Trial—everything. No obligation.



ROYAL TYPEWRITER COMPANY, Inc., Dept. D-15, Park Ave., New York, N. Y.

Tell me how I can own—for only a few cents a day—a latest model Royal Portable—with **FREE HOME TRIAL**. (DO YOU OWN A TYPEWRITER NOW? Then make it help pay! Write Make and Serial No. on coupon margin for full trade-in value.)

NAME \_\_\_\_\_ STREET \_\_\_\_\_  
CITY \_\_\_\_\_ STATE \_\_\_\_\_

# 500 Men at Once!

A **REVOLUTIONARY** Chemical Sponge has been invented that cleans wall paper and painted walls like magic. Also cleans window shades, furniture, rugs, etc. Ends cleaning drudgery. Housewives wild about it. *Approved by Good Housekeeping Institute.*

The inventor wants 500 men and women at once to help him introduce this strange chemical sponge. He offers to send samples **ON TRIAL** to the first person in each locality who writes him. No obligation. Get details. Be first—*send in your name to THE KRISTEE CO., 674 BAR ST., AKRON, O.*

# FINDS BURIED TREASURE! NEW GOLDAK RADIOSCOPE



Most efficient metal and mineral ore locator ever known. Money-back guarantee to detect buried **GOLD, SILVER, or any other metal**. Extremely powerful new models. *Put your prospecting on a scientific basis.* If you know of buried treasure, find it with the new Goldak. Write world's largest manufacturer of successful mineral locators for information.

**THE GOLDAK CO., Dept. P**  
1031 South Broadway, Los Angeles, Calif.

# KINKADE GARDEN TRACTOR

**and Power Lawnmower**  
A Practical Power Plow and Cultivator for Gardeners, Suburbanites, Florists, Truckers, Nurserymen, Fruit Growers.  
**Low Prices - Easy Terms**  
**American Farm Machine Co.**  
1058 33rd Av. SE. Minneapolis, Minn.



**FARM MODEL \$49.00**

# TURN TREES INTO MONEY WITH A BELSAW

Three capacities: 10, 14 and 20 ft. Accurate set works positive dogs. Hand or power feed. Runs on low power—Many owners use old auto engine. Pays for itself quickly—thousands in commercial service, everywhere. Write for free lumber handbook and catalog of mills, supplies, tools, saw tables, and woodworking equipment.  
**Belsaw Machinery Co., 8110-V Davidson Bldg., Kansas City, Mo.**

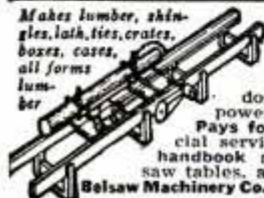

# HANDEE

Tool of 100 Uses

# A Whole Tool Shop In Your Hand

Smooth, steady power at your finger tips. Unmatched performance, with our own **CUSTOM BUILT** precision motor. For work on all materials. Uses 200 accessories,



Save Hours of Hand Work



Finest, Fastest, Most Powerful Tool for Its Weight

interchangeable in easy-working chuck to grind, drill, polish, engrave, sharpen, carve, sand, saw, rout, cut, etc. Set up shop anywhere; plug in AC or DC socket.

**STANDARD MODEL** (Shown above), 20,000 r.p.m. Wt. 16 oz. \$10.75 postpaid with 3 Accessories. **DE LUXE MODEL**, 25,000 r.p.m. Wt. 12 oz. \$18.50 postpaid with 6 Accessories.

**GET A DEMONSTRATION** at Hardware, Tool or Dept. Stores or order either model on 10-Days Money-back Trial.

# Free - 64-PAGE CATALOG

Complete information on Handee Products and their wide application in crafts work and industry all over the world.

Chicago Wheel & Mfg. Co., 1101 W. Monroe St., Dept. PM, Chicago, Ill.

Send Catalog  Standard  De Luxe  Send C.O.D.

Name.....

Address..... PM-2



## BOICE-CRANE TILTING-ARBOR SAW with Actual 9 Year "Out in Service" Record

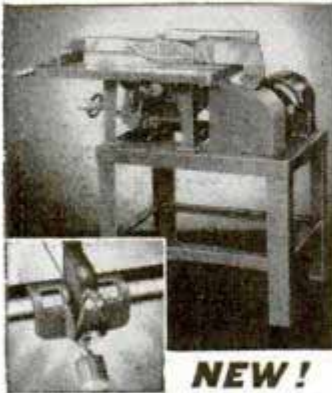

**A FINER  
TILTING-ARBOR SAW**  
with exclusive Rolling Pulley  
Drive that outperforms all  
others.

- Keeps motor cost lower
- Motor mounts out of the dust
- No troubles with lubrication
- Use any motor 1/3 to 2 h.p.
- Saves 1 motor on saw-jointer
- New dual Rip Fence Control



**NEW!**

### Dual Rip Fence Control

One control micro-sets, fast feeds, and locks rip fence. Faster, handler, increases accuracy. Only our saw has it!

### NEW HELMET-HEAD DRILL

New. Far different than others. Loaded with features. Fully enclosed drive at no extra cost. 6 spline spindle. Newest involute type spline teeth. Handsome. Ultra modern. Dozens of other features. See catalog for full details!

**SEE OUR COMPLETE LINE**

21 machines — 11 types

**SEND FOR 1939 CATALOG**

**BOICE-CRANE CO., Dept. 229, Toledo, O.**

Catalog FREE. Spinning Handbook 10c.

Name.....

No.....

City.....

State.....



## New Adding Machine Fits Vest Pocket!..

Adds, subtracts and multiplies up to one billion. Weighs only 4 ounces. Not a toy—strong guarantee. Absolutely accurate, very fast. Sells to offices, stores, homes—wherever figures are used. Write quick for FREE AGENTS sample offer and Money-Making Plan.

**VE-PO-AD, Dept. 173, 303 W. Monroe St., Chicago**



## FUN while you LEARN and EARN!

—with HOME FOUNDRY

**WOOD-BURNING SETS**

Make Plaques, Book-ends, Ash Trays, etc.; sell to friends and neighbors. Buy it with your Xmas money.

**SEND FOR FREE CATALOG:**

List Catalog Sets, 85c to \$3.85; big selection of molds; new ELECTRIC Metal-Top Sets, \$1.25, \$2; new Sand-Pen Kits, 50c to \$2.



**SET NO. 1002:**

12 large plaques,  
1 qt. book-ends,  
6-color picture and  
brush, sandpaper,  
Wonder Pen; \$2.  
50c to \$3.85.  
Other Wood-burn-  
ing sets, \$1 to \$3.



**HOME FOUNDRY MFG. CO.**

3122 W. Fifth Ave., Dept. 2P, Chicago, Ill.

## Setting Bugs to Catch Bugs

(Continued from page 253)

The Bedalia beetle is also bred and shipped to the Gulf Coast states. Growers and nurserymen there find it effective against the cottony-cushion scale that infests citrus trees and ornamental shrubs.

Orders are filled for many other kinds of insects. Commercial insecticide companies sometimes want ordinary clothes moths for experimental purposes. Taxidermists often request buffalo carpet beetles to use in cleaning skins. Professional fumigators place buffalo carpet beetles in capsules which are then spotted at various places in a house to be fumigated. After their work is done, the fumigators display the capsules containing dead beetles as proof that their work has been effective.

Another phase of Dr. Morrill's work lies in supplying high schools and colleges with biological and botanical specimens. He has more than 20,000 tropical butterflies, one of the largest collections in the world.

The methods of breeding and raising insect parasites are patterned somewhat after the technique developed by Dr. Stanley E. Flanders of the University of California. Dr. Morrill, however, has added his own inventions and variations. Much of his work is done in co-operation with the United States Department of Agriculture and various universities.

Breeding millions of insects each year calls for a large and constant food supply. Dr. Morrill has discovered that the eggs of the grain moth provide a tasty diet for most parasitic insects. These eggs are only about one-fortieth of an inch in length and are shaped like rice kernels.

The grain moths are housed in a special room where temperature, light, and humidity are regulated. They are confined within cloth sacks and the eggs are collected in glass jars at the bottom of each sack. Once a day these jars are removed, and the eggs are collected and cleaned. Some of these eggs are used as Trichogramma egg depositories, and some as food for the wasps. They may also be used as food for the Cryptolaemus beetles during shipping. These eggs also make excellent food for tropical fish.

When the eggs have been collected and sifted, they are glued to small cards. In this manner they can be handled easily and counted quickly. A sheet of paper meas-



1238

uring six by eight inches is coated with sixty-four small squares of library paste. The eggs are sprinkled over the paper and cling to the sticky squares. Each square holds about 1,000 eggs and the whole sheet about 64,000 eggs.

These egg cards are exposed to the female *Trichogramma* wasps which deposit eight or ten of their own eggs inside each egg of the grain moth. In about eight days, the adult wasps appear. To arrest development, the egg cards are sometimes kept in a refrigerator. Low temperatures produce a state of suspended animation, and the larvae may remain in "cold storage" for as long as six months.

The method of raising ladybird beetles is somewhat different. Potatoes are allowed to sprout in a darkened room. The sprouts are then thoroughly infested with mealy bugs. Adult ladybird beetles lay their eggs on the potato sprouts and as the larvae mature they eat the mealy bugs. It takes about a month for them to appear as full-grown beetles.

Dr. Morrill has developed several ways of shipping his insects. The egg cards containing the wasp larvae are cut into smaller strips and squares and packed in paper cups. As many as 50,000 potential *Trichogramma* may be shipped this way. Smaller amounts are sealed in gelatine capsules. Loose eggs for tropical fish food are usually packed in half-dram vials. Ladybird beetles are shipped in small cardboard boxes which have a wire-mesh screen on one side for ventilation.

The time element in shipping is important. Eggs containing wasp parasites must reach their destination before they hatch. When a shipment of wasp parasites is received by a farmer, a small hole is cut in the container and it is pinned in a tree. In a peach orchard, about 1,000 wasps are freed six weeks before the fruit is harvested. In citrus orchards, about 100 ladybird beetles per tree are released. Each beetle will destroy about 100 mealy bugs.

Biological control of insect pests is only one phase of America's war on insects. In recent years, however, the use of speedy air transportation has made it more effective than ever before.

Send return postage to our Bureau of Information to learn the name of the maker of any device described in this magazine.

## A BUSINESS OF YOUR OWN WITH AN IDEAL LAWNMOWER SHARPENER

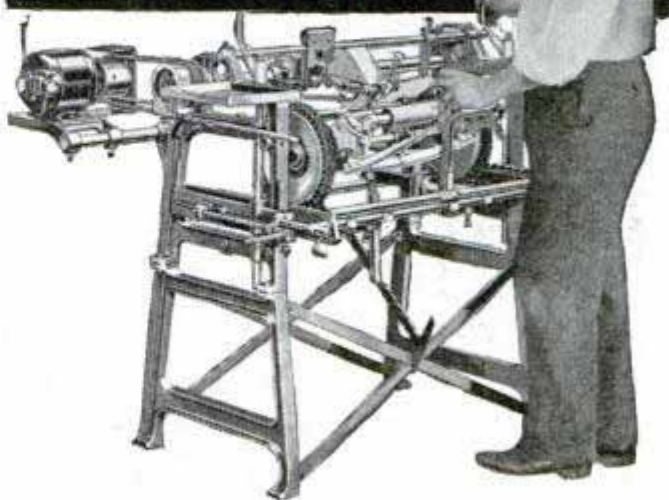

### Be Independent! Hundreds Now Have A Profitable Business of Their Own—So Can You!

Our free plans show you how to build a successful business of your own sharpening lawnmowers. Most men earn up to \$25 a week. Roy F. Stier, Wisc., writes, "I paid for my Ideal Sharpener in exactly 36 days and have to-date sharpened 200 mowers at \$1.25 each. I live in a village of 500 people." Howard Hellen, Minn., writes, "I sharpened 745 lawnmowers, sold 60 used mowers and grossed \$1100.00 from April 5 to Sept. 15." A. J. Worth, Canada, writes, "It is necessary to buy another Ideal to handle the volume of business." A. M. Larsen, Utah, writes, "We average 9 lawnmowers a day." Chas. H. Chism, Ohio, writes, "I have had as high as 30 mowers come into my shop in one day." P. G. Armour, Pasadena, Calif., writes, "We get \$1.00 for small 4-blade machines, \$1.25 for 5-blades, \$1.50 for large mowers." Frank Segre, Hartford, Conn., writes, "My customers are so well pleased with the lawnmowers I sharpen for them, they always send in their friends. This makes good business for me."

### EARN GOOD MONEY Full Time or Spare Time

Like magic, the Ideal Lawnmower Sharpener makes old, dull, badly worn mowers cut like new. Set the mower in the Ideal, make a few simple adjustments, and the machine does the rest. Sharpens any mower to a perfect edge in 15 to 20 minutes—usual charge \$1.00 to \$1.50. Customers come back year after year. Positively no experience necessary. Attach to light socket. Start in your basement or garage. Work in spare time only if you wish. Attachments for grinding skates, grass shears, hedge shears, sickles, scythes, and axes. FREE CATALOG tells complete story.

**FREE BOOK**  
tells how  
TO MAKE UP TO  
**\$25**  
PER WEEK  
EVEN IN SPARE  
TIME

SEND POST CARD FOR FREE BOOK  
**The Fate-Root-Heath Co.**  
249 Bell St., Plymouth, Ohio.

make money--  
**SHARPEN LAWNMOWERS!**

HOW TO  
BUILD A  
Profitable  
BUSINESS  
OF YOUR  
OWN



*Everything in*  
**RADIO**  
*at*  
**LOWEST PRICES!**

Sets • Parts • Kits  
P.A. • Ham Gear • Testers  
FREE! 180 Page Catalog

**1939**  
**KNIGHT SETS**  
at New Low Prices!

See the amazing new 1939 Knight Radios in your ALLIED Catalog! New features—Push-Button Tuning, "Low-Boy" cabinets, 1½ volt tubes, etc.—at new low prices. 62 models, some as low as \$6.95, 4 to 16 tubes, in AC, AC-DC, 1½ Volt, 6 Volt and 32 Volt models. Also new "Tiny Knights," phonographs, phono-radio combinations, record players, etc. They're all in ALLIED's 1939 Catalog—the Buying Guide of Radio Buyers!



Choose  
from  
**62 MODELS**

**KITS!** Complete-Ready to Build!  
Send for FREE Parts Lists!



**2 Tube DX'er Kit!**  
The favorite receiver of thousands! Low in cost, efficient, easy to build. Less coils ... **\$3.98**



**20 Watt X'mitter**  
Advanced type 6L6 Beam-Power transmitter for C. W. Tuner all bands. Complete, less tube, crystal, and key ... **\$3.60**



**Photo Cell Kit!**  
Ideal for burglar alarms, controlling lights, starting and stopping motors, etc. Complete ... **\$5.85**



**BEGINNERS! SEND FOR Allied RADIO BUILDER'S HANDBOOK**

A new and different type of book, planned especially for radio beginners. Tells how to select circuits, read diagrams, make chassis, solder, wind coils, etc. Packed with valuable data. Send coupon with 10c for your copy today! **Only 10c.**

**FREE PARTS LISTS.** We can supply Free Parts Lists covering hundreds of kits, including those above. Write!

**SAVE MONEY ON ALL YOUR RADIO NEEDS**

The new ALLIED Catalog also shows 14,000 radio parts, new P. A. Systems from 8-65 watts, Amateur Gear, Test Equipment, books, tools, etc. Write for your Free copy today—you'll save and profit on every order!



SEND  
FOR **FREE**  
CATALOG

**ALLIED Radio Corp.,**  
Dept. 5-B-9  
833 W. Jackson Blvd.,  
Chicago, Ill.

- Send me your Free 1939 Catalog.  
 Enclosed find 10c plus postage for Radio Builder's Book.  
 Send me parts list.....

Name.....

Address.....

## How to Build a Tube Tester

(Continued from page 259)

octal base tubes. A top view of the completed unit appears in photo Fig. 3-A and a close-up of the meter in Fig. 3-B.

Ordinary hook-up wire with push-back insulation is used for all connections. The double-pole, double-throw switch is an anti-capacity type, and the rotary switch is a non-shorting variety which must have at least ten taps. A 1,000-ohm wire-wound potentiometer is used, with a snap-on switch fastened to the back. The tube-testing transformer has a 115-volt primary and all color-coded secondary leads must be for the voltages specified, at 2 amp. each. The optional fixed resistor, shown in dotted lines, may be any value from 100,000 to

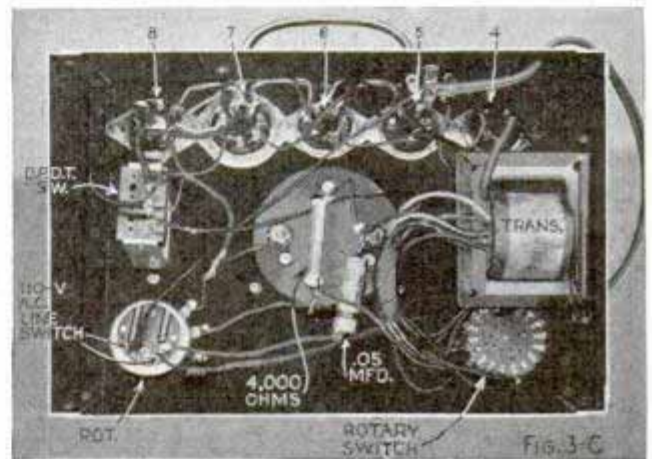

250,000 ohms, ½ watt, and is connected across the neon bulb socket if the bulb should continue to show a pale light on practically all tests for "shorts." A material list of the original parts used and additional tube-chart data can be obtained from Popular Mechanics radio department without charge. The blueprint number is R-264.

A bottom view of the completed unit is shown in Fig. 3-C and a close-up of the rotary switch connections appears in photo Fig. 3-D. These soldered connections should all be made before the transformer is mounted on the inside of the case. To test tubes, first refer to the chart for the proper settings indicated for the type of tube under test. Now, before placing the tube in a socket, adjust the rotary switch to the filament switch tap number and turn the potentiometer to the load setting indicated for that tube. Insert the tube in the socket, place cap on tube, if required, and

(Continued to page 138A)



# John made \$42<sup>50</sup> in one day in his NEW Business



### Get Into This Business Now—

a business which is so new that it is practically without competition. This alone should enable you to make really BIG MONEY. Hotels, homes, clubs, office buildings offer tremendous possibilities. Our new DETERGER washes upholstered furniture, electrically right in your customer's home, with a new soapless soap whipped into DRY suds. No liquid touches the fabric, therefore the furniture is ready for use soon after cleaning. We have helped hundreds of men get into business for themselves with our automatic equipment. The U. S. Government and many of the world's largest hotels use our machines.

### Make Money the FIRST DAY

The Deterger is ready to use when you receive it, so you ought to be taking in big profits the first day. We want an honest, ambitious man in every locality. If you are that man we will help you get started for yourself in a business with tremendous possibilities.

**No Rent to Pay** You don't have to rent a shop. You don't have to hire a building, for you do the work right in your customer's home. You save the expense of carting furniture back and forth to a central plant; the owner's home is your workshop.

### J. S. Corson says

"I cleaned seven living room sets and fourteen chairs, as well as twenty-five automobile interiors the very first month and made \$279.50." Berger Hanson wrote "My investment in your DETERGER was the wisest I have ever made. It is my most valued asset." Barrett says: "Made \$28.00 in eight hours, on another job made \$11.00 in two and one-half hours." Alex Gulkin's business expanded so fast that he already has SIX DETERGERS making money for him.



No liquid touches the fabric when cleaning with the DETERGER.

### Pay as you Earn

Only a limited amount of money is needed for a down payment. The balance you send on easy terms. Most men find it possible to make far more than the cost of the machine before the payments come due. Every machine is fully GUARANTEED and satisfied customers send their friends to you.

### Book sent FREE

Write today for copy of our booklet "Your Own Business, Profits Instead of Wages." Let us tell you how easy it is to get started in a year around business where you are your own Boss and can stop worrying about just a job. Write today—NOW.



VON SCHRADER MFG. CO., 552 Pl., Racine, Wis.

### VON SCHRADER MFG. CO., 552 Pl., Racine, Wis.

Send me (without obligation) your free booklet telling me how I can own my own business and become financially independent and how I can pay for the DETERGER on easy terms.

Name.....  
Address.....  
City.....State.....

### Write with Electricity



### USE THE ELECTROGRAF

Writes easily on the hardest metals or alloys. Positively identifies your tools, protects against theft. Absolutely permanent. Requires few seconds only—anyone can operate. Pays for itself.

\$198

POSTPAID

Send No Money—Pay Postman \$1.98 plus postage. H. M. O. or check accompanies order. We pay postage. AGENTS: Write today for our proposition.

NATIONAL LABORATORIES, Portland, Ore

### ATLAS Stick-On Letters WINDOW SIGNS

Beautiful GOLD Colored. New Styles. 5 year Guarantee. Large Sizes—Penny each. Tremendous Demand. Amazing Profits. Write for FREE SAMPLES and Starting Equipment. HURRY! ATLAS Sign Works, 7943 Halsted, Chicago

### Print Your Own

Cards, stationery, circulars, tags, labels, advertising, etc. Save money. Print for Others; Big Profits; easy rules sent. Will do popular Raised Printing like Engraving. Junior outfit \$9. Senior outfit \$17 and up. Send for free catalog and all details. KELSEY PRESSES, E-37, MERIDEN, CONN.

### Earn Cash at Home!

We paid M. M. \$1174 for exceptional "cellar crop" SNOW-KING mushrooms! Big free picture book tells if your cellar, shed, barn suitable. We furnish materials, buy all crops. Write today. Est. 1908. UNITED CO., 3848 Lincoln Ave., Dept. 304, Chicago.

### MAKE MONEY IN PAINTING BUSINESS



Paint walls, ceilings, screens, furniture, radiators, machinery faster, better! 1/4 H. P. motor 110 Volt 60 Cycle AC, complete with Spray Gun, 15 ft. hose. Weighs only 44 lbs. Carry anywhere. FULLY GUARANTEED. Only \$31.15 f. o. b. Chicago. \$5 Deposit. Balance COD, or SEE YOUR DEALER. Circular FREE. Get started making money NOW!

\$31.15 Complete

Ideal Automatic Pump Co., Dept. PM-2, 801 Washington, Chicago

### TYPEWRITER Brand NEW!

Only \$19.95 and up



10-Day Trial—Easy Terms  
Guaranteed Brand New latest REMINGTON CADET model only \$19.95 during this sensational sale. Also Royal, Corona and famous Featherweight Portables at real money-saving prices. Also standard full size office models rebuilt and fully guaranteed at 1/3 saving.

International Typewriter Exch., Dept. 201, Chicago

### ARC WELDER FROM OLD DODGE GENERATOR

For light or heavy work 75-200 amps. 35c brings complete plans and valuable catalogue listing 500 electrical items. Over 100 other generator changes. LEJAY MFG., 1347 Lejay Bldg. Minneapolis Minn.



### Work Faster Make More Money with the



Red UNIVERSAL TRACTOR

With this practical machine and attachments you can do all field and belt work hours faster at the low cost of 33c per day. Many units pay for themselves the first season. Unusually easy to handle and operate. Absolutely safe. Hundreds of users. Buy direct at low factory price. Two weeks' trial—satisfaction guaranteed. Write for colorful, free catalog.

PIONEER MFG. CO. Dept. V-29 West Allis, Wis.



(Continued from page 136A)

Get the **THRILL** of building it yourself



Get the **THRILL** of building it yourself! There's a lot of he-man thrill in a short-wave radio of your own. But the biggest thrill is putting this magic Voice-of-the-World together **YOURSELF**. Our new **FREE** radio catalog No. 73 features a wide selection of Build-it-Yourself kits and items designed to make that thrill come true. But that's not all. This big 188 page book also contains thousands of other items—tubes, accessories—everything you need in radio. And at real money-saving prices. Don't miss it!

**WORLD'S FINEST RADIO CATALOG FREE!**

**FREE**

Why wait? Begin now to save on everything you need in radio. This catalog points the way. Mail the coupon for your **FREE** copy at once.

**WHOLESALE RADIO SERVICE CO. INC.**  
 NEW YORK, N.Y. • CHICAGO, ILL. • ATLANTA, GA.  
 100 SIXTH AVENUE • 901 W. JACKSON BLVD. • 763 PEACHTREE STREET  
 BOSTON, MASS. • BRONX, N.Y. • NEWARK, N.J. • JAMAICA, L.I.

**WHOLESALE RADIO SERVICE CO., Inc.**  
 Dept. 7B9—100 Sixth Ave., New York, N. Y.  
 Rush **FREE** 1939 Radio Catalog No. 73

Name .....  
 PLEASE PRINT  
 Address .....  
 City ..... State .....

**RUSH COUPON FOR FREE CATALOG**

PASTE COUPON ON PENNY POSTCARD

**CONDON'S GIANT BEEFSTEAK TOMATO**



"King of the Market." Big Money Maker. Large Solid Fruit—Excellent Canner. To introduce to you our Vigorous Northern Grown "Pure Bred" Garden, Farm and Flower Seeds, Bulbs, House Plants, Fruits and Nursery Items, we will mail you 125 Seeds of Condon's Giant Beefsteak Tomato and our big 1939 Catalog. Most Complete Seed and Nursery Book—600 pictures, many in color. Bargain Prices. Write today.

**CONDON BROS. SEEDSMEN, Box 99, Rockford, Ill.**

**SOCIAL SECURITY PLATES**

Operate your own business. We start you without one penny investment. Over 400% profit. New plan—hire your own agents. Sell thru stores and direct. Get all the profit. Over 40 million waiting buyers. Postcard brings **FREE OUTFIT**.

**U. S. NAME PLATE CO., Box 769, Dept. 107, Chicago**



**New Amazing INVENTION! ELECTROPLATES**

by **BRUSH** EASY AS PAINTING!



**NO TANKS, Liquid Generators — Does Same Work As Big Outfits**  
 Sensational news! Marvelous new discovery actually electroplates with electric brush as easy as painting. Deposits heavy layer of actual metal—gold, silver, nickel, cadmium, copper, etc.—by electrolysis. Does same beautiful, **PERMANENT** work as big costly tank outfits. Non-liquid. Anyone can use from dry cells, storage battery or household current. Complete outfit weighs only 3 lbs.—take it anywhere.  
**FREE SAMPLE!** Send today for amazing details and **FREE** Sample that proves all claims.

Only **\$6.85**

Agents Wanted: Write for Big Money Proposition Sell Outfits—Do plating for others  
**WARNER ELECTRIC CO., Dept. F-5**  
 360 North Michigan Avenue, Chicago, Illinois

throw the d.p.d.t. switch to "test." For heater-type tubes allow a minute for the tube to heat up; the meter will then indicate the condition of the tube. Now push the d.p.d.t. switch back and watch the neon bulb. No light, or a quick flash, indicates a good tube; while a continuous light tells of a short or leakage in cathode-type tubes. However, there are a few exceptions to this rule in the case of the following tubes: types 5T4, 5U4, 5V4, 5W4, 5Y3, 5Z4 and 6A5. These tubes will test shorted but are

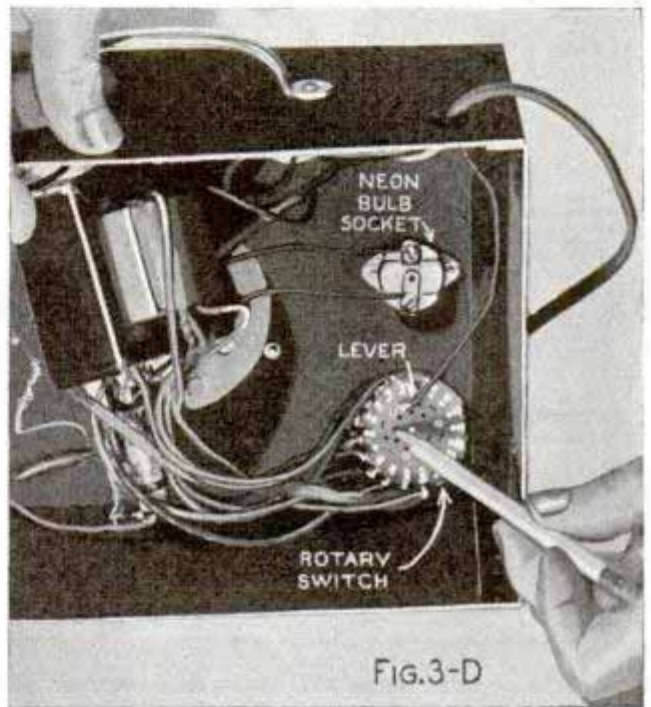

FIG. 3-D

not defective. Four-prong tubes will show no "short" test; all G-type "glass-bulb" tubes take the same chart test as the metal varieties of the same type. This compact and easily portable unit has been designed carefully to meet the needs of the set owner, experimenter and serviceman of limited means who likes to assemble his own testing equipment. With several receivers in nearly every home, all using different types of tubes, every set owner should have some means of locating a defective tube quickly.

All tube-testing devices only indicate the difference between a given tube's characteristics and those which are standard for that particular type. Since the actual operating conditions imposed upon a tube of given type may vary within wide limits in certain applications, no tube tester can be considered a final authority in all cases, but it is a most helpful device for indicating the serviceability of a tube.



# New Tilting Arbor Saw

## Turns in Remarkable Performance



● Everywhere, men who use it, say this new Delta tool is the finest Tilting Arbor Saw on the market. Perfected after seven years of patient testing and experimenting—the new Delta Tilting Arbor Saw is the ideal circular saw for small shops, home workshops, schools, contractors, shipping and maintenance departments, woodworking plants—in fact wherever a compact low-price, *efficient* circular saw is needed. Some of its outstanding points are: Powerful fully enclosed motor; highly efficient "Tex-Rope" drive; perfected raising, lowering and tilting mechanism; new scientifically designed rigid housing; patented double-face, double-lock rip gauge; exclusive precision auto-set miter gauge; patented ripping extensions; sealed-for-life ball bearings; forged alloy-steel arbor; extra large table; "Point-of-use" controls and numerous other features. The full story of this new Delta tool and the complete 1939 line of Delta tools is found in the latest Delta Catalog. Send coupon for your FREE copy today.

### Delta Manufacturing Co.

600-634 E. Vienna Avenue, Milwaukee, Wisconsin

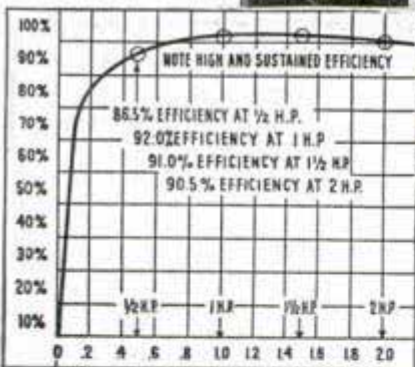

Our tests showed that the "Tex-Rope" drive—while more expensive than a gear drive—was by far the most satisfactory and trouble-free drive that could be adopted. Tests made by an independent agency show that the efficiency of the drive is not only very high, but that it is sustained at a very high peak.

**DELTA MFG. COMPANY, Dept. A239**  
**600-634 E. Vienna Ave., Milwaukee, Wis.**  
 Gentlemen: Please send me 1939 Delta Catalog and full details on the New Delta Tilting Arbor Saw.

Name.....  
 Address.....  
 City..... State.....  
 Check here if you are a Delta user now.

**RADIOS..SAVE UP TO 50%**

**YOUR AGENT'S COST PRICE \$4.95 ea.**

**DEAL DIRECT...FACTORY PRICES!** Many models to select from: AC-DC; All-Wave; armchair models; automatic tuning; car radios; Farmsets that operate like city radios! Send postcard for NEW Bargain Catalog FREE. 30-DAY TRIAL price and agent-user proposition!

**30 DAY TRIAL \$6.98 UP**

**Free Catalog**

**GOLDENTONE RADIO CO., DEPT. 101, DEARBORN, MICHIGAN**

in Lots of 3

**Beautiful Bench Arbor**

8' high, 5'-6" long, 2' wide. Easy to build. Detailed Blueprint 75c. Complete Knock-Down Bench Arbor \$42.50. TRELLISES—12 different designs. Blueprint of all 12 only 50c. CAPE COD LAWN CHAIRS—3 distinctive designs. Blueprints 50c ea. All 3 only \$1.00. For catalog send 10c.

● "Over 35,000 Satisfied Customers" ●

**CRAFTSMAN'S MODEL CO., Dept. P-26,**  
 2030 N. 41st ST., MILWAUKEE, WIS.



**SNAP-UP Electrically operated GAS TANK LOCK**

At last—An amazing invention makes possible this remarkable Electric Gas Cap. NO KEYS—To operate just press a handy button on your dash—cap unlocks and SNAPS open. Close the cap and it locks automatically. Fully guaranteed. THE COMING THING—Wonderful opportunity for Agents and Dealers. Write immediately for exclusive distributorship proposition.

**SNAP-UP GAS CAP CO., INCORPORATED ASHLAND, KY.**

**ENGINES**

A real money maker for farm or factory. Uses Cheap fuels. Pays for itself out of savings. Costs Less to Own—Less to Operate.

**LOG SAWS**

Make Money—Start a wood sawing business—turn spare timber into cash. Cash or Terms—Engine and Saw Catalog.

**WITTE ENGINE WORKS 1742 OAKLAND AVE. KANSAS CITY, MO.**



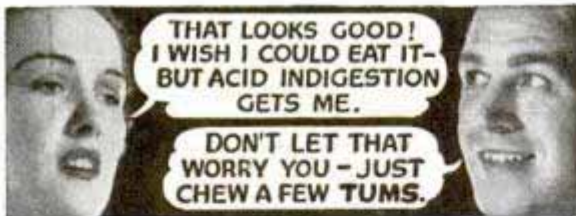

**YES—TUMS** bring amazing quick relief from indigestion, heartburn, sour stomach, gas caused by excess acid. For TUMS work on the true basic principle. Act unbelievably fast to neutralize excess acid conditions. Acid pains are relieved almost at once. TUMS are guaranteed to contain no soda. Are not laxative. Contain no harmful drugs. Over 2 billion TUMS already used—proving their amazing benefit. Get TUMS today. Only 10¢ for 12 TUMS at all druggists.

You never know when or where



Tums are anti-acid—not laxative. When you need a laxative get—*Nature's Remedy* NR TABLETS—NR. This all vegetable laxative brings such gentle, dependable relief for conditions due to constipation.

## Syncro JIG SAW

Faster! Safer! Cleaner! Real performance. Cuts with smooth, clean edges. No sanding required. Electric operation. No motor or reciprocating parts. Operates on 60 cycle, 110 volt A.C. Ideal for home craftsmen, and model makers. Two models.



7200 Strokes per minute Only \$4.95 (East of Rockies)

Write Today for FREE LITERATURE  
Export Office: 40 Worth St., New York; Western Dist.: Federated Sales Co., 2437 W. Valley Blvd., Alhambra, Cal.

**SYNCR0 DEVICES, INC.,** 511 Boydell Bldg. Detroit, Mich.

## AFTERNOONS FREE

for life's pleasures. Drive to Country or go to Movies afternoons. Work mornings till noon at HOME (Business Plan No. 4). Further Outstanding Possibilities: Plans No. 44, 75, 119. Grab the chance to get into a business while it's not yet overcrowded. Write NOW in time for a happy future. Prepare for surprise.  
**STAMFORD CO.,** Dept. 1-A, 3762 BROADWAY, NEW YORK

## FREE 28 page FILING BOOK

packed with instructions, photos by the score on choice and use of files. Every shop beginner or veteran needs one. Send note, postcard today. Nicholson File Co., 22 Acorn St., Providence, R. I., U.S.A.  
**A FILE FOR EVERY PURPOSE**

### ACE LATHE TOOL SET

**\$14.50**

**Be permanently tooled-up for every operation on your Metal Cutting Lathe**

The ACE Set is complete—there's nothing more to buy. Drop forged by the manufacturers of cutting tools used by 90 per cent of the plants and shops in industry they are correctly designed, are of special steel, are finely finished, are stronger—will last a lifetime. You can cut easier, faster and more accurately with ACE TOOLS.

At your Hardware Store—Circular FREE.

**ARMSTRONG BROS TOOL CO.**  
"The Tool Holder People"  
368 N. Francisco Ave., CHICAGO, U.S.A.

3 Turning Tools, 2 Cutting-off Tools, Knurling Tool, Boring Tool, Threading Tool, High Speed Steel Cutters and Blades, and 2 Wrenches in Filled Steel Case.

## CREDIT Given on FRUIT TREES, SHRUBS VINES, BULBS, Etc....

Small down payment books order. Easy terms on balance. Apple & Peach trees, low as 50¢. Grapevines 3¢. Ornamental shrubs 10¢, Evergreens 25¢. Garden Seed and Vegetable Plants. Write for FREE Catalog and bargain prices. **Benton County Nursery Co.,** Box 621, Rogers Ark.

### NEW BIKE GENERATOR!

EVERY BIKE OWNER NEEDS "HI-LIFE" PROTECTION AND ECONOMY. Beautiful—extra rugged—Locks on—Lights head and tail lights—no battery needed, however can be supplied for charging miniature battery—ONE YEAR GUARANTEE. PRICE \$2.85 post-paid. WRITE TODAY for 10 day money back FREE TRIAL OFFER. DEALERS, you can make friends with "HI-LIFE," **KIMLEY,** 1271 E. Ferry St., Buffalo, N. Y.

### Wind Electric Plant

**Build Your Own—We Show You How.** Easily made from old auto generator. Dime brings complete plans and Big NEW catalog of 500 electrical items. 100 other generator changes to 6, 12, 32, 110 volt Plants, Motors, Welders, Electrical Fencer. Write today. **LEJAY MFG.,** 1447 LeJay Bldg., Minneapolis, Minn.

### HANDY TAPS and DIES...

Accurate—carefully hardened and tempered. Complete range of sizes at your local five and ten cent store  
**HENRY L. HANSON, WORCESTER, MASS.**

### YOUR OWN MOVIES! 10¢ A DAY!

NATIONALLY ADVERTISED 8MM and 16MM Movie cameras, projectors. For home, business, church, school, club. MONEY BACK 10 DAY TRIAL. Payments as low as 10¢ A DAY. Satisfied customers throughout the world. FREE details. WRITE TODAY. Don Elder's Home Movies, Dept. A-2, 739 Boylston St., Boston, Mass.

### MOTOR SPEED REDUCER

Ratio 144 to 1; Ball Bearing; white metal housing; rating up to 1/4 H. P. Equipped with friction Clutch for overload protection. Originally sold for \$25.00. 12" long, 6" wide, 5 1/2" high. Close out price... **\$3.95**  
Send for Free 32 page Paint Spray Catalog.  
**NATIONAL ELECTRIC TOOL CO.,** 560 W. Washington Blvd., Dept. H, Chicago, Ill.

### For Your Class or Club

Pins, rings and emblems. Over 300 designs. Finest quality. Reasonable prices from 30¢ up. Write today for our attractive, free catalog.  
**Dept. N, METAL ARTS CO., Inc., Rochester, N. Y.**

## Welding Business Earns \$150 to \$300 for You Each Month

### "BUILD-YOUR-OWN"

Just couple your own engine to this unit, mount it on chassis and you have money making advantage of a portable welder at a saving of \$100 to \$500.

**HOBART BROS., BOX M-29, TROY, OHIO**  
Gentlemen: Send me information on ( ) Build Your Own Welder ( ) Electric Drive Welder ( ) 30 Days Trial, Easy Terms ( ) Rental Plan. Also send me free books I've checked.  
Name \_\_\_\_\_  
Address \_\_\_\_\_

### 30 DAY'S TRIAL AT HOBART'S RISK AND EASY "PAYS FOR ITSELF" TERMS

New low prices make this profitable welding service available to everyone. Opens doors to big pay jobs that carry real profit. Hobart Welders are easier to operate, faster, guaranteed to bring you quality welding business... extra profits will pay for welder without expense to you.

**NO INVESTMENT TERMS—PROFITS PAY FOR IT**  
Extra earnings and savings possible with Hobart Welders make it easy to own without expense. You can even rent a new Hobart and later purchase it without loss. Coupon brings details.

**Free!** VALUABLE BOOKLETS ON WELDING. CHECK YOURS AND MAIL THE COUPON TODAY.

New to Build-Your-Own  
 New Profits in Arc Welding  
 New Arc Welding Catalog

**HOBART**  
THE FASTEST SELLING ARC WELDER ON THE MARKET TODAY.



## Super-Safety Goes to Sea

(Continued from page 235)

ship by means of a small handwheel, or the large wooden steering wheel that stands alongside the automatic device. Still another emergency steering gear is located in the steering engine room above the rudder head in the stern of the ship. This station is provided with a compass and with a telegraph to the bridge so that steering orders can be transmitted without delay. As part of the campaign of safety, the words "port" and "starboard" no longer apply in steering directions. "Right rudder"

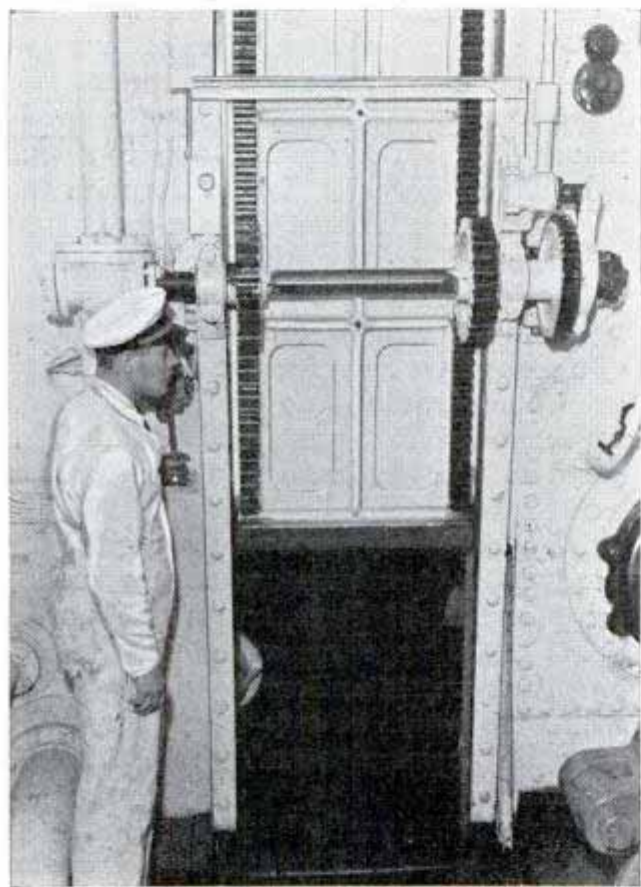

Officer closing hydraulically operated watertight door in engine-room compartment

der" and "left rudder," meaning to turn the wheel, and thus head the ship to the right or left, are used instead.

Big liners carry a fortune in emergency lifesaving gear that may never be used during the life of the ship but that must be ready for use at a moment's notice. The chief item in this equipment, of course, is the lifeboats and rafts. On large ships at least one of the lifeboats must be equipped with an engine, enough fuel for twenty-four hours operation, a searchlight, and a radio set, together with a power supply

(Continued to page 142A)

## "MATCHED PAIR" FOR THE MAN WHO SAYS,

*"My Shop deserves  
the Best!"*



### 10" GEARED POWER TILTING ARBOR SAW

Tired of playing with "toy" saws? Here's a big, rugged, precision-built tool! Direct Gear Drive delivers 30% to 40% more power to the blade. Makes full 3"

cuts—or move the saw arbor effortlessly to any angle up to 45° and cut through 2" with the table level. No belts, no pulleys—nothing but carefully machined parts, built to give years of carefree service. See it in the new catalog!

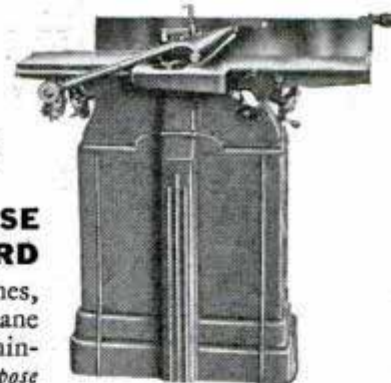

### 6" JOINTER WITH DUAL PURPOSE SAFETY GUARD

Clean, modern lines, triple knives that plane at 12,000 cuts per minute—and a dual purpose guard that lets you plane boards to ribbon thinness, or narrow stock down to minimum width—safely! Roomy tables, sealed ball bearings, protractor gauge that gives fine readings. Hand-finishing can never equal the work you do with this tool, whether you're planing, joining or rabbeting. See this Jointer in the new catalog!

**FREE**—Be one of the first to have the new Driver 1939 catalog! 48 pages of pictures, specifications, prices on Driver Tools and Accessories. Send coupon!

## DRIVER *Engineered* POWER TOOLS

Walker-Turner Co., Inc.,  
129 South Ave., Plainfield, N. J.

Send me the 1939 Driver Catalog.

Name.....

Address.....



41203

(Continued from page 141A)

# FREE TRIAL OFFER

NEW REMINGTON NOISELESS PORTABLE

AS LOW AS

**10¢**  
A DAY



The famous Remington Deluxe Noiseless Portable that speaks in a whisper is yours for a small initial deposit and terms as low as 10c a day! Brand new; standard

keyboard; automatic ribbon reverse; variable line spacer; PLUS the famous Remington NOISELESS feature.

**YOU DON'T RISK A PENNY.** Try the famous Remington Deluxe Noiseless Portable for 10 days. If you are not satisfied, send it back. We pay all shipping charges and refund your good will deposit at once.

**FREE Typing Booklet, SPECIAL Carrying Case.** With your purchase of a Remington Deluxe Noiseless Portable, you will receive free of charge, an instruction book on touch typing. Also, a sturdy carrying case is included in this price. You will incur no obligation. Send coupon now.

Remington Rand Inc., Department 152-2  
465 Washington St., Buffalo, N. Y.  
Tell me without obligation how to get a free trial on the new Remington Deluxe Noiseless Portable, including the carrying case and free typing booklet, for as little as 10c a day. Send catalog.

Name.....  
Address.....  
City.....State.....

## COMPLETE ELECTRIC PLANTS



Onan A.C. plants furnish same current as city lines, 110 Volt, 60 Cy. For farms, camps, construction jobs. Operate radios, water systems, all appliances. New models, 350 to 5000 watts, 6, 12, 32 and 110 volt D.C. Models \$57.50 and up. Also combination A.C.-D.C. units. Shipped complete, ready to run.

Write for details.  
**D. W. ONAN & SONS**  
1030 Royalston Ave.  
Minneapolis Minnesota

**YOUR TOOLCHEST**  
Should be the best.  
Machinists, toolmakers—Write for free catalog.  
**GERSTNER TOOL CHESTS**  
439 Columbia St. Dayton, Ohio

## FREE CAMERA BOOK!

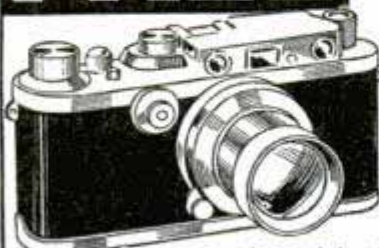

Illustrates latest developments in photography and Home Movie Making, for fun and profit. Offers hundreds of new and used still, movie cameras, lenses, films, Exposure Meters, Enlargers, Darkroom Supplies—everything photographic. All guaranteed—many at big savings. Central offers you America's most complete, varied stock of foreign and domestic merchandise from world's leading makers: Eastman Kodak, Zeiss, Feil & Howell, Graflex, Gevaert, Korina, Bausch & Lomb, etc. **SAVE** at Central! Satisfaction guaranteed or money back. We take your old camera and equipment in trade. Write for Free camera book!

**CENTRAL CAMERA CO.,** 230 S. WABASH  
Dept. K-2, CHICAGO, U.S.A.

**PHOTOGRAPHIC HEADQUARTERS since 1899**

sufficient for six hours of operation. All lifeboats are equipped with boat hooks, buckets, a compass, self-igniting red distress flares, drinking cups, flashlights, hatchets, life preservers, lanterns, life lines, matches, oars, water and provisions, and a sea anchor with a bag of storm oil. Lifeboats without motors carry a mast and sail.

Manufacturers of lifeboats have to furnish construction drawings by which the strength and seaworthiness of their boats can be determined. Davits and lowering gear must pass exhaustive tests before they may be installed. Steel lines instead of rope are used for lowering lifeboats to the water, and steel chain ladders are used for climbing down to boats on the water. Most liners employ a gravity type of davit by means of which one man is able to release a boat and lower it slowly. Repairs that are made to a lifeboat or to a davit must be reported, so that the strength of the change can be tested.

Among the fire-fighting apparatus required by law on ships are steam-smothering lines leading into the holds, double-acting steam fire pumps with suitable hydrant connections, carbon-dioxide systems as well as portable hand extinguishers for fighting different kinds of fires and overhead water-sprinkling systems in sleeping compartments, galleys, and freight spaces. Some of the large transatlantic liners have a central fire station on board where firemen keep watch twenty-four hours a day over the smoke pipe and other fire-alarm systems.

Safety at sea really begins long before a new ship is built. Sturdier bulkheads are required to make them less sinkable and they are designed with the idea of maintaining a good balance in the water even if they have been damaged seriously. Hundreds of tests under government supervision are made of steels and metals at the factories, and inspectors watch each stage of construction. Safety specifications covering many parts of the ship not previously considered have been drawn up. Even the chemical composition of bronze castings, the tensile properties of different rivets and the composition of steel plates are covered by law. Radiograph pictures are taken of boiler welds to make certain of their strength.

(Continued to page 144A)





## NEW BRUSH PLATING OUTFIT For AUTO PARTS

Connects to a battery with no tanks necessary. Plates on iron, steel, brass, copper, etc. Almost as simple as painting. Hundreds of car owners waiting for this low-cost plating. Improves appearance and value of the car.

Your opportunity to make good income plating auto parts, bathroom fixtures, reflectors, mirrors, etc.

### FREE PROOF

Write quick—big season here. Get FREE PROOF and particulars that put you in a paying business of your own.

## GUNMETAL COMPANY

AVENUE M

DECATUR, ILL.

**Given** WATCH, CAMERA or RIFLE  
Given for selling 20 packs of Garden Seed. We trust you. SEND NO MONEY.  
Write today.

**EASTERN SEED CO.**  
Dept. A-7, Lancaster, Pa.

**WRIST WATCH**  
We also have Wrist Watches, Gorgeous Dinner Sets, 35 other Prizes. WRITE TODAY



## PHOTO ENLARGEMENTS

Is Photography your hobby? Do you want a profitable easy business at home? Make PHOTO ENLARGEMENTS for yourself and others. Your cost is small and less. The Ideal Photo Enlarger is AUTOMATIC. No experience required. Also COPIES any picture. \$5.94 COMPLETE. Interesting circular FREE.

**5¢**  
ANY SIZE

IDEAL-O, 122 East 25th Street, New York City

## BUILD THE CUTTY SARK

2 FL. MODEL OF THE FAMOUS CLIPPER SHIP



Everything...including CARVED WOOD HULLS, Printed-Sabe Decks, Cast-Metal: Life-boats, Anchors, Bits, Steering Wheel, Chains, Masts, Spars, Rigging, Cement, Colored Lacquer—Full-Size Plans and Instructions.

Send for Catalog all Model's new Models...10¢ IDEAL AEROPLANE & SUPPLY COMPANY, INC. 28 West 19th Street, New York

Complete Kit makes perfect building exp. 2.50 plus 10¢ postage

## OTTAWA LOG SAW \$39

BIG BOOK FREE



PUTS THIS OTTAWA to work for you. MAKE MONEY! Wood is valuable. Does more than 10 men. Easily operated. Falls trees—saws limbs. Use 4-hp. engine for other work. Write for FREE Book. OTTAWA MFG. CO. 1627 Wood St., Ottawa, Kans.

## BUILD YOUR GRANDFATHER CLOCK

The Simple Sensible Rod-Kut way as thousands have. DIME brings PLANS and sixty picture "HOW" Book pricing many fine brass weight Westminster, tube chime, electric and battery movements showing nice beautiful colonial grandfather cases. WHY WAIT LONGER? KUEMPEL CHIME CLOCK CO., Bldg. 25, Guttenberg, Iowa.



## TRAILER PARTS

Latest type heating stoves, window assemblies, couplers. Everything for the trailer. 40 page illustrated catalog, 10c. MARVEL TRAILER PARTS CO. 19020 Celestine Ave., Detroit, Mich.



## CATCH FISH!

minnows, eels, mink, muskrat with our folding galvanised Steel Wire Traps. Great Patent Lower Hooks are so constructed that when a fish gives the slightest pull on the bait the upper hook reaches down and gets a hold that lands him. 3 for 50c. Write for descriptive catalog of Traps, Hooks, Lures, and other specialties. Walton Supply Co., 3507E Junata St., St. Louis, Mo.



## A AND N SUPPLY CO.

Bargains—Military, Sport Goods, Firearms, Clothes, Shoes, etc. Send 10¢ for new catalog, to be redeemed on first order.

EST. 1865 A & N Supply Co., 4772 Lester St., Richmond, Va.

When writing please mention Popular Mechanics

# HOT WATER with SPEED KING



## From Any Electric Light Socket

MILLIONS of homes, stores and offices everywhere need SPEED KING—the new, amazing Water Heater—that heats water boiling hot so fast it takes your breath away. No muss! No waste of time or fuel! Just a simple "plug-in" at any 110-volt light socket—and presto... just the amount of hot water you need for the bath, for shaving, for dish-washing. CHEAPER because you don't have to heat gallons when you need only a few quarts. FASTER because the intense electric heat goes directly into the water. Sells fast on a 60-second demonstration. Small in size—fits the pocket, easy to carry. Anyone can afford it.

**60-SECOND Demonstration Amazes Housewives**

## SAMPLES for AGENTS

I WANT you to know the almost uncanny heating action of this speedy water-heating invention. Write quick—a postcard will do—for my SAMPLE OFFER that brings you an actual Sample SPEED KING for demonstration. You can make plenty of cash as my agent. HURRY! Big season starting now. SPEED KING solves the hot water problem when furnaces shut down. Act quick and I'll show you how to make the fastest money of your life. Send No Money!—Just your name.

## JUST SEND

**NAME**  
WRITE your name and address in the margin, clip & mail this coupon or send penny postcard to Dept. 162.

Name .....

Address .....

City .....

## NU-WAY MFG. COMPANY

Dept. 162 Walnut Bldg., DES MOINES, IOWA

## FENCING WORLD'S FINEST SPORT HARMLESS-EXCITING FUN



Develops strong body and alert mind. HARMLESS. The spring-steel 3-foot-long foils (swords) are equipped with rubber buttons. Aluminum cup-shaped hand guards. Our De Luxe foils are built for hard usage. Complete set of two foil: (swords) and free instruction booklet, only \$1.98. We pay postage. ORDER NOW. ALL-AMERICAN FENCERS GUILD, Dept. 2PM, 45 W. 48th St., New York

## NEW KIND OF MAN'S SHOE

The new sensation in men's shoes — The Chippewa Clipper. It zips on and off in a "jiffy". Right now is the right time to get into a dignified and highly profitable shoe business of your own with this fast seller, and a complete line of almost 250 styles of dress, work and sports shoes. Prices as low as \$1.98 a pair. Free 10-second demonstrator sells super-comfort air-cushion shoes like magic.

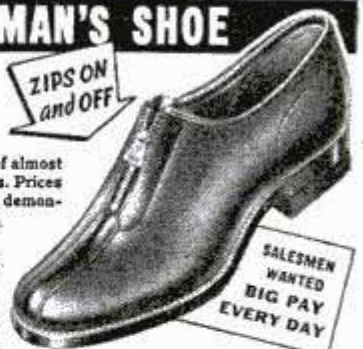

Manufacturer established 35 years wants salesmen. No experience needed. Write for complete sales kit. It's free! MASON SHOE MANUFACTURING CO. Dept. B-45 Chippewa Falls, Wisconsin

## WORLD'S GREATEST all around ELECTRIC TOOL

DRILLS — GRINDS — SANDS — SAWS POLISHES — SHARPENS — CARVES

The new WHIZ ELECTRIC TOOL is the handiest power tool ever made. Not a delicate instrument but a real rugged tool, equally effective for both power and precision work. Drills through 1/4 inch iron plate in 42 seconds or engraves intricate designs on jewelry. Handles any material Metals—Woods—Alloys—Plastics—Glass—Steel—etc. Saves time Eliminates labor. Plug into any socket AC or DC, 110 volts. Chuck 1/4 inch capacity. Ball bearing thrust. Powerful, triple-gear motor. "Worth its weight in Gold." STANDARD MODEL with Normal Speed (uses 50 different accessories, instantly interchangeable). Special Introductory Price for limited time, only \$6.95.

ONLY 6.95 POSTPAID GUARANTEED FOR ONE YEAR

FREE Accessory outfit (Value \$2) includes set of drills, mounted brush, polishing wheel, carving bur, etc. FREE with each outfit ordered NOW. We pay postage. Will send C. O. D. if desired. 10-DAY TRIAL—MONEY BACK GUARANTEE.

Special "3-SPEED" MODEL combines Normal Speed and High Speed in one outfit (uses 200 accessories) only \$8.95 complete, with same accessory outfit (value \$2) FREE.

Paramount Products Co., Dept. 2A, 48 West 48th St., New York



To Maintain the Quality  
of Your Work—

# ATKINS *Silver Steel* SAWS

● Using the wrong type of saw for the work is the mark of the beginner—and usually means a bungled job. Good craftsmen learn that quality work calls for quality tools—and they have known Atkins Saws since 1857 as "tops" in tooth design, handle balance, and edge-holding steel. Get the Work-at-Home Book, it's FREE.



E. C. ATKINS AND COMPANY  
426 South Illinois Street  
Indianapolis, Indiana

141203

(Continued from page 142A)

Then, throughout a ship's life from the time it is launched until it is withdrawn from service, it undergoes frequent inspections. An annual inspection is held at which members of the steamboat inspection service peer into boilers, examine the fire-fighting apparatus, and test all the machinery. Tail shafts are inspected at three-year intervals and special surveys may be made at four-year intervals. For these the ship must be drydocked so that the inspectors can examine the hull and rudder. Pistons and cylinders of the main and auxiliary engines are inspected and parts that are worn to certain limits have to be replaced before the ship can go to sea again. Special attention is paid to the electrical and emergency lighting systems, the telephone and engine room telegraph systems, and the condition of alarm bells. A ship at sea must be prepared to meet any emergency.

## What Your Nose Knows

(Continued from page 219)

the sense of taste, the stimulating material is in the mouth and we locate it there. Again, in smell the stimulating material is likewise in the cavity harboring the sense organ, but we do not think of it as being there. We project it into the exterior, to the object from which the odorous particles came. In this respect smell is like sight. Finally, there are only four taste qualities—salt, sweet, sour, bitter, and possibly two others, alkaline and metallic—whereas, there is no known limit to the number of odors which can be appreciated by the sense of smell."

Our smelling equipment lies in the upper region of the nasal cavity. No larger than a dime, it looks like a brownish-yellow patch and over this area are distributed the fibers of the olfactory nerve. Leaving this membrane the nerves unite into trunk lines, making their way upward to the olfactory lobe in the brain, where the impulses are interpreted into perceptions and stored in the memory.

The average person can note the odor of camphor when it is diluted in proportion of one to 400,000 and with those having a highly developed sense of smell, the detection of a millionth of a milligram of the vapors of many organic substances is possi-

GOLF GREEN MOWER

TEXTILE TRUCK

SUCKER PLANT

## DOENUT WHEELS

DOENUTS, developed and patented by the originator of the air-wheel, absorb more surface obstructions and eliminate jolting, protect wood and concrete floors. Do not sink in sand or soft ground. Cadmium plated disc wheel with adjustable ball bearings. Size 10" x 2.75" with load cap. of 225 lbs. per wheel and 12" x 3.30" with 325 lbs. load cap. Ideal for wheelbarrows, painting rigs, spraying equipment, textile trucks, dish trucks, boat dollies, food carts, etc. *Handle same loads with less than half the labor.* Unless you are a business man, literature and prices are mailed only on receipt of 10c to cover mailing cost.

**MUSSELMAN PRODUCTS CO.,**  
6225-G St. Clair Avenue, Cleveland, Ohio

ICE CREAM CART

GREASE GUN

HAND TRUCK

## The WISE ONES SAY

**"Keep a jar or tube of Lucky Tiger Ointment handy"**

Made to allay Itching and Burning Feet—Crusty Scalps—Ringworm—Rectal Irritations—Prickly Heat—Insect Bites—Stings—Itchy Scalp Irritations—Externally caused Pimples—Soothe the fire and sunburns.

Get a jar at your drug or 10c store or applications at barber shop.

**ANTISEPTIC FOR** Inhibitory Use when in proper contact—as in bandage or dressing for simple Cuts, Wounds, and Scratches.

**FREE** 25c Trial Tube if you send us name of your druggist or barber.

**LUCKY TIGER MFG. CO.**  
Dept. 77 Kansas City, Mo.



ble. In some instances, however, the human nose's performance is overshadowed by the olfactory organs of science. Proof of this is furnished in their detection of insidious carbon monoxide. Here is a deadly gas: odorless, colorless, tasteless, and non-irritating. The human nose is powerless in its presence but the laboratory-made instruments can discover as little as two and one-half parts of the toxic fumes in 100,000 parts of air.



Smelling sample of grain to detect odor of weevil, smut or other defects

Not only does a sense of smell help an animal to ferret out its food but also aids him in detecting enemies and friends.

One researcher discovered each ant hill has a separate odor and if the inhabitants of one are placed into another they will be destroyed immediately. If, however, the home crew is deprived of its smelling equipment the visitors will be unharmed.

With the exception of the greyhound, all dogs are nose animals. They smell everything with which they come in contact, and their actions show they will not accept anyone until he has passed the nose test.

☐ Popular Mechanics Magazine can furnish the name and address of the maker of, or dealer in, any article described in its pages. If you wish this information, write to the Bureau of Information, inclosing a stamped, self-addressed envelope.



*I'll go alone -*

## till you get a Barbasol Face

Any way you look at it, it makes sense. Everyone knows a Barbasol Face means a smooth, fresh, youthful looking skin. So here's something worth remembering: Every time you shave with a preparation that contains harsh irritants, it stands to reason your face coarsens and ages before its time. Not so with Barbasol! Not only does Barbasol contain no harsh irritants—it actually brings you face to face with real beneficial oils that soothe your skin, leave it feeling soft and revitalized—protected against harsh winter winds.

What's more, Barbasol makes a pleasure out of the daily shaving chore. Quicker. Slicker. Just wet your face, put on Barbasol, wet your razor—and shave. A closer shave, no half-cut stubble. Try it for ten days to convince yourself.

The large tube, 25¢. The giant tube, 50¢; the oversize, convenient jar, 75¢. Try Barbasol Blades, too. Scalpel-sharp, and only 15¢ for five.

For Modern Shaving



**No Brush • No Lather • No Rub-In**



*Beautiful Lawns*  
DON'T JUST HAPPEN  
THEY ARE  
PLANNED!



Get ready now for a beautiful . . . sparkling green . . . weed-free lawn. Write for your copy of **LAWN CARE**. It will guide you in preparing a lawn of lasting beauty . . . Mr. C. J. Hamilton, Society for Savings, Cleveland, says, "Have learned more from 'Lawn Care' than I have absorbed in the previous 50 years." You will find the solution to your problem in **LAWN CARE** . . . Send for your copy . . . it's Free.

**O. M. SCOTT and SONS COMPANY**  
18 Main Street Marysville, Ohio

*Scott's*

SCOTT'S SEED makes BEAUTIFUL LAWNS!

**BUILD YOUR OWN AC. GENERATORS**

You now can buy all parts ready for assembly to change old six volt auto generators to 110 volt AC. Make extra money at home building light plants. Send now for catalog of parts.

**CARMI TRANSFORMER WORKS** 202 Staley St. CARMI, ILL.

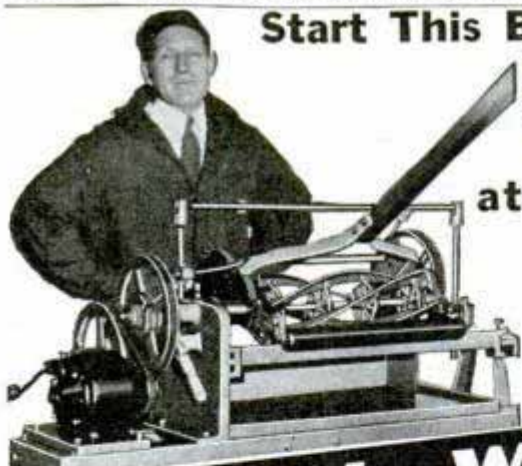

Start This Business  
in Your Spare  
Time  
at Home

**This Is the Way!  
To Make MONEY!**

That is what hundreds are saying about the Foley Electraken Lawn Mower Sharpener business. J. LeVert, N. Y., made up to \$194.50 a week clear profit last season. J. W. Anderson, Texas, reports increasing business for each of last 3 years.

**No Canvassing Necessary** Free plan tells you how to start. The Foley Electraken Lawn Mower Sharpener turns out perfect work quickly and easily, no experience needed. Simply put the mower in the machine and turn on the power. Uses same system as lawn mower factories. Sharpens all sizes and types in 15 or 20 minutes. You get \$1.00 or more for each job.

**FOLEY MFG. CO.** 207-9 Foley Bldg., Minneapolis, Minn.

Send Free Plan and Special Offer on Foley Lawn Mower Sharpener.

Name .....

Address .....

**Special Offer:**

Attachment for grinding axes, hatchets, knives, etc. FREE with Foley Lawn Mower Sharpener. Send coupon today.

**New-Type Cheap OIL BURNER INVENTED**  
*Sweeping the Country!*

**COOK and HEAT Without Coal or Wood**

In Your Present Stove or Furnace—**HOTTER—No Drudgery. Dirt or Ashes—More Heat Quick at SMALL COST.**

**OVER 40,000 SOLD**

Beats any oil burner ever gotten out for low cost, perfect performance. Burns cheap oil a new way, without pre-generating or clogging up. Quick intense heat by Simple Turn of Valve.

**30 DAYS' TRIAL**

Prove its efficiency, convenience and economical operation.

Write Immediately for **FREE BURNER OFFERTO AGENTS**

**AGENTS Salesmen BIG MONEY**

F. Silver says: "I can dispose of 250 HEAT KINGS before this year ends." Sample Burner FREE to producers. Write us now for agents' offer.



Slips Into Any STOVE RANGE or FURNACE

**Quick HEAT At Turn of Valve!**

who will demonstrate and take orders. Write quick, be first to learn how to make REAL MONEY right now, spare or full time—mail 1c postcard today. **UNITED FACTORIES, B-751, Factory Bldg., Kansas City, Mo.**

**CASH IN QUICK**

ALL OR PART TIME—MEN AND WOMEN—MAKE EASY MONEY SELLING

**GENUINE LEATHER TIES**

4-in-Hands and Bows, for Men and Boys. Beautiful patterns and colors. LOOK LIKE SILK. Won't wrinkle. Wear indefinitely. Cleaned with a damp cloth. Big profits; repeat orders. No sales ability needed. Big leader in necktie sales. Send 50 cents for sample kit. Information free.

**CENTURY TIE CO., Mfrs.,** 2345-P W. Grand Blvd. Detroit, Mich. (Originators of Leather Ties)

**WET BASEMENTS!** Amazing new Seal-Seep method, anyone can use. Applied to inner masonry wall and floor surfaces; no digging. Guaranteed permanently effective. Agents write for unusual earnings opportunity. Details FREE. **National Seal-Seep Co., Dept. 292, Cincinnati, O.**

**Waterproof Your Own** Save up to **\$100 to \$150**

**FREE TRAILER PARTS CATALOG**

We'll save you money on—axles, springs, wheels, couplers, windows, sinks, water pumps, brakes, refrigerator, beds, lamps, inside and out, 6V lamps, furniture, jacks—everything. Special discount to mfrs. Building plans & instructions, 10c.

**NATIONAL TRAILER EQUIPMENT CO.** Dept. P-12-714 W. Wisconsin Ave., Milwaukee, Wis.

**GRANDFATHER'S CLOCK, LOWER PRICED**

Our newest offering, at an unheard of price for a faithful reproduction of a real Grandfather's Clock. Scroll top, narrow waist, like picture. Shipped Knock Down. Cleverly designed. Easy to assemble. Others even cheaper. Plans 10c, Catalogue FREE.

**AMERICAN CHIME CLOCK CO.** 1678 Ruffner St. (Established 1877) Philadelphia, Pa.

**YOU'LL LIKE RESILVERING MIRRORS, REFINISHING**

Plated articles, Autoparts, Reflectors, Tableware. Making Chipped Glass Name Plates, Signs. Experience Unnecessary. Write. **SPRINKLE, Plater, 129, Marion, Indiana**

**EXTRA \$\$ in SPARE TIME PRINT at HOME**

Letterheads, Circulars, billheads, cards. Printing pays BIG. Easy, interesting, educational. **PRINTING PRESS BARGAINS \$12.** Types and Supplies, lowest prices. Send stamp for catalog. **PEIFFER Co., 2-D, 6 Columbia St., Newark, N. J.**



181244  
**Davy Jones' Treasure Chest**

(Continued from page 191)

amounts of material having fallen off one wall. Currents of water flow along the canyons, some at speeds of half a knot, and the currents reverse themselves every few hours. Currents in the canyons are measured with a device that consists of fan blades like those of an anemometer, a counter, vanes to keep the current meter pointed in the right direction, and a registering compass that records the direction the meter points.

There are a dozen or more volcanic mountains submerged off the California coast. Recently Dr. Shepard confirmed the

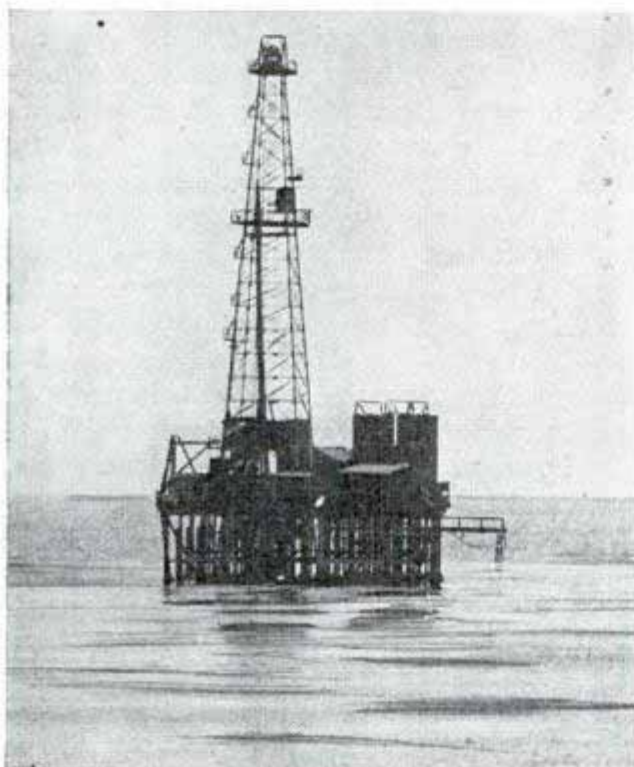

Oil well half a mile at sea in the open Pacific off the coast of California

volcanic nature of a large mountain about 150 miles off Santa Barbara. Known as San Juan mountain, the submerged peak rises 10,000 feet above its surroundings. In mass and area covered, it compares quite closely with Mt. Shasta. It has a typical crater-like depression in its summit and Dr. Shepard dredged samples of hard, basaltic lava from its slopes. There is no way of telling whether San Juan mountain still erupts intermittently although there is evidence that it has been active in historic times. Other large volcanoes have been charted off the entrance of the Golden Gate and eighty miles southwest of Carmel.

(Continued to page 148A)

# BUYS TIRES WITH WHAT HE SAVES ON AUTO INSURANCE

## Motorists Save THOUSANDS through ALLSTATE INSURANCE COMPANY

Make repairs, buy tires or licenses on your savings—as others say they do by insuring in ALLSTATE.

### EASY PAYMENTS

#### All Forms of Coverage — Prompt Claim Service

This company, organized by Sears, Roebuck and Co., is wholly independent and offers Bodily Injury or Property Damage Liability, Collision, Fire, Theft, Glass Damage and other protection at rates substantially lower than most other old line stock insurance companies. All allowed claims settled WITHOUT DELAY.

#### More than \$4,869,000 in Assets!

With assets of more than \$4,869,000 and liabilities of \$3,282,000 ALLSTATE has \$3.00 for every \$2.00 it owes. **GET THE FACTS—** Learn about EASY PAYMENTS with FULL protection while paying. No need to wait! FREE booklet and rates on request.

## ALLSTATE INSURANCE COMPANY

(Organized by Sears, Roebuck and Co.)

### SAVE MONEY—MAIL COUPON TODAY

ALLSTATE INSURANCE CO., 20 N. Wacker Drive, Chicago, Ill.

Please send information regarding Automobile Insurance.

MAU

Name \_\_\_\_\_

Residence \_\_\_\_\_

Address \_\_\_\_\_

Post \_\_\_\_\_

Office \_\_\_\_\_

County \_\_\_\_\_ State \_\_\_\_\_

Make of Car \_\_\_\_\_ Type of Body \_\_\_\_\_

Model \_\_\_\_\_ Year of Model \_\_\_\_\_

Name, Number or Series \_\_\_\_\_

Car Cost Me \_\_\_\_\_ Purchased \_\_\_\_\_

Cost Me \_\_\_\_\_  New or  Used

My present insurance expires \_\_\_\_\_

Participating policies written at standard rates in New York, New Hampshire, Virginia, Oklahoma and Texas.

# Sani-Flush

SAFE, NOT CAUSTIC

KEEPS AUTOMOBILE RADIATORS CLEAN



Now it is easy to build your own Soap Box Derby Streamliner like the one in which Bobby Berger raced to the International Championship. Learn how he met world-famous people; won a four year free college scholarship. Think of getting for the first time the way to all this great fame and fortune. Now you can have Bobby Berger's own secrets to success. No special tools needed to build this streamliner coaster wagon in your own basement or garage. Write today for complete plans, specifications and 16-page profusely illustrated book also easy-to-understand instructions. Complete details sent you for only 50c. Costs almost nothing to build. Send stamps or money order. **SPECIAL TO BOYS AND GIRLS:**—Get autographed pictures of Bobby Berger, his racer, and suggestions on building your own coaster. Will be included FREE if book and plans are ordered now. Write today. Bobby Berger, c/o Boyscraft, P. O. Box 1244, Dept. A., Lincoln, Nebr.



(Continued from page 147A)

**LOW COST TRANSPORTATION  
IN ANY WEATHER**

**AUTO-GLIDE**

*Now only \$92.45*

• 125 MILES PER GALLON  
• 35 MILES PER HOUR

WINDSHIELD EXTRA



**NEW 3-WHEEL  
DELIVERY  
MODEL**



MAKE DELIVERIES FOR  
LESS! 500 lb. cap.  
Greater safety, beauty,  
economy, convenience!

Here's everything you could ask for in modern transportation! Latest model of original heavy-duty AUTO-GLIDE, never before sold under \$125, now only \$92.45! Has quick-starting husky 1 1/2 H.P. engine for fast get-away, pick-up, zip on hills, speed on straightaway! Powerful brakes stop machine instantly. Comfortable cushion seat big enough for two. 125 MILES PER GALLON, cheaper than shoe leather! Up to 35 miles per hour! Perfect for school, work, deliveries, rental, etc.

**WRITE!** Or ask your dealer for free booklet illustrating all models! Send NOW! DEALERS: Write for special offer, facts about rental profits.

THE CUSHMAN MOTOR WORKS, Dept. P-2, Lincoln, Nebr.

## BRINGS OLD FRIENDS TOGETHER



● Holds permanently on china, glass, wood, metal, leather, paper, fabrics. Transparent, flexible, waterproof—not affected by heat. Dries quickly. Ideal for model making as well as for mending.



## DUCO CEMENT

## Start Your Own Business



Sensational new ELECTROGRAVER makes engraving of names, numbers, monograms, etc., amazingly easy. No experience needed to learn to operate. Engraves all kinds of name plates, key checks, dog tags, jewelry, fountain pens, pipes, cigarette cases, etc. Operates from A.C. light socket, 6-volt battery or 4 dry cells. Small investment. Large profits. Big field. Lifetime opportunity.

### For Social Security Plates

The ELECTROGRAVER is especially adapted for engraving permanent Social Security Plates. **SOCIAL SECURITY PLATES SELL LIKE WILDFIRE RIGHT NOW.** We furnish everything. Send 25c today for sample Gold Tone Social Security Plate, engraved with your name and number, or write for free details.

WILLIAM MOORE MFG. CO., 653 So. State St., Chicago, Ill.

## AMAZING GROFLEX SHOES!

NEED NO  
BREAKING IN

EARN BIG COMMISSIONS AND  
**YOUR OWN SHOES FREE**  
AS QUICK EASY BONUS

Sell outstanding line—men's, women's, children's shoes. 175 Spring Styles with amazing health features, including famous KUSHION-TRED and self-adjusting arch support. Offer shirts, ties, hosiery as bonus to customers. No experience needed. Big Sample Outfit furnished at no cost. Write TODAY for full information and FREE SELLING KIT. **TANNERS SHOE CO., 919 Boston, Mass.**



Soft  
as a Glove

**WRITE FOR  
FREE OUTFIT**

## MITER BOX \$1.75

Plus  
Postage

Graduated at 22 1/2-30-45°. Swivels in 90° ARC. Produces accurate work with regular saw or miter saw.

Send 1/3 of price with order  
**FT. WAYNE SPECIALTY MFG. CO.**  
1405 HURD ST., FT. WAYNE, IND.



## DECORATIVE Decalcomania Transfers



Imported Designs of all Sizes and Types—Flowers, Figures, Marquetry, Birds, Juvenile, Borders, etc., for Furniture, Walls, Trays, and what not. Catalog with 800 illustrations in Color sent for 25c. Deductible on first purchase of \$1.00 or more.

**L. C. WELLS, Dept. P. M. 92, 25 East 26th Street, New York**

Few people have ever visited the sub-sea regions except investigators who descend in diving machines or bathyspheres. Exploration must be conducted from the decks of ships. The most valuable tool of the explorers is the fathometer. This instrument measures the depth of the water by counting the seconds required for a sound wave starting at the surface to bounce back after it hits bottom. For accurate measuring of such features as canyon walls the lead line is still used, since the fathometer measures the distance from the surface to the nearest ground instead of the vertical distance under the ship to the bottom.

A "snapper," an instrument with clam-shell jaws that automatically bite into the sediment the instant they touch, is lowered to the bottom when small samples are desired. A deep-sea dredge consisting of a round steel tub or crate made of steel slats with an open end, is dragged along the bottom for gathering specimens of rock. An ingenious device also has been developed for taking cores as deep as eleven feet below the surface. The coring tube, with a 640-pound streamlined weight, is dropped to the bottom at a speed of fifteen miles per hour, plunging into the sediment and automatically closing.

Rocks and mud are not the only things the dredges and samplers bring up. Bones of prehistoric animals, porous chunks of manganese, bones from the ears of whales, old oar locks, metal buttons, waterlogged wood and fossil shells are some of the things retrieved. Working in shallow depths of less than 400 feet, the dredges bring up quantities of sponges, beautiful deep-sea ferns, fans, and bushes, as well as strange kinds of starfish and sea urchins.

It will be a long time before the explorers learn all they would like to know about the bottom of the sea. "If you should make a few flights across the United States in an airship after dark, dropping a line now and then to snag samples of the rock and dirt, you would hardly expect to obtain a very complete knowledge of the surface," Dr. Shepard remarks. "That, essentially, is what we are doing in exploring the sea bottom. In spite of this handicap we are obtaining a pretty good picture of what the submarine terrain and geology are like."



# OPPORTUNITY KNOCKS

*a  
Thousand  
Times  
in a*



## THOUSAND HELPFUL BOOKS

SELECT FROM THIS LIST OR WRITE FOR COMPLETE LIST ON ANY SUBJECT

- AIR CONDITIONING**  
Live Field; Great Future..... \$4.00
- ALUMINUM WORKING**  
For School and Home Shops. Just Out. 295 pp., illus. .... \$3.00
- AUTO ENCYCLOPEDIA**  
The Famous Dyke's Latest Edition..... \$6.00
- 110-V. GENERATORS**  
Made From Old Auto Units..... \$1.00
- BIRD HOUSES**  
Build to Sell; Easy Designs..... \$1.00
- BLUEPRINT READING**  
for the Building Trades..... \$1.25
- BOAT BOOK**  
Power, Sail, Rowing, Paddle Plans..... \$3.00
- BOY MECHANIC**  
Hundreds Things Boys Can Make..... \$2.00
- CARPENTRY, PRACTICAL**  
Complete 436 pages. Revised Edition... \$2.00
- CIVIL SERVICE**  
Home Study Courses Federal, State, City Positions..... \$1.00
- CONCRETE**  
1001 Ideas for Using. New Popular Mechanics Book... \$5.00
- DIESEL HANDBOOK**  
New! Latest Information..... \$5.00
- ELECTROPLATING**  
With Copper, Nickel and Chromium Technical bulletin..... \$1.00
- FORD V-8 CARS, TRUCKS**  
New, 700 Pages. Includes Details 1937 Cars..... \$2.50
- FORMULAS**  
1059 Money Making. Start a Business..... \$1.25
- FURNITURE MAKING**  
Tools, Materials, Design..... \$2.50
- HOUSES, SMALL**  
Book of, for Home Builders..... \$2.00
- HYPNOTISM**  
How to Become an Expert..... \$2.00

- MACHINE SHOP WORK**  
Complete. 400 Pages. 444 Illustrations..... \$2.50
- MACHINE WOOD-WORKING**  
First Complete Book..... \$3.25
- MATHEMATICS**  
Easy Guide for the Practical Man..... \$1.50
- MECHANICAL DRAWING**  
Learn Drafting; Good Salaries..... \$1.00
- MONEY MAKING IDEAS**  
1000 Ways to Make \$1000..... \$2.50
- OXYACETYLENE WELDING**  
Hard Surfacing, Lead Burning, Cutting New ed..... \$1.25
- PAINTING AND DECORATING**  
New book..... \$1.50
- PLUMBING**  
500 Facts Every Homeowner Should Know..... \$1.50
- PROSPECTORS' HANDBOOK**  
How to Mine, Appraise, Equip..... \$3.00
- RADIO SERVICING**  
Profit by Knowing Costs, Kinks, Etc!..... \$4.00
- REFRIGERATION**  
Electric, Gas. Be a Service Expert... \$5.00
- REWINDING ELECTRIC MOTORS**  
Fractional Sizes..... \$2.50
- SHIP MODEL**  
Entire Text, Famous "Sovereign" of 1637..... \$1.00
- SOIL-LESS GROWTH OF PLANTS**  
Just out..... \$2.75
- STEEL SQUARE**  
How to Figure Angles of Rafters, Roofs, Etc..... \$1.00
- TOYS**  
For Amusement or Profit. Saleable Designs... \$1.50
- UPHOLSTERY**  
Always a Big Market. Start Own Business \$2.00
- WOOD FINISHING**  
Methods, Tools..... \$2.00

## Send No Money!

Order from above list and if in U. S. or possessions, pay postman on delivery plus small C.O.D. fee. We pay postage if remittance is sent with order. Ask for complete list of books on your favorite subject. Order today.

POPULAR MECHANICS PRESS  
Room 239B 200 East Ontario St., Chicago

When writing please mention Popular Mechanics

## READY CUT HOMES

5416 and up . . . Freight Paid. Save \$500 or more. 75 home plans to select from, including 10 new feature 1939 designs. All modern, practical, distinctive, complete. Simple plans for easy assembly. Includes all lumber, insulation, roofing, bronze weather stripping, built-in features, attractive one-panel doors, latest hardware, nails, lath, paint, varnish. Also, summer cottages, garages, tourist cabins, etc. Information and plans for F. H. A. Financing requirements on request. For new 1939 full color catalog with floor plans, send 25-cents to cover mailing.

**NEW COLOR CATALOG FOR ONLY 25¢**

**INTERNATIONAL MILL and TIMBER CO.**  
Dept. P-29, Bay City, Mich.

## HARD-TO-GET MATERIALS

Just out — Our twenty-fourth annual catalog of Hard-to-Get Materials for Homecrafters, Schools, Institutions, Antique, Novelty and Cabinet Shops. Most complete line in entire country on this class of supplies. Send 10¢ in cash or stamps today. (Part in list) Chest hardware, locks, hinges, supports, casters, copper trim, etc. also midgets, overlays, etc. Finishing materials, glue, stains, varnish, wax, flint and garnet papers, rubber sanding blocks, stick shellac, burning-in knives, etc. Upholstering supplies and coverings. Complete line of electrical findings for lamp manufacture, also cluster and indirect fixtures. Chair cane, woven and in strands, spines, reeds, fibre cord, etc. Trays for smoking stands and glass liners. Large line electric and spring clock movements, with and without dials. Complete line Venetian Blind hardware, casters. Wood dowels, also dovetail screws, dovetail centers, wood screw hole buttons. Excellent line card table leg supports. Bed hardware of every description. Desk pens, complete with funnel and fastening, without base. Water transfers, inlays, small mouldings, etc. Furniture glides and casters, office chair spiders, wood legs and K. D. chair frames. Small box hardware of every description. Large selection pulls, knobs, handles, hinges, locks, catches, etc. Perforated steel panels, chair braces, revolving chair fixtures, rocker springs, candlestick sockets, bill board clamps, banquet table equipment, many sizes braces, corner irons, banister bolts, Step ladder braces, pilaster strips, sliding track and slides, Typewriter desk hardware, bin swings, mirrors, nut bowl hardware. Bar pins for novelties. Catalin Plastics.

**THURSTON SUPPLY CO.**  
Department P. M. Anoka, Minnesota

## HERE'S Your GARDEN TRACTOR

**Bellevue Tractor**

**PLOWS & CULTIVATES**

Powerful, easy to handle, low fuel cost, enclosed gears. 10 days trial—satisfaction guaranteed. An ideal all-purpose garden tractor.

**NEW LOW FACTORY PRICE**  
Save money—buy now at new low factory price. Send post card for complete details before you buy.

**BELLEVUE TRACTOR CO., BELLEVUE, OHIO**

## Calling All Cars

A MYSTERIOUS DISCOVERY

# SAVES UP TO 30% on GASOLINE or Costs Nothing to Try

Stop wasting Gas!—trim dollars off gas bills—get more power—quicker pickup—faster acceleration! Auto owners everywhere praise Vacu-matic! Proven so efficient, it is guaranteed to satisfy, or the trial costs you nothing.

**Automatic Supercharge Principle**  
Vacu-matic is entirely different! It operates on the supercharge principle by automatically adding a charge of extra oxygen, drawn free from the outer air, into the heart of the gas mixture. It is entirely automatic and allows the motor to "breathe" at the correct time, opening and closing as required. Saves up to 30% on gas costs, with better motor performance.

**Fits All Cars**  
Constructed of six parts fused into a single unit, adjusted and sealed at the factory. Easily, quickly installed by anyone in just a few minutes.

## AGENTS Get Yours FREE FOR INTRODUCING

Here's a splendid opportunity for unusual sales and profits. Every car, truck, tractor owner a prospect. Send name and address for big money making offer and how you can obtain your own Free. Write today!

**The Vacu-matic Co. 7617-412 W. State St. Wauwatosa, Wis.**



## ELECTRIC SANDING is Faster, Smoother, Easier

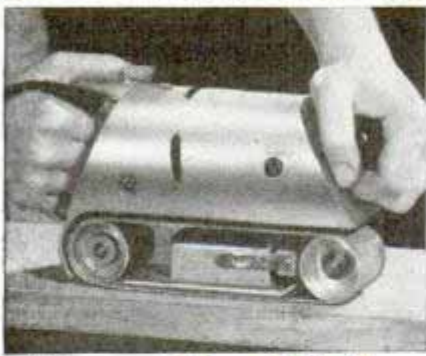

SANDS  
POLISHES  
BUFFS, GRINDS  
SHARPENS  
REMOVES PAINTS  
VARNISHES

Try this  
Yourself

## New Guild Sander PORTABLE ELECTRIC Sander

Try it yourself and see. You can do really expert sanding in one-tenth the time—with one-tenth the effort. It's electrically driven by a powerful, precision-made motor. The endless abrasive belt sands with a clean, straight stroke, with the grain. There will be no scratches, rough spots or swirls on your sanding jobs. You can work on rounded surfaces, both concave and convex. You'll like the way it sands on wood, metal, wall board, slate, plastics, marble, etc. You can remove paint and chip off rust quickly and easily. It will help you on home jobs or in your business. GuildSander plugs into any socket, AC or DC. Weighs only nine pounds. Backed by written guarantee. Try it with your own hands at your hardware dealer's or write us for full details.

SYRACUSE GILDTOOL COMPANY  
1700-2c N. Salina St., Syracuse, N. Y.



## LIKE TO FISH?

### Then Get This FREE BOOK!

Tells you how, when, and where to fish—how to bait and fly cast, tie knots, etc. Special advice by Tony Accetta on how to balance your tackle for greater skill and more thrill.

#### SPECIAL OFFER

SPORTSMAN'S LIGHTER — sure-fire in wind and rain—\$2.00 postpaid. (limited supply).

FREE 96 pg. Fishing Guide and Catalog. Write today.



SHAKESPEARE COMPANY  
486 N. PITCHER ST., KALAMAZOO, MICH.

## Home Craftsmen, Schools, Hobbyists METAL CASTINGS



produced in your own workshop allow you to design and build your own GAS-OIL ENGINE, STEAM ENGINES, STATUARY, ART OBJECTS, SPECIAL TOOLS, NEW INVENTIONS, ETC. You can also make forgings and case hardened steel. Your shop is not complete without a FOUNDRYETTE. Three sizes are available capable of making bronze castings of 1½, 3, and 6 pounds weight, aluminum, copper, brass, etc., in proportion to specific gravity. Clean scrap metal suitable for use. Each outfit includes a complete Blast furnace. Domestic gas supply and 110 volt AC or DC Electric energy required for operation.

Size	Capacity	Shipping Wt.	Casting Wt.	Price Complete
351	6 cu. in.	25 lbs.	1½ lbs.	\$13.50
352	12 cu. in.	40 lbs.	3 lbs.	19.00
353	24 cu. in.	65 lbs.	6 lbs.	27.50

Above price includes Universal high speed blower. Prices f. o. b. K. C. Check or money order acceptable, express charges C. O. D. Write for circular.

KANSAS CITY SPECIALTIES CO.

P. O. Box 6022

Dept. PM

Kansas City, Mo.

## Riding the Iron Cavalry

(Continued from page 163)

of Caterpillar treads, the barks of exhausts and the trek begins. From above comes the drone of three observation planes—the brigade's eyes on the road and in battle. In operating the combat car, you sit well forward and peer out a small slot while steering by means of two sticks, one in either hand for each track. Handle them lightly or you'll land in a ditch. On the road, the need for a crash helmet may not be as apparent as in maneuvers over rough terrain when the "tank" takes an occasional dive into a gully.

Mile after mile you move with speed and precision. From the air-corps squadron, the commanding officer learns of any breakdowns by radio or message. Before dropping the latter, the air crew places it in a weighted sack to which is affixed an orange streamer about six feet long. Then, dipping low, the plane drops it near the command scout car where a soldier on a motorcycle picks it up with a stick, transferring it to the commander in the same manner. He in turn can relay orders to the troop officer over the command network.

During a day's run the line may be strung out over thirty-five miles and several plans are used to close up gaps. For instance, you may receive a general order that at ten o'clock the brigade is going to make a twenty-minute stop and "all units will close to normal distances." Headquarters uses a check system to keep informed on the condition of the column. Check points such as bridges or landmarks are determined in advance. As each group passes this point, word is sent to the command car by radio. Reports from all units are graphed on coordinate paper and by checking with the speed at which the line is moving, the commanding officer can tell where the gaps are. If an armored, scout or combat car breaks down, it will be picked up by the ordnance company bringing up the column rear, but if the crippled vehicle is a truck, station wagon, motorcycle or passenger car, the towing facilities of the quartermaster corps are used.

Seventy-five two-way radios are scattered throughout the brigade. Tubes fitted with snubbers to withstand shock are in the radio sets, said to be 300 times more

(Continued to page 153A)



# Amazing NEW GLAZE Beautifies and Protects



Car Owners! Meet MASTER GLAZE - the sensationally different luster for new and used cars!

Not a wax - not an oil polish - not a paint - nothing that "smears" over the surface. A creamy liquid - quick and easy to apply! Gives a hard, glass-like surface. Even gasoline cannot dull it! Lasts six months to a year! Amazing luster - beautiful, sparkling clean and brilliant! Doesn't fingermark - doesn't smear! Seals the pores - protects! Nothing like it!

**FREE** Write now for Free booklet and **SAMPLE OFFER**. Free Trial offer. Just send your name and address.

**AGENTS**  
Unusual opportunity. Quick demonstrator - big profits. Good territory. Write today.

MASTER GLAZE CO., 7720-42 W. HARWOOD Ave., MILWAUKEE, WIS.

## Now! ANYONE CAN Easily CUT NEW TREAD on OLD TIRES



**WITH THIS SIMPLE INVENTION**  
NOW! YOU CAN, without previous experience, RE-GROOVE THE EXACT TREAD on old tires and put a new tread on bald tires with the Re-Nu Tire Groover, a sturdy device that does a first class job quickly, yet the price is so low anyone can afford it. RE-NU TIRE GROOVING insures quick stopping and road-gripping tread to give traction where needed. **POSITIVELY GUARANTEED** to satisfy or costs nothing to try. **MAKE BIG MONEY FOR YOURSELF** regrooving tires for your friends and neighbors and supplying this necessary invention to tire shops, garages, service stations, fleet and car owners. Get yours free now for helping to introduce it. RE-NU TIRE GROOVER Co. 2615-BE Michigan, Chicago

**The DUAL COMBINATION WOOD & METAL LATHE**

12-INCH SWING 47 to 3000 R.P.M.

"ASK FOR 1930 CATALOG" TIMKEN BEARINGS

**CLAUSING MFG. CO. OTTUMWA, IOWA.**

**FREE CAMERA CATALOG**

**SENSATIONAL BARGAINS IN CAMERAS, FILMS AND SUPPLIES**

The catalog that saves you REAL money! Latest type cameras, films, supplies, accessories—famous names—everything you need in photography—at prices you can't beat anywhere. Write today for your **FREE** copy of Camera Catalog No. 72.

**WHOLESALE RADIO SERVICE CO., INC.**  
Dept. 78C9—100 Sixth Ave., New York, N. Y.

**MAN WANTED**

HANDLE ONE OF OUR BIG PAY ROUTES

Sell To Stores on New Plan

Carry a complete "Wholesale Supply House" in your hand. Let us start you making Big Money in permanent business of your own. Show Storekeepers in every business how to **DOUBLE** profits on Nationally Advertised Goods. Over 200 Products. No experience needed. We supply everything. Free Book gives amazing facts.

**World's Products Co., Dept. 10-B, Spencer, Ind.**

**Now BOAT BUILDING MADE EASY**

**Famous Boat Book Shows How**

Detailed instructions, plans, materials, methods for building 15 most popular power, sail and row boats. Get Popular Mechanics **BOAT BOOK** and build your own at low cost. Prepared for those with limited skill and few tools. Includes also—"What a boat enthusiast should know." Only \$3.00. Pay postman on delivery or write for descriptive circular.

Popular Mechanics Press  
Room 1237D,  
200 E. Ontario St.  
Chicago

# CONTROLLED SKIING....!



Make your skis go where you wish without any hesitation or Sitzmarking... that's controlled skiing! That's what Northlands will help you do. Experts demand the extra flexibility and durability they get in Northlands. We think you'll appreciate that choice woods, expert design and hand craftsmanship produce choice skis. Northlands will make controlled skiing easier for you.

Write for your free copy, How To Ski, now.

**NORTHLAND SKI MFG. COMPANY**  
World's Largest Ski Manufacturers  
95 Merriam Park St. Paul, Minnesota

## CALLING ALL CARS! AMAZING NEW INVENTION

**Joerndt IGNITION SEAL** protects all gasoline motors against oil shorts and **MOISTURE SHORTS** caused by heavy rain storms, snow, frost or fog. **IGNITION SEAL** completely water proofs your ignition system. Properly applied, it stands every rigid test—water, dirt, oil.

**ONLY \$7.00** each. Enough for 50 Cars.  
**BIG TEST SAMPLE for 5 CARS \$1.00**

**AGENTS WANTED** A quick seller to all motorists, truck owners, service stations, garages. Sample can seals 5 cars, you charge \$1.00 a car.

**SURFA-SEAL LABORATORIES, INC.**  
221 N. LA SALLE ST. CHICAGO, ILL.

**SPARE TIME MONEY . . .**

There's a big demand for the many hand-tooled articles you can make with the **Easco Leathercraft Set**. Easily learn to make good money in your spare time. Complete outfit including tools, leathers, patterns, etc., and full instructions, only \$3.00—on sale at leading Department Stores or order direct and pay postman on arrival. \$2.50 outside U. S.

**LEATHERCRAFT**

**Free** When ordering direct, clip name of your Department Store to this ad, and we will include with your set, one extra free project. Sample Project 10c.

**E. A. SWEET CO. Dept. A-21 Binghamton, N. Y.**

**World's Best Line of TRAILER AXLES, HITCHES and PARTS**

New \$3.00 House Trailer Blue Prints Free With Axle Assembly.

**WRITE FOR FREE LITERATURE**

**HAMMER BLOW TOOL COMPANY, Dept. 102, Wausau, Wis.**

**Saw-Filing**

Pays up to \$2 or \$3 an Hour in Spare Time

A **FOLEY** Automatic Saw Filer files hand, circular and band saws better than the best hand files. Cash business, no canvassing, no eyestrain. No experience needed. Louis P. Wadwick, Ohio, says, "I have filed 764 saws in spare time and have earned \$850.00 in carpenter work due directly to my saw filing contracts." Send coupon for **FREE PLAN**, no obligation.

**FOLEY MFG. CO., 216-9 Foley Bldg., Minneapolis, Minn.**

Send Free Plan on Saw Filing business.

Name.....  
Address.....



**HELP! HELP!**

**I'LL FIX YOU STRONG AS EVER**

Fix up your crippled furniture, chipped veneers, splintered mouldings with Rogers Glue . . . they look like new. . . Stays put longer because it's stronger — 10c and up in tube, bottle and can at hardware stores or send 10c for full size bottle and free set of project plans.

ROGERS, Gloucester, Massachusetts

**ROGERS**  
the best LIQUID FISH GLUE

**SpeedWay**

**Real Quality Tools**

Designed, manufactured and guaranteed by SpeedWay, for 20 years leading manufacturers of industrial drills, these are really fine tools, correctly designed, correct speed, genuine high torque drill motors. Small, handy, powerful; 1000 RPM—drill handles to 1/4" in steel. Die cast handle and gear housing, \$7.95. Grinder operates at 20,000 RPM. High speed is essential for good grinding. With collets for 1/8" and 3/32" shanks, \$5.95, No. 250 KIT, both drill and grinder with 3 accessories in steel carrying case \$14.95. Complete line of accessories and drill press stand. Write for Circular. Dealers Write SPEEDWAY MFG. CO. 1342 S. 52nd Ave., Cicero, Illinois

**DRILL \$7.95**

**GRINDER \$5.95**

**SET \$14.95**

**New Accurate 10" Slide Rule**

Enables you to do difficult calculations instantly without paper or pencil—multiplying, proportions, division, extracting roots, etc. Accurate, white composition face. Has Standard A, B, C, D, CI, and K scales.

Special magnifying indicator. For complete outfit, including slide rule, 16-page illustrated instruction book, carrying case, send 50c in coins or U. S. stamps (60c in Canada). Mailed postpaid. Satisfaction guaranteed or money refunded. (Schools and dealers: write for quantity prices.) **BOX 3372.**

**LAWRENCE ENGINEERING SERVICE, PERU, INDIANA**

**50¢**

**STAINLESS STEEL**

18-8 STAINLESS STEEL BLANKS & STRIPS AT BARGAIN PRICES. We have a steady supply in a No. 2 and 4 finish in gauges 14 to 24. Send us your inquiries regarding sizes and gauges.

**SUPERIOR IRON & STEEL CO. 1320-22 Division CHICAGO, ILL.**

**PARMAK ELECTRIC FENCER**

**SINGLE WIRE**

PERMANENT FENCE CROP ROTATION QUICK FENCE

**A HUGE SAVING ON OVER 50,000 FARMS**

Now! Amazing 1939 Models with Flux Diverter and Dry Weather Intensifier. **New Low Prices!**

**30 DAYS TRIAL ON YOUR FARM BEFORE DECIDING.** See how a single wire holds the worst fence breakers, cuts fence costs to a fraction of ordinary fencing—banishes drudgery of digging, setting posts—saves days of time. Quick, easy fencing makes your farm earn more. Send for latest **PARMAK 1939 FREE CATALOG** and 30 days **TRIAL OFFER.** Write today, **DEALERS AGENTS, DISTRIBUTORS**—Sensational seller. Big profits on Spring fencing season just starting. Many valuable **exclusive territories** open for immediate acceptance. Write quick.

**PARKER - McCRORY MFG. CO. (Est. 1923)**  
100-B, Kansas City, Mo.

# Increase Your Earning Power

Apply time and labor-saving kinks to your work. Your efficiency will soon be recognized and you will be in line for advancement.

If you do machine shop work of any kind, sheet-metal work, painting, carpentry, auto repairing, farming, concrete work, plumbing, electrical work, welding, building-glass work, general repairing, tool-making, poultry raising, masonry or home repair work, get this

## LIBRARY OF 2400 TIME AND LABOR SAVING IDEAS FOR SHOPMEN AND HANDYMEN

JUST PUBLISHED

### SHOP NOTES for 1939

417 Articles  
806 Illustrations  
224 Pages  
Price 50c  
See partial list of contents below

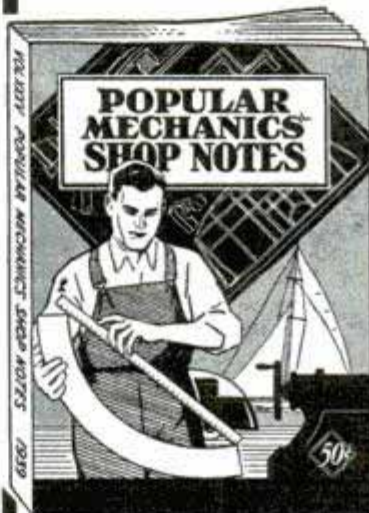

Including the new 1939 issue illustrated above, there are six volumes in the Shop Notes Library of 2400 easily understood short cuts to every-day jobs. Here are just a few of the subjects taken from the latest issue:

- |                                |   |   |
|--------------------------------|---|---|
| Alabaster, Turning             | Grease Pit, Cover for Grinding                  | Printers, Hints for Shaper, Homemade Sheet Metal Work |
| Auto Mechanics, Short Cuts for | Lathe Kinks                                     | Stainless Steel, Working                              |
| Carpentry Kinks                | Machinist's Helps                               | Telescope Mount                                       |
| Drafting Room Helps            | Marble, Imitation Metals, Buffing and Polishing | Thread Cutting  |
| Electrician's Aids             | Metals, Chemical Coloring of                    | Trailer Kinks   |
| Electro Engraving              | Motorist, Helps for Paper Hanger's Helps        | Truck Driver, Helps for Welding                       |
| Farm and Garden Helps          | Pattern Sanding                                 | Window Displays, Novel                                |
| Fluting, Spiral                | Photographic Kinks                              | Wood Bending  |
| Gas Engine, Midget             | Poultry Appliances                              | Wood Lathe, Homemade                                  |
| Generator, Wind-Driven         |   | Wood Turning, Complete Guide to                       |
| Charges Batteries              |   |   |
| Glass Blowing                  |   |   |

Each volume contains approximately 400 articles and 600 illustrations and has 200 or more pages. This unrivaled library of shop helps may be secured for a limited time only. After the present supply of books is exhausted the offer must be withdrawn.

**\*Send No Money**

**POPULAR MECHANICS PRESS,**  
200 E. Ontario St., Room 239, Chicago, Ill.

Send me, as per your offer, the following books. I will pay postman price and small amount of postage. My money will be refunded if I am not satisfied. (Check what you want.)

1939 Shop Notes and Lathe Handbook (Metal Working), both for 98c.

Shop Notes Library (6 vols.) \$2.98.

Name.....

Street and No.....

City.....State.....

\*C. O. D. applies to U. S. and possessions only. If you reside elsewhere, remittance must accompany order.

When writing please mention Popular Mechanics



(Continued from page 150A)

sensitive than the average car radio. Three command cars are the focal points for all the communications going out over the different networks set up within the brigade. A phonetic style is used in giving call letters. Brigade Station Q. M. No. 8 on the air is, "Queen-Mike-Eight" or Plane EC5 is "Easy-Cost-Five."

Coded messages are not used very extensively. Even in engagements, communications are sent in the clear when the information is not of particular benefit to hostile forces or when the action is to be executed before the enemy can take advantage of the information.

Grimy from exhaust fumes and hours of dust eating, you climb out of the combat car and slip into fatigue clothes as soon as the iron cavalry stops for the night. In the traditional manner of a cavalryman who provides for his horse's comfort first, you start cleaning and checking the tank with the other members of the crew. Naturally, maintenance is the lifeblood of the mobile force. As a precaution against road delays, rigid daily inspection of machines is held.

If you are a car commander, you have a trip ticket you must fill out and submit at the end of the run. On this tally you make a record of fuel, oil, lights and batteries. Additional spaces are provided to mark down trouble. Minor repairs you do yourself but where the job is more complex the troop's repair crew get a call. If they are not equipped to handle it, the job is turned over to regimental maintenance.

Welding outfits, lathes, milling machines, power saws and electric drills are a part of the three portable shops of the ordnance corps. There is a portable light plant, too, so repair crews may work after dark. The towing trucks can lift nine-ton combat cars without difficulty. More than fifty tons of spare parts are taken along on cross-country trips. The maintenance men are top-notch mechanics, having been put through a technical course by the army.

But don't get the idea the mechanized cavalry is going to supplant the horse troops. According to Lieut. Col. John F. Davis, training officer of the brigade, the horse troops and the iron cavalry augment and supplement one another. "Each has its own sphere of action," he explains. "The job of the iron cavalry in a battle would be

(Continued to page 154A)

## CANNED WOOD MAKES HOME REPAIRS EASY



## What Have You Got to Fix?

Even if you're all thumbs you can do a fine job of repairing quickly—

holes in tile  
loose casters  
cracks

broken chairs  
ugly nicks  
screw holes

loose drawer pulls

with this canned wood that handles like soft putty and quickly hardens into wood. You can paint it, carve it—drive nails and screws into it—It's wonderful. It's PLASTIC WOOD.

Try it. Results will surprise you. Paint, hardware, 10¢ stores sell PLASTIC WOOD in 10¢ and 25¢ tubes, 35¢ cans.



## PLASTIC WOOD

## 3-IN-ONE OIL KEEPS GOOD TOOLS GOOD!



For cleaning and oiling tools, for adding smoothness and speed to action points of braces, always use 3-In-One Oil. Its "triple-action" cleans, oils, prevents rust. At hardware, drug, grocery and 10¢ stores.

## 3-IN-ONE OIL



**RADIO AMATEURS  
EXPERIMENTERS  
AND  
SERVICEMEN**

*Save Money!*

**SEND FOR  
WARDS  
NEW 1939  
RADIO  
CATALOG**

**GREATER  
VALUES!**      **LOWER  
PRICES!**

*Everything sold on time payments!*

**MONTGOMERY WARD**

"9 GREAT MAIL ORDER HOUSES—500 RETAIL STORES"

**FREE! MAIL THIS  
COUPON NOW!**

Montgomery Ward & Co.  
Dept. TM-23  
Chicago, U. S. A.  
Please rush me Wards 1939 Catalog.

Name \_\_\_\_\_  
Address \_\_\_\_\_  
City \_\_\_\_\_ State \_\_\_\_\_

**FREE "BETTER RESULTS  
WITH GLUE"**

**IRON GLUE 10¢**

Send post card for booklet, "Better Results with Glue," containing many useful hints about mending, model making and home workshop jobs. Address: McCormick Sales Co., 402 Light St., Baltimore, Md.

at hardware, drug and 10c stores; also in cans from 1/4-pint to 1 gallon

**WRITE TO Bass FOR HIS BOOK OF BARGAINS**

**ORDER FROM THIS LIST OF BASS-GUARANTEED BARGAINS**

- Candid Midget—Schneider F:2 lens, Rapid Compur, Eveready case, list \$84.75 **\$54.75**
- 4x5 or 10x15 cm. ZEISS IRON SPEED DECKRULLO, 18 cm. Carl Zeiss Tessar F:4.5 f.p.a for both sizes and double ebony plate holder. List \$225, at **\$79.50**
- Korelle Reflex—with Victor F:3.5 lens demonstrator. List \$62.50 **\$46.50**
- 9x12 (3 1/4 x 4 1/4) Zeiss Volta—single ext. film pack and plate—Novar F:6.3 lens—f.p.a. and holder; brand new **\$11.95**
- New Belra Voran—8 or 16 shots on 126 film. Radionar F:4.5 lens, Prentor II shutter **\$19.75**

**BASS CAMERA COMPANY**  
179 W. Madison St. Dept. P Chicago, Ill.

**BILD-UR-OWN**

COASTERS • MIDGET AUTOS • SCOOTERS • BIKES • TRAILERS, ETC.

**NEW ROADSCOUT Scooter Complete \$59**

Equip your Scooter, Midget car, etc. with our Disc Wheels and Balloon tires.

**GOODRICH-GOODYEAR-FIRESTONE**  
at lowest prices. We specialize in wheel sets, scooters, motors, etc. Send 15c for valuable plans and helpful book; satisfaction or money back.

**BILD-UR-OWN DEVICES, 5237 Lake St., Dept. A-2, CHICAGO, ILL.**

1141 (Continued from page 153A)

to strike a quick, hard blow and get away fast. In a pinch, we might even take and hold a position and defend it against enemy counterattacks. In proportion to its size, our brigade has a power of fire excelling any other branch of the army."

For certain types of reconnaissance, it is pointed out, the horse troops are unsurpassed, and will never have to take a back seat to airplanes or machines of any kind.

No matter what the fashions in war may be, the iron-horse troops and the regular-horse troops, according to Major General John K. Herr, chief of cavalry, can be counted on to form a strong, hard hitting, independent combat force.

11314 **Taming Death Valley**

(Continued from page 171)

This lack of moisture leads the desert vegetation to unusual ways of collecting and retaining water. Some shrubs keep alive by shedding their leaves; others have no leaves, and in some species the leaves are reduced to scales. Some of the cacti have shallow, pulpy root systems that greedily absorb water during a rain for use in the long dry months. Most desert shrubs have extremely long roots, a twenty-six-inch salt bush, for instance, having roots that extend downward as much as twenty feet. Wild life is abundant, ranging from big-horn mountain sheep in the high ranges to coyotes, lizards, side-winder rattlesnakes, kit foxes and birds. Even tiny fish are found in some of the salty pools.

Since it was first discovered the valley area has been shunned by all except the native Shoshone Indians and hopeful prospectors. Even the Indians move into the near-by mountains during the summer. The prospectors who first went into the region followed Indian trails, chipping at likely looking ledges on the way. Some made fortunes while others, after finding rich veins, became so confused on their parched journeys back to civilization that they were unable to relocate their finds. Many so-called lost mines are in the region and some are still sought today.

No one has ever found the "Lost Gun-sight" since its original discoverer broke large chunks of almost pure silver from a deposit in the Panamint adjacent to Death

(Continued to page 156A)



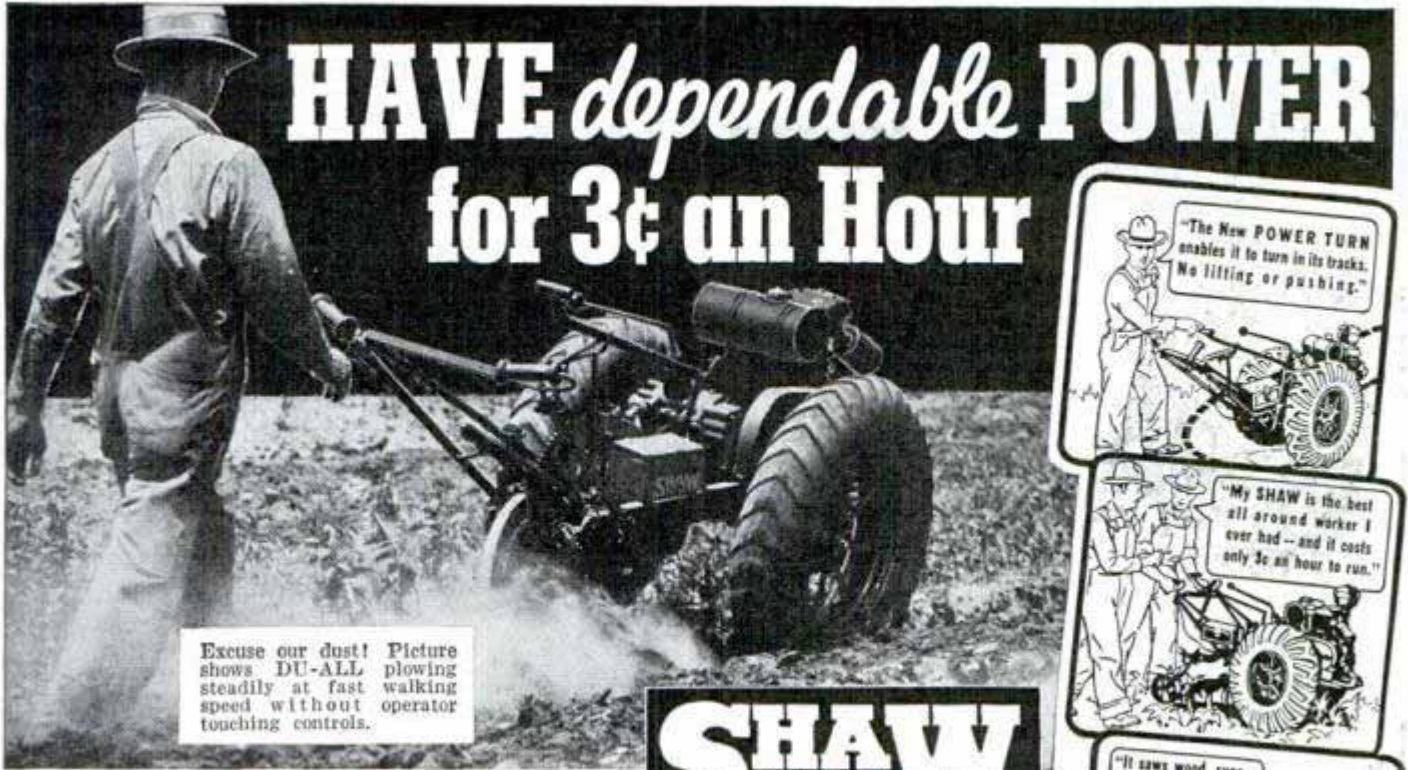

# HAVE *dependable* POWER for 3¢ an Hour

Excuse our dust! Picture shows DU-ALL plowing steadily at fast walking speed without operator touching controls.

## Get Your SHAW At LOW FACTORY PRICE!

IT'S a powerful big bargain, because all middlemen's profits are eliminated. And it's a great time, labor and money saver for farms, ranches, truck gardens, nurseries, orchards, poultry ranches and estates. The Shaw DU-ALL plows, discs, harrows, furrows, seeds, cultivates, harvests, mows, rakes, cuts tall weeds and hauls. Runs washing machines, feed grinders, corn shellers, saws, concrete mixers, pumps, lathes and nearly all belt machinery. Does deep moldboard plowing and other heavy work. Boy or woman can operate easily.

**AIR TIRES or steel wheels. Four models 2 to 5 H.P. 5 H.P. model available with either single or twin cylinder engine.**

**10-DAY TRIAL OFFER**—Try the DU-ALL on your own work for 10 days without risk. **MAIL COUPON TODAY** for details of this generous offer. **LOW FACTORY PRICES** and **FREE CATALOG.**

### THE SHAW MANUFACTURING COMPANY

4502 Front St., Galesburg, Kans.; 130G W. 42nd St., New York, N. Y.; 5812G Magnolia Ave., Chicago, Ill.; 668G North 4th St., Columbus, Ohio



**FREE BOOK COUPON**

**AGENTS** and dealers—Liberal proposition for qualified men. Mail coupon for low prices, discounts and terms.

New 56-page catalog contains action photos of DU-ALL on the job. Pictures and describes various models, attachments and tools. Quotes low factory price. Tells what users say. Mail coupon now! See how you can increase profits, save money, time and labor. Get our generous 10-day trial offer.

**SHAW**  
**'DU-ALL'**  
**TRACTOR OF '100 USES'**

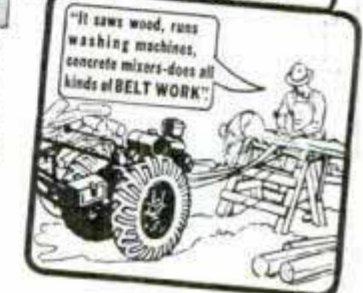

### SPECTACULAR SHAW FEATURES!

Auto-like gear shift—3 speeds forward and reverse. Special to order 6 speeds forward . . . 1/8 to 15 miles per hour. Popular new power turn enables DU-ALL to turn in its tracks. Powerful 4 cycle Briggs and Stratton motor. Air-cooled, no water to freeze.

Runs on gasoline or kerosene. DU-ALL has tool control; flexible plow hitch; convenient jiffy hitches; air cleaner; gauge wheel to regulate cultivating depth; and a complete line of tools. Write for complete details now!



### NEW PLOW RIDING ATTACHMENT

A new development—scientifically designed to throw operator's weight forward, giving DU-ALL more traction and power. Tractor with this equipment, guided by steering wheel, turns abruptly by aid of foot brakes. Has flexible plow hitch.

THE SHAW MFG. CO. (Address nearest office) 4502 Front St., Galesburg, Kans.; 130G W. 42nd St., New York, N. Y.; 5812G Magnolia Ave., Chicago, Ill.; 668G No. 4th St., Columbus, Ohio  
Send FREE information at once about the Shaw DU-ALL Tractor as checked below.

FREE book, LOW FACTORY PRICE and 10-DAY TRIAL OFFER.

Liberal proposition for agents and dealers.

NAME.....  
ADDRESS.....  
TOWN.....STATE.....



1314  
(Continued from page 154A)

## Handy... Automatic JUSTRITE BLO-TORCH

**Intense Flame . . . Easy to Handle  
Operates at Less than 1c per Hour!**

Here's a torch that's "tops" in every way! Handy — easy to carry — small enough to get into tight places. Automatic — no pumps or complicated pressure controls to adjust. Single regulating valve controls flame. An ideal tool for metal craftsmen, electricians, mechanics and plumbers. Does a real job at low cost!

**NO PUMPS—ONLY  
ONE MOVING PART!**

**101 USES!**

Order your Justrite Blo-Torch today—you'll find hundreds of uses for it. Excellent for working and tempering metal, burning off paint, bending glass, melting glue, thawing pipes, small blacksmithing operations, most all soldering work, and a host of other jobs around shop, farm or home. 100% satisfaction guaranteed—10-day money-back trial. See it at your dealer's or order direct. Shipped either postpaid or C.O.D.

**Only \$3.50**  
Complete with two soldering iron points . . .

Blo-Torch unit without soldering points—Only **\$2.95**

**FREE  
SOLDER**

and two soldering iron points packed with each Blo-Torch. Converts Blo-Torch into self-heating soldering outfit—can be used anywhere—not dependent on any other source of heat. Order yours now!

**JUSTRITE MANUFACTURING CO.**  
2091 Southport Avenue, Chicago, Illinois

## ACETYLENE WELDING GENERATORS

**Latest type \$25.00**

**JOHNSON GENERATOR CO., Brookfield, Missouri**

## CLAMPS

You can re-sharpen dull edges, can get by" with mediocre tools in many places but your clamps must be right. The least slip or opening can ruin joints or set-ups, can ruin hours of painstaking work. That is why industry has standardized on "Jorgensen" Clamps—dependable lifetime tools engineered and manufactured by "The Clamp Folks."

**ADJUSTABLE CLAMP CO.**  
"The Clamp Folks"  
421 N. Ashland Ave., Chicago, U.S.A.

Pony Miniatures 9 types—1" to 2 1/2" cap. Not toys but fine tools with 100 uses.

Pony "50" Fittings go on ordinary 1/2" pipe. Any length. Send \$3.00 plus postage (6 lbs.) for fittings for two "50" Clamps. Also "Pony" #52 Fittings for 3/4" pipe—2 sets for \$1.50 plus postage.

**Catalog FREE!**

Valley. The discoverer still had the specimens in his pocket when he stumbled into a desert town after a heartbreaking journey across the hills, but he could not locate the spot after he had recovered his health.

Most mining men today think the famous "Lost Breyfogle" for which hundreds raked the hills east of Death Valley late in the last century has since been found and worked to depletion by a group of miners who did not realize they had re-discovered the famous vein. At least, specimens of ore from a rich but small deposit of gold

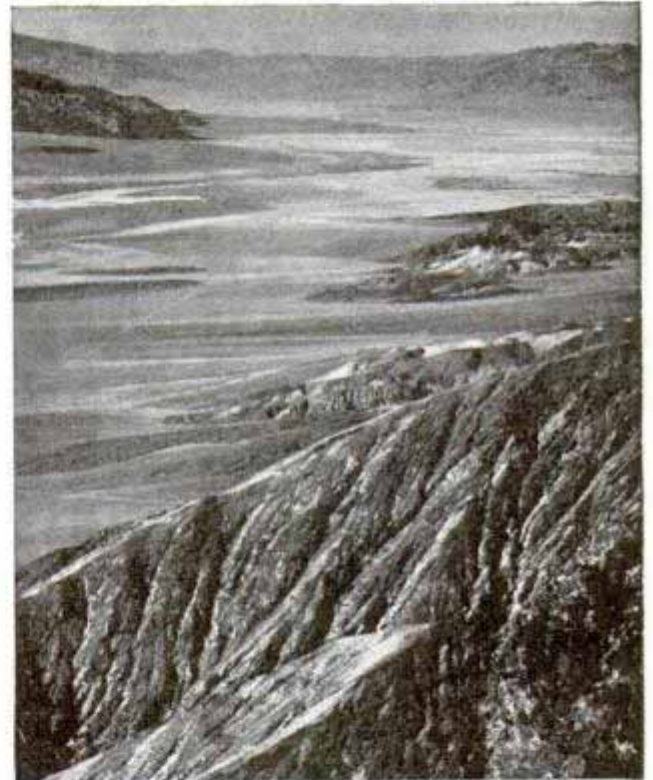

*Mountain view across Death Valley, which is 140 miles long and four to sixteen miles wide*

in a canyon overlooking Death Valley proved to be identical with the specimens thirst-tormented James Breyfogle had in his pocket when he was rescued from the desert in 1863. The most famous lost mine of all, the "Lost Peg-Leg," some mining men believe, was re-discovered by Pete Aguerreberry in 1905 in the Panamints a mile above Death Valley. The "Lost Peg-Leg" has claimed the lives of many searchers since 1853, mostly in the Colorado desert 100 miles south of Death Valley. The twin or triple buttes on which Peg-Leg Smith made his rich discovery have never been located in that area, but Aguerreberry's find, of similar rich ore, was made

## Make Big Money The American Way

Get into something for yourself where your income is practically unlimited—the AMERICAN ELECTRIC METHOD of floor surfacing gives you that opportunity. Large profits—work easy to get—no previous experience necessary. Start with as little as \$75 in this tried and proven money-making business. Write quickly—no cost or obligation.

**The American Floor Surfacing Machine Co.**  
523 South St. Clair Street • Toledo, Ohio

(Continued to page 159A)



# POWER FEEDS 4 WAYS

*THE NEW  
Atlas*

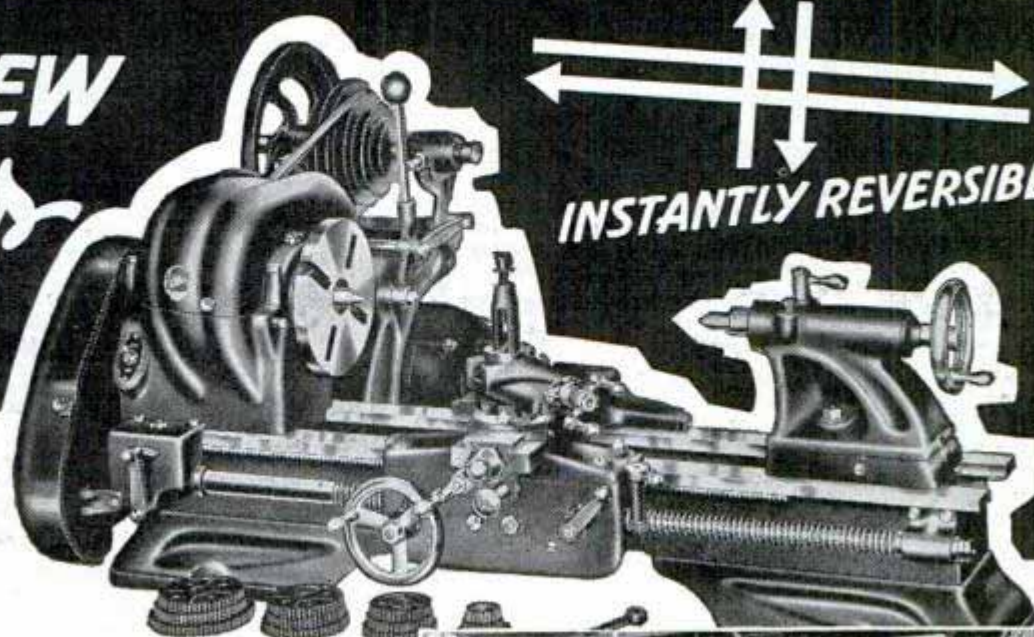

**POWER CROSS FEED**  
**Standard Equipment**  
*Plus All Other*  
**Modern Features**

Some said it couldn't be done—but Atlas engineers proved it could, by developing the new Atlas 10 inch F-Series Lathes. Now, for the first time, you can have a **low cost precision lathe with instantly reversible automatic power cross feed and power longitudinal feeds as standard equipment.**

Also furnished at no extra cost are all these modern features: Complete V-belt drive, quick-change countershafts, compact controls, precision-ground bed ways, custom-built spindle bearings, back-gearing power for heavy jobs, wide screw-cutting range, and many others. Two styles of countershaft are available—the horizontal type (complete as shown less motor) at \$104.75, or the vertical model at \$99.75.

Ask your dealer about this remarkable new lathe, its smooth operation and tremendous cutting power. Write for the new Catalog showing other models from \$59.50 up.



*An Atlas assembly line—one of the many examples of modern production methods that enable Atlas to give you more for your money in shop equipment.*

## Send for FREE Catalog

Skilled machinists as well as home craftsmen are amazed at the unusual values in the new 1939 Atlas machine tools. Term payments are easily arranged if desired. If you use machine tools in your business or home, be sure to send this coupon today for the 1939 Atlas Catalog.



**ATLAS PRESS CO.,**  
243 N. Pitcher St., Kalamazoo, Mich.

Kindly send me your 1939 Catalog. I am interested in:  
 New 10" Metal Lathes    New 6" Metal Lathe  
 New 7" Shaper    Drill Presses    Arbor Presses  
 Wood Lathes.

Name.....

Address.....

City and State.....

## ATLAS PRESS CO.

243 N. PITCHER ST.  
KALAMAZOO, MICH.

NEW YORK      PHILADELPHIA  
130 W. 42nd St.      113 N. Third St.  
CHICAGO  
35 E. Wacker at Wabash



### LATHES · DRILL PRESSES · ARBOR PRESSES · SHAPERS



**THE NATION'S  
NEWEST MUSICAL  
SENSATION!**

**PLAY IT  
LIKE AN EXPERT...  
WITHOUT A LESSON**

Imagine! A real musical instrument swing bands use—that costs so little everybody can have one. Even if you can't read a note you should be playing the latest hits in a short time. Endorsed by music teachers as the ideal pre-band instrument. Featured at dealers everywhere—or order direct. We'll mail a Tonette complete with easy instruction melody chart anywhere in the U. S. upon receipt of \$1.

**TONETTE COMPANY, Dept. PM-2**  
30 East Adams Street, Chicago

**TONETTE**  
ANYONE CAN PLAY IT!

**\$1.00 POST PAID**



**BIG OPPORTUNITY  
STUCCO SPRAYING**



Renew old buildings. Make new construction more permanent and attractive. Plastic Colorcrete is water-proofed. It fuses with any masonry surface. It fills all cracks. It can be applied in any thickness and in 30 colors. Fully proven by over 12 years actual use under all conditions and every climate.

**OFFERS BIG EARNINGS**

Owners everywhere want to enhance present values. With this machine you can supply this big waiting market with permanent Colorcrete at amazingly low cost. Operators report cost of 2c and up per sq. ft. and sell up to 7c. Some have paid for their equipment from first few jobs. Machine capacity up to 1,000 sq. ft. per hour. Get the facts. Send for the books. "Proven Business Opportunity." Write today. It offers you big extra income.

**COLORCRETE INDUSTRIES, INC.**  
570 Ottawa Ave. Holland, Mich.



**FREE WHOLESALE CATALOG**

Shows 4000 World Wide Bargains. 260 pages of Big Values. 15 selling plans. This fascinating book of Opportunity is FREE to salesmen, dealers, etc. Write for a copy today.

**SPORS**  
1939  
BOOK OF BARGAINS  
More Sales Larger Profits  
4000 MONEY MAKERS  
FAST SELLING  
NEW, UNUSUAL & RARE  
MARTIN'S - CHICAGO

**WHOLESALE CATALOG NO. 52  
SPORS COMPANY**  
12-38 MAIN ST. LE CENTER, MINN.

**GUV'NOR  
PENS & PENCILS**

No. R400 Plunger filler fountain pen. Fills and empties in one operation. Fitted with non-tarnishing, size 4 durium point. Transparent barrel shows when to refill. An astounding value, offered at a price so you can make a long profit. Jet black color.

Sample 13c Dozen \$1.40  
Gross \$16.70

No. R405 Mechanical pencil to match above pen. Has repel and impel movement. Compartment for leads.

Sample 8c Dozen 90c  
Gross \$10.80

**COSTS YOU  
85c  
E  
L  
G  
I  
N**



No. E308 Elgin quick shave electric shaver. Features: precision motor; operates on A. C.; chrome plated head. Compare with high priced electric shaver performance. Ready to operate. (Sales coupons 85c per 1000).

Sample 98c Dozen 90c each 6 Doz. 85c each  
12-38 MAIN ST. LE CENTER, MINN.

**SPORS CO.**

**Mathematics Made Easy by  
ROPP'S CALCULATOR  
AND SHORT-CUT ARITHMETIC**

Shows the Answer as Quickly as a Watch shows the Time to all Problems likely to occur in the Office, Store, Shop, Bank, Farm, or Factory.

Over 2,000,000 Sold  
Explains and simplifies every principle in Arithmetic, Mechanics, and Mensuration.

**PRICES POSTPAID**

Desk Size, Flexible Keratol Binding..... \$2.00  
Pocket Size, Art Leather Binding..... \$1.00  
Pocket Size, Cloth Binding, \$0.50

**POPULAR MECHANICS PRESS**  
Room P.10 200 E. Ontario St. CHICAGO

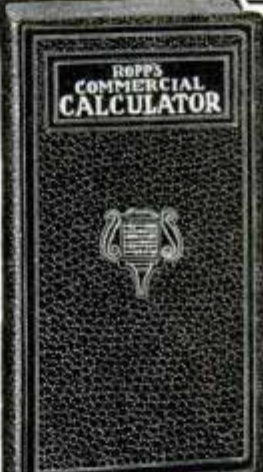

**7 for a Penny  
STREAMLINED IDEAS!**

Streamline for quick action—better jobs—bigger pay—in 1939. Cut down the resistance that holds back success. Get Shop Notes with 417 money-making, time-saving ideas and helps for mechanics and handymen. If you use tools you need it. 224 pages. 806 illustrations. Order now. Only 50 cents. Two books—Shop Notes for 1938 and 1939 Postpaid for \$1.

**SHOP NOTES FOR 1939**

Popular Mechanics Press, Room 1138-D, 200 East Ontario St., Chicago

**NEW BOOK on  
WELDING  
EXPLAINS  
ALL!**

**Covers All Types of Welding  
No Other Instruction Needed**

Welding is one of outstanding trades and professions today. Big Opportunities. Brand new edition of famous **WELDING ENCYCLOPEDIA** is book you need to get started. Gives principles and practical methods, detailed descriptions of metals and alloys, describes joints and welds, metal spraying, cutting, hardening, etc. 638 pages. Hundreds of illustrations. Nothing else like it. Sent postpaid for \$5 or if in U. S. or possessions pay postman on delivery. Write today. Get your copy now.



Metallic and Carbon Arc, Oxy-Acetylene, Electric Spot, Butt, Flash, Resistance, Thermit Welding, Etc.

**POPULAR MECHANICS PRESS, Dept. 1238A, 200 E. Ontario St., Chicago**



(Continued from page 156A)

#1314

on a triple butte in an upland valley of the Panamints. Aguerreberry is still working his mine, using modern trucks instead of the burros with which he originally prospected the area.

The abandoned ghost towns of the desert are disappearing now that new settlements are being built, lumber being so scarce on the desert that old buildings have been torn down and carted away by those who needed them. On the map, for example, the town of Harrisburg is located near Aguerreberry's mine, yet all that remains of that rich gold camp today are a few heaps of rusty machinery.

There are dozens of small gold mines scattered through the desert hills and employing from one to a score of miners, still yielding steadily on a small scale. Much of the wealth of the Panamints, many of the miners think, remains to be discovered.

The real treasures of the desert, while not yielding such spectacular get-rich-quick results as gold, are the great deposits of non-metallic minerals. Tremendous deposits of borax, rare in other parts of the world, are found in many of the ancient lake beds of the region and the refined products are shipped to all parts of the world. Thousands of tons of potash also are mined.

Off the beaten paths, Death Valley and the surrounding desert stretches are still as desolate as ever. Enameled signs at the points where dirt roads lead off the high-ways carry warnings that the routes should not be attempted without adequate provisions of water, fuel and oil. Mileage signs give the distance to the nearest water hole and occasionally a traveler finds a posted warning: "Poison Water."

Even as recently as five years ago a trip to Death Valley was a daring adventure over twisting sandy roads, with uncertainties and real dangers lurking around each turn. Today travel and recreation along the surfaced highways are as comfortable and safe as elsewhere.

Our Bureau of Information keeps on file the names and addresses of makers of, and dealers in, all devices described in the pages of Popular Mechanics Magazine. We are glad to furnish this information to our readers upon request, accompanied by stamped, self-addressed envelope.

**NOW enjoy  
EVINRUDE**

FOR AS  
LITTLE AS **\$34.50**



• Never before an Evinrude so inexpensive to own, so handy and economical to operate. The sensational new "Mate" fits your own or rented boats—drives row-boats up to 4 1/2 miles an hour, canoes up to 5 miles. Runs all day on a single gallon of fuel. Amazing starting ease — a flick of the starting cord and you're away! Write for catalog today!

**9 EVINRUDES TO CHOOSE FROM**

Evinrude offers the widest range of models, from the lightest, handiest, to the swiftest, most powerful. All are famed for exceptional starting ease, smoothness, reliability. All offer advanced Hooded Power construction, Co-Pilot steering, certified horsepower.

**AN ELTO FOR ONLY \$29.50** New Elto Cub weighs only 9 pounds, costs only 2c an hour to run. Now, a complete line of 6 Elto models—built by Evinrude—offer outstanding quality at low cost. Write for free Evinrude and Elto catalogs, Boat Directory, Boat & Motor Selector.

**EVINRUDE MOTORS**

5565 N. 27th St. Milwaukee, Wis.



**EVINRUDE MATE**  
WEIGHS ONLY 10 LBS.  
RUNS 10 HRS. ON 1 GALLON  
WRITE FOR FREE CATALOG

All Prices F. O. B. Factory

UTILITOR  
TRACTORS

for PLOWING, DISCING, CULTIVATING,  
PLANTING, MOWING, HAULING, Etc.  
Thousands in Use for 15 to 20 Years  
Riding and Walking Models 3 to 12 H.P.  
WRITE FOR FREE CATALOG  
**UTILITOR CO. MIAMISBURG, OHIO DEPT. A**





**STEAM ENGINES** for small boat models. Two-cylinder power plants, ready to run, with boiler propeller and burner.

Model SE-1, oscillating type . . . . . Price \$2.00  
Postage extra, shipping wt. 3 1/2 lb.

Model SE-3, slide-valve type . . . . . Price \$3.00  
Postage extra, shipping wt. 1 1/2 lb.

Shawnee Engine Co., Box 162, Station D, Cincinnati, O

MYSTERIOUS DEVICE

ENABLES ANYONE TO  
**WELD BRAZE AND SOLDER**



Now, an electric welding, brazing and soldering Torch, complete with power unit, goggles and supplies. Works instantly off ANY Light socket. Does a thousand and one repair jobs at amazingly Low Cost on aluminum, iron, steel and other metals. **Indispensable** for Auto, Fender and Body Repairs, and home repairs—shop, factory, farm, engineer, janitor, sheet metal, radio and bicycle repairs. Anyone can handle without previous experience with our simple instructions.

**10-DAY HOME TRIAL**  
Write At Once for Special Introductory Low Price Offer. You can try 3 in 1 Electric Torch for 10 Days at our risk, or get one absolutely Free by helping us to introduce it. Write **ELECTRO-TORCH CO.** 2613-CD Michigan Ave. Chicago



# Only \$6<sup>00</sup> a Month

## FOR THIS 9" x 3' SOUTH BEND WORKSHOP PRECISION LATHE

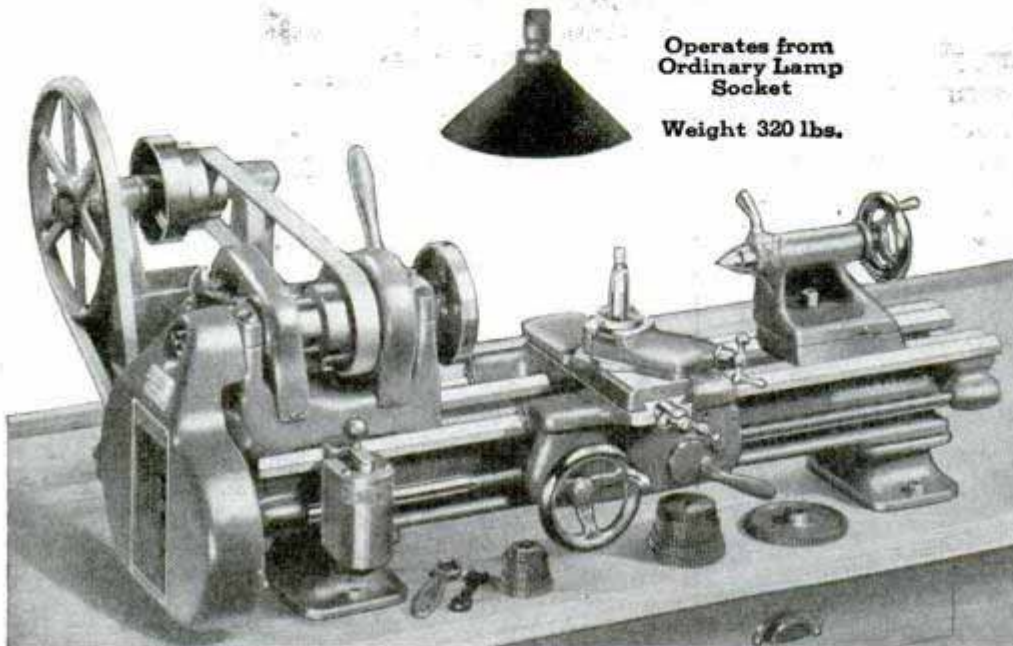

Operates from Ordinary Lamp Socket

Weight 320 lbs.

No. 415-YA, 9 1/4" swing by 3' bed Workshop Bench Lathe with Horizontal Motor Drive 1/4 H.P. Reversing Motor, Switch, Belts, Adjustable Belt Tension Countershaft and Change Gears ..... **\$117.00**

**W**ITH these easy payment terms you can now have this 9" Workshop Back-Geared, Screw Cutting Lathe for immediate use in your own shop. You receive the lathe directly on payment of \$15 down. Then you can be doing all the many machining jobs this Precision lathe is capable of handling. You deal only with us, and through no finance company or bank. Write for details, and see how simple it is to install a South Bend Metal Working Precision Lathe.

This one Universal lathe makes your shop complete. It handles machining jobs of practically all kinds: drilling, turning, boring, reaming, cutting screw threads, facing, milling, filing, in steel, iron, wood, plastics, etc.

Other features include: Automatic Longitudinal Screw Feed to Carriage, 3/4" hole through Spindle takes Collets up to 1/2", Tailstock has 3/8" set-over for taper turning, micrometer graduations on compound rest and cross feed screws. Takes 38 attachments for milling, grinding, draw-in collet chuck work, taper work, and many other jobs.

Easy payment terms also available for other sizes of South Bend Lathes—9", 11", 13", 15", and 16" swing, bed lengths 3' to 12', Motor and Countershaft Drive. \$85 to \$1500.

**SOUTH BEND LATHE WORKS**  
638 East Madison St., South Bend, Ind., U.S.A.

### SEND COUPON FOR THESE BOOKS

**SOUTH BEND LATHE WORKS**  
638 E. Madison St., South Bend, Ind., U.S.A.

- No. 46-A, 9" Workshop Catalog, Free
- No. 10-G, Easy Payment Plan, Free
- No. 34-LB, How to Run a Lathe, 25c

Class of Work.....  
Name.....  
Address.....  
City.....State.....

**Catalog No. 46-A**—Shows the 9" Workshop Lathe in 3', 3 1/2', 4' and 4 1/2' bed lengths, 8 drives.

**Easy Payment Plan**—Explains South Bend easy Payment Terms.

**How to Run a Lathe**—Interesting information on lathe practice. 128 pages, 350 illustrations.

*New*  
**LOW EASY PAYMENT PLAN**

\$15 Down Payment insures immediate Delivery to you.

You pay balance at \$6 a Mo. for 18 Mos.

All payments made direct to Factory.

You get the same lathe that is installed by these firms:

- Caterpillar Tractor Co.
- Bell Telephone Labs.
- Ford Motor Co.
- National Cash Register Co.
- Standard Oil Co.
- Frigidaire Corp.
- General Motors Corp.
- Pan-American Airways
- U. S. Government

**INSIST—**  
on These Features:

1. Handscraped V-ways
2. Precision Machine Cut Steel Gears
3. Precision Lead Screw Cuts Threads 4 to 112 per inch
4. All Steel and Iron Construction
5. Ball Thrust Bearing
6. Reverse for right and left threads and feeds



## SOUTH BEND Precision LATHES



# ADVANCING the VALUE of the UNISTEEL BODY by FISHER

AT the dawn of each new automotive year, thousands look first to the new Body by Fisher as a guide to what's what in the advancement of motoring luxury and safety.

Quite naturally, this puts Fisher craftsmen face to face with an annual obligation. They can never "let well enough alone." They must be constantly improving, continually finding new ways to add new security, comforts and conveniences to the Unisteel Body by Fisher.

Just consider how faithfully they have followed this credo for 1939.

They have restyled the Unisteel Body by Fisher from cowl to tail-light with a new streamlined beauty that is now completely graceful, without one jarring note. They have enhanced the famed solid security of its Unisteel construction with more solid door supports and numerous other refinements; made its famous No Draft Ventilation even more



A SURE SIGN to car buyers of more safety, comfort and style for their money—the famed Body by Fisher emblem marks an even greater value in 1939, stamps all of the new General Motors cars as having every advantage, both familiar and new, that the world's most famous body craftsmen have contrived.

"The Smart Buy of '39"

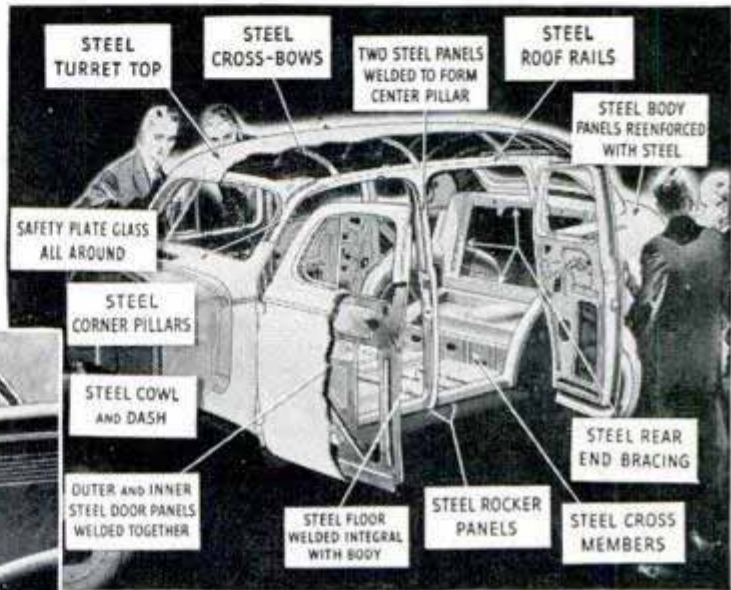

easily controllable, and added to safety by increasing its range of visibility.

In fact, throughout—from seamless Turret Top, through sound-, heat-, and cold-proofed insulated steel panels to solid steel floor—you'll find abundant new comforts, luxuries and greater safety in the new 1939 Unisteel Body by Fisher.

So there's more reason now than ever to "pick the car with Body by Fisher." It adds a new value to all General Motors cars—the only cars that have Unisteel Turret Top Body by Fisher.



BODY BY FISHER





MY NEW YEAR'S RESOLUTION

*Chesterfields*

FOR MORE PLEASURE