

TRACKERS OF THE HIGHWAY

POPULAR MECHANICS

MAGAZINE

WRITTEN SO YOU CAN UNDERSTAND IT

REGD. TRADE MARK GREAT BRITAIN No. 410628

REG. U.S. PAT. OFF.

JAN.
25 CENTS

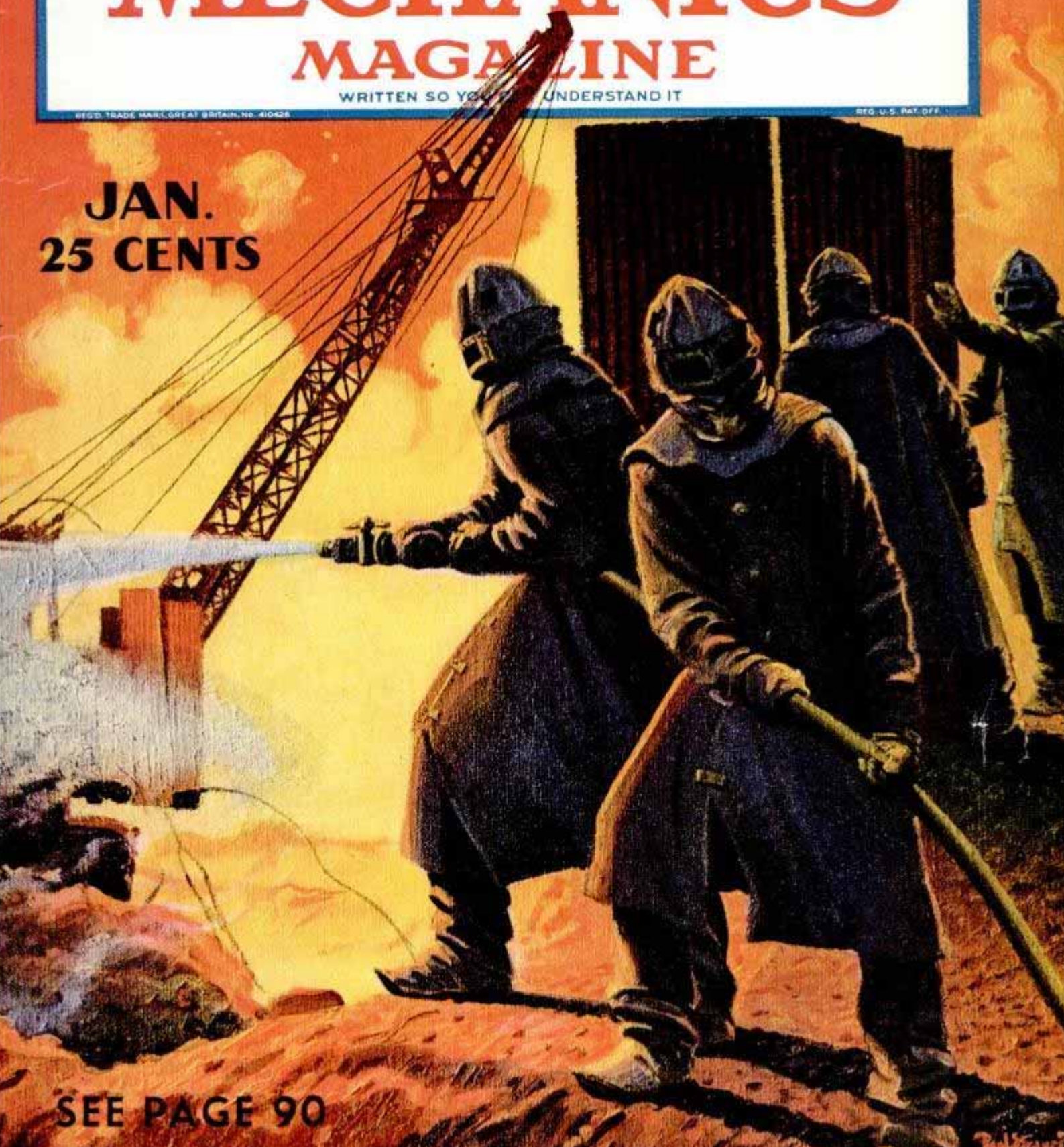

SEE PAGE 90

GENE KRUPA—the World's Highest Paid Drummer



Gene Krupa, the world's greatest swing drummer—among the many things which go to make up a great drummer, three are the most important. *First*, ability, *then* a flare of showmanship; *third*, good equipment, and that naturally means Gene Krupa uses Slingerland Radio King drums and tunable tom-toms. Thousands of the world's greatest drummers use Slingerland Radio King drums and tunable

tom-toms. They cost no more. See and try these wonder Slingerland Radio King drums and tunable tom-toms; also, Slingerland Maybell guitars, mandolins, and banjos at your local music dealer. Guaranteed more for your money. Send for a beautiful illustrated catalog, and mention instrument wanted.



SLINGERLAND BANJO & DRUM COMPANY 1330 BELDEN AVENUE CHICAGO, ILLINOIS

BETTER TOOLS

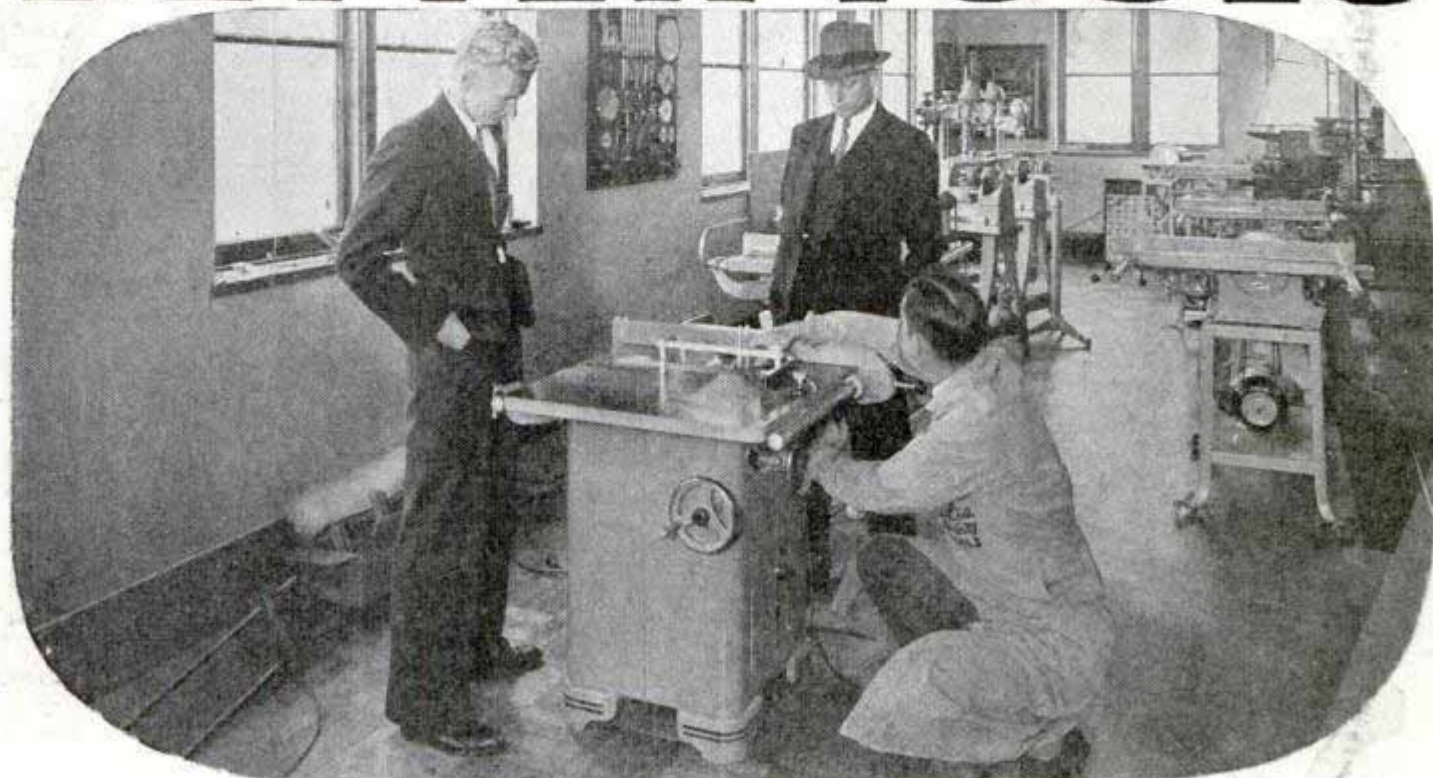

Ask your DELTA Dealer to show you why

New Features in 1939 Delta Line

The 1939 line of Delta tools contains new tools, new improvements and new accessories that are of great interest to everyone concerned with power tools. Delta tools are *better* tools. Delta pioneered the original light power tool and has been responsible for practically every worthwhile improvement in motor-driven tools. Delta has utilized its wealth of experience and knowledge possessed by no other manufacturer and has developed its own high-production methods of precision manufacture that have brought light power tool prices down to the lowest levels in modern industrial history. Today—Delta is the largest manufacturer in the world making light power tools exclusively. For the complete Delta story—send coupon for the 1939 Delta Catalog.



DELTA MANUFACTURING CO.
600-634 E. Vienna Avenue
MILWAUKEE, WIS.

Whether your interest in light power tools is for the small workshop, the manufacturing plant, the school or the building field—you will be fascinated by the story of the engineering achievements embodied in all Delta tools. Any Delta dealer can prove to you graphically why Delta tools are **BETTER** tools. He can show you cross-section analyses of design and construction that will open your eyes to the full meaning of "Delta Quality." He can show you the facts about "diamond boring" of bearing seats, pre-loading of sealed-for-life ball bearings to precision limits, efficiency of drives, basically improved designs and exclusive engineering features that make for precision, long life, convenient operation and low cost. A check up of the new 1939 Delta line is a worthwhile lesson in modern engineering. See your nearest Delta dealer **at once**. He is conveniently accessible anywhere in the world.

Send for CATALOG!

Send coupon below for 1939 Delta Catalog and complete list of Delta dealers nearest to you. (Craftsmen: Also send for new 1939 Project Book No. 5 crowded with new and "out of the ordinary" things to make. Send 10c with coupon for Delta Project Book No. 5 and 1939 Delta catalog.)

Delta Manufacturing Company, Dept. A 139
600-634 E. Vienna Avenue, Milwaukee, Wis.
Send me the new 1939 Delta Catalog and list of Delta dealers nearest to me.

I enclose 10c (stamp)
Delta Project Book No.

Name

Address

City

Check here if you are

This One



LATB-U73-1H2N

for better smoking
 ... here's tobacco men like
 in the big tin they prefer.

and for Christmas
 ... send Dad or brother,
 husband or friend a pound
 of Velvet ...

*you
 couldn't
 please 'em
 better*



*Better
 smoking
 tobacco*

Popular Mechanics Magazine

H. H. WINDSOR, Founder

H. H. WINDSOR, Jr., Editor and Publisher

January, 1939

Vol. 71, No. 1

Special Features

Making Metal Smooth as Glass	1
Teaching Wild Animals New Stunts - Roto	
Moving the Earth	18
Flying Above the Weather	24
Trackers of the Highway	34
New Jobs on the High Seas	40
Picture Your Family	45
Mining a Glacier	51
A New Frontier	57
"Minnies" Supply Punch to Movies	66
"They're Off!" to New Thrills	72
The Latest in Aviation Radio	83
Taming Wild Wells	90

(Continued on next page)

Check and Double-Check

BENNY HOWARD, test pilot who is putting the forty-two passenger, 65,000-pound Douglas DC-4 through its paces says test-flying a new airplane is not the dashing, heroic business which most people think it is. A test pilot, it seems, does not whisk an unproved plane into the sky and try to dislodge an engine or snap a wing. The whole idea of testing is to put a plane through its paces safely. If the stalling characteristics of the DC-4 are to be determined, Mr. Howard does not take this flying laboratory and its tons of instruments aloft, point its nose straight up and await developments. He creeps up on the stall. As a result, when he stalls, he knows how he is going to get out. In "Check and Double-Check" in the February issue, Mr. Howard takes you for a test flight in the biggest land plane ever constructed on this continent.

Next Month

ONE of the most difficult tunneling jobs in construction history is nearly completed—a thirteen-mile bore through rugged Mount San Jacinto, east of Los Angeles. This tunnel is the major link in a 400-mile chain of tunnels, canals, siphons, conduits and distributing lines which will transport a million gallons of water daily. An article in the February issue tells how human moles have licked "ol' man mountain."

Taming a Wild River

FOR generations the raging Colorado was known as America's wildest stream. Today this renegade among rivers has been tamed. Its once destructive energy is harnessed to do monumental tasks and the puny hands of a few score of men, backed by the mighty strength of Boulder dam, now direct its almost limitless force. An article next month describes the operation of the dam which has tamed the Colorado.

Man's Mightiest 'Eye'

THE greatest telescope ever dreamed of, a \$6,000,000 giant that "couldn't be built," soon will be sweeping the skies. Among other things, astronomers hope to discover millions of new star systems. The 200-inch reflecting telescope on Mount Palomar in California is described next month in an article illustrated by eight pages of Colorado pictures.



Are YOU using PYROIL?

From your investment of several hundred dollars in an automobile, you expect pleasurable, efficient motor performance. You can get this for *thousands more miles* if you use Pyroil!

Pyroil keeps dangerous contaminations from causing early depreciation of your investment. Hard carbon. Gum that sticks valves. Sludge accumulations. Foreign and abrasive matter. Corrosion (acid attack). Pyroil safely protects your engine against these damage creators.

In cold weather, Pyroil is an important advantage. It sheathes vital metal surfaces with a slippery film that effects easier, safer starting. Protects bare metal until regular lubricants can function properly. Reduces battery drain.

Just an ounce or two of Pyroil at only a few cents cost does a tremendous job of protection for your car. Try it today. Ask at your service station. Mail coupon for important bulletin on the care of your car in winter. Manufactured and Guaranteed by Pyroil Company, W. V. Kidder, Founder, 51 Pyroil Bldg., LaCrosse, Wisconsin, U.S.A.

FAMOUS EXPLORERS USE PYROIL ON SOUTH POLAR EXPEDITION

Commander Lincoln Ellsworth and Sir Hubert Wilkins tested Pyroil, took it with them on their daring trek into the Antarctic—for protection to motor equipment operating in frigid cold.



SIMPLY ADD TO GAS & OIL

NOTHING FINER FOR NON-ABRASIVE NEW CAR BREAK IN!

DISTRIBUTORS: CHECK AND MAIL COUPON FOR FRANCHISE FACTS.

PYROIL COMPANY,
51 Pyroil Bldg., LaCrosse, Wis., U. S. A.

Please send Bulletin on the care of my car in winter.
 Also send details of your plan for Distributors.

Name.....
Address.....
City..... County..... State.....

(Contents—Continued)

AUTOMOTIVE

Fan-belt vacuum pump drives windshield wiper....	22
Motors measured to find hidden troubles.....	23
"Cop" on beat motorized to save time.....	27
Suction grip for removing headlight lens.....	27
Detachable drawbar for trailer.....	30
Front-wheel-drive motorcycle.....	30
Midget car built from junk.....	38
Stainless steel cable saves drain on battery.....	49
Air circulator warms rear seat of car.....	76
Tire chain installed without lifting wheel.....	76
Racing car built of odds and ends.....	78
Non-skid traffic marker set in pavement.....	79
Colored mirrors in road show highway ahead.....	86
Portable auto brake tester.....	88

AVIATION

Meter forewarns pilot when pilot approaches stall... ..	28
Ramp submerges to lift ship from water.....	30
Automatic fuel system for planes.....	39
Giant landplane carries forty-two passengers.....	54
Single-seat fighters lead aerial offense.....	60
Latest war planes fly six miles a minute.....	61
Automatic direction finder helps pilot.....	71
Divers put wheels on flying boats.....	89
Automatic parachute opens itself.....	94

BOATS

Stainless steel lifeboat.....	22
Liner measures depths of sea with echometer.....	32
Fireboat hangs 20,000-gallon water screen.....	39
Latest liner is larger than the "Queen Mary".....	62
Giant boilers to drive the "Queen Elizabeth".....	63
Nickel-lined cargo ship built like submarine.....	65
"Bluebird" sets new world record.....	78
Ship speed raised by blisters on hull.....	96

CONSTRUCTION

Airport runway made of cotton.....	48
Two-mile conveyor belt hauls sand to dam.....	71
Earth crust's strength found by builder's tester... ..	77
Bookshelves of library form framework of building. 79	

FARMS

Low cost insect sprayer uses auto exhaust.....	32
Plant roots fed from tank attached to hose.....	76
Mechanical reaper cuts sugar cane.....	80
Pink and blue potatoes developed.....	81
Adjustable stilts for tree trimmer.....	86

HOUSEHOLD

Pushbutton faucet cap for bottle.....	28
Motorless dishwasher uses soap and water pressure. 33	
Folding clothes-closet rack eliminates crowding... ..	60
Mop with wringer attached.....	65
Electric doorknob lights keyhole.....	86
Adjustable step makes ladder safer.....	87
Portable electric oven.....	87
Venetian blinds of washable cellulose.....	96

PHOTOGRAPHY

Photo enlargement calculator.....	50
Two-tone tongs for darkroom.....	56
Windshield camera snaps speeder with proof.....	64
Film viewer magnifies picture.....	65
Film viewer notches negative for enlarging.....	95
Spoon for weighing chemicals.....	95
Camera "sees" high power in insulated test.....	96

RADIO AND ELECTRICITY

Candid X-ray camera.....	29
Glass yarn used to insulate electrical equipment... ..	38
Five-barred neon traffic light.....	48
Electric secretary takes dictation in plane or car... ..	54
Electric robot answers questions of Fair visitors... ..	56
Telegraph typewriter sends message.....	64
Shielded loop antenna built into console.....	97
How to build a 9-tube broadcast receiver.....	98
How to build a photocell relay.....	100
Practical radio suggestions.....	101
All-wave radio interference filter.....	102
Battlefield relics found with metal locator.....	102
Four-tube receiver built into floor lamp.....	102
Portable battery receiver employs low-drain tubes... ..	102

SCIENCE AND INDUSTRY

Telescope mirror finished in chromium bath.....	22
Retriever bullet samples rock in oil well.....	28
Radioactive grease finds flaw in metal.....	44
Electronic microscope.....	49
Hosiery fiber made from coal.....	50
Winch truck hauls 55,000-pound load.....	54
Cow's milk turned into wool.....	77

(Continued to page 6A)

TO EARN MORE MONEY • HAVE MORE FUN

Invest in PRACTICAL PROFITABLE Books

Whatever your interest—whatever your need—here are books that will help you. Popular Mechanics experts have selected them for you. Books to help you on your job . . . to help you to a better job . . . to help you earn extra money in spare-time work . . . to profitably develop a hobby . . . to gain advancement through home study. Other books for entertainment and recreation.

Successful businesses . . . profitable sidelines . . . doubled incomes . . . have resulted from a single idea. Popular Mechanics Books are filled with money-making ideas. Select from the list on this page. Profit with the latest and best-proven facts—ideas and information.



SELECT FROM THIS LIST

AUTO POWER: A fine, practical book on winding auto generators and converting "Model T" and other units into 110 and higher voltages. \$1.00.

EASY-TO-MAKE TOYS: 67 varied and novel designs. Just the thing for the home workshop or a guide to an interesting small business. \$1.50.

BOAT BOOK: Recently published! Second edition with six additional boats. Build your own boat. Full directions and details for all types small pleasure craft. 312 pages. Illustrated. \$3.00.

DYKE'S AUTO ENCYCLOPEDIA: World's Greatest Auto Book. New 18th edition just out. Now more than ever before the only book for auto and shop mechanics. 1396 pages. 4,600 illustrations. Cloth. \$6.00.

MODERN RADIO SERVICING: This radio man's "Book of Knowledge," by Ghirardi, covers every phase of radio servicing today. 1,300 pages. 706 illus. \$4.00.

AIR CONDITIONING: By Fuller. The book of the hour in this big new field. Get started in America's next big industry with this new, authoritative work. 577 pages. Illustrated. \$4.00.

DIESEL HANDBOOK: By J. Rosbloom. The standard book on modern Diesel practice. Adopted everywhere for instructions in land, marine, locomotive, automotive, aero and portable services. 544 pages. Illustrated. \$5.00.

AIRPLANE SERVICING MANUAL: New. Covers construction, materials, maintenance, overhaul, rigging, welding, repair, tools, radio, inspection, engine troubles. 1000 pages. Illus. \$6.00.

SHIP MODEL: Build finest ship model of them all. Sovereign of the Seas. A real masterpiece. Detailed instructions, plans, etc. Authentic design. 180 Pictures. \$1.00.

ARMATURE WINDING: New edition on construction, winding, repairing of A.C. and D.C. motors and generators. \$2.00.

FURNITURE DESIGN AND CONSTRUCTION: Shows how to design and make tables, chairs, desks, lamps, shelves, candlesticks, etc. \$2.50.

CONCRETE: 1001 Ideas for Using. New Popular Mechanics book. Just out. Most complete on subject. Covers all newest phases. Beautiful color illustrations. \$5.00.

WOOD TURNING: A real course of instruction in this fascinating art. Starts with simple operations. Includes spiral turning and complete jobs. \$1.50.

PROSPECTOR'S HANDBOOK: Tells what minerals to look for and where. How to locate, sample, test, appraise, mine and market; also prices. \$3.00.

BOOKKEEPING: New simplified book teaching how to keep personal and family records and set of books for a business concern. \$2.25.

A. C. POWER WIRING: Just published. A complete treatise on the practical applications and uses of alternating current for power. 461 pages. Illustrated. \$4.00.

2000 WAYS TO MAKE MONEY

A THOUSAND WAYS TO MAKE \$1,000: Tried and Tested Methods that Work—That You Too, Can Use. How hundreds of men made their first \$1,000 in their own business. \$2.50.

MONEY MAKING IDEAS: 1000 spare time ways to make money. Practical guide for young and middle aged men and women, students, boys, girls. \$1.00.



CARPENTRY AND JOINERY WORK: All details of house building; framing, building partitions, doors, windows, cornices, etc. \$3.00.

ELECTROPLATING: With copper, nickel and chromium. A technical bulletin of latest methods, formulas and trade secrets. Cleaning, polishing, buffing, etc. \$1.00.

SHOP NOTES LIBRARY: 6 vol. 2400 Wonderful shop ideas. Volumes reprinted annually from Shop Notes section Popular Mechanics. \$2.98.

WIRING: Approved economy methods for homes, buildings. Standard up-to-date book meets every requirement. \$2.50.

SEND NO MONEY—BOOKS SHIPPED C. O. D. IN U. S.

Select books from list above. Help yourself to more profitable—more enjoyable days. Send No Money. Pay postman above prices plus small C.O.D. fee. (C.O.D. in U. S. and possessions only). Books will be sent postpaid if remittance is sent with order. Act Now.

POPULAR MECHANICS PRESS
Room 139—200 East Ontario St., Chicago, Ill.



When writing to advertisers please mention Popular Mechanics

(Contents—Continued)

Invisible poison vapor detected by shadow..... 78
 Supersensitive radium detector 80
 Electric heart pumps blood through mechanical lung 81

SPORTS

Rubber sheath protects gun sight from damage.... 44
 Rubber expansion strips to line tennis court..... 88
 Quick action fly-tying vise for fishermen..... 94

TOOLS

Hand scraper with replaceable blades..... 32
 Clamp for splicing cable 48
 Table shaper for workshop 60
 "Iron alligator" cuts roots from sewer pipe..... 76
 Compressed air operates doors of tool chest..... 87
 Cylinder micrometer with dial indicator..... 88
 Electric paint gun has no compressor..... 94

MISCELLANEOUS

Miniature circus gives many "big top" thrills..... 17
 Balloon-inflating cart is aid to vendor..... 28
 Milk bottle "chute" for refrigerator..... 28
 Electric music-teaching board speeds pupil's work.. 29
 Risking lives working high in air..... 31
 Double bicycle carries family of nine..... 32
 Rude hut hides anti-aircraft gun..... 33
 Piano without soundboard is four instruments in one 38
 Rubber heel snapped on shoe by wearer..... 39
 Thrill ride for Fair's visitors 44
 Lantern defies hurricane in wind-tunnel tests..... 48
 Skimming milk made impossible 48
 Homes towed on barges to new site..... 49
 Field gun hurls ninety-five pound shell..... 50
 Fingertip puppet show in overnight bag..... 55
 Sea-going postman picks up floating mailbox..... 56
 Flashlight tray for change helps sell batteries..... 60
 Gauge checks rail alinement 70
 Models sculptured in concrete..... 70
 Pocket size explosion meter 70
 Radio sentry warns section gang of approaching train. 77
 "Wet wash" street sweeper 79
 "Pelican" ashtray swallows burned cigarette..... 80
 "Radiator" pipe cools smoke and traps tars..... 80
 Type casting machine with typewriter keyboard... 81
 How faces are made to order..... 82
 Portable desk phone booth 86
 Rock dust guards mine from coal dust explosions... 88
 Concrete disks for tractor gives more traction.... 94
 Poles have more sunlight than equator..... 95
 Sun punches clock on time chart..... 95
 Pushbutton index 96



CUTTING TAPERS
 A hinged jig, with means for securely holding one end of work away from fence, makes cutting of tapers easy

**Amazing money's worth
 KEYSTONE made by DISSTON
 CIRCULAR SAWS**

Very little money buys a dependable blade... a KEYSTONE Circular Saw—made by DISSTON! Expert sawmakers designed these saws specially for fine craftsmanship, at low cost, in your home workshop.

Keystone Saws are amazing values. They fit your machine and suit your work. Run true, stay sharp. Ask dealer for KEYSTONE Home Workshop Circular Saws—made by DISSTON.

Cross-Cut; Rip; Combination

6" (1/2" hole) \$1.70	8" (1/2", 5/8", 3/4" hole) \$2.00
7" (1/2" hole) \$1.80	10" (5/8", 3/4" hole) . . \$2.40

Rip Saws slightly less
 Hollow Ground, \$3.00 to \$5.00



Also KEYSTONE made by DISSTON Hand Saws. Skew-back and straight, cross-cut and rip. Prices, \$1.00 and up. K-3" Pacemaker, "skew-back, 26" blade, \$1.50
 Prices slightly higher in Canada

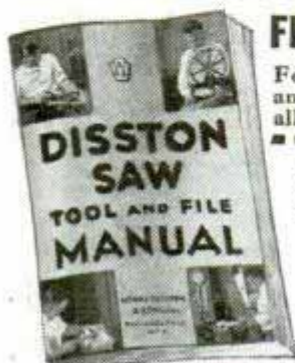

FREE BOOK SEND COUPON

For free copy of "Disston Saw, Tool and File Manual"—tells how to sharpen all kinds of saws, send this coupon to:

HENRY DISSTON & SONS, INC.
 111 Tacony, Philadelphia, U. S. A.

Name.....

Address.....

(Craftsman and Shop Notes)

AUTOMOTIVE

Altered piston forms sturdy grinder head..... 155
 Auto shortcuts 157
 Bug screen converted to winter front..... 158
 Spark-plug sandblaster 158
 Stopping oil leak in main bearing of model-A Ford... 158
 Valves at filling station locked by metal cover..... 158
 Automatic latch to hold open garage doors..... 159
 Delivery-truck driver saves time with blackboard.. 159
 Dirt between fender at joints causes squeaks..... 159
 Vacuum cups on glove to remove headlight lens... 159
 Pipe guards on deep driveway protect fenders..... 160
 "Running" on a bad connecting rod..... 160

FARM

Holder for grain sack 141
 Percolator to cook stock feed 141
 Improving spiked calf weaner 144
 Combination wheeled mortar box and feed cart..... 151
 Fruit trees protected in winter by corn shock..... 151
 Hopper for pouring feed into hog trough..... 152
 Measuring lake shore line with wheels..... 152
 Permanent cold frame 152
 Fence post puller 156
 Large barn door opens easily with strap..... 156

FURNITURE

Desk and bench for the guest room..... 108
 Adjustable lounge chair 111
 A Pendleton sideboard 114

HAND TOOLS

Ball of hinge pin for hammering brass..... 110
 Wallpaper knife sharpened on emery paper..... 110
 Emergency pipe vise from two wrenches..... 112
 Plane used as a surface plate..... 112
 Combination fine and coarse file saves time..... 120

(Continued to page 8A)

HOW SAFE IS

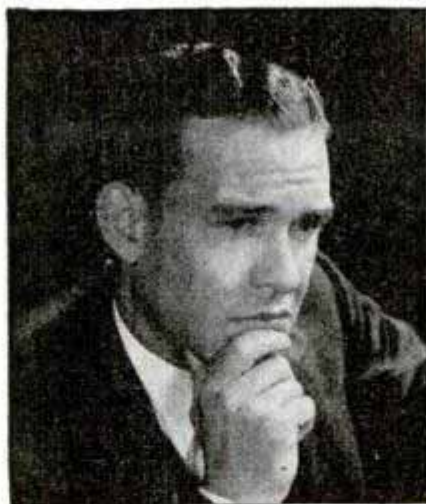

YOUR JOB?

CAN YOU CLASS YOURSELF AMONG THE "OK-MUST KEEP!" EMPLOYEES?

NO USE dodging facts! At times—in every company's history—the pay-roll goes onto the operating table for major surgery.

And when such times come, certain employees are amputated—sometimes a few, sometimes many.

Yet a certain few are always marked "OK-Must Keep!" And the many who are let out envy them—call them "lucky."

What's Behind Job-Holding "Luck"?

It can be *proved*, however, that there's almost always something more than luck involved.

Even the fellow who seems to "have a drag" may actually have a lot more on the ball than is apparent to his fellow workers.

He may have hidden values that only his superiors see or know about.

After all, the "I-Gotta-Drag-Club" has taken a bad licking. In fact, it rather completely disbanded in 1932-1933.

Yet why is it that some employees hold their jobs at the very time when others of seemingly *equal* ability lose theirs?

If it's not luck, there *must* be some explanation.

And there *is* one!

How to Insure Your Job

The secret of holding your job in hard times is to be invaluable to your employer. And a man or woman who is invaluable is usually a well-trained one.

Training is of many kinds—stems from many sources. But the LaSalle kind has been unusually successful. Nearly a million members, in a score of subjects, over a thirty year period can testify to that—and many can prove it by their pay envelopes!

They have cause to agree with us that the real secret of both promotion and job security is just this: "On your present job, make sure you are doing it well, then *train* for the job ahead!"

Why It Works

Put yourself at your own president's desk for a moment.

You are faced with cutting the pay-roll. First of all, you certainly are going to do your best to hold on to those employees who really know their present jobs.

But among them—the very last to go will be those

few who are also wholly or partly trained for the job ahead—even for the job *ahead* of the job ahead!

What You Should Do About It—

But true as these facts are, you probably will tend to do nothing about them.

"My job is safe," you think. "My company won't cut down—and even if it does, *I* won't suffer."

But doesn't the very fact that you have read this far indicate that there's some small doubt—a trifle of uneasiness in your mind?

Wouldn't you be more comfortable if right now *your* boss knew that *you* were taking LaSalle training—a piece of knowledge that upon request we take pains to bring to the personal attention of every LaSalle enrollee's superior?

What you *should* do about it is, therefore, as obvious as the coupon below.

— If You've Got What It Takes!

That coupon, you know, has helped increase the pay envelopes, brighten the lives, and secure the future for many men and women who saw what they *should* do — **AND THEN DID IT!**

It isn't easy. It will cost you hours of serious study, of leisure with friends, your radio, and the movies. And, even on our very liberal payment plan, it will also cost you some money.

But any worthwhile insurance does cost money. And since this is the nearest thing to job-certainty that we know about—it is *worth* money!

Why not at least investigate? *That* costs not a cent! The coupon will bring a quick response—may help start you on the way toward the future that's *due* you!

Better mail it now—and play safe!

FREE! Any of these booklets — or similar ones on your own field.



LASALLE EXTENSION UNIVERSITY

A CORRESPONDENCE INSTITUTION

Dept. 164-R CHICAGO

I'd like to know what you can do to help me better my job. Send me your free booklet and full details about the training I have checked below:

- Higher Accountancy Traffic Management Modern Salesmanship
 Law: LL.B. Degree Executive Management Industrial Management

Name.....Age.....

Address.....Present Position.....

HOME OWNERS:— This was written for you and is sent



FREE

Get your copy!

Do your own simple home, auto and motorboat repairing and be independent of outside repair men. You will avoid delays, save much money, and have the satisfaction of knowing that the work is well done.

The booklet contains clear diagrams and directions for correct procedure for hundreds of common jobs, and enables any home worker to get dependable results, *easily*, on any of the following:

Stopping leaks in pipes, heaters, boilers, tanks, radiators, air ducts, smoke pipes, pails, etc., at connections, seams, cracks, rivets or holes.

Tightening or anchoring loose hinges, locks, handles, screws, bolts, nuts, bases, stems, tops, casters, etc.

Making waterproof joints at skylights, roof cracks and flashing.

Making wet cellars dry from the inside, making concrete floors hard, water and oil proof, and non-dusting, making masonry walls waterproof.

On the car:—Stopping leaks in the radiator at hose connections, or in oil and gasoline lines, patching cracked water jackets, crank, gear and differential cases, tightening loose rivets, mud guards, lamp standards, hub caps and lubricator connections, loose moulding screws, etc.

Smooth-On Iron Cement with which this work is done is applied without heat, without special tools, and so easily and inexpensively that half a dollar to half a hundred dollars is saved in each instance. Smooth-On has been widely used in industrial work for over 35 years and its use is standard practice by power plant engineers and repair men.



Get the booklet by mailing the coupon and buy Smooth-On No. 1 in 7-oz., 1-lb. or 5-lb. can from your hardware store or if necessary from us.

Do it with SMOOTH-ON

SMOOTH-ON MFG. CO., Dept. 37
574 Communipaw Ave., Jersey City, N. J.

Please send the free Smooth-On Repair Book.

Name.....

Address.....

(Contents—Continued)

Copper tubing flared with wood screw.....	120
Jig to wind small coil springs.....	134
Thickness gauge carried in key case.....	141
Background stamps made from auger bits.....	144
Slot locates gauge positions in holder.....	144
Adjustable jig holds irregular work for welding.....	154
Nut catcher for box end wrench.....	154
Torch and soldering iron for roof work.....	154
Holding two shafts in line.....	155

HOME IMPROVEMENTS

Breakfast nook housed in kitchen cabinet.....	105
Auto skid chains improve private driveway gates.....	118
Smart effects for kitchen and bath.....	131

HOUSEHOLD

"Rope ladder" shelves for door.....	110
Wax finish on wood plates.....	113
Clothesline tightened by turning a crank.....	128
Anchoring stovepipe in chimney opening.....	130
Table-top garden for apartment dwellers.....	135
Solving home problems.....	136

OFFICE

Rubber band holds pencils on drawing board.....	107
Extra sheets for notebook perforated with pen point.....	130
Removing carbon paper from typewritten copies.....	134

PHOTOGRAPHY

Dimming photofloods before exposure.....	119
Sensitive beam scale for photographic chemicals.....	121
Tilting tripod head from electrical fixture.....	135
Universal enlarger.....	146

POWER TOOLS

Work shelf for drill press.....	106
Hold-down on scroll saw becomes presser foot.....	120
Self-aligning shaft hangers.....	122
Spirals made with simple lathe jig.....	139
Starting stocks and dies.....	144

STORE AND SHOP

Pantograph drawer swings out from workbench.....	107
Rack to store golf clubs.....	120
Muffin pan serves as small parts drawer.....	138
Crochet hook fastens sack tags.....	156
Rubber-stamp rack holds pad too.....	156

TOYS AND NOVELTIES

Trick box a puzzle to open.....	105
Juggling-cat toy tosses ball.....	113
Disappearing coin trick.....	129
Simple gym unit for your back yard.....	138

WOODWORKING

Fireplace screens.....	103
Casters recessed in furniture legs.....	106
Glue dropper for cabinet and chair work.....	106
Taking thin cuts from end of board.....	122

MISCELLANEOUS

Stringing lamps in the garden.....	106
Repairing a pitcher pump.....	107
Clothespins hold tree lights.....	110
Steel wool anchors screw in plastered wall.....	110
Model windows simulated with glass and ink.....	112
Radius arm improves dividers.....	112
Magnifying glass is supported by vacuum cup.....	119
Anchoring wooden pulleys on shafts.....	122
Protecting potted fish-pool plants in winter.....	122
Silk stencils for printing greeting cards.....	123
Balancing point of ladder marked with tape.....	128
Graphite lubricating pencils for small parts.....	128
Auto casings hold bricks when repairing chimney.....	130
Wallpaper seam roller from caster.....	130
Wedge blocks hold tubing while sawing it.....	130
Cat and squirrel proof bird feeder.....	134
Portholes for model boats.....	134
"Cellophane" used as shim stock.....	140
Wheeled pot to pour tar in pavement cracks.....	140
Water hammer prevented in air-conditioning unit.....	141
Tricks that help you in soldering.....	142
Chuckling small irregular lathe work.....	145
Paperhanger's paste bucket stand.....	145
Guard on oilcan spout.....	151
What you can do with a ring stand.....	153
Wrist-strap mirror aids plumber.....	154
Sash lifts form brackets for door bolt.....	156

IMPORTANT NOTICE

It is the intention of this magazine to provide its readers with information regarding the latest developments in the mechanical arts. We take no responsibility as to whether the disclosures contained in our articles are covered by patents and advise readers to investigate this subject before making, using, or selling any of the products, machines, or processes described, in order to avoid possible liability for patent infringement.



Does your
PAY ENVELOPE
keep you out
of this picture?

If it does, do something about it! Get a raise in salary—but first get the training that will entitle you to this raise. Thousands of men in the same fix as you have gotten this training by spare-time study of an I. C. S. Course. Mail the coupon today!

INTERNATIONAL CORRESPONDENCE SCHOOLS

BOX 5539-J, SCRANTON, PENNA.

★ Without cost or obligation, please send me a copy of your booklet, "Who Wins and Why," and full particulars about the subject *before* which I have marked X: ★

TECHNICAL AND INDUSTRIAL COURSES

- | | | | |
|--|--|--|--|
| <input type="checkbox"/> Architect | <input type="checkbox"/> Sheet Metal Worker | <input type="checkbox"/> Commercial Refrigeration | <input type="checkbox"/> Surveying and Mapping |
| <input type="checkbox"/> Architectural Draftsman | <input type="checkbox"/> Boilermaker | <input type="checkbox"/> Plumbing <input type="checkbox"/> Steam Fitting | <input type="checkbox"/> Bridge Engineer |
| <input type="checkbox"/> Building Estimating | <input type="checkbox"/> Telegraph Engineer | <input type="checkbox"/> Heating <input type="checkbox"/> Ventilation | <input type="checkbox"/> Bridge and Building Foreman |
| <input type="checkbox"/> Contractor and Builder | <input type="checkbox"/> Telephone Work <input type="checkbox"/> Radio | <input type="checkbox"/> Air Conditioning and Cooling | <input type="checkbox"/> Chemistry <input type="checkbox"/> Pharmacy |
| <input type="checkbox"/> Structural Draftsman | <input type="checkbox"/> Mechanical Engineering | <input type="checkbox"/> Steam Engineer | <input type="checkbox"/> Coal Mining |
| <input type="checkbox"/> Structural Engineer | <input type="checkbox"/> Mechanical Draftsman | <input type="checkbox"/> Steam Electric Engineer | <input type="checkbox"/> Mine Foreman <input type="checkbox"/> Fire Bosses |
| <input type="checkbox"/> Management of Inventions | <input type="checkbox"/> Machinist <input type="checkbox"/> Toolmaker | <input type="checkbox"/> Marine Engineer | <input type="checkbox"/> Navigation |
| <input type="checkbox"/> Electrical Engineer | <input type="checkbox"/> Patternmaker | <input type="checkbox"/> R. R. Locomotives | <input type="checkbox"/> Cotton Manufacturing |
| <input type="checkbox"/> Electric Lighting | <input type="checkbox"/> Diesel Engines | <input type="checkbox"/> R. R. Section Foreman | <input type="checkbox"/> Woolen Manufacturing |
| <input type="checkbox"/> Welding, Electric and Gas | <input type="checkbox"/> Aviation Engines | <input type="checkbox"/> Air Brakes <input type="checkbox"/> R. R. Signalmen | <input type="checkbox"/> Agriculture |
| <input type="checkbox"/> Reading Shop Blueprints | <input type="checkbox"/> Auto Technician | <input type="checkbox"/> Highway Engineering | <input type="checkbox"/> Fruit Growing |
| <input type="checkbox"/> Heat Treatment of Metals | <input type="checkbox"/> Auto Electrical Technician | <input type="checkbox"/> Civil Engineering | <input type="checkbox"/> Poultry Farming |

BUSINESS TRAINING COURSES

- | | | | |
|--|---|--|--|
| <input type="checkbox"/> Business Management | <input type="checkbox"/> Bookkeeping | <input type="checkbox"/> Service Station Salesmanship | <input type="checkbox"/> Grade School Subjects |
| <input type="checkbox"/> Industrial Management | <input type="checkbox"/> Secretarial Work | <input type="checkbox"/> First Year College Subjects | <input type="checkbox"/> High School Subjects |
| <input type="checkbox"/> Traffic Management | <input type="checkbox"/> Spanish | <input type="checkbox"/> Business Correspondence | <input type="checkbox"/> College Preparatory |
| <input type="checkbox"/> Accountancy | <input type="checkbox"/> French | <input type="checkbox"/> Stenography and Typing | <input type="checkbox"/> Illustrating |
| <input type="checkbox"/> Cost Accountant | <input type="checkbox"/> Salesmanship | <input type="checkbox"/> Civil Service <input type="checkbox"/> Mail Carrier | <input type="checkbox"/> Cartooning |
| <input type="checkbox"/> C. P. Accountant | <input type="checkbox"/> Advertising | <input type="checkbox"/> Railway Mail Clerk | <input type="checkbox"/> Lettering Show Cards <input type="checkbox"/> Signs |

DOMESTIC SCIENCE COURSES

- | | | |
|---|---|--|
| <input type="checkbox"/> Home Dressmaking | <input type="checkbox"/> Advanced Dressmaking | <input type="checkbox"/> Foods and Cookery |
| <input type="checkbox"/> Professional Dressmaking and Designing | | <input type="checkbox"/> Tea Room and Cafeteria Management, Catering |

Name..... Age..... Address.....

City..... State..... Present Position.....

If you reside in Canada, send this coupon to the International Correspondence Schools Canadian, Limited, Montreal, Canada
If you reside in England, send coupon to I. C. S., 71 Kingsway, London, W. C. 2, England

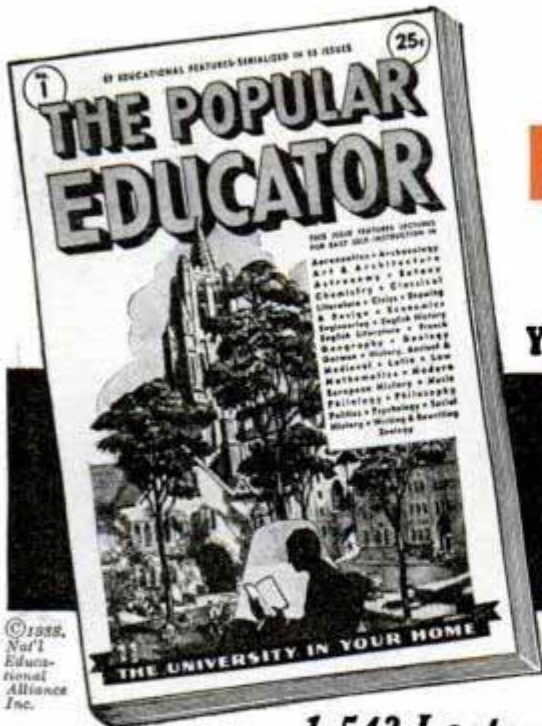

©1928,
Nat'l
Educational
Alliance
Inc.

Nearly a Quarter of a Million
People Have Enrolled

NEW CLASS NOW FORMING

You Must Register At Once. Mail Coupon On Opposite Page!

57 New Easy Reading Courses Covering 4 Years High School and 2 Years College

**ENGLISH (Speaking, Reading, Writing)—
MATHEMATICS—PSYCHOLOGY—etc.
for Only 25 Cents Each**

**1,543 Lectures—
2,437 Pictures—49 Color Plates**

Here is such a wide choice of educational opportunities that you will find all courses of instruction which you want and need. And even if you do not feel the need of studying systematically a single one of the 57 courses, you will still find in the POPULAR EDUCATOR a vast wealth of articles as fascinating as could be found in any popular non-fiction magazine. Each weekly number will give you the biggest quarter's worth you ever had!

The POPULAR EDUCATOR is truly "the poor man's higher education." Take, for example, a subject like PSYCHOLOGY. If you had to attend lectures on this subject in person at a High School or College, it would cost you hundreds of dollars—even an elementary textbook would cost you three or four. Yet the *Alliance* teaches you this useful science for a whole year—AT A TOTAL COST OF EXACTLY 25 CENTS! This is an unprecedented bargain!

Prepared by THIS NATIONAL COUNCIL OF DISTINGUISHED

Outstanding Authorities from Leading Universities and Colleges

- | | | |
|--|--|---|
| E. A. Sallers, B.S., M.A., Ph.D.
Louisiana State University | L. A. Goldblatt, Ph.D.
University of Pittsburgh | Gerald G. Walsh, S.J., B.A., M.A.,
Ph.D., S.T.D.
Fordham University |
| ACCOUNTANCY | CHEMISTRY | ITALIAN |
| Theodore von Karman, M.E., Ph.D.
Guggenheim Aeronautics Laboratory | C. J. Friedrich, Ph.D.
Harvard University | Grant M. Hyde, B.A., M.A.
University of Wisconsin |
| Frank Mallina, Research Fellow
Calif. Inst. of Tech. | CIVICS | JOURNALISM |
| AERONAUTICS | Dorrance S. White, Ph.D.
State University of Iowa | Boy J. Deferrari, A.B., M.A., Ph.D.
Catholic University of America |
| H. E. Barnes, M.A., Ph.D.
New School for Social Research | CLASSICAL LITERATURE | LATIN |
| AMERICAN HISTORY | Walter Prichard Eaton, B.A.
Yale University | E. Karl McGinnis
University of Texas |
| Walter W. Hyde, M.A., Ph.D.
University of Pennsylvania | DRAMA | LAW |
| ANCIENT & MEDIEVAL
HISTORY | Andrew M. Vincent
University of Oregon | William Whitfield Elliott, A.B., Ph.D.
Duke University |
| Clark Wissler, A.B., Ph.D., LL.D.
Yale University | H. H. Coulson, A.B., A.M., (Cantab.)
St. Louis University | MATHEMATICS |
| ANTHROPOLOGY | ENGLISH HISTORY | James D. Weinland, Ph.D.
New York University |
| Albert T. Omstead, Ph.D.
University of Chicago | Thomas A. Knott, Ph.D.
University of Michigan | MNEMONICS |
| Clark Wissler, Ph.D.; N. C. Nelson,
M.L.; G. C. Vaillant, Ph.D.; W. C.
Bennett, Ph.D.
Amer. Museum of Natural History | ENGLISH LANGUAGE | Tibor Kerekes, Ph.D.
Georgetown University |
| ARCHAEOLOGY | Hoyt H. Hudson, Ph.D.
Princeton University | MODERNEUROPEAN HISTORY |
| Ernest Pickering, B.S.C., M.Arch.
University of Cincinnati | ENGLISH LITERATURE | Howard H. Preston, Ph.D.
University of Washington |
| ART & ARCHITECTURE | Elsa Findlay
Columbia University | MONEY |
| Clyde Fisher, Ph.D., LL.D.
Amer. Museum of Natural History | EURYTHMICS | Wendell W. Wright, Ph.D.
Indiana University |
| ASTRONOMY | Earl F. Langwell, Ph.D.
University of Notre Dame | PENMANSHIP |
| G. B. Winton, M.A., D.D., Litt.D.
Vanderbilt University | FRENCH | P. W. Dykema, M.L.
Columbia University |
| BIBLE HISTORY | Samuel Tilden Bratton
University of Missouri | MUSIC |
| John Hiram Gerould, Ph.D.
Dartmouth College | Terence T. Quirke, M.Sc., Ph.D.,
F.A.A.S.
University of Illinois | O. E. Johnson, Ph.D.
State University of Iowa |
| BIOLOGY | GEOGRAPHY | PHILOLOGY |
| Loren C. Petry, B.S., M.S., Ph.D.
Cornell University | GEOLOGY | Walter E. Ekblaw, M.A., Ph.D.
Clark University |
| BOTANY | F. W. Pierce, Ph.D.
Penn State College | ECONOMIC GEOGRAPHY |
| BUSINESS ENGLISH | Henry N. Sanders
Bryn Mawr College | Frank T. Stockton, A.B., L.H.D., Ph.D.
University of Kansas |
| | GERMAN | ECONOMICS |
| | GREEK | Fred. Asa Barnes, C.E., M.C.E., F.A.A.A.S.
Cornell University |
| | | ENGINEERING |

Organized to Help Millions Broaden Their Knowledge Through the POPULAR EDUCATOR

THE HIGHER EDUCATION YOU NEED FOR SUCCESS

now yours for only

One Cent a Lesson!



The National Educational Alliance

Only 25c a Week . . . Stop Whenever You Like

NOW, at last, every man and woman who wants the benefits of more advanced schooling can have them, for the *National Educational Alliance* has brought 57 High School and College Courses within easy reach of any one who can afford to invest 25c a week in better education.

To begin with, your membership in the National Educational Alliance is *free*, and as soon as you join you start to receive the *POPULAR EDUCATOR*—which includes weekly groups of fascinating lectures—for the price of a high grade periodical—only 25c a week.

EDUCATORS

- D. H. Davis, A.B., Ph.D.
University of Minnesota
PHYS. GEOG. AND CARTOGRAPHY
 - H. E. Himwich, M.D.
Union University
PHYSIOLOGY AND ANATOMY
 - Neal D. Houghton, A.B., Ph.D.
University of Arizona
POLITICS
 - Adam B. Gilliland, B.O. B.A., Ph.D.
Northwestern University
PSYCHOLOGY
 - Richard D. Fay
Mass. Institute of Technology
RADIO
 - Harry A. Overstreet, A.B., B.Sc.
City College of New York
PHILOSOPHY
 - G. Oscar Russell, B.A., M.A., Ph.D.
Ohio State University
PHONETICS
 - L. L. Hendren, A.B., M.A., Ph.D.
University of Georgia
PHYSICS
 - Allan Nevins, A.B., M.A., Ph.D., LL.D., LL.D.
Columbia University
SOCIAL HISTORY
 - F. M. Kercherille, B.A., M.A., Ph.D.
State University of New Mexico
SPANISH
 - Rennie Wilbur Doane
Stanford University
ZOOLOGY
 - Harry Shaw, Jr.
New York University
WRITING & REWRITING
- Additional courses in **SHORT-HAND, TYPEWRITING, INTERIOR DECORATING, PHOTOGRAPHY**

IT'S NEVER TOO LATE TO LEARN

Like Reading Any Fascinating Magazine

Nothing is more effortless and interesting than the new method of education employed in the *POPULAR EDUCATOR*! Your lectures come once each week on each subject in the pages of an attractively illustrated periodical. The first weekly issue includes 32 "No. 1 Lectures," in 32 different courses of instruction—from Anthropology to Zoology. The second weekly issue brings you a similar number of "No. 2 Lectures," etc., etc. You follow only the courses you want to learn, just as you read in a magazine only the serials that interest you most.

Each course is as entertaining and informative as an expert in the subject, plus a popular writer, can make it. Each lecture is short enough to read at one sitting and so interesting that you retain it easily. The lessons are illustrated with unique photos and diagrams, sometimes copies from priceless originals in museums.



Mail Coupon Now

Wrap Up 25c And Mail It Now For Your First POPULAR EDUCATOR

NATIONAL EDUCATIONAL ALLIANCE, Inc.,
Dept. DE
37 West 47th Street, New York, N. Y.

For the enclosed 25c, please send me the first issue containing a group of 32 Lectures in the *Alliance's* courses, prepaid, and enroll me in the new class for one Year. You may send me the *POPULAR EDUCATOR* weekly at the rate of 25c a week, until I give you notice to cancel. For convenience in bookkeeping, you may bill me once a month for such copies as I receive.

Name.....

Address.....

City..... State.....

PLEASE WRITE PLAINLY



You
**HELPED
BUILD HER**

**THERE'S THE BIG THRILL
OF AN AIRCRAFT CAREER**

Why don't you step from Aero I. T. I. . . . into the great aircraft industry . . . as hundreds of Aero I. T. I. graduates have already done.

Find Out why there is such a demand in the aircraft industry for Aero I. T. I. men.

Find Out what there is about Aero I. T. I. training that makes Aero I. T. I. graduates advance so steadily.

Find Out what an aircraft career training program supervised by an Executive Board of famous aircraft builders can really mean to you.

Find Out why it pays to get your training in the largest, finest, most modern aircraft training school in the world.

GET THIS NEW BOOKLET

Find Out about careers in Aeronautical Engineering or Master Aircraft Mechanics. Send Coupon NOW.



Cliff Van Dusen
Vice-Pres., Consolidated Aircraft Corporation

John H. Northrop
formerly President, The Northrop Corp., and Vice-Pres. Douglas Aircraft Company, Inc.

Robert E. Gross
President, Lockheed Aircraft Corporation

Aero Industries Technical Institute
5253 West San Fernando Road - Los Angeles, California

Please send free booklet describing opportunities in the aircraft industry and Aero I. T. I. training. (This booklet intended only for men over 17 and under 40.)

NAME _____ AGE _____
STREET _____
CITY _____ STATE _____ a-13-p

EASIEST to Master
This New P-A

● Such beautiful tone, and so easy to play! Just touch a key and blow normally; you can't miss. Nothing to compare with these new P-A Saxes, Clarinets, Trumpets, and other P-A instruments. Fully guaranteed; your success assured. See your music dealer or write direct for beautiful, free book. No obligation. Easy terms. 1288

PAN-AMERICAN
103 P-A Building Elkhart, Indiana

ELECTRICAL ENGINEERING

ONE YEAR condensed course prepares for technical work in the electrical field. Thorough training in principles, with practical applications in laboratory and shop. High placement record. Modern buildings, dormitory, dining hall. Campus, 46th year. Catalog on request.



BLISS ELECTRICAL SCHOOL
131 Takoma Ave. Wash., D.C.

LEARN WATCH REPAIRING



AT HOME You can learn by our modern and original system of instruction every part of the Watch Repairing Trade at home. You can earn money while learning and prepare yourself for a well paying position or start in business after completing our course of instruction. Good watch repairers are in demand and generally earn very good salaries. For particulars apply to the Wisconsin School of Watch Repairing 524 E. Mason St., MILWAUKEE, WIS.

CARTOONING

PAYS WELL Turn your talent into dollars. Develop your ability with personal instruction from an internationally-known cartoonist. His exclusive, successful method of drawing and creating ideas makes it easy to learn. Write for Free Booklet explaining details of this exceptional home-study course. National School of Cartooning, 437 Penton Building, Cleveland, Ohio

EARN THE DEGREE

Doctor of Psychology (Ph.D.), Philosophy, Science. General Courses—Arts, Law, Business, etc. "CHARTERED BY STATE OF MONTANA." Send for 32-page FREE Bulletin at once. No Obligation. Temple Bar College, Dept. 2-R, 213 East Main Street Missoula, Montana, U. S. A.

NEW YORK SCHOOL OF MECHANICAL DENTISTRY

Earn big money in a few months. We show you how. Real Laboratory Training. OLDEST school. Day, Eve. Easy terms. Ask for free Catalog P and tool offer. N. Y. SCHOOL OF MECHANICAL DENTISTRY, 125 W. 31 St., N. Y. C.

MAKE MONEY AT HOME

RUBBER MOLDS Low as 6¢ EA.

Amazing rubber mold-making outfit makes perfect flexible molds of plaques, ash trays, book-ends, etc. Molds cost from 6¢ to 25¢ each. Each mold makes hundreds of novelties and gifts to sell up to \$1.00 apiece! No experience necessary. Quick and easy. Start profitable business in your home . . . sell to stores, gift shops, friends, resorts, road stands, by mail. Full or spare time. "Molders Handy Book" and list of buyers FREE. Write

SO-LO WORKS
Dept. N-827 Cincinnati, Ohio



You Ask Me What I Am Doing?



I Am Getting Ready to Earn More Money ... Preparing for a Bigger Job

I am a student of the American School, Chicago. A little more than half way through my course—already my increased knowledge has brought me promotion as a result of the hour or so a day I have been spending getting acquainted with the principles of the work I enjoy. I use only part of my spare time, so it doesn't interfere with my home and social life, and certainly helps me on the job.

I have been surprised at the practical manner in which even advanced work is explained. It is a lot easier than I had expected. I only wish I had started this plan of getting ahead a few years earlier. But when I was 18 to 20 I felt pretty sure of myself. I didn't take enough stock in what more experienced people told me about the importance of being thoroughly trained for the job I wanted.

You Can't Win If You Don't Try
American School, Dept. G145, Drexel Ave. at 58th St., Chicago

CUT ALONG THIS LINE

Try a Lesson Yourself—No Obligation

American School, Dept. G145, Drexel Ave. at 58th St., Chicago

I have checked the line of work in which I would like a good job. Please send me without expense or obligation on my part a copy of your Bulletin and an early lesson in the field I have selected.

- | | | |
|---|--|---|
| <input type="checkbox"/> Air Conditioning | <input type="checkbox"/> Electrical Engineering | <input type="checkbox"/> Law |
| <input type="checkbox"/> Architecture | <input type="checkbox"/> Diesel Engineering | <input type="checkbox"/> Liberal Arts (College) |
| <input type="checkbox"/> Automotive Engineering | <input type="checkbox"/> Drafting and Designing | <input type="checkbox"/> Mechanical Engineering |
| <input type="checkbox"/> Automobile Repairing | <input type="checkbox"/> Electric Refrigeration | <input type="checkbox"/> Merchandising |
| <input type="checkbox"/> Bookkeeping and
Cost Accounting | <input type="checkbox"/> Heating, Ventilating,
Plumbing | <input type="checkbox"/> Private Secretary |
| <input type="checkbox"/> Business Management | <input type="checkbox"/> Professional Accounting | <input type="checkbox"/> Radio and Television |
| <input type="checkbox"/> Civil Engineering | <input type="checkbox"/> Incl. C. P. A. Coaching | <input type="checkbox"/> Salesmanship |
| <input type="checkbox"/> Aviation | <input type="checkbox"/> High School | <input type="checkbox"/> Shop Practice |
| <input type="checkbox"/> Contracting, Building | <input type="checkbox"/> Highway Engineering | <input type="checkbox"/> Steam Engineering |

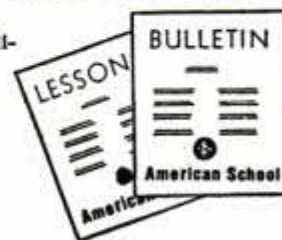

Name.....Age.....Occupation.....

Street.....City.....State.....

I Jumped from \$18 a week to \$50
--A FREE BOOK STARTED ME TOWARD THIS
Good Pay in Radio
--- HERE'S HOW IT HAPPENED
 by S.J.E. (NAME AND ADDRESS SENT UPON REQUEST)

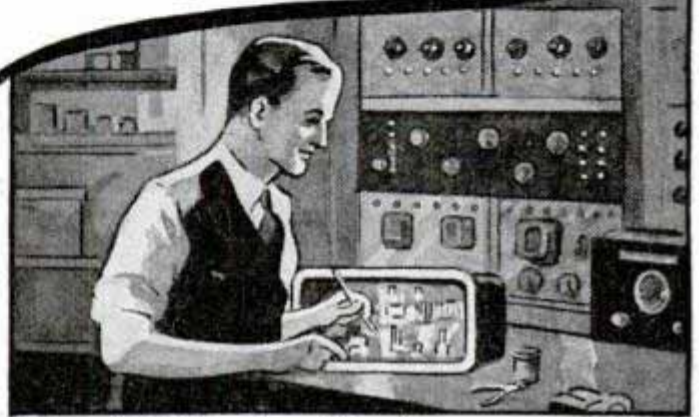

"When I finished training I accepted a job as serviceman with a Radio store. In 3 weeks I was made service manager at more than twice what I earned in the shoe factory."

**Many Make \$5, \$10, \$15 a Week Extra
in Spare Time While Learning**

The day you enroll, in addition to our regular Course, I start sending Extra Money Job Sheets; show you how to do Radio repair jobs. Throughout your training I send plans and directions that made good spare time money—\$200 to \$500—for hundreds, while learning.



Over \$1,000 Before Graduating

"Before completing half the N. R. I. Course I was servicing sets, and I made \$1,000 to \$1,200 before graduating. I am doing Radio service work for myself now."—ASHLEY G. ALDRIDGE, 1228 Shepherd St., Petersburg, Va.

\$10 to \$25 a Week in Spare Time

"I am making from \$10 to \$25 a week in spare time while still holding my regular job as a machinist. I owe my success to N. R. I."—WM. F. RUPP, 203 West Front St., West Conshohocken, Pa.



BE A RADIO
Find out How I Train

Radio offers you many opportunities for well-paying spare time and full time jobs. And you don't have to give up your job, leave home or spend a lot of money to train to get those jobs—to become a Radio Expert.

Many Make \$30, \$50, \$75 a Week

Radio broadcasting stations employ engineers, operators, station managers and pay up to \$5,000 a year. Fixing Radio sets in spare time pays many \$200 to \$500 a year—full time jobs with Radio jobbers, manufacturers and dealers as much as \$30, \$50, \$75 a week. Many Radio Experts open full or part time Radio sales and repair businesses. Radio manufacturers and jobbers employ testers, inspectors, foremen, engineers, servicemen, and pay up to \$6,000 a year. Automobile, police, aviation, commercial Radio, loud speaker systems are newer fields offering good opportunities now and for the future. Television promises to open many good jobs soon. Men I trained have good jobs in these branches of Radio. Read how they got their jobs. Mail coupon.

How You Get Practical Experience

I send you special Radio equipment; show you how to conduct experiments, build circuits illustrating important principles used in modern Radio receivers, broadcast stations and loud-speaker installations. This 50-50 method of training—with printed instruc-



“I had an \$18 a week job in a shoe factory. I'd probably be at it today if I hadn't read about the opportunities in Radio and started training at home for them.”

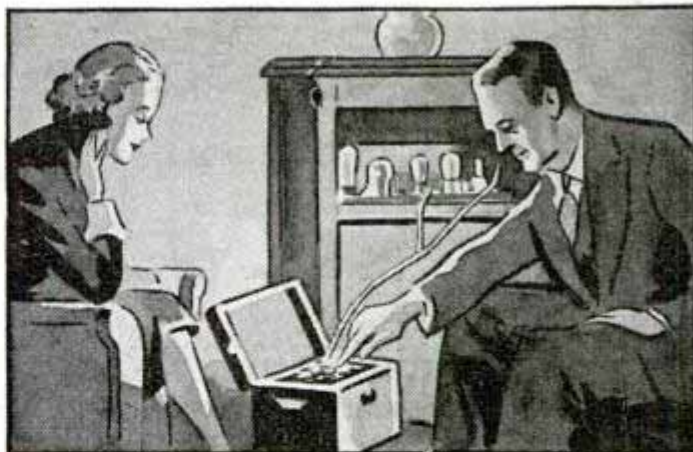

“The training National Radio Institute gave me was so practical I was soon ready to make \$5, \$10, \$15 a week in spare time servicing Radio sets.”

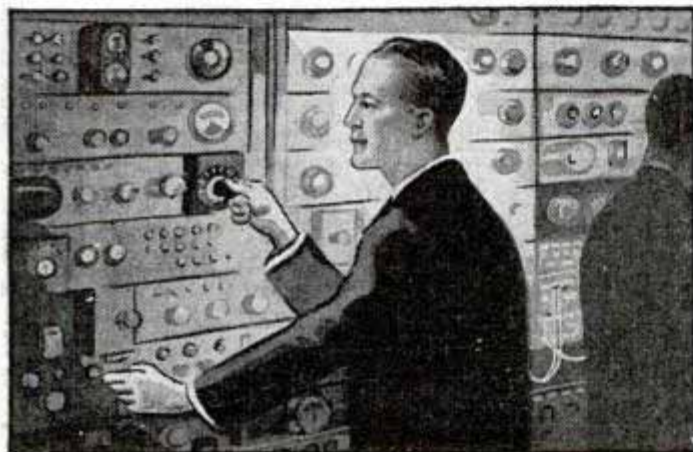

“Eight months later the N. R. I. Employment Department sent me to Station KWCR as a Radio operator. Now I am Radio Engineer at Station WSUI. I am also connected with Television Station W9XK.”

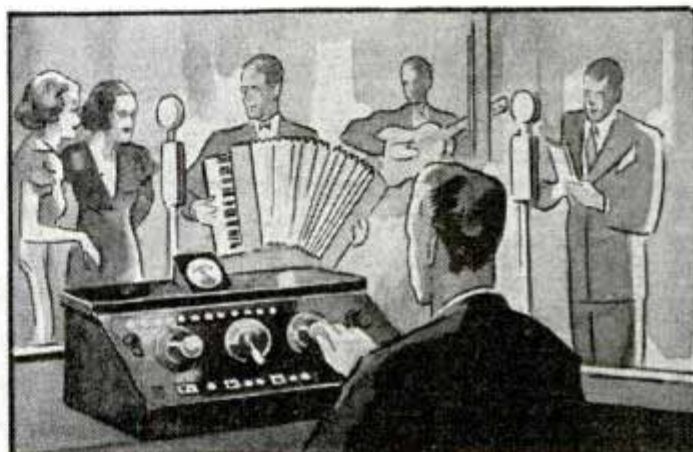

“N. R. I. Training took me out of a low-pay shoe factory job and put me into Radio at good pay. Radio is growing fast. The field is wide open to properly trained men.”

EXPERT You at Home

tions and working with Radio parts and circuits — makes learning at home interesting, fascinating, practical. I ALSO GIVE YOU A MODERN, PROFESSIONAL ALL-WAVE, ALL-PURPOSE RADIO SET SERVICING INSTRUMENT to help you make good money fixing Radios while learning and equip you with a professional instrument for full time jobs after graduation.

Money Back Agreement Protects You

I am so sure I can train you to your satisfaction that I agree in writing to refund every penny you pay me if you are not satisfied with my Lessons and Instruction Service when you finish. A copy of this agreement comes with my Free Book.

Find Out What Radio Offers You

Act Today. Mail the coupon now for "Rich Rewards in Radio." It's free to any fellow over 16 years old. It points out Radio's spare time and full time opportunities and those coming in Television; tells about my training in Radio and Television; shows you letters from men I trained, telling what they are doing and earning. Find out what Radio offers YOU! MAIL COUPON in an envelope, or paste on a postcard—NOW!

J. E. Smith, President, National Radio Institute, Dept. 9AP, Washington, D. C.



J. E. SMITH, President, National Radio Institute. Established 1914

The man who has directed the home study training of more men for the Radio Industry than any other man in America.



MAIL THIS NOW
Get 64 Page Book Free

J. E. SMITH, President, Dept. 9AP,
National Radio Institute, Washington, D. C.

Dear Mr. Smith: Without obligating me, send "Rich Rewards in Radio," which points out spare time and full time opportunities in Radio, and explains your practical method of training at home in spare time to become a Radio Expert. (Please write plainly.)

Name.....Age.....

Address.....

City.....State.....



High School Course at Home

Many Finish in 2 Years

You can complete this simplified High School Course as rapidly as your time and abilities permit. Equivalent to resident school work—prepares you for entrance to college. Standard H. S. texts supplied—Diploma. Credit for H. S. subjects already completed. Single subjects if desired. High School education is very important for advancement in business and industry and socially.

College Entrance

During the past 14 years, our High School graduates have been admitted to 531 different Universities, Colleges, Junior Colleges and Normal Schools—80% of them without entrance examination. Course also prepares for teachers' certificate and pre-professional examinations.

Business—Industry

To get and hold a good position in Business today you must be able to write clear, accurate letters and reports—do figuring involving Algebra and Geometry—talk intelligently on matters requiring a knowledge of Geography, History, and Economics.

In Industry—Mechanical and Engineering lines—you must have at least an elementary knowledge of Physics and Chemistry—be able to figure quickly and accurately—know something of Mechanical Drawing and blueprints—and be able to talk and write accurately and clearly on both your work and ordinary topics of conversation.

Our High School course meets the preparatory educational requirements for Business and Industry.

An Educational Institution

The American School was chartered in 1897 as an educational institution, not for profit—and is exempt from paying Federal income tax, like the best resident colleges and universities.

Don't Be Handicapped—Complete Your Training Now

Be a High School Graduate! Prepare yourself for promotion in Business and Industry—for the Professions, College Entrance and social success. No matter what line you may select, High School training will prove invaluable to you! Our moderate fees cover all instruction, standard textbooks and Diploma. Easy monthly terms. Get ahead in life. Start your training NOW!

20 Other Courses

Over 150 noted Educators, Engineers, and Business Men helped prepare our special instruction material, which is used by many resident schools and colleges, U. S. Navy, and Province of Manitoba, Canada. We offer you quality training at home for the best-paying lines of Industry and Business, as listed in the coupon.

Prepare yourself for promotion in Business and Industry—for the Professions, College Entrance and social success. No matter what line you may select, High School training will prove invaluable to you! Our moderate fees cover all instruction, standard textbooks and Diploma. Easy monthly terms. Get ahead in life. Start your training NOW!

Mail coupon for information about line that interests you
American School, Drexel at 58th, Chicago

American School, Dept. H-145, Drexel at 58th, Chicago

Tell me how to train for success in line checked. No obligation.

- | | |
|--|--|
| <input type="checkbox"/> Accounting & Auditing | <input type="checkbox"/> Diesel Engineering |
| <input type="checkbox"/> Architecture & B'ldg | <input type="checkbox"/> Drafting & Design |
| <input type="checkbox"/> Automotive Engin'ring | <input type="checkbox"/> Liberal Arts |
| <input type="checkbox"/> Business Management | <input type="checkbox"/> Private Secretary |
| <input type="checkbox"/> Commercial Aeronautics | <input type="checkbox"/> Hl'er Ac't'g (C.P.A.) |
| <input type="checkbox"/> Electrical Engineering | <input type="checkbox"/> Highway Engin'g |
| <input type="checkbox"/> Electrical Refrigerat'n | <input type="checkbox"/> Mechanical Eng'g |
| <input type="checkbox"/> Air Conditioning | <input type="checkbox"/> Radio & Television |
| <input type="checkbox"/> Civil Engineering | <input type="checkbox"/> Salesmanship |
| <input type="checkbox"/> Complete Law | <input type="checkbox"/> Steam Engineering |

Name.....
 Address.....

When writing please mention Popular Mechanics

AN AVIATION CAREER

OFFERS YOU A GREAT FUTURE



MORE CURTISS-WRIGHT TECH GRADUATES ARE EMPLOYED IN THE AIRCRAFT INDUSTRY THAN THOSE OF ANY OTHER SCHOOL. Train for your future in the heart of the Aircraft Industry at Aviation's foremost and oldest school, specializing in 1 Aircraft Sheet Metal, 2 Master Mechanics and 3 Aeronautical Engineering. No flying involved. Graduates are obtaining immediate employment. Return this ad with your name, age, address and the course in which you desire full information.

Dept. PM-1

CURTISS-WRIGHT TECHNICAL INSTITUTE
 GRAND CENTRAL AIR TERMINAL
 GLENDALE (LOS ANGELES) CALIF.

BIG MONEY FOR STORIES

Directed by "PLOT GENIE"

One famous writer who sells over one million words a year develops his plots entirely from the PLOT GENIE. Many other authors do likewise. The PLOT GENIE gives you new and novel plots, "surprise twists," stimulates your imagination. The greatest aid to creative thinking ever devised. Write today for Circular 107. Parker & Baird Co., (book publishers since 1898) 241 E. Fourth St., Los Angeles, Calif.

BE A PASSENGER TRAFFIC INSPECTOR



HELP YOURSELF TO SUCCESS THIS WINTER. Give a few weeks' spare time to our home-study course on Railway and Bus Traffic Inspection. Splendid opportunities for our trained graduates, whom we help place at up to \$135 per month, plus expenses, to start, or refund tuition. Men—19 to 50 eligible. Get Free Booklet. STANDARD BUSINESS TRAINING INSTITUTE, Div. 201, Buffalo, N. Y.



TRI-STATE COLLEGE

B. S. Degree in 2 years. World famous for technical 2-year courses in Civil, Electrical, Mechanical, Chemical, Radio, Aeronautical Engineering; Business Administration and Accounting.

Those who lack high school may make up work. Low tuition. Low living costs. Located in picturesque hill and lake region. Students from every state and many foreign countries. 55th year. Enter January, March, June, September.

Write for catalog. 419 College Ave. ANGOLA, IND.



Learn to Write

Begin Today. Write for our Free Book, "How to Become a Good Penman." It contains specimens and tells how others learned to write in spare time. Your name elegantly written on a card if you enclose stamp for postage. Write today. The Tamblin School of Penmanship, 418 Ridge Bldg., Kansas City, Mo.

TRAIN FOR Radio in 12 WEEKS

I WILL FINANCE YOUR TRAINING IF YOU ARE SHORT OF MONEY

Prepare for opportunities in Radio Broadcast, Talking pictures, Television, by 12 weeks of practical shop work in the great Coyne Radio Shops, on real RADIO and Sound equipment. You don't need advanced education or experience. Free Employment Service for life. Many earn while learning. Electric Refrigeration included. Mail coupon today for free book which tells you how hundreds have become successful RadioMen after taking our training. H. C. LEWIS, Pres., RADIO DIV. Coyne Electrical School 500 S. Paulina St., Dept. 15-34, Chicago, Illinois

Send Free Radio Book and facts. Tell me about your "Pay-Tuition-After-Graduation" Plan.

NAME..... AGE.....
 ADDRESS.....
 CITY..... STATE.....

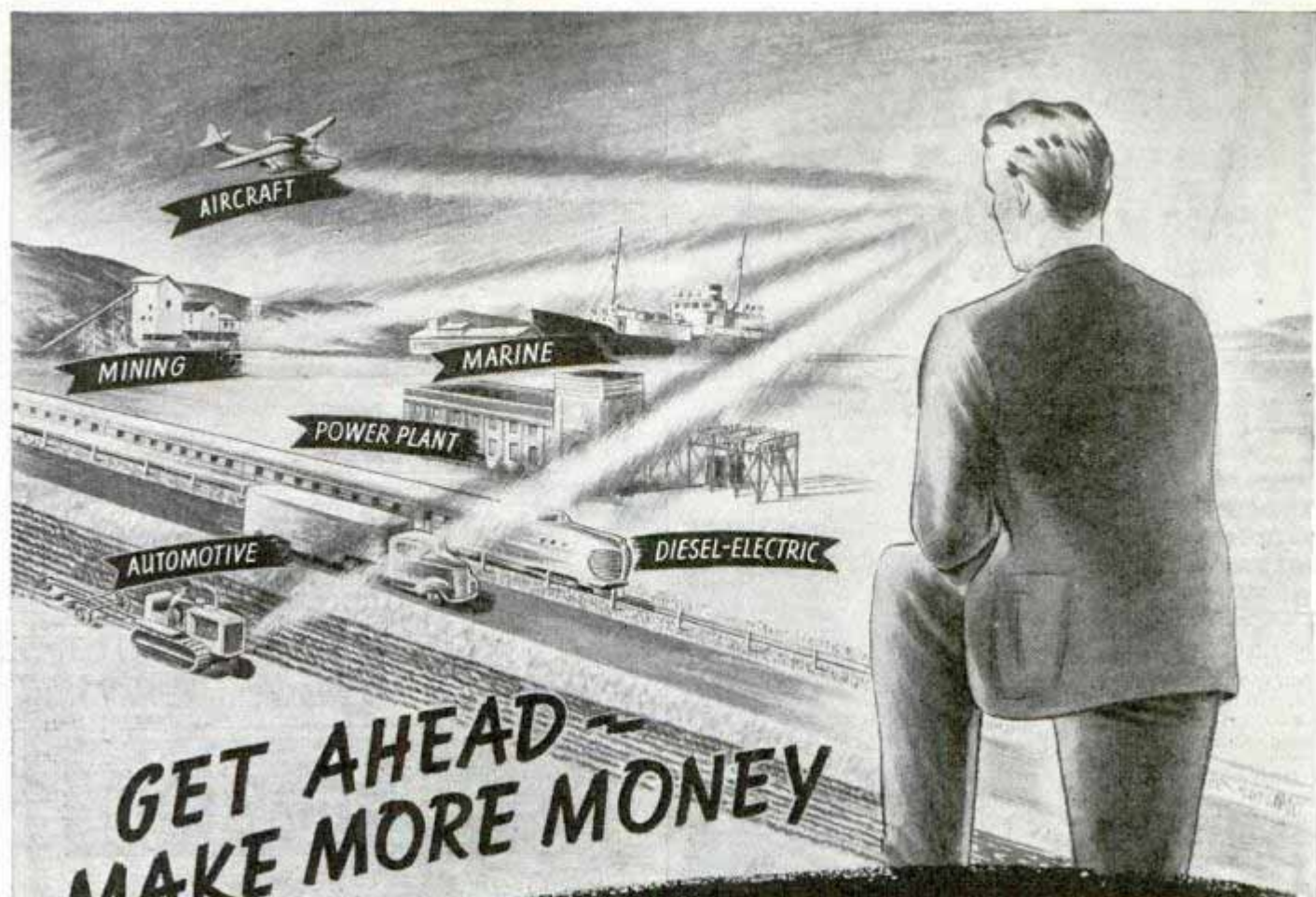

GET AHEAD -
MAKE MORE MONEY

Be a DIESEL ENGINEER

TOOK TRAINING
Now Chief Engineer

"...Since leaving your school I have been constantly employed in the Diesel field, advancing from my first job as ordinary operator, several steps ahead to my present job as Chief Engineer of the New Mexico Gold Producers Corp."
(signed) R. E. Lee

HEMPHILL DIESEL SCHOOLS

America's original exclusively Diesel training institution... fully equipped to thoroughly train you as a Diesel Engineer.

BOSTON, 114 Brookline Ave.; NEW YORK, 31-26 Queens Blvd., L. I. C.; DETROIT, 2341 W. Lafayette Blvd.; CHICAGO, 2014 Larrabee St.; MEMPHIS, 417 Monroe Ave.; LOS ANGELES, 2120 San Fernando Rd.; SEATTLE, 501 Westlake North.; VANCOUVER, 1363 Granville St.

Located only in the above named cities and not connected with any other Diesel schools.

Already booming, Diesel is repeating the spectacular growth of the automobile industry right over again -- thousands of "top" men are there because they "got in on the ground floor" ... when that industry was new and growing by leaps and bounds. Now it is the Diesel industry that offers YOU exactly the same kind of an opportunity.

WHAT ARE YOU GOING TO DO ABOUT YOUR DIESEL CAREER?

Get full information on a training plan designed to fit you to get ahead and make money as a Diesel engineer ... training you can get -- no matter where you live. Send the coupon NOW.

Please send me free new issue of "March of Diesel" booklet and information on Hemphill Diesel training. (This information intended only for men between 18 and 45).

NAME _____ AGE _____

STREET _____

CITY _____ STATE _____ m-33-p

Send This Coupon to Nearest Address Shown At Left

**"GIVE ME YOUR MEASURE
AND I'LL PROVE
IN THE FIRST 7 DAYS
YOU CAN HAVE
A BODY
LIKE MINE!"**

**No other Physical In-
structor in the World
has ever DARED make
such an offer!**

I'LL give you PROOF in 7 days that I can turn you, too, into a man of might and muscle. Right in the first week you will see and feel the improvements! Then I continue to re-build, renew and "overhaul" your body. Soon you are the proud owner of a powerful build like mine. People will notice the ruddy glow of health in your face, the sparkle in your clear eyes, the breadth of your shoulders. You will be the fellow who will walk off with the prettiest girl and the best job. Mail coupon below for a FREE copy of my new book. It reveals the secrets that changed me from a 97-pound weakling into a husky who won the title of "The World's Most Perfectly Developed Man."

Are you underweight? I'll add pounds where needed! Are you fat in spots? I'll pare you down to fighting trim!

And I'll also give you rugged health that banishes constipation, pimples, skin blotches and similar conditions that rob you of the good things of life!

I haven't any need for contraptions that may strain your heart and other vital organs. I don't dose you or doctor you. **Dynamic Tension** is all I need. It's the natural, tested method for developing real men inside and out.

48-Page Book FREE

Tells all about my method and what it has done to make big-muscled men out of run-down specimens. Shows, from actual photos, how I develop my pupils to my own perfectly balanced proportions. My system can do the same for you too. Don't keep on being only half of the man you CAN be! Put your name and address on the coupon, or a postcard, and mail it today. CHARLES ATLAS, Dept. 8-A, 115 East 23rd Street, New York, N. Y.

**CHARLES ATLAS, Dept. 8-A
115 East 23rd Street, New York, N. Y.**

I want the proof that your system of Dynamic Tension will make a new man of me—give me a healthy, husky body and big muscle development. Send me your free book, "Everlasting Health and Strength"—and full details of your 7-DAY TRIAL OFFER.



**Actual photo
showing
how
CHARLES
ATLAS
Looks
TODAY**



**Big Silver Cup
Being Given Away**

This valuable solid sterling silver cup stands about 14 inches high. I will award it to my pupil who makes the most improvement within the next 3 months. Therefore, no matter what your measurements may be now, you have an equal chance to win this cup—with YOUR name engraved on it!

Name
(Please print or write plainly)

Address

City..... State.....

When writing please mention Popular Mechanics

PARKS AIR COLLEGE
PARKS AIRPORT EAST ST. LOUIS, ILL.

**Offers YOU COLLEGE and PROFESSIONAL TRAINING
Majoring in AVIATION**

Accredited by the Illinois Superintendent of Public Instruction. U.S. approved as a Commercial Ground and Flying School and Mechanics' School. Open to high school graduates.
FOUR courses lead to B.S. degrees in Professional Piloting, Aviation Operations, Maintenance Engineering, Aeronautical Engineering.
FOURTEEN TRAINING PLANES are used in professional flight training which prepares graduates for airline flight operations. 74% of graduates enter air transportation in North and South America. 69,000 hours flight training given, 650 hours being flown monthly.
FACULTY of 31 specialists in various fields of aviation.
1541 graduates. Enrollment limited to a total of 300.
100-acre airport, 14 buildings devoted to school purposes exclusively. Dormitories and dining hall at the College.
Winter Term January 4th. Send postcard for new 60-page catalog.

**12th YEAR Registrar, Dept. PM-1
PARKS AIR COLLEGE, East St. Louis, Ill.**

ENGINEERING

DEGREE IN TWO YEARS
TECHNICAL AND APPLIED COURSES. Nonesententials omitted. TIME AND MONEY SAVED. Degrees 2 yrs., diploma 1 yr. Electrical, Mechanical, Architectural, Structural, Civil, Aeronautical, Highway. All courses include Air Conditioning, Electric, Refrigeration and Diesel. Short intensive courses 3 and 4 months in Electricity, Power Plant, Diesel-Electric, Air Conditioning, Electric Refrigeration, Drafting, Extensive modern equipment. LOW TUITION. Part-time work for room and board. Thousands of successful graduates in U. S. and foreign lands. Approved by Industry, endorsed by educators, recommended by alumni. One and two-year courses open in Sept., short courses open year round. 39th YEAR. Catalog free.

FINLAY ENGINEERING COLLEGE Kansas City, Mo.

Get U.S. Gov't. Job

Men—Women, age 18 to 50. Salaries to start, \$1260 to \$2100 yearly. For list of positions, how to qualify, locations, etc., write **OZMENT INSTRUCTION SERVICE, Dept. 111-C, St. Louis, Mo.** (This service established 1907)

**Want a Career in
photography?**

Wonderful opportunities to profit by the growing demand for photographs! Train at Home or in our modern studios. **Commercial, News, Portrait, Advertising, Natural Color and Motion Picture photography.** Famous experts will be your teachers. 29th year. Free booklet.
NEW YORK INSTITUTE OF PHOTOGRAPHY
10 West 33 St. (Dept. 49) New York City

BE A CARTOONIST

AT HOME IN YOUR SPARE TIME UNDER personal supervision of the famous cartoonist NORMAN MARSH creator of "DAN DUNN" appearing every day in big papers. Success—Fame—Real Money may be Yours when you learn Marsh's easy simple methods and secrets. Send name and address for free details of MARSH'S Personal course. ACT TODAY!
MARSH CARTOON SCHOOL
Chicago Daily News Bldg., Dept. A-100 Chicago, Ill.

SUCCEED IN LANDSCAPING

**Send for FREE Book
"Success thru Landscape Training"**
Get full details about this profession. A profitable career for men or women. Study at home in leisure time. Successful landscape architects receive large fees. Many students in spare time earn \$5, \$10, \$15 a week while learning. Pleasant, outdoor work, initiative rewarded. Write today.

**American Landscape School
6025 Grand Ave. Des Moines, Iowa**

Please send me FREE book describing how to become a Landscape Architect.

Name.....
Address.....
Age..... Occupation.....



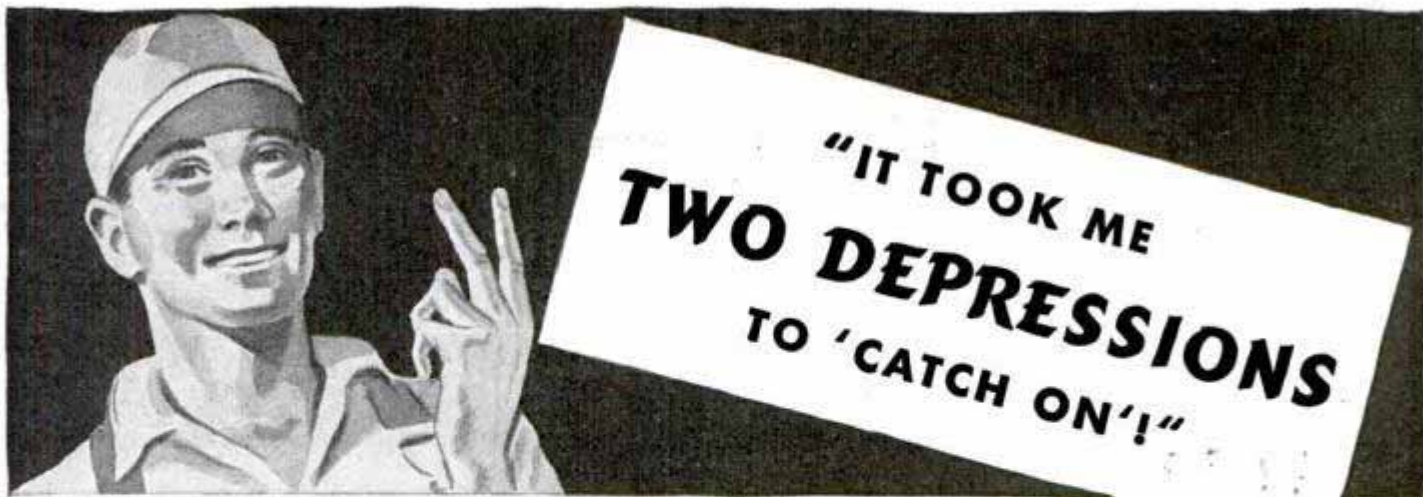

"Sure, I was 'sitting pretty' in 1928. Good job, swell girl, no worries. Then—*bang!*—it's '29 and I'm one of the first to be fired! Those were a couple of tough years, I'm telling you. Couldn't find work, and I'd been planning to get married!

"When things picked up, I was back at work — coasting along at the same pay on the same job. I got married. Thought some about the future — but didn't *do* anything about it.

"Then 'recession' came, and I was out again! But I noticed something this time. I noticed that the *trained* men, the boys who knew more than A-B-C about their jobs, weren't 'let out' right off the bat! In fact, the four fellows I knew who had been taking I. C. S. Courses kept their jobs right through the slump!

"Then I 'caught on'! I'm back at work again — and, believe you me, I'm going to stay here! The day I was rehired, I *enrolled with the I. C. S.!* They tell me there are 100,000 men enrolled with those Schools right now. (Fact is, I learned recently that my boss is an old I. C. S. graduate.) And if another business slump comes along, I'll be prepared to weather it! Because I know that the *trained* man is the *only* man equipped to 'ride out' stormy business seas!"

Do employers recognize the value of I. C. S. training? *Nearly 3000 leading industrial organizations have employee-training agreements with the International Correspondence Schools.* Mail the coupon — and mail it *today!*

INTERNATIONAL CORRESPONDENCE SCHOOLS

BOX 5540-J, SCRANTON, PENNA.

★ Without cost or obligation, please send me a copy of your booklet, "Who Wins and Why," and full particulars about the subject *before* which I have marked X: ★

- Architect
- Architectural Draftsman
- Building Estimating
- Contractor and Builder
- Structural Draftsman
- Structural Engineer
- Management of Inventions
- Electrical Engineer
- Electric Lighting
- Welding, Electric and Gas
- Reading Shop Blueprints
- Heat Treatment of Metals

- Sheet Metal Worker
- Boilermaker
- Telegraph Engineer
- Telephone Work
- Mechanical Engineering
- Mechanical Draftsman
- Machinist
- Patternmaker
- Diesel Engines
- Aviation Engines
- Auto Technician
- Auto Electrical Technician
- Radio
- Toolmaker

- Commercial Refrigeration
- Plumbing
- Heating
- Air Conditioning and Cooling
- Steam Engineer
- Steam Electric Engineer
- Marine Engineer
- R. R. Locomotives
- R. R. Section Foreman
- Air Brakes
- Highway Engineering
- Civil Engineering
- Steam Fitting
- Ventilation
- R. R. Signalmen

- Surveying and Mapping
- Bridge Engineer
- Bridge and Building Foreman
- Chemistry
- Coal Mining
- Mine Foreman
- Navigation
- Cotton Manufacturing
- Woolen Manufacturing
- Agriculture
- Fruit Growing
- Poultry Farming
- Pharmacy
- Fire Bosses

- Business Management
- Industrial Management
- Traffic Management
- Accountancy
- Cost Accountant
- C. P. Accountant

- Bookkeeping
- Secretarial Work
- Spanish
- French
- Salesmanship
- Advertising

- Service Station Salesmanship
- First Year College Subjects
- Business Correspondence
- Stenography and Typing
- Civil Service
- Railway Mail Clerk
- Mail Carrier

- Grade School Subjects
- High School Subjects
- College Preparatory
- Illustrating
- Cartooning
- Lettering Show Cards
- Signs

- Home Dressmaking
- Professional Dressmaking and Designing

- Advanced Dressmaking

- Foods and Cookery
- Tea Room and Cafeteria Management, Catering

Name.....Age.....Address.....

City.....State.....Present Position.....

If you reside in Canada, send this coupon to the International Correspondence Schools Canadian, Limited, Montreal, Canada
If you reside in England, send coupon to I. C. S., 71 Kingsway, London, W. C. 2, England



SOMETHING new for the winter sports fan has been patented. It is a coasting sled consisting of a frame and runners. One of the runners is mounted with a swivel arrangement for steering. The rider sits on a narrow board at the top rear portion of the frame, rests his feet on pivoted portions, as though he were riding a bicycle. The sled has ground-engaging parts for braking.



GREATER protection for the traffic policeman at night is provided by a garment made of light diffusing material and studded with light-reflectors. The garment is slipped over the standard uniform. Reflectors are attached at each shoulder and at front and back, outlining the officer's figure in the lights of an approaching car.



COMplete silence at the bridge table, desirable from the standpoint of many players, may be achieved through the use of a visible bidding machine patented recently. It consists of a circular box with a dial and pointer on top. Each player, in turn, operates



the dial to indicate his bid. Space is provided for "pass," "double," "redouble," and similar terms used in bridge bidding. In addition to bringing silence to the game, the bidder shows at a glance the suit and number of tricks bid, thus eliminating confusion.

DUCK hunters would find a newly patented device a convenience because it provides for complete control of decoys. The equipment consists of an inclined line with a dead bird carrier, thus permitting the hunter to use dead birds instead of wooden decoys. The line has means for controlling the position of the bird's head and neck to simulate life. This control is exercised by the hunter in the blind as the bird is carried down the line and into the water.

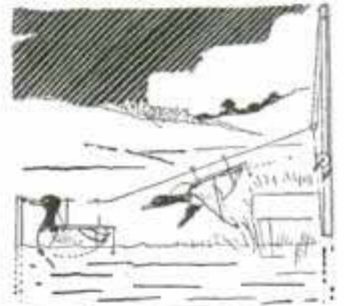

STEADINESS in holding the camera, greatly desired by the amateur photographer, may be achieved by using a newly patented support. It comprises a base with a handle and means for swivelly connecting the handle to the base. The handle loops around the hand to provide steadiness while the camera is being operated. The support is designed for small cameras.

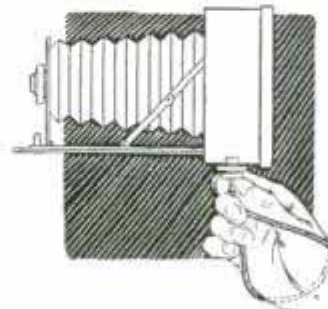

(Continued to page 33A)

THOUSANDS NOW PLAY

who never thought they could!



Learned Quickly at Home

I didn't dream I could actually learn to play without a teacher. Now when I play for people they hardly believe that I learned to play so well in so short a time.

*H. C. S., Calif.



Plays on Radio

I am happy to tell you that for four weeks I have been on the air over our local radio station. So thanks to your institution for such a wonderful course.

*W. H. S., Alabama



Wouldn't Take \$1,000 for Course

The lessons are so simple that anyone can understand them. I have learned to play by note in a little more than a month. I wouldn't take a thousand dollars for my course.

*S. E. A., Kansas City, Mo.



Surprised Friends

I want to say that my friends are greatly surprised at the different pieces I can already play. I am very happy to have chosen your method of learning.

*B. F., Bronx, N. Y.



Best Method by Far

Enclosed is my last examination sheet for my course in Tenor Banjo. This completes my course. I have taken lessons before under teachers, but my instructions with you were by far the best.

*A. O., Minn.

* Actual pupils' names on request. Pictures by professional models.

You, too, can play any instrument By this EASY A-B-C Method

YOU think it's difficult to learn music? That's what thousands of others have thought! Just like you, they longed to play some instrument—the piano, violin, guitar, saxophone or other favorites. But they denied themselves the pleasure—because they thought it took months and years of tedious study and practice to learn.

And then they made an amazing discovery! They learned about a wonderful way to learn music at home—without a private teacher—without tedious study—and in a surprisingly short time. They wrote to the U. S. School of Music for the facts about this remarkable short-cut method. And the facts opened their eyes! To cap the climax a free Demonstration lesson actually showed them how easy it was to learn.

The result? Over 700,000 men and women have studied music at home this simple, A-B-C way. Now, all over the

world, enthusiastic music-lovers are enjoying the thrilling satisfaction of creating their own music. They have found the key to good times, popularity and profit.

And that's what you can do, right now. Simply mail the coupon below. Get the proof that you, too, can learn to play your favorite instrument—quickly, easily, in spare time at home. Never mind if you have no musical knowledge, training or talent. Just read the fascinating illustrated booklet that answers all your questions—examine the demonstration lesson. Both will be mailed to you without the slightest cost or obligation. Tear out the coupon now, before you turn the page. (Instruments supplied when needed, cash or credit.) U. S. School of Music, 71 Brunswick Bldg., New York City.

Forty-first year. (Established 1898)

FREE DEMONSTRATION LESSON AND BOOKLET

U. S. SCHOOL OF MUSIC 71 Brunswick Bldg., New York City

Without cost or obligation to me, please send me your free illustrated booklet and demonstration lesson. I am interested in the instrument checked below:

PIANO
VIOLIN
GUITAR
PIANO ACCORDION
PLAIN ACCORDION
SAXOPHONE
CELLO

HAWAIIAN GUITAR
BANJO
MANDOLIN
UKELELE
CORNET
TRUMPET
HARP

CLARINET
TROMBONE
FLUTE
PICCOLO
ORGAN
DRUMS AND TRAPS
HARMONY AND COMPOSITION
VOICE CULTURE

Name..... Have you

This Instru. ?.....

Address.....

City..... State.....

FOR MEN WHO WANT TO LEARN A PROFITABLE TRADE

Complete DIESEL TRAINING

NO MATTER WHERE YOU ARE OR WHAT YOU DO — we have a training plan for YOU!

IF you are sincerely ambitious and interested in making good in the Diesel field, be sure to immediately investigate our flexible training plan that will fit your circumstances. A Plan for every Man. A Plan for those seeking immediate shop training as well as for those who cannot give up their present employment and income. For 33 years National Schools, a recognized leader in the field of trade education, has helped wide-awake men to success. This million-dollar trade school will supply you with a sincere, honest statement of facts of what you should do to quickly get into the profitable Diesel Industry. No exaggerations—no misstatements; and a definite plan to fit you.

Write Today for Full Details

Mail the coupon below. Find out how you can get the finest in Diesel training without delay. See how this great trade school operates and makes its facilities available to every ambitious man. Actual work in modern training shops, a part of every man's instruction. Shop methods time-tested for 33 years. Fascinating, efficient preparation. Get the facts.

WE ARE DEFINITELY INTERESTED IN HELPING MEN OF LIMITED INCOME AND "BLINDALLEY" JOB HOLDERS.

NATIONAL SCHOOLS



FREE BOOK *Los Angeles*

Request for Free Book

NATIONAL SCHOOLS (established 1905) Dept. 1-PMA
4000 South Figueroa Street, Los Angeles
Please send me, without obligation, your FREE BOOK and information regarding Diesel Employment Opportunities and Requirements.

NAME _____ AGE _____
ADDRESS _____ CITY _____ STATE _____

"Thanks for the JOB Mr. Miller— You helped me become a DRAFTSMAN and I got the Job"

Thousands of letters like this have been written to prove that **DRAFTING**, learned the American School way, **DOES PAY**. Here's work you will enjoy, for it's great to see some huge plant or immense building taking shape on the drawing board and the draftsman expects **STEADY WORK** for he is usually among the **first to be hired** and the last to be laid off. Why not get into drafting—have a profession instead of a trade?

Be a Draftsman — Learn at home We train you thoroughly and expertly in the half hours you can spare from work or pleasure. No need to burn midnight oil. Go as slow or as fast as your time will permit. Lessons are so clearly written that beginners can easily understand them and our system of "practice study" adds **EXTRA VALUE** to the instruction. Use head and hands in this fascinating profession, to make **more money** and put yourself in line for promotion. Write for **FREE** bulletin—there is no obligation of any kind.
O. C. MILLER, Secretary

AMERICAN SCHOOL
Dep't. DD145 Drexel at 58th Chicago

WIN YOUR DAWN WITH THE PATROL

Unequaled advantages in location for all year flying, finest equipment, highest Government approval for obtaining license in Transport, Limited Commercial, Private Flying, Radio, Sheet Metal, Mechanical Courses. For complete illustrated catalog, write—
J. D. GREEN, Director, Dept. PM 15, TULSA, OKLAHOMA



SCHOOL OF AVIATION



CARTOONING

FREE TRIAL LESSON! Cash in on your sense of humor—AT HOME—BY MAIL. Have fun! Make money! No experience needed to start. Write today for FREE LESSON, mailed postpaid. No obligation.
Moon Gag-Cartoon School, Dept. A, Fall Creek, Wis.

RADIO ENGINEERING, broadcasting, aviation and police radio, servicing, marine and Morse telegraphy taught thoroughly. Nine months' engineering course equivalent to three years' college radio work. School established 1874. All expenses low. Catalog free.
Dodge's Institute, Ada St., Valparaiso, Ind.

MAIL FOR FREE INFORMATION

BROOKLYN YMCA TRADE SCHOOL
1117 Bedford Ave., Dept. PM-68
Brooklyn, New York City, N. Y.

- Diesel Engines
 - Diesel Pre Engineering
 - Aviation Mechanic
 - Aeronautical Pre Engineering
 - Auto Mechanic
 - Refrigeration
 - Radio and Television Mechanic
 - Air Conditioning
 - Architectural-Mechanical Drafting
 - Electrical
 - Armature Winding
 - Oil Burner
 - Welding
 - Talking Pictures
 - Machine Shop
 - Window Display
- Name.....
Address.....

PATENT and SELL your INVENTION

A Simple Recipe for Inventive Success

PROBABLY the simplest recipe for inventive success would be this: First, a practical, useful invention; second, a good strong Patent; third, a buyer or a market. The inventor needs all three to get anywhere. Lacking any one, he is likely to get nowhere. The recipe is simple. Working it out isn't so simple. That is why inventors—and other inventively inclined men—have found the two books shown here so helpful. We've gone into each part of the recipe carefully. Exactly what is an invention? We tell you. What is a strong patent? We tell you. How can I go about finding a buyer? We tell you.

Many Questions Answered

But there's much more. For example, just how an Application for a Patent is made; how an inventor can safeguard himself with dated sketches as he goes along; how the pertinent Patent Office records are checked to see what other inventors may have done along the same line; how some successful

inventors have secured financial backing; simple ways to contact manufacturers; and many other points.

41 Years in the Business of Helping Inventors

The world needs, can use and will pay for practical, useful inventions. Manufacturers are on the alert for new articles, or improvements that will help them increase sales. Maybe you have one. Maybe not. These books will help you in deciding that. From that standpoint alone, they are valuable.

For more than 41 years, it has been our business to help inventors. We answer your questions and supply complete information about Patent procedure, costs, steps to take, kind of sketch or model needed, and much more. Our staff is made up of experienced Registered Patent Attorneys, Draftsmen, Searchers. Fees are reasonable—deferred payments arranged. Whether your idea is large or small, finished or still in the rough stage, you should have the facts both about Patenting and Selling. The information which we give you—based on long experience with thousands of inventors—is yours for the asking. No need to delay. These two books of facts may save you time, trouble, money, even later disappointment. Return the coupon—or write us a confidential letter—today.

115 Mechanical Movements Shown

In our book "Patent Protection" you will find illustrated 115 different mechanical movements. Maybe you'll find just what you need to work out some of your own ideas. Many other interesting pictures are shown in this book. Both books and an "Evidence of Invention" form sent to you FREE the same day we hear from you.

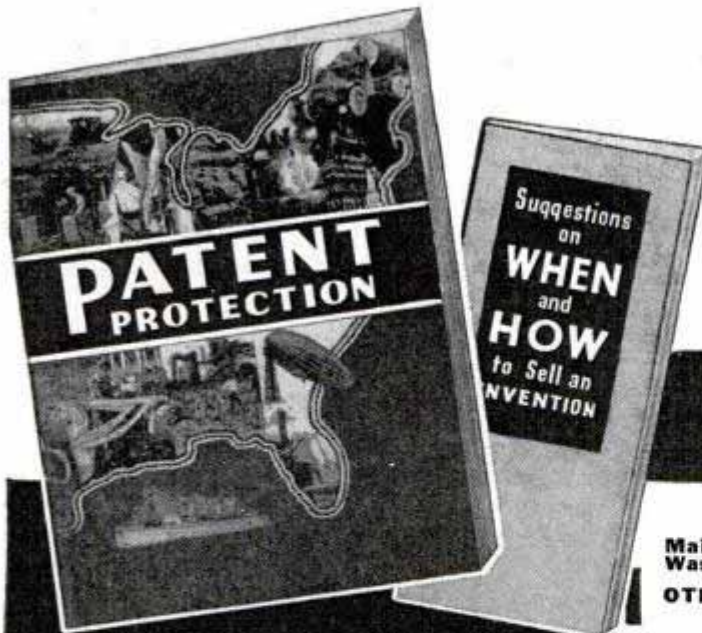

These 2 books tell you
how to go about it ..
Both Sent FREE >

VICTOR J. EVANS & Co.

REGISTERED PATENT ATTORNEYS

Main Office: 112-A Victor Building,
Washington, D. C.

OTHER OFFICES:

514-N Empire Building, Pittsburgh
405-N Garfield Building, Los Angeles
1010-N Hobart Building, San Francisco

Send me FREE copies of your books, "Patent Protection" and "When and How to Sell an Invention." (Note: Same books supplied by any of branch offices listed above.)

Name.....

Street and No.....

City or Town..... State.....

**IN THESE
FAMOUS
CHICAGO
TRAINING
SHOPS
YOU CAN**



COYNE occupies this entire Modern, fireproof Building.

Train for

**ELECTRICITY
IN 12 WEEKS AT COYNE**

Prepare yourself in my wonderful Daylight training shops, for a better job . . . a job that brings good pay—in the one industry that is constantly going ahead, even through the hardest times. After my practical shop training in this world-famous Chicago school you are ready for your start in the electrical field where real opportunities exist for the trained man.

**All Practical Training on Real Equipment
You Don't Need Advanced Education or Previous Experience**

You get triple training at Coyne—through your eyes, your ears, and your hands. And it is all practical down-to-earth training on real, modern electrical machinery and equipment. Real line generators, motors, dynamos, etc.—all right here in big daylight shops for you to work on and gain practical knowledge from actual operation. No dull books—no correspondence. You don't even need advanced education or previous electrical experience to master my easy shop training methods.

Amazing Student Scholarship Loan Plan

**PAY FOR TRAINING
AFTER YOU GRADUATE**

In Small Monthly Payments

Lack of ready cash need not stop you from getting Coyne training. If you are ambitious and determined to improve yourself—if you are anxious to get ahead in the great field of electricity—I will let you take your training now...and you can pay for it after you graduate, in easy monthly payments. And even then you take over a year to complete your payments. Send coupon today for all details of this remarkable offer.

**Spare Time Work While Training
Employment Help After Graduation**

I help you to find spare time work to help pay your living expenses while training. Then after graduation you are given the service of my employment department any time you need it.

**DIESEL • AIR CONDITIONING
ELECTRIC REFRIGERATION**

So that your training will be complete and to increase your earning capacity I will include for a short time at no extra cost training in DIESEL, Electric Refrigeration and Air Conditioning.

Send Coupon Today

Mail the coupon at once for my big, illustrated FREE BOOK that tells all about Coyne training, the amazing opportunities in the electrical field, and complete details of my spare time employment service and my "Pay After Graduation" Plan.

H. C. LEWIS, President

COYNE ELECTRICAL SCHOOL
500 S. Paulina St. Dept. 19-72 Chicago, Ill.

SEND NOW FOR FULL DETAILS!

**H. C. Lewis, Coyne Electrical School,
500 South Paulina St., Dept. 19-72, Chicago, Ill.**

Dear Mr. Lewis:—Send me your big Free Book about Coyne training, and give me all details regarding your spare time employment service and "Pay After Graduation" Plan.

NAME.....
ADDRESS.....
CITY.....STATE.....

**EASY TO PLAY
—EASY TO OWN**



You've always wanted to play this fascinating instrument. Now there is no reason to delay. Now you may thrill family and friends, with a chance to earn extra cash at dances, entertainments and on the radio. For now there is a genuine DEAGAN Marimba (including complete, easy lessons) at the lowest price in history. . . . To write for details TODAY may easily mean a LIFE-TIME of pleasure, profit and popularity!

J. C. DEAGAN, Inc., 3451 Deagan Building, CHICAGO

**LEARN AVIATION
IN LOS ANGELES**



Huge increases in aviation activity creating good paying positions. Rapid advancement for California Flyers graduates. Only U. S. Government approved Los Angeles school offering flying mechanics drafting and aircraft construction. Most modern equipment and strategically located school in America. Low tuition. Free transportation to L.A. Write for Catalog.

**CALIFORNIA FLYERS
SCHOOL OF AVIATION—Dept. PM 1
LOS ANGELES MUNICIPAL AIRPORT, INGLEWOOD CALIF.**

**Write and Speak
MASTERLY
ENGLISH**



Learn correct English with Sherwin Cody's new invention. No rules to memorize. Like a fascinating game. Spare-time study. 15 minutes each day quickly gives you command of English. Send for free book, "How You Can Master Good English in 15 Minutes a Day." Write today. SHERWIN CODY SCHOOL OF ENGLISH
51 Searle Bldg. Rochester, N. Y.

**CARTOON YOUR WAY
TO SUCCESS!**

DON'T COPY—LEARN TO ORIGINATE!
RAYE BURNS will teach you HOW TO CREATE ORIGINAL CARTOONS at home that you can SELL! Course contains 26 lessons and over 600 illustrations. All for Only \$2.85
Send name and address for free details.

RAYE BURNS SCHOOL, Dept. M, BOX 2194, Cleveland, Ohio

**Learn
MECHANICAL DENTISTRY**

A profession offering unlimited opportunities. Most modern and complete course embracing every branch from Plate to Forcelain Work, which prepares you to work for Dentists or start your own business. Individual instruction—practical training in day or night school. No books—no classes. Catalog upon request
MCCARRIE SCHOOL OF MECHANICAL DENTISTRY
297 N. Broad St. Dept. 741 Philadelphia, Pa.

**How To Secure A
Government Position**

Why worry about strikes, layoffs, hard times? Train now for a Government job. Increased salaries, steady work, travel, good pay. Let us help you become a Railway Postal Clerk, Post Office Clerk, City Mail Carrier, Rural Carrier—help you get a position in Government Classified Service. I was a Civil Service Examiner for nearly 8 years.

FREE BOOK This coaching has helped thousands. Big illustrated book tells about Government jobs and how our instruction helps to qualify you to get the one you want. Send for a free copy TODAY.

PATTERSON SCHOOL, Arthur R. Patterson
(Former Gov't. Examiner) Principal,
81 Mercantile Bldg., Rochester, N. Y.
Send without obligation, free book "How to Secure a Government Position."
Name.....
Address.....





Our Graduates Run

47% of ALL the Identification Bureaus in America!

Here's a Partial List of City and State Institutions In Which Our Graduates Were Placed As **FINGER PRINT EXPERTS**

Arrest Him, Officer!
I'll have complete facts on the other fellow tonight!



Send for complete list of over 600 bureaus where our graduates are placed. THEN write the nearest bureau and learn what our graduates think of us.

State Bureau of Massachusetts	Sault Ste. Marie, Mich.	Gadsden, Ala.	Orangeburg, S. C.	Scranton, Pa.
State Bureau of Illinois	Billings, Mont.	Decatur, Ga.	Berkeley, Calif.	Mobile, Ala.
State Bureau of Iowa	Laconia, N. H.	Anderson, Ind.	Lancaster, Ohio	Lincoln, Neb.
State Bureau of Idaho	Salem, N. J.	Massillon, Ohio	Mingo Jct., Ohio	Seattle, Wash.
State Bureau of Colorado	Cedar Rapids, Ia.	Waltham, Mass.	Okmulgee, Okla.	Ferdale, Mich.
State Bureau of Washington	London, Ohio	Grand Forks, S. D.	Hazleton, Pa.	McAlester, Okla.
State Bureau of Michigan	Elgin, Ill.	Bremerton, Wash.	Yakima, Wash.	Negaunee, Mich.
State Bureau of Utah	Miami Beach, Fla.	Long Beach, Calif.	Oklahoma City, Okla.	Lawton, Okla.
State Bureau of Ohio	Asheville, N. C.	Ft. Worth, Texas	Nunda, N. Y.	Crown Point, Ind.
State Bureau of Pittsburg, Calif.	Ft. Scott, Kans.	Nunda, N. Y.	St. Louis, Mo.	Bay City, Mich.
Kokomo, Ind.	Augusta, Ga.	St. Louis, Mo.	Lansing, Mich.	Roanoke, Va.
El Reno, Okla.	Florence, S. C.	Salisbury, N. C.	Hamtramck, Mich.	Chatham, Ont., Canada
Boston, Mass.	Hinsdale, Ill.	Elyria, Ohio	London, Ont., Canada	Glendale, Calif.
Mexico City, Mex.	New Bedford, Mass.	Carson City, Nev.	Compton, Calif.	Joplin, Mo.
Parsons, Kans.	Neosho, Mo.	Burlington, Iowa	Trenton, N. J.	Lima, Ohio
Tallahassee, Fla.	Sapulpa, Okla.	West Chicago, Ill.	Buena Vista, Col.	Selma, N. C.
Columbia, S. C.	New York, N. Y.	Amarillo, Texas	Gainsville, Texas	Stillwater, Okla.
Hull, Que., Can.	Lufkin, Texas	Winfield, Kans.	Elma, Iowa	Drumright, Okla.
Portsmouth, Ohio	Tijuana, Mexico	Cambridge, Ohio	Chillicothe, Ohio	Victoria, B. C., Canada
Selma, Ala.	Berlin, N. H.	South Orange, N. J.	Detroit, Mich.	Baton Rouge, La.
Atchison, Kans.	Greenville, S. C.	Savannah, Ga.	Great Bend, Kans.	Hawaiian Islands
Hot Springs, S. D.	Havana, Cuba	Omaha, Neb.	Kulangsua, Amoy, China	Parkersburg, W. Va.
Glens Falls, N. Y.	Seattle, Wash.	Patterson, N. J.	El Paso, Texas	Huntsville, Texas
	Meridian, Miss.	Beverly, Mass.	Everett, Wash.	New Iberia, La.
	Dodge City, Kans.	Canon City, Colo.	Schenectady, N. Y.	Sheridan, Wyo.
	Danville, Va.	St. Cloud, Minn.	Alhambra, Calif.	Little Rock, Ark.
	Easton, Pa.	Franklin, Mass.	Livingston, Mont.	Aberdeen, S. D.
	Syracuse, N. Y.	San Juan, P. R.	Saginaw, Mich.	Ada, Okla.
	El Centro, Calif.	Henderson, N. C.	Wilkes Barre, Pa.	Pontiac, Mich.
	Tampa, Fla.	Erie, Pa.		Granite, Okla.
		Pecos, Texas		Wichita Falls, Texas

Want a Regular Monthly Salary?

Be a Secret Service and Identification Expert!

Enjoy all the thrill of getting your man!—with no personal danger—PLUS a regular monthly paid salary and the opportunity to share in Rewards. Become a well paid Finger Print and Crime Detection Expert. Learn at home—in your spare time—and at low cost—the unique secrets of this young, fascinating and fast growing profession. You have exactly the

same opportunity that was offered the hundreds of our graduates who now hold splendid positions in the more than 600 institutions partially listed on this page. Each of these bureaus has anywhere from ONE to FIFTEEN of our graduates on regular monthly salaries—and new openings develop from time to time.

Wonderful Opportunity for TRAINED MEN in This Young, Fast Growing Profession

Of the many thousands of cities in America, more than three-fourths are STILL without identification bureaus and many more are bound to come! That spells OPPORTUNITY! But you must be READY for it! It is easy to

master this profession that combines thrills with personal safety AND the security of a steady income! We show you HOW—just as we have already shown the hundreds who now hold good pay positions.

FREE! The Confidential Reports No. 38 Made to his Chief

Rush coupon for YOUR free copy of these reports! Follow Operator No. 38 on his exciting hunt for a murderous gang of counterfeiters. BETTER than Fiction, because every word is TRUE. ALSO, get free, "The Blue Book of Crime," showing the wonderful opportunities in the field of Finger Prints and Crime Detection. Take TODAY your first step toward a steady income and success! Mail the coupon AT ONCE.

INSTITUTE OF APPLIED SCIENCE
1920 Sunnyside Ave., Dept. 1351, Chicago

INSTITUTE OF APPLIED SCIENCE
1920 Sunnyside Ave., Dept. 1351, Chicago.

Gentlemen: Without any obligation on my part whatever, send me the Confidential Reports of Operator No. 38, also illustrated "Blue Book of Crime", complete list of bureaus employing your graduates, together with your low prices and Easy Terms offer. (Literature will be sent ONLY to persons stating their age.)

Name.....

Address.....

.....Age.....

Boise, Idaho
Bartlesville, Okla.
Miami, Fla.
Orlando, Fla.
York, Pa.
St. Paul, Minn.
Pittsburgh, Pa.
Walla Walla, Wash.
Lincoln, Neb.
Birmingham, Ala.
Columbus, Ohio
Havana, Cuba
New Haven, Conn.
Great Falls, Mont.
Galveston, Texas
Houston, Texas
Waterloo, Iowa
Windsor, Ont., Canada

Now is the Time to... **Get Into AVIATION Train at LINCOLN**

Bill Burgess, the Pilot pictured below, trained at LINCOLN. Now he pilots his plane all over the country in aerial mapping service. Travel, adventure, good-pay... these are Bill's reward for Training at Lincoln... a Government Approved School.

BE A PILOT, MECHANIC OR AN AERONAUTICAL ENGINEER Lincoln training has helped hundreds to reach success in Aviation. It can help YOU prepare for a good position as Licensed Pilot, Mechanic or as Aeronautical Engineer. Learn to fly many types of modern airplanes; to overhaul and repair modern airplanes and engines; assist our Engineers in designing and building real airplanes. **GOOD POSITIONS and GOOD PAY** in Aviation. Our Lincoln Graduates regularly taking positions. We train you and assist Graduates in locating positions. We furnish Board and Room for part-time employment while in training. **MAIL COUPON TODAY** for complete information.

LINCOLN AIRPLANE & FLYING SCHOOL
561 Aircraft Bldg., Lincoln, Nebraska

I'd certainly like to get into Aviation. Please send complete information about Lincoln Training.

Name.....
Address.....
City..... State.....



AUTO BOOKS SENT FREE

on approval. Just mail the coupon and we'll send you a set of these remarkable auto books, just off the press. Whether you are a mechanic or helper, expert or apprentice, auto owner or driver, if you're interested in knowing all about automobile mechanics, take advantage of this FREE OFFER.

GET A BETTER JOB

A better job—in the gigantic auto industry. **BIGGER PAY**—a chance to go into business for yourself and get a share of the huge profits, are waiting for any man who even half tries to improve himself. Learn auto engineering with these wonder books a new way—without studying or memorizing. Simply use the **JIFFY INDEX** to look up the answer to any auto problem. Built by eleven of America's greatest automobile engineers, and written in simple language so you can understand it. Very newest cars, all covered.

FREE Privilege of consulting Automobile Engineers of American Technical Society for one year without cost if you mail coupon immediately

Send NOW and we will include an EXTRA volume full of up-to-date diagrams.

CAN YOU FIX IT? These wonder books tell step by step HOW to take out "play" in differential — to kill the shimmy in steering—to set TIMING—how to put your finger instantly on engine trouble and then the quick expert way to FIX it. Newest improvements fully covered. Equal to a complete trade course at less than a fourth the cost.

6 BIG VOLUMES
Brand New Edition
2500 pages, 2000 illustrations, wiring diagrams, etc., including Marine Engines, Aviation Motors, Diesel engines, etc. De Luxe edition, gold-stamped flexible binding.

AMERICAN TECHNICAL SOCIETY,
Drexel Ave. & 58th St., Dept. A119, Chicago, Ill.

I would like to see the new 6-volume edition of your AUTO BOOKS. I will pay the few cents delivery charges only, but if I choose to, I may return them express collect. If after 10 days use I prefer to keep them, I will send you \$2 and pay the balance at the rate of only \$3 a month, until \$24.80 is paid. Please include free membership and extra Volume 7, as per your offer above.

Name.....
Address.....
City..... State.....

Attach letter stating age, occupation and name and address of employer and that of at least one business man as reference.

New Oil Heater by



LACO

LOW \$23⁵⁰ AS

Beautiful! Durable! More Heat!

Now—a really sensational heater... one of the most attractive and durable we have ever built—now yours at the Lowest Price in LACO history! Installs like a stove—needs no basement. LACO's famous Two-Stage, Double-Flue burner capable of developing tremendous heat! Perfect LACO Inner-Heating-Unit utilizes utmost of the heat. Equipped with easy heat-regulator. Quiet. Safe. Circulates and humidifies the air. Beautiful lifetime steel cabinet. Your choice of sizes.

Newest LACO "Gun-Type" Burner

Now you can save money—have LACO's newest, finest pressure-type oil burner! New simplicity, new quietness, new fuel economy, new Low Price! Exclusive LACO features transform low-priced heavy oil into finest mist for extra rich mixture, extra hot flame, no waste! Result of 12 years of burner building. **GUARANTEED.**

WRITE Rush card for new free illustrated booklet giving complete details and illustrations of my Low Priced LACO Heaters and Burners. L. A. COCKLIN, Pres.



LACO OIL BURNER CO., 119 Union Ave., Griswold, Iowa

ENGINEERING DEGREE IN TWO YEARS

B. S. DEGREE courses in engineering: Electrical, Civil, Chem., Mechanical, Radio and Television, or Aeronautical. 1 yr. Mech. Drafting. Intense, practical, thorough program. Prep courses without extra charge. Earn while you learn in this industrial center. Low tuition. Enter March, June, Sept., Dec. Write for Catalog. 229 E. Washington Blvd., Fort Wayne, Ind.

INDIANA TECHNICAL COLLEGE

Regain Perfect Speech, If You STAMMER

Send today for beautifully illustrated book entitled "DON'T STAMMER," which describes the Bogue Unit Method for the scientific correction of stammering and stuttering. Method successfully used at Bogue Institute for 38 years—since 1901. Endorsed by physicians. Full information concerning correction of stammering sent free. No obligation. Benjamin N. Bogue, Dept. 198 Circle Tower, Indianapolis, Indiana.

LEARN WATCHMAKING AND ENGRAVING

BY OUR PROFIT-SHARING PLAN OUR GRADUATES SUCCEED

One of our Iowa students started in a very small way—now doing over \$30,000 a year. Another in Wisconsin, over \$10,000 the first year. Day or night classes. Call or write for FREE BOOK, Chicago School of Watchmaking, Dept. 7101, 155 N. Clark St., CHICAGO

WHY NOT spend spring, summer, fall, gathering butterflies, insects. I buy hundreds of kinds for collections. Some worth \$1 to \$7 each. Simple outdoor work with my Instructions, pictures, price list. Profit—pleasure. Send 10c (not stamps) for illustrated Prospectus before sending butterflies.

MR. SINCLAIR, DEALER IN INSECTS
Dept. 6, Box 1830 San Diego, Calif.

WILL YOU WEAR THIS SUIT and Make up to \$12 in a Day!

Let me send you a fine all-wool union tailored suit **FREE OF ONE PENNY COST.** Just follow my easy plan and show the suit to your friends. Make up to \$12 in a day easily. No experience—no house-to-house canvassing necessary.

Send for Samples — FREE OF COST

Write today for FREE details. **ACTUAL SAMPLES** and "sure-fire" money-getting plans. Send no money.

H. J. Collin, PROGRESS TAILORING CO., Dept. N-216, 500 South Throop Street, Chicago, Illinois.

QUICK CASH IN NEW POTATO CHIPS

START AT HOME

Here's your chance—a money-making business of your own. Turn potatoes into cash by making new kind of Potato Chips with my improved outfit. Makes delicious, superior, "NON-GREASY" Chips at low cost. A few hours' practice does it. Begin anywhere—city, village, town. Potatoes cheap and plentiful. Wholesale or retail. Steady year 'round business.



Groceries, markets, restaurants, taverns, do the retailing for you. **WE HELP START YOU IN BUSINESS.** Great quantities of Chips are eaten daily. Profit large—unusually so. You can start this money-making business on a "next to nothing" outlay of cash. Write for Potato Chip Booklet.

LONG-EAKINS COMPANY
128-S High St., Springfield, Ohio



CARTOONISTS

Learn to draw original Cartoons. Send one dollar for my book, **FIRST STEPS TO A CARTOON CAREER.** Written and illustrated by a nationally known cartoonist. 22 lessons based on 20 years experience as cartoonist on great metropolitan dailies. Printed on strong paper. Spiral binding.

\$1

DORMAN H. SMITH, Box C597, San Rafael, California

PIANO — HAWAIIAN (STEEL) GUITAR SPANISH GUITAR...easily learned at home

Become a skilled musician by our simple, short-cut note method. Play songs almost instantly. **COST LESS THAN 2c A DAY!** Money back guarantee. Write for free details. **HAMANN INSTITUTE, 3016 N. 24th Place, Dept. R-1, Milwaukee, Wis.**



LOOK! Baby Chicks

THOUSANDS WEEKLY ALL YEAR. Finest quality & Layers in 40 breeds. Hybrid Baby Pullets and Cockerels, B. W. D. Fasted, Ducklings, Goslings, Baby Turkeys, Guinea. In business 30 years. Catalog free. **AGENTS!** Big money made selling Nabob Chicks. Write! **NABOB HATCHERIES, BOX M, GAMBIER, OHIO**



GOOD MONEY to be made in POULTRY

Many Earn Extra Spare - Time Profits — Or You May Build a Business of Your Own



Whether you want a job at good pay or a profitable business of your own, Poultry offers you many opportunities. Poultry meat and eggs are always in demand, and at times there is a shortage of trained poultrymen. My Home Study Course shows you how to succeed—how to save money and make money, either for yourself or for an employer.

FREE Book Shows the Way to Big Pay and Big Profits

CASH IN SPARE TIME or FULL TIME

No matter where you live or what you do now, my proved course will show you what to do with poultry right from the start. If you choose to start a business of your own, I'll show you how to make a small investment grow, show you how to expand. Send for the facts today.

Mail coupon below TODAY —for my Big NEW FREE Book, "How to Raise Poultry for Profit." My forty years of experience are yours. The poultry industry may need you, and therefore you need my free book. Get it—and get in line for the extra money that can be made in poultry!



Mail NOW for FREE Book

NATIONAL POULTRY INSTITUTE, Dept. 39-D
Adams Center, N. Y., Att'n: Harry M. Lamon, Pres.

Dear Mr. Lamon: Send me your FREE Book, "How to Raise Poultry for Profit". I want to know more about my opportunity to make extra money spare or full time.

Name.....
Address.....

U. S. GOVERNMENT JOBS!

\$1140 TO \$2100 FIRST YEAR

GET A 1939 GOVERNMENT JOB

Many Government examinations include Mental Tests. Try yourself. Answer the following problems and mail at once. Our examiners will correct your work, rate, and return it. The result should tell you the possibility of a high rating on the U. S. Government examination.

MENTAL TEST

- The Postmaster General is given office by: (1) Congress; (2) The Civil Service Commission; (3) The President with the advice and consent of the Senate.
Give number of correct answer.....
- A train makes 3/5 of its trip in 54 minutes. In how many minutes will it make the entire trip?
Answer.....
- MAILBAG is to LOCK as LETTER is to (1) Stamp; (2) Seal; (3) Cancellation.
Number of Answer.....
- A letter is given special protection if mailed (1) Special Delivery; (2) Registered; (3) Air Mail.
Answer.....
- A clandestine meeting is one that is (1) Secret; (2) Accidental; (3) Romantic.
Answer.....
- If it takes 15 clerks, 30 minutes to sort a certain mail, how many clerks will be needed to sort the same mail in 25 minutes.
Answer.....
- Wheeling, W. Va., is (1) North; (2) South; (3) East; (4) West, from Trenton, N. J.
Answer.....
- The saying "Many hands make light work," means most nearly (1) When several work together the task is easier; (2) There are often too many on a job; (3) Most people prefer easy jobs.
Answer.....

FRANKLIN INSTITUTE, DEPT. F195, Rochester, N. Y.
I send you my work on Mental Test No. 1. Kindly have your examiners correct this work and return to me with my rating and at no cost to me. Kindly send 32 page book "How to Get U. S. Government Job" and full information regarding Government Jobs. Send list of Jobs and tell me how to qualify for one.

Name.....
Address.....
Age.....

I'll Train You in
DRAFTING
until You Get a
GOOD PAY JOB

GET MY PROVEN PAY RAISING PLAN

Get practical training. Take up Drafting—because it gives you bigger, better chance to get into your favorite field—Electricity, Aviation, Diesel, Air Conditioning, Automotive, Building, Machinery, Transportation, etc. Remember, everything built has its birth on the Draftsman's Table.

Draftsmen Draw Good Pay

I have trained thousands of men aged 16 to past 50 in their spare time at home, to qualify for Bigger Jobs at Better Pay. Let me train you in a short time by same easy, low cost practical method. No experience needed. High School education not necessary.

All Working Tools Furnished

You get complete Professional Draftsman's Tools and Drawing Table—sent without extra charge at once. Mail coupon for Free Book about my PROVEN PAY RAISING PLAN. Write TODAY!

FREE BOOK

ENGINEER DOBE, Div. 3371, Libertyville, Illinois

Send me your Free Book "SUCCESSFUL DRAFTSMANSHIP." Explain how you assist your graduates to good positions as Draftsmen.

NAME.....AGE.....

ADDRESS.....

TOWN.....STATE.....

Know! YOUR CAR

ASK TO SEE IT!



GOOD NEWS—JUST OUT

1938 AUDELS NEW AUTOMOBILE GUIDE is NEW from cover to cover. Explaining the Theory, Construction and Servicing of modern motor cars, trucks and buses; and the application of auto type Diesel Engines. . . . PRACTICAL INFORMATION IN HANDY FORM, 1540 PAGES COVERING . . .

AUTO REPAIRS & SERVICE HELPS

All the Parts of an Automobile—Automotive Physics—The Gas Engine—How a Gas Engine Works—Gas Engine Principles—Multi-Cylinder Engines—Horse Power—Automobile Engines—Engines: Stationary Parts—Engines: Moving Parts—Pistons—Piston Rings—Connecting Rods—Crank Shafts—The Valves—The Valve Gear—Cams and Cam Action—Valve Timing—Cooling Systems—Gasoline—Fuel Feed Systems—The Mixture—Carburetors—Automatic Choke—Super-Chargers—Transmissions—Synchro-Mesh—Clutches—Universals and Propeller Shafts—The Differential—Rear Axles—The Running Gear—Brakes—Wheel Alignment—Knee Action—Steering Gear—Tires—Lubricants and Lubrication—Automotive Electricity—Ignition Systems—Magneto Ignition—Spark Plugs—Ignition Coils—Distributors—Automatic Spark Control—Ignition Timing—Generators—Starters—Generator and Starter Testing—Lighting Systems—Storage Batteries—Battery Charging—Battery Testing Troubles, Automotive Diesel Engines. Inside Views of all Automobile Parts Fully Illustrated. To Get This Assistance for Yourself Simply Fill In and Mail Coupon Today.

\$4 COMPLETE • PAY ONLY \$1. A MONTH

THEO. AUDEL & CO., 49 WEST 23rd STREET, NEW YORK
 Please send me postpaid AUDELS NEW AUTOMOBILE GUIDE (\$4) for free examination. If I decide to keep it, I will send you \$1 within 7 days; then remit \$1 monthly until purchase price of \$4 is paid. Otherwise, I will return it to you promptly.

Name.....
 Address.....
 Occupation.....
 Reference.....-PM

Air Become An Conditioning Engineer

Big fast-growing field for men trained in design, estimating, insulating, installing and servicing. Offers real opportunities in Air Conditioning new buildings and remodeling worth-while old buildings. Write today for method of how you can prepare for this thriving industry. No obligation.

American School, Dept. AC-145, Drexel at 58th, Chicago

LAW STUDY AT HOME

Legally trained men win higher positions and bigger success in business and public life. Greater opportunities now than ever before. Big corporations are headed by men with legal training. More Ability: More Prestige: More Money. We guide you step by step. You can train at home during spare time. Degree of LL. B. Successful graduates in every section of the U. S. We furnish all text material, including 14-volume Law Library. Low cost, easy terms. Get our valuable 48-page "Law Training for Leadership" and "Evidence" books FREE. Send for them NOW. LaSalle Extension University, Dept. 164-L, Chicago. A Correspondence Institution

AVIATION APPRENTICES

GOOD PAY GOOD FUTURE
 AIRMINDED YOUNG MEN INTERESTED IN TRAINING FOR ENTERING THE WELL PAID FIELD OF AVIATION AS APPRENTICES—Write immediately, enclosing stamp. MECHANIX UNIVERSAL AVIATION SERVICE CO. Wayne County Airport, Box 857, Dept. E, Detroit, Mich.

HOW TO MAKE BETTER PHOTOS

Stop wasting good film! Do away with unnecessary camera expense! Take a good picture every time! The kind you'll be proud to show. Sell your photos to magazines and newspapers. Our easy, convenient home-study course will show you how. Write today for FREE Catalog! UNIVERSAL PHOTOGRAPHERS, Dept. 71, 10 West 33 Street, New York City.

Learn Public Speaking At home—in spare time. Many overcome "stage-fright," gain self-confidence and increase earning power, this easy way. Write for free booklet, *How to Work Wonders With Words* and requirements. North American Institute, Dept. 1351, 3601 Michigan Ave., Chicago, Illinois

CRIME DETECTION SECRET SERVICE AND FINGER PRINTS **SECRET SERVICE BOOK FREE**

No Money Down—Actual Crime Cases—If You Act Quick! We will send you this stirring book on Crime Detection, Secret Service and Identification Work for 30 days free reading. Send no money. If you decide to keep it, then send me only \$1.00. If not, return it. WRITE TODAY. Literature will be sent only to persons stating their name. T. G. Cooke, Dept. 1351, 1920 Sunnyside Ave., Chicago, Ill.

MONEY-MAKING OPPORTUNITY
 for men of character. Over \$1,600 per month earned by California man. Over \$400 a week by Georgia man. \$1,000 in a month by Delaware man. Exclusive franchises available for an invention expected to replace a multi-million dollar industry. Install on free trial. Sell itself. Recents. Exclusive proposition. Write F. E. Armstrong, Dept. 1112-A, Mobile, Alabama.

I WANT MEN

FORDS GIVEN **TEA AND COFFEE ROUTES PAYING UP TO \$60.00 IN A WEEK**

National company needs more men at once to make regular calls on local routes. No experience needed. Operate on our capital. I give producers brand-new Ford cars as bonus. Rush name on postcard for FREE facts. ALBERT MILLS 9231 Monmouth Cincinnati, Ohio

INVENTORS

COMPLETE INFORMATION ON HOW TO OBTAIN PATENT AND MARKET INVENTIONS

If you have ideas, if you have invented something, if you're interested in inventing something, you need this new 48-page book that gives the entire Story of Patents. It tells you for the first time about new phases of invention, how others succeeded, how the patent laws protect you, how to market your invention, where to obtain finances, how to form a company, partnership, or arrange for royalties from your invention's sale.

PRACTICAL BENEFITS

You will find 6 complete pages illustrated with simple inventions that have succeeded in six different fields of industry. Over 100 illustrations are in this book. You will read the stories of ten (illustrated) of America's most famous inventors. You will find an experienced and thorough survey of market conditions affecting the inventor—showing the possibilities for commercial invention today. Entire chapters are devoted to the value of a patent in promoting the final success of your invention. The

importance of quick action in applying for patent is stressed—facts revealing danger of delay are emphasized.

If you expect to realize profits from your invention you must protect it with a U. S. Patent. Otherwise you may find that all your time and labor have been lost, because it often happens that other inventors are working on the same idea. If you have an idea, an invention, or an ambition to invent—get the information on obtaining patent AT ONCE!

WHAT A PATENT DOES FOR YOU

Without a U. S. Patent, you cannot expect to reap the profits that your invention may make possible. Send at once for this book. After you get that, you'll know exactly what to do to protect yourself. Anything you write us or send us is strictly confidential between us. All letters and drawings are kept in strong, steel, fireproof files, which are open only to us or authorized members of our

staff. We have secured patents for inventors located in every State in the Union. The practice of our organization is confined entirely to Patents, Trademarks and Copyrights. We have had years of experience in Patent Matters. When you place your idea in our hands, we are in position to proceed at once to secure protection for you. Our fees are reasonable, and if you desire, we can arrange convenient terms of payment.

Get This
FREE BOOK

IMMEDIATELY MAIL COUPON TODAY!

This new 48-page book of facts is absolutely FREE! You need it NOW. Simply fill out the coupon, and mail. The field of invention changes constantly—here is the latest information. Within a very few days you will receive our Free Book, together with the Record of Invention Blank described here. Write NOW—

Get
FREE COPY



48
PAGES
Over 100
Illustrations

CLARENCE A. O'BRIEN
and HYMAN BERMAN

70-T Adams Building, Washington, D. C.

Registered Patent Attorneys Before U. S. Patent Office

Please send me at once your Big Free 48-Page Book, "Patent Guide for the Inventor" and your specially prepared "Record of Invention" form. This request does not obligate me.

Name.....

Address.....

(Please write or print plainly)

PATENTS

Booklet Free Highest References
Promptness Assured Best Results

Send drawing or model.

ALL BUSINESS GIVEN PROMPT AND PROPER ATTENTION

Listed Patent Lawyer in the latest editions of the Rand-McNally Directory of Bankers and Bank-Recommended Attorneys, published by Rand-McNally & Co., Chicago, Ill.; The Baggott & Ryall Directory of Guaranteed Attorneys, published by Legal Directory Corporation, Boston, Mass.; American Lawyers Annual, Cleveland, Ohio; Bankers Service Legal Directory, published by Bankers Service Co., Boston, Mass.; Eyre's Law List, 9 Park Place, New York City; Snow-Church Directory Co. Lawyers List, published in New York City, and the Central Guarantee Co., Bankers and Lawyers Directories, 630 Fifth Avenue, New York City.

WATSON E. COLEMAN, Victor Building, 724 Ninth Street, N. W.
REGISTERED PATENT LAWYER **WASHINGTON, D. C.**

INVENTORS PATENT YOUR IDEAS

SEND FOR FREE BOOK

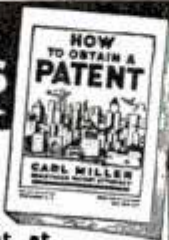

HOW TO OBTAIN A PATENT

Written by a Former Member of the Examining Corps (1922-24) of the U. S. Patent Office. If you want to profit by your idea, you should take steps to apply for a U. S. Patent at once. Your first step is to get this Free Book. This interesting illustrated book contains valuable information you should have. It tells you fully how to obtain a patent on your idea in the quickest way. With this Free Book you will also receive a "Record of Invention" form on which you can easily record your idea. Personal and Confidential Service: Your case will be personally handled only by a Registered Patent Attorney who is also a Former Member of the Examining Corps of the U. S. Patent Office. All communications confidential.

MAIL COUPON TODAY for FREE PATENT BOOK and RECORD OF INVENTION Form.

CARL MILLER

REGISTERED PATENT ATTORNEY
FORMER MEMBER EXAMINING CORPS U. S. PATENT OFFICE

Woolworth Bldg., 35th Floor, Dept. 19A, New York City
MILLER BUILDING, Dept. 19A, Washington, D. C.

Please send me your Free Book, "How to Obtain a Patent," and your "Record of Invention" form.

NAME.....

ADDRESS.....

INVENTORS PROTECT & SELL

Your unpatented invention can be sold with positive safeguards under patent laws. New, low-cost procedure. Complete details, free.
AMERICAN PATENTS CORPORATION
Dept. 4-E Washington, D. C.

PATENTS—TRADE MARKS

All cases submitted given personal attention
Form "Evidence of Conception" with instructions for use and "Schedule of Government and Attorneys' Fees"—FREE!

LANCASTER, ALLWINE & ROMMEL
Patent Law Offices

412 Bowen Bldg. Washington, D. C.

New Ideas now Salable Before Patenting

Practical, useful inventions may now be safely marketed without patenting expense. Write for proof that we successfully sell both patented and unpatented inventions.

Chartered Institute of American Inventors
Dept. 4, Barrister Building, Washington, D. C.



G E A R S

In Stock — Immediate Delivery

Gears, speed reducers, sprockets, thrust bearings, flexible couplings, pulleys, etc. A complete line is carried in our Chicago stock. Can also quote on special gears of any kind. Send us your blueprints and inquiries.

Send 10c for Complete Catalog No. 10
CHICAGO GEAR WORKS
769-773 W. Jackson Blvd. CHICAGO, ILL.

INVENTORS who derive largest profits know and heed certain simple but vital facts before applying for patents. Our book, Patent-Sense, gives those facts; sent free. Trade Marks—Copyrights.
LACEY & LACEY, Est. 1869, 635 F St., N. W., Dept. 5, WASHINGTON, D. C.

ALBERT E. DIETERICH

THEODORE H. RUTLEY

REGISTERED PATENT LAWYERS
512 B Colorado Bldg. WASHINGTON, D. C.
Booklet on Patents sent free



Earn Cash at Home!

We paid M. M. \$1174 for exceptional "cellar crop" SNOW-KING mushrooms! Big free picture book tells if your cellar, shed, barn suitable. We furnish materials, buy all crops. Write today. Est. 1908. UNITED CO., 3848 Lincoln Ave., Dept. 301, Chicago.



Best Poultry Paper 6 BIG ISSUES 10¢

Helps Increase Poultry Profits. Send coin or stamps. 50 cents for 3 years or 10 cents for 6 months trial. Agents wanted. American Poultry Journal
632 So. Clark Street Chicago, Illinois

do-it-with-squabs



Ready for market ONLY 25 DAYS OLD. Write a post-card, get FREE EYE-OPENING Picture Book. Why breed for ordinary trade when these great luxury national markets are wide open for all the SQUABS you can ship, every day in the year? Go after this desirable, profitable trade now.

RICE FARM, 636 H St., Melrose, Mass.

To PROTECT YOUR INVENTION — Use this coupon, NOW

Delays are dangerous and may be very costly. My personal service assures prompt action, strict confidence, and a minimum of expense. I suggest that you send me a model or drawing, or sketch and description of your invention, and \$5.00. I will make a search and report

promptly as to its patentability and send you a copy of my 72-page booklet. Or, if you prefer to read my booklet first, mail the attached coupon at once. I will also send my "Record of Invention" form. (Over 38 years experience as a Registered Patent Attorney.)

L. F. Randolph, 302-D Victor Bldg.; Washington, D. C.

Please send me at once, free of charge, your 72 page booklet and "Record of Invention" form.

Name.....

Address.....

A PERSONAL CONFIDENTIAL PATENT SERVICE—

don't WORRY

Why put up with years of needless discomfort and worry? Try a Brooks Automatic Air Cushion. This marvelous appliance permits the opening to close, yet holds reducible rupture securely, comfortably—day and night. Thousands report amazing results. Light, neat-fitting. No hard pads or stiff springs to chafe or gouge. Made for men, women and children. Durable, cheap, **Sent on trial** to prove it. Never sold in stores. Beware of imitations. Write for Free Book on Rupture, no-risk trial order plan, and proof of results. All correspondence confidential.



BROOKS COMPANY, 457-A State St., Marshall, Mich.

Auto-Diesel

Master a real trade. Auto Mechanics, Diesel Mechanics, Arc Welding, Acetylene Welding, etc. Let us train you to be an expert Auto-Diesel Mechanic and help you get a good job. The cost to you is reasonable. Learn on modern equipment with tools under experienced instructors. Real shop work. Steam heated buildings. Room and board in our steam heated dormitory. We pay your fare to Nashville. For free catalog write

Nashville Auto-Diesel School, Dept. 75, Nashville, Tenn.

STUDY ENGINEERING AT HOME

Home Study Courses leading to Degrees in Electrical, Civil, Mechanical, Drafting, Architectural, Automotive, Steam, Diesel, Aeronautical, Radio, Structural, Mining, Industrial, Highway, Petroleum, Marine, Refrigeration, Air Conditioning, Chemical Engineering; Arts; Sciences; Philosophy; Education; Public Health; Psychology; Sociology; Physics; Chemistry; Geology; Pol. Science; Theology; Law; Agriculture; Business Training; Accounting; Statistics; Adv.; Sales. Founded 1908. Chartered McKinley-Roosevelt Graduate Colleges, 4220 Clarendon Ave., Chicago

Refrigeration

1 Text-Book for Home Study
This new complete, practical book will teach you quickly how to service all types of refrigerators. Get into the money-making field after studying this handbook. Size: 8 1/2 x 11 in. Special price only \$1.00, postpaid. **SUPREME PUBLICATIONS, 3729 West 13th St., Chicago, Ill.**

Original POEMS—SONGS WANTED FOR PUBLICATION

WESTMORE MUSIC CORP.

Dept. 33F **Portland, Ore.**

Learn PHOTOGRAPHY at Home

Splendid opportunities. Prepare in spare time. Easy plan. No previous experience needed, common school education sufficient. Send for free booklet "Opportunities in Photography", particulars and requirements. **American School of Photography, 3601 Michigan Ave., Dept. 1351 Chicago, Ill.**



Minstrels

Unique First Parts for complete show with special songs and choruses. Make-up. Catalog Free.

T. S. Denison & Co., 203 N. Wabash, Dept. 13, Chicago



MAKE MONEY AT HOME!
Learn to color photos and miniatures in oil. No previous experience needed. Good demand. Send for free booklet, "Make Money at Home" and requirements. **NATIONAL ART SCHOOL, 3601 Michigan Ave., Dept. 1351 Chicago**

AMAZING MACHINE GROWS HAIR

"Intermittent Vacuum" stimulates deep-lying scalp blood vessels—and GROWS HAIR in thousands of cases of baldness. Stops falling hair. Tones up scalp. New hair often in 90 days. Easy to use this amazing machine at home. Only \$9.95 complete. Write quick for **FREE TRIAL OFFER.** **Only \$9.95 COMPLETE**
FULLY GUARANTEED AFTER RAND, DEPT. S-1662, NEWPORT, KY.

Inventors- FREE BOOKS



Now Tell You How To PROTECT And To CAPITALIZE On Your Invention • Save Time, Money

● At last here are the patent facts you want. Competent advice on patent procedure is essential to good results. Our 63 years' experience enables us to clearly explain everything you need to know about protecting and commercializing your idea. You will find the answers in these free booklets that are yours for the asking. If you want prompt advice from reputable patent attorneys, tear out and mail the coupon below at once.

C.A. SNOW & CO.
Registered Patent Attorneys Since 1875

FREE FACTS FOR YOU

119 SNOW BUILDING, WASHINGTON, D. C.

Gentlemen: Please send me—without cost or obligation—your FREE books, "Suggestions on How to Commercialize Your Invention" and "How We Protect You." Also Certification of Invention form.

Name

Street and No.

City or Town State

DRAFTING

BOOKS SENT FREE!
ON APPROVAL
5 VOLUMES BRAND NEW EDITION
Only 15 minutes a day with these WONDER BOOKS can prepare you for a good drafting job in less than a year. Mechanical and architectural drafting from simple straight lines to important complex plans. *A step at a time!* Built especially for beginners, for men with only grammar schooling. Drafting room practice. PLUS ENGINEERING, made easy and clear. Includes complete information on blue print reading for building and machine trades.

For Beginners or Experts

Written, so you can understand every word, by 22 well known engineers and architects. De-Luxe flexible binding, nearly 2,000 pages, 1546 blueprints, charts and diagrams; prepares you for a good drafting job in mechanical or architectural lines. Sent for 10 days' free use if you mail coupon immediately.

Big Field Big Demand Big Pay

Competent draftsmen are urgently needed right now in all building and manufacturing lines at \$30.00 to \$75.00 a week. That's just the beginning—FOR DRAFTSMEN HAVE THE BEST CHANCES FOR ADVANCEMENT. Pleasant, fascinating work, easy to learn and do. Learn quickly with these books—send coupon for a set and see for yourself.

A year's consulting membership in the American Technical Society now given to all readers of this famous cyclopedia of drafting. Many say that it is worth more than the cost of the books.

These Instruments Included



Complete set of drawing instruments if you send for these drafting books NOW. These instruments are made of the finest of German silver, are absolutely accurate and are packed in velvet lined leatherette pocket case. Real \$10 value, but included with these books.

AMERICAN TECHNICAL SOCIETY
Dept. D119, Drexel at 58th St., Chicago, Ill.

American Technical Society, Dept. D119, Drexel at 58th St., Chicago, Ill. Send for 10 days' trial New 5 volume set of drafting. I will pay the few cents delivery charges. If I wish, I may return books in 10 days and owe you nothing but if I decide to keep them, I will send \$2.00 after 10 days, then only \$3.00 a month until \$24.50, the advertising price, is paid. Send latest edition and include drawing instruments and Membership Certificate.

Name

Address

Attach letter stating age, occupation, employer's name and address and that of at least one business man as a reference.



Know Electricity as Experts Know It—and Get an Expert's Pay!

Recovery has begun! The months ahead are charged with significance and expectation. What will you do to get the jump on the other fellow?
Thousands of men have used

The Croft Library of Practical Electricity

The Croft Library is a complete electrical educator. It is founded on practice—on 20 years of shirt-sleeve experience—on work as it is actually done. It is jammed from cover to cover with the kind of hard-headed facts you want. Written so that the beginner can easily understand it, yet so sound, so thorough, that it is the daily guide of 50,000 highly paid electrical workers and engineers. Croft tells you the things you need to know about motors, generators, armatures, commutators, transformers, circuits, switchboards, distribution systems—electrical machinery of every type—wiring for light and power—wiring of finished buildings—underwriters and municipal requirements—illumination in its every phase—the most improved methods of lighting—lamps and lamp effects, etc.—how to do a complete job, from estimating it, to completion.

No money down—easy payments

Fill in and mail the coupon attached and we will send you the entire set of seven volumes for ten days' examination on approval. We take all the risk—you assume no obligation. If you decide to keep the books, send \$1.50 in ten days and the balance at the rate of \$2.00 a month. Send the coupon NOW and see the books for yourself.

EXAMINATION COUPON

McGRAW-HILL BOOK CO., 330 W. 42nd St., New York

Send me for ten days' examination on approval the Croft Library of Practical Electricity. If satisfactory I will send you \$1.50 in 10 days and \$2.00 monthly until the price of \$19.50 is paid. If not wanted, I will return the books postpaid. (To insure prompt shipment write plainly and fill in all lines.)

Name.....
Home Address.....
City and State.....
Position.....
Name of Company..... PM-1-39

Learn this Profitable Profession



in 90 Days at Home

Hundreds of men and women of all ages 18-50 make \$10.00 to \$20.00 in a single day giving scientific Swedish Massage and Hydro-Therapy treatments. There is a big demand from Hospitals, Sanitariums, Clubs, Doctors and private patients as well as opportunities for establishing your own office. Learn this interesting money-making profession in your own home by mail, through our home study course. Same instructors as in our NATIONALLY KNOWN resident school. A diploma is awarded upon completion of the course. Course can be completed in 3 to 4 months. High School training is not necessary. Many earn big money while learning.

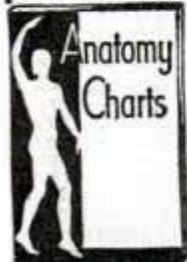

Anatomy Charts & Booklet FREE

Enroll now and we will include uniform coat, medical dictionary, patented reducing roller and Hydro-Therapy supplies without extra cost. The reducing course alone may be worth many times the modest tuition fee.

Send coupon now for Anatomy Charts and booklet containing photographs and letters from successful graduates. These will all be sent postpaid—FREE.

THE College of Swedish Massage (Successor to National College of Massage)
Dept. 164—1601 Warren Boulevard, Chicago.

You may send me FREE and postpaid, Anatomy Charts, booklet containing photographs and letters from graduates, and complete details of your offer.

Name.....
Address.....
City..... State.....



Diesel Engines produce "LOW COST" power—the newer ones are unbelievably light in weight. High Speed trains, passenger busses; huge trucks and now airplanes have adopted DIESEL POWER. Think what that will mean in the way of opportunities for DIESEL TRAINED MEN.

Learn Diesel at Home

Get into this profitable field NOW—prepare for an ever increasing demand—know the answer to any Diesel problem. We train you at home in SPARE TIME. No need to waste a minute or interfere with work or pleasure. Prepare for advancement the Diesel way. Get in line for a Big Pay Job. Write for FREE bulletin—there is no cost or obligation.

AMERICAN SCHOOL

Dept. D145 Drexel at 58th Chicago

Free AIR CONDITIONING AND REFRIGERATION TRIAL LESSON

Trained men needed. Good pay. Opportunities. Learn easily AT HOME in spare time (or at our Chicago School). Send for FREE TRIAL LESSON. No charge for this now or later. Write today.

CHICAGO TECHNICAL COLLEGE
A-303 Tech Bldg., 118 E. 26th St., Chicago, Ill.

PRACTICAL SHOP TRAINING TOOL & DIE MAKING DESIGNING MACHINIST TRADE

These are proven trades and are not seasonal. Why experiment? You get actual shop experience and can qualify in a few months for a good pay job. Learn by doing. Free employment service. Low rates. Fine equipment, expert instructors. Write today for full information.

NATIONAL SCHOOL OF MECHANICAL TRADES
Dept. 102, 628 W. Lake St., Chicago, Illinois

Learn ADVERTISING at Home

Greater opportunities now in advertising. Learn easily and quickly in spare time. Practical work. No text books. Old established school. Low tuition—Easy terms. Send for free booklet and requirements.

Page-Davis School of Advertising
Dept. 1351, 3601 Mich. Av., Chicago

"BECOME A LIGHTNING TRICK CARTOONIST"

Make money Chalk Talking. Send \$1.00 for Laugh Producing Program of 23 Trick Chalk Stunts. Illustrated Catalog 10 cents.

BALDA ART SERVICE, Dept. T-2, Oshkosh, Wis.

MYSTERY INVENTION KEEPS HANDS, FEET, BODY WARM



Even in Below-Zero Weather, Outdoors

KUMFY WARMER—carried in pocket, glove, sock, stocking, shoe or boot, or hung inside clothing, keeps you comfortably warm outdoors even on coldest days. Heats itself in 10 seconds—STAYS WARM 12 HOURS at a time. Lasts years. ABSOLUTELY SAFE—NO FLAME. Low-priced. GUARANTEED.

AGENTS—Make up to 205 percent profit. Everybody buys—workmen, housewives, drivers, sportsmen, spectators, farmers, others. Reserve your territory now for big winter profits. Write quick. KUMFY WARMER, Dept. S-2300, Cincinnati, Ohio.

NEW INVENTIONS

(Continued from page 20A)

AMONG the latest patents is one issued for an improved toothbrush, the handle of which is



shaped so that the user is forced to grip it properly. In addition, the bristles are so arranged that the free ends of the tufts are shaped to define truncated

cones, with the tops and bases of the cones in parallel relation with the head of the brush. This arrangement, together with a trough-like formation for reception of cleansing material, such as paste or powder, is said to result in easier and more effective cleaning of the teeth.

CHANGING to bathing suit and back again at the beach where dressing

rooms are not available is made possible by a recent invention. It is a knockdown dressing room adapted to coact with one door of an automobile. When occupied the structure fits closely against the side of the auto to give complete privacy. It has a base or floor as well as a top. With both doors of the car open into the little room, there is ample space to change clothing in comfort.

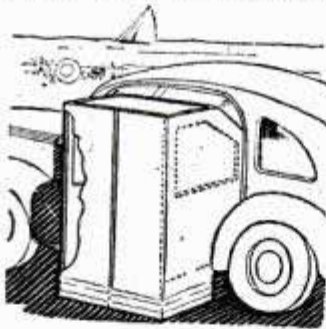

FOR the home or apartment, a milk-bottle holder designed for prevention of theft has been



patented. It consists of a metal frame that locks around the necks of two bottles. Bolted to the door frame, it frustrates the sneak thief attempting

to take the bottles from the door before the householder arises.

(Continued to page 52A)

More GOOD JOBS in DRAFTING NOW!

Calls for Draftsmen Are Increasing! Want-ads prove it. Steel mills—railroads—buildings—all are "on the up" . . . all are calling for Draftsmen. New fields like Air Conditioning and Diesels join in the call—"Give us more trained DRAFTSMEN." Some who read this advertisement will do nothing. Others, smart enough to realize this means Opportunity, will Send A Post Card or Mail the Coupon for Free Trial Lesson.



This Complete Drawing Outfit, Tools and Table sent to Chicago Tech Home-Study students in Drafting.

The draftsman's work comes first. When business improves . . . and it is improving . . . there is new construction work, new buildings, new machines, repairs and reconstruction work. All these must first be laid out on paper. So the FIRST man that must be hired is the DRAFTSMAN.

Drafting is Well-Paid Work

Drafting is clean, interesting professional-type work. It pays well to start . . . offers real opportunities for promotion. You need no previous training or experience . . . no special talent—to learn Drafting. It is one of the steadiest employment fields. No machine ever did the Draftsman's work . . . and no machine can be invented. So your job is always secure.

Learn at Home in Spare Time

(or at the College in Chicago) by the fascinating, easy, step-by-step plan originated by this 35-year old school for Draftsmen. This is the way thousands of successful men started their careers. Begin yours without delay . . . terms are low . . . and we help you to a job when ready. Send now for

TRIAL LESSON in

Free DRAFTING

Sample this easy-lesson system of learning Drafting. Send post card or this coupon. No charge now or later for this FREE LESSON. Prove to yourself how easy it is to learn Drafting by the C.T.C. Method.

FREE TRIAL LESSON

CHICAGO TECHNICAL COLLEGE

CHICAGO TECHNICAL COLLEGE

A-200 Tech Bldg., 118 E. 26th Street, Chicago, Illinois.

Please send me FREE Trial Lesson in DRAFTING and show me how I can prepare for good positions in spare time AT HOME.

Name..... Age.....

Address.....

P. O..... State.....

Traffic Management Home-Study

made interesting and practical thru problem method

YOU know that Traffic Management TODAY is one of the important departments of business—that it is a profession offering unusual opportunities, and pays many men three, five and seven thousand dollars a year and more.

The only question is—just how practical is it to train yourself adequately in Traffic Management through home-study?

And the answer lies in the LaSalle Problem Method.

For this modern plan of training not only makes Traffic Management study at home thoroughly practical but makes it interesting as well.

You Learn by Doing

Suppose it were your privilege every day to sit in conference with a traffic manager or with a successful commerce practitioner. Suppose every day he were to lay before you his problems, and were to explain the principles by which he solves them. Suppose that one by one you were to work those problems out—returning to him every day for counsel and assistance—

Under the LaSalle Problem Method you pursue, to all intents and purposes, that identical plan.

Only—instead of having at your command the counsel of a single individual—one traffic expert—you have back of you the organized experience of a great business training institution, the authoritative findings of scores of able traffic executives, the actual procedure of successful practitioners.

Thus you are coached in the solving of the very problems you must face in the higher traffic positions. Step by step,

you work them out for yourself—until you have the kind of ability and experience for which business is willing and glad to pay real money—just as it was glad to pay these men.*

Five Men Who Tested and Proved It for You

For instance, there was the traffic clerk—with two years experience—whom LaSalle training helped move up to Traffic Manager and to a salary increase of 100 percent.

There was the railroad clerk who became Traffic Manager of a great organization with a salary several times his highest expectation as a clerk.

And another railroad clerk who was earning \$55 a month and achieved an income of more than \$10,000 a year as head of his own traffic bureau.

Another man—already a successful, experienced traffic manager—cut his firm's freight costs from four percent of gross sales to two percent—on a sales volume running into millions—and his salary was more than doubled.

A fifth man—an assistant pur-

chasing agent—seeing the need of a traffic department for his firm, took this training and sold the firm on the value of creating such a department. The new department promptly proceeded to save money—as high as \$50,000 a year—and the new manager was rewarded accordingly. Today he is Director of Traffic and Assistant to the General Works Manager—with several traffic men under his direction.

LaSalle-Trained Traffic Men Everywhere

LaSalle traffic men are found wherever traffic men find a field for their services. They are serving commercial and industrial organizations; railroads and other transportation companies; chambers of commerce; trade associations and state and federal commissions. They are officers and active members of traffic clubs and national traffic organizations, and registered practitioners before the Interstate Commerce Commission.

Knowing these facts, ask yourself if there can be any further question about the practicability of this training for you—ask rather if the real question is not about your own ambition and your determination.

For Traffic Management is no magic wand for the lazy or the fearful or the quitter—it offers success only to the alert adult who has the courage to face the facts and the will to carry on.

If you are that individual, the coupon below will bring the information that can open up to you the future of which you have dreamed—ability and income and success.

Is it not worth getting that information?

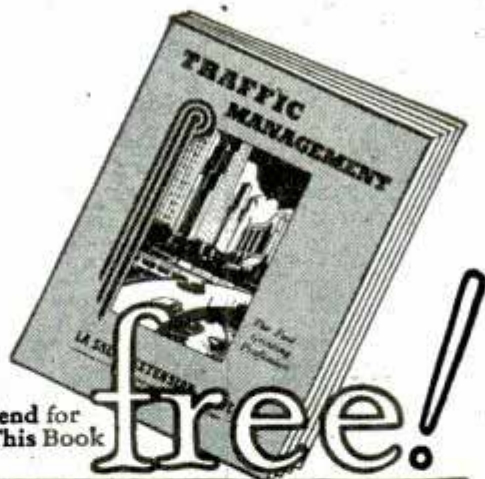

Send for
This Book

free!

*Names and addresses given on request.

LASALLE EXTENSION UNIVERSITY

A Correspondence Institution

Dept. 164-TR

Chicago, Ill.

Please send me, free of all cost or obligation, your 48-page illustrated book, and the facts about your training for success in that field.

Name.....

Address.....City.....

Position.....Age.....



When writing to advertisers please mention Popular Mechanics

**WORLD'S
BEST
WANT AD
MEDIUM**

CLASSIFIED Advertisements



Advertisements in this section, 35 cents per word, each insertion, minimum 10 words, payable in advance

To be inserted under proper classification in February issue, copy should be in our office December 8th

February issue on sale January 1st

Popular Mechanics Magazine, 200 East Ontario Street, Chicago, Illinois

YOU'LL PROFIT

By reading and answering the classified ads in this section. Hundreds of opportunities to make and save money.

Popular Mechanics Magazine,
Chicago, Ill.

Gentlemen: For the past six years we have advertised in every issue of Popular Mechanics Magazine. The results of this advertising have been most satisfactory. We keep a careful comparison of results from the different popular magazines we advertise in. The result of this comparison is 75% of our business activities are inspired through your medium. This result indicates that your readers have the greatest buying power and that your distribution covers the entire world. We congratulate you upon the pulling power of Popular Mechanics and we propose to advertise in its every issue.

Very truly yours,

COWELLS INSTITUTE.

(Original letter on file in our office)

AUTOMOBILES—MIDGET CARS

MIDGET Autos! Plans, parts, kits. Catalog—handbook, 10c. Latest list 100 used motors, midgets, parts, 20c. Free details, Shipps Midgets, Box 543-H, Zanesville, O.

"MIGHTY Midget" racer. Plans \$1.00. Gene Wilson, 4648 N. Kilbourne, Chicago.

MIDGET Racing book; facts for fans, builders, drivers; track sizes, regulations; pictures, specifications, working drawings. \$1.00 postpaid. \$1.15 C.O.D. Ray Kuns, Department 33, Madisonville, Cincinnati, Ohio.

"SCRAPE-Zit" Distributors wanted. New utility tool for home, merchant, office and motorist. Sample \$1.00. Fred M. Giddings, Galesburg, Illinois.

ANTIFREEZE Saver. Minimize evaporation. One hour to make. Complete plans 25c. Balpach Service, 5220 Fletcher, Chicago.

WANTED! Write, if interested in automobiles. Trowbridge, 7915 Parnell, Chicago.

AUTOMOBILE Mechanics who want own business or earn good extra money write fully for samples and details of nationally distributed Self Locking Triplex Piston Rings. They eliminate re-boring. Guaranteed life of car. Franchises valuable. Some territories open. Triplex, 2261 South Union, Dept. M, Chicago.

R & R Mfg. Co., Anderson, Indiana. Racing cars, midgets and speed equipment. Catalogue 25c.

BE First—Positive, outstanding, summer starting in winter pays. Practical plans, technique, expert instructions on good starting without "gadgets." With "gadgets." The latest device "Starting Ignition." How to build, avoid timer troubles and get 3/4 in. blue white starting sparks. This information cost \$9,000. Yours for \$1.00. Illustrations, working drawings, etc. Weston Laboratory, Elginburgh, Ontario, Canada.

ALUMINUM Alloy pistons, automotive, aviation, Diesel, industrial, marine, midget, model, motorcycle, outboard. Finished or semi. Judson Mfg. Co., Hedge and Gillingham, Philadelphia, Penna.

MAKE Costless cylinder oil reclaimers. Save hundreds. Instructions 50c. Other guaranteed processes. Thermo Laboratories, Peoria, Illinois.

MIDGET Cars, parts, plans. Catalog 20c. Derby Midget Cars, Woodstock, Ill.

MIDGET Race cars, midget motorcycles, motorscooters, handbook catalog, parts, plans, motors, 80 illustrations, 20c coin. Midwest Midget Motors, Box 1959, Chicago.

FORD V-8's, 1934-1938; gasoline saving device. \$1. Walert Co., 3429 No. 10th St., Milwaukee, Wisconsin.

1938 IGNITION Supercharger. Quick starting, wet or cold. Mileage, pep, power, less carbon. \$1.25. E. G. Sales Co., 321 Broadway, New York.

AUTO TRAILERS

AN Opportunity: The best organized and most soundly financed trailer manufacturer in the business, can use a few more dependable dealers. The sales franchise has unusual advantages, the opportunity for profit is exceptional. Adequate capital required. Your inquiry solicited. Vagabond Coach Mfg. Co., 530 Grand River Ave., New Hudson, Michigan.

BUILD The famous, low-cost Jim Dandy Cabin Trailer. Complete plans and instructions 50c. Plans to build the beautiful, streamlined Jim Dandy Cabin Cruiser, \$1.00. Trailer Builders Manual and catalog of trailer parts, supplies and equipment—over 100 interesting, illustrated pages, 25c. Order today. Satisfaction guaranteed. Trailer Supply Co., 411-A Jackson St., Wausau, Wisconsin.

AUTO SUPPLIES AND EQUIPMENT

CIRCUIT Analyzer for automotive electrical systems. Combination light source, continuity test, and voltage check. Bakelite case. \$2.00 postpaid, complete. Reliance Engineering Service, Rantoul, Illinois.

REFINE Used oil without cost. Samples. F. Gerwin, Fairview, Oklahoma.

AUTOGLAZE Cleans and waxes cars in 30 minutes. Sells easily on demonstration to garages, gas stations, owners. 100% profit. Write Glaze Co., Clawson, Mich.

FREE Wholesale bargain catalogue, auto supplies, equipment, tools. American, 1189 Bedford Ave., Brooklyn, N. Y.

GASMASK. Fumes, paint, \$1.95. Scoles, 6701 Prospect, Kansas City, Mo.

PLATING Outfits for auto parts. Connect to a battery. No tanks used. Free particulars and proofs. Gunmetal Co., Ave. J, Decatur, Ill.

SAVE Half! Guaranteed reconditioned truck and auto parts. All parts—all models, makes. Catalog free. General Auto, 7008-AA Cottage Grove, Chicago.

INEXPENSIVE Guaranteed protective puncture seal. Airlock Laboratory, 1460 Hollywood, Chicago.

MOTORCYCLES, BICYCLES, MOTOR SCOOTERS AND SUPPLIES

PERFECTED Generator eliminates batteries for bicycle lamps. Ideal Christmas gift for bike riders. Send for descriptive circular. Wallen Supply Co., 1725 Grange Ave., Racine, Wis.

SEND 15c For illustrated used motorcycle catalog. Bargains. Largest stock genuine Indian parts and motorcycles. Indian Motorcycle Sales, Kansas City, Mo.

THOUSANDS Building own motor scooters. We supply parts. Literature dime. Drawings free. Comet Cycle Company, Box 3032, Madison, Wisconsin.

MOTOR Scooters! Build at home, blueprints, clutch details, and photographs, complete \$1.00. McFarland Engineering Service, Box 53, Kokomo, Indiana.

HELMETS, Heavily lined, \$2.95. Air Transport, Garden City, N. Y.

MOTORCYCLE Bargains, lowest prices, bargain sheets for stamp. Motorcycle accessories. Rochester Harley Davidson Corp., 129 W. Main St., Rochester, N. Y.

ALLOY Pistons—Harley, Indian, Henderson, Excelsior, Cleveland. New and used parts for less. Cylinder grinding. Catalogue and wings pin 10c. Ballak, 1115 Chestnut, St. Louis, Mo.

INSIDE Dealer prices. Overstocked, all models. Indians and Harleys. Rebuilt, guaranteed. Dime brings latest list. Crandall-Hicks, Boston, Mass.

RECONDITIONED Motorcycles. New—used parts for all makes. Authorized Harley-Davidson dealer. Whitman Motorcycle & Supply Co., 405-9 Southwest Blvd., Kansas City, Mo.

AVIATION

FOR Sale: Surplus stock of metal tipped hardwood propellers. Tractor types only suitable for auto engines, airplane quality finish. \$5.00 to \$10.00, while they last. Write us your needs. Sensenich Bros., Litz, Penna.

AVIATION Needs men. Pilots, mechanics, draftsmen, sheet metal, positions open. Learn now. Free catalog. California Flyers School of Aviation, Dept. PMC-1, Los Angeles Airport, Inglewood, California.

PROPELLERS For airplanes, sleds. Iced-sled blueprints, supplies. Catalog dime. Lorenzen Propellers, Niles, Michigan.

"MY Experience as a Wing Walker and Parachute Jumper" with Roscoe Turner and other famous flyers. My book is a true story illustrated with actual action photos taken from movies at state fairs. Send \$1.00. Art Starnes, Box 321, Calumet City, Illinois.

FLYING. Mechanical, radio, sheet metal courses \$57.00 up. 20 years experience. Robertson Aircraft Corporation, Robertson, Missouri.

AUTHENTIC Diagrams, questions and answers for airplane mechanic's license \$1.25. Engine Mechanic's \$1.25. Both, \$2.00 postpaid. Meyer Engineering, Box-8, Hempstead, N. Y.

AVIATION Apprentices—Airminded young men interested in training for entering aviation as apprentices see ad on page 28A.

LEARN To fly free. Folder, dime. Corrigan, Box 391, Hempstead, N. Y.

CURTIS Eight cylinder engine for marine or air \$80.00. Eight foot pusher propeller \$15.00. Cap. 1035 South Vandeventer, St. Louis.

150 AIRPLANES \$40 Up. Terms. Motors, crackups, salvage. Complete catalogue 25c. Used Aircraft Directory, Athens, Ohio.

PROPELLERS—All types, including latest three blade airliners. American Flea Special \$12.50 down. Universal Aircraft, Ft. Worth, Texas.

GET Into aviation—Airline pilots get up to \$700 a month; mechanics, \$200; aeronautical engineers, \$400. Prepare now at this government approved school. Write for complete information. Lincoln Airplane & Flying School, 2004 Aircraft Bldg., Lincoln, Nebraska.

AEROSLED Motors, 80 horsepower, air-cooled, new, weight 285, overhead valves. Price \$75. Propellers \$10. Allison Aircraft, Lawrence, Kansas.

GRADUATE Airplane mechanic. Ten weeks. \$1.00 week. Graduates with leading concerns. Free catalog. United Air School, Elgin, Ill.

PROPELLERS For sleds, aircraft. Catalog 5c. Banks Propellers, Love Field, Dallas, Texas.

BATTERIES, GENERATORS, ETC.

EDISON Storage batteries for light-power systems. Non-acid. Odorless. Fifteen year life. Five year unconditional guarantee. Bargains in complete lighting systems. Low prices. Free illustrated literature. "See-Jay" Battery Co., 82 Sterling Ave., Yonkers, N. Y.

NEW 110 Volt a.c. fanbelt generators for portable power. 8 sizes. Write LeJay Manufacturing, 147 LeJay Building, Minneapolis, Minn.

PLATING Generators and motor generator sets. Write for information Hobart's new line electro plating equipment. Payments low as \$12.40 monthly. Quality machines, quick delivery guaranteed. Hobart Bros., Box M-192, Troy, Ohio.

RE-BUILD Old auto, farm light batteries. Send 25c for complete course and catalog. Tools, molds, etc. Home Occupations, St. Paul, Minn.

EDISON Lifetime storage batteries for light and power. Eliminates acid battery diseases. Long guarantee. All kinds rebuilt generating plants, motors, and miscellaneous articles at bargain prices. Free interesting literature. T. Hawley Smith Co., Croton Falls, N. Y.

10 HORSE Gasoline engine with magneto, like new, \$65.00. 500 watt, 110 volt, alternating generator \$22.50. 5 kilowatt, direct, 600 speed \$55.00. Electrical Surplus, 1885 Milwaukee, Chicago.

WIND ELECTRIC PLANTS

BUILD Wind light plant. Complete plans and valuable catalog 10c. Welders, electric fences. LeJay Manufacturing, 447 LeJay Building, Minneapolis, Minn.

ELECTRICAL SUPPLIES—EQUIPMENT

ELECTRICAL Arc experimental kit! Make powerful searchlight—melt glass, copper, iron—generate suntan rays, dozens others. Complete with power reducer, goggles, carbons, instructions. 110-volt. Postpaid \$1.99. Electrical Salvage Co., Box 524-P1C, Lincoln, Nebr.

FREE Lighting fixture catalog. Save more than 50%. Jaylite Co., 44 S. Monroe St., Monroe, Mich.

UNIQUE Invention—A light within a light combining bright reading and current saving night lamp. Free details. Hagen Import, Bulb Dept., St. Paul, Minn.

ELECTRIC Engraver, engraves all metals deeply, dollar. Hudson Bros., East Syracuse, N. Y.

MAGNET New alloy lifts 50 times own weight \$1.00. Advance, 861-P2, Minneapolis, Minn.

ULTRA Violet—Infra red. Dual ray health lamp. Two separate units in one. Promotes sun tan—vitamin "D". Automatic control. AC-DC current. \$3.90 postpaid. Details. Beyer Mfg. Co., 4515-P Cottage Grove, Chicago.

ELECTRO-SCRIBE: Electric pencil writes, engraves all metals. \$1.00 postpaid. Details. Beyer Mfg. Co., 4515-K Cottage Grove, Chicago.

WELDING AND SOLDERING

SPOT Welders, small, portable, powerful. Welds always satisfactory. Child operates safely. \$40. Gale Hollinger, Glen Ellyn, Ill.

ELECTRIC Welding taught correctly. Jackson School, 3407 Franklin, Houston, Texas.

ACETYLENE Welding outfits, \$32.95; electric welders, \$74.95. Easy-payment plan. Box 331, Hamilton, Ohio.

75-200 AMPERE Arc welders from Dodge generators. Complete plans 35c. 100 other generator changes. LeJay Manufacturing, 347 LeJay Building, Minneapolis, Minn.

44 "LESSONS In Arc-welding," Practical, not theoretical. They are the results of experience in teaching several thousand men to become welding operators. Valuable to all welders, especially inexperienced beginners. Better to be safe than sorry. You have only one pair of eyes; money can not replace them. Large one pound illustrated book: 50c in United States. (Foreign 75c.) Welders Club of America, AB-3432 M-Mart, Chicago.

DEMONSTRATORS, Electric arc welders. Money-saving prices. Used by the government. Trial and terms guaranteed. Hobart Welders, M-193, Troy, Ohio.

BLUEPRINTS For powerful 110v a.c. welder \$1.50. Marvelweld, Box 1156, San Francisco.

D.C. Arc-welder plans \$1.00 each. 25-200 amperes from 32 volt Delco light plant. 25-600 amperes from d.c. vehicle motors. 25-200 amperes from North-east Dodge 12 volt generators. Welders Club of America, AB-3432 M-Mart, Chicago.

NEW Electric welder, cheap. Free literature. Holgersons Service, Canton, Kans.

ENGINES, MOTORS, DYNAMOS

SPLIT Phase 1/3 h.p. motor. Guaranteed two years. Double drive shaft. Built-in starting switch. New departure ball bearings. Every part is extra strong. 110-120 volt, 60 cycle ac., 1750 rpm. Only \$8.95 plus 65c postage. Address Dept. D91, Sears-Roebuck, Chicago.

ELECTRICAL Shaver \$1.48; 1/4" drill \$3.67; candid type camera \$1.89. Radios; appliances; motors; grinders. Home workshop tools. Pricelist free. Mailorder Electric Co., 705 South Dearborn, Chicago.

ELECT. Motors, with flexible shafts. Write for particulars. McConnell, 1619 Edgewood, Racine, Wis.

MOTOR Rewinding lessons, illustrated. Send stamp for particulars. Motor Data Co., Box 7631, Kansas City, Mo.

BARGAIN—1/2 Hp. motors, 60 cycle, 1 phase, 110 volt, like new, guaranteed, \$7.70. Send check to Erie Electric Motor Co., 120 Church, Buffalo, N. Y.

1/4 H. P. General Electric motors, \$3.50, guaranteed. Larger sizes. List 10c. A. C. Motors, 3008 Bailey, Philadelphia, Penna.

ALTERNATING, 1/2 Horse, 110 volt, induction motors. Rebuilt, guaranteed, \$7.50. Wilmot Auto Supply, 2247 St. Paul Ave., Chicago.

MAKE Money. Rewind machine motors, auto generators. Each book \$1.00. 10c brings particulars, catalog winding materials. Ernest Knight, LaSalle, Illinois.

GOVERNORS For auto engines. Candee-Smith, 445 1/2 East 3rd Street, Los Angeles.

15 KVA Alternating generator \$235.00; other sizes. Motor-generators for magnetic chucks. Queen City Electric, 519 South California, Chicago.

MACHINERY, TOOLS AND SUPPLIES

BARGAINS, Demonstrators, electric arc welders, guaranteed, 30 days trial and terms. Write Hobart Welder Exchange, Box M-194, Troy, Ohio.

WHOLESALE Prices! Shop supplies; tools. Catalog 10c. Kostka, 2348-H South Crawford, Chicago.

ATTENTION! Experimenters, craftsmen, inventors: You need this giant ten pound hardware kit. Big box full of screws, nuts, washers, gears, springs, rivets, brackets, etc. Over 1000 parts—price \$1.49—worth \$7.50. Guaranteed satisfaction. Manufacturers Screw, 215P West Illinois, Chicago.

14" x 6' GREAVES Klusman cone head engine lathe, quick change. No. 0 Cincinnati miller, cheap. Write for particulars. Cincinnati Machinery & Supply Co., 221 E. Second St., Cincinnati, Ohio.

PLASTICS, Brass, aluminum, monel, stainless steel, gears, etc., in small quantities. Catalog 10c. Hobby Supply House, Box 2014, Pittsburgh, Penna.

SOUTH-BEND 9" Lathe milling attachment, universal movement, \$9; threading dial indicator, \$3; circular free. Unique Manufacturing Co., 4807 No. 31st Ave., Omaha, Nebr.

CONCRETE Building block machines and molds. Easy payments. Catalog free. Concrete Machine Co., 5129 South Compton Ave., St. Louis, Mo.

SELF Feed tube expanders. 1/2", 5/8", 3/4", etc. Circular. Ajax-Collins, Fairview, Penna.

BOATS, OUTBOARD MOTORS, ETC.

FORD Marine conversion parts and kits. Models A, B, V8 (domestic or foreign). Catalogue 25c (coin). Osmitson, 3101 C Street, Philadelphia, Penna., U.S.A.

USED Outboard motors, all makes. Stamp brings list. Used parts, propellers and accessories. 50% list price. Outboard Headquarters, 305 Atlantic Ave., Boston, Massachusetts.

12 FOOT Flat bottom rowboat, complete plans 25c. Free boatbuilding catalog. The Rudder, 15 Murray St., New York.

FORD-ZEPHYR Marine conversions. Catalog 10c. Lehman Engineering Company, Dept. D, Newark, N. J.

BUILD Your favorite boat—Save on the cost. The Welch System of Boat Building makes this possible. Send 10c for 32 page catalog showing Welch designs, White Cap motors, boat equipment. The Welch System completely explained in this interesting book. Use Welch Ready Cut parts and build your boat at home. Welch Boat Company, Station K-1, Milwaukee, Wis.

BOAT Blueprints, patterns, many designs, catalogue 10c. Cleveland Boat Blueprint Company, Station A-6, Cleveland, Ohio.

COMPLETE Your own boat with our pre-fabricated frames and materials. They're different. Save 2/3s and costly mistakes. Send requirements for quotations. Illustrated catalog 100 boats, 10c. Bay City Boats, Inc., Bay City, Mich., 1552 Adams St.

ASSEMBLE Your own boat. Our finished knock-down frames and materials save you 2/3 builder's cost. All types and sizes. Send 25c for big catalog. Brooks Boat Co., Inc., D4, Saginaw, Mich.

OUTBOARDS—Save 1/2. Good used parts, all makes and models. Bargains rebuilt motors. Crandall Hicks Co., 959 Commonwealth, Boston, Mass.

BOAT Designers are highly paid professionals. Complete course by mail. Catalog. Westlawn, Montville, N. J.

FIELD GLASSES, TELESCOPES AND MICROSCOPES

TELESCOPES, Microscopes, chemistry, mineralogy. Scientific catalog free. Tracey Laboratories, Evanston, Illinois.

FREE Instructions. Build powerful telescope. Jamer, Box 94, Manorville, N. Y.

USED Microscopes, binoculars, astronomical telescopes, surveying instruments—bought, sold, repaired. Send 10c for list. Rasmussen, P. O. Box 294, Amsterdam, N. Y.

SLIDE Rule 10", magnifying indicator, 49c; bargains in microscopes, binoculars, telescopes, drawing sets, etc. Before buying any scientific instrument, get our catalog. Cash for old instruments. Advance Instruments, 162 Madison, Chicago.

BUILD Reflecting telescopes, 6" kit, \$3.50; other kits—all abrasives, mirrors, eyepieces, diagonals, illustrated instructions, 10c. Catalogue free. Optical Development Corporation, Dept. G, 1560 Broadway, N. Y.

TELESCOPES, Microscopes, binoculars; 1939 bargain catalog free. Brownscope Company, 5 West 27th Street, New York.

SPORTING GOODS, GUNS, FISHING TACKLE, ARCHERY

ICEBOAT Sail rig with instructions for cheap, simple chassis, \$14. Use on boat in summer. Skate sails \$7. Try-Sail Company, Patterson, N. Y.

LEARN Gunsmithing at home. Repair your own and neighborhood's firearms. Free catalog describing 20 books on firearms and gunsmithing. Samworth, Marines, North Carolina.

FISHERMAN'S Christmas gift. Solid steel rod, level wind reel, line, spoon—only \$5.00 postpaid. Rod only \$3.00. Interesting catalogue 5c. "A-B-C" Factory, Dept. B, 433 Bates, Detroit.

SINKER Molds for making your own sinkers. Free illustrated folder. Reading Instrument Co., Box 78, Reading, Penna.

GUNS, Pistols, outdoor equipment, on time! 10% down, 10% monthly. Gun handbook and catalog illustrates, prices and describes hundreds most popular makes. Contains a wealth of advice by America's foremost shooting authorities. Send 25c for your copy. National Target and Supply Company, Dept. P-1, 1255 - 25th Street, Northwest, Washington, D. C.

MASTER Fox trapping secret explained 25c. Orvel Archery, Lakewood, Illinois.

DUCK Stamps. Any year. We pay 15c-30c each. Robertson Stamp Co., Nampa, Idaho.

FENCING Equipment. Foils, swords, masks, etc. Low prices. Free catalog. Industrial Products, Dept. 21, 48 West 48th Street, New York.

SEND 3c For illustrated catalog of Lawrence leather belts, holsters, gun cases and other sporting equipment. George Lawrence Co., Portland, Oregon.

BARGAINS! Gun catalog 5c. Fishing catalog 5c. Ski catalog 5c. J. Warshal & Sons, First and Madison-PM, Seattle, Wash.

FISHERMAN'S — Hunters' Christmas cards. "Fish-story," "hunting," etc., 24 assorted (in colors) \$1.00 postpaid. Vogue, 5434 Cologne, St. Louis, Mo.

"PUNCH And Speed" new training bags, at cost price. Free circulars. J. Andre, 3520 Mt. Elliott, Detroit, Mich.

ARCHERY Headquarters — 617 South State, Chicago. Catalogue free. Complete instruction book 50c.

HUDSON Bay blankets, Indian pack baskets, camp stoves, knives, compasses, outdoor equipment. Free catalog. Howe Fur Co., Box P, Coopers Mills, Maine.

ANTIQUES, RELICS, INDIAN GOODS

20c BRINGS You a nice selection of Indian relics on approval. L. Barron Noel, Blackwater, Va.

FIVE Fine Texas arrowheads, list 25c. Clyde O'Neal, Waco, Texas.

100 GOOD, Or 60 fine, arrowheads \$3.00. George Holder, Glenwood, Ark.

100 GOOD Arrowheads \$3. Catalog. 5c. H. Daniel, Hot Springs, Ark.

INDIAN Relics, beadwork, coins, curios, minerals, old glass. Catalog 6c. Indian Museum, Northbranch, Kansas.

TAXIDERMISTRY

PRICES Slashed! New 36-page 1939 supply catalogue free. New items. New ideas. Postcard brings yours. Taxidermic Manufacturers, Memphis, Tenn.

LEARN By mail to mount birds and animals, tan skins, make leather. Old reliable school teaches, easily, quickly, at low cost. Over 250,000 students. Rush postal for free 48 page book. Northwestern School of Taxidermy, 775 Elwood Bldg., Omaha, Nebr.

GLASS Eyes, taxidermists', furriers' supplies. Big catalog free. Elwood Company, 222 Smith Bldg., Omaha, Nebr.

TAXIDERMISTRY Supplies—Quality artificial eyes, teeth, genuine Jonas head forms. Tools, materials, etc. Everything for the progressive taxidermist. Send 10c for big illustrated catalogue. Jonas Bros., 1049 Broadway, Denver, Colo.

DOGS, PETS, BIRDS

SPORTSMEN: 200 Pointers, Setters, straight cooners, combination hunters, rabbit and fox hounds. Reasonable. List free. Ramsey Creek Kennels, Ramsey, Illinois.

SAINT Bernard woolly puppies. Lowest prices! Illustrations free. Kennels, Chazy, N. Y.

\$15.00 BUYS Trained coon hound. Opossum, fox, rabbit and bird dogs cheap. List free. Ramsey Farm Kennels, Ramsey, Illinois.

JET Black Scottish Terrier puppies \$25. Garbrae Kennels, Angola, Indiana.

STANDARD Rabbit Journal, Milton, Penna. Year 50c. Sample dime. Supplies.

BIG Profits breeding Bostons! Circulars, dime. "Sentree," Royal Oak, Michigan.

BIRDS? Get American Canary Magazine monthly. Year \$1.00. 2839-P North Halsted, Chicago.

BEAUTIFUL Pure white police dogs. Ansonia Kennels, Mose, N. Dak.

POULTRY AND FARM SUPPLIES

LOW Factory prices on electric brooders, batteries, parts, wire fabrics, etc. Free 76 page catalog. Bussey, 5151 West 65th, Chicago.

HEADQUARTERS—World champion layers. We imported 353 - 361 - 364 egg contest hens from Australia - New Zealand. Free educational catalog shows customers profits. Osborne Farm, Box 70, Holland, Michigan.

10 CASH Prizes weekly for ten weeks. Also in addition to cash prizes, 5 all-expense trips to World's Poultry Congress. Write for contest rules and free catalog telling how to make money with Davis chicks. 21 breeds. Sexed chicks \$4.50—100 and up. Davis Poultry Farm, Route 34, Ramsey, Indiana.

GREENSBURG Bloodtested chicks for broilers. Immediate delivery on Barred, White, Buff Rocks, Reds, also Leghorns \$4.50 up. Write for catalog, early order and quantity discounts. Greensburg Hatchery, Box 40, Greensburg, Indiana.

CHICKS For broilers. Immediate delivery on Reds, Barred, Buff, White Rocks, Wyandottes, Orpingtons, Leghorns. Sexed chicks 90% accuracy guaranteed on pullets. Write for low prices, quantity and advance order discounts. Salem Hatchery, Box 81, Salem, Indiana.

SEYMOUR Chicks for broilers and early layers. Our prices are always at rock bottom. Write us before you buy chicks. Get our free catalog, early order and quantity discounts. Seymour Hatchery, Box 36, Seymour, Indiana.

MORE Profit in your grain fed to broilers. Poultry prospects bright. Write today for catalog. Dubois County Hatchery, Box 912, Huntingburg, Indiana.

CHICK Raisers make extra money selling our chicks to neighbors. Write Jackson County Hatchery, Box 19, Seymour, Ind.

MAKE Money with poultry. Read America's leading poultry magazine for latest information. Three years \$1.00; nine months 25c. Poultry Tribune, Dept. E-93, Mount Morris, Ill.

TREES, SHRUBS, ROOTS, HERBS

JUST Out! World's greatest "Herbalist Almanac." Beautifully illustrated in natural colors. Contains over 200 old-fashioned herb medicine recipes for home use. 10c postpaid. Worth dollars! Botanic, 145 W. 112th St., Chicago.

FARMS AND FARM LANDS

GOOD Farms available. Washington, Minnesota, Idaho, western Montana, Oregon. Dependable crops, favorable climate. Write for impartial advice, literature and list of typical bargains. Specify state. J. W. Haw, 119 Northern Pacific Ry., St. Paul, Minn.

HIGHWAY Farm, 850 fruit trees, 95 acres, magnificent views 2 states; bus service, dandy home, 7 rooms, electricity, new \$3000 barn, other bldgs.; genuine opportunity at \$4500, terms arranged, including some crops, stock and equipment; page 88 free catalog 2000 bargains. Strout Realty, 255-P 4th Ave., New York City.

CANADIAN Tax sale lands for a dollar an acre and up. Small monthly payments. Farms, timber, hunting and fishing camps, minerals. Limited number of properties. Write at once for free illustrated booklet. Tax Sale Service, Room 613, 62 Queen St. W., Toronto, Canada.

THE Great Northern Railway serves an agricultural empire where rents, prices and operating costs are low in Minnesota, North Dakota, Montana, Idaho, Washington and Oregon. Write for free book. E. C. Leedy, Dept. 1257A, St. Paul, Minnesota.

40 ACRES, Near White River, unimproved; poultry land. \$175, \$5 down, \$5 monthly. Free list and literature. Hubbard, 218 Grossman Bldg., Kansas City, Kans.

FARM MACHINERY AND SUPPLIES

LIGHTS Easily installed on tractor. Operates direct from old auto generator without battery. Complete plans 25c. LeJay Manufacturing, 647 LeJay Building, Minneapolis, Minn.

ALL Purpose tractors at factory price. Shaw 2 to 5 horsepower, riding or walking types. Does plowing, discing, harrowing, cultivating; mows lawns, cuts weeds, does hauling; runs belt machinery. Air or steel tires. Three speeds forward and reverse. Thousands in use. Write for free catalog and 10 day trial offer. Shaw Mfg. Co., Dept. PM, Galesburg, Kansas.

PROFITABLE OCCUPATIONS

M. M. Earned \$267, three weeks, raising mushrooms in cellar! Exceptional, but your cellar, shed perhaps suitable. We buy crops. Book free. United, 3848 Lincoln Ave., Dept. 68, Chicago.

GROW Vegetables, flowers in water with our dry chemicals. Directions, chemicals \$1.00. Holland Plant Chemicals, 1519 Eggert Rd., Eggertsville, N. Y.

LAWN And garden novelties, 25 large size patterns of the nicest and best sellers, \$1.00. Arnold Novelty Co., Holland, Mich.

205 MONEYMAKING Opportunities, today's conditions. Your own business, home, office, etc. Introductory booklet free. Stamford, 3762-A Broadway, New York.

MAKE Door mats from junk tires with ordinary home workshop equipment. Complete instructions \$3.00. Thomas Kowell, 5372 St. Clair, Detroit, Michigan.

RAISE Guinea pigs. Make money. Thousands needed. We supply breeders and buy the young. Free illustrated book. Research Supply, 2436 W. York Street, Philadelphia, Penna.

MINK Easily raised. Highly profitable. Free booklet. Banks Minks, Framingham, Mass.

WANTED Original poems, songs, for immediate consideration. Send poems to Columbian Music Publishers, Ltd., Dept. P68, Toronto, Can.

NICKEL Plating outfit. Complete less battery with instructions, three dollars prepaid. Florida Products, Box 51, Daytona Beach, Fla.

MINK Raising is fun and highly profitable. Particulars. Empire Mink, Scarsdale, N. Y.

MEN—Women, operate "Specialty Candy Factory" home, all or spare time. We furnish outfits and instruction. Opportunity to earn \$20 to \$50 weekly. (Our 29th year.) Booklet free. W. Hillyer Ragsdale, Inc., Drawer 62, East Orange, N. J.

COUNTRY Drives or movies afternoons! Work mornings home. No canvassing! Folio-H, Station D, Los Angeles.

RAISE Rabbits and cavies for us. We buy at top prices. Complete details in catalog, contract and magazine, 10 cents. Stahl, Box 1, Holmes Park, Mo.

BOOKS, PERIODICALS, PICTURES, POSTCARDS

WILL Send 6 Cuban postcards, stamped if you send me 25 cents. Leon Linea, 707 Vedado, Havana, Cuba.

LIGHTNING Strikes tree at night. Unusual, clear photo 3 1/2 x 4 1/2. 25c. Resub, Box 44, Argonia, Kansas.

SPARE-TIME Subscription representatives for all magazines. Instructions, complete starting supplies; free. Pines, 583-A Monroe, Brooklyn, N. Y.

BOOKS Bought! Write. Bookery, 3941 Shaker Square Station, Cleveland, Ohio.

UNUSUAL Secrets, books, etc. Write Bagley's, 7329 N. Catlin, Portland, Ore.

YOUR Favorite magazines—Half price. Catalog, 10c. Magazine Exchange, Baseline, San Bernardino, Calif.

GAMES—ENTERTAINMENT

ENJOY Pocket baseball! The game with additional radio feature; simple, instructive, fascinating. Satisfaction guaranteed. Send 25c coin. American Game Co., Inc., Richmond, Va.

PLAY Table basket ball. Exciting as real game. Easy to make and sell. Complete instructions fifty cents. Radco, Beaver Dam, Wis.

NOTHING, New sport, personal opportunity. Dime. Wemco, 25 Chestnut, Jamestown, N. Y.

CARNIVAL Games make you money. Outfits supplied. Illustrated literature 10c. "Moore-Made." LaPeer, Mich.

PLAYS, Operettas, musical comedies, complete minstrel first-parts with song programs, blackface skits, vaudeville acts, monologs, dialogs, recitations, juvenile plays and songs, musical readings, entertainments, make-up goods. Catalog free. T. S. Denison & Co., 203 N. Wabash, Dept. 11, Chicago.

MAGIC TRICKS, PUZZLES, JOKER NOVELTIES

FREE! Magic catalog 500 tricks. Amaze. Mystify friends. Write today! Lyle Douglas, Station-A-5, Dallas, Texas.

LOOK! Funny joke goods! Pocket tricks! Unusual novelties! Thrilling magic! Exciting puzzles! Strange curiosities! Lowest prices. Complete line. Send 25c for giant surprise catalog. Free trick included! Lawson Vick Co., Dept. P3, Queens Village, N. Y.

SPECIAL! \$1.00 Assortment magical equipment, tricks, puzzles, with 200 page catalog 25c postpaid. Oaks Magical, Oshkosh, Wisconsin.

FIVE Magic tricks, complete 25c! Balfar, Box 901, Detroit, Mich.

MAGIC! Books, occult; novelties. Catalog 10c. Eastern City Sales, 8-E Randolph, Chicago.

AMAZING Tricks, home entertainment, book 25c. Foster, 44 Browns Place, Pittsburgh, Penna.

FREE Tricks! Join Magicians' Fraternity! Monthly magazine, sample 10c. International Magicians, Mt. Morris, Illinois.

ILLUSTRATED Magic catalogue 20c. Lynn, 105 Beach, Jersey City, N. J.

SVENGALI Magic decks, Bridge size, new style. Demonstrators sell them for one dollar. Dozen \$3.25. Sample postpaid thirty-five cents. Catalog 300 jokes and magics free. Adams Company, Asbury Park, N. J.

WORLD'S Largest magic shop professional catalog, 25c. Holden, 220 W. 42nd St., New York.

BECOME A magician and earn extra money in your spare time. Send 25c today for your copy of our 168 page catalogue. This book is full of tricks for everyone, from the beginner to the professional performer. Established 1910. Chicago Magic Company, 2300 North Mason Avenue, Chicago, Illinois.

EARN Money in any crowd. Call names of strangers, tell unspoken questions. Professional course mind reading, spirit writing, etc., \$1. Henderson, Box 341, San Bernardino, Calif.

LEARN Ventriloquism, 3c stamp brings particulars. Smith, 125 N. Jefferson, Peoria, Ill.

RARE COINS

COIN Collectors—Read "The Numismatist." Monthly magazine containing news and features on coins, medals and paper money. Published by The American Numismatic Association. Six months trial subscription \$1.50; sample copy 30c. Write for descriptive circular. Room 228, 99 Livingston St., Brooklyn, N. Y.

OLD Money wanted. Will pay fifty dollars for nickel of 1913 with Liberty head (no buffalo). We pay cash premiums for all rare coins. Send 4c for large coin folder. May mean much profit to you. Numismatic Co., Dept. 20, Fort Worth, Texas.

INDIAN Head cent, and list 10c. Charles Banker, Salina, Kansas.

BIG Prices paid for certain wanted coins. 1909 cent \$10.00, some silver dollars \$4000, 1864-1865 Indian head cents \$100.00 each, dimes before 1895, \$600; liberty head nickels before 1914, \$500; encased postage stamps; some large pennies \$2000; half cents, \$275.00; paper money, gold dollars \$1500, foreign coins \$165, some worth \$6000 each. You may have coins for which we pay big premiums. Therefore send 15c today for 1939 big illustrated coin book for certain wanted coins. National Coin Corporation (82), Daytona Beach, Florida.

50 OLD Coins all different \$1.00. 20 dates large cents \$2.00. Cleveland half-dollar uncirculated \$1.00. Claud Denney, Box 1825, Dallas, Texas.

XMAS Special! Silver piece of eight \$1.25; 10 for \$9.50. Lists for stamp. Maurice Gould, Box 73, Brighton, Mass.

BEAUTIFUL Collection of fifty different coins, some over hundred years old, \$5.00 postpaid. Mobley, Box 3176, Hollywood, California.

34 COINS, Bills, tokens, 25c; 100, \$1.00; 20 coins, 25c. Bishoff, 500 E. 8th, Kansas City, Mo.

ANCIENT Roman coins, fifty different, \$2.00; commemorative half-dollars, five different, \$5.00. S. Koepfel, Merritt Bldg., Los Angeles, California.

33 COINS, Bills, tokens, postpaid 25c. Otto Oddehon, Unionville, Mo.

COMMEMORATIVE Half dollars, Lincoln \$1.19; Cleveland, \$1.19; Long Island, \$1.19; Texas, \$1.19; Boone, \$1.29; Arkansas, \$1.89; Selling price list free. Bob Cohen, Box 3507-G, Cleveland, Ohio.

WILSON'S New American coin catalog. Prices all United States coins. 50c postpaid. D. M. Merrin, Box 565, Spokane, Washington.

GET Profit and pleasure in collecting old coins. Send 10c for 56-page illustrated coin catalog. You'll be delighted with it. Send for it now. B. Max Mehl, 370 Mehl Bldg., Fort Worth, Texas. Largest rare coin establishment in U. S. Established 38 years.

CERTAIN Large cents worth \$750.00; small cents \$12.00; nickels \$250.00; dimes \$300.00. Send 15c for latest 1938 complete 36 page illustrated buying book. American Coin Co., Box 3507-A, Cleveland, Ohio.

FINE Foreign 1700 coin, 2 notes and catalog 10c. Geo. Best, Cedar Rapids, Iowa.

COMMEMORATIVE Half dollars, Lincoln, Stone Mountain, Oregon, Texas, Cleveland, Kentucky, San Diego, Long Island, \$1.50 each. Illustrated catalogue No. 14, 25c. Norman Shultz, Salt Lake, Utah.

FREE! Foreign coin, banknote, and large illustrated coin catalogue. Send 4c postage. Coin approvals sent. Tatham Coinco, Springfield-125, Mass.

\$5 TO \$500 Each paid for hundreds of old or odd coins. Keep all until posted. Many very valuable. Send 10 cents for illustrated Coin Value Book, 4x6. Guaranteed buying and selling prices. 31 years in business. Coin Exchange, Box 5, Le Roy, N. Y.

RARE U. S., foreign coins, war medals. Catalogue 10c. Mengelle, Colorado Springs, Colo.

STAMP COLLECTING

SENSATIONAL Offer! 100 stamps including triangle, airmails, commemoratives, pictorials, colonials, only 5c with approvals. Leo, 853 North Martel, Los Angeles, California.

U. S., Latin American, European approvals. Write now! 101 mixed stamps only 3c. Quality Stamp Shop, Englewood, Colorado.

STAMP Cuts, 25c up. Attractive sample and catalog. 10c. Novateur Line, Box 55, Jackson, Michigan.

FREE—U. S. flag stamp in red, white and blue; 28 different Turks Caicos, triangle, diamond, etc., all free with approvals. Send 3c postage. Baer, Box, P-222, Chillihothe, Ill.

6 HONG KONG and Philippines with 25 different to approval applicants—10c. McLoughlin, North Ave., Meriden, Conn.

HINDENBURG Zeppelins complete, only 6c to approval applicants. Kuzma, 1291 Washington Ave., Bronx, N. Y.

20 DIFFERENT Luxemburg 10c to approval applicants. Approval selections made to your order. Teichmann, 1685 Fillmore, Philadelphia, Penna.

FREE—25 Different Paraguay and 10 different Palestine pictorials to acceptable approval applicants. Tingley Stamp Company, 1805 Monroe, Endicott, N. Y.

FREE—25 Different Japanese pictorials and commemoratives. Valuable collection of this popular country to approval applicants. Charles Cleveland, 806 North Humphrey, Oak Park, Illinois.

200 ALL Different U. S. postage. No revenues, only \$1.23. Jungkind, Box 806-8, Little Rock, Ark.

ATTRACTIVE Stamp album providing spaces for 2220 stamps with 700 illustrations, packet 300 different stamps, 500 hinges, tweezers, duplicate book, pamphlet which tells "How to Make a Stamp Collection Properly," bargain list of sets and packets, all for only 50 cents. Queen City Stamp Co., Room 36, 604 Race St., Cincinnati, Ohio.

FREE Stamp catalogue—Big winter issue—Giant fifty-page quarterly, listing albums, supplies, coronations, Georgians, Canadians, United States and foreign. Illustrations galore! Empire Stamp Co., Dept. PM, Toronto, Canada.

107 DIFFERENT, Caledonia, South American, Guinea, etc., 3c to approval applicants. Extra—Two scarce airmails added free! Hunziker Philatelic Service, Box 225-P, Minneapolis, Minnesota.

MEXICO—All fine copies. Nos. 575 mint, 625 used, 718 used, 980 used—55c, 15c, 50c, 80c, respectively. Approvals. Walters, 5118 West Adams, Los Angeles.

25 DIFFERENT U. S. 5c. Approvals. Delmouly, 314 Gunter Bldg., San Antonio, Texas.

WRITE For list remarkable stamp offers. Stamp Finance, Box 1028, Vancouver, Canada.

AIR Mail, 50 different, 55c. U. S. postage 100 different 40c. A. M. McFadden, Mt. Rainier, Maryland.

200 DIFFERENT Austria only 25c; approvals. Wendell Tynes, Bluff Creek, Louisiana.

TWENTY Commemoratives dime with approvals. Notro, 4909 North Seeley, Chicago.

FREE—50 Different stamps to approval applicants, 3c postage. World Stamp Co., Flint, Mich.

50 FRENCH Colonies mint commemoratives 10c, with approvals. Exchanger, Mascouche, Que., Canada.

FREE—\$1 U. S. stamp with request for 52 page list of United States and foreign stamps. Stamps on approval. References necessary. 20 different nineteenth century U. S. 28 cts. New Hussman Stamp Co., 1122 Pine, St. Louis, Mo.

60 DIFFERENT U. S. 15c, approvals. Motzer, 1022 Liberty, Cincinnati, Ohio.

SENSATIONAL! 200 Rare U. S. 35c (coin.) Dawson, 1308-F, The Dalles, Ore.

PRODIGIOUS Gift! Fantastic Indonesia, Wurttemberg "official," Perak, savage Somalicoast, Selangor, Negri Sembilan, bicolored banana airmail, Siberia. Absolutely free with approvals! Postage 3c. Saxon Company, 408-A Jay St., Brooklyn, N. Y.

FIJI (Scarce) included—Forty country mixture—100 stamps, 10c; 300, 25c. No approvals. Elsea, Bowling Green, Ohio.

THOUSAND All different \$1.00. Emil Auer, 16 Duerstein, Buffalo, N. Y.

BRITISH Colonies packet of 50 different free to approval applicants, 6c postage. Verne Livingstone, St. Ignace, Mich.

CANADA—Newfoundland. Fifty page illustrated wholesale catalogue featuring Canadians, Newfoundland, British Colonials, United States, supplies. Free. Empire Stamp Company, Dept. 5, Toronto, Canada.

ROUND The world — 1075 different stamps cataloging \$25, with free premium, \$1.85. Uncas Stamp Co., 43 E. Town St., Norwich, Conn.

\$2.00 STAMP No. 572. With approvals, 15c. Perley Porter, Wellesley, Mass.

ASK For my one and two cent approvals. Send 3c. Olivo Alvos, Guadalupe, Calif.

30 BIZARRE Stamps from Transcaucasian republics, \$2.50 value, \$1.00. Newberry's, 946 Fort, Victoria, B. C.

45 CORONATIONS Including Gilberts complete used, \$1.00. Trayford, Duddington, Stamford, England.

WHOLESALE Approval service. References. Fuld, Dickmann Building, Saint Louis, Missouri.

1000 MIXED U. S., 15c. 30 different commemoratives, 15c. Lee, Bridgeport, N. Y.

MEXICAN \$2.00 Bill and 100 different unused stamps 10c. Roy Nagle, 451 Douglass St., Reading, Penna.

150 GOOD Mixed foreign stamps 5c coin. Stanton, Niantic, Conn.

PRODIGIOUS Anniversary package! Bicolored banana airmail, Perak, savage Selangor, unique "green cross" charity, Wurttemberg, Kiwi bird, world's tiniest airmail, Sembilan, Portuguese commemorative, Siberia, striking pictorials. Only 5c with approvals! Saxon Company, 408-A Jay St., Brooklyn, N. Y.

OH Boy! Look! 75 stamps from 75 different countries 10c. Schultze, 55B, Woodhaven, N. Y.

BEST U. S. approvals in America. Huber Stamps, Palace Bldg., Minneapolis.

BIG Packet unusual stamps (no cheap Europeans.) including scarce Zeppelin; world's smallest triangle; Indo-China airmail; Liberia; Eastern Roumelia; Canada coronation, silver jubilee; Italian East Africa; giant diamond-shaped stamp. Also Holy Lands packet (Palestine, Lebanon, Iraq, etc.); many others. Only 5c to approval applicants! Frederick Pitts, Framingham, Massachusetts.

25 STAMPS Cataloging over \$3.00, including coronations, jubilees, airmails, 25c. Approvals. Goldman, 11314 Jerome Avenue, Richmond Hill, N. Y.

WILL Buy your unused United States stamps. Small discount. What have you? Mint Sheet Brokerage Co., 418 Caxton Building, Cleveland, Ohio.

12 CHRISTMAS Cards 10c with approvals. Siegel, Box 1710, Milwaukee, Wis.

MINT Hawaii catalog 75c. 15c with approvals. Wehrell, Passaic, New Jersey.

U. S. \$2.00 blue, capitol. No. 572, 17c with approvals. Hollinbeck, 250 Nicolllet, Minneapolis.

175 U. S. commemoratives, etc., 10c. 500 25c. P. O. Box 457, Newark, N. J.

FREE—25 U. S. All different, to approval applicants sending 3c postage. Allen Lloyd, Box 184B, Cincinnati, Ohio.

CANADA—47 Different, includes coronation jubilee, pictorials, commems. Only 10c to approval applicants. "Crescent Stamps," London, Canada.

NICKEL-PLATED, Flexible steel stamp tongs, and 20 different choice airmails and commemoratives, including Zepp., sent for only 10c with exceptionally fine United States and foreign approvals. Marco Stamp Co., Box 888, San Francisco, Calif.

FREE—The Stamp Finder! Our new 20 page edition, fully illustrated, which will enable you to instantly identify all difficult stamps. Also fine packet of odd and unusual stamps from Bosnia-Herzegovina, Monaco, Patiala, Cyprus, etc., including maps, ships, animals and strange scenes. All free to approval applicants inclosing 3c postage. Garcelon Stamp Co., Box 900, Calais, Maine.

GIANT Diamond-shaped stamp! Big packet 105 all different including Alexandretta (new country), Congo, Manchukuo, Ecuador constitution, Costa Rica triangle, air-mails, commemoratives; giant diamond-shaped stamp, \$5 United States; set United States telegraphs, cataloging 30c. Packet British colonies including Burma (new country), jubilee and coronations; scarce sets 2 Siberia, cataloging 50c. Illustrated lists. Everything for only 5c to approval applicants! Write to-day! Mystic Stamp Co., Dept. 80, Camden, New York.

BRITISH Solomon Islands—Land of cannibals and head hunters! Immense Solomon Islands commemorative, \$5 United States, Liberian Bongo antelope, mystery British Colony triangle (a thrilling surprise!), fantastic Manchukuo mausoleum, breathtaking beauty from Cayman Islands, etc. This astounding packet of bizarre and intriguing stamps absolutely free to approval applicants enclosing 3c postage. Viking Stamp Company, 1-Z Hanson Place, Brooklyn, N. Y.

25 STAMPS From China, Czechoslovakia, Spain. World's 3 trouble zones, 10c with approvals. Ranger Stamp Co., Box 1070, Houston, Texas.

UNDERVALUATION! 20 Different Canadian 5c. Altone, 2068 Daly, Bronx, N. Y.

\$1 STAMP With approvals, 3c postage. Leader, 1550 Seward, Detroit, Mich.

FREE Dollar packet. Inclose postage, request approvals. Secrist, Muscatine, Iowa.

FREE. U. S. \$1, \$2, \$4 and \$5 stamps. Unbeatable U. S. approvals. Nelson, 78 E. 5th St., St. Paul, Minn.

ELUSIVE! Austria Dolfuss stamp 15c. Approvals. Goldman, 11314 Jerome Avenue, Richmond Hill, N. Y.

PICTORIAL Stamp Exchange. Send 25 different U. S. stamps, and 10c; receive 25 different foreign pictorials. Waldo, Box 266, Dallas, Texas.

U. S. Constitution commem. from Dominican Republic, beautiful new Seychelles, Kenya Uganda coronation, Bolivia triangle, airmails, packet of others. 5c approvals. Clark, 1472 8th East, Salt Lake, Utah.

\$1, \$2, \$4, \$5, \$10 U. S. free with packet of 40 different U. S. before 1934. 25c approvals sent with each order. Regal Stamp Co., 3505 Aldine St., Philadelphia, Penna.

INDIAN Native states, 100 different, dollar bill. Cruz, Post Box 10, Lahore, India.

THREE Triangles; 3 diamonds; 3 coronations; 3 airmails! 3 jubilees and 3 Bermuda pictorials 25c. Approvals. Eulalia Turner, Azusa, Calif.

UNITED States approvals including revenues. Reference. R. W. Haines, Box 622, Baker, Oregon.

SPECIAL! 20 Different commemoratives to applicants for my fine foreign approvals with stamps 1c and up. Postage 3c. Dolve, 621 - 15th Ave., Southeast, Minneapolis, Minnesota.

50 STAMPS From fifty countries, triangle, giant diamond stamp, new Burma. Also stamp tongs. Only 5c to approval buyers. D. M. Ward, Desk P, Gary, Ind.

33 DIFFERENT U. S. with approvals 6c. Reynolds Stamp, Flint, Michigan.

FREE. Special to Mechanics readers. Kenmore's 80 page colonial catalogue (10c to cover mailing costs.) Kenmore Stamp Co., Inc., Kenmore, N. Y.

WE Don't sell the Brooklyn bridge, but we have a very desirable lot of 1000 selected U. S. Guaranteed to be included in this lot are 100 before 1900, 200 commems., 2 complete commemorative sets, 200 precancels, 10 parks, 50 revenues and no current 3c stamps. The price for this gigantic lot is only \$1.00. With the first 50 orders we will include, in addition, 500 foreign stamps from many parts of the globe. Meyerowitz, 1693-Y - 65 St., Brooklyn.

FREE Collection—Your album the envy of others. Stamps from darkest Africa, distant Asia. Desirable U. S., triangle, air mail, commems., many others in our free offer of 155 different with approvals. Send 5 cents for handling, mailing. Ace Stamp, Colonial Arcade, Cleveland.

2000 MIXED U. S. and foreign \$1.00. Arrowhead, Box 1793, San Antonio, Texas.

UNUSED U. S. commemoratives, 50 different \$2.50. Shoebach, 202 W. 96, New York.

SELL Stamps: Salesman (12 years up) earn cash commissions. Write for outfit. Everglades Stamp Company, Halcyon Arcade, Miami, Florida.

FREE! Brazil constitution stamp. To approval applicants enclosing postage. R. Holtzman, Fulda, Indiana.

500 DIFFERENT Foreign—29c! 100 U. S. revenues on documents—10c! (1000—60c.) Vanvoorhis, Hyndman, Pennsylvania.

UNITED States illustrated looseleaf catalog, \$1.00. Send postage for free United States price list, precancel list. Stanley Gibbons, 38-P Park Row, New York.

U. S. Constitution stamp of Ecuador, gorgeous six-color stamp showing U. S. flag in natural colors and George Washington, also Marvel packet 33 different including new Cayman Islands, Gen. Franco Spanish Morocco "war stamp" 60 yr. old Luxemburg, "bull-fight" stamp, largest diamond, tropical triangle, Chinese "midget" stamp, etc., all for 5c with approvals. Potomac Stamp Co., Dept. 101-D, Washington, D. C.

300 DIFFERENT Stamps 20c; 600, 50c; 1000, \$1; 2000, \$3; 3000, \$7. Fred Onken, 630 79th St., Brooklyn, N. Y.

GENERAL. 500 Diff. 50c; 1000 at \$1.00; 2000 at \$2.50. Br. Cois. 300 diff. \$1.25; 500 at \$3.00. Dr. A. B. Browne, Ferriday, La.

MAGNIFICENT Packet—Triangle, commemoratives, constitution, scenics, airmails, 50 others, 3c. Approvals. Far Seas Co., Box 2154, Houston, Texas.

WHENEVER You want attractive foreign approvals, 1c up, write Mitchell, Box 23, Jersey City, N. J.

FREE. 55 Different with approvals. Try our quality merchandise. We buy stamps. Kipp, 2404-W Cherry, Milwaukee, Wis.

25 STAMPS Cataloging \$2.46—10c. Stampdom, 195 Park, Lewiston, Maine.

UNITED States mixtures 35c lb. Three \$1.00. Mission, 4512 North Racine, Chicago.

CORONATIONS And jubilees in packet of 54 British Colonies, 10 cents with approvals. Swedell, 3038 Harriet Ave., Minneapolis, Minn.

CLEARANCE Sale: 35 different sets (\$2.00 value) for \$1.00. Airmails, commemoratives, included. Guaranteed to satisfy. Bargain bulletins for stamp. Riordan's, 1738 Longfellow, Detroit, Mich.

WONDER Collection: Packet odd countries, two airmail sets, United States commemoratives, mint British Colonies, triangles, diamonds, 15 Asia, 10 Africa; packet nineteenth century — everything, 5c. Wright's, 2527 Guilford, Baltimore, Md.

DUTCH Indies bargain. Those elusive stamps. 25 diff. 15c. Elholm, 1336 Deane, Racine, Wis.

U. S. Price list free. M. G. Hanna, 335 Fifth Ave., Pittsburgh, Penna.

ILLUSTRATED Album. Spaces 4000 stamps; with penny approvals 20c. Swan Stamps, 604 Swan, Dunkirk, N. Y.

GIANT Packet 200 all different, from Africa, South America, Asia, South Sea Islands, etc. Includes world's smallest stamp, triangle and diamond-shaped stamps, animal stamps, Nicaragua Olympic "baseball" commemorative; and many others. Also packet 17 different United States (cat. 65c)—all obsolete, including \$5 denomination, commemoratives, etc. Total catalog value nearly \$5.00! All for 5c to approval applicants. Write to-day! World-Wide Stamp Co., Box 600, Camden, New York.

WORLDWIDE Mixture. Packet containing 1000, 25c. Plaza Stamp Co., Box 1161, Santa Fe, N. Mex.

FREE, 50 Stamps, Iraq, etc. Postage 1c. Album 3c. Bullard, 268 Northampton, Boston, Mass.

15 DIFFERENT United States commemo- ratives 5c to foreign approval applicants. Blue Grotto Stamp Co., Flint, Mich.

FREE Collection 10 different Danzig for the names and addresses of three active stamp collectors if you ask for approvals. Reimers Company, 500 Flatiron Bldg., Ft. Worth, Texas.

10,000 VARIETIES 1c Each! Gordon Davison, Box a568, Manchester, N. H.

FREE! Triangle airmail! Diamond! Pictorials! British Colonies! Wonderful packet 61 different (no Europe) 5c to approval applicants. Bargain Co., Box 39P, Times Square Station, New York.

MONTHLY Stamp and coin magazine, six months and 25 foreign stamps, 25c. American Stamp Journal, Cedar Rapids, Iowa.

SOUNDS Impossible! 120 different— Afghanistan, Azerbaijan, Zanzibar, triangle, diamond stamps; United States commemoratives, Civil War issue, \$2, \$5 high denominations; everything—5c. Abell's, 1818 St. Paul, Baltimore, Md.

U. S., Canada, Newfoundland, Mexico: "Four Star approvals." Nothing like them! Write today. 312 mixed U. S. only 10c. Kessels, Tucson, Arizona.

BEAUTIFUL Irish girls. Second set of souvenir stamps issued by Irish Hospitals' Trust Limited, Dublin. Specimen sheet of 20 stamps supplied free of charge to all writing to Mr. J. O'Sheehan, Department PM. 28 Earlsfort Terrace, Dublin, Ireland.

SMALL Sheet of 4 different triangles 10c to approval applicants. Victoria Stamp Co., London 4, Canada.

UNBELIEVABLE! 62 Different, six tri- angles and diamonds; airmail, animal, war stamps—China, Japan, Manchukuo, insurgent Spain; Asia, Africa, South Seas. Everything, 5c! Crowder's, 127E North, Baltimore, Md.

CANNON! Set of stamps showing can- non, firing squad, cavalry charge and 200 other different stamps, only 10c to approval applicants. L. H. Reich Stamp Co., 4647 Kenmore, Chicago.

FREE! Two coronation sets. Postage 3c. Roberts, 312P Shearerbig, Bay City, Mich.

UNITED States—45 different, perfora- tion gauge, hinges, bargain pricelist—all for 10c. Seidenberg, Baroda, Mich.

PANAMA Triangle and 50 others free to approval applicants sending 3c postage. Tatham Stampco, Springfield-30, Mass.

FREE! "United States and British North America"—our valuable, complete, illustrated, 64-page catalog quoting lowest prices. Big illustrated list of foreign stamps also included. H. E. Harris & Co., 137 Transit Building, Boston, Mass.

200 DIFFERENT 10c. Big 50% approv- als. Covert Stamp, 39 State, Rochester, N. Y.

STAMPS. A superb selection sent on approval. Quality at low prices. Fred Herzberg, Box 91-P, Elmhurst, Ill.

QUEEREST Stamps packet. Receive one of world's smallest stamps; scarce Vatican City; Greek Red Cross (coiled snake in Garden of Eden!); Manchukuo; Soruth (mountain lion); Mozambique (giraffe); Palestine; many others. Also big packet 25 dif. Japan, (including earthquake stamp) and pkt. 15 dif. China. Everything for only 5c to approval applicants! R. M. Stamp Co., Box 230P, Fort Chester, N. Y.

50 DIFFERENT, Fine U. S. including perforation gauge, 10c with approvals. The Stamp Shop, 809 Holland Bldg., St. Louis, Mo.

BRAZIL, 50 Different 10c with bargain approvals. Davis, Silver Lake, Ind.

ASK For our wonderful one cent approvals. Prospect Stamp Co., 225 Broadview, Toronto, Canada.

WHOLESALE Catalog for dealers. Illustrated. Postage 5c. Frank Co., 4900 Chalmers, Baltimore, Md.

PENNY Approvals, that satisfy. Neil Gronberg, Box 5441-P, Philadelphia, Penna.

30 DIFFERENT Angola, Cape Verde, Guinea, Portugal, Mozambique, St. Thomas and Prince 5c. Approvals. Depraw, Ocean Park, Calif.

STAMP Dealers, your ad here will bring wonderful returns. Ask me for proof. F. W. Johnson, Manager, Classified Advertising, Popular Mechanics Magazine, 200 E. Ontario St., Chicago.

APPROVAL Sheets. One to three cents. Frederick B. Driver, 2009 Finance Bldg., Philadelphia, Penna.

25 UNITED States, including \$4 and \$5 stamps free to approval applicants. 3c postage. Brownie Stamp Shop, Flint, Mich.

WEEKLY Stamp magazine, thirteen weeks, 10c. Stamp Journal, Kalamazoo, Mich.

HOBBIES AND COLLECTIONS

COLLECTORS Liberty Bell paperweight novelty 50c. Joseph Winters, Pleasantville, N. J.

A FASCINATING Pastime. Exchange stamps, postcard views, etc., with other collectors everywhere. For particulars write Johnson, Box 324, Willimantic, Conn.

GIVE Matchless albums for Christmas! "Master" holds 450 match books, mixed sizes. \$2 prepaid. Matchless Album, G. C. P. O. Box 120, New York.

BOY Mechanic—Famous library of 3 volumes covers the building of almost everything a boy might want to make. Actually covers 3,000 different articles. Each volume 460 pages, fully illustrated. Cloth. Price \$2 each or set of 3 vols.—\$5 postpaid. Popular Mechanics Press, Room (C38), 200 E. Ontario St., Chicago.

PHOTO FINISHING

ANY 8 Exposure film developed and printed, including two free enlargements. 25c. Satisfaction guaranteed. Empire Photo Laboratory, Sea Breeze, New York.

MAIL Your rolls to film center of the world. Any 6 or 8 exposure roll developed and printed 25c coin. DeLuxe enlargement coupon free! Photo Finishing Shop, Est. 23 yrs., 411-CC Genesee Valley Trust Bldg., Rochester, N. Y. "The Camera City."

ROLLS Developed, printed, free album, fotoflat, enlargement coupon. 25c. Reprints 3c. Streamline, Box 5699-L, Cleveland, Ohio.

DECKLE Edge kodak pictures, 8 exposure rolls developed, printed 15c. Reprints 2c. Economy Finishers, Box 1576, Station D, Los Angeles, Calif.

MM Films, Leica, Argus, Univex, Vest Pocket or any fine grained miniature films developed free with enlarged oversize prints, 4c each; 10 or more, 3c; 25 or more, 2½c. Miniature Specialties, 6444 Diversey, Chicago.

ROLL Developed and 16 prints 25c. Reprints 20 for 25c, 50 for 50c coin. Queen City Service, Dept. C, Box 7, Niagara Square Station, Buffalo, N. Y.

A NEW Film with every eight exposure roll developed and printed, coin 50c. Sterling, Box 5556, Cleveland, Ohio.

EXPERT Miniature film developing. Very fine grain. Best 20 pictures 3x4 Kodabrom enlargements \$1.00. Reprints 4c. Regular rolls 8 prints, 2 enlargements 25c. Expert Studios, LaCrosse, Wis.

PHOTOGRAPHY For pleasure and profit. Prepare for profitable business or fascinating hobby at home. Previous experience unnecessary. Common school education sufficient. Write for information and requirements. American School of Photography, 3601 Michigan Ave., Dept. 3459, Chicago.

YOUR Choice 25c. Roll developed and (1) 2 prints each good negative, or (2) 8 prints, 2 glossy enlargements, or (3) 8 oversize fancy border prints. Reprints 2c. Enterprise Film Co., PM, Enterprise, Ore.

ROLLS Developed, printed, two 5x7 enlargements included—25c. Reagan, 406 Tenth North, Seattle, Wash.

20 REPRINTS 25c. Films developed, two prints each negative 25c. Skrudland, 6444-8 George, Chicago.

HIGHEST Class photo finishing. We use fine grain developer. Any size roll developed and printed and two enlargements 25c. One dozen reprints and two enlargements 36c. Helen Art Photo Service, Albany, New York.

LIFE Photo finishing lasts a life time. Roll developed, 8 prints, 2 enlargements 25c. Reprints 1½c. Life Photos, Hutchinson, Kansas.

TWO Glossy enlargements, 1 colored with roll 25c. Arbor Service, 10, Joliet, Ill.

35MM. ROLLS Supertone fine grain developed 36 enlargements 3½x5, \$1.00, 2 5x7s free. Texas Studios, M2, Sweetwater, Texas.

ROLL Developed, 16 guaranteed prints, two coupons on enlargements 25c. Smart Photo, Winona, Minnesota.

ANY MM, fine grain film developed with 3½x4½ prints at 4c per print, 10 or more 3c each, 25 or more 2½c each. Skrudland's Candid Dept., D-6444 Diversey, Chicago, Ill.

GENUINE Velox fadeless prints, 20 reprints 25c. Roll developed 2 sets prints and 2 enlargements 25c. Four 5x7 enlargements 25c. Filmshop, PM2, Sweetwater, Texas.

ROLL Developed, printed 15c. Reprints 1c. Howard's, 2947 Jarvis, Chicago.

TWO Beautiful enlargements, eight electrogloss prints with roll developed 25c. Mayfair, Dept. K, Box 261, Toledo, Ohio.

BEAUTIFUL Photographic Christmas cards, 75c dozen. Send negative and 10c for sample. Hench Studios, Harrisburg, Penna.

THREE Prints each good negative in roll 25c. Trial, Reprints 3c. Fred D. Eastman, Bode, Iowa.

EXCITING Photographic pastime. Collect genuine picture stars photos with roll developed including two prints each exposure—25c. Colorcraft, Box 2510-P, Hollywood, California.

ART, Your portrait painted 9x12, likeness guaranteed. Send 50c and photograph. Photoart, 857 So. 89, Wauwatosa, Wis.

SENSATIONAL Offer. Five 5x7 enlargements 29c. Eight candid enlargements, 3x4½, 25c. Cardinal Photoers, Summit, N. J.

CANDID Special. 35mm. rolls enlarged to 3½x4½, \$1.00. 18mm. rolls 60c. 3½x4½ reprints 3c. Brown Photo Company, 1910-61 Emerson, Minneapolis, Minn.

16 PRINTS With roll 25c. 16 reprints 25c. Rex Photo, Ogden, Utah.

MILLIONS Now know "Hollytints Means Better Prints." Two professional enlargements with trial roll—25c. Fascinating premiums. Unequaled service. Hollytints, P-1350, Hollywood, California.

ROLL Developed, 8 brilliant fadeproof Velox prints and two professional enlargements 25c. Embossed photo Christmas cards or calendars from your negatives, 4 for 25c, envelopes included. Overnight service. Young Photo Service, 405-C, Albany, N. Y.

BEAUTITONE Enlargement, dime and negative. Giant Snapshots, Inc., Green Bay, Wis.

GUARANTEED. Roll developed, 16 prints 25c. 20 prints 25c. Quality Photo, Hutchinson, Kansas.

QUICK Service—Rolls developed, 8 guaranteed prints; 2 enlargements; 25c coin. OK Photo Service, Ottawa, Kansas.

ROLLS Developed and printed 10c. Trial. Quality Finishers, Maywood, Ill.

PROMPT Service—Quality work; 2 beautiful double weight gloss enlargements, 8 guaranteed neverfade prints each roll, 25c. Excel Photo Service, Dubuque, Iowa.

WILLARD'S Gives your pictures a beauty treatment—they're clear, brilliant, full of life. Roll developed, 2 prints each negative 25c. Enlargement coupon. Willard's, Box 3535-A, Cleveland Heights, Ohio.

ROLLS Developed, 2 prints each and 2 free enlargement coupons, 25c; reprints, 2c each; 100 or more, 1c. Summer's Studio, Unionville, Mo.

ROLL Developed and 8 beautiful Velox glossy prints 25c coin or stamps. Reprints 3c each. Fotoprint Service, Box E, Roanoke, Va.

PROMPT Service, guaranteed work. Two beautiful portrait type double weight enlargements, eight neverfade gloss prints, each roll 25c. Dubuque Film Service, Dubuque, Iowa.

FINER Finishing. Rolls developed and printed, with one colored enlargement, or two professional enlargements. All for 25c (coin). Genuine, nationally known, Moentone superior quality. Moen Photo Service, La Crosse, Wis.

FOR The discriminating amateur, roll developed and carefully printed 25c, reprints 3c. Superior workmanship, same day service. Paramount Co., 327 E. 92nd St., New York.

MAKE Photography Pay. New book. \$1.00. Popular Mechanics, 200 E. Ontario St., Chicago.

CAMERAS, PHOTO SUPPLIES

CAMERAS And supplies. Free illustrated catalog listing everything photographic—still and movie cameras, films, lenses—at tremendous savings. Hundreds of bargains, new and used. All guaranteed. We take your old camera or equipment in trade. Write now for your free copy of our newest money-saving bargain book—just out! Limited edition. Hurry! Central Camera Co., (Photographic Headquarters Since 1899), 230 South Wabash, Dept. 1-K, Chicago.

CAMERAS On time! 10% down, 10% monthly. Liberal trade-in allowance on your old camera. New catalog illustrates, describes, prices, latest models, all makes. Contains expert advice on choosing your camera. Send 10 cents for your copy. National Target and Supply Company, Dept. P-26, 1255 - 25th Street, Northwest, Washington, D. C.

ARGUS Ever-Ready camera case, leather, \$1.69. Mirotex, 6241 Southwood, St. Louis, Mo.

WE Process 16mm. movie (negative-positive) and miniature camera film. Complete printing and enlarging service. Ask for information. Impe, 157 West Santa Barbara, Los Angeles, Calif.

MAKE Money in photography. Learn quickly at home. Spare or full time. Easy plan. Previous experience unnecessary. Common school education sufficient. Interesting booklet and requirements free. American School of Photography, 3601 Michigan Ave., Dept. 3431, Chicago.

16MM. FILMS. Save money using Thrifty Guaranteed Reversal Films. Orthotype \$1.50, panchromatic \$3, hundred foot rolls processing included. Order direct. Thrifty Films, Dept. F, Drawer 6, Arcade Annex, Los Angeles, Calif.

MAKE Money selling snapshots. Dime brings 152-page book complete instructions, buyers, real information. Lyons-Publishers, 402-P Evans Building, Washington, D. C.

CAMERAS. Wholesale discounts, accessories, movie screens. Guaranteed merchandise. Free literature. General Photo Supplies, 89 Fairview Ave., New York, N. Y.

CAMERAS—Shutters repaired. Leather bellows installed in folding and view cameras. Bellows made to order. United Camera, A-1515 Belmont, Chicago.

35MM. CARTRIDGES Refilled: 33 exposures, Super-x; 50c. Falmaco, Monessen, Penna.

SEND For new Photographic "Bargaingram" before buying elsewhere. 1,500 live specials. Large selection used buys. Trades accepted. Mogul's, 64 West 48th, New York.

PROFESSIONAL Type photo enlarger, only \$4.95. Complete with high quality lens and supply print paper. Makes clear enlargements any size. Easy to use. Nothing else to buy. N-Larg-O, Dept. S-2355, Cincinnati, Ohio.

BASS Offers you extra value in our policy of your money back without question if you are not absolutely satisfied. Few excerpts from our great Bargaingram No. 236, 56 pages of still camera values and supplies. It's free for the asking. Zeiss Ergo detective camera, V.P. size, Carl Zeiss Tessar F:4.5 lens, right angle finder, \$32.50. 2½x3½ Agfa plate and film pack camera with F:6.3 lens in shutter, precision construction, \$15.75. Midget Marvel, F:4.5 lens, 35 mm. size, \$15.75. The great Dollina II Candid, coupled range finder, Radianor F:2.9 lens, Compur Rapid shutter, \$49.75. Argus, America's own candid camera, \$12.50. But better send for this book. It is a true guide to shrewd buying. Bass Camera Company, Dept. AG, 179 W. Madison St., Chicago, Illinois.

ENLARGER \$1.59. Makes postcard size from small negatives. Fully guaranteed. Paramount Sales Company, 89 Dudley Street, Boston, Mass.

PHOTOGRAPHY Pays big profits. Make money with your camera. Over 200 recommended books on all branches of photography. Catalog free. Popular Mechanics Press, 200 E. Ontario St., Chicago.

IF You go to Mexico ask first for prices and pamphlets of finest German quality miniature and other cameras, binoculars, movie cameras and projectors. Foto Mantel Sucr. R. Rudiger V. Carranza 11. P. O. Box 1459, Mexico City.-105. Branch store: Tijuana, Baja, California. Branch store: Tijuana, Lower California. Hotel Comercial. Branch store: Monterrey, N. L., Morelos Oriente No. 557.

MAKE Powerful telephoto camera, trifling cost. Jamer, 94D, Manorville, N. Y.

NO More wasted film or unnecessary expense. Take pictures you can be proud of. Sell to magazines and newspapers. Make good money wherever you live. Easy, low-cost home study course shows you how! Free catalog. Universal Photographers, Dept. 104, 10 W. 33 St., New York City.

CAMERAS Films, paper 25% to 35% discount. Paramount Photo Division, 327 East 92nd St., New York.

HAVE You a camera? Send ten cents for recent number of our big magazine, showing how to make better pictures and earn money. American Photography, 116 Camera House, Boston, 17, Mass.

MOTION PICTURES AND SOUND EQUIPMENT

CHROMO Film! Guaranteed finest quality reversal! Full orthochromatic! Weston 8! Complete processing included! Two 30 ft. Univex reels \$1.00! Two 25 ft. "Double 8" reels \$1.90! Postpaid! Order now! Chromofilms, 156-E Springfield, Rutherford, N. J.

AMAZING, 400 Ft. 16mm. film subjects \$2.25. Golde Exchange, 609 Third Avenue, New York City.

35MM. FILMS, Projectors. Lowest prices. Demsey, 1223 Berkley, Youngstown, Ohio.

8MM.-16MM. Movies. Vision Films, 704 Mt. Hope, Cincinnati, Ohio.

UNIVEX Movie film—Develop your own. Complete instructions. Send \$1.00. Hobby Corner, 1230 Oak, Eugene, Oregon.

PROJECTORS, Cameras, recording equipment, 35mm. and 16mm. films. Phonotone Laboratories, Washington, Indiana.

MOVIES In halls or under canvas, pleasant cash occupation. Particulars 25¢. 35mm. 75¢ per reel. Catalog, samples 10¢. Miller Cine Films, So. Main, Elmira, N. Y.

FILM, 8mm., 16mm. free list. Write Leslie Barnes, Mt. Pleasant, Tenn.

BARGAINS Galore. 16mm.-8mm. listings. No-Wat-Ka, 151 Broadway, Paterson, N. Y.

FREE! Giant Christmas bargain lists. 35mm. silent. Calderara, 5119 South St. Louis, Chicago.

CHRISTMAS Films. 8mm., 16mm. sports. Free lists. All kinds films, cameras, projectors, \$3.98 up. W. N. Gravlee and Son, Box 12M, Kennedy, Alabama.

FILM For projectors. 16-8mm.; sample 10¢; lists free. Goodwill Company, Jackson, Tenn.

8MM.-16MM. Home movies. New subjects monthly. Send for free list today. Crown Film Corp., B42 Melrose St., Boston, Mass.

CHRISTMAS Special. 16mm. projectors, electric motor driven, 400 ft. with roll film, \$9.95. 100 ft. subjects \$1.50. 400 ft. subjects \$5.00. Other bargains. Complete rental library. All subjects. Films rented everywhere. Free illustrated catalogue (with sample film 10 cents.) Garden Exchange, 317 West 50th, New York.

THREE Beautifully handlettered "The End" titles, 25¢ with ad. Gard, 3240 Henri Hudson, Riverdale, New York.

EXCLUSIVE Photographs: Samples, complete list 25¢. Albert McGoldrick, Mansfield, Mass.

BARGAIN Catalog free. 16mm., 8mm. cameras, accessories. Camera Service, 1125 Howard St., Union, N. J.

GENERA Movie film for all cameras. 100 ft. single 8mm., \$1.00; double 8mm., \$1.75; 16mm., \$1.35. Sample free. Process with powders. Fromaders, Davenport, Iowa.

35MM. TALKIES, Silents, equipment, lists 3¢. Box 23, Hagerstown, Maryland.

NEW, Novel "Christmas Bargaingram" right off press. 1,500 movie specials—sound, silent—8, 16, 35mm. Used, new. Films, cameras, projectors, screens, accessories, rental library. 35mm. Powers \$750.00 portable sound film outfit, complete with speaker and amplifier \$219.50. DeVry 35mm. portable sound film projector, complete, \$169.50. Akeley 35mm. camera outfit, complete with tripod, \$675.00. 6'x8' portable screen \$8.00. Bolex 16mm. camera \$39.50. 36x48" beaded roll screen \$4.50. RCA Victor 16mm. complete sound projection outfit \$125.00. 35mm. portable motor-driven 1000' projector \$27.50. Films \$1.00 per reel. 8, 16mm. film subjects, new and used, priced low. We trade, rent, buy, sell. Mogull's, 64 West 48th, New York.

MOVIE Film. Develop yourself. Univex, Eastman, etc. Chemical samples 15¢. Raw film wholesale. Lake Camera Exchange, Gary, Ind.

BASS Wants to mail you without charge our new 52-page Cine Bargaingram No. 234—sound, silent, 8 mm., 16 mm., 35 mm. equipment, of the quality we can sell on our money back guarantee. Write for this valuable book at once. Full description of the RCA 16 mm. sound on film camera. Newsreel model is only \$250.00, and Bass is exclusive distributor. Dept. A, Bass Camera Company, 179 West Madison Street, Chicago, Illinois.

HOLLYWOOD Titles made easy. Trace, artistic titling charts, \$2.00 complete. Samples, 3¢. Stein Studios, Flatiron Building, New York.

16-35 MM. Films. List 5¢. Bedner, 5300 S. Talman, Chicago.

CHRISTMAS Film, 16mm. \$1.85, 8mm. 98¢ complete. Free 16mm., 8mm. bargain lists. Home Movies, Box 216, Easton, Pennsylvania.

TALKIE Programs rented, sold. Simpson, 1275 South Broadway, Dayton, Ohio.

COMEDIES, Westerns. 500 feet 75¢. Jersey Films, 2075 Richland, Lakewood, Ohio.

LEARN Motion picture theatre management, advertising, projection. Free catalog. Give age. Theatre Institute, Elmira, N. Y.

"THE World's Greatest Passion Play." Sound or silent. 8 reels, 16mm., rent and purchase. Superior than Oberammergau stage play. Write Hemenway Film Co., 37 Church St., Boston, Mass.

16-35MM. RENTED 50¢ Weekly; lists 3¢. Hoffman Film Service, 57 Broad, Albany, N. Y.

BARGAINS! 8mm., 16mm., free literature. Elder, B-739 Boylston, Boston, Mass.

15% TO 25% Discount on still or movie cameras. Free circular. Paramount Co., 327 E. 92nd St., New York City.

RADIOS, SUPPLIES, INSTRUCTION

SEND For free giant money saving radio and phonograph record catalogue. United Radio, Company, 1000 M, Newark, N. J.

RADIOS, Shavers, violins, watches, pens. Agents prices. Sims, Warwick, New York.

INTERFERENCE, Local and atmospheric, reduced by special aerial hookup. One dollar will bring this to you. S. Lovejoy, Box 504, Nacogdoches, Texas.

"CRYSTAL Detector" handbook; 3 beginner's plans; "Radiobuilder"—year. All—25¢. Laboratories, 7700-C East 14th, Oakland, California.

RADIOS—All kinds. Save 50%. 100 accessories. Catalog free. Marco-F, Kansas City, Mo.

RADIO Engineering, broadcasting, aviation and police radio, servicing, marine and Morse telegraphy taught thoroughly. All expenses low. Catalog free. Dodge's Institute, Ames St., Valparaiso, Ind.

DON'T Buy a radio. Get our catalog first listing over 400 nationally known standard make sets. Also 700 electric specialties for the home. Big special, 10 inch phonograph dance records, 12 for \$1. Write today. Modell's, 56 Cortlandt St., New York.

2000 BLANK Radio chassis in beautiful black wrinkle 7x9x2 only 25¢ C.O.D. Rush while they last. Request catalog. General Engineering, Charlotte, Michigan.

GET Those new tubes! Spare set! All numbers, popular brands, 50¢ each, guaranteed perfect. Clinton, 4002-6 Ave., Brooklyn, N. Y.

MUSIC AND MUSICAL INSTRUMENTS

MUSIC Composed to words. Rhyming pamphlet on request. Phonograph recording of completed song. Send poem. Keenan's Studios, Dept. PM, Box 2140, Bridgeport, Conn.

MUSIC Composed, arranged, revised. Expert work, moderate cost. Len Fleming, Wellsboro, Penna.

FLORIDA Bound, latest song hit, 25¢ coin postpaid. Satisfaction guaranteed. Murray Publishers, Box 300, Lakeland, Fla.

ORIGINAL Poems, songs wanted immediately for publication. Westmore Music Corporation, Dept. 33G, Portland, Ore.

HAVE Your song, phonograph recorded, \$5.00. Keenan's Music Service, Box 2140, Bridgeport, Conn.

SONGWRITERS! Poems, melodies. Amazing proposition. Hibbeler, C-5, 2157 No. Avers, Chicago.

SONGPOEMS Wanted: Modern service—percentage basis. Newald Music Co., Kitchel, Ind.

SONGWRITERS—Get free the inside facts on successful songwriting by famous Broadway composer. Write today. Songwriters Institute, 1234-C Broadway, New York.

SIMPLIFIED Swing! Accordion, saxophone, clarinet, trumpet, violin. Swingmaster, 1259-N Bender, East Cleveland, Ohio.

SONGS, Poems, bought, composed, arranged, published. Royalty contract, free information. Metro-Melody Publishers, 532A Geary, San Francisco.

SONGWRITERS, Poems wanted immediately. Glen Warren, 1560 Broadway, New York City.

COMPLETE Orchestrations, sheet music, 15—\$1.00. Silverman, 3303 Lawrence, Chicago.

PHONOGRAPHS, Parts, supplies. Portable \$4.95. Records 6¢. Epsteins, 50 First St., New York, N. Y.

JAZZ Piano guaranteed by mail in 20 lessons. Erskine Studios, 810 East 14th St., Oakland, California.

SONG Poem writers wanted, our 50-50 plan has aided many songwriters. Russell Duke received \$150.00 advance on his song. Burl Bogg's song won a nationwide contest. We may be able to help you. Send poems or write for free booklet today. Indiana Song Bureau, Dept. 41, Salem, Ind.

ORIGINAL Music composed to your words, \$5. 200 printed copies \$10. Reginald Belcher, Chatham, New Jersey. 30 years church organist.

WANTED Original poems, songs, for immediate consideration. Send poems to Columbian Music Publishers, Ltd., Dept. 42, Toronto, Can.

DUO-FLEX Reeds for clarinets, and saxophones eliminate your reed troubles. Write for circular. Duo-Flex Reeds, 1204 1st Ave., Evansville, Ind.

SONGWRITERS—Agents, new sales plan. National Music-D, 532 Sixteenth, Oakland, Calif.

SONG Poems wanted to be set to music. Free examination. Send poems to McNeil, Bachelor of Music, 4153-PM S. Van Ness, Los Angeles, Calif.

PIANO By ear. Free booklet. Day-V-Way, Woolworth Building, Dearborn, Michigan.

MUSIC Composed to words. Wonderful proposition. Bauer Bros., Oshkosh, Wis.

WRITE Songs. Big money and reputation. Write for information. J. Gordon Pub. Co., 201 N. Hoyne Ave., Chicago.

WANTED! Lyrics, melodies for songs. We arrange, publish, sell. Superior Song Studios, Passaic, N. J.

LEARN Swing piano! Postal brings free folder. Christensen, 751 Kimball Hall, Chicago.

SONGWRITERS: Send your poem today for immediate consideration. Richard Brothers, 24 Woods Building, Chicago.

SONG Writers. Send for publishing agreement. McKinley Music Publishers, 1501 E. 55th St., Chicago.

SONGS, Poems wanted. Edw. Madden, 1207 Carbon, Syracuse, N. Y.

PIANO, Self Instruction. Play within an hour. \$1.00. Popular Mechanics, 200 E. Ontario St., Chicago.

BUSINESS OPPORTUNITIES

BE Independent—I'll show you how to write successful selling letters for any kind of business. No books to study, no hard rules to learn, you start writing immediately. Many firms pay as high as \$25 for single letter. Complete instructions \$1 postpaid. Coykendall, Letter Specialist, Treasure Village, St. Petersburg, Florida.

PERFUMERS Make big money. Start small, grow large. Let me point the way. Small capital—profits large. Write quick for free booklet explaining all. Dr. Abell, Slavin Bldg., Pasadena, Calif.

"BINGO" New coin operated amusement game. Large income, operating "route." Small investment. Details free. Robbins, 1141P DeKalb Ave., Brooklyn, N. Y.

NEW Mail order plan for new product. Going over big. Write quick. Phelps, 1900-C Euclid Ave., Cleveland, Ohio.

RECAST Old batteries into new. Latest achievements. Battery Laboratories, St. Paul, Minn.

MAKE Artificial marble, glazed tiles, uncanny. Tabletops, plaques, floors, hones, novelties. Hard, fireproof, inexpensive, cement secrets. Brilliant tile and liquid rubber samples 3c. John A. Payn, 945 Grande Vista Avenue, Los Angeles, Calif.

ACE Profitable mail order business. Staebler, 79-20-45th, Elmhurst, N. Y.

FORMULAS—Fast selling products. Guaranteed. Laboratory tested. Lowest prices. Catalog free. Kemico, 55K, Park Ridge, Ill.

POPCORN Machines, carmelcrisp, crispettes, cheese coat, potato chips. Long Eakins, 2035-A High St., Springfield, Ohio.

MANUFACTURE For us or sell direct to homes and public buildings. A new invention. Made from discarded tin cans. Retailers for 50c. Full particulars and sample \$1.00. Albright Specialty Co., Box 346, Burbank, Calif.

STEADY Money in showcards, signs, window lettering. Easy. Amazing details free. Write Nelson Company, 2027 Manhattan Building, Chicago.

REAL Moneymaking opportunities. Big profits. Write John Ystesund, Sheboygan, Wisconsin.

M. M. Earned \$267, three weeks, raising mushrooms in cellar! Exceptional, but your cellar, shed perhaps suitable. We buy crops. Book free. United, 3848 Lincoln Ave., Dept. 67, Chicago.

LAWN Mowers, electric, gasoline. Different, rotary, light, \$37.50 up. Cuts anything. Agents wanted. Manhart-Buckley, Brandeis Theatre Bldg., Omaha, Nebraska.

COLLECTION Agency work profitable. Easily started. Write, Carew, Rumson, N. J.

IF You are ambitious you can make good money with a Raleigh route. We help you get started. No capital or experience needed. Steady work for right man. Write Raleigh's, Box A-2-PMB, Freeport, Ill.

YOU'LL Like resilvering mirrors, autographs, reflectors, making chipped glass signs. Write, Sprinkle, Plater, 127, Marion, Indiana.

MAKE Money at home! Grow mushrooms in cellar or shed, with Ami U. S. Patented Mushroom Spawn and step-by-step, easy-to-follow Manual of Instructions. Fascinating, profitable. Booklet free—write today. Anglo-American Mushroom Industries, Dept. 29, Toronto, Ont.

FLEXIBLE Mold material non shrinking, non warping, waterproof, keeps detail. Use over and over. Particulars, stamp. Thomas Sales, Box 656, Detroit, Mich.

EARN Up to \$500.00 back yard gardening. Stamp brings information. Lightning Speeds, Streator, Illinois.

SOMETHING New! Build mail order business selling Dehydrated Vegetable Products. Finest quality. Your labels. Samples, dime. Gardena System, 128B, Station "S," Los Angeles.

WIDELY Circulated "National Opportunity Catalog." Copy 25c. None free. P. O. Box 1080, Lincoln, Nebr.

STEADY Income. Manufacture and sell locally, guaranteed, tried and proven athletes' foot remedy. Ready sale, 900% profit. Formula, directions and jar of remedy postpaid on receipt of \$5.00. K. Riley, 200 Locust St., Springfield, Mass.

MAKE And sell your own products. 7 tested and proven formulas for fast selling items. Send \$1.00 for complete instructions and formulas. Mt. Hi. Engineering Co., Casper, Wyoming.

A NEW Industry is born! Veg-O-Mat extracts. Delicious vegetable juices containing all minerals, vitamins. Highly recommended by physicians. Profitable repeat business. Particulars. Domestic Electric, 118 E. 28, New York City.

AMAZING Patented screw-holding screw drivers. No competition! Factories, hardware stores buy quantities. Big profits, repeats. Foreign territories open. Free trial! Toolco, 5096 Journal Bldg., Boston, Mass.

CASH In on big demand for Mexican novelties! Large profits! Particulars free. Samples 10c stamps. Marquez-PBD, Apartado 1176, Mexico City.

"RUBBER Molds." Make them yourself. Formulas, instructions 25c. Ideal Service, 179RM, Park Ridge, Ill.

\$1.90 PROFIT On each \$2.00 mail order. Guaranteed legitimate. Particulars free. Pop-Director, Drawer 989, Edinburg, Tex.

"1939 BUSINESS Folio." Send for free copy. Hutchison, 314 North Fourth, Camden, N. J.

MOLDEX, Makes best rubber molds. Models, supplies. Pentucket Arts, Haverhill, Mass.

FREE List of 2556 occupations. Don't be a square peg in a round hole. Write today. No obligations. Vocational Guidance Bureau, 201 Park Ave., Dept. 2A, Baltimore, Maryland.

205 MONEYMAKING Opportunities, today's conditions. Your own business, home, office, etc. Introductory booklet free. Stamford, 3762-C Broadway, New York.

"MAKE Mirrors at home." Big profits. Little outlay. Also emboss, grind—foil, gold leaf, frost, chip and make imitation stained glass. Instruction course 50c. Bestovall, 4047-RM N. Whipple, Chicago.

MAKE 1939 Your "big-money-year" easily making today's greatest-selling products from latest certified formulas. Stamp brings valuable details. Miller, Chemist, 706-Jb, Tampa, Florida.

BALLGAMES, Movies afternoons. Work mornings home, your own business. Write Stamford, 3762-B Broadway, New York.

OPPORTUNITIES In Southeastern Alaska. 24 page booklet, price \$1.00. Box 2241, Ketchikan, Alaska.

GO Into business for yourself. Book tells how. 10c. Ford System, Gibsonia, Penna.

START Business anywhere—home—work mornings. Write Dunn, Box 74, Ionia, Michigan.

WRITE For free booklet, "Businesses of Your Own That Pay Best." Nu-Idea Sales, Carrollton, Ill.

ELECTRIC Razor; guaranteed two years. Local and mail distributors wanted. Big Xmas demand. Sample \$1.50, dozen \$17.00. Sterling Co., 2000 Miramar, Los Angeles, Calif.

FASCINATING Profitable home business. We show you how to make vanilla, auto polish, anti freeze, laundry bleach, etc. 25c brings simplified instructions. Home Occupations, St. Paul, Minn.

PROFIT With new products. Make, sell, repeat. Analysis. Research. Guaranteed formulas. Biggest catalog free. Special prices, leads. Gibson Laboratory, Chemists, BD-1142 Sunnyside, Chicago.

FREE. Only successful process refining old lube for market. Send stamp. Boisset, 525 Howard Avenue, New Orleans, La.

U. S. Postage dues, 1/2c to \$5.00—15c; 35 common, 15c. Pauls Stamps, 4550 N. Mobile, Chicago.

TILE Top tables—Easy, inexpensive, interesting. Beautiful, practical gifts. Tile or marble effect. No firing. Dollars in sparetime. Instructions \$1.00. Tilecraft, 3428 Fletcher Drive, Los Angeles.

PRACTICAL Opportunity mail. One year 10c. No trash. Beach, Box 156, Groton, Conn.

INVESTIGATOR. Easily learned. Good pay. Complete course. \$1.00. Particulars, Box 302, Alhambra, California.

\$12 To \$15 Weekly, year around. Rush 25c. Orphan Club, 309 Montgomery, Jackson, Michigan.

BECOME Independent. Home mail business, fully equipped \$2.95. Sample, particulars 25c. Tracy, P. O. Box 174, (Redford), Detroit, Michigan.

DOLLARS In doughnuts. Plans for making 20 kinds \$2.00. Cook, Box 31, Swampscott, Mass.

RECEIVE Stacks of mail. Your name listed in 10,000 directories 25c. Liberty Sales Service, Sheboygan, Wis.

EARN Extra money at home. You can increase your income quickly and easily at home. Wentworth supplies you with work and furnishes all materials. Write today for free booklet. Wentworth Pictorial Co., Ltd., Dept. 71, Hamilton, Ont.

6 MAIL Order magazines including all you should know about mail order business 25c. Armand Cartier, 31 Cumberland St., Woonsocket, R. I.

MONEY In butterflies, moths. See Sinclair Display Advertisement on page 26A.

SELL By mail! For inspiring, constructive, instructive literature address Jay, 6054-p Kenwood, Chicago.

4 MONEY Making mail order plans. Big profits! Information, 25c. Specialty Services, 1416 Third Avenue South, Minneapolis.

MAKE Money electroplating! Marvelous patented invention plates with electric brush—easy as painting. Does same beautiful, permanent electroplating—gold, silver, nickel, cadmium, etc.—as big tank outfits. No liquids—lightweight—portable. Anyone can use from battery or household current. Only \$6.85 complete. Write for details and sample of work done. Warner Electric Co., 360 N. Michigan, Dept. D-11, Chicago.

SELL By mail. "The Key to Business Opportunities" shows how. Particulars for stamp. Maples, 3418 South Marshfield, Chicago, Illinois.

HOME Business establishments, descriptive literature free. Byron, 82 Wadsworth Ave., New York.

LIQUID Marble—anyone can make! Colorful, glazed! Moulded, brushed, sprayed. Rubberlastic moulds. Composition flooring. Big money in these! Particulars free. Marbleizing Service, Edwardsville, Ill.

WORKABLE Mail order plans. Particulars in booklet. 25 cents. J. E. Howe, Box 183, Evansville, Indiana.

RUBBER Mold bargains. Stamp brings catalog. Colonial Arts, Derry, N. H.

CASH Daily with a route of nut and candy vendors. Small investment. Eamco, 350 Mulberry, Newark, N. J.

MARBELIKE Cement; mixed with water. Cast, brushed, sprayed over any concrete products, wall-board, wood, etc. Produces vitreous glossy finish. Dime brings assorted samples. Marbelike Cement Co., Grayling, Michigan.

MAIL Order business is your opportunity. Many began small, now earn thousands yearly. No personal contact. Boundless opportunities. Have had over 30 years experience; will help you succeed. Send 25c for valuable booklets, none free. B. Brenner, 257 S. 21st, Philadelphia.

FREE—200 Big moneymaking ideas. Kay's, 2445 1/4 Brooklyn, Los Angeles.

HOW And where to obtain capital fully explained, free particulars. Star Service, Wapakoneta, Ohio.

WE Help start you in business, furnishing outfits and instructions, operating "Specialty Candy Factory" home. Men and women, opportunity to earn \$20 to \$50 weekly, all or spare time. (Our 29th year.) Booklet free. W. Hillyer Ragsdale, Inc., Drawer 4, East Orange, N. J.

LEARN Arc welding. A growing industry with great opportunities. Consult your local school, or if there is none available write The Lincoln School of Welding, Dept. A, Box 5758, Cleveland, Ohio.

ADDED Income ideas. Mail Sales News magazine, copy 10c. Katz, 4254 No. Kimball, Chicago.

SUCCEED With your products. Make-sell them. Formulas. Processes. Accurate analyses. Catalog free. B. Thaxly Co., Washington, D. C.

COLOR Concrete with chemicals. Washing-wells. Spin concrete pottery. Stucco-rock. Miniature castles, mills, cold glass, marbling. Sample 10c. Hollywood Cement Craft, 8527 Wonderland, Hollywood, Calif.

MAN In each town to plate auto parts, reflectors, bicycles, fixtures, mirrors, by late method. Simple plan of manufacturing at home starts you in good paying business. Free particulars and proofs. Gunmetal Co., Ave. H. Decatur, Ill.

AFTERNOONS Free for outdoors, shows. \$340 month home. Unique plans. No canvassing. Prepare for surprise. Folio-F, Station D, Los Angeles.

MANUFACTURE From Phospholene. Cleaning fluid 1c gallon; bleach 2c gallon; hand soap 2c pound; and ten fast sellers. Sample 25c. Details free. Western, 6615 Denison Ave., Cleveland, O.

PLASTEX Industries offers industrious men an opportunity to start a business of their own, manufacturing art goods, novelties, souvenirs, etc., in Plastex and marble imitation. 5c material makes \$1 articles. Rubber moulds furnished for speed production. Small investment brings big returns. You are just in time for big wholesale season now starting. Write for interesting booklet mailed free. Plastex Industries, Dept. A, 1085 Washington Ave., New York.

WHERE To buy at lowest wholesale prices. Information free. Yorena, Box P-312, Bayonne, N. J.

SELL By mail. Books, novelties. Bargains! Big profits! Particulars free. B. Elfeo, 438 N. Wells, Chicago.

PROFITABLE Home business. Legitimate. No canvassing. Maywood Publishers, P-923 Broadway, New York.

CHARTERS: Delaware; best, cheapest; free forms. Colonial Charter Co., Wilmington, Del.

DELAWARE Charters: Complete service \$35. Submitted forms. Chas. G. Guyer, Inc., Wilmington, Del.

ARTIFICIAL Marble sanitary flooring, instruction covering wood or cement flooring 1/2 inch thick, fireproof, all colors, low cost, ornamental casting, concrete, plaster, papier-mache, garden furniture, statuary, flexible molds, particulars free. Chris Mahler, Elmont, N. Y.

100 PROFITABLE Mail order and local plans. Gilbert Supply, 1107 Broadway, New York.

LIKE To draw? Earn steady income tracing and duplicating advertising cartoons. Ad-Service, Argyle, Wis.

INVENTORS—We successfully sell inventions, patented and unpatented. Write for proof, and tell us what you have for sale. Chartered Institute of American Inventors, Dept. 4-C, Washington, D. C.

I WANT To send you proof of the wonderful pulling power of Popular Mechanics Magazine's classified pages. What's your proposition? Write me today. F. W. Johnson, Manager Classified Advertising, 200 E. Ontario St., Chicago, Ill.

INCORPORATE In Delaware. Liberal laws, low costs. Corporation Registration & Trust Company, 927 Market Street, Wilmington, Delaware.

WANT More business? 2c daily, opens individual New York branch office requiring no room number on your stationery or advertisements. Co-operative Mail Service, 126 Lexington Avenue, New York.

MONEYMAKING OPPORTUNITIES

\$10 DAILY At home, no canvassing, making rubber moulds and casting beautiful artistic novelties. 15c material makes \$2.50 mail order seller. Finart, 195 Van Rensselaer St., Buffalo, N. Y.

START New kind sign shop. Straley, 1017 Mulberry, Springfield, Ohio.

ONLY 25c For tested money making formula. Grows plants in water indoors. Nursery Chemical Co., 488 E. 163 St., Bronx, New York.

INTERESTED In making money? 3c stamp brings you amazing information. Universal Press Syndicate, Sarasota, Fla.

CIGARETTE Support odor eliminator. Sample 25c (silver). Smok-O-Luxe, Box PM62, Collinsville, Ill.

YOU'LL Like resilvering mirrors, auto-parts, reflectors, making chipped glass signs. Write, Sprinkle, Plater, 287, Marion, Indiana.

"RESULT Getter" magazine of money making opportunities, copy 10c. George Fenner, 1618 Lucia, Louisville, Ky.

MAKE Money at home. Simple plans. Wilbur Brubaker, Liberal, Kansas.

MILLIONS Jobless! Get dollars in mail for satisfying employment information. Keep dollars! We fill your orders. Details for stamp. Co-Operative Service, 77 Swan, Buffalo, New York.

PROSPERITY For home workers. 52 page magazine. Sample, dime. Sizemore, 4917 N. Kostner, Chicago.

ANALYSIS. Research. Newest guaranteed formulas. Biggest catalog free. Special prices, leads. Gibson Laboratory, Chemists, CS-1142 Sunnyside, Chicago.

AMAZING Money making secrets. Particulars purple stamp. Century Service, 207 E. Ontario, Chicago.

MAKE Money mailing letters. 75c profit possible on each letter. McCants Service, Weslaco, Texas.

MILLION Articles. Buy wholesale. Valuable directory dime. Ideal Service, Park Ridge, Ill.

YOUR Name—5,000 mailing lists—25c. Get samples, opportunities galore from all over world. Pines, 583-A Monroe, Brooklyn, N. Y.

BORROW Recognized moneymaking books, folios by mail 10c each. Send for details and list. Anderson, Box 548, Muskogee, Okla.

BIG Mailorder business. Home work. Davis, 337 River, Orange, Calif.

DISTRIBUTE Commission circulars. Mail or local. Darwin McFarlin, Delavan, Wisconsin.

\$25.00 STAMPING Names, per 100 key-checks. Sample 25c. Outfits furnished. Bohn Company, P. M. Box 86, Wilkes-Barre, Penna.

300 MONEYMAKING Plans 25c. Literature 3c. Morrelle, 159-N State, Chicago.

FREE—100 Wonderful business, mail-order and home work moneymaking offers. Lewis Co., 828-C Carpenter, Oak Park, Illinois.

BALLGAMES. Movies afternoons. Work mornings, home, your own business. Write Stamford, 3762-D Broadway, New York.

SPECIAL "Sparetime Moneymaking Magazine" 10c. Tuesday, 2810 Winfield, Canton, Ohio.

EMPLOYMENT: Ten tried money making propositions \$1.00. Derry, Box 219, Hobart, Ind.

COLLEGE Education! Ambitious? Work your way through! I'm working way through University California. Twenty successful plans, 25 cents. Good investment. Box 506, Berkeley, California.

PERMANENT Profitable business of your own. Small capital. Particulars free. Ad-Craft, 149 Collingwood, Detroit, Mich.

DIME Brings ways to make money easily, quickly, honestly. O'Brune, Publisher, Paulding, Ohio.

MOULDS, Guaranteed, for casting toy soldiers, Indians, trappers, warships, sinker moulds, 244 kinds. Send 5c for illustrated catalogue. Henry C. Schiercke, 645 Spencer, Ghent, N. Y.

MONEY In butterflies, moths. See Sinclair Display Advertisement on page 26A.

WANTED Original poems, songs, for immediate consideration. Send poems to Columbian Music Publishers, Ltd., Dept. P65, Toronto, Can.

IMPRINTS! Sell by mail. Big profits. Fast sellers. Low priced. Samples, prices 10c (refunded.) Success, P-13032 Chicago St., Blue Island, Illinois.

TYPISTS Earn extra money. Send 25c (coin) for "Twenty-one Ways to Make Money With the Typewriter." H. Robbins, Box 6048, Kansas City, Missouri.

PENNIES In Hamilton scales produce assured income without canvassing or selling. 1910 Vermont, Toledo, Ohio.

MAILORDER Opportunities, plans, formulas, information. Circulars free. Harvey Teeple, Decatur, Indiana.

STOP Squealing—Start crowing! Work mornings home—country drives or movies—afternoons! No canvassing! Folio-A, Station "D," Los Angeles.

MAN In each town to plate auto parts, reflectors, bicycles, fixtures, mirrors, by late method. Simple plan of manufacturing at home starts you in good paying business. Free particulars and proofs. Gunmetal Co., Ave. N, Decatur, Ill.

RAISE Earthworms for profit. Information free, stamp appreciated. Bureau Zoological Research, 106A Broadway, Peoria, Ill.

WHOLESALE Sources, 500,000 articles. Free directory. Maywoode, 925 Broadway, New York.

FORMULAS, PLANS, ETC.

YUKON Radiator anti freeze, the pride of the north. Radiator troubles over, make your own. Formula \$1 bill. Write now, Jack Fidler, Box 65, Manchester, Conn.

224 FORMULAS Of Doctor Cummings, including personal consultation, five dollars; particulars stamp. You cannot get this collection elsewhere, but only directly from sole owner. Grinstead, 505 Fifth, New York.

GUARANTEED Formulas—New fast sellers. None better. Lowest prices. Catalog free. Kemico, 49K, Park Ridge, Ill.

MOTOR Oil 2c gallon. Reclaim used oil. Formula 25c coin. George, 285 Queen, Germantown, Philadelphia, Penna.

FORMULAS—Moneymaking, fast selling products. Literature free. J. Watson Company, Stockyards Station, Kansas City, Mo.

ZEROL Anti-freeze, prevents frozen radiators to 40 degrees below zero. No alcohol. Won't rust. Complies with government standards. Manufacturing costs 15c gallon. Formula \$1.00 postpaid. Keystone Service, Topeka, Kansas.

FORMULAS—All kinds. Real moneymakers. Lowest prices. Catalog free. Clover Formulary, Niles Center, Ill.

"ANYTHING In Formulas!" Particulars free. "Research Bureau," 100 Chelsea, Charlestown, Massachusetts.

ANALYSIS. Research. Newest guaranteed formulas. Biggest catalog free. Special prices, leads. Gibson Laboratory, Chemists, BD-1142 Sunnyside, Chicago.

SIXTEEN Selected moneymaking formulas \$1.00. Pryor, Box 2066, Atlanta, Georgia.

SUCCESS Is sure with Miller's Certified Formulas with simplified manufacturing service. "Not cheapest, but best." Miller, Chemist, 706-Jf, Tampa, Florida.

AMAZING Odorless formula, destroys smelly food odors in refrigerator. Keeps them sweet and clean. Big field, bigger profits, making, selling your own. Experience unnecessary. One dollar brings formula, instructions. No free literature. Air Pure, Box 362, Garwood, N. J.

BE First to manufacture this demanded auto product. Makes water pumps, radiators, thermostats and car heaters last indefinitely. 200% profit. Formula three dollars. Other formulas free with order. 3811 Orangedale, Montrose, Calif.

FORMULAS? Literature free! (50 cosmetic formulas, \$1.00; C.O.D. \$1.18)! Galluzzo, Wilkensburg, Pennsylvania.

FORMULAS. Analysis, free literature. Hertstein, 128 So Diamond Ave., Grand Rapids, Mich.

THAXLY Formulas for perfect products. Accurate analysis assured. Resultful research. Catalog free. B. Thaxly Co., Washington, D. C.

FORMULAS: 15 Proven moneymaking formulas \$1.00. (Not stock-formula catalogue stuff), real unusual offers. List free. Marvel Laboratories, 6629 No. Maplewood, Chicago.

FORMULAS. Latest money makers. Literature free. Belfort, 4042 N. Keeler, Chicago.

10,000 MONEY-MAKING Formulas. Tells you how to make and sell almost everything under the sun; cosmetics, mucilage, anti-freeze solutions, battery solution, beverages, cheese, chewing gum, cleaning preparations, extracts, hair preparations, inks, bluing, leather polish, mirrors, perfumes, polishes, typewriter ribbons, carbon paper, washing powders, liquid soap, and hundreds of other profitable articles. \$4 postpaid. Popular Mechanics Press, Room (C38), 200 E. Ontario St., Chicago.

CHEMISTRY

ANALYSIS. Research. Newest guaranteed formulas. Biggest catalog free. Special prices, leads. Gibson Laboratory, Chemists, CT-1142 Sunnyside, Chicago.

FREE Cosmetic chemistry course to our December customers. Send 3c stamp for chemical catalog. Clinton Chemical Company, Swedesboro, New Jersey.

CHEMICALS In 5c quantities. Catalog 5c. Fleischer's Laboratories, Everett, Mass.

NEW Balance only \$8.00. Send for bulletin. General Scientific Equipment Co., North Philadelphia, Penna.

JOIN American Amateur Chemists Society. Journal, particulars 10c. Haslett, Mich.

FREE—40 Page catalog of chemical and laboratory supplies for amateur chemists. Wollensak microscopes and supplies, scientific books at big discount. J. D. Winn, 124 West 23 Street, New York City.

CHEMICALS. Laboratory, glassware, apparatus. Send 3c for catalog CP1. Biological Supply Company, 1176 Mt. Hope Avenue, Rochester, N. Y.

FREE Chemistry catalog. Supplies at 5c! Equip complete laboratory. Send 3c for postage. Kemkit Scientific Corp., 397P Bridge St., Brooklyn, N. Y.

TELESCOPES. Microscopes, chemistry, mineralogy. Scientific catalog free. Tracey Laboratories, Evanston, Illinois.

AGENTS WANTED

SELL Sensational automobile accessory. Holds car on hill without use of foot or hand brake; frees right foot for gas; fits every make car; installed in five minutes. Our men earn \$50 to \$75 weekly. Protected territories. Small capital for stock required. Write for details. Everlast Manufacturing Company, 17 East 42nd Street, New York City.

IF You are ambitious you can make good money with a Rawleigh route. We help you get started. No capital or experience needed. Steady work for right man. Write Rawleigh's, Box A-2-PMA, Freeport, Ill.

212% PROFIT Selling amazing new liquid mender. Fixes most anything; unlimited demand. Write for free sample proof. Indiana Laboratories, Dept. T-19, Elkhart, Ind.

BEAUTIFUL English Christmas cards, excellent assortment 21 in holiday box, retail value \$2.25, agent's price 50c. Fast seller. Gold Shield Products, 350-P Greenwich St., New York.

AGENTS: Smash go prices! Santos coffee 12c lb. 4-oz. vanilla 8 $\frac{1}{2}$ c. Razor blades 10 for 8 $\frac{1}{2}$ c. 100 sticks chewing gum 12c. 150 other bargains. Premiums. Experience unnecessary. Carnation Company, PO, St. Louis, Mo.

MAKE Quick profits demonstrating unique invention of electric bulb. A bright reading and current saving night light all in one. For free details and sample offer write Hagen Import, Dept. LB, St. Paul, Minn.

CARPENTERS: Sell, install overhead garage door hardware. Pays well. Circular free. Wilkie, Independence, Missouri.

SELL Guaranteed tires wholesale. Save users up to 70%. No experience necessary. Profits easy. Unlimited field. Details free. Auto Tire Company, 4502 S. Ashland, Chicago.

STRANGE Chemical sponge cleans wallpaper like magic. Banishes housecleaning drudgery. Sensational demonstration. Samples sent on trial. Rush name. Kristee, 101, Akron, Ohio.

CALLING Cards—Big profits. Samples dime. Johnson, Box 54, Worcester, A, Mass.

TIES. Wonderful proposition. Free samples. Eureka, 307 West 38th, Manhattan.

500% PROFIT With new perfected (1938) quick-action, no flint, automatic gas lighter. Retail 25c. Sample 5c. New Method Co., Box PMG-73, Bradford, Penna.

MEXICAN Novelties! 100%-300% profit. Free particulars. Samples 10c stamps. Marquez-PD, Apartado 1176, Mexico, City.

GUARANTEED Electric shavers. Tremendous Xmas seller. Sample \$1.98 postpaid. Plans free. 1917 South 70th Street, Milwaukee, Wisconsin.

WANTED—Purchasing agents, no experience or money required, write and mail 3c stamps for application to Purchasing Mgr., 176 N. Halsted St., Chicago.

SELL Artistic oil painted personal portraits! Portraiture, 826 Noble, Chicago.

FAST Selling one call foot specialty. New product. Large profits. Automatic repeat plan. Phelps, 1900 Euclid Ave., N. E., Cleveland, Ohio.

I'LL Give you groceries at wholesale besides splendid opportunity to make up to \$45.00 in a week. Brand new Ford sedan given as bonus. Details free. Albert Mills, 3206 Monmouth, Cincinnati, Ohio.

BUSINESS Proposition: Resilvering mirrors, autoparts, reflectors, making chipped glass signs. Write, Sprinkle, Plater, 128 Marion, Indiana.

PROFIT With new products. Make, sell, repeat. Analysis. Research. Guaranteed formulas. Biggest catalog free. Special prices, leads. Gibson Laboratory, Chemists, BD-1142 Sunnyside, Chicago.

500% PROFIT. Modernistic guaranteed Stick-on letters for windows, offices, trucks. Large sizes 1c. Easily applied. Free samples. Modernistic, B-3000 Lincoln, Chicago.

BIG Successful money-maker—Radiator Alcohol Seal—only 25c postpaid. Write quick. Midwest Sales, 1337 Monadnock Block, Chicago.

205 MONEYMAKING Opportunities, today's conditions. Your own business, home, office, etc. Introductory booklet free. Stamford, 3762-E Broadway, New York.

METROPOLITAN Window Letter Co. Two piece letters, penny each, free samples. 1699 Lexington Ave., New York.

MILLIONS Of prospects! Buyers everywhere! Sensational social security plates! Tremendous value! Fast seller! Big profits! Complete selling outfit free! Union Specialty, 1775-A Broadway, New York.

WHY Sell goods with stingy profits? Easily make today's newest profitable popular products yourself! Stamp brings valuable details telling how. Miller, Chemist, 706-Ja, Tampa, Florida.

ATHLETES Foot. Dime brings dollar package guaranteed Oldarme Australian. Mycolac, Importers, Atchison, Kansas.

NATIONALLY Advertised Elgin electric shavers (ac) for \$2.98. Year guarantee. Make \$1.00 profit each sale. Agents sample \$2.50. Specialty Products, Bourne, Mass.

WANTED—Reliable, ambitious men over 21 years of age with good car to travel in the country. Steady work. Write for particulars. G. C. Heberling Co., Dept. P.M., Bloomington, Illinois.

WE Are the originators of metal social security plates and cases. Ours outsell them all because we manufacture the best, 70% commission. Everlasting Records Co., 665 West Lexington St., Baltimore, Md.

MAKE More money! Selling a line no one else has! New and different radios, quick selling electrical appliances, attractive gift items. Write for catalog. Hart Products, 168 West Jackson Boulevard, Chicago.

AMAZING Product. Amazing earnings. Year-round repeat business. Details free. Sample 35c. Lyle Products, Sarasota, Fla.

SALESMEN Wanted. Sell business cards, commission. Willmar Press, 674 Main St., Pawtucket, R. I.

MONEY In butterflies, moths. See Sinclair Display Advertisement on page 26A.

BABY Shoes plated bronze, silver. Lifetime process. Agents sample \$1.50. Also general plating. Braun Electroplating, 118 E. 28th, New York.

COSTS 2c—Sells 25c. Fast selling necessity for agents, crews, demonstrators. Sample 10c. Linnell, Box 1963-E, Cleveland, Ohio.

PARING Knife. New. Peels, slices, cores. 200% profit. Sample 10c. Three other household necessities. Apex Co., 400 Dakota Bldg., St. Paul, Minn.

PROFIT 100% Selling calling cards. Bonus, prizes to workers. Outfit free. Universal, Orange, Massachusetts.

FREE Sample world's best seller. G. Mfg. Co., Washingtonville, Ohio.

AGENTS—Opportunity make money; book containing 107 successful business plans; home-office; send for free introductory booklet. Elite Co., 214 Grand St., New York.

AGENTS Make big profits on food products, bargain deals. Low wholesale prices. Rush name for trial outfit offer. Ho-Ro-Co, 2810-R Dodier, St. Louis, Mo.

SUCCEED With your products. Make-sell them. Formulas. Processes. Accurate analyses. Catalog free. B. Thaxly Co., Washington, D. C.

STARTLING Invention—Pocket adding machine. Nationally advertised \$2.50. Whirlwind seller. Big profits. Baby Calculator Co., Box 1118, Chicago.

DO You want agents for your proposition? Your ad in this space will place your message before hundreds of men seeking fast-selling products. My folder "How to Secure Agents," is filled with proof. I'll gladly send you a copy free. F. W. Johnson, Manager Classified Advertising, Popular Mechanics Magazine, 200 E. Ontario St., Chicago.

BIG Money applying initials on automobiles. Write for particulars and free samples. American Letter Company, Dept. 40, Dunellen, New Jersey.

BIG Money applying initials on automobiles. Easiest thing today. Free samples. Also, sideline salesmen for name plates and tire cover transfers. "Ralco," 1305 Washington, Boston, Mass.

500% PROFIT! Gold and colored sign letters for windows, offices, trucks, signs. Auto monograms. Easily applied by agent or customer. Neonite, Akron, Ohio.

AGENTS—To mail our literature. Good profits. Home business. Maywood, 149 Fifth Ave., New York.

FREE Sample—Amazing cleaner; sells homes, taverns, everywhere. Big profit—fast repeater. Betco, 5007 Irving Park, Chicago.

MANUFACTURE Specialties, hire agents yourself. Big money. Free literature. Gilbert Supply, 1107-P Broadway, New York.

AGENTS: Stamping names on pocket-key protectors. Sample check with your name, address, 25c. Stamping outfits. Emblem checks, check-fobs, name plates. Hart Mfg. Co., 303 Degraw St., Brooklyn, N. Y.

ENGRAVED Name plates, numbers, signs, etc., easily sold, profits large. Brett Bros., Winthrop, Mass.

REVOLUTIONARY Window cleaning tool. Good Housekeeping approval. Only ten \$2.25 sales daily to housewives, factories, schools, stores will make you \$350.00 monthly. Carter Products Corp., 900 Front Ave., Cleveland, Ohio.

GUARANTEED Gold leaf letters for store and office windows. 300% profit. Free samples. Metallic Co., 438-B N. Clark, Chicago.

ATLAS Window sign letters. Large sizes, penny each. Beautiful free samples. Atlas, 7941 Halsted, Chicago.

HIGH-GRADE SALESMEN

SALESMEN—New money-making sensation for garages, service stations, no competition, fine repeater. Automotive Laboratories, 1555 Hanchett Court, San Jose, Calif.

SELL Xmas cards, calendars, business cards \$1.50 thousand. Business stationery, book matches, advertising tape, paper towels, pencils, salesbooks, rubber stamps, free sales portfolio. 35% commission daily. Money making specials. David Lionel Press, 312 So. Hamilton, Dept. CL, Chicago.

SELL Mirror silhouettes! Best sellers in 35 years manufacturing advertising specialties. Also sensational calendar values. Harvest selling season starting now. Ad-Nov-Co, Newton, Iowa.

DID You make \$50 last week? Does your job offer you real future? If not, why not start a wholesale business of your own? Start with little as \$2.50. Handle line 200 nationally advertised 5c-10c products. Show merchants new plan for increasing sales and profits. Handle everything from your home at start. Chance to operate one of our Silver Fleet service trucks. Facts free. World's Products Co., Dept. 1910, Spencer, Ind.

SELL Popular Xmas and winter items. Fast sellers. Good commission. Glider Skate Co., Dept. 19, 3126 West 49th Place, Chicago.

\$6 To \$15.00 Daily, new; quick sales. Resale item. Car dealers, garages, service station. Write Factory, 2812 Gilham, Kansas City, Mo.

IF You are ambitious you can make good money with a Rawleigh route. We help you get started. No capital or experience needed. Steady work for right man. Write Rawleigh's, Box A-2-PMS, Freeport, Ill.

MAKE Big daily cash profits selling Top Quality Advertising Book Matches. Low prices. Experience unnecessary. Full time profits unlimited. Free sales kit. Zipper case offer. Match Corporation of America, Dept. E-1, 3433 West 48th Place, Chicago.

BIG Commission selling celluloid pricing tickets, metal shelf moulding, menu covers, changeable signs, celluloid advertising buttons. P. Pricing Press, 124 White St., New York.

SELL Brohard-Rainer "Good Shirts." Made-to-measure. 125 big samples. Three prices. Established 1924. Big opportunity for hustlers. Brohard-Rainer "Good Shirts," Dept. 700, Fourth Street, Cincinnati, Ohio.

AT Home, your own manufacturing business, making popular \$1 novelties. Cost you 3c to 15c. Everything supplied. Write So-Lo Works, Dept. N-842, Cincinnati, Ohio.

CHRISTMAS And calendar bargains! More profits! Easier sales! Catalog free! Elfko, 436 North Wells, Chicago.

SELL Crofoot stapling devices to shade shops, screen makers, and every industrial plant with a shipping department. Repeat sales of staples will establish profitable business of your own. Sells well with related industrial lines or alone. Part or full time. Write J. B. Crofoot Co., 223 Evergreen Ave., Mount Prospect, Illinois.

ATTENTION Salesmen! New deal! Merchants waiting. Particulars free. Scruggs Company, 1105 Willow, Chattanooga, Tennessee.

MYSTERY Invention, carried in pocket, keeps hands, feet, ears, body warm on coldest days. Everybody buys. Low price—big profits. Kumfy Warmer, 4208 Davis Lane, Dept. S-2301, Cincinnati, Ohio.

"KEENEREDGER" Produced 800 shaves from one blade. \$1.00 postpaid. Keener-edger, Oblong, Ill.

MIRROR Salesmen—Sell to furniture, hardware and gift shops. All prices. Jobbers write Midwest Novelty Mirror Company, 2905 Madison, Chicago.

NEWLY Invented door knob lights key hole. Install in one minute. Earn big profits. Sample \$1.00. Jaxon, 329 N. Front, Grand Rapids, Michigan.

DISTRIBUTORS Wanted. Make more money selling Twenty Grand aspirin, carded goods, big line 10c cosmetics, etc. Lowest prices. International Distributors & Rubber Goods Co., Memphis, Tennessee.

SALESMEN. Distributors—200 items—brushes, mops. Marvelous magnetic brush excels vacuum cleaner. Big profits. Neway Brush Company, Hartford, Conn.

SALESMEN—Distributors, sell complete line automobile bulbs. Davis Lamp Co., 17 East 42nd Street, New York City.

EXCELLENT Opportunity selling our complete line of brushes, largest commissions. Write for sales plan. Wire Grip Sanitary Brush Company, 2300 5th Ave., New York.

GUARANTEED Gold leaf letters for store windows. Free samples. Liberal offer to car owners. Metallic Co., 438-A N. Clark, Chicago.

MAKE More money with Red Comet Automatic Fire Extinguishers. Low price. Proved seven years. Splendid sales outfit free. Some good territory open. Exclusive. Write quick. 704 Red Comet Bldg., Littleton, Colo.

50 YEAR Established manufacturer of the widely known Mendenhall's Cough Syrup and other household remedies wants salesmen-distributors selling to drug, grocery, and general store trade. Deliver and collect. Liberal commissions. J. C. Mendenhall Medicine Co., Inc., Dept. 81, Evansville, Ind.

EARN Money in your spare time taking subscriptions to Popular Mechanics. Unlimited possibilities, every family a prospect. Easy to sell. Bonus paid in addition to liberal commission. Send postcard for further details today. Circulation Dept., Popular Mechanics Magazine, 200 E. Ontario St., Chicago.

HELP WANTED

IF You are ambitious you can make good money with a Rawleigh route. We help you get started. No capital or experience needed. Steady work for right man. Write Rawleigh's, Box A-2-PMH, Freeport, Ill.

WEAR Fine hose I send without cost with outfit while taking orders for amazing new hosiery. Replacement guaranteed against holes, snags, and runs. Rush name and hose size. Wilkmit, Desk A-37, Greenfield, Ohio.

LOCAL Agents wanted to wear and demonstrate suits to friends. No canvassers. Up to \$12 in a day easy. Experience unnecessary. Valuable demonstrating equipment, actual samples free. H. J. Graves, 1300 Harrison, Dept. N-817, Chicago.

CIVIL Service exams coming. 1000 different jobs. Free list. Notification Service, 4244 W. 59th St., Chicago.

M. M. Earned \$267, three weeks, raising mushrooms in cellar! Exceptional, but your cellar, shed perhaps suitable. We buy crops. Book free. United, 3848 Lincoln Ave., Dept. 69, Chicago.

OBTAIN Employment! Try unusual methods, including homework ideas. 50 cents. Money-back guaranteed. Particulars free. New Idea Service, 126-A Lexington Ave., New York.

EDUCATIONAL AND INSTRUCTION

IF You like to draw, sketch or paint—Write for talent test (no fee.) Give age and occupation. Federal Schools, Inc., Dept. PM19, Minneapolis, Minn.

LEARN Photo-Engraving! Always in demand! Thorough training all branches. Illinois School of Photo-Engraving, Box 510-M, Effingham, Illinois.

"UNCLE Sam" 1939 jobs. Start \$105-\$175 month. Prepare for next examinations. Full particulars, list positions, free. Franklin Institute, Dept. F3, Rochester, N. Y.

BECOME Practical scientific investigator. Modern, illustrated course. Thorough training by former agent U. S. secret service. Particulars free. International Secret Service Institute, TDM-19, Hoboken, N. J.

FOR An extremely profitable lifetime business, operate a collection-credit agency. Free folder. Cole Associates, Syracuse, N. Y.

WATCH Repairing is steady profitable work. Experts always in demand. You can learn watchmaking trade at home, spare time. New original instruction system. Script engraving course included. Write for free details today! Nelson Co., 2013 Manhattan Building, Chicago.

CHESS. Instructive. Interesting. Particulars free. Chess Thoughts, Pearl River, N. Y.

MATHEMATICS, Sciences, drafting, blueprint reading, surveying, preparation civil service, engineering examinations. Mondell, 112 West 42d, New York.

COMPLETE Course auto body and fender repairing. 285 illustrations. Special \$3.00. Money back guarantee. Hope Trade School, Burlington, Vt.

TYPING Course 35 cents complete. Palmo Systems, Box 413, West Palm Beach, Florida.

LEARN In a few weeks high class decorating, paperhanging, graining, marbling, sign painting. Catalogue No. 4 free. Chicago Painting School, 437 North Clark St., Chicago. Established 1902.

CIVIL Service arithmetic, spelling, geography, clerical tests. Principles, questions, answers. Complete \$1. Clerk-carrier \$1. Stenographer-typist, 65c. File clerk 50c. Mental tests 50c. Free descriptive folio. Merit Publications, Munsey Building, Washington, D. C.

PENMANSHIP. Learn to earn. 70-lesson course, superb pen-written copies, \$2.00. Portfolio. Beautiful specimens 10c. L. H. Hausam, 558M, Emporia, Kansas.

HOW Inventive minded become independent. Explanation free! Donald Higbee, Cantil, Calif.

BETTER. Cheaper. Two complete exams, \$1.10. List government jobs free. Write today. Pergande Publishers, Milwaukee, Wisconsin.

BLUEPRINT Reading taught by mail. Write Blueprint Reading Institute, Dept. A, Box 5662 Metropolitan Sta., Los Angeles.

SONGWRITERS Wanted. Instruction book free. Song Bureau, Dept. 44, Salem, Indiana.

SECRET Investigation. Experience unnecessary. Detective particulars free. George Wagner, M-2640 Broadway, N. Y.

LEARN Auto mechanics, body, repairing, welding, electricity, refrigeration. Diesel. Stevinson's, 2008A Main, Kansas City, Mo.

MASSAGE. Hydrotherapy, dietetics, druggists therapeutics, chiropody, taught by mail. Evans Correspondence School, Montgomery, Ala.

GOVT Jobs start \$1260-\$2100 year. Men-women age 18-50. Former examiner's tested method helps qualify you. Particulars, list jobs free. Write today. Patterson School, 8C Mercantile Bldg., Rochester, N. Y.

LEARN Machinist trade, tool, die making. Automatic and hand screw machines. Modern shop methods. Actual work. Jobs open for trained men. Employment help. Illustrated booklet free. Allied Screw Machine Co., 601 Lake St., Chicago.

CARTOONING, COMMERCIAL ART, SHOWCARD WRITING, SIGN PAINTING

PAINT Signs for profit. Fine lettering fast with Speedway Patterns. Modern styles, many sizes. Free samples, literature. For 3-in. alphabet enclose nickel. Display Letters Co., 8309 Third Ave., Brooklyn, N. Y. Dept. M.

CARTOONISTS: Complete course on "Drawing Heads." Over 200 illustrations 20c. Box 71, Mattapan, Mass.

MORGUE—Artists ready reference. Compact collection helpful drawing aids, monogramming tips. Extremely valuable to students, beginners, professionals. First series over 200 drawings, hands, arms. Send 50c coin. Metro Studios, Box 473-P, South Bend, Ind.

CARTOONING. Modern streamlined method. 50c each lesson ordered, or \$2.00 complete 5-lesson course. Individual attention. VonRuden, Poplar Bluff, Mo.

26th ANNUAL Art supply catalog on request. Ask for yours. Bart Supplies, Dept. N, 915 Marquette, Minneapolis, Minn.

PEN And ink illustrations for catalogue and general printing purposes at right prices. High grade work. Heraldic Studios, 1914 Oakdale Avenue, Chicago.

BE A lettering artist! Learn how to letter headings for magazine and newspaper advertisements. Highly paid profession. Free booklet. Guild School of Lettering and Advertising Design, 324 Summit Avenue, Hackensack, N. J.

EARN cash income, copying and duplicating simple cartoons for advertisers. 3-M Service, Argyle, Wis.

PLAYS, STORIES, MANUSCRIPTS

ORIGINAL Poems, songs wanted immediately for publication. Westmore Music Corporation, Dept. 33H, Portland, Ore.

MAKE Extra money writing in easy field. Stamp for particulars. Progress Co., Box 17, South Pasadena, California.

WRITERS! Tremendous earnings through "Master Plot Builder," absolutely revolutionary. Amazing details free. Department 71, Morgan Publishers, 3923 West Sixth, Los Angeles.

SONGWRITERS Wanted, write for free book. Song Bureau, Dept. 42, Salem, Ind.

SHORT Stories and novels rewritten and typed for marketing. Welton Tinney, Wynnboro, Texas.

WANTED, Original poems, songs, for immediate consideration. Send poems to Columbian Music Publishers, Ltd., Dept. 209, Toronto, Can.

ADVERTISING AGENCIES—LETTER WRITERS—FOR ADVERTISERS

LEARN Advertising quickly at home. Easy practical plan. No text books. Common school education sufficient. Interesting booklet and requirements free. Page-Davis School of Advertising, 3601 Michigan Avenue, Dept. 3431, Chicago.

30 WORDS 135 Canadian newspapers \$5.00. Canadian Enterprises, 1183 Bloor, Toronto, Canada.

FORCEFUL Sales letters. Hutzletter Co., 41-44 Davies Bldg., Dayton, Ohio.

YOUR Ad in 180 big newspapers \$7.68. Mailing lists compiled. Sales literature written. Faultless Advertisers, 3405 Prairie, Chicago.

INCH Display, 28 magazines, \$1.50. Paramount Press, D2, Atlanta, Missouri.

ADVERTISE—Sell by mail. Write Goodall Agency, 628 Montgomery, San Francisco.

ADVERTISING Placed all magazines, newspapers, radio. Lowest rates. Free service. 54 page rate book free. Baker Advertising Agency, A-189 West Madison, Chicago. Successors to Ankrum. Established 28 years.

MAIL-ORDER Ad reaching 1,500,000 families throughout United States \$15.40 inch. Newspaper, magazine, ratebook free. Chicago Union Agency, 20-P West Jackson, Chicago.

INCH Display advertisement 30 magazines year \$24. Wood's Popular Services, Atlantic City, (N. J.)

ADVERTISE: 24 Words in 250 newspapers \$10. Lists free. Advertising Bureau, 4515-C Cottage Grove, Chicago.

FREE—New Advertisers Rate Guide, 44 pages. Includes everything. Lowest rates. E. H. Brown Advertising Agency, 140 S. Dearborn, Chicago.

DIRECT-MAIL Advertising services. Sales letters that sell. Mailing lists. Omaha List & Letter Co., Box 2172, South Omaha, Nebr.

BUSINESS SERVICE

LOS ANGELES Mail address \$2.00 monthly. Dickey, 628 W. 9th.

AUTHENTIC Information, any subject, 50c. Paramount Press, Atlanta, Missouri.

PHILIPPINES Law cases, collection, deposition, handled. Free commercial reports. Franco Law Offices, Box 3409, Manila, Philippines.

CANADIAN Mailing address \$1.00 monthly. Canadian Enterprises, 1183 Bloor, Toronto Canada.

WASHINGTON, D. C., mail address, business, personal. Your mail reforwarded daily. Hawkins Mail Service, 817 Fourteenth.

EFFICIENT Nationwide circular mailing. 1000 6x9 \$1.50. Results guaranteed. Fuller Times, 6920 Fullerton, Chicago.

CHICAGO Mail address \$1 monthly. Your personal, business mail forwarded daily. Established 1919. General, 56 West Washington.

RUBBER STAMPS AND OFFICE SUPPLIES

2 LINES 25c, 3 Lines 35c. Stamprite, FP43, Springfield, Mass.

ORIGINAL, Cushion mounted. One, two lines 25c; three 35c; four 45c. Rotary press, type, prints postcards, \$2.50, literature. Stamp Works, 814 Bradley, Peoria, Ill.

NEW Bakelite pocket stamp, self contained pad. One line 45c; two 55c; three 65c. Box 572, Grand Rapids, Michigan.

CUSHION Mounted one-two lines 25c; three 35c. Hauer Press, 1314 Ford, Youngstown, Ohio.

NAME, Address, 2 lines 25c; 3 lines 35c. Stamp Works, Auburn, Nebr.

2 LINES 25c, 3 Lines 35c. Stamp Works, Centerport, N. Y.

TYPEWRITERS, DUPLICATORS, OFFICE DEVICES

REMINGTON'S Latest portable typewriters, four row keyboards. Cadet \$22.45—Remette \$29.75 with carrying cases. Shipped prepaid if cash accompanies order. Ed. Showers, Sheridan, Penna.

TYPEWRITERS, Adder, mimeograph, multigraph, addressograph. Send for free lists of machines that will help you at half price. Pruitt, 28 Pruitt Bldg., Chicago.

INCREASE Business now. "Excello-graph" Rotary Stencil Printer reprints thousands everything you typewrite, handwrite, draw or trace. Colors. \$19.75 to \$44. Terms. Illustrated literature free to business or professional men. Pittsburgh Typewriter Supply, Department K-2, Pittsburgh, Penna.

NEW \$3.75 Automatic adding machine. Fully guaranteed. Bassett, Box 302-K, Altadena, California.

PRINTING, MULTIGRAPHING, MIMEOGRAPHING, GUMMED LABELS

HAMMERMILL Letterheads, 300 8 $\frac{1}{2}$ x11, any color paper and ink; \$1.48 postpaid. Free particulars. Woodruff's, 217A Lewis, Duluth, Minn.

PRINTING. Lowest prices in America. Samples free. Pitz, Middle, Iowa.

1000 6x9 CIRCULARS, Letterheads, envelopes, postcards, \$2.95; 5000, \$9.45. All printing reasonable. Samples. Goodprint, Harrisonburg, Va.

300 2x3 $\frac{1}{2}$ WHITE Vellum bright finish business cards \$1.00 postpaid. Homer Woodruff, Sidney, Ohio.

POSTPAID—125 8 $\frac{1}{2}$ x11 Bond letterheads and 125 envelopes \$1.00; letterheads, billheads 300, \$1.00. Benneville, 907 West Roosevelt, Philadelphia.

1939 PRICELIST, Portfolio of samples free. McCall Press, 1326 South 27th, Omaha, Nebr.

1,000 2 $\frac{1}{2}$ x4 LABELS \$1.50; 2 $\frac{1}{2}$ x3 \$1.25. Paramount Press, Atlanta, Missouri.

250 GUMMED Shipping labels 35c. Ad-Man, 301-N New Jersey, Indianapolis, Ind.

HARVEY Labels—Marvelous values. Samples free. 6618T Quimby, Cleveland, Ohio.

RAISED Gold letterheads, 100 for 50c. Perry Press, Albion, Maine.

LABELS: All kinds. Write, samples. JESCO, Box 93, Holyoke, Mass.

500 STICKERS, Four lines, 25c. Fine labels. Cott's Spickard, Mo.

PRINTING? Bargain pricelist free. Churchill, 4316 South Salina, Syracuse, N. Y.

3,000 6x9 CIRCULARS \$4.50. Frederick Shore, 8009 Atlantic Avenue, Woodhaven, L. I.

DANKS Defies competition. We print anything. 84 Mortimer, Rochester, N. Y.

1000 BUSINESS Cards \$1.00 postpaid. Tucker, P.M. Box 65, Indianapolis.

1000 BUSINESS Cards, postpaid, \$1.00. Superba Print, 912 Towne, Los Angeles.

24 HOUR Service. 125 letterheads and envelopes—\$1.00. Postpaid. Village Press, Somerset, Mass.

HUNDRED Books personal matches \$1.00. Sanderson Match Company, Ottawa, Illinois.

PRINTING Cuts made; finest quality; zinc (line) \$1.25, (10 square inches); halftones; electros, mats; artist; free price list. Riteway, 1465 PP Broadway, New York.

BANKRUPT Paper bargain house. 1000 colored Bristol tickets, 25c. Free sample book, price list. Craft, Claremont, N. H.

FREE Stickers. Plan, sample, stamp. Mead, 2045 Linden, Riverside, Calif.

THOUSAND Letterheads—\$2.00. Prepaid. Narragansett Press, 1172, Fall River, Mass.

SENSATIONALLY Low printing prices. Stamp brings catalog. Nixons, Stevens Point, Wisconsin.

NEED Printing? Good work, service, low prices. Lonelm Press, Paulding, Ohio.

500 LETTERS Multigraphed exactly as if typewritten \$1.70 (20 lines.) Multigraphers, Ashland, Virginia.

ENGRAVURE Printing, lowest possible prices. Samples free. Sunco, Mohawk, N. Y.

3"x6" CIRCULARS. 5,000, \$3.50 postpaid. Prompt. Keelerprint, 4237-W Cermak, Chicago.

GET Our prices for better printing. The Delavan Printery, 177 Freund St., Buffalo, N. Y.

500 3/4x2 1/4 FOUR Line gummed stickers, 25c. Moritz Printery, Saginaw, Mich.

1000 6 3/4 BOND Envelopes \$1.95. Samples. Feld, Elmwood Place, Ohio.

PRINTING OUTFITS AND SUPPLIES

PRINT Your own cards, stationery, circulars, advertising. Save money. Easy rules furnished. Print for others, big profits. Junior outfit \$9.00; job presses \$11 up. Details free. Kelsey Presses, E-11, Meriden, Conn.

CUTS—All kinds. "Rollercasting" outfits. Catalog free. Nu-Ideas, Carrollton, Ill.

ZINC Line cuts, 2x3", \$1.00. Halftones, \$1.50. Printwell, Wyoming, Penna.

PRINTING Presses, type, cabinets, supplies. Send stamp. Lincoln Press, Hartwell Street, Fall River, Mass.

STEREOTYPING Made easy! New low priced equipment, \$6.00 up. Catalog, stamp. Economy, B351, Pontiac, Michigan.

ROTARY Press, prints postcard notices, handbills, etc. Actual type area, 6 1/4"x3". Type included in outfit at \$2.50. Free circular. Superior Type, 3942 Ravenswood, Chicago.

PRESSES \$5.00. Type 50c. Cuts 10c. Shops bought, sold. Complete bargain catalogs. Send stamp. Bradshaw, 3214-P Huron, Chicago.

PRESSES \$7.00 Up. Type, supplies. Lists 3c. Landis, Richland, Penna.

HAND Press, type and complete printers' supplies. Advise equipment you need and we quote prices; or send stamp for catalog. P. Peiffer, 14-C; 6 Columbia St., Newark, N. J.

BARGAINS, Presses, type. List 3c. Exchange D-15, 22 Orient, Meriden, Conn.

BARGAINS—Presses, type, supplies. Send stamp. 159 Harvard, Cambridge, Mass.

PATENT ATTORNEYS

INVENTORS: Send immediately for your copies of our new free books, "Patent Protection" and "Suggestions on Selling an Invention." Sixty-eight pages of interesting facts. They tell how Patent Laws protect you; kind of sketch or model needed; simple steps to take without cost; how successful inventors have secured financial assistance; show interesting inventions; illustrate important mechanical movements. With books we also send free Evidence of Invention form to help establish date of disclosure. Prompt service, reasonable fees, special deferred payment plan. Strictest secrecy. Forty-one years' experience. Highest references. Write us today. The facts in our books are worth money to the man with a good invention. Address: Victor J. Evans & Co., Registered Patent Attorneys, 113-A Victor Building, Washington, D. C.

PATENT Your invention with this responsible firm established in 1875. Free books answer all questions. Patent facts clearly explained. Easy budget payment plan. Write today for free copies of our booklets and "Certification of Invention" form. C. A. Snow & Co., Registered Patent Attorneys, 116 Snow Building, Washington, D. C.

PATENTS—Any country. Reasonable rates. Free information. Ramsay Company, 273 Bank St., Ottawa, Canada.

PATENTS—Before too heavy an outlay of time or money is made on an invention, a search of the Patent Office records should be made to determine as nearly as possible whether or not the same idea has been patented before. The cost of this search is small, while the value of the facts it uncovers is often considerable. We offer inventors and manufacturers a thorough prompt, confidential search service—plus experienced counsel and assistance in every phase of Patent and Trade-Mark practice. Write for our new free book containing valuable information relating to patent procedure. Clarence A. O'Brien and Hyman Berman, Registered Patent Attorneys, 58-L Adams Bldg., Washington, D. C.

INVENTORS: Use my personal, confidential patent service. Send for free facts on patenting your invention. Also suggestions on financing a patent application. Reasonable fees. Deferred payments arranged. Write Hugh E. McMorrow, Registered Patent Attorney, Dept. 201-B, Barrister Building, Washington, D. C.

PATENTS. Send sketch, photos or model and description of your invention for preliminary search and patentability report. Total expenses, including search fee, for preparing, filing and prosecuting your application quoted before you proceed. Rates reasonable. Prompt and efficient services. Lynwood B. James, Registered Patent Attorney, Established 1913, Suite 843-A National Press Building, Washington, D. C.

INVENTORS—Before disclosing your invention to anyone send for form "Evidence of Conception"; "Schedule of Government and Attorneys' Fees" and instructions. Sent free. Lancaster, Allwine & Rommel, 411 Bowen Building, Washington, D. C.

BEFORE You take any steps write for our 4-Points of Service for Inventors Bulletin. R. & S. Engineering Company, 17 East 42nd Street, New York, N. Y., Dept. DP-12.

INVENTOR'S Universal Educator; contains 900 mechanical movements; 50 perpetual motions; instruction on procuring and selling patents and selecting an attorney, etc. Suggests new ideas. Price \$1 postpaid in U.S.A. Address Albert E. Dietrich, 511-B Colorado Bldg., Washington, D. C.

PATENTS—Trade marks. Preliminary advice, book and disclosure form free. Personal service. Irving L. McCathran, 1060 International Bldg., Washington, D. C. Registered Patent Attorney.

"INVENTOR'S Guide," 100 mechanical movements, free; advises on patenting, selling inventions. Frank Ledermann, Tribune Bldg., New York.

L. F. RANDOLPH, 302-B Victor Bldg., Washington, D. C. Low cost. Book and information free.

PATENTS. Booklet free. Highest references. Best results. Promptness assured. Watson E. Coleman, Patent Lawyer, 724 Ninth St., Washington, D. C.

INVENTORS—Send for free booklet "Patent-Sense." Information based on 64 years experience. Lacey & Lacey, Dept. 5A, 635 F St., Washington, D. C.

PATENTS. Protect your idea by securing free "Proof of Invention" folder. Exceptional personal service. Established 1906. E. E. Vrooman, 871 Woodard Bldg., Washington, D. C.

FOR INVENTORS

PATENTS—Before too heavy an outlay of time or money is made on an invention, a search of the Patent Office records should be made to determine as nearly as possible whether or not the same idea has been patented before. The cost of this search is small, while the value of the facts it uncovers is often considerable. We offer inventors and manufacturers a thorough prompt, confidential search service—plus experienced counsel and assistance in every phase of Patent and Trade-Mark practice. Write for our new free book containing valuable information relating to patent procedure. Clarence A. O'Brien and Hyman Berman, Registered Patent Attorneys, 58-L Adams Bldg., Washington, D. C.

WE Locate buyers meritorious patented, unpatented inventions. If will sell, reply immediately. Descriptive booklet free. Invention Reporter, 5A-11236 South Fairfield, Chicago.

BLUEPRINT Drawing of your invention \$3.50. Free circular. Ormax Drafting Company, Bank Building, Bethesda Branch, Washington, D. C.

LISTS Of national manufacturers—10 names \$1. Stern, 7401 Sangamon, Chicago.

PROTECTION For your invention \$10.00. Details. Carland, 407 Mitchell Building, Milwaukee.

INVENTORS—Complete service, engineering, sales, patent protection. Starck, 332 Wells Building, Milwaukee.

IDEAS And practical inventions developed and promoted. Protection guaranteed. Blueprint and engineering service. Write for 4-Point Service bulletin. R. & S. Engineering Company, 17 East 42nd Street, New York, N. Y., Dept. DF-12.

HAVE You a sound, practical invention for sale, patented or unpatented? If so, write Chartered Institute of American Inventors, Dept. 4-A, Washington, D. C.

INVENTORS: Profit by your invention. A practical talk to inventors by an experienced manufacturer. Our 68 page booklet "Mind vs. Matter" mailed upon receipt of 25c. Rex Engineering Co., Cincinnati, Ohio, Dept. D.

INVENTIONS Bought, sold. Patented, unpatented. James Wallace, Homer, N. Y.

INVENTORS: "Making Inventions Pay." our 32-page illustrated book, mailed upon receipt of 3c postage. Crescent Tool Co., Dept. Z, Cincinnati, Ohio.

PENDING Patent applications can be brought before thousands of manufacturers, free of charge, through Invention Magazine. Write for details. Invention, Inc., 635 F Street, Washington, D. C.

INVENTORS—Send for 72-page book on patents. Reasonable terms. Conscientious treatment to inventors. L. F. Randolph, Registered Patent Attorney, 302-E Victor Bldg., Washington, D. C.

I SELL Patents. Established in 1900. Charles A. Scott, 773PM Garson Ave., Rochester, N. Y.

PASSENGER Locomotive (Hudson type), model lithographed in colors, size 10x46 in. Every part shown and numbered. Invaluable for study. \$1 postpaid. Popular Mechanics Press, Room (C38), 200 E. Ontario St., Chicago.

INVENTIONS WANTED

SMALL Inventions wanted by manufacturers. I'll help you sell your invention. Write for free circular. Stanley Hull, 7829-K Euclid Avenue, Cleveland, Ohio.

WE Have clients looking for new items to manufacture on royalty. Electric goods, household items, automotive, airplane improvements, etc. Must be patented, engineering completed and ready to market. Will H. Wade & Co., Industrial Financing, 134 So. LaSalle Street, Chicago, Ill.

CASH For unpatented ideas. Stamp for particulars. Mr. Ball, 9441-A Pleasant, Chicago.

INVENTIONS Wanted for commercialization, patented or unpatented. Arellano-Power Co., Box 1827, Dept. A, Chicago.

WANTED—Meritorious patented, unpatented inventions. Booklet free. Invention Reporter, 5B-11236 So. Fairfield, Chicago.

INVENTIONS Wanted by manufacturer. Purchase or royalty basis. Patented or unpatented. Arthur Adams, Box 349, Oak Park, Ill.

PRACTICAL Inventions wanted. Full protection guaranteed. Write for "4-Point Service" bulletin. R. & S. Engineering Company, 17 East 42nd Street, New York, N. Y., Dept. D-12.

SIMPLE Practical inventions wanted by manufacturers, patented or unpatented. For information write Chartered Institute of American Inventors, Dept. 4-D, Washington, D. C.

PATENTS FOR SALE

VALVE, Brass, shut-off gas, dwellings. Exhaust, device for automobile pipes. Muffler, privacy for telephone. Schultz, 124 Plum, Reading, Penna.

RADIO Tunes itself; with small, inexpensive, practical device. Sale or royalty. Write A. L. Martin, 303 E. 106 St., New York City.

PATENTED Novelty lamp, ship design. Royalty. M. Rau, 1026 Jackson St., Milwaukee, Wis.

MANUFACTURERS: For new products or profitable manufacturing opportunities, inquire. Invention Reporter, 5C-11236 So. Fairfield, Chicago.

SELL Your patent through a small classified ad in Popular Mechanics. Many inventors have found buyers in this way. Ask me for proof—I'll gladly send it to you. F. W. Johnson, Manager Classified Advertising, 200 E. Ontario St., Chicago.

MANUFACTURING

ANALYSIS. Research. Newest guaranteed formulas. Biggest catalog free. Special prices, leads. Gibson Laboratory, Chemists, DS-1142 Sunnyside, Chicago.

GENERAL Manufacturing. Models, dies, stampings, etc. Reasonable prices. Arellano-Power Co., Box 1827-B, Chicago.

INVENTIONS Manufactured in any quantities. Tools, dies, metal stampings; working models built; industrial designing. Complete blueprint and engineering service. Write for "4-Point Service" bulletin. R. & S. Engineering Company, 17 East 42nd Street, New York, N. Y., Dept. DM-12.

AUTOMATIC Screw machine products, special machinery, stampings, forgings machined. Send for quotation. Cogswell Corp., West Springfield, Mass.

DIES, Stampings, complete manufacturing, wire forms. Southern Products, Independence, Missouri.

INVENTIONS Manufactured by an experienced company, in any quantity at low cost. Metal specialties, novelties, stampings, dies, and models. Free estimates. Our booklet "Mind vs. Matter" sent upon receipt of 25c. Rex Engineering Co., Cincinnati, Ohio, Dept. C.

INVENTIONS Manufactured in any quantity at low cost. Stampings, dies, models, etc. Estimates and free catalog. Crescent Tool Co., Dept. X, Cincinnati, Ohio.

MODELS AND MODEL SUPPLIES

SEND For your free 1939 wholesale tool booklet. Machinery, tools, supplies. Homecraft Tool Supply, 236 Neptune Ave., Brooklyn, New York.

BUILD 16" Flying Cloud, Constitution. Materials, plans, \$1.50. Catalog 15c. Hancock, 323 Douglas Ave., Portsmouth, Va.

RACING Hulls, kits \$3.50 up. St. Louis Model Boat Co., 225 N. Meramec, Clayton, Mo.

AMERICA'S Most complete catalog ships, fittings 10c. Airplane engine catalog 5c. Polk's, 429 Seventh Ave., New York.

MINIATURE Boat and airplane supply catalog 5c. Selley, 1377 Gates Ave., Brooklyn, N. Y.

CATALOGUE Over 40 engines, supplies—25c. Refunded. Specialize in experimental or patent work. Howarco, A-2417 North Ashland, Chicago.

MODEL High speed gas engine castings and supplies. Send stamp for catalog. Louis Terek, 1000 N. Lamon, Chicago.

AUTO Racer model kit 50c, plan 10c. Airplane, railroad, ship model kits, supplies. List 5c. Northern Aircraft, Manitowoc, Wisconsin.

BUILD Miniature gasoline motors. Fascinating, educational, profitable. Details, drawing 10c. Wright Motor Works, 3256 Lake Park Ave., Chicago.

MODEL Makers lathe, photographs for dime. Depoy Model Shop, Muncie, Indiana.

FREE Catalog, model builders supplies, save money. Ebert Model Supplies, LaGrange, Illinois.

MODEL Railroad Shop, Dept. PM, Dunellen, New Jersey. New 24 page illustrated catalog 10c postpaid.

GASOLINE Motor for model boats, \$12.00. Circular 10c stamp. Anton Bohaboy, 2297 Price St., Rahway, N. J.

STEAM Locomotives! $\frac{3}{4}$ " scale. Build one by "Easy Steps." Our illustrated catalog lists all needs, 25c. Little Engines, Box 15B, Wilmington, Calif.

MODEL Airplanes, boats, radios, supplies. Catalog 10c. Imperial, 416-K McDonald, Brooklyn, N. Y.

MODELS—Practical models put over your ideas. We develop models from the crude to perfect working devices. Your idea might have large commercial value. Services confidential. Bank references. Registered graduate engineers at your service. Send 25c for our 68 page booklet "Mind vs. Matter." Rex Engineering Co., Cincinnati, Ohio, Dept. B.

MODELS—Your ideas developed into practical working models. 30 years' successful experience; thousands of satisfied customers. Confidential service guaranteed. Bank references. Send 3c postage for 32-page book—"Making Inventions Pay." Crescent Tool Co., Dept. Y, Cincinnati, Ohio.

SHIP And yacht model fittings; construction sets; model yacht sails; illustrated catalog 20 cents. A. J. Fisher, 1002-1 Etowah Avenue, Royal Oak, Mich.

MODEL Supplies for the inventor. Send 3c stamp for catalog. Pierce Model Works, Tinley Park, Ill.

WRIGHT "Whirlwind" engine, model lithographed in colors, size 13x22 in. Shows and names every part. Invaluable for aviation students. \$1 postpaid. Popular Mechanics Press, Room (C38), 200 E. Ontario St., Chicago.

BLUEPRINTS AND PLANS

TWELVE Inch horse and buggy, clear plans, detailed instructions, \$1.00. Clary Miniatures, Colorado Springs, 1115 Institute.

HOME CRAFTSMEN

BIRD Houses, "what-nots," cabinets, lawn ornaments, small furniture. Ideal gifts. Prints; 72 popular objects, instructions \$1.00. "Rork's," Saginaw, Mich.

EXOTIC Woods. Representing all six continents. 50c. Blue, 580 81 Street, Brooklyn, N. Y.

WALNUT, $\frac{3}{4}$ Inch 20c. Cherry 15c square foot. Money back guarantee. Write for list. Home Woodworkers Lumber Supply, R. D. No. 2, West Alexander, Penna.

LAWN Ornaments, windmills, sample prints 15c. L. Bazuin Co., Grand Rapids, Mich.

"MODERN Wood Sculpture." Complete instruction book on carving statues \$1.00. Lee Wood Art Studio, Centerville, Iowa.

20 FULL Size lawn ornaments, patterns 25c. Wickman, 744 Brooklyn, Dept. 15, Dayton, Ohio.

BETTER Band saw blades, write for quotation. Master Saw & Machine Co., Box 935, Minneapolis, Minn.

ASH Dowels, assorted, hundred feet, quarter to inch, postpaid, \$1.20. Browns Slat Factory, Gravette, Arkansas.

FIFTY Popular assorted woodworking projects, with illustrations, complete working drawings and manufacturing instructions. Only \$1.25 postpaid. Satisfaction guaranteed. Order today. Woodcraft Service, Plainview, Minnesota.

WANTED. We have many customers waiting for used machinery and equipment needed by home craftsman. Immediate cash. Must be good condition and reasonable. Send details now. Craftsman's House, 315 Harding St., Avoca, Penna.

15 FULL Size shelf bracket patterns, 25c coin. Albright Service, 6901 Railroad Ave., Omaha, Nebraska.

15 FULL-SIZED Lawn ornament patterns 30c. Modern Woodcraft, Saginaw, Michigan.

LEATHERCRAFTSMEN—Write for free instructions and price list of leather, tools, etc. Sample cards 5c. Wilder & Co., Dept. F, 1038 Crosby St., Chicago, Ill.

BUILD Your own boat—New book gives plans, methods, etc. 312 pages \$3. Popular Mechanics Press, Room (C38), 200 E. Ontario St., Chicago.

FOR THE HOME

STOVE-FURNACE Lining, will fit any and all. Circulars free. W. R. Benjamin Co., Granite City, Ill.

ANDIRONS Made to order by oldest blacksmith in state. Wrought iron light pattern, 15 lbs., \$5.00 prepaid. W. B. Fryling, Seaford, Del.

BEAUTIFY Your old furniture! Refinishing now made easy. Complete instructions 35c. Todd's Service, 262 Arlington, Youngstown, Ohio.

OLD GOLD, WATCHES, JEWELRY, PRECIOUS STONES

SILVER Filigree bracelet, best gift for mother, wife, daughter, sister, sweetheart mailed them with your card; now only \$2.00 at famous filigree center. Shopping made easy. Flores, Vallarta 1994, Guadalupe, Jalisco, Mexico.

AUSTRALIA'S Lovely opals. Illustrated catalogue free. Good selection \$5. Norman Seward, Melbourne, Australia.

1939 BULOVA Watches. Any quantity, wholesale prices. Pistilli, 51 Bridge St., Newark, N. J.

PETRIIFIED Wood ring set fifty cents. Box 808, Tacoma, Washington.

CASH By return mail for antique jewelry, discarded watches, gold teeth. Satisfaction guaranteed. Write, Lowe, 1208-PM Kesner Bldg., Chicago.

MEN'S 17-Jewel yellow gold Waltham wrist watch. Has second hand. Gold band to match. A guaranteed \$55.00 value for only \$39.75. Stanley Moore, Rte. 3, Box 35, Orangeburg, S. C.

HIGHEST Prices for old gold, teeth, watches, jewelry. Full cash value mailed day shipment received. Satisfaction guaranteed or articles cheerfully returned. Information free, or ship today. Chicago Gold Smelting Co., 300-P Champlain Bldg., Chicago.

GOLD \$36 Ounce. Ship old gold teeth, crowns, jewelry, watches—receive cash by return mail. Satisfaction guaranteed. Free information. Dr. Weisberg's Gold Refining Co., 1500-Q Hennepin, Minneapolis, Minn.

TOBACCO

GUARANTEED: Cigarette, pipe or chewing 5 lbs. \$1.00, ten \$1.75. Pay when received. Pipe and box cigars free. Rives Tobacco Co., Paducah, Ky.

RAZORS—BLADES—SHARPENING

100 **DOUBLE** Edge blades 75c. Free sharpener. Sanders, 3449 Grenshaw, Chicago.

25 **DOUBLE** Edge blades 25c. Sylvania Service, 1123B Cherry Street, Bristol, Penna.

QUALITY Razor blades. Samples for stamp. Hardware, South Zanesville, Ohio.

50 **DOUBLE** Edge blades postpaid 40c. Moneta Co., Box 1105, UP Sta., Des Moines, Iowa.

WANTED—MISCELLANEOUS

CASH For used microscopes, binoculars, cameras, slide rules, drawing sets, surveying, mechanical, scientific, and musical instruments. Highest prices paid day shipment received. Satisfaction guaranteed or shipment promptly returned. Elman's, 2302 Van Buren, Chicago.

CASH For furs, hides, wool. Keystone Hide Co., Lancaster, Penna.

WANTED—Unusual microscope subjects, write Rathbun, Box 506, Oelwein, Iowa.

PERSONAL

ORIGINAL Poems, songs wanted immediately for publication. Westmore Music Corporation, Dept. 33J, Portland, Ore.

ATHLETES Foot commonly called ringworm. Skin Specialist's Three Way Treatment destroys all germs. Money back guaranteed. \$1.50 postpaid. Dr. Butler's Research Laboratories, 3800 E. 14th St., Oakland, Calif.

MY Success in business and social life depends greatly on a winning personality; good health; radiating cheerfulness and happiness. I'll write to Dr. H. H. Buddenberg, 2614 Jefferson Ave., Cincinnati, Ohio, for his free booklet, "My Worst Enemy," which will help me attain my desires.

SOCIAL Security number, name, etched lifetime plate, including pocket holder, 25c. Brown, 993 President St., Brooklyn, N. Y.

SONG Poems wanted, 50-50 plan. Song Bureau, Dept. 43, Salem, Indiana.

NERVOUS? Fears? Depressed? Afflicted? Free helpful information. Norman Ferngold, Psychologist, Office 15, 22 Amherst St., Worcester, Mass.

WANTED. Original poems, songs, for immediate consideration. Send poems to Columbian Music Publishers, Ltd., Dept. 33, Toronto, Can.

WIN Prize money: Booklet—"Successful Contesting"—shows how. 10c postpaid. Bulletin listing \$200,000.00 prizes included. World Publishers, 4515-B Cottage Grove, Chicago.

BOOKKEEPING. Home, personal, business. \$2.25. Popular Mechanics, 200 E. Ontario St., Chicago.

MISCELLANEOUS

GRAVE Markers, high quality. Protestant, Catholic. Silver finish \$4.50. Bronze \$7.50. \$2.50 cash, balance delivery. Scott Mfg. Co., 4242 E. 54th Ter., Kansas City, Mo.

BUTTERFLIES. Cocoons. Native, exotic. Supplies. Lists. Nature Room Supply House, 2781 Grand Concourse, New York, New York.

BUSINESS Proposition resilvering mirrors, autographs, reflectors, making chipped glass signs. Write Sprinkle, Plater, 288, Marion, Indiana.

GENUINE "Elgin" electric shaver—\$1.98—other Xmas bargains. Catalog free. Meyl-Erie, 3206 N. Oakley, Chicago.

GOOD Eyesight without glasses. No drugs. Results guaranteed. Representatives wanted. Arthur Jacobson, Upsala, Minnesota.

THERMOSTATIC Bimetal, sample and price list ten cents. Dennis Plans, 2807 Ewald Circle, Detroit.

OIL Burners. Design, construction, operation, maintenance, servicing all types. New book. \$4.50. Popular Mechanics, 200 E. Ontario St., Chicago.

COLLECTORS. Swappers, contest fans, investigate free trading service. Exchange, Box 425, Detroit.

MONEY In butterflies, moths. See Sinclair Display Advertisement on page 26A.

BOOKBINDING Unit that does the entire job—vocational schools, libraries, job shops, hobbyists. Practical. Low priced. Write Pratt, A-9, 4227 Euclid Ave., East Chicago, Indiana.

TATTOOING Outfits, supplies, illustrated list free. "Waters," 965 Putnam, Detroit.

COATS-OF-ARMS And crests correctly rendered in colors or black and white. Highest grade. Estimates free. Heraldic Studios, 1914 Oakdale Ave., Chicago.

AMATEUR Tattooing outfits, illustrated catalog 6c. "Tatuco," 651A S. State, Chicago.

SWAPPER'S Friend, R4, Saline, Michigan. Interests swappers, collectors. 50c year, sample 10c.

1001 WAYS to Use Concrete. Send for large free illustrated folder describing new Popular Mechanics book covering every known use of concrete for the home, farm, building, business and industry. Popular Mechanics Press, Room (C38), 200 E. Ontario St., Chicago.

NEW MODEL DRAW-O-MATIC DRAWING BOARD
ATTACHED, SLIDING, SELF-ALIGNING, PARALLEL-BAR

Model B



A SELF-CONTAINED UNIT BUILT TO A STANDARD OF QUALITY. Thousands in use by Draftsmen, Students, Architects, Artists, Engineers, Designers and Executives.

Hard composition board stays flat. Light weight. Bar slides accurately and easily. Patent CROSSLING STRUNG bronze cable and pulley give accurate action. No thumb tacks necessary. Water, oil and acid proof. ENABLES ANYONE TO DRAW WITH ACCURACY AND SPEED. THREE SIZES: 12"x16" \$2.95, 16"x20" \$3.95, 20"x25" \$4.95 plus postage. Other models with transparent celluloid straight-edge described in FREE CIRCULAR. WRITE TODAY.

ROLLIN INSTRUMENT CO. Inc., Dept. PM 1-9, 216 No. Clinton St., Chicago, Ill.

Government Jobs
 EXAMINATIONS SOON VALUABLE INFORMATION FREE
COLUMBIAN CORRESPONDENCE COLLEGE
 WASHINGTON, D. C.

LUSCOMBE

SCHOOL OF AERONAUTICS

Limited student enrollment—specialized training in metal airplane engineering and construction including design, drafting and laboratory work. One year course. After first ninety days students are permitted part time apprentice work actually building planes of three different types now being used all over the world. Folder giving further information sent upon request.



LUSCOMBE SCHOOL AERONAUTICS
 West Trenton, N. J.
 BEAR TAVEN RD., PHONE TRENTON 6114

VOICE

100% Improvement Guaranteed

We build, strengthen the vocal organs—not with singing lessons—but by fundamentally sound and scientifically correct silent exercises... and absolutely guarantee to improve any singing or speaking voice at least 100%... Write for wonderful voice book—sent free. Learn WHY you can now have the voice you want. No literature sent to anyone under 17 years unless signed by parent.

PERFECT VOICE INSTITUTE, Studio 1351
 64 E. Lake St., Chicago

Industry Needs MECHANICAL ENGINEERS

Big opportunities for men with Engineering training. Promote yourself by preparing for jobs as Engineer, Superintendent, Master Mech., Factory Eng., Chief Draftsman, Gen'l Foreman. You mechanically employed men don't have to change lines to win promotion, but do have to get ready for jobs ahead. Write today for method for preparing for this well-paying profession. No obligation.

American School, Dept. M145, Drexel at 58th, Chicago

ARTISTS MAKE MONEY

Find out your ability. Send name, age, occupation and address for Free Vocational Art Test.

Federal Schools, Inc., 1139 Federal Schools Bldg., Minneapolis, Minn.

EARN A DEGREE AT HOME

Home Study Courses leading to Degrees in Arts; Sciences; Philosophy; Education; Public Health; Psychology; Sociology; Physics; Chemistry; Geology; Pol. Science; Theology; Law; Business Training; Accounting; Statistics; Adv.; Agriculture; Sales; Electrical, Civil, Mechanical, Drafting, Architectural, Automotive, Steam, Diesel, Aeronautical, Radio, Structural, Industrial, Highway, Petroleum, Mining, Marine, Refrigeration, Air Conditioning, Chemical Engineering. Founded 1908. Chartered.

McKinley-Roosevelt Graduate College, 4213 Clarendon Ave., Chicago

DIESEL

Get BETTER training. Realize Adcox advantages. Located in Pacific Northwest, a Diesel center. Established 28 years. Modern equipment, expert instructors. Close cooperation for YOUR success. Earn room and board while learning. Send for FREE big 40-page Diesel School Catalog No. 15. Home Study and Resident Courses.

L. L. ADCOX TRADE SCHOOL
 Portland Oregon

When writing please mention Popular Mechanics

Learn AT HOME THE MOST FASCINATING BUSINESS ON EARTH

Animated!

A NEW AND SIMPLIFIED METHOD

SECRETS OF THE PROFESSION

Thirty amazingly simple charts show each basic step in animation... explain terms and technique... how to plan and time action, "inbetweens", repeats, cycles, how to work out stories and gags, shortcuts, trailers, titles, synchronization, sound effects, etc. A complete instruction course. No lessons to send in.

Prepared by **EARL DUVAL**
A nationally known specialist of unduplicated skill and ability for the past 10 years, and writer, director, and supervisor with **WALT DISNEY**, **LOONEY TOONS**, **MERRIE MELODIES**

DO Animated Cartoons for the Commercial, Educational and Entertainment World. Be ready for an ideal future in TELEVISION.

COMPLETE COURSE Only \$4.95

Including thirty charts and instructions on heavy board, in a handsome gold-stamped ring binder. Postage prepaid.

SEND Currency, Money Order or Check TODAY

STANDARD ENTERPRISES 52 Printercraft Building Washington, D. C.

NO MORE TO PAY!

\$2.50 LEJAY ARC WELDER NOW ONLY \$1.50

Complete kit of parts for making our genuine LeJay welder which has proved such a sensation. Thousands sold to satisfied customers at \$2.50 each. LeJay now offers its customers this famous tool in kit form at a saving of \$1.00. Complete with carbon tip, solder, welding and brazing rods. Easy to assemble—no other parts needed. Operates from car battery. Welds most metals. Your first repair job will almost pay for the small amount you spend for this amazing tool! 10 day money back guarantee. Send \$1.50 for your welder to **LeJAY MFG. CO., 1347 LeJay Bldg., Minneapolis, Minnesota**

POST PAID

TRAILER BUILDERS

Send 10c for our latest DeLux Trailer plans with all the modern improvements known to trailer builders. We supply everything at bargain prices. Our new 1939 trailer supply catalog (largest and most complete) is free. **National Trailer Equipment Co., Dept. P-1, 714 W. Wisconsin Ave., Milwaukee, Wis.**

AFTERNOONS FREE

for life's pleasures. Drive to Country or go to Movies afternoons. Work mornings till noon at HOME (Business Plan No. 4). Further Outstanding Possibilities: Plans No. 44, 73, 119. Grab the chance to get into a business while it's not yet over-crowded. Write NOW in time for a happy future. Prepare for surprise. **STAMFORD CO., Dept. 12-A, 3762 BROADWAY, NEW YORK**

MONUMENT \$9.00 UP

WE PAY FREIGHT

Genuine Marble also Granite. Free Lettering. Erected if desired. Thousands of satisfied customers. Write for Catalog and samples. **U. S. MARBLE & GRANITE CO. A-18 Oneco, Fla.**

...ITALIAN... ACCORDIONS

Latest Models — Buy direct from factory representative at lowest **WHOLESALE PRICES**. Save One Half. Used musical instruments taken in trade. Write now. **ITALIAN ACCORDION MFG. CO., 323 W. Polk St., Dept. P-8 Chicago**

Ask for FREE Catalog

New Electric AUTO MOTOR HEATER

Overnight Sensation!
Circulates Water Through Cylinder Block at 180° Temperature in Sub-Zero Weather—Stops Oil Congealing—Assures Summertime Starting.

GOLD MINE FOR AGENTS, SALESMEN

Here's a revolutionary invention, the latest triumph of a renowned heating engineer. An amazing Auto Motor Heater needed by millions of motorists—offering you an exceptional opportunity to make **BIG MONEY** quick. Write for details of territory franchise.



Heat Applied Inside
Instead of applying heat in old fashioned way to outside of motor, Moto-Heat causes hot water (180° in below zero weather) to circulate constantly throughout entire cylinder block. Gives uniform, dependable heat by simply plugging into any AC or DC (110 Volt electric light outlet. Cylinders kept warm. Oil won't congeal. Car starts quickly at first touch of starter button.

Amazing Opportunity
Motorists everywhere waiting for Moto-Heat at remarkable low price. They welcome easy starting on coldest days. No more run down batteries, wasted gas, scored cylinders, lost time. Absolutely guaranteed. Men who want **BIG MONEY** all winter, write quick for sensational proposition. State territory wanted. Actual facts will amaze you! Write.

How It Heats
Heater consists of coil attached to the water motor jacket. Coil is heated by 300 watt electric glow element. Consumes little power. Water heats, expands, and is forced out of coil making room for more cool water. Warm water in cylinders kept in continuous circulation by thermo-syphon action.

FITS ALL CARS AND TRUCKS EASILY, QUICKLY INSTALLED

DUDLEY SMITH, Dept. 21, 620 N. Michigan Ave. CHICAGO, ILL.

LEARN TELEVISION NOW

Big New Field—Huge Developments Ahead
"Television ready for home", says radio Executive. Transmitters to blanket the country—televized movies of Hollywood Stars... to invade homes soon. Learn all about the revolutionary changes, the new opportunities for trained men. Get the latest startling facts that stagger the imagination.

10 LESSONS FREE TRIAL Send No Money SENT ON 5 DAYS Pay No C. O. D.

Write today and my 10 lessons (fully illustrated with over 150 pictures, charts, tables, diagrams) will be mailed you immediately FREE and postpaid for 5 days' trial. Examine the lessons, study them, see how each lesson is filled with facts, interesting, easy to grasp, things you will be amazed to know, learn all these 10 lessons teach you,—then, if you are not delighted return the lessons within five days and pay nothing. Or, keep these 10 lessons and pay only 10 cents each for them. You have everything to gain and nothing to lose, so write for your 10 lessons on free trial today—now—while this low introductory price offer lasts. **UNIVERSAL TELEVISION SYSTEM of Training, Box 601-A, Kansas City, Mo.**

When writing please mention Popular Mechanics

Welding Business Earns \$150 to \$300 for You Each Month

"BUILD-YOUR-OWN"

Just couple your own engine to this unit, mount it on chassis and you have money making advantage of a portable welder at a saving of \$100 to \$500.

"Build-Your-Own" Unit

HOBART BROS., BOX M-19, TROY, OHIO
Gentlemen: Send me information on () Build Your Own Welder () Electric Drive Welder () 30 Days Trial, Easy Terms () Rental Plan. Also send me free books I've checked.
Name.....
Address.....

30 DAY'S TRIAL AT HOBART'S RISK AND EASY "PAYS FOR ITSELF" TERMS

New low prices make this profitable welding service available to everyone. Opens doors to big pay jobs that carry real profit. Hobart Welders are easier to operate, faster, guaranteed to bring you quality welding business... extra profits will pay for welder without expense to you.

NO INVESTMENT TERMS—PROFITS PAY FOR IT
Extra earnings and savings possible with Hobart Welders make it easy to own without expense. You can even rent a new Hobart and later purchase it without loss. Coupon brings details.

Free! VALUABLE BOOKLETS ON WELDING. CHECK YOURS AND MAIL THE COUPON TODAY.

How to Build-Your-Own
 New Profits in Arc Welding
 New Arc Welding Catalog

HOBART
THE FASTEST SELLING ARC WELDER ON THE MARKET TODAY

Gas Engine Drive
Electric Drive



START \$1260 to \$2100 YEAR GET A 1939 GOVERNMENT JOB

Railway Postal Clerks

Railway Postal Clerks get \$1,900 the first year regular, being paid on the first and fifteenth of each month. (\$79.17 each pay day.) Their pay is automatically increased yearly to \$2,450. Advance may be had to Chief Clerk at \$2,700 a year. (\$112.50 each pay day.)



Travel On "Uncle Sam's" Pay Roll

3 Days On—3 Days Off—Full Pay

Railway Postal Clerks on long runs usually work 3 days and have 3 days off duty or in the same proportion. During this off duty their pay continues just as though they were working. They travel on a pass when on business. When they grow old, they are retired with a pension.

City Mail Carriers, Post Office Clerks

Clerks and Carriers now get \$1,700 the first year on regular and automatically increase \$100 a year to \$2,100 and \$2,300.

GOVERNMENT CLERK



File Clerk—Clerk
Open to Men—Women 18 to 50. Entrance salary \$1260-\$1440 Year. Appointments as File Clerks and Clerks in the Departments at Washington, D. C., are made from this examination.

Many Other Positions

Many other positions are obtainable. Those wishing these positions should qualify at once.

Get Free List of Positions

Fill out the following coupon. Tear it off and mail it today—now, at once. This investment may result in your getting a big-paid government job.

FRANKLIN INSTITUTE, Dept. F-173, Rochester, N. Y.

Rush to me, entirely free of charge (1) a full description of U. S. Government Jobs; (2) Free copy of illustrated 32-page book, "U. S. Government Positions and How to Get Them"; (3) List of U. S. Government Jobs; (4) Tell me what to do to qualify for a U. S. Government Job.

Name.....

Address.....

Use This Coupon Before You Mislays It. Write or Print Plainly.

New-Type Cheap OIL BURNER INVENTED
Sweeping the Country!

COOK and HEAT Without Coal or Wood
In Your Present Stove or Furnace—**HOTTER—No Drudgery, Dirt or Ashes—More Heat Quick at SMALL COST.**

OVER 40,000 SOLD
Beats any oil burner ever gotten out for low cost, perfect performance. Burns cheap oil a new way, without pre-generating or clogging up. Quick intense heat by Simple Turn of Valve.

30 DAYS' TRIAL
Prove its efficiency, convenience and economical operation.
Write Immediately for FREE BURNER OFFERTO AGENTS

AGENTS Salesmen BIG MONEY
F. Silver says: "I can dispose of 250 HEAT KINGS before this year ends." Sample Burner FREE to producers. Write us now for agents' offer.



Quick HEAT At Turn of Valve!

who will demonstrate and take orders. Write quick, be first to learn how to make REAL MONEY right now, spare or full time—mail in postcard today:
UNITED FACTORIES, A-751, Factory Bldg., Kansas City, Mo.

JOBS in RADIO-TELEVISION

Extension and resident training in television, aviation and police radio. Let us tell you how we train men, fit them for good jobs, help them get jobs. Write for catalog. Affiliated with KMBC, major network station. Address **MIDLAND TELEVISION, Inc., 106-A Power & Light Bldg., Kansas City, Mo.**

A AND N SUPPLY CO.
Bargains—Military, Sport Goods, Firearms, Clothes, Shoes, etc Send 10¢ for new catalog, to be redeemed on first order.
EST 1868 A & N Supply Co., 4772 Lester St., Richmond, Va.

BUCHSTEIN'S FIBRE LIMB
is soothing to your stump—strong, cool, neat, light. Easy payments. Braces for all deformities. Agents wanted.
D. BUCHSTEIN CO.
610 3rd Ave., So., MINNEAPOLIS, MINN.
Send for Catalog Today

RUPTURED?

Get Up-to-Date Relief
Now you can laugh at chafing leg-straps and binding belts, yet do hard work safely with the amazing, modern Cluthe. Positively guaranteed to hold, a condition absolutely necessary for possible improvement or recovery. **WATER-PROOF.** Wear it in bath! Recommended by doctors. Made especially to fit each individual case, yet costs so little. Write for FREE 100-page BOOK and liberal 60-Day Trial Plan, together with endorsements from grateful patrons in your neighborhood. No obligation. Address:
CLUTHE SONS Dept. 31 Bloomfield, New Jersey

BE A CAMERA REPORTER
MAKE YOUR CAMERA BRING YOU A CASH INCOME. Interesting, Easy-to-Learn, Spare Time Course Prepares You For Exciting Profession. Earn Money While You Study! Camera Reporting, Picture shooting, for scores of newspapers and magazines. A high paying profession that any man or woman can enter! **YOU NEED NO EXPERIENCE.** You learn by doing. Tasope trains you for a good job, or you can work for yourself. Most modern practices, including natural color photography! All popular cameras. Low Cost—Easy Payment Plan. Write for Beautiful Free 32-Page Photo-Illus. Book.
TASOPE' SCHOOL OF MODERN PHOTOGRAPHY, Dept. 7L8, Aurora, Mo.



EASY to play

With an easy playing Conn band instrument, you can be ready for band or orchestra in 4 to 6 weeks. A sure road to popularity if you start on a Conn. Choice of the world's greatest artists. Magnificent tone. Many exclusive features — yet they cost no more.

Ask to see the marvelous new models now being displayed by Conn dealers.

WRITE FOR THIS NEW FREE BOOK

Home trial. Easy payments. Write us for free book on whichever instrument interests you most. Mention instrument.

C. G. CONN, LTD., 131 CONN BLDG. ELKHART, IND.

CONN
BAND INSTRUMENTS

Correspondence Courses in **RADIO and ELECTRICAL ENGINEERING** **LOW AS \$25**

ELECTRICAL ENGINEERING. Get good grasp of wide electrical field. Modern. Very understandable. Theory made easy.

RADIO ENGINEERING. Extra fine course in radio, public address, photo-electric work. Trains you to be super-service man, real vacuum tube technician. Tuition ONLY \$25, either course. Deferred payment plan. Experiment kits furnished.

FREE Write for free copies of school catalog, student magazines, etc.

LINCOLN ENGINEERING SCHOOL, Box 931-P1, Lincoln, Nebr.



FREE BOOK TELLS HOW YOU CAN LEARN TO MOUNT BIRDS and ANIMALS

BE A TAXIDERMIST—Learn by Mail

Easy home lessons teach you quickly how to MOUNT BIRDS, ANIMALS, GAME-HEADS, FISH—TO TAN LEATHER, FURS. Save your hunting trophies. Have a home museum. It's thrilling! Taxidermy is wonderful. FUN, A PLEASURE HOBBY AND A MONEY MAKER—Investigate! Get this strange FREE BOOK.

EXTRA MONEY: —Earn in your spare time. Sell your mounts; and do work for other sportsmen. Students report \$30 to \$75 and more per month. Big demand. Fine prices. If you want REAL PROFIT from spare time WRITE TODAY.

FREE BOOK —with 100 photos of wild game. Tells about Taxidermy and how YOU can learn, easily, quickly. Old reliable school. 275,000 students. — STOP this minute and **TEAR OUT THIS AD NOW** as a reminder; then write; get the free book. You will be delighted, AMAZED, RUSH postal or letter and learn how to have more FUN, FASCINATION, PROFIT. State your AGE.

Northwestern School of Taxidermy, Dept. 3371 Omaha, Neb.

NEW INVENTIONS
(Continued from page 33A)

AUTOMOBILES of the future may be fitted with a movable top adapted for being attached adjustably to the body for use over the rumble seat. The top is arranged on rocker arms to permit tilting forward and backward for proper operation.

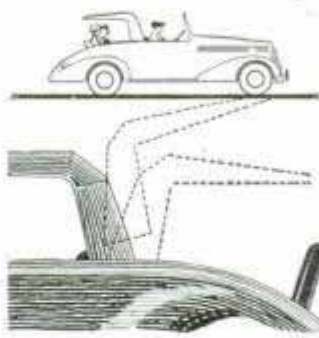

A SOLAR heater which absorbs heat from the sun's radiations and puts it to use for cooking has been patented by Dr. C. G. Abbot of Smithsonian Institution. The sun's rays are caught by the apparatus and used to heat oil. The oil, in turn, heats an oven, boiler or other device.

HANDY for the serviceman is a combination flashlight and tester patented recently. It is constructed so that the lamp circuit is closed when the terminals of an operative lamp or fuse to be tested are brought respectively into contact with the casing and with the contact. A sliding button controls operations of the light and tester.

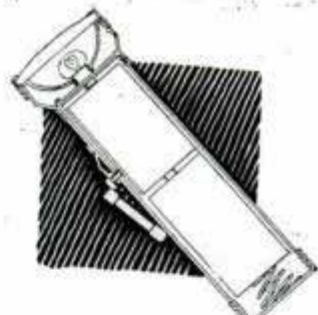

PRIVACY for the automobile occupant, as well as protection of the upholstery from the sun, is provided by a window shade that may be attached easily. The shade is closed by means of a zipper arrangement that also permits opening or closing to any size aperture desired. The released portion of the shade is then folded downward, out of the way.

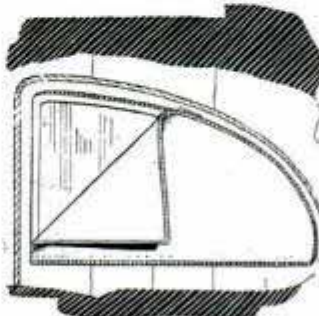

NEW YORK ELECTRICAL SCHOOL

Opportunities for Men of All Ages!

Every phase of all branches of Practical Electricity taught by Actual Practice in America's Foremost Institution of Trade Training.

Special Course in Automotive Technique

Day and Evening Sessions Open All Year.

Write for FREE Booklets.

Visitors Welcome.

New York Electrical School
44 W. 17th St., New York City

BE A TRAINED AUTO-DIESEL EXPERT *Learn AT HOME*

PREPARE NOW for rich new fields of opportunity in this fast-growing industry. Diesel-Trained Men needed for trucks, buses, tractors, farm power and lighting plants. Practical, easy, spare-time training plan offers quick way to good jobs at good pay, or a profitable auto repair business of your own. Learn from the pioneer automotive home-study school. Write today for Free AUTO-DIESEL Book and pay-as-you-learn offer.

MOTOR INSTITUTE of AMERICA
4554 Broadway, Dept. A-11, Chicago, Ill.

EARN BIG MONEY
SEND FOR FREE BOOK!

ELECTRIFY YOUR HOME

Wind Plants for Lights, Power, Radio. Send 25c for New Copyrighted Book with Over 100 Facts about Wind-chargers—Propellers—Generators, including plans for building 6 or 32 V Plant. Answers all questions. **WESCO, 450 Terminal, Minneapolis, Minn.**

MYSTERIOUS DEVICE

ENABLES ANYONE TO **WELD BRAZE AND SOLDER**

Now, an electric welding, brazing and soldering Torch, complete with power unit, goggles and supplies. Works instantly off ANY Light socket. Does a thousand and one repair jobs at amazingly Low Cost on aluminum, iron, steel and other metals. **Indispensable** for Auto, Fender and Body Repairs, and home repairs—shop, factory, farm, engineer, janitor, sheet metal, radio and bicycle repairs. Anyone can handle without previous experience with our simple instructions. **10-DAY HOME TRIAL** Write At Once for Special Introductory Low Price Offer. You can try it in 1 Electric Torch for 10 Days at our risk, or get one absolutely Free by helping us to introduce it. Write **ELECTRO-TORCH CO.** 2613-BY Michigan Ave. Chicago

MIDWEST SALE-FACTORY-TO-YOU!

PUT THIS NEW CHASSIS IN YOUR CABINET

14-TUBES

WORLD-WIDE CHASSIS



NEW!

SAVE UP TO 50%

HERE it is—the greatest radio value we have ever offered. A big, powerful, new 14-tube world-wide Midwest. Why be content with an 8 or 10-tube set . . . when it is so easy to install this big, new, powerful 14-tube chassis in your own cabinet for the same price! For a little more than the cost of new tubes, you can modernize your old radio and get exciting world-wide reception — during this special sale!

COMPLETE CHASSIS
Only \$19.95
WITH TUBES AND SPEAKER

30 DAYS TRIAL

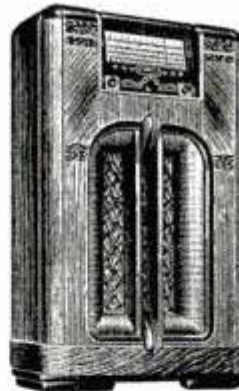

EASY TERMS

LIBERAL TRADE-IN ALLOWANCE UP TO \$40 ON YOUR OLD RADIO

. . . when you trade it in on the beautiful 17-tube 5-band Model "D" console shown here. Tell us the make and age of your present radio, so we can determine how much to allow you on it. New Time-Payment Plan makes it easier than ever before to own a Midwest. Midwest makes a radio to suit every purse . . . 6-tube to 17-tube 5-band models . . . and prices start as low as \$10.95. Absolute satisfaction guaranteed on a money-back basis. Write for FREE 1939 catalog.

Midwest radios are sold only direct from the factory—not through stores or dealers

Dept. 15-GG, MIDWEST RADIO CORPORATION, Cincinnati, O.

MIDWEST RADIO CORPORATION
Dept 15-GG
Cincinnati, Ohio

Name
Address
Town State
User-Agents Make Easy Extra Money. Check here () for details.

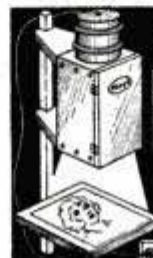

PHOTO ENLARGER Only \$4.95 COMPLETE
MAKE YOUR OWN PHOTO ENLARGEMENTS LOW AS 4¢ EACH

Enlarge your own pictures any size—earn money making enlargements for others—at home, in spare time. Also use for copying and projecting pictures on wall. Easy—automatic—no experience needed. Plugs into any light socket. Sturdy construction. Low price includes N-Larg-O complete with high-quality lens, cord, plug, and supply of print paper. Nothing else to buy. Write quick for special circular.

N-LARG-O MFG. CO., Dept. S-2353, Cincinnati, Ohio.

AUDELS Carpenters and Builders Guides 4 vols. \$6



Inside Trade Information for Carpenters, Builders, Joiners, Building Mechanics and all Woodworkers. These Guides give you the short-cut instructions that you want—including new methods, ideas, solutions, plans, systems and money saving suggestions. An easy progressive course for the apprentice and student. A practical daily helper and Quick Reference for the master worker. Carpenters everywhere are using these Guides as a Helping Hand to Easier Work, Better Work and Better Pay. To get this assistance for yourself, simply fill in and mail the FREE COUPON below.

Inside Trade Information On:

How to use the steel square—How to file and set saws—How to build furniture—How to use a mitre box—How to use the chalk line—How to use rules and scales—How to make joints—Carpenters arithmetic—Solving mensuration problems—Estimating strength of timbers—How to set girders and sills—How to frame houses and roofs—How to estimate costs—How to build houses, barns, garages, bungalows, etc.—How to read and draw plans—Drawing up specifications—How to excavate—How to use settings 12, 13 and 17 on the steel square—How to build hoists and scaffolds—skylights—How to build stairs—How to put on interior trim—How to hang doors—How to lath—lay floors—How to paint.



THEO. AUDEL & CO., 49 W. 23rd St., New York City

Mail Audels Carpenters and Builders Guides, 4 vols., on 7 days' free trial. If O.K. I will remit \$1 in 7 days, and \$1 monthly until \$6 is paid. Otherwise I will return them. No obligation unless I am satisfied.

Name

Address

Occupation

Reference

MECHANICS-WELDERS - COLLISION MEN

GOOD JOBS and Mighty GOOD PAY

Do you want to earn big money? If so let us know which of the following trades you prefer. You learn by doing. Practical work. Expert teachers. Low tuition. Personal attention. It will pay you to investigate AT ONCE. Just check the courses you'd like to take and mail today. You will receive full information, absolutely without cost or obligation. But don't delay.

Check the Trade You'd Like to Learn

- | | |
|---|---|
| <input type="checkbox"/> Complete Auto Mechanics (including Diesel) | <input type="checkbox"/> Electric Arc and Acetylene Welding |
| <input type="checkbox"/> Auto Collision | <input type="checkbox"/> Spray Painting |
| <input type="checkbox"/> Metal Finishing | <input type="checkbox"/> Body and Fender Bumping |

Ask about our "Pay After Graduation Plan"

Name

Address

Mail the above at once to

MICHIGAN TRADE SCHOOL
3758 Woodward Ave. Detroit, Mich.

Write for FREE FOLDER

Only 22¢ a Day Puts This All-Purpose **ELECTRIC ARC WELDER** IN YOUR SHOP

TEN-DAY TRIAL
Guaranteed: 10 Months To Pay

Now, for first time, it is EASY for every inventor, laboratory, home workshop owner, garage, repair shop, and factory to afford a complete welding service for manufacturing, maintenance, experimental, or repair work. Full size, heavy-duty Electric Arc Welder—Commonwealth Model 120-F8—yours for only 22c a day! Has efficiency of machines costing \$250.00 to \$1,000.00. Welds all metals and alloys. Six heats handle everything from fenders and light sheet metal to motor blocks and heavy castings. Also fine for soldering and brazing.

WORKS ON 110 OR 220-VOLT A. C.
Simply plug into 110 or 220-volt, 60-cycle A. C. electric socket. Costs only few pennies an hour to operate. Anyone can use easily. Comes complete with helmet, electrode holder, welding rods, full instructions, etc. Nothing else to buy. Fully guaranteed.

WRITE FOR 22c A DAY PLAN
Stop throwing away profits! Do your own welding. Get sensational facts about Model 120-F8 and 22c-a-day plan. Write today!

COMMONWEALTH MFG. CORP.
Dept. S-51 4208 Davis Lane, Cincinnati, O.

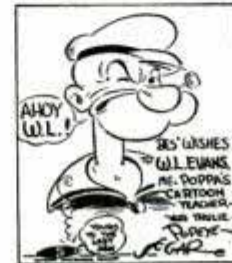

DO YOU LIKE TO DRAW?

It's easy to learn when shown in the right way. E. C. SEGAR creator of "POPEYE," CHESTER GOULD who draws "DICK TRACY," "LANK," LEONARD—"MICKY FINN" and many other famous cartoonists and comic strip artists learned how to draw during their spare time by following **CARTOONIST EVANS' SIMPLE, EASY, INEXPENSIVE COURSE**. Send 6c in stamps for full details.

THE W. L. EVANS SCHOOL OF CARTOONING
521 Premier Bldg. Cleveland, Ohio

LAW

STUDY AT HOME for Personal Success and Larger Earnings. 28 years of successful student guidance assures expert instruction. LL.B. Degree awarded. All text material furnished. Easy payment plan. Send for **FREE BOOK**—"Law and Executive Guidance," at ONCE.

AMERICAN EXTENSION SCHOOL OF LAW
Dept. R, 737 N. Michigan Ave., Chicago, Ill.

AVIATION

If you want to be an expert airplane pilot or mechanic, get off to a flying start by mastering a knowledge of atmospheric conditions, action of airstreams, stability in flight, balance of forces, etc. Our textbook "Practical Aerodynamics" makes it all very easy to learn. Send for it today—\$3 postpaid. Or write for circular on six practical aviation texts.

Thompson Aviation Pubrs., 8326 Woodward, Detroit, Mich.

S AGENTS 300% Profit SIGN LETTERS

For Store Fronts and Office Windows. Anyone can put them on. Free Samples. Liberal Offer to general agents.

METALLIC LETTER CO., 438 N. Clark St., Chicago

FREE WHOLESALE CATALOG

For Salesmen

Represents 18 years of tested selling experience. Has selling plans; money making ideas; over 4000 World Wide bargains; 260 pages of big values. Also shows top-notch prizes, business stimulators. All at rock bottom wholesale prices. Guaranteed to satisfy or money back. Obtain this fascinating Book Of Opportunity, FREE. Write for it today, NOW.

SPORS CO., 11-38 Main St., Le Center, Minn.



NEW—SENSATIONAL—KEYLESS—ELECTRIC GAS TANK LOCK

Cap unlocks—SNAPS OPEN by pressing a button on your dash. STOPS THIEVES—PROTECTS YOUR CAR—IMPROVES ITS APPEARANCE. A money maker—every garage and filling station a potential dealer. Write immediately for exclusive distributorship proposition.
THE IDEAL CHRISTMAS GIFT FOR FATHER
 IF DEALER CANNOT SUPPLY YOU, SEND FOR CIRCULAR
SNAP-UP GAS CAP CO. INC. ASHLAND, KY.

BOOKS—FOR TODAY'S BIG OPPORTUNITIES

List sent free upon request
 Popular Mechanics Press, 200 E. Ontario St., Chicago

GROW PLANTS WITHOUT SOIL Startling New Development

Complete Directions for Small and Large Scale Growing

technique which everyone is talking about. Three methods described—Water Culture, Sand Culture, Sub-Irrigation. Explains all operations. Tells how to make containers and nutrient solutions from raw materials at small cost—how to grow flowers, vegetables and fruits without soil. A fine hobby and a money-saving investment for city dwellers. A source of new business for gardeners, nurserymen, etc. Only book of its kind. Order today "Soilless Growth of Plants." Sent postpaid for \$2.75.

POPULAR MECHANICS PRESS Dept. 139 200 E. Ontario St., Chicago

Extra Money From Books

SEND NO MONEY • Books Sent C.O.D. Anywhere in U. S.

These famous Pay-Raising, Extra Money Books have helped thousands of others. Let them help you too. Check this list and mail with your

name and address. Pay postman on delivery price plus small C.O.D. fee. Or remit with order and books will be sent postpaid.



SELECT FROM THIS LIST

- AIR CONDITIONING**
Furnaces, Unit Heaters...\$3.00
- AIRPLANE SERVICING**
Manual, New, 1000 Pages, Illus.\$6.00
- AUTO RACING**
Build Midget and Other Racers...\$1.00
- AUTO REFINISHING**
Duco With Spray Gun...\$1.50
- AUTO SERVICE SHOP**
Management, Money-making Ideas...\$1.50
- BLUEPRINT READING**
For Machine Trades...\$1.50
- BRICKLAYING**
Plain and Fancy...\$1.50
- BUSINESS CORRESPONDENCE**
and Office Management \$1.75
- CARBURETORS (All Makes)**
New, Revised Edition...\$3.00
- CHEVROLET SIX**
Car, Truck, Operation Repair...\$2.50
- COLONIAL FURNITURE**
Making, 95 Pieces...\$3.50
- DANCE**
Learn at Home Without Music or a Partner...\$2.00
- FOUNDRY WORK**
Molding, Casting, etc...\$2.00

FURNITURE REPAIRING, Finishing and Decoration... \$4.00

- HIGH-SPEED DIESELS**
New, practical, non-technical...\$2.50
- HOME GROUNDS**
Furnishing...\$0.80
- LEATHER MAKING and Tanning**...\$1.00
- METAL SPINNING**
Practical New Book...\$1.00
- METALLURGY**
New, Metals, Alloys In Use To-Day...\$1.50
- MONEY-MAKING FORMULAS**
10,000 Practical...\$4.00
- OIL HEATER HANDBOOK**
Manufacture, Distribution, Installation, etc...\$3.50
- PLASTERING**
Best Instruction Manual...\$1.25
- RADIO PHYSICS COURSE**
New edition, Everything about Radio...\$4.00
- SHEET METAL**
Construction Work...\$2.50
- STEAM ENGINEER'S LICENSE**
How to Obtain...\$2.00
- WOOD TURNING**
Course In...\$1.50
- WROUGHT IRON WORK**
Practical...\$1.35

POPULAR MECHANICS PRESS
 Room 139A 200 E. Ontario St., Chicago

When writing please mention Popular Mechanics

Be An ARTIST



Trained Artists Earn \$35, \$50, \$75 Weekly
Learn to Draw at Home, in Your Spare Time, This Practical Way!

More and more trained Artists are needed each year. Magazines, advertisers, newspapers, printing houses, etc., pay good money for art work. Our practical, proven method makes it fun to learn Commercial Art, Cartooning and Designing AT HOME, in your spare time.

Two Big Artist's Outfits Given

Drawing board, paints, brushes and all materials you need come with very first lessons. The second outfit is given later in the course. Actual fun learning to draw this way.

Write Today for FREE BOOK

Our Free Book "Art for Pleasure and Profit" describes wonderful opportunities in this fascinating field and gives full details of our practical method of instruction. Tells all about our students—their successes—what they say—actual reproductions of their work—and how some earned money even while learning. Mail coupon below or paste on postcard today. State age.

\$40 Extra Per Month
 in spare time, writes student R. G. Reid, Jr. of Oklahoma.
Paid for Course
 W. R. Kent of New Jersey earned more than twice the tuition while studying.
\$25 for One Drawing
 One small picture brings easy money to Miss Goldie Hill of Kansas.

FREE BOOK gives details!

Washington School of Art, Studio 121M
 1115—15th St., N. W., Washington, D. C.

Yes! I am interested in learning to draw. Please send me your Free Book, "Art for Pleasure and Profit."

Name..... Age.....
 Address.....
 City..... State.....

DO YOU LIKE RADIO TELEVISION
DOES THE FUTURE OF TELEVISION INTEREST YOU?

Send for your free copy

You men anxious to make good in radio and related industries want the true facts,—you want to know about employment opportunities and requirements. National Schools,—a million-dollar trade school,—will supply you with a sincerely honest statement of facts on what you should do to get into the profitable radio industry. No exaggerations,—no misstatements. Mail coupon today. Send for your free copy. Real facts on radio employment requirements. You need real experience. National offers complete training with modern equipment.



NATIONAL SCHOOLS
Los Angeles

Request for FREE BOOK of DETAILS

NATIONAL SCHOOLS,
 Dept. 1-PMR, 4000 S. Figueroa St., Los Angeles, Calif.

NAME..... Age.....
 ADDRESS.....
 CITY..... STATE.....

Howard E. Bixby of Berkeley, 1105 Hillcroft Road,
Belmonte, Calif.

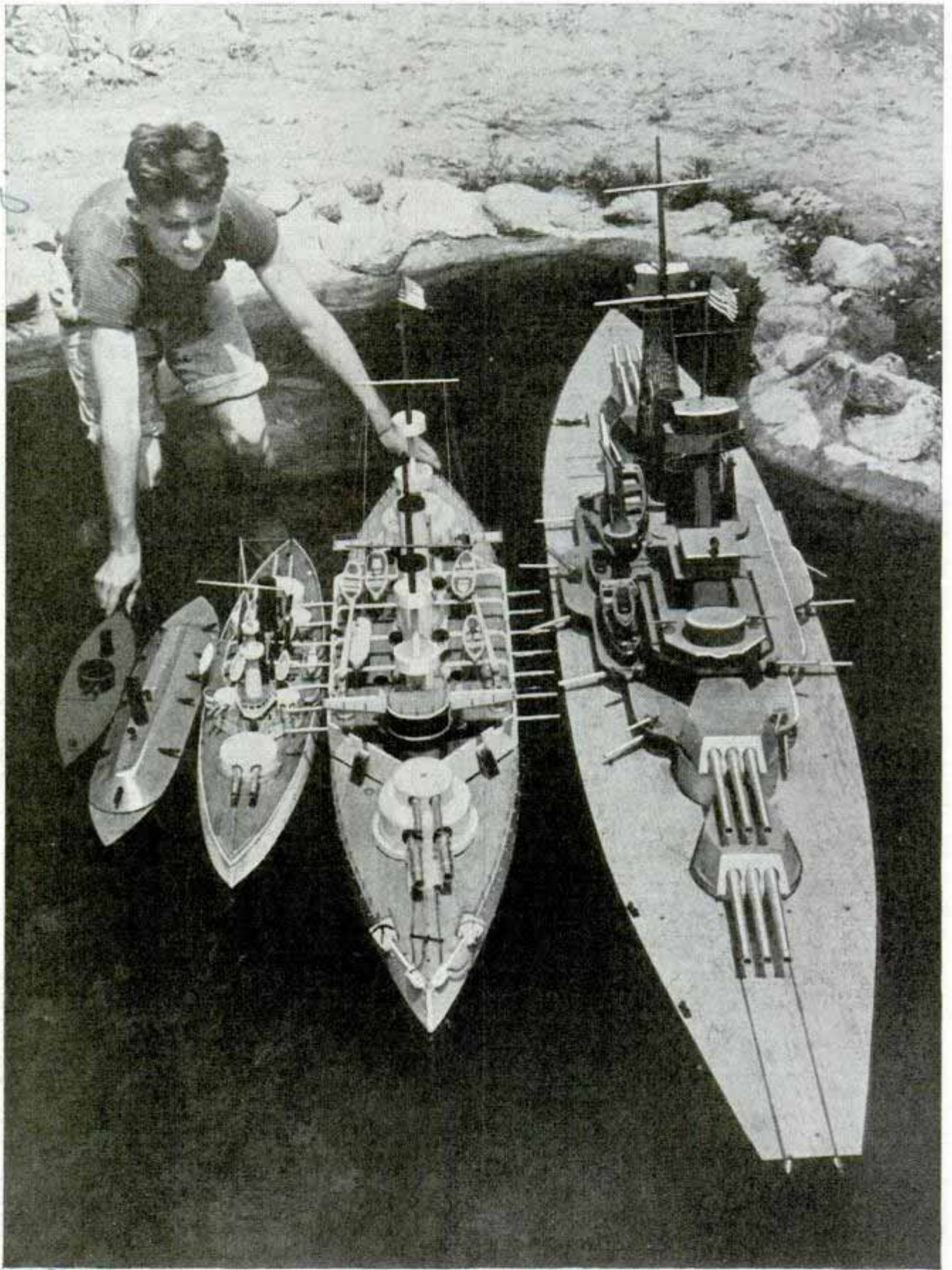

Acme

These five scale models represent development of American battleships, from the "Monitor" and the "Merrimac" through the "Oregon" and the "Kentucky" to the "California," present flagship of the fleet. The "California" is driven fifteen miles per hour by a five-horsepower gasoline engine. Howard E. Bixby, builder of the midget navy, causes the "California" and the "Kentucky" to start, stop, maneuver and fire both main and broadside batteries as he stands on shore or rides near by in a boat. He uses a telephone dial or whistles, since the boats are controlled by radio and sound

Popular Mechanics Magazine

REGISTERED IN U. S. PATENT OFFICE AND CANADA

WRITTEN SO YOU CAN UNDERSTAND IT

Vol. 71

JANUARY, 1939

No. 1

#1278

Making METAL SMOOTH as GLASS

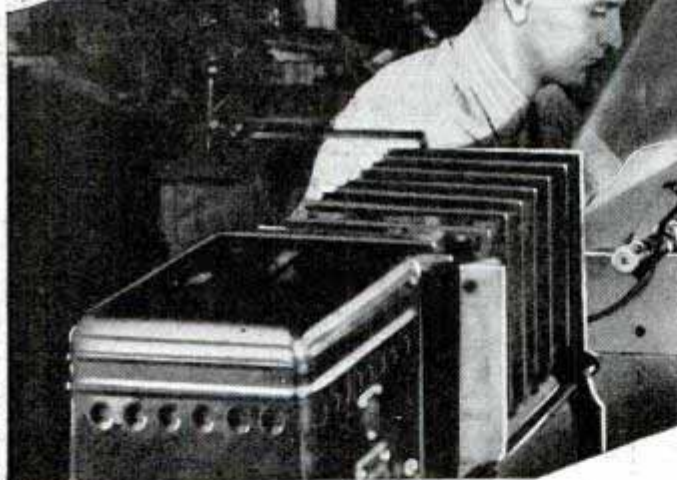
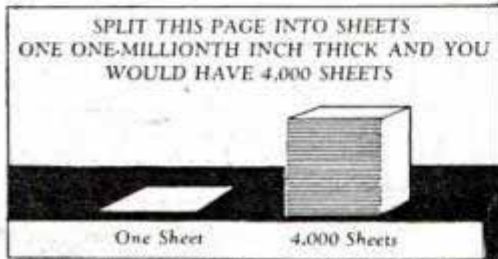

By Julian Leggett

LONG the goal of scientists and the industrial world, a revolutionary process for commercially making the surface of any piece of metal as smooth as the finest optical glass has been discovered.

In addition to being more attractive to the eye, metal finished in this manner fits together more closely when used as moving parts in a machine. Three results of such precision manufacture will be: greatly increased life for moving parts, reduction in noise, and elimination of long "run-in" periods commonly employed to bring about quiet operation in new motors.

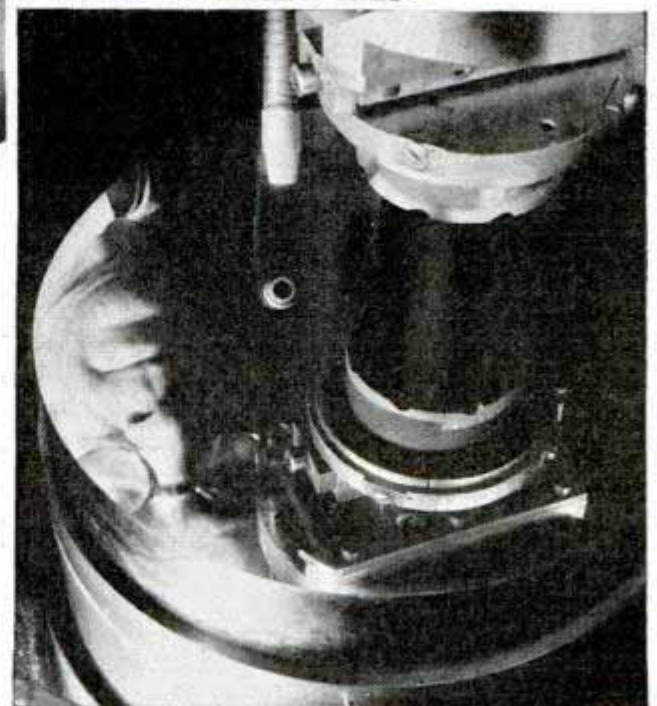

Top, measurement of surface smoothness projected on screen in millionths of an inch. Bottom, operator's reflection on Superfinished metal

Chrysler Corp
3-11
massachusetts

*Dr. J. G. ...
Physicists Research Co., Ann
Arbor Mich*

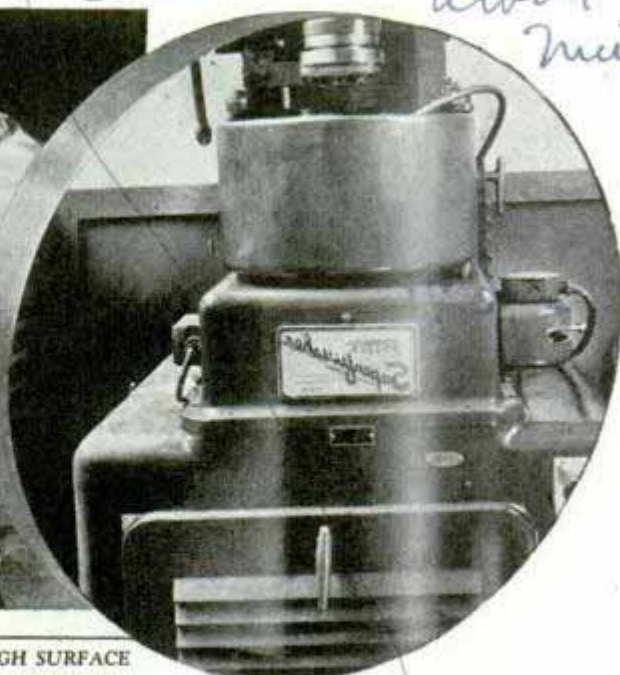

DEVELOPMENT OF SMOOTH SURFACE FROM RELATIVELY ROUGH SURFACE

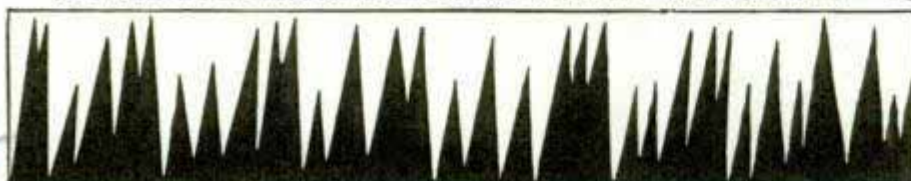

Base Metal 50 Micro-Inches



Base Metal 2 Micro-Inches

Top, left, measuring surface of piston pin with Profilometer. Right, reflection of Superfinishing machine appears in photo of smoothly finished disk. Note mirrorlike appearance of disk

Above, comparison of surface having defects fifty-millionths of an inch high with surface Superfinished to two-millionths of an inch. Right, Superfinished disks held together only by adhesion of their own surfaces. Bottom, why smoothly finished surface photographs black

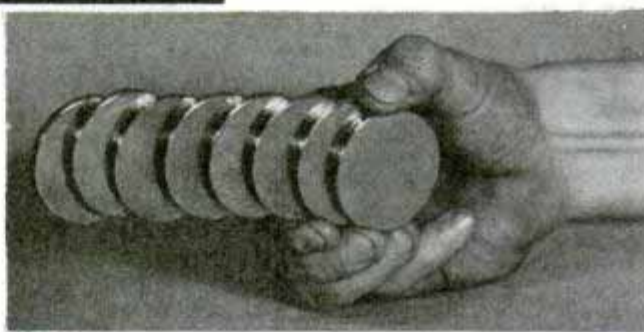

Although the satiny-looking surface of any metal object may appear to be as smooth as glass, you can prove that it isn't by scratching the finish gently with your fingernail. This simple test reveals tiny, invisible ridges and depressions which turn into mountains and valleys under the magnification of a high-power microscope.

When the surface of metal moving parts rub against each other in a machine, these microscopic jagged edges wear off gradually, no matter how well lubricated the parts are kept. Soon the little ridges are gone, tending to destroy the precision with which the parts were fitted together, and then the machine may begin to pound and vibrate, hastening the day when the parts will be worn out.

"Superfinish" is the name of the new process, which was developed under direction of David A. Wallace, President of Chrysler Division of Chrysler Corporation. Although it was devised for automotive

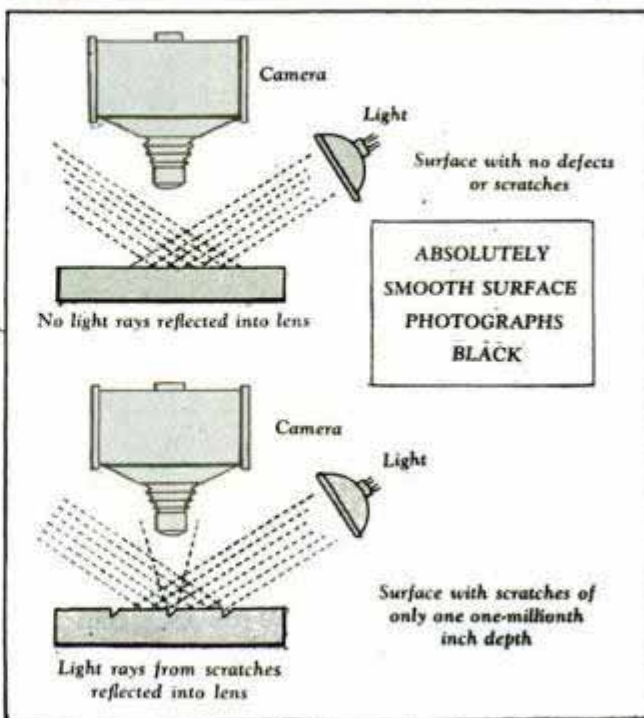

application, it has almost unlimited possibilities in other fields, lending its magical touch to tiny parts for a watch, plungers for Diesel engines, moldboards for farm plows, stainless-steel sheets for the steel mills, paper rolls for the production of paper and the hub-bearing surfaces of a variable-pitch airplane propeller.

By this process, it is possible to achieve, in ordinary production, parts whose surface defects are as little as two-millionths of an inch deep, which for commercial purposes is regarded as perfect. In experimental work, finishes with ridges no more than two-tenths of one millionth of an inch have been produced. As a means of comparison, if the sheet on which this story is printed could be split into about 4,000 sheets, one of the super-thin sheets would be approximately one millionth of an inch thick.

An optical glass finish can be produced upon flat, round, concave, convex and other types of surfaces, either external or internal, in three to thirty seconds. The operation is somewhat similar to wiping a glass surface lightly with a silk handkerchief to remove dust. After a metal surface has been finished by other means, the invisible ridges are reduced almost to the vanishing point by cutting stones running at amazingly slow speeds under extremely light pressure, ranging from a few ounces to a few pounds. A lubricant of the proper viscosity is used to wash away the cuttings and to hold the stones a sufficient distance from the surface to prevent new scratches. When the surface defects have been removed to the point where virtually all that is left is crystalline metal, the cutting action stops automatically.

Surfaces with the new finish are so nearly perfect, developers of the process say, that if they are kept properly lubricated, there is practically no measurable wear on

(Continued to page 147A)

Yoke of Eleven-Foot Tubes Built for 200-Inch Telescope

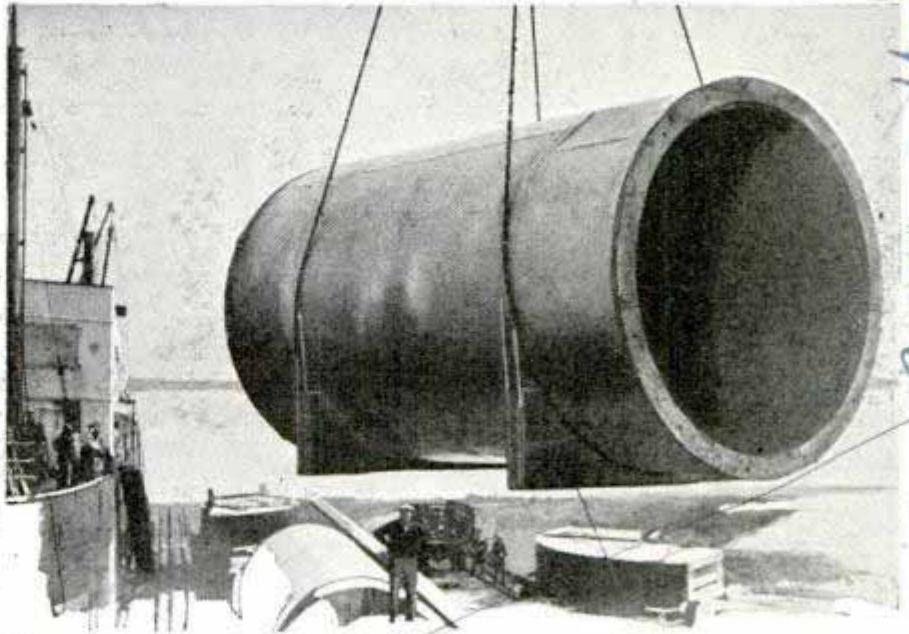

Nineteen-foot section of yoke built for world's largest telescope is hoisted aboard ship at Philadelphia for the Panama Canal and California

freighter. Pennsylvania
Some notion of the gigantic size of the 200-inch telescope being built at Mount Palomar, Calif., is obtained from a view of the huge tubes which form its yoke. Each sectional tube is eleven feet in diameter and nineteen feet long. The tubes and the horseshoe bearing for the telescope were built by the Westinghouse Electric and Manufacturing company and shipped from Philadelphia by way of the Panama Canal to California.

Automatic Rinser for Negatives Rocks under Water Stream



Rocking under the stream from the faucet, a rinsing pan for photographic films and prints keeps changing the water automatically. The pan is double, with a pivot under the center wall. As a small stream from a faucet flows into one side the pan tips on the pivot and the stream is diverted to the empty side, and the process is repeated. Slots in the ends keep draining the water.

L. S. Wright, Inc.
5209 Euclid Ave

Giant Claws of Gyro-Tiller Churn as They Plow Earth

obtain the proper key. For instance, if the house door key is in the first position, the user simply presses the button with a single notch beside it. The case holds the keys firmly, insuring against loss.

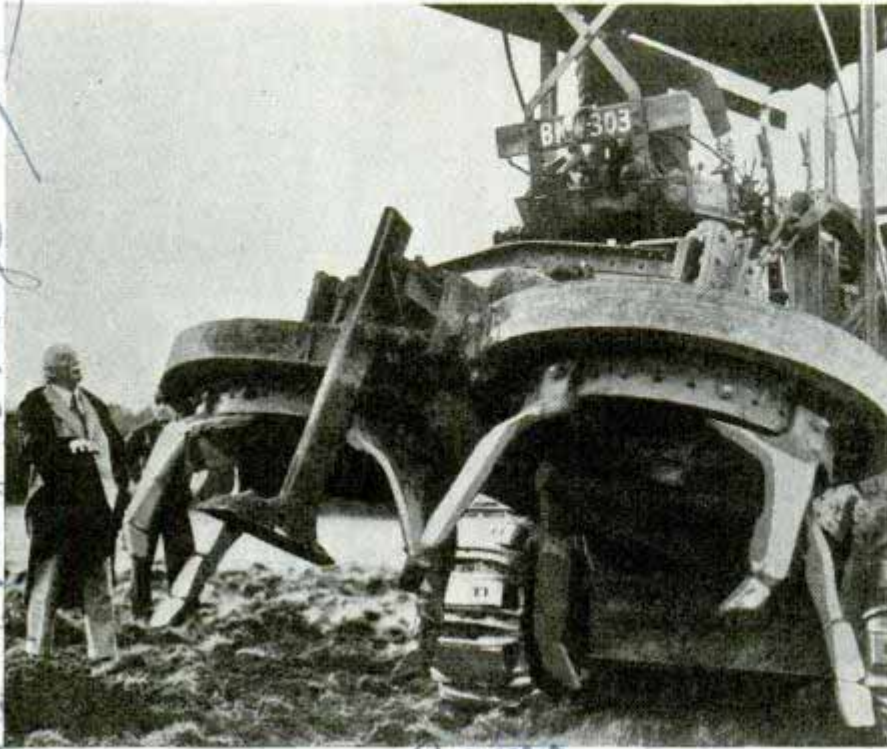

David Lloyd George, wartime prime minister of Britain, supervises operation of huge gyro-tiller as it plows deep into soil of his farm

From the primitive plowshare and hoe to the mechanical gyro-tiller is a span of but a few years, yet a whole age intervenes. In sharp contrast with the laborious methods of hand-tilling, this crawling monster bites into the earth with giant rotating claws as it churns across the field. Preparing the ground for cultivation, it breaks a trail nearly five yards across.

Right Key Pops Out of Case When Button Is Pressed



Enabling the user to select the proper key for home, automobile or office without looking at the case, a new device expels the right key when a button is pressed. If three keys are carried in the case, three buttons are provided, one for each key. Identifying notches on the case indicate to the user which button should be pushed to

Sparking points are located in the casing; the cylinders take in gasoline and air, the mixture is fired, and the exhaust fumes pass out as the cylinders rotate.

Trimming Board for Photos Has Adjustable Guides

Precise trimming of photographs can be done readily with a cutting board that has adjustable guides for the paper. There are rulers at both top and bottom, and the guides can be squared accurately.

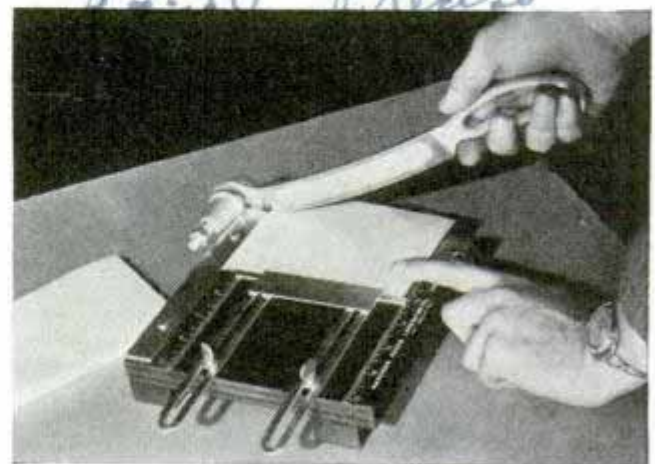

Adjustable paper guides assure an accurate trim

used on survey farm of Lloyd George

Webwood Corp. Broadway 141

way machine shop and mfg. Co. Miami Florida

H1826 Engine's Whirling Cylinders Cool Spark Plugs
In the early days of aviation the "whirling nightmare" was a rotary engine that whirled, cylinders, propeller and all, around a stationary crankshaft. A similar engine has just been developed for trial by the French air ministry, its cylinders revolving inside an outer casing, but in the new engine the crankshaft turns nine times as fast as the cylinders. Sparking points are located in the casing; the cylinders take in gasoline and air, the mixture is fired, and the exhaust fumes pass out as the cylinders rotate.
H1245
Trimming Board for Photos Has Adjustable Guides
Precise trimming of photographs can be done readily with a cutting board that has adjustable guides for the paper. There are rulers at both top and bottom, and the guides can be squared accurately.
H1249
Right Key Pops Out of Case When Button Is Pressed
Enabling the user to select the proper key for home, automobile or office without looking at the case, a new device expels the right key when a button is pressed. If three keys are carried in the case, three buttons are provided, one for each key. Identifying notches on the case indicate to the user which button should be pushed to

American Photo Laboratories Co.

wa
pu
bu
Br

Safety Bar Aids in Steering Straight Course

Designed to give greater control over the front wheels, a safety bar on one of the latest automobiles helps the driver steer in a straight line. The bar is attached to the frame across the front of the chassis with the ends angled backward to form lever arms exactly like the sway-bar. The ends of the levers, however, are connected by suitable links, not to the axle as in former practice, but to the wheel spindles. This attachment point is so located that as soon as anything turns the wheel from the straight-ahead position, whether it is the driver or wind or road shock, the bar is actually twisted like a spring and immediately it tends to pull the wheel back to center. This action, occurring directly at the wheel and not back at the steering gear where it would have to operate through several joints as well as connecting links and bars, gives a remarkable result. No matter what tendency there is for the front wheels to depart from the straight-ahead position, it

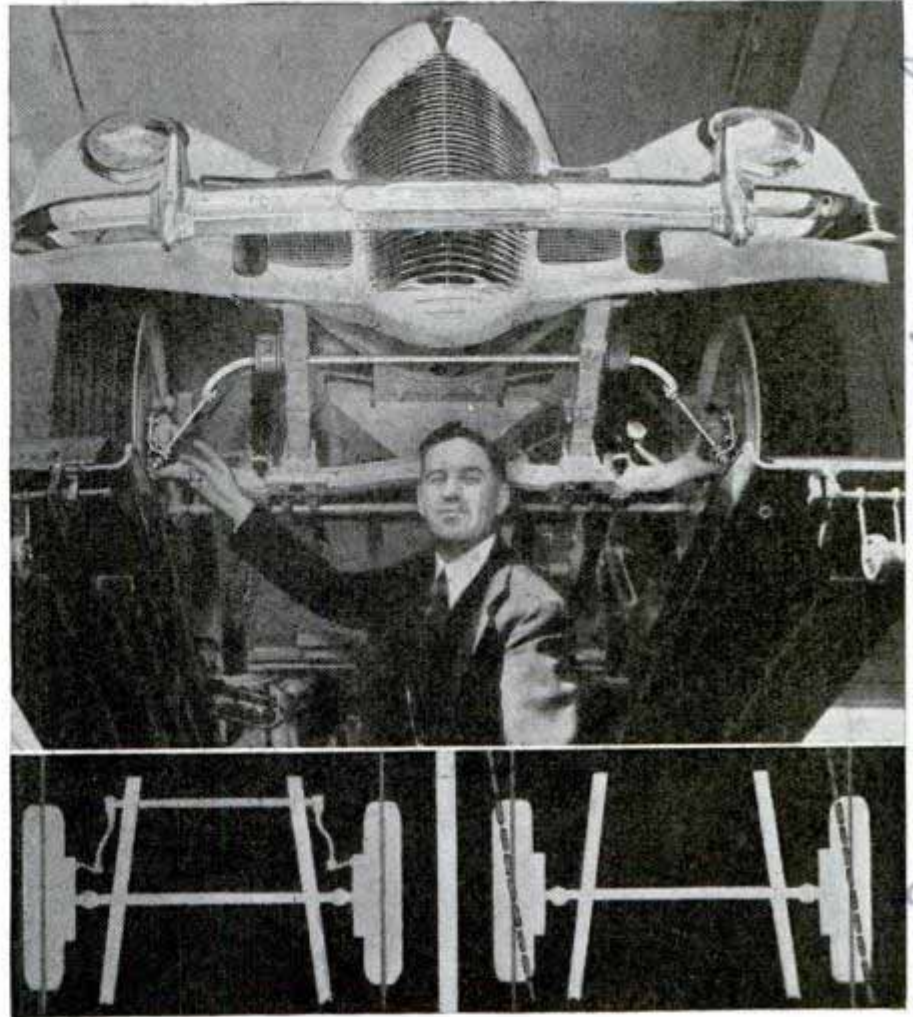

Top, Hudson's front end, with steering stabilizer bar in white. Bottom, diagrams showing how bar helps steer straight course

is immediately corrected. The device constantly helps the driver with just the proper amount of self-steer and is particularly useful in cross-winds and on curves. It was designed by Hudson engineers.

Motor Car Co.

Ten-Wheel-Drive Marsh Buggy Wades Bottomless Bog

Mud that would stop almost anything but ducks and frogs is a negotiable high-



Ten huge tires on its ten driving wheels help this "marsh buggy" navigate almost impassable bog

way for the all-wheel-drive truck developed for swampland transportation. Built to accommodate from four to ten tires measuring thirteen and one-half by twenty-four inches, this marsh buggy can wade into apparently "bottomless" mud. Special axles and gears enable it to apply driving power to ten wheels, gaining traction through a marsh even with a load of men and machinery.

☐Inquiries as to makers of articles described in Popular Mechanics, will be answered by our Bureau of Information upon receipt of return postage.

Marroni Herrington Co. Inc.
1001

12601 E. Jefferson, Detroit, Mich

STORMS



Left, Henry Ford pushes switch to start 500-ton refrigerating system in huge new weather tunnel recently placed in operation at the Ford Motor company. The tunnel will produce virtually every conceivable weather condition, enabling engineers to test automobiles without waiting for nature to create the particular conditions desired. The refrigerating system is powerful enough to maintain a temperature of twenty degrees below zero. In addition, a "cold" chamber provides temperatures as low as forty degrees below zero for cold-weather tests of engine, oil, battery and starter

HEATING SYSTEM CAN RAISE TEMPERATURE TO 150 DEGREES

400 H.P. MOTOR

PROPELLER CREATES WIND VELOCITY OF 85 MILES PER HOUR

WATER JETS FOR RAIN IN CEILING

DYNAMOMETER

SCALE

CONTROL BOARD

SAND AND DUST JET

WIND

Center, control end of weather tunnel, with automobile in test chamber. Note rain jets for subjecting car to rainstorm conditions, spout in floor for producing a duststorm, propeller for creating windstorm of eighty-five miles per hour, heating system which can raise temperatures to 150 degrees and refrigerating system for creating sleet or snowstorm conditions. Thus the tunnel may be used for making storms to order. Instruments on control board permit the taking of 100 readings of various conditions concerned with operation of the car. The vehicle under test is mounted on a treadmill connected with a dynamometer. Its spinning wheels turn the treadmill to record engine power output. The engine is controlled from board outside. At right, member of crew chipping away ice after test in below-zero "weather"



MADE *to* ORDER

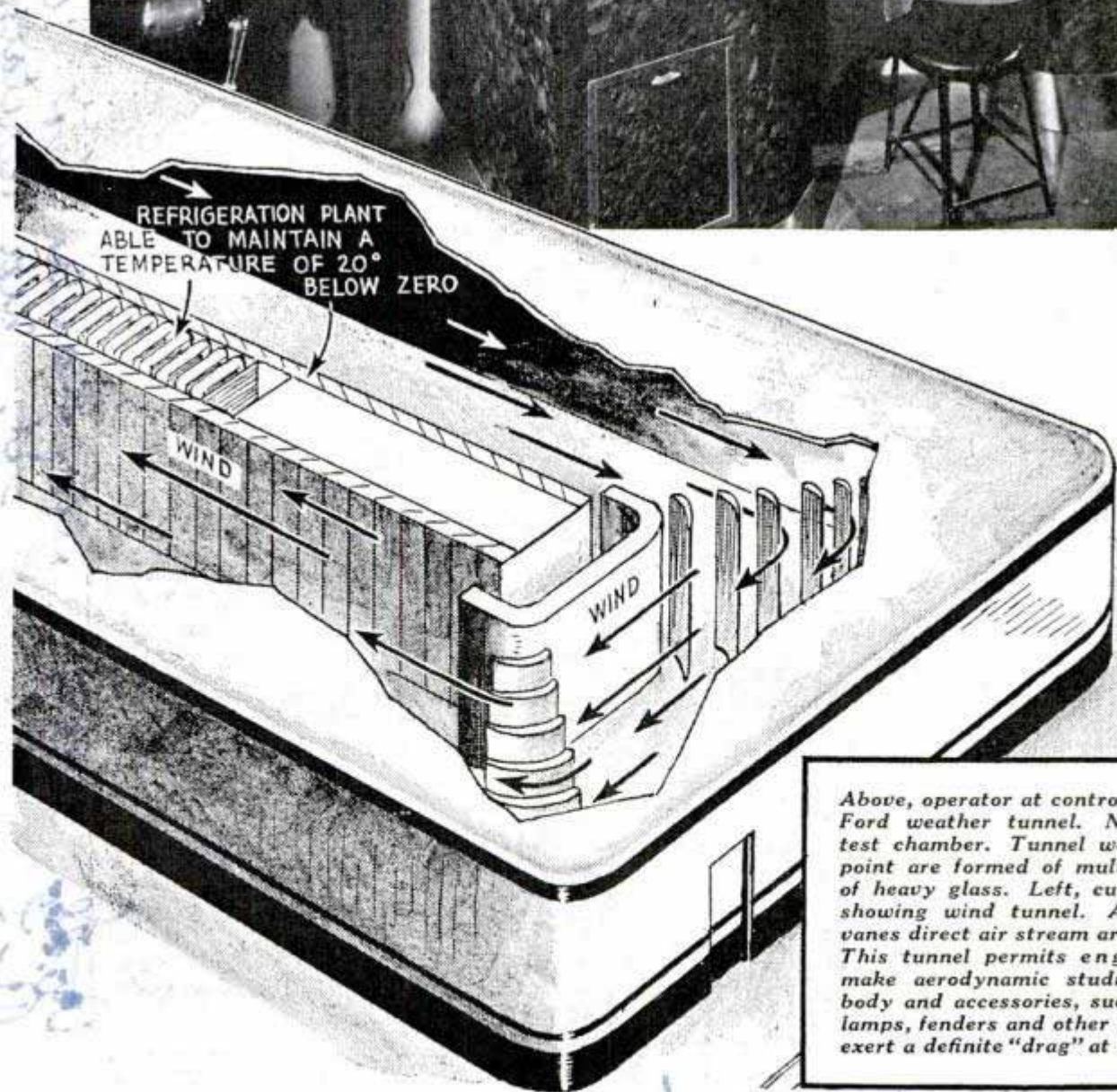

Above, operator at control console of Ford weather tunnel. Note car in test chamber. Tunnel walls at this point are formed of multiple layers of heavy glass. Left, cutaway view showing wind tunnel. Airfoil steel vanes direct air stream around turns. This tunnel permits engineers to make aerodynamic studies of auto body and accessories, such as headlamps, fenders and other parts which exert a definite "drag" at high speeds

1242

Enlarger Using Angle Light Makes Big Photo-Mural

International Research Corp
14.75 up Argus

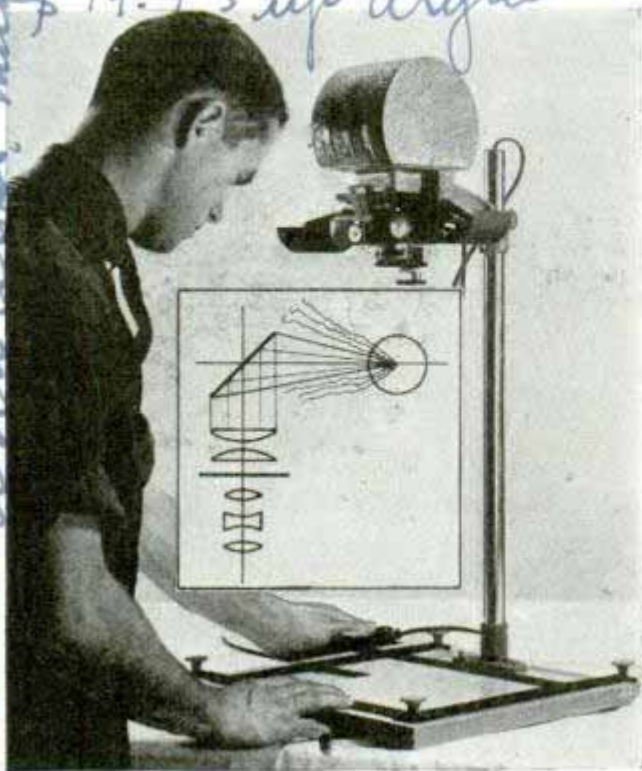

Enlarging from miniature film. The inset is a diagram of light system showing reflector and lenses

Miniatures can be made into photo-murals with an inexpensive enlarger which employs reflected light instead of the conventional direct, diffused illumination, obtaining both coolness and flat brilliance. It is a thirty-five-millimeter enlarger, and by inverting its film holder, eleven-by-fourteen pictures or even photo-murals forty inches wide can be printed. The film holder is of Bakelite, a book-type device made without glass and therefore non-scratching and dust-free. It handles strip film or single negatives. A 100-watt prefocused projection lamp is used, at right angles to the optical system.

1252

"Free-Wheeling" Paint Scraper Cleans with Whirling Teeth

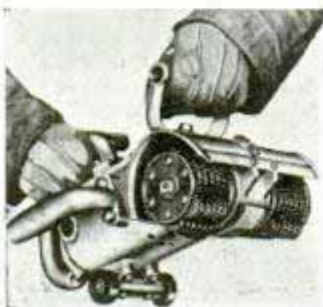

Paint, scale and rust can be removed economically with a mechanical "sand blaster" which employs whirling sawteeth instead of sand. Numerous

small cutting wheels are mounted loosely on a rotating head, and as the entire "cutting bundle" revolves at high speed the teeth are thrown outwards by centrifugal force, contacting the surface some 115,000 times per minute. Because of this loose mounting there is no gouging of the painted surface, and excessive wear on the cutters and overload of the motor are avoided. One man using the tool cleaned a 75,000-gallon tank with 3,250 square feet of surface in four days, a job that formerly took four men twelve days.

1288

Electric Plane Is Convertible into High-Speed Jointer

Capable of making a three-sixteenths-inch cut in soft wood, an electric plane just introduced will plane a surface two and one-half inches wide. Large but portable, it can be converted instantly into a high-speed jointer by using the bench bracket furnished with it. A one-horsepower universal motor drives its spiral cutter at 18,000 revolutions per minute, producing a smooth surface with or across the grain. An adjustable fence makes it possible to plane accurate bevel cuts up to forty-five degrees, and a micro-adjustment screw sets the front shoe for heavy or paper-thin cut. With a grinding attachment the plane sharpens its own cutter.

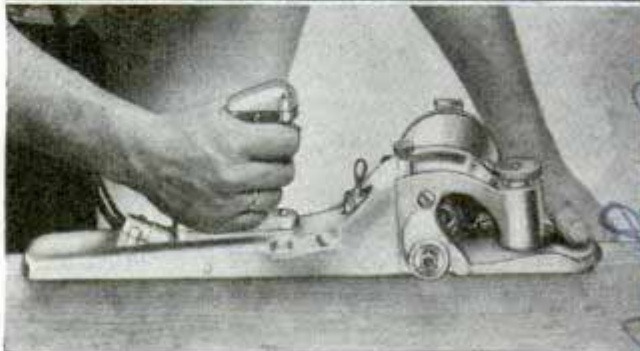
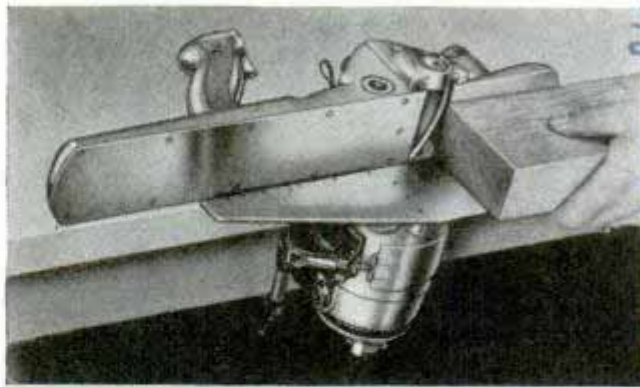

Electric tool used as high-speed jointer or plane. It can plane precise bevels to forty-five degrees

Tool works
Britain Conn
Stanley
99 Clin
12-7

Am and Info & Equipment
Co-2143

THIS lion, balancing on two tightropes and roaring ferociously, had his first lesson in this trick when he was coaxed to walk across a wide plank to get a piece of meat.

Teaching
WILD ANIMALS
NEW STUNTS

9



*Carl Thomas E. Stinson, Jr. 10555 Holman Ave
Los Angeles*

THIS trainer is working a group of "cats." The lions are called from the pyramid stand, one at a time, for individual performances.

LIONS that walk tightropes and seals that ride horseback are two of the latest attractions produced by crack animal trainers. In the circus world, new bags of tricks are necessary every year or so, and now that motion pictures are demanding wild animals to do tasks that seem almost miraculous, trainers are "educating" their animals to perform stunts of which no one dreamed before.

Teaching a lion to walk two swaying tightropes high in the air seems like a nearly impossible task until an experienced trainer tells how he does it. Charles Gay, who has a tightrope-walking lion at his lion farm at El Monte, Calif., starts to teach his cubs tricks when they are nine months old, after their trainers have gained their trust through frequent petting and feeding.

"Teaching a lion to walk the tightrope

takes about six months of steady training," says Gay. "We start with a wide plank ten feet long on supports a few feet off the ground. We tempt the animal to walk this plank by leading it with a piece of meat. After it has learned it will be rewarded for walking, we remove a central support, allowing the plank to bounce and sway under the animal's weight.

"Next we substitute two narrow planks for the wide one, gradually training the lion to walk the narrower planks until he finds himself walking a couple of pieces of two by four planks. The next step is to substitute one and one-quarter-inch iron pipes, then thick steel cables which the lion can grasp with his non-skid pads, and finally the smaller cables on which he performs his act.

"During all this time we gradually lengthen and heighten the supports so the

*Lions - C. Gray, Gray's
Lion Farm, El Monte, Calif.*

901

animal finally learns to walk ropes twenty or thirty feet long that may be twenty feet in the air. During the first part of the training, the lion may take an occasional spill, so we use a pile of wood shavings under the planks as a safety mat."

Teaching a lion to walk along a row of stilts something like the top of a picket fence is done somewhat similarly. First, the animal is coaxed to walk across three low pedestals placed in a row. Then the pedestals are replaced with three higher and smaller ones. Additional groups of three are added to the row. As the animal progresses, in pursuit of a chunk of meat, the pedestals are gradually replaced with thinner supports until the lion learns to walk along a row of tall two by four planks.

Young lions are like a bunch of children. Some are quiet and gentle while others never grow tame enough to be approached safely. Once an animal has been trained it may stay gentle all its life, or without any apparent reason it may suddenly revert to its wild disposition. From then on the trainer can never trust it.

Trainers remain constantly on their guard for the first danger signal during an act, no matter how peaceful the animals may appear.



GIANT black bear, above, engaged in a make-believe wrestling match. The seal at the left, below, is riding a pony cart and balancing on its front flippers while clapping the back flippers in a demand for applause. The seal at the right is enjoying a dainty breakfast.

Seals -



Monterey Calif



790
ELEPHANTS, like camels, are used as domestic animals in some parts of the world, and readily learn to do a large repertoire of tricks like the balancing act below.

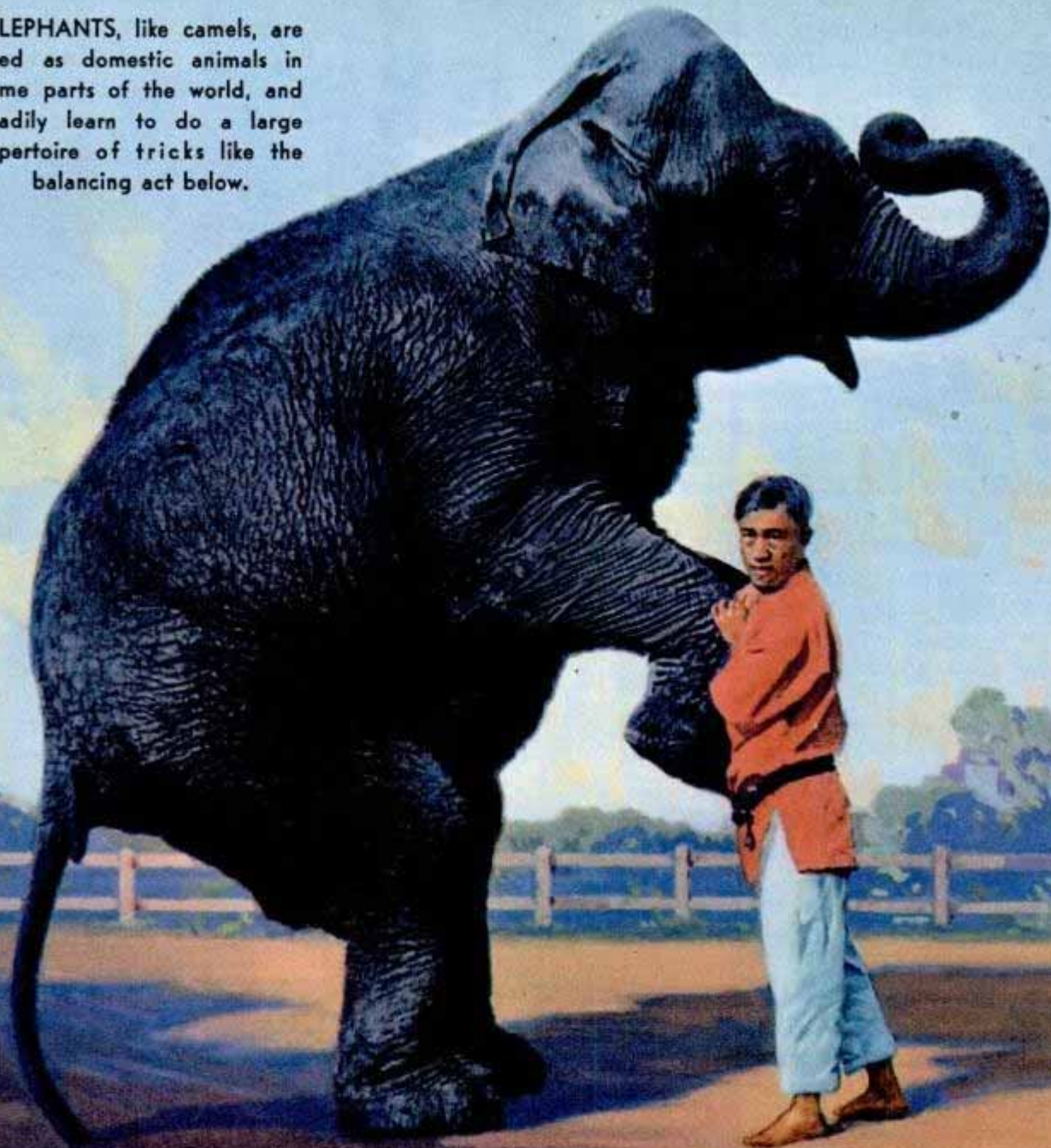

The pupils of the eyes frequently give the trainer his first inkling of approaching trouble. When a lion is calm and peaceful his pupils are small, but as he begins to grow alarmed or angry the pupils distend. When that happens an alert trainer sends the animals back to their cages. Otherwise the animal may spring on him or start a free-for-all fight.

There is always an element of danger in a lion act, even in the circus pyramid routine in which lions jump to their pedestals and roar and strike at the trainer's whip upon command. Lions that have grown up together work in groups the best, while animals that are total stran-

gers to each other are difficult to work as a group. Sometimes a lion, like a person, becomes short tempered for a day or so. Then the trainer leaves him in his cage.

It would take months and in some cases it would be impossible to train lions to do some of the things you watch them do in motion pictures. The trainers achieve the same ends by various subterfuges. If a movie studio telephones in the morning, demanding a lion for that afternoon that will jump into a trunk or pursue someone upstairs, Gay has a lion on the set at the proper time although he has no lion trained to do either stunt. Yet on the stage the lion performs as if he had been

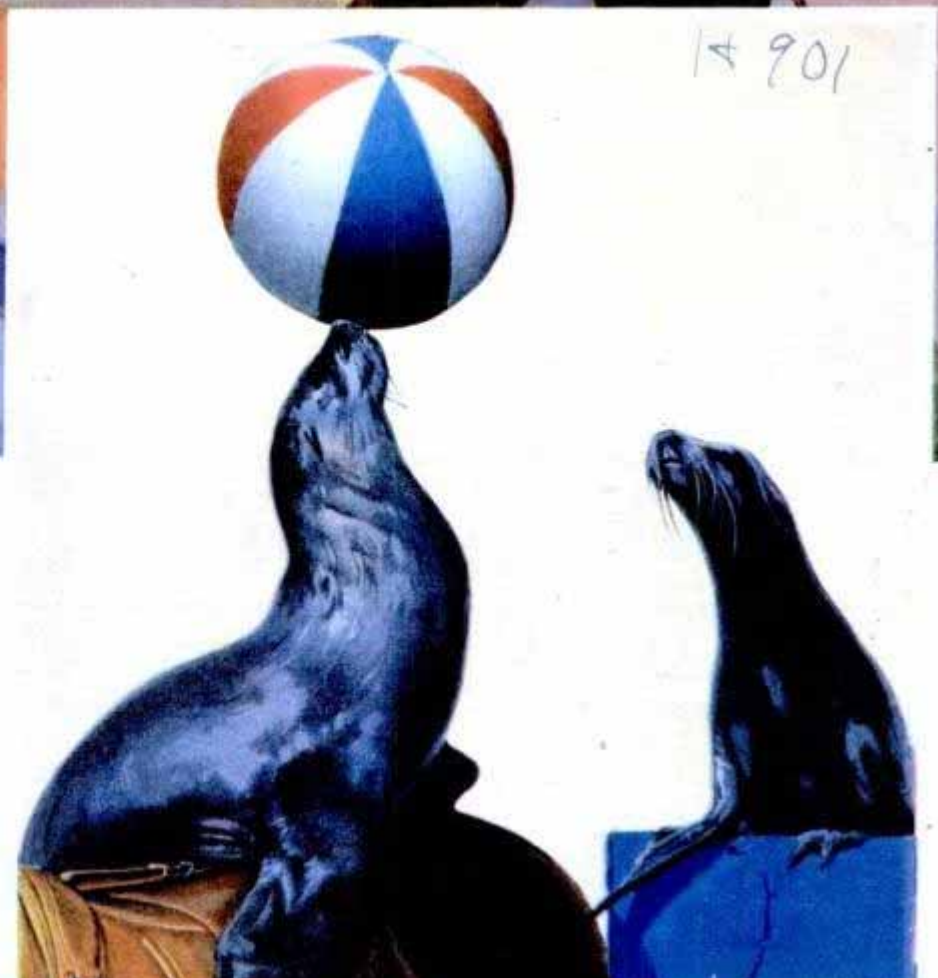

17

WRESTLING with a trained lion, as the man, above, is doing, always has an element of danger in it because no one knows what the animal may do. Right, two seals playing ball.



trained in the stunt for years. How Gay does it seems simple, once he explains it.

"If the script calls for a lion to pursue a woman up a flight of stairs," he says, "we take advantage of the fact that a lion, in strange surroundings, wants to stay inside his familiar cage. We start by placing the lion in a small cage at the top of the stairs, not far from the cage with which he is familiar. When we release him he dashes into the cage that represents home to him. Then we put him back in the small cage and carry him downstairs.

When we release him he runs back up the stairs to his home. Finally, we take the small cage, with the lion inside, and hide it downstairs out of camera range. When the cameras are ready and the heroine is running wildly up the stairs we again release the lion. To the camera it appears the vicious beast is about to overtake the girl. As a matter of fact, the lion often beats the heroine up the stairs on his way to the cage. Then we have to shoot the scene all over.

"To make a lion appear to jump into a trunk and hide we do something similar. The 'trunk' is really nothing but a low partition painted to resemble a trunk, with the lion's cage hidden behind it. When we release the lion from a smaller cage he runs toward his home cage, bounding over the partition that

STILT walking, top, left, is a difficult stunt to teach any animal, but the lion does it. The rope-walking lion is rehearsing for a movie scene in which a doll will be substituted for the stick in its mouth. Below, applying make-up to seal before a movie shot.



happens to be in the way. The way the camera sees it, the lion jumps into the trunk. It may take only half an hour to rehearse such a scene."

Seals seem to be among the most intelligent animals and some of them can be taught simple stunts in a few days. They readily learn to answer when their names are called and seem to have an intuitive knowledge of what they are being asked to do. They are sensitive to praise and scolding. Trainers have learned that the easiest way to teach them tricks is to reward each one with a small chunk of fish as soon as he does what is wanted. The catch is that from then on the seal expects to be rewarded frequently during a performance.

Simple balancing acts form the conventional repertoire of circus seals but they are capable of performing much more intricate stunts. In the motion picture,



TAKING its dinner from a bottle was not much of a trick for the lion cub, above, to master. The camel, left, has been taught a few simple tricks for circus exhibitions.

"Spawn of the North," the director wanted a seal to act as the hero's pet. His chief demand was that the seal must appear natural instead of appearing to perform stunts. H. W. Winston, who supplied "Slicker" for the picture, trained the seal so well that it was given a major part in the production.

In the picture you see "Slicker" wrestle with the hero in the water, follow him on shore like a dog, and even turn on the water in a bathtub when he wants a swim. The seal cries, shakes his head to

signify "yes" or "no," claps his flippers with joy, and in many other ways acts "human" on the screen.

At present Winston, famous for his trained seal acts, is perfecting an equestrian act in which two seals ride ponies, a third rides a pony cart, and a fourth acts as ringmaster and supplies the mounted seals with balls and double batons that they juggle while riding. Picking up a large rubber ball, the ringmaster seal balances it on his nose, then tosses it to one of the mounted seals, who

A 931



EQUESTRIAN seal act, top, with two seals riding ponies, a third the pony cart and a fourth acting as ringmaster. Bottom, trainer thrusting his arm inside the mouth of a lion which has been taught to remain gentle during performances instead of roaring and putting on a scene for the spectators as most "cats" are trained to do.

16

catches it on his nose on the fly, balances it, then passes it to the next seal. Finally, when each seal has caught the ball and juggled it, the ball is returned to the ringmaster.

The finale of the act is a routine with a fire baton, a stick with a flaming gasoline torch at each end that is tossed to the ringmaster seal. The seal flips the baton into the air, spinning it and catching it in his mouth, then he tosses it to one of the mounted seals who carries on the performance from there. Some of the seals have learned to roll over on the ground while balancing balls on upturned noses. All clap their flippers when they want applause. Winston has also taught them to balance on their front flippers and to raise their bodies into the air while clapping their back flippers.

"All seals used in stunts are captured while young," Winston says. "They have remarkably different personalities and some learn to do tricks easily while others can hardly learn to do more than simple balancing (Continued to page 128-A)

Miniature Circus Gives Many 'Big Top' Thrills

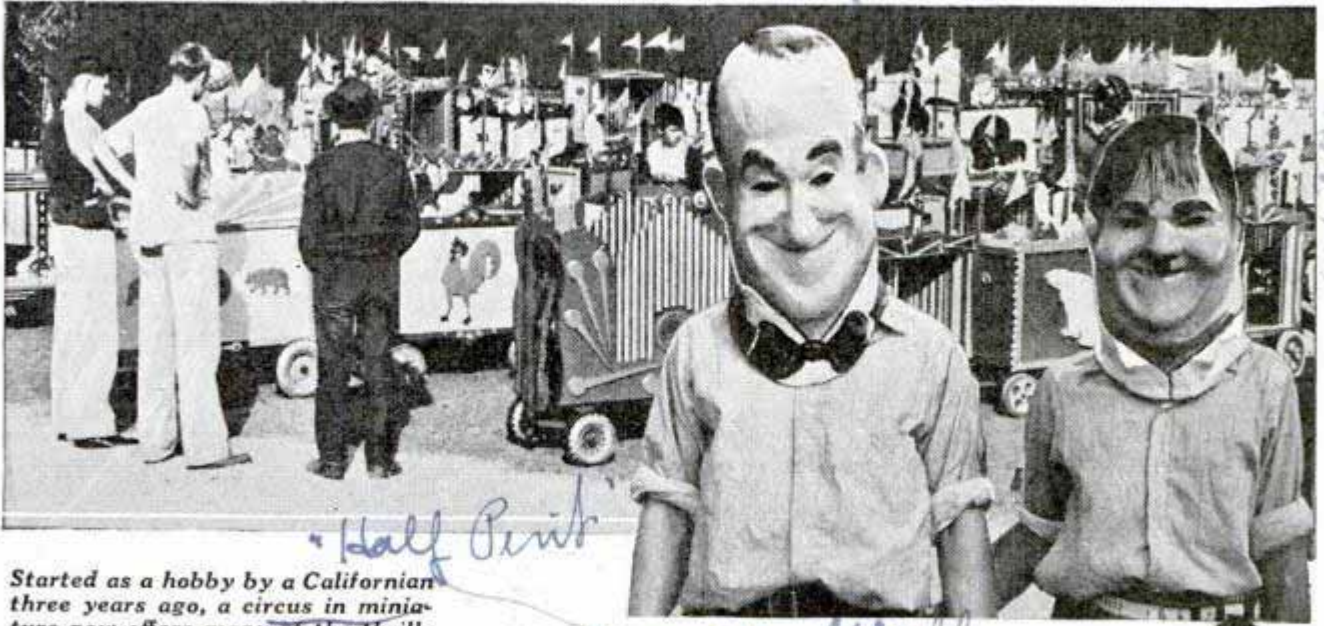

Started as a hobby by a Californian three years ago, a circus in miniature now offers many of the thrills of the "Big Top." It has grown from ten units to a full-sized parade five blocks long. Above, some of the wagons on display. Right, young actors wearing movie masks

Half Pint

*George Wahl
Mariposa, Calif.*

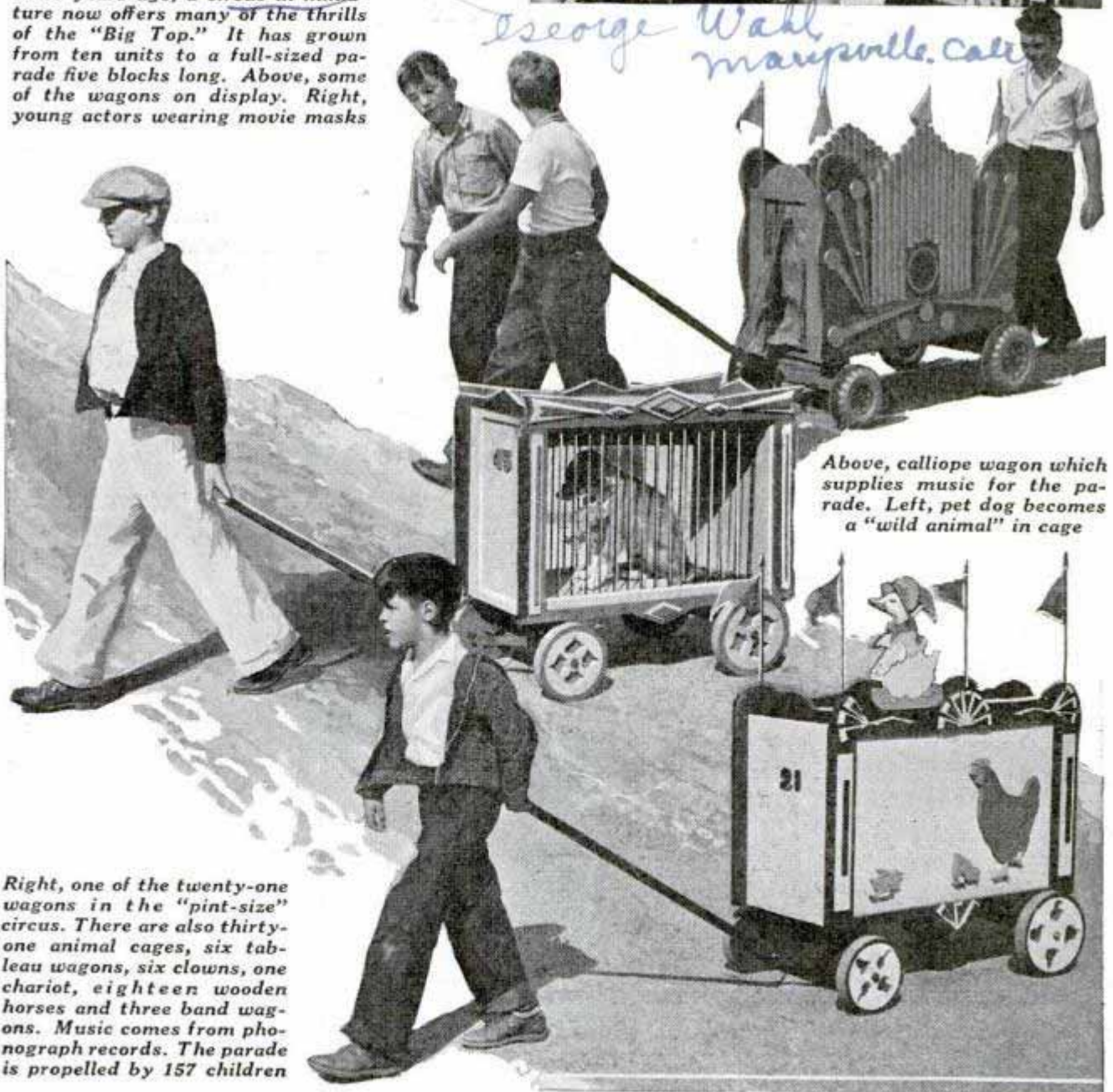

Above, calliope wagon which supplies music for the parade. Left, pet dog becomes a "wild animal" in cage

Right, one of the twenty-one wagons in the "pint-size" circus. There are also thirty-one animal cages, six tableu wagons, six clowns, one chariot, eighteen wooden horses and three band wagons. Music comes from phonograph records. The parade is propelled by 157 children

7-113 2
Plow - made for special
job by Port & Bros
Santa Ana Calif.
see letter.

MOVING

THE small boy with his pail and shovel and the tractor-bulldozer combination have something in common—they both move earth. But where the boy works by handfuls, the 'dozer works in big yardages. And does this at a speed that often rivals a landslide.

Road making, road-alinement work, canal construction, dam construction, paving and road surfacing, mining, terracing, channel deepening and tunneling are some of the projects on which the total amount of earth moved is beyond conception of the human mind.

The development of labor-saving equipment for gigantic earth movements, such as that at Grand Coulee dam, has been as remarkable as the tasks themselves. Because methods of a decade ago did not move earth fast enough, a contractor designed and built a scraper and other allied tools while working on big highways, rail-

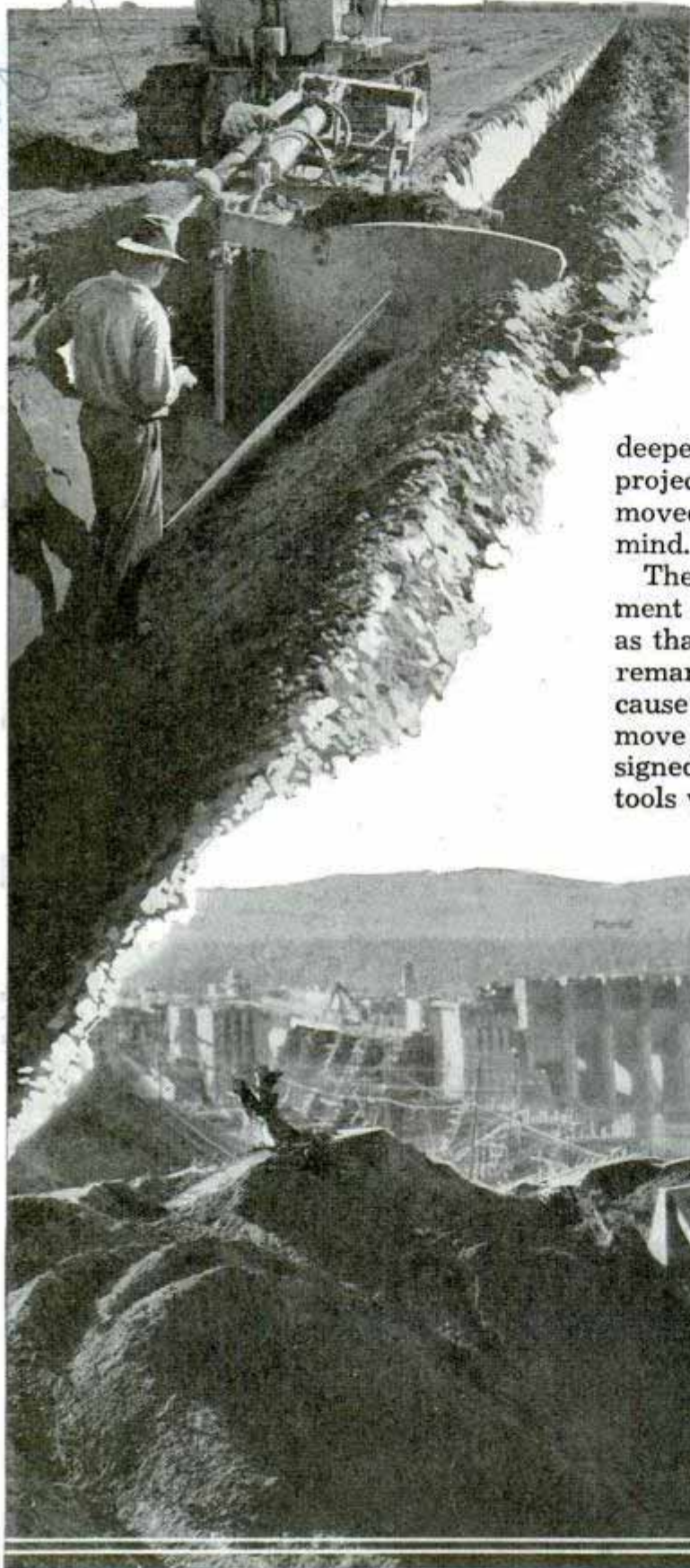

Cont. Co. M. Clark 5941 Jackson C. Blvd.
Chicago

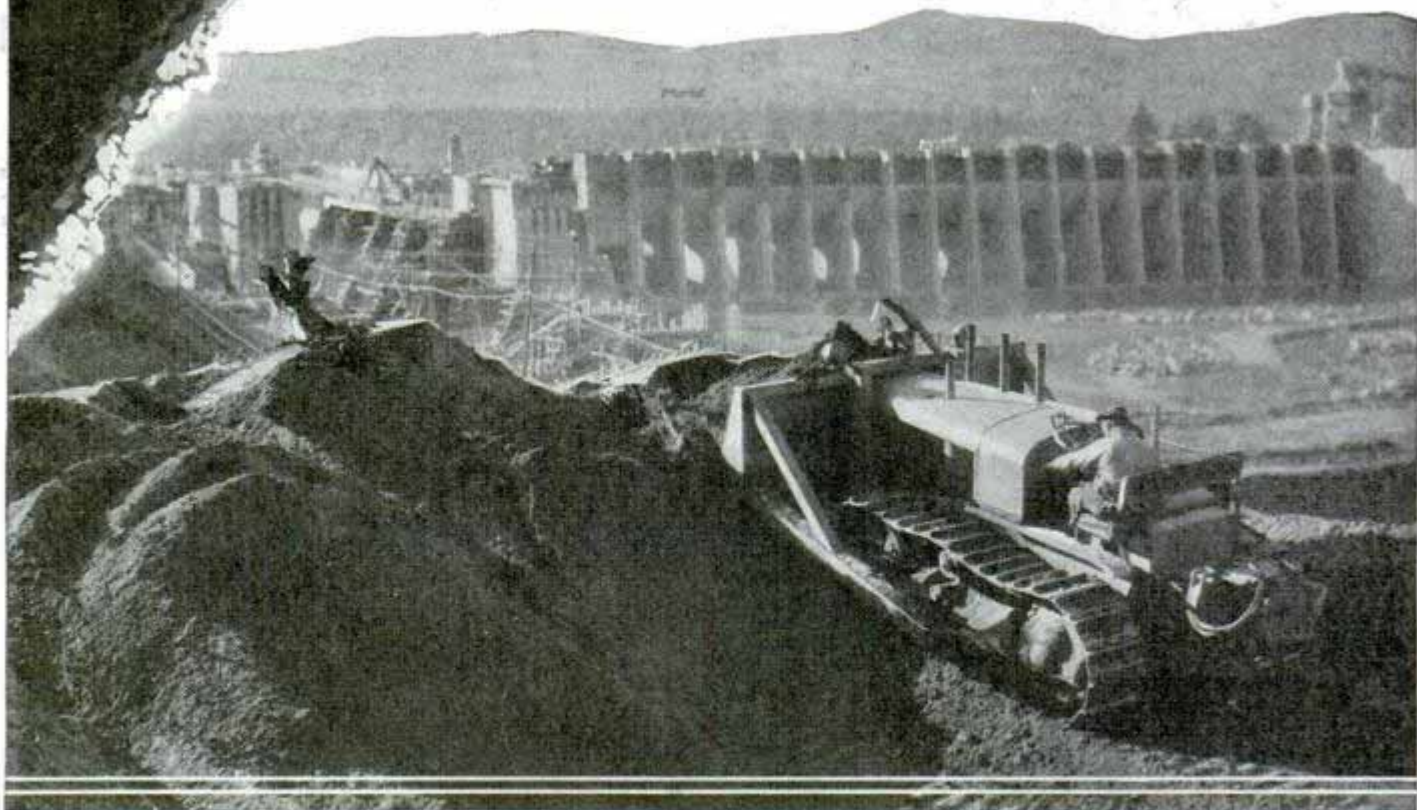

Top, tractor pulling special plow is used in reclaiming flooded land by plowing four feet deep to turn under sand and silt and bring up fertile soil. Bottom, modern construction always calls for vast movements of earth

THE EARTH

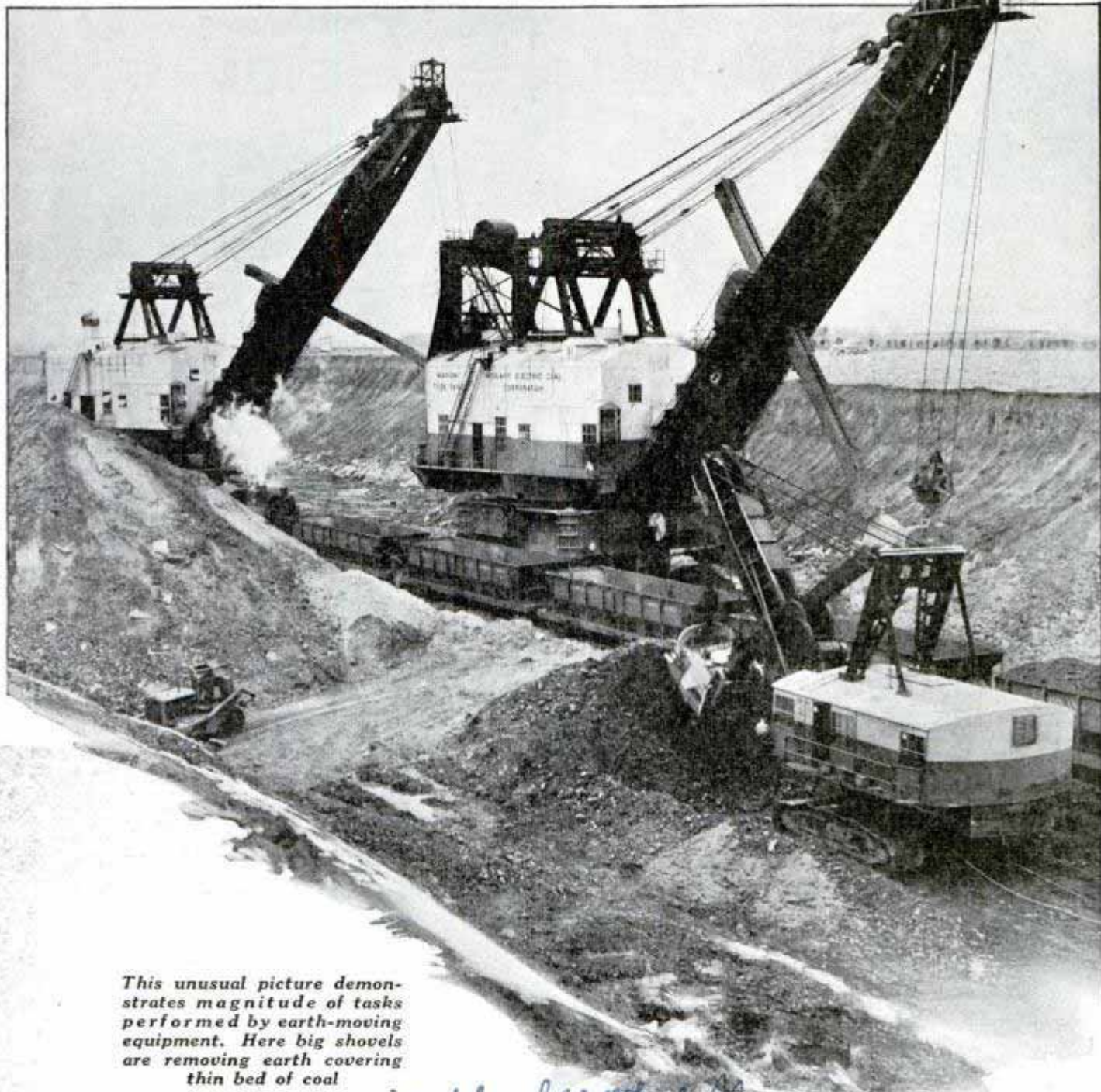

This unusual picture demonstrates magnitude of tasks performed by earth-moving equipment. Here big shovels are removing earth covering thin bed of coal

Middlebrook, Ill.

road, dam and levee contracts. Then came the present fast-operating, big-capacity "carryall" type of scrapers, bulldozers, angle dozers, sheep-foot tampers, rippers and similar apparatus.

But these tools must be pulled, pushed or otherwise operated. The track-laying type of tractor usually does the pulling or pushing on tough jobs.

The precipitous Jack-Rabbit Trail in Riverside County, Calif., was done entirely

with Diesel tractors, scrapers, bulldozers, rippers and tampers. In five months this equipment moved 650,000 cubic yards of earth. The total was something like 1,200,000 cubic yards. Only a few years ago cuts like this would have necessitated power shovels and much hauling equipment. The same fleet used on Jack-Rabbit Trail then moved on to work on a huge dam.

Precision is the chief characteristic of tractor and earth-moving machinery pro-

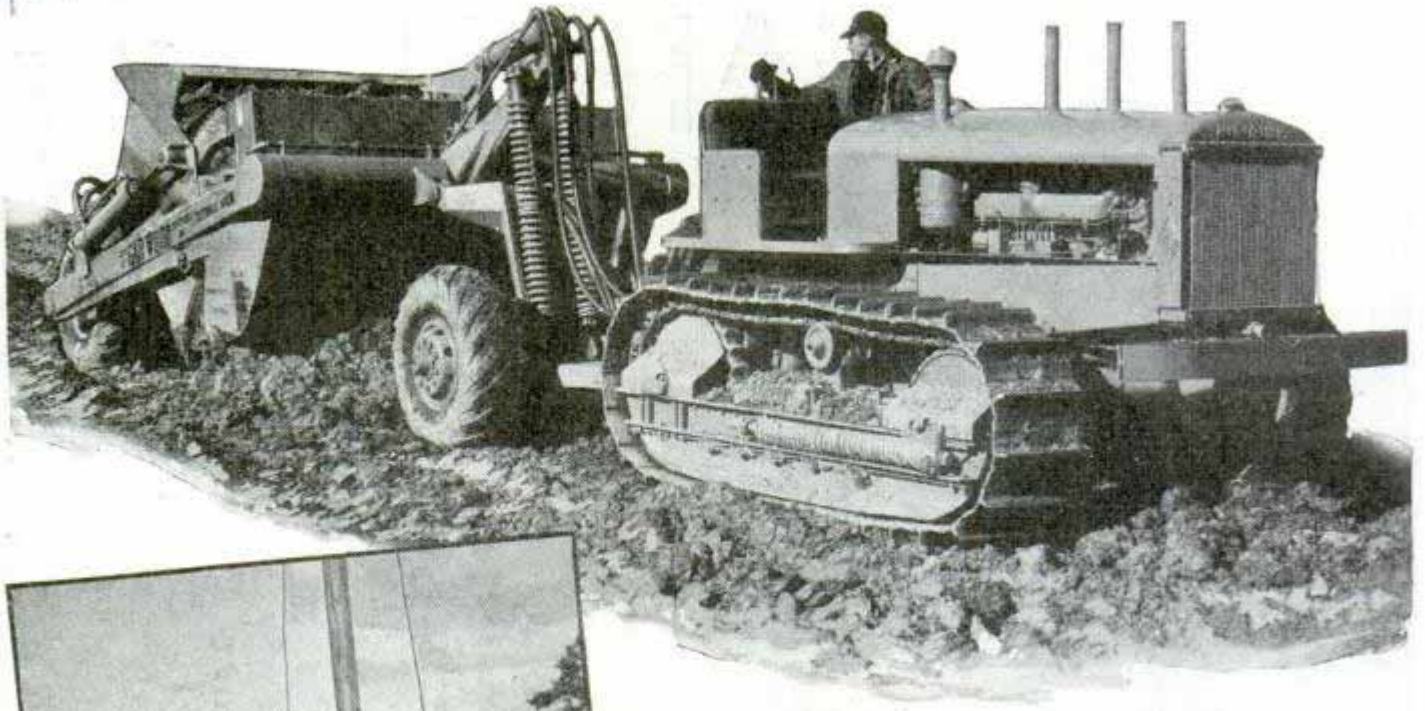

Top, one man does work of many with this tractor-scraper combination. Center, earth-borer digs hole and sets in pole. Bottom, elevating grader building mile in fifteen hours moves 6,000 yards of earth per mile

duction. Unlike automobiles this equipment has no break-in period. Tractors must be built to endure the relentless torture that goes with vast earth-removal projects. From the moment contractors put them on the job, tractors must pull or push and rip through gumbo, trees, hardpan and rock.

The onlooker does not see the accurately balanced crankshaft of the huge Diesel; the oil seals for critical bearing protection to retain oil and keep out grit, dust and moisture; the phosphor-bronze bushings that guard against wear, nor the fuel injector parts held to an accuracy of two and one-half millionths of an inch.

Operators get a big pay load because the design of the bowl, set of the cutting edge and the front carrying apron speed the filling of the bowl through a minimum movement of dead dirt. The entire weight of the scraper can be thrown onto the cutting edge. Both the front apron and tail gate can be manipulated to facilitate the loading process.

The speed of the power control unit enables the operator to instantaneously raise the cutting blade when stumps or

rocks are hit; thus the tractor need never be allowed to lug down to the point of inefficiency.

The front carrying apron forms a part of the scraper bottom; in other words the bowl fills from the middle both ways, to the back and onto the apron. The carryalls are mounted on big pneumatic tires and heavy-duty over-size roller bearings, consequently of great strength and resiliency, arc welded, reduce weight to a minimum, yet make for stout construction. As a result, the tractor pulling a carryall

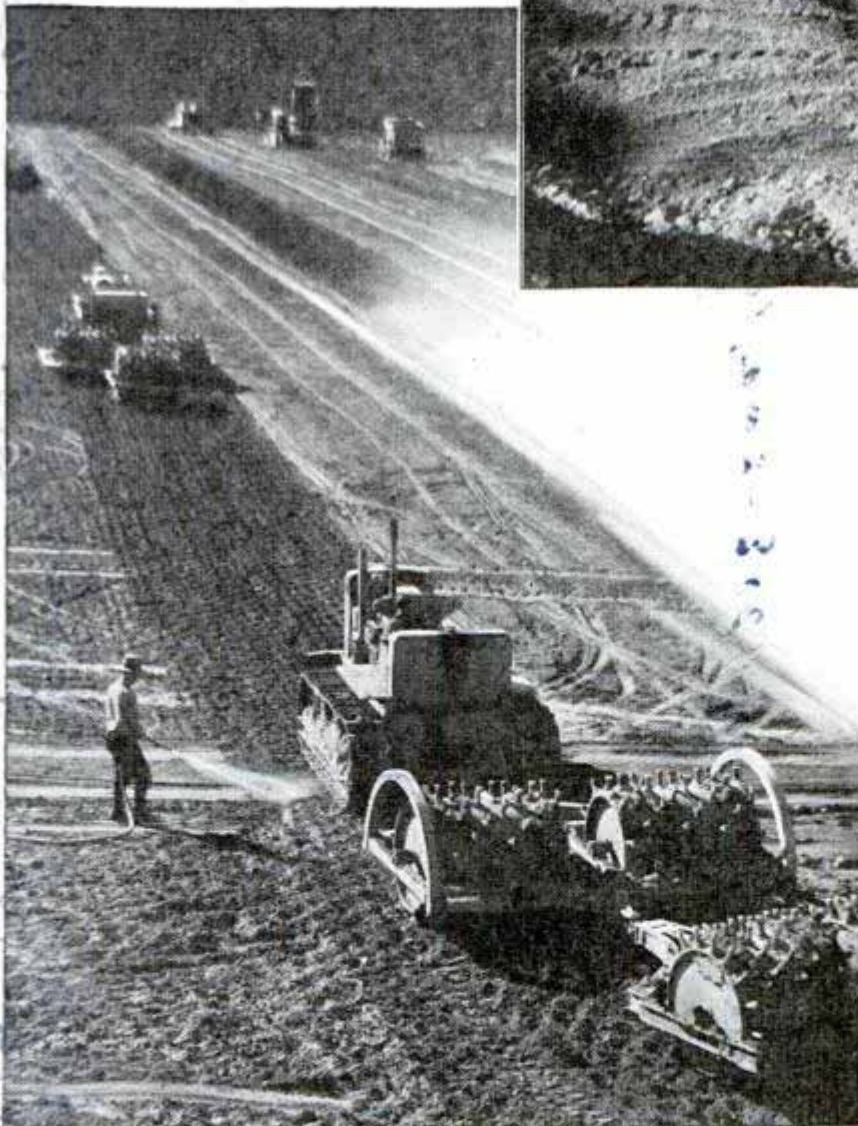
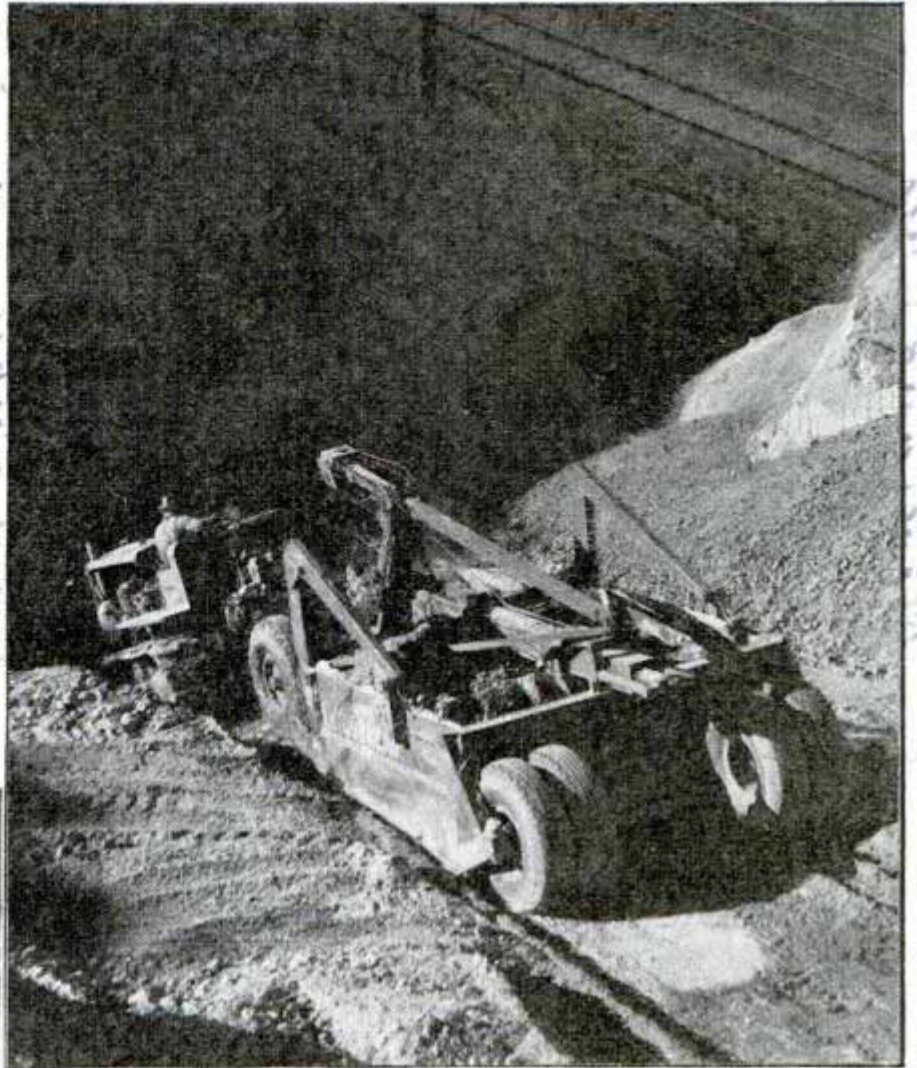

Top, more than 500,000 cubic yards of dirt were removed on cutoff near Los Angeles. Bottom, closeup of sheep-foot tamper, which is used in compacting loose earth

scraper wastes no power hauling the dead weight of heavy castings and bulky steels and so can handle bigger pay loads.

A long wheel base, coupled with instantaneous cable control, makes for fractional-inch accuracy in spreading with these carryalls—so accurate that blade graders usually can be dispensed with on finishing work.

The forepart of the load dumps automatically as the front apron is raised, the remainder of the load is forced forward and out by the sliding tailgate—there is no chance for sticky material to remain in the bowl.

And loading, hauling or spreading, the carryall is one-man operated—all operations in sight and controlled from the tractor seat.

When a road is to be made on a side hill that is too steep for a

(Continued to page 144A)

Seven-Foot Telescope Mirror Is Finished in Chromium Bath



Here is the big mirror for the telescope after its bath in chromium and aluminum. The glass is twelve inches thick

Almost exactly four years elapsed in the grinding and polishing of the eighty-two inch telescope mirror recently completed for the new McDonald Observatory in Texas. The last stage was the application of a chromium and aluminum bath in a vacuum chamber. The three-ton reflector is made of Pyrex glass twelve inches thick.

Fan-Belt Vacuum Pump Drives Car's Windshield Wiper

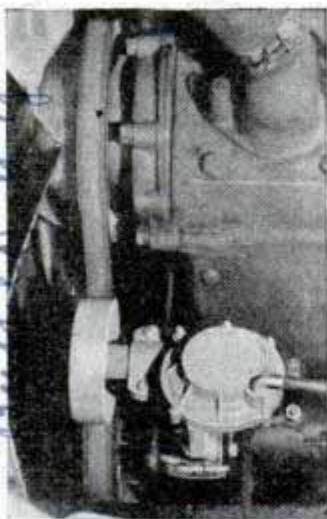

Strong, constant vacuum for operating the windshield wiper is supplied by a small pump running in contact with the outside of the fan belt. The vacuum line from the pump, which is in constant operation, runs to the wiper through a combination tee connection and check valve. Also running to the tee connection and check valve is a vacuum line from the auto's intake mani-

fold. The check valve automatically opens a line directly to the source of vacuum that is the greatest. When the motor is idling, this would be the intake manifold and when the motor is under load, it would be the vacuum pump. The combination of the two sources of vacuum assures a dependable and constant supply of vacuum, which means that the windshield wiper will operate at an even speed regardless of the load. The pump is easily installed without drilling by means of brackets. The inside of the pump requires no oiling, and the bearing is lubricated with a standard grease gun.

Lifeboat Built of Stainless Steel Resists Corrosion at Sea

Stainless steel from hull to rudder, a lifeboat which has just passed official tests is not only leakproof but virtually indestructible. Ordinary lifeboats may deteriorate even while resting on the deck, but this twenty-eight-foot craft cannot corrode. The hull plates are welded to the stiffening ribs for strength. The hull plating, only eight-hundredths inch thick, and the rudder, propeller shaft and propeller all are of stainless steel.

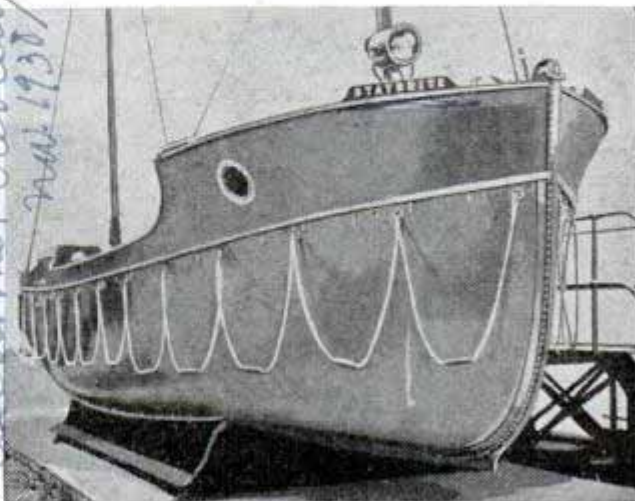

This lifeboat, made of stainless steel, is said to be virtually indestructible

Warner and Swasey Co. 5701 Carnegie Ave. Cleveland Ohio
Trico Products Corp 807 Washington St. Washington D.C.
E. A. Robert Under
Director Optical Dept
see Dept 1936-372
Dr. John Plasmeth, consultant in design H 1246
Mr. Locke
Electromek Cleveley 308 42nd Ave
Mar 1937

being a... work
Ghebers, Ltd. Stagbrite
Sheffield, England
Div. 1
England
Lister Grey & Co. Newark

U.S. - Welby Davin

Motors "Measured" to Find Hidden Troubles



These instruments that reveal hidden troubles in the auto are part of a motor-measuring unit introduced recently

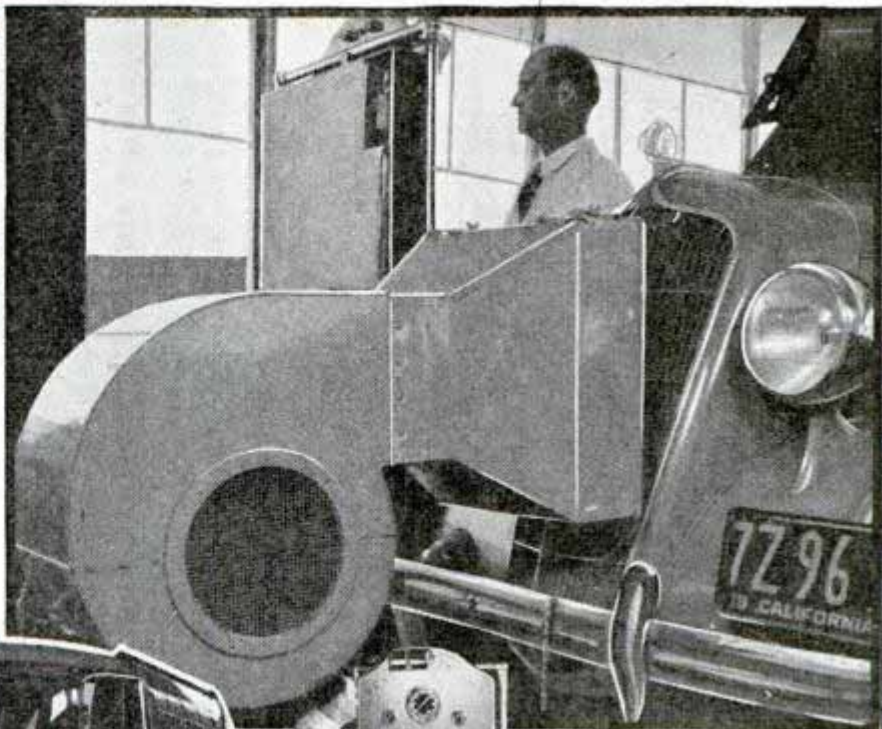

Photos courtesy Union Oil Co.



Above, big fan creating sixty-mile wind to test car radiator. Left, auto undergoing test on chassis dynamometer, which automatically checks car for gasoline mileage, horsepower and other things vital to efficient operation

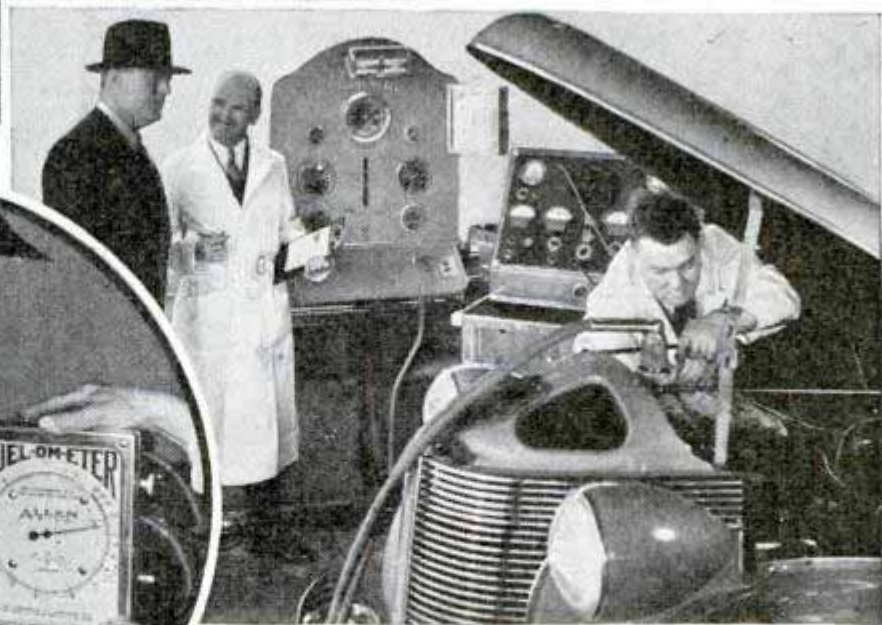

Above, testing radiator with hose line. Left, fuelometer attached to motor. These are some of the precision instruments used in checking carburetors, distributors, spark plugs. In a 1,000-car test, engineers found nine out of ten cars incorrectly adjusted. The motor-measuring unit, installed in Los Angeles, tells the owner the exact condition of the motor

Carl Thomas &
Stinson, Jr.
12555 Hollywood Ave

at Walshe Blvd.
and W. 11th place

Carl Thomas &
Stinson, Jr.
racing driver

So. California

1055 5 Holman Ave.
Los Angeles Calif

FLYING



Above, the author equipped with oxygen line for flying in substratosphere. Below, cockpit of "upper level" passenger plane

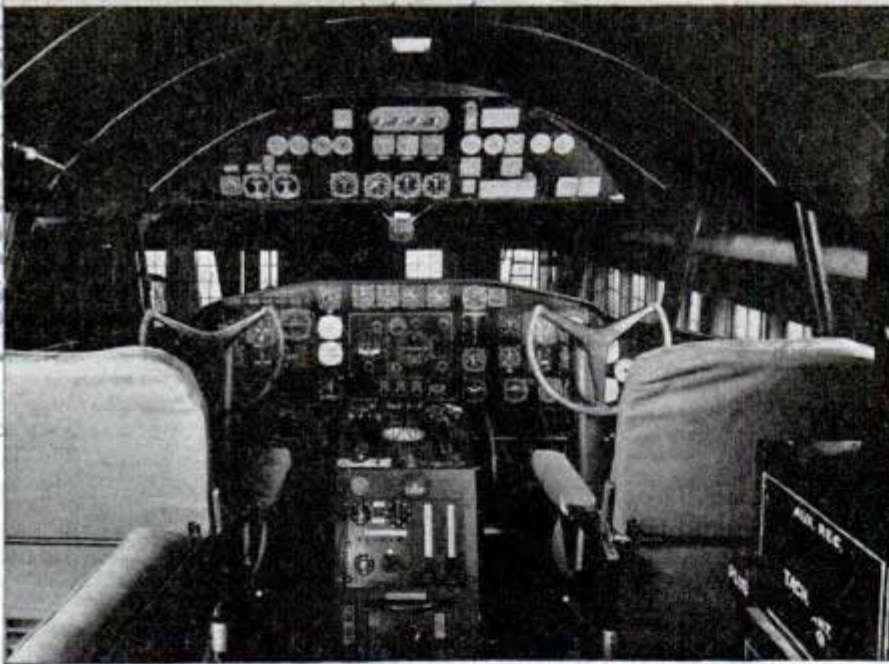

By Captain D. W. Tomlinson

Transcontinental and Western Air

Municipal Airport, Kansas

NEXT summer you will be able to board a pressurized-cabin air liner and fly across the United States higher than ever before.

You will fly faster than you do today although the plane will seem to stand still, so high will it be above the ground. If the weather is clear you will be able to see 100 miles in every direction, with more than 40,000 square miles of scenery laid out beneath the windows of the plane. If storms are raging near the surface you will still be in brilliant sunshine.

The inside of the cabin will be warm and

City, Mo
cabin normally will be only 8,000 feet and never more than 12,000 feet.

You will be flying in one of the new Boeing pressurized-cabin transports being built for TWA. These huge four-engined planes, which will carry thirty-three passengers, are being built especially for "over-weather" operation. Fresh air, drawn in through the leading edge of the wing, is compressed and heated to provide a comfortable atmosphere even though the plane may be flying four miles high.

Faster speeds and better weather are the reasons for flying high. The air is so thin that the plane moves through it with less drag, picking up speed at the rate of a one-per-cent increase for every 1,000 feet of

4800
Four 1100 hp
Wright Cyclone engines

ABOVE *the* WEATHER

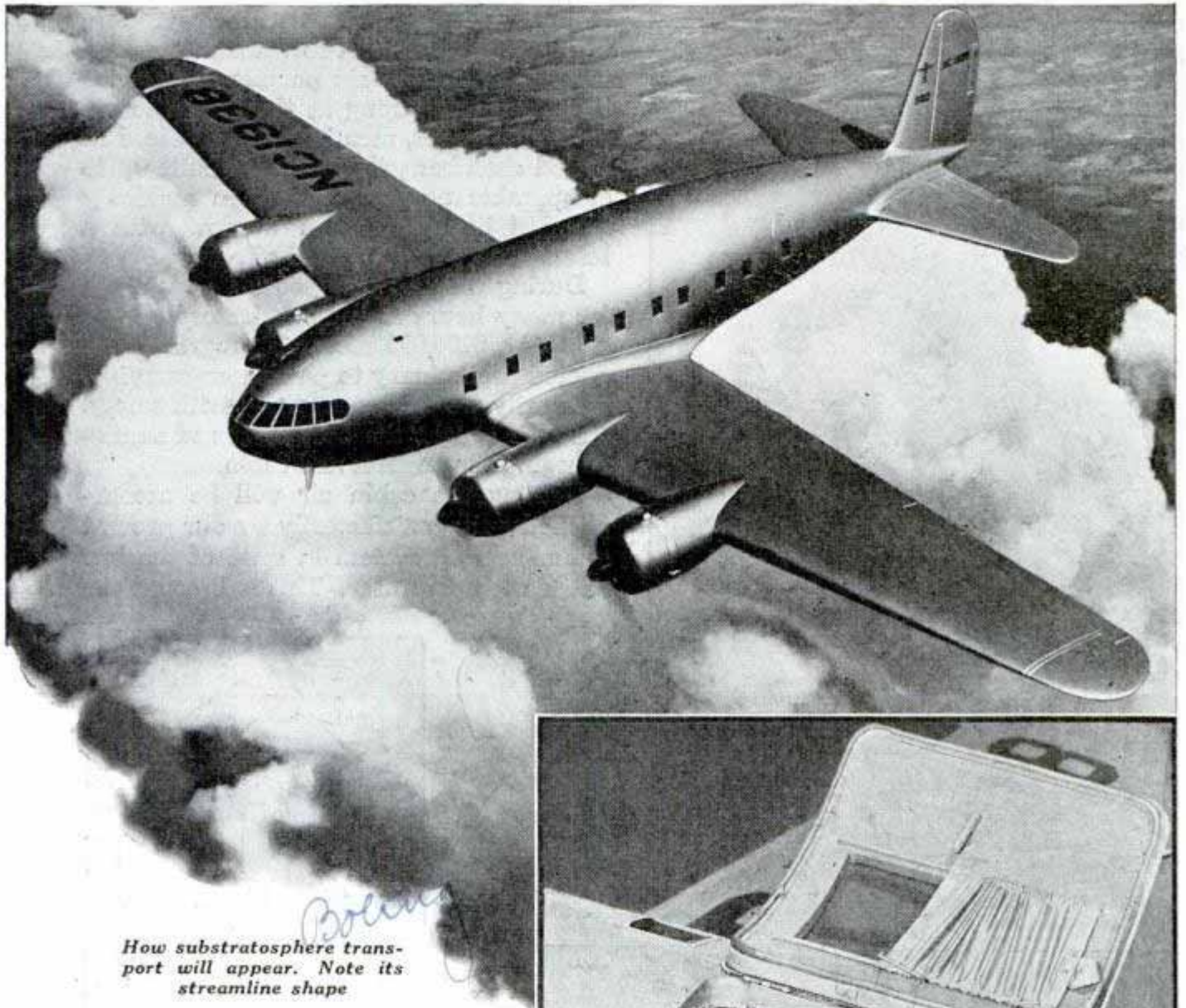

Bolton
How substratosphere transport will appear. Note its streamline shape

altitude. The viscosity of the atmosphere decreases with the temperature, reducing friction between the plane and the air.

Since 1934 we have been studying conditions in the troposphere. Many of the bugaboos that seemed to make passenger-carrying at 20,000 feet a risky business were much easier to overcome than we expected. In the upper air man resembles a fish out of water and he has to carry his own atmosphere with him. The most satisfactory way of doing this is to seal the cabin and increase the pressure inside of it, converting the plane into something like a flying



Observer holding oxygen tube in his mouth as he records readings in laboratory plane

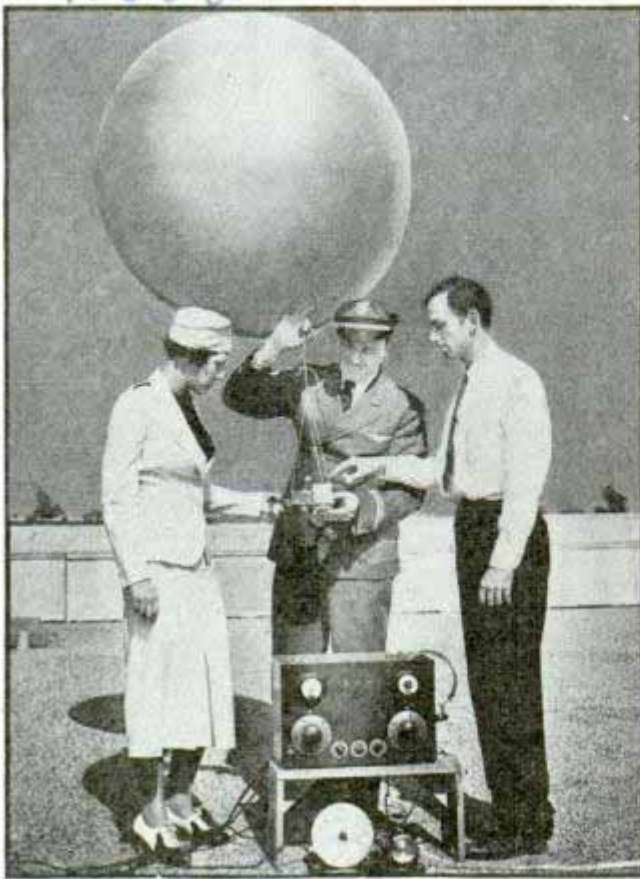

with, we decided that since passengers are flying in comfort at 8,000 feet, there is no need to maintain sea-level pressure inside the cabin. An inside pressure equivalent to 12,000 feet is even satisfactory. The planes are being built to withstand an internal pressure of six pounds per square inch, twice as strong as they need to be. As a final check, men have been placed in sealed chambers, the pressure built up to comparable amounts and then suddenly released by smashing a window with a brick. There were no bad effects.

During the last few years I have lived for many hours in the substratosphere as part of a \$100,000 research program conducted preliminary to passenger-carrying. Primarily we were concerned with safety. Also we sought the best means of supercharging the engines and cabin.

Heating the cabin air will be accomplished quite satisfactorily by our present steam-heating system in spite of the low outside temperatures. This is because the

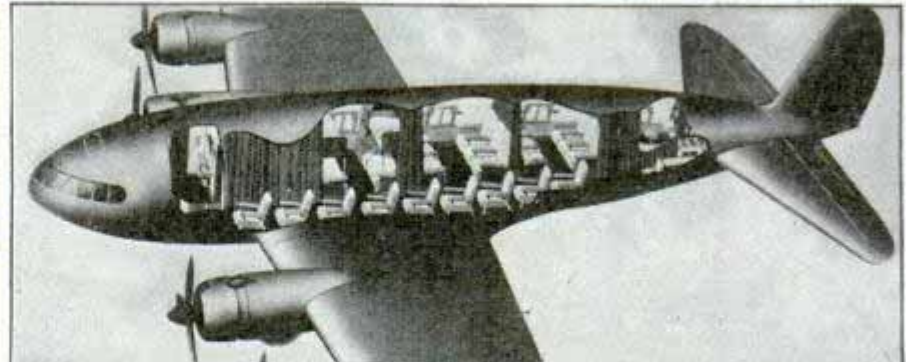
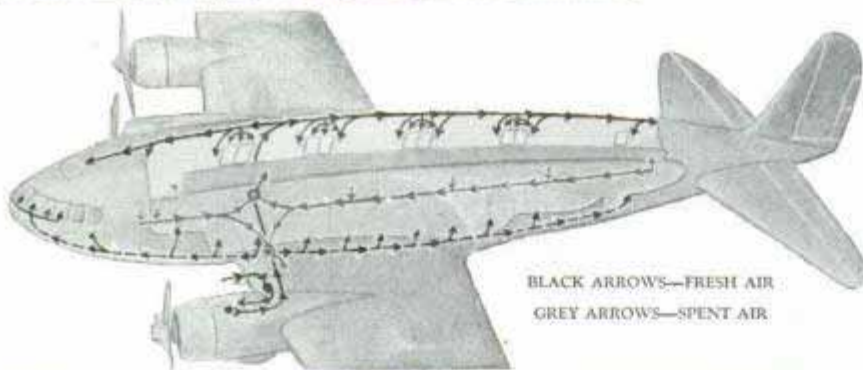

Top, radiometeorograph attached to balloon to take weather readings in high altitudes. Center, left, sketch showing air-circulation system in "upper level" ship. Right, modern kitchenette will be feature of the high-flying transport. Bottom, left, "high-altitude" dressing room. Right, cutaway drawing gives glimpse into sealed cabin.

submarine. One hazard that this suggested was that if the internal pressure ruptured a window the passengers and crew might expire in the upper air. This myth has been exploded as far as the altitudes we are contemplating are concerned. To begin

Boeing stratosphere
incoming air acquires some heat during compression in the superchargers. The ratio of oxygen and other gases remains constant in the atmosphere, hence there will be no need to supply the passengers with special respirators or introduce pure

14800

oxygen into the cabin. One part of the experimental program was to investigate conditions when storms were reaching up into the stratosphere. We found that at 20,000 feet we could fly over ninety-five per cent of all storm conditions. Even in the very infrequent cloud masses that poke up that high there are no true storm conditions such as are found at the bases of the same clouds. There is practically no turbulence or rough air even in the clouds, and the clouds are so thin and dry that they resemble wisps of smoke rather than fog. There is not enough moisture present to build up dangerous ice formations although thin coatings of hoar frost may form on the plane structure occasionally.

Winds at such altitudes are variable. That means, as today, that pilots will still shop around for favorable winds for their trips before they take off and will fly at altitudes that give them boosting tail winds. They will not always climb to 20,000 feet just because they are able to. Sometimes they will be able to take advantage of winds that will boost their speed 100 miles per hour or more. In still air at 20,000 feet the high-altitude passenger transports will cruise at 240 miles per hour on sixty per cent of power.

High-altitude operation, flying at 20,000 feet or higher, is feasible only for distances of 750 miles or more. Likewise, high-altitude hops on the commercial airways will be limited for sometime to distances not greater than 1,000 to 1,500 miles. Longer flights, considering the fuel weights necessary and the power diverted to supercharging, would mean too small a pay load.

Taking off in a pressure-cabin transport, the pilot will head toward his destination as soon as he leaves the ground and will climb steadily at the rate of 500 feet per

(Continued to page 142A)

"Cop" on Beat Is Motorized to Save Both Time and Feet

motor scooter



Three policemen demonstrate how they cover their beats faster by using motor scooters. The transportation is quite economical

Suburbanites in Inglewood, Calif., no longer need feel sorry for the policeman walking his long, long beat through the neighborhood. The patrolmen have been motorized. They ride a fleet of small motor scooters which cover the ground faster and cover the beat oftener, traveling thirty miles an hour and 130 miles on a gallon of gas. Further, the scooters enable the police to respond quickly to emergency calls.

Suction Grip for Auto Headlight Saves Lens from Breakage

To prevent breakage of the lens when removing it from an automobile headlight, a vacuum grip has been developed. It is a bell-shaped tool with lever grip, employing the mechanical vacuum principle instead of natural suction and thus providing a firm and certain grip.



Edto. Co. Hildebrand
 due 6 7 23 Hildebrand

...wishes made by ...
 ...

over the wings is interrupted. To detect a stall before it happens, a sharp edge is built into the leading edge of the wing and just before the main wing reaches a stalling angle, a local stall over the small, sharp edge is produced. A meter detects this local stall by a drop in pressure, and sets off a warning indicator in the cockpit.

H 12 24
**Electric Music Board
 Is Aid in Teaching**

Operated by an electric motor, a board designed to facilitate the teaching of music permits the pupil to see, touch and hear the notes being studied. The device is a blackboard containing three music staves. The center staff contains the master scale ranging from B-flat to A above the staff. On either side are sharps and flats of various tones. Top and bottom staves show scales from one to six flats and from one to six sharps. The pupil hears the tone played from a soundbox located back of the board. The electric motor blows air through accordion reeds to produce the tones. The board, thirty by thirty-five inches, is portable. Its use is said to speed up instruction in music.

Industrial
**'Candid' X-Ray Picture Snapped
 in One-Hundredth of a Second**

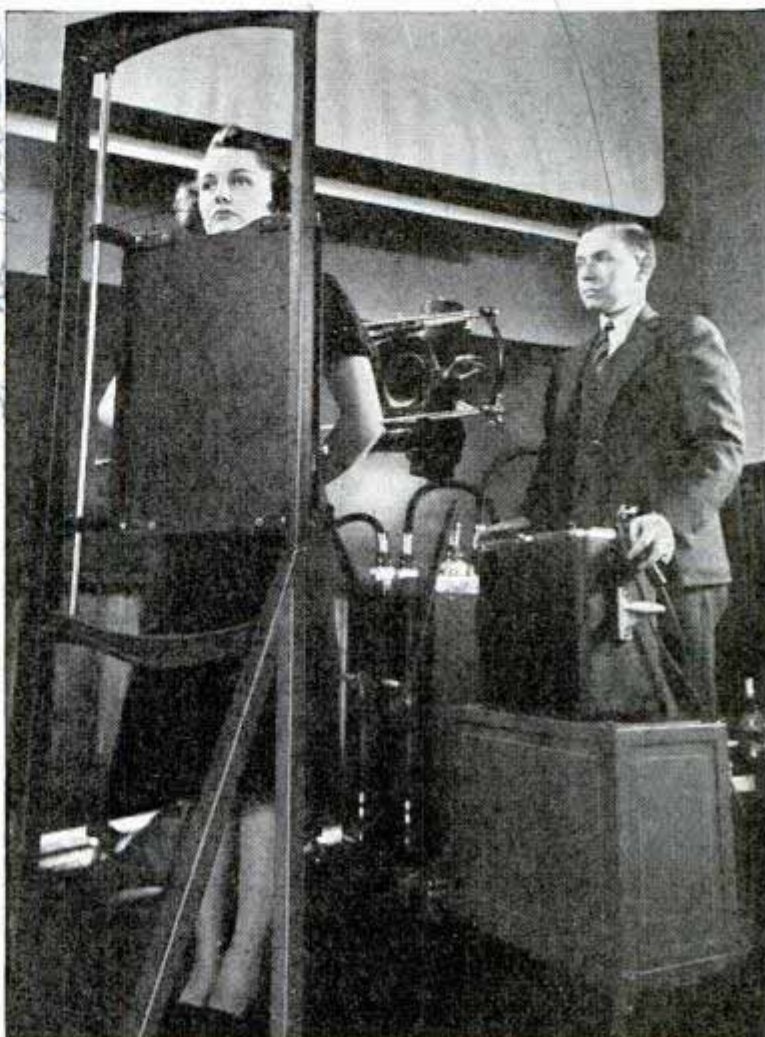

Taking X-ray picture of the chest with aid of "trigger tube" which is powered by ordinary lighting current

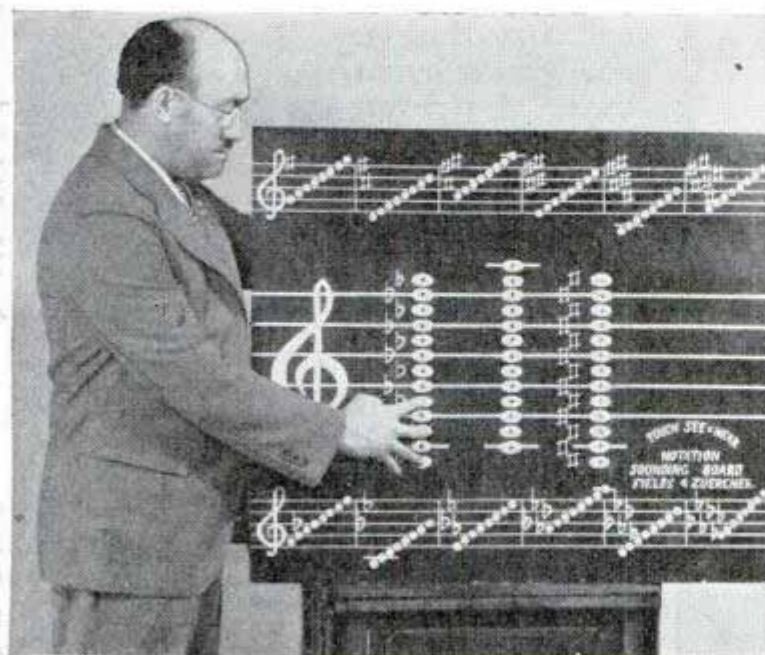

Showing position of hands on keyboard is one of the advantages of electric chart designed to teach music

Storing up power drawn from an ordinary 110-volt light socket, a small glass "trigger tube" just developed by Westinghouse makes possible a candid X-ray snapshot of the human chest taken in less than one-hundredth second exposure, free from distortions sometimes caused by heart movement. The tube controls the flow of 110-volt power to condensers, and when a button is pressed after eight seconds the stored power is released as an 89,000-volt maximum discharge through the X-ray tube. This vacuum "trigger tube" incloses electric coils letting power flow from socket to condensers until the coils become heated. then the condensers discharge.

Mr. Victor E. Hecks, Westinghouse
Mr. Charles C. ...
Dr. ...
Chris Guesser
Fields

Seaplane Ramp Submerges to Lift Craft from Water



Seaplane on turntable after being lifted from water by the ramp. The plane can be taken from the water in thirty seconds

by Vito Marriano

Designed to lift seaplanes from the water, a portable ramp has been demonstrated. It submerges and the seaplane is maneuvered over it. Then the ramp rises, picking the ship from the water in thirty seconds. It has a turntable on which aircraft may be turned in any direction desired.

Front-Wheel-Drive Motorcycle Carries Engine over Fork

Engine and front fork of a front-wheel-drive motorcycle are built as one unit and the frame and rear wheel form another unit. The two sections can be dismantled in a minute for quick, convenient packing.

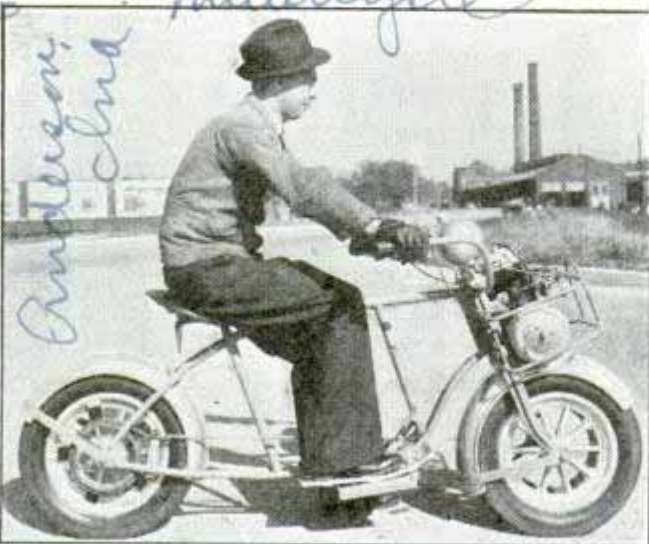

This motorcycle, with engine over front wheel, can be taken apart quickly

The two-cycle, single-cylinder engine is mounted over the front wheel where the air is clean and its cooling power is unobstructed. The wheel is chain-driven through a two-speed transmission, both throttle and transmission being controlled by handle-grips. Rigid brake drums on the rear wheel are operated by a foot pedal. Light and fast, the motorcycle weighs 150 pounds, can carry two men, and travels ten to sixty miles an hour at 100 to 125 miles per gallon. The wheelbase is forty-eight inches.

Adjustable Drawbar for Trailer Switches from Car to Car

Attachable to any automobile without drilling, cutting, welding or otherwise marring the car, a drawbar for trailers can be adjusted to raise or lower the trailer to level position. Easily detached and installed on another car by an unskilled person in less than a half hour, it is of special value to motorists using a trailer for only short periods and to agencies renting out trailers for vacation use.

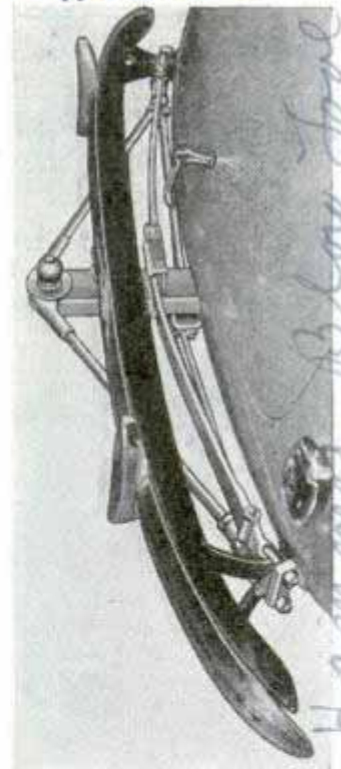

Our Bureau of Information keeps on file the names and addresses of makers of, and dealers in, all devices described in the pages of Popular Mechanics Magazine. We are glad to furnish this information to our readers upon request, accompanied by stamped, self-addressed envelope.

Handwritten notes in the left margin: "at Newark Seaplane", "1208", "1473", "Chas. E. Miller", "1403 Main St.", "Anderson", "Miller", "1205", "14.00", "15.00", "Hammer", "Waller", "Co."

Risking Lives High in Air Is All in Day's Work

Wide World Photos

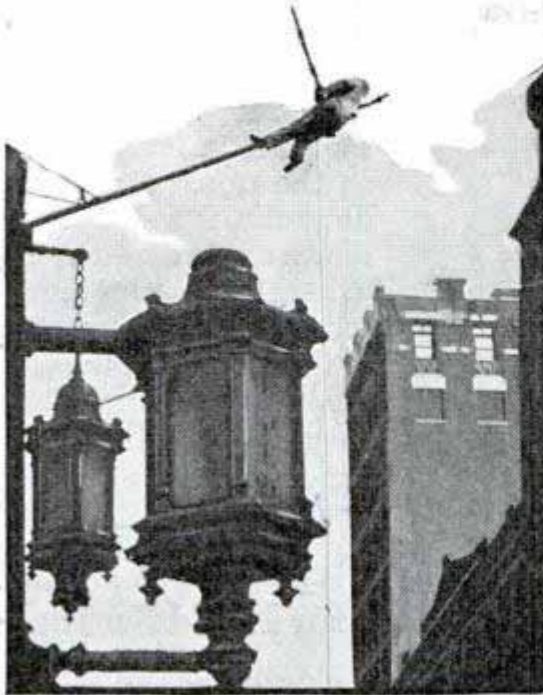

Risking his life high above ground is just a part of the job to this steeplejack overhauling the flagpole at entrance to a New York building

James Amley



Here another daring worker appears unworried by the fact that he is oiling a skip carrier on a cableway 150 feet above the site of a large dam

Lakeswater Westmoreland England

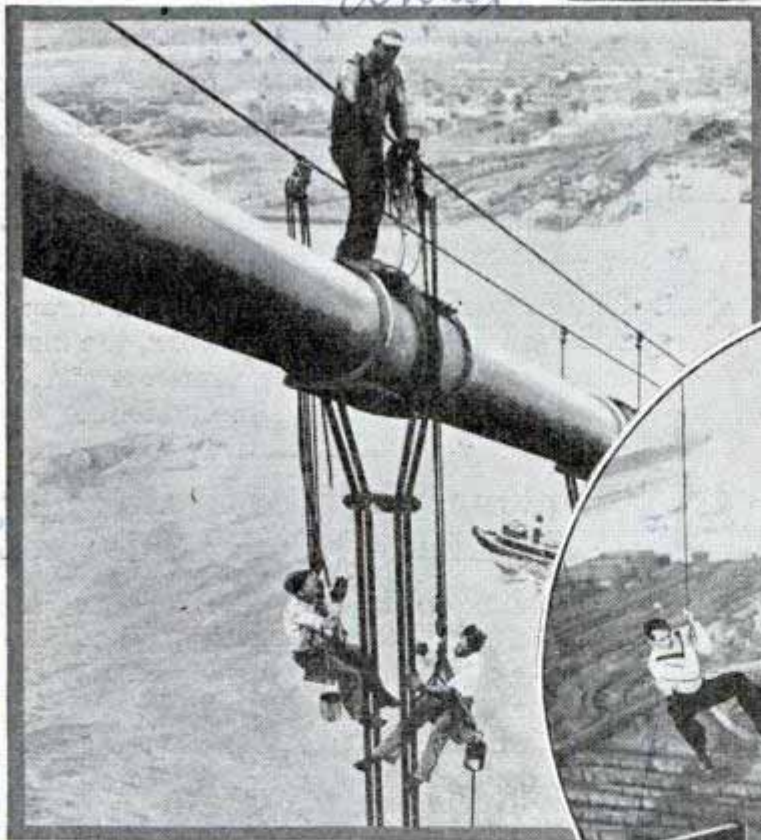

Above, dangerous to be sure, but it's all in the day's work for these painters dangling 350 feet above the water on Delaware River bridge cable. Right, another steeplejack gambles with death on a forty-two story building as he swings from one point to another

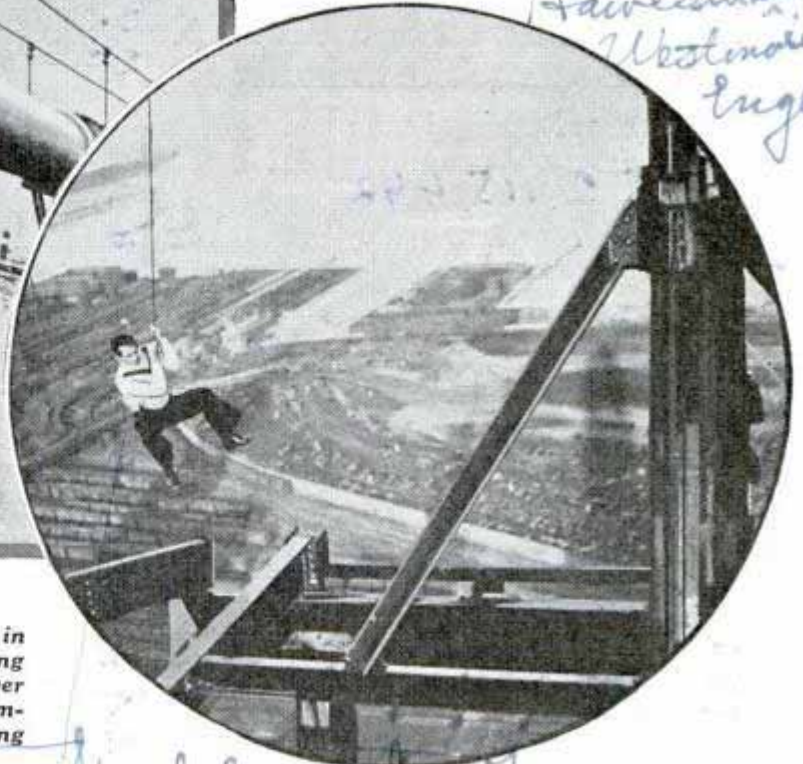

Steeplejack Jerry

Wellough

Family of Nine Rides 'Bike' with Rumble Seat for Four



Count 'em! The five in front do the work; the four behind just ride

Anything less than a bus might seem crowded when a family of nine climbs aboard—yet here is a bicycle carrying dad, mother and seven children! Rather, it is a double bicycle, with front seats for the pilot and his wife, saddles for three behind them, and a "rumble seat" at the rear accommodating four more. This unusual vehicle, owned by a family in Switzerland, is propelled on a "share-the-work" plan.

blades are available for shop work, the blades costing, it is estimated, about one-tenth the cost of making a scraper by hand. The blades stand hard usage, one blade



Hand scraper and kit of blades which reduce cost, outlasting ordinary type of scraper

Low-Cost Insect Sprayer Run by Automobile Exhaust

Farmers and orchard men can fight insects effectively with an inexpensive power



Exhaust gas in large hose blows insecticide in mist

being equal to an ordinary hand scraper reformed five times. When worn, the blade is replaced and you have a new scraper. It need not be reground, simply stoned.

Contour "Map" of Ocean Floor Made by Depth Finder

Standing on the bridge of the new liner "Mauretania," the navigating officer can watch an indicator giving an instant and continuous measurement of the depth of the sea under his keel. Taking soundings formerly was the work of ten minutes or more. The radio echometer, using a high-frequency beam reflected from the ocean floor, records the depth of water many times per minute by a "peak" of light on a calibrated scale. Thus it plots a graph of the contours of the sea bed and helps the navigator verify his position by comparison with charts of known contours.

as Lindenger

H 1264

2 145 442

d. w. W. T. Emery

Handwritten notes and signatures including 'Cunard White Star', 'Mauretania', and 'Dinner'.

Vertical handwritten notes on the right side of the page, including 'Packard' and 'my Co'.

Log Cabin in Woods Hides Anti-Aircraft Gun

To observers in enemy planes riding far overhead, this ramshackle log hut in the midst of a forest of scrub pines seemed harmless enough if, indeed, it could be spotted at all by airmen flying thousands of feet above. But when air raiders appeared within range, the trap was sprung—the roof timbers were quickly cleared and the hidden anti-aircraft gun elevated into firing position, ready to blast the invaders out of the sky. This was one of the defense tricks in the recent maneuvers at Fort Bragg, N. C., where army officers demonstrated what they termed the world's finest anti-aircraft equipment.

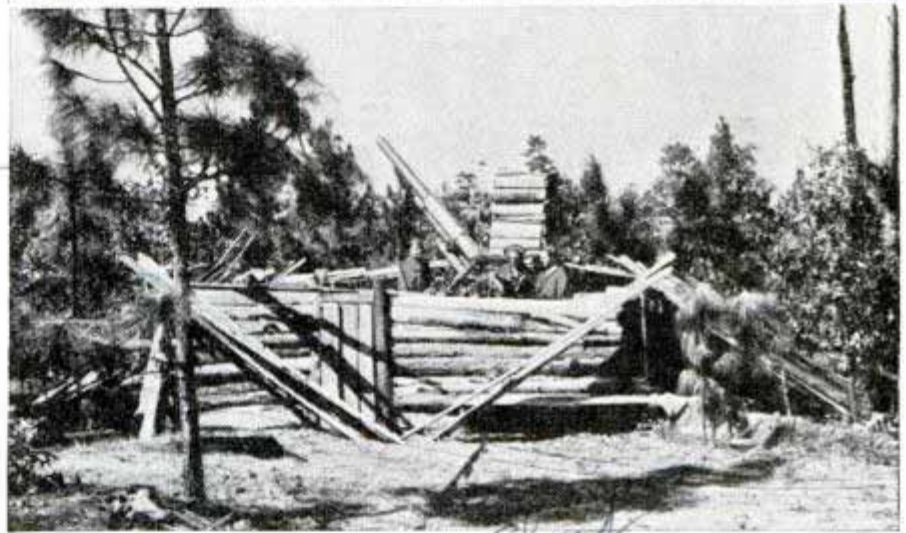

At top you see an old log shack in scrub pines of North Carolina. Below, it is suddenly revealed as hiding place of anti-aircraft gun

Motorless Dishwasher Uses Water Pressure and Soap

Operating without motor or moving parts, a simple home dishwasher now on the market uses water pressure and com-

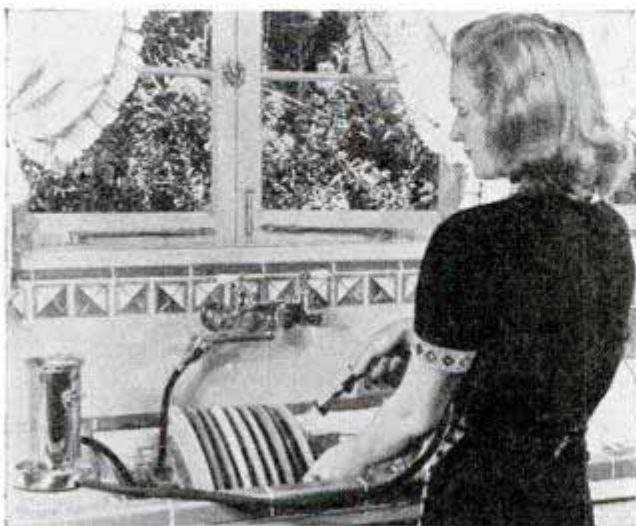

Using the home dishwasher. Note soap container (at left) with hose connection to faucet

mon soap. It consists of a small chromium-plated soap chamber three inches in diameter and eight inches high, with hose running to a faucet adapter and to a needle spray head. The adapter, made of rubber, fits any size faucet. It is held securely to the tap by a small chain. By flicking a lever on the side of the soap chamber, the user diverts the water through the chamber to obtain a strong spray of hot suds. Turning the lever back seals off the soap and enables the user to get clear hot water for rinsing. The amount of soap used is controlled by the valve. Dishes are placed in a rack fitted with a sliding panel which may be adjusted to accommodate the number of dishes to be washed, up to the capacity of the rack. A second rack holds the silver. The entire apparatus may be stored in a cupboard when not in use.

Spray foam dishwasher G. 11757 Dan Viscito

TRACKERS

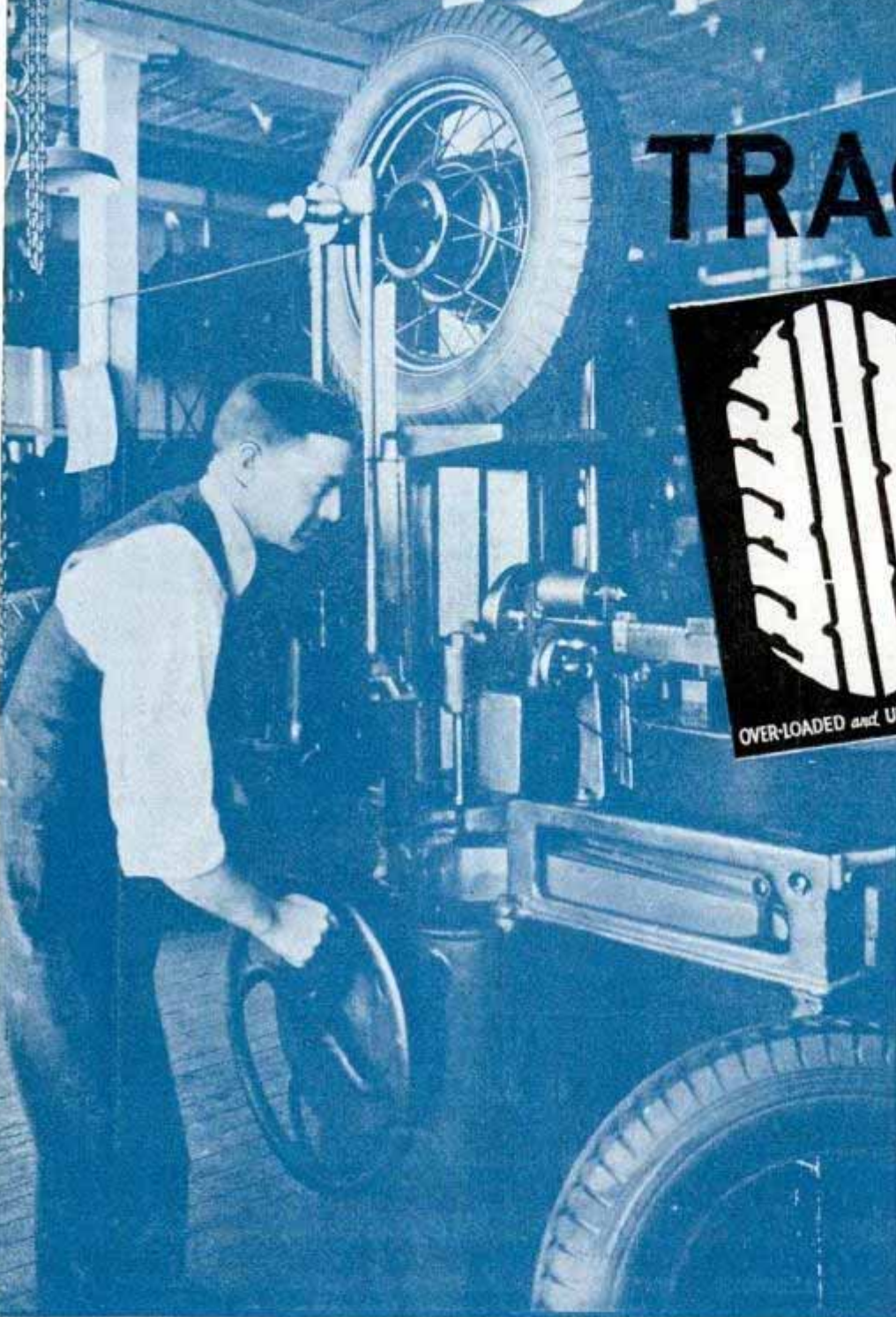

Left, making tire print in Fisk laboratory. Right, two examples of prints. The one at left indicates there were several occupants in car driven by a careless person. The other indicates car had several occupants, front wheels were defective and the driver unskilled, the tire showing results of being banged and scraped against curb

*Chapel
falls
mass*

*Carl Cruise
727
Schuermacher
Park Ave
New York*

JUST as the cunning Indian scouts of an earlier day could "read the signs" of the man whose trail they were following, modern trackers of the highway with scientific precision can tell much about the man who drives an automobile, even if the car has been swallowed up by the 900,000 miles of roads that crisscross the country.

No longer is the automobile the lawbreaker's perfect means of escape. Many times it leaves telltale "fingerprints" which are as individual and revealing to a tire expert as a set of teeth is to a dentist.

Lawbreakers are being tracked down all over the country with the aid of 2,799 tire-tread prints filed in the Bureau of Federal Investigation in Washington. Once a tire

print is obtained at the scene of a crime, the chances are 100 to one that the tire can be identified because the collection of patterns on file covers not only all models made in the United States and Canada but also the products of tire rebuilders.

Tire-sleuthing, though an infant branch of criminology, is an important scientific one. A pioneer in its development is A. E. Benson, product development manager of the Fisk Tire company and one of the world's foremost tire engineers.

"As a growing child develops its own personality," says Mr. Benson, "a new tire as it gains in mileage reflects the peculiarities of the car and owner through irregular wear. Presence and arrangements of

of the HIGHWAY



these peculiarities give the tire its personality.

"Five years ago, tire purchases were based primarily on size and quality, but the development of the automobile for specific purposes has brought about specialty tires designed to meet particular service conditions. Today the tire industry offers such major types as the start-stop for delivery trucks that stop frequently in city service; mud and snow;



Top, left, two prints of over-inflated tires, the one at left indicating preparations for long, fast trip. Right and bottom, broadcasts of tire prints help police track down criminals



edging on design units and along the ribs."

Tire prints also tell the experts many things about the driver. They can tell the approximate number of occupants by the depths of a print. From its width (under or over inflation) they can tell whether the driver is cautious or overconfident and by scuffing at the sides, where he may have hit the curb when parking, whether or not he is

farm tractor; safety and bus, passenger car and truck tires of various sizes.

"First inspection of the print immediately reveals whether a truck, bus or passenger tire was used. If it was a passenger tire, it is a simple matter of deduction, combined with a knowledge of tire sizes, to judge whether the car was in the Chevrolet, Buick or Cadillac class. At times it is possible to determine precisely which one and its age, because a Chevrolet, for example, may carry a certain manufacturer's tire for a particular year.

"If the car was in an accident, the probabilities are that the wheels were knocked out of alinement. Before the car has been driven many miles in this condition, excessive wear will begin to show in the tire tread.

"Front wheels only half an inch out of alinement will drag tires eighty-seven feet in every mile. Such wear is immediately evident to the expert's eye, as revealed in the print. When brake drums are out of round, another condition will soon become apparent. Gripping always in the same spot, the tread will be worn in egg-shaped spots while the remaining tread will show only normal wear.

"Caster, camber, toe-in and toe-out action in the front wheels all leave their identifying marks. Too much camber results in gouged-out front tires. Excessive toe-in or toe-out action leaves feather-

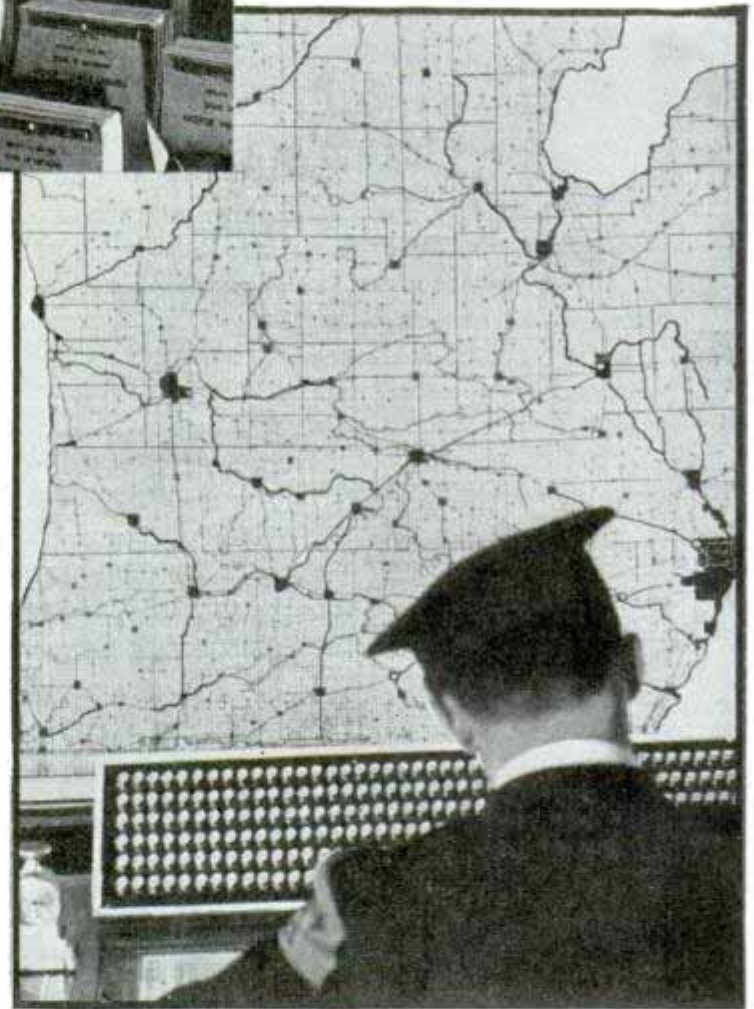

Top, checking motor license plates. Bottom, radio dispatcher at control desk with road map in front of him is ready to help trap escaping car

careless. A tire leaves a "positive" design when it passes over a wet road or ground, marking its wet track over a dry portion similar to a printing process. If the same tire stamps its track in mud or other soft substance the tracks become a mold or a "negative" impression. In the Fisk laboratories, experts have developed their own

method of making impressions by machinery. Federal experts, when assigned to a case, will photograph a positive impression and make a cast of a negative impression, using paraffin, white wax or plaster of paris in the mold to preserve every detail.

With almost 1,100 hit-and-run tragedies annually leaving few if any clues to the killers' identities, the tire print has become an important aid in the solution of crimes of this type. Such tire prints have been found at the side of the road where the

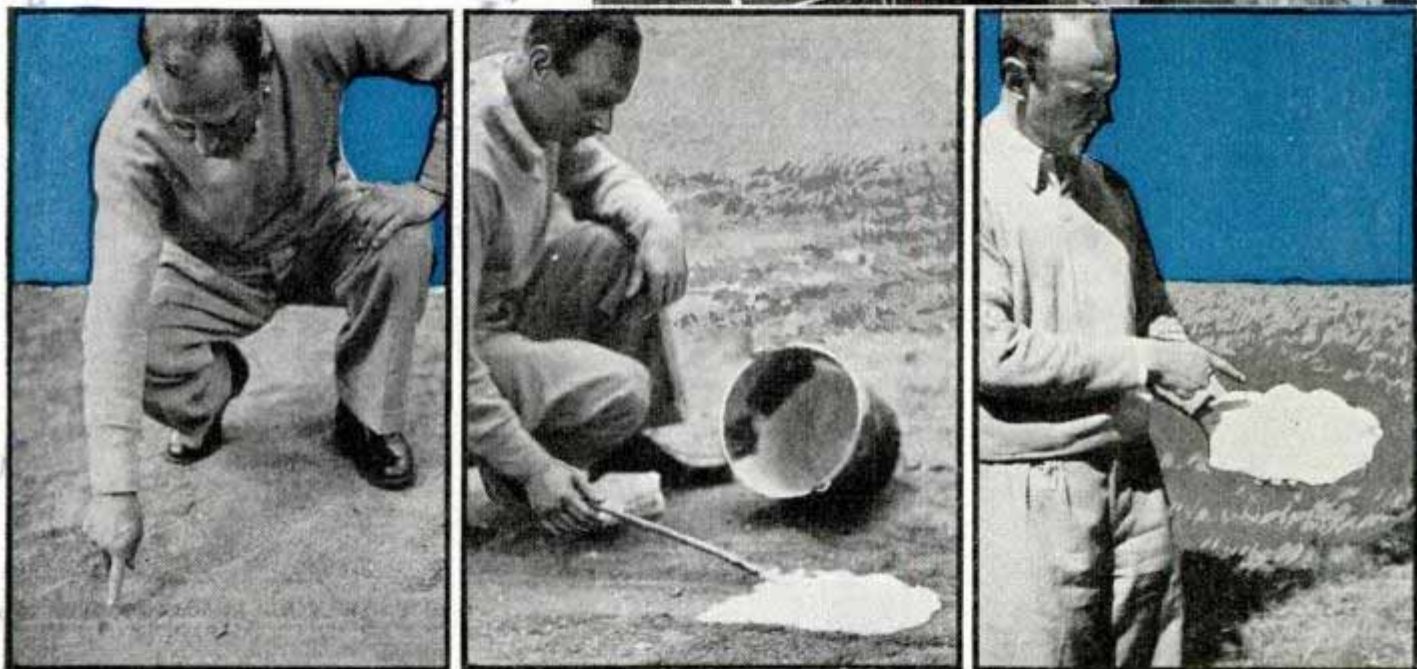

Top, "lie detector" frequently is used to check clues in hit-run cases. Bottom, left, examining tire track. Center, pouring in plaster of paris. Right, tire print recorded in mold

motorist swerved in a vain attempt to avoid his victim, in dirt positives on concrete roadways after similar swerving and in rubber "scorched" on the asphalt as the driver futilely applied his brakes; and printed in the victim's own blood.

Recently a Connecticut policeman, graduate of the National Police Academy of the Bureau of Investigation, tracked down a hit-and-run driver who had killed a boy. The policeman made a mold of the track left by the death car. He found a car with a tire that matched the cast. A comparison of glass found near the tire track aided the identification. Confronted with that evidence, the driver confessed.

"Apprehending hit-and-run drivers requires all the facilities of a modern police department," says Commissioner Oscar G. Olander of the Michigan state police. "Every possible contact between police officers and garage men, managers of parking lots and the general public must be made to secure information as to the whereabouts of the violator's car."

With more and more police authorities throughout the country adding "tire-sleuthing" to their scientific equipment, officers are now able to piece together more information than formerly in sending out general alarms—and with prompt-

(Continued to page 136A)

Newark Ohio

Piano Without a Soundboard Is Four Instruments in One

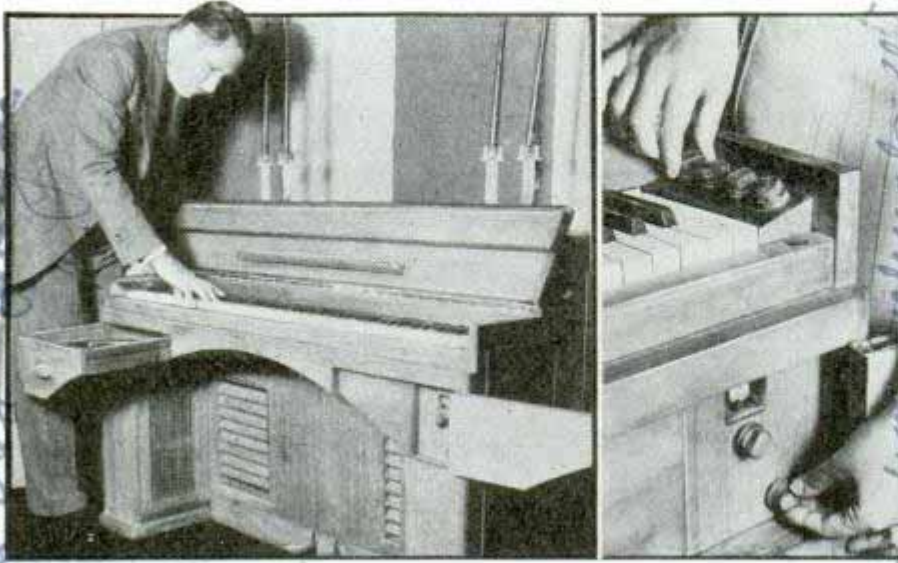

© Andrew Halbram
Two views of combination musical instrument. Left, phonograph and radio compartments open. Right, operating the radio

Phonograph, radio, electronic piano and conventional piano have been combined into a single instrument. With a full eighty-eight note keyboard, it is, first of all, a conventional piano with the usual hammers and strings, but minus the soundboard. When played in this manner it possesses an exquisite tone but, because of the absence of a soundboard, the vibrations do not carry far enough to disturb neighbors. At the turn of a switch the piano is converted into an electronic piano, the vibrations of each string being picked up electrically, amplified and reproduced through the loudspeaker in its base, thereby producing tones of a different character. Sliding out a compartment on the left converts it into an electrical phonograph and opening a door on the right makes it a long and short wave radio. The instrument is three feet high, two feet one inch deep, and four feet six and one-half inches wide.

Glass Fibers Used to Insulate Electrical Equipment

Glass insulation for electrical equipment, including wire and motors, is being used in steadily increasing quantities. The insulation comes in the form of yarn, woven tape, braided sleeving and cloth, and is applied by manufacturers. Fiber-

glas, made by the Owens-Illinois Glass company, is one of the insulating materials on the market. It has superior electrical properties, is resistant to high temperatures and will not burn, does not absorb moisture and is undamaged by occasional overloads. In addition, it permits reduction in size of equipment, such as a motor, with resultant savings in materials. Fiberglass is composed of extremely fine fibers, .0002 inch in diameter, made from the remelting of glass marbles. One marble three-fourths inch in diameter makes approximately ninety-eight miles of fiber. Deltaglass is the name of glass fiber insulation used for magnet wire manufactured by the General Electric company. The wire is recommended for apparatus windings where the temperature does not exceed 125 degrees centigrade. The insulation is flexible, has high dielectric strength and resists abrasion, due to a coating of special varnish.

Midget Car Built from Junk Has Eighty-Mile Speed

Made from junk automobile parts, a midget car constructed recently has a speed of eighty miles per hour. It is equipped with small tires of a standard make. Acetylene and arc-welding equipment were the principal tools used in the work.



Midget automobile constructed from junk parts

wheelbase 44" x 82"

*2/1-10-49 ck
Arthur C. Anzley
Anzley Radio
L. J. ...
C. Anzley's ...*

*insulation ...
Jameson, N.Y.
Harold J. Lagg
General Jr. & Co.*

Fireboat Hangs 20,000-Gallon Screen of Water



Two views of New York's newest fireboat undergoing trial tests. It can pump 20,000 gallons per minute

Its hoses raised in fanlike formation, New York's new fireboat hung a thick curtain of water over the Hudson river in its trial demonstrations recently. Its Diesel-electric engines can pump 20,000 gallons a minute at a nozzle pressure of 150 pounds per square inch, and propel the boat at better than sixteen knots.

Rubber Heel Snaps on the Shoe without a Trip to Cobbler

Rubber heels that can be clipped on the shoe by the wearer himself are being introduced in England. Metal plates are screwed to the shoes, and the heels are easily snapped on by means of simple locking clips molded into the rubber.

Automatic Fuel System Saves Airplane from Gas Failure

Promising added safety by eliminating the danger of running out of gas while landing, taking off or flying low, an automatic fuel system for airplanes automatically switches from an empty tank to a full one. The device relies on falling fuel

pressure in the emptying tank to turn the fuel cock to the next tank. Should it be empty, the fuel cock would continue turning until it did come to a tank containing fuel enough to boost the pressure above the level at which the device operates.

Swan June 10/6/58

U.S. Army Air Corps, Material Div.

Agent
Park Lane
11 Park Lane
Let's

see Aug. 1939 - 242.
see June 1942 - 39

NEW JOBS *on the*



from freighters to giant passenger liners are going to be built under the American flag. Though some will take the place of vessels wearing out, an army of about 10,000 new sailors, including steam and Diesel engineers, captains, navigators and radio men, will be needed to man the new fleet.

Technical skill has already replaced brawn at sea and a new breed of sailormen is in demand. The derisive jeer of old tars, "wooden men and iron ships," is as out of date now as the iron men and wooden ships that the first vessels propelled by steam replaced.

IF YOU want to go to sea, Uncle Sam will do all he can to help you rise to command. Nearly all the officers of America's merchant marine worked their way from the fo'c'sle up to the bridge and today the Maritime Commission is starting a serious effort to help young men make a success of their seagoing careers.

In the next ten years 500 ships ranging

Specifically, the commission is opening seamanship schools at which men who have already shipped to sea can be trained to increase their rank and pay. The commission is also overhauling the cadet system by which young men receive instruction at sea. In the past cadets sometimes regarded their ocean trips simply as vacations but now an applicant for such a post must apply to the

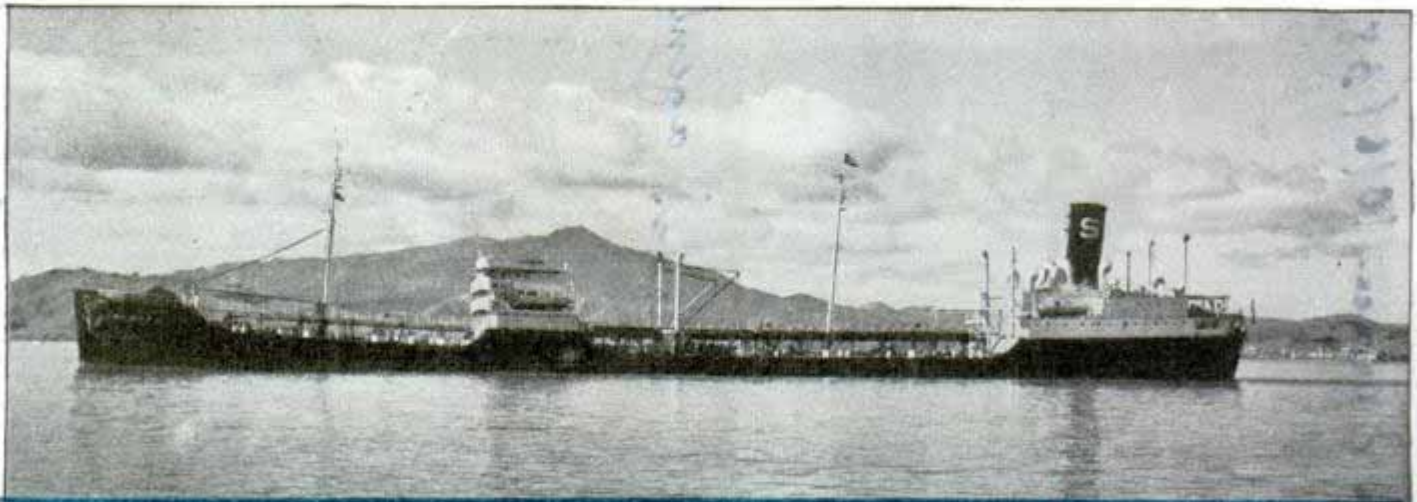

Plotting exact location of ship at start of voyage, top, by taking bearings on objects ashore. Bottom, the "W. H. Berg," one of new oil tankers of Standard Oil Company of California

HIGH SEAS

director of maritime personnel, United States Maritime Commission, Washington, D. C., who makes sure that the young man really wants to go to sea before signing him on. Each vessel sailing under an operating or construction subsidy is required to carry a small number of cadets who receive personal instruction from the officers after they have finished their daily duties.

The cadet plan is intended to train young men to become competent offi-



Cadet on passenger liner testing public-address system by which passengers and crew can be commanded during emergencies. Top, the "Tusitala," full-rigged sailing ship just after she had arrived in Honolulu from New York. She made the trip in eighty-four days



cers so they will be qualified for jobs in the growing merchant fleet. Prospective cadets must be between eighteen and twenty-three years old and must be high-school graduates with fourteen standard credits. There are other classifications for those who have had other training, such as instruction on a state school ship.

New marine schools, to be operated jointly by the Maritime Commission and the Coast Guard, are being established at Hoffman and Swinburne islands in New York, at Government island in California, and at a site on the Gulf Coast. The



schools will use the S.S. "Edgemoor" and the full-rigged sailing ships "Tusitala" and "Joseph Conrad" for training cruises. Bona fide merchant seamen who are unemployed are eligible for enrollment and will receive a three months' course with pay, food, clothes and quarters. Pay runs from \$36 to \$125 per month, depending on the rank of the applicant. The requirements are that the student must be a citizen, twenty-one years of age or older, and must have served a minimum of twenty-four months at sea. Instruction in the schools will include lifeboat drill, abandon ship drill, care of staterooms, overhauling of equipment and engine room and deck machinery, with special instruction for radio, electrical and clerical ratings. The commission expects that the schools will graduate 3,000 men and 300 officers per year, providing a reserve of capable men for the expansion of the merchant marine.

Life at sea today is nothing like the life of the past. Working conditions and pay on American vessels are the best in the world, having been improved considerably

in the last few years. Men in the deck and engine-room departments work eight hours a day, four hours on and eight hours off, and are paid extra when overtime is necessary. Safety at sea is always more important than punching a time clock.

Seamen box and wrestle on their off watches and engage in other sports. In the tropics they sleep on deck if they desire. Libraries of several hundred volumes are provided on most ships. You get

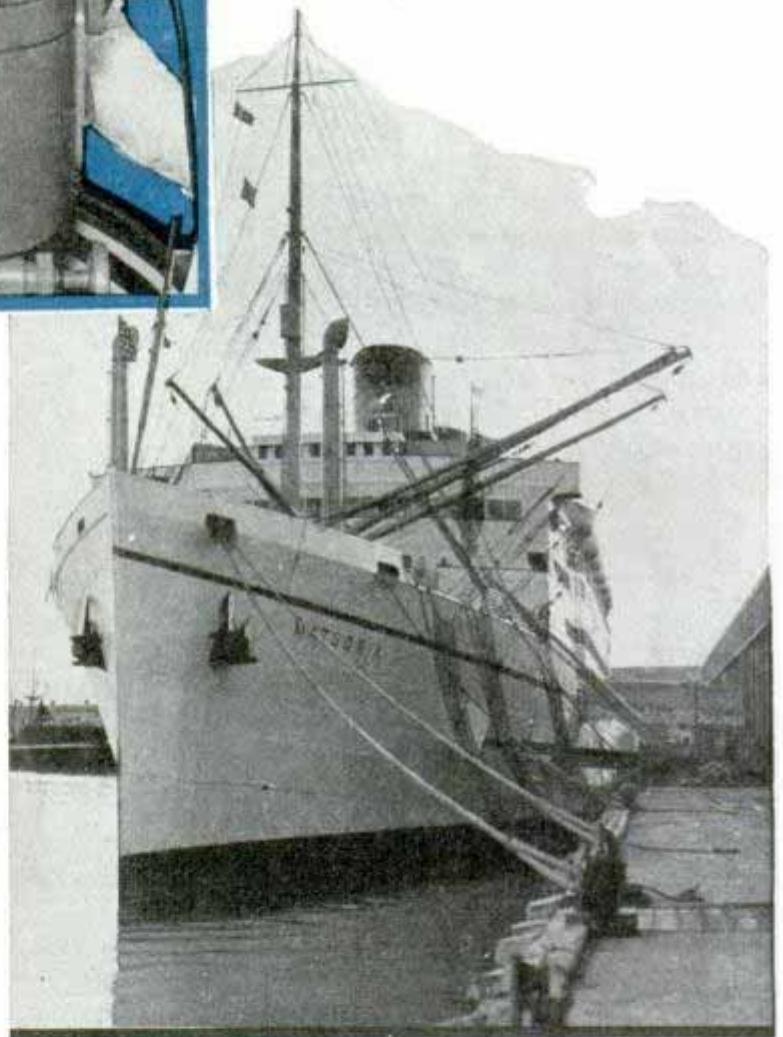

Quartermaster, top, at hand steering wheel on bridge. Below, trans-Pacific passenger vessel at dock

Sundays and holidays off when the ship is in a safe harbor. At foreign ports, with the captain's permission and depending on port regulations, seamen go ashore to see the sights and shop for curios.

Instead of the traditional damp, cramped and smelly forecastles the crews live in comfortable quarters on modern ships. On the two new oil tankers recently put

in commission by the Standard Oil company of California each normal crew of thirty-seven men live and sleep in light, airy cabins. Ordinary seamen get quarters as desirable as officers' staterooms. No room is occupied by more than two men. Each bunk has a deep spring mattress, sheets, and blankets. There are reading lights, rugs on the floor, hot and cold water in the porcelain washstand, desk and chairs, and even a built-in antenna for personal radio sets. There is warm and cold air circulation for each room, regulated with the weather, as well as electric fans. A harmonious color scheme decorating the walls, furnishings and curtains makes each cabin a comfortable home at sea. Old seamen used to shipping on freighters built twenty years ago can't believe their eyes when they see the quarters.

When crew members on tankers go off duty they may loaf in the unlicensed personnel's recreation room, fitted with upholstered furniture, where they will find others reading, playing cards and swapping yarns. The crew's messroom is just as modern and the ship's galley is equipped on a small scale like a passenger liner's. These two ships have the most up-to-date living quarters of any vessels afloat and they are serving as models in the designing of crew's quarters for other new ships.

(Continued to page 119A)



Some of crew of the "W. H. Berg," top, in their recreation room. Center, crew's messroom of this modern oil tanker. Food similar to that served to passengers on the big liners is served to crews these days. Bottom, crew's quarters for two men on oil tanker. Note the commodious quarters which are the men's floating home

Giant Crane to Lift Riders in Cages to See Exposition

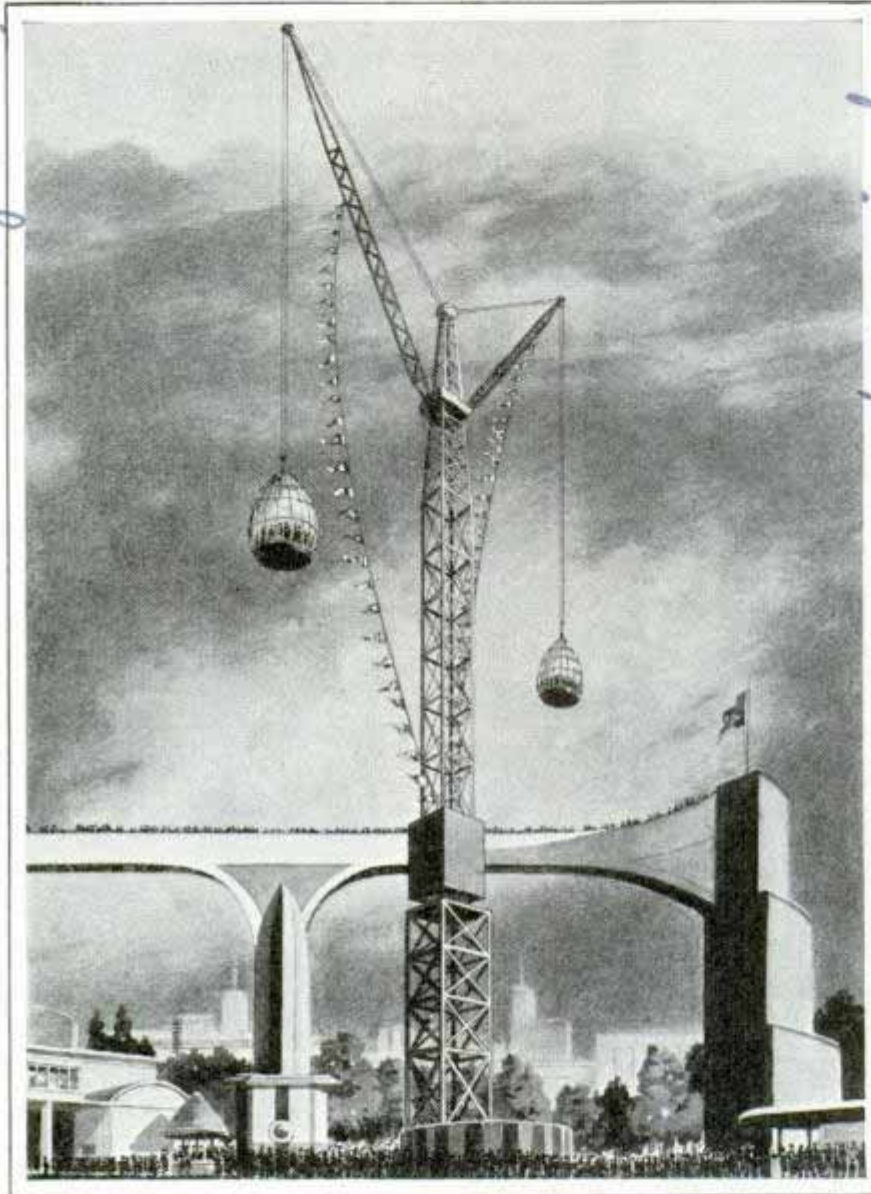

Drawing of huge crane which will lift two cages, loaded with visitors to exposition, high into the air for view of fair

Visitors to the 1939 Golden Gate International Exposition on San Francisco Bay will be given a thrill ride by a giant crane. Swinging two large steel cages 166 feet into the air, the crane will provide a new kind of sky ride. The cages will accommodate twenty-five passengers each and will be swung out over a wide arc as the crane revolves, giving the spectators a dizzy view of the exposition.

Radioactive Grease Finds Flaw in Surface of Metal

Tiny flaws in the surface of metals are being hunted by means of radioactive

grease and sensitive photographic paper. Weakly radioactive compounds of thorium are mixed with amber petrolatum and smeared over the metal, which is then placed in a chamber where a pressure of 1,000 pounds to the square inch forces the grease into any surface crack. An alcohol wash removes all the grease except that which has penetrated into cracks. Then the metal is wrapped in the sensitive paper and stored for a week, during which the traces of radioactive matter leave their imprint on the paper.

Gun Sight Protected from Damage by Rubber Sheath

Knock your gun sight accidentally against a fence or tree and the jolt may ruin the accuracy of the rifle. If the sight is a hairbreadth out of line your aim at a target a few hundred yards away is uncertain. A rubber sheath, however, prevents any injury to the sight. It slips over the gun sight and the end of the barrel, thus keeping dirt and dust out of the barrel while it protects the sight.

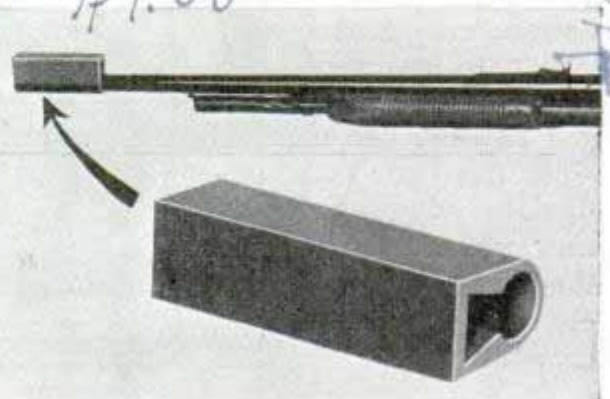

Rubber guard fits over gun sight as shock absorber

Designed by the M. E. Engineers, Ltd. London England

Prepared by American & early for metals

Patent 10/14/38
Navajo

Naval Research Lab.

Har & equip protectors

H 1222

\$1.00

Comp. ...
Edelweiss Service Bureau,
Eastman Kodak Co

PICTURE YOUR FAMILY

Rochester
ny

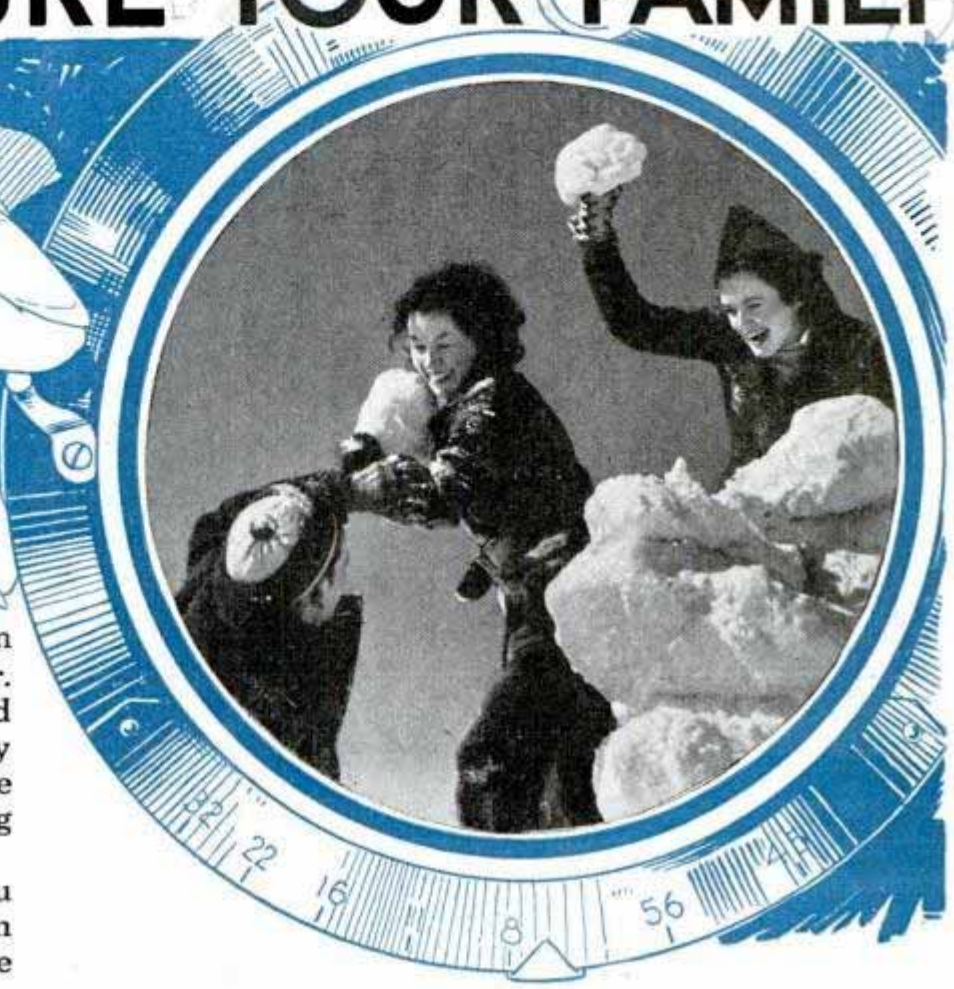

YOU had a lot of fun during the last year. Do you have any record of it now—any quick way of turning back to those good times and enjoying them again?

The chances are you haven't. Yet, if you own a camera you have the perfect means for keeping a record of all the things you do and enjoy, so that you can review them whenever you wish.

Any family should keep such a history of its good times. The results are a constant delight—not only when the pictures are viewed for the first time, but in later

years. As a person grows older, nothing is more cherished than memories, and a camera is the ideal means of crystallizing memories in enduring form.

Many people overlook the hundreds of picture opportunities that occur every year in any home, thinking only an unusual occasion or striking subject deserves a picture. As a matter of fact, it is usually the small, everyday occurrences that yield

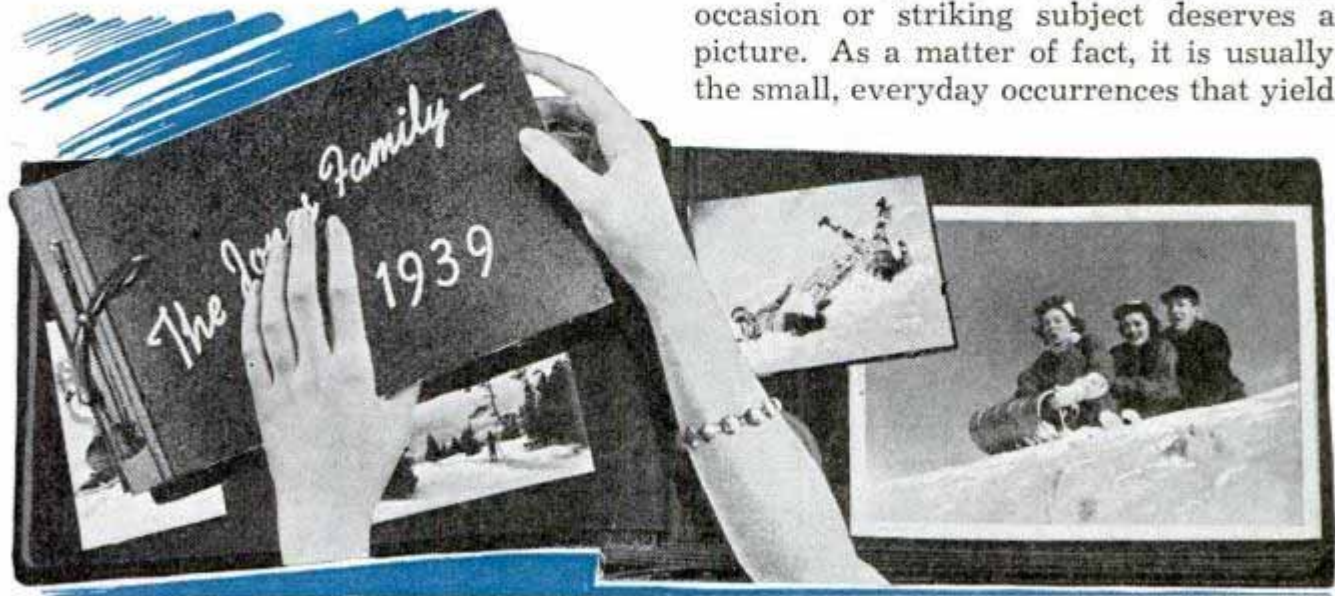

Top, an animated "still" makes a lively entry in the pictorial annals of the family. Below, the family history book. It should be a loose-leaf album to permit additions from time to time



Baking of a historical cake is good for a series of pictures—and watch the candles grow on a cake from birthday to birthday! Silhouette, below in center, adds decorative quality to family record. And don't neglect the pets

pictures with the most appeal. A traveler can make a grand picture of towering mountains or a lofty waterfall somewhere in the west; such pictures are certainly well worth while. But a picture of your small son with pencil and paper, trying to draw circles around an inverted saucer, is far more valuable to you than the grandeur of all the mountains in the world.



What pictures belong in your family book? Pictures of anything you want to remember, whether it be some special celebration, or the baby smiling to display a brand-new tooth. Around the home, an alert snaphooter can find picture opportunities twenty-

four hours a day, 365 days in the year. Just take down your 1939 calendar and note the special occasions: New Year's Day, Easter, Fourth of July, Christmas and the rest. Each means holiday activities. Each has a story to be told in pictures. Now, note the family birthdays and anniversaries, graduation days, the opening of school, and possibly a wedding day.

But hundreds of other occasions, not so special, are replete with picture opportunities. There are outdoor and indoor sports—baseball on the

lawn, checkers in the living-room, sleigh rides and skating parties. There are week-end trips, a summer camp, and a vacation that certainly demand ample picturing. Fishing and hunting excursions are full of picture chances.

What about pictures around the house? Homes and furnishings change, so take pictures of the rooms for comparison

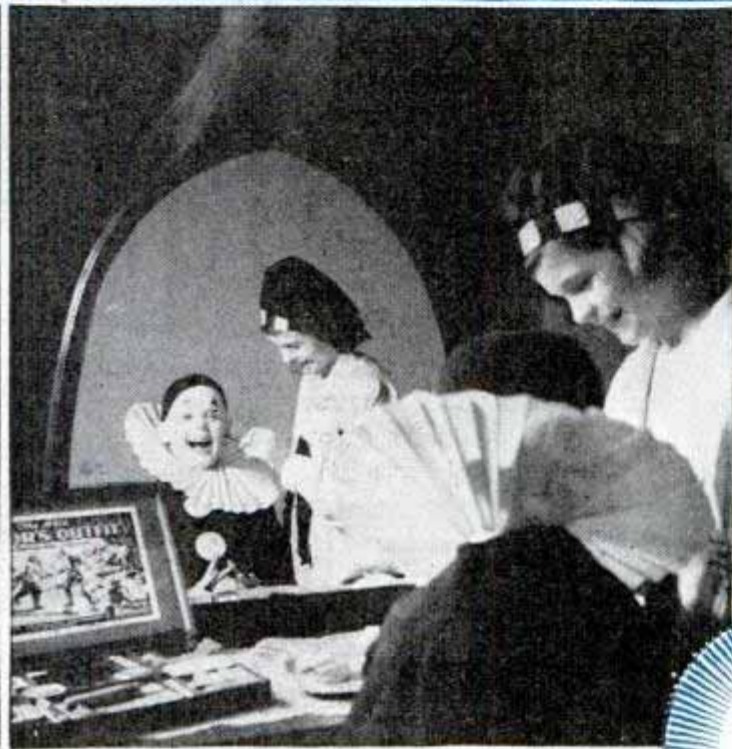

Top, the family orchestra rehearses. Don't fail to picture children dressing for a party. Drawing shows how to enlarge from movie film; below, a bedroom scene worth remembering



from year to year. Details are interesting, too; the sunny corner in the bedroom, flowers in the kitchen window. Outside, there are improvements in landscaping, new shrubs, new flagstones in the garden walk. Before-and-after pictures tell the story well, and to make it complete, catch a few in-between snaps of the actual placing of the flagstones, the planting of flowers.

There are opportunities for biography, too. Indeed, each member of the family deserves a special section of the family

(Continued to page 114A)

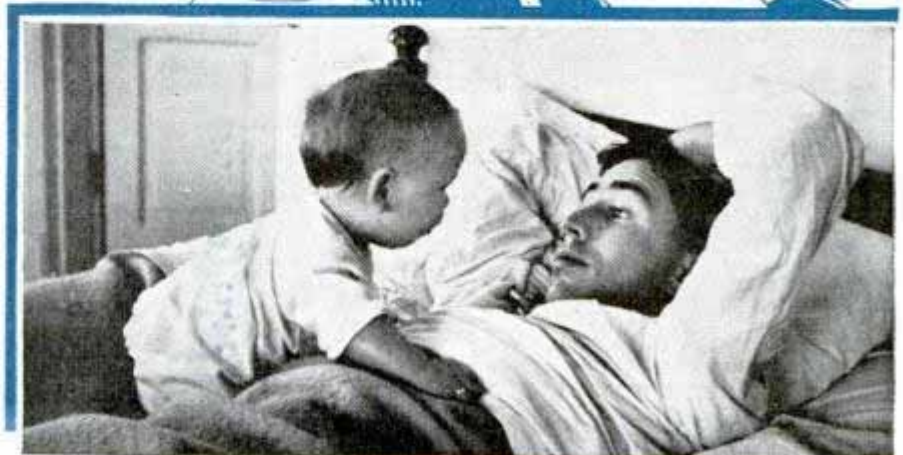

Cotton Runway for Airport Is Covered with Asphalt



Three men unroll cotton binder on airport runway after truck lays down adhesive coating of tar

Airplanes are taking off from a cotton runway at Reilly field in Alabama. Cotton fabric was used as a binder for the surfacing. A tar preparation was first sprayed over the runway; then workmen unrolled the long "blanket" of cotton. This was covered with asphalt and then rolled smooth.

Skimming Milk Made Impossible by Crushing the Cream

Milk can be fixed so that the cream cannot be skimmed off, it has been found. The feat is accomplished by distributing the fat, which forms cream, so thoroughly through the milk that it is never able to unite. A cream-spreading machine drives fresh milk through small openings under pressure of 2,000 to 2,500 pounds, crushing the fat globules into tiny particles.

Five-Barred Neon Traffic Light Costs Less to Operate

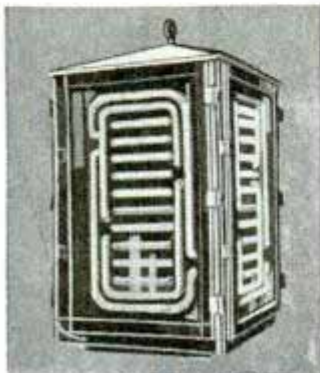

Motorists watching a five-barred traffic light know just how soon the signal will change. The bars are neon tubes which gleam through the thickest weather; when one-fifth of the time cycle has

elapsed, one of the light tubes goes out, another is extinguished after the next fifth, and so on, and the driver can always tell how long he must wait for the change to red or green.

Clamp for Splicing Wire Rope Eliminates Tedious Work

Hours of cable-splicing can be reduced to minutes of easy work by a clamp, which is available for all standard sizes of wire rope.

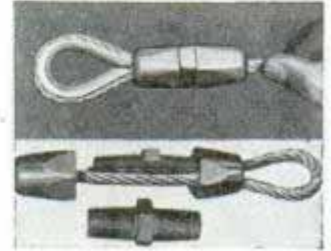

The necessity of calling in a skilled cable rigger is obviated, for anyone can apply the clamp. Inside the clamp are two half-sleeves which fit snugly around a section of the cable and join together to form a threaded core around the joint to be made. This core tapers slightly from the center so that the sections of cable are forced together tightly as the heavy locking nuts are screwed toward the center.

Lantern Defies a Hurricane in Wind-Tunnel Tests

Hurricane blasts exceeding 100 miles per hour were employed recently to test a pressure mantle lantern. Placed in a wind tunnel used for testing airplane parts and construction, the lantern was not extinguished by the hurricane-like wind created by the big propeller.

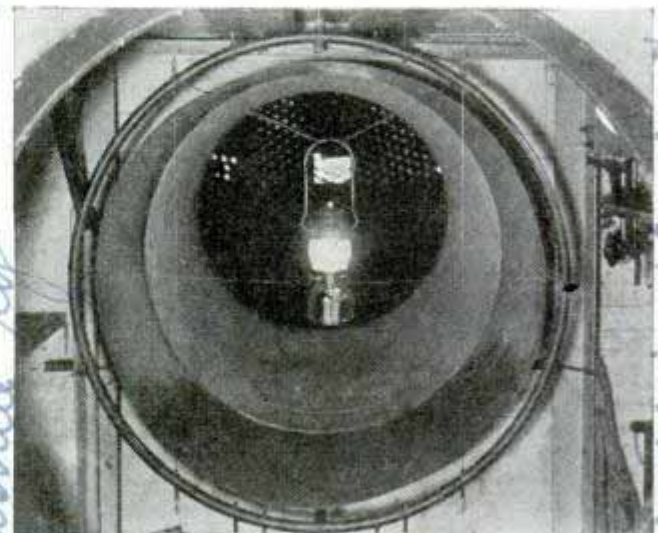

Lantern suspended in wind tunnel for test in hurricane blast of 100 miles per hour

Conaburg cotton see perf

Corvill University d. chava, ref

James J. Robertson

3178 Bellense to Electric, reel

12207

1226

Stare to Wichita, Lane Coleman Camp

Fifteen-Mile Field Gun Hurls Ninety-Five Pound Projectile

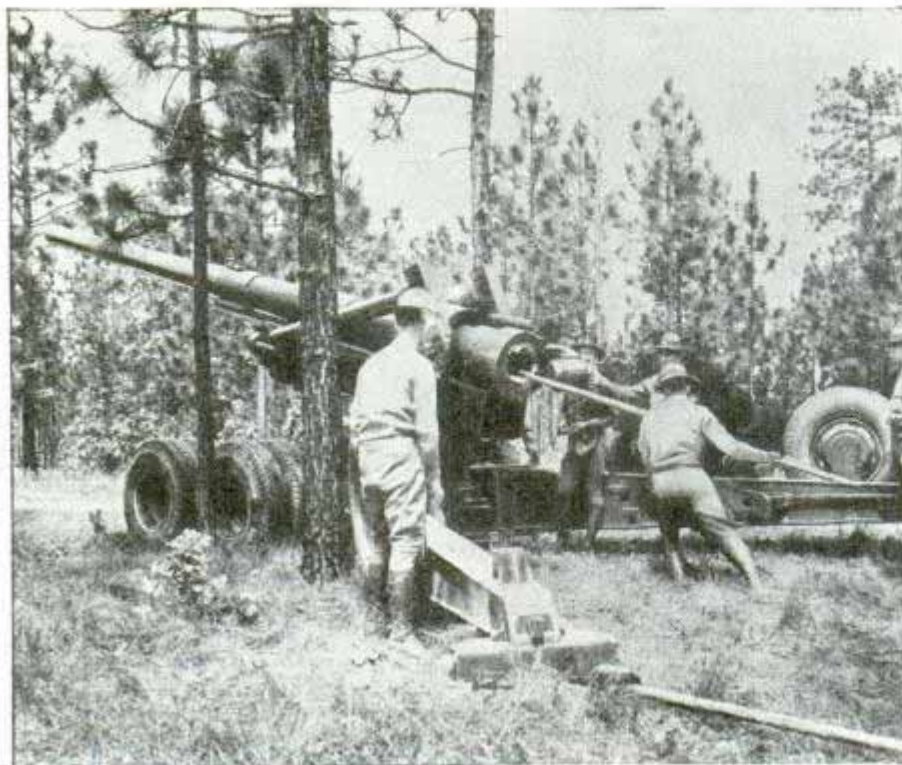

Official photo by U. S. Army Air Corps

chf
Big field gun being cleaned after firing ninety-five pound shell. The weapon rides on a carrier fitted with ten rubber-tired wheels

tested at Holt Wragg, N.C.
Firing a ninety-five pound shell at the rate of one a minute, the U. S. army's new 155-millimeter gun has a range of about fifteen miles. The shell reaches a height of 30,000 feet at the top of its trajectory. Complete with its heavy, ten-wheeled rubber-tired carrier, the gun weighs fifteen and one-half tons, but is towed in one load. It can be set up in firing position in thirty to forty-five minutes. Developed in the last two years, the gun is one of the few field artillery guns of purely American design.

Hosiery Fiber Made from Coal Is Elastic but Strong as Steel

H 1279
From such common raw materials as coal, water and air, du Pont chemists have developed a synthetic fiber for hosiery, fabrics, bristles and plastic products. Given the name "Nylon," this fiber can be drawn into filaments as strong as steel and yet more elastic than natural fibers, fine and lustrous. It is described as the first organic textile fiber made by man from minerals. Already toothbrush bristles are being made from the new product. One of its most promising uses is in the manufacture of hosiery of extreme sheerness, elas-

ticity, strength and resistance to runs. Other possibilities are sewing thread, knit goods, racket strings, fishing lines, transparent wrapping film and clothing fabrics.

Photrix Calculator Figures Enlarging Time

H 1209
Exposure time for enlarging photos can be arrived at accurately and simply with the aid of a "slide rule" calculator just brought out. The strength of the light emerging from the enlarger lens must first be measured with a light meter, and the emulsion speed of the paper must be known. Then the calculator is put to work, figuring proper exposure time from the area, emulsion speed, and flat or contrasty quality of the negative. The picture size scale extends up to forty by sixty inches, and the exposure time scale from ten minutes down to fifteen-hundredths second.

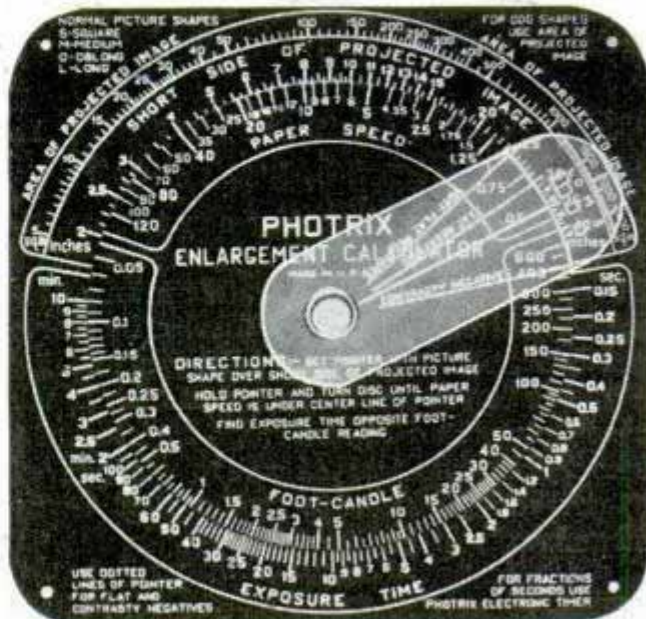

This simple slide-rule calculator helps to find exposure time for enlarging photos

E. d. du Pont de Nemours & Co. Wilmington, Del. Nylon fiber

W. W. of other media of cloth, just...

*International
Mar. between Cuba*

Adams Island
Mount St. Helens

MINING *a* GLACIER

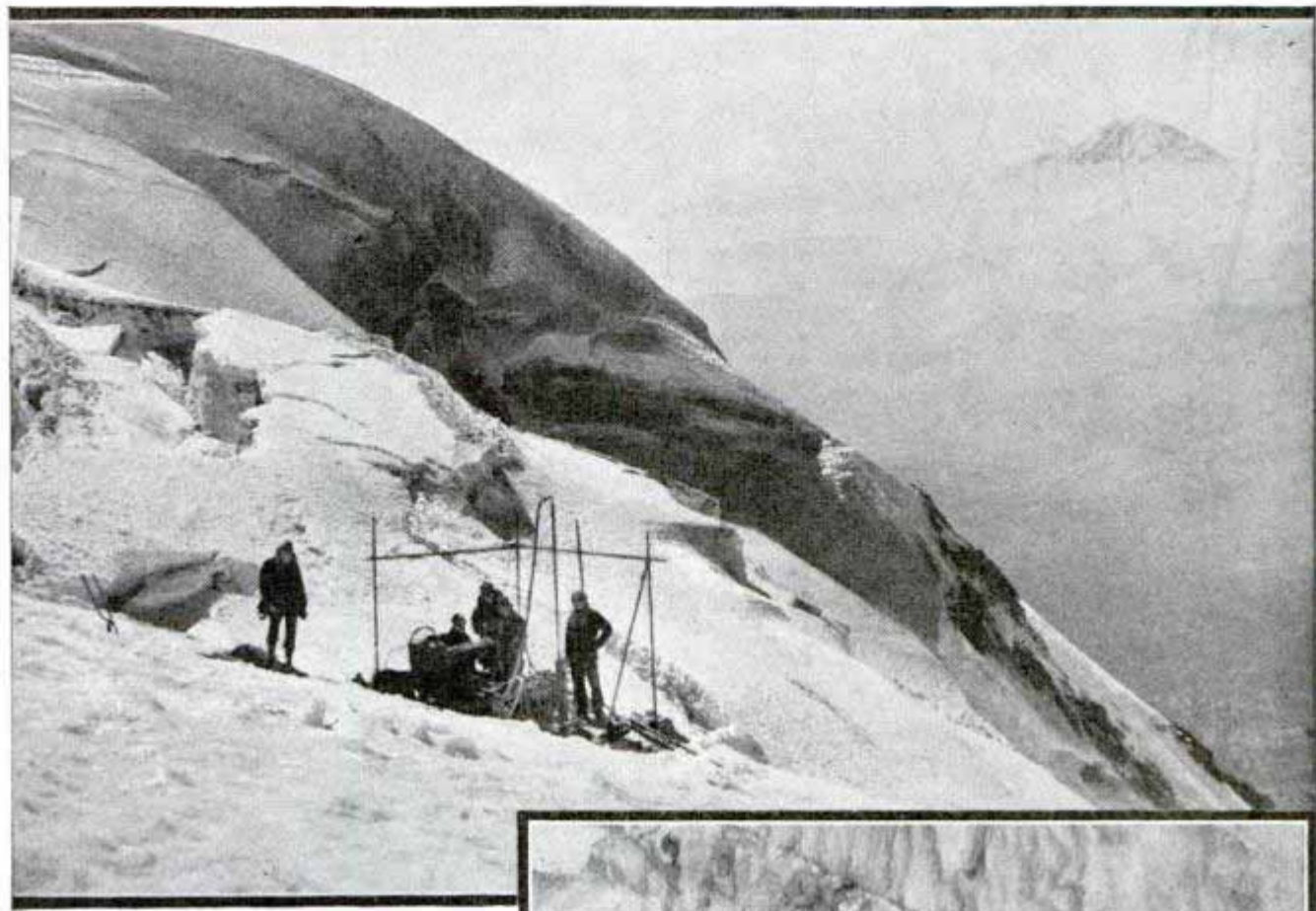

Top, drilling at lower edge of crater.
Bottom, rope taut, and nerves taut, for descent into crevasse

IT TAKES from three o'clock in the morning until noon to climb up the steep rock walls and over the treacherous glaciers to the summit of snow-capped Mount Adams in southern Washington. More than once you are tempted to give up as your lungs heave for more oxygen and your muscles cramp from cold and overexertion. When you get there, 12,307 feet above sea level, you expect to find a storm-ripped flag, and little else.

But the shriek of the wind over the last hump brings with it the whinnying of horses and the throb of a gasoline engine. Impossible as it seems, the scene on top of the Pacific Northwest's second highest mountain is one of industry.

The reason is a fortune in sulphur ice-bound in the summit crater. Blinding bliz-

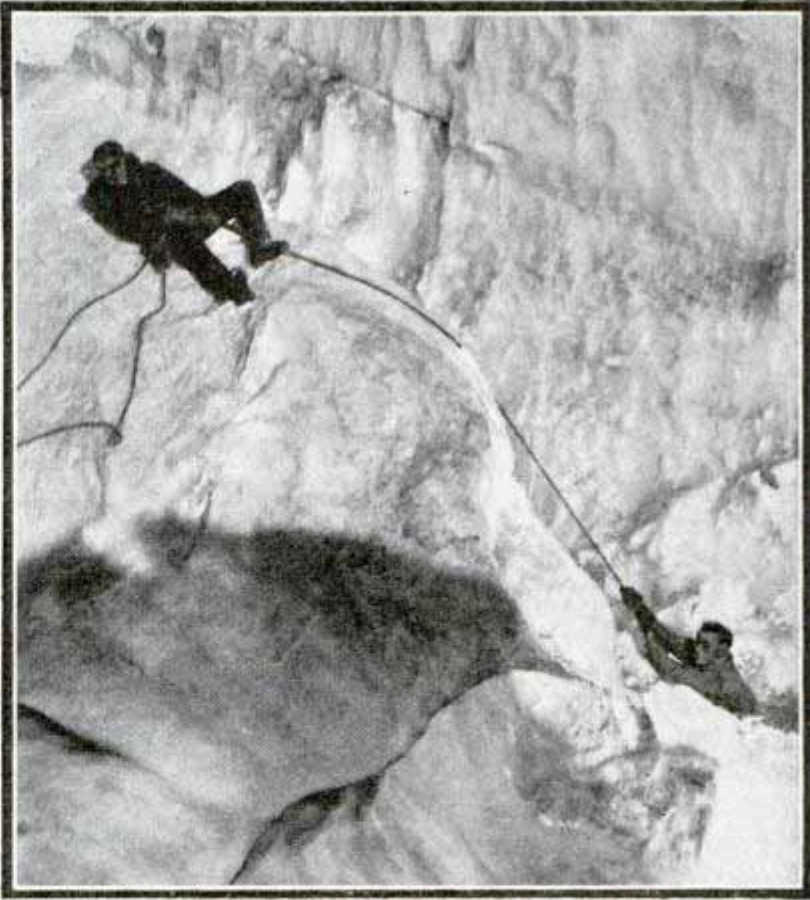

zards, tremendous ice crevasses and all the dangers of Arctic-like high-altitude conditions stand between it and its market, but determined Wade H. Dean doesn't care

Cont. Harold Mansfield 9677-47th Ave. S.W.

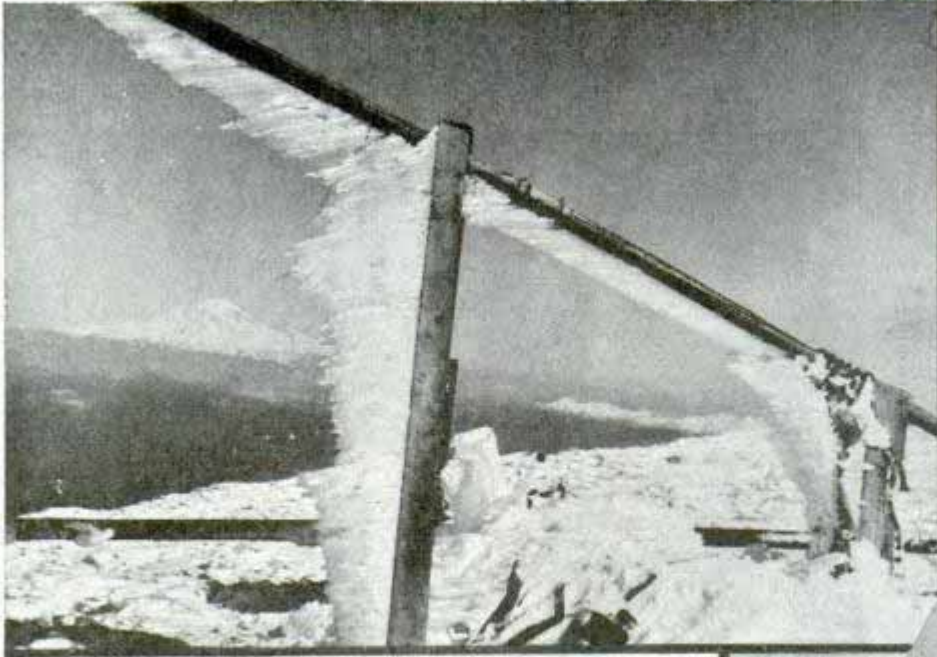
Mount Rainier in background

Left, storm-streamlined ice on overturned drill jig. Below, a sulphur prospector goes climbing near mountaintop mine



about that. He said eight years ago that he would "lick that mountain" if it took him fifteen years, and now his goal appears within his grasp.

His crew of fur-clad prospectors has made a home on the bleak summit and between blizzards has succeeded in digging enough holes through the flinty ice to "prove up" a million-ton deposit of fifty per cent sulphur ore, more than 100,000 tons of thirty-three and one-third per cent alum (aluminum sulphate) and substantial deposits of gypsum. Now plans are being laid for a nine-mile aerial tramway to bring the ore literally out of the sky.

The Mount Adams project is considered commercially practical because of the ready Northwest market for the sulphur as a farm fertilizer and a chemical reagent used in paper mills. The gypsum may be used either as a fertilizer or in the making of plaster of paris. Alum is widely used in the purification of water, and interesting prospects for its use as a source of aluminum are being investigated.

Upon reaching the top you stand in a chilling wind and survey the unusual scene from the ice-covered roof of a little cabin which is the prospectors' headquarters. Built in 1921 as a United States Forest Service lookout station but later abandoned as impractical, the cabin is anchored with heavy cables so the wind cannot toss it over a 1,000-foot precipice just a few yards away.

The icy surface of the crater slopes slightly downward to the north—a great

white 200-acre shelf ending abruptly in the emptiness above the clouds. A black rock projection which Dean identifies as "the Pinnacle" juts skyward to the left, a remnant of the west crater rim. Where the other crater walls long since have been carried away, the ice is bent over at the edges, cracked into mighty crevasses, perched perilously before beginning its near-vertical descent in the tumultuous Adams Glacier. Beyond, in a sea of clouds, Mount Saint Helens protrudes its symmetrical white head to the left, and over more cotton carpeting on its right the defiant high summit of Mount Rainier looks deceptively close.

The Sky Mine has few visitors, but when one appears, he and Dean rope themselves together for safety to descend a steep ice



embankment to the crater's flat surface.

"Chock-full of ice," Dean shouts in the roar of the wind. "Most of the sulphur's underneath."

He points out three dark ridges of sulphur rock, each about 400 feet long and varying from 100 to 400 feet in width.



Top, oil barrel serves as bathtub. Bottom, pack train headed for the mine. Circle, pack horses and crew on the summit



"Here's South Island—it's an island in ice. . . Over there where we're going is North Ridge," Dean calls out the sulphurous landmarks. "You can see the end of

another ridge farther over to the right. That one hasn't been named. It's a bad spot—full of hydrogen sulphide gas. Some of the boys have had some mighty narrow escapes in the fumes."

The smell of sulphur is all over the mountaintop, and workmen near the source of the fumes find silver coins in their pockets tarnished in only a few hours. On one end of South Island a fumarole exhales the gas and water vapor at a tem-

(Continued to page 129A)

Giant Landplane Has Space for Forty-Two



With a passenger capacity of forty-two, one of the largest landplanes in regular service has retractable undercarriage which folds into the engine nacelles when the ship is in the air. The plane weighs twenty-one tons, has a top speed of 200 miles per hour and cruises at 160 miles an hour. Its wing span is 123 feet. The plane, Imperial Airways' new "Ensign," was built for European and Empire service.

Twenty-one ton passenger-carrying landplane in flight. Note that undercarriage has been retracted into the engine nacelles

Winch Pulls 55,000-Pound Load aboard Up-Tilted Truck

Cargoes so tremendous that they tilt the truck cab up in the air are loaded with the greatest of ease by a winch truck, the winch being geared to the truck motor. The triple-motored machine being loaded in the photograph shown here weighed 55,000 pounds. As it was pulled forward, of course, the front end settled to the ground. The winch is controlled by the driver.



This unusual photo shows front of truck tilted into air while powerful winch pulls a load of 55,000 pounds onto the truck bed

Electric Secretary Rides Along for Dictation in Plane or Automobile



Dictating to the "electric secretary" in auto

You can take your secretary along on your next business trip by plane, train or automobile and dictate a "talking letter" that folds into an envelope and is mailed for three cents. It is an electric secretary, recording and reproducing the dictator's voice on a material so thin that ten average-size letters weigh only an ounce. The apparatus itself is about the size and weight of a portable typewriter. It can be operated by automobile batteries. The salesman or executive can dictate letters while driving his car, play the record back to himself immediately, and listen to "pep talks" received from the home office.

General Communication Products Co. Lexington, Va.
 Cont. H. Earl Gold
 207 1/2 E. Second St. Tulsa, Okla.
 Tulsa Winch Mfg. Co. 823 E. 12th St. Tulsa, Okla.
 White Motor Co. 842 E. 79th Cleveland, Ohio
 at Vine, Hollywood, Calif.

Fingertip Puppet Show Fits in Overnight Bag

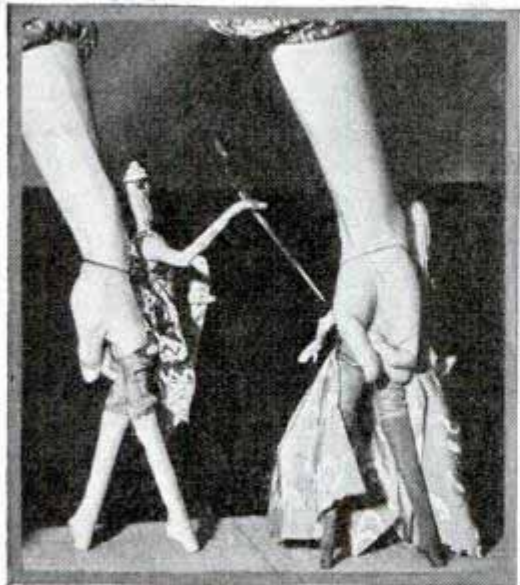

Above, "backstage" view of operator's hands with dolls on fingers ready for action. Cloth-covered pencils are used here for long legs. Right, new and old puppets demonstrated; three lower dolls are "fingertettes." Without strings, bulky stages are unnecessary



Black backdrop near table edge brings out light-costumed dolls by contrast and operator's arms, wrapped in black, are almost invisible. When room is darkened for show, ordinary battery flashlight provides spotlight effects. Operator at left is holding colored glass in front of flashlight

There are no strings to the puppet show staged by a Chicago couple. Theirs is a fingertip performance—and the whole table-top troupe fits neatly into an ordinary overnight bag. The dolls are fashioned in the usual manner, but without legs. Two holes in the lower part of the costume serve as openings for two fingers of the operator's hand, which form the marionette's legs. In the bottom picture, one operator controls two dolls at left, another controls the dragon, a cloth over the arm becoming the dragon's body

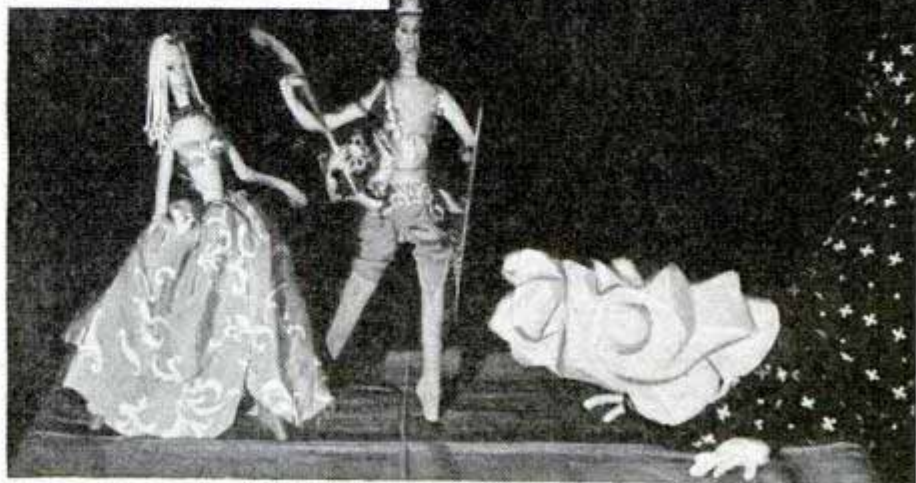

Sea-Going Postman Picks Up Floating Mailbox



Sea-going postman finds floating mailbox dropped from ship and removes the letters to be forwarded to their destinations

Floating mailboxes, dropped overboard by passing ships, are picked up offshore by wading postmen. The boxes are carried to shore by the tide and the mail in them is forwarded to destination. Thus ships save the time of putting into port for nothing more than mailing a few letters.

Two-Tone Tongs Handy for Darkroom

Red tongs that show white under the ruby light of the darkroom, and black tongs that stay black, are offered as an aid to the photographer to keep from mixing chemicals. Made of unbreakable plastic, acid-proof and stainproof, they are sold in pairs. The red pair is intended to be used only for handling prints in the developer solution and the black one only for the hypo solution.

Electric Robot Walks and Answers Visitors' Questions

Visitors to the Golden Gate International Exposition this year may be surprised to find an electrical robot at the information desk of a public utility company's exhibit. It will answer questions, move about and perform simple actions. You step to the information desk and dial your question to the "clerk in charge." The robot, at a microphone, tunes in by remote control and reacts to the question by giving complete information on rural electrification, family budget and other power-industry problems.

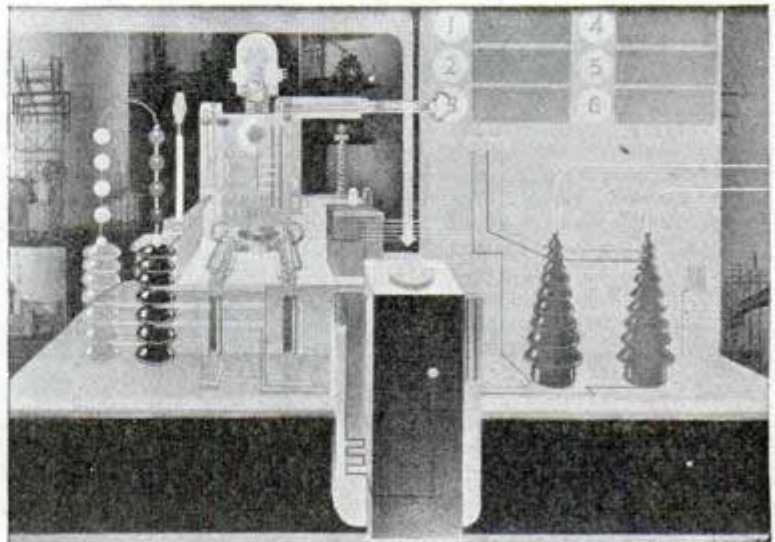

Robot ready to answer questions of visitors

H 123.6

at meadow, N.Y. are New York

H 1285
Two-Tone Tongs Handy for Darkroom
Shuckell 756
Raygram Corp. 425-4th

H 1263

Parke Loosand
Electric Co.

#1147
 Model # 22
 Peoria, Ill.
 Dept. of Agriculture
 Washington
 D.C.

A NEW FRONTIER

Write Aural Rehabilitation Div.

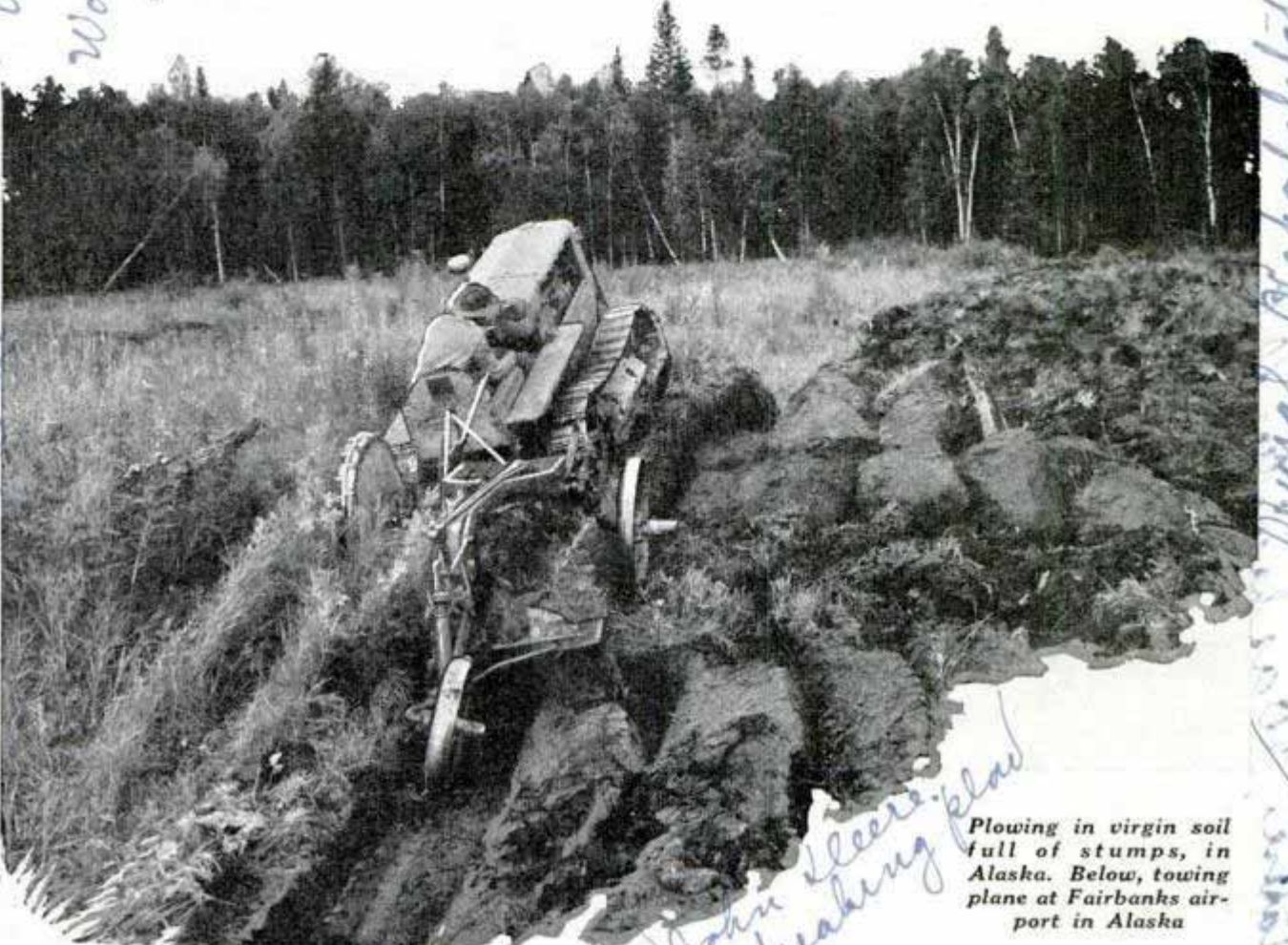

Plowing in virgin soil full of stumps, in Alaska. Below, towing plane at Fairbanks airport in Alaska

John Deere
 breaking plow

By Ruth and Bill Albee

WEST of the Mackenzie river, and stretching northwest from central British Columbia to Bering strait, lies an area half as large as the United States. Here are vast unpopulated areas containing resources of farm lands, grazing lands, timber, minerals, oil and water power, all waiting for the modern pioneer or adven-

turer to come and claim as his own. This area has as great a range of climate and almost as many opportunities as the northern half of the United States had when our forefathers settled there. Economists claim that one reason this last depression was severe was that there were no more new frontiers where the un-

William Albee & Harry Beardsley
 Peoria, Ill.

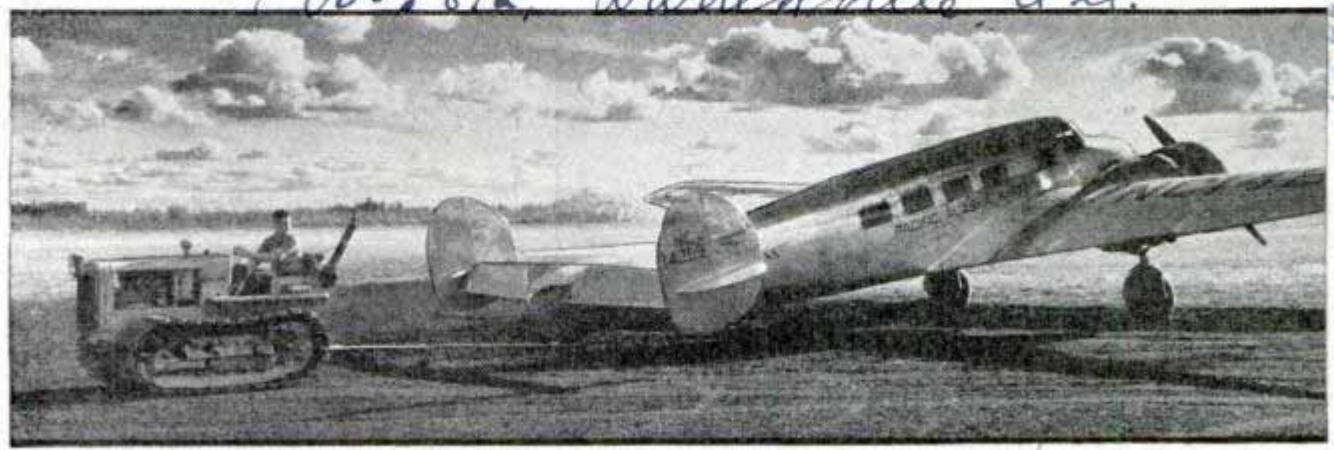

#22

Pacific Alaskan Airways

Special Rehabilitation work
 at Fairbanks Alaska
 2604 W. Harrison
 Peoria, Ill.

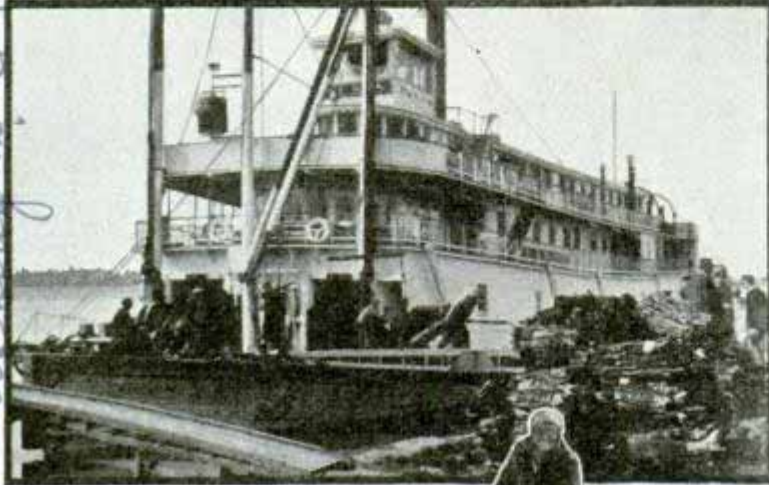
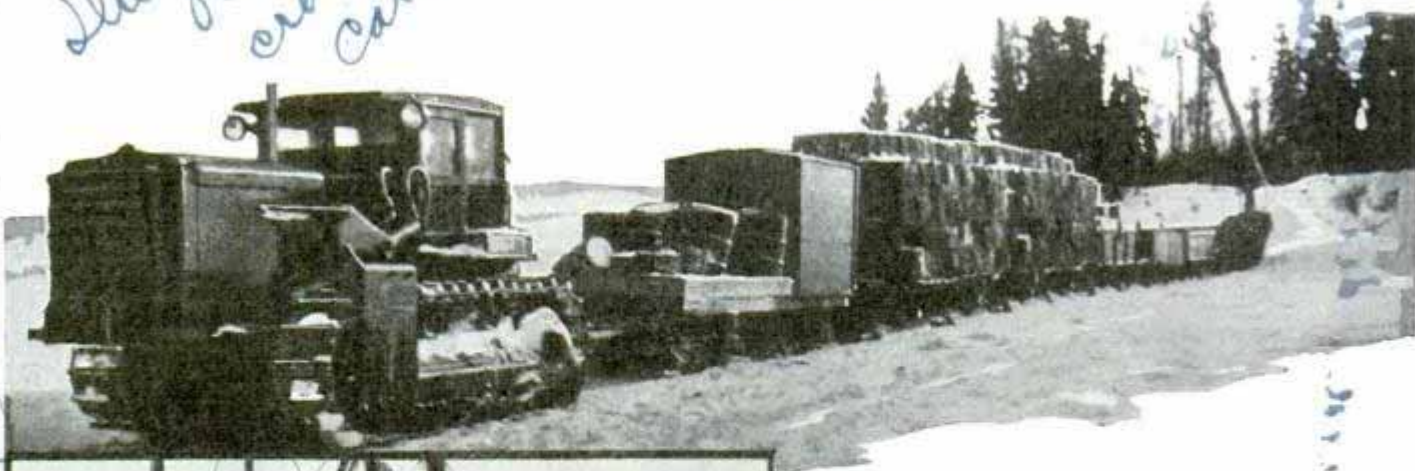

Top, a northern freighter with a load of supplies. Below, unloading baled salmon at Fort Yukon, a road roller made of logs in Yukon territory, and using dogs as pack animals in summer. In winter the dogs are sled animals

employed could start life anew, acquire a "stake," and develop new sources of wealth and new markets for goods. The depression has developed in the hearts of thousands a yearning for the security and independence for which the frontier has become a symbol—a piece of land they can call their own, a shelter, however crude, against cold and storm, and the opportunity to live off the land regardless of the booms and depressions of the industrial world.

There may be no new frontiers within the geographical limits of the United States, but what of Alaska and northwestern Canada? The opportunity is there for those who really want it. Why, then, haven't more people taken advantage of it? The answer seems to be, first, the widespread misconception of the country; second, the general lack of pioneering knowledge and temperament among the younger generation.

No one wants to send a horde of tenderfeet into the "sticks." And yet it is likely that a young man or woman is in less danger out in the wilderness than in the modern city. You hear of people torn apart by grizzlies, freezing to death in blizzards, drowning in rapids, getting lost and starving in the wilds. But they are no more representative of life in the far north than the daily stories in the newspapers about shootings, kidnappings and auto accidents, are representative of life in the cities.

Fishing and trapping - Alaska, is postman / Cotechkan, Alaska
 (Alaskan Representative was hunting)

Serial
 Pilot
 crossing
 Carrol

On the edge of the frontier boys of twelve often are found doing men's work—driving dogteams, tractors, running swift rivers in poling boats, shooting moose and butchering them for the family larder. Today the pioneer has available all sorts of modern devices with which to conquer the wilderness if he has the money to buy them. The continuous-track tractor goes where there are no roads, and hauls enormous loads over snow and ice. The airplane brings the most remote localities within a few hours of civilization. The outboard motor makes possible the navigation of the swiftest and shallowest streams. The radio

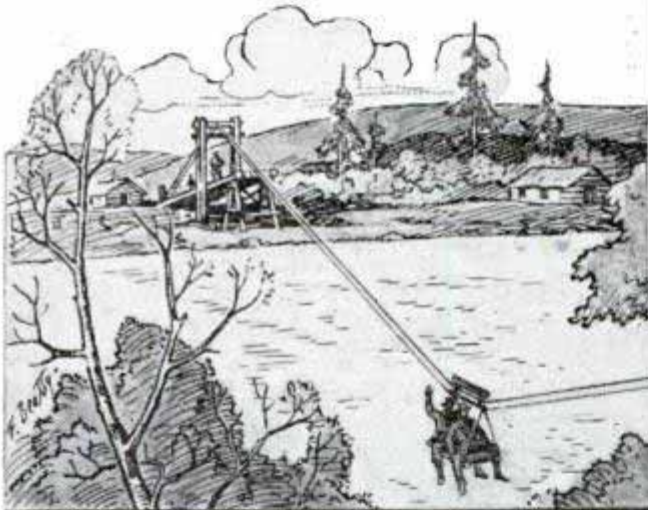

connects the isolated cabins with the entire world. Gasoline lamps are common. Some northern pioneers have individual electric power plants with all the modern electrical conveniences.

Even though the average pioneer may not be able to afford these mechanical aids at first, he benefits by their mere presence. The airplane, for instance, is always available to rush a doctor or medical supplies to remote localities in emergencies, often at government expense. Actually, the ax, the rifle and a few simple tools are all that the modern pioneer needs, if he has the will to use them.

(Continued to page 149A)

#22.
 Top, seining salmon, a major Alaskan "crop." Center, using a cableway to cross an Alaskan river. Bottom, bad roads or even lack of roads do not stop freight "trains" like this in Alaska

Owner: Frank Lee

From Peter Creek

*Kingston-on-Thames
England*

Rack for Clothes Closet Eliminates Crowding

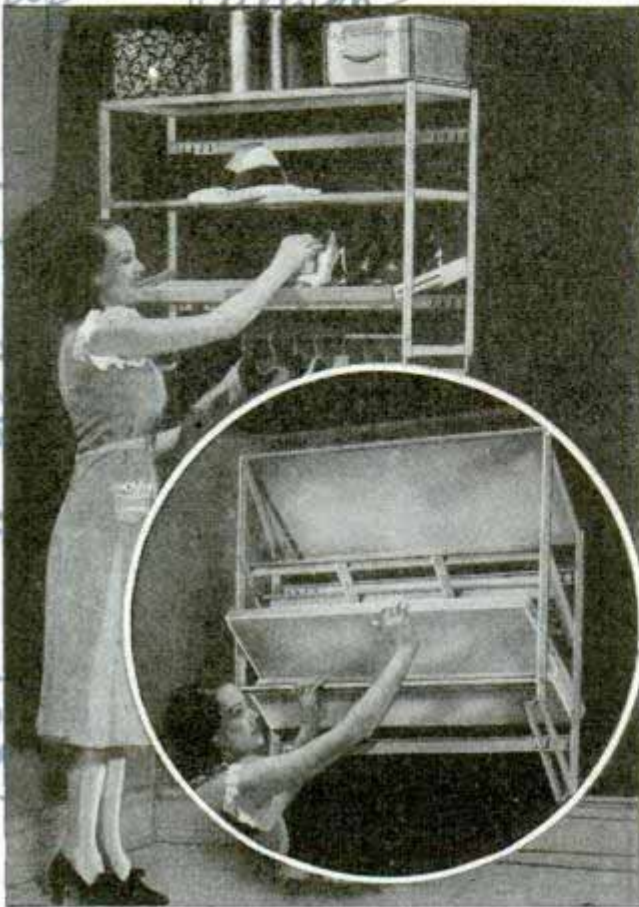

Clothes closet rack in place. Inset, folding rack against wall of the closet

Increasing closet capacity by permitting storage of clothing more efficiently, a folding rack for home, apartment or office is on the market. Made of steel, it comes in standard lengths of two, three or four feet, or may be obtained in sizes to fit some particular closet. The rack is mounted on the wall with four screws. It provides a full-length hanger bar for coats, suits and dresses, a full-length shoe shelf, a ventilated hat shelf with dust cover, a general utility shelf and two belt and tie racks.

Flashlight Tray for Change Helps Sell Batteries



Sales of flashlight batteries multiplied when stores introduced a counter tray for change which flashes "thank you" when the

customer reaches for his money. On each side of the tray there is display room for three batteries, serving as a reminder to the customer.

741239

Speedy Single-Seat Fighters Lead Aerial Offense

Claimed to be two of the fastest single-seat fighting planes in the world, the "Hurricane" and the "Spitfire," shown on the opposite page, are being produced in quantities for Great Britain's Royal Air Force. The "Hurricane" has a rated speed of 350 miles per hour, but has attained slightly more than 400 miles an hour in some tests. It has a liquid-cooled Rolls-Royce twelve-cylinder engine which develops 1,100 horsepower. The ship can climb to 15,000 feet in six minutes and has a service ceiling of 39,000 feet. Split flaps enable it to land at sixty miles per hour. It carries eight guns, four in each wing. The "Spitfire," an all-metal plane, is reported to have a speed of about 400 miles per hour. It also is driven by a Rolls-Royce engine.

741265

Table Shaper for the Workshop Has Tilting Motor Holder

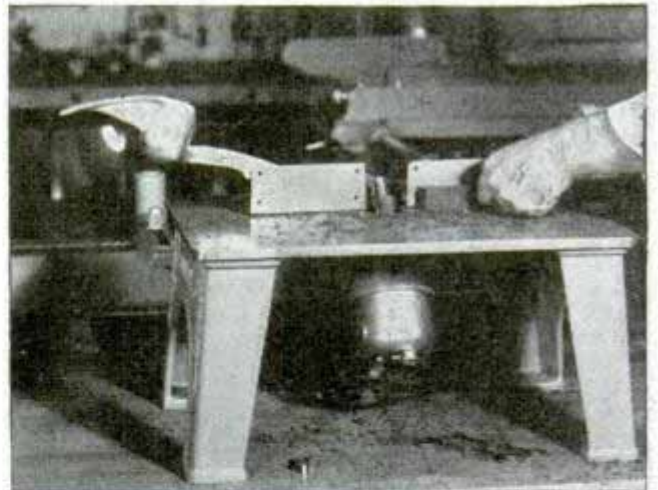

This table shaper with tilting motor is handy for the home or professional craftsman

With a tilting motor holder that permits changing the angle of the motor, a table shaper can be used for tonguing and grooving, rabbeting, rounding over corners and all types of molding cuts. It has a three-eighths horsepower motor. An adjustable straight guide and a safety guard with spring tension are available for use with the shaper.

*Stanley Tools
195 Elm St*

*Vogel. Peterson C. Chevy. Chicago
H. J. Wolcott
Ray-O-Vac Co
Madison Wis
H 1217
3012*

Latest Fighting Planes Fly Six Miles a Minute

see opposite page

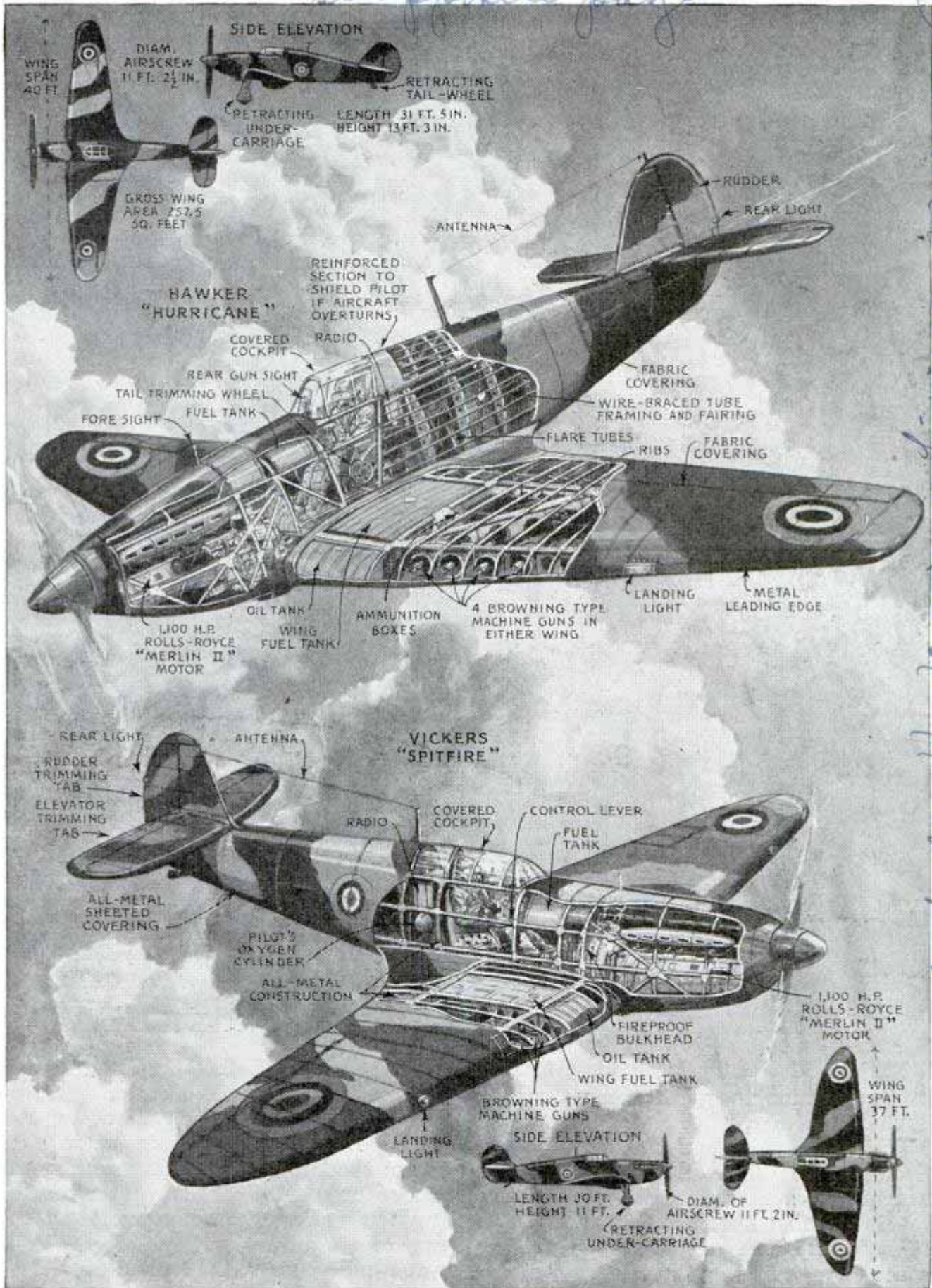

Cont. to H. Davis' 'Lemmers', 'Hellside Road', Surrey, England

Here are drawings of England's latest fighting planes, both of which are rated at speeds around six miles per minute. Note Browning-type machine guns in wings of both ships

Cont. to H. Davis' 'Lemmers', 'Hellside Road', Surrey, England

Latest Liner Is Larger than the "Queen Mary"

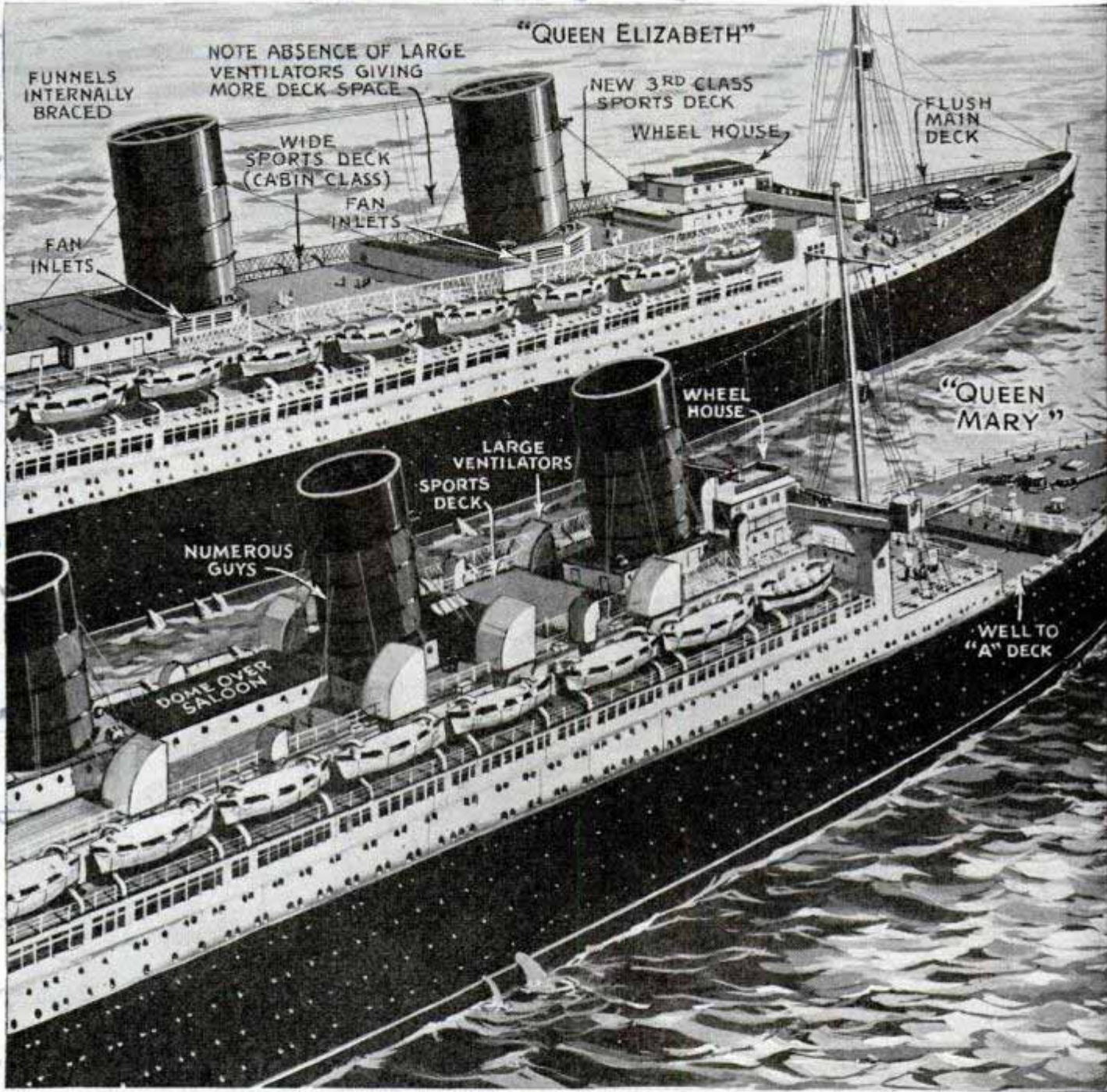

Outstanding in this comparison of "Queen Elizabeth" and "Queen Mary" is the vast increase in deck space. Note, in the new liner, that provision has been made for a third-class sports deck

INTRODUCING the latest ideas in ship construction, the gigantic new Cunard-White Star liner, "Queen Elizabeth," was launched recently at Clydebank, Glasgow, Scotland, and the work of fitting begun. The great passenger-carrying vessel is ten feet longer than her sister ship, the "Queen Mary," and offers considerably more deck space than either the "Queen Mary" or the big French liner, "Normandie." This is due to the absence of large ventilators and to the lowering of the main saloon's height on

the "Queen Elizabeth." Space on deck is reserved for sports activities of first, second and even third class passengers. Reducing the height of the main saloon eliminates the necessity for interrupting the run of the sports deck, as was the case on the "Queen Mary." Another feature of the new ocean queen is the use of very large water-tube boilers, the largest ever fitted into a ship. They are so large that they could not be lowered into the vessel in one piece, as is usually done, but had to be

Built at Shipyard of John Brown & Co. Ltd., Glasgow, Scotland

Sumner, Hillside Road, Ewell, Surrey, England.

Queen Elizabeth is 10 feet longer than the Queen Mary.

Giant Boilers to Drive the "Queen Elizabeth"

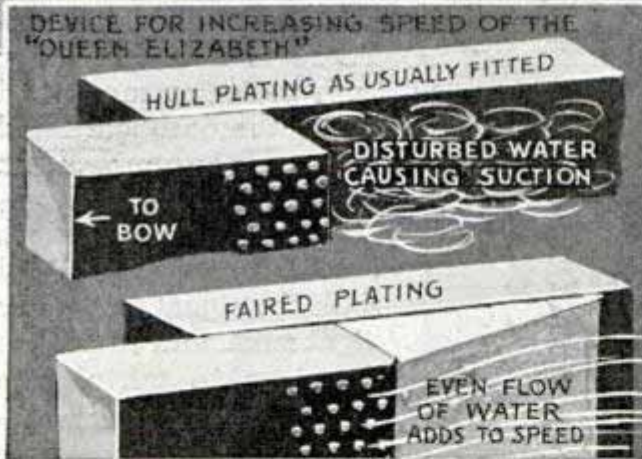
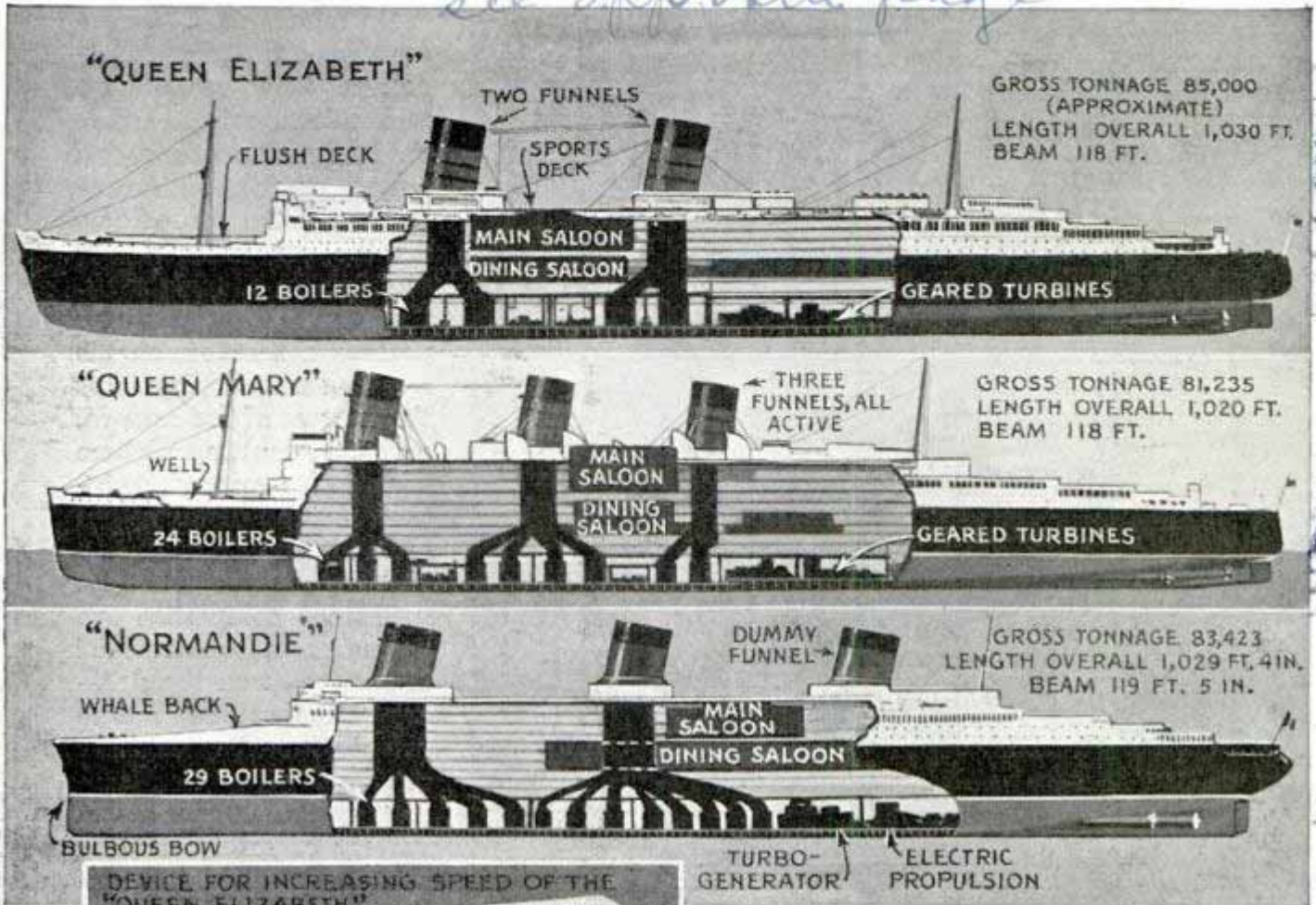

made in sections and then fitted together in the boiler rooms. The boilers are in four stokeholds, making it possible to fit only two funnels. The "Queen Elizabeth" has finer lines forward than the "Queen Mary," with a greater rake to the bow. When it was found that very little water came aboard over the bows of the "Queen Mary" in a gale, for which she was provided with a well, this type of construction was eliminated in the "Queen Elizabeth" and the main deck was carried forward flush to the stem. Still another feature is the provision of expansion joints to take the strain off

Above, note difference in number of boilers in each ship. Left, fair plating gives new liner more speed

the lighter metal of the superstructure when the ship is "hogging" and "sagging" in heavy weather. To decrease skin friction and "drag," all the underwater plating has been faired, producing an increase in speed without adding to the power plant. The "Queen Elizabeth" has only twelve boilers, compared to twenty-four in the "Queen Mary" and twenty-nine in the "Normandie." Her tonnage, approximately 85,000 tons, is larger than either of the other two vessels, the "Queen Mary" having 81,235 tons and the "Normandie" 83,423 tons. Thus the new ship will offer large cargo space. Instead of big ventilators that robbed passengers of deck space, the "Queen Elizabeth" has fan inlets through which air is drawn to ventilate all parts of the ship. The inlets are located inconspicuously around the funnels at deck level. Another deck-clearing device on the new liner is bracing of funnels internally, eliminating numerous guy wires, such as are found on the "Queen Mary."

Windshield Camera Snaps Speeder with Proof

maker - Traffic - I am going to submit at national safety congress 1933 W. Madison, Chicago

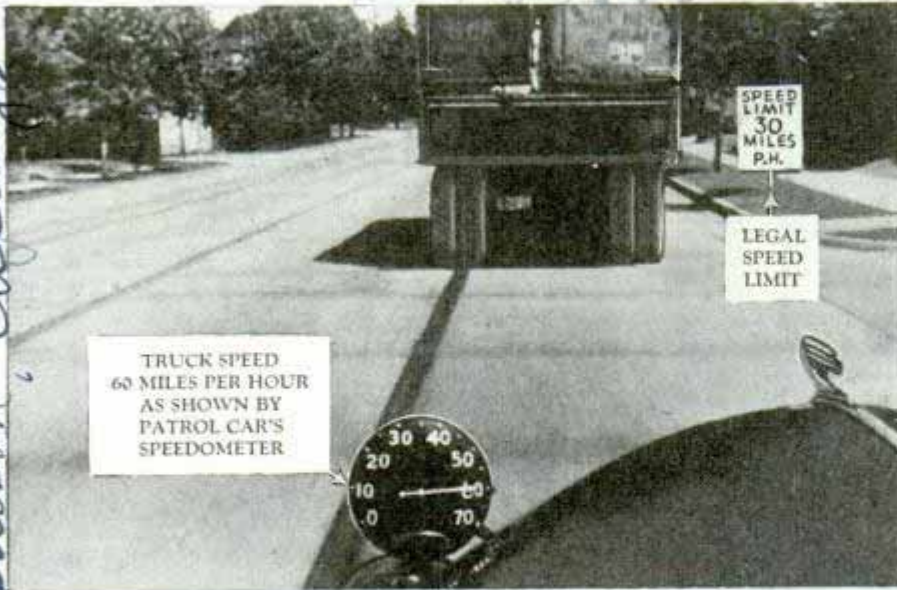

By mounting a speedometer on the front fender and a camera on the windshield, police or private investigators can collect photographic evidence against speeders. As the car trails a law violator on the highway, the pursuing driver presses a button on his steering wheel. This trips the shutter of the camera, and the resulting picture shows the speed registered on the meter at the moment, the car ahead and its license number. Insurance companies are using this method of checking up on the drivers of insured cars. One private investigator's car outfitted with this "candid" camera carries also a variety of safety devices and test instruments. There is a brake tester with indicator mounted below the dashboard and a speed governor lock which helps in checking speed violators. Levers below the steering wheel flash the signal for left or right turn, and there is a directory to which the driver can refer for numbers of cars to be watched.

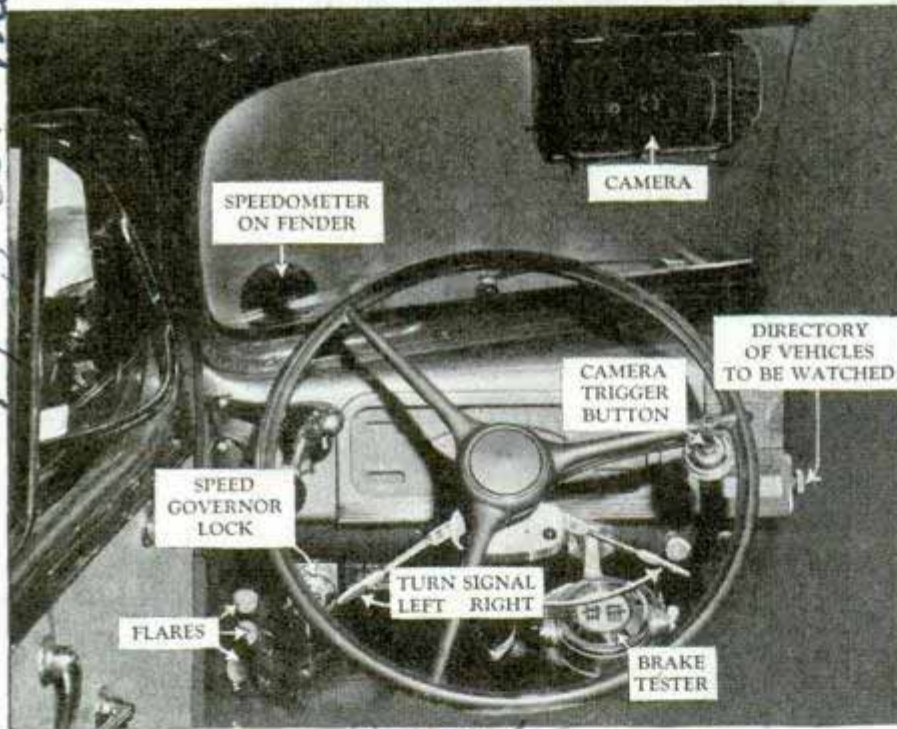

Top, picture snapped by windshield camera shows speedometer, speed limit sign and truck violating law. Below, "cockpit" of investigator's car

Typewriter Sends on Telephone to Telegraphic Printer

Newspaper reporters covering a news event in the field may soon be able to typewrite their stories and transmit them simultaneously to the city editor over telephone wires. A simple telegraph printing system which has just been patented makes possible the use of the telephone instead of the private leased wires such as carry the news of the great press associations today. Thus the cost of transmission can be cut to the mere tolls the telephone company would charge for a local or long-

distance call for the actual time the line was kept busy. The invention is that of W. G. H. Finch, formerly assistant chief engineer of the Federal Communications Commission. The transmitting device is a special typewriter keyboard which may be carried by the reporter or any field worker requiring portable telegraphic printing facilities, and is operated from the nearest telephone. It feeds its signals into the telephone line by electrical induction without actually touching the wire.

Science Service 10/27/38

Pat. # 2,133,811 Finch Telecommunications Laboratory 37 W. 57 St

*Electric Co. 12818 Cort Road
Cleveland Ohio.*

Nickel-Lined Cargo Ship Built Like Submarine



Resembling a submersible ship, the "Dolomite IV" is really a tanker plying the Great Lakes and Atlantic. By steam-cleaning its nickel-lined hold it can change cargo overnight from molasses or kerosene to grain

More like a submarine in appearance than the traditional freight steamers of the Great Lakes, a Diesel-powered cargo ship made her maiden voyage recently with 1,200,000 gallons of kerosene in her nickel-lined hold, unloaded her cargo and took on a load of wheat in the same tanks the next day. The entire ship was welded. The hull was made of electrically welded steel channels bent to form the main structure, and this entailed no less than forty miles of welding. The five cargo tanks were lined with sheet nickel welded to the frame, and

at the seams. The nickel lining permits shipment of corrosives in bulk, and immediate changeover from oil or other liquid cargo to grain, for the tank walls are rapidly cleaned by means of steam jets. In regular service on the lakes and between Atlantic and gulf ports, the ship named "Dolomite IV" is intended to carry kerosene, wheat, molasses, lye, oil and other products. The vessel never was actually launched. Built in a dry spur of the old Erie canal, the "Dolomite" was floated by siphoning water into the lock.

Lighted Film Viewer Magnifies Negative for Inspection

Lighted from beneath, a desk-type film viewer has a magnifying lens at the top to enlarge the image for close inspection. An entire strip of negatives can be drawn through the tunnel from side to side for examination. Since the film need not touch any part of the viewer, there is no danger of scratching it. The light plugs in on the house electric circuit.



Examining a strip of film under magnifying glass

Mop with Wringer Attached Is Dried by Twisting Key



Attached to a new household mop is a wringer of its own. A few simple twists of a key winds the mop tight and squeezes it practically dry. Metal parts are cadmium-plated.

H1183 Quick Lube. \$1.00 up.

*Quick Lube Mop Co.
1523*

Dolomite name built by Dolomite name

*Examining a strip of film under magnifying glass
Dausch & Lomb
Optical Co.*

"MINNIES" Supply

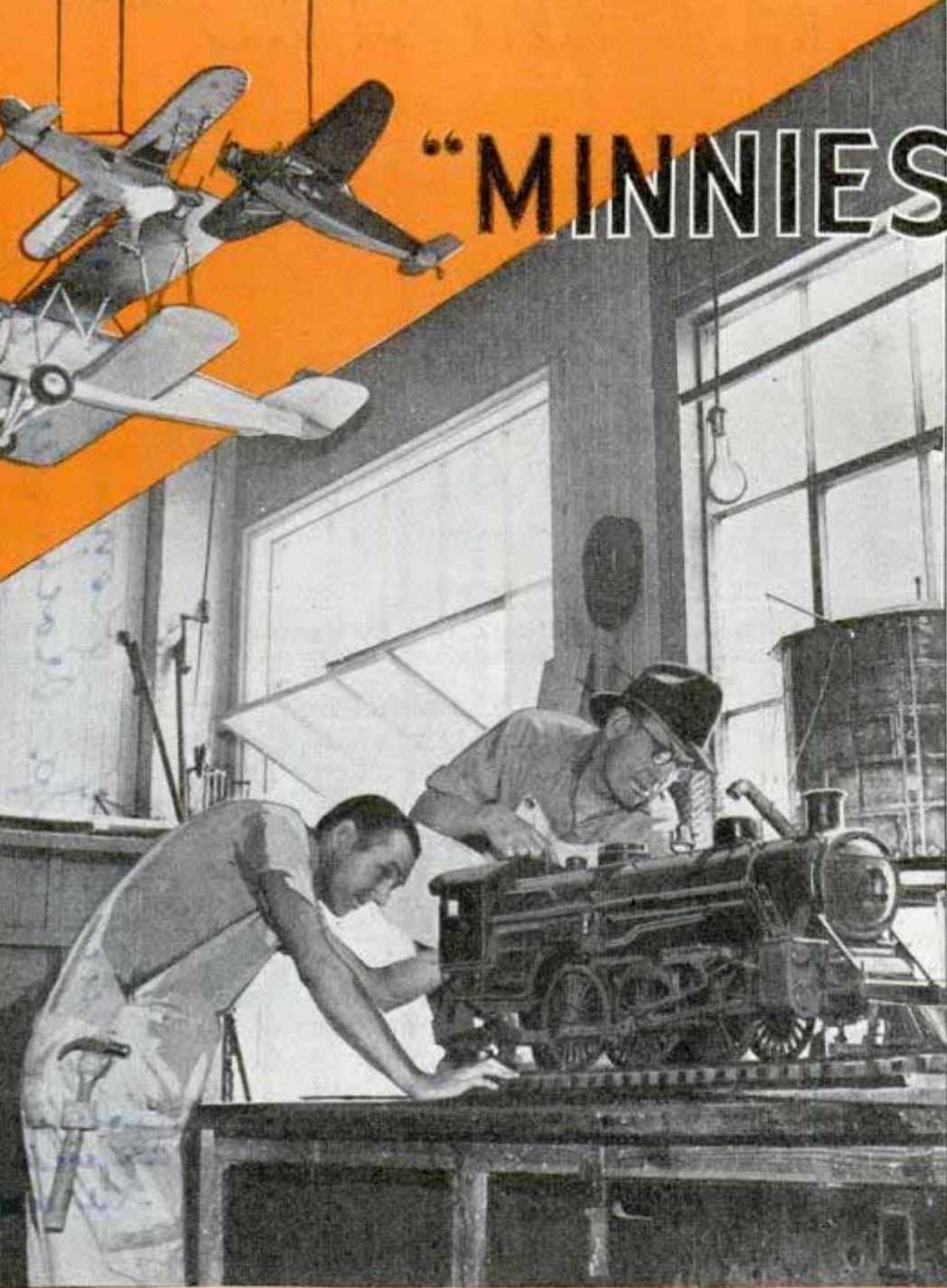

boats and the prow of the ship buried deep in a plaster iceberg that extends to the ceiling. By means of hydraulic jacks, the entire set is tipped to simulate the natural list of a ship. The davits holding the lifeboats are operated by electric winches and with passengers scurrying around in a terrified manner, the commands of the crew blending with distress cries, the crunching of ice on the deck—all amid an overhanging fog—the scene is vested with startling realism.

The actual collision is effected by means of miniatures and the process screen. First, the iceberg is built so it sticks a foot or two above water in a studio tank and is filmed by a camera moving toward it at a speed com-



Top, miniature builders preparing train for movie. Bottom, models of principal sets in "The Adventures of Robin Hood" were used to plan action and determine camera angles before the full-size set was constructed.

ON THE theater's screen, an ocean liner is plowing through a choppy sea. Suddenly, an iceberg appears. A crash is inevitable and there is the crunch of steel against ice, then a grim picturization of tragedy on the high seas.

Engrossed in the story, you do not question the realism of the scene. But afterwards, perhaps, you wonder how such an effect was attained. Filming such a sequence, you know, would be impossible, even though you disregarded the sheer impracticability of it.

The answer lies, partly at least, in miniatures.

In order to weave this action into a film, a slice of an ocean greyhound is built on the sound stage, showing life-

Ent. James Mc Queeny
 439 W. 60 St. Toledo
 Kansas City, Mo

PUNCH TO MOVIES

parable to the speed of the liner.

After the life-sized prow has been constructed, a process screen is placed in front of it. On the bridge are stationed two men looking into the transparency as if they were trying to catch a glimpse of an iceberg in the fog. As soon as the first glimpse of the iceberg flashes onto the screen, action on ship-board starts, carrying out the illusion that the ship has ripped into the mass of ice.

This is but one example of the way in which miniatures are being used on the screen. When stage-coaches go over cliffs, don't weep for the horses going to their doom. They're only miniatures. If a submarine is split asunder, a city burned to the ground, or a native village swept away by a hurricane, it's usually more of the same. War films of land and sea, and usually, the air, would be pretty tame affairs if it

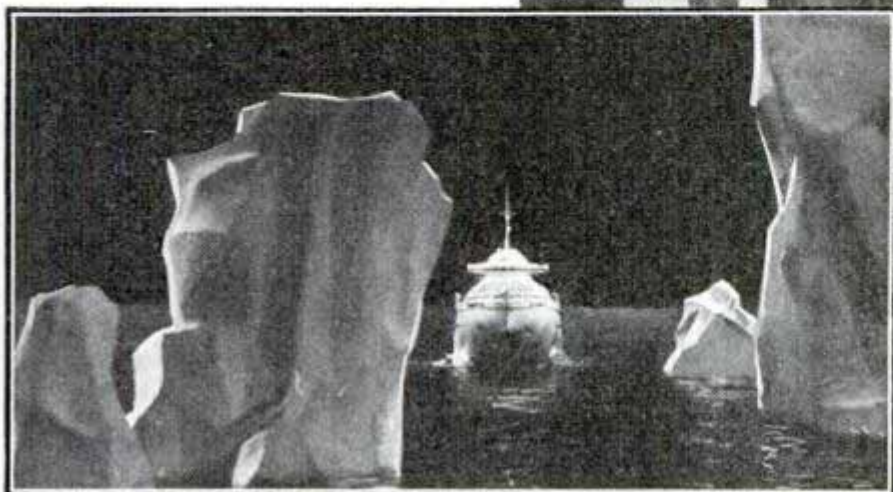

Top, preparing inflated figure for "A Midsummer Night's Dream." Bottom, model of modernistic ocean liner used in the film, "The Big Broadcast of 1938"

R. Beresford, Jerequino expert and inventor of the model

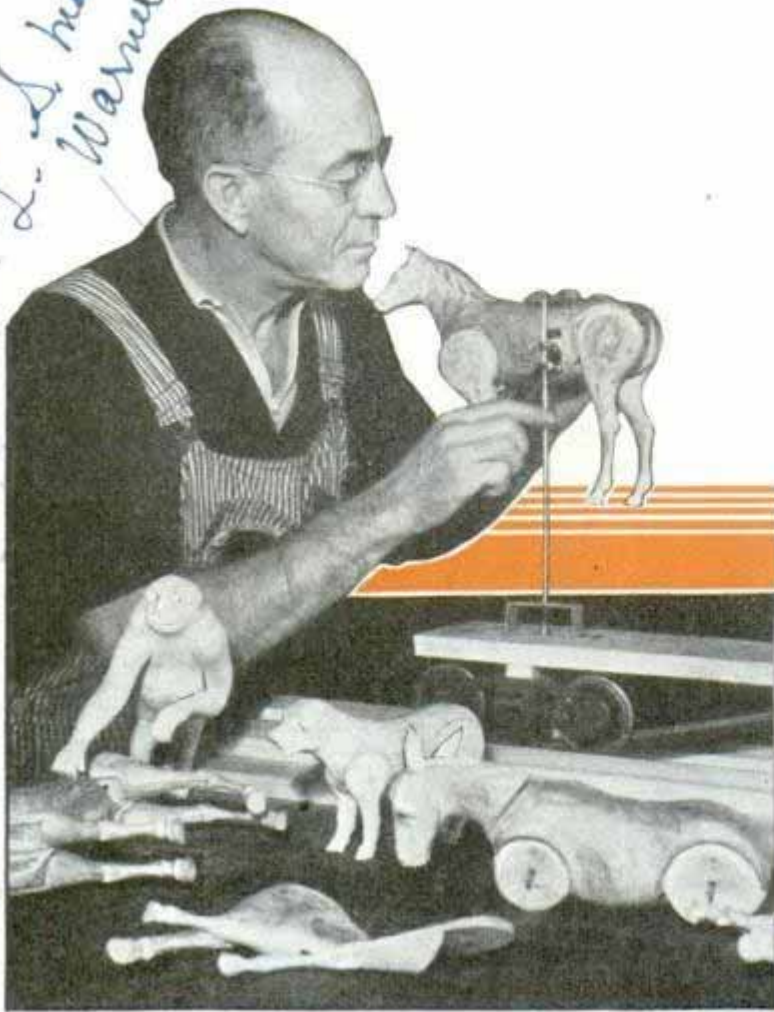

In "Submarine D-1," the submarine comes to the surface in the path of a gunboat and the latter rams into its side. Slowly the submarine sinks. A shadow appears on the water and then fades away—the submarine is on its way to the floor of the sea. Expert engineering skill and \$25,000 worth of labor and materials went into a twenty-five-foot submarine controlled from an electric panel on a barge. Under the direction of James Gibbons, Warner's No. 1 special effects man, studio workers produced a working model. Nine one-horsepower motors furnished its power and there were ingenious mechanisms for guiding and submerging it. This plant was in a sealed section and the rest of the underwater boat was so arranged that it would sink in a credible manner. Near the prow

weren't for "minnies" and that goes double for pictures featuring mine blasts as was the case in "Black Fury" and the earthquake in "San Francisco."

Four square miles of buildings were burned and \$2,000,000 went up in the smoke of the great Chicago fire of 1871. Translating this catastrophe to the screen was done with a huge miniature of the city and lake front as it looked at the time.

Covering four acres of ground and costing \$25,000 to build, the model provided for many spectacular effects, including the illusion of huge clouds of gas bursting into flames hundreds of feet above the main blaze; iron girders melting and a river ablaze with burning oil.

For long shots, direct views of the conflagration were spliced directly into the film as part of the running action. These were only momentary flashes, however, as the film makers will not run the risk of having a miniature detected by keeping it too long on the screen. Other angles made of the burning city were projected on a transparency before which the actors performed and the whole re-shot.



Top, building animation into animal carvings. Center, model plane built for film of crash into mountain. Below it is racing plane resting on plaster mountain. Bottom, miniature plane before crash

was placed a breakaway plate, a section that would remain airtight while the boat was in operation but which would buckle as soon as the cruiser plowed into it. So perfectly did the costly toy function that an underwater camera made an excellent record of the craft as it sank to its grave.

The effect produced in a miniature is heightened by the completeness of the supplementary close-ups. A recent film called for the wreck of a crack train. Engines were built in the studio shops and the long shots turned out without any trouble. For realistic close-ups a string of Pullman cars were routed into a large shed converted into a sound stage, jacked up and tipped over one another with their trucks being pulled at right angles across the tracks after having been dismantled. Rails were uprooted and twisted; steam pipes were laid from boilers to points where coupling and hose connections would naturally be broken. This escaping vapor, together with the mud-splattered passengers, the first-aid crews, and trainmen gave the scene the proper authenticity.

A miniature is so built that it may be filmed from many different angles and not infrequently does it provide background for dozens of scenes. Generally, they are built one-forty-eighth the size of original objects.

When whole cities are built, as is frequently done, they are complete with pedestrians, motor cars, surface and elevated cars, signal lights and other bits of animation that are found in the metropolitan city.

The most elaborate of
(Continued to page 116A)

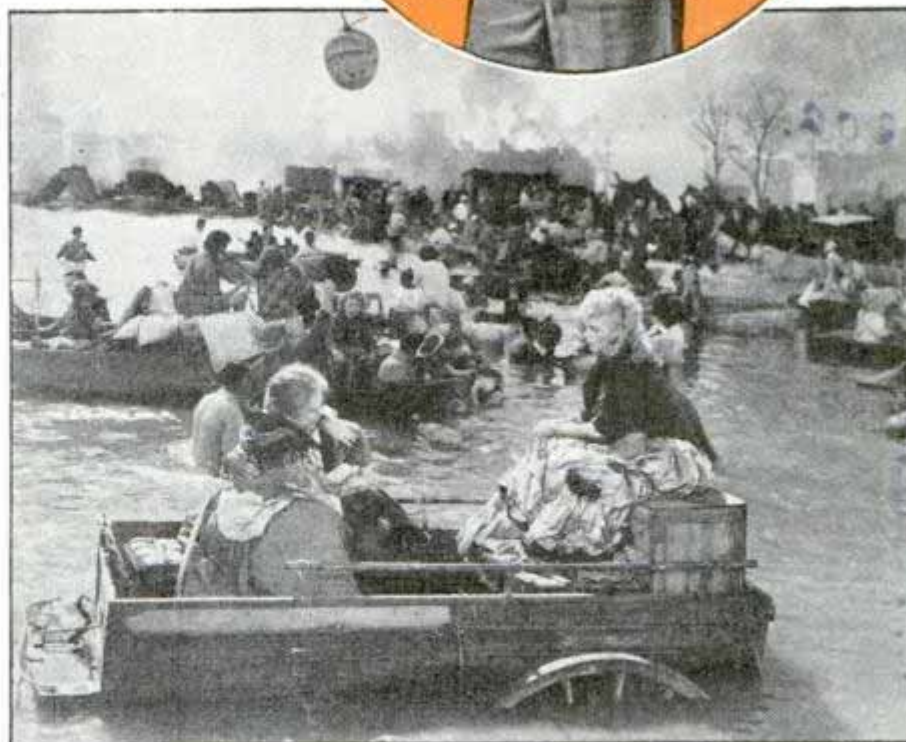

Top, scene from "King Kong," a triumph for the miniature builders. Center, model transport being strung on guide wire for action in film. Bottom, burning of Chicago in movie, "In Old Chicago"

Handwritten signature or note in blue ink at the bottom right of the page.

Gauge Checks Rail Alinement for a Hundredth-Inch Error

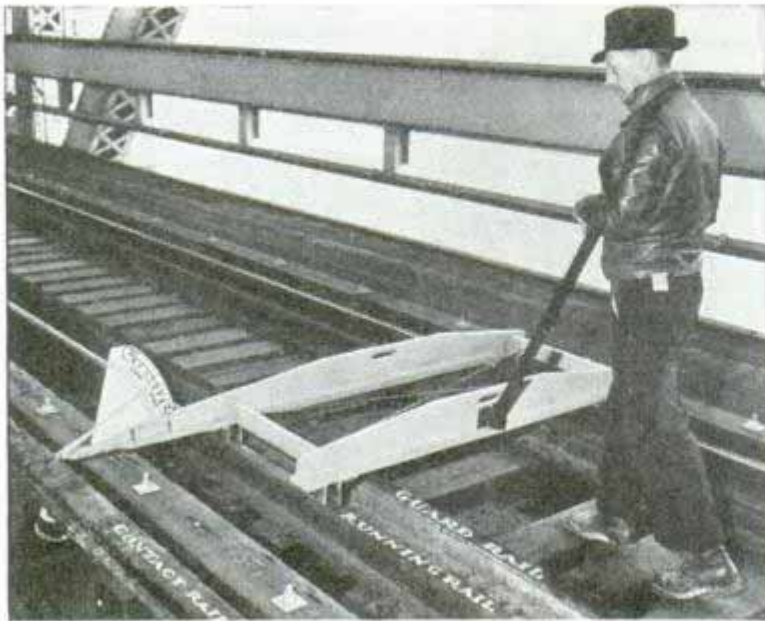

Inspector pushes gauge along interurban track of San Francisco Bay bridge and watches dial showing alinement of three rails

Variations as small as one-hundredth of an inch in alinement of rails can be detected by a gauge used on the third-rail line crossing the San Francisco-Oakland Bay bridge. Pushing the five-wheeled gauge along the track, the inspector watches a dial and measures the elevation of the third rail as fast as he can walk. The gauge at once checks the alinement of the running rail, height of the protection timber above the third rail and the horizontal distance from rail to timber, and the height of third rail above running rail.

Pocket-Size Explosion Meter Tests Combustible Gas



Concentration of combustible gases in the air can be measured with a pocket-size explosion meter which gives an instant reading. A single control knob turns the instrument on or off and adjusts its balanced electrical circuit. The sample of air to be tested is drawn in by a piston-type pump and flows over a hot platinum detector filament

which forms part of a balanced circuit. Combustion of gases on the surface of this filament increases the temperature of the wire and unbalances the circuit, causing a deflection of the needle on the dial. The meter weighs less than three pounds.

Sculptor Models Concrete for Fun as Well as Profit

After working with concrete for thirty-five years, a Wooster, Ohio, man turned to modeling in concrete as a hobby. Some of his sculpture is marketable, some is done purely for fun. A miniature dinosaur was built for display at a gasoline station. One of his most ambitious projects in concrete was a tiny amusement park on a table top. It included fountains, a lake to hold several small fish, a lighthouse and numerous animals, one of them a monkey on a tightrope. Other products of his hobby include a concrete mailbox and various garden decorations, such as animals, frogs and toadstools.



Dinosaur sculptured in concrete becomes an attraction at a gasoline filling station

Designed by L. V. Cantrell, State Inspected.
Designed by L. V. Cantrell, State Inspected.
Mine Safety Appliances Co. Broadway, Thomas and Meade
Pittsburgh, Pa.

#1202.

\$65.00

M. S. A. Explosion Meter

#1177

William A. Stein
318 W. Vine.

Sperry Mag. Brooklyn NY
Automatic Direction Finder Is Aid to Pilot
William R. ... American Airlines pilot

Latest radio aid to air navigation is an automatic direction finder that helps the pilot stay on course. Once tuned to a station, the device points continuously to the station so that the pilot need pay no attention to its operation, merely glancing at the pointer on its face. Developed by engineers of the Sperry Gyroscope company and the RCA Manufacturing company, the instrument indicates the exact bearing of the radio station to which it has been tuned. In addition, it immediately shows the pilot when he has passed over the station and gives positive information to confirm the "cone of silence" which he may have received if he has been flying on the regular radio beam. The direction finder also provides a means of obtaining a drift or "crab" angle at any given time. The pilot may tune in a station toward which he is flying and observe whether or not the heading of the airplane is constantly changing. It is only necessary then to turn the plane to the right or left and note the difference between the actual heading of the plane and



Acme.
 Automatic direction finder in cockpit of plane. Here the instrument is being set to tune in radio station

the direction of the station to know the amount of drift angle the plane must take. When flying along a regular beam, any station on the right or left may be tuned in and the pointer will show how far along the beam the plane has progressed.

H 12 10.
Two-Mile Conveyor Belt Hauls Tons of Gravel to Dam

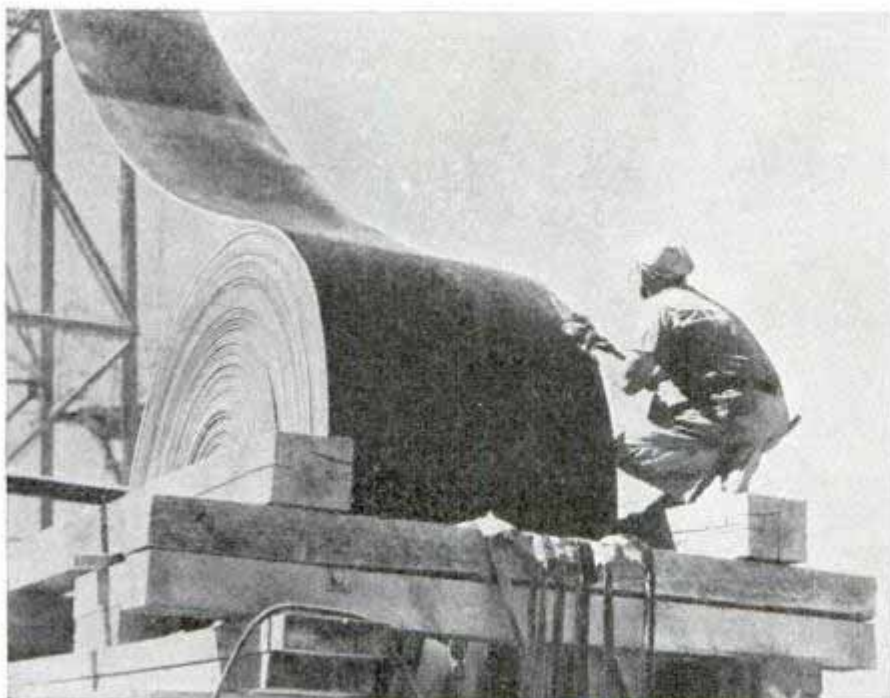

Unrolling two-mile belt used to haul sand and gravel at Grand Coulee dam

Two miles of belting does a job that would require a tremendous fleet of trucks in hauling material to the Grand Coulee dam. Mounted on roller-bearing rollers, this endless conveyor is capable of carrying 30,000 tons of sand and gravel a day to the site of construction. The belt itself weighs eighty tons.

There were 185,000 forest fires in the United States in 1937—one every three minutes, but eighteen per cent fewer than in 1936.

Dept. of Agriculture

"THEY'RE OFF!" *to* NEW

Cont. Philip Bailey. 122 1/2 5th Ave
Los Angeles. Calif.



THE parade to the post is an exciting time for the thoroughbreds and they grow even more tense as they arrive at the starting gate. The starter, on a raised platform by the inner rail, must exercise the patience of Job and the coolness of a general as he directs assistants and jockeys attempting to line up the jittery animals.

Just as the task seems finished, a nervous horse rears. Seeing its wild actions,

several others bolt from their starting stalls—and the starter has his work to do over. But at last they are all lined up as evenly as a platoon of soldiers. Then the starter presses the button which sounds the bell on the starting gate and the shout, "They're off!" echoes in thousands of throats.

Two-year-olds are the hardest to handle at the post. Before they make their first start, they go through much schooling.



Bunched at the turn and, above, track movie photographer recording start of race at Santa Anita. Rough riding is revealed by the movies taken at various points around the track

THRILLS

They learn how to enter the gate properly and to respond the second the bell sounds. The slightest noise may send these skittish youngsters off. Even a camera click has caused a whole field of two-year-olds to break. Fortunately most horses become better post actors as they grow older,

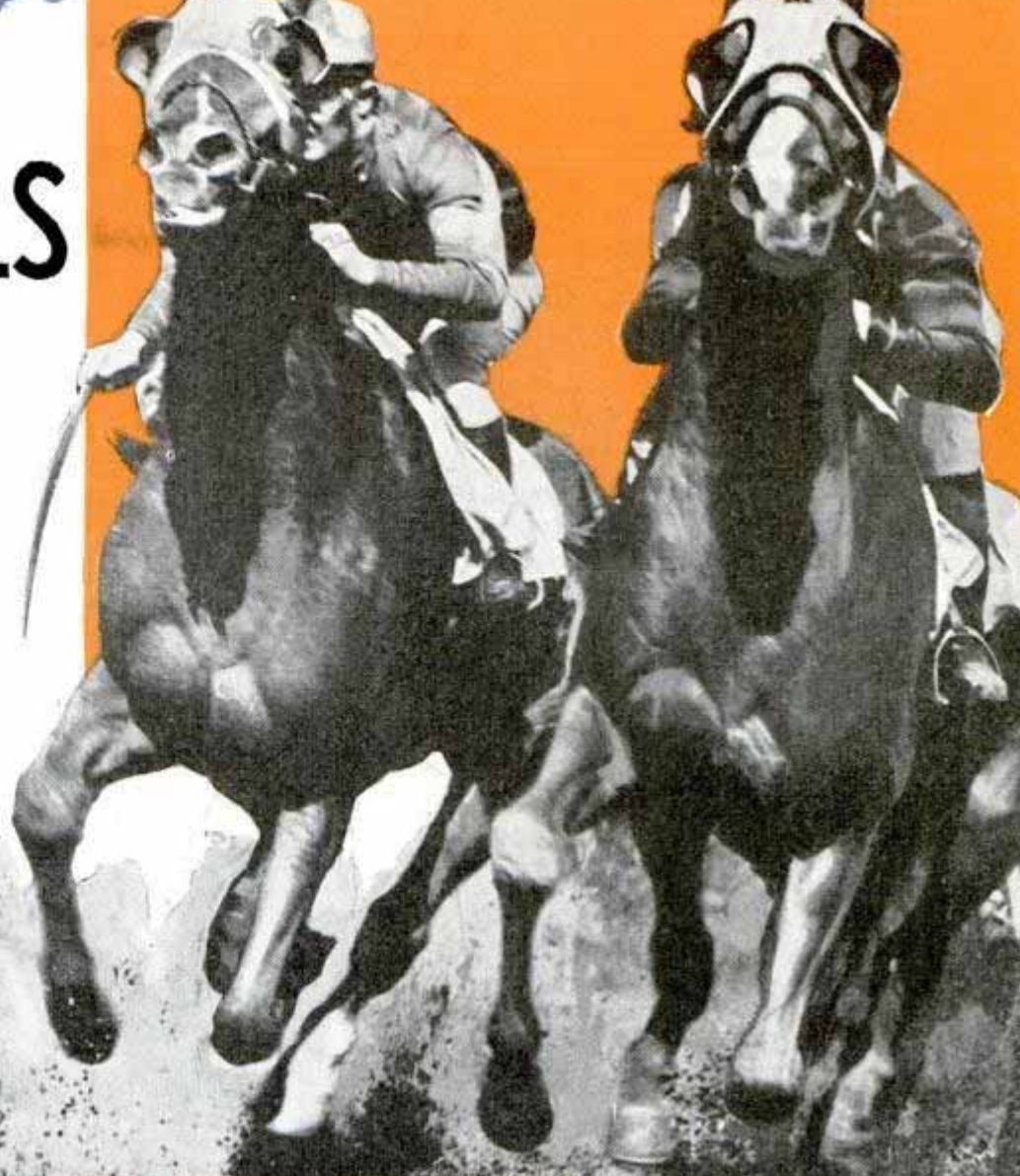

Neck-and-neck down the back stretch and, below, screen in enclosed paddock at Hollywood Park where finish, as seen by camera, is shown

Hollywood Calif.

but some who develop bad traits often grow worse.

The start is an exciting time for the jockeys too. Each tries to have his mount break ahead of the field at the bell. A horse reared so abruptly at a track recently that he hung his jockey on the starting gate. As he flew off his mount, the jockey's

clothes caught on an overhead part of the gate. He was helped down, not much hurt.

For years Johnny Adams, champion United States jockey for 1937, put on his "crash helmet" before leaving the tack room, just as all jockeys are required to do. The helmets are little black skull caps constructed of an Australian fiber. They are



worn under their silk caps. Johnny often wondered of what value it was to him. At the last Del Mar meeting he was on a horse that had never been started before. As it left the post it bolted for the rail. When the horse hit the rail Adams was knocked from the saddle. His foot caught in the stirrup and he was dragged for several yards before he fell to the turf. At the hospital they found the little black helmet dented and cracked by the horse's hoofs, but it had saved his skull.

Each new race track tries to bring more comfort with racing thrills. Latest of the million-dollar racing projects is Hollywood Park at Inglewood, Calif. Its most unique feature is an inclosed paddock built like an amphitheater at one end of the huge grandstand, which seats over 12,000 people. Here 3,000 fans may view the horses being

saddled at close range. The paddock is soundproof and has an artificial daylight lighting system so the horses will not be bewildered by the sunlight. The ground in the paddock and in tunnels, to and from it, is covered with redwood bark.

The grandstand and clubhouse follows the latest modernistic architecture. It is painted turquoise which has been found to cut off much glare of the California sun. Glass windows in the back of the stands and glass partitions on the sides make it draft free.

Hollywood Park has a sunken infield, in which there are three lakes, each at a different level, and two man-made waterfalls. Swans, ducks, and geese swim on the



The finish of a close race and, above, a dog which serves as a companion for one of the thoroughbreds.

Jockey - Johnny Adams
lakes and a girl in Dutch costume keeps an eye on them to see that they don't wander out on the track.

The tote board in the infield has been sunken so it doesn't affect the view of fans in the lower grandstand. The stewards' stand is on the roof and the jockeys weigh in after the races in an underground, glass-enclosed booth at the finish line. Thus there

is nothing to obstruct the view of the finish from any point in the stands. Three elevators in the grandstand and clubhouse carry people to the higher tiers.

From inner rail patrol judge boxes, it is easy to watch what goes on along the course. The large race tracks have patrol judges stationed about every sixth of a mile around the

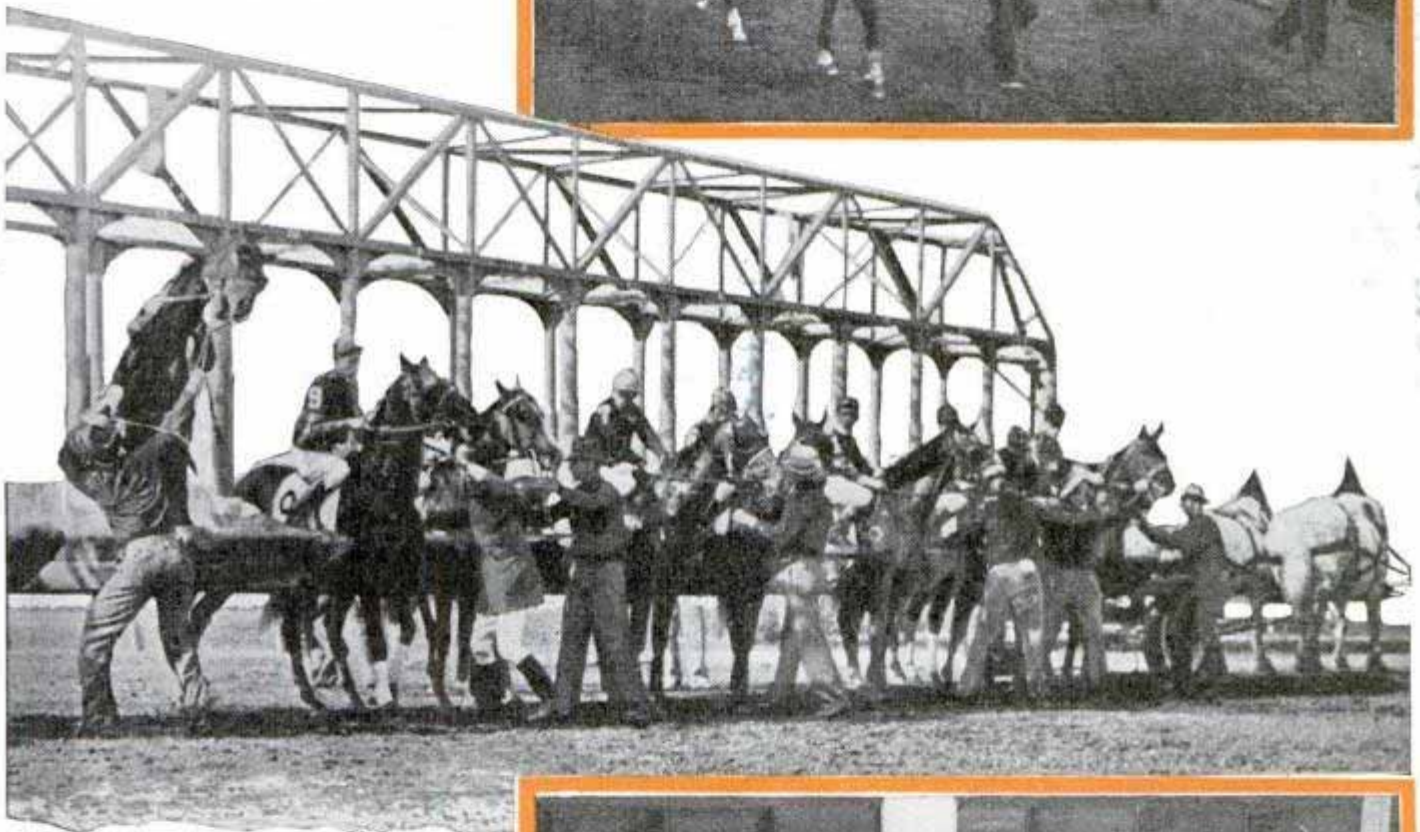
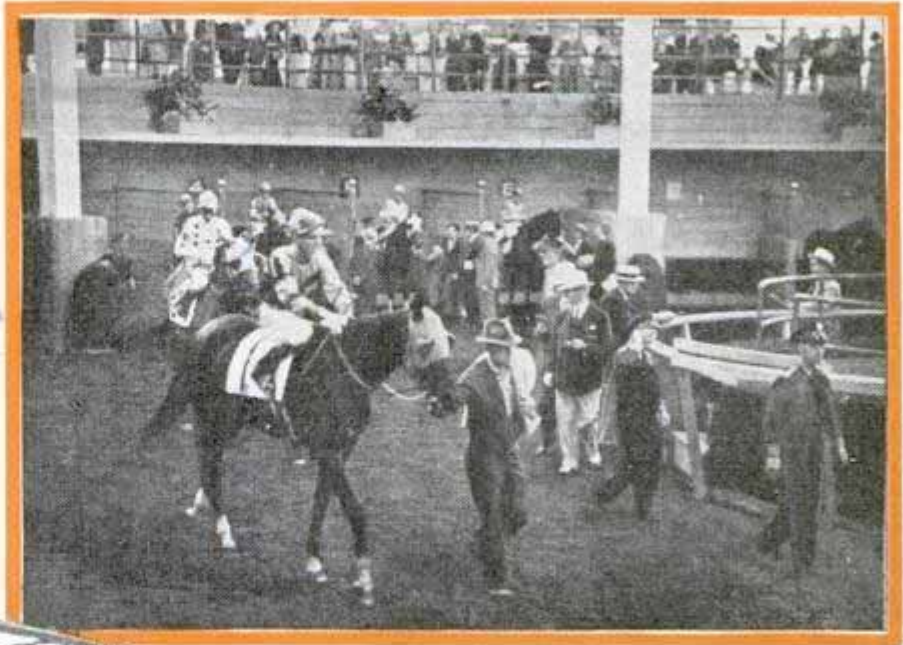

course. It is their duty to watch the horses as they go by their portion of track. They have telephones to notify the stewards if they observe anything improper. The new patrol judges' boxes are mounted on single steel supports sixteen feet above the track. The judge sits on a revolving seat, and is directly over the inner rail as he watches the race through binoculars.

Years ago horsemen
(Continued to page 146A)

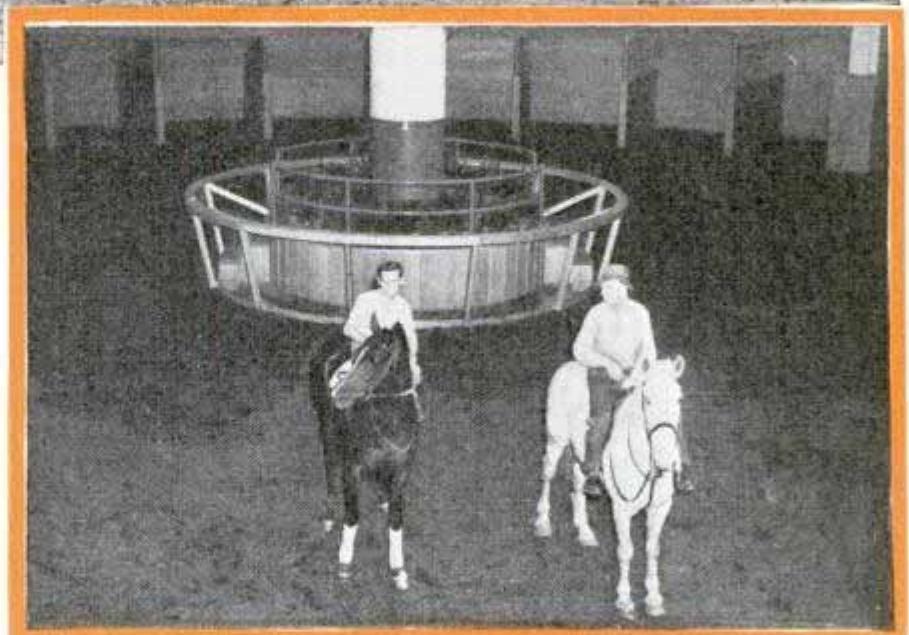

Top, horses leaving the inclosed paddock at Hollywood Park. Center, action at the post. Note horse rearing. Bottom, acquainting two horses with the inclosed paddock before crowd arrives

sucked. If these samples contain mercury vapor, some of the blue and ultraviolet light is absorbed, resulting in a slight shadow that is visible to the photoelectric tube at the end of the tunnel. As little as one part of mercury vapor to one billion parts of air can be detected by this means. The photoelectric tube then turns on a red light, warning of the presence of the poison fumes.

Bookshelves Form Building Frame and Save Space

Bookshelves in the Oregon state library at Salem will not only be built like a skyscraper, they will be part of one. Steel cases to accommodate 450,000 volumes form part of the frame of the library structure itself, thus saving not only space but also material and construction costs.

Rubber Disks Set in Asphalt for Non-Skid Traffic Marks



Photo shows successive stages of heating asphalt, preparing recess, lining it with hot tar and then laying non-skid traffic markers in place

Non-skid traffic markers recessed into the pavement are being tested for durability in Philadelphia. They are made of a hard-wearing rubber composition, of high visibility and skidproof qualities under adverse conditions. In laying them, the pavement asphalt is first heated with a blowtorch, then scraped out and the hole is lined with hot tar to seal the marker disk in place.

"Wet Wash" Street Sweeper Maneuvers in Tight Places

Teaming a steel brush revolving horizontally with a tough fiber brush revolving vertically, a street cleaner that washes as it sweeps will pick up anything from dust

to glass, scrap iron and bricks. A single front wheel makes it highly maneuverable, in order to sweep close behind and around parked cars and to clean the curb on narrow streets and sharp curves. It can sweep a "figure eight" on a thirty-six foot pavement. The small horizontal brush at the front sweeps refuse away from the curb to be picked up by the large vertical brush and tossed into a cubic-yard receptacle. The machine has a 140-gallon water tank and sprinkles the entire sixty-six-inch swath, softening encrusted dirt.



Sweeping a "figure eight" on a thirty-six foot pavement. A sprinkler and horizontal and vertical brushes do a thorough job of street cleaning

Austin - Western Machinery Co.

Underwood Engine
W. D. Ames Co. 1.50
Sax 4.00

15/1/80

Farrell Safety Road Marker, Ames
Austin, D. H.

Detector Finds Lost Radium at Hundred-Foot Distance



The highly sensitive radium detector goes hunting for a lost bit of the mineral in a wastebasket

Hunting for lost radium is no longer like the proverbial search for a needle in a haystack. So sensitive is a radium detector just invented that it will react to the presence of a bit of radium weighing only 1/29,000 of an ounce, at a distance of 100 feet. The inventor is Dr. L. F. Curtiss of the U. S. Bureau of Standards, shown demonstrating the device in the picture above.

"Radiator" Pipe Cools Smoke and Traps Irritating Tars

For a cool, non-irritating smoke, a "radiator" pipe with briar bowl and duralumin tubes is on the market. Scientifically designed, it has a radiator chamber of sufficient volume to hold the smoke and cool it between puffs, letting the objectionable heavy oils, tars and water vapor condense without reaching the smoker's throat. A

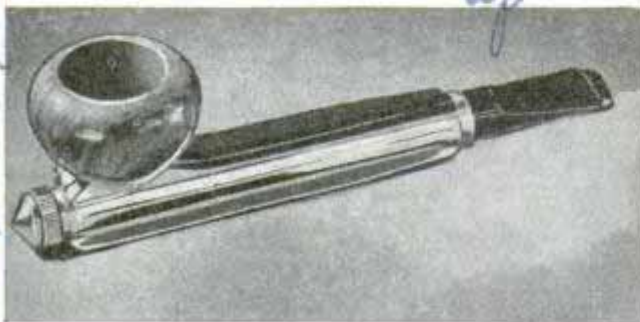

Irritating vapors are cooled and condensed in large duralumin chamber of pipe without reaching throat

valve prevents these condensed liquids from returning to the bowl. The pipe is readily demountable for cleaning, and its parts are interchangeable and can be replaced if damaged.

Pelican Ash Tray Snaps Its Bill to Swallow Burning Cigarette

Forgotten cigarettes left burning on the bill of a "pelican" ash receiver are swallowed automatically when the heat flips the bird's mouth shut. A thermostatic metal coil does the trick. Placed on the bill, a cigarette will continue to burn until its heat causes the coil to unwind, raising the bill and flipping the cigarette inside the bird. Ashes may be emptied from the base.



Reaper Harvests Sugar Cane at Twenty Tons per Hour

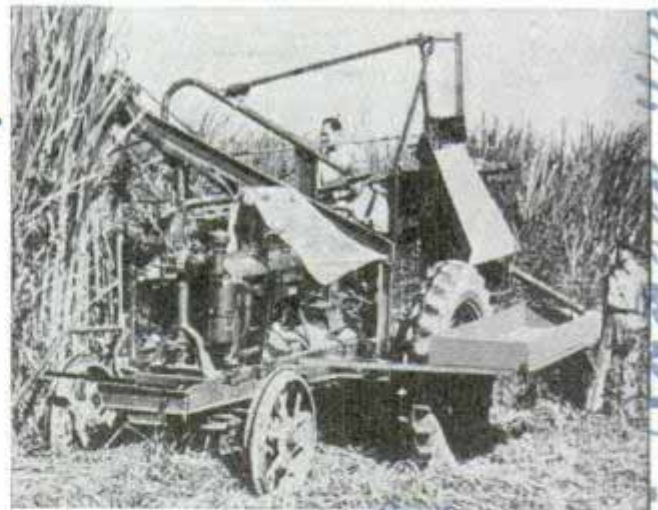

Mechanical reaper cutting sugar cane twice as high as a man. It does work of fifty machete wielders

Wading through a forest of sugar cane twelve feet high, a mechanical reaper proved it could top, strip and bunch the stalks at a rate of one ton every three minutes. The sugar-cane harvest has always been a hand operation, the field workers swinging machetes much as they did when Louisiana reaped its first cane crop back in 1795. The mechanical harvester can equal the work of fifty field hands.

Handwritten notes in blue ink:
- Top right: "magnified"
- Middle right: "82.50 retail"
- Middle right: "7' lops. d. l."
- Middle right: "Carpenter"
- Middle right: "Washing"
- Middle right: "Plantation"
- Middle right: "Pouite"
- Middle right: "Duck"
- Middle right: "Allan Ramsey"
- Middle right: "Canehub"
- Middle left: "H 1172"
- Middle left: "H 1129"
- Middle left: "H 1122"
- Middle left: "Wash"
- Middle left: "ap"
- Bottom left: "Kristen Pipe Co"
- Bottom left: "Boys 70-40"
- Bottom left: "Search Wash"

Caslagse Corp. 116-122 Chicago

Setting Up Type with a Typewriter Keyboard

One of the latest short cuts for the business office is a type-casting machine operated by a conventional typewriter keyboard. It was introduced at a recent exhibition of business machines, when a stenographer demonstrated that anyone who is familiar with the operation of a standard typewriter keyboard can cast printing type.

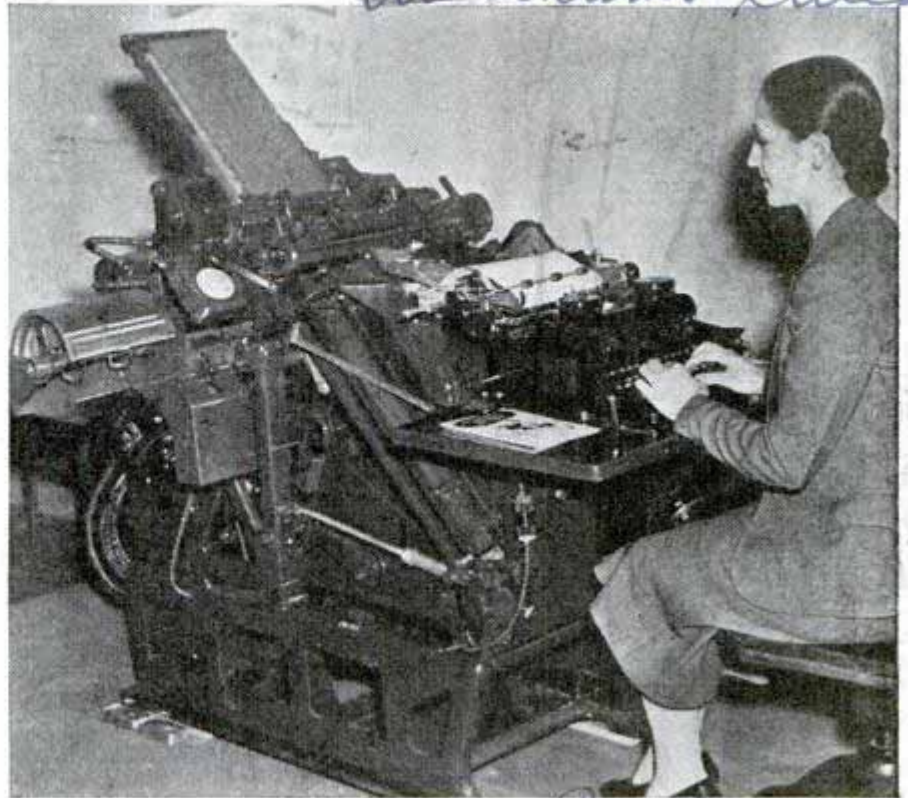

Here is a new way of cutting corners. Instead of typing copy and then turning it over to type-caster for second operation, the stenographer herself sets type with casting machine using a typewriter keyboard.

H. 1198.

Electric Heart Pumps Blood through Mechanical Lung

Human life may be saved some day by diverting the blood stream through artificial lungs and heart outside the body when the natural organs are damaged. Such a mechanism already has been tested in a laboratory, and proved capable of sustaining life in animals. A tube is inserted in the animal's vein and blood is sucked out by an electric pump. As the blood

travels to the mechanical lung, it is kept warm by water circulating in a glass tube surrounding the blood-carrying tube. The "lung" is a chromium-plated steel cylinder, rotating at several hundred revolutions per minute. The spinning spreads the blood in a thin film on the inside wall of the cylinder so that it can readily absorb oxygen flowing through the chamber. The blood thus purified by oxygen is then pumped back into the animal.

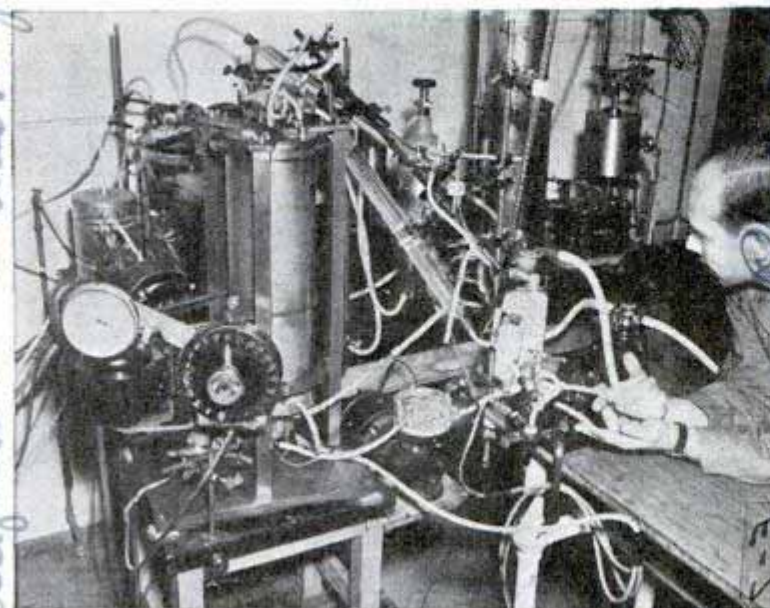

Cylinder at left is artificial lung. Slanting glass tube in center holds warm water to keep blood at proper temperature

Pink and Blue Potatoes Taste Just the Same

It may not be long before the corner grocery sells you potatoes to match the table decorations or the wallpaper. Potatoes with "color appeal"—pink potatoes, blue potatoes, reds, yellows, russets, whites; whites with blue eyes or red eyes, and potatoes that are purple all the way through, have been developed. Forty different varieties, all edible and tasty, have been exhibited at the Pennsylvania state department of agriculture.

Designed and built by Dr. John W. Robinson Jr.

medicine. Philadelphia 1200

Christian Science Monitor 10/8/38

Pellies in Harrison Dept.

Harroburg Pa

How Faces Are Made to Order for the Movies

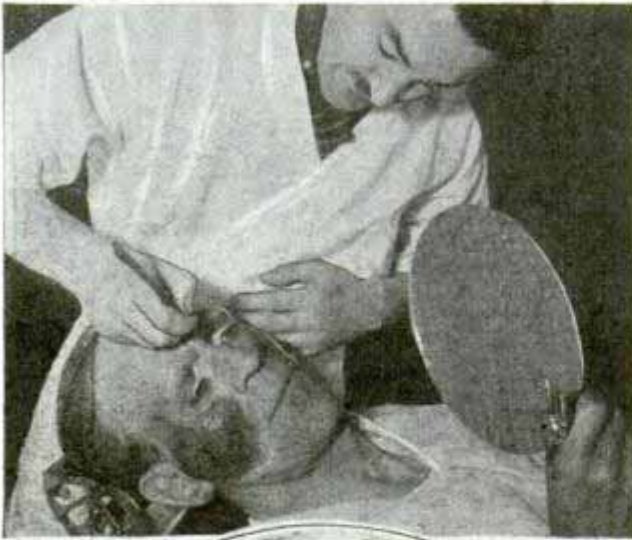

Faces are made to order for the movies with the aid of a plastic substance known as No. 6, the invention of Jack Dawn, makeup artist. With this material, an actor's features can be revamped to conform with those of a known character or a copy of a historical face can be molded and superimposed on the actor's face. While wearing these thin, gelatine-like masks, a player can smile, yawn, laugh or cry and the plastic will react as though it were a part of his own skin. Being porous, the material absorbs perspiration and can be applied or removed without harming the skin. Its use also permits the actor to be made up in an unusual way without physical discomfort. If he is to be depicted with a deep scar on the forehead, No. 6 provides one quickly, whereas the old method called for the skin of the temples to be pinched together and held by drying colloid. For "Marie Antoinette," Dawn transformed Robert Morley into such a perfect likeness of the original Louis XVI that it was possible to use an actual portrait of the king in one sequence where the actor appeared beside the picture. Dawn changed a veteran character actor into twenty-year-old Franz Josef for "The Great Waltz," then aged him into the seventies.

Top, Jack Dawn making up Boris Karloff for "War Lord." Circle, Karloff ready for camera. Bottom, photos showing transition of John Barrymore into tramplike character for "Bulldog Drummond Comes Back"



times, the operators' voices rising and falling through heavy static, but today the pilots can hear the messages as easily as if they were connected by telephone.

Aviation radio is making tremendous strides. Scores of improvements to transmitters and receivers have increased range and reliability and have made garbled, distorted voices practically a thing of the past. Static is being controlled much better than before. Radio's new status permits "on schedule" flying through all sorts of weather and enables dispatchers to control the planes with the ease of chess players moving their men. Every kind of situation is handled safely. If three or four airplanes are stacked up in the clouds above an airport at the same time, all wanting to land, the dispatcher holds all except the lowest one in the air, flying different courses on the adjacent radio range and at 1,000-foot differences in altitude until the lowest plane has landed. Then, one at a time, he drops each plane down another 1,000 feet and clears the lowest for its approach. Airways are divided into blocks, and clearances to proceed from block to block, depending upon the weather conditions ahead, are radioed the pilots in flight.

"Radio today is aviation's most versatile handy man," states James Flynn, superintendent of communications for American Air Lines. "Now that we have trained it

to do so many jobs we are going to load still more work on its shoulders."

So rapid is the advancement that radio systems that were brand new last year are partly obsolete today. The modernization program goes on continuously. Similar progress is being made in bringing up to date such radio aids as the Department of Commerce radio beam stations. Some of these radio ranges are being relocated so that one of the beams points straight down the landing runway of an adjacent airport. All

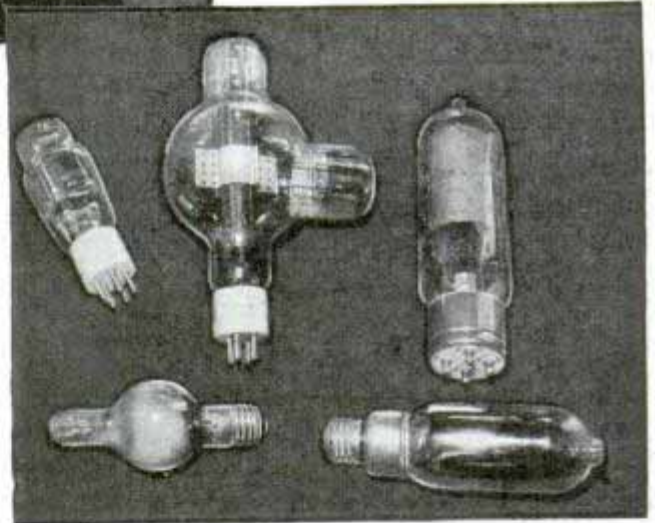

Top, field dispatcher telephoning air-line operations office. Bottom, various kinds of tubes used in airways radio communication

the stations are being improved to eliminate having to switch off the guiding signals while the periodic weather broadcasts are made. The cones of silence above the stations, used by pilots as a way of keeping track of their progress along an airway, are being changed from negative to positive signposts by using small transmitters that radiate identifying signals vertically above the stations.

Useful as the radio beams are, they are sometimes confusing to pilots. Blind spots in which the beams fade out, wandering beams that bend one direction on one day and another the next, and split beams and other quirks have kept pilots from depending on them too completely. The lo-

cation of a station seems to have an influence upon its reliability and some of the stations are being moved to new locations. For precise navigation inside small areas "localizer" beam stations are being installed, operating on wavelengths different from the main airways beams. Eventually, the present beams are to be replaced by ultra high-frequency beams that will be even more reliable. In fact, the whole trend in aviation radio is toward short waves since these insure more reliable communication for every purpose.

The first step in this short-wave program is the installation of twenty-two fan-type radio markers along the airways this winter. These marker beacons throw up vertical curtains or fans of signals across an airway, giving a pilot a positive check on his position. They will be used for traffic control, as warnings of the proximity of high ground, and as "let down" markers in making blind ap-



proaches. The radio markers operate on seventy-five megacycles and their pattern at 3,000 feet in the air is three miles wide and twelve miles long. The antenna of the marker beacon consists of horizontal rods

(Continued to page 124A)

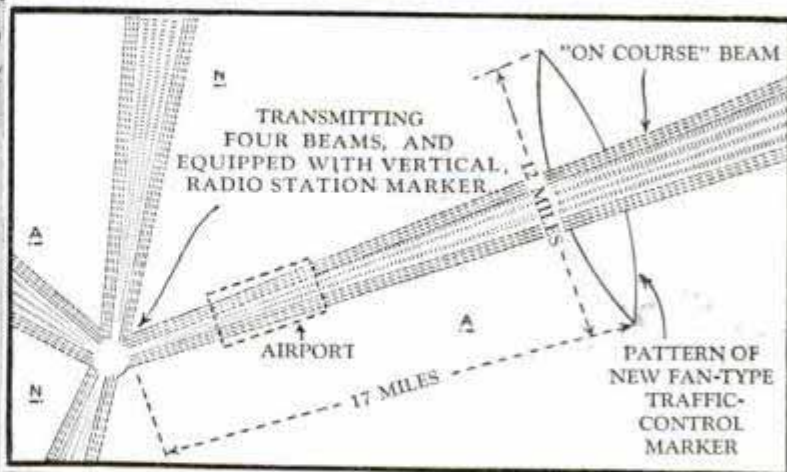
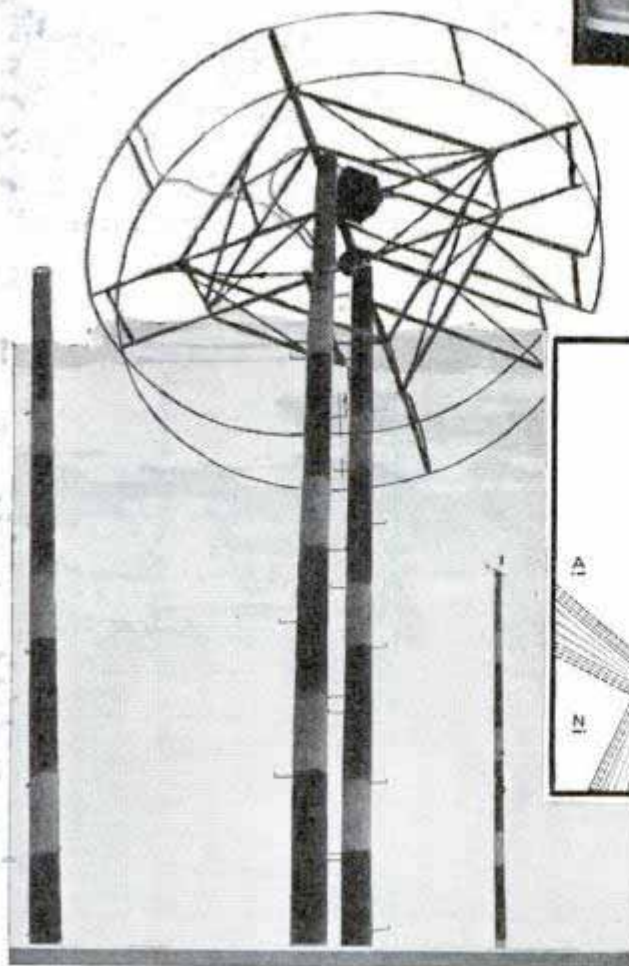

Top, another view of dispatcher, showing battery of loudspeakers, each of which is connected to phone system. Left, "squirrel cage" type of transmission antenna. Right, diagram of new fan-type radio marker used on the airways

Tree Trimmer Wears Stilts Made of Aluminum Tubing



Orchard worker speeds his work by walking on aluminum stilts which are adjustable to various heights

Stilts are being used by orchard workers instead of ladders, for greater safety and speed in getting around. The stilts are made of adjustable tubes of aluminum alloy, one tube sliding inside the other. They can be locked in any stage, increasing the wearer's position above the ground from thirty-one and one-half inches to sixty-eight and one-half inches. The cast aluminum footplates are also adjustable for different sized shoes. Each stilt weighs nine pounds. A carrier for pruning shears and other tools is provided on one stilt.

Colored Mirrors Stud Highway to Show Type of Road Ahead

Red, white and amber reflectors to mark the center line of the highway and indicate, by the color, the hazards of the road ahead are proposed by a Texas inventor. The buttons would reflect headlights and would be visible 1,000 feet ahead at night.

If the road is straight and safe, white reflectors would tell the driver so. Amber reflectors would indicate a curve or hill, and red markers would warn of a crossroad or railway. Markers being tested in Texas cities are made of malleable iron finished with porcelain enamel, virtually indestructible, the reflectors being set in the housing to protect them from traffic.

Electric Light in Doorknob Illuminates Keyhole

To light up the keyhole at night, an electric doorknob can be installed in place of the old knob without any wiring. A tiny bulb beneath the knob floods the keyhole with light at your finger touch; entirely self-contained, it is operated by a flashlight battery.

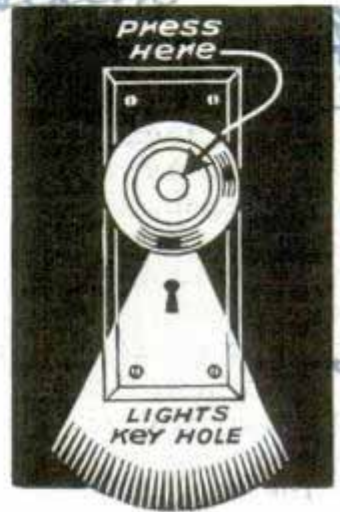

Portable Desk Phone Booth Handy in Noisy Office

Designed for use in noisy offices, a portable soundproof telephone booth is installed by merely placing it upon a desk or table. The booth is twenty-two inches wide, twenty-four inches high and nineteen inches deep, so shaped that users may write as they use the phone. Although it

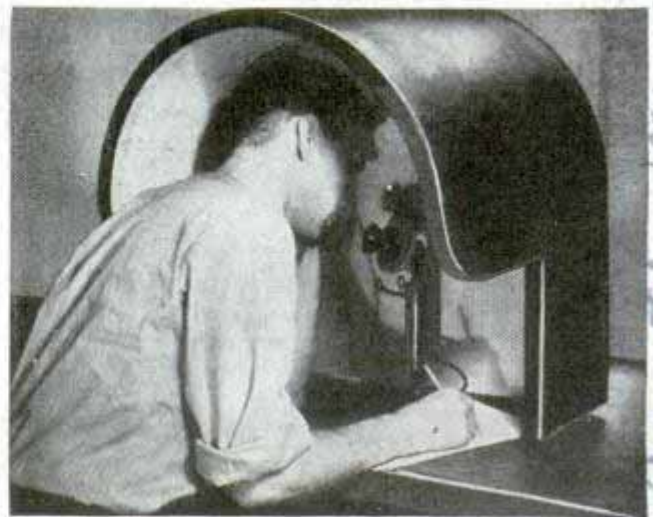

Using the desk phone booth which is insulated to absorb noises in office

Burgess Battery Co.

(Inv. W.C. Lauch, 1035 Holwood Ave. Kent, Ohio)

U.S. Pat. 2,113,611
H 1136
Presente.
\$25.00 per pair.

H 1123

H 1157

H 1155

Van A. Hamilton

James W. ...
Chicago

has no door, the booth absorbs virtually all interfering outside noise. It is lined with a "quieting sheet" material that absorbs instead of excluding the noise, thus creating a zone of silence around the telephone. The quieting sheet consists of an outer layer of perforated metal plate, behind which is a thick, soft sound-absorbing blanket. Similar sheets are being used on engine mufflers, air ducts, airplane cabins and other places where noise is a problem.

41120
Compressed Air Opens Doors of Homemade Tool Chest

From scrap lumber and metal, Lyman Loetscher of Livingston, Mont., has built a tool kit whose compartments open, close and lock by compressed air. It is a bird's-eye maple chest large enough for 1,600 tools, compact enough to be portable, and consisting of three rotating trays, four drawers and two special compartments. One lever opens the lid, unlocking the lower doors and drawers. Another lever lifts the trays which then are hand-rotated to select tools. A third lever cuts off the air. The chest is connected to a compressed-air nozzle, a one-inch cylinder eighteen inches long being sufficient to raise the lid. It requires only thirty pounds of air.



Compressed air, controlled by three levers, opens lid and drawers of this maple tool chest

Box 301, Oak Park
Adjustable Step for Ladder Adds Safety and Comfort

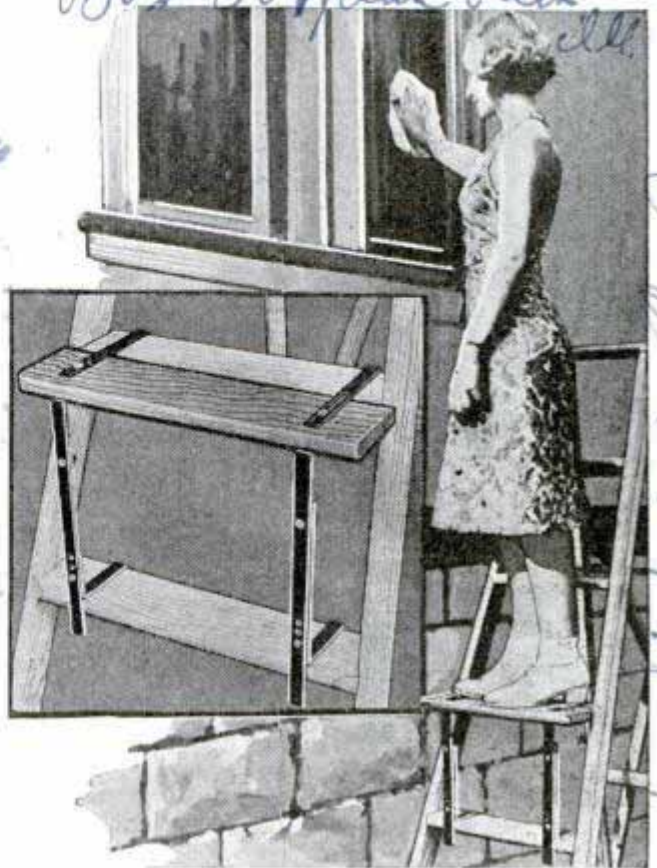

Inset shows that width of the step is doubled by attaching the adjustable step, which fits any ladder

Work on a stepladder can be made safer and more comfortable at the same time by installing an adjustable step which fits any ladder. It makes the platform wider, and is adjustable either for higher riser or for wider step. Rigidly built, it will support a 250-pound man easily.

41153
Portable Electric-Oven Unit Will Roast, Bake or Broil

Big enough for the family dinner, a portable electric oven brings the advantages of electric cooking to the small home. It weighs thirty-five pounds and has a cooking area of 1,415 cubic inches.



For roasting, baking or cooking, the oven unit is placed in the bottom of the oven; for broiling, it is placed in the top.

Landers, Harry's Clark
 1937, Pinball Sts

The
 inst
 Thank

Comfy Step mfg. Co., 10-23-37

380 Whitehead Road 9/29/38

Portable Car Brake Tester Helps Equalize Wheels



Taking a reading of the braking power of one automobile wheel with the portable tester

Braking power on each wheel of the automobile can be measured individually by a portable tester just introduced. Accurate and easy to operate and read, it is mounted on rubber-tired wheels and weighs only forty pounds. By testing each wheel separately, it helps to equalize opposite wheels and distribute braking action properly between front and rear wheels.

H 1150

Bags of Rock Dust Guard Mine from Coal-Dust Explosions

Clouds of inert rock dust form an effective way of preventing and limiting coal-mine dust explosions, the U. S. Bureau of Mines has found. Coal miners soon may see paper bags on little platforms near the ceilings of mines, if the new method is widely adopted. The bags contain limestone treated so that it does not absorb water. When the first shock wave of an explosion sweeps down a coal mine and blows coal dust with it, the vibration shakes the bags off their platform. A wire rips open the bags and the rock dust spreads to form a barrier that has two functions. If it falls into coal dust so heated that it is about to explode, the rock dust will absorb the heat

Washington

and lower the temperature below the ignition point. Too, the presence of the rock powder in the air helps to dilute the coal dust and makes the explosion less severe.

Rubber Lines for Tennis Court Let Concrete Expand

Rubber expansion strips such as are laid in concrete pavement joints are now being used to line tennis courts. The white rubber strip is permanent, making it unnecessary to renew paint, lime or tape. At the same time the rubber joint protects the surface of the court, letting the concrete expand and contract without cracking.

H 1124

Cylinder Gauge Reads Directly on a Dial Indicator

Cylinder size, taper and out-of-roundness can be read directly with micrometer accuracy on a gauge that has a dial indicator. It has a tripod centering device and can be used to measure over the entire length and circumference of the cylinder, showing up any pockets, distortion or wear at any part of the wall. The dial can be read at a distance easily. There is a master gauge for setting the dial to standard cylinder size.

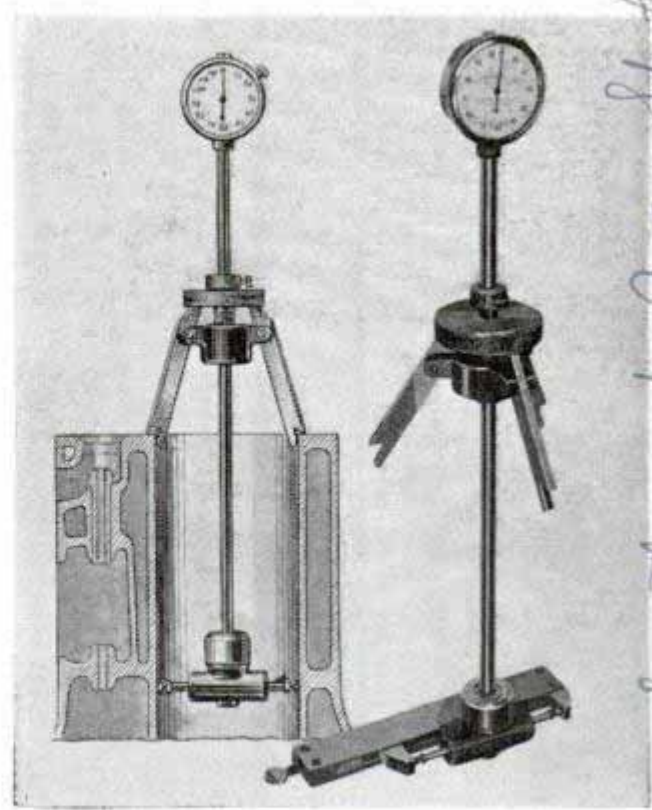

Tripod cylinder gauge and a drawing showing how it takes inside dimensions of cylinder wall

mechanical drawing school
and Southwest Av. St. Louis, Mo.

the Duay. Norris

Expert Divers Put Big Wheels on Flying Boats

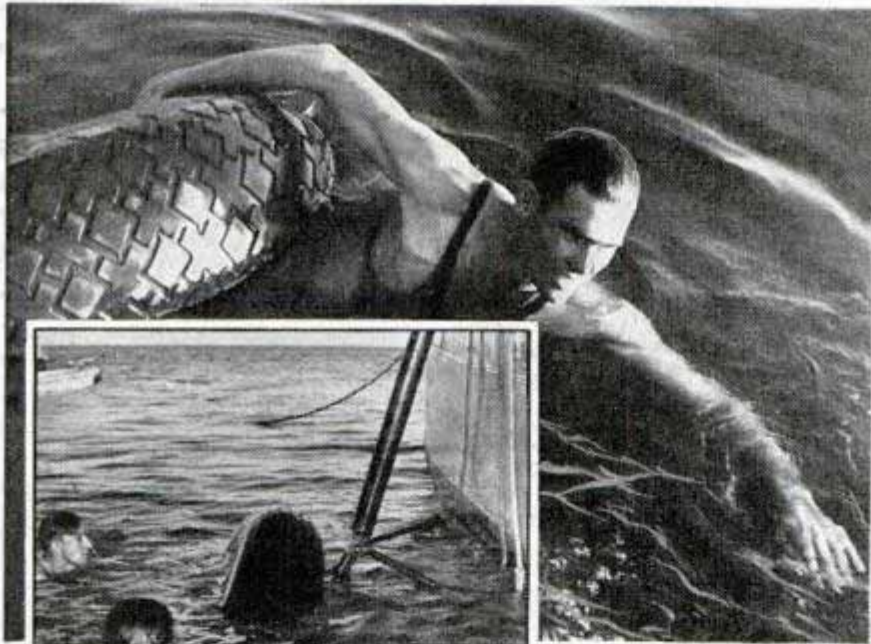

135 E 42nd Street
 Before Pan-American Airways' flying boats can be rolled out of the water at Miami, Fla., expert swimmers and divers must attach big wheels and tires. Top, a flying boat lands. Left, swimmer towing huge tire to the plane.

Above, it takes two divers about five minutes to get the big wheel on its axle securely enough to support the weight of the flying boat

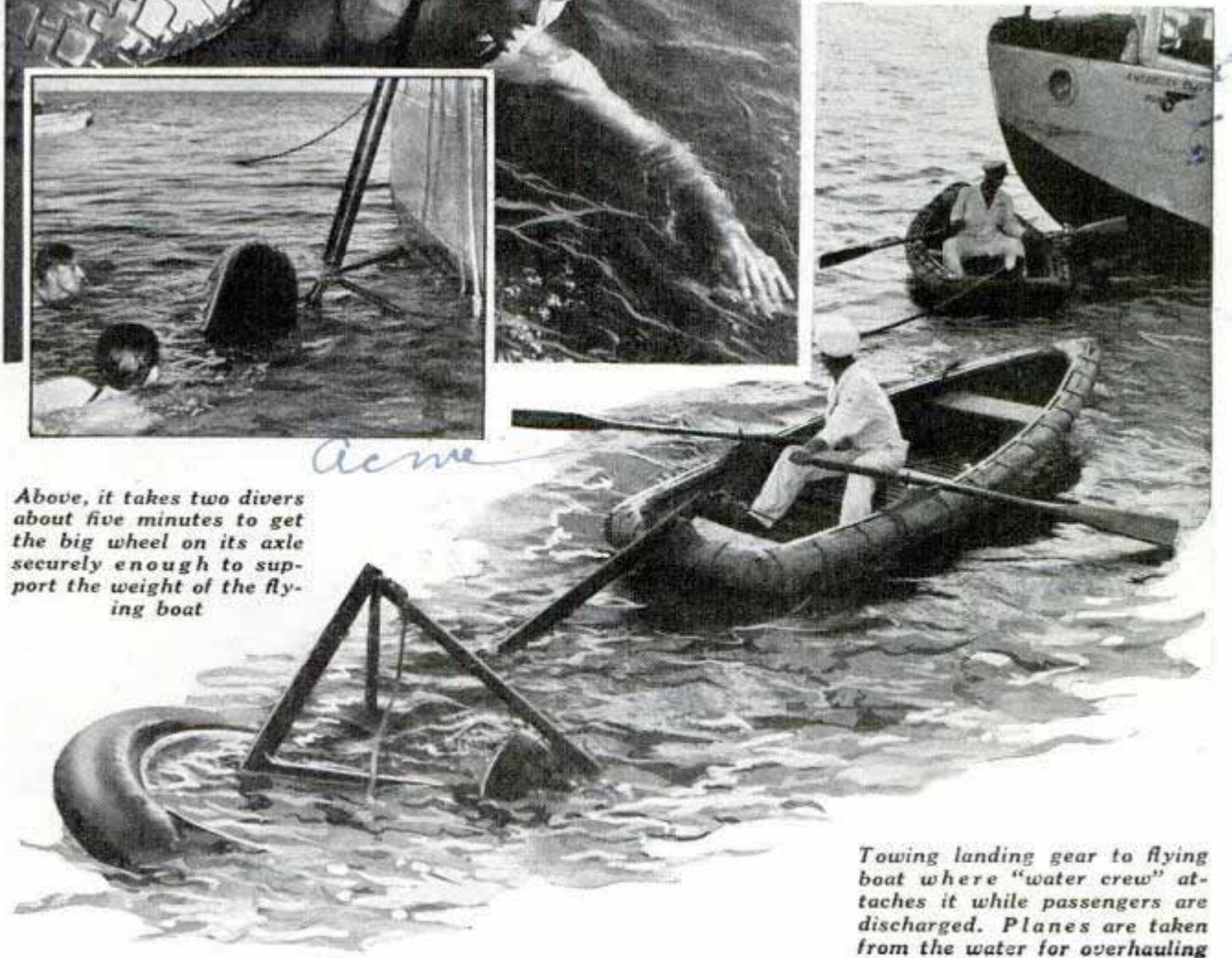

Towing landing gear to flying boat where "water crew" attaches it while passengers are discharged. Planes are taken from the water for overhauling

was before flying boat
 135 E 42nd Street
 was before flying boat

TAMING

HAVE you ever seen oil wells go on a rampage and catch fire? Here is how it happens:

A well is about to be brought in. The derrick stands on the open plain, steam boilers near by with smoke rising from their stacks. A few automobiles are drawn up near the rig. Men are working on the derrick floor. Suddenly someone shouts. A rumbling fills the air, drowns out the chuffing of the pumps. Men scurry from the derrick, running for their lives.

Behind them a gray column of gas and oil screams through the derrick with a bellow that can be heard for twenty miles. Timbers swish into the sky like toothpicks. In a few seconds a thundering detonation shakes the earth and the derrick is enveloped in rocketing flame

Reader says this was Haven's first wild well
at La Blanca, near Edinburg, Texas



Top, fire fighters inspect flaming oil well from behind tin shields. Bottom, left, dredge being sprayed with water as it digs away dirt from buried casing. Right, casing being pulled into position with cables. Note size of the crater. In this photo the fire has been extinguished, but stream of gas and oil rushing from casing is visible

721099
960121

WILD WELLS

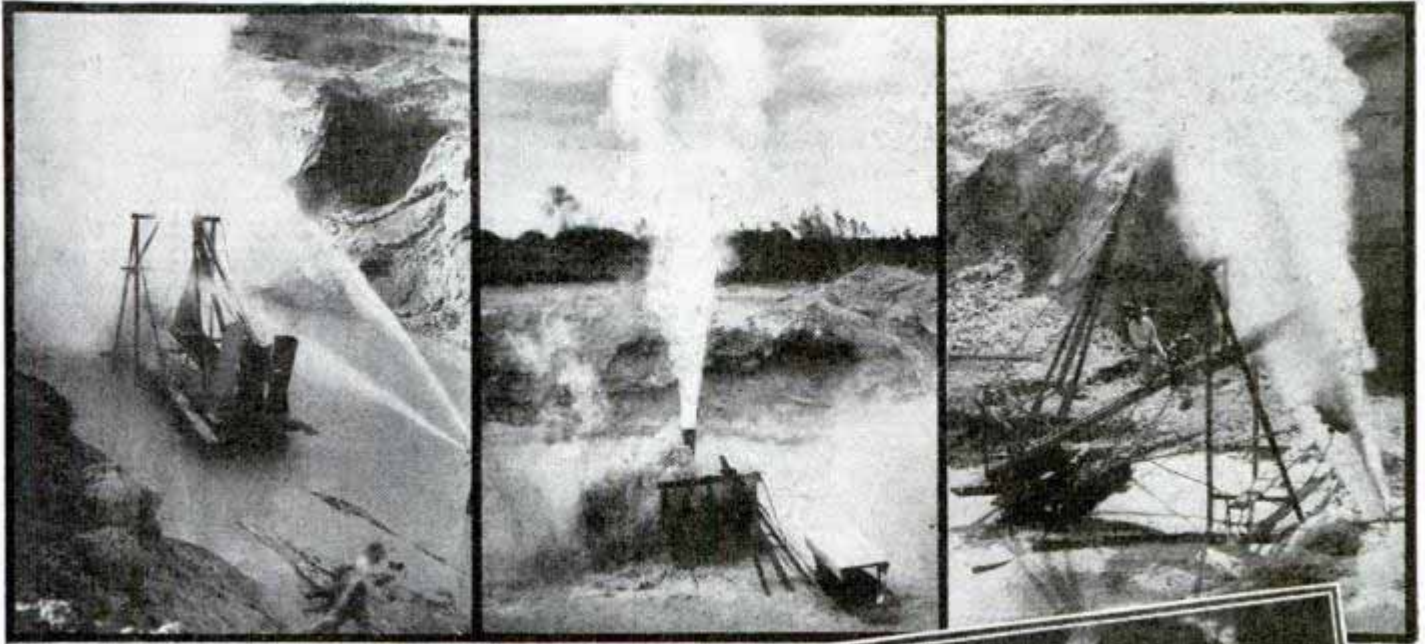

that shoots 100 feet high.

If they have been lucky the men will stop running a quarter-mile away where the heat can be endured. If they have not been lucky one or two or three of them will be lying back in the red-hot wreckage, caught by the rush of gas or hurled to death by the explosion.

The men will stand looking at the inferno, watching huge chunks of earth going up with the flame. "She's beginning to crater," they'll say, and move still farther off as rocks and earth begin thudding down around them. The derrick, white hot, begins to sag, then disappears without adding a sound to the bellow of escaping gas.

Night comes, but not darkness. For fifteen miles around cherry-red light flickers from this source. Next morning you see nothing but flame leaping into the sky from



Top, left, Patton's capping machine in crater with manifold enveloped by flames. Center, men in tin-shielded boat on boiling lake. Right, dropping swedge into casing. Below, fire breaks out in new spot as swedge restricts flow in casing. Bottom, wheeling nitroglycerine into crater



their short exciting lives but put out such fires.

If there is a possibility that the fire can be extinguished and the well brought under control, they will come with heavy manifolds, high-pressure pumps, dredges, asbestos suits, boxes of nitroglycerine jelly and special well-capping equipment, and set about their task so calmly that you would never guess the chances are two to one some of them will be badly hurt or burned or blown to bits before the job is done.

Not long ago fire fighters were working on a wild well in south Texas. The morning after the well caught fire it was a forty-foot crater. Flame geysered

Top, nitroglycerine in place beside flaming well. Center, exploding the charge that snuffed out the fire. Bottom, measuring pipe with calipers preparatory to cutting it off. Noise here is terrific. This is another step toward capping well after fire has been extinguished

a crater city blocks across with a clean rim that shimmers under the sun because heat has turned the sand to glass.

A high-pressure well has gone wild. Can the owner do anything but cross off as a loss the thousands of dollars invested in it? Perhaps if the casing has given way or the crater is more than forty or fifty feet deep nothing can be done, and it will burn on for weeks or months or years until stones and debris shooting up the hole gradually wedge fast and the decreasing gas pressure is not strong enough to dislodge them. Or it may be possible to drill another well to tap the oil-bearing sand within a few feet of the bottom of the wild well and pump in mud or cement that will seal it.

But there is another way of saving a wild burning well if the casing is still intact. The owner calls in a company of wild-well fire fighters, men who do nothing during

three hundred feet into the sky from a stream of gas and oil.

The H. L. Patton Corp., of Houston, arrived with equipment two days after the blow-out. The fire fighters built tin shields with wooden hand-grips and walked up to the crater rim pushing the shields before them against heat that charred the wooden handles. They put on asbestos suits and stalked about at the bottom of the hole

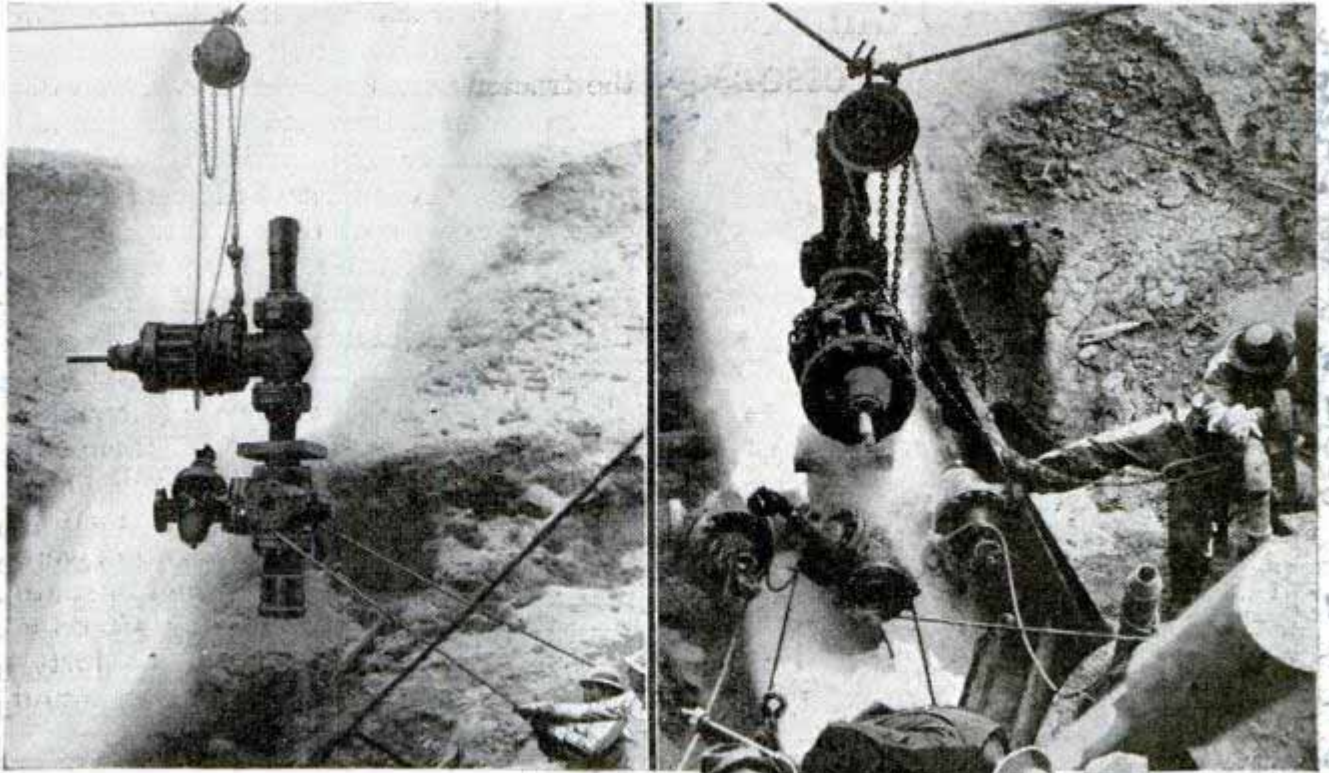

deciding where it would be necessary to dig in order to find the buried casing.

They laid water lines to the edge of the crater, brought in a dragline dredge to dig a ramp to the bottom of the hole. To keep the dredge boom from buckling in the intense heat a water line was strung to spray its entire length. Shields were attached to the dredge so that its operators would not be roasted alive, and men behind other shields on the crater rim directed streams of water against the machine's sizzling exterior.

After weeks of digging, the casing was uncovered in the bottom of the crater, lying in horizontal position spewing its seven-inch stream of gas. Asbestos-clad men went into the hole with cables, fastened them to the big pipe and with heavy block and tackle it was pulled upright.

For capping wild wells, H. L. Patton depends largely upon a capping manifold that is his own invention. It consists of a thirteen-inch, twenty-five-foot stack or manifold held in vertical po-

(Continued to page 122A)

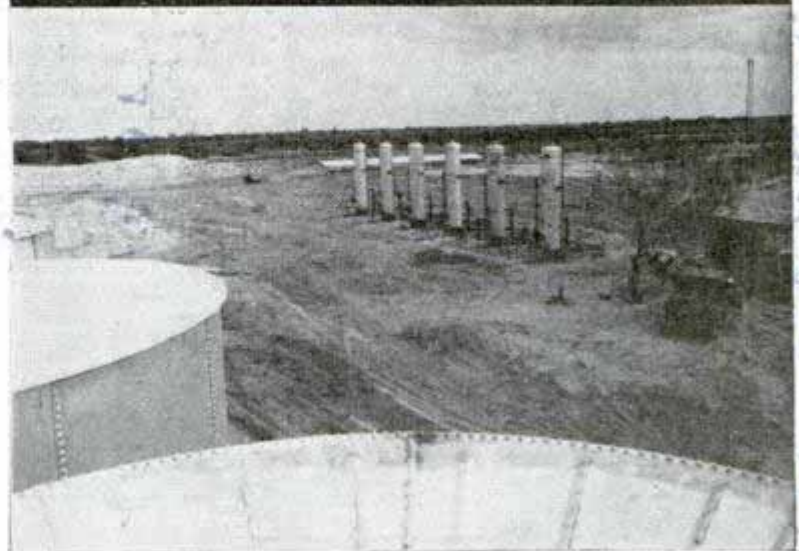

Top, left and right, working manifold up to casing head. Center, looking into manifold after gas flow has been diverted. Bottom, the wild well after being tamed

General Electric Co. 570 Atlantic Ter Englewood New York

R a d i o

ANTENNA *in Receiver Cabinet*

NO EXTERNAL antenna or ground leads need be used with this console receiver recently developed by the engineers of General Electric Co. A built-in shielded loop antenna is employed for the reception of local high-fidelity programs. The set may be moved about a room or home at will and plugged into a socket in the same manner as a floor lamp.

The loop is completely inclosed in a special shield of the Faraday type; this possesses the properties of excluding electrostatic fields,

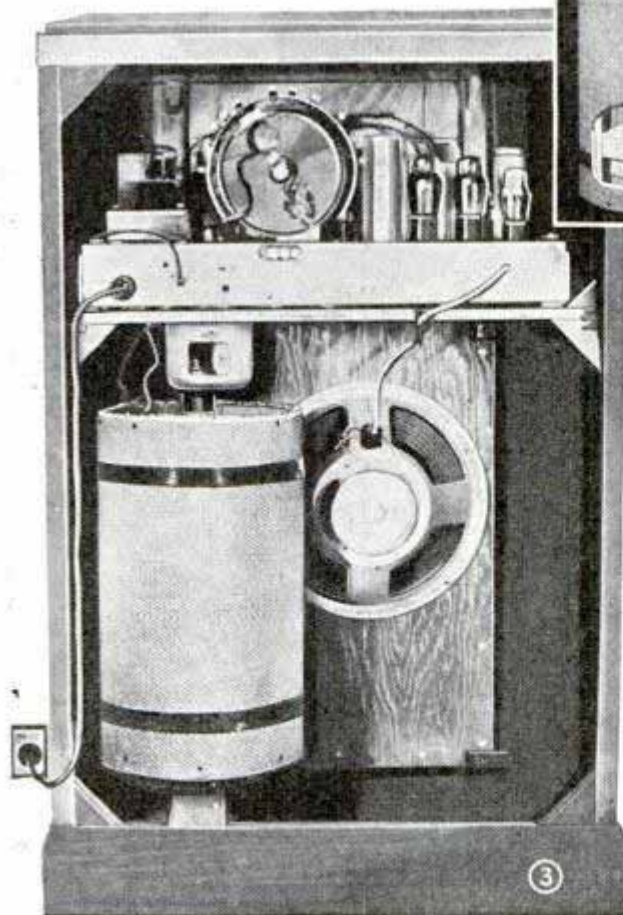
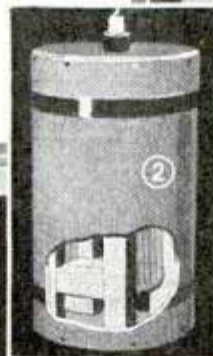
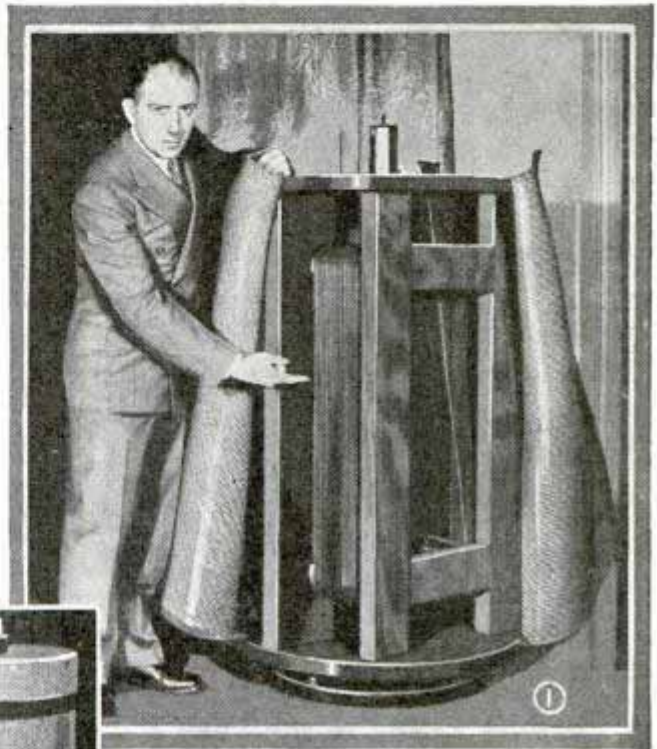

permitting only electromagnetic fields to pass. Since most interference is of electrostatic nature it is greatly reduced. A large demonstration model of the loop is shown in photo Fig. 1; the receiver loop assembly appears in Fig. 2 and the complete receiver installation is shown in Fig. 3. The standard loop unit is about 12 in. wide by 24 in. long.

Ordinary antenna reception may be obtained by merely throwing the switch indicated in diagram Fig. 4.

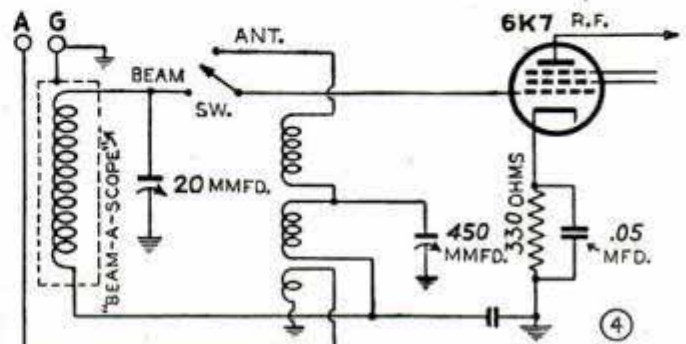

PM ECONOMY NINE

By F. M. Lund

IN BUILDING the 9-tube superheterodyne receiver to be described, several objectives were kept in view. It had to be simple, inexpensive, easy to construct and adjust, yet it must have the best possible sensitivity and selectivity consistent with fine tone quality. Although designed for the broadcast band only, nothing has been overlooked in order to obtain maximum performance on this band.

A full-size chassis base avoids crowding of parts and simplifies construction. Either metal or glass-bulb octal-base tubes may be used in the 8-prong tube sockets. If metal tubes are employed, the tube shields are, of course, not required. Other outstanding features include, tuning eye, push-pull output, no audio transformers, no chokes, phase inverter, 10-watt output, one microvolt sensitivity and even channel selectivity; also full automatic volume control, variable tone control and phonograph pick-up jacks which enable the user to play records through the audio system and use the radio vol-

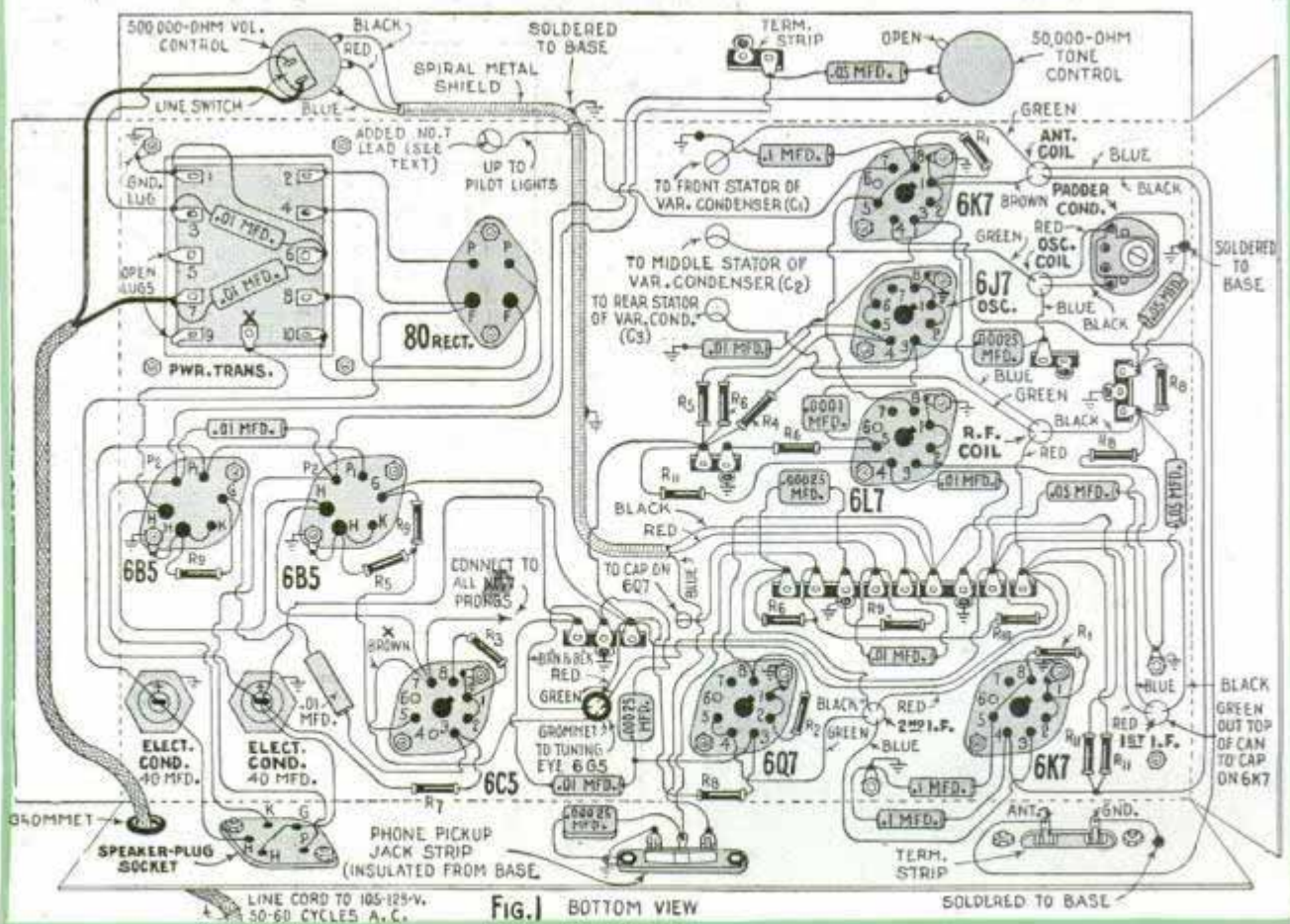
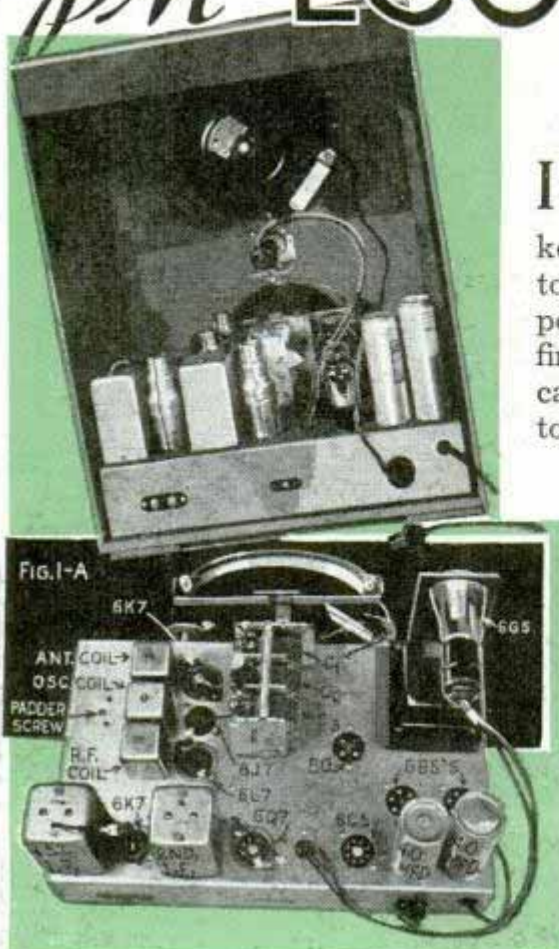

FIG. 1 BOTTOM VIEW

BROADCAST RECEIVER

ume control. Type-6B5 power-amplifier tubes in push-pull insure unusually fine tone quality if a good 8-in. dynamic speaker is employed.

A simplified wiring diagram appears in Fig. 1, and the 3-gang variable condenser connections are all clearly shown in Fig. 2. This ganged variable condenser should be mounted on soft rubber washers, the nuts on the mounting screws being left loose so that the unit is cushioned on the base. A strip of flexible woven-wire braid is used to make the ground connection to the metal base.

Complete base details are given in Fig. 3. This sheet metal should be of fairly heavy-gauge steel or similar metal that can be soldered easily. The schematic circuit diagram, Fig. 4, includes wiring details for the tuning-eye socket which is a standard Amphenol 5-wire assembly for a type 6G5 tube, and is altered to 4 leads. It may be mounted temporarily on a strip of Bakelite screwed to the chassis base as shown in photos Figs. 1-A and 1-B; photo Fig. 1-C is a bottom view of the completed set. Although the materials used

(Continued to page 138A)

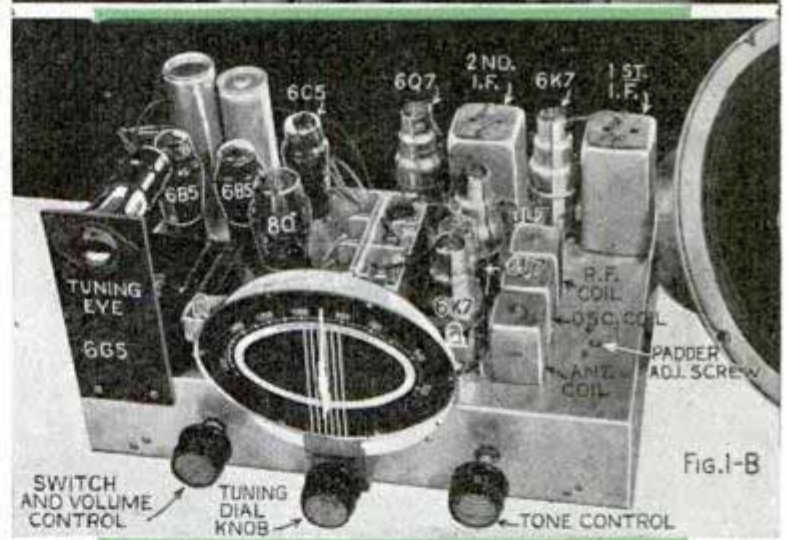

Fig. 1-B

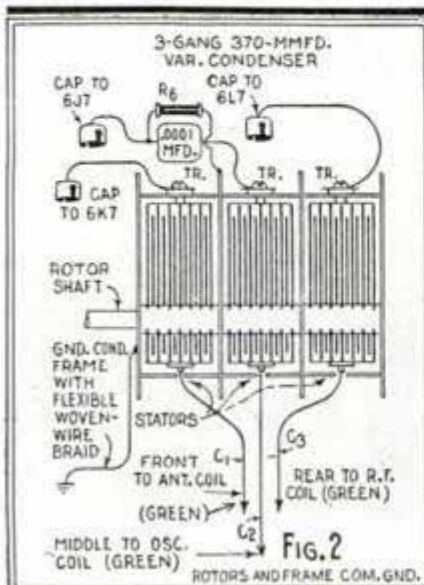

FIG. 2

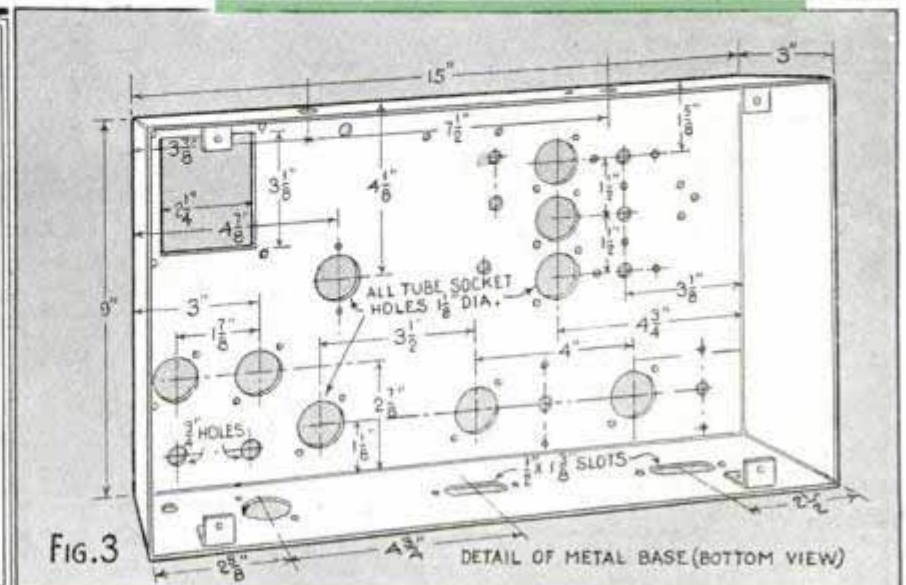
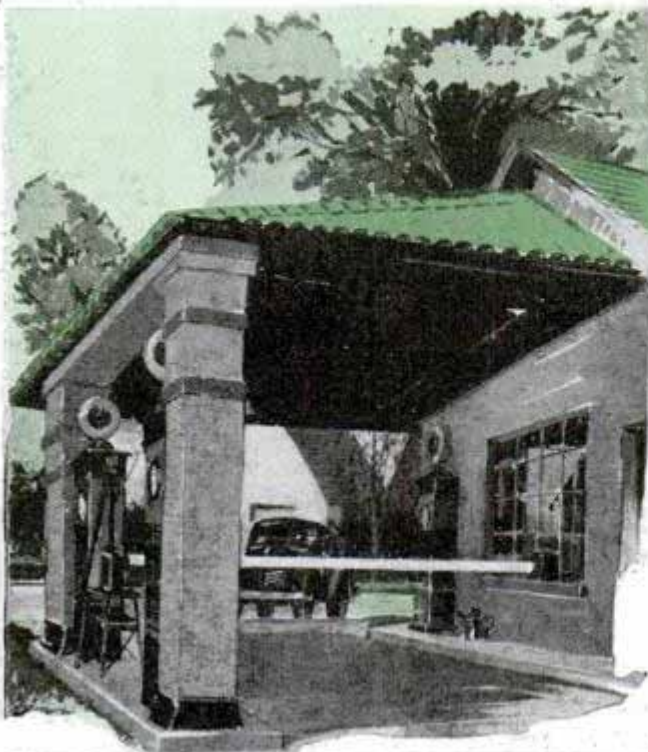

FIG. 3

DETAIL OF METAL BASE (BOTTOM VIEW)

How to Build an Inexpensive Photocell Relay

By M. N. Beitman



THIS simplified 110-volt a.c.-d.c. photocell unit will permit efficient control of lights, alarm bells, counters or other electrical equipment by means of changes in light intensity. In other words, this photocell "magic box" may be made to switch "on" or "off" associated electrical equipment with either an increase or decrease of light, handling loads up to 3 amps.

The photocell may be exposed directly to light, or it may be shielded and the control light source directed in a beam through a lens in the manner illustrated in the sketch at upper left. The car coming in to the gas station interrupts the light beam and the photocell relay closes an electric bell circuit to summon the attendant.

All parts are mounted on a $\frac{1}{8}$ by 7 by 10 in. pressed wood base and should be arranged just as shown in the simplified wiring diagram Fig. 1. A schematic circuit diagram is given in Fig. 2. Excellent stability and sensitivity are obtained by connecting the photocell in the control grid circuit of the dual-purpose 25A7-G tube. The 1,500-ohm, 2-watt potentiometer is easily adjusted for the light condition present so that changes in intensity of the light source will cause the plate current to change and the relay to operate. Condenser-filtered rectified current is placed on the plate and screen grid of the pentode section of the 25A7-G tube; chatter of the relay is prevented by the second 8-mfd. section of the dual electrolytic condenser unit.

A photo of the completed relay is shown in Fig. 1-A; it may be operated in this

(Continued to page 134A)

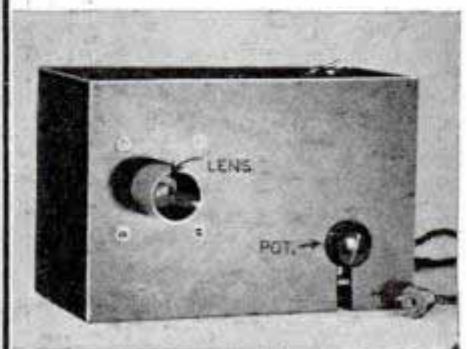
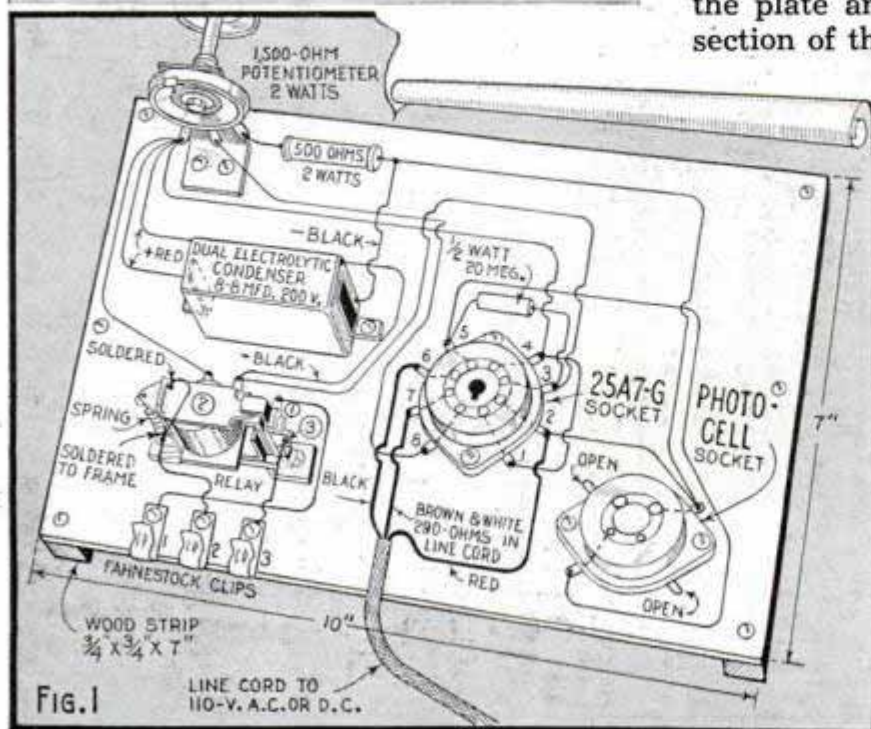
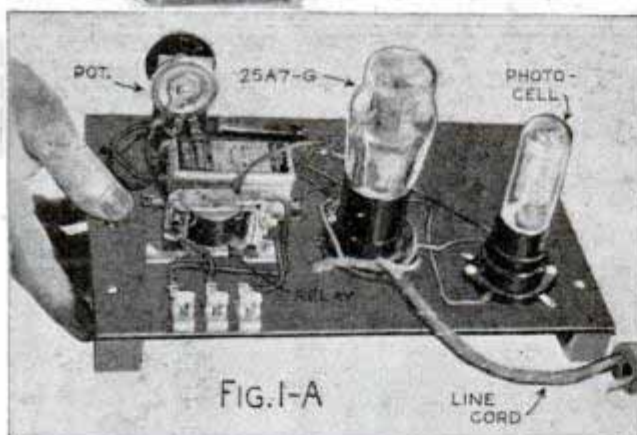

PRACTICAL RADIO SUGGESTIONS

Below, 8-prong wafer-type tubes socket for tubes having octal bases. Standard pin numbering is always clockwise from alining key in bottom view. Right, easily assembled cabinet for Peridynamic speaker; no baffles are necessary. Kit includes speaker and knocked-down inclosure

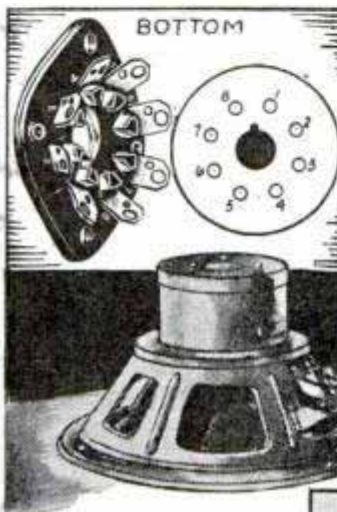

Right, Figs. 1 and 2 show simple methods for vernier tuning with an ordinary dial

Designed for amateur assembly, this compact self-supporting push-pull r.f. power amplifier unit, at right, is suitable for any of the popular triode tubes having ratings of from 100 to 300 watts output per pair

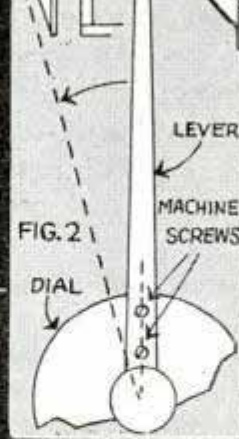
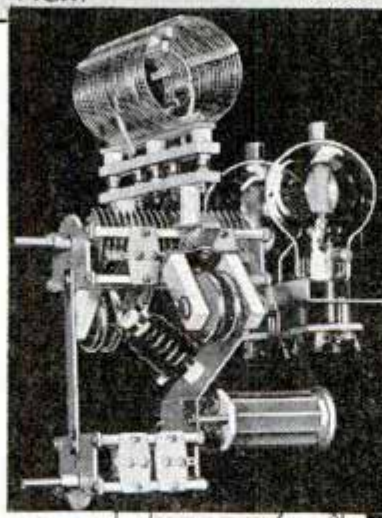
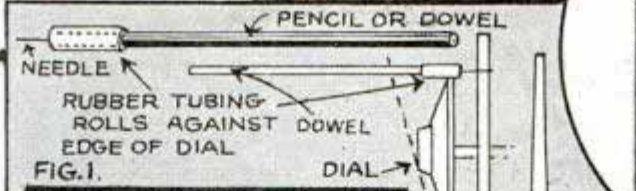

Below, rubber tubing provides temporary substitute for a porcelain-tube insulator to bring antenna lead-in into building. Lower left, easily portable automatic push-button device for remote tuning; may be attached to any a.c. radio receiver by means of a 25-ft. cord; buttons can be set for five favorite local stations

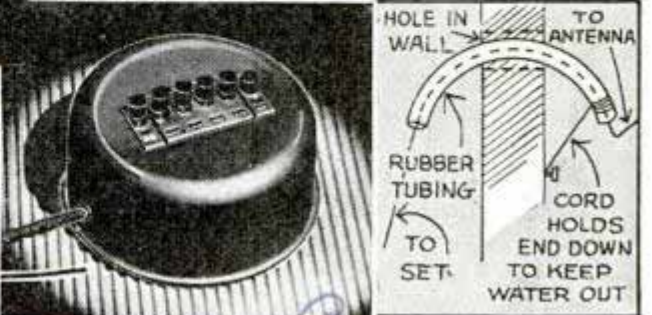
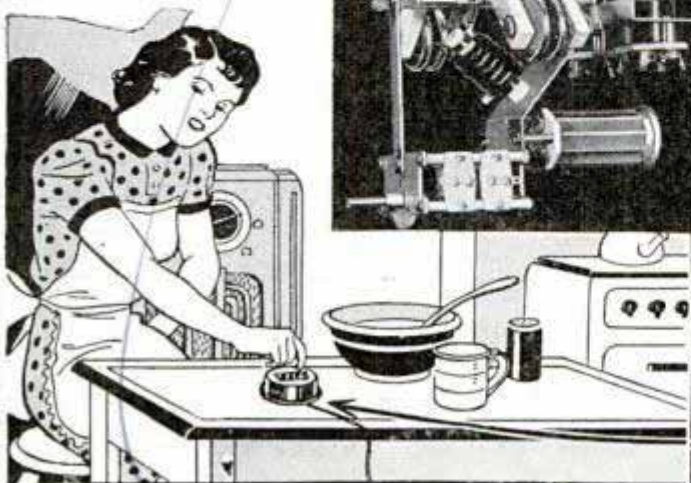

Battlefield Relics Found with Metal Locator



Twelve 6-in. shells and two pieces of bursted cannon were located and dug up on a civil war battlefield near Vicksburg, Miss., by Mr. James Nave in a single day. The above photo shows Mr. Nave with his trophies and the 5-tube radio metal locator, R-213, which he built from the construction article that appeared in the September, 1935, issue of Popular Mechanics Magazine. He has found about 750 pounds of battlefield relics and states that he has located more near the site of an old fort.

Radio Built into Floor Lamp

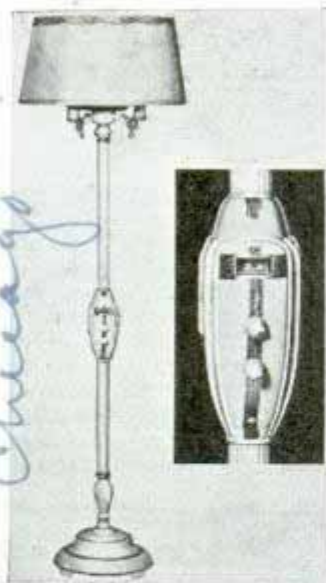

This combination lamp and receiver is a space saver in small apartments. A complete 4-tube set is built into the base; tuning controls and illuminated dial are located within easy reach of a chair for convenient operation and the speaker is in the top of the lamp.

All-Wave Line Filter

Used in connection with the supply cord of a radio receiver, this filter is claimed to prevent unwanted signal pickup and direct-line noise interference from the house-wiring system. It employs double duo-lateral wound chokes and twin condensers. It is also suitable for use in eliminating interference from small electrical appliances such as fans and vacuum cleaners.

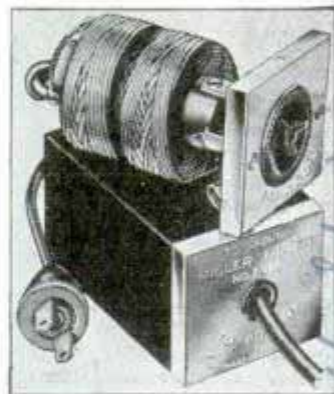

Portable Battery Receiver

Operating on a single No. 6 dry-cell A-battery, and two small B-batteries, this 4-tube super employs new low-drain tubes for economical operation. The A-battery drain is said to be less than $\frac{1}{4}$ amp. It is available complete in cabinet or as a wired chassis and separate speaker for installation in a cabinet of your own construction.

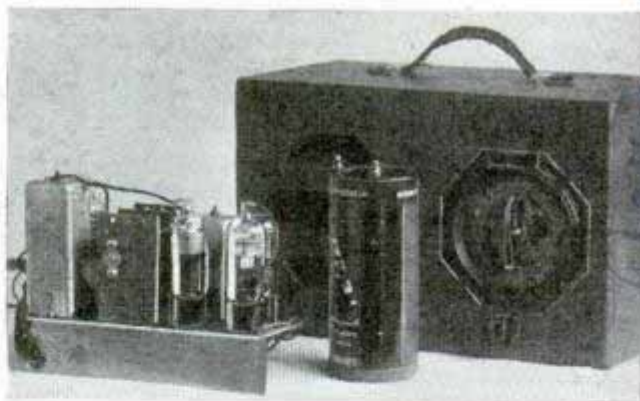

Blueprints covering radio construction articles in past issues are available for 25 cents each; original material lists and additional information can be obtained from our Radio Department without charge upon receipt of postage.

NEXT MONTH—How to Build a Radio Tube Tester. This simplified unit can be used to check over 120 different types of modern tubes. Operates on 105 to 120-volt, 50 to 60-cycle a.c. power line and is not critical in adjustment. Also—**An Inexpensive Low-Power CW Transmitter for Beginners**, complete with power supply.

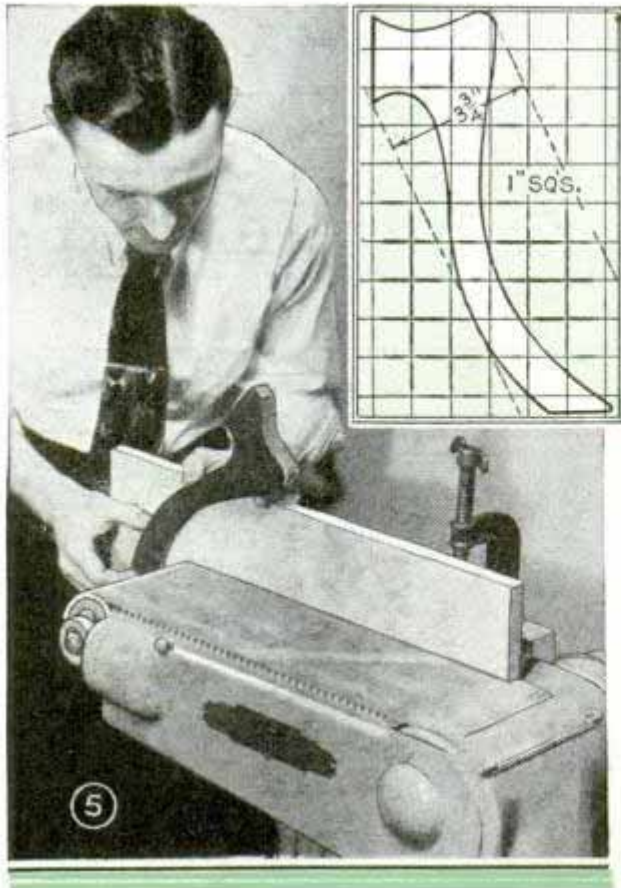

the legs to the column. The lathe index pulley can be used to good advantage in spacing them 120 degrees apart as in Fig. 1.

A similar procedure is used in working up the alternate design shown in Fig. 7. To simplify the turning, the upper shaft may be of a standard 3/4-in. dowel, stained to match the lower section. The beaded legs are likewise dowel fastened and capped with a standard claw foot. Aside from the rectangular screens, which can be mitered from standard stock picture molding, Figs. 6 and 8 give several irregular shapes which can be used. The scalloped and oval shapes shown are molded on the shaper while the shield is simply a veneer-faced plywood panel decorated with a decalcomania transfer. The screen is made adjustable on the upper section of the pedestal by means of a small 1/4-in. bullet catch fitted to a bracket which in turn is screwed to the back of the screen as in Fig. 8. The open-type frames are fitted with a 1/4-in. plywood panel over which a floral needle-point or tapestry is stretched before tacking with brads in the rabbeted edge. Care must be taken to space the brads equally to avoid wrinkles or uneven stretching of the tapestry panel.

of the plug is used in mounting the work between centers.

From the detail in Fig. 4, a full-size paper pattern should be enlarged from which the profile is traced onto the stock. Three legs are required and these can be gotten out of stock slightly less than 4 in. wide. By inverting the pattern they can be sawed out of just about the minimum of stock. To save time and assure identical cuts band-saw these in sandwich form. After sanding and shaping the edges, the plumb cuts are made slightly concave to conform with the diameter of the turned column. This can be done with a small sanding drum or a wide sweep gouge. Dowels and glue are used in fastening

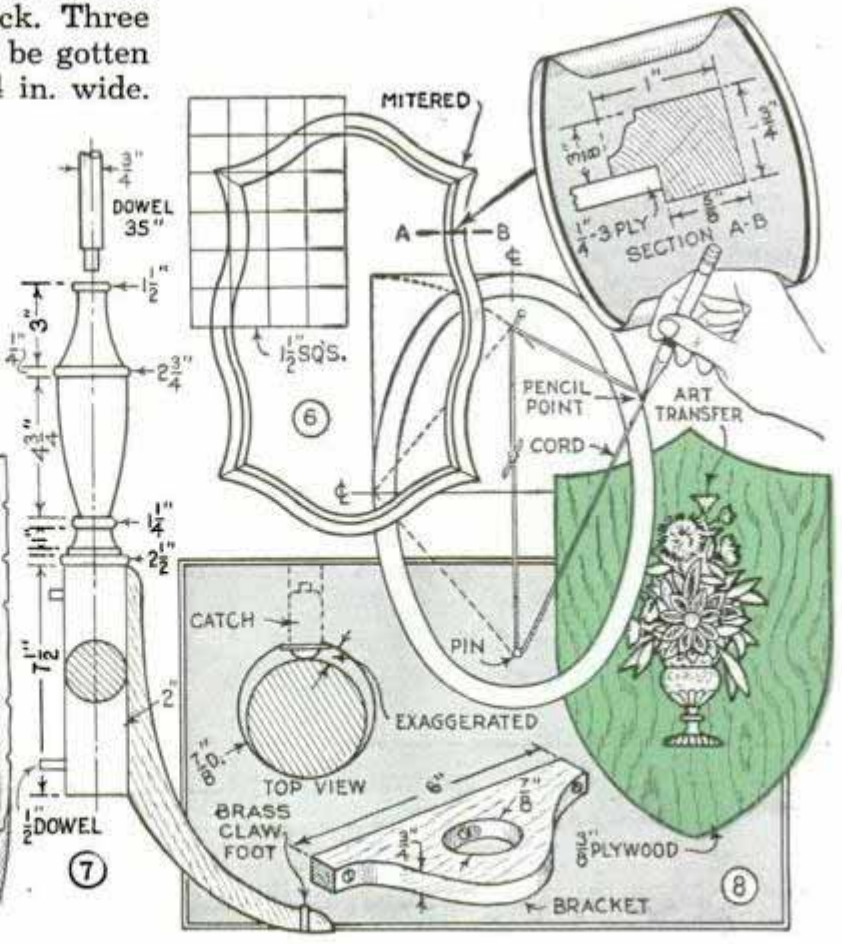
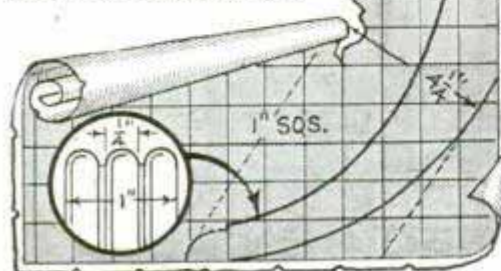
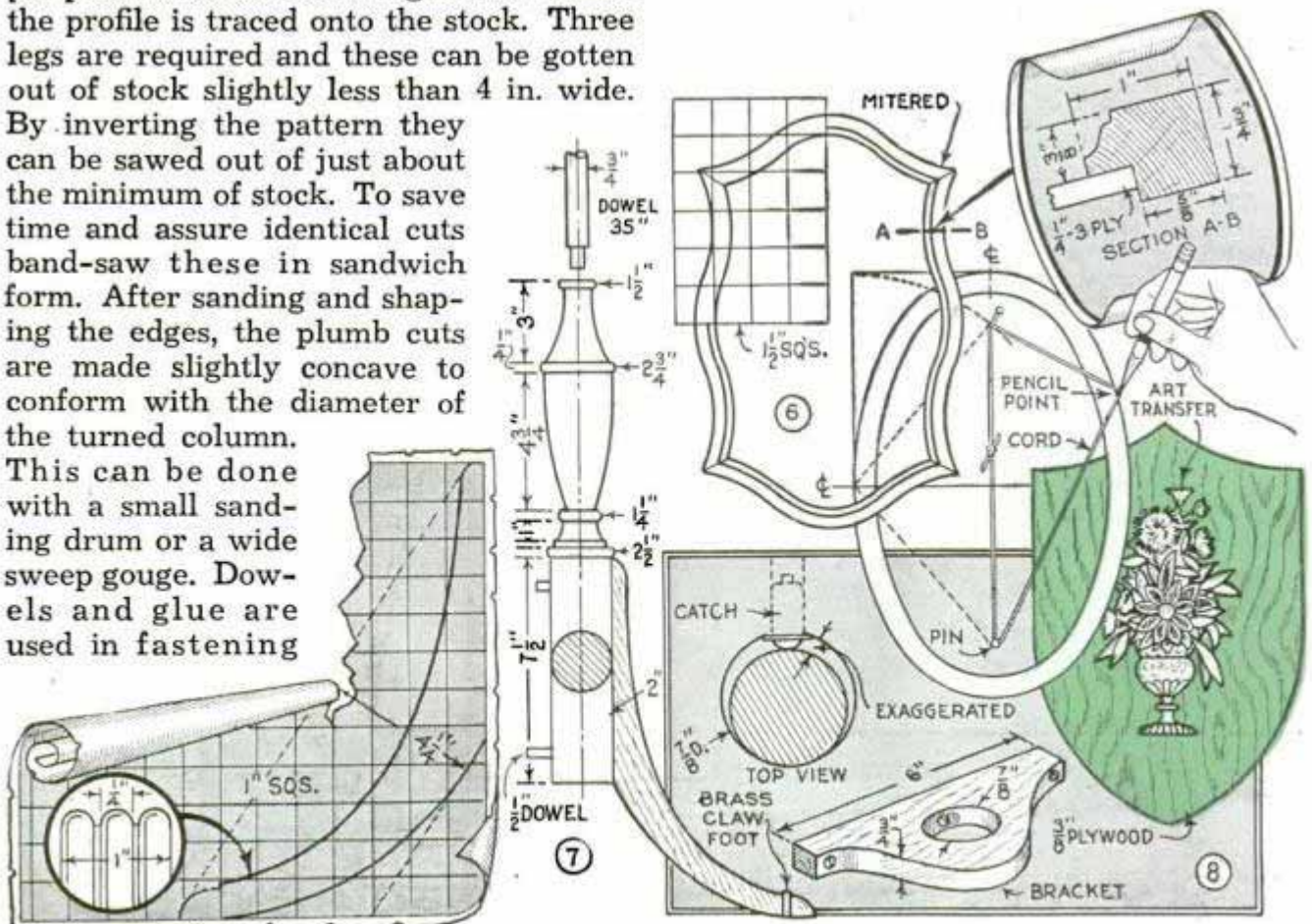

'Breakfast Nook' Housed in Kitchen Cabinet

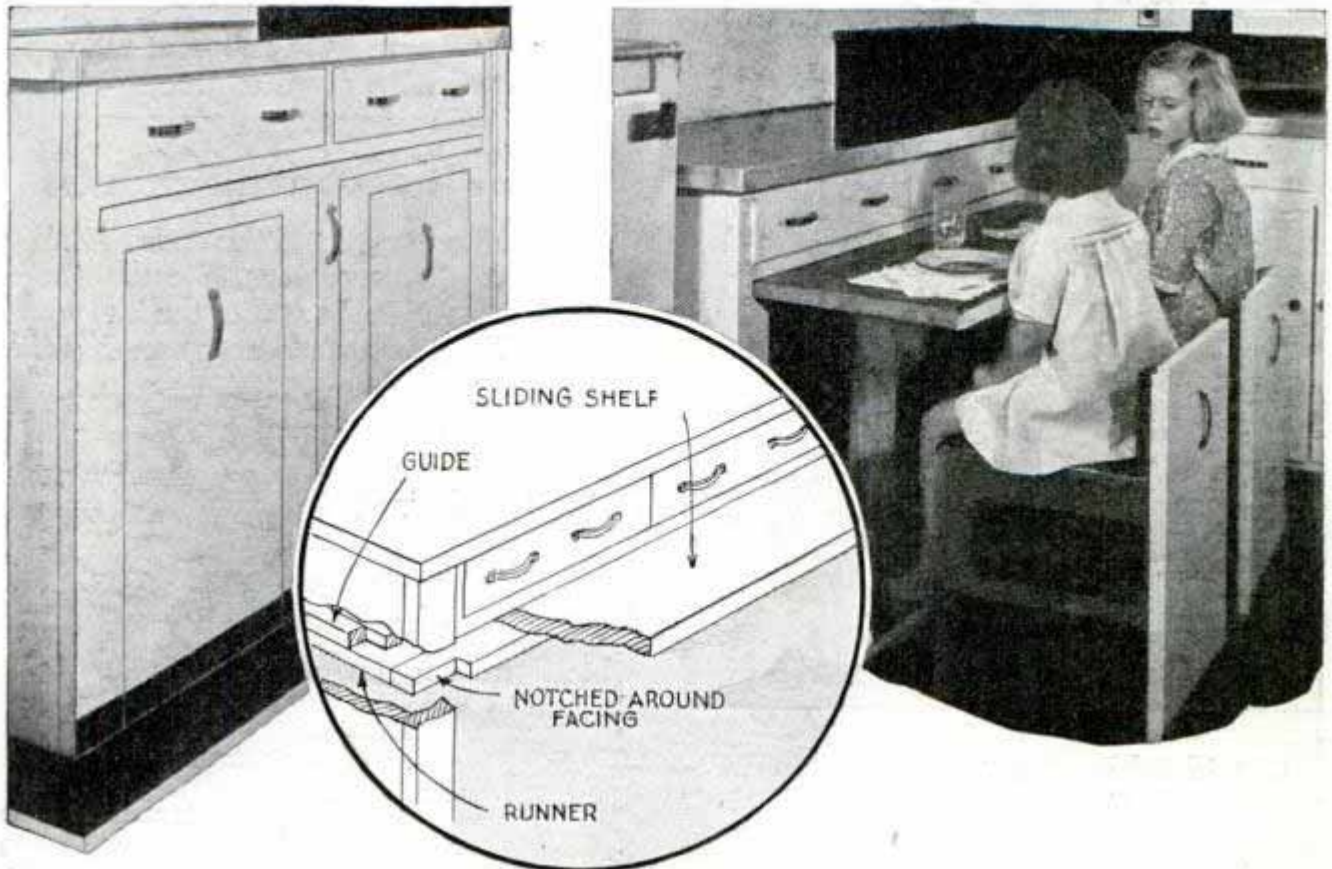

Here's a neat and useful space saver. It's simply an ordinary kitchen cabinet altered to house a table and two chairs as you see in the photos above. The detail in the circle shows how to alter a cabinet of the type having two drawers directly under the top and a shelf compartment below. Usually the compartment doors can be made to serve as chair backs, or, the latter

can be made of $\frac{3}{4}$ -in. plywood. The shelf or table top is supported on an extra rail-and-runner frame just like a drawer. The shelf should be provided with a center leg and a handle or drawer pull as in the upper-left view. To prevent the shelf sliding out too far, stop blocks are screwed to the back edge.

—Daniel R. Merrill, Montclair, N. J.

Gravity and Steel Ball Solve Puzzle to Open This Trick Box

To open this box, the two-piece lid must be slid away from the peg and swung around. But this is impossible when the box is closed and standing top side up, because a steel ball is then lodged in the slot next to the screw on which the lid parts pivot. To dislodge the ball from the slot and transfer it into a blind hole in the top part, turn the box upside down and swing the top part out. Then, holding the box normally, you slide the second part back. The blind hole may be located directly over the ball when the top part is closed, or at any other point the same distance from the screw, so the ball drops into the hole at a certain position of the top part.

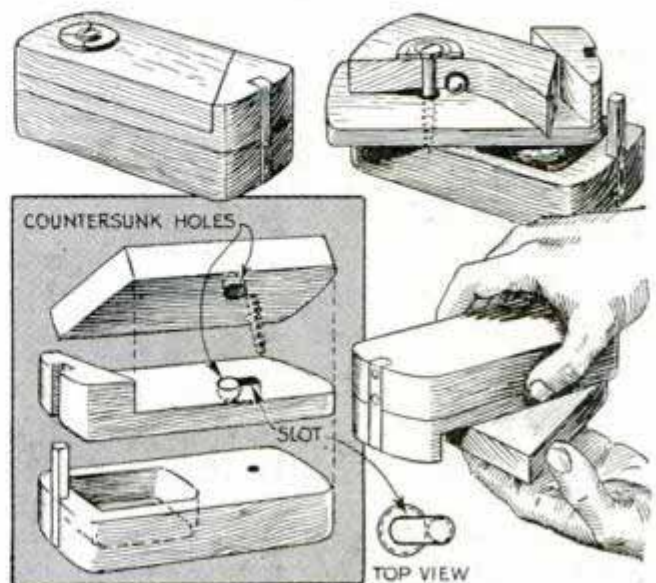

Hanging Shelf on Drill Press Holds Small Work

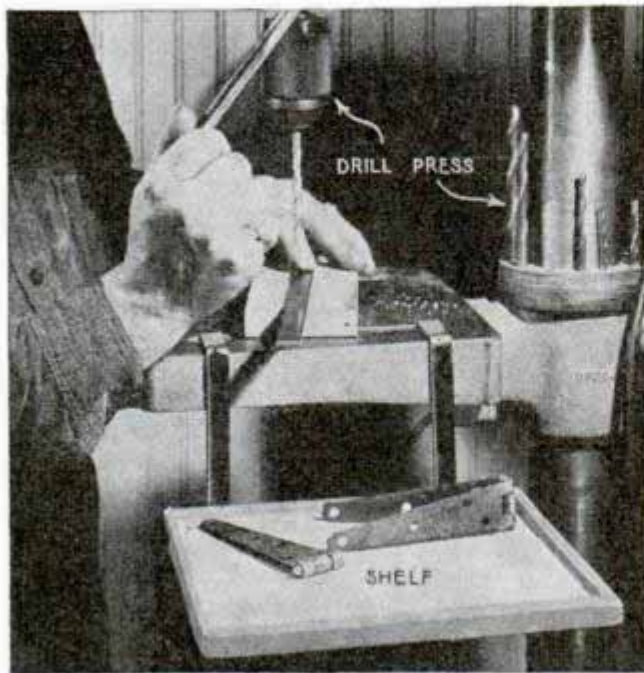

Considerable time can be saved in drill-press work if you provide a small shelf that can be attached to the table to hold small parts. The one shown here was made of $\frac{3}{8}$ -in. plywood cut to the same size as the drill-press table, and fitted with a narrow molding around the edge. Two lengths of flat iron, bent to form hooks, were screwed to the bottom. When the shelf is needed, the hooks are slipped into one of the table slots. The shelf is quickly removed for operations where the hooks would interfere.

Glue Dropper for Cabinet Work

Here's a dropper that will be found handy for applying glue in small dowel holes, blind mortises, etc. A short length

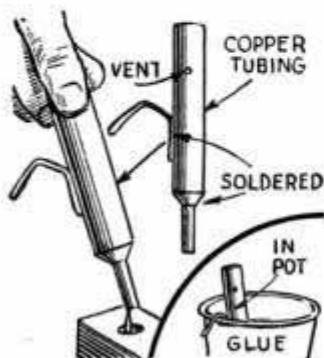

of copper tubing with one end closed has a spout soldered to the other end. A piece of wire soldered to the tube permits hanging it on the gluepot when not in use. A vent in the tube near the closed end permits

air to escape while filling, which happens each time the dropper is hung inside the

gluepot. When the dropper is removed, a finger is placed over the vent to keep the glue from running out where not wanted. Raising the finger from the vent momentarily allows a few drops of glue to escape.

Casters Recessed in Furniture

In mounting casters to the ends of bulky or massive furniture legs, a counterbore should be made in the end of the leg, when possible, large enough to accommodate the sweep of the caster. Furniture manufacturers often use a special recessing tool that makes a cut for the purpose at the same operation in which the leg is drilled to receive the caster shank. However, it is

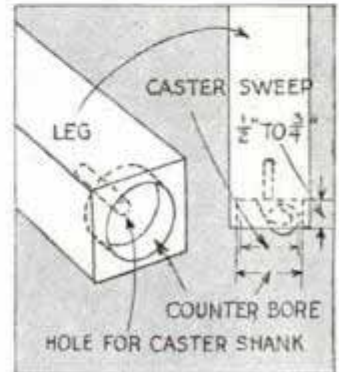

quite possible to make a counterbore serve the same purpose, provided the leg is large enough to accommodate the caster sweep, and still leave a margin of wood standing all around.

Stringing Lamps in the Garden to Avoid Short Circuits

For illuminating lawns, gardens, parking spaces, etc., an improvement over the frequent method of stringing lamp cord around for the purpose, is to use two lengths of weatherproof, rubber-covered wire, which you can get from any dealer in electrical supplies. Wood spreaders serve the double purpose of spacing the

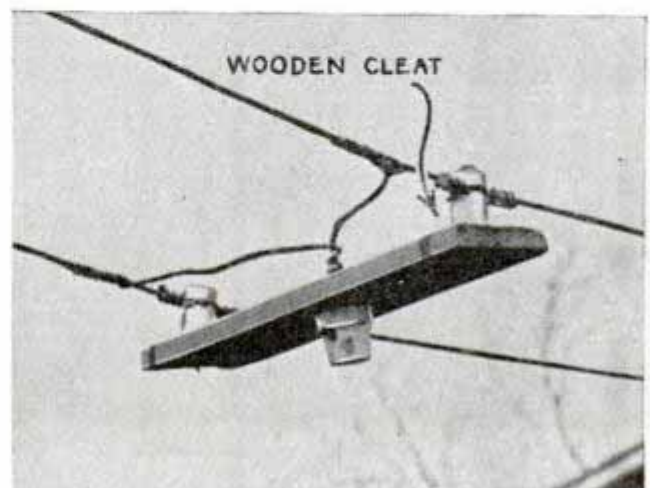

wires and carrying the lights. With this arrangement, constant movement of the wires cannot result in chafing and short-circuiting, which is one objection to using lamp cord. While the size of the wire is determined by the load, No. 12-gauge will be satisfactory usually. The spreaders are all cut to the same length and electrician's porcelain "knobs" are used to attach the wire. A cleat receptacle is screwed to the underside of the spreader and short lengths of the same wire are connected to the receptacle after which they are spliced, soldered and taped as indicated. The leads are connected to a fused branch circuit block so that the circuit will be independent of all others.

Repairing a Pitcher Pump

When new leathers in the cylinder fail to repair a pitcher pump, the trouble may be due to wear on the iron disk as it moves in the plunger head. The hole in the disk becomes enlarged and the pump rod wears smaller. This allows the disk to slip sideways so that it does not cover the openings in the bottom part, thus allowing water to leak back. The meeting surfaces of the

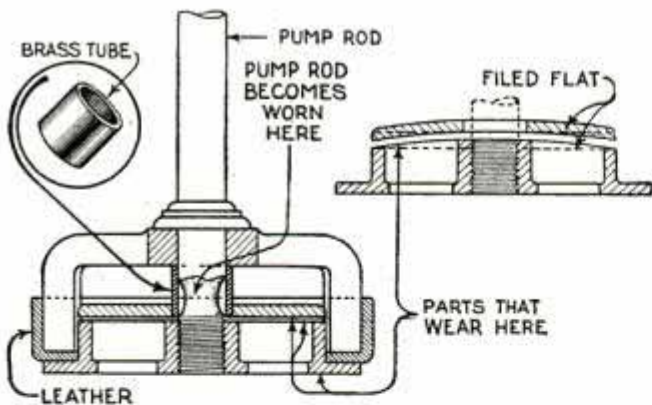

disk and bottom part also become worn, allowing more leakage. A simple repair for this condition is effected by slipping a short piece of thin brass tubing over the worn place on the pump rod and filing the disk and bottom part flat where they touch.

—David Jenkins, Xenia, Ohio.

Have you found an easier way to do some commonplace job around the home? If you have, send us a short description of how you did it, together with a snapshot or rough drawing. Popular Mechanics will mail you a check for all material accepted. Address Homecraft Editor.

'Pantograph' Drawer Swings Out from Workbench



This drawer can be pulled out to its full length with less effort than the sliding type because its weight is carried on four pivoted legs instead of cleats on the underside of the bench top. The drawer should be built sturdily, and reinforced along the sides where the legs are attached. A chain fastened to the back of the bench and to the rear end of the drawer limits its forward movement. A block is nailed to the underside of the bench top to serve as a stop when the drawer is swung back. When the drawer is resting against the block, the legs should slant toward the back slightly so it will not fall forward.

Pencils Held on Drawing Board

Stretched across one corner of a drawing board and fastened at the ends with thumb tacks, an ordinary rubber band provides a good emergency pencil holder. Just slip the pencils under the rubber band which will keep them from rolling.

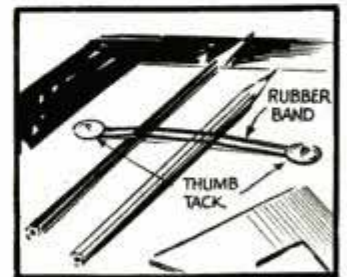

—Horace Taylor, Anderson, Ind.

Wallpaper Knife Is Sharpened on Emery Cloth



Tacked to the pasting table near one corner, a piece of emery cloth is handy to keep a wallpaper trimming knife sharp. A few strokes of the knife across the abrasive surface of the paper at intervals will do the trick.

"Rope Ladder" Shelves for Door

Suggestive of rope ladders used on ships, these shelves look well on glass doors and give added space to the indoor gardener. They are useful for walls and windows, too. Ropes through holes near the corners of the shelves support the boards on knots tied just below the holes. The ropes are supported from brackets on the door so that the latter may be opened without dis-

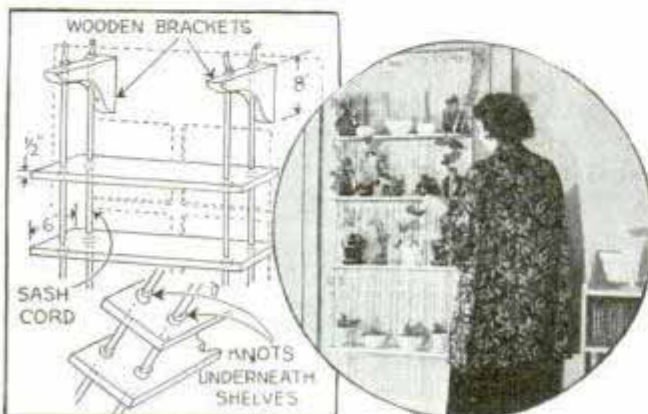

turbing the shelves. The holes in the shelves should be just a trifle larger than the rope used, but small enough so that a single knot will not pull through them.

—John G. Roberts, Chicago.

Screws Held in Plastered Wall with Steel Wool

The next time you want to drive a screw into plaster, make a small hole in the wall and tamp it tightly with steel wool. Then drive in your screw. Besides anchoring the screw, the wool prevents the plaster from crumbling and making an ugly hole.—Ralph Baker, Santa Ana, Calif.

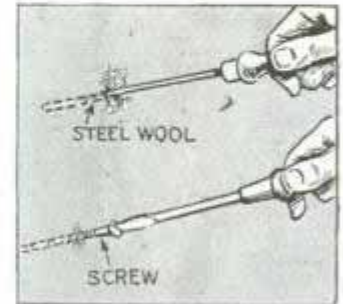

Clothespins Hold Tree Lights



If Christmas-tree lights are fastened to spring-type clothespins by their socket and wires with rubber bands as shown, they can be clamped in a vertical position safely along the

tree branches instead of hanging downward loosely. The clothespins should be painted green to harmonize with the green needles of the tree.

Ball of Hinge Pin Makes Tool for Hammering Brass

In the absence of a ball-peen hammer for decorating sheet brass, a good substitute can be improvised quickly by simply using the round end of a butt-hinge pin. One of these can be taken temporarily from a door.

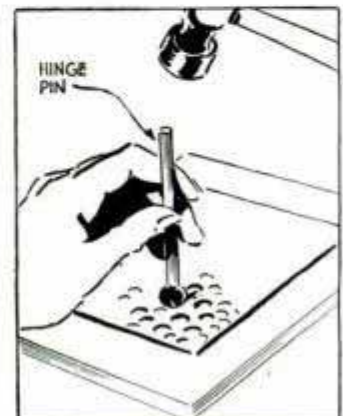

LOUNGE CHAIR

is adjustable

IDEAL for the porch, and nice enough for den or playroom, this comfortable lounge chair is inexpensive and has an adjustable seat and back. Construction consists largely of making four $\frac{1}{4}$ -in. plywood panels, two for the chair sides and two for the seat and back. All joints in the frame should be mortised and tenoned or doweled. The two seat frames are the same size, and are held together with two butt hinges. After paneled sides of the chair have been made, the two panels can be fitted together with the various cross members. The upper crosspiece at the back should be rounded on the top edge to permit the seat back to slide against it. The two slanted members on which the seat rides are dadoed into the cross members, the joints being secured with dowels. Stop blocks are nailed to the slanted members to stop the backward travel of the seat; a second set of blocks nailed to the underside of the seat stops the forward travel.

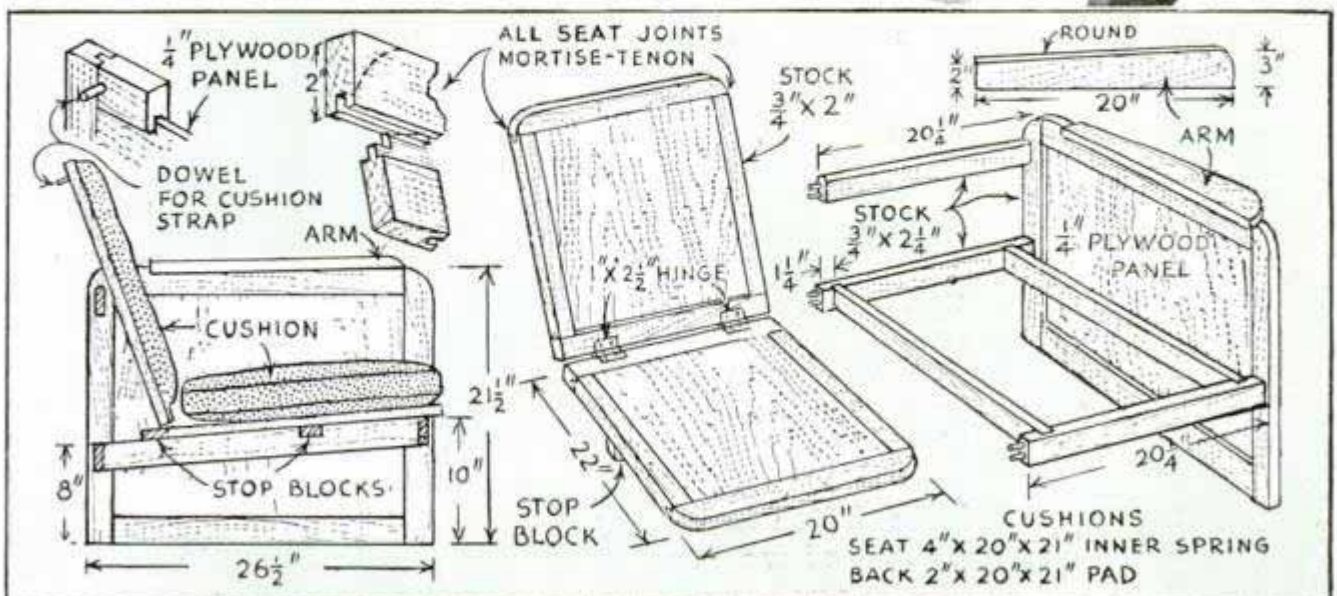

Simulating Casement Windows on Model Buildings

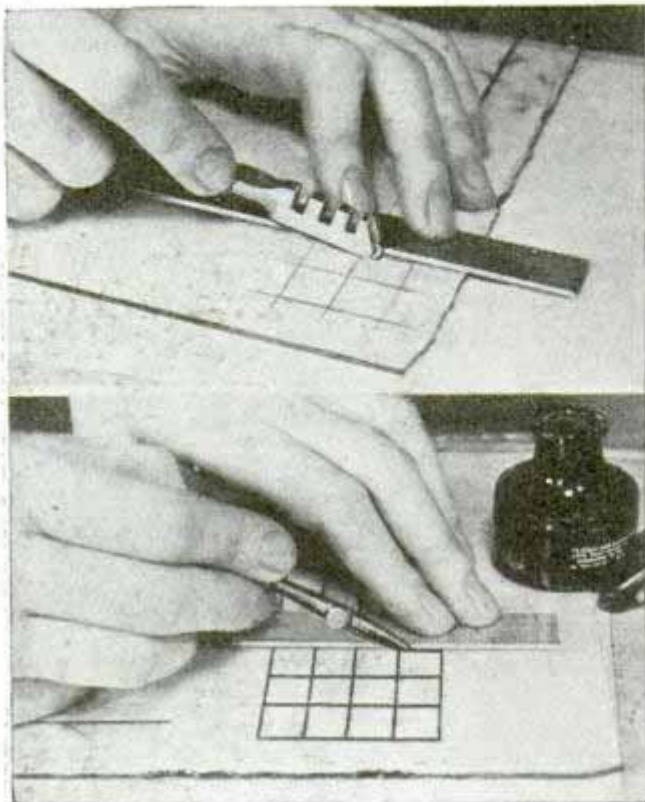

A good way to simulate windows on model buildings is to rule them on glass with India ink. Two methods may be used: The glass may be ruled with a glass cutter, the scored lines being filled later with the ink, or the lines may be made directly on the glass if its surface has been rubbed lightly with a piece of putty. After the ink has dried, the rest of the glass is carefully wiped clean. Then a coat of shellac is applied over the entire surface.

Improved Pipe Vise

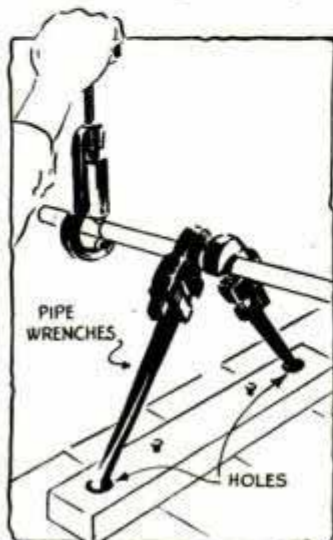

Home handy men who have no pipe vise, can improvise one from two pipe wrenches, which will serve well in an emergency. After adjusting the wrench jaws to grip the pipe securely, the handles are set in holes drilled in a piece of wood, which is nailed to

the bench top near one end. The end of the pipe extending beyond the bench can be cut or threaded then with little difficulty.—Opie Read, Jr., Chicago.

Calibrated Radius Arm on Dividers

Here's a way to set a pair of dividers or a compass to any desired radius quickly with the aid of this calibrated arm. It is cut from a piece of sheet brass to the shape shown and is slotted in the center, after which it is soldered to one leg of the instrument. A hole is drilled and tapped in the other leg for a thumbscrew, which fits the slot of the arm and locks the legs at any desired adjustment. To calibrate the arm, set the legs exactly 1 in. apart at the points and scribe both the arm and the leg. Then calibrate the remaining part of the arm in the same way.

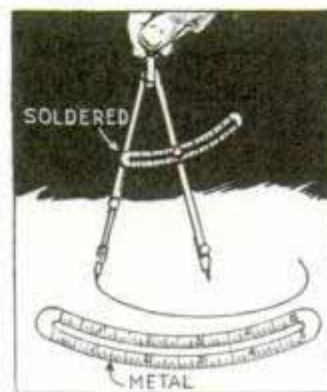

Plane Used as Surface Plate

As a substitute for a surface plate, a hand plane clamped upside down in a vise serves nicely. Of course, the cutter must be withdrawn and the sole wiped clean. In the illustration, a surface gauge is being set to a combination square.

—S. J. Gancher, Richmond Hill, N. Y.

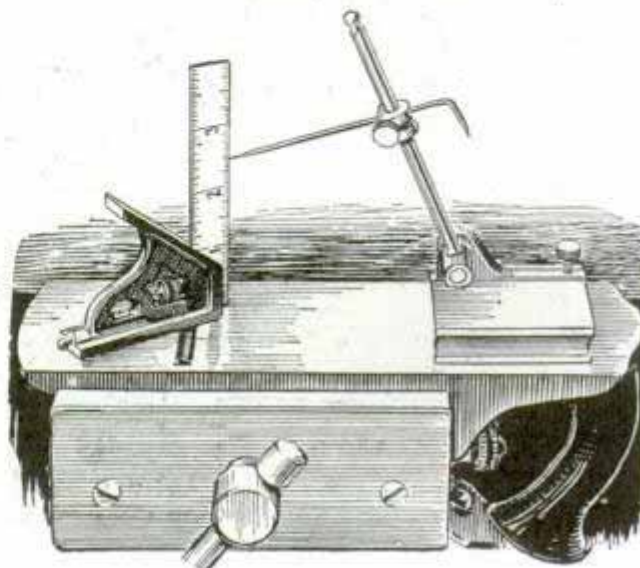

"Juggling Cat" Tosses Ball from Paw to Paw

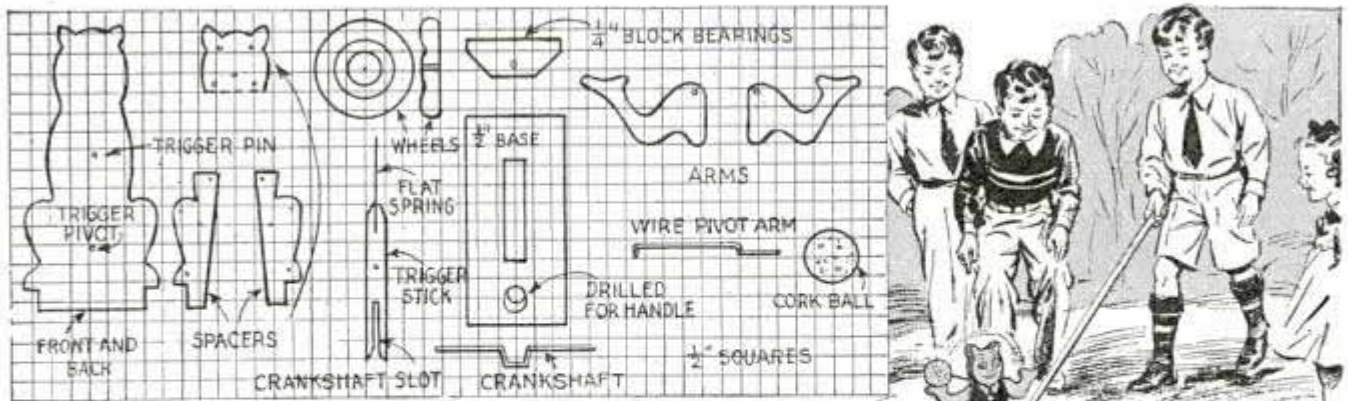

Wheeled across a floor, this cat tosses a cork ball from one paw to the other and it will entertain a small child for hours. Simple construction permits the parts to be cut in duplicate so that you could assemble a number of toys and sell them at a profit. Thin stock is used for the body, which consists of two duplicate parts with spacing blocks between, which are bradded together, leaving sufficient space for the pendulum to swing. This is provided with a piece of clock spring. The pendulum, pivoted on a brad driven through the toy, rides the crankshaft axle and is moved back and forth as the axle turns, snapping the spring strip across the trigger pin. The force of the spring striking the pivoted arms alternately flips them upward in an arc, tossing the cork ball back and forth over the head of the figure. The ball is impaled upon a wire which pivots at the central point of the figure. If desired, you can make the toy to suit the season. A rabbit can be substituted for the cat, and the ball can be replaced with an "egg," to convert the toy into an Easter special.

A Wax Finish on Wood Plates, Spoons and Salad Bowls

Here is an excellent penetrating wax that will give a high luster to natural-finished wood plates, salad bowls, etc., and contains nothing that contaminates or imparts a flavor to the food. It is made by melting pure, white beeswax and stirring in an equal amount of olive oil as the wax cools. The mixture will solidify at room temperature. A lump of it will smooth out under the warmth of the bare hands as it is rubbed on the work with the fingers. Fur-

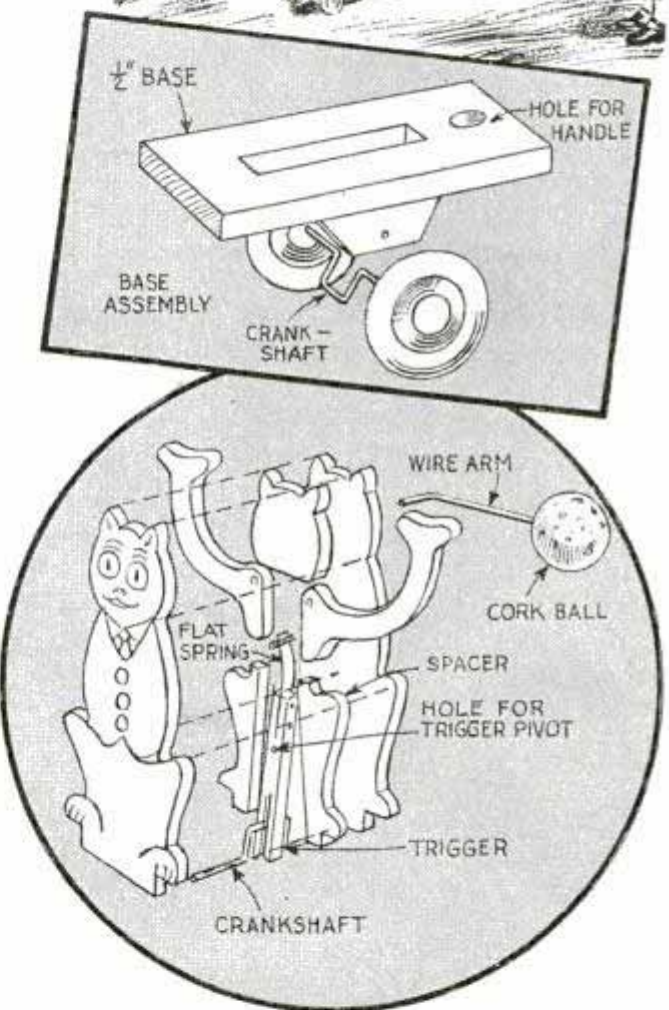

ther friction of polishing with a soft cloth makes a perfect spread of the right consistency. The finish is brightened easily without polish and is impervious to finger marks.—H. Thompson, Westfield, N. J.

☞ Gauze bandage material provides good facings for sheer wash frocks when the hem has been let down and there is no matching goods. It has the advantage of being pre-shrunk and therefore does not pucker when laundered.

A PENDLETON



Photo, courtesy Rhode Island School of Design

By R. O. BUCK

Lane Technical High School, Chicago

gives the general dimensions and also the location of the various decorative bands of holly inlay. The brass bail or pulls detailed are not exactly like the originals but resemble them so closely that they are suggested as a style that is available at a nominal cost.

The carcass: The cut-away drawing, Fig. 2, shows the method of framing the carcass. The ends and back panels are mortised into the legs with the outer faces flush with the faces of the legs. This type of construction requires very careful fitting so that no unsightly lines will be evident. It is advisable to set the panels in just a trifle when fitting so that a little may be planed from the leg later if necessary to make them perfectly flush. On the original, even the legs and rails are veneered. For your reproduction it is suggested that solid wood be substituted, and veneer, if used, confined to the larger areas such as the top, ends, drawer fronts, and doors. The compartment framing is un-

ONE of the choicest pieces in the famous Pendleton collection of American furniture of the Revolutionary era is the Pendleton sideboard shown in Fig. 1. The original is made of mahogany veneer, inlaid with fine lines of holly. The simplicity of the design gives the piece a distinction and individuality which makes it useful as a sideboard or serving table in most any dining room. The working drawing, Fig. 5,

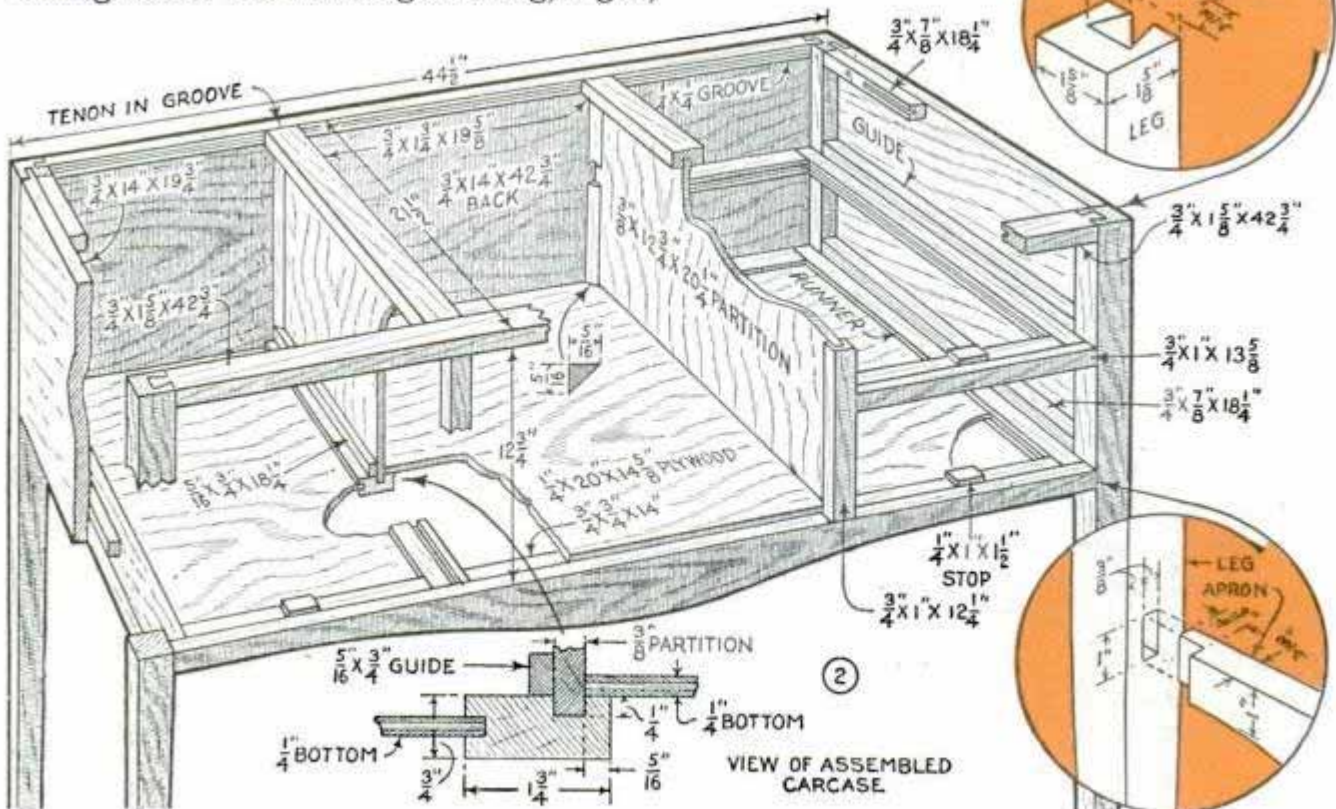

SIDEBOARD

Built in the true American tradition — an accurate copy of a famous original

usual, as shown in the detail of the partition cross rail. These pieces carry the partition, form a ledge for the compartment and a runner for the drawer. The partitions at the sides of the compartment are mortised into the top rail and apron, and the dividing rail for the drawers is mortised into the leg and vertical member in a similar manner. The partitions are secured at the back with triangular cleats, which are tacked and glued into place, but all other edges of the partitions are housed in grooves.

Framing for the drawer section is shown in Fig. 4. Note that these frames are set into grooves in the ends, back and apron, resulting in an unusually rigid construction. See sections A, B, C and D, Fig. 4. Plywood panels are set into the bottom frames to make the drawers dusttight. The frame for the upper, right-hand drawer is made in a similar manner, but is set in grooves on only three sides, and simply

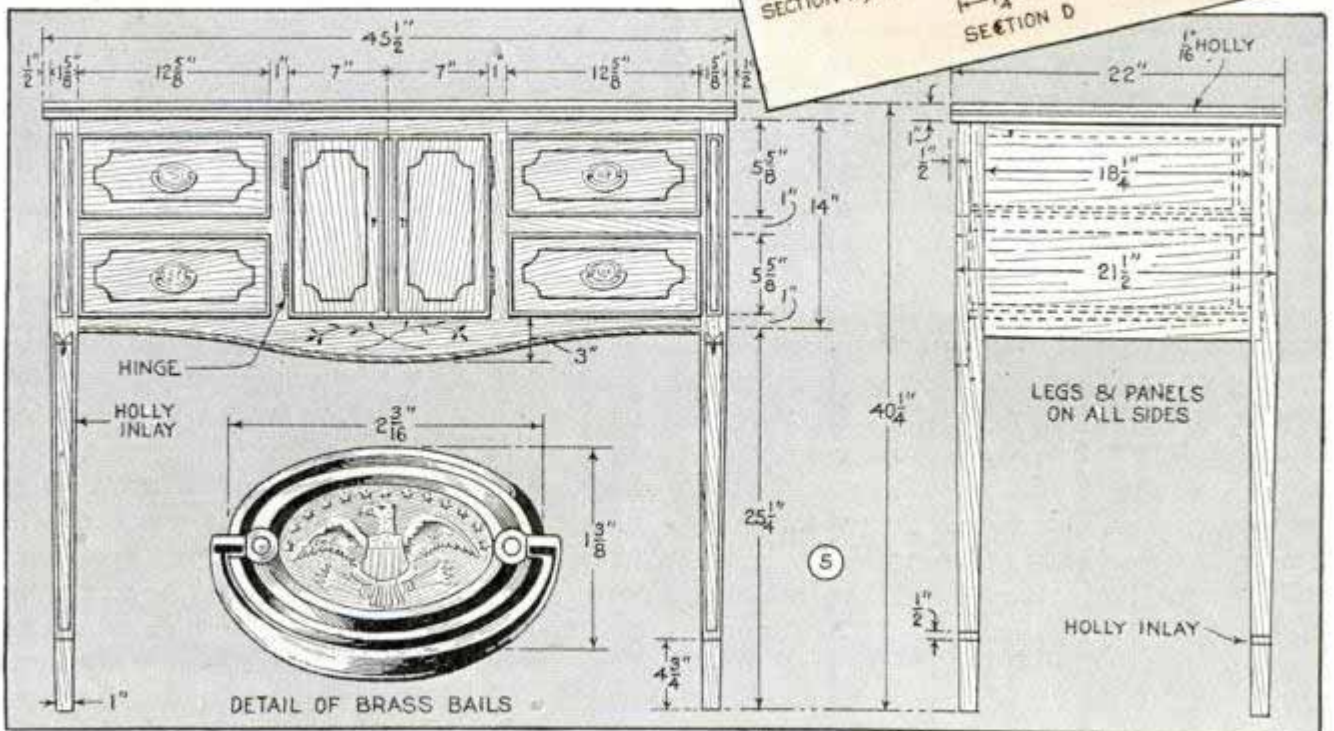
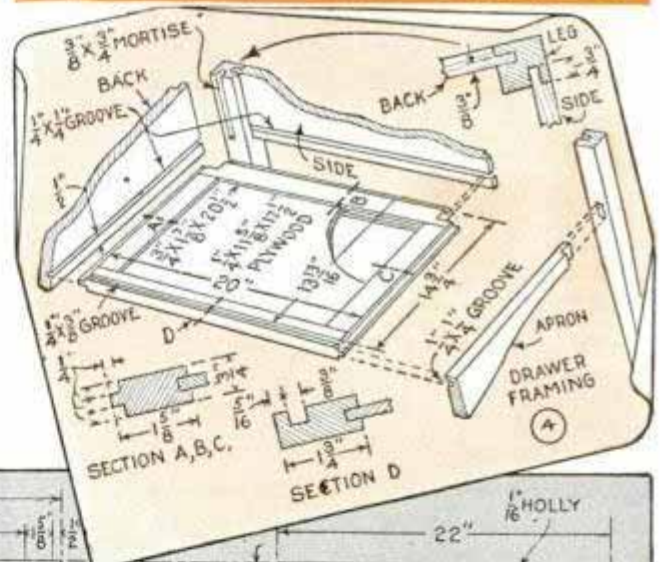

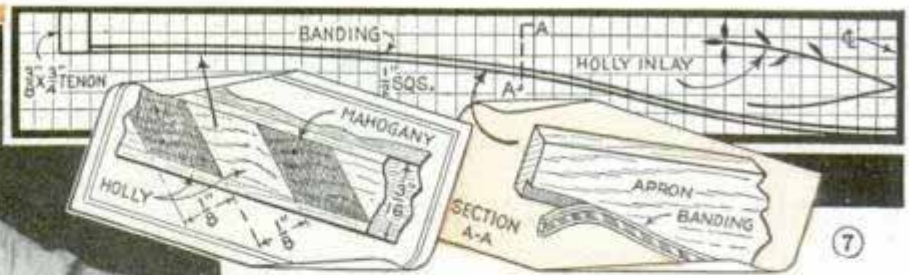

of the easiest methods for cutting the long panel mortises in the legs is shown in Fig. 3, using a routing bit and guide on a drill press.

The top: The top is made perfectly plain except for a single band of holly set into the edge. The groove for this inlay is cut by running the piece over a circular saw set to a depth of $\frac{1}{16}$ in. In order to allow for possible expansion or shrinkage the top is fastened in place with twelve hardwood clamp blocks, which are screwed to the top and engage grooves in the framing members as shown in Fig. 11.

Doors: The compartment doors are or-

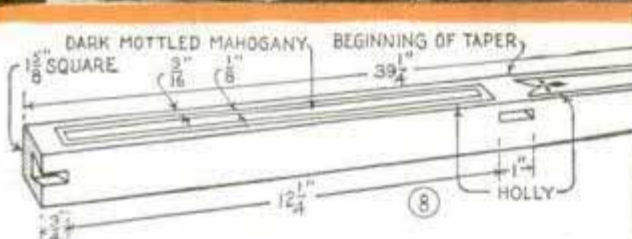

glued against the partition on the other. The plywood panel in this frame is optional. Dovetail joints used at the ends of the top rail are detailed in Fig. 2, also the single shoulder tenon used on the ends of the apron. The shape of the apron should be worked out from the squared pattern shown in Fig. 7, then band-sawed to shape. This piece is ornamented with an inlaid spray of holly and also a band of marquetry along the bottom edge. The spray is simply cut into the stock with a sharp knife. If veneered stock is used it is necessary to cut only through the first ply. For solid stock a depth of $\frac{1}{32}$ in. is sufficient. Marquetry banding is set into a shallow rabbet cut along the curved edge of the apron. As this banding can be purchased ready-made, at a nominal cost, it is not practical to make it. The method of applying the banding and inlays is described later. The tapered legs are detailed in Fig. 8. A dovetail mortise in the top of the front legs is laid out from the dimensions given in Fig. 2. One

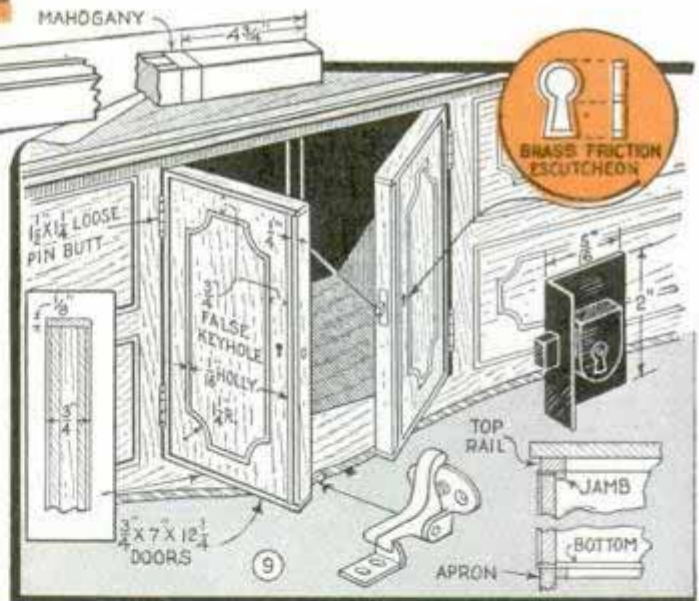

namented with holly inlays as shown in Fig. 9. Grooves for the inlays can be cut with the grain by means of a special cutter which is readily made from a piece of hacksaw blade or clock spring, to the shape shown in Fig. 13. The cutter, after grinding to a keen edge, is inserted in an ordinary wood marking gauge in place of the usual point. Cuts across the grain are made with a straightedge and sharp knife or the router as in Fig. 14. The method shown in Fig. 15 for scoring the concave corners works well if the points of the dividers are sharp. The block clamped at the corner

prevents making an unsightly hole. After scoring the curved lines with the dividers, the wood is readily removed by following with the knife. The edges of the doors are covered with strips called "cockbeading." This feature serves the double purpose of covering the plywood joints and ornamenting the doors. The beading is applied by gluing and tacking, as shown in Fig. 10. Note that it is omitted at the meeting edge, Fig. 9.

The doors do not have a rabbeted joint as is customary in modern work, but are simply made to fit rather close. A rim lock is installed in the right-hand door, with a tongue mortise to correspond in the left. Both doors are fitted with an escutcheon of the type shown but the one to the left is false. The left door is held closed by means of an elbow catch. The doors swing on antique brass hinges, set $1\frac{1}{4}$ in. in from the top and bottom. The sectional view through the compartment shows the bottom, which forms a jamb, and the location of the top

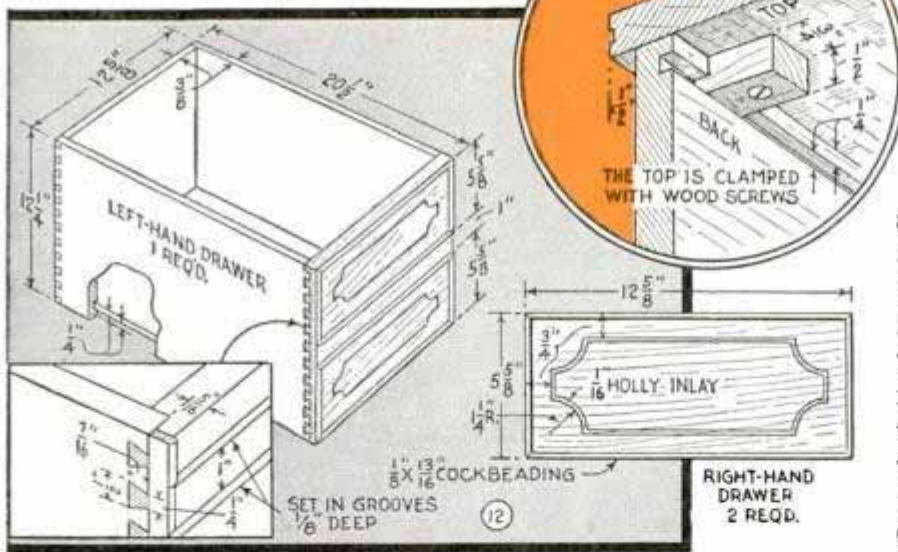
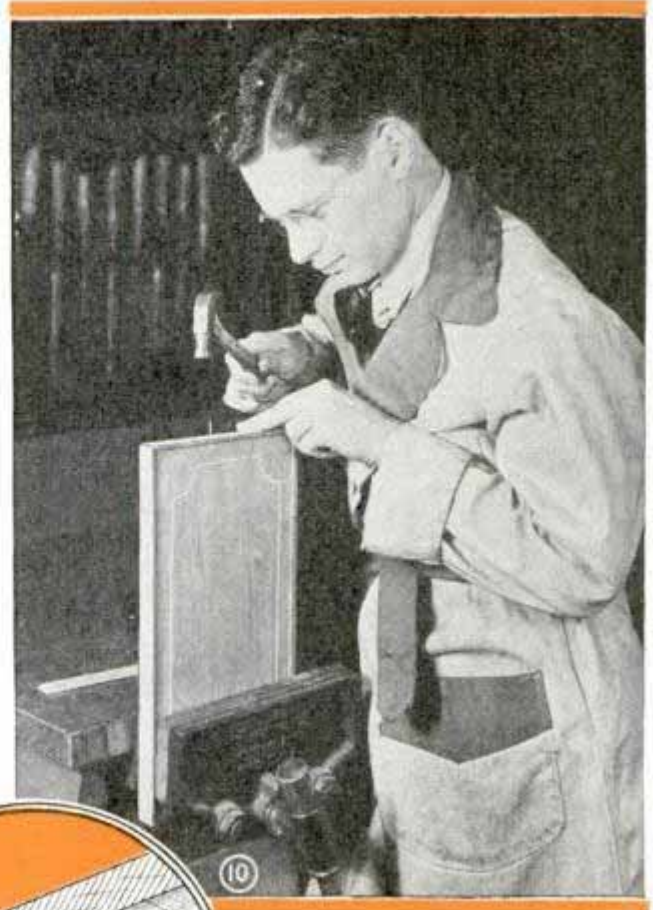

jamb strip. See lower-right detail, Fig. 9.

Drawers: One of the unusual features of the piece is the left-hand drawer, Fig. 12, which is made to simulate two drawers and thus give a symmetrical arrangement. This feature may be omitted if desired and four uniform size drawers provided by simply making the drawer framing identical on both sides of the compartment. The drawer fronts are ornamented with a cockbeading and holly inlays to match the doors. A recess is cut along the ends to house the cockbeading. This allows for cutting the dovetail joint into the end

grain without having to cut through the beading. The two strips which give the appearance of outlining the top of one drawer and the bottom of the other are set into shallow grooves as indicated. The dovetailing should be laid out and the pins cut on the side piece first, Fig. 12. This piece is then laid on the front and the sockets carefully scribed in the manner shown in Fig. 6. The blind dovetail in the front is cut with a bit and

chisel in the usual manner, before the narrow strip of cockbeading is tacked into the recess.

Open dovetailing is used at the back corners and the bottom is set in a groove in the usual way. Stop blocks, glued to the front rails, Fig. 2, prevent the drawer from being pushed in too far. The two drawers for the right-hand side are duplicates.

Inlaying: The inlaying, which should be done before the various members are assembled, is simple, but requires careful work. After the corners of the grooves have been squared up, strips of the band-

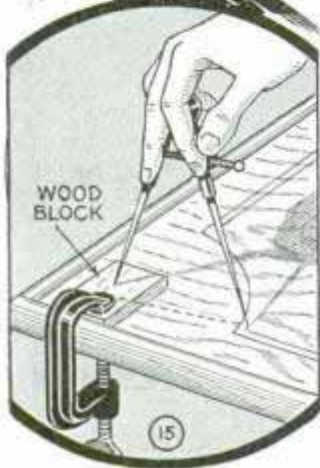
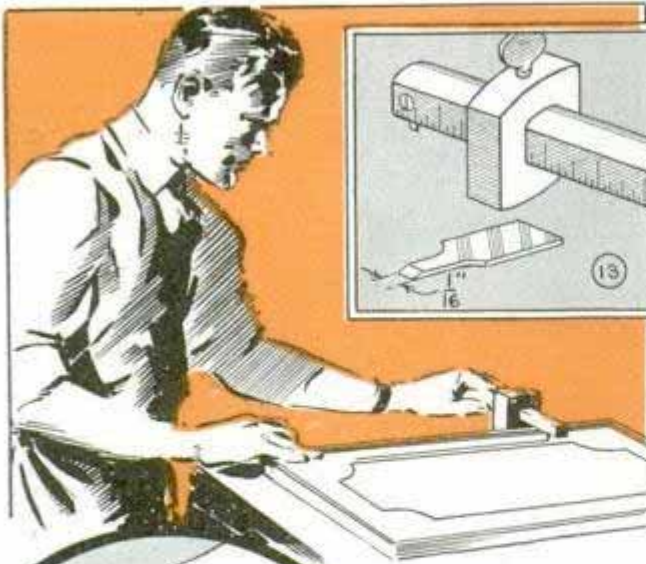

ing are cut to a rather snug fit and the corners mitered with a knife or razor blade. The strips should be large enough so that they extend slightly above the surface when they are in place. Thin glue is applied

sparingly to both the grooves and the strips, and the latter forced into place by tapping with a hammer over a block of wood. The piece is then covered with a strip of paper to absorb any glue which may ooze out and tend to stick the inlay to the gluing strip. The latter is simply a piece of scrap which is laid over the work to equalize the pressure and prevent the clamps from marring the surface. When

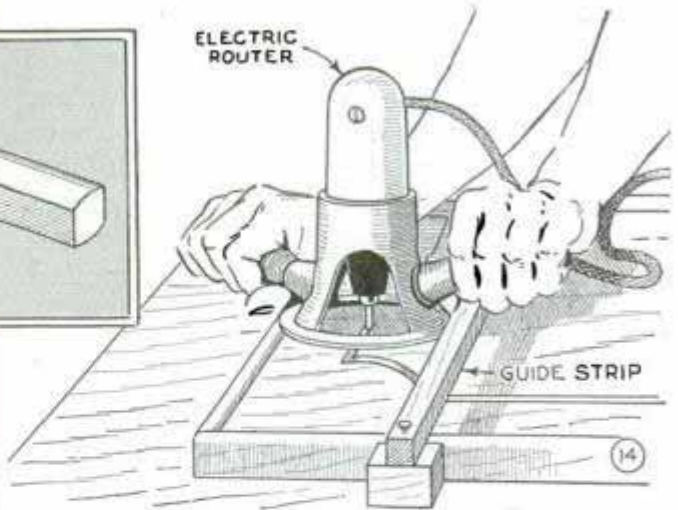

the glue is dry the banding is sanded down flush. The marquetry along the bottom of the apron is applied in a similar manner. Many craftsmen obtain good results by using plastic wood for inlays, and of course this process is much simpler, especially for the spray design in the apron. Care must be taken in using this material, however, that it is not spread over the surfaces around the grooves as it is likely to cause a discoloration in the finish later. The original sideboard is finished in a deep-red color and has a rich dull sheen that is exceedingly beautiful. This finish is achieved by the use of a red mahogany filler, followed by an oil stain of the same color, one coat of thin shellac and three of rubbing varnish. The shellac and varnish should be sanded lightly after each coat and at least three days allowed between applications. Pumice and water are used to rub the final coat to an egg-shell gloss.

Skid Chains on Driveway Gate Keep Out Cats and Dogs

Old skid chains were fastened under a gate of a private driveway to fill the space between the bottom of the gate and the surface of the recessed driveway to keep out small animals. The chains were wired to the gate and lead weights were attached to the bottom of the chains.

—Dale R. Van Horn, Lincoln, Nebr.

☐ To avoid cutting a mimeograph stencil too deeply, place a piece of thin tissue paper, of the kind used for tracing, over the stencil to absorb some of the blow from the typewriter keys.

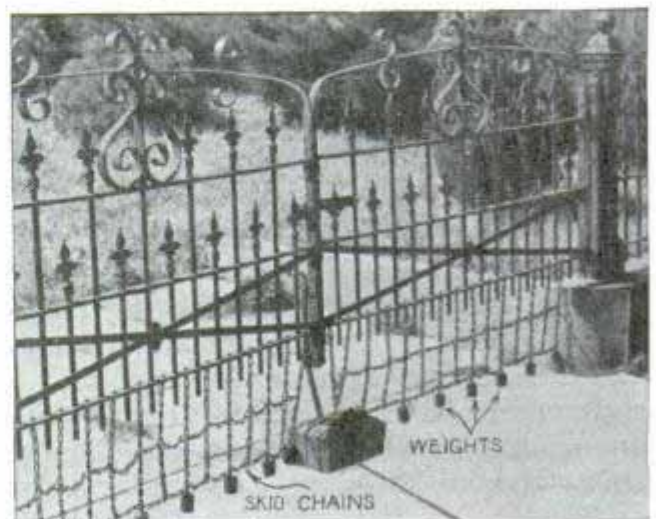

Photoflood Lamps Dimmed While Focusing

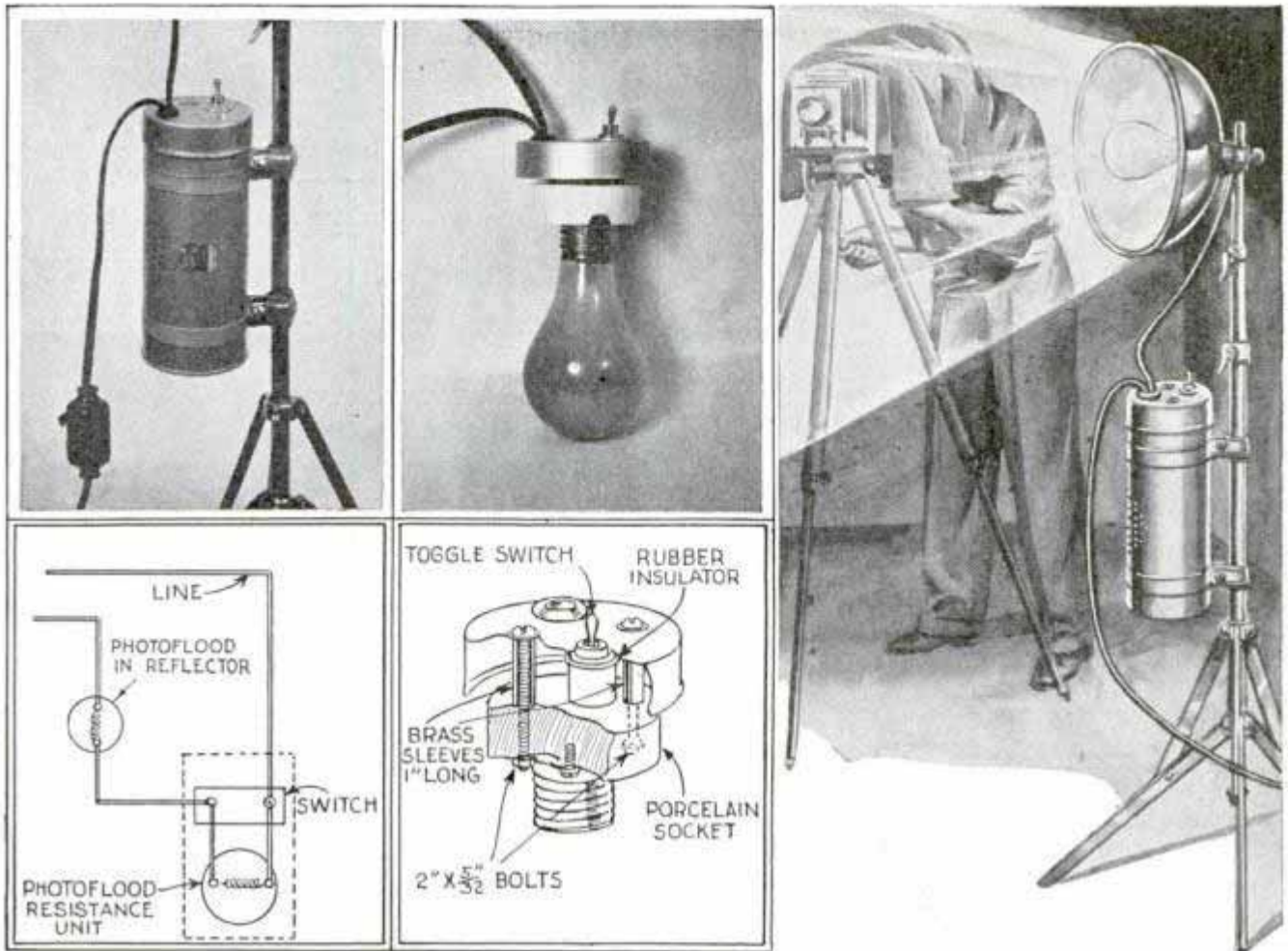

Dimming the photoflood lamps while preparing to make an exposure prolongs the life of the lamps considerably besides eliminating the discomfort to a person being photographed. To do this conveniently by just snapping a switch, one photographer designed a neat unit comprising a bicycle dry-cell case in which a second photoflood lamp, the same size as the one in the reflector, was mounted. After drilling holes in the case to assure adequate ventilation, a porcelain socket was fastened inside of the lid with machine screws and a

small toggle switch of the panel-mounting type designed for 110-volt operation, was located next to the socket as shown. Wiring was done according to the diagram at the left, using flexible rubber-covered cable. After the unit was assembled and wired, the case was clamped to the lamp stand. Pushing the switch toward one side caused both photofloods to light at much less brilliancy than normal, and pushing the switch the other way cuts out the lamp in the unit and allows the one in the reflector to burn at full brilliancy.

Magnifying Glass Held by Vacuum Cup Leaves Hands Free

Modelmakers and others who often have to examine small parts under a magnifying glass will like this method of anchoring it to leave both hands free. The handle of the glass is drilled to take the screw in a vacuum cup of the type used to fasten ash trays to car windshields. This permits the glass to be set on some smooth surface of the bench, wall, or any other place desired.

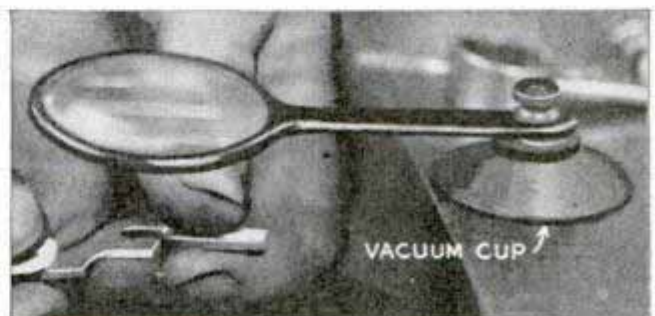

Wooden Rack Protects Golf Clubs Against Warping

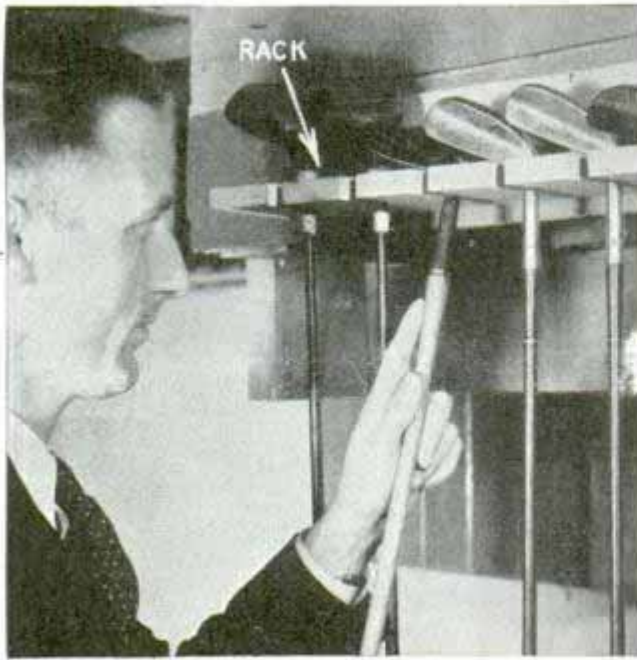

Before storing your golf clubs for the winter, assemble this simple little rack and hang them in it. It assures protection for the clubs so that they will not warp as they might if left standing in a corner. The rack is nothing more than a length of wood with slots cut in it to take the shank of the club handle close to the head.

—Joseph P. Driscoll, Buffalo, N. Y.

Fine and Coarse File Combined to Save Time

When you have a job in which you first outline the work roughly with a coarse file and finish it with a fine one, this combination file will save time. It consists of a fine and coarse file fastened together with a piece of paper between them to protect the teeth. A small improvised C-clamp can be

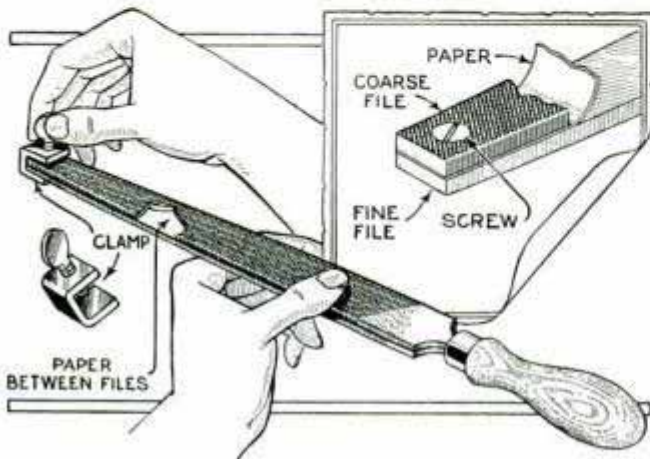

used to fasten them or the metal can be annealed back an inch or so from the end and drilled to take a small bolt, counter-sinking the head of the latter. When one side of each file has become worn, you can take them apart and change the faces.

—M. M. Warren, Monterrey, N. L., Mex.

Hold-Down on Power Scroll Saw Converted to Presser Foot

When cutting thin material in a scroll saw where the hold-down has to press against the work so tightly that the latter is hard to slide over the table, this presser foot, which is somewhat similar to one on a sewing machine, will solve the problem. Get a small collar that fits over the shaft of the hold-down after



which you drill and tap the collar for a thumbscrew. Then slip a coil spring over the shaft and adjust the collar against the spring to give the required pressure on the work, leaving the adjustment screw on the hold-down loose so that the shaft is free to move up and down.

—A. H. Waychoff, Tempe, Ariz.

Wood Screw Flares Tubing

In an emergency, the end of a piece of copper tubing can be flared quite satisfactorily to take a compression fitting with an ordinary flat-head wood screw. Select a screw with a head somewhat larger in diameter than the inside diameter of the tubing. While holding the tubing with one hand rotate the screw with the screwdriver, pressing against it firmly. The bevel on the underside of the screw will tend to flare the end of the tubing.

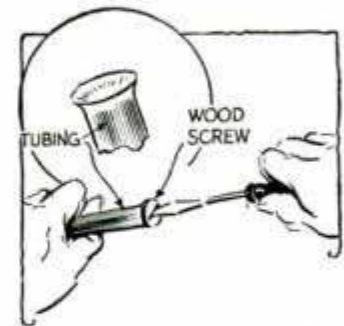

Sensitive BEAM SCALE for photographic chemicals

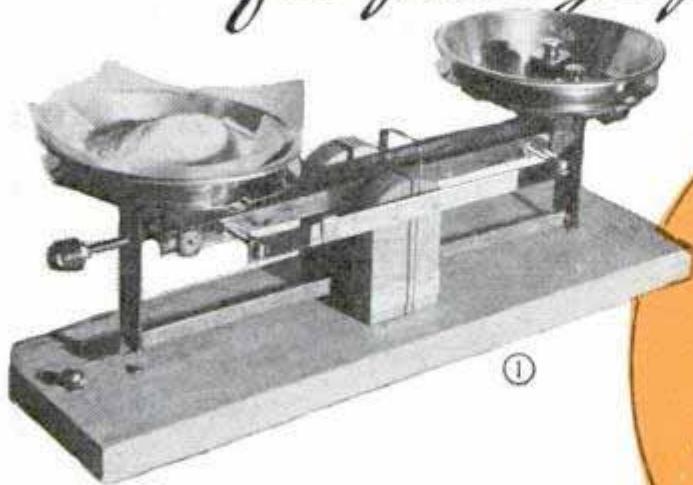

①



Ideally suited to the photographer who wants an inexpensive scale on which to weigh photo-developing chemicals, this one is accurate for most purposes, and can be assembled from odds and ends. Fig. 1 shows the completed scale, while Fig. 2 gives an end view showing one tray and the adjustable balancing weight. The base and two vertical supports are wood, and all metal parts are light flat iron

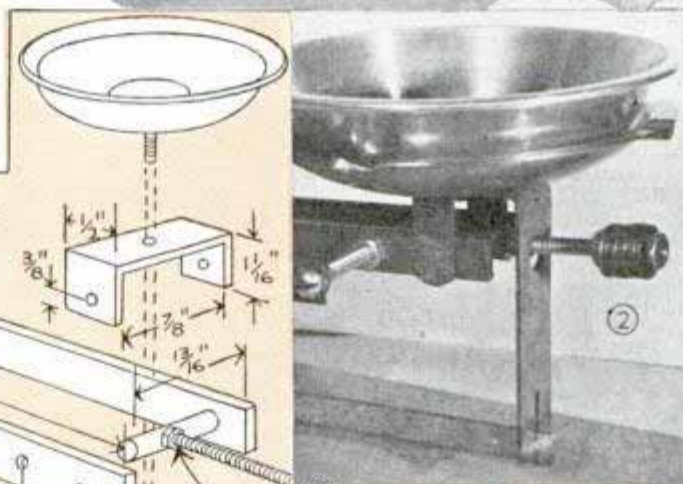

②

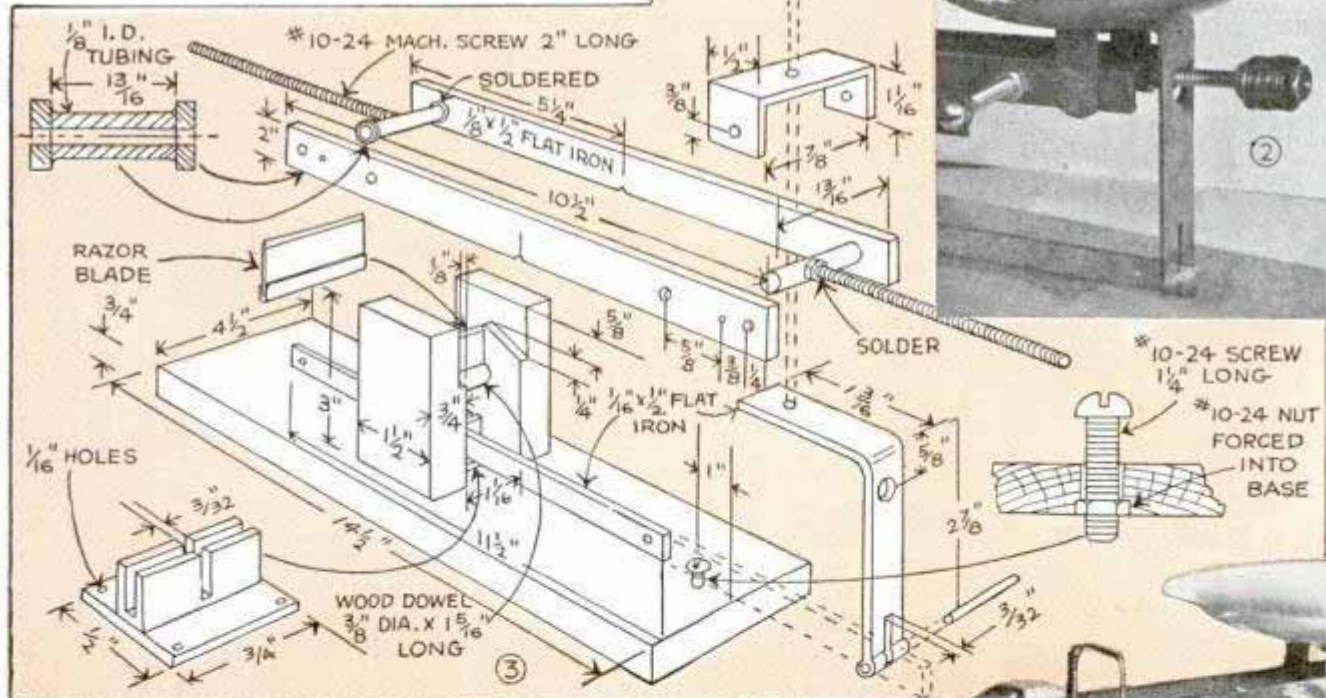

Method of assembly is indicated in Fig. 3. The beam is supported on a razor-blade fulcrum, which is set in a dowel pressed tightly between the vertical supports. The base rests on two rubber-headed tacks at one end and on an adjustable leveling screw at the other. This is a machine screw with the nut pressed tightly into the underside of the base. The beam is graduated as indicated in Fig. 4. A piece of adhesive tape may be stuck to the metal and the divisions marked on it. A steel wire bent to shape and soldered to the beam centrally between the ends serves as a pointer

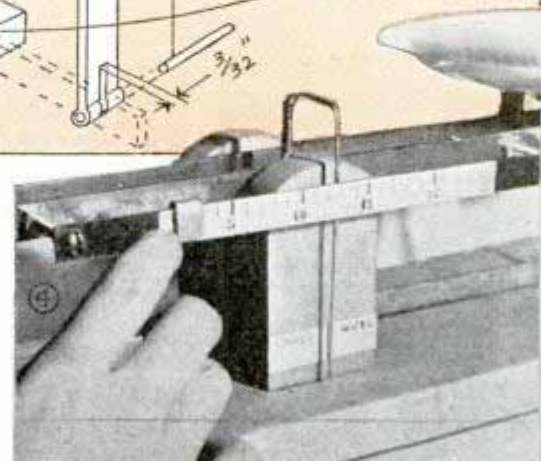

Self-Alining Shaft Hangers for Light Work

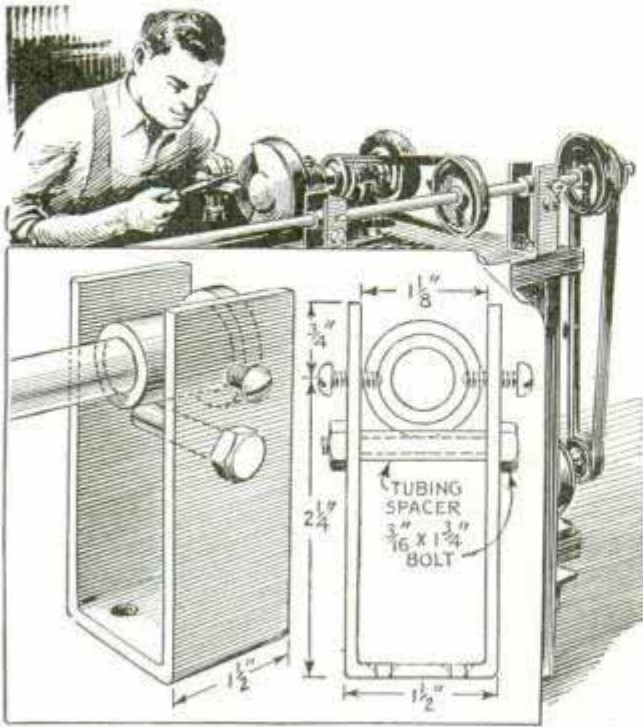

These hangers are suitable for running most light home workshop machines, and are made easily with hand tools. Soft steel for the frame should be bent to shape before drilling and tapping. Model-T Ford bronze spindle-bolt bushings are used for bearings. These will fit a 1/2-in. shaft with slight reaming. Hangers are self-aligning, and will take 4-in. pulleys.

—Walter Clark, Portsmouth, N. H.

Fastening Wood Pulley on Shaft

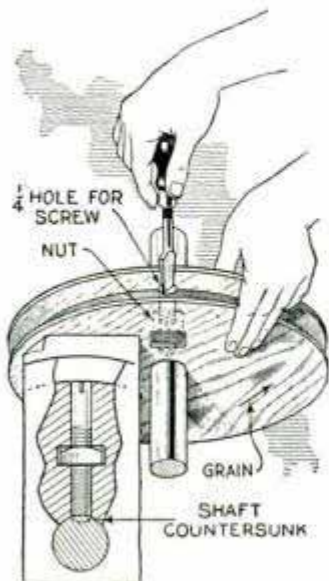

When a small pulley is needed, I turn it from a piece of 1-in. hardwood and fasten it to the shaft by the method indicated. After turning the pulley, drill a 1/4-in. hole across the grain from the top of the pulley to the shaft, and then make a slot about 3/8 in. from the shaft to take the nut of a stove bolt,

which serves as a set screw. After cutting off the head of the bolt, the end is slotted

for a screwdriver to tighten it. A shallow countersink in the shaft helps to keep the bolt from slipping when the pulley is under a stiff pull.

—Arthur Salzsieder, Oshkosh, Wis.

Taking Thin Cut on Board

If you happen to cut a piece of work a trifle too long so that you have to remove a thin strip from one end, try the following method: Lay the work on a piece of scrap board as shown and saw through both pieces. The scrap piece tends to guide the saw so that it doesn't break off the thin strip that is being removed.



—Sigmund Segson, New Milford, N. J.

Protecting Plants in Fish Pool During Cold Weather

Here's a good way to protect plants in your fish pool during the winter. When they are set out in the spring place them in boxes of suitable depth and size. A layer of gravel is applied over the soil in the boxes. When fall comes, trim down the plants, drain off the water, tramp straw around the pots and then cover the straw with a 5 or 6-in. layer of earth.

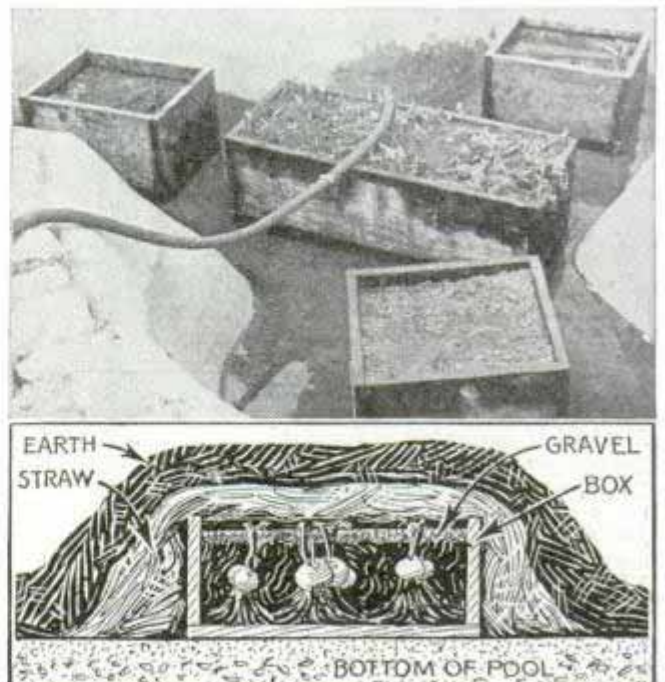

SILK STENCILS

SIMPLER than cutting linoleum blocks, silk-screen stencils offer the home craftsman one of the fastest and cleanest methods for painting greeting cards and cutouts. Painting can be done on any flat surface, and the design can be worked on wood, cardboard, cloth, or any other material. Photographic processes simplify the art work, so that intricate designs can be reproduced easily by the average worker.

The setup is simple. As shown in Fig. 3, there is a wooden frame on which is stretched a piece of stencil silk or organdy. The

The perfect method for painting greeting cards, cutouts and novelties

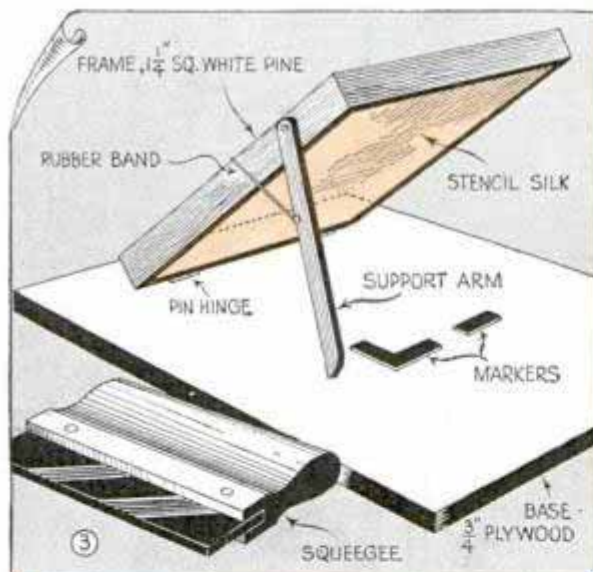
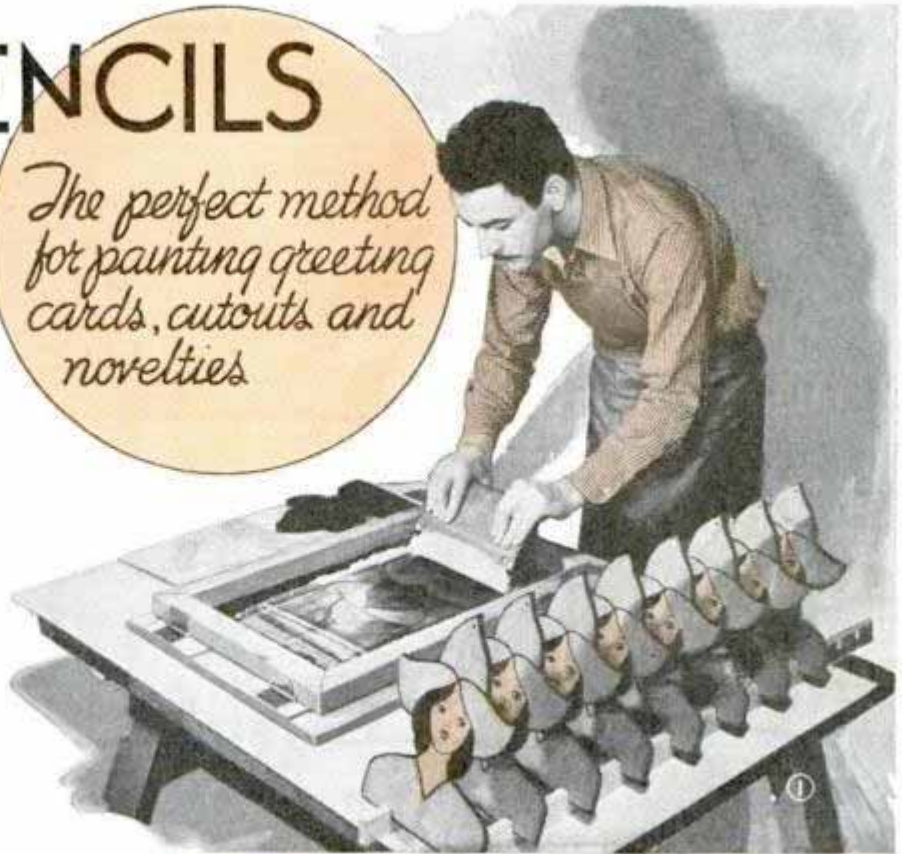

frame is hinged to a base board with two pin hinges. The design is painted or blocked out on the silk screen and is reproduced by forcing paint through the open meshes of the screen, using a rubber squeegee.

In setting up for any job, the first thing required is the wooden frame. For average-size work, this is made from 1 1/4-in. square white pine. The frame should be about 2 in. wider than the design and about 6 in. longer, inside dimensions. Frame members are mitered and grooved, as shown in the detail, Fig. 2. The stencil silk is fitted to the frame by first tacking it loosely in place; then, 1/2-in. square cleat sticks are pushed into the grooves, as shown in Fig. 4, stretching the silk drum-tight.

One of the simplest methods of getting the design onto the screen is the paper mask or knife-cut stencil, as shown in Figs. 5 to 13 inclusive. In the example, Fig. 6 is the copy, which is drawn full size. A sheet of tracing paper large enough to cover the screen is coated with shellac, as shown in Fig. 7. While this is drying, the copy is coated with wax, rubbing on a thin film with the fingers, as shown in Fig. 8. A good wax for this pur-

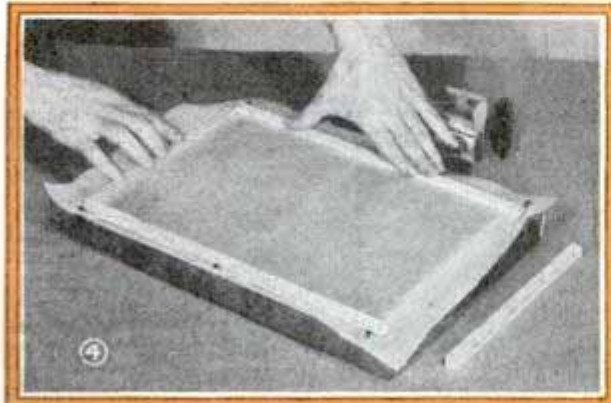



completely blocked off except for the design. Then you pour a quantity of paint onto the screen, and wipe it across the design with the squeegee, as shown in Fig. 12. Fig. 13 shows the screen in an up position, with the work in place, registered by two cardboard markers fastened to the base.

Another method of getting the design onto the screen is to block it out with a special lacquer filler. The Dutch-girl cut-

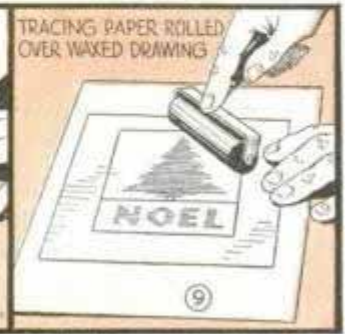
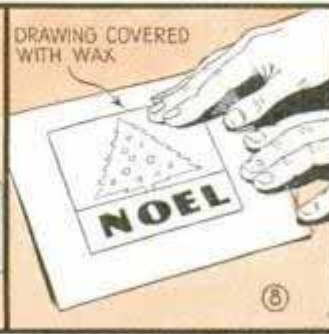

pose is made from equal parts of beeswax, kerosene and linseed oil. The tracing paper, shellacked side up, is then rolled over the waxed drawing, Fig. 9. All portions of the design which are to print are now cut out with a stencil knife or razor blade and stripped off, as shown in Fig. 10, the wax coating holding the design firmly in place. After the cutting is complete, the silk screen is placed over the design, and, using a thin, soft pressing cloth and a medium-hot iron, the design is adhered to the screen, as shown in Fig. 11. Finally, the inside edges of the screen are lined with masking tape, as shown in Fig. 5, to prevent paint from leaking through. The result is a screen

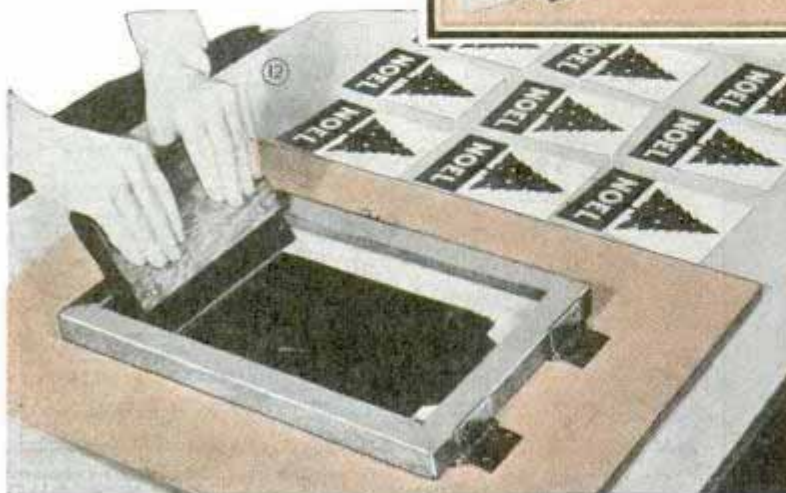
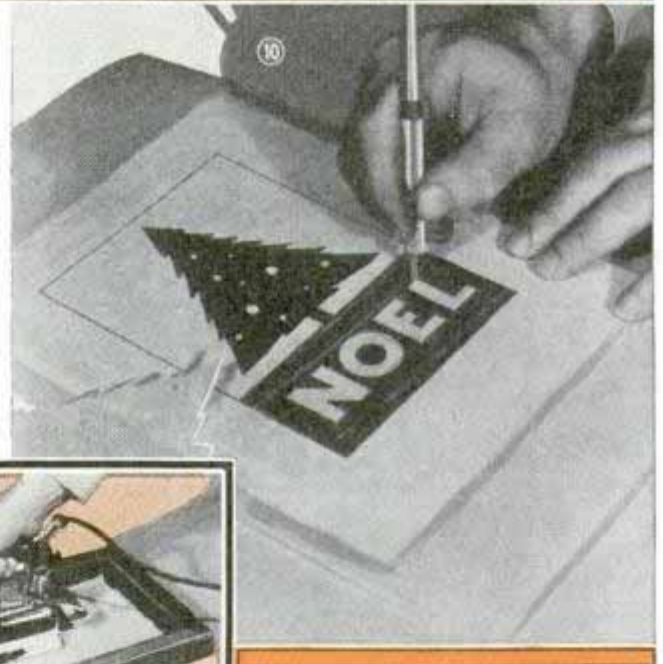



out for the top of a laundry bag, Fig. 14, is an example. Start, as before, by making a full-size copy of the design. Transfer the outline of the design to $\frac{1}{4}$ -in. plywood or wallboard and cut out the required number on the band saw or scroll saw. Stack the cutouts on edge and spray with black paint, as shown in Fig. 15, then, spray or paint the faces of the cutouts, as in Fig. 16. In the example, however, the first step is to secure an all-black cutout. The second is to make the screen, which is done by placing the screen over the copy, as in Fig. 17. The design, which is plainly visible through the silk, is then traced with a medium-hard pencil and painted with the lacquer filler. Since the cutout is already black, we will not want any of the black in the design to print. Hence, everything that is black on the copy is filled in with lacquer on the

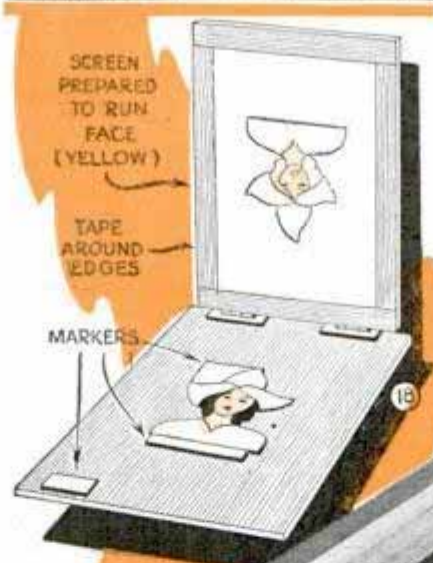
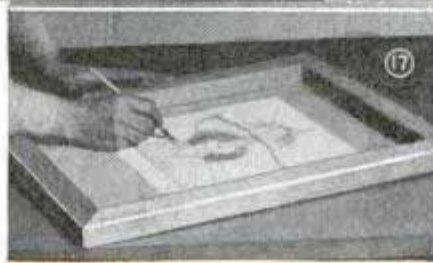

screen, also, all the area outside the design is blocked off, as shown by the black in Fig. 18. This design is in two colors, yellow face and red hat and dress. The yellow is printed first, and, in order to protect the red, all the red areas are blocked out. This is done with a filler which is soluble in water. In Fig. 18, the gray portions of the design represent water filler. Thus, only the yellow face is left open, and this is painted on the black cutout, as shown in Fig. 19. After the



run in yellow is complete, the water filler is washed out, leaving the original lacquer-filled screen. The yellow face is then blocked off with water filler, leaving the red hat and dress open for painting, Fig. 1.

The stencil silk used for brush-filled screens is what is known as No. 16, running about 140 threads per inch. It is available in several grades. Knife-cut stencils of open design can be run on organdy. The paints used should be made especially for screen work. These are available in flat and gloss, also in a special-process lacquer, and are put up in paste form, being thinned as required with a special non-clogging varnish. Average consistency for painting on cardboard or wood should be slightly thinner than soft grease.

The photographic method requires no artistic ability, since the worker can copy designs directly from any book or magazine with the aid of a camera. In the example, Fig. 21 is the copy. As in any photographic process, a negative is required, that is, the copy must be transferred, in black, to a clear sheet of celluloid or tracing paper. If desired, the negative can be made by hand by placing a sheet of heavy tracing paper over the copy, as shown in Fig. 20, so that the design can be filled in with photographer's opaque or black ink. In the second method of making a negative, the copy can be made with a camera. This gives a negative which has white lines on a black ground. This first negative is then exposed to a second film, which results in a true copy of black lines on a clear ground.

So much for the negative. The next job is to sensitize the silk screen so that it can be printed just the same as a photographer prints a photograph. No. 16 stencil silk is used. The sensitizer can be purchased from any process supply house, and requires

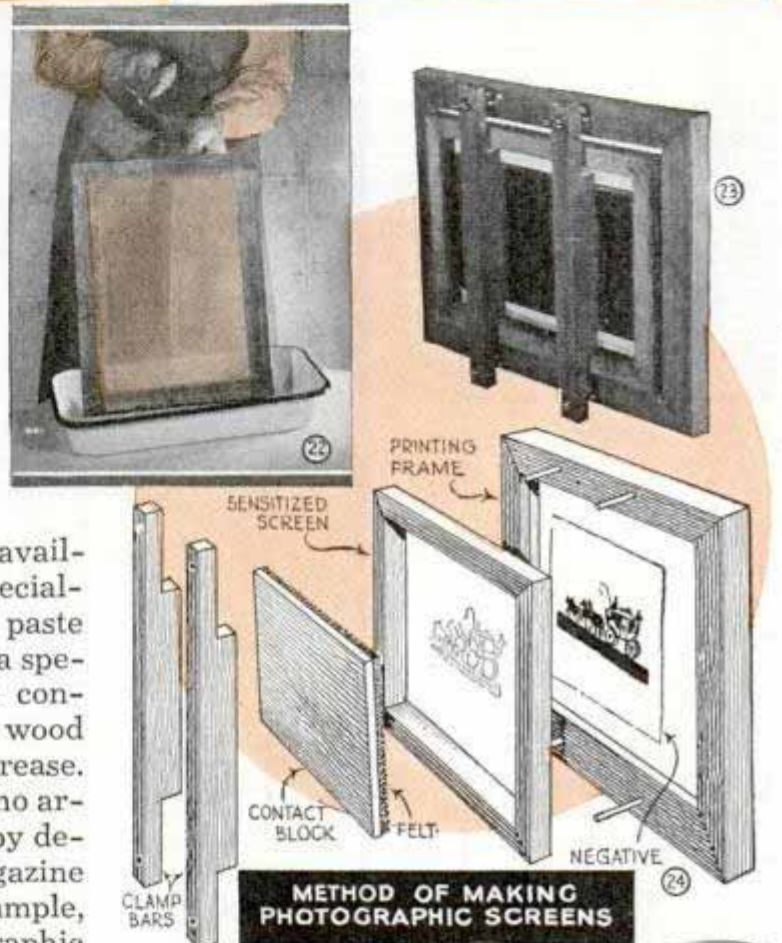



only mixing with water to make it ready. The solution is flowed on over the face of the screen, as shown in Fig. 22. All operations can be done in ordinary room light except the drying of the sensitized screen, requiring about 30 min., which should be in a darkened room. After the screen is dry, the print can be made. This is done just the same as printing a photograph, Fig. 24 showing the setup. The negative is placed face up (reading position) on the glass in the printing frame. The silk screen, face down, is then placed over the negative, followed by a contact block and clamps. Fig. 23 shows the frame ready for printing, while Fig. 25 shows the exposure being made, using a photoflood lamp. Exposure time is approximately 15 min., and has the effect of hardening the exposed portions of the screen. After printing, the screen is held under a stream of warm water, Fig. 27, which washes out the soft, protected parts of the design. Fig. 26 shows the finished photographic screen; Fig. 28 shows the job being run. While the example shows printing in one color only, as many colors as desired can be run by blocking out with water filler as previously described.

A useful dodge which can be used to advantage for certain types of two-color work is shown in Fig. 29. The copy is the Dutch girl previously shown, but in this case the hat is to be red and the dress blue. By fastening a cardboard bridge to the screen with masking tape and using two squeegees, both the red and the blue can be run at one time. Another method of multi-color printing is the elimination process. Using the Dutch girl again for an example, the first run would paint the hat, face and dress in red. The red hat and



AFTER PRINTING, THE SCREEN IS HELD UNDER HOT WATER TO BRING OUT THE PICTURE-LEFT

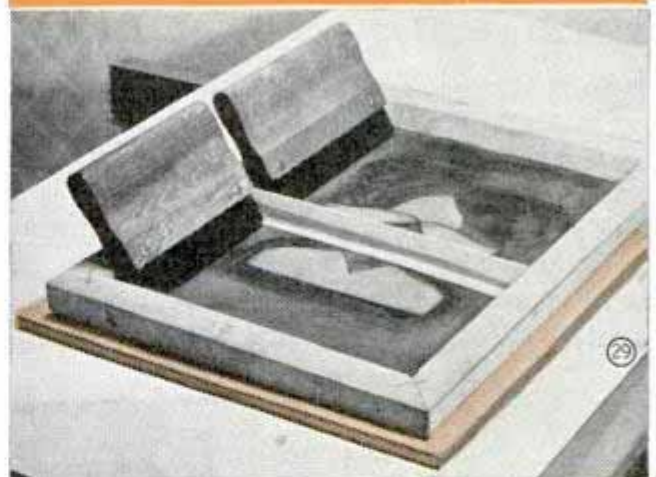

dress would then be blocked out, leaving only the face which would be run in yellow. Then, if desired, the face could be blocked out, leaving only the eyes to print in blue.

☐ Dipping a rubber eraser in emery powder will make it suitable for cleaning rusted or corroded metal surfaces quickly.

Balancing Point of Ladder Marked with Tape

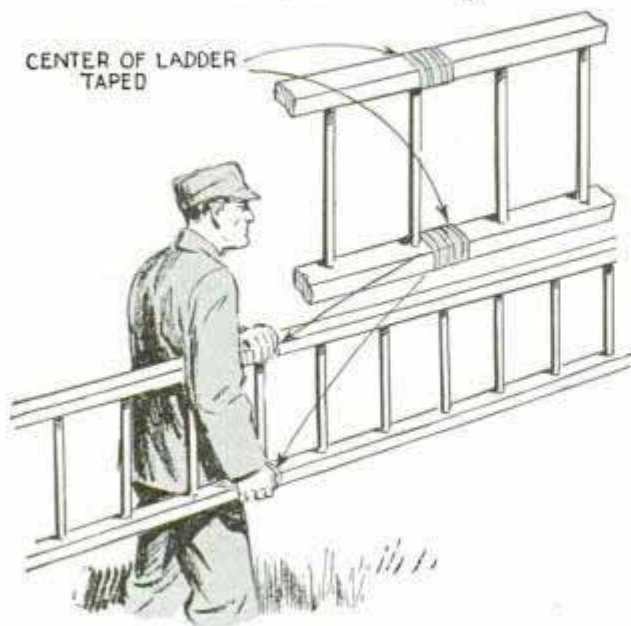

Painters who are obliged to carry ladders from place to place are often annoyed and delayed by the necessity of "trying" the ladder for balance. If the center of balance is located and each standard of the ladder is given a wrapping of electricians' tape at those points, the tape will serve as an easy handgrip for carrying and the ladder will balance evenly when lifted from the ground and carried.

Making Up Graphite-Core Pencils

Soda straws filled with a lubricant made by mixing paraffin and graphite are handy to use on locks, hinges and other moving parts where graphite is preferred to oil. Get a dozen or so soda straws and tie them together. Then melt a small quantity of paraffin and while it is kept melted over heat, stir in graphite until the mixture is

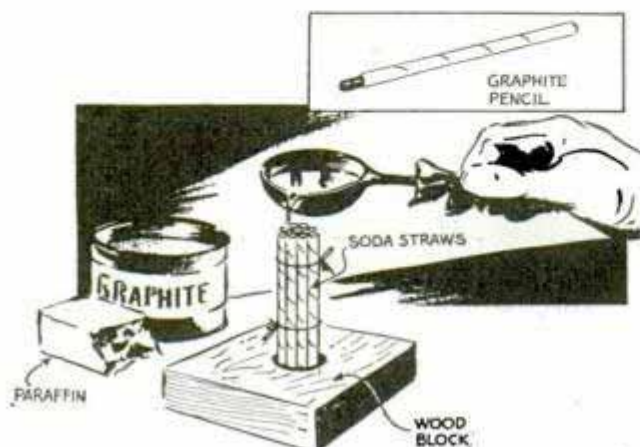

the consistency of heavy syrup. Place the straws in a wood block, as shown, pour in the mixture and let it cool. In use the end of a straw is torn off and the pencil rubbed on the object to be lubricated.

Two-Wire Clothesline Tightened with a Crank

If you have this clothesline in your yard, you can throw away the line props because you just turn a crank to tighten the wires. Two support posts with crossarms are required. One arm carries two pulleys near the ends, and the other one carries two hooks near the ends and a pulley in the center. The pulleys on the arm should be of the type that have one side open so that the wires or ropes can be slipped into them easily. In use, one wire is fastened to one

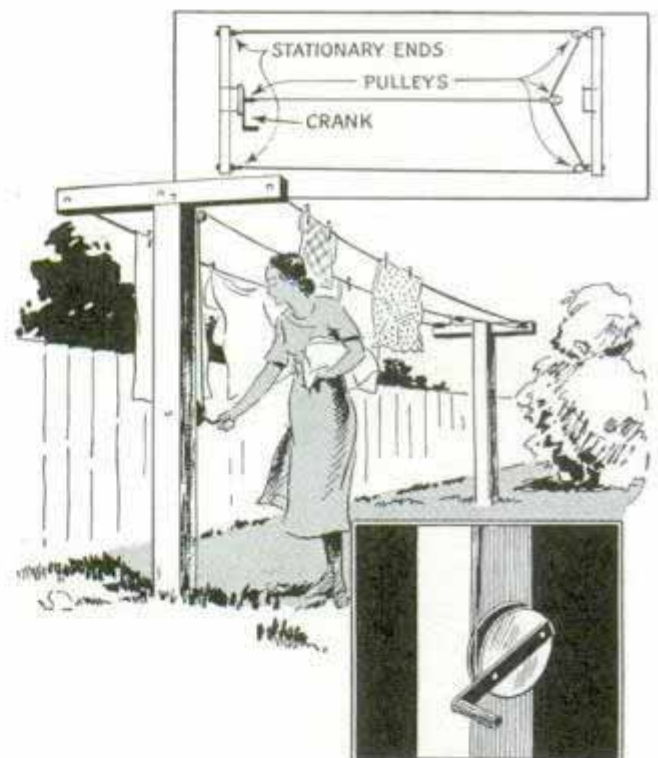

of the hooks, then run over the pulleys and back to the other hook. The tightening wire has a closed-type pulley on the end to run over the first wire between the two pulleys on the arm as indicated. This wire is then run over the closed pulley between the two hooks to a crank mounted on the support post. The original crank was of the type used to shut off windmills. If this type is unavailable, you can make one easily, using a grooved wood disk with a crank attached to it.

—Conrad L. Lenstrom, Arcadia, Nebr.

This Disappearing Coin Trick Is a Real Poser

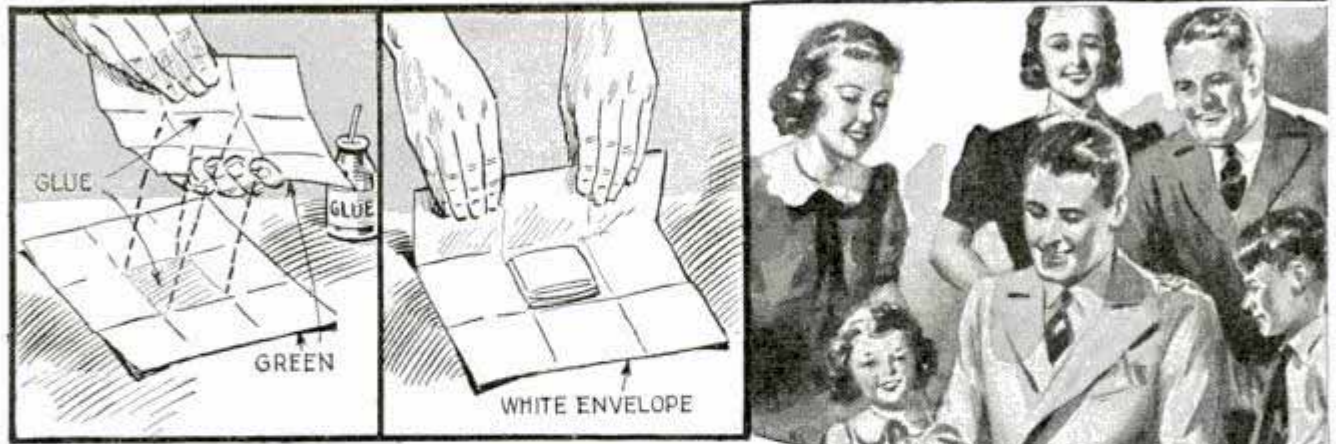

Here's a little trick to remember for the next party. A coin is wrapped inside of three small sheets of paper, one over the other. Then, keeping the wrapped coin right before your eyes, the performer shows you how completely the coin is wrapped and even allows you to pinch the paper for assurance. Next, he lays the paper on the table, unwraps it carefully in full vision of spectators, who are amazed to discover that the coin has disappeared entirely, seemingly right through the paper without even leaving a hole.

And now to explain just how it's done. Cut seven squares of colored paper to the dimensions shown—two yellow, two pink and two green; the largest and last one being white paper. Crease the sheets to fold as indicated by the dotted lines, place the two green sheets back to back and stick the center panels together with glue. Place the green sheets on the table with one pink and one yellow sheet on top, and fold each envelope, starting with the yellow one which should be inclosed in the pink one, and so on. When the folds are completed, reverse the packet so that the unfolded green sheet is uppermost and repeat the process. You now have two packets of folded envelopes but the green ones are glued together through the center panels so that the assembly appears as one package. With this inclosed in the white envelope you are ready for the performance. Placing the packet on the table, you borrow a coin. Ask the donor to observe the date so that when you return it he will see it is the same coin.

Unwrapping the envelopes, and leaving them in the order shown, place the coin in

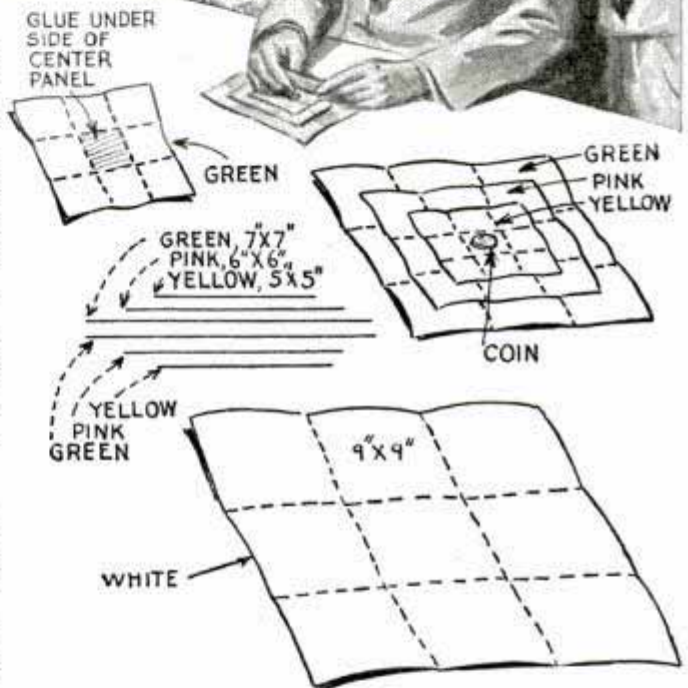

the center of the smallest envelope and re-fold them separately as before, but, before finishing by inclosing in the white envelope, give the green packet an extra turn which will bring the empty assembly of envelopes uppermost. This extra flip of the package will not be noticed by the spectators as your folding is accomplished by turning each envelope over in its turn. Now unfold the sheets. The last and yellow envelope will be found empty. To make the coin re-appear, simply re-fold the envelopes and repeat the turning of the packet after the green one is closed.

—G. E. Hendrickson, Argyle, Wis.

☐ A quickly vanishing red ink can be made by dissolving a small quantity of phenolphthalein in strong ammonia. Writing done with this ink disappears a short time after it has been exposed to the air.

Auto Casings Hold Bricks on Roof for Chimney Work



It will not be necessary to build a stand or bench on the roof to hold bricks, when repairing a chimney, if a couple of discarded auto casings are tied together with a stout rope and placed over the roof, as indicated. The bricks are placed inside of the casings on each side of the roof.

Flexible Cable Cut Off Squarely When Held Between Blocks

When working with flexible tubing or cable, you can cut it off squarely with a hack saw if it is held between blocks as shown in the photograph. One block of rectangular shape is fastened to the bench and another block of the same size and shape is cut diagonally across to form two wedges. One of these is nailed to the bench near the first one so that the other wedge-shaped piece can be driven in to grip the

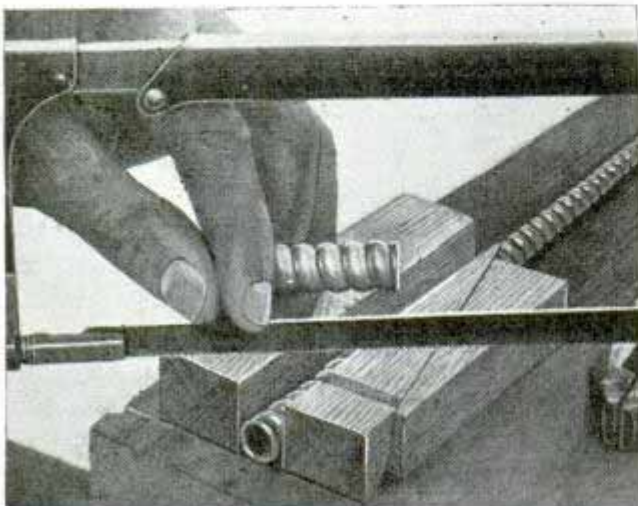

tubing tightly. If care is taken in locking the blocks, the wedge-shaped piece can be driven up flush with the end of the rectangular one so that the two ends will serve as a saw guide.

Notebook Sheets Perforated with a Pen Point

The next time you want to insert an unperforated sheet of paper in a loose-leaf notebook, punch the holes neatly with an ordinary pen point. The same method is also handy for perforating paper to take the corners of cards and photos as a substitute for gummed corner tabs.

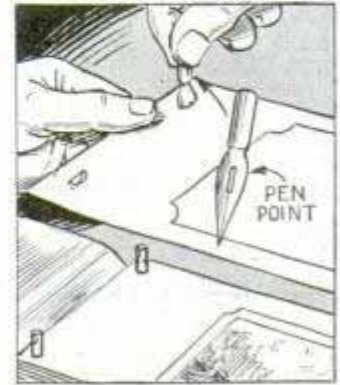

Fastening Stovepipe in Chimney

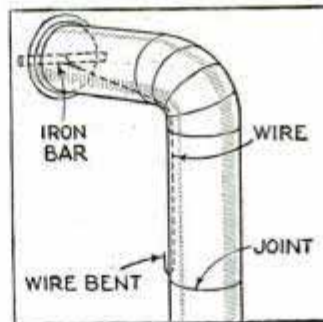

One home owner who had experienced considerable trouble by having his stovepipe slip out of the chimney opening, anchored it as indicated. A small iron bar was placed across the inside surface of the chimney opening. Then a wire was tied to this and run down inside the pipe where it was hooked over the edge of one section.

—Walter Fowler, Lawrence, Kans.

Wallpaper Seam Roller

In the absence of a regular roller for smoothing seams in wallpaper, you can improvise a serviceable one from a furniture caster of the wheel type. If desired, the stem of the caster can be fitted with a suitable handle for added convenience.

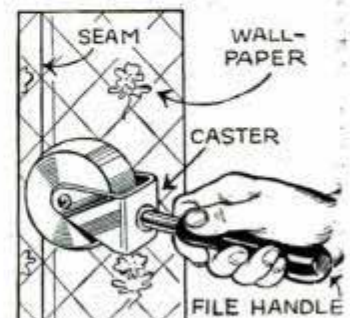



WALL MAGIC

Smart Effects for Kitchen and Bath

MODERNIZING those two ugly ducklings—the kitchen and bathroom—becomes a simple job with the variety of structural materials now available. Linoleum, tileboard, structural glass, metal tile, clay tile, asbestos, rubber, cork and oilcloth are the many materials now offered in colorful patterns.

One of the most popular

materials is tileboard. This is available in sheets 4 ft. wide by 6, 8, 10 and 12 ft. long, the surface of the board being ruled off into 4-in. square tiles. The board comes in various grades of hardness and thickness, the latter being usually $\frac{1}{8}$ to $\frac{3}{16}$ in. In installing tileboard, loose wall-paper should be removed. A straightedge is used to locate inequalities in the plaster surface, and these should be leveled off. Breaks in the plaster must be cut out and the hole shimmed with strips of wood, as shown in Fig. 4. Check with a level to determine if there is a definite low spot in the room, as shown in Fig. 7, and, if so, the height of the tileboard should be measured at

this point. Strike a level line around the room with a chalkline or straightedge. Cut through the plaster and fit wood blocks in place to take all screw-fastened fixtures, as shown in Fig. 5. Apply the tileboard by coating the wall with the special cement provided as in Fig. 6. Nailing, if required, should be done with $1\frac{1}{4}$ -in. No. 16 finish-

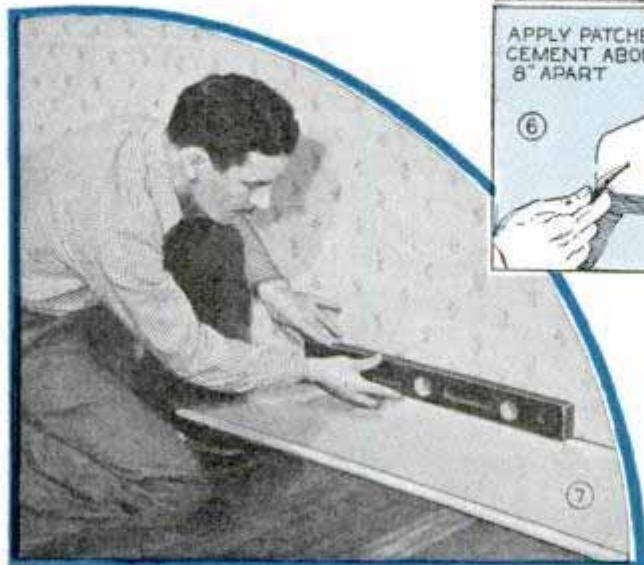
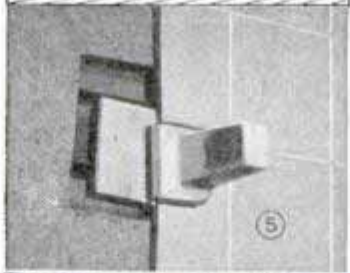
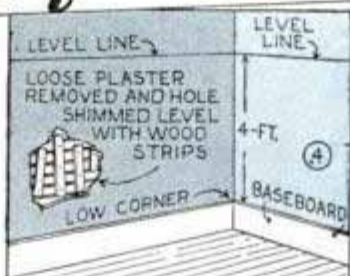

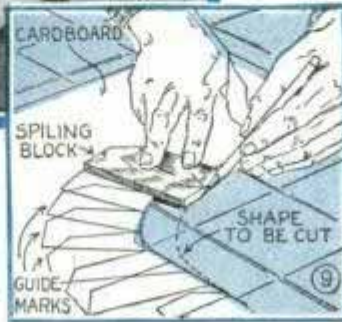

ing nails inserted through the tile scorings, as in Fig. 3. In most cases, plumbing fixtures can and should be removed. Where this is not practical, perfect fitting is done by spiling the shape on a piece of cardboard cut roughly to such size that it will fit around the fixture; then, with a small block of wood, as in Fig. 8, take off the contour. When the cardboard is removed and placed over the tile-board, as in Figs. 9 and 10, the relocation of the guide marks will give an exact cutting line. When cutting at the baseboard, a small block of wood with a hole drilled through it to take a pencil, can be used to advantage. The tileboard is tacked an inch or so higher than its actual position. Then, with the wood block riding the top of the baseboard, the pencil will mark the exact cutting line, as shown in Fig. 11. The same method is useful in determining the cutting line for corners.

The simplest styles of wood moldings can be made readily in the home workshop to the patterns shown in Figs. 12, 13 and 14. Among ready-made moldings, chromium trim is the most popular. Prices include cap moldings, inside and outside corners, division strips, edging strips, and a number of others. In the simplest kind of job, only the cap molding is required, as shown at the left in Fig. 16. In the center of the same illustration is shown a solid metal outside-corner molding, while Fig. 15 shows the popular snap-on style.

Stainless-steel tiles make an attractive wall surface. These are 4-in. square and are applied by mounting to the wall with cement, as in Fig. 17. Inside and outside corners are worked by scoring the fiber backing of the tile, as in Fig. 18, after which it can be bent over a straightedge. The tiles and other materials fastened with cement should be rolled thoroughly after application, as shown in Fig. 19.

Now, in figuring the cost of installation, the probable life of the material also should be considered. Oilcloth, for example,

Indulge in steel tiles. - W. Alverley.

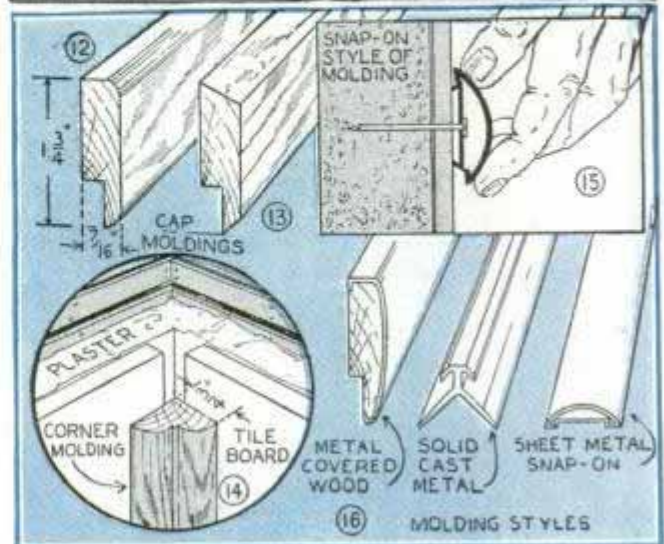
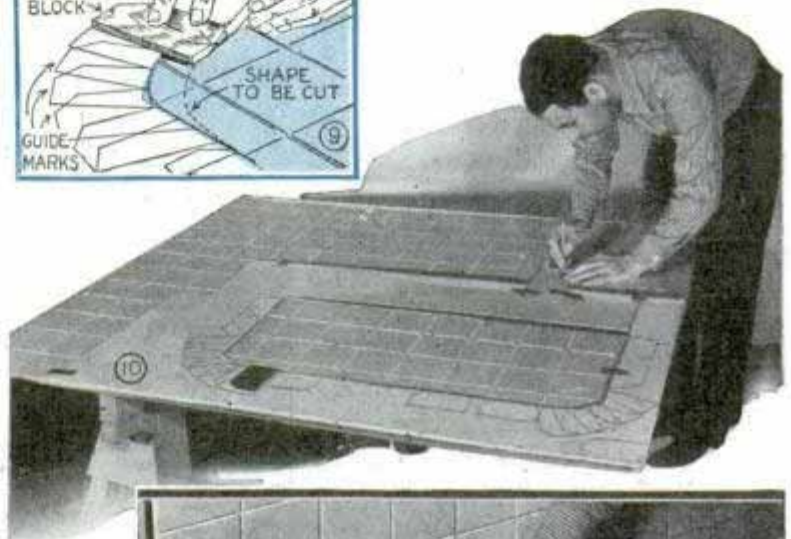

makes an attractive wall, but of course does not last as long as some of the more expensive materials. Linoleum is a good material to use when the entire wall is to be covered. Although the initial cost is fairly high, colored glass in various structural shapes undoubtedly makes the smartest and most durable wall surface. But, barring accidental breakage, such beautiful wall surfaces will practically last a lifetime, always retaining their original luster. Monel-metal tiles or prefabricated metal panels are particularly useful in some rooms and often can be used to

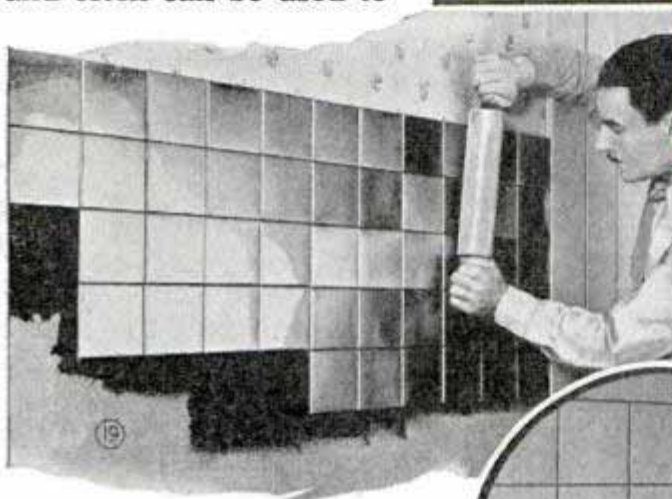
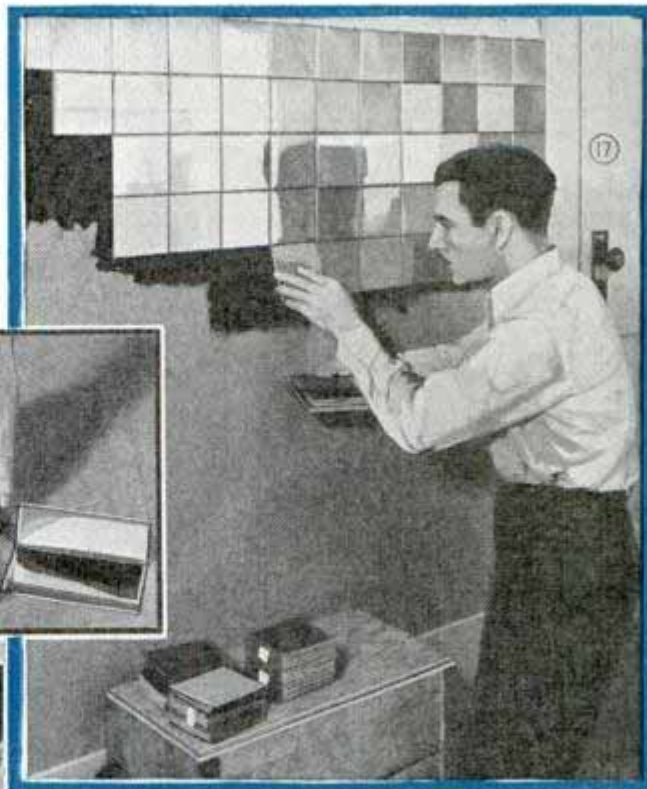

surface of the board. Freehand work can be done with an ice pick with the point rounded over, while straight tile marks can be impressed with a strip of metal, as in Fig. 21. After painting, the tile scorings can be run in with a ball-type lettering pen, Fig. 20, using black, white or colored waterproof ink.

advantage in combination with less expensive coverings. Sheet plastic compressed into asbestos or plywood panels makes sparkling walls. The least expensive way of using any of these products is to cover the lower portion of the wall only, treating the upper portion with paint or wallpaper. However, the various wallboards are so inexpensive that all-over treatment is usually not prohibitive. Excellent effects can be obtained by using a tiled board for the lower portion of the room and a plain board, with finish already applied, for the upper portion. Currently popular is the horizontal style of treatment as shown in Figs. 1 and 2 where the upper wall is done in plain wallboard with narrow division strips of chromium. Panel effects in any of the softer tileboards can be obtained easily by working any suitable picture directly on the

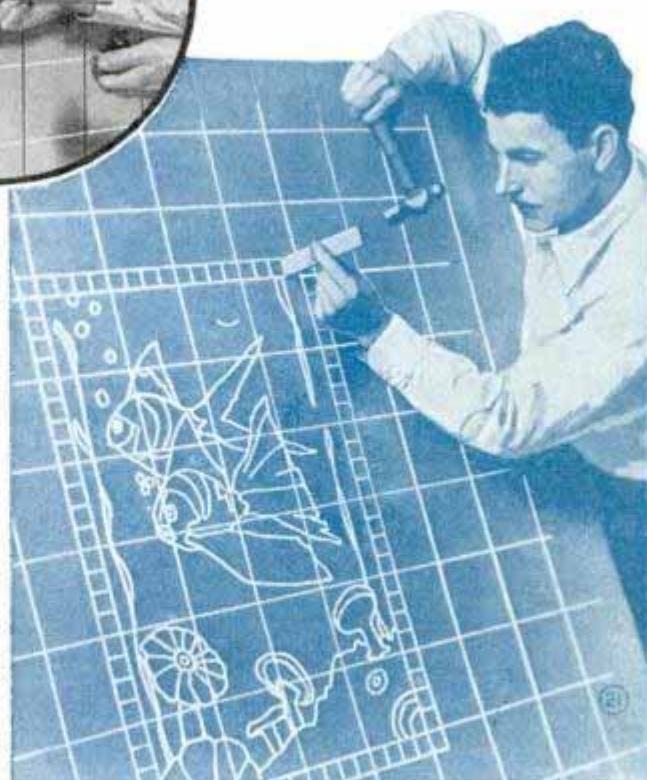
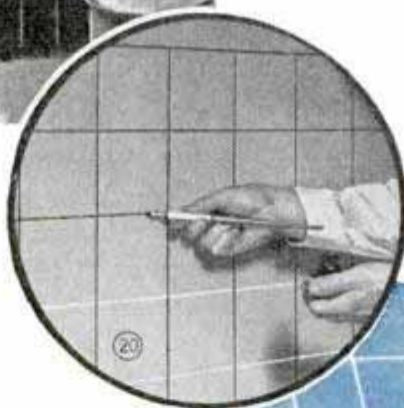

Bird Feeder Is Made Cat Proof by Can Lid on Standard

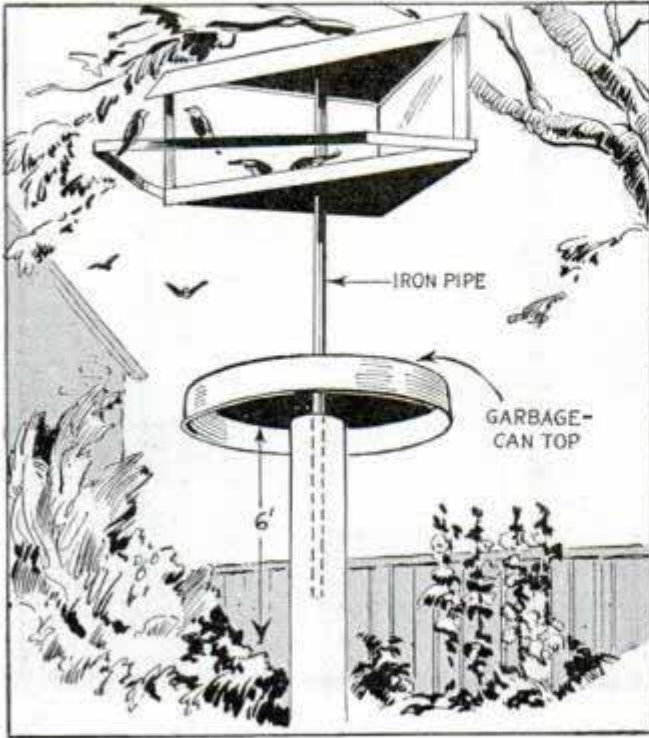

Finding that squirrels were robbing a bird feeder set up in his backyard, one home owner stopped the trouble by mounting a garbage-can lid on the standard of the feeder as shown. The lid is also effective in preventing cats from climbing the post and catching the birds.

Winding Small Coil Springs

The next time you have to wind a small coil spring, get a bolt of the proper diameter and file a small V-groove in one side of the nut. Then clamp the bolt in a vise,

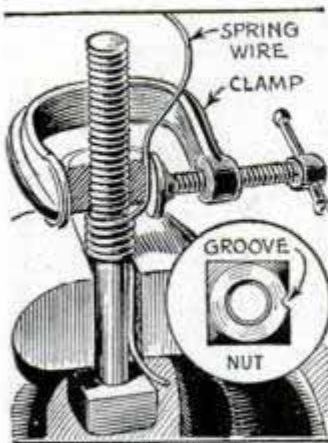

placing the end of the wire from which the spring is to be wound between one side of the bolt and one of the vise jaws so that the assembly will be clamped tightly. Run the wire in the groove of the nut and put a C-clamp over it as indicated. Then using the C-clamp as a handle, turn the nut. This will cause the wire to be wound tightly on the threads. The groove in the

nut should be shallow enough to allow the screw of the C-clamp to press against it slightly, causing a slight tension on the wire while winding it.

—Roy Mahal, Chicago.

Carbon Paper Removed Easily from Typewritten Copies

The usually difficult job of removing several sheets of carbon paper from a number of typewritten copies, is simplified

by cutting out a portion of the carbon sheets at the top. Select carbon paper that is a trifle longer than the typewriter paper so that the carbon sheets project a little at the bottom. To separate the carbons from the typewritten

copies grip the latter over the cut-out portion of the carbons, and pull the sheets apart.—John E. Bautsch, Denver, Colo.

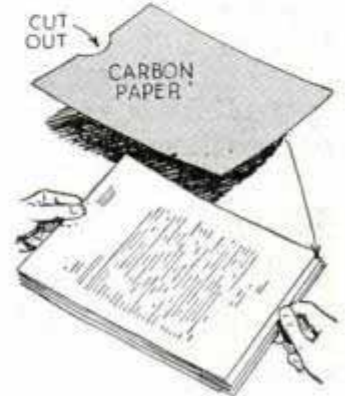

Portholes for Model Boats

When constructing your next model boat try this simple method of making realistic portholes: Get a narrow strip of "Cellophane" of the desired shade, coat one side with shellac and apply to model so it covers the spots where the portholes are to be located. Using a belt punch, which you can get at any hardware store, press it through the Cellophane by hand and at the same time recess the wood slightly. Then strip off the excess stock.

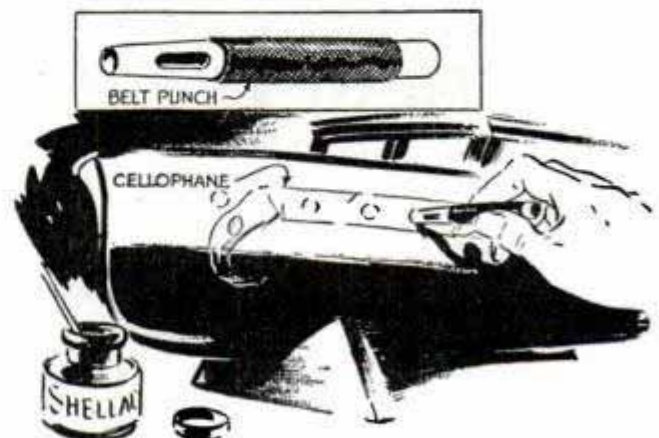
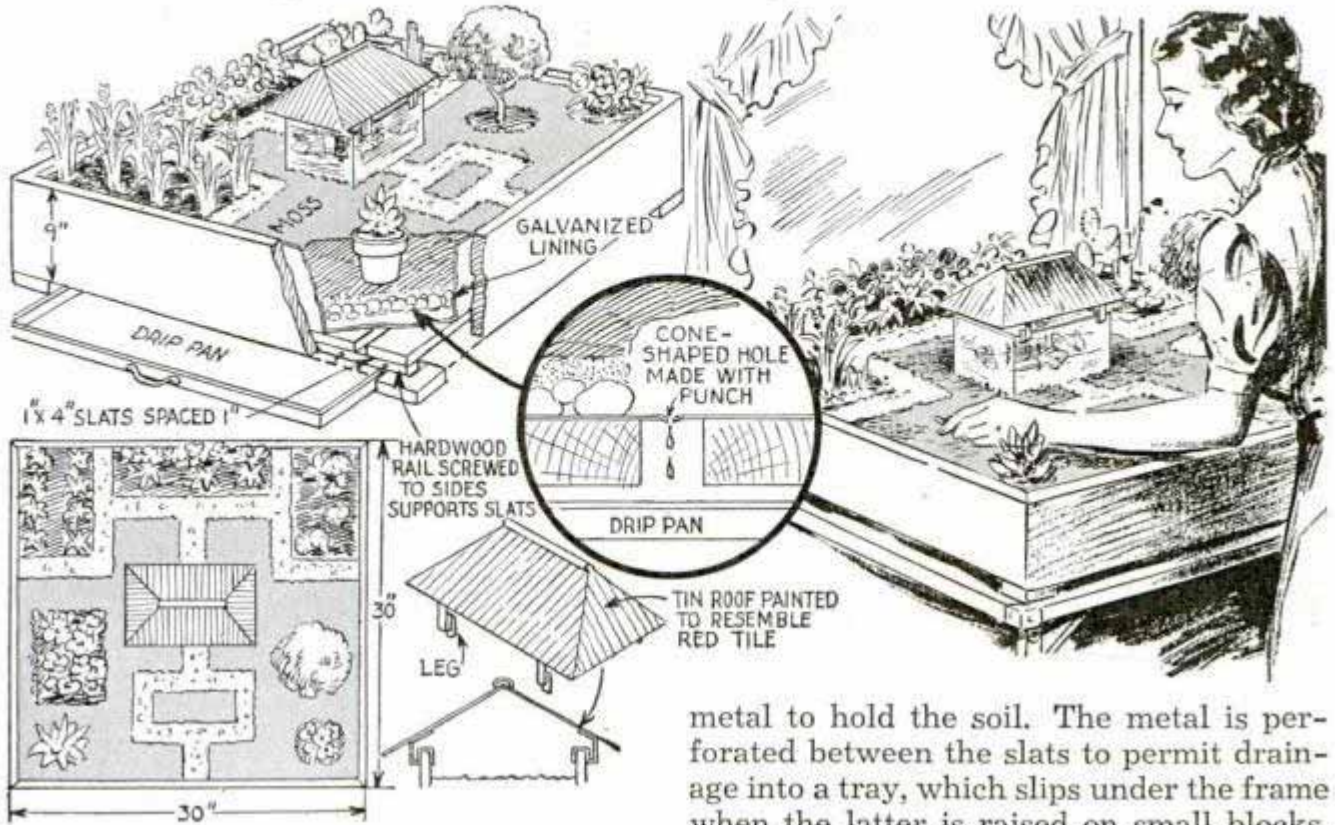

Table-Top Garden for Apartment Dwellers



Even with limited space, city dwellers can enjoy plants and flowers indoors with this miniature table-top garden. It can be laid out in formal plan with geometric walks and beds, or it can be developed into an old-fashioned type. The garden comprises a mitered frame with a slatted bottom. The slats and inside surfaces of the frame are coated with tar, after which the frame and bottom are lined with sheet

metal to hold the soil. The metal is perforated between the slats to permit drainage into a tray, which slips under the frame when the latter is raised on small blocks. To prepare the garden, spread small stones over the bottom, then cover with cinders or sand. Potted plants are used, and rich soil is packed around them. Lay out the walks with clean fine-mesh gravel, and plant grass or Helexine moss in spaces between the pots. An aquarium makes an attractive center piece, and if rectangular in shape, it can be made to resemble a glass house by providing a tin hip roof. Paint the roof to resemble red tile.

Tilting Tripod Head for Camera from Electrical Fixture

From a ball-and-socket electrical fitting, obtainable at many dime stores, I assembled a tilting tripod head to take small cameras. First saw off the threaded end of the socket, and insert a screw to take the camera. Fill the socket with solder to anchor the screw. Then solder a nut over the large end of the socket to take the tripod screw. The head can be tilted to hold the camera at any angle.

—Arthur Trauffer, Davenport, Ia.

☐ A back rest for bed patients who wish to sit up is quickly improvised by inserting a washboard between the back of the pillow and the pillow case

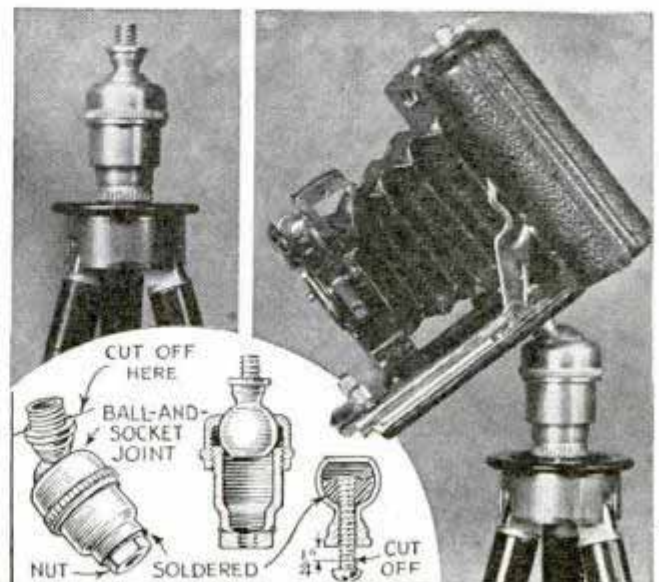

Solving HOME



①

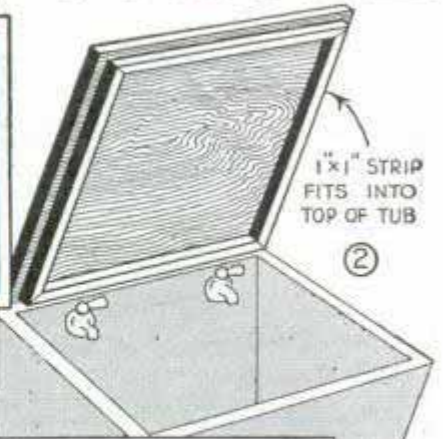
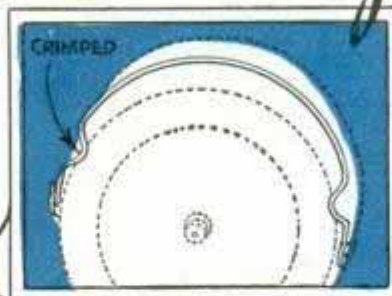

1"x1" STRIP
FITS INTO
TOP OF TUB

②

The lid of a stewing kettle is not likely to drop off and burn your hands if you crimp the bail to engage the lid as in 1. One side of a double laundry tub provides a good shelf while the other side is in use, when the wood lid in 2 is used. Next time you have a glove to darn, slip a marble into the end of the finger as in 3. It's a dandy emergency darning ball.

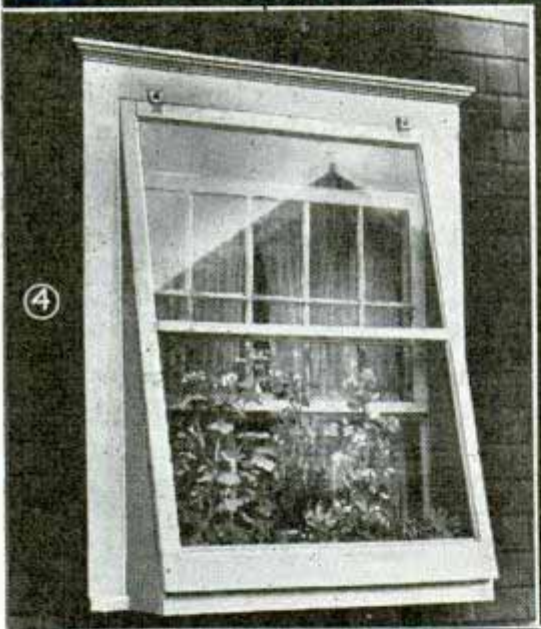

④

You can have a miniature greenhouse by tilting a storm sash and blocking behind it as in 4. Be sure that it's airtight

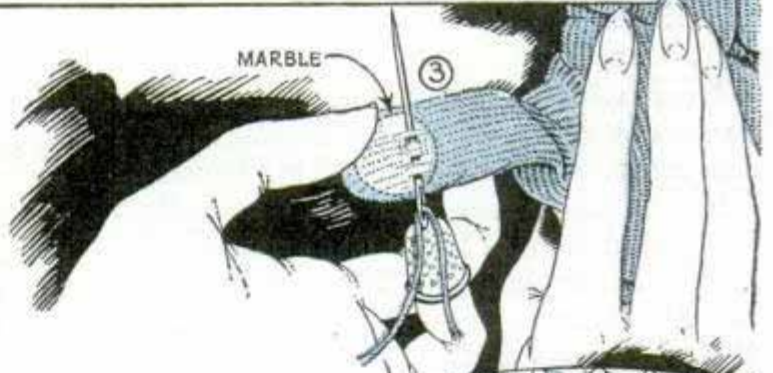

MARBLE

③

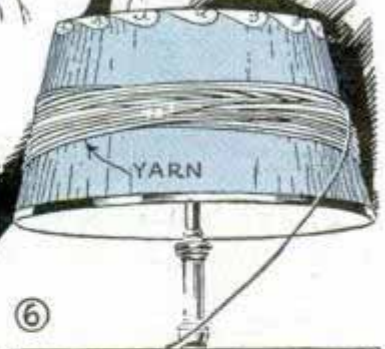

⑥

When you want to wind a skein of yarn into a ball, a lampshade provides a good substitute for a reel as in 6. Just drop the skein over the shade, loosen the ornament so that the latter will turn freely and wind the ball

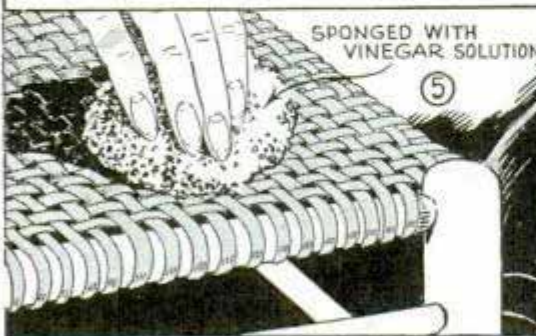

SPONGED WITH
VINEGAR SOLUTION

⑤

A cane chair seat that sags can be shrunk taut by sponging it top and bottom with a hot solution of vinegar and water, 5. Let it dry in the sun

PROBLEMS

BAKELITE JAR CAP

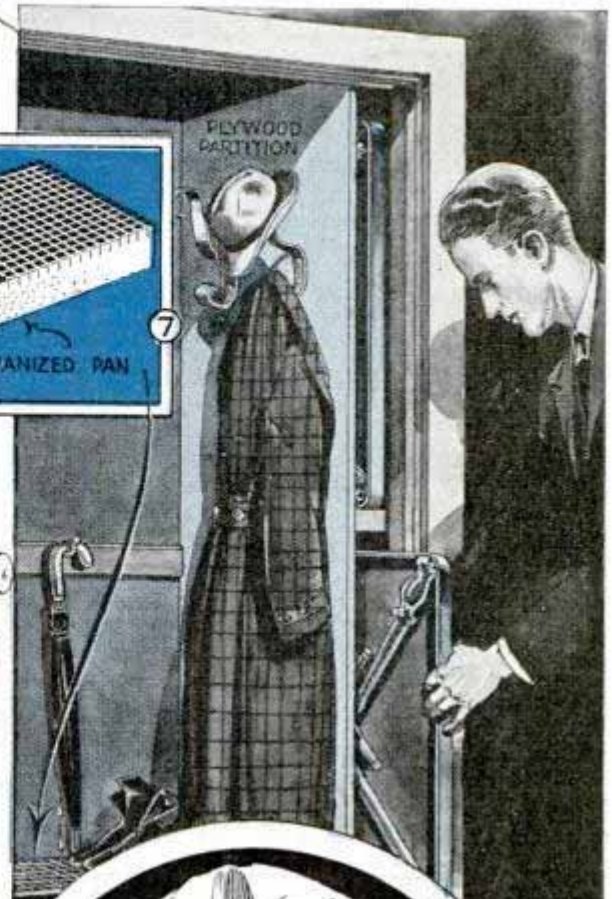
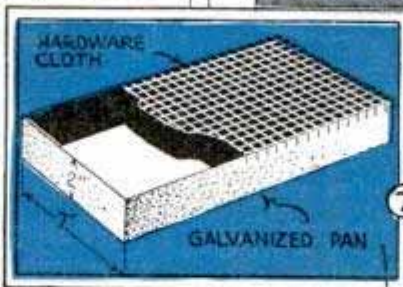
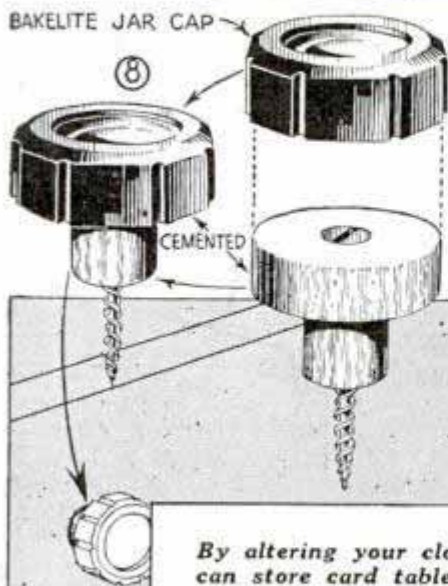

By altering your closet as in 7, you can store card tables, wet umbrellas and galoshes easily besides other clothing. Any tinsmith can make the drip pan, and you can easily shape the hat hangers from flat iron. Bakelite and plastic tops from empty jars of cosmetics provide attractive drawer pulls when cemented to a shouldered hardware cloth as in 8. A wood screw or stove bolt inserted into the turned plug prior to cementing permits attaching the cap in the usual manner



Your wet paintbrushes won't dry out if you put them in a can of turpentine and slip a silk food cover over the top of the can as in 9

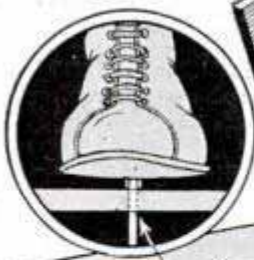
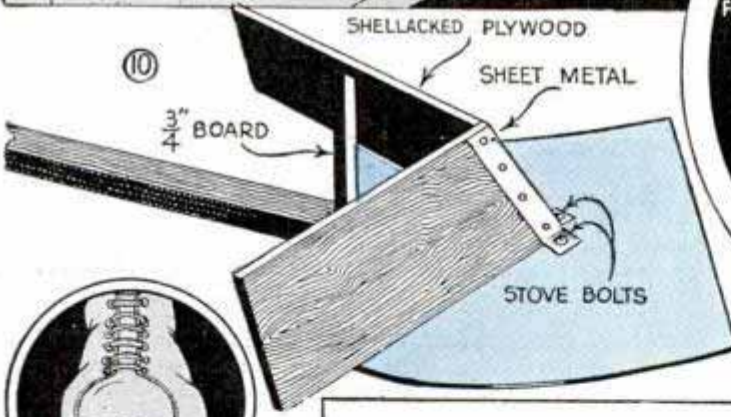

The combination snow shovel and plow in 10 is just the thing to clean walks around the home, while the problem of storing ice skates is solved by setting them in slits cut in a shelf as in 11. Blisters that form in newly hung wallpaper can be removed with a warm iron as in 12

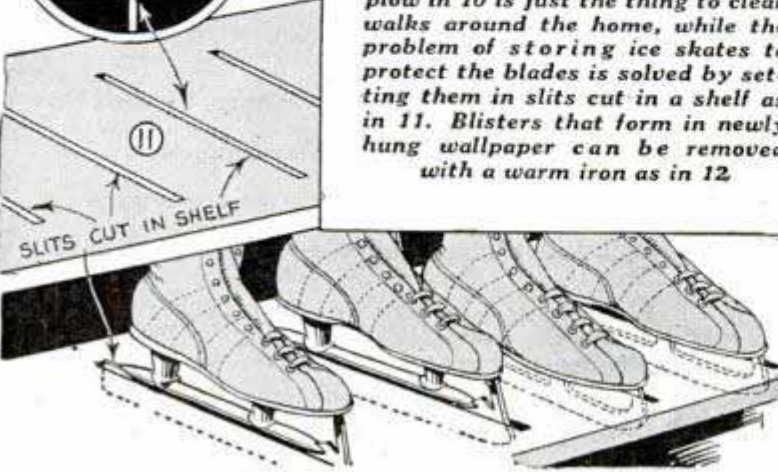

Three Units in Outdoor Gym on Single Frame

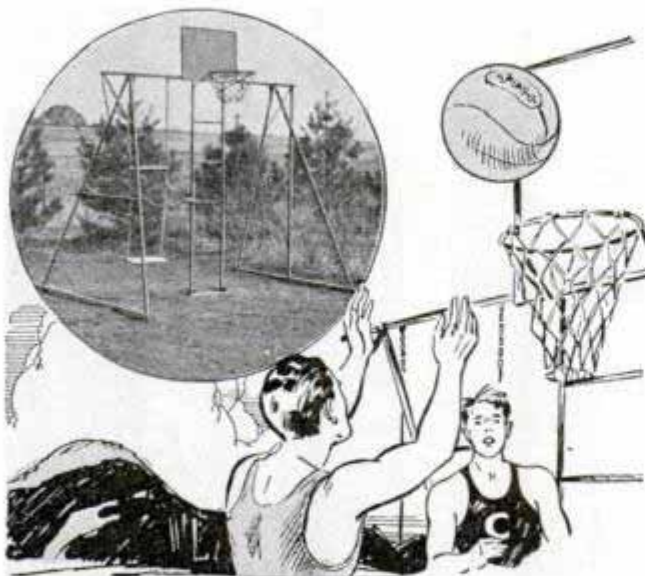

Located in the back yard of a private home in Lincoln, Nebr., the gym unit shown in the photo not only contains the usual swing, trapeze bars, etc., but also has

a basket and backstop for practicing basketball. The unit is assembled from iron pipe at small cost, and the various parts are arranged so that any one of them can be used without interfering with the others.

Muffin Pan Provides Drawer for Small Parts

When you want a bench drawer with a number of small partitions to hold screws, washers, nails and other small parts, why not save time and work by using a muffin pan?

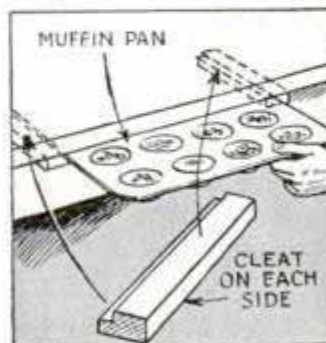

It can be mounted under a bench top by means of two cleats, as indicated, which are rabbeted to take the edge of the tray.

—Lawrence B. Johnson, Spokane, Wash.

Latest Plan Catalogue for Home Craftsmen

Hundreds of useful and attractive things to make in your workshop

Profusely illustrated to show just what the articles listed look like when finished



Includes

MODERN AND COLONIAL FURNITURE of all kinds such as tables, chairs, stands, magazine baskets, cupboards, cabinets, chests, sewing baskets, etc.

HOME AND GARDEN IMPROVEMENTS comprising items like Venetian blinds, shutters, trellises, arbors, fireplaces, bird houses, Dutch windmills, etc.

WORKBENCHES, TOOL CABINETS, MOTOR-DRIVEN MACHINES such as drill presses, scroll saws, circular saws, belt, drum and spindle sanders, shapers.

MODELS OF ALL KINDS, both scale-type historic models and tournament-type model racing yachts.

OUTDOOR-SPORT DEVICES, rowboats, motorboats, canoes, kayaks, iceboats, skis, bobsleds, kites.

ELECTRICAL DEVICES, soldering irons, spot welders.

RADIO EQUIPMENT, receivers, transmitters, amplifiers.

TOYS AND NOVELTIES for gifts or resale purposes.

JUVENILE ARTICLES such as midget auto, doll house.

The only cost to get this new catalogue is a three-cent stamp. When ordering be sure to print or write your name and address carefully

POPULAR MECHANICS PLAN SERVICE, 200 E. Ontario St., Chicago, Illinois



SHOP NOTES

SPIRALS

SPIRAL twists and rope moldings of all kinds, as well as straight fluting and reeding, can be done with this lathe jig. The unit, Fig. 1, is assembled from standard pipe fittings and consists of a track mounted behind the lathe to support a sliding carriage which carries a shaft, the latter being machined to fit $\frac{5}{16}$ -in. hole shaper cutters. A cable attached to the sliding carriage works over the lathe pulley to furnish the spiral feed, the work being rotated by the cable as the

*All Kinds
Easily Made
with this
Simple Lathe
Jig*

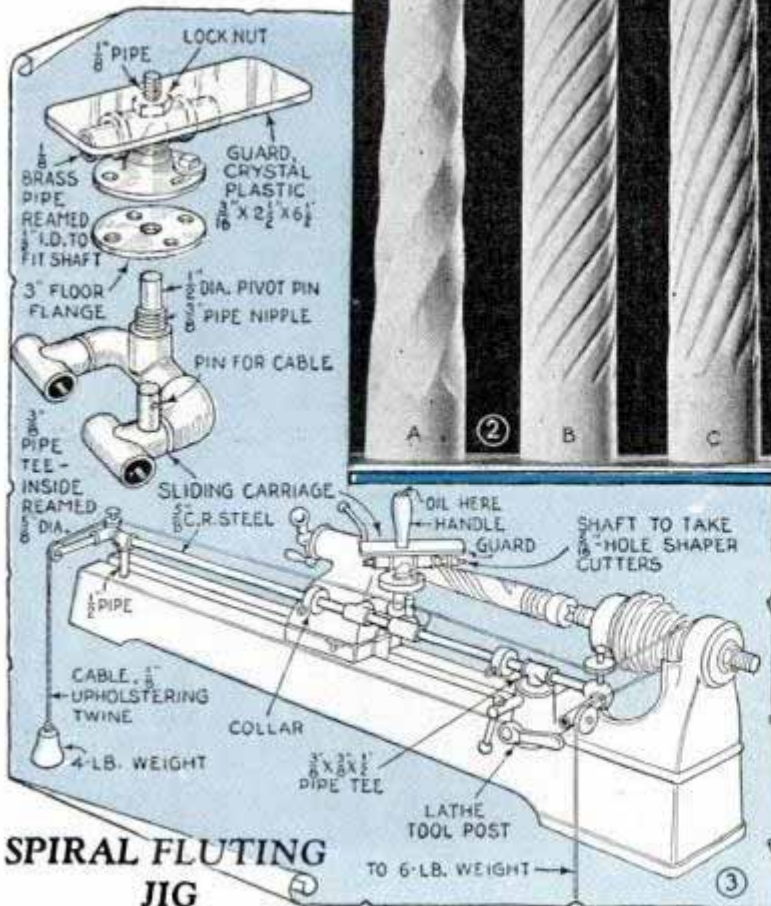
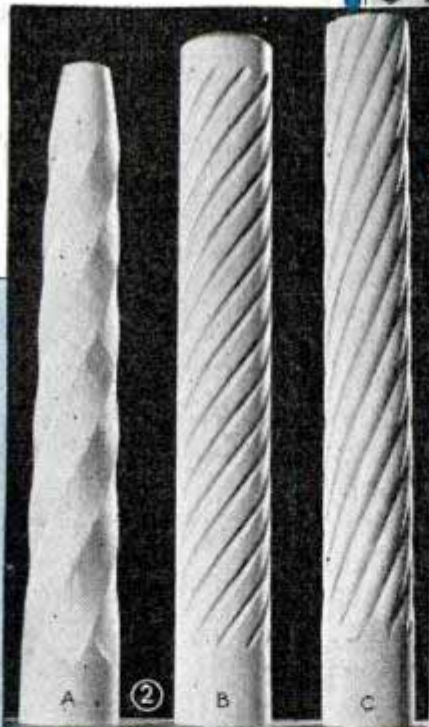
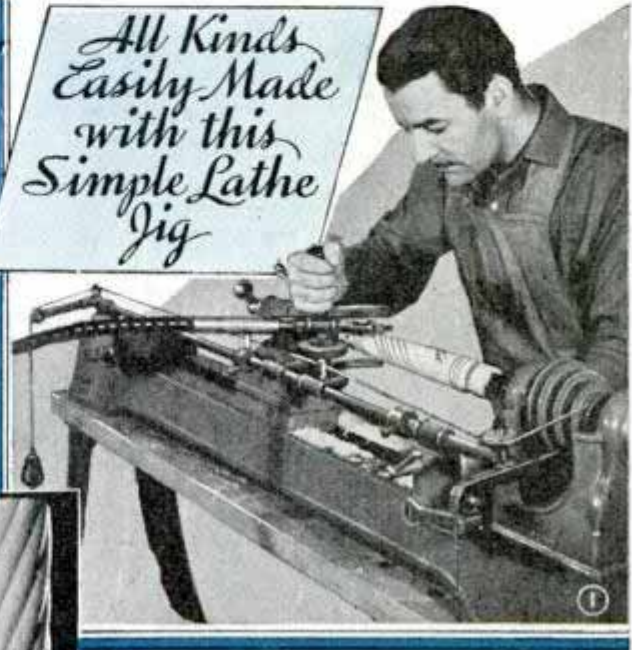

**SPIRAL FLUTING
JIG**

carriage is pulled along the track.

Fig. 3 shows the essential points in construction. The track is $\frac{5}{8}$ -in. diameter cold-rolled steel, which is fitted into two pipe tees. These are provided with short lengths of $\frac{1}{2}$ -in. pipe to fit inside two regular lathe tool posts. The track is adjusted in or out, and up and down as required, in this manner. The sliding carriage is made from flangeless pipe fittings, held together with short nipples. Two 3-in. floor flanges are machined to make the turntable, the upper one of these being fitted to a $\frac{3}{8}$ -in. pipe tee which supports the shaft bearing. The shaft is machined to $\frac{1}{2}$ -in. diameter to fit the bearing and to make connections with a flexible shaft. The latter can be driven with a motor or from your drill press as indicated in Fig. 4. The working end of the shaft is machined and threaded to take standard shaper cutters. Spirals of various pitches can be obtained

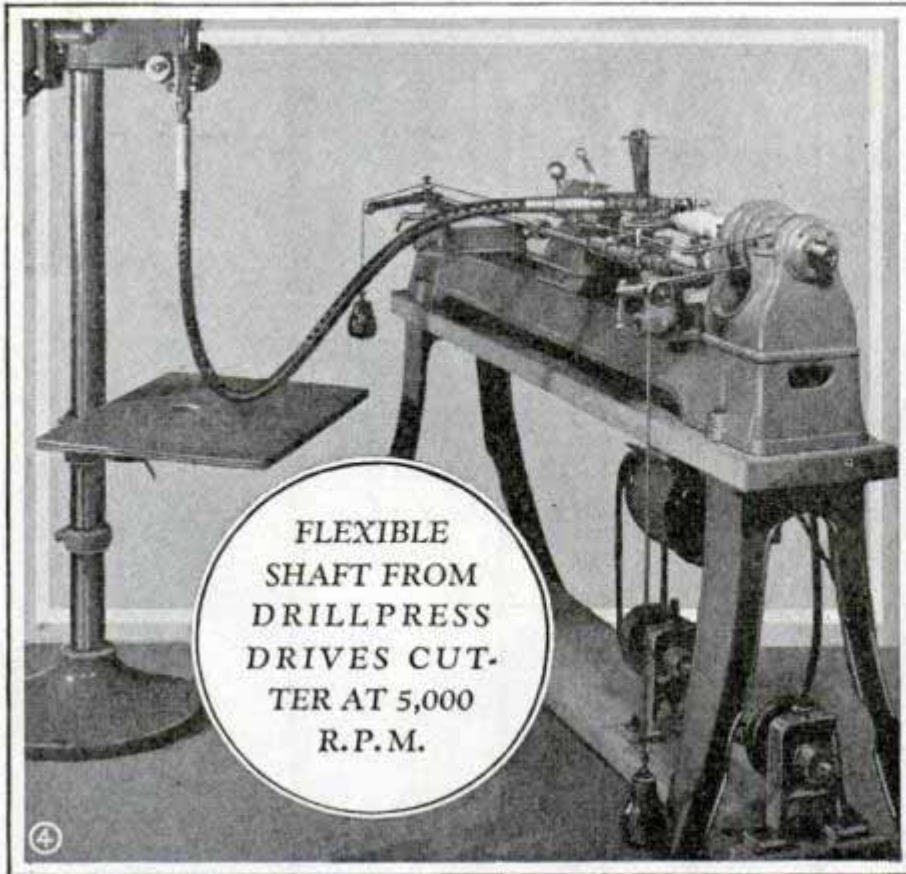

FLEXIBLE
SHAFT FROM
DRILL PRESS
DRIVES CUT-
TER AT 5,000
R.P.M.

by working the cable over any of the four steps of the lathe pulley, the lead of the spiral being equal to the circumference of the pulley over which the cable is run. Various shaper cutters can be used to obtain different effects. In Fig. 2, example A is cut with a straight cutter; B with a round-nose cutter, and C is made with a concave shaped cutter. Combining B and C would give the familiar spiral twist. A depth collar is used to control the depth of cut. Straight fluting and reeding can be done by turning the shaft at right angles to the work and disengaging the cable.

Wheeled Pot Speeds Job of Filling Cracks in Pavement

Perfected by a California highway maintenance foreman, this wheeled pot for applying hot asphaltum to cracks and expansion joints in concrete pavements saves time, allows the workman to stand upright and relieves back strain, besides saving considerable time in application. As the weight of the pot is carried on the wheel, the workman can guide it accurately above the crack as he moves forward. A small wheel is attached to the spout end of the pot by means of a flat-iron bracket, the latter being bent to one side so that the wheel is offset about $1\frac{1}{2}$ in. from the center of the spout. This allows the wheel to run at one side of the crack, yet have the spout end directly over it.

—W. W. Wheatly, Lakeside, Calif.

"Cellophane" Used as Shim Stock

I have substituted Cellophane, which is about .001 in. thick, for metal shims where clearances are not critical. It is tough, durable and convenient to handle. I have used it in setting up dies, production machines, tool-room jobs, etc.

—Jack McClintock, Cleveland, Ohio.



Thickness Gauge in Key Case



If you carry a thickness gauge in a leather key case, it can be kept oiled so that it will not rust, and the leather covering tends to protect the thin plates. A few drops of fine

oil are applied occasionally to the leather which contacts both sides of the gauge.

Steam Traps Prevent Hammer in Air-Conditioning Unit

It sometimes happens that in certain air-conditioning installations, a single steam trap, detail A, fails to carry off condensation fast enough to permit the necessary rapid action of the automatic valves in delivering new supplies of steam. In some instances this deficiency will cause severe hammering. The remedy is to install a second trap as shown in detail B. This arrangement practically doubles the capacity for returning condensation to the boiler.

—L. H. Georger, Buffalo, N. Y.

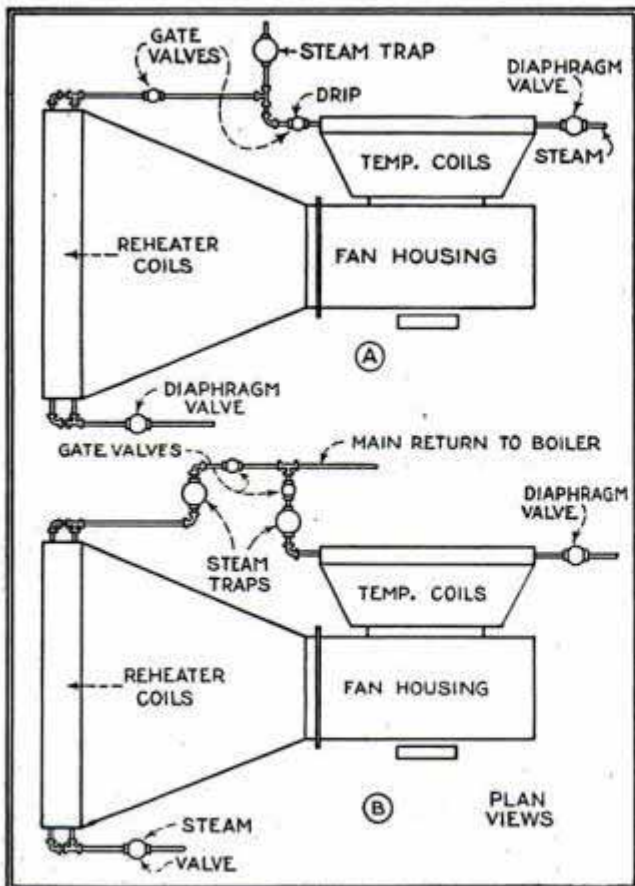

Mouth of Grain Sack Kept Open by Spring Holder



The task of holding a grain sack open while an assistant shovels grain into it from a scoop may be simplified with this holder. It consists of a length of steel rod, which is bent as shown to provide two handles and an open loop. The loop portion is inserted in the sack by compressing the handles, which are then spread apart.

Percolator to Cook Stock Feed

All you need for an inexpensive percolator to quickly cook feed for poultry and livestock is a length of pipe and an old auto brake drum. One end of the pipe is threaded and is locked in the opening of the drum by means of a nut on each side.

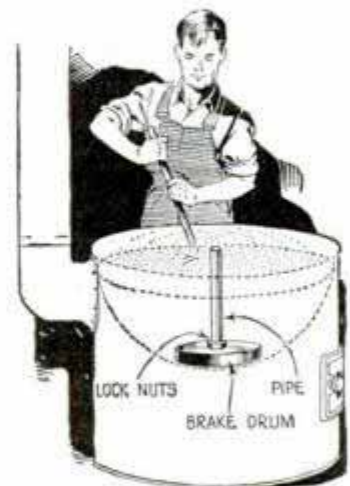

Because the boiling liquid contacts the top of the feed, as well as the bottom, cooking time is reduced and less stirring required.

Tricks that help you

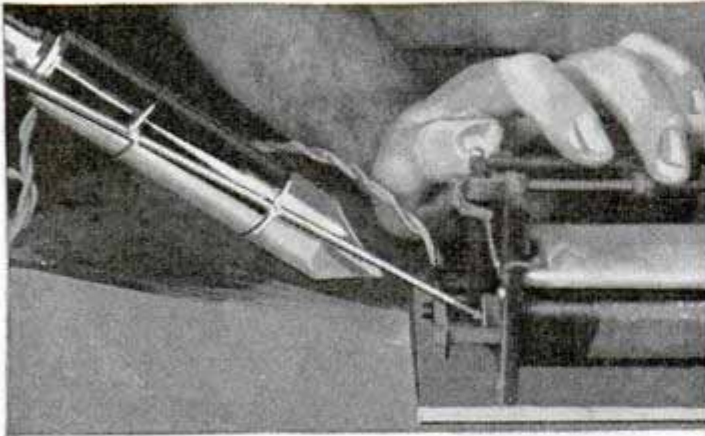

Where you have only a large 175-watt soldering iron and you are likely to have trouble joining small, intricate work, the problem can be solved often by the method shown at the left. Simply wire a short length of copper rod to the iron, file the end to a diamond point and tin it. Heat from the iron will travel down the rod to the work.

Here two pieces of sheet brass are being soldered together at right angles. The vertical member is attached to a square block of wood with brads. This makes it possible to hold the part exactly at 90 degrees and at the same time, place it in just the position necessary to make a neat, strong joint.

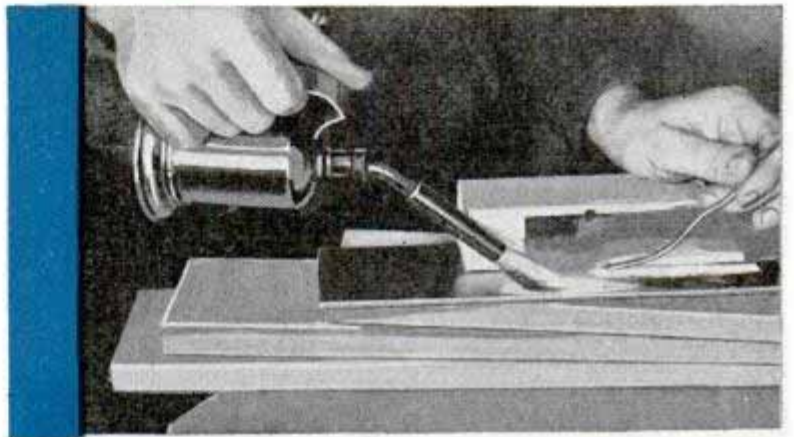

When you have to tin the bared ends of a number of wires, try the setup shown. Just clamp the soldering iron in the vise at an angle, set a small can cover on one of the facets of the iron and drop several small pieces of solder into it. When these have melted, dip the bared ends of the wire into the molten solder.

Suppose you wish to solder small parts that have been enameled and do it without charring the enamel. That's easy. Just suspend the parts with wire in a glass of water as shown at the right, leaving exposed only the joint that is to be soldered. The water absorbs and dissipates the heat, protecting the enamel from charring.



when SOLDIERING

Good soldering may be done only when plenty of heat is applied to the surfaces to be joined. The solder must penetrate the surface of the metal and should not crystallize too soon when cooling. So, when necessary to join pieces of sheet metal with large radiating surfaces, you can prevent heat loss by wrapping the parts in asbestos paper and using two irons.

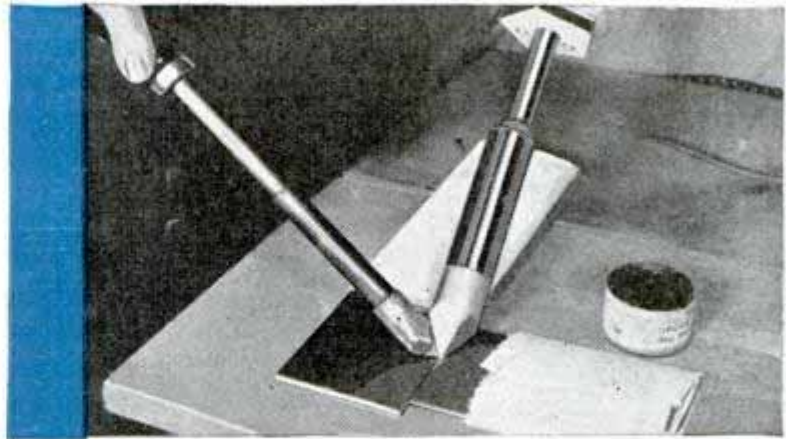

There really is no such thing as a universal flux. Hence, if you have a variety of work to do, you should have a kit containing tallow or rosin for soldering lead, hydrochloric acid for galvanized steel, zinc chloride for gold or silver, Gallipoli oil for pewter, ammonium chloride for gun metal and a can of ordinary commercial paste flux for electrical work.

It often happens that a small part must be soldered which is adjacent to other parts already soldered in place. If the heat is not controlled the parts previously joined will be loosened and perhaps fall off. To prevent this, wrap the work in rags soaked in cold water, leaving only the joint exposed. This prevents flow of the heat to parts already soldered.

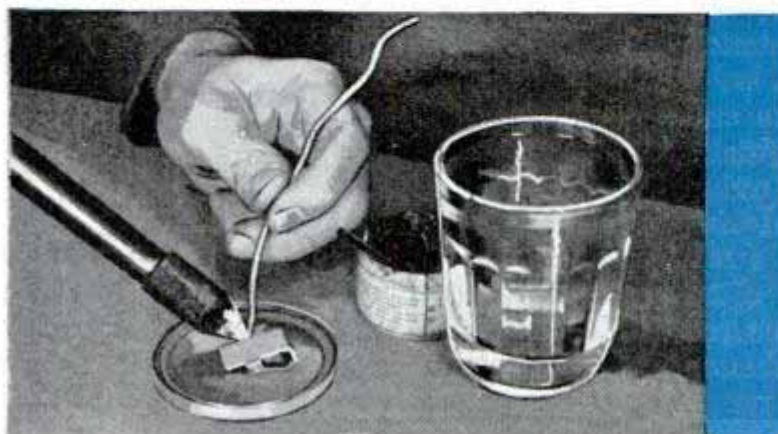
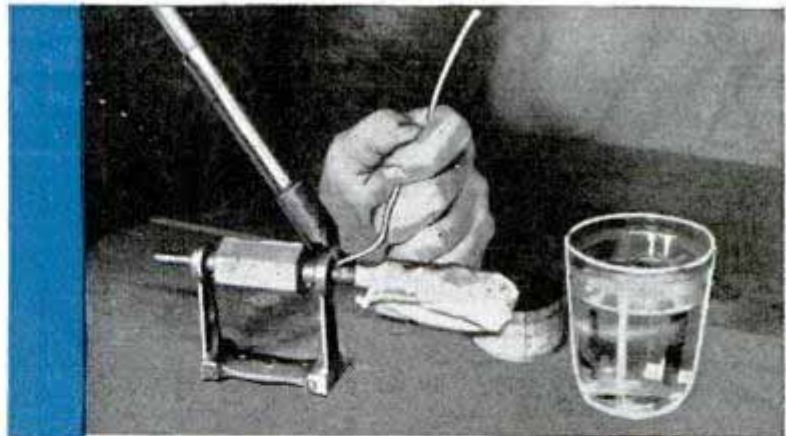

Another handy method of restricting the flow of heat is shown at the left. Here two small parts have been soldered in place and a third piece is to be joined. To prevent softening solder already applied, the work is immersed in water in a shallow container such as a can lid. Only the surface that is to join the third piece is left exposed. In this way the heat will be confined to the joint being soldered.

*A. Langley & Co.
159th St. New York
Chicago*

Slot Locates Gauge Positions in Holder



Ordinarily, plug gauges must be examined when they are returned to the case to make sure of the size so that they can be placed in the correct groove. A quicker and better method is as follows: Fasten a piece of sheet metal having a tapered slot to the back of the wood holder. The width of the taper over each groove in the case must be exactly equal to the size of the gauge fitting that groove, from the largest to the smallest. When a gauge is slid along in the slot until it stops, it will be directly over the groove in which it belongs.

Starting Stocks and Dies

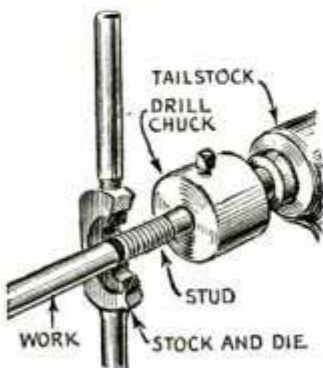

Small-diameter work can be threaded to standard size in a lathe with stocks and dies, much quicker than with a single-pointed tool. But many such threads are often spoiled because

the die is not started squarely, or because the pressure by the tailstock is too much or too little. To avoid this trouble, a stud

or screw of the same size as the work to be threaded is gripped securely in a drill chuck. The die is run on the stud first, nearly to its full depth, and then the tailstock spindle is advanced until the die touches the end of the work. When the stock is turned the die runs off the stud and onto the work correctly.

Improving Spiked Calf Weaner

As calf weaners of the spike type are sometimes responsible for injuries to other animals confined to the same enclosure, one farmer follows this simple method to minimize such trouble:



He impales ordinary fuller balls on the spikes so that only a short portion of the points project, which does not defeat the purpose of the weaner.

Background Stamps

Steel used in auger bits is well suited for making background stamps for wood carving, leather and even copper work. The square shank permits easy handling and prevents rolling when laid on the

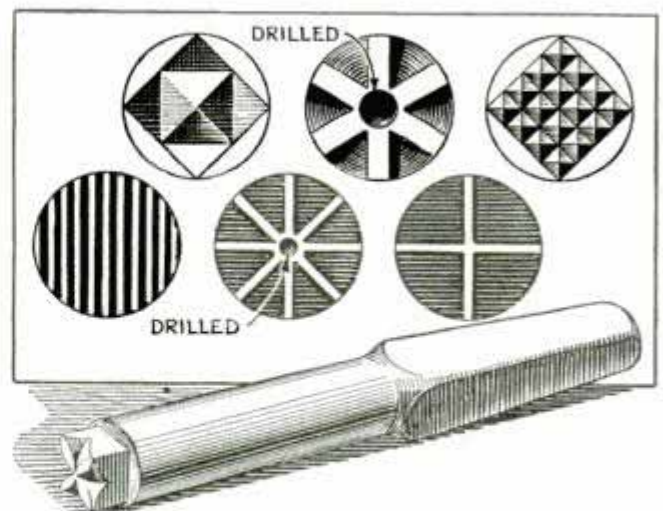

bench. First cut the bit in two with a hacksaw and then square the end on the side of a grindstone. As an aid in laying out a design in the face, coat it with a copper-sulphate solution. You will find that this steel can be filed very easily.

Paperhanger's Portable Paste-Bucket Stand

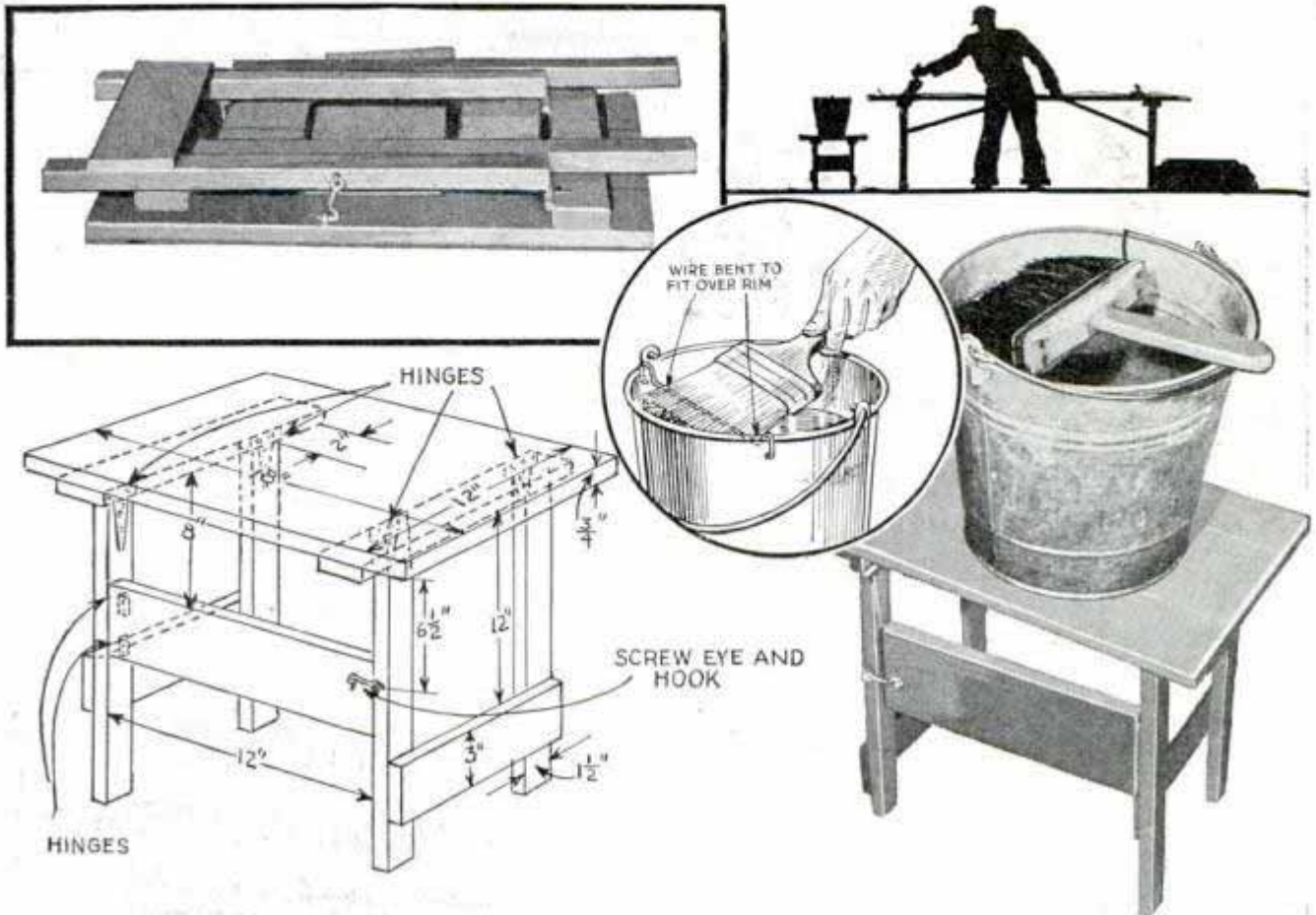

This folding stand for the paperhanger's paste bucket takes very little space when transported from job to job. The top is plywood, and the legs are hinged to it in pairs, one pair being offset so that they will fold over the other pair. The legs are

braced with a crosspiece, which is hinged to one leg, and folds flat when the table is closed. Another labor saver is a wire across the mouth of the paste bucket to support the brush as shown in the circular detail.—Loyal R. Jones, Lansing, Mich.

Irregular Lathe Work Supported on Center While Chucking

It's a simple job to chuck small irregular-shaped work in a lathe to face or bore it, if the nature of the work permits a pilot hole to be drilled as indicated by pieces A and B. Using a short piece of drill rod held in a drill chuck as a pilot, slip the work over the rod, and move it between the opened jaws of the lathe chuck. While the jaws are being tightened on the work, special care must be taken not to spring the rod out of line.

—Milo Shutt, Homeworth, Ohio.

Small oil-color brushes may be kept soft between jobs if not thoroughly cleaned by rubbing a little lard or vaseline into the bristles. Rinse this out with turpentine before using. Glycerine will do for brushes used for showcard or tempera color.

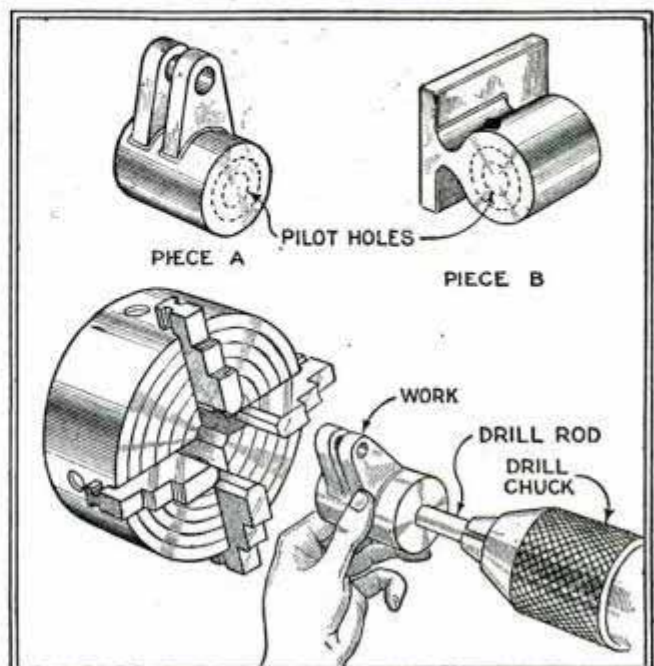

UNIVERSAL

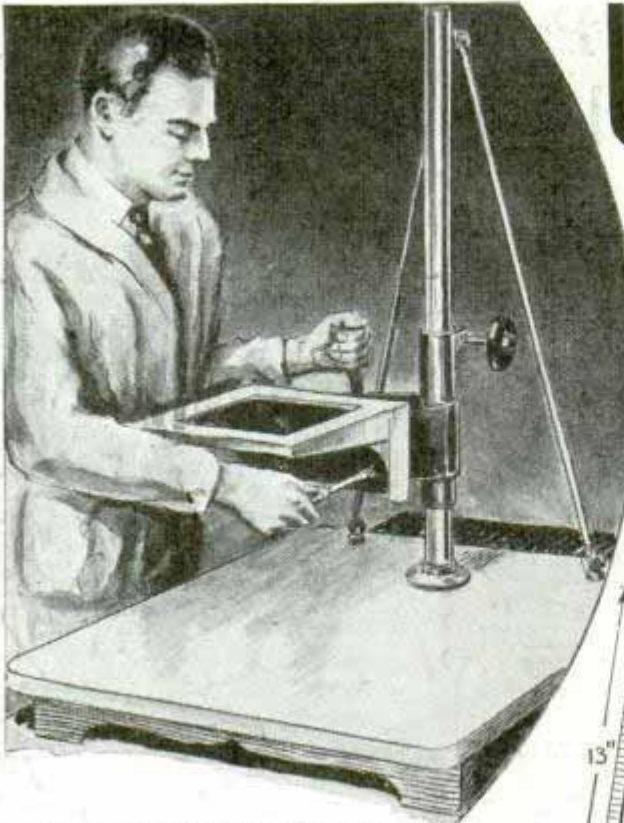

IT'S NO TROUBLE TO BUILD IT FROM STOCK MATERIALS

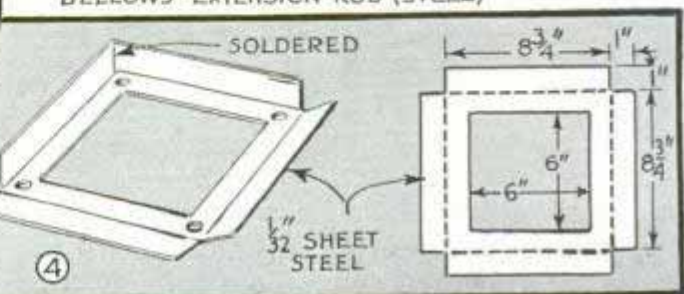
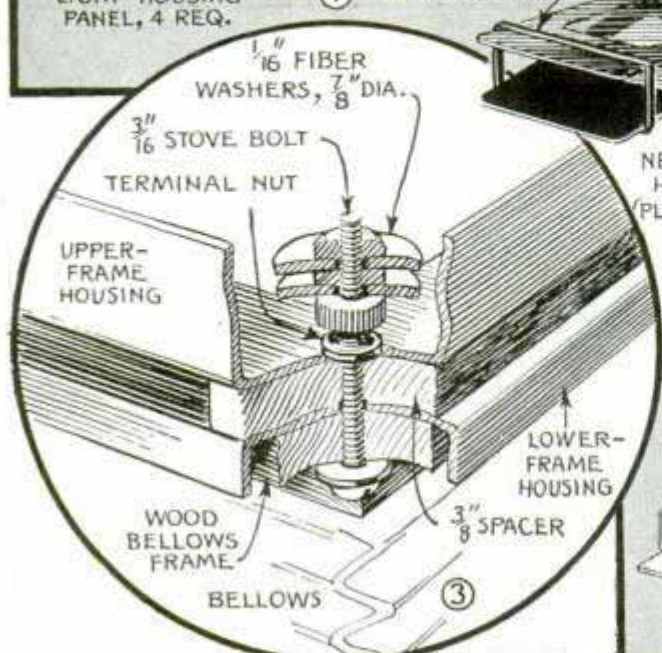
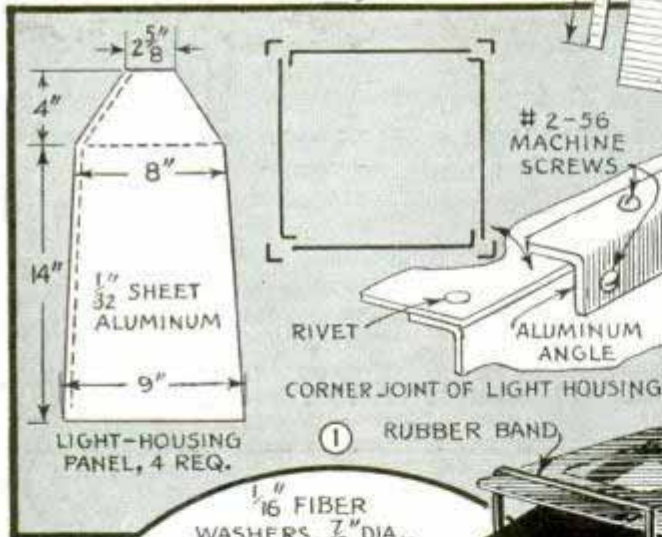
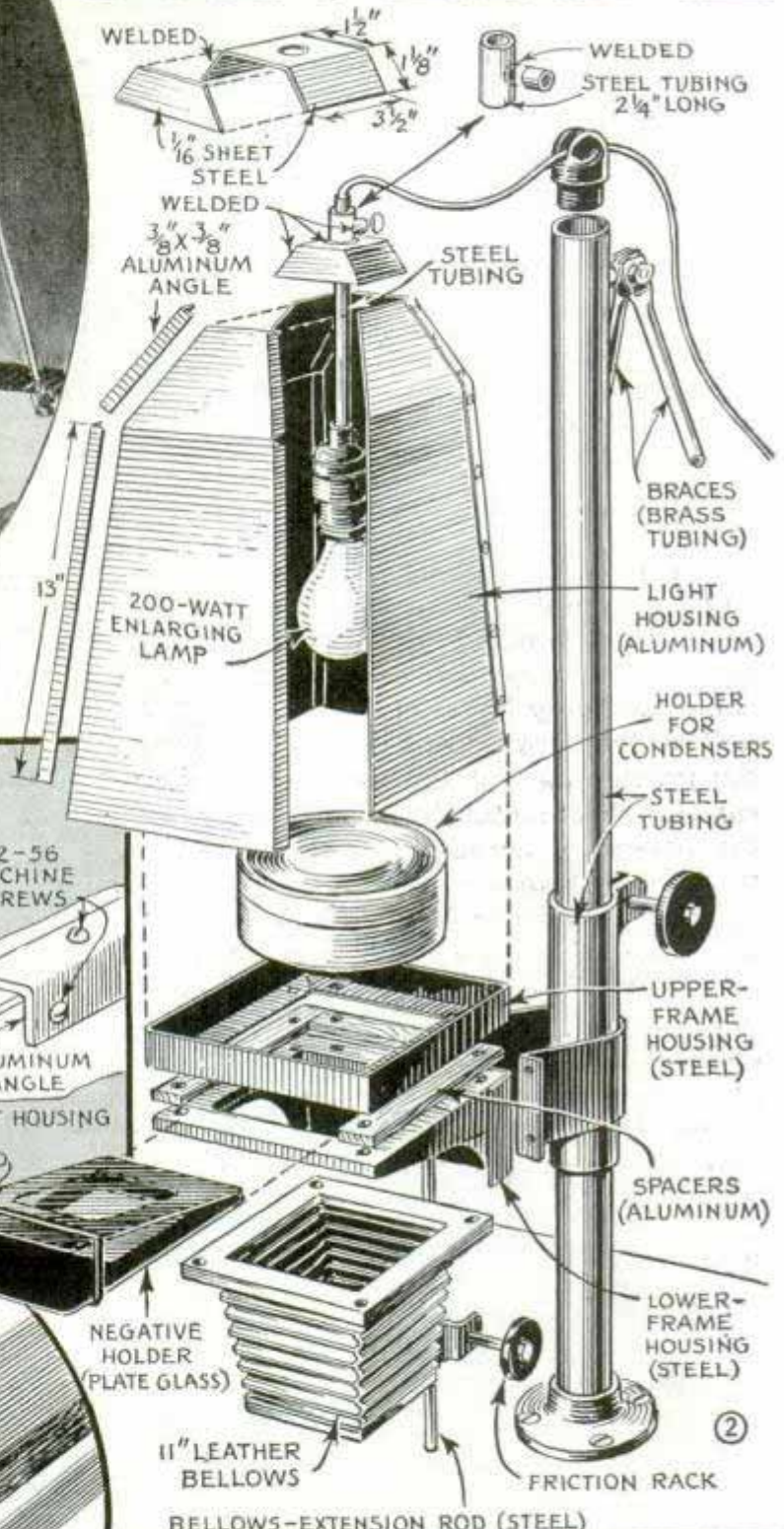

ENLARGER

... has an adjustable light and is designed to hold any one of three sets of lenses and condensers so you can enlarge negatives ranging from 35 mm. to 4 by 5 inches

By JOSEPH OTT

THIS photo enlarger has been especially designed for the individual builder, which means that the parts and materials used are easy to get and are inexpensive. The assembly has been so worked out that only a few common tools are needed to build it complete ready for work. As you will see from Figs. 1 to 4 inclusive, the greater part of the assembly calls for sheet metal. This reduces the necessary equipment needed for this work to a rule, a scribe, a pair of tin snips and a few blocks of hardwood to serve as forming dies. In certain details and in the material list the dimensions given are only close approximations because of the necessity of bending and fitting a number of parts.

Now, to be truly universal in scope, an enlarger should accommodate, with simple adjustments, all film sizes ranging from 35 mm. to the popular large size, 4 by 5 in. This enlarger accommodates these and other intermediate sizes. To cover the three film sizes mentioned, it is necessary to have three different focal-length lenses with three matching sets of condensers, that is, the focal length of each lens should match the focal length of the companion set of condensers. If the enlarger is constructed to take the 4 by 5-in. film with matching focal length lens and condensers, the smaller lenses and condensers can be interchanged easily. For the 1 by 1½-in. or 35-mm. film, a focal length lens of 50 to 75 mm. will be required. Condensers to match should be approximately 3 to 3½ in. in diameter. The intermediate size of 2¼

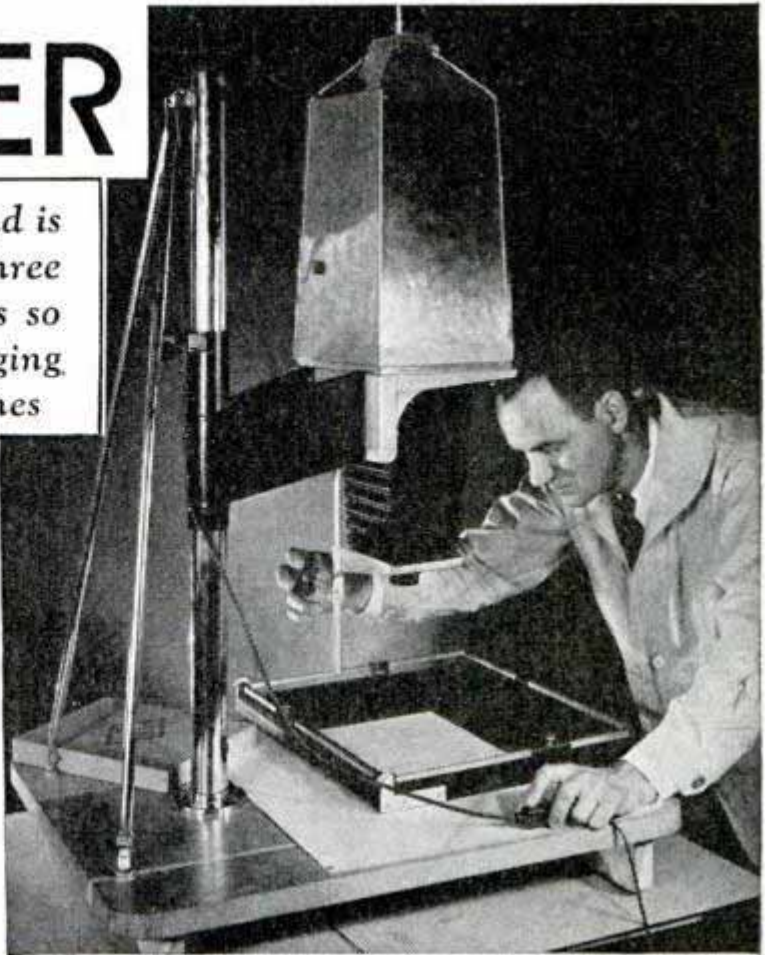

THE TUBING AND RODS FORMING THE COLUMN AND BRACES MAY BE CHROMIUM PLATED FOR APPEARANCE. THE HOOD IS ALUMINUM AND THE BASEBOARD IS EITHER PLYWOOD OR GLUED-UP STOCK

by 2¼ in. should have a lens of approximately 4 to 4½-in. focal length and condensers to match should be approximately 5½ in. in diameter. For the larger size of 4 by 5 in. the focal length of the lens should be approximately 5¼ or 6 in. and the condensers 8 in. in diameter. The condensers when paired and placed in a frame, with convex sides facing, should give a focal length equivalent to the focal length of the lens. The above condenser diameters give the required focal length for the lenses mentioned. When the focal lengths of condensers and lens match, focusing of the image is sharp and the distribution of light to all corners is uniform. This equal distribution of light is very essential in practice. The reason for having condensers and lenses of various sizes is to shorten the movement of the enlarging unit.

A 1 by 1½-in. film can be placed in the 4 by 5-in. film holder and focused through the 8-in. condensers and 6-in. lens but it would be necessary to raise the enlarger to a height of from 6 to 10 ft. above the

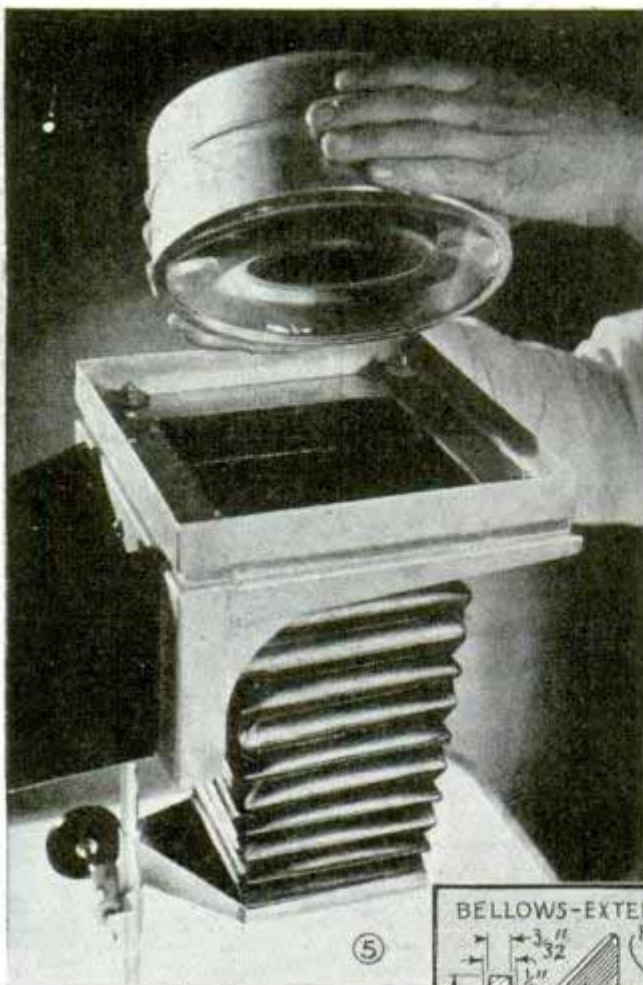

DOUBLE CONDENSERS GIVE HIGH ILLUMINATION FOR CRITICALLY SHARP FOCUSING AND SHORT EXPOSURES

enlarging board. In most cases only a small part of the negative is used and it would be impossible to operate the enlarger because of the height necessary to secure the desired enlargement. This enlarger is designed to operate on an upright 42 in. high, which allows the image of a full 4 by 5-in. film to be enlarged to approximately 20 by 30 in. and likewise the 1 by 1½-in. and the 2¼ by 2¼-in. films can be enlarged to this same size. It is advisable, in the beginning, to construct the enlarger to accommodate the large-size film, 4 by 5 in., and to purchase the lens and condensers to match the particular size film you used. Changing the condensers from one size to another requires only the removal of the light housing and the lenses are changed by removing from the lower-bellows housing

as in Fig. 12. Flanges of different sizes can be fitted into the housing.

Provision is also made for the use of a ground or opal glass in place of condensers. Although certain advantages are claimed for the ground-glass diffuser, the amount of light necessary is approximately three to four times that required with condensers. Through ground-glass diffusion light falls off rapidly toward the edges and the image is not as sharp as with condensers. However, to reduce the cost of this enlarger, the builder can follow the general construction, using a ground-glass diffuser and a lens of the proper focal length. Later he may add matched condensers and still later other lenses and condensers to fit other films.

Now, in Figs. 5 to 11 inclusive you will find a number of the parts shown in Figs. 1 to 4 detailed separately. Although it is not especially important, proceeding to make the parts in a regular sequence will

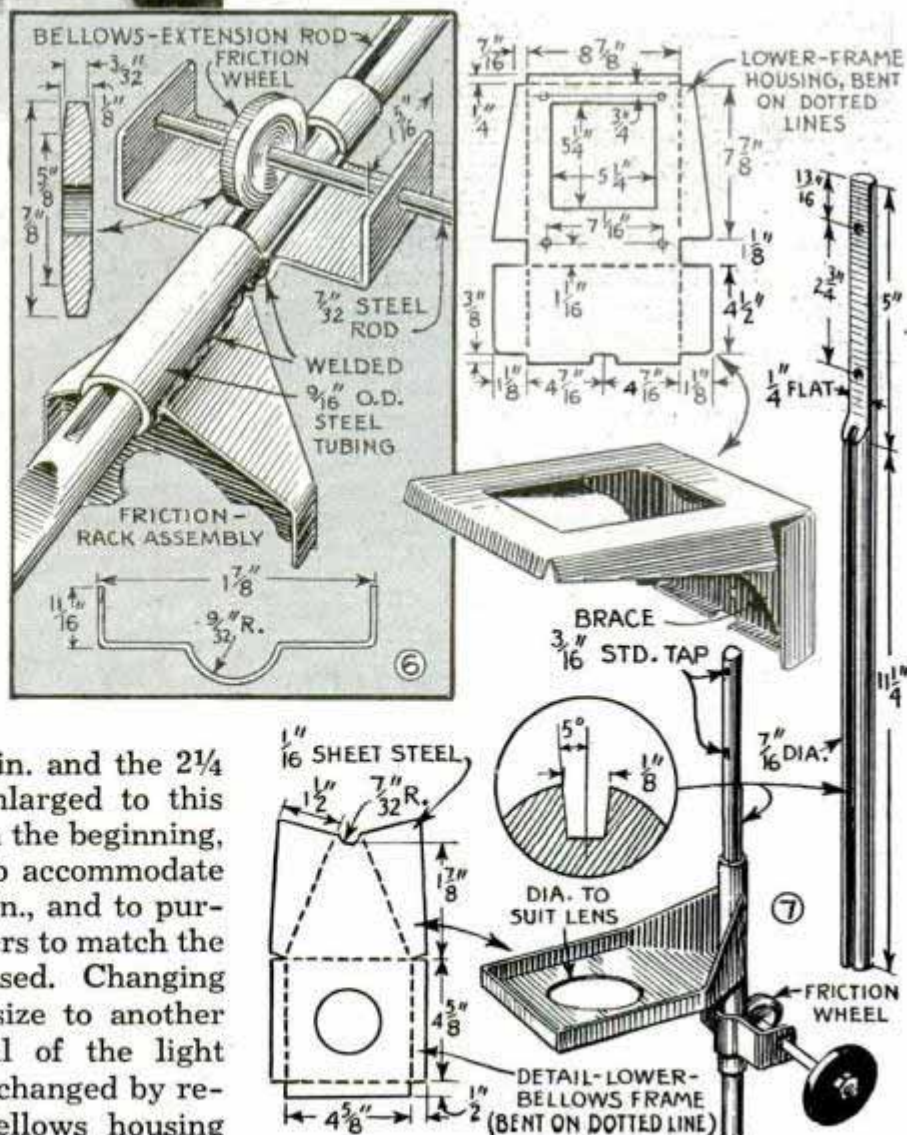

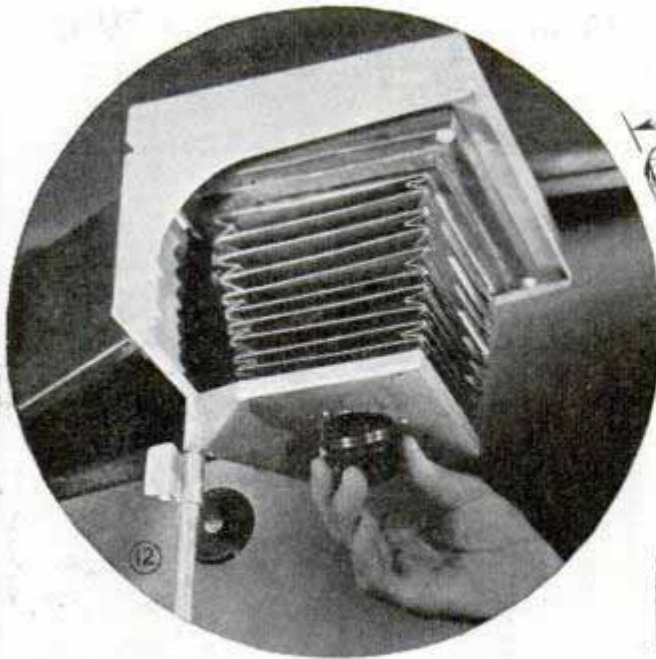

FOR VARYING SIZES OF FILM, SIMPLY CHANGE THE LENSES AND CONDENSERS

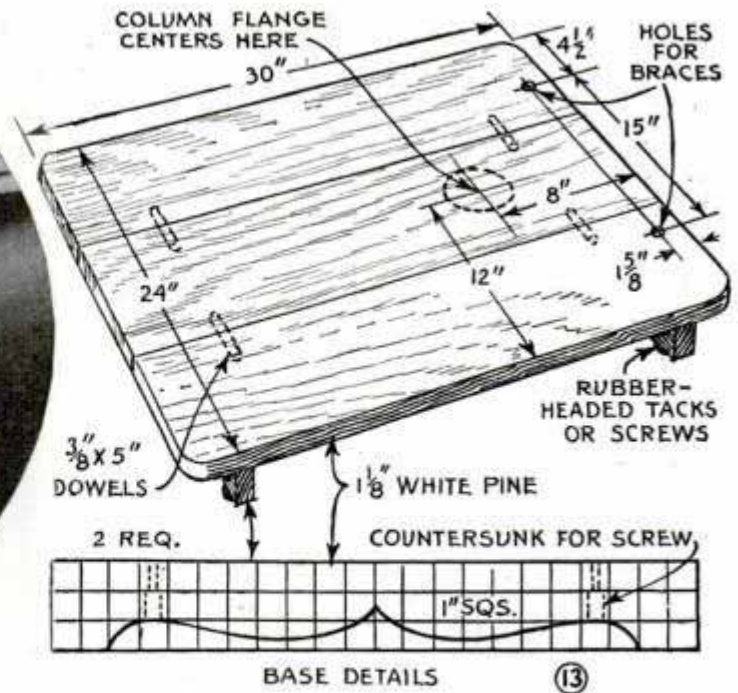

MATERIAL LIST

Part	Kind of Material	Quantity	Size
Enlarging board	Pine	1	1 x 20 x 30 in.
Brace	Pine	2	1 x 4 x 18 in.
Upright column	Steel tubing	1	1/16 x 1 7/8 x 42 in.
Braces	Brass tubing	2	1/16 x 1/2 x 45 in.
Sliding column	Steel	1	10 in. long to fit over upright
Extension for housing	Steel sheet	1	1/32 x 5 1/2 x 20 in.
Bellows	Leather	1	5 x 5 x 11 in. extension
Film holder	Plate glass	2	3/8 x 6 1/2 x 9 in.
Lower-frame housing	Steel	1	1/32 x 10 x 14 in.
Upper-frame housing	Steel	1	1/32 x 11 x 11 in.
Spacers	Aluminum	3	3/4 x 1 x 9 in.
Top housing	Aluminum	4	1/32 x 9 in. at bottom 6 in. at top—20 in. long
Corner of housing	Aluminum	4	1/32 x 1 x 20 in.
Top of housing	Steel sheet	1	1/32 x 4 x 4 in.
Upright extension	Steel tubing	1	7/16 x 12 x 1/16 in. wall
Light socket	Standard	1	To fit enlarging bulb
Thumb setscrew	Steel	1	3/16 in. thread— 5/8 in. knurled head
Bellows-extension rod	Steel	1	7/16 x 16 1/4 in.
Lower bellows frame	Steel sheet	1	1/32 x 5 x 8 in.
Handwheels	Bakelite	2	1/4 x 3 in. diameter
Rack-wheel shaft	Steel	1	7/32 x 4 1/2 in.
Tapered rack wheel	Steel	1	3/8 x 7/8 in. diameter
Rack spring	Steel	1	1/32 x 1-5/16 x 4 in.
Upright flange	Cast iron	1	3/4 x 4 in. diameter
Anchor bolt	Steel	2	3/8 x 2 in. long
Flanged bolts	Steel	4	5/16 x 2 in. long
Finishing head	Wood-turned	1	To fit diameter of column
Rubber rests	Sunk screw and rubber	4	3/4 in. diameter
Diffusion glass	(Or opal glass)	1	3/16 in. thick to fit frame
Extension cord, switch and plug		1	12 ft. long
Nuts and bolts	Steel	8	1 1/2 in. long
Nuts and bolts	Steel	3	3/4 in. long
Rod	Steel	1	3/16 x 4 in.
Rod	Steel	1	1/2 x 4 in.
Housing-assembly screws	Steel	36	Size No. 2-56

this before drilling any of the holes. Note also that in Figs. 2 and 10 the lips or "ears" of the supporting arm are shown bent in opposite directions. On the original the lips were bent inward but, due to the weld at the tubular slide, it may be necessary to bend them outward as in Fig. 2, when fitting the parts together.

With the assembly at this stage you're ready for the lower-bellows frame and the friction-rack assembly, Figs. 2, 6, 7 and 9. This is a bit more exacting and several machine operations are necessary. It's especially important that the sides of the groove milled in the bellows-extension rod be inclined approximately 5 degrees and that the sides of the friction wheel be machined to correspond. Of course, some filing and trial fitting will be necessary after you cut out the lower-bellows frame or housing, Fig. 7, as the dimensions are only ap-

proximate. The complete assembly is shown in Figs. 6 and 9. The rack spring mentioned in the material list is dimensioned in the lower detail in Fig. 6 and shown in place in the upper detail. Bent to the shape shown and drilled, it provides tight bearings for the friction-rack hand-wheel, Figs. 6 and 11.

It should be noted in Fig. 2 that the enlarging bulb is placed in a socket attached to a tube which is adjustable through the top of the housing. When using condensers it is necessary to place the light far enough above the condensers to give uniform illumination. For this reason, the top of the housing for a 4 by 5-in. film is 18 in. above the negative. The enlarging lamp should be about 250 watts for a 4 by 5-in. film using 8-in. condensers. Without condensers a 1,000-watt light is required. For a 2¼ by 2¼-in. film with condensers, a 100 to 125-watt lamp is sufficient and for the 1 by 1½-in. film, approximately 60 watts.

Mortar Box on Wheels Is Moved Wherever Desired

A Nebraska farmer uses this portable mortar box, not only for transporting batches of concrete and plaster about the farm, but also for moving liquid feeds. The mortar box is carried on an iron frame fitted with three wheels. The front end as-

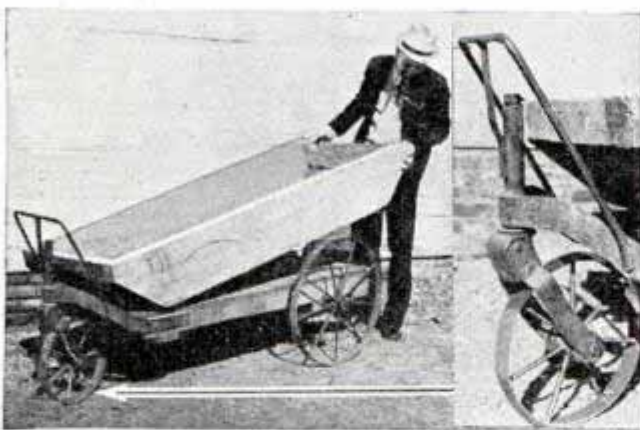

sembly comprises a swivel from an old side delivery rake and a wheel from a plow. The frame is welded together, the rear end of the cart being supported on two small cultivator wheels, which rotate on a pipe axle. A handle to pull the cart is attached to the frame directly over the front wheel. As the box is easy to remove from the cart, the latter can be used for other purposes.

Fruit Trees Protected in Winter by Corn Shock



To protect his young orchard against broken limbs due to ice collecting on them during the winter months, and also to keep stock from rubbing against the brittle limbs, one farmer shocked corn around each tree. After setting one layer of bundles about the tree, a double binder twine was tied snugly around the shock to hold it in place.

Guard on Oilcan Spout

Light machine oil that has a tendency to run down the spout, when the can is used for numerous applications of oil, can be kept from getting on the can by using this guard. It is a rubber cigar holder with the small end cut out to fit snugly over the spout. A little waste packed inside the holder around the spout absorbs the oil as it runs down and can be renewed from time to time.

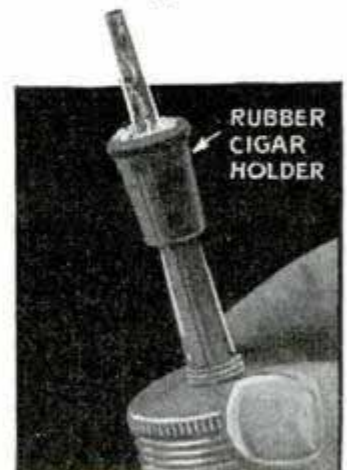

'Funnel' in Center of Hog Trough Avoids Spilling Feed



Spilling of feed when hogs crowd into a trough, was eliminated by one farmer who rigged up this "funnel." It is one-half of a rear-axle housing of an automobile and is mounted in a vertical position on a cross-piece in the center of the trough. The bell end of the housing projects upward, forming a funnel.

Cold Frame Built Against House Is Accessible from Basement

Highly convenient because it is accessible from the basement, this permanent cold frame nestles snugly against the house, and is centered over a basement window.



There's no need to go outdoors every day to water the seedlings, as you can do this and adjust the glass cover for ventilation from the inside. The preferred position is on the south side of a house because here the box will receive the most protection and prevailing sunshine in early spring. If the thing is to be a permanent affair, it is advisable to make the front and side walls of concrete rather than wood. The glass panel is hinged at the rear to permit adjustment for ventilation and it may be best to protect the glass with $\frac{1}{2}$ -in. galvanized wire mesh.

Measuring Shore Line with Wheel

Having land that adjoined a lake and desiring to rent certain footages to summer campers, one farmer used a wheel and a forked stick to take the measurements. A lightweight cultivator wheel was set between the limbs of a forked tree branch



and held in place by a bolt, after which a red cloth was tied to one of the spokes. Counting the number of revolutions of the spoke and multiplying this by the circumference of the wheel gave the actual footage of the shore line.

☐ Transparent windows in envelopes may be made by rubbing the envelope with a solution of paraffin, 1 oz., and carbon tetrachloride, 4 oz., or some similar solvent.

What You Can Do with a RING STAND

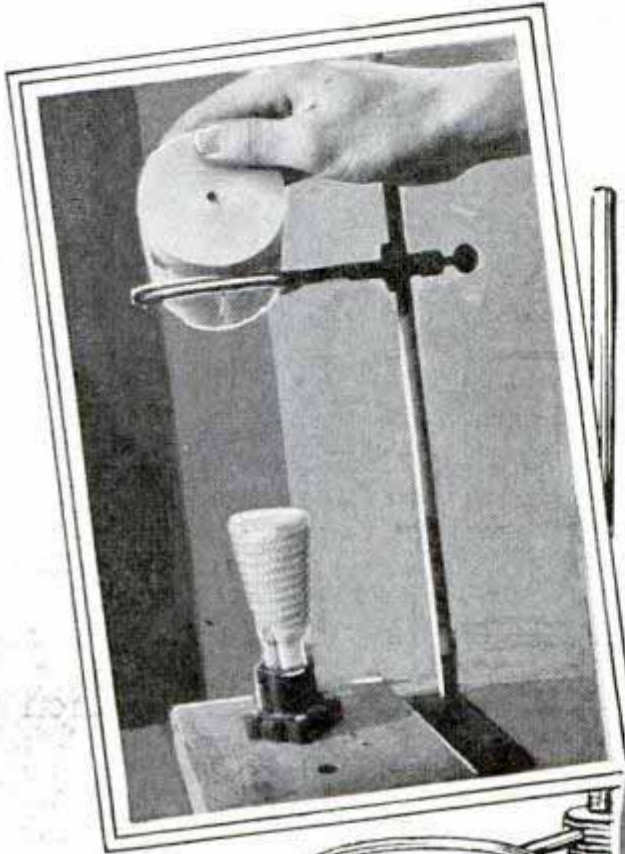

Above, a quick job of removing pins from aluminum pistons can be done by placing the piston on the ring stand and lowering it over a heater element as shown. This affords quick heat without danger of warping. Below, work on commutators can be done with greater ease and efficiency by mounting a reading glass in the ring-stand clamp. The glass can be held steady at any convenient height

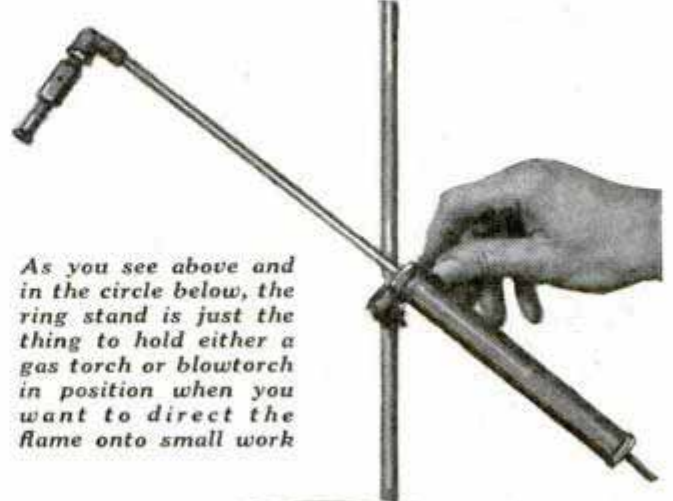

As you see above and in the circle below, the ring stand is just the thing to hold either a gas torch or blowtorch in position when you want to direct the flame onto small work

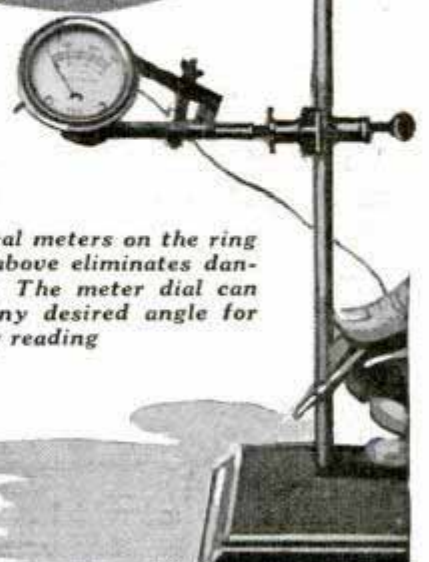
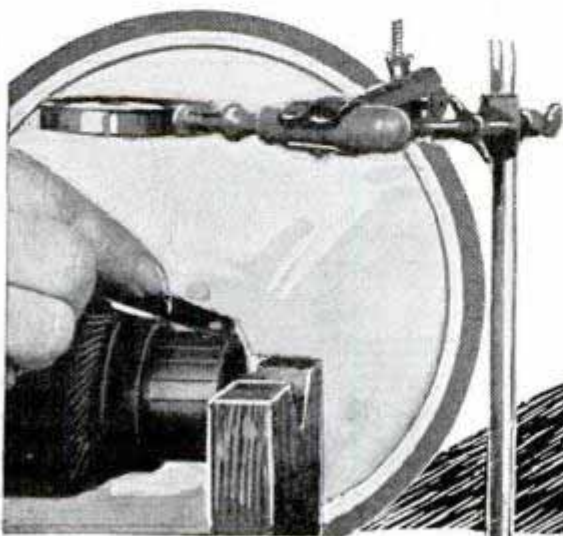
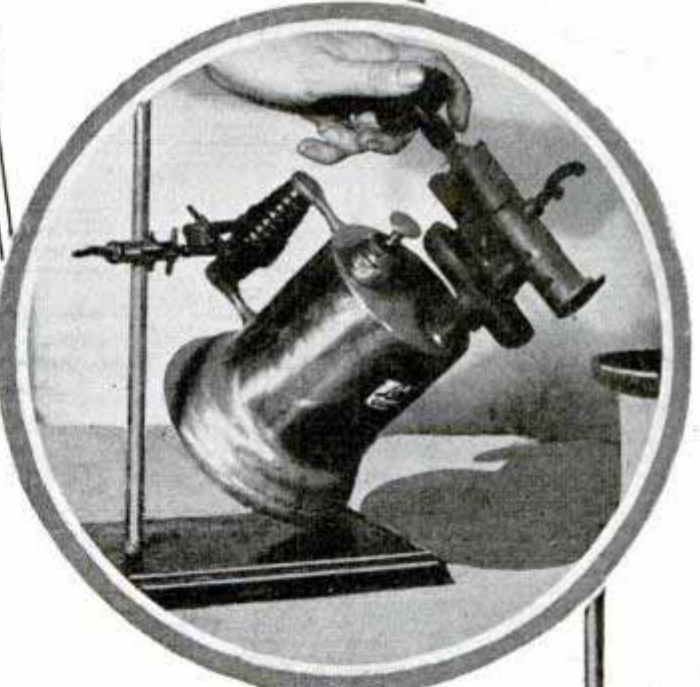

Mounting electrical meters on the ring stand as shown above eliminates danger of breakage. The meter dial can be clamped at any desired angle for easy reading

Adjustable Jig on Welder's Bench Grips Irregular Work



The problem of holding small irregular work while welding it is solved with this jig, the two arms of which can be adjusted to clamp around any part of the work. A 4-in. channel-iron base carries the arms, each rod consisting of three short pieces of flat iron pivoted at the ends. Each arm carries a C-clamp, which is welded to a short piece of $\frac{3}{8}$ -in. iron rod, the rods being fastened to the arms by means of U-bolts. These can be loosened to adjust the clamps in any desired position. Also, by loosening the bolts in the arms, they can be adjusted to almost any height or angle.—Clifford Tanner, Cranston, R. I.

Torch and Soldering Iron Handy for Roof Work

To save time in changing soldering irons and carrying them back and forth on a large roofing job, one tinsmith attached the iron directly to the torch. This was accomplished by fitting a soldering point inside of a short

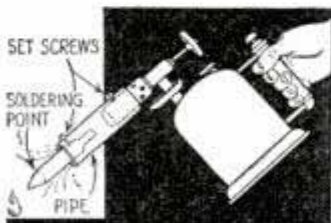

length of pipe, of which the inside diameter was slightly larger than that of the point. Two or three screws fitting tapped

holes in both pipe and point held the latter so that there would be a slight space between both. The pipe was then slipped over the flame tube of the torch, where it was securely fastened by a setscrew.

Wrist-Strap Mirror Aids Plumber

Plumbers, or pipe fitters, whose work includes laying and calking of water mains or soil pipe, will find the work somewhat simplified by the employment of a small pocket mirror, mounted on a wrist strap. By

placing the arm, or wrist, in such position that the mirror reflects the underside of the pipe, the calking of the joint may be observed and many possible leaks avoided.

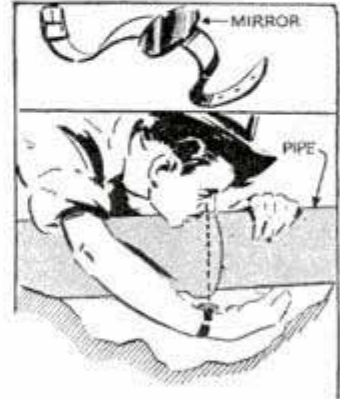

Nut Catcher on Box Wrench

Often when a box wrench is used, the nut drops out of the wrench into the work and is difficult to recover. To avoid this, the wrench can be fitted with a nut catcher by drilling a small hole through it

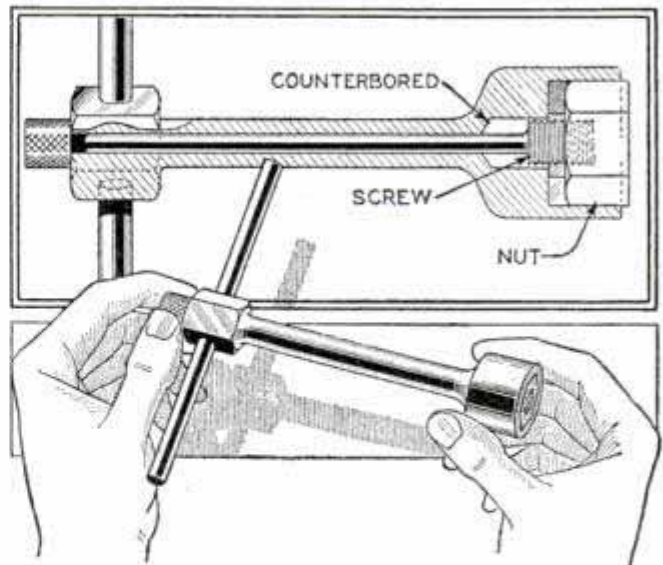

lengthwise and counterboring the boxed end as shown. A rod, with one end threaded to screw into the nut loosely, and having a knurled head on the other end, is all that is required. After the nut has been loosened, the rod is turned to screw the threaded end into the nut.

Altered Piston Forms Sturdy Grinder Head

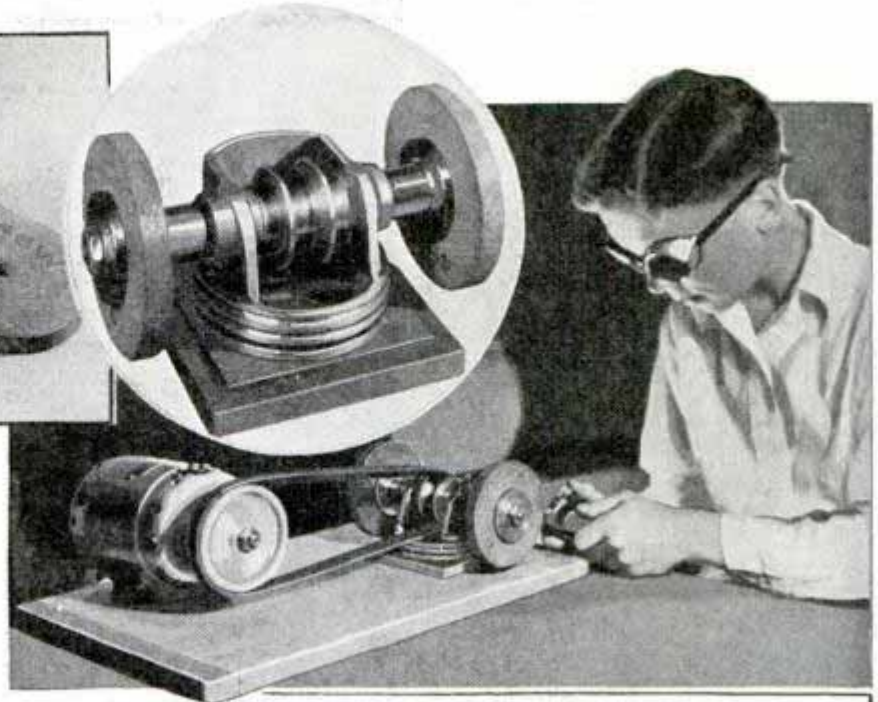
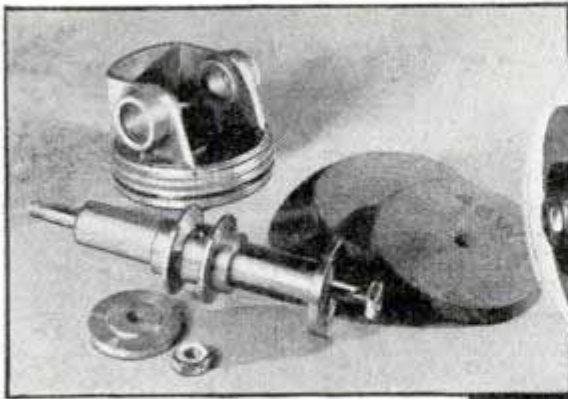

With little alteration, an old auto piston can be converted into a grinder head for light work. The piston skirt is sawed off just below the wristpin bosses. Part of the remaining piston wall is then cut away to allow for the V-belt drive. By cutting a hole in the base of the grinder it can just as well be driven from underneath. The shaft is a cold-rolled rod with its ends turned down to fit the grinding-wheel holes and threaded for retaining nuts. Collars are made to hold the grinding wheel. The pulley is turned from steel and is held in place with a setscrew. Oil holes are drilled in the shaft bearings. After drilling screw holes in the base, the grinder is ready to fasten to the bench.

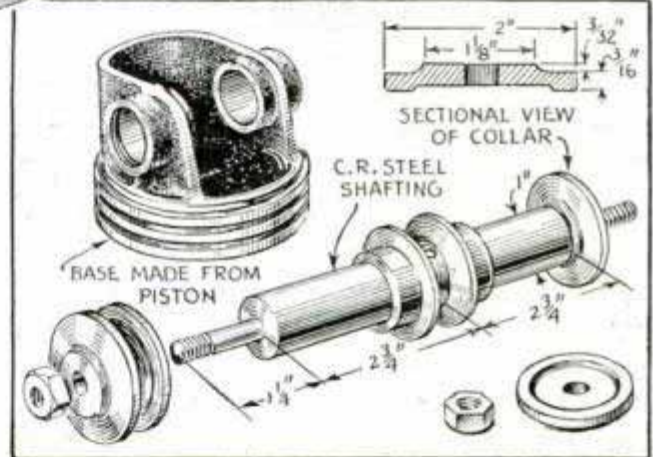

Two Shafts Gripped in Line While Transferring Holes

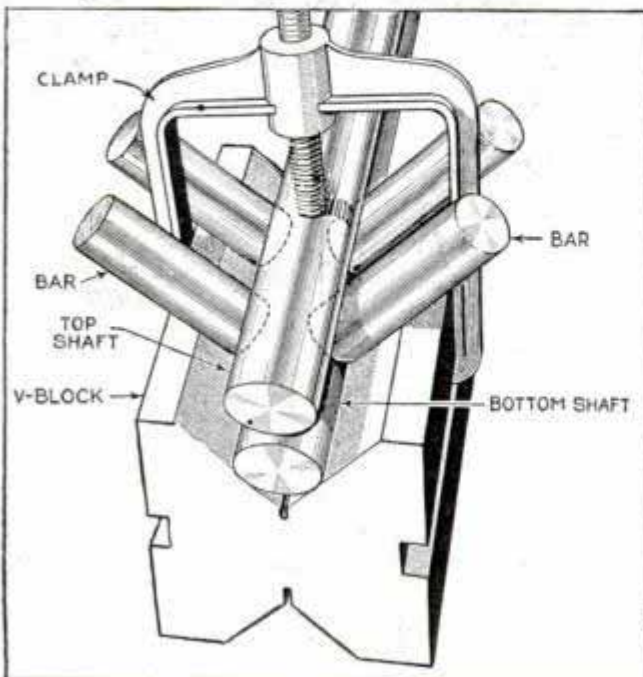

When it is necessary to hold two shafts, one directly above the other, for transferring or marking off drilled holes, the job can be done by using a V-block, a tightening clamp and four short pieces of round rod of slightly less diameter than the shafting. One of the shafts is laid in the V-block, two rods are placed on each side, as indicated in the illustration, and finally the top shaft is laid on these, after which the clamp is screwed down to keep the assembly firmly in position.

—H. Moore, Leeds, England.

☐ Nuts and bolts that are exposed to the weather may be prevented from rusting by applying a coating of asbestos roofing cement to the threads of the bolts before tightening the nuts.

Posts Removed Single-Handed with This Puller

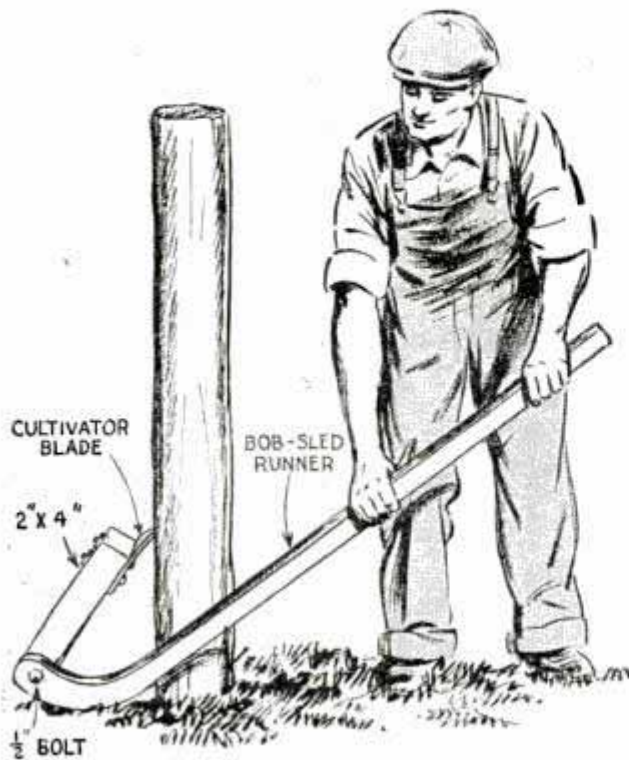

To remove fence posts single-handed, one farmer devised this simple puller. It consists of a discarded bob-sled runner to which a short length of 2 by 4-in. wood is pivoted. The free end of the short piece is fitted with a cultivator blade.

Large Barn Door Easy to Open by Exerting Pull at Top

Large, sliding doors are often hard to open because the pull is applied at the lower corner, thus throwing all the weight



of the door on one roller. If a stout strap or rope is fastened to the door at the point indicated, it may be rolled easily as the door is not lifted from either roller.

Sash Lifts Form Brackets for Sliding Door Bolt

Desiring an inside sliding bolt for the door of his implement shed, one farmer screwed several metal sash lifts across the doors as shown. A hardwood bar to slide through the lifts freely served as a bolt, and a wood pin driven tightly into a hole in the bar provided a hand grip for operating the bolt.

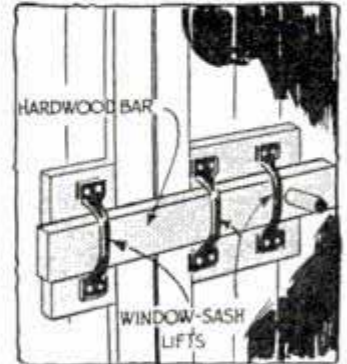

Stamp Pad Stored on Rack

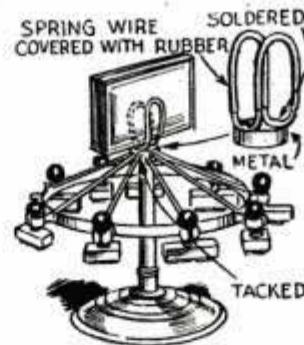

When a rotating rack is used to store rubber stamps, why not provide a clamp on the rack to hold the stamp pad? A clamp can be shaped from a piece of spring wire and soldered to the top end of the rack standard. If desired, the wire can be covered with a piece of rubber tubing.

Crochet Hook Fastens Sack Tags

A Wisconsin grain and seed dealer, who found it difficult to thread a sack needle when stitching shipping tags to filled bags, used a crochet hook for the purpose. The hook is forced through the side of the bag to engage the string or wire of the tag and pull it through the cloth.

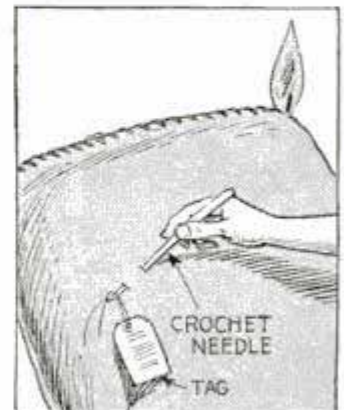

Auto SHORTCUTS

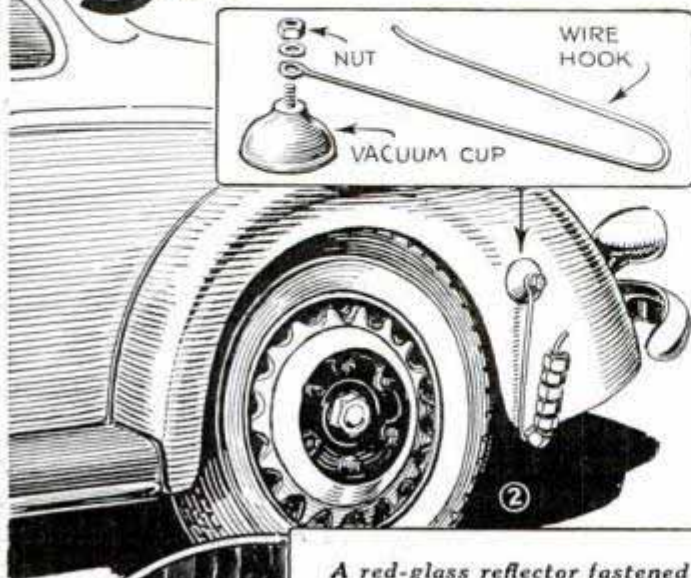

A red-glass reflector fastened inside the front door, Fig. 1, may prevent an accident when leaving car at night, as a motorist coming from the rear can see the reflector. A wire hook and vacuum cup to stick on a fender, Fig. 2, is handy for storing wheel nuts when changing a tire

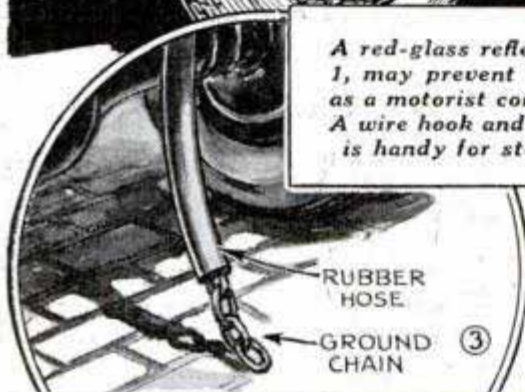

Encasing the drag chain of an oil truck in a rubber hose, as in Fig. 3, will reduce much of the noise. A thermostat of the type shown in Fig. 4, will operate more accurately if it is insulated against cold air directed on it by the fan. Much time can be saved when marking off a new gasket from an old one if you use a pounce bag, Fig. 5

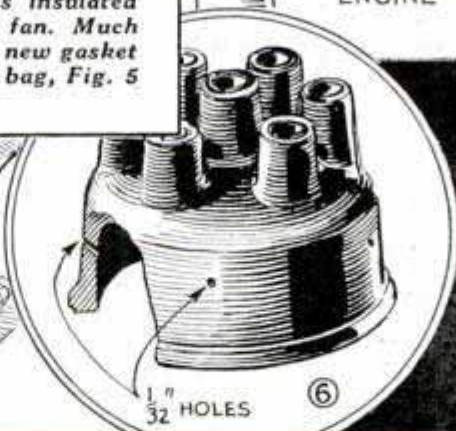
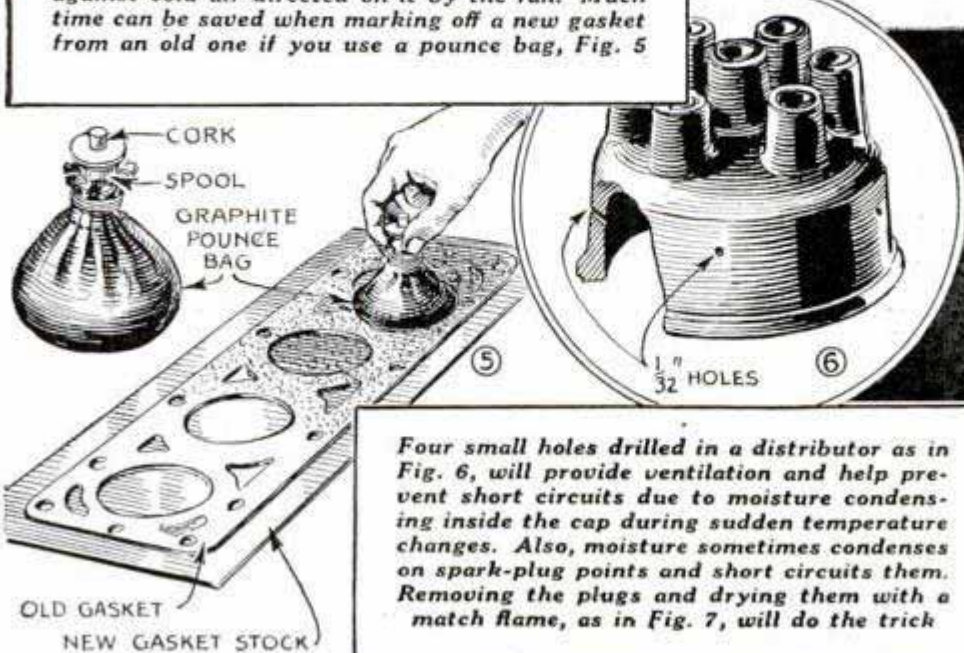
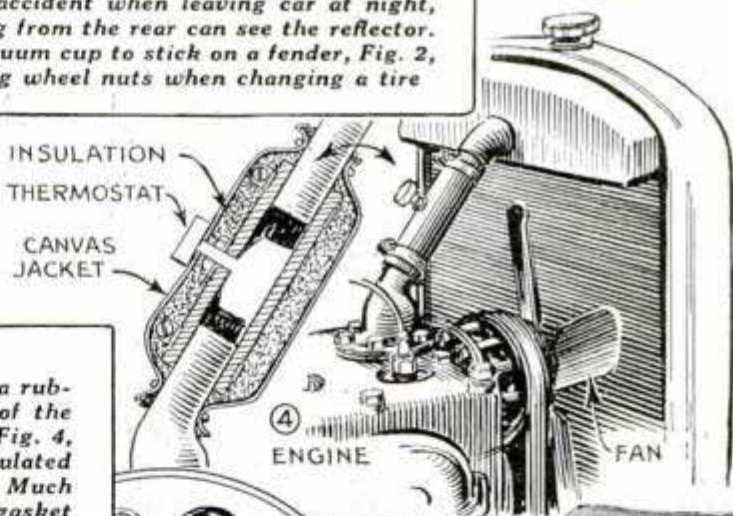

Four small holes drilled in a distributor as in Fig. 6, will provide ventilation and help prevent short circuits due to moisture condensing inside the cap during sudden temperature changes. Also, moisture sometimes condenses on spark-plug points and short circuits them. Removing the plugs and drying them with a match flame, as in Fig. 7, will do the trick

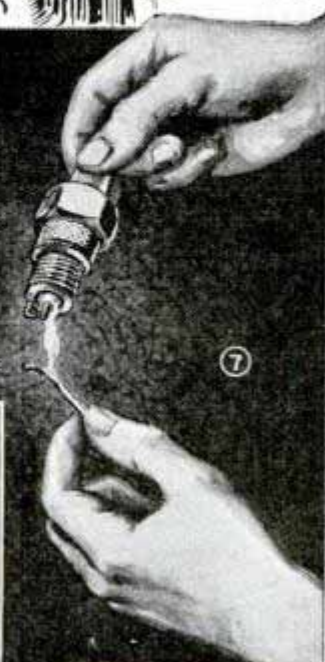

Valves Outside of Filling Station Locked by Metal Cover

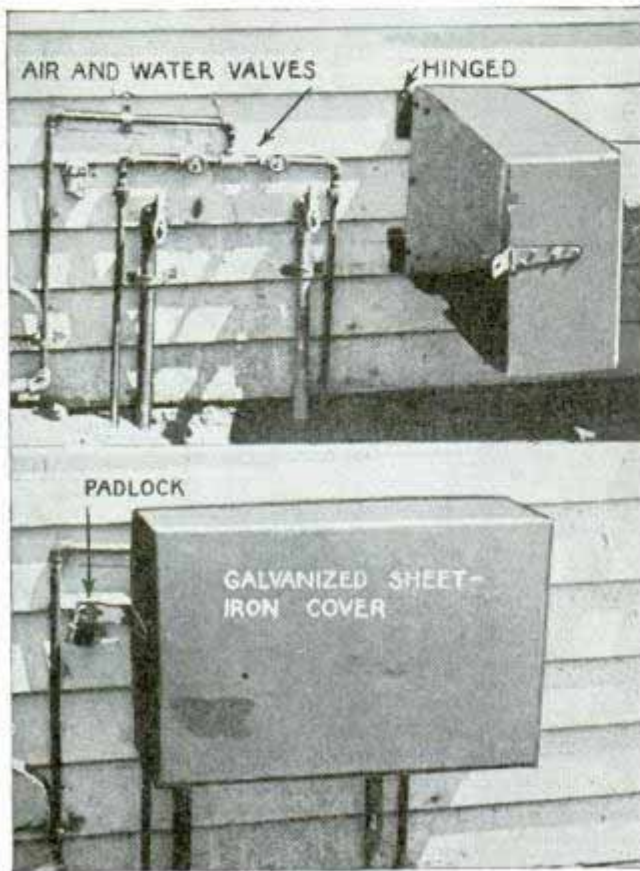

Having the air and water valves located on the outside of the building, the owner of one filling station hinged a galvanized, sheet-iron cover to the wall of the building so that it can be swung around over the valves and locked. This prevented anyone from tampering with them at night after the station had been closed. The next morning it was only a matter of a minute to unlock the cover and swing it around to expose them.

Bug Screen Serves as Winter Front

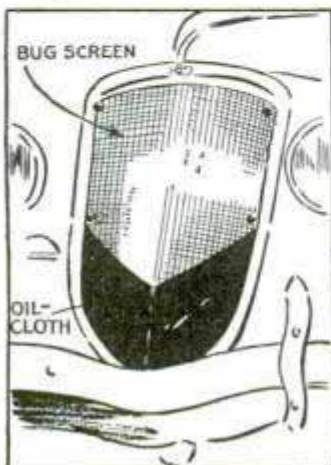

If you have a bug screen on the radiator grill of your car, you can improvise a winter front quickly at practically no cost. Just get a piece of oilcloth, cut it to the shape of the screen and stitch it to the latter. If desired, you can

slit the oilcloth down the center a few inches from the top to provide flaps. A couple of snap fasteners will enable you to open or close the flaps as desired.

—Charles Ahlgrimm, Bettendorf, Iowa.

Stopping Oil Leak in Main Bearing of Model-A Ford

Model-A Fords that have a tendency to leak oil through the rear main bearing often can be repaired as follows: Drop the oil pan, remove the bearing and drill a hole

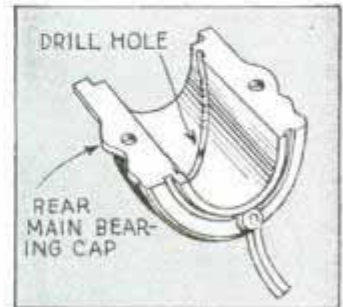

through it from the underside to break into the oil groove cut into the babbitt. This allows excessive oil to drain back into the crankcase instead of being forced back into the flywheel housing.

—H. Thomas Winston, Claremont, Va.

Sandblast Spark-Plug Cleaner

Here's a spark-plug cleaner that does the work in short order, and it can be assembled from an old vacuum tank and odd parts that are available in most any garage. First remove everything inside the tank. Then cut a hole in the bottom to take the top of a screw-top can, insert a U-shaped piece of tubing and connect it with the air hose by means of a gas cock. File a notch in the tube at the bottom of the U and adjust the free end so that it will be about $\frac{1}{2}$ in. from the bottom of a spark plug in-

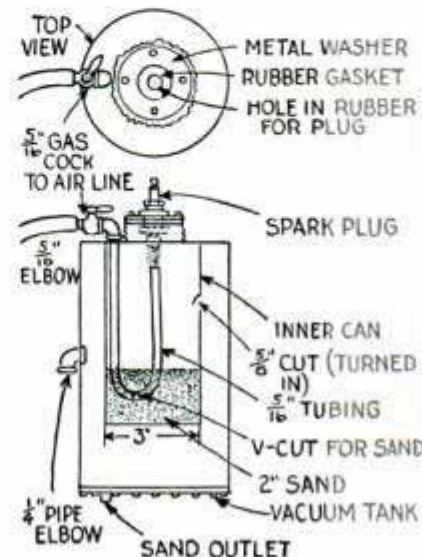

serted in top of the screw cover. Make a small cut in the side of the can and push it in to provide an opening for the air to escape. Now solder the can to the vacuum tank. Also attach an elbow to a hole in the side of the tank for the air to escape from it. Cut a 1-in. hole in the screw top of the can, stretch a piece of inner tube over it and fasten it in place with a metal washer attached to the cover with stove bolts. Make a small hole in the rubber to take the end of a spark plug tightly. Sand that escapes into the tank can be removed and put back into the inner can.

Dirt Between Fender at Joints Causes Squeaks

Squeaks sometimes result at the joints between the car body and its fenders, or similar places. The usual cause for this in the case of older cars, is road grit, which works into the fabric strips used between the parts. It is helpful to loosen the bolts at the joint a few turns, and then wash out the dirt by a stream from a garden hose. In old cars, when sections of the anti-squeak material wear or rot out, pieces of heavy gasket paper placed between the metal surfaces make a cheap repair.

Garage Doors Held Open by Latch Tripped with Your Foot

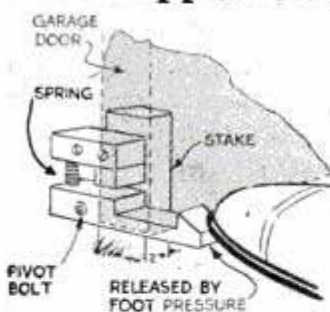

Much easier to use than a hook to hold garage doors open, this latch automatically grips the door and is released with your foot. The latch is pivoted to

a stake driven into the ground, and consists of a pivoted block beveled at one end and notched to accommodate the door. A coil spring causes the latch to bear up against the door while holding it. Pressing down on the beveled end of the latch with the foot frees the door.

☛ Tar spots on the enamel of an automobile or motorcycle can be removed without danger to the surface by rubbing them with a piece of cloth dampened with carbon bisulphide.

Blackboard in Top of Truck Cab Speeds Up Deliveries



To avoid any unnecessary driving on his delivery route, one truck driver writes the addresses of the various stops on a blackboard mounted above the windshield where they are seen easily. Before starting, he runs through the orders and plans the shortest route to the various stops, which are then recorded on the blackboard.

Headlight Lens Removed Safely with Gloves and Vacuum Cups

To reduce the possibility of breaking a headlight lens when removing it, one mechanic rigged up a pair of gloves for the purpose by attaching four small vacuum cups to the palm of each glove. The cups gripped the glass so that there was less chance of it slipping out of his hands.

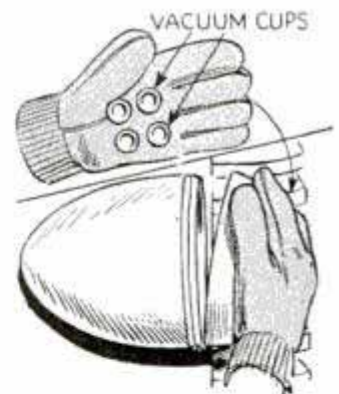

Wanted—More Auto Kinks!

Simple things that will add to the convenience of driving and touring—easily made repairs for minor troubles and disorders of cars—precautions that will avoid troubles—these are some of the many things motorists would like to know about. Possibly you have devised something for your car or garage that will be helpful to thousands of others. Just describe the idea briefly but completely, illustrate it with a sketch or photo and let's have a look. Perhaps it fits in with our needs and if so, a check will be sent promptly. Avoid old practices, ideas that are of use only occasionally or those that involve too much trouble and expense. Ideas must be found workable by actual practice. Address Technical Editor.

Pipe Guards on Walled Driveway Prevent Cars from Scraping

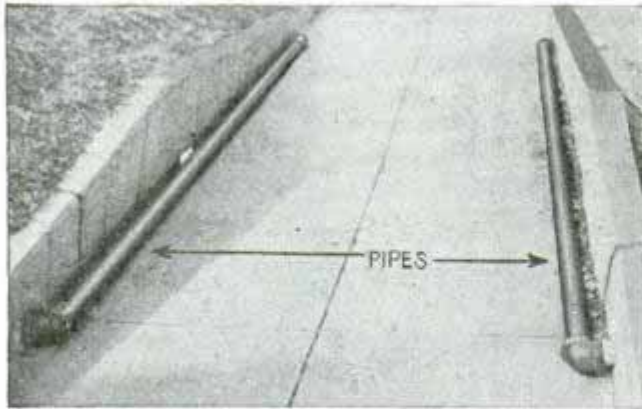

The driveway shown in the photo had to be sunken considerably to lessen the slope from the street to the garage and necessitated concrete retaining walls. As the

driveway was quite narrow, there was danger of scraping hub caps, tires and fenders. To prevent this, 3-in. iron pipes were installed as shown to keep the wheels away from the walls.

Running on Bad Connecting Rod

When a connecting-rod bearing on my car burned out several miles from the nearest garage, I immediately disconnected the spark-plug wire over the damaged rod to eliminate explosions against the piston with consequent hammering on the crankshaft. This minimized the danger of damaging the bearing surface of the latter, besides greatly reducing noise as I proceeded at a slow rate of speed to the garage.—John P. Crandell, Urbana, Ill.

Plan-of-the-Month—A New Service

How to get a collection of plans designed by leaders in craftwork

Complete, easy-to-follow plans including photos, material list and full instructions on building simplified but worthwhile articles with hand tools, without previous experience

Send coupon and 10c in stamps for Craftplan of
COLONIAL COFFEE TABLE



This satin-finished coffee table stands 18 in. high and has a 22-in. top to which four tapered legs are pegged

DAILY USEFULNESS

Of practical, everyday value in any home, it's a worthwhile project if you want your share of interesting and valuable recreation possible from a home workshop.

THE COST IS SLIGHT

As you need only a few pieces of maple, some stain and shellac, the cost of the table is very little besides the time required to do the work—time that you will want to spend in the pleasures of woodworking at home.

CRAFTPLAN SHOWS HOW

You don't have to be able to read blueprints to understand the Craftplan. It includes simplified, easy-to-follow pictures showing all details and sizes, gives step-by-step directions for assembling; describes jigs to bore holes accurately; explains how legs are tapered and top is rounded so that even beginners can do it. Also contains material list and instructions for finishing.

MAKE SPARE-TIME PROFITS

Why not use your spare time to make simple things like this that find a ready market? Others have done so! Many a small but profitable business was started in a home workshop.

POPULAR MECHANICS PLAN SERVICE
200 East Ontario Street Chicago

Name

Use pencil

Street

City and State

Enclosed 10c in stamps.

* COFFEE TABLE—CRAFTPLAN No. 3001

Atlas PRESENTS THE NEW F-SERIES LATHES

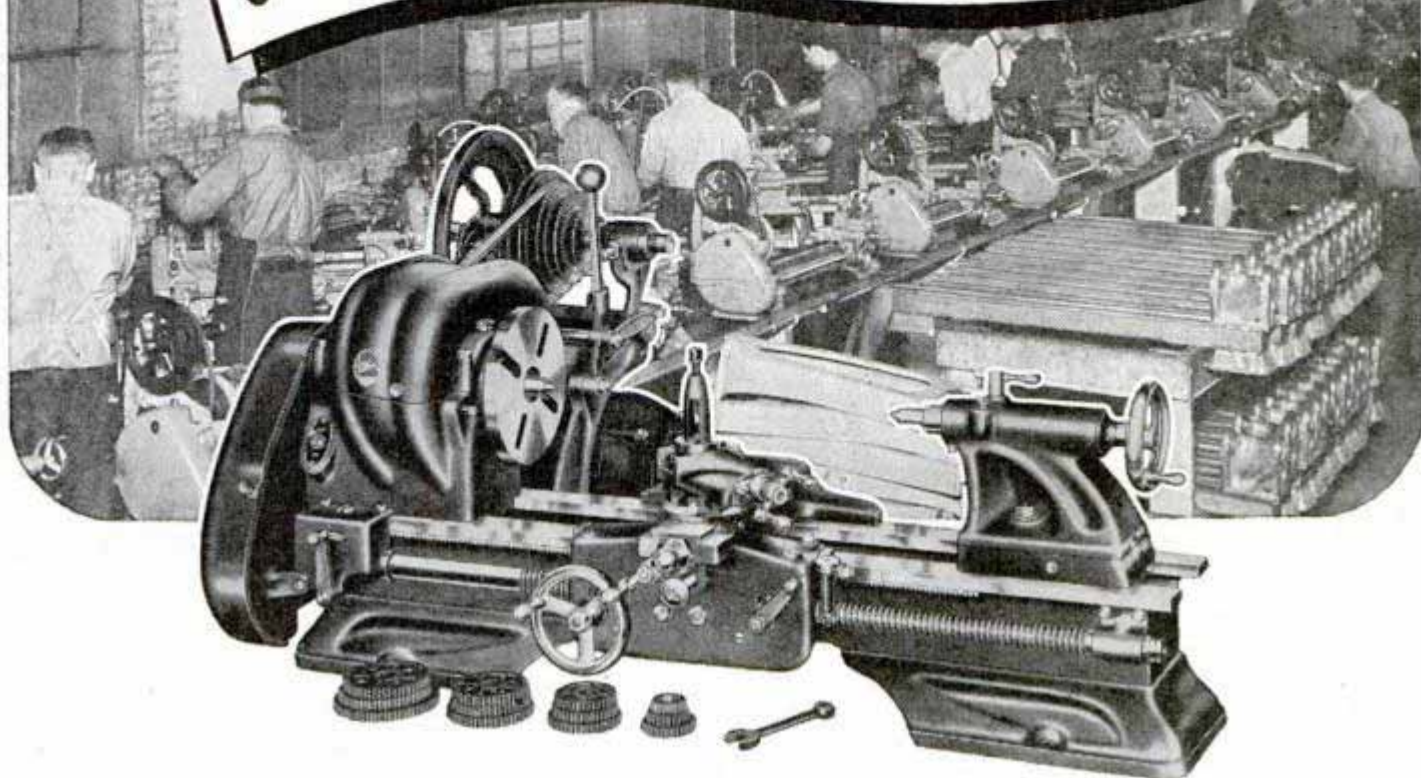

THE ONLY POPULAR PRICED LATHE with ALL THESE MODERN FEATURES

Power Cross Feed Standard Equipment

Now it can be told! Today Atlas dealers in all sections of the country are ready to show you the new Atlas F-Series Lathes, with one of the most outstanding developments in our 28 year history. Now, for the first time, you can have a popular priced lathe with instantly reversible power cross feed and longitudinal feeds as standard equipment.

It's the only lathe, too, with complete V-belt drive, quick-change countershafts, compact controls, precision ground bed ways, custom-built spindle bearings, extra power for heavy jobs, and many other modern features at the low price of \$104.75 for the 10" lathe with horizontal countershaft (complete as shown less motor) or \$99.75 for the vertical countershaft model.

Ask your dealer to show you the new Atlas and send today for the big new 1939 Atlas Catalog.

**SEE IT
AT YOUR
DEALER'S AND
MAIL THIS
COUPON**

ATLAS PRESS CO., 143 N. Pitcher St., Kalamazoo, Mich.

Kindly send me your 1939 Catalog. I am interested in:
 New 10" Metal Lathes New Small Lathe New Shaper
 Drill Presses Arbor Presses Wood Lathes.

Name.....

Address.....

City and State.....

ATLAS PRESS CO. 143 N. PITCHER ST KALAMAZOO, MICH.

NEW YORK
130 W. 42nd St.

CHICAGO
35 E. Wacker at Wabash

PHILADELPHIA
113 N. Third St.



LATHES · DRILL PRESSES · ARBOR PRESSES · SHAPERS

Picture Your Family

(Continued from page 47)

history book—especially the youngsters. Through the camera, you can watch them grow from babies to school age, 'teen age, maturity. Pictures of their hobbies, their activities, their friends, all provide rich material for memory.

Even ordinary household activities offer chances for good pictures. A picture of yourself repainting an old table, your wife dressing the small daughter for Sunday School, even a snapshot (with the aid of a "self-timer") of you both washing dishes



Letters are important chapters in a family history. Their arrival or posting makes a "newsy" picture

—all these are parts of daily life; and these snapshots in future years will call back many a happy incident.

Don't overlook the pets, for they are very much a part of the family, and appealing animal snapshots add spice.

One caution: Have an idea behind each picture. Make each tell a story. A snapshot of your son standing beside the house and smiling is hardly material for the book. But a snapshot of the boy repairing his bicycle is a "news" picture—the sort that makes the record interesting.

(Continued to page 116A)

KODAK

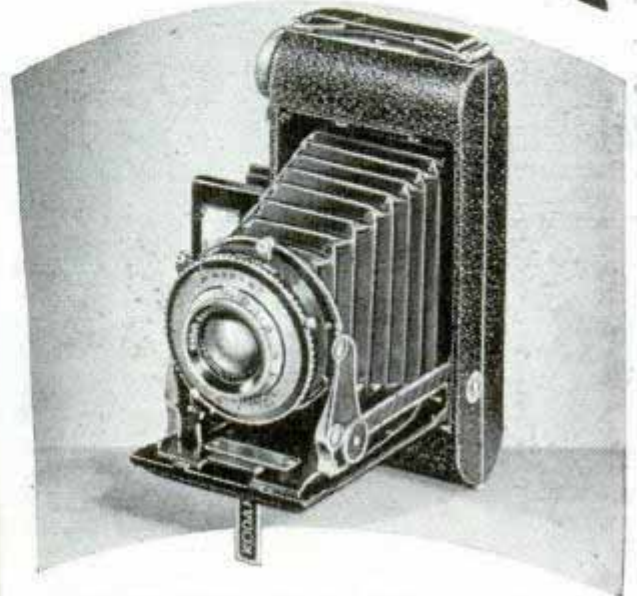

KODAK SENIOR SIX-20 (f.4.5) . . . Combination of body shutter release and eye-level finder offers new picture-making certainty . . . minimizes camera movement, catches the scene when it's exactly right. Kodak Anastigmat f.4.5 lens; 1/200 Kodamatic shutter. One-finger bed release. 2¼x3¼-inch pictures. **\$28**

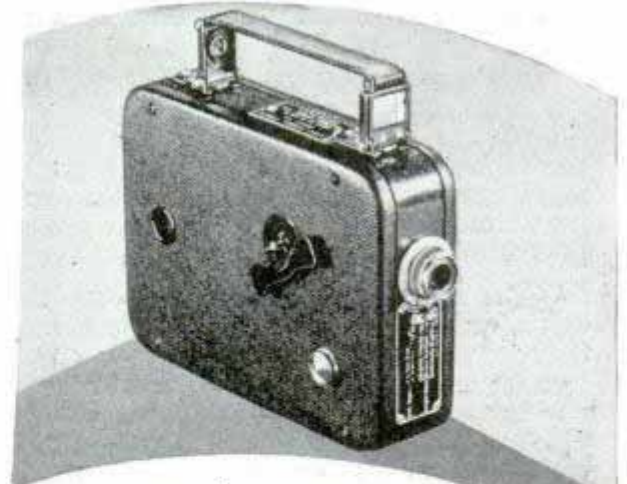

CINÉ-KODAK EIGHT

"Economy" movie camera. Gives you 20 to 30 movie scenes of newsreel length on a roll of film costing \$2.25, black-and-white, *finished, ready to show*. Kodachrome (full-color) movies cost just a few cents more a scene. **\$32⁵⁰**

CHRISTMAS CATALOG



KODAK RETINA II (*left*) with anastigmat $f.2.0$ lens. 1/500 Compur-Rapid shutter. Coupled range finder. Body shutter release. Price, \$140. Kodak Retina II, $f.2.8$, \$115. (Prices include sportsman's field case.) Both models load with a wide range of Kodak Film, including Kodachrome for gorgeous full color. **\$140**

KODAK RETINA I (*not illustrated*)... the original Retina, with Kodak Anastigmat EKTAR $f.3.5$ lens. Shutter, 1/500 Compur-Rapid. Film-centering mechanism. Exposure counter. **\$48⁵⁰**

KODAK BANTAM SPECIAL (*right*) Lens, Kodak Anastigmat EKTAR $f.2.0$ —extra-fast, super-corrected. Shutter, 1/500 Compur-Rapid. Built-in military-type range finder linked with lens mount gives hairline focus instantly. Film-centering device locks film accurately in position for each exposure. New low price includes field case. **\$87⁵⁰**

KODAK BANTAM FAMILY also includes Kodak Bantam $f.4.5$ at \$27.50 and Kodak Bantam $f.5.6$ at \$16.50. All three models load with full-color Kodachrome Film. Lower priced Kodak Bantams, for black-and-white pictures only, include the $f.6.3$ model at \$9.50 and $f.8$ model at \$4.75.



NEW KODAK 35 FAMILY (*left*)

A really outstanding group of new precision miniature cameras that are priced impressively low. Fast lenses—fully corrected for color—and accurate shutters. For critical results in black-and-white, or full-color Kodachrome. Kodak 35, with $f.5.6$ lens and 1/100 Kodex shutter (*illustrated*), \$18.50; with $f.4.5$ lens and 1/150 Diomatic shutter, \$29.50; with Kodak Anastigmat Special $f.3.5$ lens and 1/200 Kodamatic shutter, \$39.50. **\$18⁵⁰**



BROWNIES FROM \$1 — KODAKS FROM \$4.75 — SEE THEM AT YOUR DEALER'S
EASTMAN KODAK COMPANY, ROCHESTER, N. Y.

Only EASTMAN makes the KODAK

(Continued from page 114A)

Often, phases of the family history can be told in a short series of pictures better than in one. Your history of Christmas, 1938, could well begin with the decoration of the tree, and the hanging of stockings, then show the children discovering their gifts, close-ups of delighted faces as they examine new possessions, and shots of them playing with the new sled or train. Christmas dinner could well be pictured, and the holiday series might end with a shot of exhausted youngsters sound asleep, toys clasped in their arms.

No specialized equipment is needed to keep a family history, but a fairly good camera—say, one with a lens at least as rapid as f.6.3—is a great help. With such a camera, you can use a cable release and self-timer, which enables you to get into your own pictures. The extra speed of the lens is an advantage in taking night snapshots, with two or three inexpensive amateur photo bulbs providing illumination. And if you can get a miniature camera with ultrarapid lens, you can take these home snaps with no special illumination, just room light.

Make it a point to file negatives carefully, because in later years you may wish to have new prints made for a more elaborate and finished presentation. The value of these family books increases as years pass, and if one should be damaged it is a serious loss unless the negatives are available for reprinting.

If you are a movie-maker, you can keep your family history in movies as easily as in "still" form. Indeed, recently developed home equipment enables you to obtain enlarged still pictures from your movie frames. The movies can be in full-color, and the prints in black-and-white.

With movies, dramatic stunts are possible which add an extra touch of interest. For example, take one twenty-five-foot sequence of your boy or girl each year for a number of years. Splice these sequences together in proper order—and in a few minutes of projection time, you can watch the child grow up right on the screen!

A family history in pictures provides a rich storehouse of memories that can be obtained in no other way. The longer the maker lives, the more value they have.

"Minnies" Supply Punch to Movies

(Continued from page 69)

all vest-pocket cities was made for the film musical, "Just Imagine." It was a glimpse of New York of the future—a \$200,000 glimpse. Housed in a dirigible hangar, the reproduction covered seventy-five by 225 feet and some of its two-hundred-story skyscrapers were forty feet high. There were nine levels for subway and elevated trains; helicopters, dirigibles, and airplanes could discharge passengers at any building level, and streets and office buildings were perfectly illuminated.

Incredible action is achieved in the miniatures. Noah's ark in "Green Pastures" was loaded with small wooden animals that moved on a concealed track. The siege of the town of Port Royal in "Captain Blood" was made in this same way. The tiny town was built along the bank of Warner Brothers' tank and a fleet of battleships set afloat on the pond. When cameras were trained on the scene, fire spat from tiny cannons protruding from portholes. Shore guns retaliated and townspeople were seen running for cover. The citizenry were fig-

ures mounted on tracks and moved by wires, and the firing was done from an electric panel by an operator at the director's elbow. Electric wires led from each point where an explosion was to take place and it was just a matter of pressing a button to set off a gun or powder mine. The effect of shells showering about the warships was gained by snipers peppering the water with rifle shots from a perch high above the set.

Film experts regard James Basevi as Hollywood's ace man on special effects. He was responsible for the hurricane in the Nordhoff-Hall thriller, "Hurricane." The island of Manukura, which in the story is inundated by the sea whipped into wrath by the hurricane's force, was built. At one end of the island was the miniature village of Motu Tonga to be destroyed by the force of the wind and sea.

Coconut palms were made with trunks of lead and fronds of copper. Batteries of wind machines, four on each of the two

(Continued to page 118A)

The Movie Camera That Couldn't Wait For Next Year!



NEW 1939 MODEL "STOPS THE SHOW!" 60 GREAT NEW FEATURES MAKE FRONT PAGE NEWS!

Never before has a movie camera, at anywhere near this price, brought such perfection of detail . . . such simplicity of operation . . . such economy!

No wonder when it was previewed at the great International Camera Convention in Chicago, dealers said—"We want it now!" And so here it is—just in time for Xmas!

Check Sensational Features!

All America is talking about the new 1939 UniveX! Its magnificent new styling . . . its amazing performance . . . its 60 great features that you'd expect to find only in a high-priced camera! New built-in optical view-finder . . . new improved governor . . . new automatic shutter . . . new snap-lock hinged cover! Improved F 5.6 lens, instantly interchangeable. New quiet, powerful, smooth-running spring motor.

Just think—the new 1939 UniveX has all these important features—and many more! And, in addition, it's the only camera in the world that takes sharp, clear movies at less cost than snapshots! (UniveX Ciné film-roll costs only 69¢.)

DON'T DELAY! Know the thrill of taking living action pictures of your family and friends—movies you'll cherish all your life! See the new 1939 UniveX Ciné "8" at your dealer's today before his limited supply is exhausted.

Universal Camera Corporation
New York • Chicago • Hollywood

Features Like These Found Only in High-Priced Cameras!

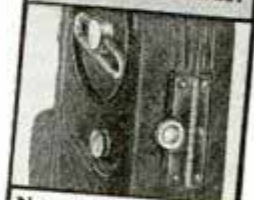

New built-in optical view-finder insures getting exactly what you see



New re-designed loading mechanism. Self-locking hinged cover simplifies loading; makes film jamming impossible



New-type, quiet-running powerful motor. Automatic self-capping shutter. Automatic footage indicator.



Sensational New Guarantee Insures Your Movies!

For the first time, a movie camera makes this guarantee: "Satisfactory movies if instructions are followed or a new roll of film free." This is your proof that it is possible for a \$12.50 camera to get perfect results!

NEW 1939 UniveX CINE 8

BIG NEW STREAMLINED LATHE AT SENSATIONAL BARGAIN PRICE



Swings 10 inches

Imagine! This extra heavy wood lathe, steel bed 48" long, at low prices. Heavy duty head stock, 4-step cone pulley for V-belt, No. 2 Morse Taper Centers, Sealed ball bearings, 6" face plate screws onto spindle. Tool rest 10" long. Complete line of accessories at amazing low prices. Write today for free catalog describing Blue Star full line precision woodworking machinery. Factory-to-you prices. Not sold through agents.

BLUE STAR PRODUCTS, 601 Wood Ave., Fairfield, Iowa

BURN YOUR NAME ON TOOLS WITH THE ARKOGRAF

PROTECT YOUR TOOLS FROM THEFT

Write with electricity any name or design on the hardest and finest tools and instruments, or any metal, like writing on paper with pen or pencil. **Complete Outfit \$3.50—Prepaid Anywhere** Interesting illustrated circular free. Write today. Agents wanted. **ARKOGRAF PEN CO., 3027 S.E. Stark St., Portland, Ore.**

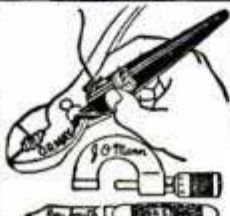

Home Craftsmen, Schools, Hobbyists METAL CASTINGS



produced in your own workshop allow you to design and build your own GASOLINE ENGINES, STEAM ENGINES, STATUARY, ART OBJECTS, SPECIAL TOOLS, NEW INVENTIONS, ETC. You can also make forgings and case harden steel. Your shop is not complete without a FOUNDRYETTE. Three sizes are available capable of making bronze castings of 1½, 3, and 6 pounds weight, aluminum, copper, brass, etc., in proportion to specific gravity. Clean scrap metal suitable for use. Each outfit includes a complete Blast furnace.

Domestic gas supply and 110 volt AC or DC Electric energy required for operation. Size Crucible Shipping Wt. Price

Capacity	Wt.	Casting Complete
351 6 cu. in.	25 lbs.	1½ lbs. \$13.50
352 12 cu. in.	40 lbs.	3 lbs. 19.00
353 24 cu. in.	65 lbs.	6 lbs. 27.50

Above price includes Universal high speed blower. Prices f. o. b. K. C. Check or money order acceptable, express charges C. O. D. Write for circular.

KANSAS CITY SPECIALTIES CO.
P. O. Box 6022 Kansas City, Mo.

2 NEW BAND SAWS

**PERFECTED FROM DRIVER'S
EXPERIENCE IN BUILDING 50,000!**

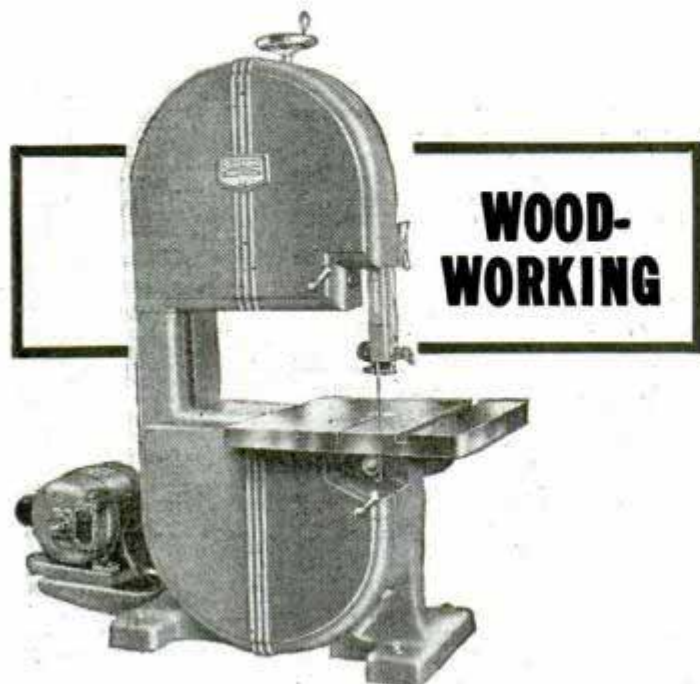

This new Driver Band Saw offers a wide usefulness. Its keen blade, traveling at 2535 feet per minute, zips through heavy oak or a scrolled panel with equal ease. It rips, cross-cuts, makes curved, angle and mitre cuts accurately. The carefully-balanced wheels, running on large, dust-sealed ball bearings—the heavy one-piece cast iron frame—the big 16" x 16" tilting table—all are quality features that will amaze you at the low price.

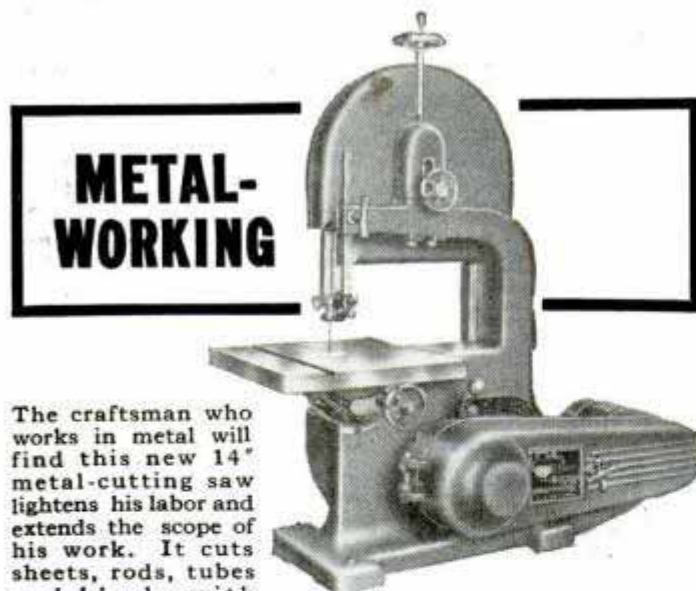

The craftsman who works in metal will find this new 14" metal-cutting saw lightens his labor and extends the scope of his work. It cuts sheets, rods, tubes and blocks with amazing speed and accuracy. Wide range of speeds permits cutting molded plastics or hard die steel. Speed range with recommended motor, 175 to 4630 feet per minute; eight speeds, provided by positive geared unit.

When you see these new saws and get the low prices, you'll appreciate the value built into them. New 1939 catalog on request. Walker-Turner Co., Inc., 119 South Avenue, Plainfield, N. J.

DRIVER *Engineered* **POWERTOOLS**

78/05
(Continued from page 116A)

sides of the 100-foot tank, provided the 110-mile-an-hour gale that devastated the island and supplied the realism in the close-ups when the principals were shown in the grip of the hurricane. Human wave-makers with large boxlike paddles helped churn up the waves.

Ship models usually are powered by a cartridge of compressed air with a vent beneath the surface or by Dry Ice that creates gas as it evaporates. The special effects men have another problem to contend with when they are working with ship models. If you have ever watched a toy

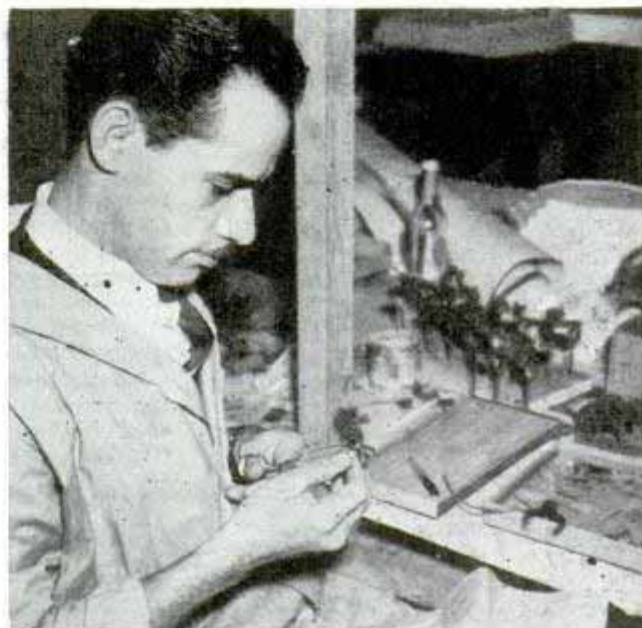

Cheesecloth and sponge go into the making of tiny trees for movie miniatures

boat on a lake, you have probably noticed it rolls and pitches much more rapidly than is the case with a real liner. Consequently, the motion of the model ships must be slowed down to the speed of their full-sized counterparts. A quantity of glycerin sometimes is placed in the water tanks to make the roll of the water appear heavier and more natural.

When the script calls for airplanes to fly in fog or close to mountains or tree tops, models generally get the assignment. In a small racing plane rigged for a breakaway, a crash in the "mountain" on which it is resting, the ribs and wing sections are complete in every detail so they look genuine when they shear off in the crash. The trailing edges of both wings next to the fuselage have small pieces of lead inserted in them to give a smashing effect at the moment of impact.

New Jobs on the High Seas

(Continued from page 43)

The age of hardtack and salt pork has gone and crews today are fed the same fare as passengers, possibly without some of the trimmings. Refrigeration has done away with the old practice of carrying livestock "on the hoof" on deck although chicken coops and pigpens may still be seen on some foreign vessels. Food that old sailors would hardly recognize is on the daily menu. For a coast-to-coast voyage a freighter is apt to carry seventy-five gallons of fresh milk and twenty-five gallons of buttermilk in the refrigerator rooms, as well as large assortments of meat. The cook, making up his requisitions, often includes asparagus, green peas, endives and what other fresh vegetables



Servicing a liner. Water and half a dozen different oils and fuels are taken aboard as soon as liner docks

may be in season. His department serves bottled pickles, olives, relish, onions, horseradish and assortments of fresh jams and jellies. The crew usually has a choice of ice creams for dessert.

Pay at sea starts at around \$55 per month in addition to board and room. This is raised to \$72.50 per month after a man serves a year as ordinary seaman and passes an examination covering such subjects as deck duties, lines, knots and gear. He graduates as an able-bodied seaman although three years must pass before he obtains a full certificate. The A.B.'s keep the lookouts and steer the ship, as well as doing other work. The next promotion is quartermaster, who assists the mates.

With diligence and ability a man may graduate to third or fourth mate three or four years after he first ships and start

(Continued to page 120A)

LECTRO-SHEAR

**CUTS ALL SHEET METALS
QUICKER, EASIER,
MORE ACCURATELY**

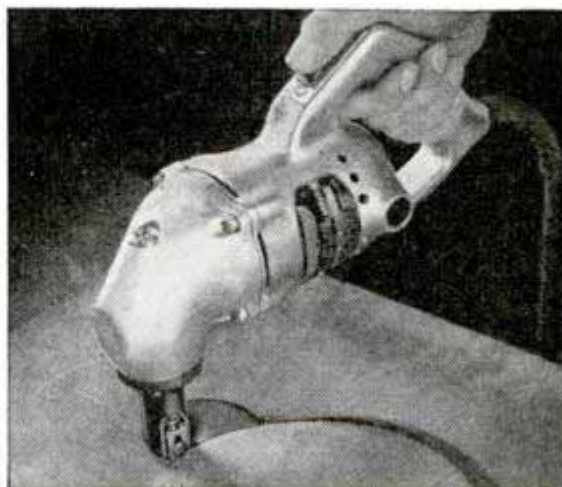

Here's a versatile tool that saves endless time, trouble and effort on a wide variety of sheet metal operations. Once you use it, you'll never be without it—for with its powerful motor and specially designed cutting head, the Black & Decker LECTRO-SHEAR makes short work of cutting special shapes and patterns in varying types and thicknesses of sheet metal. Its easily adjusted, easily sharpened blades make faster straight cuts—sharper curves. LECTRO-SHEAR is light in weight, ruggedly constructed, easily-handled. Two sizes—with capacities up to 16 and 18-gauge metal. Sold through leading jobbers. Get full details today. Black & Decker Mfg. Co., 601 Pennsylvania Ave., Towson, Maryland.

BLACK & DECKER

BLACK & DECKER

World's Largest Manufacturer of
PORTABLE ELECTRIC TOOLS

NEW MOTIVE POWER

● There are two "firsts" in the new Gilbert American Flyer line . . . the new switching locomotive and the new B. & O. "President Washington." "O" gauge men wanted them! A. C. Gilbert has built them, *just as they should be built*. Top quality in design, proportion and detail. Top quality in construction and workmanship.

FOR "O" GAUGE PIKES

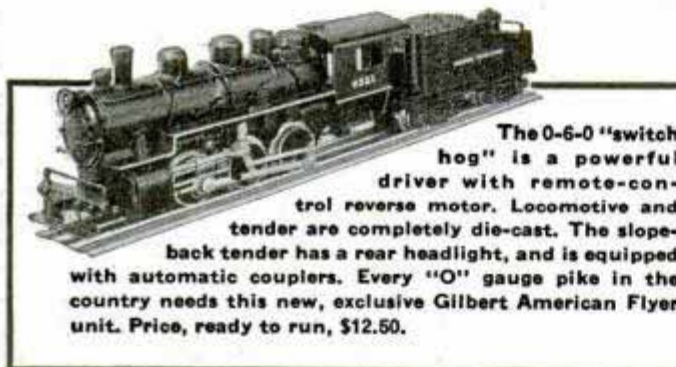

The 0-6-0 "switch hog" is a powerful driver with remote-control reverse motor. Locomotive and tender are completely die-cast. The slope-back tender has a rear headlight, and is equipped with automatic couplers. Every "O" gauge pike in the country needs this new, exclusive Gilbert American Flyer unit. Price, ready to run, \$12.50.



Few "O" gauge locomotives offer the true-to-life lines and proportions of the new B. & O. "President Washington." It's the 4-6-2 Pacific type, with remote control and six-wheel drive. Locomotive and tender completely die-cast. A "natural" for fast passenger and freight service. Price, ready to run, \$15.

● Send for your FREE copy of the new Gilbert American Flyer Catalog. Get the latest train news right off the press.

GILBERT

AMERICAN FLYER TRAINS

MADE BY THE A. C. GILBERT COMPANY
516 Erector Square New Haven, Connecticut

(Continued from page 119A)

drawing \$135 per month. Getting his mate's ticket, however, is not the whole battle, for jobs are scarcer as he climbs the ladder. First mates draw an average of \$195 per month and masters' salaries are arranged in conference.

In the engine-room department a man may start as wiper, graduate to fireman at the end of six months, and then to water tender or oiler. On each step up the line he has to pass examinations. Wages are higher in the engine room than on deck. A chief engineer draws an average of \$275 per month.

Men in the steward's department on passenger ships work slightly longer hours



Gear and brake used for snubbing lifeboat as it is swung away from ship and lowered

and their wages are about the same as those on deck. Both members of the crew and the licensed officers have to pass rigid examinations in the shipping office of a port before they can be promoted to a higher rank. Oil tankers pay better than most cargo and passenger ships because the service is considered more hazardous and because the tankers are noted for short "turn-arounds," spending only a few hours in port before starting the return voyage.

☐ Names and addresses of manufacturers and dealers in articles described in this magazine will be furnished by our Bureau of Information upon request accompanied by stamped, self-addressed envelope.

John made **\$42⁵⁰**
in one day
in his **NEW**
Business



● **Get Into This Business Now —**

a business which is so new that it is practically without competition. This alone should enable you to make really **BIG MONEY**. Hotels, homes, clubs, office buildings offer tremendous possibilities. Our new **DETERGER** washes upholstered furniture, electrically right in your customer's home, with a new soapless soap whipped into **DRY** suds. *No liquid touches the fabric*, therefore the furniture is ready for use soon after cleaning. We have helped hundreds of men get into business for themselves with our automatic equipment. The U. S. Government and many of the world's largest hotels use our machines.

Make Money the FIRST DAY

The Deterger is ready to use when you receive it, so you ought to be taking in big profits the first day. We want an honest, ambitious man in every locality. If you are that man we will help you get started for yourself in a business with tremendous possibilities.

No Rent to Pay You don't have to rent a shop. You don't have to hire a building, for you do the work right in your customer's home. You save the expense of carting furniture back and forth to a central plant; the owner's home is your workshop.

J. S. Corson says

"I cleaned seven living room sets and fourteen chairs, as well as twenty-five automobile interiors the very first month and made \$279.50." Berger Hanson wrote "My investment in your **DETERGER** was the wisest I have ever made. It is my most valued asset." Barrett says: "Made \$28.00 in eight hours, on another job made \$11.00 in two and one-half hours." Alex Gulkin's business expanded so fast that he already has **SIX DETERGERS** making money for him.

Pay as you Earn

Only a limited amount of money is needed for a down payment. The balance you send on easy terms. Most men find it possible to make far more than the cost of the machine before the payments come due. Every machine is fully **GUARANTEED** and satisfied customers send their friends to you.



No liquid touches the fabric when cleaning with the **DETERGER**.

Book sent FREE

Write today for copy of our booklet "Your Own Business, Profits Instead of Wages." Let us tell you how easy it is to get started in a year around business where you are your own Boss and can stop worrying about just a job. Write today—**NOW**.

VON SCHRADER MFG. CO., 551 Pl., Racine, Wis.



VON SCHRADER MFG. CO., 551 Pl., Racine, Wis.

Send me (without obligation) your free booklet telling me how I can own my own business and become financially independent and how I can pay for the **DETERGER** on easy terms.

Name.....
Address.....
City..... State.....

CASH IN QUICK

Now Till Christmas
Men and Women, Make easy money selling
GENUINE LEATHER TIES
4-in-Hands and Bows, for Men and Boys. Beautiful patterns and colors. Won't wrinkle. **LOOK LIKE SILK**. Wear indefinitely. Cleaned with a damp cloth. Big profits; repeat orders. No sales ability needed. Big leader in necktie sales. Send 50 cents for sample kit. Information free.
CENTURY TIE CO., Mfrs. 2345-P W. Grand Blvd. Detroit, Mich.
(Originators of Leather Ties)

TRAILER BUILDERS · BUYERS · OWNERS

Over 100 pages! Beautifully Printed and Illustrated! Trailer Suggestions and Ideas galore! Catalog shows America's greatest line of Trailer Parts and Equipment at lowest prices. Everything from wheels to top. Rush 25c today. Satisfaction positively guaranteed!
TRAILER SUPPLY CO. Box 438-A WAUSAU, WIS.

BUILD IT YOURSELF

The Jim Dandy Cabin Cruiser
The Trailer that has everything. Clean! Roomy. Easy to build in any size with my simplified Plans and Instructions—Price \$1.00. Rush dollar bill today to **JIM DANDY** Box 125-A WAUSAU, WIS.

NEW BRUSH PLATING OUTFIT For AUTO PARTS

Connects to a battery with no tanks necessary. Plates on iron, steel, brass, copper, etc. Almost as simple as painting. Hundreds of car owners waiting for this low-cost plating. Improves appearance and value of the car. Your opportunity to make good income plating auto parts, bathroom fixtures, reflectors, mirrors, etc.

FREE PROOF
Write quick—big season here. Get **FREE PROOF** and particulars that put you in a paying business of your own.

GUNMETAL COMPANY
AVENUE M DECATUR, ILL.

SAVE YOUR TOOLS FROM DAMAGING RUST With QUIK-TRIK RUST REMOVER

For less than the price of one of your least expensive tools, save all of them from rust. Quik-Trik removes rust from anything. Your money back if you don't agree that it's the best you've ever used. Tell your friends. Send 50 cents for one-half pound jar. Postage prepaid; U. S. only. **AGENTS!**

BRAVO PRODUCTS COMPANY
6432 Cass Avenue Detroit, Michigan

MEGOW'S GAS-POWERED MODEL AIRPLANE

The Cardinal
World's champion Bassett's new 48" gas-powered crack-up proof sensation! Finished prop., many ready-made parts, rubber wheels. Also the famous **QUAKER FLASH, FLYING QUAKER** and others. Also rubber-powered Giant Fliers with motor-hum device \$1.00 up.
\$3.95 plus 20c post.

SHIPS . . . carved hulls, many ready-made parts, complete plans and materials. **XEBEC** (Rob. Crusoe); **HISPANIOLA** (Treasure Island), **ARABELLA** (Capt. Blood) and others, \$2.00 (15c postage).

HO-GAUGE MODEL RAILROADS. Most realistic freight cars. 50c. Send 5c postage for 100-page illustrated catalog Model Kits, ready-made parts and supplies.

MEGOW'S Dept. PM., Howard & Oxford Sts. Philadelphia Pa. or 217 N. Desplaines St., Chicago, Ill.

XEBEC

When writing please mention *Popular Mechanics*

H 1099

Taming Wild Wells

(Continued from page 93)

sition on a carrying apparatus which can raise, lower, or tilt the stack. His method is to slide this seventeen-ton machine up to the casing head of the wild well, lower the stack and weld it to the casing. Then heavy valves attached to the bottom of the manifold are closed slowly. When they have been shut they are left upon the casing and the manifold is pulled away. The well is under control. Very simple.

But in the present instance it was not so simple. Before the manifold could be lowered to take in the entire flow of gas, part of the gas belched out at the bottom of the



Dredge trying to catch piece of broken casing with hook to pull it from crater

stack, enveloping the rig in flames and making it impossible for anyone to get near, even in an asbestos suit, to lower the stack.

So an irrigation canal was diverted into the crater until water was almost to the top of the manifold. But flames came up through the water and soon it was boiling. The crew rigged a boat with tin shields and rowed onto the boiling lake with a hook to try to catch the chain that would lower the manifold. Some under-water projection stove in the bottom of the boat and almost pitched the men out. With boiling water flooding into their craft they raced for shore, reaching it just as the boat capsized.

But the fighters were not stumped. With the crater full of water the manifold was pulled away from the casing. The gas roared unhindered through the lake, sucking up water as it went into the air. The

You'll Like
Alka-Seltzer
Too!



I LIKE
ALKA-SELTZER
FOR
HEADACHES



I LIKE
ALKA-SELTZER
FOR A SOUR
STOMACH



I LIKE
ALKA-SELTZER
FOR ACID
INDIGESTION



I LIKE
ALKA-SELTZER
FOR RHEUMATIC
ACHES and PAINS

Try This Easy Way to
Pleasant, Quick Relief

● An Alka-Seltzer Tablet in a glass of water makes a sparkling alkalizing solution, containing an analgesic (sodium acetyl salicylate). When you drink it, it gives relief in **TWO** ways—quick relief from the pain and discomfort and relief from the excess acid condition so often associated with common ailments.

AT ALL DRUG
STORES
30c—60c
Pkgs.



DO YOU

WANT a new business profession of your own, with all the trade you can attend to? Then become a foot correctionist, and in a few weeks earn big income in service fees.—not medical nor chiropody—easy terms for home training, no further capital needed, no goods to buy, no agency. Established 1894. Address Stephenson Laboratory, 1 Back Bay, Boston, Mass.

K1099

water mixing with the gas raised its point of combustion, the fire wavered and wavered and then snuffed out.

When the crater was empty again, the manifold was ready to go in once more, this time with a long tapering swedge that would go inside the casing and wedge fast. The swedge went down into the casing and the stream of gas shot out of the top of the manifold. But suddenly gas began bubbling out of the ground near by. Evidently a leak had occurred underground. The swedge and manifold could do no good now. Frantically the men worked to loose their machine from the casing before the explosion that was sure to come. All at



Asbestos-clad men making cable fast to casing at the bottom of the crater

once some inner sense told them that it was time to go. And they went, running for their lives. Behind them the bottom of the crater let go with a tremendous roar and fire reached out over the crater rim. The concussion tumbled the men end-over-end, but only one was burned about the face.

From a distance they looked at the well, once more a tremendous furnace, but this time with \$2,000 worth of equipment at its bottom. Wearily they admitted defeat and went away.

But the well had not yet won the battle. M. M. Kinley, probably the most experienced fire fighter in the game, decided that it was not yet a hopeless proposition. He came with his crew and with high-pressure hoses washed away the earth from Patton's wrecked machinery, then removed it with tractors. Next his men carried in a can filled with forty quarts of nitroglycerine jelly and placed it beside the fire.

(Continued to page 124A)



... here comes a

**Flexible
Flyer**

They will have to get out of the way when you come down the hill with one of these new streamlined Flexible Flyers.

They sail along like nobody's business, ride bumps like a new car, sweep around curves like a racer. They're the smoothest, speediest, safest sleds ever made... just what you want for Christmas!

Tell Dad and Mother about Super-Steering, with a turning range double that of other sleds. It gives you full control at all times. Tell them about the new Safety-Runners, with no sharp ends to cut you.

Take Dad to the store and show him the smooth Airline Eagle. He'll understand why Flexible Flyer is still the favorite sled of red-blooded boys and girls — just as it was when he whizzed down the hills.

Show it to the folks and tell them why you want this streamlined beauty for Christmas. You'll be the king of the snow trails this year!

Write for FREE cut-out model of the Airline Eagle. It steers just like a real sled.

S. L. ALLEN & CO., Inc.
451 Glenwood Avenue
Phila., Pa.



*The
Airline Eagle*

**Flexible
Flyer**

1099

for a Merry Christmas and a HOBBY NEW YEAR



All-Purpose MOTO-TOOL

Moto-Tool makes an attractive, practical gift every craftsman will appreciate — for no other motor-in-hand tool in its class matches Moto-Tool in speed, power, ease of handling or in exclusive construction advantages that provide, long trouble-free service. Moto-Tool does in seconds jobs that require hours of hard hand work. Handles all accessories, works on all materials, runs on A. C. or D. C. Absolutely safe. Thousands in use. Model 1, 6 oz. 25,000 r. p. m., for light work. Model 2, more powerful, 13 oz. about 27,000 r. p. m. \$16.50 postpaid. At leading dealers — or order by mail on money-back trial. Write for free illustrated booklet. **Dremel Mfg. Co. 281 Ct., Racine, Wis.**



Price **\$985** Post-paid

Model 1

America's Exclusive Maker of Motor-in-Hand Tools

\$7.50 EACH POSTPAID

Most Unusual MOVIE OFFER EVER MADE

GET BOTH CAMERA & PROJECTOR

for Only **\$13.50** Complete and Postpaid

Everything to take and show real 16 mm. movies at less cost than taking snapshots.

CAMERA — Spring Motor drive — Automatic Release Button — Footage Indicator — 50 foot capacity. No adjustments necessary.

PROJECTOR — Quiet, smooth and flickerless — Motor driven — sturdily built. Uses any standard 16 mm. film.

Write NOW for Big **FREE** Catalogue of Movie Supplies and Film Subjects. **We are never undersold.**

PARAMOUNT MFG. CO., DEPT. G - 96 BOX 224, BACK BAY, BOSTON, MASS.

JIG SAW \$1.50

COD or outside U.S.A. \$1.25

POST PAID

Including 12 assorted blades, Adapters, manual, and roller Saw Guide formerly found on expensive machines only. All metal, 15" long, 8" high, 3/4" table. A swift and easy cutter—best ever made for the money.

FREE CATALOG describing \$150 prize contest (1st prize, \$25; 2nd, \$15; 3rd, \$10; 66 other cash and merchandise prizes). Cat. illustr. complete power tool line: Shaper, Circular Saw with oilless bearings, \$3 each; Drill Press, \$2.50; completely equipped Lathes, \$2 and \$4.90; Sander, \$1, etc. Order today or send card for Catalog.

\$150 PRIZE CONTEST

"The Jigmaker" cuts wood 2" thick.

J & H Metal Products Co. 5 Commercial St. Rochester, N. Y.

(Continued from page 123A)

Heat could have exploded it before they regained the crater edge, but it didn't. When the charge was exploded electrically, the concussion snuffed the fire.

The men went back into the crater when the well had cleaned itself, dug down along the casing with hydraulic diggers, and poured tons of cement about the pipe. Then they cut off the battered top of the casing, and on a cable strung from side to side of the crater they ferried in a capping manifold. It was jockeyed over the casing, fastened solidly to stay bolts in the concrete.

When four flow lines had been laid up out of the crater to separators for extracting the oil from the gas and had been attached to valves on the manifold, the main valve was closed. The gas then passed out of the crater through the flow lines and deposited its oil in storage tanks at a rate of four hundred barrels a day. The dry gas shot out of a vertical pipe high into the air in the middle of a deserted field where it could do no harm. The wild well had been tamed.

The Latest in Aviation Radio

(Continued from page 85)

mounted above a bed of wires that act as reflectors in directing the signals upward.

The next step in the program will be the use of high-frequency radio sets in passenger transport cockpits next summer for talking with the control towers of airports while the planes are in range. Short-wave radio signals travel in straight lines and communication is virtually limited to line-of-sight distances. The new sets will be tiny in comparison with the equipment used for working on longer wave lengths and will require much less power.

With the aid of short waves, safe landings in fog so thick the pilots can't see their wing tips are expected to be ordinary routine within a year. United Air Lines pilots have made thousands of such blind landings in practice, utilizing a "bent" radio beam that leads them down safely to the field. TWA has been experimenting with the same system. Another method allows the pilot to "see" his landing field on the fluorescent screen of a cathode-ray tube in the cockpit, a short-wave transmitter on the field providing a point of

(Continued to page 126A)

see June 1937

New Invention WITH SUPERCHARGE PRINCIPLE SAVES GAS



AT LAST! Automotive engineers have smashed down the barriers to perfected combustion! The new VACU-MATIC solves the secret of greater power! With almost magical action, this amazing invention instantly puts new life and pep in any motor. It adds mileage to every gallon of gasoline . . . produces split-second pick-up, sensitive accelerator response, quicker starting, greater speed and smoother running.

Automatic - Nothing Like It!

The self-starter — four wheel brakes — knee action — streamlining . . . and now VACU-MATIC! The sensational money-saving invention! With it, engineers have achieved a practical means of balancing air and gasoline automatically for all speeds.

VACU-MATIC is *entirely different!* It operates on the supercharge principle by automatically adding a charge of extra oxygen, drawn free from the outer air, into the heart of the gas mixture. It is entirely AUTOMATIC and allows the motor to "breathe" at the correct time, opening and closing automatically as required. No idling troubles—no carburetor adjustments necessary. It is so simple it will amaze you —so practical it will save you many dollars on gas costs.

USERS REPORT
3 to 7 MILES MORE PER GALLON
MOTORIST SAVES \$180.00 a YEAR
 "On my V-8 Ford it works miracles. Its added power, acceleration and top speed has sold me. The results are unbelievable."—Ralph Field, Mass.
 "Very glad to say, the Buick showed an increase of 3 miles more per gallon."—A. V. Grove, Washington.
 "On my Plymouth, I obtained an average of 22 miles per gallon, an increase of 7 miles. This means a saving of \$15 a month or \$180 a year."—F. S. Peck, Calif.
 "It saves me one gallon a day. I had to buy 2 gallons each day—now only 4 gal."—L. V. Sweet, Pa.
 "I have twelve VACUMATICS on cars now, and they all show an increase in mileage. The car owners are very well pleased."—Fred Taylor, Okla.
 "I have been placing VACU-MATICS on expert mechanics' cars. All are well pleased."—J. W. Donahoe, W. Va.

Guaranteed Gas Savings
 VACU-MATIC proves itself on every car. It is guaranteed to give worthwhile gas savings, quicker pick-up, and more power or it costs you nothing. You can instantly tell the difference in added power and motor performance — you quickly notice the cash savings on gasoline.

Fits All Cars
 VACU-MATIC is constructed of six parts, assembled and fused into one unit, correctly adjusted and sealed at the factory. Nothing to regulate. Any motorist can attach VACU-MATIC in ten minutes. Once in, its only reminder is the surge of instant power and speed it gives to the motor and the savings it affords your pocketbook.

Free Details
 You owe it to yourself to know all about this remarkable discovery. Mail the coupon below. Start saving gas with VACU-MATIC and enjoy a new driving thrill! There's no obligation—so get the facts now! Write today!

The VACU-MATIC Co. Wauwatosa, Wis.

FREE OFFER COUPON

THE VACU-MATIC COMPANY
 7617-405 W. State St., Wauwatosa, Wis.

Gentlemen: Please send me full particulars concerning the VACU-MATIC and details of your Free Offer. This of course does not obligate me in any way.

Name.....
 Address.....
 City..... State.....
 Check here if interested in selling proposition

COMET CLIPPER GAS MODEL

\$4.95

NEW 36 PAGE CATALOG
 Hundreds of models, 10c up. Gas model kits, motors, accessories. Send 5c stamps to
COMET, 2509 CERMAK ROAD, CHICAGO, ILL. Dept. P1

Prize-winning, record-breaking, 6 ft. gas model. Removable power unit; detachable wing and tail; difficult parts finished. Kit with automatic timer, \$4.95; postage 25c, or buy from dealer.

New Adding Machine Fits Vest Pocket!..

Adds, subtracts and multiplies up to one billion. Weighs only 4 ounces. Not a toy—strong guarantee. Absolutely accurate, very fast. Sells to offices, stores, homes—wherever figures are used. Write quick for **FREE AGENTS** sample offer and Money-Making Plan.
VE-PO-AD, Dept. 163, 303 W. Monroe St., Chicago

Costs only \$2.95

HANDY TAPS and DIES...

Accurate—carefully hardened and tempered. Complete range of sizes at your local five and ten cent store
HENRY L. HANSON, WORCESTER, MASS.

ENGINES

A real money maker for farm or factory. Uses Cheap fuels. Pays for itself out of savings. Costs Less to Own—Less to Operate.

LOG SAWS

Make Money—Start a wood sawing business—turn spare timber into cash. Cash or Terms—Engine and Saw Catalog.

WITTE ENGINE WORKS
 1741 OAKLAND AVE., KANSAS CITY, MO.

While 1000 Sets Last! For Only 59 PIECES OF WOOD \$3.95!

MANY RARE PIECES

Here's a regular "treasure find" of all sorts of rare woods that will thrill every wood craftsman. Sensational low price Introductory Set of 59 pieces to introduce King Midas woods to you. Truly a great bargain!

ORDER NOW SUPPLY LIMITED

Only 1,000 sets at this amazingly low price. Mail coupon with \$1.00 deposit and this huge value of 59 pieces of wood will be shipped you C. O. D. for balance. Do so NOW while supply lasts.

YOUR MONEY BACK IF NOT FULLY SATISFIED

You Get All of This

18 sq. ft. of Beautiful Plywood for Inlaying in Satin Wood, Zebra Wood, East India Rosewood, Gum, Oak, Poplar, Birch, Mahogany, and Walnut . . . from 1/8 in. up through 3/4 in. in thickness.

Also

- 4 Turned Legs
- 10 Dowels
- 1 Midget Table Top
- 1 Piece Press Wood
- 4 Knobs
- 16 Pieces Veneer, 3 ft. and over

A total of 59 pieces in all
 Shipping Weight Between 20 and 25 lbs.

FREE of Extra Cost With Each Order BOOKLET "How to Grade Plywood"

Gentlemen: I enclose \$1.00. Send me your Introductory Set of 59 pieces of wood. I'll pay balance C. O. D., plus postage.

Name..... Address..... City..... State.....

KING MIDAS LUMBER LAND
 2225 So. Ashland Ave. CHICAGO, ILL.

Don't miss on CHRISTMAS PICTURES

... get good clear photos
with G-E Photoflash bulbs



Split-second flash gets vivid shots like this indoors or at night. And you are sure of *enough* light for good, clear pictures with all modern film. Easy to use. Operate on flashlight batteries or house current. Grand for color shots. Each lamp gets one picture. For holiday scenes you don't want to miss, use G-E MAZDA Photoflash lamps.

FOR DOZENS OF SHOTS GET G-E PHOTOFLOODS

G-E MAZDA Photoflood lamps last for dozens of pictures. 2 G-E Photofloods in reflectors permit snapshots at night with box cameras and new super speed film. Great for home movies. Buy G-E MAZDA Photo lamps where you buy film.



For best results,
read and follow simple directions on each package.



G-E MAZDA
Photoflood lamps

No. 1 . . . 25¢ list
No. 2 . . . 50¢ list



G-E MAZDA
Photoflash lamps

No. 10 . . . 15¢ list
Other sizes to fit your needs

GENERAL ELECTRIC
MAZDA PHOTO LAMPS

2995
(Continued from page 124A)

light on the screen that is lined up with reference points of light obtained electrically from the artificial horizon on the instrument panel. Very narrow radio beams of less than one meter in wave length are being investigated at the Massachusetts Institute of Technology for use in blind landings. The Army Air Corps has worked out a blind-landing technique useful with any of the different radio guides, in which the automatic pilot is used to hold the plane in a "let down" glide after it passes over the radio landing approach beacon. With the plane descending in a safe landing position and with wheels and flaps down it practically lands itself. Airplanes are already making instrument approaches to airports but are not permitted to land unless there is half a mile visibility on the ground and a ceiling of at least 600 feet.

Another use to which the cathode-ray tube is being put is a hook-up by which "panoramic" reception from several different ground radio stations, obtained via the plane's radio compass loop, is shown visually on the screen. The angles between the different ground stations to the plane gives the pilot an accurate "fix" of his position. Another system allows the pilot to pre-select several ground stations, and to then obtain their directions one at a time simply by pressing a button that operates the small electric motor that revolves the loop mechanism. A still additional improvement lines the ground stations up in reference to true north instead of magnetic north, eliminating the need to figure variation.

For point-to-point transmission on the ground the air-line ground stations are working out new ideas in directional antennas that are revolutionizing radio communication. The new antenna systems throw as much as eighty per cent of the energy in one direction, focusing the power along a path toward the receiving station and reducing interference with other stations. Fractions of the power formerly needed to work long distances are being used. Such a directional antenna system consists of two parallel vertical wires, one of which radiates the signals and the other of which acts as the reflector. A few years ago stringing up an antenna was a haphazard job that could be done in a few hours but now the engineers spend as

much as a week in plotting radiation patterns and making slight changes in the system to get the best results.

On aircraft, signal strength can be controlled to some extent to radiate either in a fore-and-aft direction or at right angles to the path of flight merely by changing the length of the trailing transmission antenna. On Howard Hughes' world-circling Lockheed an electric reel was used for letting the antenna out to exactly the proper length, practically doubling the radiation in the direction desired.

The new directional ground antennas are being experimented with in the modernization of American Air Lines' radio system, which comprises sixty-six different transmitters in thirty-seven different stations, making it one of the largest private radio systems in the country. The radio network operates twenty-four hours a day over 6,700 miles of airways. New high-powered Bendix transmitters are being installed to operate on any one of ten frequencies which is selected by the operator by simply dialing a number. The sets provide 1,000 watts for voice and 1,250 watts for long-distance radiotelegraph. The Newark and Chicago stations of the system each has four transmitters with an operator on continuous duty at each set, two of them engaged in ground-to-plane transmission and the other two occupied with point-to-point radiotelegraph, flight contact, and weather reports. The system employs 175 operators and twenty-nine maintenance engineers and mechanics, including teletype personnel.

For convenience in arranging frequencies and schedules the major air lines have organized Aeronautical Radio, Inc., a non-profit organization that handles the ninety-nine different frequencies used by more than 250 ground stations and 350 aircraft stations in the country. The organization is working with the radio development section of the Bureau of Air Commerce on a long-range program of putting short waves to use, including the new frequencies between one and ten meters that recently have been assigned to aviation.

Names and addresses of manufacturers and dealers in articles described in this magazine will be furnished by our Bureau of Information upon request accompanied by stamped, self-addressed envelope.

BIG MONEY!

ASSEMBLING MEAD'S

New PORTABLE KI-YAK

IN A FEW DAYS AT HOME!



Weight as little as 20 LBS.

Use with PADDLE! OARS! SAIL! MOTOR!

—from Complete Cut-To-Fit Construction Kit!

Assemble for PROFIT or Personal FUN! NO Experience Needed!

MEAD'S perfected, patented, aluminum-ribbed Cut-To-Fit Construction Kit GUARANTEES successful assembly easily, quickly, *INEXPENSIVELY*—in a few days at home with simple hand tools without previous experience. Build yours for personal sport use, or sell at *splendid profit!* Mead's quality KI-YAKS (available in 4 models, kits or factory assembly) are beautiful and **PORTABLE**. Take yours anywhere by hand or use for paddling, sailing, rowing, outboarding, touring, fishing, camping, hunting. Leak-proof. Seaworthy. Durable. THOUSANDS in use. Strong as a giant—light as a feather! More fun at less cost! \$6.00 Double-Blade Paddle GIVEN with your CK KI-Yak—if you hurry! Mail 10c and Coupon below for Giant Colored Circular, special paddle offer. Low Introductory Prices!



SEE AS THEY SAY THE FIRST THING YOU EVER SAW! YOU GET EASY WORK AND EDUCATIONAL, TOO! SEE THIS IS FUN, DAD!



OK-2

Weights only 50 lbs. Takes ANY Outboard 4 1/2 H. P. or less!

Carry motor in one hand—OK-2 in other!

AMAZING LOW COST!

Don't buy any boat until you see the amazing Low Introductory Prices on MEAD KI-YAK Construction Kits and Factory-Built jobs. (You can even Pay As You Build, on our special Progressive Group plan!) **EARN** money assembling, selling! Remember, Mead KI-YAKS are unsurpassed... the lightest, strongest, most portable boats of their kind! Join in the FUN—and PROFITS being made. Rush Coupon and dime NOW for Free details BEFORE prices go up!



OK-2 as rowboat



OK-2 as motor boat. Convertible in 10 minutes into fast sailboat.

Mail Coupon NOW!

\$6 PADDLE GIVEN

with your CK-KI-YAK—if you hurry!



"CK" Paddle and sail

Gentlemen: I enclose 10c as handling, postage charge. Please rush your New Colored KI-YAK Circular, Low Introductory Prices, and \$6 Gift Paddle Offer. (Please Print Plainly.)

NAME.....

STREET & NO.....

CITY..... STATE.....

RUSH ME WITH 10c TO—

MEAD GLIDERS

15 S. MARKET ST. Dept. B-19 CHICAGO, U.S.A.

IT'S NOT TOO LATE

To get your copy of the 52-page

**1938
LIONEL**
catalog

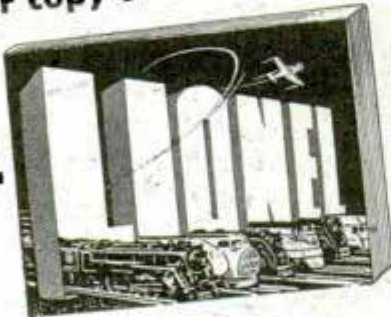

• Write at once for your copy of this big, full-color book of railroading—and you will receive it by mail, in plenty of time to make your selection from the 1938 Lionel fleet of speed wizards—the only trains in the world with electric whistling, uncoupling, loading, unloading and reversing. Act at once!

The Lionel Corporation Dept. TL
15 East 26th Street, New York, N. Y.
Enclosed is 10 cents for a copy of the new 1938 52-page, full color Lionel Catalog. Send it to:

Name _____
Address _____
City _____ State _____

NEW Clever AUTOMATIC INSIDE LATCH for CABINET DOORS that won't stay shut

Nothing like it!

THE AUTOMATIC HAND THAT REACHES OUT—



PULLS DOORS SHUT (EVEN WARPED DOORS)

Larger sizes for cupboard or closet doors and casement windows. Easily installed. Replace old balky fittings now!

WIN-DOR

Snugger

THE CASEMENT HARDWARE COMPANY
400-K North Wood Street Chicago, Ill.

AT YOUR HARDWARE STORE

NEW BENJAMIN AIR PISTOLS WITH MULTIPLE LEVER HAND PUMP FOR TARGET-SMALL GAME-CAMPING-ETC.



Guaranteed—Accurate—Practical—Economic—Safe—Clean—Quiet. Adjustable Force—Amazing Maximum Velocity. No smoke or fumes. Bolt Action—Hammer Fire—Hair Trigger—Safety Lock—Hand Pump. Single Shot BB \$8.50; Single Shot cal. 177 or 22 with rifled barrel \$8.50; BB 8-Shot \$10.00; Holster \$2.00. Also a complete line of Benjamin Genuine Compressed Air Rifles for BB and cal. 177 or 22. No license required from dealer or factory. Ask for complete specifications and Free Targets. BENJAMIN AIR RIFLE CO., 890 Marion St., St. Louis, Mo., U.S.A.

WRITE TODAY!

VEST POCKET ADDING MACHINE IDEAL XMAS GIFT

Adds, subtracts, multiplies, divides. Does work of more costly machine. Counts up to million, made of steel—weighs 8 ounces. Simple, accurate. Not a toy. Guaranteed 5 years.

— FREE TRIAL —
SEND NO MONEY!

\$2.50
Total Cost

Order from ad, not sold in stores. Just send name and address. On delivery pay postman \$2.50 (plus few cents postage). (If outside U. S. send cash.) 10¢ additional in Leatherette Case. If not satisfied after 10 days' trial you get your money back. Thousands of satisfied users. Write for Agent's proposition. CALCULATOR MACHINE CO. (Mrs.) Dept. 101, P. O. Box 1118, Chicago, Illinois.

Teaching Wild Animals New Stunts

(Continued from Coloroto Section)

stunts. Training starts when they are about eighteen months old. An intricate act such as the equestrian performance may take six months or longer to perfect, although an intelligent seal learns a simple stunt in a few days—as soon as he learns not to be frightened and that he will be rewarded with a piece of fish for doing what he is told.

"In the equestrian act there is one thing I would like to teach the ringmaster seal. I would like the ringmaster to toss hunks of fish to the mounted seals as rewards, but so far every piece of fish the ringmaster gets vanishes right there and I have to feed the mounted seals myself."

Ice Crusher on Wall Bracket Chops Ice in Three Sizes

Built to fit into a slotted wall bracket that accommodates other kitchen tools, a hand-cranked ice crusher just brought out will deliver ice in three sizes. A flick of the finger changes it from fine to medium and coarse. The working parts are all non-rusting stainless steel. The ice cup is of colored plastic.



#90
 #162
 and Carter St Louis
 triple
 Casey Churn & Ice Warmer

Mining a Glacier

(Continued from page 53)

perature of 150 degrees Fahrenheit. Deep crevasses in the ice breathe it also.

The crater is surprisingly big. Mountaintop distances are always magnified because you can't walk fast at high altitudes without stopping often for breath, and in this case it is particularly hard going because the snow and ice are honeycombed by the wind into thousands of pinnacles each about two feet high.

Eventually the visitor reaches a spot where several men, hunched against the wind, are working. In perfect harmony



Ice and snow-encrusted cabin after severe blizzard has swept the mountaintop

with the frigid surroundings, their Arctic garb is crusted with ice and their faces are a leathery Eskimo brown. As a protection against the extreme cold, the glaring sun, and the driving wind, they cover their skin with a special preparation consisting of equal parts olive oil and vinegar and a few drops of iodine. To prevent snow blindness as well as eye injuries from the tiny wind-driven ice pellets, they wear colored goggles with shielded sides. For warmth they have parkas lined around the face with wolverine fur, the one part of their clothing to which ice will not cling.

Some of the men are digging holes with pick and shovel—test pits from which to get samples of the sulphur ore for laboratory examination. Others are operating a gasoline-engined diamond drill. One test

(Continued to page 131A)



... builds, repairs, patches . . . with lifetime strength

● Want *one* good glue—to do many good jobs? Call for CASCO. Proved on many of industry's toughest gluing problems, CASCO mends most everything from attic to cellar. Glues wood, cloth, leather, etc. Its weatherproof bond resists heat and moisture.

NO MESS. Just mix CASCO with water... no heating, no waste. **LOW COST.** Get *all* glue for your money...no liquid preservatives. 10c to 65c at hardware dealers.

FREE—NEW KIND OF HANDBOOK "Home Workshop Handbook" includes list of free and low-cost booklets on Tools, Plans, Finishes, etc. **CASEIN COMPANY OF AMERICA, DEPT. PM 139**
350 Madison Avenue, New York, N. Y.

CASCO POWDERED CASEIN GLUE

GROBET BURS set of 24—\$6.65. AN IDEAL CHRISTMAS GIFT!
Ask for Bur catalog PMB; also catalog PMF of precision Swiss files.



GROBET FILE CORP. OF AMERICA, 3-9 Park Place, New York City



Renew old buildings. Make new construction more permanent and attractive. Plaster Colorcrete is waterproofed. It fuses with any masonry surface. It fills all cracks. It can be applied in any thickness and in 30 colors. Fully proven by over 12 years actual use under all conditions and every climate.

OFFERS BIG EARNINGS

Owners everywhere want to enhance present values. With this machine you can supply this big waiting market with permanent Colorcrete at amazingly low cost. Operators report cost of 2c and up per sq. ft. and sell up to 7c. Some have paid for their equipment from first few jobs. Machine capacity up to 1,000 sq. ft. per hour. Get the facts. Send for books, "Proven Business Opportunity." Write today. It offers you big extra income.

COLORCRETE INDUSTRIES, INC.
570 Ottawa Ave. HOLLAND, MICH.



"IT TAUGHT THE OLD DOG A NEW TRICK"



"Junior showed us your ad as a Christmas hint," writes W. W. B. "Wanted a Royal Portable for his homework."

"But with your Free Home Trial offer I said 'Why wait?' So we sent in the coupon that very night."

"Before Christmas Junior was already doing homework easier, faster. And that gave me an idea. . . ."



"Typing's a cinch—with a Royal. I work out ideas on it. I get a raise Jan. 1. Happy New Year!"

FOR CHRISTMAS . . . GIVE THEM THIS BIG FAMILY HELP

A Royal Portable helps you write faster, think faster. It's an opportunity for a better, brighter future—a chance for you, your whole family, to do more, be more! It's the success-full Christmas gift! **FREE HOME TRIAL!** Try a Royal in your own home. Know all about it before you risk a penny. See exactly how a Royal will help you, whatever your job. Then—own it on your own terms—pay cash or . . .

PAY CASH, OR ONLY A FEW CENTS A DAY. The easy, modern way to own a Royal. Your choice of four models at four prices—all factory-new, reasonably priced.

ACT NOW! Mail coupon today for full details of Royal's offer—all about models, prices, terms—everything. No obligation.

OWN A ROYAL PORTABLE ON YOUR OWN TERMS

FREE! Royal's Instant Typing Chart shows you how to type RIGHT. INCLUDED with every Royal Portable at no extra cost—a handsome, all-weather Carrying Case.

ROYAL TYPEWRITER COMPANY, Inc., Dept. C-85, 2 Park Ave., New York, N. Y. Tell me how I can own—for only a few cents a day—a latest model Royal Portable—with **FREE HOME TRIAL.**

Name _____ Street _____
City _____ State _____



Build this Smith Compressor

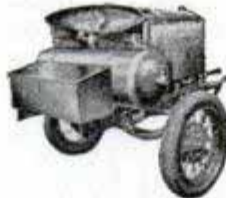

We will furnish complete instructions with a **Smith Compressor Head and Accessories**

With a Ford Motor and shop facilities you can easily assemble a Smith Air Compressor. You'll have a powerful, efficient compressor that will render smooth performance on a majority of all compressor work. Here's a way to **SAVE MONEY!** Write for complete information.

Address Department D
GORDON SMITH & CO., Inc., Bowling Green, Ky.

BUILD THE CUTTY SARK

2 ft. MODEL OF THE FAMOUS CLIPPER SHIP



Everything.. including CARVED WOOD HULLS, Painted-Salsa Decks, Cast-Metal Life-boats, Anchors, Bits, Steering Wheel, Chains, Mast, Spars, Rigging, Cement, Colored Lacquer—Full-Size Plans and Instructions.

Send for Catalog and all the new Models.. 10¢ IDEAL AIRPLANE & SUPPLY COMPANY, INC. 20 West 19th Street, New York

Complete kit makes perfect building copy. **2.50** plus 15¢ postage

Net 10 1/4 lbs. Ship. wt. 12 lbs.



MOTOR SPEED REDUCER

Ratio 144 to 1; Ball Bearing; white metal housing, rating up to 1/4 H. P. Equipped with friction Clutch for overload protection. Originally sold for \$25.00. 12" long, 6" wide, 5 1/2" high. Close out price... **\$3.95**

Send for Free 32 page Paint Spray Catalog. NATIONAL ELECTRIC TOOL CO. 560 W. Washington Blvd., Dept. K, Chicago, Ill.

EXTRA \$5 in SPARE TIME PRINT at HOME

Letterheads, Circulars, billheads, cards. Printing pays BIG. Easy, interesting, educational. **PRINTING PRESS BARGAINS** \$12. Types and Supplies, lowest prices. Send stamp for catalog. PEIFFER Co., 1-D, 6 Columbia St., Newark, N. J.



OTTAWA LOG SAW \$39

BIG BOOK FREE



PUTS THIS OTTAWA to work for you. **MAKE MONEY!** Wood is valuable. Does more than 10 men. Easily operated. Falls trees—saws limbs. Use 4-hp. engine for other work. Write for FREE Book. OTTAWA MFG. CO. 1527 Wood St., Ottawa, Kans.

BOYS—MEN! GET THIS FINE GIFT!

Radio-Electrical EXPERIMENT KIT

Only \$3.99 6 Books FREE

25 UNITS genuine salvage commercial apparatus with fine experimental manual! **BUILD** radio circuits. 110-volt AC motor, eaves-dropping phone, thief detector, powerful ultra-violet rays, are furnace, scores more! Learn at home! **SEND ONLY \$3.99** for Special DeLuxe Kit and 6 FREE fine Electrical Radio books. Books alone worth \$3.00! Sent C.O.D. if desired. Stamp brings Bargain Catalog! **ELECTRICAL SALVAGE CO., Box 524-P1, Lincoln, Nebr.**



Gibson GUITAR BOOK FREE

Gene Autry Popular Movie Star



Have fun—be popular—make money!

Play guitar, banjo, mandolin, get the 52 page Gibson Book, learn how you can do it.

PLAY GUITAR!

GIBSON, Inc. 112 Parsons Street Kalamazoo, Michigan YES, I want to have fun, be popular and make money. I am interested in () Guitar () Banjo () Mandolin.

Name _____
Address _____
City _____ State _____

(Continued from page 129A)

hole that goes down sixty-eight feet through solid ice was abandoned when the drillers found no sign of rock bottom. The hole is four feet in diameter—just room enough for one man at a time to hack the ice away while a helper at the surface hauled up the buckets. You can picture the plight of the workman—alone in the bottom of the shaft, close-quartered with flint-like ice at his feet and at his elbows, and icy blue shadows far above. At least once or twice he must have imagined the floor giving way and dumping him into some hot cavern in the maw of the crater.

In an attempt to find how deep the ice really is in the middle of the crater, Dean and his crew put the diamond drill to work. It was still chipping through ice at 308 feet. They had no more drill rod. All but one of several other drill holes reached through to sulphur.

At the edge of the crater, the visitor looks down into ice crevasses 200 or 300 feet deep, a vacant blue to the bottom. Perilous as this may seem, men work deep in those crevasses. One man, lowered 150 feet down on a stout rope in search of precious yellow samples, shouts, "Come on in, the ice is fine."

The wind suddenly becomes colder and noisier, and a new fog, phantomlike, forms out of nowhere, stinging faces and hurrying on its way to form a "cloud cap" at the lee side of the summit.

The cabin is a twelve by twelve foot room with an addition on one side full of bunks. It contains a radio that plays swing music, to the accompaniment of the high wind's roar. The crew eats at a square shiplap table. But they never get hot coffee because at this altitude water boils at too low a temperature.

A member of the original crew of seven that shouldered thirty-five-pound packs and labored seven miles to the cabin tells this story:

"When we took over this cabin it was solid ice inside," he said. "Three winters on this iceberg makes the snow hard as stone, and the snow in here had stood for eight years. We had a tough time hacking out room for our sleeping bags."

The mountaineers are well accustomed to blizzards. Three or four "good" storms, ordinarily lasting from two to four days,

(Continued to page 132A)

INSURE YOUR CAR ON EASY PAYMENTS YET SAVE MONEY!

ALLSTATE INSURANCE COMPANY

(Organized by Sears, Roebuck and Co.)

Saves THOUSANDS for Motorists

Don't lose your home or bankrupt your business through judgments against you in automobile accidents! Carry full protection in ALLSTATE insurance.

All Forms of Coverage—Prompt Claim Service

This company, organized by Sears, Roebuck and Co., is WHOLLY independent and offers Bodily Injury or Property Damage Liability, Collision, Fire, Theft, Glass Damage and other protection at rates substantially lower than most other old line stock insurance companies. All allowed claims settled WITHOUT DELAY.

More than \$4,869,000 in Assets!

With assets of more than \$4,869,000 and liabilities of \$3,282,000 ALLSTATE has \$3.00 for every \$2.00 it owes. **GET THE FACTS—** Learn about EASY PAYMENTS with FULL protection while paying. No need to wait! FREE booklet and rates on request.

ALLSTATE INSURANCE COMPANY

—SAVE MONEY—MAIL COUPON TODAY—

ALLSTATE INSURANCE CO., 20 N. Wacker Drive, Chicago, Ill.

Please send information regarding Automobile Insurance.

MAT

Name _____

Residence _____

Address _____

Post _____

Office _____

County _____ State _____

Make of Car _____ Type of Body _____

Model _____ Year of Model _____

Car Name, Number or Series _____ Purchased

Cost Me _____ New or Used

My present insurance expires _____

Participating policies written at standard rates in New York, New Hampshire, Virginia, Oklahoma and Texas.

NOW ONLY

\$5⁰⁰



REAL ENGINE VALUE

Over 7,000 GHQ Gas Engine Kits have been sold at \$8.50. Now is your chance to buy the New Improved kit for \$5.00. Absolutely complete with coil, plug, etc. For boats and planes. All parts guaranteed. Send only \$1.—Shipped Express Collect for balance same day. Catalog 3c. **DEALERS WRITE.**

A screwdriver is the only tool needed. 1/5 H.P. Average assembly time 30 minutes.

GHQ MOTORS, 854B East 149 St., New York, N. Y.

New Accurate 10" Slide Rule

Enables you to do difficult calculations instantly without paper or pencil—multiplying, dividing, proportions, division, extracting roots, etc. Accurate, white composition face. Has Standard A, B, C, D, CI, and

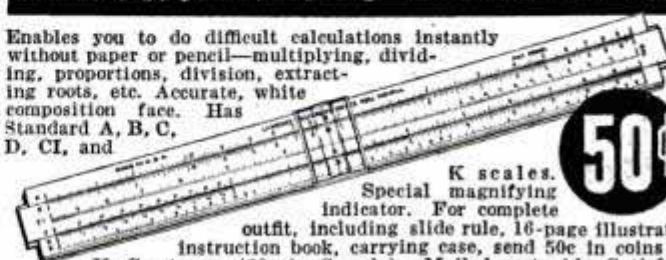

50¢

K scales. Special magnifying indicator. For complete outfit, including slide rule, 16-page illustrated instruction book, carrying case, send 50c in coins or U. S. stamps (60c in Canada). Mailed postpaid. Satisfaction guaranteed or money refunded. **SEND TODAY TO BOX 3371. LAWRENCE ENGINEERING SERVICE, PERU, INDIANA**



PLAY IT LIKE AN EXPERT WITHOUT A LESSON!

THE NATION'S NEW MUSICAL SENSATION!

Not a toy—but a high quality instrument used by orchestras and professionals. So simple a child can play it in a few minutes even if he can't read a note. Teachers recommend it for musical training. The perfect gift for every musical youngster and grown-up. For sale at stores everywhere—or order direct. We'll mail a Tonette, complete with easy instruction melody chart, anywhere in the U. S. in time for Xmas upon receipt of \$1.

TONETTE COMPANY, Dept. PM-1
30 East Adams Street, Chicago

TONETTE
ANYONE CAN PLAY IT!

\$1.00
POST
PAID



Bargains FOR WOOD WORKERS!



Cal.
1939

HERE is our 1939 New
Catalog No. 11, a re-
markable 136 page book.

BESIDES being packed with solid information and latest ideas, such as new hints for wood finishing and inlay processes and 235 brand new scroll patterns, besides all this, this catalog No. 11 contains a series of special deals—tremendous bargains, some in standard American woods; and other deals at astoundingly low prices for the choicest kinds of rare, hard-to-find lumber from inner Africa, Australia, East Indies and all over the globe.

Write for this Book

If you are not now a
wood worker then

Learn Wood Working

Learn this fascinat-
ing hobby and money
maker for spare time.
We supply begin-
ners with detailed
directions.

CRAFTSMAN WOOD SERVICE CO.,
2731 S. Mary Street, Chicago, Ill.

I enclose 10c (stamps or coin) for
which please send the new 1939 Bar-
gain Catalog No. 11 for Woodworkers.

Name

Street
and No.

Town..... State.....

(Continued from page 131A)

are part of the normal summer-weather menu on the summit. The wind reaches an estimated velocity of seventy-five to 100 miles an hour. Between storms the temperature varies from twenty or so degrees below zero to thirty-five degrees in the shade, or warm enough for shirt-sleeve working in the sun.

"We get an electric storm once in a while," one of the men says. "One time when we were sitting here at dinner there was a blinding flash and a wild crackling noise and the sparks hopped around in front of our faces. The lightning had skipped the guy cables outside. It came in through the wall over there, crossed our dinner table, and crashed through that window. On the way out it melted a hole through a washpan by the window."

More feared by the workmen than either the storms or the ice hazards of the summit is the sulphide gas that often catches them unaware in the prospecting holes. All of them have had close brushes with death after inhaling the gas.

As a result of five full summers of prospecting and many conferences with experts, Dean is convinced this mineral wealth can be mined profitably despite the extreme barriers. His projected nine-mile tram, from the summit crater to a base with a year-around water supply, would consist of a chain of towers and suspensions as high as two or three hundred feet above the surface of the mountainside in places, carrying half-ton capacity buckets spaced three or four hundred feet apart. The weight of descending ore would more than offset the weight of ascending freight and passengers. Under a permanent shelter, the upper end of the tram would connect with a 1,500-foot ventilated tunnel leading under the dome of the mountain into the beds of ore.

Dean pictures a complete mining community built into the mountainside, with living quarters, stores and recreational facilities deep inside where workmen would be immune from the ravages of high-altitude winters.

Names and addresses of manufacturers and dealers in articles described in this magazine will be furnished by our Bureau of Information upon request accompanied by stamped, self-addressed envelope.

\$200 My First Week



... Now in my OWN Business.

Would you, too, like to own a business where you could take in \$200 your first week as did L. A. Eagles in Madison, Wisconsin?

We want a reputable, honest man in each county. This man need not have any special experience or more than ordinary ability, but he must be honest and courteous.

Such a man we will start in business for himself. You can make far above average profits in the rug-washing business—a high-grade business all your own. Many earn \$125 to \$200 per week—some considerably more.

NO SHOP NECESSARY

The rug-washer finishes rugs like new on the customer's floor. Anyone can run it. Electricity does the work. A quick, thorough and highly-efficient method that restores the natural beauty of floor coverings.

There are hundreds of customers—in your vicinity and nearby towns. The business grows steadily. Simply wash a few rugs or carpets. These customers tell others and also give you their future work. Soon you will have a prosperous year-around business. Send coupon for booklet explaining everything.

"Profits Pay for Home"

Harry Hill built and paid for a home from rug-washer profits. His first day's business was \$86. Another man writes, "Made \$70 in 13 hours." A. L. Miller says, "Have had rug-washer 6 years—have earned as high as \$92 a day." M. O. Malmin earned 3 times the cost of his machine the first two months. You, too, can enjoy a large income.

VON SCHRADER MFG. CO., 101 PL., RACINE, WIS.

Free Book!
MAIL COUPON now

VON SCHRADER MFG. CO.
101 Pl., Racine, Wis.

Send at once (no obligation) your free booklet illustrating rug-washer and telling how I can own my own permanent business; how I can earn large profits at prices below other methods; how I can become financially independent in a short time; and how I can pay on easy terms.

Name.....
Address.....
City.....State.....

"Never a Complaint"

C. J. White says: "\$100 business in six days—never a complaint." That is the nicest part of this business—every customer is more than satisfied. Stains and blotches disappear and vivid colorings and freshness in faded floor coverings come back.

EVERY MACHINE GUARANTEED

You take no risk. These machines have been manufactured since 1918 and are used by the United States Government and by many of the world's largest hotels. They are fully GUARANTEED.

EASY TERMS

The complete equipment is inexpensive. A reasonable down payment brings everything to you and the balance is paid monthly. From the start, you have your own business—one that is profitable and of which you can be proud.



MAIL COUPON Today

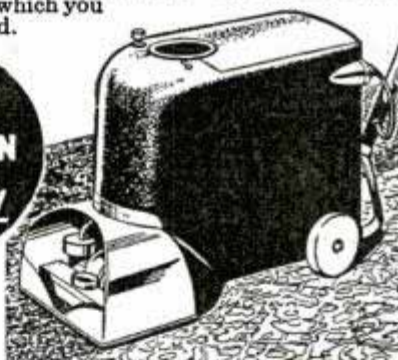

Write Now! **BASS SENDS THIS Candid Midget** *from only \$19.50*

Has sharp-cutting F4.5 Hugo Meyer Anastigmat lens. Vario shutter speeds to 1/100th. Time and Bulb. \$19.50. Address Dept. P. Send for Free Bass Bargaining No. 236

BASS CAMERA CO.
179 W. MADISON ST. CHICAGO, ILL.

A Gift in the Right Direction

Everyone on your gift list will receive lasting enjoyment and practical use from a Hull Streamline Auto Compass—directions of travel are never a problem. Streamlined Bakelite case, built-in compensator, genuine sapphire bearing. Follow this excellent gift suggestion—only \$2.95 at your dealer. Attractive holiday package. Write for circular.

HULL MFG. CO., P. O. Box 246-D9, WARREN, OHIO

PHOTO ENLARGEMENTS **5¢ ANY SIZE**

Is Photography your hobby? Do you want a profitable easy business at home? Make **PHOTO ENLARGEMENTS** for yourself and others. Your cost 5c each and less. The Ideal Photo Enlarger is **AUTOMATIC**. No experience required. Also **COPIES** any picture. **\$5.94 COMPLETE**. Interesting circular **FREE**.

IDEAL-O, 122 East 25th Street, New York City

FREE 28 page FILING BOOK packed with instructions, photos by the score on choice and use of files. Every shop beginner or veteran needs one. Send note, postcard today. Nicholson File Co., 22 Acorn St., Providence, R. I., U.S.A. **A FILE FOR EVERY PURPOSE**

FOR YOU ALONE **\$3.50** **POSTPAID**

Light Exactly Where You Want It!

Whether you want to read in bed without disturbing others, or want a concentrated, controllable light for your shop, you will want **PERSONALITE**. Has countless uses. Stream-lined. Choice of modern blue, cream or brown finishes. Order now.

BROWN ELECTRIC CO., 69 Morton Street, Rochester, N. Y.

COMPLETE ELECTRIC PLANTS

AC DC

Onan A.C. plants furnish same current as city lines, 110 Volt, 60 Cy. For farms, camps, construction jobs. Operate radios, water systems, all appliances. New models, 350 to 5000 watts, 6, 12, 32 and 110 volt D.C. Models \$57.50 and up. Also combination A.C.-D.C. units. Shipped complete, ready to run.

Write for details.
D. W. ONAN & SONS
1029 Royalston Ave.
Minneapolis Minnesota

BIG OPPORTUNITIES

MANUFACTURING MATERIALS FOR LOW COST BUILDING



OPPORTUNITY COMPLETE, READY-MADE FOR YOU IN YOUR LOCALITY—One that is proven—ready for you to cash in big on the great building up-turn under way. It includes all the essentials upon which sound and successful business enterprises are established.

SUPERIOR PRODUCT, LOW COST PRODUCTION—You will produce a material nearly 20% lighter in weight—A product capable of meeting all known building requirements—One accepted by Government and City Building Departments—Requiring 20% less material—Made by line production machines. Raw materials will enter at one end and your finished products will emerge from the other end—reducing costs to lowest minimum.

EARNING POWER AND FUTURE—Present DUNKIRK-DUNSTONE Manufacturers already point the way for you. Some are selling output at 100% over cost. Others show earnings of more than \$1,000 per month right from the start—others are rapidly expanding from earnings.

WE EQUIP YOU WITH LINE PRODUCTION MACHINERY—Large production—only one or two men—high standard quality. Equipment costs but fraction of other processes of equal capacity. Franchise granted covering your locality—protecting your market, business and future.

INVESTIGATE NOW—Send for "4 Keys to Success." It tells the complete story—How present manufacturers are making outstanding progress in this new industry—One that offers unlimited opportunity for growth, expansion and profit. Write today.



INDUSTRY WAITING FOR BETTER MATERIAL AT LOWER COST

Countless numbers of new homes, apartments and structures for business and industrial purposes are needed today. Government, industry, financial institutions are helping to stimulate building and to hasten prosperity—actually preparing the way for the man equipped to supply this tremendous demand.

Your product will be permanent, fire and termite proof—in a full range of beautiful colors, shades and textures. Improved design cuts construction costs to the level of frame; and with factory-to-job delivery, offers new standard of service to building trade in your community.

W. E. DUNN MFG. CO. 600 W. 24TH ST., HOLLAND, MICHIGAN

BUILD YOUR GRANDFATHER CLOCK

The Simple Sensible Red-I-Kut way as thousands have. DIME brings PLANS and sixty picture "HOW" Book pricing many fine brass weight Westminster, tube chime, electric and battery movements showing nice beautiful colonial grandfather cases. WHY WAIT LONGER!

KUEMPEL CHIME CLOCK CO., Bldg. 24, Guttenberg, Iowa.



World's Best Line of TRAILER AXLES, HITCHES and PARTS

New \$3.00 House Trailer Blue Prints Free With Axle Assembly.

WRITE FOR FREE LITERATURE

HAMMER BLOW TOOL COMPANY, Dept. 101, Wausau, Wis.

BUILD ELECTRIC FENCE FROM OLD FORD COIL

Costs nothing to build—Dime brings complete Plans (formerly 35c) and Big NEW T COIL catalog listing over 550 electrical items at new low money saving prices. Send 10c to LEJAY MFG., 1947 LeJay Bldg., Minneapolis, Minn.



Class Pins 30¢ up

Artistic pins, rings and emblems for classes and clubs. Attractive prices. Finest quality, gold plated, silver, etc. Over 300 designs.

FREE

CATALOG

Write Dept. N, METAL ARTS CO., Inc., Rochester, N. Y.

Print Your Own

Cards, stationery, circulars, tags, labels, advertising, etc. Save money. Print for Others; Big Profits; easy rules sent. Will do popular Raised Printing like Engraving; Junior outfit \$9. Sample outfit \$17 and up. Send for free catalog and all details. KELSEY PRESSES, F-37, MERIDEN, CONN.



New Kind of POTATO PEELER

Just Out—Sells Like Wild

Revolutionary invention replaces old-fashioned paring knife. Peels potatoes faster, easier—without waste. Preserves vitamins and minerals. Shreds cabbage, long or short, equal thickness. Slices vegetables, fruits uniformly. Grates, garnishes, shells, cleans. Prevents cut fingers. Stays sharp. Housewives wild about it. Low priced. Lightning seller. AGENTS WANTED EVERYWHERE. Hustlers cleaning up!

SAMPLE OFFER Samples sent on trial to first person in each locality who writes. No obligation. Get details. Be first—send in your name TODAY! KRISTEE CO., 673 Bar St. Akron, Ohio



THIS IS THE Life

Don't merely WISH for fun. HAVE GOOD TIMES! Join a motorcycle riders' club—make new friends—go places and do things! See the Harley-Davidson dealer and his 1933 models. Write for literature and FREE copy of motorcycle magazine, "THE ENTHUSIAST." HARLEY-DAVIDSON MOTOR CO., Dept. P-133, Milwaukee, Wis.

HARLEY-DAVIDSON MOTORCYCLES

PICK UP EXTRA MONEY

Stencils, Rubber Stamps, etc.! Every business concern needs dozens of items in our 96-page catalog, but doesn't know where to buy them. Here's your chance! A hot side-line! Write today!

National Rubber Stamp Co., Dept. 101, Bay City, Mich.

Catalog FREE

NEW Electric Oxidizing Tool

Decorates Leather, Cork, Wood

Get this amazing HOT SPOT Electric tool for deep-etching designs in rich brown color on leather, cork, wood. Plugs to any electric outlet. Will last indefinitely. Use like a pencil. Doubly air cooled.

Complete HOT SPOT Outfit, \$2.00

Special holiday offer of heavy full color utility case, 7½" x 11½" including Electric Tool, Cork materials, colors and brush for finishing, and complete set of attractive designs, \$2. Similar set with leather materials and foil, also special leather finishing tool, \$2.50.

MAKE MONEY or GIFTS

Valuable art objects, home decorations and other useful articles with oxidized designs can be sold at huge profit or make handsome gifts. See this remarkable outfit at dealers or write.

SEND FOR FREE BOOK

RAPAPORT BROS., 703 W. Ohio St., Chicago

FREE TRIAL OFFER

NEW REMINGTON NOISELESS PORTABLE



AS LOW AS

10¢
A DAY

FAMOUS Remington Noiseless Portable that speaks in a whisper, as

little as 10c a day. Standard Keyboard. Automatic ribbon reverse. Variable line spacer and all the conveniences of the finest portable ever built. PLUS the NOISELESS feature. Act now. Send coupon TODAY for details.

You don't RISK a Penny. We send you a Remington Noiseless Portable for 10 days' free trial. If not satisfied send it back. We pay all shipping charges.

Typing course and carrying case. You will receive FREE a complete simplified home course in Touch Typing. Also, a handsome, sturdy carrying case. No obligation. Mail coupon for full details—NOW.

Remington Rand Inc., Dept. 152-1
465 Washington St., Buffalo N. Y.

Tell me, without obligation, how to get a Free Trial of a new Remington Noiseless Portable, including Carrying Case and Free Typing Course for as little as 10c a day. Send Catalogue.

Name.....
Address.....
City..... State.....

60 POWER TELESCOPE . . . \$2.19

VARIABLE EYEPIECE 20X—40X—60X

NEW! Three telescopes in one. 3 different magnifications. 20 power for ultra-bright images with 40 and 60 power for extra long range. Guaranteed to bring distant objects, people, sports events, ships, moon, stars, etc., 60 times as close.



most powerful made for anywhere near the money. Closes to less than a foot in length. Multiple lens system. 30 mm. objective lens. 5 sections. Directions included for using as a compound 4 lens microscope. American made. We pay the postage. Only \$2.19.

1400 POWER MICROSCOPE . . \$18.75

Most powerful amateur microscope made. All refinements including photographically corrected achromatic lenses. Adjustable to all powers 150X to 1400X. Rack & pinion focus. concave mirror, adjustable stand, 11 inches, prepared and plain slides, wood carrying case, 100% American made, only \$18.75.

Catalog of Microscopes, Binoculars, Telescopes FREE on request.
BROWNSCOPE CO., DEPT. 41, 5 W. 27th St., New York, N. Y.

The DUAL COMBINATION WOOD & METAL LATHE
12-INCH SWING 47 to 3000 R.P.M.
"ASK FOR 1939 CATALOG"
TIMKEN BEARINGS
CLAUSING MFG. CO. OTTUMWA, IOWA.

AUTO ENGINE SPEED CONTROL GOVERNORS
CANDEE-SMITH GOVERNOR
445 E. 3rd St. Los Angeles, Calif.

\$1.50
At Electrical Stores or Post-paid
TEST-O-LITE
Tests Everything Electrical
The Neon light tells instantly where trouble lies in electric circuits, fuses, cut-outs, motors, radios, etc. Has 1,001 uses for electricians or home. Tests any voltage, 110 to 550; tells A.C. from D.C. Excels ordinary clumsy test bulb. Fountain-pen size with pocket clip. Lifetime guarantee.
L. S. BRACH MFG. CORP.
55 Dickerson St. Newark, N. J.

A-1085
Trackers of the Highway

(Continued from page 37)

er arrests of the culprits as a result. This is especially true in Michigan, New York, New Jersey, Pennsylvania and Connecticut where state police are equipped with all the latest devices for war on crime.

"Time and again a local station announces a hit-and-run car last seen traveling in the direction of some neighboring village," says Commissioner Olander: "State Police Radio Station WRDS relays the announcement to patrol cars whose operators adjust their movements to head off the fleeing motorist.

"Checking of garages is standard practice in practically all cases where an apprehension is not made within a reasonable time after the accident. In Michigan we have a law which requires garages to report damaged vehicles to the police. Cooperation on the part of the garages is good. Much of our information comes from garages and service stations."

A garage man, as Mr. Benson points out, who has been supplied with information regarding mechanical or structural defects of a car involved in a crime can be of aid to the police even if the driver has attempted to cover his steps by hastily repainting his car, and straightening out the bent bumper or mudguard. Mr. Benson explains:

"Clues which tire experts discover from tire prints—wheels out of alinement, chassis out of alinement, uneven brake drums and similar deficiencies—are rarely thought about by the lawbreaker who is principally concerned with the external appearance of his car. These are dead giveaways which may be instrumental in effecting his arrest and conviction."

Cattle thieves of the southwest and freight and merchandise thieves of the east use trucks, so tire prints of truck tires are playing an increasingly important part in combating these types of crime.

"Truck and bus tires operate under their own peculiar conditions and have their individual problems of wear," says Mr. Benson. "Although the ordinary driver is not aware of it, it is a fact that truck tires generate heat that reaches over 300 degrees—eighty-eight degrees higher than the boiling point of water.

"Often the dual tires on the rear of a

H 1085

truck are not properly mated. The inside tire paralleled on one side by its mate and in most instances mounted directly over the brake drum has less chance to cool and at the same time is subjected to greater heat. As a result the pressure in the inside tire increases more rapidly than that in the outside tire. This increased inflation makes it less flexible than the outside tire and consequently it carries more of the load. Again, a truck riding the center of a crowned road would be supported more by the two inside tires because of the shorter perpendicular distance from the axle to the road at those points.

"Knowing these facts, it does not take an expert long to identify a tire as having been used as an inside or outside dual truck tire. In some cases it is even possible to tell the general locality from which the truck came, as in the case of cambered roads.

"A tire sleuth can quickly determine from a tire print whether the truck leaving the scene of a crime is over-loaded. In some cases he may even make a general estimate as to its getaway speed. A ten-ply tire, for example, which is not driven in excess of forty miles an hour has a thirty per cent greater carrying capacity than the same tire driven at fifty-five miles an hour.

"These are some of the telltale clues revealed to the modern trackers of the highways. American tire manufacturers have spent \$55,000,000 on research in the past ten years. It is this intensive study and a thorough knowledge of their product that now make it possible to turn fingerprinting of tire treads to the use of the law."

Fingerprints of Fisk tires are made on a tread contact machine in the factory. When a new tread design goes into production, a print is produced and forwarded to the Federal Bureau of Investigation.

To make such a print, the tire is inflated to the pressure it will use when mounted on a car wheel. The tread is inked and white paper placed under it. Then the tire is lowered and pressure equivalent to the weight of an automobile is exerted on it, and a perfect print of a normal tire is obtained.

☐ Inquiries as to makers of articles described in Popular Mechanics, will be answered by our Bureau of Information upon receipt of return postage.

If You Want to Be A BETTER CRAFTSMAN

Get the
Right Saw
For the Job



• Often the finished job that looks best comes from knowing which saw to use, rather than better handling of the tools. A single hand saw is not an all-purpose tool. A rip saw does its particular job better than a cross cut would, and vice versa, while several others are each best for certain work. The right saw is an Atkins, and which type to use is explained in a helpful booklet. Send 10c for the "How To Do It Book."

E. C. ATKINS AND COMPANY
426 So. Illinois St., Indianapolis, Ind.



ATKINS

Silver Steel
SAWS

AMAZING HEATLESS SOLDER



—FLOWS LIKE LIQUID!
HARDENS LIKE METAL! 25¢

THE ORIGINAL, GENUINE SUCCESSFUL HEAT-LESS SOLDER! Permanently mends, builds, most everything with weld-like bond—glass, china, wood, leather, metal, etc. Hundreds of uses. Won't harden in tube. Waterproof, gasolineproof. Thousands use, praise it. Money-back guarantee. 25c at your hardware, or send direct to

TIP-TOP PRODUCTS CO., Dept. P, Omaha, Neb.

**FREE
CAMERA
CATALOG**

SENSATIONAL BARGAINS IN CAMERAS, FILMS AND SUPPLIES

The catalog that saves you REAL money! Latest type cameras, films, supplies, accessories—famous names—everything you need in photography—at prices you can't beat anywhere. Write today for your FREE copy of Camera Catalog No. 72.

WHOLESALE RADIO SERVICE CO., INC.
Dept. 7AC9—100 Sixth Ave., New York, N. Y.

READY CUT HOMES

\$416 and up . . . Freight Paid. Save \$500 or more. 75 home plans to select from, including 10 new feature 1939 designs. All modern, practical, distinctive, complete. Simple plans for easy assembly. Includes all lumber, insulation, roofing, built-in features, attractive one-panel doors, latest hardware, nails, lath, paint, varnish. Also, summer cottages, garages, tourist cabins, etc. Information and plans for F. H. A. Financing requirements on request. For new 1939 full color catalog, with floor plans, send 25-cents to cover mailing.

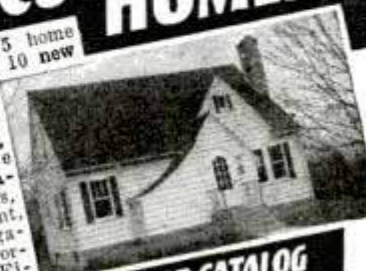

NEW COLOR CATALOG
FOR ONLY
25¢

INTERNATIONAL MILL and
TIMBER CO.
Dept. P-19,
Bay City, Mich.



THE WORLD'S FINEST RADIO CATALOG FREE!

188 Pages of smashing values! 60 great new 1939 Lafayette radios plus parts, tubes, test equipment, television, tools—everything in radio—more than 50,000 items, nationally advertised, offered to you here at tremendous savings. Send for this remarkable FREE catalog immediately. Simply paste coupon on penny postcard.

BUILD YOUR OWN RADIO!

Build any of the circuits described in this magazine. We supply parts for all of them. See our free catalog.

WHOLESALE RADIO SERVICE CO. INC.

NEW YORK, N.Y. CHICAGO, ILL. ATLANTA, GA.
100 SIXTH AVENUE 901 W. JACKSON BLVD. 265 PEACHTREE STREET
BOSTON, MASS. • BRONX, N.Y. NEWARK, N.J. • JAMAICA, L.I.

WHOLESALE RADIO SERVICE CO., INC.
Dept. 7A9—100 Sixth Ave., New York, N.Y.

Rush FREE 1939 Catalog No. 73.

Name.....

Address.....

City..... State.....

PASTE COUPON ON PENNY POST CARD!



Make Your Own Movie Titles

Kramark's wood-letter title set includes—100 letters 1 1/2" high and 3/4" thick, just right for casting rich shadows, 1 centering guide and directions for use.

Complete kit \$2.50, 25c more West of Mississippi.

Send for Free Title-Kit Catalog. KRAMARK, Inc., 26 W. 19th St., N.Y.C.

NEW Grinding Attachment

For 8" to 16" Metal Lathes. Build It Yourself

At last, a precision grinder within your means. You save 2/3 by finishing our semi-machined castings, on your own lathe. HURON handles both internal and external grinding. Accuracies to .00025". Mirror finish easily obtained. Grinds valves, pistons, bushings, shafts, hard or soft, holes, lathe centers, sharpen reamers, milling cutters. Does eccentric drilling, laps, polishes; scores of other uses, for home workshops, garages, machine shops. Write for FREE illustrated folder and full information.

HURON MACHINE & TOOL CO., Dept. B-1, Yale, Mich.



Semi-Machined Castings Only \$5.95

Stoves AT FACTORY PRICES!

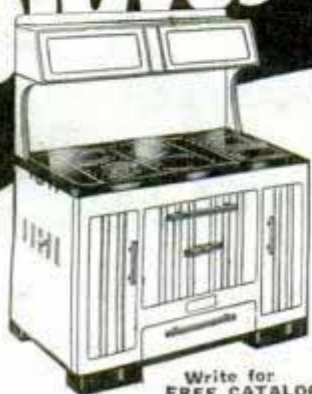

Write for FREE CATALOG

SALE CATALOG—FREE

Nearly 200 Styles and Sizes of Heaters, Ranges, Furnaces at FACTORY PRICES. Easy Terms. Write today for FREE CATALOG. New styles, new features—24-hour shipments. Kalamazoo Stove & Furnace Co., 391 Rochester Avenue, Kalamazoo, Michigan. Over 1,300,000 Satisfied Users. 39 Years in Business.

A Kalamazoo Direct to You

PM Economy Nine Receiver

(Continued from page 99)

in this receiver are not expensive they should be of good quality and just as specified, to insure maximum results. A list of the original parts used in the model can be obtained from Popular Mechanics radio department without charge. The blueprint number is R-262. Inside dimensions of the cabinet shown in the photos are as follows: 15 1/2 in. wide, 11 in. deep and 20 in. high. Any table-type cabinet or console of similar chassis-space size may be used.

When wiring the set keep all grid and plate leads as short as possible, and be sure the soldered connections are mechanically and electrically tight. No. 20 hookup wire

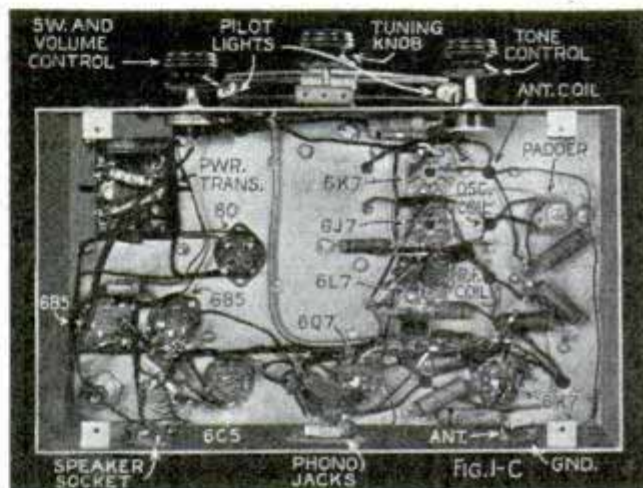

with push-back insulation is employed for all wiring; this wire is available with insulation in various colors. The antenna, oscillator and r.f. coils specified are provided with the color-coded leads indicated in diagrams Figs. 1 and 4. Rosin-core solder is recommended for all connections; do not use acid-core solder. Cable connections for the speaker plug are shown in Fig. 3 as viewed looking into the plug. Always be sure that this plug is inserted in the speaker-plug socket before turning on the set.

To balance the receiver, turn all four top I.F. transformer trimmer (Tr.) screws completely closed, with a small screwdriver, then turn them out about 3/4 of a turn. Next, turn the 3-gang variable condenser to minimum capacity, fully open position. Now screw the trimmer (Tr.) on the oscillator condenser section (C₂) down tight and then back it off one full turn. Connect an-

(Continued to page 140A)

NOW YOU CAN GET A HEAVY DUTY INDUSTRIAL WELDER



Works Off 110-Volt Light Socket
This marvelous DYNAMIC Power Welder will do the work of much higher priced types. It is easily portable. **WELDS Cylinder Blocks, Bumpers, Fenders, Tanks, Farm Machinery, and etc.** Will also solder and brace on the lightest material. Works on iron, steel, tin, brass, copper and all other metals. Men without previous experience can make as much as \$5.00 on a one hour repair job. Go into business—Open a Welding Shop NOW. **AGENTS—**Make big profits selling to garages, factories, junk stores and machine shops. Write TODAY for our 10-DAY TRIAL OFFER.

\$195 RETAIL

DYNAMIC WELDER COMPANY
2226-GB Silverton Road Chicago, Illinois

MAKE MONEY IN PAINTING BUSINESS



Paint walls, ceilings, screens, furniture, radiators, machinery faster, better! $\frac{1}{4}$ H. P. motor 110 Volt 60 Cycle AC, complete with Spray Gun, 15 ft. hose. Weighs only 44 lbs. Carry anywhere. **FULLY GUARANTEED.** Only \$31.15 f. o. b. Chicago. \$5 Deposit, Balance COD, or SEE YOUR DEALER. Circular FREE. Get started making money NOW!

\$31.15 Complete

Ideal Automatic Pump Co. Dept. PM-1, 801 Washington, Chicago

YOUR OWN MOVIES! 10¢ A DAY!



NATIONALLY ADVERTISED 8MM and 16MM movie cameras, projectors. For home, business, church, school, club. **MONEY BACK 10 DAY TRIAL.** Payments as low as 10¢ A DAY. Satisfied customers throughout the world. FREE details. WRITE TODAY.

Don Elder's Home Movies, Dept. A-1, 739 Boylston St., Boston, Mass.

ATLAS Stick-On Letter Window SIGNS



Beautiful GOLD Colored. New Styles. 5 year Guarantee. Large Sizes—Penny each. Tremendous Demand. Amazing Profits. Write for **FREE SAMPLES** and Starting Equipment. **HURRY!**

ATLAS Sign Works, 7843 Halsted, Chicago

CATCH FISH!



minnows, eels, mink, muskrat with **our** folding patented Steel Wire Traps. Greer Patent Lever Hooks are so constructed that when a fish gives the slightest pull on the bait the hook reaches down and gets a hold that lands him 3 for 50¢. Write for descriptive catalog of Traps, Hooks, Lures, and other specialties. **Walton Supply Co., 3507B Juniata St., St. Louis, Mo.**

TRAILER PARTS



Latest type heating stoves, window assemblies, couplers. Everything for the trailer. 40 page illustrated catalog. 10¢.

MARVEL TRAILER PARTS CO.,
19020 Celestine Ave., Detroit, Mich.

SLIDE-VALVE STEAM ENGINE



model SE-3, for small boat models. A complete power plant, ready to run, with two-cylinder engine (as illustrated), boiler, safety valve, denatured alcohol burner and propeller rig. Price \$3.00. Postage extra, shipping wt. 1 1/2 lb.

SHAWNEE ENGINE CO., Box 162, Station D, Cincinnati, O.

SHAMED BY PIMPLES AT 17?

Help protect your skin from a common cause of these pimples

Face blotched with ugly hickies? Why go on being shunned and laughed at? Look for a common cause of the trouble . . . and take steps now to overcome it.

Between the ages of 13 and 25, rapid growth is often accompanied by disturbances throughout the body. The skin may become oversensitive. Waste poisons from the intestines often get into the blood and may cause ugly pimples to break out.

Do what so many others have found wonderfully helpful! Eat Fleischmann's Yeast—3 cakes a day! This remarkable fresh food helps eliminate intestinal wastes before they get into the blood. Pimples from such causes have a chance to clear up. Don't run the risk of permanent scars from neglected pimples of this sort. Eat Fleischmann's Yeast regularly—one cake 1/2 hour before meals. Begin now!

When writing please mention Popular Mechanics

BOICE CRANE Presents **2 NEW and IMPROVED POWER TOOLS**

HELMET-HEAD DRILL



New. Far different than others. Loaded with features. Fully enclosed drive **at no extra cost.**

6 Spline spindle. No ordinary splines either but **newest involute type.** Handsome. Ultra Modern. Dozens of other features. See our catalog.

FINER TILTING-ARBOR SAW



Boice-Crane again leads the Tilt-Arbor Saw field featuring exclusive new Rip Fence with single control handle. Rolling Pulley Drivestill outperforming all others.

MOST COMPLETE LINE in America.
19 Machines. 11 Types.
All Quality Built.

SEND FOR 1939 CATALOG

BOICE-CRANE CO. Dept. 219 Toledo, O.
Catalog FREE. Spinning Handbook 10¢.

Name

No.

City

State

Synco JIG SAW



7200 Strokes per minute

Only \$4.95 (East of Rockies)

Faster! Safer! Cleaner! Real performance. Cuts with smooth, clean edges. No sanding required. Electric operation. No motor or reciprocating parts. Operates on 60 cycle, 110 volt A.C. Ideal for home craftsmen, and model makers. Two models.

Write Today for **FREE LITERATURE**

Export Office: 40 Worth St., New York; Western Dist.: Federated Sales Co., 2437 W. Valley Blvd., Alhambra, Cal.

SYNCO DEVICES, INC., 511 Boydell Bldg. Detroit, Mich.

ONE-MAN SAWMILL



Makes lumber, shingles, lath, ties, crates, boxes, cases, all forms lumber.

TURN TREES INTO MONEY WITH A BELSAW

Three capacities: 10, 14 and 20 ft. Accurate set works positive dogs. Hand or power feed. Runs on low power—Many owners use old auto engine. Pays for itself quickly—thousands in commercial service, everywhere. Write for free lumber handbook and catalog of mills, supplies, tools, saw tables, and woodworking equipment.

\$49.00

Belsaw Machinery Co., 8110-U Davidson Bldg., Kansas City, Mo.

BILD-UR-OWN

COASTERS • MIDGET AUTOS • SCOOTERS • BIKES • TRAILERS, ETC.



NEW ROADSCOUT Scooter Complete \$59

Equip your Scooter, Midget car, etc. with our Disc Wheels and Balloon tires.

GOODRICH-GOODYEAR-FIRESTONE at lowest prices. We specialize in wheel sets, scooters, motors, etc. Send 25¢ for valuable plans and helpful book; satisfaction or money back.

BILD-UR-OWN DEVICES, 5237 Lake St., Dept. A-1, CHICAGO, ILL.

CLAMPS

Use more clamps as "helps" for firmer joints, for setting-up, for accurate drilling, sawing and joining, for holding, drawing-in and lifting—you can't have too many good clamps, and "Jorgensen" and "Pony" Clamps are the very best. Those illustrated have been selected for the home work shops.

ADJUSTABLE CLAMP CO. "The Clamp Folks"



421 N. Ashland Ave., Chicago, U.S.A.

Pony Miniatures
9 types—1" to 2 1/2" cap. Not toys but fine tools with 100 uses.

Pony "50" Fittings go on ordinary 1/2" pipe. Any length. Send \$3.00 plus postage (5 lbs.) for fittings for two "50" Clamps. Also "Pony" #52 Fittings for 1/2" pipe—sets for \$1.50 plus postage.

Catalog FREE!

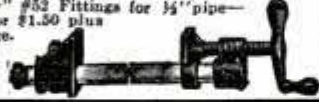

Jorgensen Handcrews
Genuine "Jorgensen" Handcrews grip at all angles, never slip, split or loosen. All sizes. Send \$3.20 plus postage (7 lbs.) for 2 No. 1 Handcrews—open!

PALMGREN ANGLE VISE ONLY \$4.95

For Home, Shop, Garage or Laboratory

New Invention—Has No Equal



Saves time and labor. Eliminates wedging and use of clamps. Simplifies setting up angle work, making jigs or fixtures. You can cut, drill, grind or file at any angle with one quick adjustment. Beautifully machined. Accurately graduated in degrees. Strong and durable. Construction guaranteed. Width 1-1/2 inches. Opens 1-3/4 inches. **SPECIAL INTRODUCTORY OFFER \$4.95**, plus postage. (\$5.95 with Swivel Base, which locks in any position. Specify which.) Remit in full or send \$1.00 and pay balance C.O.D. Put this Wonder Vise to work for you at once. **Mail your order today.**

CHICAGO TOOL & ENGINEERING CO., 8365 So. Chicago Ave., Chicago, Ill.

NEVERSLIP PULLEY

Transmits more power with less belt wear, unaffected by weather. No pulley covering, no belt dressing required. Replace troublesome pulleys with NEVERSLIPS. All sizes. Money-back guarantee. Ask for NEVERSLIP Pulleys on ALL power machinery you buy. Write for folder and prices. **ROSENTHAL CORN HUSKER CO.** Box 16-1 Milwaukee, Wisconsin



POST CARD, ROTARY \$9.95 DUPLICATOR only

PRINT-O-PRESS Post Card Duplicator duplicates post cards by thousands—or any card 3 1/4 x 5 1/2, from stencil with true rotary principle assuring fast duplication with accurate and perfect register. Comes complete at this amazing low price of \$9.95 including supplies. User-Agents write. Details FREE, with samples of work. Also Letter Size Duplicators.

Professional Products Corp., Dept. 110, Silvertown, Ohio

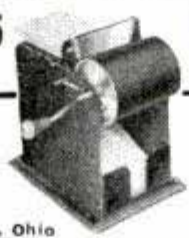

KINKADE GARDEN TRACTOR

and Power Lawnmower

A Practical Power Plow and Cultivator for Gardeners, Suburbanites, Florists, Truckers, Nurserymen, Fruit Growers

Low Prices - Easy Terms

American Farm Machine Co.
1058 33rd Av. SE, Minneapolis, Minn.



Catalog Free

NEW "HI-LIFE" BIKE GENERATOR!

EVERY BIKE OWNER NEEDS "HI-LIFE" PROTECTION AND ECONOMY. Beautiful—extra rigged—Locks on—Lights head and tail lights—no battery needed, however can be supplied for charging miniature battery—ONE YEAR GUARANTEE. PRICE \$2.85 postpaid. WRITE TODAY for 10 day money back FREE TRIAL OFFER. DEALERS, you can make friends with "HI-LIFE." KIMLEY, 1271 E. Ferry St., Buffalo, N. Y.

A GERSTNER TOOL CHEST

will bring a New Year of satisfaction to machinists and toolmakers. Free Catalog.

GERSTNER TOOL CHESTS
439 Columbia St. Dayton, Ohio



Earn Cash at Home!

We paid M. M. \$1174 for exceptional "cellar crop" SNOW-KING mushrooms! Big free picture book tells if your cellar, shed, barn suitable. We furnish materials, buy all crops. Write today. Est. 1908. UNITED CO., 3848 Lincoln Ave., Dept. 302, Chicago.

New . . . Different . . . Exclusive

Wood Cigdor, Cigarette Case, Beautiful Grained Solid Wood—Natural Finish—Automatic Ejector—Light Weight—Thin—Won't Crack—Separate Compartments. Fits pocket and ladies purses. Made in 4 woods: Walnut, Maple, Beech and Red Gum. \$1.00 postpaid in U. S. and Canada. Agents write for sample offer. **SPLendid HOLIDAY GIFT AND BRIDGE PRIZE.** WILLOTT NOVELTY CO., Box 520, Grand Rapids, Mich.



NEED NEW SKIS....?

IF you need skis this year, see Northlands before you buy them. Champions demand these matched skis that promote faster, easier skiing. Northlands are famous for their choice wood, expert design and master craftsmanship. Each pair absolutely uniform throughout. Identified by the famous Deerhead.



Write for your free copy of Northland's How to Ski booklet, now.

NORTHLAND SKI MFG. COMPANY

World's Largest Ski Manufacturers

95 Merriam Park

St. Paul, Minnesota

WORLD'S KEENEST KNIFE FOR HOBBY, ARTS AND CRAFTS

Keen as a surgeon's scalpel. Cuts cleaner, faster and "ALWAYS SHARP." Interchangeable blades, instantly removable by a slight twist of the chromium plated steel chuck which holds blades in vise grip. New Aluminum handle. The ideal gift indispensable for the Model maker and the professional.

12 styles of blades to choose from, only 10c each. Order blades by number No. 1 handle for blades No. 10 to 17 No. 2 handle for blades No. 18 to 23. Add 5c for postage and packing. Send 10c for Model Ship and Fitting or 5c for Airplane and Engine Catalogue.

DEALERS: Write on letterhead for profitable information about this fast selling item.

VISIT THE MOST COMPLETE HOBBY SHOP IN THE EAST
POLK'S MODEL CRAFT HOBBIES, INC.
424 SEVENTH AVENUE, NEW YORK, N. Y.

Handle and Blade 50c

XACTO

NEW LOW PRICE! AUTO-GLIDE \$92.45 FOR CHRISTMAS

What a buy! Ideal Christmas gift for the whole family! Newest model of original heavy-duty AUTO-GLIDE, never before sold under \$125, now only \$92.45! Sturdiest machine ever built. Husky 1 1/2 H. P. engine starts instantly in any weather. . . has fast get-away and pick-up, zip on hills. Handles marvelously in traffic. Safe on slickest pavement. Powerful brake stops machine on a dime. Comfortable cushion seat big enough for two. 121 MILES PER GALLON—cheaper than shoe leather! Up to 35 miles per hour!

MANY MODELS, 2 and 3 wheel, for pleasure, rental, delivery, school, office, etc.

FREE BOOKLET shows all models and the very low price. Write NOW!

THE CUSHMAN MOTOR WORKS, Dept. O-1, Lincoln, Nebr.

ASSEMBLE THIS HIGH GRADE ELECTRIC RAZOR AT HOME

\$1.65 each
In lots of 2
Samples \$1.95 each

Earn Big Money!

BUY ALL PARTS READY FOR INSTANT ASSEMBLY—

NO TOOLS NEEDED—Make \$5 or more on every razor you sell. All matched unit parts from regular production line. Motor, field coils and cord come already assembled. No soldering equipment needed. A few minutes of your spare time can start you in a profitable business of your own making a regular standard super quality electric razor—just like the ones selling in the higher-priced brackets (up to \$15.00). Order your first Kit from this AD or write for information.

SIMMONS MFG. CO., 126 W. North Ave., Chicago, Ill.

Send C. O. D. 1 sample razor kit for which I will pay postman \$1.95 plus a few cents postage.

Name:

Address:

If it's **HOME FOUNDRY**
—it's **THE BEST!**

Wood Burning

WITH THE NEW WONDER PEN

All Home Foundry Wood-Burning Outfits have the sensational patented Air-Flow Wonder Pen! SET NO. 1001: Contains 5 original printed 3-ply basswood plaques, paint palette, brush, sandpaper, Wonder Pen, with cord and plug—\$1. Others \$2, \$3, \$4 and \$5.



Home Casting

WITH EXCITING NEW MOLDS



SET NO. D46: Casts 3 large figures 2½" high—3 soldiers in thrilling action! Underwriter approved electric stove and casting ladle; also may be operated non-electric. Non-slip vise; 3 screw-type handles; 12 pigs metal, smoking torch and liquid; 4 jars paints and 2 brushes—\$2.95. Others 85c to \$3.95.

Electric Metal-Tap

WITH THE NEW ELECTRIC TAPPER

Plug it into light socket, does all the work itself! Hundreds of taps a minute. AIR-COOLED FEATURE. NO. XL100: Contains 5 plaques, electric tapper, cord and plug—\$1.25. NO. XL200, large, electric set, \$2. Others, non-electric, 50c to \$2.



Sand Pictures

WITH NEW SAND PEN KITS



Latest sensation! Apply special glue to picture; color with Sand Pens! SET No. 502: Contains 16 large pictures, 8 pens, 8 cans different colored sand, large bottle glue, brush—\$2. Others 50c and \$1.

FREE CATALOG
Lists Kits, Plaques, Molds, etc. Many Xmas ideas!

HOME FOUNDRY MANUFACTURING COMPANY
3122 Fifth Ave., Chicago Dept. P1
Send me sets No. _____ Money order enclosed. (Orders under \$2, add 25c for handling)
NAME _____
ADDRESS _____

WHERE's the Man Who Doesn't Thrill to Model Railroading?



• He can only be among the unfortunates who haven't yet learned the whole fascinating story of this thrilling hobby as told and pictured in all its magic in the new Scale-Craft Catalog. Here's a perfect gold mine of useful information, colorful facts about railroading, charts, diagrams, illustrations—a complete guide to all aspects of model railroading from the first exhilarating steps of the beginner to the very latest developments in new-style equipment. Fun to read! Invaluable for constant reference! Send 25c for your copy today to Scale-Models, Inc., 1516 S. Wabash Avenue, Dept. A., Chicago, Ill.

Flying Above the Weather

(Continued from page 27)

minute. But the passengers will be climbing only 300 feet per minute, at least as far as pressure changes are concerned. They will not experience the usual discomfort of a fast climb because the atmospheric pressure inside the cabin will be reduced at a slow and comfortable rate.

Shortly after taking off the pilot cuts in the cabin superchargers at low speed. At 5,000 feet the passengers will be in an atmosphere of only half that apparent altitude. At 10,000 feet the pilot shifts the superchargers to high speed and by the time he has climbed to 14,700 feet the apparent altitude inside the cabin is only 8,000 feet. At 20,000 feet the pressure inside the cabin is the same as at a 12,000-foot altitude, still low enough for comfort. It will take about forty minutes of climbing for the pilot to reach his cruising altitude. In approaching his destination the pilot will start descending while still half an hour or more out, dropping at an efficient angle in order to recapture some of the power expended in the climb. During the descent, cabin pressures will be held at a rate of change more comfortable than is possible in present transports.

The Boeing pressure air liners will have two independent sets of supercharging and heating apparatus, either one of which can assume the full load.

Twenty thousand feet is just about the optimum altitude for passenger-carrying. When we go much higher than that all sorts of complications appear. The air becomes so thin that engines are hard to cool in spite of the low temperature. Gasoline starts to evaporate and fuel tanks and carburetors have to be supercharged. The cabin structure must be built strong enough to withstand pressures of more than 1,000 pounds per square foot. Air is not a good insulator above 25,000 feet and we run into spark-plug trouble.

To me, predictions that we will be flying at 100,000-foot, 50,000-foot, or even 35,000-foot levels within five or ten years are ridiculous. By that I don't mean that higher flight is impossible or that it won't be done now and then as a matter of research or for military purposes, but that the idea now appears impractical as a passenger-carrying project.

YOUR NEW

SHAW
"DU-ALL"
TRACTOR OF
"100 USES"

Four Models
—2 to 5 H. P.
Run on Gasoline or Kerosene. Gauge Wheel also Available with Air Tire.



**IS READY
AT THE
FACTORY**

Buy Direct..

AT LOW FACTORY PRICE!

Here's dependable power for hundreds of uses. New DU-ALL does all field, road and belt work for only 3c an hour. Amazing money-maker for farms, truck gardens, orchards, nurseries, poultry ranches, wherever portable power is needed.

Plows, discs, harrows, cultivates, mows lawns, cuts weeds, hauls. Runs feed grinders, concrete mixers, buzz saws and other belt machinery. Does deep mold-board plowing and other heavy work. Can be run by woman or boy.

3 speeds forward and reverse. Special 6 speed gear, to order, runs 1/8 to 15 mi. per hr. Has Power Turn; Improved Tool Control; 4-Cycle Air-Cooled Engine; Gauge Wheel to regulate cultivating depth; Air Tires or Steel Wheels. Air Cleaner; Flexible Plow Hitch; Power Take-off Pul-

ley; Riding and Walking Attachments.

10-DAY TRIAL —We'll take the risk while you try DU-ALL on your own work for 10 full days. Mail coupon for details.

FREE BOOK —Pictures and describes models, attachments, tools. Quotes **LOW FACTORY PRICES**. 56 pages. Mail coupon for facts.

SHAW MANUFACTURING CO.

4501 Front St., Galesburg, Kans.
130-G West 42nd St., New York, N. Y.
5812-G Magnolia Ave., Chicago, Ill.
668-G North 4th St., Columbus, Ohio



RUSH COUPON NOW !!!

THE SHAW MFG. CO., (Address nearest office), 4501 Front St., Galesburg, Kansas; 5812-G Magnolia Ave., Chicago, Illinois; 130-G West 42nd St., New York, N. Y.; 668-G No. 4th St., Columbus, Ohio.

Rush FREE book, low factory prices and details of 10-DAY TRIAL OFFER.

NAME

ADDRESS

CITY..... STATE.....

**ALL THESE EXTRAS
AT NO EXTRA COST**

Low factory price includes six cultivator steels, six pin break standards, tool holder plates, improved tool beams, steel tool box, wrenches, screw driver, pliers, Alemite grease gun and oil can.

When writing to advertisers please mention Popular Mechanics

GET OUT OF THE "Snapshot Class!"



\$750
DE LUXE
MODEL

FEATURES: LENS—Vitar f:7.9 color corrected. SHUTTER—Three speeds, instantaneous, time and bulb. Iris diaphragm with four stops, f:7.9, 11, 16, 22. CONSTRUCTION—Precision shutter in chromium collapsible mount CASE—Die-cast alloy (all metal, no plastics). Hinged back for quick loading. VIEW FINDER—Optical, precision type with minimum parallax error PICTURE SIZE—1½"x1½" Enlarges beautifully **FILM ECONOMY!** Only candid camera that uses fast UniveX 15¢ ULTRAPAN Film. Standard Model, Satin Black Finish with Chromium Trim . \$5.95

Free Iris Booklet. Dept. 206
Universal Camera Corp., New York

XMAS GIFT BOX

Contains new 1939 UniveX Iris De Luxe Candid Camera; handsome, rich, brown grained-finish, suede-lined Camera Case; and **\$985** cable release.

Prices Higher Outside U.S.A.

UniveX IRIS



Masons—Look

Pin dollar bill to this ad and receive this genuine morocco billfold-card case. **MADE TO FIT YOUR LODGE CARD.** Holds 5 cards. Masonic emblem stamped in gold FREE. Your name stamped 35c extra. Oldest Masonic supply house in U. S.

The REDDING MASONIC SUPPLY CO., Inc.
17 W. 23rd Street, New York, N. Y.

SpeedWay

Real Quality Tools

Designed, manufactured and guaranteed by SpeedWay, for 30 years leading manufacturers of industrial drills, these are really fine tools, correctly designed, correct speeds, genuine high torque drill motors. Small, handy, powerful; 1000 RPM—drill handles to 1/4" in steel. Die cast handle and gear housing, \$7.95. 20,000 RPM Grinder with collets for 1/8" and 3/32" arbors, equal in every way to grinders costing several times \$5.95. No. 250 K11, both drill and grinder with 5 accessories in steel carrying case \$14.95. Complete line of accessories and drill press stand. Write for Circular. Dealers Write. **SPEEDWAY MFG. CO.** 1842 S. 52nd Ave., Cicero, Illinois

DRILL \$7.95

GRINDER \$5.95

SET \$14.95

SPARE TIME MONEY

There's a big demand for the many hand-tooled articles you can make with the Easco Leathercraft Set. Easily learn to make good money in your spare time. Complete outfit including tools, leathers, patterns, etc., and full instructions, only \$2.00—on sale at leading Department Stores or order direct and pay postman on arrival. \$2.50 outside U. S.

LEATHERCRAFT

Free When ordering direct, clip name of your Department Store to this ad, and we will include with your set, one extra free project. Sample Project 10c.

E. A. SWEET CO. Dept. A-20 Binghamton, N. Y.

A 1132

(Continued from page 21)

tractor-grader it is customary to first cut a "shelf" from which grading operations can follow. A blade mounted on the front of a tractor is ideal for this. The U. S. Forest Service has developed such a tool called



Tractor equipped with bulldozer building rim road at east edge of Crater lake

a "trailbuilder." Its blade is set at an angle so it cuts into the bank with the point and delivers the materials toward the rear. The blade also is reversible and can be set at a right angle to the tractor axis, whereupon it becomes a bulldozer.

Earth-moving operations, especially in rolling country where "cut and fill" constitutes much of the work, may be classified in general as, loosening, loading, transporting, dumping, spreading and compacting. Sometimes several of these are done at one time, or by one piece of equipment. For example, an elevating grader may loosen and load. Again, scrapers may load dirt without any previous loosening and may transport, dump and spread it.

When earth is "drifted" with a bulldozer the tractor is kept on the same path with each successive trip. This causes the material wasted over the ends of the blade to fall in windrows. After the windrows are formed they serve to hold the material in front of the scraper or blade and thereby prevent wastage. On big jobs these dozers work in pairs, often moving an amount of earth rivaling that of a landslide.

The elevating grader is considered one of the most efficient pieces of equipment in earth removal for side casting earth directly into an embankment or fill, or for loading trucks or tractor wagons for hauling to a fill. The apparatus is essentially a

plow, disk shaped, and a belt conveyor mounted on a frame supported by four wheels. It is drawn by the tractor, the plow cutting the soil and turning it onto the belt. The belt carries the material upward and finally discharges it.

When fills are made, the subsequent settlement problem is of great importance. Usually the earth is spread in layers with bulldozers and blade graders, after which the compacting is done with tractor-drawn tamping rollers also called "sheep-foot tampers." These are heavy hollow cylinders with projecting steel pins or feet, eight or nine inches long, spaced all around the surface. As the roller is pulled forward over a layer of loose soil, the feet penetrate the layer and drive some of it down, compressing it to great density.

The earth borer, which contributes its share to labor-saving equipment, is especially valuable in setting poles. The equipment generally is mounted on a twenty-five horsepower tractor. The boring bit whirls downward to dig a hole quickly and then the equipment hoists the pole so it can be placed into position.

Terracing is being used more and more today as a means of soil-erosion control.



One of the biggest trucks ever made for earth movement moves eighty-five cubic yards per hour

Present-day methods and equipment, as in other great earth-moving projects, have made it possible to build bigger and better terraces not possible a few years ago with hand labor. Blade graders, elevating graders and terracers of different sizes do the work behind track-type tractors of corresponding size.

Inquiries as to makers of articles described in Popular Mechanics, will be answered by our Bureau of Information upon receipt of return postage.

HELP! HELP!

I'LL FIX YOU STRONG AS EVER

Fix up your crippled furniture, chipped veneers, splintered mouldings with Rogers Glue . . . they look like new . . . Stays put longer because it's stronger — 10c and up in tube, bottle and can at hardware stores or send 10c for full size bottle and free set of project plans.

ROGERS, Gloucester, Massachusetts

ROGERS
the best LIQUID FISH GLUE

SAYS GLUEKY

\$5 GIVES YOU TROUBLE-PROOF SHAVING!

The HANLEY AC
A MARVEL OF MECHANICAL SIMPLICITY FOR AC CURRENT—No Radio Interference

At last trouble-proof electric shaving! A shaver simply—yet scientifically—constructed. Only 2 moving parts. Has twice the power to cut wiriest beard. Proven exclusive shearing mechanism shaves barber-close. Guaranteed satisfaction.

Order from your dealer or direct—\$5 (Money Order or check). Or order C.O.D., enclosing \$1 with order and pay postman \$4 on delivery.

CLIPSHAVE, INC., 10 North Pearl St., Port Chester, N. Y.

Operates on DC with special current converter \$1.50.

NEW PRODUCTS WANTED

A long established, reliable and successful metal parts manufacturer in the middle West with facilities and resources for manufacture, sales and distribution is interested in **NEW PRODUCTS** to be made of metal for sale to trade or consumer markets. If you have such an item—one that is practical and for which there is a need — preferably patentable, please communicate by mail, giving full details. We mean business, but interviews cannot be granted without our first having full information by mail. Address Dept. C — Box 22, Grand Rapids, Michigan.

REALISM for Your Railroad

Freight Station \$2 Passenger Station \$1 Signal Tower 75c

True-to-life railroad and village buildings in scale with "O" gauge trains. Just what every railroader (toy or scale model) wants. Skyline Builder comes in kit form. Quick and easy to assemble. Windows and doors died-out. All parts cut to size. Made of fibre-like Tensilite. Wealth of realistic detail. Transparent window panes and skylights. Walls and roofs printed scale size to resemble brick, clapboard or shingle. See these colorful buildings today. Sold by model shops and department stores everywhere. Dept. D, The Schoenhut Manufacturing Co., 2058 Castor Ave., Phila., Pa.

NOTE LOW PRICES

Other Buildings

Residences (each)	75c
Fire House	75c
Garage	75c
Church	\$1.50
School	\$1.50
Factory	\$2.00

If dealer can't supply you send check or money-order. We will ship postage prepaid to any point in U. S. A.

SKYLINE BUILDER

the 18 al: se rt

I want Truck Co. Verward

Trosser Truck

Caterpillar Diesel engine



LOOK FOR THIS DISPLAY

\$3.50 LIST and up

EASY TO READ!

Black markings on a crack-proof white surface—easy to read, even in poor light. Full strength steel checks kinks or curls. Bonded surface, easy to clean, protects the steel from rust. Surveyors and engineers have long preferred Wyteface Steel Tapes. New, popular-priced model sold by hardware and building supply dealers. 25-50-100 ft. lengths. Send coupon for illustrated folder and prices.

K & E FAVORITE WYTEFACE

Steel Measuring Tapes

MADE IN U.S.A.

*REG. U.S. PAT. OFF. TRADE MARK

KEUFFEL & ESSER CO...Est. 1867...Dept. 26, Hoboken, N. J.

Name

Address



U. S. Patent No. 2015459.

BUILD IT WITH DOENUTS

DOENUTS, developed and patented by the originator of the air-wheel, absorb more surface obstructions and eliminate jolting. Protect wood and concrete floors. Do not sink in sand or soft ground. Cadmium plated disc wheel with adjustable ball bearings. Size 10" x 2.75" with load cap. of 225 lbs. per wheel and 12" x 3.30" with 325 lbs. load cap. Ideal for wheelbarrows, painting rick, spraying equipment, textile trucks, dish trucks, boat dollies food carts, etc. Handle same load with less than half the labor. Unless you are a business man, literature and prices are mailed only on receipt of 10c to cover mailing cost.

MUSSELMAN PRODUCTS CO.
6225-F St. Clair Avenue, Cleveland, Ohio



Saw-Filing

Pays up to \$2 or \$3 an Hour in Spare Time

A FOLEY Automatic Saw Filer files hand, circular and band saws better than the best hand filer. Cash business, no canvassing, no eyestrain. No experience needed. Louis P. Wadovich, Ohio, says, "I have filed 764 saws in spare time and have earned \$850.00 in carpenter work due directly to my saw filing contracts." Send coupon for FREE PLAN, no obligation.



FOLEY MFG. CO., 116-9 Foley Bldg., Minneapolis, Minn.

Send Free Plan on Saw Filing business.
Name

Address

When writing please mention Popular Mechanics

"They're Off!" to New Thrills

(Continued from page 75)

had many arguments as to whether all four hoofs of a horse ever leave the ground at once. It was not until men developed cameras with fast lenses and shutters that it was proved that all the hoofs of some horses are completely off the turf at once while making fast strides for the wire.

Photography has played a big part in the improvement of American racing. Photo-finish outfits have given race fans added confidence as the camera doesn't lie if properly installed. Business has doubled at many tracks that have adapted photo-finish cameras to decide nose finishes.

At Hollywood Park a large silver screen has been built in the inclosed paddock. After a race the picture of the finish is flashed on the screen for fifteen minutes.

Some tracks also hire several miniature movie cameramen, to film the race from different points around the mile oval. If rough riding is charged, one or more of the films usually reveal the episode. Several tracks are experimenting with a motion-picture camera that can follow the horses around the track from its high position on the grandstand roof. The camera is equipped with powerful telephoto lens. To be effective it must be able to keep well in focus and take sharp close-ups that will reveal "wild west" riding by jockeys.

Most tracks today have a horse ambulance, a trailer-like affair usually pulled by a truck or tractor. It is low built, the floor being only six inches from the ground. Lamé horses easily can be led into it. On an overhead beam is a block and tackle for lifting in sick horses.

It takes a dozen or more men to keep a mile track in good shape. Where the weather is dry, it is often necessary to sprinkle the track after every race. The sprinkler is followed by two tractors, dragging harrows to keep the "cushion," as the top of the track is called, in fast shape. Rain brings mud and that's another problem for the track maintenance crew. The track must be drained as well as possible. Pools of water are filled with dry dirt.

Race-track people have their own lingo, just as circus, railroad, motion-picture, and other groups have. "Swipes" are the fellows who manicure and massage the

(Continued to page 149A)

Making Metal Smooth as Glass

(Continued from page 3)

moving parts, thus resulting in longer life for machines.

A part treated by this process appears to the eye to have a beautiful nickel finish, but under the microscope, or by microphotography, it appears black because no scratches remain to reflect light. A so-called bright mirror finish entirely satisfactory to the eye does not necessarily mean that all the surface material has been removed from the metal. If the surface still appears bright when microphotography is used, it means that there are enough

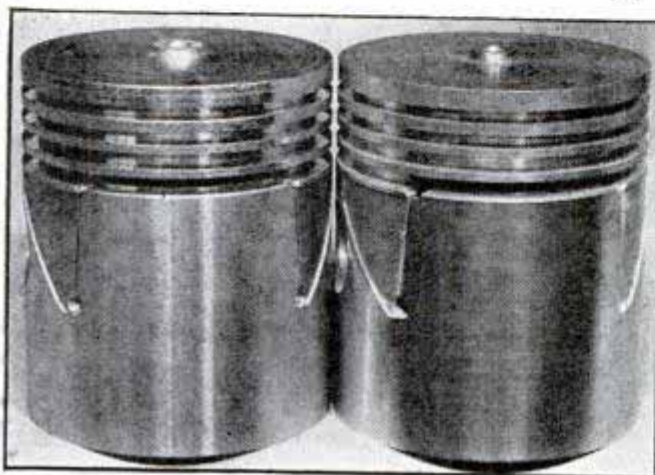

Piston before and after Superfinishing. Smooth surface at right fails to reflect light

tiny ridges to reflect light to the camera's eye and that the finish contains numerous defects.

So fine are Superfinished surfaces that it is necessary to measure them with an Abbott Profilometer, a special instrument whose readings are in millionths of an inch. This instrument uses cathode rays to reveal the character of a surface as a tiny diamond point is drawn over the surface. Movement of the diamond tip up and down as it follows the irregularities in the surface sets up an electric current that is strong or weak in proportion to the height or the depth of the irregularities. The current is amplified and sent to a meter which gives a reading on the roughness of the surface in terms of millionths of an inch.

Among the parts of Chrysler Corporation automobiles which have been treated successfully by the new process are crankshafts, camshafts, cams, pistons, brake shoes and brake drums, tappet heads, tappet stems, valve stems, flywheel clutch faces, cylinder block line bearings and pis-

(Continued to page 148A)

SAND 10 TIMES FASTER

— get Better jobs this Easy way!

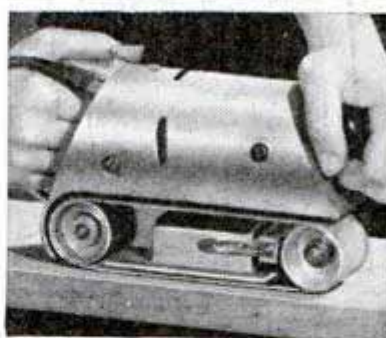

SANDS—GRINDS
POLISHES
BUFFS—SHARPENS
REMOVES PAINTS,
VARNISHES,
LACQUERS

New Guild PORTABLE ELECTRIC Sander

This handy power sander turns out better work 10 times faster and easier. Ends all the drudgery of hand sanding. Anyone can use it without practice.

Driven by a powerful motor, the endless abrasive belt sands with the grain. Leaves no ugly swirls, no cross-grain scratches. Gives uniform finish on flat surfaces . . . is handier around curves. Sands wood, wall board, metal, slate, marble, bone or plastics.

GUILD SANDER is a popular-priced precision tool —with a 5-year guarantee. Works from any light socket. Weighs only 9 lbs. Try it at your hardware dealer's, or write direct for details.

SYRACUSE GUILD TOOL COMPANY
1700-1C N. Salina St., Syracuse, N. Y.

\$13.95
Full Set



MICROMETERS

Six piece set, in velvet lined leather case. Special price, only \$13.95. Precision machined in one thousandths, up to 4" outside and 3 3/4" inside measurements. Guaranteed accurate, easy to read and adjust. Satisfaction guaranteed or money back.

FREE FOLDER

This is your opportunity to get one at a Bargain Price if you act now. Shipped prepaid on receipt of remittance. On C.O.D. shipments, send deposit of \$2.00.

MICRO PRODUCTS, 529 E. Jefferson Ave., Detroit, Mich.

New Amazing INVENTION! ELECTROPLATES

by BRUSH EASY AS PAINTING!

NO TANKS, Liquid Generators.— Does Same Work As Big Outfits

Only \$6.85

Sensational news! Marvelous new discovery actually electroplates with electric brush as easy as painting. Deposits heavy layer of actual metal—gold, silver, nickel, cadmium, copper, etc.—by electrolysis. Does same beautiful, PERMANENT work as big costly tank outfits. Non-liquid. Anyone can use from dry cells, storage battery or household current. Complete outfit weighs only 3 lbs.—take it anywhere.

FREE SAMPLE! Send today for amazing details and FREE Sample that proves all claims.

Agents Wanted: Write for Big Money Proposition Sell Outfits—Do plating for others

WARNER ELECTRIC CO., Dept. E-5
360 North Michigan Avenue, Chicago, Illinois

DECORATIVE

Decalomania Transfers

Imported Designs of all Sizes and Types—Flowers, Figures, Marquetry, Birds, Juvenile, Borders, etc., for Furniture, Walls, Trays, and what not.

Catalog with 800 Illustrations in Color sent for 25c.

Deductible on first purchase of \$1.00 or more.

L. C. WELLS, Dept. PM-812, 25 East 26th Street, New York

H 1278

(Continued from page 147A)

NEW STANLEY PLAN PACKET

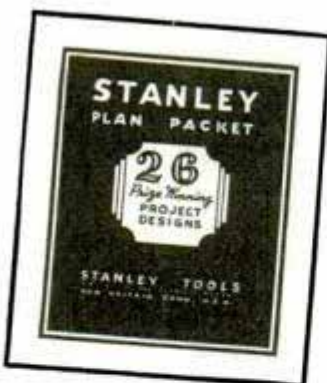

ONLY 50¢

26 prize-winning plans for every man who enjoys working with tools and wood! You'll want to make every project, whether your shop is large or small. Important feature—each drawing is on a separate 8½ x 11" sheet of tough paper. Write today for the Stanley Plan Packet; only 50¢ postpaid anywhere in the U. S.

STANLEY TOOLS

Division of The Stanley Works

105 Elm Street, New Britain, Conn.

STANDARD GARDEN TRACTORS

Plow Seed Cultivate Mow Hay and Lawns Powerful Gas Tractors for Small Farms, Gardeners, Florists, Nurseries, Fruit Growers, Poultrymen.
1 & 2 Cylinders High Wheels. Rubber or Steel Tires. Walk or Ride.
Do Belt Work—Free Catalog
STANDARD ENGINE CO.
Minneapolis, Minn. Philadelphia, Pa. New York, N. Y.
3221 Como Ave. 2546 Market St. 290 Cedar St.



CAPE COD CHAIRS

Style "B", "C", "A", "A", Blueprint 50c. All 3 for \$1.00. MIO—Martin House 8 faming
ily Beautiful Castle Style, Blueprint only 65c. For catalog illustrating over 75 practical projects, send 10c. Free with order. "Over 35,000 Satisfied Customers."

CRAFTSMAN'S MODEL CO.
2030 N. 41st Street Dept. P-25 Milwaukee, Wis.

KNUDSEN'S MECHANICS HANDBOOK

A compact reference book for machinists, toolmakers, draftsmen—tap and drill sizes, taper pins, hardening helps, solution of triangles, square root, reading the metric micrometer, etc.
70 pages 5½x7½-in. leather cover. Price \$1.00 postpaid.
G. A. KNUDSEN, 523 48 St., BROOKLYN, N. Y.

SEND... AND GROW PRIZE FLOWERS AND VEGETABLES WITHOUT SOIL!
\$1 ONLY
No digging, no failures, grow summer or winter. This \$1.00 postpaid kit makes 24 gallons of solution. Contains full instructions by experts. Address orders to
PONIX DALMO LABORATORIES
511 HARRISON ST., SAN FRANCISCO, CALIF.

ton pins—almost all the working parts of the engine.

As outlined by the developers, these two advantages are obtained through use of the Superfinish method:

First, the crystalline surface, when exposed in an undisturbed condition, provides a much finer surface for supporting



Metal surface so smooth that it reflects the photographer taking its picture

oil film, carrying off heat and load-carrying capacity on either a moving or static part.

Second, the mechanical work produces a true surface which allows a greater contact and a more constant contact so that the pressure on the oil is uniform and eliminates surface points and projections above the bearing surface that rupture oil films under high pressures and thereby permit metal-to-metal contact that will wear or destroy a bearing.

Soil Pasteurizer Makes War on Enemies of Plants

Man's newest weapons in the eternal war on insects and other enemies of plants are an electric soil pasteurizer and a "hot box." Wedge-shaped metal strips of the pasteurizer are thrust into the soil of the greenhouse "flats," in which young plants are started. Electric current generates heat in the soil, kills the microorganisms, insects, weed seeds and other elements harmful to the plant. The treatment takes only six or eight minutes. The hot box is a chamber in which flowering plants are placed to rid them of the troublesome cyclamen mite.

W. C. ... College
 new Brunswick, N. J.
 d. ...
 N. Y. Agricultural Station
 Dr. Mr. Clyde

(Continued from page 146A)

thoroughbreds. A "run-out bit" keeps a horse from racing wide on a turn. A jockey who shuts off other horses is called a "herder." A horse that gallops last all the way is said to have "carried the target."

Maybe you wouldn't expect to find monkeys, dogs, cats, goats, ducks, chickens, sheep and various other pets wandering around the stable area, but you will at most tracks. They are companions for the horses and help to make the thoroughbreds less nervous.

Everything is done to make the horses comfortable in their stables which are made as draftproof as possible. At Santa Anita they even have a pile of sand for the horses to roll in. This same track maintains an X-ray room for injured bangtails.

A New Frontier

(Continued from page 59)

To see the cabins of some of the trappers, prospectors, and homesteaders in the more remote sections of the northwest is to be reminded of the days of the Pilgrim Fathers. Both had the same materials and tools with which to work and so achieved the same results. Yet these modern pioneers do not think of their life as one of hardship. They pity the city dweller, with all his conveniences, for his lack of freedom and his dependence on others.

The 1930 census showed there were only about 60,000 people in Alaska, half whites, and half natives, in a territory of 586,400 square miles—about one person to every ten square miles. But that doesn't tell half the story. Three-fourths of these people live on the coast, only one-fourth in the great interior. And this one-fourth lives mostly along the Yukon river or the Alaska railroad, the main routes of travel. Most of them have never been more than a few miles from home. That accounts for the fact that there are vast unpopulated areas where one can travel hundreds of miles without seeing a single human being. In most of the interior the population probably averages less than one person to every thirty square miles.

Yet some authorities estimate that about one-fifth of the total area of Alaska, about 64,000,000 acres, is suitable for agriculture. It lies mostly in the interior. There is about

(Continued to page 150A)

HANDEE

TOOL OF 1001 USES

This Year Give Him A HOBBY

Men and boys of all ages satisfy their inherent urge to make scores of useful articles with the famous Handee.

A WHOLE TOOL SHOP IN YOUR HAND

This amazing tool and your choice of accessories do a multitude of jobs on all materials. Set up shop wherever there is an electric outlet. De Luxe Model weighs 12 oz. 25,000 r.p.m. \$18.50 Postpaid with 6 Accessories.

200 ACCESSORIES

Quality built. Largest assortment, one for every job. See at dealers or in catalog.



Grinds
Drills
Polishes
Engraves
Saws
Sands
Cuts
Carves
Routs
Cleans

ULTRA DE LUXE SET
A treasure chest. De Luxe Model and 26 popular Accessories in metal case. This practical gift will be appreciated, used for years. \$25.00 postpaid. Project book included.

STANDARD MODEL
20,000 r.p.m. Weighs 16 oz. \$10.75 postpaid with 3 Accessories.

GET A DEMONSTRATION

at any store or order either model on 10-Days Money-Back Trial. Catalog Free.

Chicago Wheel & Mfg. Co., 1101 W. Monroe St., Dept. PM, Chicago, Ill.
© 1938 by Chicago Wheel & Mfg. Co.

Send Catalog De Luxe Model Ultra De Luxe Set Standard Model Send C. O. D.

Name.....

Address.....

MADE \$102500

in 9 Months with the



FOLEY LAWN MOWER SHARPENER

"A substantial increase in grind jobs each year, proves beyond any doubt that Foley Grinders do very satisfactory work. We have ground 723 mowers since February 1 to date, November 9. Our total receipts on lawn mower service alone during that period has grossed us \$1,025.00. The prevailing price of grinding and adjusting service is \$1.00 and \$1.25—repairs and parts extra."—W. A. Tulp, Phoenix, Ariz.

You Too Can Make Big Money

Free plan tells you how to start. The Foley Lawn Mower Sharpener turns out perfect work quickly and easily, no experience needed. Simply put the mower in the machine and turn on the power. Uses same system as lawn mower factories. Sharpens all sizes and types in 15 or 20 minutes.

Special Offer: Attachment for grinding axes, hatchets, knives, etc., included FREE with Foley Lawn Mower Sharpener on our Special Offer, brings you business the year around. Send coupon today.

FOLEY MFG. CO. 107-9 Foley Bldg., Minneapolis, Minn.

Send Free Plan for making money sharpening lawn mowers, and Special Offer on the Foley Lawn Mower Sharpener.

Name.....

Address.....

(Continued from page 149A)

KRW Inveradiant Gas HEATER!



**RADIATES HEAT
DOWNWARDS—WARMES
THE COLDEST
AREAS
FIRST!**



This sensational new heater operates on a scientific principle which directs the heat outwards and downwards, thereby warming the "living zone" of the room first. Result is greatly increased efficiency and operating economy. Light, compact, portable, beautifully finished in heavy chrome-plate and assorted colors of crackle enamel. Fully approved by American Gas Ass'n and other testing laboratories—no odor, fumes or carbon monoxide—healthful and safe. Price, only \$12.00, cash with order, or C.O.D. shipped express collect—wt. 14 lbs. Fully guaranteed, with 30-day return privilege if not entirely satisfied.

AGENTS DEALERS

Write for our generous resale proposition, offering real profit opportunity.

K. R. WILSON, 17 Lock St., BUFFALO, N. Y.
Builders of Shop Equipment for Ford Dealers Since 1916
West Coast: 722 Mateo St., Los Angeles. Export Office: 90 West St., New York

FENCING

WORLD'S FINEST SPORT
HARMLESS-EXCITING FUN

Develops strong body and alert mind. HARMLESS. The spring-steel 3-foot-long foils (swords) are equipped with rubber buttons. Aluminum cup-shaped hand guards. Our De Luxe foils are built for hard usage.

Complete set of two foils (swords) and free instruction booklet, only \$1.98. We pay postage. **ORDER NOW.**

ALL-AMERICAN FENCERS GUILD, Dept. 1PM, 48 W. 48th St., New York

WORLD'S GREATEST all around ELECTRIC TOOL

DRILLS — GRINDS — SANDS — SAWS
POLISHES — SHARPENS — CARVES

The new WHIZ ELECTRIC TOOL is the handiest power tool ever made. Not a delicate instrument but a real rugged tool, equally effective for both power and precision work. Drills through 3/4 inch iron plate in 42 seconds or engraves intricate designs on jewelry. Handles any material: Metals—Woods—Alloys—Plastics—Glasses—Steel—etc. Saves time. Eliminates labor. Plug into any socket AC or DC, 110 volts. Chuck 3/4 inch capacity. Ball bearing thrust. Powerful, triple-gear motor. "Worth its weight in gold." STANDARD MODEL with Normal Speed (uses 50 different accessories, instantly interchangeable.) Special Introductory Price for limited time, only \$6.95.

FREE Accessory outfit (Value \$2) includes set of drills, mounted 1 1/2 inch grinder, sanding discs, cutting wheels, mounted brush, polishing wheel, carving bur, etc. **FREE** with each outfit ordered NOW. We pay postage. Will send C. O. D. if desired. **10-DAY TRIAL—MONEY BACK GUARANTEE.**

Special "2-SPEED" MODEL combines Normal Speed and High Speed in one outfit (uses 200 accessories) only \$8.95 complete, with same accessory outfit (value \$2) FREE.

Paramount Products Co., Dept. 1A, 48 West 48th St., New York

Work Faster Make More Money with the

Red UNIVERSAL TRACTOR

With this practical machine and attachments you can do all field and belt work hours faster at the low cost of 33c per day. Many units pay for themselves the first season. Unusually easy to handle and operate. Absolutely safe. Hundreds of users. Buy direct at low factory price. Two weeks' trial—satisfaction guaranteed. Write for colorful, free catalog.

PIONEER MFG. CO. Dept. V-19 West Allis, Wis.

the same amount of grazing land. The census showed that there were about 9,000 acres of improved land in 1930. There is about the same proportion of agricultural land in northwestern Canada.

Here are some of the advantages of life in the wilds of the north. There are no poisonous snakes, no snakes at all, for that matter. There are no poisonous plants, berries or mushrooms—at least we couldn't find any, and we sampled everything we could find. Meat can be obtained almost anywhere. Reliable estimates place the number of caribou in Alaska alone at more than 2,000,000. Moose are numerous and almost as tame as cattle in some parts of the country. The meat is as good as any beef. If you like fishing, you will be in a fisherman's heaven. The one bad pest is the mosquito.

On land suitable for agriculture, hay, small grains and most of the vegetable crops of the more northern states can be grown very successfully. During the summer, the long days make up for the shorter season, so that the total hours of sunlight between spring and autumn frosts are about the same as in localities farther south. The crops mature rapidly, producing vegetables of fine quality.

But, you say, where is the market for these crops? There is no market at present. These farms are subsistence farms, as were those of our pioneer forefathers. For his money crop, the northern pioneer can trap, fish, mine, raise fur animals, guide hunting parties or cut cordwood for nearby settlements—to mention only a few possibilities.

Even the steady cold winter is often an advantage. The average winter temperature is around zero, although acclimated inhabitants prefer the calm crisp clear days of ten to thirty below. Then one can work in the timber in shirt sleeves without getting too hot. That seems odd, but Alaskans have a saying that "as long as you can keep cool you are not apt to freeze." It is dampness, such as perspiration, that is dangerous in winter. You must learn to dress cool enough, not warm enough.

The constant cold preserves food perfectly. Frozen carcasses stay fresh all winter. Bread, cakes, pies and pastries all are kept fresh by freezing and wrapping in

Handwritten: K 114 0

waxed paper to prevent them from drying out. Even left-over beans or stews can be kept for months. Just freeze them in a tight container, turn them out like loaves, wrap in waxed paper and store in the woodshed or cache.

Housing is one of the simplest problems for the northern pioneer. Most of the interior country is covered with a fair growth of spruce or jackpine. Both make good cabin logs. It has been demonstrated many times at Fairbanks and Dawson that a properly built log cabin is as warm and comfortable as the most modern insulated house. Clothing is the biggest economic problem, although native garments can be worn—the moose-hide moccasins and mittens of the Athabaskan Indians, or the mukluk boots, caribou socks and parkas of the Eskimos. The main luxury of most "old-timers" is woolen underwear, which they wear both winter and summer. They say it keeps them healthy.

This brings us to the health problem. We have gone through the sticks all summer, half the time wet to the skin from tramping through wet brush or wading streams. And not once did we have a cold while we were away from habitations. When we did come to a village, though, we often caught cold, regardless of our physical condition.

But what about the danger of accidents? What if one should break a leg, or have appendicitis? There are many pursuits right here at home that have more risks. Some will say that the life of the pioneer is alright for a young man but not for a young woman. But doctors with long experience in the north claim that a woman of average health and strength, such as the girl who goes out for school athletics, often can outdo a man in the north. She has more native stamina. It has been proved many times among tribes of Indians and Eskimos that the women survive long ordeals better than the men.

We traveled this great interior territory from southern British Columbia to Cape Prince of Wales, Alaska, and it offers splendid opportunities to those who want to strike out for themselves. The principal requirements are moderately good health, plus the ambition and willingness to adapt oneself to whatever conditions one may encounter in a frontier country—and make the best of them.

Treet Topics

IT CAN'T BUY
FLOWERS ~



NOR TICKETS
TO A
SHOW ~

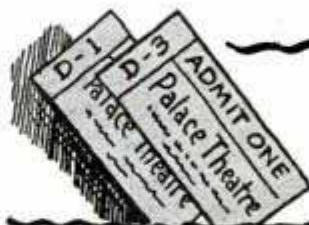

BUT THAT
SAME
THIN DIME ~



UMM...
SO
NICE!

WILL TAKE
YOU A
LONG WAY
ON A DATE



IF YOU
DO THIS -

TREET
BLADES!

YESSIR
4 FOR 10¢



-AND TREET YOURSELF
TO A PACK OF
PERFECT SHAVES!



Treet Safety Razor Corporation, Newark, New Jersey

**DISTINCTIVE . .
IN FINE
WORKMANSHIP
AND DESIGN**

\$85⁰⁰

Less Motor Drive
Sold on Easy
Payments as
Low as \$6.00 a
Month for 12
to 18 Months.

No. 415-YA, 9 $\frac{1}{4}$ " swing by 3'
bed Workshop Bench Lathe
with Horizontal Motor Drive,
 $\frac{1}{4}$ h.p. Reversing Motor,
Switch, Belts and Adjustable
Belt Tension
Countershaft **\$117.00**
(\$15 down—\$7 Mo. for 18 Mo.)

Weight
320
lbs.

F. O. B. South Bend, Ind.

NO METAL working machine has ever before been offered to equal the high quality and low price of the 9-inch Workshop South Bend Lathe. It is capable of doing the finest work on tools, dies, jigs, and fixtures. The exacting requirements to which this lathe is held in thousands of industries is guarantee and proof of its precision.

Manufacturing plants, machine shops, tool rooms, laboratories, automotive repair shops, home workshops—all are installing the 9-inch Workshop Lathe. Choice of engineers and mechanics everywhere.

Features include: V-ways on lathe bed, Precision Lead Screw for cutting screw threads 4 to 112 per inch, Ball Thrust Bearing on Spindle, Automatic Longitudinal Screw Feed, Twin Gear Reverse to Lead Screw, $\frac{3}{4}$ " hole through spindle for collets up to $\frac{1}{2}$ ", Precision cut steel gears, Tailstock set-over for taper turning.

38 attachments are available for milling, grinding, draw-in collet chuck work, Taper work, and many other jobs. Powered by $\frac{1}{4}$ H.P. motor from ordinary lamp socket.

SOUTH BEND LATHE WORKS
637 E. Madison St., South Bend, Ind., U.S.A.

**SOUTH BEND
BACK-GEARED
SCREW-CUTTING
PRECISION LATHE**

This 9-inch South Bend Lathe used by:
**MANUFACTURERS
TOOL ROOMS
LABORATORIES
MACHINE SHOPS**

- Automotive
- Electrical
- Gun Smiths

**U. S. GOVERNMENT
SCHOOLS
HOME WORK
SHOPS
INVENTORS**

The 9" x 3' South Bend Precision Lathe does these operations:

**TURNS—BORES
—CUTS SCREW
THREADS—FACES
—DOES MILLING,
CHUCKING, REAM-
ING, DRILLING,
FILING AND HUN-
DREDS OF OPERA-
TIONS IN STEEL,
IRON AND OTHER
METALS.**

There are 5 sizes of South Bend Lathes—9", 11", 13", 15" and 16" swing with bed lengths 3' to 12'. In motor or countershaft drives. Priced \$85 to \$1500.

Send Coupon

FOR THESE BOOKS
Latest and most authoritative shop information. New "How to Run a Lathe" has 128 pages and over 350 illustrations on lathe operation. 1,500,000 copies in use. Catalog No. 46-A illustrates, describes, and prices 9-inch lathe in 3', 3 $\frac{1}{2}$ ', 4' and 4 $\frac{1}{2}$ ' bed lengths and 8 different drives.

LATHES ARE STOCKED IN PRINCIPAL CITIES

Boston, Massachusetts—The MacKenzie Machinery Company, Inc., 36 Oliver Street
Bridgeport, Conn.—A. C. Bisgood Machinery & Equipment Co., 17-21 Union Square
Chicago, Ill.—C. B. Burns Machinery Company, 541 West Washington Boulevard
Cleveland, Ohio—The Reynolds Machinery Company, Inc., 2034 East 22nd Street
Dallas, Texas—The Machinery Sales and Supply Company, Inc., 2124 Main Street
Denver, Colorado—The M. L. Foss Machinery Company, Inc., 1901 Arapahoe Street
Detroit, Michigan—The Lee Machinery Company, Inc., 6318 East Jefferson Avenue
Houston, Texas—The Wessendorf, Nelms & Company, Inc., 317 Preston Avenue
Los Angeles, Cal.—Eccles & Davies Machinery Company, Inc., 1910 Santa Fe Avenue
Milwaukee, Wisconsin—W. A. Voell Machinery Company, 1533 North 16th Street
New York, New York—The A. C. Colby Machinery Company, Inc., 183 Centre Street
Philadelphia, Penn.—W. B. Rapp Machinery Company, Inc., 132 North Third Street
Portland, Oregon—The Portland Machinery Company, Inc., 208 So. West First Avenue
Providence, Rhode Island—George T. Reynolds & Son Co., Inc., 171 Pine Street
Rochester, New York—The Ogden R. Adams Machinery Company, 266 State Street
St. Louis, Mo.—Colcord-Wright Machinery & Supply Co., 1223-1229 No. Broadway
San Francisco, California—The Moore Machinery Company, Inc., 550 Fifth Street
Seattle, Washington—The Star Machinery Company, Inc., 1741 First Avenue, South
Syracuse, New York—H. A. Smith Machinery Co., Erie Blvd. E. and So. Townsend St.
Tulsa, Oklahoma—The Machine Tool & Supply Company, 215-219 East First Street

SOUTH BEND LATHE WORKS,
637 E. Madison St., South Bend, Ind., U.S.A.

- No. 34LB "How to Run a Lathe," 25c
- No. 46-A, 9" Workshop Catalog, Free
- Easy Payment Plan

Class of Work.....
Name.....
Address.....
City.....State.....

SOUTH BEND Precision LATHES

GE MOTOR POWERED BALL BEARINGS

DURO HEAVY DUTY

Grinder

\$14⁹⁵

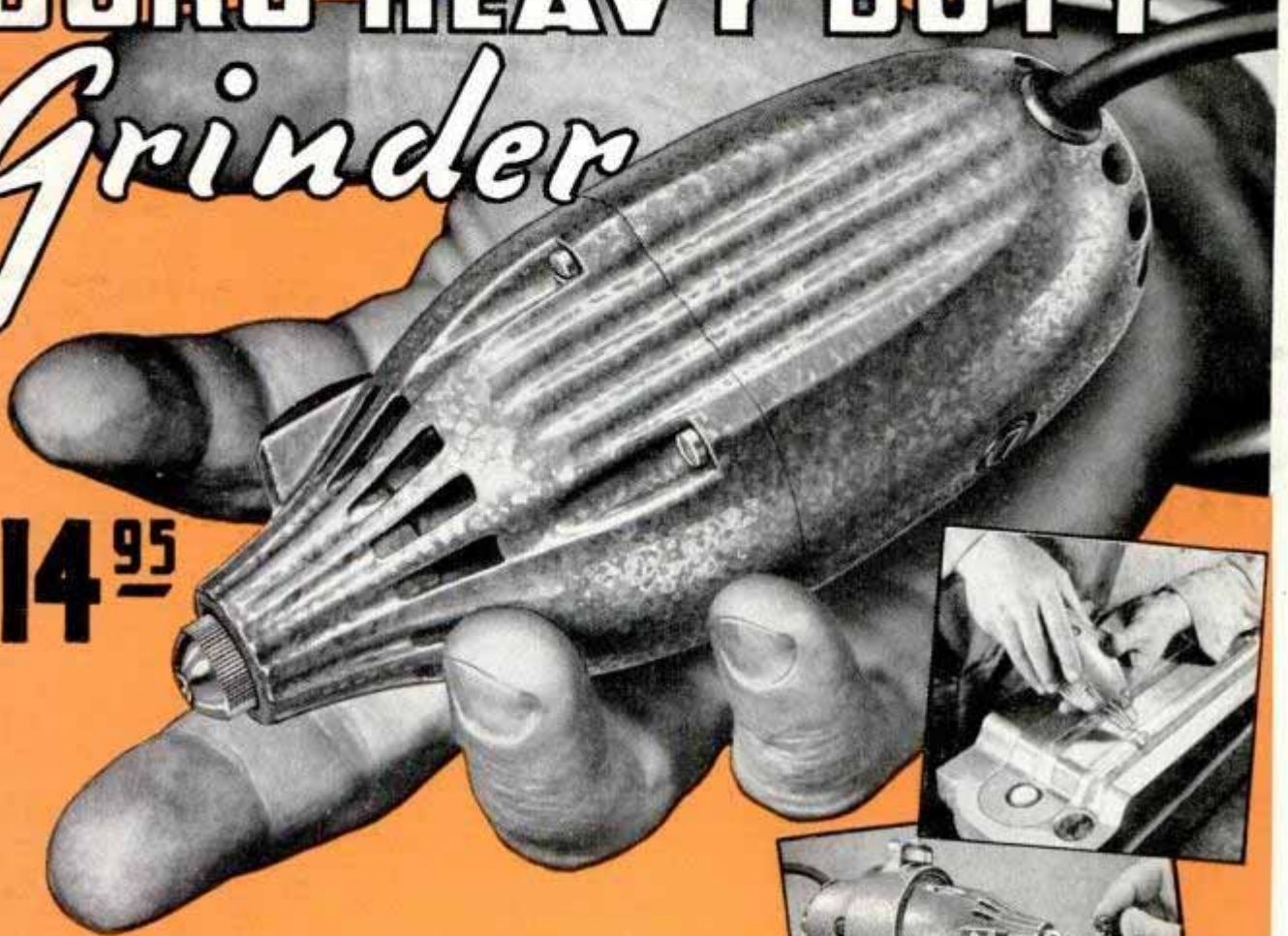

Value and wide range of Adaptability is the keynote of acclaim being received about the Duro Heavy Duty Grinder and Accessories.

The Craftsman, the Tool Room and the Production Shop have found a new value in the Grinder field. They are amazed, as you will be, at the **QUALITY** built into these units.

Precision workmanship on the Grinders and Accessories, the use of Motors and Bearings made by some of the World's largest manufacturers and large line production are reasons for the finest Quality unit ever developed at this price.

GENERAL ELECTRIC Universal Motor with over 40 watts output and running at 24,000 R.P.M. Square cartridge type brushes ride on periphery of commutator. Underwriters approved continuous rotary switch. Three wire rubber covered cord. Extra wide, permanently sealed, **NEW DEPARTURE** Precision Ball Bearings, Propellor type fan. Machined alloy metal housing with machined rabbett fit forms a sturdy, rigid and vibration free unit. $\frac{3}{8}$ inch and $\frac{1}{8}$ inch collet chuck. Chuck lock. Streamline design—only 7 inches overall. Priced for 110 volt 60 cycle or less, A. C. or D. C. 220 volts supplied at a small additional charge.

Try the Duro Hand Grinder, it is a small investment but a tremendous value. Send your order now for 10 day money back trial.

DURO METAL PRODUCTS CO.
DEP. B2 2651 NORTH KILDARE AVE.
CHICAGO ★ ILLINOIS

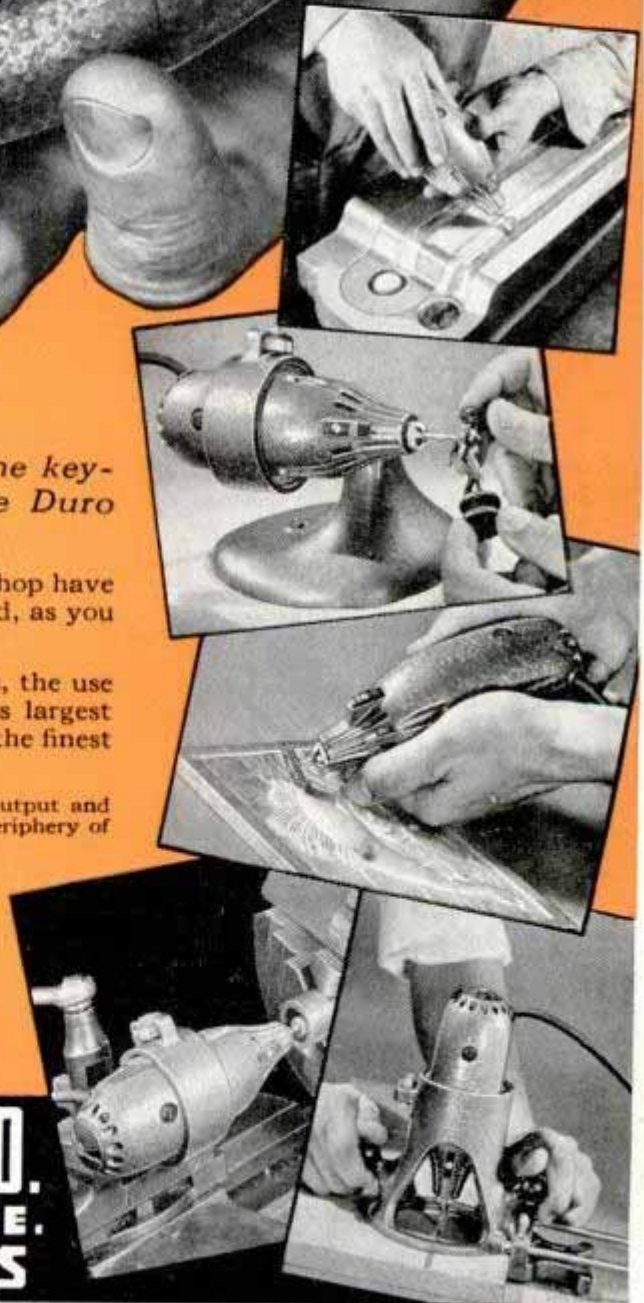

WITNESSED STATEMENT SERIES:
James Walker—Independent Buyer
—has smoked Luckies for 10 years.

TOBACCOLAND'S FINEST GIFT

Favorite of America's
Independent Tobacco Experts

CIGARETTES! An ever-welcome gift! But certainly you want to give the *best*. To be certain, give Luckies. For sworn records show that, among *independent* tobacco experts ... auctioneers, buyers and warehousemen ... Luckies have *twice* as many exclusive smok-

ers as have all other cigarettes put together.

And, *only* Luckies give you the throat protection of the exclusive "Toasting" process. Toasting takes out certain harsh throat irritants found in *all* tobacco. So Luckies are a light smoke—easy on your throat.

Sworn Records Show That— WITH MEN WHO KNOW TOBACCO BEST—IT'S LUCKIES 2 TO

