

FLYING THE WINGED BULLETS

POPULAR MECHANICS MAGAZINE



YOU CAN UNDERSTAND IT

REG'D. TRADE MARK. GREAT BRITAIN. INC.

REG. U.S. PAT. OFF.

OCT.
25 CENTS



SEE PAGE 546

YOU CAN DEPEND ON CHAMPIONS



FOR OUTSTANDING ENGINE PERFORMANCE

There are many reasons why Champion Spark Plugs excel and outsell; but none so convincing as the fact that Champions exact maximum performance and dependability from every engine.

In the recent 11th annual Albany-to-New York Outboard Marathon, 77 boats started out on the 132-mile ride in the worst weather in the history of the race. Each entrant had but one goal—to win.

With one exception, every engine in every boat, in every class, was equipped with Champion Spark Plugs. This voluntary choice of Champions is an extraordinary

endorsement of their reputation for dependability.

The winners and all who survived the choppy seas used Champion Spark Plugs and gave them punishing treatment without parallel in any type of service. Most of the boats were powered by two-cycle engines, requiring double the sparking frequency in general and automotive use, turning speeds up to 7000 r.p.m., and using a mixture of gas and oil—all of which combined to make it an extreme test of spark plugs.

Demand Champions because you can depend on them.

CHECK AND CLEAN SPARK PLUGS WHEN YOU CHANGE OIL

**ACTUAL SIZE
V-PLUG**



V- $\frac{3}{8}$ "
24 Thread
V-2 $\frac{1}{4}$ "
32 Thread
65c

**MODEL BUILDERS
—ATTENTION!**

Specially designed for model gas engines giving the same dependable performance as regular Champions. Absolutely gas-tight, alloy needlepoint electrode, one-piece construction. If not available through your dealer, write Champion Spark Plug Company, 900 Upton Ave., Toledo, Ohio.

REPLACE SPARK PLUG WIRES

EVERY 10,000 TO 15,000 MILES

You bet!
**AND MAKE SURE
 YOU GET
 PACKARD 440!**

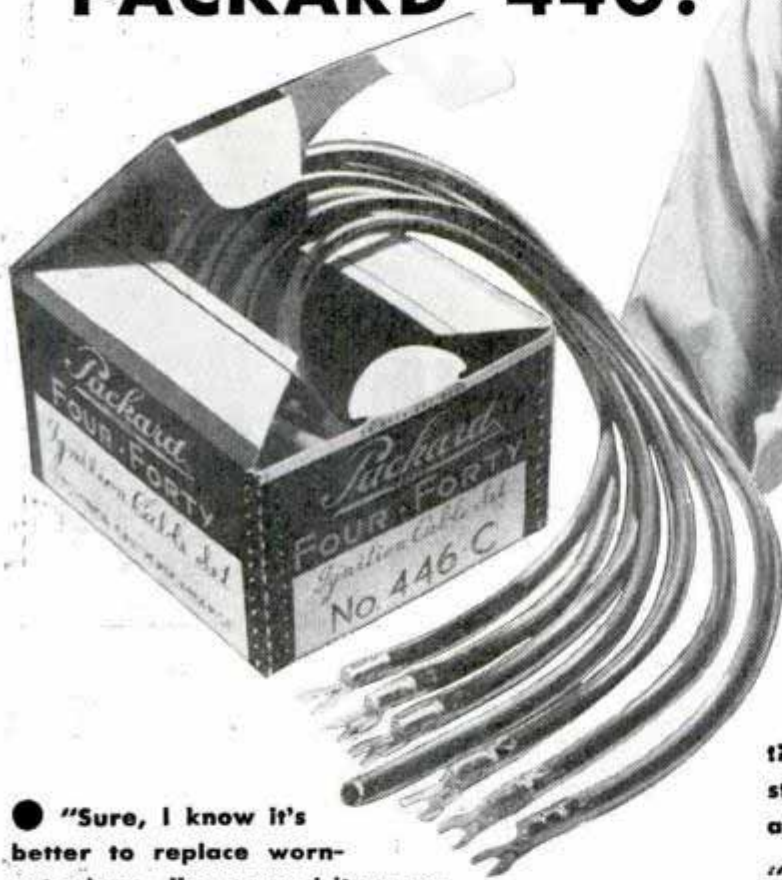

● "Sure, I know it's better to replace worn-out wires—I've proved it on my own car. And every customer who comes into our shop for a tune-up gets new Packard Four-Forty, if his old cables are hardened or oil-soaked—as they usually are!

"I've worked over motors for a long time, putting them in shape for long summer trips, tuning them up for winter driving, and improving their performance and economy of operation. And I know that nothing else I do to a motor will put it in A-1 shape if the spark plug wires are wasting juice—causing cross-firing and fouling spark plugs.

Packard
REG. U.S. PAT. OFF.
 TRADE MARK



"I insist on Packard Four-Forty because it's the first cable I ever saw that can 'take' the heat under that hood in hot weather . . . remain flexible and crack-free under the cold of winter months . . . and still withstand the effects of corona, age, oil and abrasion after miles of high-speed driving.

"I needn't go into all the details about Packard Four-Forty's secret-formula inorganic sheath—just take my word for it. I know what I'm talking about—and you'll agree with me, after you see how much better your car runs with a new set of Packard Four-Forty!"

Packard Four-Forty Ignition Cable Sets for any car are available at most service stations. Install a set NOW. The cost is low and you'll benefit by faster pick-up, more power and lower gasoline bills. Packard Electric Division, General Motors Corporation, Warren, Ohio.

THE STANDARD WIRING EQUIPMENT OF THE AUTOMOTIVE INDUSTRY

BEHIND YOUR GOOD TELEPHONE SERVICE IS THE *Constant Courtesy* OF

THE VOICE WITH A SMILE



THE MAN ON THE JOB



THE MEN AND WOMEN
IN THE TELEPHONE OFFICE



This country is entitled, in good times and bad, to the best telephone service at the lowest possible price.

A great factor in the continued improvement of telephone service is the real

spirit of service that has become a tradition to telephone workers. Courtesy and efficiency are important words in the Bell System.

BELL TELEPHONE SYSTEM



When writing to advertisers please mention *Popular Mechanics*

Popular Mechanics Magazine

H. H. WINDSOR, Founder

H. H. WINDSOR, Jr., Editor and Publisher

October, 1938

Vol. 70, No. 4

Special Features

Poor Boy Still Makes Good	481
The Age of Color	Coloroto
Setting Traps for Fire Bugs	498
Steel Carves a Waterway	506
Millions for Movie Ideas	514
Toys for Men Only	520
Shipping on Underground Railways	530
Wild Horses Corralled from Air	541
Flying the Winged Bullets	546
Riding Herd on 2,000,000 "Horses"	552
The Romance of the Locomotive	564
Picture Your Pets	571

(Continued on next page)

Three Seconds from Death!

THERE are seventeen men and six women in Hollywood who live entirely by seconds, seldom being more than a count of three from disaster while working. They draw twice as much salary as the average movie star for the actual time they work, they are seen on the screen daily by millions, yet they are totally unknown except to their friends and fellow workers. This little group is composed of the thrill-makers of motion pictures, the "stunters" of the movies. In their work, a second means more than a day to most of us because it generally spells the difference between safety and tragedy. "Timing" is their religion for they work entirely by count, a count which becomes almost subconscious with them but which, if they forget it, may mean death. An article next month takes you on location with a Hollywood stunt man. It's the kind of story readers with weak hearts will want to skip.

Next Month

THE rapid strides of radio in recent years make possible world-girdling hook-ups which, in the space of an hour, transport you around the world—into yesterday, today and tomorrow. What goes on behind the scenes in these ether-jumping programs makes an interesting story which you'll find in the November issue. It is titled "Ether Jumpers Never Sleep" and is illustrated in Coloroto.

Secrets of Speed

THE world's fastest airplane is an Italian ship which cost more than \$1,000,000 and flew 440 miles an hour four years ago. That record could be broken today at much less cost. A 500-miles-an-hour ship could probably be constructed for \$60,000. The price of speed has gone down because our knowledge of speed has increased. The secrets of speed form the basis for an article next month.

Winged Lifeguards

EARTHBOUND and surfbound for generations, the Coast Guard has taken to the skies. The service now uses giant long-range flying boats which cruise more than 2,000 miles non-stop at 125 miles an hour. The boats can land in rough water far out at sea to pick up twenty or more people in an emergency. An article in the November issue describes the work of the aerial branch of the Coast Guard.

Published monthly by POPULAR MECHANICS CO., 200 East Ontario Street, Chicago, U. S. A. Single copy in United States, 25 cents; \$2.50 a year, \$4.00 for two years, \$5.00 for three years in United States and possessions, Canada, Newfoundland, Labrador and countries of the Pan-American Postal Union including Spain. To all other countries add \$1.00 a year extra for overseas postage. Changes in address must be reported to us immediately to eliminate delay. Entered as Second Class Matter, Sept. 15, 1903, at the Post Office at Chicago, Illinois, under Act of March 3, 1879. Entered as Second Class Matter at the Post Office Department, Canada. Copyright 1938, by Popular Mechanics Co. in the United States, Australia and France.

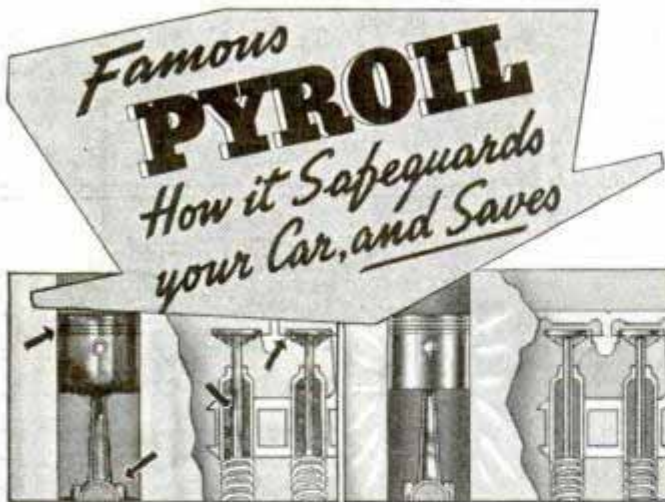

1. When an engine is torn down for inspection you can see the actual damage that sun, sludge and hard carbon have caused. Result: costly repairs.

2. Pyroil's powerful solvent action (entirely safe) thoroughly removes these power-stealing contaminants. In new cars, Pyroil prevents their formation.

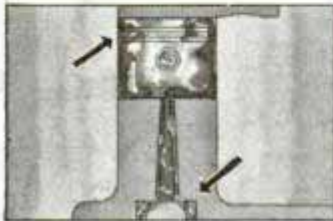

3. Corrosion (acid attack) rapidly "eats" away vital metal parts. Corrosion is one of today's worst operation problems. Another creator of costly repairs.



4. Pyroil's singular, highly protective ingredients keep your engine safe from this destructive enemy. Pyroil prevents corrosion—stops its further attack.



5. In everyday operation, internal friction robs your engine of power. It eats up gas and oil, creates overheating and produces extra wear that costs you money.



6. The famous Pyroil adsorbed film greatly reduces friction and overheating. Makes your engine "purrr" with new power and flexibility. Saves you money!

Whether your car is brand new or old, you can give it no finer protection than Pyroil! You can offset many common repairs with Pyroil. Have a car that runs constantly as it should. Merely add a few ounces of this famous lubrication process to gasoline tank and to crankcase. Costs only a few pennies. Yet it saves dollars. Be among the millions who use Pyroil regularly—and save. Ask for it, today, at your service station or garage. Manufactured and Guaranteed by Pyroil Company, W. V. Kidder, Founder, 510 Pyroil Bldg., LaCrosse, Wisconsin, U. S. A.



NOTHING FINER FOR NON-ABRASIVE NEW CAR BREAK IN!

DISTRIBUTORS: CHECK AND MAIL COUPON FOR FRANCHISE FACTS.

SIMPLY ADD TO GAS & OIL

PYROIL COMPANY,
 510 Pyroil Bldg., LaCrosse, Wis., U. S. A.
 Please send me further important Pyroil facts.
 Also send details of your plan for Distributors.
 Name.....
 Address.....
 City..... County..... State.....

(Contents—Continued)

AUTOMOTIVE

Powerful Diesel road grader has reversible blade...497
 Anti-skid flange for rural auto...504
 Wind tests on model autos...504
 Fifteen riders stunt on three motorcycles...510
 Collapsible camp house carried on car roof...525
 Air-conditioner for bus...526
 Glasped kennel for dog on auto fender...529
 Automatic brake checks backward roll of car...535
 Wind-electric units tested on truck...538
 Midget racer "fishtailed" for speed and safety...540
 Speed indicator warns driver by flashing light...545
 Safety drive powers both wheels...550
 Air intake and exhaust in cab roof...557
 Theftproof gasoline tank cap...559
 Vapor lock eliminator...560
 Cam angle protractor synchronizes distributor...563
 Family tours in sea-going "covered wagon"...569
 Non-petroleum lubricant takes squeak out of rubber...569
 Engine bucks wind at seventy...576

AVIATION

Pilot tries diver's helmet in high altitude...502
 Rubber pontoon for seaplanes...511
 Dry sprinkler system rids plane of insects...524
 Spare propellers carried under transport plane...528
 Giant flying boats for week-end cruises...538
 "Plate-lifter" brake latest for airplanes...556
 Tandem propellers spin in opposite directions...576

BOATS

Dredge to seek gold lost in 1799...528
 Propellerless boat cruises in river shallows...529
 Old river boats revive early rivalry...561

CONSTRUCTION

Two-wheeled wheelbarrow...524
 One-man plow and winch replace gang...540
 Round-cornered brick makes leakless wall...543
 Cement-hulled sloop wears its ballast outside...545
 Lead head nail locks metal roofing...551
 Steel framework for plaster strengthens the house...558
 Wood buildings made stronger by timber connectors...568
 Wire screen protects rain gutters from debris...141A

HOUSEHOLD

Alarm clock wears shutter for traveling...503
 Garbage can holder prevents loss of lid...535
 "Map" rug for the playground...536
 Portable "plug-in" electric stove...539
 Asbestos collar for stove burner saves gas...543
 Safety window washing seat...544
 Valve mixes water to desired temperature...574

LAWNS AND GARDENS

Lawn mower steered by remote control...527
 Three thousand flower colors are charted...528
 Garden made a bird sanctuary...558

MODELS

Stradivari violin made in amateur workshop...534
 Model of "stratoliner" tested in wind tunnel...536
 Auto racer builds car models...568
 "Clay" made from old newspapers...568

PHOTOGRAPHY

Color photos projected for backdrop of stage...505
 Electric drier for photo prints...526
 Camera sets itself for correct exposure...544
 Drawing projected on desk from microfilm...569
 Rotary fire-finder's photos help spot flames...574
 Handle for miniature cameras...576

RADIO AND ELECTRICITY

Electric sunshine floods night baseball game...497
 Hydrogen tank forms setting for pageant...524
 Bee trouble a new hazard for trouble shooter...526
 Telegrams ride the tones of electric organ...527
 Red and green lights police power flow...536
 Loud speaker in a "manhole" directs sport festival...558
 Forest patrol radio sends 500 miles...563
 Television takes the road in twin van studio...570
 A-B eliminator for two-volt farm sets...577
 Portable two-tube a.c.-d.c. push-button receiver...578
 Portable junk box for radio workers...580
 Practical radio hints...581
 Auto antenna is vacuum operated...582
 Phototube relay in kit form...582
 Push-button remote control...582
 Receiver in combination clock and lamp cabinet...582

(Continued to page 6A)

PALS

...through the years



IN 1907 . . . "Meetin' the right pipe tobacco is pretty near as difficult (and important) for a man as courtin' the right girl. I didn't get hep to Union Leader until a travelin' man loaned me some about the time this snapshot was taken. But I've had cause to thank that fellow ever since for my favorite smoke."



TODAY . . . "Here's the 'right gal, the right tobacco' and me, all photographed together. When a man, woman and tobacco get along good as us all these years they got to have something. Union Leader's got enough goodness to last a man all his life." C. S. Ross, Route 3, Farmington, Ia.

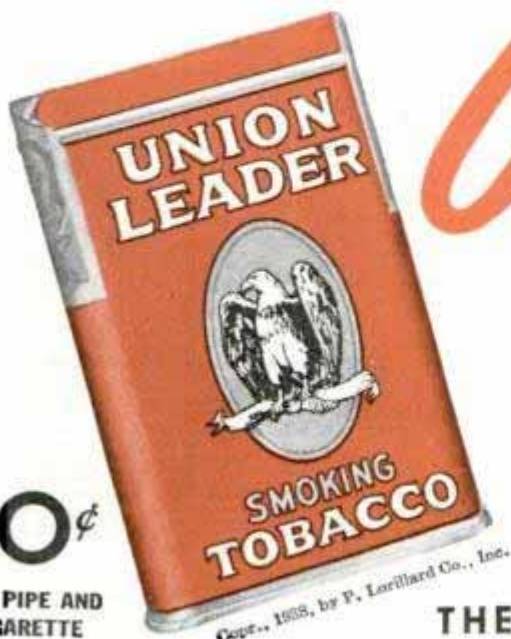

10¢
FOR PIPE AND
CIGARETTE

Copyright, 1955, by P. Lorillard Co., Inc.

Union Leader

ALWAYS . . . Since it made its bow, over a third of a century ago, UNION LEADER has been a favorite of American smokers. This tobacco is flavor-filled Burley from the hill crops of Kentucky. Mellowed in oaken casks and specially processed to remove all trace of harshness or tongue-bite. It's the friendliest smoke a dime ever bought.

THE GREAT AMERICAN SMOKE

When writing to advertisers please mention Popular Mechanics



STOP the hidden gas waste— HAVE YOUR PLUGS CLEANED 5¢ EACH

As your spark plugs become dirty (coated with oxide, soot, and carbon), they misfire with gradually increasing frequency. The hot oxide coating acts as a conductor and becomes "the line of least resistance" for the electric current.

This misfiring is seldom noticeable. Yet, after 4,000 miles of driving, it occurs frequently enough to cause a gas waste of as much as one gallon in ten. It also causes a loss of power, and makes the engine hard to start.

Registered AC Spark Plug Cleaning Stations (there is one near you) are equipped to clean plugs—quickly and thoroughly—while you wait. Visit them regularly, every 4,000 miles, and you'll save gas and have a more responsive car.



Look for this
SIGN
when you need plugs
or plug service.



REPLACE PLUGS
THAT ARE WORN
WITH AC
THE QUALITY
SPARK PLUG

AC SPARK PLUG DIVISION
General Motors Corporation, FLINT, MICHIGAN

(Contents—Continued)

SCIENCE AND INDUSTRY

Earth's crust tested by blasts recorded	511
Energy source to replace coal learned from stars	518
Castor bean used in paint and chemicals	526
Rubber springs absorb shocks in big machines	560
Tarnishproof "skin" protects metal's color	560
New drills promise to bore miles into earth	562

SPORTS

Bicycle lamp generator mounts under saddle	504
Outboard racing boat trailer has living quarters	557
Wheeled tripods carry boat in trailer fashion	559
Weedless lure without barb latest for fishermen	574
Bike trailer carries surfboard	575

TOOLS

Scratcher disk for removing paint	503
Wrench with reversible jaw works automatically	503
Pocket size hardness tester	535
Table-top power tool unit for modelmaker	537
Grinder and drill with lever feed mounting	550
Scraper attached to blowtorch removes paint	120A

MISCELLANEOUS

Bayou "battleship" fights plant-locked river	502
Compressed-air gun shoots fish on ocean floor	503
Apples milled into baking flour	505
Sea life made visible in tanks with portholes	510
Moistureproof metal locator	512
Police carry shield and armor	512
Sawdust practical fuel for heating homes	512
Cotton picker does seventy-five men's work	513
Pumps no larger than the hand	518
Ship monument marks site where Swedes landed	518
Diesel-powered ocean liner sets speed record	519
Glass spheres sprayed on signs reflect light	519
Four mirrors on table show head at angles	539
Safety nut locks on bolt	539
Collecting poisonous spiders becomes a business	551
House with eight sides turned into museum	551
Wall washer saves paint and reduces work	560
Miniature trailer towed by a tricycle	561
"Loch Ness monsters" on parade in Paris	575

Craftsman and Shop Notes

AUTOMOTIVE

Fender-straightening tools grouped in rack	625
Helps for the auto mechanic	638
Clean crankcase ventilators often	639
How fleet operator saves gas	639
Portable sidewalk sign of pipe	639
Inexpensive hoist for tow truck	639
Battery hydrometer stored in radiator hose	640
Fitting oversize piston pins	640
Horn button moved to avoid short circuits	640
Tin can supports inner tube for repairs	640

CAMPING AND FISHING

Fish can't swallow triangle hook	586
Chemical kindling ignites campfires quickly	608
Rubber bands provide grip for flashlights	614

ELECTRICAL

Double-filament lamps in single-contact sockets	614
Choke coils control a.c. voltage	626
Rewiring building with aid of compressed air	630

FARM

Carrying of poultry diseases prevented	622
Barn-door hook pulls staples	624
Gate held open by hook at hinged end	624
Simple ventilator for poultry houses	632
Gate supported to prevent sagging	637
Wire ring supports poultry bucket on arm	637

FURNITURE

Modern mirrors you can build	583
White ironwork adds charm to chairside table	587
Hanging wall shelf of white pine	588
Tot's own dining set	591
Stool converted into baby's high chair	615

HAND TOOLS

Truing up distorted thread box	620
Gauge for selecting right nail quickly	624
Measuring tapers with two scales	625
Spring to eject small parts from vise	630
Pocket depth gauge from hacksaw blades	632
Swinging rack for drills	632

(Continued to page 8A)

When jobs are looking for men -that's news!



..... NOW IS THE TIME!

RIGHT now, in many lines there is a search for really good men—managers, leaders—men who can take charge of departments, businesses, branch offices, and set things humming.

As always, there are not enough ordinary jobs to go 'round—but rarely before in the history of American business, has there been so much room at the top!

Ordinarily, there would be plenty of men to fill these jobs—men in junior positions who have been studying in spare time. But most men have been letting their training slide during these dark years of depression . . . "What's the use?"—You have heard them say. Perhaps there has been some excuse for sticking to any old kind of a job one could get the past few years—but the door is wide open for the man with ambition **NOW!**

And don't let anyone tell you that "Opportunity Only Knocks Once"—that's one of the most untruthful sayings ever circulated. Opportunities flourish for every American

every day of his life.

Far more to the point is to be ready—be prepared—to make yourself interesting to the big-time employer—and, LaSalle offers you a short-cut method of qualifying for opportunity jobs in accounting, law, traffic, executive management, and kindred occupations.

LaSalle Extension is 30 years old—over 30,000 students enroll annually—60 American firms each employ 500 or more LaSalle-trained men—surveys show that average LaSalle students attain good salary increases after graduation—nearly 10% of all C. P. A.'s in the U. S. A. are LaSalle alumni.

Why not find out what LaSalle has done and is doing for men in your position? Send and get the facts; see what LaSalle can do for you personally!

There's no question about it—jobs are looking for trained men—the time has come for you to qualify for future prosperity. Mail this coupon today!

LaSalle Extension University, Dept. 1064-R Chicago

Kindly send me your free booklet on the business field I have checked—and tell me!

<input type="checkbox"/> Business Management	<input type="checkbox"/> Business Correspondence	<input type="checkbox"/> Salesmanship
<input type="checkbox"/> Business English	<input type="checkbox"/> Traffic Management	<input type="checkbox"/> Accountancy



Name.....

Address.....

LASALLE EXTENSION UNIVERSITY A CORRESPONDENCE INSTITUTION

When writing to advertisers please mention Popular Mechanics

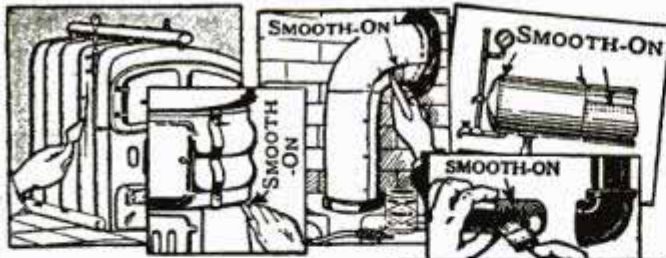

BE THRIFTY!
Do your own repairing with **SMOOTH-ON No. 1**

THIS cement hardens into metallic iron, costs little, is easy to apply and makes dependable permanent and emergency repairs that save the householder big sums.

By following directions in the Smooth-On instruction booklet you can stop steam and water leaks from joints or cracks in the boiler, heater, piping and radiators, stop leaks from gas lines, stop leaks of fumes from air furnaces, ovens and smoke pipes, in every instance avoiding a big labor bill and often the cost of a renewal part.

Smooth-On No. 1 is also excellent for resetting loose screws, nuts, rivets, hooks, hinges, locks, handles, drawer pulls, casters, etc., anchoring bolts and pipe posts in concrete, plugging holes or seam openings in tanks, troughs and pails, tightening loose bases, etc.

Be prepared for emergencies by sending for the free book and keeping a can of Smooth-On No. 1 in your workshop. Get Smooth-On No. 1 in 7-oz., 1-lb. or 5-lb. can from any hardware store, or if necessary from us direct.



Write for **FREE BOOK**



Do it with **SMOOTH-ON**

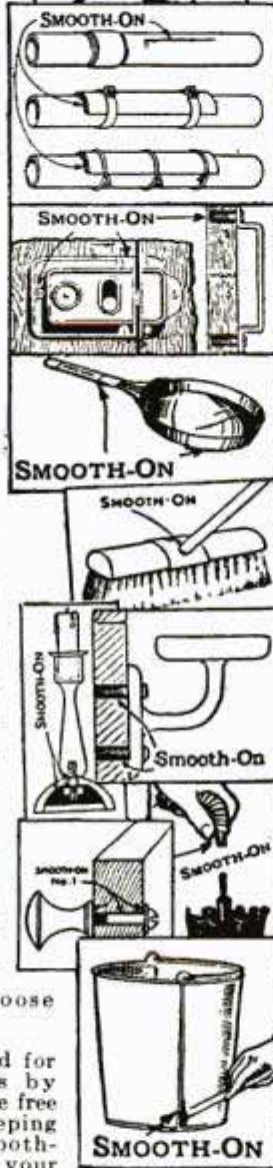

(Contents—Continued)

HOME IMPROVEMENTS

Porch light in polished brass 585
Attic door forms bookcase 587
Tricks of hanging wallpaper 594
Sparrow-proof martin house 618

HOUSEHOLD

Mask to decorate cakes and cookies 590
Wool socks dried on coat hanger 590
Rubber sink plug scours kitchen utensils 592
Guard over door crack protects child's fingers 600
Secret latch for bathroom cabinet 600
Stovepipe cleaned with skid chain 600
Bunny letter holder for the children 602
Partitioned clothes hamper 610
Solving home problems 616
Removing fish odor from dishes 621
Removing odor from bottle 625

MODELS

Graphite improves model plane 590
Modelmaker's clamps from safety pins 600
Modeling a Viking ship 611

PHOTOGRAPHY

Photos given background of gold or silver 590
Tripod adjusted to take photos close to ground 602
Photos framed with embroidery hoops 610

POWER TOOLS

Foot feed on drill press saves time 586
Lathe parting tool supported to avoid chatter 593
Keeping work from turning on a drill press 609
Midget circular saw for precision work 619
Knob improves drill-press feed handle 621
Tenoning jig for circular saw 621
Pan under lathe catches oil and chips 622
Spun finishes for lathe projects 623
Heavy arbor centered single-handed 630
How to build small gem-cutting bench 633

SPORTS

Arrow gun from old paintbrush 586
Golf balls stored in airtight can 586
How to clean your gun 605
Camera gun for fast action shots 615

STORE AND SHOP

Rack to carry garments on coat hangers 605
Magnet retrieves hairpins in beauty parlor 622
Books held at angle in window 637

MISCELLANEOUS

Neckties held on silent valet 585
Siding boards scored before sawing 586
Telescoping rule for inside measurements 590
Bilge pump drains boat quickly 592
Hooks to hold bar stock in vise 592
Producing microscopic effects 592
Removing bubbles from varnished surfaces 592
Defeating your dog 593
Rotating shelves for small-parts jars 593
Scissors to cut deckle edges 600
Aquarium fountain has no water connection 601
Inserting extra pages in spiral-bound books 602
Vacuum cups deaden vibration of small motor 602
Turned clock case has spun face 603
Check protected against altering in typewriter 605
Drawing board improved by strip on end 605
Hugo the hound whittled 606
Flowering bulbs grown successfully indoors 609
Warm hands in wet gloves 609
Hand pad used in carving with chisels 610
Jig to glue mitered joints 610
Wings add realism to bird cutouts 610
Concrete forms tied across top can't sag 614
Connecting small rubber tube to water faucet 614
Glass jug protected by rubber harness 614
Scraper on blowtorch cleans knife 614
Simple reels shaped from heavy wire 618
Refrigerating compressors started by using by-pass 622
Reducing noise in forced-air heating plant 624
Installing modern centrifugal pump 630
Bottle converted into glass funnel 632
Welding rods carried on torch 637

IMPORTANT NOTICE

It is the intention of this magazine to provide its readers with information regarding the latest developments in the mechanical arts. We take no responsibility as to whether the disclosures contained in our articles are covered by patents and advise readers to investigate this subject before making, using, or selling any of the products, machines, or processes described, in order to avoid possible liability for patent infringement.

Name.....
Address.....
10-38.....

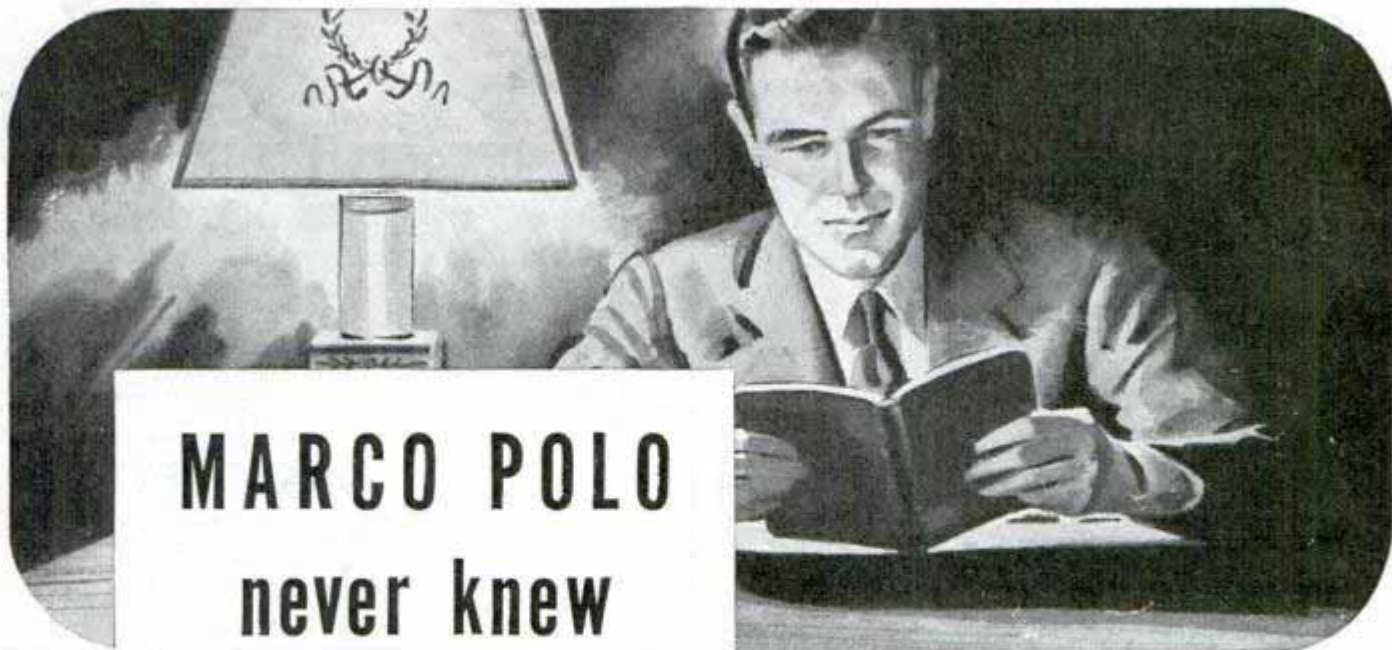

MARCO POLO
never knew

GREATER THRILLS

BOLD MARCO POLO, pushing eastward into the unknown, never knew greater thrills of discovery than this student of the International Correspondence Schools! His I. C. S. text is his guide-book to new and thrilling adventures in the world of knowledge.

The I. C. S. student learns the *why* while he studies at night. The very next

day, on his job, he experiences the grand ADVENTURE of seeing newly learned truths demonstrated.

For 47 years, the International Correspondence Schools have been training ambitious, adventuresome men. Today, many of them occupy high positions in Business and Industry—just as from the 100,000 I. C. S. students of today will come tomorrow's leaders, in many fields of business!

INTERNATIONAL CORRESPONDENCE SCHOOLS

BOX 5528-J, SCRANTON, PENNA.

★ Without cost or obligation, please send me a copy of your booklet, "Who Wins and Why," and full particulars about the subject *before* which I have marked X: ★

TECHNICAL AND INDUSTRIAL COURSES

- | | | | |
|--|--|--|--|
| <input type="checkbox"/> Architect | <input type="checkbox"/> Sheet Metal Worker | <input type="checkbox"/> Commercial Refrigeration | <input type="checkbox"/> Surveying and Mapping |
| <input type="checkbox"/> Architectural Draftsman | <input type="checkbox"/> Boilermaker | <input type="checkbox"/> Plumbing <input type="checkbox"/> Steam Fitting | <input type="checkbox"/> Bridge Engineer |
| <input type="checkbox"/> Building Estimating | <input type="checkbox"/> Telegraph Engineer | <input type="checkbox"/> Heating <input type="checkbox"/> Ventilation | <input type="checkbox"/> Bridge and Building Foreman |
| <input type="checkbox"/> Contractor and Builder | <input type="checkbox"/> Telephone Work <input type="checkbox"/> Radio | <input type="checkbox"/> Air Conditioning and Cooling | <input type="checkbox"/> Chemistry <input type="checkbox"/> Pharmacy |
| <input type="checkbox"/> Structural Draftsman | <input type="checkbox"/> Mechanical Engineering | <input type="checkbox"/> Steam Engineer | <input type="checkbox"/> Coal Mining |
| <input type="checkbox"/> Structural Engineer | <input type="checkbox"/> Mechanical Draftsman | <input type="checkbox"/> Steam Electric Engineer | <input type="checkbox"/> Mine Foreman <input type="checkbox"/> Fire Bosses |
| <input type="checkbox"/> Management of Inventions | <input type="checkbox"/> Machinist <input type="checkbox"/> Toolmaker | <input type="checkbox"/> Marine Engineer | <input type="checkbox"/> Navigation |
| <input type="checkbox"/> Electrical Engineer | <input type="checkbox"/> Patternmaker | <input type="checkbox"/> R. R. Locomotives | <input type="checkbox"/> Cotton Manufacturing |
| <input type="checkbox"/> Electric Lighting | <input type="checkbox"/> Diesel Engines | <input type="checkbox"/> R. R. Section Foreman | <input type="checkbox"/> Woolen Manufacturing |
| <input type="checkbox"/> Welding, Electric and Gas | <input type="checkbox"/> Aviation Engines | <input type="checkbox"/> Air Brakes <input type="checkbox"/> R. R. Signalmen | <input type="checkbox"/> Agriculture |
| <input type="checkbox"/> Reading Shop Blueprints | <input type="checkbox"/> Auto Technician | <input type="checkbox"/> Highway Engineering | <input type="checkbox"/> Fruit Growing |
| <input type="checkbox"/> Heat Treatment of Metals | <input type="checkbox"/> Auto Electrical Technician | <input type="checkbox"/> Civil Engineering | <input type="checkbox"/> Poultry Farming |

BUSINESS TRAINING COURSES

- | | | | |
|--|---|--|--|
| <input type="checkbox"/> Business Management | <input type="checkbox"/> Bookkeeping | <input type="checkbox"/> Service Station Salesmanship | <input type="checkbox"/> Grade School Subjects |
| <input type="checkbox"/> Industrial Management | <input type="checkbox"/> Secretarial Work | <input type="checkbox"/> First Year College Subjects | <input type="checkbox"/> High School Subjects |
| <input type="checkbox"/> Traffic Management | <input type="checkbox"/> Spanish | <input type="checkbox"/> Business Correspondence | <input type="checkbox"/> College Preparatory |
| <input type="checkbox"/> Accountancy | <input type="checkbox"/> French | <input type="checkbox"/> Stenography and Typing | <input type="checkbox"/> Illustrating |
| <input type="checkbox"/> Cost Accountant | <input type="checkbox"/> Salesmanship | <input type="checkbox"/> Civil Service <input type="checkbox"/> Mail Carrier | <input type="checkbox"/> Cartooning |
| <input type="checkbox"/> C. P. Accountant | <input type="checkbox"/> Advertising | <input type="checkbox"/> Railway Mail Clerk | <input type="checkbox"/> Lettering Show Cards <input type="checkbox"/> Signs |

DOMESTIC SCIENCE COURSES

- | | | |
|---|---|--|
| <input type="checkbox"/> Home Dressmaking | <input type="checkbox"/> Advanced Dressmaking | <input type="checkbox"/> Foods and Cookery |
| <input type="checkbox"/> Professional Dressmaking and Designing | | <input type="checkbox"/> Tea Room and Cafeteria Management, Catering |

Name.....Age.....Address.....

City.....State.....Present Position.....

If you reside in Canada, send this coupon to the International Correspondence Schools Canadian, Limited, Montreal, Canada
If you reside in England, send coupon to I. C. S., 71 Kingsway, London, W. C. 2, England

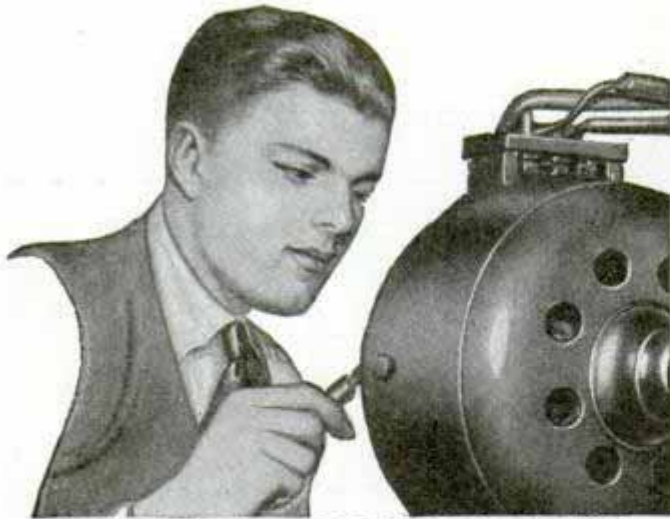

AMAZINGLY EASY WAY TO GET INTO

ELECTRICITY

12 Weeks' Practical Training in the big Chicago Coyne Shops

Let us prepare you for your start in a good paying field. Let us teach you how to prepare for positions that lead to good salaries in Electricity—NOT by correspondence, but by an amazing way we teach right here in the great Coyne Shops. You get a practical training in 90 days. Electricity offers many opportunities to the trained man. Prepare today to take your place in the great field of Electricity. Mail coupon today.

LEARN BY DOING—IN 90 DAYS BY ACTUAL WORK—IN COYNE SHOPS

I don't care if you don't know an armature from an air brake—I don't expect you to! Coyne training is practical "learn-by-doing" training. Don't let lack of money hold you back from getting all details of my amazing plan.

MANY EARN WHILE LEARNING

If you need part time work to help pay your expenses, we may be able to help you as we have hundreds of others. When you graduate we'll give you lifetime employment service. And, in 12 brief weeks, in the great shops of Coyne, we train you as you never dreamed you could be trained . . . on one of the greatest outlays of electrical apparatus ever assembled . . . real dynamos, engines, power plants, autos, switchboards, housewiring, armature winding and many other branches of Electricity.

ELECTRIC REFRIGERATION AIR CONDITIONING

Right now we are including additional instruction in Electric Refrigeration and Air Conditioning without extra cost so that your training will be more complete and you can get into this marvelous, rapidly expanding field.

GET THE FACTS Coyne is your great chance to get into Electricity. This school is 39 years old—Coyne training is tested. You can find out everything absolutely free. Simply mail the coupon and let us send you the big, free Coyne book with photographs . . . facts . . . opportunities. Tells you how many earn expenses while training and how we assist our graduates in the field. No obligation to you. So act at once. Just mail coupon.

BIG FREE BOOK! Send for my big book containing photographs and telling the complete story—absolutely FREE.



COYNE ELECTRICAL SCHOOL

500 S. PAULINA ST., Dept. 78-72, CHICAGO, ILL.

H. C. LEWIS, Pres., COYNE ELECTRICAL SCHOOL
Dept. 78-72, 500 S. Paulina St., Chicago, Ill.

Dear Mr. Lewis: Without obligation send me your big, free catalog with facts about Coyne Training and details of your "Plans" to help me.

Name..... Age.....

Address.....

City..... State.....

EASY

SOPRANI AMPLIPHONIC

Simplifies Playing

● Lighter, easier to play, less bellows-ing, plus more beautiful tone and volume,—that's how Soprani's exclusive Ampliphonic feature has simplified this accordion. Assures rapid progress. Home trial. Easy terms. See your music dealer or send for beautiful free book. Write today.



Nunzio, New York, with his Soprani 182

SOPRANI, INC. Dept. 1029, 630 S. Wabash Ave. Chicago, Illinois

GAG-CARTOON!



AND MAKE BIG MONEY—AT HOME—BY MAIL! Magazines pay up to \$200.00 per cartoon. Get in this NEW FIELD and be your own boss! My 50 lesson—1000 Illustration course shows you how. **CARTOON MARKETS INCLUDED—\$280**
All for.....

Send for FREE details, **MOON GAG-CARTOON SCHOOL**
Box 106 — Dept. A6, Fall Creek, Wis.

SONG POEM WRITERS

... WRITE POEMS FOR US ...
Our progressive methods have aided many song poem writers to have their poems set to music and to secure publication of their songs.
Send for free booklet, "THE KEY TO YOUR FUTURE IN SONGWRITING" and information about our 50-50 plan.
Submit poems for free examination. (Our 17th year of service.)
INDIANA SONG BUREAU, Dept. 19, Salem, Indiana

BE A PASSENGER Traffic Inspector

A Good, Well-Paid Job for YOU!
Railway and Bus Lines constantly ask for our trained graduates. Men—19 to 50—make good and advance quickly with experience. Short, home-study course qualifies you and upon completion, we help place you at up to \$135 per month, plus expenses, to start, or refund tuition.
Write for the interesting story of Traffic Inspection.
STANDARD BUSINESS TRAINING INSTITUTE, Div. 216, Buffalo, N. Y.

LEARN WATCHMAKING AND ENGRAVING BY OUR PROFIT-SHARING PLAN OUR GRADUATES SUCCEED

One of our Iowa students started in a very small way—now doing over \$30,000 a year. Another in Wisconsin, over \$10,000 the first year. Day or night classes. Call or write for FREE BOOK.
Chicago School of Watchmaking, Dept. 6801, 155 N. Clark St., CHICAGO.

EARN THE DEGREE

Doctor of Psychology (Ph.D.), Philosophy, Science, General Courses—Arts, Law, Business, etc. "CHARTERED BY STATE OF MONTANA." Send for 32-page FREE Bulletin at once. No Obligation.
Temple Bar College, Dept. 2-R, 213 East Main Street Missoula, Montana, U. S. A.



FOLLOW THIS MAN

Secret Service Operator No. 38 is on the job! Running down dangerous Counterfeit Gang. Tell-tale finger prints in murders; girl's room.
Free The Confidential Report Operator No. 38 made to his chief. Write for it.
Earn a Regular Monthly Salary
YOU can become a Finger Print Expert at home, in your spare time, at small cost. Write for confidential full report and details. Literature will be sent only to persons stating their age.
INSTITUTE OF APPLIED SCIENCE
Dept. 1357 1920 Sunnyside Ave. Chicago, Ill.

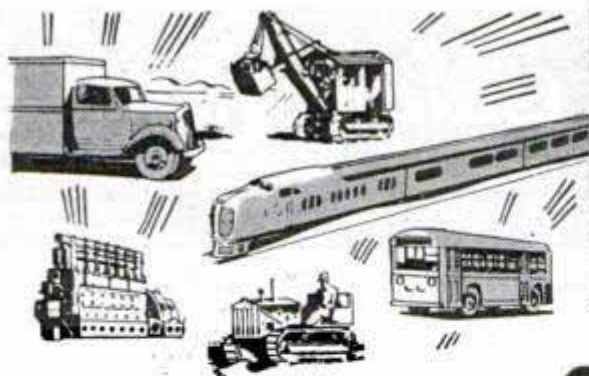

DIESELS

THE NEXT GREAT INDUSTRY

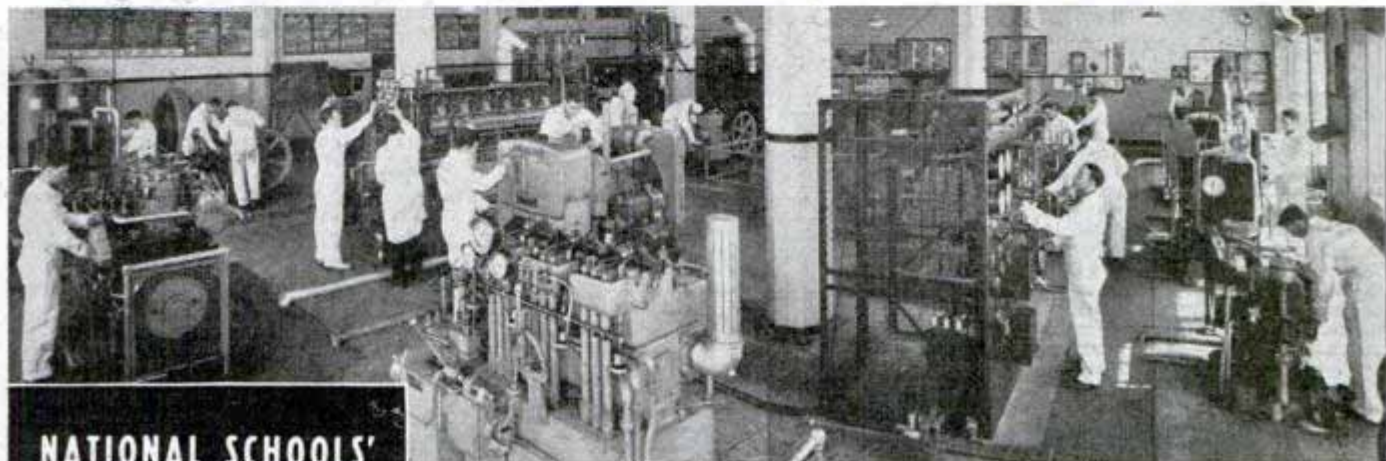

Engine Department of National's Diesel Shops and Laboratories, a portion of a million-dollar trade school occupying its own modern three-story building. Here you are trained by an experienced staff of engineers and instructors with latest equipment.

NATIONAL SCHOOLS' Master Training includes:

- DIESEL ENGINES
- DIESEL FUEL SYSTEMS
- GAS AND OTHER INTERNAL COMBUSTION ENGINES
- DIESEL AND AUTOMOTIVE ELECTRICITY
- MACHINE SHOP
- DIESEL ELECTRIC POWER GENERATION

YOU NEED REAL SHOP EXPERIENCE WITH TIME-TESTED TRAINING

Mail the coupon at right. In the literature you will be sent, you will see exactly how other men like you are preparing themselves for success in National's modern training shops. You learn on the latest, finest equipment. You do real job work. You learn by time-tested, shop practice methods. Your training is fascinating in every detail. You are taught how to make good, and helped to make good after you graduate. All of this and much more is clearly pictured for you in the Free Book of Facts we will send to you.

TESTED TRAINING—REAL SHOP EXPERIENCE INTERNAL COMBUSTION ENGINES—AUTOMOTIVE SERVICE

Unquestionably Diesel Power is the next GREAT industry. Trucks, tractors, trains, generators, marine and mining equipment are accepting Diesel Power. Mass production of Diesels has started. Millions are being invested. 1938 sales of Diesels should show a 20 per cent increase.

Ambitious men who want to learn a profitable trade should get National's sincere, honest statement of facts about the Diesel Industry. Diesel operation requires precise knowledge. Men with practical training are in demand. National School's actual shop practice methods of instruction will qualify you for good-paying jobs in this rapidly developing field.

TRANSPORTATION ALLOWED TO LOS ANGELES

National students are allowed coach railroad fare from any point in the United States. (Canadian students from nearest point of entry.)

EARN ROOM & BOARD

Many students are helped with spare-time jobs to earn room and board while learning. Graduate employment cooperation.

NATIONAL SCHOOLS

Los Angeles

MAIL THIS COUPON

NATIONAL SCHOOLS (Established 1905)
Dept FMA-10, 4000 E. Figueroa St., Los Angeles
Please send me, without obligation, your FREE BOOK and information regarding Diesel Employment Opportunities and Requirements.

NAME _____

CITY _____ STATE _____

ADDRESS _____ AGE _____

FREE
DIESEL
OPPORTUNITY
BOOK OF
TRAINING FACTS

I WONDER, CAN I BECOME A DRAFTSMAN...OR IS THIS AD TALKING TO SOMEONE ELSE?

Become a Draftsman



READ HOW THEY EARN BIG PAY!

STEADY WORK

Nearly all manufacturing and construction starts on the drafting table. This means that the draftsman is one of the first to be hired and one of the last to be laid off. Drafting is a steady, life-time job that a man can keep . . . without fear of reduced wages as a result of growing old. In fact, the older a draftsman becomes, the more experience he has, the greater his earning capacity should be!

WHAT A DRAFTSMAN DOES

Somebody gets an idea. A draftsman is called into the boss' office. The idea is conveyed to him. He goes to his drafting table and puts the idea on paper. It may be a new kind of nut or bolt . . . even such a simple thing as that may provide weeks of good pay for the draftsman. It might be a mile-long bridge . . . a 10,000 horse-power motor . . . a new kind of elevator . . . an improved type of railroad locomotive. Right now draftsmen are working on 300 passenger airliners! It might be anything, but the draftsman has to be called in first . . . and he IS.

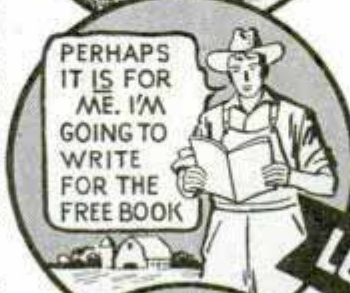

PERHAPS IT IS FOR ME. I'M GOING TO WRITE FOR THE FREE BOOK



LATER

BILL, THERE GOES THE NEW DIESEL LOCOMOTIVE I HELPED DESIGN

(TO HIMSELF) AND TO THINK THAT ONCE I DOUBTED

GIVES BEST CHANCE FOR PROMOTION

The draftsman always works directly with the important men of the organization. It may be the superintendent . . . the engineer . . . or even the prospective buyer with whom he consults. Because he comes to know the boss so well, he usually gets first consideration when a new, better job opens up.

YES, THIS AD IS FOR YOU LEARN AT HOME IN SPARE TIME

It makes little difference what you have done before or what you are doing now . . . this ad is for you. Whether you can draw or not . . . this ad is still for you. The success of our students and graduates indicates that no special talent or education are needed beyond that contained in our training. And you can take this training at home . . . without giving up your present job. The lessons are simple, easy and you progress rapidly to your goal. Remember . . . no matter what you are doing now . . . the great field of drafting with all its rewards, is open to you.

DON'T GROW OLD AT 40 . . . WRITE FOR FREE BOOK

Begin at once to train for a big drafting job . . . so that you can be independent and self-supporting now . . . and in later years. A drafting job will help you to increase your earning power more and more as time goes on, and by so doing you will be able to do far more for yourself and your family than if you try to continue as an untrained man. Don't be one of those who goes down-hill at 40. Become a draftsman . . . enjoy progress! . . . contentment! . . . independence! Write at once for FREE BOOK "How to Become a Draftsman." It explains everything. American School, Dept. DD-745, Drexel at 58th, Chicago

Know! YOUR CAR

ASK TO SEE IT!

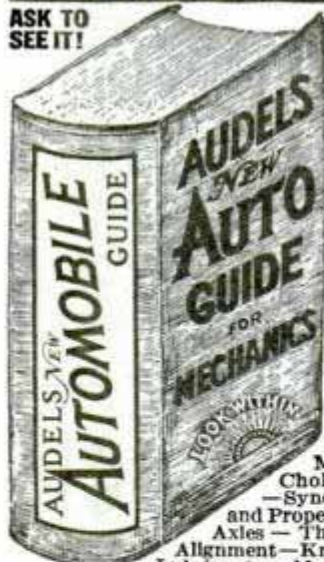

GOOD NEWS—JUST OUT

1938 AUDELS NEW AUTOMOBILE GUIDE is NEW from cover to cover. Explaining the Theory, Construction and Servicing of modern motor cars, trucks and buses; and the application of auto type Diesel Engines. . . . PRACTICAL INFORMATION IN HANDY FORM, 1540 PAGES COVERING . . .

AUTO REPAIRS & SERVICE HELPS

All the Parts of an Automobile—Automotive Physics—The Gas Engine—How a Gas Engine Works—Gas Engine Principles—Multi-Cylinder Engines—Horse Power—Automobile Engines—Engines: Stationary Parts—Engines: Moving Parts—Pistons—Piston Rings—Connecting Rods—Crank Shafts—The Valves—The Valve Gear—Cams and Cam Action—Valve Timing—Cooling Systems—Gasoline—Fuel Feed Systems—The Mixture—Carburetors—Automatic Choke—Super-Chargers—Transmissions—Synchro-Mesh—Clutches—Universals and Propeller Shafts—The Differential—Rear Axles—The Running Gear—Brakes—Wheel Alignment—Knee Action—Steering Gear—Tires—Lubricants and Lubrication—Automotive Electricity—Ignition Systems—Magneto Ignition—Spark Plugs—Ignition Coils—Distributors—Automatic Spark Control—Ignition Timing—Generators—Starters—Generator and Starter Testing—Lighting Systems—Storage Batteries—Battery Charging—Battery Testing Troubles. **Automotive Diesel Engines.** Inside Views of all Automobile Parts Fully Illustrated. To Get This Assistance for Yourself Simply Fill In and Mail Coupon Today.

\$4 COMPLETE • PAY ONLY \$1. A MONTH

THEO. AUDEL & CO., 49 WEST 23rd STREET, NEW YORK
Please send me postpaid AUDELS NEW AUTOMOBILE GUIDE (\$4) for free examination. If I decide to keep it, I will send you \$1 within 7 days; then remit \$1 monthly until purchase price of \$4 is paid. Otherwise, I will return it to you promptly.

Name _____
Address _____
Occupation _____
Reference _____ PM

When writing please mention Popular Mechanics

ELECTRICAL ENGINEERING

ONE YEAR condensed course prepares for technical work in the electrical field. Thorough training in principles, with practical applications in laboratory and shop. High placement record. Modern buildings, dormitory, dining hall. Campus. 46th year. Catalog on request.



BLISS ELECTRICAL SCHOOL
120 Takoma Ave. Wash., D.C.

LEARN MECHANICAL DENTISTRY

SEND FOR FREE BOOK YOUR FUTURE

Special Tool Offer—Now!

Don't waste the best years of your life. Learn this **money-making** business in a few months, Day or Evening, and become independent. Big demand. *Highly endorsed—oldest school.* Practical, individual training. Easy terms. Write NOW for free catalog P and trial offer.

New York School of Mechanical Dentistry,
125-127 West 31st Street, Dept. 9, New York City

LEARN AVIATION

Great Opportunities For Trained Men

Aviation needs trained men. Come to Roosevelt—Government approved for all classes of pilots and mechanics certificates—and let our experts prepare you for a position in this fast growing industry. Roosevelt offers career courses in Flying, Mechanics, Sheet Metal and Design. Write for full information; state age. Address Dep't. P. M.

ROOSEVELT AVIATION SCHOOL

MINEOLA, LONG ISLAND, NEW YORK



I jumped from \$18 a week to \$50
-- a Free Book started me toward this
GOOD PAY IN RADIO

HERE'S
How it
Happened
 by S. J. E.
 (NAME AND ADDRESS
 SENT UPON REQUEST)



"I had an \$18 a week job in a shoe factory. I'd probably be at it today if I hadn't read about the opportunities in Radio and started training at home for them."



"The training National Radio Institute gave me was so practical I was soon ready to make \$5, \$10, \$15 a week in spare time servicing Radio sets."



"When I finished training I accepted a job as serviceman with a Radio store. In 3 weeks I was made service manager at more than twice what I earned in the shoe factory."

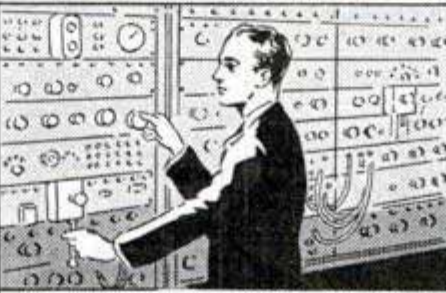

"Eight months later N.R.I. Employment Department sent me to Station KWCR as a Radio operator. Now I am Radio Engineer at Station WSUL. I am also connected with Television Station W9XK."



"N.R.I. Training took me out of a low-pay shoe factory job and put me into Radio at good pay. Radio is growing fast. The field is wide open to properly trained men."



Find out today how I Train You at Home
to BE A RADIO EXPERT

J. E. SMITH,
 President
 National Radio
 Institute
 Established 1914

**Many Make \$30,
 \$50, \$75 a Week**

Do you too want a better job? Do you too want to make more money? Radio offers many spare time and full time opportunities for good pay.

Get Ready Now for Jobs Like These

Broadcasting stations employ engineers, operators, station managers and pay up to \$5,000 a year. Fixing Radio sets in spare time pays many \$200 to \$500 a year—full time repair jobs pay many \$30, \$50, \$75 a week. Many Radio Experts open full or part time Radio businesses. Radio manufacturers and jobbers employ testers, inspectors, foremen, engineers, servicemen, paying up to \$6,000 a year. Automobile, police, aviation, commercial Radio, loud speaker systems, offer good opportunities now and for the future. Television promises good jobs soon. Men I trained have good jobs in these branches of Radio.

Many Make \$5, \$10, \$15 a Week Extra in Spare Time While Learning

The day you enroll I start sending Extra Money Job Sheets showing how to do Radio repair jobs. Throughout your training I send plans and ideas that made good spare time money—\$200 to \$500 a year—for hundreds. I

send Special Radio Equipment to conduct experiments, build circuits, get practical experience. I ALSO GIVE YOU A MODERN, PROFESSIONAL ALL-WAVE ALL-PURPOSE RADIO SET SERVICING INSTRUMENT TO HELP FIX SETS QUICKER—SAVE TIME, MAKE MORE MONEY.

Find Out What Radio Offers You

Mail the coupon now for "Rich Rewards in Radio." It's free to any fellow over 16 years old. It points out Radio's spare time and full time opportunities, also those coming in Television; tells about my Training in Radio

and Television; shows 131 letters from men I trained, shows what they are doing, earning; shows my Money Back Agreement. MAIL COUPON in an envelope, or paste on penny post card—NOW!

J. E. SMITH,
 President, Dept. 8KP
 National Radio
 Institute
 Washington, D. C.

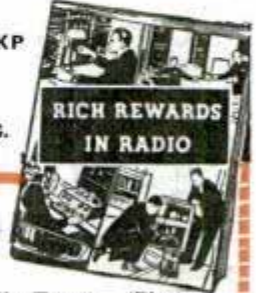

**J. E. SMITH, President, Dept. 8KP
 National Radio Institute, Washington, D. C.**

Dear Mr. Smith: Without obligating me, send "Rich Rewards in Radio," which points out spare time and full time opportunities in Radio, and explains your practical method of training at home in spare time to become a Radio Expert. (Please write plainly.)

Name..... Age.....
 Address

When writing to advertisers please mention Popular Mechanics

**This
MACHINISTS'
Home-Study
Course**



helps men get ahead

Newly assembled—specially priced—these five recent books give you the practical facts on modern machines, up-to-date methods, you need to advance in machine shop work. Take advantage of the other man's experience as found in books, to solve your problems, increase your efficiency, with

**The NEW AMERICAN
MACHINISTS' LIBRARY**

5 volumes—2014 pages—1853 illustrations

(A combined home-study course and reference library)

This library of machine shop practice was written for practical men. It gives you the best methods for every kind of machine shop work. It fully explains lathes, drills, and other machine tools and their operation, automatic screw machines, speeds and feeds, gear design and production, punch and die work, metal surfacing, etc., etc. Plainly written—completely illustrated—the best kind of help to the machine shop man who wants to advance himself.

No money down—special price—easy payments.

FREE EXAMINATION COUPON

McGraw-Hill Book Co., 330 W. 42nd St., New York

Send me for ten days' free examination the new American Machinists' Library. If satisfactory I will send you \$1.50 in 10 days and \$3.00 monthly until the price of \$16.50 is paid. If not wanted, I will return the books postpaid. (To insure prompt shipment write plainly and fill in all lines.)

Name

Home Address

City and State

Position

Name of Company

PM-16-38

**Learn this
Profitable
Profession**



in 90 Days at Home

Hundreds of men and women of all ages 18-50 make \$10.00 to \$20.00 in a single day giving scientific Swedish Massage and Hydro-Therapy treatments. There is a big demand from Hospitals, Sanitariums, Clubs, Doctors and private patients as well as opportunities for establishing your own office. Learn this interesting money-making profession in your own home by mail, through our home study course. Same instructors as in our NATIONALLY KNOWN resident school. A diploma is awarded upon completion of the course. Course can be completed in 3 to 4 months. High School training is not necessary. Many earn big money while learning.



Anatomy Charts & Booklet FREE

Enroll now and we will include uniform coat, medical dictionary, patented reducing roller and Hydro-Therapy supplies without extra cost. The reducing course alone may be worth many times the modest tuition fee.

Send coupon now for Anatomy Charts and booklet containing photographs and letters from successful graduates. These will all be sent postpaid—FREE.

THE College of Swedish Massage (Successor to National College of Massage)
Dept. 764—1601 Warren Boulevard, Chicago.

You may send me FREE and postpaid, Anatomy Charts, booklet containing photographs and letters from graduates, and complete details of your offer.

Name

Address

City

State

**EASIEST
to Master**



This New P-A

Such beautiful tone, and so easy to play! Just touch a key and blow normally; you can't miss. Nothing to compare with these new P-A Saxes, Clarinets, Trumpets, and other P-A instruments. Fully guaranteed; your success assured. See your music dealer or write direct for beautiful, free book. No obligation. Easy terms. 1286

PAN-AMERICAN
1003 P-A Building Elkhart, Indiana

**ENGINEERING DEGREE IN
TWO YEARS**

B.S. DEGREE courses in engineering; Electrical, Civil, Chem., Mechanical, Radio and Television, or Aeronautical. 1yr. Mech. Drafting, Intense, practical, thorough program. Prep courses without extra charge. Earn while you learn in this industrial center. Low tuition. Enter March, June, Sept., Dec. Write for Catalog. 229 E. Washington Blvd., Fort Wayne, Ind.

INDIANA TECHNICAL COLLEGE

WIN YOUR DAWN WITH THE PATROL

Unequaled advantages in location for all year flying, finest equipment, highest Government approval for obtaining license in Transport, Limited Commercial, Private Flying, Radio, Sheet Metal, Mechanical Courses. For complete illustrated catalog, write—



J. D. GREEN, Director, Dept. PM 12, TULSA, OKLAHOMA

SCHOOL OF AVIATION

LEARN WATCH REPAIRING



AT HOME You can learn by our modern and original system of instruction every part of the Watch Repairing Trade at home. You can earn money while learning and prepare yourself for a well paying position or start in business after completing our course of instruction. Good watch repairers are in demand and generally earn very good salaries. For particulars apply to the Wisconsin School of Watch Repairing 524 E. Mason St., MILWAUKEE, WIS.

Learn MECHANICAL DENTISTRY AT HOME!

To make Crowns, Plates, Bridgework, etc., for Dentists. Easy practical way to learn mechanical dentistry at home in spare time. FULL EQUIPMENT OF TOOLS AND MATERIALS INCLUDED WITH COURSE. Low tuition. Easy terms. Write for FREE BOOK about this money making profession that is not affected by machine era. McCARRIE SCHOOL OF MECHANICAL DENTISTRY 207 N. Broad St., Dept. 738, Philadelphia, Pa.

Photography



for PLEASURE or PROFIT

Prepare for profitable business or fascinating hobby, at home under guidance of qualified instructors. No previous experience necessary, common school education sufficient. Many earn while learning. Our practical studio methods also qualify for well-paying positions upon graduation. Send coupon below at once for free booklet "Opportunities in Modern Photography", particulars and requirements.

AMERICAN SCHOOL OF PHOTOGRAPHY
3601 Michigan Avenue Dept. 1357 Chicago, Illinois

Send booklet, "Opportunities in Modern Photography", full particulars and requirements.

Name

Address

City

State



**IT'S DIESELS
Everywhere
YOU LOOK!**



On the Rails



On the Sea



In the Air



On the Highways

*.. and Where There Are Diesels
You Find H. D. S. Graduates*

Almost every day . . . right in your own daily life . . . you see Diesels at work . . . read about, or hear about, this great new form of power . . . about how it is spreading like wildfire. Hemphill Schools graduates are in the thick of this great swing to Diesel. Back of thousands of Diesel horsepower turning the wheels, driving the propellers . . . meeting the world's numerous power needs . . . are Hemphill men, in the many interesting, "big future" jobs offered by Diesel.

H. D. S. graduates are operators, chief engineers, sales engineers, superintendents, service men, master mechanics . . . to name only a few of the types of positions. They qualified for their jobs and opportunities the proven Hemphill way . . . through practical training that you, too, can obtain at any one of the Hemphill Diesel Schools you may prefer to attend. Or you can start your training at home . . . now. For complete information on Hemphill Diesel courses, send the coupon today.



**HEMPHILL
DIESEL SCHOOLS**

Located only in the cities listed below and in no way connected with any other schools of similar name.

BOSTON, 114 Brookline Avenue
NEW YORK, 31-26 Queens Blvd., L. I. City
DETROIT, 2341 W. Lafayette Blvd.
CHICAGO, 2014 Larrabee Street
MEMPHIS, 417 Monroe Avenue
LOS ANGELES, 2120 San Fernando Road
SEATTLE, 501 Westlake North
VANCOUVER, B. C., 1363 Granville Street

Please send me new issue of "March of Diesel" booklet and details on Hemphill Diesel training. (This special information is intended only for men between the ages of 18 and 45).

NAME _____ AGE _____

STREET _____

CITY _____ STATE _____ m-30-p

Send This Coupon To Nearest Address Shown At Left



High School Course at Home

Many Finish in 2 Years

You can complete this simplified High School Course as rapidly as your time and abilities permit. Equivalent to resident school work—prepares you for entrance to college. Standard H. S. texts supplied—Diploma. Credit for H. S. subjects already completed. Single subjects if desired. High School education is very important for advancement in business and industry and socially.

College Entrance

During the past 14 years, our High School graduates have been admitted to 531 different Universities, Colleges, Junior Colleges and Normal Schools—80% of them without entrance examination. Course also prepares for teachers' certificate and pre-professional examinations.

Business—Industry

To get and hold a good position in Business today you must be able to write clear, accurate letters and reports—do figuring involving Algebra and Geometry—talk intelligently on matters requiring a knowledge of Geography, History, and Economics.

In Industry—Mechanical and Engineering lines—you must have at least an elementary knowledge of Physics and Chemistry—be able to figure quickly and accurately—know something of Mechanical Drawing and blueprints—and be able to talk and write accurately and clearly on both your work and ordinary topics of conversation.

Our High School course meets the preparatory educational requirements for Business and Industry

An Educational Institution

The American School was chartered in 1897 as an educational institution, not for profit—and is exempt from paying Federal income tax, like the best resident colleges and universities.

Don't Be Handicapped— Complete Your Training Now

Be a High School Graduate! Prepare yourself for promotion in Business and Industry—for the Professions, College Entrance and social success. No matter what line you may select, High School training will prove invaluable to you! Our moderate fees cover all instruction, standard textbooks and Diploma. Easy monthly terms. Get ahead in life. Start your training NOW!

20 Other Courses

Over 150 noted Educators, Engineers, and Business Men helped prepare our special instruction material, which is used by many resident schools and colleges, U. S. Navy, and Province of Manitoba, Canada. We offer you quality training at home for the best-paying lines of Industry and Business, as listed in the coupon.

Mail coupon for information about line that interests you
American School, Drexel at 58th, Chicago

American School, Dept. H-745, Drexel at 58th, Chicago

Tell me how to train for success in line checked. No obligation.

- | | |
|--|--|
| <input type="checkbox"/> Accounting & Auditing | <input type="checkbox"/> Diesel Engineering |
| <input type="checkbox"/> Architecture & B'lding | <input type="checkbox"/> Drafting & Design |
| <input type="checkbox"/> Automotive Engin'ring | <input type="checkbox"/> Liberal Arts |
| <input type="checkbox"/> Business Management | <input type="checkbox"/> Private Secretary |
| <input type="checkbox"/> Com'ercial Aeronautics | <input type="checkbox"/> Hi'er Ac't'g (C.P.A.) |
| <input type="checkbox"/> Electrical Engineering | <input type="checkbox"/> Highway Engin'ring |
| <input type="checkbox"/> Electrical Refrigerat'n | <input type="checkbox"/> Mechanical Engin'ring |
| <input type="checkbox"/> Air Conditioning | <input type="checkbox"/> Radio & Television |
| <input type="checkbox"/> Civil Engineering | <input type="checkbox"/> Salesmanship |
| <input type="checkbox"/> Complete Law | <input type="checkbox"/> Steam Engineering |

Name.....

Address.....

When writing please mention Popular Mechanics

PARKS AIR COLLEGE

PARKS AIRPORT

EAST ST. LOUIS, ILL.

Offers YOU COLLEGE and PROFESSIONAL TRAINING Majoring in AVIATION

Accredited by the Illinois Superintendent of Public Instruction. U.S. approved as a Commercial Ground and Flying School and Mechanics' School. Open to high school graduates.

FOUR courses lead to B.S. degrees in Professional Piloting, Aviation Operations, Maintenance Engineering, Aeronautical Engineering.

THIRTEEN TRAINING PLANES are used in professional flight training which prepares graduates for airline flight operations. 74% of graduates enter air transportation in North and South America. 69,000 hours flight training given, 650 hours being flown monthly. FACULTY of 34 specialists in various fields of aviation.

1503 graduates. Enrollment limited to a total of 300.

100-acre airport, 14 buildings devoted to school purposes exclusively. Dormitories and dining hall at the College.

Winter Term January 4th. Send postcard for new 60-page catalog.

12th YEAR **Registrar, Dept. PM-10**
PARKS AIR COLLEGE, East St. Louis, Ill.

You Can Regain Perfect Speech, if you

STAMMER

Send today for beautifully illustrated book entitled "DON'T STAMMER," which describes the Bogue Unit Method for the scientific correction of stammering and stuttering. Method successfully used at Bogue Institute for 37 years—since 1901. Endorsed by physicians. Full information concerning correction of stammering sent free. No obligation. Benjamin N. Bogue, Dept. 195 Circle Tower, Indianapolis, Indiana.

ENGINEERING

DEGREE
IN TWO
YEARS

TECHNICAL AND APPLIED COURSES. Nonesentials omitted. TIME AND MONEY SAVED. Degree 2 yrs., diploma 1 yr. Electrical, Mechanical, Architectural, Structural, Civil, Aeronautical, Highway. All courses include Air Conditioning, Electric Refrigeration and Diesel. Short intensive courses 3 and 4 months in Electricity, Power Plant, Diesel-Electric, Air Conditioning, Electric Refrigeration. Drafting. Extensive modern equipment. LOW TUITION. Part-time work for room and board. Thousands of

successful graduates in U. S. and foreign lands. Approved by Industry, endorsed by educators, recommended by alumni. One and two-year courses open in Sept., short courses open year round. 39th YEAR. Catalog free.

FINLAY ENGINEERING COLLEGE

1001 Indiana Avenue

Kansas City, Mo.



Learn to Write

Begin Today. Write for our Free Book, "How to Become a Good Penman." It contains specimens and tells how others learned to write in spare time. Your name elegantly written on a card if you enclose stamp for postage. Write today. The Tamblin School of Penmanship, 418 Ridge Bldg., Kansas City, Mo.

RADIO ENGINEERING

broadcasting, aviation and police radio, servicing, marine and Morse telegraphy taught thoroughly. Nine months' engineering course equivalent to three years' college radio work. School established 1874. All expenses low. Catalog free.

Dodge's Institute, Ada St., Valparaiso, Ind.

MONEY-MAKING OPPORTUNITY

for men of character. Over \$1,000 per month earned by California man. Over \$400 a week by Georgia man. \$1,000 in a month by Delaware man. Exclusive franchises available for an invention expected to replace a multi-million dollar industry. Install on free trial. Sells itself. Repeat. Exclusive proposition. Write F. E. Armstrong, Dept. 1112-K, Mobile, Alabama.

Stop Slamming Doors AMAZING MONEY MAKER!

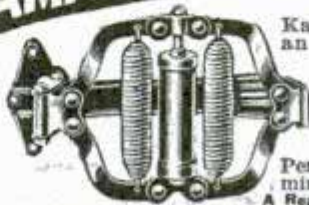

Kant-Slam Door Check is an amazing invention that closes all doors silently and automatically. Closing speed easily adjusted by turning screw at top of check. Holds doors open when wanted open. Operates on hydraulic principle. Low priced. Permanent. Easily installed in ten minutes. Never needs attention.

A Real Demonstrator Furnished Every Agent
You get orders quickly demonstrating actual sample on easy to carry miniature door. Every office, factory, store, institution, and public building needs a Kant-Slam for every door. Rush name and address for details of amazing money-making opportunity.
FREE Demonstrator to Workers
KANT-SLAM DOOR CHECK CO.
Dept. D-53, Bloomfield, Ind.

A Message to Those Interested in Getting a Government Position

By *A. C. Kehr, Managing Director,
The Patterson School of Rochester, N. Y.*

THE Patterson School of Rochester, N. Y., was founded in 1911 by Arthur R. Patterson. Its sole activity is to prepare students for Civil Service examinations. Mr. Patterson still serves the School as its Principal. His life work has been the training of men and women for Government positions.

Although for nearly eight years previous to his founding of the Patterson School, Mr. Patterson was a member of the Civil Service Board of Examiners at Rochester, N. Y., the School *does not now have, nor has ever had, any connection with the U. S. Government.* It is a private school.

During the 27 years of its existence—under six U. S. Presidents—the School has enjoyed an excellent record of success. Hundreds upon hundreds of its graduates have passed their Civil Service examinations with high marks, and as a consequence received appointments to well-paid Government jobs.

Why Are These Examinations So Important?

Naturally, Government examiners cannot personally interview and test every applicant, for every one of the positions that are filled each year. So group examinations are held, to determine which applicants are best fitted for appointments.

Therefore you can see how a high mark on your examination is all-important. The applicants who get the highest marks receive first consideration for appointments. For Uncle Sam knows nothing about you, except your name and a few other general facts—until you show him, on your examination paper, that you are worthy of employment.

There's no "bluffing your way through"; no special appeal you can make. You either pass or you don't pass. Either you get a high mark or you don't. And, to get a high mark, you should be informed—you should be prepared.

How the Patterson School Prepares You

Frankly, you might obtain the necessary preparation yourself—if you knew what kind of information you would be asked, and how much you are expected to know. But obviously this is not practical. So why not receive your training from a school which has been highly successful in this work?

Under the Patterson home-study method of instruction each student receives *individual* preparation. The training is not stereotyped,

high-pressure group-preparation. When the student enrolls in the school, he is given a preliminary test to determine exactly where he needs the most training, and where he simply needs brushing up. The course you take is fitted to your own individual needs by experts. And we frankly advise any student against taking any examination if in our estimation he has not yet perfected his preparation.

The knowledge of just what is required in Civil Service training gained over a quarter century in this particular field enables us to handle your individual problems quickly and surely. I say this in all sincerity. I can offer no better proof of it than this School's record of success in fitting American citizens for positions in the U. S. Government service.

Would You Like This Free Book?

If you have already been considering the possibility of entering Government service, the Patterson School has prepared an illustrated book, "How To Secure A Government Position," which describes the Civil Service, and the opportunities Civil Service offers any American citizen with the energy and ambition to prepare for it. The book explains the requirements and starting salaries of \$1260 to \$2300 per year paid in various branches of government service. It tells, too, how our coaching method, originated by Mr. Patterson, prepares you for your Civil Service examinations.

You may have this book simply by mailing the coupon below. It is free of charge; there is no obligation involved in sending for it. Address: A. C. Kehr, Managing Director, Patterson School, 810 Mercantile Bldg., Rochester, N. Y.

**A. C. Kehr, Managing Director
Patterson School, 810 Mercantile Building,
Rochester, N. Y.**

I am interested in the U. S. Civil Service. Please send me your free illustrated book, "How To Secure a Government Position." I understand that sending for this book will not obligate me to you in any way, whatever.

Name.....Age.....

Address.....

City.....State.....

These Tools and Other Equipment

all shipped to you at once, the day you start the practical training in your own home under the direction of Engineer Dobe. Investigate!



Learn Drafting

At Home From An Engineer

Prepare for real opportunities as a professional draftsman. Or train yourself in draftsmanship for its fundamental value; it's a great stepping stone to success in many walks of life. Don't miss this opportunity.



Engineer Dobe, for many years, has trained successful students, aged 16 to past 50. Turn your spare evenings into cash. Remarkable results in a few months, thanks to the Dobe "work-job" method. Act right NOW!

Don't lose this opportunity. Find out where you can better yourself. Send the coupon today—AT ONCE!

Valuable Book Free

Your Chance Now! Time is money. Prepare NOW.

Engineer DOBE, Dept. 3377 Libertyville, Illinois
Please send free book on Draftsmanship and explain your pay-raising plan.

Name _____ Age _____
Address _____

Write and Speak MASTERLY ENGLISH



Learn correct English with Sherwin Cody's new invention. No rules to memorize. Like a fascinating game. Spare-time study. 15 minutes each day quickly gives you command of English. Send for free book, "How You Can Master Good English in 15 Minutes a Day." Write today. SHERWIN CODY SCHOOL OF ENGLISH, 510 Searle Bldg., Rochester, N. Y.

HOW TO GET A RAISE IN PAY

Read this Book to Earn More Money



Most helpful book ever written. Self-analysis chart at end of each chapter. 38 chapters, any one worth the price. James Clayton Wilson, author. \$1.00 postpaid. 10c postage extra C.O.D. orders. Canada \$1.20 duty paid. 5 days proof this book will help you or money refunded. 8

DOLLAR PUBLICATIONS
737 North Michigan Ave., Chicago

\$1 I want to get ahead. Send me your new book, \$1 attached.
Name _____
Address _____
City and State _____

SEE AND TRY SLINGERLAND RADIO KING DRUMS MAY-BELL GUITARS

Don't buy Guitar, Mandolin, Banjo, Electric Guitars, Bugles or Drums until you have seen and tried the Slingerland May-Bells. Guaranteed More for your Money. Wonderful, snappy, powerful, pleasing tone. No equal in price. Sold on easy payments and 5 days free trial by all leading music dealers.

Cut this Adv. Out—Good for \$1.00 Credit. Ask for Special Information on How to Organize Drum and Bugle Corps. Send for free catalog. Mention instrument wanted. Write today.

SLINGERLAND MUSICAL INSTRUMENT MFG. CO.
1330 BELDEN AVE. CHICAGO, ILLINOIS

Gene Krupa

LAW STUDY AT HOME

Legally trained men win higher positions and bigger success in business and public life. Greater opportunities now than ever before. Big corporations are headed by men with legal training.

More Ability: More Prestige: More Money

We guide you step by step. You can train at home during spare time. Degree of LL. B. Successful graduates in every section of the U. S. We furnish all text material, including 14-volume Law Library. Low cost, easy terms. Get our valuable 48-page "Law Training for Leadership" and "Evidence" books FREE. Send for them NOW.

LaSalle Extension University, Dept. 1064-L Chicago
A Correspondence Institution

Want a Career in photography?

Profit by the growing demand for photographs! Wonderful money-making opportunities in Commercial, News, Portrait, Advertising and Motion Picture Photography. Train at home or in our modern, completely equipped studios. 28th year. Send for free booklet.

NEW YORK INSTITUTE OF PHOTOGRAPHY
10 West 33 St. (Dept. 49) New York City

Correspondence Courses in **RADIO and ELECTRICAL ENGINEERING** **LOW AS \$25**

ELECTRICAL ENGINEERING. Get good grasp of wide electrical field. Modern. Very understandable.

RADIO ENGINEERING. Extra fine course in radio, public address, photo-electric work. Trains you to be super-service man, real vacuum tube technician. Tuition ONLY \$25, either course. Deferred payment plan. Experiment kits furnished.

FREE Write for free copies of school catalogs, student magazines, etc.
FREE LINCOLN ENGINEERING SCHOOL, Box 931-99, Lincoln, Nebr.

MAIL FOR FREE INFORMATION

BROOKLYN YMCA TRADE SCHOOL

1117 Bedford Ave., Dept. PM-65
Brooklyn, New York City, N. Y.

- Diesel Engines
- Diesel Pre Engineering
- Aviation Mechanic
- Aeronautical Pre Engineering
- Auto Mechanic
- Refrigeration
- Radio and Television Mechanic
- Air Conditioning
- Architectural-Mechanical Drafting
- Electrical
- Armature Winding
- Oil Burner
- Welding
- Talking Pictures
- Machine Shop
- Window Display

Name _____
Address _____

EARN BIG MONEY... DRAW FOR THE MOVIES!



at Last!
YOUR CHANCE TO LEARN

ANIMATED CARTOONING BY MAIL

Animators Make Up to \$20,000 Yearly!

NOW! Former Walt Disney artist will instruct you in this fascinating and highly profitable field at home. Brand new course, with simple, easily understood charts and detailed explanations teaches you to draw such characters as Mickey Mouse, Donald Duck, Snow White and the Seven Dwarfs, Popeye, etc., develop gag situations, and learn every phase of animation. Animated cartoon music studios seek artists, yet you need no previous art training to learn through our "Visual Method." Course includes optional two month training period at resident school in Washington, D. C. Send for our big FREE Booklet today.

Write now—if you can draw a circle, we can teach you animated cartooning.

FREE SEND FOR BIG FREE CATALOG!



WASHINGTON STUDIOS OF ANIMATION
RKO-KEITH BLDG., WASHINGTON, D. C.
First School in America Exclusively Devoted to
Animated Cartoon Instruction



Go to High School at Home

You can secure a high school education in your spare time by studying the new courses prepared by the International Correspondence Schools.

These courses are equivalent to the courses given in resident high schools. They have been specially arranged for men and women who wish to meet college entrance examinations, to qualify for a business position, or to make up the education they missed in past years.

The lessons are easy to understand and you will make rapid progress because you will be in a class by yourself and you will study under the guidance of instructors who are sincerely interested in you.

Just mark and mail the coupon and we will gladly send you interesting free booklets describing the High School Courses of the I. C. S. or any other subject in which you are interested.

INTERNATIONAL CORRESPONDENCE SCHOOLS

Box 5530-J, Scranton, Penna.

Without cost or obligation, please send me a copy of your booklet, "Who Wins and Why," and full particulars about the subject before which I have marked X in the list below:

- College Preparatory Course
- High School Commercial Course
- High School English Course
- High School Vocational Course
- High School Agricultural Course

BUSINESS TRAINING COURSES

- | | |
|--|---|
| <input type="checkbox"/> Business Management | <input type="checkbox"/> Service Station Salesmanship |
| <input type="checkbox"/> Office Management | <input type="checkbox"/> Business Correspondence |
| <input type="checkbox"/> Industrial Management | <input type="checkbox"/> Lettering Show Cards |
| <input type="checkbox"/> Traffic Management | <input type="checkbox"/> Stenography and Typing |
| <input type="checkbox"/> Accountancy and C.P.A. Coaching | <input type="checkbox"/> Civil Service |
| <input type="checkbox"/> Bookkeeping | <input type="checkbox"/> Mail Carrier |
| <input type="checkbox"/> Secretarial Work | <input type="checkbox"/> Railway Mail Clerk |
| <input type="checkbox"/> Cost Accountant | <input type="checkbox"/> Grade School Subjects |
| <input type="checkbox"/> Salesmanship | <input type="checkbox"/> First Year College |
| <input type="checkbox"/> Advertising | <input type="checkbox"/> Illustrating |
| <input type="checkbox"/> Wallpaper Decorating | <input type="checkbox"/> Cartooning |
| <input type="checkbox"/> Salesmanship | <input type="checkbox"/> Lumber Dealer |
| <input type="checkbox"/> Signa | |

TECHNICAL AND INDUSTRIAL COURSES

- | | | |
|---|--|--|
| <input type="checkbox"/> Architect | <input type="checkbox"/> Plumbing | <input type="checkbox"/> Heating |
| <input type="checkbox"/> Contractor and Builder | <input type="checkbox"/> Air Conditioning | |
| <input type="checkbox"/> Structural Draftsman | <input type="checkbox"/> Sheet Metal Worker | |
| <input type="checkbox"/> Structural Engineer | <input type="checkbox"/> Steam Engineer | |
| <input type="checkbox"/> Electrical Engineer | <input type="checkbox"/> Civil Engineer | |
| <input type="checkbox"/> Reading Shop Blueprints | <input type="checkbox"/> Surveying and Mapping | |
| <input type="checkbox"/> Telegraph Engineer | <input type="checkbox"/> Refrigeration | |
| <input type="checkbox"/> Telephone Work | <input type="checkbox"/> R. R. Locomotives | <input type="checkbox"/> Air Brakes |
| <input type="checkbox"/> Mechanical Engineer | <input type="checkbox"/> R. R. Signalman | |
| <input type="checkbox"/> Machinist | <input type="checkbox"/> Highway Engineering | |
| <input type="checkbox"/> Toolmaker | <input type="checkbox"/> Chemistry | <input type="checkbox"/> Pharmacy |
| <input type="checkbox"/> Patenting | <input type="checkbox"/> Coal Mining Engineer | |
| <input type="checkbox"/> Patternmaker | <input type="checkbox"/> Navigation | <input type="checkbox"/> Boilermaker |
| <input type="checkbox"/> Heat Treatment of Metals | <input type="checkbox"/> Textile Overseer or Supt. | |
| <input type="checkbox"/> Bridge Engineer | <input type="checkbox"/> Cotton Manufacturing | |
| <input type="checkbox"/> Gas Engines | <input type="checkbox"/> Woolen Manufacturing | |
| <input type="checkbox"/> Diesel Engines | <input type="checkbox"/> Agriculture | <input type="checkbox"/> Fruit Growing |
| <input type="checkbox"/> Aviation Engines | <input type="checkbox"/> Marine Engineer | <input type="checkbox"/> Radio |
| <input type="checkbox"/> Automobile Mechanic | | |

Name..... Age.....
 Address.....
 City..... State.....
 Occupation.....

If you reside in Canada, send this coupon to the International Correspondence Schools Canadian, Limited, Montreal, Canada

When writing please mention Popular Mechanics

TRI-STATE COLLEGE

B. S. Degree in 2 years. World famous for technical 2-year courses in Civil, Electrical, Mechanical, Chemical, Radio, Aeronautical Engineering; Business Administration and Accounting. Those who lack high school may make up work. Low tuition. Low living costs. Located in picturesque hill and lake region. Students from every state and many foreign countries. 55th year. Enter September, January, March, June. Write for catalog. 4108 College Ave. ANGOLA, IND.

130,000 GOV'T POSITIONS

added to U. S. classified Civil Service. Now 633,000 Civil Service Positions. This means hundreds of more vacancies and many examinations. Men—women get ready for next call. Age 18-50. Splendid salaries, short hours, long paid vacations and good pension when old. Write immediately for big list of positions and our new plan for helping you.

OZMENT INSTRUCTION SERVICE, 111-B, St. Louis, Mo.

LEARN ACCOUNTANCY

SECRETARIAL AND OFFICE WORK

EARN MORE MONEY

HILL'S WAY

Big pay goes to those who train for it. Hill's trains men and women quickly to fill highly paid positions. Easy to acquire, yet completely thorough. Learn at home during time now wasted. Low tuition fee; easy payments. Send today for our inspiring SUCCESS Book FREE.

HILL'S EXTENSION SCHOOL
603 West Main St., Oklahoma City, Okla. • Est. 1907

Name..... Age.....
 Address.....
 City..... State.....



DRAFTING

BOOKS SENT FREE!
ON APPROVAL
5 VOLUMES BRAND NEW EDITION

Only 15 minutes a day with these WONDER BOOKS can prepare you for a good drafting job in less than a year. Mechanical and architectural drafting from simple straight lines to important complex plans. *A step at a time!* Built especially for beginners, for men with only grammar schooling. Drafting room practice, PLUS ENGINEERING, made easy and clear. Includes complete course in blueprint reading.

Big Field Big Demand Big Pay
Competent draftsmen are urgently needed right now in all building and manufacturing lines at \$30.00 to \$75.00 a week. That's just the beginning—FOR DRAFTSMEN HAVE THE BEST CHANCES FOR ADVANCEMENT. Important, fascinating work, easy to learn and do. Learn quickly with these books—send coupon for a set and see for yourself.

A year's consulting membership in the American Technical Society now given to all readers of this famous cyclopedia of drafting. Many say that it is worth more than the cost of the books.

Complete set of drawing instruments if you send for these drafting books NOW. These instruments are made of the finest of German silver, are absolutely accurate and are packed in velvet lined leatherette pocket case. Real \$10 value, but included with these books.

AMERICAN TECHNICAL SOCIETY
Dept. D719, Drexel at 58th St., Chicago, Ill.

For Beginners or Experts

Written, so you can understand every word, by 22 well known engineers and architects. Deluxe flexible binding, nearly 2,000 pages, 1546 blueprints, charts and diagrams; prepares you for a good drafting job in mechanical or architectural lines. Sent for 10 days' free use if you mail coupon immediately.

These Instruments Included



American Technical Society, Dept. D719, Drexel at 58th St., Chicago, Ill. Send for 10 days' trial New 5 volume set of drafting. I will pay the few cents delivery charges. If I wish, I may return books in 10 days and owe you nothing but if I decide to keep them, I will send \$2.00 after 10 days, then only \$3.00 a month until \$24.80, the advertising price, is paid. Send latest edition and include drawing instruments and Membership Certificate.

Name.....
Address.....
Attach letter stating age, occupation, employer's name and address and that of at least one business man as a reference.

MECHANICS-WELDERS - COLLISION MEN

GOOD JOBS and MIGHTY GOOD PAY

Do you want to earn big money? If so let us know which of the following trades you prefer. You learn by doing. Practical work. Expert teachers. Low tuition. Personal attention. It will pay you to investigate AT ONCE. Just check the courses you'd like to take and mail today. You will receive full information, absolutely without cost or obligation. But don't delay.

Check the Trade You'd Like to Learn

- Complete Auto Mechanics (including Diesel)
- Electric Arc and Acetylene Welding
- Auto Collision
- Spray Painting
- Metal Finishing
- Body and Fender Bumping

Ask about our "Pay After Graduation Plan"

Name.....
Address.....

Mail the above at once to

MICHIGAN TRADE SCHOOL
3758 Woodward Ave. Detroit, Mich.

Write for FREE FOLDER

Cheaper HEAT Without COAL



New Invention Fits Any Stove or Range—30 Days Free Trial
Remarkable invention burns 96% air, 4% of a cheap variety of oil obtainable everywhere. Does away with coal, wood, ashes, dirt and drudgery. Clean, silent, quick, like gas heat. 3 times hotter than coal and cheaper. Temperature controlled. No more getting up on bitter cold, wintry mornings. Many automatic features. No gas or electricity needed. Safe as any ordinary kitchen range. Easy to install—no damage to stove—simply sits in firebox of any stove, range or heater. Costs just a few cents a day to operate. **TRY 30 DAYS AT OUR RISK.** Low introductory price and 30-day trial. Write for FREE CATALOG, AGENTS and spare time workers; Oil heat saves money this year; people buy to save. Write for free burner offer that starts you in business for yourself. **Act NOW!** Listed as approved by Nat'l Board of Fire Underwriters. **BRIGHAM OIL BURNER CO., 3640-K Forest Park Blvd., St. Louis, Mo.**

Be a TELEVISION EXPERT



First National's modernistic method of training is new and different. 75 profusely illustrated lessons in addition to COMPLETE APPARATUS for over 100 Radio and Television experiments will be given you—prepare you for employment in good pay Radio-Television field. You will also be qualified for the examination for your first class Radio-Telephone Operator's License. Get the facts! **FREE**—Write now for free 24-page booklet "Vision" describing this training.

FIRST NATIONAL TELEVISION
(Training Division)
Dept. A-10 Fidelity Bldg. Kansas City, Mo.

BE A BATTERY EXPERT

Restore Storage Batteries to original strength and condition

Steadily-profitable business with many fascinating features. Start anywhere as employee or employer—all or part time. Make plenty of money, build ever-increasing trade. THE BUSINESS for a man who likes work along electrical lines and wants to make a real financial success quickly. Openings everywhere. WE TEACH YOU COMPLETELY in three easy installments. Costs little. WRITE NOW for free information.

DERR INSTITUTE, 266 McKinley St., Baldwin, New York

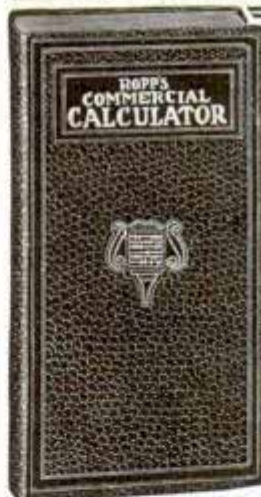

Mathematics Made Easy by ROPP'S CALCULATOR AND SHORT-CUT ARITHMETIC

Shows the Answer as Quickly as a Watch shows the Time to all Problems likely to occur in the Office, Store, Shop, Bank, Farm, or Factory.

Over 2,000,000 Sold
Explains and simplifies every principle in Arithmetic, Mechanics, and Mensuration.

PRICES POSTPAID
Desk Size, Flexible Keratol Binding..... \$2.00
Pocket Size, Art Leather Binding..... \$1.00
Pocket Size, Cloth Binding..... \$0.50

POPULAR MECHANICS PRESS
Room P.10 200 E. Ontario St. CHICAGO

BUILD a BOAT AT HOME

FOR PLEASURE OR PROFIT

Now you can have just the boat you've always wanted—power, sail, or rowboat—and at rock bottom cost, plus the fun of building. Make a nice profit if you want to sell. Get the

BOAT BOOK—New Edition

Have Your Own Boat This Year or Build Them to Sell

This famous book with 6 new boats added, shows exactly how to build 18 different popular boats. Step-by-step instructions with hundreds of pictures. Gives all plans, methods and materials. Includes rigging, hydroplane, inboards, outboards, sailing and sectional boat to carry on car. Also old Ford motor for marine use and all boating terms, pilot rules, boat kinks, navigation rules, etc. You can't go wrong. Specially prepared for those with limited tools and skill. Price only \$3. Write for descriptive folder at order now and pay postman on delivery.



Popular Mechanics Press
Room 1038R
200 East Ontario Street
CHICAGO

DEMAND for Aero I.T.I. graduates has exceeded SUPPLY!

- WHY?** • Superior training—complete, thorough, practical.
- A training program designed and carried out under the supervision of an Executive Board of leading aircraft industry executives and engineers—men who know **WHAT** should be taught . . . and **HOW** men should be trained.
 - Carefully selected students—men who can meet the rigid requirements of both Aero I.T.I. and the industry.
 - Training on the greatest array of special aircraft production equipment ever assembled for instructional use.
 - Training that duplicates the actual aircraft engineering or construction duties the graduate must understand and carry out when he takes his place in the industry.
 - Superiority of Aero I.T.I. training borne out by graduates quickly making good and winning rapid promotion.

The reception accorded Aero I.T.I. graduates by major aircraft plants points to a constantly mounting demand for men trained the exclusive Aero I.T.I. way.

EXECUTIVE BOARD

- C. A. VAN DUSEN** Vice-Pres. Consolidated Aircraft Corporation
JOHN K. NORTHPROP formerly Pres. The Northrop Corp. and Vice-Pres. Douglas Aircraft Company, Inc.
ROBERT E. GROSS President, Lockheed Aircraft Corporation

Aero INDUSTRIES TECHNICAL INSTITUTE

5253 WEST SAN FERNANDO ROAD · LOS ANGELES, CALIFORNIA

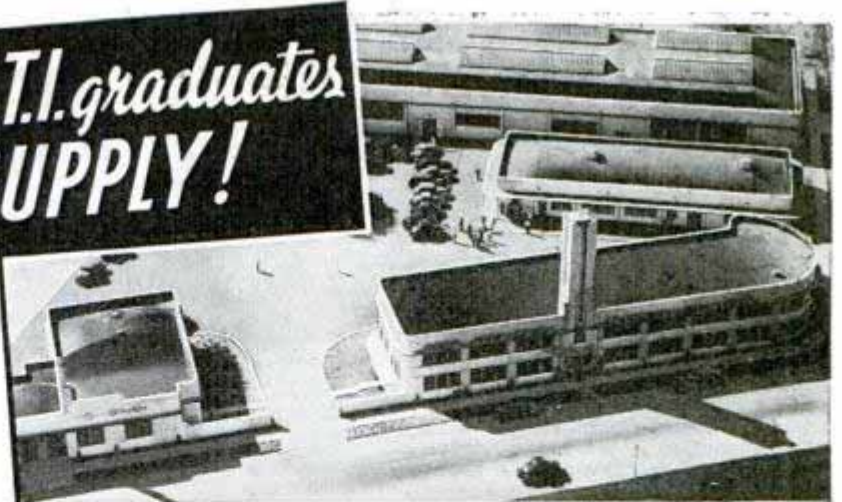

AERO I. T. I. COURSES

AERO I.T.I. Supervised Courses are confined to the designing and building of modern airplanes (no flying involved). They include: Master Aircraft Mechanics; Aeronautical Engineering; Design and Drafting; and Combination Aircraft Mechanics, which may be started at home no matter where the student lives, with later practical training in the extensive Aero I.T.I. Shop.



AERO INDUSTRIES TECHNICAL INSTITUTE
 3353 WEST SAN FERNANDO ROAD · LOS ANGELES, CALIFORNIA

Please send immediately complete details on your training program, and free copy of your new booklet describing today's opportunities in the aircraft industry. I am 18 years of age or over and can furnish character references.

NAME _____ AGE _____
 STREET _____
 CITY _____ STATE _____ a-12-p

Photo-Engraving

LEARN QUICKLY AT HOME BY LATEST EXPERT METHOD
 An easy, quick, thorough, Home Study Course. Oldest and largest school in the world **TEACHING PHOTO-ENGRAVING** by correspondence and residence. Many unusual features—Experimental. Equipment for home use—Rare Reference Books—Camera Journalism, Plate Layout Examples, Lifetime Consulting Service. "30 Photo-Engraving Ways to Make Money from the Day You Start Your Studies!" . . . All included at no extra cost. Write today for Free 38-page Opportunity Booklet.

BIG PAY!
 IDEAL WORKING CONDITIONS
 INCREASING DEMAND



AURORA SCHOOL OF PHOTO-ENGRAVING
 Dept. 1108 AURORA, MISSOURI

Learn to MOUNT Birds and Animals



FUN · PROFITS

Send Today for Free Book

Old reliable school (250,000 students) will teach you **AT HOME** to mount **BIRDS, ANIMAL HEADS, FISH and TAN SKINS and FURS**. Write now—at once.

SPORTSMEN: Save your trophies. Game is growing scarcer—every **Specimen** is valuable. Keep them—save them—mount them. Decorate your den. Fun and fascination. Profits, too.

TAN heavy and light skins and furs. Make real **HARNESSES, LEATHER, BUCK SOLE LACE, ETC.** Best method known, but easy and simple. Don't sell those hides cheap. Tan them for your own use. Make leather vests, belts, gloves, etc. **TAN FOR OTHERS.**

FUR-WORK for men and women. Tan and make up scarfs, capes, coats, muffs, mitts, trimmings. Quickly, easily learned.

EXTRA MONEY \$40 to \$80 a month, even more. Some students report. Big demand for **TAXIDERMY, TANNING AND FUR-WORK**. A real spare-time business—good in every community. If you need extra money, **WRITE!**

FREE BOOK

48 pages, 100 beautiful pictures, tells **ALL** about Taxidermy, Tanning, Fur-Work. Write **Today**—this minute for this **STRANGE, MARVELOUS FREE BOOK**. A postal will do. State **AGE**.

N. W. School of Taxidermy, 3377 Elwood Bldg., Omaha, Neb.



CARTOONING

PAYS WELL Turn your talent into dollars
 Develop your ability with personal instruction from an internationally-known cartoonist. His exclusive, successful method of drawing and creating ideas makes it easy to learn. Write for Free Booklet explaining details of this exceptional home-study course.
 National School of Cartooning, 437 Penton Building, Cleveland, Ohio

MAKE MONEY AT HOME

RUBBER MOLDS

Low as 6¢ EA.

Amazing rubber mold-making outfit makes perfect flexible molds of plaques, ash trays, book-ends, etc. Molds cost from 6c to 25c each. Each mold makes hundreds of novelties and gifts to sell up to \$1.00 apiece! No experience necessary. Quick and easy. Start profitable business in your home . . . sell to stores, gift shops, friends, resorts, road stands, by mail. Full or spare time. "Molders Handy Book" and list of buyers **FREE**. Write



SO-LO WORKS

Dept. K-827 Cincinnati, Ohio

Inflation or Reflation?

What Is the Difference?

DEPRESSION or recession? Ideology or idealism? Neurosis or psychosis? You'll find every difference of meaning clearly explained, with examples of use, in

THE NEW MERRIAM-WEBSTER

To talk and read intelligently about current events—to win a reputation for being well-informed—look up unfamiliar word-meanings in the Merriam-Webster. This new Second Edition of Webster's New International Dictionary (unabridged) also contains thousands of encyclopedic articles, written by 207 leading authorities, which supply comprehensive information on all the topics talked and written about today. 600,000 entries; 3,350 pages. See it at your bookdealer's, or write for free illustrated booklet to G. & C. MERRIAM COMPANY, 124 Bdwy., Springfield, Mass.

Look for the Circular Trade-Mark



It Identifies the "Supreme Authority"

WEBSTER'S NEW INTERNATIONAL DICTIONARY • Second Edition

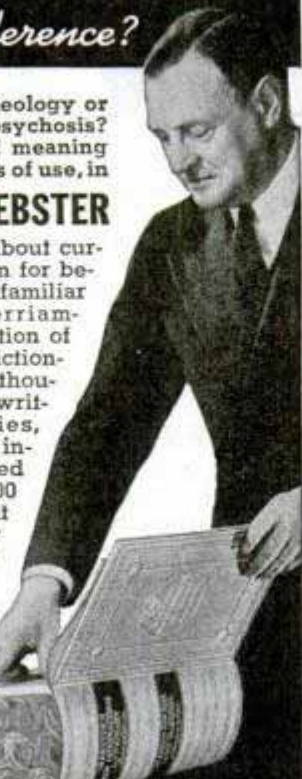

U.S. GOVERNMENT JOBS



START \$1260 to \$2100 YEAR

Many appointments each year. GET READY Immediately

Dependable Positions

Common Education Usually Sufficient

Mail Coupon Today—SURE

Franklin Institute
Dept. B173
Rochester, N. Y.

Gentlemen: Rush to me FREE of charge, list of U. S. Government big pay jobs. Send me FREE 32-page book describing salaries, vacations, hours and work. Tell me how to qualify for one of these jobs.

Name.....
Address.....

AN AVIATION CAREER

OFFERS YOU A GREAT FUTURE



MORE CURTISS-WRIGHT TECH GRADUATES ARE EMPLOYED IN THE AIRCRAFT INDUSTRY THAN THOSE OF ANY OTHER SCHOOL. Train for your future in the heart of the Aircraft Industry at Aviation's foremost and oldest school, specializing in 1 Aircraft Sheet Metal, 2 Master Mechanics and 3 Aeronautical Engineering. No flying involved. Graduates are obtaining immediate employment. Return this ad with your name, age, address and the course in which you desire full information.

Dept. PM-10

CURTISS-WRIGHT TECHNICAL INSTITUTE
GRAND CENTRAL AIR TERMINAL
GLENDALE (LOS ANGELES) CALIF.



HOW TO MAKE BETTER PHOTOS

Stop wasting good film! Do away with unnecessary camera expense! Take a good picture every time! The kind you'll be proud to show. Sell your photos to magazines and newspapers. Our easy, convenient home-study course will show you how. Write today for FREE Catalog! **UNIVERSAL PHOTOGRAPHERS**, Dept. 710, 10 West 33 Street, New York City.

FREE CATALOG

VOICE

100% Improvement Guaranteed

We build, strengthen the vocal organs—not with singing lessons—but by fundamentally sound and scientifically correct silent exercises... and absolutely guarantee to improve any singing or speaking voice at least 100%... Write for wonderful voice book—sent free. Learn WHY you can now have the voice you want. No literature sent to anyone under 17 years unless signed by parent.

PERFECT VOICE INSTITUTE, Studio 1357
64 E. Lake St., Chicago



CARTOON YOUR WAY TO SUCCESS!



DON'T COPY—LEARN TO ORIGINATE!

RAYE BURNS will teach you HOW to CREATE ORIGINAL CARTOONS at home that you can SELL! Course contains 26 lessons and over 600 illustrations. All for Only **\$285**. Send name and address for free details.

RAYE BURNS SCHOOL, Dept. M, BOX 2194, Cleveland, Ohio

Learn Public Speaking

At home—in spare time. Many overcome "stage-fright," gain self-confidence and increase earning power, this easy way. Write for free booklet, *How to Work Wonders With Words* and requirements.

North American Institute, Dept. 1357
3601 Michigan Ave., Chicago, Illinois



The **BRISCHOGRAPH** makes you an artist INSTANTLY. Use any size copy. Junior covers 4 x 4 inches at one time. Projects in colors and up to life size. Comes completely wired, with lamp, lenses and transpose mirror. Dealers in principal cities and foreign countries. Send \$10, money order, try it ten days. Money back guaranteed. Commercial models \$25, \$50, and \$100.

The **BRISCHOGRAPH CO.** 24 W. Weisheimer Rd. Columbus, O. Established 1926. Canada: Winnipeg Map & Blue Print Co., 318 Berald St; Winnipeg, Man.

MAKE MONEY

AT HOME! Learn to color photos and miniatures in oil. No previous experience needed. Good demand. Send for free booklet, "Make Money at Home" and requirements.

NATIONAL ART SCHOOL
3601 Michigan Ave. Dept. 1357 Chicago



Auto-Diesel

Master a real trade. Auto Mechanics, Diesel Mechanics, Arc Welding, Acetylene Welding, etc. Let us train you to be an expert Auto-Diesel Mechanic and help you get a good job. The cost to you is reasonable. Learn on modern equipment with tools under experienced instructors. Real shop work. Steam heated buildings. Room and board in our steam heated dormitory. We pay your fare to Nashville. For free catalog write

Nashville Auto-Diesel School, Dept. 75, Nashville, Tenn.

for
quick
action

SEND
TO-DAY

MAIL COUPON NOW

for Free Book and Record of Invention Form

CLARENCE A. O'BRIEN and HYMAN BERMAN
70-P Adams Building, Washington, D. C.
Registered Patent Attorneys Before U. S. Patent Office

Please send me at once your Big Free 48-Page Book "Patent Guide For the Inventor" and your Specially Prepared "Record of Invention" Form. This request does not obligate me.

Name.....
Address.....
City..... State.....
(Please write or print plainly)

YOU CAN PATENT



REQUEST OUR BOOK—NOW!

Know exactly what you should do to secure a Patent—what must be done every step of the way—how the Patent Law protects you—what we, as Registered Patent Attorneys, can do for you. Mail the coupon NOW for our Big Booklet and "Record of Invention" Form.

NEW IDEAS FOR IMPROVEMENTS IN MACHINERY, ARTICLES, DESIGNS, FORMULAS, ETC.

Every year thousands of Patents are granted. Very few, however, represent the discovery of entirely new principles. Most of them provide new methods of doing some everyday thing in a better way—changes for greater efficiency, usefulness, adaptability, or beauty in some previously Patented thing. These IMPROVEMENTS are Patentable if new, and actually represent new invention. These improvement Patents offer large chances for profit if commercially useful. The business world wants improved products and services.

MODELS and FINISHED DRAWINGS UNNECESSARY

Our Big Book tells you how you can start immediately to apply for Patent Protection even if you haven't finished models or drawings available now. It will tell you how we can prepare the specifications and finished drawings necessary in the form prescribed by the Patent Office—so as to secure for you full Patent Protection. Mail Coupon for Our Big Book TODAY.

OUR SERVICES TO YOU

We are registered Patent and Trade-Mark Attorneys, serving Inventors all over the United States and abroad. Our Organization is complete. We have Draftsmen, experienced Searchers and Attorneys to serve your interests. We can act as your legal adviser in all Patent Matters. Our complete service is described in our Big Book. Mail Coupon for it NOW.

IN CASE YOU FEEL THAT YOU HAVE NOT SUFFICIENT FUNDS AVAILABLE FOR PATENT FEES

Our Big Book tells you how to legally assign an interest in your invention—before filing application—to some friend willing to aid you. Better to do this than to delay indefinitely and see another inventor develop your idea and Patent it before you do. Send Coupon NOW.

REASONABLE FEES—CONVENIENT TERMS

Don't worry about finances. Our fees are very reasonable—we can arrange convenient terms of payment. It is our custom to permit clients to pay for our services in installments as the application progresses in our office. See our Big Book for fees in obtaining Patent. It explains our arrangements clearly. Send for it NOW.

CLARENCE A. O'BRIEN & HYMAN BERMAN

70-P ADAMS BUILDING

Registered Patent Attorneys

WASHINGTON, D. C.

NEW**INVENTIONS**

FOR the convenience of milady, a newly patented lipstick mirror is equipped with a light that facilitates application of lipstick at night. The illumination is directed on the user's mouth so that the image is reflected sharply in the elongated mirror.



The light is switched on by holding the mirror between the opposed fingers of one hand. Its rays come from a small window at the side of the mirror.

AMONG the latest ideas in window construction is one for a standard vertical sliding sash equipped for opening inward like a French window. This sash, in the standard window, would be the lower one, the upper sash being of the usual construction. Improved control of ventilation is among the claims made for the sash.



SOMETHING that may revive the popularity of the rumble seat is a newly patented cover which protects the occupants from the weather. The cover, or hood, may be lifted to permit access to the rumble seat or it may be detached when weather



conditions permit. The hood consists of a unitary windshield, rigid side wall structure and means for holding the flexible, detachable cover in rigid position. The hood is attached at its forward edge to the automobile to facilitate opening.

INCREASING the safety factor for airplane passengers by using a giant parachute to lower the ship or the cabin in emergencies is not a new idea, but a recent patent seems to be a step ahead of others in practicality. The cabin is detachable, as well as airtight. A cover, hinged at the rear of the plane, may be released in an emergency, permitting the big parachute to pull the cabin out of the plane in a rearward sliding movement. The cabin slides on a skidway formed by the opened cover.



DRIVERS who find it difficult to use the rear-view mirror with which the modern car is equipped probably would welcome a new version patented recently. This mirror is designed to reflect to the driver's eyes the image of whatever is behind the car, but the image is caught over the roof of the vehicle instead of through the rear window. This arrangement is said to give a wider range of vision than is possible with present mirrors.



(Continued to page 33A)

FACTORY-TO-YOU SAVES YOU UP TO 50%

... Also AS MUCH AS

\$30⁰⁰ FOR YOUR OLD RADIO AND UP

AS A SPECIAL TRADE-IN ALLOWANCE!

17-TUBE WORLD-WIDE MIDWEST

ONCE again Midwest scoops the radio world with its new and sensational 1939 radios that just sparkle with new features. Merchandising men, everywhere, are amazed not only at their brilliant world-wide performance, but at their sensationally low factory-to-you prices, which make your radio dollar go twice as far. You buy at wholesale prices, just like a dealer.

While the \$39.95 Midwest "Special" represents one of the most amazing radio values offered today—the Super DeLuxe 5-band "17" and DeLuxe 5-band "12"-tube Midwest, radios are even greater bargains. The new-design, 5-band, 17-active-tube *Midwest, shown here, is an outstanding example of Midwest's greater values. It gives you high priced performance for the cost of an ordinary 10 or 12-tube set. It will delight you with its tremendous 12,000-mile range on 5 bands, glorious new tone and brilliant overseas reception. Stations on the other side of the world come in like "locals." Only Midwest gives you a combination of features like Dial-A-Band Wave Changer, Acousti-Filter, Electric Touch-Button Split-Second Tuning and Fidel-A-Trol!

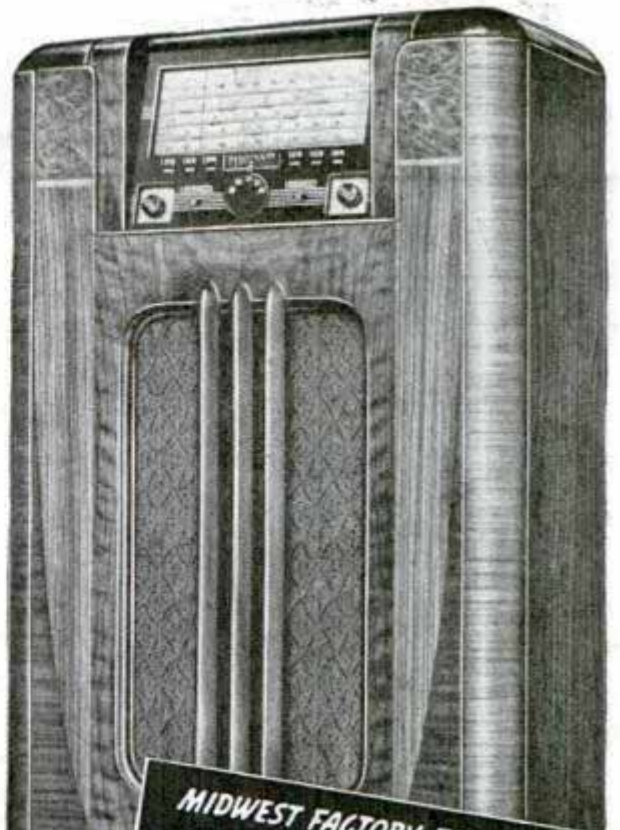

MIDWEST FACTORY-TO-YOU PRICE... \$69.⁹⁵
TRADE-IN ALLOWANCE... \$30.⁰⁰

YOU PAY ONLY

\$39.⁹⁵ ABSOLUTELY COMPLETE

30 DAYS FREE TRIAL

SPECIAL 17-TUBE CONSOLE



Costs No More to Operate Than 7-Tube Radio

HATTIESBURG, MISS.—Midwest has the clearest and sweetest tone of any set I have ever owned. My Midwest surely has been praised above much higher priced radios. I was afraid it would be expensive to operate but it does not cost any more to operate than my seven-tube radio did. (A. N. Green)

Send for the new FREE 1939 catalog and feast your eyes on its history-making values. It pictures many new 1939 models—to suit every purse. The famous Midwest 30-day Trial Plan gives you 30 days to make up your mind. You be the sole judge! If you decide to keep it, you secure as much as \$30.00 credit on your old set. Even higher trade-in allowances on some Midwest models. Don't buy any radio until you see for yourself how and why Midwest gives you so much more for your money!

*Only \$76.75 for the Super DeLuxe 17-tube 5-band model illustrated.

AMAZING NEW EASY-PAY PLAN

SEND FOR FREE 1939 FACTORY CATALOG

You save up to 50%, and make your radio dollar go twice as far when you order direct from the Midwest Factory! Remember, you get 30 days FREE trial. Midwest Guarantees your absolute satisfaction. Write today for FREE 1939 catalog.



PASTE COUPON ON 1¢ POSTCARD... OR

Write Today!

MIDWEST RADIO CORPORATION
Dept. 15-DD Cincinnati, Ohio

Send me your new FREE catalog, complete details of your liberal 30-day FREE trial offer, and factory-to-you wholesale prices.

Name..... (PLEASE PRINT CLEARLY)

Address.....

Town..... State.....

Use Agents Make Easy Extra Money

Check Here for details

MIDWEST *Factory-to-You* RADIOS

DEPT. 15-DD MIDWEST RADIO CORPORATION...CINCINNATI, OHIO, U.S.A.
Manufacturers of Quality Radios Since 1920

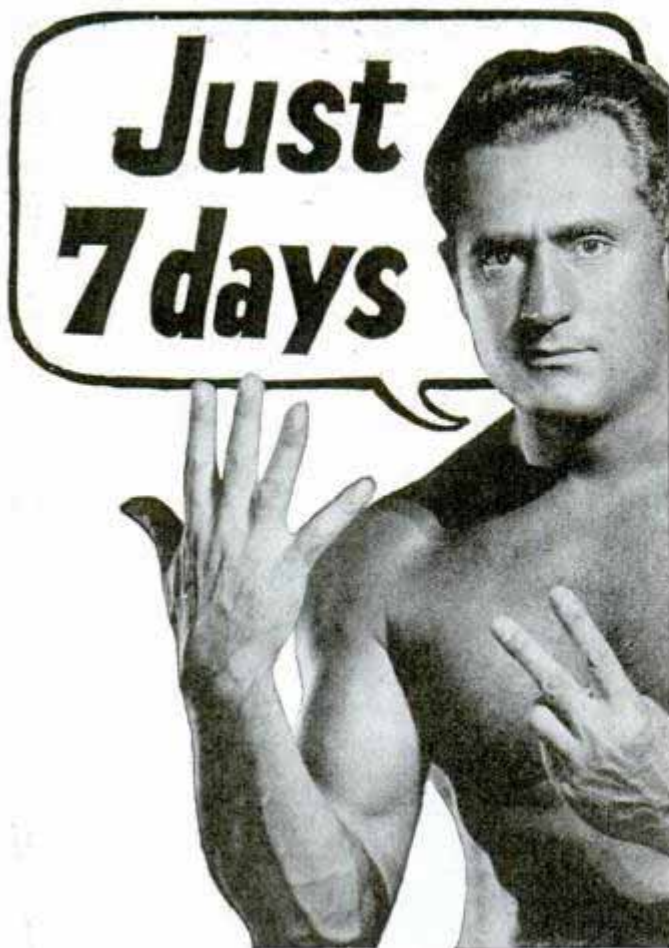

Photo by Tornello

that's all I need to **PROVE** I
can make **YOU** a **NEW MAN!**

BY CHARLES ATLAS

Holder of the Title: "The World's Most Perfectly Developed Man"—Won in open competition in the only National and International Contests held during the past 15 years.

ONE week! That's all I need to **PROVE** I can make you a **new man of vitality and power.** I was once a 97-lb. weakling, with a sickly, flabby body. How I became "The World's Most Perfectly Developed Man" is told in my book, "Everlasting Health and Strength," which I will send you **absolutely free.**

Now I offer you a 7 days' trial of my famous method, **Dynamic Tension,** to **PROVE** that I can and will put firm layers of muscle where **YOU** need them most, tone up your whole system, and banish constipation, poor digestion, bad breath, pimples, joy-killing ailments.

I've got no use for tricky weights or pulleys that may strain your heart or other vital organs. I don't dose or doctor you. My **Dynamic Tension** is a natural tested method. It builds powerful muscle, gets rid of surplus fat, gives you vitality, strength, pep that wins the admiration and respect of every man and woman.

FREE BOOK! Send for your free copy of my book, illustrated with many actual photos. Learn how I changed from a weak no-muscle "runt" to the physique you see here. Gamble a stamp to mail my coupon—to learn how **YOU** can now win life's biggest prize—a handsome, healthy, husky body. Address **CHARLES ATLAS, Dept. 810, 115 East 23rd Street, New York, N. Y.**

**CHARLES ATLAS, Dept. 810,
115 East 23rd Street, New York, N. Y.**

I want the proof that your system of **Dynamic Tension** will make a New Man of me—give me a healthy, husky body, and big muscle development. Send me your free book, "**Everlasting Health and Strength**"—and full details of your 7-DAY TRIAL OFFER.

Name
(Please print or write plainly)
Address
City..... State.....



**This Sterling
Silver Cup
Being
Given Away**

This valuable cup stands about 14 inches high on a black mahogany base.

I will award it to my pupil who makes the most improvement in his development within the next three months.

TECHNICAL BULLETINS

Technical Data
Simplified for the
Practical Man

A Valuable
Popular Mechanics
Service • \$1⁰⁰ Each

Here is a valuable, inexpensive service for mechanics, inventors, technical specialists and practical craftsmen of all kinds. Popular Mechanics Technical Bulletins give the needed basic and practical information on a wide variety of subjects—

briefly, concisely and simply presented—yet complete in every detail. No advanced mathematics, chemistry or physics needed to understand them. Material never before in print, now specially prepared in bulletin form. Postpaid \$1 each or sent C.O.D. in United States. Ask for list of complete bulletin service.

D-101—Using Nichrome Resistance Wire.—Features electrical appliance repairs.

D-102—Cleaning Products for all Purposes.—Includes ten formulas for making.

D-103—Automobile Specialty Chemical Products.—Complete instructions for making wide-selling products.

D-104—Silver Soldering and Brazing.—Includes data, methods and materials needed.

D-105—Latest Gas-Welding Practice.

D-106—Rewinding Electric Motors.—A difficult subject made simple and easy.

D-107—Electro-Plating with Copper, Nickel and Chromium.

D-108—Electro-Plating with Gold and Silver.

D-109—Electro-Plating with Zinc and Cadmium.

D-110—Electro-Plating Non-Metallic Objects and Electro-Forming.

D-111—Designing and Building Transformers.

D-112—Designing Electro-Magnets.

D-113—How to Design Solenoids and Plunger Magnets.

D-114—Designing Thermostats for Air Conditioning and Heat Control Purposes.

D-115—Flexible Molds for Casting Small Objects.

D-116—Printing Photos on Cloth, Paper, Etc.

D-117—The A B C of Air Conditioning.

LATEST BULLETINS—JUST PUBLISHED

D-118—Electrical Water Pipe Thawing Equipment.

D-119—Electroplating with Alloys.—Bronze, brass and cadmium silver alloys.

D-120—Gas Fired Blast Furnace for Melting Metals, Alloys and Heat Treating.

D-121—Corrosion, Causes and Preventative Measures.

D-122—Stainless Steel Easily Soldered, Brazed or Welded.

D-123—Mirror Silvering.—Silvering glass, resilvering old mirrors, and making new ones.

D-124—Soldering.—Brass, copper, lead and low-melting point metals, stainless steel, aluminum, etc.

D-125—Buffing and Polishing Metals.

D-126—How to Design and Build Hydraulic Rams.

D-127—Small Electric Light Plants, Design and Construction.—For cottages, camps or country homes.

D-128—Diesel Engines, Operation and Service.—For the mechanic or layman.

D-129—Coloring Metals Chemically.—No knowledge of chemistry required for success. Instructions for producing colored finishes on brass, copper, iron, aluminum and alloys.

POPULAR MECHANICS PRESS

Room 1038B

200 East Ontario Street

Chicago

GROW PLANTS WITHOUT SOIL

Startling New
Development

Complete
Directions
for Small
and Large
Scale Growing

Get the new book
"Soilless Growth
of Plants" and
learn this new

technique which everyone is talking about. Three methods described—Water Culture, Sand Culture, Sub-Irrigation. Explains all operations. Tells how to make containers and nutrient solutions from raw materials at small cost—how to grow flowers, vegetables and fruits without soil. A fine hobby and a money-saving investment for city dwellers. A source of new business for gardeners, nurserymen, etc. Only book of its kind. Order today "Soilless Growth of Plants." Sent postpaid for \$2.75.

POPULAR MECHANICS PRESS Dept. 1038B 200 E. Ontario St., Chicago



Sensational New BURN-OUT PROOF ARC WELDER

Insulated with Flexible Glass
GUARANTEED For Continuous Service



NOW! A genuine Commonwealth A. C. Arc Welder with transformer coils of heat-proof, burn-out proof FLEXIBLE GLASS-INSULATED magnet wire is making history in the Welding industry. The ideal Welder for every garage, machine shop, factory, home work shop, etc. Use it all day long, in hot, damp climates, steam-filled rooms, or anywhere, because this amazing Welder is not affected by moisture, acid or alkali fumes, age or rot. Does all types of welding, light or heavy, on all weldable metals or alloys. Operates on 110 or 220 volt alternating current. Instant-change Control panel gives 20 to 120 ampere welding heats, in six scientifically planned steps. Uses standard welding rods. Streamlined steel cabinet. Portable, and easily moved on tough rubberized casters. Economical and amazingly efficient. Out-performs Welders costing much more than its modest price. Sold on easy payment terms if desired. Protected by sensational ONE-YEAR GUARANTEE.

Send Now For FREE SAMPLE!

This new Welder with Flexible Glass-Insulated Transformer will make and save money on every metal-working job. Comes complete with Welding Helmet, Cables, Electrode Holder, supply of Welding Rods, etc. Nothing else to buy. So EASY to operate that anyone can use it with a few minutes practice. Opens Opportunities to get into Big-Pay Welding field. Rush your name and address TODAY for details and FREE ACTUAL SAMPLE of wonderful FLEXIBLE GLASS INSULATION, with instructions for making fascinating tests. Act NOW.

The Commonwealth Manufacturing Corp., Dept. N-51, Cincinnati, Ohio.

DIESEL

Get BETTER training. Realize Adcox advantages Located in Pacific Northwest, a Diesel center. Established 28 years. Modern equipment, expert instructors. Close cooperation for YOUR success. Earn room and board while learning. Send for FREE big 40-page Diesel School Catalog No. 18. Home Study and Resident Courses.

L. L. ADCOX TRADE SCHOOL

Portland Oregon

STUDY AIR CONDITIONING AT HOME

Home Study Courses leading to Degrees in Air Conditioning, Electrical, Civil, Mechanical, Diesel, Architectural, Aeronautical, Automotive, Drafting, Radio, Refrigeration, Highway, Mining, Petroleum, Industrial, Marine and Chemical Engineering; Arts; Sciences; Philosophy; Education; Writing; Psychology; Chemistry; Theology; Law; Agriculture; Business; Advertising; Sales; Accounting. Chartered by State of Illinois. McKinley-Roosevelt Graduate College, 4214 Clarendon Ave., Chicago.



"No more tiresome work for me. I get a real thrill out of being an arc welder—and don't forget it, I'm getting more money than I ever earned on hit or miss jobs."

You, too, can become part of this great new industry! There's almost no limit to what welders can accomplish—they cut manufacturing costs way down. Because they know the "How and Why" of Welding, Metallurgy, Drawing, Blueprint Reading, Set-Up Work and Fabrication.

No wonder manufacturers all over the country are demanding practically trained School of Engineering Welding Operators, Welding Technicians, and Welding Engineers!

Don't be content with ordinary work at low pay—when in a short time you can become a thoroughly Trained Specialist in Welding.

MILWAUKEE SCHOOL OF ENGINEERING Institute of Electrotechnics

P.M. 1038 Broadway and E. State, Milwaukee, Wis.

Send Free Booklet "ARC WELDING, World-Wide Dawn of a Gigantic Industry." Also tell me how I can become an

- Are Welding Operator in 3 1/2 months..... Gas Welding Operator (6 weeks).....
- Welding Technician (4 months)..... Welding Engineer (1 year).....
- Send details of Student Loan Plan..... Earn Part Expense Plan.....
- Name..... Age.....
- City..... State.....
- (If interested in other courses, check here. Refrigeration and Air Conditioning Technician (3 mo.)..... Radio and Television Service Man (6 Mo.).....
- Commercial Radio Engineer (1 Yr.)..... Electrical Engineer B.S. Degree (4 yrs.).....

NOW...YOU CAN LEARN TO DRAW AT HOME



Be an Artist

You can earn \$5, \$10, \$15 for ONE drawing

USE COUPON FOR FREE BOOK

The fascinating field of Art offers opportunity to men and women of all ages. Trained Artists are capable of earning \$30, \$50, \$75 a week. We teach you right in your own home in your SPARE TIME—no previous experience is necessary. It's actually fun to learn this practical way. Make your dreams come true—train NOW to be an Artist!

COMMERCIAL ART • DESIGNING • CARTOONING ALL in ONE Practical Course

For 23 years W.S.A. graduates have been "making good" in Art—YOU CAN, TOO! Pleasant periods of study and drawing during your spare time should give you the ability to earn good money. Our complete course includes all the important branches of Commercial Art. If you want to draw—we can help you. Write for details at once.

TWO ARTISTS' OUTFITS

Included in the W. S. A. Course

Drawing board, paints, brushes and all materials you need to start the course come with the first lessons. The second, more advanced outfit, is given later in the course. Send for free book — clip coupon — mail today.



FREE BOOK gives details!

WASHINGTON SCHOOL OF ART
Studio 1210E, 1115—15th Street, N. W.
Washington, D. C.

Without obligation, please send me your Free Book, "Art for Pleasure and Profit."

Name..... Age.....

Address.....

City..... State.....

When writing please mention Popular Mechanics

GROWING INDUSTRIES OFFER SUCCESS FOR YOU

RADIO

Why waste time in hard, poor-paying drudgery jobs when by thorough training you can be prepared to fill a position in the ever-advancing and always-interesting field of Radio? Hundreds of young men with little previous preparation have already done it with the thorough, up-to-date training given by National Schools—located right at the heart of one of the most active centers of Radio broadcasting in the world.



EVERY FACILITY AT YOUR HAND

Think of the advantages of a million-dollar school that operates a fully equipped broadcasting station where you see, handle and can learn everything about Radio, from building and repairing receivers and transmitters to every phase of operation. Such training fits you for any Radio position—on land, water or in the air. A chance for adventure and good pay.

TELEVISION

With training in Radio, you advance through every step of modern Television development. You work with practical operating equipment—learn the theory as well as the building and handling of equipment—assist in actual transmission and reception. Training in National Schools is so thorough that students are fitted to do original work in promoting this newest and most promising field of work.



COSTS NOTHING TO INVESTIGATE

National Schools offer you a fully illustrated booklet about the opportunities for fascinating and highly paid employment in Radio, Television, Sound Recording and related activities. Home study and resident courses are given in this—the largest trade school in the West—with thirty-three years of notable success in preparing men for good positions in all the advancing industries, Radio, Television, Diesel and Gas Engineering, Air Conditioning and Refrigeration. Coach fare allowed from any point in the United States.

**NATIONAL
SCHOOLS**
Los Angeles

NATIONAL SCHOOLS

Dept. PMR-10 4000 S. Figueroa St., Los Angeles

Request for Free Booklet on Radio and Television

NAME _____ AGE _____

ADDRESS _____

CITY _____ STATE _____

In answering an advertisement with a coupon, be sure to write name and complete address clearly.

MECHANICAL DENTISTRY
Big Paying Profession
BE YOUR OWN BOSS!



Older men as well as young men—all have the same golden opportunity to obtain a rare training and establish themselves in steady, uncrowded and good-paying profession of Mechanical Dentistry.

Soundness of teaching methods is proved by outstanding success of enthusiastic students. Our Diploma of Merit is evidence of technical proficiency.

You can earn as you learn in this practical training school of Mechanical Dentistry. Enter uncrowded and profitable field. Become a trained Dental Technician. Earn up to \$75 a week—and more. Write for plan of earning while learning.

National School of Mechanical Dentistry
Dept. 110, 10 W. Jackson Blvd., Chicago

DO YOU KNOW?
THE U.S.A.
EXPORTS
41 MILLION
FALSE
TEETH
IN 1937.

YOU'LL LIKE RESILVERING MIRRORS, REFINISHING

Plated articles, Autoparts, Reflectors, Tableware. Making Chipped Glass Name Plates, Signs. Experience Unnecessary. Write. **SPRINKLE, Plater, 129, Marion, Indiana**

BUILD YOUR GRANDFATHER CLOCK

The Simple Sensible Red-i-Kut way as hundreds have, DIME brings PLANS and sixty picture "HOW" Book pricing many fine brass weight Westminster, tube chime, electric and battery movements showing nine beautiful colonial grandfather cases. WHY WAIT LONGER! **KUENPEL CHIME CLOCK CO., Bldg. 21, Guttenberg, Iowa.**



SAVE OVER ONE-HALF!

Typewriters—Duplicators—Adders—Addressographs—Checkwriters—Dictaphones—Multigraphs for sale at less than one half manufacturer's original price. Look and operate like new. Terms as low as 10c a day. Write for money-saving information today.

PRUITT, 9 Pruitt Bldg., Chicago, Illinois

REGROOVE NEW TREAD

on Your
OLD TIRES

RETAILS **\$3.75** Works Off
COMPLETE AUTO BATTERY
OUTFIT OR LIGHT SOCKET

A NEW invention makes it possible for anyone, without previous experience, to regroove the exact tread on old tires. Puts new tread on bald tires. This Re-Nu Tire Groover is a fine, precision built, sturdy device that does a FIRST CLASS JOB QUICKLY and EASILY.

Stop Dangerous Skidding!

Countless lives are lost annually due to skidding caused by smooth tires. Protect yourself by regrooving your old tires. Don't throw away good casings just because the tread is worn. Have road-gripping tread to give traction where needed. Positively guaranteed to satisfy or money refunded. MAKE BIG MONEY for yourself REGROOVING tires for your friends and neighbors.

FREE OFFER to AGENTS—Every garage, service station, fleet and car owner a prospect for a Re-Nu Tire Groover. By helping us introduce it, you get yours FREE and make big profits for yourself besides. Write for Free particulars today.

RE-NU TIRE GROOVER CO. 2615-AB Michigan Av. Chicago, Ill.

GET THIS
**FREE
BOOK**

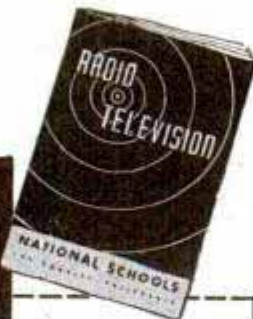

You Have a Right to Know The Hidden Truth

What facts of life were concealed in the Middle Ages? What ancient truths were withheld by church and state for centuries? Why did tyrants fear these findings?

Do you want to know the astounding truths about these mysteries and learn how they can help you?

This Sealed Book—FREE

Send for the fascinating Sealed Book revealing what the Rosicrucians know.

Address SCRIBE G.R.G.

The **ROSICRUCIANS**

SAN JOSE (AMORC) CALIFORNIA
[Not a Religious Organization]

AVIATION



If you are interested in a comprehensive Technical Training Program for

APPRENTICESHIP MECHANICS PILOTS METEOROLOGISTS

Write, immediately, enclosing stamp—
MECHANIX UNIVERSAL AVIATION SERVICE CO.

Strathmore Station

Dept. E

Detroit, Michigan

Learn
ADVERTISING
at Home

Greater opportunities now in advertising. Learns easily and quickly in spare time. Practical work. No text books. Old established school. Low tuition—Easy terms. Send for free booklet and requirements.
Page-Davis School of Advertising
Dept. 1357, 3601 Mich. Av., Chicago

AIRPLANE SERVICING MANUAL

COVERS

**Construction — Materials
Maintenance — Over-Haul
Rigging — Welding — Repair
Tools — Radio — Inspection
Troubles**

Popular Mechanics Press, Dept. 1038, 200 E. Ontario St., Chicago



Get this
Book Now!

MONEY MAKING FORMULAS

1059 PRICELESS FORMULAS ALL IN ONE BOOK FOR \$1.25

FORTUNES MADE WITH FORMULAS LIKE THESE

Cosmetics Remedies Beverages
Fertilizers Preservatives Lubricants
Auto Products Food Products
Glues Metal Products,
Polishes Etc.
Inks
Soaps

Hundreds of big selling products—earning millions in profits—grew from a simple formula. Your own product may bring you fame and fortune. Get this big 200 page book with 1059 formulas, and start a spare or full time business of your own. Everything explained—what to make—how to make it—where to get materials. This is the book that lifts the veil of secrecy from a profitable and fascinating business. Get your copy now. Only \$1.25 postpaid.

Popular Mechanics Press, Dept. 1038-B, 200 East Ontario St., Chicago

68 Pages of facts for INVENTORS

These books were prepared for men of ideas—men who have an article in mind that will make money, save money, save labor or give pleasure. Leading thinkers agree that the world of a few years from now will be radically different because of the contributions to progress that inventors will make. Now is the time—if you have an idea—to see about protecting it.

Many Little Ideas May Have Big Commercial Possibilities

Don't think that to be profitable an idea needs to be complicated. Simple articles—just a person's hunch—have often proved profitable. The crinkly hair pin, the metal tip for shoe laces, the paper clip are good examples. Also improvements on patented articles sometimes prove more profitable than the original article itself.

Don't Delay—Send for These Free Books Now

Many a man has waited until too late to protect an idea by a United States Patent. Remember someone else may be thinking along the same lines that you are, and the Patent Laws favor the man who files his application for a patent first. Delays of even a few days can sometimes mean the loss of a patent. So learn the important facts about Patent Protection at once.

40 Years of Proven Service

For forty years, this capable organization has served inventors from all over the country. Our large staff of patent specialists gives you expert and prompt service. Our fees are reasonable; we also help with deferred payments.



VICTOR J. EVANS & Co.

REGISTERED PATENT ATTORNEYS
MAIN OFFICE: 20-L, VICTOR BUILDING
WASHINGTON, D. C.

OTHER OFFICES: 514-N, Empire Bldg., Pittsburgh
405-N, Garfield Bldg., Los Angeles
1010-N, Hobart Bldg., San Francisco

Send me FREE copies of your books, "Patent Protection" and "When and How to Sell an Invention". Also Free "Evidence of Invention" form. (Note: Same books supplied by any of the other offices listed above.)

Name.....
Street and No.....
City or Town.....State.....

When writing please mention Popular Mechanics

MAIL COUPON TODAY FOR YOUR COPIES

PATENTS

Booklet Free Highest References
Promptness Assured Best Results

Send drawing or model.

ALL BUSINESS GIVEN PROMPT AND PROPER ATTENTION

Listed Patent Lawyer in the latest editions of the Rand-McNally Directory of Bankers and Bank-Recommended Attorneys, published by Rand-McNally & Co., Chicago, Ill.; The Baggott & Ryall Directory of Guaranteed Attorneys, published by Legal Directory Corporation, Boston, Mass.; American Lawyers Annual, Cleveland, Ohio; Bankers Service Legal Directory, published by Bankers Service Co., Boston, Mass.; Eyre's Law List, 9 Park Place, New York City; Snow-Church Directory Co. Lawyers List, published in New York City, and the Central Guarantee Co., Bankers and Lawyers Directories, 630 Fifth Avenue, New York City.

WATSON E. COLEMAN, Victor Building, 724 Ninth Street, N. W.
REGISTERED PATENT LAWYER WASHINGTON, D. C.

INVENTORS PATENT YOUR IDEAS SEND FOR FREE BOOK



HOW TO OBTAIN A PATENT

Written by a Former Member of the Examining Corps (1922-24) of the U. S. Patent Office. If you want to profit by your idea, you should take steps to apply for a U. S. Patent at once. Your first step is to get this Free Book. This interesting illustrated book contains valuable information you should have. It tells you fully how to obtain a patent on your idea in the quickest way. With this Free Book you will also receive a "Record of Invention" form on which you can easily record your idea. Personal and Confidential Service: Your case will be personally handled only by a Registered Patent Attorney who is also a Former Member of the Examining Corps of the U. S. Patent Office. All communications confidential.

MAIL COUPON TODAY for FREE PATENT BOOK and RECORD OF INVENTION Form.

CARL MILLER

REGISTERED PATENT ATTORNEY
FORMER MEMBER EXAMINING CORPS U. S. PATENT OFFICE

Woolworth Bldg., 35th Floor, Dept. 108A, New York City
MILLER BUILDING, Dept. 108A, Washington, D. C.

Please send me your Free Book, "How to Obtain a Patent," and your "Record of Invention" form.

NAME.....

ADDRESS.....

Inventions Wanted Patented or Unpatented

We have been successfully selling inventions, patented and unpatented, since 1924. Write for proof, and tell us what you have for sale.

Chartered Institute of American Inventors
Dept. 4, Barrister Building, Washington, D. C.

PATENTS—TRADE MARKS

All cases submitted given personal attention
Form "Evidence of Conception" with instructions
for use and "Schedule of Government
and Attorneys' Fees"—FREE!

LANCASTER, ALLWINE & ROMMEL
Patent Law Offices

412 Bowen Bldg. Washington, D. C.

INVENTORS PROTECT & SELL

Your unpatented invention can be sold with positive safeguards under patent laws. New, low-cost procedure. Complete details, free.
AMERICAN PATENTS CORPORATION
Dept. 4-E Washington, D. C.

INVENTORS who derive largest profits know and heed certain simple but vital facts before applying for patents. Our book, Patent-Sense, gives those facts; sent free. Trade Marks—Copyrights.
LACEY & LACEY, Est. 1869, 635 F St., N. W., Dept. 5, WASHINGTON, D. C.

RUPTURED?

Get Up-to-Date Relief

Now you can laugh at chafing leg-straps and binding belts, yet do hard work safely with the amazing, modern Cluthe. Positively guaranteed to hold, a condition absolutely necessary for possible improvement or recovery. WATER-PROOF. Wear it in bath! Recommended by doctors. Made especially to fit each individual case, yet costs so little. Write for FREE 100-page BOOK and liberal 60-Day Trial Plan, together with endorsements from grateful patrons in your neighborhood. No obligation. Address:

CLUTHE SONS Dept. 31 Bloomfield, New Jersey



BUCHSTEIN'S FIBRE LIMB

is soothing to your stump—strong, cool, neat, light. Easy payments. Braces for all deformities. Agents wanted.

D. BUCHSTEIN CO.
610 3rd Ave., So., MINNEAPOLIS, MINN.

Send for Catalog Today

FREE BOOK



RAISE GIANT FROGS

WE BUY! Good prices year round! Other markets waiting for all you can ship. Get ready now for next spawn. Breeder lays 20,000 eggs yearly. Small pond starts you. Free book shows sketch. Send no money. Write American Frog Canning Co. (Dept. 133-T), New Orleans, La.

AGENTS: UP TO \$8.00 IN A DAY
Everybody needs food. Cash in BIG with my plan. No experience. Earnings very first day. Amazing line, rapid selling, big profit, home necessities. Facts mailed FREE.
ALBERT MILLS, 6450 Monmouth, Cincinnati, O.



To PROTECT YOUR INVENTION—Use this coupon, NOW

Delays are dangerous and may be very costly. My personal service assures prompt action, strict confidence, and a minimum of expense. I suggest that you send me a model or drawing, or sketch and description of your invention, and \$5.00. I will make a search and report

promptly as to its patentability and send you a copy of my 72-page booklet. Or, if you prefer to read my booklet first, mail the attached coupon at once. I will also send my "Record of Invention" form. (Over 38 years experience as a Registered Patent Attorney.)

L. F. Randolph, 302-D Victor Bldg., Washington, D. C.

Please send me at once, free of charge, your 72 page booklet and "Record of Invention" form.

Name.....

Address.....

A PERSONAL CONFIDENTIAL PATENT SERVICE

NOW I KNOW WHAT FRED MEANT WHEN HE SAID HE GOT HIS PAY BOOST OUT OF A TWO DOLLAR BOOK.



PAY RAISING EXTRA MONEY BOOKS THAT WILL HELP YOU WIN SUCCESS

You, too, will find the selected list of practical books below just what you need to help you improve your job, prepare for a better one, or add to your income through spare time earnings. Thousands give these books credit for their success.

SEND NO MONEY! Use this advertisement as an order blank. Check books wanted. Add name and address and mail. Just pay postman price plus few cents postage. (In U. S. and possessions.) Or remit with order and add 10 cents per book for postage.

POPULAR MECHANICS PRESS

Room 1038B 200 East Ontario Street Chicago

- AIR CONDITIONING**
Live Field; Great Future..... \$3.50
- ALUMINUM WORKING**
For School and Home Shops. Just Out. 295 pp., illus. \$3.00
- AUTO ENCYCLOPEDIA**
The Famous Dyke's Latest Edition..... \$6.00
- 110-V. GENERATORS**
Made From Old Auto Units..... \$1.00
- BIRD HOUSES**
Build to Sell; Easy Designs..... \$1.00
- BLUEPRINT READING**
for the Building Trades..... \$1.25
- BOAT BOOK**
Power, Sail, Rowing, Paddle Plans..... \$3.00
- BOY MECHANIC**
Hundreds Things Boys Can Make..... \$2.00
- CARPENTRY, PRACTICAL**
Complete 436 pages. Revised Edition... \$2.00
- CIVIL SERVICE**
Home Study Courses Federal, State, City Positions..... \$1.00
- CONCRETE**
1001 Ideas for Using. New Popular Mechanics Book... \$5.00
- DIESEL HANDBOOK**
New! Latest Information..... \$5.00
- ELECTROPLATING**
With Copper, Nickel and Chromium Technical bulletin..... \$1.00
- FORD V-8 CARS, TRUCKS**
New, 700 Pages. Includes Details 1937 Cars..... \$2.50
- FORMULAS**
1059 Money Making. Start a Business... \$1.25
- A.C. POWER WIRING**
Covers all uses of a.c. for power..... \$4.00
- FURNITURE MAKING**
Tools, Materials, Design..... \$2.50
- HOUSES, SMALL**
Book of, for Home Builders..... \$2.00
- HYPNOTISM**
How to Become an Expert..... \$2.00
- LOCOMOTIVE**
Folding Chart Shows all Parts..... \$1.00

- LOG CABINS**
Easy Plans; Build for Profits. Value!..... \$3.00
- MACHINE WOOD-WORKING**
First Complete Book on Subject..... \$3.25
- MATHEMATICS**
Easy Guide for the Practical Man..... \$1.50
- MECHANICAL DRAWING**
Learn Drafting; Good Salaries..... \$1.00
- MONEY MAKING IDEAS**
1000 Ways to Make \$1000..... \$2.50
- OFFICE MACHINES**
All Makes. Care and Operation..... \$2.50
- PAINTING AND DECORATING.** New book..... \$1.50
- PLUMBING**
500 Facts Every Homeowner Should Know..... \$1.50
- TEST GOLD—PLATINUM**
Identify—Buy—Sell, By C. M. Hoke... \$1.00
- PROSPECTORS' HANDBOOK**
How to Mine, Appraise, Equip..... \$3.00
- RADIO SERVICING**
Profit by Knowing Costs, Kinks, Etc!..... \$4.00
- REFRIGERATION**
Electric, Gas. Be a Service Expert... \$5.00
- REWINDING ELECTRIC MOTORS**
Fractional Sizes. Value!..... \$2.50
- SHIP MODEL**
Entire Text, Famous "Sovereign" of 1637 \$1.00
- SHOP NOTES LIBRARY**
5 Vol. 2000 Wonderful Shop Ideas..... \$2.50
- SOIL-LESS GROWTH OF PLANTS.** Just out..... \$2.75
- STEEL SQUARE**
How to Figure Angles of Rafters, Roofs, Etc..... \$1.00
- TOYS**
For Amusement or Profit, Saleable Designs... \$1.50
- TRAILER BUILDING**
New Book..... \$1.00
- UPHOLSTERY**
Always a Big Market. Start Own Business \$2.00
- WOOD FINISHING**
Methods, Tools, Materials..... \$2.00



INVENTORS these Free Books tell

How To Protect And To Profit From Your Ideas • How You Can Save Time and Money

● Right now is the time for you to take the first steps to protect your ideas — and this costs you nothing! C. A. Snow & Co. can save you time and expense by giving you advice based on 63 years' experience. If you want competent, professional advice and service, mail the coupon now for our free books on patent facts and special "Certification of Invention" form.



MAIL NOW FOR FREE BOOKS

C.A. SNOW & CO.
Registered Patent Attorneys Since 1875

Dept. 1108, SNOW BUILDING, WASHINGTON, D. C.

Gentlemen: Please send me absolutely free and without obligation on my part, your original document "Certification of Invention", together with your two guides for Inventors, "How We Protect You" and "Suggestions On How to Commercialize Your Invention."

Name

Street and No.

City or Town..... State.....

Be a Civil Engineer!
Learn—Quick Reference Way

It's Paying Big Right NOW



Cyclopedia of Civil Engineering
7 great volumes, 2,800 pages, 1,600 illustrations. New revised edition by twelve of America's greatest engineers.

Earn \$3000

with the help of these books

A Year—and Up!

"Civil engineers are wanted NOW. Enormous amounts are being spent in all kinds of public works and not a dime is spent until the Engineer has prepared plans. Then He must direct the work. It's a big job and there are not enough men to go around. Everywhere you go, you see road work going on—water and sewer systems being built—vast projects of all kinds. Here is Your Opportunity to get the necessary training right at home. These books are complete and simply written so anyone can understand them. Start now on our FREE examination plan. Mail the coupon without obligation.

American Technical Society
Dept. C719 Drexel at 58th St., Chicago

American Technical Society
Drexel at 58th St., Dept. C719, Chicago
I want to examine the CIVIL ENGINEERING Cyclopedia for 10 days FREE. I will gladly pay the few cents express, but I am to pay nothing for the 7 big volumes if I return them within 10 days. If I wish to keep them I will send you \$2 after the 10 days, then \$3 a month until advertising price, \$29.80 is paid. Send latest Edition and Slide Rule.

Shipped Free

For Examination **Slide Rule**

Be prompt and we will include a brand new, circular slide rule to carry in coat pocket. Invaluable in solving all kinds of engineering problems.

Name.....
Address.....
(Attach letter stating age, occupation, employer's name and address and that of at least one business man as reference.)

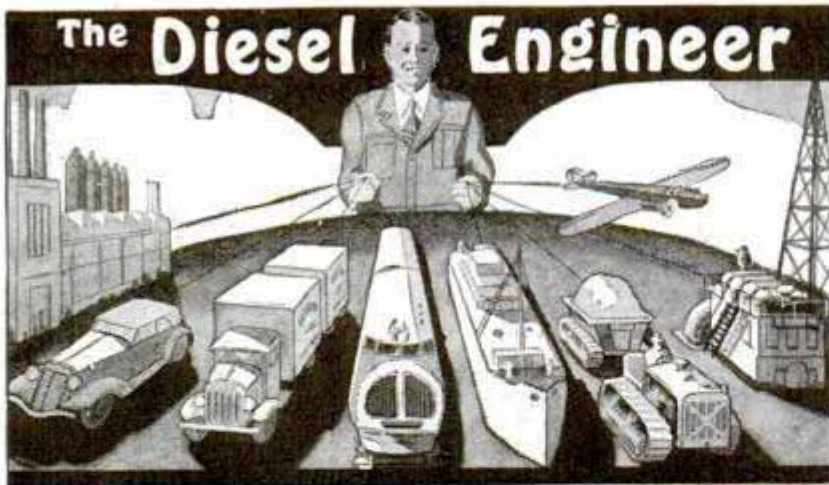

The Diesel Engineer

Is Your Job Safe?

Just as the gasoline engine changed the jobs of thousands who depended on horse-drawn vehicles for their living—so now the Diesel engine is fast invading both the power and transportation fields, and threatening the present jobs of thousands.

What This Field Offers You

Diesel engines are replacing steam and gasoline engines in power plants, motor trucks and busses, locomotives and ships, aircraft, tractors, dredges, pumps, etc.—opening up well-paid jobs for Diesel-trained men. You get all the latest Diesel developments in our course. Special diagrams for quick understanding of this new power.

For Men Earning Under \$40 a Week

Diesel—The New Power

Now is your chance to get into a big new industry and grow up with it in an important position. Today there is practically no competition in the Diesel field, but the increasing use of Diesel engines will result in keen competition for jobs after a few years. If you start your training now and get established in this field, you need not worry about competition.

Job Facts in Diesel

Learn how quickly you can prepare for growing opportunities in Diesel by our Job-Instruction method. Train at home for this good pay field where there is chance for rapid promotion. Free employment service to graduates. Low monthly terms. If you want a good job get FACTS! Write for booklet today!

AMERICAN SCHOOL, Dept. D745, Drexel Avenue at 58th Street, Chicago, Illinois

Fit Yourself For a Good Pay Job



CARTOONING

To those earnest students of this fascinating profession who realize the advantage of PERSONAL INSTRUCTION by a nationally known cartoonist, I offer a system of study recommended by America's foremost cartoonists. It's as near like private tutoring as is possible in a home study course. Write at once for free details.

DORMAN H. SMITH, Box C597, San Rafael, California



Know Electricity as Experts Know It—and Get an Expert's Pay!

Recovery has begun! The months ahead are charged with significance and expectation. What will you do to get the jump on the other fellow? Thousands of men have used

The Croft Library of Practical Electricity

The Croft Library is a complete electrical educator. It is founded on practice—on 20 years of shirt-sleeve experience—on work as it is actually done. It is jammed from cover to cover with the kind of hard-headed facts you want. Written so that the beginner can easily understand it, yet so sound, so thorough, that it is the daily guide of 50,000 highly paid electrical workers and engineers. Croft tells you the things you need to know about motors, generators, armatures, commutators, transformers, circuits, switchboards, distribution systems—electrical machinery of every type—wiring for light and power—wiring of finished buildings—underwriters' and municipal requirements—illumination in its every phase—the most improved methods of lighting—lamps and lamp effects, etc.—how to do a complete job, from estimating it, to completion.

No money down—easy payments

Fill in and mail the coupon attached and we will send you the entire set of seven volumes for ten days' Free Examination. We take all the risk—you assume no obligation. If you decide to keep the books, send \$1.50 in ten days and the balance at the rate of \$2.00 a month. Send the coupon NOW and see the books for yourself.

FREE EXAMINATION COUPON

McGraw-Hill Book Co., 330 W. 42nd St., New York

Send me for ten days' free examination the Croft Library of Practical Electricity. If satisfactory I will send you \$1.50 in 10 days and \$2.00 monthly until the price of \$19.50 is paid. If not wanted, I will return the books postpaid. (To insure prompt shipment write plainly and fill in all lines.)

Name.....
 Home Address.....
 City and State.....
 Position.....
 Name of Company..... PM-10-38

When writing please mention Popular Mechanics

AMAZING MACHINE GROWS HAIR

“Intermittent Vacuum” stimulates deep-lying scalp blood vessels—and GROWS HAIR in thousands of cases of baldness. Stops falling hair. Tones up scalp. New hair often in 90 days. Easy to use this amazing machine at home. Only \$9.95 complete. Write quick for FREE TRIAL OFFER.

Only \$9.95 COMPLETE

FULLY GUARANTEED WITH RAND. DEPT. N-1662, NEWPORT, KY.

STUDY ENGINEERING AT HOME

Home Study Courses leading to Degrees in Electrical; Civil; Mechanical; Diesel; Architectural; Aeronautical; Automotive; Drafting; Radio; Air Conditioning; Refrigeration; Highway, Mining, Petroleum, Industrial, Marine, Chemical Engineering; Arts, Sciences; Philosophy; Education; Writing; Psychology; Chemistry; Theology; Law, Agriculture; Business; Advertising; Sales; Accounting. Chartered by State of Illinois.

McKinley-Roosevelt Graduate College, 4240 Clarendon Avenue, Chicago

LAW HIGH-GRADE INSTRUCTION BY CORRESPONDENCE

College, Post, Grad. and Bar Ex. Rev. Courses. Law has attracted more keen, brainy men than any other calling. Send today for catalog. Low cost, easy terms. Text books loaned free.

Chicago School of Law Dept. 801, Reaper Block CHICAGO, ILL.

CHICAGO PAINTING SCHOOL

36TH YEAR TEACHING PAINTING—PAPERHANGING—DECORATING—SIGN PAINTING—SHOW CARD WRITING—GRAINING & MARBLING—PICTORIAL PAINTING. Courses from 6 to 10 weeks. Folder Free. Dept. PM-10 437 N. CLARK STREET CHICAGO, ILL.

5c TIRE MAKES \$2.00 MAT

Make springy, long-wearing Rubber Mats out of old auto tires. Any length or width. BIG sale to schools, factories, stores, homes. Think of the profit. Brand new business, fully patented. Field untouched. Reasonable investment and simple hand machine starts your local plant. Write quick for free information. Don't lose a minute—this is BIG!

FABRIX, INC. Dept. 710 325 W. Huron St., Chicago, Ill.

Sparkling Clear GLASS EYES

The best for less!—Crystal Clear, Enameled Glass Eyes. Head Forms, Shields, Panels, Tools, Chrome-Tan Crystals... everything needed in Taxidermy. NEW 32-PAGE CATALOG FREE. Full of Bargains. New Ideas. Send postcard TODAY for your FREE COPY. Taxidermic Manufacturers, Dept. J-10, Memphis, Tenn.

FREE 32-Page Catalog

Midget Portable Electric or Battery Radios

WORLD'S SMALLEST RADIOS

Just a handful—Wt. only 2 lbs. Size 3 1/2 x 5" — 4 tube performance! Midget BUILT IN LOUD-SPEAKER and AERIAL. Has Broadcast and Short Wave bands! Simple to operate. Ideal Radio for Office, Apts., Bed-rooms, College, Camps, Trailers, etc. Battery model has batteries inside case for use on Farms, Boats, Autos, etc. Electric model uses 110 Volt A.C. D.C. Either model kit of parts for \$6.49. Wired and tested 50c extra or \$1.99 complete ready to listen! (Batteries for Battery model \$1.79 extra). SEND ONLY \$1.00 and pay postman balance on delivery. ORDER NOW! GUARANTEED.

TINYTONE RADIO CORPORATION, Dept. P-10, Kearney, Nebr.

NEW INVENTIONS #816

(Continued from page 24A)

DESIGNED to reduce glare from approaching headlamps, a simple eye shield for the automobile has been patented. It has a bracket to which a panel of anti-glare material is attached. The panel is movable, so the driver may swing it out of the



way during the day or when it is not in use at night. The bracket, with the anti-glare panel, is mounted outside the car, on the cowling. A metal arm with a handle extends into the driver's compartment so that the shield may be swung to and fro.

INTEDED probably as a vehicle for children or for sports purposes, an odd-looking bicycle patented recently is manually operated. It has a high front wheel and a low rear wheel, above which is located the seat. The operator places his feet on the low platform connecting the wheels, then propels the bike by pushing a lever up and down to actuate the front wheel.

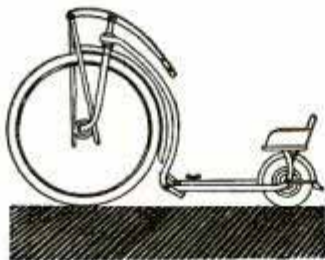

FOR the apartment or small home, a newly patented combination ironing board and bench for the breakfast table is a space-saver. From a cabinet positioned within the wall, the ironing board may be lowered from folded position to serve either of its uses. A leg, which supports the board when it is used as breakfast-table bench, folds against the under side when ironing is in progress. A brace supports the board for ironing. The board is adjustable, up or down.

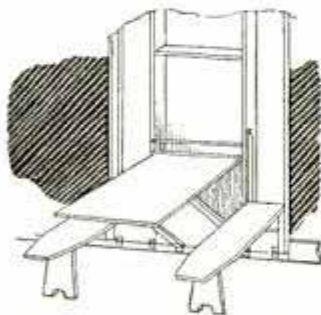

(Continued to page 54A)

THOUSANDS HAVE LEARNED TO PLAY THIS EASY WAY..



Everything was so plain and easy, I began actual music in less than two months! My friends were astonished—they wondered when and where I had ever taken music lessons.
* Miss R. P. Southmont, N. C.



I enjoy practicing your lessons and am making great headway. I play in a church as second violinist and have also signed up with the M—Band of Ohio, getting \$2 per playing hour.
* Mr. E. C. R., Pemberville, Ohio.

*Actual pupils' names on request
Pictures by Professional Models

FREE BOOKLET.. and demonstration lesson

SEE for yourself how simple and easy it is to learn to play your favorite instrument through this famous short cut method. The U. S. School of Music will gladly send you a Free Demonstration Lesson and explanatory booklet which describes the amazingly simple principles on which this method is built. No needless exercises. No expensive teacher. You learn at home in your spare time—and much faster than by old-fashioned tedious methods.

More than 700,000 people have studied music this easy way—and what they have done you, too, can do. . . . The cost is surprisingly low, averaging only a few cents a day. If you really *do* want to play your favorite instrument—fill out and mail the coupon NOW! The Free Booklet and Demonstration Lesson will be sent you at once. Instruments supplied when needed, cash or credit. Address U. S. School of Music, 710 Brunswick Bldg., New York City.

Pick Your Course	
Piano	Guitar
Violin	Saxophone
Organ	Mandolin
Cornet	Ukulele
Trombone	Harp
Piccolo	Clarinet
Flute	Cello
Hawaiian Steel	Guitar
	Trumpet
	Piano Accordion
	Plain Accordion
	Voice and Speech
	Culture
	Harmony and Composition
	Drums and Traps

U. S. SCHOOL OF MUSIC.
710 Brunswick Bldg., New York City

Send me your amazing free book, "How You Can Learn Music in Your Own Home," with inspiring message by Dr. Frank Crane; also Free Demonstration Lesson and particulars of your easy payment plan.

Have You
Instrument Instrument?

Name

Address

Be Somebody—

**Get more money; prestige; a better career
You can do it. Read this**



- "YOU KNOW, MARY, I DREAMED OF BETTER THINGS FOR US— BUT SOMEHOW I'VE FAILED TO GET WHAT WE HOPED FOR—"
- "I KNOW, JIM—WE'VE WORKED HARD, TOO. BUT YOU DO WORK ANYONE COULD DO. THERE MUST BE SOMETHING—"

AND there is something. Here it is: Become an Accountant; train at home in your spare time—with LaSalle! Fit yourself to get bigger pay in a modern respected profession. Prepare yourself to get what you want from life—a home, money for education, a car, luxury for your family—everything you've hoped for!

Accountancy through home study opens two fields for you. First, it can put you in line for higher bracket jobs in your present company. It can give you the drop on untrained men—can lift you out of their class. Your increased value will quickly be apparent in your work and noticed by your superiors. Accountancy training can give you ability and experience for which business is looking—for which it is glad to pay.

The second opportunity LaSalle Home Study Accountancy offers is a profitable profession of your own! Right now the professional accountant faces a greater demand than ever before. It is not uncommon for trained accountants to earn \$3,000, \$5,000 and more.

Three Men Who Proved It Can Be Done

Read the actual experience of three men who started accountancy training with us several years ago:

After a short period of intensive study, the first man started bookkeeping jobs on the side. Soon he got

enough of them so he opened his own business. Today he is his own boss, a successful business man with a splendid income. All in one year!

Another member—five months after starting his study—was called into the office and given a more responsible position paying \$40 a month more. His employer told him anyone studying a LaSalle home-study course was obviously more alert than most men and therefore capable of a bigger job.

To the employer of the third member we sent information about the member's study. The letter resulted in his being chosen—above five other candidates—for a better position with shorter hours and more pay.

Just three of thousands who tell us that LaSalle home study was the turning point in their lives. Their cases, which may seem extraordinary to you, are not uncommon to us. Many others have done as well. Perhaps you can, too. At least, it's worth investigating.

Send for This Free Book

The facts about LaSalle training in Accountancy and the opportunities in this growing field are clearly outlined in a 48-page book which LaSalle will send you free. If you have the urge and the will to increase your income, clip and mail the coupon for it—NOW.

LASALLE EXTENSION UNIVERSITY, A Correspondence Institution Dept. 1064-HR Chicago, Ill.

I'd like to see whether I should take up Accountancy. Send me—without obligation or cost to me—your booklet *Accountancy, the Profession That Pays*, and full information about your Accountancy training program.

Other LaSalle Opportunities:

Higher Accountancy

If more interested in one of the fields indicated below, check and mail now.

- | | | |
|--|---|--|
| <input type="checkbox"/> Business Management | <input type="checkbox"/> Railway Accounting | <input type="checkbox"/> C. P. A. Coaching |
| <input type="checkbox"/> Modern Salesmanship | <input type="checkbox"/> Practical Accounting and Office Management | <input type="checkbox"/> Business Correspondence |
| <input type="checkbox"/> Law—Degree of LL.B. | <input type="checkbox"/> Expert Bookkeeping | <input type="checkbox"/> Business English |
| <input type="checkbox"/> Commercial Law | | <input type="checkbox"/> Stenotypy |

Name..... Age.....

Present Position.....

Address.....

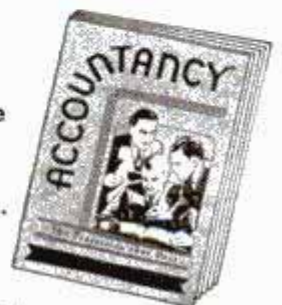

When writing to advertisers please mention Popular Mechanics

**WORLD'S
BEST
WANT AD
MEDIUM**

CLASSIFIED Advertisements



Advertisements in this section, 35 cents per word, each insertion, minimum 10 words, payable in advance
To be inserted under proper classification in November issue, copy should be in our office September 8th

November issue on sale October 1st

Popular Mechanics Magazine, 200 East Ontario Street, Chicago, Illinois

YOU'LL PROFIT

By reading and answering the classified ads in this section. Hundreds of opportunities to make and save money.

Mr. F. W. Johnson,
Popular Mechanics Magazine,
200 E. Ontario St.,
Chicago, Ill.

Dear Mr. Johnson: I feel it is my duty to write and tell you of the fine results I have obtained from my ad in Popular Mechanics. What counts is the amount of cash that comes in, and the number of repeats. I know that every time my ad appears in your paper I will receive 60 to 70 crisp dollar bills. Each month this amount increases, because 10 per cent are repeats. Your readers have the cash, but what's more, they are willing to part with it.

(Original letter on file in our office)

Yours faithfully,
L. PRICE.

AUTOMOBILES

MIDGET Racing book; facts for fans, builders, drivers; track sizes, regulations; pictures, specifications, working drawings. \$1.00 postpaid. \$1.15 C.O.D. Ray Kuns, Department 30, Madisonville, Cincinnati, Ohio.

FORDS '37 Action brakes \$2.25. Information free. Crandall Parts Co., 452 West 19th, Houston, Texas.

MIDGET Cars, parts, plans. Catalog 20c. Derby Midget Cars, Woodstock, Ill.

NEW Method saves gas, oil. Community Research, Box 323, Farrell, Penna.

AMAZING Offer to motorists. Information free. Hutchison, 314 N. 4th, Camden, N. J.

MIX Your own anti-freeze; costs but few cents per gallon. Slow evaporating, non-inflammable, non corrosive, and has high boiling point. Instructions \$1.00. The Montan Anti-freeze, Glasgow, Montana, Box 456.

1938 IGNITION Supercharger. Quick starting, wet or cold. Mileage, pep, power, less carbon, \$1.25. E. G. Sales Co., 321 Broadway, New York.

FORD V-8's, 1934-1938; gasoline saving device. \$1. Walert Co., 3429 No. 10th St., Milwaukee, Wisconsin.

MIDGETS! Catalog—plan book, 10c. List 100 used motors, midgets, parts, 20c. Details free. Shipps Midgets, Box 543-H, Zanesville, Ohio.

AUTO TRAILERS

BUILD The famous, low-cost Jim Dandy Cabin Trailer. Complete plans and instructions 50c. Plans to build the beautiful, streamlined Jim Dandy Cabin Cruiser, \$1.00. Trailer Builders Manual and catalog of trailer parts, supplies and equipment—over 100 interesting, illustrated pages, 25c. Order today. Satisfaction guaranteed. Trailer Supply Co., 411-A Jackson St., Wausau, Wisconsin.

BUILD Your own house trailer now. We furnish everything complete for \$92.50. Box 283, Mansfield, Ohio.

AUTO SUPPLIES AND EQUIPMENT

SAVE Half! Guaranteed reconditioned truck and auto parts. All parts—all models, makes. Catalog free. General Auto, 7008-AA Cottage Grove, Chicago.

FREE 1938 Wholesale bargain catalogue auto supplies, equipment, tools. Lefte, 1189 Bedford Ave., Brooklyn, N. Y.

GARAGE Door holders, 50c pair (coin). Julian Bradbury, Jr., Fennimore, Wis.

PLATING Outfits for auto parts. Connect to a battery. No tanks used. Free particulars and proofs. Gunmetal Co., Ave. J, Decatur, Ill.

MOTORCYCLES, BICYCLES, MOTOR SCOOTERS AND SUPPLIES

MOTORCYCLE Bargains, lowest prices, bargain sheets for stamp. Motorcycle accessories. Rochester Harley Davidson Corp., 129 W. Main St., Rochester, N. Y.

BUILD Your own motor scooter. We furnish parts. Literature dime. Drawings free. Comet Cycle Company, Box 3032, Madison, Wisconsin.

SEND 10c In stamps for illustrated bulletin of cut-rate motorcycle supplies, new and used parts. Authorized Harley distributors. Tulsa Motor & Cycle Co., 917 E. 2nd, Tulsa, Oklahoma.

ALLOY Pistons—Harley, Indian, Henderson, Excelsior, Cleveland. New and used parts for less. Cylinder grinding. Catalogue and wings pin 10c. Ballak, 1115 Chestnut St. Louis, Mo.

INSIDE Dealer prices. Overstocked, all models, Indians and Harleys. Rebuilt, guaranteed. Dime brings latest list. Crandall-Hicks, Boston, Mass.

REBUILT Motorcycles, all makes, new and used Harley-Davidson parts. Send 10c for bulletin. Western Harley-Davidson Distributors, 914 E. 15, Kansas City, Mo.

RECONDITIONED Motorcycles. New-used parts for all makes. Authorized Harley-Davidson dealer. Whitman Motorcycle & Supply Co., 405-9 Southwest Blvd., Kansas City, Mo.

SEND 15c For illustrated used motorcycle catalog. Bargains. Largest stock genuine Indian parts and motorcycles. Indian Motorcycle Sales, Kansas City, Mo.

AVIATION

PROPELLERS For airplanes, sleds. Also leased blueprints. Catalog dime. Lorenzen Propellers, Niles, Michigan.

PROPELLERS—Sled, aircraft. Catalog 5c. Woodcraft Propellers, Love Field, Dallas, Texas.

AVIATION Needs men. Pilots, mechanics, draftsmen, sheet metal, positions open. Learn now. Free catalog. California Flyers School of Aviation, Dept. PMC-10, Los Angeles Airport, Inglewood, California.

PROPELLERS: Including latest 3 blade type, more efficient, attractively priced. Sleds, aeroplanes, ventilating generator, fans, list free. Universal Aircraft, Ft. Worth, Texas.

TO Highest bidder: American flea ship, Fort Worth, Texas, production. Flown little. Warren Butz, 1176, Coalinga, Calif.

GET Into aviation. Air transport pilots get up to \$6,000 per year, mechanics \$2,500. Learn at this government approved school. Write for complete information. State age. Lincoln Airplane and Flying School, 2004 Aircraft Building, Lincoln, Nebraska.

INSTRUCTION For professional airmen. Transport license texts which take the drudgery out of study are published only by Thompson Aviation Publishers, 8318 Woodward, Detroit, Mich. Write for literature.

AIRPLANE Mechanic's license questions with answers, diagrams, \$1.25. Engine Mechanic's \$1.25. Both, \$2.00 remittance. Meyer Engineering, Box-8, Hempstead, N. Y.

AVIATION Apprentices. Good pay—Big future. Write, immediately, enclosing stamp. Mechanix Universal Aviation Service, Strathmoor Station, Dept. E2, Detroit, Michigan.

HOW I learned flying without money. Circular, dime. Meyer Engineering, Hempstead, N. Y.

BATTERIES, GENERATORS, ETC.

BUILD Wind electric plant. Complete plans and valuable catalog 10c. Wind plant parts, welders, electric fences. LeJay Manufacturing, 447 LeJay Building, Minneapolis, Minn.

A. C. Generators, hand-driven, generates 110 volts, original price \$5.50. Special 98c. Electrical Salvage, Box 524-86, Lincoln, Nebr.

PLATING Generators and motor generator sets. Write for information Hobart's new line electro plating equipment. Payments low as \$12.40 monthly. Quality machines, quick delivery guaranteed. Hobart Bros., Box M-1082, Troy, Ohio.

FREE Plans for wind plant with each Ford rewind slow speed generator at \$3.50 each. Plans only—10c. Wesco, Minneapolis, Minn.

EDISON Storage batteries for light-power systems. Non-acid. Odorless. fifteen year life. Five year unconditional guarantee. Bargains in complete lighting systems. Low prices. Free illustrated literature. "See-Jay" Battery Co., 82 Sterling Ave., Yonkers, N. Y.

WHOLESALE Prices automobile air cooled generators for cars and trucks. New and rebuilt. Wilt Electrical Co., 7829 So. Racine Ave., Chicago.

EDISON Lifetime storage batteries for light and power. Eliminates acid battery diseases. Long guarantee. All kinds rebuilt generating plants, motors, and miscellaneous articles at bargain prices. Free interesting literature. T. Hawley Smith Co., Croton Falls, N. Y.

AIR-CONDITIONING

HOME-STUDY Air conditioning course, complete. Worth \$10.00, special \$2.95. Free circular. Supreme, 3727 West 13th, Chicago.

ELECTRICAL SUPPLIES—EQUIPMENT

CUT Coal bill in half and control heat. Two months use saves equipment cost. Stamp. Serv-al Products, Schenectady, N. Y.

ELECTRO-SCRIBE: Electric pencil writes, engraves all metals. \$1.00 postpaid. Details. Beyer Mfg. Co., 4515-K Cottage Grove, Chicago.

ELECTRIC Meter, pyrometer, repairs, calibration, new and used meters, pyrometer supplies, for sale. Cleveland Electric Laboratory Co., 1988 E. 66 St., Cleveland, Ohio.

ULTRA Violet—Infra red. Dual ray health lamp. Two separate units in one. Promotes sun tan—vitamin "D". Automatic control. AC-DC current. \$3.90 postpaid. Details. Beyer Mfg. Co., 4515-P Cottage Grove, Chicago.

ELECTRIC Pen, engraves all metals, 30c prepaid. Hudson Bros., East Syracuse, N. Y.

ELECTRIC FENCING

FENCE Controller easily converted from Ford T coil. No extra cost. Complete plans 35c. LeJay Manufacturing, 847 LeJay Building, Minneapolis, Minn.

ELECTRIC Fencer, complete, \$3.95. Approved. Guaranteed. Free circular. Electric-Fence Company, 1529 South Komenky, Chicago.

NEW And used electric fences bought, sold and exchanged. Write for list. Smith, Judd, Grandview, Washington.

WELDING AND SOLDERING

HIGHEST Grade "Rubyfluid" soldering flux and solder. Old reliable brand. Special trial offer. Send \$1.00 and receive can flux, can paste, pound spool acid-core solder. You'll want more. Ruby Chemical Co., 68 McDowell, Columbus, Ohio.

ARC-WELDER Plans \$1.00 each. Delco plan 25-200 amperes from Delco 32 volt light plant generator. Heavy duty plan 25-600 amperes from d.c. truck motors, etc. Dodge plan 25-200 amperes from North-east (Dodge) 12 volt automobile generators. Welders Club of America, AB-3432 M-Mart, Chicago. (Positively no armature winding.) Agents desired.

SUPER Welding rod. A finer a.c. or d.c. welding rod. 2 lb. sample \$1.00 postpaid in U. S. Welders Supply Co., Box 132, Bellefontaine, Ohio.

DEMONSTRATORS, Electric arc welders. Money-saving prices. Used by the government. Trial and terms guaranteed. Hobart Welders, M-1083, Troy, Ohio.

WELDING Rods—Scientifically designed for a.c. transformers, flat, vertical, overhead welding. Per lb. 3/16"—17c, 5/32"—19c, 1/8"—21c, 3/32"—29c, 1/16"—58c. Send \$1.00 for 2 3/4 lb. assortment, or order. Welder Company, 2137 Wabash, Chicago, Illinois.

REBUILT a.c. d.c. Arc welders, all sizes; engine governors, idlers. Terms. Low prices. Guaranteed. Service Co., 3732 Cedar Ave., Cleveland, Ohio.

ACETYLENE Welding outfits, \$32.95; electric welders, \$74.95. Easy-payment plan. Box 331, Hamilton, Ohio.

ENGINES, MOTORS, DYNAMOS

THREE To ten KVA alternating generators. Motors, converters. Queen City Electric, 519 South California, Chicago.

GOVERNORS For auto engines. Candee-Smith, 445 East 3rd Street, Los Angeles.

ELECTRICAL Bargains. 1/4" drill \$3.67; cleaner \$5.35; shaver \$4.25; numeral clock \$3.75; coffee maker \$2.20. Home workshop tools. Motors. Free pricelist. Mailorder Electric Co., 713 So. Dearborn St., Chicago.

FOR Sale—Small elect. motors, high speed, 1/10 h.p., 115 volt, universal. Rebuilt—\$2.00 postpaid. McConnell, 1619 Edgewood, Racine, Wis.

BARGAIN—1/2 Hp. motors, 60 cycle, 1 phase, 110 volt, like new, guaranteed, \$8.25. Send check to Erie Electric Motor Co., 120 Church, Buffalo, N. Y.

GUARANTEED. Slightly used 1/2 horse, 110 volt, alternating motors \$7.90. Wilmot Auto Supply, 2247 St. Paul Ave., Chicago.

WINDING Data, 225 motors, single and three phase. Price \$1. Motor Data Co., Box 7631, Kansas City, Mo.

MACHINERY, TOOLS AND SUPPLIES

14" x 6' **BRADFORD** Cone head engine lathe, quick change. No. 0 Cincinnati miller, cheap. Write for particulars. Cincinnati Machinery & Supply Co., 221 E. Second St., Cincinnati, Ohio.

CONCRETE Mixers, hand and power. Also machines made for mixing many other materials. S. T. Hatcher Co., 4528 Easton, St. Louis, Mo.

CONCRETE Building block machines and molds. Easy payments. Catalog free. Concrete Machine Co., 5 North Main St., St. Louis, Mo.

KELLOGG Air compressors, \$6.00. Refrigeration units, \$15.00. Taylor, 105 East 102nd Street, New York.

BARGAINS, Demonstrators, electric arc welders, guaranteed, 30 days trial and terms. Write Hobart Welder Exchange, Box M-1084, Troy, Ohio.

PLASTICS, Brass, aluminum, monel, stainless steel, gears, etc., in small quantities. Catalog 10c. Hobby Supply House, Box 2014, Pittsburgh, Penna.

SOUTH-BEND 9" Lathe milling attachment, universal movement, \$9; threading dial indicator, \$3; circular free. Unique Manufacturing Co., 4807 No. 31st Ave., Omaha, Nebr.

GIANT Gadget kit. Screws, nuts, washers, gears, brackets, rivets, springs, etc. Experimental motor. Ten lbs. Over 1,000 items. Price \$1.49—worth \$7.50. Satisfaction guaranteed. Manufacturers Supply, 217 W. Illinois, Chicago.

COMPLETE Portable paint spraying outfits, thoroughly rebuilt, \$15.00. Limited supply. 15 Harper, Detroit, Michigan.

SLIDE Rule bargain. American 10" white face, magnified cursor and case. With instruction and practice books 75c. Satisfaction guaranteed. Grant's, 1649 44th Street, Brooklyn, N. Y.

BOATS, OUTBOARD MOTORS, ETC.

FORD Marine conversion parts and kits. Models A, B, V8 (domestic or foreign). Catalog 25c (coin). Osmithson, 3101 C Street, Philadelphia, Penna., U.S.A.

FORD And Zephyr marine engines. Send 10c coin. Lehman Engineering Company, Newark, N. J.

12 **FOOT** Weldwood boat—sail, row, outboard. Complete building plans 35c. Free catalog. Rudder, 15 Murray Street, New York.

BARGAINS In rebuilt outboard motors. Send stamp for list. Murray Boat Shop, Traverse City, Mich.

BUILD A boat—Everything for building or equipping your boat. Build a boat by the Welch system. Use Welch Ready Cut Parts. Inexpensive, interesting and profitable. Send 10c for catalog showing boats of many types; propellers; boat hardware and White Cap marine motors. Welch Boat Company, Station K-1, Milwaukee, Wisconsin.

\$10.00. **COMPLETE** 12' Kayak kit. Exceptional value. Playaks, Dedham, Mass.

PROPELLERS, Gear pumps, stuffing boxes, bearings, etc. Wm. Baker, Pond St., Quincy, Mass.

ASSEMBLE Your own boat. Our finished knock-down frames and materials save you 2/3 builder's cost. All types and sizes. Send 25c for big catalog. Brooks Boat Co., Inc., D4, Saginaw, Mich.

OUTBOARDS—Save 1/2. Good used parts, all makes and models. Bargains rebuilt motors. Crandall Hicks Co., 959 Commonwealth, Boston, Mass.

BOAT Designers are highly paid professionals. Complete course by mail. Catalog. Westlawn, Montville, N. J.

SPORTING GOODS, GUNS, FISHING TACKLE, ARCHERY

HUDSON Bay blankets, Indian pack baskets, camp stoves, knives, compasses, outdoor equipment. Free catalog. Howe Fur Co., Box P, Coopers Mills, Maine.

FREE Hunting equipment catalog No. 21. Moccasins, boots, gun cases, wool goods, etc. Nichols Corp., Yarmouth, Maine.

FENCING Equipment. Foils, swords, masks, etc. Low prices. Free catalog. Industrial Products, Dept. 210, 48 West 48th Street, New York.

ENJOY Camping, fishing, wearing fine Bobinet Pipehole Headnet. Protection from gnats, mosquitoes, etc. \$1.50, tariatan \$1.25. Joined handle, butterfly net 42 inches long, \$1.50 postpaid. Cope Mfg. Co., 3726 N. Tenth, Philadelphia, Penna.

BARGAIN Gun catalog, send 5c. Bargain tackle catalog, send 5c. J. Warshall & Sons, First and Madison-PM, Seattle, Wash.

REPAIR And remodel your own guns. 20 books on gunsmithing and firearms. Free catalog. Samworth, Marines, N. C.

GOLF Clubs. Five club matched set \$2.50. Lincoln Surplus, 123 Galena, Freeport, Ill.

TREASURE Finders? Read Goldak advertisement on page 131A.

FIELD GLASSES, TELESCOPES AND MICROSCOPES

FREE Instructions. Build powerful telescope. Atensco, Box 213, Flushing, N. Y.

USED Microscopes, binoculars, astronomical telescopes—Bought, sold, repaired. Send 10c for list. Rasmussen, P. O. Box 294, Amsterdam, N. Y.

TELESCOPES, Microscopes, binoculars; 1938 bargain catalog free. Brownscope Company, 5 West 27th Street, New York.

TELESCOPES, Microscopes, chemistry, mineralogy. Scientific catalog free. Tracey Laboratories, Evanston, Illinois.

BUILD Reflecting telescope, 6" kit, \$3.50; instructions 10c, catalog free. Optical Development Corporation, 1560 Broadway, New York.

ANTIQUES, RELICS, INDIAN GOODS

LARGEST Catalog fine Indian material ever issued. 25c, no stamps. Bernard, Box 192, Oakland, California.

100 **GOOD,** Or 60 fine, arrowheads, \$3.00. George Holder, Glenwood, Ark.

100 **GOOD** Arrowheads \$3. Catalog. 5c. H. Daniel, Hot Springs, Ark.

INDIAN Relics, beadwork, coins, curios, minerals, old glass. Catalog 6c. Indian Museum, Northbranch, Kansas.

TAXIDERMISTRY

LEARN By mail to mount birds and animals, tan skins, make leather. Old reliable school teaches, easily, quickly, at low cost. Over 250,000 students. Rush postal for free 48 page book. Northwestern School of Taxidermy, 775 Elwood Bldg., Omaha, Nebr.

"**TAXIDERMY** News" magazine. Professional? Amateur? Sample. For sale—deerheads, bear rugs, birds. Hofmann, 992 Gates, Brooklyn, N. Y.

GLASS Eyes, taxidermists', furriers' supplies. Big catalog free. Elwood Company, 222 Smith Bldg., Omaha, Nebr.

TAXIDERMISTRY Supplies—Quality artificial eyes, teeth, genuine Jonas head forms. Tools, materials, etc. Everything for the progressive taxidermist. Send 10c for big illustrated catalogue. Jonas Bros., 1049 Broadway, Denver, Colo.

DOGS, PETS, BIRDS

I CAUGHT 46 coons last season. Have male Coon Hound, 3 1/2 years old, Bluetick-Redbone bred, large size, wide hunter, fast, good voice, true at tree, rabbit, fox, stock, deer proof, \$15.00. Ten days trial. Bank reference, picture of myself furnished. J. N. Ryan, Murray, Ky.

SPORTSMEN: 200 Pointers, Setters, straight cooners, combination hunters, rabbit and fox hounds. Reasonable. List free. Ramsey Creek Kennels, Ramsey, Illinois.

"**BABY**" Saint Bernards shipped anywhere our risk. Dime brings illustrations; souvenir! Royal Kennels, No. 8, Chazy, N. Y.

\$15.00 **BUYS** Trained coon hound. Opossum, fox, rabbit and bird dogs cheap. List free. Ramsey Farm Kennels, Ramsey, Illinois.

BEAUTIFUL Pure white police dogs. Ansonia Kennels, Mose, N. Dak.

POULTRY AND FARM SUPPLIES

DAVIS Chicks for broilers and layers. 21 different breeds. Sexed chicks, poulters \$3.50—100 and up. Free catalog. Davis Poultry Farm, Route 34, Ramsey, Indiana.

GREENSBURG Chicks—\$3.50 per 100 and up. Also sexed chicks. Greensburg Hatchery, Box 40, Greensburg, Indiana.

BEE Hives, finest quality, lowest prices. Write catalog. The Stover Apiaries, Mayhew, Miss.

MAKE Money with poultry. Read America's leading poultry magazine for latest information. Three years \$1.00; nine months 25c. Poultry Tribune, Dept. E-93, Mount Morris, Ill.

TREES, SHRUBS, ROOTS, HERBS

GINSENG Growing instructions free, frog leaflet 10c. Specialty Farm, Rockford, Minn.

JUST Out! World's greatest "Herbalist Almanac." Beautifully illustrated in natural colors. Contains over 200 old-fashioned herb medicine recipes for home use. 10c postpaid. Worth dollars! Botanics, 145 W. 112th St., Chicago.

FARMS AND FARM LANDS

THE Great Northern Railway serves an agricultural empire where rents, prices and operating costs are low in Minnesota, North Dakota, Montana, Idaho, Washington and Oregon. Write for free book. E. C. Leedy, Dept. 1057A, St. Paul, Minnesota.

\$315 SECURES Bank bargain, 40 acres, considerable fruit, 2½ miles fine town of 9000; 6-room house and barn; price only \$915, easy terms; picture page 106 free catalog of 2000 bargains. Strout Realty, 255-P 4th Ave., New York City.

GOVERNMENT Lands ten cents acre up. Information all states twenty-five cents. National Tax Service, 600A Majestic Bldg., Detroit, Mich.

40 ACRES, Near White River, unimproved; poultry land. \$175, \$5 down, \$5 monthly. Free list and literature. Hubbard, 216 Grossman Bldg., Kansas City, Kans.

GOOD Farms available. Washington, Minnesota, Idaho, western Montana, Oregon. Dependable crops, favorable climate. Write for impartial advice, literature and list of typical bargains. Specify state. J. W. Haw, 119 Northern Pacific Ry., St. Paul, Minn.

PROFITABLE OCCUPATIONS

205 MONEYMAKING Plans. Start your own business from home, office, etc., making \$25-\$75 weekly. Booklet free. Stamford, 3762-A Broadway, New York.

NO Selling! M. M. earned \$267, three weeks, raising mushrooms in cellar! Exceptional, but your cellar, shed perhaps suitable. We buy crops. Book free. United, 3848 Lincoln Ave., Dept. 62, Chicago.

"RAISE Frogs!" We buy! Good prices year round. Small pond starts you. Free book shows sketch. American Frog Canning, (153-T) New Orleans, Louisiana.

RAISE Mink, dime for general information. Lomman's Fur Farm, Spangler, Penna.

POSITIONS At sea—Literature free. No employment agency. Julius, Amarillo, Texas.

WRITERS: Sales consideration \$1.00. Folder, questions answered twenty-five cents. Richard Tooker, Box 148-M, Phoenix, Ariz.

RAISE Angora wool rabbits! Easy, profitable, fascinating! Wool brings \$3 to \$6 lb. Catalogue, wash samples 10c. Clay's Farm, Sharon, Wash.

NATIONWIDE Opportunities—10c. Get on our list. Swaty's, Mentone, California.

MAKE Rainbow photo rings, initial jewelry. Samples 10 cents coin. Rainbow Ring Company, Box 690, Omaha, Nebraska.

TREASURE Finders? Read Goldak advertisement on page 131A.

SELL Greeting cards all year. 100% profit. Baker Brothers, Roselle, New Jersey.

WANTED Original poems, songs, for immediate consideration. Send poems to Columbian Music Publishers, Ltd., Dept. P66, Toronto, Can.

COUNTRY Drives or movies afternoons! Work mornings home. No canvassing! Folio-H, Station D, Los Angeles.

RAISE Rabbits and covies for us. We buy at top prices. Complete details in catalog, contract and magazine. 10 cents. Stahl, Box 1, Holmes Park, Mo.

FREE Booklet describes 107 plans for making \$20-\$100 weekly, in home or office, business of your own. Elite Co., 214 Grand St., New York.

RAISING Jumbo frogs. Interesting. Big future. Females lay 10,000 eggs. Free literature. American Frog Industries, Box 336, Rayne, La.

BOOKS, PERIODICALS, PICTURES, POSTCARDS

YOUR Favorite magazines—Half price. Catalog, 10c. Magazine Exchange, Baseline, San Bernardino, Calif.

FREE Catalog scientific, mechanical and technical books. Readers Service, 800-7 North Clark, Chicago.

CASH For used books! Information free! Bookery, 3941 Shaker Square Station, Cleveland, Ohio.

BOY Mechanic—Famous library of 3 volumes covers the building of almost everything a boy might want to make. Actually covers 3,000 different articles. Each volume 460 pages, fully illustrated. Cloth. Price \$2 each or set of 3 vols.—\$5 postpaid. Popular Mechanics Press, Room (C38), 200 E. Ontario St., Chicago.

YOUR Favorite magazine, postage only. Exchange basis. Information dime. Exchange, Box 13, West Wichita, Kansas.

GAMES—ENTERTAINMENT

FUN Playing Cuban. Easily made. Directions, full size layout, 25c. Fran, 17195 Strasburg, Detroit, Mich.

BINGO Games make money everywhere. Catalog free. Warwick Bingo Co., Conimicut, Rhode, Island.

CROQUET Owners: New, interesting, copyrighted game for your set rules. Instructions postpaid 25 cents. Gobakay Co., 1517 Rock Glenn, Glendale, Calif.

SHUF-L-BORD Played anywhere, two or three players; 9x2 "board," discs and pushers, \$2.50. Lange, R.802, 20 E. Jackson, Chicago.

PLAYS, Operettas, musical comedies, complete minstrel first-parts with song programs, blackface skits, vaudeville acts, monologs, dialogs, recitations, juvenile plays and songs, musical readings, entertainments, make-up goods. Catalog free. T. S. Denison & Co., 203 N. Wabash, Dept. 11, Chicago.

CARNIVAL Games make you money. Outfits supplied. Illustrated literature 10c. "Moore-Made," LaPeer, Mich.

MAGIC TRICKS, PUZZLES, JOKER NOVELTIES

KNIFE Throwing secrets exposed! Beginners and experts get this book now! 40 tricks and throws used by professionals, \$1.00 postpaid. Frank Dean, 1294 E. San Fernando St., San Jose, California.

FREE! Oaks Marvelous Memory—Spectacular mindreading cards—with 200 page magic catalog, ten cents. Oaks Magical, Box 171M, Oshkosh, Wis.

BE A magician. Large professional magic catalogue of latest tricks 25c. Cash paid for complete Tarbell Magic Courses. Write, Ireland, C-109 North Dearborn, Chicago.

SVENGALI Magic decks, magic, magic cards, joker's novelties, puzzles. World's largest manufacturers. Catalog describing 300 items free. Adams Company, Asbury, Park, N. J.

FREE! Magic catalog 500 tricks. Amaze. Mystic friends. Write today! Lyle Douglas, Station-A-5, Dallas, Texas.

LARGE 172 Page magic catalog. All prices. 25c. Chicago Magic Company, 2300 North Mason Avenue, Chicago.

VENTRILOQUISM, Complete instructions and dialog \$1.00. Illustrated puppet catalog 25c. Frank Marshall, 5518 So. Loomis Blvd., Chicago, Ill.

EARN Money in any crowd. Call names of strangers, tell unspoken questions. Professional course mind reading, spirit writing, etc., \$1. Henderson, Box 341, San Bernardino, Calif.

LEARN Ventriloquism, 3c stamp brings particulars. Smith, 125 N. Jefferson, Peoria, Ill.

WORLD'S Largest magic shop professional catalog, 25c. Holden, 220 W. 42nd St., New York.

STAMP COLLECTING

STAMP Dealers: Illustrated wholesale catalogue featuring Canadians, New foundland, British Colonials. Free. Empire Stamp Company, Dept. 5, Toronto, Canada.

AIRMAILS And commemoratives, 25 different, including Columbian, Edison, Olympic, etc., only 5c with United States and foreign approvals. Marco Stamp Co., Box 888, San Francisco, Calif.

UNITED States approvals. Write for selection on approval. 19th century airmails, revenues. No premiums but good stamps, fast service. John Daub, Wabash Bldg., Pittsburgh, Penna.

FREE—World's largest stamp, catalogs \$1.25, to approval applicants. Charles Cleveland, 806 North Humphrey Avenue, Oak Park, Illinois.

GENEROUS Offer: Big packet stamps including scarce North Ingermanland, Comoro Islands, Afghanistan, triangle, old Tasmania and over 100 different others. Everything only 10c to approval applicants. Heiken, Benson, Ill.

COLLECTIONIST Liquidating Mexico. Unusual 50—100—150 all different; 30c—90c—\$3.00. Other opportunities. V. Trevino, Apartado, 79, Guadalupe, Mexico.

FREE—20 Different commemoratives. Postage 3c. Penny approvals that satisfy. Dolve, 621 - 15th Ave. S. E., Minneapolis.

U. S. 6c 1918 Airmail used, catalogue 85c for only 25c. U. S. or foreign approvals with each order. W. C. Phillips, 750 Main St., Hartford, Conn.

ROOSEVELT Guatemala miniature sheet \$1.00. Approvals by countries. Creevey, Berwick, Penna.

STAMP Bargains galore! See "The Hinger." Torgesen, Chestnut, Teaneck, N. J.

FREE—Packet British Colonies, pictorials, coronations, to approval applicants. Stamp Exchange, Stillwater, Maine.

FREE 25 Large commemoratives, pictorials, etc., to approval applicants. Matthews, Washougal, Wash.

75 DIFFERENT—All British—only 10c with approvals. Crescent Stamps, London, Canada.

100 U. S. 1870-1907, 25c. Coe, Box 775, Ponca City, Okla.

GIANT Diamond-shaped stamp! Big packet 105 all different including Alexandretta (new country), Congo, Epirus, Manchukuo, Ecuador constitution, Costa Rica triangle, air-mails commemoratives; giant diamond-shaped stamp, \$5 United States; set United States telegraphs, cataloging 30c. Packet British colonies including Burma (new country), jubilee and coronations; scarce Venezuela, cataloging 50c. Illustrated lists. Everything for only 5c to approval applicants! Write to-day! Mystic Stamp Co., Dept. 80, Camden, New York.

OUR Big illustrated standard U. S. buying guide (1938 edition) with 400 photo illustrations shows the prices we pay for all U. S. stamps. Postpaid 25c. Brookman, 500 Plymouth Bldg., Minneapolis, Minn.

UNPICKED! 100 U. S. revenues on documents—10c. (1,000—60c). Vanvoorhis, Hyndman, Penna.

CANADA, 50 Different 25c. Jensen, Box 174-P Benton Harbor, Mich.

FREE Ace bargain card of outstanding values. Send for it today. Ace Stamp, Colonial Arcade, Cleveland, Ohio.

FILLER-UPPERS U. S. approvals under nickel. House Stamps, Box 1039, Redding, Calif.

FREE Congo set. Ruzicka, 924 17 Avenue E., Cedar Rapids, Iowa. Postage.

EARN Cash-stamps, sell my approval books. Nickel packets. Ellison, 2841 West 37th St., Brooklyn, New York.

\$2.00 CATALOG Value 10c approvals. Quality Stamp Shop, Englewood, Colorado.

AIRMAILS, 25 Different 25c. Fifty 75c. Schoenbach's, 202 West 96, New York.

DEALERS (Also part time) send for free samples printed philatelic forms. These, 10526 Anzac Ave., Los Angeles, Calif.

TRY My penny approvals that please. Olivo Alvos, Guadalupe, Calif.

EXCHANGE Stamps, postcards. Universe. "Exchangers," Bry 226 pres, Paris, France. Particulars free.

SCOTT'S 1939 Standard catalogue (regularly \$3.00)—\$2.60. Thumbindexed \$3.00. U. S. specialized (illustrated) \$2.60. Postpaid. September 19th. Fitts Company, Framingham, Massachusetts.

WALLET Overflowing with stamps: Oversize diamond-shaped, scarce Cantonese, interesting photogravure stamps. Many others. Everything 3c. Approvals. Laffal, 90-50F Parsons Blvd., Jamaica, N. Y.

LOANS On unused U. S. stamps to 80% of face value. U. S. stamp purchases financed. Write for bulletin 7 for full details. Malcolm Davis, Second National Bank Bldg., Boston.

SETS! Scarce, complete sets from India, Russia, Bosnia, Roumania plus rare Syke-Bator variety. All free including accurate perforation gauge to approval applicants sending 5c postage. Gopher Stamp Co., 4705 South Lyndale, Minneapolis.

GERMAN Von Hindenburg burning Zeppelin (35c value), coronations from Bahamas, Jamaica, Turks, England, Ceylon for 5c with approvals. Extra! Scarce Ceylon Queen Victoria 1872 stamp. Plymouth, Dept. A36, Bell, California.

BEAUTIFUL Irish girls. Second set of souvenir stamps issued by Irish Hospitals' Trust Limited, Dublin. Specimen sheet of 20 stamps supplied free of charge to all writing to Mr. J. O'Sheehan, Department PM, 28 Earlsfort Terrace, Dublin, Ireland.

BIG 5c Offer! Consists of Ecuador (large commemorative), Chile, Jamaica, Costa Rica, Australia (kangaroo), Cuba, Manchukuo, Indo-China, 10 diff. Peru, and 10 diff. Mexico—all for 5c to approval applicants. Maynard Sundman, D119, Bristol, Conn.

PINE Approvals, freshly arranged by countries. What ones shall I send you? Milton Skinner, 306 East Fourth, Long Beach, Calif.

MAMMOTH Contest! First prize: stamp collection, 6,000 varieties, \$150.00 value. Send 3c postage for particulars. No approvals. Stamp House, Wenatchee, Wash.

PRODIGIOUS Gift! Fantastic Indo-China, German state, savage Somalicoast, Perak, Selangor, Negri Sembilan, bicolored Banana airmail, Siberia—Absolutely free with approvals! Postage 3c. Saxon Co., 408-a Jay St., Brooklyn, N. Y.

U. S., Canada, Newfoundland, Mexico: "Four Star approvals." Nothing like them! Write today, 312 mixed U. S. only 10c. Kessels, Tucson, Arizona.

25 DIFFERENT U. S. commemoratives 10c. 40 different 30c. 200 different foreign 10c. 1000, 65c. 5000, \$12.95. Dutton Efker, Anaheim, Calif.

BULLFIGHT Stamp, triangles, airmails, many others. Five cents with approvals. Tillotson, Pearsall, Texas.

UNUSUAL! Civil War illustrated envelopes, 9 different \$1.00. 100 different U. S. stamps 55c. Brighton Stamp Co., Box 21, Brighton, Mass.

U. S. Bargain lots \$1.00, from your want list. Satisfaction guaranteed. Approvals if desired. A. Grove, 306 Blanchard, Seattle, Washington.

PREMIUMS! Choose any 10 from big approvals. Airmails, triangles, Constitution, colonials, coronations, jubilees, jungle stamps for 5c mailing expense. Poppenger Stamps, Akron, Ohio.

FREE! Eight page Christmas seal price lists. Budd, Route 1, Box 49P, Mesa, Ariz.

MAP Stamps, 30 different 25c; bridge stamps 25 different 25c. Stadler, Vine-land, N. J.

BEST U. S. approvals in America. Huber, Three South Eighth, Minneapolis.

FREE! 50 Stamps, Manchukuo, etc. Postage 1c. Album 3c. Bullard, 268 Northampton, Boston, Mass.

DENMARK Jubilees, Scandinavian packet, 5c. Approvals. Wood, 2915 Stafford, Pittsburgh, Penna.

UNUSUAL Foreign approvals. Fine premium 10c. Hawk's, P-322 South Market, Canton, Ohio.

FREE! Fifty different airmails. Send 3c postage for particulars and approvals. Spartan Stamp, 3420 Grey, Montreal, Canada.

FREE Packet including Canadian airmail. 3c please. Oromocto Stamps, Kitchener, Ontario, Canada.

BEST One cent approvals in America. Elvin Stanton, Niantic, Conn.

FREE! Triangle airmail! Diamond! Pictorials! British Colonies! Wonderful packet 106 different, 5c to approval applicants. Bargain Co., Box 39P, Times Square Station, New York.

WE Buy stamps. Illustrated booklet, 10c. Liberty Stamp Co., St. Louis.

TRADE Those Raleigh and United Profit Sharing coupons for foreign precancelled, U. S. Send stamped envelope. Martin Born, Ashland, N. J.

U. S. Mixture, unpicked, pound 75c; 3 lbs. \$2.00. Brooks, 2502C Kenmore Place, Brooklyn, N. Y.

1897 Grand Comore, Liberian Bongo antelope, Turks Caicos, Cayman Islands, genuine Baden, etc. Everything 3c with approvals. Viking, 1-Z Hanson Place, Brooklyn, N. Y.

PACKET Commemoratives, airmails, triangle, old U. S. 5c. Approvals. Far Seas Co., Box 2154, Houston, Texas.

BEGINNERS—Approvals 1/2c up. Free packet. Billy's, 2542 - 42 Street, Long Island City, New York.

25 DIFFERENT South America 10c with approvals. Breen, 82 Washington, Chicago.

FREE! 127 Different stamps, 3c with approvals. Kirst, 1550D Carroll, St. Paul, Minn.

PAPUA Coronation set, 1c, 2c, 3c, 5c; mint 35c; used 50c. Roger Newberry, 946 Fort, Victoria, Canada.

NICE Lot "foreigners," pictorials, New issues, \$1.00. Chas. Hurford, Ponca City, Okla.

200 DIFFERENT Foreign stamps 10c. Monjar, 1542 Waverly, Cincinnati, Ohio.

UNITED STATES approvals! Reasonable to adult collectors! Box 822, Minneapolis.

APPROVAL Offer supreme. Collection of 120 different stamps, including jubilees, coronations, airmails, animals, map, Australian savage, Netherland triangle, Costa Rica diamond, etc. Only 10c to serious applicants for my really fine approvals. Bill Boyd, 3422 Tuxedo Ave., Dept. M, Cleveland, Ohio.

FREE 1000 Hinges to approval applicants sending 3c postage. Shepard Service, 180 North Wacker Drive, Chicago.

500 MIXED Stamps (prize set) 20c with approval. Schultz, 1304 19th, Two Rivers, Wisconsin.

VALUE! Approvals 1/2c up. Harne Co., Box 1645, Portland, Maine.

STAMP Collectors—Get Canadian annual:—Features Canadian, United States, Newfoundland, colonial and foreign stamps. Complete listing of philatelic supplies. Sixty pages. Hundreds of illustrations to aid collectors. Sent free. Gray Stamp Company, Dept. PM, Toronto, Canada.

NINE Airmails from Syria, Guatemala, Lebanon, etc., and others from Oceania, Manchukuo, Kenya, 5c to approval applicants. Lindgren, Box 448-A, San Francisco.

1000 BETTER Mixed, 25c. Ex-Austria, wartorn China, etc. Plaza Stamp Co., Box 1161, Santa Fe, N. Mex.

PENNY Approvals that please purchasers. C. W. Ritchie, Watertown, So. Dak.

SMALL Sheet of 4 different triangles 10c to approval applicants. Victoria Stamp Co., London 4, Canada.

FREE Dollar packet. Inclose postage, request approvals. Secrist, Muscatine, Iowa.

FREE! \$1 U. S. stamp with approvals. Leader, 1550 Seward, Detroit, Mich.

FREE—\$1 U. S. stamp with request for 52 page list of United States and foreign stamps. Stamps on approval. References necessary. 20 different nineteenth century U. S. 28 cts. New Hussman Stamp Co., 1122 Pine, St. Louis, Mo.

300 DIFFERENT Stamps 20c; 600, 50c; 1000, \$1; 2000, \$3; 3000, \$7. Fred Onken, 630 79th St., Brooklyn, N. Y.

UNBELIEVABLE! 62 Different, six triangles and diamonds; airmail, animal, war stamps—China, Japan, Manchukuo, insurgent Spain; Asia, Africa, South Seas. Everything, 5c! Crowder's, 127E North, Baltimore, Md.

ESTONIA—20 Different including scarce imperforated issues only 5c! Imperial Stamps, G.P.O. Box 130-M, New York.

MEMBERSHIP Card free—The James Lee Stamp Club, 210-A North First Street, Phoenix, Arizona.

CANNON! Set of stamps showing cannon, firing squad, cavalry charge and 200 other different stamps, only 10c to approval applicants. L. H. Reich Stamp Co., 4647 Kenmore, Chicago.

NEW Rivera nude stamp! World's largest triangle! Congo, Sudan, South Seas, bicolored, pictorials and many others. Only 3c with approvals. Cactus Junior Approvals, Box 1870-B, Tucson, Arizona.

FREE. U. S. \$1, \$2, \$4 and \$5 stamps. Unbeatable U. S. approvals. Nelson, 78 E. 5th St., St. Paul, Minn.

4 1/2 TRIANGLES! Guatemala bisect (diagonal half-stamp), beautiful Liberia, three additional triangles, 27 other stamps, 5c. Abell Co., 1818 St. Paul, Baltimore, Md.

FREE—The Stamp Finder! Our new 24 page edition, fully illustrated, which will enable you to instantly identify all difficult stamps. Also fine packet of odd and unusual stamps from Bosnia-Herzegovina, Monaco, Patiala, Cyprus, etc., including maps, ships, animals and strange scenes. All free to approval applicants inclosing 3c postage. Garcelon Stamp Co., Box 900, Calais, Maine.

FREE! Two coronation sets. Postage 3c. Roberts, 312F Shearerbig, Bay City, Mich.

GIANT-SIZED Russian zeppelin stamp, cat. val. 20c, and beautiful Lithuania air mail triangle; also big packet of 53 different stamps including Azerbaijan, Epirus, new Martinique, etc., and illustrated lists, all for 5c to approval applicants! World-Wide Stamp Co., Box 600, Camden, New York.

UNITED STATES—45 different, perforation gauge, hinges, bargain pricelist—all for 10c. Seidenberg, Baroda, Mich.

LIBERIA Snake triangle, giant Spanish triangle, 50 other stamps, 5c. Wright Co., 2527 Guilford, Baltimore, Md.

ILLUSTRATED U. S. list, price 50c, large complete U. S. price list free. Send postage. Stanley Gibbons, 38P Park Row, N. Y.

PENNY Approvals that please. Haywood, 395 Adams St., Pomona, Calif.

PANAMA Triangle and 50 others free to approval applicants sending 3c postage. Tatham Stampco, Springfield-30, Mass.

FREE! "United States and British North America"—our valuable, complete, illustrated, 64-page catalog quoting lowest prices. Big illustrated list of foreign stamps also included. H. E. Harris & Co., 137 Transit Building, Boston, Mass.

QUEEREST Stamps packet. Receive one of world's smallest stamps; scarce Vatican City; Greek Red Cross (coiled snake in Garden of Eden!); Manchukuo; Soruth (mountain lion); Mozambique (giraffe); Palestine; many others. Also big packet 25 dif. Japan, (including earthquake stamp) and pkt. 15 dif. China. Everything for only 5c to approval applicants! R. M. Stamp Co., Box 230P, Port Chester, N. Y.

50 DIFFERENT. Fine U. S. including perforation gauge, 10c with approvals. The Stamp Shop, 809 Holland Bldg., St. Louis, Mo.

200 DIFFERENT 10c. Big 50% approvals. Covert Stamp, 39 State, Rochester, N. Y.

STAMPS. A superb selection sent on approval. Quality at low prices. Fred Herzberg, Box 91-P, Elmhurst, Ill.

BRAZIL, 50 Different 10c with bargain approvals. Davis, Silver Lake, Ind.

ASK For our wonderful one cent approvals. Prospect Stamp Co., 225 Broadview, Toronto, Canada.

WHOLESALE Catalog for dealers. Illustrated. Postage 5c. Frank Co., 4900 Chalmers, Baltimore, Md.

PENNY Approvals, that satisfy. Neil Gronberg, Box 5441-P, Philadelphia, Penna.

30 DIFFERENT Angola, Cape Verde, Guinea, Portugal, Mozambique, St. Thomas and Prince 5c. Approvals. Depraw, Ocean Park, Calif.

STAMP Dealers, your ad here will bring wonderful returns. Ask me for proof. F. W. Johnson, Manager, Classified Advertising, Popular Mechanics Magazine, 200 E. Ontario St., Chicago.

APPROVAL Sheets. One to three cents. Frederick B. Driver, 2009 Finance Bldg., Philadelphia, Penna.

25 UNITED STATES, including \$4 and \$5 stamps free to approval applicants. 3c postage. Brownie Stamp Shop, Flint, Mich.

WEEKLY Stamp magazine, thirteen weeks, 10c. Stamp Journal, Kalamazoo, Mich.

U. S. Classification difficulties solved! At last federal law permits beautiful new booklet with 341 large-scale photographs separating U. S. stamps by standard catalogue numbers! Send only 30 cents for booklet 6! Malcolm Davis, 75 Federal St., Boston.

RARE COINS

OLD Money wanted. Will pay fifty dollars for nickel of 1913 with Liberty head (no buffalo). We pay cash premiums for all rare coins. Send 4c for large coin folder. May mean much profit to you. Numismatic Co., Dept. 20, Fort Worth, Texas.

BARGAIN Collection rare coins; U. S. 20c, 5c and 3c silver, 2c bronze, large and half cents. F.O.B. \$1.50. Schultz, 419 First National Bank Building, Cincinnati, Ohio.

FINE Foreign 1700 coin, 2 notes and catalog 10c. Geo. Best, Cedar Rapids, Iowa.

50 OLD Coins, all different \$1.00; 100 different coins \$2.50; 20 different dates large cents \$2.00; 30 different dates Indian head cents \$1.00. Claud Denney, Box 1825, Dallas, Texas.

LINCOLN Commemorative $\frac{1}{2}$, \$1.00; five different dates U. S. gold dollars, \$12.00. S. Koepfel, Merritt Bldg., Los Angeles, Calif.

WANTED: Certain Lincoln pennies. Album and information—10c. M. L. Kath-an, Cornelius, Oregon.

OLD Coins wanted. Highest prices paid. Send 25c (coin) for catalog. Brockton Loan, 39 Pleasant, Brockton, Mass.

3 COINS, 3 Notes 10c. 100 foreign \$1.25. List for stamp. Maurice Gould, Box 73, Brighton, Mass.

FREE! Uncirculated San Francisco mint cent with 10c coin list, 3 dates 25c. London, 1733 Wilshire Station, Los Angeles.

COMMEMORATIVE Half dollars. Lincoln, Cleveland, Stonemountain \$1.00 each, 25 different foreign 50c. Free lists. Hussmann, 211 South 7th, St. Louis, Mo.

COMMEMORATIVE Half dollars. Lincoln, Stone Mountain, Oregon, Texas, Cleveland, Kentucky, San Diego, Long Island, \$1.50 each. Illustrated catalogue No. 14, 25c. Norman Shultz, Salt Lake, Utah.

UNITED States coins at bargain prices. 2c piece and newest 1938 selling price list 10c. Em. Cohen, Box 3507, Cleveland, Ohio.

FREE! Foreign coin, banknote, and large illustrated coin catalogue. Send 4c postage. Coin approvals sent. Tatham Coinco, Springfield-125, Mass.

GET Profit and pleasure in collecting old coins. Send 10c for 56-page illustrated coin catalog. You'll be delighted with it. Send for it now. B. Max Mehl, 370 Mehl Bldg., Fort Worth, Texas. Largest rare coin establishment in U. S. Established 38 years.

\$5 TO \$500 Each paid for hundreds of old or odd coins. Keep all until posted. Many very valuable. Send 10 cents for illustrated Coin Value Book, 4x6. Guaranteed buying and selling prices. 31 years in business. Coin Exchange, Box 5, Le Roy, N. Y.

RARE U. S., foreign coins, war medals. Catalogue 10c. Mengelle, Colorado Springs, Colo.

UNITED States. Large cent, 2c bronze, 3c nickel and bargain list, 25c. Eleven dates large cents, \$1. George P. Coffin Co., Augusta, Maine.

BIG Prices paid for certain wanted coins. 1909 cent \$10.00, some silver dollars \$4000, 1864-1865 Indian head cents \$100.00 each, dimes before 1895, \$600; liberty head nickels before 1914, \$500; encased postage stamps; some large pennies \$2000; half cents, \$275.00; paper money, gold dollars \$1500, foreign coins \$165, some worth \$6000 each. You may have coins for which we pay big premiums. Therefore send 15c today for 1938 big illustrated coin book for certain wanted coins. National Coin Corporation (80), Daytona Beach, Florida.

HOBBIES AND COLLECTIONS

UNPRINTED Match books. Profitable hobby decorating, selling. VanDorn's, Ottawa, Illinois.

FREE Samples cellophane envelopes for stamps, coins, covers. Wetzel, Box 235M, North Bergen, N. J.

FREE! Magic catalog 500 tricks. Amaze, mystify friends. Write today! Lyle Douglas, Station A-12, Dallas, Texas.

UNUSED Book match covers, 100 all different. \$1.00. Free list. Charles Edelman, 1311C East 84, Cleveland, Ohio.

MAKE Photography Pay. New book. \$1.00. Popular Mechanics, 200 E. Ontario St., Chicago.

PHOTO FINISHING

PHOTO Mill. Immediate service! No delay! Roll developed, carefully printed and choice of two beautiful 5x7 double weight professional enlargements, one tinted enlargement, or eight reprints—for 25c coin. For sample Christmas card send negative and five cents. The Photo Mill, Box 629-12, Minneapolis, Minnesota.

20 REPRINTS 25c. 100 Reprints \$1. Roll developed with 16 prints 25c. Newtowne, 4, Maywood, Ill.

35 MM. FILMS Developed and printed. Good shots enlarged to 3 $\frac{1}{2}$ x2 $\frac{1}{4}$. \$1.00. Candid Photo, P. O. Box 71, Warm Springs, Calif.

PADED Photos renewed to original brilliancy. Details for self-addressed envelope. Box 722, Rockford, Ill.

THREE Prints each good negative in roll 35c. Reprints 3c. Fred Eastman's Photos, Bode, Iowa.

CORNELL Studios, 28 years at 521 Woodward Ave., Detroit, Michigan. Roll film developed and printed, 25 cents, coin. Finest quality. Return postage paid.

KODAK Rolls developed, 8 glossy prints 25c. Reprints 3c. Receive beautiful frame folder with 25c order. Franklin Studio, F-1, 1416 Ogden, St. Louis, Mo.

IDEAL Photos. Regular size (deckle edge) 25c per roll. Double size 35c per roll. Snapshot folder and enlargement coupon free. Ask for our illustrated price-list. Ideal Photo, Box 2255, Paterson, N. J.

IMMEDIATE Service! Better pictures. Sixteen guaranteed prints from roll, 25c. One colored or two plain enlargements and 8 guaranteed prints 25c. Sixteen reprints only 25c coin. Candid rolls developed free! Prints enlarged to 3x4, only 4c each. One day service. American Studios, Box B, LaCrosse, Wis.

16 PRINTS With roll 25c. 16 reprints 25c. Rex Photo, Ogden, Utah.

MAIL Your rolls to film center of the world. Any 6 or 8 exposure roll developed and printed 25c coin. DeLuxe enlargement coupon free! Photo Finishing Shop, Est. 23 yrs., 411-Z Genesee Valley Trust Bldg., Rochester, N. Y. "The Camera City."

FILMS Retouched, make beautiful enlargements. Imperfections removed, 25c and up. Thir, 504 East Weidman, Lebanon, Pennsylvania.

5x7 ENLARGEMENT Colored, framed, 50c. Roll developed, Velox prints, 25c. Lescault Studio, Rockland, Mass.

MILLIONS Now know "Hollytints Means Better Prints." Two professional enlargements with trial roll—25c. Fascinating premiums. Unequaled service. Hollytints, P-1350, Hollywood, California.

DEVELOP Pictures at home. Complete outfit \$2.95. Instructions included. Fotokit, 476a East 98th Street, Brooklyn, N. Y.

FREE—4 Big enlargements—8 prints every roll 25c. 20 reprints 25c; 100—\$1.00. Filmco, Albany, Wis.

PHOTO Mill. Immediate service! No delay! Roll developed, carefully printed and choice of two beautiful 5x7 double weight professional enlargements, one tinted enlargement, or eight reprints—25c coin. For sample Christmas card send negative and five cents. The Photo Mill, Box 629-12, Minneapolis, Minnesota.

35MM. ROLLS Fine grain developed and each shot enlarged to 3 $\frac{1}{2}$ x5", \$1.00. Ideal Films, Birmingham, Ala.

ROLL Developed, two sets prints, enlargement coupon, 25c. Fulton Foto Finishers, Box 7, Fulton, Illinois.

ENLARGEMENTS From your treasured photo snapshot or negative 5x7, 25c; 8x10, 50c. Originals returned. Marcin Photo Service, 84M Armbruster, Buffalo, N. Y.

FREE Miniature camera! Film developed and eight glossy two-tone pictures, plus 1 enlargement and free miniature camera offer. All for 25c (coin). George Herbert, 600-C South Michigan Ave., Chicago.

ROLLS Developed, 8 prints, one 5x7 coupon, 25c. Weicks, 2840 Zenobia Street, Denver, Colorado.

ROLL Developed, printed 20c. Snappy Photo Service, Box 56, Colvin Sta., Syracuse, N. Y.

ROLL Developed, printed 15c. Reprints 1c each. Howard, 2947 Jarvis, Chicago.

EIGHT Enlargements from roll or negatives, 35c. 36 exposure rolls enlarged, \$1.50. Midwest, Humboldt, Iowa.

ROLL Developed with 16 Velox prints, 25c. Eastern Photo, Milford, Conn.

ROLL Developed, 8 brilliant fadeproof Velox prints and two professional enlargements 25c. Embossed photo Christmas cards or calendars from your negatives, 4 for 25c, envelopes included. Overnight service. Young Photo Service, 405-C, Albany, N. Y.

FREE Album and negative file and 2 enlargement coupons with each roll developed; 8 guaranteed prints 25c. Memrilane Studios, General P. O. Box 666, Dept. P, New York.

35MM. ROLLS Fine grain developed free. 36 enlargements \$1.00, cartridge reloaded 35c. Photoshop, Linton, Ind.

BEAUTITONE Enlargement, dime and negative. Giant Snapshots, Inc., Green Bay, Wis.

SPECIAL Trial! Rolls developed and printed with wide border deckle edge prints only 15c. Quality guaranteed. Deckletone Finishers, 6444 Diversey, Chicago.

FREE Enlargement with each photo finishing order. 20c per roll. Photo Lab, 103 Cottage Street, Auburn, New York.

GUARANTEED. Roll developed, 16 prints 25c. 20 prints 25c. Quality Photo, Hutchinson, Kansas.

EXPERT Photo finishing. One day service. 8 genuine expensive Velox prints, two double weight professional enlargements 25c. Expert Studios, LaCrosse, Wis.

QUICK Service—Rolls developed, 8 guaranteed prints; 2 enlargements; 25c coin. OK Photo Service, Ottawa, Kansas.

ROLLS Developed and printed 10c. Trial. Quality Finishers, Maywood, Ill.

ROLLS Developed, 8 prints, 2 enlargements, 25c. Mayfair, Box 261-K, Toledo, Ohio.

PROMPT Service—Quality work; 2 beautiful double weight gloss enlargements, 8 guaranteed neverfade prints each roll, 25c. Excel Photo Service, Dubuque, Iowa.

WILLARD'S Gives your pictures a beauty treatment—they're clear, brilliant, full of life. Roll developed, 2 prints each negative 25c. Enlargement coupon. Willard's, Box 3535-A, Cleveland Heights, Ohio.

TWENTY Reprints 25c. Roll developed and two prints each negative, 25c. Mail orders only. Star Photos, 109 N. Dearborn, Chicago.

ROLL Developed, 16 guaranteed prints 25c. Smart Photo, Winona, Minnesota.

PROMPT Service, guaranteed work. Two beautiful portrait type double weight enlargements, eight neverfade gloss prints, each roll 25c. Dubuque Film Service, Dubuque, Iowa.

ROLL Developed and 8 guaranteed prints including two enlargements, 25c coin. Super Snapshot, Winona, Minnesota.

PROMPT Service! Rolls developed, two Velox prints each negative 25c. Hench Studios, Harrisburg, Penna.

TWO Prints each with every roll developed, 25c. Very finest quality. Reprints 2c each. Brown Photo Company, 1910-34 Emerson, Minneapolis, Minnesota.

ROLLS Developed, two sets prints plus enlargement coupon 25c. Reprints 3c. Over 19 reprints 2 $\frac{1}{2}$ c. Jones Studios, Davenport, Iowa. "Where the West Begins."

ROLLS Developed, 2 prints each and 2 free enlargement coupons, 25c; reprints, 2c each; 100 or more, 1c. Summer's Studio, Unionville, Mo.

ROLL Developed and 8 beautiful Velox glossy prints 25c coin or stamps. Reprints 3c each. Fotoprint Service, Box E, Roanoke, Va.

FINER Finishing. Rolls developed and printed, with one colored enlargement, or two professional enlargements. All for 25c (coin). Genuine, nationally known, Moentone superior quality. Moen Photo Service, La Crosse, Wis.

TWO Glossy enlargements, 1 colored with roll 25c. Arbor Service, 10, Joliet, Ill.

FOR The discriminating amateur, roll developed and carefully printed 25c, reprints 3c. Superior workmanship, same day service. Paramount Co., 327 E. 92nd St., New York.

ROLL Developed and printed. Two enlargements, one of them in colors, all for 25c coin. The Photo Finisher, Station E, Box 42, Columbus, Ohio.

FILMS Developed, 2 prints of each 25c. 20 reprints 25c. Pine Photo, M-5134 Nevada, Chicago.

LARJARGRAPH Finishing. Five 5"x7" enlargements 25c. Miniature films developed 10c. Enlarged prints 2 1/2"x4", 2 1/2c. Cardinal Photoers, Summit, N. J.

20 REPRINTS 25c. Films developed, 16 prints 25c. Enlargements 8x10-25c; 5x7-10c. Low Photo, M-2657 Neva, Chicago.

CAMERAS, PHOTO SUPPLIES

SHOTGUNS, Rifles, target pistols, other good firearms accepted in trade on Leicas, Contaxes, and all motion picture and photographic equipment. Authorized dealers for every leading manufacturer including Bell Howell, Argus, Weston, Zeiss, Keystone, etc. All photographic equipment bought, sold and exchanged. National Camera Exchange, Established in 1914, 11-PM South Fifth St., Minneapolis, Minn.

CORONET Midget, the new "Minican." \$2.50. Film 6 ex. 20c. Coronet Vogue, larger picture, \$5.00. Film 6 ex. 25c postpaid. G. Gennert, 20 W. 22nd St., New York.

THREE Filters for \$1.00. Yellow, red, and green with hard fiber frames and adjustable springs for lenses up to 1 1/4 inches in diameter. Kay Photo Supplies, Box 51M, Cicero, Illinois.

ENLARGER 89c. Makes postcard size from small negatives. Fully guaranteed. Paramount Sales Company, 89 Dudley Street, Boston, Mass.

CUT Rate movie cameras. 705 Park Ave., Utica, N. Y.

FREE Illustrated Photographic Almanac listing everything photographic—still, movie cameras, films, lenses—at tremendous savings. Hundreds of bargains, new and used. All guaranteed. We take your old camera or equipment in trade. Write for free copy of new Photographic Almanac and money-saving bargain book—just out! Limited edition. Hurry! Central Camera Co. (Photographic Headquarters since 1899), 230 South Wabash, Dept. 10-K, Chicago.

MAKE Money in photography. Learn quickly at home. Spare or full time. Easy plan. Previous experience unnecessary. Common school education sufficient. Interesting booklet and requirements free. American School of Photography, 3601 Michigan Ave., Dept. 3432, Chicago.

WESTON Meter—Latest model, exchange for Art or other films. J. Josephs, 5360 Lacrestia Court, Los Angeles, Calif.

IF You go to Mexico ask first for prices and pamphlets of finest German quality miniature and other cameras, binoculars, movie cameras and projectors. Foto Mantel Sucr. R. Rudiger V. Carranza 11. P. O. Box 1459, Mexico City.-105. Branch store: Tijuana, Baja, California.

CAMERAS, Shutters repaired. Leather bellows installed in folding and view cameras. Bellows made to order. United Camera, A-1515 Belmont, Chicago.

SAVE Film. "Wesco" visual exposure meter guaranteed correct all films, day, night, movies, stills, moving objects. Satisfaction or money back. Send \$1.00. "Wesco" Company, 254 Sutter St., San Francisco.

ARGUS Camera case, genuine cowhide leather, very special price \$1.69. Mirotext, 6241 Southwood, St. Louis, Mo.

PHOTOTIPS. Valuable information, ideas. Free information. Bill Kraus, 13 Willard St., Boston, Mass.

MAKE Powerful telephoto camera. Tripping cost. Jamer, 4D, Bayside, N. Y.

DARK Room lamp complete with four filters \$3.00 postpaid. Brassington, 1211 Irolo, Los Angeles.

WHAT Would you do with \$150.00? That's one of the cash prizes you may win in this month's Minican "Water Picture" contest. Write for free folder giving you all details—or send 25c for sample copy of this sensational, packed-with-dynamite 108-page miniature camera magazine. Special—You also secure free 8-page brochure entitled "How to Make Every Shot a Prize Shot." Write—Minican Magazine, 6 E. 12th St., Cincinnati, Ohio.

TREASURE Finders? Read Goldak advertisement on page 131A.

NO More wasted film or unnecessary expense. Take pictures you can be proud of. Sell to magazines and newspapers. Make good money wherever you live. Easy, low-cost home study course shows you how! Free catalog. Universal Photographers, Dept. 104, 10 W. 33 St., New York City.

DUPONT Superior panchromatic, guaranteed; 35mm. 25' roll, \$1.00. Optical Development Corporation, 1560 Broadway, New York.

CAMERAS Films, paper 25% to 35% discount. Paramount Photo Division, 327 East 92nd St., New York.

BASS Unusual quality values: Half or full V. P. Dolly, Corygon F:3.5 lens, Compur shutter, new, \$23.75. 2 1/4"x3 1/4 Zeiss Voita P. P. and P., F:6.3 lens, automatic shutter, P. P. A. and holders, \$12.50. Sport DeFranne, full or half 2 1/4"x3 1/4, F:3.8 Anastigmat with carrying case, \$29.75. Dollina II, coupled range finder, Radionar F:2.9 lens, Rapid Compur 1/500th shutter, \$49.75. Argus, F:4.5 lens, \$12.50. Above and hundreds of other bargains in Bass Bargaingram No. 235, a 52-page book. Money with a smile guarantee. Bass Camera Company, Dept. AG, 179 W. Madison St., Chicago, Illinois.

HAVE You a camera? Send ten cents for recent number of our big magazine, showing how to make better pictures and earn money. American Photography, 116 Camera House, Boston, 17, Mass.

WE Purchase and accept in trade used photographic equipment. Send for bargain list. Fotoshop, 134R W. 32nd, New York City.

MOTION PICTURES AND SOUND EQUIPMENT

DEMONSTRATORS, New, used, movie projectors, cameras. Box 633, Morgantown, W. Va.

TRACE, Illustrate your movie titles easily. Script alphabets, \$2.00. Samples 3c. Stein Studios, Flatiron Building, New York.

16-35MM. RENTED 50c Weekly; lists 3c. Hoffman Film Service, 57 Broad, Albany, N. Y.

35MM. FILMS, Projectors. Lists free! Demsey, 1223 Berkley, Youngstown, Ohio.

NEW Rental catalogue. 16mm. and 8mm. Enclose postage. National Cinema Service, 3 West 29th Street, New York.

NEW Fifty foot cartoon comedy, travel, 8mm., 16mm., \$1.00 postpaid. State camera projector wanted. New, used bargains Castle films, screens. Discount on movie and still equipment. List stamp. W. N. Gravelle & Son, Box 12M, Kennedy, Ala.

16MM. CAMERA \$19.50, 16mm. motor driven projector \$3.50, 8 and 16mm. films. Stamp for catalogue. Excel, 622 Madison, Toledo, Ohio.

8-16MM. FILMS, All latest subjects, silent and sound, sale, rent, and exchange. Films rented everywhere. Free illustrated catalogue (with sample film 10c.) Garden Exchange, 317 West 50th, New York.

8MM.-16MM. Palomar positive titling film, data. Lens, titlers. Film Specialties, El Monte, California.

BARGAINS Galore—16mm.-8mm. listings. No-Wat-Ka, 151 Broadway, Paterson, N. J.

35MM. RENTED, Sold. Silent only. Calderara, 5119 South St. Louis, Chicago.

GENERA Film, 100 feet double 8mm. \$1.75; 100 feet for Univex, \$1.00, postpaid. Sample free. Promaders, Davenport, Iowa.

35MM. SOUND Films, Sale or rentals. Moore Bros., Portsmouth, Ohio.

MOVIESCOPE Shows dandy still movies with 100 different films. 35c coin. Alderman, 225 Orchard, New Haven, Conn.

SILENT-SOUND Film 16mm. library. Films sent anywhere. 8mm. library. Reasonable rates. Catalogs free. Mogull 100 feet 16mm. camera film \$2.39 including developing. All movie and photographic equipment; trades accepted. Mogulls, 68J West 48th, New York City.

MOVIE Film. Develop yourself. Univex, Eastman, etc. Chemical samples 15c. Raw film wholesale. Lake Camera Exchange, Gary, Ind.

"THE World's Greatest Passion Play." Sound or silent, 16mm. Superior than Oberammergau stage version. 8 reels. Write Hemenway Film Co., 37 Church St., Boston, Mass.

CAMERAS, Projectors, accessories. Free literature. G. Taylor, Box 234, Corning, N. Y.

8MM. MOVIE Equipment, films for sale and rent. Send stamp for catalog. Abbe Films, 1265 Broadway, New York City.

LEARN Motion picture theatre management, advertising, projection. Free catalog. Give age. Theatre Institute, Elmira, N. Y.

"HERE'S News from Bass." A 52-page Cine Bargaingram No. 234. A veritable encyclopedia of motion picture apparatus, 8 mm. and 16 mm., silent and sound. Sound cameras. You must have a copy of this book. It's hot off the press. Your copy is waiting. Don't delay, and send for this valuable book. Dept. A, Bass Camera Company, 179 West Madison Street, Chicago, Illinois.

BARGAINS! 8mm., 16mm., free literature. Elder, B-739 Boylston, Boston, Mass.

8-16MM. TITLES, 2c Word. Catalogue. Cineshop, 1812 Piedmont, Charleston, West Virginia.

15% TO 25% Discount on still or movie cameras. Free circular. Paramount Co., 327 E. 92nd St., New York City.

NEW 200-Watt 8mm. motor projectors \$19.50 prepaid. Free 16mm., 8mm. bargain lists. Home Movies, Box 216, Easton, Penna.

35MM. TALKIES For rent. Complete show, feature, cartoon, serial, \$7.00 weekly, with projector \$22.50. Motion Picture Exhibitors, 3865 West 25th Street, Cleveland, Ohio.

RADIOS, SUPPLIES, INSTRUCTION

GET Into television. Prepare for employment in this good pay field. Complete apparatus for over 100 radio and television experiments given every student. Learn at this approved school. Write for complete information and free book "Vision." Address Training Division, 1st National Television, Dept. A-101, Fidelity Bldg., Kansas City, Mo.

LEARN Radio, \$1 lesson. Missouri Tech, 3907 North 25, St. Louis.

LATEST Releases Vocalion, Decca, Melotone, Bluebird, \$1.00 per dozen; Victor, Brunswick, Columbia, 19c, 6 for \$1.00. Send for giant radio catalog free. United Radio Company, 56 N. Market St., Newark, N. J.

AUTO Radios. New, used. Bargain list. Battery Service, 318 Dewy, Goshen, Ind.

FREE Information on how to obtain government license to operate your own radio transmitting station, also instructions for building transmitter. Technical Radio Co., 33 Hudson St., Yonkers, N. Y.

PORTABLE 20c Dry battery radio. Chassis separate \$12.00. Solter's, 103 No. 7th St., Minneapolis, Minn.

DETAILED Self-instruction course for wireless code. Complete. One dollar. Systems, Box 281, Dallas, Texas.

RADIO Engineering, broadcasting, aviation and police radio, servicing, marine and Morse telegraphy taught thoroughly. All expenses low. Catalog free. Dodge's Institute, Ames St., Valparaiso, Ind.

MUSIC AND MUSICAL INSTRUMENTS

MAKE Your own violin for pleasure or profit, from materials and simple, complete instructions we furnish. Surprisingly low cost. Tony Wons made five in year. Scores of others now busy at this fascinating hobby. Enjoy the thrill of playing violin of your own manufacture. Amaze your friends. Write today. Catalog 10c. Voit and Geiger, 14 East Jackson, Chicago. Over forty years in fine violin construction and repair.

SPANISH Guitar, new tuneful, whistle-able song, G. 40c. WessRuss, 118 Lake Avenue, Worcester, Mass.

SONGWRITERS — Marketing advice, rhyming dictionary, instruction booklet, gladly mailed on request. Songwriters Institute, 1234-C Broadway, New York.

SONG, Poem, melody writers. Write Studio PM2, Guaranty Bldg., Hollywood.

TWO Songs free if you send ten cents for song catalog. Dewey Music Publisher, 9825 Ave. M, Chicago.

PLAY, Teach, publish pictured music. Blessing, Box 447, Lansing, Michigan.

SONG Writers: verse or music. Brilliant opportunity. Write immediately. Vanburen, B62, Rockhaven, Ky.

SONGS Arranged, composed and printed. Satisfaction guaranteed. Modern Melodies, Box 1681, San Francisco, California.

SONGWRITERS! Write your own. Particulars 10c. Littig, 215 Mason Theatre, Los Angeles, California.

SONGWRITERS! Proposition you'll appreciate! Hibbeler, C-5, 2157 No. Avers, Chicago.

MUSIC Composed to words. Rhyming pamphlet on request. Phonograph recording of completed song. Send poem. Just released "Joyce." Copy 25c. Keenan, Box 2140, Bridgeport, Conn.

SONGPOEMS Revised, set to music, copies printed. Modern, expert service. Roy Allen, Kitchel, Ind.

ORIGINAL Music composed to your words, \$5. 200 printed copies \$10. Reginald Belcher, Chatham, New Jersey. 30 years church organist.

SEND Piano Shorthand Music Company, Springfield, Illinois, one dollar for How to Play Piano by Ear.

SONGS, Poems, bought, composed, published. Royalty basis. Free information. Metro-Melody Music Publishing Company, 532 Geary, San Francisco.

REPRESENTATIVES Wanted. Forty hits. Samples free. McDaniel Publishers, Elizabeth City, N. C.

SONGS Composed, arranged. Gilbert Wolfe, Room 1102, 210 Fifth Ave., New York.

WANTED Original poems, songs, for immediate consideration. Send poems to Columbian Music Publishers, Ltd., Dept. 42, Toronto, Can.

FREE Melody to songpoems. Piano arrangements. National Songland, Thomaston, Maine.

DUO-FLEX Reeds for clarinets, and saxophones eliminate your reed troubles. Write for circular. Duo-Flex Reeds, 1204 1st Ave., Evansville, Ind.

SONG Poems wanted to be set to music. Free examination. Send poems to McNeil, Bachelor of Music, 4153-PM S. Van Ness, Los Angeles, Calif.

TERRIFIC Success. New copyrighted courses. Quick, thorough. Radio Method of Piano Jazz, P.O. Box 1024, Dept. 17, San Francisco.

SONGS—Arranged, revised by arranger "Cherry Blossom Lane." "Gypsy Tear-room," others. Send for details. Harold Potter, 1619(P) Broadway, New York.

MUSIC Composed, arranged, songs, orchestra, band. Frank Wildt, Lancaster, Pennsylvania.

PIANO By ear. Free booklet. Day-V-Way, Woolworth Building, Dearborn, Michigan.

SONGWRITERS Wanted, write for free book. Indiana Song Bureau, Salem, Ind.

MUSIC Composed to words. Wonderful proposition. Bauer Bros., Oshkosh, Wis.

LATE Phonograph records, some new, some slightly used. Fifty—\$2.50. Davis Sales Company, Syracuse, New York.

WRITE Songs. Big money and reputation. Write for information. J. Gordon Pub. Co., 201 N. Hoyne Ave., Chicago.

WANTED! Lyrics, melodies for songs. We arrange, publish, sell. Superior Song Studios, Passaic, N. J.

LEARN Swing piano! Postal brings free folder. Christensen, 751 Kimball Hall, Chicago.

POEM Writers, songwriters—Send for free Rhyming Dictionary, Songwriters' Guide. Submit best poems, melodies today for bonafide, superior offer. MMM Studios, Dept. 33G, Portland, Ore.

SONGWRITERS: Send your poem today for immediate consideration. Richard Brothers, 24 Woods Building, Chicago.

SONG Writers. Send for publishing agreement. McKinley Music Publishers, 1501 E. 55th St., Chicago.

BUSINESS OPPORTUNITIES

\$20,000 A YEAR opportunity for exclusive distributor. World's greatest air conditioning line having thousands of satisfactory installations in use. Includes everything needed to do a profitable business. Equipment lowest priced and of guaranteed high quality. Exclusive distributor can enjoy profitable business in the fast growing air conditioning industry. Roger Babson says that air conditioning within 10 years will be as large an industry as automobile industry is today. Here's a real opportunity for you to have a business of your own and grow with the air conditioning industry. You will have hundreds of dealers making money for you through their sales. \$500 cash working capital required. We will teach any sincere man of average intelligence to successfully handle this opportunity. We have others earning \$200 to \$1800 weekly. You should too. For details write Department 27, Box 187, Lafayette, Indiana.

BIG. Steady, profit business for you! Spare or full time. Marvelous invention electroplates with electric brush—easy as painting. Equals beautiful, permanent plating—gold, silver, nickel, cadmium, etc.—as costly tank outfits. No liquids. Portable, lightweight—anyone can plate anywhere on the spot. No dismantling of article you plate. Complete—ready to use models—from \$6.85 up to \$27.50 for professional, heavy duty type. Work from dry battery or household current. Write at once for big money proposition; you can also make steady money plating for others. Warner Electric, 360 N. Michigan Ave., Dept. C, Chicago, Ill.

OWN Growing business. \$2.00-\$5.00 hourly profit. Clean, mothproof, upholstery, carpets, clothing in homes, hotels, institutions. "Earned \$90.00 one day"—Anderson. "Working 12 hours daily"—Lookbill. "Repeat orders building business"—Hargrave. Portable electric machines, materials, advertising furnished. Little as \$88 establishes business. Write while territories open. Home Service, Deerfield, Illinois.

THE Office specialty sensation of the year; new model envelope sealer, sells \$2.50. Demonstration makes quick sale. Responsible distributors write. Kendall Sealer Co., Dept. B, East Jaffrey, N. H.

FASCINATING Business. Repair, adjust typewriters, adding machines. Learn easily at home from factory expert. Earn up to \$15.00 daily. Complete instructions covering all makes \$3.00 postpaid or sent C.O.D. Adding Machine Equipment Service, 3601 Michigan, Dept. 3437, Chicago.

"MAKE Mirrors at home." Big profits. Little outlay. Also emboss, grind—foil, gold leaf, frost, chip and make imitation stained glass. Instruction course \$1.00. Bestovall, 4047-RM N. Whipple, Chicago.

NO Selling! M. M. earned \$267, three weeks, raising mushrooms in cellar! Exceptional, but your cellar, shed perhaps suitable. We buy crops. Book free. United, 3848 Lincoln Ave., Dept. 61, Chicago.

FREE Booklet describes 205 moneymaking plans. Start your own business from home, office, etc., making \$25-\$75 weekly. Stamford, 3762-A Broadway, New York.

LEARN Arc welding. A growing industry with great opportunities. Consult your local school, or if there is none available write The Lincoln School of Welding, Dept. A, Box 5758, Cleveland, Ohio.

FORMULAS—Fast selling products. Guaranteed. Laboratory tested. Lowest prices. Catalog free. Kemico, 55K, Park Ridge, Ill.

FREE Particulars describe mail order and other business plans. Select Books Co., 2732 Woodburn Ave., Cincinnati, Ohio.

107 MONEYMAKING Plans for home or office. Particulars free. Dolve, 621 - 15th Ave. S. E., Minneapolis, Minnesota.

OWN Business; make chemical specialties. Write Grinstead, 505 Fifth, New York.

1,000 OPPORTUNITIES, 25c, silver, 1c stamps. How Book Co., 557PM Mithoff St., Columbus, Ohio.

"RESILVERING Mirrors" and 50 other moneymakers 10c. Ideal Service, 179-M, Park Ridge, Ill.

PLASTER Casting. Stamp brings full information. Colonial Art, Derry, N. H.

WE Show you how to raise capital for your business. Write Enterprise Bureau, Syracuse, N. Y.

LOCAL And mail distributor wanted for modern products. D. Heminway, Oak Knoll Road, Natick, Mass.

"RESULT Getter," monthly magazine, filled with money making opportunities, copy 10c. George Fenner, 1618 Lucia, Louisville, Ky.

CHAIN Store business—How to get into. Send stamp to H. Kuhn, 301 Alpine St., Perth Amboy, N. J.

MAKE Money growing vegetables, fruits, flowers, plants without soil. Use only water and chemicals. Formula 50c. Kemixal, 179, Park Ridge, Ill.

DISTRIBUTORS—Wonderful new bicycle accessory. Kimley, 1271 E. Ferry, Buffalo, N. Y.

(BRENISER) Profitable dollar mail business, 10c coin, 6c stamps. Green, 15788 Parkside, Detroit, Michigan.

\$50.00 WEEKLY! Operate mail order business for us. Product furnished. Iron-So-Ezee, Mt. Washington, Ohio.

MAKE Beautiful glass and illuminated signs, emblems, picture mounts, mirrors. Cheney Signs, 325 Ohio, Wichita, Kansas.

YOU'LL Like resilvering mirrors, auto-parts, reflectors, making chipped glass signs. Write, Sprinkle, Plater, 127, Mari-on, Indiana.

205 MONEYMAKING Plans. Start your own business from home, office, etc., making \$25-\$75 weekly. Booklet free. Stamford, 3762-A Broadway, New York.

MAKE Artificial marble, glazed tiles, uncanny. Tabletops, plaques, floors, hones, novelties. Hard, fireproof, inexpensive, cement secrets. Brilliant tile and liquid rubber samples 3c. John A. Payn, 945 Grande Vista Avenue, Los Angeles, Calif.

"LITERATURE Explaining" latest business ideas, plans, opportunities. Process Co., 4437 Lincoln, Chicago, Ill.

LEARN Mold making, with our liquid rubber. Sets solid in 4 hours, any thickness. Illustrated novelties, and samples free. Novelty Supply Co., Grayling, Mich.

ADDED Income ideas. Mail Sales News magazine, copy 10c. Katz, 4254 No. Kimball, Chicago.

FREE—"Big 32-page book" explaining composition novelty manufacture! Tells you how to make extra money in your spare time! Supply limited! Write today! Stewart's Studio, Dept. P9, 2927 Wilcox, Chicago.

REAL Money making opportunities. Write Churchill, 4316 So. Salina, Syracuse, N. Y.

SUCCEED With your products. Make-sell them. Formulas. Processes. Accurate analyses. Catalog free. B. Thaxly Co., Washington, D. C.

DECORATE Fast selling novelties, experience unnecessary. Large profits, 10 cents brings full particulars. Plastic Arts Studio, 711 Neely, Muncie, Indiana.

GIGANTIC Mail, unlimited opportunities, bargains. Send dime. Details sent free. Let us mail your circulars. 30c per hundred. Special: directory of wholesale firms carrying half million articles for 25c. PM2, Ippolito, 279 Myrtle, Buffalo.

MAKE Your own rubber molds. Details free. June, 101-B Beech, Holyoke, Mass.

CERTIFIED Formulas! Duplicating or surpassing nationally advertised products. Less cost. Largest profits. Millar's Formula Messenger (free) explains everything. Millar, Chemist, Tampa, Florida.

MONEY At home. Full, part time, spare room, basement, garage; making moulds, casting, glazing beautiful artistic novelties. Revolutionary, new, patented, entirely different materials. Experience unnecessary. Exclusive franchise. Amazing profits. Stamp brings details. Foreign inquiries invited. Finart, 189-199 Van Rensselaer St., Buffalo, N. Y.

RECAST Old batteries into new. Latest achievements. Battery Laboratories, St. Paul, Minn.

NEW Moneymakers! \$10.00-\$20.00 daily! Details free. Samples 10c. Marquez-PBA, Apartado 1176, Mexico City.

PROFIT With new products. Make, sell, repeat. Analysis. Research. Guaranteed formulas. Biggest catalog free. Special prices, leads. Gibson Laboratory, Chemists, BD-1142 Sunnyside, Chicago.

\$250 STARTS "Chain" of penny gum and confection vending machines. Steady cash income. Details free. Robbins Co., 1141P DeKalb Ave., Brooklyn, New York.

DON'T Buy, grow your own fruits, flowers, vegetables year round with simple soilless method. Chemicals, instructions, formula, bibliography, \$1.00 postpaid. Chemi-Culture, 4701PM Sheridan, Chicago.

MONEY Made quickly, honestly. No canvassing. "Business opportunity" circulars free on request. Board's Distributing Center, 1912 14th St. N. W., Washington, D. C.

MAKE Up to \$50-\$100 weekly selling real estate without charging commission to either buyer or seller. Complete guaranteed instructions, forms, letters, only \$2. Gommels, 1229 NW 27, Oklahoma City.

MONEYMAKING And spare time plans in Sterling Digest Magazine, 10c copy, 907 4th Street, Sheboygan, Wisconsin.

VALUABLE 104 Page book. "120 Ways to Make Money." Postpaid \$1.00. Circular free. P. Buckley, 810 North President, Jackson, Miss.

PROFITABLE Mail order business in your home. Kessler, Box 311-M, East St. Louis, Ill.

GROW Flowers, vegetables, in water all year round. Instructions, formula, chemicals, complete \$1.00 postpaid. Gordon Laboratories, 509-E 5th Ave., New York.

IMPORTERS Make big profits. Be an importer. Details one dime. Continental, Box 119, Franklin Square, N. Y.

BETTER Signs with letter patterns, all sizes. Anyone can use them. Booklet and sample mailed for 3c stamp. John Rahn, B1330 Central, Chicago.

ESTABLISH Yourself in profitable mail order business. No goods to buy, no orders to fill. Send for free literature. Alfred Siddall, Atascadero, Calif.

"THINK And Grow Rich." Information 7c. stamps. Suchan, Alpha, Minnesota.

COLOR Concrete with chemicals. Washing-wells. Spin concrete pottery. Stucco-rock. Miniature castles, mills, cold glaze, marbling. Sample 10c. Hollywood Cement Craft, 8527 Wonderland, Hollywood, Calif.

CALIFORNIANS Growing plants without soil, fascinating. Sample ingredients, formula 50c. RSRC Laboratories, 4327 So. Normandie Avenue, Los Angeles.

BATTERY Business answers your wish for interesting happy occupation as employee or employer. Makes you independent, brings plenty of money. You restore automobile, airplane and other storage batteries at large fees. All or part time. Need everywhere. We teach completely in few weeks. Write for booklet. Derr Institute, 26 McKinley St., Baldwin, N. Y.

QUIT Playing at the mail order business! Make real money—others are! "6000 word folio," 3c. Dr. Swearingen, Station "S," Los Angeles.

SELL By mail from home; spare time. Personal contacts unnecessary. Unlimited opportunities. Become independent. Novel revolutionary plan. \$2.95 supplies everything necessary. No get rich quick scheme. Get sample, particulars 25c. Nothing free. Specialty Services, Box 515, Minneapolis.

MAN In each town to plate auto parts, reflectors, bicycles, fixtures, mirrors, by late method. Simple plan of manufacturing at home starts you in good paying business. Free particulars and proofs. Gunmetal Co., Ave. H, Decatur, Ill.

MANUFACTURE Our product. Basement suitable. 10c brings sample, information. Continental Insulation Co., 412 Watson St., Aurora, Ill.

OPERATE Electric Simonizing station. Cash in on labor-saving invention. Only \$39.50. Should net you approximately \$300-\$400 month. Write Bissell's Manufacturing, 3320-P Archer, Chicago. Dealers wanted.

PROFITABLE Home mail business, fully equipped, \$2.95. (\$15.00 value). \$1.00 sample; particulars 25c. Nothing free. Thompson, Box 241, Duluth, Minn.

DO You need capital? Raising capital made easy. Write for free information. P. Seminole Company, 45 West Forsyth Street, Jacksonville, Florida.

TREASURE Finders? Read Goldak advertisement on page 131A.

YOUR Opportunity, mail order information, dime. Box 58, Huntington, Vermont.

AMAZING. New, economic plant fertilizer. 25c. Sanquist Co., Pomeroy, Iowa.

SELL By mail. "The Key to Business Opportunities" is a secret that will make you independent. Sent free. Maples, 3418 So. Marshfield, Chicago, Illinois.

BE Rich, make 900% profit bottle vanilla extract. Free labels. Tharp, 914 Lexington, Cumberland, Md.

\$15.00 DAILY Easily earned buying up old bottles, magazines, rags, scrap metal, used merchandise, herbs, etc., for Northern Commission Co., B-PM, Buffalo, Minnesota.

MAKE Money growing real pearls. Send dime for information. C. Mick, 253 E. 148 St., Bronx, New York.

\$1.90 PROFIT On each \$2.00 mail order. Guaranteed legitimate. Particulars free. Pop-Director, Drawer 989, Edinburg, Tex.

MAKE Money manufacturing new building material. Low in cost, permanent, attractive. Big growing market. Equipment \$25.00 up. Equipment Co., Holland, Mich.

MEXICAN Feather pictures. 100% profit, easy sales. 50c (stamps) bring \$2.00 worth samples, details. Refunded if unsatisfied. Mexicanart-M, Apartado 1593, Mexico City.

USED Popcorn poppers, caramelcorn equipment. Northsyde, 1528 - 19th, Des Moines, Iowa.

AFTERNOONS Free for outdoors, shows. \$340 month home. Unique plans. No canvassing. Prepare for surprise. Folio-F, Station D, Los Angeles.

MANUFACTURE From Phospholene. Cleaning fluid 1c gallon; bleach 2c gallon; hand soap 2c pound; and ten fast sellers. Sample 25c. Details free. Western, 6615 Denison Ave., Cleveland, O.

WHERE To buy at lowest wholesale prices. Information free. Yorena, Box P-312, Bayonne, N. J.

HOW And where to obtain capital fully explained, free particulars. Star Service, Wapakoneta, Ohio.

PLASTEX Industries offers industrious men an opportunity to start a business of their own, manufacturing art goods, novelties, souvenirs, etc., in Plastex and marble imitation. 5c material makes \$1 articles. Rubber moulds furnished for speed production. Small investment brings big returns. You are just in time for big wholesale season now starting. Write for interesting booklet mailed free. Plastex Industries, Dept. A, 1085 Washington Ave., New York.

LIQUID Marble—anyone can make! Colorful, glazed! Moulded, brushed, sprayed. Rubberlastic moulds. Composition flooring. Big money in these! Particulars free. Marbleizing Service, Edwardsville, Ill.

WE Start you in business, furnishing outfits and instructions, operating Specialty Candy Factory home. Men and women, earn \$25 up to \$60 weekly, all or spare time. (Our 29th year.) Booklet free. W. Hillyer Ragsdale, Inc., Drawer 4, East Orange, N. J.

SELL By mail. Books, novelties. Bargains! Big profits! Particulars free. B. Fifco, 438 N. Wells, Chicago.

PROFITABLE Home business. Legitimate. No canvassing. Maywood Publishers, P-923 Broadway, New York.

I WANT To send you proof of the wonderful pulling power of Popular Mechanics Magazine's classified pages. What's your proposition? Write me today. F. W. Johnson, Manager Classified Advertising, 200 E. Ontario St., Chicago, Ill.

CHARTERS: Delaware; best, cheapest; free forms. Colonial Charter Co., Wilmington, Del.

DELAWARE Charters: Complete service \$35. Submitted forms. Chas. G. Guyer, Inc., Wilmington, Del.

ARTIFICIAL Marble sanitary flooring, instruction covering wood or cement flooring 1/2 inch thick, fireproof, all colors, low cost, ornamental casting, concrete, plaster, papier-mache, garden furniture, statuary, flexible molds, particulars free. Chris Mahler, Elmont, N. Y.

MAIL Order business is your opportunity. Many began small, now earn thousands yearly. No personal contact. Boundless opportunities. Have had over 30 years experience; will help you succeed. Send 25c for valuable booklets, none free. B. Brenner, 257 S. 21st, Philadelphia.

100 PROFITABLE Mail order and local plans. Gilbert Supply, 1107 Broadway, New York.

6 MAIL Order magazines, including all you must know about mail order business 10c. Armand Cartier, 31 Cumberland St., Woonsocket, R. I.

LIKE To draw? Earn steady income tracing and duplicating advertising cartoons. Ad-Service, Argyle, Wis.

INVENTORS—We successfully sell inventions, patented and unpatented. Write for proof, and tell us what you have for sale. Chartered Institute of American Inventors, Dept. 4-C, Washington, D. C.

MONEYMAKING OPPORTUNITIES

WILL Buy your unused United States stamps. Small discount. What have you? Mint Sheet Brokerage Co., 418 Caxton Building, Cleveland, Ohio.

MILLIONS Jobless! Get dollars in mail daily, like we do, for amazing employment information. Keep money; we fill your orders. "32 Ways to Make \$1,000,000"—included for stamp. Co-Operative Service, 77 Swan, Buffalo, N. Y.

205 MONEYMAKING Plans. Start your own business from home, office, etc., making \$25-\$75 weekly. Booklet free. Stamford, 3762-A Broadway, New York.

MAILORDER Opportunities, plans, formulas, information. Circulars free. Harvey Teeple, Decatur, Indiana.

MONEYMAKING Specialties: from our formulas. Write Grinstead, 505 Fifth, New York.

YOU'LL Like resilvering mirrors, auto-parts, reflectors, making chipped glass signs. Write, Sprinkle, Plater, 287, Marion, Indiana.

MILLION Articles. Buy wholesale. Valuable directory 10c. Ideal Service, Park Ridge, Ill.

1000 MONEYMAKING Ideas, book 50c; literature free. Harvey Teeple, Decatur, Ind.

WEALTH, Money. Learn 13 steps necessary to acquire it. Book "Think, Grow Rich" tells all. Price \$2.00. Canada \$2.50. No circulars. Strom, 15 Oakcrest Pl., Nutley, N. J.

START New kind mail order business. Straley, 1017 Mulberry, Springfield, Ohio.

GROW Without soil—Flowers, vegetables, plants. Year round, anywhere. Only water and common chemicals used. Formula 50c. Bestovall, 4047-W North Whipple St., Chicago.

PROSPERITY For home workers. 52 page magazine. Sample, dime. Sizemore, 4917 N. Kostner, Chicago.

SIX Jobs for spare time. Pay well, give satisfaction, make friends and boosters. Choose the one you like or which suits you best. I teach and help you start. Must work with hands. Information free. Custer, Box 1765p, Fall River, Mass.

FREE—100 Wonderful business, mail-order and home work moneymaking offers. Lewis Co., 828-C Carpenter, Oak Park, Illinois.

ANALYSIS. Research. Newest guaranteed formulas. Biggest catalog free. Special prices, leads. Gibson Laboratory, Chemists, CS-1142 Sunnyside, Chicago.

"SCHEMER," Alliance, Ohio, (40th year) prints schemes, tips, opportunities, formulas; big producers; \$10,000 to \$25,000 reported. Year, \$1.00. Get wise! Six months trial only 30c.

HEALTH, Wealth, happiness. Grow evergreens, shrubs, flowers. Write Mayflower Nursery, LaPorte, Indiana.

MAKE Signs for restaurants, stores with C.F.B. cutout raised letters. Assortment 104 letters, white 20c, colored 25c. Postpaid. Blumenthal, Manufacturer, 2909 Newkirk, Brooklyn, N. Y.

INVESTIGATE New profitable industry. California Earthworm Farms, Highland Park, Los Angeles, California.

OVER 2000 Ways to make money, full or spare time. Illustrated book 10c. Write Marvin Studios, 203 So. Dearborn, Chicago.

SOMETHING New. Make big money giving away cards. No selling. Fleck, Box 306P, Columbia City, Indiana.

"\$10.00 DAILY." Stamping names on keychecks. Sample and details 25c. Bohn Co., Box 86P, Wilkes-Barre, Penna.

MAKE Wringer rollers for washing machines. Instructions one dollar. Universal Service, Anderson, Ind.

PROFITABLE Home work, complete instructions 25c (coin). Webster, 3931 Third St., Detroit, Michigan.

TREASURE Finders? Read Goldak advertisement on page 131A.

MOULDS, Guaranteed, for casting toy soldiers, Indians, trappers, warships, sinker moulds, 244 kinds. Send 5c for illustrated catalogue. Henry C. Schiercke, 645 Spencer, Ghent, N. Y.

MONEY Means pleasure. My 64 page book shows how, 25c. Write today. Gurney, 4825 So. Marshfield, Chicago.

DIME Brings six months Our Salesman, 1202 Mathewson, Wichita, Kansas.

YOUR Name—5,000 mailing lists—25c. Get samples, opportunities galore from all over world. Pines, 583-P Monroe, Brooklyn, N. Y.

STOP Squealing—Start crowing! Work mornings home—country drives or movies—afternoons! No canvassing! Folio-A, Station "D," Los Angeles.

MAN In each town to plate auto parts, reflectors, bicycles, fixtures, mirrors, by late method. Simple plan of manufacturing at home starts you in good paying business. Free particulars and proofs. Gunmetal Co., Ave. N, Decatur, Ill.

RAISE Earthworms for profit. Information free, stamp appreciated. Bureau Zoological Research, 106A Broadway, Peoria, Ill.

WHOLESALE Sources, 500,000 articles. Free directory. Maywoode, 925 Broadway, New York.

10c BRINGS Copy National Mail Order News. Box 1773-PM11, Roanoke, Virginia.

EARN Money collecting reptiles, toads, frogs. We buy all varieties. Splendid opportunity. Particulars free. Biological Research Laboratories, Dept. 14-d, Springfield, Missouri.

FORMULAS, PLANS, ETC.

FORMULAS — Fast selling products. Guaranteed. Laboratory tested. Any formula 50c, three \$1.00. Franklin-Allen Laboratories, South Paris, Maine.

GUARANTEED Formulas—New fast sellers. None better. Lowest prices. Catalog free. Kemico, 49K, Park Ridge, Ill.

PROFITABLE Products. Get my formulas. Particulars free. Ritter, 1713 Powers, Cincinnati, Ohio.

SELECTED Formulas, for every article. Write Grinstead, 505 Fifth, New York.

25c **BRINGS** 5 Outstanding quality formulas. Solar, 3026-32, Minneapolis, Minn.

SELL Perpetual incense! Formula 25c coin. Philip Bruce, Box 341, Palo Alto, Calif.

ANALYSIS. Research. Newest guaranteed formulas. Biggest catalog free. Special prices, leads. Gibson Laboratory, Chemists, BD-1142 Sunnyside, Chicago.

"**ANYTHING** in Formulas." \$1.00 each, five \$3.00. (Satisfaction guaranteed.) Research Bureau, 100 Chelsea, Charlestown, Massachusetts.

THAXLY Formulas for perfect products. Accurate analysis assured. Resultful research. Catalog free. B. Thaxly Co., Washington, D. C.

MANUFACTURE High grade auto cleaner-polish. Complete instructions \$5.00. A. B. Schooley, Waukegan, Illinois.

SECURE Latest formulas free from world's foremost chemists. Source information \$1.00. Burton, Box 298, Richmond, Va.

WHY Buy necessities? Make them. Adhesives, cleaners, photography, etc. 100 guaranteed formulas 25c. Chemco, 1754 Weeks Avenue, New York City.

NEWEST Guaranteed formulas. Lowest prices. Valuable information free. Hodge Laboratories, Elkhart, Indiana.

ANY Formula 30c or money back. Latest catalog free. Ogg Laboratories, Tampa, Florida.

ANY Formula 25c; 6 for \$1.00. Satisfaction guaranteed. Bestovall Formulary, 4047 No. Whipple St., Chicago.

THREE Up-to-date mirror formulas \$10.00. Samples free. Nashville Mirror Co., 427 Broadway, Nashville, Tenn.

MONEY Makers, 60 pages, 100 plans 25c. P. Beck, 317 West 109th, New York.

FORMULAS: 15 Proven moneymaking formulas \$1.00. (Not stock-formula catalogue stuff), real unusual offers. List free. Marvel Laboratories, 6629 No. Maplewood, Chicago.

FORMULAS. Latest money makers. Literature free. Belfort, 4042 N. Keeler, Chicago.

CHEMISTRY

PERSONAL Prompt answer by chief chemist to any technical question. Expert advice on engineering problems by qualified engineer. Absolutely confidential. Patent protection service. Our technicians regularly consulted by America's leading industries. Send \$1.00 with your question. Technical Service Bureau, Laboratory 22, 6803 North Clark, Chicago.

PROFIT From chemistry; through manufacturing. Write Grinstead, 505 Fifth, New York.

ANALYSIS. Research. Newest guaranteed formulas. Biggest catalog free. Special prices, leads. Gibson Laboratory, Chemists, CT-1142 Sunnyside, Chicago.

CHEMICAL Analysis, industrial problems, estimates free. Essco Laboratories, 2206 Lycaete, Detroit, Michigan.

FREE—Chemistry's history, also chemical bacteriological catalog. Bactachem, 737 Stone, Brooklyn, N. Y.

FREE Chemistry catalog. Supplies at 5c! Equip complete laboratory. Send 3c for postage. Kemkit Scientific Corp., 397P Bridge St., Brooklyn, N. Y.

TELESCOPES. Microscopes, chemistry, mineralogy. Scientific catalog free. Tracey Laboratories, Evanston, Illinois.

HELP WANTED

MAN Wanted by sales division of largest shoe manufacturer in direct selling. Good pay every day underselling competition. No experience needed. Complete sales outfit and air-cushion sample sent free. Write Consolidated Shoe System, Dept. D4, Chippewa Falls, Wisconsin.

WEAR Fine hose I send without cost with outfit while taking orders for amazing new hosiery. Replacement guaranteed against holes, snags, and runs. Rush name and hose size. Wilknit, Desk 37-J, Greenfield, Ohio.

STEADY Work—Good pay. Reliable man wanted to call on farmers. No experience or capital required. Pleasant work. Home every night. Make up to \$12 a day. Wonderful new proposition. Particulars free. Write McNess Co., Dept. 216, Freeport, Illinois.

INSTRUCTION — Obtaining positions, homework. Free offers. Henry 126-A Lexington, New York.

EXECUTIVES Earning \$2,500 or more yearly and seeking advancement should write Executive's Promotion Service, 301 B-st., S. E., Washington, D. C.

AGENTS WANTED

GREATEST Need for every business fulfilled. Agents enthusiastic. Your territory might be open. Write Advertising and Collection System, 607 Law Building, Richmond, Virginia.

AGENTS Make bigger profits on food products, bargain deals. Low wholesale prices. Rush name for trial outfit offer. Ho-Ro-Co, 2810-R Dodier, St. Louis, Mo.

EARN Up to \$4 daily—spare time, showing smart personal Christmas cards. Also 21-card assortment, \$1. Profit 100%. Others; 50 with name, \$1. Samples free. Wetmore & Sugden, 749 Monroe, Dept. B.J.L., Rochester, N. Y.

CASH In on new patent; 12 ounce trouser creaser. Removes knee bag! Presses knife edge crease over night! Start now—your sample and particulars \$1.50, satisfaction guaranteed. Box 445, Vancouver, Washington.

BIG Money taking orders: shirts, ties, hosiery, underwear, raincoats, pants, dresses, etc. Sales equipment free! Experience unnecessary. Write Nimrod, 4922-AN Lincoln, Chicago.

CHRISTMAS Card sensation! Sell 21 gorgeous Christmas folders in "Copper Gift Box" for \$1; profit 100%. 7 other assortments. Finest personal Christmas cards, with name. Get samples. James Art Studios, 198 Anson Pl., Rochester, N. Y.

500% PROFIT Selling new "20-in-1" kitchen utensil. Retail 25c. Costs you \$1 a dozen or \$7.20 a gross. Sample 10c. New Method Co., P.M.M.-69, Bradford, Penna.

EASY Cash—Show new "Ruby" 21 folder Christmas assortment. Big \$1 seller. Your commission 100%. Many other Christmas assortments, gift wrappings, religious, birthday. Also personal cards with name. Big money makers. Samples offered free. Chilton Greetings, 179 Lincoln, Dept. 2-D, Boston, Mass.

AT Home, your own manufacturing business, making popular \$1 novelties. Cost you 3c to 15c. Everything supplied. Write So-Lo Works, Dept. K-842, Cincinnati, Ohio.

SELL 50 Personal Christmas cards \$1.00. Amazing bargain! 50 folders with customer's name imprinted. Sells fast. Pays big profit. Free samples. Also unequaled \$1 Christmas card assortments. General Card, 400 S. Peoria St., Dept. P-309, Chicago.

CHRISTMAS Cards. Double profits with Dixie line. Boxed assortments packed from overruns. Retail value \$1.00. Your cost 25c box. Minimum order ten boxes. Order now. Keelin Press, Dept. P, 153 Spring N. W., Atlanta.

AMAZING Opportunity—Give away valuable premiums and samples with famous quality coffee, spices, 400 other necessities. Steady work—excellent pay. Your groceries at wholesale. \$500.00 yearly bonus and free samples to all qualified dealers. Experience unnecessary. Togstad Co., Dept. 672, Kokomo, Ind.

BE Your own boss! Operate used-new clothing business from store, home, auto. 200%-300% profit. Everything furnished. Catalog free! V. Portnoy, 566-AL Roosevelt, Chicago.

NEW Invention turns auto headlamps into amber foglights. Snaps on. Inexpensive. Sensational seller. Samples sent on trial. Rush name. Kristee, 106, Akron, Ohio.

AMAZING Invention, fast selling ink-well specialty. Pills fountain pens automatically without use of pen mechanism. Distributorships open. Terry Penfiller Co., Dept. PM 10, Janesville, Wis.

UTTERLY New scientific substance. Solid, potent, flexible, sensuous, translucent, waterproof. Must see, feel, smell, use to know all 28 joys for men, women. 3 regulars (75c worth) 17 ways sell dozens daily. Bank letter and refund coupon sent for 25c. Origin, 224 S. Michigan Ave., Chicago.

EARN Cash quick. Sell double value Christmas cards. 1938 leaders. Personal cards, stationery, box assortments. Season's most complete line. Profit up to 100%. Experience unnecessary. Free samples. Wallace Brown, 225 Fifth Ave., Dept. 71-D, New York.

WE Have that sells itself article that every man and woman wants. Sample 25c. Inventors Laboratory, 1821 Farrington, Memphis, Tenn.

MONOGRAMMING Automobiles real money maker. Write for samples. International Co., Box 9360, Philadelphia, Pa.

CHRISTMAS Cards. Absolutely finest assortment. Big profits. Write for samples. Robinson Cards, 401 Orange, Clinton, Mass.

"**KEENEREDGER**" Produced 750 smooth shaves from one blade. Sample \$1.00. Keeneredger, Oblong, Ill.

MAKE Extra money spare time showing my gorgeous, new \$1 assortment 21 Christmas folders. You make 50c box. Friends, others buy eagerly. Other fast-selling Christmas money makers. Free sample offer. Schwer, Dept. J-30, Westfield, Mass.

MEXICAN Novelties! 100%-300% profit. Free particulars. Samples 10c stamps. Marquez-PC, Apartado 1176, Mexico, City.

NEW European novelty, used by every man and woman. Sells itself. Direct or retail trade. Send 25c for samples. A. R. Beveridge, 3771 West 23rd Avenue, Vancouver, Canada.

WATER Pen: Fill with water, writes ink. Price \$1.00. Agents wanted. Trident Traders, Inc., 67 Wall Street, New York City.

DOUBLE Profit: making and selling. Write Grinstead, 505 Fifth, New York.

PHARMACEUTICALS. Household, toilet specialties, soap. Williams Mfg. Co., North Bellmore, N. Y.

AGENTS!—205 Moneymaking opportunities. Start your own business from home, office, etc. Descriptive booklet free. Stamford, 3762-A Broadway, New York.

BUSINESS Proposition: Resilvering mirrors, autographs, reflectors, making chipped glass signs. Write, Sprinkle, Plater, 128 Marion, Indiana.

500% PROFIT With new perfected (1938) quick-action, no flint, automatic gas lighter. Retail 25c. Sample 5c. New Method Co., Box PMG-70, Bradford, Penna.

MAN Wanted to supply Rawleigh's household products to consumers. We train and help you. Good profits for hustlers. No experience necessary. Pleasant, profitable, dignified work. Write today. Rawleigh's, Dept. J-53-PPM, Freeport, Ill.

CALLING Cards—Splendid sellers. Good profit. Samples free. Chestnut Press, 6019 Chestnut, Philadelphia, Penna.

SIZZLING! Hot! Snappy illustrated 3 color Sho-Cards. Fastest 25c sellers. Cost 4c. Samples 10c. Hansen Signs, 3129 N. Linder, Chicago.

DOUBLE Your money! Wolverine zipper money pocket dress belts sell quickly. Made of cowhide bridle leather; black, brown, gray; initial or harness tongue buckle; 65c. Be convinced! Mail money order for sample. Wolverine Belt Co., Detroit, Mich.

100% PROFIT For agents, truck jobbers, distributors. Sell Super-Lax, the sensational peppermint candy laxative packed in rolls of 14 tablets for 10 cents. Full carton of 12 rolls and information, 50c in coin. Name counties wanted. Super-Lax Company, Anderson, S. Car.

YOUR Social security number, auto and operator license numbers, name and address stamped in chrome plated identification tag, lightweight and attractive, can be attached to key ring. You should have one. 25 cts. postpaid. Agents wanted. J. F. Roulter Co., 221 Frost Ave., Rochester, N. Y.

CHRISTMAS Cards. Sell 50 assorted folders, name imprinted, \$1.00. Cost you 50c. Samples free. Dunbar, New Brunswick, N. J.

AGENTS. Lowest subscription rates ever offered. Metropolitan Magazine Service, 71 Jewell Street, Garfield, New Jersey.

JAY-WAY Doorholder money-making proposition. Jay-Way, 26 Journal Square, Jersey City, N. J.

YOUR Own shoes as bonus and quick cash commissions showing complete shoe line. Experience unnecessary. Selling outfit free. Tanners Shoe Co., 843, Boston, Mass.

OFFICIALLY Approved advance world's fair views. Sell individuals, stores, sub-agents. 35c brings fifteen samples and terms. Mead Publishing Company, Dept. 10, Middletown, N. Y.

THE Klik hook locks on belt; carries safely; keys, knife, flashlight. 25 cents. Postpaid. Morrison, 8335 Anthony Circle, Hollywood, Calif.

MEN—Women, sell the new Bulmer corn decolber. Makes corn canning easy. Bulmer Machine Works, 3123 Alderwood Ave., Bellingham, Wash.

FLUID Typewriter type cleaner. B. Omoto, 2552 Hyperion, Hollywood, Calif.

WRITE For big money making proposition. Sadin Company, Richmond, Virginia.

SUCCEED With your products. Make-sell them. Formulas. Processes. Accurate analyses. Catalog free. B. Thaxly Co., Washington, D. C.

THREE New fast sellers. Vincent, 822 N. 24th, Milwaukee, Wis.

ELGIN, Waltham, Hamilton watches. Make big money. Send for illustrated catalog. Plymouth Jewelry Exchange, 163-B Canal Street, New York.

PROFIT With new products. Make, sell, repeat. Analysis. Research. Guaranteed formulas. Biggest catalog free. Special prices, leads. Gibson Laboratory, Chemists, BD-1142 Sunnyside, Chicago.

DON'T Be a "job hunter" all your life! Settle down in permanent grocery agency with earnings up to \$45 first week. I'll help you; operate on my capital. Details free. Albert Mills, 6271 Monmouth, Cincinnati, Ohio.

FAST Selling necessity. Costs 2c, sells 25c. Sample 10c. Linnell, Box 1963-E, Cleveland, Ohio.

DISTRIBUTORS, Dealers, agents and tradesmen, to sell new ladder roller, just out. Particulars. Write Marless Safety Rollers, Appleton, Wisconsin.

PERFUME Concentrate. Big profits, quick sales. Pleasant work for ladies and gentlemen. Free carded odors. Persian Perfume Company, 1231 Olive, Desk 12, St. Louis, Mo.

HABERDASHERY Store in your pocket! Huge selection customized shirts, each made in 90 sizes! Complete line of hosiery, ties, underwear, pajamas and winter jackets. Half price offer creates terrific values. Simply display complete self-selling free outfit. Write orders. We deliver and collect. Advance cash commissions; bonuses! Everything guaranteed one year! We pay over \$100,000.00 yearly commissions. Get your share. Postcard brings you outfit prepaid. Rosecliff-Quaker, "Shirtmakers since 1895," 1239 Broadway, Dept. 108, New York.

WORLD'S Fastest money maker. Sell 50c packs of razor blades for 5c. Tharp, 914 Lexington, Cumberland, Md.

100-300% PROFIT! Suits \$1.50, coats 50c, dresses 10c. Catalogue free. Fairmount, 164-M Henry, New York.

CHRISTMAS Card box assortments selling like "wildfire." People who have never sold a thing in their lives are reaping harvests with our sensational 21 folder "Champion" assortment. Costs 50c—Sells for \$1.00. Also amazing etchings, gift wrappings, religious, humorous and everyday assortment. Write today. Samples on approval. Silver Swan Studios, 320 Fifth Ave., Dept. 74, New York.

SANTA Claus card talks like phonograph, speaks the greeting, Merry Christmas. Sensational seller. Sample 10c. Talking Card Company, 4451 Irving Park Blvd., Chicago.

MAKE \$35 Weekly passing out free baking powder. Write Blako, 9459 Alstyn Ave., Elmhurst, New York.

SELL Magic Kote. New sensational product. Guards hands against paint, grease, etc. Free particulars. Paramount Products, Box 74, Sta. A, New Haven, Conn.

FREE Information! Three daily necessities. Repeaters. Burlite Company, Hudson, Ohio.

NEW Beauty thrill—"Valizon Bubble Bath." Sample 10c. Valtex Products, Rochester, N. Y.

STARTLING Invention—Pocket adding machine. Nationally advertised \$2.50. Whirlwind seller. Big profits. Baby Calculator Co., Box 1118, Chicago.

AGENTS: Smash go prices! Santos coffee 12c lb. 4-oz. vanilla 8½c. Razor blades 10 for 8½c. 100 sticks chewing gum 12c. Christmas cards, 21 in box 14c. 150 other bargains. Premiums. Experience unnecessary. Carnation Co., P.O. St. Louis, Mo.

DO You want agents for your proposition? Your ad in this space will place your message before hundreds of men seeking fast-selling products. My folder "How to Secure Agents," is filled with proof. I'll gladly send you a copy free. F. W. Johnson, Manager Classified Advertising, Popular Mechanics Magazine, 200 E. Ontario St., Chicago.

BIG Money applying initials on automobiles. Write for particulars and free samples. American Letter Company, Dept. 40, Dunellen, New Jersey.

BIG Money applying initials on automobiles. Easiest thing today. Free samples. Also, sideline salesmen for name plates and tire cover transfers. "Ralco," 1305 Washington, Boston, Mass.

500% PROFIT! Gold and colored sign letters for windows, offices, trucks, signs. Auto monograms. Easily applied by agent or customer. Neonite, Akron, Ohio.

AGENTS—To mail our literature. Good profits. Home business. Maywood, 149 Fifth Ave., New York.

FREE Sample—Amazing cleaner; sells homes, taverns, everywhere. Big profit—fast repeater. Betco, 5007 Irving Park, Chicago.

AGENTS: Stamping names on pocket-key protectors. Sample check with your name, address, 25c. Stamping outfits. Emblem checks, check-fobs, name plates. Hart Mfg. Co., 303 Degraw St., Brooklyn, N. Y.

MANUFACTURE Specialties, hire agents yourself. Big money. Free literature. Gilbert Supply, 1107-P Broadway, New York.

ENGRAVED Name plates, numbers, signs, etc., easily sold, profits large. Brett Bros., Winthrop, Mass.

REVOLUTIONARY Window cleaning tool. Good Housekeeping approval. Only ten \$2.25 sales daily to housewives, factories, schools, stores will make you \$350.00 monthly. Carter Products Corp., 900 Front Ave., Cleveland, Ohio.

BIG Profits. The perfect eyeglass cleaner. Wonderful demonstrator. Prevents steaming. Sample 15c. Shurberg Chemical, Hartford, Conn.

GUARANTEED Gold leaf letters for store and office windows. 300% profit. Free samples. Metallic Co., 438-B N. Clark, Chicago.

ATLAS Window sign letters. Large sizes, penny each. Beautiful free samples. Atlas, 7941 Halsted, Chicago.

WANTED — District purchasing agents. No experience or money required. Write Purchasing Manager, 174 N. Halsted, Chicago.

EARN Money in your spare time taking subscriptions to Popular Mechanics. Unlimited possibilities, every family a prospect. Easy to sell. Bonus paid in addition to liberal commission. Send postcard for further details today. Circulation Dept., Popular Mechanics Magazine, 200 E. Ontario St., Chicago.

HIGH-GRADE SALESMEN

CASH Income weekly for salesmen—Spare or full time. Many make \$50.00 or more in a week selling highest quality Stark trees, shrubs, roses, etc. Healthful outdoor work. Write quick for free sales making outfit and weekly income plan. No cash or experience needed. If you can't sell, buy Stark trees. Largest nurseries in world. Nearly 125 years old. Write for catalog. Stark Nurseries, Box C-8108, Louisiana, Mo.

SALESMEN Sell suits on our easy credit plan. Free suits and pants given as bonus besides large cash profits, premiums and gifts. Sell only (5) suits to get a free suit. No limit to number of free garments you may earn. Wholesale prices \$17.95 and up. Sample line free. No experience needed to make easy sales. All garments individually cut and tailored to measure. Satisfaction or money back guarantee. Three Star Clothes, Inc., 330 South Franklin St., Dept. CA2, Chicago, Ill.

\$50 WEEKLY Possible from start placing nationally advertised counter card goods with stores. Chance to double earnings in few weeks. Most unusual selling opportunity in wholesale field. Permanent connection. World's Products Co., Dept. 1010-A, Spencer, Ind.

SPECIALTY Salesmen to sell new line of advertising calendars and earn good commission. Write letter telling your territory, we will send samples and contract. Shield Press, Indianapolis, Ind.

SELL Candidates. No competition. Unaffected by "recession." Most complete line of auto-signs, posters, novelties on market. Also investigate our new Art-Plax line of thermometers, silhouettes, mirrors. Ad-Nov-Co, Newton, Iowa.

SELL Clothes on credit. Get own suit as bonus. Finest union made-to-order suits, overcoats retail \$20.75 up. Quality woolens, styling, workmanship. Undersell all others. Special fabrics selected your locality. Amazing features get you 50% more orders. Big commissions. Two orders daily pay up to \$60 week. Cash bonus too. New multi-vision outfit free. Fairbanks Tailoring Co., Dept. F-36, Oakley at Wabansia, Chicago, Ill.

MANAGERS, Supervisors, age 25-60; also distributors wanted at once for established firm; to appoint, manage authorized exclusive dealers, every town 200 population up. "New automotive method and proposition alone in field"—product makes spectacular, truly convincing demonstration. Fast turnover, conducting new Super Sales Parades and Circuses; large profits now and on repeat business, based on sales. If desired, a dealer-consignment plan available with 100% insurance protection for you. A guarantee for you under Plan "A". Write, wire, today for details. Craver-Jay Corp., Dept. 108, Kansas City, Mo.

HUNDRED Christmas and calendar bargains! Catalogue free! Twenty-one piece boxes 15c; 12 pieces 8c; fifty imprint folders 25c; Cellophane packages 5c. More profits! Easier sales! Elfko, 436 North Wells, Chicago.

SELL Business cards \$1.50 thousand. Business stationery, book matches, advertising tape, paper towels, drinking cups, pencils, salesbooks, labels, rubber stamps, tags, menu covers. Free sales portfolio. 35% commission daily. Money making specials. Willens, 2130 Gladys, Dept. AN, Chicago.

NEW Patented specialty. Ideal gift. Start now. Year's salary in two months. Beebe Specialty Co., Box 501, Binghamton, N. Y.

NO Competition—Selling new product. Experience in drug lines preferred but not necessary. Stainex, Leavenworth, Kans.

SELL Monogrammed stationery. Make big money. Read, 3401 Parnell Avenue, Chicago.

BIG Money taking orders; shirts, ties, hosiery, underwear, raincoats, pants, dresses, etc. Sales equipment free! Experience unnecessary. Write Nimrod, 4922-AP Lincoln, Chicago.

FREE Booklet describes 205 moneymaking plans. Start your own business from home, office, etc., making \$25-\$75 weekly. Stamford, 3762-A Broadway, New York.

SELL New Hexagon portraits. Big profits. Lowest prices portraits, frames. Catalogue free. Picture-Man Friedman, Dept. 9, 528 Cornelia, Chicago.

POPCORN Machines, caramelcrisp, crispettes, cheese coat, potato chips. Long Eakins, 2035-K High St., Springfield, Ohio.

SALESMEN! Collect \$3.00 profit from every service station and garage. New invention revolutionizing industry. Airpower Co., Newton, Iowa.

SELL America's most complete line of business necessities. Regular and novelty size book matches, gummed labels, political items, pricing sets, restaurant supplies, salesbooks, embossed stationery, shipping supplies, office supplies, printed gummed tape, advertising pencils, thermometers, business stimulators, holiday novelties, beautiful line greeting cards and calendars. Complete line printed business forms and hundreds of other fast sellers. Competition undersold. Cash commissions advanced daily, extra bonus. Experience unnecessary. Complete sales outfit free. Northwestern, AR-301 South Desplaines, Chicago.

BRUSH Salesmen. If you ever sold brushes write for our money making proposition. Donald Brush Co., Dept. P.M., Camden, N. J.

BIG Commission selling celluloid pricing tickets, metal shelf moulding, menu covers, signs, celluloid buttons, cards. P. Pricing Tickets, 124 White St., New York.

SALESMEN To sell florist ribbon. Bargain prices. Big commission. Arrow Textile Co., 1123 Broadway, New York City.

WONDERFUL Opportunity. Secure exclusive territory Push-Pull self cleaning rake and Push-Pull hoe and cultivator. Big commission. Push-Pull, Dept. K, Independence, Kansas.

MAKE Simple, costless cylinder oil reclaimers—save hundreds. Instructions 50c. Also information other processes, fast-sellers, money-makers for manufacturers and salesmen free. Thermo Laboratory, Peoria, Illinois.

MAKE Big daily cash profits selling top quality advertising book matches. Low prices. Experience unnecessary. Full time profits unlimited. Free sales kit. Zipper case offer. Match Corporation of America, Dept. E-10, 3433 West 48th Place, Chicago.

SELL Beautiful Colorado evergreen Christmas wreaths; grave blankets; crosses. They're new. No competition. Season starting, Riley, 2657 So. Lincoln, Denver, Colo.

TIRE Accessories. Guaranteed 10,000 mile Tiger Grip Tire Patch, and complete fast-selling line auto accessories. Salesmen-distributors easily make up to \$75 weekly, and over. Protected territory. Economy Rubber Products Co., 644 Burkhardt, Dayton, Ohio.

CHRISTMAS Cards selling now. Get early start. Make more money. Special box assortments of 21 and 25 cards, ready for imprinting. Colorful, artistic. Big profits. Write at once to Star Novelty Utilities, 107 S. Wells, Chicago.

ENORMOUS Daily profits selling wholesale, retail, fastest selling household necessity; needed wherever water runs. Top-eka drain cleaners; scrapes pipes clean inside; sample, territory postpaid 50c. Patented Products Company, Dept. PM, Topeka, Kas.

SALESMAN—Experienced, educational field. References required. Jourden Schools, Philadelphia, Penna.

SALESMEN—Sell calendars, complete line, all sizes, including jumbos; beautiful subjects. Samples free! Fleming Calendar Co., 6539 Cottage Grove, Chicago.

OUR New 1938 complete line of brushes now ready. Largest commissions. Write for sales plan. Wire Grip Sanitary Brush Company, 2300 5th Ave., New York.

NEW Specialty—Sells every business and professional man. Four \$15 sales daily pay \$280 weekly. Farrell cleared over \$1,000.00 monthly. Write, F. E. Armstrong, President, Dept. PM, Mobile, Ala.

GUARANTEED Gold leaf letters for store windows. Free samples. Liberal offer to car owners. Metallic Co., 438-A N. Clark, Chicago.

MAKE More money with Red Comet Automatic Fire Extinguishers. Low price. Proved seven years. Splendid sales outfit free. Some good territory open. Exclusive. Write quick. 704 Red Comet Bldg., Littleton, Colo.

SALESMAN—Make over \$12.00 daily now, and a harvest at Christmas time, selling 25c to \$1.00 ready-to-fly model airplanes to stores. Western Aircraft, 1271 S. Norton, Los Angeles.

EDUCATIONAL AND INSTRUCTION

LEARN Watchmaking. Lessons, Elgin model, trial tools, wholesale bargain watch, tool, material catalog \$1.00. Stewart Watches, 721 Olive, St. Louis, Mo.

IF You like to draw, sketch or paint—Write for talent test (no fee). Give age and occupation. Write Federal Schools, Inc., Dept. PM 108, Minneapolis, Minn.

FOR An extremely profitable lifetime business, operate a collection-credit agency. Free folder. Cole Associates, Syracuse, N. Y.

"UNCLE Sam" jobs. Start \$105-\$175 month. Men-women. Prepare now for next examinations. Common education usually sufficient. Particulars, list positions, free. Franklin Institute, Dept. B3, Rochester, N. Y.

BECOME Casualty investigator and adjuster. Dignified, fascinating, profitable profession. Easily mastered. Capital unnecessary. Overstocked publisher sacrificing new, regular \$5.00 instruction course, complete, 25c silver. Box 302, Alhambra, California.

ATTAIN Mastery! Nervousness, fear, worry! Psychological instructions. Free literature. John A. Englund, Ontonagon, Mich.

LEARN Electric arc welding, by experienced welder. Free particulars. Roy Ankerman, Wapakoneta, Ohio.

BECOME Practical scientific investigator. Modern, illustrated course. Thorough training by former agent U. S. secret service. Particulars free. International Secret Service Institute, PM-108, Hoboken, N. J.

IF You are unemployed or dissatisfied with your present position, earnings or pay check, and believe our investigation will disclose you as honest, moral, upright, energetic and of average intelligence, write at once, giving your age, present occupation and past experience to The Modern Scientific Extension Aid, Dept. A, Box 114, Rochester, New York.

DRAFTSMEN—Increase income \$100 to \$1000. Preliminary instruction, 25c. Draftsmen's Foundation, West Medford, Mass.

WORK For "Uncle Sam." Books \$1.00. Postal, auditors, messenger. List 50 jobs, questions, qualifications, free. Pergande, Publishers, PM, Milwaukee, Wis.

UNEMPLOYED! Discouraged? For results try our job hunting methods. Write Employment Counsellors, Box 1283K, Milwaukee, Wis.

WATCH Repairing is steady profitable work. Experts always in demand. You can learn watchmaking trade at home, spare time. New original instruction system. Script engraving course included. Write for free details today! Nelson Co., 2010 Manhattan Building, Chicago.

PREPARE For big jobs. Drafting for diesel, welding and streamlining; blueprint reading. Manager, 7050 Kimbark, Chicago.

SIMPLIFIED And mental arithmetic, you can understand. Pay postman \$1.98 plus postage or sent postpaid for \$2.00. Arith-Magic, 60, Elmhurst, Ill.

SHORTHAND—Touch typewriting. Easily learned at home. Details free. Severance, 220 Garden, Fountain City, Tenn.

DRIVING Easily learned with simple illustrated instructions. Free details. Educational Service, 261 Boerum St., Brooklyn, N. Y.

MAKE More money. Get a U. S. government job. Get our new plan for obtaining one—no obligations. Age 18-50. Write Ozment Instruction Service, 101, St. Louis, Mo., immediately.

MASSAGE, Hydrotherapy, dietetics, drugless therapeutics, chiropody, taught by mail. Evans Correspondence School, Montgomery, Ala.

GOV'T Jobs start \$1260-\$2100 year. Men-women age 18-50. Former examiner's tested method helps qualify you. Particulars, list jobs free. Write today. Patterson School, 8C Mercantile Bldg., Rochester, N. Y.

LEARN Machinist trade, tool, die making. Automatic and hand screw machines. Modern shop methods. Actual work. Jobs open for trained men. Employment help. Illustrated booklet free. Allied Screw Machine Co., 601 Lake St., Chicago.

LEARN Auto mechanics, body, repairing, welding, electricity, refrigeration, Diesel. Stevinson's, 2008A Main, Kansas City, Mo.

SPEECHES, Essays, theses, themes; prepared for any occasion on any subject by University of Michigan graduate (Phi Beta Kappa). Minimum acceptance \$2.50. Address inquiries: E. Henry Fellhauer, Box 562, Monterey, California.

LEARN Air conditioning—America's next big industry. Thousands of opportunities. Get your start with complete book by E. W. Riesbeck. \$3.50 postpaid. Popular Mechanics Press, Room (C38), 200 E. Ontario St., Chicago.

CARTOONING, COMMERCIAL ART, SHOWCARD WRITING, SIGN PAINTING

ARTISTS! Sell your drawings, cartoons, designs; establish paying studio. Hundreds buyers listed; \$35,675.00 prizes; illustrated instructive articles produce success, bigger money. Regular 25c sample 10c. Artist, 320 Doty, Madison, Wisconsin.

ARTISTIC Lettering simplified. Quick work. Samples free. Thompson School, 872P, Pontiac, Michigan.

CARTOONISTS, Illustrators. Sell your drawings. Particulars for stamp. Feather, Parkville, Mo.

CARTOONING, Lettering, etc. 46 lessons, 600 illustrations, including practice sheets, pens, pencils. Drawings criticized. \$1.00 complete. Allen Service, 1799 E. 100th, Cleveland, Ohio.

CARTOONISTS: Sell your work. Free details. Cartoon Studios, LaCrosse, Wis.

CHALK Talks. Laugh producing program, \$1.00. Catalog 10c. Balda, the Cartoonist, Oshkosh, Wisconsin.

DRAW Amusing comic cartoon characters. 30 cartoon lessons, 400 illustrations, 50c. Field, 7036 Ogontz, Philadelphia, Penna.

CARTOONING, Sketching, etc. 46 lessons, 600 illustrations, including drawing paper, pens, pencils, \$1.00 complete. Fraba Service, Poplar Bluff, Missouri.

PEN And ink illustrations for catalogue and general printing purposes at right prices. High grade work. Heraldic Studios, 1914 Oakdale Avenue, Chicago.

LETTERING Artists wanted! Earn \$50 to \$200 a week lettering headings, etc., for advertisements. Easy, fascinating, steady work. Big future. Surprising information on this profitable profession in our free booklet. The Guild School of Lettering and Advertising Design, 155 East 44th Street, New York City.

EARN cash income, copying and duplicating simple cartoons for advertisers. 3-M Service, Argyle, Wis.

MAKE Art Pay. Advanced art students. \$1.00. Popular Mechanics, 200 E. Ontario St., Chicago.

PLAYS, STORIES, MANUSCRIPTS

STORIES Complete rewritten and typed for marketing. Welton Tinney, Winnsboro, Texas.

MANUSCRIPTS Expertly typed. 35c 1000 words. Martin Keaveny, 538 Belden, Chicago, Illinois.

WANTED, Original poems, songs, for immediate consideration. Send poems to Columbian Music Publishers, Ltd., Dept. 209, Toronto, Can.

POEM Writers, songwriters. Send for free Rhyming Dictionary, Songwriters' Guide. Submit best poems, melodies today for bonafide, superior offer. MMM Studios, Dept. 33H, Portland, Ore.

ADVERTISING AGENCIES, LETTER WRITERS, FOR ADVERTISERS

LEARN Advertising quickly at home. Easy practical plan. No text books. Common school education sufficient. Interesting booklet and requirements free. Page-Davis School of Advertising, 3601 Michigan Avenue, Dept. 3432, Chicago.

FIFTY Words, 20,000 M.O. magazines, only 50c, inch 75c. Three insertions price of two. Parker Publications, Peterboro, Ont., Canada.

DISPLAY Advertisers! Drawing and zinc cut \$5 up. Gill Art Service, Huntsville, Alabama.

INCH Display, 28 magazines, \$1.50. Paramount Press, Atlanta, Missouri.

INCH Display advertisement 30 magazines year \$24. Wood's Popular Services, Atlantic City, (N. J.)

ADVERTISE: 24 Words in 250 newspapers \$10. Lists free. Advertising Bureau, 4515-C Cottage Grove, Chicago.

FREE—New Advertisers Rate Guide, 44 pages. Includes everything. Lowest rates. E. H. Brown Advertising Agency, 140 S. Dearborn, Chicago.

MAILORDER Ad reaching 1,500,000 families throughout United States \$15.40 inch. Newspaper, magazine, ratebook free. Chicago Union Agency, 20-P West Jackson, Chicago.

ADVERTISING Placed anywhere. Helpful, free service. Rate guide book free. Baker Advertising Agency, 189 W. Madison, Chicago. Successors to Ankrum Advertising Agency. Established 28 years.

LETTERHEADS That dominate! Artist drawing and zinc cut \$10. Gill Art Service, Huntsville, Alabama.

BUSINESS SERVICE

CHICAGO Mail address: business, personal—referred to you \$2 monthly. Simons Service, Suite 1958, 608 So. Dearborn St.

WHERE To buy anything! We represent wholesalers, manufacturers. Special discounts to 50%. Universal Buyers Service, Lakewood, New York.

WASHINGTON, D. C., mail address, business, personal, branch office. Hawkins Mail Service, 817 Fourteenth.

CHICAGO Mail address: business, personal. Mail referred to you. \$1 monthly. General, 56 West Washington.

AGENCIES WANTED

REQUIRE Australian wholesale agencies, any good selling line, any country. Killgarriff, Box 1015J, Adelaide, South Australia.

RUBBER STAMPS AND OFFICE SUPPLIES

NAME, Address, 2 lines 25c; 3 lines 35c. Stamp Works, Auburn, Nebr.

CUSHION Mounted one-two lines 25c; three 35c. 100 letterheads, 100 envelopes \$1.00. Hauer Press, 1314 Ford, Youngstown, Ohio.

2 LINES 25c, 3 Lines 35c. Stamp Works, Centerport, N. Y.

TYPEWRITERS, DUPLICATORS, OFFICE DEVICES

CAROLINA Bond fountain pen ink 80c quart, delivered. Record, stamp pad, indelible and other inks. Ask for price list. Vacco, Winston-Salem, N. C.

AMERICAN Flyer typewriter, \$4.25 prepaid. Folder request. Carl A. Jonas, No. 27 Church Street, Lowville, New York.

ENVELOPES—1000—6 $\frac{3}{4}$'s \$1.75; 1000—10's \$2.85; 100 sheets carbon paper \$1.50. Prepaid. "Everything for the office," Labahn, 603 Main, Evanston, Illinois.

POSTCARD Size duplicator, \$4.98 complete, postpaid. Specialties, 4303 Roscoe, Chicago.

NEW \$3.75 Automatic adding machine. Fully guaranteed. Bassett, Box 302-D, Altadena, California.

TYPEWRITERS, Duplicators, multi-graphs. Write for free list office machine bargains. Save half. Pruitt, 518 Pruitt Bldg., Chicago.

INCREASE Business now. "Excellograph" Rotary Stencil Printer reprints thousands everything you typewrite, hand-write, draw or trace. Colors. \$19.75 to \$44. Terms. Illustrated literature free to business or professional men. Pittsburgh Typewriter Supply, Department K-2, Pittsburgh, Penna.

PRINTING, MULTIGRAPHING, MIMEOGRAPHING, GUMMED LABELS

LETTERS, Circulars, price lists, etc., mimeographed, 100 \$1.25, (20 lines). Additional hundreds 10c. Complete mailing service. Ruth Brown, Waseca, Minnesota.

LETTERHEADS, Envelopes, statements, order blanks, etc. Free estimates. Johnson and Lee, Fort Atkinson, Wis.

FINE Value. Printed stationery. 300 Maxwell bond letterheads 6x7, 150 envelopes to match. Send \$1.00 postpaid. Established 1927. Franklin Printing Company, Franklin, Ohio.

PRINTED Envelopes, letterheads, statements, circulars, 1,000—\$2.95. Turnbaugh Press, Loysville, Penna.

\$1.00 POSTPAID—125 8 $\frac{1}{2}$ x11 Letterheads and 125 envelopes. Benneville, 907 West Roosevelt, Philadelphia.

1000 LETTERHEADS, Envelopes, statements \$2.75; 5000, \$8.00. Wolverine Envelope Co., Grand Rapids, Mich.

MATCHES—Special printed book matches. (Salesmen wanted.) Sanderson's, Ottawa, Illinois.

250 8 $\frac{1}{2}$ x11 LETTERHEADS \$1.00. 250 6 $\frac{3}{4}$ Envelopes \$1.00 prepaid. Victors Printery, Exeter, N. H.

BUSINESS Cards, 1,000 prepaid \$1.25. Quick service. Henry Bergman, Box 70-P, Springfield, Missouri.

HAMMERMILL Letterheads, 300 8 $\frac{1}{2}$ x11, any color paper and ink, \$1.48 postpaid. Free particulars. Woodruffs', 217A Lewis, Duluth, Minn.

FIFTY Book matches—printed your name, 50c. VanDorn's, Ottawa, Illinois.

HARVEY Labels. Sensational values. Samples free. 6618T Quimby, Cleveland, Ohio.

500 LETTERS, \$2. Letterhead, typewriter body; sample free. Beasley, 694 Bay St., Stapleton, N. Y. C.

2000 QUALITY Business cards \$1.50 cash postpaid. Berco, Brooklyn, N. Y.

1000 6x9 CIRCULARS \$2.50. Each additional thousand \$1.00. Edward Hutter, 666 Tloga Ave., Kingston, Penna.

125 EACH Letterheads, envelopes \$1.00. 1000 business cards \$1.00. Tucker, Box 65, Indianapolis.

PRINTING? Lowest prices, samples free. Churchill, 4316 So. Salina, Syracuse, N. Y.

600 HIGH Grade business cards. Plate finish. Postpaid \$1. Guaranteed. Skilling Bargain Printers, 2529 Telegraph Ave., Berkeley, California.

1000 6x9 CIRCULARS, Letterheads, envelopes, postcards, \$2.95; 5000, \$9.45. All printing reasonable. Samples. Goodprint, Harrisonburg, Va.

6x9 CIRCULARS—1000, \$2.75; 5000, \$8.00 postpaid. Marcus, 1627 South Hamlin, Chicago.

1,000 2 $\frac{1}{2}$ x4 LABELS \$1.50; 5,000, \$5.00. Paramount Press, Atlanta, Missouri.

BUSINESS, Personal printing; 100 letterheads and envelopes \$1.00. Free lists. Craftprinters, 1771 East 47th, Cleveland, Ohio.

1,000 BOND Letterheads or envelopes \$2.85. Moyer, B-241-P, Milton, Penna.

FREE 1938 Pricelist, sample letterheads, envelopes, statements, blotters. McCall Press, 1326 South 27th, Omaha, Nebraska.

500 STICKERS, Four lines, 25c. Fine labels. Cott's, Spickard, Mo.

MIMEOGRAPHING, Multigraphing, by reliable lettershop. Quick service. Neat work. Reasonable prices. Reminder Lettershop, St. Charles, Ill.

SALES Letters written to your order. \$5.00. Get results! Helm Letter Service, 915 Broadway, New York.

QUALITY Envelopes, lowest prices. Samples free. M. Myhaluk, East Paterson, N. J.

STATEMENTS, Envelopes, letterheads, 500 \$1.95; thousand \$2.95 cash. Press, Elwood, Indiana.

250 EACH Envelopes, letterheads, \$1.75 postpaid. Jones Press, 1269 Beniteau, Detroit.

STRETCH Your printing dollar at The Dollar Printers, Grafton, N. Y. Request list.

1,000 6x9 CIRCULARS \$2.50. 5,000 \$7.50. Peerless Printing, Altoona, Penna.

100 ENVELOPES Printed, 2 colors, 75c. Press, Box 3232, Rochester, N. Y.

LABELS: All kinds. Write, samples. JBSCO, Box 93, Holyoke, Mass.

SUPERBO Print, 912 Towne, Los Angeles. 1000 business cards \$1.00 postpaid.

500 2 $\frac{1}{2}$ x2 $\frac{1}{4}$ FOUR Line gummed stickers, 25c. Moritz Printery, Saginaw, Mich.

5,000—5x9 CIRCULARS \$9.00. Hamilton Press, 4341 No. Meade, Chicago.

PRINTING OUTFITS AND SUPPLIES

PRINT Your own cards, stationery, circulars, advertising. Save money. Easy rules furnished. Print for others, big profits. Junior outfit \$9.00; job presses \$11 up. Details free. Kelsey Presses, D-11, Meriden, Conn.

SPECIAL—One font 14 point Bodoni shaded card (new) and list of type bargains 50c. Econofoundry, 7137 Constance, Chicago.

PRESSES, \$7.00 Up. Type, supplies. Lists 3c. Landis, Richland, Penna.

PRESSES \$5.00. Complete catalog. Send stamp. Bradshaw, 3214P Huron, Chicago.

STOCK Cuts 40c up. Catalog 10c. Gregor's, 79-N Main Street, Belleville, N. J.

BARGAINS, Presses, type. List 3c. Exchange D-15, 22 Orient, Meriden, Conn.

BARGAINS—Presses, type, supplies. Send stamp, 159 Harvard, Cambridge, Mass.

PATENT ATTORNEYS

PATENTS—Before too heavy an outlay of time or money is made on an invention, a search of the Patent Office records should be made to determine as nearly as possible whether or not the same idea has been patented before. The cost of this search is small, while the value of the facts it uncovers is often considerable. We offer inventors and manufacturers a thorough prompt, confidential search service—plus experienced counsel and assistance in every phase of Patent and Trade-Mark practice. Write for our new free book containing valuable information relating to patent procedure. Clarence A. O'Brien and Hyman Berman, Registered Patent Attorneys, 58-G Adams Bldg., Washington, D. C.

WHAT To do with your invention? Free books tell all. Patent facts clearly explained. 63 years' experience at your immediate service—on easy budget plan. Write today for free copies of our booklets and "Certification of Invention" form. C. A. Snow & Co., 1105 Snow Building, Washington, D. C.

PATENTS—Trade marks, Preliminary advice, book and disclosure form free. Personal service. Irving L. McCathran, 1060 International Bldg., Washington, D. C. Registered Patent Attorney.

L. F. RANDOLPH, 302-B Victor Bldg., Washington, D. C. Low cost. Book and information free.

INVENTORS: Send immediately for your copies of our new free books, "Patent Protection" and "Suggestions on Selling an Invention." Sixty-eight pages of interesting facts. They tell how patent laws protect you; kind of sketch or model needed; simple steps to take without cost; how successful inventors have secured financial assistance; show interesting inventions; illustrate important mechanical movements. With books we also send free Evidence of Invention form to help establish date of disclosure. Prompt service, reasonable fees, special deferred payment plan. Strictest secrecy. Thirty-nine years experience. Highest references. Write us today. The facts in our books, are worth money to the man with a good invention. Address: Victor J. Evans & Co., Registered Patent Attorneys, 12-L Victor Building, Washington, D. C.

INVENTORS. Protect your rights before disclosing your invention to anyone. Form "Evidence of Conception"; "Schedule of Government and Attorneys' fees" and instructions sent free. Lancaster, Allwine & Rommel, 411 Bowen Building, Washington, D. C.

"INVENTOR'S Guide," 100 mechanical movements, free; advises on patenting, selling inventions. Frank Ledermann, Tribune Bldg., New York.

PATENTS, Booklet free. Highest references. Best results. Promptness assured. Watson E. Coleman, Patent Lawyer, 724 Ninth St., Washington, D. C.

INVENTORS—Send for free booklet "Patent-Sense." Information based on 64 years experience. Lacey & Lacey, Dept. 5A, 635 F St., Washington, D. C.

PATENTS. Protect your idea by securing free "Proof of Invention" folder. Exceptional personal service. Established 1906. E. E. Vrooman, 871 Woodard Bldg., Washington, D. C.

FOR INVENTORS

EXPERT Advice on your electrical, mechanical and chemical problems. Absolutely confidential with patent protection. Send your problem and \$1.00 for prompt service to this long established organization of qualified engineers. Technical Service Bureau, Laboratory 21, 6803 North Clark, Chicago.

HAVE Increasing number of requests from manufacturers and distributors for information on new worthwhile inventions, with or without patents. Long established, non-profit organization. National Inventors Congress, LaSalle Hotel, Chicago, Illinois.

PATENTS—Before too heavy an outlay of time or money is made on an invention, a search of the Patent Office records should be made to determine as nearly as possible whether or not the same idea has been patented before. The cost of this search is small, while the value of the facts it uncovers is often considerable. We offer inventors and manufacturers a thorough prompt, confidential search service—plus experienced counsel and assistance in every phase of Patent and Trade-Mark practice. Write for our new free book containing valuable information relating to patent procedure. Clarence A. O'Brien and Hyman Berman, Registered Patent Attorneys, 58-G Adams Bldg., Washington, D. C.

WE Locate buyers meritorious patented, unpatented inventions. If will sell, reply immediately. Descriptive booklet free. Invention Reporter, 5A-11236 So. Fairfield, Chicago.

INVENTORS' And craftsmen's kit. Includes experimental motor, stampings, and generous assortment of gears, springs, brackets, screws, nuts, washers, etc. Ten lbs.—1,000 parts. \$1.49—worth \$7.50. Guaranteed bargain. Manufacturers Supply, 201-B W. Illinois, Chicago.

INVENTORS: Profit by your invention. A practical talk to inventors by an experienced manufacturer. Our 68 page booklet "Mind vs. Matter" mailed upon receipt of 25c. Rex Engineering Co., Cincinnati, Ohio, Dept. D.

INVENTIONS Bought, sold. Patented, unpatented. James Wallace, Homer, N. Y.

PRACTICAL Inventions wanted, unpatented, protection guaranteed, working models build, tools, dies, development and experimental work. Engineering service. Ask for particulars. Dept. A. R. & S. Engineering Company, 17 East 42nd Street, New York, N. Y.

INVENTORS: "Making Inventions Pay," our 32-page illustrated book, mailed upon receipt of 3c postage. Crescent Tool Co., Dept. Z, Cincinnati, Ohio.

INVENTOR'S Universal Educator; contains 900 mechanical movements; 50 perpetual motions; instruction on procuring and selling patents and selecting an attorney, etc. Suggests new ideas. Price \$1 postpaid in U.S.A. Address Albert E. Dietrich, 511-B Colorado Bldg., Washington, D. C.

PENDING Patent applications can be brought before thousands of manufacturers, free of charge, through Invention Magazine. Write for details. Invention, Inc., 635 F Street, Washington, D. C.

INVENTORS—Send for 72-page book on patents. Reasonable terms. Conscientious treatment to inventors. L. F. Randolph, Registered Patent Attorney, 302-E Victor Bldg., Washington, D. C.

I SELL Patents. Established in 1900. Charles A. Scott, 773PM Garson Ave., Rochester, N. Y.

HAVE You a sound, practical invention for sale, patented or unpatented? If so, write Chartered Institute of American Inventors, Dept. 4-A, Washington, D. C.

SELL Your patent through a small classified ad in Popular Mechanics. Many inventors have found buyers in this way. Ask me for proof—I'll gladly send it to you. F. W. Johnson, Manager Classified Advertising, 200 E. Ontario St., Chicago.

INVENTIONS WANTED

SMALL Inventions wanted by manufacturers. I'll help you sell your invention. Write for free circular. Stanley Hull, 7829-K Euclid Avenue, Cleveland, Ohio.

INVENTIONS Of merit wanted: Patented, unpatented applied. Northlake, Peoria, Illinois.

CASH For unpatented ideas. Stamp for particulars. Mr. Ball, 9441-A Pleasant, Chicago.

WANTED—Prominent manufacturer wants ideas or inventions pertaining to automatic coin-operated devices of all descriptions. All correspondence confidential. Western, 925 W. North Ave., Chicago.

SIMPLE Practical inventions wanted by manufacturers, patented or unpatented. For information write Chartered Institute of American Inventors, Dept. 4-D, Washington, D. C.

PATENTS FOR SALE

UNIQUE Sanitary sugar bowl. Paul DeMartini, 75 Rico Way, San Francisco, California.

PATENT 2,109,127. Combination "door-stop and baseknob." Otto E. Carlson, Vernonia, Oregon.

NEW Cooker. Amazing invention. Reasonable. J. Stevens, Valley City, North Dakota.

MANUFACTURING

AUTOMATIC Screw machine products, special machinery, stampings. Cogswell Corporation, West Springfield, Mass.

HIGHEST Profits: in chemical manufacturing. Write Grinstead, 505 Fifth, New York.

STAMPINGS, Dies, screw machine products, specialties. Forsberg Engineering Co., Northfield, Ohio.

MANUFACTURERS And inventors: Increase profits. Let us manufacture your product in whole or part. Accurate machine work, screw machine products, special machines, models, tools, jigs. Inventions improved and developed. Send for estimate. Wright Mfg. Co., 21 Commonwealth, Elgin, Ill.

ANALYSIS. Research. Newest guaranteed formulas. Biggest catalog free. Special prices, leads. Gibson Laboratory, Chemists, DS-1142 Sunnyside, Chicago.

INVENTIONS Manufactured by an experienced company, in any quantity at low cost. Metal specialties, novelties, stampings, dies, and models. Free estimates. Our booklet "Mind vs. Matter" sent upon receipt of 25c. Rex Engineering Co., Cincinnati, Ohio, Dept. C.

DIES, Stampings, wire forming, complete manufacturing. Southern Products, Independence, Missouri.

INVENTIONS Manufactured in any quantity at low cost. Stampings, dies, models, etc. Estimates and free catalog. Crescent Tool Co., Dept. X, Cincinnati, Ohio.

MANUFACTURING, Dies, machinery, models, brasswork, white metal casting moulds. Catalog 3c. Baum's Metal Specialties, Kansas City.

METAL Furniture in modified modern design, how to make, described in Shop Notes for 1937 only 50 cents postpaid. Popular Mechanics Press, Room (C38), 200 E. Ontario St., Chicago.

MODELS AND MODEL SUPPLIES

BUILD New Queen Elizabeth—sister ship of Queen Mary. Biggest passenger ship afloat. Beautiful 30-inch scale model, complete in every detail. \$4.50 plus postage. Other models \$1.00—\$6.00. Catalog, 3c stamp. Miniature Ship Models, Dept. RTT, Perkasie, Penna.

MODEL Power compressed air turbine \$1.00. Viscomotor, 1302 Barry, Chicago.

AMERICA'S Most complete line ship model fittings, kits. Catalog 10c. Polk's Modelcraft, 421 Seventh Avenue, New York.

STEAM Locomotives! $\frac{3}{4}$ " scale. Build one by "Easy Steps." Our illustrated catalog lists all needs, 25c. Little Engines, Box 15B, Wilmington, Calif.

RAILROADERS, Fans and modelmakers. Second edition just off the press. Interesting, informative book on trains. Picture on cover alone worth the price. Only book of its kind. Not a catalog. 25c in coin. 1069-D Transportation Bldg., Chicago.

BUILD Miniature motors. Fascinating; instructive; profitable. Details 10c. Wright Motor Works, 3256 Lake Park Ave., Chicago.

POWER Models, steam locomotives, electric railways, gasoline, steam engines, ship machinery, accessories. 80 page catalog 35c. Chas. Cole, Ventura, Calif.

MODEL Airplanes, boats, radios, supplies. Catalog 10c. Imperial, 416-K McDonald, Brooklyn, N. Y.

CATALOGUE Of over 40 engines, castings, supplies, 25c. Refunded. Howard Co., A-2417 North Ashland, Chicago.

4 FOOT Sky Flyer—50c, postpaid. Circulars free. Hare Products, Whitinsville, Mass.

GIANT Supply kit. Screws, nuts, washers, rivets, gears, springs, brackets. Ten lbs. Over 1,000 items \$1.49. Guaranteed bargain. Manufacturers Supply, 205-W W. Illinois, Chicago.

RAILWAY Models. Catalog handbook 25c. Walthers, 247 E. Erie, Milwaukee.

MODELS—Practical models put over your ideas. We develop models from the crude to perfect working devices. Your idea might have large commercial value. Services confidential. Bank references. Registered graduate engineers at your service. Send 25c for our 68 page booklet "Mind vs. Matter." Rex Engineering Co., Cincinnati, Ohio, Dept. B.

MODEL Supplies for the inventor. Send 3c stamp for catalog. Pierce Model Works, Tinley Park, Ill.

MODELS—Your ideas developed into practical working models. 30 years' successful experience; thousands of satisfied customers. Confidential service guaranteed. Bank references. Send 3c postage for 32-page book—"Making Inventions Pay." Crescent Tool Co., Dept. Y, Cincinnati, Ohio.

MAKE It Yourself—Hundreds of practical and useful devices described in our big book. Plain instructions and illustrations show you how. Save money on things for yourself or make profit selling to others. 900 articles. 480 pages. 823 illustrations. \$3 postpaid. Popular Mechanics Press, Room (C38), 200 E. Ontario St., Chicago.

SHIP And yacht model fittings; construction sets; model yacht sails; illustrated catalog 20 cents. A. J. Fisher, 1002-1 Etowah Avenue, Royal Oak, Mich.

BLUEPRINTS AND PLANS

WEAVE Your own beautiful things. Build hand loom. Details free. O. R. Rug Co., Dept. 10, Lima, Ohio.

HOME CRAFTSMEN

NEW Hobby outfit, Enright engraver—Everything you need. Interesting. Instructive. Profitable. \$3.50 in U. S. Write for literature. Dept. A, Enright, 121 S. 13th St., Philadelphia, Penna.

15 FULL-SIZED Lawn ornament patterns 30c. Modern Woodcraft, Saginaw, Michigan.

SQUAREKNOTTERS! Make belts, handbags, etc. Quality cord samples with catalog, free. Beginners book, catalog and samples, 10c. Special! Regular \$1 book with 50c beginners outfit, all for \$1. P. C. Herwig Co., Dept. J-10, 121 Sands St., Brooklyn, N. Y.

KNOCKDOWN Furniture, lumber, plywood, veneers. Illustrated catalog 10c. Giles-Kendall Co., Decatur, Alabama.

MAKE Your workshop pay. Particulars 25c. Harwells, Byrdstown, Tenn.

HEMOCRAFT Industries. Particulars for stamp. Homecraft Industries, North Chelmsford, Massachusetts.

HOME Craftsmen, make your own violin, easily, enjoyably. See Voit & Geiger ad under Music and Musical Instruments.

STOKER Blueprints, castings. Build yourself. Information 3c. 1718 Bouton, Appleton, Wis.

ALABASTER Turns easily as wood. (Four) selected lathe butts, \$1.00. Demonstrators, 1741 Harrison, Chicago.

GIANT Hardware kit. Full of screws, nuts, brackets, washers, gears, springs. Ten lbs. 1,000 items. Guaranteed bargain \$1.49. Manufacturers Supply, 207-H W. Illinois, Chicago.

LEATHERCRAFTSMEN—Write for free instructions and price list of leather, tools, etc. Sample cards 5c. Wilder & Co., Dept. F, 1038 Crosby St., Chicago, Ill.

HOMEMADE Band saw, saw table, jointer, grinder and 350 other practical shop subjects in Shop Notes, Vol. 32, only 50c postpaid. Popular Mechanics Press, 200 E. Ontario St., Chicago.

OLD GOLD, WATCHES, JEWELRY, PRECIOUS STONES

WATCHMAKERS' Supplies, tools, watches, jewelry. Sold, purchased. Box 1000A, Chicago.

HIGHEST Prices for old gold, teeth, watches, jewelry. Full cash value mailed day shipment received. Satisfaction guaranteed or articles cheerfully returned. Information free, or ship today. Chicago Gold Smelting Co., 300-P Champlain Bldg., Chicago.

AUSTRALIA'S Lovely opals. Illustrated catalogue free. Good selection \$5. Norman Seward, Melbourne, Australia.

GOLD \$35 Ounce. Ship old gold teeth, crowns, jewelry, watches—receive cash by return mail. Satisfaction guaranteed. Free information. Dr. Weisberg's Gold Refining Co., 1500-Q Hennepin, Minneapolis, Minn.

5000 REBUILT Elgin, Waltham, Hamilton watches. Also ladies, gents wrist watches. Make big money! 12 size, 7 jewel, Elgin or Waltham, \$4.75; 16 size, 17 jewel, \$7.50. Send for free watch and diamond catalogue. The New York Jobbers, Dept. M, 74 Bowery, New York, N. Y.

HOW To identify and determine value of old precious metals. Where to buy. To whom to sell. Reliable and up-to-date information. Complete instructions only \$1 postpaid. Popular Mechanics Press, Room (C38), 200 E. Ontario St., Chicago.

TOBACCO

CIGARS. Special selection, excellent values. Sundot Cigars, 43 Depeyster, Tarrytown, N. Y.

GUARANTEED: Cigarette, pipe or chewing 5 lbs. \$1.00, ten \$1.75. Pay when received. Pipe and box cigars free. Rives Tobacco Co., Paducah, Ky.

FREE With 25c trial package of Varsity blend, handy combination pipe tool with case. Varsity Cigar Shop, Evanston, Ill.

RAZORS—BLADES—SHARPENING

100 SUPER Double edge blades. \$1.00 postpaid. Satisfaction guaranteed. Chartley Sales Co., D-ABC, Chartley, Mass.

A REAL electric dry shaver \$3.95 with wallet. Harris Electric Co., 2013-A Jerome Ave., Bronx, N. Y.

BLADES (Double edge), surgical steel, 50 postpaid 50c. Tissue thin Swedish watch spring steel, 100 postpaid \$2.00. McLain, 135 West 225th St., New York City.

SURVEYING INSTRUMENTS

GUARANTEED Factory rebuilt transits and levels for rent (with purchase option) or sale (cash or terms). Order now before prices advance. We will repair, trade in, or buy your old instruments. Ship prepaid for estimate and valuation. Write for List M-310 and complete information to Warren-Knight Co., 136 N. 12th St., Philadelphia, Penna.

WANTED—MISCELLANEOUS

CASH For used microscopes, binoculars, cameras, slide rules, drawing sets, surveying, mechanical, scientific, and musical instruments. Highest prices paid day shipment received. Satisfaction guaranteed or shipment promptly returned. Elman's, 2302 Van Buren, Chicago.

PERSONAL

MONEY For you in prize contests. Thousands win prizes monthly. So can you. Let Contest Magazine help you. Largest, most widely circulated medium in the field. Single copy 25c. Freese Publications, Drawer 2-M, Upland, Indiana.

ATHLETE'S Foot sufferers, cracked toes, excessive sweating with bad odor. Quick relief or money back. Chiroprapist's prescription \$1. Dr. Dillingham, Newark, N. J.

OVERCOME Scalp disorders forever! Prevent baldness. Enjoy beautiful hair. New scientific discovery tells all. Write for interesting true facts. Physical Culture Studios, 116 Church, Foxchase, Philadelphia, Penna.

NERVOUSNESS. Fear, successfully relieved! "Psychological analysis"; amazingly helpful method. Free literature. John Englund, Ontonagon, Mich.

MEXICAN Cases; no publicity. American Attorney, Box 1736, El Paso, Texas.

CCC Lingo by ex-enrollee! Amusing! Quarter. Floyd Johnson, 538 Belden, Chicago, Illinois.

TREASURE Finders? Read Goldak advertisement on page 131A.

WANTED. Original poems, songs, for immediate consideration. Send poems to Columbian Music Publishers, Ltd., Dept. 33, Toronto, Can.

DANDRUFF Can be cured. Scalpiness dissolves dandruff, relieves itching, promotes growth. Contains no alcohol or acids. Harmless, effective. Money back guarantee. \$1 jar, postpaid or send stamp for particulars. Scalpiness Laboratories, Box 1066, Liberty, N. Y.

WIN Prize money: Booklet—"Successful Contesting"—shows how. 10c postpaid. Bulletin listing \$200,000.00 prizes included. World Publishers, 4515-B Cottage Grove, Chicago.

SENSATIONAL! Amazing new trick. Detect instantly every card of any pack, without preparation, partner or skill. HP. 237, 43, Chaussee Antin, Paris, France.

POEM Writers, songwriters. Send for free Rhyming Dictionary, Songwriters' Guide. Submit best poems, melodies today for bonafide, superior offer. MMM Studios, 33-J, Portland, Ore.

MISCELLANEOUS

CUTS Anybody can make. Zinc etching process. Specimens, particulars, testimonials, for stamp. J. C. Day, Windfall, Ind.

BUSINESS Proposition resilvering mirrors, autoparts, reflectors, making chipped glass signs. Write Sprinkle, Plater, 288, Marion, Indiana.

MONUMENTS. Reasonable. Lettered. Delivered. Guaranteed. Reliable Granite Company, A17, Oneco, Florida.

STAR Gazing. Know and find your stars with a Wez Planetarium \$3.50. Star charts 25c. Box 558 P. La Jolla, Calif.

FURNACE Regulator, automatic for hot air or steam. Complete plans including bimetal for thermostat \$1.00. Dennis Plans, 14046 Ohio Ave., Detroit.

SOCIAL Security card duplicated lifetime bronze plate with holder 25c. Brown, 993 President St., Brooklyn, N. Y.

PRESTO Oiler looks like fountain pen. 50c. Satisfaction guaranteed. Wingerter, 8786 116 St., Richmond Hill, N. Y.

BEAUTIFUL Felt souvenir pennant New York world's fair. Perisphere and trylon design. Gorgeous colors. Postpaid 35c. W. George, 920 Webster, Ft. Wayne, Ind.

COCOONS. Butterflies, collectors' supplies, butterfly art materials. Free lists. Maynard, 1192 Lewiston, Rochester, N. Y.

BUILD Better and save \$500.00 on home. Use free byproduct. Details and booklet \$1.00. Builders Service Company, Portland, Oregon.

MEXICAN Jumping beans. Great curiosity. 3 for 10c. Hottiman, LaCrosse, Wis.

FREE By-product building material replaces brick. Obtainable anywhere. Saves almost half. Booklet explains construction, \$1.00. Burton Macon, Ramseur, N. C.

TREASURE Finders? Read Goldak advertisement on page 131A.

COATS-OF-ARMS And crests correctly rendered in colors or black and white. Highest grade. Estimates free. Heraldic Studios, 1914 Oakdale Ave., Chicago.

AMATEUR Tattooing outfits, illustrated catalog 6c. "Tatuco," 651A S. State, Chicago.

SWAPPER'S Friend, R4, Saline, Michigan. Interests swappers, collectors. 50c year, sample 10c.

1001 WAYS to Use Concrete. Send for large free illustrated folder describing new Popular Mechanics book covering every known use of concrete for the home, farm, building, business and industry. Popular Mechanics Press, Room (C38), 200 E. Ontario St., Chicago.



AUTO BOOKS SENT FREE

on approval. Just mail the coupon and we'll send you a set of these remarkable auto books, just off the press. Whether you are a mechanic or helper, expert or apprentice, auto owner or driver, if you're interested in knowing all about automobile mechanics, take advantage of this FREE OFFER.



GET A BETTER JOB

A better job—in the gigantic auto industry. BIGGER PAY—a chance to go into business for yourself and get a share of the huge profits, are waiting for any man who even half tries to improve himself. Learn auto engineering with these wonder books a new way—without studying or memorizing. Simply use the JIFFY INDEX to look up the answer to any auto problem. Built by eleren of America's greatest automobile engineers, and written in simple language so you can understand it. Very newest cars, all covered.

FREE Privilege of consulting Automobile Engineers of American Technical Society for one year without cost if you mail coupon immediately

Send NOW and we will include an EXTRA volume full of up-to-date diagrams.

CAN YOU FIX IT? These wonder books tell step by step HOW to take out "play" in differential — to kill the shimmy in steering—to set TIMING—how to put your finger instantly on engine trouble and then the quick expert way to FIX it. Newest improvements fully covered. Equal to a complete trade course at less than a fourth the cost.

6 BIG VOLUMES
Brand New Edition
2500 pages, 2000 Illustrations, wiring diagrams, etc., including Marine Engines, Aviation Motors, Diesel engines, etc. De Luxe edition, Gold-stamped flexible binding.

AMERICAN TECHNICAL SOCIETY,
Drexel Ave. & 58th St., Dept. A719, Chicago, Ill.

I would like to see the new 6-volume edition of your AUTO BOOKS. I will pay the few cents delivery charges only, but if I choose to, I may return them express collect. If after 10 days use I prefer to keep them, I will send you \$2 and pay the balance at the rate of only \$3 a month, until \$24.80 is paid. Please include free membership and extra Volume 7, as per your offer above.

Name.....
Address.....
City..... State.....

Attach letter stating age, occupation and name and address of employer and that of at least one business man as reference.

YOU CAN TEACH YOURSELF
LET US TEACH YOU AT HOME
NEW SIGNS SHOW CARDS
EASY TO LEARN
COURSE POSTER AND ALL FREEHAND LETTERING

Write Dept. M, REGINA SCHOOL OF LETTERING, 77 West Washington Street, Chicago, Illinois

NO FRIENDS SINCE PIMPLES CAME?

Get this help in guarding against skin-blotching intestinal poisons

Are ugly skin eruptions spoiling your good times... making others shun you? Find out what the trouble may be—and take steps to help it.

Between the ages of 13 and 25, or even longer, important gland changes often upset the system. The skin often becomes over-sensitive. Waste poisons from the intestinal tract may get into the blood stream... and be carried to the skin to cause disfiguring pimples.

Many have been helped by the regular use of Fleischmann's Yeast. Millions of tiny, live plants in each cake of this fresh food act to help keep intestinal waste poisons from the blood... and so help your broken-out skin. Start eating Fleischmann's Yeast now—one cake 1/2 hour before meals. Buy some today!



You'll Agree LACO is AMERICA'S FINEST LOW-PRICED OIL BURNER!

Years Ahead in Engineering Features!

Write for Free Books and amazing LOW PRICES on my new room heaters and pressure-type oil burners. L. A. COCKLIN



● Now, a new type Oil-Burning Heater (left), with greatly improved features, that delivers more heat at lower cost—is more durable—more attractive—than any other we ever built!

This new LACO needs no basement—is giving wonderful results in homes, stores, offices, etc. Easily adjusted to radiate its heat as wanted. Has very large heating capacity for the cold days—yet uses Little Fuel.

Inside the beautiful steel cabinet is LACO's special "Two-Stage, Double-Flue" burner—and new "Inner Heating Unit." Burner develops truly hot flame—big-surface Unit delivers this heat with little waste into room.

Quiet! Safe! Circulates, humidifies the air. Choice of sizes.

FREE BOOK! Mail coupon below or postcard for details, money-saving prices.

● With this very newest Gun-Type LACO—you can enjoy clean, automatic oil heat at its finest! LACO's, for years, have given extra good satisfaction. Now, this New LACO beats them all! New simplicity (only 1 moving part), new quietness, new fuel economy (often cheaper than coal). "High Pressure Carburetor" feature transforms heavy oil into finest mist, produces extra-rich mixture, extra-hot ball of flame. Approved by Underwriters' Lab. Factory-tested, Guaranteed.

WRITE Send postcard or coupon for full details and very Low Prices.

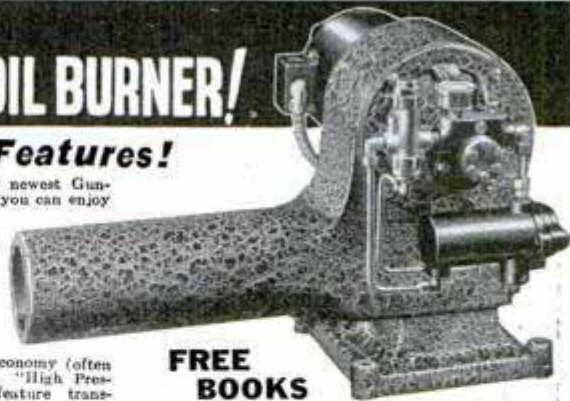

FREE BOOKS

SEND NOW

LACO OIL BURNER CO.,
1108 Union Ave., Griswold, Iowa
Please mail literature and prices on
 LACO Oil-Burning Room Heaters
 LACO Pressure-Type Oil Burners

NAME.....
ADDRESS.....

LACO OIL BURNER CO.
1108 Union Ave., Griswold, Iowa

LOW AS
\$40.00
F.O.B. Factory

LACO OIL BURNERS

Saw-Filing

Pays Up to \$2 or \$3 an Hour —Start in Spare time

NO EXPERIENCE NEEDED to file hand, band and circular saws with FOLEY Automatic Saw Filer, J. W. Anderson, Texas, writes: "My fourth year with Saw Filer and third with FOLEY Lawn Mower Sharpener, on side line. Business has increased until it is almost full time."

Used by Leading Saw Makers

Atkins, Disston, Simonds and by industrial plants and repair shops all over U. S. Cash work. No canvassing. No eye strain. Postcard brings FREE PLAN and special offer of Foley Saw Setter free. No obligation.

FOLEY MFG. CO. 1016-8 Foley Bldg.
11 Main St., N. E., Minneapolis, Minn.



NOW YOU CAN GET A HEAVY DUTY INDUSTRIAL WELDER

Works Off 110-Volt Light Socket
This marvelous DYNAMIC Power Welder will do the work of much higher priced types. It is easily portable. WELDS Cylinder Blocks, Bumpers, Fenders, Tanks, Farm Machinery, and etc. Will also solder and braze on the lightest material. Works on iron, steel, tin, brass, copper and all other metals. Men without previous experience can make as much as \$5.00 on a one hour repair job. Go into business—Open a Welding Shop NOW. AGENTS—Make big profits selling to garages, factories, janitors and machine shops. Write TODAY for our 10-DAY TRIAL OFFER.

for Only **\$195**
RETAIL



DYNAMIC WELDER COMPANY
2226-FE Silverton Road, Chicago, Illinois

NEW models EASIER TO PLAY

Find out about these sensational new Conn Band Instruments. Many wonderful, exclusive features! Today, more than ever, Conns are the "choice of the artists." You'll advance faster and take more pride in a genuine Conn—made by the world's largest manufacturer. See your dealer or write us for Home Trial, Easy Payment offer. Mention instrument.

C. G. CONN, LTD.
1031 Conn Bldg., Elkhart, Ind.

CONN BAND INSTRUMENTS

WRITE FOR FREE BOOK

ARTISTS MAKE MONEY

Find out your ability. Send name, age, occupation and address for Free Vocational Art Test.
Federal Schools, Inc., 10138 Federal Schools Bldg., Minneapolis, Minn.

AVIATION WANTS MORE LINCOLN TRAINED MEN



Earn Big Pay . . \$200 to \$700 a month as Pilot, Mechanic or Aeronautical Engineer. Airlines and Factories requiring more trained men. Lincoln Government Approved Training will prepare you for one of these good-pay positions.

BE AN AIR PILOT—Learn to fly fast modern type airplanes. Prepare for fascinating career as Gov't. Rated Transport or Commercial Pilot. Learn night, blind and cross-country flying. Land at different airports. Veteran Instructors train you. Flat, level countryside, ideal for training.

BE AN AVIATION MECHANIC—Get Lincoln's Practical training on modern airplanes and engines. Learn airplane maintenance, construction, overhaul, repair. Lincoln's Government Approved Training prepares you for good position as Government Licensed Airplane and Engine Mechanic.

BE AN AERONAUTICAL ENGINEER—We train you for high-pay position as a designer and builder of airplanes. Training includes experience in designing and building complete modern airplanes. We help you with plans for a plane of your own design.

NOW is the TIME for YOU to TRAIN at this Lincoln Government Approved School. Aviation needs and must have more trained men. Lincoln Graduates in demand. Our Graduates regularly taking positions. **MAIL COUPON TODAY** for complete information.

LINCOLN AIRPLANE & FLYING SCHOOL
5510 AIRCRAFT BLDG., LINCOLN, NEBRASKA



LINCOLN AIRPLANE & FLYING SCHOOL
5510 Aircraft Bldg., Lincoln, Nebraska

I want to get into Aviation. Please send me complete information about Lincoln Training.

Name..... Age.....
Address.....
City..... State.....

When writing to advertisers please mention Popular Mechanics

Big Profits!

IN NEW PROFESSION

Start Earning At Home



No soliciting! No canvassing! We show you how to make big money decorating fast-selling Giftwares. We start you with a big \$10 Artist's Outfit. We supply you with \$150 worth of Giftwares free of extra charge and show you how to dispose of them without leaving your home. We give you 29 Tested Plans for making money. One Fireside Member says, "I made \$100 on furniture in one week." Another writes, "My sales were \$500 for 5 weeks. This is my first year." R. M. P., of Ill., says, "I did \$3,500 worth of business last year and over \$12,000 this year." D. W., New Mexico, reports, "I would not take \$1000 for my course."

No Experience Needed

You too may have a splendid income opportunity with Fireside. No tiresome study. You learn by doing. No artistic ability necessary. Our easy 3-Step Method makes the work easy to learn and easy to do and fits you to make good money practically from the start.

Quick Sales in Your Home

No need to leave the house to dispose of everything you make. Our new automatic salesman does all the selling for you. Designed to quickly find cash buyers for all the Giftwares you can turn out.

No Cost Plan

Mail coupon for Free Plan showing how to earn your course and Big Profits besides.

FIRESIDE INDUSTRIES
Dept. 66-P
Adrian Mich.

Fireside Industries
Dept. 66-P, Adrian, Mich.

Send me FREE Book on Home Decorating for a big steady income. Also details of plan that will pay for my Course and give me big profits besides.

FREE!
Book on decorating at home for big money. Tells how to get big assortment of beautiful Giftwares free of extra charge.

NAME _____
ADDRESS _____
CITY _____ STATE _____



LEARN A TRADE NOW

TOOL & DIE MAKING

DESIGNING

MACHINIST TRADE

WE GUARANTEE YOU practical shop training on actual shop equipment and machines. No overcrowding in our new modern shops. Day and evening classes for your convenience. Free Employment Service. If you are over 17 and mechanically inclined, write for new FREE booklet.

NATIONAL SCHOOL OF MECHANICAL TRADES
Dept. P. M. 628 W. Lake St. Chicago, Ill.

LEARN CARTOONING

by the method that has developed hundreds successfully. Send name, address and age for free chart to test your ability.

THE LONDON SCHOOL, 1737 National Bldg., Cleveland, Ohio

HAWAIIAN or SPANISH GUITAR

easily learned at home

Play songs almost instantly. Become an expert, modern guitarist or tuition refunded. COST LESS THAN 2c A DAY! Write NOW for free details. **HAMANN INSTITUTE, 3016 N. 24th Place, R-10, Milwaukee, Wis.**



A & N SUPPLY CO.

Bargains—Military, Sport Goods, Firearms, Clothes, Shoes, etc. Send 10¢ for new catalog, to be redeemed on first order.

EST. 1868

A & N Supply Co., 4772 Lester St., Richmond, Va.

ATLAS Stick-On Letters

WINDOW SIGNS

Beautiful GOLD Colored. New Styles. 5 Year Guarantee. Large Sizes—Penny each. Tremendous Demand. Amazing Profits. Write for FREE SAMPLES and Starting Equipment. HURRY!
ATLAS Sign Works, 7943 Halsted, Chicago

Earn Cash at Home!

We paid M. M. \$1174 for exceptional "cellar crop" SNOW-KING mushrooms! Big free picture book tells if your cellar, shed, barn suitable. We furnish materials, buy all crops. Write today. Est. 1908. **UNITED CO., 3848 Lincoln Ave., Dept. 309, Chicago.**

AUDELS Carpenters and Builders Guides

4 vols. \$6



Inside Trade Information for Carpenters, Builders, Joiners, Building Mechanics and all Woodworkers. These Guides give you the short-cut instructions that you want—including new methods, ideas, solutions, plans, systems and money saving suggestions. An easy progressive course for the apprentice and student. A practical daily helper and Quick Reference for the master worker. Carpenters everywhere are using these Guides as a Helping Hand to Better Work, Better Work and Better Pay. To get this assistance for yourself, simply fill in and mail the FREE COUPON below.

Inside Trade Information On:

How to use the steel square—How to file and set saws—How to build furniture—How to use a mitre box—How to use the chalk line—How to use miter and scales—How to make joints—Carpenters arithmetic—Solving mensuration problems—Estimating strength of timbers—How to set girders and sills—How to frame houses and roofs—How to estimate costs—How to build houses, barns, garages, bungalows, etc.—How to read and draw plans—Drawing up specifications—How to excavate—How to use settings 12, 13 and 17 on the steel square—How to build hoists and scaffolds—skylights—How to build stairs—How to put on interior trim—How to hang doors—How to lath—lay floors—How to paint.



THEO. AUDEL & CO., 49 W. 23rd St., New York City
Mail Audels Carpenters and Builders Guides, 4 vols., on 7 days' free trial. If O.K. I will remit \$1 in 7 days, and \$1 monthly until \$6 is paid. Otherwise I will return them. No obligation unless I am satisfied.

Name.....
Address.....
Occupation.....
Reference..... P.M.

When writing please mention Popular Mechanics

TRAIN FOR Radio in 12 WEEKS

BY SHOP WORK NOT BOOKS

GET OUT OF THE LOW PAY CLASS

Prepare for opportunities in Radio Broadcast, Talking pictures, Television, by 12 weeks of practical shop work in the great Coyne Radio Shops, on real RADIO and Sound equipment. You don't need advanced education or experience. Free Employment Service for life. Many earn while learning. Electric Refrigeration included. Mail coupon today for free book which tells you how hundreds have become successful RadioMen after taking our training. **H. C. LEWIS, Pres., RADIO DIV., Coyne Electrical School 500 S. Paulina St., Dept. 78-3H, Chicago, Illinois**

Send Free Radio Book and facts. Tell me about your "Plans" to help me get Coyne Practical Shop Training.

NAME _____ AGE _____
ADDRESS _____
CITY _____ STATE _____

EASY TO PLAY — EASY TO OWN



You've always wanted to play this fascinating instrument. Now there is no reason to delay. Now you may thrill family and friends, with a chance to earn extra cash at dances, entertainments and on the radio. For now there is a genuine DEAGAN Marimba (including complete, easy lessons) at the lowest price in history. . . . To write for details TODAY may easily mean a LIFE-TIME of pleasure, profit and popularity!

J. C. DEAGAN, Inc., 2458 Deagan Building, CHICAGO

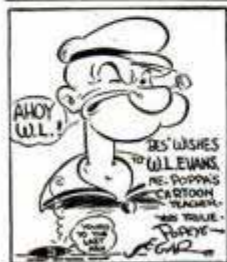

DO YOU LIKE TO DRAW?

It's easy to learn when shown in the right way. E. C. SEGAR who draws "POPEYE," CHESTER GOULD who draws "DICK TRACY," "LANK" LEONARD — "MICKY FINN" and many other famous cartoonists and comic strip artists learned how to draw during their spare time by following CARTOONIST EVANS' SIMPLE, EASY, IN-EXPENSIVE COURSE. Send 6c in stamps for full details. THE W. L. EVANS SCHOOL OF CARTOONING Cleveland, Ohio 521 Premier Bldg.



FREE! WHOLESALE CATALOG

Has: 15 selling plans; 30 money making ideas; 4000 world wide bargains; 260 pages of big values. Also shows top-notch prizes; business stimulators. All at rock bottom wholesale prices. Salesmen-Dealers, Obtain this fascinating Book Of Opportunity FREE. Write for it today, to

SPORS CO., 8-38 Main St., LeCenter, Minn.

EARN A DEGREE AT HOME

Home Study Courses leading to Degrees in Arts and Sciences; Philosophy; Education; Writing; Psychology; Chemistry; Theology; Law; Agriculture; Business, Accounting, Sales; Advertising; Electrical, Civil, Mechanical, Diesel, Architectural, Aeronautical, Automotive, Drafting, Radio, Air Conditioning, Refrigeration, Highway, Mining, Petroleum, Industrial, Steam, Chemical Engineering. Chartered by State of Illinois. McKinley-Roosevelt Graduate College. 4213 Clarendon Ave., Chicago

FREE MYSTERIOUS ERECTORSCOPE. Brings you sights so amazing you can scarcely believe your eyes. Write A. C. Gilbert Co. (1) Erector Square, New Haven, Conn.

BIG MUSCLES FOR SALE



Oh boy! Wouldn't that be swell? If you could only buy muscles by the pound and attach them to your body. I'll tell you what I will do though, I'll take that body of yours, whip it into shape and give you big, strong muscles in a short time, just as I have done for myself and so many others. If you want big muscles and a huge, robust body, send for my book "Puissant Body Building" now. It is absolutely FREE and is yours to keep.

TOMMY LOUGHRAN
Undeclared World Champion

TOMMY LOUGHRAN
Dept. 68, 4 S. 15th Street, Philadelphia, Pa.

FREE
"Puissant Body Building"
Sign here →
Postal card will do.

Name.....
Street.....
City..... State.....

OVERCOME MALNOURISHMENT AND YOU WILL KNOW THE JOY OF HEALTH & STRENGTH

A Simple Change Brings New Hope to Thousands!

Frequently Folks Like Yourself are MALNOURISHED (not Getting Sufficient Minerals and Iodine for the System to get the Real Good out of Food)

If your weakness and skinniness keep you everlastingly embarrassed and unhappy . . . if you can't seem to gain an ounce of flesh or strength no matter how much you eat . . . here's good news. Experts in nutrition say the cause of these conditions is often malnourishment. When that's what's wrong . . . try Kelpamalt.

Don't resign yourself to being a skinny, scrawny physical wreck. Kelpamalt, rich in minerals and iodine, has brought the joy of health and strength to thousands who were weak and underweight for years. That's because the body's normal chemical processes, which change digested food into rich blood and firm flesh, require certain minerals . . . elements often deficient in the daily diet. Without them, good nourishment may be wasted. **KELPAMALT HELPS PROVIDE THESE NUTRITIONAL ELEMENTS.** Its iron, copper and calcium, as well as its natural sea-plant iodine, help the system get the real good out of food.

MAKE THIS TEST

Try Kelpamalt for at least a week. Thousands say they eat better, sleep better, look better, feel better, too. When underweight, they are amazed at quick gains of solid, "stay-there" flesh, often in a few weeks. Kelpamalt comes in easy-to-take tablets and costs but a few cents a day to use. And, remember, your money back if you're not completely satisfied with results. For sale at all good drug stores. Get Kelpamalt today.

SPECIAL FREE OFFER

Send for free, fascinating, instructive 50-page booklet on How to Build Strength and Add Weight. Information on minerals, iodine and vitamins and their effects on the human body. Weight and Measurement Charts, Daily Menus. Absolutely no obligation.

Kelpamalt Co., (Dept. 1458), 21st St. and Borden Ave., L. I. City, N. Y.



Posed by professional model

Learn AUTO Mechanics QUICKLY IN A FEW WEEKS

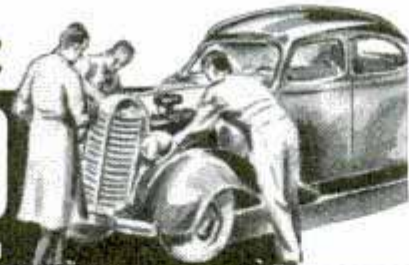

**Good-Pay Jobs
Are Available!**

Trained men earn top wages in these fascinating well-paying trades. This is not a correspondence school—no books—no lessons. Don't look for a job—**TRAIN FOR IT.** Read below how a McSweeney-trained man made good.

LEARN EASILY, QUICKLY:

- AUTO MECHANICS
- AVIATION MECHANICS
- DIESEL MECHANICS

Collision Repair (Complete)
Body and Fender Repair
Auto Painting

- WELDING—Arc and Gas

You Get Actual Shop Training

Work on real equipment with real tools. In a few weeks you should be trained by actual work to hold down a Good Pay Job.

**We get
many letters
like this**

1801 E. 65th St., Cleveland, O. Dear Mac—Immediately after leaving school I went to work for United Motors and am now located in Cleveland where I hold a good position. I have been able to take care of the most complicated electrical jobs. I think I have done fine considering I had no experience before coming to your school.
—Hubert Todd

LEARN NOW—PAY LATER!

We will give you complete information on how to get your training now and pay for it later out of your earnings.

FREE Write today for Big Free Book. Get the facts about jobs; and low Tuition Offers. Mailing the coupon does NOT obligate you. It obligates ME to tell YOU how you can train for Big Money in a few short weeks. Address Dept. 10-10.

McSWEENEY SCHOOLS

DETROIT, MICH. and KANSAS CITY, MO.
Write Our School Nearest You



DETROIT

In Big New McSweeney Buildings

The finest of their kind. Every modern facility for thorough instructions.



KANSAS CITY

McSWEENEY TRADE SCHOOL

Dept. 10-10, Detroit, Mich., or Kansas City, Mo.

Without cost or obligation send me your big FREE Book.

**I am interested
in the course on**

Name _____

Street _____

Town _____

State _____

Age _____

FREE New! Sensational!

"SUCCESS PLAN" for Distributors of Justrite
COMBINATION SOLDERING IRON AND BLOW TORCH



Amazing New "Success Plan" banishes guesswork for Distributors of the famous Justrite Combination Soldering Iron and Blow Torch. Questions answered on major points of selling!
BIG MONEY—full or part time for men who will call on Mechanics, Engineers, Plumbers, Sheet Metal Workers, Garage Men, Battery Shops, etc., to demonstrate this **MARVELOUS TOOL!** Operates with 100% satisfaction on less than one cent per hour—with NO stoves, NO charcoal, NO air pumps, NO electricity. Fully portable. For hundreds of uses in shops, plants, homes.
ACT NOW! Distributorships open for men of ability. Write for Complete Information TODAY!
JUSTRITE MANUFACTURING CO.
Dept. 291, 2061-81 Southport Ave., Chicago, Ill.

LEARN TO CUT GEM STONES

"The Art of Gem Cutting," a complete treatise on this fascinating hobby. Send \$1.00 for your copy.

We supply completely detailed blue prints for building your own Lapidary Bench. Also the necessary parts, or the bench complete. The highest quality equipment for the amateur gem cutter.

Write for free illustrated folder describing VRECO Lapidary equipment and supplies.

VRELAND LAPIDARY MFG. CO.

2642 N. E. Union Ave.,

Portland, Oregon

How To and Keep It - - \$1

Get A Job

Send immediately for 175-page illustrated book. Contains Rules and New approach method to get More than just a job. It shows how to get the job you want and how to keep it. \$1 Postpaid. Details on how it can help YOU sent FREE!

PERSONAL RELATIONS FOUNDATION
318 So. 19th Street Omaha, Nebraska

Learn The RESTAURANT Business

BIG PAY for those who can qualify as Managers, Asst. Mgrs. of City Restaurants, Cafes, Grilles and Night Clubs. **LEARN** the Secrets of this profitable, fascinating business **QUICKLY** at Home. Big Money awaits those who can buy, prepare and sell Food at a Profit. This is the only Restaurant Training School in U. S. Both resident and Home Study courses on easy terms. Valuable Diploma given Graduates. Write today.

BARBEAU TRAINING SCHOOLS, 259-64 4th St. Arcade, Dayton, Ohio

TRAILER BUILDERS

Lowest prices in the industry for windows, couplers, lifting devices and other items. Send 10c for 40 page illustrated catalog.

MARVEL TRAILER PARTS CO.
19020 Celestine Detroit, Mich.

OFFICE MACHINES—Care

and operation of 29 different makes. Typewriters, adding machines, duplicators, etc. Only book on subject. 384 pages, illustrated. \$2.50 postpaid.

POPULAR MECHANICS PRESS
200 East Ontario Street Chicago

Own A Profitable Greaseless DOUGHNUT BAKESHOP Start In Your Kitchen!

Who else wants to enjoy profits from this amazing new business you can start in your own kitchen? New electrical invention turns out delicious, different Brown Bobby Doughnuts. Everybody wants them! Stores eager to sell for you. Profits up to \$16.25 in a day possible selling production of one machine at wholesale only. We supply equipment and tested money making plans. This is your chance. Send No Money. Rush postcard for FREE details.

BROWN BOBBY CO.
325 W. Huron St., Dept. C-1810, Chicago, Ill.



QUICK CASH IN NEW POTATO CHIPS

START AT HOME

Here's your chance—a money-making business of your own. Turn potatoes into cash by making new kind of Potato Chips with my improved outfit. Makes delicious, superior, "NON-GREASY" Chips at low cost. A few hours' practice does it. Begin anywhere—city, village, town. Potatoes cheap and plentiful. Wholesale or retail. Steady year 'round business.



Groceries, markets, restaurants, taverns, do the retailing for you. **WE HELP START YOU IN BUSINESS.** Great quantities of Chips are eaten daily. Profit large—unusually so. You can start this money-making business on a "next to nothing" outlay of cash. Write for Potato Chip Booklet.

LONG-EAKINS COMPANY
1028-5 High St., Springfield, Ohio



"Why, Bill—here's an extra \$20!"

"Yes, Betty, I've had another raise! Twenty dollars—think of it! That's a thousand more a year. We can have the new furniture now, dear, and save more than ever, besides. You certainly were right about that International Correspondence Schools Course. You said I'd make some headway, once I had the training. And studying at home in my spare time wasn't hard, either.

"Remember, I said the Boss had been talking to me about technical points, and that I was able to answer his questions? He told me today that the I.C.S. people had written him about my course. He's been watching my work, and he decided this week that I was ready for promotion. "This is only the start, dear. Nobody can stop me now, for I've got the training to handle my job and the job ahead."

Thousands of I. C. S. students are earning promotion and increased pay through spare-time study. Your employer is watching you. If he sees you have the training for a bigger job, you'll get it.

One hour a day, spent with the I. C. S. in the quiet of your own home, will prepare you for success in the work you like best. Put it up to us to prove it.

Mail this Coupon for Free Booklet

INTERNATIONAL CORRESPONDENCE SCHOOLS

Box 5529-J, Scranton, Penna.

Without obligation, please send full particulars about the subject before which I have marked X:

TECHNICAL AND INDUSTRIAL COURSES

- | | |
|--|---|
| <input type="checkbox"/> Architect | <input type="checkbox"/> Auto Technician |
| <input type="checkbox"/> Architectural Draftsman | <input type="checkbox"/> Auto Electric Technician |
| <input type="checkbox"/> Building Estimating | <input type="checkbox"/> Plumbing <input type="checkbox"/> Heating |
| <input type="checkbox"/> Contractor and Builder | <input type="checkbox"/> Air Conditioning and Cooling |
| <input type="checkbox"/> Structural Draftsman | <input type="checkbox"/> Commercial Refrigeration |
| <input type="checkbox"/> Structural Engineer | <input type="checkbox"/> Steam Engineer |
| <input type="checkbox"/> Electrical Engineer | <input type="checkbox"/> Steam Electric Engineer |
| <input type="checkbox"/> Electric Lighting | <input type="checkbox"/> Marine Engineer |
| <input type="checkbox"/> Welding, Electric and Gas | <input type="checkbox"/> Civil Engineer <input type="checkbox"/> Highway Engineer |
| <input type="checkbox"/> Reading Shop Blueprints | <input type="checkbox"/> Bridge Engineer |
| <input type="checkbox"/> Telegraph Engineer | <input type="checkbox"/> Bridge and Building Foreman |
| <input type="checkbox"/> Telephone Work <input type="checkbox"/> Radio | <input type="checkbox"/> Surveying and Mapping |
| <input type="checkbox"/> Mechanical Engineer | <input type="checkbox"/> R. R. Locomotives <input type="checkbox"/> Air Brake |
| <input type="checkbox"/> Mechanical Draftsman | <input type="checkbox"/> R. R. Section Foreman |
| <input type="checkbox"/> Machinist <input type="checkbox"/> Toolmaker | <input type="checkbox"/> R. R. Signalmen |
| <input type="checkbox"/> Patternmaker <input type="checkbox"/> Boilermaker | <input type="checkbox"/> Chemistry <input type="checkbox"/> Pharmacy |
| <input type="checkbox"/> Foundry Practice | <input type="checkbox"/> Coal Mining <input type="checkbox"/> Navigation |
| <input type="checkbox"/> Sheet Metal Worker | <input type="checkbox"/> Cotton Manufacturing |
| <input type="checkbox"/> Heat Treatment of Metals | <input type="checkbox"/> Woolen Manufacturing |
| <input type="checkbox"/> Management of Inventions | <input type="checkbox"/> Agriculture <input type="checkbox"/> Fruit Growing |
| <input type="checkbox"/> Diesel Engines <input type="checkbox"/> Aviation Eng. | <input type="checkbox"/> Poultry Farming |

BUSINESS TRAINING COURSES

- | | |
|--|--|
| <input type="checkbox"/> Business Management | <input type="checkbox"/> Lettering Show Cards <input type="checkbox"/> Signs |
| <input type="checkbox"/> Industrial Management | <input type="checkbox"/> Stenography and Typing |
| <input type="checkbox"/> Traffic Management | <input type="checkbox"/> Civil Service <input type="checkbox"/> Mail Carrier |
| <input type="checkbox"/> C. P. Accountancy | <input type="checkbox"/> Railway Mail Clerk |
| <input type="checkbox"/> Bookkeeping | <input type="checkbox"/> Grade School Subjects |
| <input type="checkbox"/> Secretarial Work | <input type="checkbox"/> High School Subjects |
| <input type="checkbox"/> Cost Accountant | <input type="checkbox"/> College Preparatory |
| <input type="checkbox"/> Salesmanship <input type="checkbox"/> Advertising | <input type="checkbox"/> First Year College Subjects |
| <input type="checkbox"/> Service Station Salesmanship | <input type="checkbox"/> Illustrating <input type="checkbox"/> Spanish |
| <input type="checkbox"/> Business Correspondence | <input type="checkbox"/> Cartooning <input type="checkbox"/> French |

DOMESTIC SCIENCE COURSES

- | | |
|---|---|
| <input type="checkbox"/> Professional Dressmaking and Designing | <input type="checkbox"/> Foods and Cookery |
| <input type="checkbox"/> Home Dressmaking | <input type="checkbox"/> Tea Room and Cafeteria Management. |
| <input type="checkbox"/> Advanced Dressmaking | <input type="checkbox"/> Catering |

Name.....Age.....
Address.....
City.....State.....

Present Position.....
If you reside in Canada, send this coupon to the International Correspondence Schools Canadian, Limited, Montreal, Canada

When writing please mention Popular Mechanics

YOU ARE now offered a new business profession of your own, with opportunities unlimited, catering to foot sufferers. In a few weeks you stand to earn substantial fees. Not medicine or chiropody. Mere fraction of usual cost for training, conducted by mail. Material supplied with course eliminates need for capital. No canvassing. Either sex; anywhere. Established 1934. Rush name to The Foot Appliance Guild, Inc., Dept. 9, St. Petersburg, Florida.



Sketch Me!

WIN A TWO YEAR
FREE SCHOLARSHIP
IN COMMERCIAL ART

Enter this contest now. Copy the roguish little fellow shown here... It's easy! If you are an amateur, over 15 and like to draw, here's your opportunity to become a well-trained, well-paid artist. Learn commercial art at home through America's oldest and finest school. Hundreds of successful graduates. This contest may change your future. Send your sketch today with name, address and age to:

SCHOOL OF APPLIED ART
Dept. 178, 10 E. Huron St., Chicago, Ill.

New York Established
1902
Electrical
Ask for free booklet **School**
44 West 17th St., N. Y. C.

AU **AERONAUTICAL UNIVERSITY**
Engineering (B.S. Degree)—Administration—Certificated
Mechanics—Radio—Sheet Metal—Welding
A real technical university education in less time at less cost. Write for Illustrated Bulletin. Address Aeronautical University, Curtiss-Wright Bldg., Dept. A, 1342 S. Michigan Ave., CHICAGO, ILL.

BIG MONEY from POULTRY



I show you how to greatly increase profits, start your own business, or secure a good job in a big poultry plant. I train you at home in spare time quickly. Show you very latest methods. Give you facts worth money to yourself or employer. Men and women in small towns or suburbs will be particularly interested because latest scientific methods mean unusual profits for them. My home-study course used by thousands. 32-page book, "How to Raise Poultry for Profit" comes to you FREE. Mail coupon today.

SCIENTIFIC POULTRY RAISING

HARRY M. LAMON, Pres., National Poultry Institute,
Dept. 36-D, Adams Center, N. Y.

Please send me your FREE Book about poultry raising, and facts about your Course.

Name.....
Address.....
City (R.F.D.).....State.....

NEW INVENTIONS

(Continued from page 33A)

HANDY for the amateur or professional craftsman is a multiple purpose welding jig patented recently. A V-shaped support, a pair of arms slidably mounted on the support and a clamp on one end of the arms are arranged to hold the work. The jig has counterbalancing means and a base which holds the support in upright position. The jig would be especially useful to the amateur who frequently runs the risk of burning himself by attempting a welding job without the proper tool to hold the work.

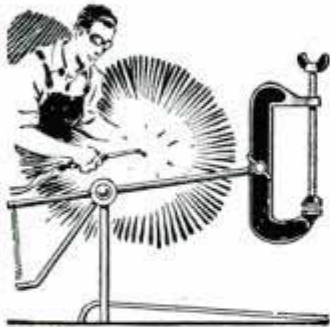

AN INEXPENSIVE bending and off-setting tool for copper and other pliable tubing was patented recently for field or bench work. One size tool with cables and pulling rods will bend three-fourths-inch, five-eighths-inch and three-eighths-inch tubing without the aid of expensive dies. To insure easy drawing out of the cable for uniform bends and to avoid marring, rubber is fastened on all curved bending surfaces.

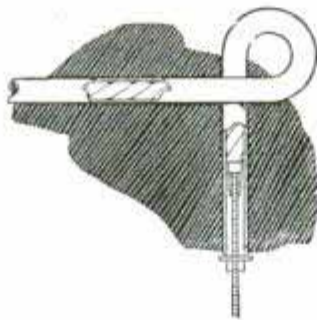

OF UNUSUAL interest in the automotive field is the patent issued to Henry Ford on a saddle motor to be mounted over the rear axle of passenger automobiles. The motor is designed to be installed without upsetting the delicate balance of passenger cars. The cylinder block and crankshaft are mounted over one-half of the rear axle and the engine flywheel, clutch and other heavy parts are balanced over the other half with a rigid shaft con-

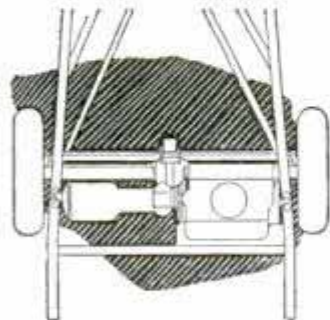

necting them. Driving gears, connected with the two balanced halves of the engine, are located exactly at the middle of the axle. Automobile manufacturers have long considered the feasibility of producing rear-engined cars. This patent, regarded as overcoming many difficulties which have prevented mass production, may be an important step toward giving American drivers a new kind of vehicle.

FASTER loading of sand, gravel or similar materials is the purpose of a newly patented device which is constructed for attachment to trucks. It consists of a vertically swinging frame supported at the fore part of the chassis, near the driver's compartment. A pair of levers, pivotally connected to opposite sides of this frame, may be swung vertically to either side. The levers support a load carrier, such as a large scoop. The device has means for swinging the load carrier to either side and for releasing and lowering the frame, so that the load of material may be deposited in the truck body.



UNUSUAL in the watch and small-clock field is a timekeeping device enclosed in a crystal cylinder equipped with a cover. The cylinder is adapted to receive the movement so that it is held firmly. A frame partially surrounds the cylinder, for protection, but leaves an opening through which the dial is fully visible.



(Due to the fact that many of the devices described in this department are still in the patent office stage and are not on the market, Popular Mechanics Magazine cannot undertake to supply further information regarding them.

THIS COMPLETE, SIMPLE, PRACTICAL COURSE FOR SELF-INSTRUCTION WILL QUICKLY GIVE YOU

A Complete Mastery of MATHEMATICS

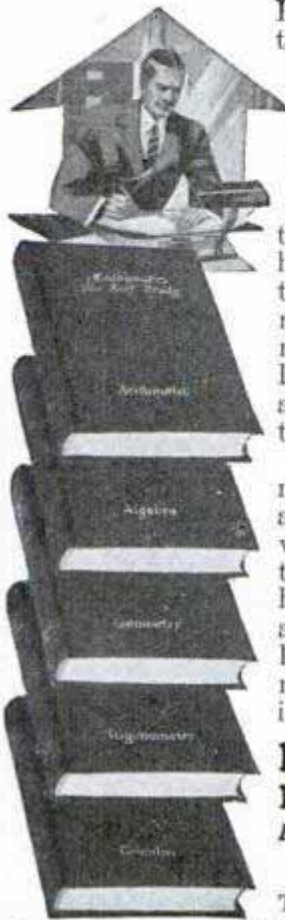

A Complete Course and Reference Library in 5 Volumes

Arithmetic
Algebra
Geometry
Trigonometry
Calculus

1598 Pages Illustrated

Prepare now to advance yourself to an important job by *Mathematics Training*. Mathematics is the foundation of all mechanical and scientific work, and of all business or industry based on science. Without this essential knowledge even the most capable man is left behind while others forge ahead to better jobs, bigger contracts, more money. You need mathematics to solve technical problems and to improve, speed up and check on your work and the work of others.

Now you can learn mathematics by an easy, inexpensive and time-saving method. A very simple and extremely interesting course in book form has been prepared for you by an expert who has devoted a lifetime to teaching practical men the fundamentals of this important subject.

MATHEMATICS FOR SELF-STUDY

By *J. E. Thompson, B.S., A.M., Dept. of Mathematics, Pratt Institute*

These books start right from the beginning with a review of arithmetic that gives you all special short-cuts and trick methods that save countless hours of your time. Then they go right into higher mathematics and show you how simple it is when an expert explains it for you. In no time at all you will be tackling with ease the most difficult questions on this subject.

An Expert's Simplified Methods

Mr. Thompson, the author of these books, has had many years' experience in mathematical training. He presents each practical method and problem in the clearest, simplest way. He gets right down to the kind of information that you need in your daily work.

Send No Money—Mail This Coupon for FREE EXAMINATION

D. Van Nostrand Co., Inc., 250 Fourth Ave., New York
Send me MATHEMATICS FOR SELF-STUDY in 5 volumes. Within 10 days I will either return the books or send you \$2.95 as first payment and \$2.00 per month for 3 months—total \$8.95 (5% discount for cash). (PM-10-38)

Name

Address

City and State

Reference

Address

FOR FREE CATALOG of best books of practical instruction and technical information, check here. If you do not want *Mathematics for Self-Study* cross out paragraph above.

New Edition

Thoroughly revised—greatly enlarged
—offering a wealth of new up-to-the-minute information

THE RADIO MANUAL



Here's the only complete Handbook for students, amateurs, operators, and inspectors. It covers the entire field of radio in 1,000 pages with hundreds of illustrations and diagrams. It is actually a complete course of training in radio operation and a complete reference book for everyone in the field. It gives instantly the answer to every question about principles, methods, and apparatus of radio transmitting and receiving.

New 1938 Edition

Covers in full detail the Electron Tube—Vacuum Tube Amplifiers and Oscillators—Modulation and Modulation Analysis—Microphones—Radio and Audio Frequency Measurements—Antenna Resistance Measurements—Latest Broadcast Transmitters with installations, adjustments, operation, and maintenance instructions—Latest Marine Radiotelegraph Transmitters and Receivers—Duties of Ground Station Radio Operators—Theory, Operation and Use of Radio Range and Marker Beacons (localizers) Landing Beams including Lorenz System of Instrument Landing—Radio Direction Finder—the two U. S. Auto Alarms approved by the F. C. C.—Ultra-high Frequency Police Transmitters and Receivers—All Important Radio Provisions of the Communications Act of 1934 as amended effective 1937—Rules and Regulations of F. C. C.—General Radio Regulations Governing Distress Signals, etc.

This is just a hint of the vast amount of information packed into this great book. It is essential to every student, operator, and inspector.

The author, G. E. Sterling, is Assistant Chief, Field Section, Engineering Dept., Federal Communications Commission. The book is bound in durable flexible Fabrikoid.

EXAMINE THIS BOOK FREE

Send No Money—Mail This Coupon

D. VAN NOSTRAND CO., 250 Fourth Ave., New York
Send me on approval THE RADIO MANUAL. Within 5 days after I receive the book, I can return it and owe nothing. If I keep it, I will send you \$2.00 as first payment and I will pay \$2.00 monthly thereafter for 2 months—\$6.00 in all. (5% discount for cash.) (PM-10-38)

Name

Address

City

State

Reference

Address

FOR FREE CATALOG of best books of practical instruction and technical information, check here. If you do not want *The Radio Manual* cross out paragraph above.

When writing to advertisers please mention *Popular Mechanics*

OL' JUDGE ROBBINS' TRAILER TRIP

MY OLD FRIEND, THE SKIPPER OF THIS FISHING SCHOONER, CAN TELL YOU MANY A SALTY STORY OF THE SEA

AT GLOUCESTER, MASSACHUSETTS

HOWDY SKIPPER--I SEE YOU'RE STILL YOUR TRIM SELF!

AHOY! WE'VE BROUGHT OUR SEA-LEGS AND EVERYTHING!

GLAD TO SEE YOU AGAIN, JUDGE. JUST TAKE YOUR THINGS BELOW, PLEASE. WE'RE ABOUT TO GET UNDER WAY. **LIVELY NOW, LADS!**

IT'S VERY SHIPSHAPE BELOW, SKIPPER. I SEE YOU KEEP PLENTY OF STORES ABOARD

YES, ESPECIALLY TOBACCO. I ALWAYS REMEMBER AN EXPERIENCE MY GRANDFATHER HAD YEARS AGO

OH, PLEASE TELL US ABOUT IT!

"WELL, MY GRANDFATHER'S SHIP, 'THE GULL', WAS LONG DELAYED BY CALMS, AND THE TOBACCO RATIONS RAN OUT. THE MEN STARTED A MUTINY FOR WANT OF A SMOKE, WHEN SUDDENLY-----"

SAIL HO! ON THE PORT BOW!

"FORTUNATELY, THE PASSING SKIPPER OBLIGED THEM WITH SOME OF HIS OWN TOBACCO RATIONS, AND THE CREW WAS HAPPY AGAIN. SO GRANDAD'S SHIP MADE PORT SAFELY."

BY THE LOOKS OF ALL THE PRINCE ALBERT ABOARD, I SEE YOU ALSO MAKE SURE THAT THE TOBACCO IS THE **RIGHT** KIND TOO, EH SKIPPER?

YOU BET YOUR BOOTS WE DO, JUDGE. WE SEAFARING MEN KNOW WHAT A GRAND SHIPMATE PRINCE ALBERT IS ON A LONG VOYAGE

ON LAND OR SEA, P.A. ASSURES RICH, MELLOW SMOKING IN EVERY PIPEFUL. PRINCE ALBERT'S THE **STANDBY FOR PIPE-JOY**, ALL RIGHT!

SMOKERS! MAKE EVERY DAY A HOLIDAY FROM TONGUE-BITE!

PRINCE ALBERT IS **NO-BITE** TREATED—SMOKES **COOL** AND **MILD** WITHOUT HARSHNESS!

P.A. IS CRIMP CUT—TWIRLS **FAST INTO TRIM**, **MELLOW 'MAKIN'S'** SMOKES TOO—I GET AROUND **70 TO A TIN**

THE **2** OZ. TIN
SO MILD—SO TASTY



50 pipefuls of fragrant tobacco in every 2-oz. tin of Prince Albert

Copyright, 1938, R. J. Reynolds Tob. Co.

PRINCE ALBERT

THE NATIONAL JOY SMOKE

MONEY BACK IF YOU SAY SO

Smoke 20 fragrant pipefuls of Prince Albert. If you don't find it the mellowest, tastiest pipe tobacco you ever smoked, return the pocket tin with the rest of the tobacco in it to us at any time within a month from this date, and we will refund full purchase price, plus postage. (Signed) R. J. Reynolds Tobacco Co., Winston-Salem, N. C.

Popular Mechanics Magazine

REGISTERED IN U. S. PATENT OFFICE AND CANADA

WRITTEN SO YOU CAN UNDERSTAND IT

Vol. 70

OCTOBER, 1938

No. 4

Poor Boy Still Makes Good- CORRIGAN Proves It!

By Lowell Thomas

THERE are but few men on this earth—outside of those in high official rank—whose names require no added words of explanation. For example, if you mention Charles A. Lindbergh, everybody from Pt. Barrow, Alaska, to the “ham” radio operators at the Cape of Good Hope will know instantly what he stands for, what he has accomplished. You would hardly need all the fingers of one hand to count all the other living persons of whom this is true.

But there is one recent, overnight addition to the list. Two months ago we had never heard of him, did not know he existed. Today the name of



The \$900 plane in which Douglas Corrigan flew the Atlantic and, above, Corrigan working on his ship in New York before the take-off for California by way of Dublin

4877
Rudy Arnold Photos
Corry & Bennett
Airport. Brooklyn N.Y.

14 877
482

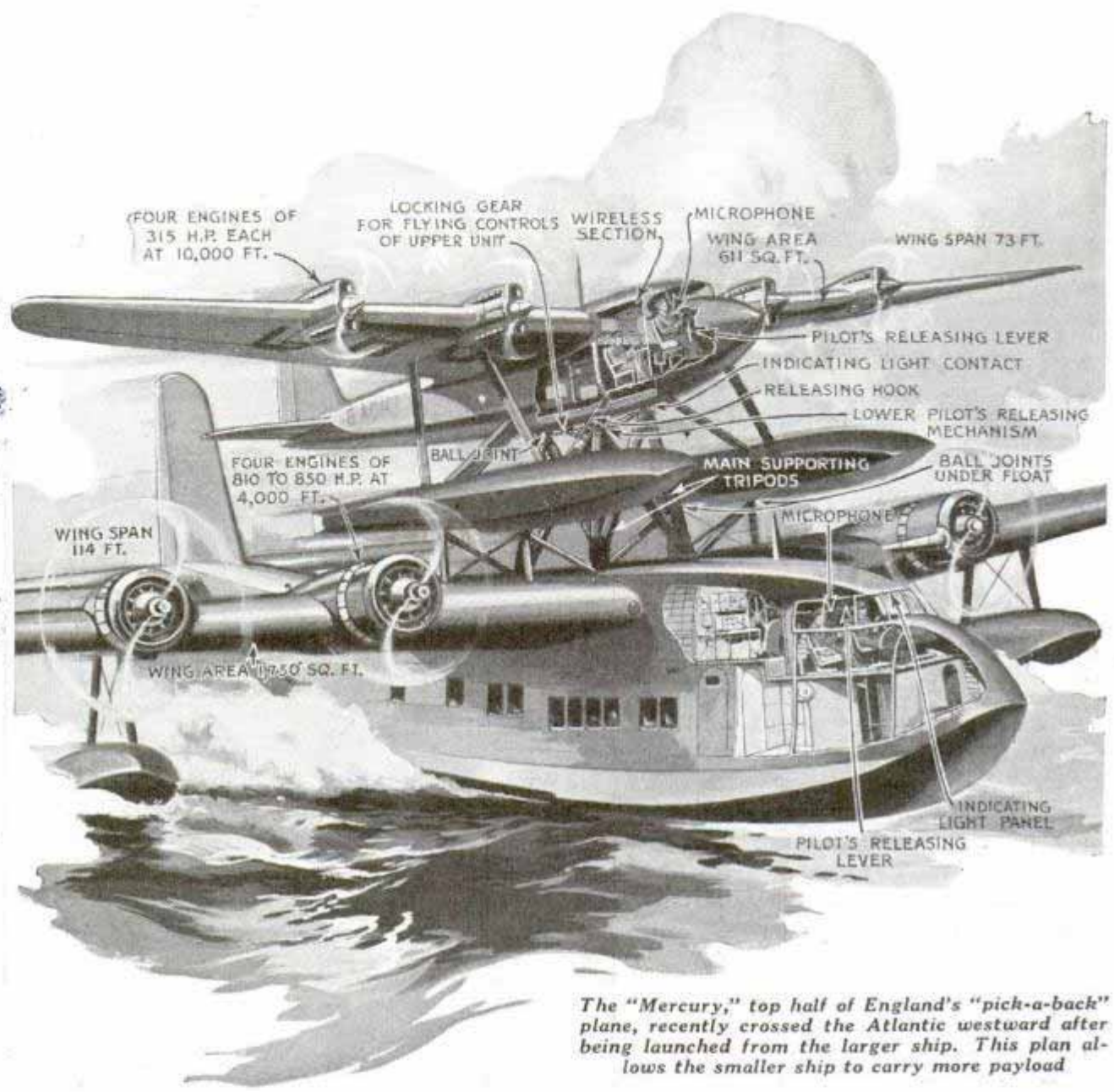

The "Mercury," top half of England's "pick-a-back" plane, recently crossed the Atlantic westward after being launched from the larger ship. This plan allows the smaller ship to carry more payload

young Douglas Corrigan is on the lips of all, young and old. Physically he flew, completely without benefit of publicity, from New York unaided and alone to Dublin. Actually he flew in twenty-eight hours, swiftly and surely, into the hearts of everybody with eyes to read or ears to listen. And that is putting the case mildly.

Now the first, fine, careless rapture of excitement and amazement is over. So let's examine what lies behind the exploit that has made Corrigan famous.

One fact that captured the world's admiration was the Lindberghlike precision with which the flight was executed. Corrigan had none of the instruments with which Howard Hughes was equipped. An ordinary compass and an inclinometer, which he had installed himself at a cost of

\$60, represented virtually the whole of his scientific apparatus. Nevertheless he reached his goal easily and surely. Insofar he quite earned the admiration and respect that have been showered upon him.

But Corrigan achieved more than that. He illustrated with graphic and unmistakable clarity the capacity and resourcefulness of the mechanical mind. He became the latest personification of the type of mentality that has lifted mankind within three centuries from a race of crawlers to a generation of fliers, the kind of mind which has given us modern surgery, modern plumbing and the ability to talk to one another though separated by thousands of miles of space.

Since it first began to function, the mechanical mind has been up against a long,



unvarying, endless struggle, not merely the struggle to acquire knowledge, to overcome difficulties, to express its ideas in elaborate machines and instruments. Its toughest struggle has been the conflict with scepticism. Its worst enemy has been the Brahmin mind. The Brahmins say: "Thus and so is the world, thus and so it must remain." They have said: "It is impossible to travel faster than fifteen miles an hour. Nay more, it is wrong." The mechanics replied "Is that so? Then take a look at this." Whereupon they produced the steam locomotive. There is not a single modern appliance, whether telegraph instrument, motorcar or radio set that was not developed in the teeth of similar hostility.

Probably it was experienced by the genius who invented the wheel and thus laid the foundation for all the swift means of locomotion on land. Every schoolboy knows it was the fate of Galileo Galilei who established that the planets move around the sun, then was tortured until he made his lip-service recantation. Didn't somebody nickname the first steamboat in America "Fulton's Folly?" And in the Smithsonian Institution is an antique flying machine known as "Langley's Folly."

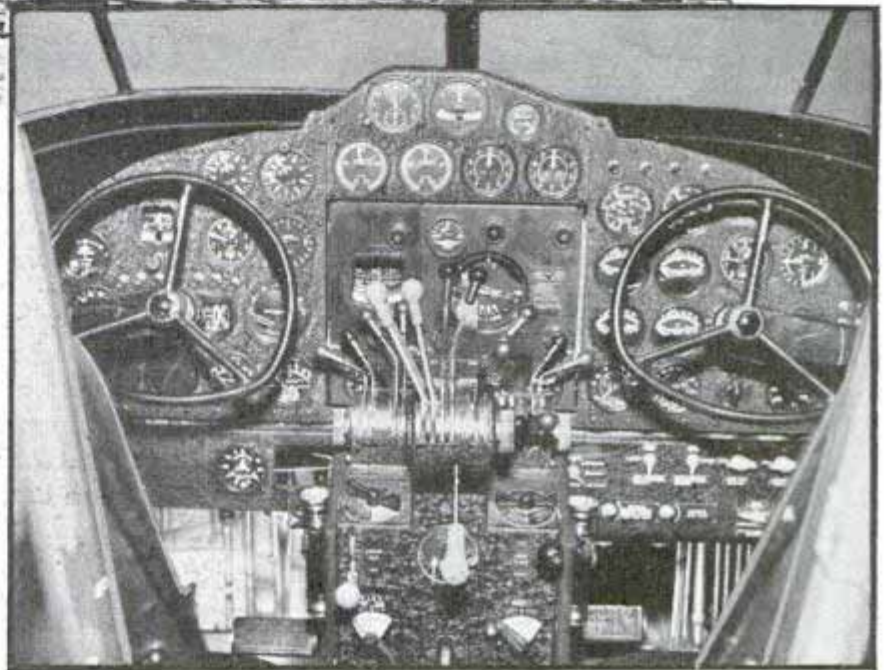

Cockpit of Hughes' round-the-world ship and, above, the German catapult seaplane, "Nordmeer," after her Atlantic crossing

What about the two bicycle mechanics at Dayton, O., who worked independently of Prof. Langley and who beat him to it by being the first to demonstrate concretely and beyond dispute that man can fly? The Wright brothers encountered even more scepticism and jeers than attended the experiments of Langley. For after they had flown, most of the editors of thirty years ago brushed aside those historic experiments at Kitty Hawk and asked: "So what? Of what importance is it?"

Douglas Corrigan, mechanic and airplane pilot par excellence, has not yet invented anything, so far as we know. Neither had Col. Lindbergh when he accomplished his epoch-making flight to Paris in 1927. But it is significant that since then he has applied his mechanical mind to the workings of the human body and has

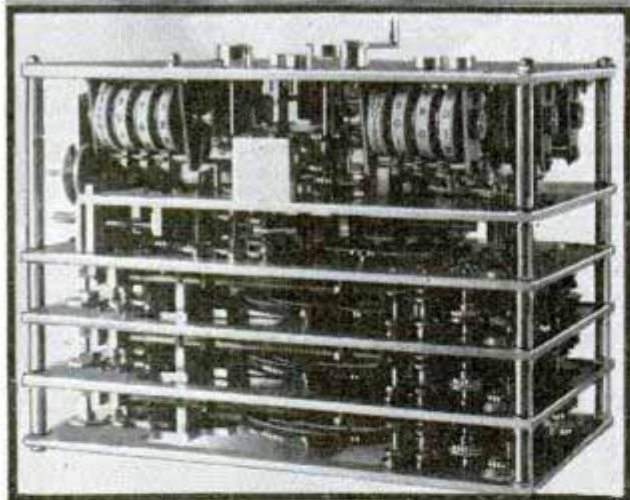
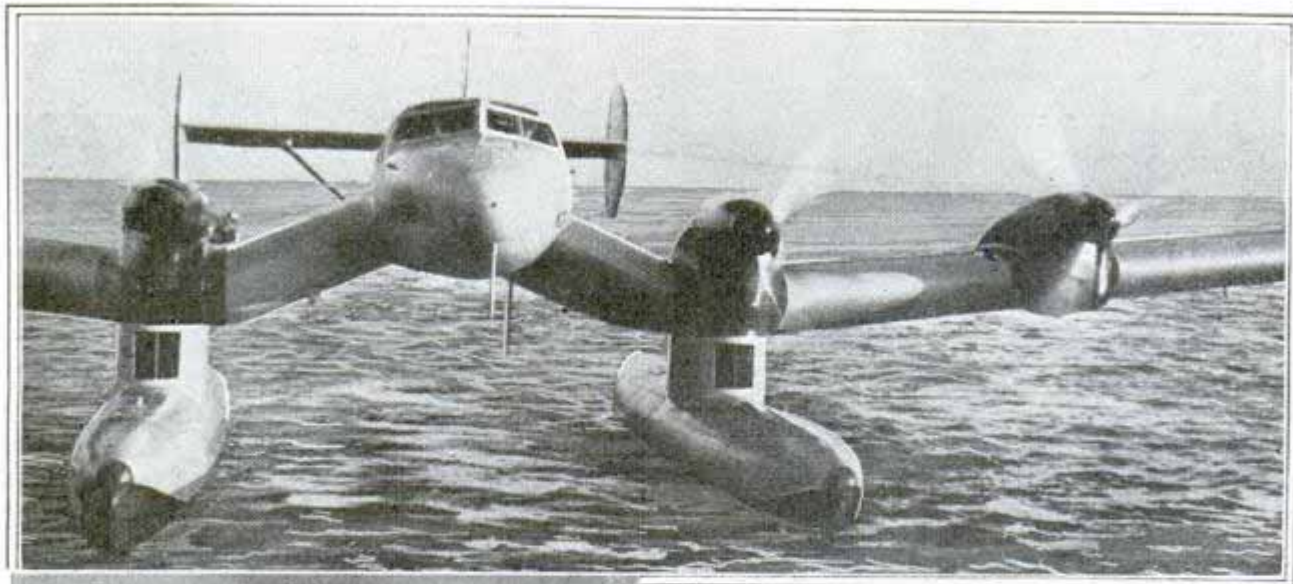

Head-on view of one of German catapult planes and, bottom, front and back views of U. S. Army Air Corps robot computer carried by Howard Hughes for determining latitude and longitude of plane in flight. To operate the device, you take two sights on the sun or a star, note the time and then turn cranks. Out comes the plane's geographical position

developed apparatus that is making a notable and valuable contribution to the advancement of surgical science, a contribution so important that Lindbergh has been adopted as a collaborator by the eminent

Dr. Alexis Carrel. So if, ten years hence, we hear of Corrigan's having achieved some addition to mechanical development, I, for one, will not be surprised.

However, that lies in the future. We are now concerned with what this modest young mechanic has done already. In the light of what he accomplished, his background is particularly interesting because there is so little of it. His history is that of thousands of young men who can be found any day in factories, machine shops and garages anywhere in America. Any one of those thousands have the same advantages, antecedents as good as Corrigan has. The difference lies in what Corrigan has made out of the assets with which he started.

Douglas Corrigan has no diploma from any famous technical school. He has in short, no academic background whatsoever. But he is a born mechanic. Working at it has been not merely his means of earning a livelihood. It has been his passion, the best fun he knows, his life. Not only his hours in the factory but his spare time—playtime to other men—has been given up to mechanics. The only pastime he has known, sailing, he made a means to the end he accomplished when he flew the Atlantic.

In this he had the help and encouragement of an uncle, the Rev. Frazer Langford, Los Angeles minister. He taught young Douglas the pleasures and science of sailing and the art of navigation. In the pleasant hours they passed handling a boat, the boy got from his preacher-sports-

(Continued to page 149A)

H 887

Three-Dimension Pictures in Natural Colors

Old-time stereoscopic pictures are revived with startling reality and beauty by the use of modern natural color film. Three-dimension color scenes in the garden, at the beach, in vacationland and national parks have a breath-taking quality of depth; pictures of the family and action shots are vivid and lifelike. To make these stereoscopic pictures the new way, twin

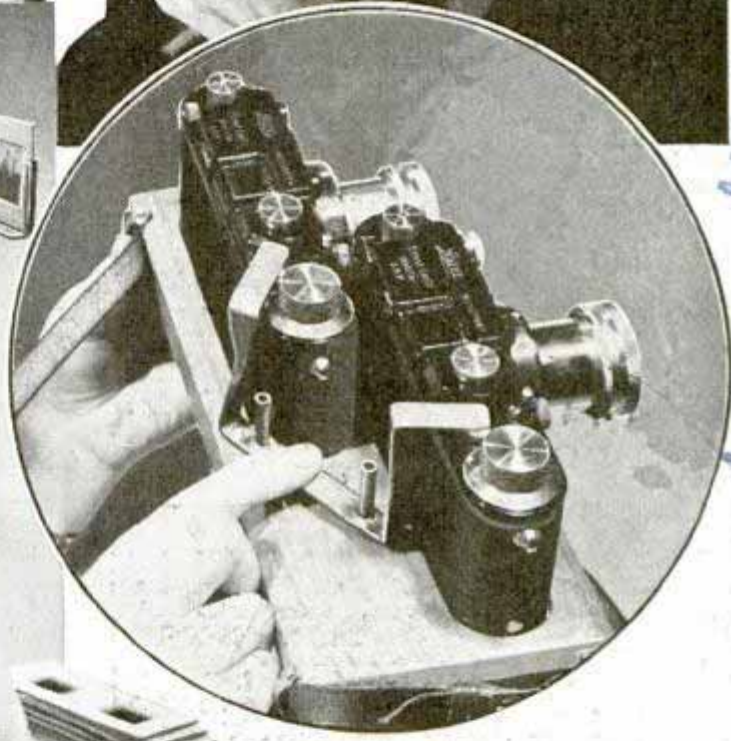
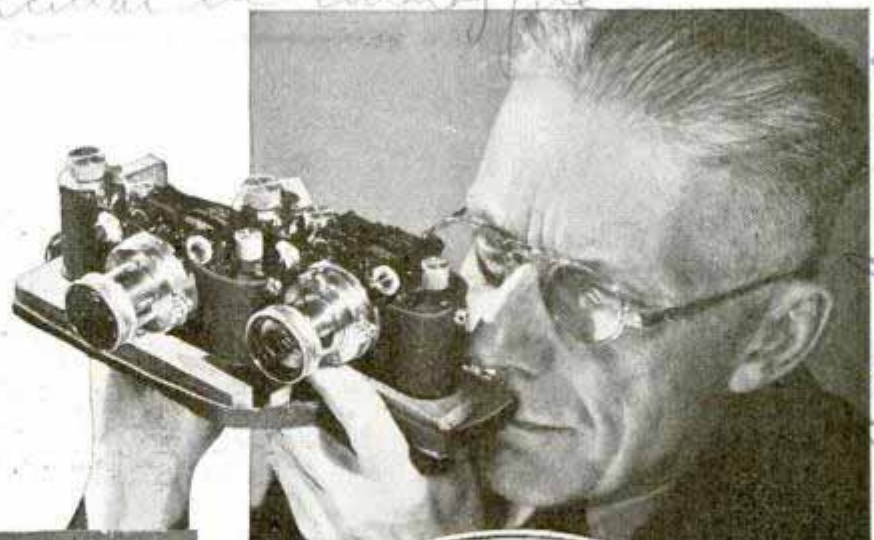

Top, sighting for three-dimension scene; below, the dual shutter release. Left, looking at color picture in stereoscopic viewer

cameras are mounted side by side—their lenses as far apart as your eyes—and equipped with a joint shutter release for simultaneous exposure. Each camera is loaded with color film. Exposure time, distance focus and diaphragm opening must be identical. After being developed, the twin color films are framed and mounted in cardboard made to slip into the slots of a stereoscopic viewer. In mounting the two films side by side care must, of course, be taken to place the "positive" from the left-hand camera at the right of the viewer.

Eraser Made Like a Lead Pencil Has Paper-Strip Wrapper

Made like a lead pencil, a rubber eraser bound in paper strips is especially handy for fine work. As the rubber wears down, a new section is exposed by unwinding one of the strips. The eraser is six and one-half inches long and its rubber core has a quarter-inch diameter.



Blaidell Pencil Co
141 Berkeley St.

Chicago Stereographic Attachments
Electro Co 730-5th Ave NYC

Cabins in Wings of 100-Passenger Flying Boat

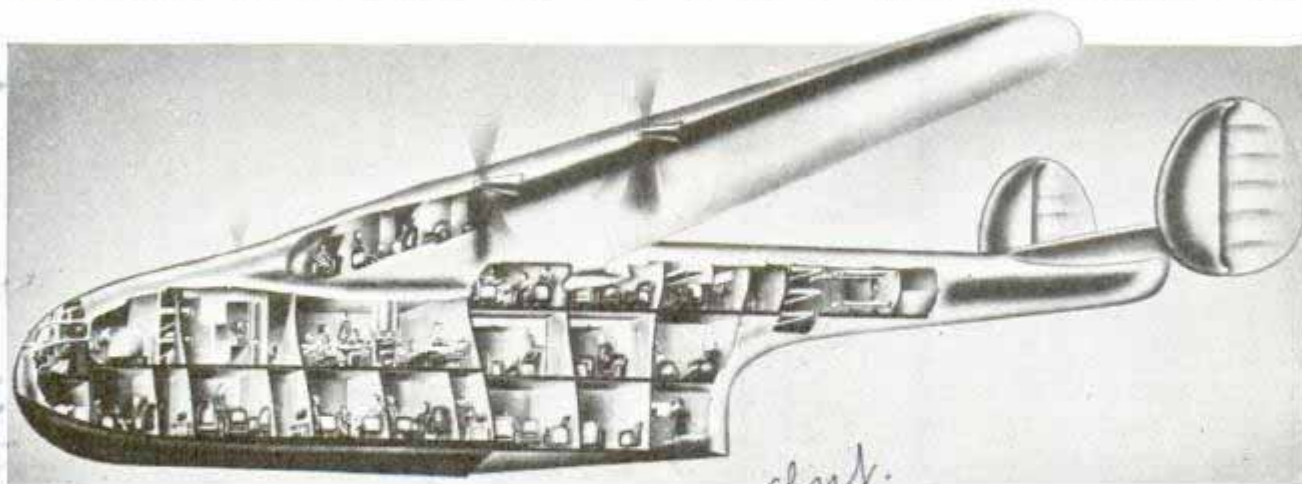

Cutaway drawing shows placement of cabins in high wing of Consolidated Aircraft's version of 100-passenger transoceanic flying boat. With four engines, this aerial hotel will have 5,000-mile cruising range

Cruising at an altitude of 20,000 feet, the oceanic flying boat designed by Consolidated Aircraft corporation for Pan-American Airways will race along with its hundred passengers and crew of sixteen at a top speed of 276 miles an hour—four and one-half miles a minute! Thirty-six of the passengers will be accommodated in cabins enclosed in the high wing, the rest

being assigned to the main compartment. The cabins will be soundproof and air-conditioned. Specifications call for a wing span of 194 feet, an over-all length of 102½ feet and gross weight of 168,000 pounds. The four engines of 2,150 horsepower will enable the ship to reach an absolute ceiling of 30,000 feet, and it will have a cruising range of five thousand miles.

corp. San Diego Calif

14786
Man-Power Giro-Cycle "Flies" Without Aid of Motor



Rider pedals to drive the big airscrew, then pulls lever which the man is shown operating. This changes airscrew's pitch and the machine "flies"

Vertical flights of a heavier-than-air machine, propelled solely by human power, are being made. The machine is known as a giro-cycle, which is a helicopter of the simplest form. Its lifting element is a two-bladed variable pitch airscrew of fourteen feet diameter, mounted on a vertical drive shaft driven through a pinion gear of two-to-one ratio by bicycle foot pedals. As set up in the laboratory, the giro-cycle is not yet a completely free flying machine, but is controlled laterally by a stationary tripod. The operator mounts the saddle, revolves the propeller to the maximum velocity obtainable with his power while the blades remain flat or at zero pitch. At the moment the highest speed is attained, the operator pulls the pitch control handle, thus increasing the pitch of the blades to the position of maximum lift. The thrust thus produced raises the machine and the rider into the air. While ascents have been no more than one or two inches, the machine is expected to be capable of twelve-foot flights when perfected.

designed by Dr. W. Frederick Herhard.

ms. Juliana de Tucson Olympic Games

Idea. Sept. of permanent stability engineering with 1 cent.

Patient Travels in Trailer with an 'Iron Lung'

Kept alive by an "iron lung" for many months since he was stricken with infantile paralysis while traveling in China, Frederick B. Snite, Jr., of River Forest, Ill., now has a trailer fitted with an iron lung for touring in this country. The portable "lung" is pushed up a runway into the trailer and supplied with power by a generating plant behind the cab. The mechanical device does his breathing for him while he watches the scenery in a rear-view mirror or in a periscope mirror on the roof. The trailer is air conditioned and has its own kitchen.

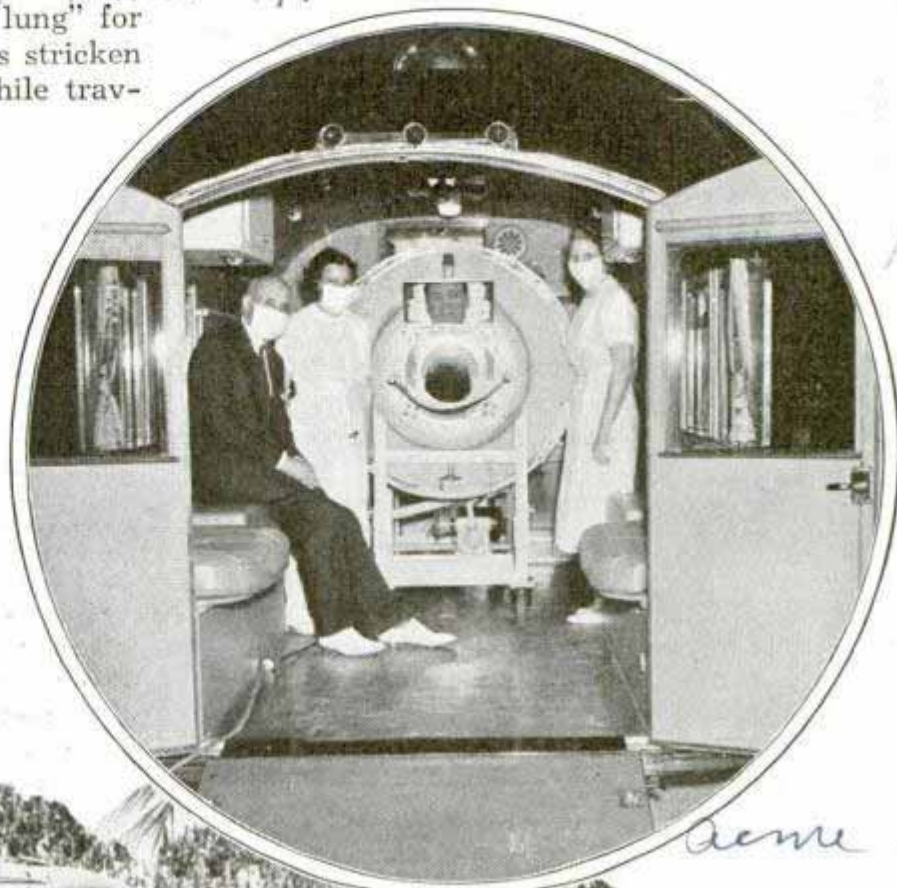

Top, patient in his "iron lung" smiles into mirror in which he sees view through rear observation window of trailer. Left, the air-conditioned trailer which has kitchen equipment. Right, periscope mirror on top

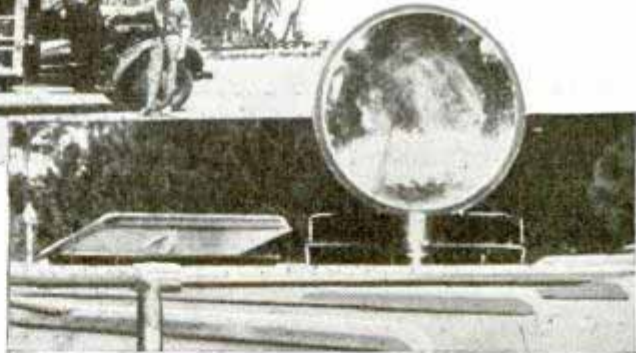

Airplane "Props" Drive Tractor over Swamp and River

Wading through marshes and on rivers and bayous near New Orleans is a "swamp buggy" driven by two airplane propellers. The "wheels" of this amphibious tractor are large drums, light enough to keep the strange vehicle from bogging down or sinking in the rivers. Two eight-cylinder automobile engines are connected to the propellers by chain drive. The "buggy" can average thirty miles an hour.



Twin propellers turned by automobile engines drive this "drum-wheeled buggy" over southern marshes

Send return postage to our Bureau of Information to learn the name of the maker of any device described in this magazine.

Built by an air company.

see April 1937

529

1876

Acme

'Pendulum' Car Takes Curve Like Monorail

Calif
see Jan 1941-2

Developed by W. E. Van Doren, J. C. Lindvall, and C. J. Hill

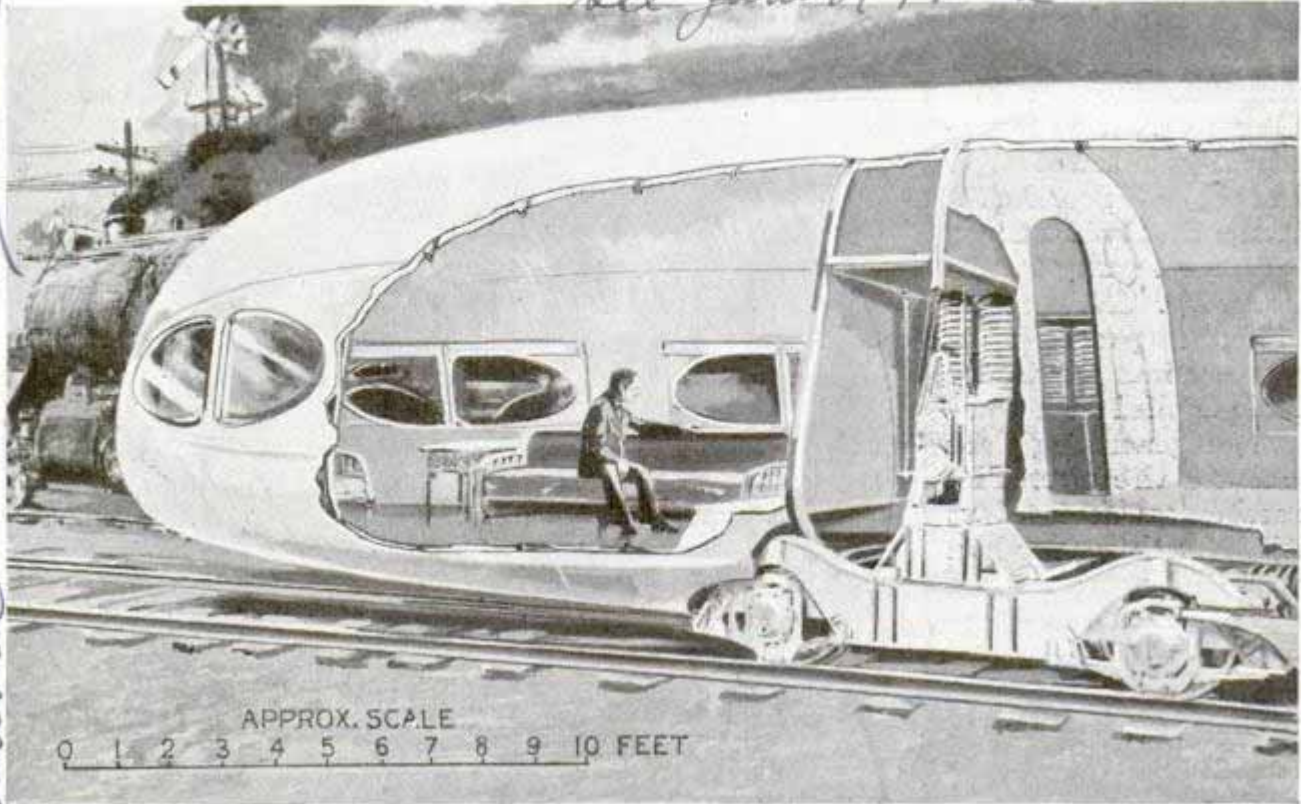

Cutaway drawing shows flexible coil springs mounted on towers over trucks of coach. This suspension mechanism is enclosed in narrow space between sections of car, to which it imparts a pendulum motion

One glance at the cutaway drawing reveals the radical departure in "pendulum" suspension which makes the Santa Fe railroad's experimental coach ride like a monorail. Instead of resting on springs, the car hangs like a hammock. It borrows the principles of the overhead-suspended

monorail. On a curve, the floor swings out farther than the ceiling, its pendulum motion averting any sensation of centrifugal throw. Above the four-wheeled truck are two towers reaching halfway to the ceiling. The car is hung from flexible springs mounted on the towers.

Television over the Telephone Sends Images of Speakers



Distant speaker is seen in window on wall; round television "eye" sends picture of local operator

Television by telephone has been achieved in Germany. In a conversation over 400 miles of telephone line between Berlin and Munich the operators not only heard but saw each other. With this milestone passed, the technicians press on to the distant goal of making regular television service available to telephone subscribers. In the photograph, the microphone on the transmission cell held by the Berlin operator is not necessary on ordinary connections; the microphone and loudspeaker partly hidden beyond the operator transmit impulses between cities. On the wall is the picture received of the Munich operator; to the right, the round "eye" picks up the image of the Berlin speaker and sends it to Munich.

1941
Jan 1941

12 14 Cont. James Mc Feely 451 W. 60th
Terrace, Kansas City, Mo

The AGE of COLOR

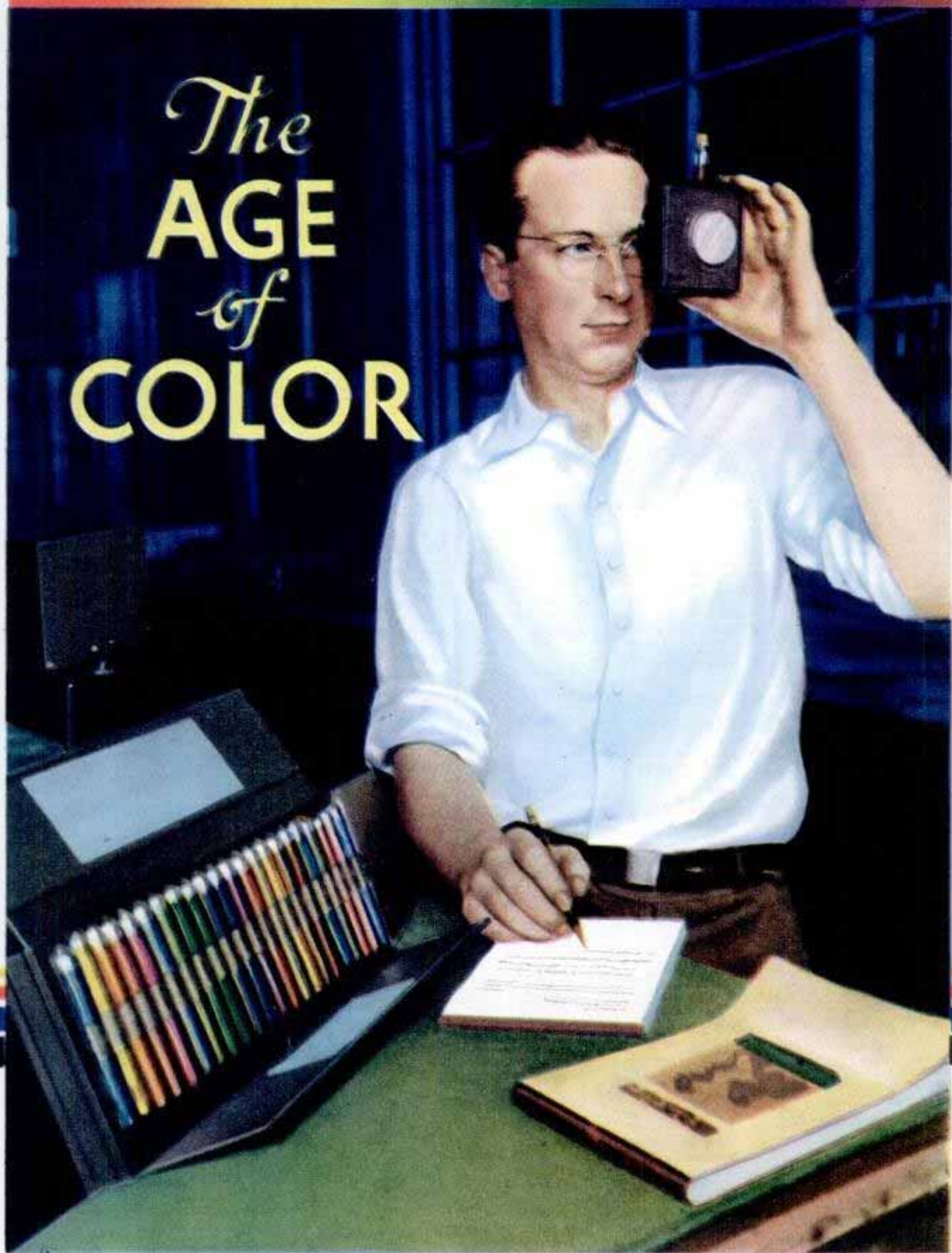

484

MEASURING color of a varnish. Sample is placed in vial and matched with one of series of colored glass disks mounted on wheel in black box.

1874

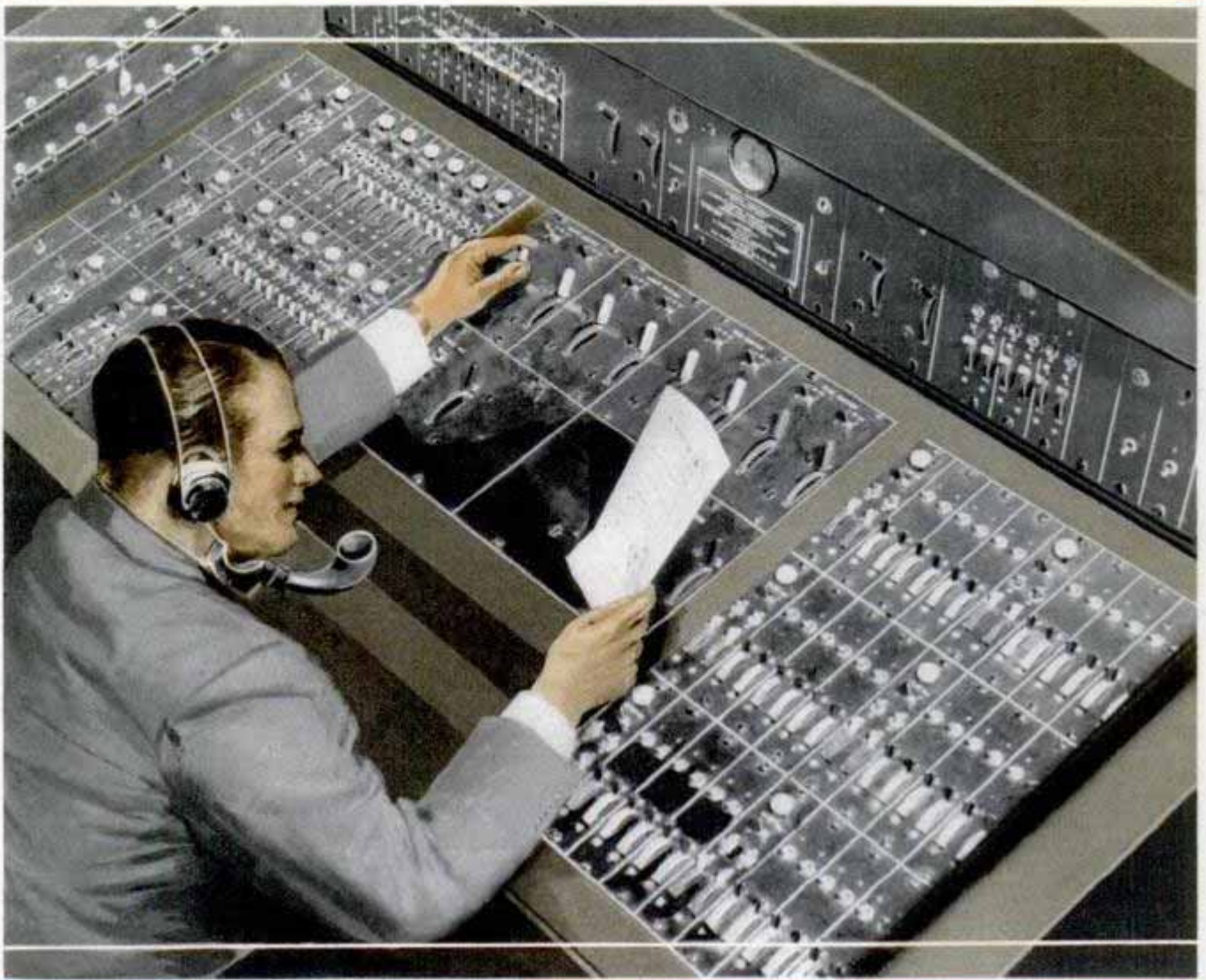

490

LIGHT control board for theater. One of the rules of the theater is to play comedy scenes in yellow light which seems to relax the audience.

THE world is spending millions for color today and, as a result, is rapidly changing from a dull, drab sphere into a gay and cheerful place garbed in all the hues of the rainbow.

America alone is using about \$50,000,000 worth of dyes a year. These dye-stuffs sell, or help to sell, six or seven billion dollars' worth of merchandise annually because, to a great extent, we buy what pleases the eye.

Without color, the demand for many everyday articles would decrease or, in some cases, vanish entirely. Changing the color of an article or even the color of its surroundings may induce you to buy it, or refuse to buy it, since color exerts a psychological influence on all of us.

More billiard tables were sold when purple felt covers were substituted for green, and the sale of wall mirrors jumped when they were offered in colored glass. A packing house increased

meat sales by changing the interior of its coolers from white to turquoise blue and a cafeteria doubled the sale of salads by displaying them on green plates instead of white.

While colors relieve the monotony of our surroundings; they also exert an emotional effect upon us. Red is regarded as the symbol of war, hate, danger and courage while orange signifies warmth, harvest and autumn. Green is linked with victory, safety and sickness and we associate yellow with cowardice and deceit.

Blue exerts a cooling effect, a fact of which one manufacturer took advantage in painting workbenches where welding was being done. They were colored light blue to counteract the feeling of heat produced by the welding. The tops were painted a deeper blue to suggest coolness while an orange trim relieved the monotony of the blues.

Howard Ketcham, color consultant for

49

du Pont

A 74

several large manufacturers, has found blue is the favorite color of most American men and red of most women. He has made color surveys for everything from toothbrushes to motorcars and once showed that a red handle sells more ten-cent toothbrushes while amber sells more twenty-five cent ones. He has even determined the color preferences of house flies. Flies like orange, dark yellow and dark blue but shun light green and ivory.

Color is responsible for every sensation made upon the eye. We see shape because of the contrast of one color with another. Color, however, is not a quality of objects. When we look at a blue car, it appears blue simply because its surface reflects chiefly the blue rays of white light and absorbs most of the other colored rays. If it absorbed them all, the car would appear black. If it reflected most of them, you would see a white car.



TESTING colored skeins of yarn for strength and shade of the dye used. A trained eye can recognize thousands of different shades.

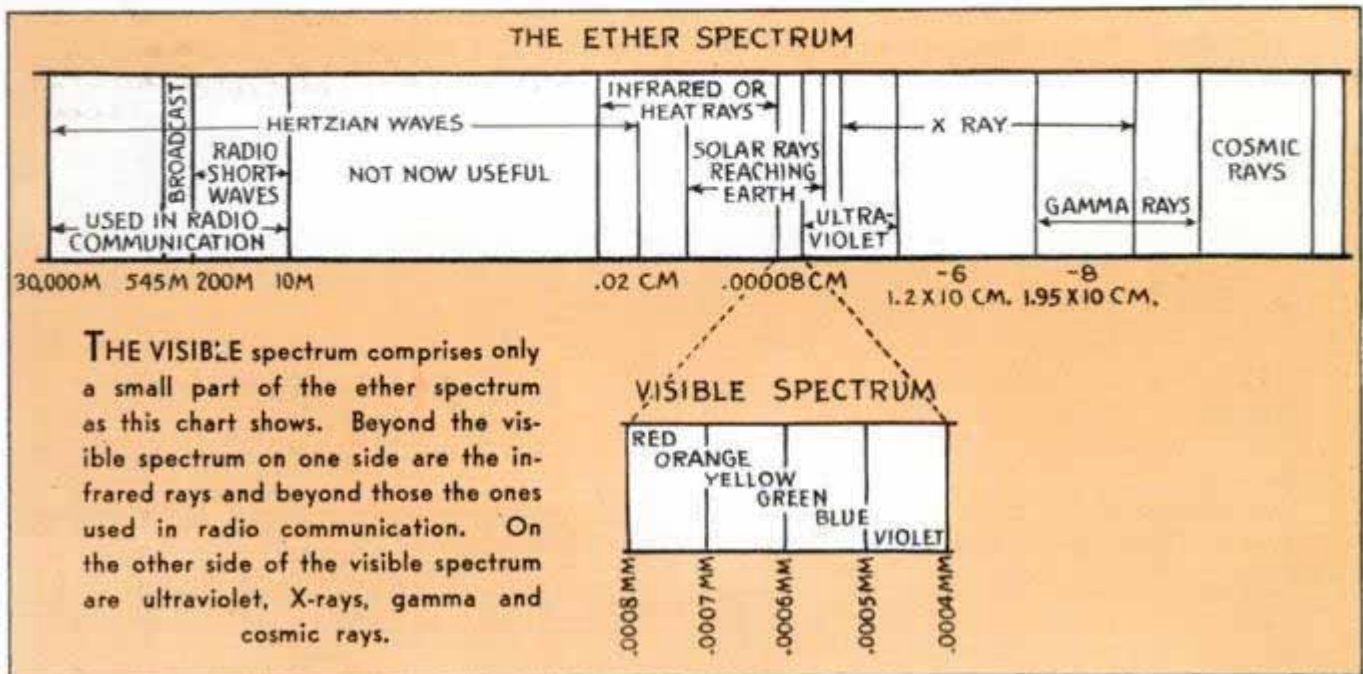

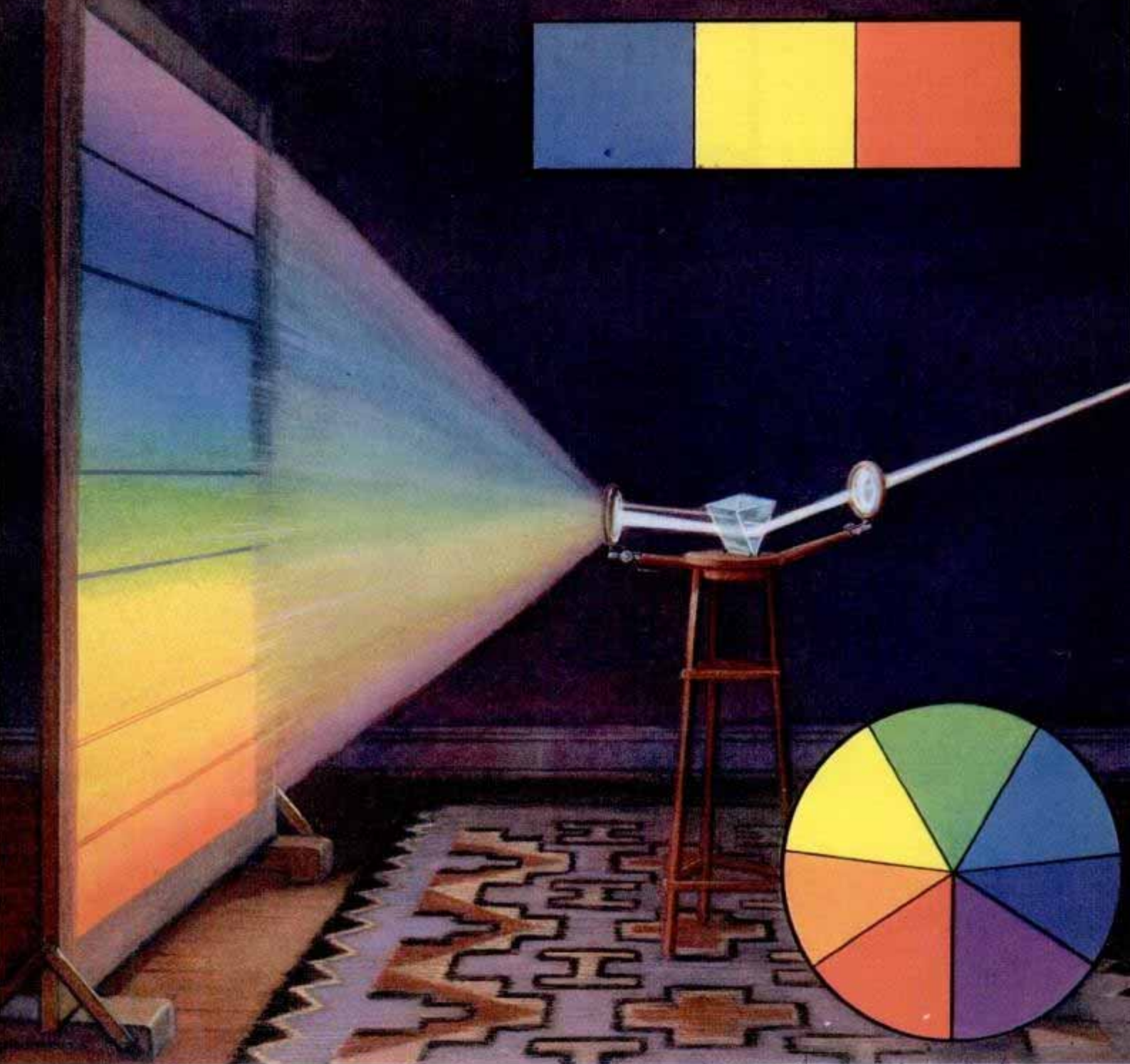

THE COLORS in sunlight are shown by passing a ray of light through a prism to break it up into different wave lengths. Insets show primary and solar spectrum or rainbow colors.

The eye is sensitive to only a narrow band of light rays, but in this band a trained eye can recognize thousands of colors. Skilled observers who examine skeins of yarn in testing dyes can detect the presence of one twenty-thousandth as much red dye as yellow in a batch of yellow skeins. A machine could do this too, but a machine cannot determine the psychological response to color while the eye can.

One machine, developed by Mr. Ketcham, does more than the eye can do, however. It is called Colorcable and, by means of a simplified system of code letters, can transmit thousands of separate

colors over regular telegraph or cable communications. In this manner it is possible, for example, to send the most popular shades exhibited in a Paris style show to New York in a few hours, or even a few minutes.

There are two principal sources of all the color we enjoy, pigments and dyes. Dyes are soluble in something while pigments are insoluble in water and usually in most other liquids. Also, a dye must have an "affinity" for the substance it colors and be able to become a part of it. A pigment, however, lends color merely by mixing physically, not chemically, with whatever it decorates.

Pres. Howard Ketcham, 74
 492
 1201 W. Rightwood Ave
 Chicago
 New York
 Plagen

Esartner Scientific Co.
 1201 W. Rightwood Ave
 Chicago
 Also Central Scientific Co.

493

1294

COLOR matching and analyzing machine being used to check flat paint samples, one of the many testing processes developed to insure uniformity of color.



THE RADIO spectrum, below, constitutes only a small part of the ether spectrum but the visible spectrum and the photoelectric spectrum are even smaller. The audible spectrum, lower left, ranges from about sixteen to 16,000 cycles per second.

THE RADIO SPECTRUM

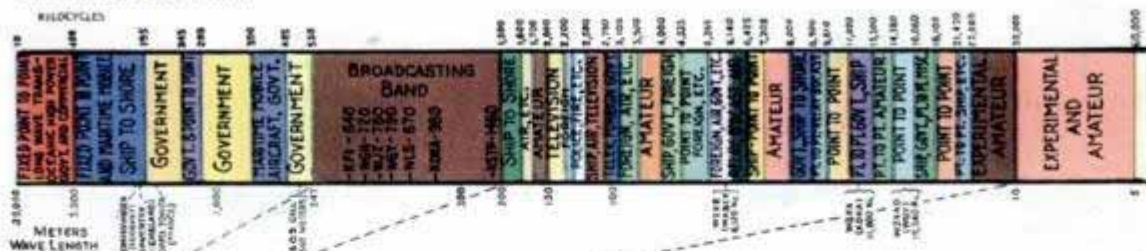

THE ETHER SPECTRUM

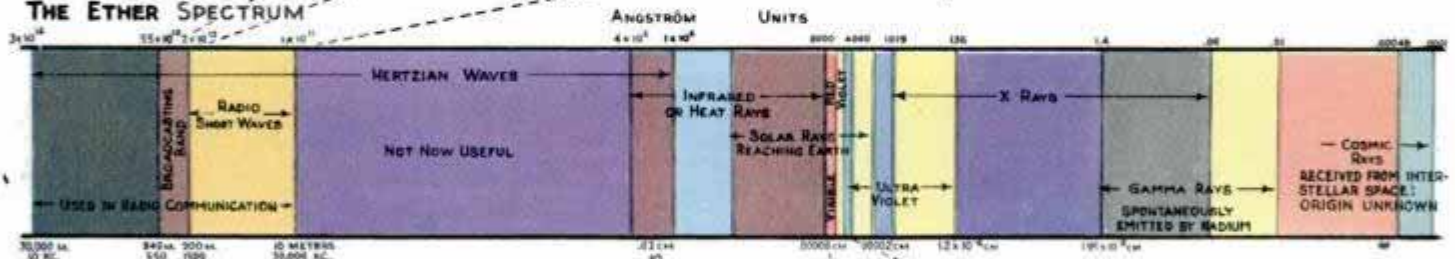

THE AUDIBLE SPECTRUM

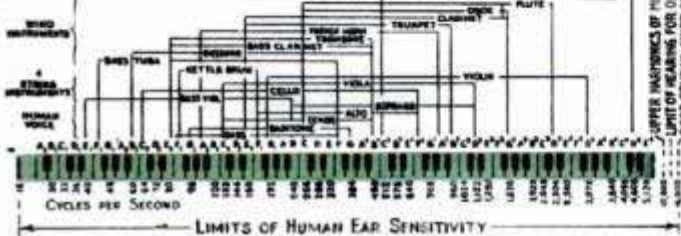

THE PHOTO-ELECTRIC SPECTRUM

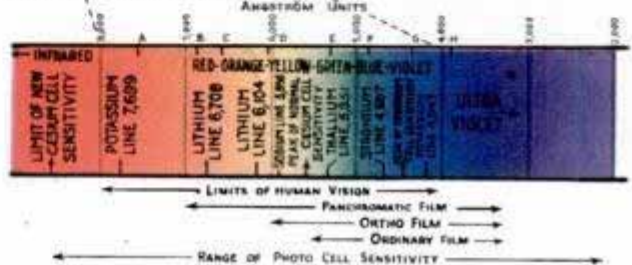

1274



494

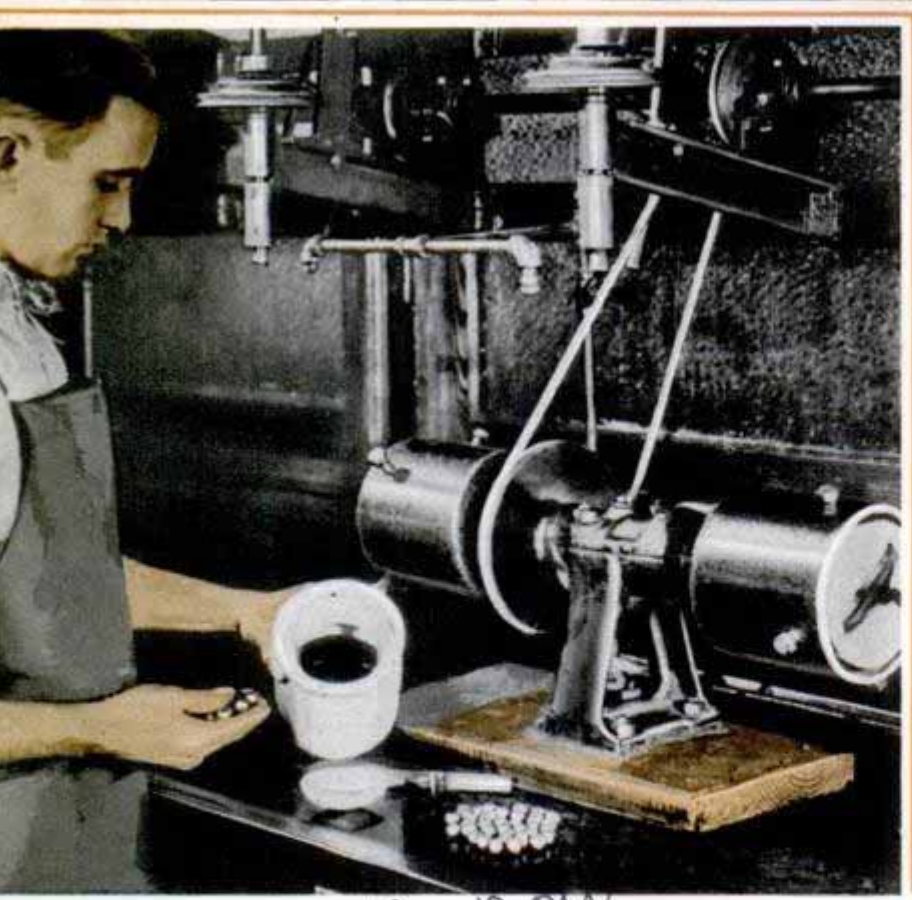

In his first attempts to capture color, man used the pigments and dyes of nature. He obtained a red pigment from iron oxide or green from copper salts and he got his dyes from woods, berries and various plants. The earth pigments which can withstand high temperatures still provide the colors for ceramic ware.

But obtaining soluble colors such as dyes from natural substances was both unsatisfactory and very expensive. Frequently the colors would not unite with the product which man wanted to color. Or if the early dyer did find something which would unite with the product, perhaps it was not the color he desired. So for hundreds of years only royalty and the very wealthy

the p m v
BALL grinding machine which pulverizes pigments for inks and, above, winding four skeins of yarn from forty-eight spools to obtain average weight and composition before making dye test.

*Technical Laboratory. Dyestuffs Dept
 Leebswater, Paul, N.Y.*

could afford richly colored possessions.

Today nearly everything we own is decorated with color and the most inexpensive piece of cotton goods may be adorned with most of the hues of the spectrum. This miracle has been wrought largely by coal and chemistry.

When coal is heated, as in making coke, it yields a thick, gummy tar. The residue of this tar, after the volatile substances are driven off, is pitch which we use to make roofing and asphalt. In the middle of the last century, Sir William Perkin, British scientist, tried to make quinine out of one of the constituents of coal tar.

The substance he obtained, when dissolved in water, produced a red solution which imparted a mauve color to various products to which it was applied. Instead of quinine, he had produced the first artificial dye, a dull red color from black, sticky coal tar!

But this was only the beginning. To his amazement, the Englishman found that by varying the chemical treatment he could produce still other colors. Or by starting with a different coal-tar base, yet more hues were obtained. Locked in this evil-smelling, gooey tar were hundreds or even thousands of colors waiting to be released by the magic hand of the chemist.

When coal tar is distilled, it yields different substances at different temperatures. One is benzol, a clear liquid. Another is naphthalene, a white, crystalline solid which, when pressed into a marble, is our

A TEXTILE printing machine testing dyes which are to be used to color fabrics.



496

274

Technical Laboratory
Sleepwater Court, N.Y. (Seymour's lab)

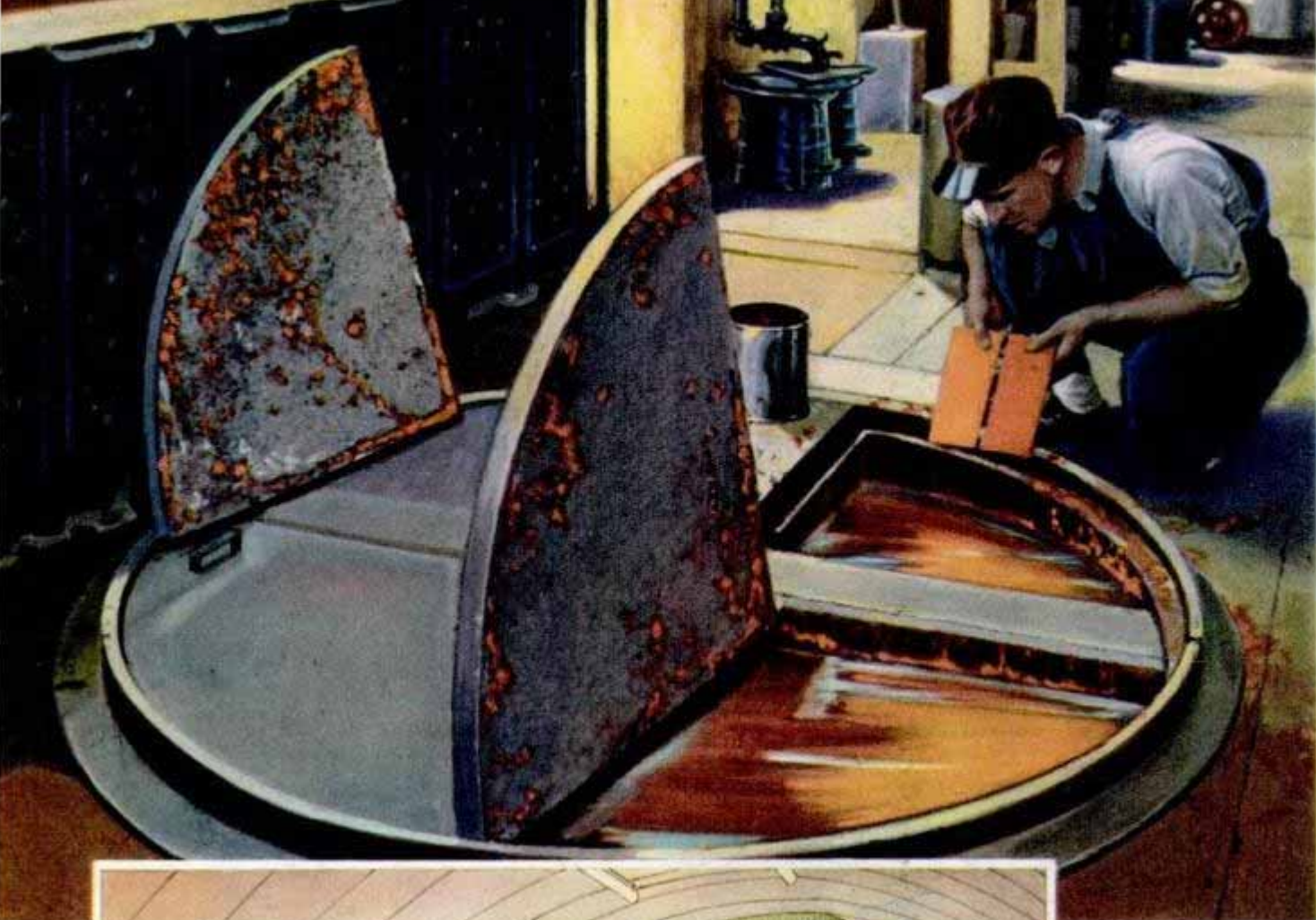

COMPARING sample of paint taken from tank, above, with standard color chart. Color today is ascending into the skies as indicated by drawing at left, showing interior of new Boeing Stratoliner arranged as a lounging room.

familiar mothball. A third is anthracene, closely related to naphthalene. There are others, but these three bases or "crudes" are the starting point for many dyes used today.

When these and other crudes are treated with acids, alkalis and other chemicals, intermediates are obtained. Intermediates are not dyes and they are not crudes. They are the bricks of the color house because, when two or more of them are combined chemically, dyes

result, the color depending on the treatments they have received.

Benzol, for example, yields a colorless intermediate, aniline, which, when treated and combined with other intermediates, yields hundreds of dyes. But finding the intermediates to use and the treatment to produce a certain color was a long and expensive process.

One German company spent twenty years and \$5,000,000 before it found how
(Continued to Page 128-A)

12-180

Electric Sunshine Floods Night Baseball Game



View from top of grandstand as 80,000 fans watch night baseball game in Cleveland's Brookside Stadium. Field is drenched with light from batteries of lamps totaling 150,000 watts, making highest fly visible

When man-made sunshine floods the baseball diamond at night, the fans flood the grandstand. Eighty thousand persons, rivaling a world's series game, crowded into Brookside Stadium in Cleveland the first night they turned on the battery of a hundred 1,500-watt floodlights that had been installed by the Westinghouse Elec-

tric and Manufacturing company. Even the highest fly can be spotted clearly against the black sky. The floodlights are mounted on eight towers—four for the outfield, two near home plate and two more off first and third base. Each light has an individual fuse, and power is distributed by seventy-five-kilovolt-ampere transformers.

12794.
Powerful Diesel Road Grader Has a Reversible Blade

Equipped with a blade which can be turned completely around for working in reverse gear, a powerful Diesel-power road grader has been produced for efficient and economical road building and maintenance work. The reversible blade feature is valuable for sub-grade work, shaping bad spots, working short stretches or where turning is difficult. A six-cylinder Diesel engine is mounted directly over the driving axle.



Here is the big road grader, at work on a typical job. The blade can be turned completely around for working in reverse gear

Caterpillar Tractor Co

H 862

Montgomery

SETTING TRAPS

George Schumacher
Chief Arson Laboratory

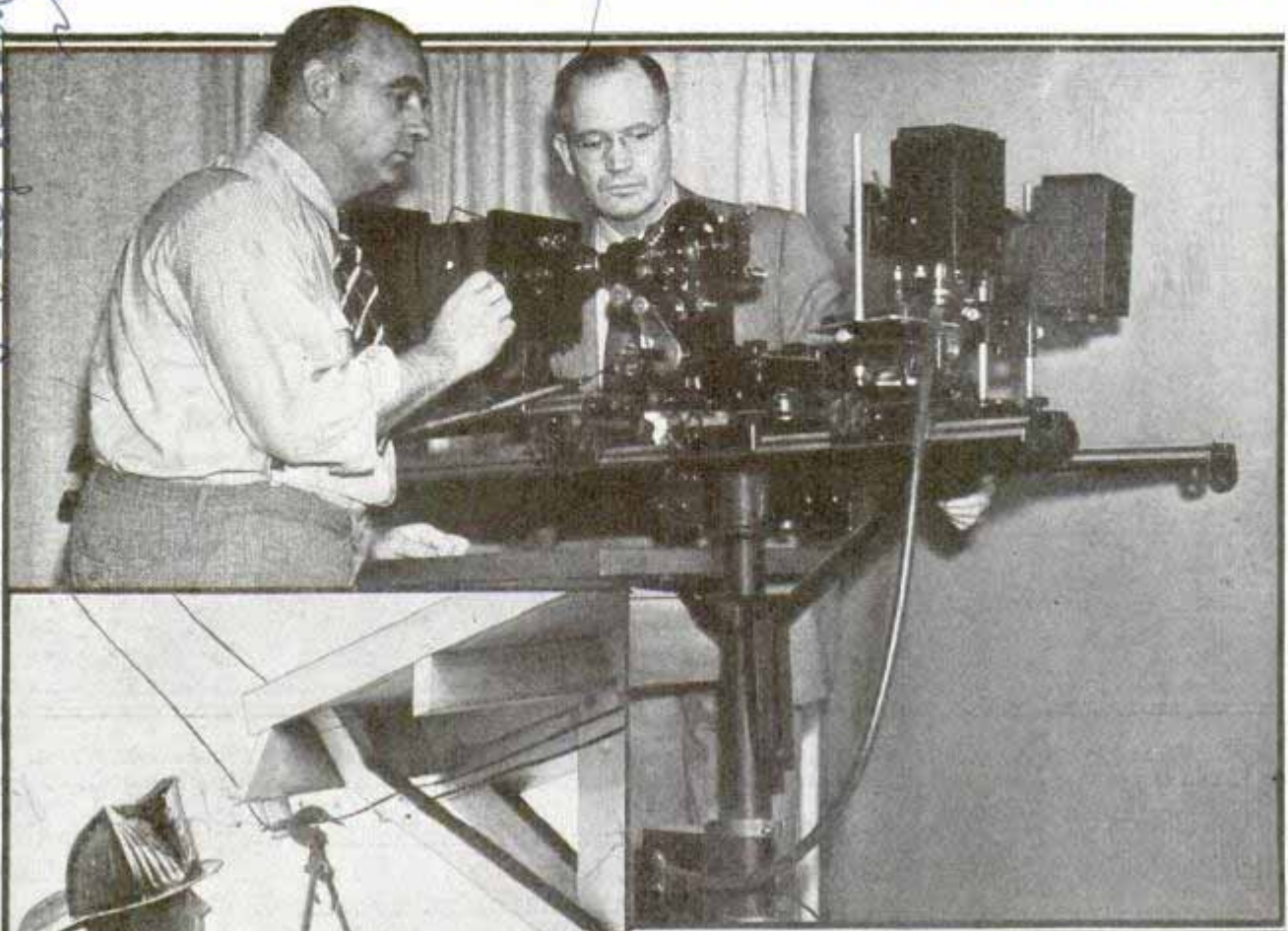

Preparing to take photomicrograph of remnant of burned fur coat to determine whether coat was valuable. Left, snipping electric wires leading to burning residence to prevent shocks to firemen inside



By Capt. Everett Harris

Chief Investigator, Arson Bureau,
Los Angeles Fire Dept.

A FEW months ago a passerby saw smoke seeping around the window cracks of a bungalow and turned in a fire alarm. There was no one home, apparently, for windows and doors were locked and the shades were down.

The firemen forced the door, expecting to find a big blaze. But there were no flames in the front rooms. In the kitchen they found a pile of papers smoldering by

the stove. A couple of squirts from a portable extinguisher put the fire out.

But there was too much smoke to have come from a pile of papers. The walls in every room were scorched. Starting at the front door and leading first to one overstuffed piece of furniture and then another, and on into the other rooms was a winding trail of cotton batting, black and charred on top and smelling of gasoline. The beds and clothing in the closets were dripping with the inflammable fluid.

It was an arson job, pure and simple. The fire bug had laid his trails, gone out, tossed a match inside, then had walked away after closing the door. But he didn't provide any ventilation. The fire had flashed into every room, consuming some of the gasoline and blistering the walls, then had died.

We figured the owner had set his house

Capt. Thomas E. Shuman, Jr.
10555 Holman Ave
Los Angeles.

217 d Hae H

H 8.62

for FIRE BUGS

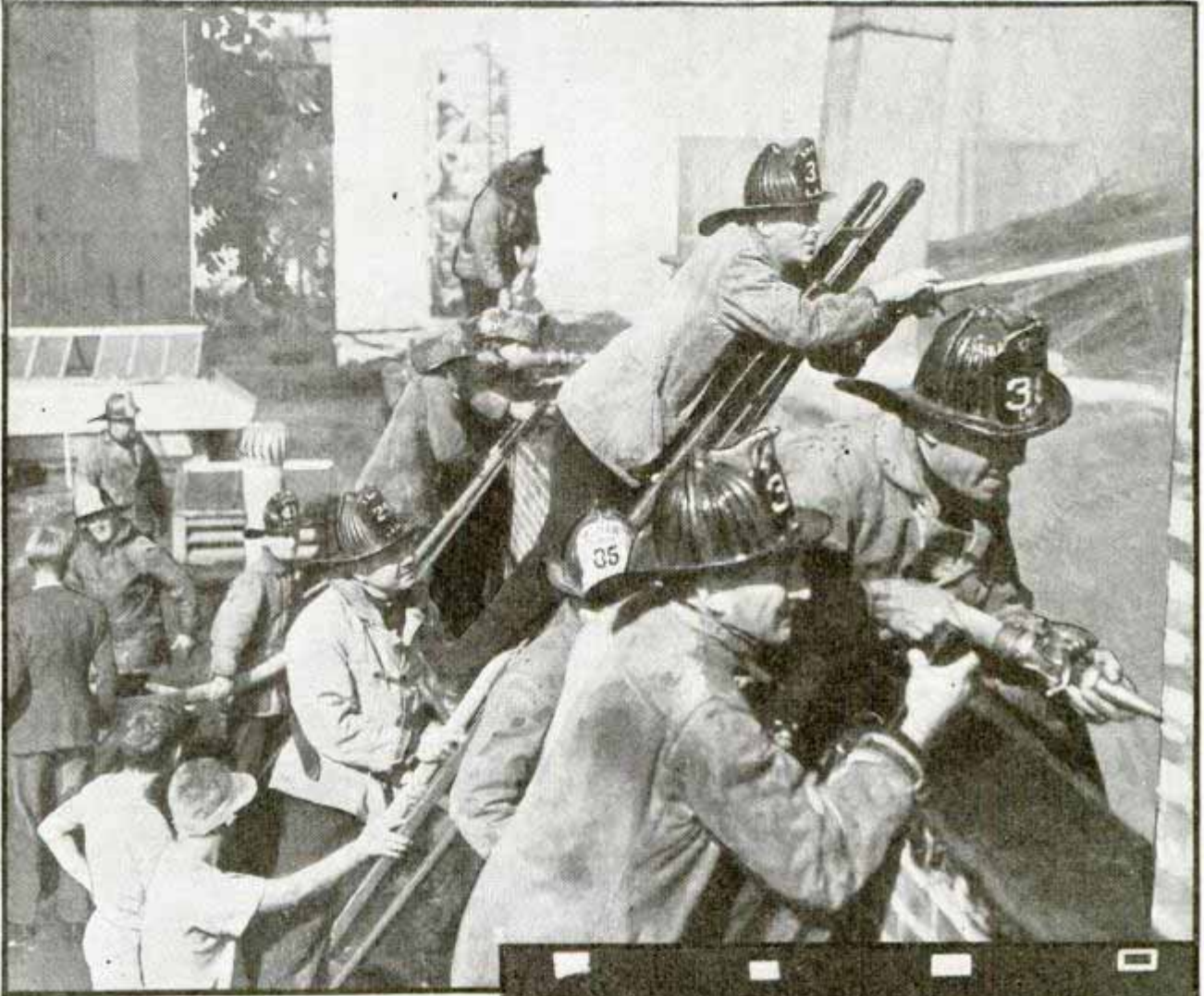

on fire to collect the insurance. But he proved he had left the house a couple of hours before in the presence of witnesses who had been inside and had seen nothing out of the ordinary. The owner and the others had gone to a ball game where he met other friends. His alibi was perfect.

But we were sure he had guilty knowledge of the fire. He must have employed a fire bug to do the job for him. Two of the arson squad investigators dropped in at the owner's store to question him further. The phone rang and the owner answered. He talked in a low tone and replied in monosyllables. The detectives figured the fire bug was on the line, so one of them grabbed the phone, tried to



Top, firemen attacking roof blaze. Bottom, arson squad members looking over pictures of suspicious fire in effort to determine how it was started

Capl. Harris

Investigator
Montgomery



disguise his voice and spoke four words, "Where are you now?" Unsuspectingly the man at the other end told him. The detective replied that he would see him in a few minutes. Then, with the owner still in custody, they went and made the arrest. From then on it was cut and dried.

This case is typical except that the fire bug forgot to open a few windows so the fire would keep burning. But we catch them even when the fire virtually destroys the building. For one thing, open windows and doors are a dead giveaway in an unoccupied house. Holes chopped in the roof or the lower floor also will be observed by the firemen. Suspicious bits of evidence added together usually tell the story.

Professional fire bugs are constantly changing their tactics in an effort to outwit the arson squads. In the old days, "torches" used clockwork to delay the start of a fire until they had gone out and established an alibi. But gears and springs don't burn and sharp-eyed fire detectives usually found them. Then the fire bugs tried candles, the fire starting after the candle had burned down to a kerosene-soaked string which led to a pile of rubbish. But that also was easy to spot, once the place where the fire started had been found and the burned surfaces examined under a microscope. Inflammable chemicals were popular for a while as a time-

delay means, but here again the fire bugs learned that it's pretty hard to burn up all the evidence.

Lately they have turned to gasoline to spread the fire. They avoid leaving any evidence of a time-delay mechanism simply by tossing a match toward one end of a gasoline trail as they leave the house.

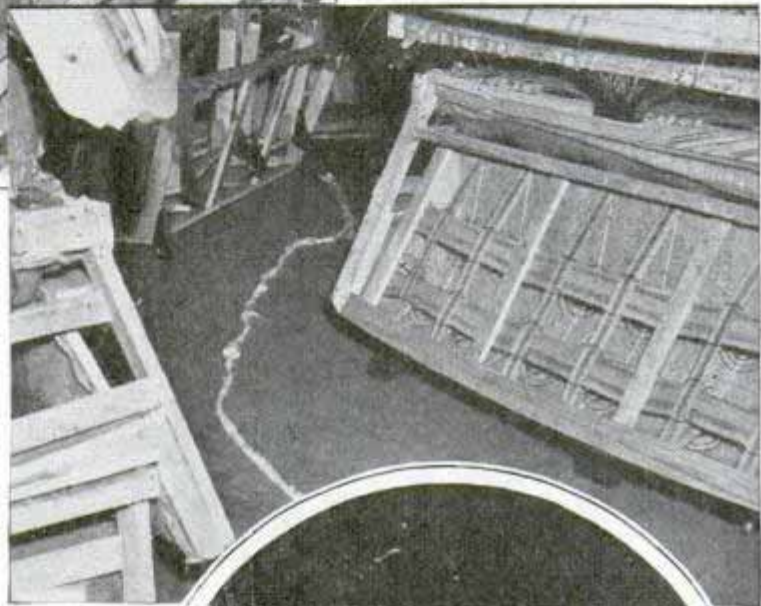

These pictures helped convict fire bugs. Top, papers attached to roof inside attic to help spread fire. Center, fire trail consisting of gasoline-soaked cotton. Bottom, photomicrograph showing how broken knife blade fits cuts in lath made by fire bug to provide ventilation

But the fire bug has trouble trying to establish a fake alibi, and there's always a chance he may be seen leaving.

One trick they tried was to fill a bladder with gasoline and suspend it from a ceiling by a string, over a pile of trash that was burning slowly. That gave the fire bug a

Handwritten notes in blue ink at the bottom of the page, including "Café! Home" and other illegible scribbles.



Top, fighting roof blaze. Right, these wooden tubs had been tied with string, instead of metal hoops, and filled with gasoline by a professional torch

few minutes to get away before the heat burst the bladder, scattering flaming gasoline over the room. The trouble was that the gasoline did too good a job, burning things so completely that there was no plausible reason for it.

Another stunt was to substitute string for the metal hoops of a wooden tub, filling the tub with gasoline, and setting up a slow-burning fire trail that led to the tub. When the fire reached the strings the tub would collapse, flooding the floor with gasoline. But everything low in the room would be burned more than the walls and the upper parts of the furniture. So such fires were easy to solve, particularly since large quantities of gasoline leave an unmistakable odor.

A while back, we had an epidemic of clothes-closet fires. Someone would explain he had struck a match to see into a dark corner of the closet, the match had

(Continued to page 142A)

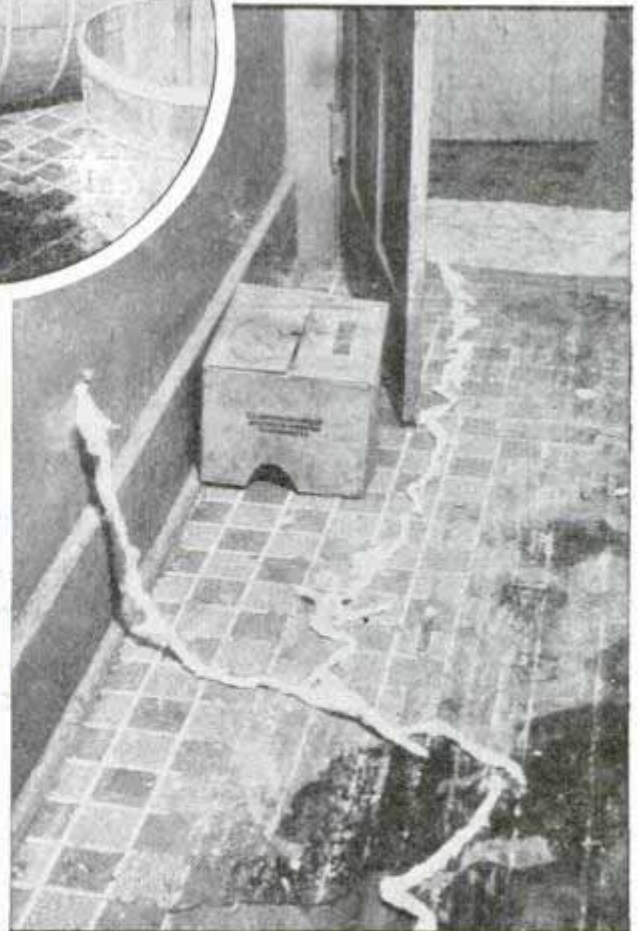
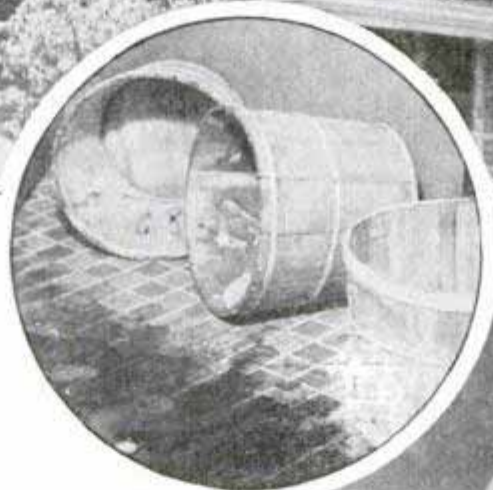

Typical fire trail of gasoline-soaked cotton batting discovered by firemen before it could be touched off by a fire bug

no. 10. 11. 12. 13. 14. 15. 16. 17. 18. 19. 20. 21. 22. 23. 24. 25. 26. 27. 28. 29. 30. 31. 32. 33. 34. 35. 36. 37. 38. 39. 40. 41. 42. 43. 44. 45. 46. 47. 48. 49. 50. 51. 52. 53. 54. 55. 56. 57. 58. 59. 60. 61. 62. 63. 64. 65. 66. 67. 68. 69. 70. 71. 72. 73. 74. 75. 76. 77. 78. 79. 80. 81. 82. 83. 84. 85. 86. 87. 88. 89. 90. 91. 92. 93. 94. 95. 96. 97. 98. 99. 100.

cont. Is. H. Gray, 1736 Es St., N.W. Washington, D.C.

Bayou 'Battleship' Fights Plant-Locked River

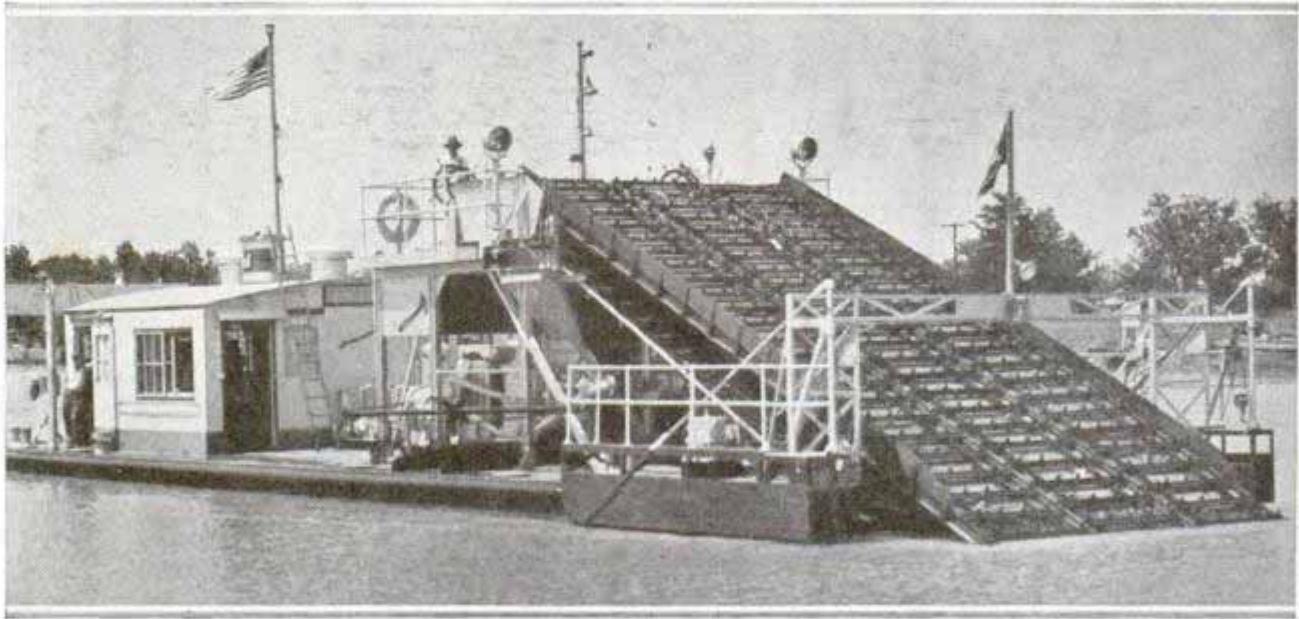

Purple water hyacinths that choke river navigation in the south climb to their death on this escalator. Caught by moving belt at front of barge, plants are carried up to be crushed between corrugated rollers

Engaged in a war to break the blockade of shipping in the rivers, bayous and coastal inlets of Louisiana and Mississippi is a unique battleship. The enemy is the gorgeous purple water hyacinth, whose luxuriant masses form floating islands that entangle ships and hinder navigation seriously. Attempts to keep the channels open by hand-removal of the flower pests or by poison sprays proved impractical; the sprays endangered human and animal life, for cattle relish the hyacinth as feed. Now the U. S. engineer corps has put to work the all-steel, self-propelled barge "Kennedy," whose bow is an endless belt of toothed conveyors. Extending two feet under the surface, this belt acts as a "water rake" gathering up all the vegetation in its path and carrying it up to a hopper where corrugated rollers crush and pulverize the plants into harmless debris. Hydraulic rams driven by a small air compressor hold these two crushing rollers against each other under twenty tons pressure. Outriggers which support a pair of swinging guides at the extreme forward corners of the barge hull steer the water plants into the conveyor, and the barge is usually pointed upstream and held stationary to let the current drive the vegetation into it. One of the crushers has a swing of six inches to let small logs pass through. A centrifugal flush pump delivers 1,100 gal-

lons of water per minute to wash the macerated debris overboard. The bayou "battleship" last year converted 2,625,000 cubic yards of hyacinth into "mincemeat."

285

Pilot Tries a Diver's Helmet on High-Altitude Flight

It worked satisfactorily under the water, so why not over the earth? So a pilot at Milwaukee put on a new diving helmet the other day and climbed into the cockpit of his plane to try it out at high altitudes. The helmet was made of spun copper, and



Putting oxygen bottle into cockpit of plane before altitude flight. Pilot is wearing a diver's helmet

Edward Weber.

oxygen was fed into it from a bottle by means of automatic valves. A telephone built into it permitted the aviator to converse during the experiment.

Wrench with Reversible Jaw Works Automatically



Featuring a reversible jaw, a new wrench operates either right or left and does not slip. It works automatically, no adjustments being necessary. The handle is made

loose so that it may be shoved to one side when working in close places. The tool is designed to handle bolts and pipe.

Scratcher Disk Removes Paint with Self-Sharpening Teeth

Heavy paint that would ordinarily fill up an abrasive disk can be removed quickly with a scratcher disk just put on the market. It has a circle of self-sharpening teeth of extremely long wearing qualities. Adapted particularly to removal of heavy paint from trucks and buses, it can be used also for scraping paint from metal signs and for cleaning the gummy insulation from inside car bodies before straightening.

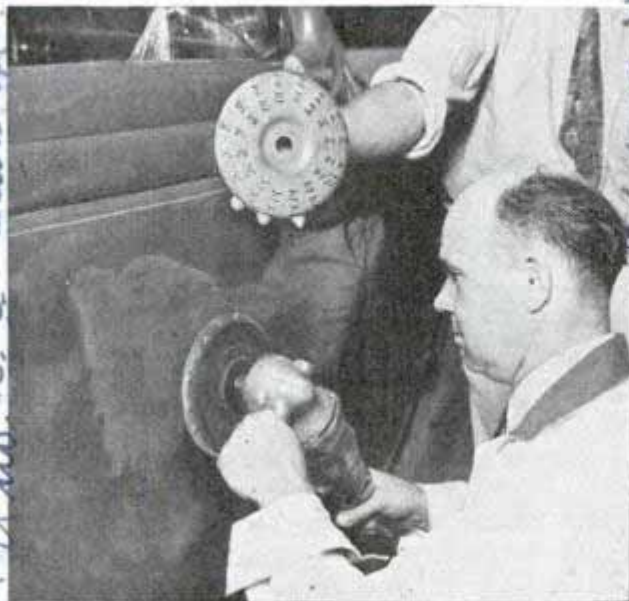

Notice teeth on abrasive disk. Operator is scratching paint from auto door without harming surface

Ocean Hunters Shoot to Kill with Compressed-Air Gun



Compressed-air submarine gun shoots a brass dart and can kill a fish at fifty feet on the ocean bottom

Hook, line and net are old-fashioned. Deep-sea hunters are using air guns now. Divers on an expedition in Puerto Rican waters have been equipped with one of these compressed-air weapons for shooting fish on the ocean floor. It fires a brass dart under 2,000 pounds pressure and can kill fish at a distance of fifty feet under water.

Alarm Clock Wears a Shutter for Protection on Trips

With a sliding shutter to cover its face, an alarm clock intended for travelers is well protected when packed in a suitcase or parked on a dresser in trailer, train or boat. One key winds a single spring operating both time and alarm, and the red alarm hand follows the same numeral track as the hour and minute hands.



Western States Mfg Co. Times City

Westclox General Time

Blvd. A. is aware!
we the I. have writ New
Stam. C. & Shunkalo

John D. Craig
Writen John D. Craig
Hook, line and net are old-fashioned.
Deep-sea hunters are using air guns now.
Divers on an expedition in Puerto Rican waters have been equipped with one of these compressed-air weapons for shooting fish on the ocean floor.
It fires a brass dart under 2,000 pounds pressure and can kill fish at a distance of fifty feet under water.
8 3.95

Chief Engineer
Wind Tests on Model Autos Show Design Efficiency



Scale model of car is suspended upside down in wind tunnel to test operating efficiency of body lines

Plymouth Roadking
Just as aviation tests its planes in miniature form in wind tunnels before they are built, the automobile industry is turning to the wind tunnel to determine operating efficiency of the latest model cars. The exact-scale midget autos are installed upside down in the tunnel, just as are the planes, and winds of various velocities are created by powerful blowers. The tests show the efficiency of the car's body design, whether it is resistant to wind and to what degree.

1834
Anti-Skid Flange for Rural Auto Is Attached to Tire Chain



Icy roads meant nothing but trouble for a rural mail carrier at Belvidere, Ill., until he devised a scheme to make his car skidproof. He installed extra flanges, attaching them to the tire

chains in such a way that the automobile could not sideslip on the glassiest ice of a high-crowned country road, nor would it skid with the brakes applied hard while turning a corner. The nonskid flanges were rolled out of one-inch flat stock and brazed to a one-inch back. Now the mail always goes through regardless of winter highway conditions.

H 781
Generator for Bicycle Lamps Mounts Under the Saddle

Designed with a remote-drive feature that makes possible its mounting on the frame under the saddle, a new bicycle lamp generator yields a steady five volts at all speeds. Attached under the saddle, it is powered from the rear tire. The generator also may be mounted on the front of the bike or in the tool and battery case



Bicycle lamp generator with remote drive can be mounted to take power from front or rear wheel

with which many bicycles are equipped. Another feature is automatic lighting, enabling the rider to have light at all times, even when standing still. The generator lights both front and rear lamps.

W. E. Lincoln
Belvidere, Ill.
Chrysler Corp
34 Massachusetts
Dr
Belvidere, Ill.

Harold H. Nichols
engineer

Sheppard Wastes
No. 7, article, 1/22/35
make
to
1935
1935
1935

44.95 - 45.50

11 699

Color Photo Projected for Backdrop of Stage

Photographs taken in natural colors replace the usual painted scenery as backdrops for stage sets in a community playhouse at Pasadena, Calif. In one play which required forty-seven different scenes, the tremendous expense of preparing the traditional scenery was avoided by building miniatures, photographing them and then projecting the transparent color pictures on a white backdrop screen. The projector is concealed above the stage, casting the picture down at a sharp angle to allow the

Edward Sheffield

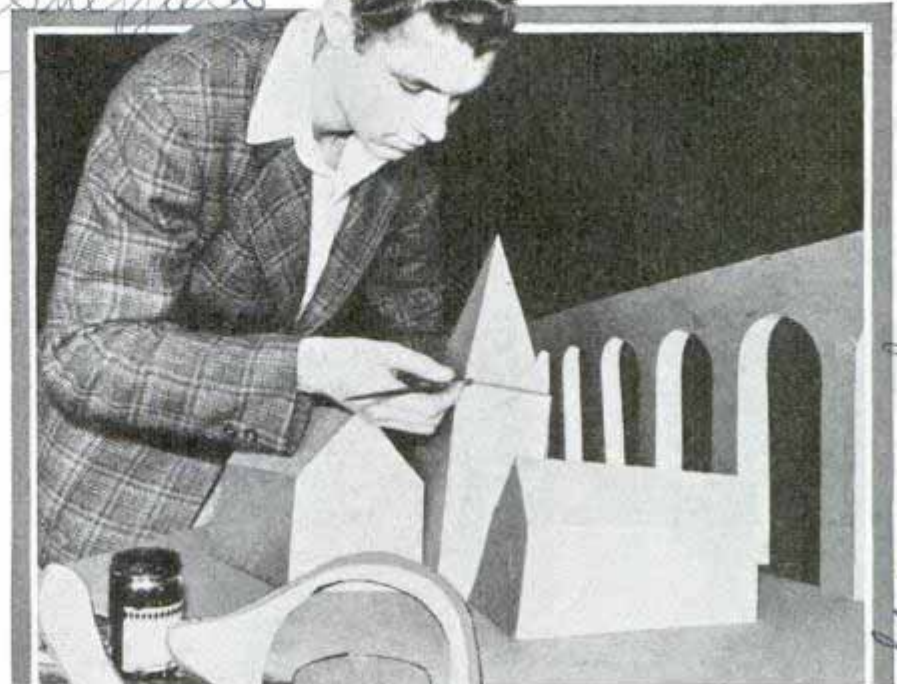

Above, building models to be photographed; below, method of projecting scene on backdrop of stage

actors full use of the stage without interfering with the beam. This entails a forcing of perspective in making the pictures. Buildings are constructed in miniature with broad bases and slanting walls so that they appear in natural perspective when projected down against the backdrop. A squat tree with wide base becomes tall and willowy when thrown on the curtain. The miniatures are usually small cardboard models, hand-painted in the colors desired.

Apples Milled into Baking Flour Produce Tasty Bread

Bread baked from apple flour is a tasty innovation in Seattle. Each one and one-half pound white loaf contains the equivalent of a large apple. The milling of apples into flour was made possible by a vacuum dehydration process which reduces the moisture content to about one per cent; the

flour is then added to other dry ingredients used in the bread mix, including a proportion of wheat flour. Due to the presence of apple pectin, apple bread does not dry out like ordinary wheat breads and so can be used to the last slice. A ton of apple flour calls for fifteen tons of apples.

Pomona Products Co., Selah, Wash.

Thomas & Stinson, Jr. 10555 Holman Ave. Los Angeles, Calif.

The Appella Corp.

A 843

Cont. Alexander Maxwell,
720 Sherman Ave.
Evansville, Ind.

STEEL CARVES

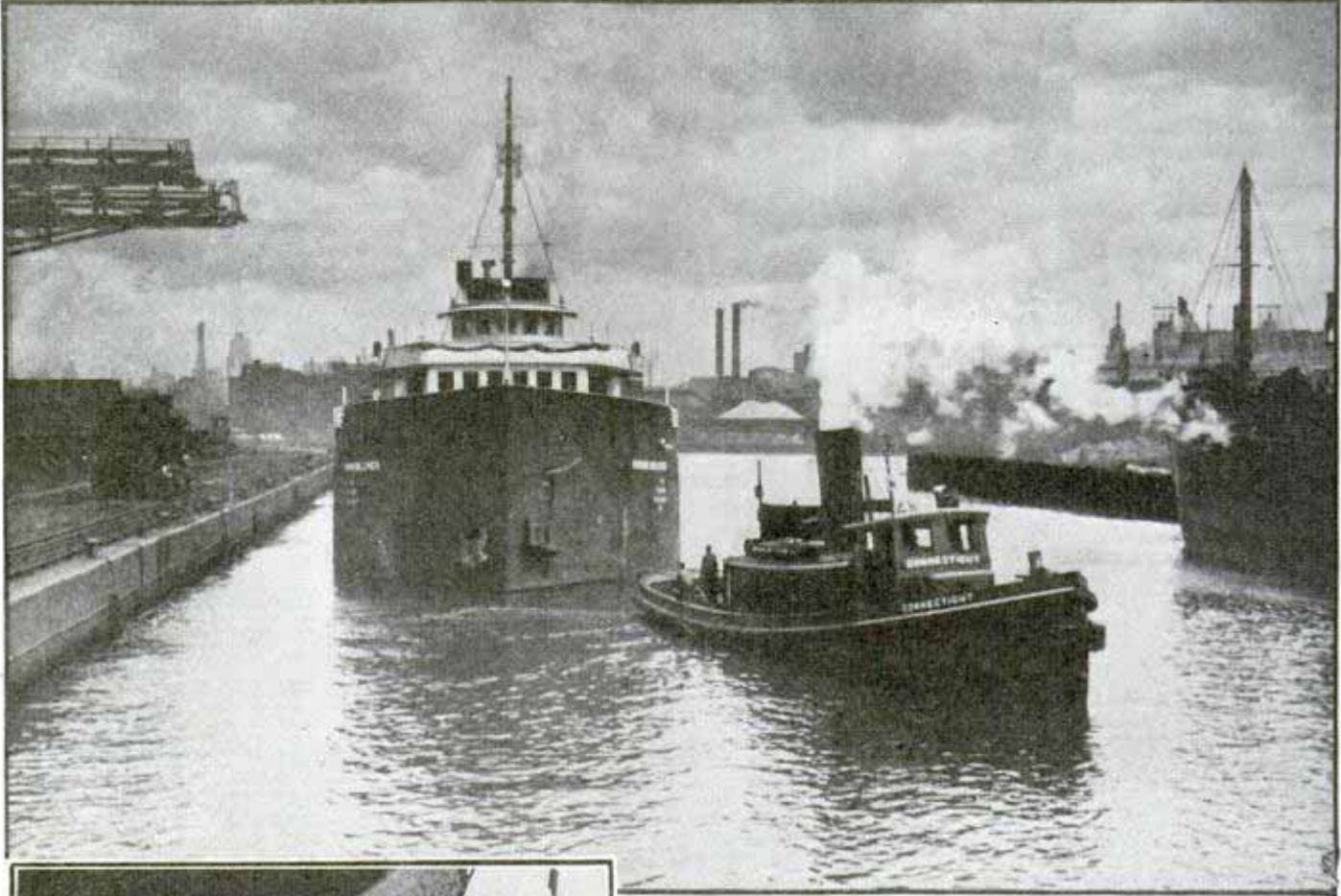

PEOPLE on vacation along the shores of the Great Lakes usually are mystified by the long, lean steamers crawling along the purple horizon. They go their way, quietly, efficiently, bothering nobody. Because they mind their own business and shun the haunts of vacationland very little is heard of them.

But whether you live in the "Corn Belt" or in South Africa, those boats play an important part in your life. The car you drive was once iron ore. It was carried by boat from the Minnesota mines down to the steel mills of Chicago, Detroit or Lake Erie. Quite likely the finished car took a ride on a lake freighter before being delivered to you.

Nearly all American steel is made from Minnesota iron ore. Wherever civilization penetrates, American steel follows in the form of farm machinery, railroads, hardware, fence wire, munitions and even kerosene cans. There is hardly a man in the entire world who has not come in contact with American steel in some form or

The rudder of this lake freighter is twenty feet high and ten feet wide. Top tug assisting a lake freighter up the Cuyahoga river at Cleveland.

Frank Bellinger

4843

a WATERWAY

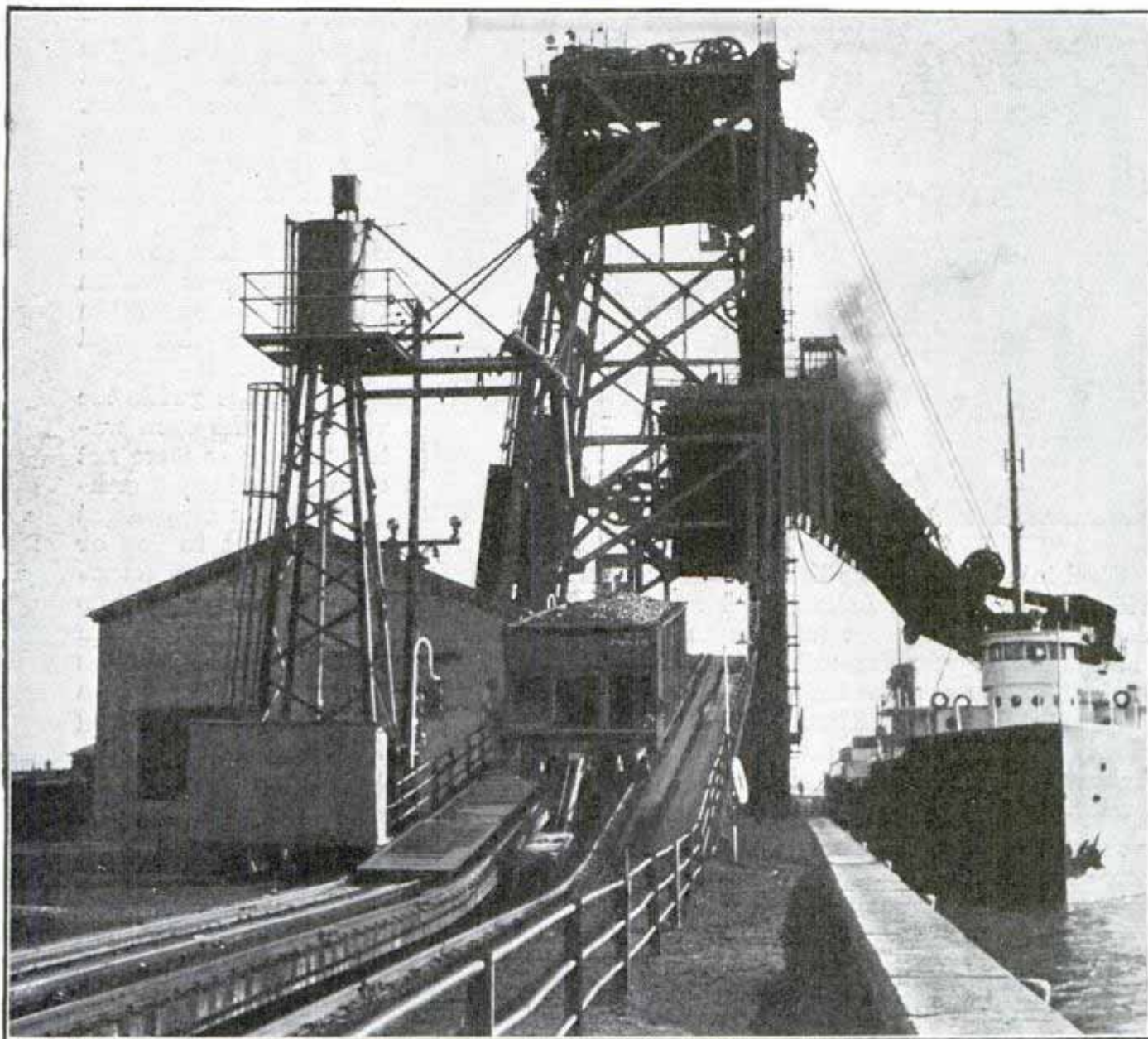

Coal being loaded aboard a freighter, a carload at a time. The entire gondola is hoisted and tipped, the coal pouring down a chute into the hold of the vessel

Martin Muller Brownhoist loader

other, and ninety per cent of it has been carried in the long, silent lake freighters.

American and Canadian grain feeds the world. Wheat, oats and corn come by rail to Chicago, Milwaukee or Fort William, Canada, to be loaded on boats and sent to the mills or shipped abroad. Wherever people need bread, American grain goes, and it makes part of the trip in a lake freighter.

There is no coal in the northwest, so the boats that carry down grain and iron ore bring back coal. The tonnage carried annually on the Great Lakes would stagger

the imagination, yet it is done so quietly nobody even notices. It was not always this way. Fifty years ago a trip the length of the lakes was a major adventure. Bleaching ribs and battered hulks studded the shore lines. The lakes, deep, cold and stormy were connected by narrow, winding rivers, full of sharp rocks and sandbars. Niagara Falls isolated Lake Ontario and the St. Marys Falls kept ships out of Lake Superior. The only open water route was between Port Huron and Chicago, and one-third of this was through island studded channels.

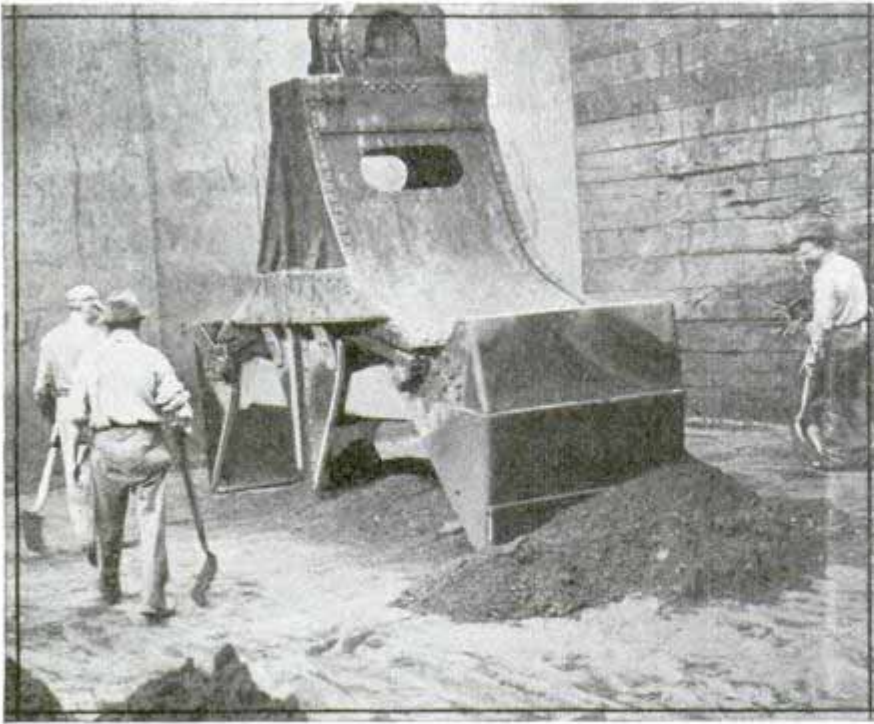

Steel interests on Lake Erie looked enviously at the virgin Lake Superior iron deposits. It would cost millions to get them, but progress demanded more and better iron. Canada, the United States and private interests worked hand in hand and slowly but surely the treacherous Great Lakes were converted into the safest and busiest waterway in the world. The Soo Canal, started as a private enterprise, was taken over by the government, enlarged and improved until it can handle four giant steamers at once.

The rock-bottomed St. Marys river was chipped and blasted into a channel twenty-six feet deep. In one place, a brand new channel was cut through dry land to make two traffic lanes, one up and one down. Sandy Lake, St. Clair and the connecting rivers were dredged. Below Detroit another channel was cut through a swamp, making a double traffic circuit. Today more than 200 of the 850 miles between Duluth and Buffalo is through channels with banks of stone, concrete or piling.

The waters leading to the channels are marked by buoys. A skipper looks for buoy number one, then for number two, and so on until he gets into the channel. The buoys are lighted at night and some have bells and whistles for foggy weather. In the winding channels the captain steers by rifle-sight methods. Lights on the bank are so arranged that as long as he is on

his course two are visible, one above and behind the other. The boat is steered toward these until two more lights are seen around a bend, then the first pair is forgotten. By day these lights appear as twin targets, white with identifying black markings. Each pair is slightly different, so if the captain forgets which ones he has passed, a glance at his chart will remind him.

Lighthouses guide the vessels on the open water, but these were not enough and radio compass stations supplement them. Thus in fog or

when the light is below the horizon, a vessel still can find its position. The radio compass transmitters are grouped in threes, because it requires three readings to establish a bearing. Each group has a different wave length. Any vessel desiring a position tunes in a group of three stations, notes the angle of each in turn, marks these on the chart and where the three lines cross is the spot the vessel is



Unloading iron ore with the aid of clamshell unloaders such as the one shown at top of page

U. S. Kerr, Lorain, Ohio

located. This method of radio direction finding is quick and very accurate.

The lake vessels are large. The deck of an average ore carrier is higher than a three-story building, the roof of the pilot house towers another three stories and the boat is as long as a city block. Lake boats are highly specialized and their appearance is disturbing to one used to pictures of ocean liners. They are designed for just one purpose, to carry as much ore as possible. Supplementing this are the factors of meeting the prevailing weather, and navigating the numerous channels with speed and safety.

In spite of the extreme length, they are as responsive to the wheel as a good automobile. It is possible to steer a freighter through a channel where the sides clear the banks by a matter of inches and not scrape off any paint. This must be done at least once each trip, for all the docks on Lake Erie and most of those on Lake Michigan are several miles up narrow, winding rivers. Tugs are used on the worst of these, but many of the smaller ports have no tugs and the ship must get in as best it can. They always get in. And not only that, they get out again. Many a salt-water sailor has groaned in agony as he saw a lake boat courting what he considered positive disaster, then slipping through with ease when all appeared lost.

(Continued to page 138A)

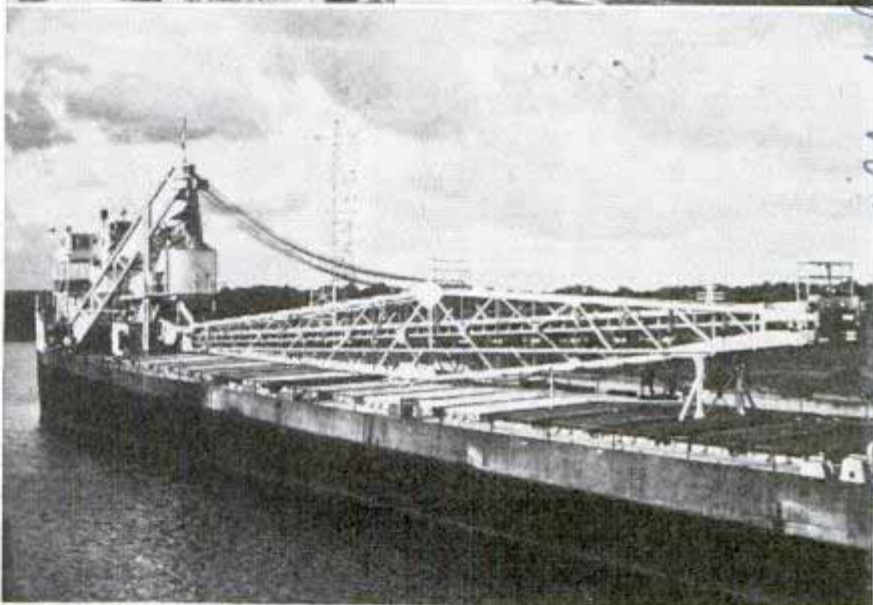

Top, deckhands of a docking lake freighter being sent ashore on the landing pole while the ship is still twenty feet out in the channel. Center, the chromium boom of a self-unloader. Bottom, seagoing post office at Detroit transferring mail to a lake freighter with the aid of a bucket on a rope

J. F. S. Schellkopf Jr.

Sea Life Made Visible in Tanks with Portholes



Left, crowd looks on sea life from rim of Florida marine gallery. Below, view through underwater porthole as diver ventures into tank where porpoise, turtle, and other creatures live in natural surroundings



Two large tanks equipped with portholes are being used to reveal the wonders of the sea to the public. Visitors watch colorful and strange creatures of the sea from above the tanks or through the portholes, of which there are 207. The tanks, housed in a brick and steel structure located in Florida, contain a wide variety of marine creatures. A large porpoise and its baby, a 300-pound turtle, sharks and fish of all kinds are housed in the tanks, living together as they would in the open sea.

Acme
Archimede

Fifteen Riders Thrill Crowd by Stunting on Three Bikes



Chicago's motorcycle police ride five-passenger motor bikes—but only for stunt riding. At a recent spectacular demonstration by police and firemen, a team of fifteen riders climbed aboard three motorcycles and, linked abreast, swept across the arena. Three were in the saddles; three more, heads dangling down in front of the wheel, rode backwards on the fenders; nine others rode standing in two rows linking the motorcycles together.

Count them—three drivers and twelve passengers perched precariously on three motorcycles, one of the thrilling stunts at a Chicago police show

14808.

Capt. Ashley C. Mc Kinley

40 Babylon Seaplane

Base, Babylon, L.I.

Seaplane Floats on Rubber-Balloon Pontoons

Seaplanes are wearing rubber shoes. In place of the metal or wooden pontoons, a former army air officer has developed rubber balloons which, inflated to a low pressure, act as shock absorbers in taking off and alighting and thus eliminate the jolts transmitted throughout the plane when the former type of rigid floats struck the water. The rubber pontoons are impervious to corrosion and act as their own bumpers when they collide with buoys and driftwood.



Above, pumping up rubber pontoons. At left, the floats are inflated and ready for takeoff



Each pontoon is divided into five compartments with separate valves, and is inflated to three pounds pressure per square inch; along the sides are rubber tube "spray" strips, slightly inflated, which flatten out as the ship gains speed, and aid in the takeoff.

H. 892.

Earth's Crust Tested by Blasts Recorded on Seismograph

Is this world made like an onion, its crust consisting of concentric layers of rock? Scientists are putting that theory to test by setting off explosives to induce artificial earthquakes, and recording those tiny tremors on supersensitive seismographs. Twelve of these portable instruments are stationed at intervals within 100 miles of the site of the blasts, and from the read-

ings at the various posts the scientists hope to derive information on the nature of rock formations twenty miles deep in the earth's shell. Each recording station also has a radio set and the time lag between the actual blast, as received by radio, and the recording of the shock by the seismograph can be determined. An earth movement of 1/100,000 inch can be detected.

Scientific Monthly Aug 1938

Andrew Talbain 3741-83rd St. New York
 Jackson Heights

Psychological Society of America
 3419 W. 107th Street, New York

Police Use Shield and Armor Like a Medieval Knight



Paris policeman girds himself for battle in bullet-resistant chest protector, headguard and shield

Breastplate and shield reminiscent of the armor worn by knights in the middle ages are carried by policemen of the Paris gas squad for protection in gun battles with desperate criminals. The bullet-resistant chest guard is hung from a strap around the neck. The left hand holds a rectangular metal shield, and a head shield fends off bullets from the upper part of the face and skull.

Sawdust Practical as Fuel for Heating Homes

Sawdust is being used in heating more than 15,000 homes, offices, theaters and other buildings in British Columbia. In cooperation with combustion engineers, the forest products laboratories of the Canadian department of mines and resources have devised methods of using sawdust as fuel and for storing it safely. As a fuel, sawdust is clean, cheap, very low in ash content and light in weight. It burns freely, requires little attention and makes a fire that is easily controlled. The sawdust requires an auxiliary grate, but special furnaces are unnecessary. The grate is de-

signed so that it may be attached to any standard heating unit. The fuel is fed as required by gravity from a storage hopper placed above the grate. The hopper is filled two or three times a day. Formerly regarded as unavoidable waste, sawdust soon may be returning to mill owners of the United States and Canada thousands of dollars for a product once sent to refuse burners. The quantity of sawdust produced annually in Canada is estimated to be sufficient to cover fifteen to twenty city blocks to a depth of 100 feet.

Moistureproof Metal Finder Hunts Sunken Treasure

Unaffected by moisture, a metal locator invented by a Miami man hunts treasure in sunken ships or plumbing pipes under the earth. It was used recently to find several hundred buried relics of Indians in southern Florida. It is adapted, too, to practical uses by surveyors and electricians. When seeking submarine metal, the circular locator is let down with a cable. As it approaches the metal, a recording is made on a meter box aboard the boat.



Dropping the metal locator from stern of power boat, the operator watches record made on meter box

*Civil. George J. Paul
537
Chicago*

*Canadian Dept. of
Mines and Resources
see material here*

Headed in sub address

see 1940-157a

File - Lumber

*Headed Metal
Locators. see
10230 (11) Secura*

180 N. Michigan Chicago
Cotton Picker Does Job of Seventy-Five Men

Thrusting its barbed, rotating fingers into the heart of the cotton plant and drawing out the ripe cotton, a mechanical picker introduced by a leading farm implement company this year can do the work of seventy-five average hand pickers. Attached to a standard type farm tractor, this single-row harvester has two vertical and parallel revolving cylinders between which the cotton plants pass. From each cylinder protrude 154 spindles

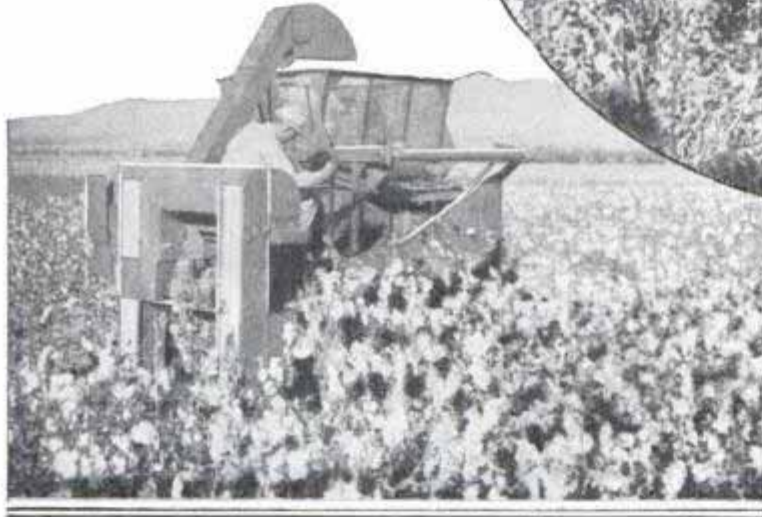

Picker at top deposits cotton in bags; left, basket collects cotton from conveyor. Below, another view of spindle-type harvester attached to standard farm tractor

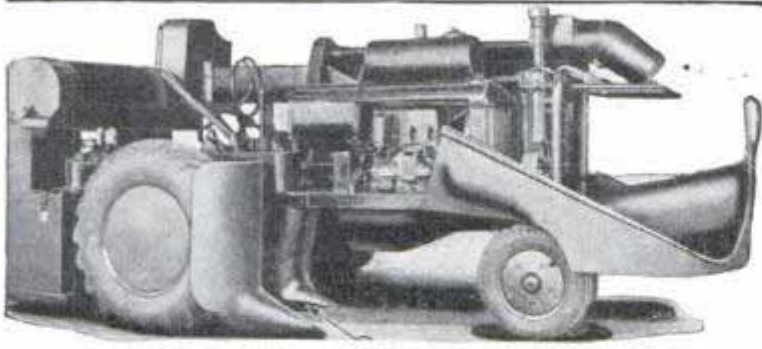

machine. Traveling at two and one-half miles an hour, the picker covers one-half to three-quarters of an acre in an hour. The amount harvested depends on yield per acre, but assuming a yield of one bale per acre it picks an average of 1,500 pounds of seed cotton in an hour and twenty minutes, which when ginned makes a standard 500-pound bale. The manufacturer points out that the machine results from more than thirty years of development, and

which remove practically all the cotton from the stalks without doing serious damage to the plants or immature bolls. Each spindle has many tiny needles or barbs to catch the lint, and as the revolving drums carry the spindles around, the cotton is removed by doffers rotating at a higher speed than the spindles; then the cotton falls on a conveyor belt and is carried to an overhead basket or bags on the front of the

that refinements are still being made. While the rising cost of hand-picking and increasing scarcity of field labor are expected to stimulate the demand for mechanical pickers, introduction of these machines will be gradual over a long period before they affect the labor situation. Numerous cotton-picking machines have been patented since 1850, yet cotton still is the least mechanized division of agriculture.

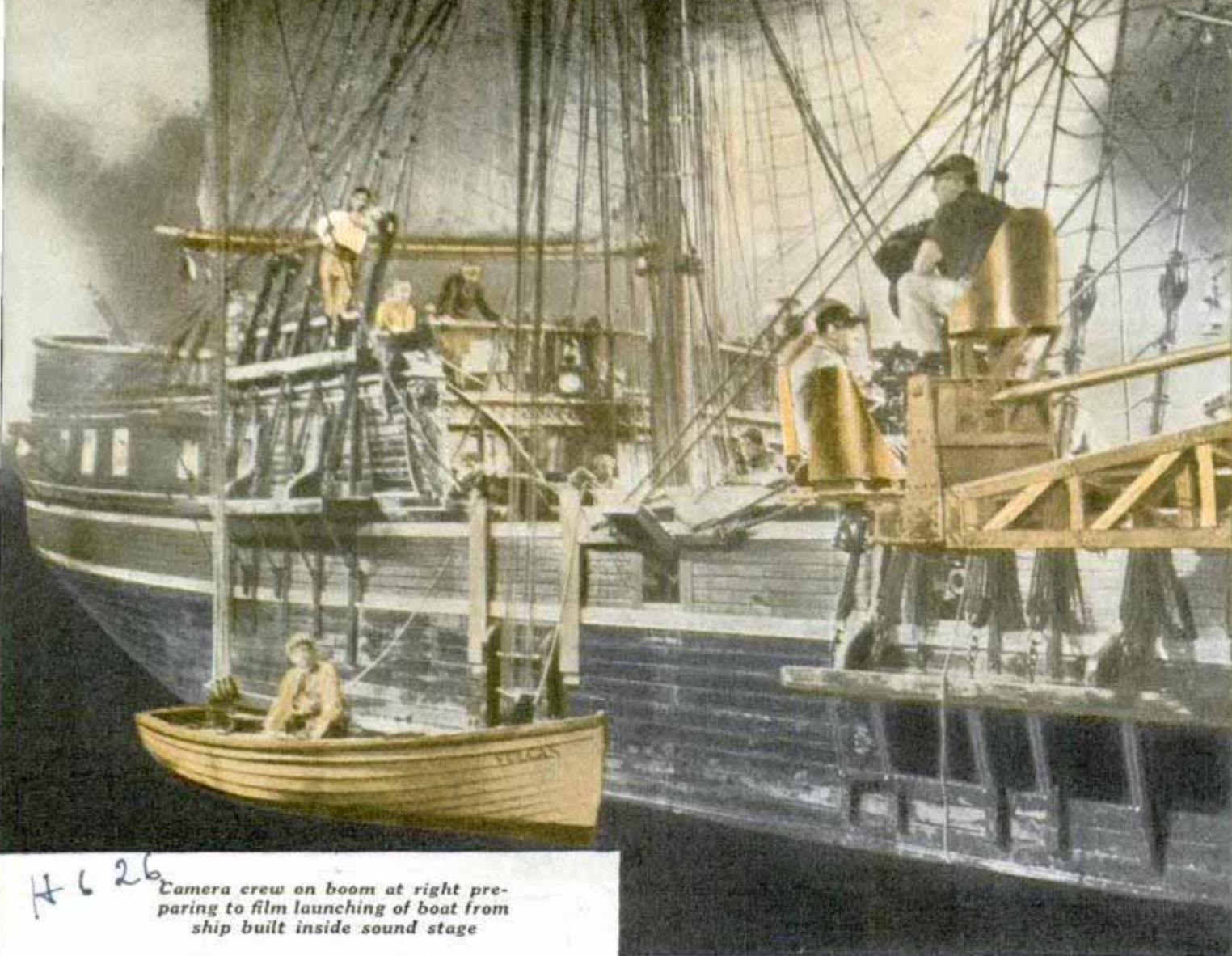

H 6 26
 Camera crew on boom at right preparing to film launching of boat from ship built inside sound stage

MILLIONS *for* MOVIE

Los Angeles

THERE is upward of one million dollars waiting for you in Hollywood if you can find a satisfactory way of projecting motion pictures in three dimensions. There's another million for some device which will create a universal focus for a camera. Possibly you could drive an even better bargain.

But before you start, remember that the best brains in the industry have been struggling with the ideas for years and nothing worth-while has been found. Hundreds of letters come to the studios, containing both shrewd suggestions and fantastic ideas, and still the search goes on. Scores of patents have been issued on both subjects and yet nothing good enough seems to have turned up.

Motion pictures seem almost perfect when compared to the pictures of twenty

By Frank Lloyd

Paramount Producer-Director

54 51 Marathon

or even five years ago, but there is still room for improvement. To mention only a few things, we would like to achieve a more even gradation of light across the screen. We would like to improve the steadiness of the image on the screen. Eliminating side-seat distortion would be a great advance, and a lot remains to be done in obtaining perspective in sound.

The goal of the sound technicians is the "delay" idea. They want you to hear sounds exactly as you would have heard them had you been present when the original sounds were made, the only difference being the delay in releasing them until you decide to listen. Such an improvement may come next year, in ten years, or possibly never.

Color is still so new we are looking for many improvements. Some will enhance

"Blimp" which prevents camera noises from being recorded by sound mechanism. Below, examining the weaving lines on a "wax disk," representing sound in one stage of transformation from speech to film

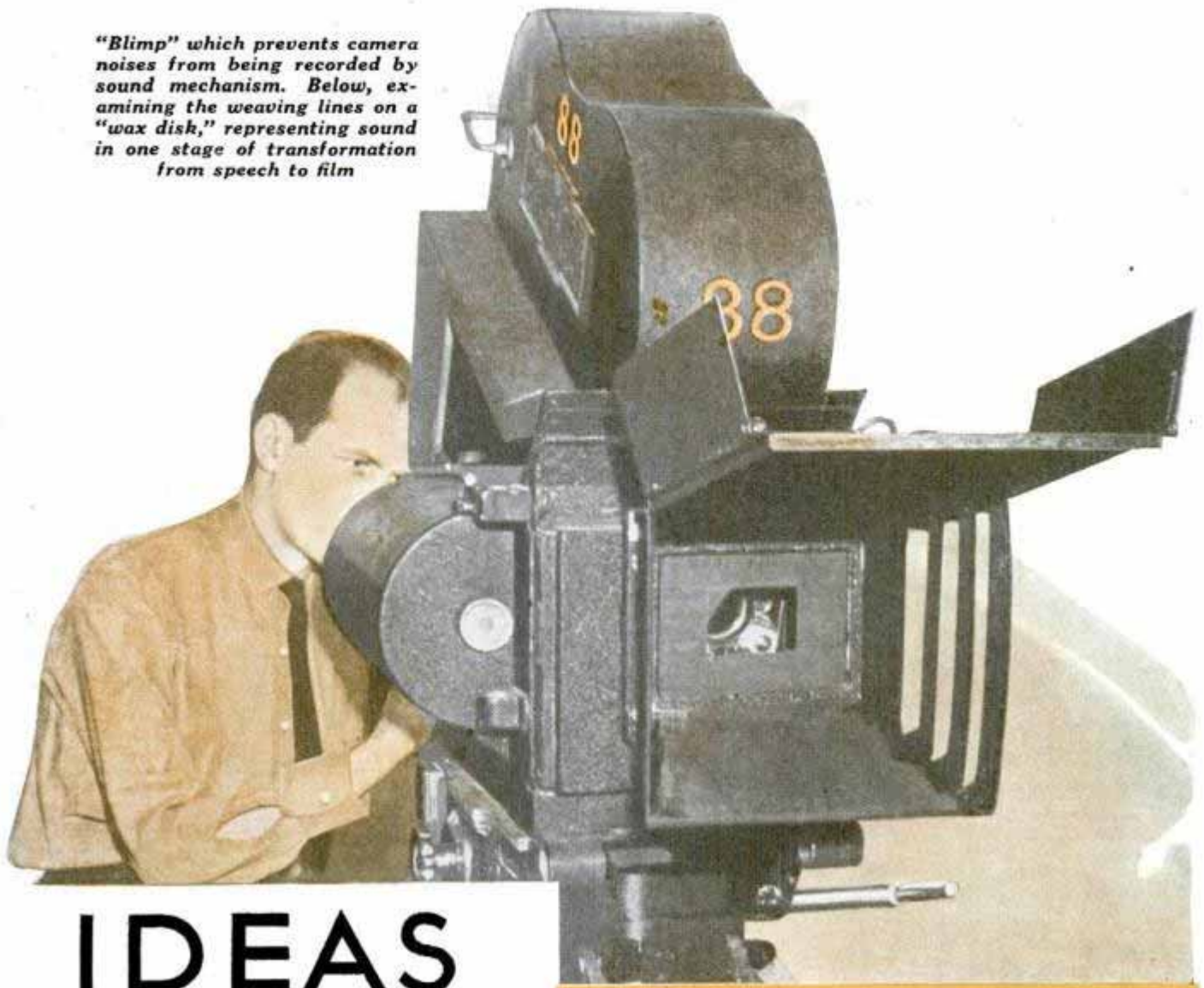

IDEAS

the quality of color on the screen and some will never be apparent to an audience, but will be important because they will make color easier to handle in the studio. At present color is expensive and demands special lights, special film, and special training by everyone who handles it.

Continuous improvement in technique and equipment has been the history of motion pictures. Some who helped develop the art have become famous. The point is that progress never stops and many more improvements are going to be made. The door of opportunity is still open.

Of course, improvements such as increasing the quality of sound usually result from adding togeth-



14626



emulsion manufacture ... and has provided a tool to obtain, under adverse conditions, high quality photographic results heretofore impossible."

Eleven awards were made for outstanding technical achievements in the industry last year, including awards for a new design of film drive mechanism, a semi-automatic follow focus device and its application to cameras, and for a multi-plane camera that tends to create an illusion of depth in color cartoons.

Another award was given "for the exceptional application of acoustic principles to the sound-proofing of gasoline generators and water pumps."

er many minor improvements instead of being achieved by one revolutionary invention. Usually, too, a technical achievement results from a group of men working together over a common problem. But sometimes credit must go to one man alone. It's also true that most improvements in movie-making are suggested by people already working in the studios because they understand best just what the problems are. But the industry owes a debt to scores of people who have never seen Hollywood. Workers in film laboratories and telephone laboratories have played their part in the technical development, contributing improvements both to film and sound.

Here are some recent improvements judged outstanding enough to receive special awards by the Academy of Motion Picture Arts and Sciences. Heading the list is an award to a film manufacturing company for the development of new ultra-speed films. The award statement says in part: "The development of these two films represents a major achievement in research and

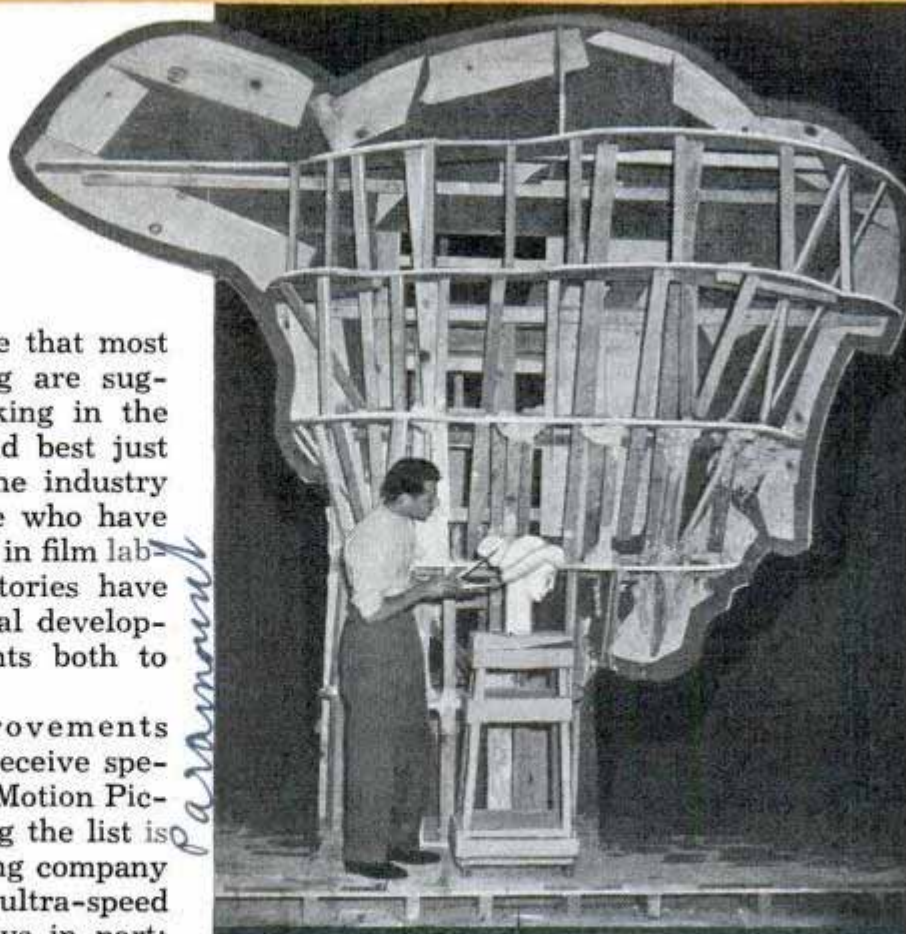

Building woman's head from model in studio plaster shop. Top, adjusting camera's electric motor drive in the studio camera repair shop

This might seem to have little to do with making better pictures. But it is noteworthy because now such units as generators can be operated close to the microphone without creating noises and that's important in sound pictures. Even an improvement to a sound boom or a better way of loading film may be important.

In the past, awards have been made for a multi-cellular high-frequency horn and receiver, for the production of infrared films,

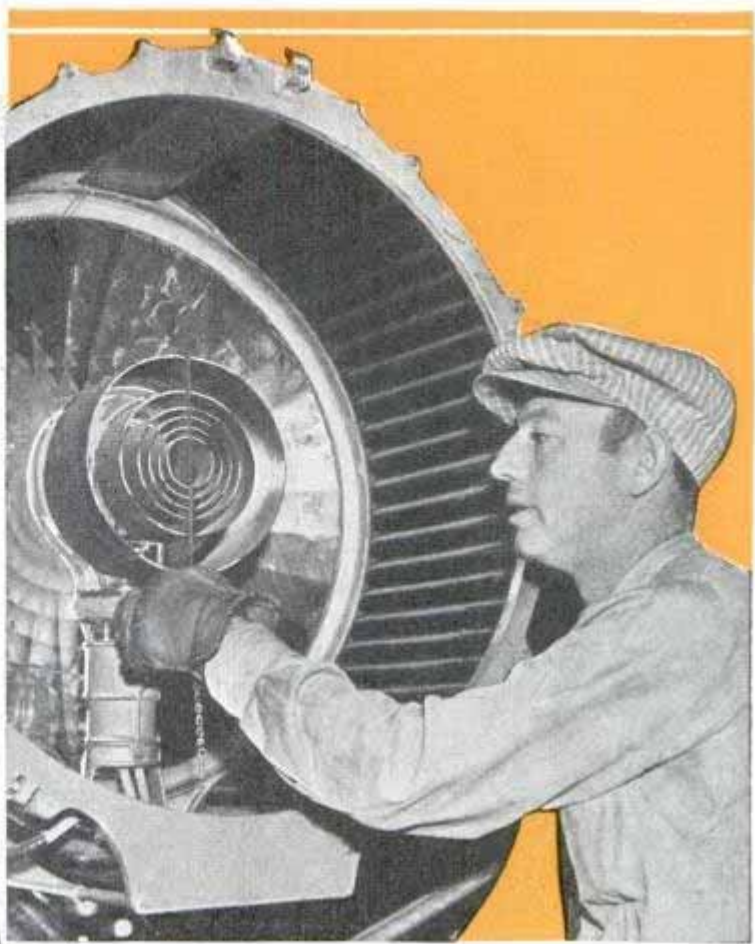

Setting focusing vanes, top, in one of sun arcs used in making colored movies. Left, plaster sculptor working on large hand for movie set. Below, "playback" machine with which sound tracks on film are dubbed together

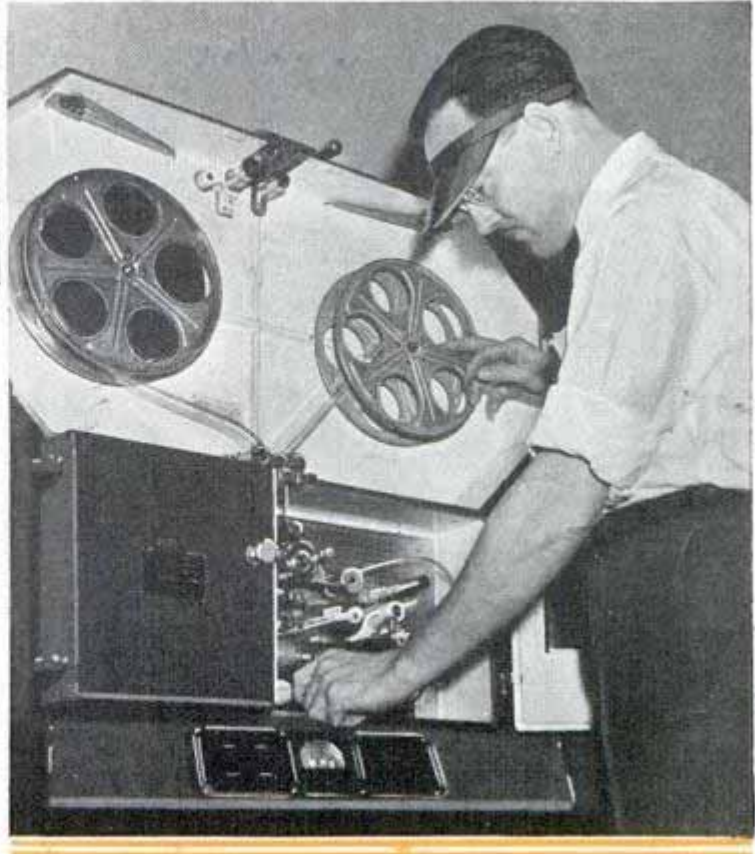

for the development of a quiet wind machine, for improved spotlights, an air-turbine developing machine, and for recording sound with ultraviolet light.

Such developments, few of which are ever heard about, are occurring all the time. It is estimated that the studios this year are going to turn out pictures for \$6,000,000 less than last year because of better use of process-background and trick-photogra-

(Continued to page 116A)

Science Service
6/24/38

Ship Monument Marks Site Where Swedes Landed



Monument in Delaware park commemorates establishment of Fort Christina by Swedish colonists

Surmounted by a sculptured sailing ship, a monument dedicated recently in Fort Christina (Delaware) State Park marks the spot where Swedish colonists landed to establish their first settlement in America, three hundred years ago. The crown prince and princess of Sweden came to this country to participate in the tercentenary ceremonies of Fort Christina.

Energy Source to Replace Coal May Be Learned from Stars

Long before our coal and other power sources have dwindled away, man may learn new sources of energy from the sun and stars. Dr. Arthur H. Compton, Nobel prize physicist, believes science will some day find the secret of what keeps stars bright and productive of heat. For a billion years the sun has poured radiant heat on the earth at about the same rate. Chem-

ical energy such as coal burning in oxygen could not have supplied this power for more than 1,000 years before the sun would cool. Most promising of stellar heat theories now is based on atomic nuclear reactions similar to radioactivity. These can be produced in the laboratory, but how they can be made an efficient source of energy on earth is a problem for the future.

Pumps No Larger Than the Hand Serve Many Purposes

So tiny that they can rest in the palm of the hand, midget electric pumps are used for many purposes—to operate small fountains in gardens, rockeries, floral shops and even on banquet tables, to maintain regulated flow of water in miniature aquariums and to make liquids flow or bubble in window displays. Industrially, the pumps are used for air-conditioning and refrigeration equipment; circulating water and light liquids in filter systems, washing baths, condensers and constant temperature instruments; draining commercial refrigerators, seepage in basements and fire pits; to pump cutting solvent on lathe tools, for wet grinding of valve faces in machine shops and garages; in food and drug laboratories and by dentists and doctors. Noiseless in operation, these pumps come in several models and capacities. There are vertical types ranging from twelve ten-



Inset, tiny pump rests in palm of hand. Below, fountain operated by midget pump

U. of Chicago
H 977

Centerville

Oakland Calif

Lloyd Bowen
14 2 Santa Clara
Dr.

Diesel-Powered Ocean Liner Sets a Speed Record to U. S.

thousandths of one horse-power to a fiftieth. The smallest will pump one-half gallon a minute to a height of one foot and the largest one gallon per minute to a height of six feet. There are horizontal types with motors from a fiftieth to a quarter horse-power and capacities from a gallon per minute to a height of four feet to twenty gallons per minute to a height of twelve feet. Both types are easy to install. The smallest will run 100 hours for between three and four cents at an average electrical rate.

H 803

Tiny Glass Spheres Sprayed on Signs to Reflect Light

100 gal.

Tiny glass spheres shot from a spray gun make traffic signs luminous at night as far as the rays of a headlight beam can reach. A liquid binder, clear or colored, is first spread in the pattern or lettering desired, then the spheres are applied while the binder is still sticky. Spread thus on a traffic dividing line, on the end of a culvert or highway

Empire State Bldg. New York

Reflectants



Spray

sign, or on sides and rear of a truck, the bits of glass catch the glint of headlights. The hard, pebbly surface withstands the severest weather.

Highway Safety Products

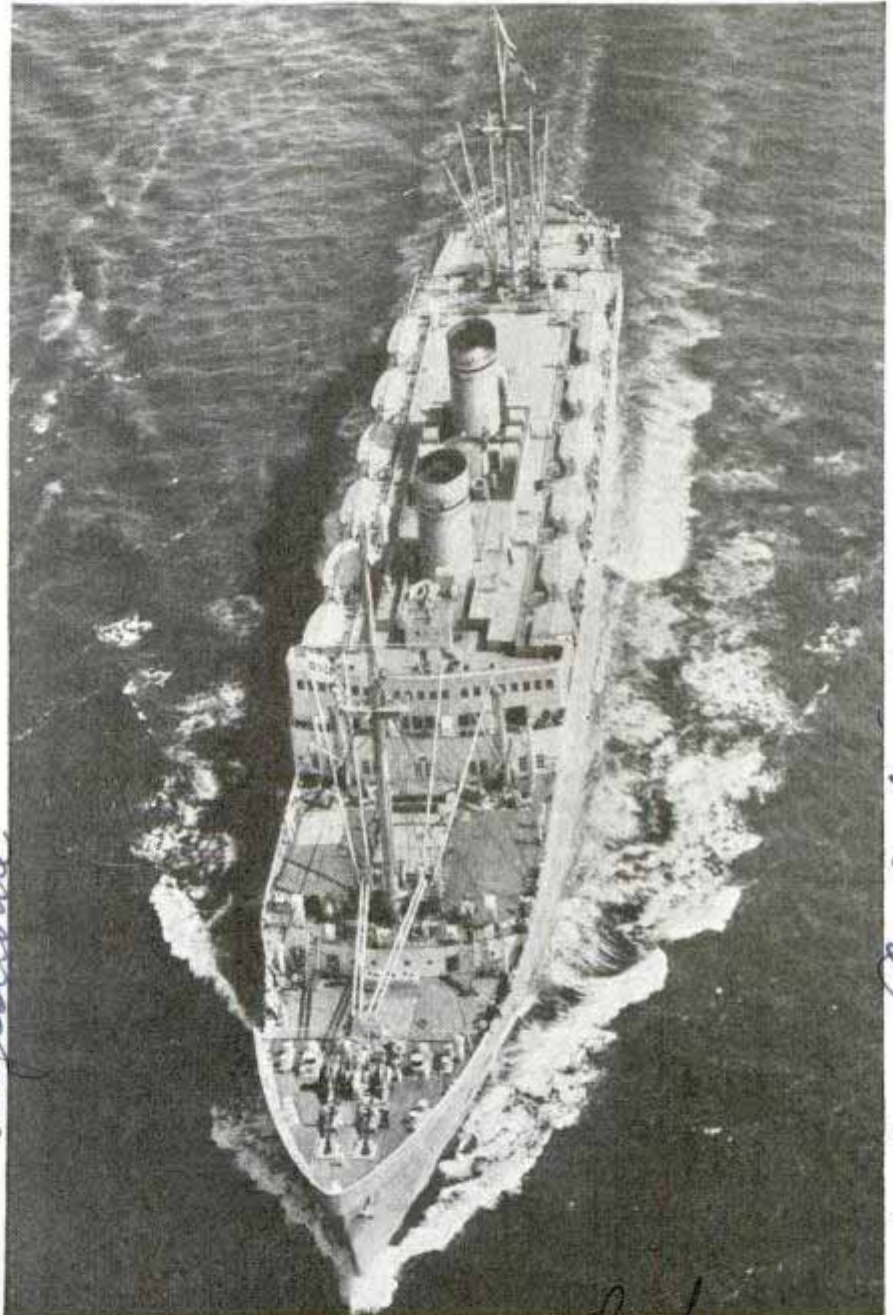

dup.

Looking downward on the Diesel-powered liner as it arrives at New York after first crossing from Norway in record time

motor liner - Caleford

Highest powered ocean liner ever designed for propulsion with hydraulic-gear Diesel engines, the new flagship of the Norwegian-American Line recently set a speed record for the direct crossing from Norway to the United States. The time was cut from seven and one-half to seven days. The liner, with a capacity for 800 passengers, has a speed of twenty knots.

24 State, New York

When the 43,000-pound Douglas DC-4 Super-skyliner, largest American land plane, took off for its first flight it carried 8,500 pounds of test instruments.

Douglas Aircraft Co. Santa Monica, Calif

H 67 1. Thomas E. Stinson, Jr.
10555 Holman Av
Los Angeles

TOYS for

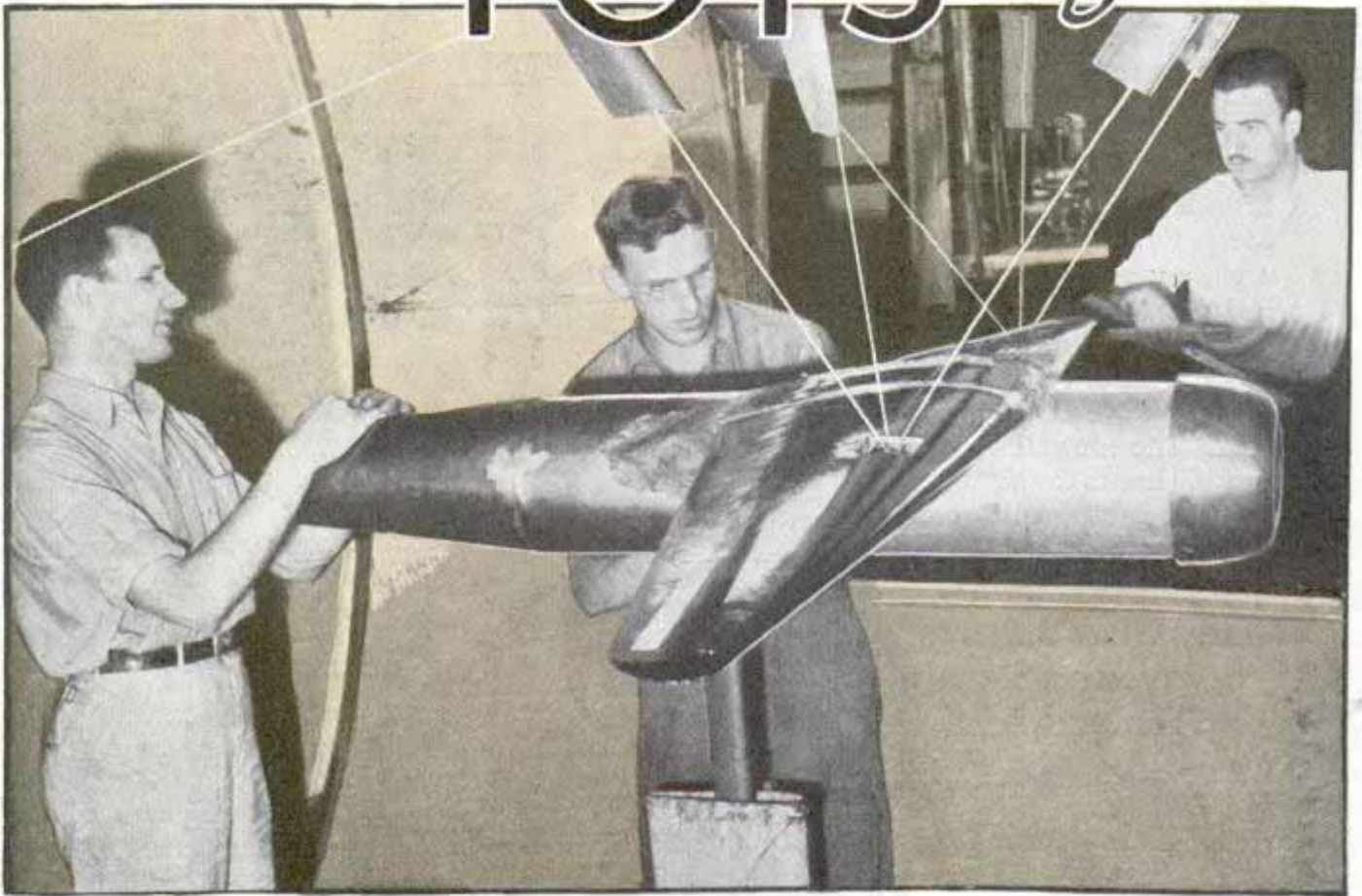

Preparing scale-model plane, above, for wind-tunnel tests at California Institute of Technology. Below, scale model of Mount Palomar observatory dome used to check wind, rain and snow loads



WORK is mere play for the research engineers. At least, that's how any small boy would look at it if he saw these grown men tinkering with toy trains and planes, boats and automobiles, electric motors and compression engines.

But if you could examine all the playthings of all these engineers, you would enjoy a glimpse into the world of the future, for the toys of today are working models of the mechanical marvels of tomorrow—reflections of engineering visions.

Toys have had a profound effect on human progress. The gyroscope, for example, was merely a toy until its properties

Hc 71

MEN ONLY

were applied. Then it grew up to fly airplanes and steer ocean liners. Boys sent electric trains dashing around toy tracks long before railroads used electric locomotives, and operated toy machines with miniature electric motors while the wheels of industry still were being turned by steam.

Today trains cling to the rails better, automobiles run more smoothly and planes travel faster partly because research men have learned valuable lessons from toys. Without working models, engineering and scientific progress in many fields would be retarded greatly because man still would be forced to learn by the costly process of trial and error.

When the modern engineer starts to design a new airplane, a new car or a new boat, he first evolves a plan which appears sound in theory, something which "looks all right on

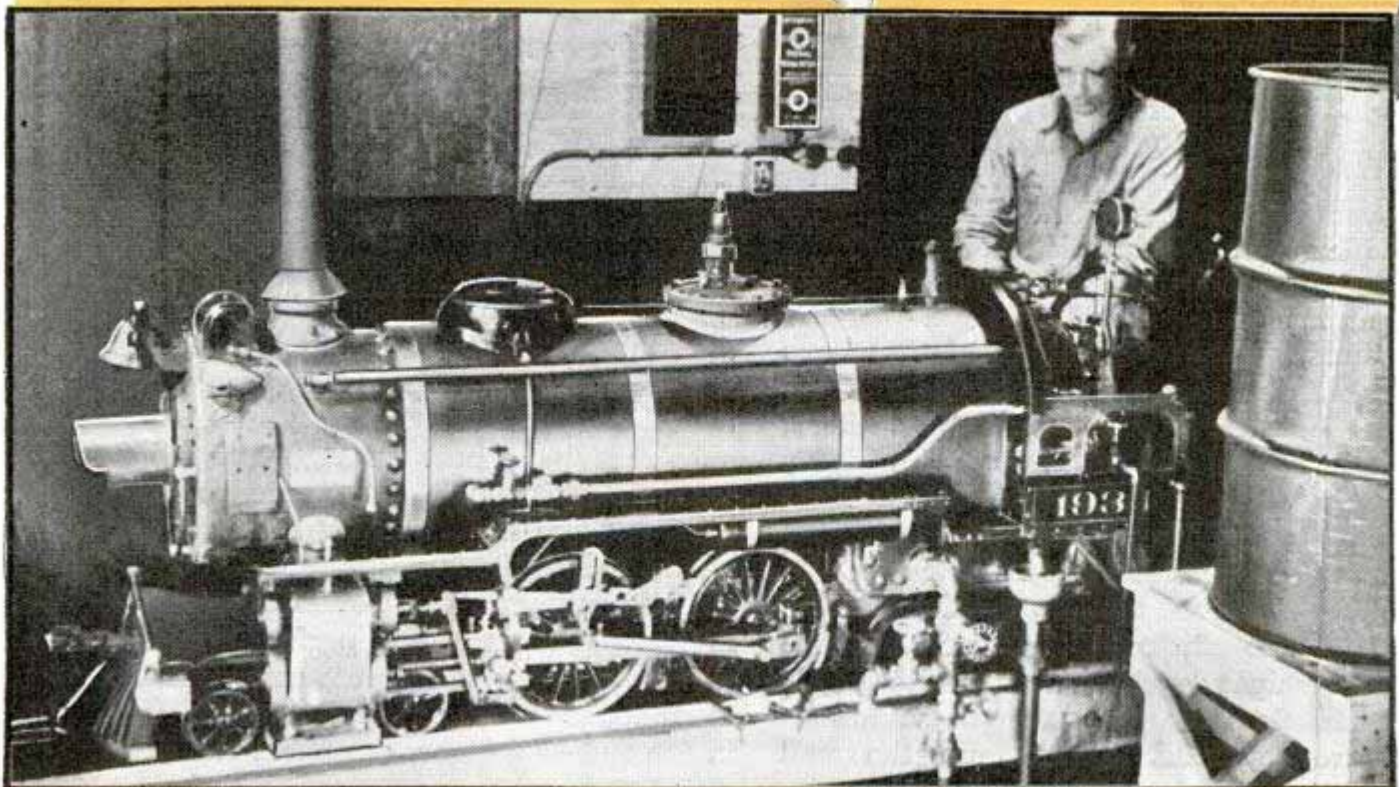
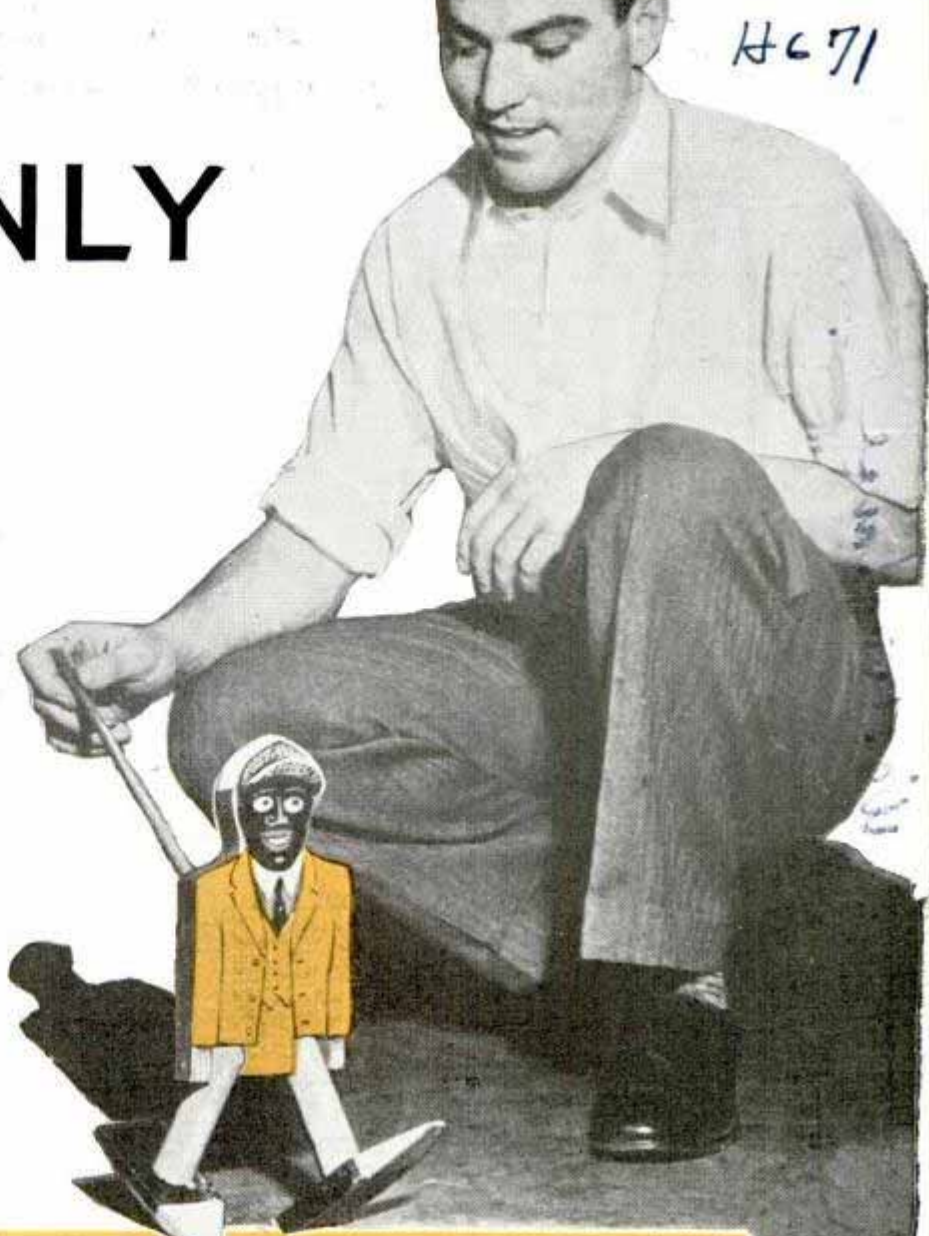

Walking wooden doll, top, which displays same sort of vibration that causes machines to shake apart. Bottom, scale-model locomotive boiler in which corrosion-resisting agents are studied

Laboratory - Dearborn Chemical Co. 521
205 E. 42nd St New York City



Another type of vibration has plagued the railroads, lateral pressure of wheel flanges against the rails which causes lateral derailments. By using a toy electric locomotive, a Westinghouse researcher was able to study the forces which cause lateral derailments. He ran the locomotive on two rollers at a top speed corresponding to ninety miles an hour for a full-size engine. By taking motion pictures of the toy he determined the oscillations at different speeds and eventually demonstrated with his toy that a modern electric locomotive can operate safely at a speed even greater

Westinghouse

paper." Then he builds a working model and by experimenting with it he finds the "bugs" in his design before he constructs his plane or car or boat. Nothing is too big or too complicated to be duplicated in miniature. A model was built of Boulder dam and models have been constructed of whole watershed areas in studying flood-control projects.

Working models of complicated machines may cost hundreds or even thousands of dollars but they pay for themselves many times over by enabling engineers to discover their mistakes ahead of time. Models have enabled engineers to eliminate dangerous vibrations from machines. Waterwheel generators weighing thousands of tons have shaken themselves to destruction in the past because of self-induced vibrations, airplane wings have "fluttered" with an intensity which threatened to tear them from the fuselage and motors have felt the power of such vibrations in their bearings.

The engineers used to build machines, then try to eliminate whatever vibrations the machines developed. Now, with the aid of models, they eliminate the vibrations before they build. By calculating the small vibrations of a machine model, they can predict whether the actual machine will be susceptible to self-induced vibrations.



Model of Golden Gate International Exposition and, above, boat propelled by heat from alcohol lamp

than the highest for which it is designed.

In testing new airplane shapes, wind-tunnel experiments with scale models not only reveal the best fuselage design but aid in determining the effectiveness of ailerons, rudders and other control surfaces, and in finding the forces required to operate these surfaces. Quite often, after learning how a scale model performs in the wind tunnel, and taking into consideration the amount of power which is to be used in the full-size plane, engineers can predict speed and other performance figures of a plane within one-half of one per cent—before the plane is built.

Boulder P.D. Joyelle

Handwritten notes and signatures at the bottom of the page.



But airplanes are not the only models subjected to wind-tunnel tests. Architects use wind tunnels to test building models and thus learn in advance the effect of wind pressure on buildings during violent storms and cyclones. The latest models to be subjected to wind-tunnel tests are the various types of windmill vanes used in

Cornelius Vanderbilt Jr

generating electric power from the wind on farms.

The effects of earthquakes on various types of buildings are also studied with models. The "earthquake" is produced by a quick-acting piston which shakes a table on which the models are mounted. There are models of coal mines where engineering problems can be worked out before ground is broken for a shaft, and there are models, too, of rivers, beaches and oceans for studying navigation and flood-control problems. Even lightning is produced in the laboratory in model form to study its effect on buildings.

One of the most difficult models ever attempted was that of the supports for the 200-inch telescope being constructed on Mount Palomar in California. Here Westinghouse engineers were called upon to build a miniature of something so unusual that no one had ever seen it or anything like it. It was

(Continued to page 125A)



Model homes like this enable builders to solve many construction problems in advance. Top, model street and model buildings used in studying traffic problems

A. H. G. model I am at San Diego

Hydrogen Tank Forms Setting for Pageant of Modern Power

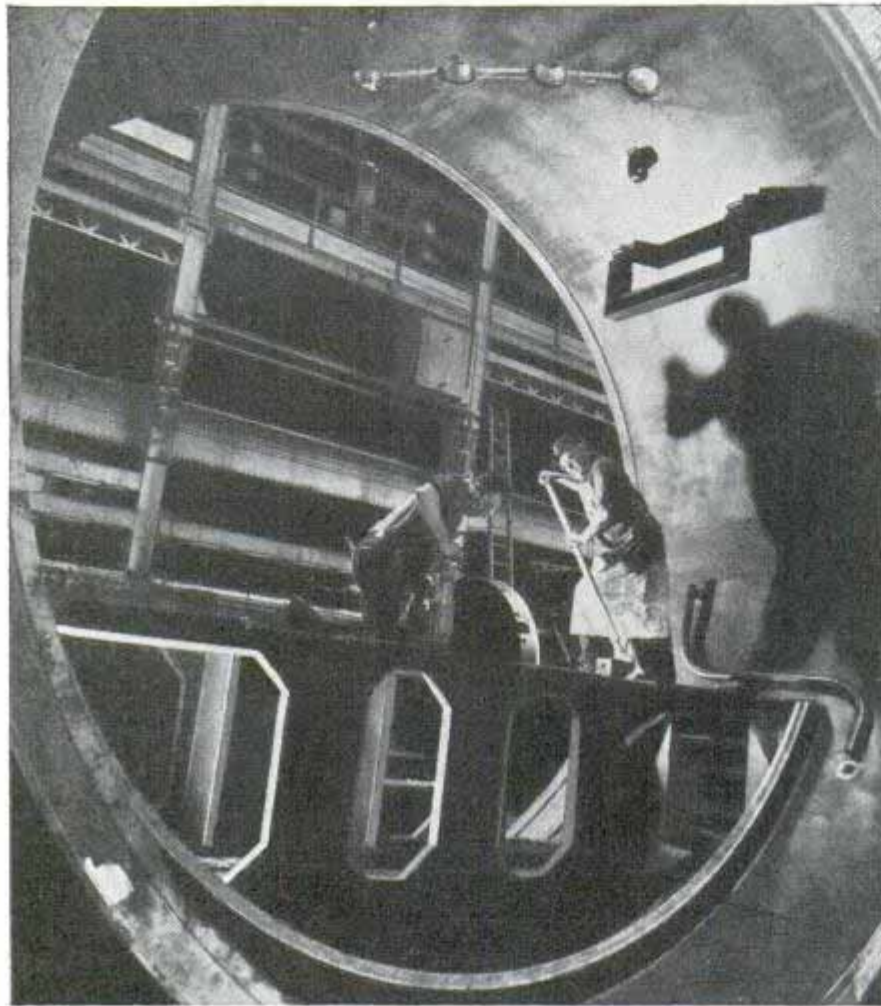

Assembling the bearing and gas cooler section of a big hydrogen tank enclosure destined for a power station of Southern California Edison company

Dramatic as the setting appears, this picture is no staged portrayal of man's conquest of earth by machinery. The two workmen were caught by a photographer while assembling a bearing and gas cooler section of a giant hydrogen tank enclosure. It was being manufactured by the Westinghouse Electric & Manufacturing company for the 60,000-kilovolt-ampere hydrogen-cooled synchronous condenser, to be installed at a Southern California Edison company substation at Chino, Calif.

Each Pittsburgh Pa

Dept. of Commerce 6/27/38 mem

Dry-Sprinkler System in Plane Rids Cabin of Insects

To rid airplane cabins of insects and prevent migration of the tropical pests from one area to another, Imperial Airways engineers have developed an insecticide sprinkler system. The disinfecting fluid is forced under pressure through a piping

system and emerges from vents as a fine dry spray which permeates every corner of the aircraft. Non-inflammable, the spray does not affect upholstery or clothes and has no objectionable odor. The system is being tested on a plane in South Africa. Insect traps have been used on air vents of Imperial Airways planes for some time.

H 740

Two-Wheel Barrow Makes the Load Easier

With two wheels instead of one, a wheelbarrow can carry four or five hundred pounds of material with much less human effort. By centering the weight about a pivotal point, the designers reduced the necessary handle-lift so that a 400-pound load requires an effort of only eighty-seven pounds, against a 125-pound lift with the ordinary type. The wheelbarrow has pneumatic non-skid tires.

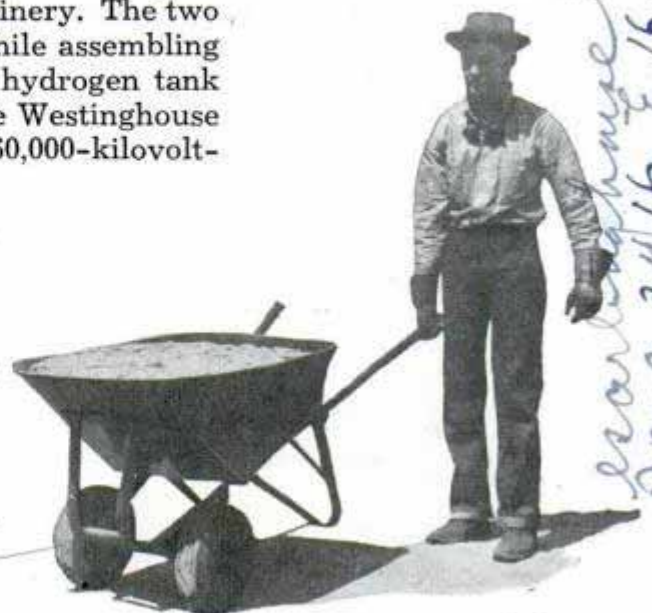

Workman can manipulate this two-wheeled barrow with one hand, its construction easing the load

earl westinghouse 1800. 2416 E 16th Ave

more to be used H A I

Collapsible Camp House Carried on Car Roof

Vacation tourists can carry their traveling home on top of the automobile. A collapsible, lightweight house just put on the market folds into a six-by-nine-foot "package" extending only two feet above the car, where it rests on a metal rack. Whenever the tourists reach an inviting camp site, one man can unload the house, and in ten minutes it can be ready for use. Adjustable legs keep it level despite uneven ground, and the solid wood floor is always six or eight inches above

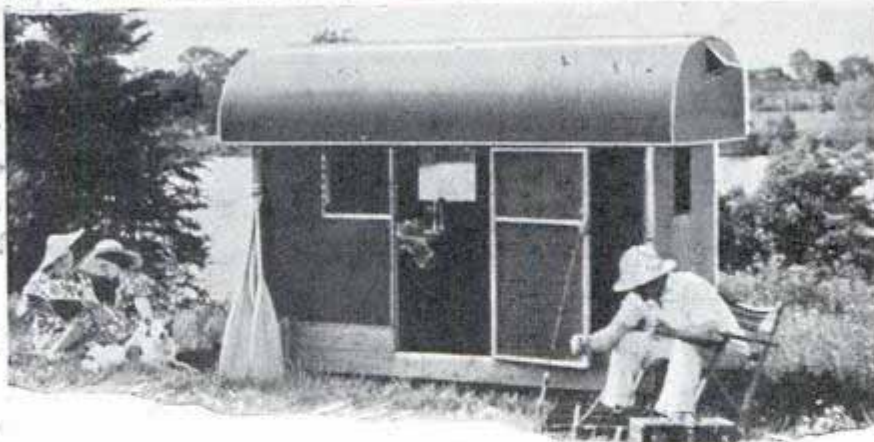
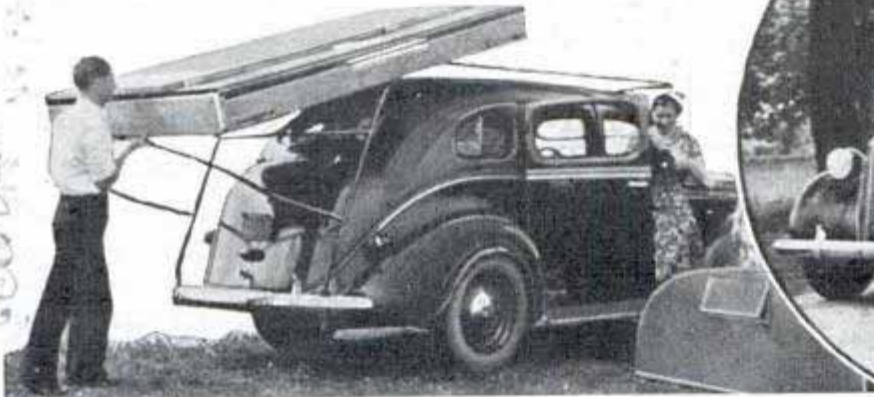
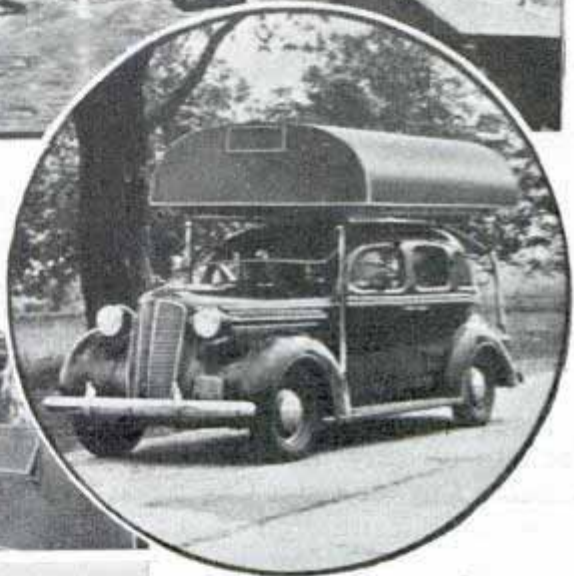
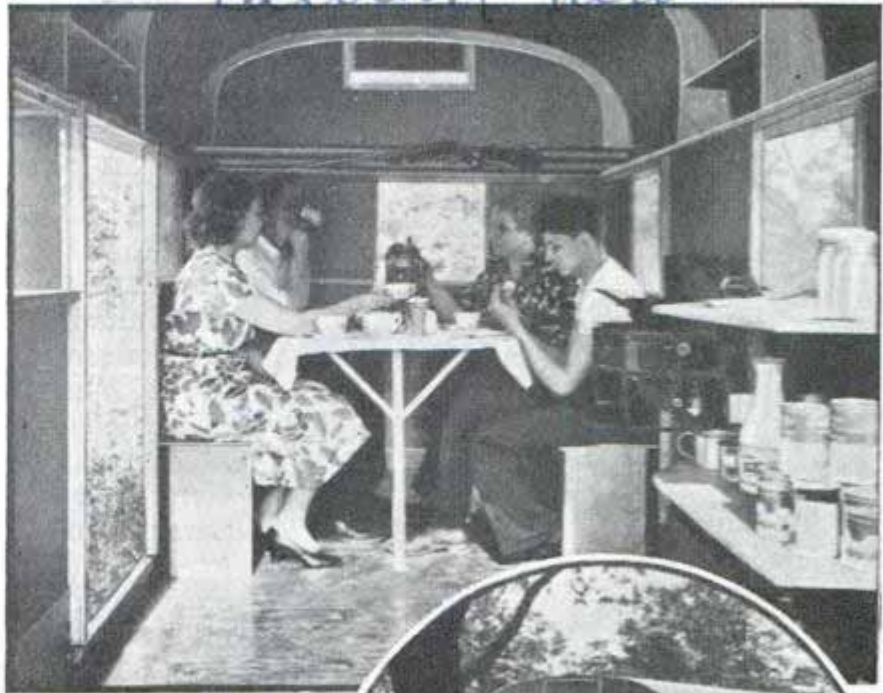

The turtle carries his home on his back—and so can the motoring vacationer! Here is a collapsible house carried (circle) on bracket over the car; at left, one man eases it down and erects it on ground in ten minutes. Top, interior view at lunchtime; bottom, exterior of the portable camp

\$99.50

ground. A table is installed at one end of the room, and benches drop on hinges to seat four persons. High-placed beds avoid interfering with use of the house, and when not occupied the beds may be rolled against the wall. The material is moisture-proof and the walls have a dead-air space for insulation. There are six windows

with sliding glass and permanent screens. Less expensive than the more luxurious trailer and offering no difficulties to the driver, the collapsible house provides a shelter for overnight or summer-long stay. An arm attached to house and roof-top rack acts as a fulcrum, making it easy for one person to carry the load in dismantling.

Patrick Collapsible House Carried on Car Roof
5220 Third St. Detroit Mich

Patricia - Carried on Car Roof

Patrick Collapsible House Carried on Car Roof

Bee Trouble a New Hazard for Trouble Shooter

chamber holding twenty-four prints of eight by ten inch size or a larger number of smaller prints. Current consumption is less than 400 watts.

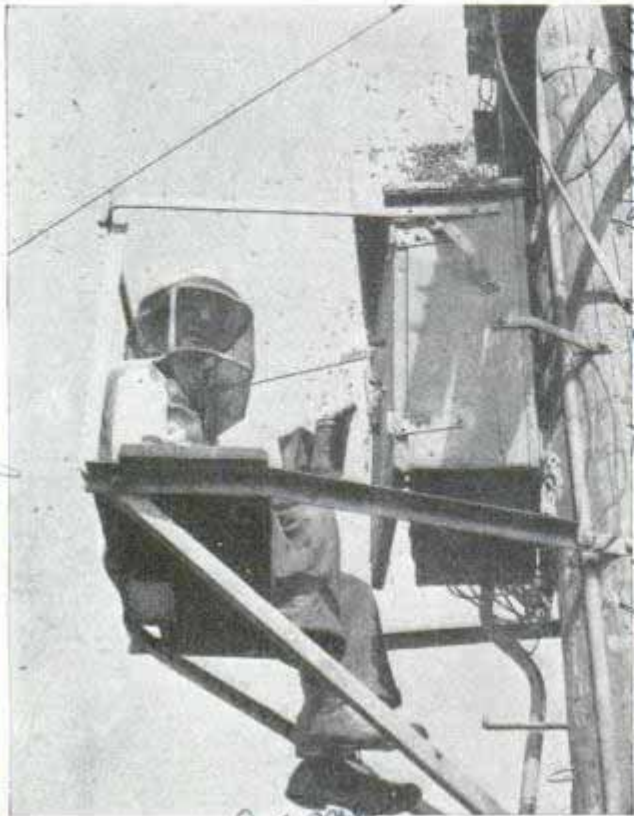

Wax insulation proved attractive to bee colony, so the trouble shooter had to carry out eviction order

As if there were not enough varieties of trouble already in his line of work, the trouble shooter for a California telephone company encountered bees the other day. They were swarming in a terminal box on a pole, and it was his assignment to dispossess them. Always ready for anything, the trouble shooter put on a helmet and gloves and smoked out the intruders. The wax insulation on the heavy wire had attracted them.

Electric "Oven" for Photo Prints Speeds Up Drying Process

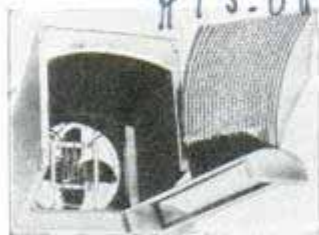

Photographic prints dry out rapidly in a compact electric "oven" in which a fan forces warm air over the paper. Single-

weight prints are dried practically flat in thirty to forty minutes. They are placed face down on chemically treated lintproof blotters, the ten by ten by fifteen-inch

Castor Bean Finds New Uses in Paint and Chemicals

Castor oil as a substitute for the tung oil from the Orient is but one of the products stimulating growth of the castor bean in the United States. The stalk of the bean has been found to contain a fiber that may prove valuable. The inner stalk can be fabricated into a cellulose material more absorbent than cotton. Some poisonous element in the plant is deadly to grasshoppers and may be isolated as an insecticide, leaving a residue possibly suitable for stock feed. The protein remaining after the oil is removed from the beans can be made into plastics, and is good for fertilizer. Castor oil blended with petroleum is a highly regarded automotive lubricant.

Air-Conditioning Unit for Bus Filters Out Dust and Odors

Cross-country bus travel is cleaner and more comfortable in the buses equipped with an air-conditioner which not only filters out dirt and dust but eliminates fumes and odors as well. Its thermostatic control keeps temperature in the bus constant. Flexibly connected, the unit can be pulled out from its housing for inspection while in operation.

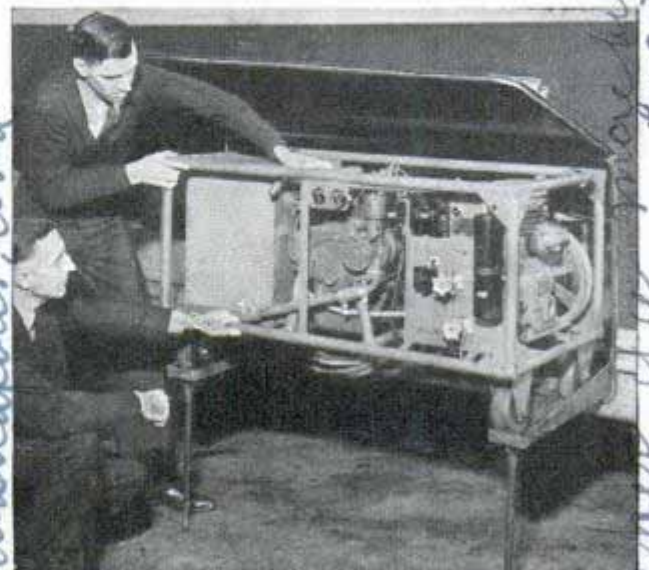

Flexibly connected, the air-conditioning unit is pulled out from body of bus to be serviced

Freeman F. Robertson, Co. Los Angeles. Associated Telephone Co.

American Society of Agricultural Engineers

From International Telephone & Telegraph Co.

Castor Bean - American

Belts - Lenaha

15 2 2

Moore Products, 5921 Guilford Ave

Telegrams Ride the Tones of Electric Organ

Telegraph engineers have learned from the electric organ how to send ninety-six telegraphic messages in one direction over a single wire at the same time. They borrowed from the Hammond organ the idea of dispatching multiple messages on different tone pitches. To demonstrate how the organ generator functions in such a telegraphic system, Western Union engineers installed an organ console next to a bank of carrier channel equipment and used a "tone detective" which, by a series of clefs on the musical scale, showed the frequencies of the tones produced on the organ and the tones being used by the generator for the telegrams.



Telegraph operators team up with electric organ to demonstrate how messages can be transmitted over different tone pitches on single wire

H 731

Wear water

Twin-Motored Lawn Mower Steered by Remote Control

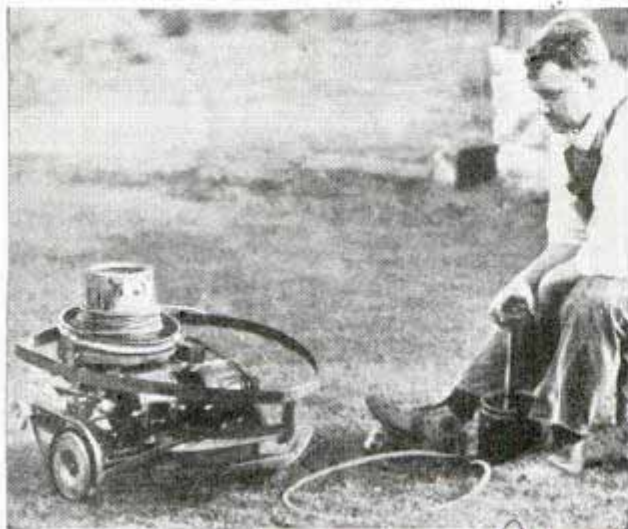

Separate motor runs each wheel of lawn mower, enabling operator to steer it remotely by varying speed

Ideal for the lazy man is the remote-controlled lawn mower invented by a Pennsylvania mechanic. While he sits in a comfortable chair the operator can guide the twin-motored cutter around the lawn. Starting with a regular cutter, the inventor installed two motors whose speed is regulated by the control box beside the chair. When both motors are running at the same speed the mower runs straight; by diminishing the speed of one or the other, the machine is turned to right or left. A 100-foot length of wire, connecting the controls to the motors, is wound on a revolving paint can mounted on the mower. An old barrel hoop and mixing bowl provide bumper and shock absorber.

Alvin Lodge
Millsville, Pa.

Dredge to Seek Sunken Gold Lost in Shipwreck of 1799

expected the color chart will be used by horticulturists so that flowers of identical color will have the same color name around the world.

Paint Machinery Co
The Hague Holland.

Biltton

Chicago
slightly news
6/25/58

Robert F. Wilson, Dir.
Director, British Color
Council, and Committee

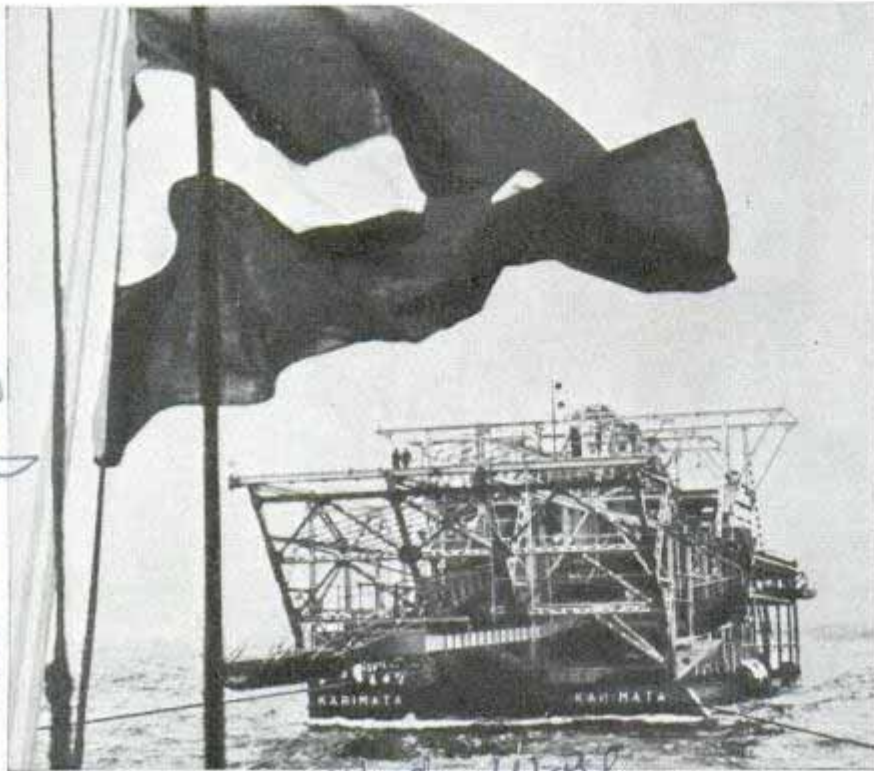

Towing the salvager "Karimata" to the site off the entrance to the Zuyder Zee where gold-laden English vessel has rested on bottom for 139 years

Sunken treasure that has lain on the ocean floor for 139 years is the goal of the S.S. "Karimata," salvage ship from The Hague. A terrific storm in October, 1799, sent the British naval vessel "Lutine" to the bottom with gold bullion valued at about ten million dollars. Much of the cargo has been recovered, including the ship's bell that signals arrival of marine news in the office of Lloyd's of London; but there still remains enough treasure to lure the 250-foot "Karimata" to the scene of the wreck, off the entrance to the Zuyder Zee. The ship has a dredging depth of 100 feet.

Three Thousand Flower Colors Are Named and Charted

After three years' work, a British committee has charted and standardized 3,000 flower colors. Four thousand different flowers from around the world were included in the survey, and sixty-four full hues were subdivided into the many shades. Of the few pure colors found, the committee listed the orange of marigolds, the yellow of mimosa, the red of salvia and the blue of gentian. When published, it is

Plane Carries Two Spare Propellers for Emergency

Spare propellers may be carried on army and commercial transport planes soon, just as spare tires are carried on automobiles. Army airmen at Wright Field are testing this method of preparing for emergencies. Two extra tri-bladed propellers are fastened under the fuselage of a big transport ship by means of braces, the job taking fifteen minutes. It would take three hours to assemble controllable-pitch propellers from the "knockdown" state, and blades and tools are not always available when emergencies demand them. The spares carried outside the plane are expected to reduce air speed not more than five miles an hour.

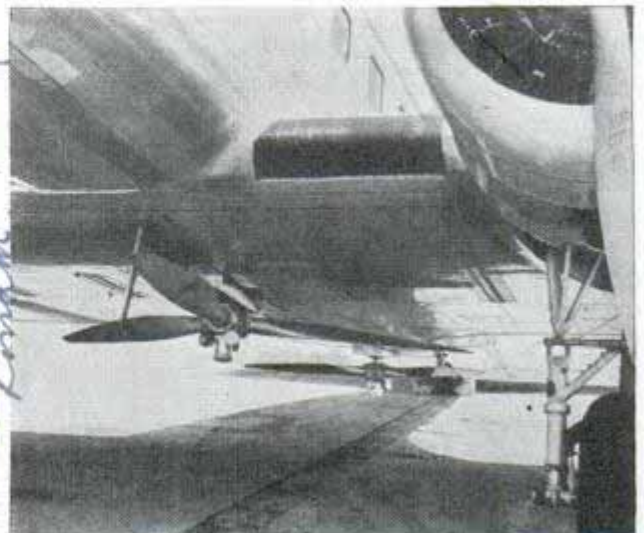

Army transport plane tries out practicability of carrying extra propellers under fuselage for emergency

Wid. Wall
London Society

H 766

H 775

H 70 Fred Hingle Boat Works

Mississippi River app. Airport
St. Paul, Minn.

Propellerless Boat Cruises in River Shallows.

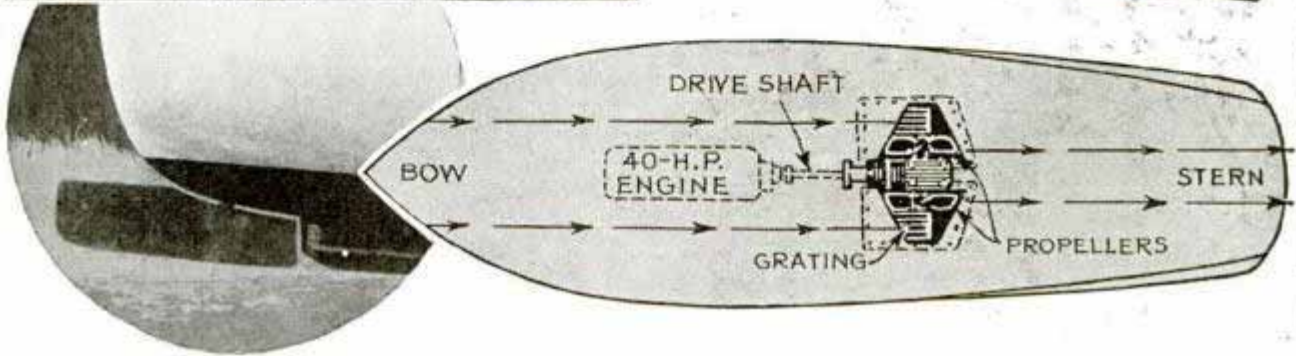
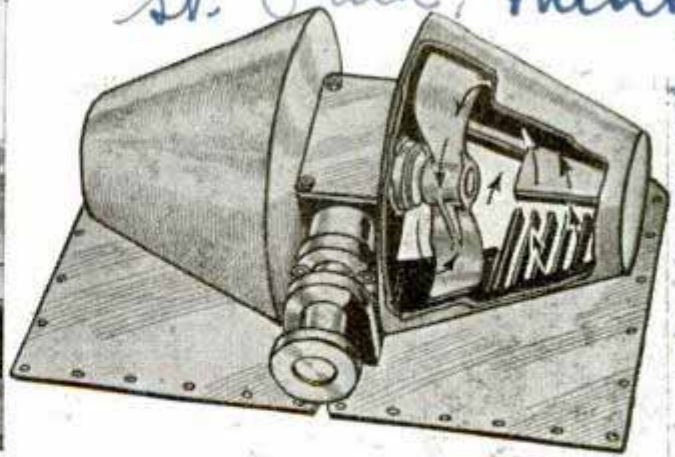

Left, propellerless Mississippi river boat and view of stern, showing rudder without usual screw. Right, diagrams show how blades revolving in twin cones at center of hull draw in and expel water

Cruising in the shallows of the upper Mississippi is a power boat without a propeller, first of its kind built in the United States. Instead of the traditional screw, this forty-foot cruiser is driven by two thirty-three-inch cones imbedded in mid-section of the hull, operating on the principle of the centrifugal pump: pulling in and expelling water by means of revolving blades. An opening under each cone allows water to enter through metal grids.

Weeds and debris sucked through the grids are ejected without causing damage. Since the cones do not extend beyond the surface of the hull there is no danger to the motive equipment in shallow water, and the boat draws only twelve inches of water, running as smoothly as do propeller-driven boats in deep water. Its forty-horsepower engine drives the craft at fifteen miles an hour. The hull is a miniature of that of the liner "Queen Mary."

Glassed Kennel on Car Fender Carries Dog in Comfort



Sedan "kennel" is copy of car on whose fender it is mounted. The dog disdains its protective windshield

If a family can tour comfortably in a closed car, why not the pup? A Spokane motorist could see no reason why not; so he built traveling kennels for his dogs. The first was merely a well-padded box mounted over the left front fender, with a high windshield. "Mike" likes to stay in the lee of that windshield, but "Pooch," the other dog, with ten years' motoring experience, prefers riding with head and forefeet on the outside shelf at high speed even though his new touring kennel is completely glassed-in and modeled after the newer car on which it is mounted.

Wash
C. L. ...

Cons. Advertis. Co., Ltd., 423 Long
Acre, London W.C. 2, England.
Page 6, Modern Wonder, June 18/1936.

DISPATCHING on the

Pipeline. Cntl. & Transm. - Reference
Pipe Line Dept. General Petroleum Corp.

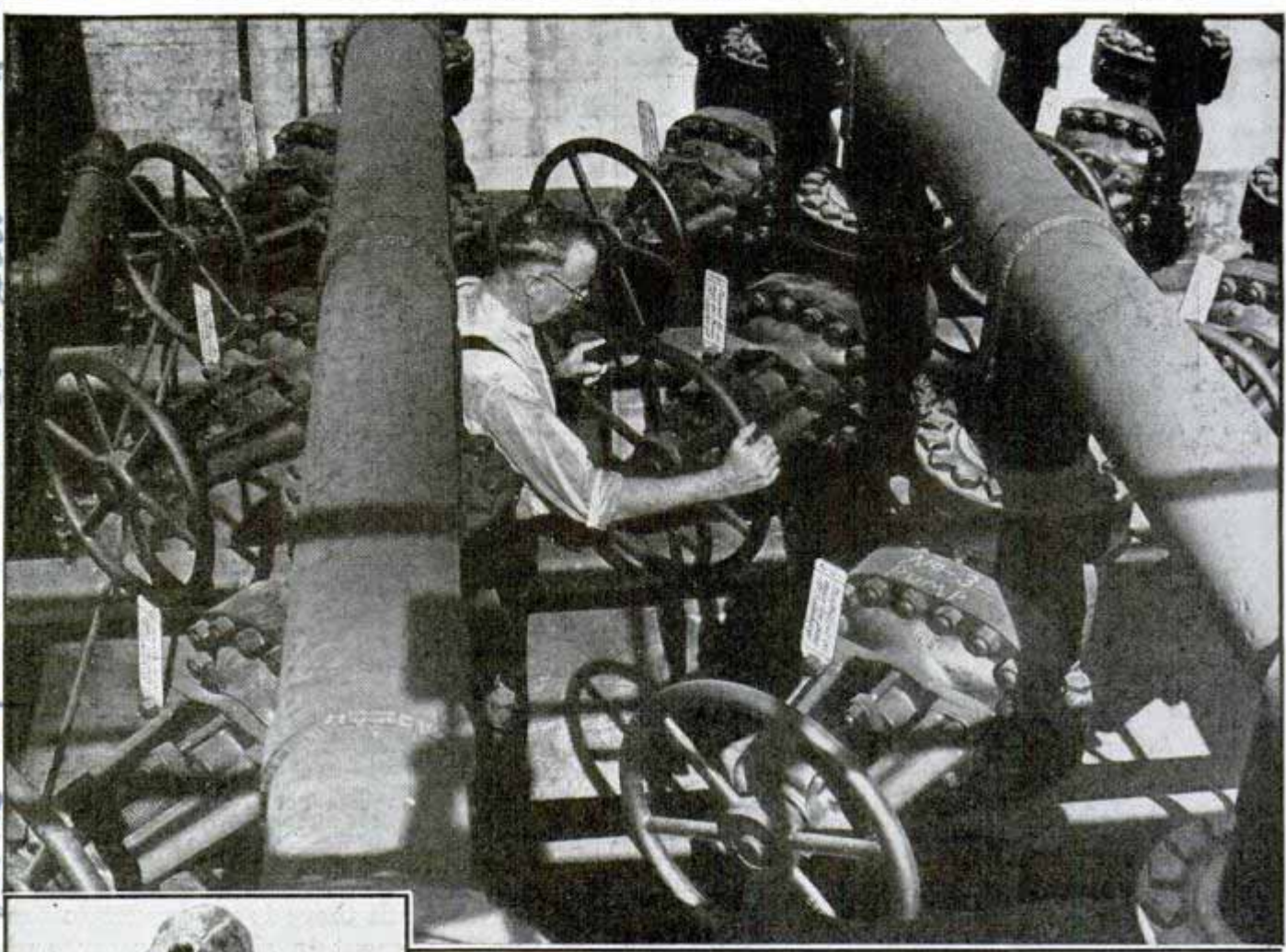

Some of the valve handles in a pipe-line "switching yard."
Left, electrical exploring coil for detecting buried pipe used
by thieves to lead off part of flow

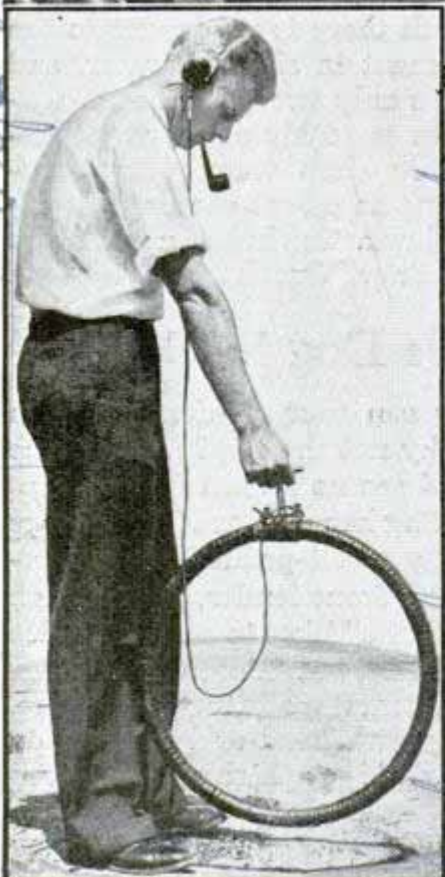

makes unknown - suggest

SHIFTING his eyes from the complicated chart in front of him, the chief dispatcher of the pipe-line system picks up his phone and dials a pumping plant several hundred miles away.

"Charlie? A slug of aviation crude will be coming along about two o'clock. Switch it to Line four for Long Beach. Repeat."

As the pumpman's voice repeats the message, the dispatcher checks every inch of the complex pipe line to make sure the 10,000-barrel shipment will flow direct to the proper tank 1,000 miles away. Orders for one shipment may involve turning dozens of valves and a single wrong order or mistake by one of the switchmen might divert the oil to a city far from its proper destination. Closing a wrong valve against the moving stream of oil might blow up the line. A man's first mistake is his last on the pipe lines.

The great "white oil" trunk lines of the middle west, filled with gasoline and kerosene from Texas and Okla-

108 W. Second St. 3rd
Los Angeles Calif
pipe locator -
Engineering Laboratory

1874

UNDERGROUND RAILWAYS

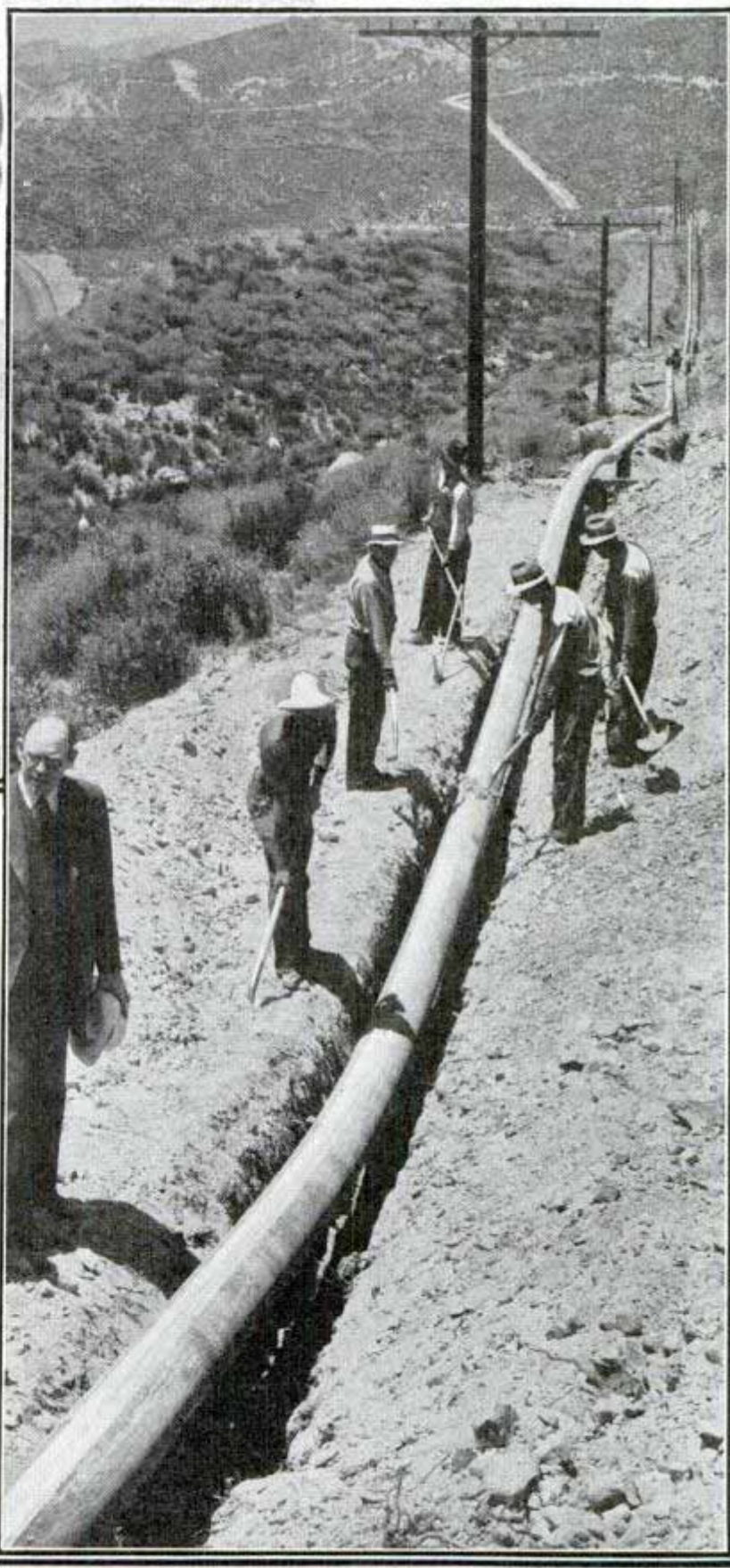

homa refineries, may move half a dozen different shipments, one behind the other. One shipment may be destined for Kansas City, the next, of a different grade, for New York, and a third for Chicago. Each slug or shipment is marked at the end with colored dye so the switchman, drawing samples from the line, can tell when to open one valve and close another. Black oils can't be marked with dye, and the dispatcher must recall a dozen problems in pump displacement, viscosity, heat, and hydraulics in preparing a timetable for his orders.

These vast underground railroads form the cheapest and least known important type of transportation. More than 1,000,000 miles of main pipe lines are in use in the

Construction crew laying a ten-inch high-pressure line. Above, "go-devil" used to clean out a four-inch petroleum pipe line

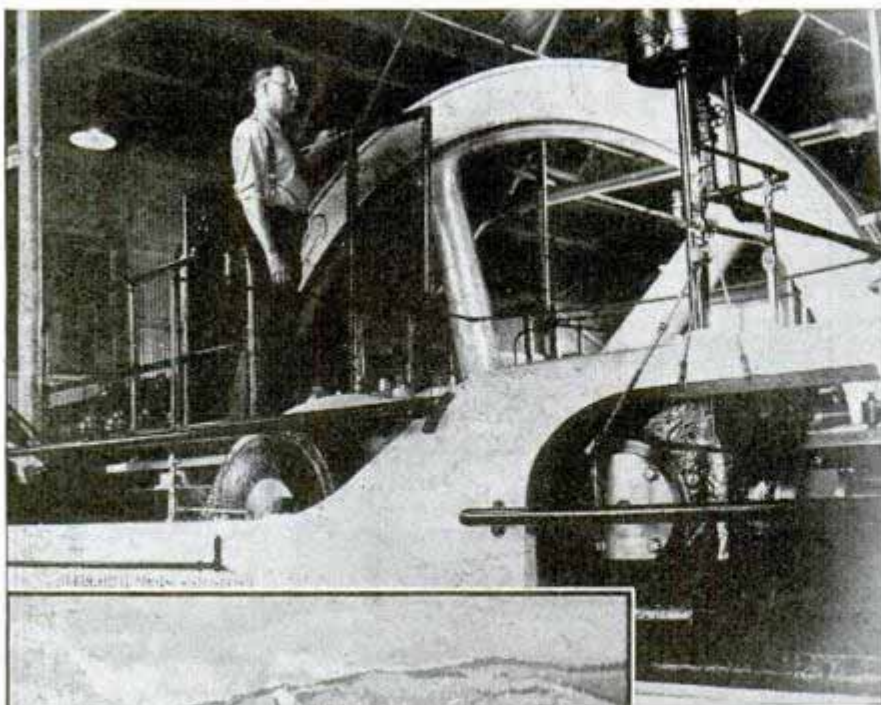

United States, four times as much as the total railway trackage. The lines move tremendous quantities of petroleum products. Some of the big lines are public carriers and accept shipments at numerous fields for delivery at distant points. Each major oil company maintains its own private system. Usually each system uses separate lines for black and white oils to avoid contamination. Gasoline and kerosene are moved through one line and crude, lubricating, and fuel oils flow through another.

These liquid cargoes are pumped at pressures up to 850 pounds per square inch and move at speeds of five miles per hour. Powerful pumping stations are spaced a few miles apart on the up-hill sides of mountain ranges and may be seventy miles apart on the descending slopes.

Dispatching oil is similar to train dispatching. Movements are scheduled ahead of time and orders are issued over tele-

Top, one of battery of pumps in petroleum pipe-line pumping plant. Left, the British Aluminum company uses this river, imprisoned in pipe lines, to turn its turbines

Karlochereva, Aigyptskine Engd

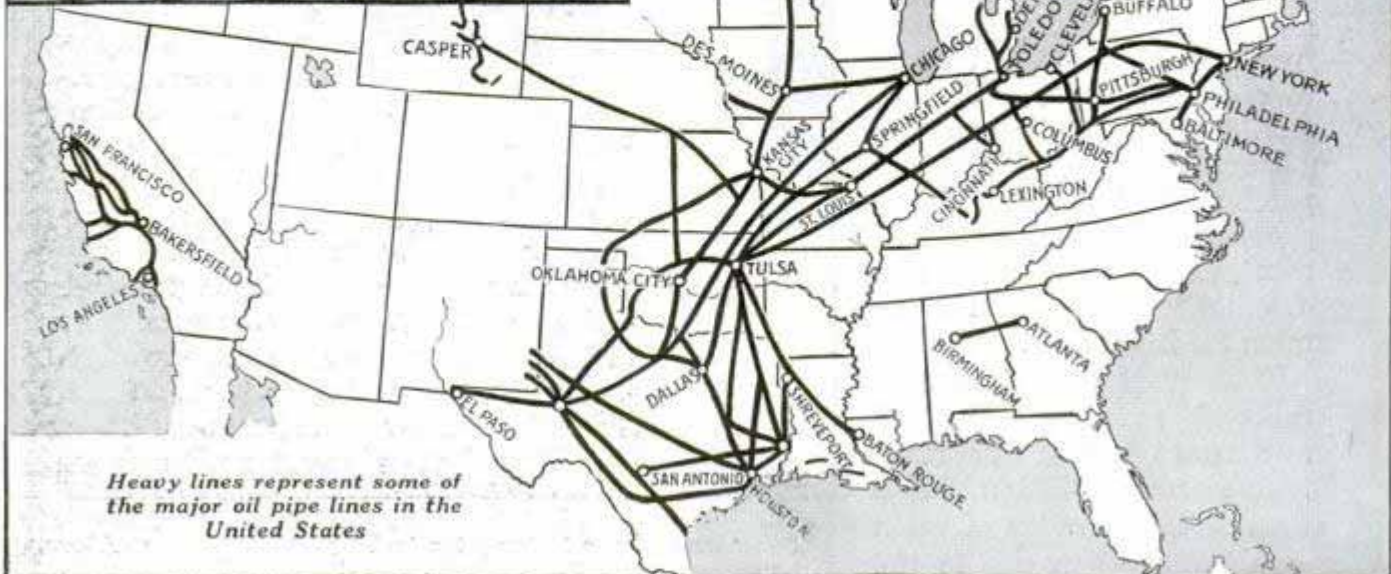

Heavy lines represent some of the major oil pipe lines in the United States

phone or teletype lines that connect all the pumping stations and switch points. It's a ticklish job and a fortune in oil could be spoiled in a few minutes if a wrong order goes out.

"One thing that complicates pipe-line operation is the temperature problem," says a dispatcher for the General Petroleum Corporation. "A day's schedule may call for a shipment of light oil drawn from a tank at atmospheric temperature to be followed by 20,000 barrels of fuel oil fresh from the refinery with a temperature of 160 degrees. After this there may be another consignment of cold oil or a ship-

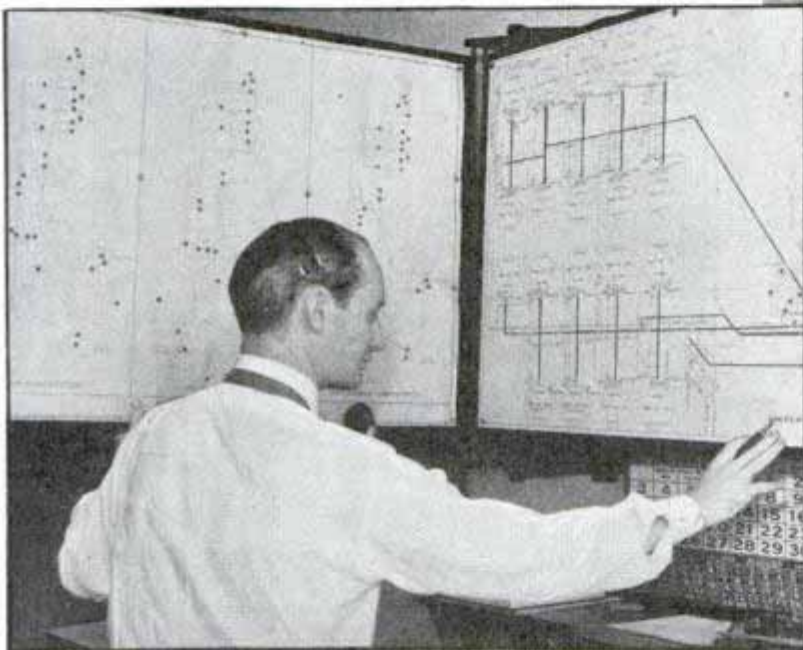
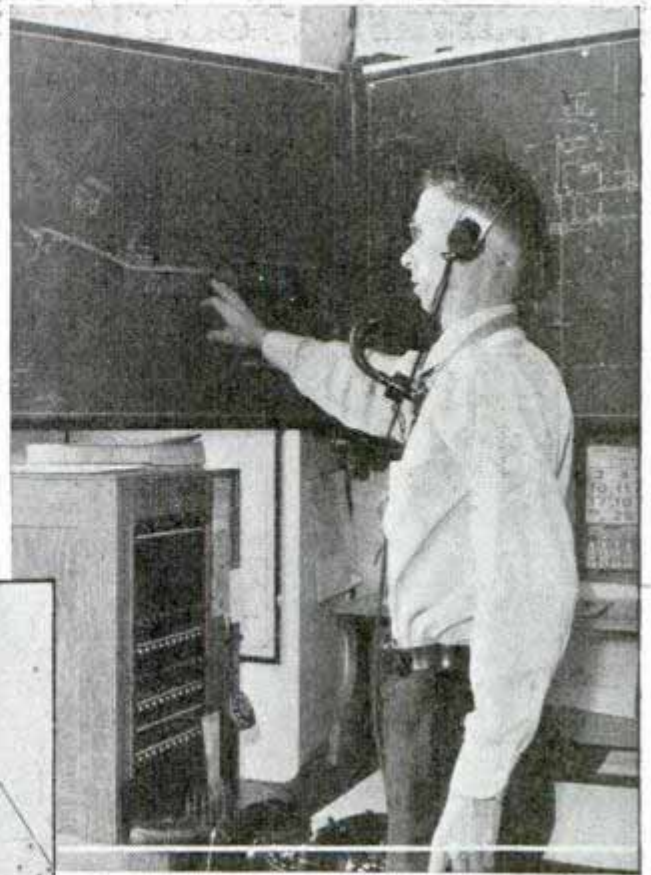

Bottom photo courtesy Union Oil Co.

Dispatcher, above, checking valve numbers in planning an oil shipment. Left, checking valve number on chart before telephoning orders to pump house. Below, 125-foot cracking tower in a modern refinery where petroleum is broken down into gasoline and light oils

ment of heavy crude so viscous it must be reheated at every pumping plant. Dispatching a hot shipment immediately after a cold one may expand the line, making the pipe twist under ground and even humping it out of its trench at some point. This puts a tremendous strain on the connections and may start leaks.

"Far worse is what occasionally happens when a shipment of cold oil is put into a pipe immediately behind heated oil. In this case contraction takes place and a pull-apart may occur. Thousands of barrels of oil then are apt to be lost. Care in slowly introducing oil of a different temperature into the line and numerous expansion sleeve joints on the pipe keep temperature troubles at a minimum. Most leaks occur in hard ground that grips the pipe and

(Continued to page 144A)

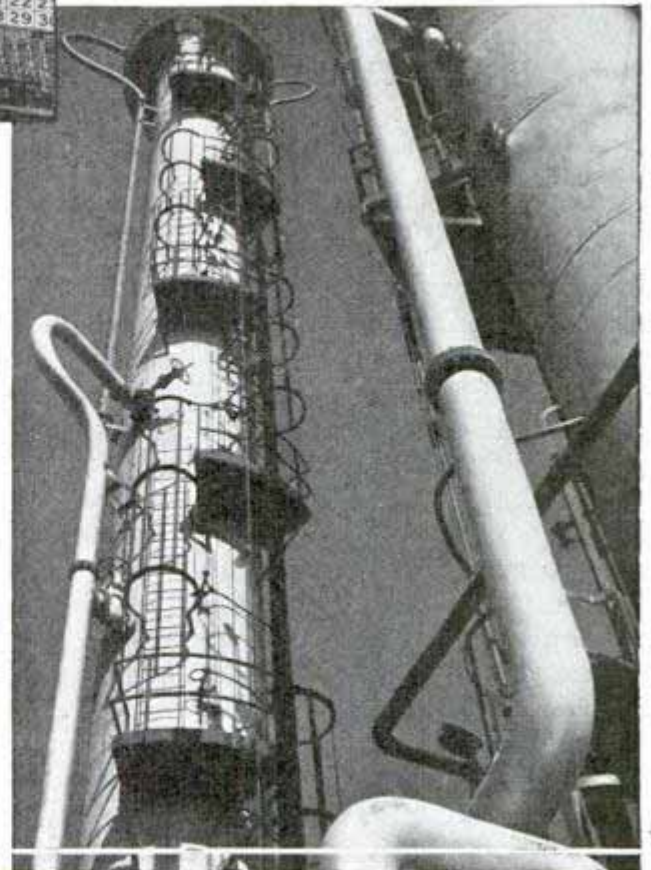

'Stradivari' Violin Built in Amateur Workshop

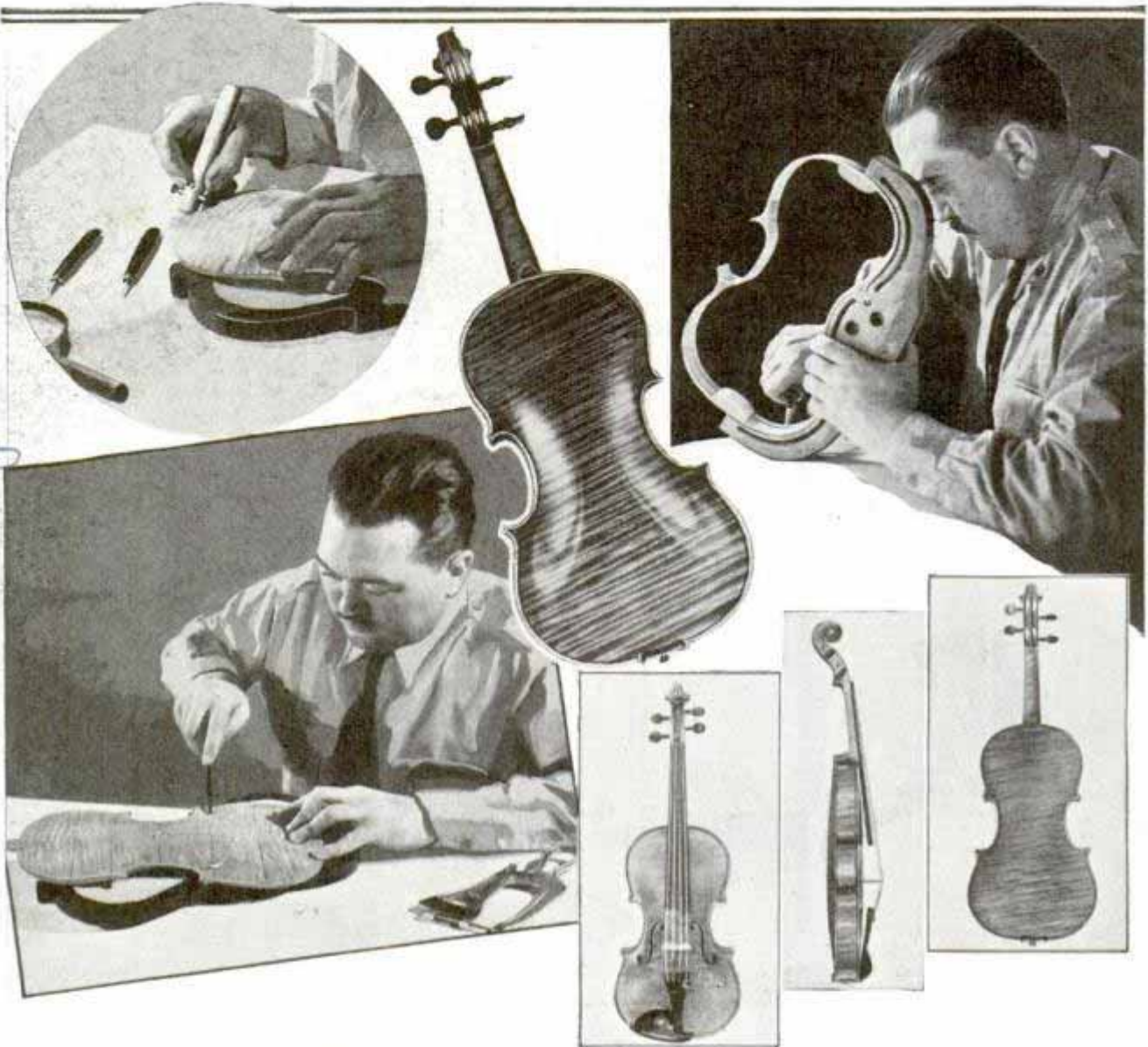

Reflections on violin at center show how light is used to obtain perfect symmetry. Top, left, marking edge for inlay; right, trimming lining of frame; lower left, gouging arch of back; right, the finished violin

Offhand, you'd say that violinmaking is no hobby for amateurs. You would be inclined to leave such delicate work to experienced craftsmen. Yet a Chicago man, S. A. Sheridan, who is a metallurgical engineer and had attempted nothing in the way of handicraft since high-school days, has just finished constructing a violin of rare beauty and tone whose value has been estimated above \$1,000. It is a faithful copy of one of the violins made by the eighteenth century master, Antonio Stradivari, and the wood of which it is built came from the same forests where Stradivari obtained his materials. Tone qualities of the violin depend upon the texture of the wood, the craftsmanship, the varnish

and the aging. Given the patience and the will, an amateur shop worker can build a violin without previous experience, as Mr. Sheridan demonstrated. Starting "from scratch," he obtained drawings and the necessary special tools—scrapers, purfling knives, saws, gouges, assembly forms and the like—which are available commercially. Long-aged maple of beautiful grain, for the back, and spruce for the face of the violin are obtainable from the same European forests the old master violinmakers used. The varnish materials and methods of the craftsmen of 1700 are known. Time and care are important elements. Mr. Sheridan spent 980 hours at the bench over a period of more than two years, insisting on

all ad 4 0 P. under music

100 23 Perry Ave. Chicago

completing the work himself; he built his violin to micrometer measurements, carving and scraping the beautiful arching rather than pressing the wood into shape. The curves were perfected by working with oblique illumination and shadows in a photographic darkroom, watching the reflections of light on the arched back and face and smoothing the wood to perfect bisymmetry. A creditable violin, it is said, can be turned out by an amateur in less time than Mr. Sheridan devoted, but he was striving for perfection and it was his first handicraft project. The result is a violin described by professionals as "the best ever made by an amateur, and better than most professionally made violins."

H P 3 3

Backward Roll of Car Stopped by Automatic Brake

Inconvenience and danger in stopping an automobile on a hill are eliminated by an automatic check which holds the brake set and keeps the car from slipping backward downhill. It can be installed on recent model cars which have hydraulic brakes. When he halts the car, the driver applies the brake and disengages the clutch in the conventional way; the automatic check keeps up the hydraulic pressure in the brake system as long as the clutch pedal is depressed, so that the driver can take his foot off the brake to operate the accelerator. When the clutch is released, the brake is automatically released and the car moves ahead.



Drawings show location of backroll brake mechanism; it operates so long as clutch is depressed

Pocket Size Hardness Gauge Gives Fingertip Reading

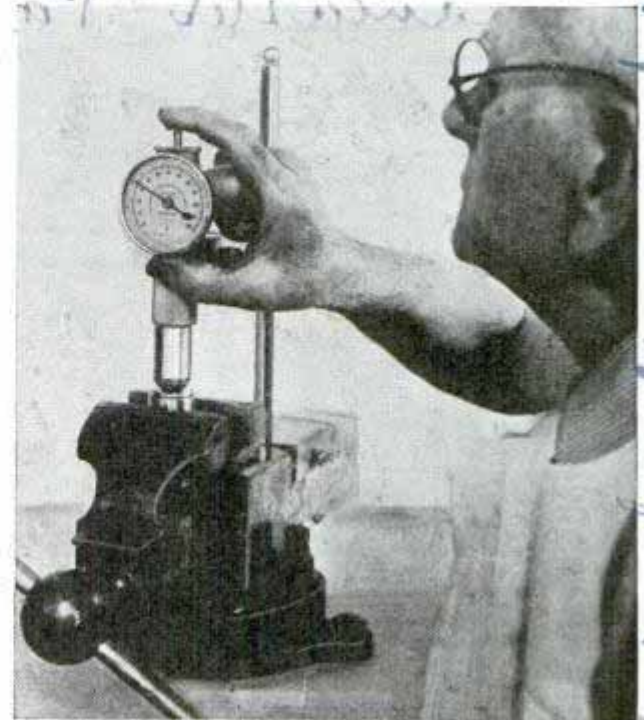

Press the button on top of barrel and the dial instantly shows hardness of metal being tested

Only six inches long and weighing one pound, a pocket size hardness indicator tests metals at the touch of a finger. The test can be made in a bench vise, on a surface plate, or free-handed. The instrument is placed on the work, and the button on top of the barrel is pressed down. The pointer then automatically indicates the hardness on an enclosed dial.

H P 3 7

"Handyman" for Garbage Can Prevents Loss of Lid

Here's an end to the mysterious disappearance of garbage-can lids. A "handyman" just introduced holds the can in a bracket, and the lid is fixed to a swinging arm projecting from a post. The lid lifts and swings to either side, then drops automatically on top of the can when it is swung back in place. The holder also keeps the garbage can off the ground, away from dogs and free from insects.



Walter J. Fishering
Leo Road
Waukegan, Ill.

Wagner Electric Corp. are M. Lewis, Ind. 6400 Plymouth Ave.

I have instrument & but I am. Wash line and call.

Automotive Parts
Lid.

14822
Armstrong Coil & Vibroking
POPULAR MECHANICS
Pittsburgh Pa
Lancaster Pa

'Map Rug' for the Playroom Shows Main U. S. Highways



Playing "trailer tourist" on the map rug. Notice the drawings around the border showing development of transportation on land and sea

Youngsters can tour the highways of the United States on a felt base playroom rug on which is printed a huge map of the nation. The states, their capitals, principal cities and emblems of their leading products are indicated, and around the border is a panorama of the development of transportation on land, sea and in the air.

Red and Green "Traffic" Lights Police Electric-Power Flow

Like the stop-and-go lights that keep traffic moving in orderly fashion across the nation's highways, nearly 200 sets of red and green lights "police" the flow of power along the transmission lines from Boulder dam to Los Angeles. So long as a circuit remains closed, a red light shows on one of the panels in the main powerhouse. But let lightning or other trouble interfere

and within a half second a relay trips a circuit breaker and a code message flashes back in "carrier current" to the main control panel and a green light tells the operator to reroute the power or wait until trouble on the line is cleared. Power and carrier current never interfere with each other, since they travel on different frequencies.

Model of Stratoliner Performs in Wind Tunnel

Before the four-motored "stratoliners" now under construction are sent up for actual flying tests, a model is being given performance tests in a wind tunnel glass-walled for observation purposes. The model is subjected to terrific wind velocities to determine reaction of the liners to various weather conditions. Six of the sky giants are being built to carry passengers across the continent at 15,000 to 20,000-foot altitudes, at 242 miles an hour.



Watching test of model in glass-walled wind tunnel

K 864

Aeronautical engineer

14822
Armstrong Coil & Vibroking
Pittsburgh Pa
Lancaster Pa
14822
Armstrong Coil & Vibroking
Pittsburgh Pa
Lancaster Pa

Washington D.C.

H 755. Checo wheel and mfg. Co.
 1101 W Monroe Chicago
Table-Top Power Tool Unit for Modelmaker

Requiring only three square feet of space on table or workbench, a combination power-tool outfit is available for the modelmaker or apartment-dwelling craftsman. A small, high-speed hand grinder serves as the power unit and is clamped in a casting. The lathe has a clearance of eight inches between centers and is useful for small turnings, such as chessmen and numerous items for modelmakers. Only a moment is required to replace the tool-post holder with a circular-saw table fitted with a miter and a rip fence so that cuts from forty-five to ninety degrees can be made. This arrangement also serves as a table for a disk sander. When used as a drill press, the unit is set up vertically and a thumbscrew is tightened to lock it in position. In this position, the unit also is used for small routing jobs.

For shaping and spindle-sanding operations, the unit is inverted and a cutter or sander mounted in the motor chuck. For routing or carving on large work, the grinder can be detached from the head casting and used separately.

Several views of table-top shop and jobs on which it may be used. Top, in use as a lathe

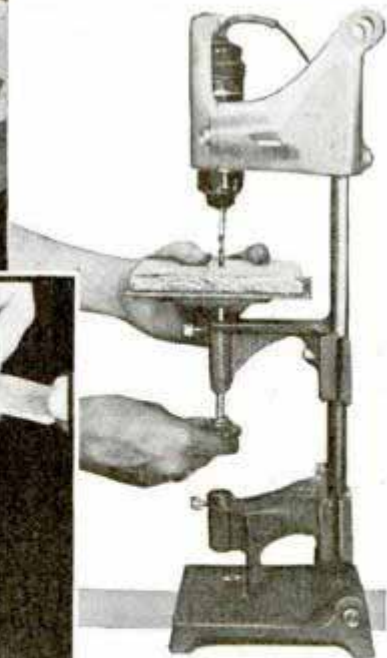
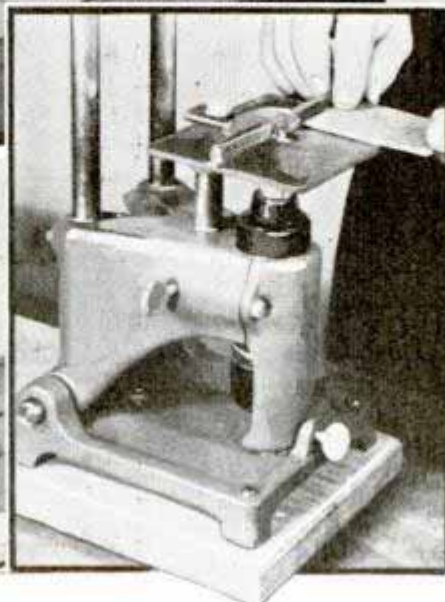
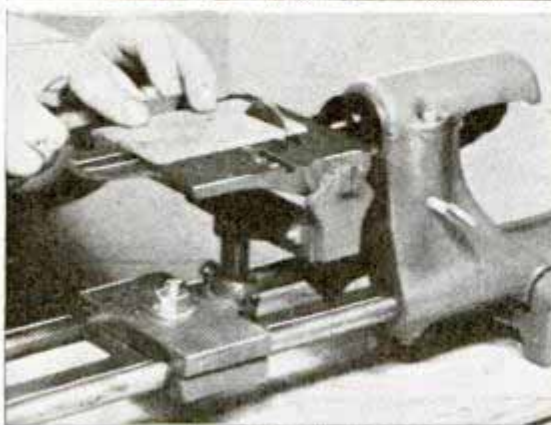

Top, left, table-top shop and attachments. Bottom, left to right, three more uses of the compact unit

3150 S. ...
 ...

Giant Flying Boats for Week-End Sky Cruises

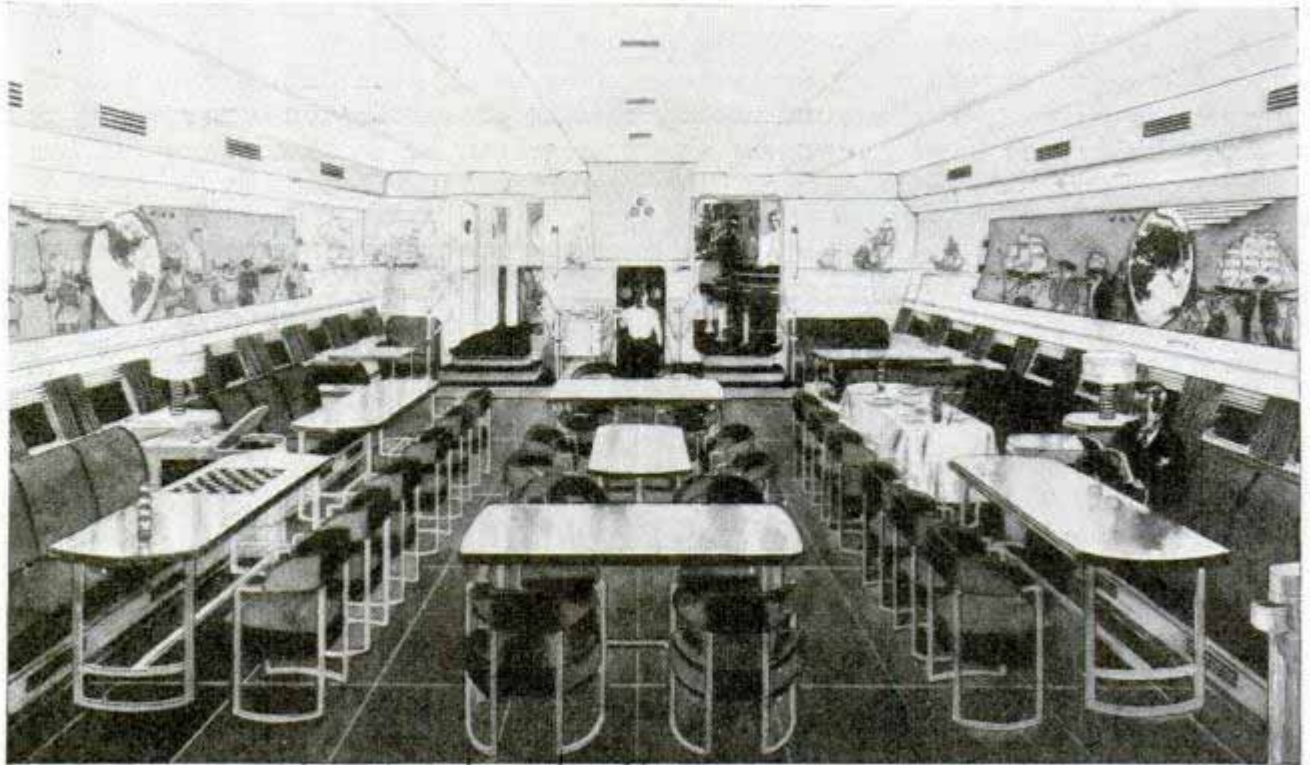

© Sikorsky Aircraft

Budapest, Conn.
Artist's idea of dining saloon aboard giant flying boat of the future. The saloon might be used also for recreation. Accommodations for 100 passengers would be provided

Comfortable week-end cruises to the North Pole or one-week cruises around the world in 100-ton flying boats within a few years are predicted by Igor I. Sikorsky, aeronautical engineer and designer of two widely used types of clipper planes. These flying boats, which will bring Liverpool within twelve or fifteen hours of Quebec, or India and Australia within three days of America, will appear like zeppelins with a wing on the upper surface, he says. A 100-passenger flying boat, designed by the engineer in response to Pan American Airways' request for a ship having a payload of 25,000 pounds capable of flying 5,000 statute miles at speeds between 200 and 300 miles per hour, would have stateroom accommodations, dressing rooms, dining saloon, a galley and crew quarters for sixteen. The designer points out that it appears that above the sizes of fifty or 100 tons, the flying boat will become the most efficient and also the most practical type of heavier-than-air machine. The Sikorsky "S-42," the clipper used by Pan-American between New York and Bermuda and on other runs, is more efficient in many respects than its smaller and older sister ship, the "S-40."

Twin-Blade Truck Gives Test to Wind-Electric Units

In order to test wind-electric units and conduct experiments in their design, an engineer devised a special truck which carries two propellers on frames mounted over the engine. Between the blades there is a highly sensitive velometer to determine the exact wind velocity during the

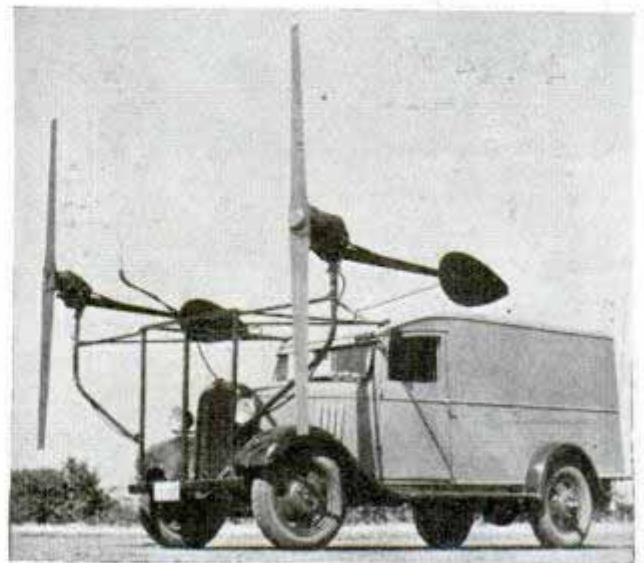

Twin instrument boards inside the truck show wind velocity and current generated by propellers

*Carris. Lunni
Cuda. Clarinda. Clary*

Salome Strone 6/22/38

*4760
4859*

tests. Inside the panel body of the truck are the instruments—master ammeters, voltage gauges, velometer dial and batteries of various voltages. With duplicate dials the engineers can obtain comparative readings on any two wind-electric units while operating under identical conditions.

Four Mirrors on Dressing Table Show Head at Several Angles



Posing with four mirrors to produce four different angle photos suggests the use of extra mirrors on dressing table

Portable "Plug-In" Stove for Cottage or Apartment

Built for "light house-keeping" in apartment, summer cabin, tourist camp or small home, a portable electric stove of the "plug-in" type offers the advantages of low costs both for installation and operation. Yet it is big enough to cook for a family. There are two surface units and a ten-quart roaster and baker which has automatic controls. Available with or without chrome legs, the stove is offered in various wattage combinations, one with the low total demand of 2,660 watts and the other a total of 4,410 watts.



Putting dinner into baking-roasting unit. The stove is compact, portable, and adequate for family cooking

Giving greater visibility when the user desires to inspect her hairdress or hat, four mirrors may be arranged at the dressing table to give views from different angles. The idea was suggested by a photographer who used several mirrors in snapping a picture of Florence Mitchell, selected as daisy queen in a Maine festival.

Safety Nut Locks on Bolt and Cannot Loosen

Similar to a steel spring in which a thread is cut, a new safety nut locks on the bolt without the aid of locknut or spring washer. It cannot become unscrewed. If the nut is screwed up tightly, it is compressed into contact with maximum surface area and the tension of the springing effect locks the nut in position. It is the product of a German engineering company.

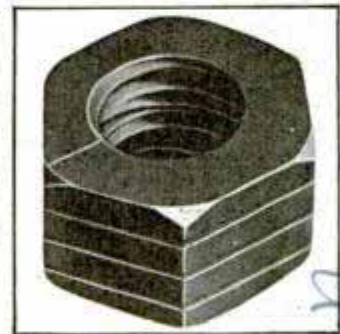

*malleable iron
C. Deaver*

*U.S. agent
American*

*Wilde W. ...
Bangor
ma 11 - machinery fabric
Augsburg, Nürnberg, Germany*

Designer: Clyde Jones

Midget Car Is 'Fishtailed' for Speed and Safety

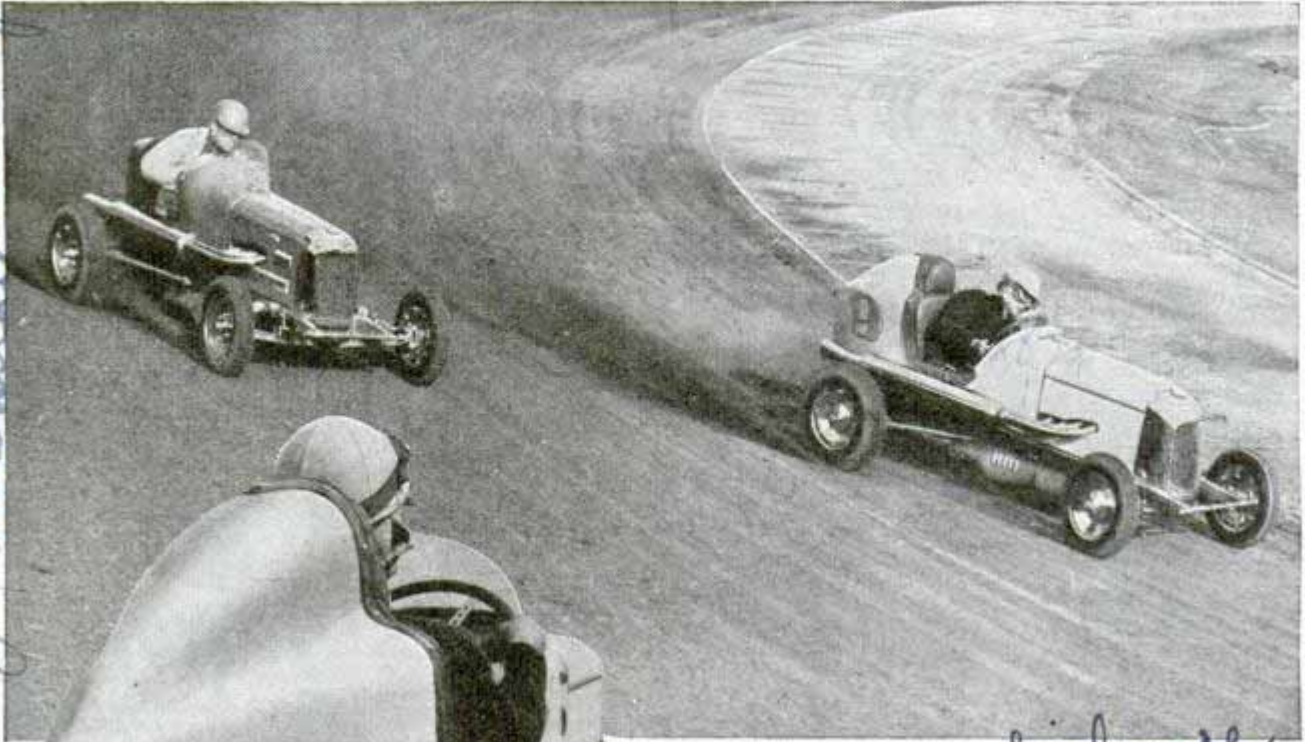

Silvane

Streaking around a Los Angeles stadium the other day, a "fishtailed" midget racing car set up an unofficial record of 138 miles an hour. Its streamline form was given part of the credit for the fast time, but the stubby, fin-topped tail has another reason for existence. Besides speed, it promotes safety. Acting as a headrest, it relieves the driver from stiff neck and nerve strain in bucking the wind, and in case of an upset it forms a protection beneath which the driver can crouch as the car rolls over.

Hugging inside of track is 138-mile-an-hour "fishtailed" car, rear view of which is seen below

One-Man 'Plow' and Winch Replace Gang Filling Ditch

One man guiding a mold board hauled by a winch can do the work of the pick-and-shovel gang in back-filling trenches dug for pipe or cable lines. The winch is controlled by a truck driver who applies motor power from the cab. The steel cable hauling the "plow" board is drawn through a guide pulley on the truck bumper and thence to the winch at the back of the cab. When the dirt load has been deposited in the trench, the winch clutch is released and the board pulled back into position.



Send return postage to our Bureau of Information to learn the name of the maker of any device described in this magazine.

Designed and constructed by Clyde Jones. Large California representative for index reports. Los Angeles

17844

17844

17844

1520.

Wild Horses Corralled from Air

By Jeff Sparks

W O W Agency Staff 1440 Pyramid Nevada

Sutcliffe Nevada
Floyd Hanson, right, aerial cowboy, and the plane he uses to round up wild mustangs, a quicker and more profitable method than that illustrated below

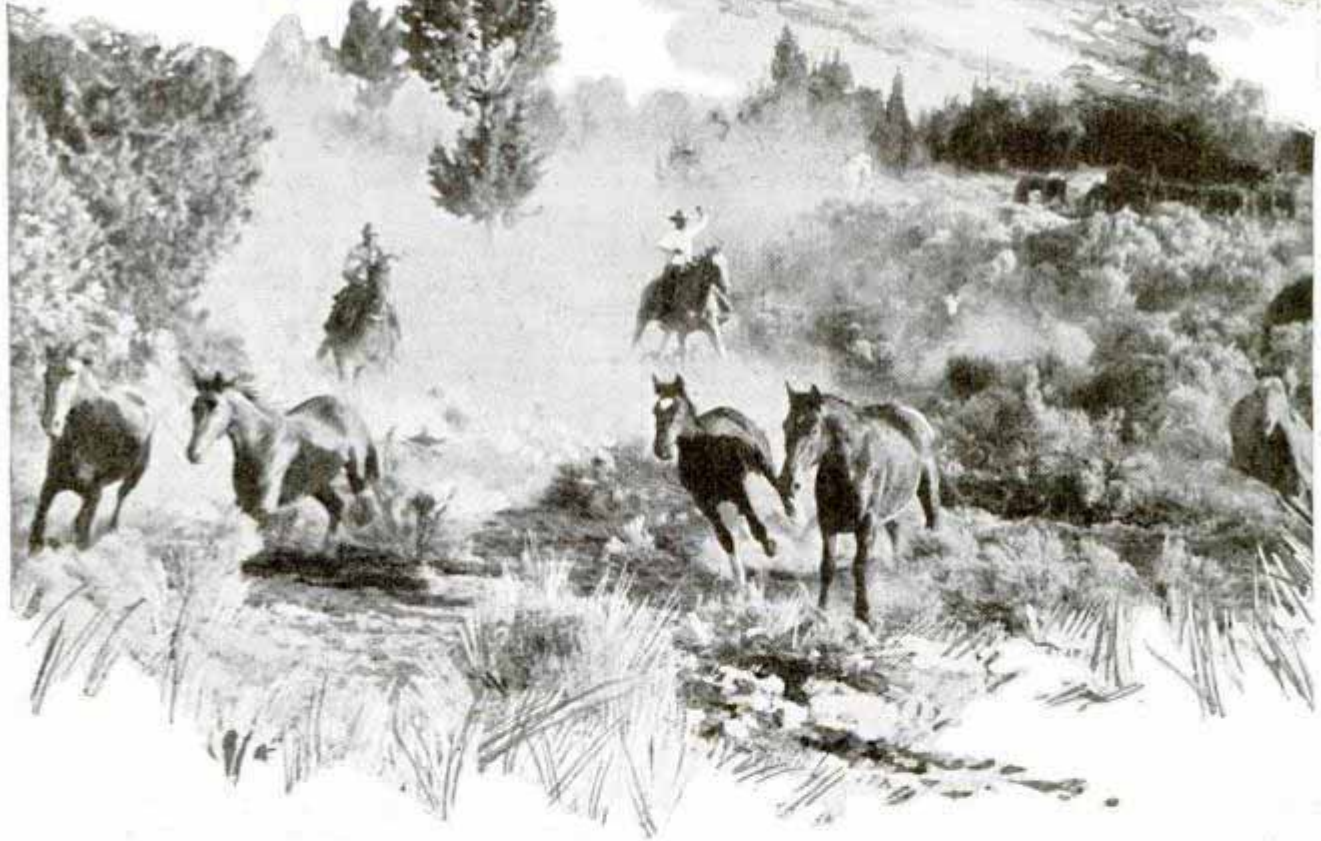

SUTCLIFFE, Nev., they call it. It fringes old "ghost" mining towns of gold-rush days which remain as the prospectors left them. Our ranchouse is high up in the Sierra Nevadas, on the bank of Pyramid lake.

While dozing, one summer afternoon, I was startled by a strange, screaming whistle. I hopped to my feet and peered out the cabin window. An airplane—out here—diving right at me—well, near enough.

Down it came and landed in a clearing. I ambled over to the small open cockpit job, and a tall, gangling, cheerful fellow climbed out. The flier introduced himself as Floyd Hanson, aerial horse wrangler. He used the plane, he explained, to hunt and capture wild mustangs. And pretty soon I was eye witness to as risky a business as ever broke a neck.

It all started, it seems, in 1936 when a contractor got a crazy idea. If he could



Routing wild horses from some mountain canyon like this is the first task of the aerial cowboy. After that, he drives them into a natural corral formed by converging cliffs

find someone capable of using a plane to round up mustangs, there was money to be made. Wrangling from the air had been tried before without much success but Hanson decided to have a try at it anyhow. Wild horses are rounded up, "broken" to the saddle and sold to riding academies and other markets for from twelve to fifty dollars each. Hitherto, mustangs have been caught in tedious style. Twelve or fifteen cowboys might spend two months or more on the job and end with a total "catch" of about six head.

But suppose you could catch sixty or eighty horses per day. Then five dollars for each horse captured was a pretty good proposition. About twenty mustangs in a herd; say—four herds a day—that meant \$400. There was only one hitch. Hanson didn't know a thing about horses. But—he did know planes. So he became an aerial cowboy.

Here is his two-seater warming up. So let's have a look-in on this wild horse "ketchin" business:

Take-off is set for just before sunup—3:45. Our camp is at the edge of the horse country. We head toward the feeding and watering grounds. Then I solved the mys-

tery of that curdling whistle which awakened me the first time Hanson dropped in on me. Attached to the ship's fuselage is a siren, used to startle the quarry, to make them run. Once in the open, they can be cornered. Frequently, the animals must be coaxed out of mountain canyons. Treacherous air currents guard the approach to the domain of King Mustang. But the little one-motor job darts in and out of tiny cracks and crevices in the very bosom of the hills.

Then we spy mustangs up ahead. They detect our motor and siren three miles away and as we catch up they're on the run. Hanson picks out the best looking bunch and starts a dive. Instinctively, they make for their feeding and watering places. This is in the opposite direction from the corral where he is trying to steer them. The plane shoots down on their tails to head them off. The mustangs are puzzled and frantic. But they are game. They struggle desperately and give every inch of ground grudgingly. Another dive. The wheels almost touch the backs of the fleeing horses. Hanson skims over them and flips into an upward loop. They keep running from us, but gradually they're being

edged toward the corral. Another dive—another slide over the galloping pack—and up into another loop. And again. Ten long trying miles of this. Suppose the motor were to go dead. Suppose we were to fall into the midst of these berserk animals. Better not think about this.

The herd has been run to the verge of exhaustion. Their most heroic defense just can't match the "bird that never tires." Foaming flanks and wearied gait excite your sympathy. Suddenly, they seem to be giving up the fight and are running without resistance where the flier wants them. The plane drops back a half mile—a mile—but in wide circles. At last, the objective is in sight. But our troubles aren't over.

The tough job is to get the horses into a natural corral created by two towering rock walls. The enclosure is effected by blocking off one end and erecting a gate at the other. Hanson must drive the herd into this trap. Then cowboys will jump from their lookout post and slam the gate.

The mustangs are jittery; they sense the presence of humans. So far, they've been jousting with a huge eagle. Now they get wind of the buckaroos in hiding. In the next instant, seeming to realize that they've been tricked, the animals turn about in a frenzy. Hanson dives, darts and sideslips the plane, trying to coax them into the corral. It's a stubborn duel all over again. A moment stretches into a minute—five minutes—ten minutes—a half hour. At last they decide it's a losing game and take the trail into captivity.

But the prize isn't safe yet. To drive them deeper into the corral, Hanson drives straight down between the precipitous walls. It is vitally necessary to gain sufficient altitude before attempting this maneuver. Shooting down from less than 1,000 feet would be suicidal. There would be insufficient momentum to carry the plane back over the top. Yet the higher the starting point, the more difficult to hit the opening and avoid the walls. It's a matter of inches.

Below us, the herd keeps running. We start a power dive. Down we go into the stone alley—wing-tips scarcely clearing the sides. When dangerously near the ground, Hanson pulls the stick back into

(Continued to page 120A)

Leakless Wall Made of Brick with Rounded Corners



Garden wall being constructed with rounded-corner brick. Note reinforcing bars

Strong, waterproof walls for house and garden may be constructed with rounded-corner brick and steel reinforcing bars. The round corners of the bricks permit an easier flow of concrete grout between brick and steel bars, resulting in a bond which resists severe fire tests.

Asbestos Attachment on Burner Cuts Down the Gas Bill

Asbestos attachments which form a collar around the burner on the kitchen stove are said by the manufacturer to reduce gas bills on an average of thirty per cent. The asbestos ring extends down to the under grate and is one-eighth to one-fourth inch thick. It prevents outside air currents from dissipating the heat, and intensifies the flame.

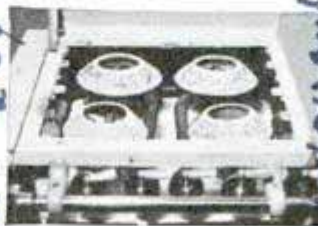

12520

A 749

In Angeles
Carick Co. 8th and 100th Ave

same. 250 plus postage

14751

Eureka Economy Co.
727 E. 213th St.
Astoria, Ore.

Eureka Economy Co.
727 E. 213th St.
Astoria, Ore.

Automatic Camera Sets Self for Correct Exposure

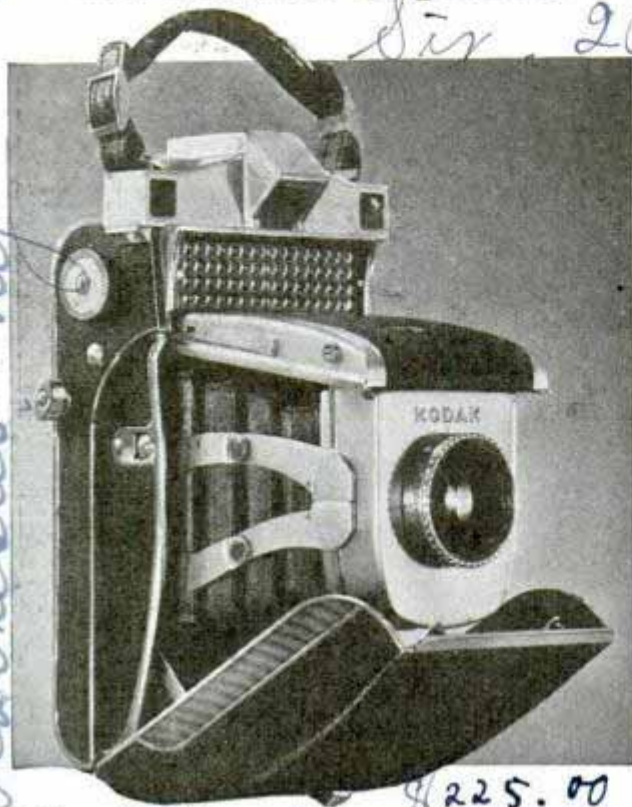

Photocell which controls automatic setting of diaphragm is behind multiple lens near top of camera

\$225.00

Here is a camera that thinks for itself. Focus on your subject, set the shutter speed according to the action, and the camera itself will automatically adjust its own diaphragm to the proper opening according to the light conditions at the moment. Eastman technicians accomplished this feat in the new camera by coupling the diaphragm with a photoelectric cell. Perfect exposure at snapshot shutter speeds from one twenty-fifth to one two-hundredth second is thus assured. The light-sensitive cell is located behind a multiple collective lens which covers the exact field of the camera lens, so that the photocell reacts only to light within the scene being photographed. At the split second the shutter is tripped, the photocell actuates a galvanometer and causes the diaphragm to open or close to the proper aperture according to the shutter speed in use. Double exposure is prevented by a device which makes it necessary to operate the film-winding lever before the shutter can be tripped again, and a red warning dot shows in the window of the shutter speed scale to indicate that the film must be wound. The built-in range finder has a

triangular split field making it easy to focus from four feet to infinity on horizontal or vertical lines without tilting the camera. The picture size is two and one-quarter by three and one-quarter inches, the camera carrying a roll of eight. The f.3.5 lens closes down to f.22. The shutter is adjustable for speeds of one-tenth to one second besides the snapshot speeds, and a self-timer permits a delayed shutter release of about twelve seconds. For special effects, the automatic feature can be thrown out by a lever, converting the camera to the conventional focusing type.

#827

Safety Window-Washing Seat Handy for the Home

Designed to make window washing less hazardous in home or office building, a safety seat now ready for the market clamps on the sill. The user sits comfortably and safely in the seat, with feet inside the window, while he washes the outside panes of the windows, both top and bottom. Made of plywood and aluminum, the seat will support 1,000 pounds.



Two views of the window washer's safety seat for use in home or office building

C. M. Thompson
6432 N. Lakewood

Eastman Kodak Co. Rochester, N.Y.

4139

H 674 Com. James Washington
 3416 N. 31st St. 545
 Tacoma, Wash.

Cement-Hulled Sloop Wears Ballast Outside

Breaking from the conventional method of placing cement inside the boat for ballast, a Tacoma, Wash., yachtsman has built a sloop with its ballast outside. The lower part of the "Boren's" hull is made of cement, joined to a conventional upper hull section of wood. The sloop is thirty-eight feet long with a twelve-foot beam. On trial runs the cement-bottomed craft performed in a highly satisfactory manner. Its owner, C. E. Hogberg, prefers comfort to speed on the water.

Tacoma Yacht Club

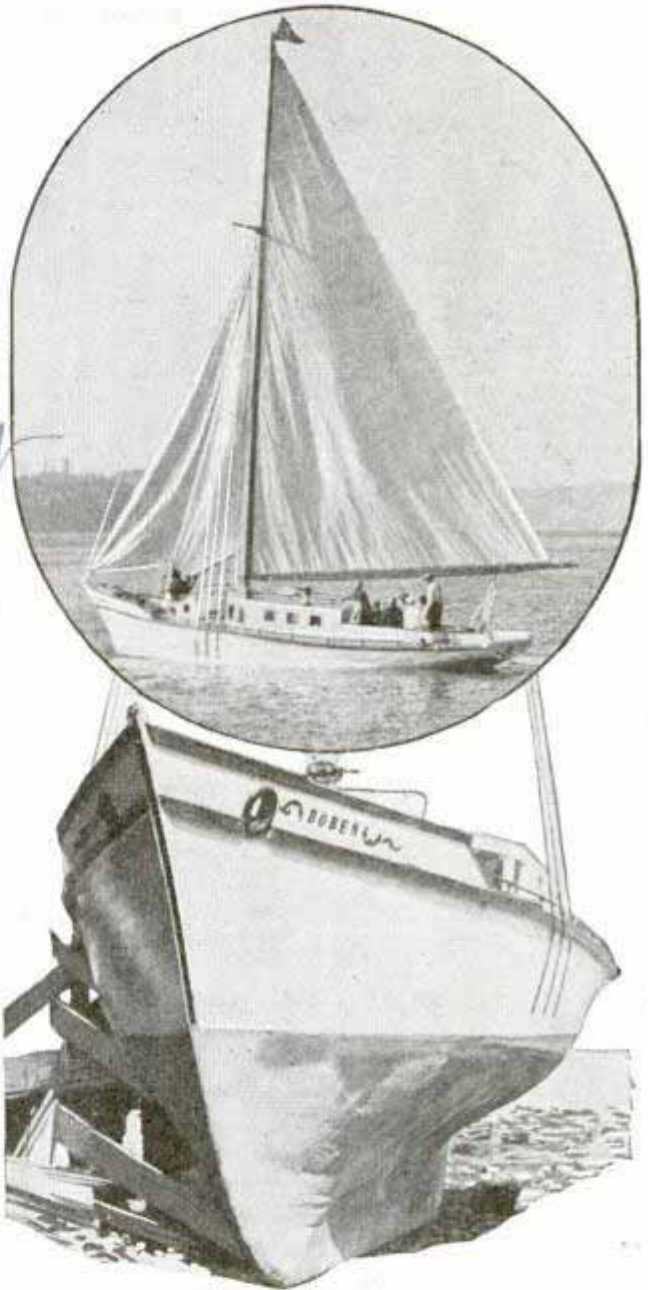
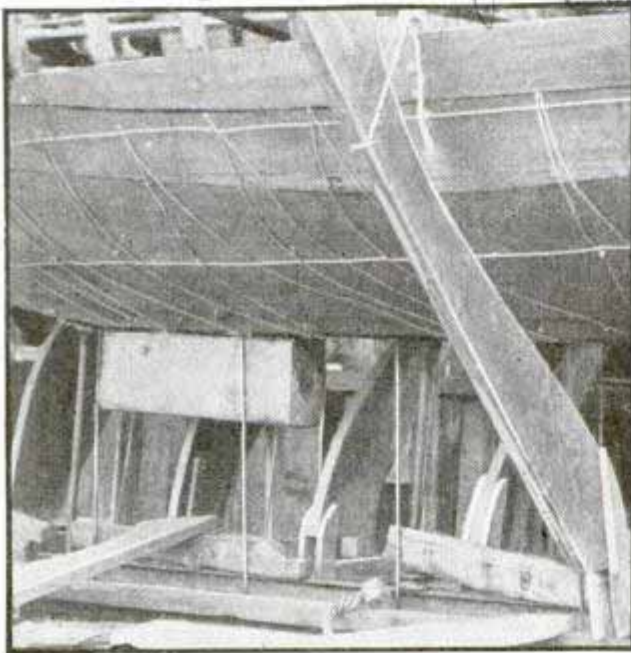

Above, building the cement-hulled "Boren." Right, the sloop ready for launching, showing where upper hull of wood is joined to cement undersection; above at right, the owner makes a satisfactory trial cruise

H 705

Speed Indicator Warns Driver by Flashing Red Light

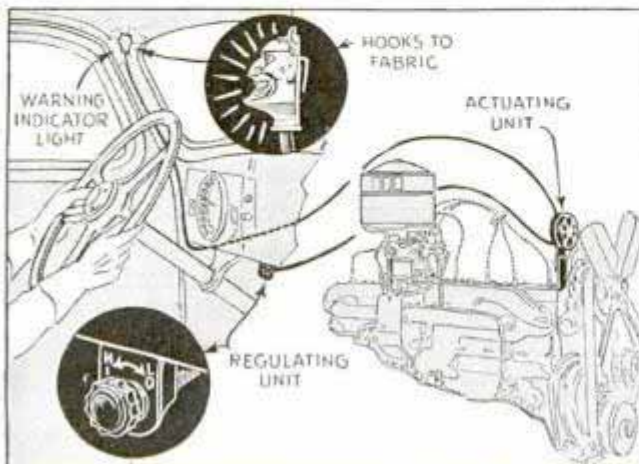

When the automobile exceeds a predetermined speed, a new indicator flashes a red light to warn the driver. The indicator, made in the form of a devil's head, is red. Inside it is a light which is turned on when electrical contact is established by a metal disk actuated by air current from the automobile's fan. The air current fluctuates in relation to the motor speed. Tension of the disk may be adjusted by means of a regulator on the dash. The indicator is small and may be hooked to the fabric in the top of the car, at the driver's left.

Casco Products Corp.
 100 Ridgely St. Conn.

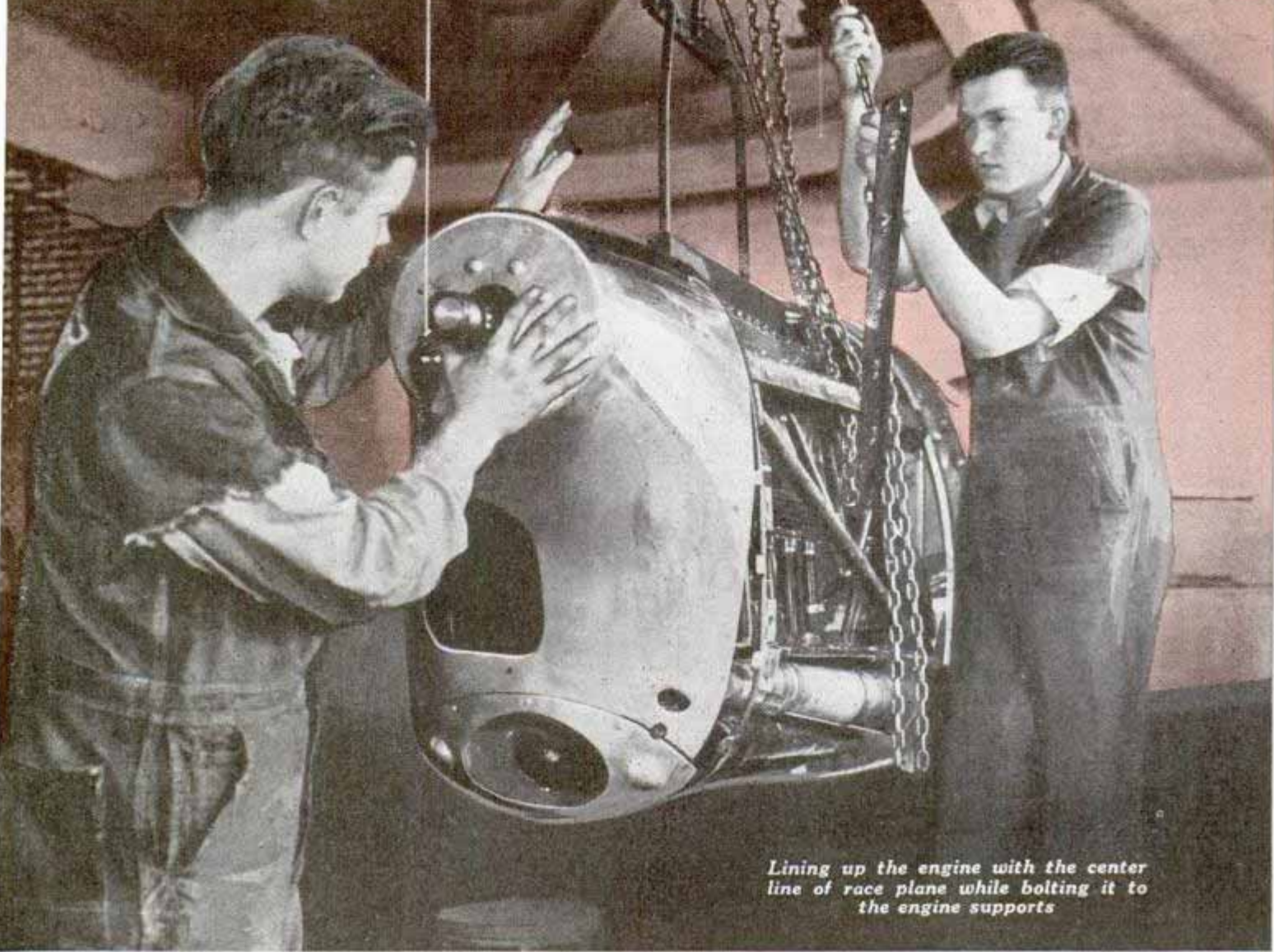

Lining up the engine with the center line of race plane while bolting it to the engine supports

FLYING *the* WINGED

1528
2500 w. 7 Blvd
H. Los Angeles

ONE mile and a half from shore and only fifty feet above the water, the crankcase of Art Chester's tiny racing plane suddenly burst and vibration almost shook the wings off before Chester could cut the switch.

The pilot didn't have a parachute, nor altitude to use one. Yet a minute later, instead of crashing into the water at 250 miles per hour, he was setting his wheels down on the airport at the edge of the lake. Sheer speed had saved his life. Traveling close to five miles per minute when the engine failed, Chester automatically pulled back on the stick while he was fumbling for the switch, and momentum had swung him up nearly 1,000 feet above the water. From that altitude he was able to glide safely to the field.

"You can always tell, during a race, when someone gets into trouble," Chester

says. "The planes will be roaring along in level flight and then suddenly you notice that one of them has started to skyrocket. When something happens, the smart thing is to zoom as high as your speed will carry you, giving time to get your wheels down and a chance to pick out the best landing area within a mile or so."

Modern race planes are unbelievably small, no larger than is necessary to get the engine, pilot, and fuel supply off the ground and still permit good maneuverability. Small as the wings are, the pilots would cut them smaller if most races were not held around closed courses. If the wings are too small the plane mashes sideways when making a vertical turn around a pylon, while another plane whose wings "stick" better in the air can whip around the marker and make off at once on the next leg of the course.

*Cent. Thomas & Hinman, Pasadena, Calif. H 528.
 10555 Holman Ave
 Los Angeles 186/8 Malibu Road Pacific Palms*

This year, with more planes than ever being groomed for the races, new American speed records are anticipated. Straightaway speeds of 300 miles per hour, and averages of 275 miles per hour around closed courses will be surpassed, the pilots think. More than a score of competitive speed planes were built during the spring and competition will be hotter than ever, due to the larger prizes offered. More than \$100,000 will be posted for winners of the National Air Races, an increase of 30 per cent above prizes in the past.

Fast as they will be, however, the American

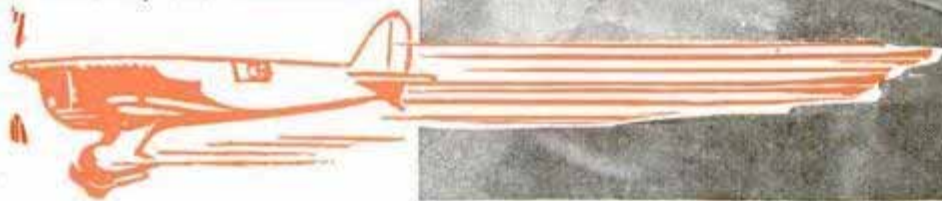

BULLETS

Top, closing cockpit hatch which completes streamlining of racing plane. Hole in transparent cowling enables pilot to signal the starter. Bottom, putting on parachute before testing new speed plane

*Harry Crosby
 915 N. Hollywood
 Burbank, Calif*



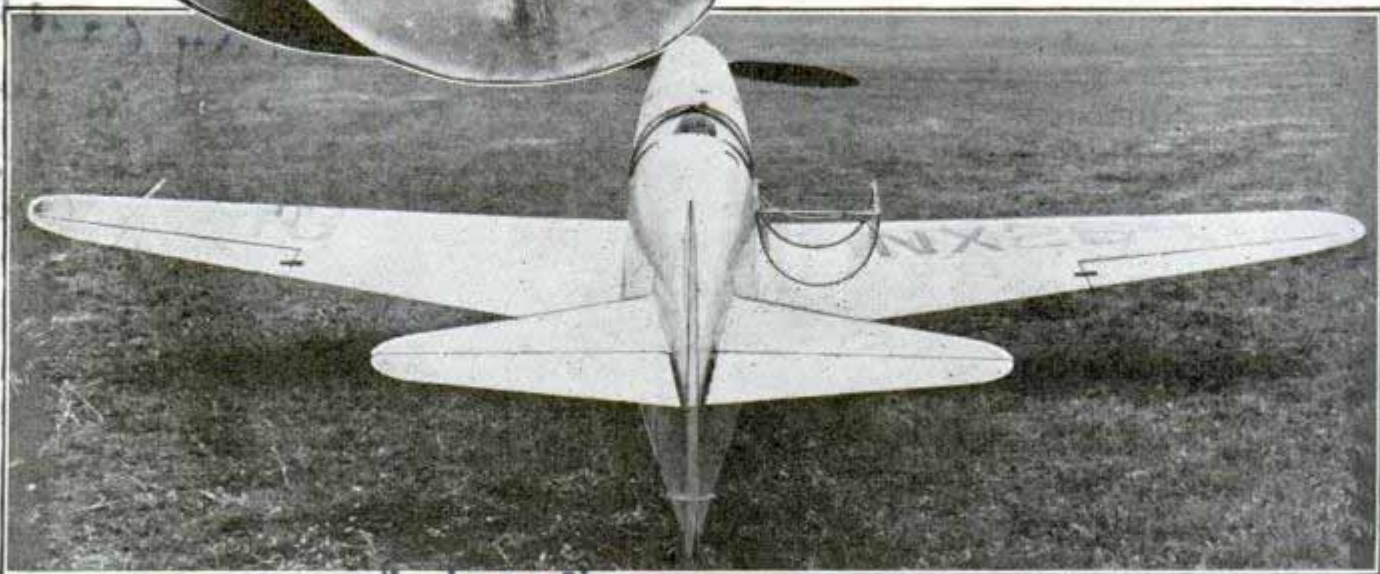
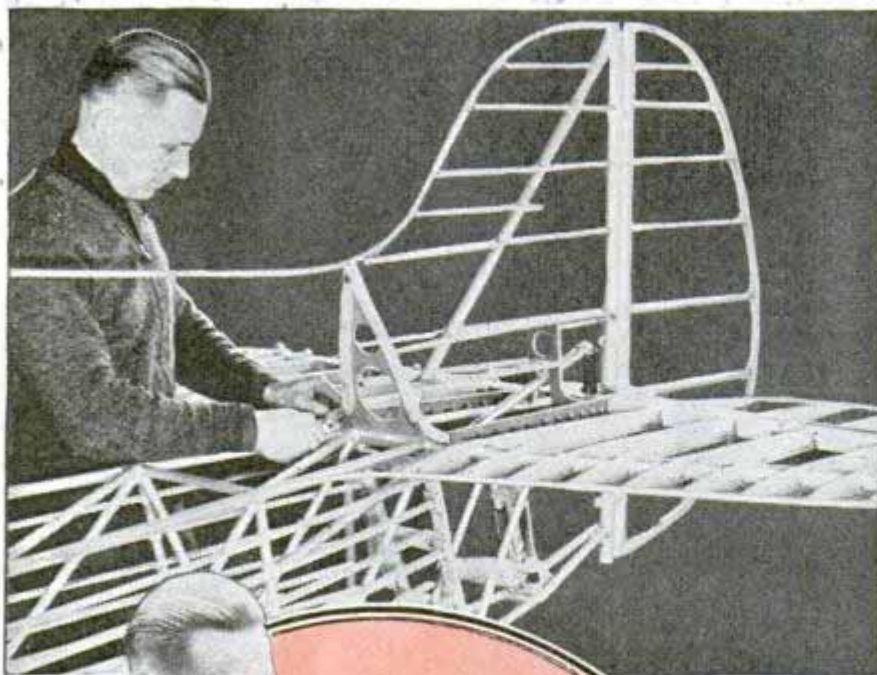

ships probably will set few international records. Each American speed pilot has to create his airplane at his own expense. With no racing engines available, the pilots use stock commercial engines worked over for greater speed. The average American pilot may spend \$8,000 to build a plane for the 550-cubic-inch class, while many times as much goes into each subsidized foreign speed creation built to uphold national prestige by smashing records.

Pilots like Art Chester and S. J. Whitman, who finance, build and fly their own race planes, know exactly what they need to fly much faster, but a special racing engine of 1,000 horsepower or more, for instance, would cost a fortune to design and build. Another thing the racing fraternity needs is a variable pitch propeller, not now available in the small sizes suitable for racing planes. A fast propeller ideal for high-speed racing has small diameter and extremely high pitch, but such a propeller would not develop enough thrust to pull the

Top, working on tail assembly of new racing plane. Center, odd-shaped fuel tank fits into fuselage behind cockpit. It is designed to take advantage of every cubic inch of space. Bottom, rear view shows streamlining of racing ship. The fuselage is just wide enough to accommodate the in-line engine

18520 Art Chester

55000

plane off the ground and get it into the air. Present racing propellers are a compromise, with the diameter and pitch suitable for getting the plane off the ground, and with still enough pitch to the blades to develop fairly high speeds in the air.

"In many respects, airplane racing today is similar to automobile racing," one of the pilots says. "Both the airplanes and cars used in competition are built by individuals or by small syndicates that have no money to waste. The big difference has been that in the past there was far less prize money to be won in aviation, and a successful pilot could hardly gross more than his expenses and the cost of his plane during a racing season. Most of our best racing planes are backyard jobs, built in private garages and the corners of hangars, and financed on shoestrings."

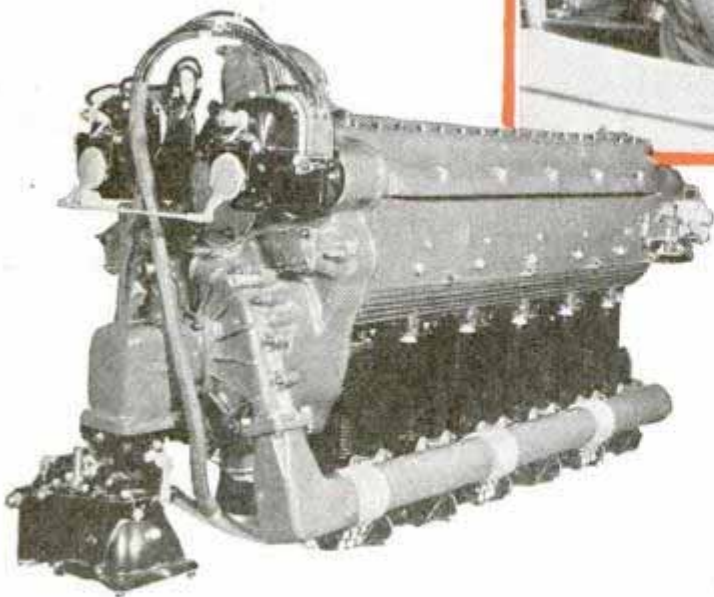
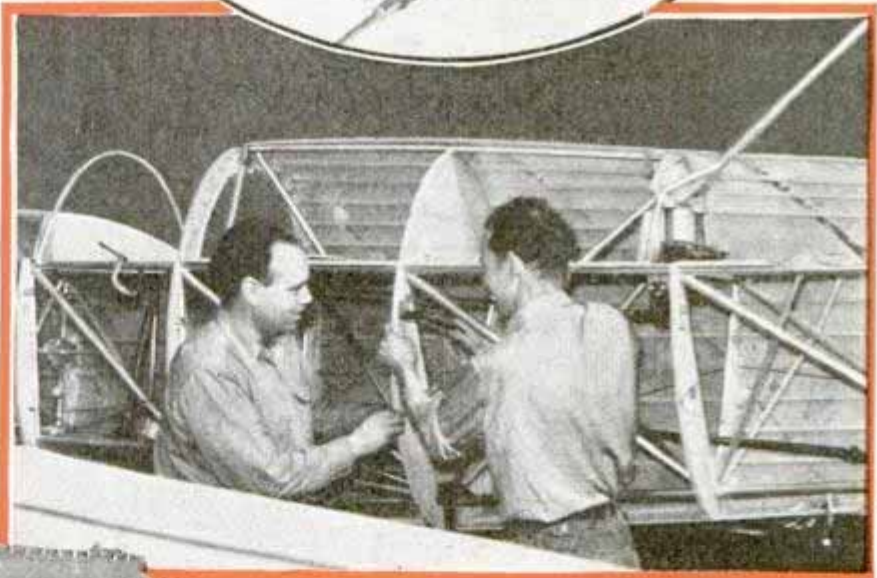
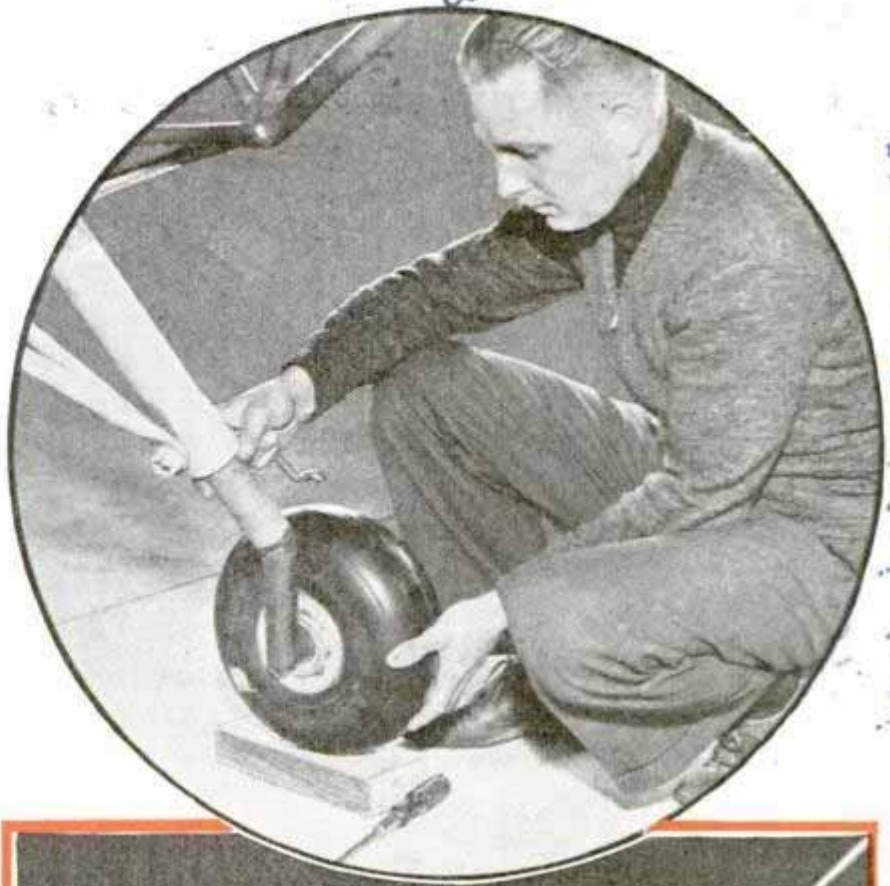

Top, fitting tiny air wheel on retractable landing gear of a racing plane. Center, attaching plywood skin to steel tubing fuselage. Bottom, 260-horsepower air-cooled in-line engine which pilots "soup up" to deliver 500 horsepower for racing

In spite of their lack of proper engines and propellers, American speed planes are steadily drawing closer to the marks set by European racers. Many of the improvements in radial and in-line engines during the last few years have resulted from knowledge learned on the race courses.

There are two principal classes in racing, one limited to planes powered with engines of 550-cubic-inch displacement or less, and the other the so-called "unlimited" class in which any airplane having an engine of 1,875-cubic-inch displacement or less may compete. Most of the

(Continued to page 118A)

*menaced
inserted*

Grinder and Drill Have Stand for Lever Feed

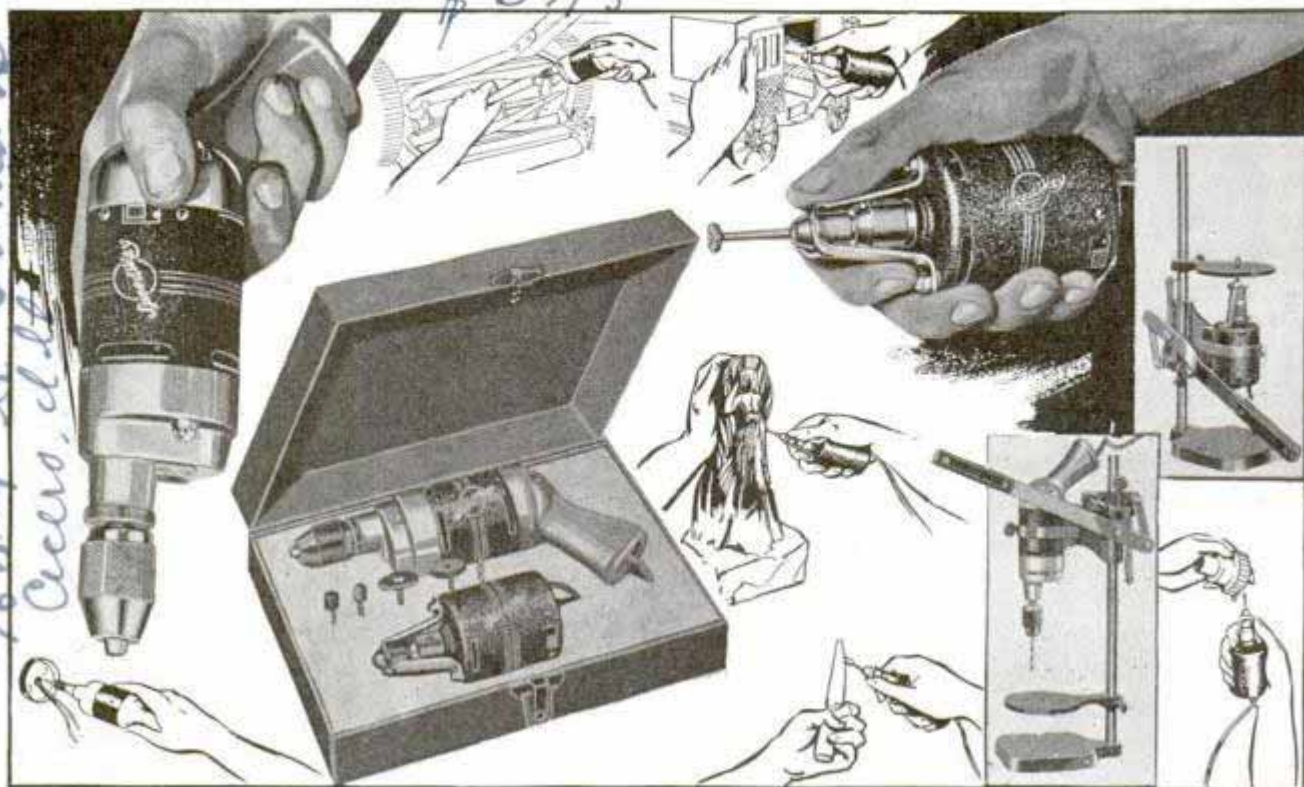

Drill at left and grinder, upper right, are available in steel kit. Some of their uses are sketched. At right the tools are mounted on stand with lever feed for upright and inverted use

Offered in a kit with steel case and five accessories, a combination electric grinder and drill is a rugged and efficient tool for various jobs in the workshop or laboratory. The grinder operates at the extreme high speed of 20,000 revolutions per minute, the

drill at 1,000 revolutions, the latter handling up to one-fourth inch steel. The tools fit the hand easily, but for precise work where accurate drilling and routing are required there is a stand on which drill or grinder can be mounted for lever feed.

Safety Drive Distributes Power to Both Rear Wheels

One rear wheel of a truck, bus or automobile cannot spin, independent of its mate, if the vehicle is equipped with a spur gear type of differential which transmits all the power exerted at the ring gear to both wheels, whether the car is on a straightaway, turn or curve. The differ-

ential action of this drive is positively locked or static except on a turn or curve, a worm and worm gear forming the locking members. When the car is steered to left or right, the gear train goes into action and the increase in speed of the outside rear wheel is in exact proportion to the decrease in speed of the inside wheel. Thus on a straightaway both rear wheels move together in a positive locked position, always rotating at exactly the same speed, while on a turn or curve, the increase in speed of the outside rear wheel is compensated for automatically by the decrease in speed of the mate. Tests of this novel drive, its makers state, have shown that the distribution of power to both rear wheels at all times not only greatly increases traction and gasoline mileage but

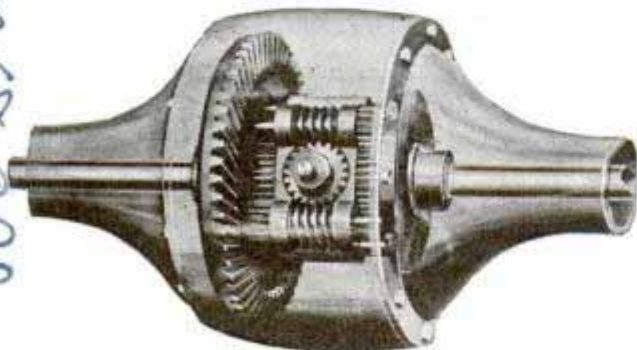

Differential which transmits power to both rear wheels whether car is on straightaway or curve

Speedway Mfg. Co.
 1634 St. Paul
 Cicero, Ill.
 4713
 Coniell Ltd.
 606 Wabash, Chicago

makes braking easier since both wheels are retarded equally. It is also claimed that this drive prevents side sway, increases tire life and eliminates the danger of one wheel spinning on a slippery surface, thus minimizing the skidding hazard. There are no springs or keys in the drive, nor is there anything to lock or unlock, cam or uncarn, gear in or gear out, open or close. The action is entirely automatic and it is both unnecessary and impossible to cause the clutch to slip. If one axle should break, which the makers say is unlikely with power equally distributed, the other axle would still have power. Because power is brought to both wheels simultaneously and none is dissipated back of the ring gear, it is claimed that the engines of cars equipped with this differential can be one-third smaller in horsepower than the motors of cars with conventional drives and still deliver as much or more useful power to the rear wheels.

H 733

Odd House with Eight Sides Turned into Museum

So well planned that there is virtually no wasted space, an odd eight-sided house at Watertown, Wis., has been turned into a museum. A circular staircase permits visitors to reach the top story. Although it is eighty-five years old, the house has not settled on any part of its foundations.



Octagonal house in which museum is now located has virtually no waste space

Collecting Poison Spiders Becomes a Business



Collector catching a poisonous insect for which he has obtained an order

Starting as a hobby, collection of poisonous insects is now returning a profit to a Californian who is receiving orders for black widow spiders, tarantulas, scorpions and similar creatures usually avoided by the average man. Scientific laboratories and pet stores send in most of the orders. The collector does not regard his business as dangerous; he never has been bitten by any of the insects for which he finds a market.

H 753

Lead-Head Nail Seals Hole and Locks Steel Roofing

Designed for use in laying sheet-steel roofing, a lead-head nail now on the market locks the nail, the lead and the sheet together. When the nail is driven, the roofing sheet springs up over a bump on the shank, locking the nail in the sheet. The lead head also seals the hole, preventing leakage.

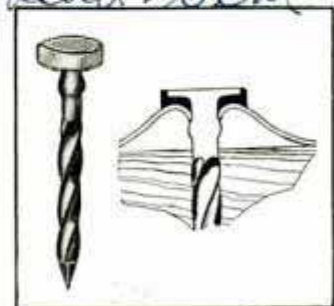

The Illustion Co
4856 S. Western Ave

W. D. ... Calif

... order ...

Wide World

E. Schulerberg (clutch)
vanemism line patrolman

H 638

General Electric Co
Schulerberg. 29

RIDING HERD on



By Charles M. Ripley
Publicly kept.

MAN cannot stop earthquakes or bolts of lightning, but he does something today which is almost as remarkable. He stops an amount of current which normally represents 2,000,000 horsepower in just one-twentieth of a second!

And because he has learned how to halt this tremendous energy in the wink of an eye when an emergency occurs, thousands of tons of falling water at Boulder dam supply a smooth flow of power to Los Angeles, 270 miles distant.

If you could safely stop a sixty-horsepower car traveling sixty miles an hour within two feet two inches, you would be able to stop in about one-twentieth of a second. But you wouldn't stop 2,000,000 horsepower, which is

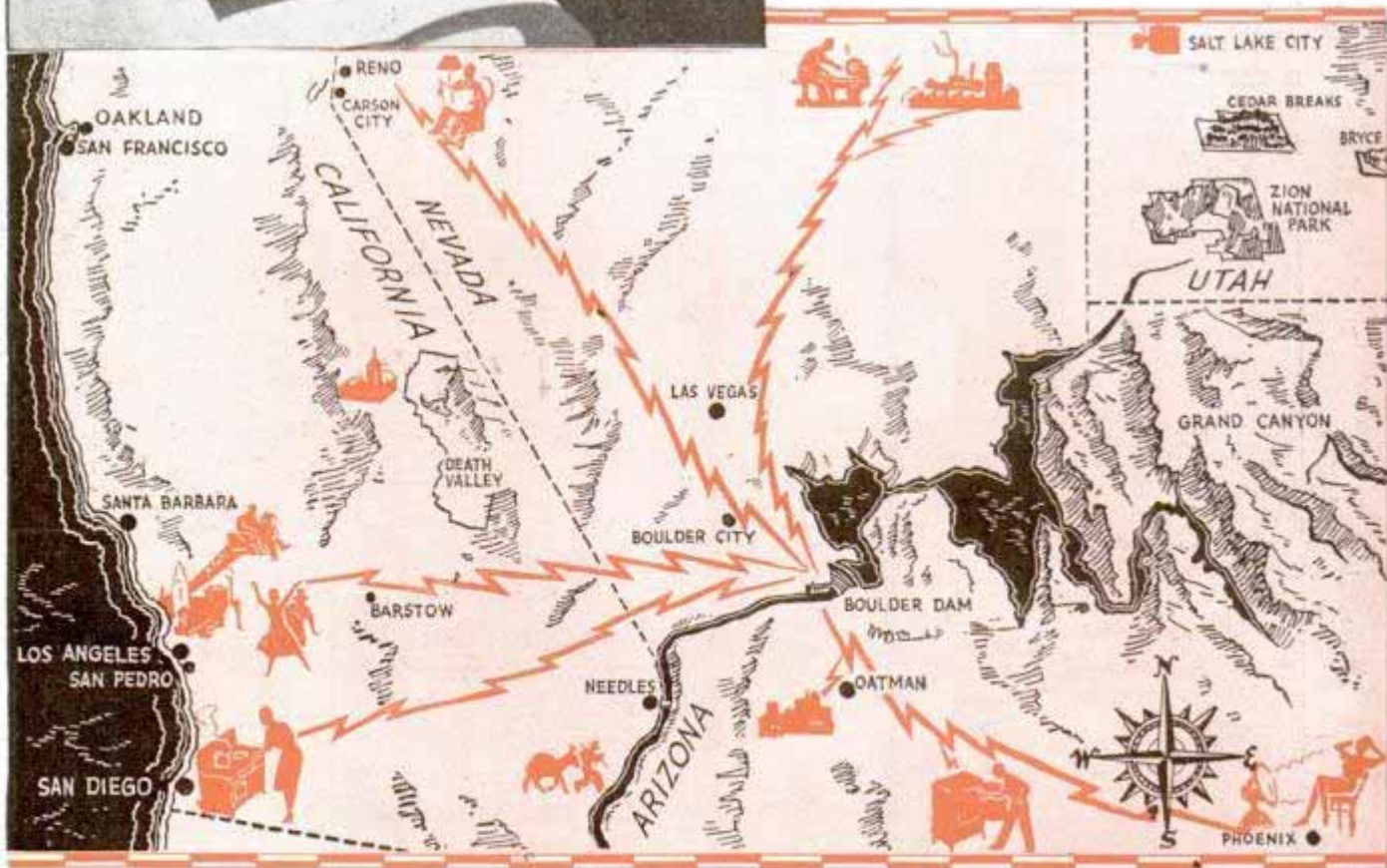

Map shows terrain traversed by transmission lines carrying electric power from Boulder dam to Los Angeles and other cities. One of line patrolmen, top, in specially equipped car, ready to ride herd on 2,000,000 electrical "horses"

8238

2,000,000 "HORSES"

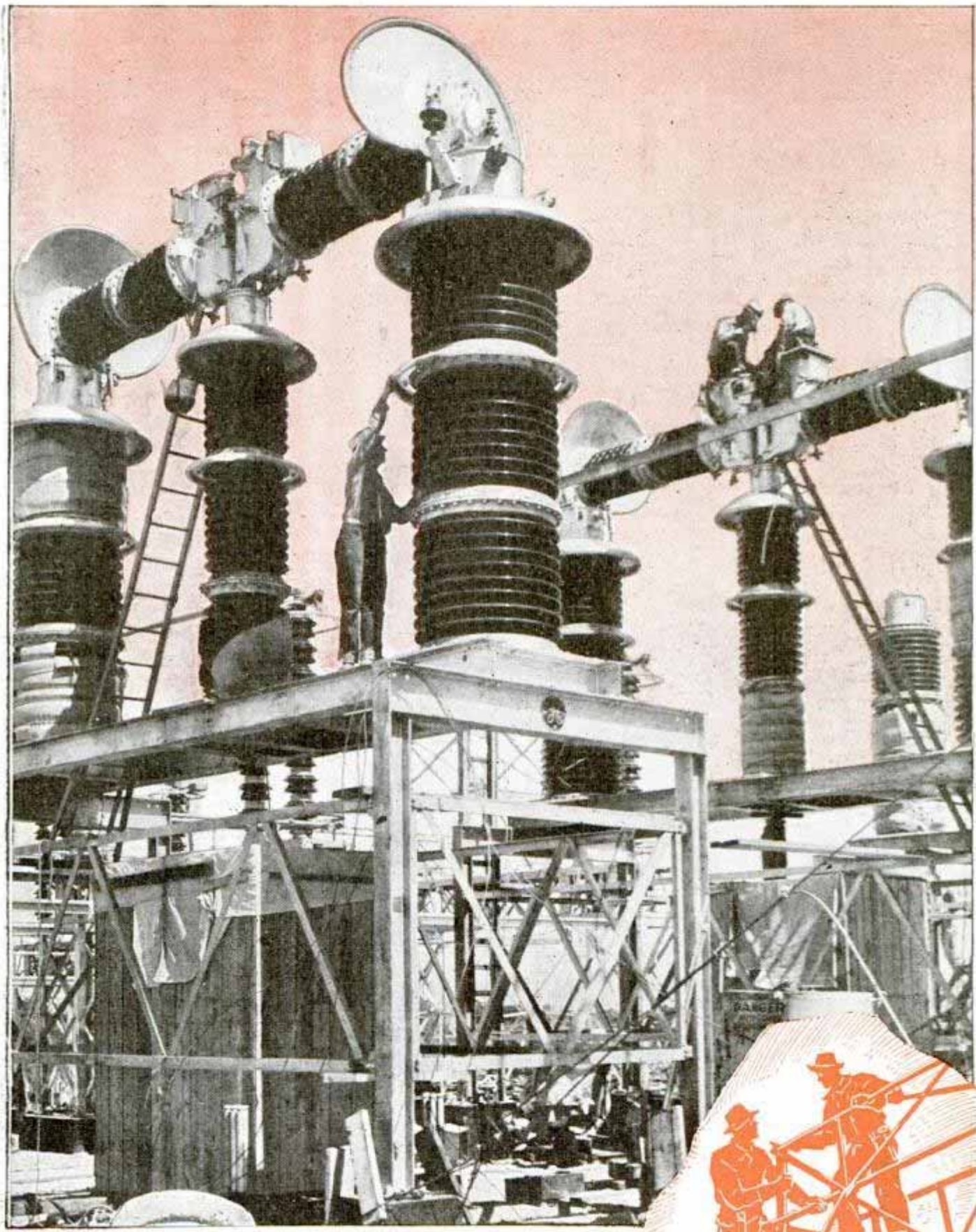

General Electric impulse oil circuit breaker at Boulder dam. This is the "strong-arm guy" which halts a great surge of electrical energy in a split-second

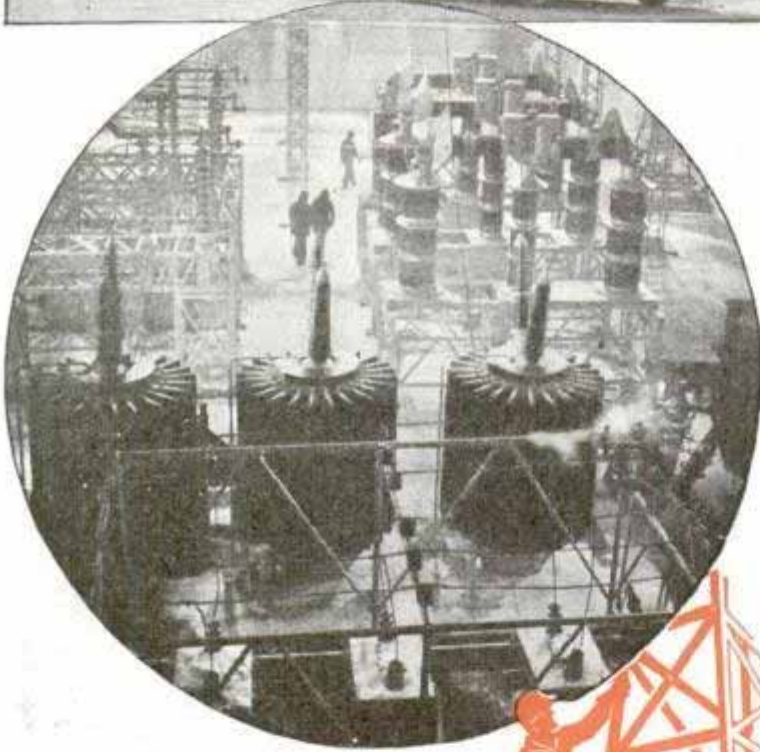
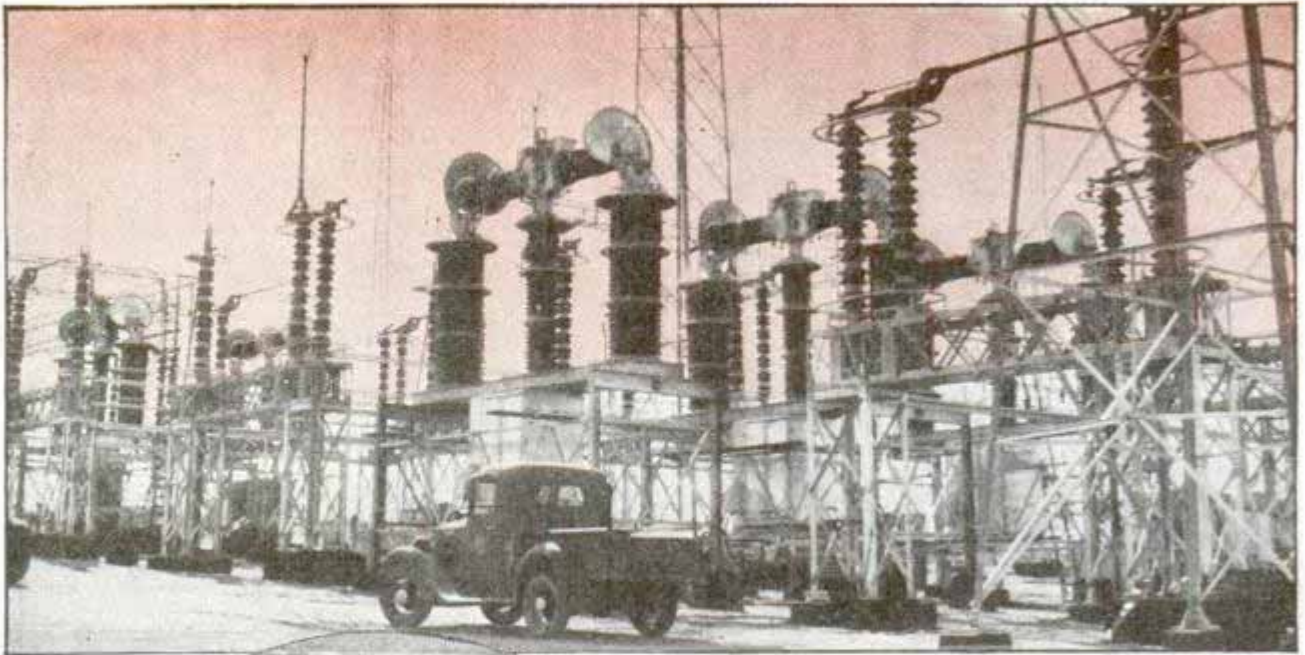

Swift-acting circuit breakers like these protect the high-voltage power lines emanating from Boulder dam from damage when an emergency occurs



more power than most people have ever seen at work.

Four hundred of our biggest locomotives of 5,000 horsepower each, pulling 400-mile-long loaded freight trains at fifty miles per hour, would represent 2,000,000 horsepower in action. These trains could not be braked to a stop in one-twentieth of a sec-

ond or even in several seconds.

The power which man stops in a split-second is, of course, not the momentum of a moving body like a train or automobile, but the electrical energy surging through two of the most wonderful transmission lines in the world. These twin lines of the Los Angeles Bureau of Power and Light linking Boulder dam and Los Angeles, are remarkable not only because of their length, but also because of the very high voltage, the large amount of power transmitted, the unusual terrain they traverse, and the automatic safety features which prevent interruption to service and damage to the system when trouble occurs.

They can convey 300,000 kilowatts, or 400,000 horsepower, for a distance of 270 miles and the transmitting voltage is the highest in the world in regular service—287,000 volts. The three wires of each line are hollow, almost one and one-half inches in diameter

and large enough so that if an emergency occurs in any section, the other line in that section can carry all the power. Normally, however, half the power flows over each line.

In thousand-foot steps these lines stride across the Mojave desert, hopping from one steel tower to another more than 100

feet above the ground. They are 800 feet above sea level when they skirt the entrance to Death Valley. Then they climb 4,800 feet to cross the Sierra Madre mountains. Although mostly in desert country, the lines are often exposed to storms, floods and lightning. The days may be blistering hot, the nights cold.

Maintenance crews patrol the lines by following a single road adjacent to them in specially equipped cars. These patrol cars are equipped with big tires to battle the shifting dunes, and contain radios tuned in on the high-frequency carrier current sent over the power wires. So, when within 1,000 feet of the lines, the men can receive messages from headquarters at the dam or at Los Angeles. Sometimes their progress is hampered by high winds, powdered alkali, sand and dust storms, cactus, sagebrush, mesquite and the ever shifting dunes. In such a barren wasteland, the system must be virtually independent of the human element, almost automatic in operation. And it is.

For safeguarding these costly lines, and preventing destructive damage to them, two desert "switching stations" have been built, one ninety miles from the dam and the other 180 miles out. A few patrolmen live near these stations to maintain the equipment, but for the most part the operations are automatic and can avert disaster in a fraction of a second.

At each switching station four electromechanical marvels called circuit

(Continued to page 122A)

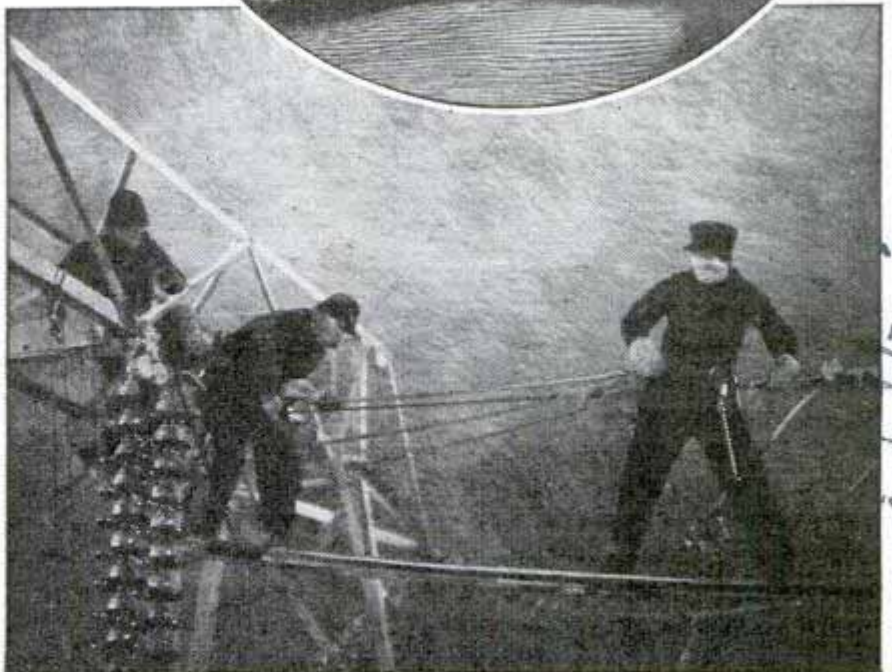
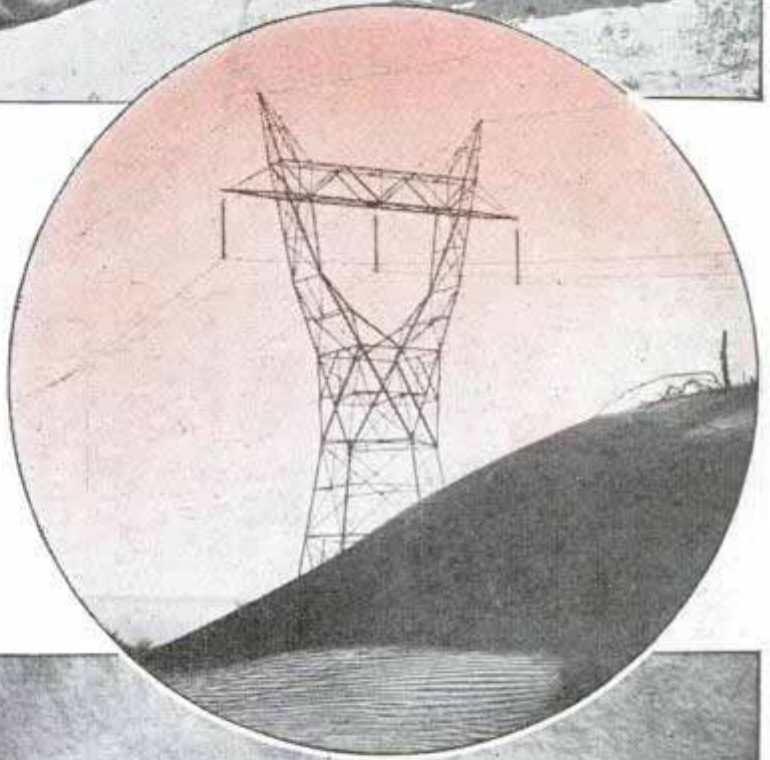

Trouble car, top, servicing radio patrol car along Boulder dam transmission line. Bottom, transmission line tower, and linemen at work

more slim.

'Plate-Lifter' Brake Is the Latest for Airplanes

THAT gadget known as a plate lifter, consisting of a rubber bulb, several feet of tubing and a deflated rubber balloon on the other end, with which practical jokers cause dinner plates to do flip-flops at unexpected moments by pressing the bulb after putting the balloon under the plate, supplied the basic principle for one

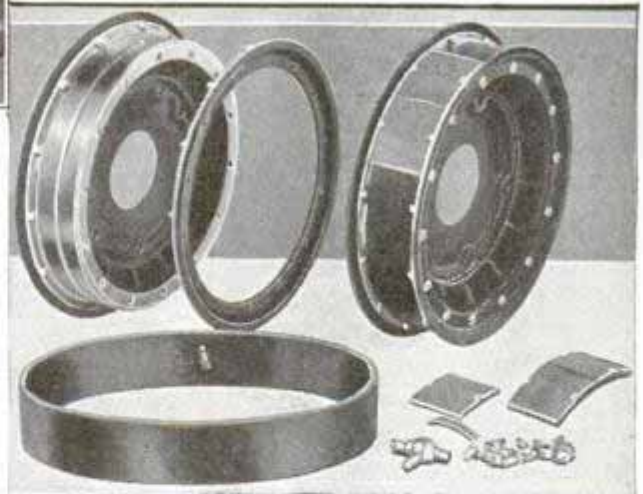
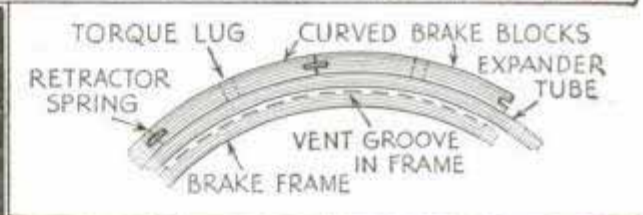
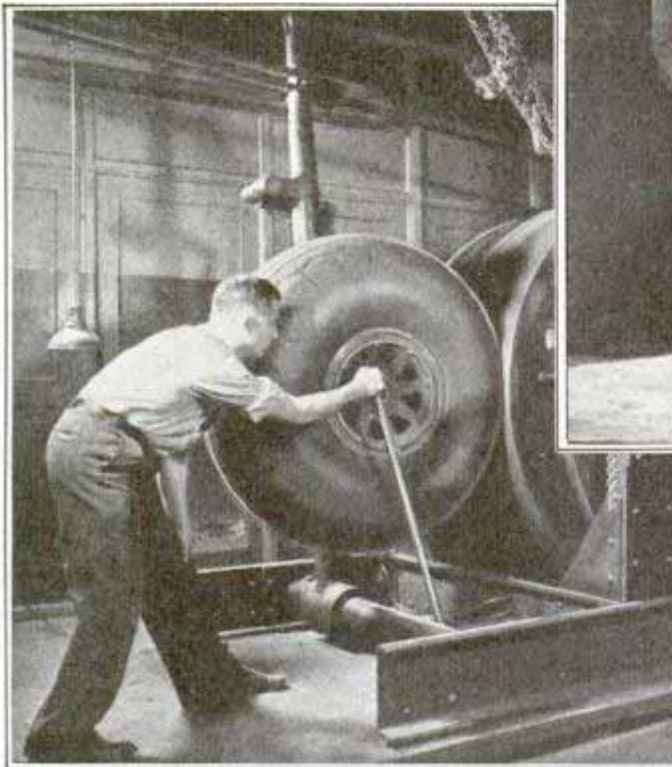

Above, testing new brake. Right, giant air liner equipped with brake. Center, sketch of brake. Bottom, parts of brake, demonstrating its simplicity

of the most effective and simplest airplane wheel brakes ever developed, the new Goodrich expander tube brake. The brake has a full circle of braking surface consisting of a series of curved brake blocks which are pushed outward by a flattened, expansible tube into which the brake fluid is forced. Each block slides between a pair of lugs through which the brake torque is transmitted to the frame, which acts as a brake shoe, torque plate and fairing plate combined. Because the forces are distributed equally throughout a full 360 degrees, this frame can be made of lightweight metal such as magnesium alloy or, more economically, of light steel stampings. The brake is being made in various sizes rang-

ing from five-inch diameter to twenty-five-inch, and some of the larger units are duplex, with two rows of blocks. The heart of the brake is the expander tube. Essentially it is a single-tube tire held in a flattened position, for it has an inner tube, fabric-reinforcing structure, and an outer "tread" to withstand service conditions. If the brake is to be operated by a mineral

B. F. Goodrich & Akron, Ohio

Outboard Racing-Boat Trailer Has Living Quarters for Crew

oil, the inner tube is made of a special Neoprene compound that will not be affected by oil. Otherwise a rubber compound is used. The fabric structure is so designed that it is not subjected to excessive strain when the tube is fully expanded. The outer surface and edges of the tube are covered with heat-resisting compound. The tube is put on the brake under tension, which helps to squeeze the fluid out when braking pressure is released. The tube does little work even when great hydraulic pressure is applied to the brake, its chief function being to confine the fluid, which does all the

work. The tube will withstand enormous pressure, because it is surrounded on three sides by the metal frame and on the fourth by the brake block assembly, which moves outward only a small fraction of an inch. The brake tube nozzle may be connected to the piping of the airplane hydraulic system through a standard swivel fitting equipped with a bleeder unit. The brake can be taken apart or assembled with only a screwdriver and wrench. Edges of the blocks provide a wiping action that helps break films of moisture between lining and drum, thus maintaining efficiency when brakes are wet. Among planes on which the brake has been installed are the 65,000-pound, four-engined Douglas "DC-4" and the giant four-engined Boeing "Flying Fortress." A special brake, designed to operate under salt water, is being used extensively on the beaching gear of navy flying boats. Development of the new brake was made possible by a testing machine with which practically all conditions encountered in actual operation can be duplicated in the laboratory, and their effects on brake and tire action recorded with instruments, to be studied exhaustively by engineers. The machine consists essentially of a giant flywheel against which an airplane tire wheel and brake assembly can be forced or "landed."



Unloading outboard racer from trailer designed especially for transporting the water speedsters between race courses

Designed for carrying outboard racing boats and motors, a dual-wheel trailer introduced recently has living quarters for the boat crew. It has a streamline roof. Two racing shells are carried in the rear of the trailer. The roof may be raised and the doors swung outward to permit removal of boats. The new trailer provides complete protection of the boats, motors, extra propellers and other equipment from the weather. Living quarters in the front of the trailer include kitchen galley, a dav- enport which opens out into a double bed, wardrobe space and a lavatory.

Air Intake and Exhaust in Roof Ventilate Cab of Truck

Continuous ventilation even when the truck is standing still is provided by a unit installed in the ceiling of the cab. It has both intake and exhaust vents, each controlled by the driver. Incoming air can be directed toward the windshield or the driver, while the exhaust draws out foul air and gas fumes.



Evans Products Co.
Division Guardian

Covered Wagon Co.
 Covered Wagon Co.
 Covered Wagon Co.

Steel Framework for Plaster Strengthens the House

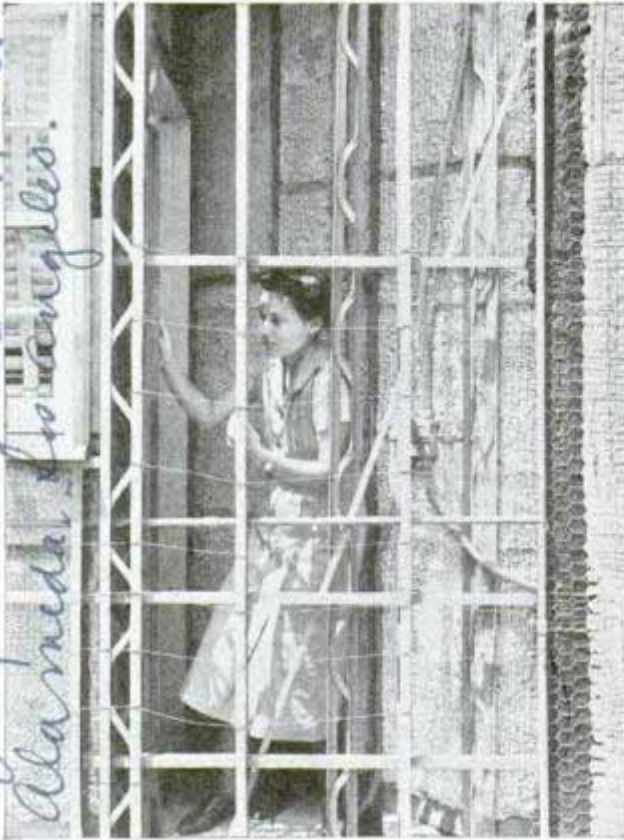

Showing how steel framework is arranged before plaster is applied to structure

Lending permanency and rigidity to house construction, a new steel framework method of building calls for tying metal lath to the frame with metal wires. Plaster is applied in the usual manner.

Garden Made a Bird Sanctuary by Planned Planting

If you want birds to make your garden their home, plant the flowers, shrubs, trees and grasses that attract them. You don't need acres of meadow—the average home with a little land around it can be made an attractive garden and bird sanctuary if planned with that in mind. Some birds want seed plants: grasses, asters, poppies, sunflowers. Others prefer pulpy fruits such as cherries, mulberries and the like. More than seventy desirable bird families like wild grapes, among them the cardinal, catbird, brown thrasher, bluebird and quail. Elderberry, a good background shrub, is a favorite of the olive-backed thrush, grosbeak, catbird and a hundred others. To bring the goldfinches, white-throated spar-

rows, chickadees and juncos into your yard, plant forget-me-nots, asters, California poppies—best of all, sunflowers, whose seed is a favorite food; sunflowers, too, fill up corners and hide fences well. The decorative mulberry brings the red-headed woodpecker, thrush, robin, oriole and mockingbird. The flowering honeysuckle is good for nesting and produces a midsummer berry attractive to birds. Sumac is beautiful, and furnishes lunch for chewink and wood thrush, robin, bluebird, downy woodpecker and others. Then there are the mountain ash, hawthorn and dogwood, pokeberry, holly and snowberry, all of which pay dividends in making your garden a stopping place for songsters.

Loudspeaker in a "Manhole" Directs Athletes in Drill

Mass athletic drills on the great sports field at Breslau, Germany, are directed by commands over a loudspeaker in a "manhole." The speaker is set in the ground at the center of the arena, and its ornamental circular grille is shaped to radiate the sound outward in all directions. It was first used in a big gymnastic festival.

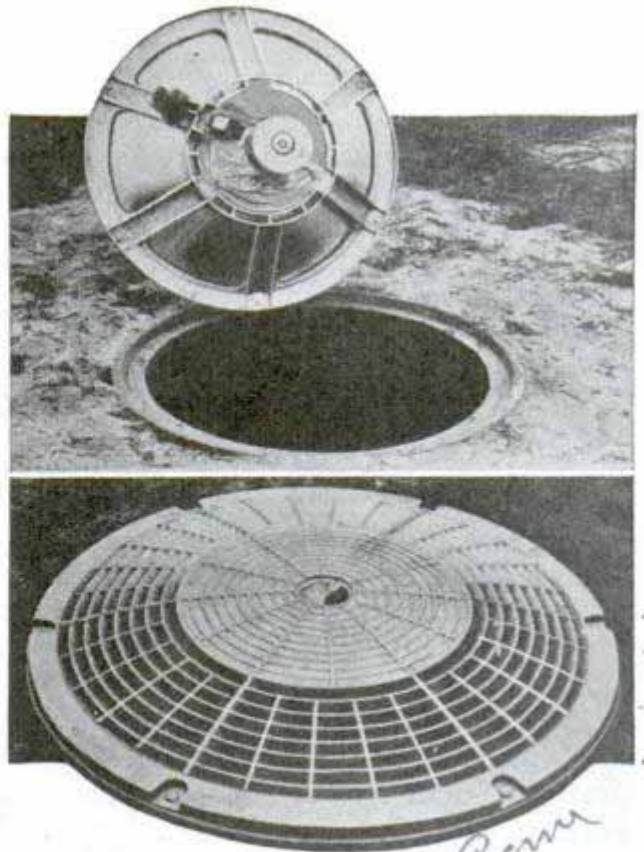

Above, the under side of ground loudspeaker, Below, notice how grille radiates sound in all directions

Since all work and equipment Co 6811/10 d. Alameda, So Angeles.

8 769

F1364 by Planned Planting
Cyril Q de Becker
Lecture 1934

Wheeled Tripods Form Trailer to Carry Boat

How to get his boat to fishing grounds was solved by one angler who devised a trailer device. It consists of two tripods, each with a pneumatic-tired wheel. Two of the arms of the tripod are attached to small castings on the boat's keel, while the third snaps on a casting on the gunwale. The third arm is made of two tubes, one slipping inside the other, with a coil spring taking up shock of rough spots on the road. The bow of the boat is hooked to the auto bumper with ball-and-socket hitch. The whole trailer weighs only thirty pounds and may be thrown into the back of the auto when not in use.

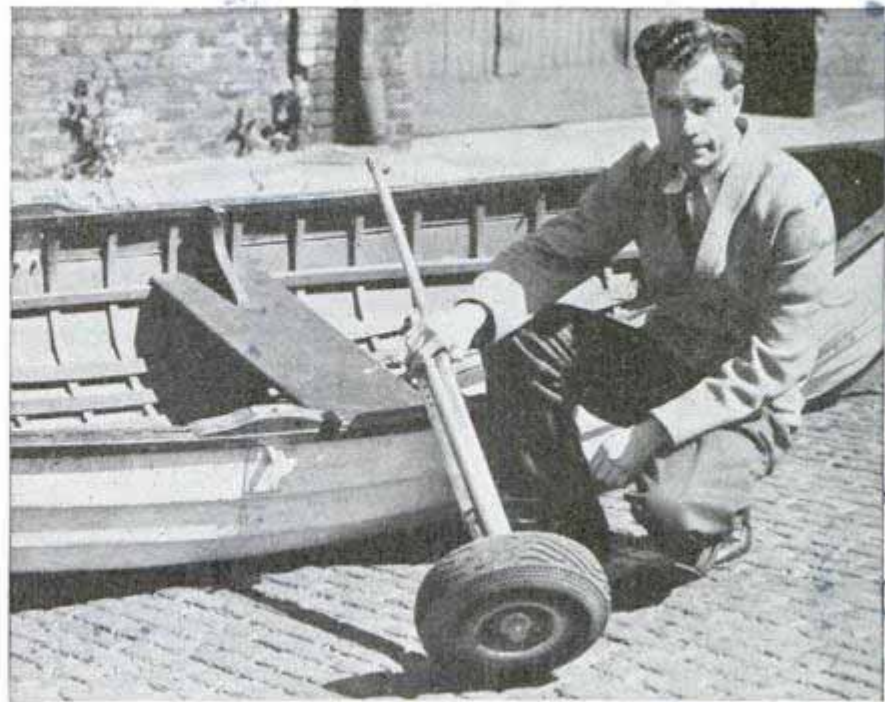

Top, right, wheel ready to be clamped on boat to form handy trailer. Bottom, boat on wheels and hooked to tow car.

H 742

Cont. B. W. Brinitally
914 J. Airneworth Ave

Theftproof Gasoline Tank Cap Stops Siphoning or Spilling

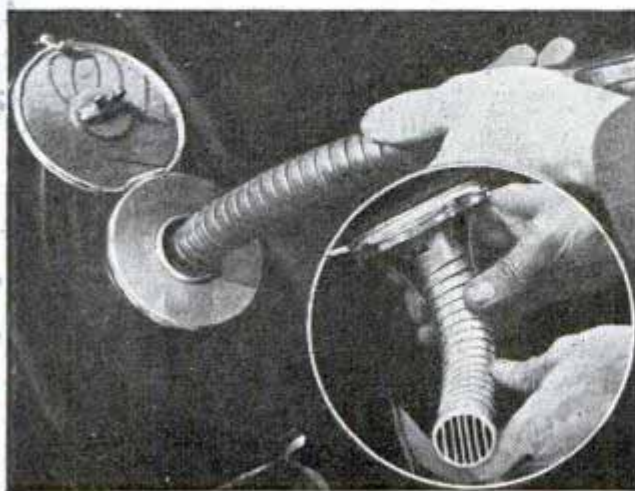

Flexible spout fits into neck of gas tank and prevents either siphoning or spilling when tank is filled

Theft or loss of gasoline from the automobile tank can be checked by a keyless tank cap. Its flexible spout is installed inside the neck of the tank, being designed to fit all automobiles. Siphoning is impossible, and the cap eliminates spilling caused by a "blow-back" of air when the tank is being filled. The cap is hinged.

Popular Mechanics Magazine can furnish the name and address of the maker of, or dealer in, any article described in its pages. If you wish this information, write to the Bureau of Information, inclosing a stamped, self-addressed envelope.

Sullivan Automotive Equipment Co.
5708 1/2 Fountain Ave. Hollywood, Ca.

Wall Washer Saves Paint and Reduces Work



Cleaning walls with aid of machine which closely resembles modern radio receiver

Taking the drudgery and mess out of washing walls, a new machine uses a tested cleaning fluid which does not injure the paint. Carrying buckets of water and soap, wringing out cloths and similar work are eliminated. The machine is portable. One man using the washer can do the work ordinarily done by five washing by hand.

Vapor-Lock Eliminator Adjusts Faulty Fuel Pumps



Vapor lock and its attendant troubles of stalled motors, backfiring, starving of carburetor and hard starting can be checked by installing a vapor-lock eliminator now available. It is a

metallic filler mounted under the diaphragm of the pump to increase the vacuum and capacity of the pump by bringing the diaphragm stroke to normal.

Rubber Springs Absorb Shocks of Big Industrial Machines

Huge industrial machines are being mounted on rubber springs to absorb shock and vibration. They are not mere pads, but real springs made of specially compounded rubber. Great punch presses delivering blows to their foundations of twenty-five to thirty-five per cent of their own weight are cushioned on these rubber springs and ninety per cent of their impact on the floor is absorbed by the rubber. New methods of bonding rubber on metal also permit the use of rubber-covered metal springs.

Tarnishproof "Skin" for Metal Protects Color and Polish

To protect metal surfaces from tarnish or rust and to preserve their true color, a transparent seal has been developed. It forms a film over the metal and keeps it bright. Intended for use instead of lacquers, varnishes and paints, it can be applied to streamline trains or airplanes, boats, tools, kitchen equipment, machinery and similar products.



Dressing a streamliner in transparent film which preserves shiny appearance of metal

Von Schuder mit G. Bly. 6090 Racine, Wis.

406 S. Grand Ave. Los Angeles

Manufacturers Products Co. 406 S. Grand Ave. Los Angeles

Chicago metal & allied products 510 N. Dearborn

Purley's

pend. 9.00

Manufacturers Products Co. 1406 S. Grand Ave. Los Angeles

11-995

Old Rivalry Is Revived in Race of River Boats

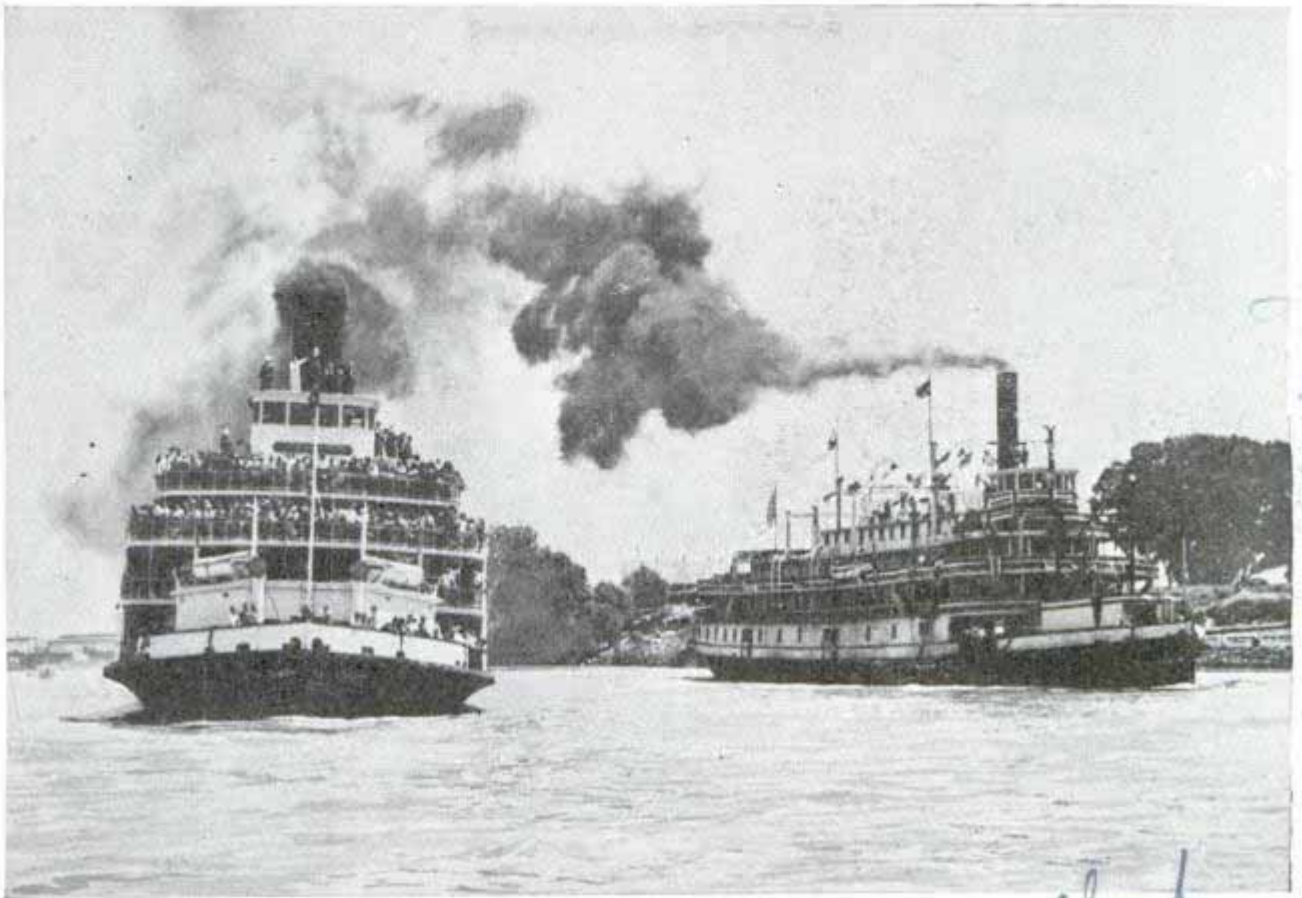

It wasn't exactly an even race because one boat was loaded with passengers and the other carried only its crew, so they called it a draw when "Delta Queen" finished a length behind the "Port of Stockton"

club.

Reminiscent of early days on the Sacramento river, two passenger boats revived old-time rivalry recently in a twenty-six mile race from Sacramento to the Freeport bridge and return. At the end of two hours and forty-five minutes the two river boats

crossed the finish line a length apart, "Port of Stockton" leading the blunt-nosed, paddle-sweeper "Delta Queen." The latter, however, carried 1,000 passengers and the former was unencumbered so the judges called it a draw.

H 806

"Tourist" Trailer for Youngsters Is Towed by a Tricycle

Touring the seashore at Venice, Calif., is a streamline trailer towed by a streamline tricycle. Tiny as it is, the miniature trailer is big enough for two little girls to "keep house" in as they play on the beach. Their grandfather built the two-wheel trailer.



Two sisters tour a California beach with a tricycle and a miniature trailer built by their grandfather

*aim
Ely
Sisters, Elaine
and Shirley, Venice, Calif.*

Vertical handwritten notes on the right margin, including "11-995" and "H 806".

New Drills Promise to Bore Miles into Earth

R. W. Small, 1888 Delaware St.

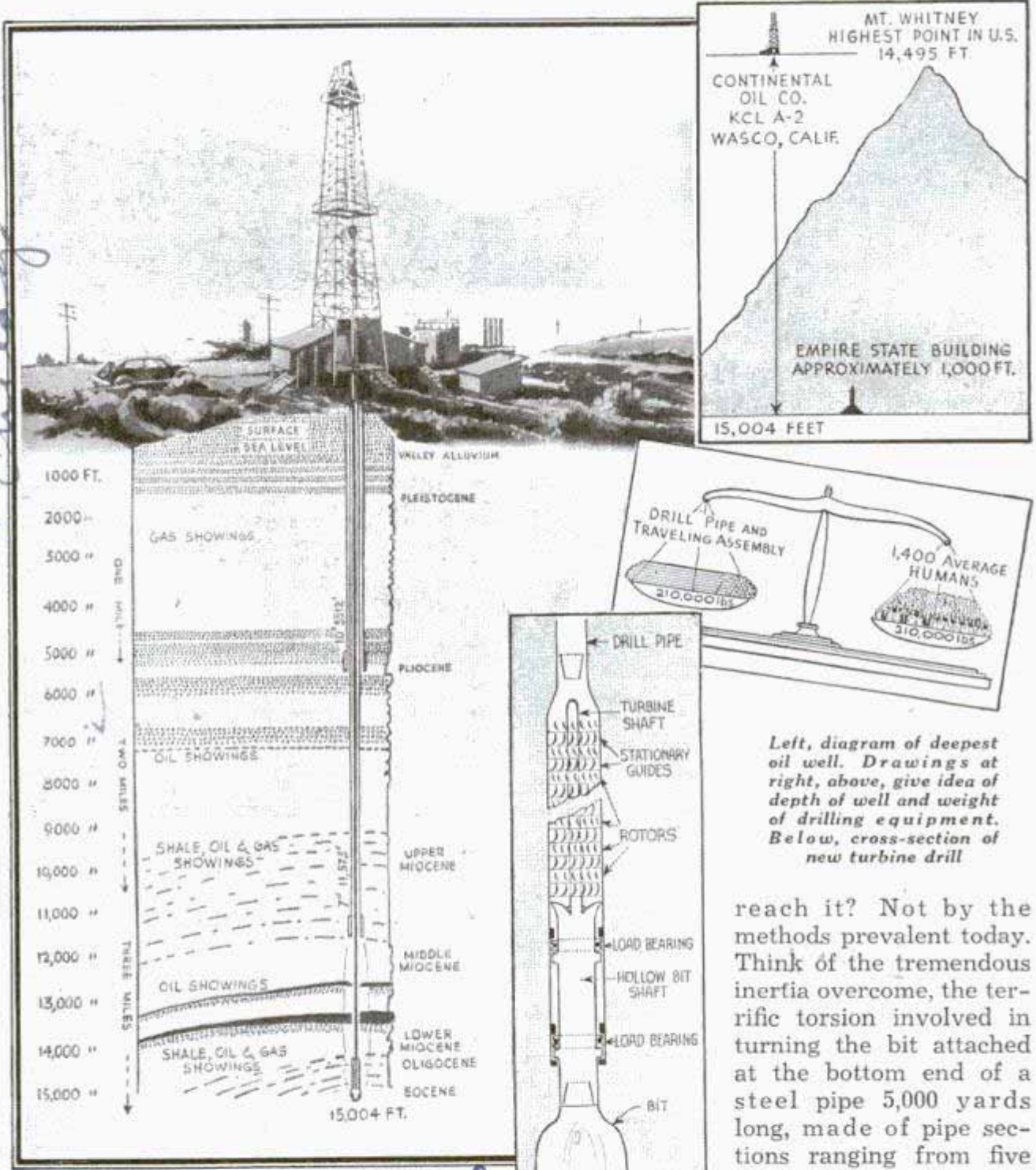

Continental Oil Co

Fresh from the achievement of sinking a bit by traditional methods to a record depth of 15,004 feet in the earth, engineers are working today with revolutionary types of drills that may bore oil wells miles deep. Deepest hole in the earth is the one which was completed last April near Wasco, Calif.; yet seismographic studies indicate there is oil thirty-five miles down in the crust of the earth. How can man ever

reach it? Not by the methods prevalent today. Think of the tremendous inertia overcome, the terrific torsion involved in turning the bit attached at the bottom end of a steel pipe 5,000 yards long, made of pipe sections ranging from five and nine-sixteenths inches down to three and one-half inches, screwed together into one long rod. It is like twisting an elongated screwdriver whose tip is fitted in the slot of a screwhead some fifty city blocks away. The engineers believe they have reached a limit of drilling by the conventional method of applying power at the top of the rod; to go deeper, they must apply the power at the bit. One of the two revolutionary methods which may make over the drilling

Left, diagram of deepest oil well. Drawings at right, above, give idea of depth of well and weight of drilling equipment. Below, cross-section of new turbine drill

Francis W. Woods

Forest Patrol Radio Phone
Has 500-Mile Range

825

industry is the use of electric cable to carry power down the hole to be applied directly to the bit; this plan awaits certain refinements by the manufacturer of the equipment. The second method is the use of a twenty-five foot turbine attached to the bit. Drilling fluid impinges on rotors inside the tube and turns the bit at 600 revolutions per minute, thrice as fast as ordinary rotary drilling speed. Higher speed permits lighter weight bits and faster drilling. The fluid pressing down against the rotors develops seventy-five horsepower in normal operating conditions. On sight, it would appear that the traditional method which bored a hole nearly three miles deep in California involves a crude waste of power: imagine the twisting force required at the top of a rod weighing more than 200,000 pounds and higher than the loftiest mountain in North America! The engineers, too, must meet new problems of cave-ins and high temperatures as they bore to new depths. The Wasco well needed a steel casing weighing between 500,000 and 750,000 pounds to protect the well from caving in as it deepened. A temperature of 260 degrees was encountered long before the three-mile bottom was reached and engineers say deeper drilling will call for more heat-resistant tools.

14768

refer to section for similar article



Forest rangers are aided in fighting wilderness fires by radio set built for long-range communication

engineer in charge of radio control
U.S. Forest Service
assist. radio technician

Electric Cam Angle Protractor Synchronizes Distributor

Operated by a single dry cell, a cam angle protractor for garage men takes the "ping" out of motors due to improper setting of the engines. It is used to set contact points and synchronize distributors.

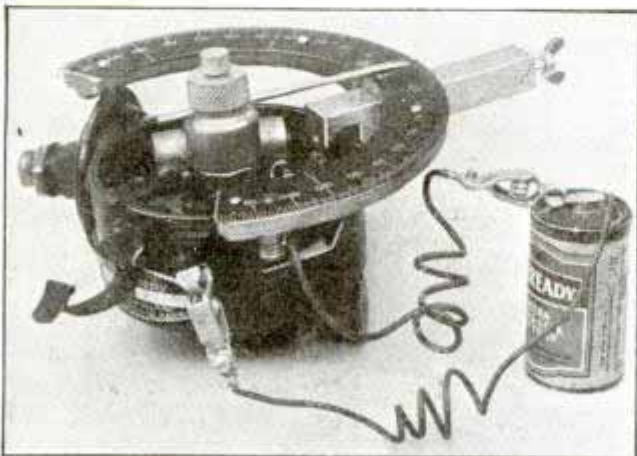

Battery-operated cam angle protractor helps garage men tune engines by synchronizing distributors

Fire fighters of the U. S. Forest Service are being equipped with two-way radio sets that use the regular short waves instead of the ultra-high frequencies assigned to police squad cars, and so obtain a greater communication range than the extreme high frequencies. The transmitter sends at least twenty-five miles under adverse conditions, and in ordinary conditions can be heard 250 to 500 miles away. The antenna is a seven-foot metal fishpole costing about sixty cents. The set has high efficiency in transfer of energy from transmitter to antenna and from antenna to receiver.

Names and addresses of manufacturers and dealers in articles described in this magazine will be furnished by our Bureau of Information upon request accompanied by stamped, self-addressed envelope.

Lunagan ana Hoke, chie.
1638 - 40 W. Tunling Park Ave.

72594 cont. Frederick M Westcott,
Webster, NY

The ROMANCE

Continental Ltd
Canadian National

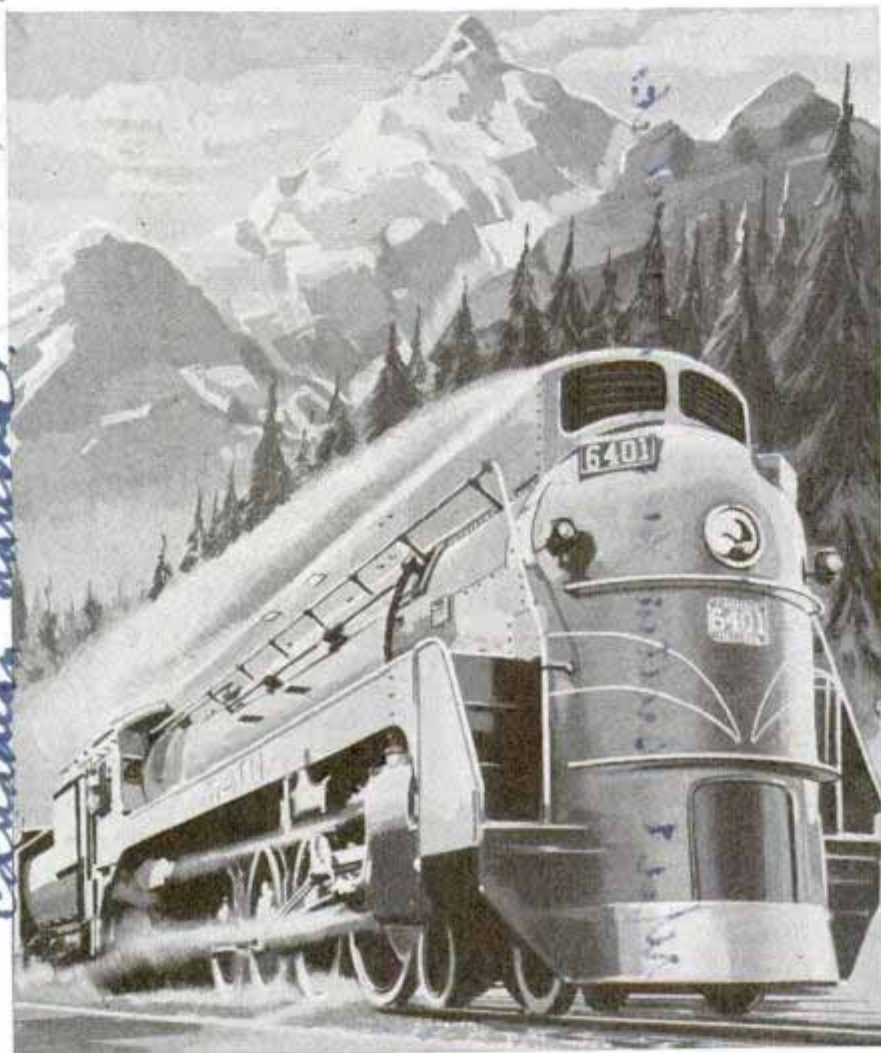

Stephenson did not invent the steam locomotive or construct the first one. But this English mine engineer who turned locomotive builder contributed much to railroading because in his "Rocket" he combined in one engine all the primary elements of a successful locomotive.

The biggest, fastest and most economical modern steam locomotives are but refined and enlarged "Rockets." Thousands of locomotives have been built since the advent of this little pacemaker, and all of them have succeeded or failed as they have adhered to, or departed from, the basic design of the "Rocket."

Stephenson's achievement is all the more remarkable because he applied knowledge which had been available to

STEAM power, ruler of the rails for more than a century, today is being challenged by Diesel. Basically, this struggle for supremacy is a contest between the internal combustion engine and the principles which George Stephenson embodied in the "Rocket" more than 100 years ago.

others for years. Long before the Christian era, Hero of Alexandria wrote of the expansive force of steam and described most of the basic elements of a steam engine. But it was not until late in the seventeenth century that steam was put to work.

At that time Thomas Savery, an Eng-

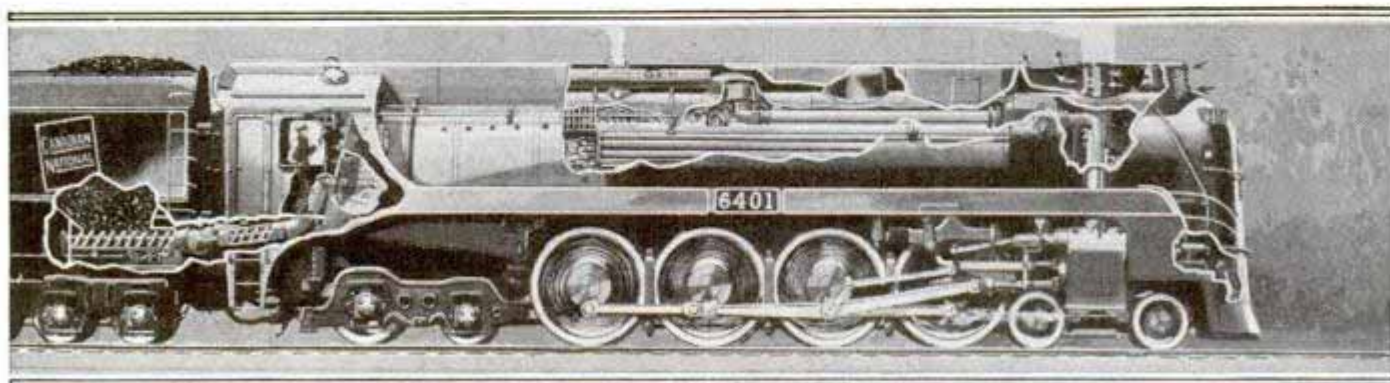

Action shot and cross-sectional view of modified streamliner of the Canadian National Railways. It is more than ninety-four feet long. Note automatic stoker

of the LOCOMOTIVE

lishman, made a steam-operated device to raise water from coal mines, a task previously performed by horsepower. It embodied none of the elements of the steam engine, however. Its sole application was in moving water and it is used today in about the same form.

Stephenson's "Rocket," forerunner of the modern locomotive, and two of her unsuccessful competitors, the "Novelty" and "Sanspareil"

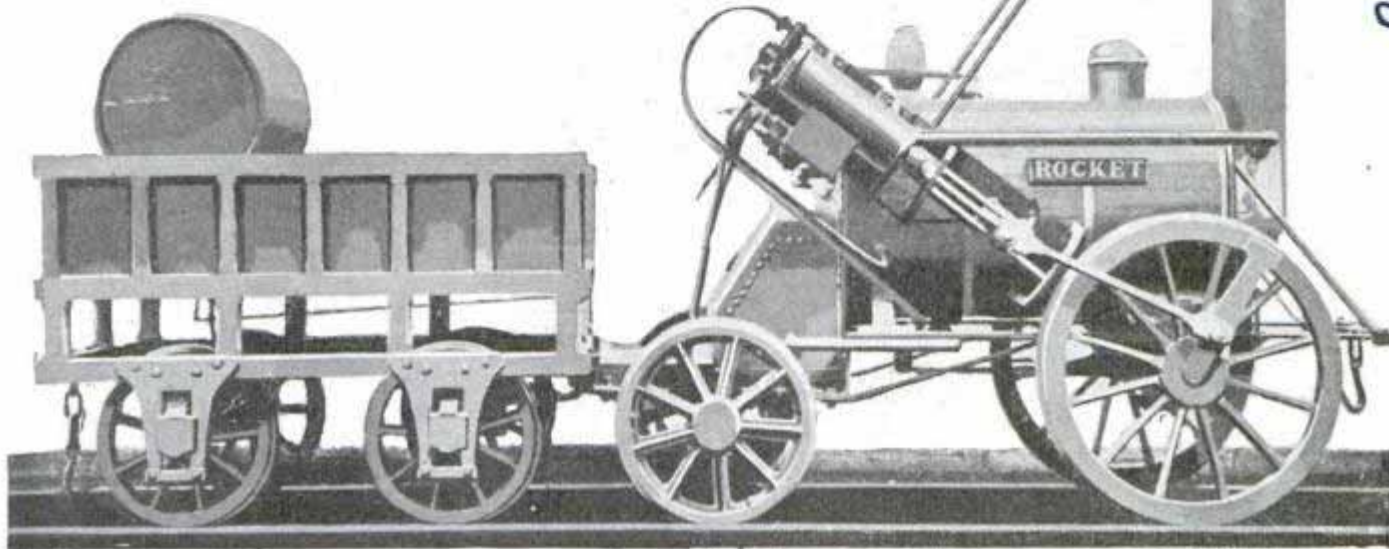

A few years later, Thomas Newcomen, an English blacksmith, built a steam engine operated by atmospheric pressure. His idea was to produce a vacuum on one side of a piston in a cylinder, utilizing the air pressure on the other side to do the work. He accomplished this by filling the space below the piston in an upright cylinder with low-pressure steam which was condensed by injecting cold water.

Newcomen's engine had a twenty-inch cylinder nearly eight feet long. It made twelve strokes per minute and was used to lift water from a coal mine, raising fifty gallons per minute from a depth of 156 feet. Early engines of this sort were used and gave good service until quite recent times.

It has been claimed that a boy was hired to operate the valves of Newcomen's engine. The lad was lazy, so the story goes, and devised a system of ropes to do the work for him. A copper-plate engraving of the engine, however, shows the valves were operated by mechanically actuated tappets.

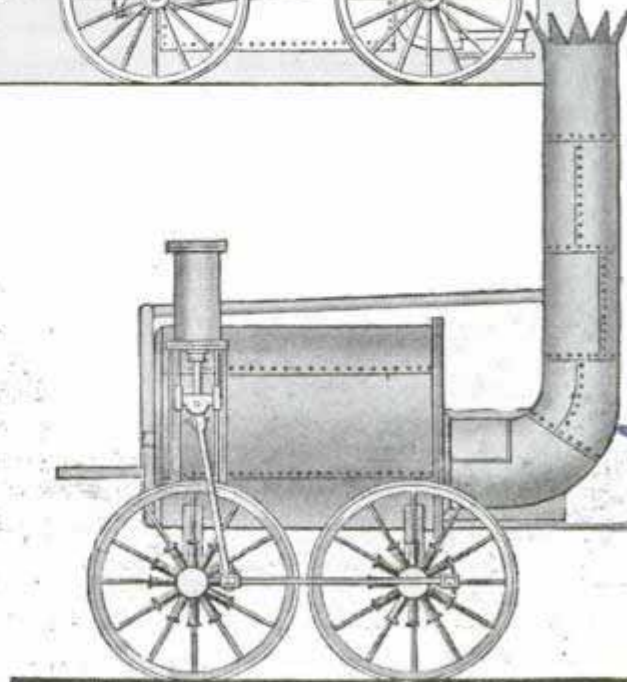
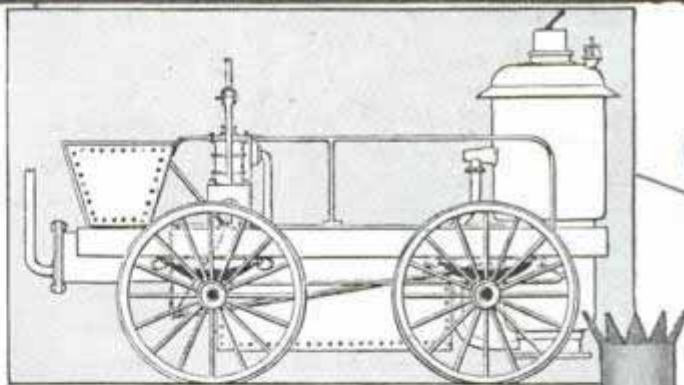

1829
Braithwaite and Ericsson

Hacheco
1829



Another myth is that James Watt conceived the idea for his steam engine after watching steam raise the lid of a teakettle. Watt examined one of Newcomen's engines and from it got the idea for increasing the steam pressure to a point greater than atmospheric pressure and making the steam do the work, then condensing the exhaust steam in a separate vessel. Watt contributed much to human progress but little to the locomotive. His ponderous, slow-moving engines worked at pressures little above that of the atmosphere.

The first real attempt at steam locomotion was made, not upon one of the many mine tramways then in use, but on a country road. A French military engineer, Nicholas Joseph Cugnot, built a steam-propelled gun carriage which carried four passengers at two and one-fourth miles an hour. News of this invention eventually reached Richard Trevithick, a talented, ingenious Englishman who has been called the "father of the locomotive."

Trevithick, convinced that Watt's system of low pressure and condensation could be improved upon, had designed and built engines and boilers, some of which used the then unprecedented pressure of 145 pounds per square inch. He had discussed the steam-propelled gun carriage with a friend and this friend, sensing the possibilities, made a bet of 500 guineas that ten tons of iron could

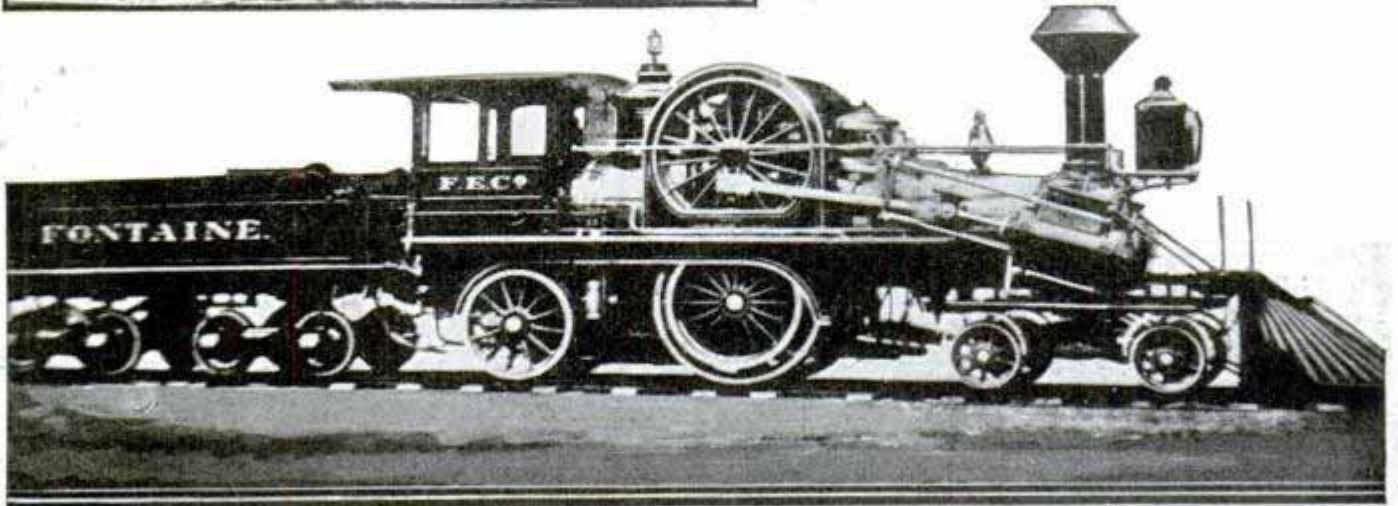
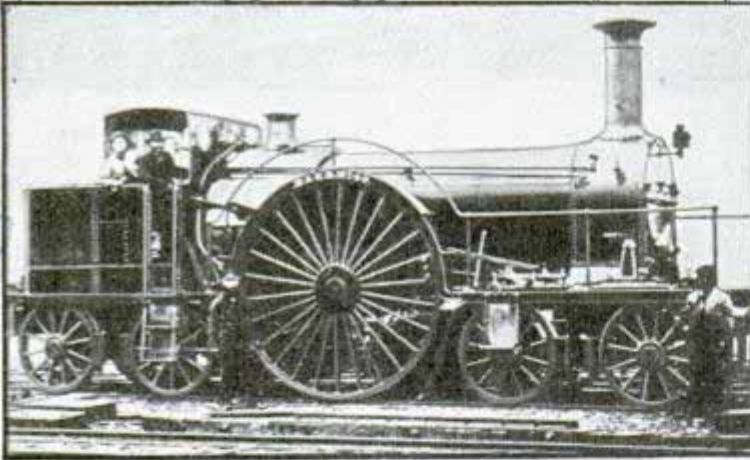
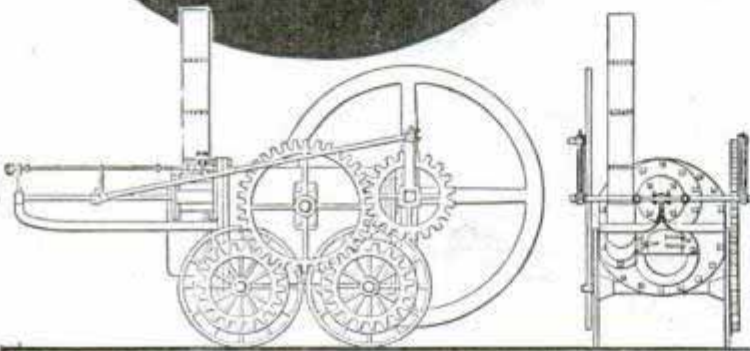

Richard Trevithick and his "Tram Wagon," first steam-propelled locomotive to run on rails. Bottom, Pearson's "Bogie Tank" and the "Fontaine" which had speed, but little else

Crampton



be hauled nine and three-fourths miles by steam power alone. Then he asked the inventor to help win the bet.

In trying to aid his friend, Trevithick built his "tram wagon," a steam engine and five cars or "wagons" to be operated over a mine tramway. The test was made in 1804. Ten tons of iron and seventy men were hauled over the distance specified in four hours and five minutes. The engine attained a speed of five miles an hour but was delayed, Trevithick wrote, because "we had to cut down some trees and

(Continued to page 135A)

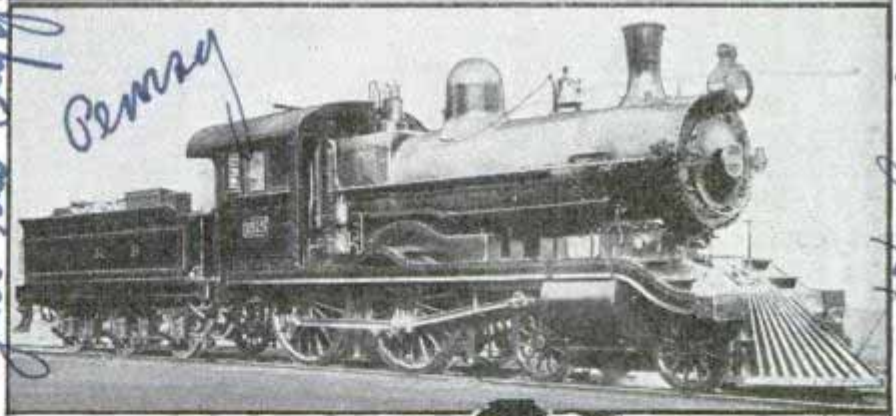
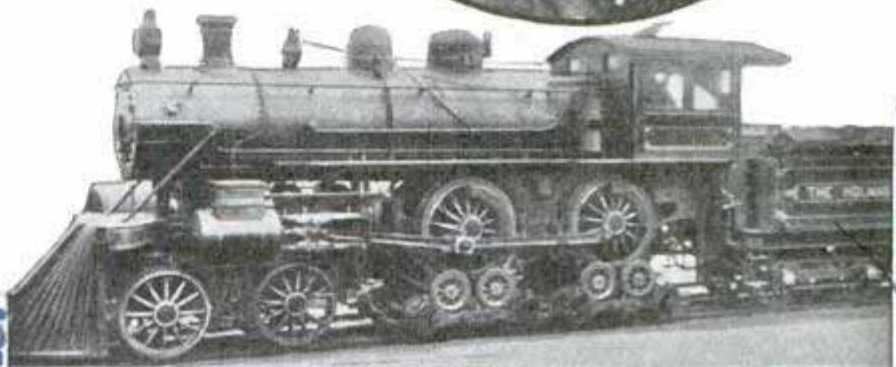

Pemsey

Just the Crampton

Stephenson

Hydraulic

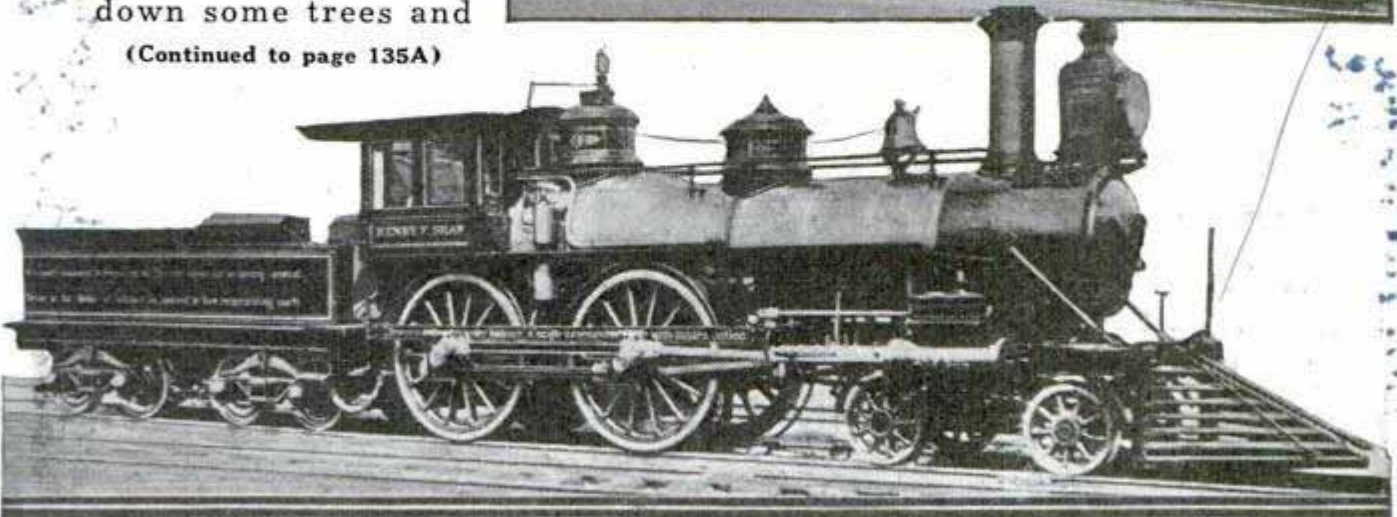

Stephenson and some unsuccessful locomotives which did not follow principles of his "Rocket." Top to bottom, a "Crampton," the "Speeding Truck," compound engine and so-called "balanced" locomotive

Canalen and Anby

72594

Handwritten notes and signatures on the right margin, including 'Stephenson', 'Hydraulic', and 'Canalen and Anby'.

Auto Racer Turns to Models First for Fun, Then Business

Revell - Glanes
and March Ltd.

28 Berkeley St.
London, W. 1.
Eng

March models Ltd.
discontinued.
9/22/38.
see letter.

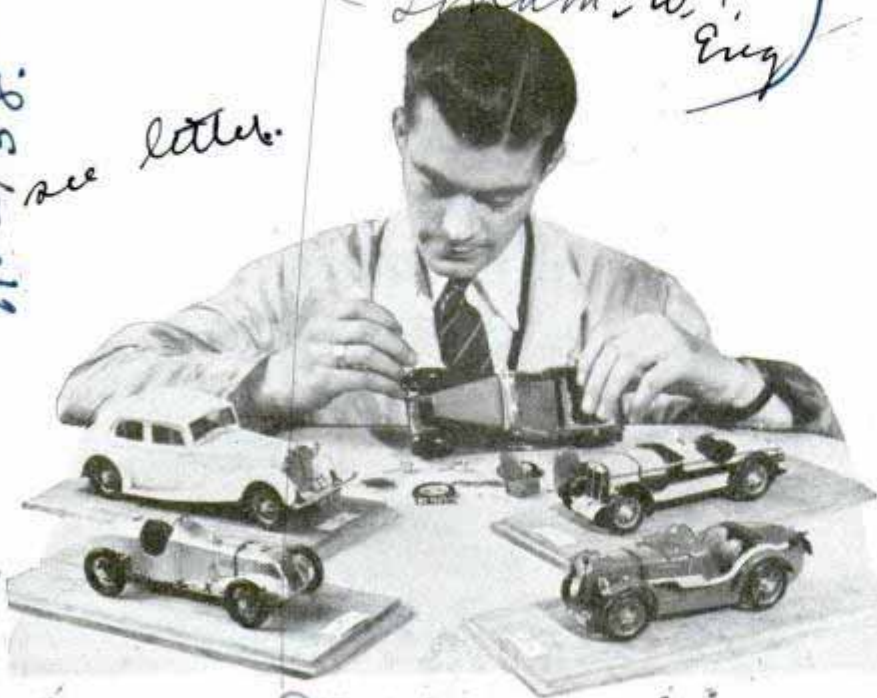

© Planet News, Ltd.

These miniatures, built to scale from photographs and drawings of real automobiles, are produced by a company formed by one-time racing driver

reduces the sizes, and thus the weight and cost, of members required to carry a given load. Made from malleable iron or sheet steel, the connectors come in various sizes and shapes. A spiked grid connector, shaped in the form of a grid, has sixteen sharp spikes projecting from each face. It is placed between timbers to be connected and is embedded in the wood by high pressure to such an extent that the grid is not visible when the joint has been completed, virtually making the joined timbers as strong as if in one piece. Pressure can be applied by means of a special bolt and wrench arrangement or by a hydraulic jack.

Once a mechanic in a racing-car factory and later a racing driver himself, the English Duke of Richmond and Gordon started making miniature automobiles as a hobby in his spare time. Finding a good market for scale models, he started building them as a business. The company turns out exact copies made from photographs and drawings of the original cars, and builds all kinds of models for manufacturers.

Wood Buildings Made Stronger by Timber Connectors

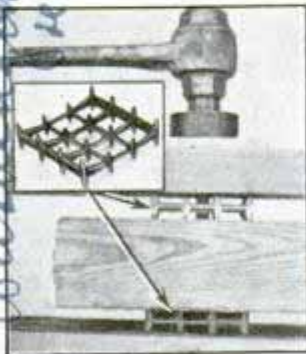

Increasing the load-bearing capacity of wooden structures from fifty to 100 per cent by strengthening the joints, simple timber connectors are creating a new designing technique, making it possible for architects to use inexpensive timbers in many places where it formerly was thought necessary to specify steel. Use of the connectors also

increases the load-bearing capacity of wooden structures from fifty to 100 per cent by strengthening the joints, simple timber connectors are creating a new designing technique, making it possible for architects to use inexpensive timbers in many places where it formerly was thought necessary to specify steel. Use of the connectors also

"Clay" Made from Newspapers Is Molded into Pottery

Old newspapers are transformed into pretty vases by a secret process just patented. The inventor strips the waste paper into shreds and treats the pulp chemically, turning it into a plastic, lightweight "clay." From this he shapes vases, plaques and similar bric-a-brac that are described as virtually unbreakable when dry. Ornamental designs such as the flowers on the

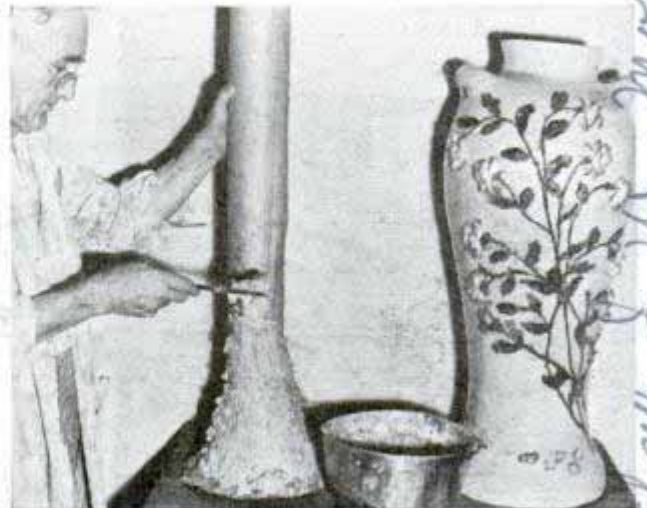

Even the flowers on this "paper" vase are shaped from clay made of chemically treated waste paper

Timber Engineering Co. N.W.
1337 Connecticut Ave. N.W.
17783

W. Morgan
714 St. Albans
W. 11

see June 1941
10-1941

vase pictured here are finger-shaped from the clay. Such a vase weighs less than half as much as a similar ceramic clay piece. The clay is ninety per cent paper.

HP 32

Family Tours in Boat Frame Made into a Covered Wagon

Engineer's Drawing Projected on Desk from Microfilm

Engineering plans of a Detroit company are all reduced for storage and record purposes to photographic films, a drawing thirty-three by forty-four inches occupying a single frame of thirty-five-millimeter film. To make this miniature film readily available for the engineer's use, a special projection desk was developed. When he wants to consult a certain drawing, the engineer inserts the negative in the desk, depresses a foot treadle and views the drawing, illuminated, at its full original size.

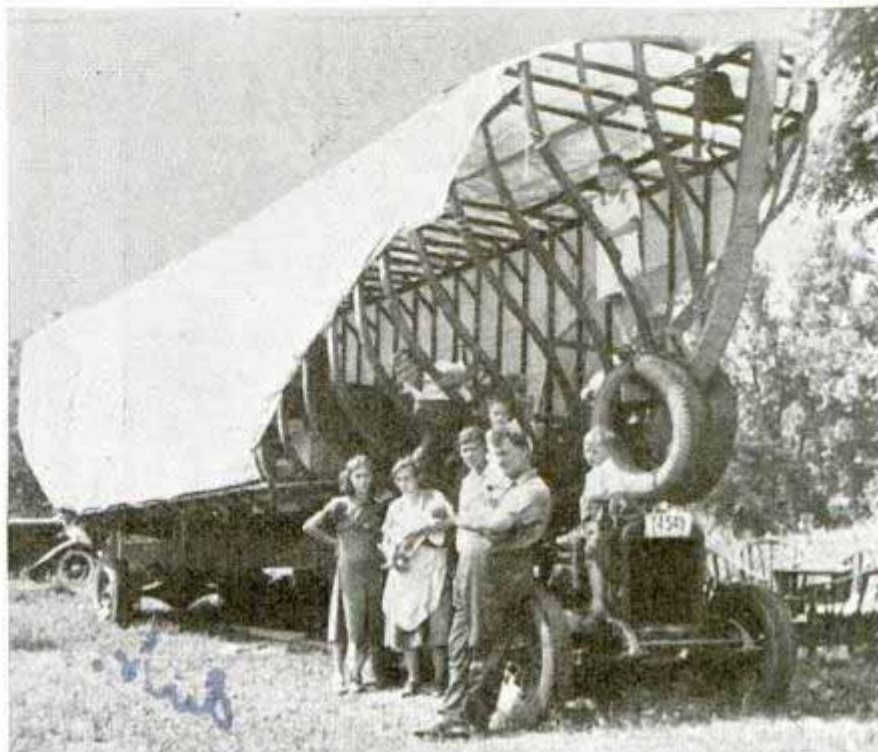

Forty-foot boat frame is home for family of ten crossing states; when they reach Pacific, boat will be completed to take them to new Alaska home.

In a sea-going "covered wagon" a family of ten is headed from Richmond, Va., for Alaska in search of a new home. Across the states their boat rides the truck; up the coast to Alaska the truck will ride the boat. Head of this migrating family is an unemployed iron welder. With his wife and eight children ranging from a few weeks to seventeen years old he lives in a traveling home made in the canvas-covered skeleton of a boat. The frame is of iron, forty feet long, eight feet wide and twelve and one-half feet high. He drives from within, controlling brakes, transmission and accelerator with cables and levers. The car can make forty miles an hour.

Non-Petroleum "Oil" for Rubber Stops Chassis Squeaks

Chemists have developed a non-petroleum lubricant which takes the squeak out of rubber parts or metal-to-metal chassis bearings of automobiles and trucks. The new product resulted from a search for a lubricant harmless to rubber. It is not intended for use in crankcase or transmission nor where it would come in contact with the car body finish.



Engineer's plans reduced to thirty-five-millimeter film for storage are projected full size on this desk

Recordak Corp. 350 Madison Ave

Neufel

Paul Sakko
to rings
L. D. du Pont de Nemours & Co.
Washington, D.C.

4820

Clrel

made in U.S.A.

camera technician
R. W. Richard
Television field supervisor
Harold P. Lee

Television Goes on Road in Twin Van Studio

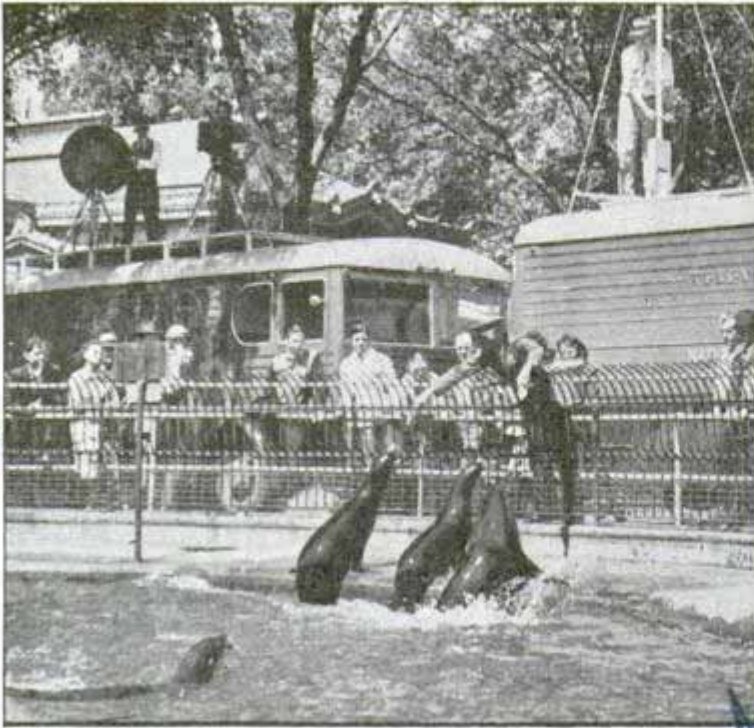

Television has gone on the road. A mobile studio, two ten-ton motor vans containing pick-up and transmitting apparatus, is bringing television through experimental stages to reality: "shooting" outdoor events, sending picture and sound to New York NBC transmitter. Above at left, camera and parabolic "mike" on left truck pick up zoo scene; collapsible antenna on companion van is being erected at right

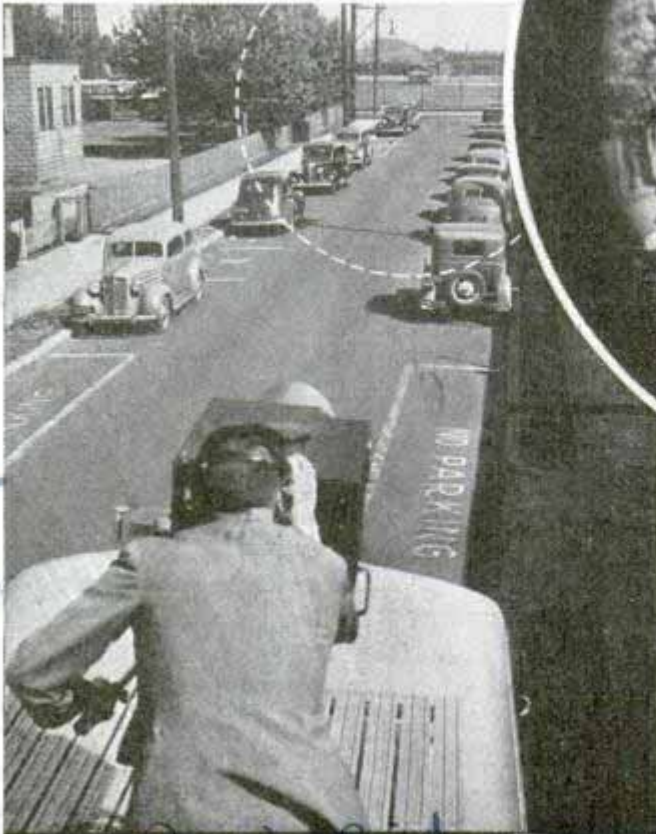

At left, the iconoscope camera technician focuses television eye from catwalk atop mobile studio. In circle above is the scene he recorded as it appeared on distant viewing screen. Truck housing pick-up equipment includes also a control room where engineers see picture transmitted. Second van is connected to first by 500 feet of coaxial cable when in operation, and houses all the apparatus for transmitting picture and accompanying sound on frequency of 177,000 kilocycles to television studio of NBC atop Empire State building, from which program is rebroadcast

R. W. Richard

National Broadcasting
Co., 30 Rockefeller
Plaza New York

Empire State Building
NBC
New York

collapsible antenna
pick-up truck

Kinoscope

H 5/5. 22. St. Brown Editorial Service Sept.

PICTURE YOUR PETS

Eastman Kodak Co. Rochester NY

Character study of cat portrays lordliness; pony picture will be cherished in family album. Alert pose of dog adds much to snapshot against sky



STALK that new litter of kittens, ambush them with your camera. Trap your pup or pony for the family album. Shoot those rabbits with a lens. If there are pets in the family, they belong in a snapshot book of their own.

Photo-cartoons of sad-eyed bloodhounds, tough-mugged bulldogs, playful or disdainful cats and laughing horses earn places in the roto pages every day. And portraits of pets, humorous shots, "play" pictures of the antics of both pets and children, all these should be earning places in the family history book.

With some pets, particularly those that have silky or woolly coats, you can experiment with lighting effects. With any pet that is active, you can find opportunity for "story telling" pictures. Animals with a definite character—whether lordly Persian cats or wistful-eyed nondescript mongrel dogs—are splendid material for





experiments in portraiture. A clever picture book may be built around one pet, around a group of pets, around an unusual friendship between two pets, or the companionship between a child and a dog, pony, or other animal friend. Such albums can include both humor and sentiment, and titles suggest their possibilities. "Travels of a Dog," "The Troubles of Pedro the Pup," "Kitten on Tour," "Whiskers: The

Biography of a Cat," and "Pony Girl" are a few titles that tease the imagination—you can think of others to fit the "scenario" of your own pets.

Children delight in being pictured with their pets and few gifts are more acceptable to a child than an attractive picture book built around that association. Keep a picture record of your daughter's summer fun with her pony, or your son's excursions with his dog, and the children will have something to treasure for years.

The majority of pet pictures should be close-ups. Restlessness of a pet may bother you at first, but you quickly learn to anticipate the moves, and to catch an interesting bit of action or expression in a flash.

Any camera can be used. However, you are less limited if you have a fast lens and speedy shutter, permitting a higher shutter speed when the pet is active and moving and a large lens opening when light is bad. The better cameras also have focusing adjustments which enable you to make close-ups of pets without placing a portrait attachment over the lens.

In taking close-up pictures, accurate judgment of distance from camera to sub-

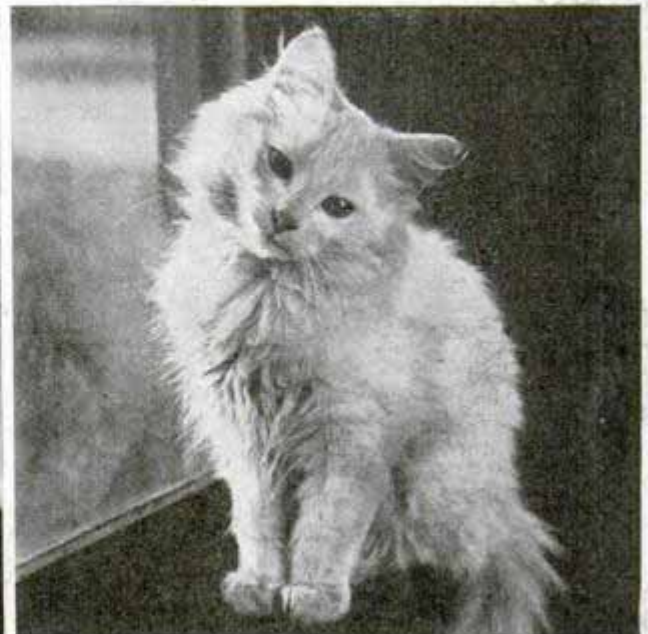

Youngster and pup are caught experimenting in humorous shot at top. Silhouette tells story of comrades, while cat picture is "made" by tilt of head, lighting, and dark background

ject is necessary. There is less "depth of field" or range of sharpness when a camera is close to the subject and if you err, the subject will appear fuzzy and out of focus in your picture. The best practice is to select a standard distance for close-ups—say, three and one-half or four feet for smaller pets—and train your eye to judge this distance accurately.

For increased depth, use as small a lens opening as the light will permit. An extremely small lens opening, with high shutter speeds, will give you underexposed pictures; but in good sunlight, if the pet is reasonably still, f.8 and $\frac{1}{50}$ second, or f.11 and $\frac{1}{25}$ second will yield good negatives.

Alertness and the ability to snap a picture the moment an opportunity appears, are factors that make for appealing animal snapshots. Expressions are fleeting and often the momentary cock of an ear, loll of a tongue, gleam of interest in an eye, give the added "spark" that lifts a



picture out of the "ordinary" class. Learn to recognize the small points that add liveliness and meaning to the picture—and train yourself to snap the shutter before opportunity passes.

Look for story-telling picture chances but don't pass up an expression or bit of action because a "picture idea" is not im-

(Continued to page 114A)



There's always action—comedy, too, in dog's bath. Snapshot of child with pigeons is easily made and appealing. Contrast between baby and dog makes "luncheon for two" effective

Rotary Fire-Finder's Photos Help Spot Flames in Forest

San Bernardino National Forest

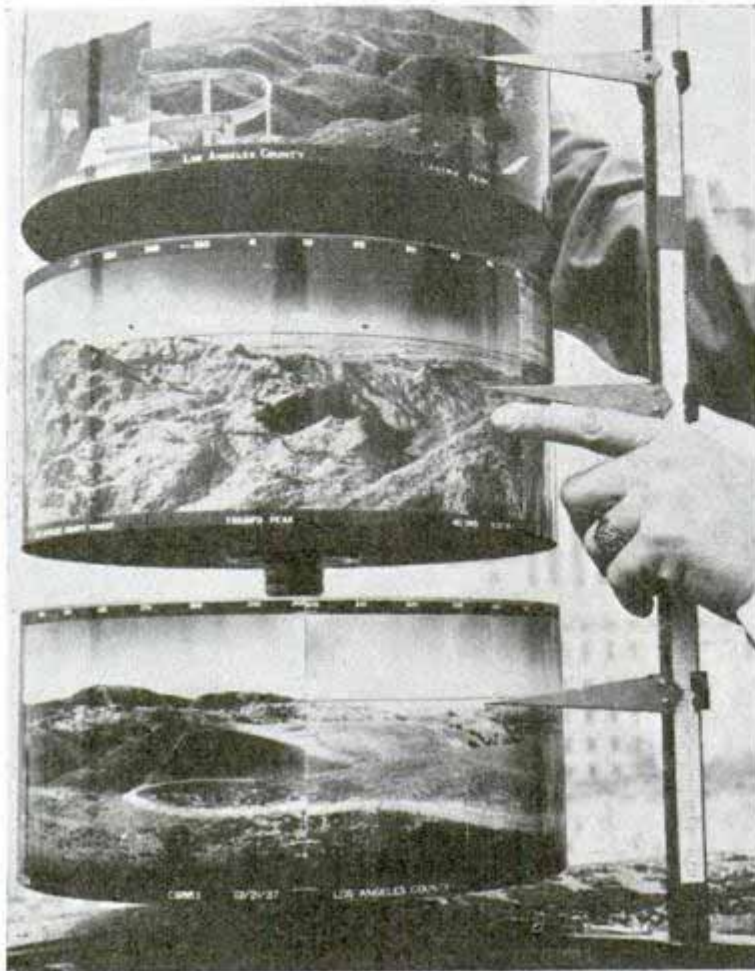

Pointing to fire-finder. Note photos mounted on rollers so they may be revolved in locating a forest blaze

By consulting photographs mounted on rollers, forest lookouts now may spot fires by pointing a finger at the pictured location. They employ a rotary fire-finder invented by a California forestry officer. It consists of a rack containing panoramic pictures taken from four different towers whose coverages are composite. Four adjustable pointers, one for each drum, indicate both the direction and elevation of a fire anywhere in the district.

tive spiral bi-metallic thermostatic element operates the valve, and once the adjustment handle—located conveniently outside the valve—is set for the right temperature, the water is exactly mixed. Water pressure and variation in the hot or cold supply do not affect its operation.

Weedless Fishing Lure Has Barbless Hook

Fully weedless and equipped with a barbless hook, a new lure is available for the fisherman. No wire weed guard is used. The hook is directed downward, its sharp point resting in a protecting pocket which is pressed out of its main metal body. The fish does not have to bite up and above the whole body of the lure. A slight snap at its rear portion forces the hook down and through the cartilage of the lower jaw and resprings into its protecting pocket, thus forming a closed loop from which the fish cannot free itself. The lure is a lifelike wiggler, with two teardrop spinners which strikingly resemble the actions of gills and front fins of a live minnow.

marvelous

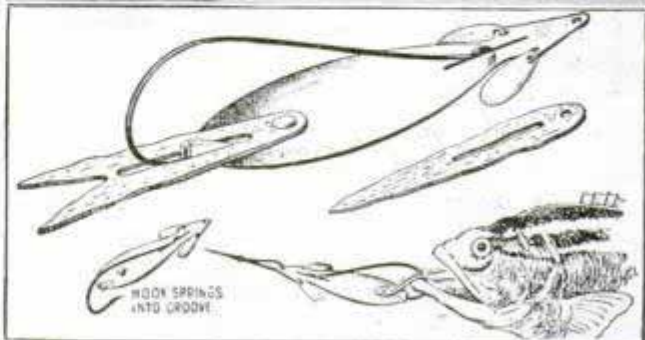
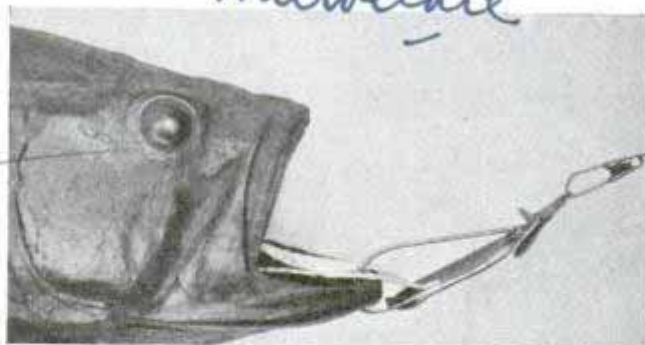

Barbless and weedless fish lure. Above, how lure catches the fish and holds it

Tempering Valve Mixes Water to Desired Temperature



Steady flow of water at any desired temperature is assured by a thermostatic tempering valve. An extremely sensi-

12824
All Heat Utilities Co.
118 E 28th New York

Advance Lures Co.
2847 Milwaukee Ave

Paris Sees "Loch Ness Monsters" on Parade



Parisians are "seeing things" on the Seine. Fantastic creatures of the sea parade in a river carnival planned as part of the entertainment for King and Queen of England during their visit to France

Monsters of the sea seldom get to Paris, but this year Parisians watched a whole school of "Loch Ness monsters" on the

Seine. The parade was arranged as part of a river carnival in honor of the state visit by the British king and queen to France.

4826 Bike Trailer Hauls Surfboard from Home to Seashore

Getting his heavy surfboard from his home to the beach more than a mile away was simplified by a California youth who hitched a trailer to his bicycle. It was built of two rubber-tired wheels from a discarded toy wagon, a ten-foot length of narrow board, and a strap-iron gooseneck to hook on the saddle of the bicycle. Even with the weight of the surfboard, it rolls easily.



Living some distance from the beach, this Californian built a trailer to haul his heavy surfboard behind his bicycle

Chester Orrell Newport Beach Calif

H 762

Handle for Miniature Camera Helps Steady the Grip

\$1.00 per pend

*Mini camera 1309 Third St
St. Petersburg Fla*



Handle screwed into tripod socket of miniature camera is attached at other end of neck strap

Miniature camera fans find it possible to steady the camera by using a special handle which screws into the tripod socket. Shaped to fit the hand, it is attached to a neck strap and can be carried conveniently around the neck or in the pocket.

Engine Uses Half Its Power to Buck Wind at Seventy

*New Service Bureau
1327 49th St. Dayton
Ohio*

Streamlining in automobiles was the artist's idea—not the engineer's. It began with the search for more graceful lines, not with the intent to save power. Air resistance didn't mean much when cars were driven at a top speed of around forty-five miles an hour, but at the high speeds prevalent today streamlining is "first aid" to the motor. In the conventional automobile running at seventy miles an hour, about half the indicated engine output is used to overcome air resistance! Streamlining is no new discovery. It was put to work long before the modern airplane brought it to sudden perfection. As early as forty years ago railroads in France and England fitted their locomotives with wind-cleaving devices such as conical boiler fronts and V-shaped cabs, some of which have sur-

vived. Scientific streamlining, however, only reached the railroads within the last five years. Wind-tunnel tests on model locomotives at Ottawa, Ont., indicated a forty-three per cent reduction in air resistance could be achieved if it were possible to streamline a locomotive completely, but limitations are set by the necessity for access to the running gear, interference with the draft to the firebox, and safety requirements which prevent concealing steps and handholds. The firebox draft problem is eliminated, of course, in the Diesel-electric engines. While it may seem strange that streamlining quickly reached its highest perfection in the newest industry—airplane and airship transportation—while automobiles and railroads lagged, the answer is that airplanes reached high speed long before cars and trains, and air resistance is unimportant below forty or fifty miles an hour.

Twin Propellers of Army Ship Spin in Opposite Directions

Tandem propellers are being tried on army planes on the theory that they make more efficient use of power. Mounted on concentric shafts and geared to a single engine, the two blades revolve in opposite directions. Engineers say advantages are elimination of torque and increased power without adding to propeller diameter.

*Curtis pursuit plane
at Wright field.*



More power and less torque is result of single engine driving twin propellers in opposite directions

R a d i o



A-B Eliminator for TWO-VOLT FARM SETS

WHEN your new power line is in, radio battery expense is over. However, don't throw away your battery receiver, merely substitute a good A and B-battery eliminator specially designed to supply the same hum-free operating voltages directly from the new 110-volt a.c. line.

The unit shown in photos Figs. 1 and 2 furnishes well filtered, steady direct current for any type radio receiver which operates on 2 volts filament A supply and B-battery voltages up to a total of 180 volts, equal to that obtained from four 45-volt B-batteries. Another model recently developed provides a maximum of $3\frac{1}{4}$ amperes at 6-volts direct

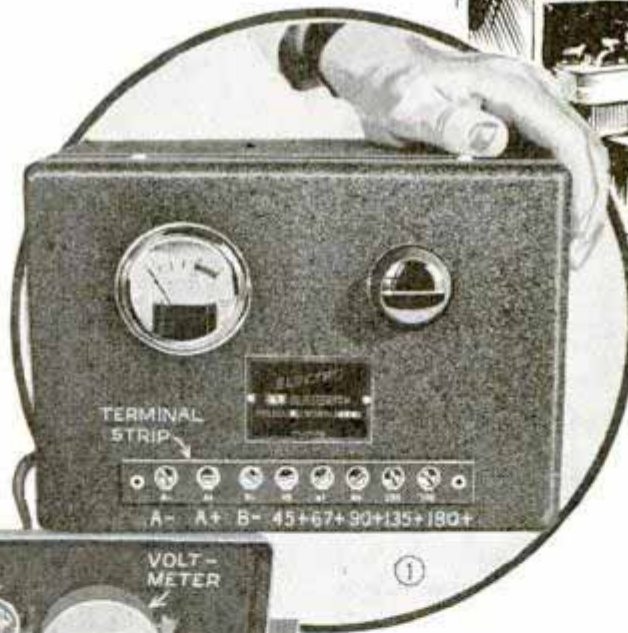

current for 6-volt farm sets which employ a vibrator B-voltage supply system. The A-B eliminator unit will power any battery-operated

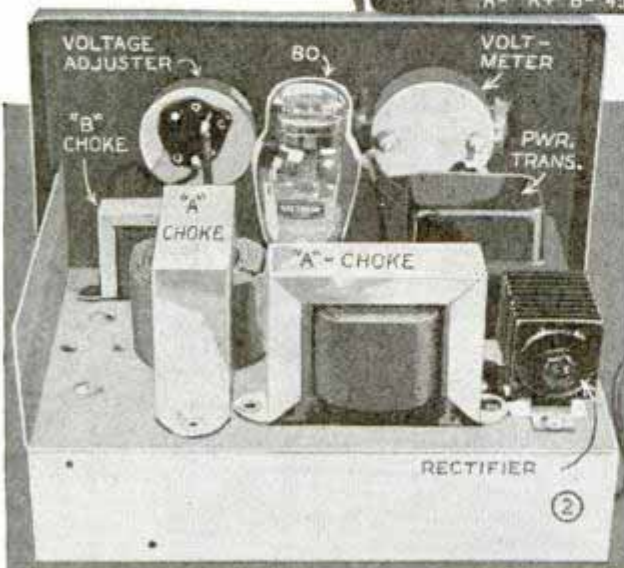

receiver using up to eleven tubes.

All A and B terminals are plainly marked. It is impossible to burn out the tube filaments, because a potentiometer connection limits voltage to that indicated on the voltmeter, shown at upper left in Fig. 1. The voltage-adjusting knob, right, includes switch and potentiometer, whereby first rotation movement of the knob switches power on the eliminator and further rotation increases voltage output from the A-power source.

Electro Products Laboratories, Inc. Chicago 166

Portable TWO-TUBE A.C.-D.C.

By G. C. Crose

MERELY by pushing a button, any one of your five local broadcasting stations can be received with good volume and clarity on this simple and compact 2-tube receiver. Using the latest dual-function tubes, and designed to operate efficiently on any 105 to 120-volt d.c., or 50 to 60-cycle a.c. line supply, this tiny push-button set will find favor as an extra receiver around the house, traveler's companion, sick-room or office-desk radio.

All construction details have been simplified so that this new type of receiver

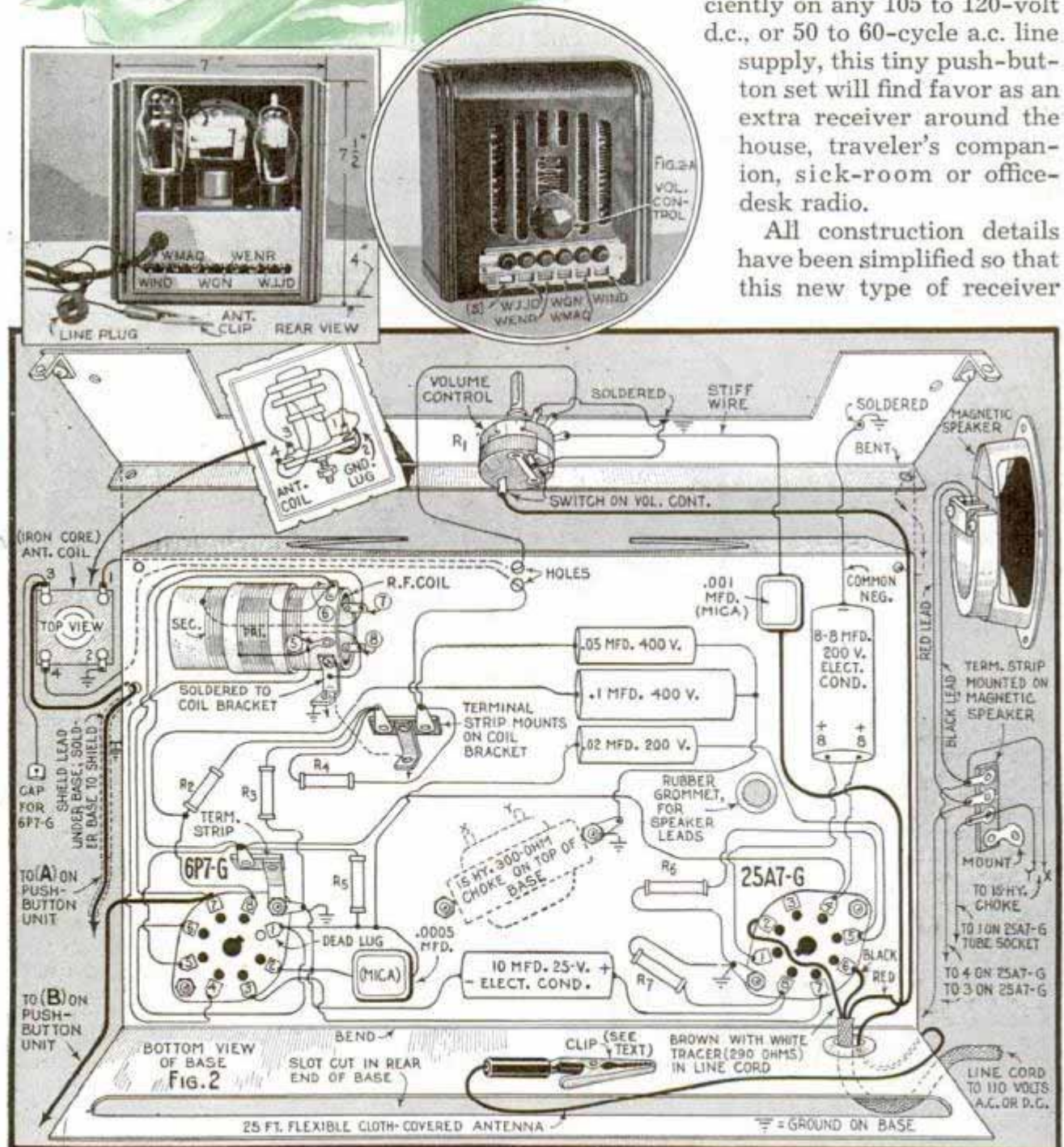

PUSH-BUTTON Receiver

can be assembled by any radio experimenter. It differs from the usual midget set in several respects. However, all parts are inexpensive, standard and easily obtained. The sheet-metal chassis base is detailed in Fig. 1; this base can be made in the home workshop or purchased formed and drilled.

The simplified wiring diagram, Fig. 2, shows all parts and connections under the base and also clearly indicates every lead to the speaker, volume-control, antenna coil and push-button unit. This unit comes assembled and wired ready for use, as illustrated in the photo opposite Fig. 2. It is mounted under the base, in the position shown, by means of two short machine screws through holes drilled near the small angle brackets in the separate base-supporting panel, after all of the set wiring has been completed. There are only four soldered connections to be made to the push-button unit and two of these are grounds to the metal base. Connections A and B are made to terminal lugs on top and bottom of unit, connecting the two groups of trimmer condensers in the circuit. Woven-wire metal shielding should be used on the portion of lead (A) that runs under the panel from terminal 3 on the antenna coil; this shield should be grounded on the metal base as indicated.

(Continued to page 130A)

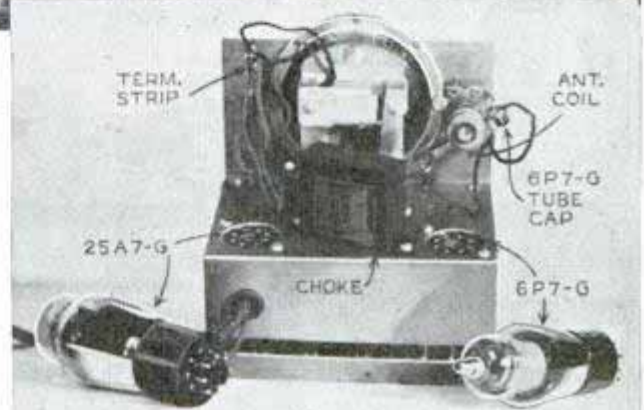

FIG. 2-B

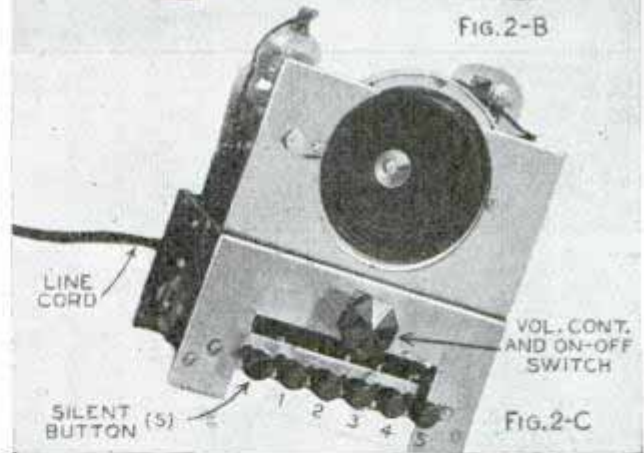

FIG. 2-C

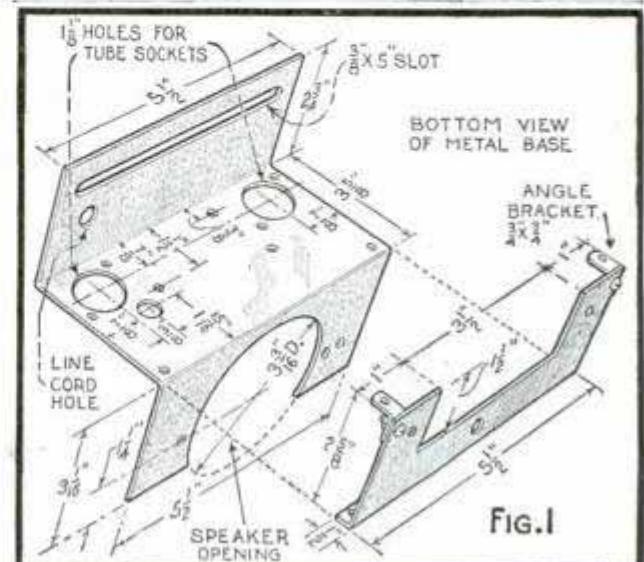
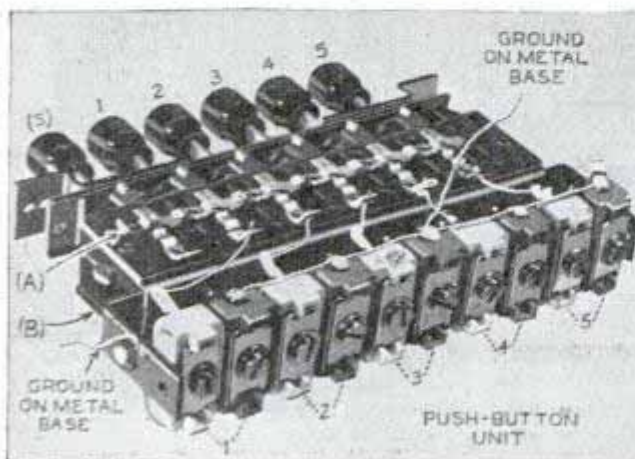

FIG. 1

Handy Portable Junk Box for Radio Workers



EVERY radio experimenter and serviceman knows that much unnecessary and valuable time is wasted in searching for various small parts and tools. This simple and easily made box can be opened on the worktable, placing all materials for set building and repair within easy reach.

Compartments are provided for tools, various radio parts, tube manuals, blueprints and magazines. Removable glass jars, with screw-top lids bolted to the top of the box, serve as containers for machine screws, nuts, washers, bushings and other small hardware. Ordinary screw-top jam jars may be used for the purpose.

Although the arrangement can be altered to suit the individual needs of the builder, general construction details are shown in Fig. 1. The first step is to make a wood frame, each of the inside dimensions of which measures 14 inches. This frame is constructed with 1-in. white pine and the ends are closed with plywood panels. The box is then sawed in two in order to form halves that will fit properly. These halves are hinged and padlock hasps serve as loops for the removable leather handle. Figs. 2 and 2-A show completed assembly.

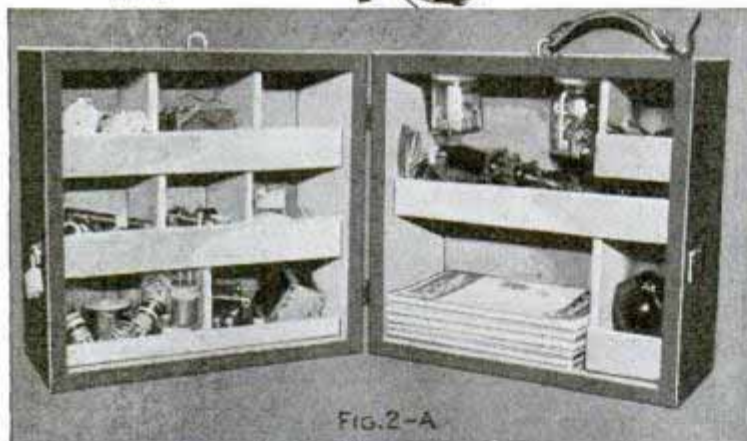
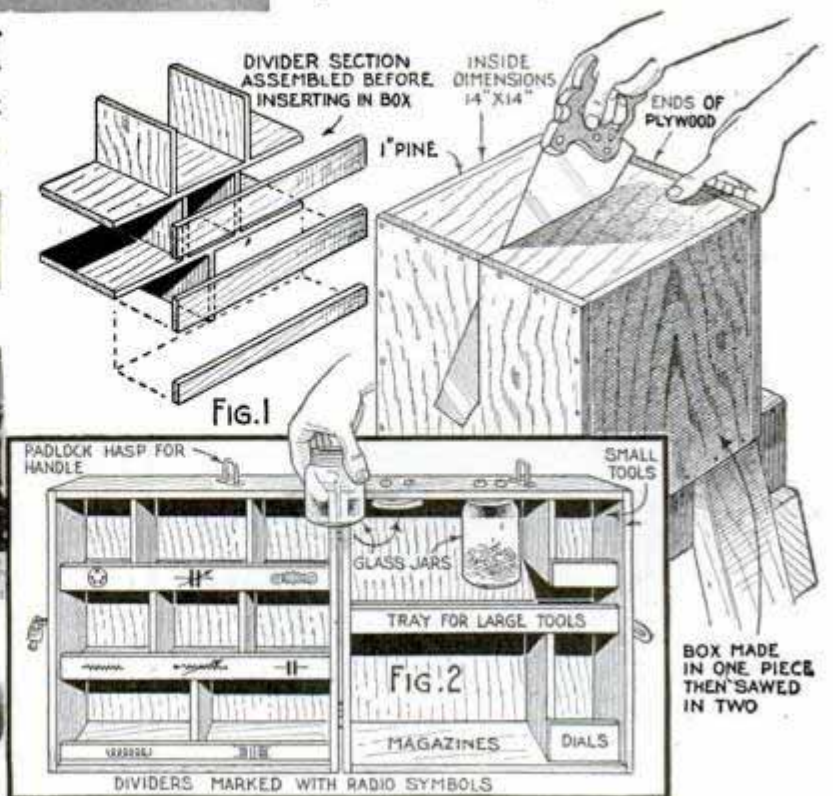
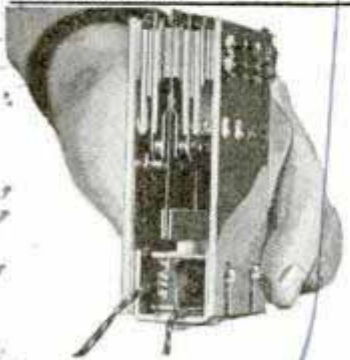
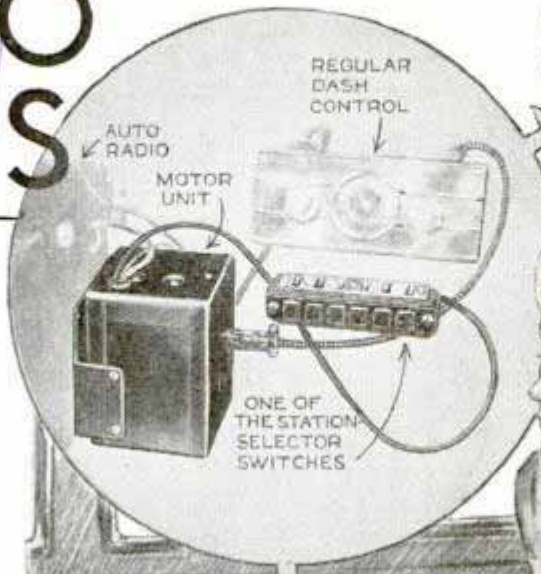

FIG. 2-A



*Electronic Laboratories
122 W. New York St.
Indianapolis
Ind.*

PRACTICAL RADIO HINTS



Above, 500-watt vibrator unit has 20 contact points; designed for use in 6-volt converter to supply high-voltage d.c. for portable amplifiers and transceivers

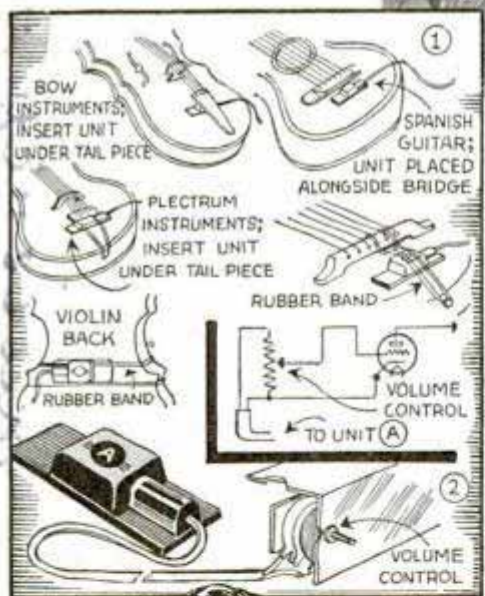

Above, motor-driven tuning unit, easily connected to any auto radio, provides 6-station push-button tuning from both front and rear seats. No tools are required to set push buttons for a new group of stations. Left, Fig. 1, suggested methods for using a contact-type microphone to reproduce vibrations of various musical instruments for amplification. Operating on the magnetic induction principle, it can be attached to all stringed instruments including a piano. Fig. 2 shows connection to volume control of a radio receiver, the set taking the place of special amplifier and speaker equipment. Below, compact cathode-ray oscilloscope in steel cabinet 4½ by 6½ by 8 in.; employs a 1-in. screen RCA 913 tube with 6X5 rectifier. Right, multi-tap plug-in switch made with tube socket

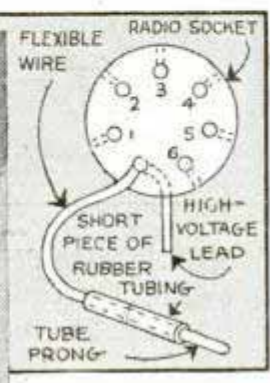
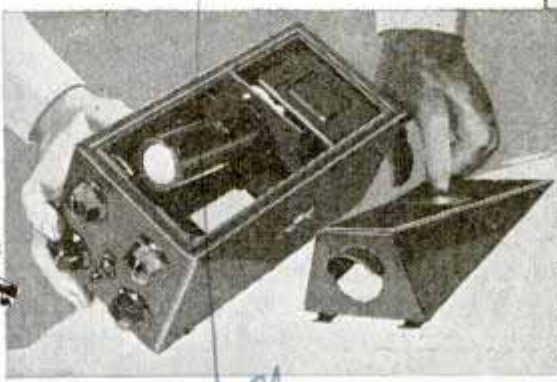

*Crowe Radio & Supply Co.
701 Riverside Drive
New York 27, N.Y.*

*The Acapelite
561 Broadway*

Phototube Relay in Kit Form



Suitable for experimental or research work, for educational problems or lecture demonstrations, this photoelectric relay unit is furnished as a kit for student assembly, or, completely assembled and ready for use. It may be adapted for controlling liquid levels, signals from moving devices, or starting and stopping apparatus. Employed as a sensitive electronic relay, only 1 or 2 microamperes need be controlled in the input circuit to control a 100-watt load by the relay. This makes the device useful for regulating constant temperature baths with a mercury thermostat.

Lamp, Clock and Radio Cabinet

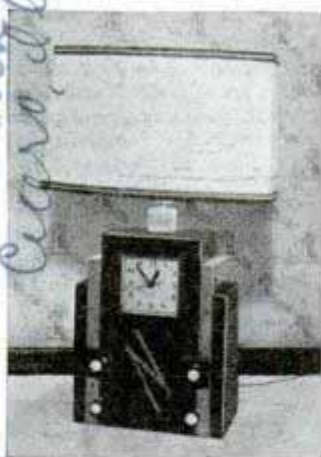

This combination boudoir lamp, clock and radio cabinet was designed and built by Mr. I. H. Harder to house the 3-tube Little Giant "Pup" a.c.-d.c. receiver described in the July, 1937, issue of Popular Mechanics Magazine. The cabinet is made of 1/4-in. plywood. The a.c. type clock is mounted directly over the speaker.

Vacuum Operated Auto Antenna

Out of sight when not in use, this adjustable auto antenna may be raised or lowered and stopped at any desired position by merely pushing a button on the instrument panel.

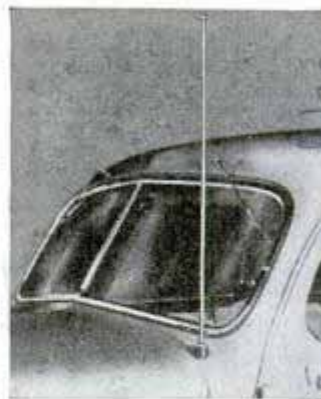

Push-Button Remote Control

No tools are required to install this push-button remote-control unit that connects to the antenna and ground posts only of any radio receiver. Eight push buttons provide a choice of seven stations or dial tuning; remote volume control is included.



Blueprints covering radio construction articles in past issues are available for 25 cents each; original material lists and additional information can be obtained from our Radio Department without charge upon receipt of postage.

NEXT MONTH—How to Build an All-Purpose Power Supply for Either Battery or A.C. Operation. Three separate units, one of which is a filter and voltage divider. Supplies B-voltages from 22½ to 300 volts from either a 6-volt storage battery or 110-volt a.c. line. Also—An A.C. Operated Volt-Ohmmeter

Es. M. Laboratories
1731 Detroit
9201 1900...
Primary plan...
521...
Electrical...
Harder
1508 & 1509...
measuring...
mt. Carmel, I.D.



MODERN MIRRORS

... you can build

By WAYNE C. LECKEY

*Aurora
453 West 10th Ave
d l l*

EITHER one of these distinctive mirror frames shows a careful selection in good taste and they can be made right in your home workshop, inexpensively, from very little material. The frame shown in Fig. 1 will go well among conservative furnishings, while the one in Fig. 2, with its gleaming tubing and natural-wood or bone-white finish, is for a strictly modern setting. While the frame in Fig. 1 is more or less of a shaper job, it can be made without such a tool by rounding the edges by hand and ripping the rabbet for the glass before assembling. First, the four side pieces are ripped to size according to the dimensions given at Fig. 4. Butt joints are used and these are strengthened by means of dowels. The top piece of the frame should be bandsawed to shape before gluing, using the waste to form a square corner for clamping. The bottom rail is glued and clamped to the sides first, then the top piece. After the glue has dried, the rabbet is cut for the glass with a straight-face cutter on the shaper spindle and a collar bearing against the work. You can square up the corners with a chisel. Before shaping the face edges of the frame, 1-in. pieces, scored $\frac{1}{8}$ in. deep on the saw, are doweled and glued to the sides. A ready-made fiber

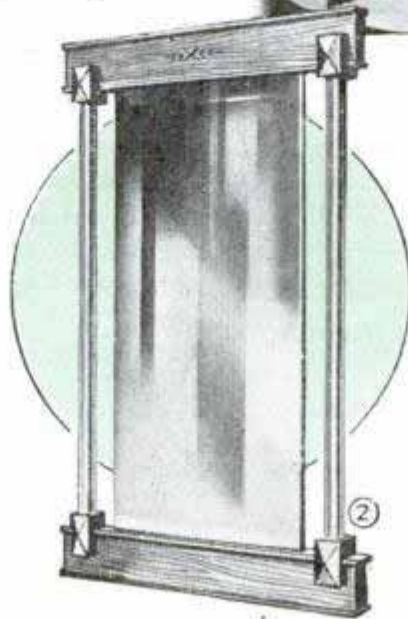

overlay is purchased, centered, and glued to the top of the frame. After a thorough sanding with progressively finer sandpapers, carefully apply a varnish, wax or oil finish.

The frame shown at Fig. 5 is very simple to make. Except the cutting of the grooves for the glass, which is done on a circular saw as shown in Fig. 3, the whole thing can be made with hand tools. Your first

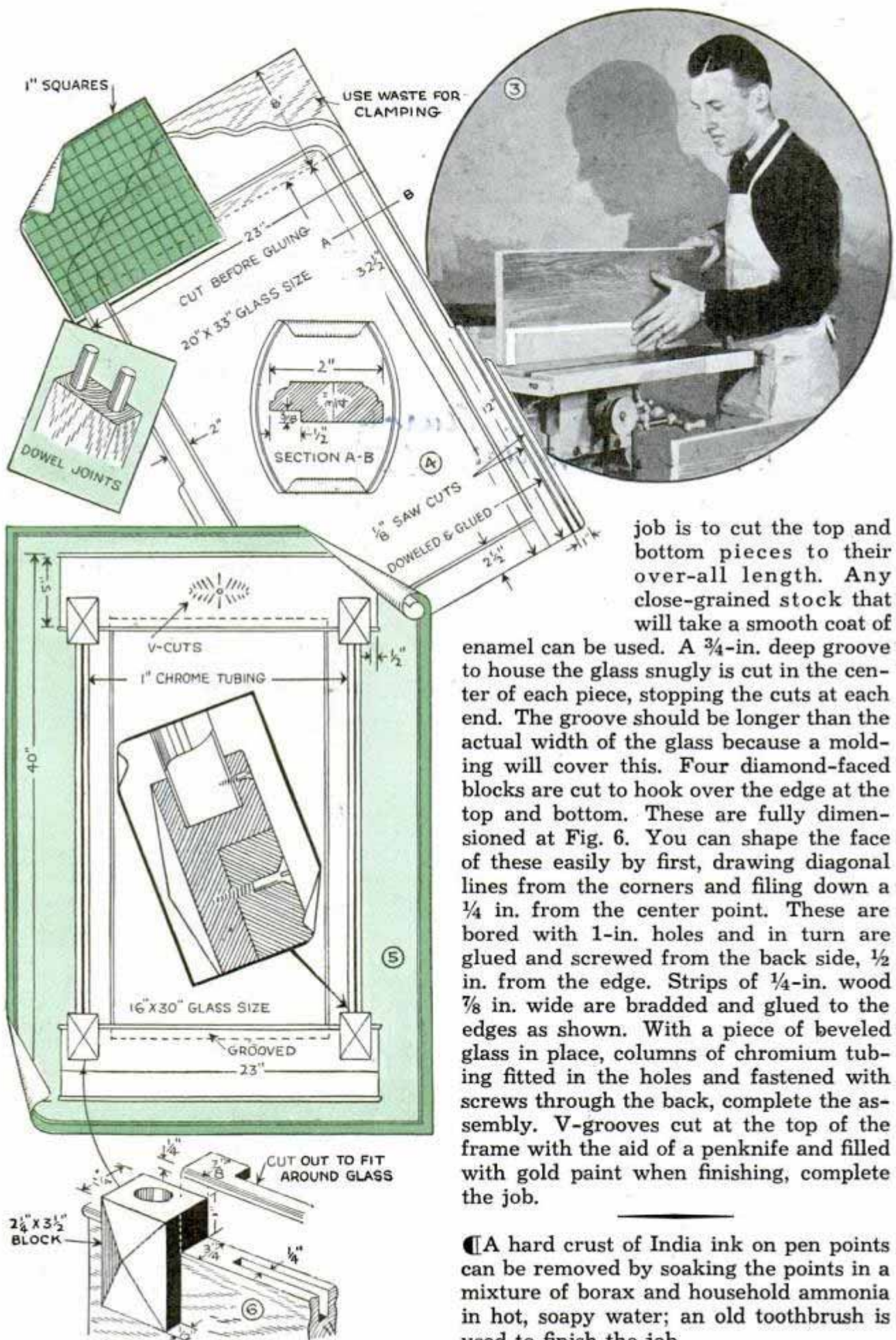

job is to cut the top and bottom pieces to their over-all length. Any close-grained stock that will take a smooth coat of

enamel can be used. A $\frac{3}{4}$ -in. deep groove to house the glass snugly is cut in the center of each piece, stopping the cuts at each end. The groove should be longer than the actual width of the glass because a molding will cover this. Four diamond-faced blocks are cut to hook over the edge at the top and bottom. These are fully dimensioned at Fig. 6. You can shape the face of these easily by first, drawing diagonal lines from the corners and filing down a $\frac{1}{4}$ in. from the center point. These are bored with 1-in. holes and in turn are glued and screwed from the back side, $\frac{1}{2}$ in. from the edge. Strips of $\frac{1}{4}$ -in. wood $\frac{7}{8}$ in. wide are bradded and glued to the edges as shown. With a piece of beveled glass in place, columns of chromium tubing fitted in the holes and fastened with screws through the back, complete the assembly. V-grooves cut at the top of the frame with the aid of a penknife and filled with gold paint when finishing, complete the job.

☞ A hard crust of India ink on pen points can be removed by soaking the points in a mixture of borax and household ammonia in hot, soapy water; an old toothbrush is used to finish the job.

A Distinctive Porch Light in Polished Brass

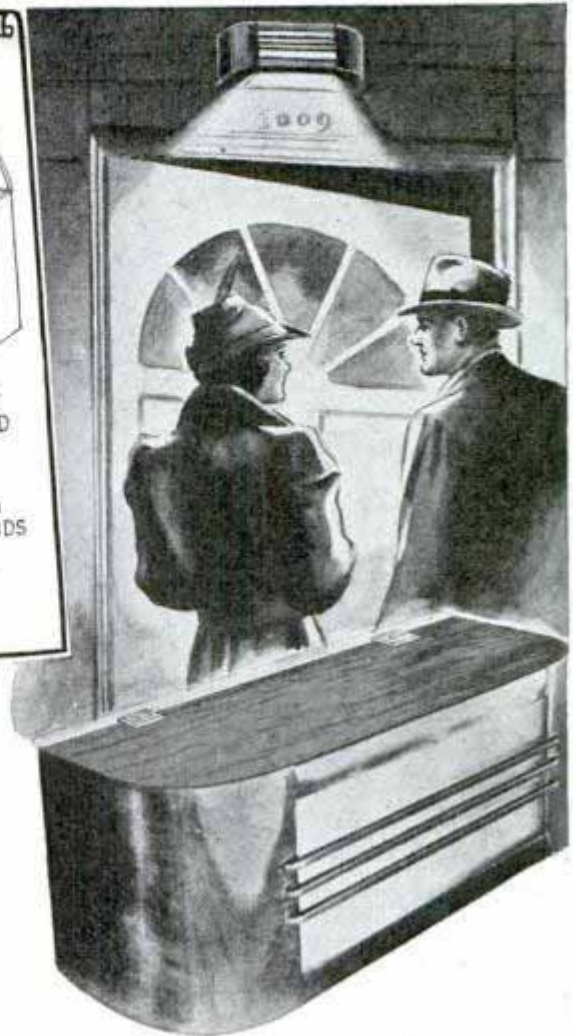
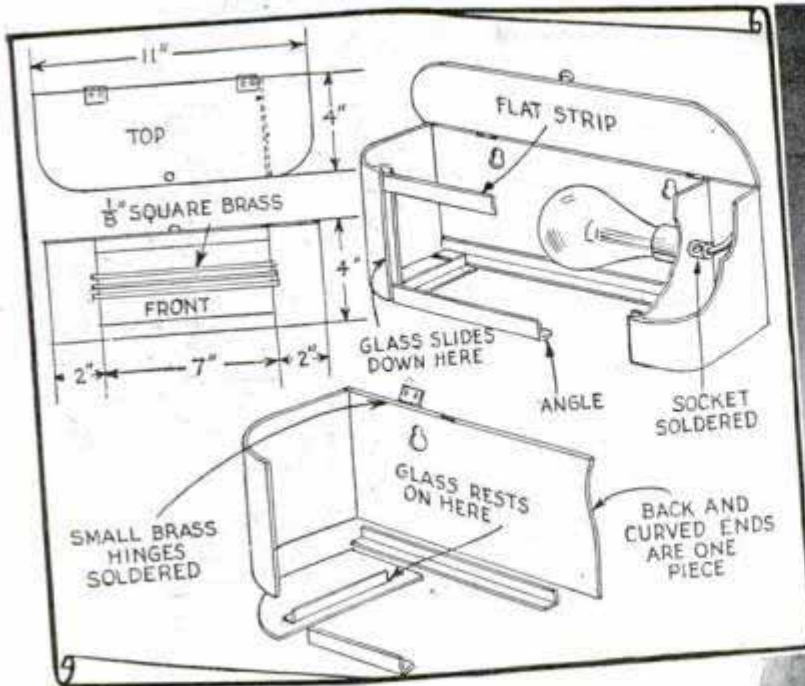

So simple in construction that you can practically build it complete in one evening, this new porch light gives a soft, diffused light over a wide area. The frame and hinged top are of sheet brass, polished and lacquered to prevent tarnishing. Ground-glass panels are fitted in the front and bottom openings and are held in place with short lengths of brass angle. The latter should be sweat-soldered in place.

Neckties Hung on Outstretched Arms of This Silent Valet

Fastened to the wall in your bedroom or to the inside of the closet door if you prefer to keep it out of sight, this silent valet which is designed to hold neckties, is some-

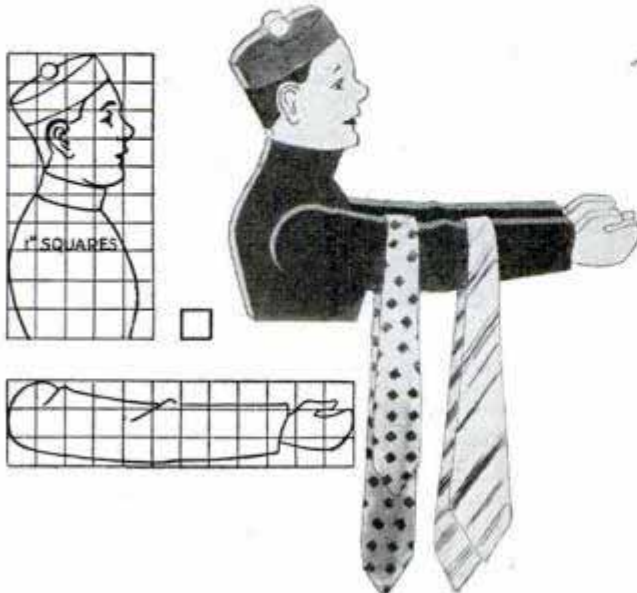

thing different from the usual necktie holder. It can be varied in color to be complementary to the furnishings and color scheme of the room. To make it, you can use regular stock such as poplar, running the grain of each piece lengthwise, or you can use $\frac{1}{4}$ or $\frac{3}{8}$ -in. plywood. The wood should be well filled in at the edges by applying a couple of coats of shellac and then paint. Previous to painting, all edges should be sanded to render them smooth so it won't be possible to damage the neckties as they are slipped on or off the arms when you're in a hurry.

—H. F. Showalter, Davenport, Nebr.

☞ When stringing beads that have very small holes, first twist the cord tightly, then dip the end into household cement or glue. When the cord is dry, it will pass through the holes easily.

Foot Feed on Drill-Press Spindle Is Handy When Routing

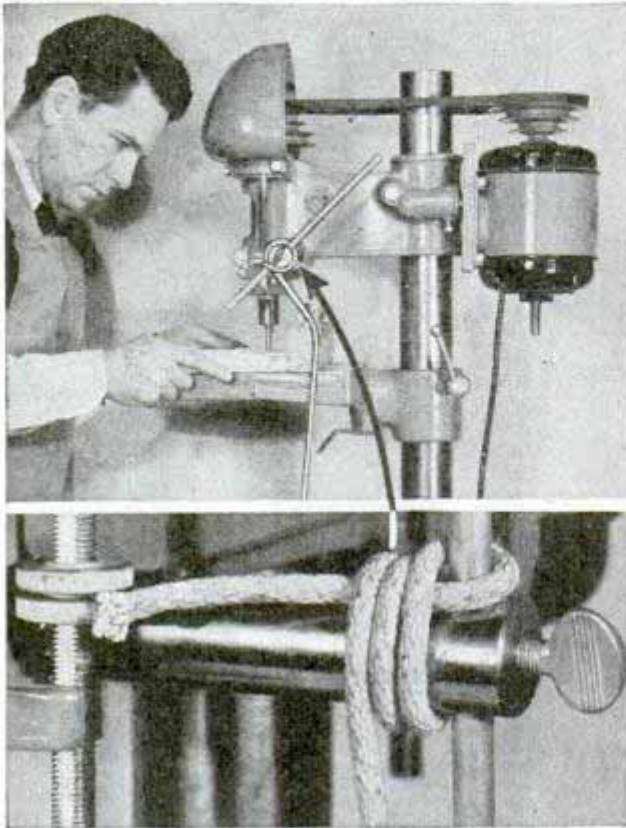

Drill-press feed operated by foot when routing, leaves both hands free to manipulate the work

Routing jobs on a drill press often can be speeded up considerably by controlling the spindle with your foot so that both hands are free. This can be done with a length of sash cord, one end of which is wrapped around the drill-press feed as indicated in the lower detail, the other end terminating in a loop for the foot about 2 in. above the floor.

Arrow Gun from Paintbrush

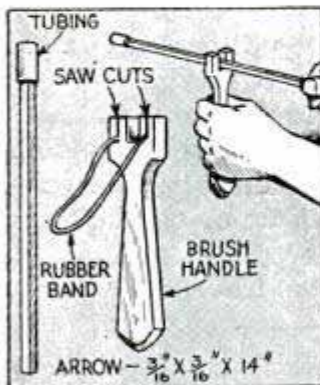

To make an arrow-shooting gun from an old paintbrush, just remove the ferrule and bristles and cut out a section of wood in the center of the handle as indicated, running two saw cuts beside the cut-out

portion to hold the ends of a rubber band. Arrows, which should be about 14 in. long, can be made from dowel or any small stock

that you may have at hand. For safety's sake, it's a good idea to slip a short piece of rubber tubing or a penny eraser over the end of each one.

House Siding Should Be Scored Before Sawing

Carpenters who are particular about fitting siding board claim that no saw is sharp enough to cut it without leaving a ragged edge, which is hard to fit neatly. A sharp knife should be used to score the boards before sawing them. This breaks the outside grain of the wood with a smooth end which need not be destroyed with the saw.

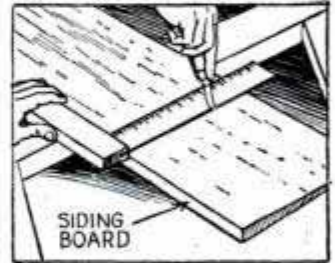

Fish Can't Swallow This Hook

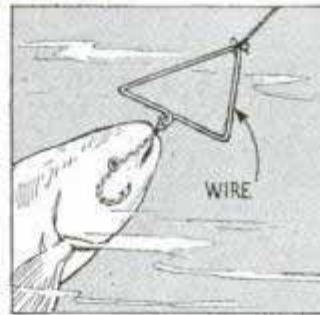

Fish of the bull-head, perch and sunfish variety have such voracious appetites that they often swallow the hook before the fisherman knows that they have begun

to nibble. To prevent this, one fisherman attaches the hook to the line with a piece of wire bent as indicated. The wire also serves as a sinker.

Golf Balls Stored in Airtight Can Do Not Dry Out

When you store golf balls for the winter, put them in an airtight can and they are less likely to dry out and lose their resiliency. This is an especially good idea if the balls are kept in houses heated with hot water or steam where the humidity is usually very low.



—Joseph P. Driscoll, Buffalo, N. Y.

Ironwork Adds Charm to Chairside Table

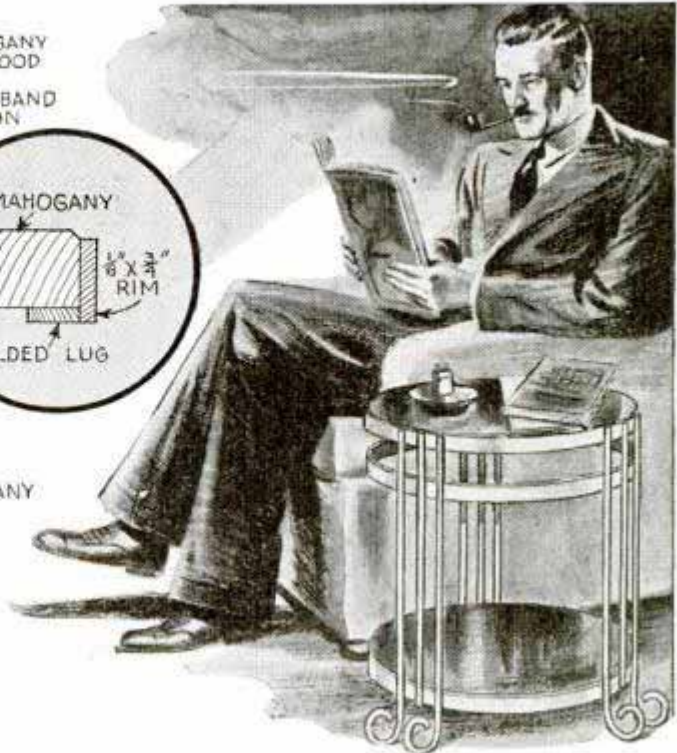
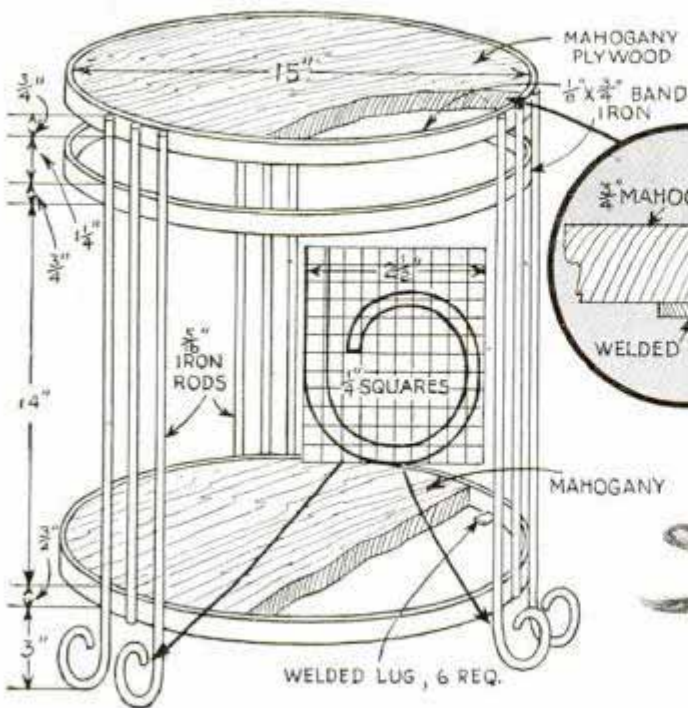

Polished mahogany or glass combines with the white iron framework of this sturdy little table, producing a distinctly modern effect. While welding is best to assemble the iron parts, it is possible to drill the pieces and use iron rivets. If the holes are countersunk, it is possible to

peen the rivets down to fit so they will not be noticeable, especially if dressed down flush with a file. In case you wish to build this table without welding, you may be able to use pins to support the shelf and top, the pins being threaded to fit tapped holes in the rims.

Door to Attic Storage Space Forms Built-In Bookcase

When extra rooms are built in an attic, it's a good idea to leave an opening in the wall so that the space extending to the

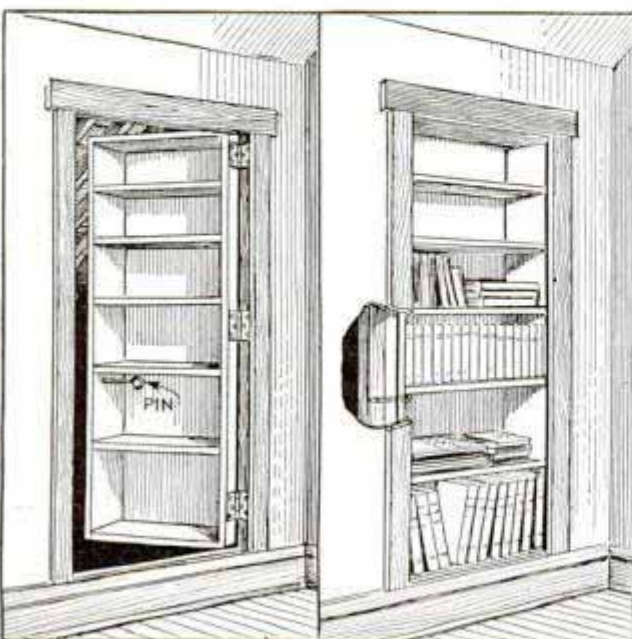

eaves may be utilized for storage purposes. However, a small door will accentuate the usual low ceiling of an attic room, which makes the room look squatty. Therefore, instead of an ordinary door, built-in shelving may be hung on hinges from a stud of the partition. This serves both as a door and as a convenient place to store a few books, magazines or other items. After hinging the bookcase, it is pulled firmly shut against the casings, and a short pin is pushed through one side into a stud to lock it in place. This also helps to make the presence of the door still more inconspicuous. It will be advisable to use very little space for books because the weight of many books will cause the case to tear from the hinges. A small wheel or caster attached under the case near the edge that swings open, will carry the weight and reduce strain on the hinged side.

—Chester W. Colburn, North Weare, N. H.

Colonial Wall Shelf

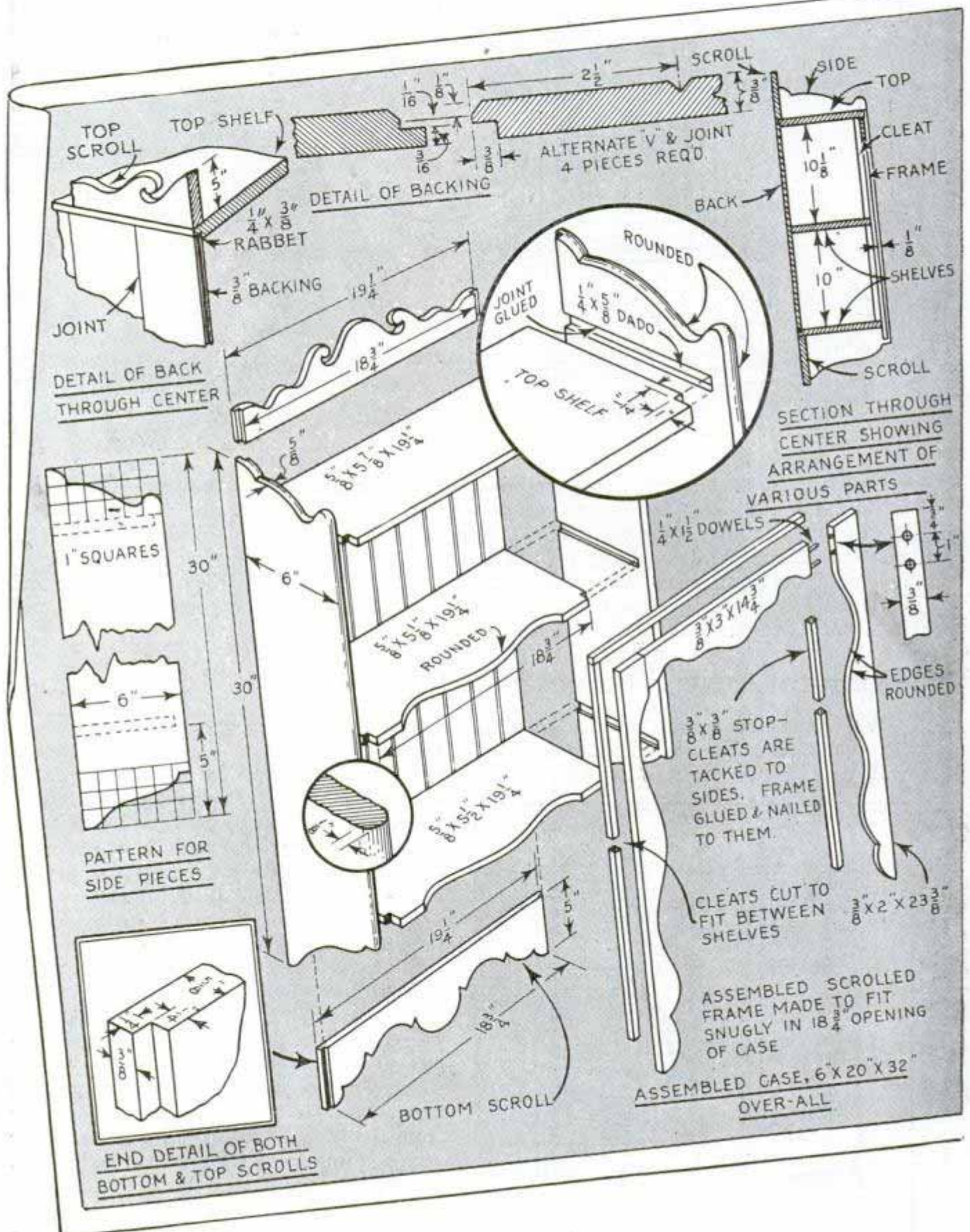

in white pine

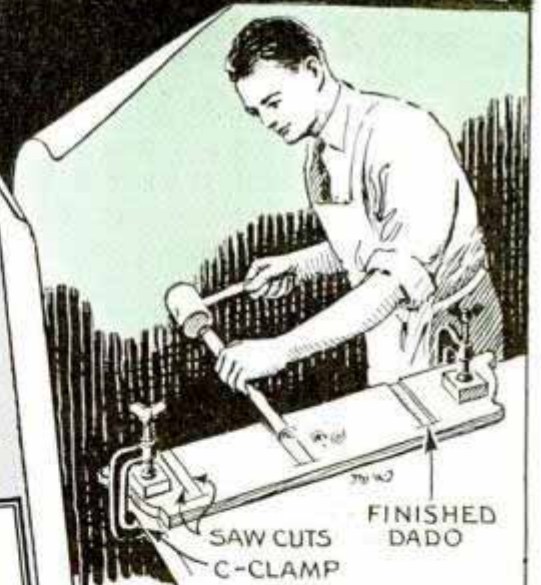
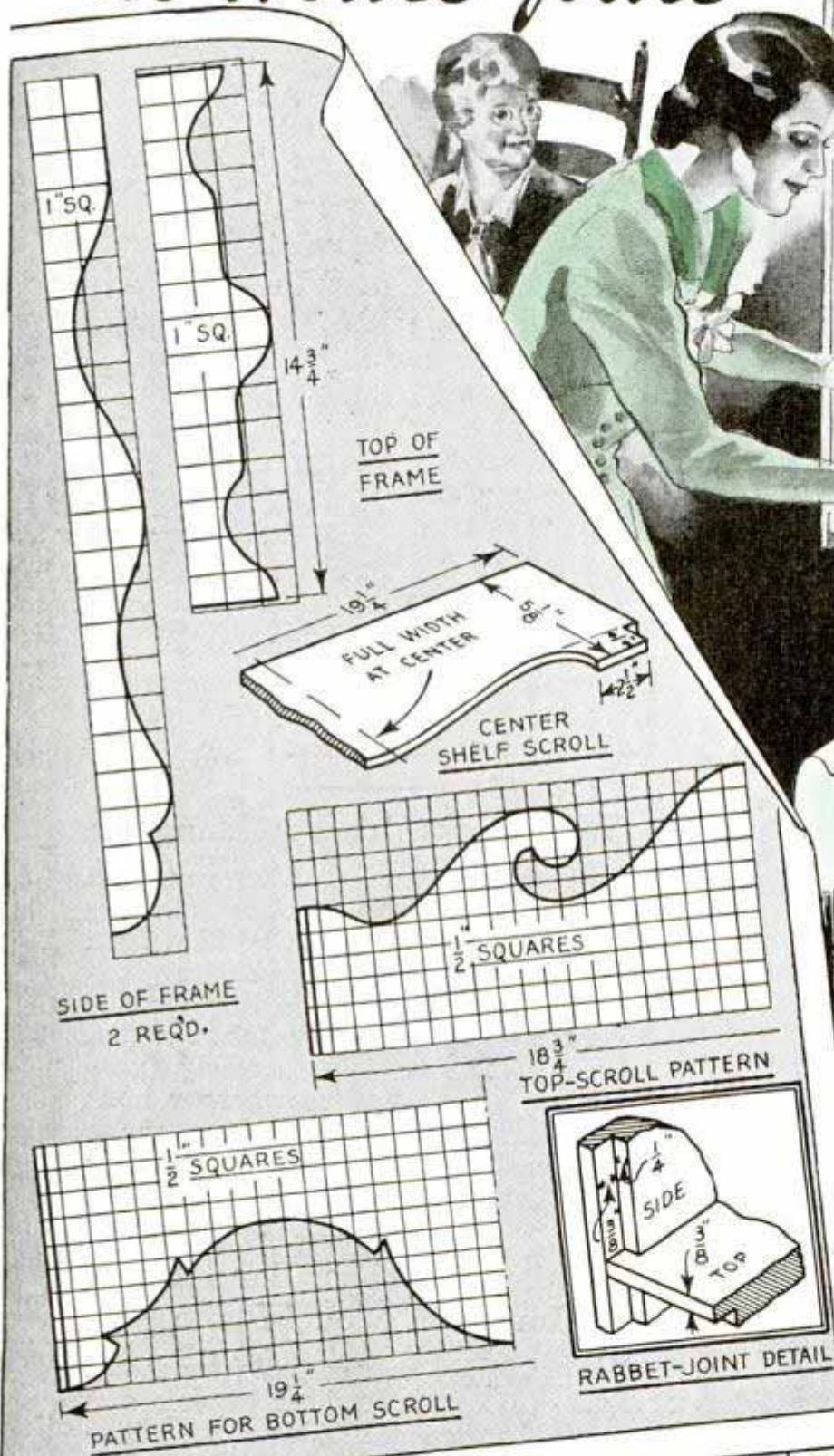

DADOS ARE SAWS AS FAR AS POSSIBLE THEN FINISHED WITH CHISEL

- BILL OF MATERIALS**
- 2 SIDES - $\frac{5}{8}$ " X 6" X 30"
 - 1 TOP SHELF $\frac{5}{8}$ " X $5\frac{7}{8}$ " X $19\frac{1}{4}$ "
 - 1 CENTER SHELF $\frac{5}{8}$ " X $5\frac{1}{8}$ " X $19\frac{1}{4}$ "
 - 1 BOTTOM SHELF $\frac{5}{8}$ " X $5\frac{1}{2}$ " X $19\frac{1}{4}$ "
 - 2 SCROLLS $\frac{5}{8}$ " X 5" X $19\frac{1}{4}$ "
 - 2 FRAME SIDES $\frac{3}{8}$ " X 2" X $23\frac{3}{8}$ "
 - 1 FRAME TOP $\frac{3}{8}$ " X 3" X $14\frac{3}{4}$ "
 - 4 PCS. BACKING $\frac{3}{8}$ " X $5\frac{1}{4}$ " X $21\frac{1}{2}$ "
 - 1 TOP CLEAT $\frac{3}{8}$ " X $\frac{3}{8}$ " X $18\frac{3}{4}$ "
 - 2 SIDE CLEATS $\frac{3}{8}$ " X $\frac{3}{8}$ " X $20\frac{1}{4}$ " *
- *ALLOWANCE FOR JOINT FITTING.

For the kitchen, den or living room, this pleasing wall shelf distinctly shows colonial influence, the graceful scrollwork and the V-grooves in the back lending quiet dignity. The shelves are sturdily housed into the side pieces, the back is set into a rabbet and the whole case is stiffened by the back. Use dark brown stain and apply rubbed-effect varnish, or merely wax the surface

Telescoping Yardstick Is Handy for Inside Measurements

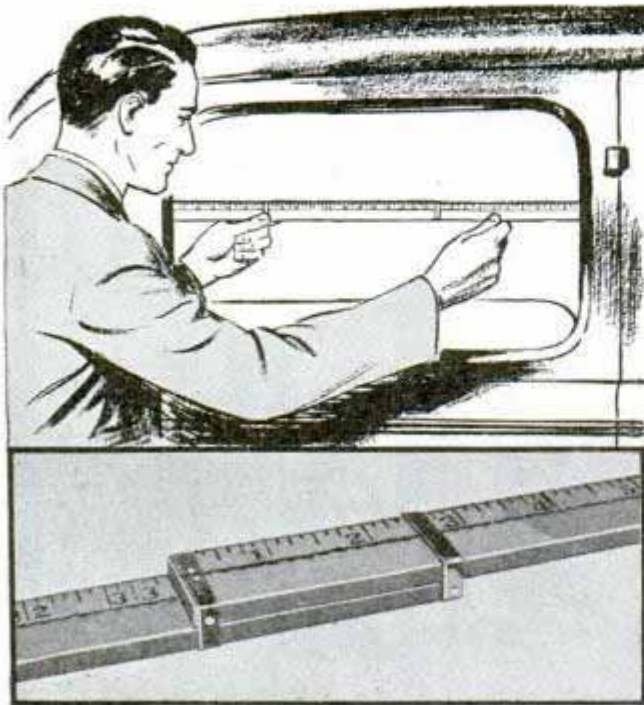

Yardstick cut in half and provided with brass strips forms a telescoping rule

Here is a rule for taking inside measurements such as of windows. It is just a yardstick cut in half, the two halves being held together by brass bands allowing the pieces to slide. Attach the bands at the end of each half bearing the number "1".

Give Your Photos Background of Gold or Silver

The appearance of your prized photographs can be enhanced further by applying gold or silver leaf to the background. To do this, make a transparency by print-



Prized pictures enhanced by applying gold or silver leaf over background

ing the negative on a slow film, and, after fixing, harden the emulsion in a 5-percent Formalin solution. After the film has been washed and dried, coat the emulsion side with a thin gum-arabic solution; then gently press the gold or silver leaf in place. Burnish it with a wad of cotton, and allow the gum to dry for several hours before mounting the picture.

Mask Helps Decorate Pastry with Colored Sugar

When colored sugar is used to decorate frosted cookies or cakes, you can do the work quickly, and outline the design uniformly, by using a cardboard mask. When cutting the mask, leave a suitable length of the cardboard to serve as a handle, and apply the sugar by sifting it from a salt shaker.

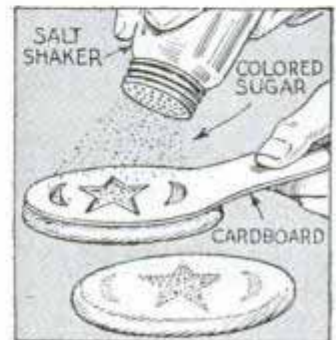

Wool Socks Dried on Hanger



After you wash wool socks, they can be kept from shrinking by slipping them on this stretcher to dry. It is simply a wire coat hanger bent to the shape indicated. The hook of the hanger enables you to hang the stretcher on a nail or clothesline.

Graphite on Rubber-Band Motor Improves Model Plane

Longer flights may be had from model airplanes driven by rubber-band motors if the rubber strands are dusted thoroughly with finely powdered graphite. The graphite lessens friction and lets the strands slip among one another freely, not only avoiding breakage but also giving more winds which means more power and longer flights.

—Chauncey Burrows, McKee's Rocks, Pa.

Tot's Own DINING SET

replaces high chair

Just the right size for sturdy, active youngsters of nursery age, this tiny dining set is patterned after the Dutch Colonial designs of long ago. If you wish it to match other juvenile furniture of the Early American type, make it of hardwood which will take stain well. Or, if it must be enameled in bright, cheery colors, pine, poplar or birch will do. When the set is to be painted most parts of the table can be made of plywood, but if stained, it's best to use solid stock. The top of the table is a two-part affair with a removable tray held in place with dowels, the ends of which drop into notches cut into the edge of the top proper.

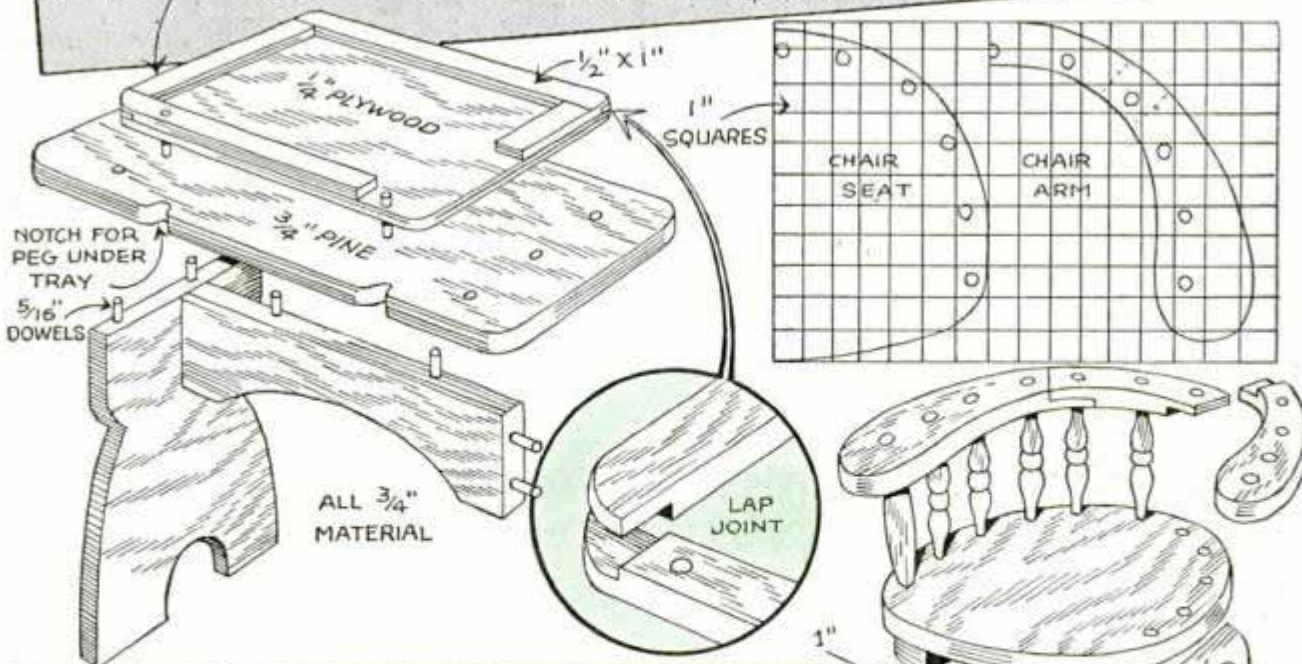
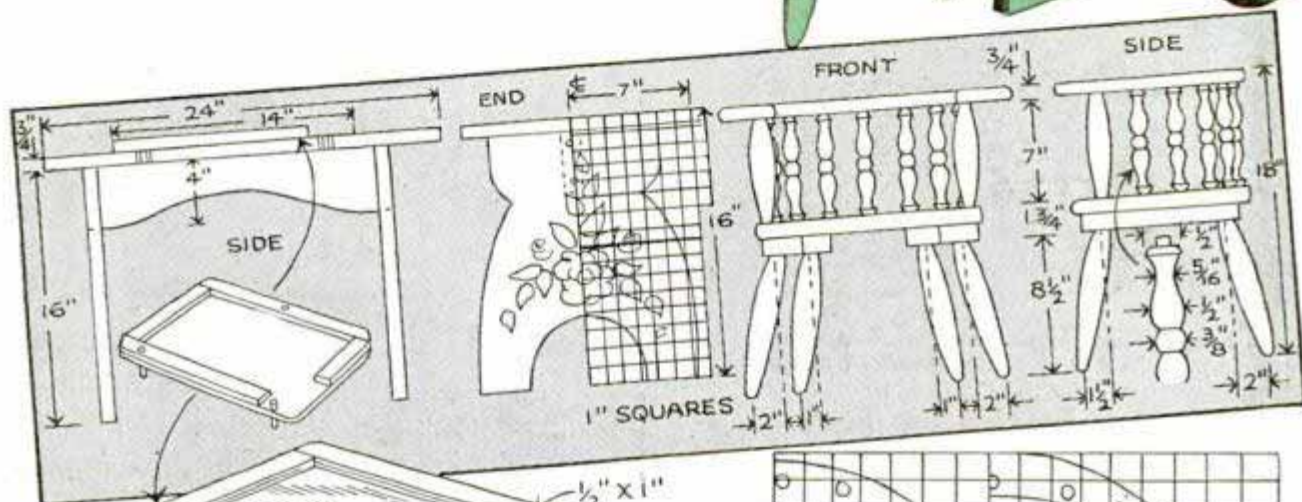

You'll find the construction easier because most of the parts to be made are duplicates. Once you get set up it's a simple matter to make these rapidly by completing one set of duplicates before starting another. There are no mortised joints; only dowels and glue are used. Turn down 1/2-in. dowels to make the chair spindles. Sand all parts smooth before finishing.

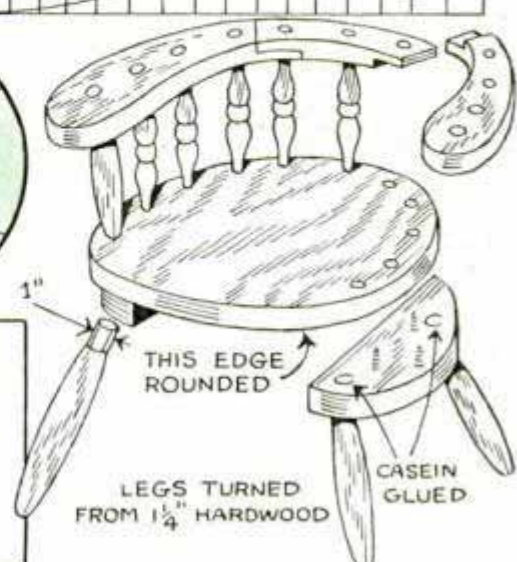

Bilge Pump from Scrap Parts Drains Boat Quickly

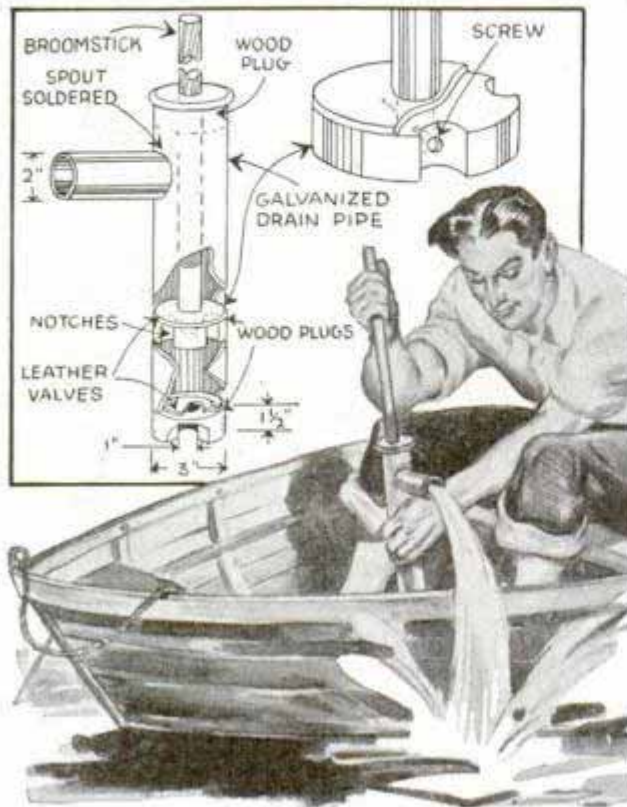

Boats, shallow basements and sump holes are rapidly drained with this improvised pump

Suitable for pumping out boats, basements, or sump holes, this pump is constructed from a piece of eave downspout. The plunger is a broomstick or other round rod, with a wood plug on the end which is a snug sliding fit in the pipe. Four notches are cut as shown and a round piece of leather is put on top. It is held down at the center by a shoulder on the broomstick, which allows the edges to act as a valve, opening and closing the notches. At the bottom is a tight plug with a 1-in. hole drilled in center and covered with a leather flap, which also acts as a valve. The pump is completed by adding a guide at top and a spout at the side.

Sink Plug Good for Scouring



Charged with any good scouring compound, a rubber plug from your sink provides a dandy polisher for kitchen utensils. The plug makes a

firm contact with the utensil, and as the scouring powder accumulates in the hollow center, all foreign matter is scrubbed from the surface. The plug is especially handy for removing stubborn deposits which accumulate in photographic developing trays.—J. G. Roberts, Chicago, Ill.

Bubbles Removed from Varnish with Gasoline and Brush

If bubbles appear in freshly varnished surfaces after the latter have dried too much to permit removal by repeated brushing, dip a camel's-hair brush in gasoline or naphtha, and touch the bubbles lightly with this. The gasoline will dissolve the bubble film and allow the air to escape.

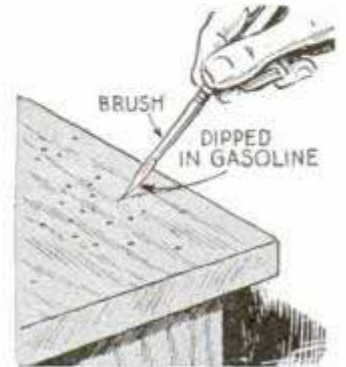

Hooks Hold Bar Stock in Vise

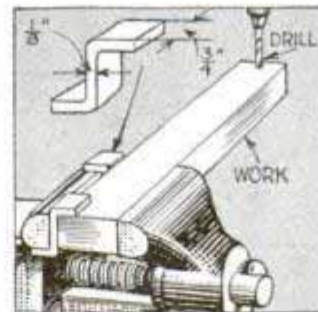

With an assortment of these S-shaped hooks, any thickness of bar iron may be gripped in a vise, and hammered, drilled or otherwise worked on at its extreme end with less tendency to slip. The hooks are made from pieces of steel $\frac{1}{8}$ in. by $\frac{3}{4}$ in.
—Burl Knutson, Bismarck, N. Dak.

Producing Microscopic Effects

When you want to experiment with a microscope, and none is at hand, you can secure low-power effects in a pinch simply by using a photo enlarger. Place the specimen in the same position as an ordinary negative so that light passing through the object casts an image on the sensitized

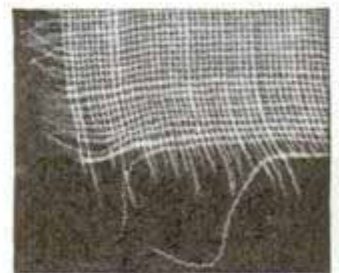

paper held in the enlarging easel. For best results, a contrasting enlarging paper should be employed. Leaves, insect wings and other flat, semi-transparencies are probably best fitted for camera study in the enlarger, and some startling effects can be obtained with a little experimentation. In the photograph, a fringed corner of a silk handkerchief was enlarged several times. Although closely woven, the cloth under enlargement shows glaring irregularities, such as thread size differences, not noticeable ordinarily to the human eye.

Defleaing Your Dog

An effective method of applying de-fleaing solution to your dog, especially if it has long hair, is to use the nipple of a baby's nursing bottle on a screw-top can as an applicator. Slightly enlarge the holes of the nipple and use as a brush, parting the hair as you go. Having applied the liquid in this manner, thoroughly massage the animal lightly, working the solution into the pores of the skin.

—David E. Anderson, Alhambra, Calif.

Lathe Parting Tool Supported to Prevent Chatter

Lathe operators who have trouble with a parting tool, which chatters against the work because the regular ring and wedge do not hold it rigidly enough, will find that this support stops the trouble. It consists of a large steel ring, which is machined to

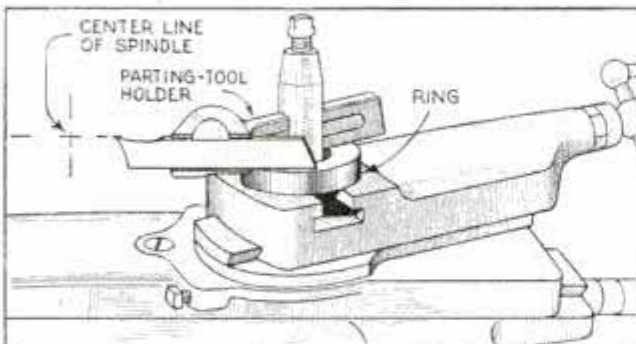

Large ring substituted for regular ring and wedge on tool-post holder supports parting tool rigidly

just the right thickness to raise the tool at the correct height. The ring is used in place of the regular ring and wedge of the tool post.

—E. E. Brown, Berkeley, Calif.

Rotating Shelves in Workshop Hold Small-Parts Jar

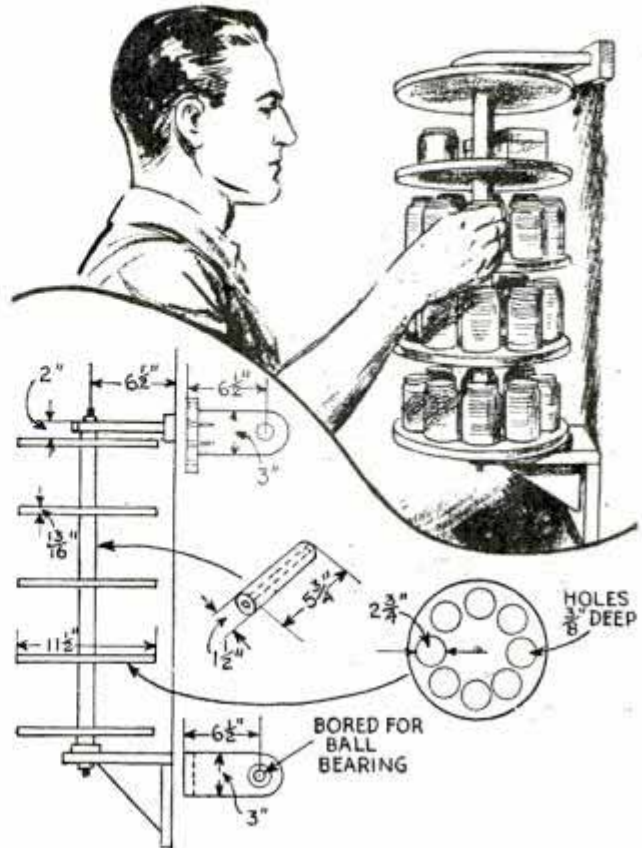

The right size nails or screws are located easily if the containers are set on these rotating shelves

These rotating shelves are just the thing for the home workshop owner who likes to keep screws, nails and other small parts in glass jars. The shelves are plywood disks drilled through the centers for a long iron rod. Pipe, cut to short lengths, is used to space the shelves. If desired, shallow holes or depressions can be formed in the upper surfaces of the shelves to take the jars so they cannot slip off when the shelf is turned. The assembly is mounted on a wall between two wood brackets, the lower one of which contains a simple ball thrust bearing as indicated. This permits the shelves to be rotated easily when they are heavily loaded.

—Clayton C. Jackson, Ft. Wayne, Ind.

¶ If you have an idea that might be used for a short article in these pages, send it to the Homecraft Editor. Inclose a snapshot or drawing and give all the necessary information in as few words as possible. To be accepted, material must be of general interest and different from any we have published previously.

The Tricks of

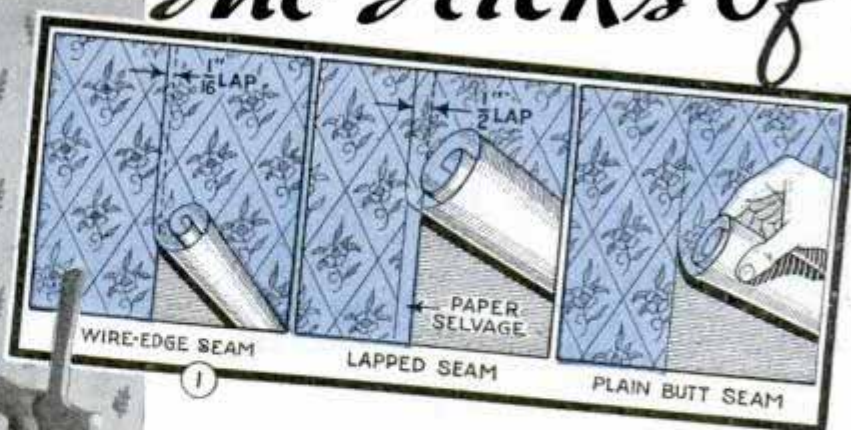
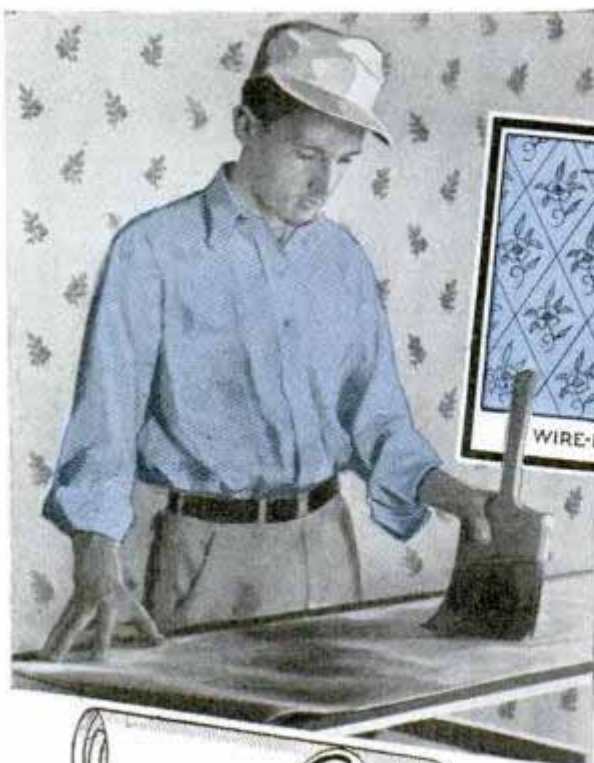

ONCE the tricks of paper hanging are fully understood, decorating with the many beautiful papers available is something the average home mechanic can master easily.

Tools: It is possible to do excellent work with the most ordinary and simple tools, Fig. 2. These will be found available in kit form

at a nominal cost at most paint stores. Besides these, you will also need a stepladder or two, several sturdy planks and a light table for pasting and trimming. The latter can be improvised from a plywood panel supported on a couple of lightweight trestles as in Fig. 9. By hinging the panel in the center, it can be stored easily for future use. In this case a couple of 2 by 4-in. stringers are first laid across the horses. Some prefer to do their trimming on a zinc strip fastened along one edge of the table. However, this is optional as it is possible to obtain clean, sharp edges on the paper by cutting on a wood surface. As for a straightedge for trimming, you can make a serviceable one by jointing a true edge on a length of hardwood. If you are careful in not allowing the knife to slip and cut into the edge and spoil its trueness when using, such a straightedge will serve the purpose admirably.

Wall Preparations: For sanitary reasons and because better work can be done, all old paper should be stripped from the walls before repapering. Papering over old paper is poor practice. While there are several ways of removing the old paper, perhaps the most effectual and commonly

used method is by soaking. Take a pail of hot water and a whitewash brush and go around the entire room, Fig. 3, wetting the paper until it will absorb no more water. The work will go much faster than if small patches are done here and there. Oftentimes a little

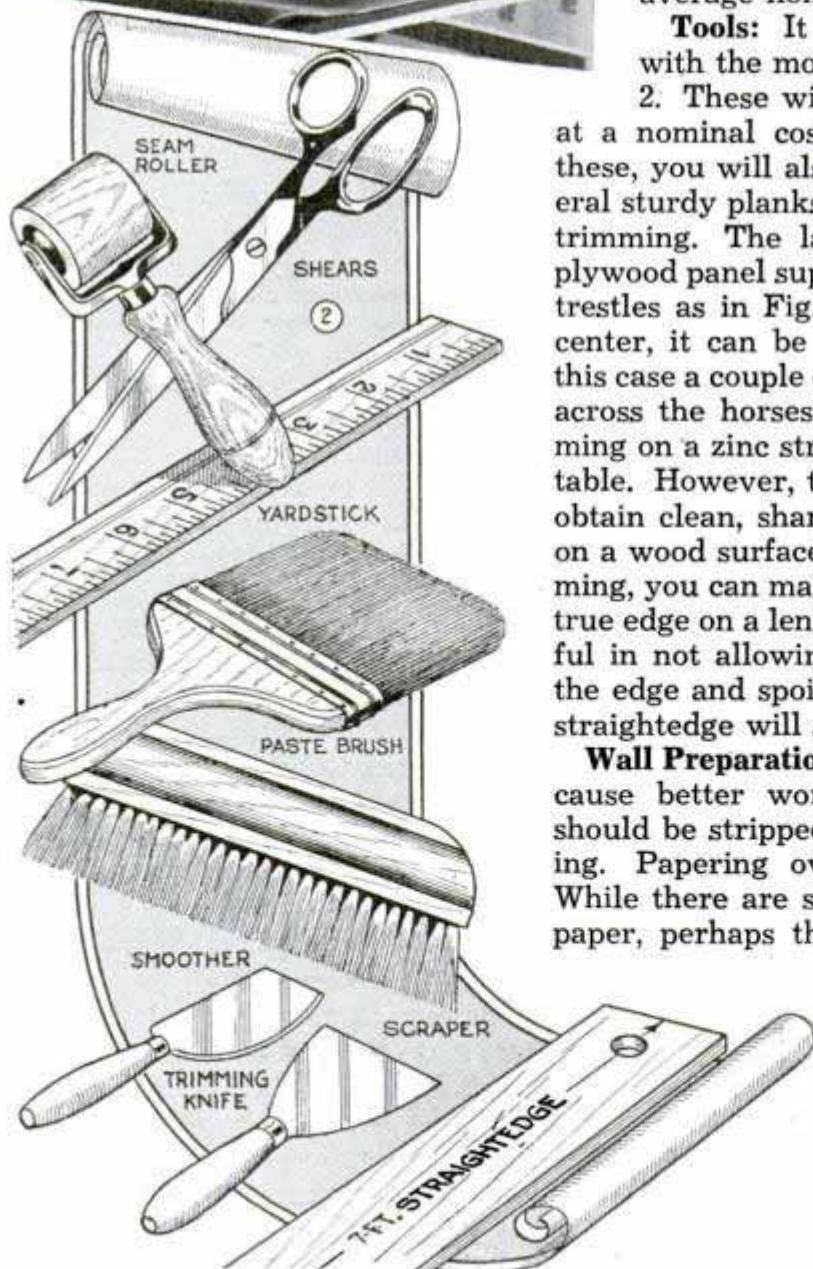

Hangings WALLPAPER

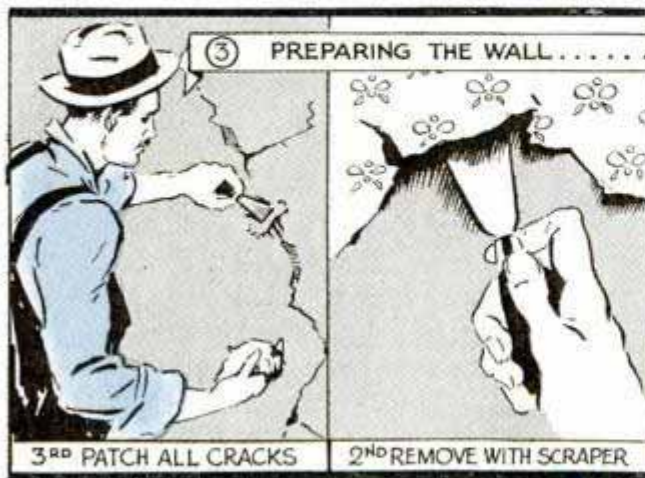

baking soda, sal soda, borax or ammonia added to the water will aid in softening up the old paste. By the time you have finished soaking, the paper where you first started should be loose enough so that it can be taken off in sheets with a scraper blade. When all the old paper has been removed, wash down the walls with a sponge and let dry. A little carbolic acid added to the clear water will make a sanitary job of it. Any defects or cracks in the walls, of course, should be filled smoothly with a prepared patching compound. Porous plaster as well as new plaster should be glue-sized preparatory to papering. The size should be rather thin and applied hot in a warm room, using a large brush to apply it quickly before it jells, Fig. 5. As a rule, one coat will suffice.



If the walls you intend to paper have been painted previously, it will be necessary, in order to make the paste stick, to kill the gloss and oil in the paint by first sanding with rough paper and then washing with a weak solution of sal soda and water, Fig. 4. Follow this with a size of plain vinegar. In the case of particularly rough walls such as a sand finish, you must first cover with a lining paper available especially for the purpose or, if you should have a number of odd rolls of paper you wish to use up, you can use this instead, placing the figure of the paper next to the wall. For lining papers the paste should be fairly stiff. Use a wide, stiff, smoother

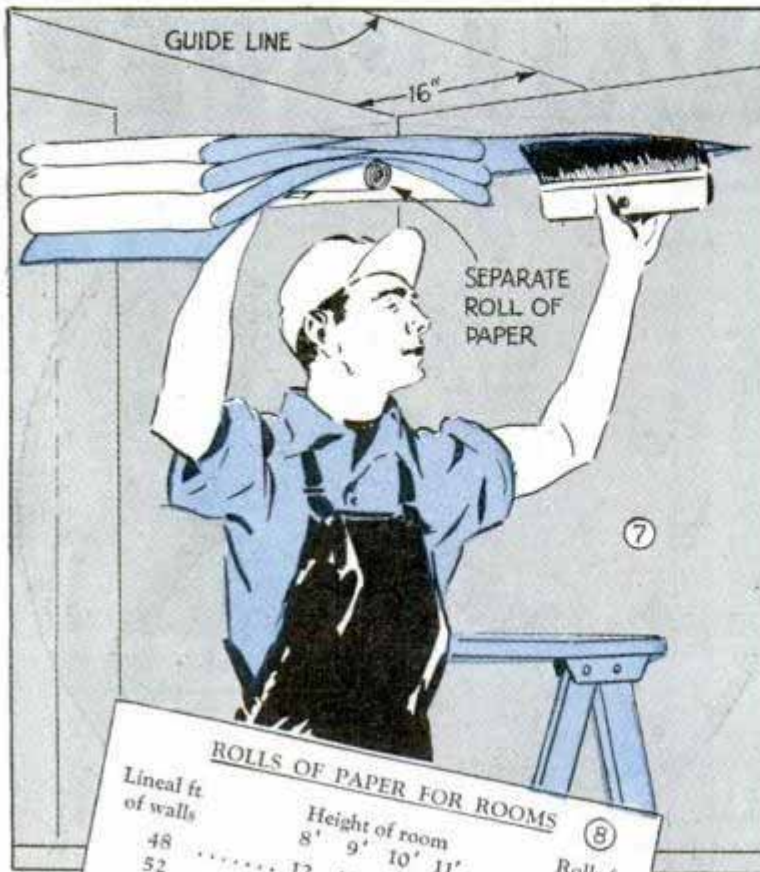

ROLLS OF PAPER FOR ROOMS (8)

Lineal ft of walls	Height of room				Rolls for ceiling
	8'	9'	10'	11'	
48	12	13	15	16	2
52	13	15	16	18	3
56	14	16	17	19	3
60	15	17	19	20	3
64	16	18	20	22	3
68	17	19	21	23	3
72	18	20	22	24	3
76	19	21	23	26	4
80	20	22	25	27	4
84	21	23	26	28	4
88	22	24	27	30	4
92	23	26	28	31	4
96	24	27	30	32	8
100	25	28	31	34	10
104	26	29	32	35	13
					14

Single rolls

brush and brush the paper down hard to assure a firm bond to the sand particles.

Estimating Material: The prepared table of estimates in Fig. 8 gives the number of rolls required for both ceiling and walls of various sized rooms. These figures are based on the standard single roll of 8 yds. length. Since nearly all papers are now put up in double rolls, you need purchase only half of the specified amount. In figuring individual requirements not covered in the given table, one of the simplest methods is to multiply the running feet of the walls by 12 and divide by 18 which gives you the required number of strips around the room, running from ceiling to baseboard. For example, if the room is 8 ft. high, you will be able to get three strips from a single roll (which contains approximately 8 yds.) or six strips from a double roll. This, of course,

figures the room as a solid with no deductions made for openings, unless they are exceptionally large such as double doors, etc. In such cases, you will be safe in deducting one-half single roll for each. Other openings are figured to take care of the waste consumed in cutting and matching and it is always best not to figure too

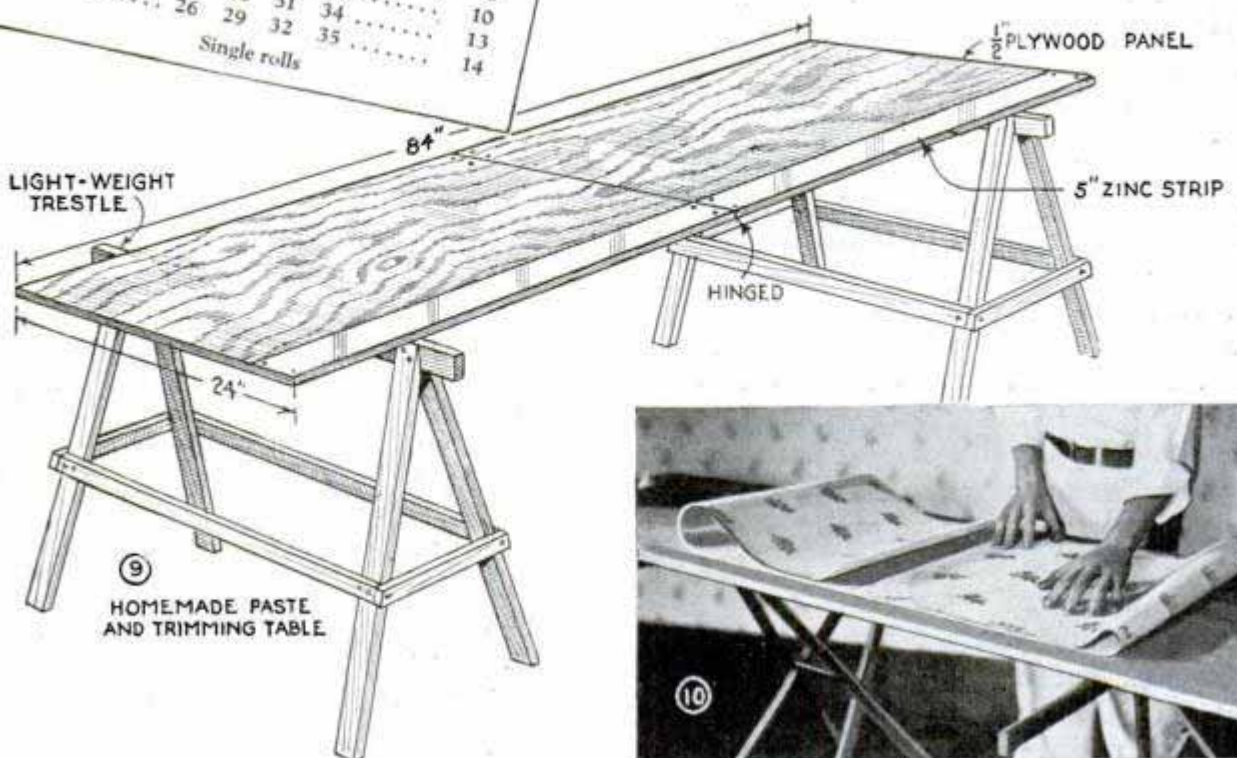

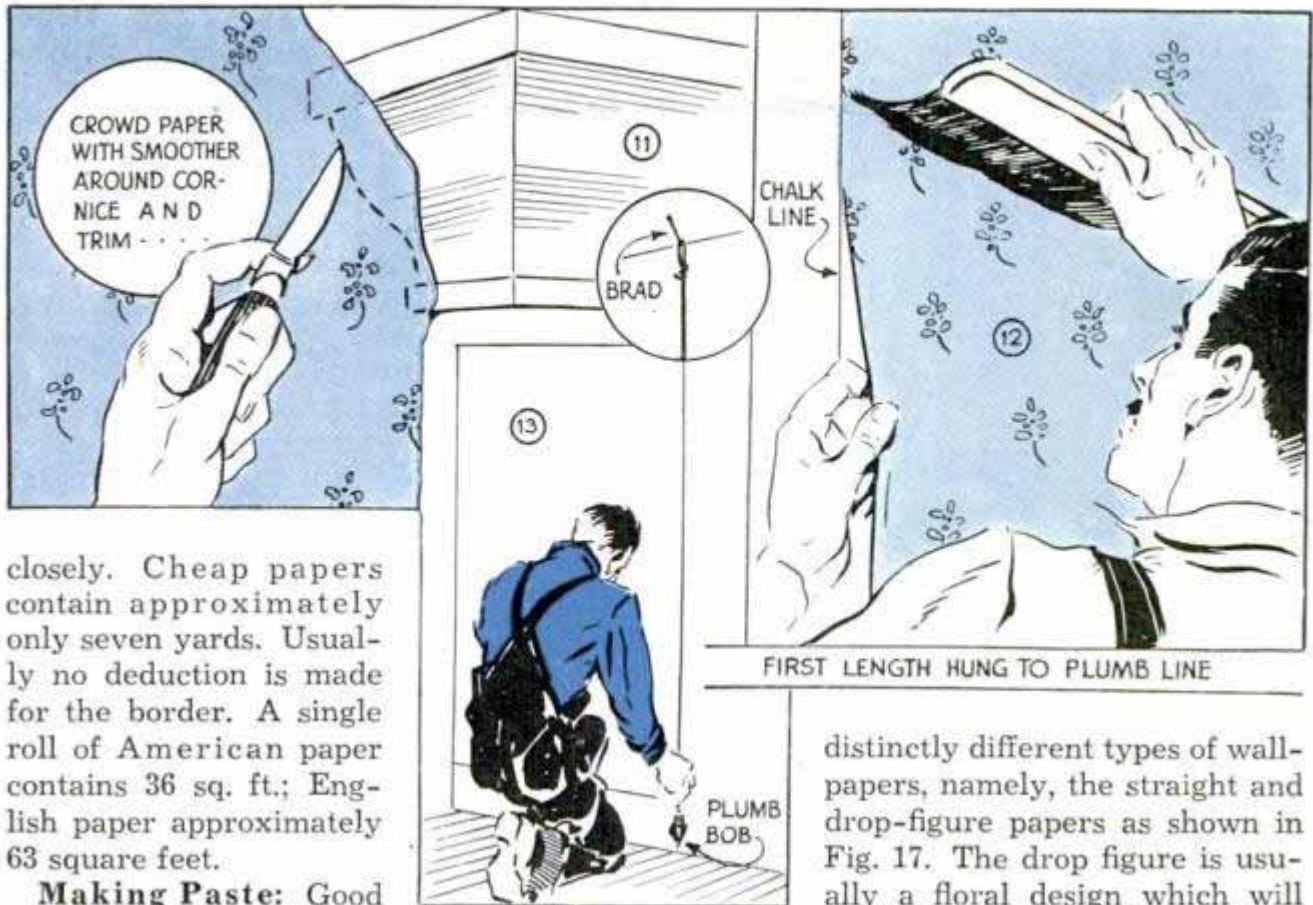

closely. Cheap papers contain approximately only seven yards. Usually no deduction is made for the border. A single roll of American paper contains 36 sq. ft.; English paper approximately 63 square feet.

Making Paste: Good paste is not difficult to make, yet it requires some pains. The worker can use either a commercial ready-made paste sold in 5-lb. packages or he can make his own, following the formula given in Fig. 6. Mix your flour with cold water until it has the consistency of thick cream. Be thorough in beating the batter smooth. Any lumps present in the mixture can be removed by straining through a fine sieve. The addition of alum makes the paste firmer; preserves it from spoiling and makes it easier to spread. Place the mass over a flame and boil, stirring continuously; then remove and add cold water until about like cream. Let the paste stand until perfectly cold before using. A tablespoonful of Venice turpentine to a pail of paste, added while the mixture is hot, will increase its adhesiveness considerably. The proper consistency of the paste, of course, depends upon the quality of the paper to be hung. If delicate, lightweight paper is to be used, make the paste fairly thin, while with heavier material use the paste quite stiff.

Cutting the Paper: Prior to cutting the paper to length, you must first examine and study the pattern to be able to cut it with the least waste. You will find two

distinctly different types of wallpapers, namely, the straight and drop-figure papers as shown in Fig. 17. The drop figure is usually a floral design which will not match immediately opposite

and consequently must be dropped or moved downward to match the adjacent strip. This drop measures one-half of the full figure and must be cut accordingly. For example, if your pattern is 18 in. long, the opposite length of paper must be lowered 9 in. Along the margin of commercial papers you will find equally spaced markings which indicate where the pattern should be cut. This makes it simple for the worker as he will cut one strip the required length by cutting on the "join here" mark of the paper and the next strip he will cut half-way between the "join

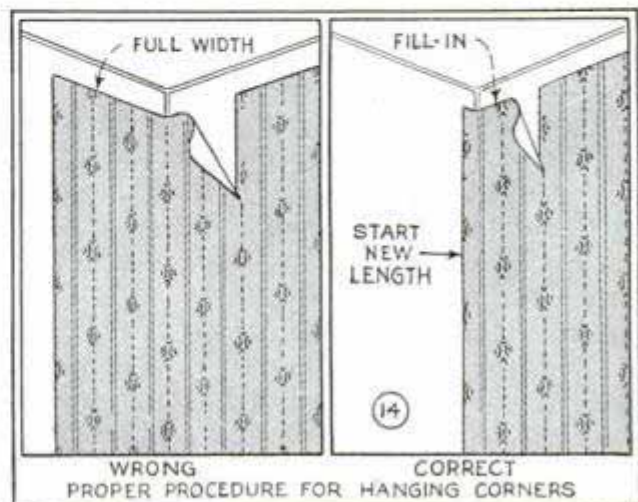

WRONG CORRECT
PROPER PROCEDURE FOR HANGING CORNERS

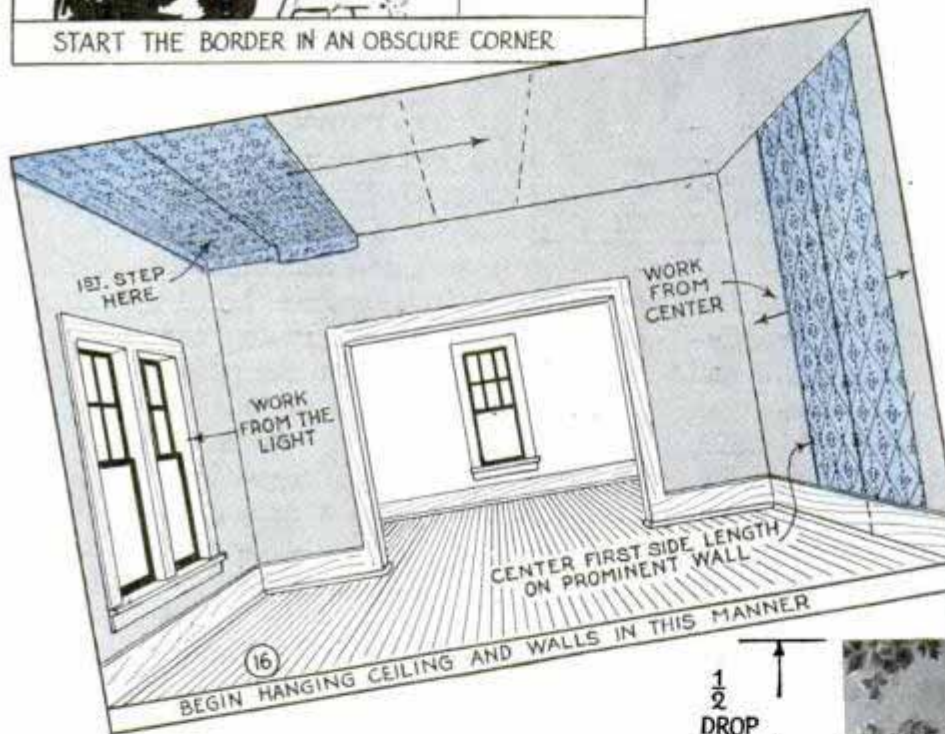

here" marks. You should cut from two rolls of paper in case of a drop-figure pattern, cutting on the marks from one roll and between the marks from the other roll.

The straight-figure paper, however, does match immediately opposite and all lengths are cut on the marks. If you notice your particular pattern has half figures on the margin of the paper, this is also termed a straight-figure pattern, and it, too, can be cut on the marks. In measuring the length of strips for a 9-ft. ceiling, there is no need of cutting the paper full 9 ft. long as you have a border at the top and a baseboard at the bottom. For a 9-ft. room, cut the paper in $8\frac{1}{2}$ -ft. lengths.

Pasting and Trimming: Fig. 2 shows three types of joints or seams which can be used; namely, the butt, lap and wire edge. Of the three, the lapped seam is the simplest, requiring only the trimming of one edge. On some papers the edge is trimmed, that is, the edge is perforated so that it can be folded over and torn off. A ready-trimmed edge is only suitable for a lapped seam. For a butt seam both edges of the paper must be trimmed by hand regardless of whether it may be ready-trimmed. This type of joint is preferable as the seam is visible only upon close inspection and therefore makes a neater job. The wire-edge seam is more or less a lapped joint, which resembles a butt joint with less skill required in keeping the joint closed. Trimming is done after the length has been pasted. Here the pasted ends of the paper are temporarily folded over midway as shown in Fig. 10, keeping the edges perfectly even, after which the straight edge is laid parallel to the edge of

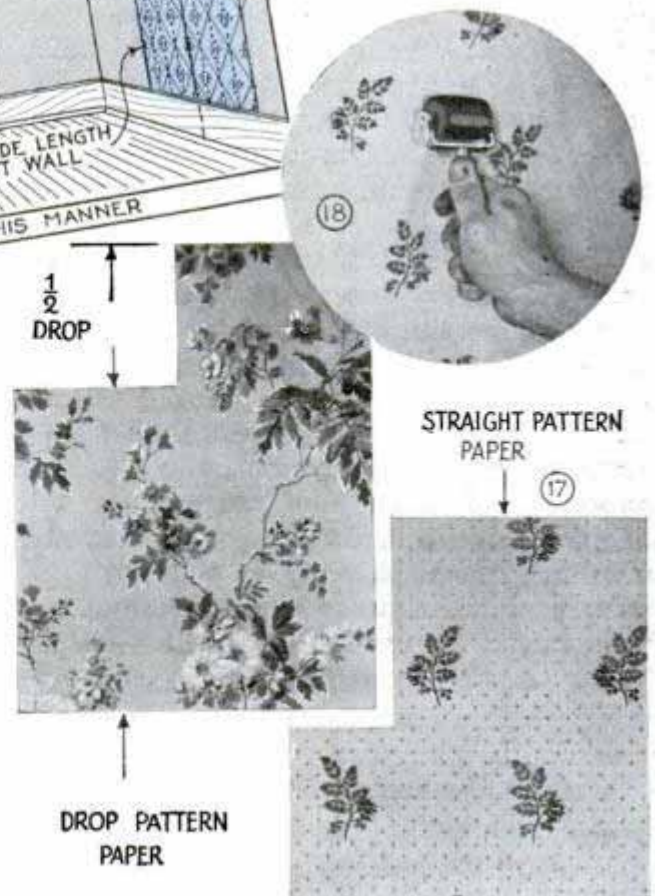

the paper to guide the knife in trimming the selvage (Fig. 19). When only one edge of the paper is to be trimmed, first make sure you are trimming the correct edge. In pasting thin and delicate papers you will have to work a little faster as the paper will become overly wet and if left too long it is apt to tear while hanging. Also, above all, get the habit of wiping your paste board off each time. Otherwise you will have some objectionable stains on your finished paper.

Hanging the Paper:

Papering the ceiling is looked upon by many as the most difficult part of the whole job but, through actual experience, you will find this to be easier than fitting paper around window and door cornices, fixtures, etc. The whole secret of the job is the manner in which the paper is prepared prior to hanging. With a butt-type seam it makes little difference whether the paper is run the length or width of the room. But with a lap seam, it is important to work from the lighted side of the room, as shown in Fig. 16, for the reason that if not done, shadows will be cast from each seam, making the ceiling very noticeable upon entering the room. As the length of paper is gradually pasted, it is folded back and forth in loose folds as shown in Fig. 7 and is carried up on the scaffold with a roll stick or an odd roll of wallpaper. If the angle of the ceiling is not true, you first strike a guide line about 16 in. from the wall and hang to this. "Tack" the end of the strip in place with the smoother brush, allowing it to extend down the side wall about $\frac{1}{2}$ in. As you continue across the room, the paper will unfold. Brush it out smoothly and avoid blisters. Follow this strip with succeeding ones. The seams are rolled down firmly as shown in Fig. 18. After the ceiling has been completed, the

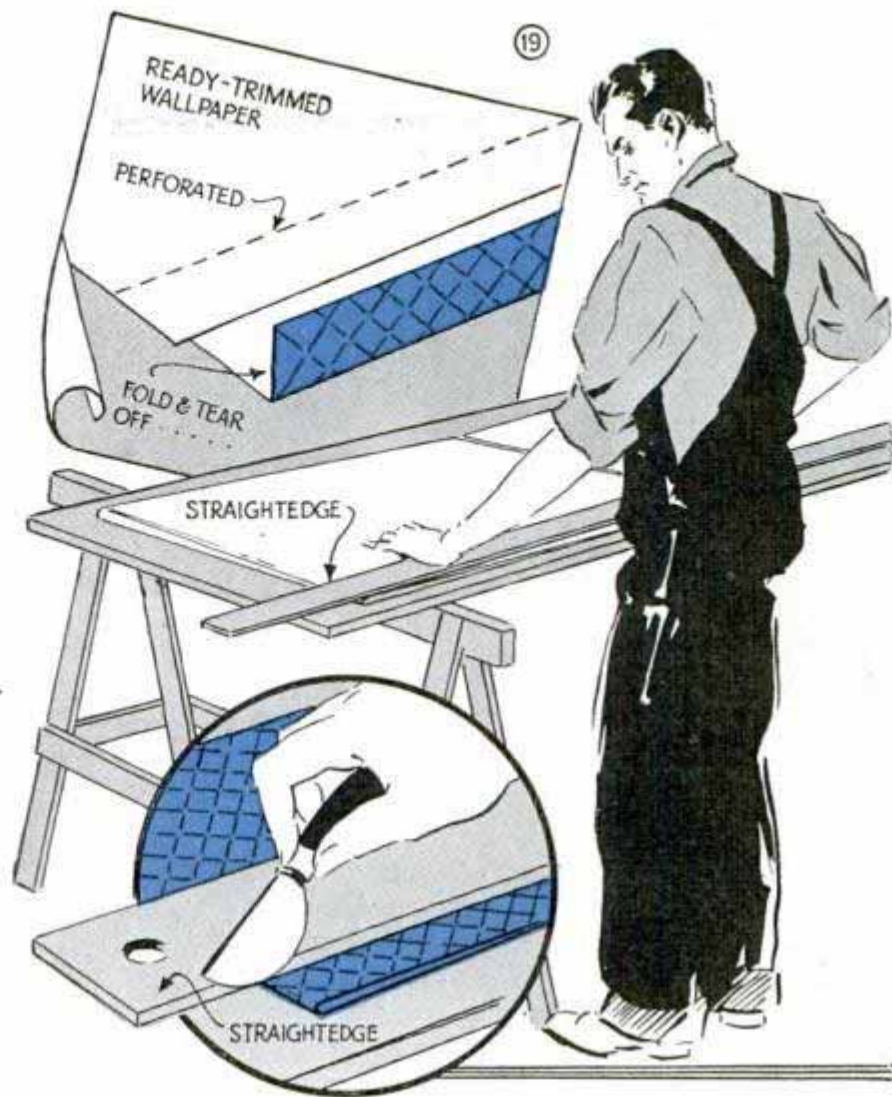

first consideration in hanging the first side wall strip is having it plumb. Select a prominent wall on which to center the strip, Fig. 16. A plumb line from the ceiling to the baseboard is snapped as shown in Fig. 13. The starting length of paper is hung to this line as in Fig. 12, working each way from this center strip. If a lap seam is employed, it is not necessary to trim either edge of this first strip. In entering a corner, do not continue a full width strip around the angle as shown in the left detail of Fig. 14. Instead, cut a "fill-in" strip of the proper width as shown on the right. Use your trimming knife in cutting the paper to length at the baseboard. At window and door cornices, crowd the paper around the molding with the smoother and trim carefully with a knife as in Fig. 11. Finally the border is hung, starting in an obscure corner of the room, Fig. 15. Keep the pasted side off of the lower side wall while hanging to avoid staining.

Scissors Have Irregular Notches to Cut Deckle Edges

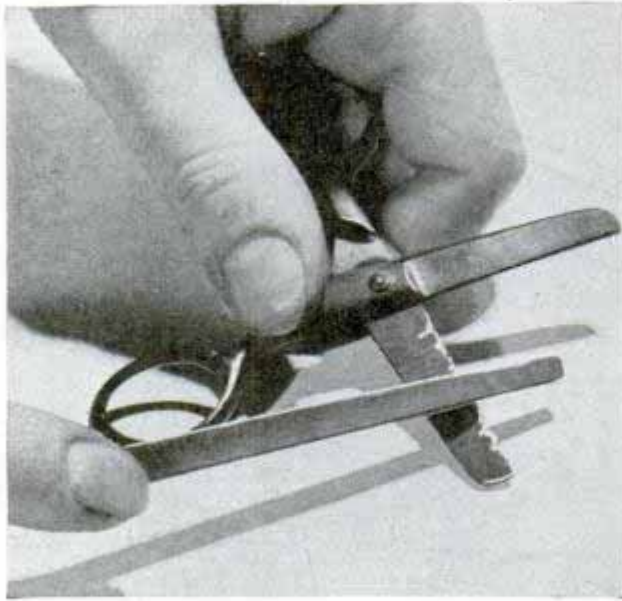

Cheap pair of scissors with notches filed in blades to cut deckle edges on photos

Attractive deckle edges, popular on photographs, stationery, etc., can be made with an ordinary pair of cheap scissors. These are first heated to a red heat over the flame of a gas stove. When they have cooled, irregular and unequal notches are filed in the blade as shown. The more irregular the notches the more attractive will be the cut. Filing is continued until the scissors produce the desired rough edge on the paper.

Rubber Guard on Edge of Door Protects Baby's Fingers

Unless some precaution is taken to prevent a baby from putting its fingers between the casing and the door when the



A small child cannot stick its finger in crack between door and casing if this guard is used

latter is open, a badly crushed finger may result. To avoid this, just tack or cement a strip of rubber or canvas over the edge of door and casing as indicated.

Secret Latch on Medicine Cabinet Is Hidden from Children

Here's a secret latch for your medicine cabinet that is not likely to be opened by children. A bent nail, which is the secret trigger of your lock, is below the eye line and is not detected easily. If the door of the cabinet does not swing open when unlatched, it may be well to install a spring between it and one of the shelves.

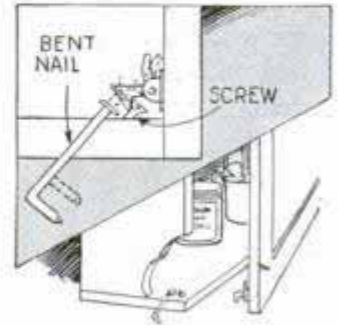

—Palmer Back, Fort Apache, Ariz.

Modelmaker's Safety-Pin Clamp

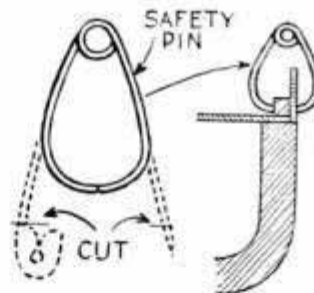

A tiny clamp for use in holding small parts of a model together while glue dries—is made in a jiffy from a safety pin. Just cut off the head and point of

the pin and bend the severed ends as indicated. The coiled end of the pin causes the severed ends to grip tightly the small work held between them.

—Edw. Hartel, Jamaica Plain, Mass.

Skid Chains Clean Stovepipe

Instead of pounding stovepipes with a board or paddle to remove the accumulation of soot, try using a discarded auto skid chain inside of the pipe as indicated. By whirling the chain in the pipe, the soot will be loosened.

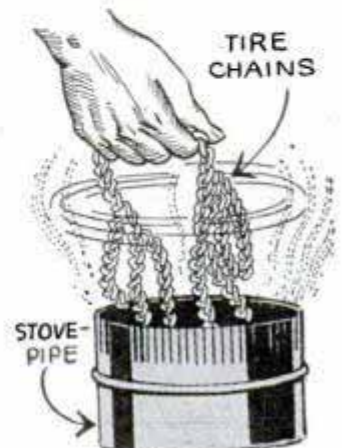

AQUARIUM FOUNTAIN

has no water connection

THIS novel little fountain adds to the attractiveness of any small aquarium and at the same time takes care of the aeration problem. In looking over the details, Figs. 1 and 2, you will see readily how it works. When lowered from its position behind a curtain to the level of the aquarium, the bottle picks up its supply of water through a system of simple check valves. When raised it will empty in 8 or 10 minutes. In Fig. 3 are details of both valves and in Fig. 4 you see how they are assembled. Bend the brass tubing before you solder the parts together. The jet is

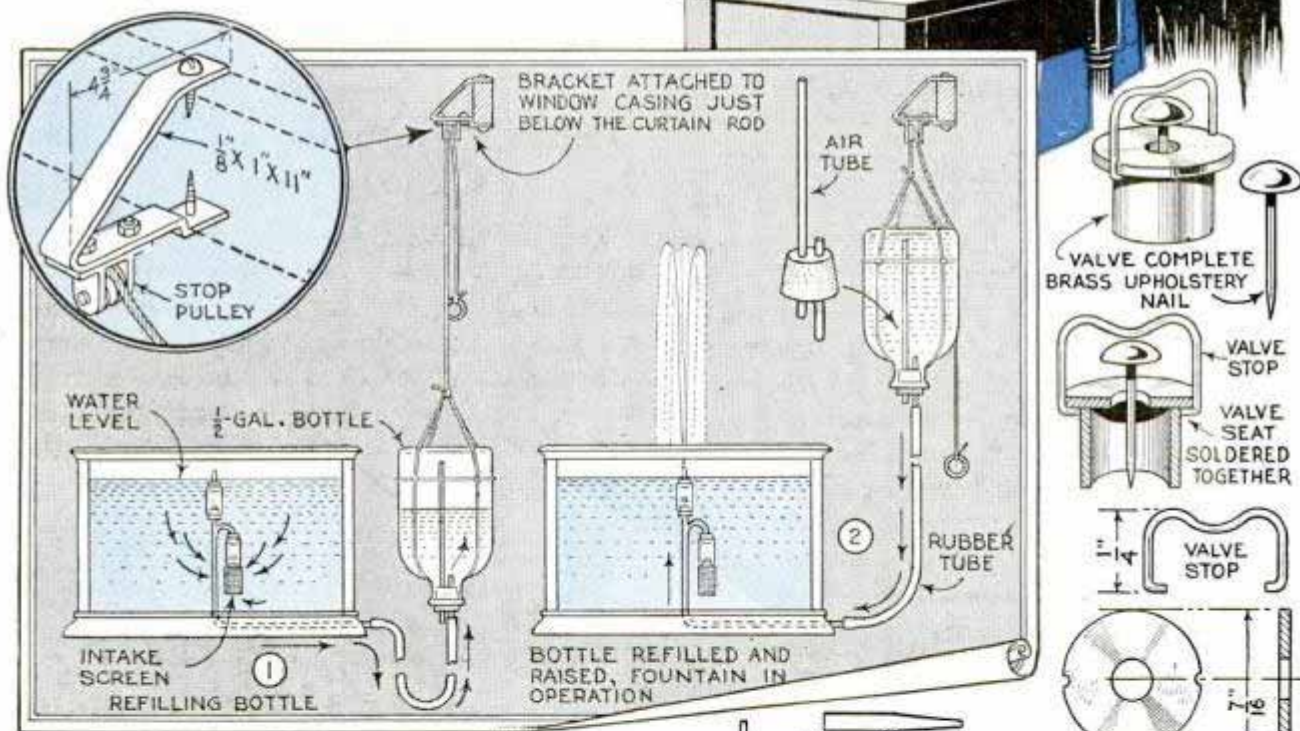

formed from the tip of a medicine dropper. Heat this until the glass softens and then draw out the tip so that the opening is about the size of a sewing needle. Holes through the corks can be drilled with a short length of thin-walled steel tubing, one end of which is sharpened to a cutting edge. Drill a hole through the glass bottom of the aquarium with the same piece of tubing and valve-grinding compound. The tube can be driven either with a drill press or a hand drill.

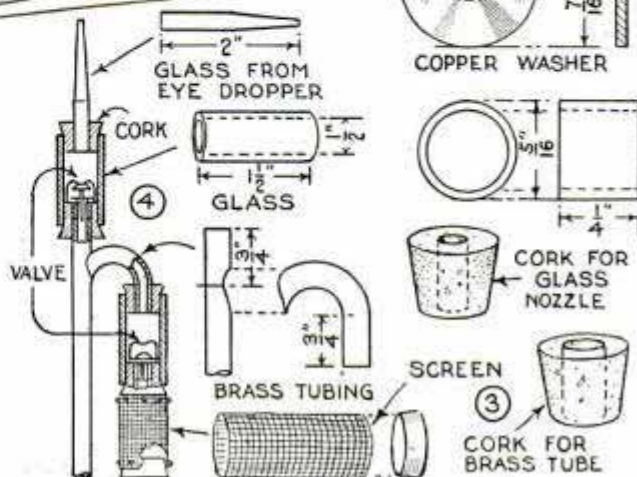

"Watchful Bunny" Letter Holder for the Home Desk



Just the thing for the children's desk, this letter holder can be sawed out and assembled quickly

Patiently holding letters or memos, this bunny cutout is just the thing for the home, especially if the children have a desk. Walnut or mahogany is ideal for the cutout, although any wood can be used if it is painted. A 3½-in. brass clip, known as a banker's clasp, is nailed behind the bunny's head to hold the letters, and a crossbar set in the bottom keeps it from tipping. A wood strip will do for this, although a metal bar is better as it adds weight.

—Lester P. Young, Culver, Ind.

Inserting Extra Pages Easily in Spiral-Bound Book

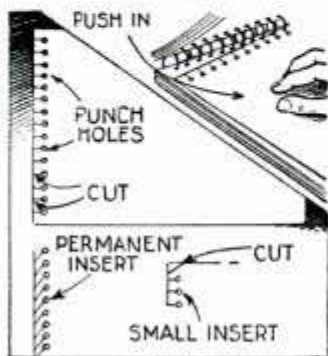

It's a simple matter to insert extra pages in a spiral-bound book or catalogue by punching the required number of holes in line at the edge of the paper and then cutting a slit from each hole

to the edge of the paper. If the paper is to be inserted temporarily, the slits can be made straight from the hole to the edge of

the paper, but if the page is to be inserted permanently, it will stay in place better if the slits are cut at an angle as shown in the lower left detail.—S. Ware, Chicago.

Vibration of Motor Is Absorbed by Rubber Vacuum Cups

Vibration of small motors and the resulting noise can be deadened usually by supporting the motors on vacuum cups. These should be of the type that are fitted with small stove bolts, which can be picked up at almost any ten-cent store. Just insert the bolts into the mounting-screw holes on the legs of the motor and tighten up the nuts.

—R. S. Detlor, Montreal, Que., Can.

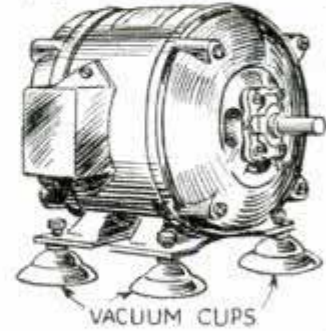

Tripod Adjusted to Take Photos Close to Ground

Tripods that have sliding center camera supports are easily converted to take a photo with the camera close to the ground. All you have to do is to remove the support and insert it from the underside. Then attach the camera in the regular way. Be sure that it is turned so that one of the tripod legs is not in the way.

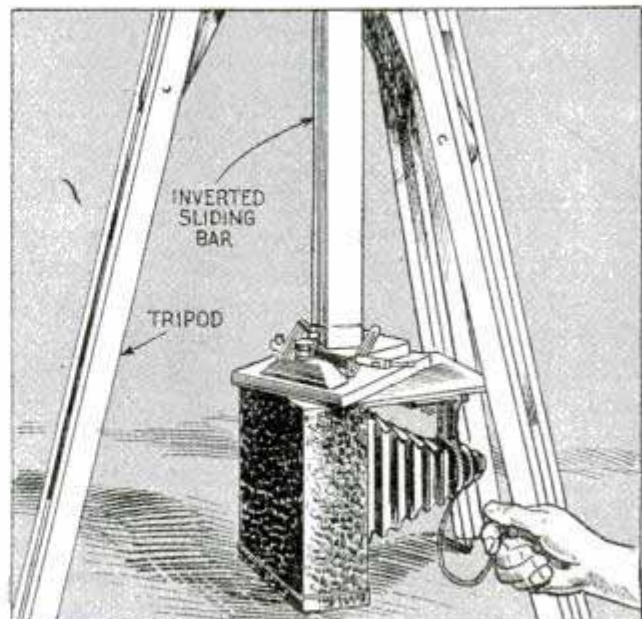

Photos taken with camera close to ground by inverting sliding support in tripod

Turned CLOCK CASE

has spun face

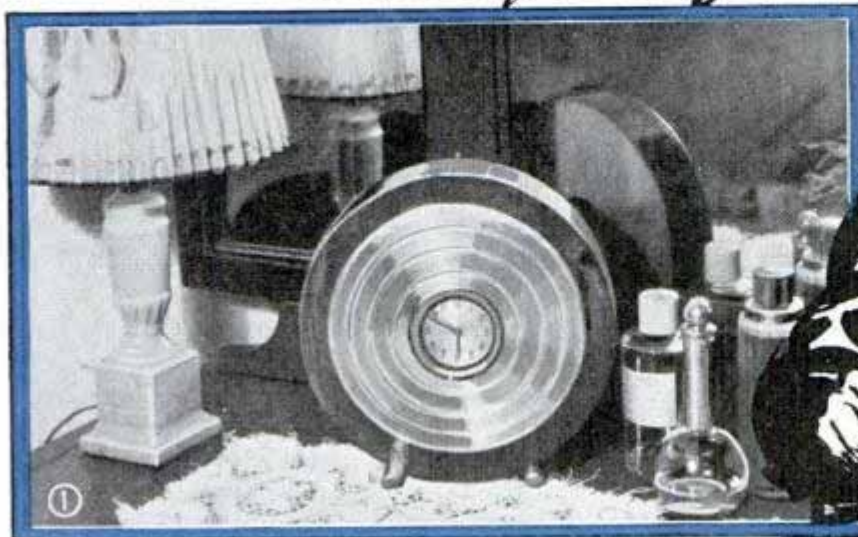

HERE'S a dandy two-evening lathe project that combines the simplest wood turning with metal spinning and finishes up into a novel clock case for either a spring-wound or electric movement as in Fig. 1.

In spinning the metal face the first step is to turn out a backing block or chuck of 1½-in. pine, to 6¼ in. diameter. Then, from the same material a follower block of equal diameter and cupped about ¼ in. on the inside face. See Figs. 3 and 4. If you use walnut or gumwood for the turned portion of the case, ⅛-in. soft aluminum makes a pleasing contrast. Spun copper is also very attractive. Scribe a 7-in. circle on a sheet of either metal, cut out the disk and locate the exact center. Scribe a circle on the metal about the center which is the same diameter as the clock face, and locate holes for four small screws inside the circle. Then screw the disk to the wood chuck and mount in the lathe as in Figs. 2 and 3. Run up the follower block against the metal disk and you are ready to turn over the edge of the metal.

If you don't have metal-spinning tools you can easily improvise them as in Fig. 6, using either a square of cold-rolled steel or an old screwdriver with a steel ball welded to the end as shown. Take several minutes to spin over the edge and keep oil or grease on the track of the ball to prevent cutting. When the metal has been

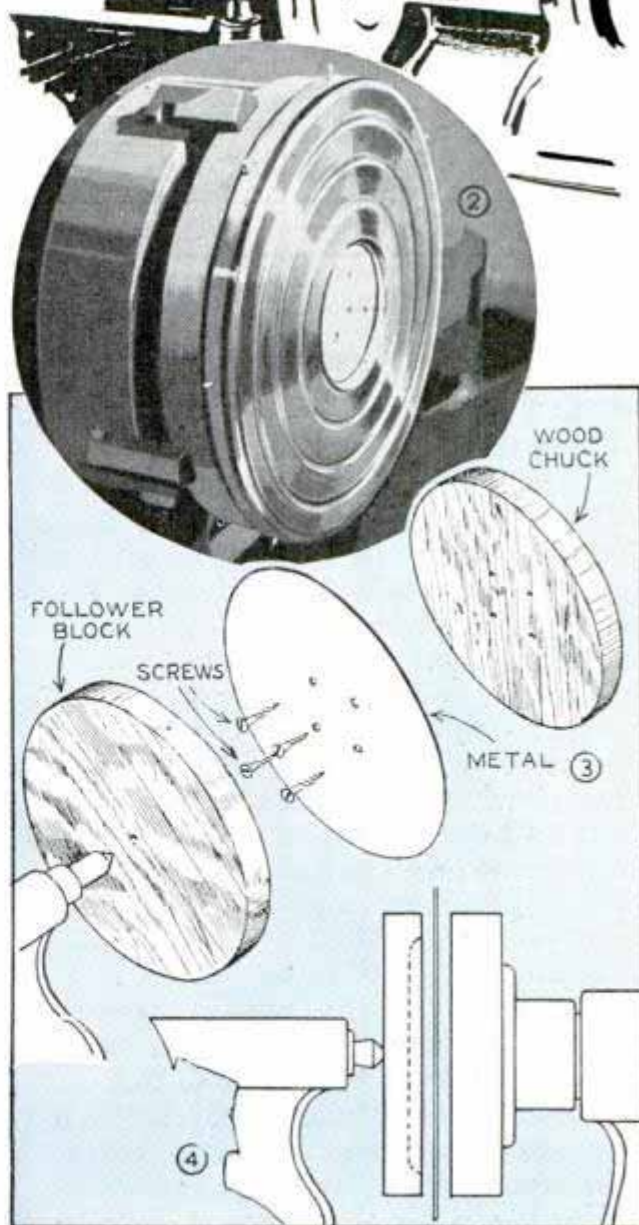

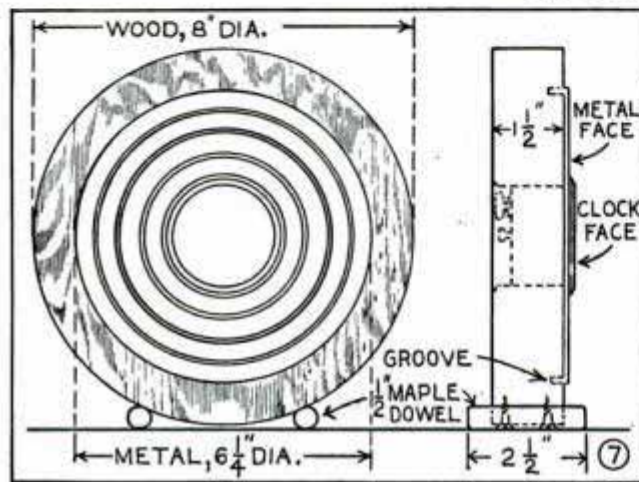
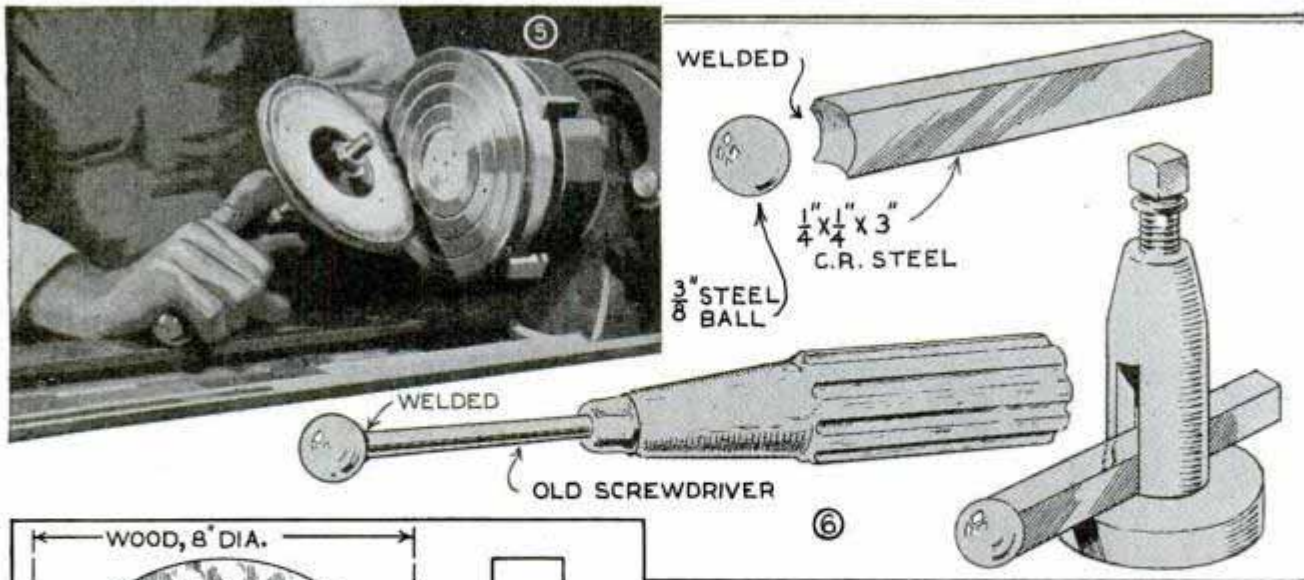

turned over, drive several small brads through the extreme edge of this turned-over portion to lock the disk in place as in Fig. 2. Then back away the follower block.

Cover the face of the metal with grease and score it concentrically with the steel ball as indicated. Press one groove lightly, then the next and so on. When all three have been indented slightly, repeat, forcing each one a little deeper. This prevents undue strain on the sheet. Then speed up the lathe, wipe off the free grease with a cloth, and polish with No. 000 steel wool. This polishing can be speeded up by using a flexible shaft and cloth buff as in Fig. 5. To cut off the rim waste, set a small cold chisel in the tool post so it won't rub at the lower corner, and score the rim deeply, $\frac{1}{4}$ in. from the front. Instead of cutting clear through, leave at this point, and in the same way, score an opening in the center of the disk just large enough to take the clock works to be used. Cut this clear out, then pull the brads and remove the rim waste with a pair of pliers.

So much for the metal spinning. The walnut block, Fig. 7, is turned down to 8

in. in diameter and $1\frac{1}{2}$ in. thick and sanded. With a file tang, a groove $\frac{3}{8}$ in. deep is cut the same diameter as the metal face rim and a hole turned out in the center just large enough to take the clock works but only half way through.

Fill and finish the rim and face to the groove with clear lacquer, white shellac or spar varnish. When dry, rub lightly with No. 000 steel wool, then a rag and finally apply wax. To remove the waste from the center, reverse the block in the lathe and continue the groove from the back side, making the final cut with a knife point, turning the lathe by hand.

Two maple dowels, $\frac{1}{2}$ in. in diameter and $2\frac{1}{2}$ in. long with two holes in each and each reamed out slightly to take the screw heads, form the two clock feet. These are fastened to the bottom just far enough apart to hold the lowest part of the wood disk from touching the table or mantel.

Storing Vegetables for Winter

Keeping vegetables in good condition while in storage is mostly a matter of maintaining the proper temperature and humidity. With but few exceptions, vegetables will keep best at a temperature of 35 to 38 deg. Fahr. Root crops and leafy vegetables need a high degree of humidity. Requirements of some commonly stored vegetables are as follows: Cool and dry, dry beans and onions; warm and dry, pumpkins, squashes, sweet potatoes; cool and moist, carrots, beets, turnips; cool and moderately moist, potatoes and cabbage.

How to Clean Your Gun

Guns may be cleaned with a mixture consisting of machine oil, 2 parts, dissolved in benzine, 1 part. Rust may be removed from the inside of the gun barrels by scouring them with a piece of oakum attached to the cleaning rod and saturated with a compound made by mixing paraffin oil, 4 oz., in turpentine, 1 oz., and benzine, 1 oz. Swabbing with the rust remover should be repeated until the last trace of rust has disappeared. The barrel next should be washed with a swab saturated with a solution made by dissolving caustic potash, $\frac{1}{2}$ oz., in water, 1 qt. After this treatment the barrel must be well rinsed with water and dried with cotton. To prevent rusting, it should be oiled thoroughly with any good grade of gun oil. In using the caustic potash solution, care should be taken to keep it away from other parts of the gun.

Check Protected Against Altering in Your Typewriter

If you have access to a typewriter, it's a simple matter to protect your personal check so that it cannot be altered. The check is first written and then inserted in the typewriter with a blotter behind it to



Check protected against alteration by perforating it with apostrophe or quotation mark on typewriter

serve as an impression sheet. It is necessary, of course, to lock the ribbon so that the writing is not blurred. Striking the key of the quotation mark or an apostrophe will perforate the paper.

Small brushes in which oil color has hardened can be cleaned with acetone.

Handy Rack to Carry Garments on Coat Hangers

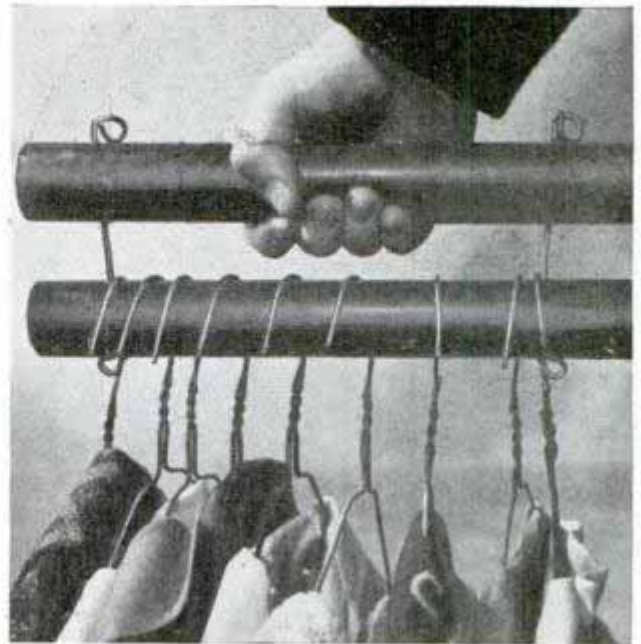

You can carry several garments on hangers at one time with this simple handle

Few loads are so clumsy as garments on hangers. But with the device shown it is a simple matter to carry ten or more. Two wood rods are wired together as shown in the photograph. The top rod serves as a handle and the bottom one holds the hooks on which the garments are hung. The wire is twisted at the ends to hold the two bars far enough apart so that the hand does not touch the lower bar.

Strip at End of Drawing Board Gives T-Square Good Bearing

As some of the drawings that I make are almost as wide as the drawing board, it is necessary to provide some means of giving the T-square a good bearing when it is used near the top of the drawing. To do this, I screwed a 3-in. strip to the end of the board so that it projected 2 in. beyond it at the top and 4 in. at the bottom. This enabled me to use the T-square at the extreme top or bottom without any possibility of it twisting out of line.

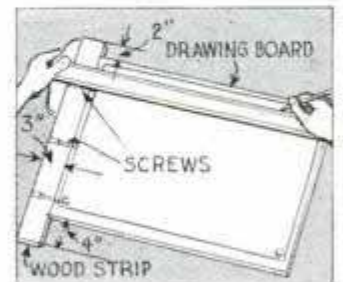

—Harold Larison, Elwood, Ind.

HUGO the HOUND



STUCK UP



ON HIS WAY

By E. J. TANGERMAN

JUST seven acts of a long and lanky "houn" dog expressed in wood with a pocketknife and a few careful daubs of brown or black paint—that's Hugo. In Figs. 1, 2, 5, and again over in Fig. 8 he's posing for you and doing it very casually and credibly as you see, but there are several details that he's fussy about. Notice, for example, his wrinkled nose, a personal characteristic that he is

probably rather jealous of because it shows up in all his poses. Hugo's body is angular, very much so, and being a good model he takes pains to emphasize it. In doing this he's really trying his best to make it easy for you to carve his likeness because rough cutting of a sawed profile block gives just the body characteristics needed. Hugo has huge feet and what's more he's proud of them. You won't have to look far in the details to see that. Another reason Hugo has posed specially for his pictures is to show you that his tail is just as much a part of his personality as is his wrinkled nose.

Whittlers usually have their own preferences as to the type and size of pocket or pen knife to use for this particular work and also their own ideas about sharpening the blade of the knife. However, it vir-

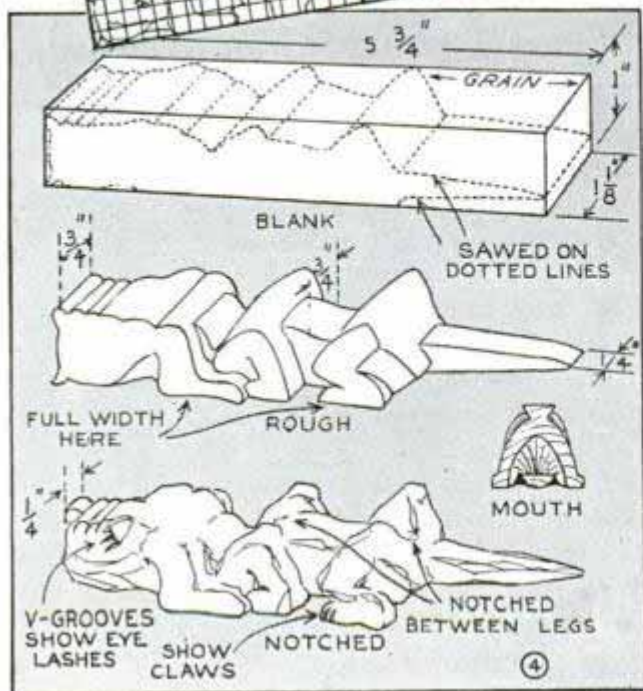
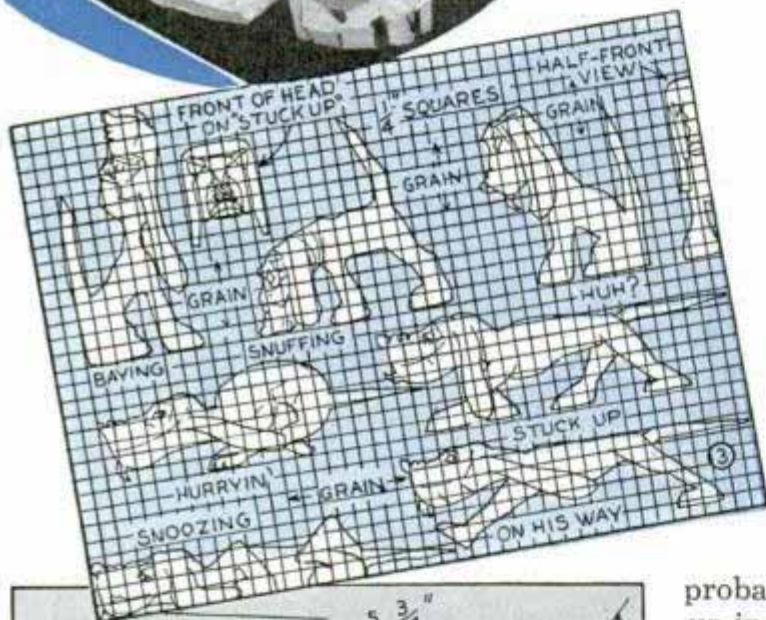

WHITTLED in SEVEN POSES



HURRYIN'



SNOOZING ⑤

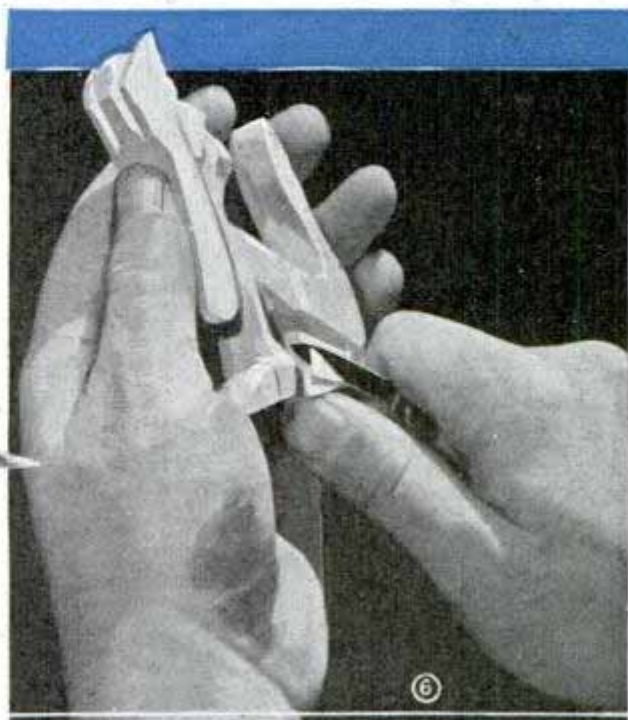

tually goes without saying that the knife you use must be top quality, otherwise you can't get a suitable edge on the blade. The handle must be of a size and shape that suits your hand individually and the blade will have to be selected for proper length, otherwise your hand and wrist will tire quickly. As an example, if you have long fingers you will probably find a fairly long blade comfortable to use, for you can manipulate it more readily and it won't cramp your hand. To work satisfactorily in white pine, where it must cut in all directions with equal facility regardless of the direction of grain, the blade must have a fine, smooth edge without the slightest waviness or nicks. If the edge is wavy, that is, indented even very slightly, you will have trouble making a shearing cut such as is necessary at certain points. Although it takes longer, it's best to sharpen the blade on a very fine oilstone and finish on a leather strop. A section of an old razor strop tacked to a block is just the thing. When properly sharpened, the edge will slip through the wood with a smooth, velvety feel and the chip will lift steadily away from the uncut portion, leaving a glass-smooth surface, Fig. 6.

Now as you see in Figs. 3, 4 and 7 all the poses are just variations, the variables being the ear position and general body shape. Whittle any one from 1 1/8-in. straight-grained white pine or basswood. Just see that Hugo's tail points in the direction of the grain. Starting with Fig. 4,

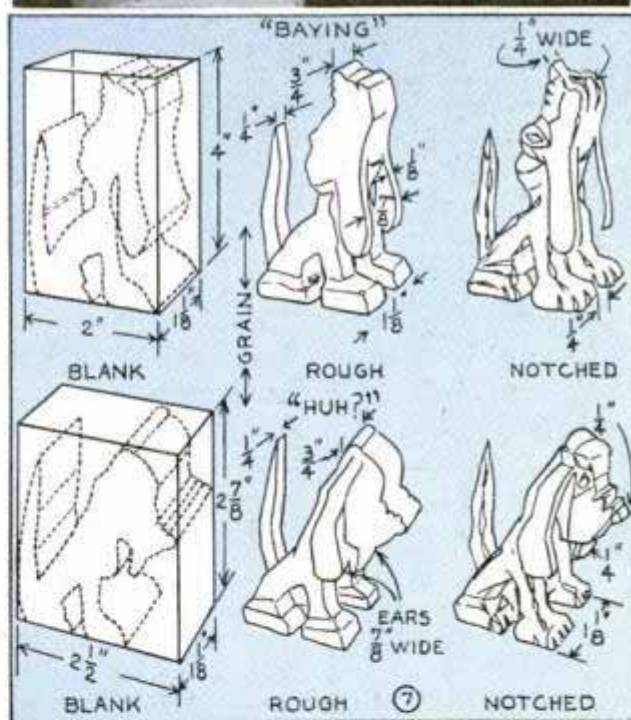

draw 1/4-in. squares on one flat face of the block, and transfer the pattern from Fig. 3, square by square. Saw out the blank on the dotted lines in Fig. 4 to get the profile. Then just follow through the three steps shown. Any other pose can be done the same way. "Hurryin'," "Stuck Up," and "On His Way" are not sketched in body detail because they are so very similar to the others. However, Fig. 9 shows the ar-

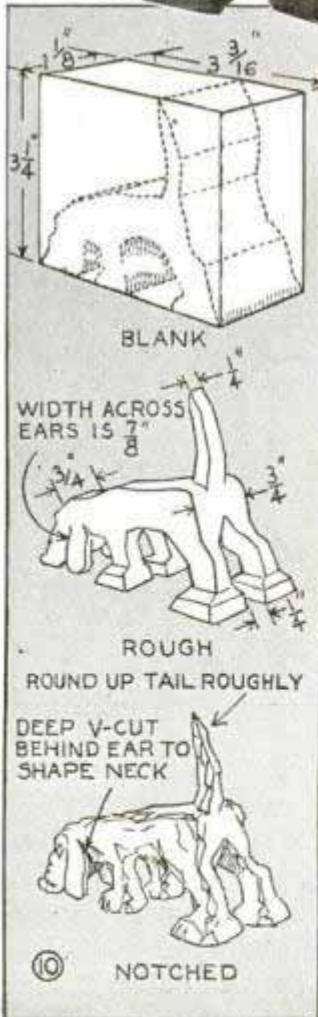
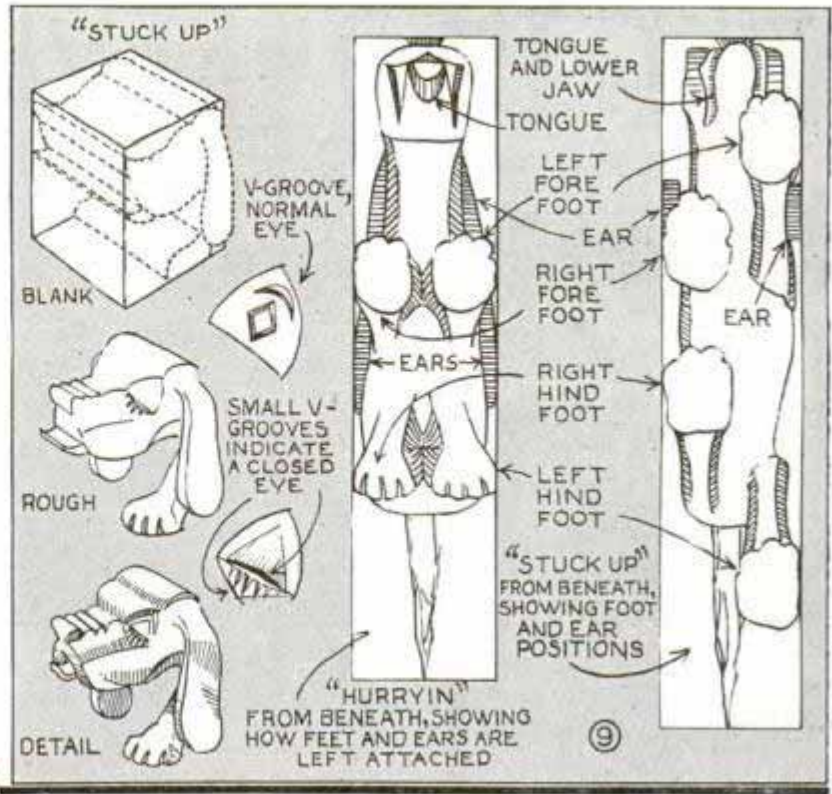

Use a fine-toothed blade to saw out the profile

arrangement of the feet on "Hurryin'," the foot arrangement on "Stuck Up," and details of the face. Note that here, as on "Snoozing," Fig. 4, the eye is not a complete diamond but just a straight line at the base of the flat surface on which the eye is carved.

As shown in the details, particularly in Fig. 10, the full width of the block is always used for Hugo's huge feet. The body should be between $\frac{3}{4}$ and $\frac{7}{8}$ in. thick, the head $\frac{3}{4}$ in., which allows $\frac{1}{16}$ in. on each side for the ears to project from the head. Thin the neck down to $\frac{3}{8}$ in. or even a little less to make the head appear larger. Cut large V-notches to break up the flat surfaces and indicate the joints—don't use small notches because they'll make Hugo look like he has a shaggy coat. And, don't smooth the edges; whittle them crudely, and leave them that way. Notches also indicate Hugo's claws and his wrinkled nose.

Paint on Hugo's spots or not, as you will—then use him for a desk ornament, mantel, knickknack corner, coffee table, dresser, book-end or for any of the dozens of other things that will suggest themselves to you. If you want Hugo bigger, choose a larger block and make your original squares larger— $\frac{1}{2}$ -in. squares make Hugo twice as big. And if you want to polish him, use mahogany, walnut, or maple instead of pine. But in any case, don't sandpaper Hugo—you'll round off all his character.

Chemical Kindling Ignites Campfires Quickly

Campers will find these kindlers convenient in starting fires, especially when the wood is damp. To make them, melt rosin, 3 lbs., and tar, 1 qt., together, and while cooling, work in as much sawdust and charcoal as possible. After the mixture has cooled, break it into pieces the size of an egg. These kindlers will ignite from the flame of a match.—Roy Tichenor, Cincinnati, Ohio.

Flowering Bulbs Grown Successfully Indoors

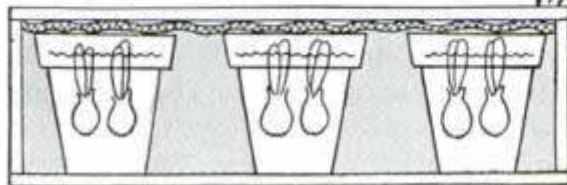

Almost any bulbs can be grown successfully in the house during winter. You begin with a box in the garage. Build a box large enough to hold a dozen pots and fit it with a tight cover. Pot the bulbs as shown and place them in the box early in the fall. Cover with burlap, then close the box and water every three weeks. Keep them there until January when they may be brought into a cool basement. The bulbs should continue to grow in the dark until

they are about 6 in. tall and the flower bud is well out of the bulb. Then gradually bring them into a warmer place in the basement. Hyacinths, tulips and daffodils will all blossom in the house if so treated, for it gives them an excellent root growth. In about two weeks after they are brought upstairs in the light, they will blossom. The one necessity is regular watering.

Holder Keeps Thin Stock from Turning on Drill Press Table

Have you ever had real thin work twist suddenly on a drill press when the drill broke through resulting in injury to your

hands? If so, this simple holder will help to avoid this trouble. It is shaped from a wood block and has four bolts and wing nuts, which slide in slots to permit adjusting them to clamp the work effectively. A large hole in the center of the holder allows the drill to pass through, while one end of the block is whittled down to form a handle.



Warm Hands in Wet Gloves

Here's a way to keep your hands dry and warm during winter when working with gloves that constantly become wet. First slip on a pair of thin, cloth or leather gloves, then a pair of rubber gloves and over these the work gloves.

Small Photos Are Framed Easily with Embroidery Hoops

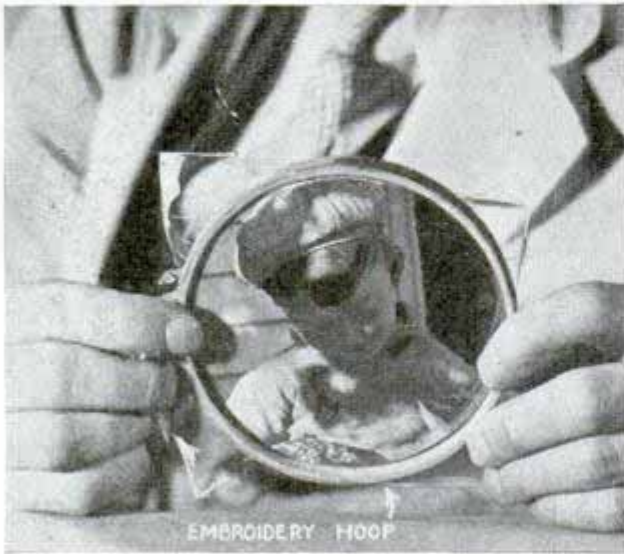

Embroidery hoops are obtainable in a number of sizes and cost very little

A quick and simple method of framing a small photograph is to use a pair of embroidery hoops, which may be waxed or stained if desired. Cut the picture to the size of the inside hoop, cover it with a piece of plain or colored Cellophane, and slip the larger hoop over both. Trim the excess Cellophane from the back.

Framing Vise from Wood Block

Fastening mitered joints such as picture frames is rather difficult without a suitable clamp to hold the pieces together. For this purpose the jig shown can be made in a jiffy. A small hardwood block with two

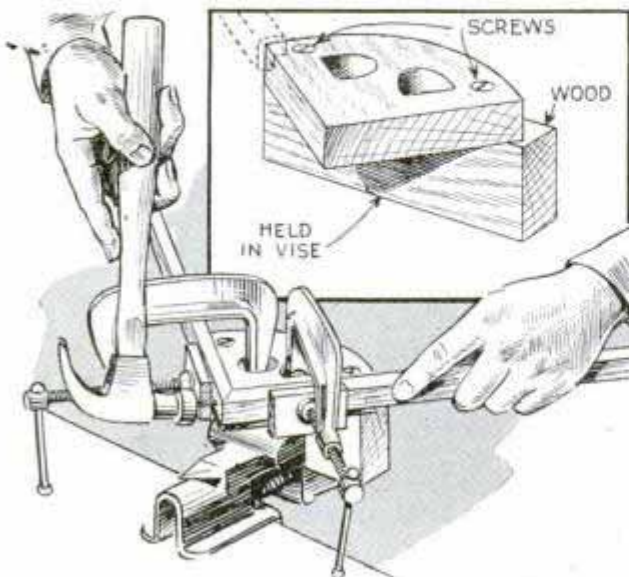

Picture frames are held accurately with this simple jig, for gluing the mitered joints

sides at right angles is screwed to the edge of another block which is clamped in a vise. Before screwing the pieces together holes are bored to take C-clamps.

Partition in Laundry Hamper Separates Clothes

Instead of putting all of your soiled clothes together in a hamper, why not partition it so that the colored garments can be kept on one side and the white ones on the other? This saves the job

of sorting them on wash day. The partition is a piece of $\frac{1}{4}$ -in. plywood cut to shape to fit snugly inside the hamper.



Hand Pad Helps in Chiseling



Carvers and others who often use small chisels and tap them on the ends of the handles with the palms of their hands, will find this pad handy. It is merely a square piece of leather, or it may be a disk, to fit in the palm, and it is provided with a wide rubber band or piece of elastic to slip over the hand.

Realistic Wings for Bird Cutout

This metal cut-out of a bird has been given a realistic appearance by adding metal wings. These are soldered to each side of the bird, and are spread slightly to simulate the action of a live bird on a hot day. Proper coloring and shading add much to the effect.

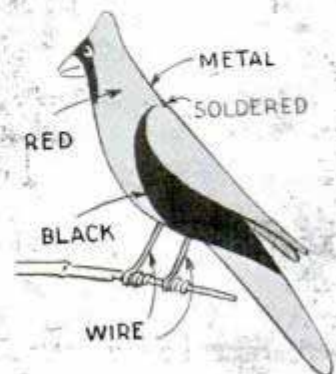

Modeling a VIKING SHIP

By A. JORGENSEN

THIS Viking ship is patterned after what was generally known as the "Dragon-ship" type, built in lengths up to one hundred feet, with a high bow for protection against oncoming seas and a correspondingly high stern to fend off the following waves, Fig. 1. The single sail was always a brightly decorated and embroidered affair and was used only on long voyages, the oars being relied upon for maneuvering the ship in battle or in a calm.

The first step in the construction is to get out the rough blocks from which the hull is shaped. There are two of these, as you see in Fig. 5, with a $\frac{3}{8}$ -in. filler between them.

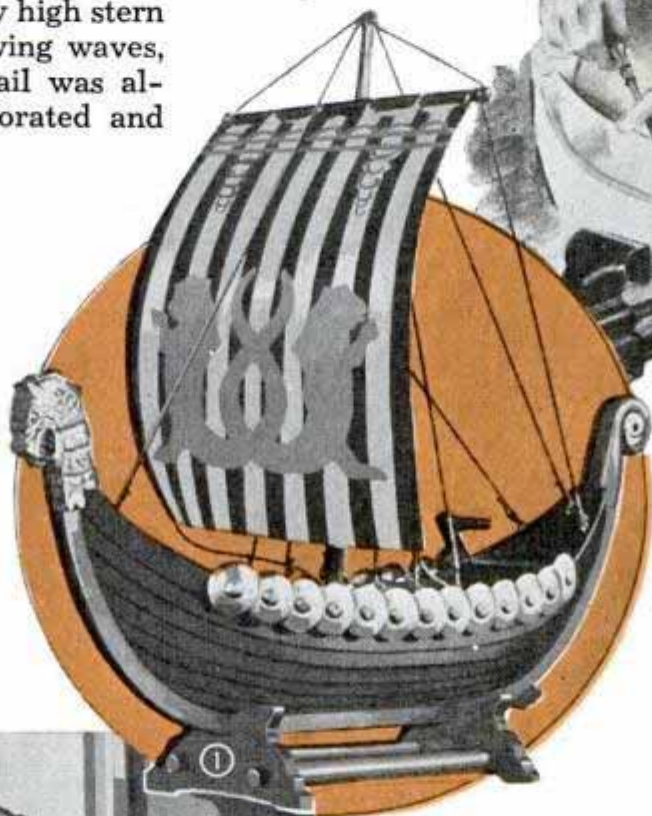
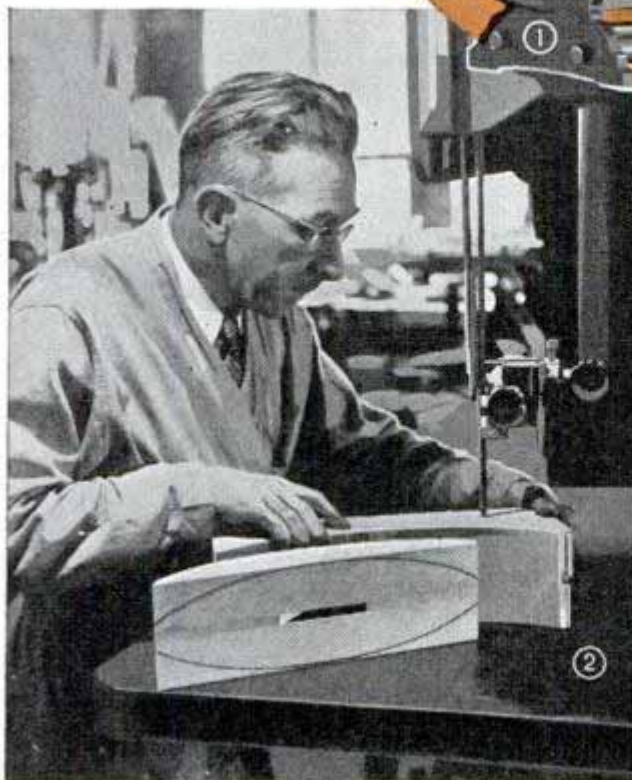

Note particularly that this filler is dimensioned to leave a $\frac{1}{4}$ by $\frac{3}{8}$ -in. groove for the keel when the blocks are glued together. Although they are not shown, it's a good idea to use two $\frac{1}{4}$ -in. dowels to strengthen the

joint. When the glue is dry you draw a full-size profile from the crosshatched section, Fig. 6. The curves are the same at both ends. Once you have the profile laid out on the block, saw it to the rough size as in Fig. 2, keeping the blade outside the lines in the waste. Save the waste pieces and tack them back in place so that you can saw the top profile, as in the deck plan, Fig. 6. It's well to saw the deck curves to a regular radius, although when finished the curves sharpen a trifle before meeting the stem and stern posts. Because of the regularity of the curves no station lines are used.

Now the carving, taking the inside of the hull first. The dotted line in the side view, Fig. 6, gives the contour of the main and poop decks and the fo'c'sle, and the deck

with another. Make the oars and fasten in place with a spot of glue. Follow with the keel, the carved dragon head and tail. Then the rudder, rowing benches, and stand.

Now you're ready to set up the mast and rigging, Figs. 7 and 9. Run the center shrouds through a small hole drilled in the mast. Knot the ends. Tie the lower ends to small screw eyes in the rails. The fore and back stays tie to screw eyes in the deck.

Although the sail may be made of silk or linen it can be shaped easier if made of soft sheet brass as in Fig. 11. Fig. 8 shows the decoration which is an overlay of sheet brass and sweat-soldered in place. Paint the sail with red and white stripes as in Fig. 1. Tie the two guy ropes from the ends of the yard to screw eyes in the rail near the stern. Now to finish up, give all the exposed wood a coat of weathered oak stain. Allow this to dry thoroughly, then apply two coats of varnish. If you desire, you may omit the oars and overlap the shields as is shown in Fig. 1. This will

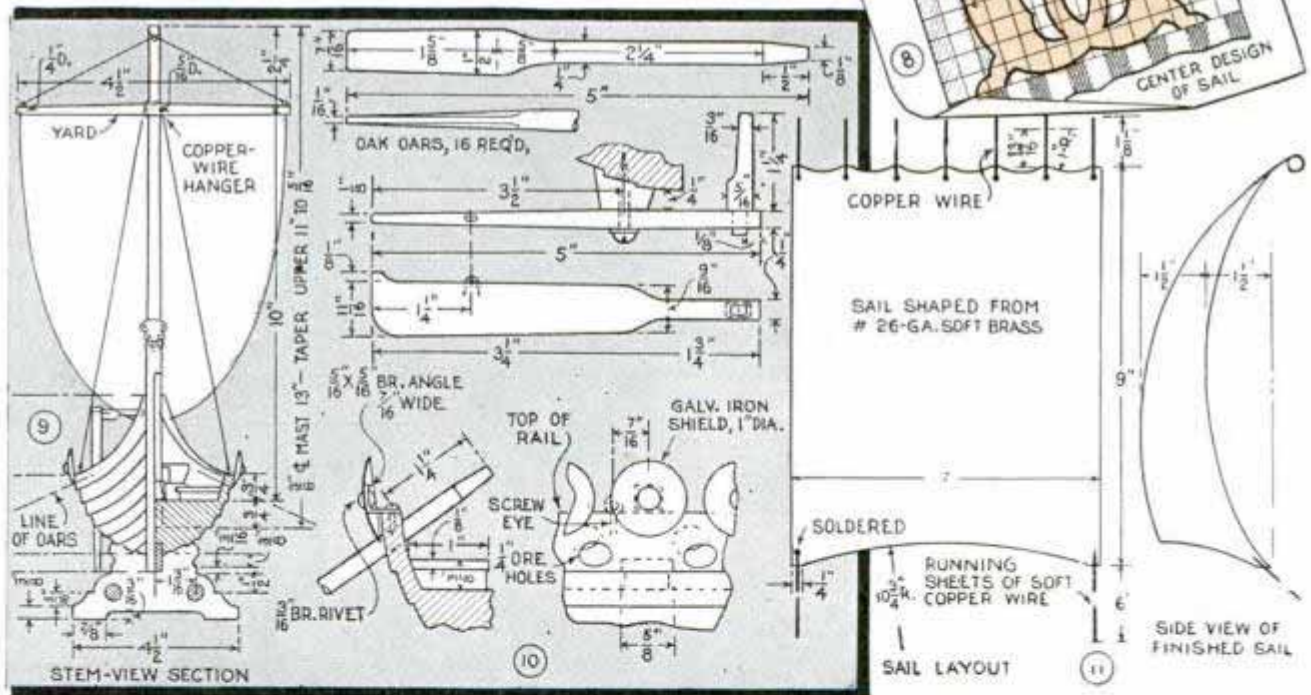
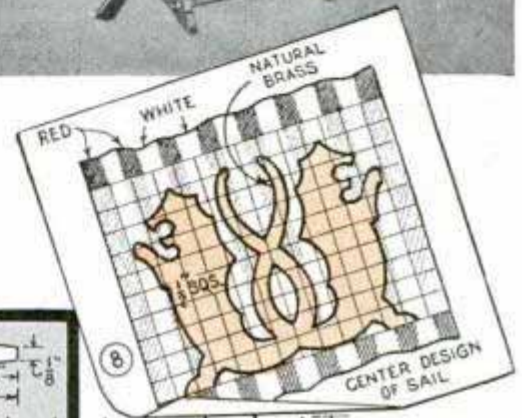

vary the spacing of the shields from that given in Fig. 10. In Fig. 1 the shields are spaced $1\frac{3}{16}$ in. on centers and overlap from front to rear, as you see. The forward edge of each shield is tilted inward slightly. Enamel the shields a bright yellow.

Another way of finishing the hull is to use a Vandyke brown color pigment ground in oil. Thin with turpentine to

make it brush easily and draw out smoothly. If you're careful in applying it a neat job is sure to result. Use an artist's brush with sable bristles. The trick is to get the color on evenly, without piling or overlapping and with as little brushing as possible. Of course, the wood will have to be sanded carefully to a uniformly smooth surface before applying the finish.

Concrete Forms Braced Overhead Assure Straight Sidewalks

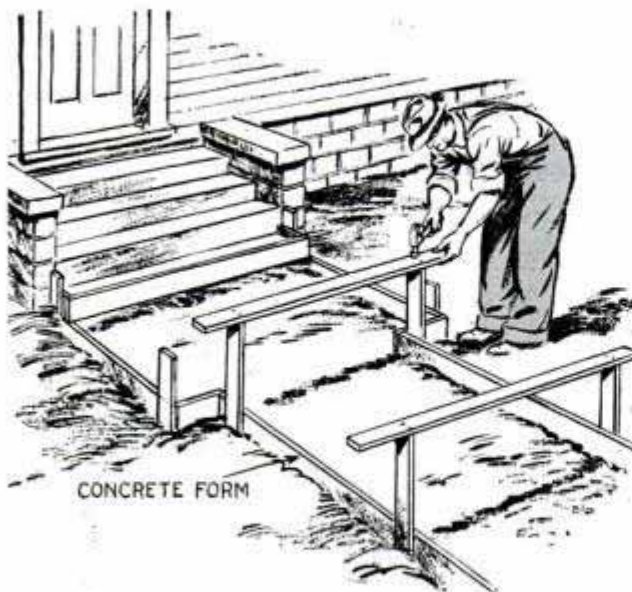

CONCRETE FORM

Tying concrete sidewalk forms across the top so that the edges will be straight

Instead of bracing the stakes that hold the forms for pouring concrete sidewalks, try the method shown. Use long stakes and tie the tops with cleats as indicated. This will assure straight, square walks with no chance for the weight of the concrete to force any portion of the form out of line.

Using Double-Filament Lamps in Single-Contact Sockets

If the running lights on a boat are fitted with double-contact sockets, disconnect one of the wires and solder it to the frame of the lamp, and get double-filament bulbs. Then, if a light burns out, just raise the bulb and turn it halfway around, and replace in the socket and the other filament will light.—John Hohner, Elizabeth, N. J.

Connecting Tubing to Faucet



PENCIL FERRULE

When you want to attach a length of small rubber tubing to a water faucet, such as in your darkroom, a rubber spark-plug protector will slip tightly over most faucets. A lead-pencil ferrule is

just the right size to fit snugly into both the tubing and the small end of the protector for connecting them together.

—Frank Bentley, Clinton, Ia.

Scraper on Torch Cleans Knife When Burning Off Paint

Bolted to the bottom rim of a blowtorch, an angle of heavy galvanized sheet iron provides a good scraper for cleaning the putty knife when burning off paint. This saves time because you do not have to set down the blowtorch and pick up a scraper—merely pull the knife across the scraper.

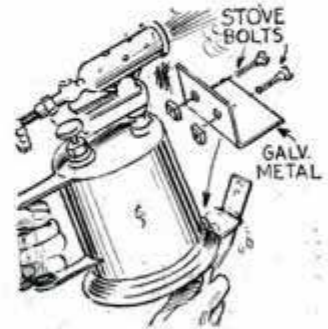

Protector for Glass or Stone Jug

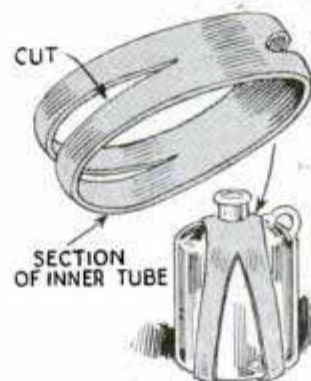

the jug so that two strips cross the bottom.

Glass or stone jugs may be protected against accidental breakage, when placed on a cement floor, by fitting them with a harness cut from a large inner tube. This is snapped over and around

Rubber Grip for Flashlight

A good grip for the ordinary tubular flashlight can be had by slipping a number of rubber bands over the outside. Wide bands are best for this purpose, as they will stand more handling than the narrow ones and do not tend to roll on the surface of the flashlight.

—E. T. Gunderson, Jr., Humboldt, Ia.

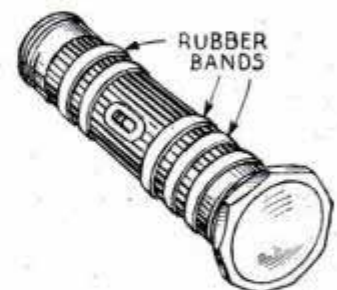

☐ An eraser hung on a wire hook attached to your typewriter will always be at hand.

Camera Gun Helps to Take Fast Action Shots

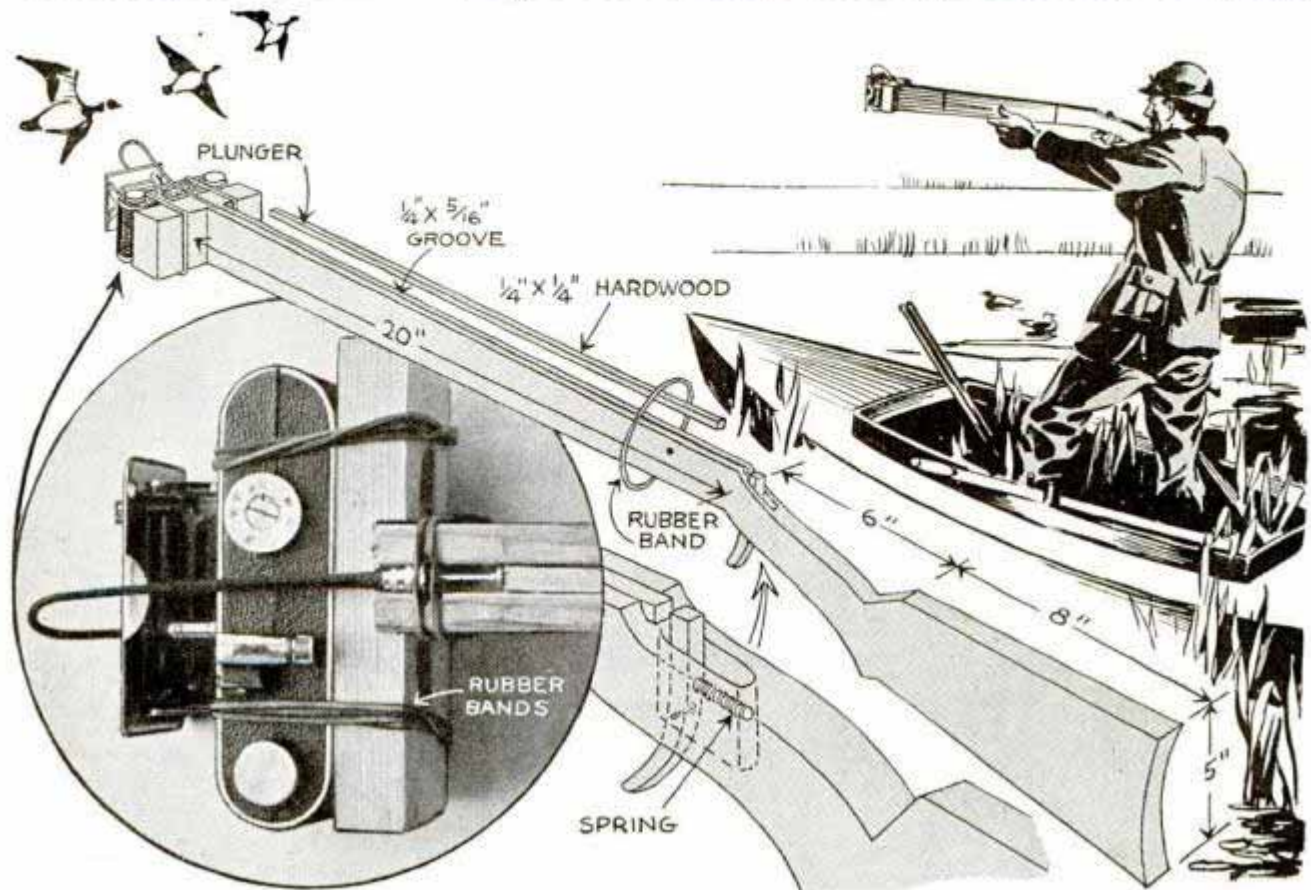

In shooting fast action photos, such as birds on the wing, it's rather difficult to catch the scene quickly through the view finder of a miniature camera because the sighting radius is practically zero. With this contrivance you aim the camera in much the same fashion as you would a shotgun. Pulling the trigger trips the shut-

ter. Be sure that the block supporting the camera is exactly at right angles to the stock. Before you chance any critical shots take a few test photos to make certain that any object which is in the line of sight over the gun is included in the field of the camera lens.

—Claude W. Clifford, Salem, Ore.

Baby's Seat Bolted on Kitchen Stool Becomes High Chair

If you have occasional use for a baby's high chair when friends visit, it is not necessary to keep a regular high chair around when you can convert your kitchen stool into one at a moment's notice. The top and seat, minus the legs, of a regular high chair are used and are fastened to the top of the stool by means of a bolt and wing nut as indicated, the head of the bolt being countersunk in the seat. It takes only a moment to attach or remove the high-chair seat when needed.

☐ Wearing a rubber finger tab while developing cut films in a tray makes separation of the films easy.

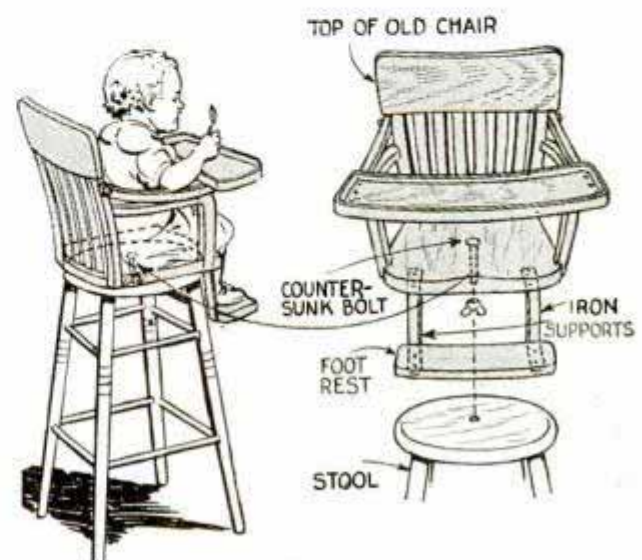

Solving HOME



Instead of scattering moth balls through clothing in a trunk, attach them to the underside of the tray with a strip of screen wire as above. Tape the edges of the wire and then tack it in place. Where there's a lady's hat, there should be a mirror. So why not put one on the costumer as shown below? An auto rear-view mirror is just the thing for this purpose as it is small and inconspicuous, and can be tipped or moved sideways to catch the light



Why "freeze" your hands inside rubber gloves when hanging out the wash during cold weather? Just slip the gloves over a pair of woolen ones

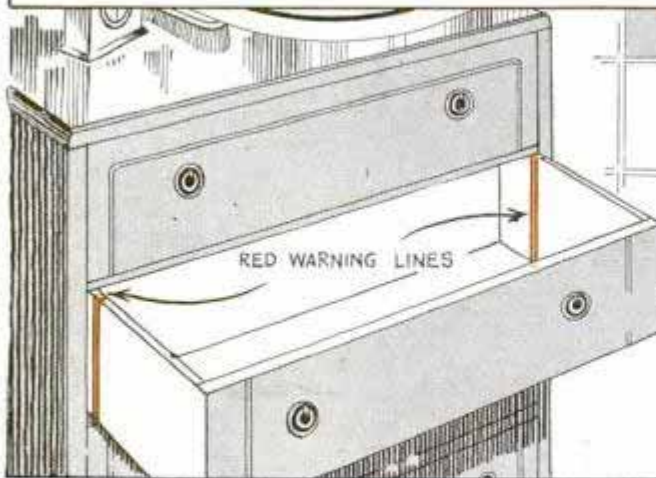

Did you ever accidentally pull out a drawer too far and spill the contents—or maybe crack your shin bone or injure a toe? Red lines painted on the sides of the drawer as above will show when the drawer has been pulled out almost to the limit. Your thimble will always be at hand if it is stored in the chair seat as at the right. A cork driven tightly into a blind hole in the underside of the seat and then drilled to take the thimble snugly does the trick

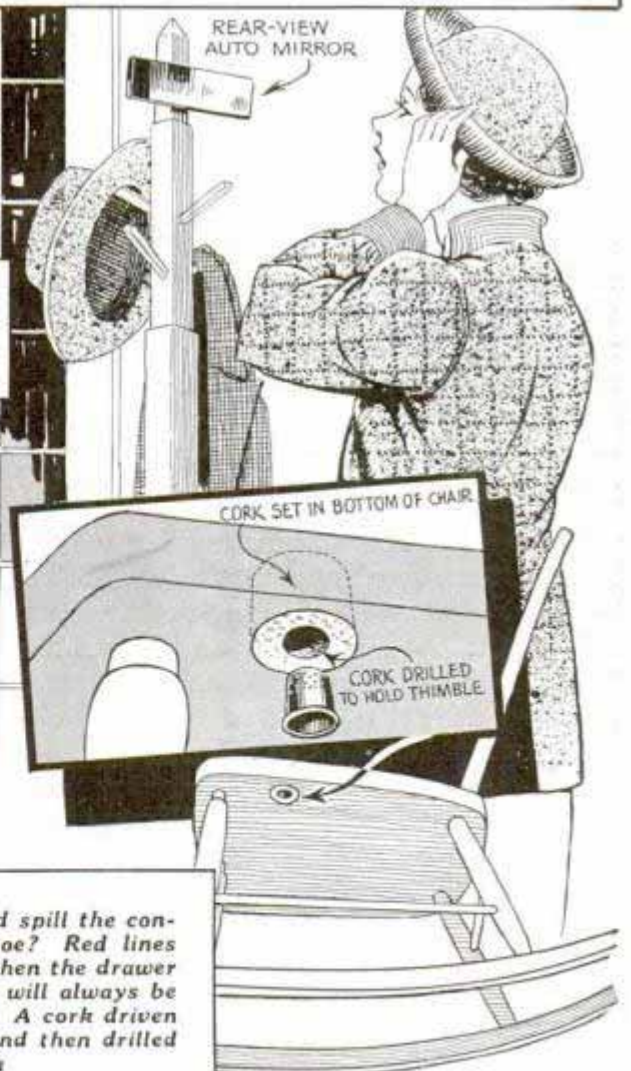

PROBLEMS

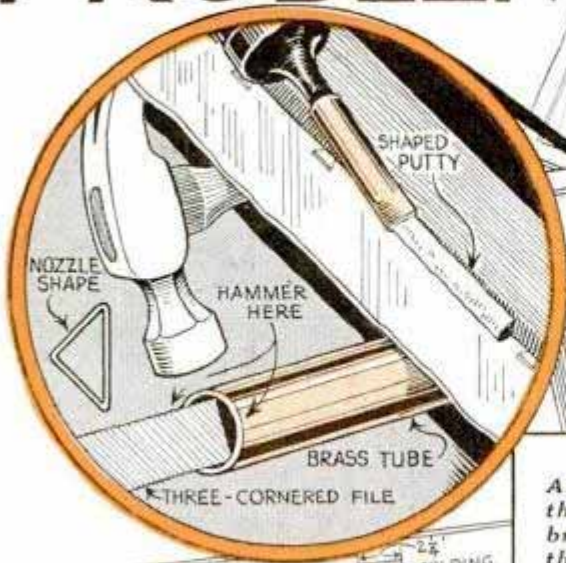

An Alemite grease gun fitted with a special nozzle will aid the amateur glazier in puttying windows. The nozzle is a brass tube threaded at one end to screw on the gun. A three-cornered file inserted into the other end serves as a die in forming the end to a triangular shape with a hammer

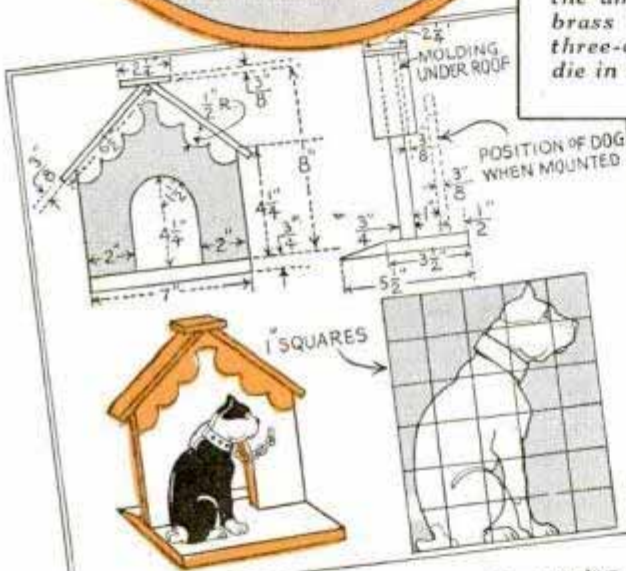

Depicting in miniature a watch dog sitting in front of his kennel, this unusual doorstop is both decorative and highly effective



Put these traps in the eave troughs in front of each downspout and you'll keep a lot of dirt from entering your cistern. The trap is a 1-ft. length of downspout with a tight-fitting cap over the lower end. Clean the traps once each year

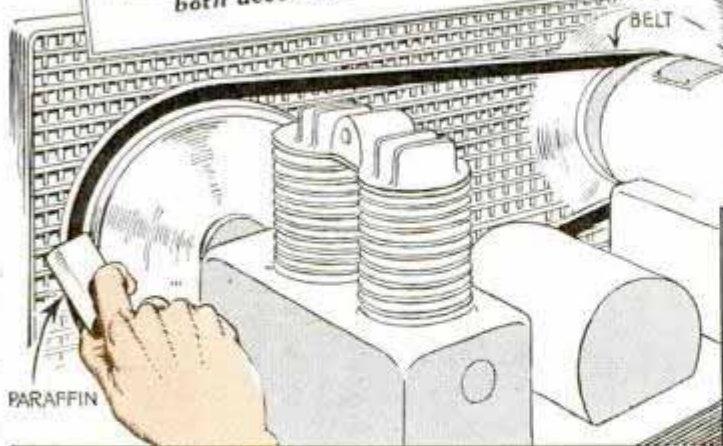

If the compressor of your refrigerator is driven by a belt which seems to be unduly noisy, a coating of paraffin may silence it. While the motor is running hold a cake of paraffin against the surfaces of the belt that contact the pulleys. When the doors of a bookcase are hard to close because they tend to compress the air inside, a vent of the type at the right will release the pressure. The flap over the vent can be cut from rubber

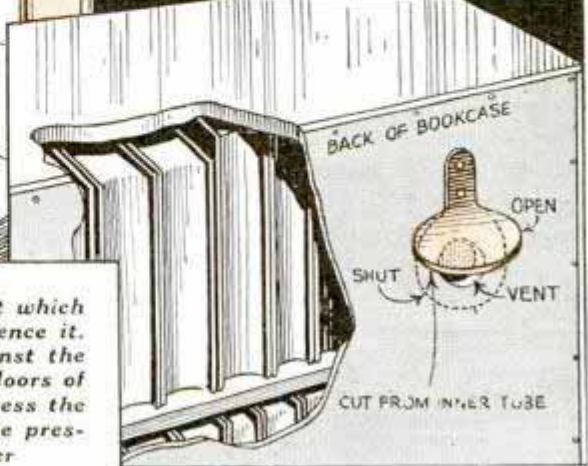

Reels for Use Around Your Home Bent from Stiff Wire

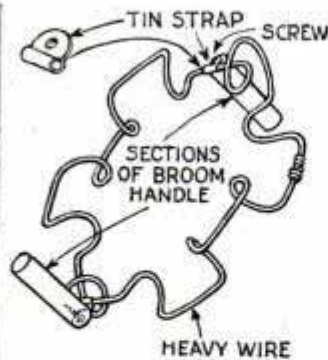

Wire reels you can make for winding rope and wire around the home

Reels in which to wind rope, wire, etc., around the home or farm, are easily bent to shape from stiff wire. Two short pieces of broom handle attached to opposite sides

of the reel provide good grips, which are attached by means of clamps shaped from strips of tin or sheet metal.

—Dale R. Van Horn, Lincoln, Neb.

Sparrow-Proof Martin House

If you want to keep sparrows out of a martin house between the time the martins leave in the fall and return in the spring, substitute a pivoted shelf for the regular perch as indicated. Then the perch is tipped up against the opening and left there until it is time for the birds to return in the spring.

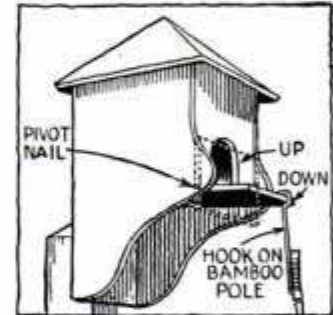

Why Not Start a Home Workshop?

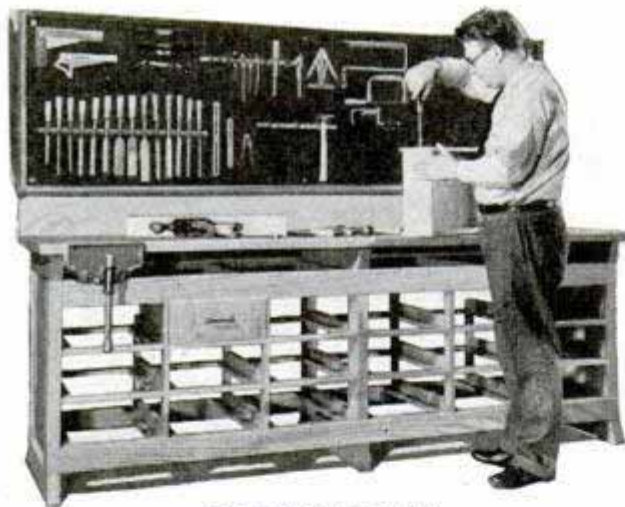

Cabinet Workbench—898

12-IN. BAND SAW—836: Smooth running and sturdy. Cuts 2-in. stock easily—25c.

DRILL PRESS—895: Pipe fittings. $\frac{1}{2}$ -in. chuck and ball-bearing spindle. 28 in. high—25c.

BELT SANDER—579: Heavy-duty type. Angle-iron framework and a 5 by 46-in. belt—25c.

CIRCULAR SAW TABLE—910: Angle-iron frame. 24 by 36-in. table. 10-in. blade—25c.

CARPENTERS' TOOLBOX—824: $8\frac{1}{4}$ by $13\frac{3}{4}$ by $31\frac{1}{4}$ in. in size. Has special rack for auger bits—25c.

Any six of these blueprints (not sets of prints) will be sent postpaid upon receipt of \$1.00

A few homemade machines will enable you to get into this interesting field. Whether you want a shop for pleasure or profit, our plans will give you all of the information you need.

CABINET BENCH—898: Nearly 8 ft. long, 27 in. wide, 35 in. high. 20 drawers—25c.

THREE EASILY MADE WORKBENCHES—896 and 897: Designs that are applicable to benches of various sizes. Two prints 50c.

22-IN. SCROLL SAW—771: Pipe fittings and hardwood. Has sewing-machine drive—25c.

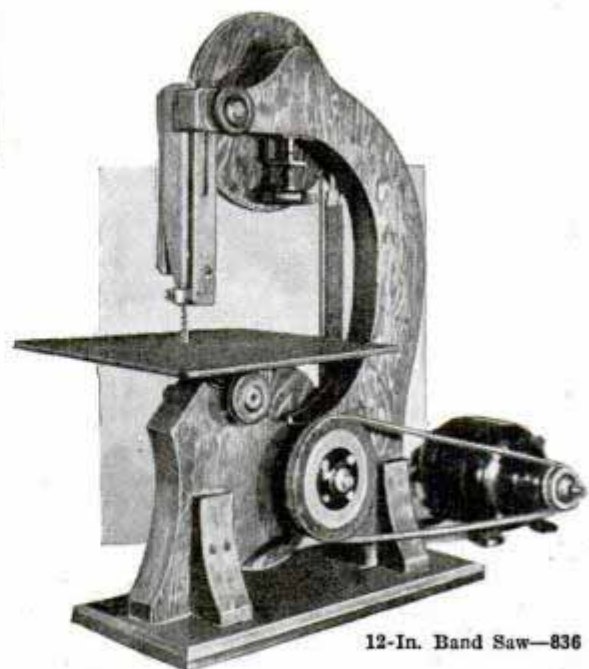

12-In. Band Saw—836

Blueprint Department, Popular Mechanics Magazine, 200 E. Ontario St., Chicago



SHOP NOTES

MIDGET CIRCULAR SAW *for precision work*

DID you ever wish you had a tiny precision saw for close work in getting out small, delicate model parts? Then here it is; a homemade affair carrying a 2 $\frac{3}{4}$ -in. blade that is just right for most small jobs. As you will see from Figs. 1 and 2, the base is made from a 1 $\frac{7}{8}$ -in. length of rail, preferably a section cut from one of the older, smaller sizes of rail. A hole is drilled and reamed lengthwise through the tread to take the spindle

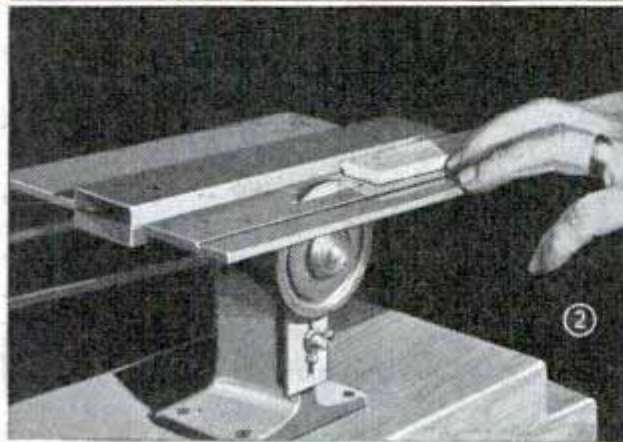
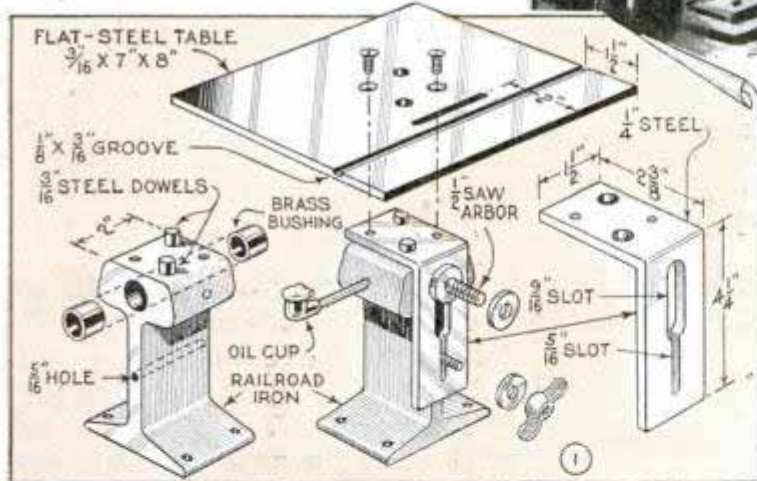

bushings, another through the web to take the bolt holding the L-shaped slide and four small holes through the foot of the rail for screws attaching the machine to a bench. The slide is made of 1/4-in. angle steel, which is slotted as shown by drilling a series of adjacent holes and finishing up with a file. The table is cut from 3/16-in. cold-rolled steel. These parts are taken to your local machine shop where the

top and one end of the base are milled flat to a 90-degree angle. Also, both legs of the slide should be milled flat on both sides and to a 90-degree angle. Lastly, the table is grooved and slotted as indicated. The length of the slot is not given as this will have to be determined from the size blade you expect to use. The slot should be just wide enough to clear the saw; no more, for otherwise it is difficult to handle fine work.

Unless you have facilities for turning out the arbor as in Fig. 3, it may be best to

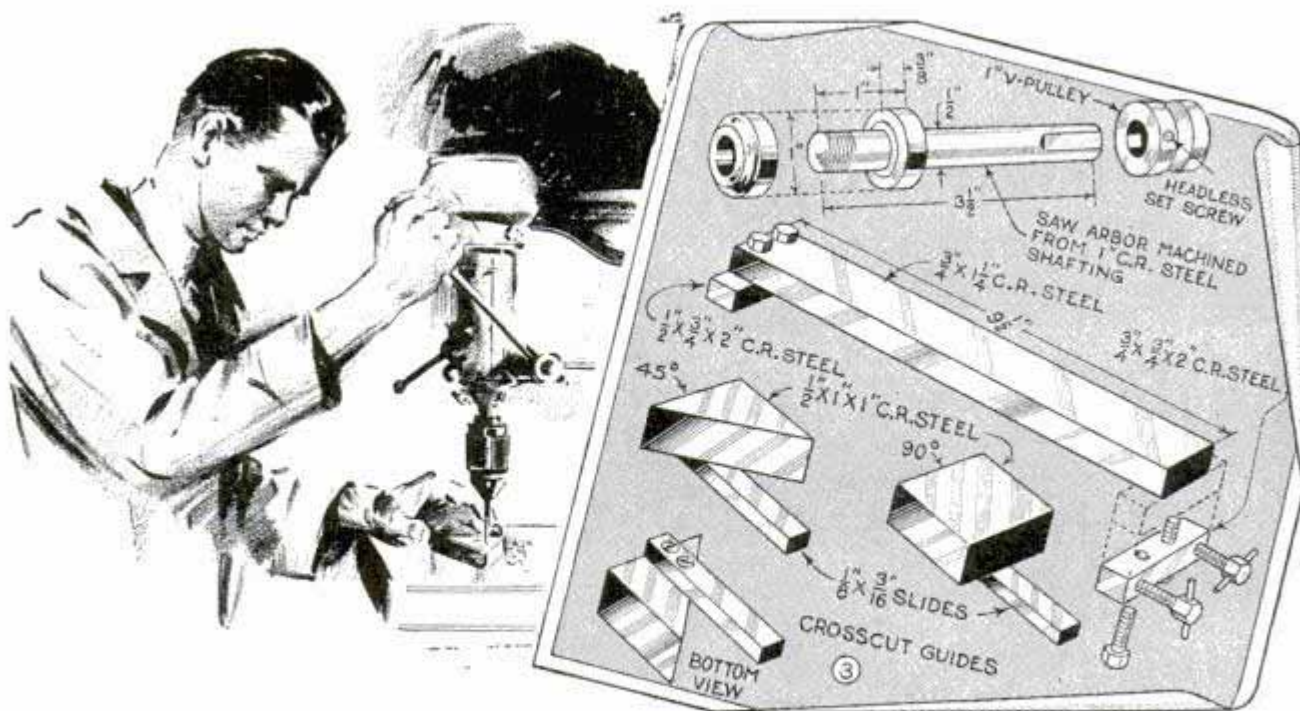

have the machine shop do this job also. Then you're ready to assemble the parts as in Fig. 1. Note that there are four holes drilled in the table and four in one leg of the slide. These must register exactly so it's best to make a jig. Two diagonal holes in the top are countersunk for capscrews, which turn into tapped holes in the slide. The remaining two holes in the top take the ends of steel dowels which are a drive fit in holes drilled in the slide as shown in Fig. 1.

Ripping and crosscut guides are easily

made from squares and flats of cold-rolled steel. You can get out the parts with a hacksaw and file or have them milled to size. Although you can use regular wood-cutting blades the best for this particular purpose is the metal-slitting type of circular blade. Usually you can get a used one from a machine shop and have the teeth reground and reshaped for cutting wood. This type of blade cuts extremely smooth when driven at a speed of from 4,000 to 5,000 r.p.m. When driven at this speed a light oil is applied to the spindle.

Distorted Box Threads on Screw Jack Trued Up with a File

After the threads on a screw jack had been distorted by a sudden overload, due

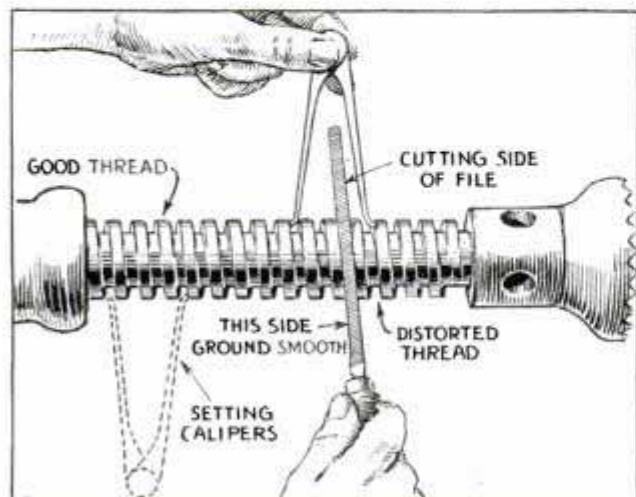

Distorted threads on screw jack trued up with a file which is smooth on one side

to another jack tipping over, the threads were trued up with a file as follows: The direction and extent of the distortion were first found by setting a pair of inside calipers to the top side of a good thread and the bottom of another good one some distance farther up the screw, as indicated by the dotted lines. The calipers were then tried up and down the screw to locate the distorted threads. After this had been done, one side of a file was ground away until it would pass between the threads, after which a little filing at exactly the right place reduced the distortion until the screw would pass through the female thread in the base. Then some grinding paste was applied and a few turns in and out finished the job.

—Earl Pagett, Coffeyville, Kans.

Tenoning Jig Clamps Work at Various Angles

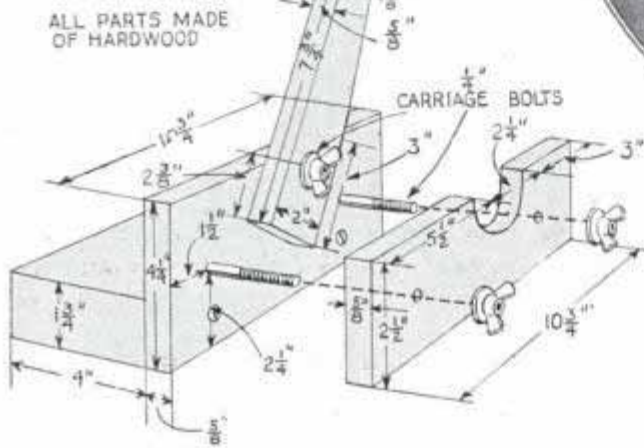
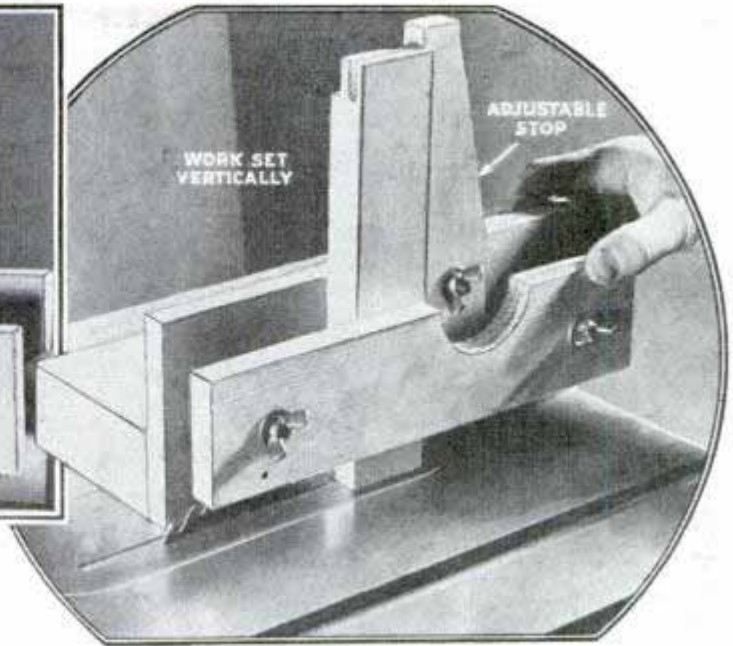
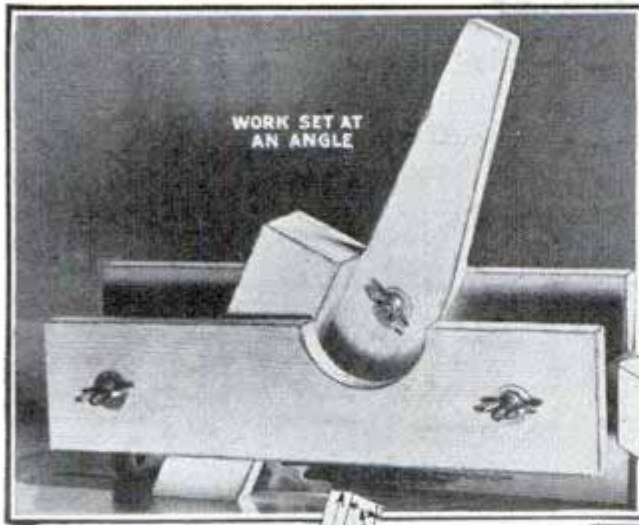

Cutting tenons anywhere from the vertical to a 45-degree angle, is something you can do with the aid of this simple jig. After adjusting the extending arm or stop to the angle desired, you lay the work against it and then tighten the outer piece to clamp the work securely. The jig is slid along the ripping fence, which was previously set for the cut.

Drill-Press Lever Improved by Adding Auto Steering Knob

When confronted with the task of drilling holes through fairly thick material, either wood or metal, you require an unusually delicate control of the drill-press feed lever. This is especially true where the thickness of the work makes it necessary to swing the feed lever through a semicircle, as you may have to shift your grip just before the drill breaks through. However, by attaching an auto steering-wheel knob to the feed lever as shown you can apply uniform movement and pressure.

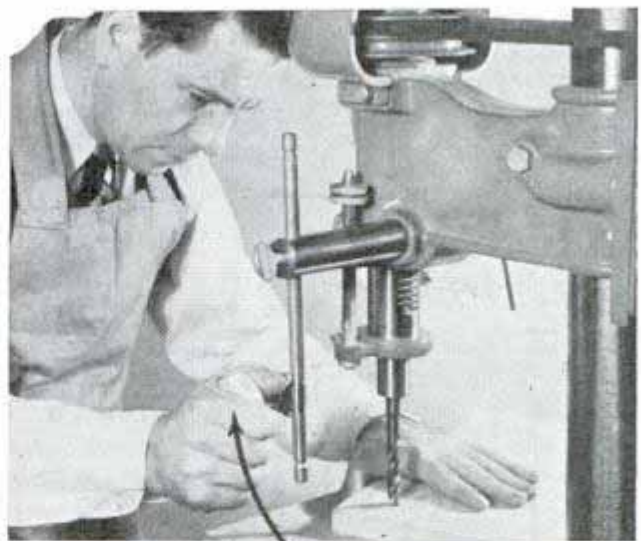

Removing Fish Odor from Dishes

It's a simple matter to remove the strong, objectionable odor from dishes that have been used for fish. Just give them a thorough washing in hot soapsuds to which a liberal quantity of baking soda has been added. For a panful of water, a couple of teaspoonfuls of soda should be sufficient.

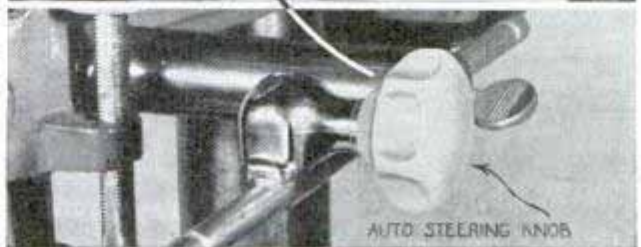

Carrying of Poultry Diseases Prevented by Sawdust Bag

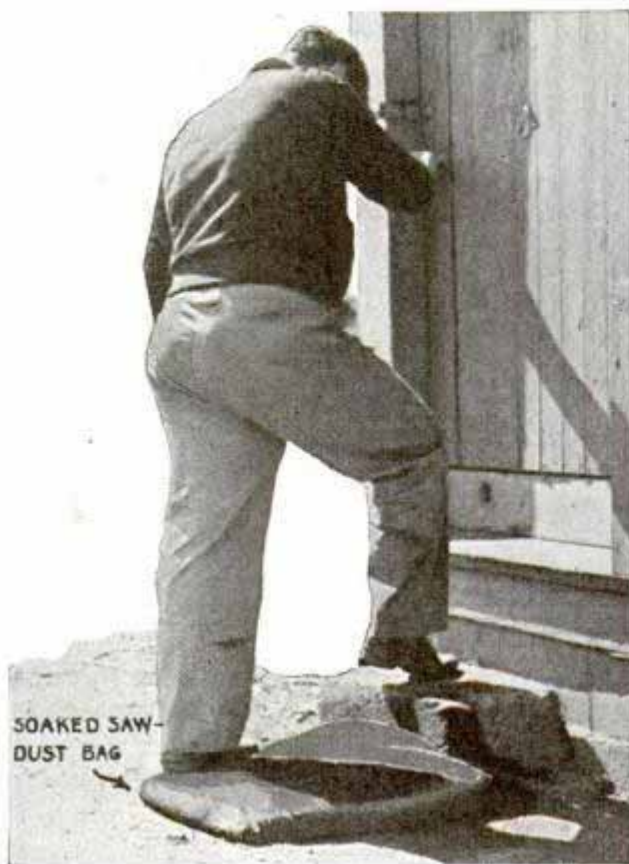

Workers wipe shoes on disinfected sawdust bags when entering and when leaving poultry houses

On one large poultry farm, the danger of carrying disease germs from one house to another on the shoes of workers was minimized by sawdust bags soaked in disinfectant. These were placed on the ground in front of the doors. Before entering, and when leaving a building, workers wiped their shoe soles on the bags.

Compressors Are Started Easily by Using By-Pass

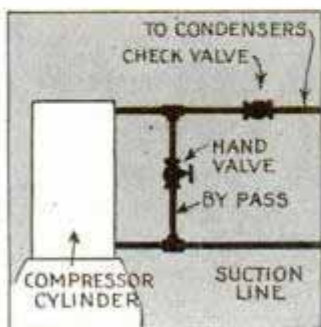

Instead of using a friction clutch to start ammonia compressors on ice and refrigerating machines, I install by-passes between the suction and discharge lines as indicated. Also, I place check valves in the discharge lines between the by-passes and the condensers, locating them on their side to prevent

check hammer. To start the compressor, have by-pass, suction and discharge valves open. When the machine is ready to be put into service, close the by-pass valve. Pressure will open the check valve at the correct time. The check valve will also afford protection should anything happen to the machine to relieve the pressure, such as a lost head or bursted pipe.

—W. C. Drake, Dallas, Tex.

'Magnetic Broom' in Beauty Shop Picks Up Hairpins

To pick up hairpins dropped on the floor of a beauty parlor, one operator suggests a small magnet fitted in the end of the broom handle. With this, the pins may be recovered from the floor without stooping.

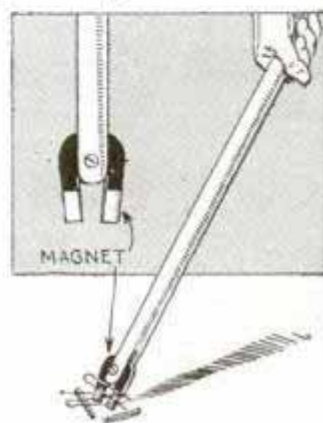

Sunken Metal Pan under Lathe Keeps Bench Clean

The operator of a bench lathe disposes of chips and dripping oil quite easily with this sheet-metal tray, which is set in a well cut in the bench top so that it slopes toward one end. Chips collect in it and can be removed as necessary, but the oil drains out at the lower end into a container set underneath it.

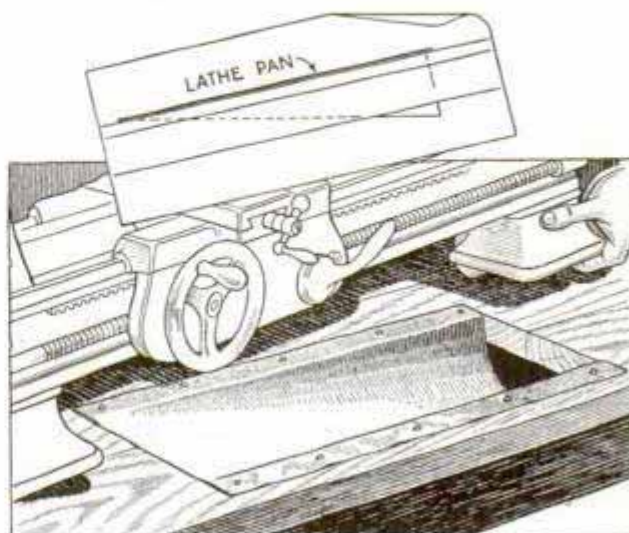

Pan in bench top under lathe drains off waste oil and collects metal chips, which are removed as necessary

Spun FINISHES for Lathe Projects

Wood turnings can be finished quickly and neatly in a lathe with wax, stick shellac or French polish. This enables you to produce a high polish with little labor by simply holding a cloth against the work as it rotates, the lathe being driven in second speed. Wax gives a soft, satiny finish, stick shellac an eggshell gloss, and French polish a high luster. Wax and stick-shellac polishing can be done in one operation. The French polish requires six or seven thin coats with one hour of drying time between them. All of these finishes work to best advantage on hard, close-grained woods, such as maple, birch and cherry



Wax

Prepared furniture wax can be used, or one can be made by shaving beeswax into a glass and covering it overnight with turpentine. The wax is applied with the fingers, cloth or brush to the stationary work. Allow it to dry for 15 min., and then polish with a soft cloth

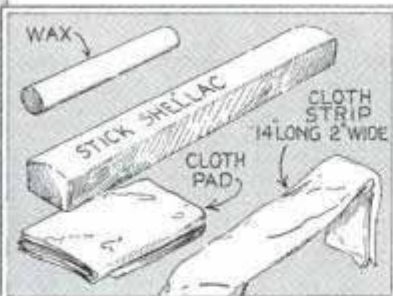

Stick Shellac

Stick shellac or wax is available in a variety of colors. Press the stick to the rotating work and hold a pad below to catch drippings as it melts due to frictional heat. Polish the ridges of shellac with a cloth until they flow out smoothly. One coat is usually sufficient

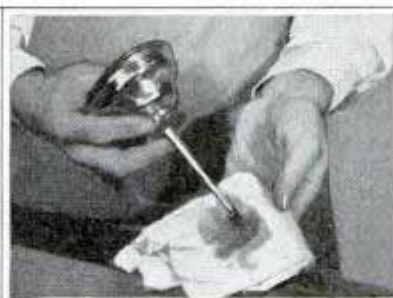
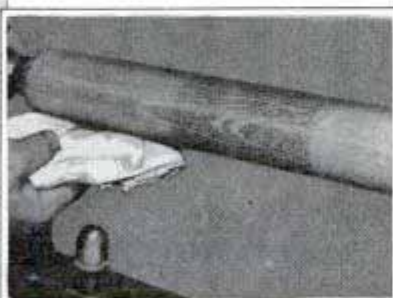

French Polish

Dilute white shellac, 1 part, with denatured alcohol, 4 parts, and apply with a cloth pad, running the lathe in second speed. Keep the pad moving and add more shellac as the pad dries. Two or three drops of linseed oil will keep the pad from sticking to the work. Use a clean cloth and pure alcohol to finish. The pad should be barely moist

Farm Gate Is Easy to Hold Open at Hinged End

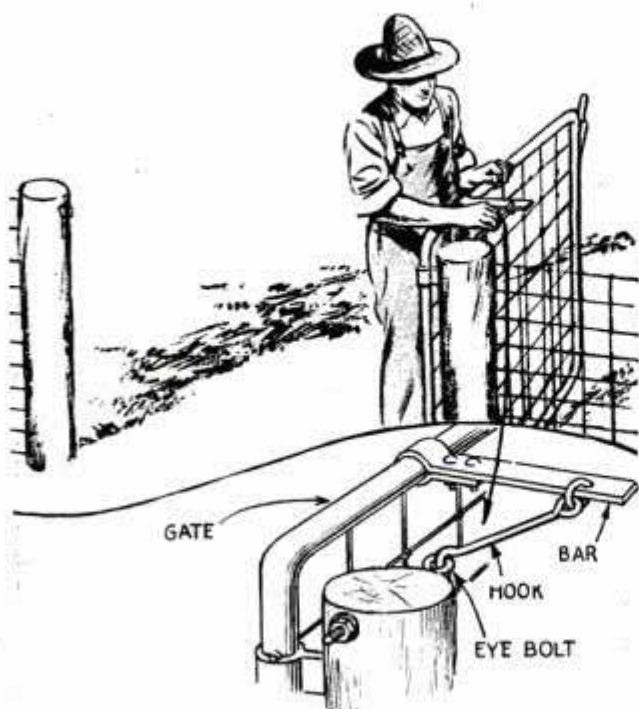

Large farm gate kept open by hook which slips into eye bolt in post to which gate is hinged

Instead of swinging a farm gate open and then walking around to prop it, or fasten it to a stake, use this simple hook arrangement. When you unlatch the gate, swing it and walk across to the other post and slip the hook into an eye bolt, thus saving many steps. The hook is attached to a bar clamped on the gate.

Gauge for Selecting Right Nail Marked on End of Rule

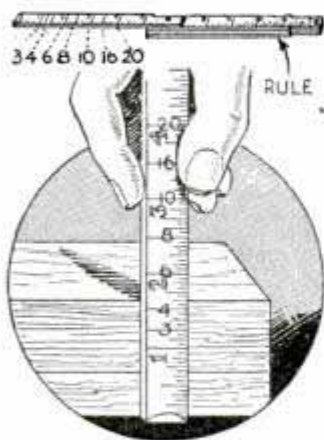

If a nail is to give its best holding power, it should lack just a fraction of an inch of passing through the work. In order to select quickly the nail having the right length, one carpenter scribed a nail gauge on his rule so that all he had to do was to hold it against the edge of the work into which the nail was to be driven. When scribing the gauge, the heads of nails of known sizes were held flush with the end of the rule and a line scribed

across it at the pointed end of the nail, after which a figure indicating the nail size was marked at the line.

Barn-Door Hook Pulls Staples

A barn-door hook of the type shown, is a good staple puller. Grind the end of the hook to a chisel shape, and then start it under the staple by tapping it lightly with a hammer. It is then easy to pry out the staple by turning the hook to one side.

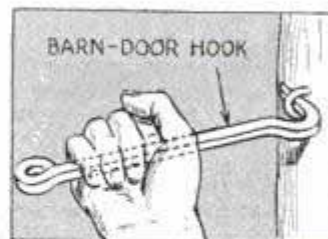

Reducing Noise in Heating Plant Caused by Fan and Motor

It is claimed that transmission of noise from a fan and motor on a forced-air heating plant to the floors above can be reduced to a minimum by enlarging a short section of the cold-air return duct. The enlarged portion changes the intensity, or produces a loss of energy in the sound waves traveling up the duct so that very little noise issues from the registers.

—L. H. Georger, Buffalo, N. Y.

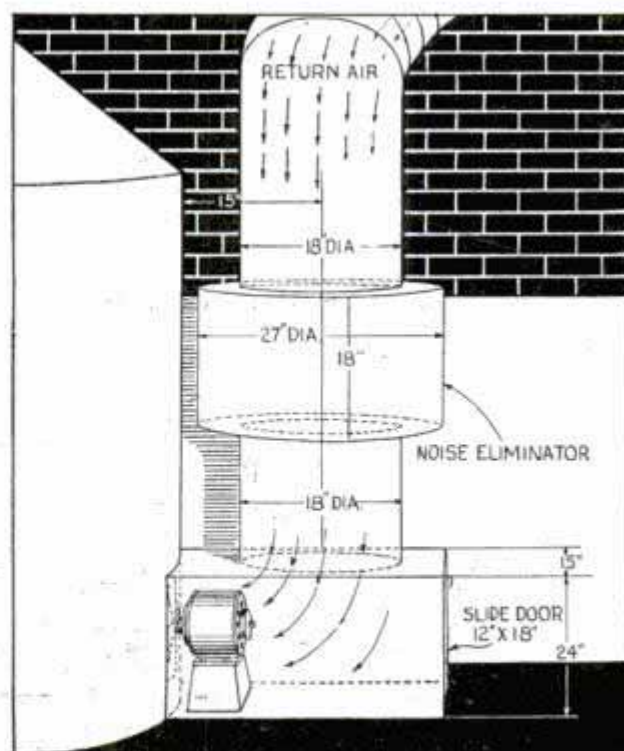

Enlarging section of cold-air return duct of forced-air heating plant reduces transmission of noise

Fender-Straightening Tools Grouped in Rack

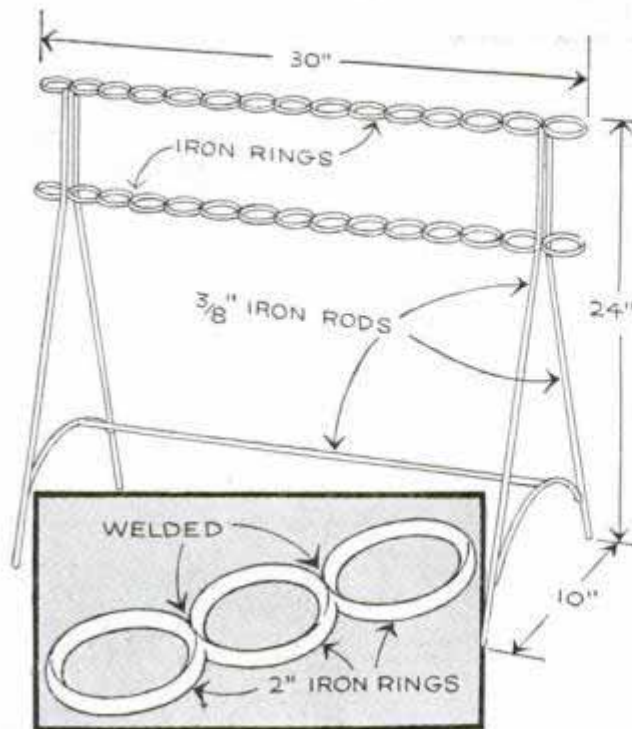

The little work required to assemble this rack is worth-while because it saves time often wasted in hunting over the shop for tools whenever a dent has to be removed from a car fender

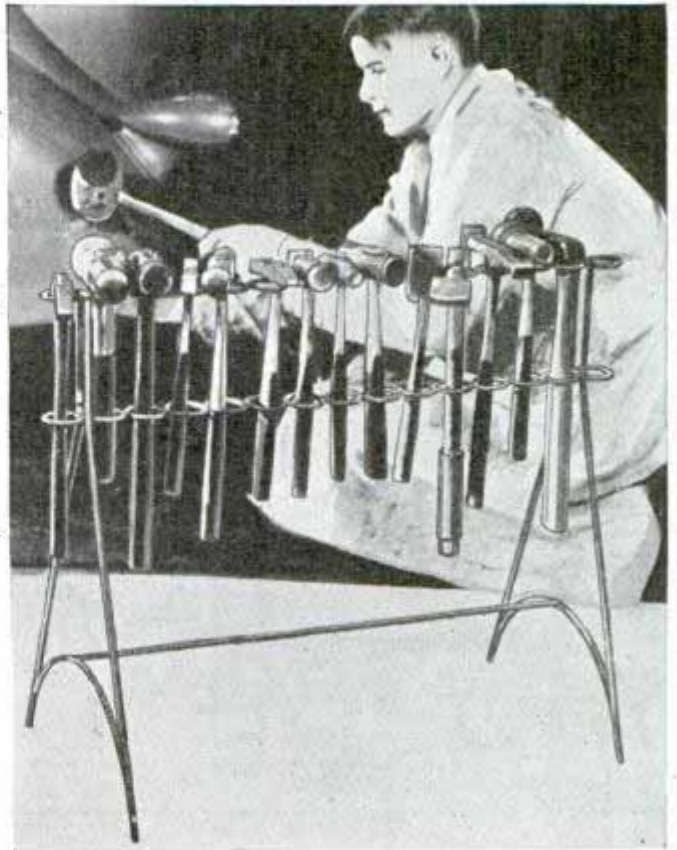

When stored in this portable rack, hammers and other tools needed to remove dents from car fenders are always together, so that the entire set can be carried right to the job without walking around the shop to collect them. The rack con-

sists of a number of standard-size iron rings welded together to form two rows, which are then welded to end supports shaped as indicated. A brace near the bottom keeps the supports from spreading. The tool handles are inserted into the rings.

Tapers on Round Stock Measured with Aid of Two Scales

Here's a simple method of measuring the taper per inch on round work when the

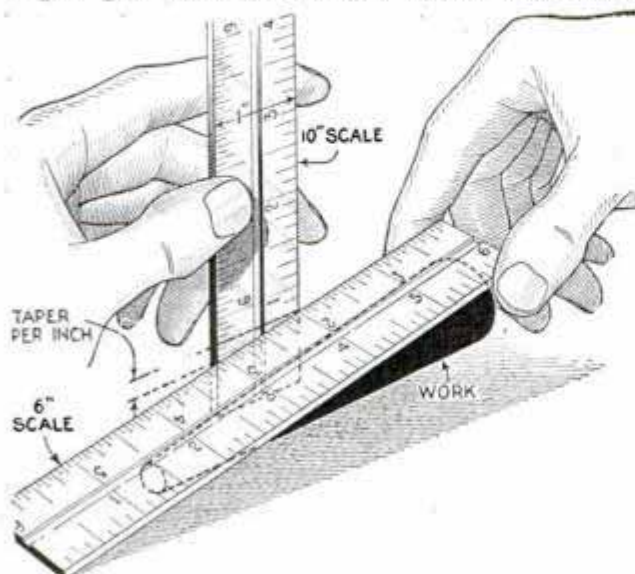

Two steel scales used to measure taper per inch on round work when measurements are not critical

measurement is not too critical. The work is laid on a surface plate and one scale, laid on top, is slid down the taper until the end touches the plate. Combination set scales are nearly always exactly 1 in. wide and, if one of these is held upright touching the edge of the first scale, the taper per inch can be seen at a glance. To facilitate the reading, the upright scale should be moved along until an even scale mark at one side coincides with the edge of the first scale, the difference, or taper per inch, can then be seen on the other side.

Removing Odor from Bottle

A pinch of dry mustard added to cold water will remove odor from a bottle. The mixture should be allowed to stand in the bottle at least an hour before it is rinsed.

CHOKE COILS *Control*

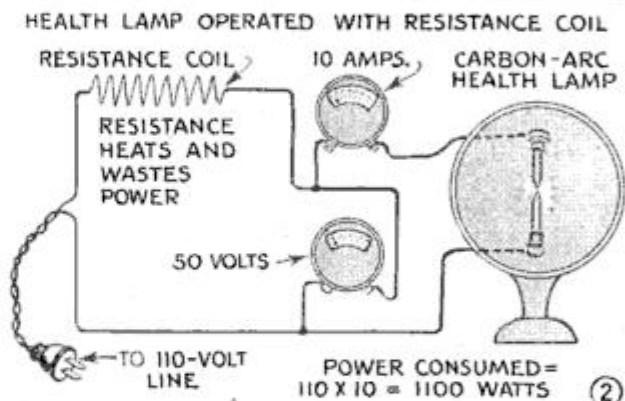
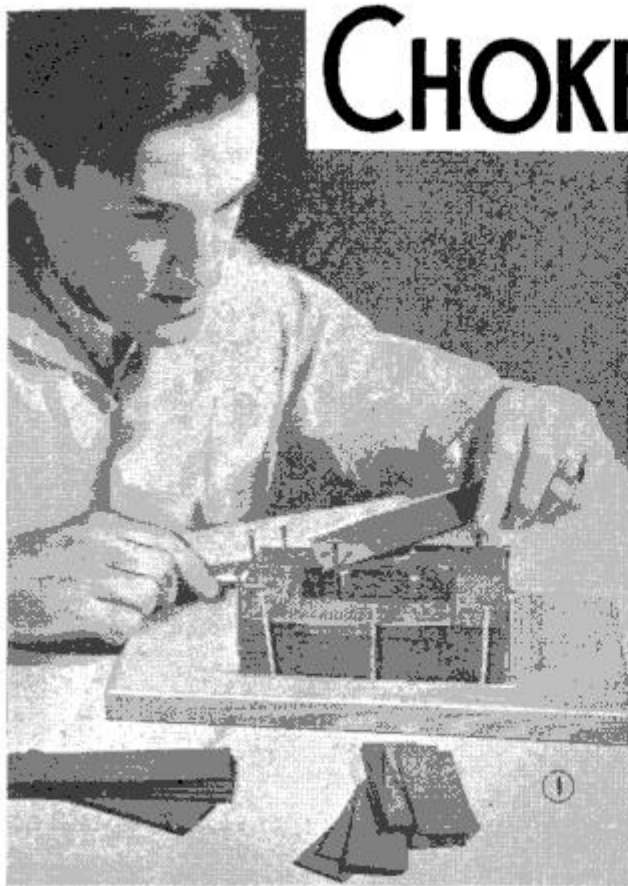

By C. A. CROWLEY

FOR controlling devices that operate on a.c. lines, the use of choke coils is often preferable to the use of resistance coils, because the former accomplish the same object with much less waste of electric power as is indicated in Figs. 2 and 3. All that a choke coil consists of is a coil of wire wound on a laminated iron core. It is connected in series with the apparatus it is to control. While resistance coils work on both a.c. and d.c., choke coils work on a.c. only. It is obvious that various types of apparatus, which differ in the amount of voltage and amperage required, must have specially designed choke coils to suit their requirements and control them efficiently.

A summary of step-by-step directions for choke-coil design is given in Table I. To make these directions clear, we will go through the design of a coil to control a sun lamp.

Step I: The first step is to find how much current must flow in the apparatus and what voltage is required across the apparatus. Let us assume that our sun lamp requires 10 amperes and 50 volts. These values often can be found on the name plate of the apparatus or by testing with a voltmeter and ammeter. In some cases when ei-

TABLE I
STEPS IN DESIGNING A CHOKE COIL

Procedure	Example
I. Determine current and voltage required for apparatus	Voltage required equals 50 volts Current required equals 10 amps. Line voltage equals 110 volts Line frequency equals 60 cycles
II. Find frequency number corresponding to voltage required (Curve I)	Use the 110-volt, 50-133 cycle curve (Curve I). Frequency number for 50 volts equals 1.48
III. Find current factor (Table II). Core area equals frequency number times current factor	Current factor for 10 amps. equals 3.16. Core area equals 1.48 times 3.16 equals 4.68 square inches
IV. Number of turns of wire equals 555 times core area divided by current	Number of turns of wire equals 555 times 4.68 divided by 10 equals 260 turns
V. Wire size required. Continuous operation: Circular mils equals 1000 times current Intermittent operation: Circular mils equals 750 times current Find corresponding gauge number from Table III	Intermittent use: 750 times 10 equals 7,500 circ. mils. From Table III, No. 11 wire is 8234 circ. mils and No. 12 is 6530 circ. mils. Use No. 11 D.C.C. wire
VI. Window area equals 1.25 times number of turns divided by turns per square inch	Turns per sq. in. for No. 11 D.C.C. equals 97.5 (Table III.) Window area equals 1.25 times 260 divided by 97.5 equals 3.34 sq. in.
VII. Find width of core laminations and dimensions of core parts from Table IV	W equals 2¼ in. (Table IV). Long pieces (A) 5¾ in. times 2¼ in. (Table IV). Short pieces (B) 3¾ in. times 2¼ in. (Table IV)
VIII. Thickness of core equals area of core divided by width of core	Thickness of core equals 4.68 divided by 2.25 equals 2.08 in.

Voltage in A.C. APPARATUS

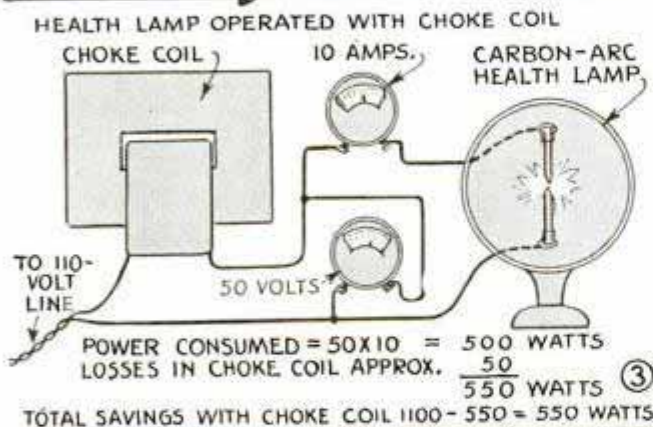

ther the current or the voltage is unknown, the power consumption or the resistance of the apparatus may be known. The current or the voltage, whichever is required, can then be found by means of one of the following relations:

(1) Voltage equals current times resistance; (2) Current equals power divided by voltage; (3) Voltage equals power divided by current; (4) Current equals voltage divided by resistance. It is also necessary to know the line voltage and frequency supplied. We will assume that the supply is 110 volts and 60 cycles.

Step II: We now refer to Chart I to find the frequency number. This is simply a number that enables us to find the dimensions of the choke. On Chart I there are four lines, corresponding to 110 volts, 25 to 40, and 50 to 133 cycles, and 220 volts, 25 to 40, and 50 to 133 cycles. To find the frequency number, locate the voltage required (50 volts in this case), move straight across to the proper curve (labeled 110-volt, 50

Current Required	Current Factor
1	1.00
2	1.41
3	1.73
4	2.00
5	2.24
6	2.45
7	2.64
8	2.83
9	3.00
10	3.16
12	3.46
14	3.74
16	4.00
18	4.24
20	4.47

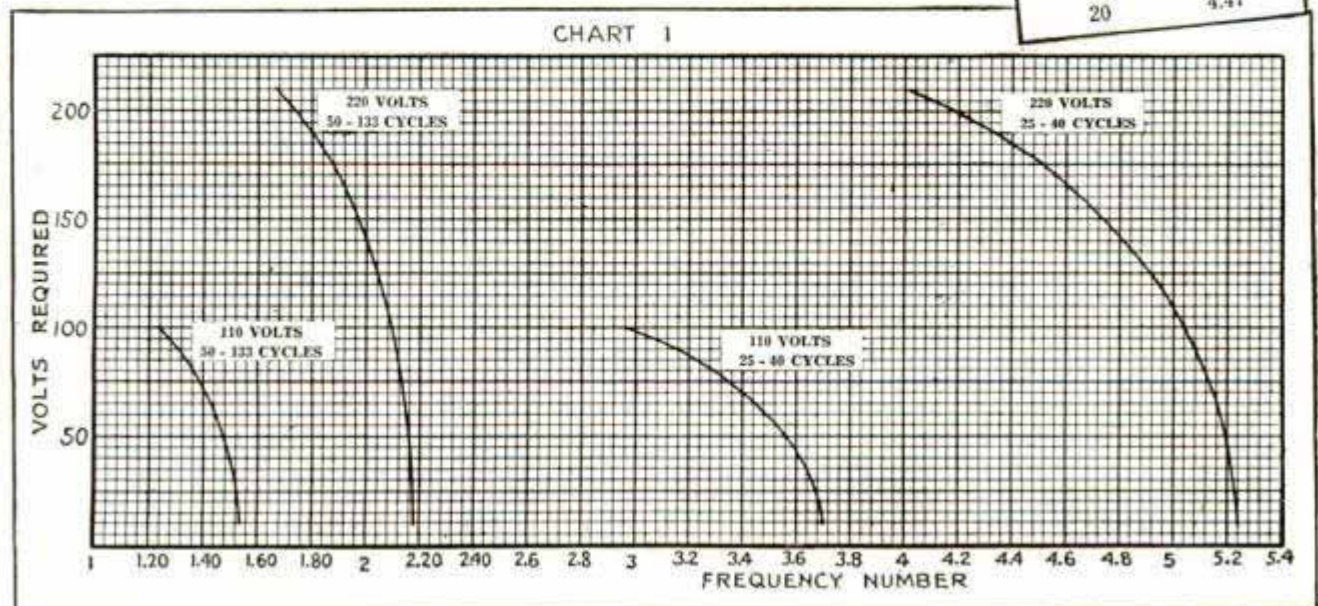

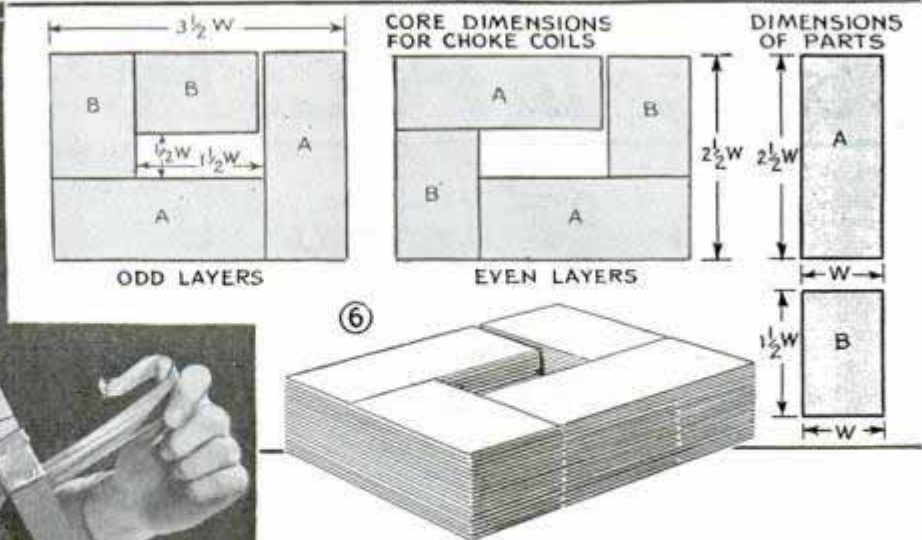
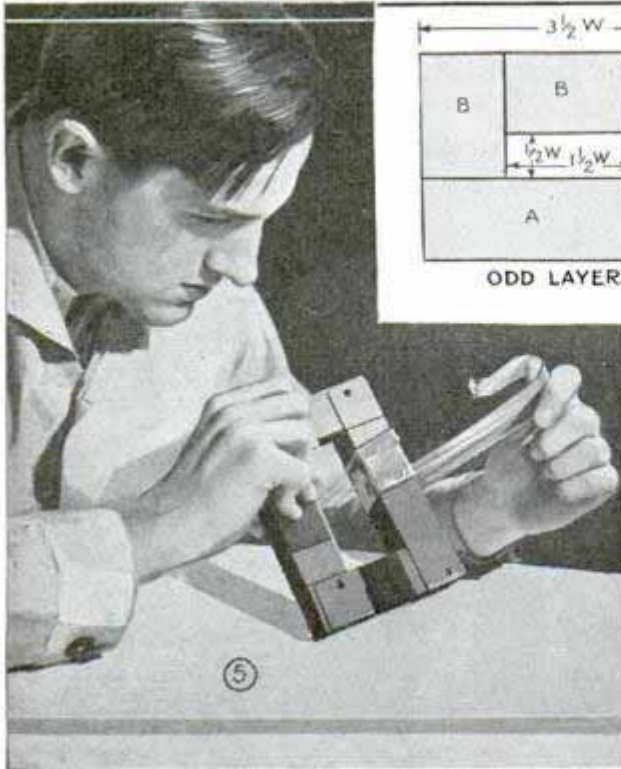

to 133 cycles), and read off the frequency number directly below on the bottom of the chart. In our example the frequency number is 1.48.

Step III: Next, from Table II we find the current factor for the current required. If the current required is not given in the table, use the next larger value. In our case, the current is 10 amps. and the current factor is found to be 3.16. The core area is then found by multiplying the frequency number by the current factor, or 1.48 times 3.16 which equals 4.68 sq. in., as the core area.

Step IV: Multiplying the core area by 555 and dividing this answer by the current will give the number of turns of wire required, or 4.68 times 555 gives 2,597. Dividing by 10 amp., we get 259.7 or 260 as the number of turns.

Step V: If the coil will be used continuously, the area of the wire in circular mils should be 1,000 times the amps. For intermittent use, a wire size in circular mils 750 times the amps. will be large enough. To find the gauge number corresponding to the calculated circular-mil area, refer to the first and second column of Table III. As our choke coil will

be used intermittently, the cross-sectional area of the wire required will be 750 times 10 or 7,500 circ. mils. According to Table III, this comes between No. 11 (8,234 circ. mils) and No. 12 (6,530 circ. mils). In such a case, one should always use the larger size, or No. 11 double-cotton-covered (d.c.c.) wire. In case a wire larger than that given in the table is required, use two or three smaller wires wound together. Thus, for 20,000 circ. mils use two No. 10 wires, which total 20,760 circ. mils.

B.&S. or A.W.G. No.	Circular Mils	Turns per Sq. In.			Lbs. of Copper per Cu. In.		
		Enamel Cov- ered	S.C.C. or D.S.C.	Double Cotton Covered	Enamel Cov- ered	S.C.C. or D.S.C.	Double Cotton Covered
10	10380	92.2	87.5	80	.241	.228	.209
11	8234	116	110	97.5	.241	.228	.202
12	6530	146	136	121	.241	.225	.199
13	5178	184	170	150	.241	.222	.196
14	4107	232	211	183	.241	.218	.189
15	3257	293	262	223	.241	.215	.183
16	2583	365	321	271	.238	.209	.177
17	2048	460	397	329	.238	.206	.170
18	1624	572	493	399	.234	.202	.164
19	1288	718	592	479	.231	.193	.154
20	1022	912	775	625	.234	.199	.161
21	810	1150	940	754	.234	.193	.154
22	642	1430	1150	910	.231	.186	.148
23	510	1780	1400	1080	.228	.180	.138
24	404	2240	1700	1260	.228	.173	.128
25	320	2820	2060	1510	.228	.167	.122
26	254	3560	2500	1750	.228	.161	.112
27	202	4420	3030	2020	.225	.154	.103
28	160	5580	3670	2310	.225	.148	.092
29	127	6900	4300	2700	.222	.138	.087
30	101	8700	5040	3020	.222	.128	.077
31	80	10700	5920		.215	.119	
32	63	13500	7060		.215	.112	
33	50	17000	8120		.215	.103	
34	40	21100	9600		.212	.096	
35	32	26300	10900		.209	.086	
36	25	32000	12200		.202	.077	

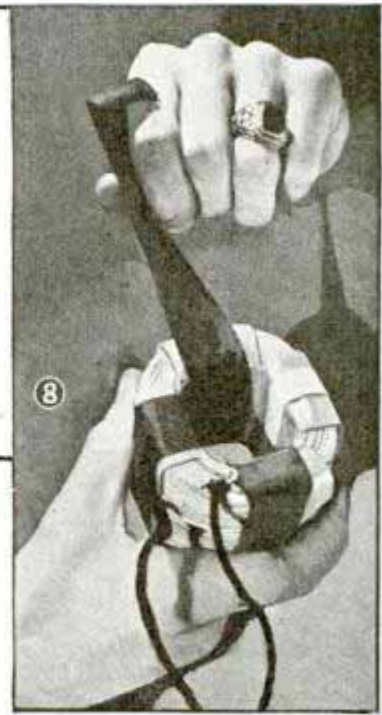
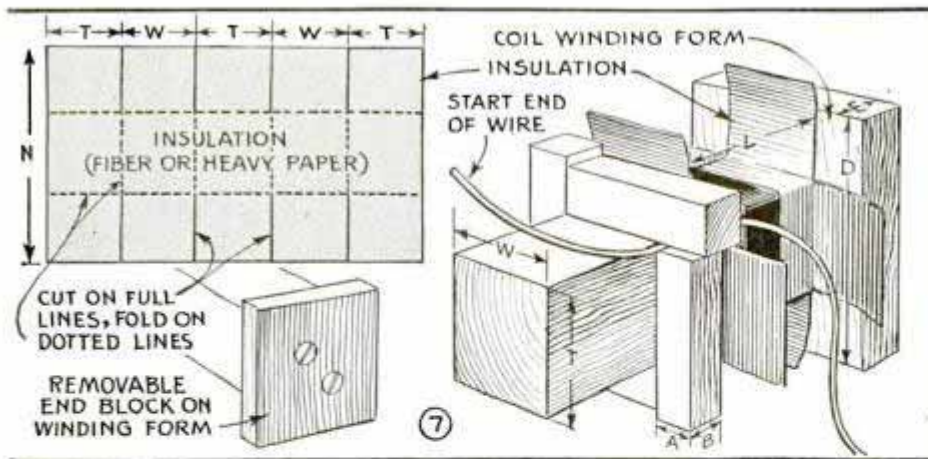

Step VI: To find the window area which is the open space enclosed by the silicon-steel core, multiply the number of turns of wire by 1.25, and divide the product by the number of turns per sq. in. as found in Table III. No. 11 d.c.c. wire winds 97.5 turns per sq. in. The window area, therefore, is 260 times 1.25 divided by 97.5, which equals 3.34 sq. in.

Step VII: The core size which should be used depends upon the window area required. To determine this size, refer to the third column of Table IV, and select the smallest window area which is larger than the value found above. From the corresponding line of the table, you will be able to read off the dimensions for the silicon steel core parts required. All dimensions are expressed in terms of the width of the core laminations, W , and the thickness of the core, T . In the example, this is 3.81 sq. in., which is designated as a size J core. The width of the laminations for this size core is $2\frac{1}{4}$ in.; also the "A" or long core pieces will be $5\frac{5}{8}$ in. long and the "B" or short pieces will be $3\frac{3}{8}$ in. long.

Step VIII: The thickness of the core is found by dividing the core area from Step III by the width W from Step VII, or 4.68 divided by 2.25 which equals 2.08 in. ($2\frac{3}{32}$ in.) which is T or the core thickness.

Cutting the Core: We now have all the design data necessary for building the choke. The laminations are cut from No. 28-ga. or thinner silicon steel to the dimensions found in Step VII. Cut enough pieces of each size to make two piles, each the thickness of the required core when compressed in a vise. No. 28-ga. steel will stack between 60 and 65 laminations per inch. Therefore, for our core, $2\frac{3}{32}$ or 2.08 in. thick, we need about 2 times 2.08 times 65 which equals 266 pieces of each size.

Winding the Coil: The coil is conveniently wound on a wooden form as shown in Figs. 4 and 7. Dimensions W and T are slightly greater than the corresponding di-

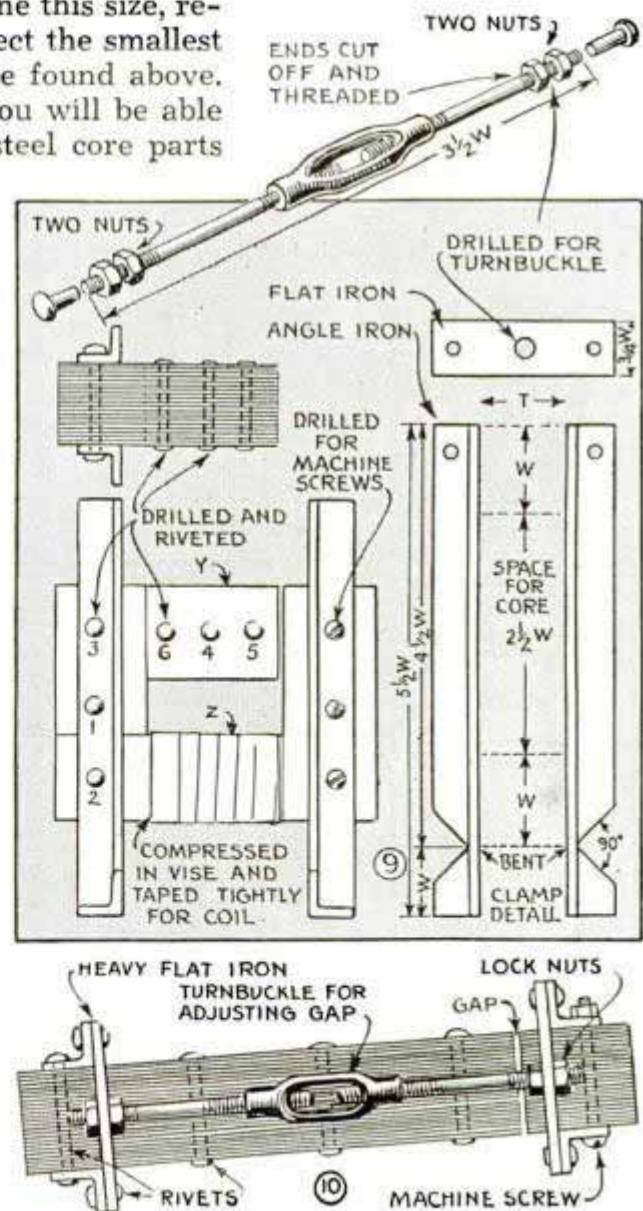

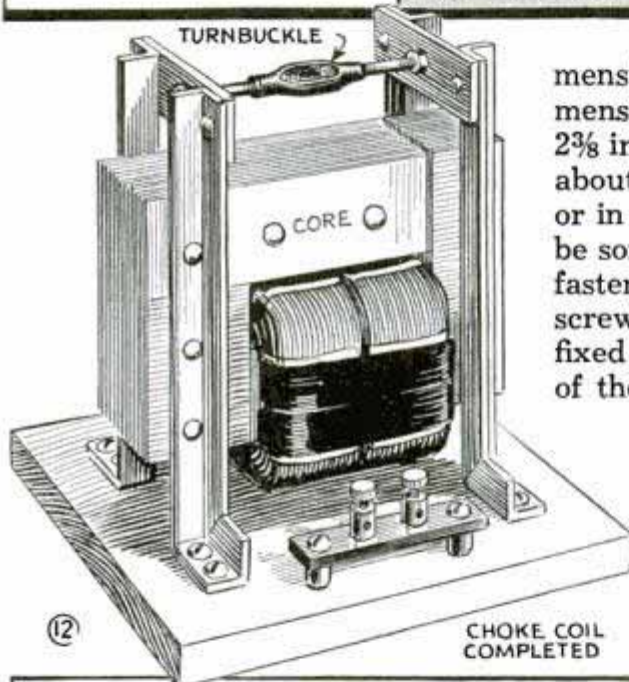
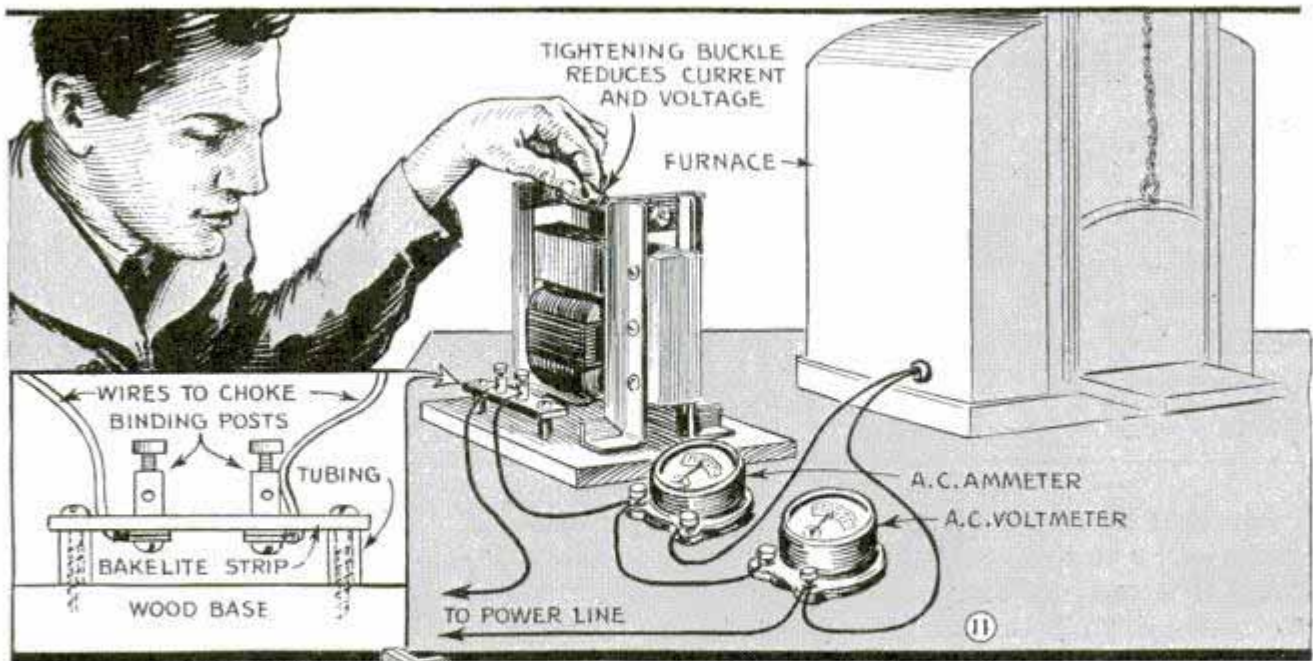

dimensions of the core. Allowing $\frac{1}{8}$ in. for each dimension, we will make the wood core $2\frac{1}{4}$ plus $\frac{1}{8}$ or $2\frac{3}{8}$ in. by $2\frac{3}{32}$ plus $\frac{1}{8}$ or $2\frac{7}{32}$ in. The form should be about 1 ft. long so that it can be held in the hand or in a lathe while winding. The end block should be somewhat larger than the completed coil, and is fastened to the end of the form with two wood screws. The distance between the removable and fixed blocks should be a little less than the length of the winding space. Since our winding space is $1\frac{1}{2}$ times $2\frac{1}{4}$ or $3\frac{3}{8}$ in. long, we will set the blocks $3\frac{3}{8}$ or $3\frac{1}{8}$ in. apart. Before starting to wind the coil, a sheet of heavy paper or cardboard is cut as shown in detail of Fig. 7 and laid in the winding space as shown. The coil should be wound very carefully in tight, even layers. Damaged insulation should be repaired at once with brown paper, or with oiled paper for fine wire. Paper is laid over each layer of winding, or if space is lacking for that, a layer of paper is used over every other or every third layer. The completed coil is wrapped with two layers of brown paper and cotton tape is tied around it. The end block is slipped off and the coil is removed from the form. Next the coil is permanently bound in four places only with bands of friction tape as shown in Fig. 8. Covering the whole coil with tape would cause overheating. The coil is soaked in shellac or air-drying insulating compound until saturated, and dried thoroughly in the air.

Core Assembly: The core assembly pattern shown in Fig. 6, is different from that used for transformers and must be fol-

TABLE IV
CORE DIMENSIONS

Size	Width of Laminations in Inches	Window Area in Sq. In.	Length of "A" Pieces in Inches	Length of "B" Pieces in Inches
A	1	.750	$2\frac{1}{2}$	$1\frac{1}{2}$
B	$1\frac{1}{8}$.95	$2\frac{3}{16}$	$1\frac{1}{16}$
C	$1\frac{1}{4}$	1.17	$3\frac{1}{8}$	$1\frac{7}{8}$
D	$1\frac{3}{8}$	1.42	$3\frac{7}{16}$	$2\frac{1}{16}$
E	$1\frac{1}{2}$	1.68	$3\frac{3}{4}$	$2\frac{1}{4}$
F	$1\frac{5}{8}$	1.98	$4\frac{1}{16}$	$2\frac{7}{16}$
G	$1\frac{3}{4}$	2.30	$4\frac{3}{8}$	$2\frac{5}{8}$
H	$1\frac{7}{8}$	2.64	$4\frac{11}{16}$	$2\frac{3}{16}$
I	2	3.00	5	3
J	$2\frac{1}{4}$	3.81	$5\frac{5}{8}$	$3\frac{3}{8}$
K	$2\frac{1}{2}$	4.68	$6\frac{1}{4}$	$3\frac{3}{4}$
L	$2\frac{3}{4}$	5.68	$6\frac{7}{8}$	$4\frac{1}{8}$
M	3	6.75	$7\frac{1}{2}$	$4\frac{1}{2}$
N	$3\frac{1}{2}$	9.18	$8\frac{3}{4}$	$5\frac{1}{4}$
O	4	12.00	10	6

lowed carefully. Note that there is an air gap at one point. After stacking the core, in a simple jig, Fig. 1, and taping the winding leg, Fig. 5, two pairs of clamps are cut from angle iron to the pattern shown in Fig. 9 and drilled as shown, the two parts of each clamp not being drilled alike.

The clamp is placed around the leg as shown in Fig. 9 and clamped tightly in position. Starting from the three holes in one part of the clamp (1, 2 and 3), drill completely through the core and the other clamp in the order indicated in Fig. 9. As each hole is completed, the core and clamps are riveted together. When this leg is finished, clamp the leg marked "Y" in Fig. 6 between two pieces of heavy metal and drill and rivet the laminations in three places. The leg marked "Z" is tightly taped and the laminations of the fourth leg are removed from the core. Then the coil is slipped over the taped leg and the laminations of the fourth leg are woven back in place exactly as they were originally. A piece of cardboard or similar material $\frac{1}{16}$ to $\frac{1}{8}$ in. thick is placed in the air gap and the remaining pair of clamps are put in position. This leg is drilled and fastened with machine screws.

Adjusting Device: The adjusting mechanism is shown clearly in Fig. 10. The ends of a $\frac{1}{4}$ -in. turnbuckle are cut off and threaded as shown in the detail. The turnbuckle is mounted between the clamps as shown in Figs. 10 and 12. The coil can be mounted on a wooden base as suggested in Fig. 12. If it is to be permanently mounted in a circuit, the leads from the coil can be connected to the desired apparatus. If not, the leads are connected to binding posts mounted on a short length of Bakelite.

Adjustment: To adjust the coil to produce the proper current and voltage for the particular apparatus, remove the cardboard from the air gap and connect the coil in the circuit as shown in Fig. 11. Then the turnbuckle is tightened until the required current flows, as indicated by an ammeter, Fig. 11, or until the apparatus operates satisfactorily.

Dispenser for Blueprint Paper Is Equipped with Cutter

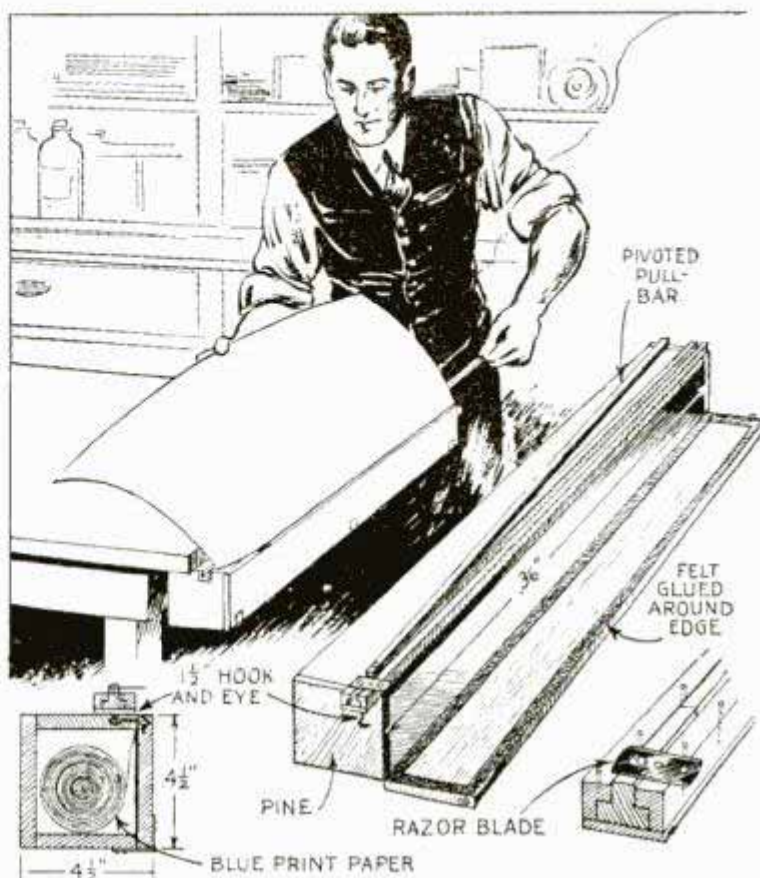

This dispenser handles sensitized paper with practically no waste from exposure to light

Here is a dispenser for handling blueprint and other sensitized paper that speeds cutting to length and at the same time prevents the paper from being exposed to light. It consists of a rectangular box $4\frac{1}{2}$ by 36 in. inside dimensions, with a hinged side, and a felt gasket, which keeps light out and permits the paper to be drawn through smoothly. Fastened to the top of the box is a razor blade which cuts the paper quickly and evenly. Only a small strip about $\frac{1}{2}$ in. wide is left exposed to the light. The box may be nailed up out of $\frac{1}{2}$ by $4\frac{1}{2}$ -in. pine and the guide for the cutter out of two small strips rabbeted on the edge and nailed to a piece of $\frac{1}{4}$ -in. plywood. The whole assembly can be fastened to the underside of a table and the paper may be drawn out over the top and cut to size with a minimum of waste. By changing the dimensions, the design easily may be made for any size roll. The same type of dispenser is also useful in handling tracing and drawing paper.

—J. M. Elliott, Rome, Ga.

Drill Rack Used by Two Workmen Swings Between Them

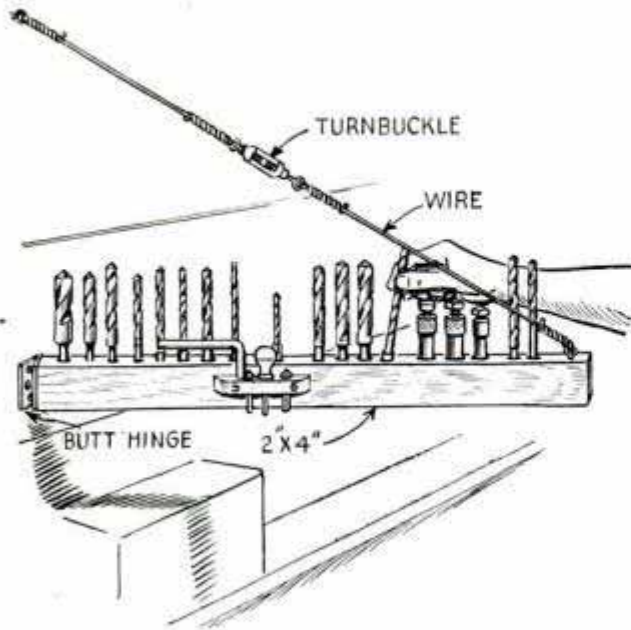

In tight places, several racks can be mounted above each other by eliminating the brace wires

Mounted on a wall by means of a butt hinge and a diagonal wire brace to the outer end, a length of 2 by 4-in. stock with holes spaced along one edge throughout its length, provides a convenient holder for twist drills and similar tools in places where one set serves two machines or benches. The rack is swung around like a door, to the desired position. Several such holders can be mounted one above the other, to be swung out one at a time, where space is at a premium. If more than one rack is installed, it's best to use hinges strong enough to support the assembly without need of brace wires.

Bottle Converted into Funnel



of course, not to break the glass. Such a funnel is especially handy where a metal

An old bottle can be converted into a combination scoop and funnel by cutting off the bottom to the angle indicated in the drawing. The edges should be smoothed down with a fine file or on a grinding wheel, taking care,

scoop or funnel is not desirable. You can scoop up material with it, using the bottle neck as a handle, and then turn it over to let the contents run into a small-mouthed container.

Pocket Depth or Shoulder Gauges

Old hack-saw blades can be converted into a pocket depth gauge that will have many uses. Grind the teeth off the edge of the blades and then grind shoulders on the ends, varying the depths of them as desired. Usually a variation of $\frac{1}{8}$

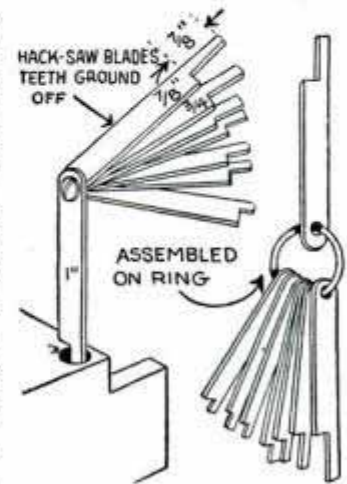

in. will be about right. The blades can be assembled on a ring or, if preferred, they can be assembled with a friction screw as shown.—Chas. H. Willey, Penacook, N. H.

Ventilator for Poultry Houses

Vents in a wall of a poultry house to let air escape slowly in winter or summer, even when the doors are closed, are made by punching a piece of sheet metal as in-

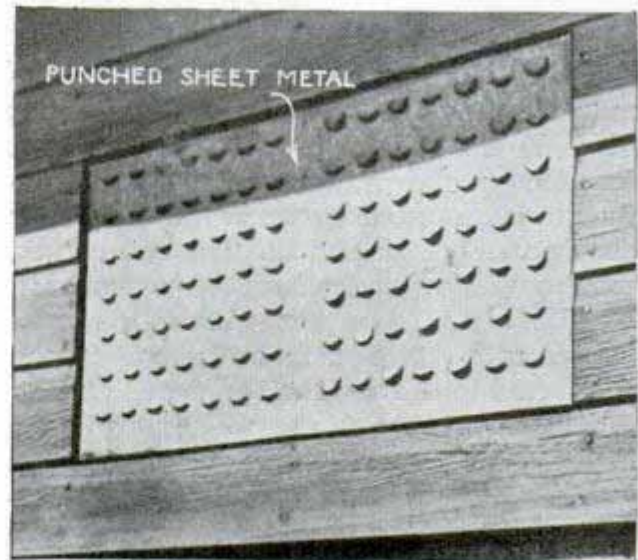

Punched sheet metal nailed over opening of poultry house provides good ventilator

indicated in the photo. Sharpen the end of a piece of pipe at an angle and use it as a punch to perforate the sheet metal, which is laid on the end grain of a wood block.

Rep. 222 # 72 Walker Plainfield, N.J.

How to Build a Small GEM-CUTTING BENCH

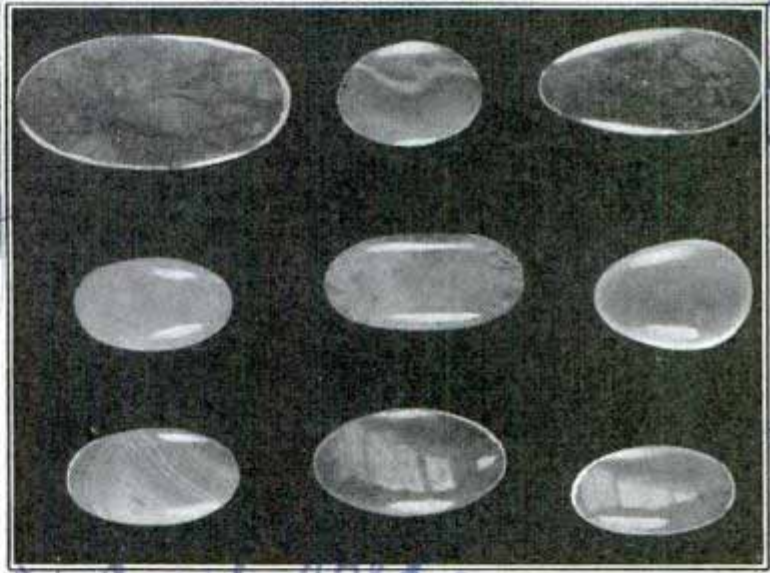
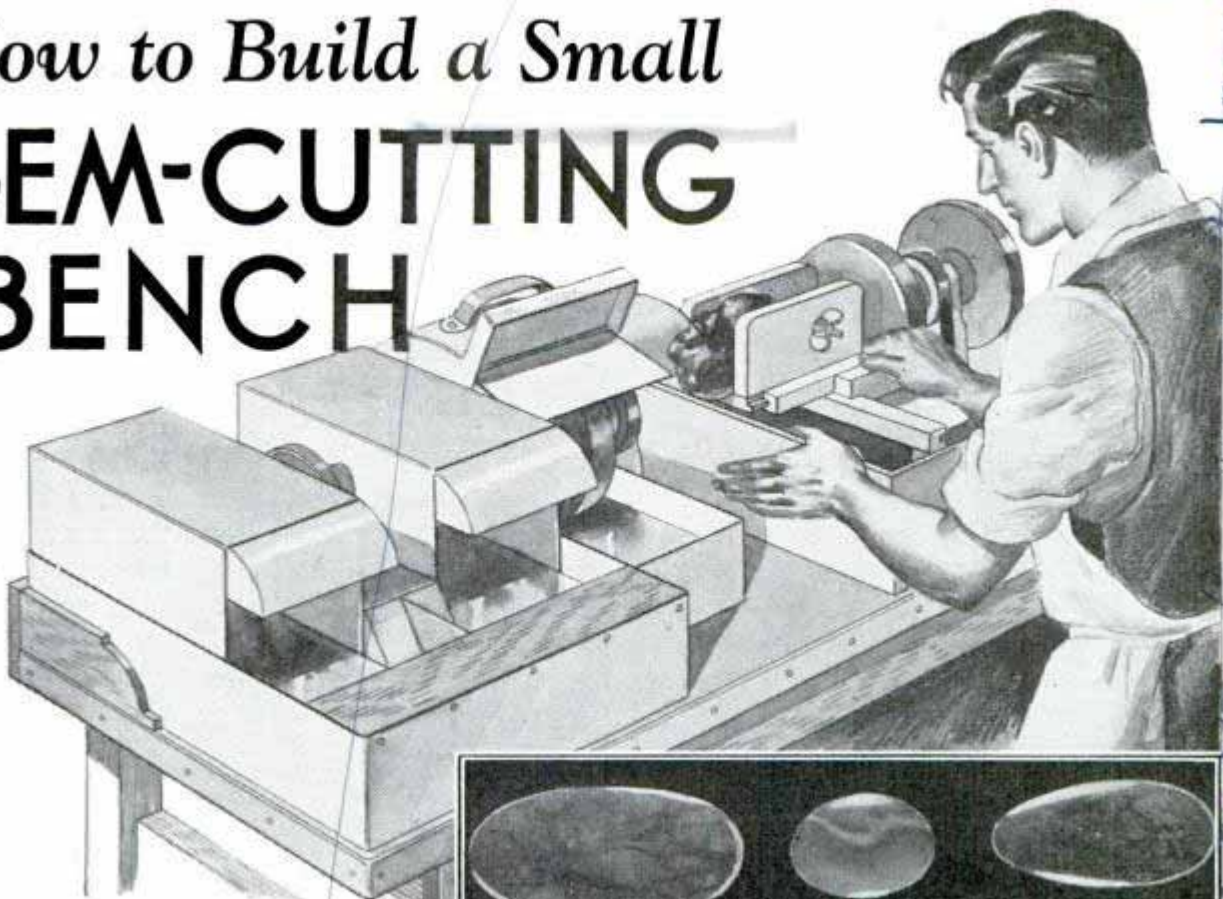

By **FRED S. YOUNG**
c/o The Mineralogist

SPARKLING gems can be cut and polished from rough gem stones with this outfit, a complete cutting, grinding and polishing machine mounted on one bench and driven by a single motor. Except for the mechanical units, the motor and grinding heads, you can easily make the whole thing yourself. Rough materials suitable for working into beautiful and often valuable gems are widely distributed and comparatively easy to find. The lower illustration on this page gives you a good idea of the appearance and general contour of the finished gems. These are of the cabochon style, which means that they are convex and highly polished, but not faceted. Although it is possible to purchase the rough, unworked stones from supply houses at a very nominal outlay, prospecting afield for the raw material is not only recreational, but also a part of the whole fascinating hobby of gem cutting.

The bench: The work of building up the equipment begins with the bench detailed in Fig. 2. While the dimensions are not critical they have been worked out to suit

a well-known make of small bench grinding head, three of which are used as you see in Fig. 5. If you use grinding heads with somewhat different base sizes, it is well to check up on the bench dimensions before you cut stock. Hardwood is best to use throughout in the construction of the bench and you should take pains to get sound, tight-fitting joints so that you finish up with a rigid structure. It's well to be rather particular about the top also. Join a number of narrow strips of 1¼-in. stock edge to edge with dowels and glue to make sure that it does not warp. As the top is covered with galvanized sheet iron, clear white pine will do very well. Paint or varnish all the wood parts.

After you have the bench completed,

Worcester Mass. Abrasive Norton Co. Carbonium Co. Plainfield, N.J. Robert J. Abraham. Davis Creek, Calif.

Smiths Agate Shop, Portland, Ore.

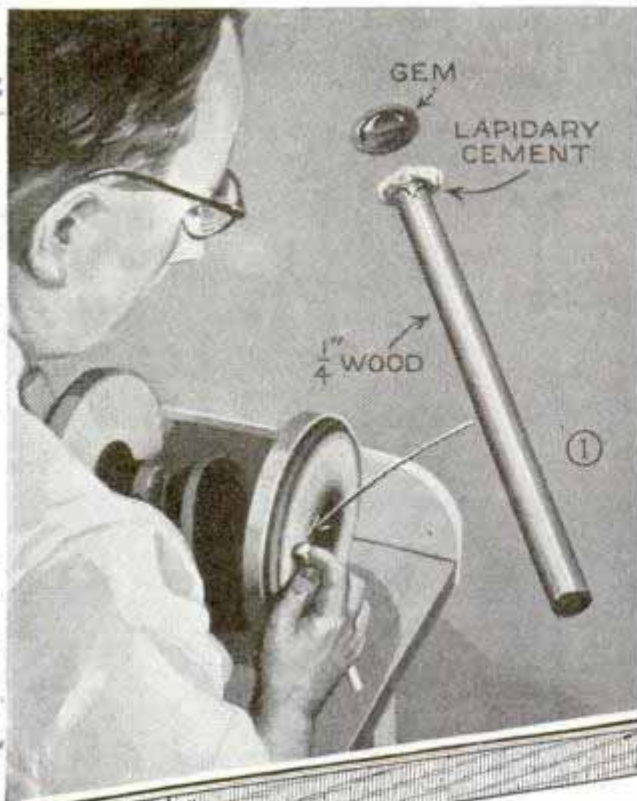

slightly to adapt the fittings to the heads you intend to use. Notice in Fig. 5 that there are three guards or hoods. The principal purpose of two of these is to catch the water and oil thrown off the grinding wheels and saw, and return them to the pans. Note especially the variation in construction of the hood in the upper left and upper right details in Fig. 5. The first consists of two hoods (only one of which is shown) and two pans for water. The second comprises a single hood and the saw carriage detailed in Fig. 4. The oil reservoir in the latter is small, only 2 in. deep and 8 in. long as shown back of the cut-away portion, Fig. 5. The bottom is a separate piece of sheet metal soldered on

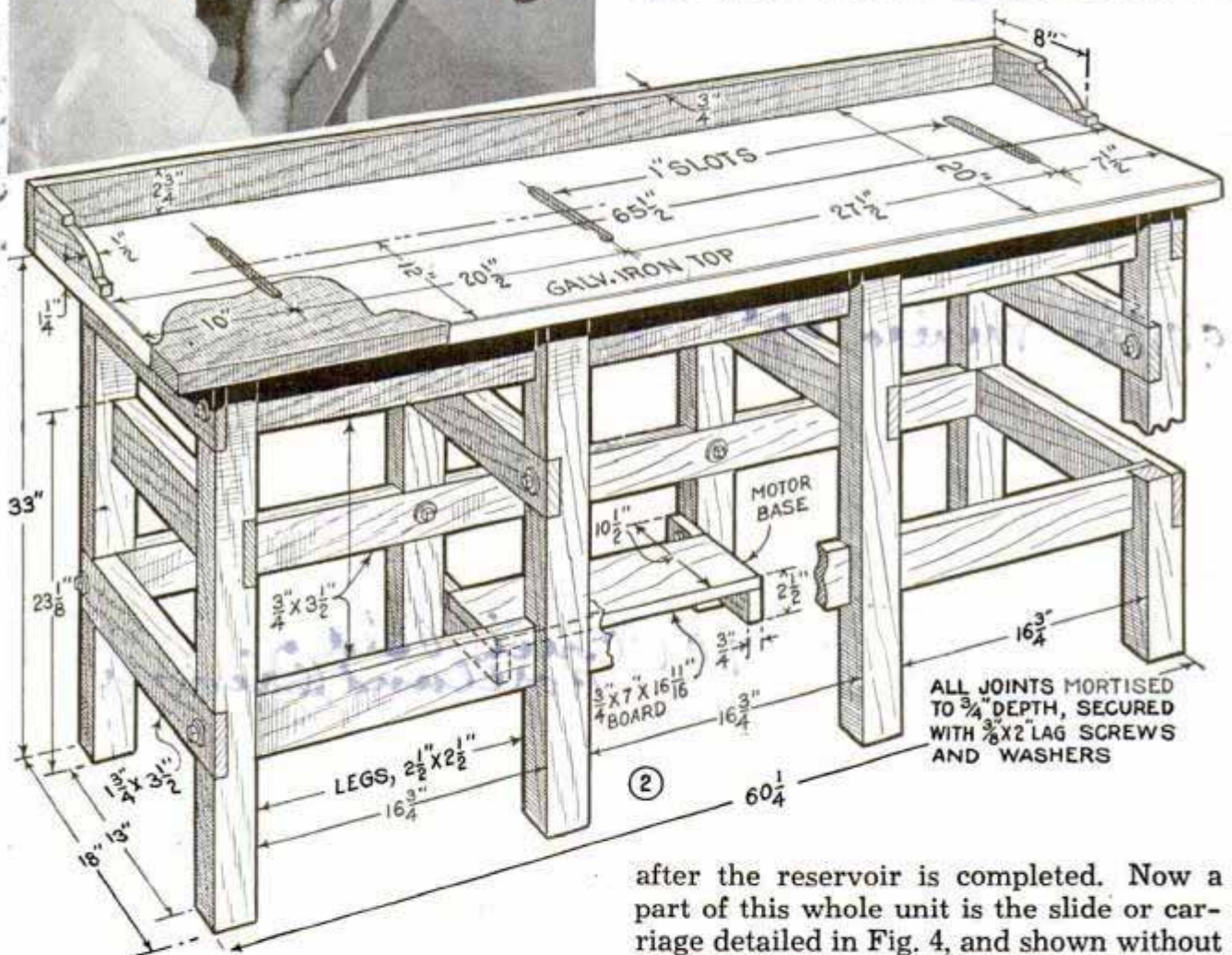

the two really important details are the diamond-saw carriage shown in Figs. 3 and 4, and the water and oil pans and wheel guards in Fig. 5. The latter are made of galvanized sheet iron. A tinsmith can help you out when making these, or if you have good soldering equipment you can make them yourself. Again the dimensions given may have to be changed

after the reservoir is completed. Now a part of this whole unit is the slide or carriage detailed in Fig. 4, and shown without the hood in Fig. 3. The work is held in a clamp or vise and is fed to the saw by means of a spring with an adjustable tension device. Carefully made of hardwood, this arrangement works very nicely. The diameters of pulleys on both the countershaft and the heads are given in Fig. 5. Driven by a 1,750 r.p.m. motor these pulleys give the correct spindle speeds for this work. If the pulleys on the heads you are

William H. Dyer, Inc. 32 E. Kinross

to use differ from those given you can easily get the correct speeds by varying pulley diameters on the countershaft. Use four ball-bearing pillow blocks on the countershaft as shown in Fig. 8.

Sawing: Small-sized fragments of gem stone can be shaped directly on the grinding wheels, but more often larger specimens must be reduced to proper size by the diamond-charged saw. The latter is simply a metal disk, made of No. 20-ga. steel. Small notches are cut in the edge of the saw with a cold chisel as in the upper detail in Fig. 7, and crushed diamond bort mixed with a small amount of vaseline is applied to the notches. By hammering lightly and rolling with a case-hardened steel roller as in the lower detail, Fig. 7, the notches are closed, thus embedding the diamond fragments in the metal and giving each side of the blade a "set." About 1 carat of diamond bort (value about \$2.00) will charge an 8-in. saw. A properly charged saw will section a great many pieces of very hard gem materials before recharging. It must be remembered

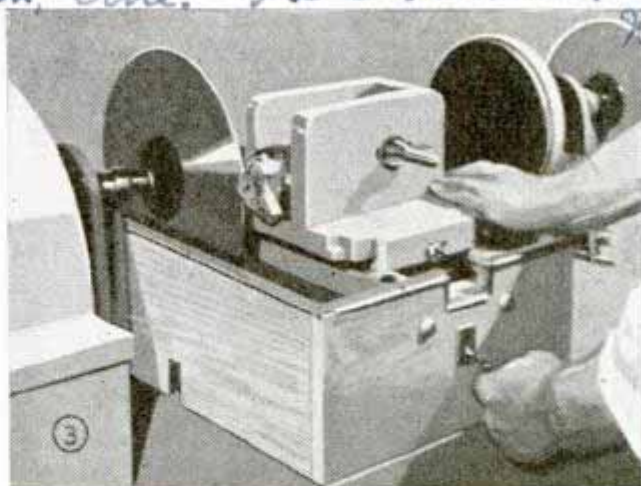

Marking

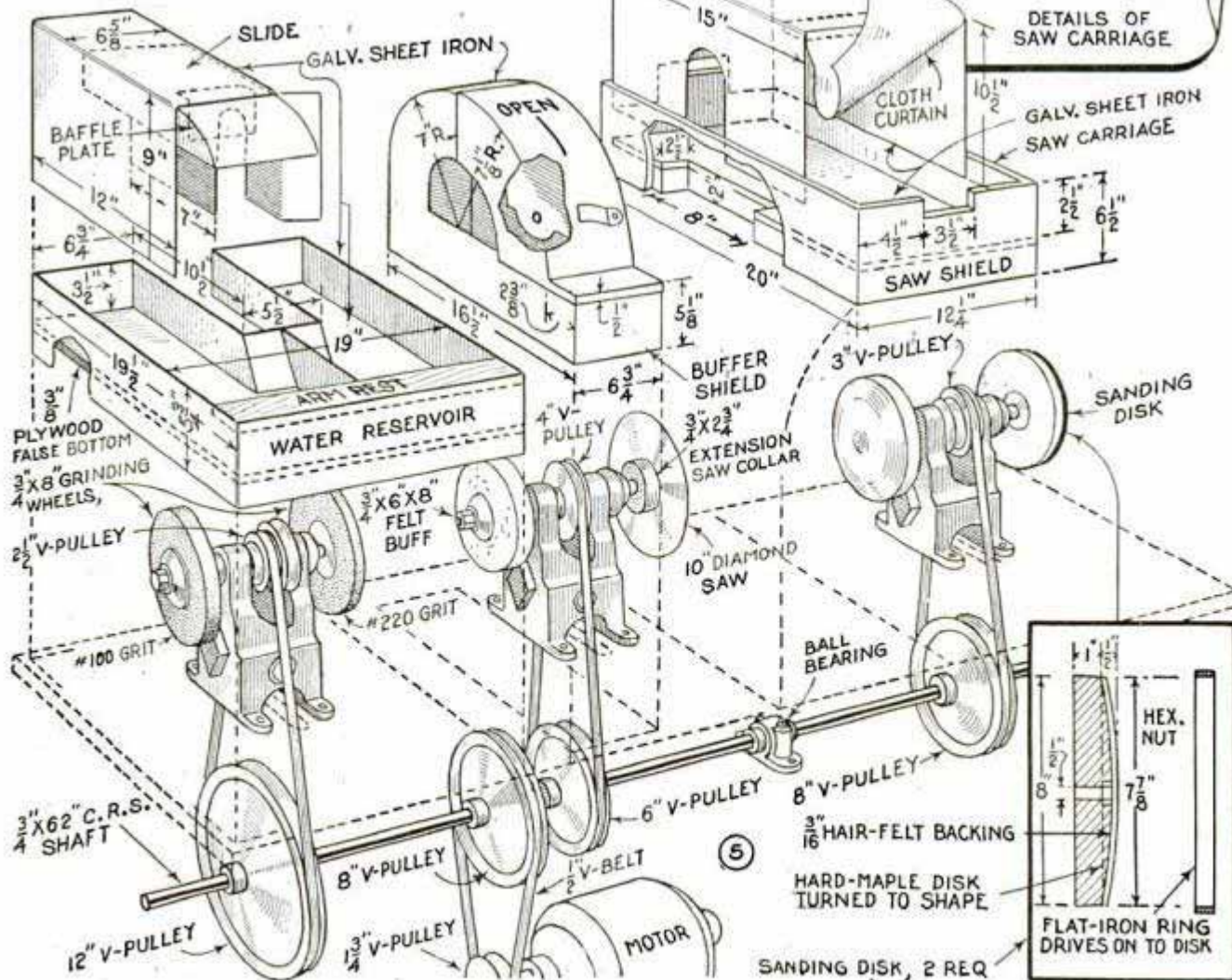
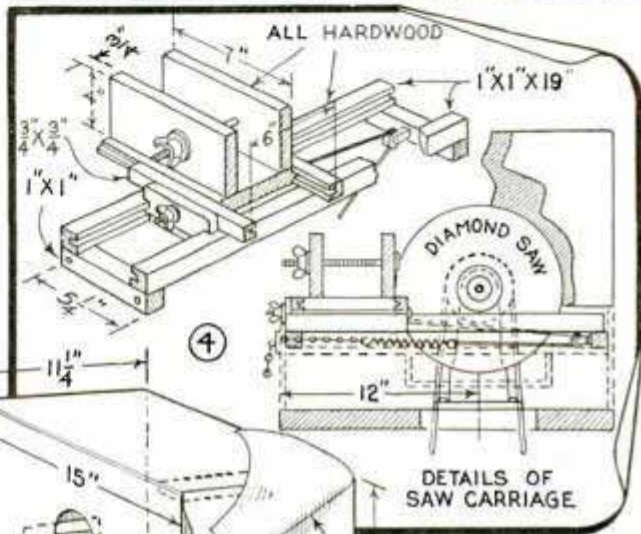

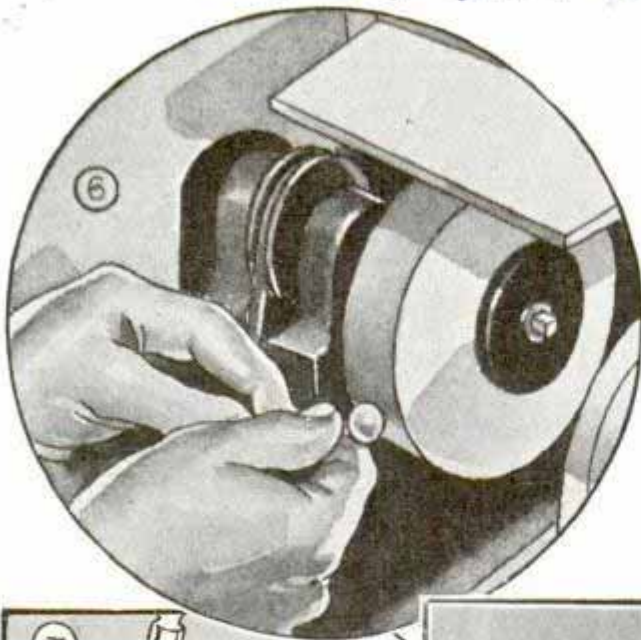

With the fingers, work the cement around the sides, leaving the upper portion of the stone exposed.

Grinding: Silicon-carbide wheels are used to cut and shape the cabochon gem to proper size. A very large stone can be held and worked against the wheels by hand, but the ordinary sizes should be dopped as described above. Two grinding wheels are mounted on the bench grinder head as shown at the left in Fig. 5. The wheels should be No. 100 or No. 120 and No. 220 grit respectively. The "J" or "K" bonded wheels are suitable for gem cutting. After the gem stone has been properly shaped to size and all excess or in-

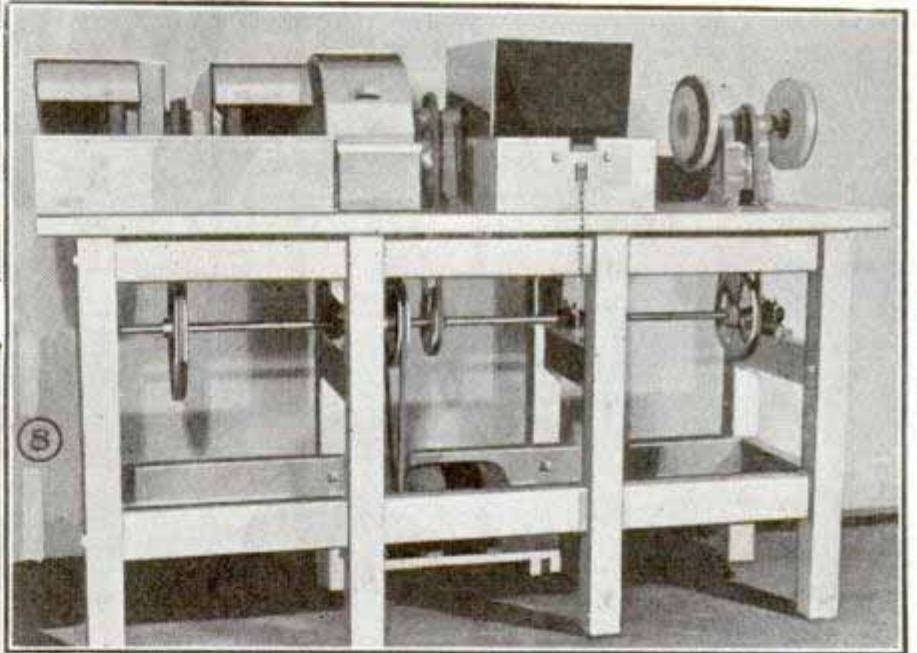
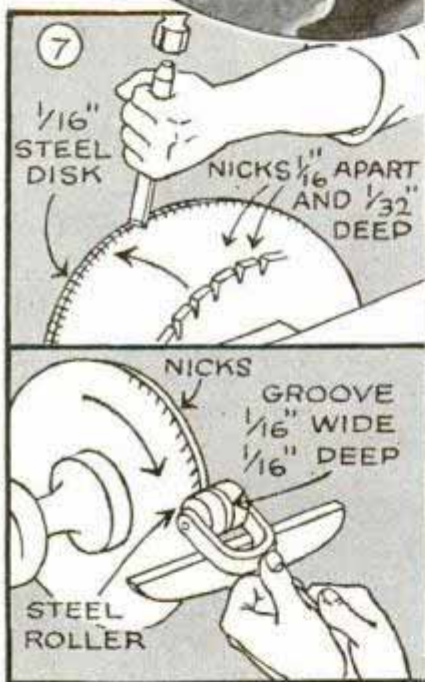

that semi-precious gem minerals like agate are harder than the best tool steel, and can be cut satisfactorily only with the diamond saw. In operation the 8-in. diamond saw is run at approximately 600 r.p.m., and is kept lubricated by running with the edge in a mixture of equal parts kerosene and crankcase oil.

"Dopping" the Gem: After the material has been cut roughly to shape it will be advisable to cement—"dop"—the stone to a short length of dowel to facilitate handling, Figs. 1 and 6. Special lapidary cement is used for this purpose. This is usually a mixture of sealing wax, 3 parts, and flake shellac, 1 part. To dop the gem, first warm the stone until quite warm to touch. Apply a small amount of cement to the dowel, melt, and press the gem into it.

ferior material ground away, it is then "sanded" to remove all deep scratches left by grinding wheels.

Sanding: The sanding wheel is a wooden disk, crowned on one face as in the lower-right detail in Fig. 5. Two disks are required. The working face of each is covered with silicon-carbide cloth of No. 220 grit, held in place with a metal band or ring as shown. The deep scratches are removed from the gem stone by holding against the abrasive cloth. This operation is run dry and the disks need not be shielded. The work should be moved about to avoid undue heating and to reach all parts of the gem.

Polishing: The final high glossy polish is given to a gem stone (cabochon style) by the use of a hard-felt buff. Tripoli, tin

oxide, and various other commercial polishing agents are used. The polishing powder is mixed with water and applied to the buff with a small stiff brush. The buff is operated at the same speed as the saw and is therefore attached to the same arbor. No attempt should be made at polishing until all deep scratches are first removed on the sander. Polishing will not prove a long, tedious operation if the stone is properly prepared.

Extra Welding Rods at Hand

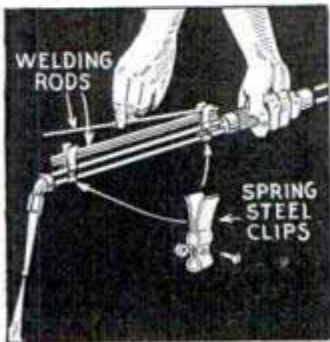

When welding tanks and when working on a scaffold or ladder, one welder finds it convenient to carry a supply of welding rods right on the torch. These are held between a couple of spring-steel clips which are attached to the shank of the torch by means of stove bolts.

Auto Rim Supports End of Gate to Prevent Sagging

Heavy, wooden field gates sag on their hinges so that it is difficult to fasten them with the hooks or latches installed when the gate was erected. If half of an auto-wheel rim is set in the ground at the foot of the latch post, the free end of the gate will be supported permanently when closed so that sagging will be avoided.



HALF OF OLD AUTO RIM
Weight at free end of gate supported on wheel rim when closed

Books Held at Angle in Window by Simple Wire Stands

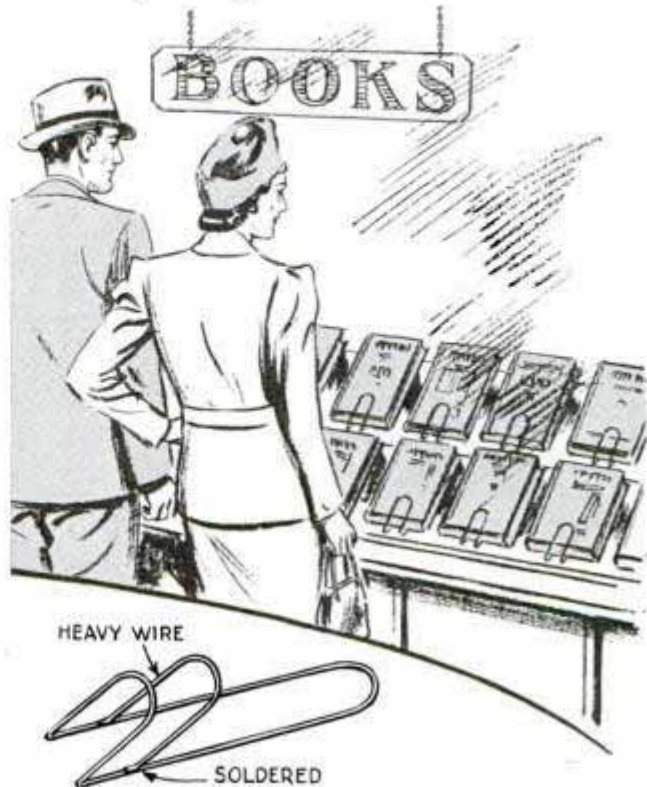

Books supported neatly at angle in show window so that titles can be seen clearly

When books are placed in a show window, they are usually laid flat which makes it difficult to read the titles. The wire supports shown will hold the books at the right angle so that people passing by will be able to read the titles easily. Each support is bent from heavy wire as indicated in the lower detail.

Wire Ring Holds Bucket on Arm While Feeding Poultry

To support a feed pail conveniently with one hand when scattering grain for poultry, attach a wire ring to the bail as indicated. By slipping the arm through the ring the pail may

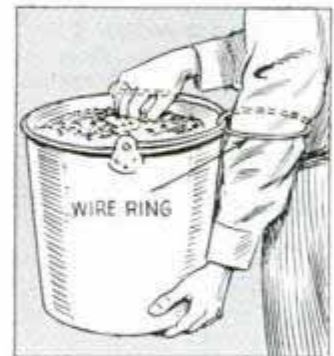

be supported with one hand while the other one is free to do the scattering.

Small rubber bands slipped over each end of a ruler will prevent it from slipping when ruling lines or cutting glass.

HELPS *for the* AUTO MECHANIC

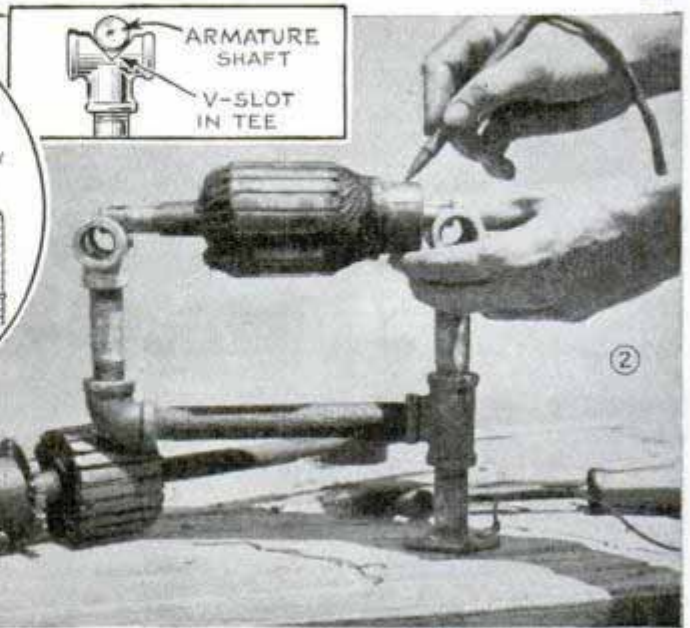
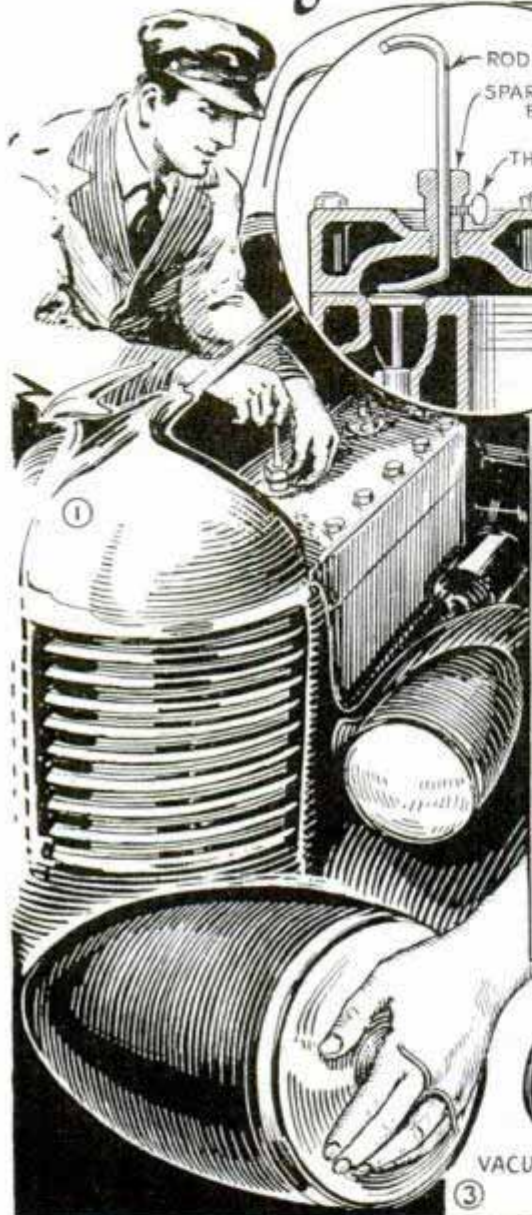

By using the tool in 1 to hold down a valve, you can replace a broken spring in a few minutes without removing the cylinder head. A spark-plug base babbitted to take a rod and tapped for a thumbscrew is all you need. The rod is bent as indicated, and is flattened at the lower end. Assembled from pipe and supported by a single floor flange on the bench, the armature rack shown in 2 allows free access to all parts of the armature, and it swivels to any convenient angle. It can be unscrewed from the bench and removed when not needed

When you remove a headlight lens, there's slight possibility of dropping it accidentally if you apply a vacuum-cup grip as in 3. 4 shows a rubber tube slipped over a screwdriver shank, when working on an electrical system, to prevent those unexpected "shorts" which are hard on the nerves and drain the battery

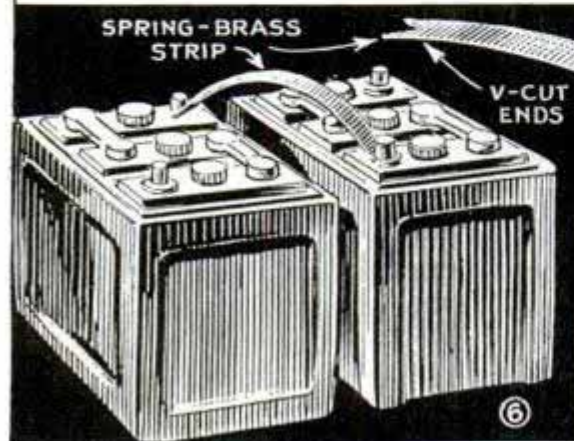
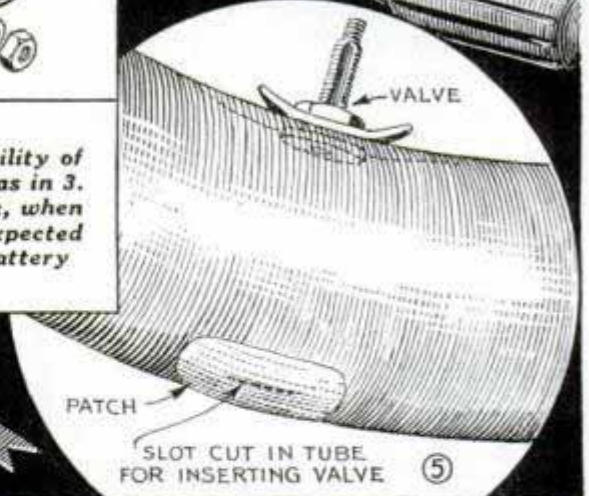
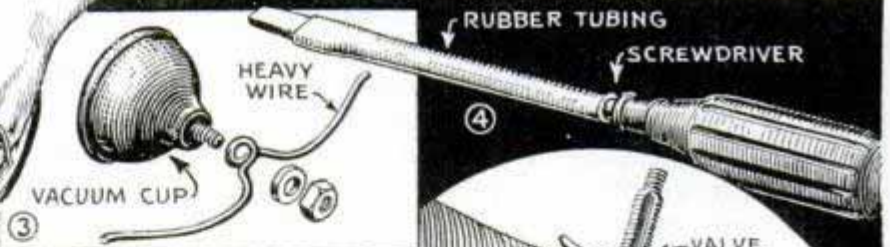

One of the simplest methods of replacing a damaged valve stem is to slit the tube opposite the valve as in 5, so that it can be pulled out. A patch repairs the slit. Spring-brass strips with V-notches cut in the ends, 6, are handy to connect batteries when charging them. Rocking the strips, after placing the ends against the battery posts, assures good electrical contact

Clean Crankcase Ventilator Often

Regardless of the type of air cleaner or crankcase ventilator on your car, the need for a periodic cleaning of both cannot be overemphasized. The length of time between the cleaning periods depends upon the type of roads where the car is used. A dust-fouled filter element cuts down the free flow of air, and the lessened volume of air that does go through travels with increased velocity, which has a tendency to break off chunks of the caked dust around the filter openings, eventually carrying this abrasive dust inside the motor.

How Fleet Operator Saves Gas

Finding that the new type gasoline accelerator pedals were costing him money by wasting gasoline, the operator of a fleet of light cars screwed wooden blocks to the floor boards at the right of the pedals, to steady the drivers' feet. As all modern carburetors have accelerator pumps, which force fuel into the manifold every time the

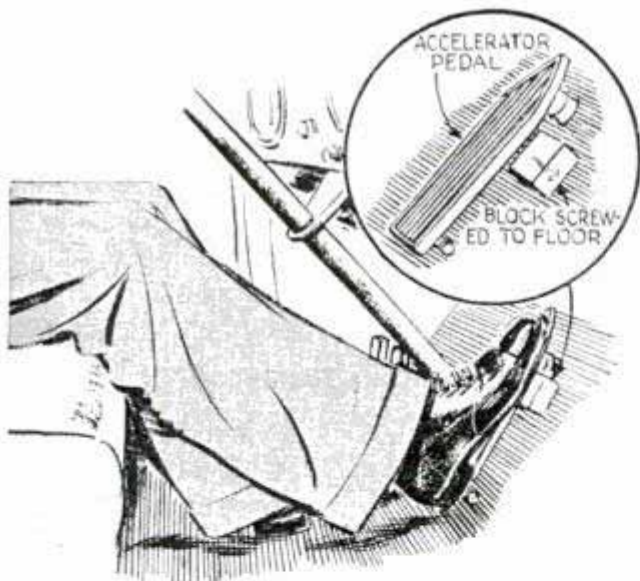

Wood footrest permits driver to control operation of accelerator without over-feeding motor

throttle is moved, this steadier control of the latter increased mileage up to three miles to the gallon. By fitting the wooden block at a height level with the pedal when the speed is about 20 m.p.h., it is easy to get any speed by merely rocking the foot, thus avoiding jerky driving.

☐ When reassembling ball or roller bearings of the cageless type, and no thick grease is available, soft soap can be used.

Inexpensive Hoist for Tow Truck Assembled from Car Frames

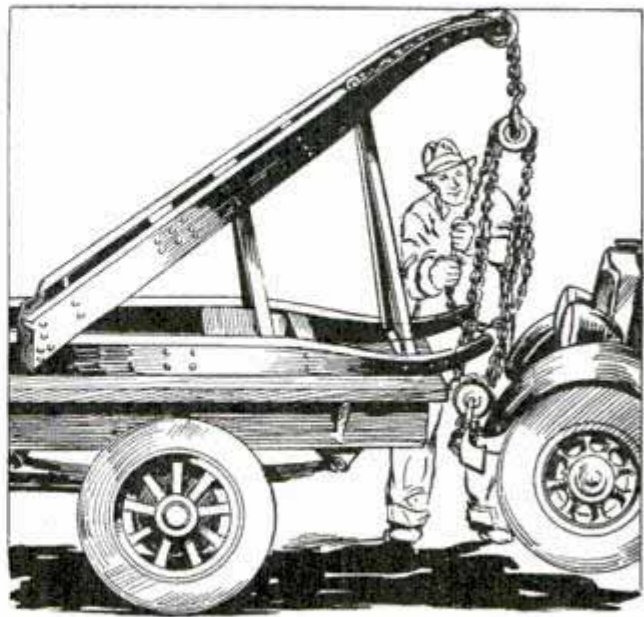

Strong enough to lift one end of a car, this hoist is moved about easily by one man

Serving a number of purposes around a garage or wrecking yard, this hoist is assembled inexpensively from old auto frames bolted and welded together. It can be pulled around in a garage or wrecking yard by one man, and it is light enough to be lifted onto a tow truck easily for hoisting the end of a car.

Jos. C. Coyle, Tucson, Ariz.

Portable Sidewalk Sign of Pipe and Auto-Spring Leaves

A filling-station proprietor, having need of several portable signs to advertise his products, constructed them from lengths of pipe and auto-spring leaves.

Each support consisted of a 1/2-in. iron rod bent at right angles to rest in a notch cut in the upper end of the pipe and extending down through the spring leaves to receive a lock nut on the threaded end, thus holding the assembled parts firmly together. The sign itself is a piece of sheet iron which is given a coat of blackboard paint so that the wording may be lettered in chalk.

—G. E. Hendrickson, Argyle, Wis.

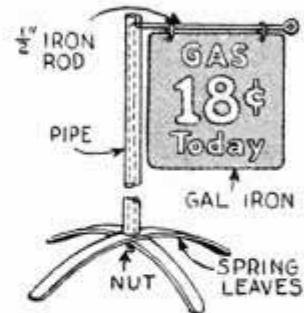

"Bench" to Repair Inner Tubes from Tin Pail

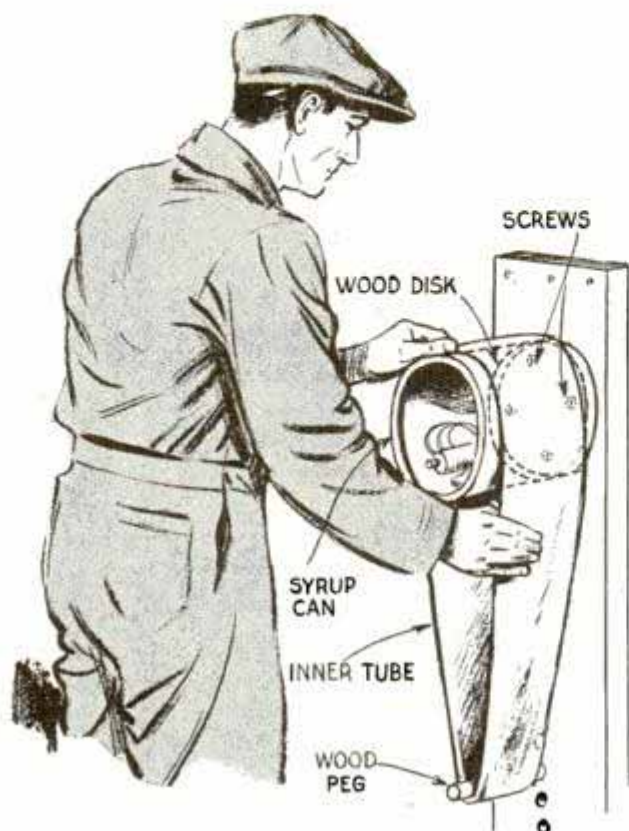

Tin syrup pail attached to garage bench, post or wall for repairing inner tubes

A handy bracket or bench to support inner tubes while repairing them in the home garage is provided by nailing a tin syrup pail to a stud or post in the garage. It's a good idea to insert a wooden disk in the bottom of the pail and drive the screws through the wood. This will keep the heads of the screws from pulling through the pail bottom. Repair cement, roller and other incidentals may be kept inside of the pail. Stretching the tube to hold it more securely may be done by placing one foot in the lower loop, or using a wood peg which fits any one of several holes drilled in the upright.

Fitting Oversize Piston Pins

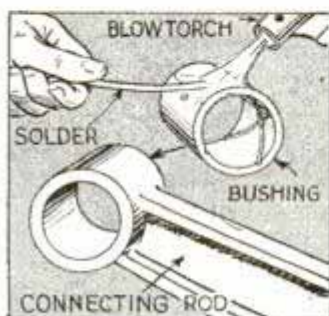

On jobs of fitting connecting rods with oversize piston pins, where one or two of the pins fit too loosely in the bushings, I eliminate the trouble as follows:

Press the bushing out of the rod and clean the outside surface with fine emery cloth. Then take a small torch and acid-core solder and tin the outer surface of the bushing. Put it back in the rod, being careful to have the oil hole in the right position. This will shrink a bushing from .001 to .002 in. which is usually sufficient.

—T. E. Bordner, Willard, Ohio.

Horn Button on Gear-Shift Lever to Avoid Short Circuits

After the horn wires of my car had short-circuited several times at the lower end of the steering column, where accumulations of grease had damaged the insulation, I moved them to the gear-shifting lever. A push button was taped



to the lever near the upper end, after which the wires were run down along the lever and through the floor. Fiber or rubber insulating sleeves should be used at this point to avoid chafing the insulation.

—Burnard Sanders, Shelbyville, Tenn.

Battery Hydrometer Kept in Hose Is Protected Against Breakage

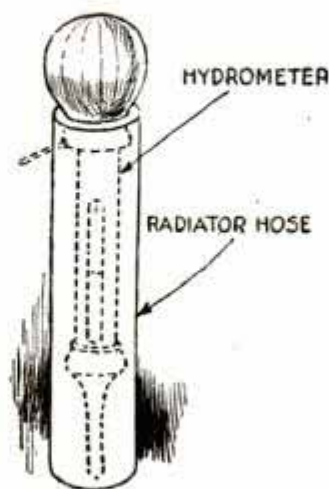

Nailed to the wall of your garage in a convenient place, a length of radiator hose provides a safe place to store a hydrometer. The hose should be large enough to take the glass tube of the hydrometer freely, but not large enough to let

the rubber bulb drop through. Besides protecting the hydrometer from breakage, the hose also protects the wall and saves your clothes from drops of battery acid.

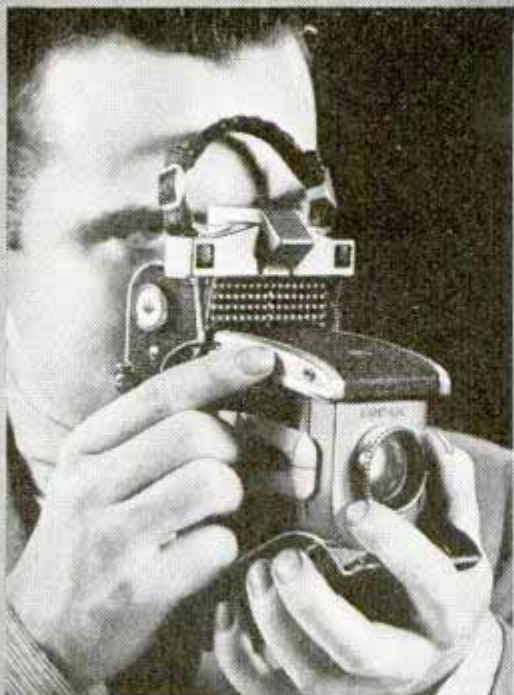

The photoelectric cell, mounted behind multiple collective lenses, automatically preselects proper aperture for the picture.

Presenting SUPER KODAK SIX-20

The camera with the "electric eye"



One lever sets the shutter, actuates the window cover, advances the film.

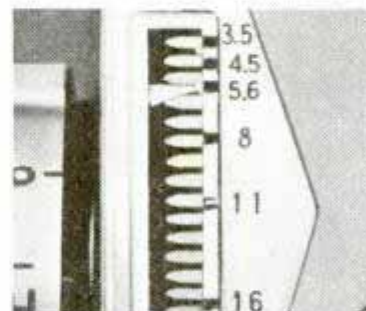

This automatic scale shows the aperture at which the exposure will be made.

● Built-in photoelectric cell measures light and sets camera at correct "stop" for any hand-held shutter speed. Built-in range finder. Double-exposure prevention device. Shutter

set by film-winding lever. Has Kodak Anastigmat Special $f.3.5$ lens, 1/200 shutter, fine-camera equipment throughout. Pictures, $2\frac{1}{4} \times 3\frac{1}{4}$ inches. Price . . . **\$225**

KODAK BANTAM FAMILY

● A "miniature" to suit every purse. The special $f.4.5$ and $f.5.6$ models take Kodachrome as well as black-and-white.

Kodak Bantam Special has extra-fast, super-corrected lens, Kodak Anastigmat EKTAR $f.2.0$, 1/500-second Compur-Rapid shutter. Built-in coupled range finder, split-field military type. Film-centering device. New low price includes field case.

KODAK BANTAM SPECIAL, \$87.50

NEW KODAK BANTAM ($f.4.5$)

(right) Kodak Anastigmat Special $f.4.5$ lens. 1/200-second shutter. Plunger-type body shutter release helps minimize camera movement. Folding optical eye-level finder. Automatic film-centering mechanism. \$27.50.

NEW KODAK BANTAM ($f.5.6$)

(not illustrated) Palm size. Kodak Anastigmat $f.5.6$ lens. Shutter has speeds of 1/25, 1/50, and 1/100 second. Eye-level finder. Film-centering mechanism. \$16.50.

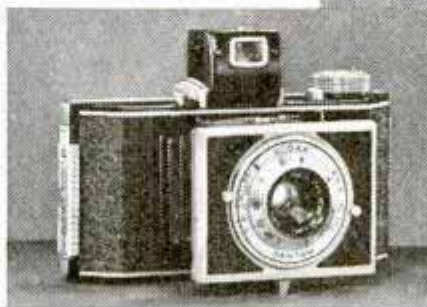
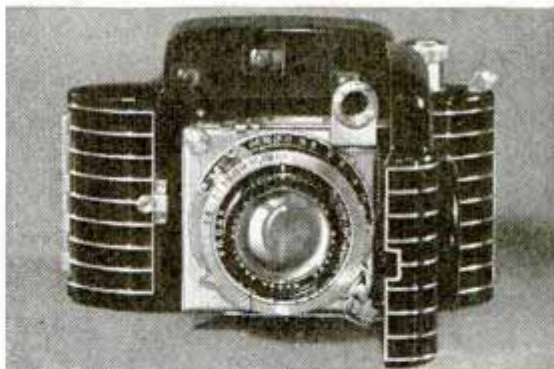

Lower priced Kodak Bantams, for black-and-white pictures only, include the $f.6.3$ model at \$9.50 and the $f.8$ model at \$4.75. See these and other up-to-the-minute Kodaks at your dealer's . . . Eastman Kodak Company, Rochester, N.Y.

Only EASTMAN makes the KODAK

Picture Your Pets

(Continued from page 573)

mediately apparent. Clever captions and titles in your picture book can make "story" pictures out of almost any snapshot in which the pet wears an interesting expression. Such captions can be used also to weave individual pictures into a connected series that tells a story of its own.

Try this: collect a group of expressions of one pet and caption each with a direct quotation, as if the pet were speaking. Let him voice his own thoughts—the things he might be thinking in that particular picture. Such captions will add human quality and character to the animal snapshots.

As an aid in getting natural, unposed pictures of the children, try snapping them at play with the pets. They won't look at



Puppies are always amusing, but this picture was helped by good arrangement and a plain background

the camera, finding the kittens and puppies more interesting. At the same time, the pets add an extra touch of appeal to the child pictures.

Viewpoint is important in any animal picture. Sometimes, when you are portraying the pet as an individual with expression and character of his own, you will want to hold the camera at the level of his eyes. Such a camera viewpoint produces pictures that show the pet's own view of things about him. At other times, you will want to have the camera at the usual eye level or waist level. In some story-telling pictures—as of the kitten on the floor, tangled in a skein of yarn—an angle shot is best, with the camera pointed downward toward the subject.

Another case where an angle shot would be best is a picture of a cat perched on a

high mantelpiece, ready to jump. Here, the camera could be pointed upward to emphasize the height of the mantel.

It's fun to play with "effect" lightings for pictures of pets—when the pet will "stay put" for you. Try picturing a white cat with backlighting—for instance, on the sill of a sunny window—so that the fur is converted into a bright, silken halo. A white, woolly pet lamb can be pictured effectively in the same fashion, with sunlight coming from above and slightly behind it, instead of from the front.

To get the best pet pictures, take the color of the pet into account in figuring your exposure and arrangement. A white cat can be backlit but a black Scotty or spaniel should be pictured from the sunny side—for from the shady side, he will photograph as a mere mass of black.

Choice of film depends partly on the colors of the pets. Chrome-type film serves nicely in most cases. But if you are picturing such subjects as brightly colored parrots, or dogs and kittens with unusual coloring, try film of the supersensitive panchromatic type. A light yellow color filter (the Wratten K-1, for example) will help render colors still more naturally, and will also help add sky tone in your outdoor pet pictures. Be sure, when using any filter, to increase exposure according to the instructions that come with it.

Some people think the best way to take pet pictures is to dress up the animal, or (especially in the case of a puppy or kitten) stuff it into a vase or old shoe with only the head sticking out. This may be all very well if you like that sort of thing, but it probably strikes the pet as pretty silly—and most observers are likely to have the same reaction. The best animal pictures present the animal naturally—as an individual, a personality, a member of the family. Make yours that way and you will like them better and enjoy them longer.

Our Bureau of Information keeps on file the names and addresses of makers of, and dealers in, all devices described in the pages of Popular Mechanics Magazine. We are glad to furnish this information to our readers upon request, accompanied by stamped, self-addressed envelope.

When you get
your first taste
of **VELVET**
the smile's too big
for the picture!



*Better
smoking
tobacco*

Velvet

- the **MILDNESS** of fine old Kentucky Burley aged in wood
- the **FLAVOR** of pure maple sugar for extra good taste

*Velvet packs easy in a pipe
Rolls smooth in a cigarette
Draws right in both*

NEW SPEEDY WAX

MADE BY DU PONT



WAXES CARS IN HALF THE TIME
IT CLEANS AS IT WAXES



Who says automobile waxing is a tough job? Not the man who has tried the new Du Pont Speedy Wax (liquid). He knows it waxes cars

in half the time, because it cuts out the preliminary cleaning operation. Speedy Wax cleans as it waxes! And it gives beauty and protection to your car finish! It's easy! And it's quick!

SAMPLE FOR YOU. Send 6c for postage, and get a sample can of Speedy Wax—enough for fenders and hood. (Offer good in U. S. only.) Write Du Pont, Dept. PM-5, Wilmington, Delaware.



Made by Du Pont, makers of No. 7 Duco Polish

Du Pont No. 7 Polish, the world's most popular auto polish, has now been made even better. Works faster and easier. Try it!



Always ask for
DU PONT POLISH

H 626

Millions for Movie Ideas

(Continued from page 517)

phy methods, new lighting, sound recording, and improvements made in cameras and in negative and print developing.

About 2,000 regular employes at Paramount receive salaries ranging from those of rough labor to sums several times that paid the President. Nearly every profession is represented. Air-conditioning engineers, foundry workers, and carpenters are as necessary as cameramen. Painters,



Switchboard in sound laboratory through which sounds from different stages are switched to proper recording machines

draftsmen, truck drivers and machinists all have jobs and from them come many ideas which make pictures better.

Frequently amazing developments are achieved by the technical departments between pictures. During the filming of "If I Were King" at Paramount, we had a new type of perambulating "mike" boom which was not available during the making of "Wells Fargo" a few months before. Three-wheeled and rubber-tired, with variable tread, it is highly mobile and maneuverable. Using it in crowd scenes, the sound-recording crew is able to move in and out and obtain more lifelike recordings. It is constructed of lightweight metal and one man can handle it easily.

Similarly, we discovered an air-gun artist on this picture. He is "Scotty," standby painter, otherwise called Joseph McIlroy. The new high-speed film we are using

H 626

makes possible very fine photographic effects with low key lighting but the drab, Middle Age interiors of the picture were inclined to register almost solid black. "Scotty" changed all that by painting in highlights at a moment's notice. He covered up the old ones and created new ones with every change of camera angle.

They say the chance of becoming a star in Hollywood is about one in 10,000. The number of people who rise to the top behind the scenes is nearly in the same proportion. Why? You can find one answer in the application cards filled out in the studio employment offices. Three out of four applicants, when answering the query, "Type of work desired," say they don't know or don't care.

Making motion pictures is one of the most highly specialized professions. The pace is fast and you have to be good to keep up. Yet the average person who applies for work doesn't even know what he would like to do. And even knowing what you would like to do isn't enough these days. The studios have their pick of experts. When a job is open the man with the best training and ability gets it. That's the kind of competition faced by those whose only qualification is a desire to work in the movies.

Even when you have ability there still is no guarantee that you can get the job. In some cases, ambitious people who wanted to be actors or writers started working in other departments until they could get a chance to prove themselves. Right now even this loophole is pretty small because there are more people qualified for jobs than there are jobs.

Still, Hollywood is full of success stories of people who started at the bottom. Grover Jones, the writer, began as a scenery painter. Mervyn LeRoy, the producer, and Charles Barton, the director, each got his start as an office boy. Many heads of technical departments, people just as important to pictures as the stars, have risen from the ranks.

That's the history of Hollywood. Five or ten years hence, reviewing some film created in 1938, we will take for granted all the improvements made after 1938. How those improvements will be made, no one knows, and no one knows the names of those, inside and outside the industry, who will contribute the improvements.

POLISH METAL THIS EASY WAY

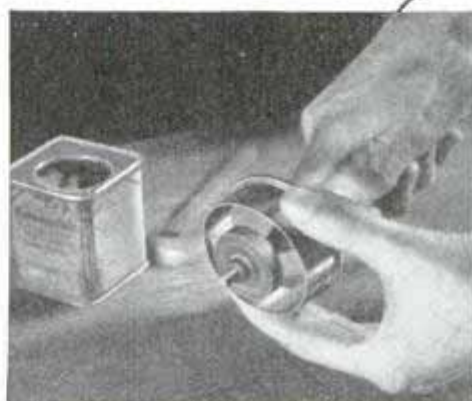

Charging a small leather wheel with Carborundum Brand Powder makes it easy to give metal a high, smooth polish.

● Not only metal, but hundreds of things can be polished with Carborundum Brand powders and grains. You can use Carborundum Brand powder for gem cutting, rubbing down lacquer finishes, drilling holes in glass.



● Every workshop needs a Carborundum Brand Silicon Carbide Combination Sharpening Stone. You'll find it puts a sharp, keen-cutting edge on chisels, knives, and other edged tools. At your local hardware store.

THE CARBORUNDUM COMPANY

REG. U. S. PAT. OFF.

Niagara Falls, N. Y.

Carborundum is a registered trademark of The Carborundum Company

CARBORUNDUM

REG. U. S. BRAND PAT. OFF.

ABRASIVE PRODUCTS



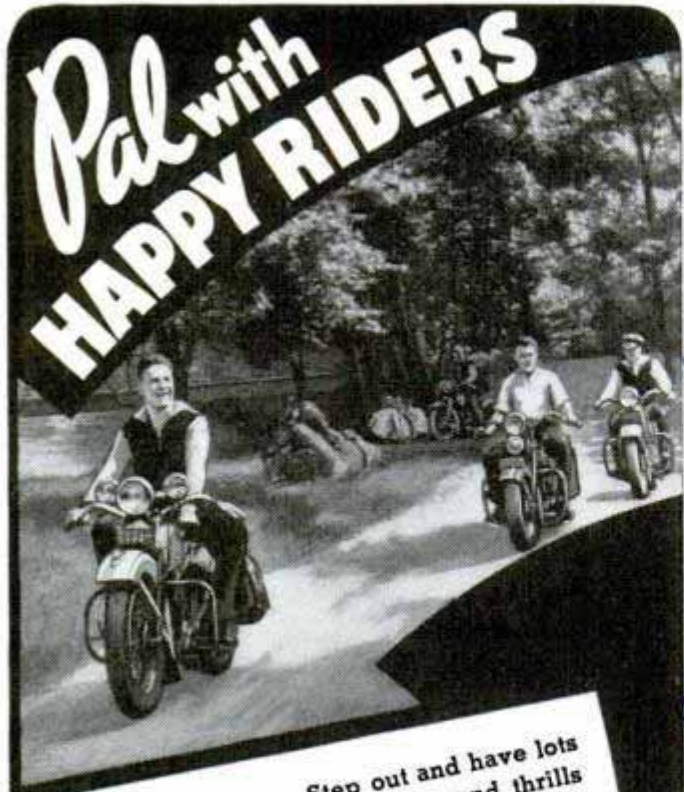

Quit wishing for fun. Step out and have lots of it! Get into the thick of action and thrills with fun-loving members of a motorcycling club. They'll show you why motorcycling is America's greatest outdoor sport — with something doing all the time. Spins along sunlit trails—club rides to fun spots—gypsy tours—reliability and endurance runs—hill-climbs—tourist trophy races—provide more pleasure than you've ever thought possible.

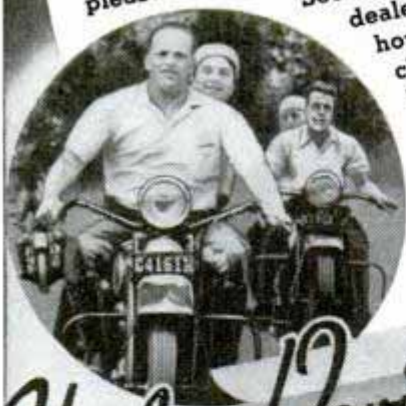

See the Harley-Davidson dealer — he'll tell you how to join a live-wire club—show you the latest model Harley-Davidsons—tell you about his Easy Pay Plans. Be sure to mail coupon NOW!

Harley-Davidson
WORLD'S CHAMPION MOTORCYCLE

MAIL THE COUPON Today!

HARLEY-DAVIDSON MOTOR CO.
Dept. P-1038, Milwaukee, Wis.
Send illustrated literature and FREE copy of "ENTHUSIAST,"
Motorcycling Magazine. Stamp is enclosed for mailing cost.

Name.....
Address.....

Flying the Winged Bullets

(Continued from page 549)

planes in the unlimited class have been powered with radial engines in the past but now many pilots think that the day of the radial engine is about over in racing. Last year's Thompson Trophy race was won by a tiny plane powered with a stock

Lars. Olin



The tiny ten-inch landing wheels retract into the low wing of this racing plane

260-horsepower in-line engine, that beat radial engines of as much as 1,000 horsepower to win. The better streamlining allowed by the smaller frontal area of an in-line engine more than compensated for its low power.

Most of the planes in the 550-cubic-inch displacement class are powered with a stock-inverted in-line air-cooled six-cylinder engine rated at 260 horsepower. Some pilots extract nearly twice the rated power from these engines by increasing the compression ratio and supercharging ratio, changing the valve timing, and turning them up to 2,900 revolutions per minute. To some extent the pilot who is the best engine mechanic has the most successful racing season. Likewise, he needs nerve to fly the "souped up" engine wide open in the air, and luck enough for the engine to hold together through each race.

A number of the pilots have re-built and re-engined their planes for this summer's competition, but more than half a dozen brand new race planes have also been built. Art Chester is flying a 550-cubic-inch class full cantilever low-wing monoplane equipped with flaps and retractable landing gear and tail skid. The

9716 Burbank 14528
 wing, with a span of eighteen and one-half feet, has only sixty-six square feet of surface, and is plywood-covered for better streamlining and increased strength.

Harry Crosby's new 550-cubic-inch racer is an all-metal full cantilever low-wing monoplane with a special wing curve, retractable landing gear, flaps, and a span of sixteen feet and a length of twenty-one and one-half feet. He has a one-piece transparent cover for the cockpit, an adjustable seat that raises six inches to provide better visibility for taking off and landing, and a fresh-air intake under the wing to ventilate the cockpit.

Just the opposite from the construction standpoint is the new all-wood racer in the same class built by Keith Rider. It is a full cantilever low-wing monoplane, with a twenty-two-foot span and a length of twenty feet, equipped with retractable gear, flaps, and brakes. Molded plywood covering permits complete streamlining.

In the unlimited class, Lee Williams will fly a new high midwing monoplane powered with a "souped up" liquid-cooled V-type Curtiss Conqueror, rated at 625

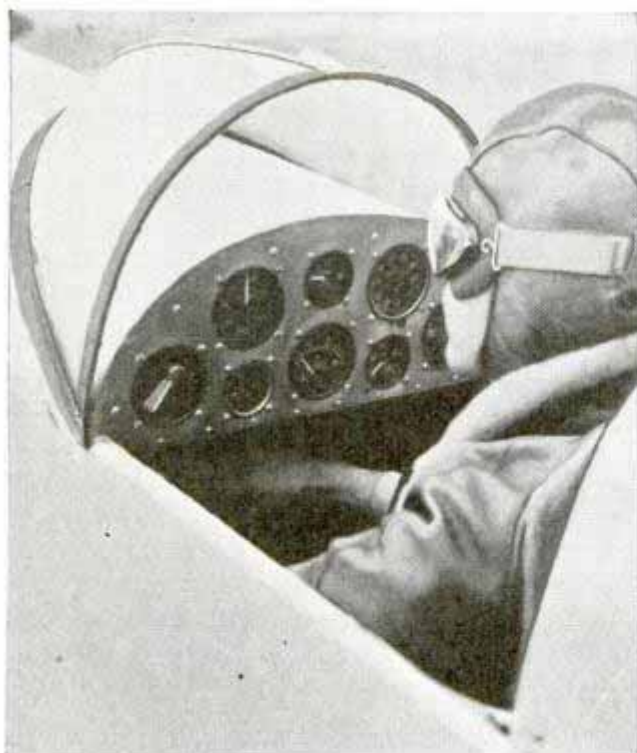

Pilot in cockpit. The instrument board contains the conventional instruments

horsepower, that delivers close to 800 horsepower at full throttle. Some of the other racers built this year are being held under wraps until their pilots learn exactly how fast they will fly.

Treet Topics

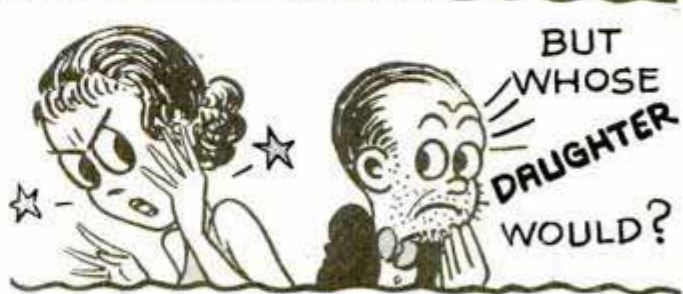

4 FOR 10¢

Treet SINGLE EDGE BLADES
 FOR GEM AND EVER-READY RAZORS

Treet Safety Razor Corporation, Newark, New Jersey

SUPERFEX OIL HEATER DIRECTS HEAT TO THE "LIVING ZONE"

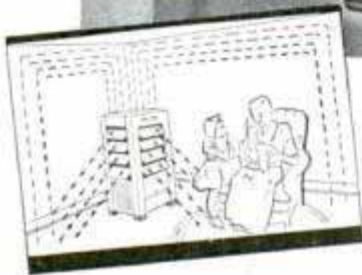
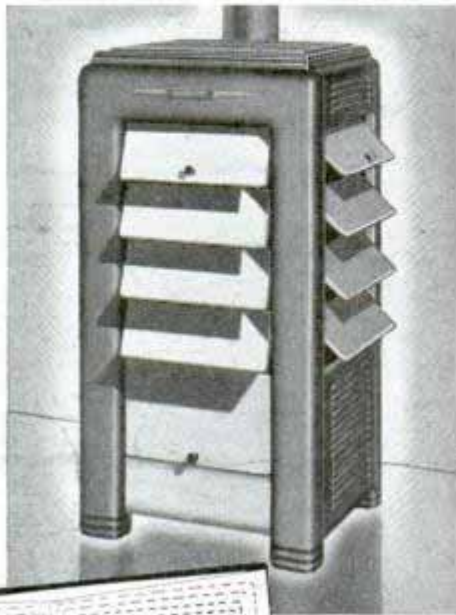

Only the Superfex Heat-Director gives you *both* circulating heat, which rises to ceiling and heats adjoining rooms (see dotted lines) and *radiant* heat (see arrows) which can be directed to floor or straight out from heater to warm the "living zone!"

NO MORE ASHES AND DRUDGERY . . . no more cold, drafty floors! The new Superfex Heat-Director brings modern oil heat to homes without central heating. Gives continuous warmth overnight. Economical too, for it burns a wide variety of inexpensive fuel oils, available everywhere! There are Heat-Directors and Radiant models in sizes and prices to fill every need. Easy payment plans—send for free booklet.

The Mark
of Quality

The best way to heat is with oil,
and the best oil heaters are



SUPERFEX
OIL BURNING HEATERS

A PRODUCT OF THE PERFECTION STOVE CO.

PERFECTION STOVE COMPANY
7610A Platt Avenue, Cleveland, Ohio

I would like to know more about the advantages of the Superfex Heat-Director . . . also the Radiating Heaters. Please send your free booklet.

Name _____

St. or R. F. D. _____

Post Office _____

County _____ State _____

Wild Horses Corralled from Air

(Continued from page 543)

another upward circle. I begin praying for the motor to carry enough "kick" to clear the height. Zoom! we're over—and out of the canyon. But there go some stragglers. Down we plummet—then up. And back again for another plunge. This time, going into the canyon further than before, we run up against an extremely small passage—too narrow to accommodate the wing-spread. By piloting that makes my hair stand on end, Hanson caroms through like a skidding billiard ball. We're flying sideways! Now up into an almost impossible "chandelle" and out into the sky again. The last horse is inside the corral. A buckaroo jumps from his hiding place, shuts the gate, and there are twenty blooded mustangs rounded up—the hard way.

The actual capture isn't the end of a wrangler's troubles. A wild horse will bite a man with diabolical emphasis. And recently, while trying to transport a load of mustangs by truck, the vehicle was kicked to pieces by its unwilling passengers.

Something that smacks of fiction happened to Hanson not long ago. He was flying his "dawn patrol." Straight ahead loomed a cloud of desert dust; a wild herd. A formation of mustangs is something to see. Each group, or "family," travels by itself, commanded by a leader, the senior stallion. A military column was never more orderly or precise. The animals move in single file, led by the "boss hoss."

In a few minutes, the plane caught up with the running troop. The flier felt rather sorry for the big white mustang lagging far behind and figured the beast would collapse before it could catch up. An hour passed and the herd had been driven to within eyeshot of the corral. Suddenly, the trailing stallion turned—stood on hind legs—pawed the air—and was off like a streak, in the opposite direction, the entire herd following. A surprise break! It meant the loss of many hard won horses, but defeat was not so bitter when it came from a mustang with the resourcefulness of a field general.

But when Hanson landed, the cow-punchers ran over, shouting, "You big stiff! That was 'Silver King!'"

"Silver King" was almost a legend, a pure white stallion, handsome, intelligent,

12520

elusive. For twelve years, every rancher in the territory had tried to capture him but none could lay hand on him. Hanson kicked himself. Then he decided to go after "Silver King."

Early next morning, he packed into his "Flying Bronco" and was off on the search. Lady Luck was riding along. Soon he sighted the herd he sought. And there—in the rear guard position again—was "Silver King."

Motor open wide and siren screaming, Hanson came down and started a see-saw duel which lasted an hour and a half and seemed like a day and a night. "Silver" called on every wile he knew. But no use. An earthbound horse can't fight a feelingless Pegasus.

"Silver King" was bagged. But Floyd Hanson kept the prize of a decade in the corral just long enough for the boys to come and look—and then, nonchalantly walked over and opened the restraining gate. The great piece of wild-horse flesh galloped out like a thunderbolt and in twenty seconds disappeared behind the snaky mountain pass. For all his wiry nerve, I think this flying cowboy is as sentimental as a poet in the moonlight.

"Say, Floyd," I said, "mind my telling about all this? Since you're the only fellow in the world rounding up horses with a plane, it might wake up some competition."

"If someone else wants to have a try," drawled Hanson, "he has my blessings and my sympathy."

H-840

Scraper Attached to Blowtorch Speeds Paint Removal



For quick removal of paint, a manufacturer offers a blowtorch with scraper attached. Only one hand is needed to operate it, leaving the other free to steady the ladder or scaffold. As the

torch softens the paint, the scraper follows it and skims off the paint with the same stroke. Blades of several shapes are available for use in difficult places.

Lashin Mfg Co
 1117 W. Westwood Ave. Baltimore

THE X-RAY TELLS THE STORY OF DELCO BATTERY LIFE

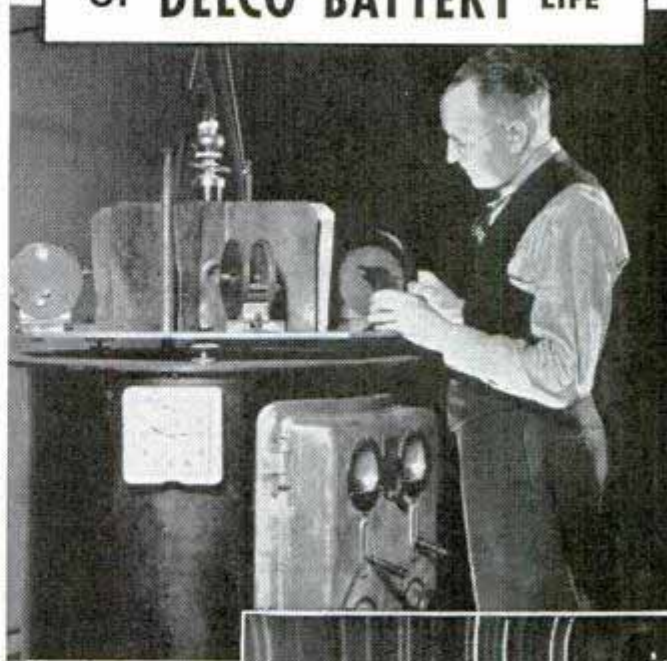

This powerful X-ray Spectroscope is used in the Delco-Remy laboratory to examine and check the chemical action that takes place inside the Delco battery . . . The small picture is an X-ray Spectrogram showing how finely divided metallic lead appears on the X-ray film.

NOT satisfied with the knowledge obtained through chemical and microscopic analyses alone, Delco-Remy battery engineers turn to a powerful, especially designed X-ray Spectroscope to study the changes in physical form and chemical composition that occur within a Delco battery in actual use. Raw materials that go into Delco batteries . . . new batteries just off the production line . . . old batteries that have given months and years of service . . . batteries at every stage of charge and discharge are subjected to minute X-ray examinations to show the changes that occur in the active material and grids. Delco-Remy battery engineers always have a clear picture of what goes on inside the battery under all conditions to guide them in designing and building better Delco batteries. As a result of this X-ray research—as well as of tests and inspections at every stage of manufacture—Delco batteries have exceptionally quick cold-weather starting ability and long-lasting qualities.



Delco battery sales and service requirements are available at United Motors Service Stations and dealers everywhere.

Delco-Remy

ANDERSON, INDIANA

World's Largest Manufacturer of Automotive Electrical Equipment

TUNE IN
**THE NATIONAL
 BARN DANCE**
 SATURDAY NIGHT
 NBC-NETWORK

30¢ & 60¢ PKGS.
 OR BY THE GLASS
 AT DRUG STORE
 SODA FOUNTAINS

An Alka-Seltzer
 Tablet in a glass of water makes a sparkling pleasant-tasting solution. Drink it and it gives quick relief from Headaches, Sour Stomach, Distress after meals and other common ailments. It also helps overcome excess acid condition so often associated with these troubles

Be Wise - Alkalize



ESPECIALLY IN THE MORNING, AFTER THE NIGHT BEFORE

GREAT STUFF/THAT ALKA-SELTZER, TO EASE A HEAD THAT'S SORE.

A GLASS OF ALKA-SELTZER, EXACTLY WHAT YOU NEED

I'VE GOT AN UPSET STUMICK, GUESS SOMETHIN' DISAGREED.

I THINK THAT ALKA-SELTZER MUST HAVE DONE THE TRICK.

I NEVER KNEW A HEADACHE TO DISAPPEAR SO QUICK.



MORNING AFTER



UPSET STOMACH



HEADACHE

Alkalize with Alka-Seltzer AT ALL DRUGGISTS

DO YOU WANT a new business profession of your own, with all the trade you can attend to? Then become a foot correctionist, and in a few weeks earn big income in service fees,—not medical nor chiropody—easy terms for home training, no further capital needed, no goods to buy, no agency. Established 1894. Address Stephenson Laboratory, 1 Back Bay, Boston, Mass.

Riding Herd on 2,000,000 'Horses'

(Continued from page 555)

breakers tower thirty feet above the sand. "Thinking" instruments, known as relays, pull the triggers of these General Electric circuit breakers, which are like eight-barreled oil guns. These breakers are the strong-arm guys that cut loose the damaged wires, stop the rush of electricity and switch the load to other wires, all in the twinkling of an eye. At the same instant, these relays flash an order to circuit breakers at the other end of the damaged line and those breakers disconnect that end. They all act in unison and at the same instant, although ninety miles apart. And

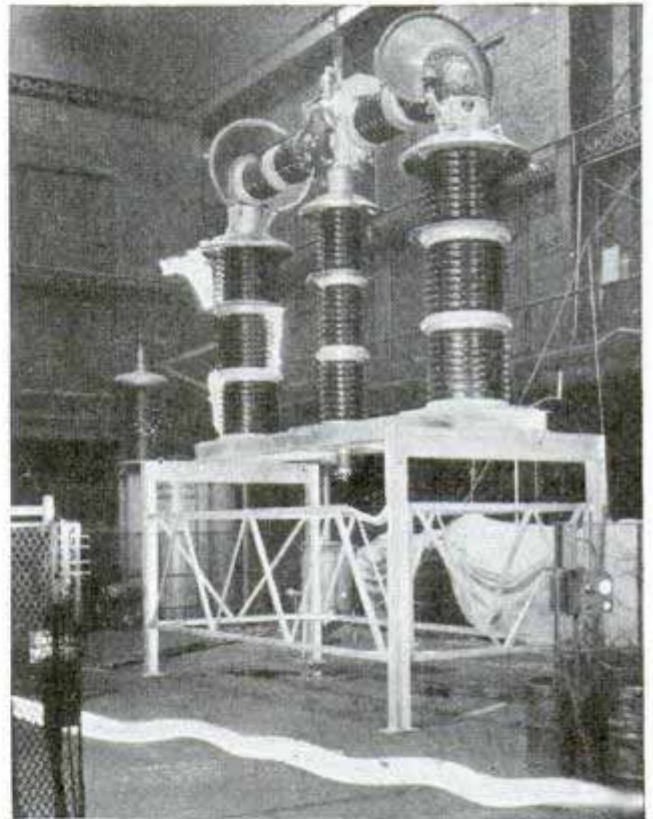

Picture of oil circuit breaker snapped as flashover was occurring at end of column

they act so fast that people in Los Angeles don't know the difference—their lights don't even blink.

It sounds simple to say that circuit breakers "open" to interrupt the flow of current, but it is not as easy as it sounds. To interrupt a damaged electrical circuit of high voltage means stopping not the normal flow of current, but a rush of many times normal. Speed in cutting loose a disturbed section is absolutely essential if interruption of service and damage to the system are to be prevented. Electrical accidents can do a lot of damage in a fraction

of a second because the current has the power of thousands of tons of falling water behind it.

So, instead of "breaking" or stopping a normal flow of 400,000 horsepower, or 300,000 kilowatts, the breakers in an emergency may be called upon to halt an abnormal current flow representing as much as 2,000,000 horsepower. The breakers actually can stop 3,350,000 electrical horsepower, and do the job in one-twentieth of a second, but so severe a duty is seldom imposed.

While the circuit breakers are the big bruisers that catch and throw and tie up the runaway electrical horses when a line is damaged, the relays do the thinking and order the breakers to go into action. An array of instruments in a little box about the size of a suitcase constitutes the all-seeing, high-speed relay which is a detective, judge and diagnostician, all in one, for it detects every disturbance, determines the cause of the trouble and prescribes the proper remedy.

Ordinarily lightning bolts which may strike the line are harmlessly conducted to earth. But should an unusually heavy bolt strike the line and cause flashover of an insulator, the relays act within one-sixtieth of a second, ordering the circuit breakers to cut loose the disturbed section from the rest of the system. Each triple-pole circuit breaker is like three oil guns, all loaded and cocked. The relays have their fingers on the triggers and, when real trouble occurs, they instantly pull the triggers of the proper guns and the breakers go into action. On the damaged line, they separate their contacts which are connected with each of the three wires. They do this under oil, inside the circuit breaker.

This sounds easy, but 287,000 volts don't give up without a struggle. Electricity, like a speeding train or car, has momentum and wants to keep on flowing. So after the contacts have been separated, the current keeps on flowing, now through the oil in the space between the contacts. The heat turns the oil into gas, chiefly hydrogen, and the current still keeps on flowing—now through the gas in the form of an arc. And arc temperatures mount so rapidly they are virtual explosions.

But while the current has been struggling to keep on flowing, first through oil

(Continued to page 124A)

REMINDE ME TO
GIVE YOU SOME
SANI-FLUSH
FOR THAT RADIATOR!



It's more than annoying, when a radiator overheats. It's dangerous. It robs your car of power. It threatens damage to the pistons and cylinders. An overheated radiator is an unnecessary waste. Clean out the cooling system of your own car for 10c (25c for the largest truck or tractor). SANI-FLUSH does it, in a few minutes.

Just pour this harmless powder in the radiator. (Directions on the can.) Run the engine. Drain, flush and refill with clean water. The job is done! SANI-FLUSH removes rust and scale. It cleans out clogging sediment. Motors run cool and safe. It cannot hurt the motor or fittings because it's not caustic. You'll find SANI-FLUSH in most bathrooms for cleaning toilets. Sold by grocery, drug, hardware, and five-and-ten-cent stores. 25c and 10c sizes. The Hygienic Products Company, Canton, Ohio.

Sani-Flush **Safe**
KEEPS RADIATORS CLEAN **NOT CAUSTIC**



NEW BRUSH PLATING OUTFIT
For
AUTO PARTS

Connects to a battery with no tanks necessary. Plates on iron, steel, brass, copper, etc. Almost as simple as painting. Hundreds of car owners waiting for this low-cost plating. Improves appearance and value of the car.

Your opportunity to make good income plating auto parts, bathroom fixtures, reflectors, mirrors, etc.

FREE PROOF

Write quick—big season here. Get **FREE PROOF** and particulars that put you in a paying business of your own.

GUNMETAL COMPANY

AVENUE M

DECATUR, ILL.

UNSIGHTLY WALLS

MADE GOOD AS NEW



You can easily repair holes in walls with Rutland Patching Plaster. Anyone can make a perfect job with Rutland.

YOU CAN GET A BIG PAY CHECK EVERY WEEK!



FOR BIG PROFITS

Just by taking orders for the new self-sharpening Hunter Electric Dry Shaver! Show your friends how to get close, quick shaves . . . without blades, lather, brushes, lotions or even water! Take orders on our daring Easy Payment Plan. Your customers pay only 7c a day! You get paid at once—thousands of \$\$\$\$ in commission checks being sent to producers right now! Write at once for Selling Franchise Plan. Also learn how to get your own shaver free. Costs nothing. Just write—

HUNTER SHAVER CO.
790 Broad St., Dept. L-50, Newark, N. J.

THIS Fascinating
FREE BOOK

opens the door to exciting scientific experiments you can do in your own home, that will amaze your friends and may lead you to a successful business career... This book sent absolutely Free... Address

"ADVENTURES
IN SCIENCE"
**CHEMISTRY
MICROSCOPY
BIOLOGY
ELECTRICITY
LIGHT CONTROL
PHYSICS**

PORTER CHEMICAL CO.
50 PROSPECT AVE.
HAGERSTOWN,
MD.

(Continued from page 123A)

and then through gas, the mighty circuit breaker has not been idle. Even before the arc could start, a spring-actuated piston began driving fresh oil through the arc path, shooting about 100 gallons of cool oil straight up through openings about as large as the muzzle of a double-barreled shotgun. This oil is under pressure of 100 pounds per square inch and moves 128 feet per second. This oil under pressure blows away the gas, the arc is destroyed, and the current flow is stopped—all within one-twentieth of a second.

Alternating current changes direction like a swinging pendulum and just at the moment of change in direction, there is no current for an instant. The breakers are designed to take advantage of this weak moment. Just at the precise moment when the current is changing direction from plus to minus, the oil blast is under full headway. An instant later the voltage comes up from zero to full strength but it's too late. The arc has been destroyed.

The contacts under oil are separated, not at one place only, but at eight different places in a row. Thus in each of the three phases of the circuit, eight oil blasts, instead of one, are blowing out the eight arcs. As these eight gas bubbles, each containing an arc, are shot upward by the oil, they meet partitions which divide each bubble into two parts. So there are really sixteen gaps in a row where rapidly moving oil blocks any further passage of electricity. It would seem that the terrific arc temperatures might damage the enclosing structure of the breakers in the brief instant they exist. Actually the cool oil protects the breaker parts from the arc.

While the breakers do the spectacular strong-arm work in protecting the system when 2,000,000 wild horses cut loose, the little relays do the real brain work. Faithful sentinels which never sleep, these "thinking" instruments observe, reason and make decisions, their fingers always resting on the triggers of the oil-gun circuit breakers, ready to fire these Big Berthas and stop 2,000,000 wild electrical horses dead in their tracks in the twinkling of an eye.

Send return postage to our Bureau of Information to learn the name of the maker of any device described in this magazine.

Toys for Men Only

(Continued from page 523)

decided to make the mounting in the form of a huge hollow yoke which would be welded into a single piece and to float the mounting in oil under pressure to prevent vibration. But not a piece of metal could be machined until it was determined just how the telescope would operate.

So the engineers began building models. One after another was constructed and discarded. Finally a satisfactory model was constructed of celluloid. To measure the tiny movements of the celluloid parts an electrified micrometer connected to a bell was used so the builders could tell the instant the micrometer screw touched a part being measured. The celluloid pieces were actually welded into place just as their larger counterparts are to be welded, but the "welding" was done with acetone.

Experiments with celluloid models have solved many welding problems, incidentally, because celluloid warps like steel as a result of heating and cooling. For this reason, and because it is transparent, models of steam turbines often are made of celluloid. Engineers can watch the operation of moving parts in celluloid turbine models and the behavior of celluloid when supporting a weight can be translated into the behavior of a full-size turbine. Recently a celluloid model of a propeller-type blower was operated at a speed of 6,000 revolutions per minute. By studying the model, engineers determined the capacity, rate of flow of air and other characteristics of the real machine before it was built.

At the Westinghouse plant in East Pittsburgh, a \$550,000 flood-control system of steel gates and pumps has been erected to keep the flood waters of a creek from backing up a valley. Before a shovelful of dirt was turned, the builders knew just how much water could be pumped through three tunnels around the sides of the flood gates because they had built a model and pumped water through it.

The robot or mechanical man is a laboratory scarecrow turned out by the research engineers when they want to demonstrate dramatically some of their devices which perform difficult or tedious jobs better than humans. Dressed to simulate the actions and appearance of a man, such

(Continued to page 126A)

**CANNED WOOD WILL
HIDE THESE NICKS—
SO DON'T SPANK HIM ANY MORE**

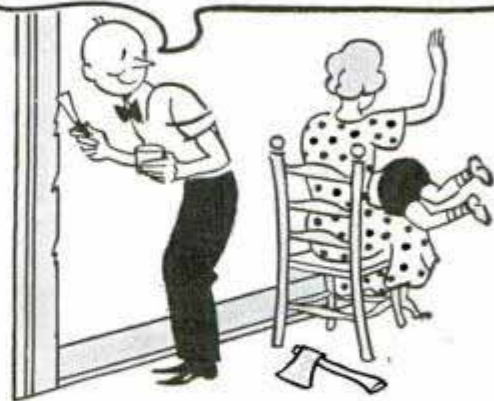

Easiest Way to Make Repairs

Anybody can do a fine job of repairing broken chairs, loose casters, nicks, cracks, etc. with PLASTIC WOOD. It handles like putty and hardens into wood. Try it. Paint, hardware, 10¢ stores sell PLASTIC WOOD in 10¢ and 25¢ tubes, 35¢ cans.



PLASTIC WOOD

**PROVED BEST IN
EVERY TEST!**

**MAKES QUICK
REPAIRS**

Quickly, permanently joins and repairs china, glass, wood, etc. Transparent; or metal color. At paint, hardware and 10¢ stores.

**Old English
CEMENT**

PORTABLE SALE!

Brand NEW!
Only \$19.95 and up

10-Day Trial — Easy Terms

Brand New, latest model Remington Cadet only \$19.95 during this sensational sale. Also, Royal, Corona and world-famous Featherweight Portables at real money-saving prices.

NO MONEY DOWN—Sent on 10 days trial—Easy terms. Guaranteed latest models—up-to-date streamline features. Limited offer. Descriptive literature sent free. Act at once. FREE course in typing included. Also standard, full-sized office models rebuilt and fully guaranteed at 1/2 saving.

International Typewriter Exch., 231 W. Monroe St. Dept. 1001, Chicago



Featherweight Model



RESERVE YOUR COPY NOW!



WRITE
ATLAS PRESS CO.
1043 N. Pitcher St., Kalamazoo, Mich.

**LATHES · DRILL PRESSES
ARBOR PRESSES · SHAPERS**

ONE-MAN SAWMILL

Makes lumber, shingles, lath, ties, crates, boxes, cases, all forms lumber.

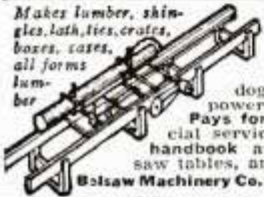

TURN TREES INTO MONEY WITH A BELSAW

Three capacities: 10, 14 and 20 ft. Accurate set works positive dogs. Hand or power feed. Runs on low power—Many owners use old auto engine. Pays for itself quickly—thousands in commercial service, everywhere. Write for free lumber handbook and catalog of mills, supplies, tools, saw tables, and woodworking equipment.

Belsaw Machinery Co., 8110-R Davidson Bldg., Kansas City, Mo.

FARM MODEL
\$49.00



Power Pays a Big Profit with a

Red Universal Tractor

Does all field and belt work. Handles easily. Absolutely safe. Operates for 33c a day. Hundreds in use. Buy direct at low factory price. Two weeks trial—satisfaction guaranteed. Write for your free colorful catalog.

PIONEER MFG. CO.
DEPT. V-108 WEST ALLIS, WIS.

CROSMAN SILENT .22 RIFLE



Rifled barrel

**NO CLEANING
ADJUSTABLE POWER
LOW COST AMMUNITION**

Grooves inside barrel make the Crosman a real rifle with all the hair-splitting accuracy this term implies. Shoots bullet (pell) same diameter as .22 powder rifle, but silently, powerfully, with no recoil, using the terrific force of compressed air—same force U. S. Navy uses to drive 2000 lb. torpedoes. Marvelous for target, small game. New features. Single and 20 shot repeater models. No license required.

SuperPells



Best for all .22 cal. air rifles. Heavier, longer, more perfectly formed (secret process), thus harder hitting and more accurate. Made to American standards by American workmen. Write for folder.

FREE BOOK

Containing important target and game shooting facts; also Crosman Catalog. Write, Ask Your Dealer to Show You a Crosman.

CROSMAN ARMS CO., Inc., 387 St. Paul St., Rochester, N. Y.

(Continued from page 125A)

a robot may sing, talk after a fashion, answer the telephone, smoke, laugh, cry and perform other amazing feats.

Such a toy is Willie Vocalite, a sturdy metal man born in a Westinghouse research laboratory. Willie can taste with an "electric palate," talk, smoke and, when spoken to, will get up out of his chair. His voice and actions are controlled by photoelectric tubes while his taster is an "electrynx," so sensitive that it records the acidity of fruits by registering the action of one-millionth of an ampere. That's about one-tenth the "wing power" of a house fly.

The latest toy to attract attention in many laboratories is a tiny sun-driven motor, the electromotive power being supplied by four very sensitive photoelectric cells. Their light-sensitive surfaces are covered by a film of platinum so thin as to be semi-transparent. This film increases the cell's sensitivity to light. The cells convert light energy directly into electric energy and the motor, with jewel bearings, is connected directly to the cells. The speed at which the motor turns depends on the amount of light the cells receive. Direct sunlight whirls the motor at about 400 revolutions per minute. As yet, no practical application has been found for the sun-driven motor which is rated at about four ten-millionths of a horsepower, a bit less than one flea-power.

Another laboratory toy which has not yet been put to work is the radiometer. It has four small vanes balanced on a jeweled pivot in a partly evacuated bulb. One side of each vane is polished and the other is black, the black side of one vane facing the polished side of the next. When heat rays from the sun or some artificial source fall on the vanes, they move in the direction of the polished sides.

The reason given is that the black sides absorb more radiation than the polished ones. When the molecules of gas remaining in the bulb are set in motion, they collide with the vanes but they bounce off the black, or warmer sides with greater force than they bounce off the polished sides, thus driving the vanes around.

Perhaps some day ways will be found to produce large amounts of power by applying the principles of the sun-driven motor or the radiometer. Then two more toys will grow up and go to work—and we shall get power direct from the sun!

**AMAZING LOW PRICED
FOG-LITE INVENTION**



**Strange New Material
SNAPS ON HEADLAMPS**

KNOCKOUT SELLER. Turns headlamps into AMBER FOG-LITES. Pierce's Fog, Snow, Sleet and Rain. Prevents "blind driving." Cuts glare. Helps save life, property. Low priced. Gripping demonstration. Agents wanted everywhere. Phenomenal profits.

SAMPLE OFFER Samples sent on trial to first person in each locality who writes. No obligation. Get details. Be first—send in your name **TODAY!**
KRISTEE CO., 680 Bar St., Akron, O.

**John made \$42⁵⁰
in one day
in his NEW
Business**



GET INTO THIS BUSINESS NOW—a business which is so new that it is practically without competition. This alone should enable you to make really BIG

MONEY. Hotels, homes, clubs, country estates offer tremendous possibilities. Our new **DETERGER** washes upholstered furniture, all sorts of fabrics, electrically, with a new soapless soap whipped into **dry suds.** We have helped hundreds of men get into business for themselves with our automatic equipment. The U. S. Government and many of the world's largest hotels use our machines.

Make Money the FIRST DAY

You are ready to go to work the minute you get the outfit, so you ought to be taking in **big profits** the first day. C. M. Cheadle made \$121.00 his first week. Barrett says, "Made \$28.00 in 8 hours." We want an honest, ambitious man in every locality. If you are that man we will help you start for yourself in a business with tremendous possibilities. Only a limited amount of money is needed for a down payment—the balance you send on easy terms. You don't need to rent a shop or hire a building, for the work is done right in your customer's home.

Write Today for FREE BOOK

Send for "Get Into Business For Yourself". Let us show you how easy it is to get started in a year around business. Be your own boss and stop worrying about just a job. Write today—**NOW.** No obligation.

VON SCHRADER MFG. CO.
550 Pl. Racine, Wisconsin



PHOTO ENLARGEMENTS

Is Photography your hobby? Do you want a profitable easy business at home? Make **PHOTO ENLARGEMENTS** for yourself and others. Your cost 5¢ each and less. The Ideal Photo Enlarger is **AUTOMATIC.** No experience required. Also **COPIES** any picture. **\$5.94 COMPLETE.** Interesting circular **FREE.**

IDEAL-O, 122 East 25th Street, New York City

5¢ ANY SIZE

BUILD THE CUTTY SARK



2 1/2 H. MODEL OF THE FAMOUS CLIPPER SHIP

Everything...including **CARVED WOOD HULLS, Printed-Balsa Decks, Cast-Metal Life-boats, Anchors, Bits, Steering Wheel, Chains, Masts, Spars, Rigging, Cement, Colored Lacquer—Full-Size Plans and Instructions.**

Send for Catalog all Ideal's new Models...
IDEAL AEROPLANE & SUPPLY COMPANY, INC.
28 West 19th Street, New York

Complete kit makes perfect building easy.
2.50 plus 15¢ postage

New Adding Machine Fits Vest Pocket!..

Adds, subtracts and multiplies up to one billion. Weighs only 4 ounces. Not a toy—strong guarantee. Absolutely accurate, very fast. Sells to offices, stores, homes—wherever figures are used. Write quick for **FREE AGENTS** sample offer and Money-Making Plan.

VE-PO-AD, Dept. 130, 303 W. Monroe St., Chicago

Costs only \$2.95

EARN MONEY MAKE COLOR GLAZED CONCRETE PRODUCTS

MAKE Color-glazed concrete pottery without molds or costly tools. Use only sand, cement, cheap materials. Glazed tiles, walls, gravestones, etc. **MEN (only):** Write for **FREE** colorplate, details of this new money-making business.

NATIONAL POTTERIES COMPANY
Room 6, 13 W. 26th St., Minneapolis, Minn.

MONUMENT \$11.00 Freight Paid or Erected.

Genuine Marble, also Granite. Lettered Free. Freight paid. Erected if desired. Thousands satisfied customers. **FREE** Catalog and samples.

U.S. MARBLE & GRANITE CO. A-18 Oneco, Fla.

For 32 YEARS

Gerstner Tool Chests shown in Free Catalog, have been the choice of machinists and toolmakers everywhere.

GERSTNER TOOL CHESTS
438 Columbia St. Dayton, Ohio

Print Your Own

Cards, Stationery, Advertising, etc. Save Money. Easy Rules Sent. Junior Outfit \$9.95 Senior \$12.49. In. Postals Free. Write Kelsey Presses, A-37, Meriden, Conn.

EXCELSIOR PROFIT PRINTING FOR OTHERS

TRAILER BUILDERS · BUYERS · OWNERS

TRAILER Send 25¢ for this Big Book Today

Over 100 pages Beautifully Printed and Illustrated! Trailer Suggestions and Ideas galore! Catalog shows America's greatest line of Trailer Parts and Equipment at lowest prices. Everything from wheels to tops. Rush 25¢ today. Satisfaction positively guaranteed!

TRAILER SUPPLY CO. Box 438-A WAUSAU, WIS.

BUILD IT YOURSELF

The Jim Dandy Cabin Cruiser

The Trailer that has everything. Clean! Roomy. Easy to build in any size with my simplified Plans and Instructions—Price \$1.00. Rush dollar bill today!

JIM DANDY Box 125-A WAUSAU, WIS.

work faster

ALL-PURPOSE MOTO-TOOL

Everyone who works with his hands—at home, shop, school, or profession—can use the efficient, attractive Moto-Tool to advantage. Grinds, drills, routs, carves, polishes all materials. Chuck uses many tools. You do in seconds jobs that require hours of hard, hand work. Safe, thousands in use. Two fine models. No. 1 weighs 6 oz.—about 20,000 r.p.m. No. 2 weighs 13 oz.—about 25,000 r.p.m. Order on 10-day money back trial, or send for free booklet.

Dremel Mfg. Company
2834 CT., Racine, Wis.

Model 1 \$9.85 postpaid 10 Day Trial

Model 2 \$16.50 Postpaid

HEAT for 1 1/2¢ per hour

or COSTS NOTHING TO TRY

Amazing new Radiant Heater. Burns 96% air. Makes its own gas. No piping. No installation. A few pints of cheap liquid transforms ordinary air into many hours of clean, healthful, penetrating heat like sunshine, for 1 1/2 cents an hour. Hotter than gas or electricity, at one-tenth the cost. **EASY TO OPERATE.** No smoke, soot, ashes or odor. Portable.

30 DAYS' TRIAL!

Write at once for special introductory low-price offer. Try it at our risk. Prove to yourself that you can have Radiant heat at 1 1/2 cent an hour. No obligation! Send now.

AKRON LAMP & MFG. CO.,
1200 High Street, AKRON, OHIO

AGENTS!
Make Big Money! NEW EASY PLAN! Write quick for territory and Outfit Offer.

474

The Age of Color

(Continued from Coloroto Section)

Are you selling on PRICE?

If you're selling against heavy competition, there's no need to let sales costs eat your profit. For Wiggins Vellotype cuts business card costs—yet nobody loses prestige in using it.

Sales managers of hardware, machine tool, industrial supply, and electrical firms use it and **SAVE MONEY.**

Prominent inventors and small manufacturers exploiting their own products, **USE NOTHING ELSE.**

How about *you*? Is your business so good that you don't have to save money?



SEND FOR SAMPLES
Compare your present business cards in cost and quality, with Vellotype.

The John B. Wiggins Company
1167 Fullerton Ave., Chicago

Wiggins

VELLOTYPE BUSINESS CARDS

GOVERNS SPEED OF ANY GAS ENGINE

It's easy and economical to supply your own power for operating all types of machinery, and do more work for less money. Simply remove the engine from a used automobile or truck, set it up where you like, attach a PIERCE UNIVERSAL GOVERNOR, start the engine and you have constantly controlled power for the operation of electric lighting plants, are welders, refrigerating units, air compressors, feed grinders, hoists, saw mills and innumerable other applications.

The load may change but the PIERCE UNIVERSAL GOVERNOR will maintain a uniform engine speed. For close regulation of speed and dependable performance PIERCE GOVERNORS are never equalled. Installation is simple. Either V or flat belts can be used. Complete Governor outfits are also available for nearly all makes and models of industrial engines.

Write for illustrated literature and prices.

THE PIERCE GOVERNOR COMPANY
1631 Ohio Avenue, Anderson, Indiana



PIERCE GOVERNORS THE BRAINS OF ANY GAS ENGINE

Stoves AT FACTORY PRICES!



SALE CATALOG—FREE

Nearly 200 Styles and Sizes of Heaters, Ranges, Furnaces at **FACTORY PRICES.** Easy Terms. Write today for **FREE CATALOG.** New styles, new features—24-hour shipments.

Kalamazoo Stove & Furnace Co.,
391 Rochester Avenue
Kalamazoo Michigan
Over 1,300,000 Satisfied Users
39 Years in Business

"A Kalamazoo Direct to You"
Trade Mark Registered

Write for **FREE CATALOG**

to make synthetic indigo, the most widely used textile color today. Almost as much time and money were spent in developing other colors. Germany made the most rapid progress in solving the secrets of coal tar and, until the World War, much of the dyes used in this country were imported from there.

With the war, dye imports were cut off and America faced a color famine. Out of this acute need eventually developed the American dye industry and the wealth of color we enjoy today, but it was a slow and costly development. E. I. du Pont de Nemours and Company alone spent \$40,000,000 in research and experimental and plant equipment in five years before making a penny from any dyestuffs.

Today du Pont makes hundreds of dyes, each of a different chemical structure. There are, all told, about 2,000 separate colors commercially available from all sources, nearly all of them made in America.

But this is not the limit of shades by any means. By combining or blending any two or more of these 2,000 colors, many more thousands are possible. But instead of trying to make more colors, dye men today are struggling to limit the number. To do that they must develop colors which are very fast, very brilliant and not too expensive.

One step in this direction, insofar as pigments are concerned, has been taken with the commercial development by du Pont of an insoluble coloring material yielding strikingly brilliant shades of blue. It is known as "Monastral" Fast Blue and is so close to a pure blue that it is hailed as almost a miracle, a wonder color. Blues hitherto obtainable have all possessed some faults which interfered not only with the production of pure blue hues but also affected the other colors in which blues were used.

This new blue pigment is virtually fade-proof. It is not only very fast to light but is also fast to other color-destroying agents like acids and alkalies. The products to which it can be applied include almost everything into which pigments enter—printing inks, paints, varnishes, enamels, nitrocellulose lacquers, carbon paper, wall-

Organic Chemicals Dept. Wiggins Co. Chicago

H 74
paper, coated and colored papers, coated textiles, linoleum and cement.

The general use of "Monastral" Fast Blue eventually may give faster and more brilliant color to everything from your magazine to your automobile. It is, however, a pigment and not a dye. Dyes cannot be mixed indiscriminately as the artist mixes pigments. And dyes cannot be used at random on any fabric.

A dye must have an "affinity" for the material it colors and since materials differ in physical and chemical structure, there is as yet no universally applicable dye. This is one reason so many dyes are needed. One which can be used to color an animal fiber like wool may not work at all on a vegetable fiber such as cotton. Even the physical properties of fibers influence the choice of dyes to color them.

Dye chemists classify the colors they produce into groups such as acid, basic, chrome, developed, direct, vat, sulphur and acetate dyes. These group names are derived from the manner in which the colors are applied to material or from the chemical structure of the dyestuff.

Vat dyes are the aristocrats in the field of fast color. These dyes are imprisoned in the fiber and will last as long as the fabric, often becoming brighter and deeper in shade after repeated laundering. At the other end of the scale are the sulphur colors, the cheapest of all, which color the great rank and file of inexpensive cotton goods.

The cost of all this beauty and color which we enjoy today is almost negligible when compared with the cost of the products which the color decorates. The dye in a man's work shirt, for example, may cost four or five cents, and in his blue serge suit there may be a quarter's worth of dye.

But that quarter's worth of dye probably sold the blue serge to the man who wanted that particular shade just as color today sells everything from cars and carpets to clothes and kitchenware.

☐ Popular Mechanics Magazine can furnish the name and address of the maker of, or dealer in, any article described in its pages. If you wish this information, write to the Bureau of Information, inclosing a stamped, self-addressed envelope.

Here's the \$1⁰⁰ anti-freeze

**YOU CAN PUT
IN THIS
VERY DAY**



**FIFTY CENTS' WORTH NOW KEEPS MOST
CARS SAFE DOWN TO 10° ABOVE ZERO**

MAYBE this is an "Indian Summer" day, when you're not even thinking of anti-freeze. But you *know* a cold snap will come. Set your mind at ease now. Drive in to your dealer or service station today and have a couple of quarts of Du Pont "Zerone" Anti-Freeze put in your car.

Check the radiator solution from time to time. When winter gets down to real business, add enough "Zerone" for lower temperatures. Scientific tests prove that radiator losses are chiefly mechanical, and even then you lose a solution of "Zerone" and water—not one or the other alone. And remember, "Zerone" costs only \$1.00 a gallon, 25c a quart! With "Zerone" you get improved engine performance, due to better heat dissipation, and more pep and efficiency, through prevention of rust and corrosion in a clean cooling system.

Only \$1⁰⁰ a gallon
Made by **DU PONT**

**SAVE MONEY
WITH THIS
BRAND NEW
FREE
RADIO CATALOG!**



**188 PAGES
OF SUPER
VALUES**

**1939
EDITION**

Valu-Bill Says:

This book is full of bargains in:

- 1939 RADIOS
- PARTS • TUBES
- PUBLIC ADDRESS EQUIPMENT
- HAM APPARATUS
- ELECTRICAL APPLIANCES
- TELEVISION KITS
- CAMERAS

**SAVE ON EVERYTHING
YOU BUY IN RADIO**

The 1939 Super Value number of the greatest catalog in radio is ready! Send for your **FREE** copy today. It makes no difference how many catalogs you have. You won't want to miss this one. New television kits, over 50,000 parts, public address equipment, "ham" apparatus, cameras plus the new 1939 line of LAFAYETTE receivers. Here's a book that brings you up-to-date and saves you big money. It's **FREE!** Mail the coupon today.

WHOLESALE RADIO SERVICE CO. INC.

NEW YORK, N. Y. • CHICAGO, ILL. • ATLANTA, GA.
100 SIXTH AVENUE • 901 W. JACKSON BLVD. • 265 PEACHTREE STREET
BOSTON, MASS. • BRONX, N. Y. • NEWARK, N. J. • JAMAICA, L. I.

WHOLESALE RADIO SERVICE CO., INC.
100 SIXTH AVENUE NEW YORK, N. Y.
Rush **FREE** 1939 Catalog No. 73-7K8

Name.....

Address.....

City.....

State.....

**YES!
RUSH
MY
COPY**

PASTE COUPON ON PENNY POSTCARD

Portable Two-Tube Receiver

(Continued from page 579)

These A and B leads should be as short and direct as possible.

It will be noted that the antenna is coupled to the receiver through a fixed condenser. This eliminates any possibility of shorts, and no external ground is used. The flexible antenna may be extended to full length, or, it can be partially rolled up

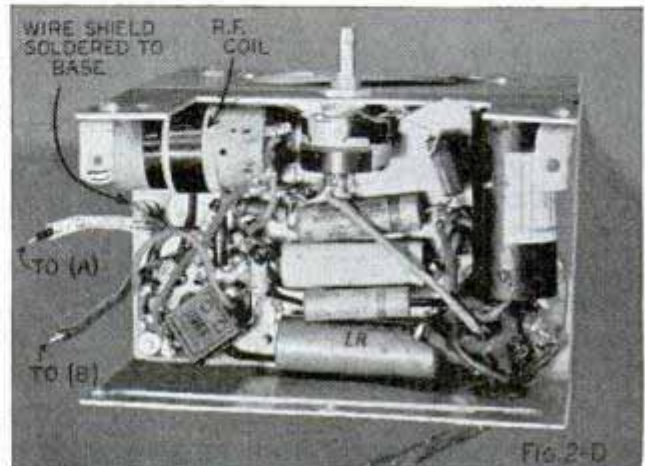

and clipped to a radiator for convenient portable operation. Photos Figs. 2-A, 2-B, 2-C, 2-D and 2-E show various views of the construction steps and the completed receiver; schematic circuit diagram appears in Fig. 3. Although the various parts are not expensive they should be of good quality and just as specified. A material list of the original parts and additional

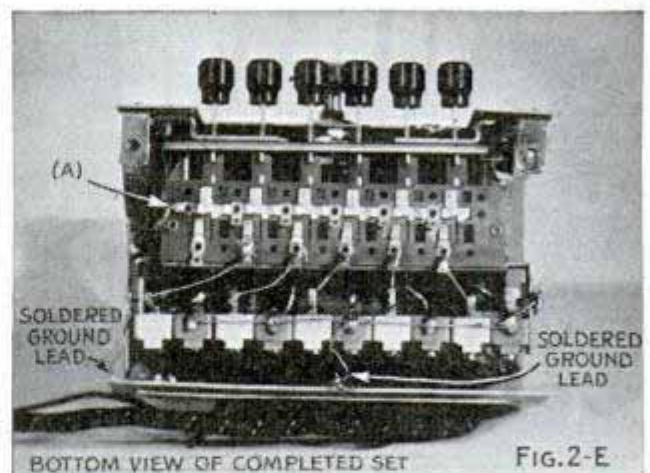

data, can be obtained from Popular Mechanics radio department without charge. The blueprint number is R-258.

The heart of this little receiver is the high-gain r.f. circuit developed around the type 6P7-G tube, the r.f. pentode section

(Continued to page 132A)

You'll Call It Marvelous . . .
WE CALL IT—



Univex
IRIS
STANDARD MODEL
\$5.95
PRICES SLIGHTLY HIGHER OUTSIDE U.S.A.
CANDID CAMERA

Eveready case with leather shoulder and hand strap—
\$2.00

BEWARE OF IMITATIONS

- Vitar f:7.9 lens, color corrected.
- Provision for cable release.
- 3 speeds: instantaneous, time, bulb.
- Optical precision view finder.
- 4 stops: f:7.9, 11, 16 and 22.
- Uses fast Ultrapan film, 15c a roll.
- Genuine Iris Diaphragm.
- Chromium trimmed metal alloy case.

DeLuxe model illustrated. Full chromium with leatherette cover and focusing mount. \$7.50.

See Your Dealer Today

NEW IMPROVED MODEL NOW READY



Univex EXPOSURE METER
NEW, IMPROVED MODEL NOW READY

No more spoiled film. For all movie or still cameras. The only extinction-type meter with official Weston speeds, General Electric moulded construction, and automatic compensation for filter factors, film speeds and types of subject. Compact case, 35c.

\$7.95

UNIVERSAL CAMERA CORP.
Dept. 103, 32 West 23rd St., New York, N. Y.

FREE BOOKLET

Please send me latest information on Univex Movie Cameras and Candid Cameras.

NAME _____
ADDRESS _____
CITY _____ STATE _____

Don't Drive WRONG ROADS!
How often have you found yourself on the wrong road? You know how annoying it is to retrace your way when you are in a hurry. The Hull Auto Compass always shows the direction of travel, saving you miles, money, worries and delays. Only \$2.95 at your dealer. Two-piece model \$1.95. Write for circular.

HULL MFG. CO., P. O. Box 246-D6, WARREN, OHIO

MAKE MONEY IN PAINTING BUSINESS
Paint walls, ceilings, screens, furniture, radiators, machinery faster, better! 1/4 H. P. motor 110 Volt 60 Cycle AC, complete with Spray Gun, 15 ft. hose. Weighs only 44 lbs. Carry anywhere. FULLY GUARANTEED. Only \$31.15 f. o. b. Chicago. \$5 Deposit, Balance COD, or SEE YOUR DEALER. Circular FREE. Get started making money NOW!

Ideal Automatic Pump Co., Dept. PM-10, 801 Washington, Chicago **\$31.15** Complete

AUTOMATIC STENCIL DUPLICATOR
Amazing new Print-O-Press Stencil Duplicator. Automatic feeding. Automatic inking. Full 8 1/4 x 14 legal size. Other models also, at sensational low prices. Details free, also free samples of work done. User-Agents write.

Professional Products Dept. 1010, Silverton, O. **\$13.95** Complete
Order direct

FINDS BURIED TREASURE! NEW GOLDAK RADIOSCOPE
Most efficient metal and mineral ore locator ever known. Money-back guarantee to detect buried GOLD, SILVER, or any other metal. Extremely powerful new models. Put your prospecting on a scientific basis. If you know of buried treasure, find it with the new Goldak. Write world's largest manufacturer of successful mineral locators for information.

THE GOLDAK CO., Dept. P 1031 South Broadway, Los Angeles, Calif.

• 24000 R.P.M.
• OVER 40 WATTS OUTPUT
DURO HEAVY DUTY GRINDER

WE'VE GOT SOMETHING HERE! An apt expression by one of the Duro Organization after the first tests had been run on the new Heavy Duty Grinder.

How true this is can only be realized by using this new tool.—The amazing power and high speed, the compact streamline design with weight enough to assure rigidity, the coolness and quiet performance on continuous operation and many other features will prove that we really have something here.—"An outstanding Hand Grinder regardless of price."

BUT THEN IT SHOULD BE GOOD—We are using the finest materials with precision machine fits. General Electric Motors and New Departure Ball Bearings.

Furthermore, General Electric and New Departure engineers have worked in close harmony with Duro engineers, adding their knowledge to our own vast experience as manufacturers of Woodworking, Electric and Automotive Tools, in designing this Hand Grinder.

DURO METAL PRODUCTS CO.
2657 N. Kildare Ave., Dept. B1, Chicago, Illinois

1939 WOODWORKING CATALOG SOON READY ASK FOR IT!

FREE! ALLIED'S 1939 RADIO AND PARTS CATALOG

**15,000 RADIO ITEMS
At Lowest Prices**

NEW SETS!

See radio's greatest values!—powerful new 1939 Knight Radios, at amazing low prices! 62 models, advanced new features, Push-Button Tuning—4-16 tubes, for AC, AC-DC, 32 Volt, battery and auto operation—new "Tiny Knights", low-drain battery sets (1.4 volt tubes). Phono-radios, record players, phonographs, etc. Send coupon today!

NEW KITS—PARTS!

ALLIED'S catalog shows more than 14,000 exact duplicate and replacement parts for building or repairing any circuit! And—Radio's biggest selection of Build-Your-Own kits: Beginners' 1, 2, 3 tubes; 6 tube auto set; Photo Cell; Electric Fence; 4 Tube Portable; low-cost transmitters, etc.—and 100 diagrams and projects!

NEW HAM GEAR!

Giant new Ham section, an Amateur Catalog in itself! New Hallcrafters ship-to-shore, National, Hammarlund, Utah, and GTC Xmitters at prices to fit any purse; new receivers: National NC-510 and NC-44; Hallcrafters "Dual Diversity" and "Marine"; Sargent "Streamliner"; Howard, many others, all at lowest prices!

NEW SOUND SYSTEMS!

See a complete range of revolutionary new P.A.—8 to 65 watts—remarkable values! New Portable systems, 30-watt Mobile System, Booster-Power Stage, Electric Guitar Amplifier, New Record Changers, Players—most complete line of recording equipment, discs, etc. in any Radio Catalog! Write for ALLIED'S free catalog today!

TESTERS, BOOKS, TOOLS!

Complete Stocks!
Lowest Prices!

FREE! BUILDERS' PARTS LISTS

Write for Free Parts Lists showing equipment needed for building any kit described in this or any other magazine.

**Free! SEND
COUPON**

ALLIED RADIO CORP.
Dept. 5-K-9
833 W. Jackson Blvd., Chicago, Ill.

- Send me your new FREE 1939 Catalog.
 Send me Parts List No.

Name

Address

City..... State.....

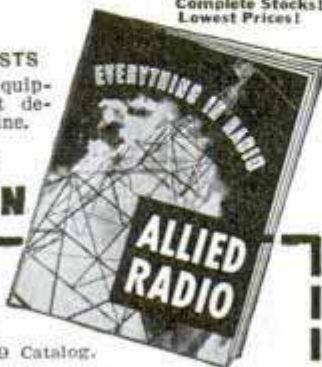

(Continued from page 130A)

being coupled back to the triode section which serves as a power detector. This is resistance-coupled to the pentode output section of the 25A7-G tube. Plenty of volume is thus obtained to drive the 3-in. magnetic speaker. Both tube heaters (H) are wired in series and the 290-ohm line-cord resistor reduces the line voltage to the required value.

All tuning is done by means of the push-button unit which employs adjustable trimmer condensers. There are 5 trimmers used in connection with the antenna coil and 5 for the r.f. coil. The push buttons and their corresponding trimmers are numbered on the photo of the push-button unit. Button S is for silencing the set temporarily between programs without turning off the line switch. Be sure the line main switch is turned off when set is not in use. Looking at the push-button unit in the position shown, it will be noted

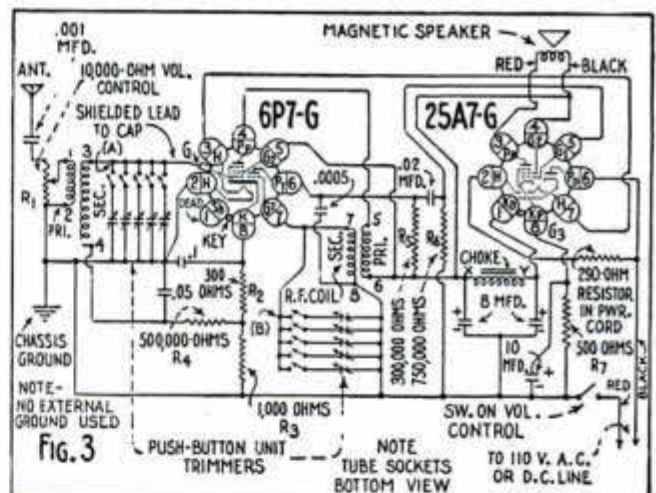

that the large-capacity trimmer condensers, those with the thickest insulation, are at the right end of the unit. These are for the low-frequency stations. Turn on the set by advancing the volume-control knob, and push down button No. 5. Now beginning at the right-hand side, looking at the slot in the rear of the receiver base, insert a small screwdriver and adjust trimmers No. 5 for the lowest frequency, longest wave-length, local station wanted. When this station comes in with maximum volume, the same adjustment is made on button No. 4 and trimmers No. 4 for the local station having the next lowest frequency, and, so on for the other buttons and trimmers. A sheet of gummed labels for all U. S. broadcasting stations is supplied for the escutcheon of the push-button unit.

OWN A ROYAL



Believes Royal helped him get ahead!

"The day I got my Royal I started typing my reports. The boss liked it. Soon I had a larger territory. Now I have 5 men under me."

PORTABLE ON



Glad they picked a Royal

"All of us use our Royal Portable—Junior for his homework—I to work out assignments for a correspondence course which I'm taking."

YOUR OWN TERMS



Ideas typed on Royal bring raise

"Ideas count where I work. Since I got my Royal, I've typed mine out. Already I've had one raise, and I expect another."

Only a Few Cents a Day

FREE HOME TRIAL FOR EVERY

MEMBER OF THE FAMILY! A Royal Portable will help you write faster, think faster. A practical, modern necessity—it's an opportunity for a better, brighter future! A chance to do more, *be more!*

Without risking a penny prove—right in your own home—that a Royal will help you—whatever your business or profession—help you to set down your ideas and reports *legibly, impressively*. Prove too, that it will help the children with their homework . . . *help every member of your family with their writing!*

READ WHAT ROYAL GIVES YOU! Standard, full-sized keyboard. Easy, effortless action, Touch Control, Finger Comfort Keys, Genuine Dust Protection, Automatic Paper Lock, Touch-set Tabulator and many other office typewriter features. Tested, proved, guaranteed!

FREE! Royal's Instant Typing Chart, shows you how to type **RIGHT**. INCLUDED with every Royal Portable at no extra cost—a handsome, all-weather, triple-convertible Carrying Case.

SEE what a Royal will do! Then own it on your own terms—cash or *only a few cents a day!* Mail coupon today for full details of Royal's offer—prices, terms, Free Home Trial—everything. No obligation.



ROYAL TYPEWRITER COMPANY, Inc., Dept. C-82, 2 Park Ave., New York, N. Y.

Tell me how I can own—for only a few cents a day—a latest model Royal Portable—with **FREE HOME TRIAL**. (DO YOU OWN A TYPEWRITER NOW? Then make it help pay! Write Make and Serial No. on coupon margin for full trade-in value.)

NAME _____ STREET _____
CITY _____ STATE _____

PHOTOGRAPHIC ALMANAC



Free!



Free 1938 Almanac includes: (1) Special month-by-month Photographic Calendar. (2) Authoritative photographic article. (3) Handy Exposure Table, Exposure Guide. (4) 100 pages of still & movie cameras, films, lenses, enlargers, chemicals—everything photographic—many at big savings. **ALL GUARANTEED on 10 Day Money Back Trial.** (Used equipment accepted in trade.) Write for Free copy! Central Camera Co., (Est. 1899) 230 S. Wabash, Dept. K-10, Chicago

GET YOUR TRACTOR AT FACTORY PRICE

3 Speeds Fwd. and Reverse. Runs 4 to 8 hrs. per gallon

Amazing money maker for farms, truck gardens, orchards, nurseries, poultry ranches, country homes, etc. Plows, discs, harrows, cultivates, mows lawns, cuts weeds. Runs belt machinery, 2 to 3 H.P. riding or walking types. Write for **FREE CATALOG, Low Factory Prices and 10 day Trial Plan.** Address **Nearest Office:** SHAW MFG. CO. 4510 Front St., Galesburg, Kans. 130 W. West 42nd St., New York, N.Y., 5812 G Magnolia Ave., Chicago, Ill., 668 G North 4th St., Columbus O.

Air Tires or Steel Wheels

SHAW DU-ALL TRACTOR

HANDY TAPS and DIES . . .

Accurate—carefully hardened and tempered. Complete range of sizes at your local five and ten cent store.

HENRY L. HANSON, WORCESTER, MASS.

ENGINES

A real money maker for farm or factory. Uses Cheap fuels. Pays for itself out of savings. Costs Less to Own—Less to Operate.

LOG SAWS

Make Money—Start a wood sawing business—turn spare timber into cash. Cash or Terms—Engine and Saw Catalog.

WITTE ENGINE WORKS
1747 OAKLAND AVE., KANSAS CITY, MO.

HANDEE

TOOL OF 1001 USES

ACTUALLY A WHOLE SHOP FULL OF TOOLS IN ONE

Uses 200 different accessories, instantly interchangeable in easy-working chuck. For faster, better work on all materials, at home, in shop, or take to job. Plugs in any AC or DC socket, 110 volts. You'll be amazed at its unmatched performance, precision and almost human response.



- Grinds
- Drills
- Polishes
- Engraves
- Sharpens
- Carves
- Cleans
- Sands
- Cuts
- Saws

STANDARD MODEL
13,000 r.p.m. Weighs 16 oz. \$10.75 postpaid with 3 Accessories.

DE LUXE MODEL
25,000 r.p.m. Fastest, smoothest, most powerful tool for its type and weight, 12 oz. \$18.50 postpaid with 6 Accessories.



GET A DEMONSTRATION at Hardware, Tool or Dept. Stores, or let us send either model on 10-days Money-back Trial. Catalog Free.

New ROUTER and SHAPER
Convert your De Luxe Handee into an easy-to-handle Router or Shaper that will inlay, rout, carve, make molding cuts to 100th of an inch accuracy. \$12.50.

Chicago Wheel & Mfg. Co., 1101 W. Monroe St. Dept. Q, Chicago, Ill.

Send Catalog Router-Shaper Set PM10
 De Luxe Model Standard Model Send C. O. D.

Name.....
Address.....



Build Your Own ICE YACHT

Enjoy old Man Winter in a Mead Ice Yacht—"Skeeter" type or Batwing—available in construction kit or factory-built. Or build your own Motor Sled. Rush dime for complete details on Mead Winter Sportcraft.



(Above) MEAD SKEETER

Build Your Own MOTOR SLED

Mead

MEAD GLIDERS, 15 S. Market, Dept. B-108, CHICAGO

CUT TRANSPORTATION COSTS IN HALF WITH

Auto-Glide

Powerful Cushman Engine



Now you can get to school, work, make trips or deliveries quickly at a New Low Cost! JUST THINK—120-miles per gallon! Up to 35 miles an hour! Powerful 1 1/2 or 2 H. P. engine (2-speed transmission) rips up steep hills. Built really rugged for hard use, long trips. Clutch makes it easy to start and stop. Genuinely comfortable riding. Parks anywhere.

AUTO-GLIDE, streamlined pleasure model for youngsters, business and office folks. **KARI-PAC**, big rear carrier for school, deliveries, etc. **SIDE-KAR**, attaches to above models. Make 3-wheel unit.

WRITE See your dealer or send for book illustrating all models. Send NOW!

DEALERS: Write for Special Offer!

THE CUSHMAN MOTOR WORKS, Dept. G-10, Lincoln, Nebr.

New Amazing INVENTION!

ELECTROPLATES

by BRUSH EASY AS PAINTING!

Easily.. Expertly.. Cheaply!

Sensational new discovery. **Only \$6.85** actually electroplates. It's easy... just brush on. Deposits heavy, durable layer of metal by electrolysis. Results permanent—equal to beautiful work of costly tank outfits. **Non-liquid**—Portable—Battery or household current. Take it to the job. No dismantling... plate where and what you want. Outfit in sturdy case, complete for instant use. Junior Battery Model: \$6.85. Heavy-Duty Professional Sets up to \$27.50.

AGENTS WANTED: Write at once for Big Money Proposition. You can also make steady money plating for others.

WARNER ELECTRIC COMPANY, Dept. W-6, 360 No. Michigan Avenue, CHICAGO, ILL.



JIG SAW \$1.50

COD or outside U.S.A. \$1.75

POST PAID



Including 12 assorted blades. Adapters, manual, and roller Saw Guide formerly found on expensive machines only. All metal, 15" long, 8" high, 6 1/2" table. A swift and easy cutter—best ever made for the money.

"The Jigmak-er" cuts wood 2" thick.

\$150 PRIZE CONTEST

FREE CATALOG describing \$150 prize contest (1st prize, \$25; 2nd, \$15; 3rd, \$10; 66 other cash and merchandise prizes). Cat. illustr. complete power tool line: Shaper, Circular Saw with oilless bearing, \$3 each; Drill Press, \$4.50; completely equipped Lathes, \$2 and \$4.90; Sander \$1, etc. Order today or send card for Catalog.

J & H Metal Products Co. 5 Commercial St. Rochester, N. Y.

BRAKES—ELECTRIC, VACUUM AND AUTOMATIC—AXLES AND HITCHES FOR ANY TRAILER.

All treads, all spring spreads.

New \$3.00 House Trailer Blue Prints Free With Axle Assembly

WRITE FOR FREE LITERATURE.

HAMMER BLOW TOOL COMPANY, Dept. 110

WAUSAU, WIS.



BURN YOUR NAME ON TOOLS WITH THE ARKOGRAF

PROTECT YOUR TOOLS FROM THEFT

Write with electricity any name or design on the hardest and finest tools and instruments, or any metal, like writing on paper with pen or pencil.

Complete Outfit \$3.50—Prepaid Anywhere

Interesting illustrated circular free. Write today. Agents wanted.

ARKOGRAF PEN CO., 3927 S.E. Stark St., Portland, Ore.



NEED MONEY? Men or Women

Part time or full time to sell

Beautiful LEATHER TIES

In fancy embossed patterns and handsome colors. Can't be told from silk. A clever novelty, long-wearing, won't wrinkle. Cleaned with a damp cloth. Sell on sight. Everybody wants them. No sales ability needed. Send 50c for samples and information on how to get started.

CENTURY TIE CO., 2345-L, W. Grand Blvd., Detroit, Mich.



FREE ATTRACTIVE CATALOG

Artistic pins, rings and emblems for classes and clubs. Attractive prices. Finest quality, gold plated, silver, etc. Over 300 designs.

Write Dept. H, METAL ARTS CO., Inc., Rochester, N. Y.

30¢ PINS



M.M. EARN \$1174 at Home!

Earn Cash at Home!

We paid M. M. \$1174 for exceptional "cellar crop" SNOW-KING mushrooms! Big free picture book tells if your cellar, shed, barn suitable. We furnish materials, buy all crops. Write today. Est. 1908.

UNITED CO., 3848 Lincoln Ave., Dept. 310, Chicago.

SAVE 10% to 40% ON LEWIS CASTINGS

Thirty day, nation-wide sale on castings, semi-finished projects, and finished machine tools. Free B/P service. Write NOW for catalog and special discount sheet.

LEWIS MACHINE TOOL COMPANY
1625 Van Ness Ave. San Francisco, California

1001 Farm Supply BARGAINS

Send for your FREE copy of Jim Brown's Big Fall Bargain Book Today. Start saving money the way 1,500,000 others do. Everything for the Farm and Home, Jim Brown Pays the Freight and Postage. Write TODAY. It's FREE!

JIM BROWN . . . DEPT. 3445-A
Cleveland, Ohio or Memphis, Tenn.

STOVES FENCING PAINT ROOFING RADIOS

When writing please mention Popular Mechanics

The Romance of the Locomotive

(Continued from page 567)

move some large rocks out of the road." Such was the first trip of the first steam-operated locomotive to run on rails.

Stephenson, whose life had been spent operating mine machinery, saw a second engine built by Trevithick, decided he could build a better one and began trying. Some of his locomotives were used in mines and on a short railway, but the attempts of Stephenson and others, up to this time, to solve the problems of steam locomotion with little six-ton creations, burdened with upright cylinders, walking beams, cog wheels and chain drives, and with steam pressures often as low as ten pounds, were almost pathetic.

About this time the merchants of Liverpool and Manchester decided to build a railway between the two cities to avoid the high rates and delays imposed by canal shipping. No one gave much thought to the power to be employed until the road was almost finished. Then Stephenson, who had established a locomotive building shop at Newcastle, urged the adoption of steam locomotives. Every prominent engineer was against him. Finally, however, he built one locomotive which was used in the final stages of the construction project.

Meanwhile the directors were deluged with plans for drawing trains along the line by water power, hydrogen, carbonic-acid gas and atmospheric pressure. They inspected locomotives in use at Newcastle but could not agree. Two engineers hired to report on the best kind of power suggested stationary engines and cable traction, involving the building of twenty-one fixed engines, with cables and machinery.

The harried directors objected to the expense. At last they offered a prize of 500 English pounds for the best locomotive for the purpose. The engine was to cost not more than 550 pounds and was to rest on six wheels if of the maximum weight of six tons. A lighter engine was preferred, so the rules specified that if it did not weigh more than four and one-half tons, it could rest on four wheels. If of maximum weight, the engine must be able to draw a weight of twenty tons, including the tender, at ten miles per hour and steam pressure was not to exceed fifty pounds per square inch.

(Continued to page 136A)

FREE trial in your home



ENJOY THIS
LAFAYETTE FOR
A WHOLE MONTH
AT OUR RISK!



DISCOVER AMERICA'S No. 1 RADIO VALUE!

Looks like a rich man's luxury — this handsome Lafayette, Model FS-11, 5 tube AC-DC combination, until you look at the price! Has all the extra-value features you expect to find only in combinations selling for three times the cost. *New beauty, new tone — even more amazing performance! It's a value Bombshell! In our FREE catalog.*

ONLY
\$19⁹⁵
COMPLETE
READY TO
OPERATE

MORE THAN 50 OTHER LAFAYETTE RADIOS!

Quality built, richly toned, economically priced — Lafayette for 1939 is truly America's standout "buy"!

★ 30 DAY ★
FREE TRIAL
Try a Lafayette for 30 days. If you're not satisfied we will cheerfully refund your money.

FREE NEW CATALOG!

The Open Door to remarkable savings in radio. Complete line of parts, new tubes, "ham" equipment, etc. Special Camera Section! Send for it today!

PIONEER IN TELEVISION

See the new television kits licensed by RCA — featured in our catalog. Complete with specifications and diagrams, you build them yourself. You'll be amazed at their low price!

WHOLESALE RADIO SERVICE CO. INC.

NEW YORK, N.Y. • CHICAGO, ILL. • ATLANTA, GA.
100 SIXTH AVENUE • 101 W. JACKSON BLVD. • 245 PEACHTREE STREET
BOSTON, MASS. • BRONX, N.Y. • NEWARK, N.J. • JAMAICA, L.I.

WHOLESALE RADIO SERVICE CO., INC.
100 SIXTH AVENUE • NEW YORK, N. Y.
Rush FREE 1939 Catalog No. 73-7KA

VALU-BILL
says:
**CLIP THIS
COUPON!**

Name.....

Address.....

City.....

PASTE COUPON ON PENNY POSTCARD

12594
(Continued from page 135A)

**HABER & FINK
RECOMMEND
PHOTRIX
EXPOSURE METER**



because

- It is **TRULY** sensitive.
- One dial...easy to read.
- Nothing to set.
- Compact...streamlined.
- Wrist watch operation.
- Built with the precision of the finest watch.

Haber & Fink recommendations have been guiding professional and amateur photographers for over twenty years.

They endorse **PHOTRIX.**



No matter which exposure meter you own, exchange it here for this most modern photoelectric **PHOTRIX EXPOSURE METER.**



Let this friendly and complete photographic store fulfill all of your camera and photographic needs. Free demonstration of **PHOTRIX**... gladly! Write for descriptive literature and bulletin of many other specialties.

- **PHOTRIX EXPOSURE METER \$15.00**
- Ever-ready Leather Case 1.00
- Wrist-strap for fastening **PHOTRIX** to the wrist 1.00

HABER & FINK INC.
16 WARREN ST., NEW YORK

60 POWER TELESCOPE . . . \$219

NEW! VARIABLE EYEPIECE 20X-40X-60X
Three telescopes in one. 3 different magnifications. 20 power for ultra-bright images with 40 and 60 power for extra long range. Guaranteed to bring distant objects, people, sports, events, ships, moon, stars, etc., 60 times as close.



Most powerful made for anywhere near the money. Closes to less than a foot in length. Multiple lens system. 30 mm. objective lens. 5 sections. Directions included for using as a compound 4 lens microscope. American made. We pay the postage. Only \$2.19. Catalog of Microscopes, Binoculars, etc. FREE on request. **BROWSCOPE CO., Dept. 410, 5 W. 27th St., New York, N. Y.**



AUTO ENGINE SPEED CONTROL GOVERNORS

445 E. 3rd St. Los Angeles, Calif.



VEST POCKET ADDING MACHINE

IDEAL FOR BUSINESS OR PERSONAL USE: Adds, subtracts, multiplies, divides. Does work of more costly machines. Counts up to million, made of steel—weighs 5 ounces. Simple, accurate. Not a toy. Guaranteed 5 years.

**— FREE TRIAL —
SEND NO MONEY!** **\$2.50 Total Cost**

Order from ad, not sold in stores. On delivery pay postman \$2.50 (plus few cents postage). (If outside U. S. send cash.) 10c additional in Leatherette Case. If not satisfied after 10 days' trial you get your money back. Thousands of satisfied users. Write for Agent's proposition. **CALCULATOR MACHINE CO. (Mrs.) Dept. 115, P. O. Box 1115, Chicago, Illinois.**

Engine and tender were to be mounted on springs, the "chimney" was not to exceed fifteen feet in height, and the engine was to "effectually consume its own smoke" because many declared that if locomotives came into general use, the sun would be obscured most of the time.

A straight stretch of track near Liverpool was selected as the testing ground. The length of the test run was to be one and one-half miles. Each engine was to travel the distance forty times, pulling on twenty runs in one direction and pushing on twenty in the opposite direction.

As the time for the test approached, four engines were nearing completion, among them Stephenson's "Rocket" which made her historic test run on October 8, 1829. Stephenson had learned from previous mistakes, and instead of upright cylinders, those on the "Rocket" were in an inclined position and applied the power direct to the drive wheels.

The multitubular boiler contained twenty-five copper tubes three inches in diameter, and the engine, being of the lesser weight prescribed, rested on four wheels. With the boiler full of water, the "Rocket" weighed 8,500 pounds, exclusive of the tender which weighed 6,400 pounds. On her test run, the "Rocket" hauled two "wagons," the total weight of engine, tender and train being seventeen tons.

The first twenty to-and-fro runs, totaling thirty miles, were made in two hours and fourteen minutes. The last twenty required only two hours and six minutes, an average of more than fourteen miles an hour. The quickest run was made in three minutes and forty-four seconds, equivalent to twenty-four miles an hour. Fourteen years later the "Rocket" attained a speed of sixty miles an hour. Two other engines eventually competed for the prize. One was the "Novelty," a "tank" engine which carried fuel and water on its own frame. The other was the "Sanspareil" with upright cylinders and return flue boiler. Both broke down during test runs, and the prize went to the "Rocket."

Thus George Stephenson, who did not invent the locomotive or any essential part of it, triumphed where others had failed. His happy combination of the multitubular boiler with the power of two cylinders applied directly to the drive wheels, and a

11594

proper relation between cylinder size and drive-wheel diameter established a principle which, after the lapse of more than a century, still holds good. To Trevithick, however, must go the credit for inventing what has been called "the greatest civilizing force of all time." He built and operated the first locomotive to run on rails and broke through Watt's system of condensation and low pressure.

Railroad history is filled with freaks which ignored the principles established by Stephenson. When the seven-foot gauge Great Western Railway was built in England, many innovations were tried out. One, the "Hurricane," had two ten-foot driving wheels and the boiler on a separate carriage from the locomotive proper. She hit 100 miles an hour when running light, but could not pull even a light train.

Passenger engines with nine-foot drivers were designed for the seven-foot gauge Bristol and Exeter Railway and ran for some years, but the design was not perpetuated. About the middle of the last century, the London and Northwestern Railway produced the "Liverpool" which developed high speed but had little hauling capacity. Similar engines were built in this country and later discarded.

The "Fontaine" locomotive employed the principle of the large and small pulley to obtain a high rate of revolution for the drive wheels. One such engine reached a speed, with two light coaches, of a mile in thirty-two seconds, a record for many years. When hooked to a heavy train, however, the "Fontaine" failed to deliver.

The return flue boiler, favored by many early designers, was revived in improved form several years ago. Theoretically, the return flue type saves fuel but higher cost of manufacture and upkeep more than offset this. Elimination of the "hammer blow" of the drivers on the rails at high speed was claimed for the "Henry Shaw," called a "balanced" locomotive. There were four cylinders and connecting rods but the remedy was worse than the disease.

Near the close of the last century, the compound locomotive was hailed as the engine of the future. Then came superheated steam with its greater economy and the compound engine disappeared—leaving the simple, two-cylinder locomotive first designed by George Stephenson again in possession of the field.



Making FILES Easier To Use

This new booklet will make files mean more to you than ever before! Tells how to sharpen your saws and edge tools — which kind of file to use for each job — and shows and describes all popular kinds of files. The information in this booklet is worth many dollars to a home craftsman, repair man, factory worker or farmer. It's yours — absolutely free! Send a note or postcard today to Nicholson File Company, 22 Acorn St., Providence, R. I., U. S. A., Canadian Plant, Port Hope, Ontario.

... and Easier to BUY!



The No. 66 Display Unit is awaiting you in your hardware store, complete with popular Nicholson or Black Diamond Files, each cellophane wrapped. Make your own selection. Price plainly marked! Stop in your hardware dealer's tomorrow!

NICHOLSON

"A FILE FOR EVERY PURPOSE"

8437 b

Get the Thrill of **EXPERT SANDING** With this **NEW** and Better Tool -

The Guild PORTABLE **Sander** ELECTRIC

You'll enjoy sanding — do an expert job—when you use the new portable electric Guild-SANDER. No more slow, tiresome hand work. The new GuildSANDER gives you a finer, faster finish. Continuous abrasive belt smooths evenly, with the grain, both large and small flat surfaces and a wide variety of curved surfaces. Miter and joints are sanded to a smooth, tight fit. Takes off paints and varnishes easily, without messy removers.

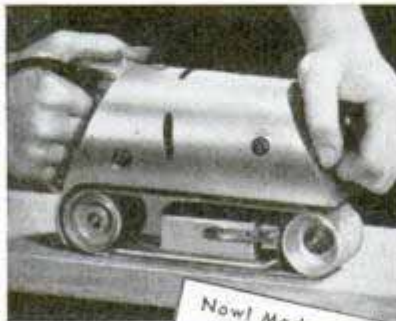

The GuildSANDER weighs only 9 lbs., plugs into nearest light socket. Has Universal motor. Anyone can operate it without previous training. Works on wood, metal, marble, glass, plastics and compositions. Built by sander experts. Completely guaranteed. Find out for yourself what the GuildSANDER will do.

- Now! Moderate PRICE
- Smoother FASTER FINISH
- NO EXPERIENCE Needed
- MANY USES

Write FOR COMPLETE INFORMATION AND TRIAL OFFER

Syracuse GuildTool Company

1700-10c NORTH SALINA STREET, SYRACUSE, NEW YORK

NEW BENJAMIN AIR PISTOLS WITH LEVER HAND PUMP



WRITE TODAY!

Now You Can Use Benjamin Genuine Compressed Air Pistols With New Multiple Lever Hand Pump Anywhere—Indoors & Outdoors—In living room or rathskeller and out in the wide open spaces for Target—Hunting—Camping, etc. No noise—smoke or fumes. Adjustable Force with Amazing Maximum Velocity. Bolt Action—Hammer Fire—Hair Trigger—Safety. Guaranteed—Economic—Practical—Accurate—Safe. Single Shot BB Air Pistol with smooth barrel \$8.50; cal. 177 or 22 Single Shot Air Pistols with rifled barrel \$8.50; BB 8-Shot Air Pistol with smooth barrel \$10.00; Hailer \$2.00. We also make a complete line of Benjamin Genuine Compressed Air Rifles for BB and cal. 177 or 22 pellets and darts. No license required to purchase from dealer or prepaid from factory. Write Today for Complete Specifications & Free Targets. Benjamin Air Rifle Co., 890 Marion St., St. Louis, Mo.



SAVE OIL WITHOUT REDORING RESTORE POWER
HALING'S FOUR PIECE PISTON RINGS
Cup seals worn groove, saves oil. Distributors wanted. Piston Expanders, Steel Vented Rings, Segment and Plain Rings. Get circular and users testimonials.
HALING CO. Dept. P. Rochester, Minn.

SAVE ME! **I'M COMING!**

Don't live with crippled furniture, chipped veneers, splintered mouldings. It's fun "doing them over" with Rogers! Made only from cod fish skins. Stays put longer because it's stronger. 10¢ and up in tube, bottle or can at hardware stores, or send 10¢ for full size bottle and set of project plans.
ROGERS, Gloucester, Massachusetts

ROGERS
the best LIQUID FISH GLUE
SAYS GLUEKY

Steel Carves a Waterway

(Continued from page 509)

Of all the lake boats, the largest is the "Lemoyne," a Canadian craft. It can carry 571,885 bushels of wheat. This would make a train of 211 cars, or more than two miles. Putting such a load on board is a delicate task as it must be distributed evenly the length of the keel and built up gradually. Taking it out, the process must be reversed. This is all done by machine. The ship runs alongside an elevator, spouts swing down to the open hatches and an operator directs the flow of grain. Between breakfast and lunch the entire load is taken aboard. At the other end the load is sucked out by a long-nosed conveyor which looks like a giant mosquito.

Grain is fluid and easy to handle compared with coal and iron ore. A water bucket of iron ore weighs 125 pounds. A ship is loaded to capacity when the cargo hold is less than half filled. The largest ore carrier is the "D. G. Kerr," which holds the record for speedy loading—12,508 tons of ore taken aboard in sixteen and one-half minutes. The usual time is two hours. Ore docks are as high as a ten-story building. The ship runs under and a spout is lowered in each hatch. Behind each spout is a hopper holding 400 tons. When the hoppers are empty the ship moves along to a new group. Ore docks are one-half mile long and have 1,000 hoppers each.

Taking the ore out is more spectacular than putting it in, for giant clamshells reach down and take out from five to twenty tons at a bite. The newer ones work at the rate of forty tons a minute, and with four or five working at once, unloading is but a matter of hours. Before 1905 there were no clamshells. Laborers then went down with pick and shovel and heaved the ore into bucket hoists.

All of the "yo ho and heave" tactics still common in seaports are absent. There is no excitement, very little noise and even with coal the dirt is kept down by sprinkling the cargo as it comes aboard. Lake ships are as well kept as yachts and take pride in their glistening white cabins. Anyone who smudges any of the bright work is instantly out of favor. Port workers know this and refrain from leaning against cabins in dirty overalls.

(Continued to page 141A)

A NEW DELTA TOOL



Eagerly Awaited by Craftsmen All OVER THE WORLD

One of the most remarkable motor-driven tools ever designed by Delta will be announced soon. For seven years Delta engineers have been working on this new development. The result has been a motor-driven tool so revolutionary in design, so basically improved over anything hitherto available, that it is considered Delta's greatest contribution to the power tool field. The full story of this remarkable new tool is so comprehensive that it cannot be given on a small circular or a few catalog pages. A special booklet is being prepared that will be sent free to all those who are interested. Send for this booklet today. It will be mailed with the new 1939 Delta Catalog.

• SEND FOR THE NEW 1939 DELTA CATALOG

It will be off the press shortly. It will contain the latest up-to-the-minute listings of the complete Delta line of Drill Presses, Saws, Sanders, Jointers, Shapers, Grinders and accessories—with all the new improvements and refinements and information about the newest tool accessories.

Delta "Quality" tools are recognized the world over for their built-in value, dependable performance, for their rugged, accurate construction. From the smallest of home shops to huge industrial plants, Delta tools have established themselves as low-cost time and labor savers. Don't miss the latest tool news in the 1939 Delta catalog.

SEND COUPON so your name will be on the mailing list. Don't take a chance of not receiving your 1939 Delta Catalog promptly. Just fill out the coupon below and mail it at once!



The home of the Delta Manufacturing Company in Milwaukee—the world's largest manufacturers of modern, low-cost power tools exclusively.

Delta Mfg. Co. 600-634 E. Vienna Ave.
Milwaukee, Wisconsin.



DELTA MFG. COMPANY, Dept. A1038
600-634 E. Vienna Ave., Milwaukee, Wisconsin.

Gentlemen: Please place my name on the mailing list to receive the 1939 Delta Catalog just as soon as it is off the press—and a free copy of the booklet giving the full detailed story of the new revolutionary Delta tool.

Name

Address

City..... State

Check here if you are a Delta user now.

When writing to advertisers please mention Popular Mechanics



ONLY \$3.35
FOR GUARANTEED
ELECTRIC DRY SHAVER

Pays for itself in 2 months by saving on blades, brushes, soaps and lotions . . . Churchill Electric Dry Shaver gives you a fast . . . smooth . . . close shave . . . at the same time massages and re-conditions skin.

READ THESE ADVANTAGES

1. Self-sharpening, self-oiling, self-cleaning and non-clogging.
2. All-purpose shaving head with double cutting edges . . . New hand-fitting shark skin finished case of attractive moulded plastic.
3. Fully tested and approved by underwriters laboratories . . . New improved long life motor . . . Economical in operation.
4. Complete with approved cord and plug set attractively packed in a colorful utility package.

Ten Day Money Back Free Trial. . . Compare with any \$15 competition . . . Fully Guaranteed. . . Operates on either 110 or 120 volts AC or DC current. Send one dollar and your shaver will be forwarded immediately C.O.D. \$2.35 plus 15c postage.

F. G. DENNISON CO. P.O. A-94
HARVARD SQUARE CAMBRIDGE, MASS.

Woodworkers:

Be sure to write for this remarkable 100 page

catalog. Full of valuable information including the newest, latest ideas for wood workers.



Write for this CATALOG-10c.

Wonderful, entertaining, healthgiving hobby for business men; also a profit maker for spare time. You can start with a \$1.98 scroll saw outfit.

THIS CATALOG contains the most complete list of woodworking supplies in the world—Standard American woods cut-to-size at bargain prices. Also rare imported woods, Veneers, plywoods, inlays, carved-legs, mouldings, decorations, special tools, hard-to-find ornamental hardware, scroll saw patterns, wood-finishing instructions, many, many, blue prints—tells how to make Venetian Blinds at 1/3 store prices. Send 10c.

Craftsman Wood Service Co.
2737 S. Mary Street, Chicago, Ill.

SpeedWay Real Quality Tools

Designed, manufactured and guaranteed by SpeedWay, for 30 years leading manufacturers of industrial drills, these are really fine tools, correctly designed, correct speeds, genuine high torque drill motors. Small, handy, powerful, 1000 RPM—drill handles to 1 1/4" in steel. Die cast handle and gear housing. \$7.95. 20,000 RPM Grinder with collets for 1/8" and 3/32" arms, equal in every way to grinders costing several times \$5.95. No. 250 KIT, both drill and grinder with 5 accessories in steel carrying case \$14.95. Complete line of accessories and drill press stand. Write for Circular.

SPEEDWAY MFG. CO.
1842 S. 52nd Ave., Cicero, Illinois

DRILL \$7.95
GRINDER \$5.95
SET \$14.95

BILD-UR-OWN
COASTERS • MIDGET AUTOS • SCOOTERS •

NEW ROADSCOUT Scooter Complete \$59

Equip your Scooter, Midget car, etc. with our Disc Wheels and Balloon tires. **GOODRICH-GOODYEAR-FIRESTONE** at lowest prices. We specialize in wheel sets, scooter kits, motors, parts, etc. Send 10c to cover cost of mailing book and Free Plans.

BILD-UR-OWN DEVICES, 5237 Lake St., Dept. A-10, CHICAGO, ILL.

BIG SAVINGS ON EVERY THING YOU NEED
BIKE TRAILERS, ETC.

COMPLETE ELECTRIC PLANTS
AC DC

Onan A.C. plants furnish same current as city lines, 110 Volt, 60 Cy. For farms, camps, construction jobs. Operate radios, water systems, all appliances. New models, 350 to 5000 watts, 6, 12, 32 and 110 volt D.C. Models \$57.50 and up. Also combination A.C.-D.C. units Shipped complete, ready to run.

Write for details.
D. W. ONAN & SONS
1026 Royalston Ave
Minneapolis Minnesota

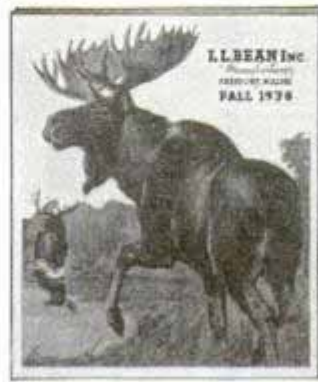

Free Fall Catalog

Showing Hunting Footwear, Clothing, and forty other leather and canvas specialties of our own manufacture for campers and hunters.

L. L. BEAN, INC.
262 Main Street
FREEPORT MAINE

Only \$18.90 at Bass

Dollina O
Special—grand camera—with Carl Zeiss Jena F. 4.5 lens, Variotar shutter, speeds 1/25, 1/50, 1/100, time and bulb. At Bass . . . \$18.90

Send for free Camera Catalogue No. 236
Bass CAMERA Co.
179 W. MADISON ST., CHICAGO, ILL.

FREE 48-Page POWER TOOL Catalog sent to any home craftsman interested in improving his work. Full descriptions of DRIVER Engineered Power Tools and Accessories. Write today!
Walker-Turner Co., Inc., 1108 South Avenue, Plainfield, N.J.

DRIVER Engineered POWER TOOLS

WIND ELECTRIC PLANT
Build Your Own—We Show You How!
Easily made from old auto generator. Dime brings complete plans and 1938 catalog. 100 other generator changes to 6, 12, 32, 110 volt plants, motors, welders, elec. fence, etc.
LeJay Mfg., 347 LeJay Bldg., Minneapolis, Minn.

3 IN 1 Electric TORCH
WELDS BRAZES SOLDERS

Now, an electric welding, brazing & soldering torch complete with inbuilt power unit, goggles and supplies. Works instantly off any light socket. Does a thousand and one repair jobs at an amazingly low cost on aluminum, iron, steel and other metals. Indispensable in auto shops for fender and body repairs. Unbeatable for home repairs, shop, factory, farm, engineer, janitor, sheet metal, radio and bicycle repairs. Anyone can handle without previous experience with our simple instructions. Does many industrial and production jobs.

COMPLETE \$6.95
WHOLESALE TO YOU

10-DAY HOME TRIAL
You can try 3-in-1 Electric Torch for 10 days at our risk or get one absolutely Free by helping to introduce it. Write for Free particulars.
ELECTRO-TORCH CO.
2613-AX Michigan Ave., Chicago

H 843

(Continued from page 138A)

Of all the specialized craft, none is more independent than the self-unloaders. There are now sixty-five of these and they carry coal, sand, crushed stone, cement and coke. On the deck of each is a long boom containing a conveyor belt. The ship ties up to a dock, the boom is swung over the shore, and as the machinery turns the cargo is lifted out and neatly deposited in a pile. One self-unloader, the "Huron," from April to December carried fifty-seven cargoes of crushed limestone and seventy-three of soft coal, a total of 922,833 tons of payload in one season. This would fill a freight train 185 miles long. A self-unloader can work a third faster than a vessel depending on dock facilities.

In one year more than 100,000,000 tons are carried on the lakes. This is more than that passing through the Panama and Suez canals combined, making the Great Lakes the busiest waterway in the world. Once every twenty minutes, day and night, a ship passes Detroit and another goes through the Soo canal. Fifty years ago there were no giant freighters, the Soo canal was an experiment and every sailor took his life in his hands when he stepped on board. Today an endless stream of red and black vessels slips silently past, protected by all the safeguards known to science, equipped with all the comforts and luxuries of the finest hotels, each a floating community by itself. Complete in every particular, they handle the transportation problem of the leading industries of America and Canada, and do it so quietly and efficiently nobody pays any attention to them.

H 866

Wire Screen over Rain Gutter Keeps Debris Out of Pipes

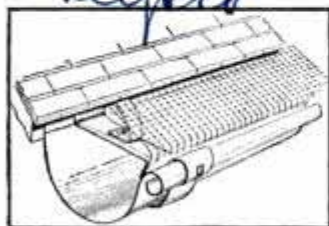

Clogged eaves and drainpipes are a nuisance that can be prevented by a protective screen. Made of copper or galvanized steel, the screen fits snugly over the troughs and keeps out leaves and twigs, and stops squirrels and birds from nesting there. The screens snap in place to be held by spring tension.

nized steel, the screen fits snugly over the troughs and keeps out leaves and twigs, and stops squirrels and birds from nesting there. The screens snap in place to be held by spring tension.

Dayton Eaves Protector Co. 350 S Broadway
Cincinnati Ohio

GREATEST BARGAIN IN TEN YEARS

NEW REMINGTON NOISELESS PORTABLE TYPEWRITER



AS LITTLE AS

10¢ A DAY

Money Back Guarantee
10-Day Free Trial Offer

AT LAST! The famous Remington Noiseless Portable that speaks in a whisper is available for as little as 10c a day. Here is your opportunity to get a real Remington Noiseless Portable equipped with all attachments that make for complete writing equipment. Standard keyboard. Automatic ribbon reverse. Variable line spacer and all the conveniences of the finest portable ever built, PLUS the NOISELESS feature. Act now while this special opportunity holds good. Send coupon TODAY for details.

YOU DON'T RISK A PENNY

We send you the Remington Noiseless Portable for 10 days FREE trial. If you are not satisfied, send it back. WE PAY ALL SHIPPING CHARGES.

● FREE TYPING BOOKLET

With your new Remington Noiseless Portable we will send you—absolutely FREE—a 24-page typing instruction booklet. It teaches the Touch System, used by all expert typists. It is simply written and completely illustrated. Instructions are as simple as A, B, C. Even a child can easily understand this method. A little study and the average person, child or adult, becomes fascinated. Follow this instruction booklet during the 10-Day Trial Period we give you with your typewriter and you will wonder why you ever wrote letters by hand.

● SPECIAL CARRYING CASE

Also under this new Purchase Plan we will send you your Remington Noiseless Portable in a special carrying case sturdily built of 3-ply wood. This handsome case is covered with heavy du Pont fabric. The top is removed by one motion, leaving the machine firmly attached to the base. This makes it easy to use your Remington anywhere—on knees, in chairs, on trains. Don't delay . . . send in the coupon for complete details!

SEND COUPON WHILE LOW PRICES HOLD

Remington Rand, Inc., Dept. 152-10
465 Washington St., Buffalo, N. Y.

Tell me, without obligation, how to get a Free Trial of a new Remington Noiseless Portable, including Carrying Case and Free Typing Booklet for as little as 10c a day.

Name

Address

City State

Turn JUNK TIRES IN TO Cash! START AT HOME

The Most Sensational
Business Opportunity
Since 1929

Like turning lead into gold,
here is a business with gigantic
possibilities. Factories,
Clubs, Stores, Schools, Homes,
spend millions every year for
rubber mats. Think of your
profit when a

**HAND
MACHINE
and**

**5¢ TIRE
MAKES \$2.00 MAT**

Brand new. Fully patented. Few men already started
report unprecedented success. Wm. Eagle writes:
"Can't make mats fast enough. First week brought
over 200 orders for \$1.00 to \$10.00 each." Flush
from Harris says: "Orders enough to keep 15 men
busy all the time." Gunter got big order from
County Commissioners and now reports: "Just
signed up order for all Grade Schools and High
Schools." No wonder responsible men are
throwing everything else aside to establish
local FABRIX factories.

COSTS NOTHING to get complete facts. Just send name and address.
We'll send description of simple hand machine that quickly slices old
tires into strips; show you how patented method forms strips into thick,
springy, long-wearing FABRIX Mats—how five cents worth of Junk
Tires make a \$2.00 Mat; how you can start on a reasonable investment
and build a business so big, so fast, that it will take your breath away.
Don't delay a minute. Write or wire today. All information is free.
FABRIX, Inc., 325 W. Huron St., Dept. 710, Chicago, Ill.

First Time at
This Low Price!



**CANDID TYPE
CAMERA**

**\$2.50
POST
PAID**

Uses standard film—16
pictures on one roll.
Genuine 50 mm. lens.
Bakelite case; 5" x 3".
Taken sharp pictures—
enlarge to 3" x 4". Eye-
level view finder.

FREE—TWO ROLLS OF FILM—Money-back
if not satisfied. Lifetime guarantee. Sent post-
paid anywhere in U.S. Order direct from this ad.

SILVER MFG. CO., INC., Dept. C, 2865 Elston, Chicago, Ill.

TRAILER BUILDERS

Send 10c for our latest DeLuxe Trailer plans with all the modern improve-
ments known to trailer builders. We supply everything at bargain prices.
Our new 1938 trailer supply catalog (largest and most complete) is free.
National Trailer Equipment Co., Dept. P-10, 714 W. Wisconsin Ave., Milwaukee, Wis.



Boy.. What a Profit! NEW

Get in quick. Install self attaching electric out-
lets in a second. No screws, nails or tools. Snap
on and collect. Buildings, schools, homes, stores,
all prospects. Big discount to AGENTS. Andy sold 7 dozen one day.
Write or wire for terms.
WODDY MFG. CO., Dept. 71A, 5639 N. Ashland, Chicago

Saw-Filing

**Pays up to \$2 or \$3 an Hour in Spare
Time—No experience needed**

A FOLEY Automatic Saw Filer files hand, circular
and band saws better than the best hand
filer. Cash business, no canvassing, no eye-
strain. Louis P. Wadwick, Ohio, says, "I have
filed 764 saws in spare time and have earned
\$850.00 in carpenter work due directly
to my saw filing contracts." Send coupon
for FREE PLAN, no obligation.

FOLEY MFG. CO., 1016A-8 Foley Bldg.,
Minneapolis, Minn.

Send Free Plan on Saw Filing business.

Name.....
Address.....

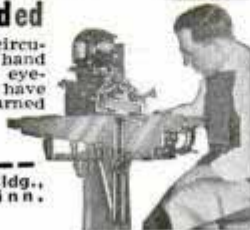

When writing to advertisers please mention Popular Mechanics

Setting Traps for Fire Bugs

(Continued from page 501)

14862
accidentally ignited a dress, and every-
thing in the closet had burned, usually in-
cluding a fur coat. The catch is that fur
coats are hard to burn so completely that
no identifiable parts remain. If we did find
remnants of a coat, the microscope might
prove it to be rabbit instead of the seal on
which an insurance claim was made.

Pyromaniacs are a hard problem because
this form of insanity leads to firing the
houses of innocent people. An unusually
helpful spectator or one lurking in the
background is often the guilty party and
many "pyros" have been caught because
arson squads keep an eye out for spectators
who act suspiciously at a fire. Once a py-
romaniac is caught we keep track of him
after he has been freed, checking regularly
to make sure he starts no more fires.

Not long ago we picked up a combina-
tion fire bug and burglar who had worked
out what he thought was a foolproof stunt.
He waited until after dark, set fire to a
garage behind a home, then rushed to the
house and breathlessly informed the peo-
ple their garage was on fire. In the con-
fusion that followed, he prowled through
the house. He left his fingerprints on some
silverware on one job. We caught him the
same night, recovered \$10,000 worth of
watches and jewelry, and started him on a
fifty-year sentence.

In Los Angeles, the arson squad gets the
jump on the fire bugs by answering alarms
with the firemen. Two arson squad inves-
tigators accompany the firemen to every
blaze in the business district and in the
residential areas the fire detectives dash
out as soon as a fireman phones that the
damage will be greater than \$100. With
the detectives go a photographer. Photo-
graphs taken at the scene, showing evi-
dence the arson squad has found, are pret-
ty convincing in court.

There is always a reason for a fire and
the arson squad works right alongside the
firemen. If the fire seems to have started
mysteriously, the investigators stay on the
job until they find the true cause. The re-
sult is that "torch" rings have been broken
up. Steady work by the arson squads is
taking the profit out of incendiarism and
the number of "mystery" fires is being re-
duced every year.

Extra Money From Books

SEND NO MONEY • Books Sent C.O.D. Anywhere in U. S.
 These famous Pay-Raising, Extra Money Books have helped thousands of others. Let them help you too. Check this list and mail with your name and address. Pay postman on delivery plus few cents postage. Send 3c stamp to cover postage and ask for catalog of other books.



SELECT FROM THIS LIST

- AIR CONDITIONING**
Furnaces, Unit Heaters...\$3.00
- AIRPLANE SERVICING**
Manual. New. 1000 Pages. Illus.....\$6.00
- AUTO REFINISHING**
Duco With Spray Gun...\$1.50
- BLUEPRINT READING**
For Machine Trades...\$1.50
- BRICKLAYING**
Plain and Fancy.....\$1.50
- CARBURETORS (All Makes)**
New, Revised Edition...\$3.00
- CHEVROLET SIX**
Car, Truck, Operation Repair.....\$2.50
- COLONIAL FURNITURE**
Making, 95 Pieces.....\$3.50
- DANCE**
Learn at Home Without Music or a Partner...\$2.00
- BUSINESS CORRESPONDENCE**
and Office Management \$1.75
- ELEMENTS DIESELS**
Engineering Questions and Answers.....\$4.00
- FOUNDRY WORK**
Molding, Casting, etc. \$2.00
- FURNITURE REPAIRING**
Finishing and Decoration.....\$4.00

- HIGH-SPEED DIESELS**
New, practical, non-technical.....\$2.50
- HOME GROUNDS FURNISHING**.....\$0.80
- INVENTIONS**
1500 Needed.....\$2.50
- LEATHER MAKING**
and Home Tanning.....\$1.00
- MACHINE SHOP WORK**
Tools and Methods...\$2.50
- METAL SPINNING**
Practical New Book...\$1.00
- MONEY-MAKING FORMULAS**
10,000 Practical.....\$4.00
- PLASTERING**
Best Instruction Manual.....\$1.25
- RADIO PHYSICS COURSE**
New edition, Everything about Radio...\$4.00
- SHEET METAL**
Construction Work.....\$2.50
- STEAM ENGINEER'S LICENSE**
How to Obtain.....\$2.00
- STEEL SQUARE**
Hodgson, 500 pp. 300 Illustrations.....\$2.00
- TAXIDERMISTRY, HOME**
Mount Trophies Profit, Pleasure.....\$1.50
- WOOD TURNING**
Course In.....\$1.50
- WROUGHT IRON WORK**
Practical.....\$1.35

POPULAR MECHANICS PRESS

Room 1038A 200 E. Ontario St., Chicago

Now You Can Learn DESIGN and PRACTICE OF METAL AIRPLANE STRUCTURES

NEW BOOK Sent to Any Address

Rush order today. Postpaid \$5.00 or pay postman on delivery.

FOR EVERYONE INTERESTED IN AVIATION

Just published! Metal Airplane Structures by Major F. E. Loudy, Air Corps Reserve. 500 pages. Over 300 illustrations and tables. Thoroughly covers design and construction. For students, Mechanics and engineers. One of aviations most important books as metal ships will replace all others. Get your copy today.

Popular Mechanics Press, Dept. 1038, 200 E. Ontario St., Chicago

900 WORK SHOP IDEAS!

How to Make Articles of Beauty and Utility that Sell

Get the most out of your hobby. Turn your Work Shop hours into profit. The "Make It Yourself" book shows you what to make and how to make it, with that "professional touch"—models—toys—useful decorative articles of all kinds. Newest edition—480 pages, 823 pictures, 7 x 10 inches. Sent postpaid for \$3.00 or in U. S. and possessions C. O. D.—you pay postman. Order Now.

"MAKE IT YOURSELF" INCLUDES:

- Toys—Models—Furniture—Garden Equipment—Home Repairs—Sports Equipment—Auto Kinks—Radio Equipment—Workshop Tools and Machinery. Articles on Working: Wood, Metal, Leather, Glass, Etc., Etc., Etc.



POPULAR MECHANICS PRESS, Room 1038B

200 E. Ontario St., CHICAGO

U. S. Patent No. 2015459.

BUILD IT WITH DOENUTS

Build your own wheelbarrow, scooter, bicycle trailer, wagon, midge auto, street marker, boat dolly, lawn chair, etc., with Musselman DOENUT wheels. Developed and patented by the originator of the airwheel for airplanes. Sizes 10" x 2.75" and 12" x 3.25". Operate on as low as 13 lbs. air. Absorb surface obstructions. No jolting. Do not sink into sand or soft ground. Roll same load with less than HALF THE EFFORT. Send 25c for simple blue print drawings of any vehicle shown here or \$1.00 for all 6. For literature only send 10 cents postage.

THE MUSSELMAN PRODUCTS CO.
6247-E St. Clair Ave., Cleveland, Ohio



NEW! VOGUE ELECTRIC DRY SHAVER!

Now you can get that PERFECT QUICK, CLOSE SHAVE with the NEW VOGUE ELECTRIC DRY SHAVER! Retail for \$15.00, U.S.A. For dealer information write

UNIVERSAL SALES CORP.
407 So. Dearborn St., Chicago, Ill.

S AGENTS 300% Profit SIGN LETTERS

For Store Fronts and Office Windows. Anyone can put them on. Free samples. Liberal Offer to general agents.

METALLIC LETTER CO., 438 N. Clark St., Chicago

Tells How to Use—

Concrete About the Home; Concrete in the Garden and Yard; Concrete About the Farm; Concrete Homes and Buildings; Making Recreation Devices; Concrete in the Workshop; Concrete Products for Manufacture; Concrete in Business and Industry, etc. Gives 146 Concrete Kinks.



The Book of the hour for the workshop fan, handy man and home owner.

Money Making Facts - Best Methods - Materials - New Colored Concrete - 146 Kinks

"1001 Ways to Use Concrete" strips the mystery from the fascinating work of making useful articles with concrete. This book, just published covers every known use of concrete for the home, farm, building, business and industry, plus newer uses in decoration and arts. Includes new fast setting and gloriously colored concrete and 146 valuable usable kinks. 1001 uses of concrete including homes, garden furniture, pools, statuary, etc., recreation devices, farm improvements, driveways, walks, etc. Describes all methods and materials. Shows how to do real professional type jobs.

NEW Concrete BOOK Makes Cement Work of All Kinds Easy

256 Pages — 16 Colored Plates, Hundreds of Pictures

Large book 7 x 10 inches. Handsome cloth binding. Sent postpaid for only \$3. Sent COD in U. S. if preferred. Order today. Make concrete work a fascinating hobby or a profitable business.

POPULAR MECHANICS PRESS - 200 East Ontario St., Dept. 1038B - CHICAGO

ELECTRIC UNLOADING



Thrill of Thrills
in new 1938

LIONEL TRAINS

Touch a button and by remote control the body of this electric dump car tilts until its load of coal is deposited alongside track, right where you want it. Read all about electric unloading, uncoupling and whistling. Catalog contains full details and color pictures of the greatest fleet of model trains in all train history.

The Lionel Corporation
15 East 26th Street, New York, N. Y.

Dept. E

Enclosed is 10 cents for a copy of the new 1938, 52-page, full color Lionel Catalog. Send it to:

Name _____

Address _____

City _____ State _____

MODEL AIRPLANE ENGINE

**NOW
ONLY
\$13.75**



Set the Pace — with the
SYNCRO ACE

At left, the modern, streamlined power plant, for model airplanes and boats. Immediate deliveries, with all 1938 improvements.

**THE NEW
Syncro BEE
\$12.50**

Now in production. Has $\frac{1}{2}$ " bore and $\frac{3}{8}$ " stroke. Weighs less than 4 oz. Both models, as well as special model makers motorless electric jig saws, at your dealer's.

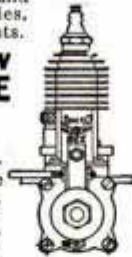

**LITERATURE
FREE**

SYNCRO DEVICES, INC., 511 Boydell Bldg., Detroit, Mich.

FREE! CAMERA CATALOG

Here's the "value book" of the year! A sure guide to savings in everything you need for photography. Cameras, films, supplies, accessories. All famous makes, all bargain priced. Read the whole thrilling story. Send for your copy of Catalog No. 72-7K8 today. It's **FREE**.

**1001
PHOTO VALUES
IN THIS NEW
FREE
CATALOG**

**WHOLESALE RADIO SERVICE CO., INC.
105 SIXTH AVENUE • NEW YORK, N. Y.**

Underground Railways

(Continued from page 533)

prevents the expansion joints from taking up the slack. The dispatcher also must be careful about forcing light oil at too high a pressure behind a shipment of sluggish heavy oil. Light oil can travel fast but if the pumps force it too rapidly the heavy oil ahead plugs the line and breaks the pipe."

A pull-apart causes an immediate fall on the pressure gauges at adjoining pumping stations. Pumps are shut down to minimize the loss and a line-riding crew sets



Pumpman drawing sample from line to check end of one shipment and beginning of another

out in a light truck that carries electric and acetylene welding outfits and short sections of pipe. In many cases the buried pipe parallels a highway and the trouble crew rides at full speed, keeping a sharp lookout for a telltale discolored area in the dirt above the line. The worst kind of break is one that occurs at the bottom of a dip between two ranges of hills. In such a case the oil may drain out of the pipe from both directions, flooding the surrounding area and wasting a shipment worth thousands of dollars.

Crews cover every inch of the lines every week even if there are no suggestions of leaks. Vigilance spots many a small leak before it becomes serious. Black oil flooding a highway can cause complicated traffic accidents and leaking gasoline near a highway can be even worse. Once when

such a break had been discovered and flagmen had been posted to halt traffic, one driver decided to go through. He roared past the flagman and got half way through the pool of gasoline when an exhaust spark touched off the fumes. What was left of car and driver were removed after the fire.

Stealing oil and gasoline from buried pipes used to be tried by some people who knew how to tap a main line and lead off part of the flow in their own buried pipe. Thefts are uncommon now because they can be detected almost at once. Receipts are checked against transmission every hour on a major system. If the figures show a leak the line riders haven't been able to find, the pumping plants put a "squeeze" on the line with the exhaust end of the pipe blanked off. Under this heavy pressure the oil will flow faster through any natural leak. If no leak still is found, the line riders get out a theft detector, an electrical exploring coil which they carry along the pipe, listening for a signal in the earphones that gives away the presence of a buried pipe running from the main line.

One of the worst kind of leaks is an electrolytic corrosion caused by an electrical battery action between a buried pipe line and various soils. Heavy moist clays are anodic to sandy soils having an excess of oxygen and when a pipe line passes through adjoining districts it acts as a conductor for the current, corroding away in the negative area at the rate of twenty pounds of metal per ampere per year. Similar battery effects are apt to occur in swampy ground and mineralized districts.

This kind of corrosion is counteracted now by reversing the current, making the pipe act as the cathode in circuits set up in areas where corrosion is troublesome. As much as fifty amperes of current may be used to protect ten miles of pipe, with the negative side of the circuit attached to the pipe and with lines from the positive pole grounded at different points in the soil. Unattended windmills generate the current for fighting electrical corrosion when winds are fairly constant.

Periodic cleaning of the black-oil lines is necessary because the heavy waxy crudes build up deposits. Cleaning is done with a "go-devil," a traveling semi-flexible carriage consisting of a number of

(Continued to page 146A)

MY ALL-TIME ALL-AMERICAN TEAM!

BY
GRANTLAND
RICE

Why
America's
No. 1 Football
Expert Shaves
with a Gillette
Blade in the
Gillette
Razor!

"WHEN it comes to picking an all-time All-American *shaving* team," says Grantland Rice, famous sportsman and football expert, "I'll cast my vote for a Gillette Blade in a Gillette Razor every time! This pair gets my nomination for top honors because it gives me smooth, close, exhilarating shaves that just can't be duplicated any other way. Substitute blades and other shaving methods are 'out' with me." Take this tip from Grantland Rice. Ask your dealer for Gillette Blades . . . precision-made to fit your razor exactly. You'll agree this combination gives the easiest, cleanest shaves money can buy!

Try Gillette's amazing new Brushless Shaving Cream, made with peanut oil. It softens tough wiry whiskers, speeds shaving, soothes and tones the skin. Big tube, 25¢.

PRECISION-MADE FOR EACH OTHER

"MILLION-DOLLAR" SHAVES FOR LESS THAN A PENNY A DAY

Gillette RAZORS AND BLADES

MORE SHAVING COMFORT FOR YOUR MONEY



• In the big lumber camps, in the finest wood-working factories, in the leading metal working plants . . . wherever saw performance is under the watchful eye of expert craftsmen . . . Atkins Saws of famous *Silver Steel* have first call. For best results, with the least energy, equip your work bench with Atkins Circular, Hack and Hand Saws including special types, such as keyhole and compass, coping, etc. Their blades of unmatched "silver steel," with true set teeth and taper grinding have been "tops" with craftsmen . . . professional and amateur . . . since 1857. There's an Atkins dealer in your neighborhood. E. C. ATKINS AND COMPANY, 426 S. Illinois Street, Indianapolis, Indiana.

Useful 40-page Home Workshop Book, "HOW TO DO IT," is yours for only 10c, to cover handling.

ATKINS SILVER STEEL SAWS

NEW STAPLING MACHINE! It Staples, Pins, Tacks!

Famous ACE-SCOUT stapling machine. NEW MODEL uses superior undulated staple to make a tie of amazing strength. Hundreds of uses—in offices, homes, schools, stores, factories, etc. Made of highest quality steel, chromium finished—it is jamproof, dogproof and fool proof. Send for SPECIAL BARGAIN OFFER TODAY—Package of 1,000 ACE STAPLES plus machine, ready to use for only \$1.85 we pay postage or C. O. D., plus postage.



**ONLY \$1.85
WITH 1,000 STAPLES**

GUTHMAN CO., 600 W. Jackson, CHICAGO, ILL.
(Attractive Proposition for Agents Everywhere)

BUILD U.S. ELECTRIC FENCES

Eliminate old fashioned costly fences the U.S. way. Absolutely safe - 4 to 12 volts DC. battery current - long lived - economical - uses Guardian relays. Assemble in less than an hour

U. S. ELECTRIC FENCE Dept. C

119 South Jefferson Street, Chicago, Illinois

FOR YOUR NEIGHBORS!
BIG PROFIT

KIT OF PARTS

ONLY \$9.95
POSTPAID

SELLS FOR
\$12.95

ASSEMBLED

OVERHEAD GARAGE DOORS

You can install this hardware on your old doors, or new ones. Door opens in one piece. Heavy steel springs do the work. Closes air-tight. Needs no overhead room. Absolutely noiseless. Complete with instructions, \$10.00. Circular free. Agents Wanted.

R. W. WILKIE CO., Independence, Missouri

FREE Sensational OFFER 2 FENCING SWORDS FREE FENCING WORLD'S FINEST SPORT

HARMLESS-EXCITING FUN
Develops strong body and alert mind. HARMLESS. The spring-steel 3-foot-long foils (swords) are equipped with rubber buttons. Aluminum cup-shaped hand guards. Our De Luxe foils are built for hard usage.

Complete set of two foils (swords) and free instruction booklet, only \$1.58. We pay postage. Two additional fencing swords FREE for limited time. (Regular price of these two sets of foils \$3.56.) ORDER NOW, ALL-AMERICAN FENCERS GUILD, Dept. 10PM, 48 W. 48th St., New York

(Continued from page 145A)

scraping fins and several leather washers. When the go-devil is placed in the line the washers plug the pipe so the oncoming oil forces the go-devil along ahead of it. Occasionally a go-devil gets stuck. Then another is put in behind it to force it free. Lines with turns so sharp the traveling carriage can't get around the curves are cleaned with large wax plugs placed in the moving streams of oil.

Pipe lines even more extensive than those used for carrying liquid petroleum products are used for moving natural gas.

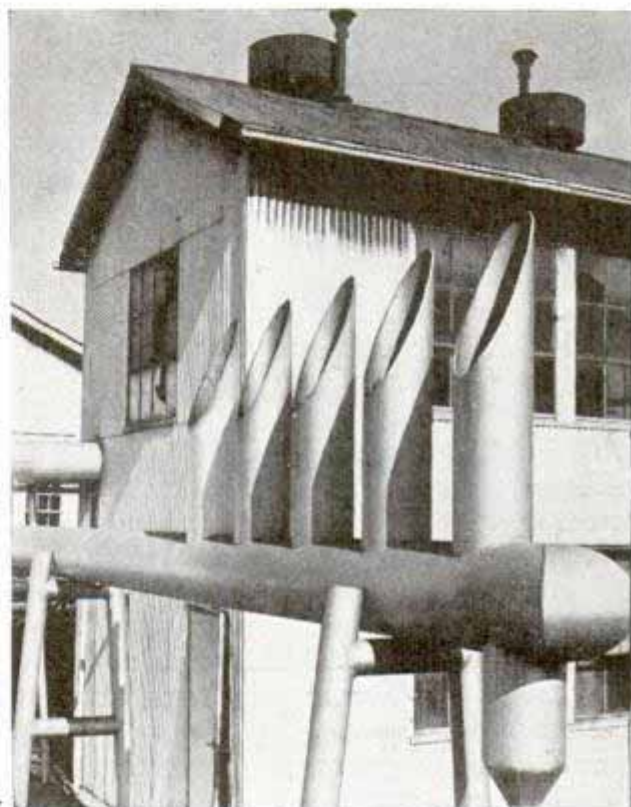

Heater house at pumping plant where heavy oils are warmed to make them flow more freely

In the early days "icicles" of welding metal frequently dripped into the pipe and impeded the flow of oil but now all welding is done against interior rings at the joints that keep the hot metal from trickling inside. On some lines today, shipments are moved by self-priming electrical pumping plants that automatically operate as long as flowing oil reaches them. Steam, however, is still used on many systems because it is needed for heating heavy oils as well as turning the pumps.

Send return postage to our Bureau of Information to learn the name of the maker of any device described in this magazine.

KILL RATS WITHOUT POISON

YOUR MONEY BACK IF RATS DON'T DIE



K-R-O won't kill Livestock, Pets or Poultry, Gets Rats Every Time. K-R-O is made from Red Squill, a raticide recommended by U.S. Dept. Agr. (Bul. 1533). Ready-Mixed, for homes, 35¢ and \$1.00; Powder, for farms, 75¢. All Drug and Seed Stores. Damage each rat does costs you \$2.00 a year. K-R-O Co., Springfield, O.

K-R-O KILLS RATS ONLY

MASTERCRAFT MILLING TABLE for the Drill Press...

Saves the Price of a Milling Machine!

Precision tool for routing out dies; small jig boring; profiling or precision drilling; milling flats, squares, or angular indexes; cutting accurate dovetail slides or internal slotting operations on drill presses. For safe, accurate drilling without dividers, scale, or center-punch. Rotary table graduated in 360 degrees... 7" square, 4 1/2" travel both ways.

Distributors—Dealers—Write for Discounts

Material and Workmanship Unconditionally **\$22.50**

Guaranteed — COMPLETE — POSTPAID

Send Postal Money Order to Dept. 300

F. & M. SALES CO., P.O. Box 1345, Hollywood Station, Los Angeles, Cal.



NOW ONLY \$5.00 REAL ENGINE VALUE

Over 7,000 GHQ Gas Engine Kits have been sold at \$8.50. Now is your chance to buy the New Improved kit for \$5.00. Absolutely complete with coil, plug, etc. Send only \$1.—Shipped Express Collect for balance same day. Catalog 3c.

DEALERS WRITE.

A screwdriver is the only tool needed. Average assembly time 30 minutes.

GHQ MOTORS, 854B East 149 St., New York, N. Y.



YOUR OWN MOVIES! 10¢ A DAY!

NATIONALLY ADVERTISED 8MM and 16MM MOVIE cameras, projectors. For home, business, church, school, club. **MONEY BACK 10 DAY TRIAL.** Payments as low as 10¢ A DAY. Satisfied customers throughout the world. FREE details. WRITE TODAY, Don Elder's Home Movies, Dept. A-10, 739 Baylston St., Boston, Mass.



SLIDE-VALVE STEAM ENGINE

model SE-3, for small boat models. A complete power plant, ready to run, with two-cylinder engine (as illustrated), boiler, safety valve, dematured alcohol burner and propeller rig. Price \$3.00. Postage extra, shipping wt. 1 1/2 lb.

SHAWNEE ENGINE CO., Box 162, Station D, Cincinnati, O.

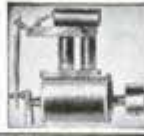

When writing please mention Popular Mechanics

YOUR OPPORTUNITY STUCCO SPRAYING



Renew old buildings. Make new construction more permanent and attractive. Plastic Colorcrete is waterproofed. It fuses with any masonry surface. It fills all cracks. It can be applied in any thickness and in 30 colors. Fully proven by over 12 years' actual use under all conditions and every climate.

OFFERS BIG EARNINGS

Owners everywhere want to enhance present values. With this machine you can supply this big waiting market with permanent Colorcrete at amazingly low cost. Operators report cost of 2c and up per sq. ft. and sell up to 7c. Some have paid for their equipment from first few jobs. Machine capacity up to 1,000 sq. ft. per hour.

Get the facts. Colorcrete Books tell the whole story. Write today. It may mean business independence for you.

COLORCRETE INDUSTRIES, INC.
570 Ottawa Ave. Holland, Mich.

SCALE MODEL TRAINS



MIN-I-SCALE MODELS "0" GAUGE

KITS { Locomotives. \$47.50
Pass. Cars. . 8.50
Freight Cars. 5.00

Perfect, die cast scale models, accurate to the smallest detail. Absolute scale accuracy. Sturdy construction. Precision workmanship. All locomotives "run-in" under power. Locomotive, 25 1/4"; Pullman, Baggage and Day Coach, 22"; Box car, Hopper, Tank, 11 1/2". Kits assembled easily without drilling or machining. Write today for full information.

CONGRESS TOOL & DIE CO.
9028 Lumpkin Ave., Detroit, Mich.

FREE FOLDER

What! Only \$6.94 FOR THIS SILVER RADIO

Yes, it's true—just \$6.94 buys this all-electric radio complete with full size tubes and aerial. Rush \$1 deposit, balance C.O.D. plus postage. Money back if not satisfied.

FREE New Catalog, just off press. Models for farms, homes and cars. Radios that get Europe. Automatic tuning. Consoles and table models. Save up to 30%.

SILVER MANUFACTURING CO., Inc.
2868 Elston Ave., Dept. P-10, CHICAGO.



Send for This!

Earn \$150 to \$300 EXTRA PROFIT monthly with "Simplified" ARC WELDING



Yes, you can "Build Your Own." Save \$300 to \$500

Get your **FREE Book** on New Profits for Welding Shops



• Start a big pay business of your own now, with new 40 Volt Simplified Arc Welder. New low prices and easy pay-out-of-profit terms makes equipment available to everyone. Exclusive Hobart features guarantee easier, faster operation. Same machine as used by largest manufacturers. Extra earnings easily pay for it without expense to you.

30 DAYS TRIAL TO PROVE IT PAYS

Use this welder for 30 days on your work, at our risk. See for yourself how many profitable jobs it can do before you buy. Write today for complete details on 30 Days Trial and Easy Terms. No obligation.

HOBART BROS., Box M-1081, TROY, OHIO

AS LITTLE AS \$20 Monthly puts it in your shop

Start a POTATO CHIP BUSINESS

IN YOUR KITCHEN *and* MAKE MONEY!

Buy Potatoes for **2c A POUND**

Sell Them as Vita-Seald Chips for **35c A POUND**

THERE'S big money in potato chips for any man or woman who wants a business capable of paying big daily profits from the very start. Just think of it. You can install the wonderful new machine in your kitchen—just manufacture and sack a sensational new kind of "Greaseless" Potato Chip—and let the stores sell them for you. Only \$2.50 invested in raw materials brings back \$10.00 in cash.



EVERYTHING FURNISHED You don't have to have a lot of money to start this business. A small investment in the machine puts you in a big profit business of your own. I send you everything including speed-dicer, cooker, oil-extractor (for making new "GREASELESS" chip), a big supply of printed bags and free advertising material. No experience is needed as I send complete, simple instructions showing how to make a profit the first day. Prices, pictures, and complete plans will be sent free for the asking.

DON'T BUY ANYTHING Just send your name and address on a post-card for all this Free information including the "Secret of Making Greaseless Potato Chips." No obligation but hurry and you may become independent as so many others have done with these fast selling new "Greaseless" Chips. Address your card to

G. H. Hardt, 325 W. Huron St., Dept. D-510, Chicago, Illinois

DRESS YOUR OWN LUMBER — SAVE \$ \$



12" x 4" Capacity Thickness Planer

Finished lumber from low cost rough stock in your own shop with a B-C 12"x4" Thickness Planer. Save planing cost and waiting at the mill. Pays for itself. E-Z Terms. Also, B-C Saws, Jointers, Sanders, Shapers, Band and Jig Saws.

BOICE-CRANE TOOLS
Dept. PM-2108, Toledo, O.

Send 10c for Catalog

MEGOW'S

New Sensation!

Gas-Powered MODEL

\$3.95
plus 20c postage



AIRPLANE MODEL KITS . . . world's champion Bassett's new 48-in. gas-powered crackup-proof Sensation. Finish prop., many ready-made parts, rubber wheels, \$3.95 plus 20c postage. Also new—Giant Fillers with motor-hum device, \$1.00 up.



Arabella

SHIPS . . . carved hulls, many ready-made parts, complete plans and materials. HIS-PANIOLA (Treasure Island), XEBEC (Robinson Crusoe), BEAR OF OAKLAND (Adm. Byrd), ARABELLA (Capt. Blood) and others, \$2.00 plus postage.

HO GAUGE MODEL RAILROADS, Freight Cars, etc. Send 5c post. for complete illus. Catalog of model kits, ready-made parts and supplies for all model-crafters.

MEGOW'S Dept. PM., Howard & Oxf. Sts., Phila., Pa. or 217 N. Desplaines St., Chicago, Ill.

POWERAY
New, powerful 6-volt electric lantern. 80-100 hours light. 700 ft. beam. Unbreakable lens. 4½ in. reflector.

Buy ONE OF THESE "BIG LITE" DELTAS

\$1.50 LESS BATTERY

POWERLITE
6-volt. Deluxe electric lantern. 800 ft. beam. 80 to 100 hours light. 2 reflectors, front, spot beam; top, floodlight. Unbreakable lens. At DELTA ELECTRIC COMPANY, Marion, Indiana, Dept. 300

Mr. Motorist, you wouldn't drive your car with the brakes dragging, would you? Then why drive a motor dragging with gummy valve guides, carbon, etc.

NEW INVENTION Permanently removes gum, eliminates motor trouble, saves gas, repair bills, increases motor efficiency, softens carbon. Large fleet owners getting sensational, money-saving results. **BIG MONEY-MAKER** for distributors. Nothing like it. Regular \$5.99 seller. **OCTOBER INTRODUCTORY OFFER, \$3. ORDER TODAY** on our **MONEY-BACK GUARANTEE**. Specify year and make of car. Write for proof and distributor's liberal plan.

WILSON-RIESEN, 743 N. 4th St., Milwaukee, Wis.

PISTOL GRIP SOLDERING IRON with 3 degrees of heat!



Hold it like a pistol. Get into any inaccessible place with this pistol grip adjustable-point soldering iron. You do in seconds the jobs that would ordinarily require minutes of your time. Gives three degrees of heat. Interchangeable soldering points. Sturdy construction. Guaranteed. Act now. Get one at a bargain price. Shipped prepaid on receipt of remittance. On C. O. D. shipments send deposit of \$1.00. **\$3.00** Postpaid

SUPREME INSTRUMENTS CORP. GREENWOOD MISS., U.S.A.



CATCH FISH!

minnows, eels, minn, muskrat with our folding galvanized Steel Wire Traps. Greer Patent Lever Hooks are so constructed that when a fish gives the slightest pull on the bait the upper hook reaches down and gets a hold that lands him. 3 for 50c. Write for descriptive catalog of Traps, Hooks, Lures, and other specialties. **Walton Supply Co., 3507B Junata St., St. Louis, Mo.**

YOU TOO CAN DO IT!



BOOKBINDING is easy with the **PRATT BOOKBINDING UNIT**. Does the entire job. Easily attached to any work bench. Make money binding books, magazines, for libraries, schools, shops. For illustrated circular, write **G. A. Pratt, 4227 Euclid Ave., 5A, East Chicago, Indiana.**



Print Your Own

Cards, stationery, circulars, tags, labels, advertising, etc. Save money. **Print for Others; Big Profits; easy rules sent.** Will do popular Raised Printing like Engraving. Junior outfit \$9. Senior outfit \$17 and up. Send for free catalog and all details. **KELSEY PRESSES, E-37, MERIDEN, CONN.**

See **REBUILT BY**

WOODSTOCK BUILDER

Used to win most International Commercial School Contests

EASY TERMS—FREE TRIAL
WRITE FOR LITERATURE DEPT. B-47

WOODSTOCK TYPEWRITER CO., WOODSTOCK, ILL.

Poor Boy Still Makes Good

(Continued from page 484)

man relation the complete knowledge of how to go from one place to another without signposts or beacons to guide him. That, we might say, is one respect in which Douglas Corrigan was helped by luck. But how many others have turned such luck to such good account?

This was an important part of Corrigan's background, but by no means the most important. Most valuable of all was his mechanical aptitude plus his devotion to it. From that we come to the indispensable possession of character. After ten hours of work—or even eight or six—most men, particularly young men, are willing to call it a day, and devote the rest of their waking hours to recreation. Corrigan found his recreation by improving himself in his craft. After the whistle blew at the factory he went to work tinkering with machinery, taking down, reassembling, finding new methods of making an engine run more smoothly. While others went to the movies, Corrigan read books and periodicals on mechanical science.

The legend runs today that Lindbergh became Corrigan's inspiration. It seems a fair enough deduction, since it is known that Corrigan was working at the Ryan Airplane factory while Lindy's plane, "Spirit of St. Louis," was being built there and he was one of those who helped put together that famous craft. So even if the legend is not true, it might well be and, in fact, should be.

Corrigan's flight to Dublin took only twenty-eight hours and a few minutes. But it took years to lead up to the factual accomplishment, years to perfect himself in his craft, and to save up, nickel by nickel and dollar by dollar, the \$900 it cost him to buy the "old crate" that newspapers have described so often and scornfully. But Douglas had acquired the skill to make that old crate as fine a piece of aircraft as its vintage would allow. He worked long evening hours on it, replacing worn parts with stout ones, then did a canny bit of "horse-trading" to acquire two used motors and made out of them one as good as new. Other hours were spent experimenting, testing, perfecting, studying, learning, memorizing maps.

(Continued to page 151A)

WORLD'S GREATEST all around ELECTRIC TOOL



- DRILLS
- GRINDS
- SANDS
- SAWS
- POLISHES
- SHARPENS

The new WHIZ ELECTRIC TOOL is the handiest, most useful power tool ever made. Not a delicate instrument but a real rugged tool, equally effective for both power and precision work. Drills through 1/4 inch iron plate in 42 seconds or engraves intricate designs on jewelry. Handles any material: Metals-Woods-Alloys - Plastics - Glass - Steel etc. Saves time. Eliminates tedious labor. Plug into any socket AC or DC, 110 volts. Chuck 1/4" capacity. Ball bearing thrust. Powerful, triple-gear motor. "Worth its weight in gold," to a mechanic or handy man. STANDARD MODEL with Normal Speed (uses 30 different accessories, instantly interchangeable). Special Introductory Price for a limited time, only \$6.95.

FREE Accessory outfit (Value \$2) includes set of drills, mounted brush, polishing wheel, sanding discs, cutting wheels, mounted brush, polishing wheel, carving bur, etc. FREE with each outfit ordered NOW. We pay postage. Will send C.O.D. if desired.

10-DAY TRIAL—MONEY BACK GUARANTEE. Special "2-SPEED" MODEL combines Normal Speed and High Speed in one outfit (uses 200 accessories) only \$8.95 complete, with same accessory outfit (value \$2) FREE.

PARAMOUNT PRODUCTS CO.
Dept. 10A, 48 West 48th Street, New York, N. Y.

POCKET SLIDE RULE



Save time and mental effort with this mighty midget! Has A-B-C-D Scales. Multiplies, divides, squares, takes square root, finds circumference and area of circles. 6 inches long—thin construction. NO WOOD OR CELLULOID. Fits in vest pocket. Send \$1.00 (\$1.25 Canada and foreign countries) and receive slide rule in genuine leather case with instructions. Postage paid. **INDECO SALES** STRATFORD, CONN.

Earn BIG MONEY MAKING ELECTRIC RAZORS at home!

BUY ALL PARTS READY FOR INSTANT ASSEMBLY NO TOOLS NEEDED
Make \$5 or More on Every Razor Sold

Just think, a complete \$15 type razor for \$1.95 or less. You can make \$5 or more for fifteen minutes of your spare time. Start AT ONCE, big or small—with one unit or 100—make your own electric razor or sell to others—you can profit both ways!



Costs \$1.95 in lots of 3 SAMPLES \$2.25 EACH
Make your own electric razor just like the ones selling in the high price brackets. Earn money assembling electric razors for others in your spare time or full time. Buy parts from us complete matched units. Every part standardized precision-built made by the most popular together to make one of the most popular standard super-quality Electric Razors. (The same high quality parts now used in Shavers selling for much higher prices.)
Write for information or order your first unit at once and prove the money-making possibilities to your own satisfaction.
SIMMONS MFG. CO.
128 W. North Ave., Chicago



FREE
Screwdriver and instructions with order for first unit. You need no other tools... no soldering equipment.

SIMMONS MFG. CO.
128 W. North Ave., Chicago
 Send C.O.D. 1 sample razor kit for which I will pay postman \$2.25 plus a few cents postage.
 Enclosed find \$..... for..... Electric Dry Shaver Kits including free instruction, tools and money making plans.

Name.....
Address.....

CAN YOU BEAT THESE POWER COSTS?

Save up to **\$293⁸⁰** Per Month on power costs

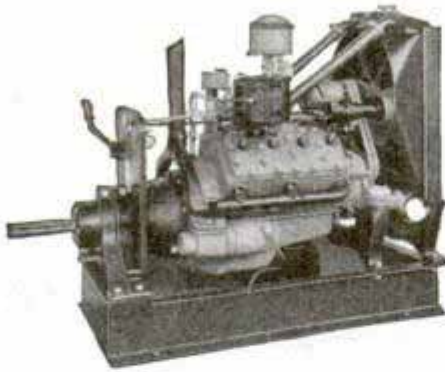

with a KRW FORD V8 Unit

50 H. P. with KRW V8 Unit using natural gas (1125 BTU) @ 30c per 1000 cu. ft. \$ 46.80 per month
 50 H. P. with KRW V8 Unit using gasoline @ 10c per gal. (no tax) \$140.40 per month

Above figures show primary fuel costs (lubricating oil not included) for operating a KRW V8 Unit to develop 50 H. P. for 10 hours per day—20 days per month. Compare this with electricity @ 3¢ per KWH which amounts to \$340.60 per month. You can pay for a KRW Unit in a few short weeks out of actual savings!

KRW V8 Units are daily saving money for operators of air conditioning and refrigeration equipment, mills, factories, shops, welders, compressors, pumps, well-drilling outfits, contractors' equipment, etc. New KRW "GUARDIAN" automatically stops engine in case of cooling or lubrication failure.

Write for new bulletin just off the press—packed with useful information, engineering data, etc. You can buy through your local Ford Dealer and benefit by local service and low-cost Ford engine replacement feature.

K. R. WILSON 17 Lock St. BUFFALO, N. Y.
 Builders of Shop Equipment for Ford Dealers Since 1916
 West Coast Branch: 722 Mateo St., Los Angeles.
 Export Office: 90 West St., New York.

NEW! DIFFERENT *Wrist Action* CORD SET MONEY MAKER.

Women ARE GOING WILD ABOUT THIS New WRIST ACTION CORD:

Here is no ordinary new product. This new Wrist-Action Plug is one of the most remarkable new devices ever offered! You never saw anything like it. Housewives are fascinated—held spellbound by the instant demonstration you can give with this new electric iron cord that swings freely in any direction. Ends kinking and twisting—prevents broken wires, burned fuses. Swivel action plug spins round and round—swings from side to side—keeps cord out of the way—no wonder housewives say, "Just what I want," as soon as they lay eyes on it!

FREE Makes no difference what you have sold or if you never sold anything in your life before you are bound to be successful. Nothing on the market like it—simply show it and the sale is made. Get the facts at once. **WRITE** Learn how you can GET YOUR **TODAY** DEMONSTRATOR FREE. Write for big money making plan.

NO-TRO ELECTRIC APPLIANCE CORP.
 800 N. Clark St., Dept. P-10, Chicago



2400° F METAL FOUNDRY

FOR SCHOOL OR HOME WORK SHOPS

COMPLETE OUTFIT FOR CASTING AND HEAT TREATING

These outfits consist of Gas Furnace, Electric Motor Blower, operating on 110 Volt, AC or DC current. Crucibles, tongs, moulding sand, flask, hose, etc., including full instructions for use. There is fun and profit casting models, jewelry, statues, art objects, shop equipment tools, etc., out of aluminum, copper, bronze, silver, brass and alloy. Practical for forging, case hardening, heat treating steel and for developing new alloys and new materials and plastic, out of glass, borax, wax, etc. Price of complete Foundryette as follows:

Size	Crucible Capacity	Price
351	6 cubic inches	\$13.50
352	12 cubic inches	19.00
353	24 cubic inches	27.50

Check or M. O. Acceptable Express Charges C. O. D.



Write for **FREE CIRCULAR**
KANSAS CITY SPECIALTIES CO.
 Dept. B, Box 6022, Kansas City, Missouri

Amazing NEW GLAZE Beautifies and Protects



Car Owners! Meet **MASTER GLAZE**—the sensationally different luster for new and used cars!

Not a wax—not an oil polish—not a paint—nothing that "smears" over the surface. A creamy liquid—quick and easy to apply! Gives a hard, glass-like surface. Even gasoline cannot dull it! Lasts six months to a year! Amazing luster—beautiful, sparkling clean and brilliant! Doesn't fingermark—doesn't smear! Seals the pores—protects! Nothing like it!

FREE Write now for Free booklet and **SAMPLE OFFER**. Free Trial offer. Just send your name and address.

MASTER GLAZE CO., 7720-35 W. HARWOOD AVE., MILWAUKEE, WIS.

GRANDFATHER'S CLOCK, LOWER PRICED



Our newest offering, at an unheard of price for a faithful reproduction of a real Grandfather's Clock. Scroll top, narrow waist, like picture. Shipped Knock Down. Cleverly designed. Easy to assemble. Others even cheaper. Plans 10c, Catalogue **FREE**.

AMERICAN CHIME CLOCK CO.
 1674 Ruffner St. (Established 1877) Philadelphia, Pa.

BUILD THESE PROJECTS

For garden or lawn. Easy to build. Easy to sell. Detailed Blueprints Model B-25 Dutch Windmill 39c; Model OM-60 Old Mill, 85c. Lawn Figure Patterns—Sunbonnet Girl, Dutch Boy, Tulip Girl, Holland Pair, 35c each, all 4—\$1.00. Catalog illustrating many models, send 10c, today.

CRAFTSMAN'S MODEL CO., Dept. P-22, 2030 N. 41st St., Milwaukee, Wis.

SPARE TIME MONEY

There's a big demand for the many hand-tooled articles you can make with the Exact Leathercraft Set. Easily learn to make good money in your spare time. Complete outfit including tools, leathers, patterns, etc., and full instructions, only \$2.00—on sale at leading Department Stores or order direct and pay postman on arrival. \$2.50 outside U. S.

LEATHERCRAFT

Free When ordering direct, clip name of your Department Store to this ad, and we will include with your set, one extra free project. Illustrated catalog 10c.

E. A. SWEET CO. Dept. A-17 Binghamton, N. Y.

\$150 TO \$300 PROFIT MONTHLY WITH Simplified ARC WELDING

BUILD A PAYING BUSINESS OF YOUR OWN

New low prices on modern 40 Volt Simplified Welder opens big profit opportunities even to the smallest shop.

FREE BOOK "NEW PROFITS FOR WELDING SHOPS" Write for it!

ONLY \$20 MONTHLY will put it in your shop

New Hobart Welder insures easier, faster operation. Extra earnings from new work lets you own without expense to you. 30 Days Trial, at our risk, before you buy. Write today for complete details, no obligation to you. Pay out of increased profits.

30 DAY'S TRIAL at our risk to PROVE it is Profitable

HOBART BROS., Box M-108, TROY, OHIO

(Continued from page 149A)

4897

Douglas Corrigan had no press agent, no manager to relieve him of business details. As a matter of fact, he had no business details. He wasn't after any record, could see no reason to enlist a syndicate to finance him. I thoroughly believe he had no thought of publicity whatsoever. No man who wanted fame would have timed his flight to coincide with the record-breaking around-the-world hop of Howard Hughes, a \$350,000 enterprise under the combined spotlights of all the channels of publicity in the entire world.

The young Californian couldn't even obtain official permission for his journey. He knew it would be useless to apply. The Brahmins would have asked: "Have you a \$100,000 plane? Or even a \$25,000 one?" The answer would have been: "No, sir." "Have you an earth-inductor compass? An altimeter? A barograph? An engine thermostat? An oil temperature thermometer? A sextant? Retractable landing wheels? And, above all, a radio?" Answer: "No, no and again no." "Then what you propose cannot be done."

Said Douglas Corrigan, most respectfully: "Probably you are right, sir." But his tongue must have been in his Irish cheek. For he went ahead, gave the Brahmins the slip, and did it.

All honor to the officials of the Air Commerce Bureau. After Douglas had accomplished the impossible they acknowledged the fact and took it in good part. They realized that once again the mechanical mind had shown the stuff of which it is made.

H 841

Heater Mounted under the Hood "Air-Conditions" Auto

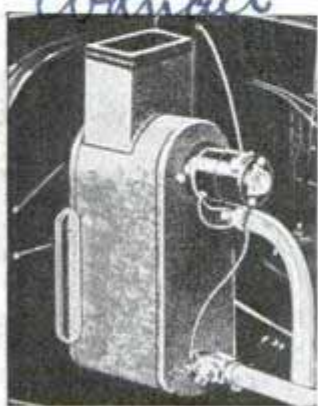

Fresh, filtered air for the motorist is provided by a heater that is mounted under the hood of the automobile, allowing additional leg room in the front seat. It draws outside air through a louver in the hood, filters and warms it, then distributes the "conditioned" air inside the car. The direction of flow can be adjusted by a crank.

Select model

Evans Products Co

Evans Products Co

And Now PERFECT VALVE GRINDING with this new BLACK & DECKER WET GRINDING VALVE REFAKER

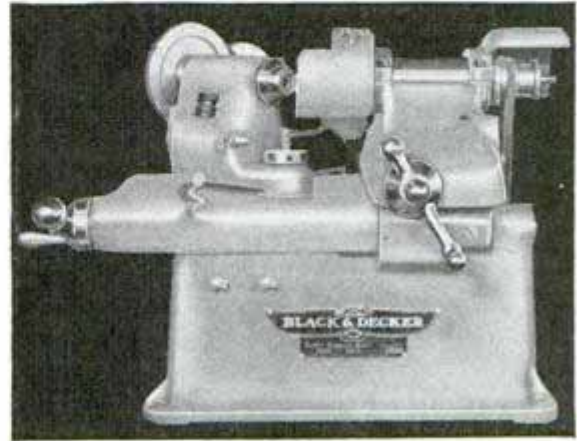

Newer, Faster, Better Finish—that's the story of Black & Decker's new Super-Service WET-grinding Valve Refacer. Here's the perfected method that motorists have been waiting for—that gives quicker and better results—that makes the shop that owns one the best-equipped shop in town.

Perfected WET-grinding—available only in this new Black & Decker machine—reduces grinding heat, prevents valve face burns and gives a *mirror-like, tool-room finish!* Yes-sir, this new refacer does a perfect job and does it *faster*. That's important to both the motorist and shop owner.

Don't put it off—send today for complete details about this new valve refacer. Sold by leading jobbers. The Black & Decker Mfg. Co., 610 Penna. Ave., Towson, Md.

BLACK & DECKER



World's Largest Manufacturer of
PORTABLE ELECTRIC TOOLS

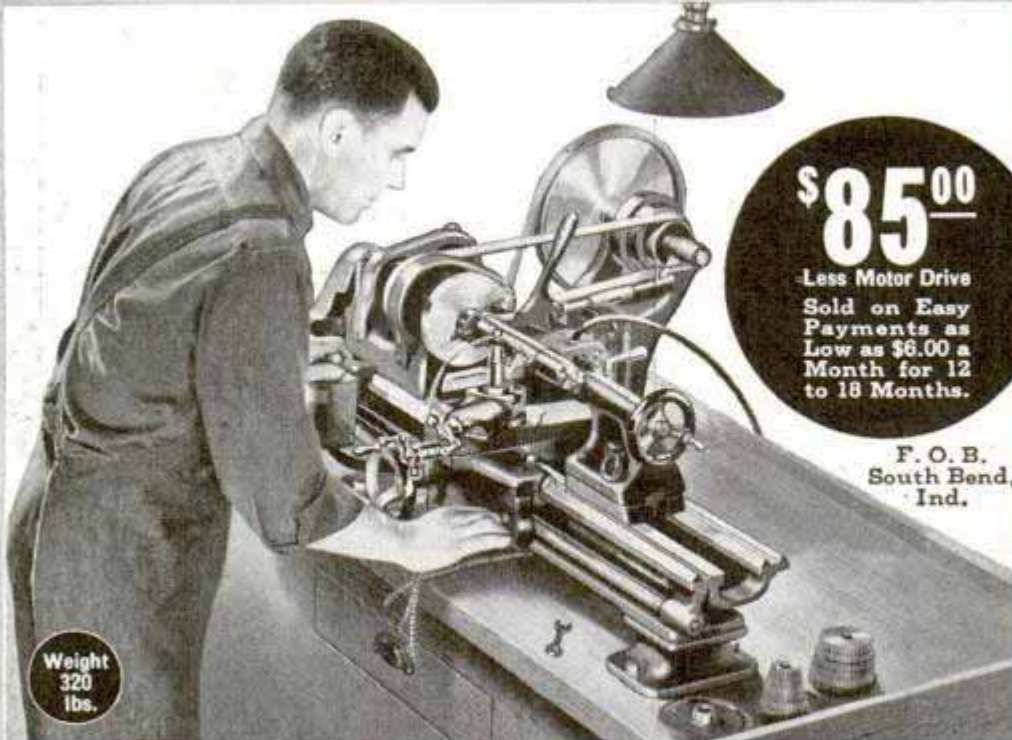

\$85.00
 Less Motor Drive
 Sold on Easy
 Payments as
 Low as \$6.00 a
 Month for 12
 to 18 Months.

F. O. B.
 South Bend,
 Ind.

Weight
 320
 lbs.

No. 415-YA. 9 1/4" swing by 3' bed Workshop Bench Lathe with Horizontal Motor Driven Adjustable Countershaft, 1/4 h.p. Reversing Motor, Switch and Belts. **\$117.00**
 (\$15 Down—\$6 Monthly for 18 Months)

**SOUTH BEND
 BACK-GEARED
 SCREW-CUTTING
 PRECISION LATHE**

This 9-inch South Bend Lathe used by:
**MANUFACTURERS
 TOOL ROOMS
 LABORATORIES
 MACHINE SHOPS**

- Automotive
- Electrical
- Gun Smiths

**U. S. GOVERNMENT
 SCHOOLS
 HOME WORK
 SHOPS
 INVENTORS**

The 9" x 3' South Bend Precision Lathe does these operations:

- TURNS—BORES**
- CUTS SCREW THREADS—FACES**
- DOES MILLING, CHUCKING, REAMING, DRILLING, FILING AND HUNDREDS OF OPERATIONS IN STEEL, IRON AND OTHER METALS.**

There are 5 sizes of South Bend Lathes—9", 11", 13", 15" and 16" swing with bed lengths 3' to 12'. In motor or countershaft drives. Priced \$85 to \$1500.

**INVALUABLE TO INDUSTRIES
 EVERYWHERE FOR HANDLING
 PRECISION OPERATIONS . . .**

WELL-KNOWN industries everywhere are using the 9-inch Workshop South Bend Lathe—and finding it a most profitable investment. Workmanship and features insure speed, accuracy, and versatility. Industry finds it cannot afford to overlook this remarkable tool.

Features: Hand-scraped V-ways on Lathe bed, Twin Gear Reverse to Lead Screw, Ball Thrust Bearing on Spindle, Cuts screw threads 4 to 112 per inch, 3/4" Spindle Hole for Collets up to 1/2". 38 attachments for milling, grinding, draw-in collet chuck work, taper work and other manufacturing jobs. 3', 3 1/2', 4', and 4 1/2' bed lengths.

SOUTH BEND LATHE WORKS
 634 E. Madison St., South Bend, Ind., U.S.A.

LATHES ARE STOCKED IN PRINCIPAL CITIES

- Boston, Mass.—The MacKenzie Machinery Co., 36 Oliver St.
- Bridgeport, Conn.—A. C. Bisgood Mchy., 17-21 Union Sq.
- Chicago, Ill.—C. B. Burns Mchy. Co., 541 W. Wash. Blvd.
- Cleveland, Ohio—Reynolds Mchy. Co., 2034 E. 22nd St.
- Dallas, Texas—Machinery Sales & Supply Co., 2124 Main St.
- Denver, Colo.—M. L. Foss Machinery Co., 1901 Arapahoe St.
- Detroit, Mich.—Lee Machinery Co., 6318 E. Jefferson Ave.
- Houston, Texas—Wessendorff, Nelms & Co., 317 Preston Ave.
- Los Angeles, Cal.—Eccles & Davies Mchy., 1910 Santa Fe
- Milwaukee, Wis.—W. A. Voell Mchy. Co., 1533 N. 16th St.
- New York, N. Y.—A. C. Colby Machinery Co., 183 Centre St.
- Philadelphia, Pa.—W. B. Rapp Mchy. Co., 132 N. Third St.
- Portland, Ore.—Portland Mchy., 208 So. West First Ave.
- Providence, R. I.—George T. Reynolds & Son, 171 Pine St.
- Rochester, N. Y.—Ogden R. Adams Mchy. Co., 266 State St.
- St. Louis, Mo.—Colcord-Wright Mchy., 1223 No. Broadway
- San Francisco, Cal.—Moore Mchy. Co., 1625 Van Ness Ave.
- Seattle, Wash.—Star Machinery Co., 1741 First Ave., So.
- Syracuse, N. Y.—H. A. Smith Mchy. Erie Blvd. E. & S. Townsend
- Tulsa, Okla.—Machine Tool & Supply, 215-219 E. First St.

WRITE FOR THESE BOOKS

- No. 34LB, "How to Run a Lathe," 25c
- No. 36A, "How to Cut Screw Threads," 10c
- No. 35, "How to Grind Cutter Bits," 10c
- No. 46-A, "9-in. Workshop Catalog," Free.

SOUTH BEND LATHE WORKS,
 634 E. Madison St. South Bend, Ind., U.S.A.
 Please send the books checked here.
 Class of Work.....
 Name.....
 Address.....
 City..... State.....



SOUTH BEND Precision LATHES

Here's a Real "POWER HOUSE" for your Car!



A NEW BATTERY

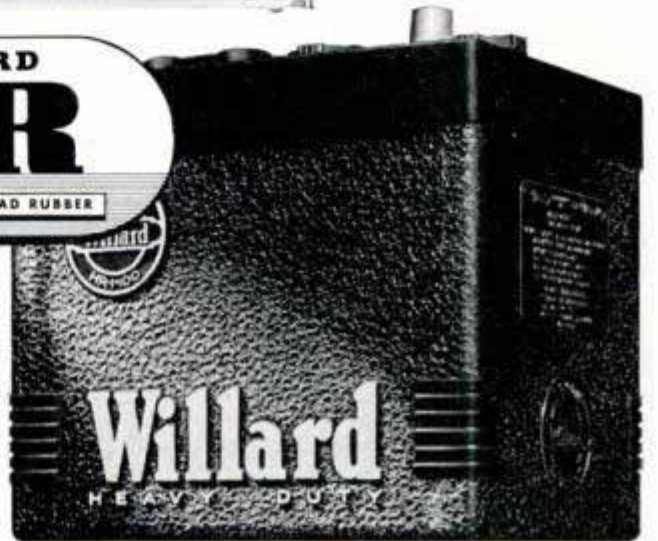

THAT LASTS 68% LONGER!

New type Willard Thread Rubber Insulators and Willard High Quality plates give the Willard "H-R" top performance and a life 68% above the average of over 100 other brands, including all the best known makes

● It really IS an individual power house—this new Willard "H-R" Battery.

It feeds electricity to your starter, your ignition system, your car radio, your horn, your lights, and other current consuming devices whenever it is needed—regardless of weather conditions.

Almost any battery built, will probably do that—at first.

But *here's* the difference—the Willard "H-R" does all the things a battery is supposed to do —and it keeps on doing them for 68% longer than the average of competing batteries.

Your Willard dealer will be glad to show you the new "H-R" and explain its many advantages. If your present battery is old or showing signs of weakness, install a new "H-R" now *before* you "get stuck."

WILLARD STORAGE BATTERY COMPANY • Cleveland • Dallas • Los Angeles • Toronto

ASK FOR IT BY NAME AT



YOUR WILLARD DEALER'S

THRILLS *from the* CIRCUS

FEATURING
ANTOINETTE CONCELLO
 TRAPEZE SENSATION
 AND
TERRELL JACOBS
 LION KING

MISS CONCELLO, HOW ARE CHANCES FOR A STORY ON YOUR BIGGEST THRILL AS AN AERIALIST?

TONY, TELL HIM ABOUT YOUR FIRST TRIPLE SOMERSAULT IN THE AIR.

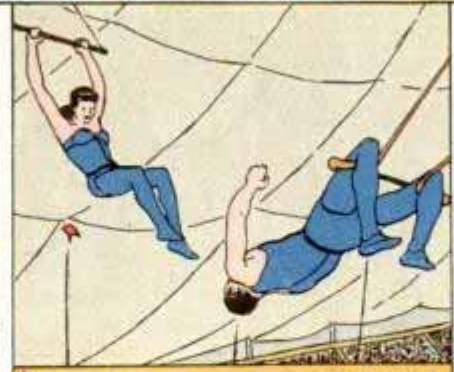

"NO WOMAN, TO MY KNOWLEDGE, HAD EVER EXECUTED A TRIPLE MID-AIR SOMERSAULT. I HAD TO DEPEND ALMOST ENTIRELY ON AUTOMATIC TIMING..."

"... BUT AS I WHIRLED OFF INTO SPACE... ONCE... TWICE... FOR A SPLIT-SECOND I PRACTICALLY LOST CONSCIOUSNESS..."

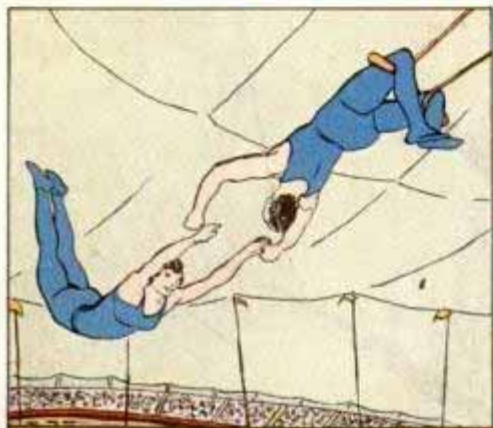

"...THREE TIMES... AND... I MADE IT! THRILLED AND SAFE!"

TERRELL, TELL HIM ABOUT THE TIME SPARKY, OVER THERE, ALMOST FINISHED YOU



"I HAD ALMOST COMPLETED MY ACT WITH 25 LIONS, WHEN SPARKY AND ANOTHER MALE WENT FOR EACH OTHER..."



"TRYING TO BREAK IT UP, I WAS KNOCKED DOWN AND SPARKY TURNED ON ME. THINGS LOOKED PRETTY BAD..."

"BUT I GOT THE UPPER HAND. BEFORE I LEFT THE CAGE, EVERY LION WAS BACK IN PLACE."



AFTER A TURN IN THE BIG CAGE, I NEED A 'LIFT' IN ENERGY, AND I GET IT FROM A CAMEL. I'VE SMOKED CAMELS FOR 16 YEARS. HAVE ONE, TONY?

YOU BET, TERRELL, THERE'S A BIG DIFFERENCE BETWEEN CAMELS AND OTHER KINDS - IN MILDNESS - IN SO MANY WAYS!



One Smoker tells another...
"CAMELS AGREE WITH ME"

PEOPLE DO APPRECIATE THE COSTLIER TOBACCOS IN CAMELS THEY ARE THE LARGEST-SELLING CIGARETTE IN AMERICA

CAMELS ARE A MATCHLESS BLEND OF FINER, MORE EXPENSIVE TOBACCOS - TURKISH & DOMESTIC (SIGNED) R.J. REYNOLDS TOBACCO CO., WINSTON-SALEM, N.C.

