

PHOTOS THAT HAVE MADE FORTUNES

POPULAR MECHANICS

★

MAGAZINE

WRITTEN SO YOU CAN UNDERSTAND IT

REGD. TRADE MARK GREAT BRITAIN NO. 41028

REG. U.S. PAT. OFF.

AUG.
25 CENTS

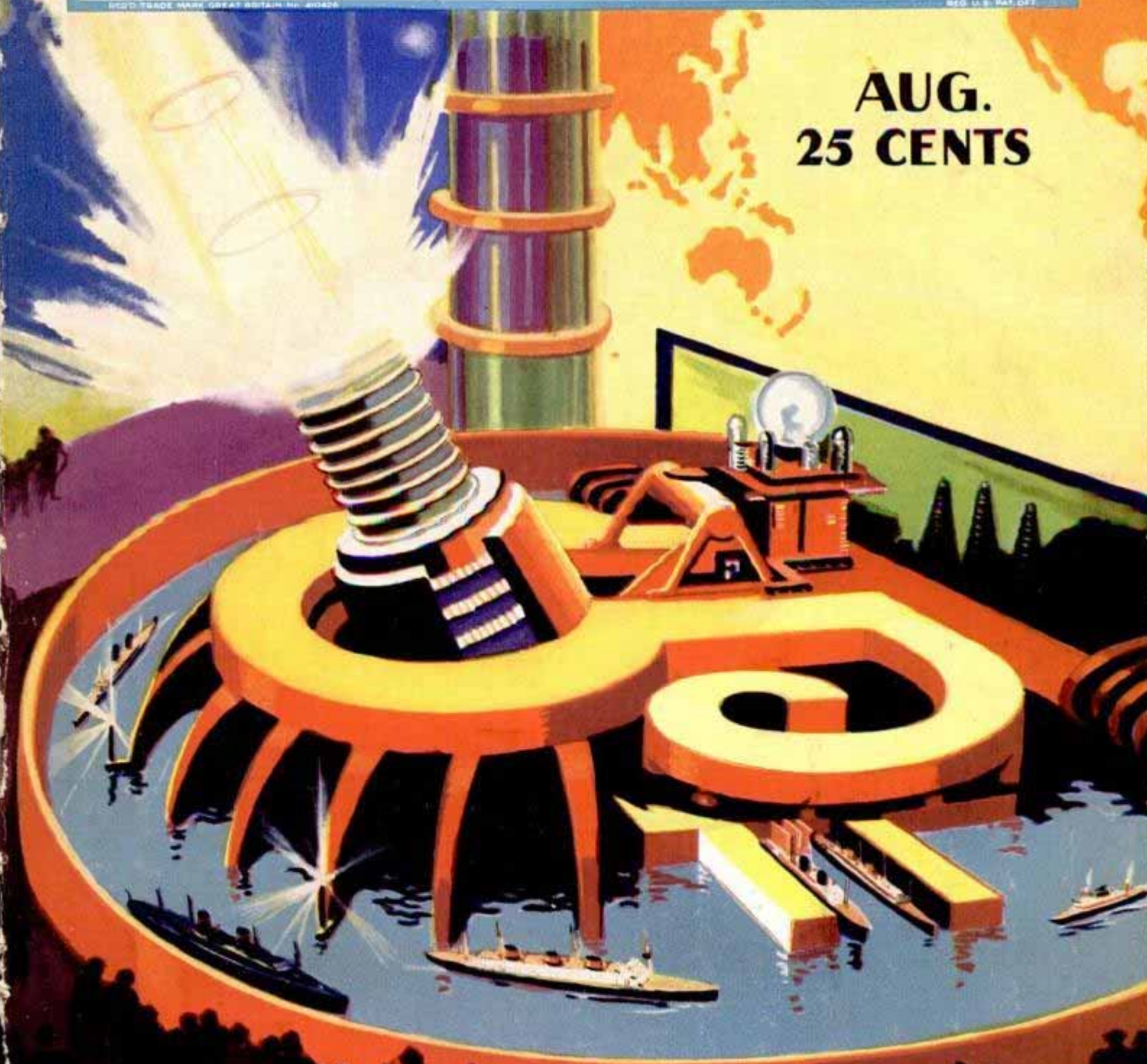

SEE COLOR SECTION

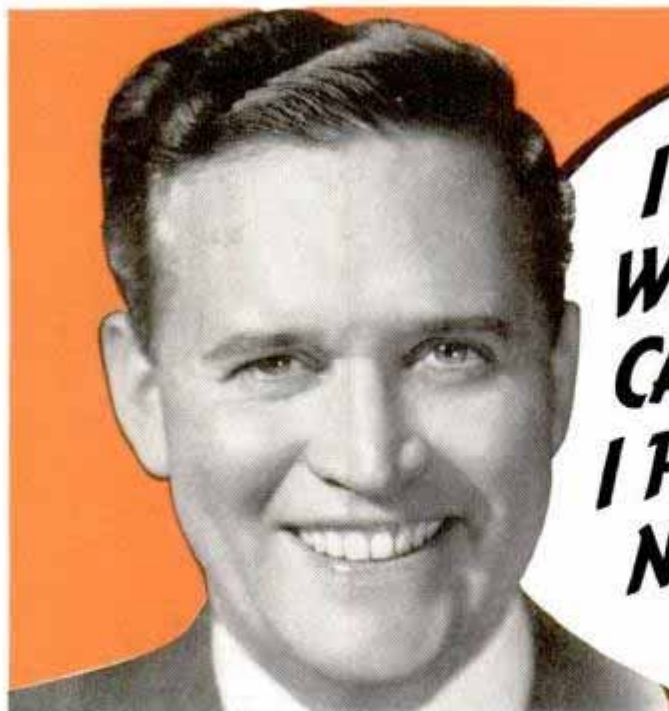

**I NEVER KNEW
WHAT A PEPPY
CAR I HAD UNTIL
I PUT IN A SET OF
NEW AUTO-LITE
SPARK PLUGS**

**THIS NEW TYPE SPARK PLUG
PEPS UP PICKUP . . . STEPS UP
TOP SPEED . . . STOPS GAS WASTE
. . . GIVES EASIER STARTING**

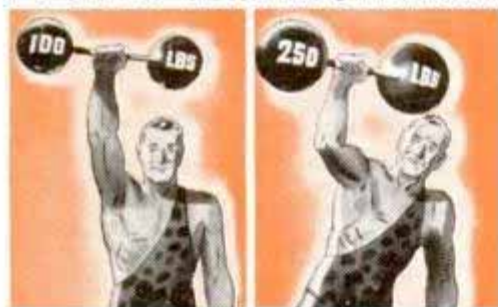

LESS STRESS ON ENTIRE IGNITION SYSTEM

These pictures give you a quick idea of the difference between the action of Auto-Lite Spark Plugs and others. By sparking at reduced voltages, Auto-Lites ease the load, and better the action of the entire ignition system.

say MOTOR CAR OWNERS BY THOUSANDS

To the eye, this new Auto-Lite spark plug is the same as all the others. But in your car its performance as a unit of the ignition system is entirely different—*more efficient!*

Reason number one is the new Auto-Lite Konium Electrode with its "geometric" gap design. In everyday language, this new electrode makes it easier for all the ignition units to work together and produce the vital operating spark. Konium and its more efficient "geometric" gap design were developed by Auto-Lite research engineers to pro-

duce a spark at reduced voltages—and increase the firing certainty of the entire ignition system!

Leading motor car engineers carefully examined the performance of this new kind of spark plug, and today one out of every four new cars sold is factory-equipped with Auto-Lites. That's an endorsement that's hard to get! No matter what kind of car you drive you'll notice immediately its improved performance—Auto-Lites "put new life in your motor!"



**FIRST SIGNIFICANT SPARK PLUG
IMPROVEMENT IN YEARS**

Auto-Lite's new Konium Electrode, by sparking at reduced voltages, gives 4 important new benefits . . . (1) prompter starting, (2) gas saving, (3) more snap and pickup, (4) added top speed!

**AUTO-LITE
1938 PARADE OF STARS**

Lovely, exotic Parisienne, DANIELLE DARRIEUX, in her new Universal picture "The Rage of Paris" leads the 1938 Parade of Stars. Ask your Auto-Lite dealer for an autographed photograph.

**DEALERS AND
SERVICE STATIONS:**

In the next few months millions of motorists will be told in dynamic advertising the advantages and benefits of this sensational new spark plug. Write The Electric Auto-Lite Co., Dept. PMS, Toledo, Ohio, for 1938 merchandising plan.



AUTO-LITE SPARK PLUGS

**WHAT'S ALL THIS
TALK ABOUT A
PURE OIL!**

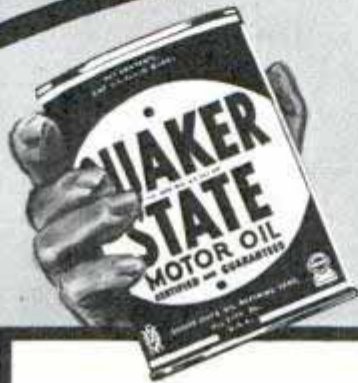

Your automobile requires pure oil . . . oil that will not break down into sludge, carbon or corrosion-forming elements.

Acid-Free Quaker State is a scientific achievement in motor oil *purity*. In four, great modern refineries . . . operating under the most exacting control . . . the finest Pennsylvania crude oil is freed of all trace of impurities. Every drop of *Acid-Free Quaker State Motor Oil* is rich, pure lubricant. Retail price, 35¢ a quart. Quaker State Oil Refining Corporation, Oil City, Pennsylvania.



**Buy Acid-Free
Quaker State**

IT MAKES CARS RUN BETTER. LAST LONGER

This One



5P6Y-E78-EAJW



"THANKS FOR CALLING"

The telephone helps a lot of folks to know each other better. Business is easier—friends are nearer—life is richer—because of it.

"Thanks for calling," spoken over the telephone many times a day, is a friendly reminder of the usefulness, dependability and value of Bell System service.

BELL TELEPHONE SYSTEM



Popular Mechanics Magazine

H. H. WINDSOR, Founder

H. H. WINDSOR, Jr., Editor and Publisher

August, 1938

Vol. 70, No. 2

Special Features

<u>Diesels for Airplanes</u>	<u>161</u>
<u>The World of Tomorrow</u>	<u>Coloroto</u>
<u>Where Is Television Now?</u>	<u>178</u>
<u>Riding Hobby Horses to Fame</u>	<u>187</u>
<u>Running the Electric Liners</u>	<u>194</u>
<u>Cloak of Fire Guards Drop of Steel</u>	<u>200</u>
<u>The Wonders of "Silent" ^(Ultra sound) Sound</u>	<u>210</u>
<u>Making Money with Your Pictures</u>	<u>218</u>
<u>"Gentlemen Drivers" of Speedboats</u>	<u>226</u>
<u>The Truth about Tank Farming</u>	<u>232</u>
<u>Raising Rabbits for Profit</u>	<u>242</u>
<u>Thrill Hunters of the Air Lanes</u>	<u>250</u>

(Continued on next page)

Why Is Grass Green?

A COMPLETE answer to this simple question would solve one of the great riddles of science. The schoolboy will tell you that grass is green because of chlorophyll, the active tie between the sun's energy and life. But how does it work? That's the puzzle. The whole earth receives energy from the sun but the green leaf uses this energy. Without chlorophyll, no life could exist on land for it is the ultimate source of all materials. Solving the secrets of chlorophyll may mean longer life, better health, absolute conservation of natural resources, reduction of living costs, a great rise in standards of living and an entirely new era of power and energy, an age in which an automobile may run 200 miles on a gallon of fuel. An article in the September issue discusses this riddle and the results which may be expected when science finally solves it.

Next Month

IF YOU have what it takes, Uncle Sam will pay you a salary while he teaches you to pilot one of his great "Flying Fortresses." An article next month tells you how to take advantage of this opportunity. The story is illustrated with eight pages of Coloroto pictures taken at March Field.

Our "Dumb" Friends

BEFORE you again refer to dogs, cows and horses as "our 'dumb' friends," consider "Skippy," "Whitey" and "Barney." "Skippy," a terrier, earns a weekly salary running into three figures. "Whitey," a cow, has earned about \$12,000 in the past fifteen years. "Barney" is a sway-backed horse and gets \$35 a day when he works. They're all in the movies, three of the many animals you have seen working in the films. An article next month tells how the animals are trained for their roles before the camera.

Amateur Auto Races

HOW fast will it go? That's what every young driver wants to know when he has finished "hopping up" an old car. Out in California they find out—safely. Instead of chancing death on the highway, these drivers hold amateur racing meets—a sort of kindergarten for future speed kings. An article in the September issue tells about these amateur speed contests.

Another INDIANAPOLIS SPEEDWAY RECORD FOR PYROIL!



RONNEY HOUSEHOLDER, Daring Auto Race Pilot, Smashes All Time Qualifying Record For Indian- apolis 500 Mile Race, Using Pyroil.

Blistering the track with a speed of 125.769 miles per hour for a distance of 25 murderous miles, Ronney Householder, daring West Coast auto speed ace, hung up an all time record in the qualifying time trials for the Indianapolis 500 mile race last May 30. Householder, a constant user of Pyroil, achieved his sensational record in the Pyroil treated, Thorne-Sparks Special race car pictured above.

On the Speedways of the world, you'll find Pyroil a favored stand-by of famous drivers. With it they build their cars, tune them, race them.

To improve the performance of *your* car—to safeguard its valves, pistons, cylinders, bearings, shafts; to reduce friction, wear; to eliminate and prevent carbon, gum, sludge and ruinous corrosion—*use Pyroil every mile you drive!* Ask your service station attendant for it, today. **SEE COUPON BELOW.** Manufactured and Guaranteed by Pyroil Company, W. V. Kidder, Founder, 58 Pyroil Bldg., La Crosse, Wisconsin, U.S.A.



**SIMPLY
ADD TO
GAS & OIL**

**NOTHING FINER FOR
NON-ABRASIVE NEW
CAR BREAK IN!**

**DISTRIBUTORS:
CHECK AND MAIL
COUPON FOR FRAN-
CHISE FACTS.**

PYROIL COMPANY.

58 Pyroil Bldg., LaCrosse, Wis., U. S. A.

Please send me a Free copy of your interesting Booklet, "My Greatest Thrill on the Speedway."

Also send details of your plan for Distributors.

Name.....

Address.....

City..... County..... State.....

(Contents—Continued)

AUTOMOTIVE

Strange armored war car captured in Spain.....199
Precision valve stem grinder saves time.....206
Ventilator makes a kennel of automobile trunk...208
Emergency hospital in a trailer.....225
Steel rail on center line prevents crash.....239
Alarm wakes drowsy driver.....241
Airplane speed indicator promotes fuel economy...254
Armored car flies motorized cavalry colors.....255

AVIATION

Stagecoach and sky liner weld a continent.....177
Camouflaged attack planes in air maneuvers.....199
Building a five-mile-a-minute racing plane.....223
Canoes carried by airplane to northern waters....231
Wind-tunnel test ends fire peril.....256

CONSTRUCTION

Upturned rowboat forms roof of tiny cottage.....190
Welded pipeline crosses river as suspension bridge.222
Window in builders' fence permits public to watch.237
Dual heating-cooling system for home.....240

FARMS AND GARDENS

Retired airplane guards orchard from frost.....208
Farm tractor built of odd car parts.....214
Profit for farmer in drugs now imported.....237
Power lawn mower has floating cutter.....256

HOUSEHOLD

Food mixer with flexible paddles.....192
Domed grille cooks bacon flat without turning...193
Folding metal basket for shopping.....205
Gentle-fugal juice extractor does its job quickly...238
Suction cups hold tray on wrought-iron stand....238
Chemical suction pump clears clogged drain.....246
Necktie rack.....246
"Winter garden" shelf does not mar woodwork...247
Dog has private entrance in door panel.....249
"Fly ash" trouble cured by control of fire.....254

MODELS

Eleven-foot model of luxury liner "Queen Elizabeth".193
Miniature pressure gauge for modelmakers.....239
Sculptor is dentist to prehistoric monster model...240

MOVIES

Motor-driven camera films "Hollywood" effects...206
Movies fade into wall increasing field of action...214
Sixty-seat movie theater in a trailer.....248

PHOTOGRAPHY

Camouflaged camera takes evidence for police....186
Projected scene aids in making composite photo...204
Low-cost enlargements printed from miniature film.208
Vise for binding photo slide.....214

RADIO AND ELECTRICITY

Vacuum tubes and alloys bring back harpsichord...177
Radio installed on tractor lightens farm work....192
Sound-on-film radio programs.....198
New Jersey lights a fifty-six mile highway.....204
Lamp filament burns above steel's melting point...206
String instrument plays through loudspeaker....224
Ultra-short wave radio horn sends pencil beam...236
Contact "mike" on violin helps deaf player.....246
Cost of ten million volts of lightning.....246
Healing ray focuses power on specific organ.....247
Television in natural colors is offered.....248
Portable amplifier employs beam-power tubes...257
Three low-cost progressive receivers for beginners..258
Sectional cabinet relay racks for amateurs.....260
Hints for radio experimenters.....261
Polarity changer operates a.c. appliances on d.c....262
Six-tube radio-phonograph has push-button tubing.262
Swinging-link inductor coils.....262

SCIENCE AND INDUSTRY

Nearest star loses the honor.....190
Steel-silo atom-smasher holds big vacuum tube...205
Air cleaner for welding or grinding shop.....207
Diamonds and coal prove purity by float test....209
Wood as chemical material finds new uses.....216
Heart of stars is heavy.....224
Northern lights reproduced on planetarium sky...229
Electric meter gauges emotion by skin reaction...230
Master chairmaker carves twenty-four pieces at once.231
Floor magnets sort metal from factory dust.....236
Bronze joined to steel with permanent bond.....241
Whirling molds cast metal into stronger auto parts.254
Air jet pulverizer grinds powder superfine.....256

SPORTS

Baseball game for the blind.....191
Bicycle test measured work output of athlete.....215

(Continued to page 6A)

NOW READY! At your Willard Dealer's

A NEW BATTERY THAT LASTS 68% LONGER

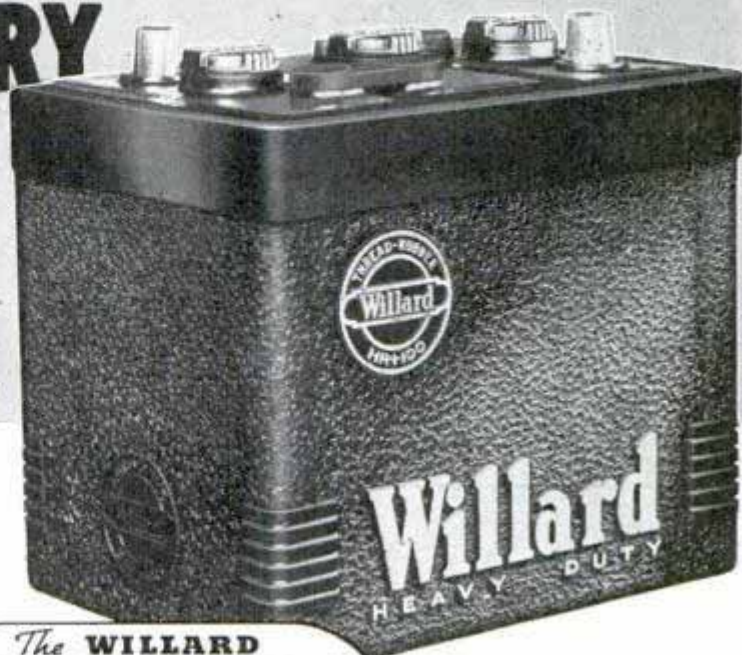

Get the Protection of This New Heavy Duty Willard that...

... does all the things you've always wanted a battery to do—and keeps on doing them for 68% longer than the average of 178 other brands, including all the best known makes!

... starts your motor over and over and over again—countless times—quickly—without fuss—and regardless of the weather!

... takes the strain of hard, continuous driving—day after day—without flinching.

... is a made-to-order power house to handle the extra demands of car radios, heaters, and other current-consuming devices.

This Willard "H-R" was developed after a 9-year study of 78,000 batteries driven over one billion miles. Its unusual performance is due to new developments in battery construction, exclusive with Willard. Most important single feature is a *new type* of Willard Thread Rubber Insulator that definitely increases battery life—and protects you against the sudden failures so often caused by "shorts" or buckled plates.

If you are one of the millions of car owners who will need a new battery this Fall, be sure to see the *new* "H-R". Its long life and low price mean true economy. Now on display at your Willard dealer's.

The WILLARD
H-R

HEAVY DUTY

THREAD RUBBER

7 OUTSTANDING FEATURES OF THE WILLARD "H-R"

- 1 Protected with the new-type Willard Thread Rubber Insulators that give the battery 68% longer life.
- 2 Reserve Capacity means longer life, plenty of power for radio or accessories.
- 3 Plates expertly designed, formed and processed to insure top performance.
- 4 Extra power for Winter starting—and superior resistance to summer heat.
- 5 Delivers high voltage to starter—saves gasoline, and oil dilution.
- 6 Handsome, new-style Hard-Rubber Container—tough and rugged.
- 7 Written guarantee and adjustment policy, backed up by 42,000 Willard Dealers from coast to coast.

HERE'S WHY THE "H-R" WILL LAST 68% LONGER

No battery can last longer than its insulators. The positive and negative plates are like fighting roosters always trying to get at each other through the "fence" or insulator. If the plates wear a hole through an insulator and touch each other a "short" occurs and the battery goes dead immediately. This is the cause of many battery failures.

After years of research, Willard engineers have perfected a new insulator of cotton threads and latex. This new Thread Rubber is porous enough to permit fast chemical action between plates—yet tough enough to keep the plates apart until they wear out.

Combined with Willard's superior plate construction these Thread Rubber Insulators give the "H-R" top performance and a life 68% above the average of competing batteries.

WILLARD STORAGE BATTERY COMPANY • Cleveland • Dallas • Los Angeles • Toronto

ASK FOR IT BY NAME AT

The WILLARD
H-R

YOUR WILLARD DEALER'S

GOING!...GOING!...GONE!



TALK ABOUT ANTIQUES! Get a whiff of that rancid old tobacco! Here—clean the goo out of your pipe and then switch from that stinko brand to Sir Walter Raleigh.



SOLD! Sold to a million and more men who want a *milder* burley blend that smells good to the man smoking, and to his friends, too! Fifteen cents buys two heaping ounces.



HOW TO
TAKE CARE
of
YOUR PIPE

FREE BOOKLET tells how to make your old pipe taste better, sweeter; how to break in a new pipe. Write for your copy today. Brown & Williamson Tobacco Corporation, Louisville, Kentucky. Dept. P-88.

TUNE IN Tommy Dorsey and his famous orchestra. Every Wednesday evening, coast-to-coast NBC Red Network.

(Contents—Continued)

Mining on target range recovers lead bullets.....	217
Air-filled tubes eliminate tent poles.....	239
TOOLS	
Machine tools in bright colors.....	186
Pocket gauge measures in fractions of an inch.....	198
Spray gun for stain collects drippings in pan.....	236
Copper-wheeled soldering iron for sealing packages.....	238
Pipe connector installed outside the tank.....	238
Shop owner builds portable metal cutting tool.....	240
Grinder on fender is powered by engine.....	249
Miter box for home shop.....	249
MISCELLANEOUS	
From block to blockhead in two days.....	184
Chiseling stage dummies.....	185
Cleaning skyscraper windows calls for nerve.....	190
Aluminum-shod race horses lower track records.....	192
Old streetcar made into boat.....	193
Midget photoengraving plant for small newspaper.....	198
Two-way steering wheel for motorboat.....	205
Clamp holds lawn mower and aids repairman.....	207
Wool made from fish albumin and cellulose.....	207
Charlie McCarthy can walk, thanks to carpenter.....	214
Concrete buoy is topped by lights.....	215
"Room with bath" on new streamline trains.....	216
Life-size figures molded in sand.....	217
Flexible traffic signs bend when hit.....	222
Plug to make blasting safer seals drill holes.....	222
Automatic bridge game board.....	224
Hydraulic shock absorber for bicycle seat.....	229
Origin of freak fires.....	230
Merry-go-round test shows up unbalanced bullets.....	236
Glass case guards baby from gas attack.....	237
Aircraft carrier "Enterprise" joins the navy.....	241
Wooden duck's wings move when wind blows.....	249
Toy airplane circles pylon under remote control.....	255

Craftsman and Shop Notes

AUTOMOTIVE

Midget trailers.....	279
Auto shortcuts.....	317
Assorted shoes equalize brakes.....	318
Funnel holds valve-grinding compound.....	318
Increasing life of mud hooks.....	318
Removing shrunk-fit piston pins.....	318
Tightening tubular terminals on spark plugs.....	318
Bumper vise stand to repair cars on road.....	319
Poor adjustment of free-wheeling causes noise.....	319
Spring catch locks garage-door bar.....	319
Bugs removed from windshield with wet block.....	320
Checking storage battery for cracked cells.....	320
Lubricating windshield wipers.....	320
Patching rack for inner tubes from spade.....	320
Sliding straps on robe rail hold umbrella.....	320

BOAT AND BOATING

Boat carrier rides on car top.....	265
Combined boat pennant and light.....	266
"Water bug," a beach play boat.....	287

CAMPING, FISHING, HUNTING

Fish cleaned with car valve.....	270
Keeping weed seeds out of boots.....	281
Preserving fish in sawdust.....	309

FARM

Opening in fence admits people but not livestock.....	289
Hay rope prevented from twisting at carrier.....	302
Wing buttons prevent cattle lifting gate hook.....	302
Hay delivered from baler directly to wagon.....	305
Short fence across creek saves main one.....	305
Tools carried on implements in rubber kits.....	306
Wheeled feed rack saves time.....	310
Sled to cut sweet potato vine.....	312
Fence corner boarded over provides sunshade.....	316

FURNITURE

Spindle racks for books and bric-a-brac.....	268
Hinged-top dressing table.....	271
Modern porch furniture from old car parts.....	281
Modern drawer pull from old auto pistons.....	284
Modern plant stands.....	307

HAND TOOLS

Thin sheet metal cut with razor blades.....	267
Screwdriver turns wrench in tight place.....	270
Weight on glass cutter relieves finger strain.....	270
Metal rods pointed with hand drill.....	278
Handy splayed-jaw clamp.....	304
Hammer slung from wrist to avoid dropping.....	306
Rubber patch on glove to turn screwdriver.....	310
Hacksaw lubricated with water.....	312
Holder to grip screws in vise.....	316

(Continued to page 8A)



HOW LONG? HOW LONG?
THIS HEART-BREAKING
MONOTONY?
THIS WRETCHED PAY?

"If I Could Only Recover Those Ten Lost Years!"

[[The True Experience of a Man Who *Almost* Enrolled for LaSalle Home-Study Training]]

In December, 1921, an American employed with a mining firm in Mexico, clipped and signed a LaSalle advertisement coupon. *But he did not enroll!*

Ten years of silence followed . . . ten years of haphazard jobs, long hours, wretched pay . . .

Then, in January, *nineteen thirty two*, that silence was broken by a dramatic letter, high-spotted by these words: "Please send the first lessons with the least possible delay, as time is a highly important factor to me in this year of our Lord!"

Through five typewritten pages he recounted the hardships of those intervening years. A really able man, he had moved from one position to another, only to find advancement closed to him for lack of specialized training.

No need here to recite those hardships—though in justice to him it is only fair to say that on four separate occasions he had *almost* enrolled . . . and that on each occasion he had postponed action because of some unexpected reverse seemingly beyond his power to avoid.

"For five months now," so he wrote, "I have been 'on vacation.' Not a chance to take a course now—according to my carefully laid out and conscientiously followed program . . .

"But—supposing I had *chucked* that program at any time in the last 10 years? Supposing I had enrolled, in the face of seeming disaster, even though I had had to borrow the money to do it? Supposing even that I had enrolled only five months ago, at the beginning of my enforced vacation? In all likelihood I could have mastered the training by now. Or I might in the meanwhile have found a congenial and profitable position, thanks

to my increased knowledge. As it is, for all I know, there may be another five months without any position . . . with all sorts of dim prospects . . . and meanwhile I am getting older . . .

"*That settles it! To blaze with further procrastination! To thunderation with my financial program! I've borrowed the money, and I'll borrow some more . . . but I'll do something with my time! This year is going to see a big change in my affairs—and right here is where we start!*"

Send for Free Booklet

These are searching times—and wise is the man who takes full measure of his competition . . . gets the special training that he needs . . . and thus commands the unfolding opportunities of our new-day business world.

If you need to be *convinced* of those opportunities, forget that you ever read this message. For those opportunities are not for you . . .

But if you are determined to be out in front when men are picked for leadership one year, two years, ten years from now—do not, on your life, risk a day's delay.

Below is a coupon. It will bring you—without cost—books that have led to increased earnings running into many thousands of dollars! Men of action—*hundreds of them*—will use this coupon for their personal advancement. Be one of those men who will steadily win their way to the better-salaried positions.



Ask for one of these booklets—or a similar one on your own field of business. They are FREE!

LASALLE EXTENSION

LaSalle Extension, Dept. 864-R, Chicago, Illinois

I would like to have your special booklet—without any cost or obligation to me—about my opportunities and your success training in the business field I have checked.

- | | | |
|--|--|--|
| <input type="checkbox"/> Business Management | <input type="checkbox"/> Law: Degree of LL. B. | <input type="checkbox"/> Business Correspondence |
| <input type="checkbox"/> Higher Accountancy | <input type="checkbox"/> Expert Bookkeeping | <input type="checkbox"/> Business English |
| <input type="checkbox"/> Traffic Management | <input type="checkbox"/> C. P. A. Coaching | <input type="checkbox"/> Effective Speaking |
| <input type="checkbox"/> Modern Salesmanship | <input type="checkbox"/> Industrial Management | <input type="checkbox"/> Stenotypy |
| <input type="checkbox"/> Commercial Law | <input type="checkbox"/> Modern Foremanship | |

Name _____ Age _____

Position _____ Address _____

When writing to advertisers please mention Popular Mechanics

ANCHORING PARTS in CONCRETE or TILE

Tight anchoring in concrete or tile—one of your worst puzzles—is easy with Smooth-On No. 1.

For light service, as in attaching bath-room fixtures (Fig. 1), hooks, etc., drill slightly over-size holes, fill with a soft putty of Smooth-On No. 1, set screws in this soft cement and turn up tight.

To anchor a railing post (Fig. 2), make a hole large enough to insert end of post, and tamp the space surrounding the end of post full of Smooth-On No. 1.

To anchor bolts in a concrete wall, make the hole large enough to clear the bolt head and of proper depth. Insert the bolt head and fill around bolt with Smooth-On No. 1. Large bolts can be set in Smooth-On No. 7. Tamping the cement into place gives a tighter hold. When the cement is hard, the bolt is ready for service.

Lag screws are held by making the hole just large enough in diameter to clear the screw. Put a soft putty of Smooth-On No. 1 into the hole, insert lag screw and turn it up into place.

In all of the above applications, the slight expansion of Smooth-On No. 1 in hardening gives a very strong hold of bolt, screw or post.

Use Smooth-On No. 1 in the home also for tightening loose parts and stopping leakage of water, steam or gas.

Doing this work in accordance with instructions and diagrams in

the Smooth-On Home and Auto Repair Booklet enables any home mechanic to get perfect results and effect big annual savings. Mail the coupon for your copy.

Get Smooth-On No. 1 in 7-oz. or 1 or 5-lb. can from your hardware store or from us.

SMOOTH-ON MFG. CO.,
Dept. 37,
574 Communipaw Ave.,
Jersey City, N. J.

Please send the free Smooth-On Repair Book.

Name.....

Address.....

8-38.....

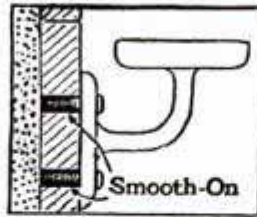

1. Fixtures set in tile or masonry

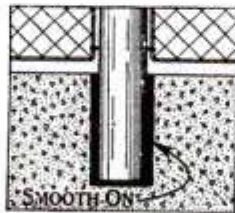

2. Railing post

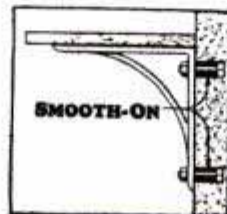

3. Shelf bracket

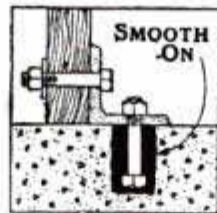

4. Wood partition



Write for
FREE BOOK



Do it with SMOOTH-ON

When writing please mention Popular Mechanics

(Contents—Continued)

HOUSEHOLD

Homemade soap shaver.....	266
Rubber tube protects garment on clothesline.....	272
Screen-door hook kept from swinging by magnet.....	272
Can opened with aid of suction cup.....	278
Tabs on tin funnel hold strainer cloth.....	278
Window draperies held straight.....	289
Chinese lantern basket makes table ornament.....	294
Window silencers from ink erasers.....	294
Home problems easily solved.....	296

METALWORKING

Ornamental iron railings made without welding.....	263
Bending sheets for bends in sheet metal.....	273
High-speed polishers from typewriter erasers.....	295
Container for soldering flux.....	316

OFFICE

Silencing typewriter tables.....	272
Tracings and blueprints stored in window shades.....	310
Month number on calendar aids typist.....	312

PHOTOGRAPHY

Cleaning camera lens.....	270
Guard for photoflash bulbs.....	285
Tripod for small camera.....	286
Wood screw removes small corks.....	286
Photomicrographs through a mailing tube.....	291
Film rolls tabulated on bottle neck.....	295
Top putty seals camera pinholes.....	295
Novel backgrounds for close-up photos.....	303
Wheel platform supports camera tripod.....	304

POWER TOOLS

Squaring wide work on small circular saw.....	278
Disk-sander face carries two abrasives.....	280
Small boring bar.....	304
Cardboard adjusts lathe to cut slight taper.....	310
Truing lathe center without using compound rest.....	312

STORE AND SHOP

Clothespins distributed with grocery circulars.....	301
Spoons as small-parts holders for jeweler.....	304
Shipping clerk's alphabetical bill file on wire.....	316

TOYS AND NOVELTIES

Toy electric motor easily made.....	266
Animated weather vane is amusing.....	273
Playhouse assembled without nails.....	282

WOODWORKING

Self-adjusting sanding block.....	265
Circular saw converted into disk sander.....	267
Jig to finish ends of small work rapidly.....	284
Cutting small work on band saw.....	294
Sawhorses have handholes for easy carrying.....	306

MISCELLANEOUS

Pictures exhibited without marring walls.....	267
Model-plane wheels from ink erasers.....	270
Simple paper cutter from razor blade.....	272
New water sports.....	274
Shoestring clasp from toothpaste tube.....	278
Bottle rack leaves both hands free.....	280
Culvert guards from auto casing.....	280
Sun glasses have paper glare shields.....	280
Tacks provide feet for small boxes.....	284
Umbrella garden trellis has luncheon table.....	285
Rubber tube improves weak pencil clip.....	286
Tool quickly removes pipe from well.....	286
Wire flower basket lasts indefinitely.....	289
Auxiliary table on shaper gives extra support.....	290
Fixture holds wire for soldering.....	290
Attractive signs made with solder.....	294
Rubber bands serve as stop masks.....	295
Increasing capacity of rule pocket.....	298
Portholes for ship models from shoe eyes.....	298
Water-operated ejector drains tanks and cisterns.....	299
Rounding dowel ends quickly.....	301
Data sheet handy on drill press.....	302
Eye shield of Cellophane when cutting glass.....	302
Saw knife to remove insulation from wire.....	302
Grease fitting on countershaft to lubricate pulley.....	306
Protecting motorcycle instruments.....	310
Arrows matched on homemade tester.....	311
Preventing wear on rubber-glove fingertips.....	311
Armored cable cut without rough edges.....	312
Hand loom weaves cane into webbing.....	313

IMPORTANT NOTICE

It is the intention of this magazine to provide its readers with information regarding the latest developments in the mechanical arts. We take no responsibility as to whether the disclosures contained in our articles are covered by patents and advise readers to investigate this subject before making, using, or selling any of the products, machines, or processes described, in order to avoid possible liability for patent infringement.



YOUR MIND IS

Burglar-Proof

• Gold may be stolen. Stocks and bonds may depreciate in value. But *knowledge* — the ability to hold a better, higher-paying position — never can be taken from you! *Training* endures through depression and prosperity.

Thousands of men in *your* industry — men

you will have to *compete* with in the struggle for advancement — are training their minds for the future through the International Correspondence Schools. Will you *watch* them advance — or will you advance *with* them?

Whether or not you mail this coupon will help determine the answer to that question.

INTERNATIONAL CORRESPONDENCE SCHOOLS

BOX 5518-J, SCRANTON, PENNA.

★ Without cost or obligation, please send me a copy of your booklet, "Who Wins and Why," and full particulars about the subject *before* which I have marked X: ★

TECHNICAL AND INDUSTRIAL COURSES

- | | | | |
|--|--|--|--|
| <input type="checkbox"/> Architect | <input type="checkbox"/> Sheet Metal Worker | <input type="checkbox"/> Commercial Refrigeration | <input type="checkbox"/> Surveying and Mapping |
| <input type="checkbox"/> Architectural Draftsman | <input type="checkbox"/> Boilermaker | <input type="checkbox"/> Plumbing <input type="checkbox"/> Steam Fitting | <input type="checkbox"/> Bridge Engineer |
| <input type="checkbox"/> Building Estimating | <input type="checkbox"/> Telegraph Engineer | <input type="checkbox"/> Heating <input type="checkbox"/> Ventilation | <input type="checkbox"/> Bridge and Building Foreman |
| <input type="checkbox"/> Contractor and Builder | <input type="checkbox"/> Telephone Work <input type="checkbox"/> Radio | <input type="checkbox"/> Air Conditioning and Cooling | <input type="checkbox"/> Chemistry <input type="checkbox"/> Pharmacy |
| <input type="checkbox"/> Structural Draftsman | <input type="checkbox"/> Mechanical Engineering | <input type="checkbox"/> Steam Engineer | <input type="checkbox"/> Coal Mining |
| <input type="checkbox"/> Structural Engineer | <input type="checkbox"/> Mechanical Draftsman | <input type="checkbox"/> Steam Electric Engineer | <input type="checkbox"/> Mine Foreman <input type="checkbox"/> Fire Bosses |
| <input type="checkbox"/> Management of Inventions | <input type="checkbox"/> Machinist <input type="checkbox"/> Toolmaker | <input type="checkbox"/> Marine Engineer | <input type="checkbox"/> Navigation |
| <input type="checkbox"/> Electrical Engineer | <input type="checkbox"/> Patternmaker | <input type="checkbox"/> R. R. Locomotives | <input type="checkbox"/> Cotton Manufacturing |
| <input type="checkbox"/> Electric Lighting | <input type="checkbox"/> Diesel Engines | <input type="checkbox"/> R. R. Section Foreman | <input type="checkbox"/> Woolen Manufacturing |
| <input type="checkbox"/> Welding, Electric and Gas | <input type="checkbox"/> Aviation Engines | <input type="checkbox"/> Air Brakes <input type="checkbox"/> R. R. Signalmen | <input type="checkbox"/> Agriculture |
| <input type="checkbox"/> Reading Shop Blueprints | <input type="checkbox"/> Auto Technician | <input type="checkbox"/> Highway Engineering | <input type="checkbox"/> Fruit Growing |
| <input type="checkbox"/> Heat Treatment of Metals | <input type="checkbox"/> Auto Electrical Technician | <input type="checkbox"/> Civil Engineering | <input type="checkbox"/> Poultry Farming |

BUSINESS TRAINING COURSES

- | | | | |
|--|---|--|--|
| <input type="checkbox"/> Business Management | <input type="checkbox"/> Bookkeeping | <input type="checkbox"/> Service Station Salesmanship | <input type="checkbox"/> Grade School Subjects |
| <input type="checkbox"/> Industrial Management | <input type="checkbox"/> Secretarial Work | <input type="checkbox"/> First Year College Subjects | <input type="checkbox"/> High School Subjects |
| <input type="checkbox"/> Traffic Management | <input type="checkbox"/> Spanish | <input type="checkbox"/> Business Correspondence | <input type="checkbox"/> College Preparatory |
| <input type="checkbox"/> Accountancy | <input type="checkbox"/> French | <input type="checkbox"/> Stenography and Typing | <input type="checkbox"/> Illustrating |
| <input type="checkbox"/> Cost Accountant | <input type="checkbox"/> Salesmanship | <input type="checkbox"/> Civil Service <input type="checkbox"/> Mail Carrier | <input type="checkbox"/> Cartooning |
| <input type="checkbox"/> C. P. Accountant | <input type="checkbox"/> Advertising | <input type="checkbox"/> Railway Mail Clerk | <input type="checkbox"/> Lettering Show Cards <input type="checkbox"/> Signs |

DOMESTIC SCIENCE COURSES

- | | | |
|---|---|--|
| <input type="checkbox"/> Home Dressmaking | <input type="checkbox"/> Advanced Dressmaking and Designing | <input type="checkbox"/> Foods and Cookery |
| <input type="checkbox"/> Professional Dressmaking and Designing | | <input type="checkbox"/> Tea Room and Cafeteria Management, Catering |

Name.....Age.....Address.....

City.....State.....Present Position.....

If you reside in Canada, send this coupon to the International Correspondence Schools Canadian, Limited, Montreal, Canada



**IT'S YOUR PLANE
--TAKING OFF FOR
THE FIRST TIME**

"Your" plane--the work of your hands and your mind--takes off for the first time. What other career could offer a greater thrill than this exciting moment--for any man?

But there are far more than momentary thrills in an aircraft industry career. Every hour is filled with absorbing duties . . . every day opens up broader opportunities.

Here is a career worth training for . . . the Aero I. T. I. way . . . which means that even *before* you enter the industry you are thoroughly trained in aircraft production methods . . . on the world's greatest array of aircraft production equipment--under an exclusive training system supervised by the renowned aircraft builders and designers on the Aero I. T. I. Executive Board. *Aeronautical Engineering* and *Master Aircraft Mechanics* courses, exclusively. Applicants subject to entrance requirements. Your training can start at home, if necessary. For complete information, send coupon.

EXECUTIVE BOARD

C. A. VAN DUSEN Vice-Pres. Consolidated Aircraft Corporation	JOHN K. NORTHROP Formerly President, The Northrop Corp., and Vice-President, Douglas Aircraft Company, Inc.	ROBERT E. GROSS President, Lockheed Aircraft Corporation
---	--	---

Aero Industries Technical Institute
5253 West San Fernando Road - Los Angeles, California

Please send details on Aero I. T. I. training for aircraft industry careers. (NOTE: This information intended only for men over 17 and under 40 years of age).

NAME _____ AGE _____
STREET _____
CITY _____ STATE _____ a-11-p

When writing please mention Popular Mechanics

**SEE AND TRY
SLINGERLAND
RADIO KING DRUMS
MAY-BELL
GUITARS**

Don't buy Guitar, Mandolin, Banjo, Electric Guitars, Bugles or Drums until you have seen and tried the Slingerland May-Bells. Guaranteed More for your Money. Wonderful, snappy, powerful, pleasing tone. No equal in price. Sold on easy payments and 5 days free trial by all leading music dealers.

Gene Krupa

Cut this Adv. Out—Good for \$1.00 Credit.
Ask for Special Information on How to Organize Drum and Bugle Corps.
Send for free catalog. Mention instrument wanted. Write today.

SLINGERLAND MUSICAL INSTRUMENT MFG. CO.
1330 BELDEN AVE. CHICAGO, ILLINOIS

**You Can Regain Perfect Speech, if you
STAMMER**

Send today for beautifully illustrated book entitled "DON'T STAMMER," which describes the Bogue Unit Method for the scientific correction of stammering and stuttering. Method successfully used at Bogue Institute for 37 years—since 1901. Endorsed by physicians. Full information concerning correction of stammering sent free. No obligation. Benjamin N. Bogue, Dept. 193 Circle Tower, Indianapolis, Indiana.

ENGINEERING DEGREE IN TWO YEARS

B. S. DEGREE courses in engineering: Electrical, Civil, Chem., Mechanical, Radio and Television, or Aeronautical. 1 yr. Mech. Drafting. Intense, practical, thorough program. Prep courses without extra charge. Earn while you learn in this industrial center. Low tuition. Enter March, June, Sept., Dec. Write for Catalog. 229 E. Washington Blvd., Fort Wayne, Ind.

INDIANA TECHNICAL COLLEGE

Operator No. 38

FOLLOW THIS MAN
Secret Service Operator No. 38 is on the job! Running down dangerous Counterfeit Gang. Tell-tale finger prints in murdered girl's room.

Free The Confidential Report Operator No. 38 made to his chief. Write for it.

Earn a Regular Monthly Salary
YOU can become a Finger Print Expert at home, in your spare time, at small cost. Write for confidential full report and details. Literature will be sent only to persons stating their age.

INSTITUTE OF APPLIED SCIENCE
1920 Sunnyside Ave.
Dept. C-135 Chicago, Ill.

LEARN WATCHMAKING AND ENGRAVING
BY OUR PROFIT-SHARING PLAN
OUR GRADUATES SUCCEED

One of our Iowa students started in a very small way—now doing over \$30,000 a year. Another in Wisconsin, over \$10,000 the first year. Day or night classes. Call or write for FREE BOOK. Chicago School of Watchmaking, Dept. 6601, 155 N. Clark St., CHICAGO.

WANTED: MAN with CAR

Make regular calls on Local Coffee Route. Nationally known, complete line of 250 household necessities. Fast-moving, big-profit, quick-repeating products. Boyne reported \$67 profit in a week; Cooper, \$82; Wellman, \$96. Experience not required. Earnings begin at once. Positively no money risk. Ample stocks sent on credit, once you start. Details FREE—no obligation. WRITE! Albert Mills, 5348 Monmouth Avenue, Cincinnati, Ohio

Become a Draftsman

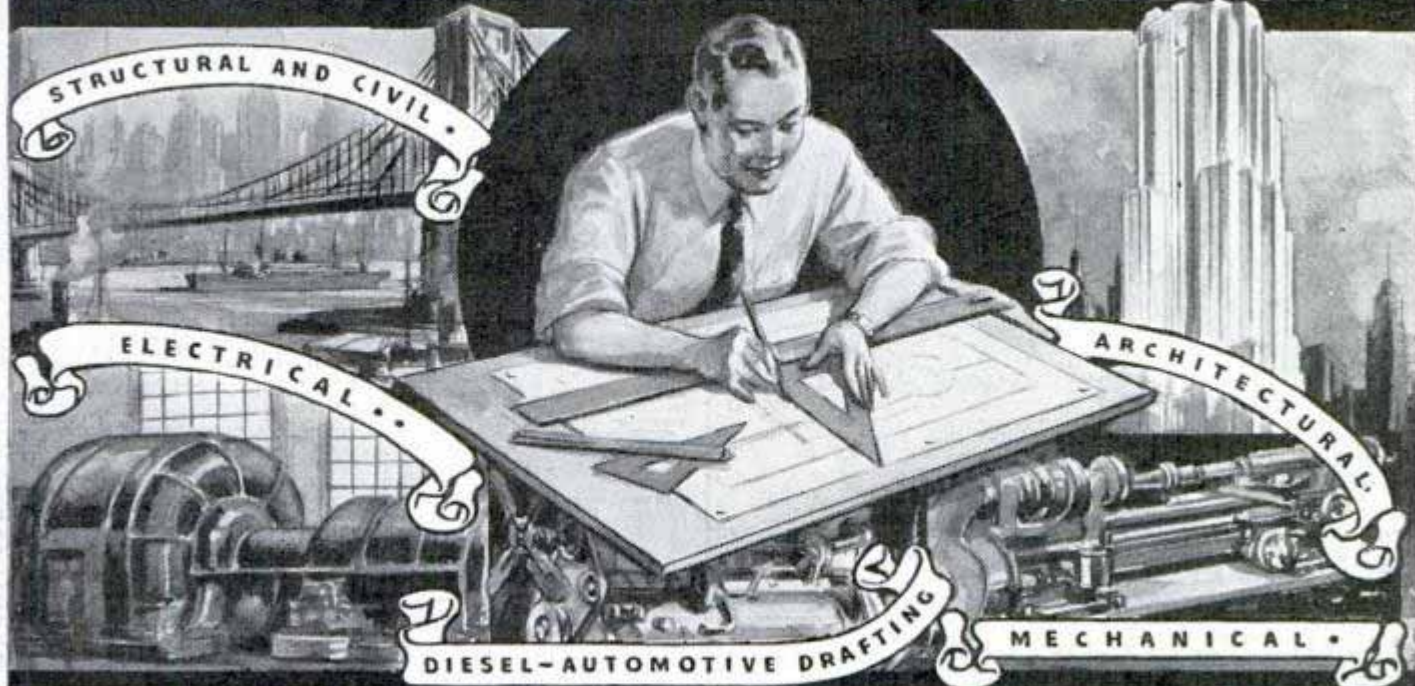

Enjoy a Real Job in Industry

Steady Work

As nearly all manufacturing—construction—building starts on the drafting table, the draftsman is one of the first to be hired and one of the last to be laid off. It is his blueprints, his specifications, that give the last word in what the workmen are to do. No article—building or construction job is started before the plans drawn by the draftsman have been officially approved.

Good Pay

The draftsman has been called the Junior Engineer which title just about describes his work—position and pay. He combines his knowledge of principles, mechanism and construction details with the ability to draw and reproduce motions and methods on paper. On the average, his salary is considerably above the wages of the mechanic and, of course, less than that of the engineer.

Chance for Promotion

Working on plans, helping design new machines or new methods of construction, the draftsman is working directly with the important men of the organization. Consequently he knows what is being considered and planned. It may be the superintendent—the engineer—or even the prospective buyer with whom he consults. Because of these contacts, his experience and knowledge of the business in general he is in an excellent position to be promoted when next there is a good opening.

Young at 40

Athletes—farmers—and factory and shop workers who rely on muscle start growing old even before they reach 40 while office workers—executives—teachers—professional men, in fact, all kinds of brain-workers are just approaching their prime at 40 to 50. Training increases your value at once and continues to help boost your earning power as you mature.

Don't Be Just Average

What happens to the average man? Not having thorough training for a worth-while job, he goes along year after year, wishing he had a good job, but wishing was never a substitute for training. \$40 a week is about his top, usually never that high. Grows old on the job, starts down at 40, finds himself slipping in speed and salary.

But the ABOVE AVERAGE MAN loses no time getting his training. Prepared for the job ahead, he is in line for RAPID PROGRESS—his WORK STEADY, his PAY GOOD. Trained, a young executive, young Draftsman drawing plans for great projects, YOUNG ON THE JOB at 40, at 45, at 50! And still has 10 or 15 years active service at good pay to which he can look forward! Training—the sooner you get it—the sooner it can help LIFT YOU ABOVE THE AVERAGE!

Don't grow old at 40. Train now for the job you want at 50. Training helps you to be independent—self-supporting. It helps you to enjoy associations that are denied the untrained man. Training helps you to increase your earning power and by so doing to offer members of your family advantages far in excess of what you could give them as an untrained man. Train and enjoy PROGRESS—CONTENTMENT—INDEPENDENCE.

American School, Drexel at 58th, Chicago

Get the Facts—Write Today

American School, Dept. DDC-45
Drexel Avenue at 58th Street, Chicago

Without the slightest obligation, send complete facts "How I can become a Draftsman" and free bulletin.

Name..... Age.....

Address.....

City..... State.....

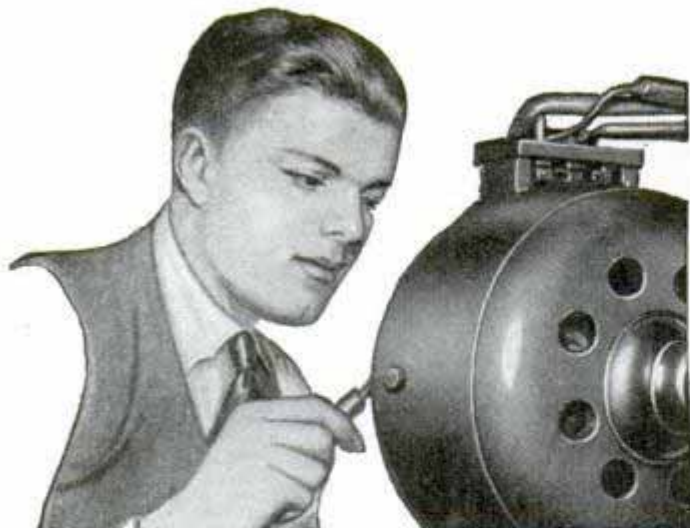

AMAZINGLY EASY WAY TO GET INTO ELECTRICITY

12 Weeks' Practical Training in the big Chicago Coyne Shops

Let us prepare you for your start in a good paying field. Let us teach you how to prepare for positions that lead to good salaries in Electricity—NOT by correspondence, but by an amazing way we teach right here in the great Coyne Shops. You get a practical training in 90 days. Electricity offers many opportunities to the trained man. Prepare today to take your place in the great field of Electricity. Mail coupon today.

LEARN BY DOING—IN 90 DAYS BY ACTUAL WORK—IN COYNE SHOPS

I don't care if you don't know an armature from an air brake—I don't expect you to! Coyne training is practical "learn-by-doing" training. Don't let lack of money hold you back from getting all details of my amazing plan.

MANY EARN WHILE LEARNING

If you need part time work to help pay your expenses, we may be able to help you as we have hundreds of others. When you graduate we'll give you lifetime employment service. And, in 12 brief weeks, in the great shops of Coyne, we train you as you never dreamed you could be trained... on one of the greatest outlays of electrical apparatus ever assembled... real dynamos, engines, power plants, autos, switchboards, housewiring, armature winding and many other branches of Electricity.

ELECTRIC REFRIGERATION AIR CONDITIONING

Right now we are including additional instruction in Electric Refrigeration and Air Conditioning without extra cost so that your training will be more complete and you can get into this marvelous, rapidly expanding field.

GET THE FACTS Coyne is your great chance to get into Electricity. This school is 39 years old—Coyne training is tested. You can find out everything absolutely free. Simply mail the coupon and let us send you the big, free Coyne book with photographs... facts... opportunities. Tells you how many earn expenses while training and how we assist our graduates in the field. No obligation to you. So act at once. Just mail coupon.

BIG FREE BOOK! Send for my big book containing photographs and telling the complete story—absolutely FREE.



H. C. Lewis

COYNE ELECTRICAL SCHOOL

500 S. PAULINA ST., Dept. C8-72, CHICAGO, ILL.

H. C. LEWIS, Pres., COYNE ELECTRICAL SCHOOL
Dept. C8-72, 500 S. Paulina St., Chicago, Ill.

Dear Mr. Lewis: Without obligation send me your big, free catalog with facts about Coyne Training and details of your "Plans" to help me.

Name..... Age.....
Address.....
City..... State.....

LEARN AVIATION

Great Opportunities For Trained Men

Aviation needs trained men. Come to Roosevelt—Government approved for all classes of pilots and mechanics certificates—and let our experts prepare you for a position in this fast growing industry. Roosevelt offers career courses in Flying, Mechanics, Sheet Metal and Design. Write for full information; state age. Address Dep't. P. M.

ROOSEVELT AVIATION SCHOOL

MINEOLA, LONG ISLAND, NEW YORK

LEARN WATCH REPAIRING

AT HOME You can learn by our modern and original system of instruction every part of the Watch Repairing Trade at home. You can earn money while learning and prepare yourself for a well paying position or start in business after completing our course of instruction. Good watch repairers are in demand and generally earn very good salaries. For particulars apply to the Wisconsin School of Watch Repairing 524 E. Mason St., MILWAUKEE, WIS.

Become an expert photographer

Send for big free booklet that tells how you can become an expert in Commercial, News, Portrait, Advertising or Motion Picture Photography. Big money-making opportunities. Personal Attendance and Home Study training. 28th year.

NEW YORK INSTITUTE OF PHOTOGRAPHY

10 West 33 St., (Dept. 49) New York City

BE A RAILWAY TRAFFIC INSPECTOR

WRITE TODAY

OUR TRAINING MEANS GOOD JOBS, GOOD PAY!

Qualify as Railway and Bus Passenger Traffic Inspector by our easy, home-study course. Earn good pay to start and advance quickly with experience. Men—19 to 50—upon completion of training are placed at up to \$135 per month, plus expenses to start, or we refund tuition. Free Booklet outlines our 19-year record. Write

STANDARD BUSINESS TRAINING INSTITUTE
Dept. 208, Buffalo, N. Y.

WILL YOU WEAR THIS SUIT

and Make up to \$12 in a Day!

Let me send you a fine all-wool union tailored suit FREE OF ONE PENNY COST. Just follow my easy plan and show the suit to your friends. Make up to \$12 in a day easily. No experience—no house-to-house canvassing necessary.

Send for Samples—FREE OF COST

Write today for FREE details. ACTUAL SAMPLES and "sure-fire" money-getting plans. Send no money.

H. J. Collin, PROGRESS TAILORING CO., Dept. H-216, 500 South Throop Street, Chicago, Illinois.

MAIL FOR FREE INFORMATION

BROOKLYN YMCA TRADE SCHOOL

1117 Bedford Ave., Dept. PM-63
Brooklyn, New York City, N. Y.

- Diesel Engines
- Diesel Technical
- Aviation Mechanic
- Aeronautical Technical
- Auto Mechanic
- Refrigeration
- Radio and Television Mechanic
- Air Conditioning
- Architectural-Mechanical Drafting
- Electrical
- Armature Winding
- Oil Burner
- Welding
- Talking Pictures
- Machine Shop
- Window Display

Name.....
Address.....



**IT'S DIESELS
Everywhere
YOU LOOK!**

On the Rails



On the Sea



In the Air

.. and Where There Are Diesels You Find H. D. S. Graduates

Almost every day . . . right in your own daily life . . . you see Diesels at work . . . read about, or hear about, this great new form of power . . . about how it is spreading like wildfire. Hemphill Schools graduates are in the thick of this great swing to Diesel. Back of thousands of Diesel horsepower turning the wheels, driving the propellers . . . meeting the world's numerous power needs . . . are Hemphill men, in the many interesting, "big future" jobs offered by Diesel.

H. D. S. graduates are operators, chief engineers, sales engineers, superintendents, service men, master mechanics . . . to name only a few of the types of positions. They qualified for their jobs and opportunities the proven Hemphill way . . . through practical training that you, too, can obtain at any one of the Hemphill Diesel Schools you may prefer to attend. Or you can start your training at home . . . now. For complete information on Hemphill Diesel courses, send the coupon today.

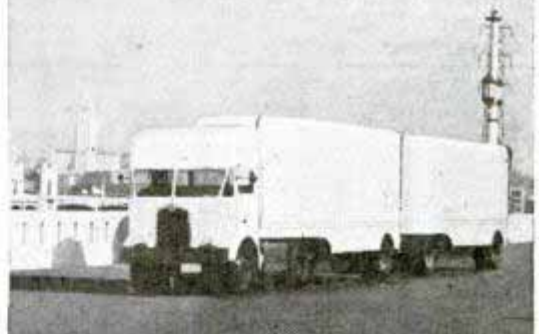

On the Highways



On Construction Jobs



On Farms



In Power Plants

HEMPHILL DIESEL SCHOOLS

Located only in the cities listed below and in no way connected with any other schools of similar name.

BOSTON, 114 Brookline Avenue
NEW YORK, 31-26 Queens Blvd., L. I. City
DETROIT, 2341 W. Lafayette Blvd.
CHICAGO, 2014 Larrabee Street
MEMPHIS, 417 Monroe Avenue
LOS ANGELES, 2120 San Fernando Road
SEATTLE, 501 Westlake North
VANCOUVER, B. C., 1363 Granville Street

Please send me new issue of "March of Diesel" booklet and details on Hemphill Diesel training. (This special information is intended only for men between the ages of 18 and 45).

NAME _____ AGE _____

STREET _____

CITY _____ STATE _____ m-30-f

Send This Coupon To Nearest Address Shown At Left

Let Engineer DOBE TRAIN YOU AT HOME FOR DRAFTING!



If you want to learn drafting as a profession—or if you want to learn drafting to advance in your present work—Engineer Dobe can train you at home in your spare time by his long established, proven-practical "Work-Job" Method. He has trained thousands of successful students, age 16 to 18 to past 50. Previous experience not required. High school education not needed. He offers you a real opportunity to get a complete training in drafting right in your own home in a surprisingly few months. Engineer Dobe teaches his students until thoroughly trained and until holding a good paying job. Drafting offers big opportunities in many fields. Mail the coupon today for FREE illustrated book "Successful Draftsmanship" and full details of Engineer Dobe's remarkable offer that includes all necessary tools and equipment.

ALL TOOLS FURNISHED
When You Start!

Engineer Dobe,
Div. C337
Libertyville, Ill.

Send for **FREE BOOK**

Send me your free book "Successful Draftsmanship." Please explain how you assist your graduates to good positions as draftsmen.

Name

Address

Town State Age

Learn this Profitable Profession



in 90 Days at Home

Hundreds of men and women of all ages 18-50 make \$10.00 to \$20.00 in a single day giving scientific Swedish Massage and Hydro-Therapy treatments. There is a big demand from Hospitals, Sanitariums, Clubs, Doctors and private patients as well as opportunities for establishing your own office. Learn this interesting money-making profession in your own home by mail, through our home study course. Same instructors as in our NATIONALLY KNOWN resident school. A diploma is awarded upon completion of the course. Course can be completed in 3 to 4 months. High School training is not necessary. Many earn big money while learning.



Anatomy Charts & Booklet FREE

Enroll now and we will include uniform coat, medical dictionary, patented reducing roller and Hydro-Therapy supplies without extra cost. The reducing course alone may be worth many times the modest tuition fee.

Send coupon now for Anatomy Charts and booklet containing photographs and letters from successful graduates. These will all be sent postpaid—FREE.

THE College of Swedish Massage (Successor to National College of Massage)
Dept. C64—1601 Warren Boulevard, Chicago.

You may send me FREE and postpaid, Anatomy Charts, booklet containing photographs and letters from graduates, and complete details of your offer.

Name

Address

City State

When writing please mention Popular Mechanics

PARKS AIR COLLEGE

PARKS AIRPORT EAST ST. LOUIS, ILL.

Offers YOU COLLEGE and PROFESSIONAL TRAINING Majoring in AVIATION

FOUR courses lead to B.S. degrees in Professional Piloting, Aviation Operations, Maintenance Engineering, Aeronautical Engineering.

TWELVE TRAINING PLANES are used in professional flight training which prepares graduates for airline flight operations. 74% of graduates enter air transportation in North and South America. 61,000 hours flight training given, 650 hours being flown monthly.

FACULTY of 34 specialists in various fields of aviation.

1491 graduates. Enrollment limited to a total of 300.

100-acre airport, 14 buildings devoted to school purposes exclusively. Dormitories and dining hall at the College.

Accredited by the Illinois Superintendent of Public Instruction. Government approved as a Commercial Ground and Flying School and Mechanics' School. Open to high school graduates.

Fall Term September 26th. Send postcard for new 60-page catalog.

Registrar, Dept. PM-8
12th YEAR PARKS AIR COLLEGE, East St. Louis, Ill.

ELECTRICAL ENGINEERING

ONE YEAR condensed course for ambitious men. Theory and practice combined. Mathematics, mechanical drawing. Students construct motors, install wiring, test electrical machinery. Bliss men hold responsible positions. Modern buildings; campus. 46th year begins Sept. 28. CATALOG.



BLISS ELECTRICAL SCHOOL
268 Takoma Ave., Washington, D. C.



VOICE

100% Improvement Guaranteed

We build, strengthen the vocal organs—not with stinging lessons—but by fundamentally sound and scientifically correct silent exercises... and absolutely guarantee to improve any singing or speaking voice at least 100%... Write for wonderful voice book—sent free. Learn WHY you can now have the voice you want. No literature sent to anyone under 17 years unless signed by parent.

PERFECT VOICE INSTITUTE, Studio C-135
64 E. Lake St., Chicago

CARTOONING

PAYS WELL Turn your talent into dollars
Develop your ability with personal instruction from an internationally-known cartoonist. His exclusive, successful method of drawing and creating ideas makes it easy to attain success. Write for Free Booklet and details of this exceptional home-study course.

The National School of Cartooning, 437 Penton Bldg., Cleveland, Ohio

Learn ADVERTISING at Home

Greater opportunities now in advertising. Learn easily and quickly in spare time. Practical work. No text books. (Old established school. Low tuition—Easy terms. Send for free booklet and requirements.)

Page-Davis School of Advertising
Dept. 135C, 3601 Mich. Av., Chicago



WHY NOT spend spring, summer, fall, gathering butterflies, insects. I buy hundreds of kinds for collections. Some worth \$1 to \$7 each. Simple outdoor work with my instructions, pictures, price list. Profit—pleasure. Send 10c (not stamps) for illustrated Prospectus before sending orders.
MR. SINCLAIR, DEALER IN INSECTS
Dept. 6, Box 1830 San Diego, Calif.

RADIO ENGINEERING, broadcasting, aviation and police radio, servicing, marine and Morse telegraphy taught thoroughly. Nine months' engineering course equivalent to three years' college radio work. School established 1874. All expenses low. Catalog free.
Dodge's Institute, Ada St., Valparaiso, Ind.

Train at home for GOV'T. JOBS!

\$90 to \$175 month—Men and Women—Age 18 to 50

- () POSTMASTER
- () Auditor
- () Stenographer
- () U. S. Border Patrol
- () Telephone Opr.
- () Watchman
- () Meat Inspector
- () Secret Service Opr.
- () Ry. Mail Clerk
- () R. F. D. Carrier
- () Special Agent
- () Stock Clerk
- () City Mail Carrier
- () P. O. Clerk
- () File Clerk
- () Special Investigator
- () Typist

Good pay; steady work; pensions; vacations. Hundreds of jobs open every month. Check jobs you want. We have trained men and women for government jobs for 30 years. Get full details today.

OZMENT INSTRUCTION SERVICE

Dept. 115-A, St. Louis, Mo.

Send me FREE particulars "How to Qualify for Government Positions" marked "X". Salaries, locations, opportunities, etc. ALL SENT FREE.

Name

Address

**FOR MEN
WHO WANT
TO LEARN A
PROFITABLE
TRADE**

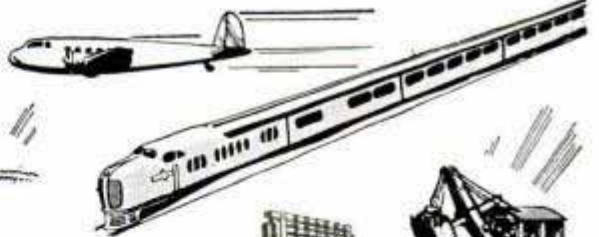

Complete

DIESEL

Training

**with all types INTERNAL COMBUSTION ENGINES,
ELECTRIC POWER GENERATION, etc.**

YOU MEN who are sincerely ambitious to make good in the Diesel and related industries, want to know the true facts—you want to know about employment opportunities and employment requirements. For 33 years, National Schools, a recognized leader in the field of trade education, has played a vital part in helping wide-awake men to qualify for success in industry. National Schools—a million-dollar trade school—will supply you with a sincere, honest statement of facts on what you should do to get into the profitable Diesel Industry. No exaggerations—no mis-statements.

nearest point of entry.) Student social life includes inspection trips, excursions, athletic activities, etc. Special doctor service. Personality coaching. Many students are helped with spare-time jobs to earn room and board while learning. (Canadians excepted.) Graduate employment cooperation.

YOU NEED REAL SHOP EXPERIENCE WITH TIME-TESTED TRAINING

Mail the coupon below. In the literature you will be sent, you will see exactly how other men like you are preparing themselves for success in National's modern training shops. You learn on the latest, finest equipment. You do real job work. You learn by time-tested, shop practice methods. Your training is fascinating in every detail. You are taught how to make good, and helped to make good after you graduate. All of this and much more is clearly pictured for you in the Free Book of Facts we will send to you.

TRANSPORTATION ALLOWED TO LOS ANGELES

National Students are allowed coach railroad fare from any point in U. S. (Canadian students from

National Training is so thorough and all-inclusive, that no ambitious man can afford to consider Diesel Training without first knowing all of the facts regarding the many advantages available to him as a National Student. INVESTIGATE.

PUBLIC SCHOOL SUPERINTENDENT PROFITS BY NATIONAL TRAINING

"I have attended two state universities and two state normal schools and I want you to know that I feel I have received more for my money at National than at any other school I have attended. One cannot be too high in praise of the instructors—of their determination to see that each student received complete instruction and thorough understanding of each assignment."

J. Stover, Jr.,
Sup't., Palouse Public Schools,
State of Washington.

NATIONAL SCHOOLS *Los Angeles*

SEND FOR YOUR COPY TODAY

— Real Facts on Diesel
Employment Requirements

Free
**NEW BOOK
OF
TRAINING FACTS**

Request for Free Book

NATIONAL SCHOOLS
(established 1905) Dept. PMA-8
4000 S. Figueroa St., Los Angeles

Please send me, without obligation, your FREE BOOK and information regarding Diesel Employment Opportunities and Requirements.

NAME _____ AGE _____

ADDRESS _____

CITY _____ STATE _____



High School Course at Home

Many Finish in 2 Years

You can complete this simplified High School Course as rapidly as your time and abilities permit. Equivalent to resident school work—prepares you for entrance to college. Standard H. S. texts supplied—Diploma. Credit for H. S. subjects already completed. Single subjects if desired. High School education is very important for advancement in business and industry and socially.

College Entrance

During the past 14 years, our High School graduates have been admitted to 531 different Universities, Colleges, Junior Colleges and Normal Schools—80% of them without entrance examination. Course also prepares for teachers' certificate and pre-professional examinations.

Business—Industry

To get and hold a good position in Business today you must be able to write clear, accurate letters and reports—do figuring involving Algebra and Geometry—talk intelligently on matters requiring a knowledge of Geography, History, and Economics.

In Industry—Mechanical and Engineering lines—you must have at least an elementary knowledge of Physics and Chemistry—be able to figure quickly and accurately—know something of Mechanical Drawing and blueprints—and be able to talk and write accurately and clearly on both your work and ordinary topics of conversation.

Our High School course meets the preparatory educational requirements for Business and Industry.

An Educational Institution

The American School was chartered in 1897 as an educational institution, not for profit—and is exempt from paying Federal income tax, like the best resident colleges and universities.

Don't Be Handicapped—Complete Your Training Now

Be a High School Graduate! Prepare yourself for promotion in Business and Industry—for the Professions, College Entrance and social success. No matter what line you may select, High School training will prove invaluable to you! Our moderate fees cover all instruction, standard textbooks and Diploma. Easy monthly terms. Get ahead in life. Start your training NOW!

20 Other Courses

Over 150 noted Educators, Engineers, and Business Men helped prepare our special instruction material, which is used by many resident schools and colleges, U. S. Navy, and Province of Manitoba, Canada. We offer you quality training at home for the best-paying lines of Industry and Business, as listed in the coupon.

in Business and Industry—for the Professions, College Entrance and social success. No matter what line you may select, High School training will prove invaluable to you! Our moderate fees cover all instruction, standard textbooks and Diploma. Easy monthly terms. Get ahead in life. Start your training NOW!

Mail coupon for information about line that interests you

American School, Drexel at 58th, Chicago

American School, Dept. HC-45, Drexel at 58th, Chicago

Tell me how to train for success in line checked. No obligation.

- | | |
|--|--|
| <input type="checkbox"/> Accounting & Auditing | <input type="checkbox"/> Diesel Engineering |
| <input type="checkbox"/> Architecture & B'ldg | <input type="checkbox"/> Drafting & Design |
| <input type="checkbox"/> Automotive Engin'ring | <input type="checkbox"/> Liberal Arts |
| <input type="checkbox"/> Business Management | <input type="checkbox"/> Private Secretary |
| <input type="checkbox"/> Commercial Aeronautics | <input type="checkbox"/> Hi'er Ac't'g (C.P.A.) |
| <input type="checkbox"/> Electrical Engineering | <input type="checkbox"/> Highway Engin'g |
| <input type="checkbox"/> Electrical Refrigerat'n | <input type="checkbox"/> Mechanical Eng'r'g |
| <input type="checkbox"/> Air Conditioning | <input type="checkbox"/> Radio & Television |
| <input type="checkbox"/> Civil Engineering | <input type="checkbox"/> Salesmanship |
| <input type="checkbox"/> Complete Law | <input type="checkbox"/> Steam Engineering |

Name.....

Address.....

When writing please mention Popular Mechanics

TO YOUNG MEN— STENOTYPY THE WAY TO SUCCESS

Stenotypy, the new profession, offers unusual opportunities to ambitious young men. It's a man's way of recording speech in this machine age—a silent little machine that types plain print letters faster than anyone can talk. It opens up preferred jobs now—leads to executive careers later. One of the surest, quickest ways to get into Business on the right basis.

Now you can learn Stenotypy in your spare time. Low cost—convenient terms. Get full details. Write for valuable free booklet, "Advantages to You in Stenotypy," describing the unusual opportunities for young men in this growing field and telling how you may enter it successfully. Write Dept. 864-ST.

THE STENOTYPE COMPANY
4101 S. Michigan Ave., Chicago, Ill.



AUTOMOTIVE

ENGINEERING



Bachelor of Science Degrees—in Automotive, Aeronautical, Architectural, Chemical, Electrical, Industrial and Mechanical engineering! Modern equipment. All college activities. Low tuition. Write today for Catalog.

LAWRENCE INSTITUTE OF TECHNOLOGY
15182 Woodward Ave.
DETROIT, MICH.

CATALOG ON REQUEST

WIN YOUR DAWN WITH THE PATROL

Unequaled advantages in location for all year flying, finest equipment, highest Government approval for obtaining license in Transport, Limited Commercial, Private Flying, Radio, Sheet Metal, Mechanical Courses. For complete illustrated catalog, write—

J. D. GREEN, Director, Dept. PM 10, TULSA, OKLAHOMA



SCHOOL OF AVIATION

NEW YORK TRADE SCHOOL

Electricity Plumbing and Heating Sheet Metal Work

One-Year Intensive Courses. Also shorter courses in Auto Mechanics and Welding. Fall term: Sept. Register now.

Oldest School of Its Kind in America

NEW YORK TRADE SCHOOL

An endowed institution not operated for profit.
306 East 67th Street. New York, N. Y.



Learn to Write

Begin Today. Write for our Free Book, "How to Become a Good Penman." It contains specimens and tells how others learned to write in spare time. Your name elegantly written on a card if you enclose stamp for postage. Write today. The Tamblin School of Penmanship, 418 Ridge Bldg., Kansas City, Mo.

Photography



for PLEASURE or PROFIT

Prepare for profitable business or fascinating hobby, at home under guidance of qualified instructors. No previous experience necessary, common school education sufficient. Many earn while learning. Our practical studio methods also qualify for well-paying positions upon graduation. Send coupon below at once for free booklet "Opportunities in Modern Photography", particulars and requirements.

AMERICAN SCHOOL OF PHOTOGRAPHY
3601 Michigan Avenue Dept. 135C Chicago, Illinois

Send booklet, "Opportunities in Modern Photography", full particulars and requirements.

Name..... Age.....

Address.....

City..... State.....

BILL, YOU SURE HAVE A SWELL BUILD! DID YOU TRAIN FOR A LONG TIME?



ABSOLUTELY NOT! THE ATLAS DYNAMIC TENSION SYSTEM MAKES MUSCLES GROW LIKE MAGIC!

Here's the Kind of NEW MEN I Build!

Do YOU Want to Be One?

Charles Atlas

An actual, untouched photo of Charles Atlas, twice winner of the title, "The World's Most Perfectly Developed Man"—who offers you this amazing 7-DAY TRIAL OFFER.

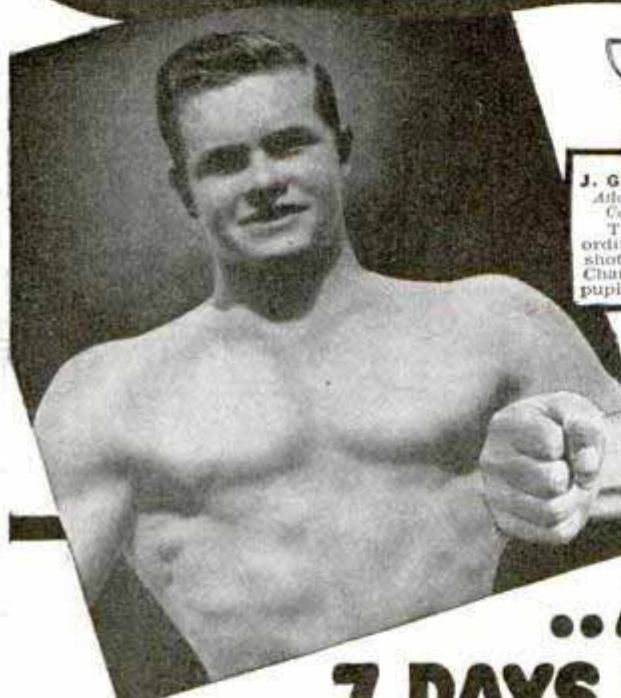

J. G. O'BRIEN
Atlas Champion Cup Winner
This is an ordinary snapshot of one of Charles Atlas' pupils.



..And I'll PROVE in Just 7 DAYS I Can Make YOU One!

MEN—meet J. G. O'Brien, of California, one of my Silver Cup Winners! A smashing example of what my **Dynamic Tension** can do! Look at that strong neck—those broad, handsome, perfectly-proportioned shoulders—that muscled chest and stomach. Read what he says: "It seems only a few days ago that I mailed you that coupon. Look at me **NOW!** **Dynamic Tension** works like magic. Those 7 days certainly **proved** you can make a fellow a **NEW MAN**—right in the privacy of his own home. I'm proud of the **natural**, easy way you have made me an 'Atlas Champion'!"

Do you want a prize-winning body like this? Are you fed up with having no strength, no vigor, being only **HALF-ALIVE**? Then listen—

YOU'LL SEE AND FEEL RESULTS IN ONE WEEK!

That's all I ask—**SEVEN DAYS!** In the **FIRST WEEK** I'll absolutely **PROVE** that I can give you, too, the kind of body men respect and women admire! You will actually see and feel the improvement in even this short time. And as the weeks go by you will see yourself transformed into a **NEW MAN**—a stronger, healthier and more handsome man!

I was once a skinny, timid weakling of only 97 lbs. I didn't know what real health or strength were. I was afraid to fight, ashamed to be seen in a bathing suit.

Then I discovered the amazing secret that changed me, like magic, into "The World's Most Perfectly Developed Man"—

the title I won **twice** and have held **ever since**, against all comers. My secret is **Dynamic Tension**. It is the **tested, natural** method of developing you **inside and out!** It not only can give **YOU** the powerful, rippling muscles you'd like to see in your own mirror. . . . It **also** digs down into your system after such needless, joy-killing conditions as ordinary constipation, pimples, indigestion, underweight and overweight.

My **Dynamic Tension** method will make a **NEW MAN** of you in double-quick time—and I'm ready to **PROVE** it to you in a 7-day **TRIAL OFFER**. Unless you get results in the first week it costs you absolutely **NOTHING!**

FREE BOOK ON DYNAMIC TENSION

Let me show you the amazing results produced for thousands of other men! I'll send you **FREE** my famous book, "**Everlasting Health and Strength**." It shows actual photos. It tells exactly what I can now do for **your** body! Write your name and address carefully on coupon. Mail to me personally **today**. I'll rush your free copy to you **AT ONCE!** Charles Atlas, Dept. 88, 115 E. 23rd Street, New York, N. Y.



CHARLES ATLAS,
Dept. 88, 115 East 23rd Street,
New York, N. Y.

I want the proof that your system of **Dynamic Tension** will make a **New Man** of me—give me a healthy, husky body and big muscle development. Send me your **FREE** book, "**Everlasting Health and Strength**" and full details about your 7-day **TRIAL OFFER**.

Name.....
(Please print or write plainly)
Address.....
City..... State.....

THIS STERLING SILVER CUP BEING GIVEN AWAY

This valuable cup stands about 14 inches high on a black mahogany base.

I will award it to my pupil who makes the most improvement in his development within the next three months.

When writing to advertisers please mention Popular Mechanics

Be An ARTIST



Trained Artists Earn \$35, \$50, \$75 Weekly
Learn at Home This Amazingly Simple Way

More and more trained Artists are needed each year. Magazines, advertisers, newspapers, printing houses, etc., pay good money for art work. Our simple, proven method makes it fun to learn Commercial Art, Cartooning and Designing AT HOME, in spare time.

Two Big Artist's Outfits Given

Drawing board, paints, brushes and all materials you need come with very first lessons. The second outfit is given later in the course. Actual fun learning to draw this way.

Send for FREE BOOK

Our Free Book "Art for Pleasure and Profit" describes wonderful opportunities in this fascinating field and gives full details of our simple method of instruction. Tells all about our students—their successes—what they say—actual reproductions of their work—and how some earned money even while learning. Mail coupon below or paste on postcard today.

\$40 Extra Per Month
 in spare time, writes student R. G. Reid, Jr. of Oklahoma.
Paid for Course
 W. R. Kent of New Jersey earned more than twice the tuition while studying.
\$25 for One Drawing
 One small picture brings easy money to Miss Goldie Hill of Kansas.

FREE BOOK gives details!

Washington School of Art, Studio 128E
 1115-15th St., N. W., Washington, D. C.

Yes! I am interested in learning to draw. Please send me your Free Book, "Art for Pleasure and Profit."

Name Age
 Address
 City State

Air-Conditioning

a NEW Profession
 with **BIG PAY!**

The latest subject in the world today is Air-Conditioning. It is revolutionizing building, heating and ventilating systems. The famous Tribune Building in Chicago, Sears Roebuck's new south side store and many other great buildings are Air-Conditioned and wide publicity is being given them.
 Anyone in the building field must know this subject or he can't compete with experts in this line.
 Here is your opportunity to "brush up". To get the latest facts in a convenient, quick reference, way. Put your finger on what you want to know in a jiffy.

6 Big Books shipped FREE!

Give us your name and address and we will ship you this encyclopedia of the latest Air-Conditioning information available. Systems for single rooms, systems for great office buildings, stores and factories are all covered in an easily understood way. Here is a new profession in a field practically without competition and with these books you can qualify for any Air-Conditioning job QUICKLY.

Experts needed NOW!

Look about you. Read the papers and in almost every issue you will see mention of Air-Conditioning and how it is revolutionizing industry. It is the newest subject in the world. Experts are needed everywhere on both small and big jobs. It is going to be one of the finest of big pay professions. Start now. Send for these books on our free examination offer and see how quickly you can get the important details of this amazing new science.

American Technical Society, Drexel at 58th St., Dept. KC19, Chicago

You may send me the complete encyclopedia on AIR-CONDITIONING, six volumes, for free examination. I will pay the few cents delivery charges only, but if I am not more than satisfied I will return the books in ten days and owe you nothing. If I decide to keep them I will send \$2.00 in ten days, then \$3.00 a month until the special introductory price of \$24.80 is paid.

Name
 Address
 City State

Please write us a letter and give us the name and address of your employer and that of at least one business man as a reference.

SPARE-TIME WORK AT HOME

Yes, you—anybody can make a lot of money right at home, and what's more, have real fun doing it. We show you how, we furnish everything necessary on an easy basis.

COSTS NOTHING to learn about our plan, free. Write today for all details are given you in idea book full of colored pictures telling all about our methods which have made so many people independent. Learn how easy it is to make from \$10 to \$25 per week in the most delightful home work you can imagine. Don't miss this opportunity. **Write Now—it's FREE!**
 Fireside Industries, Dept. 66-K, Adrian, Mich.

\$\$\$



THERE'S MONEY IN YOUR CAMERA!

Others make good incomes selling pictures to publications. **FREE CATALOG** describes home-study course (which may be paid for in easy installments) and tells how YOU can do it too! Universal Photographers, Dept. 78, 30 West 33 Street, N. Y. C.

CARTOON YOUR WAY TO SUCCESS!

DON'T COPY—LEARN TO ORIGINATE!

RAYE BURNS will teach you HOW to CREATE ORIGINAL CARTOONS at home that you can SELL! Course contains 26 lessons and over 600 illustrations. All for Only **\$2.85**

Send name and address for free details.
 RAYE BURNS SCHOOL, Dept. M, BOX 2194, Cleveland, Ohio

AUTO-MECHANICS & WELDERS

Auto Mechanics and Welders are in big demand. Complete courses in arc and acetylene welding, body and fender bumping, spray painting and metal finishing. Pay after graduation plan. Special low rates. Write today.
MICHIGAN TRADE SCHOOL
 3758 Woodward Ave., Detroit, Mich.

Write for FREE CIRCULAR

AVIATION APPRENTICES

GOOD PAY BIG FUTURE
 If you are interested in training yourself for a highly paid position in the aviation industry—Write, immediately, inclosing stamp.
MECHANIX UNIVERSAL AVIATION SERVICE CO.
 Strathmore Station Dept. E Detroit, Mich.

NEW YORK SCHOOL OF MECHANICAL DENTISTRY
 Earn big money in a few months. We show you how. Real Laboratory Training. OLDEST school. Day, Eve. Easy terms. Ask for free Catalog P and tool offer.
N. Y. SCHOOL of MECHANICAL DENTISTRY, 125 W. 31 St., N. Y. C.

EASY TO LEARN ACROBATICS
 New, Fast-learning Method of Acrobatics, Hand Balancing and Tumbling fully illustrated and diagrammed. Easily understood by Beginners as well as Professionals. Natural body builder. My Acrobatic Poses and literature sent FREE.
KEN COOPER, ACROBAT
 733 N. Van Buren St. Milwaukee, Wis.

MONEY-MAKING OPPORTUNITY
 for men of character. Over \$1,600 per month earned by California man. Over \$400 a week by Georgia man. \$1,000 in a month by Delaware man. Exclusive franchises available for an invention expected to replace a multi-million dollar industry. Install on free trial. Sells itself. Repeats. Exclusive proposition. Write **F. E. Armstrong, Dept. 1112-H. Mobile, Alabama.**

Earn Cash at Home!
 We paid M. M. \$1174 for exceptional "cellar crop" SNOW-KING mushrooms! Big free picture book tells if your cellar, shed, barn suitable. We furnish materials, buy all crops. Write today. Est. 1908.
UNITED CO., 3848 Lincoln Ave., Dept. 305, Chicago.

Tells How to Use—

Concrete About the Home; Concrete in the Garden and Yard; Concrete About the Farm; Concrete Homes and Buildings; Making Recreation Devices; Concrete in the Workshop; Concrete Products for Manufacture; Concrete in Business and Industry, etc. Gives 146 Concrete Kinks.



The Book of the hour for the workshop fan, handy man and home owner.

NEW
Concrete
BOOK
Makes Cement
Work of All
Kinds
Easy

256 Pages — 16 Colored Plates, Hundreds of Pictures

Large book 7 x 10 inches. Handsome cloth binding. Sent postpaid for only \$5. Sent COD in U. S. if preferred. Order today. Make concrete work a fascinating hobby or a profitable business.

Money Making Facts - Best Methods - Materials - New Colored Concrete - 146 Kinks

"1001 Ways to Use Concrete" strips the mystery from the fascinating work of making useful articles and permanent improvements with concrete. This book, just published covers every known use of concrete for the home, farm, building, business and industry, plus newer uses in decoration and arts. Includes new fast setting and gloriously colored concrete and 146 valuable usable kinks. 1001 uses of concrete including homes, garden furniture, pools, statuary, etc., recreation devices, farm improvements, driveways, walks, etc. Describes all methods and materials. Shows how to do real professional type jobs.

POPULAR MECHANICS PRESS - 200 East Ontario St., Dept. 838C - CHICAGO



Build a BOAT
FOR PLEASURE OR PROFIT



Shows
EXACTLY HOW TO BUILD 15 DIFFERENT BOATS

This is the new edition with 42 added pages, 6 new boats, and conversion of Ford motor for marine use. Full directions and details for cabin cruiser, racing, hydroplane, outboard runabout, sail boats, kayak, sled type—15 boats in all. Also sectional boat to carry on car.

SEND NO MONEY

Write for new edition of Boat Book today! Sent anywhere. Pay postman \$3.00 plus few cents postage. Outside U. S. and possessions remit with order. Money refunded if not satisfied.

POPULAR MECHANICS PRESS—Room 838A
200 East Ontario St., Chicago

EASY—LOW COST
with
POPULAR MECHANICS BOAT BOOK

Build a boat at home! You can do it. Just the kind you've wanted—power, sail, or row boat. The "Boat Book" shows you how in simple step-by-step directions. Specially prepared for those with limited tools, little skill and money. Build boats to sell for profit too. Book tells how.

GIVES PLANS, METHODS AND MATERIALS

Actual working plans and photos of real boats under construction makes building easy. Shows materials needed and rock-bottom costs. Hundreds of pictures. No chance for mistake. Includes also, navigation and pilot rules, handling sailing craft, boat kinks, boating terms. Everything a boat enthusiast should know. Size 7x10 inches. 312 pages. Fine cloth binding.

DON'T LET

OPPORTUNITY

PASS YOU BY



• **OPPORTUNITY will pass you—unless you are prepared to stop it. Knowledge — training — education — facts, whatever you choose to call *personal power*, is the real thing with which to capture passing opportunities or create opportunities. Acquire this *personal power* in your spare time. Mail this coupon and learn what an I. C. S. Course can mean to you. Why not do it right now?**

INTERNATIONAL CORRESPONDENCE SCHOOLS

Box 5520-J, Scranton, Penna.

Without obligation, please send full particulars about the subject before which I have marked X:

TECHNICAL AND INDUSTRIAL COURSES

- | | |
|--|---|
| <input type="checkbox"/> Architect | <input type="checkbox"/> Auto Technician |
| <input type="checkbox"/> Architectural Draftsman | <input type="checkbox"/> Auto Electric Technician |
| <input type="checkbox"/> Building Estimating | <input type="checkbox"/> Plumbing <input type="checkbox"/> Heating |
| <input type="checkbox"/> Contractor and Builder | <input type="checkbox"/> Air Conditioning and Cooling |
| <input type="checkbox"/> Structural Draftsman | <input type="checkbox"/> Commercial Refrigeration |
| <input type="checkbox"/> Structural Engineer | <input type="checkbox"/> Steam Engineer |
| <input type="checkbox"/> Electrical Engineer | <input type="checkbox"/> Steam Electric Engineer |
| <input type="checkbox"/> Electric Lighting | <input type="checkbox"/> Marine Engineer |
| <input type="checkbox"/> Welding, Electric and Gas | <input type="checkbox"/> Civil Engineer <input type="checkbox"/> Highway Engineer |
| <input type="checkbox"/> Reading Shop Blueprints | <input type="checkbox"/> Bridge Engineer |
| <input type="checkbox"/> Telegraph Engineer | <input type="checkbox"/> Bridge and Building Foreman |
| <input type="checkbox"/> Telephone Work <input type="checkbox"/> Radio | <input type="checkbox"/> Surveying and Mapping |
| <input type="checkbox"/> Mechanical Engineer | <input type="checkbox"/> R. R. Locomotives <input type="checkbox"/> Air Brakes |
| <input type="checkbox"/> Mechanical Draftsman | <input type="checkbox"/> R. R. Section Foreman |
| <input type="checkbox"/> Machinist <input type="checkbox"/> Toolmaker | <input type="checkbox"/> R. R. Signalmen |
| <input type="checkbox"/> Patternmaker <input type="checkbox"/> Boilermaker | <input type="checkbox"/> Chemistry <input type="checkbox"/> Pharmacy |
| <input type="checkbox"/> Foundry Practice | <input type="checkbox"/> Coal Mining <input type="checkbox"/> Navigation |
| <input type="checkbox"/> Sheet Metal Worker | <input type="checkbox"/> Cotton Manufacturing |
| <input type="checkbox"/> Heat Treatment of Metals | <input type="checkbox"/> Woolen Manufacturing |
| <input type="checkbox"/> Management of Inventions | <input type="checkbox"/> Agriculture <input type="checkbox"/> Fruit Growing |
| <input type="checkbox"/> Diesel Engines <input type="checkbox"/> Aviation Eng. | <input type="checkbox"/> Poultry Farming |

BUSINESS TRAINING COURSES

- | | |
|--|--|
| <input type="checkbox"/> Business Management | <input type="checkbox"/> Lettering Show Cards <input type="checkbox"/> Signs |
| <input type="checkbox"/> Industrial Management | <input type="checkbox"/> Stenography and Typing |
| <input type="checkbox"/> Traffic Management | <input type="checkbox"/> Civil Service <input type="checkbox"/> Mail Carrier |
| <input type="checkbox"/> C. P. Accountancy | <input type="checkbox"/> Railway Mail Clerk |
| <input type="checkbox"/> Bookkeeping | <input type="checkbox"/> Grade School Subjects |
| <input type="checkbox"/> Secretarial Work | <input type="checkbox"/> High School Subjects |
| <input type="checkbox"/> Cost Accountant | <input type="checkbox"/> College Preparatory |
| <input type="checkbox"/> Salesmanship <input type="checkbox"/> Advertising | <input type="checkbox"/> First Year College Subjects |
| <input type="checkbox"/> Service Station Salesmanship | <input type="checkbox"/> Illustrating <input type="checkbox"/> Spanish |
| <input type="checkbox"/> Business Correspondence | <input type="checkbox"/> Cartooning <input type="checkbox"/> French |

DOMESTIC SCIENCE COURSES

- | | |
|---|--|
| <input type="checkbox"/> Professional Dressmaking and Designing | <input type="checkbox"/> Foods and Cookery |
| <input type="checkbox"/> Home Dressmaking | <input type="checkbox"/> Tea Room and Cafeteria Management, Catering |
| <input type="checkbox"/> Advanced Dressmaking | |

Name.....Age.....

Address.....

City.....State.....

Present Position.....

If you reside in Canada, send this coupon to the International Correspondence Schools Canadian, Limited, Montreal, Canada



DESIGNED to serve two purposes, a convertible table settee has been patented.



The piece of furniture may be changed from a settee into a table simply by swinging the backboard upward and forward. It is provided with a small wheel on each side

at the rear to facilitate moving it around the room. Furniture of this type would find many uses in the small home or apartment.

HOME workshop operators, plumbers and others would find useful a patented pipe-joint welding clamp. The clamp provides for gripping two pieces of pipe firmly in position for welding. The pipes are held in a trough by two clamps. Once the pipes are made secure, the worker is free to operate his welding outfit.



ENABLING blind persons to write script, a line guide has been patented. It consists of a frame with two members adapted to extend along opposite edges of the writing paper and a number of strands of resilient material which connect these



guiding members. The strands are sufficiently close to the paper to flexibly guide a pencil in the hand of a person writing on the device.

INTENDED to provide more comfort for the automobile driver in winter, a lap robe which permits operation of gear shift and brake levers has been patented.

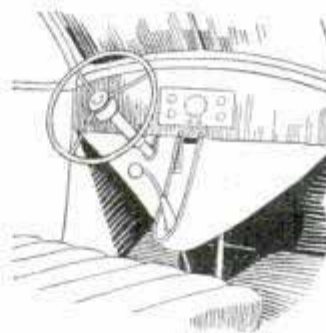

The robe is secured at its forward margin to the instrument panel. In use, it extends over the driver's lap to exclude chilling drafts. At other times, its rear margin may be buttoned to the instrument panel, the robe folding to form a sort of bight. The levers may be operated when the robe is in this inactive position.

INCREASED comfort for the bicycle rider is one purpose of a spring-like frame patented recently. The frame has a tubular spring rear fork curving downward and rearward to a short forward bend forming resilient loops. Wheel supporting members are secured to the forward ends of the resilient loops. A lower tubular spring rear fork has its rear ends connected to the wheel supports. Springiness of this bicycle frame is said to result in absorption of many road shocks ordinarily



(Continued to page 28A)

FACTORY-TO-YOU SAVES YOU 50%

Also... **\$30⁰⁰** **AND UP** **FOR YOUR OLD RADIO**
AS A SPECIAL TRADE-IN ALLOWANCE!

17-TUBE WORLD-WIDE

MIDWEST

MIDWEST FACTORY-TO-YOU PRICE... \$69⁹⁵
 TRADE-IN ALLOWANCE... \$30⁰⁰

30 DAYS FREE HOME TRIAL

YOU PAY ONLY **\$39⁹⁵** **ABSOLUTELY COMPLETE**

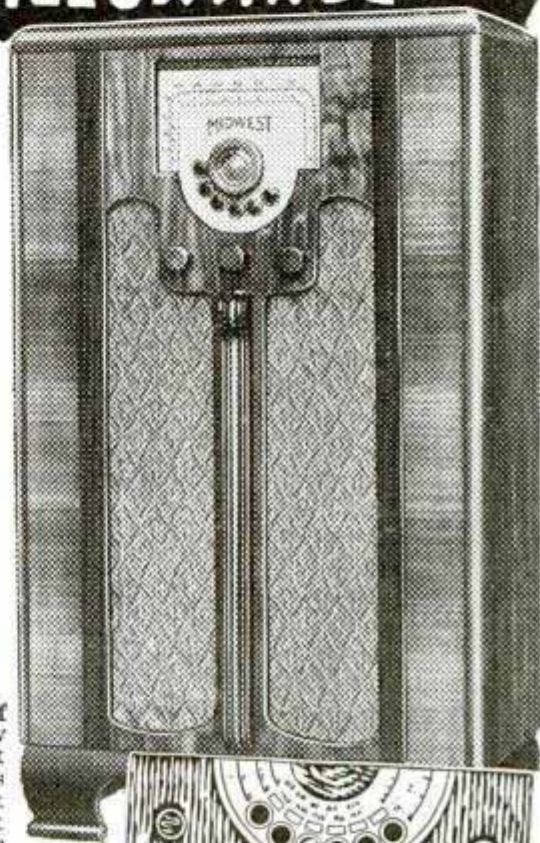

TOUCH BUTTON FLASH TUNING!

HERE it is—the radio headliner of the year—the sensational new 17-Vital-Tube 1939 world-wide Midwest that just sparkles with new features. Regarded as today's greatest radio value, this Midwest gives you high-priced performance for what you would expect to pay for an ordinary 8 or 10-tube set. Use it for 30 days, in your own home, FREE, before you make up your mind. If you decide to keep it, you secure \$30.00 credit and up on your old set.

This 1939 Midwest will delight you with its tremendous range (550 KC to 18,000 KC), glorious new tone and brilliant world-wide reception. Stations 10,000 miles away come in like "locals." Just imagine a radio so big, so fine, so powerful, so luxurious... in a big, beautiful, richly-finished Walnut console... at such an amazingly low factory-to-you price.

Let us tell you about our complete 1939 line with many features like Dial-A-Band Tuning, Electric Touch-Button Split-Second Tuning, Acousti-Filter, Fidel-A-Trol, Tun-A-Lite Indicator, and scores of other features.

SEND FOR FREE 1939 FACTORY CATALOG

Factory-to-You Wholesale Price Saves You 50%
 The famous Midwest factory-to-you plan, proven by 19 years of success, is just as exciting! You buy at wholesale prices, just like a dealer. You save up to 50%, and make your radio dollar go twice as far. Now, pay as little as 59c a week on the famous Midwest Easy Pay Plan. Remember, you get 30 days' FREE Home Trial. Midwest guarantees your absolute satisfaction.

PASTE COUPON ON 1¢ POSTCARD... OR

MIDWEST RADIO CORPORATION
 Dept. 15AA Cincinnati, O.
 Send me your new FREE catalog and complete details of your liberal 30-day FREE trial offer.

WRITE TODAY!

Name.....
 Address.....
 Town..... State.....

User-Agents Make Easy Extra Money. Check here () for details.

MASSACHUSETTS—
 "Your Midwest has a marvelous tone quality that can make other radios on the market take a backseat." Thomas F. Walsh.

TEXAS—
 "Midwest's wonderful tone, splendid foreign reception and marvelous selectivity are second to none. Many of my friends say that in beauty and performance it is far superior to radios costing twice as much." C. Huddleston.

MIDWEST *Factory-to-You* RADIOS
 DEPT. 15AA MIDWEST RADIO CORPORATION...CINCINNATI, OHIO, U.S.A.
Manufacturers of Quality Radios Since 1920

**ARE YOU
ONE OF THESE**
4 Types of

W W W

1

**IF YOU ARE THINKING
OF INVENTION AS A
CAREER**

There are many people today who are making a good living from inventions. If you have inventive originality and the ability to recognize human needs, you should go far in the commercial world. If you are considering invention as a career, write for our FREE BOOK at once.

2

IF YOU HAVE A MECHANICAL INVENTION

There is probably a bigger demand for mechanical inventions today than any other type. If your invention is of a mechanical nature, the first step is to have a search made at the U. S. Patent Office to ascertain that no one has gotten ahead of you. You will find this FIRST STEP fully covered in our FREE BOOK, "Patent Guide for the Inventor."

WHAT OUR PATENT SERVICE DOES

THE first important step in securing a patent is to obtain the services of a Registered Patent Attorney. The U. S. Patent Office advises that you secure the aid of a Registered Patent Attorney to prepare your application and counsel you.

We have secured patents for inventors located in every state in the Union. Our organization is a large and efficient one. Our practice is confined entirely to Patents, Trade-Marks, and Copyrights. We have had years of experience in Patent Matters. When you place your invention in our hands, we are in position to proceed at once to secure protection for you.

Don't worry about finances. Our fees are very reasonable—we can arrange convenient terms of payment. It is our custom to permit clients to pay for our services in installments as the application progresses in our office.

**THE ANSWER TO YOUR QUESTION
"HAVE I A SALEABLE INVENTION?"**

Some of the most successful commercial inventors—men who amassed large fortunes—reaped their rewards on simple everyday creations; the kind of things that make thousands ask themselves the question: "why didn't I think of that myself?" If you can beat the other fellow to the little gadgets always cropping up that make life more comfortable, easier, or exciting, you may succeed as a successful inventor. Are you convinced that you have "something?" Then don't flounder around trying to make up your mind to start; ascertain right now if you have hit upon an original idea by having us institute a Search of the U. S. Patent Office Records to determine if your invention has been anticipated.

IMPORTANCE OF ACTION

The greatest curse of the average inventor is delay in making practical use of his invention. The day-dreaming inventor may have wonderful ideas but unless he gets a Patent on his invention he is likely to remain a dreamer all his life.

Your invention of a practical article or an improvement upon an old one should be patented NOW. Frequently many of the thousands of applications filed in the U. S. Patent Office each year are for the same or almost the same invention. In such case, the burden of proof rests with the last applicant to file. Sometimes a delay of even a few days in filing the application means the total loss of the patent. LOSE NO TIME.

CLARENCE A. O'BRIEN & HYMAN BERMAN

70-L ADAMS BUILDING, WASHINGTON, D. C.
Registered Patent Attorneys before U. S. Patent Office

When writing to advertisers please mention Popular Mechanics

ENTORS

3

IF YOU HAVE A NOVELTY INVENTION

Go through the 10c stores and see the millions of articles offered for sale. The majority of these simple gadgets are patented, manufactured in big quantities at a substantial profit. If you have a novelty invention, get information on direct steps necessary to obtain Patent. Send for our FREE BOOK.

4

IF YOU HAVE A GENERAL UTILITY INVENTION

Have you an invention that makes home life easier and more attractive or serves a general purpose of utility? Some of the simplest inventions have found a quick market and earned immediate incomes for the inventor. Learn all about the possibilities of General Utility inventions. Write today for our FREE BOOK.

OUR OFFICES IN THE HEART OF THE NATION'S CAPITAL

Located in Washington, D. C., within a few blocks of the U. S. Patent Office, we are able to give you immediate advice and accurate, authentic information on all matters concerning Patents and Trade-Marks, particularly if it is necessary to examine the records in U. S. Patent Office.

This FREE BOOK TELLS HOW

There are certain definite facts the inventor must know to Patent and market his invention. Our FREE BOOK gives complete information: How Patent Application is made, what kind of drawings and sketches are necessary, what papers must be filled out, the value of action in applying for patent, how the patent laws protect you, why it is necessary to secure patent to protect your invention, etc. Don't be discouraged or disheartened about the future until you get our FREE BOOK and learn how other inventors succeeded despite lack of funds, remoteness from market, lack of mechanical skill, education, and other handicaps. Send coupon for this FREE BOOK today!

FREE RECORD OF INVENTION FORM

This FREE Record of Invention Form enables you to make in convenient form a sketch of your invention and have it witnessed in a manner of value to you should the occasion for evidence arise. MAIL THE COUPON TODAY and obtain our FREE BOOK and Record of Invention Form.



CLARENCE A. O'BRIEN
& HYMAN BERMAN
 70-L ADAMS BUILDING
 WASHINGTON, D.C.
 REGISTERED PATENT ATTORNEYS
 BEFORE U.S. PATENT OFFICE

Please send me at once your Big FREE 48-Page Book, "Patent Guide for the Inventor" and your Specially Prepared "Record of Invention" form. This request does not obligate me.

NAME.....
 ADDRESS.....

(Please write or print plainly)

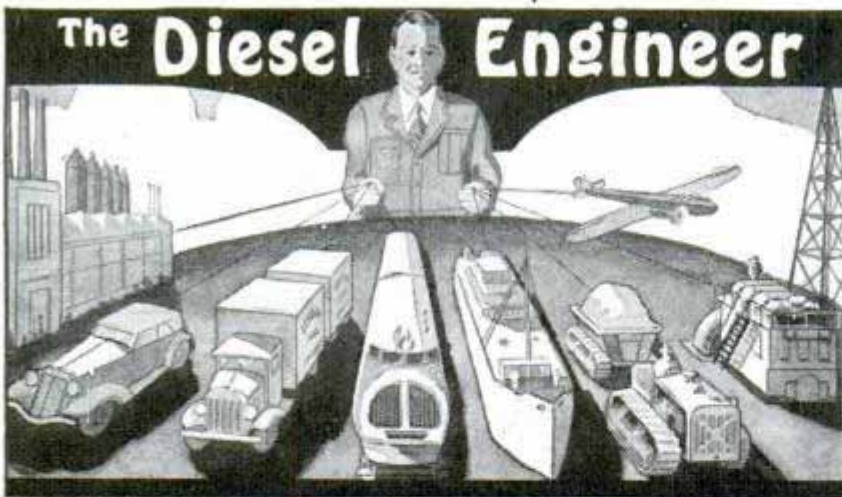

The Diesel Engineer

Is Your Job Safe?

Just as the gasoline engine changed the jobs of thousands who depended on horse-drawn vehicles for their living—so now the Diesel engine is fast invading both the power and transportation fields, and threatening the present jobs of thousands.

What This Field Offers You

Diesel engines are replacing steam and gasoline engines in power plants, motor trucks and busses, locomotives and ships, aircraft, tractors, dredges, pumps, etc.—opening up well-paid jobs for Diesel-trained men. You get all the latest Diesel developments in our course. Special diagrams for quick understanding of this new power.

For Men Earning Under \$40 a Week

Diesel — The New Power

Now is your chance to get into a big new industry and grow up with it to an important position. Today there is practically no competition in the Diesel field, but the increasing use of Diesel engines will result in keen competition for jobs after a few years. If you start your training now and get established in this field, you need not worry about competition.

Job Facts in Diesel

Learn how quickly you can prepare for growing opportunities in Diesel by our Job-Instruction method. Train at home for this good pay field where there is chance for rapid promotion. Free employment service to graduates. Low monthly terms. If you want a good job get FACTS! Write for booklet today!

AMERICAN SCHOOL, Dept. DC45, Drexel Avenue at 58th Street, Chicago, Illinois

Fit Yourself For a Good Pay Job

ONLY 22¢ A DAY!



Puts This All-Purpose ELECTRIC ARC WELDER IN YOUR SHOP!

TEN-DAY TRIAL Guaranteed: 10 Months to Pay

Now, for first time, it is EASY for every inventor, laboratory, home workshop owner, garage, repair shop,

and factory to afford a complete welding service for manufacturing, maintenance, experimental, or repair work. Full size, heavy-duty Electric Arc Welder—Commonwealth Model 120-PS—yours for only 22¢ a day! Has efficiency of machine costing \$250.00 to \$1,000.00. Welds all metals and alloys. Six heats handle everything from fenders and light sheet metal to motor blocks and heavy castings. Also fine for soldering and brazing.

WORKS ON 110 OR 220-VOLT A.C. WRITE FOR 22¢ A DAY PLAN

Simply plug into 110 or 220-volt, 60-cycle A. C. electric socket. Costs only few pennies an hour to operate. Anyone can use easily. Comes complete with helmet, electrode holder, welding rods, full instructions, etc. Nothing else to buy. Fully guaranteed. Write today!

Stop throwing away profits! Do your own welding. Get sensational facts about Model 120-PS and 22¢ a-day plan. Write today!

COMMONWEALTH MFG. CORP.
Dept. L-51, 4208 Davis Lane, Cincinnati, Ohio

DETAILS FREE!

Midget Portable ELECTRIC OR BATTERY Radios

WORLD'S SMALLEST RADIOS
Just a handful—Wt. only 2 lbs. Size 3 1/2x5". 4 tube performance! Midget BUILT IN LOUD-SPEAKER and AERIAL. Has Broadcast and Short Wave band! Simple to operate. Ideal Radio for Office, Apts., Bed-rooms, College, Camps, Trailers, etc. Battery model has batteries inside case for use on Farms, Boats, Autos, etc. Electric model uses 110 Volt A.C. D.C. Either model kit of parts for \$6.49. Wired and tested 50¢ extra or \$6.99 complete ready to listen! (Batteries for Battery model \$1.75 extra). **SEND ONLY \$1.00 and pay postman balance on delivery. ORDER NOW! GUARANTEED.**
TINYTONE RADIO CORPORATION, Dept. P-8, Kearney, Nebr.

5c TIRE MAKES \$2.00 MAT

Make springy, long-wearing Rubber Mats out of old auto tires. Any length or width. BIG sale to schools, factories, stores, homes, Think of the profit. Brand new business, fully patented. Field untouched. Reasonable investment and simple hand machine starts your local plant. Write quick for free information. Don't miss a minute—this is BIG!
FABRIX, INC. Dept. 78 325 W. Huron St., Chicago, Ill.

GUITAR

You'll enjoy learning for less than 2¢ a day. Full particulars Free. Write today.

HAMANN INSTITUTE, 3016 N. 24th Place, P-8, MILWAUKEE, WIS.

BE YOUR OWN BOSS

Adjust, repair, typewriters, adding machines. Offices, factories, stores. Learn at home from factory expert. Good men can earn up to \$15 daily. Complete instructions all makes only \$3.00 postpaid or sent C. O. D. in U. S. Money returned if not satisfied. Send today. **ADDING MACHINE EQUIPMENT SERVICE, 3601 Michigan, Dept. 135C, Chicago.**

Government Jobs

EXAMINATIONS SOON VALUABLE INFORMATION FREE
COLUMBIAN CORRESPONDENCE COLLEGE
WASHINGTON, D. C.

SPORS 4000 MONEY MAKERS

FREE! WHOLESALE CATALOG

Has: 15 selling plans; 30 money making ideas; 4000 world wide bargains; 260 pages of big values. Also shows top-notch prizes; business stimulators. All at rock bottom wholesale prices. Salesmen-Dealers. Obtain this fascinating Book Of Opportunity FREE. Write for it today, to

SPORS CO., 6-38 Main St., LeCenter, Minn.

LEARN ACCOUNTANCY SECRETARIAL AND OFFICE WORK HILL'S WAY

EARN MORE MONEY

DON'T WASTE SPARE TIME! men quickly to fill highly paid positions. Easy to acquire, yet completely thorough. Learn at home during time now wasted. Low tuition fee; easy payments. Send today for our inspiring **SUCCESS Book FREE.**

HILL'S EXTENSION SCHOOL
603 West Main St., Oklahoma City, Okla. • Est. 1907

Name _____ Age _____
Address _____
City _____ State _____

When writing please mention Popular Mechanics

WOULD YOU LIKE TO BE A PRACTICAL ELECTRICIAN?

● Do things around the house, develop a hobby, and maybe earn an extra dollar occasionally? Here's a spare-time course of study that will provide you with the training you need!

INTERNATIONAL CORRESPONDENCE SCHOOLS
Box 5521-J, Scranton, Penna.

BOWS AND ARROWS OF EXCELLENCE

It's easy to make your own high grade, hard shooting bow and arrows with a Ben Pearson archery kit. Kit includes select, seasoned stave, cut to shape for flat type hunting or target bow. Seven select Port Orford cedar arrow shafts, nocked and tenoned. Sufficient prepared feathers, paints, strings, glue, wax. Detailed instructions and illustrations. Complete, \$2.35, prepaid. Satisfaction guaranteed. Send for catalogue of finest bows, arrows, raw materials in America.
Ben Pearson, Inc., Dept. PMM 3 Pine Bluff, Ark.

Free AIR CONDITIONING AND REFRIGERATION TRIAL LESSON

Trained men needed. Good pay. Opportunities. Learn easily AT HOME in spare time. Write today for **FREE TRIAL LESSON**.

CHICAGO TECHNICAL COLLEGE
K302 Tech Bldg., 118 E. 26th St., Chicago, Ill.
If you can go away to college to learn Air Conditioning, Engineering, Architecture, Drafting, Electricity, or Radio, send for **Free Blue Book**.

U.S. GOV'T JOBS

Earn \$1260 to \$2100 at Start

Excellent opportunities for citizens 18 to 50. No special experience usually required. Railway Postal Clerks may earn \$155 first month; Customs Inspectors as high as \$3,000 a year. Send for **FREE BOOK "How to Secure a Government Position."** It tells about many good government positions and how our tested method will help you pass examinations. Write **AT ONCE. PATTERSON SCHOOL, Arthur R. Patterson (former Gov't. Examiner), Principal, 88 Mercantile Bldg., Rochester, N. Y.**

EARN THE DEGREE

Doctor of Psychology (Ph.D.), Philosophy, Science, General Courses—Arts, Law, Business, etc. **"CHARTERED BY STATE OF MONTANA."** Send for 32-page **FREE Bulletin** at once. **No Obligation.**
Temple Bar College, Dept. 2-R, 213 East Main Street Missoula, Montana, U. S. A.

Learn Public Speaking

At home—in spare time. Many overcome "stage-fright," gain self-confidence and increase earning power, this easy way. Write for free booklet, *How to Work Wonders With Words* and requirements.
North American Institute, Dept. 135C 3601 Michigan Ave., Chicago, Illinois

SKINNY? Thousands report quick gains of solid pounds with this fine mineral-iodine concentrate. At all drug stores.

SEEDOL Kelpamalt Tablets

BE AN ARTIST

WE CAN TEACH YOU DRAWING in your own home during your spare time. Thirty-five years of successful teaching proves our ability. Artists receive large salaries.

Write today for Art Year Book
SCHOOL OF APPLIED ART
Dept. 108-C 10 E. Huron St., Chicago, Ill.



MAKE ME PROVE that I can train you at home for a GOOD JOB in RADIO



MAIL COUPON FOR FREE SAMPLE LESSON



Operates Public Address System

"I have a position with the Los Angeles Civil Service operating the Public Address System in the City Hall Council. My salary is \$170 a month." **R. H. ROOD, R. 136, City Hall, Los Angeles, Calif.**

\$80 Monthly in Spare Time



"I work on Radio part time, still holding my regular job. Since enrolling seven years ago, I have averaged around \$80 every month." **JOHN B. MORISSETTE, 809 Valley St., Manchester, N. H.**



Makes \$50 to \$60 a Week

"I am making between \$50 and \$60 a week after all expenses are paid, and I am getting all the Radio work I can take care of, thanks to N. R. I." **H. W. SPANGLER, 126 1/2 S. Gay St., Knoxville, Tenn.**

Many Radio Experts Make \$30, \$50, \$75 a Week

Radio broadcasting stations employ engineers, operators, station managers and pay up to \$5,000 a year. Spare time Radio set servicing pays as much as \$200 to \$500 a year—full time Radio servicing jobs pay as much as \$30, \$50, \$75 a week. Many Radio Experts own and operate full time or part time Radio businesses. Radio manufacturers and jobbers employ testers, inspectors, foremen, engineers, servicemen, paying up to \$6,000 a year. Automobile, police, aviation, commercial Radio, and loud speaker systems offer good opportunities now and for the future. Television promises many good jobs soon. Men I have trained at home have good jobs in all these branches of Radio.

Many Make \$5, \$10, \$15 a Week Extra in Spare Time While Learning

Almost every neighborhood needs a good spare time serviceman. The day you enroll I start sending Extra Money Job Sheets showing how to do Radio repair jobs. Throughout your Training I send plans and ideas that made good spare time money for hundreds. I send Special Equipment to conduct experiments, build circuits, get practical experience. **I ALSO GIVE YOU A COMPLETE, MODERN, PROFESSIONAL ALL WAVE, ALL PURPOSE RADIO SET SERVICING INSTRUMENT TO HELP SERVICE SETS QUICKER—SAVE TIME, MAKE MORE MONEY.**

Get My Lesson and 64-Page Book Free—Mail Coupon

In addition to my Free Sample Lesson I'll send you my 64-page book "Rich Rewards in Radio." It's FREE to anyone over 16 years old. My book points out Radio's spare time and full time opportunities and those coming in television; tells about my Training in Radio and television; shows you letters from men I trained, telling what they are doing and earning; tells about my Money Back Agreement. **MAIL THE COUPON** in an envelope, or paste it on a penny postcard—NOW!

J. E. SMITH, President National Radio Institute Dept. 8HP, Washington, D. C.

Mail this Now FREE Get 64-page Book

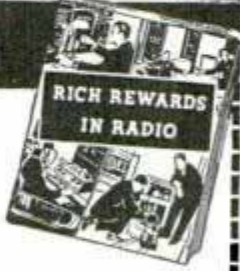

J. E. SMITH, President National Radio Institute Dept. 8HP, Washington, D. C.

Dear Mr. Smith:
Without obligation, send me the Sample Lesson and your free book about the spare time and full time Radio opportunities, and how I can train for them at home in spare time. (Please write plainly.)

Age.....
Name.....
Address.....
City..... State..... IFR



Know Electricity as Experts Know It—and Get an Expert's Pay!

Recovery has begun! The months ahead are charged with significance and expectation. What will you do to get the jump on the other fellow?
Thousands of men have used

The Croft Library of Practical Electricity

The Croft Library is a complete electrical educator. It is founded on practice—on 20 years of shirt-sleeve experience—on work as it is actually done. It is jammed from cover to cover with the kind of hard-headed facts you want. Written so that the beginner can easily understand it, yet so sound, so thorough, that it is the daily guide of 59,000 highly paid electrical workers and engineers. Croft tells you the things you need to know about motors, generators, armatures, commutators, transformers, circuits, switchboards, distribution systems—electrical machinery of every type—wiring for light and power—wiring of finished buildings—underwriters' and municipal requirements—illumination in its every phase—the most improved methods of lighting—lamps and lamp effects, etc.—how to do a complete job, from estimating it, to completion.

No money down—easy payments

Fill in and mail the coupon attached and we will send you the entire set of seven volumes for ten days' Free Examination. We take all the risk—you assume no obligation. If you decide to keep the books, send \$1.50 in ten days and the balance at the rate of \$2.00 a month. Send the coupon NOW and see the books for yourself.

FREE EXAMINATION COUPON

McGraw-Hill Book Co., 330 W. 42nd St., New York
Send me for ten days' free examination the Croft Library of Practical Electricity. If satisfactory I will send you \$1.50 in 10 days and \$2.00 monthly until the price of \$19.50 is paid. If not wanted, I will return the books postpaid. (To insure prompt shipment write plainly and fill in all lines.)

Name.....
Home Address.....
City and State.....
Position.....
Name of Company..... I M-8-38

MAKE MONEY AT HOME

RUBBER MOLDS Low as 6¢ EA.

Amazing rubber mold-making outfit makes perfect flexible molds of plaques, ash trays, book-ends, etc. Molds cost from 6c to 25c each. Each mold makes hundreds of novelties and gifts to sell up to \$1.00 apiece! No experience necessary. Quick and easy. Start profitable business in your home... sell to stores, gift shops, friends, resorts, road stands, by mail. Full or spare time. "Molders Handy Book" and list of buyers FREE. Write



SO-LO WORKS

Dept. H-827 Cincinnati, Ohio

NEW models EASIER TO PLAY

Find out about these sensational new Conn Band Instruments. Many wonderful, exclusive features! Today, more than ever, Conns are the "choice of the artists." You'll advance faster and take more pride in a genuine Conn—made by the world's largest manufacturer. See your dealer or write us for Home Trial, Easy Payment offer. Mention instrument.

C. G. CONN, LTD.
831 Conn Bldg., Elkhart, Ind.

CONN BAND INSTRUMENTS

WRITE FOR FREE BOOK

Extra Money From Books

SEND NO MONEY • Books Sent C.O.D. Anywhere in U. S. These famous Pay-Raising, Extra Money Books have helped thousands of others. Let them help you too. Check this list and mail with your name and address. Pay postman on delivery plus few cents postage. Send 3c stamp to cover postage and ask for catalog of other books.



SELECT FROM THIS LIST

- AIR CONDITIONING** Furnaces, Unit Heaters \$3.00
- ARMATURE WINDING** For A.C. and D.C. Machines..... \$2.00
- AUTO REFINISHING** Duo With Spray Gun \$1.50
- BLUEPRINT READING** For Machine Trades... \$1.50
- BRICKLAYING** Plain and Fancy..... \$1.50
- CARBURETORS (All Makes)** New, Revised Edition... \$3.00
- CHEVROLET SIX** Car, Truck, Operation Repair..... \$2.50
- COLONIAL FURNITURE** Making, 95 Pieces.... \$3.50
- DANCE** Learn at Home Without Music or a Partner... \$2.00
- BUSINESS CORRESPONDENCE** and Office Management \$1.75
- ELEMENTS DIESELS** Engineering Questions and Answers..... \$4.00
- FOUNDRY WORK** Molding, Casting, etc. \$2.00
- FURNITURE REPAIRING** Finishing and Decoration..... \$4.00

- HIGH-SPEED DIESELS** New, practical, non-technical..... \$2.50
- HOME GROUNDS** Furnishing..... \$0.80
- INVENTIONS** 1500 Needed..... \$2.50
- LEATHER MAKING** and Home Tanning... \$1.00
- MACHINE SHOP WORK** Tools and Methods... \$2.50
- METAL SPINNING** Practical New Book... \$1.00
- MONEY-MAKING FORMULAS** 10,000 Practical..... \$4.00
- PLASTERING** Best Instruction Manual..... \$1.25
- RADIO PHYSICS COURSE** New edition. Everything about Radio... \$4.00
- SHEET METAL** Construction Work... \$2.50
- STEAM ENGINEER'S LICENSE** How to Obtain..... \$2.00
- STEEL SQUARE** Hodgson, 500 pp. 300 illustrations... \$2.00
- TAXIDERMY, HOME** Mount Trophies Profit, Pleasure..... \$1.50
- WOOD TURNING** Course In..... \$1.50
- WROUGHT IRON WORK** Practical..... \$1.35

POPULAR MECHANICS PRESS

Room 838A 200 E. Ontario St., Chicago

GROW PLANTS WITHOUT SOIL

Startling New Development

Complete Directions for Small and Large Scale Growing

Get the new book "Soilless Growth of Plants" and learn this new technique which everyone is talking about. Three methods described—Water Culture, Sand Culture, Sub-Irrigation. Explains all operations. Tells how to make containers and nutrient solutions from raw materials at small cost—how to grow flowers, vegetables and fruits without soil. A fine hobby and a money-saving investment for city dwellers. A source of new business for gardeners, nurserymen, etc. Only book of its kind. Order today "Soilless Growth of Plants." Sent postpaid for \$2.75.

POPULAR MECHANICS PRESS, Dept. 838, 200 E. Ontario St., Chicago



Get this Book Now!

MONEY MAKING FORMULAS

1059 PRICELESS FORMULAS ALL IN ONE BOOK FOR \$1.25

FORTUNES MADE WITH FORMULAS LIKE THESE

- Cosmetics
- Remedies
- Beverages
- Paints
- Glues
- Polishes
- Inks
- Soaps
- Fertilizers
- Preservatives
- Lubricants
- Auto Products
- Food Products
- Metal Products, Etc.

Hundreds of big selling products—earning millions in profits—grew from a simple formula. Your own product may bring you fame and fortune. Get this big 200 page book with 1059 formulas, and start a spare or full time business of your own. Everything explained—what to make—how to make it—where to get materials. This is the book that lifts the veil of secrecy from a profitable and fascinating business. Get your copy now. Only \$1.25 postpaid.

Popular Mechanics Press, Dept. 638-B, 200 East Ontario St., Chicago

When writing please mention Popular Mechanics

NOW ANYONE CAN LEARN TO PLAY MUSIC THIS QUICK EASY WAY

New simplified home-study method ends gambling and guess-work—over 700,000 students. Fraction of the cost of old way methods

IT'S surprising to discover how many folks have learned to play music this new, quick, easy way—people who you imagined had practiced for years and spent huge sums on personal teachers' fees. Yet up to a short time ago they were in the same position as you are today.

You, too, can learn to play real music. And you won't need a private teacher, either. You'll learn all by yourself—right in your own home. And best of all the cost is only a small fraction of what it used to cost by old-fashioned methods.

More than 700,000 have studied this U. S. School of Music way. It is easy as A-B-C. No special talent is required—no previous musical training. You learn to play from real notes—the same as those used by accomplished musicians. The best part of it

all is that it is so simple—so crystal clear—so easy to understand. It's all right before you in print and pictures. First you are told how to do a thing. Then a picture shows you how to do it. Then you actually do it yourself and hear it.

FREE Booklet and Demonstration Lesson

So that you may see for yourself how easy, how pleasant it is to learn by this modern, simplified method,

EASY AS A.B.C.

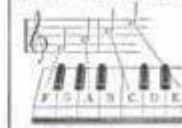

HERE'S THE EASY WAY I LEARNED TO PLAY MUSIC

the U. S. School of Music has prepared an Illustrated Booklet and typical Demonstration Lesson which are yours for the asking. They explain fully the principles of this remarkable method and how it enables you to become a popular musician in a surprisingly short time, at a cost of only a few cents a day. If you are really serious about wanting to learn music—become popular—send for this Free Booklet and Free Demonstration Lesson. Act now! Instruments supplied when needed, cash or credit. U. S. School of Music, 78 Brunswick Building, New York, N. Y.

U. S. SCHOOL OF MUSIC,
78 Brunswick Bldg., New York City

Send me your amazing free book, "How You Can Learn Music in Your Own Home," with inspiring message by Dr. Frank Crane; also Free Demonstration Lesson and particulars of our easy plan.

Name.....
Address.....
Instrument..... Have you Instr.?

LEARN TO PLAY BY NOTE

Piano Guitar
Violin Saxophone
Organ Mandolin
Tenor Banjo
Hawaiian Guitar
Piano Accordion
Or Any Other Instrument

Free TRIAL LESSON IN DRAFTING

More good jobs now in Drafting. Learn AT HOME in spare time (or at our Chicago School). Send post card for **FREE TRIAL LESSON** and see how easy to learn and get a good job.

CHICAGO TECHNICAL COLLEGE
K209 Tech. Bldg., 118 E. 26th St., Chicago, Ill.

If you can go away to college to learn Drafting, Engineering, Architecture, Electricity, Air Conditioning or Radio—send for **Free Blue Book**.

GAG-CARTOON!

AND MAKE BIG MONEY—AT HOME—BY MAIL! Magazines pay up to \$200.00 per cartoon. Get in this **NEW FIELD** and be your own boss! My 50 lessons—1000 illustration course shows you how. **CARTOON MARKETS INCLUDED—\$280**

All for.....
Send for **FREE** details,
MOON GAG-CARTOON SCHOOL
Box 106 — Dept. A6, Fall Creek, Wis.

BIG MONEY from POULTRY

I show you how to greatly increase profits, start your own business, or secure a good job in a big poultry plant. I train you at home in spare time quickly. Show you very latest methods. Give you facts worth money to yourself or employer. Men and women in small towns or suburbs will be particularly interested because latest scientific methods mean unusual profits for them. My home-study course used by thousands. 32-page book, "How to Raise Poultry for Profit" comes to you **FREE**. Mail coupon today.

SCIENTIFIC POULTRY RAISING!

HARRY M. LAMON, Pres., National Poultry Institute, Dept. 34-D, Adams Center, N. Y.

Please send me your **FREE** Book about poultry raising, and facts about your Course—

Name.....
Address.....
City (R.F.D.)..... State.....

ELECTRICAL ENGINEERING

ONE YEAR CONDENSED COURSE

Prepares for technical work in the electrical field. Thorough training in principles, with practical applications in laboratory and shop. Interesting work; interestingly taught.

HIGH PLACEMENT RECORD

Bliss men hold responsible technical and executive positions. 7,000 graduates. Course approved by educators; endorsed by industry. Modern buildings, dormitory, dining hall, campus.

46th YEAR BEGINS SEPTEMBER 28 . CATALOG ON REQUEST



BLISS

ELECTRICAL SCHOOL
118 TAKOMA AVENUE WASHINGTON, D. C.

DO YOU LIKE RADIO DOES THE FUTURE OF TELEVISION INTEREST YOU?



Send for
your
free copy



You men anxious to make good in radio and related industries want the true facts,—you want to know about employment opportunities and requirements. National Schools,—a million-dollar trade school,—will supply you with a sincerely honest statement of facts on what you should do to get into the profitable radio industry. No exaggerations,—no mis-statements. Mail coupon today. [Send for your free copy. Real facts on radio employment requirements.] You need real experience. National offers complete training with modern equipment.

NATIONAL SCHOOLS

Los Angeles

Request for **FREE BOOK** of DETAILS

NATIONAL SCHOOLS,
Dept. PMR-8, 4000 S. Figueroa St., Los Angeles, Calif.

NAME _____ Age _____

ADDRESS _____

CITY _____ STATE _____



on approval. Just mail the coupon and we'll send you a set of these remarkable auto books, just off the press. Whether you are a mechanic or helper, expert or apprentice, auto owner or driver, if you're interested in knowing all about automobile mechanics, take advantage of this **FREE OFFER**.



CAN YOU FIX IT?

These wonder books tell step by step **HOW** to take out "play" in differential — to kill the shimmy in steering—to set **TIMING**—how to put your finger **instantly** on engine trouble and then the quick expert way to **FIX** it. Newest improvements fully covered. Equal to a complete trade course at less than a fourth the cost.

6 BIG VOLUMES
Brand New Edition
2500 pages, 2000 illustrations, wiring diagrams, etc., including Marine Engines, Aviation Motors, Diesel engines, etc. De Luxe edition, gold-stamped flexible binding.

AMERICAN TECHNICAL SOCIETY,
Drexel Ave. & 58th St., Dept. AC19, Chicago, Ill.

I would like to see the new 6-volume edition of your **AUTO BOOKS**. I will pay the few cents delivery charges only, but if I choose to, I may return them express collect. If after 10 days use I prefer to keep them, I will send you \$2 and pay the balance at the rate of only \$3 a month, until \$24.80 is paid. Please include free consulting membership as per your offer above.

Name _____
Address _____
City _____ State _____

Attach letter stating age, occupation and name and address of employer and that of at least one business man as reference.

NEW INVENTIONS

H596 (Continued from page 20A)

transmitted to the rider. The front fork also is curved, adding to the streamline appearance of the bike.

MORE secure fastening of heels to women's shoes is provided by a method patented recently. The heel literally is bolted to the shoe by means of a screw and a threaded connector. The work can be accomplished with two small machines. The

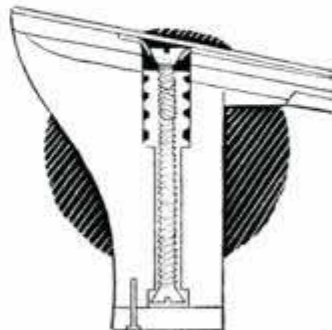

method prevents the heel from becoming loose and from breaking off. Weight of the shoe with its heel attached by this method is slightly less than that of shoes manufactured in the ordinary manner.

PROTECTION for the automobile hood, fenders and engine is afforded by a

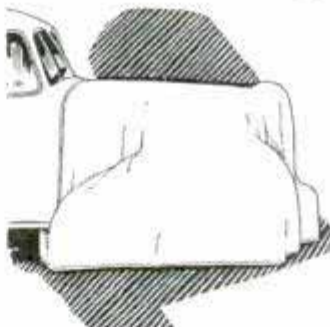

cover patented recently. The cover is made to fit closely around the front of the car and down over the fenders and wheels. Thus, a complete, snug housing for the

front end is provided. The cover is especially useful on camping trips or tours where the car cannot be kept in a garage at night, and in bad weather.

LAATEST of lamps made with novelty burners is one with a design representing a volcano

in eruption. The burner, made to fit an ordinary lamp, is in the shape of Mount Pelee. It has an arrangement of indentations



against or through which the flame of the burning lamp glows to represent streams of lava pouring from the black volcano. The base shows a city

(Continued to page 49A)

A Simple Recipe for Inventive Success

PROBABLY the simplest recipe for inventive success would be this: First, a practical, useful invention; second, a good, strong Patent; third, a buyer or a market. The inventor needs all three to get anywhere. Lacking any one, he is likely to get nowhere. The recipe is simple. Working it out isn't so simple. That is why inventors—and others inventively inclined—have found the two books shown here so helpful. We've gone into each part of the recipe carefully. *Exactly what is an invention? We tell you. What is a strong Patent? We tell you. How can I go about finding a buyer? We tell you.*

But there's much more. For example, just how an Application for a Patent is made; how an inventor can safeguard himself with dated sketches as he goes along; how the pertinent Patent Office records are checked to see what other inventors may have done along the same line; how some successful inventors have secured financial backing; simple ways to contact manufacturers; and many other points.

40 Years in the Business of Helping Inventors

The world needs, can use and will pay for practical, useful, inventions. Manufacturers are on the alert for new articles, or improvements that will help them increase sales. Maybe you have one. Maybe not. These books will help you in deciding that. *From that standpoint alone, they are valuable.* For more than 40 years, it has been our business to help inventors. We answer your questions and supply complete information about Patent procedure, costs, steps to take, kind of sketch or model needed, and much more. Our staff is made up of experienced Registered Patent Attorneys, Draftsmen, Searchers. Fees are reasonable—deferred payments arranged. Whether your idea is large or small, finished or still in a rough stage, you should have the facts both about Patenting and Selling. The information which we give you—based on long experience with thousands of inventors—is yours for the asking. No need to delay. These two books of facts may save you time, trouble, money, even later disappointment. **Return the coupon—or write us a confidential letter—today.**

115 Mechanical Movements

The mechanical movements shown below are taken from 115 such movements illustrated in our book, "Patent Protection." Maybe you'll find just what you need to work out some of your own ideas. Many other interesting pictures are shown in this book. Both books and an "Evidence of Invention" form sent to you FREE the same day we hear from you.

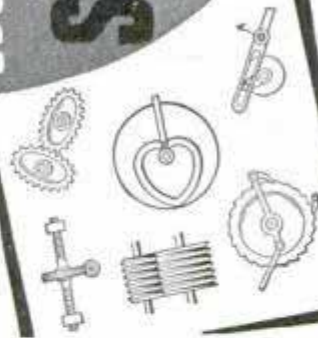

PATENT and SELL your INVENTION

Suggestions
on
WHEN
and
HOW
to Sell an
INVENTION

**PATENT
PROTECTION**

**VICTOR J.
EVANS & Co.**

REGISTERED PATENT ATTORNEYS

Main Office: 20-J, Victor Building,
Washington, D. C.

Other Offices: 514-N, Empire Bldg., Pittsburgh
405-N, Garfield Bldg., Los Angeles

Send me FREE copies of your books, "Patent Protection" and "When and How to Sell an Invention." (Note: Same books supplied by either of the branch offices listed above.)

Name.....

Street and No.....

City or Town..... State.....

PATENTS

Booklet Free **Highest References**
Promptness Assured **Best Results**

Send drawing or model.

ALL BUSINESS GIVEN PROMPT AND PROPER ATTENTION

Listed Patent Lawyer in the latest editions of the Rand-McNally Directory of Bankers and Bank-Recommended Attorneys, published by Rand-McNally & Co., Chicago, Ill.; The Baggott & Ryall Directory of Guaranteed Attorneys, published by Legal Directory Corporation, Boston, Mass.; American Lawyers Annual, Cleveland, Ohio; Bankers Service Legal Directory, published by Bankers Service Co., Boston, Mass.; Eyre's Law List, 9 Park Place, New York City; Snow-Church Directory Co. Lawyers List, published in New York City, and the Central Guarantee Co., Bankers and Lawyers Directories, 630 Fifth Avenue, New York City.

WATSON E. COLEMAN,
 REGISTERED PATENT LAWYER

Victor Building, 724 Ninth Street, N. W.
WASHINGTON, D. C.

INVENTORS PATENT YOUR IDEAS SEND FOR FREE BOOK



HOW TO OBTAIN A PATENT

Written by a Former Member of the Examining Corps (1922-24) of the U. S. Patent Office. If you want to profit by your idea, you should take steps to apply for a U. S. Patent at once. Your first step is to get this Free Book. This interesting illustrated book contains valuable information you should have. It tells you fully how to obtain a patent on your idea in the quickest way. With this Free Book you will also receive a "Record of Invention" form on which you can easily record your idea. Personal and Confidential Service: Your case will be personally handled only by a Registered Patent Attorney who is also a Former Member of the Examining Corps of the U. S. Patent Office. All communications confidential.

MAIL COUPON TODAY for FREE PATENT BOOK and RECORD OF INVENTION Form.

CARL MILLER
 REGISTERED PATENT ATTORNEY
 FORMER MEMBER EXAMINING CORPS U. S. PATENT OFFICE

Wentworth Bldg., 35th Floor, Dept. 88A, New York City
 MILLER BUILDING, Dept. 88A, Washington, D. C.

Please send me your Free Book, "How to Obtain a Patent," and your "Record of Invention" form.

NAME.....

ADDRESS.....

Inventions Wanted Patented or Unpatented

We have been successfully selling inventions, patented and unpatented, since 1924. Write for proof, and tell us what you have for sale.

Chartered Institute of American Inventors
 Dept. 4, Barrister Building, Washington, D. C.

ALBERT E. DIETERICH
THEODORE H. RUTLEY
 REGISTERED PATENT LAWYERS
 512 B Colorado Bldg. WASHINGTON, D. C.
Booklet on Patents sent free

INVENTORS who derive largest profits know and heed certain simple but vital facts before applying for patents. Our book, Patent-Sense, gives those facts; sent free. Trade Marks—Copyrights.
LACEY & LACEY, Est. 1869, 635 F St., N. W., Dept. 5, WASHINGTON, D. C.

No JOKE TO BE DEAF

—Every deaf person knows that—



Mr. Way made himself hear his watch tick after being deaf for twenty-five years, with his Artificial Ear Drums. He wore them day and night. They stopped his head noises. They are invisible and comfortable, no wires or batteries. Write for TRUE STORY. Also booklet on Deafness.



Artificial Ear Drum

THE WAY COMPANY
 729 McCombly Bldg. Detroit, Michigan



BUCHSTEIN'S FIBRE LIMB

is soothing to your stump—strong, cool, neat, light. Easy payments. Braces for all deformities. Agents wanted.

D. BUCHSTEIN CO.
 610 3rd Ave., So., MINNEAPOLIS, MINN.



FREE BOOK

RAISE GIANT FROGS

WE BUY! Good prices year round! Other markets waiting for all you can ship. Get ready now for next spawn. Breeder lays 20,000 eggs yearly. Small pond starts you. Free book shows sketch. Send no money. Write American Frog Canning Co. (Dept. 133-R), New Orleans, La.



Print Your Own

Cards, stationery, circulars, tags, labels, advertising, etc. Save money. **Print for Others; Big Profits;** easy rules sent. Will do popular Raised Printing like Engraving. Junior outfit \$9. Senior outfit \$17 and up. Send for free catalog and all details. **KELSEY PRESSES, D-37 MERIDEN, CONN.**

INVENTORS PROTECT & SELL

Your unpatented invention can be sold with positive safeguards under patent laws. New, low-cost procedure. Complete details, free.
AMERICAN PATENTS CORPORATION
 Dept. 4-E Washington, D. C.

PATENTS—TRADE MARKS

All inventions submitted held confidential and given personal attention by members of the firm. Form, "Evidence of Conception" and instructions, "How to Establish Your Rights"—FREE!

LANCASTER, ALLWINE & ROMMEL
 Patent Law Offices

412 Bowen Bldg. Washington, D. C.

To PROTECT YOUR INVENTION - Use this coupon, NOW

Delays are dangerous and may be very costly. My personal service assures prompt action, strict confidence, and a minimum of expense. I suggest that you send me a model or drawing, or sketch and description of your invention, and \$5.00. I will make a search and report

promptly as to its patentability and send you a copy of my 72-page booklet. Or, if you prefer to read my booklet first, mail the attached coupon at once. I will also send my "Record of Invention" form. (Over 38 years experience as a Registered Patent Attorney.)

L. F. Randolph, 302-D Victor Bldg., Washington, D. C.

Please send me at once, free of charge, your 72 page booklet and "Record of Invention" form.

Name.....

Address.....

A PERSONAL CONFIDENTIAL PATENT SERVICE

NOW I KNOW WHAT FRED MEANT WHEN HE SAID HE GOT HIS PAY BOOST OUT OF A TWO DOLLAR BOOK.



PAY RAISING EXTRA MONEY BOOKS THAT WILL HELP YOU WIN SUCCESS

You, too, will find the selected list of practical books below just what you need to help you improve your job, prepare for a better one, or add to your income through spare time earnings. Thousands give these books credit for their success.

SEND NO MONEY! Use this advertisement as an order blank. Check books wanted. Add name and address and mail. Just pay postman price plus few cents postage. (In U. S. and possessions.) Or remit with order and add 10 cents per book for postage.

POPULAR MECHANICS PRESS
Room 838B 200 East Ontario Street Chicago

- AIR CONDITIONING**
Live Field; Great Future.....\$3.50
- ALUMINUM WORKING**
For School and Home Shops. Just Out. 295 pp., illus.....\$3.00
- AUTO ENCYCLOPEDIA**
The Famous Dyke's Latest Edition.....\$6.00
- 110-V. GENERATORS**
Made From Old Auto Units.....\$1.00
- BIRD HOUSES**
Build to Sell; Easy Designs.....\$1.00
- BLUEPRINT READING**
for the Building Trades.....\$1.25
- BOAT BOOK**
Power, Sail, Rowing, Paddle Plans.....\$3.00
- BOY MECHANIC**
Hundreds Things Boys Can Make.....\$2.00
- CARPENTRY, PRACTICAL**
Complete 436 pages. Revised Edition.....\$2.00
- CIVIL SERVICE**
Home Study Courses Federal, State, City Positions.....\$1.00
- CONCRETE**
1001 Ideas for Using. New Popular Mechanics Book.....\$5.00
- DIESEL HANDBOOK**
New! Latest Information.....\$5.00
- ELECTROPLATING**
With Copper, Nickel and Chromium Technical bulletin.....\$1.00
- FORD V-8 CARS, TRUCKS**
New. 700 Pages. Includes Details 1937 Cars.....\$2.50
- FORMULAS**
1059 Money Making. Start a Business.....\$1.25
- A.C. POWER WIRING**
Covers all uses of a.c. for power.....\$4.00
- FURNITURE MAKING**
Tools, Materials, Design.....\$2.50
- HOUSES, SMALL**
Book of, for Home Builders.....\$2.00
- HYPNOTISM**
How to Become an Expert.....\$2.00
- LOCOMOTIVE**
Folding Chart Shows all Parts.....\$1.00

- LOG CABINS**
Easy Plans; Build for Profits. Value!.....\$3.00
- MACHINE WORKING**
First Complete Book on Subject.....\$3.25
- MATHEMATICS**
Easy Guide for the Practical Man.....\$1.50
- MECHANICAL DRAWING**
Learn Drafting; Good Salaries.....\$1.00
- MONEY MAKING IDEAS**
1000 Ways to Make \$1000.....\$2.50
- OFFICE MACHINES**
All Makes. Care and Operation.....\$2.50
- PLUMBING**
500 Facts Every Homeowner Should Know.....\$1.50
- TEST GOLD—PLATINUM**
Identify—Buy—Sell. By C. M. Hoke.....\$1.00
- PAINTING AND DECORATING.** New book.....\$1.50
- PROSPECTORS' HANDBOOK**
How to Mine, Appraise, Equip.....\$3.00
- RADIO SERVICING**
Profit by Knowing Costs. Kinks, Etc!.....\$4.00
- REFRIGERATION**
Electric, Gas. Be a Service Expert.....\$5.00
- REWINDING ELECTRIC MOTORS**
Fractional Sizes. Value!.....\$2.50
- SHIP MODEL**
Entire Text, Famous "Sovereign" of 1637.....\$1.00
- SHOP NOTES LIBRARY**
5 Vol. 2000 Wonderful Shop Ideas.....\$2.50
- SOIL-LESS GROWTH OF PLANTS.** Just out.....\$2.75
- STEEL SQUARE**
How to Figure Angles of Rafters, Roofs, Etc.....\$1.00
- TOYS**
For Amusement or Profit. Saleable Designs.....\$1.50
- TRAILER BUILDING**
New Book.....\$1.00
- UPHOLSTERY**
Always a Big Market. Start Own Business.....\$2.00
- WOOD FINISHING**
Methods, Tools, Materials.....\$2.00



WHAT TO DO With Your INVENTION?

Free Books TELL ALL!



Patent facts clearly explained. Everything you need to know about protecting and commercializing your ideas. Mail coupon below for free copies of our booklets, "How We Protect You" and "Suggestions on How to Commercialize Your Invention". We will also enclose our original Certification of Invention form, valuable proof in showing priority.

OUR 63 YEARS' EXPERIENCE

is your assurance that you are dealing with a reliable firm of registered patent attorneys. We are ready to serve you quickly, efficiently, confidentially.

C.A. SNOW & CO. FREE FACTS FOR YOU!
Registered Patent Attorneys Since 1875

Dept. 188, Snow Building, Washington, D. C.

Gentlemen: Please send me absolutely free and without obligation on my part, your original document, "Certification of Invention," together with your two guides for inventors, "How We Protect You" and "Suggestions on How to Commercialize Your Invention."

Name.....
Street and No.....
City or Town.....State.....



DO YOU WANT

\$36.50

A WEEK?

U. S. Government Jobs

START \$1260 TO \$2100 A YEAR

MEN—WOMEN

Paid Vacations
Common education usually sufficient
Mail Coupon Today—SURE

COUPON

Gentlemen: Rush to me, FREE of charge, list of U. S. Government big pay positions. Send me FREE 32-page book describing salaries, hours, work, vacation, and giving full particulars on how to qualify for a position.

Name.....
Address.....

FRANKLIN INSTITUTE
Dept. W173
Rochester, New York

TRI-STATE COLLEGE

ENGINEERING DEGREE IN 2 YEARS

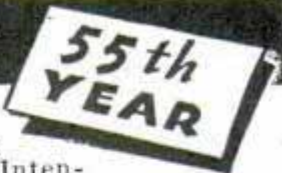

Courses in Civil, Electrical, Mechanical (108 weeks), Chemical, Aeronautical (108 weeks), Radio Engineering. Essentials of engineering training included and non-essentials eliminated. B. S. Degree granted upon completion of course. For ambitious, earnest students. Those who lack high school may make up required work. Graduates compete successfully with those of 4-year schools. Technical instruction at lowest cost and in least

time consistent with thorough training. Intensive instruction in accord with individual ability. Courses also in Business Administration and Accounting. Also short diploma courses (36 weeks) in Surveying and Drafting. Students from all parts of the world. Tri-State graduates make good. Tuition, living expenses low. 55th year. Enter September, January, March, June. Write for catalog. 488 College Ave., Angola, Ind.

Know! YOUR CAR

ASK TO SEE IT!

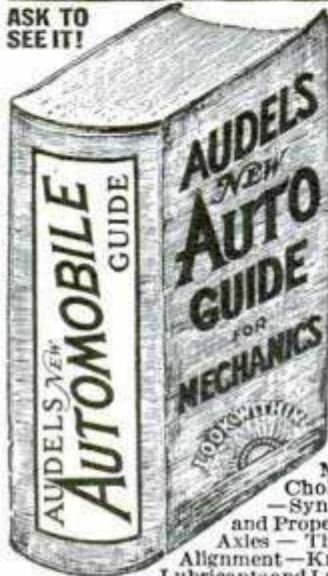

GOOD NEWS—JUST OUT

1938 AUDELS NEW AUTOMOBILE GUIDE is NEW from cover to cover. Explaining the Theory, Construction and Servicing of modern motor cars, trucks and buses; and the application of auto type Diesel Engines. . . . **PRACTICAL INFORMATION IN HANDY FORM, 1540 PAGES COVERING . . .**

AUTO REPAIRS & SERVICE HELPS

All the Parts of an Automobile—Automotive Physics—The Gas Engine—How a Gas Engine Works—Gas Engine Principles—Multi-Cylinder Engines—Horse Power—Automobile Engines—Engines: Stationary Parts—Engines: Moving Parts—Pistons—Piston Rings—Connecting Rods—Crank Shafts—The Valves—The Valve Gear—Cams and Cam Action—Valve Timing—Cooling Systems—Gasoline—Fuel Feed Systems—The Mixture—Carburetors—Automatic Choke—Super-Chargers—Transmissions—Synchro-Mesh—Clutches—Universals and Propeller Shafts—The Differential—Rear Axles—The Running Gear—Brakes—Wheel Alignment—Knee Action—Steering Gear—Tires—Lubricants and Lubrication—Automotive Electricity

Ignition Systems—Magneto Ignition—Spark Plugs—Ignition Coils—Distributors—Automatic Spark Control—Ignition Timing—Generators—Starters—Generator and Starter Testing—Lighting Systems—Storage Batteries—Battery Charging—Battery Testing—Troubles, **Automotive Diesel Engines, Inside Views of all Automobile Parts Fully Illustrated. To Get This Assistance for Yourself Simply Fill In and Mail Coupon Today.**

\$4 COMPLETE • PAY ONLY \$1. A MONTH ←
THEO. AUDEL & CO., 49 WEST 23rd STREET, NEW YORK
 Please send me postpaid AUDELS NEW AUTOMOBILE GUIDE (\$4) for free examination. If I decide to keep it, I will send you \$1 within 7 days; then remit \$1 monthly until purchase price of \$4 is paid. Otherwise, I will return it to you promptly.

Name _____
 Address _____
 Occupation _____
 Reference _____ PM

Photo-Engraving

BIG PAY!
 IDEAL WORKING CONDITIONS
 INCREASING DEMAND

LEARN QUICKLY AT HOME BY LATEST EXPERT METHOD
 An easy, quick, thorough Home Study Course. Oldest and largest school in the world TEACHING PHOTO-ENGRAVING by correspondence and residence. Many unusual features—Experimental Equipment for home use—Rare Reference Books—Camera Journalism. Plate Layout—Examples. Lifetime Consulting Service. **"30 Photo-Engraving Ways to Make Money from the Day You Start Your Studies!"** . . . All included at no extra cost. Write today for Free 38-page Opportunity Booklet. . . .
AURORA SCHOOL OF PHOTO-ENGRAVING
 Dept. 188 AURORA, MISSOURI



Genuine LACO Automatic OIL-BURNING HEATER

Lots of Heat—Amazing Low Fuel Cost!

Write today for free book showing LACO's new oil-burning heater for home, store, filling station, etc. No basement needed. Complete with special LACO "2-Stage" burner—and new-type Inner Heating Unit with 20% greater heating surface! Delivers big volume of heat from small amount of oil. Self-contained fuel tank. Beautiful steel cabinet. Quiet. Safe. Humidifies, circulates the air. Choice of sizes.

WRITE! Send for Free Book, photos, low prices. If you prefer furnace-type oil-burner, ask for book on Pressure-Type and Mineral-Wick models.

DEALERS: Sample burner sent new dealers for examination, no obligation. WRITE!

LACO OIL BURNER CO., 188 Union St., Griswold, Iowa



LOWAS \$40 FOB Factory

Auto-Diesel

Master a real trade. Auto Mechanics, Diesel Mechanics, Arc Welding, Acetylene Welding, etc. Let us train you to be an expert Auto-Diesel Mechanic and help you get a good job. The cost to you is reasonable. Learn on modern equipment with tools under experienced instructors. Real shop work. Steam heated buildings. Room and board in our steam heated dormitory. We pay your fare to Nashville. For free catalog write

Nashville Auto-Diesel School, Dept. 75, Nashville, Tenn.

LEARN TELEVISION

at home! Absolutely NEW kind of training. In ADDITION to text books you get complete practical Television Equipment that actually transmits and receives. Fascinating, thrilling home training. Easy time payments . . . only 39c a day pays for BOTH training and equipment. Write for complete details and FREE book. No obligation.

American Television Institute
 Dept. PM 838, 433 E. Erie St. Chicago, Ill.



College Course at Home

You can get College Training—

Instruction by 41-year old educational institution. Standard college texts with special lecture material supplied. YOU H. S. graduates unable to go to College; YOU Jr. Executives who need College education for advancement; YOU men and women who want higher education for social activities—learn how you can get College Education by Home Study.
American School, Dept. LAC 45, Drexel at 58th, Chicago



CARTOONING

To those earnest students of this fascinating profession who realize the advantage of PERSONAL INSTRUCTION by a nationally known cartoonist, I offer a system of study recommended by America's foremost cartoonists. It's as near like private tutoring as is possible in a home study course. Write at once for free details.

DORMAN H. SMITH, Box C597, San Rafael, California

AN AVIATION CAREER OFFERS YOU A GREAT FUTURE



Demand for trained aircraftmen in Southern California plants is increasing and already exceeds supply. Curtiss-Wright Technical Institute, Aviation's foremost and oldest school, is located in heart of this activity and specializes in Sheet Metal, Master Mechanics and Aero Engineering. (No flying involved.) Graduates are obtaining immediate employment. Write for details NOW!
MAIL THIS COUPON TODAY →

Dept. P.M.S

MAJOR CAREER COURSES

AERONAUTICAL ENGINEERING MASTER MECHANICS

NAME _____

ADDRESS _____



Increase Your Earning Power

Apply time and labor-saving kinks to your work. Your efficiency will soon be recognized and you will be in line for advancement.

If you do machine shop work of any kind, sheet-metal work, painting, carpentry, auto repairing, farming, concrete work, plumbing, electrical work, welding, building-glass work, general repairing, tool-making, poultry raising, masonry or home repair work, get this

LIBRARY OF 2000 TIME AND LABOR SAVING IDEAS FOR SHOPMEN AND HANDYMEN

RECENTLY PUBLISHED

SHOP NOTES for 1938

318 Articles
645 Illustrations
224 Pages
Price 50c
See partial list of contents below

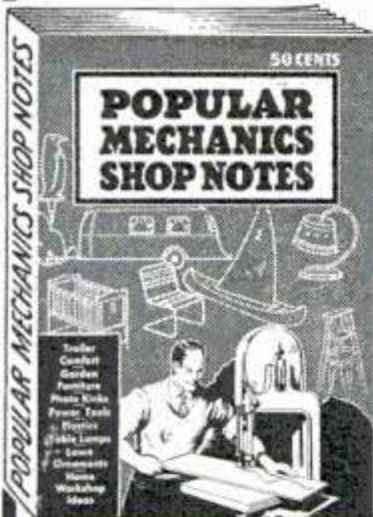

Including the new 1938 issue illustrated above, there are five volumes in the Shop Notes Library of 2000 easily understood short cuts to every-day jobs. Here are just a few of the subjects taken from the latest issue:

- | | | |
|--|---|---|
| Arc Welder, Auto Motor Runs | Garden Furniture, Metal Gas Engine Midget | Plastic Ornaments |
| Bits, Wood-boring Cabinet Humidifier over Radiator | Hacksaw, Electrically Driven | Sail Rig, Airstream Sander, Oscillating Saw, Power-Driven Table |
| Carpenters, Hints for Child's Crib | Hydraulic Rame for Country Homes | Shaper Projects |
| Corrosion, Guarding Against | Jigs for Belt Sander | Snow Plow, Small Rotary Table Lamps from Pistons and Metal |
| Drilling, Safe Drills, Using | Jigs for the Shaper | Temperature Indicator, Electric |
| Drills, Using | Kinks for Photographers | Trailer Brakes, Vacuum Trailer Coupler |
| Driveways, Durable | Ladder Chair | Torch, Electric Arc |
| Electroplating | Laundry Cart | Wood Turning Kinks |
| Frozen Water Pipes, Thawing Electrically | Lawn Ornaments | |
| Garage, Profit Makers for | Movie Film, Power Reel for Developing | |
| | Photographic Equipment | |

Each volume contains approximately 400 articles and 600 illustrations and has 200 or more pages. This unrivaled library of shop helps may be secured for a limited time only. After the present supply of books is exhausted the offer must be withdrawn.

Send No Money

POPULAR MECHANICS PRESS, 200 E. Ontario St., Room 838, Chicago, Ill.

Send me, as per your offer, the following books. I will pay postman price and small amount of postage. My money will be refunded if I am not satisfied. (Check what you want.)

- 1938 Shop Notes and Lathe Handbook (Metal Working), both for 98c.
- Shop Notes Library (5 vols.) \$2.50.

Name.....

Street and No.....

City..... State.....

*C. O. D. applies to U. S. and possessions only. If you reside elsewhere, remittance must accompany order.



Go to High School at Home

You can secure a high school education in your spare time by studying the new courses prepared by the International Correspondence Schools.

These courses are equivalent to the courses given in resident high schools. They have been specially arranged for men and women who wish to meet college entrance examinations, to qualify for a business position, or to make up the education they missed in past years.

The lessons are easy to understand and you will make rapid progress because you will be in a class by yourself and you will study under the guidance of instructors who are sincerely interested in you.

Just mark and mail the coupon and we will gladly send you interesting free booklets describing the High School Courses of the I. C. S. or any other subject in which you are interested.

INTERNATIONAL CORRESPONDENCE SCHOOLS

Box 5519-J, Scranton, Penna.

Without cost or obligation, please send me a copy of your booklet, "Who Wins and Why," and full particulars about the subject before which I have marked X in the list below:

- College Preparatory Course
- High School Commercial Course
- High School English Course
- High School Vocational Course
- High School Agricultural Course

BUSINESS TRAINING COURSES

- | | |
|--|--|
| <input type="checkbox"/> Business Management | <input type="checkbox"/> Service Station Salesmanship |
| <input type="checkbox"/> Office Management | <input type="checkbox"/> Business Correspondence |
| <input type="checkbox"/> Industrial Management | <input type="checkbox"/> Lettering Show Cards <input type="checkbox"/> Signs |
| <input type="checkbox"/> Traffic Management | <input type="checkbox"/> Stenography and Typing |
| <input type="checkbox"/> Accountancy and C.P.A. Coaching | <input type="checkbox"/> Civil Service |
| <input type="checkbox"/> Bookkeeping | <input type="checkbox"/> Mail Carrier |
| <input type="checkbox"/> Secretarial Work | <input type="checkbox"/> Railway Mail Clerk |
| <input type="checkbox"/> Cost Accountant | <input type="checkbox"/> Grade School Subjects |
| <input type="checkbox"/> Salesmanship <input type="checkbox"/> Advertising | <input type="checkbox"/> First Year College |
| <input type="checkbox"/> Wallpaper Decorating | <input type="checkbox"/> Illustrating <input type="checkbox"/> Spanish |
| <input type="checkbox"/> Salesmanship | <input type="checkbox"/> Cartooning <input type="checkbox"/> French |
| | <input type="checkbox"/> Lumber Dealer |

TECHNICAL AND INDUSTRIAL COURSES

- | | |
|--|--|
| <input type="checkbox"/> Architect | <input type="checkbox"/> Plumbing <input type="checkbox"/> Heating |
| <input type="checkbox"/> Contractor and Builder | <input type="checkbox"/> Air Conditioning |
| <input type="checkbox"/> Structural Draftsman | <input type="checkbox"/> Sheet Metal Worker |
| <input type="checkbox"/> Structural Engineer | <input type="checkbox"/> Steam Engineer |
| <input type="checkbox"/> Electrical Engineer | <input type="checkbox"/> Civil Engineer |
| <input type="checkbox"/> Reading Shop Blueprints | <input type="checkbox"/> Surveying and Mapping |
| <input type="checkbox"/> Telegraph Engineer | <input type="checkbox"/> Refrigeration |
| <input type="checkbox"/> Telephone Work | <input type="checkbox"/> R. R. Locomotives <input type="checkbox"/> Air Brakes |
| <input type="checkbox"/> Mechanical Engineer | <input type="checkbox"/> R. R. Signaller |
| <input type="checkbox"/> Mechanical Draftsman | <input type="checkbox"/> Highway Engineering |
| <input type="checkbox"/> Machinist <input type="checkbox"/> Toolmaker | <input type="checkbox"/> Chemistry <input type="checkbox"/> Pharmacy |
| <input type="checkbox"/> Inventing and Patenting | <input type="checkbox"/> Coal Mining Engineer |
| <input type="checkbox"/> Patternmaker | <input type="checkbox"/> Navigation <input type="checkbox"/> Boilermaker |
| <input type="checkbox"/> Heat Treatment of Metals | <input type="checkbox"/> Textile Overseer or Supt. |
| <input type="checkbox"/> Bridge Engineer | <input type="checkbox"/> Cotton Manufacturing |
| <input type="checkbox"/> Gas Engines <input type="checkbox"/> Diesel Engines | <input type="checkbox"/> Woolen Manufacturing |
| <input type="checkbox"/> Aviation Engines | <input type="checkbox"/> Agriculture <input type="checkbox"/> Fruit Growing |
| <input type="checkbox"/> Automobile Mechanic | <input type="checkbox"/> Marine Engineer <input type="checkbox"/> Radio |

Name..... Age.....

Address.....

City..... State.....

Occupation.....

If you reside in Canada, send this coupon to the International Correspondence Schools Canadian, Limited, Montreal, Canada

Business Demands Accountancy

—because Accountants Command Business

ACCOUNTANTS have been in demand—at far better than average earnings.

But today—more than ever before—the competent accountant finds his services at a tremendous and increasing premium.

In the depression business tightened up the reins and is watching costs—prices—every move—striving to operate on that basis of close control so essential to profits.

Then too, progressive business is building now for increased prosperity—laying plans for expansion, for new processes, new markets—getting ready for the unparalleled opportunities of the next ten years.

The Home Study Way to Accountancy Success

Thousands upon thousands of men have trained for Accountancy with LaSalle—at night—at home.

Their success—their progress—is a matter of record.

Whether their goal was a C. P. A. degree or advancement in business, our files are full of overflowing with letters reporting income increases so far out of line with the time and cost investment that there is no comparison.

Note, for instance, these four cases chosen out of thousands more we might cite. (Names on request.)

F. F. A. was a railroad yard clerk at \$112 a month when he began accountancy training with LaSalle. Five years later, his income was 500% larger and he was a Certified Public Accountant and attorney. F. C. was 22 years of age and general all-around man in an Arkansas lumber yard at \$75 a month. Five months later, his firm made him manager at \$125, and ten months later promoted him to a larger yard at \$250 plus a commission on sales.

O. D. always thought stories about LaSalle training were fairy tales until the training helped him—a clerk at \$75 a month—move up in six months to \$125, and within four years to \$250. He became General Auditor of a large national organization—with his income more than seven times his starting salary.

As an assistant bookkeeper in a great Western bank, C. F. H. looked forward to slow progress. But LaSalle accountancy training speeded up his climb to Assistant Trust Officer and to a salary increase of 400 per cent.



These Men Won Success in Ordinary Times—You Will Profit by Coming Prosperity

Remarkable as is the success of these men—you will have a decided advantage over them—you will be entering accountancy when unusual business conditions work with you for success.

Present conditions and the upturn to prosperity not only call for more capable accountants—but offer unusual opportunities for both quick and permanent success. The accounting student of 1938 will face real opportunity in 1939 and the accounting leaders of 1940-45 will be largely determined in 1938-1939.

—If You Can Qualify

Ask yourself three questions:

1. Are you ambitious?
2. Have you determination?
3. Can you see and grasp an opportunity?

If the answers are "Yes"—you are qualified.

If you have determination; if you are ambitious; if you can take advantage of circumstances—*prove it* by investigating. A two-cent stamp, sixty seconds time, and the coupon below will bring you full information regarding Accountancy training and the opportunities to which such training leads. *Then* you can judge intelligently.



LaSalle Extension

LASALLE EXTENSION, Dept. 864-HR, CHICAGO

Opportunities in Accountancy—Check below and we will send you a free copy of "Accountancy, the Profession that Pays," also information about our new training in Higher Accountancy, all without obligation.

Higher Accountancy

Other LaSalle Opportunities: If more interested in one of the other fields of business indicated below, check that:

- | | | |
|--|--|--|
| <input type="checkbox"/> Business Management | <input type="checkbox"/> Law: LL. B. Degree | <input type="checkbox"/> Business Correspondence |
| <input type="checkbox"/> Expert Bookkeeping | <input type="checkbox"/> Commercial Law | <input type="checkbox"/> Stenotypy |
| <input type="checkbox"/> C. P. A. Coaching | <input type="checkbox"/> Industrial Management | <input type="checkbox"/> Modern Salesmanship |
| <input type="checkbox"/> Railway Accounting | <input type="checkbox"/> Modern Foreman-ship | <input type="checkbox"/> Business English |
| <input type="checkbox"/> Traffic Management | | |
| <input type="checkbox"/> Effective Speaking | | |

Name.....

Present Position.....

Address.....

**WORLD'S
BEST
WANT AD
MEDIUM**

CLASSIFIED Advertisements



Advertisements in this section, 35 cents per word, each insertion, minimum 10 words, payable in advance

To be inserted under proper classification in September issue, copy should be in our office July 8th

September issue on sale August 1st

Popular Mechanics Magazine, 200 East Ontario Street, Chicago, Illinois

YOU'LL PROFIT

By reading and answering the classified ads in this section. Hundreds of opportunities to make and save money.

Mr. F. W. Johnson,
Popular Mechanics Magazine,
200 E. Ontario St., Chicago, Ill.

Dear Mr. Johnson: It is very hard to believe or convince anyone that a musical instrument ad would draw better in the Classified section of Popular Mechanics Magazine than it does in music magazines, but it's the truth. However! Since I have been advertising in the classified, reading it more carefully I can plainly see that this classified section is a wonderful buying guide for most anything, and with a tremendous circulation, an ad is bound to pull.

(Original letter on file in our office)

MANUTYPE CO.

AUTOMOBILES

FORD V-8's, 1934-1938; gasoline saving device. \$1. Walert Co., 3429 No. 10th St., Milwaukee, Wisconsin.

MIDGET Cars, parts, plans. Catalog dime. Derby Midget Cars, Woodstock, Ill.

TOOL For removing pointer from speedometer \$2.50. Ostrander Speedometer Ser., 1042 State St., Schenectady, N. Y.

1938 IGNITION Supercharger. Quick starting, wet or cold. Mileage, pep, power, less carbon, \$1.25. E. G. Sales Co., 321 Broadway, New York.

MIDGETS! Catalog—plan book, 10c. List 100 used motors, midgets, parts, 20c. Details free. Shipps Midgets, Box 543-H, Zanesville, Ohio.

MIDGET Racing book; facts for fans, builders, drivers; track sizes, regulations; pictures, specifications, working drawings. \$1.00 postpaid, \$1.15 C.O.D. Ray Kuns, Department 28, Madisonville, Cincinnati, Ohio.

BUILD Fast pumping air compressor from automobile motor. Description stamp. Instruction \$1.00. Tuck Garage, 73 Shirley, Pontiac, Mich.

REFINISH Your car. Instruction book treats all phases of painting and refinishing autos and trucks. Written for the man who wants to renew his own car, but covers also the business end of refinishing for the professional. \$1.65 postpaid. Popular Mechanics Press, Room (C38), 200 E. Ontario St., Chicago.

AUTO TRAILERS

BUILD The famous, low-cost Jim Dandy Cabin Trailer. Complete plans and instructions 50c. Plans to build the beautiful, streamlined Jim Dandy Cabin Cruiser, \$1.00. Trailer Builders Manual and catalog of trailer parts, supplies and equipment—over 100 interesting, illustrated pages, 25c. Order today. Satisfaction guaranteed. Trailer Supply Co., 411-A Jackson St., Wausau, Wisconsin.

POPULAR Mechanics "Family Trailer," complete illustrated plans for building in Shop Notes for 1937 only 50 cents postpaid. Popular Mechanics Press, Room (C38), 200 E. Ontario St., Chicago.

AUTO SUPPLIES AND EQUIPMENT

AIRLOCK Stops punctures, lengthens tire life. Fully guaranteed. One tire \$1.00, four \$2.50. Airlock Laboratory, 1460 Hollywood Ave., Chicago, Illinois.

SAVE Half! Guaranteed reconditioned truck and auto parts. All parts, all models, makes. Catalog free. General Auto, 7008-AA Cottage Grove, Chicago.

PLATING Outfits for auto parts. Connect to a battery. No tanks used. Free particulars and proofs. Gunmetal Co., Ave. J. Decatur, Ill.

TROUBLE Lamp, heavy duty, 50 foot, for garage, workshop, with guard, switch, reflector, hook, side outlet, 250 volt, 18 gauge wire, \$2.25 postpaid. Antwerp Trading Company, 102 Chambers St., New York.

MOTORCYCLES, BICYCLES, MOTOR SCOOTERS AND SUPPLIES

INSIDE Dealer prices. Overstocked, all models, Indians and Harleys. Rebuilt, guaranteed. Dime brings latest list. Crandall-Hicks, Boston, Mass.

ALLOY Pistons—Harley, Indian, Henderson, Excelsior, Cleveland. New and used parts for less. Cylinder grinding. Catalogue and wings pin 10c. Ballak, 1115 Chestnut, St. Louis, Mo.

REBUILT Motorcycles, all makes, new and used Harley-Davidson parts. Send 10c for bulletin. Western Harley-Davidson Distributors, 914 E. 15, Kansas City, Mo.

RECONDITIONED Motorcycles. New—used parts for all makes. Authorized Harley-Davidson dealer. Whitman Motorcycle & Supply Co., 405-9 Southwest Blvd., Kansas City, Mo.

SEND 15c For illustrated used motorcycle catalog. Bargains. Largest stock genuine Indian parts and motorcycles. Indian Motorcycle Sales, Kansas City, Mo.

MOTORCYCLE Bargains, lowest prices, bargain sheets for stamp. Motorcycle accessories, Rochester Harley Davidson Corp., 129 W. Main St., Rochester, N. Y.

ORDER Your Keen Power Cycles now! Real profit makers. Delay may cost thousands in future business. Live wire dealers wanted. Keen Manufacturing Company, Madison, Wis.

PARTS And accessories. Send 10c for Motorcycle Manual. Bootz, 622 East Grand, Des Moines, Iowa.

BUILD Your own motor scooter. We furnish parts, drawings. Literature dime. Comet Cycle Company, Box 3032, Madison, Wisconsin.

SAVE. Enjoy motor scooting. Economical transportation. Make your own from used or new parts. Plans one dollar. L. R. Bault, Spencer, Indiana.

AVIATION

HOW To fly. Send dollar for student's manual. Anderson Flying Service, City Airport, Detroit, Mich.

PROPELLERS For airplanes, fans, sleds, icesled blueprints. Catalog dime. Lorenzen Propellers, Niles, Michigan.

GET Into aviation. Air transport pilots get up to \$8,000 per year, mechanics \$2,500. Learn at this government approved school. Write for complete information. State age. Lincoln Flying School, 2004 Aircraft Building, Lincoln, Nebraska.

AVIATION Apprentices. Good pay—Big future. Write, immediately, enclosing stamp. Mechanix Universal Aviation Service, Strathmoor Station, Dept. E2, Detroit, Michigan.

AVIATION Needs men. Pilots, mechanics, draftsmen, sheet metal, positions open. Learn now. Free catalog. California Flyers School of Aviation, Dept. PMC-8, Los Angeles Airport, Inglewood, California.

LOOK Under models and model supplies for our new announcement. Johnson Airplane & Supply Co.

"GETTING Ahead in Aviation," for stamp. Meyer, Box 8, Hempstead, N. Y.

BATTERIES, GENERATORS, ETC.

EDISON Storage batteries for light-power systems. Non-acid. Odorless, fifteen year life. Five year unconditional guarantee. Bargains in complete lighting systems. Low prices. Free illustrated literature. "See-Jay" Battery Co., 82 Sterling Ave., Yonkers, N. Y.

WHOLESALE Prices automobile air cooled generators for cars and trucks. New and rebuilt. Wilt Electrical Co., 7829 So. Racine Ave., Chicago.

MAKE Slow wind generators. Model T. No rewinding. Instructions 50c postpaid. B. Brumelle, 199 Eastpike, Zanesville, O.

BUILD Wind light plant. Complete plans and valuable catalog 10c. Wind plant parts, welders, electric fences. LeJay Manufacturing, 447 LeJay Building, Minneapolis, Minnesota.

DIME Brings 6 different windcharger plans, price list. Partco, Box 82, Glendale, Calif.

PLATING Generators and motor generator sets. Write for information Hobart's new line electro plating equipment. Payments low as \$12.40 monthly. Quality machines, quick delivery guaranteed. Hobart Bros., Box M-884, Troy, Ohio.

FACTORY Rewound 110 volt a.c. generators, 175-10,000 watts. Also slow speed 6-110 volt d.c. generators for wind and water power plants. Sold for rewinding costs. Guaranteed. Monroe Mfg. Co., Box 3343, St. Paul, Minn.

EFFICIENT Alternator produces inexpensive city electricity from batteries, wind-charged. \$1.00 brings plans and guaranteed no middleman's profits through my agencies. High wattage plant costs approximately \$75.00. Harold Ramsey, Corning, Ohio.

EDISON Lifetime storage batteries for light and power. Eliminates acid battery diseases. Long guarantee. All kinds rebuilt generating plants, motors, and miscellaneous articles at bargain prices. Free interesting literature. T. Hawley Smith Co., Croton Falls, N. Y.

FREE Plans for wind plant with each Ford rewind slow speed generator at \$3.50 each. Plans only—10c. Wesco, Minneapolis, Minn.

ELECTRICAL SUPPLIES, EQUIPMENT

ULTRA Violet—Infra red. Dual ray health lamp. Two separate units in one. Promotes sun tan—vitamin "D." Automatic control. AC-DC current. \$3.90 postpaid. Details free. Beyer Mfg. Co., 4515-P Cottage Grove, Chicago.

ELECTRIC Pen, engraves all metals. 50c prepaid. Hudson Bros., East Syracuse, N. Y.

SAVE 25% On brand new nationally advertised $\frac{1}{4}$ " and $\frac{1}{2}$ " electric drills. Quantity limited. 15 Harper, Detroit, Michigan.

PERMANENT Magnet lifts 5 pounds \$1.00. Advance, 861P, Minneapolis, Minn.

VACUUM Cleaner bags 35 cents. Quantities less. Salesmen wanted. Perkiomen Co., Palm, Penna.

ELECTRO-SCRIBE: Electric pencil writes, engraves all metals. \$1.00 postpaid. Details free. Beyer Mfg. Co., 4515-K Cottage Grove, Chicago.

ELECTRIC Eye catalog and reprint "Photocell Experience in Factory" free for stamp. 32 page book "Electric Eye in Theory and Practice" 50c. Dept. 84, Photobell, 96 Warren Street, New York.

ELECTRIC FENCING

COMPLETE Electric fencer \$3.95. Guaranteed. Free circular. Electrofence Company, 1529 South Komensky, Chicago.

FENCE Controller easily converted from Ford "T" coil. No extra costs. Complete plans 35c. LeJay Manufacturing, 847 LeJay Building, Minneapolis, Minnesota.

WELDING AND SOLDERING

REBUILT Electric arc welders, all sizes, a.c.—d.c. guaranteed. Lowest terms. Money-saving prices. Service Co., 3732 Cedar Ave., Cleveland, Ohio.

ELECTRIC Welders, 110-220 volt, fan-cooled, can be used for hours, \$75.00. Box 331, Hamilton, Ohio.

COMPLETE Simplified blueprints of powerful \$89.50 welder. Uses 5/32" rod, 110 v., a.c., high, medium, low, welding heats. Send \$1.50. Marvelweld, Box 1156, San Francisco.

D.C. ARC-WELDER, 25-200 Amperes built from North-East (Dodge) automobile generators. Positively no armature winding. Guaranteed plans \$1.00 (money back if not satisfied) airmail or c.o.d. 12c extra. Welders Club of America, AB-3432 M-Mart, Chicago. Special! Earn money, spare time selling plans. Agents desired.

ELECTRIC Arc welder, only 22c a day! Sensational commonwealth all-purpose heavy duty, continuous operation arc welder. Ten months to pay from profits. Handles all welding—lightest sheet metal to heaviest castings. Operates from electric socket. Complete, nothing else to buy. 10-day trial. Details free. Commonwealth, Dept. L-55, Cincinnati, Ohio.

DEMONSTRATORS, Electric arc welders. Money-saving prices. Used by the government. Trial and terms guaranteed. Hobart Welders, M-882, Troy, Ohio.

D.C. ARC-WELDER, 25-600 Amperes. Build it yourself. Positively no rewinding. Use d.c. motors from battery driven electric trucks, conveyors, mules, etc. Guaranteed plans \$1.00. Welders Club of America, AB-3432, M-Mart, Chicago. Special! Agents desired.

ARC-WELDER From Dodge generator. No rewinding. Plans 25c coin. Monroe, Box 165, St. Paul, Minn.

IS There money in welding? Recent book gives valuable information showing welding is a growing field offering opportunity to anyone looking for a trade. \$1 postpaid. Popular Mechanics Press, Room (C38), 200 E. Ontario St., Chicago.

ENGINES, MOTORS, DYNAMOS

FOR Sale—Small elect. motors, high speed, 1/10 h.p., 115 volt, universal. Rebuilt—\$2.00 postpaid. McConnell, 1619 Edgewood, Racine, Wis.

GUARANTEED. Slightly used $\frac{1}{2}$ horse, 110 volt, alternating motors \$7.90. Wilnot Auto Supply, 2247 St. Paul Ave., Chicago.

BARGAIN— $\frac{1}{2}$ Hp. motors. 60 cycle, 1 phase, 110 volt, like new, guaranteed, \$8.25. Send check to Erie Electric Motor Co., 120 Church, Buffalo, N. Y.

WINDING Data, 225 motors, single and three phase. Price \$1. Motor Data Co., Box 7631, Kansas City, Mo.

MAKE Money, rewind washing machine motors, auto generators. Each book \$1.00, 10c coin brings particulars, catalog of winding materials, tools. Ernest Knight, LaSalle, Illinois.

ELECTRIC Shaver \$4.25; $\frac{1}{4}$ " drill \$3.67; 10" oscillating fan \$4.20; electric hand cleaner \$5.35; candid type camera \$3.98 postpaid. Home workshop tools. Bargain pricelist free. Mailorder Electric Company, 713 South Dearborn St., Chicago.

MACHINERY, TOOLS AND SUPPLIES

CONCRETE Building block machines and molds. Easy payments. Catalog free. Concrete Machine Co., 5 North Main St., St. Louis, Mo.

ATLAS Demonstrators, lathes, drill presses and accessories at big savings. 15 Harper, Detroit, Michigan.

SOUTH Bend 9" lathe milling attachment, universal movement, \$9; threading dial indicator, \$3; circular free. Unique Manufacturing Co., 4807 No. 31st Ave., Omaha, Nebr.

NEW "12 In 1" Shop Gage. Few of the features: Center finder, fractional diameters, drill point gage, plane and chisel bevel, screw diameters. Scales. Dollar prepaid with instruction. Herberts, 113 North McCamly, Battle Creek, Michigan.

MICROMETER Bargains, complete set, \$13.95 in case. Send for details. Micro Products, 529 E. Jefferson, Detroit, Mich.

USED Power tools, workshop equipment—direct owner prices. Buy or sell through our service. Latest lists, 20c. Toolisting, Box 581-H, Zanesville, Ohio.

MAGNET—Lifts 50 times its weight. Wonderful for repairmen, machinists, etc. Write for information. Robt. C. McCloy, Oreland, Penna.

TREMENDOUS Surplus of factory tools selling out. Drills, taps, files, hacksaws, etc. Send for free lists, include six cents postage. Travers Tool Co., 264 Jackson Ave., Long Island City, N. Y.

14" x 6" BRADFORD Cone head engine lathe, quick change. No. 0 Cincinnati miller, cheap. Write for particulars. Cincinnati Machinery & Supply Co., 221 E. Second St., Cincinnati, Ohio.

DRILL Presses, steam boilers, oil, gas burners. Wholesale price. Get circular. Peerless Machinery, 2020 E. 12 St., Oakland, California.

FORMULAS, Tool etching ink, belt dressing, gun oil. All \$1.00. Canaday, McCall, Idaho.

MICROMETER Pouch, 1" genuine leather, 20c postpaid. $\frac{1}{2}$ doz.—\$1.10. Granat Products, 1649 - 44th St., Brooklyn, N. Y.

WHOLESALE Prices: Tools, supplies, motors, speedreducers, pumps, gears. Catalog 10c. Kostka, 2348-G South Crawford, Chicago.

MOTOR Rails, silent, adjustable, vibrationless, fits $\frac{1}{4}$, $\frac{1}{3}$, $\frac{1}{2}$ h.p. electric motors. \$3.00. Specialty Mfg. Co., Los Angeles, Calif.

BARGAINS, Demonstrators, electric arc welders, guaranteed, 30 days trial and terms. Write Hobart Welder Exchange, Box M-883, Troy, Ohio.

COMPLETE Portable paint sprayer reconditioned with new gun and hose. \$12.50 while they last. 15 Harper Ave., Detroit, Michigan.

STRETCH Your dollar with Atlas Shop Equipment. Metal and wood lathes, drill presses, arbor presses, shapers, vises, motors, grinders, tools, and attachments. Send for new 1938 catalog. Atlas Press Co., 1718 N. Pitcher St., Kalamazoo, Mich.

BOATS, OUTBOARD MOTORS, ETC.

12-FOOT Flat bottom rowboat—complete plans 25c. Free boatbuilding catalog. The Rudder, 15 Murray St., New York.

FORD Marine conversion parts and kits. Models A, B, V8 (domestic or foreign). Catalogue 25c (coin). Osmithson, 3101 C Street, Philadelphia, Penna., U.S.A.

PROPELLERS, Gear pumps, stuffing boxes, bearings, etc. Wm. Baker, Pond St., Quincy, Mass.

FORD And Zephyr marine engines. Send 10c coin. Lehman Engineering Company, Newark, N. J.

ASSEMBLE Your own boat. Our finished knock-down frames and materials save you 2/3 builder's cost. All types and sizes. Send 25c for big catalog. Brooks Boat Co., Inc., D4, Saginaw, Mich.

OUTBOARDS—Save $\frac{1}{2}$. Good used parts, all makes and models. Bargains rebuilt motors. Crandall Hicks Co., 959 Commonwealth, Boston, Mass.

BOAT Designers are highly paid professionals. Complete course by mail. Catalog. Westlawn, Montville, N. J.

BUILD Your own boat—New book gives plans, methods, etc. 312 pages \$3. Popular Mechanics Press, Room (C38), 200 E. Ontario St., Chicago.

BARGAINS Manganese bronze hardware, snipes, moths, other small boats. List on request. Hampton, Room 230, 742 Market St., San Francisco, Calif.

KAYAK Construction kits. New designs in lightweight canvas kayaks and canoes. Nine to fifteen feet from \$9.95 to \$39.50. Also sold assembled. Mail dime for literature. Jamestown Specialty Co., Dept. P838, Titusville, Penna.

BUILD 12' Kiyak, two man capacity. Blueprint 35c. Ware Boats, New Egypt, N. J.

BUILD A boat. Everything for building or equipping a boat. Build a boat by the Welch system. Use Welch Ready Cut parts. Inexpensive; interesting and profitable. Send 10c for catalog showing boats of many types; boat hardware; Welch White Cap motors. Welch Boat Company, Station K-1, Milwaukee, Wisconsin.

BARGAINS In rebuilt outboard motors. Send stamp for list. Murray Boat Shop, Traverse City, Mich.

OUTBOARD Parts, reconditioned, new. Discount, new motors. Literature dime. Cramer's, 1500 N. Wells, Chicago.

SPORTING GOODS, GUNS, FISHING TACKLE, ARCHERY

TENNIS Strings, gut, silk, tendon at sensational reductions. Write for free samples and prices. Crescent, 2535 Patricia, Los Angeles.

TENTS, Factory to you. Catalog free. Willis Co., Everett, Mass.

FLY And leader materials and tools. 24 page list free. Casting and trolling catalog free. For 104 page general fly tackle catalog full of valuable dope send 3c. Paul Young, 8065 C-6 Grand River, Detroit, Mich.

HUDSON Bay blankets, Indian pack baskets, camp stoves, knives, compasses, outdoor equipment. Free catalog. Howe Fur Co., Box P, Coopers Mills, Maine.

BARGAIN Gun catalog, send 5c. Bargain tackle catalog, send 5c. J. Warshal & Sons, First and Madison-PM, Seattle, Wash.

KENTUCKIE Rifles \$5.00. Geo. Brulle-sauer, 3957a Castleman, St. Louis, Mo.

BOOMERANGS! Secrets of making and throwing. Interesting sport. Send 25 cents to Box 10, Schenectady, N. Y.

ROWING Revolutionized. New oarlock—Row facing bow of boat. Send for circular. Selleck, Box 743, New London, Conn.

COOK Outdoor meals with aluminum Picnik Grill. No firewood, only newspapers needed. Pans unnecessary. Folds 1"x12". \$2.00 postpaid. Wagner Manufacturing Company, Sidney, Ohio.

FENCING Equipment. Foils, swords, masks, etc. Low prices. Free catalog. Industrial Products, Dept. 28, 48 West 48th St., New York.

3,000 GOLF Clubs, bankrupt stock. Five club set \$2.50. Lincoln Surplus, 123 S. Galena, Freeport, Ill.

FIELD GLASSES, TELESCOPES, MICROSCOPES AND TELESCOPES

TELESCOPES, Microscopes, binoculars; 1938 bargain catalog free. Brownscope Company, 5 West 27th Street, New York.

FREE Instructions. Build powerful telescope. Atemsco, Box 213, Flushing, N. Y.

TELESCOPES, Binoculars, microscopes, 1938 bargains free. Hobby Man, Jefferson, Iowa.

TELESCOPES, Microscopes, chemistry, mineralogy. Scientific catalog free. Tracey Laboratories, Evanston, Illinois.

LENS Kit makes 3" diameter 25-150 power astronomical telescope. \$1.00 post-paid. Instructions lens list free. Optical Works, PM8B, Milton, Penna.

BUILD Reflecting telescope, 6" kit, \$3.50; instructions 10c, catalog free. Optical Labs, Larchmont, N. Y.

USED Microscopes, binoculars, astronomical telescopes—Bought, sold, repaired. Send 10c for list. Rasmussen, P. O. Box 294, Amsterdam, N. Y.

ANTIQUES, RELICS, INDIAN GOODS

100 GOOD Arrowheads \$3. Catalog, 5c. H. Daniel, Hot Springs, Ark.

100 GOOD, Or 60 fine arrowheads \$3.00. George Holder, Glenwood, Ark.

SWORDS, Rapiers, daggers, pistols, armor, curios. List stamp. Abels, 860 Lexington Ave., New York.

SIoux Model tepee! \$3.00 complete! Realistic. Spirit America, Chiefs, 1322 Chase, Chicago.

PREHISTORIC Tomahawk, arrowhead and spearhead \$1.00. List 5c. 100 good arrows \$2.50. Caddo Trading Post, Glenwood, Ark.

INDIAN Relics, beadwork, coins, curios, minerals, old glass. Catalog 6c. Indian Museum, Northbranch, Kansas.

LOOK—50 Assorted Indian relics \$2.00. Frank V. Linker, Danville, Penna.

TAXIDERMY

TAXIDERMY Supplies—Quality artificial eyes, teeth, genuine Jonas head forms. Tools, materials, etc. Everything for the progressive taxidermist. Send 10c for big illustrated catalogue. Jonas Bros., 1049 Broadway, Denver, Colo.

DOGS, PETS, BIRDS

BEAUTIFUL Pure white police dogs. Ansonia Kennels, Mose, N. Dak.

BEARLIKE Baby Saint Bernards! Dime brings photographic particulars, colored souvenir! Royal Kennels, No. 8, Chazy, N. Y.

PEDIGREED Newfoundland puppies. Protect your family. Earl Thurston, Hartsville, Indiana.

POULTRY AND FARM SUPPLIES

MAKE Money with poultry. Read America's leading poultry magazine for latest information. Three years \$1.00; nine months 25c. Poultry Tribune, Dept. E-93, Mount Morris, Ill.

SEYMOUR Chicks. A grade Barred, Buff, White Rocks, Reds, Wyandottes \$6.75, pullets \$8.95; cockerels \$6.40. Leg-horns \$6.25, pullets \$11.40, cockerels \$2.50. AA grade 1/2c per chick more. Seymour Hatchery, Box 36, Seymour, Indiana.

DAVIS Chicks for broilers and layers. 21 different breeds. Sexed chicks, poults \$2.50-100 and up. Free catalog. Davis Poultry Farm, Route 34, Ramsey, Indiana.

GREENSBURG Chicks, \$2.50 per 100 and up. Also sexed checks. Greensburg Hatchery, Box 40, Greensburg, Indiana.

TREES, SHRUBS, ROOTS, HERBS

JUST Out! World's greatest "Herballist Almanac." Beautifully illustrated in natural colors. Contains over 200 old-fashioned herb medicine recipes for home use. 10c postpaid. Worth dollars! Botanics, 145 W. 112th St., Chicago.

FARMS AND FARM LANDS

FARMS That pay in the Great Northern Railway agricultural empire. Minnesota, North Dakota, Montana, Idaho, Washington, Oregon. Fertile black soil, high production crops, grain, fruit, vegetables, feed and livestock. Many kinds of farms for selection. Write for book on state you prefer. E. C. Leedy, Dept. 757, Great Northern Railway, St. Paul, Minnesota.

WANT To hear from owner of property for sale or trade. Details free. Real Estate Salesman, Desk B, Lincoln, Nebr.

MONEY-MAKING 258 Acres, equipment valued at \$4500, including 28 cattle, 4 fine horses, farm machinery, valuable crops; attractive 9-room house, Grade-A barn 40x92; on improved road; \$10,300 complete, part down; page 38 free 2000-bargain catalog. Strout Realty, 255-P 4th Ave., New York City.

40 ACRES. Near White River, unimproved; poultry land. \$175, \$5 down, \$5 monthly. Free list and literature. Hubbard, 216 Grossman Bldg., Kansas City, Kans.

CANADIAN Tax sale lands for a dollar an acre and up. Small monthly payments. Farms, timber, hunting and fishing camps, minerals. Limited number of properties. Write at once for free illustrated booklet. Tax Sale Service, Room 613, 72 Queen St. W., Toronto, Canada.

GOOD Farms available. Washington, Minnesota, Idaho, western Montana, Oregon. Dependable crops, favorable climate. Write for impartial advice, literature and list of typical bargains. Specify state. J. W. Haw, 119 Northern Pacific Ry., St. Paul, Minn.

PROFITABLE OCCUPATIONS

WE Start you in business, furnishing outfits and instructions, operating Specialty Candy Factory home. Men and women, earn \$25 up to \$60 weekly, all or spare time. (Our 29th year.) Booklet free. W. Hillyer Ragsdale, Inc., Drawer 62, East Orange, N. J.

RAISE Rabbits and cavies for us. We buy at top prices. Complete details in catalog, contract and magazine. 10 cents. Stahl, Box 1, Holmes Park, Mo.

FREE Booklet describes 107 plans for making \$20-\$100 weekly, in home or office, business of your own. Elite Co., 214 Grand St., New York.

COUNTRY Drives or movies afternoons! Work mornings home. No canvassing! Folio-H, Station D, Los Angeles.

RAISING Jumbo frogs. Interesting. Big future. Females lay 10,000 eggs. Free literature. American Frog Industries, Box 336, Rayne, La.

M. M. earned \$267, three weeks, raising mushrooms in cellar! Exceptional, but your cellar, shed perhaps suitable. We buy crops. Book free. United, 3848 Lincoln Ave., Dept. 70, Chicago.

"RAISE Frogs!" We buy! Good prices year round. Small pond starts you. Free book shows sketch. American Frog Canning, (153-R) New Orleans, Louisiana.

WEDDING Invitations, stationery, cards. Samples free. Sharra, 325 Atwood, Pittsburgh, Penna.

205 "RECESSION Plans"—best opportunities making \$25-\$75 weekly, today's conditions. Particulars free. Stamford, 844-F Riverside Drive, New York.

GROW Pearls—Make gold, in bedroom. Postal brings information. Scientific Publishers, Woodside, New York.

POSITIONS At sea. Literature free. No employment agency. Julius, Amarillo, Texas.

MINK Raising is fun and highly profitable. Particulars. Empire Mink, Scarsdale, N. Y.

BOOKS, PERIODICALS, PICTURES, POSTCARDS

ANY Book in print. Booklet announcing current new books on request. Stenger's, 203 S. Dearborn, Chicago.

YOUR Favorite magazines—Half price. Catalog, 10c. Magazine Exchange, Baseline, San Bernardino, Calif.

MAGAZINE Subscriptions. Attractive club prices. Castellazzo, 3717 Redwood, Oakland, Calif.

RED Grange will send you an autographed copy of his great football book, "Zuppke of Illinois," for \$2 postpaid. Mail your order and remittance to Popular Mechanics Press, 200 E. Ontario St., Chicago.

WATCHMAKING "Practical Benchmark for Horologists" tells in plain language principles of adjusting and repairing watches, making parts, setting jewels, using delicate equipment. 346 pages, 438 illustrations. Price \$5.00. Horology, 747 S. Hill St., Los Angeles.

FREE Catalog scientific, mechanical and technical books. Readers Service, 800-2 North Clark, Chicago.

FUR Farming—Profitable business. 60c book, now 25c. Fur Farms Publishing Co., Karcade, Utica, N. Y.

GAMES—ENTERTAINMENT

CARNIVAL Games make you money. Outfits supplied. Illustrated literature 10c. "Moore-Made," LaPeer, Mich.

PLAYS, Operettas, musical comedies, complete minstrel first-parts with song programs, blackface skits, vaudeville acts, monologs, dialogs, recitations, juvenile plays and songs, musical readings, entertainments, make-up goods. Catalog free. T. S. Denison & Co., 203 N. Wabash, Dept. 11, Chicago.

BE The first in your neighborhood to play croquol. Directions for construction 50c. Paul Daniels, 3155 Estara Ave., Los Angeles.

BINGO Games make money everywhere. Catalog free. Warwick Bingo Co., Conimicut, Rhode, Island.

MAGIC TRICKS, PUZZLES, JOKER NOVELTIES

JUST Off the press! Our large catalog of magic for everyone. From the beginner to the professional magician. Send 25c for your copy. Chicago Magic Co., 2300 N. Mason Ave., Chicago.

SVENGALI Magic decks, magic, magic cards, joker's novelties, puzzles. World's largest manufacturers. Catalog describing 300 items free. Adams Company, Ashbury Park, N. J.

EARN Money in any crowd. Call names of strangers, tell unspoken questions. Professional course mind reading, spirit writing, etc., \$1. Henderson, Box 341, San Bernardino, Calif.

LEARN Ventriloquism, 3c stamp brings particulars. Smith, 125 N. Jefferson, Peoria, Ill.

MAGIC Catalogue, latest tricks, 10c. Frank Lane, Little Bldg., Boston, Mass.

LOOK! Giant wonder catalog of latest novelties, tricks, jokes, puzzles, magic, curiosities 25c. Lawson Vick Co., Queens Village, N. Y.

FREE. Magic catalog escapes, novelties, illusions. Oaks Magical, Oshkosh, Wis.

WORLD'S Largest magic shop professional catalog, 25c. Holden, 220 W. 42nd St., New York.

"WHAT Man Knows About Woman." A big laugh! Satisfaction guaranteed! Send dime to L. C. Bureau, 104 Elmwood Ave., London, Canada.

BE A magician. Large professional magic catalogue of latest tricks 25c. Cash paid for complete Tarbell magic courses. Write, Ireland, C-109 North Dearborn, Chicago.

RARE COINS

UNITED States commemorative \$1's, five different, \$5.00. S. Koepfel, Merritt Bldg., Los Angeles, Calif.

UNITED States coins at bargain prices. 2c piece and newest 1938 selling price list 10c. Em. Cohen, Box 3507, Cleveland, Ohio.

COMMEMORATIVE Half dollars, Lincoln, Stone Mountain, Oregon, Texas, Cleveland, Kentucky, San Diego, Long Island, \$1.50 each. Illustrated catalogue No. 14, 25c. Norman Shultz, Salt Lake, Utah.

FREE! Foreign coin, banknote, and large illustrated coin catalogue. Send 4c postage. Coin approvals sent. Tatham Coinco, Springfield-125, Mass.

GET Profit and pleasure in collecting old coins. Send 10c for 56-page illustrated coin catalog. You'll be delighted with it. Send for it now. B. Max Mehl, 370 Mehl Bldg., Fort Worth, Texas. Largest rare coin establishment in U. S. Established 38 years.

\$5 TO \$500 Each paid for hundreds of old or odd coins. Keep all until posted. Many very valuable. Send 10 cents for illustrated Coin Value Book, 4x6. Guaranteed buying and selling prices. 31 years in business. Coin Exchange, Box 5, Le Roy, N. Y.

RARE U. S., foreign coins, war medals. Catalogue 10c. Mengelle, Colorado Springs, Colo.

UNITED States. Large cent, 2c bronze, 3c nickel and bargain list, 25c. Eleven dates large cents, \$1. George P. Coffin Co., Augusta, Maine.

WANTED To buy. Commemorative half dollars. Other commemorative issues. L. W. Evans, 1816 E. 75 St., Kansas City, Mo.

25 DATES Indian head cents \$1. Stamp brings selling price list. Ramsay, 224 W. Market, York, Penna.

MONTHLY Coin bargains 10c. No cheap material. W. Webb, Westminster Road, Rochester, N. Y.

FINE Foreign 1700 coin, 2 notes and catalog 10c. Geo. Best, Cedar Rapids, Iowa.

OLD Money wanted. Do you know that coin collectors pay up to \$100.00 for certain U. S. cents? And high premiums for all rare coins? We buy all kinds. Send 4c for large coin folder. May mean much profit to you. Numismatic Co., Dept. 20, Fort Worth, Texas.

LINCOLN 1909 Cent and price list 10c. Eugene Morrison, Culver City, California.

NEW. Old money wanted. Send dime for latest buying booklet. 1½c for selling list. A French, R. D. 1, Troy, N. Y.

BIG Prices paid for certain wanted coins. 1909 cent \$10.00, some silver dollars \$4000, 1864-1865 Indian head cents \$100.00 each, dimes before 1895, \$600; liberty head nickels before 1914, \$500; encased postage stamps; some large pennies \$2000; half cents, \$275.00; paper money, gold dollars \$1500, foreign coins \$165, some worth \$6000 each. You may have coins for which we pay big premiums. Therefore send 15c today for 1938 big illustrated coin book for certain wanted coins. National Coin Corporation (80), Daytona Beach, Florida.

STAMP COLLECTING

PICTORIAL Set six, 10c. Ten others free. Robert, 6864 Irwin, Montreal, Canada.

FREE Collection—25 different Portugal—for correct names and addresses of 3 active stamp collectors. Reimers, 100 Flatiron Bldg., Ft. Worth, Texas.

FINE Approvals, freshly filled books. Tell me the countries you prefer, and I will send just what you want. Milton Skinner, 306 East Fourth, Long Beach, Calif.

MEMBERSHIP Card free—The James Lee Stamp Club, 210-A North First Street, Phoenix, Arizona.

U. S., Canada, Newfoundland, Mexico: "Four Star approvals." Nothing like them! Write today. 312 mixed U. S. only 10c. Kessels, Tucson, Arizona.

FREE Set with penny approvals. Irvin's Stamp Mart, 3361 Milwaukee, Chicago.

FREE Dollar packet to approval applicants. Harlan, 5307 South Marshfield, Chicago.

SUMMER Sale. Usual dime packets now 7c. Examples—5 Armenia, 5 Mongolia, 5 Nyassa, 5 Eritrea, 5 Porto Rico, 6 Kenya, 7 Iraq. Reimers, 150 Flatiron Bldg., Fort Worth, Texas.

CANNON! Set of stamps showing cannon, firing squad, cavalry charge and 200 other different stamps, only 10c to approval applicants. L. H. Reich Stamp Co., 4647 Kenmore, Chicago.

FREE—\$1 U. S. stamp with request for 52 page list of United States and foreign stamps. Stamps on approval. References necessary. 1 lb. U. S. mixed with one U. S. coin before 1850, 50c. New Hussman Stamp Co., 1122 Pine, St. Louis, Mo.

NEW Rivera nude stamp! World's largest triangle! Congo, Sudan, South Seas, bicolors, pictorials and many others. Only 3c with approvals. Cactus Junior Approvals, Box 1870-B, Tucson, Arizona.

AT 1/10 Catalog, U. S., British Colonies. Meyerowitz, 1756Y 70 Street, Brooklyn, N. Y.

FREE. U. S. \$1, \$2, \$4 and \$5 stamps. Unbeatable U. S. approvals. Nelson, 78 E. 5th St., St. Paul, Minn.

FREE—The Stamp Finder! Our new 24 page edition, fully illustrated, which will enable you to instantly identify all difficult stamps. Also fine packet of odd and unusual stamps from Bosnia-Herzegovina, Monaco, Patiala, Cyprus, etc., including maps, ships, animals and strange scenes. All free to approval applicants inclosing 3c postage. Garcelon Stamp Co., Box 900, Calais, Maine.

NEW Irish souvenir stamps. A set of beautiful and interesting souvenir stamps has been issued by Irish Hospitals' Trust Ltd. A specimen sheet of 24 of these stamps may be obtained free of charge on applying to Dept. P.M., Mr. J. O'Sheehan, 28 Earlsfort Terrace, Dublin, Ireland.

FREE! Two coronation sets. Postage 3c. Roberts, 312P Shearerblg, Bay City, Mich.

4½ TRIANGLES! Guatemala bisect (diagonal half-stamp), beautiful Liberia, three additional triangles, 27 other stamps, 5c. Abell Co., 1818 St. Paul, Baltimore, Md.

GIANT-SIZED Russian zeppelin stamp, cat. val. 20c, and beautiful Lithuania air mail triangle; also big packet of 53 different stamps including Azerbaijan, Epirus, new Martinique, etc., and illustrated lists, all for 5c to approval applicants! World-Wide Stamp Co., Box 600, Camden, New York.

UNITED States—45 different, perforation gauge, hinges, bargain pricelist—all for 10c. Seidenberg, Baroda, Mich.

DIAMOND-SHAPED Stamp, Liberia gunboat triangle, two other triangles, silver jubilee, 27 others, 5c. Crowder Co., 127E North, Baltimore, Md.

LIBERIA Snake triangle, giant Spanish triangle, 50 other stamps, 5c. Wright Co., 2527 Guilford, Baltimore, Md.

ILLUSTRATED U. S. list, price 50c, large complete U. S. price list free. Send postage. Stanley Gibbons, 38P Park Row, N. Y.

PENNY Approvals that please. Haywood, 395 Adams St., Pomona, Calif.

FREE! Triangle airmail! Coronation! Pictorials! British Colonies! Wonderful packet 110 different, 5c to approval applicants. Bargain Co., Box 39P, Times Square Station, New York.

PANAMA Triangle and 50 others free to approval applicants sending 3c postage. Tatham Stampco, Springfield-30, Mass.

300 DIFFERENT Stamps 20c; 600, 50c; 1000, \$1; 2000, \$3; 3000, \$7. Fred Onken, 630 79th St., Brooklyn, N. Y.

FREE! "United States and British North America"—our valuable, complete, illustrated, 64-page catalog quoting lowest prices. Big illustrated list of foreign stamps also included. H. E. Harris & Co., 137 Transit Building, Boston, Mass.

QUEEREST Stamps packet. Receive one of world's smallest stamps; scarce Vatican City; Greek Red Cross (coiled snake in Garden of Eden!); Manchukuo; Soruth (mountain lion); Mozambique (giraffe); Palestine; many others. Also big packet 25 dif. Japan, (including earthquake stamp!) and pkt. 15 dif. China. Everything for only 5c to approval applicants! R. M. Stamp Co., Box 330P, Port Chester, N. Y.

50 DIFFERENT. Fine U. S. including perforation gauge, 10c with approvals. The Stamp Shop, 809 Holland Bldg., St. Louis, Mo.

200 DIFFERENT 10c. Big 50% approvals. Covert Stamp, 39 State, Rochester, N. Y.

FREE! 110 Different stamps to approval applicants. 3c postage. Zephyr, 5124 George, Chicago.

STAMPS. A superb selection sent on approval. Quality at low prices. Fred Herzberg, Box 91-P, Elmhurst, Ill.

50 DIFFERENT British Empire including jubilee, Edwards, 50 different new, recent and pictorial world issues, 15 different airmails, 500 hinges, perforation gauge, all for 25c. Approvals sent. Lists free. Victoria Stamp Co., London, 4, Canada.

BRAZIL, 50 Different 10c with bargain approvals. Davis, Silver Lake, Ind.

ASK For our wonderful one cent approvals. Prospect Stamp Co., 225 Broadview, Toronto, Canada.

WHOLESALE Catalog for dealers. Illustrated. Postage 5c. Frank Co., 4900 Chalmers, Baltimore, Md.

PENNY Approvals, that satisfy. Neil Gronberg, Box 5441-P, Philadelphia, Penna.

30 DIFFERENT Angola, Cape Verde, Guinea, Portugal, Mozambique, St. Thomas and Prince 5c. Approvals. Depraw, Ocean Park, Calif.

STAMP Dealers, your ad here will bring wonderful returns. Ask me for proof. F. W. Johnson, Manager, Classified Advertising, Popular Mechanics Magazine, 200 E. Ontario St., Chicago.

APPROVAL Sheets. One to three cents. Frederick B. Driver, 2009 Finance Bldg., Philadelphia, Penna.

25 UNITED States, including \$4 and \$5 stamps free to approval applicants. 3c postage. Brownie Stamp Shop, Flint, Mich.

FOREIGN First day covers direct to you: Holland throne ascension 30c, Suriname throne ascension 30c, New Zealand health 18c, Swiss miniature 75c, Tscherner, Columbia Street, Farmingdale, New York.

PRODIGIOUS Gift! Fantastic Indo-China, German state, savage Somalicoast, Perak, Selangor, Negri Sembilan, bicolored Banana airmail, Siberia—Absolutely free with approvals! Postage 3c. Saxon Co., 408-a Jay St., Brooklyn, N. Y.

STAMP Annual free: Describes and illustrates albums, supplies, United States, coronations, British Colonials, Canadians, foreign stamps. This fifty-page catalogue free. Gray Stamp Company, Dept. P.M., Toronto, Canada.

NEWFOUNDLAND 50 Mixed, including jubilee, coronation, Gilbert, and mint set royal family, new issue \$1.00. L. P. Moss, Deer Lake, Newfoundland.

FREE—3 Months subscription to Hobby Reporter to approval applicants sending 5c to cover postage. Mayfair Stamp Co., 71 Union St., Lynn, Mass.

UNITED States approvals. Want lists solicited. Donald Unger, Columbus, Ind.

DIAMOND Shaped air mail—Big packet 105 all different, including air mail, commemoratives, Congo, Epirus, Manchukuo, etc.; set of two ex-King Edwards and Costa Rica diamond shaped air mail; scarce U. S. telegraph, cat. 30c; pkt. British Colonies—Gwalior, Hyderabad, Silver Jubilees; big lists. Everything for 5c to approval applicants. Send today! Mystic Stamp Co., Dept. 80, Camden, New York.

1897 GRANDE Comore Island, Liberian Bongo antelope, rare old genuine Baden, Turks Caicos, \$5 U. S., British Colony map stamp, etc. Everything 3c with approvals. Viking, 1-Z Hanson Place, Brooklyn, N. Y.

EARN Money selling postage stamps as our agent. Send \$1.00 deposit and receive our stamps and plan. Bargain Co., Box 39, Times Sq. Sta., New York, N. Y.

FREE! 127 Different stamps, 3c with approvals. Kirst, 1550A Carroll, St. Paul, Minn.

\$1.00 PACKET Free! Enclose postage, request approvals. Secrist, Muscatine, Iowa.

3 GIGANTIC Multicolored Constitution airmails only five cents with approvals. Tillotson, Pearsall, Texas.

103 ALL Different U. S. postage 38 cents postpaid with Arkansas stamp. Jungkind, Box 806-8, Little Rock, Ark.

500 MIXED Foreign 10c with approvals. Hecht, Belle Plaine, Iowa.

FOUR Mint five colored Ecuador Constitution stamps 5c with approvals. Wright Philatelic, Box 611, Kansas City, Mo.

EXTRAORDINARY! Free collection! Azerbaijan, Belgiancongo, Tanganyika, including approvals. Rosenberg, Miller, Indiania.

WEEKLY Stamp magazine, thirteen weeks, 10c. Stamp Journal, Kalamazoo, Mich.

100 DIFFERENT Stamps with mint air set only 5c to approval applicants. Leo, 833 North Martel, Los Angeles, California.

EXCHANGE—Send 200 mixed United States—Receive 200 different foreign. Grampp, 441 Highgate, Buffalo.

100 U. S. 1870-1907, 25c. Coe, Box 775, Ponca City, Okla.

DIME Brings Costa Rica's imperforate triangle block; lists. Win Burbank, Hanover, N. H.

CURACAO Airmail, scarce, 3c to approval applicants. Leduc, Saint Petersburg, Florida.

Try Money saving 1½c approvals. Omans, 642 Broadway, St. Paul, Minn.

FREE: \$1 U. S. stamp with approvals. Leader, 1550 Seward, Detroit, Mich.

1½c APPROVALS. Big values! Others. Harne Co., Box 1645, Portland, Maine.

FREE! Fifteen Canada, with approvals. Atkinson, 2273 Souvenir, Montreal, Can.

EXCHANGE Stamps, postcards, Universe. "Exchangers." Bry 226 pres, Paris, France. Particulars free.

SUMMER Bargain approvals. Y Stamp Company, Box 107, Port Chester, N. Y.

SWEDEN. Buy direct from abroad. Sensational set. Send \$1 to S. V. I., Box 5008, Stockholm, Sweden.

U. S. Byrd No. 733! 10 different maps, 10c; approvals. Brown, 1 Marble Hill, New York.

BEST One cent approvals in America. Elvin Stanton, Niantic, Conn.

BEGINNERS—1½c To 3c approvals. Free packet. Billys', 2542 - 42 Street, Long Island City, New York.

OPPORTUNITY Stamp surprise packet, dime. Robert Stine, Louther, Carlisle, Penna.

ECUADOR'S U. S. Constitution issue. Six different mint, ten cents. Approvals. Nacado Stamp Co., Box 4229, Washington, D. C.

NINE Airmails from Syria, Guatemala, Lebanon, etc., and others from Oceania, Manchukuo, Kenya, 5c to approval applicants. Barker, Box 448-A, San Francisco.

FREE! Trial four months' subscription! 3c postage. "Stampist," Hyndman, Penna.

APPROVAL Sheets, 1 to 3 cents, and sets. Try mine. Dorothy Leuch, 308 W. North Ave., Milwaukee, Wis.

500,000 STAMPS! General line approvals. Where? Petersen's, Box 300, St. Paul, Minn.

WANTED: All stamps. Highest prices. Philatelic Service, 116 Nassau Street, New York City.

U. S. Commemoratives, 25 different 10c. C. F. Siegel, 2213 North 31 Street, Milwaukee, Wis.

BRITISH Colonies included—100 from fifty different countries, 10c. No approvals. Elsea, Bowling Green, Ohio.

UNITED States approvals! Reasonable prices! Service! Box 822, Minneapolis, Minn.

25 DIFFERENT Canada 3c to approval applicants. Maynard Sundman, D95, Bristol, Conn.

UNPICKED! 100 U. S. Revenues on documents—10c. (1,000—60c). Vanvoorhis, Hyndman, Pennsylvania.

SPECIAL Offer—100 assorted Canada 25c. Wynn Stamps, London, Canada.

FOREIGN Coin, 15 Egypt stamps, 10c. Fanter, 5452 Robin, St. Louis.

222 DIFFERENT, Cat. value \$4.50, dime with approvals. Lockwood, Postal Box, Muskegon, Mich.

15 AIRMAILS 7c. U. S. airmail approvals. George Davis, Webster, Mass.

HOBBIES AND COLLECTIONS

UNUSED Book match covers, 100 all different, \$1.00. Free list. Charles Edelman, 1311C East 84, Cleveland, Ohio.

PHOTO FINISHING

EXPERT Photo finishing. One day service. 8 genuine expensive Velox prints, two double weight professional enlargements 25c. Expert Studios, LaCrosse, Wis.

12 HOUR Service. Roll developed, printed, your choice two 6x8 Platesunk enlargements, one enlargement colored or etched or 8 reprints for 25c coin. The Artists, Box 230F, Minneapolis, Minnesota.

ROLLS Developed, 8 prints on Velox, 25c. Deluxe enlargement in 8" lock easel frame, 39c. 3 for \$1.00. Photoshop, Box 218, Augusta, Ga.

FILMS Developed, 16 prints, 2 enlargements, 25c. Truefoto, Dept. 30, Des Moines, Iowa.

QUICK Service—Rolls developed, 8 guaranteed prints; 2 enlargements; 25c coin. OK Photo Service, Ottawa, Kansas.

ROLLS Developed and printed 10c. Trial. Quality Finishers, Maywood, Ill.

RECOGNIZED As a leader for high quality and better service. Do not be misled. It is easy to copy a name but hard to meet our superior quality. Roll developed, 8 guaranteed glistening prints and 2 enlargements 25c. The old reliable American Photo Service, 2946M Nicollet, Minneapolis, Minn.

SAMEDAY Service: Roll developed, 8 glistening prints, 2 enlargements—25c. Midwest Photo, B-54, Janesville, Wis.

MAKE Photography Pay. New book. \$1.00. Popular Mechanics, 200 E. Ontario St., Chicago.

ROLLS Developed, 8 prints, 2 enlargements, 25c. Mayfair, Box 261-K, Toledo, Ohio.

SNAPSHOT Folder with every roll developed, 8 prints, painted enlargement—25c. Reprints 3c. Fast service. Janesville Film, A-54, Janesville, Wisconsin.

PROMPT Service—Quality work; 2 beautiful double weight gloss enlargements, 8 guaranteed neverfade prints each roll, 25c. Excel Photo Service, Dubuque, Iowa.

SNAPSHOTS In colors—Roll developed, 8 natural color prints—25c. Natural color reprints—3c. Amazingly beautiful. Natural Color Photo, C-54, Janesville, Wis.

WILLARD'S Gives your pictures a beauty treatment—they're clear, brilliant, full of life. Roll developed, 2 prints each negative 25c. Enlargement coupon. Willard's, Box 3535-A, Cleveland Heights, Ohio.

ROLLS Developed and printed with two hand colored enlargements, 25c. Colorgraph, Dunning Station, Chicago.

TWENTY Reprints 25c. Roll developed and two prints each negative, 25c. Mail orders only. Star Photos, 109 N. Dearborn, Chicago.

ROLL Developed, 16 guaranteed prints 25c. Smart Photo, Winona, Minnesota.

GUARANTEED. Film developed, 16 prints 25c. 20 prints 25c. Quality Photo, Hutchinson, Kansas.

BE Convinced—Globe photos are unexcelled. 8 Duo-Tone prints, 2 5x7 enlargements. Send next roll 25c coin to Globe Photo Shop, La Crosse, Wis.

PROMPT Service, guaranteed work. Two beautiful portrait type double weight enlargements, eight neverfade gloss prints, each roll 25c. Dubuque Film Service, Dubuque, Iowa.

ROLL Developed and 8 guaranteed prints including two enlargements, 25c coin. Super Snapshot, Winona, Minnesota.

FILMS Developed. Two beautiful glossy, double weight, professional enlargements and 8 prints all for 25 cents coin. Reprints 3 cents. Dependable quality and service. Allied Photo Service Company, Drawer 289 I, Sparta, Wisconsin.

LATEST In photo finishing. Miniature rolls developed and printed 3x4—5c each print. Radio Film, LaCrosse, Wisconsin.

PROMPT Service! Rolls developed, two Velox prints each negative 25c. Hensch Studios, Harrisburg, Penna.

GET The best. Roll developed, beautiful hand colored enlargement, 8 neverfade border prints, 25c coin. Prompt service. Sun Photo Service, Drawer T, St. Paul, Minn.

TWO Prints each with every roll developed, 25c. Very finest quality. Reprints 2c each. Brown Photo Company, 1910-34 Emerson, Minneapolis, Minnesota.

ROLLS Developed, two sets prints plus enlargement coupon 25c. Reprints 3c. Over 19 reprints 2½c. Jones Studios, Davenport, Iowa. "Where the West Begins."

ROLLS Developed, 2 prints each and 2 free enlargement coupons, 25c; reprints, 2c each; 100 or more, 1c. Summer's Studio, Unionville, Mo.

ROLL Developed and 8 beautiful Velox glossy prints 25c coin or stamps. Reprints 3c each. Fotoprint Service, Box E, Roanoke, Va.

FINER Finishing. Rolls developed and printed, with one colored enlargement, or two professional enlargements. All for 25c (coin). Genuine, nationally known, Moentone superior quality. Moen Photo Service, La Crosse, Wis.

TWO Glossy enlargements, 1 colored with roll 25c. Arbor Service, 10, Joliet, Ill.

ROLLS Developed—Two new Beautitone Dubiwater professional enlargements, 8 guaranteed fadeless Beautitone prints, 25c. Giant Snapshots, Inc., 667A, Green Bay, Wis.

FOR The discriminating amateur, roll developed and carefully printed 25c, reprints 3c. Superior workmanship, same day service. Paramount Co., 327 E. 92nd St., New York.

ROLLS Developed. Two beautiful 5x7 enlargements and 8 guaranteed never fade perfect tone prints, 25c coin. Write for price list. Elgin Photo Service, Box B-164, Elgin, Ill.

5x7 ENLARGEMENTS 10c. 12 For \$1.00. Rolls expertly developed, carefully printed 25c. 24 hr. service. Proposition for free developing and printing mailed with order. Photo-Craft, Box 670d, Canton, Ohio.

ROLLS Developed—One print and one enlargement of each exposure 25c. Trial. Reprints 20 for 25c. Henry, 25 River Grove, Illinois.

PHOTO Mill. Immediate service! No delay! Roll developed, carefully printed and choice of two beautiful 5x7 double weight professional enlargements, one tinted enlargement, or eight reprints—for 25c coin. The Photo Mill, Box 629-12, Minneapolis, Minnesota.

ROLLS Developed, 8 prints, 25c coin. Reprints 3c each. Give us a trial and note detail high gloss. M. S. Photo Service, Box 107, Massillon, Ohio.

MILLIONS Now know "Hollytints Means Better Prints." Two professional enlargements with trial roll—25c. Fascinating premiums. Unequaled service. Hollytints, P-1350, Hollywood, California.

YOUR Favorite snapshot colored, 10c coin and stamp. Elite Service, P. O. Box 482, Oak Park, Ill.

IMMEDIATE Service! Better pictures. Sixteen guaranteed prints from roll, 25c. One colored or two plain enlargements and 8 guaranteed prints 25c. Sixteen reprints only 25c coin. Candid rolls developed free—prints enlarged to 3x4, only 4c each. Pictures sent back same day film is received. American Studios, Box B, LaCrosse, Wis.

20 REPRINTS 25c. 100 Reprints \$1. Roll developed with 16 prints 25c. Newtowne, 4, Maywood, Ill.

MAIL Your rolls to film center of the world. Any 6 or 8 exposure roll developed and printed 25c coin. DeLux enlargement coupon free! Photo Finishing Shop, Est. 23 yrs., 411-X Genesee Valley Trust Bldg., Rochester, N. Y. "The Camera City."

8 ENLARGEMENTS (Instead ordinary prints) per roll for 25c. Hilo, Yale, Okla.

ROLL Developed, eight highest quality Velox prints, wide paneled borders, de luxe album, two valuable enlargement coupons, premium catalogue, all 25c. Knickerbocker Fotos, 129 West 27th, New York City.

HAVE Modern service. Modern quality. Modern prices. Our modern methods give quick service and bright guaranteed neverfade pictures. Roll developed, 16 prints, 25c, coin; 16 reprints, 25c. Enlargement coupon. Send next roll or reprint order to The Modern Finishers, St. Paul, Minnesota.

ROLL Developed, Hi-Glare-Tone prints, Deckle-Edge-Craft enlargement included, 25c. Illinois Foto, G-3125 Milwaukee Ave., Chicago, Illinois.

ROLL Developed and printed. Two enlargements, one of them in colors, all for 25c coin. The Photo Finisher, Station E, Box 42, Columbus, Ohio.

FILMS Developed, 2 prints of each 25c. 20 reprints 25c. Pine Photo, M-5134 Nevada, Chicago.

FREE Album and negative file and 2 enlargement coupons with each roll developed, 8 guaranteed prints 25c. Memrlane Studios, General P.O. Box 666, Dept. P, New York.

IDEAL Photo. 25c per roll, finished with round corner prints. Coupon and snapshot folder free with initial order. Ideal Photos, Box 2255, Paterson, N. J.

LARJAROGRAPH Finishing. Five 5"x7" enlargements 25c. Miniature films developed 10c. Enlarged prints 2½"x4", 2½c. Cardinal Photoers, Summit, N. J.

BEAUTIFUL Oil colored enlargement, in deluxe frame, with each roll developed 25c coin. Speedy service. Rainbow Film Service, LaCrosse, Wis.

FREE—4 Big enlargements, 8 prints every roll 25c. 20 reprints 25c; 100, \$1.00. Filmco, Albany, Wis.

DEVELOPING And 8 beautiful double deckle gloss Velox prints, 5x7 enlargement, 25c, guarantee no fade. Elkhart Photo Service, Elkhart, Ind.

35MM. ROLLS Developed and good shots enlarged to 3½"x5". 36 exposures \$1.00. 18 exposures 60c. Ideal Films, Birmingham, Ala.

20 REPRINTS 25c. Films developed, 16 prints 25c. Enlargements 8x10—25c; 5x7—10c. Low Photo, M-2657 Neva, Chicago.

PHOTO Mill. Immediate service! No delay! Roll developed, carefully printed and choice of two beautiful 5x7 double weight professional enlargements, one tinted enlargement, or eight reprints—25c coin. The Photo Mill, Box 629-12, Minneapolis, Minnesota.

BEST Quality 6-8 exposure 20c. Brown, Box 198D, Niles Center, Illinois.

CAMERAS, PHOTO SUPPLIES

CAMERAS—Shutters repaired. Leather bellows installed in folding and view cameras. Bellows made to order. United Camera, A-1515 Belmont, Chicago.

BASS Unusual quality values: Half or full V. P. Dolly, Corygon F:3.5 lens. Compur shutter, new, \$23.75. 2¼x3¼ Zeiss Volta F. P. and P., F:6.3 lens, automatic shutter, F. P. A. and holders, \$12.50. Sport DeFranne, full or half 2¼x3¼, F:3.8 Anastigmat with carrying case, \$29.75. Dollina II, coupled range finder, Radionar F:2.9 lens, Rapid Compur 1/500th shutter, \$49.75. Argus, F:4.5 lens, \$12.50. Above and hundreds of other bargains in Bass Bargaingram No. 235, a 52-page book. Money with a smile guarantee. Bass Camera Company, Dept. AG, 179 W. Madison St., Chicago, Illinois.

DUPONT Superior panchromatic. 35mm. five foot lengths. (tongued). 25' can. \$1.30. Optical Development Corporation, Larchmont, New York.

IF You go to Mexico ask first for prices and pamphlets of finest German quality miniature and other cameras, binoculars, movie cameras and projectors. Foto Mantel Suer, R. Rudiger, V. Carranza 11. P.O. Box 1459, Mexico City.-105. Branch Store: Tijuana, B. C.

ATTENTION Photographers! Increase profits substantially by taking photocopies (commonly called photostats) with your regular camera. No film, no prism, details free. The Barbour Manufacturing Co., Warren, Ohio.

FREE! Book, "How to Sell Snapshots." Fomo Company, Canton, Ohio.

CAMERAS Films, paper 25% to 35% discount. Paramount Photo Division, 327 East 92nd St., New York.

INCOME From your camera instead of expense. Low cost home course teaches you to make photographs for magazines, newspapers, advertisers. Tremendous demand. Earn good money wherever you live. Free book. Universal Photographers, Dept. 104, 10 W. 33rd St., New York.

HAVE You a camera? Send ten cents for recent number of our big magazine, showing how to make better pictures and earn money. American Photography, 116 Camera House, Boston, 17, Mass.

WE Purchase and accept in trade used photographic equipment. Send for bargain list. Fotoshop, 134R W. 32nd, New York City.

YOUR Favorite picture processed by amazing new method on lovely box for cigarettes, jewelry, etc. Thrills everybody. Lasts lifetime. Send any print up to 3"x4" and \$1.50 for each box desired. Money refunded if not delighted. Agents wanted. Personalized Products, 10A West 33rd St., New York.

ARGUS Genuine cowhide leather Eveready cases. Special price \$1.75. Guaranteed. Ellis & Co., Box 405, Mansfield, Ohio.

CAMERA Bargains galore. Get my 1938 Hobbygrams. Hobby Man, Jefferson, Iowa.

CORONET Midget, the new "Minicam." post paid \$2.50. Film 6 exposures 20c. G. Gennert, Inc., 20 West 22nd Street, New York City, N. Y.

FREE Illustrated Photographic Almanac listing everything photographic—still, movie cameras, films, lenses—at tremendous savings. Hundreds of bargains, new and used. All guaranteed. We take your old camera or equipment in trade. Write for free copy of new Photographic Almanac and money-saving bargain book—just out! Limited edition. Hurry! Central Camera Co. (Photographic Headquarters since 1899), 230 South Wabash, Dept. 8-K, Chicago.

WANTED — Cameras and equipment. State condition and price. Jersey State Electric Company, Elizabeth, New Jersey.

MAKE Money in photography. Learn quickly at home. Spare or full time. Easy plan. Previous experience unnecessary. Common school education sufficient. Interesting booklet and requirements free. American School of Photography, 3601 Michigan Ave., Dept. 3432, Chicago.

CASH For amateur snapshots! Thousands wanted. Stamp brings details. Division 25; International Photos; 32 South Hidalgo, Alhambra, California.

LIFELIKE Color in your photos. Easy with Pyramid oil color outfit; complete—palette, colors, instructions, charts. Sold on money refund basis. \$1.00 postpaid. Doran, 2 Marine Avenue, Brooklyn, N. Y.

SPECIAL! Only 25c per roll, expertly developed, beautifully printed and 2 "Dubl-Wate" enlargements, also free cigarette lighter! Limited offer expires August 1st. New York Photo Studio, Post Office Box 801-F, Church Street Annex, New York, N. Y.

THIRD Dimensional attachment fits any camera. New invention. Marvellous life-like pictures. \$1.00 with complete instructions. Elder & Adams Mfg. Co., 6340 Woodland Ave., Philadelphia, Penna.

FREE List. Photographic books and bargains. Argus cameras \$12.50, \$15, \$25. Box 402, Hutchinson, Kansas.

MAKE Money with your camera. New book tells how. 46 pages. 50c. Popular Mechanics Press, Room (C38), 200 E. Ontario St., Chicago.

MOTION PICTURES AND SOUND EQUIPMENT

"HERE'S News from Bass." A 52-page Cine Bargaingram No. 234. A veritable encyclopedia of motion picture apparatus, 8 mm. and 16 mm., silent and sound. Sound cameras. You must have a copy of this book. It's hot off the press. Your copy is waiting. Don't delay, and send for this valuable book. Dept. A, Bass Camera Company, 179 West Madison Street, Chicago, Illinois.

BARGAINS! 8mm., 16mm., free literature. Elder, B-739 Boylston, Boston, Mass.

8-16MM. TITLES, 2c Word. Catalogue. Cineshop, 1812 Piedmont, Charleston, West Virginia.

15% TO 25% Discount on still or movie cameras. Free circular. Paramount Co., 327 E. 92nd St., New York City.

TITLES, 8mm.-16mm., Beautifully hand lettered, printed; reasonable. Samples; "end." Lambert, 147-37 Beech Ave., Flushing, N. Y.

NEW 200-Watt 8mm. motor projectors \$19.50 prepaid. Free 16mm., 8mm. bargain lists. Home Movies, Box 216, Easton, Penna.

VALUES. New catalog featuring latest home movie accessories and photo supplies. Postage 3c. Hollywood Cine Film Distributors, 7561 Sunset, Hollywood, Calif.

MOVIE Films. Develop yourself. Univex, Eastman. Raw film wholesale. Chemical samples 15c. Lake Camera Exchange, Gary, Ind.

LEARN Motion picture theatre management, advertising, projection. Free catalog. Give age. Theatre Institute, Elmira, N. Y.

WHOLESALE — 16mm.-8mm. Bargaingrams. Stamp. No-Wat-Ka, 151 Broadway, Paterson, N. J.

BIG Sale! 35mm. films. Projectors. Demsey, 1223 Berkley, Youngstown, Ohio.

8-16MM. All latest subjects, silent and sound, sale, rent, and exchange. Films rented everywhere. Free illustrated catalogue (with sample film 10c.) Garden Exchange, 317 West 50th, New York.

35MM. Sound features sold, rented, exchanged. Paul Oakley, Nelsonville, Ohio.

SOUND Features and shorts, 35mm. only. Moore Bros., Portsmouth, Ohio.

200 FEET 16mm. Film \$1.00. Visual Products, 459 West 22 Street, New York City.

AMBERTINT 16mm. Camera film, \$1.85 for 100 feet, including machine processing. Daylight loading Weston Eight. Nonhalation. Two rolls \$3.50. Order now. Hollywood Studios, South Gate, Calif.

COMPLETE 16mm. Rental library. Low rates. Shipped anywhere. Write for new catalogue. National Cinema Service, 3 West 29th Street, New York.

16MM. Nonhalation film, 110 ft. \$2.50, including processing. Cope Studios, 3720 South Figueroa, Los Angeles.

UNUSED Univex Cine "8." \$8.75. Projector \$13.45. Printwell, Wyoming, Penna.

MOGULLS Removal sale! Sensational specials: 35mm. slide projector \$9.50; 35mm. portable S-O-F projector, 15 watt amplifier, speaker \$189.50; Hayden projector stand, fits all 8-16mm. \$5.85; Victor, No. 25, 16mm. sound projector, like new, complete \$195; 35mm. Holmes projector, complete \$50; Safety 35mm. subjects, complete \$1.75; 100' 16mm. film, includes processing \$2.39; sateen screen, 9x12, \$15. Request removal issue, new Bargaingram, free. Enormous sound-silent rental library. Trades accepted. Mogulls, 68-J West 48th, New York City.

MAKE Money with "The World's Greatest Passion Play." Sound or silent 16mm. Hemenway Film Co., 37 Church St., Boston, Mass.

NEW Pin letters simplify titling. Romeo Saleservice, Patchogue, New York.

35MM. TALKIES For rent. Complete show, feature, cartoon, serial, \$7.00 weekly, with projector \$22.50. Motion Picture Exhibitors, 3865 West 25th Street, Cleveland, Ohio.

16MM. VELOTEX. Perfect outdoor film. 50 ft. rolls \$1.29, 100 ft. \$1.95 including processing. Sample free. Velotex Laboratories, Gary, Ind.

35MM. BARGAINS! Projectors. Films. Lists. Calderara, 5119 South St. Louis, Chicago.

EVERLASTING Movie titling letters, cast metal. Circular and sample 5c. Wolf-films, 6858-D Stony Island, Chicago.

GENERA Film, 100 feet for Univex, \$1.00 postpaid. Processing powders. Circulars. Promaders, Davenport, Iowa.

35MM. FILMS, Projectors. List 10c coin. Capital Productions, Rosedale, Kas.

16MM. ART Modeling, unique, exclusive. Stamp only. Sefel, New Braunfels, Texas.

RADIOS, SUPPLIES, INSTRUCTION

BARGAINS: Wholesale prices on standard make radios, refrigerators, washers, ranges, sweepers and other appliances. Write for prices. Wholesale Appliance Company, 312 - 21st, Toledo, Ohio.

RADIO Engineering, broadcasting, aviation and police radio, servicing, marine and Morse telegraphy taught thoroughly. All expenses low. Catalog free. Dodge's Institute, Ames St., Valparaiso, Ind.

AMATEUR Radio licenses, home study course in code and theory. Reasonable, efficient and thorough. Results guaranteed. American Radio Institute, 1430 North Dearborn Parkway, Chicago, Illinois.

LATEST Releases Vocalion, Decca, Melotone, Bluebird, \$1.00 per dozen; Victor, Brunswick, Columbia, 19c, 6 for \$1.00. Giant radio-phonograph catalog free. United Radio Company, 58-N Market St., Newark, N. J.

PLANS 18 Distance record crystal sets with "Radiobuilder"—year, 25c. Laboratories, 7700-C East 14th, Oakland, Calif.

RADIOS (Popular makes) 50% discount. Radioman, Box 452, Maryville, Tenn.

AMAZING Pocket radio. Plugs in light socket, \$2.99 post paid, guarantee. Pocket Radio Mfg. Co., Post Office Box 68, Phoenix, Ariz.

RADIO Bargains, electrical appliances. Save half. Free bulletin. Mack Brothers, 2045 Chicago Ave., Chicago.

MUSIC AND MUSICAL INSTRUMENTS

SONGWRITERS—Send best poems today. Remarkable offer. Free rhyming dictionary and instruction book by famous Broadway composer. Songwriters Institute, 1234-C Broadway, New York.

SONG Poems wanted to be set to music. Free examination. Send poems to McNeil, Bachelor of Music, 4153-PM S. Van Ness, Los Angeles, Calif.

SONGWRITERS Wanted immediately. Glen Warren, 1560 Broadway, New York City.

TERRIFIC Success. New copyrighted courses. Quick, thorough. Radio Method of Piano Jazz, P.O. Box 1024, Dept. 17, San Francisco.

SONGS—Arranged, revised by arranger "Cherry Blossom Lane." "Gypsy Tea-room," others. Send for details. Harold Potter, 1619-P Broadway, New York.

EARN More! Learn modern music arranging by personal correspondence. Melodic Music Methods, P. O. Box 1297, New Orleans, La.

MUSIC Composed, arranged, songs, orchestra, band. Frank Wildt, Lancaster, Pennsylvania.

PIANO By ear. Free booklet. Day-V-Way. Woolworth Building, Dearborn, Michigan.

LATE Phonograph records, some new, some slightly used. Fifty—\$2.50. Davis Sales Company, Syracuse, New York.

SONGWRITERS Wanted, write for free book. Indiana Song Bureau, Salem, Ind.

MUSIC Composed to words. Wonderful proposition. Bauer Bros., Oshkosh, Wis.

WRITE Songs. Big money and reputation. Write for information. J. Gordon Pub. Co., 201 N. Hoyne, Ave., Chicago.

WANTED! Lyrics, melodies for songs. We arrange, publish, sell. Superior Song Studios, Passaic, N. J.

SONGS Published. Free melodies to poems. Songland, "PM," Thomaston, Maine.

LEARN Swing piano! Postal brings free folder. Christensen, 751 Kimball Hall, Chicago.

ACCORDIONS. All makes, 25%-50% discounts. Dulcet Conservatory, Department L7, Carnegie Hall, New York, N. Y.

VIOLINS—Handmade masterpieces, best since Stradivarius. Free trial. John Lehto, San Pedro, Calif.

POEM Writers, songwriters—Send for free Rhyming Dictionary, Songwriters' Guide. Submit best poems, melodies today for bonafide, superior offer. MMM Studios, Dept. 33G, Portland, Ore.

SONGWRITERS: Send your poem today for immediate consideration. Richard Brothers, 24 Woods Building, Chicago.

POEMS Wanted. Free melody. We publish. Great Eastern, Thomaston, Maine.

PROFESSIONAL Songwriter aids amateurs. Particulars for stamp. Sherwin, Sausalito, California.

PLAY Piano by piano shorthand music. Teach yourself. Very easy method. \$1.00. Piano Shorthand Music, Springfield, Ill.

SONGS Published, royalty basis. W.C.M. Publishing Company, 942 Market Street, San Francisco, California.

MUSIC Written to song poems. New plan. Healy, 5421 Congress, Chicago.

MUSIC Composed to words. Rhyming pamphlet on request. Phonograph recording of songs. Send poem. Studio 10, Keenan, 259 Beach St., Bridgeport, Conn.

SONG Writers. Send for publishing agreement. McKinley Music Publishers, 1501 E. 55th St., Chicago.

BUSINESS OPPORTUNITIES

START Your own pleasant profitable business at home, spare time. Begin on "shoe string," soon be independent and happy. Free booklet "Key to Business Opportunities" explains. Write today. Mosher, Box 742, 305 West 8th, Los Angeles, Calif.

RUBBER Mold bargains! Stamp brings catalog. Colonial Art, Derry, N. H.

"MAKE Mirrors at home." Big profits. Little outlay. Also emboss, grind—foil, gold leaf, frost, chip and make imitation stained glass. Instruction course \$1.00. Bestovall, 4047-RM N. Whipple, Chicago.

MAKE Money manufacturing new building material. Low in cost, permanent, attractive. Big growing market. Equipment \$25.00 up. Equipment Co., Holland, Mich.

HERE'S A real opportunity. If you want a business of your own that is substantial money maker right now and has unlimited future, and if you have \$500 cash to operate a business in an industry which Roger Babson predicts will, in ten years, be larger than automobile industry is today, write Department 20, Box 187, Lafayette, Indiana, for complete details.

RUN A local business of your own—be independent. Send for free literature on "The Art of Making and Applying Plastitex." A wonder product that provides tremendous possibilities. Nu-Tex Industries, 302½ Lowell St., Vandergrift, Penna.

FORMULAS—Fast selling products. Guaranteed. Laboratory tested. Lowest prices. Catalog free. Kemico, 55G, Park Ridge, Ill.

STEADY Cash income operating latest mail order plan. Details 3c stamp. Earle Smyth, 2109 Gilles Street, Wilmington, Delaware.

PURE Liquid rubber. \$1.50 quart. Mold making instructions, free. Novelty Supply Co., Grayling, Michigan.

10,000% HOME Business. Send stamp. Fred Harriman, Plymouth, N. H.

WORLD'S Tiniest handcarved camel passes through 2" needle eye \$1.00. Motiwala, Third Bhoiwada 38T, Bombay 2.

MEXICAN Feather pictures. 100% profit, easy sales. 50c (stamps) bring \$2.00 worth samples, details. Refunded if unsatisfied. Mexicanart-M, Apartado 1593, Mexico City.

"RESULT Getter," monthly magazine of money making opportunities, copy 10c. George Fenner, 1618 Lucia, Louisville, Ky.

FASCINATING Business. Repair, adjust typewriters, adding machines. Learn easily at home from factory expert. Earn up to \$15.00 daily. Complete instructions covering all makes \$3.00 postpaid or sent C.O.D. Adding Machine Equipment Service, 3601 Michigan, Dept. 343C, Chicago.

SAVE Money. Electric shaver \$4.75; Chemi-Grow \$1.00; office supplies, money making books. Stamp brings folders. Lightning Speeds, Streator, Illinois.

INSURE Against failure. Start manufacturing mail order business inexpensively; complete details and \$1.00 group sure-fire formulas 10c. Jennings, 1425 Eutaw Place, Baltimore, Md.

"RESILVERING Mirrors" and 50 other moneymakers 10c. Ideal Service, 179-M, Park Ridge, Ill.

STOP Experimenting. I'll show you how to make a fortune without capital. I did. You can. Stamp appreciated. Peris, 107-G, East Rochester, N. Y.

BUY Sweetmeats. It's a book you should own. Price \$2.00. E. Guncelle, Mgr., Westhampton, L. I., N. Y.

USED Popcorn poppers, caramelcorn equipment. Northsyde, 1528 - 19th, Des Moines, Iowa.

BIG Pay made from mail order business in home, office. Write. Wm. Strauss, Owings, West Va.

OVER 20 Moneymaking opportunities with other valuable information on how to get dollars in mail daily. Dime and stamp. Johnson, 126-M Lexington Ave., New York.

RUBBER Mold bargains! Stamp brings catalog. Colonial Art, Derry, N. H.

MAKE Money. Mail order. I do, you can. Details dime. Chapman, Victor House, Bellingham, Wash.

MANUFACTURE From Phospholene. Cleaning fluid 1c gallon; bleach 2c gallon; hand soap 2c pound; and ten fast sellers. Sample 25c. Details free. Western, 6615 Denison Ave., Cleveland, O.

TWELVE (12) Money making plans, "including free plans," for 50c. United Distributors, 32 Everett Street, Lynbrook, N. Y.

"SUCCESS Beacon," 52 pages! Money-making schemes, ideas, opportunities. Dime. Jay, Publishers, 6054-p Kenwood, Chicago.

OPERATE Profitable "route" four compartment vendors. Small investment. Penny King, 1233D Chouteau, St. Louis.

WHERE To buy at lowest wholesale prices. Information free. Yorena, Box P-312, Bayonne, N. J.

MAKE Money growing vegetables, fruits, flowers, plants without soil. Use only water and chemicals. Complete formula and process \$1.00. Kemixal, 179, Park Ridge, Ill.

START Profitable mail order business. "Mail Order Success," 28 pages, facts, ideas, methods of getting profitable returns on every dollar invested. Dime. Mail Plan Bureau, Fillmore, N. Y.

LEARN The answers and make big money. Inside legal information. 25c. Dept. B, 234 Hurst Bldg., Buffalo, N. Y.

KAR-O-MEL. Ten other popcorn formulas, including cheese, directions, etc. \$1.00. Dietz, Toledo, Ohio.

BE Successful in business. Learn elementary and guiding principles from expert. Don't lose time and money experimenting; study and win. Complete course reasonable. Free booklet. Gardner & Gardner, 212-A Eighth, S.W., Cedar Rapids, Iowa.

DOLLAR Profit on dollar mail sale. Sales guaranteed. Stamp brings details. Adams, 85 Steelawanna, Lackawanna, N. Y.

PLASTEX Industries offers industrious men an opportunity to start a business of their own, manufacturing art goods, novelties, souvenirs, etc., in Plastex and marble imitation. 5c material makes \$1 articles. Rubber moulds furnished for speed production. Small investment brings big returns. You are just in time for big wholesale season now starting. Write for interesting booklet mailed free. Plastex Industries, Dept. A, 1085 Washington Ave., New York.

HOW And where to obtain capital fully explained, free particulars. Star Service, Wapakoneta, Ohio.

COLOR Concrete surface with chemical solutions. Beautiful pottery without moulds. Garden wishing-wells. Stucco rock. Glazing concrete. Sample 10c. Hollywood Cement Craft, 8527 Wonderland, Hollywood, California.

LIQUID Marble—anyone can make! Colorful, glazed! Moulded, brushed, sprayed. Rubberlastic moulds. Composition flooring. Big money in these! Particulars free. Marbleizing Service, Edwardsville, Ill.

107 WAYS To make money, in home or office, business of your own. Full particulars free. Elite Co., 214 Grand St., New York.

AFTERNOONS Free for outdoors, shows, \$340 month home. Unique plans. No canvassing. Prepare for surprise. Folio-F, Station D, Los Angeles.

DONUT, Potato chip, cheese pop corn. Home made. Big profits. Vanderpol, Springfield, Ohio.

WE Start you in business, furnishing outfits and instructions, operating Specialty Candy Factory home. Men and women, earn \$25 up to \$60 weekly, all or spare time. (Our 29th year.) Booklet free. W. Hillyer Ragsdale, Inc., Drawer 4, East Orange, N. J.

SUCCEED With your products. Make-sell them. Formulas. Processes. Accurate analyses. Catalog free. B. Thaxly Co., Washington, D. C.

PROFITABLE Home business. Legitimate. No canvassing. Maywood Publishers, P-923 Broadway, New York.

SELL By mail. Books, novelties. Bargains! Big profits! Particulars free. B. Elfco, 438 N. Wells, Chicago.

FREE Booklet describes 107 plans for making \$20-\$100 weekly, in home or office, business of your own. Elite Co., 214 Grand St., New York.

I WANT To send you proof of the wonderful pulling power of Popular Mechanics Magazine's classified pages. What's your proposition? Write me today. F. W. Johnson, Manager Classified Advertising, 200 E. Ontario St., Chicago, Ill.

CHARTERS: Delaware; best, cheapest; free forms. Colonial Charter Co., Wilmington, Del.

DELAWARE Charters: Complete service \$35. Submitted forms. Chas. G. Guyer, Inc., Wilmington, Del.

ARTIFICIAL Marble sanitary flooring, instruction covering wood or cement flooring ½ inch thick, fireproof, all colors, low cost, ornamental casting, concrete, plaster, papier-mache, garden furniture, statuary, flexible molds, particulars free. Chris Mahler, Elmont, N. Y.

MAIL Order business is your opportunity. Many began small, now earn thousands yearly. No personal contact. Boundless opportunities. Have had over 30 years experience; will help you succeed. Send 25c for valuable booklets, none free. B. Brenner, 257 S. 21st, Philadelphia.

100 PROFITABLE Mail order and local plans. Gilbert Supply, 1107 Broadway, New York.

MONEY Making plans to fit your needs. Particulars free. Select Books, 2732 Woodburn Ave., Cincinnati, Ohio.

M. M. earned \$267, three weeks, raising mushrooms in cellar! Exceptional, but your cellar, shed perhaps suitable. We buy crops. Book free. United, 3848 Lincoln Ave., Dept. 69, Chicago.

\$250 STARTS "Chain" of penny gum and confection vending machines. Steady cash income. Details free. Robbins Co., 1141P DeKalb Ave., Brooklyn, New York.

UNBELIEVABLE Profit. Unlimited market. Instructions simple beauty and health product. Dollar. Essaness Co., Beaverton, Ore.

SELL Snow balls. Own a business—400% profit. Outfits \$4.75 up. Circular free. Instructions 10c. Snowball Company, Riverview, Jacksonville, Fla.

ARC Welder bargains. Used, trade-ins, rentals, demonstrators. Write for price list. The Lincoln Electric Co., Room 21, Cleveland, Ohio.

MAKE Your spare time profitable. Free details. Key Systems, 18 Delmont St., Staten Island, N. Y.

SELL By mail from home, spare time. Easy, simple; no personal contacts. Unlimited opportunities throughout nation. New revolutionary plan. \$2.95 starts you with everything needed. No get rich quick scheme. Get sample, particulars 25c. Nothing free. Specialty Services, Box 515, Minneapolis.

COLOR-GLAZED Concrete pottery, tiles, walls. New method. No molds. Use only sand, cement, cheap materials. Money-making business for men. Colorplate, details free. National Potteries, 13 West 26th, Minneapolis, Minn.

INVENTORS—Small ideas may have large commercial possibilities. Write us for free book, "Patent Guide for the Inventor" and "Record of Invention" form. Delays are dangerous in patent matters. Free information on how to proceed. Clarence A. O'Brien and Hyman Berman, 58-E Adams Bldg., Washington, D. C.

\$50.00 WEEKLY! Operate mail order business for us. Product furnished. Iron-So-Ezee, Mt. Washington, Ohio.

PROFITABLE Home mail business. fully equipped, \$2.95. (\$15.00 value). Enormous returns. Product details 25c. Thompson, Box 241, Duluth, Minn.

DID You make \$50 last week? Does your job offer you real future? If not, why not start a wholesale business of your own? Little or no capital needed. Handle line 200 nationally advertised 5c-10c products. Show merchants new plan for increasing sales and profits. Handle everything from your home at start. Chance to operate one of our Silver Fleet service trucks. Facts free. World's Products Co., Dept. 8810, Spencer, Ind.

YOU'LL Like resilvering mirrors, auto-parts, reflectors, making chipped glass signs. Write, Sprinkle, Plater, 127, Marion, Indiana.

MONEY In butterflies, moths. See Sinclair Display Advertisement on page 14A.

OPERATE Electric Simonizing station. Cash in on labor-saving invention. Only \$39.50. Should net you approximately \$300-\$400 month. Write Bissell's Manufacturing, 3320-P Archer, Chicago. Dealers wanted.

PROFITABLE Moneymaking plans. Literature free. Silvester, BX217, Old Bridge, N. J.

REVOLUTIONARY New industry can make you independent. Grow vegetables, flowers, without soil, year round, small space. Supply chemicals, instructions, formula, bibliography—all \$1.00 postpaid. Chemi-Culture, 4701-PM Sheridan, Chicago.

PROFIT With new products. Make, sell, repeat. Analysis. Research. Guaranteed formulas. Biggest catalog free. Special prices, leads. Gibson Laboratory, Chemists, BD-1142 Sunnyside, Chicago.

ORDERS Waiting! Help us fill tremendous demand for easily cast, expensive-looking, amazingly beautiful, mother-of-pearl-like, translucent Pinart ware. Nothing like it. Co-workers wanted—we need castings. Rich object d'art free. Stamp brings details. Pinart Studios, 9 Indian Church Road, Buffalo, New York.

NIFTY Compass combined with magnifying glass or mirror, 25c. Ralph Brooks, Arkansaw, Wis.

MAKE \$25-\$75 Weekly; home, office, etc. 205 plans. Particulars free. Stamford, 834-F Riverside Drive, New York.

READ Miller's advertisement (Formulas column). Money success, security! No uncertainties! You'll profit! Miller, Chemist, Tampa, Florida.

SELL Best canned coffee. Samples \$1.00. Box 1518, San Juan, P. R.

MAKE Rustic pottery. Particulars 10c. Frank H. Faucett, Box 9478, Dover, Del.

HYDROPONICS: Grow plants and flowers without soil. Chemical crop culture. Interesting, educational. Unusual yields. Formulas, instructions and selected bibliography \$1. Hydroponics, Box 613, Guthrie, Ky.

GROW Your own coffee. Enough for 25 lbs., 25c coin. Burns, 838 So. 16th, Newark, N. J.

START Your own business; home, etc. Making \$25-\$75 weekly. 205 plans. Particulars free. Stamford, 842-F Riverside Drive, New York.

DOLLAR Bill puts you in mail order business; remit now, or postcard Roadman's Guide, 57 Miller Bldg., Toledo, Ohio.

QUIT Playing at the mail order business! Make real money—others are! "6000 word folio," 3c. Dr. Swearingen, Station "S," Los Angeles.

CHIPPING Glass signs. Booklet free. Beveridge, 169-22 P Locust, Jamaica, N. Y.

MAKE Photo rings. Free rings with course \$1.00. Pulltite Company, 815 South 20 Street, Omaha, Nebraska.

MAKE Artificial marble, glazed tiles, uncanny. Tabletops, plaques, floors, hones, novelties. Hard, fireproof, inexpensive, cement secrets. Brilliant tile and liquid rubber samples 3c. John A. Payn, 945 Grande Vista Avenue, Los Angeles, Calif.

AMAZING. New, economic plant fertilizer. 25c. Sanquist Co., Pomeroy, Iowa.

SOAP Making. Learn at home. Complete formulas. No machinery needed. Stamp appreciated. Posera, 4545A Bartlett, Milwaukee, Wisconsin.

EXTRAORDINARY Flowers, superb vegetables from Supergrowth solution. Formula, complete instructions, \$1.00. Consulting Engineers, Jackson, Michigan.

1000% PROFIT! "Big 32-Page Book" tells you how to make it in your spare time manufacturing art novelties. Send dime or, send \$1.95 for our beginners kit, regular \$3.75 value! Stewart's Studio, 2927 Wilcox, Chicago.

FREE Circulars describing hundreds of moneymaking opportunities by mail. Vickers, Dept. PM-1, Chapmansville, West Virginia.

6 MAIL Order magazines, including all you must know about mail order business 10c. Armand Cartier, 31 Cumberland St., Woonsocket, R. I.

OPPORTUNITIES Aplenty! Money-makers that "click"! Unusual "idea" service! Particulars free! Cee-Tee Company, P-1079 Madison St., Brooklyn, N. Y.

RECENT Developments in earthworm markets are interesting. Investigate. California Earthworm Farms, Highland Park, Los Angeles.

LIKE To draw? Earn steady income tracing and duplicating advertising cartoons. Ad-Service, Argyle, Wis.

MAKE Marbleite flooring with mastic in colors. Sell to builders or do work yourself. Thirty years experience in Canada. Agencies wanted. Write Marbleite Flooring, 76 Kingston Rd., Toronto, Canada.

\$1,000,000 IDEA. The secret how to remove shine from clothes. Details free. Leon, 31 New York Ave., Atlantic City.

8 YEARS Experience teaching successful dependable mail order selling. Absolute satisfaction guaranteed. Get valuable plans, formulas, booklet, particulars 25c. Nothing free. Sheal, Box 263, Duluth, Minnesota.

BE Independent, learn truss fitting. Interesting, big money maker. Send 10 cents for chart and fundamental principles of hernia. Holdfast Truss Co., 217 - 12th St., Oakland, Calif.

MONEYMAKING OPPORTUNITIES

YOUR Name—5,000 mailing lists—25c. Get samples, opportunities galore from all over world. Pines, 583-P Monroe, Brooklyn, N. Y.

START Mailorder business. Details free. Pederson, 1609 1/2 East Fifth, Duluth, Minn.

GROW Without soil—Flowers, vegetables, plants. Year round, anywhere. Only water and common chemicals used. Formula \$1.00. Bestovall, 4047-W North Whipple St., Chicago.

STOP Squealing—Start crowing! Work mornings home—country drives or movies—afternoons! No canvassing! Folio-A, Station "D," Los Angeles.

MILLIONS Jobs! Get dollars in mail daily, like we do, for amazing employment information. Keep money; we fill your orders free. Stamp brings details. Co-Operative Service, 77 Swan, Buffalo, N. Y.

MAN In each town to plate auto parts, reflectors, bicycles, fixtures, mirrors, by late method. Simple plan of manufacturing at home starts you in good paying business. Free particulars and proofs. Gunmetal Co., Ave. N, Decatur, Ill.

RAISE Earthworms for profit. Information free, stamp appreciated. Bureau Zoological Research, 106A Broadway, Peoria, Ill.

MOULDS, Guaranteed, for casting toy soldiers, Indians, trappers, warships, sinker moulds, 244 kinds. Send 5c for illustration-catalogue. Henry C. Schiercke, 645 Spencer, Ghent, N. Y.

107 PLANS For making \$20-\$100 weekly in home or office business of your own. Descriptive booklet free. Elite Co., 214 Grand St., New York.

WHOLESALE Sources, 500,000 articles. Free directory. Maywoode, 925 Broadway, New York.

BE Independent, dime brings copy of 52 page opportunity forum, free business plan and dozens of money making chances. Chas. Spooner, 224 So. 10th St., Minneapolis, Minn.

INDEPENDENCE Can be yours now! Advance financially. Work for yourself! Send for free literature. Literary Sales, 166 Market, Hamilton, Canada.

PROVEN Formula, 3 plans, 25c. L. W. Bryce, Ronceverte, W. Va.

10c PACKAGE Orangeoole makes gallon delicious orange flavor drink. Send dime. Geiger, 6538 North Maplewood, Chicago.

FREE! Celebrating 40th year, publisher "Schemer," Alliance, Ohio, presents dollar check to each sending 25c for three copies, different—contains schemes, ideas, business opportunities, formulas.

MILLION Articles. Buy wholesale. Valuable directory 10c. Ideal Service, Park Ridge, Ill.

MONEY In butterflies, moths. See Sinclair Display Advertisement on page 14A.

MAILORDER Opportunities. Attractive novelty, dandy plan; 5c. Daufeldt, Atalissa, Iowa.

10c BRINGS Copy National Mail Order News. Three months 25c. Box 1773PM9, Roanoke, Virginia.

IMMEDIATE Cash income, advertising! Particulars dime. M. Benton, Liberty, N. Y.

EXCELLENT Mailorder opportunity. Details stamp. JS Service, 126 Lexington, New York.

YOU'LL Like resilvering mirrors, auto-parts, reflectors, making chipped glass signs. Write, Sprinkle, Plater, 287, Marion, Indiana.

"PROGRESSIVE Salesman" magazine. Moneymaking opportunities (10c). Box 428, Kennett, Missouri.

EARN Money collecting reptiles, toads, frogs. We buy all varieties. Splendid opportunity. Information free. Biological Research Laboratories, Dept. 14A, Springfield, Missouri.

FREE! "World's Fair Highlights." Moneymaking proposition. Richards, 280 Broadway, New York.

OPERATE Mail order business on \$1.00 capital. Stamp appreciated. Williamson, 917 Walnut, McKeesport, Penna.

MAKE \$10.00 Daily stamping names on keychecks. Sample and instructions 25c. Bohn Co., Box 86-PM, Wilkes-Barre, Penna.

OPPORTUNITIES, Money making plans, profitable ideas formula and trade secrets. Choice selection. Local or mailorder. Farm & Home Industries, 156 Seneca, Gardenville, New York.

BE Independent! Make \$25-\$75 weekly, your own business, 205 ways. Free particulars. Stamford, 838-F Riverside Drive, New York.

START Now. Make money manufacturing art objects, book ends, artificial marble, rubber molds that need no greasing. Free particulars. Plastic Arts, Homewood, Ala.

GET Dollar bills, quarters by mail galore. Nearly all profit. Particulars free. Stamp appreciated. Vicker's, Dept. PM-2, Chapmansville, West Virginia.

FREE—100 Wonderful business, mail-order and home work moneymaking offers. Lewis Co., 828-C Carpenter, Oak Park, Ill.

ANALYSIS. Research. Newest guaranteed formulas. Biggest catalog free. Special prices, leads. Gibson Laboratory, Chemists, CS-1142 Sunnyside, Chicago.

FORMULAS, PLANS, ETC.

MAKE Polishpads. Quick seller. Formula 25c coin. Auto polish formula included. Any formula 35c. Louran, Box 755, Rockland, Maine.

"ANYTHING In Formulas" \$1.00 each. Five \$3.00. (Satisfaction guaranteed.) Research Bureau, 100 Chelsea, Charlestown, Massachusetts.

GUARANTEED Formulas—New fast sellers. None better. Lowest prices. Catalog free. Kemico, 49G, Park Ridge, Ill.

MONEY Making plans! Formula books! Details, postal. Rogers, Waverly, Va.

ORDER Your formulas from experienced chemists. Anything analyzed. Duplication guaranteed. Cameron Research Chemists, 1216 E. Michigan, Indianapolis, Indiana.

100 MONEYMAKING Formulas 25c. Descriptive literature free. Harvey Teeple, Decatur, Ind.

NEWEST Formulas, all lines. Catalog free. Hodge Lab., Elkhart, Ind.

ICELESS Ice! Colder! Cleaner! Cheaper! Instructions, 25c. Duffy, Covington, Ky.

WATERLESS Soap guaranteed, clean dirtiest hands in America. Formula \$1. Jerome Jones, Hollins, Alabama.

FORMULAS: 15 Proven moneymaking formulas \$1.00. (Not stock-formula catalogue stuff), real unusual offers. List free. Marvel Laboratories, 6629 No. Maplewood, Chicago.

THAXLY Formulas for perfect products. Accurate analysis assured. Resultful research. Catalog free. B. Thaxly Co., Washington, D. C.

FORMULAS. Latest money makers. Literature free. Belfort, 4042 N. Keeler, Chicago.

TWELVE Leading formulas for growing all kinds plants without soil, process fully explained, \$1.00. Leland, 4701-PM Sheridan, Chicago.

ANALYSIS. Research. Newest guaranteed formulas. Biggest catalog free. Special prices, leads. Gibson Laboratory, Chemists, BD-1142 Sunnyside, Chicago.

MAKE Money manufacturing your own products. Proof with every formula. W. S. Michelbach, 326 W. Peyton Ave., Mt. Ida, Alexandria, Va.

FIREWORKS—Ten formulas 25c. Free chemical catalog. Meshna, Malden, Mass.

UNUSUAL. Uncommon new specialties pay best! Here you'll find foremost guaranteed correct, exclusive, authentic formulas to easily produce them. Not catalogue recipes. Stamp brings interesting details. Miller, Manufacturer's Chemist, Jetton, Tampa, Florida.

DIME Brings 10 valuable formulas. Chemicals. West. Monkton, Ontario, Can.

CHEMISTRY

CHEMICALS. Laboratory glassware, apparatus. Send 3c for catalog CP1. Biological Supply Company, 1176 Mt. Hope Avenue, Rochester, N. Y.

HANDBOOK For chemical experimenters, hundreds of experiments, illustrated, 50c. Experiment booklet, 15c. Chemical catalogue, 10c. Reading Scientific Co., Reading, Penna.

FREE Chemistry catalog. Supplies at 5c! Equip complete laboratory. Send 3c for postage. Kemkit Scientific Corp., 397P Bridge St., Brooklyn, N. Y.

TECHNICAL Bulletin. Many subjects. List free. Popular Mechanics, 200 E. Ontario St., Chicago.

TELESCOPES. Microscopes, chemistry, mineralogy. Scientific catalog free. Tracey Laboratories, Evanston, Illinois.

ANALYSIS. Research. Newest guaranteed formulas. Biggest catalog free. Special prices, leads. Gibson Laboratory, Chemists, CT-1142 Sunnyside, Chicago.

AGENTS WANTED

AGENTS: Smash go prices! Santos coffee 12c lb. 4-oz. vanilla 8½c. Razor blades 10 for 8½c. 100 sticks chewing gum 12c. Christmas cards, 21 in box 14c. 150 other bargains. Premiums. Experience unnecessary. Carnation Co., PO, St. Louis, Mo.

COSTS 3c; Sells 25c. Household necessity. Carry day's supply in pocket. Sample free. Abar, 8341 Wood, Chicago.

STARTLING Invention—Pocket adding machine. Nationally advertised \$2.50. Whirlwind seller. Big profits. Baby Calculator Co., Box 1118, Chicago.

SENSATIONAL Plan. Give free can of baking powder with each purchase. Write. Blako, 9459 Alstyne Ave., Elmhurst, New York.

400% PROFIT—The Perennio Calendar 640 years. Vest pocket size, 24 pages, \$5.75 hundred. Sample 10c. Box 386, Baltimore, Md.

DO You want agents for your proposition? Your ad in this space will place your message before hundreds of men seeking fast-selling products. My folder "How to Secure Agents," is filled with proof. I'll gladly send you a copy free. F. W. Johnson, Manager Classified Advertising, Popular Mechanics Magazine, 200 E. Ontario St., Chicago.

AGENTS Make bigger profits on food products—bargain deals. Low wholesale prices. Big display case sent on trial. Ho-Ro-Co, 2810-R Dodier St., St. Louis, Mo.

BIG Money applying initials on automobiles. Write for particulars and free samples. American Letter Company, Dept. 40, Dunellen, New Jersey.

BIG Money applying initials on automobiles. Easiest thing today. Free samples. Also, sideline salesmen for name plates and tire cover transfers. "Ralco," 1305 Washington, Boston, Mass.

500% PROFIT! Gold and colored sign letters for windows, offices, trucks, signs. Auto monograms. Easily applied by agent or customer. Neonite, Akron, Ohio.

BIG Money taking orders; shirts, ties, hosiery, underwear, raincoats, pants, uniforms, etc. Sales equipment free! Experience unnecessary. Write Nimrod, Dept. 8, 4922-28 Lincoln, Chicago.

MAN In each town to plate auto parts, reflectors, bicycles, fixtures, mirrors, by late method. Simple plan of manufacturing at home starts you in good paying business. Free particulars and proofs. Gunmetal Co., Ave. H, Decatur, Ill.

AGENTS—To mail our literature. Good profits. Home business. Maywood, 149 Fifth Ave., New York.

SUCCEED With your products. Make-sell them. Formulas, Processes. Accurate analyses. Catalog free. B. Thaxly Co., Washington, D. C.

AGENTS—Opportunity to make money; book containing 107 successful business plans; home or office; send for free introductory booklet. Elite Co., 214 Grand St., New York.

FREE Sample—Amazing cleaner; sells homes, taverns, everywhere. Big profit—fast repeater. Betco, 5007 Irving Park, Chicago.

AGENTS: Stamping names on pocket-key protectors. Sample check with your name, address, 25c. Stamping outfits. Emblem checks, check-fobs, name plates. Hart Mfg. Co., 303 Degraw St., Brooklyn, N. Y.

MANUFACTURE Specialties, hire agents yourself. Big money. Free literature. Gilbert Supply, 1107-P Broadway, New York.

ENGRAVED Name plates, numbers, signs, etc., easily sold, profits large. Brett Bros., Winthrop, Mass.

SELL 50 Personal Christmas cards—\$1.00. Amazing bargain! 50 folders with customer's name imprinted. Sells fast. Pays big profit. Free samples. Also unequaled \$1 Christmas card assortments. General Card, 400 S. Peoria St., Dept. P-309, Chicago.

\$100 WEEK Selling Artisan paints. Exclusive territory. Washable, fireproof exterior, interior, silos, dairies, kitchens, factories, homes; all colors, dry powder, mix with water. For wood, brick, concrete, plaster. Send \$1. Makes one gallon, covers 350 square feet. Wood Company, 5326 Virginia Ave., Hollywood, California.

AUTOMATIC Golf bag tripod holds bags erect. Sincere representatives can succeed with only practical device. Tripod Co., 2239 Catalpa Drive, Dayton, Ohio, or 1690 Poplar, Memphis, Tenn.

REVOLUTIONARY Window cleaning tool. Good Housekeeping approval. Only ten \$2.25 sales daily to housewives, factories, schools, stores will make you \$350.00 monthly. Carter Products Corp., 900 Front Ave., Cleveland, Ohio.

BIG Profits. The perfect eyeglass cleaner. Wonderful demonstrator. Prevents steaming. Sample 15c. Shurberg Chemical, Hartford, Conn.

GUARANTEED Gold leaf letters for store and office windows. 300% profit. Free samples. Metallic Co., 438-B N. Clark, Chicago.

NEW Kind of heat boils water instantly. Make to \$30 daily. Pocket size minute demonstration. No installation. Free offer. No investment. Write the Lux Co., Dept. B-208, Elkhart, Indiana.

450% PROFIT Quick-Action automatic gas lighter. No flint. 25c seller to every home, office and restaurant. Sample 10c. New Method Co., Box PMG-68, Bradford, Penna.

SOCIAL Security account number engraved and enameled on beautiful brass key ring tag. Send 25c coin with security number for sample. H. I. Laboratories, 1451 Broadway, New York, N. Y.

GOOD Profit! Household necessity. Rubberizing preparation prevents slipping, wrinkling rugs. Sample and details, 25c. Wildon, Metropolitan, Box 5032, Los Angeles.

WONDERFUL Opportunity to make up to \$240 in a month, \$45 first week. Be a grocery route dealer. I send everything complete on trial; no money risk. Details free. Albert Mills, 6226 Monmouth, Cincinnati, Ohio.

BUSINESS Proposition: Resilvering mirrors, autographs, reflectors, making chipped glass signs. Write, Sprinkle, Plater, 128 Marion, Indiana.

SENSATIONAL New sellers, free catalogue, samples. Paty Company, Somerville, Mass.

SELL Pal polishing cloth. Sample free. Albert Nahabit, 116 Sylvian, Central Falls, R. I.

MEXICAN Novelties! 100%-300% profit. Free particulars. Samples 10c stamps. Marquez-PA, Apartado 1176, Mexico City.

MONEY In butterfiles, moths. See Sinclair Display Advertisement on page 14A.

AMAZING Profits selling colored folks. Hair preparations, bleach creams, perfumes, incense, 300 products. Write for free samples. Valmor, 2241-S.N. Indiana Ave., Chicago.

BOYS! Girls! Sell seasoning. Particulars free. Chels Choice, 1322 Chase, Chicago.

ATLAS Window sign letters. Large sizes, penny each. Beautiful free samples. Atlas, 7941 Halsted, Chicago.

TOILETRIES. 2½c! Woodbury toilettries. Merchandise. Samples, 25c (coin) starts business! Harry Andrews, Fredericksburg, Virginia.

DISTRIBUTE Circulars appointing agents who work for you. Everything furnished. No investment. 10c brings trial employment outfit. Rome, 206-F Market Ave., Brooklyn, N. Y.

AGENTS. Sell rugs, kind the boys get big money for. Imported Rug Company, 2834 West Garrison, Baltimore, Maryland.

CHRISTMAS Cards—50 beautiful folders, name imprinted, cost you 65c, sell for \$1.00. Also marvelous box assortments, 100% profit. Samples free. Write! New England Art Publishers, North Abington, 256, Mass.

AMAZING New formula—Hando! Free samples sell for you! Applied to hands before work assures clean hands, arms, face, fingernails after working in oil, grease, paint, ink, etc.! Send now for free sample plan that makes quick money. Write for free sample to prove it! Wex Mfg. Co., 1733 Grand, Kansas City, Mo.

NEW 25c Pocket knife, uses razor blades, 200% profit. Lorrac, Albany, N. Y.

EARN Up to \$4 daily—spare time, showing smart personal Christmas cards. Also 21-card assortment, \$1. Profit 100%. Others; 50 with name, \$1. Samples free. Wetmore & Sugden, 749 Monroe, Dept. BH, Rochester, N. Y.

BALLGAMES. Movies afternoons. Work mornings, up to \$75 weekly. 205 different ways. Particulars free. Stamford, 840-F Riverside Drive, New York.

AGENTS—Every service station wants new reversible sheep skin auto washing mitt. Big profit. No competition. Easy fast sales. Write quick. Be first in your territory. Blue Bonnet, Gainesville, Tex.

CHRISTMAS Cards. Get biggest line—make more money. Personal cards, stationery, box assortments galore. 1938 leader \$1 assortment 21 folders. Your profit 100%. Experience unnecessary. Samples free. Wallace Brown, 225 Fifth Ave., Dept. 71-B, New York.

BIG Money in hot water. Drop Speed-ee electric heater in water. Steaming instantly. Price \$2.75. Sample \$1.00. Speed-ee Mfg. Co., P218, Goshen, Ind.

PROFIT With new products. Make, sell, repeat. Analysis. Research. Guaranteed formulas. Biggest catalog free. Special prices, leads. Gibson Laboratory, Chemists, BD-1142 Sunnyside, Chicago.

SOMETHING Different: Vitalin for health, weight, digestion 20c lb. Real tennis guts 70c, racket \$2.50. Handcarved mahjong \$3.50. Artistic 19 piece luncheon set \$2.00. Bridge set 50c. Will represent American manufacturers, only free samples accepted. Otto Schmidt, Box 1292, Shanghai, China.

CHRISTMAS Cards. Quick profits. Sensational "Ruby" 21-folder assortment. Sells \$1—you make 50c. Novel, unique. Everybody buys. Also gift wrappings, etchings, religious, humorous, others. Portfolio personal Christmas cards. Write for free sample offer. Chilton Greetings, 179 Lincoln, Dept. 2-B, Boston, Mass.

MAKE Extra money spare time showing my gorgeous, new \$1 assortment 21 Christmas folders. You make 50c box. Friends, others buy eagerly. Other fast-selling Christmas money makers. Free sample offer. Schwer, Dept. F-28, Westfield, Mass.

ANNOUNCING new companion items for famous breath purifier "Rid"—same large profits. Write for distributor's proposition today. All American Industries, 56-P West Washington, Chicago, Illinois.

QUICK. Easy a les—big profits, repeats, every business needs it. Sample \$1.25. Write Advertis'g and Collection System, 607 Law Building, Richmond, Virginia.

WANTED—District purchasing agents. No experience or money required. Write Purchasing Manager, 174 N. Halsted, Chicago.

CHRISTMAS Cards. Earn \$2 an hour. Take orders galore from friends. 50 exquisite folders with name at \$1. Free album 20 designs. Fastest selling 12 folder box in America. Costs 50c. Sells \$1. Re-quest samples. Sunshine Art, Dept. E, 154 Nassau, New York.

HIGH-GRADE SALESMEN

SALESMEN—Sell calendars, complete line, all sizes, including jumbos; beautiful subjects. Samples free! Fleming Calendar Co., 6539 Cottage Grove, Chicago.

SALESMEN: Sell advertising novelties, calendars, fans, thermometers, etc., for nationally known firm. Liberal commissions. Stanwood Hillson Corp., 21 Station St., Brookline, Mass.

BIG Money taking orders; shirts, ties, hosiery, underwear, raincoats, pants, uniforms, etc. Sales equipment free! Experience unnecessary. Write Nimrod, Dept. 65, 4922-28 Lincoln, Chicago.

ATLAS Window sign letters. Large sizes. Penny each. Beautiful free samples. Atlas, 7941 Halsted, Chicago.

OUR New 1938 complete line of brushes now ready. Largest commissions. Write for sales plan. Wire Grip Sanitary Brush Company, 2300 5th Ave., New York.

NEW Specialty—Sells every business and professional man. Four \$15 sales daily pay \$280 weekly. Farrell cleared over \$1,000.00 monthly. Write, F. E. Armstrong, President, Dept. PM, Mobile, Ala.

GUARANTEED Gold leaf letters for store windows. Free samples. Liberal offer to car owners. Metallic Co., 438-A N. Clark, Chicago.

MAKE More money with Red Comet Automatic Fire Extinguishers. Low price. Proved seven years. Splendid sales outfit free. Some good territory open. Exclusive. Write quick. 704 Red Comet Bldg., Littleton, Colo.

FREE Booklet describes 107 plans for making \$20-\$100 weekly, in home or office, business of your own. Elite Co., 214 Grand St., New York.

SELL America's most complete line of business necessities. Regular and novelty size book matches, gummed labels, political items, pricing sets, restaurant supplies, salesbooks, engraved like stationery, shipping room supplies, office supplies, printed gummed tape, advertising chewing gum, advertising pencils, thermometers, business stimulators. Complete line printed business forms and hundreds of other fast sellers. Business cards \$1.50 thousand. Stationery \$2.70 thousand. All competition undersold. Cash commissions advanced daily, extra bonus. Experience unnecessary. Complete sales outfit free. Federal, AP-301 South Desplaines, Chicago.

SALESMEN Sell suits on our easy credit plan. Free suits and pants given as bonus besides large cash profits, premiums and gifts. Sell only (5) suits to get a free suit. No limit to number of free garments you may earn. Wholesale prices \$17.95 and up. Sample line free. No experience needed to make easy sales. All garments individually cut and tailored to measure. Satisfaction or money back guarantee. Three Star Clothes, Inc., 330 South Franklin St., Dept. CA1, Chicago, Ill.

SELL Political candidates. Not affected by "recessions." Get orders now for finest line auto signs, printing. Novelties. Big commissions. Ad-Nov-Co., Newton, Iowa.

AUTOMOTIVE And tool salesmen—write for details on profitable C-S line for garages and service stations. Central Sales Company, Hastings, Nebraska.

MEN Wanted by world wide industry. Write today for particulars about few good old Rawleigh routes that have paid well for years. Established, profitable business. Over 200 farm and home necessities. Industry and reliability main qualifications. Man with auto preferred. Give age, experience, references. Rawleigh's, Dept. H-N-PPM, Freeport, Ill.

SELL Business cards \$1.50 thousand. Business stationery, book matches, gummed tape, paper towels, drinking cups, pencils, salesbooks, labels, rubber stamps, tags, menu covers. Free sales portfolio. 35% commission daily. Order getting specials. Willens, 2130 Gladys, Dept. V, Chicago.

POPCORN Machines, caramels, crisps, cheese coat, potato chips. Long Eakins, 2035-H High St., Springfield, Ohio.

SALESMEN! Collect \$3.00 profit from every service station and garage. New invention revolutionizing industry. Airpower Co., Newton, Iowa.

SALESMAN—Make over \$12.00 daily now and a harvest at Christmas time, selling 25c to \$1.00 ready-to-fly model airplanes to stores. Western Aircraft, 1271 S. Norton, Los Angeles.

INVESTIGATE New revolutionary sales system. See specialty services advertisement under business opportunities.

SELL Quality portraits, frames. Lowest prices—big profits. Good foreign market. Catalogue free. Friedman's Studio, 528 Cornelia, Chicago, Ill.

SALESMEN Sell ink remover to cleaning plants. F. R. Welch Co., Bridgman, Mich.

BIG Commission selling celluloid pricing tickets, metal shelf moulding, menu covers, signs, celluloid buttons, cards. P. Pricing Tickets, 124 White St., New York.

SALESMEN, Distributors—200 items, brushes, mops, chemicals, waxes, brooms, marvelous magnetic brush, excels vacuum cleaner, pocket size. Highest commissions. Exclusive territory. Neway Brush Co., Hartford, Conn.

\$50 WEEKLY Possible from start placing nationally advertised counter card goods with stores. Chance to double earnings in few weeks. Most unusual selling opportunity in wholesale field. Permanent connection. World's Products Co., Dept. 8810-A, Spencer, Ind.

MAKE Up to \$1200 per month. Exceptionally high grade big money making opportunity. Write quick. Box 283, Mansfield, Ohio.

BRUSH Salesmen. If you ever sold brushes write for our money making proposition. Donald Brush Co., Dept. P.M., Camden, N. J.

MATCHES—Advertising book matches. Extraordinary! (Salesman wanted). Sanderson's, Ottawa, Illinois.

MANAGERS Wanted in every city and town. Small investment will realize \$100.00 weekly. Sayers Systems, 2801-03 Sheffield Ave., Chicago, Ill.

DISTRIBUTORS, Supervisors, salesmen. Age 30-60. Est. firm. Appointment, conduct and manage exclusive authorized dealers and New Super Sales Parade and Circus in every town of 200 population up. "Automotive method and proposition alone in field." (covered by insurance). Makes spectacular and truly convincing demonstration. Fast turn-over, quick cash profits with big repeat business—territory protection—a guarantee under Plan A for you. Quick action necessary. Details. Write or wire. Manager, 1606 Main St., Dept. 106, Kansas City, Missouri.

START Exterminating business. Enjoy steady ever-increasing income, the year round. No store, etc., necessary. We furnish everything. By-Products, 1758-A-Lunt, Chicago.

MAKE Up to \$50.00 weekly part time selling top quality advertising matches at low prices. Experience unnecessary. Full time profits unlimited. Free sales kit and zipper case. Match Corporation of America, Dept. E-8, 6041 West Grand, Chicago.

HELP WANTED

MAN Who can live on \$125 first month for landscape service work; handle orders for old, new customers; experience unnecessary. Christy Nurseries, Newark, N. Y.

WEAR Fine hose I send without cost with outfit while taking orders for amazing new hosiery. Replacement guaranteed against holes, snags, and runs. Rush name and hose size. Wilknit, Desk 37-H, Greenfield, Ohio.

MAN And wife—to run local coffee agency. Earnings up to \$240 in a month. New Ford sedan given you as bonus. I send complete outfit. You don't risk a penny. Details free. Albert Mills, 6220 Monmouth, Cincinnati, Ohio.

LOCAL Agents wanted to wear and demonstrate suits to friends. No canvassers. Up to \$12 in a day easy. Experience unnecessary. Valuable demonstrating equipment, actual samples free. H. J. Graves, 1300 Harrison, Dept. H-817, Chicago.

CARTOONIST, Writers, book lovers. Instructions and sample magazine 20c. Want Ad World, Box 280, Mansfield, Ohio.

AGENTS—New wildfire puzzle. Hourly profits \$2. Dime brings sample. Hundred \$2. Concession Specialties, 310-A East 35th, New York.

INSTRUCTION—Obtaining positions, homework. Free offers. Henry, 126 Lexington, New York.

EDUCATIONAL AND INSTRUCTION

DRIVING Easily learned with simple illustrated instructions. Free details. Educational Service, 261 Boerum St., Brooklyn, N. Y.

UNEMPLOYED? Business improving. Thousands jobs opening. Instructive information free. Write. Employment Counsellors, Box 1283-K, Milwaukee, Wisconsin.

MAKE More money. Get a U. S. government job. Get our new plan for obtaining one—no obligations. Age 18-50. Write Ozment Instruction Service, 101, St. Louis, Mo., immediately.

TELEGRAPHY Taught thoroughly. New railroad retirement act creating renewed openings for operators. Enroll now. Expenses low. Catalog free. Dodge's Institute, Hiatt Ave., Valparaiso, Ind.

MASSAGE, Hydrotherapy, dietetics, drugless therapeutics, chiropody, taught by mail. Evans Correspondence School, Montgomery, Ala.

GOV'T Jobs start \$1260-\$2100 year. Men-women age 18-50. Former examiner's tested method helps qualify you. Particulars, list jobs free. Write today. Patterson School, 8C Mercantile Bldg., Rochester, N. Y.

PIANO Tuning and repairing taught. Average \$60 to \$100 weekly. Our instructions simple, easy to follow. \$1 brings plan and first three lessons. Start now. School of Applied Mechanics, 1085-p White St., Far Rockaway, N. Y.

LEARN Machinist trade, tool, die making, Automatic and hand screw machines. Modern shop methods. Actual work. Jobs open for trained men. Employment help. Illustrated booklet free. Allied Screw Machine Co., 601 Lake St., Chicago.

LEARN Auto mechanics, body repairing, welding, electricity, refrigeration, Diesel. Stevinson's, 2008A Main, Kansas City, Mo.

DEGREES Earned through home study—Psychology, theology, law—others. Air-conditioning and Diesel courses. Request free bulletin. No obligation. Temple Bar College, Missoula, Montana.

INSTRUCTION For professional airmen. Transport license texts which take the drudgery out of study are published only by Thompson Aviation Publishers, 8318 Woodward, Detroit, Mich. Write for literature.

KNOCK-EM-COLD! Learn police Jiu Jitsu! 36 secret knockout blows without fists, many one-fingered headlock breaks, etc. New complete illustrated course by world-famous instructor, only 25c today. S. J. Jorgensen, 411 Maritime Bldg., Seattle, Wash.

WORK For "Uncle Sam." Start \$1260-\$2100. Men-women. Try next examinations. List positions and particulars telling how to qualify—free. Write Franklin Institute, Dept. W3, Rochester, N. Y.

LEARN Real estate business by mail. Few weeks spare time. Low cost. Information free. R. J. Anderson, 551 Dickinson S.E., Grand Rapids, Mich.

FREE Physical perfection course (write now). Sid's System, Southgate, California.

FOR An extremely profitable lifetime business, operate a collection-credit agency. Free folder. Cole Associates, Syracuse, N. Y.

BECOME Practical scientific investigator. Modern, illustrated course. Thorough training by former agent U. S. secret service. Particulars free. International Secret Service Institute, PM-88, Hoboken, N. J.

SIMPLIFIED And mental arithmetic. You can understand. Pay postman \$1.98 plus postage or sent postpaid for \$2.00. Arith-Magic, 60, Elmhurst, Ill.

LEARN Photo-Engraving! Always in demand! Thorough training all branches. Illinois School of Photo-Engraving, Box 510-M, Effingham, Illinois.

SHORTHAND Simplified \$1.00, Lesson 10c. Teaching opportunities. Simmons, Rocky Hill, Connecticut.

TYPEWRITER Repairing taught on real machines. Earn while learning. Our instructors show you how. \$1 brings plan and first three lessons. School of Applied Mechanics, 1085-p White St., Far Rockaway, N. Y.

"1,000 WAYS To Make \$1,000." You can do it—others have. This amazing book will startle you. 475 pages, only \$2.50. Popular Mechanics Press, Room (C38), 200 E. Ontario St., Chicago.

CARTOONING, COMMERCIAL ART, SHOWCARD WRITING, SIGN PAINTING

EARN cash income, copying and duplicating simple cartoons for advertisers. 3-M Service, Argyle, Wis.

LETTERING Made easy. "A to Z." Two volumes, \$2.00. Samples for stamp. Stein Studios, Flatiron Building, New York.

NEW Work for amateur cartoonists. Hartman, 2438 W. Lincoln, Nebr.

CASH In! Copying advertising cartoons. Paisley, Kinloch Bldg., St. Louis, Mo.

WANT To sell your cartoons? Send 25c. American Engravers, Box 1381, San Antonio, Texas.

MAKE Art Pay. Advanced art students. \$1.00. Popular Mechanics, 200 E. Ontario St., Chicago.

PLAYS, STORIES, MANUSCRIPTS

WANTED—Authors' manuscripts. Immediate marketing. Revel, 73 West 44th, New York.

POEM Writers, songwriters. Send for free Rhyming Dictionary, Songwriters' Guide. Submit best poems, melodies today for bonafide, superior offer. MMM Studios, Dept. 33H, Portland, Ore.

STORIES Rewritten and typed for marketing. Welton Tinney, Winnsboro, Texas.

WRITERS: We revise, edit, market, radio and picture material. Skeels-Lauhon Productions, 6513 Hollywood Blvd., Hollywood, California.

ADVERTISING AGENCIES, LETTER WRITERS, FOR ADVERTISERS

INCH Display advertisement 30 magazines year \$24. Wood's Popular Services, Atlantic City, (N. J.)

ADVERTISE: 24 Words in 250 newspapers \$10. Lists free. Advertising Bureau, 4515-C Cottage Grove, Chicago.

FREE—New Advertisers Rate Guide, 44 pages. Includes everything. Lowest rates. E. H. Brown Advertising Agency, 140 S. Dearborn, Chicago.

GUARANTEED Resultful mailorder letters, literature, campaigns created. Investigate! Finkel Advertising, 364-pm Lincoln Place, Brooklyn, N. Y.

ADVERTISE Your products through selected mediums! Free manufacturing recommendations. If it can be sold we can sell it. Write giving all information. Arrow Advertising, Kearney, Nebraska.

MAILORDER Ad reaching 1,500,000 families throughout United States \$15.40 inch. Newspaper, magazine, ratebook free. Chicago Union Agency, 20-P West Jackson, Chicago.

LEARN Advertising quickly at home. Easy practical plan. No text books. Common school education sufficient. Interesting booklet and requirements free. Page-Davis School of Advertising, 3601 Michigan Avenue, Dept. 3432, Chicago.

ADVERTISING Placed anywhere. Helpful, free service. Rate guide book free. Baker Advertising Agency, 189 W. Madison, Chicago. Successors to Ankrum Advertising Agency. Established 28 years.

24 WORDS. 65 Newspapers, magazines \$3.00. Goodall, 742 Market, San Francisco.

ADVERTISING Placed over 3,700 weekly newspapers. Castellazzo, 3717 Redwood, Oakland, Calif.

BUSINESS SERVICE

INFORMATION—Where to buy anything! Addresses of any manufacturers, wholesalers. 50c (coin). Universal Buyers Service, Lakewood, New York.

\$2.00 MONTHLY Maintains Washington, D. C., branch office. Business, personal purposes. Hawkins Mail Service, 817 Fourteenth.

RUBBER STAMPS AND OFFICE SUPPLIES

NAME. Address, 2 lines 25c; 3 lines 35c. Stamp Works, Auburn, Nebr.

CUSHION Mounted one-two lines 25c; three 35c. 100 letterheads, 100 envelopes \$1.00. Hauer Press, 1314 Ford, Youngstown, Ohio.

ORIGINAL. Cushion mounted. One, two lines 25c; three 35c; four 45c. Facsimile signature \$1.50. Stamp Works, 814 Bradley, Peoria, Illinois.

2 LINES 25c, 3 Lines 35c. Stamp Works, Centerport, N. Y.

TYPEWRITERS, DUPLICATORS, OFFICE DEVICES

TYPEWRITERS, Duplicators, multi-graphs. Write for free list office machine bargains. Save half. Pruitt, 518 Pruitt Bldg., Chicago.

INCREASE Business now. "Excello-graph" Rotary Stencil Printer reprints thousands everything you typewrite, hand-write, draw or trace. Colors. \$19.75 to \$44. Terms. Illustrated literature free to business or professional men. Pittsburgh Typewriter Supply, Department K-2, Pittsburgh, Penna.

NATIONALLY Advertiser portable typewriters delivered at 20% discount from regular prices. Catalogue free. Typewriter Exchange, Sac City, Iowa.

NEW \$3.75 Automatic adding machine. Fully guaranteed. Bassett, Box 302-D, Altadena, California.

PRINTING, MULTIGRAPHING, MIMEOGRAPHING, GUMMED LABELS

1000 6x9 CIRCULARS, Letterheads, envelopes, postcards, \$2.95; 5000, \$9.45. All printing reasonable. Samples. Cuts. Goodprint, Harrisonburg, Va.

PRINTED Envelopes \$1.10 M. Letterheads, statements. Maloney Sales, Box 182, Rochester, N. Y.

SEND Dollar bill for 1000 business cards. Woodprint, Woodstock, Virginia.

500 3/4x2 1/4 FOUR Line gummed stickers, 25c. Moritz Printery, Saginaw, Mich.

HAMMERMILL Letterheads, 300 8 1/2x11, any color paper and ink; \$1.48 postpaid. Free particulars. Woodruff's, 217A Lewis, Duluth, Minn.

SPECIAL! 5,000 Labels \$1.95. (Combination, 200 noteheads, 100 envelopes, 200 cards with case \$1.95. Free samples. Okayprint, Martins Ferry, Ohio.

MAKE \$50 Week, sell 1000 bus. cards 50c. (2000 lots) 15c post. per 1000. Bieble, 106 N. 6th, Philadelphia.

1938 PRICELIST, Samples, free. McCall Press, 1326 South 27th, Omaha, Nebr.

250 8 1/2x11 LETTERHEADS, 250 6 3/4 Envelopes, both \$1.50. Victors Printery, Exeter, N. H.

1000 BILLHEADS, Statements, envelopes \$1.95. The Delavan Printery, 177 Freund St., Buffalo, N. Y.

FREE, 1000 Business cards! Real quality. Landis Printery, Auburn, Nebr.

POSTPAID—125, 8 1/2x11 Letterheads and 125 envelopes \$1.00; letterheads, billheads, 250—\$1.00. Benneville, 907 West Roosevelt, Philadelphia.

1000 BUSINESS Cards 50c, (2000 lots), 15c post. per 1000. Bieble, 106 N. 6th, Philadelphia.

1,000 3x6 CIRCULARS, 90c. 5,000—\$3. Postpaid. Osborne Service, McVeytown, Penna.

1000 BUSINESS Cards \$1.45 postpaid. Cheser, 55 S. Albany, Chicago.

BEAUTYPRINT Stationery, cards. Samples. Nist, 720 Evergreen Ave., Millvale, Penna.

\$1.98 POSTPAID—250 8 1/2x11 Letterheads and 250 envelopes. Aho, 4902 Oneida, Duluth, Minn.

250 2 1/2x4 LABELS 60c; 2 1/2x3 50c. Paramount Press, Atlanta, Missouri.

1000 LETTERHEADS, Envelopes \$2.95 prepaid. Richardson, 28-P Avon, Hyattsville, Maryland.

500 STICKERS, Four lines, 25c. Fine labels. Cott's, Spickard, Missouri.

ENVELOPES, 500 White, \$1.00. Morey Press, 87 Somerset Street, Springfield, Mass.

PRINTING Cuts made; finest quality; zinc (line) \$1.25. (10 square inches); halftones; electros, mats; artist; free price list. Riteway, 1465 PP Broadway, New York.

LABELS For shipping, packaging, advertising. Samples. Artcraft Label Company, Asheville, N. C.

LETTERHEADS, Envelopes printed, 250—\$1.00, 1,000—\$3.00. Secrist, Muscatine, Iowa.

1,000 BOND Letterheads or envelopes \$2.85. Moyer, B-241-P, Milton, Penna.

MATCHES—Advertising book matches. Extraordinary! (Salesman wanted). Sanderson's, Ottawa, Illinois.

50 HEAVY Fine bristol business cards, 25c. Times, Warrensburg, Ill.

PRINTING OUTFITS AND SUPPLIES

HAND Presses, type, supplies. Big lists 3c. Landis, Richland, Penna.

BARGAINS—Presses, type, supplies. Send stamp, 159 Harvard, Cambridge, Mass.

BARGAINS, Presses, type. List 3c. Exchange D-15, 22 Orient, Meriden, Conn.

HAND Press, type and complete printers' supplies. Advise equipment you need and we quote prices; or send stamp for catalog. P. Peiffer, 11-C; 6 Columbia St., Newark, N. J.

AUTOMATIC Card press. Thomas Amos, 323 N. Mathison St., Dayton, Ohio.

PRINT Your own cards, stationery, circulars, advertising. Save money. Easy rules furnished. Print for others, big profits. Junior outfit \$9.00; job presses \$11 up. Details free. Kelsey Presses, D-11, Meriden, Conn.

6x9 PRESS \$5.00. Bargain literature free. Novelty Shop, Downsview, Louisiana.

PATENT ATTORNEYS

WE Successfully sell inventions, patented and unpatented. Write for proof, and tell us what you have for sale. Chartered Institute of American Inventors, Dept. 4-C, Washington, D. C.

"INVENTOR'S Guide," 100 mechanical movements, free; advices on patenting, selling inventions. Frank Ledermann, Tribune Bldg., New York.

PATENTS, Instructions "How to Establish Your Rights" and form, "Evidence of Conception"—sent free! Lancaster, Allwine & Rommel, 411 Bowen Bldg., Washington, D. C.

PATENTS, Booklet free. Highest references. Best results. Promptness assured. Watson E. Coleman, Patent Lawyer, 724 Ninth St., Washington, D. C.

INVENTORS—Send for free booklet "Patent-Sense." Information based on 64 years experience. Lacey & Lacey, Dept. 5A, 635 F St., Washington, D. C.

L. F. RANDOLPH, 302-B Victor Bldg., Washington, D. C. Low cost. Book and information free.

PATENTS, Protect your idea by securing free "Proof of Invention" folder. Exceptional personal service. Established 1906. E. E. Vrooman, 871 Woodard Bldg., Washington, D. C.

SELL Your unpatented ideas. I tell you how and help you make the sale. Particulars free. Write Wilson Holmes, 907 Barrister Bldg., Washington, D. C.

HOW To protect and capitalize on your invention. Write for free books answering all the questions you want to know about your patent, and its commercial possibilities. Over 63 years experience. Deferred payment plan. Write for free books today. C. A. Snow & Co., 185 Snow Building, Washington, D. C.

INVENTORS: Send immediately for your copies of our new free books, "Patent Protection" and "Suggestions on Selling an Invention." Sixty-eight pages of interesting facts. They tell how patent laws protect you; kind of sketch or model needed; simple steps to take without cost; how successful inventors have secured financial assistance; show interesting inventions; illustrate important mechanical movements. With books we also send free Evidence of Invention form to help establish date of disclosure. Prompt service, reasonable fees, special deferred payment plan. Strictest secrecy. Thirty-nine years experience. Highest references. Write us today. The facts in our books, are worth money to the man with a good invention. Address: Victor J. Evans & Co., Registered Patent Attorneys, 12-J Victor Building, Washington, D. C.

INVENTORS—Small ideas may have large commercial possibilities. Write us for free book, "Patent Guide for the Inventor" and "Record of Invention" form. Delays are dangerous in patent matters. Free information on how to proceed. Clarence A. O'Brien & Hyman Berman, 58-E Adams Bldg., Washington, D. C.

FOR INVENTORS

WORKING Models built. Tools, dies and experimental work. Engineering service. Ask for estimate. Esquire Tool and Die Corp., 3115 W. Cameron Ave., Milwaukee, Wis.

INVENTIONS, Financed, patented, marketed. Inventors Limited, 6556 S. Halsted, Chicago.

INVENTOR'S Universal Educator; contains 900 mechanical movements; 50 perpetual motions; instruction on procuring and selling patents and selecting an attorney, etc. Suggests new ideas. Price \$1 postpaid in U.S.A. Address Albert E. Dietrich, 511-B Colorado Bldg., Washington, D. C.

PENDING Patent applications can be brought before thousands of manufacturers, free of charge, through *Invention Magazine*. Write for details. *Invention, Inc.*, 635 F Street, Washington, D. C.

UNPATENTED Ideas can be sold. I tell you how and help you make the sale. Particulars with list of manufacturers and wanted inventions, sent free on request. Write *Wilson Holmes*, 907-A Barrister Building, Washington, D. C.

INVENTORS—Send for 72-page book on patents. Reasonable terms. Conscientious treatment to inventors. *L. F. Randolph*, Registered Patent Attorney, 302-E Victor Bldg., Washington, D. C.

INVENTORS: "Making Inventions Pay," our 32-page illustrated book, mailed upon receipt of 3c postage. *Crescent Tool Co.*, Dept. Z, Cincinnati, Ohio.

I SELL Patents. Established in 1900. *Charles A. Scott*, 773PM Garson Ave., Rochester, N. Y.

HAVE You a sound, practical invention for sale, patented or unpatented? If so, write *Chartered Institute of American Inventors*, Dept. 4-A, Washington, D. C.

INVENTORS, Authors, composers! Reliable protection for unpatented inventions, uncopyrighted scripts. Details \$1. *Box 304, Columbus, Ohio*.

LET Us sell your invention. Write, *American Inventors Aid Association*, Box 68, West Allis, Wis.

BUYERS Located meritorious patented, unpatented inventions. Descriptive booklet, disclosure form free. If will sell, reply immediately. *Invention Reporter*, M-11236 South Fairfield, Chicago.

INVENTORS: Send immediately for your copies of our new free books, "Patent Protection" and "Suggestions on Selling an Invention." Sixty-eight pages of interesting facts. They tell how patent laws protect you; kind of sketch or model needed; simple steps to take without cost; how successful inventors have secured financial assistance; show interesting inventions; illustrate important mechanical movements. With books we also send free Evidence of Invention form to help establish date of disclosure. Prompt service, reasonable fees, special deferred payment plan. Strictest secrecy. Thirty-nine years experience. Highest references. Write us today. The facts in our books are worth money to the man with a good invention. Address: *Victor J. Evans & Co.*, Registered Patent Attorneys, 13-J Victor Building, Washington, D. C.

INVENTORS—Small ideas may have large commercial possibilities. Write us for free book, "Patent Guide for the Inventor" and "Record of Invention" form. Delays are dangerous in patent matters. Free information on how to proceed. *Clarence A. O'Brien & Hyman Berman*, 58-E Adams Bldg., Washington, D. C.

INVENTIONS WANTED

CASH For unpatented ideas. Stamp for particulars. *Mr. Ball*, 9441-A Pleasant, Chicago.

WANTED—Prominent manufacturer wants ideas or inventions pertaining to automatic coin-operated devices of all descriptions. All correspondence confidential. *Western*, 925 W. North Ave., Chicago.

SIMPLE, Practical inventions wanted by manufacturers, patented or unpatented. For information write *Chartered Institute of American Inventors*, Dept. 4-D, Washington, D. C.

SMALL Inventions wanted by manufacturers. I'll help you sell your invention. Write for free circular. *Stanley Hull*, 7829-K Euclid Ave., Cleveland, Ohio.

INVENTIONS Commercialized. Non-profit or commission plans. Booklet, details for stamp. *Inventors Service Agency*, Box 15, Pennsboro, N. J.

MAIL Order item for national distribution, royalty basis, \$1.00 sellers preferred. Send full details. *Ward Rogers*, Pittsfield Bldg., Chicago.

PATENTS FOR SALE

PATENTED Household article. *Paul DeMartini*, 75 Rico Way, San Francisco, California.

CABINET Makers, carpenters tool. Patent No. 1,967,123. P.O. Box 912, Baltimore, Md.

MANUFACTURING

DIES, Stampings, wire forming, complete manufacturing. *Southern Products*, Independence, Missouri.

INVENTIONS Manufactured in any quantity at low cost. Stampings, dies, models, etc. Estimates and free catalog. *Crescent Tool Co.*, Dept. X, Cincinnati, Ohio.

MANUFACTURING, Dies, machinery, models, brasswork, white metal casting moulds. Catalog 3c. *Baum's Metal Specialties*, Kansas City.

SPRINGS, Wire specialties, stampings, special machines, tools. *Wilkie*, Independence, Mo.

MANUFACTURING Tools, dies, models, metal stamping. *Federich Tool Co.*, Box 12, East McKeesport, Penna.

ANALYSIS, Research. Newest guaranteed formulas. Biggest catalog free. Special prices, leads. *Gibson Laboratory*, Chemists, DS-1142 Sunnyside, Chicago.

WE Manufacture inventions in any quantity. Models made. Reasonable price and expert workmanship. *Arellano-Power Co.*, One LaSalle, Chicago.

MODELS AND MODEL SUPPLIES

MODEL Railroad supplies catalog 10c. *Box PM, Dunellen, New Jersey*.

MODEL Supplies for the inventor. Send 3c stamp for catalog. *Pierce Model Works*, Tinley Park, Ill.

SHIP And yacht model fittings; construction sets; model yacht sails; illustrated catalog 20 cents. *A. J. Fisher*, 1002-1 Etowah Avenue, Royal Oak, Mich.

MODELS—Your ideas developed into practical working models. 30 years' successful experience; thousands of satisfied customers. Confidential service guaranteed. Bank references. Send 3c postage for 32-page book—"Making Inventions Pay." *Crescent Tool Co.*, Dept. Y, Cincinnati, Ohio.

THE Oldest airplane supply house, established 1919, now solicits your model airplane supply business. Full line carried. Kits, engines, supplies. Low prices. Send orders now. Money refunded if not satisfied. Free catalog upon request. *Johnson Airplane & Supply Co.*, 445 East First St., Dayton, Ohio.

MAKE Your own model castings of aluminum, brass. Drawings for furnace operated by blow torch, and plans for making crucibles, \$1.00. *R. K. Models*, P.O. Box 312, Southbridge, Mass.

HO Railroads! List 10c. *Lange*, 20 E. Jackson, R. 814, Chicago.

INVENTORS—Small ideas may have large commercial possibilities. Write us for free book, "Patent Guide for the Inventor" and "Record of Invention" form. Delays are dangerous in patent matters. Free information on how to proceed. *Clarence A. O'Brien & Hyman Berman*, 58-E Adams Bldg., Washington, D. C.

CATALOGUE Of over 40 engines, castings, supplies, 25c. Refunded. *Howard Co.*, A-2417 North Ashland, Chicago.

BUILD Better miniature motors than you can buy. New design. No castings. Details 10c. *Wright Motor Works*, 3256 Lake Park Ave., Chicago.

RAILROADERS, Fans and modelmakers. Send for second and greatly enlarged edition of interesting and instructive book on trains. Only one of its kind. 25c in coin. *Trains*, 1069-D Transportation Bldg., Chicago.

WRIGHT "Whirlwind" engine, model lithographed in colors, size 13x22 in. Shows and names every part. Invaluable for aviation students. \$1 postpaid. *Popular Mechanics Press*, Room (C38), 200 E. Ontario St., Chicago.

BLUEPRINTS AND PLANS

COMPLETE Solar heater plans \$2.00. Sunshine will heat water for your home. *Emerson Solar Heater*, Escondido, Calif.

HOMEWORKERS Handy drill press and bench vise. Make it yourself, easy. Send 15c for working drawings. *Fords*, Box 173, Elkhart, Ind.

ROTRACTOR Drawing instrument. Compass, divider, protractor, rule, square, bevel, gauge, mitre, plumb, level, angle finder, all in one, with instructions. Quarter million sold. 25c postpaid. *Doran*, 2 Marine Avenue, Brooklyn, N. Y.

HOME CRAFTSMEN

LEATHERCRAFTSMEN—Write for free instructions and price list of leather, tools, etc. Sample cards 5c. *Wildor & Co.*, Dept. F, 1038 Crosby St., Chicago, Ill.

DESIGN Your own furniture. Our complete course shows you how. Only \$8.50. Invaluable to home craftsmen. Write for descriptive folder. *Klok Institute*, 430 Lyon, Grand Rapids, Mich.

BIG Profits—Make, sell unique lawn ornaments, book ends, door stops in spare time. 20 patterns, designed by real artist, full instructions \$1.00 postpaid. *Wickman*, Dept. 38-C, 744 Brookline Ave., Dayton, Ohio.

SQUAREKNOTTERS! Make belts, handbags, etc. Quality cord samples with catalog, free. Beginners book, catalog and samples, 10c. Special! Regular \$1 book with 50c beginners outfit, all for \$1. *P. C. Herwig Co.*, Dept. J-8, 121 Sands St., Brooklyn, N. Y.

HEAVY-DUTY Jigsaw, home workshop shaper, drum sander and 458 other practical articles in Vol. 28 Shop Notes only 50c postpaid. *Popular Mechanics Press*, Room (C38), 200 E. Ontario St., Chicago.

NEW Hobby. Stone polishing. Bench construction book and information \$1.00. *Smith's Agate Shop*, 228 W. Alder St., Portland, Ore.

20 **FULL-SIZED** Lawn ornament patterns 25c. *Modern Woodcraft*, Saginaw, Michigan.

OLD GOLD, WATCHES, JEWELRY, PRECIOUS STONES

HIGHEST Prices for old gold, teeth, watches, jewelry. Full cash value mailed day shipment received. Satisfaction guaranteed or articles cheerfully returned. Information free, or ship today. *Chicago Gold Smelting Co.*, 300-P Champlain Bldg., Chicago.

GOLD \$35 Ounce. Ship old gold teeth, crowns, jewelry, watches—receive cash by return mail. Satisfaction guaranteed. Free information. *Dr. Weisberg's Gold Refining Co.*, 1500-Q Hennepin, Minneapolis, Minn.

AUSTRALIA'S Lovely opals. Illustrated catalogue free. Good selection \$5. *Norman Seward*, Melbourne, Australia.

5000 **REBUILT** Elgin, Waltham, Hamilton watches. Also ladies, gents wrist watches. Make big money! 12 size, 7 jewel, Elgin or Waltham, \$4.75; 16 size, 17 jewel, \$7.50. Send for free watch and diamond catalogue. *The New York Jobbers*, Dept. M, 74 Bowery, New York, N. Y.

HOW To identify and determine value of old precious metals. Where to buy. To whom to sell. Reliable and up-to-date information. Complete instructions only \$1 postpaid. *Popular Mechanics Press*, Room (C38), 200 E. Ontario St., Chicago.

QUESTION—Where can I get discounts on jewelry, gifts, necessities? Answer—*Frank Milligan Company*, Jefferson, Iowa. 10c (refunded) brings thirty-two page illustrated catalog and valuable free offer.

GOLD Rings reset Nevada turquoise \$1.50. Thunderbird brooches and tie-holders \$1.00 each. Turquoise Indian rings \$1.50. *Minnie Price*, 411 No. 7th, Los Vegas, Nevada.

LOOK! Three different uncut gems \$1.00! *William Pruitt*, Edgemont, South Dakota.

TOBACCO

CIGARETTE Making machine, cigarette case, tobacco; \$1.00 postpaid. Outfit sent free for 5 day trial. Particulars. *Berkeley*, 1704 Stephen Street, Brooklyn, N. Y.

GUARANTEED: Cigarette, pipe or chewing, 5 lbs., \$1.00; ten, \$1.75. Pay when received. Pipe and box cigars free. *Rives Tobacco Co.*, Paducah, Ky.

FREE Sample pipe or cigarette rolling tobacco. Name favorite brand. *Pete Moberly*, Box 1060, Owensboro, Kentucky.

RAZORS—BLADES—SHARPENING

SENSATIONAL Electric dry shaver, \$4.35 postpaid. 100 blades, sharpener, styptic, 75c. *Denis Laboratories*, 4806 North Springfield, Chicago.

BLADES (Double) 100 postpaid 95c. *Radioman*, Box 452, Maryville, Tenn.

RESHARPEN Own blades. No gadgets. Barber's secret. Complete. Send (dime) or (stamps). *Philip Di Lemme*, 680 E. 235 St., New York City.

SURVEYING INSTRUMENTS

GUARANTEED Factory rebuilt transits and levels for rent (with purchase option) or sale (cash or terms). Order now before prices advance. We will repair, trade in, or buy your old instruments. Ship prepaid for estimate and valuation. Write for List M-38 and complete information to Warren-Knight Co., 136 N. 12th St., Philadelphia, Penna.

FOR SALE OR EXCHANGE

TRADERS Bulletin, hundreds of trades and bargains. Mack Brothers Exchange, 2041 Chicago Ave., Chicago.

WANTED—MISCELLANEOUS

CASH For used microscopes, binoculars, cameras, slide rules, drawing sets, surveying, mechanical, scientific, and musical instruments. Highest prices paid day shipment received. Satisfaction guaranteed or shipment promptly returned. Elman's, 2302 Van Buren, Chicago.

MODERN Refrigeration. New industry needs trained men for installing, servicing, repairing. If you seek a new field with larger opportunities get latest book by Althouse and Turnquist. \$5 postpaid. Popular Mechanics Press, Room (C38), 200 E. Ontario St., Chicago.

PERSONAL

FOOT Remedy guaranteed to stop offensive perspiration. \$1.00. Noxodor, Box 384, Ypsilanti, Michigan.

WIN Prize money: Booklet—"Successful Contesting"—shows how. 10c postpaid. Bulletin listing \$200,000.00 prizes included free! World Publishers, 4515-B Cottage Grove, Chicago.

ATHLETE'S Foot cured quickly, easily, permanently. \$1. Box 188-A, Station S, Los Angeles.

UNEMPLOYED—Dissatisfied with present job? Let me help you. (Not a selling proposition.) Particulars free. Trable, 528 West Dickens, Chicago.

POEM Writers, songwriters. Send for free Rhyming Dictionary, Songwriters' Guide. Submit best poems, melodies today for bonafide, superior offer. MMM Studios, 33-J, Portland, Ore.

PHYSICAL Culture and free voice course. Both complete \$2.89 or C.O.D. plus postage. One alone worth much more. J. Flynn, 333 Livermore Avenue, Westleigh, Staten Island, New York.

DISCOURAGED! Friendless? Unpopular? Antagonize others? Don't ask them why they don't like you—check yourself and know. Amazing self-analysis chart 10c. Glaser Publishing Company, 333 N. Michigan Ave., Chicago.

OUTDOOR Sports for everyone—Enjoy them all your round with aid of book published by Popular Mechanics. Hundreds of ideas for new and popular sports for every season; complete instructions for making necessary equipment at small cost. 350 pages and 650 illustrations. \$2 postpaid. Popular Mechanics Press, Room (C38), 200 E. Ontario St., Chicago.

MISCELLANEOUS

MEXICAN Legal matters. American Attorney, Box 1736, El Paso, Texas.

COATS-OF-ARMS And crests correctly rendered in colors or black and white. Highest grade. Estimates free. Heraldic Studios, 1914 Oakdale Ave., Chicago.

STANDARD Electric lamp insect killer. \$2.00 up. Literature free. Sauer Bros., San Leandro, Calif.

AMATEUR Tattooing outfits, illustrated catalog 6c. "Tatuco," 651A S. State, Chicago.

YOUR Caricature in pen and ink. Send photo and \$1 to Luther A. Pride, 321 Auburn St., Portland, Me.

MOTHER Of pearl inlays. Different colors from all over the world. Selection of 33 pieces, includes pearl strips, diamond shapes, dots, squares. Instructions how to inlay your guns, cribbage boards, jewel cases, etc. Price list on other inlays included. Send money order \$1.50 in U.S.A. \$2.00 foreign. Jos. Phetteplace, 3060 5th Ave., Chicago, Ill.

SAVE \$500.00 Building home. I did. Use free by-product. Booklet explains in detail. Postpaid, \$1.00. Burton Macon, Ramseur, N. C.

BOOK Matches make fascinating, valuable collection. Fifty books, unused, no two alike 50c postpaid. Souvenir Match Co., Toledo, Ohio.

PENCILITE Write in the dark. Agents sample 50c. Sunset Stamp Works, Seattle, Wash.

SPECIAL Offer: Regular 8" slide rule, only 30c prepaid. National Specialties, Evanston, Illinois.

HAVE You a sense of golf humor? Copyrighted printed booklet, "Fellow Duffers." Written by a humorist. Twenty-five cents. Engdahl Features Service, 36 Howard St., New Britain, Conn.

ENGRAVED Metal name plates. Rustless, no polishing, read in semi darkness. Particulars. Lock 1476, Washington, D. C.

LUMINOUS Paint! Startle, entertain your friends. Novel decorations. Generous supply, 25c. Cold Light Materials, 51 Manor Ave., Oaklyn, N. J.

PREVENT Theft—etch your name on tools, guns, etc. Complete outfit \$1.00. King, 662 Dorr, Toledo, Ohio.

TATTOOING Outfits, supplies, illustrated list free. "Waters," 965 Put-nam, Detroit.

MONEY In butterflies, moths. See Sinclair Display Advertisement on page 14A.

MAKE It Yourself—Hundreds of practical and useful devices described in our big book. Plain instructions and illustrations show you how. Save money on things for yourself or make profit selling to others. 900 articles, 480 pages, 823 illustrations. \$3 postpaid. Popular Mechanics Press, Room (C38), 200 E. Ontario St., Chicago.

MONUMENTS. Reasonable. Lettered. Delivered. Guaranteed. Reliable Granite Company, A17, Oneco, Florida.

SWAPPER'S Friend, R4, Saline, Michigan. Interests swappers, collectors. 50c year, sample 10c.

BUSINESS Proposition resilvering mirrors, autographs, reflectors, making chipped glass signs. Write Sprinkle, Plater, 288, Marion, Indiana.

QUICK CASH IN NEW POTATO CHIPS

START AT HOME

Here's your chance—a money-making business of your own. Turn potatoes into cash by making new kind of Potato Chips with my improved outfit. Makes delicious, superior, "NON-GREASY" Chips at low cost. A few hours' practice does it. Begin anywhere—city, village, town. Potatoes cheap and plentiful. Wholesale or retail. Steady year 'round business.

Groceries, markets, restaurants, taverns, do the retailing for you. **WE HELP START YOU IN BUSINESS.** Great quantities of Chips are eaten daily. Profit large—unusually so. You can start this money-making business on a "next to nothing" outlay of cash. Write for Potato Chip Booklet.

LONG-EAKINS COMPANY
828-S High St., Springfield, Ohio



When writing please mention Popular Mechanics

AERONAUTICAL UNIVERSITY



ENGINEERING [B. S. DEGREE] — ADMINISTRATION — CERTIFICATED MECHANICS — RADIO — SHEET METAL — WELDING

A real technical university education in less time at less cost. Graduates with all leading aviation companies and air lines. Day and eve. classes. State Accredited. Government approved. Write for Illustrated Bulletin. Address

Aeronautical University, Curtiss Wright Bldg. Dept. A, 1342 S. Michigan Ave., CHICAGO, ILL.

STUDY ENGINEERING AT HOME

Home Study Courses leading to Degrees in Electrical; Civil; Mechanical; Diesel; Architectural; Aeronautical; Automotive; Drafting; Radio; Air Conditioning; Refrigeration; Highway; Mining; Petroleum; Industrial; Steam; Chemical Engineering; Arts; Sciences; Philosophy; Education; Writing; Psychology; Chemistry; Theology; Law; Agriculture; Business; Advertising; Sales; Accounting; Public Speaking. **McKINLEY-Roosevelt Graduate Colleges, 4246 Clarendon Ave., Chicago.**



TRAILER BUILDERS

Lowest prices in the industry for windows, couplers, lifting devices and other items. Send 10c for 40 page illustrated catalog.

MARVEL TRAILER PARTS CO.
19020 Celestine Detroit, Mich.

ENGINEERING

Technical and applied courses — nonessentials omitted — fundamentals stressed

Chartered by the State. Recommended by graduates, endorsed by industry, approved by engineers and educators. Courses include Air Conditioning, Electric Refrigeration and Diesel. Extensive modern equipment. Low tuition. Part-time work for room and board. **Degree in two years, diploma in one year.** Also short intensive courses of

three and four months in Electricity, Diesel-Electric, Power Plant, Refrigeration, Air Conditioning and Drafting. **One and two-year courses open in September,** short courses open the year round. Thousands of successful graduates in U. S. and foreign lands. **Write for catalog.**

39th
YEAR

FINLAY ENGINEERING COLLEGE

1001 Indiana Avenue

Kansas City, Missouri

AUDELS Carpenters and Builders Guides

4 vols. \$6



Inside Trade Information for Carpenters, Builders, Joiners, Building Mechanics and all Woodworkers. These Guides give you the short-cut instructions that you want—including new methods, ideas, solutions, plans, systems and money saving suggestions. An easy progressive course for the apprentice and student. A practical daily helper and Quick Reference for the master worker. Carpenters everywhere are using these Guides as a Helping Hand to Easier Work, Better Work and Better Pay. To get this assistance for yourself, simply fill in and mail the FREE COUPON below.

Inside Trade Information On:

How to use the steel square—How to file and set saws—How to build furniture—How to use a mitre box—How to use the chalk line—How to use rules and scales—How to make joints—Carpenters arithmetic—Solving mensuration problems—Estimating strength of timbers—How to set girders and sills—How to frame houses and roofs—How to estimate costs—How to build houses, barns, garages, bungalows, etc.—How to read and draw plans—Drawing up specifications—How to excavate—How to use settings 12, 13 and 17 on the steel square—How to build hoists and scaffolds—skylights—How to build stairs—How to put on interior trim—How to hang doors—How to lath—lay floors—How to paint.



THEO. AUDEL & CO., 49 W. 23rd St., New York City

Mail Audels Carpenters and Builders Guides, 4 vols., on 7 days' free trial. If O.K. I will remit \$1 in 7 days, and \$1 monthly until \$6 is paid. Otherwise I will return them. No obligation unless I am satisfied.

Name.....

Address.....

Occupation.....

Reference..... P.M.

Law!

LEARN AT HOME

Are you adult, alert, ambitious, willing to study? Investigate LAW! We guide you step by step—furnish all texts, including 14-volume Law Library. Training prepared by leading law professors and given by members of bar. Degree of LL. B. conferred. Low cost, easy terms. Send NOW for Free, 64-page "Law Training for Leadership."

LASALLE EXTENSION, Dept. 864-L Chicago

TRADES THAT PAY

Auto, Diesel, Aviation Mechanics, Body, Fender Repair, Painting, Welding. Learn with a few weeks practical training. Trained men get the openings. Write for FREE BOOK, low tuition rate. State course interested in. McSWEENEY SCHOOLS, Dept. 10-56, Detroit, Mich., or Kansas City, Mo.

LIVE BODIES FOR SALE

Oh boy! Wouldn't that be swell—I'll tell you what I will do though, I will take that scrawny body of yours and whip it into shape just like I have done for myself and so many others. Do you want big muscles and a huge robust body? My book "Puisant Body Building" is absolutely FREE.

TOMMY LOUGHRAN, Dept. 19, 4 S. 15th St., Philadelphia, Pa.

New York Established 1902
Electrical
 Ask for free booklet **School**
 44 West 17th St., N. Y. C.

\$ MONEY-MAKING \$ OPPORTUNITIES

For those who need larger incomes or must seek new occupations. The following workable, tested plans are adaptable both to the needs of the country or city dweller either for part time development or principal income source.

Every idea set forth in these books has been used by others for profit. They are well worth your consideration.

Plan No. 1—1000 Ways to Make \$1,000. Practical new book of tried, tested methods that work that you too, can use. Price \$2.65.

Plan No. 2—Radio Servicing. Let an expert teach you how to engage in this money making business. Price \$4.15.

Plan No. 3—Refrigeration Service. Official manual covers all makes. Good service men are needed. Price \$5.00.

Plan No. 4—Automobile Refinishing. Start a lucrative business of your own. Fine possibilities here. Excellent new instruction book. Price \$1.50.

Plan No. 5—Outdoor Opportunities. The raising of small animals, birds and plants for profit. Price \$2.00.

Plan No. 6—10,000 Money-Making Formulas. Complete instructions for the making of commodities at small cost that may be sold at a handsome profit. Price \$4.00.

Plan No. 7—1000 Spare Time Money Making Ideas. A job for everybody. 146 page book tells how. Price \$1.00.

Plan No. 8—100 Civil Service Examinations. Covering steady Government jobs. All types of positions. Better business means thousands of new jobs. Prepare now by studying this new book. Price \$2.50.

Plan No. 9—Making Poultry Pay. The proper breeding and management of fowls for higher egg production. Price \$2.00.

Plan No. 10—A Living from the Land. Answers the question "How can I successfully get established in the country?" Price \$1.50.

Plan No. 11—Rabbits for Food and Fur. A complete guide to the successful rearing and breeding of rabbits. Price \$2.00.

Plan No. 12—The Frog Industry. Should be considered more as a side line than as a major means of income. Price \$1.00.

Plan No. 13—Is There Money in Welding? Factual information shows welding is a growing field offering opportunity to anyone looking for a trade. Price \$1.00.

Plan No. 14—Auto Service Shop Management. Money-saving and business-producing ideas by two men who know just what is essential to a profitable service shop business. Price \$1.50.

Any of the above mailed postpaid upon receipt of price or sent C.O.D. anywhere in U. S. Pay postman price and few cents postage.

POPULAR MECHANICS PRESS

Room 638 200 E. Ontario St. Chicago, Illinois

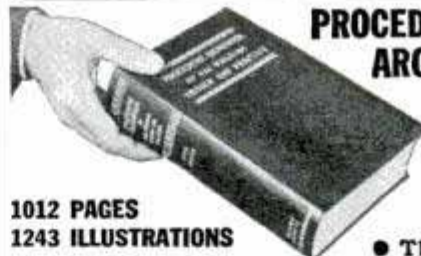

PROCEDURE HANDBOOK OF ARC WELDING DESIGN AND PRACTICE

ONLY \$1.50 in U.S.A. POSTPAID

Elsewhere \$2.00

1012 PAGES
1243 ILLUSTRATIONS

The big new fifth edition Procedure Handbook gives you valuable, up-to-date information that will enable you to improve your position and increase your earning power. This complete, authoritative Handbook gives you quickly the right answers to problems in the development, production or utilization of steel products. It is one of the wisest investments you can make for your future welfare. Order your copy today.

POPULAR MECHANICS PRESS
CHICAGO, ILLINOIS

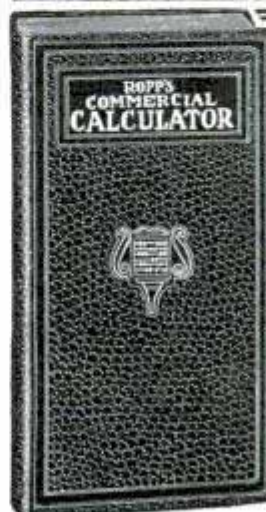

Mathematics Made Easy by ROPP'S CALCULATOR AND SHORT-CUT ARITHMETIC

Shows the Answer as Quickly as a Watch shows the Time to all Problems likely to occur in the Office, Store, Shop, Bank, Farm, or Factory.

Over 2,000,000 Sold

Explains and simplifies every principle in Arithmetic, Mechanics, and Mensuration.

PRICES POSTPAID

Desk Size, Flexible Keratol Binding.....\$2.00

Pocket Size, Art Leather Binding.....\$1.00

Pocket Size, Cloth Binding.....\$0.50

POPULAR MECHANICS PRESS
Room P.3 200 E. Ontario St. CHICAGO

NEW INVENTIONS

(Continued from page 28A)

being destroyed by the lava while ships come and go in the rough waters of the bay. The standards grip the globe tightly, lessening the chance of its being dropped.

TIME of attaching the garden hose to the faucet is reduced materially by a quick-acting connector. The device, which is attached to a regular hose connection, has jaws which close over the threads of the faucet. A knurled sleeve tightens the jaws to form a perfect connection. A turn locks the sleeve around the jaws. The connector is in a unit, there being no springs, pins, screws or special gaskets.



DESIGNED for sanitation and for safety, a waxed paper channeled ring for attachment to the rim of drinking glasses has been patented. The waxed ring provides a lip shield for protection against cracked rims of glasses. It also affords an additional safeguard against passage of germs from glass to the user's mouth in drinking. The ring is pleated all around to provide a resilient action for making close contact with the glass.

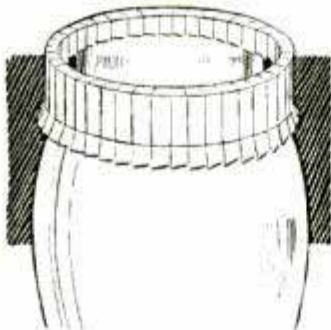

APPLICATION of liquids, such as hair dressing or scalp tonics, is made easier by a fountain comb patented recently. The comb's main rib is a hollow tube and its handle is designed to receive a fluid reservoir. A connection between the tube and reservoir permits the fluid to flow freely. Fluid ducts, each surrounding one tooth of



(Continued to page 51A)

SUPPRESSED KNOWLEDGE OF THE AGES

What strange powers did the ancients possess? Where was the source of knowledge that made it possible for them to perform miracles? Were these profound secrets burned with ancient libraries, or are they buried beneath crumbling Temple walls? These wise men of the past knew the mysteries of life, and personal power. This wisdom is not lost—it is withheld from the mass. It is offered freely TO YOU if, with an open mind, you wish to step out of the rut of monotonous existence and MASTER YOUR LIFE.

THIS FREE BOOK

Man's intolerance has at times swept his achievements from the face of the earth, yet secret brotherhoods have preserved this sacred wisdom of the ages. The Rosicrucians, one of these ancient brotherhoods, INVITE YOU to write and secure a free copy of "The Secret Heritage." It will point out how you may receive age-old truths. You can learn to MAKE YOUR LIFE ANEW—the fulfillment of your ideals awaits you. Address:

Scribe Y. Z. H.

The Rosicrucians

— AMORC —

SAN JOSE, CALIFORNIA

The Rosicrucians are NOT a religious organization

SNUBBED BECAUSE OF "ADOLESCENT SKIN"?

**Act now to help keep your blood
free of pimple-making poisons**

Don't go on being cursed by loathsome pimples. Don't make others feel ashamed of you or shun you. Find out what's the matter and correct it.

During the period of adolescence, in the years between 13 and 25, important glands are developing. This causes disturbances throughout your body. Waste poisons from the intestines often find their way into the blood . . . and may break out in ugly skin eruptions. You must help free your system of these intestinal poisons.

Thousands of young people have solved this problem—simply by eating Fleischmann's Yeast. Each cake of this fresh food contains millions of tiny, living plants that act to help you eliminate waste poisons from the body—before they can get into the blood. Your skin becomes clearer and fresher again. Many get remarkable results in 30 days or less. Don't lose time. Start eating Fleischmann's Yeast now . . . 3 cakes daily, one before each meal.

Learn AVIATION

Come to LINCOLN PREPARE NOW AT THIS GOVERNMENT APPROVED SCHOOL

for a good position as Pilot or Mechanic. Air Transport Pilots earn up to \$6000 a year; Aviation Mechanics up to \$2400.

LINCOLN'S FLIGHT TRAINING prepares you for your Government Rating as Transport, (Commercial), Limited Commercial or Private Pilot. 14 Training Planes; Veteran Instructors; Large, modern Airport.

LINCOLN'S GOVERNMENT APPROVED MECHANICS TRAINING gives you practical experience in modernly equipped Shops and Laboratories. Prepares you for immediate employment with Government Rating as Airplane and Engine Mechanic.

POSITIONS FOR MORE LINCOLN TRAINED MEN. Through our employment service, Lincoln Graduates are regularly taking positions with leading companies.

WRITE TODAY for complete information.

LINCOLN AIRPLANE & FLYING SCHOOL
558 Aircraft Building Lincoln, Nebraska

LEARN MECHANICAL DENTISTRY

A profession offering unlimited opportunities. Most modern and complete course embracing every branch from Plate to Porcelain Work, which prepares you to work for Dentists or start your own business. Individual instruction—practical training in day or night school. No books—no classes. Catalog upon request.

Dept. 736

McCARRIE SCHOOL OF MECHANICAL DENTISTRY
207 N. Broad St. Phila., Pa.

Correspondence Courses in RADIO and ELECTRICAL ENGINEERING LOW AS \$25

ELECTRICAL ENGINEERING. Get good grasp of wide electrical field. Modern. Very understandable.

RADIO ENGINEERING. Extra fine course in radio, public address, photo-electric work. Trains you to be super-service man, real vacuum tube technician. Tuition ONLY \$25, either course. Deferred payment plan. Experiment kits furnished.

FREE Write for free copies of school catalogs, student magazines, etc. LINCOLN ENGINEERING SCHOOL, Box 931-91, Lincoln, Nebr.

3 IN 1 Electric TORCH WELDS BRAZES SOLDERS

Now, an electric welding, brazing & soldering torch complete with inbuilt power unit, goggles and supplies. Works instantly off any light socket. Does a thousand and one repair jobs at an amazingly low cost on aluminum, iron, steel and other metals. Indispensable in auto shops for fender and body repairs. Unbeatable for home repairs, shop, factory, farm, engineer, janitor, sheet metal, radio and bicycle repairs. Anyone can handle without previous experience with our simple instructions. Does many industrial and production jobs.

10-DAY HOME TRIAL
—You can try 3-in-1 Electric Torch for 10 days at our risk or get one absolutely Free by helping to introduce it. Write for Free particulars.

ELECTRO-TORCH CO.
2613-AL Michigan Ave., Chicago

COMPLETE \$6.95
WHOLESALE TO YOU



DIESEL

Get BETTER training. Realize Adcox advantages Located in Pacific Northwest, a Diesel center. Established 28 years. Modern equipment, expert instructors. Close cooperation for YOUR success. Earn room and board while learning. Send for FREE big 40-page Diesel School Catalog No. 18. Home Study and Resident Courses.

L. L. ADCOX TRADE SCHOOL
Portland Oregon

HOME STUDY COURSES

Home Study Courses leading to Degrees in Arts and Sciences: Philosophy; Education; Writing; Psychology; Chemistry; Theology; Law; Agriculture; Business; Accounting; Sales; Advertising; Electrical, Civil, Mechanical, Diesel, Architectural, Aeronautical, Automotive, Drafting, Radio, Air Conditioning, Refrigeration, Highway, Mining, Petroleum, Industrial, Steam, Chemical Engineering. Chartered by State of Illinois. McKinley-Roosevelt Graduate College, 4228 Clarendon Ave., Chicago



The BRISCHOGRAPH makes you an artist INSTANTLY Use any size copy. Junior covers 4 x 4 inches at one time. Projects in colors and up to life size. Comes completely wired, with lamp, lenses and transpore mirror. Dealers in principal cities and foreign countries. Send \$10, money order, try it ten days. Money back guaranteed. Commercial models \$25., \$50. and \$100.

The BRISCHOGRAPH CO. 24 W. Weishelmer Rd. Columbus, O. Established 1926. Canada: Winnipeg Map & Blue Print Co., 318 Donald St; Winnipeg, Man.

ARTISTS MAKE MONEY

Find out your ability. Send name, age, occupation and address for Free Vocational Art Test.

Federal Schools, Inc., 8138 Federal Schools Bldg., Minneapolis, Minn.

BUILD ELECTRIC FENCE FROM OLD FORD T COIL

Costs nothing to build.

Operates on 6 volt battery. 35c brings complete plans and valuable catalog listing over 500 electrical items. No extra costs. LEJAY MFG., 447 LeJay Bldg., Minneapolis, Minn.

Monuments \$11. Up WE PAY FREIGHT

Best Marble or Granite. Big Saving. Lettered. Guaranteed. Send Today for our FREE Catalog and samples.

U. S. MARBLE & GRANITE CO., A-18, Oneco, Fla.

BUILD CLOCKS for PLEASURE—PROFIT



Hall clocks are high priced in stores—you can make good money building them or electrifying spring clocks. Dime brings drawing of easily built Grandfather Case with "HOW" Book pricing banjo, desk, mantel, spring. ELECTRIC chime. BATTERY CLOCKS from \$1.40. Hall clock. Brass weight chime movements from \$16.95. Start now. KUEMPEL CHIME CLOCK CO. Building 19 Guttenberg, Iowa

RADIO SERVICE MEN ♦ EXPERIMENTORS

Schematic Diagram—Any Radio..... .50
Builders Plans—Any Type Radio..... 1.00
Any Single Technical Radio Question Answered..... .25

RADIO RESEARCH LABORATORIES, Dept. 3, 415 Deadrick St., Knoxville, Tenn

BIND YOUR OWN MAGAZINES AND BOOKS

It's easy with the Pratt Bookbinding Unit. It does the entire job. Easily attached to any work bench. Make money doing binding for others. Unit will pay for itself in a short time. Send for free illustrated circular—G. A. Pratt, 4227 Euclid Ave., East Chicago, Indiana.

900 WORK SHOP IDEAS!

How to Make Articles of Beauty and Utility that Sell

Get the most out of your hobby. Turn your Work Shop hours into profit. The "Make It Yourself" book shows you what to make and how to make it, with that "professional touch"—models—toys—useful decorative articles of all kinds. Newest edition—480 pages, 823 pictures, 7 x 10 inches. Sent postpaid for \$3.00 or in U. S. and possessions C. O. D.—you pay postman. Order Now.

"MAKE IT YOURSELF" INCLUDES:

Toys—Models—Furniture—Garden Equipment—Home Repairs—Sports Equipment—Auto Kinks—Radio Equipment—Workshop Tools and Machinery. Articles on Working: Wood, Metal, Leather, Glass, Etc., Etc., Etc.

POPULAR MECHANICS PRESS, Room 837B

200 E. Ontario St., Chicago

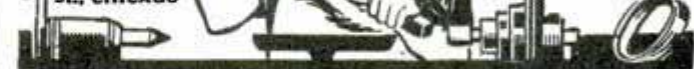

"I WANT TO TAKE THIS OPPORTUNITY TO THANK YOU FOR DOING ME A FAVOR BY SELLING ME MY HOBART WELDER. I CERTAINLY AM WELL PLEASSED WITH IT AND IT HAS HELPED ME BUILD MY BUSINESS MORE THAN I CAN SAY."
—DANBURY, CONN.



SIMPLIFIED ARC WELDING BRINGS BIG PROFITS EVERY MONTH

New low prices make this profitable welding service available to everyone. Opens doors to big pay jobs that carry real profit. Hobart welders are easier to operate, faster, guaranteed to bring you quality welding business... extra profits will pay for welder without expense to you.

NO INVESTMENT TERMS—PROFITS PAY FOR IT

Extra earnings and savings possible with Hobart Welders make it easy to own without expense. Write for details.

HOBART BROS., Box M-831, TROY, OHIO



NEW INVENTIONS

(Continued from page 49A)

the comb, are provided for the flow from tube to the user's head.

AN attractive addition to the library or "den" in the home would be an illuminated terrestrial globe which has just been patented. The globe, which is translucent, has an opening for receiving an electrical socket into which is screwed a light

bulb. The socket forms one bearing point on which the globe may be rotated when desired. An annular ring is attached to the globe at the location of the equator.

SERVING the two purposes of clothes hanger and brushing rack, a handy device for the home has been patented. It has parts for engaging the shoulders of coats and means for pivotally supporting the hanger on a vertical surface and for swinging it from horizontal into vertical position. In position for brushing, the device affords protection against wrinkling of clothes.

FOR making underwater observations or explorations in comparatively shallow

water, a diving hood has been patented recently. It consists of a dome-shaped flexible head-encasing member, the lower end of which extends down around the neck. The neck

portion may be drawn closely about the neck by means of a cord so that air spaces may be eliminated from all portions of the hood except at the front, adjacent to the nose and mouth. An air hose or tube supplies air in the usual manner. Air pressure keeps water from entering.

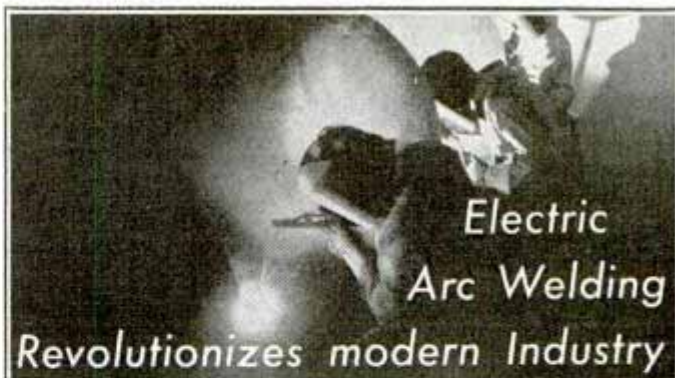
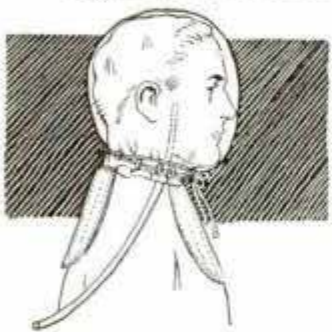

U. S. Manufacturers desire men to learn Electric Arc Welding and get practical experience under actual production conditions in the laboratories of the School of Engineering. Moderate training Fee. Accepted applicants will be fully trained until ready to pass rigid test and assisted in securing employment. **ARC WELDING** presents one of the outstanding opportunities for steady income and future success. Welding is growing rapidly, replacing large and intricate castings, rivets, nuts, bolts, screws. It is commonly used in assembling cranes, hoists, bridges, structural steel work, etc. No limit to the application of welding to industry, increasing durability and reducing manufacturing costs. There is a decided shortage of properly trained Welding Operators, Technicians, and Welding Engineers. Why be content with ordinary work, hit and miss jobs and low pay when in a short time you can become a trained Specialist in Welding?

MILWAUKEE
SCHOOL of ENGINEERING
Institute of Electrotechnics

Dept. PM-838, Broadway & E. State, Milwaukee, Wis.

EXTRA!

'THE DAWN OF A GIGANTIC INDUSTRY'
Seventh Edition!
Just off the press!
Get this new popular, fascinating large-size 68 page book, biggest ever published on Welding Training for Industry. It's free to Men of Action!

Without obligation send Free Booklet "The Dawn of a Gigantic Industry and its Outstanding Opportunity."

Also tell me How to Become an
Arc Welding Operator (3 1/2 mo.).....
Gas Welding Operator (6 wks.).....
Welding Technician (4 mo.).....
Welding Engineer (1 yr.).....
Electrical Engineer
B. S. Degree (4 yrs.).....
Air Conditioning & Refrig. Tech. (3 mo.)
Radio Serviceman (6 mo.).....
Student Loan Plan.....
Earn Part Expense Plan.....

Name.....Age.....

City.....

State.....(PM-838)

YES, BOB, MOUNTING BIRDS and ANIMALS IS A GRAND HOBBY! I'VE DOUBLED MY FUN FROM HUNTING—AND AVERAGE \$14 PER WEEK, SPARE TIME, MOUNTING FOR HUNTERS—WHY DON'T YOU WRITE TO THE N. W. SCHOOL FOR THEIR FREE BOOK?

FREE BOOK!

Learn Taxidermy at home. Write today for Free Book. State age.
N. W. School of Taxidermy
C337 Elwood Bldg., Omaha, Nebr.

TRAIN FOR Radio in 12 WEEKS
I WILL FINANCE YOUR TRAINING IF YOU ARE SHORT OF MONEY

Prepare for opportunities in Radio Broadcast, Talking pictures, Television, by 12 weeks of practical shop work in the great Coyne Radio Shops, on real RADIO and Sound equipment. You don't need advanced education or experience. Free Employment Service for life. Many earn while learning. Electric Refrigeration included. Mail coupon today for free book which tells you how hundreds have become successful RadioMen after taking our training.
H. C. LEWIS, Pres., RADIO DIV., Coyne Electrical School
500 S. Paulina St., Dept. CS-3H, Chicago, Illinois

Send Free Radio Book and facts. Tell me about your "Pay-Tuition-After-Graduation" Plan.

NAME.....AGE.....

ADDRESS.....

CITY.....STATE.....

OL' JUDGE ROBBINS'

TRAILER TRIP—at
BOSTON



THIS IS THE FAMOUS MASSACHUSETTS STATE HOUSE, CHUBBINS

THAT'S REAL GOLD ON THE DOME, ISN'T IT, DAD?



THIS OLD NORTH CHURCH IS REALLY ONE OF AMERICA'S GREAT HISTORICAL SHRINES

OH, DAD, LOOK AT THAT MAN'S PIPE. HIS OWN FACE IS CARVED ON IT



HOW'S THAT AGAIN?

I SAY, WOULD YOU MIND LETTING ME KNOW WHERE YOU HAD YOUR PIPE CARVED?



SAY, YOU'RE JUDGE ROBBINS, AREN'T YOU? IF YOU'LL RIDE WITH ME, I'LL GLADLY TAKE YOU TO THE PIPE-CARVING SHOP

WELL, THAT'S VERY KIND OF YOU, SIR. THIS IS MY DAUGHTER, CHUBBINS



A FEW DAYS LATER...

OH HELLO, JUDGE--- I SEE YOU'VE HAD YOUR PIPE CARVED. NOW YOU HAVE SOMETHING TO BE EXCITED ABOUT ON BOTH SIDES OF YOUR PIPE

HA, HA--- THAT'S RIGHT! **OUTSIDE**, I'VE A FINE ADDITION TO MY PIPE COLLECTION-- **INSIDE**, THE GRAND-EST TOBACCO A PIPE-SMOKER COULD IMAGINE



WELL, I'VE TRIED A LOT OF TOBACCOS IN MY TIME, BUT PRINCE ALBERT IS BY FAR THE MOST FRIENDLY AND GRATIFYING

I FIND MOST PIPE-SMOKERS FEEL THAT WAY ABOUT PRINCE ALBERT, AND NOT ONLY HERE, BUT **EVERYWHERE** I GO!

THE STORY OF SMOKING JOY



PRINCE ALBERT TASTES THE WAY IT SMELLS—**RICH BUT MILD.** AND THE **NO-BITE** PROCESS TAKES OUT RAWNESS

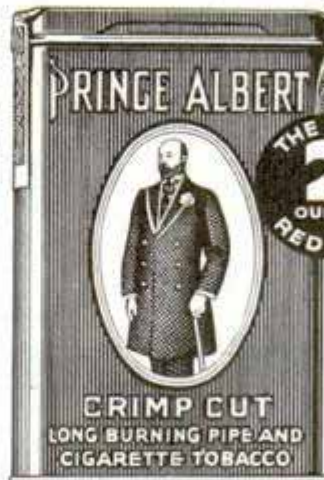

"MAKIN'S" SMOKERS
P.A. TWIRLS UP QUICKER, SMOKES Milder. AROUND 70 SWELL "MAKIN'S" SMOKES TO THE TIN

READ THIS GENEROUS OFFER

Smoke 20 fragrant pipefuls of Prince Albert. If you don't find it the mellowest, tastiest pipe tobacco you ever smoked, return the pocket tin with the rest of the tobacco in it to us at any time within a month from this date, and we will refund full purchase price, plus postage. (Signed) R.J. Reynolds Tobacco Company, Winston-Salem, North Carolina

Copyright, 1988, R. J. Reynolds Tobacco Company

50

pipefuls of fragrant tobacco in every 2-oz. tin of Prince Albert

PRINCE ALBERT
THE NATIONAL JOY SMOKE

Popular Mechanics Magazine

REGISTERED IN U. S. PATENT OFFICE AND CANADA

WRITTEN SO YOU CAN UNDERSTAND IT

Vol. 70

AUGUST, 1938

No. 2

The DIESEL in the AIR



The "Nordmeer" waiting to be hoisted on board catapult ship after transatlantic crossing. This seaplane is equipped with four 600-horsepower Diesel engines

MANY Diesel-engined planes are now in use in Europe and their number is rapidly increasing every year. This change-over from the gasoline engine started in 1931, when a plane equipped with a Junkers Diesel was tried out by Deutsche Lufthansa, Germany's national air line. That year, only 1,634 miles were flown, but from that small beginning, Diesel mileage has increased steadily. Last year, at least 25,000 miles a week were flown with Diesel-engined craft and this

By Paul H. Wilkinson
Author of "Diesel Aircraft Engines"

year, from all indications, the mileage will be near the 50,000-mile-a-week mark. The engine making these flights possible is the Junkers "Jumo" Diesel. Development work commenced as far back as 1912, so many years elapsed before success was attained. Now, the importance of the Diesel can be judged from the fact that a huge new factory near Dessau has been built to produce these "Jumo" power plants. The current production model is the "Jumo" 205, which has power ratings

Chicago Tribune 5/8/38

slant
21-9.
Lang
Parsons Blvd. Flushing, L.I.
New York

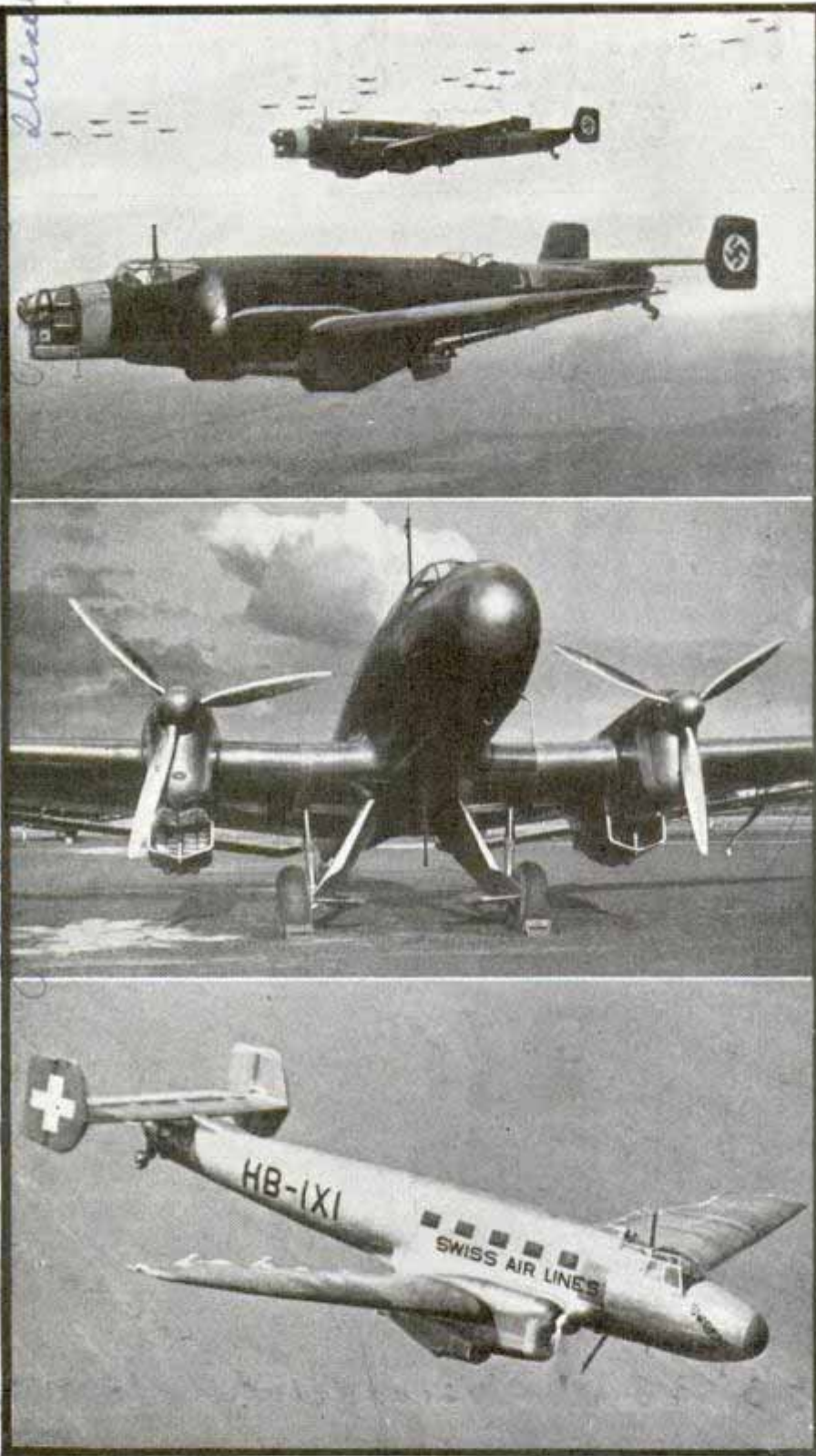

Top, Junkers Ju 86 K fighter-bombers are Diesel powered. Center, German air liner powered with water-cooled Diesel engines. Bottom, air liner in Swiss Air service is driven by Diesels

product of the same concern which builds the engines. This is the Junkers Ju 86, a modern all-metal, ten-passenger air liner similar in appearance to the twin-engined Lockheed in this country. Powered with two 600-horsepower "Jumo" 205 Diesels, it cruises at 175 miles per hour and has a range of about 1,000 miles.

Versatility of the engines on these planes was demonstrated a short time ago when one of them visited Kabul, in Afghanistan. In that remote region, Diesel fuel was unobtainable but there was plenty of kerosene available, so the plane was tanked up and continued on its way, 950 miles to its next port of call, without difficulty.

The "Jumo" Diesel is also utilized for military purposes. The military version of this plane is the Ju 86 fighter-bomber extensively used by the German Air Corps. These planes have special turbo-supercharged engines which develop their rated power of 700 horsepower at an altitude of 20,000 feet. Many squadrons of these bombers are in service, and the engine is being tried out on other types of fighting craft.

On air-mail routes, the Diesel has some fine flights to its credit. Outstanding was the 3,600-mile non-stop flight of a Junkers Ju 86 mailplane with its crew of three from the factory at Dessau, to Bathurst in British Gambia, on the west coast of Africa. This flight was first accomplished in 1936, at an average speed of 180 miles per hour. Since then, it has been repeated frequently. The maximum range of these planes, carrying

ranging from about 600 to 700 horsepower.

Deutsche Lufthansa uses Diesel-engined planes on many of its routes in Germany, and on routes to Holland, Switzerland, Poland and Denmark. Swiss Air, too, employs the Diesel on its air lines between Zurich and Vienna. The plane in which the engine is most extensively used is a

mile non-stop flight of a Junkers Ju 86 mailplane with its crew of three from the factory at Dessau, to Bathurst in British Gambia, on the west coast of Africa. This flight was first accomplished in 1936, at an average speed of 180 miles per hour. Since then, it has been repeated frequently. The maximum range of these planes, carrying

2 unpowered
 Lufthansa
 Diesel
 Junkers Ju 86

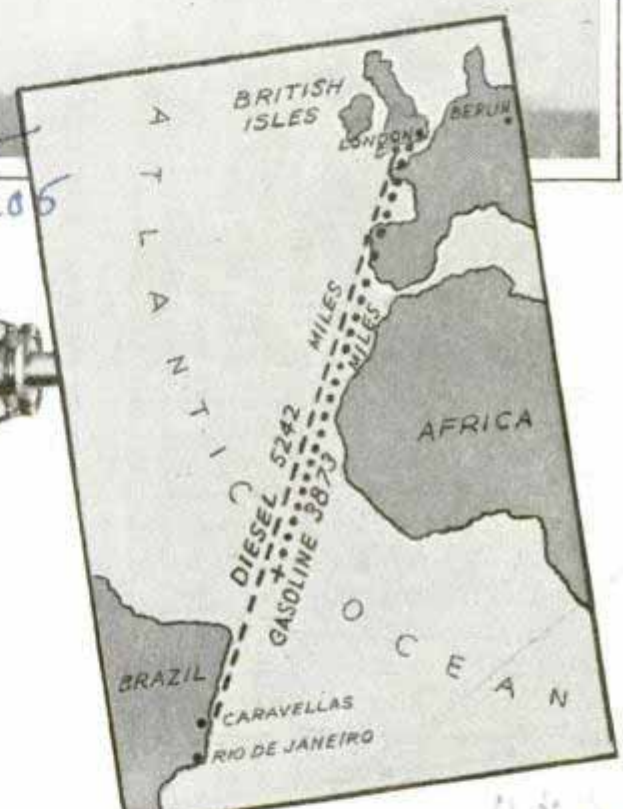
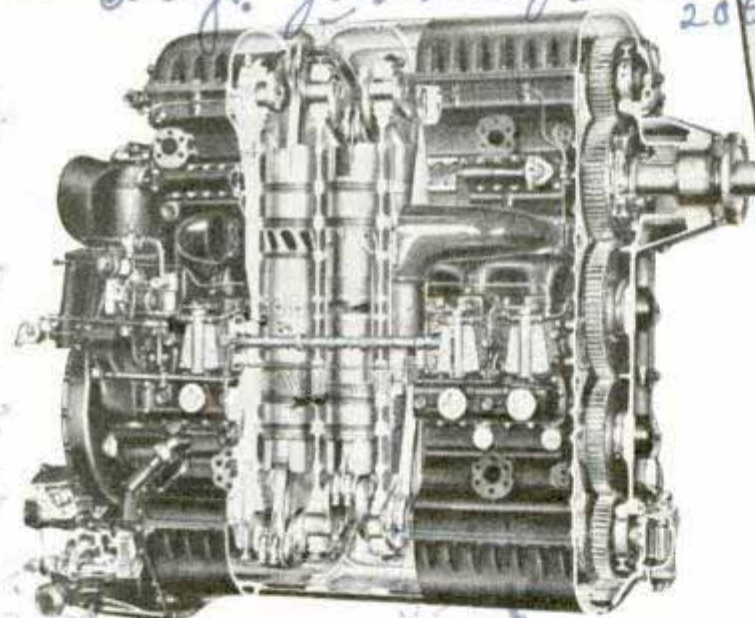

Top, Diesel flying boat which set world's seaplane distance record. Bottom, left, sectional view of aviation Diesel. Right, map shows distances that two similar planes of equal fuel capacity would travel if one were equipped with Diesel engines and the other with gasoline engines. The Diesel gives about one-fourth more miles per gallon under average flying conditions

1,000 pounds of mail, is about 4,000 miles. From Bathurst, Deutsche Lufthansa operates a fleet of four Dornier Do 18 flying boats across the 1,900-mile stretch of the South Atlantic to Natal, in Brazil. These planes are named the "Aeolus," the "Zephir," the "Pampero" and the "Zyklon." Their engine installation is noteworthy in that it consists of two 600-horsepower "Jumo" 205 Diesels mounted in tandem, back to back, along the axis of the plane. This makes possible excellent streamlining of the engine nacelle, and as the propellers then revolve in opposite directions, their torque is neutralized. The Do 18 carries a

crew of four, has a cruising speed of 125 miles per hour, and can carry a 1,000-pound payload a distance of 2,400 miles.

The "Aeolus" and the "Zephir" will be remembered for their survey flights across the North Atlantic in 1936, when they made eight scheduled flights between New York and the Azores. So well did their engines perform over the 2,400 miles between these points, that two larger planes with similar power plants were ordered by Deutsche Lufthansa for their 1937 flights. These powerful Hamburg Ha 139 seaplanes, the "Nordmeer" and the "Nord-

(Continued to page 134A)

Steel Ingot Weighing 230 Tons Is Produced in English Plant

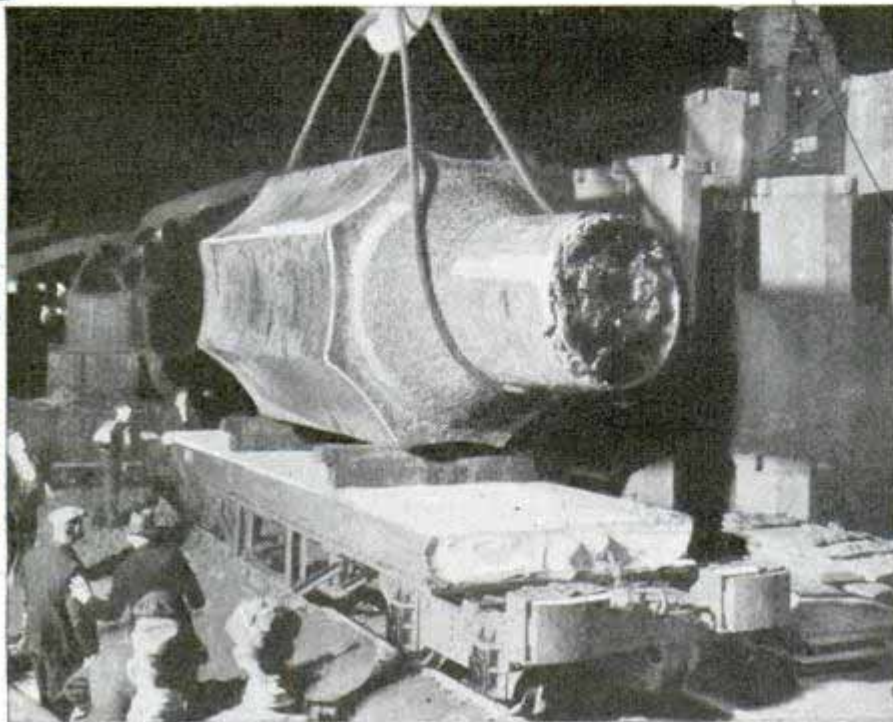

Loading the big chunk of steel on a flatcar. It required a 250-ton crane to manipulate the 230-ton ingot, largest ever produced in England

Destined to be made into large forgings for use in the British re-armament program, a 230-ton steel ingot turned out recently by a plant at Sheffield set a new record for England, if not the world. It measured twenty-five feet by eight feet nine inches, and required steel from four acid open-hearth furnaces. A 250-ton crane set it on a railroad truck.

Chemists Convert Waste Lignin into Valued Raw Material

Once a waste product of the forests, lignin at last is being converted by chemists into highly valuable raw materials. In the U. S. Forest Products Laboratory at Madison, Wis., ways have been found to make lignin into wood alcohol; into propyl-cyclohexanol, which may be used as a lacquer solvent or a wood preservative; into an adhesive resin which promises to become a valuable plastic material, and into other compounds for the chemical and lacquer industries. The method of conversion is hydrogenation, used previously to obtain petroleum oils from coal. Lignin comprises twenty to thirty per cent

of the stems of trees and woody plants, and more than seventy per cent of it can be converted into chemicals for industrial use. One source already available is the 1,500,000 tons of lignin discarded every year by factories.

Wigwag Headlight Used as Passing Signal for Auto

Swinging from side to side to command attention, a wigwag headlight for private automobiles is used as a passing signal to the car ahead. It is the type of light used by fire and police cars and some high-speed railroad trains, but on the private car it is a white light, mounted on the front bumper bracket and focused below the eye level to avoid dazzling. When passing a car, rounding a curve or meeting a driver whose lights are out of order it is an effective warning. Touching a button on the floor causes reflector and light bulb to move; all operating parts are sealed against dirt and moisture.

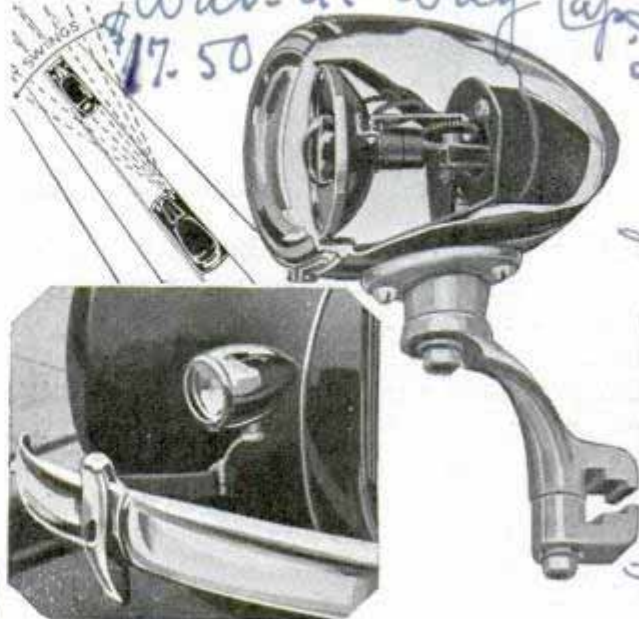

THE BEAM IS BELOW EYE LINE

Button on floor of car sets bulb and reflector in side-wise motion, lens and housing remaining still

*English Steel Corporation
Vickers Works Sheffield
Collage
H 570
H 640
Wash. D. C. Way
17.50
Science Service
5/24/38
Vickers Works Sheffield England
English Steel Corp.*

Wireless Box Runs Radio by Remote Control

A radio receiver in the living room may be operated from the kitchen, a bedroom or any other part of the home with the aid of a small remote-control cabinet which has no wires leading to the receiver or any other physical connection with it. Since it is unnecessary to "plug in" the portable control unit or to attach it to the receiver, it is as easy to play the radio while sitting on the front porch as when in the living room beside it. With the aid of the wireless box, a Philco receiver designed for this form of remote control can be operated from a distance or tuned with controls built in the cabinet, whichever is handier. With the remote-control unit, any one of several stations can be selected, a change can be made from one station to another, volume can be adjusted or the set can be turned off, simply by operating a dial in the top of the wireless box. The makers claim each unit will operate only the set for which it is designed. While this is the first time wireless remote control has been applied to a commercial radio receiver, a tractor was operated by radio at Chicago's Century of Progress and wireless units have also been employed to control model boats, automobiles and airplanes. In the latter cases, the remote-control units usually consist of battery-



The radio receiver, above, can be operated from any room in the home with the aid of the remote-control box which is not connected by wires or in any other physical way with the receiver



operated radio oscillators transmitting high-frequency impulses. These controlling impulses actuate relays which operate the mechanism in the various devices.



Soilless Farm Yields Vegetables for Wake Island Colony

Passengers and crew of the trans-Pacific "Clipper" planes and the maintenance force on Wake Island dine there on fresh vegetables produced on the island's soilless farm. In ten days recently the shallow, water-filled trays yielded thirty-three pounds of tomatoes, twenty pounds of lettuce, twenty pounds of string beans, fifteen pounds of squash and forty-four pounds of corn. Lacking soil but favored by tropical weather, Wake Island was found to be an ideal place for hydroponic farming, in which essential minerals in water take the place of soil.

Philco Radio Corp. Television Corp. Traga and C. St. Phila Philco Mystery Control

Pan. American Airways 135E 42 nd.

Service Station

It's Time for Canning in the Tennis Factories



Above, a final stage in manufacture of tennis balls; putting on outer covering, sewing and "spooling"—ironing the seams down. Below, at right, the beginning of a tennis racket. Here a factory worker is bending strips of ash into shape. Rackets must conform to high standards as to weight, balance and stress

This is the season for canning corn—and tennis balls. Above, balls being packed in cans to keep them "live"

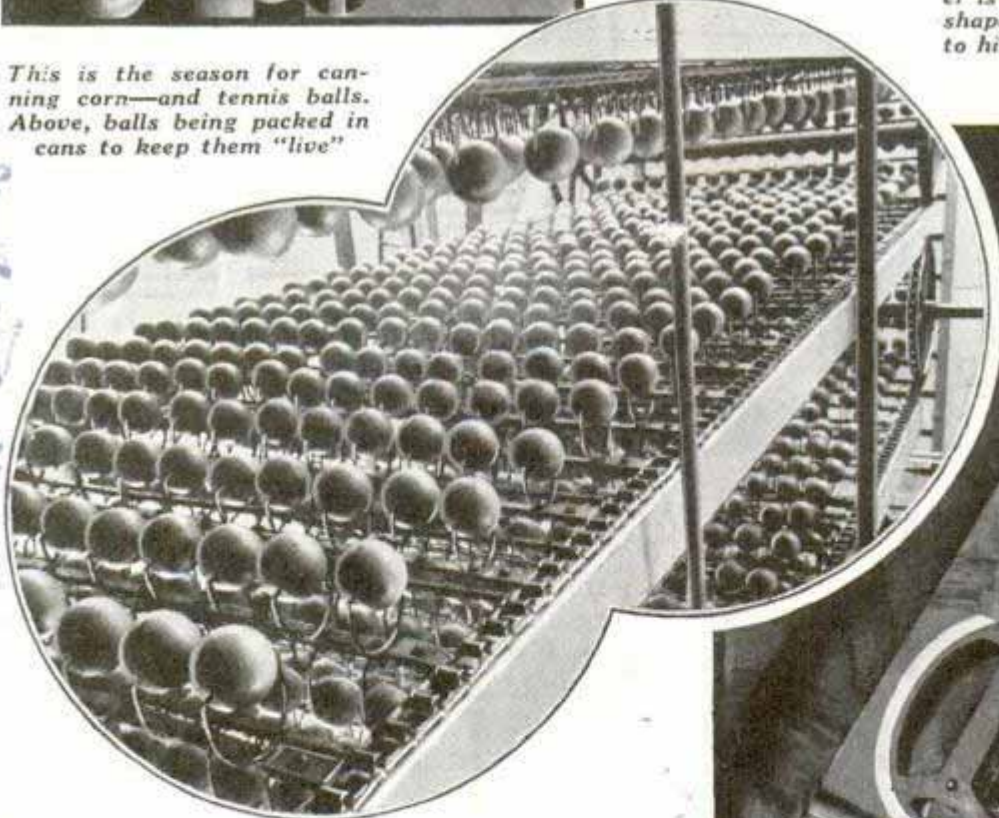

Thousands of Americans are smashing tennis balls over—and into—nets in parks and club grounds and thousands more are engaged in busy factories where rackets, balls, nets and equipment are produced. What you see, above, is not a parking lot for balloons but hundreds of tennis ball centers on drying racks in a factory. They have been coated with cement and are awaiting the proper moment for being covered

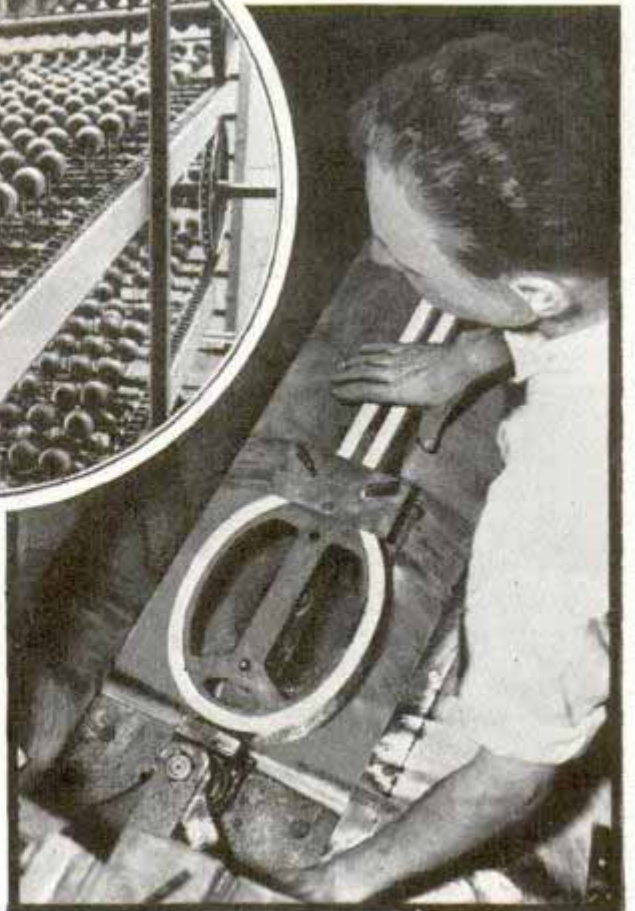

A. L. Spalding and Bros, 105 Nassau Street, New York

Anti-Air Raid Net Is Supported by Balloons

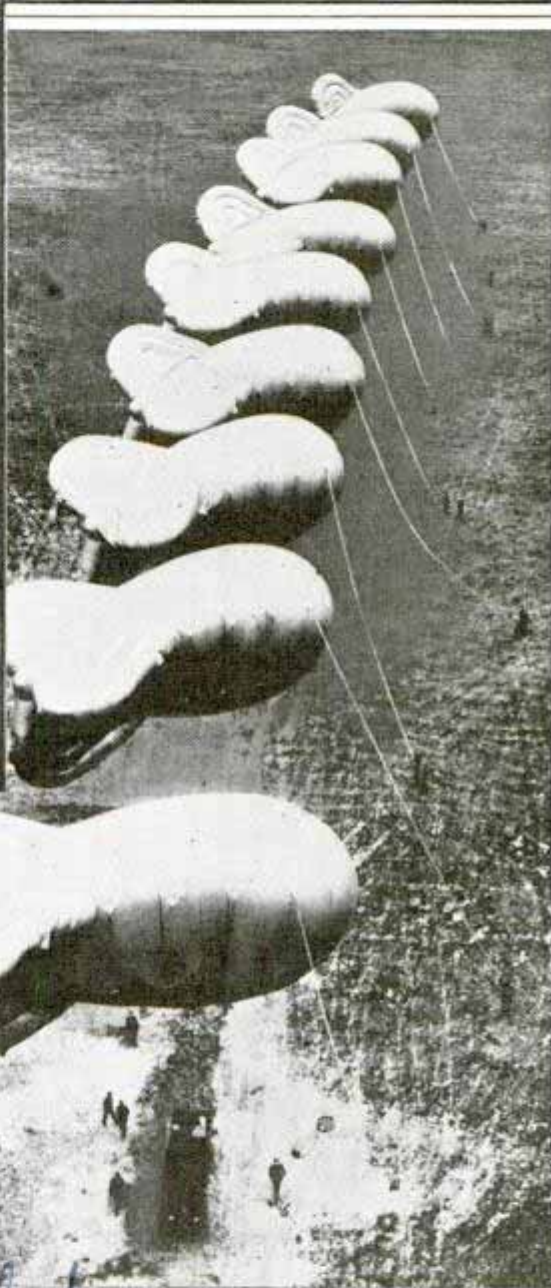
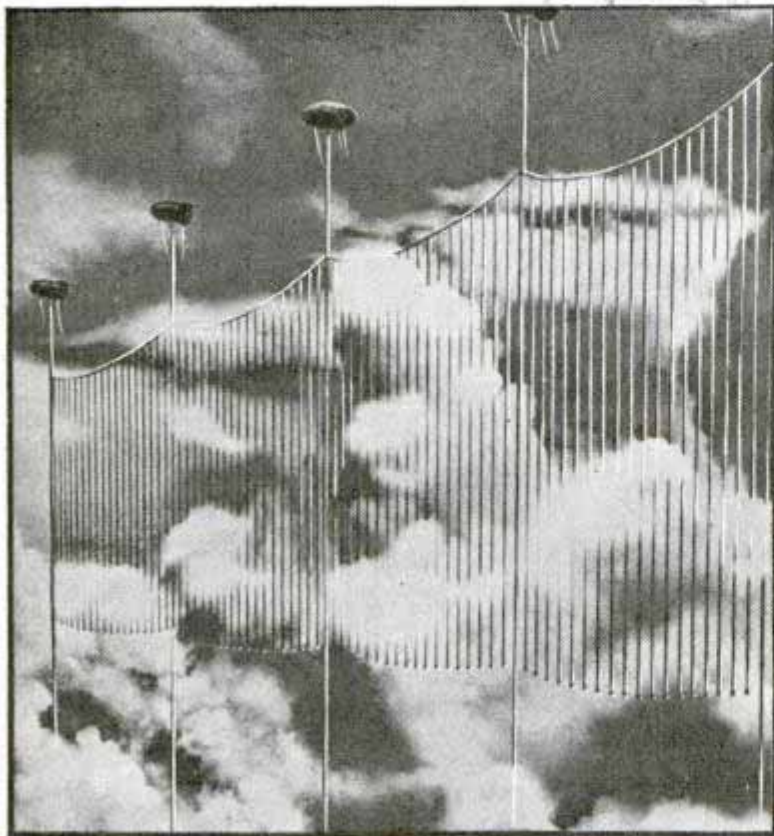

Left, balloon barrage or net as it would appear in use. Right, ground crew raising the captive balloons

Enemy planes attacking London will be entangled like flies in a spiderweb by an anti-air raid net which will be supported by captive balloons. If the planes rise to avoid the net, they will be flying too high to drop bombs with any degree of accuracy, yet will still be within range of anti-aircraft guns. Squadrons to handle the defense net will have forty to fifty captive balloons which will be inflated at the first warning that raiders are on the way. Personnel of the squadrons will be trained for the work of inflating and get-

ting the balloons into the air quickly. The balloon net already has been demonstrated to the satisfaction of Great Britain's military authorities.

Washing-Machine Motor Drives Midget Racing Auto

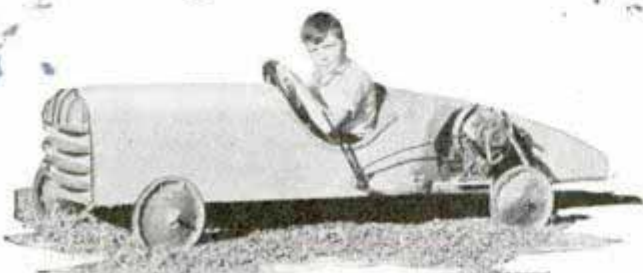

Missouri boy at wheel of one-cylinder midget car

Built on racing lines, a midget automobile constructed by Grover Revelle of Fredericktown, Mo., for his younger brother is powered by a one-cylinder washing-machine motor. Its "radiator" is copied after the latest style die-cast grilles. The tiny car will travel fifteen miles an hour on the level, and runs fifty to sixty miles on a gallon of gasoline.

Handwritten notes on the right margin:
Cardington, England
Cent. G. Fred Miller - Gutierrez de Larrea
No 26a

Handwritten notes at the bottom:
Bill... Grover Revelle, Mo.

Ball-Shaped Rotary Shovel Speeds Up Work

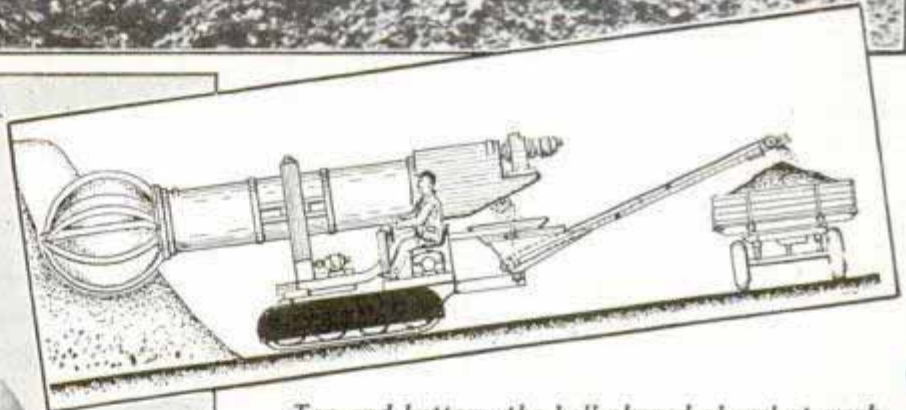
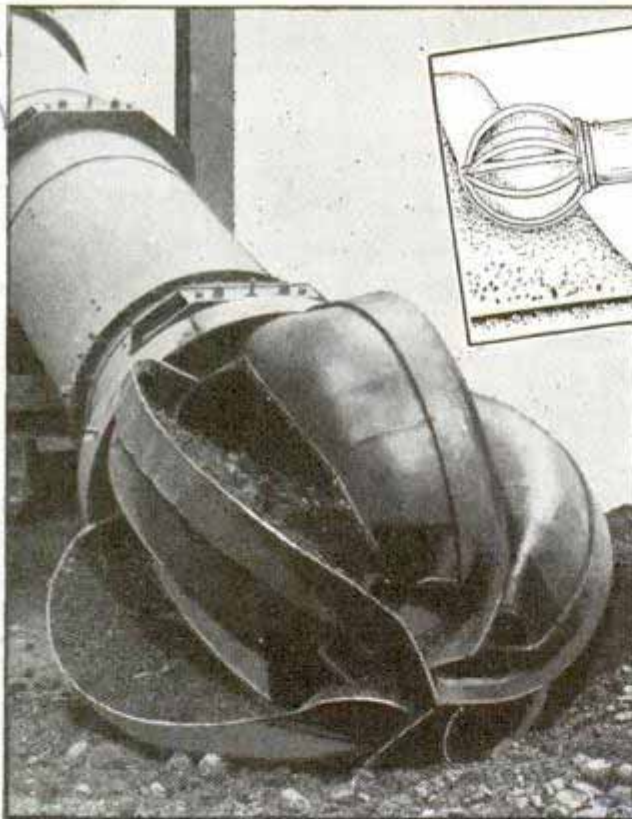

Top and bottom, the ball-shaped shovel at work. Inset, sketch of the machine

six scoops which are operated much like a bucket-dredger. The earth falls from the scoops as they approach their uppermost position and rests on inclined plates mounted on the stationary portion of the head. These plates guide the material onto a conveyor belt that runs inside the tubular backbone of the machine. The rotating part of the shovel head is driven by a six-horsepower motor.

Designed for excavating loose ground and simultaneously dumping the soil into trucks, a rotary ball-shaped shovel has been introduced in Germany. The shovel replaces the ordinary excavator and elevator, which cost more to maintain due to their lower resistance to wear. The head of the shovel has a rotating ring fitted with

Electron-Ray Supermicroscope Magnifies 100,000 Times

With a supermicroscope just developed in Berlin, scientists claim the ability to magnify an image 100,000 times—a drastic advance over the previous limit of 2,000 magnifications. The instrument uses electron rays instead of ordinary light rays.

1938 - Campbell's...
 1939 - Campbell's...
 1940 - Campbell's...
 1941 - Campbell's...
 1942 - Campbell's...
 1943 - Campbell's...
 1944 - Campbell's...
 1945 - Campbell's...
 1946 - Campbell's...
 1947 - Campbell's...
 1948 - Campbell's...
 1949 - Campbell's...
 1950 - Campbell's...
 1951 - Campbell's...
 1952 - Campbell's...
 1953 - Campbell's...
 1954 - Campbell's...
 1955 - Campbell's...
 1956 - Campbell's...
 1957 - Campbell's...
 1958 - Campbell's...
 1959 - Campbell's...
 1960 - Campbell's...
 1961 - Campbell's...
 1962 - Campbell's...
 1963 - Campbell's...
 1964 - Campbell's...
 1965 - Campbell's...
 1966 - Campbell's...
 1967 - Campbell's...
 1968 - Campbell's...
 1969 - Campbell's...
 1970 - Campbell's...
 1971 - Campbell's...
 1972 - Campbell's...
 1973 - Campbell's...
 1974 - Campbell's...
 1975 - Campbell's...
 1976 - Campbell's...
 1977 - Campbell's...
 1978 - Campbell's...
 1979 - Campbell's...
 1980 - Campbell's...
 1981 - Campbell's...
 1982 - Campbell's...
 1983 - Campbell's...
 1984 - Campbell's...
 1985 - Campbell's...
 1986 - Campbell's...
 1987 - Campbell's...
 1988 - Campbell's...
 1989 - Campbell's...
 1990 - Campbell's...
 1991 - Campbell's...
 1992 - Campbell's...
 1993 - Campbell's...
 1994 - Campbell's...
 1995 - Campbell's...
 1996 - Campbell's...
 1997 - Campbell's...
 1998 - Campbell's...
 1999 - Campbell's...
 2000 - Campbell's...

Schmeisser. 3 4

1938 - Campbell's...
 1939 - Campbell's...
 1940 - Campbell's...
 1941 - Campbell's...
 1942 - Campbell's...
 1943 - Campbell's...
 1944 - Campbell's...
 1945 - Campbell's...
 1946 - Campbell's...
 1947 - Campbell's...
 1948 - Campbell's...
 1949 - Campbell's...
 1950 - Campbell's...
 1951 - Campbell's...
 1952 - Campbell's...
 1953 - Campbell's...
 1954 - Campbell's...
 1955 - Campbell's...
 1956 - Campbell's...
 1957 - Campbell's...
 1958 - Campbell's...
 1959 - Campbell's...
 1960 - Campbell's...
 1961 - Campbell's...
 1962 - Campbell's...
 1963 - Campbell's...
 1964 - Campbell's...
 1965 - Campbell's...
 1966 - Campbell's...
 1967 - Campbell's...
 1968 - Campbell's...
 1969 - Campbell's...
 1970 - Campbell's...
 1971 - Campbell's...
 1972 - Campbell's...
 1973 - Campbell's...
 1974 - Campbell's...
 1975 - Campbell's...
 1976 - Campbell's...
 1977 - Campbell's...
 1978 - Campbell's...
 1979 - Campbell's...
 1980 - Campbell's...
 1981 - Campbell's...
 1982 - Campbell's...
 1983 - Campbell's...
 1984 - Campbell's...
 1985 - Campbell's...
 1986 - Campbell's...
 1987 - Campbell's...
 1988 - Campbell's...
 1989 - Campbell's...
 1990 - Campbell's...
 1991 - Campbell's...
 1992 - Campbell's...
 1993 - Campbell's...
 1994 - Campbell's...
 1995 - Campbell's...
 1996 - Campbell's...
 1997 - Campbell's...
 1998 - Campbell's...
 1999 - Campbell's...
 2000 - Campbell's...

The WORLD of TOMORROW



169

NIGHT view of the Perisphere at the New York World's Fair of 1939, as conceived by an artist. Moving patterns of colored light on the ball will cause it to appear to turn.

(Maree)

389

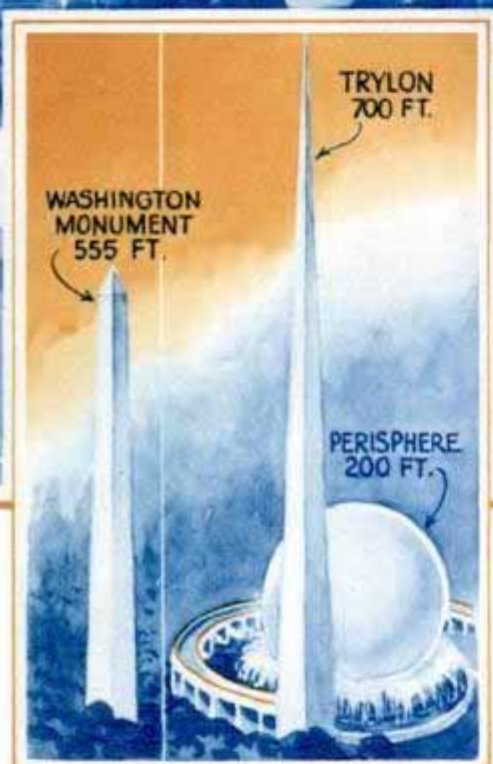
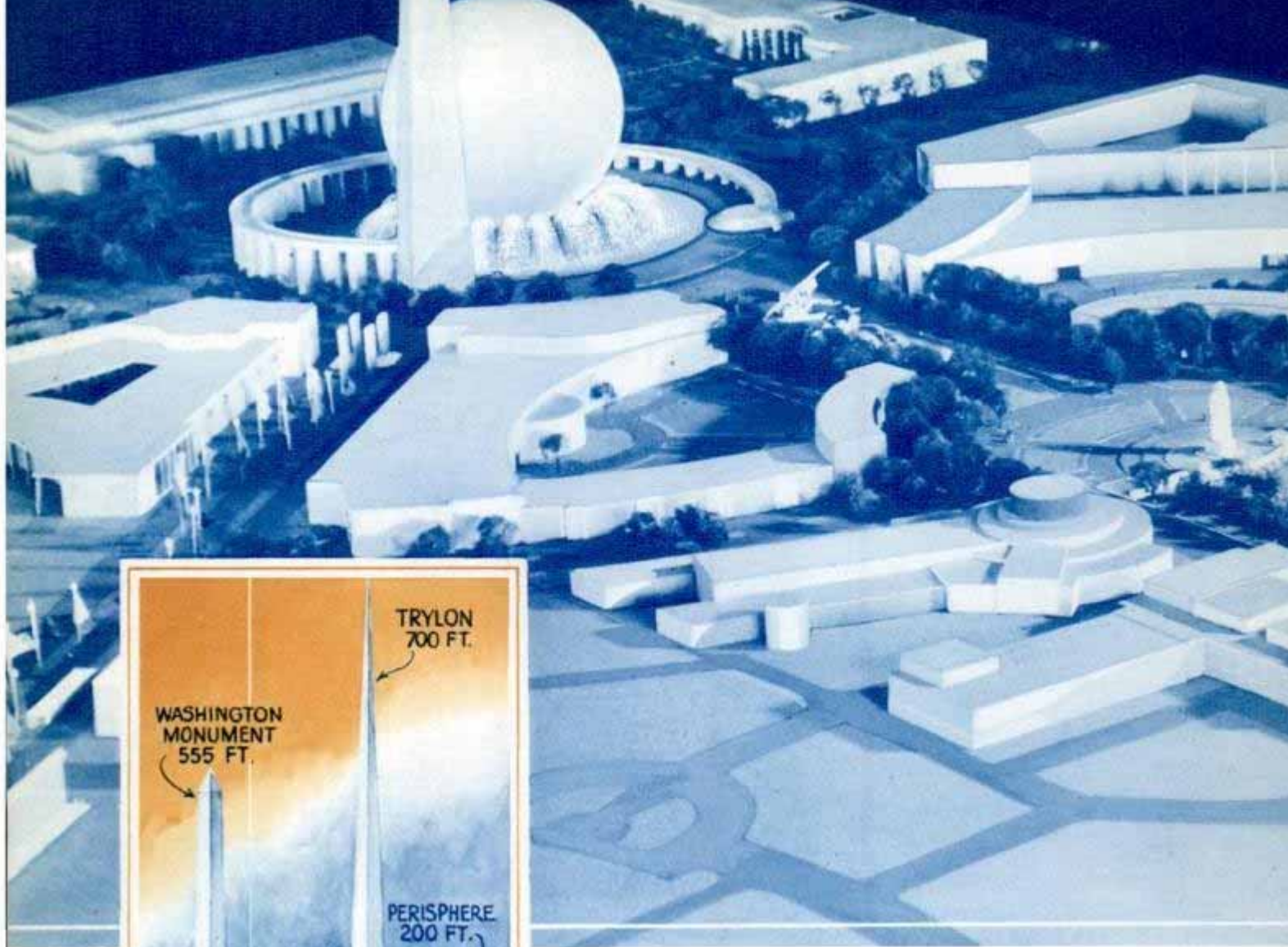

MIDDLE sector of the \$60,000,000 mile-long Central Mall which will extend like a jeweled band across the main exhibit area. Inset shows the Perisphere and Trylon as compared with the Washington monument.

AMERICA'S largest city next year will stage the world's largest fair, a \$150,000,000 exposition costing about three times as much as Chicago's famed Century of Progress.

In addition to costing three times as much, the New York fair will be three times as big as the Chicago fair. The Century of Progress covered 424 acres. The New York World's Fair of 1939 will extend over 1,216 acres.

In fact, New Yorkers point out happily, if Chicago's Columbian Exposition and Century of Progress were combined, both of them together would not be as large in area or as costly as the fair New York is planning. And whereas the Century of Progress attracted about 38,650,000 visitors in two seasons, New York

expects to entertain 50,000,000 visitors in six months.

Building the world of tomorrow will be the New York fair's central theme and when it opens next April 30, just 150 years after the inauguration of George Washington in New York City as our first president, it will present an example of man-made magic as amazing as the blooming of a lily out of the mire. For Flushing Meadow Park, the exposition site on Long Island, was formerly a city dump and this fair is rising out of a mountain of ashes to demonstrate how the tools and processes and knowledge of today can be used to create a better world tomorrow.

The theme center of the exposition and the dominant architectural feature is to

170

12389

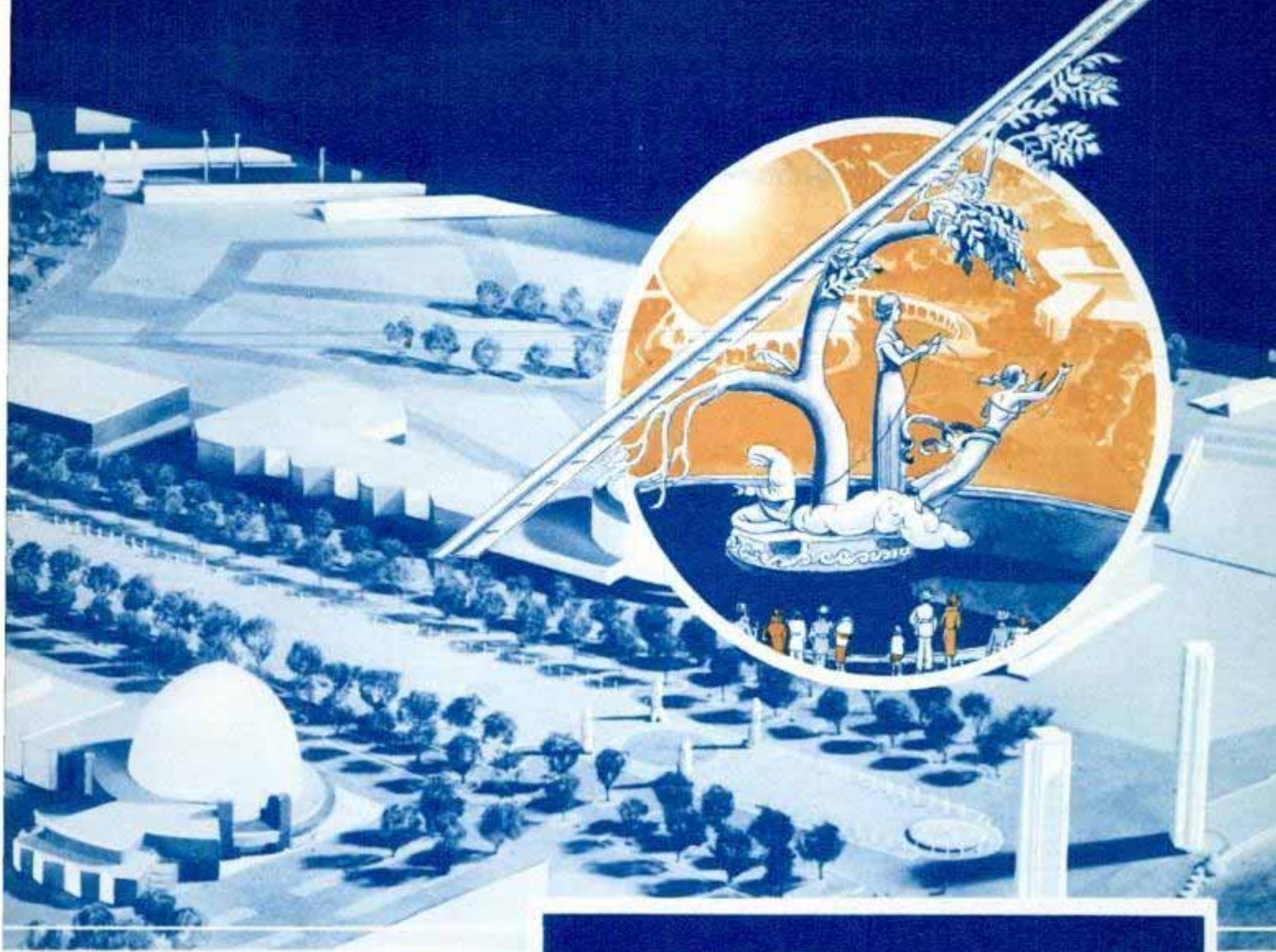

TELEVISION programs will be featured in the RCA building, shaped like a radio tube, shown in model form at right. In circle, model of a fifty-foot sundial.

be a white globe 200 feet high seemingly poised on a cluster of fountains and flanked by a 700-foot triangular shaft. This great white ball, called the Perisphere, will rise eighteen stories above the ground and will be broader than a city block. Except for the tower, it will be the fair's highest structure and will house the key exhibit, a spectacular portrayal of the world of tomorrow.

An endless stream of humanity will flow into the Perisphere night and day by way of a glass-enclosed moving stairway, the world's longest. From the top of this flight, five stories above the ground, visitors will step on a "magic carpet" or circular moving platform for their journey into the world of the future.

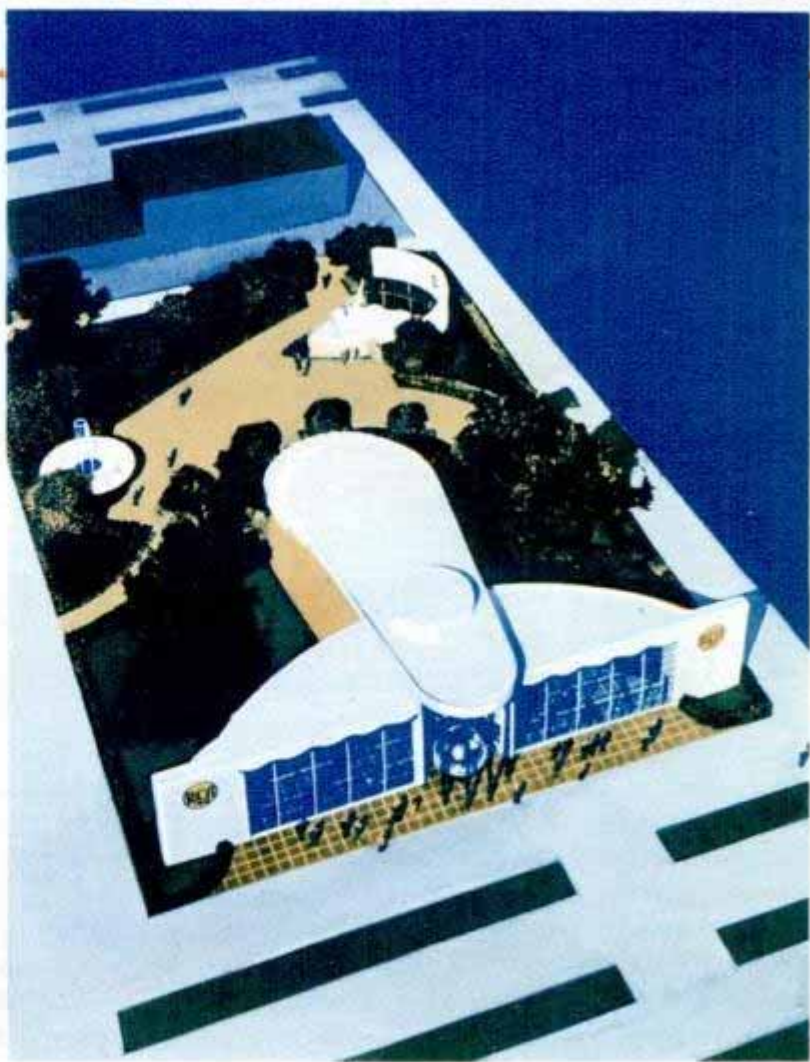

171



172
H 389
WORKING model of an interplanetary rocketport of the future at the moment the rocket departs. Ships, planes and trains of tomorrow will also be seen in model form.

As this platform, fourteen feet wide, 450 feet in circumference and carrying 1,200 passengers, moves slowly around the sphere, the crowds will gaze down on a vast panorama showing cities and towns, factories and farms and fields stretching off to the horizon on all sides and blending into the clouds and light patterns of the dome.

Here will be shown all the elements of society linked together for the common good. Ships and trains and trucks will be observed bringing raw materials from

farms and fields to cities and factories, and carrying manufactured products back to the country. A voice will explain the significance of all this movement, stressing the fact that each person today is dependent for his existence on the efforts of many other persons and pointing out how the problems of living have been simplified by cooperation.

From the exit, visitors will cross a bridge linking Perisphere and tower, descending a stairway inside the shaft or walking down a 900-foot "helieline" or

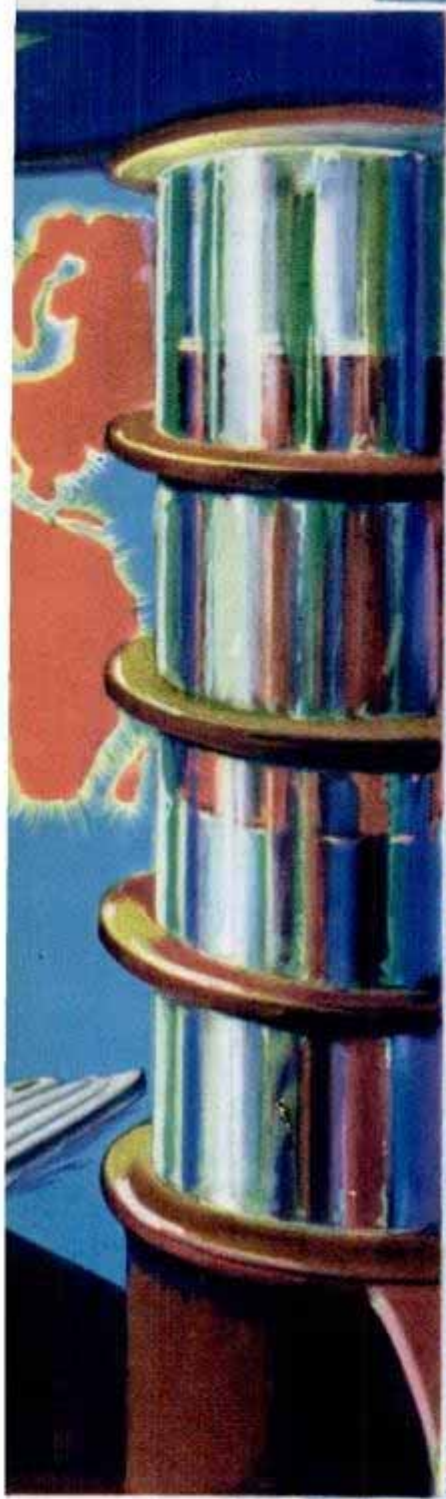

H 389

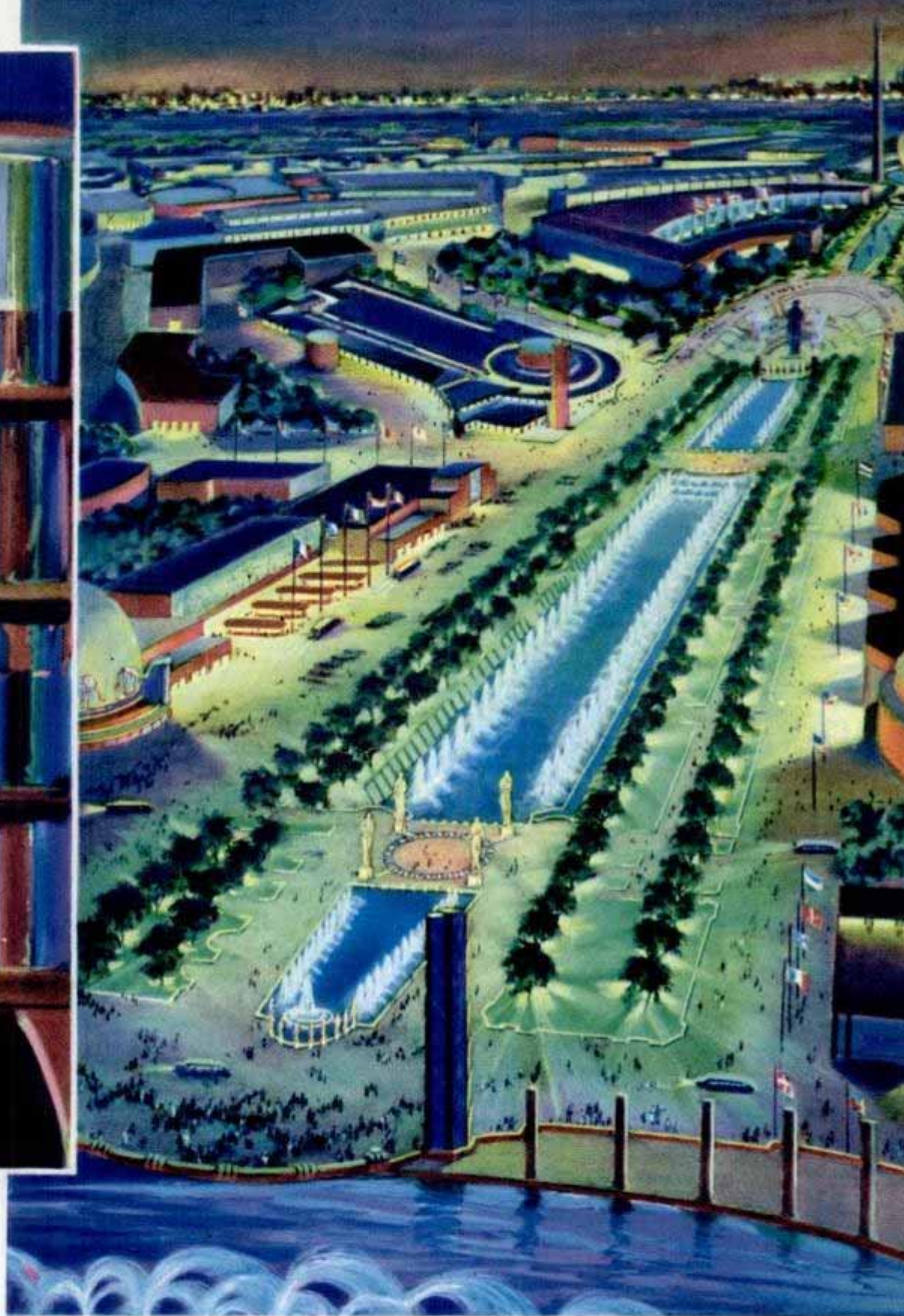

NIGHT scene along the Central Mall as conceived by an artist. Mercury vapor lights, sunk in the ground, will cast a glow into the trees, causing the under sides of the leaves to fluoresce and bathe the entire area in a luminous radiance after dark.

ramp winding around the fountain basin beneath the sphere. The top of this heli-cline, fifty feet above the ground, will be the highest point to which visitors will be admitted and will command a view of the entire fair.

Spectacular illumination will make the globe an awe-inspiring sight at night. Batteries of projectors will spot the sphere in color and other projectors will superimpose moving patterns of light on the ball, creating the illusion that it is a glowing, almost transparent bubble of changing color rotating lazily atop supporting clusters of spouting fountains.

Actually, the Perisphere, of articulated steel frame construction with a light outer covering and weighing more than



12 389

COURT of Peace, above, with the imposing federal building at one end of vast parade ground. Below, artist's sketch of seventy-foot entrance facade of Hall of Communications.

9,000,000 pounds, will be supported on eight sturdy columns but spectators will not see them because they will be encased in glass and water will be pumped up around them, making it appear that the bubble is held up by the rush of water.

The shaft, christened the Trylon, half again as tall as the Washington monument, will have a triangular base of sixty-three feet on each side and will serve as a fair guidepost since it will be visible for miles. It also will be a steel frame with a light covering and, while it has not been planned to use it for observation purposes, there will be space for installing elevators.

The Trylon is not to be illuminated at

night, except for reflected light, but will serve as the source of fair broadcasts. From it the "voice of the fair" will issue announcements over a new type of long range sound projector which will make it possible to blanket the entire grounds with beams of sound, thus eliminating overlapping and unpleasant variations in volume.

Water, flame, color and sound in almost incredible proportions are to be combined in providing two nightly spectacles expected to rival in sheer size and grandeur anything ever conceived by man for entertainment alone. One spectacle will feature the play of super-fountains and super-flames, synchronized with color effects, music and sound.

194



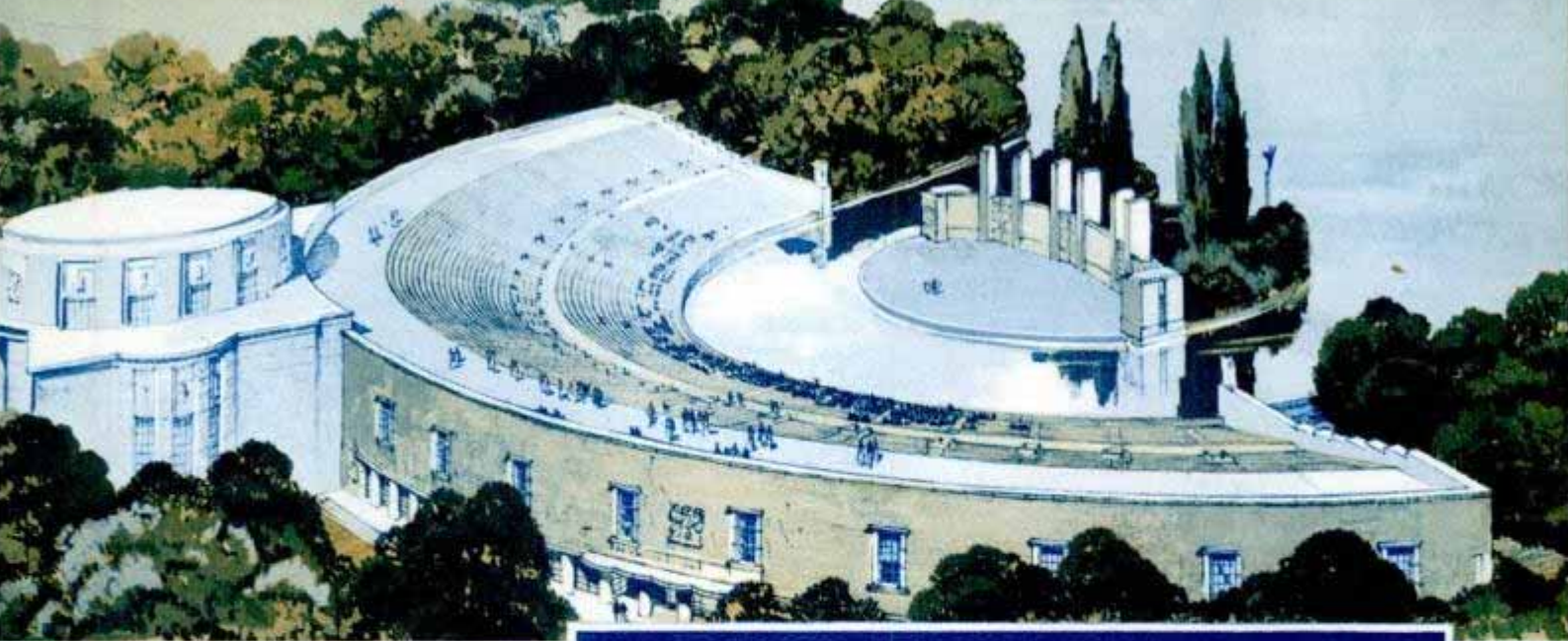

14 389
 The other will be a man-made Niagara plus a man-made Vesuvius, an approach to chaos.

Hydraulic engineers, gas-company chemists, fireworks manufacturers, illumination experts, musicians, display engineers, architects, color specialists and artists collaborated in planning these two displays which require installations costing \$700,000 and which are on so large a scale that two gas companies have united their resources to assure enough fuel.

The controls for these spectacles have been planned so carefully that a composition in water, flame, color and sound can be "played" from a central



175
MARINE amphitheater and island stage, top, which the State of New York will erect and where great pageants and spectacles will be presented. Above, model of the \$250,000 Aviation building. Below, twin ship prows, each eighty feet high, will give a nautical touch to the main entrance of the Hall of Marine Transportation.



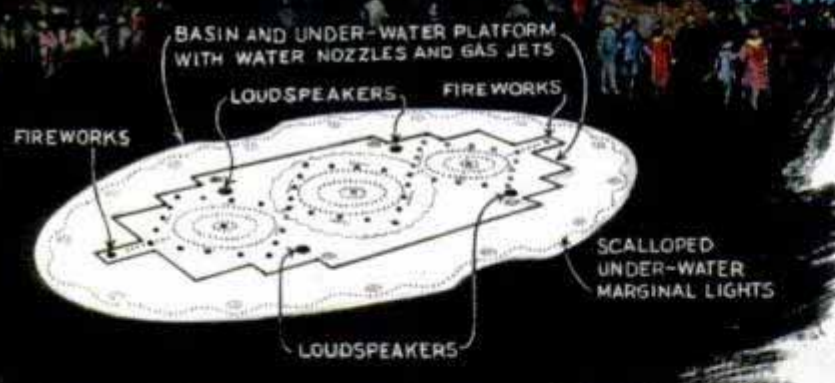

ARTIST'S sketch of a nightly spectacle in which water, flame, color and sound will be combined in almost incredible proportions. At the touch of a control, fountain jets and towers of flame 150 feet high will spring from hundreds of water nozzles and gas burners to form awe-inspiring designs.

196

2389

board much as one would render some great work on a pipe organ. At the touch of one control, a thousand fountain jets, some 150 feet high, can be made to spring from invisible sources, or towers of flame equally high can be produced to combine with the uprushing water in a furious battle of the two elements.

Then, at the height of this display, all valves can be closed so quickly that fifty tons of water will seem to hang suspended in midair. The apparent color of the water and the actual color of the fire can be controlled as easily, and the strains of a violin or music as tremen-

dous as thunder can be produced from the very heart of the spectacular turmoil.

One spectacle will be presented from an 800-foot lagoon in the main exhibit area, the other from a lake in the amusement zone. The lagoon display will require 1,000 water nozzles and many twenty-four-inch gas burners of the Bunsen type. Water nozzles will be grouped to produce the 150-foot columns, and one circle of jets which will produce a sheaf of golden wheat ninety feet high will require as much pumping force as would be exerted by sixty-two fire pumpers.

For the lagoon display, the many circles and pat- (Continued to page 128-A)

Stagecoach and Sky Liner Weld a Continent

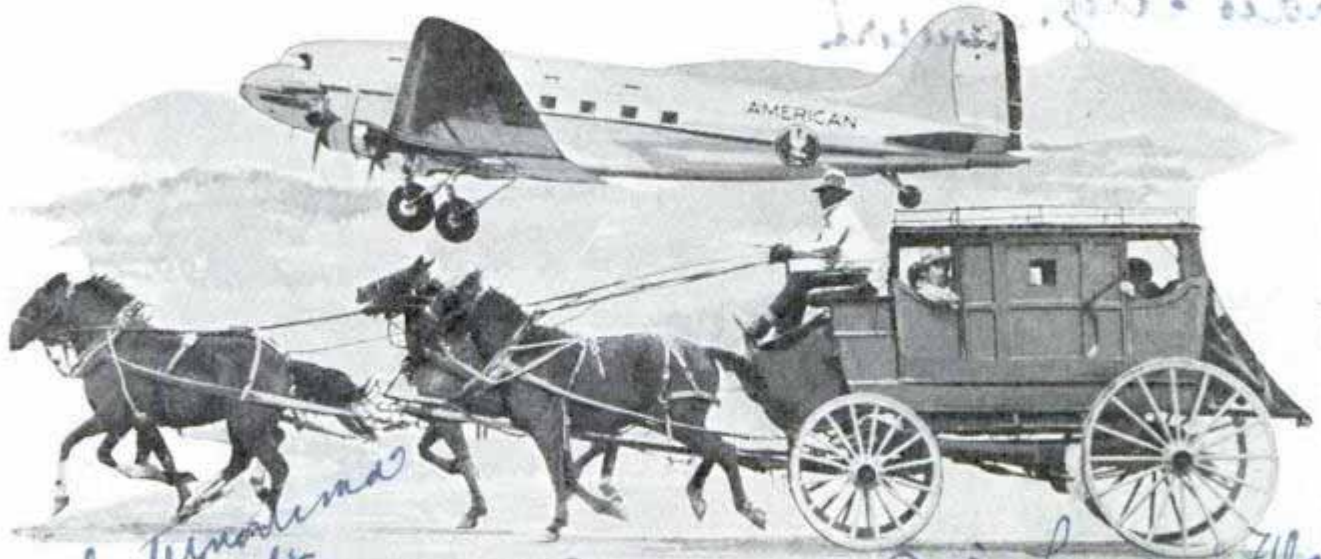

Western stage coach and a 1938 style air liner "take off" side by side, dramatizing the conquest of a continent by transportation. There is less than a century separating the horse-drawn coach from the flagship

It was only a half century from stage-coach to sky liner! A half century that moved swiftly, as pony express, stage-coach, railroad, motor road and finally the airplane brought city closer to city, until today the mail and passenger planes span

the continent in less than a day. The parts that stage and air liner have played in welding the nation were remembered dramatically the other day when an old-time western coach rattled along a highway while a giant flagship rose beside it.

Vacuum Tubes and Alloys Bring Back the Harpsichord

Scarcely more than a museum piece since the piano sent it into eclipse, the harpsichord is coming back. Vacuum-tube

amplifiers, twentieth-century mechanics and hard metals have overcome the handicaps of the instrument that almost disappeared after dominating the musical world for several hundred years. Piano strings are vibrated by a hammer blow, and the strength of the sound is varied by the strength of the finger blow. The harpsichord strings are plucked. The electric model has nickel-silver picks with long wearing qualities; tone control at the fingertips like the piano, and amplification. Instead of the string vibration being transferred to the sounding board of the instrument, the vibration simply varies an electrical current in a magnetic field and sets up an electrical copy of the mechanical vibration. By means of a tone-color control the shape of the electrical pattern can be changed and thus change the timbre of the tone produced.



Playing the electric harpsichord, which has tone control and amplification impossible in the original instrument

Frank I. Dalton & Co.

Am. Van...
Press div, National Broadcasting
Co. Inc. RCA Building
Radio City, New York

WHERE IS

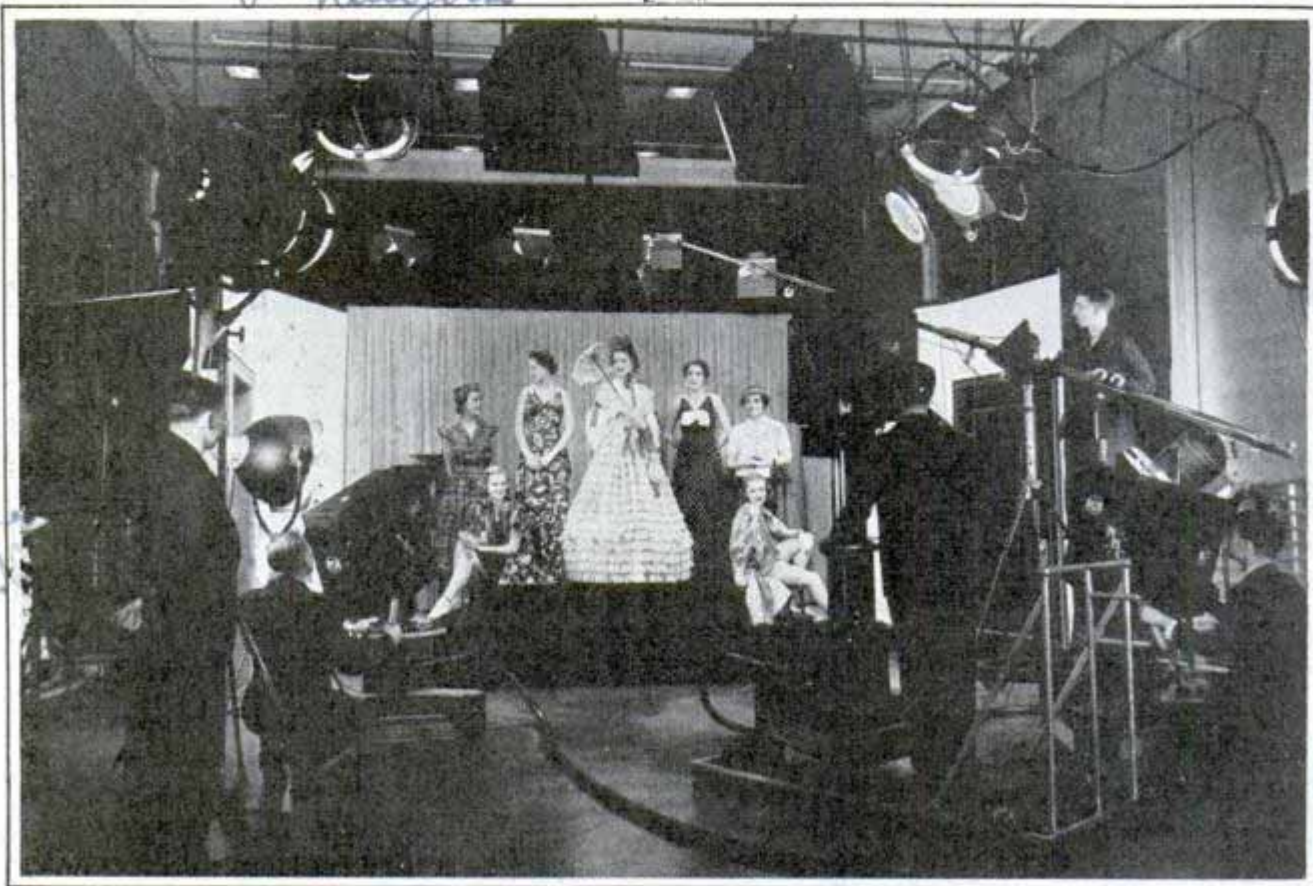

Photos courtesy National Broadcasting Company

Scene in NBC experimental television studio in RCA building, New York, during a television fashion parade. Eighty-seven programs were telecast by NBC last year

TEN years ago a woman sat under blinding lights in John L. Baird's television studio in London while a group of men, assembled around a receiver in Hartsdale, N. Y., saw her face on a screen.

That radio transmission of a moving picture across 3,000 miles of ocean led many to believe that television, a new Twentieth-century wonder, was about to round the corner and, like radio, enter most American homes. But years passed and nothing of this sort happened. People still are asking, "When will we have television?"

There are three different answers to this question, all of them true. We have television right now—as a laboratory accomplishment. We have it also in the home—but it is limited to the homes of a few experimenters living within a few miles of a few stations. As far as most people are concerned, however, we do not have it at all. And no one knows, even now, when it will be ready for the general public.

Indeed, it might appear to the layman

that television has moved backward, instead of forward, since 1928. Baird's historic telecast spanned an ocean, but the pictures which you may see eventually in your home probably will come from a transmitter, the effective range of which will be limited to the horizon line—twenty to fifty miles, depending on the height of the antenna.

If a 3,000-mile telecast was possible ten years ago, why are they limited to fifty miles now? There are several reasons.

Clearer pictures are being transmitted today and they are being transmitted over short waves, instead of long ones. If a wide band of long-wave frequencies were available, and if weather and other conditions are favorable, the range of good television signals is sufficient to transmit a low-definition picture clear around the globe, according to C. W. Farrier, NBC television coordinator.

But to transmit a picture of high definition by short wave and under varying con-

No. 5 Television studio H 458

TELEVISION NOW?

ditions, the dependable radius of a single transmitter has been found to be limited to the horizon—about as far as you can see. To send a program beyond the horizon without fear of failure, two or more transmitters must be connected by co-axial cable, the only known metallic conductor which can be used for telecasting.

And co-axial cable, capable of conducting fre-

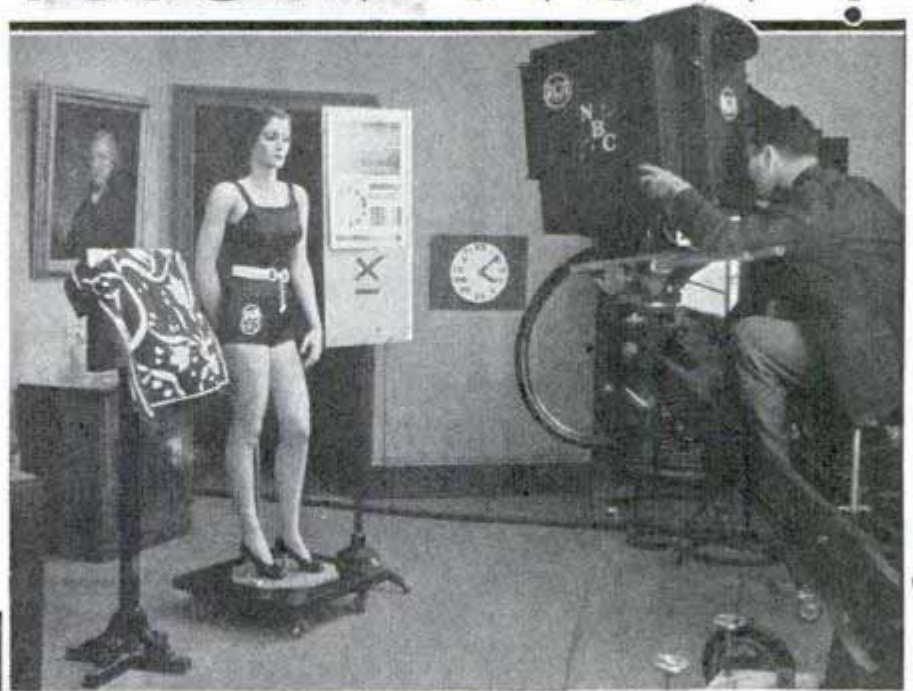

Engineer at control board as he monitors television image. Above, focusing on Miss Patience in television studio before a telecast

these costly transmitters are built and linked together by co-axial cable, only those living within a few miles of the transmitters will be able to receive pictures.

A television receiver is much more complicated than a sound receiver because it must be exactly in step with the transmitter to the millionth part of a second or there will be—no picture. Video, as television may soon be known, is a system of

quencies as high as 1,000 kilocycles or of carrying 200 telephone conversations at once, is expensive. But this is still inadequate for modern high-definition television transmission. One such circuit now connects New York and Philadelphia, but it will cost millions of dollars to crisscross the country with co-axial cables and link many transmitters together. Until this is done, however, there can be no chain television transmission like the radio broadcasts which go out to a network of stations from a central point.

Also, a television transmitter costs more to buy and to operate than a radio station of comparable quality. And even after

synchronizing and harmonizing many vital parts. If receivers and transmitters do not fit, as a key fits a lock, the system cannot function.

One stumbling block to public television today is lack of standardization. Uniform standards are more essential in television than in sound broadcasting because of the precise synchronization required between transmitter and receiver. Standardization will enable you to "look in" on two or three video programs in your territory instead of only one. Ten standards have been agreed on and a committee of the Radio Manufacturers' Association is attempting to agree upon others which will enable re-

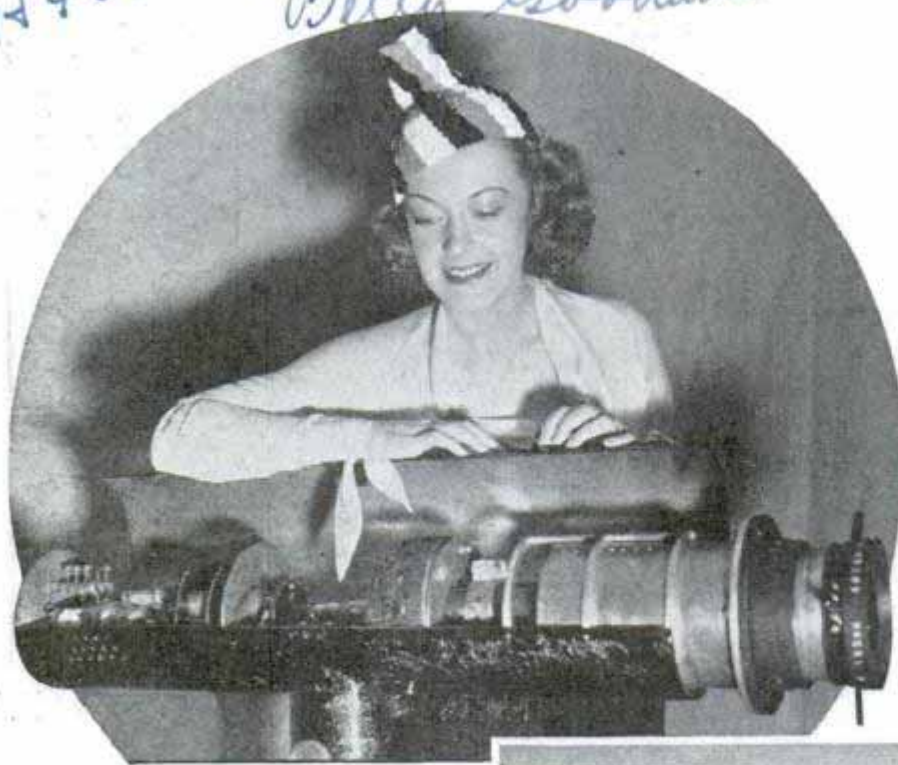

white, "two" signifies gray and "three" black. By dividing the scene into imaginary squares, 100 each way, numbering them in sequence from one to 10,000, and sending a friend 10,000 digits, each representing the shade in one square, you would enable him to reproduce the scene on a sheet of paper ruled into 100 squares each way.

Obviously, this would be a tedious process. If, however, instead of sending numbers by telegraph code, you transmitted one

ceiver makers to provide instruments which will not become obsolete over night.

Despite the rather gloomy outlook for television for the masses in the immediate future, notable advances have been made in the art in recent years. One of the most important was Dr. Vladimir Zworykin's invention of electronic scanning which helped overcome the time element, one of the big problems in television, but of no consequence in sound broadcasting.

In sound broadcasting, Arthur Van Dyck of RCA points out, only one sound is transmitted at a time and this sound, even if it is a complex one, can be represented by one electric current. But no picture can be represented by one current or one anything else because it is composed of many elements. If you look at a scene ten feet square from a distance where the eye can see objects one inch in diameter, there are nearly 15,000 one-inch areas, which you must describe to convey the exact scene to someone else.

Given unlimited time, you might do this with a simple telegraph code. Suppose you arrange a code in which "one" means

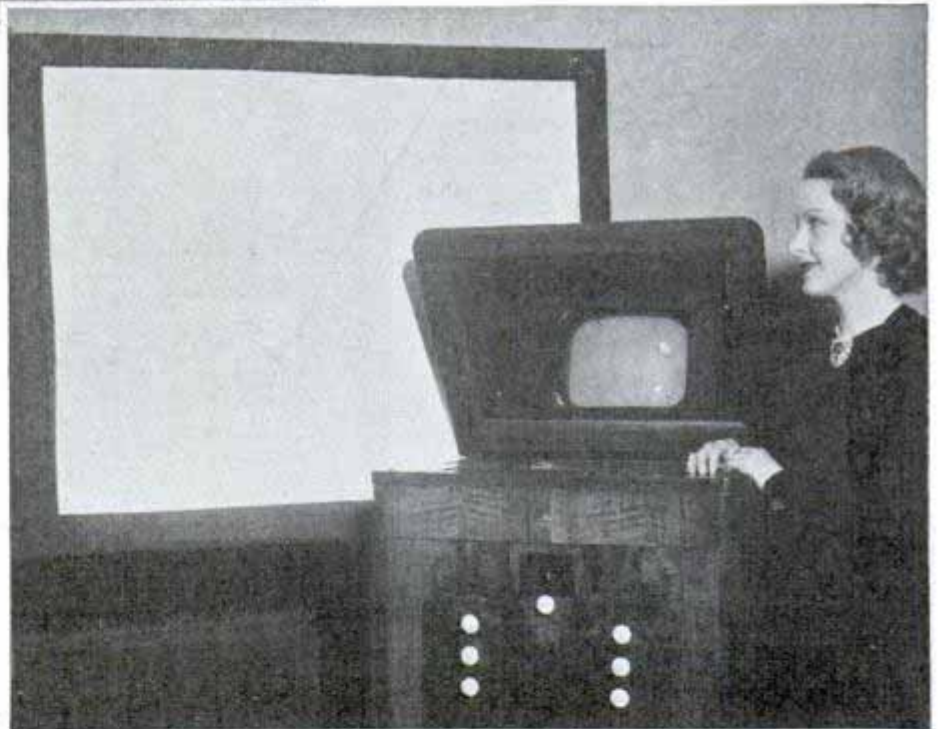

Regulation television receiver and three-by-four-foot screen on which image was "stepped up." Above, "Kinescope" projection tube which cast enlarged image on screen

electric impulse for each square in sequence, the strength of each impulse corresponding to the degree of light in the square it represents, you might send a description of the picture in 10,000 seconds, or two and one-half hours, if you transmitted one impulse per second.

At the receiving end a printing device would be necessary to record each impulse in the same order and location and with an ink intensity corresponding to the current intensity of each impulse. The chief prob-

H458

Goodman N.B. Radio City studios



lem is one of synchronization between transmitter and receiver. This is the facsimile system, used on wire and radio, except that several impulses are sent each second, so only ten minutes or so are required to transmit a picture, instead of two and one-half hours.

But here's the rub. Television must transmit moving scenes, sending as many as thirty pictures per second so that, as in the movies, the eye will be deceived into believing it sees a continuous scene rather than a succession of stills. To send thirty pictures per second, transmitting information about each little part of each picture and repeating the process many times each second, a system 18,000 times faster than facsimile is required.

Here we have the primary cause of most of the television engineering problems—the time element, the necessity for transmitting an enormous amount of information very accurately and very quickly. Electronic scanning with the aid of the "Iconoscope" has helped solve the problem.

The Iconoscope converts light waves into electricity just as the microphone converts sound waves into electricity. The Iconoscope contains a plate upon which the scene being televised is focused. The surface of this plate is covered with thousands of photoelectric cells, microscopic in size,

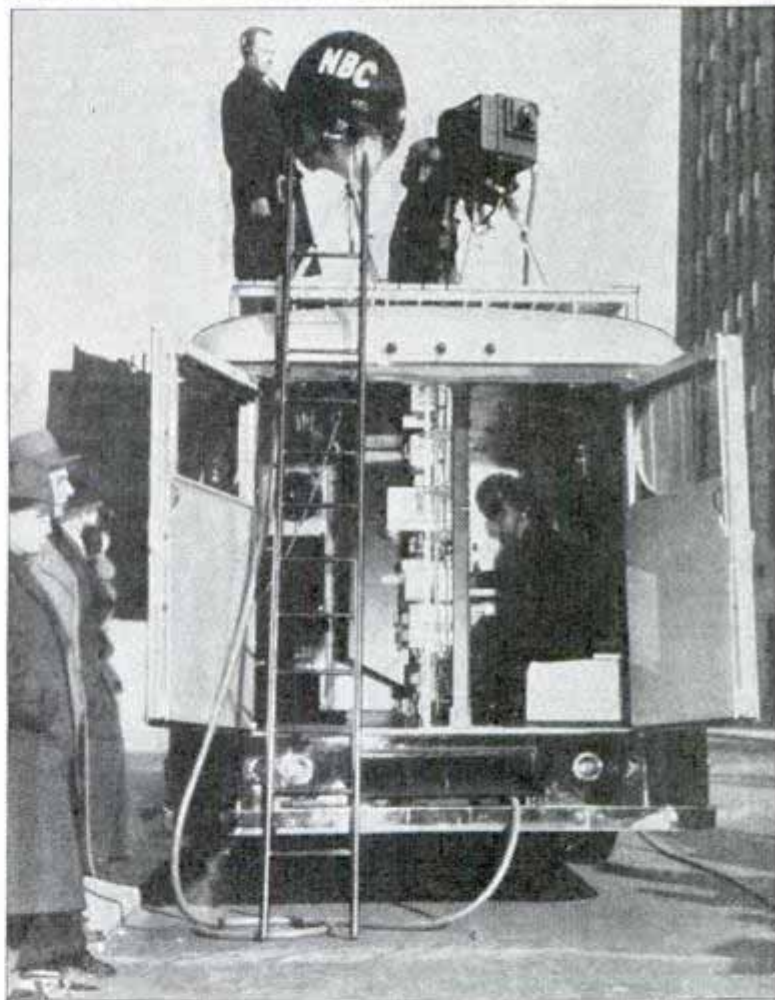

Mobile television unit which picks up both sight and sound. Top, girl as she appeared before "Iconoscope" camera and the 441-line televised image of girl as it appeared in television receiver

each separate from the others and each generating electric voltage proportional to the light which strikes it. To use these voltages, they must be collected from each cell.

This might be done by brushing a tiny wire across the plate, contacting the whole area bit by bit. But the idea is imprac-

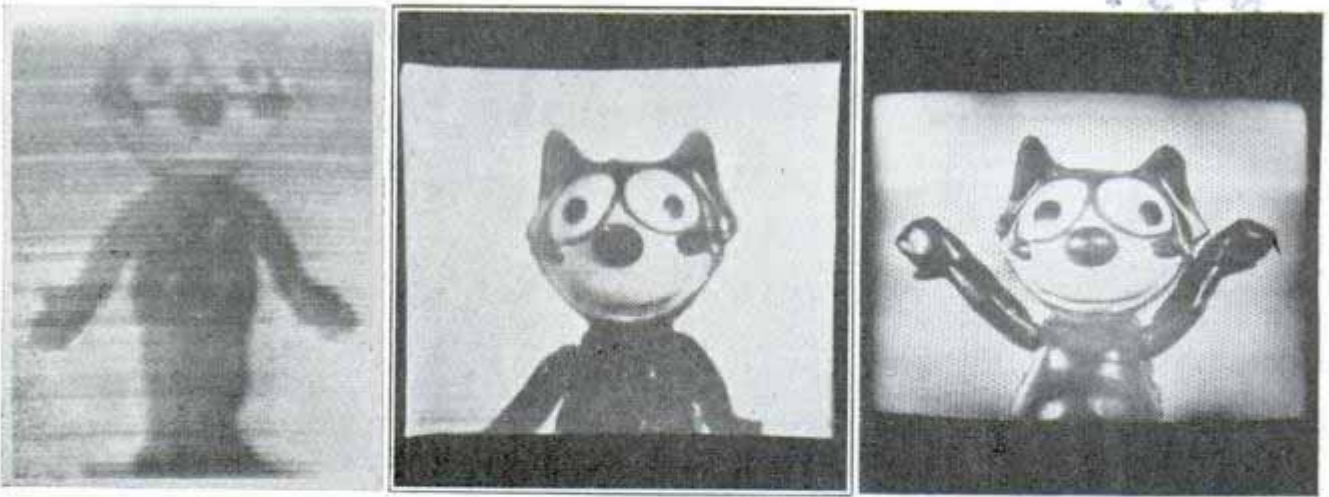

Photos at top © by Felix the Cat, Inc.

Above, left to right, image transmitted with sixty-line, 120-line and 441-line definition. Dots on map show locations of television receivers in New York metropolitan area which get programs from antenna atop Empire State building, below

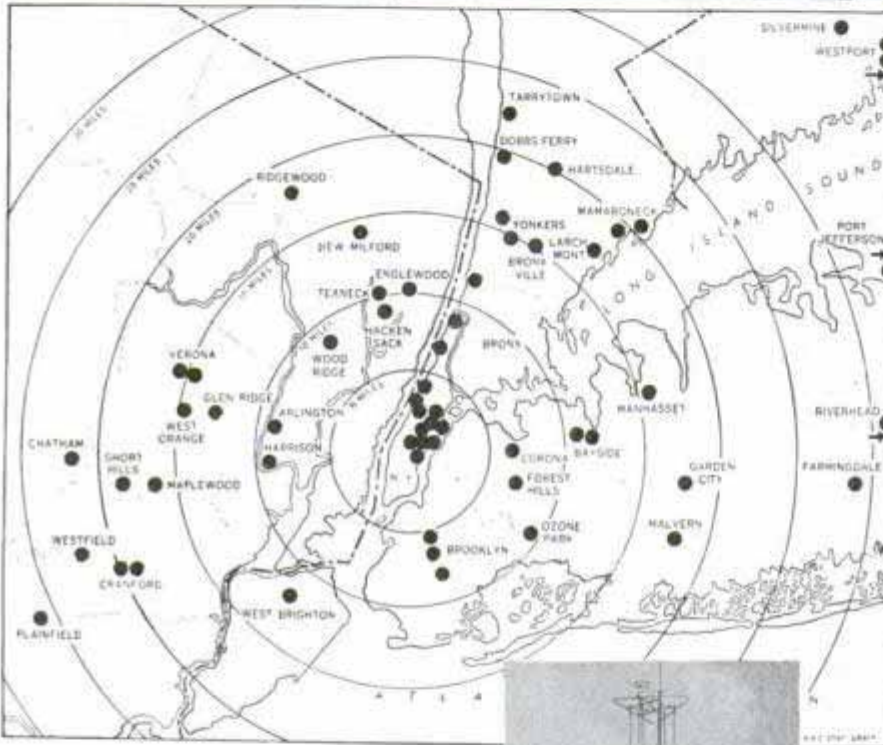

441 lines is the best compromise between picture quality and apparatus difficulty and this number has been made standard for this country.

The beam explores the whole plate thirty times per second and there are about 250,000 spots to be thus visited. It "reads" from left to right at two miles per second, and from right to left at twenty miles per second. If your eye could move that fast, you could plow through a 1,000-page book in about five seconds. Thus this beam is about the busiest thing in this world.

The electric currents obtained by the beam from the cells are small but they can be amplified and then you have currents carrying intelligence representing the picture. These currents control the transmitter antenna current. At the receiving end, the entire process is reversed with the aid of the "Kinescope," the inverse of the "Iconoscope."

The Kinescope has a plate and beam of electrons playing

tical, partly because of the speed with which the operation must be performed. So a beam of electrons is utilized instead. This tiny "searchlight" travels over the plate, line by line, collecting the electric charge from each cell in turn.

The present standard calls for 441 of these lines on the plate from top to bottom, whereas the first systems had only twenty-four. The greater the number of lines, of course, the greater the detail of the pictures. But the more lines there are to cover, the more work the little beam must do and the more information there is to transmit. It has been found that

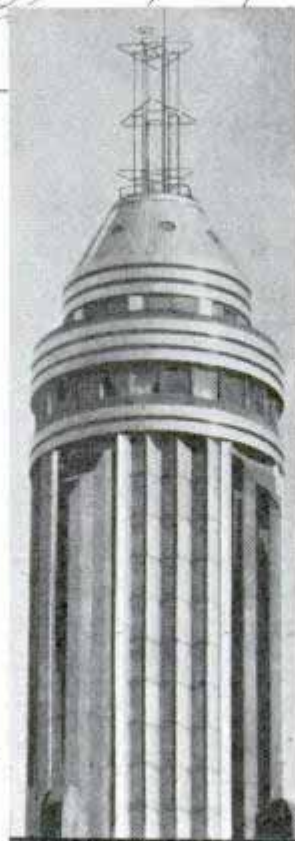

upon it, just as does the Iconoscope. In the former, however, the plate or screen comprises one end of the tube itself, is made nearly flat, and coated on the inside with a thin layer of material which fluoresces, or gives off light, when electrons strike it. When the electron beam in the Kinescope strikes the screen in one spot, about the size of a pinhead, this spot glows, its brightness varying as the strength of the beam varies.

That spot of light is used to reproduce each spot of the picture, one at a time. The beam "paints" the lights and shadows of each tiny element of the picture as a series of spots, but to our slowly reacting eyes, the spots are not visible and the screen appears to be illuminated evenly all over. The flying beam of the Kinescope must be in perfect step with the flying beam of the Iconoscope, miles distant, or there will be no picture. Synchronization is one of the television problems which has been solved.

Scenes of any size can be televised by the transmitter but at the receiving end, the size of the picture is determined definitely by the size and brilliancy of the Kinescope screen. At present, there are two standard sizes, one about five by seven inches, the other about seven by ten inches. Last fall, NBC showed television on a seven-by-ten-foot screen, but there is a size limit for the tubes beyond which it is impractical to go. It has been found that the most desirable size of picture for television or movies is one where the height of the picture represents one-fourth the distance between screen and observer. In the home, the desirable viewing distance may be eight or ten feet, so the picture height should be about two feet.

"There is good promise of eventual accomplishment of this goal," says Mr. Van Dyck, "but at present it seems probable that the television receiver which is 'just around the corner' will have a picture about seven by ten inches."

Partly because so much information must be crowded into so small a period of time, tremendously high frequencies are necessary in television. Your light circuit

(Continued to page 139A)

Baby Goes for a Buggy Ride with Trained Cat for Nurse



Proving a cat can be trained to do tricks, "Bum," dressed up as nursemaid, takes the proper pose for pushing the pram

Here is a buggy rated at one catpower. All dressed up in her Sunday best, "Bum," the trained cat, poses at the "controls" ready to take the baby for an afternoon's outing in the pram.

Two Pedal but Only One Steers on Bike with Rumble Seat

Rumble seats for bicycles—a new version of the "bicycle built for two." It is an Australian's idea. The "aft" seat was mounted low for the junior member of the family, who can help pedal but has to let dad do all the steering. The diameter of the rear wheel is only half that of the front.



Here is the father-and-son bicycle built in Australia, a two-level model with the youngster down under

Dea Alta Hamilton

Acme

17 556

A. Bishop, Richmond, Australia

From Block to Blockhead in Two Days' Time

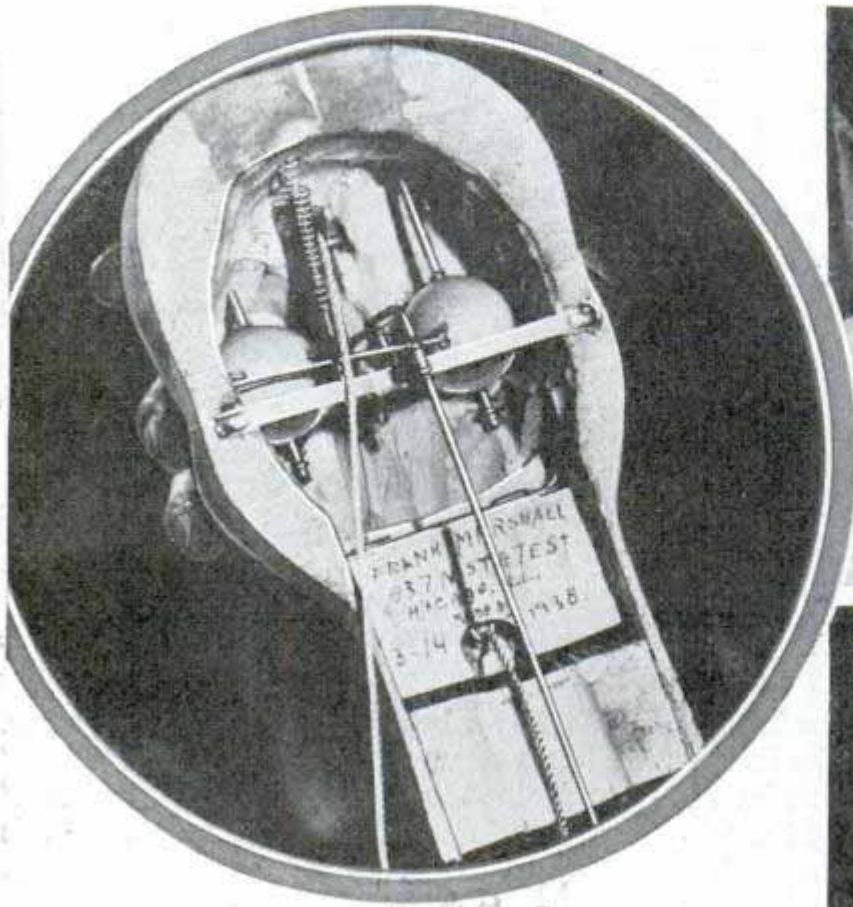

There's no such thing as mass production in the dummy-making business. One day your friend Charlie McCarthy was a chunk of wood. Next afternoon he was Charlie McCarthy, ready to talk if someone would think out loud for him. In two days a block becomes a blockhead, without benefit of factory methods. Every dummy is made to order, chiseled to fit the personality desired by the ventriloquist; only one machine operation takes place, the slitting of the dummy's chattering chin by a bandsaw. The rest is hand work. Above, you see a dummy's brain: the finger controls which manipulate chin and eyeballs. From top down around the page are the first stages in a dummy's life: a cube of basswood or buckeye; chiseling out the face contours; shaping the mouth; screwing the head together after installing "brains," and sawing the chin



Chiseling Dummies Is a One-Man Industry

Design figures used by all leading ventriquist

1837 model

"Daddy" of most stage dummies, including impish Charlie McCarthy, is Frank Marshall of Chicago. For twenty years he has been carving blockheads and marionettes for the theatrical trade; skilled fingers, a tool chest full of assorted chisels, a bandsaw and paintbrush his principal tools. The dummy starts as four slabs of wood glued into a block, with paper glued in the center so that the head can be split apart and hollowed out. Simplest of dummies have only a movable chin, but Mr. Marshall will, if you like, install eyes that roll from side to side, and a winking eyelid; or a soft leather upper lip that curls upward in a smile revealing a nice set of teeth. The mouth can be manipulated by a remote-control air bulb. In the circle is a split head, the wobbling chin sawed out, ready for installation of mechanism. Below, touching up eyebrows and complexion with special dull-finish paint containing pumice. Right, Mr. Marshall has a farewell chat with one of his "babies"



Handmade, measure

Police Camera in Disguise "Shoots" Evidence

Suspected criminals are photographed especially for police and crime detection work. Its specialized equipment includes

a synchronized flash attachment, a spotlight view finder for night photography, portrait and fingerprint attachments. Disguised by a screen mask over its face, the camera can be placed in an unostentatious position in police headquarters to photograph a suspect while he is being questioned. The shutter can be released by remote control without attracting attention. Close-ups of fingerprints, signatures and small objects are made with a special attachment, and portraits can be made the exact size for standard criminal index cards. The entire equipment packs in a carrying case. Four small dry cells supply current to operate the shutter, the photoflash bulb, night spotlight view finder and illumination for the fingerprint attachment.

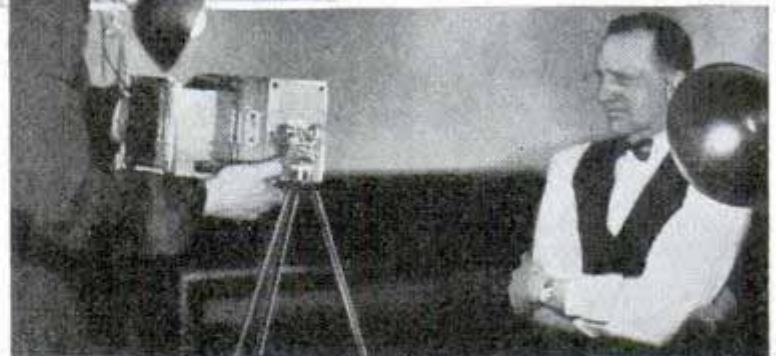
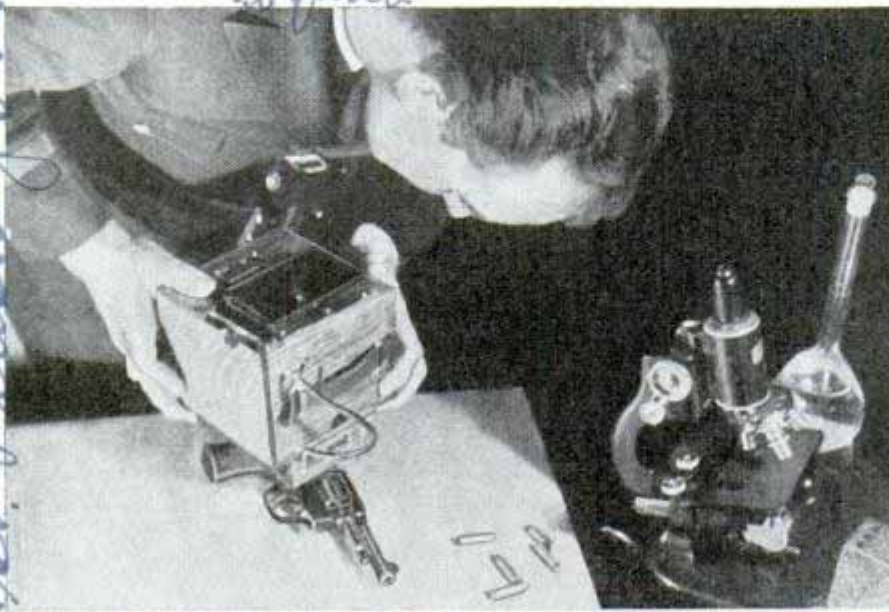

Top, photographing fingerprints on revolver. Center, the police camera, ruggedly built to stand rough use, with its accessories including lens mask and portrait attachment which is seen in action at police headquarters, at right. Below, the camera and equipment in the carrying case

Machine Tools in Bright Colors

As an experiment, a manufacturer tried out on his employes three identical hand drilling machines painted different colors—red, orange, and gray. The orange machine proved most popular, particularly with the night force, seeming warm and cheerful. The red machine was next in popularity, and the gray a poor third.

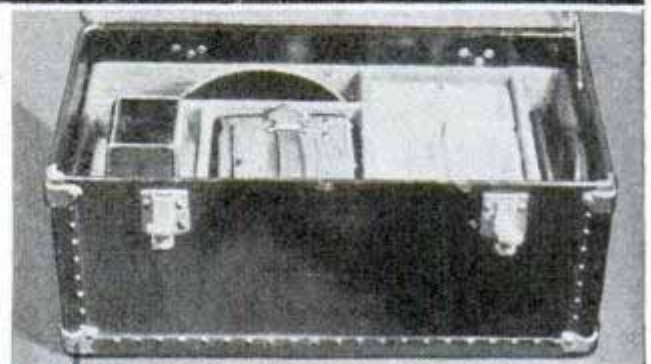

J. Federal Laboratories Inc. 185-91st. Pittsburgh Pa.

Squad

H612

American Machinist

455
14

W. C. Miller & Burleson
1032 Glouca Ave
Akron, Ohio

RIDING HOBBY HORSES *to* FAME

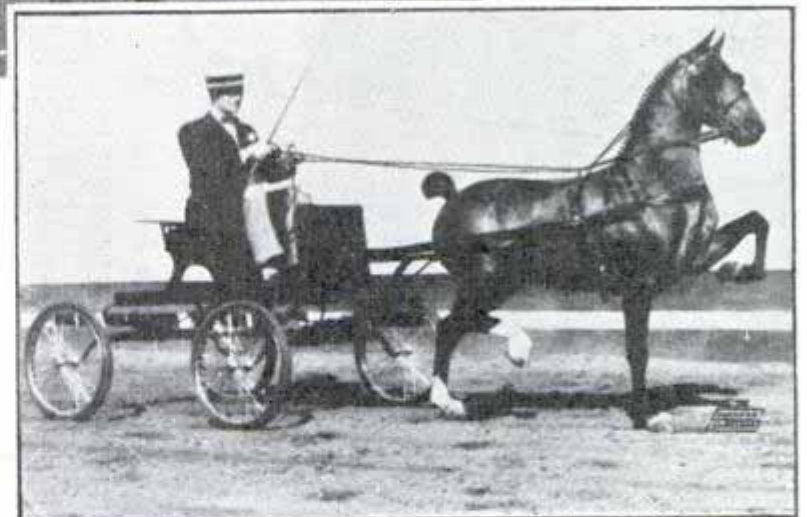
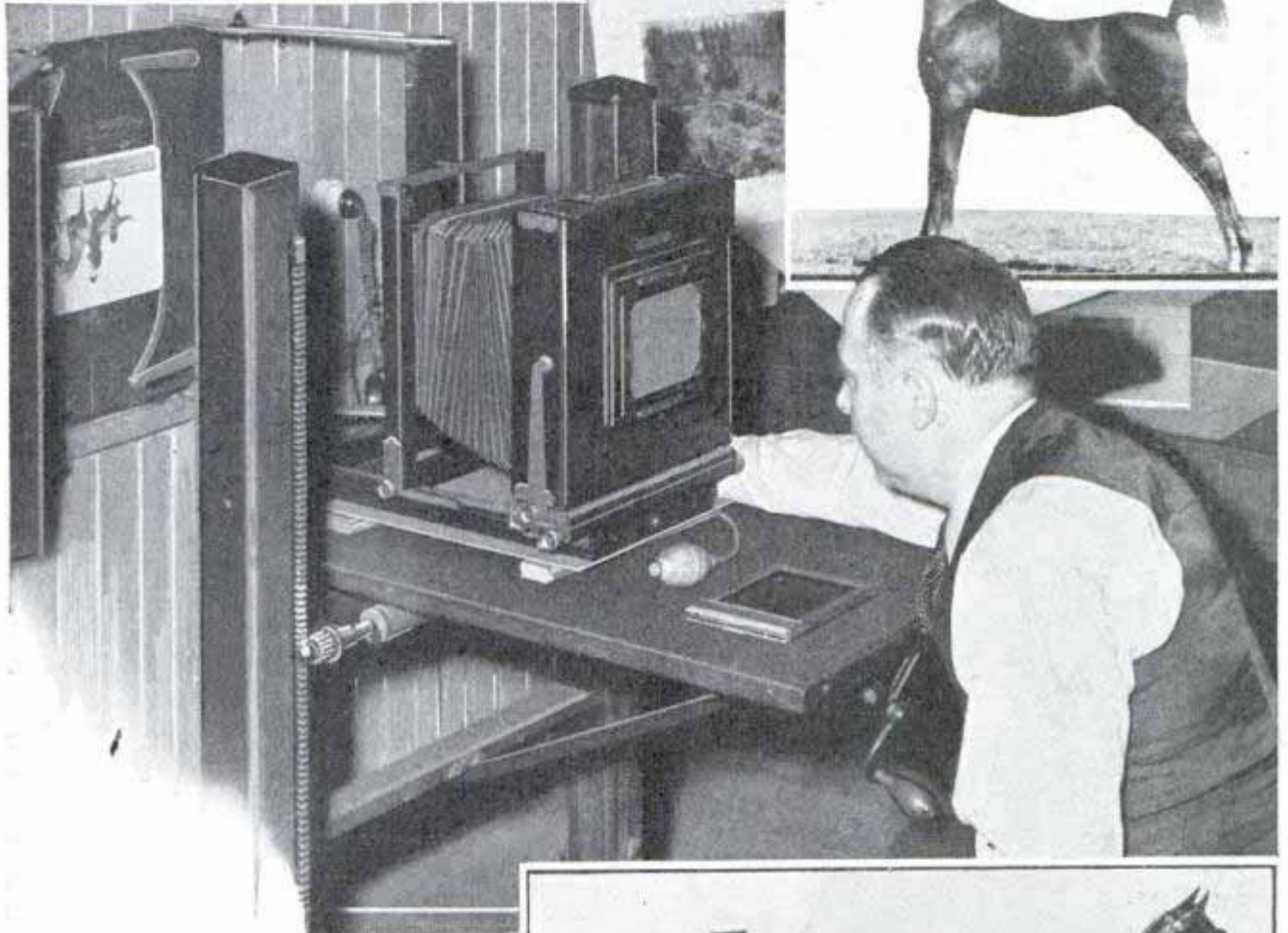

A MUSICIAN whose hobbies included riding and photography decided, some years ago, that his neighbor and his neighbor's horses ought to be recorded. So he took his camera along on one of his saddle expeditions. In due time, he had two dozen horse pictures which he carried with him the next time he went riding, and proudly showed to the neighbor and several other horsemen.

A few minutes later he tore the prints into tiny bits, all twenty-four of them.

There had been nothing wrong with those pictures, photographically, but from the standpoint of the horsemen, they were total failures, because the horses were not shown in the approved manner. Ears were down, tails were out of kilter and various

Top, one of Photographer Shannon's finest pictures of a filly. Center, Shannon focusing his copy camera. Bottom, picture of a champion hackney, showing extremely excellent leg action

other details were either too much in evidence or too much concealed.

From that failure, the musician-horseman-cameraman has traveled a long way, and is now one of the three leading photographers of horses in this country. To-

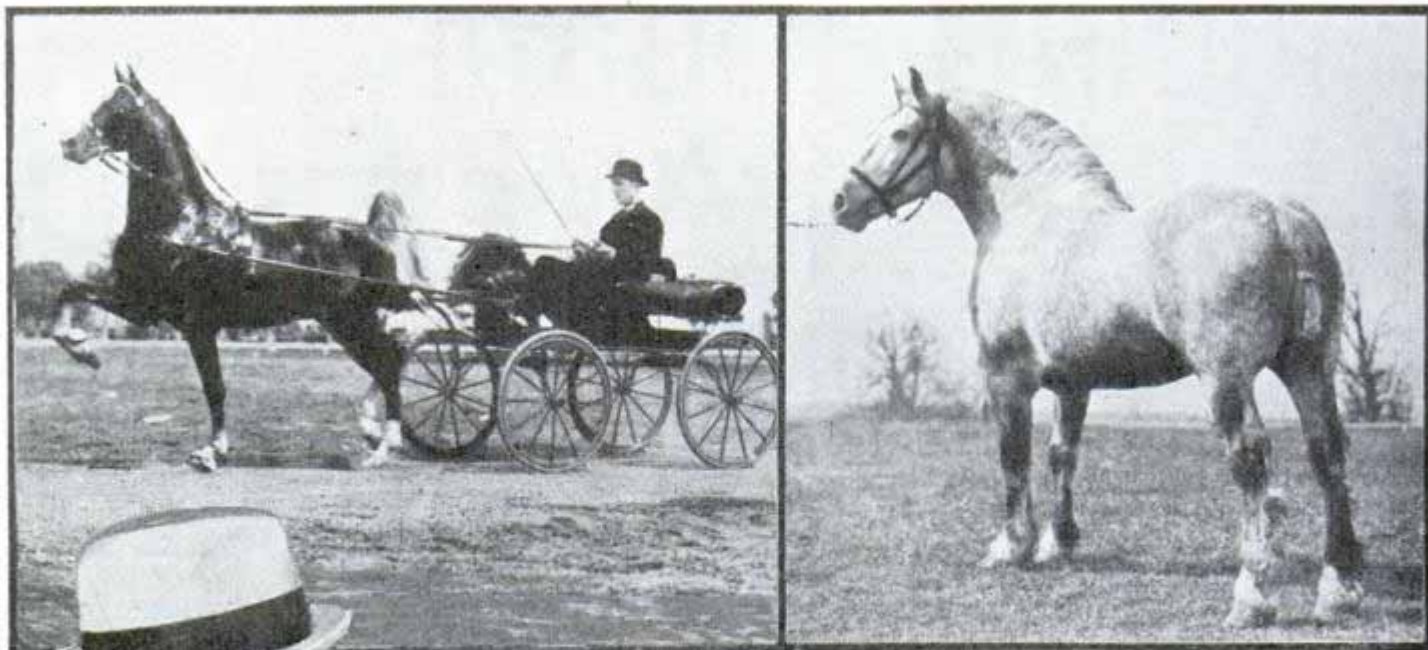

Top, left, fine harness horse, with good leg action. Right, draft horse in typical pose. Bottom, Shannon in action

day, Ray Shannon's name and work are known wherever horses are to be found, fine horses, that is, such as those kept in the leading stables and exhibited at horse shows.

To become a successful horse photographer he had to become first a horse expert, had to find out just how to pose horses to show the fine points in which their owners and other horsemen were mainly interested. He learned the language of the stables so he could talk intelligently with trainers. He studied the characteristics of three and five-gaited horses. To study more accurately the actions of horses' hocks, knees and muscles, he took thousands of feet of

slow-motion movies, and spent untold hours examining them on the screen.

Before long, his horse pictures began to attract attention and found ready sale. Soon all his spare time was taken up by horse photography, and in a short while, he began devoting all his time to the business which had developed from a combination of his two hobbies.

Shannon has for his "beat" the greater part of the United States. For lack of time, he confines his field to the regions east of the Rocky Mountains. Wherever there are to be found high-class breeding stables, horse shows and private stables, his lens is seen in action at least once during the course of a year. He shoots horse pictures winter and summer, in good light and bad. He has photographed the fine saddle horses, in which type he specializes, of most of the wealthy sportsmen and sports-women of the country. Much of his work is done in Kentucky, Ohio and Texas. To reach the stables where the horses are kept, he travels in an automobile loaded with equipment. One nine-week trip of 11,000 miles is a sample of the way he gets around. Now his jobs are almost always assignments. He generally is booked for a solid year ahead.

Shannon uses various kinds of cameras including reflecting types, but the bulk of his work is done with a four by five speed camera of a type popular with news photographers. Its focal-plane shutter, normally working at top speed of $\frac{1}{1000}$ second, is pepped up by stronger springs until it

3337 Virginia Ave. Cleveland Ohio



provides a minimum exposure of $\frac{1}{2000}$ second, none too fast for stopping all action of a horse's feet and legs. Seldom does Shannon start out on a job with fewer than a hundred holders loaded with the fastest film he can get.

For a long time, Shannon did his work in a small darkroom in the basement of his home in Cleveland, Ohio. He finally was forced to expand, which he did by excavating the area beneath the front porch, and building two rooms there. One is a completely equipped photographic laboratory, with sinks, enlarger and other standard equipment. The other room contains a desk, worktable, copy camera and airbrush tank.

When Shannon travels, he takes along an assistant who does most of the driving, and who helps handle the cameras. On long trips, exposed films are sent back to Cleveland, where a laboratory assistant develops them and makes prints, which are forwarded to Shannon at some point in his itinerary.

Shannon shoots his horse pictures on four by five film, and enlarges them to the



Top, left, model five-gaited horse. Note the superb neck. Right, fine picture of three-gaited saddle horse trotting. Bottom, spotting a print with artist's brush

size required. The bulk of his prints are on eight by ten glossy paper, and are used by the customers for publicity purposes. He also makes larger pictures, carefully colored with water and oil pigments applied with an airbrush. These are exhibition pictures, and are purchased by owners and trainers for framing.

Taking the pictures is but a fraction of the work. The most important step, Shan-

(Continued to page 123A)

Skyscraper Tests the Nerve of Window Cleaners



Weds 11/11
Clinging like flies to the building, these window cleaners constantly flirt with death

Always flirting with death, skyscraper window cleaners constantly entrust their lives to the harness-leather belts as they dangle high above the street. The world's tallest building, the Empire State, which rises 1,248 feet above the sidewalks of New York, has its own window-cleaning force. Its staff of workers are employed the year around and are paid an exceptionally high rate for unskilled labor. These window cleaners are a picked lot, unaffected by high-altitude work. They receive frequent medical examinations and are insured. Despite the hazardous work, none has fig-

ured in an accident since the building was erected. This is due in part to the strict rules which forbid crossing from window to window from the outside and to frequent checkup on equipment. The cleaners never work singly, under a regulation placed in effect after one man was locked out by the sticking of a newly painted window. In that case, the worker was forced to kick through the glass to get back inside.

H 630.

"Nearest" Star Loses the Honor to Thirty Closer Neighbors

"Wolf 424," recently announced as nearest fixed star, is not so close to earth's door after all. Observations of the star's spectrum at the University of Chicago's Yerkes Observatory indicated it had the large parallax of eight or nine tenths of a second, meaning it was close to the earth. But Dr. D. Reuyl of the University of Virginia's Leander McCormick Observatory has found by the trigonometric method a preliminary parallax of only one-fourth that found at Yerkes, indicating that thirty or more stars are nearer than is Wolf 424.

H 493

Upturned Rowboat Forms Roof of Tiny One-Room Cottage

All's shipshape in this little cottage at Whitstable in Kent, England! An upturned rowboat forms the tight gable roof of the one-room house, whose walls meet in a point beneath the bow of the boat. Not so nautical is the big brick chimney.



Tight little cottage in Kent, England, built to fit its roof—an upturned rowboat

Scene Service 6/20/38
University, Va.
and 100 Belmont Square

Baseball Game for Blind Is Played by Sound

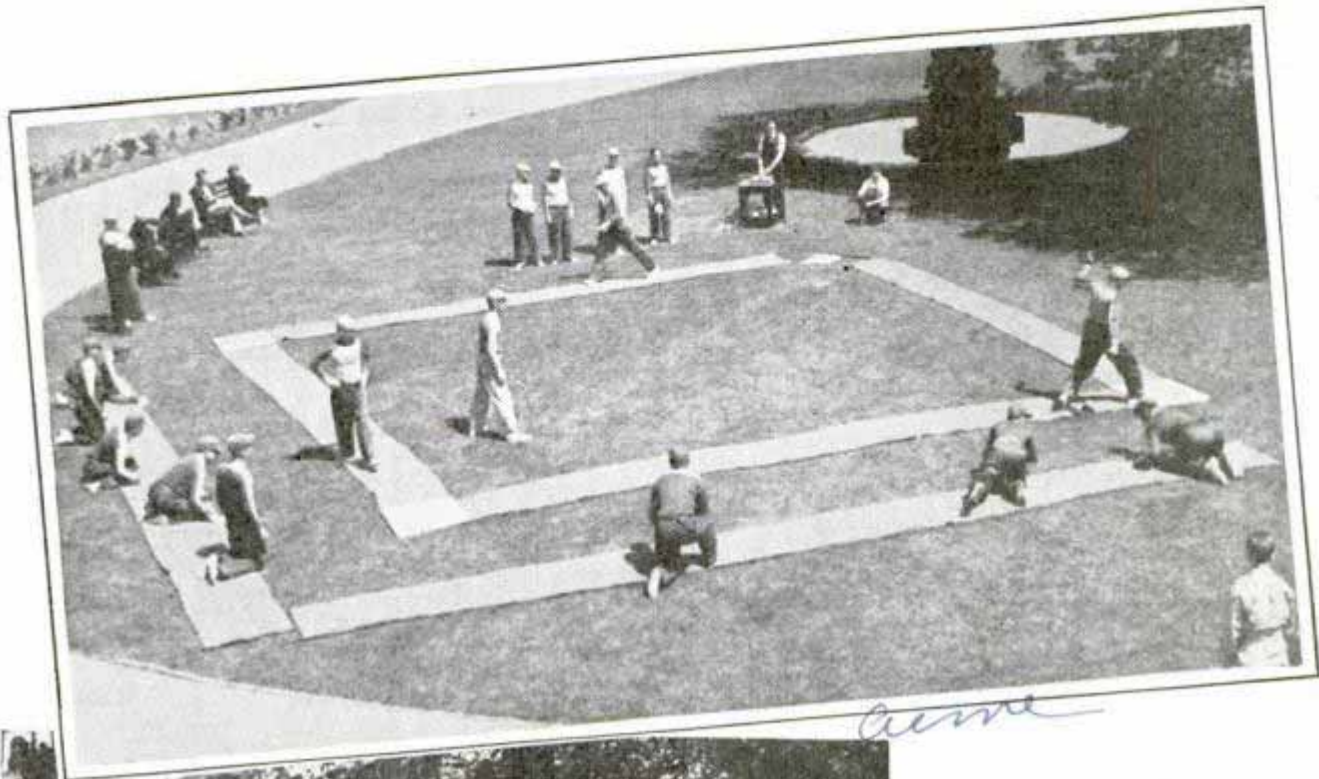

same



Top, baseball game for the blind in progress. Note runners advancing to second and third. The fielders are kneeling on pads. Left, batter using hockey stick has just scored a hit. Note control board operated by umpire at left

Although none of the players can see, there's real action in baseball games at the Industrial Home for the Adult Blind, Oakland, Calif. Sound baseball, originated by Superintendent R. V. Chandler, is played with a playground ball containing jinglers which produce sound when it is rolled, batted or otherwise put in motion. A different toned buzzer sounds at each base as the runner advances and a bell rings at home plate. The players use a regular-size indoor baseball diamond. There are ten men on each side. One catcher, who has partial vision, is used by both teams. The fielders kneel on a pad placed back of the base path between the bases. When the

pitcher, who has sight but who does not bat, rolls the ball toward the catcher, the batter judges its location by the sound and swings a hockey stick. A control board, operated by an umpire with normal sight, signals whether the ball hit by the batter is fair or foul and the fielders then attempt to stop the ball by judging its position solely on sound. A put-out is scored by rolling the ball between the runner and the base toward which he is advancing.

☐ Astronomers estimate there are 100 billion stars in the "neighborhood" of the earth—so close their light reaches us within 100,000 years.

Lecture by Prof. Jason of applied science Cleveland, O.
Prof. Nassau

Radio Installed on Tractor Lightens Farm Work



Top, closeup showing radio beside driver. Bottom, starting for the fields

Installation of new or used automobile radios on tractors to relieve the monotony of farm work is becoming popular. One Nebraska farmer has used a radio in this manner for two years. The big problem usually found in attaching the radio is that vibration is difficult to eliminate. If the tractor has rubber tires and a well-constructed radio is used, the chassis and speaker are mounted so that no direct shock can reach them. The speaker is placed near the operator's seat, making it unnecessary to muffle the motor exhaust.

Aluminum-Shod Race Horses Set Many Track Records

Thoroughbreds shod with aluminum are marking up new records on the racetracks of America. The aluminum racing plate was introduced by Leonard Liepman,

Maryland sportsman, and in the last five years 300 track records have been lifted by horses running on aluminum—five of them world records and seventeen others American high marks. Most of the wear on a horseshoe occurs at the toe. Instead of using all-steel plates, a calk of extremely hard tool steel is inserted in the toe by a patented process, eliminating half the weight. The aluminum plates weigh only two ounces. They have withstood rigorous tests for wear and today probably four-fifths of the race horses on American tracks wear them.

464

Flexible Paddles of Egg Beater Turned with One Hand

Flexible paddles that can spread to a seven-inch radius to stir efficiently every part of the food mix are features of an egg beater just introduced to housewives. It will operate in a half-pint cream bottle or a flat pan, beating and stirring in a lively whip-cracking movement. There are two models, one permitting single-handed operation so that the other hand is free to add ingredients; the other has a straight stem which is twirled between the two palms for heavy mixing work.

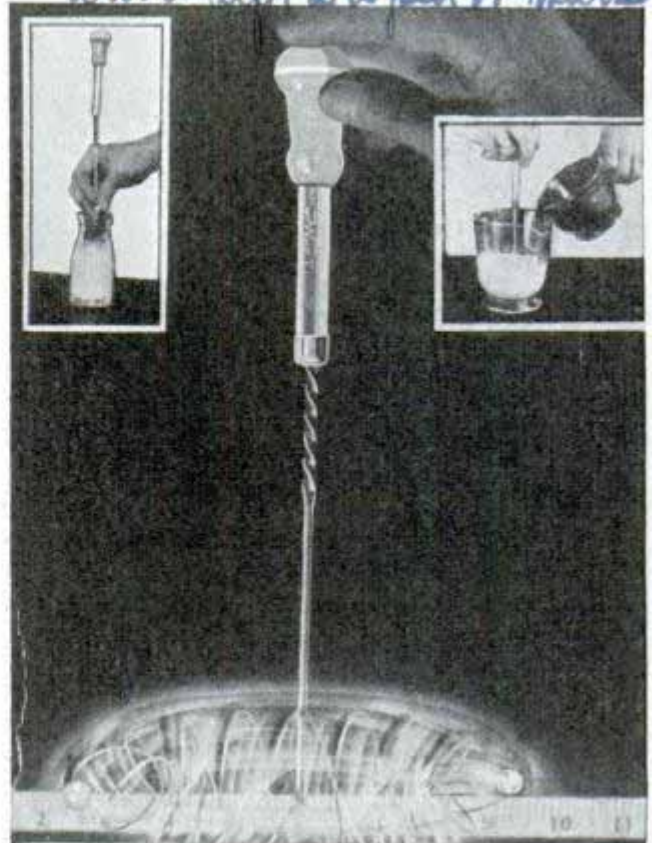

Food whipper operates as efficiently in a shallow pan as in a half-pint cream bottle

4338

and also R. Fisher, 632
Seward St. Seward, Neb.

Aluminum shoes
Chicago 1928

9 America
1856
Pittsburgh Pa

18 553

Eleven-Foot Model Is Preview of Luxury Ship

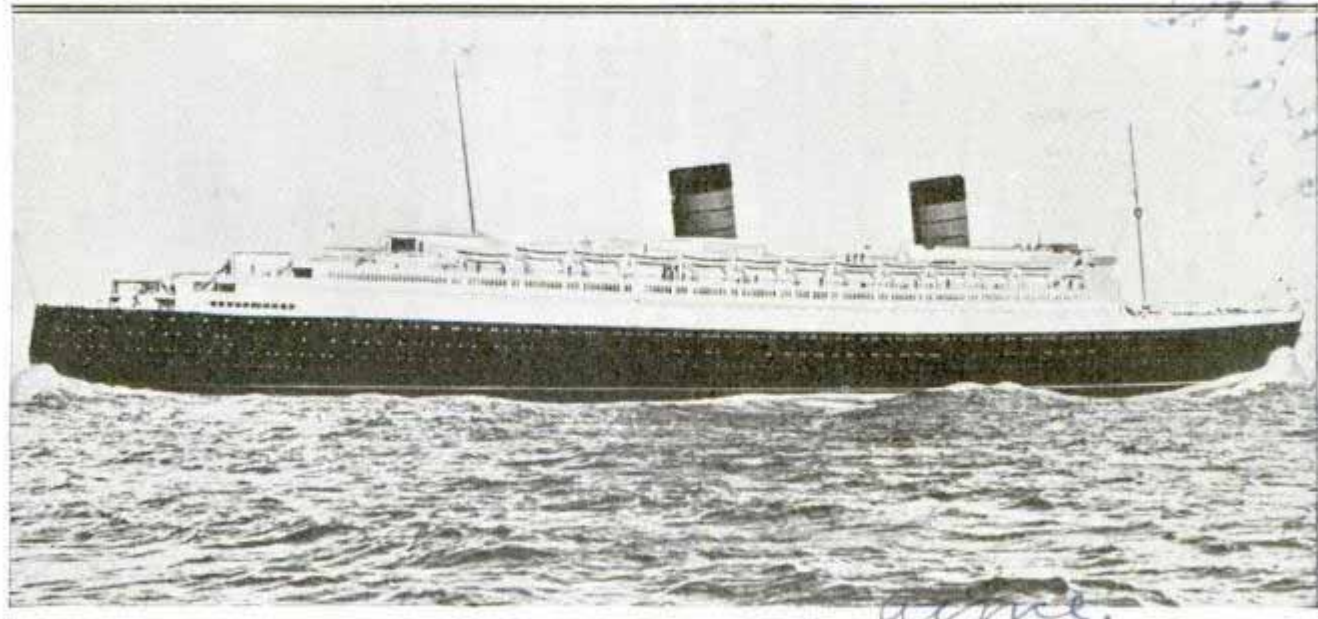

This introduces "Queen Elizabeth," the 85,000-ton Cunard-White Star passenger ship to be launched in September after christening by the Queen of England. The photograph shows an eleven-foot scale model

Britain will offer the sea a new queen next September 27 when the 85,000-ton luxury liner "Queen Elizabeth" is scheduled for launching. The graceful lines of the vast Cunard-White Star vessel are seen in this photograph of an eleven-foot scale model. Its bow is of semi-clipper design, slanting back to the waterline. The two huge funnels are pear-shaped. Miss-

ing from the decks are the traditional ventilators, which are supplanted by a louver ventilating system by which fans will distribute fresh air at a controlled temperature, hot or cool, to the cabins and public rooms. Between bridge and bow a streamline breakwater will sweep water overboard. Queen Elizabeth of England is to christen the newest passenger ship.

An Old Streetcar Converted into Boat at Small Expense

Conversion of an abandoned streetcar into a boat at small expense has produced a seaworthy river craft. The streetcar was prepared for installation on the hull by sawing off part of the lower section. Driven by a standard engine, the craft is useful as a river pleasure boat.

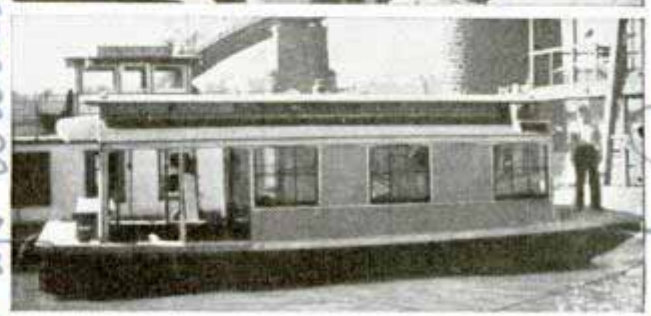

Two views of old trolley car after its conversion into a river pleasure craft

Domed Grille Cooks Bacon Flat without Being Turned



Perfectly flat, crisp strips of bacon come hot from the domed top of a stainless steel grille. Cooked over a low, slow flame, the bacon

need not be turned over. It is held flat to the grille by a wire cover while cooking, and the grease drains off to the "gutter."

The Fair, 6th floor

18 542

at Cincinnati

18 274

Warner Carriage Co.

comb. Day Trenchery 1404 Walnut, Cincinnati, Ohio

Ingersoll Steel and

#13

Mr. O. H. ...
10555 Holman Ave
Los Angeles, Calif

RUNNING the

Reference: Dougherty's
Leaflet, Esrae
Line, 525 W. 9th St.
Los Angeles
Calif

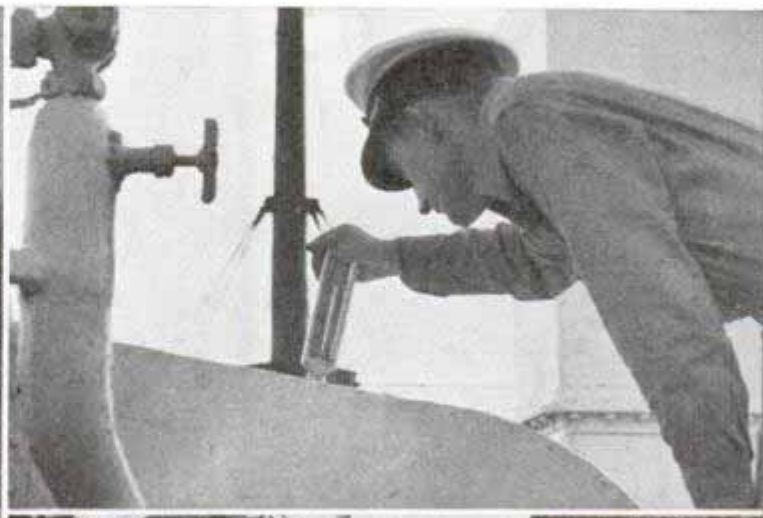

Left, swinging engine-room ventilator to catch the wind. Right, top, taking temperature of air drawn into air-conditioning apparatus. Bottom, drawing fire to light additional boilers

PRACTICALLY everything on ship-board from the whistle gear down is electrically operated these days. Electrical installations on ships have to be the sturdiest and most reliable made, for scores of lives may depend upon marine electrical equipment operating under conditions in which ordinary equipment would fail.

Once a ship's chief electrician on shore leave attended a movie showing news reels of the burning of a big liner at sea. The news commentator, describing the episode on the screen, declared that the crew and passengers had to abandon ship because the electric pumps failed and there was no water to fight the fire.

Suddenly the electrician gripped the arm of his neighbor. "See the water coming out of that discharge pipe on the side

of the ship," he demanded. "There's an electric motor behind that pipe running the pump. The electric motors haven't failed after all. That ship has been on fire and abandoned by all hands for five hours and the motors are still running. They'll keep on operating until the motor coils burn up or the steam supply fails."

Subsequent investigation revealed that the crew really had abandoned ship because smoke and gas fumes filled most of the vessel and made it unbearable. What really happened, the investigation disclosed, was that the ship's air-circulating equipment actually had helped to increase the fury of the fire and to spread its effects all through the ship. No one had thrown the switches to turn the motors off. Today rigid orders are posted on all vessels that

ELECTRIC LINERS



the first thing to do when the fire alarm sounds is to shut down all ventilating intake motors and to keep all air exhaust motors going so as to provide no more fresh air for the fire and to clear the ship of the smoke and fumes.

Standing in front of his long switchboard on a balcony overlooking the main engines, the chief engineer plays an important part in getting a ship out to sea and settled down for its voyage. Electric motors operate most of the pumps in the fire rooms and engine room, and pumps are a vital part of marine engines.

Getting under way is different on every voyage. The bridge may ask for its standard cruising speed,

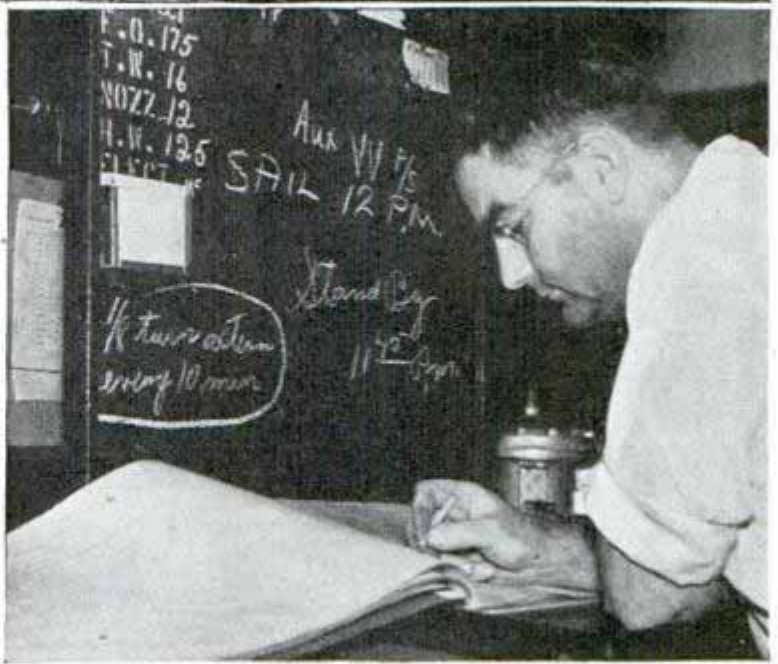

Left, inspecting electric motor. Right, top, telephoning engine room from bridge. Bottom, writing engine-room log. Blackboard contains instructions for staff and time of next sailing



a certain number of propeller revolutions per minute, but there are no standard adjustments that can be made in the fire rooms and engine room to provide it. A head wind means bucking the weather, and more steam has to be provided and the engines must work harder to keep up the revolutions. A following sea helps to push the ship along, and adjustments may have to be made to keep the steam pressure down. If the oil in the fuel tanks is cold or if a shift is made to a tank having a different temperature, blower speeds have to be changed and burners adjusted to

maintain the proper heat in the boilers. In the engine room a hundred gauges are watched and pumps have to be speeded up or slowed down until exactly the correct readings show on the instruments.

During this period of adjustment the chief electrician stands watch over his control boards, making sure that power is available where it is needed and ready to route power through different combinations of switches if something goes wrong. The electrical staff of a big liner numbers only a small handful of men, yet the chief electrician is considered almost as important as the chief engineer.

On fast luxury liners, such as the Grace Line's "Santa Paula" and her sister ships, all the electrical equipment is designed to operate automatically as much as possible. In port, when the main engines are shut down some steam is maintained all the time to operate the turbines that spin two 500-kilowatt generators which are kept running to supply power for the ship's pumps, deck machinery, and lighting. After the ship gets under way and the "all clear" bell is rung from the bridge, the chief electrician cuts in two similar generators that are attached directly to the ship's main turbine gears and then the entire load is taken over by these attached generators. The load at sea is normally 2,600 amperes at 220 volts.

In an emergency, such as a quick stop in which the main engines are shut down, the ship would be without current temporarily except for an automatic arrange-

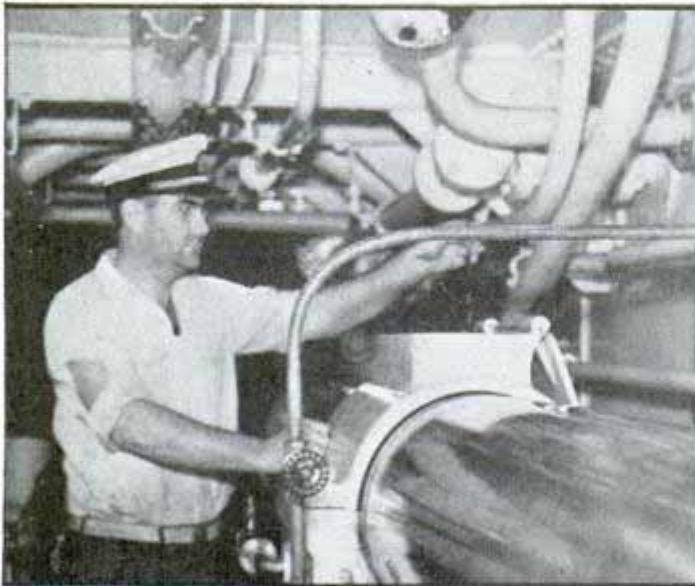

Above, operating valve which closes all watertight doors at once. Bottom, left, checking lubrication of bearings. Right, inspecting part of ship's fire-fighting equipment

ment by which the two idle steam-driven generators are immediately started up and the load is switched back to them.

In the improbable event that all of the main generators are put out of commission, as might happen if the engine room becomes flooded, all lighting circuits immediately and automatically switch over to several tons of 340 ampere-hour standby batteries and continue to draw power from this source until the emergency motor generator is cranked up and operating. Either of these emergency sources is able to provide power for operating the ship's radio, the navigating lights, and to illuminate the ship's interior. Both the batteries and the emergency generator are located on the upper deck.

On the "Santa Paula" there are some 200 power motors under the care of the chief electrician, ranging from a 100-horsepower motor on the main feed pump down to two-horsepower motors, as well as numerous smaller motors such as those used to operate cabin fans. One heavy motor is kept connected all the time the ship is in commission, to operate a large pump that keeps up pressure in the fire mains. In case of an alarm

(Continued to page 122A)

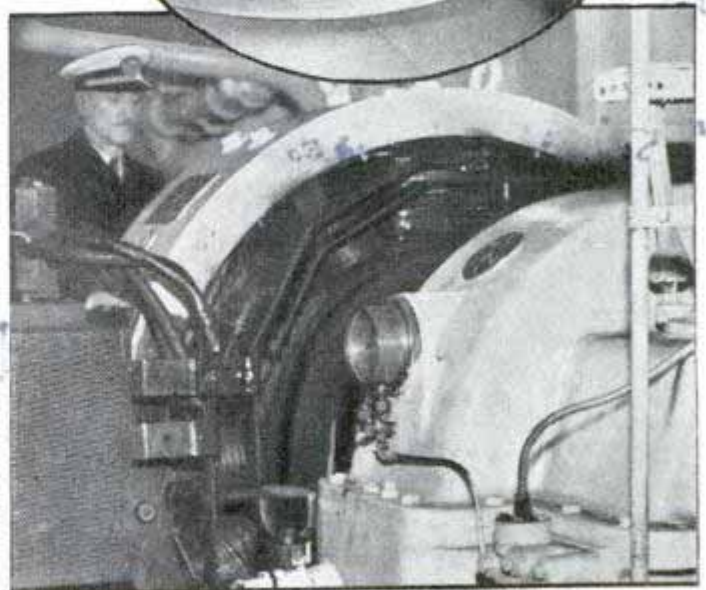
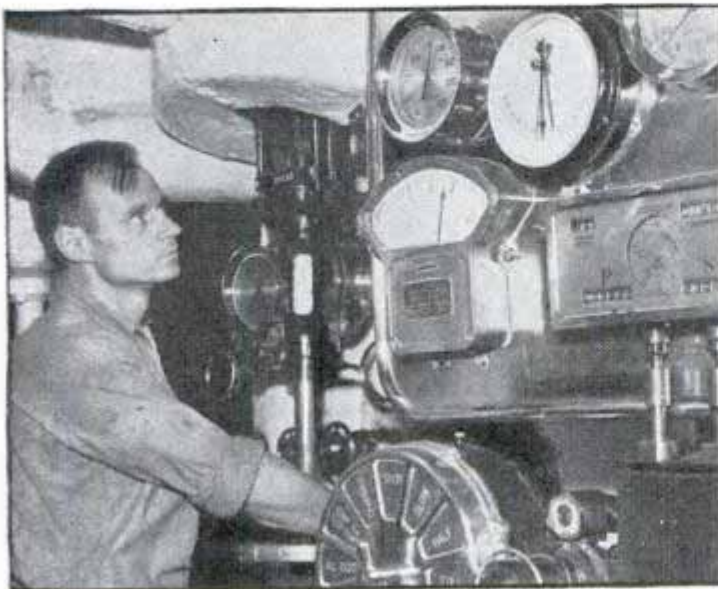
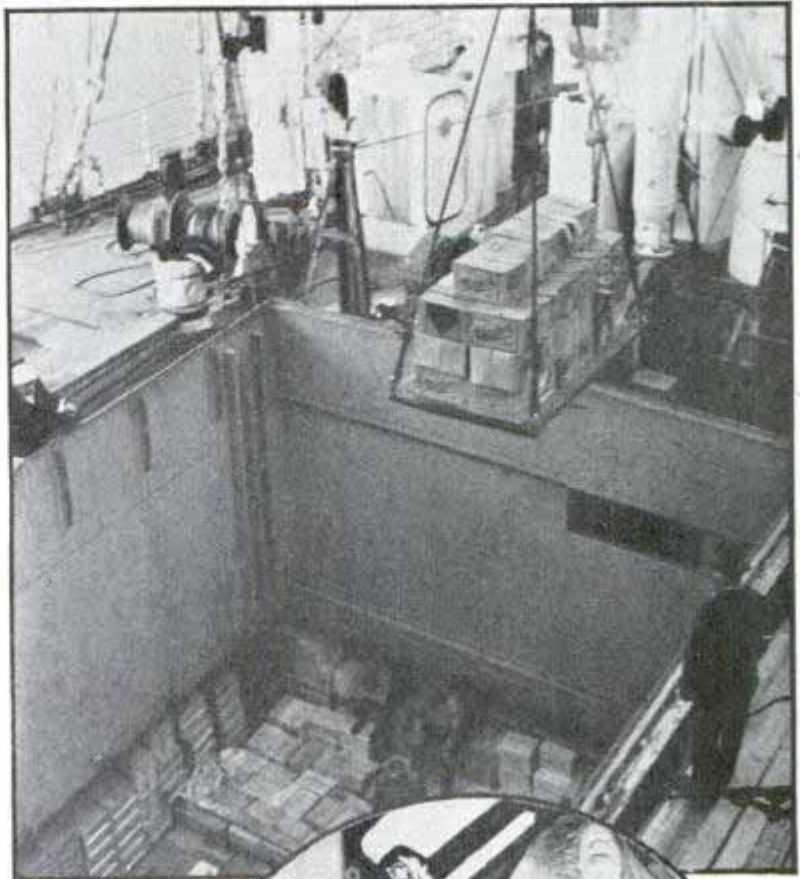

Top, loading ship with electric motors. Circle, giving compass reading to quartermaster. Bottom, engineer at throttle, and, 500-kilowatt generator with steam turbine which runs it

Midget Photoengraving Plant Built on Table

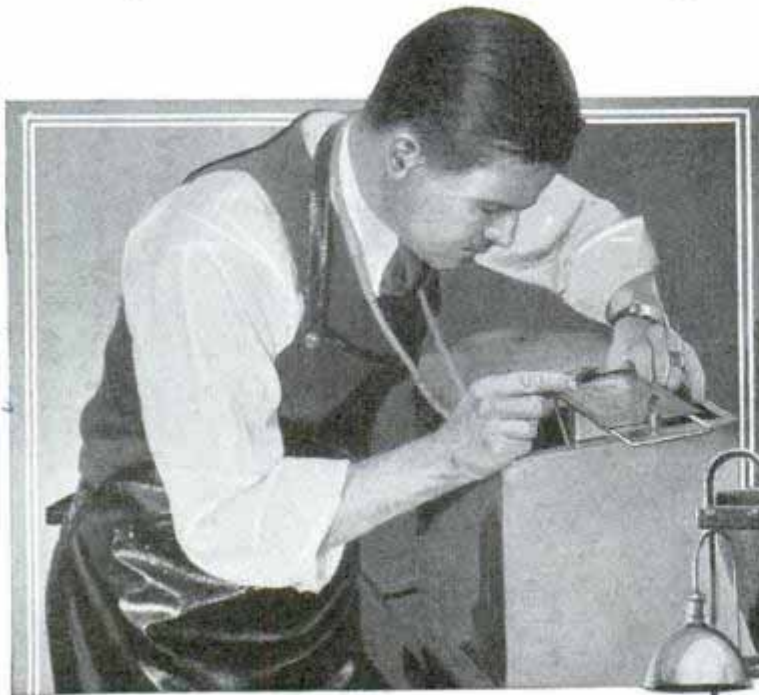

Designed to meet the needs of the small daily or weekly newspaper, the amateur photographer and the artist, a midget photoengraving plant has been introduced. The plant has a maximum plate size of six by eight inches. The entire equipment, built into a table three by six feet, consists of camera, retouching desk, whirler, printing frame, printing lamp, burning-in stove, powder cabinet, roll-up table and motor-driven etching machine. The unit is shipped ready to be plugged into the nearest electrical outlet.

Top, examining plate. Center, photoengraving plant mounted on table. Bottom, closeup of the equipment. The plant produces engravings six by eight inches

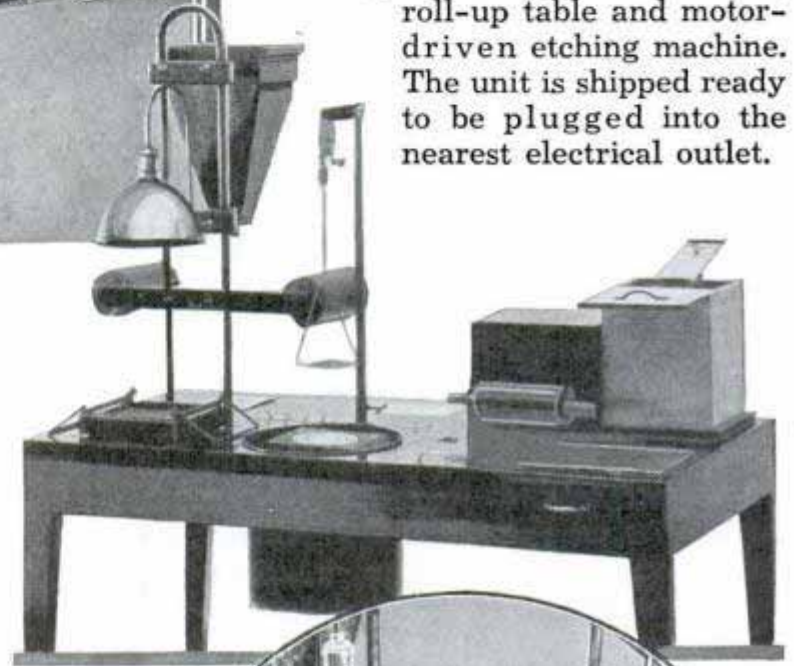

Handy Pocket Gauge Measures in Fractions of an Inch

Measuring in fractions of an inch, from sixty-fourths up, an accurate pocket gauge is on the market. The tool is handy for picking out drills, reamers, taps, round or flat stock and odd-shaped parts. It is accurate enough to check sizes of work-in-process and finished goods. Quick acting and easy reading, the lightweight instrument is so small it fits into the vest pocket.

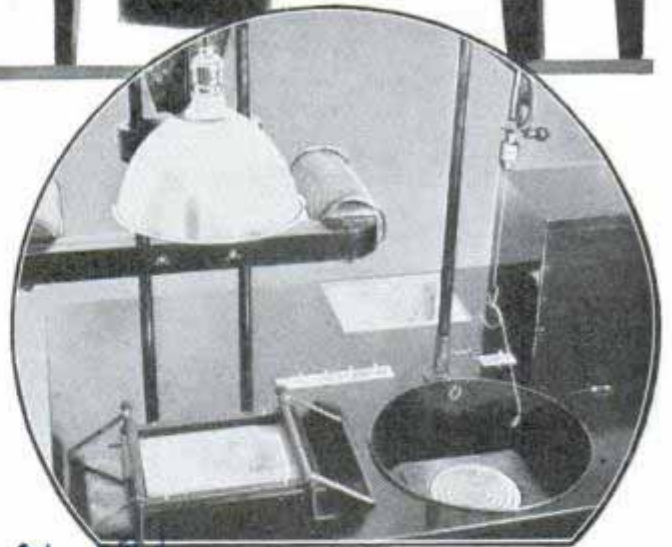

Sound-on-Film Radio Program May Replace Wax Disks

Sound recordings on film, similar to that used for motion pictures, may replace the wax disk transcriptions used in radio. The sound-on-film process has been worked out to a point where it apparently offers these advantages over wax transcriptions:

Aurora. School of Photo. Engraving
 Aurora, Missouri.

#511
 #7.50 plus postage
 Serial scale #21

B.C. Ames Co.
 Hollywood Reader
 LEAF 7 certain

6808 Fountain

Hollywood Records
6808 Fountain Ave. Hollywood Calif

first, the original cost of a feature-length show on film is about one-third that on wax; second, sound film projectors start and stop instantly; third, lengths of shows can be varied with sound film, from five minutes to four hours, whereas the wax record runs but a short time, and fourth, it is possible to make an entirely new show or a combination of shows from the recorded film on file by selecting musical numbers from the film and "dubbing in" the commercial announcements. A vacuum drum, instead of a sprocket, is used with the sound film to give the sound an even motion, free from flutter. With the elimination of sprocket holes, film that is torn or otherwise damaged can be run through the machine with no difficulty, where it would ordinarily require mending or cutting.

Strange Armored War Car Captured in Spanish Drive

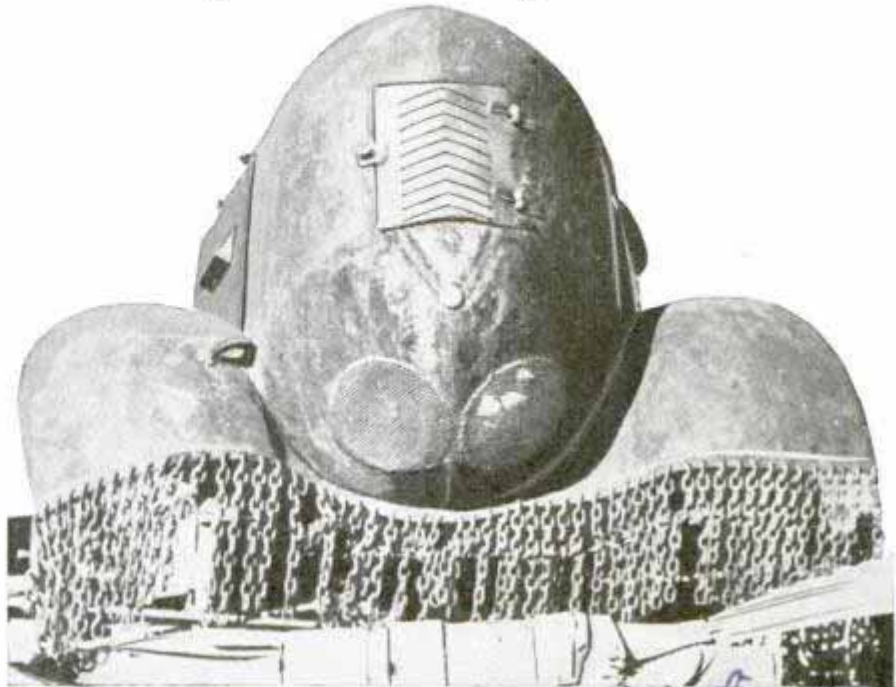

This monster of war, an armored car with protective chains attached to front of fenders and apron, was captured in Spain recently

Latest of strange machines employed in war is an armored car of new design being used in the Spanish civil strife. Said to be of Russian origin, one of the grim-looking vehicles was captured by the rebel army in its drive toward the Mediterranean. Heavy chains, attached to the lower edge of the fenders and the apron beneath the nose, are a feature. Closely screened openings admit air to the motor.

Camouflaged Attack Planes Maneuver in Sham Sky War

Camouflage in peacetime air maneuvers was tried out recently by the 98th Attack Squadron. The speedy sky fighters were dressed up in blotches of cloud-like paint to make them difficult targets either for

anti-aircraft batteries of the defenders or squadrons of "enemy" planes. The squadron was inspected at the Hartford, Conn., flying field before participating in the maneuvers along the eastern seaboard.

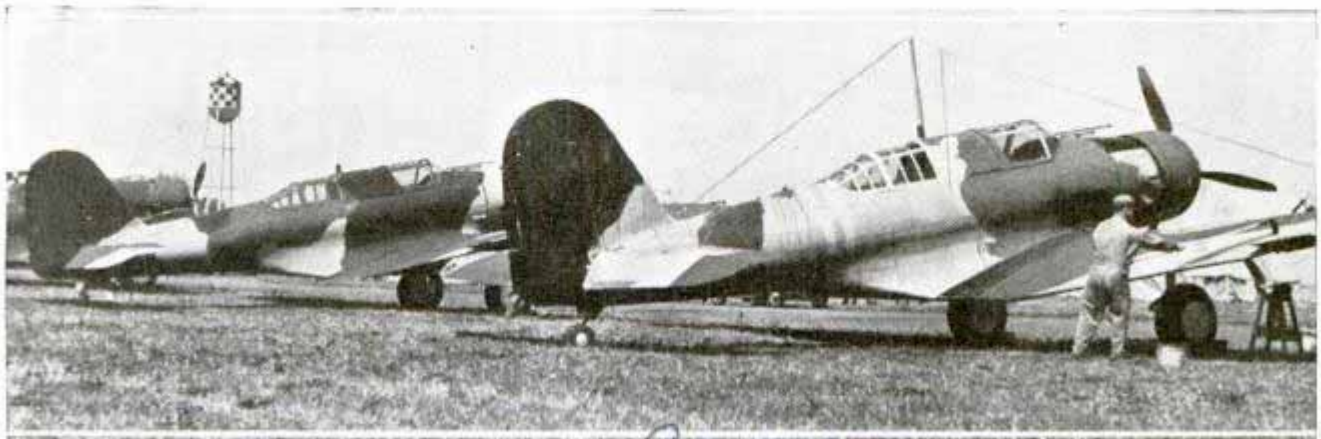

In preparation for "invasion" of New England, these sky fighters are being camouflaged with blotches of paint to render them invisible—or at least poor targets—for enemy planes and anti-aircraft guns

Electric Welding Section
436 Brick Bldg.
Pittsburgh
Pa.

CLOAK of FIRE Guards

By H. S. Card

Development Director, Electric Welding
Section, National Electrical Manu-
facturers' Association

WHEN science found a way to cloak a drop of liquid steel in a protecting blanket, for a journey of not more than a quarter-inch, there developed a rapid and complete reversal of engineering and industrial viewpoints concerning the metallic arc-welding process. Where arc welding had been considered unreliable, it soon became the key to some of the most significant industrial improvements made in recent years.

The process is not new, but there have been limitations on it which no longer exist, limitations which caused engineers to protest when it was proposed to weld this or that structure. Those same engineers today will request the

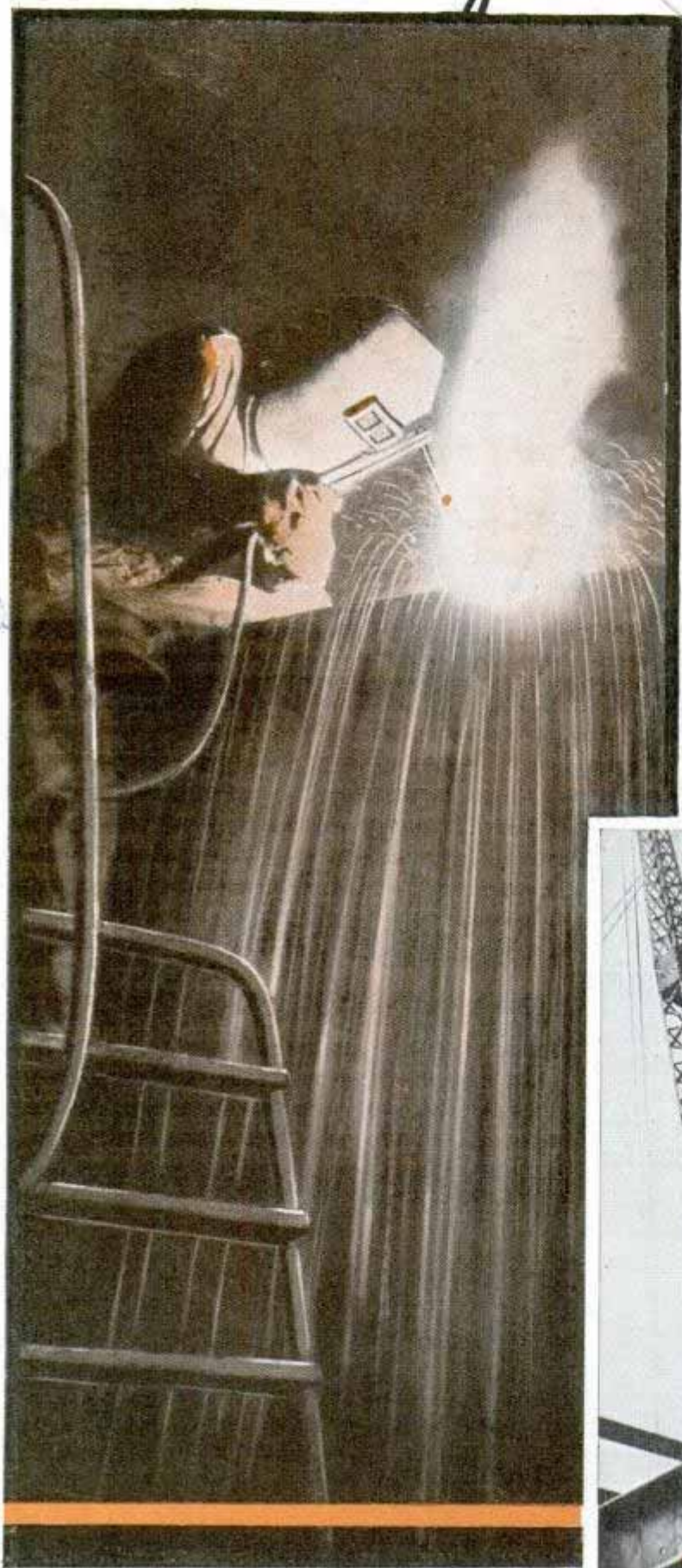

Left, welder at work. Special glass in helmet enables him to see through arc glare. Right, welding frame of industrial building

Van Dyke, built for
welded elec-

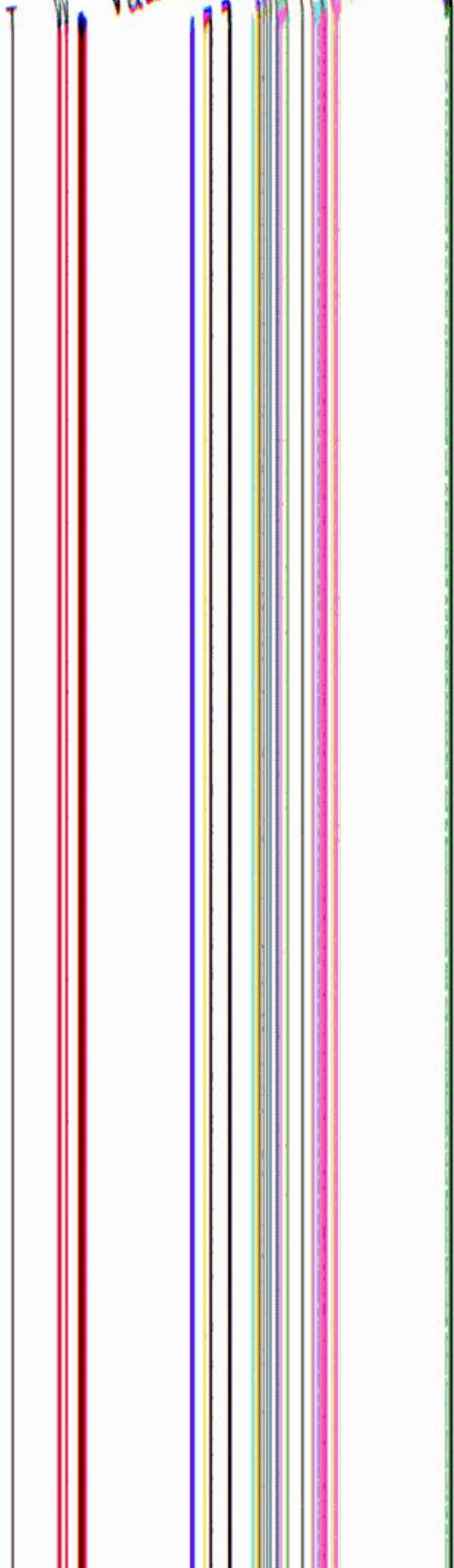

DROP of STEEL

same structures to be welded for strength.

Among important things being welded these days are: a traveling crane of 200 tons capacity; a 900-ton capacity press for making parts of auto bodies; ocean liners and cargo vessels, which are increased in size by being cut in two and new sections, thirty to fifty feet long, welded into their middles; the largest adjustable blade hydroelectric turbines ever built have welded parts totaling over 1,500,000 pounds; the penstocks at Boulder Dam; marine boilers, power boilers and pressure vessels operating at temperatures up to 1,100 degrees Fahrenheit and at pressures up to 2,500 pounds per square inch; road-building machinery, which probably takes greater punishment than any other variety of equipment.

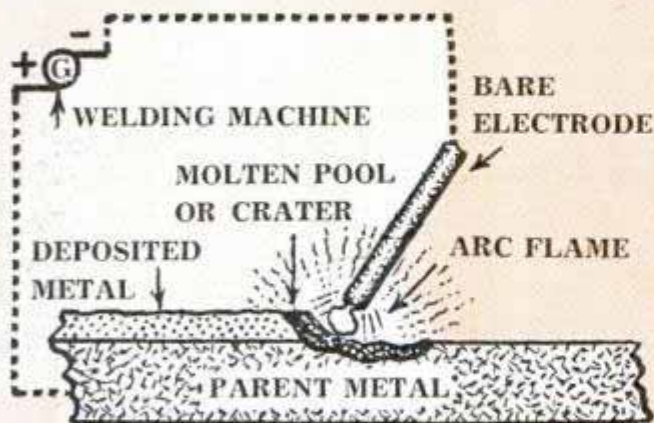

BARE WIRE ARC WELDING

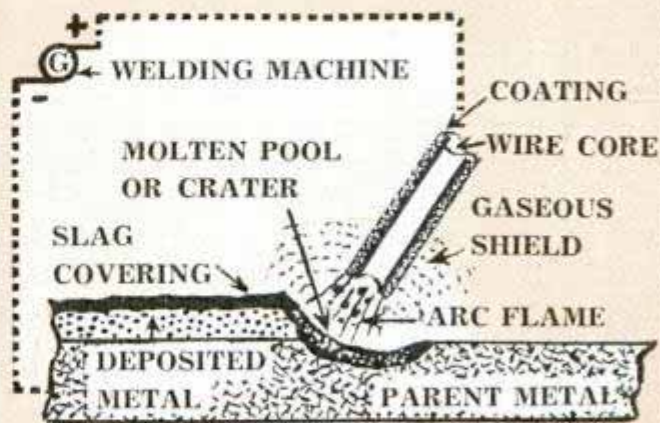

SHIELDED ARC WELDING

Top, 18,500-ton welded tanker which holds gasoline enough to supply 10,000 motorists for a year.
Bottom, diagrams comparing old welding method (left) with the new process (right)

Atlantic Refining Co. 201

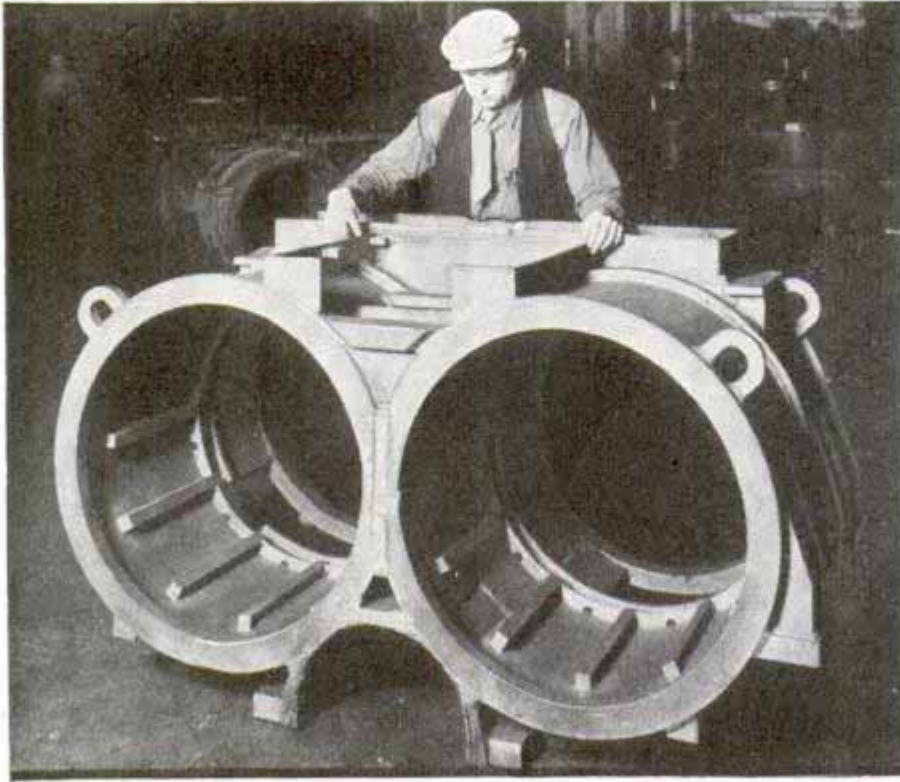

The principle of arc welding is as simple as burning the tip of your screwdriver while testing the battery in your car. The work to be welded and a handle gripping a piece of steel wire are connected by cables in a suitable electrical circuit. The end of the wire is touched lightly to the work piece and withdrawn in the same motion, to start a tiny arc. A fierce heat is generated, which melts both the end of the wire and a small crater of metal in the work piece, and as long as the arc is maintained there is a flow of metal from the wire to the work, which, in general, consists of two separate pieces of steel placed close enough together so that the crater can bridge the junction and thus be fused into a solid piece. If this is done in the open air the liquid steel will pick up oxygen and nitrogen, and after cooling will not be so strong as steel normally is.

Today's preference for arc welding is largely accounted for by that matter of shielding little drops of steel from the air. This was accomplished by coating the welding wire with a substance which melts simultaneously with the wire and causes a blanket of incandescent gas to form around the stream of molten drops and over the welder's crater, shielding it from corrosive action of the air and finally laying a thin, impervious crust of slag over the deposited metal to protect it further

until it has cooled and solidified. This method is often described as welding with heavily coated electrodes, but the term "shielded-arc" is preferred. It took the combined efforts of chemists, metallurgists and electrical engineers, working experimentally for more than twenty years, to translate the original conception of this device for protecting arc deposited steel into practical and economical utility. Now that it has been done, a properly welded

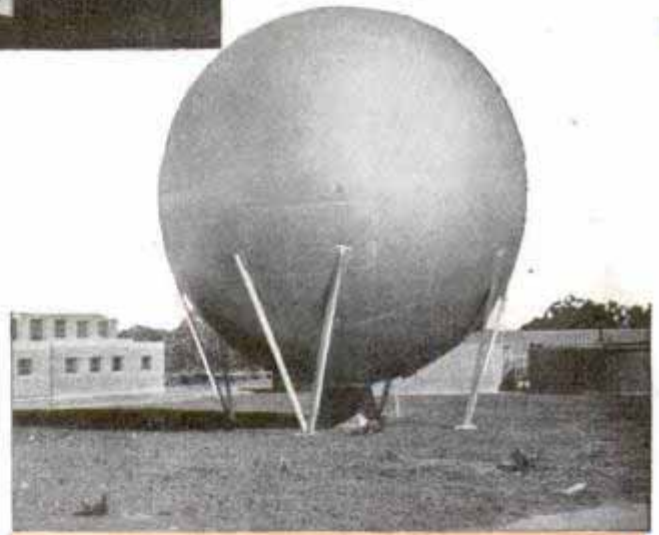

Top, welded twin motor frame for streamline locomotive. Bottom, welded sewage sphere

structure is solid, one-piece, jointless, and cannot be jarred, ripped or pulled apart by any force insufficient to rupture the parent metal itself.

First-class welds are commonly even stronger than the parent metal. For example, an arc-welded radio antenna tower was nearing completion last year when a guy rope snapped and fifty tons of steel work crashed to the ground with such terrific impact that the upper sections were completely buried and a number of the solid three and one-half inch round bars snapped apart, but not a single weld cracked, out of a total of about 3,800.

It might seem fantastic that there is no upper limit to the size and weight of structures which can be built up safely by

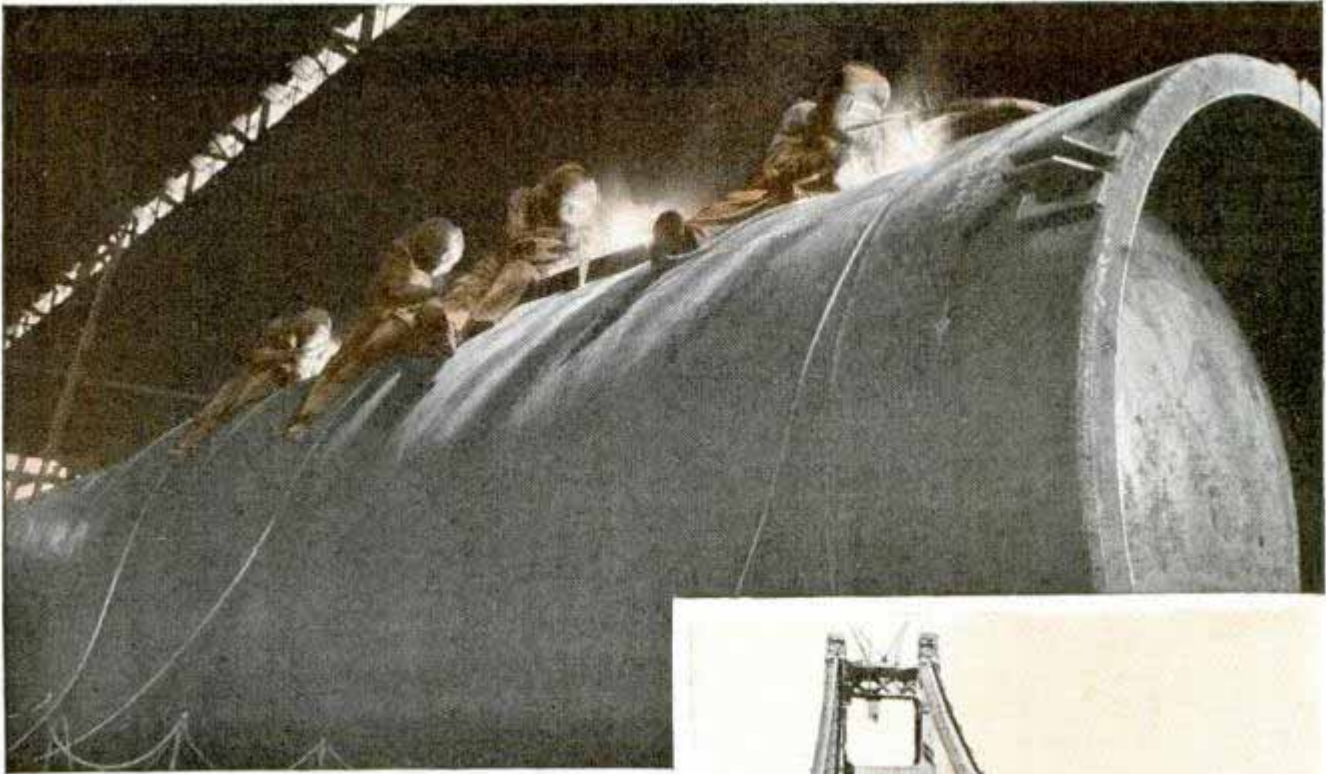

melting them together with a slender steel wire, drop by drop, yet no welding engineer today recognizes any such limit. The most beneficial results derived from using the process are due to development of more efficient equipment which could not be built successfully in any other manner. Several examples are found in the petroleum industry, which pushes billions of barrels of inflammable and explosive materials annually through hundreds of thousands of miles of pipe lines, storage tanks, processing tanks, process piping and delivery systems, and uses are welding at every step from the time the drill strikes the ground in the oil fields until gasoline

(Continued to page 120A)

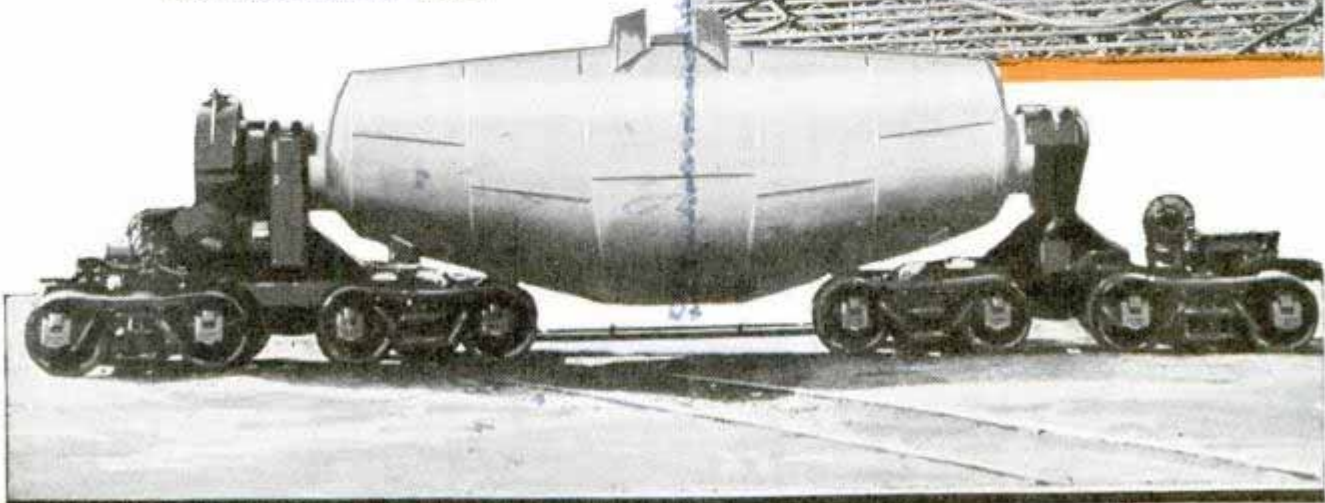

Top, weird-looking craftsmen welding giant tanks. Center, welders installing trusses in deck of Golden Gate bridge. Bottom, new type of hot metal car carries 125 tons of liquid steel

Emt. *Universal City, Calif.*
Box 248, Universal City, Calif.

Projected Scene Helps Make Composite Photo

Circle, ready to project scene (shown below) on screen. Bottom, subjects seated before screen on which scene will be flashed. Top, right, picture resulting from photographing subjects and scene



ing crossed the ocean. Teague's process involves the use of a large translucent rubber screen and a giant projector. The picture to be used as the background is placed on a lantern slide and projected on the huge screen. In front of this screen is placed the foreground part of the picture, usually people. Then a picture is made of the foreground and the scene on the screen, which composes the two and makes the finished photograph appear to have been taken in the locale pictured. The problem to be overcome was how to get enough light on the screen to permit normal exposure of the foreground without burning up the lantern slide. This was solved by treating the lantern slide in a hardening solution and by immersing it in a water cell during projection. Water circulating through the cell reduced the temperature and prevented blistering.

K 5 36 World's Longest Lighted Road Spans New Jersey

When the lights were turned on in June, the White Horse Pike across New Jersey was pronounced the longest stretch of illuminated highway in the land. The state has installed the lights the full length of the fifty-six mile road from Atlantic City to Camden, using a few sodium lamps for

By projecting a distant scene on a screen and then photographing a subject in the foreground, satisfactory composite still photographs can be produced. The process has been perfected by George J. Teague. It makes possible the photographing of persons or any object, such as an automobile, against a background of the Pyramids without the foreground subjects ever hav-

Universal City, Calif.
Special Effects
c/o Universal Pictures

test purposes but chiefly the luminaires developed by General Electric engineers. These incandescent luminaires consist of a hemispherical reflector and prismatic refractor which flood the pavement with light in an elongated oval pattern, shielding the eyes of the driver from glare.

H 275

Metal Picnic or Shopping Basket Folds Up for Storage.

Folding baskets for picnics, marketing trips and general use, made of light metal to withstand long, hard service, have just been put on the market. They collapse into a small space for storage in cabinet or drawer, and are easy to open. Bottoms and handles are of metal, handle grips are hardwood and side walls are heavy duck, mildew-resistant and water-repellent.



weight 4 lbs.

H 393

Two-Way Wheel for Motorboat Lets Pilot Stand or Sit

Motorboat skippers find added convenience in a two-way steering wheel offered this year. It tilts to vertical position or lies horizontal, making it readily accessible for the pilot whether standing or sitting.

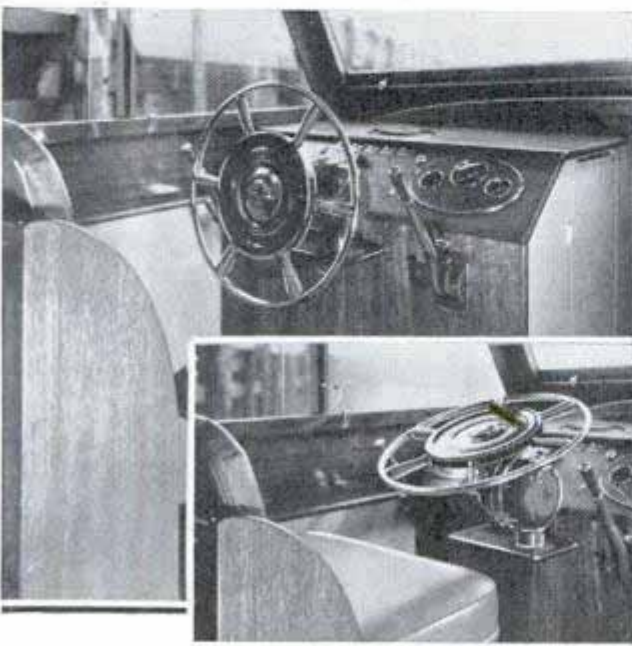

Vertical wheel, above, in convenient position for pilot standing; below, position when pilot is seated

Steel "Silo" Atom Smasher Holds Big Vacuum Tube

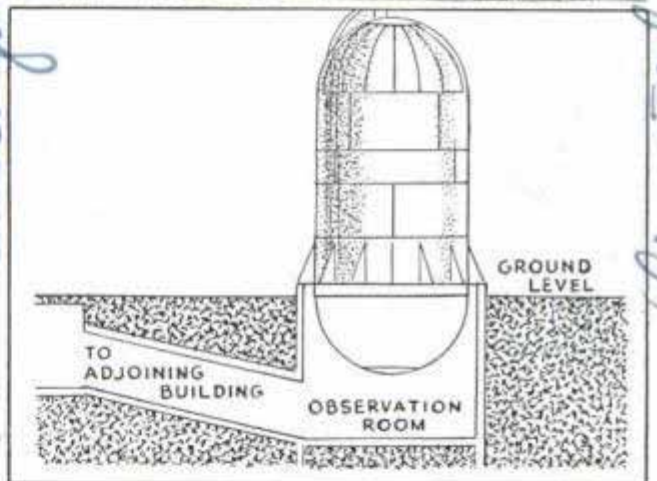
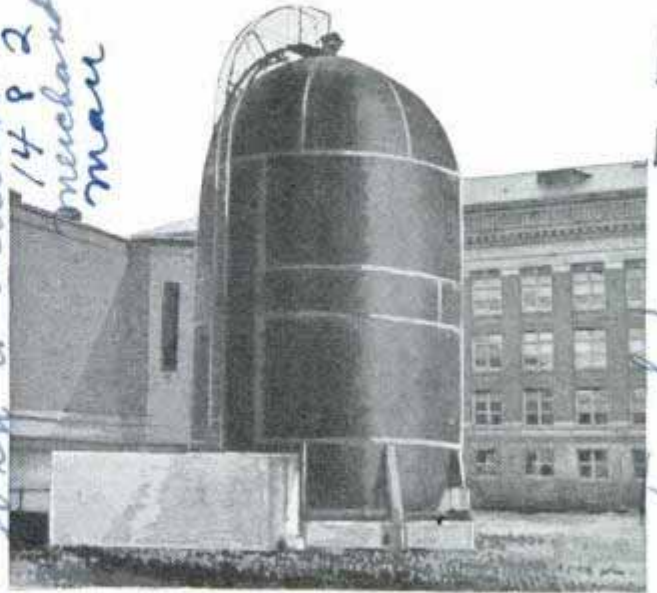

Photo and diagram of atom-smashing tank on Minnesota campus. Its steel walls are electric-welded

Like a great silo thirty-six feet high and eighteen feet in diameter, a forty-ton atom smasher is being equipped on the University of Minnesota campus for experimental work. Its electrically welded wall of prefabricated steel is one and one-fourth inches thick, built to withstand pressures up to 100 pounds per square inch. Radioactive elements whose characteristics permit scientists to follow their movements through plant and animal bodies will be manufactured inside the tank by bombarding various "targets" with electric "bullets" shot through a twenty-one-foot porcelain vacuum tube at a speed of 10,000 miles per second. Struck with such tremendous force, the target disintegrates and a new element forms. To safeguard the operators, the control room is shielded by a six-foot wall of earth and concrete.

Metwood Mfg. Co. Rapford, O.

Schenectady, N.Y.

Chicago, Ill. & Leadstone, Wis.

Animal - Perryman 1720

The Electro Works

High-Efficiency Filament Burns above Melting Point of Steel



Straight coil is the old-type filament, spiral coil is magnified model of new high-efficiency filament

Without the aid of a microscope it is impossible to see the intricate twists of the tungsten filaments in the new high-efficiency lamps. Aluminum models of the old and new sixty-watt lamp filaments are being exhibited by the General Electric company to show the change in construction that increased light output ten per cent. Pencil-thick in the model, in reality the lamp filament is less than .002 inch in diameter. The tiny wire burns at temperatures nearly twice those at which Bessemer steel melts, yet is designed for 1,000 hours of life.

14534
\$16.00 Valvoh

Precision Valve Stem Grinder Saves Time and Labor

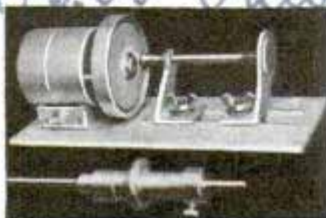

Correct tappet clearance may be obtained quickly by using a low-priced Ford valve stem grinder now

on the market. The precision tool correctly gauges Ford tappet clearance and then accurately grinds off excess material in one operation, saving hours of time and assuring perfect performance of the engine. The high-speed grinder motor operates on alternating or direct current.

14580

Motor-Driven Amateur Camera Films "Hollywood" Effects

Built for the amateur movie fan yet versatile enough to produce many "Hollywood" effects, a sixteen-millimeter camera is equipped for spring or electric drive, and its battery-operated release can even "trip" the shutter for single-frame exposures by remote control. It has a double-lens turret and its basic f.1.9 lens is interchangeable with seven accessory lenses. For extremely sharp focusing—the camera is capable of filling your screen with an object only .047 inch in width—a reflex finder is provided, which, by means of its ground-glass screen and built-in magnifying glass, shows the exact field and focus of whatever lens is in use. With the accessory lenses it is possible to film as close



Sixteen-millimeter movie camera with electric motor, reflex finder and accessory lens attached

hela Park Cleveland

Belmont Ave. Chicago

Kodak Light Model 20

as eighteen inches from the object and cover an area only two and one-eighth inches wide. Almost microscopic magnification is achieved with extension tubes and a standard one-inch lens.

H 558
**Air Cleaner for Machine Shop
 Filters Out Smoke and Dust**

Smoke-eater and dust-remover in one, a small air-conditioning unit developed especially for the welding and grinding shop filters about ninety-five per cent of the dirt from the air in the immediate vicinity of the work. A motor-driven fan sucks air through a flexible metal tube and exhausts it through a filter. The machine can draw smoke and heat away from the workbench, contributing to the efficiency of welders, and since it removes the dirt at its source, before it is mixed through the air of the entire shop, it provides air-conditioning at lower cost. Heat is also conserved, since no air is brought in or blown outside the building.

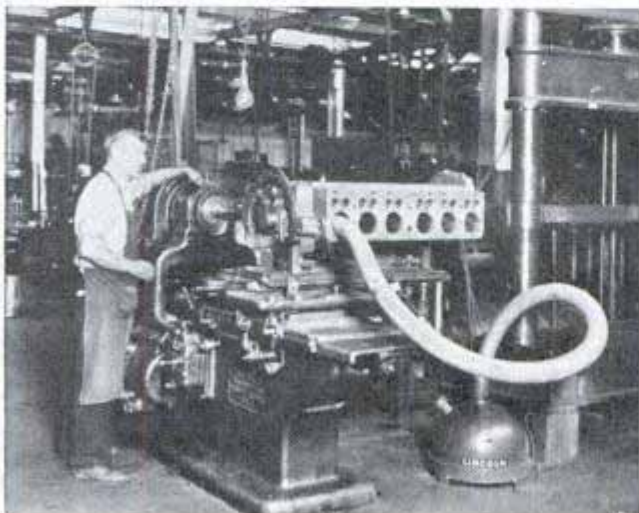

Air cleaner mounted to suck smoke, heat and dirt away from welder's bench and grinding machine

H 585
**Clamp Holds Lawn Mower
 and Aids Repairman**



Lawn mower, held in handy position by clamp, is easy to repair or to sharpen

Leaving both hands of the repairman free, a clamp which holds a lawn mower rigid in any position is now on the market. It eliminates the old method by which the repairman attempted to hold the mower steady with one hand and arm while he applied his tools with the other. The clamp suspends the mower at three points between roller and tie rod, with a snap hook around the center of the tie rod.

H 560
**Wool Made from Fish Albumin
 Mixed with Cellulose**

Fish wool, made from fish albumin and cellulose, is being produced in Germany, another in that nation's list of synthetic products. Comparing favorably in strength, resistance to washing and wear resistance with good grade fiber made by the viscose process, which is widely used in the United States, the new product is precipitated from a solution containing fifty per cent fish albumin and fifty per cent cellulose. When the solution is spun out, the cellulose coagulates first and the albumin later, producing a thread with a cellulose core and an albumin outer sheath.

Lincoln Electric Co. 13016 Cisl Road, Cleveland Ohio

U.S. Patent Office
 May 23 1934

Scene Service May 23 1934

Ventilator for Auto Trunk Makes It Safe for Dogs

In trunk

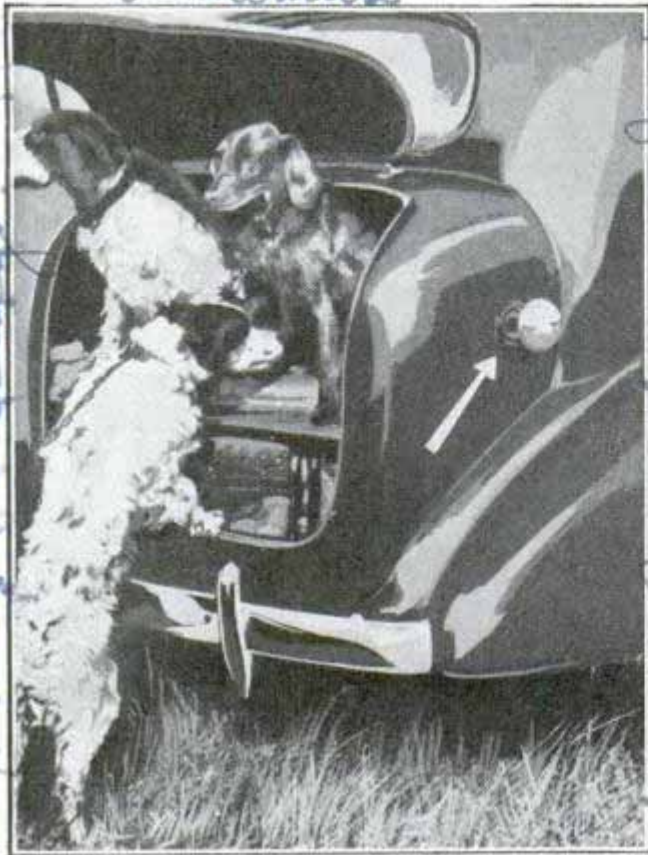

Arrow points to ventilator, which adjusts to admit proper amount of fresh air to dogs riding in trunk

Hunters' dogs and other pets can be carried safely in the automobile trunk if a ventilator is provided. A vent which resembles the cap of the gasoline tank can be installed at the side of the trunk, well above the exhaust fumes. It is adjustable so that the proper supply of air can be supplied the dogs in warm or cold weather.

Low Cost Enlargements Printed from Miniature Negatives

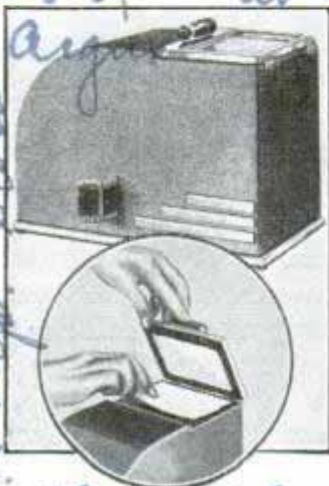

As fast and as simple in operation as a contact printer, a photographic enlarger just introduced makes prints two and three-quarters by four and one-quarter inches from double-frame miniature negatives of the thirty-five

millimeter size. Having a fixed focus and no adjustments to make, the process is easy. Ready-cut sensitized paper is laid on the glass and the printer handle pressed down a few seconds to make the automatic electrical contact and exposure. It is possible to make as many as 200 prints an hour in this manner.

"Retired" Plane Finds New Job Guarding Fruit from Frost

Long since retired from the air lanes, a cabin plane once worth \$50,000 is on duty today protecting an orchard at Painesville, Ohio, from frost. The airplane was once owned by David S. Ingalls, former assistant secretary of the Navy. It has been hoisted to the top of a forty-foot steel tower, where it rotates slowly, its propeller sending blasts of air over the treetops to prevent dew from forming on the trees and freezing. On one occasion the prospective



Rotating slowly on top of tower, this plane—once worth \$50,000—fans air to prevent frost in orchard

1938 peach and apple crop was saved by building a fire at the foot of the tower when the temperature had dropped to twenty-six degrees. As the warm air rose it was blown through the orchard by the propeller. Not one bud was frozen.

2310 W. 69th Chicago
1547
Pachner & Koller, reborn
255 E. W. 109th Chicago
1535
General Camera Leaf-Plate Argon
Boas
International Research

farm of mantle and mantle
1530
1535
60 acre

1530
1535
1540
1545
1550
1555
1560
1565
1570
1575
1580
1585
1590
1595
1600
1605
1610
1615
1620
1625
1630
1635
1640
1645
1650
1655
1660
1665
1670
1675
1680
1685
1690
1695
1700
1705
1710
1715
1720
1725
1730
1735
1740
1745
1750
1755
1760
1765
1770
1775
1780
1785
1790
1795
1800

Diamond and Coal Prove Purity by Float Test

Diamond or paste? Ruby, sapphire, or spurious gem of mere colored glass? Pure coal, or fuel weighed down with worthless slate? Science has found one test for the purity of all these—the sink-float test. If you were to separate, simply, pebbles from chips of wood, you would immerse the lot in a bucket of water; the pebbles would

fall to the bottom, the chips float. It is not quite so simple as that to sort precious metals, to distinguish precious gems from fake, to separate pure coal from rock and slate and iron; but the same principle is followed. Instead of water, heavy liquids are used. Dissolving salts known as thallium formate and thallium mullonate in

Right, flotation test in a glass jar of "parting liquid": coal floats, slate settles to the bottom. Below, control panel, and pure coal emerging from separation process in a coal plant

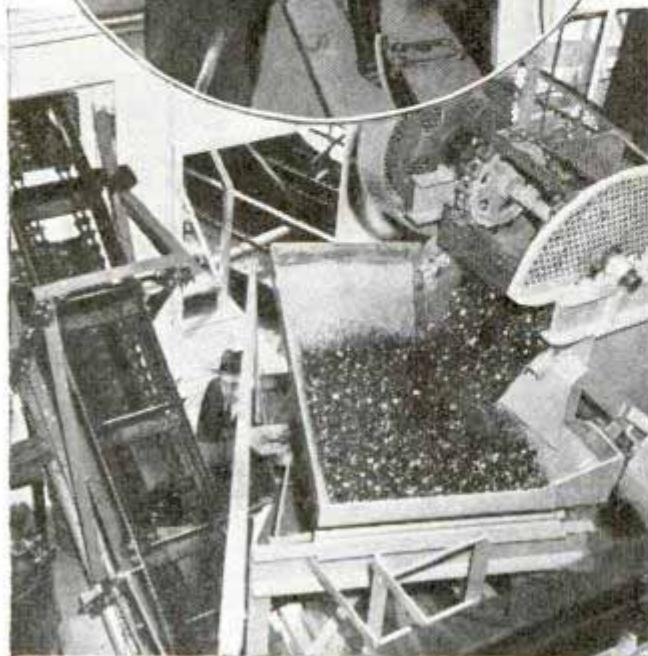
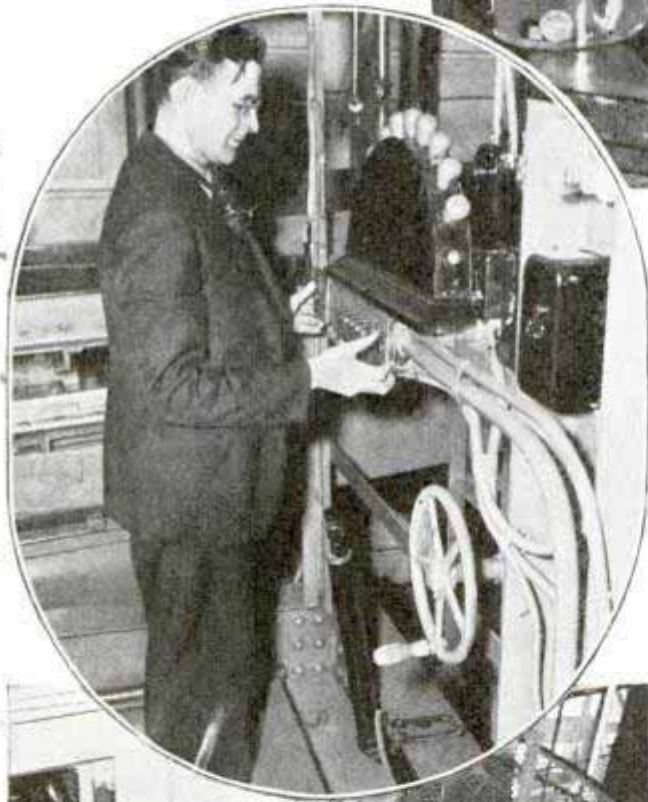
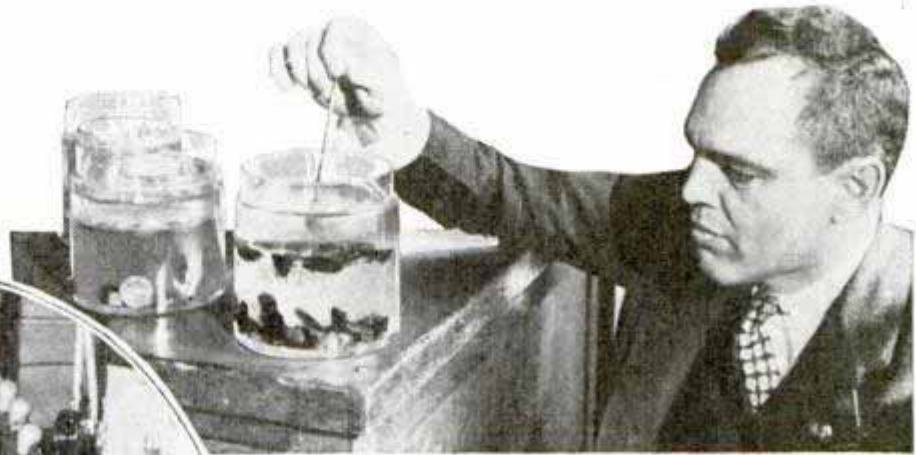

water, a solution four times as heavy as water can be made. By varying the amount of salts, the specific gravity of the solution is controlled. Every pure gem has its own specific gravity: quartz 2.66, cut diamonds 3.54, tourmaline 3.1 and so on. To test a diamond's purity, it is immersed in a vial containing fluid mixed to a specific gravity of 3.54; the impure diamond will sink or float; the pure gem will remain suspended. Du Pont engineers recently developed several halogenated hydrocarbons, such as pentachlorethane and tetrabromethane, the latter thrice as heavy as water, for use as "parting liquids" at the coal mine. A heavy liquid whose specific gravity is between that of coal and slate is supplied to the mine. Immersed in this liquid, pure coal—being lighter—floats; slate sinks to the bottom. This process, enabling the coal operator to market a uniform, slate-free fuel of low ash and high heat content, is now commercially feasible, for there is little loss of the parting fluid and it can be used again and again. Before the coal is immersed in this heavy liquid it is treated with a solution of tannic acid or starch acetate which forms a film around the coal, preventing the parting fluid from adhering to the coal and slate and thus being lost for future use.

Wilmington, Del.

Raymond H. Chemical

The WONDERS

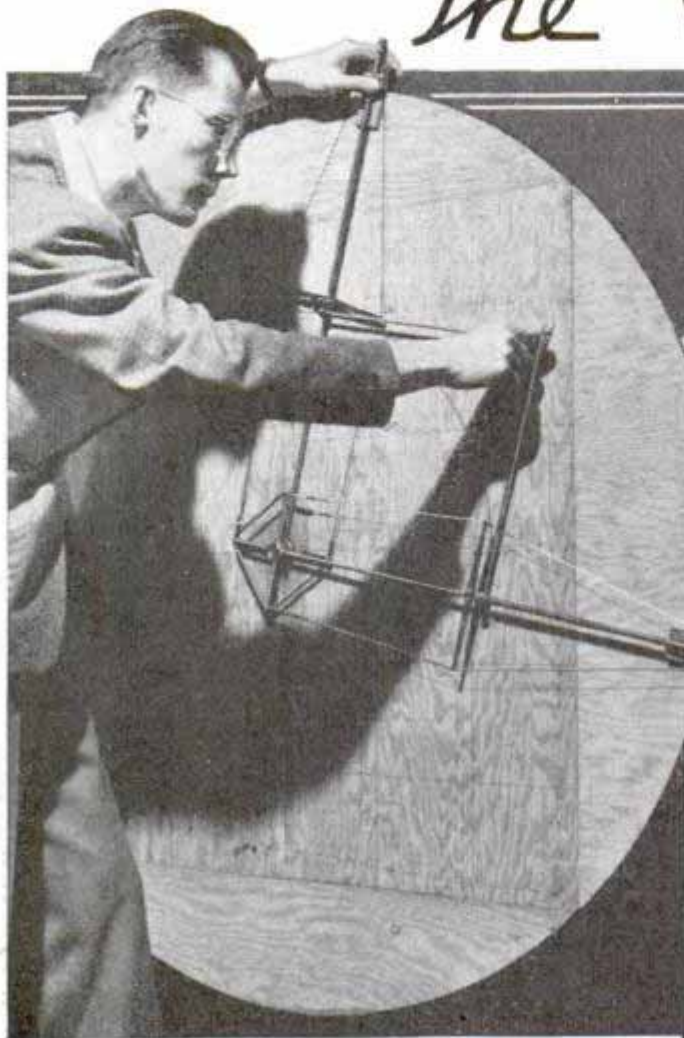

Above, pantagraph arrangement by which position of pickup microphone inside small reverberation chamber can be changed

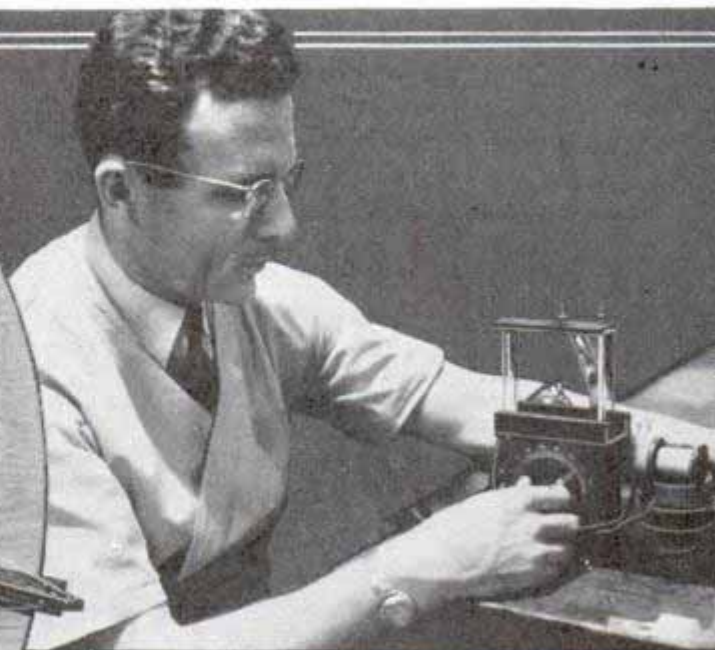

SOUND "SPECTRUM"
(Not drawn to scale)

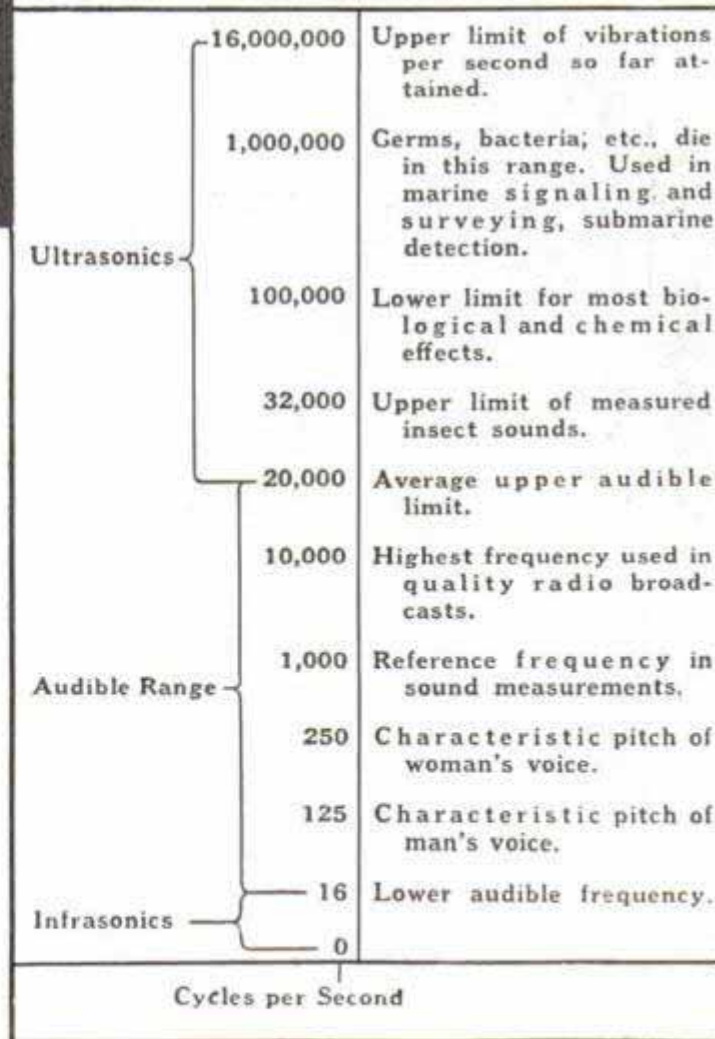

A KETTLE of water boiling lustily looks so hot that you wouldn't think of plunging your hand into it, yet if you should you would find that the water was just about at room temperature.

Liquid in a flat pan defies gravity and humps itself up into a liquid mountain. A metal rod projecting from a coil of wire is cold to the thermometer but you would get a bad burn if you tried to hold it. A chunk of glass crumbles into white powder upon command. Chips of wood burst into flames, and heavy oil vaporizes into a mist.

These are some of the queer tricks that can be played with a brand new science just emerging from the laboratory. Not much more than a decade old, ultrasonics has the promise of becoming a spectacular tool in science and industry.

Sound waves far above the limit of human audibility mix oil and water into a

Top, right, inspecting ultrasonic generator that employs crystal to make sound waves of about 1,000,000 cycles frequency. Bottom, sound "spectrum"

of

SILENT SOUND

14934
Large plaster parabolic reflector by which sounds emanating from tube at focus of reflector are transmitted in straight waves.

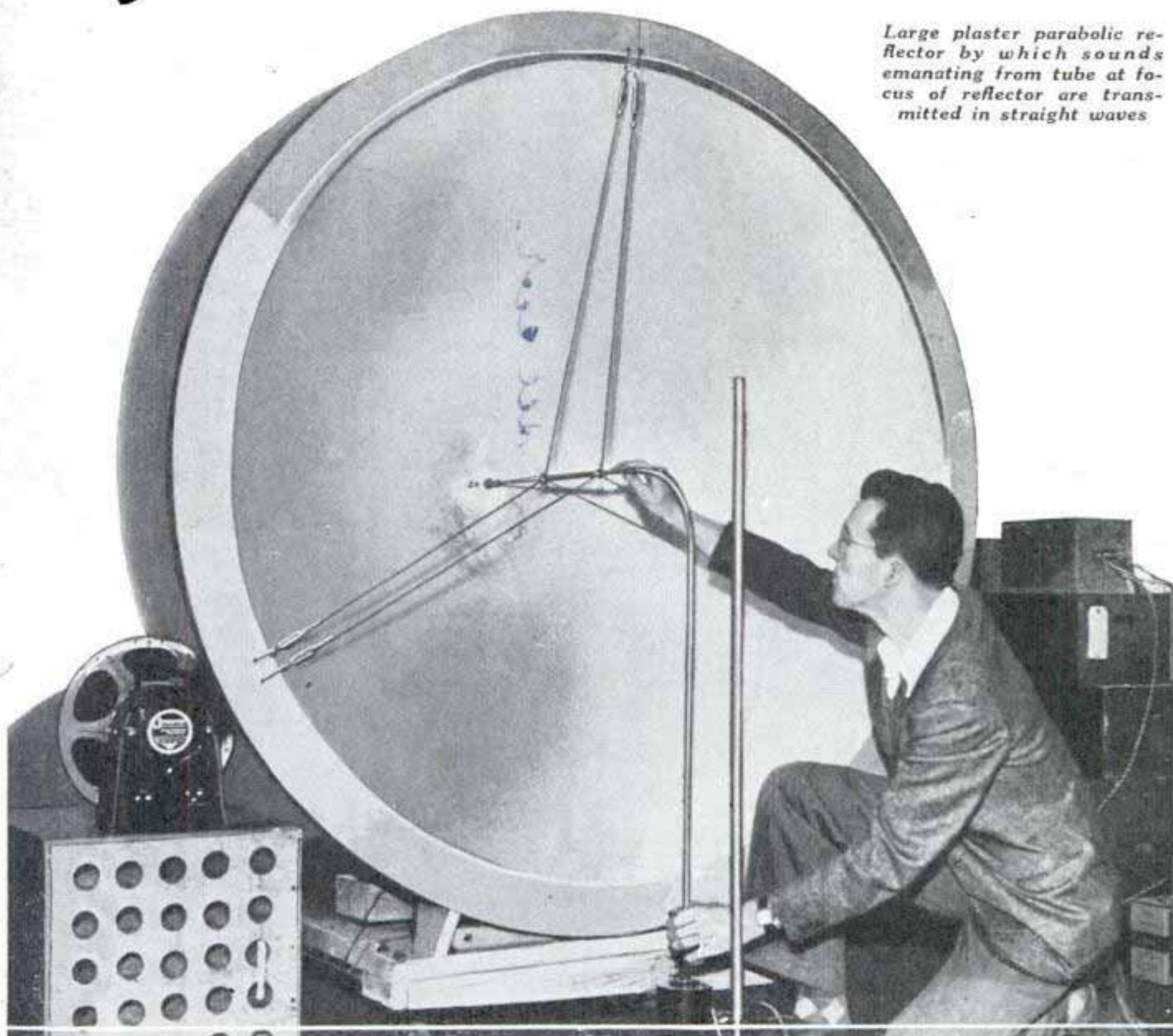

homogeneous liquid. Mercury and water that never would mix before stir into a dirty emulsion. Chemical compounds change their identity. Bacteria that stubbornly resist age and heat shake apart and die. The discovery that a high-pitched noise annoys a disease germ offers important possibilities in medicine and sanitation. With one kind of sound you can soft-boil an egg without raising its temperature. With another kind of sound you can halt decay. Raw eggs treated with ultrasonics remain fresh for months at room temperatures. Other foodstuffs remain fresh and appetizing for weeks although untreated "control" samples of the same food shrivel

up or decay in a couple of days. Some types of bacteria live for fifty years and even strong germicides fail to kill the spores. Boiling, freezing and pasteurizing have no effect on them, yet they die at once when exposed to ultrasonic vibrations. Milk pasteurization at low temperatures, control of bacteria that affect the sweetness of sugar during refining, better control in the preparation of serums and the production of completely sterile solutions at ordinary temperatures are some things research workers expect will become practical.

In chemistry, ultrasonics acts as a catalyst in bringing on many reactions, and speeds up reaction time in others. Starch

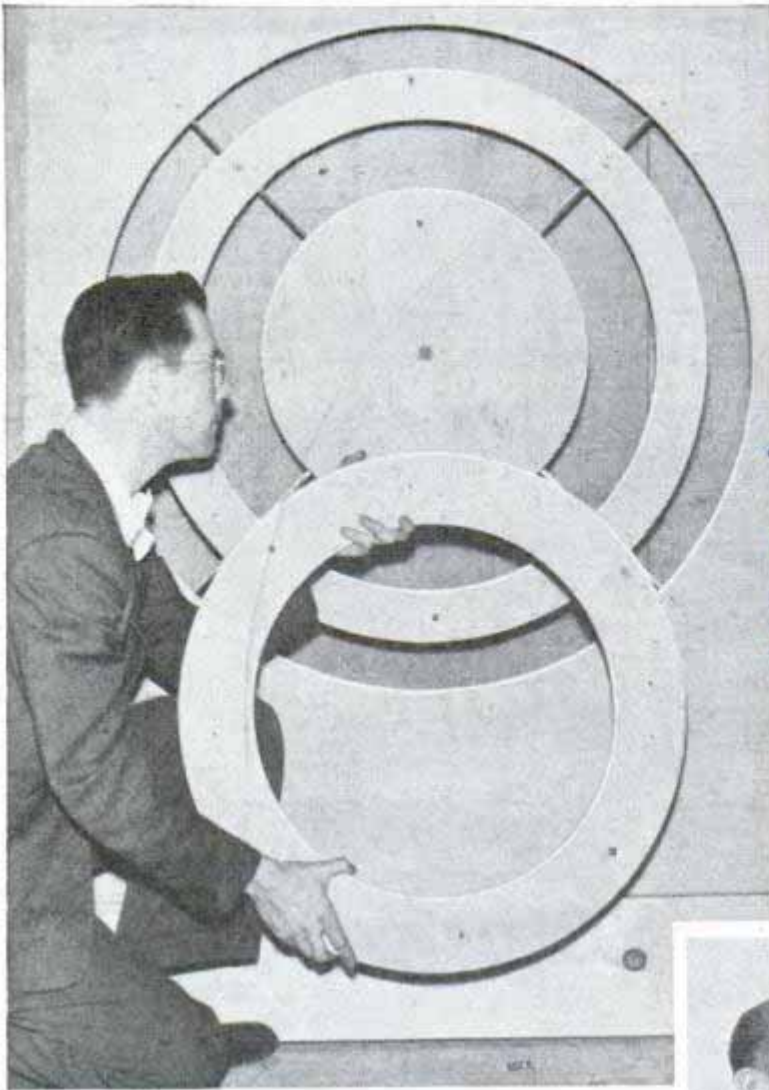

breaks down into dextrin, acetylene is generated from vegetable oils, and other substances break apart or combine under the influence of the waves. Plant seeds speed up their maturing process and in some cases the genes are rearranged so that sports and hybrids occur.

Such miracles as these are achievements of "silent" sound. Sounds are simply mechanical ripples or pressure waves that spread through the air. Our ears are tuned to register only a narrow band of these waves and take no notice of vibrations that occur above or below the range of audibility. The shaking of leaves, the striking of a match, and the rustle of clothing all produce slight sounds that we can hear but in each of these cases other sound waves are also created that happen to be so high in pitch that they can't be heard.

The human ear is tuned to pick up sounds of from sixteen to around 20,000 vibrations per second, but some insects that can be seen but not heard by man

communicate by sounds that reach 32,000 vibrations per second. Only the lower notes of a humming bird's song are audible to humans and the rest of the time the bird seems to be silent although its throat swells and its beak moves as it keeps on trilling notes too high for us to hear.

Ultrasonics got its start when research workers learned to generate sounds that vibrate millions of times per second. Such noises are infinitely too high in pitch to be detected by the ear. Supersonic waves travel slightly faster than audible sound and the wave lengths become shorter as the frequency increases. Sixteen-cycle sound has a wave twenty-one feet between crests in air, 16,000-cycle sound is one-quarter of an inch between crests, and sounds vibrating 1,000,000 times per second have a wave length of one-sev-

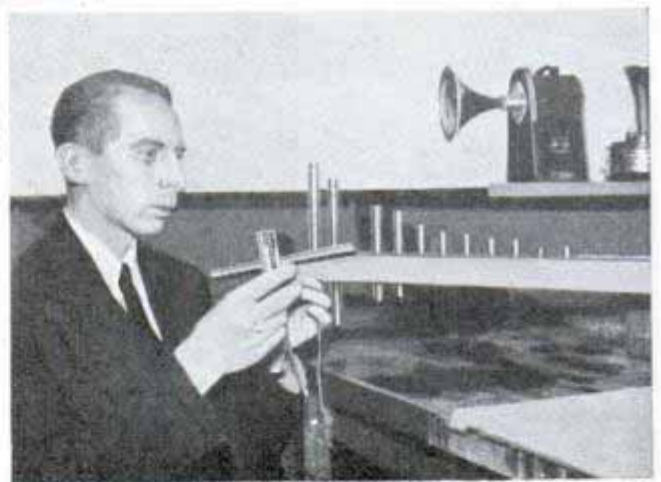

Left, wooden zone plates act as acoustical lens, gathering sound waves and converging them to a focus behind the open rings. Right, mounting magnetostriction rod in electrical coils that will cause it to produce ultrasonic waves

enty-fifth of an inch. Such high-frequency vibrations dissipate quite rapidly in air but travel for considerable distances in liquid.

High-frequency sound has some of the properties of light. It can be directed in narrow beams, it reflects back or at angles just like light, and it even may be brought to a focus. Used like a beam of light, ultrasonic vibration is useful in underwater signaling and surveying. It has possibilities for detecting the presence of near-by

ships in fog. One of its valuable uses is in submarine detection, for it can locate the exact position of a submarine even when the submersible is lying at rest on the bottom with all motors and electric circuits shut down. One type of automatic listening device has been used to detect the first change in note of rotating machinery so that incipient breakdowns can be avoided.

Sound waves of up to 100,000 cycles per second are generated by magnetostriction, the repeated constriction that occurs to a hollow metal rod when it is placed in an alternating magnetic field. This lengthening and shortening of the rod in turn creates tiny pressure waves in the air. From 100,000 cycles on up into the millions the pressure waves are best produced

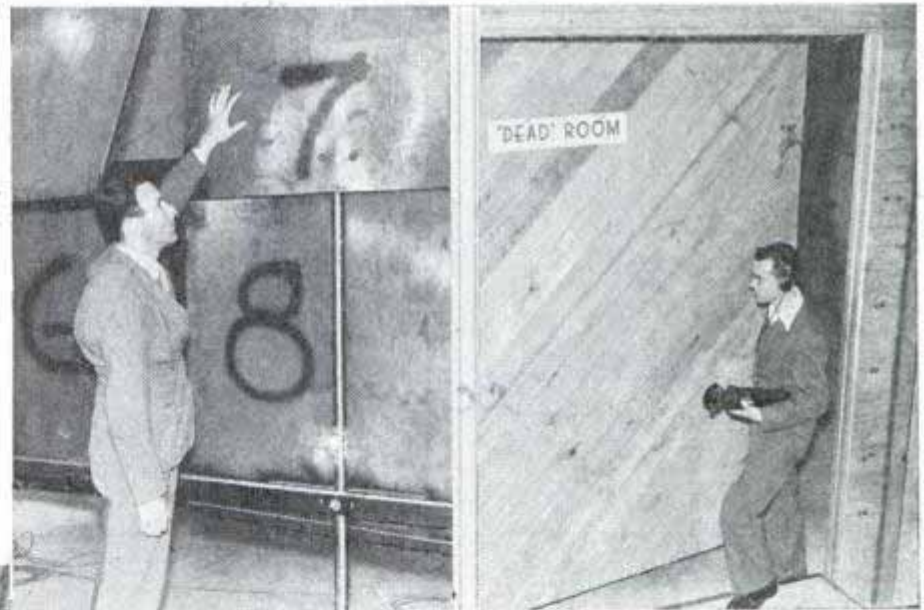

Above, taking readings of ultrasonic waves projected into chamber filled with nitrogen

Top, equipment used to keep track of temperatures in different parts of "dead" room, necessary for making corrections in studying speed of sound. Center, left, metal plates in reverberation chamber magnify sounds. Right, entrance to dead room where absolute quiet is obtained by insulation

by quartz disks. Pure quartz crystals have electrical as well as optical properties. A thin slab cut from such a crystal acquires small electric charges on its faces when the crystal is compressed. Conversely, electric charges applied to the faces compress the slab. Such crystals are used by radio broadcasting stations to stabilize their frequencies on the air and are also used in the crystal microphones that detect ultrasonic vibrations.

When high-frequency alternating current is applied to plates on the faces of such a piezoelec-

(Continued to page 126A)

70 E 45 St. N. Schermer, New York
W-44 St.

Now Charlie Can Walk Thanks to Carpenter



Charlie McCarthy, stepping spryly along on newly acquired legs, takes Edgar Bergen for a walk

By this time Charlie McCarthy has probably developed a very important strut and a condescending salute, for wooden-head McCarthy of the radio and movies is wearing a new set of arms and legs. Carpenters on a Hollywood movie lot fixed him up with properly jointed limbs. When he—or Bergen—learns to walk correctly on the stage and acquires good dramatic gestures, Charlie expects to become a great actor.

Movies Fade into Theater Wall Increasing Field of Picture

By means of a lighting arrangement just developed by two motion-picture engineers, the sharp border of present-day screens is abolished and the movie appears to fill the entire front of the theater. Pictures fade into the theater wall surrounding the screen, increasing the field of ac-

tion and the effect of realism. Light transmitted through the edges of the screen is reflected around the edges; lights and shadows around the screen change in accordance with lights and shadows at the edge, giving the illusion that action is not confined to the screen itself.

Vise Holds Photo Slide Firm While Tape Is Applied

Binding of photo slides is made easier by a special vise with a locking action which holds the slide firmly during application of the tape yet permits it to be rotated. It locks at ninety-degree intervals corresponding to the four edges of the slide.



Tractor Built of Old Car Parts Run by Stationary Engine

When the Rev. W. T. McWilliams of Edison, Ohio, cultivates his garden he steers a homemade tractor out of the barn, hooks on his plow and demonstrates what can be done with a few old auto parts, a few dollars and donations. The tractor travels on automobile wheels mounted on a sawed-

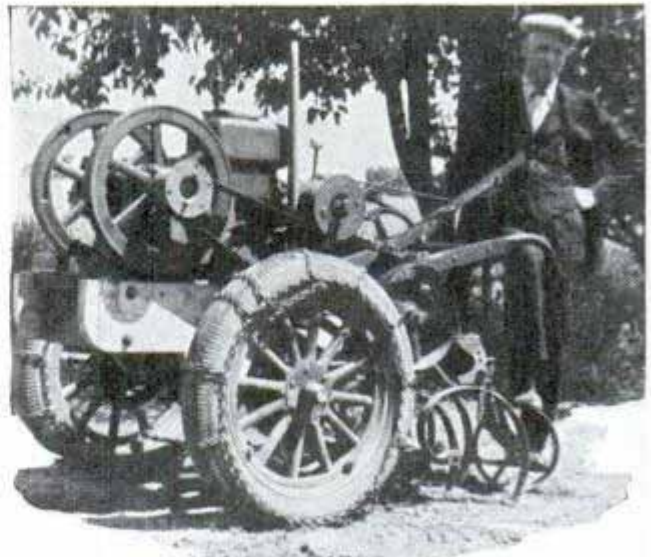

This garden cultivator cost but a few dollars, for it was homemade of odd parts

Movie Letter of introduction. - Adolph Menjou and John Seals

Photo and Producers Co

Long Island City

Science Service

off Ford rear axle, connected to a Chevrolet transmission and, through beveled gears, to the pulley back of the engine. The pulley-on-belt clutch, manipulated by a handle taken from a small hand cultivator, is used on the three-inch driving belt. The motive power is a one and one-half horsepower stationary engine set on quarter-inch angle iron bolted to the two-inch boards forming the platform, which in turn is bolted to the axle and the small rear turning wheel.

14583.

Concrete Buoy to Guide Boats Is Topped by Lights

Replacing floating buoys, concrete shafts topped by big oil-burning red and green lights are being constructed on inland navigation streams. The concrete pyramid extends down into the bed of the river. The lights are mounted above the shaft and can be seen by boats at great distances. The markers also serve to record the rise and fall of the river, having a gauge on the side for this purpose.

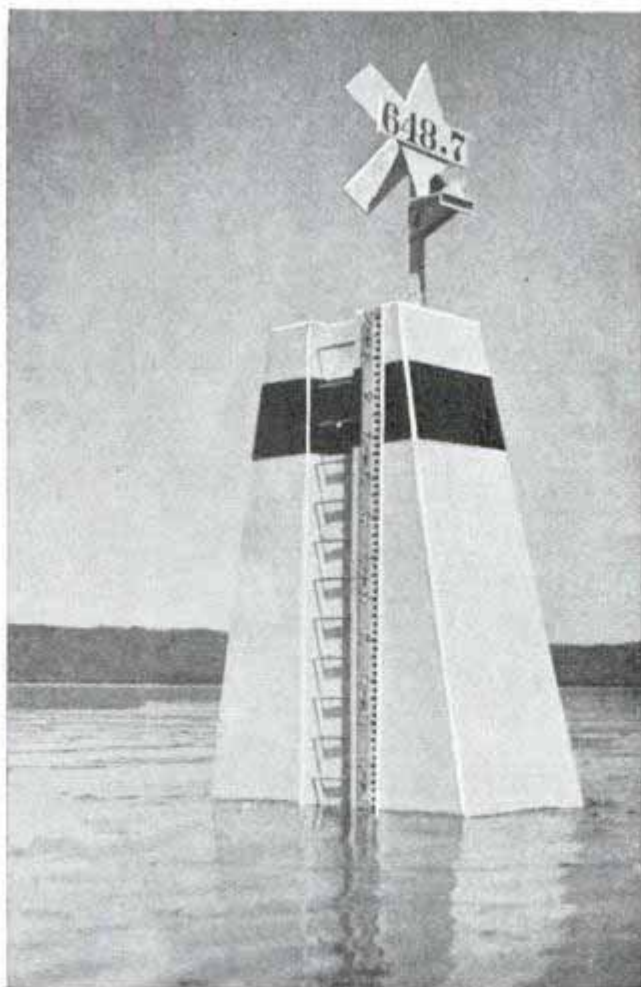

Permanent concrete shafts like the one above are replacing floating buoys in inland streams

Mississippi River

Work Capacity of Athlete Measured in Bike Test

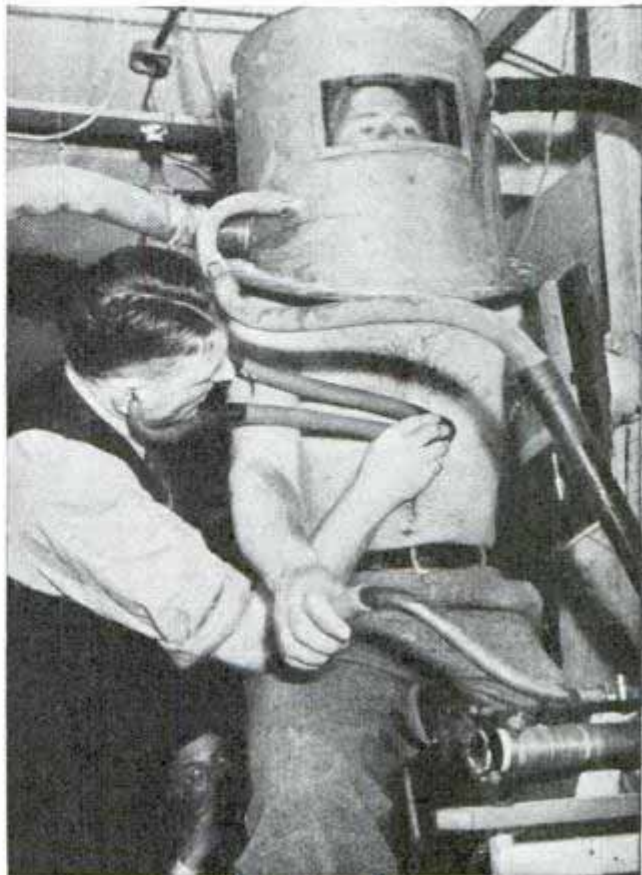

While this athlete pumps his bicycle pedals, his heart is watched and oxygen consumption measured

How much work can an athlete turn out, and what does it cost him in oxygen consumption and heart effort? A group of Stanford University athletes has set out to measure their work-output capacity and "fuel" consumption while pedaling a test bicycle. The driving sprocket of the "bike" is connected to a dynamometer which translates leg effort into horsepower. Over the subject's head is placed a copper helmet into which measured air is pumped, then exhausted air from the lungs is piped away to be measured for oxygen depletion and production of carbon dioxide. One forty-five minute bicycle pumping test showed that the student breathed twenty gallons of air per minute and his pulse was 195 beats per minute, sending seven and one-fourth gallons of blood through the heart each minute. His work output was one-quarter horsepower.

made by Craig Taylor and Floyd Robert T. merritt. Stanford Univ.

test

Send return postage to our Bureau of Information to learn the name of the maker of any device described in this magazine.

"Room with Bath" Offered on Streamliners

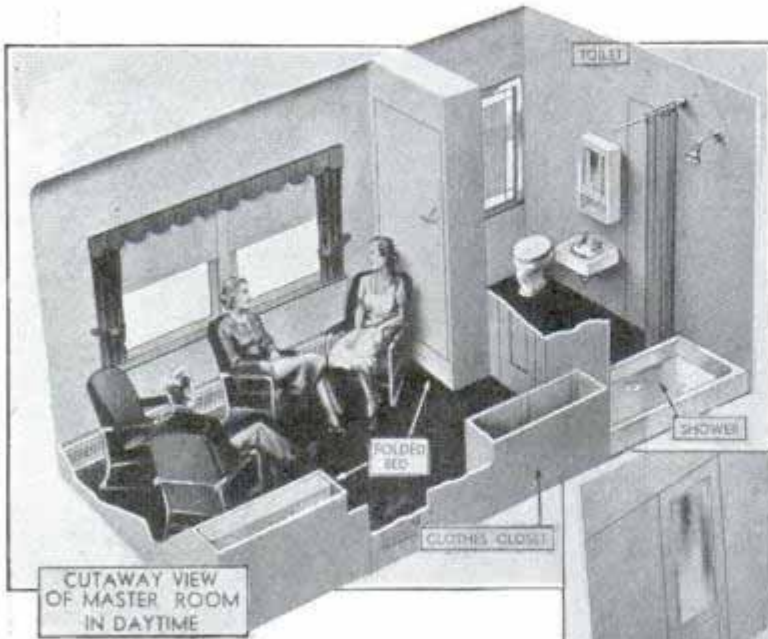

Left, master bedroom on new Chicago-New York trains arranged for day travel, with beds folded to wall. Below, same room at night. Notice the private shower. Bottom, arrangement of single rooms in the new double-deck car

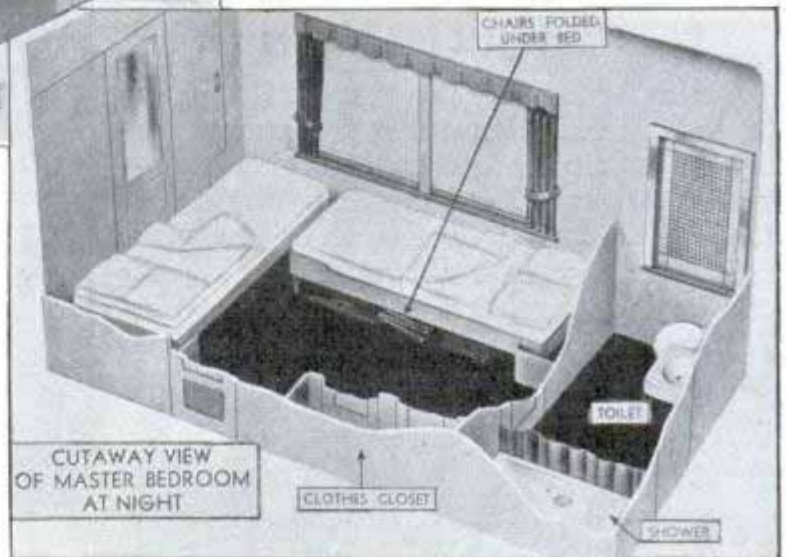

Master bedrooms with private baths, and twin-deck cars with single rooms on separate levels feature the new streamline passenger trains on the Pennsylvania and the New York Central lines. The master rooms have two beds which fold up into wall compartments during the day; each is as wide as the traditional standard Pullman berth and can accommodate two persons. When the beds are folded away, four chairs are provided. These fold under the beds at night. Adjoining the master room is a bathroom with shower. Each railroad has assigned fifty-two new cars to its sixteen-hour Chicago-New York trains. The Pennsylvania will use the equipment on four trains and the New York Central will have four complete 20th Century Limiteds.

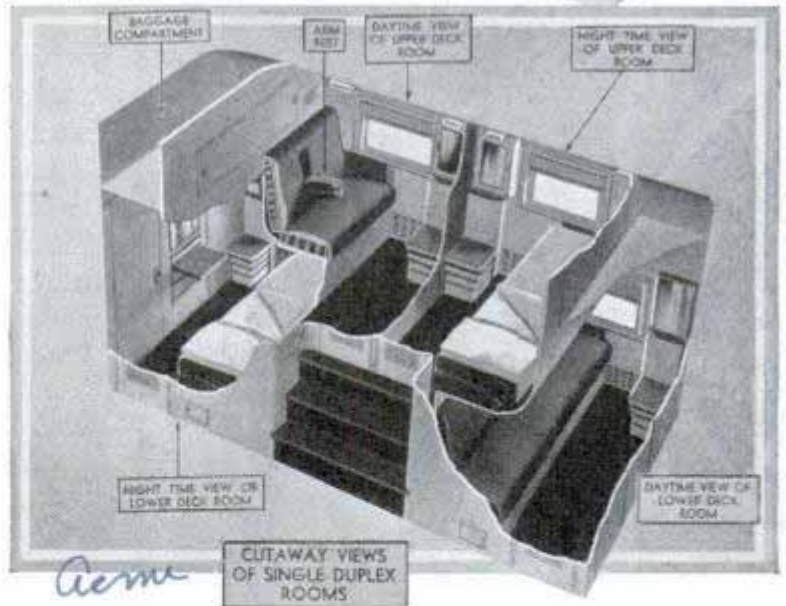

New Ways of Using Wood Found by Research

New and more efficient methods of utilizing the world's forests are permitting the wood products industry to approach the high efficiency of meat packers who boast that they use everything but the pig's squeal. Forests are now looked upon as a source of raw materials for cellulose derivatives, paper pulp, staple fiber, naval

stores, wood distillation products and wood plastics. In a recent address, Dr. H. K. Benson, professor of chemical engineering at the University of Washington, pointed out that through chemistry the supplies of pine trees in the south and the giant Douglas firs in the west are becoming available as sources of paper pulp. Through

Seattle, Wash.

research the naval stores industry is seeing new methods introduced. The older method of using rotted trees is being supplemented by new ways of using tree stumps for their high resinous content. Among the advances are improved stump-pulling derricks and a tremendous 2,800-pound stump ax which, falling vertically, splits the stump down the middle and makes for easy removal by ten-ton tractors. Great technical strides have been achieved in wood distillation, and wood plastics are finding increased use. The U. S. Forest Products laboratory is developing wood plastics by partial hydrolysis of wood and hot-molding the residue. Digestion of the wood under pressure in water and aniline also yields a material which may be molded. These plastics are hard, black, take a high polish and are cheap to make. At the University of Idaho wood is being gelatinized. Drying wood in a kiln removes the water particles surrounding the oriented structures and the wood shrinks. If water is now added, the crystallites in the wood spread apart, regular orientation is lost and a swollen, gelatinous mass of wood results. When this mass is compressed, the water is squeezed out without the wood regaining its former structure. What remains is a mass of continuous physical form like vegetable parchment and vulcanized fiber. This gelatinized wood can be molded and colored during the process. It is about twice as resistant to rupture as the original wood.

Madison, Wis.
Mining on Target Range Recovers Lead Bullets



above
 Dumping scrapings from target range into machine which recovers the lead bullets

Scout City Gun Club
 Five tons of lead per day are recovered by a lead miner who reclaims the bullets fired on target ranges by members of gun clubs. The mining apparatus is mounted on a truck. A scraper is employed to collect the surface soil containing the lead shot, which may have been accumulating on the range for many years. Other apparatus washes the soil from the lead, leaving the metal to be sacked and sold.

17592
Life-Size Figures Molded in Sand by One-Armed Artist



Note life-size sand model of the fallen hero and horse

Fort Wayne
 Life-size, realistic models in sand are fashioned by a one-armed artist in an Indiana city. So true to life are the figures that they bring praise and coins from passersby. The artist's work is remarkably realistic and shows much attention to small details. The only tools used by the sand sculptor are several sharp-pointed trowels, paintbrushes of various sizes and a bucket of water.

Carl = Cletus Junk 1409 Pemberton

H-290 Mr. ...
Editorial Service Bureau.
Eastman Kodak Co., Rochester, N.Y.

MAKING MONEY

John Leary Chicago Tribune

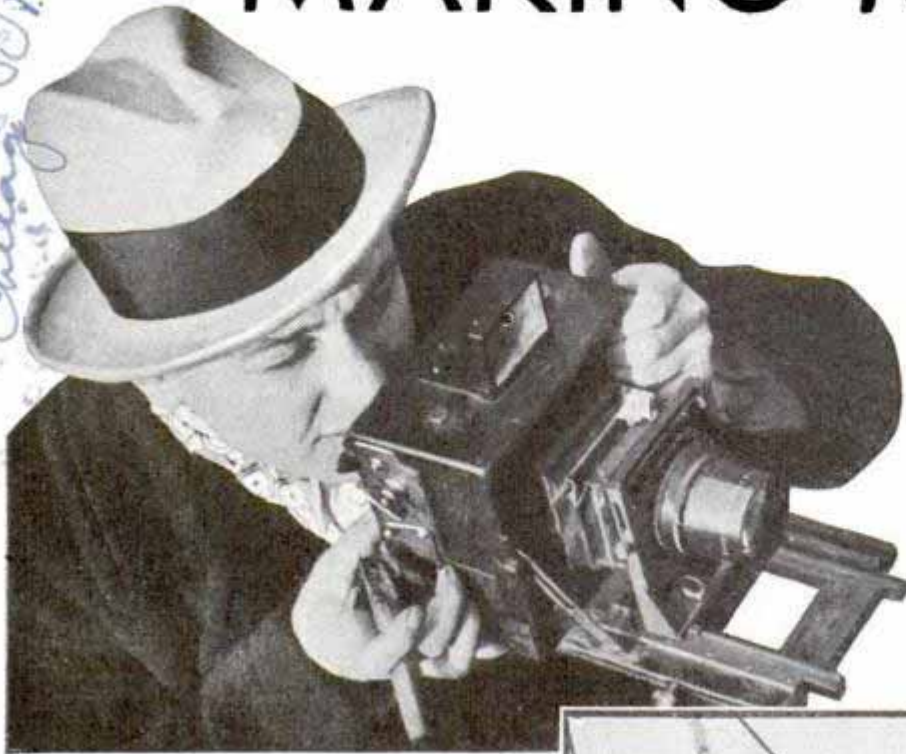

thought to record the scene as passengers and crew, panic written on their faces, struggled toward lifeboats and clung to ropes stretched across the slanting deck.

Hanson had no speed flash bulbs, no costly lens, not even a fast grade of film. He had an inexpensive folding camera loaded with ordinary roll film. As the storm-battered "Vestris" began to list heavily he was sent below

WOULD you take \$9,000 for that prize snapshot of yours? Well, would \$13,000 interest you?

It's not ridiculous. Good shots by amateurs with ordinary cameras have turned into "best sellers" earning money in four and five figures. In fact, some are worth more—and are recognized familiarly by more people—than a painting by an old master.

Who doesn't remember, for example, that famous picture of the sinking of the "Vestris"? It was one of the best sellers of all time; earned more than a thousand dollars for the young pantry man who was the only person cool enough in the face of death to cock a camera and click the shutter; and undoubtedly earned thousands for the picture services distributing it to newspapers and magazines. It is still earning money ten years later—witness the fact that this magazine paid sixty-five dollars for the privilege of printing it here.

Probably there were many cameras aboard the "Vestris" but only Fred Hanson, a cook's assistant,



© News Syndicate Co., Inc.
Top, a news cameraman on the job. Below, famous picture snapped on deck of sinking "Vestris" by a cook's assistant

Fred Hanson

A10 78

with Your PICTURES

to help bail. Let him tell his story from there.

"We were called up to the decks later and told to put on life preservers," he related. "I went to my bunk to get mine, and got my camera too. On deck I started taking pictures. Several times I was knocked down by waves. Once I thought my camera was gone. Everyone was screaming and yell-

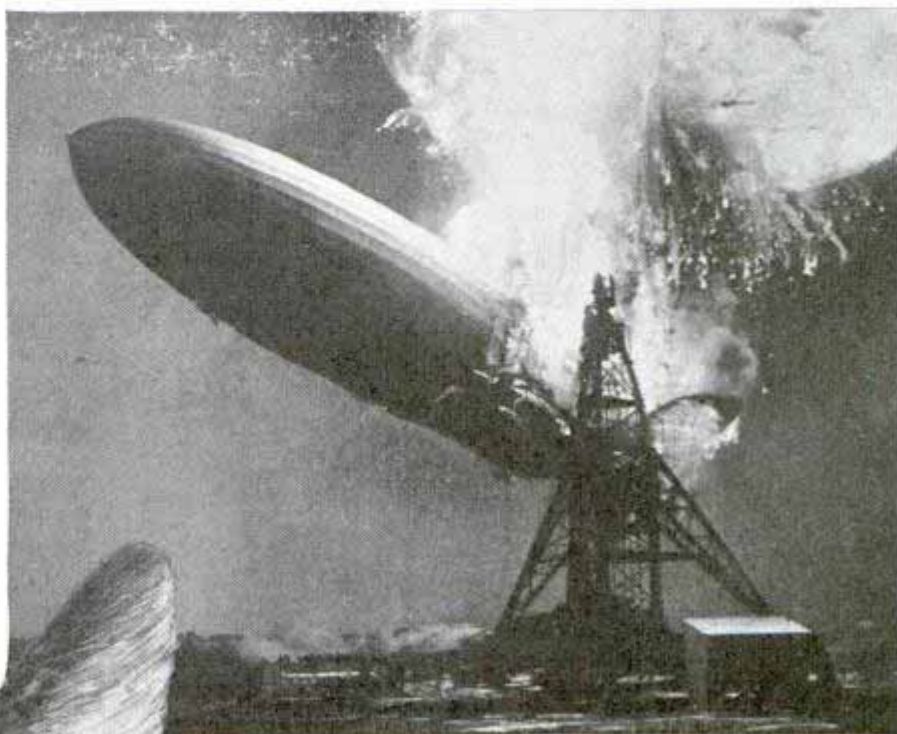

Top. © International News Photos; left, by Underwood & Underwood "Hindenburg" photo won first prize as outstanding news picture of 1937. "Laughing Cat" picture has earned \$13,000. Below, remarkable action shot of collegiate race

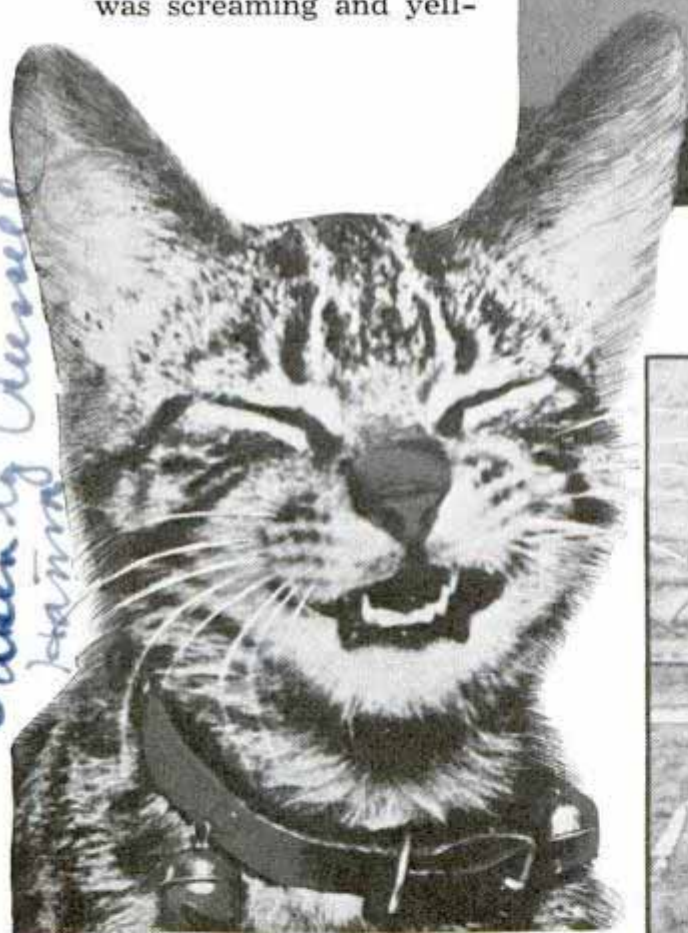

ing. With everyone trying to get into the lifeboats, I knew I might as well stay and take pictures. I did until I thought all the boats were launched except one. I jumped into it, after taking my last picture on deck."

In New York, the rescue ship was met by newspapermen hunting photographs of the disaster. No one seemed to have any. Then

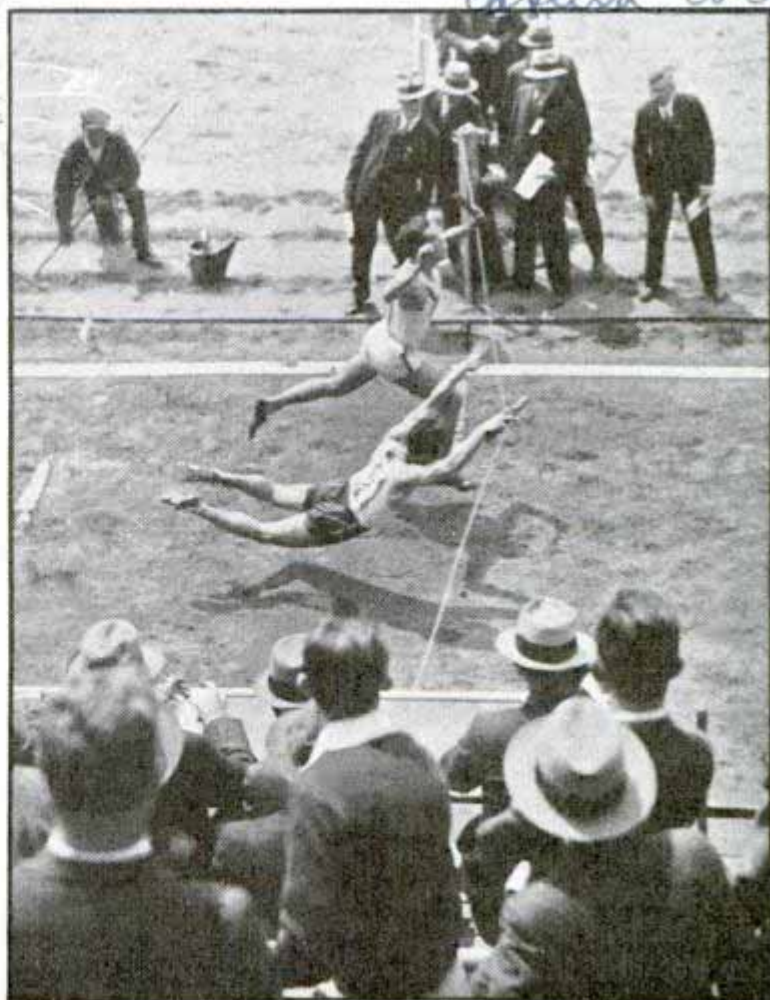



Hanson approached a man from the New York Daily News. He had snapped a few pictures, he said. He was hurried to the newspaper office, his roll was rushed to the darkroom. His pictures, best of them the dramatic shot reproduced here, made papers throughout the world.

Of course, you don't have an opportunity every day to photograph a shipwreck. But more homely subjects are packed with human appeal and potential earning power. Take the "Laughing Cat."

It happens to be from the camera of a professional, Russell Hamm, now staff photographer of the Chicago Daily News; but it could as easily have been yours.

Hamm had been sent down near St. Louis to make a feature picture of a mother cat with her litter of fifteen kittens. When he had finished, the woman owner remarked that she was training another cat to make facial expressions. Hamm asked to be shown. The lady set up a mirror in front of her pet and immediately the cat grinned and gri-

maced. The photographer took a shot at the reflection in the mirror and went home. From the developing tank came "The Laughing Cat," so genuinely humorous that newspaper, magazine and trade journal editors around the globe bought and printed it, and in fifteen years that picture has earned \$13,000!

Big money goes to those rare shots whose appeal is not just for the moment, but lasting. But thousands of less important snap-

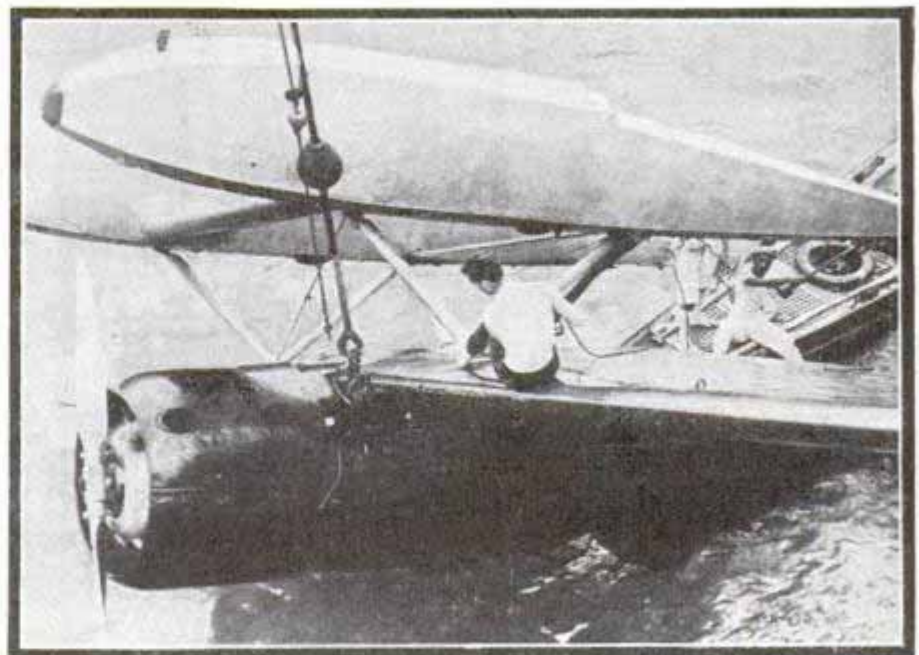

Top photo by Acme News Pictures, Inc.; lower, © Wide World
 Top, auto-race disaster caught by cameraman who was on the job. Below, one of the snapshots of capsized Lindbergh plane for which \$9,000 was paid

Hankow, China

shots are bought every year from amateurs smart enough to know a picture when they see one and to keep a camera at hand every minute, loaded and ready.

Amateur scoop of 1938 thus far was the action shot of the collapse of the Niagara Falls bridge. There was a case where a whole colony of press photographers had been waiting for days to catch the crash. Yet not one professional got the big picture. An amateur did. For nearly a week an ice jam had been menacing the Falls View span. William K. Kirkwood of Simcoe, Ont., visiting Niagara Falls on a business trip, drove over for a look and a picture of the jam. The water level was reced-

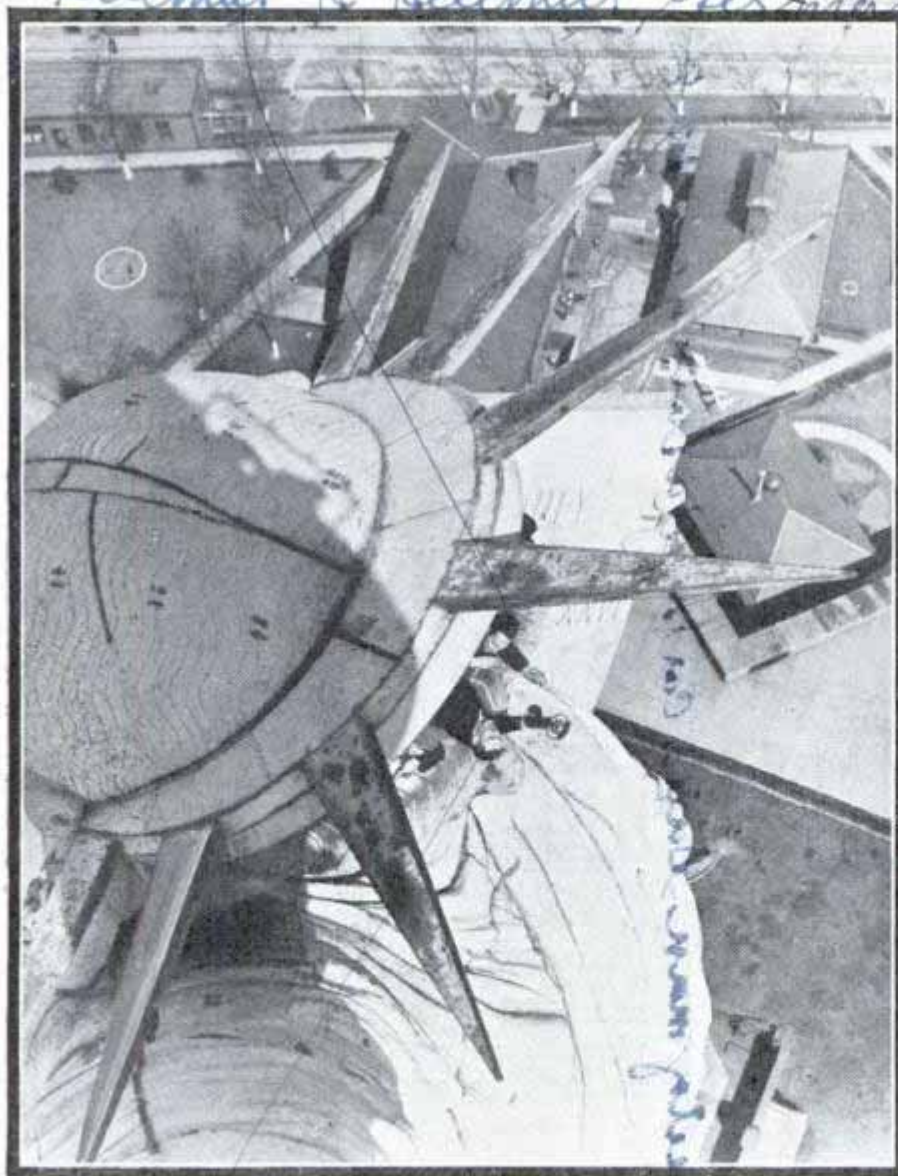
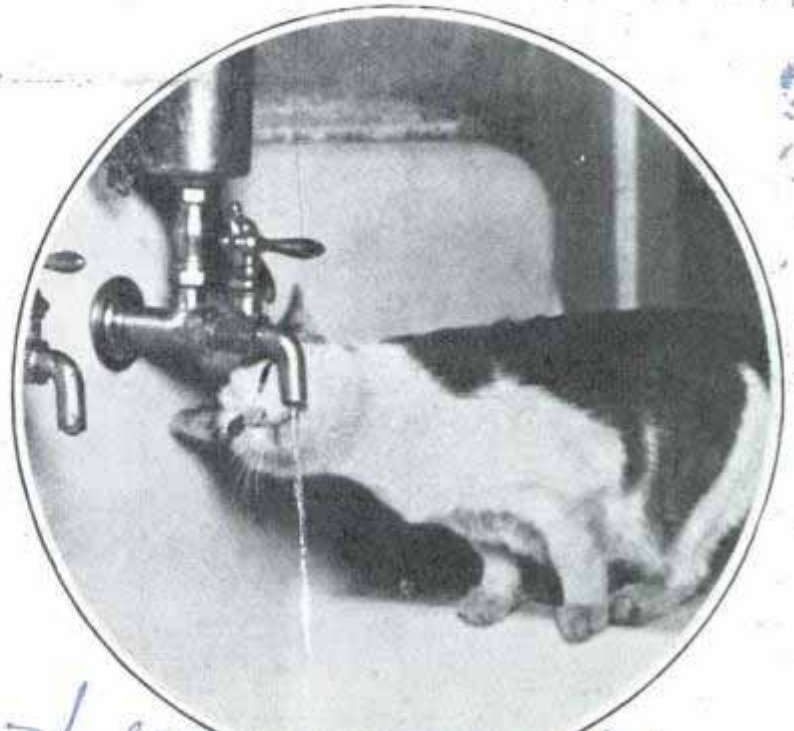

Top, here is the sort of picture with general appeal that any amateur can turn into money. Below, unusual angle view of the Statue of Liberty

ing and the newspapermen had relaxed their vigilance.

Just as Kirkwood raised his camera, the bridge buckled. As fast as he could, he wound the film, pressed the shutter release, wound it again. A matter of seconds, and it was all over.

Then Kirkwood wondered what he had. He didn't see any other cameras around, and on an impulse he telephoned a Toronto newspaper. The editor said he had his own photographers there and the big picture syndicates were covering him too. Mr. Kirkwood insisted he hadn't seen any photographers so the editor finally took his name.

By the time he reached his hotel there was a long-distance call from Toronto awaiting him. Would he please take his film right away to a certain address? He did. Press photographers who

(Continued to page 132A)

James Wallington

Traffic Sign Made Flexible to Bend when Hit



Demonstrating how flexible traffic post can be bent. Note spring at base.

When a new-style traffic sign in a Texas city is struck by auto or truck, it bends to the pavement and then returns to its upright position after the vehicle has passed. The sign is flexible. It was made by welding a large tractor spring to two lengths of iron pipe, one of which was set into the street paving in cement.

made by U. J. Babinke
Mayor of San Juan, Texas

Malick Bldg.

Plug to Make Blasting Safer Seals Drill Holes

For safer and more economical blasting, a plug is being used instead of ordinary sand or dirt bags to seal drill holes. The plug consists of a composition-rubber cylinder closed on one end and hollowed on the other with a tapered opening into which is inserted a wooden wedge of the same taper. The rubber member is chemically treated to eliminate toxic gases and odors in confined areas. After the charge

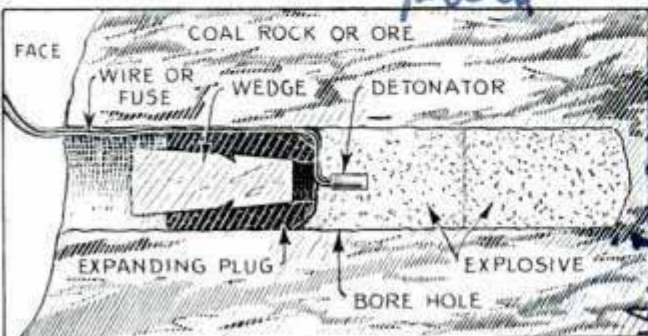

Sketch shows how blasting plug is arranged so that it seals the drill hole

of explosive has been placed in the drill hole, a plug, one-eighth inch smaller in diameter than the size of the hole, is inserted and followed with the wooden wedge until it rests against the charge, then the wedge is tapped with a tamping stick. By test, twenty-five per cent more breakage is accomplished with the same amount of explosive. In case of a misfire, an additional charge of explosive is put into the drill hole, resealed with another plug and fired, detonating the misfired charge. Thus are the hazards of handling misfired charges eliminated.

Welded Pipeline Crosses River as a Suspension Bridge

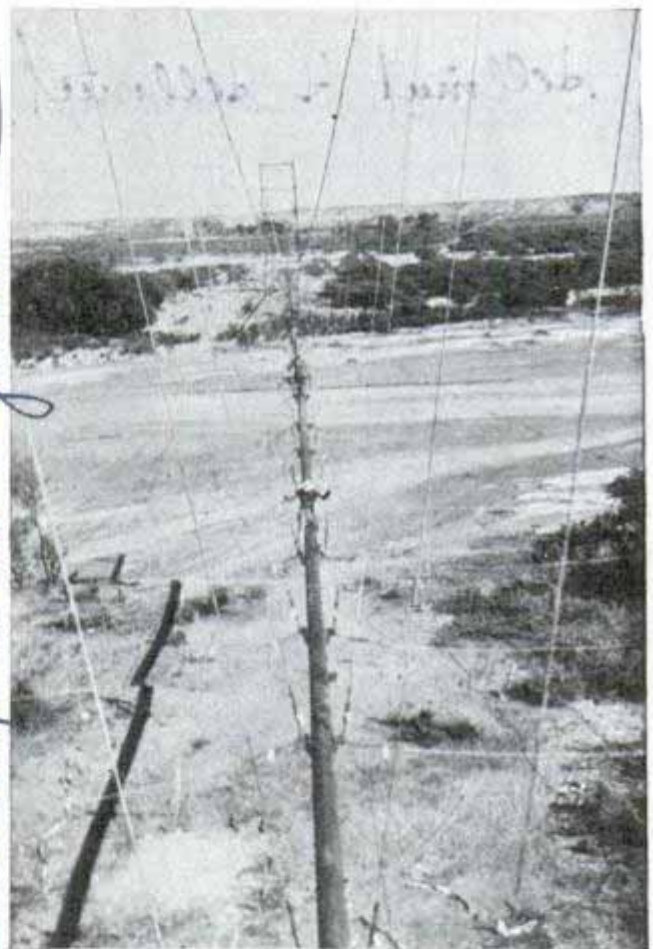

Welded pipeline slung on suspended cables "ferries" natural gas safely above flood level of river

High above the rampaging floodwaters of a river at Benson, Ariz., a natural-gas pipeline crosses the stream on a suspension bridge of its own. Spring floods made any ordinary pipe-crossing perilous, so the engineers raised two eighty-five foot towers, 1,000 feet apart, suspended saddles from the cables and then fed out welded pipes from each bank to the middle.

Washington

Blasing
Product
Linde
Safety

Building a Five-Miles-a-Minute Racing Plane

Tailor-made speed in the sky comes at the end of long months of planning and building in the aeronautical shop. Clayton Folkerts designed the trim little racing plane that Rudy King piloted to win the Greves and Thompson Trophy races in last year's National Air Races. Its top speed was 307 miles an hour. That was 1937. Folkerts has been months at the Kansas City Municipal Airport building his "SK-4," the ship he hopes will do 330 miles an hour

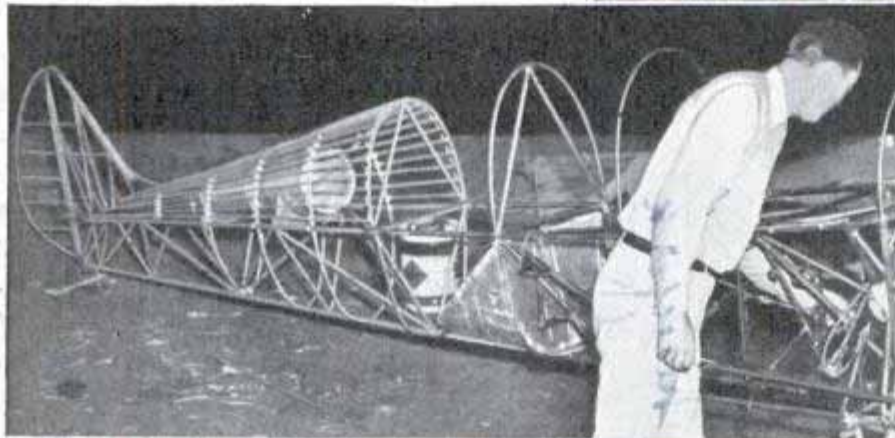

Top, tail assembly; bottom, the supercharged 400-horsepower motor of the "SK-4." Left, skeleton of the racer, showing round oil reservoir in tail and gasoline tank amidships

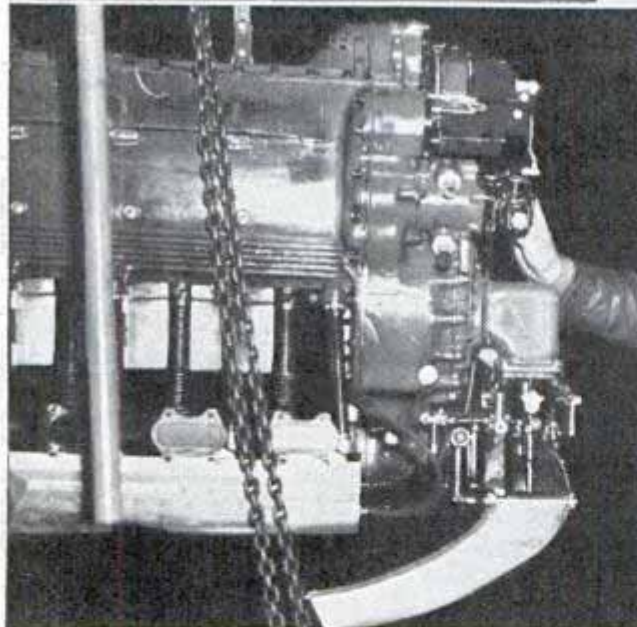

and average close to 280 miles an hour around the 300-mile Greves course in the 1938 races. Much of the time he has worked alone, fitting tiny braces into the one-piece, seventeen-foot wing or welding the tubular steel frame. Three months were spent on the wing alone, evolving slight changes in plans as the stubby wing took

shape around its two main spars. The mid-wing plane carries the thoroughly braced, plywood and fabric-covered wing threaded through its fuselage like thread through a needle. The new model, Folkerts believes, will pick up twenty miles an hour speed with the addition of a metal propeller and a 400-horsepower streamlined Menasco motor. Only the propeller is outside the fuselage, the inverted, supercharged motor being encased in the streamline nose. Over-all length of the racer is twenty-five feet. The retractable landing gear is hand-cranked up beneath the pilot's legs. Oil tank and two small gas tanks are in the tail, for balance; an oil pump provides for circulation. The other two gas tanks are above the wing, in front of the eighteen-inch cockpit. Elevator surfaces are covered with plywood and fabric, but the rudder and fin have merely fabric sheaths. Folkerts has been designing and building airplanes since 1926, with racing models his recent specialty. Pilot Joe Jacobson, a veteran of the air races, believes he has a winner this year.

Five-Foot String Instrument Plays into Loudspeaker



This seven-stringed instrument has no sounding board but plays through electric amplifier

Lacking the traditional sounding board, a five-foot stringed instrument invented by an Oklahoma City musician plays through a loudspeaker. The seven steel strings span an open metal framework and are plucked, bowed or struck with cork hammers. Under each string is a magnetic pickup connected to an amplifier system so that the instrument can fill an auditorium with its music. By manipulating a volume control, a chord can be sustained for a half-minute. Rich new harmonies are possible with the instrument.

Heart of the Stars Is Heavier than Anything on Earth

There is nothing in the world so heavy as the heart of a star. If your watch were as heavy proportionately, it would scale almost a ton and you could neither carry

it around with you nor lay it down without wrecking the furniture. Scientists theorize that the reason for the great weight of the material forming the core of some stars is that the terrific heat and energy inside the star breaks up atoms and drives electrons from their central core. Stated simply, matter is more compact, with less waste of space, than on earth. If, for example, all the atoms in a 180-pound man were broken up and all the electrons driven closer together, with no waste space between them, the man would take up no more room than the point of a pin.

H 596

Automatic Bridge Game Board Permits One Person to Play

Designed so that bridge may be played by only one person, an automatic board has been introduced. The game is contract, played exactly as though the player were sitting in a four-handed game. The player bids and the board automatically makes bids for the three missing players. The player plays his hand and the Dummy and opponents put up perfect defense, through the board. The player sees only the cards he would in actual play, concealed and revealed trick by trick. Any mistakes are instantly detected and corrected by the board.

Boards \$ 3.00



Air line passenger playing automatic bridge while the stewardess looks on

And Paul W. Thomas 1235 Zorcho
St. Louis, Mo. Okla. City
Guthrie Okla. City

Autobud and me 380 Second Ave. New York

Prof. of Astronomy
Case School of Applied
Science, Cleveland Ohio

H 647

Two-Bed Trailer Hospital "Covers" Disasters

*H 579. Comr. Charles J. Osauer
Dayton Journal
Dayton, Ohio*



Emergency hospital in trailer has bed at each end and medical equipment for first aid. It stands by to help disaster victims and is stationed at county fairs and similar gatherings

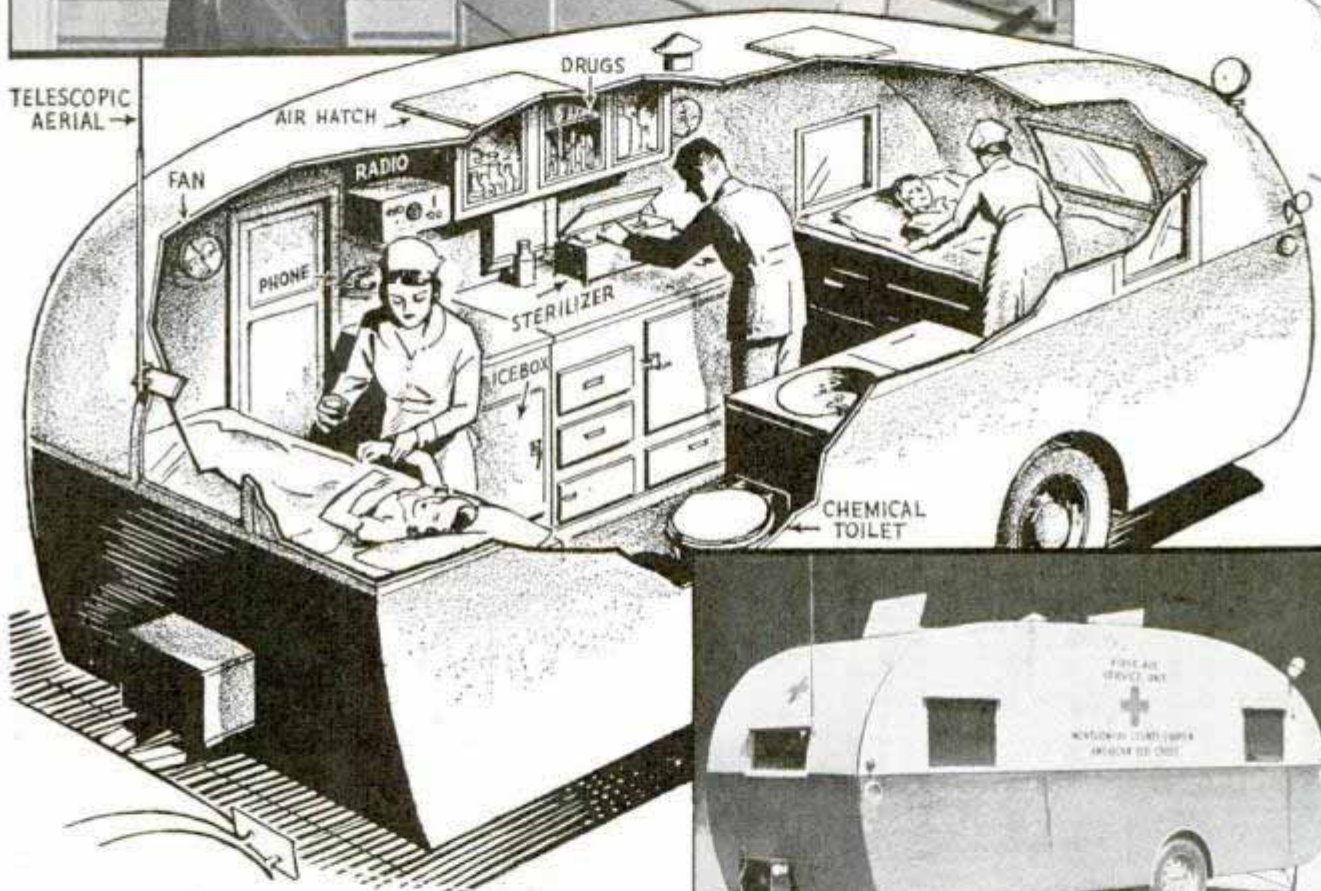

*Mr. Trotwood Trailer
Trotwood, Ohio*



Ready for emergency duty at any disaster, answering all major fire alarms, and standing by to offer first-aid at county fairs, large picnics and similar assemblages is a trailer hospital equipped by the Montgomery county (Dayton), Ohio, chapter of the Red Cross. This mobile emergency ward has two hospital-high beds at front and rear of its conventional trailer shell; between them, an aisle flanked by a cabinet containing physicians' instruments and supplies, a sink, chemical toilet and storage space. Medical equipment includes an electrically heated sterilizer and distilled water. For communication, the hospital has a telephone and both long-wave and police radio sets. Five screened win-

dows, fresh-air hatches and fans provide ventilation. Stretchers and portable spotlight are ready for field rescue work. When the trailer is anchored, a fourteen-foot canvas canopy attaches at right angles to the door to serve as reception room, screened on its open sides. The tires are punctureproof, and the entire trailer, fully equipped, weighs 1,990 pounds.

☐ Inquiries as to makers of articles described in Popular Mechanics, will be answered by our Bureau of Information upon receipt of return postage.



“GENTLEMEN DRIVERS”

Top, runabouts coming out of sharp turn, with mechanics sprawled across decks to help bank the boats. Bottom, rescue crew picking up driver and mechanic after a spill

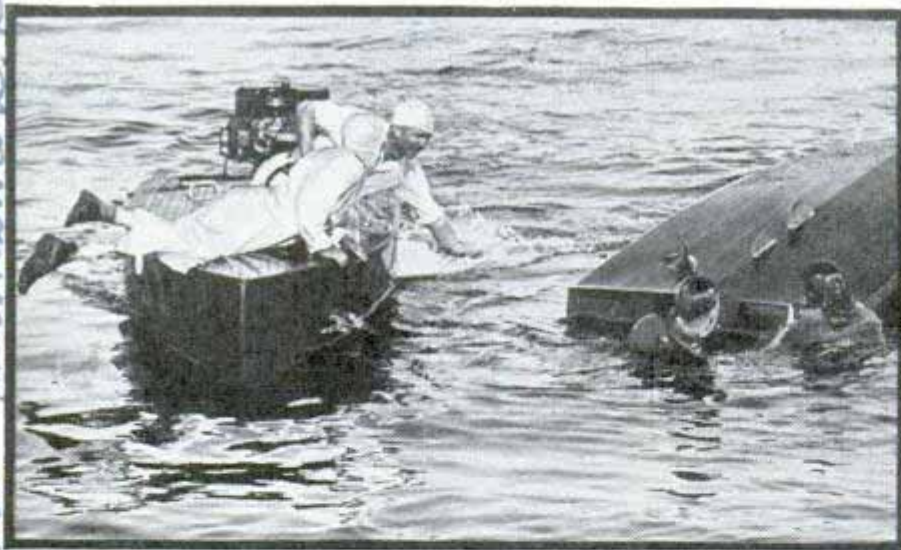

much more standardized than in the past, driving skill counts more than ever. Records are falling every season.

In one of the speedy little boats you get all the excitement of a championship automobile race with a few extra thrills thrown in, at a fraction

of the cost and hazard. Forty miles an hour on the water seems faster than three or four times that speed on land. With the new premium on driving skill there's always a chance that a beginner will develop the judgment and daring necessary to win race after race and capture a national championship.

An experienced driver completely overhauls a new engine before he puts it in the water. Pistons, connecting rods, and other

OUTBOARD boat racing is turning into an amateur sport and racers are competing for cups and glory instead of cash. On the Pacific coast no money prizes are being offered any more and in other parts of the country semi-professionalism is dying out.

The result is that more young men than ever are entering the exciting game of racing their high-powered “shingles” across the water. With engines and hulls

*Cont. Thomas & Simmons Jr.
10555 Dolman Ave. Los Angeles, Calif.*

W. W. Journey 3552 Laundry Ave
Long Beach Calif
H 3588
Florence Ave. Los Angeles



of the SPEEDBOATS



Top, driver and mechanic wearing helmets and life jackets. Note hand grip to which mechanic clings while balancing boat. Bottom, two hydroplanes riding high as they come out of a turn

moving parts must balance statically and dynamically. That makes the motor smoother and avoids breakdowns at high speed. Good drivers want their engines to run as cool as possible so they can set all the parts up tight. Small clearances reduce leakage past the piston rings. They use a "cold" alcohol fuel, cold-type spark plugs and increase the amount of cooling water that circulates through the engine

by opening up the water ports and using oversize water pipes. In races high above sea level fairly hot spark plugs are needed to fire the fuel.

The hand of a big clock provides the drama at the start of a race. When the five-minute gun sounds a black ball drops down a pole at the starting line. One more ball falls at the end of each minute. With one minute to go, the hand of a big clock



Top, various propellers used during season of racing. Circle, inspecting hydroplane bottom. Below, balancing pistons on scales

starts to rotate and the aim of each driver in the race is to hit the starting line "wide open and going away" exactly when the clock hand reaches zero and the starting gun goes off. If a driver reaches the line too soon he must circle back and start over. If he hits the line a second or two after the gun the chances are that others will cross ahead of him.

Drivers have to be skillful at making two different kinds of turns. Depending upon the dimensions of the water, the course may be laid out with easy five-buoy turns or sharp one-buoy "corners." To get around one of the sweeping turns you shift your weight toward the buoys and depend on your weight to bank the boat around. In rivers or channels where the

width of the course is restricted, one buoy marks a turn and to get around it fast you approach it at full speed, circle around, and double back. Good drivers hit these sharp turns with the same technique used on the race track.

"To get around such a turn at the fastest possible speed you approach the buoy with the motor wide open," says W. W. Downey, who has held several national championships. "Almost parallel to the mark you jam the throttle shut, yank it open again, and at the same time spin the steering wheel over. Tripping the throttle like that helps put the boat in a slide. You skid around the mark broadsiding through the water. If you should try to steer around instead of going into a slide you couldn't hold the high speed and you would capsize.



"Most spills occur when the boats are coming out of a corner and are straightening up. A speedboat is under control just as long as you have power enough to keep shoving ahead but in a power slide a little too much rudder may overcome the push of the motor and flip the boat on its side. Even if you have judged the turn perfectly there is still a chance of capsizing, for you may hit some one else's wake at the wrong moment. That trips the bottom of the boat and over you go.

"If the fin that serves as a keel under the hull is wrenched off in a turn, you are going to have a wild ride. Without the fin the boat acts just like a car on a wet pavement and you skid and slide all over the course until the speed drops. Spills are expensive, and it may cost fifty dollars or more to overhaul your engine if water gets into it."

A spill happens so fast the driver is hardly aware of just what went on. Drivers are required to wear life jackets and rarely get more than a wetting when a boat tips over, although Downey once received a couple of broken ribs and a fractured skull when his boat "looped" and he fell back into the engine. A boat is apt to fall over backwards if a strong gust of wind catches under the raised bow. Race drivers equip their boats with a "deadman" throttle so that if their hand leaves the fuel control the engine stops, but in one collision, Downey's throttle control jammed and after he was tossed out the boat kept speeding wildly around the lake until it filled up through its broken timbers and stopped.

In a national championship contest a few years ago, the leading boat rolled over on a turn, spilling its driver, and then righted itself. The driver swam back to the hull, started the engine, and went on to win the race. That was possible because the other boats were barely able to keep going in the rough salt water that kept fouling their motors.

Proper preparation is the second most important thing in winning a race. The high-speed engines, literally packages of mechanical dynamite that wind up to 6,500 revolutions per minute, have to be tuned and adjusted just before every race because changing atmospheric conditions affect the carburetion. A can of ether to shoot into the firing chambers and

(Continued to page 116A)

Northern Lights Reproduced on Planetarium's Indoor Sky

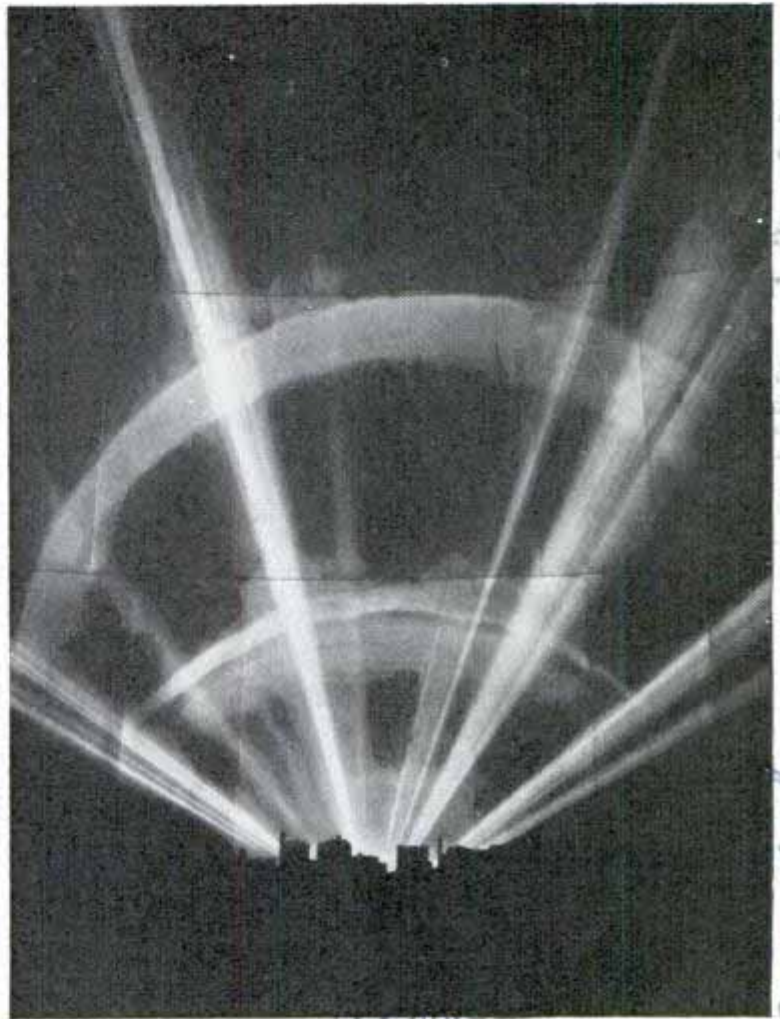

Photo by American Museum of Natural History

Realistic display of aurora borealis produced by colored lights projected in arcs and beams on ceiling of Hayden Planetarium

Northern lights "under wraps" shimmered and danced recently on the indoor sky of the Hayden Planetarium. The planetarium scientists reproduced the aurora borealis with dramatic realism, brilliant streamers and arcs dipping and fading, changing color from apple green to glowing red. The demonstration was arranged during the epidemic of sunspots and magnetic storms which have attracted world-wide attention.

Hydraulic Shock Absorber for Bicycle



Exact counterpart on a small scale of the shock absorber used on millions of automobiles, a hydraulic cushion is now available for bicycles. Mounted under the saddle, it smooths out the jolts of the road.

Electric Meter Tests Skin to Gauge Emotion



Emotions shown on faces in background are recorded by instrument sensitive to electric resistance of skin. Scientist is testing young woman

Call it an emotion meter, lie detector or what you will, an electric device contrived by Dr. D. Ulrich Greenwald at the University of Iowa draws a curve of your emotions as they run the gamut of joy, horror, fear, surprise, love. As you react to some stimulus that "gets under your skin," the electric needle reacts to emotional changes in resistance in your skin. Used by Dr. Christian A. Ruckmick in studies of emotion, this instrument is called a dermohmograph; derm for skin, ohm for electrical resistance, graph for its record on photographic paper. The scientists theorize that human emotion causes a piling up of positive and negative ions on the walls of skin cells, affecting resistance of the skin to passage of electricity. Essentially the emotion meter consists of dry cells, electrodes, fixed and variable resistances and a galvanometer. By reading the galvanometer while the subject watches a motion picture or reads a letter, his emotional reaction can be seen. For recording purposes, the deflection of the galvanometer guides a beam of light striking a moving roll of sensitized paper.

Dust and Water, Birds and Cats Are Blamed for Starting Freak Fires

"Fire of mysterious origin destroyed three business houses today at a loss of \$15,000." The mysterious origin turns out to be a cat that knocked a carton from a merchandise shelf to a lighted gas stove.

Cats and birds, water, even sleet cause many a freakish fire. An eagle swooped down to perch on a power line, shorted the wires, burst into flames and dropped to the ground. Its blazing feathers set fire to

Emb. Harvey W. Muinty, Greenfield, et al.

Emb. Darrell Neff, 103 S. Governor St., Iowa City, Iowa
 Emb. 552
 Emb. 93
 Emb. 93

Iowa City, Iowa

213 Convo Ave. St. Paul Minn
H 452
**Master Chairmaker Carves
Twenty-Four Copies at Once**

the grass and 100 acres of grazing land were burned over. Occasionally a bird looking for nesting material picks up a lighted cigarette, and soon a fire starts under the eaves. Water is the enemy of flames, yet water acting on lime or other chemicals, or water acting as a lens to focus sunlight—perhaps through a fish-bowl—sometimes is the cause of a fire. Sleet and snow increase the forest-fire hazard by snapping off branches, thickening the tangle of underbrush that speeds fire through the forest in summer. Dust explosions are a well-known fire hazard. Steam pipes close to wood may by daily heating reduce the wood to charcoal, and then it is easily ignited. A sheep huddled too close to a water heater in a barn one day, its wool caught fire, the barn burned down. Someone stroked a cat's fur as it was placed in the lethal gas chamber of a humane society, and a static spark exploded the gas—saved the cat, injured the attendant and started a fire.

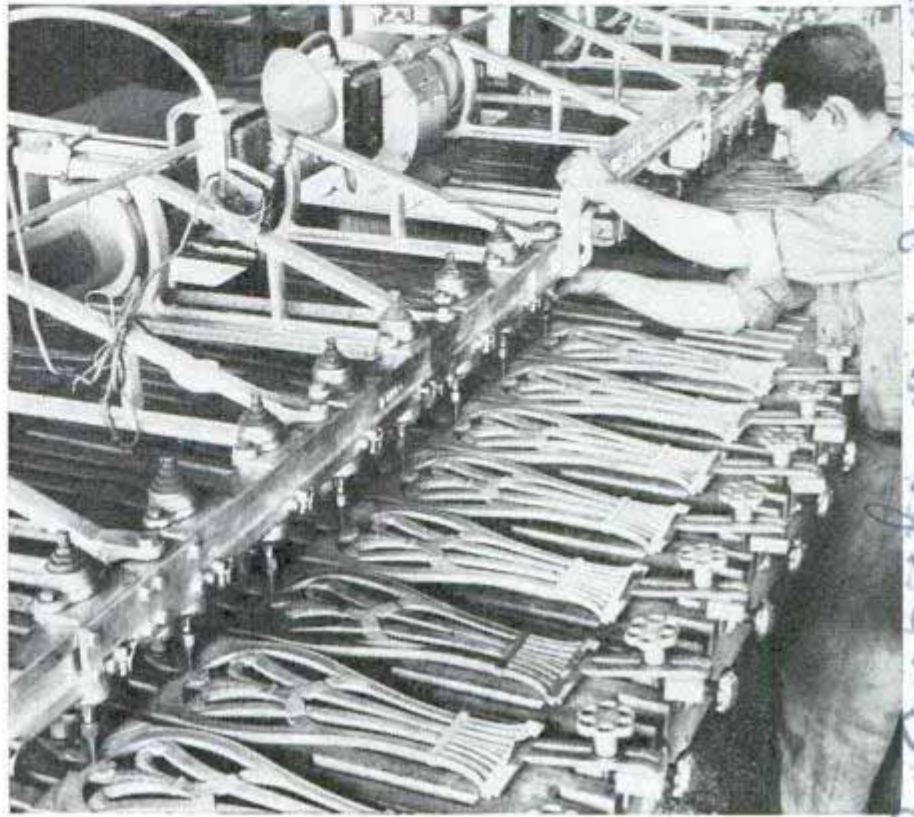

© Andrew Halbran
Following chair pattern with master spindle, operator automatically guides twenty-four other spindles which reproduce the carving in exact detail

One man operating a giant master carving machine can turn out, at once, twenty-four exact copies of any hand-carved piece of furniture. This multiple shaping tool is used to manufacture chair backs, legs or any piece formerly hand-carved. The operator simply clamps the original piece at the center of the machine and traces its design with a spindle, while twenty-four duplicate spindles automatically follow his hand motions and reproduce the carving. The machine is capable of very intricate and detailed work.

H 514
Canoes Are Carried by Airplane to Northern Waters



Two canoes are shown strapped on airplane, ready for journey to northern stream or lake

Such bulky objects as canoes and airplane floats are carried easily by airplane through methods devised by northern pilots. The canoes are carried either on the wings, if skis are being used, or on the floats if they are transported during the summer. The floats are carried in the same manner.

Names and addresses of manufacturers and dealers in articles described in this magazine will be furnished by our Bureau of Information upon request accompanied by stamped, self-addressed envelope.

Carl Edward Green

The TRUTH about TANK

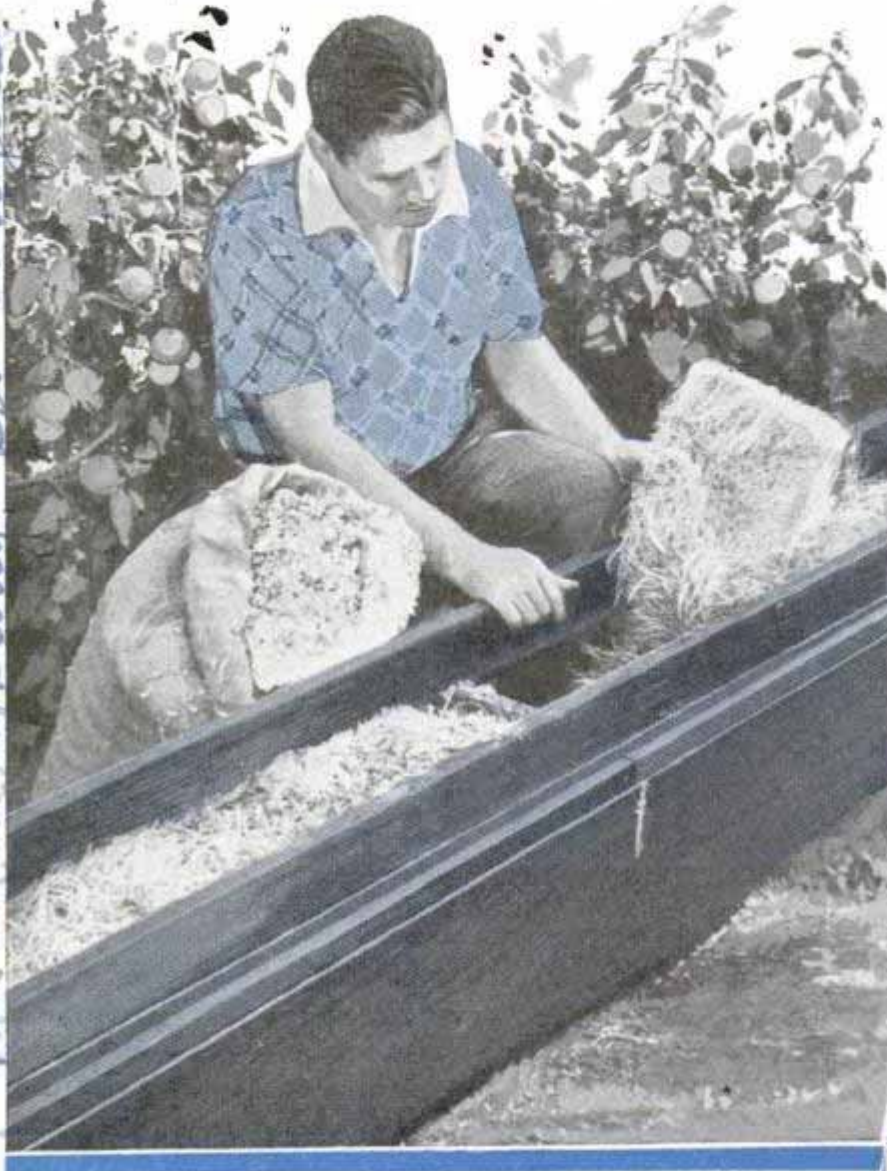

years ago, Dr. W. F. Gericke of the university conceived the idea that certain fruits and vegetables could be grown on a commercial scale by water-culture methods. In the greenhouse on the Berkeley campus, he produced giant tomato plants that had to be harvested from a stepladder, tobacco plants whose tops crowded the roof, and impressive yields of colorful flowers. One year an exceptionally good crop of potatoes was ob-

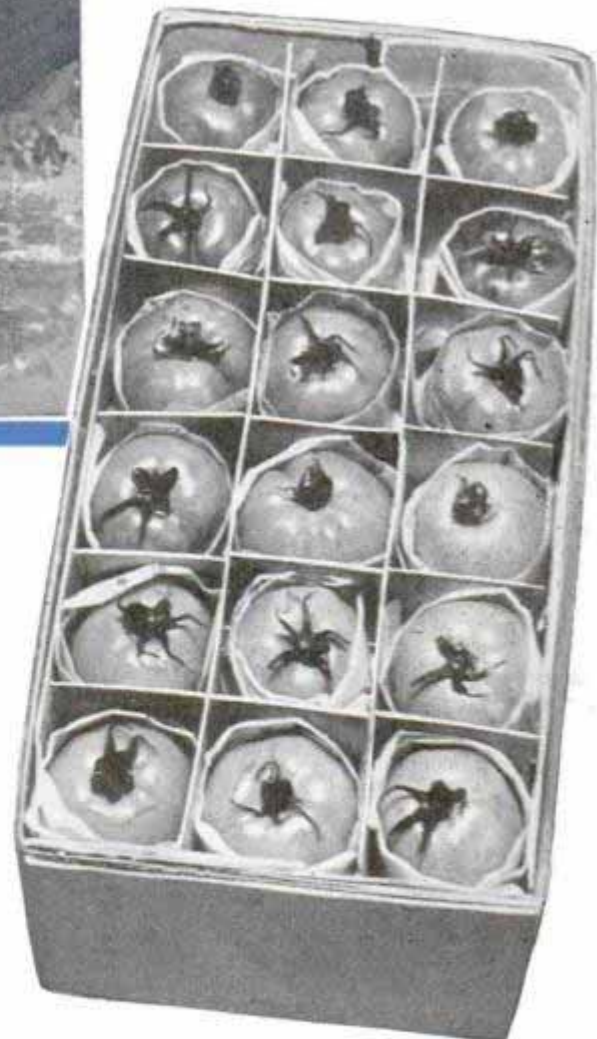

DURING the past few years, much publicity has been given to the growing of plants without soil. This agricultural science, since its inception, has been called by various names, including "tank farming," "tray agriculture," "chemical farming" and "hydroponics."

Most stories about water culture have left the impression that a startlingly new discovery has been made which will completely revolutionize agriculture. Water culture, however, is at least three-fourths of a century old. Since 1850 scientists have known that plants could grow and bear fruit in water containing nutrient salts, and hundreds of laboratory investigators have used water-culture methods to study nature's laws of plant growth.

At the University of California, plant physiologists have long employed water-culture methods in the laboratory in studying problems that beset the state's \$500,000,000 agricultural industry. Some

Choice tomatoes grown by water-culture method and, above, preparing a seed bed. Pine excelsior, pine sawdust or rice hulls can be used for this purpose

Cont. Andrew Hamilton of The Times
110 1st and Spruce with article

FARMING

tained in an outdoor experiment.

The novelty of Dr. Gericke's experiments fired the public imagination. The passing of the old-style dirt farmer was predicted; "skyscraper gardens" were foreseen for city dwellers; and it was even rumored that a chain of New York restaurants was growing its vegetables in the basement. These predictions and rumors had little basis in fact. A Sunday newspaper supplement pictured a pretty young housewife harvesting tomatoes in her kitchen. The vines were growing in a small tank in the pantry. For illumination there were a few feeble electric lights. A pretty picture—but not scientific!

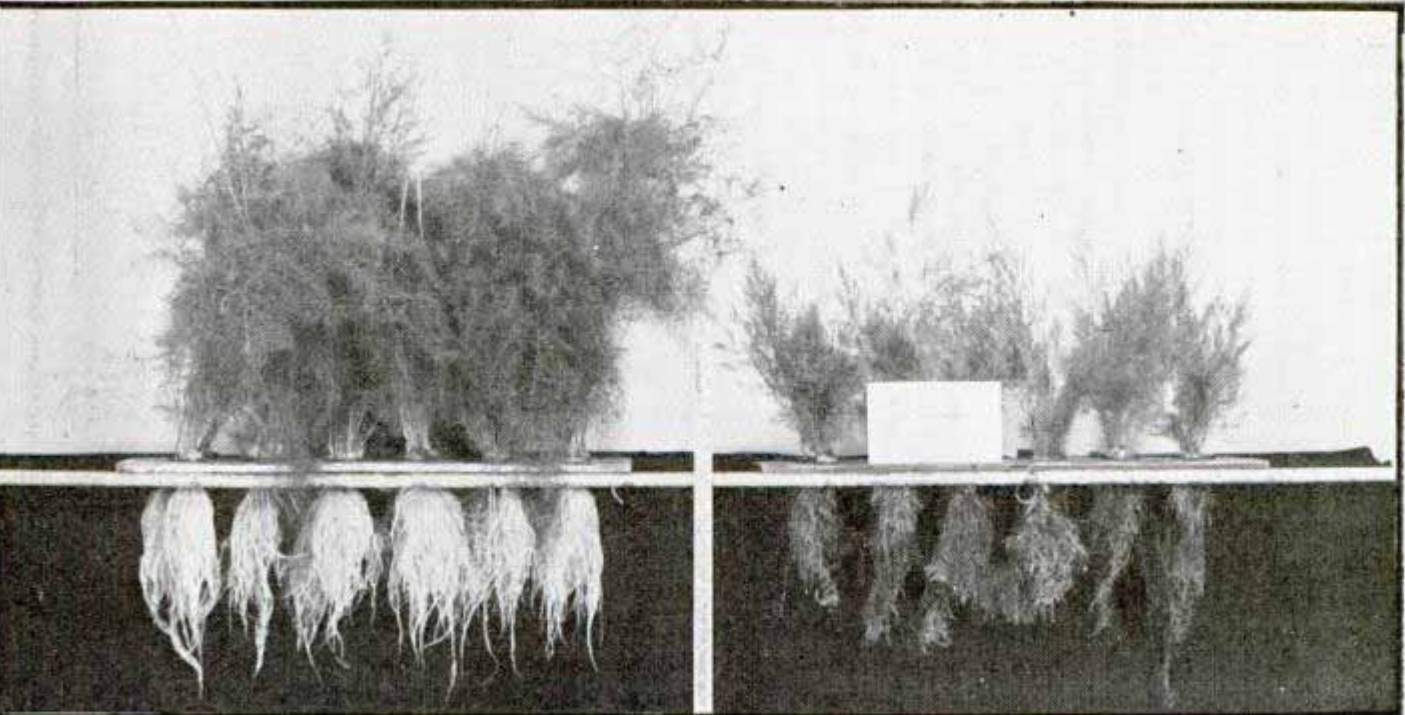
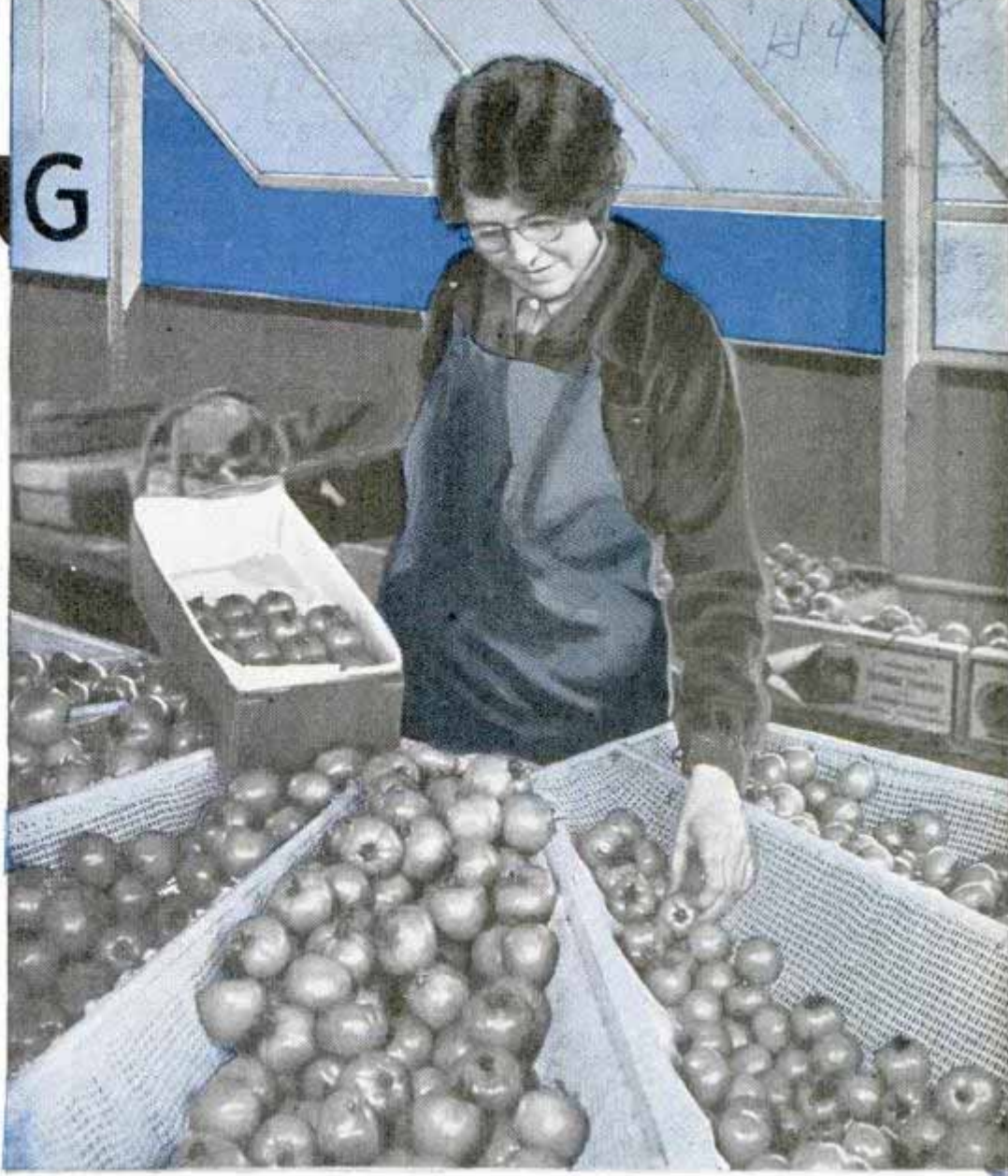

Water-culture tomatoes being sized and packed for the market. The crop is harvested continuously from January to August, when field-grown tomatoes are not on the market. Below, asparagus at left received correct nutrient balance while that at the right did not

Checked by E. M. G. J. Hoagland

Ernest W. Borland
Montebello, Cal.

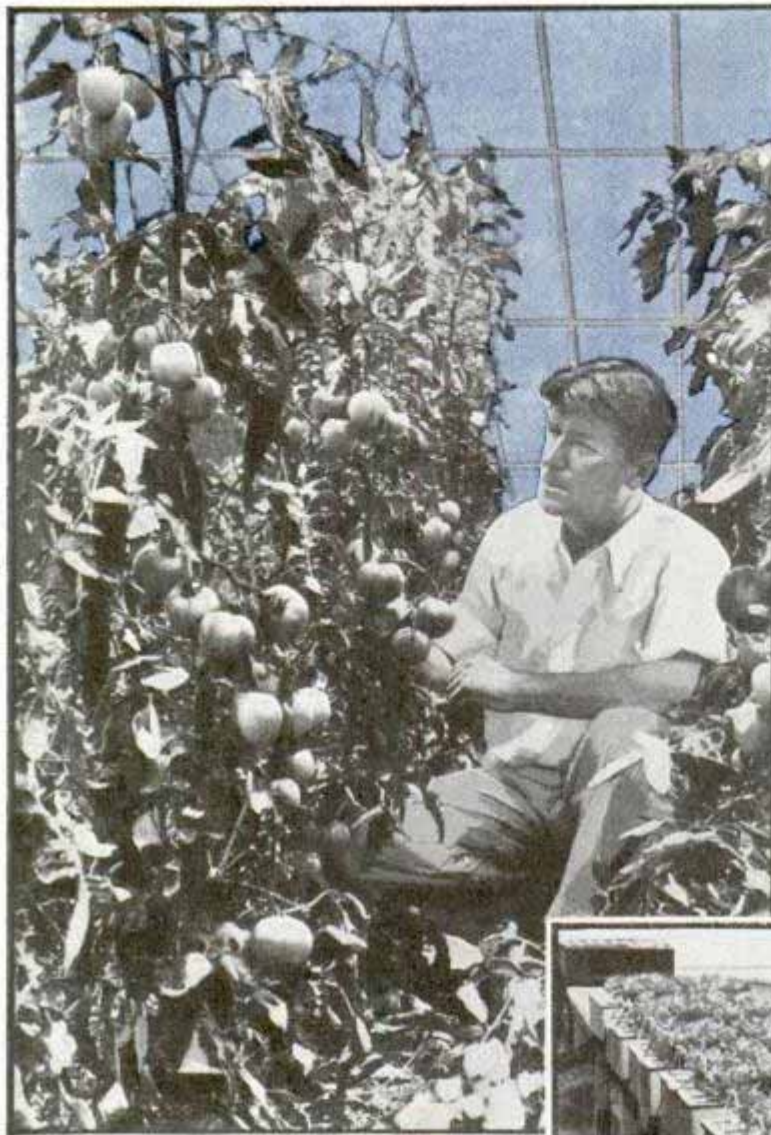

Part of the misconception of water culture has arisen from confusing two different lines of experiments at the University of California. One is Dr. Gericke's development of large-scale, commercial methods of growing tomatoes, tobacco, potatoes and flowers by water culture. The second is the study of laws of plant growth in specially controlled chambers under varying conditions of temperature, humidity and artificial illumination.

The growing of plants in chemical solutions has been hailed as a "marvel of science." The growth of plants is indeed marvelous—but no more so when grown by the water-culture method than when grown in soil. Commercial "tank farming" rests upon no newly discovered principle of plant nutrition. It is merely the conversion of a laboratory technique to a large-scale, commercial basis. The funda-

mental laws of plant growth and fruit production are the same whether the plants are grown in chemical solutions or in the soil. In either case, certain factors are essential, including favorable temperature, humidity and illumination, an adequate supply of water, and the necessary mineral salts and oxygen for the roots. Plants cannot grow in dimly lighted places such as basements, where they would not grow in soil.

At present, the tomato is the chief commercially grown water-culture crop but only a few water-culture tomato greenhouses are operating. Other crops under experimentation include lettuce, asparagus, tobacco, potatoes, cucumbers, string beans, peas and melons. The cost of equipment and operation will probably limit the use of water culture to high-



Lettuce plants, below, supported in corks which are placed in holes drilled in metal covers. Above, harvesting water-culture tomatoes

priced crops grown out of season in greenhouses.

The equipment for commercial "tank farming" consists of long, narrow, shallow tanks. They may be constructed of wood, cement or black iron. To prevent toxic substances from getting into the solutions, the tanks are coated with asphalt paint or some other cheap, non-toxic material. Wire screens are placed on top of the tanks. These screens support a layer of bedding material three to five inches thick, de-

pending upon the kind of plant grown. This material may be prepared from pine excelsior, pine sawdust or rice hulls. Some materials—especially redwood—contain toxic substances and should be avoided.

In the moist beds, seed is planted or young plants are set out. The roots develop not only in the solution of the tanks, but also in the bedding material. The shallow tanks and the porous nature of the beds permit good aeration of the root system.

Thousands of requests have reached the University of California for a nutrient solution formula. But nutrient solutions for water culture are no closely guarded secrets. You may find the formulas in any plant physiology text. Plants show a marked adaptation to different nutrient solutions—just as they are able to grow in many kinds of soil. Therefore a fairly wide range of concentrations and proportions of the salts can be employed. Circulars published by agricultural experiment stations contain various formulas.

Once the plants begin to grow, they require expert attention. As the nutrient salts are absorbed by the roots, the composition of the solution gradually changes. Plants use up some chemicals faster than others. Accurate tests should be made at intervals, and the proper adjustments made. In fertile soil, many of these adjustments take

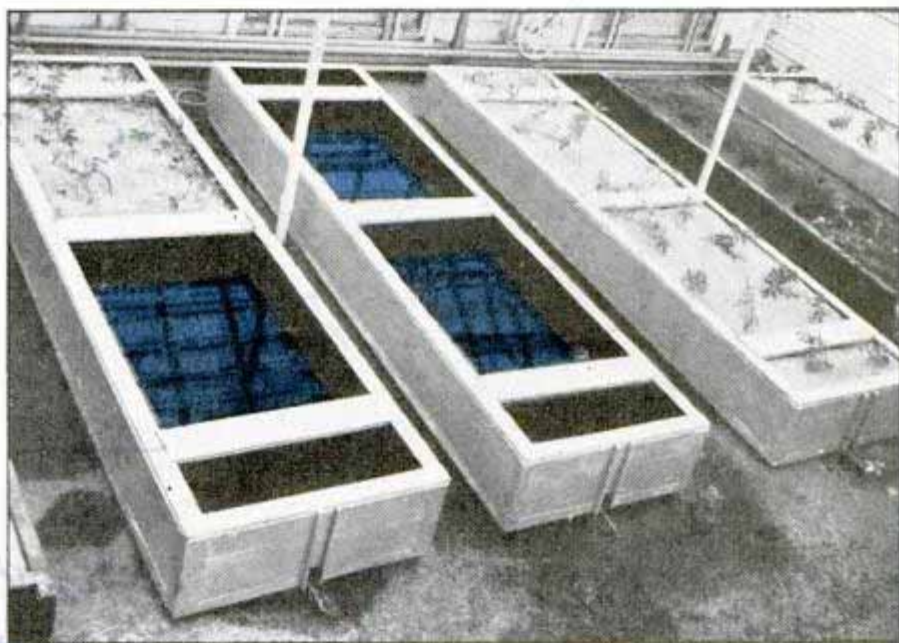

Top to bottom, planting seeds after beds are prepared, plants arranged in double rows, and tomato roots as they appear when pulled from solution

(Continued to page 118A)

Spray Gun Uses Stain Again as Drippings Drain in Pan



Excess stain drains from chair to perforated circular drip pan and flows back to tank for use again

Furniture makers are adopting a low-pressure spray gun which saves excess stain by collecting it in a perforated drip pan which sends it back into the tank for re-use. The quarter-horsepower motor and bronze pump builds up only ten pounds pressure so that the stain is applied in a coarse spray giving a fuller coverage, and eliminating the loss of a fine spray in the atmosphere. As little as five gallons of spray can be used in the tank, reducing the fire hazard of the large dip tank.

"Merry-Go-Round" Bullet Test Shows Up Unbalanced Ones



Bullets that are not exactly balanced won't spin smoothly. A cartridge manufacturer uses this principle in an electric tester that separates perfect from imperfect bullets. It is a dish placed above three magnets so arranged as to concentrate their field in a small area, exerting a pull on the bullet

High speed steel C High Budget, N.J.
 that makes it spin on its nose. Imperfect bullets tend to wobble, showing even the slightest error in balance.

Floor Magnets Collect Metal from Dust of Factory

To safeguard a New Jersey steel plant from explosions in its exhaust stacks, magnets have been installed on the floor at the exhaust intake to sort out any metal fragments. Dirt and sawdust are drawn into the ducts, but metal objects gather on the brass plate beneath which are four permanent magnets.

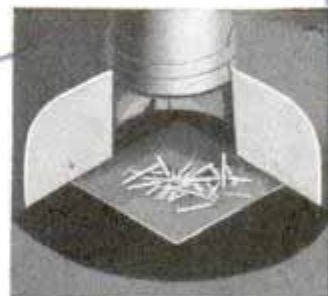

Ultra-Short Wave Radio "Horn" Sends Pencil-Like Beam

Somewhat resembling a primitive phonograph, an efficient ultra-high frequency radio transmitter developed by Dr. Wilmer L. Barrow at Massachusetts Institute of Technology is expected to prove valuable in micro-ray communication and in airplane and ship navigation. Its square-faced electromagnetic horn "antenna"



High-frequency waves started from square tube behind horn are shot forward in narrow beam

sends a narrow pencil-like beam of radio waves only a few inches long. The waves are started from a square, hollow tube behind the throat of the horn.

Swaby Mfg. Co. Road 233 W. 4th St. Chicago
Peter Cartmidge Rev. Remington Arms Co. Budgetpart

Normal safety tests

Glass Case Protects Baby from Poison Gas

Masked nurses clad in gasproof rubber garments are testing out the latest invention of war-fearing Europe. It is a portable glass case in which babies can be thrust at the alarm of a gas attack and carried to a zone of safety.



Here is a "full dress" rehearsal of a gas attack in Europe, with attendants dressed in gasproof rubber suits sealing baby in glass case for removal to safety

Profit for Farmer in Drugs Now Being Imported

American farmers may find profit in raising some plants which are the basis of crude drugs now imported to the extent of \$8,000,000 a year. Dr. Perrin H. Long, of Johns Hopkins University, points out that United States soil and climate are favorable for producing licorice, mahuang (ephedrine), castor beans and tragacanth, now imported from Russia, China, Brazil and Persia. Licorice grows as a weed in the southwest, and mahuang is cultivated in North Dakota. Dr. Long observes that hand cultivation here would make costs too high compared with cultivation abroad, but science and industry may develop machines which would make it possible to produce these crops profitably.

Windows in Builders' Fence Permit Public to Watch



Passersby are shown watching construction crew, safe behind the window built into fence around the building project

Recognizing the interest which the public takes in watching others work, a construction company built windows into the fence around the job on which its employes were working recently. The windows permit passersby to watch, in complete safety.

Two gears in the shaft drive of the "Mauretania," new Cunard-White Star liner, will be forty-six feet in diameter and have 500 teeth.

Queen Anne 4/26/38

H 506

Baltimore Md

dup

H 496

Auster Construction Co 777 E Washington

Hollywood

CC by I have may

National Broadcaster

Hollywood

Suction Cups Grip Tray on Serving Stand



Four upturned suction cups on wrought-iron stand give a tight anchorage to tea tray

Serving trays cannot slip off a wrought-iron stand just brought out. At the top of its four posts are suction cups which take a firm grip on any tray set down, preventing any upsets from jarring. Any size tray can be used on it.

Copper-Wheeled Soldering Iron for Sealing Packages

With a copper wheel in place of the conventional tip, a soldering iron has been developed for sealing packages and "tacking" thin sheets of material together by heating. Certain sheet packaging materials such as rubber are adhesive when heated. The wheel can be smooth-faced

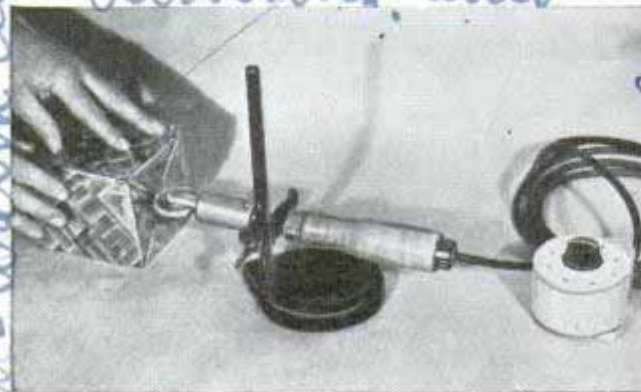

"Welding" a parcel with a wrapping material which is sealed by the copper wheel of the soldering iron

for attaching photographs to mounts with dry-mounting tissue, pressing corners and edges together; or it can be ridged so that the sealing action takes place along a series of narrow lines. The iron operates through a 150-step rheostat controlling temperature to close limits. A conventional tip can be installed for ordinary soldering.

"Front-Drive" Pipe Connector Installed Outside the Tank

Attaching pipes to containers without any shut-down for draining and flushing tanks is facilitated by a "front-drive" pipe connector which is installed from the outside. One operator can insert the connector, give the "action nut" a turn and have the line ready for connection in five minutes. It can be used on water, air, gas, steam or oil lines and will withstand high pressure.

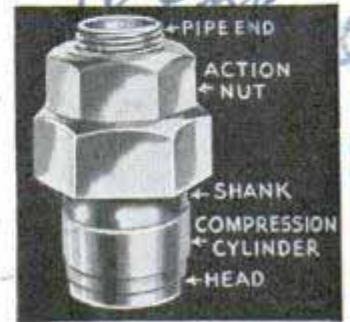

One operator can insert the connector, give the "action nut" a turn and have the line ready for connection in five minutes. It can be used on water, air, gas, steam or oil lines and will withstand high pressure.

Centrifugal Juice Extractor Does Its Job Quickly



This juice extractor works rapidly, producing a glass of juice in about one minute

Using centrifugal force, a new electrical fruit and vegetable juice extractor does its job almost instantly, leaving the pulp nearly bone-dry. A glass of apple juice is produced in about sixty seconds and a glass of carrot juice in a few seconds more.

Cadigan dr. 238, 5th av. New York

123 N. Jefferson Chicago

209, 9698

70 cups

497

Price \$49.50

Ravenna Ohio

158151
large amounts of Sybil's baby's brains of 158151
modern
milk washes, U.S.

Tubes Filled with Air Eliminate Tent Poles

Air-filled tubes replace poles as supports for the latest tent. The tubes may be inflated quickly for erecting the tent or deflated easily for packing. The four tubes are connected and are blown up from the same valve. The tent is large enough to accommodate four or five.

H 526

Steel Rail at Center of Road Prevents Head-On Crash

White center lines on the highway warn motorists to stay in their own lanes, but they don't prevent a crash if someone ventures across the line at the wrong time. Real protection is now offered by a center-line guard rail of convex steel strips supported by spring-steel posts, sturdy and resilient enough to absorb the shock of impact and deflect the car back to its proper lane. This traffic divider occupies no more space than is taken by the double white line.



Top, inflating the tent's air tubes. Bottom, the tent in use. Inset, tent folded and being carried to a new location

Miniature Pressure Gauges Built to Scale for Models

Miniature pressure gauges, some no wider than your little finger, are available for model makers. Exact copies of the gauges used on real engines and machinery, they are manufactured to register any levels of pressure the model builder desires and use the Bourdon tube transmission system.



Kept from colliding head-on at center of the highway, two cars carom off from convex steel guard rail

E 50th and Magnolia
Los Angeles, Calif

Road Center Divider

W. U. Sargent. 2/28/39
My U. Sargent
Kansas City
John Delquist
Spring

United States Spring

Standard Machine Shop Boulder Colo

Sculptor Performs Dental Job for Model of Tyrannosaurus

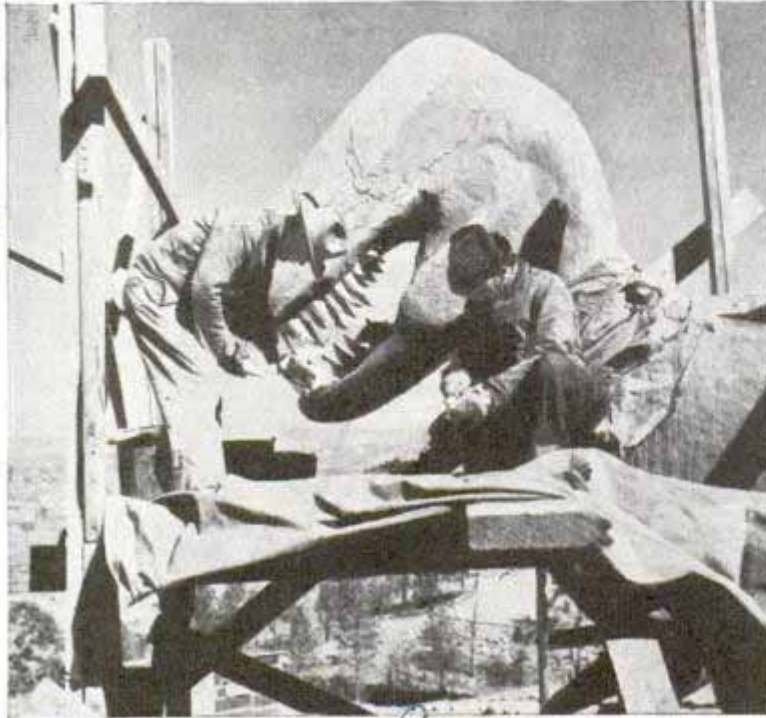

Sculptor Sullivan is seen here giving a set of teeth to the concrete image of Tyrannosaurus Rex in a Rapid City, S. D., park

Dentist to the monsters of "Dinosaur Park" at Rapid City, S. D., is part of the assignment E. A. Sullivan drew as sculptor of the images of prehistoric beasts in this strange outdoor exhibit. Here Mr. Sullivan is installing a set of teeth in the huge jaw of Tyrannosaurus Rex, one of the colony of steel-and-concrete reptiles and animals.

Home Kept Hot or Cool by Fluid Circulated in Radiators

Serving the dual purpose of heating the small home in winter and cooling it in summer, a radiation system just developed circulates a water-sodium-lactate solution in a "closed" circuit of small copper tubing. In winter the basement coils are heated by an oil burner, the solution permitting a temperature of 240 degrees Fahrenheit, and even higher since the heating system is under sixty pounds pressure. In summer the solution by-passes the heating coils and is cooled by a refrigerator unit to about twenty-eight degrees at the refrigerator. A pump keeps it in circulation. The radiators are cabinets eighteen by thirty by eight inches, consisting of copper coil providing 100 square

feet of radiating surface; near the base is an electric "squirrel-cage" fan drawing air into the front of the cabinet to escape through a latticework top. A drip pan underneath gathers moisture precipitated from the air in summer. Installation costs not much more than a heating system alone.

Metal-Cutting Tool Built by Shop Owner

At a cost of only about \$200, a Colorado machine-shop owner built himself a metal-cutting machine light enough to be moved to any part of his shop, and saved himself about \$3,000 under factory prices. The cutter will slice through eighteen inches of metal. In operation, half of the cutter is suspended over the metal to be cut; the other half is above a small iron plate where the designs are placed. The two parts are so coordinated that when the "tracer" part is moved over the pattern, the intense heat of the flame cuts the design in the metal.

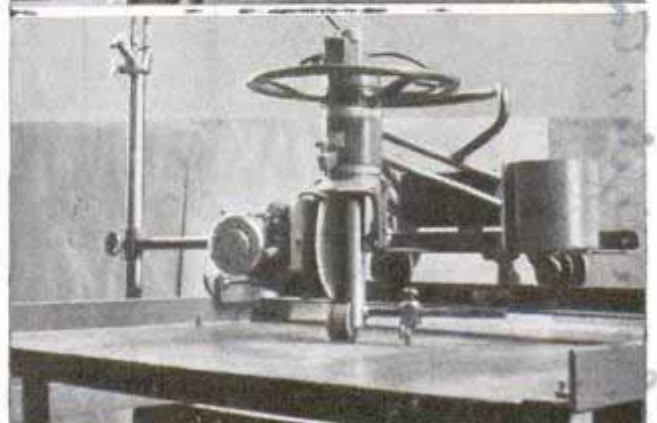
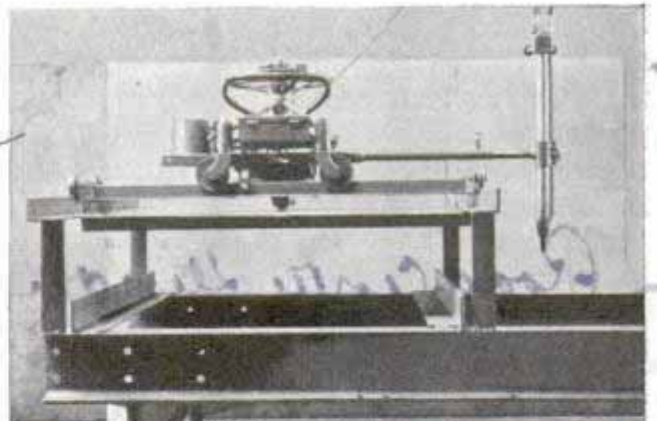

Light enough to be moved about from one job to another, this machine cuts through eighteen-inch metal

Handwritten notes in blue ink on the left margin, including 'main 2320', 'Moore', 'St. Phela', and '5/18'.

Handwritten notes in blue ink on the right margin, including '2320' and other illegible scribbles.

Aircraft Carrier "Enterprise" Joins the Navy



Official U. S. Navy photograph

clerk.
Port broadside view of the United States navy's newest aircraft carrier, the \$21,000,000 "Enterprise," as the big vessel was placed in commission at Norfolk navy yard recently before her "shakedown cruise"

Latest recruit to the rapidly growing United States navy is the aircraft carrier "Enterprise," a formidable addition to the air arm of the sea forces. This gigantic floating airport cost the government \$21,-

000,000. Formally placed in commission at the Norfolk navy yard, the ship was ordered to proceed to southern waters for a shakedown cruise before threading the Panama Canal to join the Pacific fleet.

Alarm Wakes Drowsy Driver When Hand Relaxes Grip



Small ring is held away from steering wheel by springs, and sounds horn if driver's grip relaxes

Like the "dead-man control" that halts the passenger train when the disabled engineer relaxes his grip, a safety device for the motorist sounds the horn as an alarm and shuts off the ignition if he dozes at the wheel. A metal-reinforced rubber ring is attached just below the steering wheel. After the alarm key is turned to "on," a slight pressure on the ring is required to keep the alarm from sounding. If the driver nods or is inattentive, springs push the ring away from the steering wheel and the alarm operates. On parking the car, the key is turned to "theft" and any attempt to move the car will sound the horn.

Molten Bronze Is Joined to Steel with Bond That Cannot Be Severed

Development of a method of uniting bronze and other copper alloys with steel is announced by an Ohio manufacturer. Although the joint is not welded, it is so firm that the two metals cannot be split apart. The bronze is molten when applied to the steel. This process is being used for making bronze-faced rolls, machinery slides and other products requiring the strength of steel and the wearing and corrosion-resistant qualities of copper.

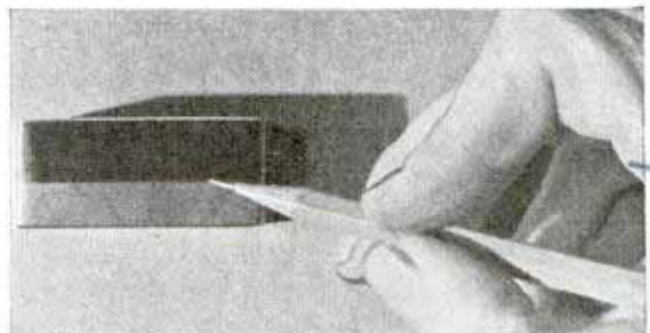

Small block shows a permanent bond of steel and bronze, the bronze being molten at time of application

Handwritten notes on the right margin:
Enterprise
clerk.
K 568
U.S. Agent wanted
Cryder and Maddox
8400
Carter
W. W. Wain

RAISING RABBITS



Top, mother and two young rabbits. Bottom, shipment of rabbits ready for market

hobby, but now many people are devoting all their time to the small animals. Small initial capital, the small amount of space required, and the rapid development of rabbits to market size are factors that have stimulated the industry.

To get into the business you should first investigate marketing arrangements in your area. In some places slaughter houses that specialize in rabbits call for the live animals when they are ready. In other localities you arrange with a butcher to handle the output of your hutches. Domestic rabbit flesh is a delicious, tender meat comparable to breast of chicken.

Successful raisers estimate that it costs about seven cents per pound to raise rabbits commercially, but this figure is apt to vary depending on the price of grain. Returns to the raiser usually run from fourteen to sixteen cents per pound live weight. Although rabbits thrive in cold weather the biggest profits are made in southerly states where the mild winters permit breeding four times a year. Profits depend a great

RAISING rabbits for the market is a back-yard industry that has grown to million dollar proportions in the last few years. It is estimated that rabbit owners are receiving five million dollars annually from meat and fur, with the demand still going up.

In the past raising rabbits was simply a

1389
Cm. Thomas & Simpson, Inc. 10855 Hollywood Ave. Los Angeles, Calif.

see April 1940 - 508

H384

for PROFIT



Top, hanging up pelts stretched for drying. Bottom, good commercial New Zealand, with short ears and legs. Small heads also are preferred

deal upon starting out with a good breed.

"Most commercial rabbit men specialize in the white New Zealand rabbit," says D. Monroe Green, president of the National Rabbit Institute. "This type has a desirable white fur and has been developed by scientific breeding into a fine commercial animal. It commands a higher market price than do varieties that have a lower percentage of usable flesh. A good white New Zealand should have a low set body, deep shoulders, and short legs, neck, and ears.

"One mistake beginners are apt to make is to start out with poor stock. Good breeding stock costs five dollars per animal and up. A few superior animals can be the nucleus of a large and growing group of rabbits. Young does that show promise can be held from the market and added to the breeders. A good doe should be expected to earn at least six dollars net in

33 Isena

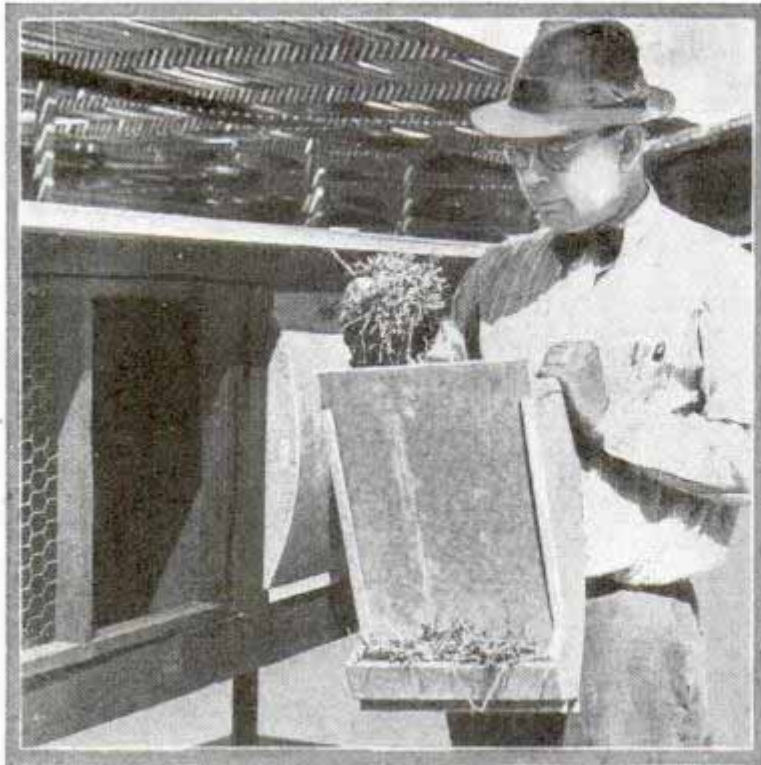

marketable young after all expenses every year."

A doe can be bred at the age of six months and may be bred four times a year thereafter. The young are born within a month's time and from six to eight are saved out of each litter. The young animals are ready for the market at the age of two months, when they should weigh approximately four pounds. Butchers like all the animals to come within half a pound of that weight.

Without help and with the right equipment, one man can care for about 500 breeding does, although most people who are raising rabbits keep a smaller number and take care of them as a part-time occupation. One woman who started in three years ago with five does and one buck now maintains 100 working does in backyard hutches. A few hours work per day brings her a steady income of from forty to fifty dollars per month.

"In the first place," Green explains, "one should prepare a proper place in which to keep

the rabbits. The small animals need plenty of light and fresh air. They should be protected from heat and moisture. In the south the hutches may be kept under a simple roof but in the east and north the lower half of the walls of the rabbit house should be boarded in, leaving the upper part of the walls open except for canvas curtains that can be dropped during rain and storms. The animals need a protective roof even during the summer because their fur coats shouldn't be exposed to hot sun. In hot weather a sprinkling system on top of the roof will help lower the temperature under it. A dirt or concrete floor under the hutches is best.

"The individual hutches should have ten square feet of floor space. Standard dimensions are four feet

long, two and a half feet wide, and two feet high. The top, back, and ends should be built of boards if you live in a section having a cold winter climate, while if the climate is mild the top and back may consist of one-inch wire netting, allowing better circulation of air. The floor of the hutch should consist of five-eighths-inch mesh metal hardware cloth or netting, so that droppings can fall to the floor and be swept away. Consistent and complete sanitation is of the first importance. The hutches should be suspended about four feet above the ground by supports extending down

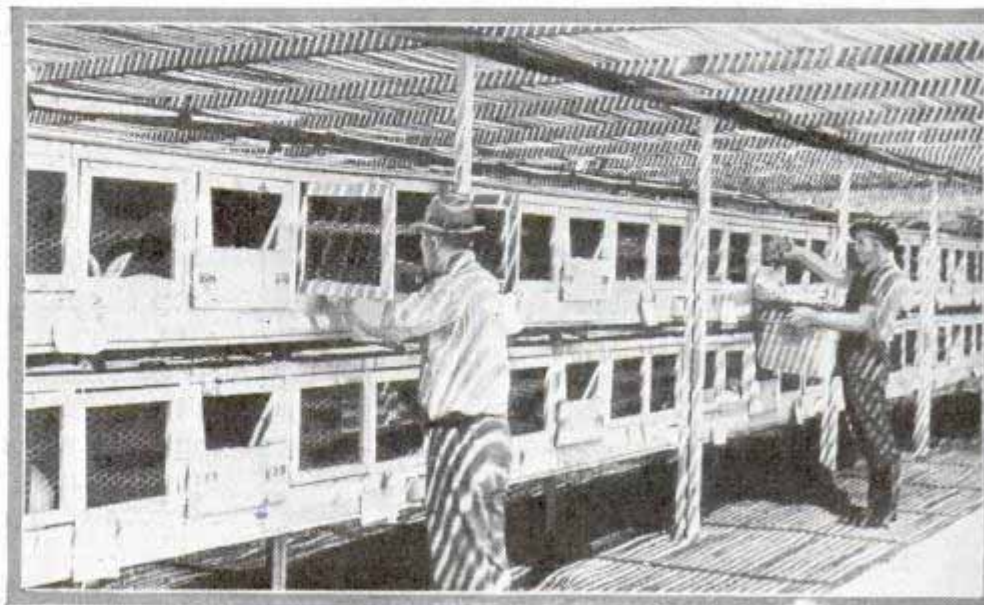

Top, filling galvanized iron feeding rack with chopped alfalfa hay.
Bottom, part of large rabbitry near Los Angeles

July article re. rabbit care
1931 O. J. ...

A 384

from the roof as a protection from other animals. When eight or ten weeks old young animals have to be placed in individual hutches to prevent them from fighting.

"A two-compartment hutch saves time in feeding. The two full-size compartments are divided by a wire-mesh feeding rack into which hay and other greens may be placed, permitting both rabbits to reach the same

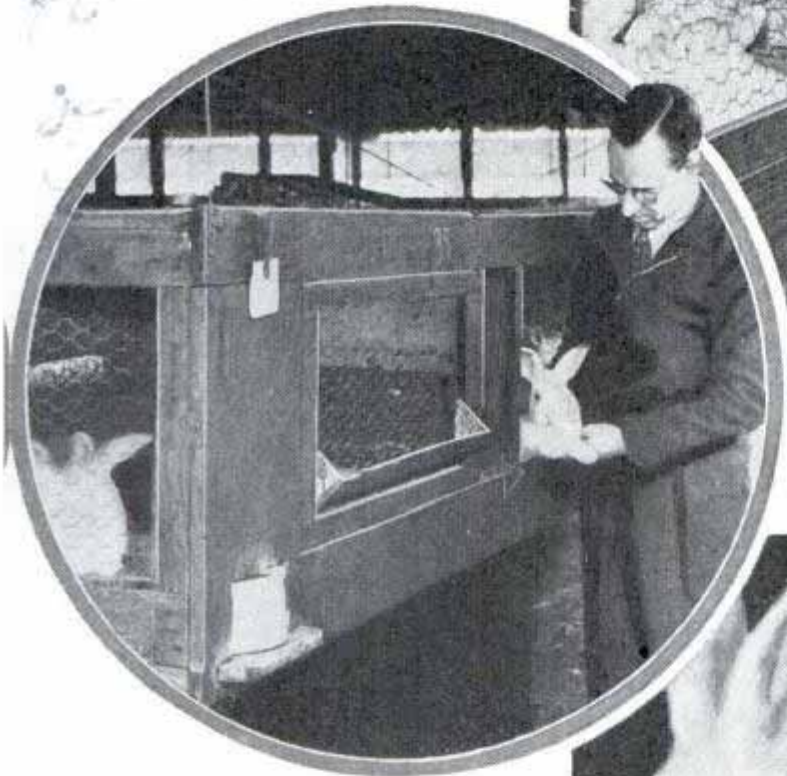

Top, food pellets for the rabbits. Circle, inspecting the animals. Bottom, two-month-old rabbit at the weight considered ideal for the market

food supply. A trough below the rack is provided as a place for hard foods. Nest boxes in which the does may raise their litters should be eighteen inches long, twelve inches wide, and thirteen inches high. A round door at one end should be seven inches in diameter, raised five inches from the bottom of the box. That will keep the young from climbing out until they can take care of themselves. The nest box should be roofed in cold weather and both the top and the bottom should be

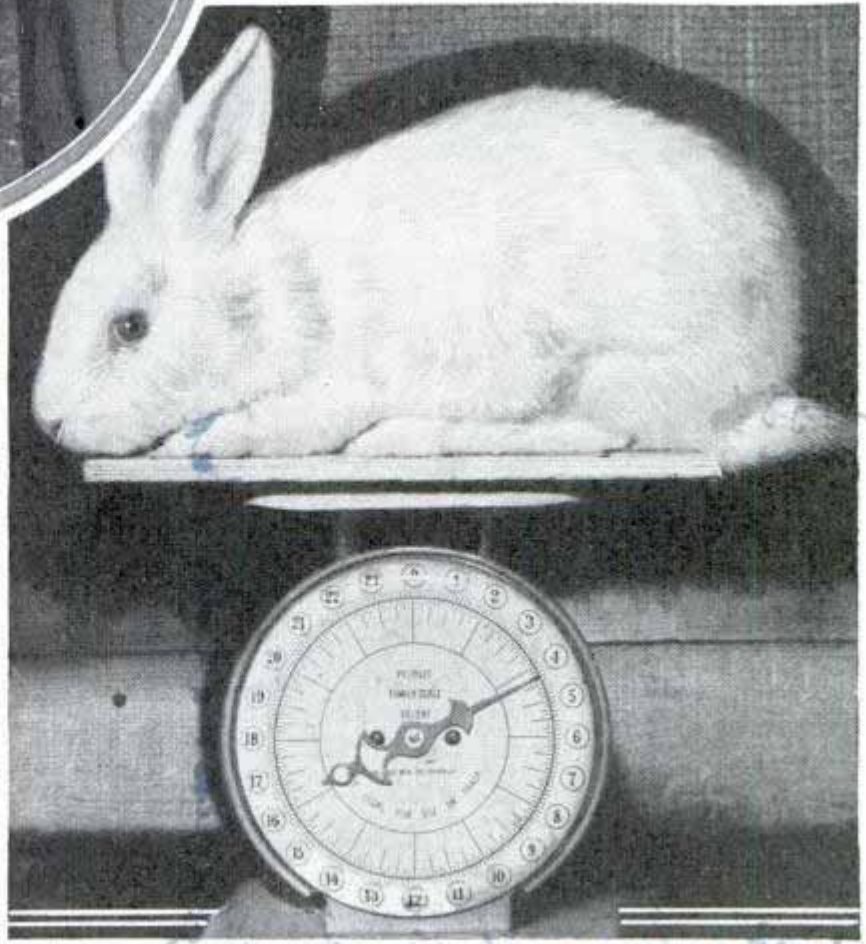

(Continued to page 125A)

Handwritten notes on the right margin, including 'Rabbit care' and other illegible text.

Handwritten notes at the bottom of the page, including 'Rabbit care' and other illegible text.

Contact "Mike" on Violin Helps Deaf Player

H 540

Contact



Wire from contact microphone on violin carries sound through amplifier to deaf person's earphones

Deaf persons gain new enjoyment and greater skill in playing musical instruments by the aid of a contact microphone which reproduces the vibrations of any instrument to which it is attached—violin, guitar, piano, and even the winds—trumpet and clarinet. The unit is connected to the instrument, and the sound is fed through a small amplifier to the earphones or bone conductor. The entire musical range is reproduced without distortion or annoying peaks.

Suction Pump for Clogged Drain Injects Chemicals by Hose

H 381



Strong solvents can be used to clear out clogged drain pipes without danger of hand burns or inhalation of fumes, by means of a suction pump just developed. It is first used mechanically

to pump the drain partly clear. Then the solution is placed in the container and introduced through a hose, sealed airtight to prevent escape of fumes or solution.

H 365

Necktie Chosen from Wall Rack without Disturbing Others

Pravaliah

Two rows of slanting hooks hold neckties on a wall rack so arranged that the desired tie can be chosen by looking at the material spanning the center of the rack. Then the tie is pulled from the rack without disturbing any others.

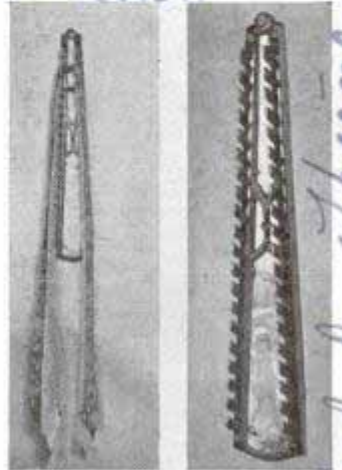

H 557

Ten Million Volts of Lightning Cost Twenty Cents on Meter

Lightning does strike twice in the same place—in fact, it strikes five to ten times in a fraction of a second, one stroke on top of another. If you were charged for a sin-

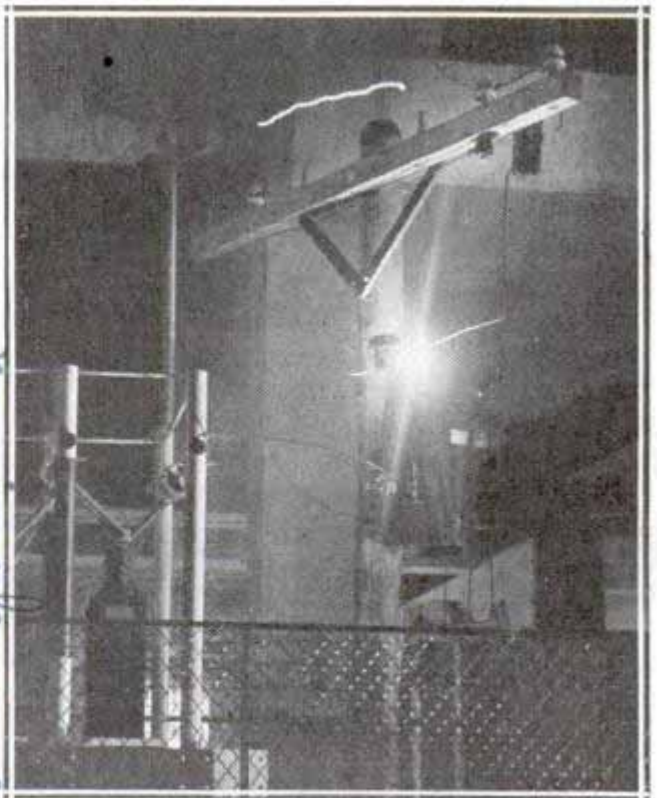

Half-million-volt lightning stroke is seen at top; flash occurs on pole as arrester grounds bolt

Ampente Co, 561 Broadway
New York

Carl G. Thompson
1445

Langerkamp Wheeler

gle stroke on your house electric bill, the meter would show you had bought about twenty cents' worth. And the energy from that stroke would be that of a thirty-pound shell fired from a gun with a muzzle velocity of 2,200 feet per second! These are some of the interesting facts developed by scientists "playing" with lightning. The other day Westinghouse engineers shot a man-made bolt from a half-million-volt lightning generator into a wooden pole, and another bolt into a transmission line illuminating a toy house in a display. The pole exploded into splinters. The lights in the house went out. Then the engineers put a lightning arrester on the line and repeated the demonstration: the lights didn't even flicker, for the lightning flowed off to the ground through the arrester. To build up the 500,000-volt artificial lightning, a rectifier stepped up the ordinary 110-volt supply to 100,000 volts and changed it to direct current. Then the rectifier charged five condensers in parallel, shooting 100,000 volts into each set of aluminum foil plates, and thence the electricity emanated in series so that the entire 500,000-volt force formed a small length of actual lightning. With the aid of a special camera, the scientists have found that natural lightning strokes are only about four inches in diameter.

Healing Ray Focuses Power on Afflicted Portion of Body



Extension tube from short-wave therapy machine focuses healing rays on patient's neck without affecting other parts of body

Ability to train the healing power of short waves on the specific organ or part of the body affected by disease is claimed for a machine used by a noted Paris physician. Thus the treatment can be applied without affecting other organs. If his findings are accepted by the medical profession generally they may increase vastly the use of the healing rays.

'Winter Garden' Shelf Hung without Marring Woodwork



Shelf for potted plants, with its chromium rail, is attached to window sill without screws or nails

Without using screws or nails and without marring the woodwork, a portable "winter garden" shelf can be fastened quickly and simply to any window sill. The shelf is nine inches wide and either eighteen or twenty-eight inches long, made of three-ply birch enameled in various colors with a chromium guard rail. It does not interfere with operation of the window.

There were 69,700,000 radio sets in use around the world at the end of 1937, an increase of 6,250,000 in a year.

Cummings & Crawford, N.Y.
 36
 W. H. Scheff

28 Rue de Valenciennes
 Paris, XI^e
 France

Weme.
 M. Esclapart Lévêque

Motion Picture Herald

Movies Travel to Town in a Trailer Theater

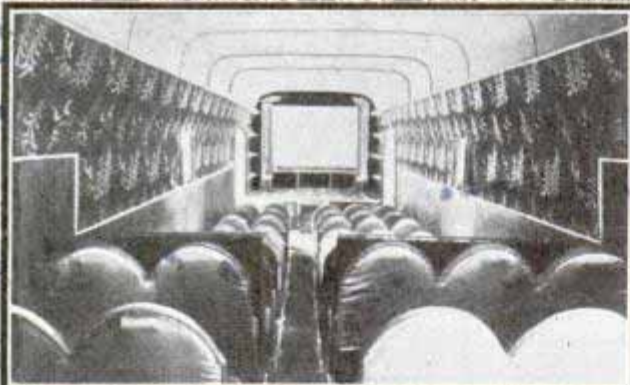
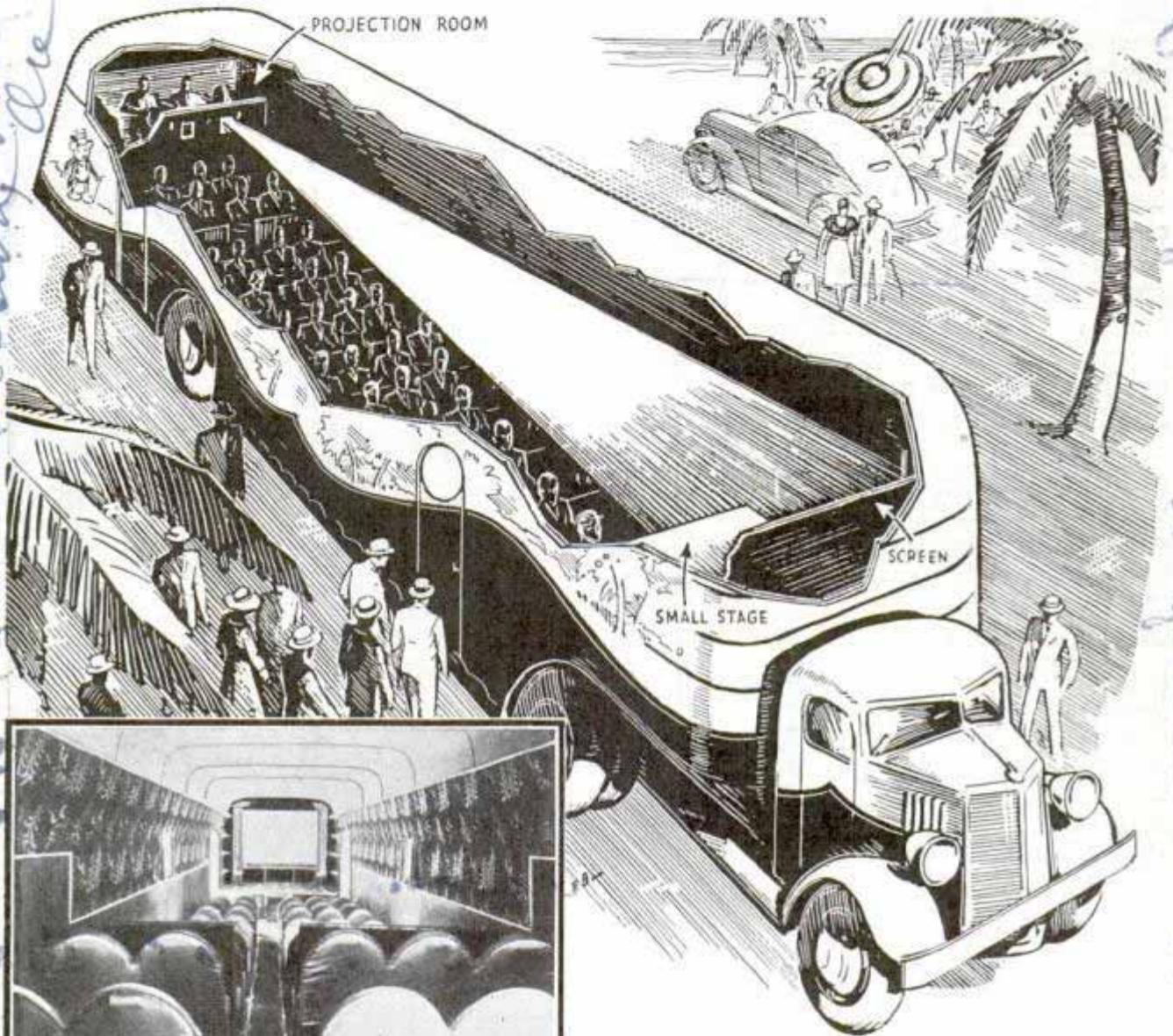

Above is a phantom drawing of the traveling movie theater. Left, interior view looking forward to screen and tiny stage, and outside appearance

date movies against a rolling screen. If power lines are not handy, the plant can furnish its own 110-volt current. Electric fans have been installed.

#561

Television in Natural Colors Offered by New System

Traveling from town to town throughout the northwest, a trailer theater is bringing talking movies to communities lacking theaters of their own. This mobile movie house is fifty-five feet long and comfortably seats sixty persons in bus-style chairs, which are permanently fixed. A small stage over the front wheels permits vaudeville or lectures, and two projectors in a fireproof booth show up-to-

Natural color television images may be produced by a system on which a patent has been issued. The method relies on superposition of primary colored images to achieve the desired effect. Color filters and suitable lenses break up the scene to be televised to produce one image for each of the basic colors. These images are then directed at a special scanning disk to be converted into electrical signals for radio

Science Service

cmd. Wm. C. Dwyer, 134
597 N. Grand Ave., Portland, Ore.

for information J. Spencer 955
1500 1st St. S.E. Tacoma, Wash.

transmission. At the receiving end, the signals are converted into light signals in a similar manner, except that the process takes place in reverse. Separate primary color images are then combined to produce the colored image. The method employs a mechanical scanning disk, no longer in general television use because of serious mechanical difficulties.

Metal Miter Box for Home Shop Set Quickly for Any Angle

Its index plate marked for cutting angles from zero to fifty degrees, a metal frame miter box is offered the home workshop owner. The box can be set quickly for any angle of cut. Its back is cut away so that the work can be held easily while sawing, and the adjustable bench stops hold the box in position on the workbench when the box is being used.



Grinder Mounted on Fender Is Powered by Car Engine

With his grinder mounted on a plank bolted to the fender of his automobile, a Nebraskan travels from town to town sharpening shears and knives. The various emery wheels take their power from a belt connected with the fan belt shaft.



Sharpening tools and knives with grinder run by belt connected to fan belt shaft of automobile

Dog Has Private Entrance in Lower Panel of Door

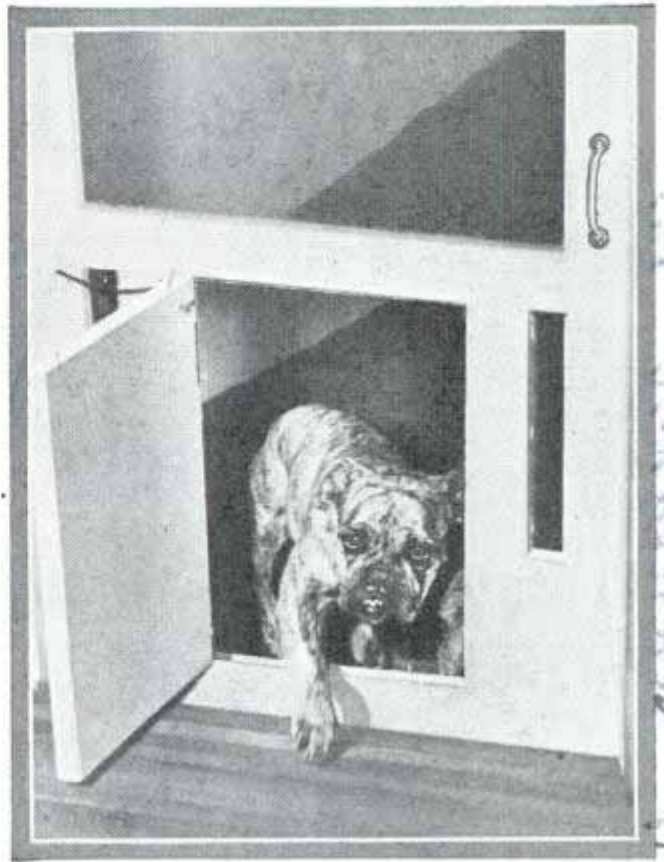

This dog doesn't have to bark or scratch the door to get in. He has his own double-hinged entrance

There is a strictly private entrance for the pup at Tod Oviatt's home in Burbank, Calif. In the lower panel of the screen door has been fitted a small door for the dog, kept shut by a coil spring and equipped with double-acting hinge. Noiseless, it lets the dog come and go without the bother of opening the main door.

Wooden Duck's Wings Move When the Wind Blows

When the wind blows, a wooden duck, mounted atop a pole in Tulsa, Okla., flaps its wings in realistic manner. The duck's body and head are carved from a single piece of wood and painted. Mounted on an eccentric axle which permits them to rise and fall and to move back and forth, the wings actually move in a flying motion closely approximating the flight of a real duck.



Handwritten notes on the left margin:
Stanley Tool Works
Boston
U.S.A.
Cnd. George W. Amerswald
Habeleok Neb.
Jack Merritt
Lincoln Neb.
see data file

Handwritten notes on the right margin:
H 529
H 567
H 533
H 539
make unknown
Cnd. Ernest W. Fair

THRILL HUNTERS



Scene in a National Broadcasting company studio, with the audience listening while an orchestra puts a program on the air. Thousands upon thousands of people attend radio performances daily

PART II

WHEN radio was in its early days, the idea of a comic strip of the air, a ten-minute skit based on the lives of two characters and broadcast every night at the same time, was developed through a Chicago station.

It was desired to pattern the series after the newspaper feature, "The Gumps." Two professional singers were commissioned to work up the idea. One of the team confessed he knew nothing of the ups-and-downs of married life and suggested a program built around two Negro characters. The station manager agreed and in January, 1926, Freeman F. Gosden and Charles J. Correll made their bows as radio actors. That was the beginning of the radio serials.

Today, the air lanes are filled with continued stories. There are daily capsules of

romance, mystery, comedy and adventure; serials about married couples, young lovers, detectives, rustics, newspaper reporters, stage and screen life, the foreign legion, aviation, the circus—virtually every romantic locale and exciting occupation has been exploited in radio continuities.

Despite the mushroom growth of the strips, Gosden and Correll, as Amos 'n' Andy, are still doing business. More than 3,200,000 radio sets are tuned to their program wave length each day they are on the air, a recent survey shows. As they broadcast five nights a week this means a weekly audience of 16,000,000 sets. No program series has ever before garnered so many listening ears. Their years of microphone service have been highlighted with the portrayal of more than 190 different char-

of the AIR LANES



Top, cast of "Carol Kennedy's Romance." Bottom, Correll and Gosden holding Amos 'n' Andy scripts

acters. Not until a year or so ago did anyone appear with them on their show.

Gosden and Correll started out as Sam 'n' Henry. For a week or two they devoted their afternoons to the job and then, for almost two years, the sketches were written one hour before the broadcast. Frequently they would repair to a room adjoining their studio at 9:30 o'clock and twenty minutes later would emerge with a 1,500-word script. Their late morning and early afternoon hours are now given over to preparation of their material. When the task is finished, two copies are made, one being sent to Washington to be copyrighted and one is placed in the files. In their office are bound volumes containing every word they have written.

Amos 'n' Andy broadcast alone, without audience. They permit no one in their studio or to watch them from the outside.

Where do radio scripts originate? The big successes have come out of the imagi-





Left, radio director amused at a script rehearsal. Right, cast of Myrt 'n' Marge makes last-minute change in scripts under direction of Stuart Hawkins, producer of the well-known serial

nations of persons who have had little or no formal training. The fifteen-minute programs have baffled famous dramatists and fictioneers and yet, aviators, college boys, housewives, and retired troupers have been successful in creating little worlds of mythical characters who have become real personalities to millions.

Chester Lauck and Norris Goff, pronounced Lum and Abner, were corporals in the ranks of business in Mena, Ark., before they started in radio. Lum was manager of a motorcar finance company and Abner secretary of a wholesale grocery company. On a special program given by a luncheon club over the radio, the pair gave a skit in which they mimicked some of the home folks with whom they were doing business. After that, they were spoiled for any other work.

Myrt 'n' Marge are classical examples of fictional people who have followed almost entirely the personal adventures of real ones. During the depths of the depression, Myrtle Vail was living in Chicago as a housewife while her daughter, Donna, was dancing in a night club. She tried her hand at writing a script based on her experiences in the theater. She sold the idea to a large company and then began weaving her experience as a stock, vaudeville, and musical comedy player into the radio series of a mother and daughter seeking success in the theatrical world.

Many famous characters of the air lanes have never lived at all. Carol Kennedy is a composite creation, a fusion of many wealthy society girl types observed by Marie Blizzard during her many years of reporting. Big Sister was the outgrowth of a remark made by the late Arthur Brisbane to Lilian Lauferty. The columnist admired Mrs. Lauferty's mother, a Boston social worker, and remarked: "With a mother like yours, you ought to be able to Big Sister the world."

An ex-schoolteacher, Irna Phillips, writes three five-times-a-week scripts at once, a job requiring approximately nine hours of dictation daily and netting over two million words a year.

Once a character or group of characters are born, a plot is created around it or them. The general plan is to have the story reach a high pitch of excitement at the end of the week so the audience's interest will carry over to the week following. The serials must be planned several weeks ahead. However, as soon as the characters become set in their creators' minds the stories almost write themselves. Some character injected into a script for a few words sometimes provides material for two or three months' adventure. With a thousand complicated details of plot and character on their hands, the radio creators must be very particular about keeping an accurate record of what has happened.

If they do not, listeners lose faith and interest. Some keep full biographies of every one who has ever appeared in a script and have a complete map of where the action takes place.

Because the audience is alert to "boners," the program makers spend considerable time in research when they are dealing with specialized professions and types. A program depicting a doctor's life necessitated the radio creator spending several days a week at a hospital, taking notes on the routine and talking to nurses and doctors.

Several weeks before a radio serial takes the air lanes, it is cast. It's an important task because more than half a show's reality depends upon finding good characters. They are the ones who



bring the warmth of the human voice to the written line and the little tricks of speech that establish the personality.

Many auditions are held to find the right voice, the right face, the right personality. In the case of Arlene Blackburn, who was selected after many auditions for the role of Pretty Kitty Kelly, an Irish girl with amnesia, even hair counted. Her auburn tresses were one of the main reasons for her being selected for the role.

Over the air, the script must sound as natural and unhurried as life. To obtain this effect, the script must be rehearsed carefully and timed to a split second. This involves exceptionally good cutting and skillful direction. The producer and script man must work hand in hand. A director will ask the writer about a cut, making certain no necessary pivotal points or clues are omitted for



Top, Lum and Abner on the air. Center, Michael Raffetta, N.B.C. actor in "One Man's Family." Bottom, Director Charles Martin and a cast of radio actors caught in a tense scene

(Continued to page 116A)

Whirling Molds for Metal Make Strong Auto Parts

*A. H. McCarroll
metallurgical*

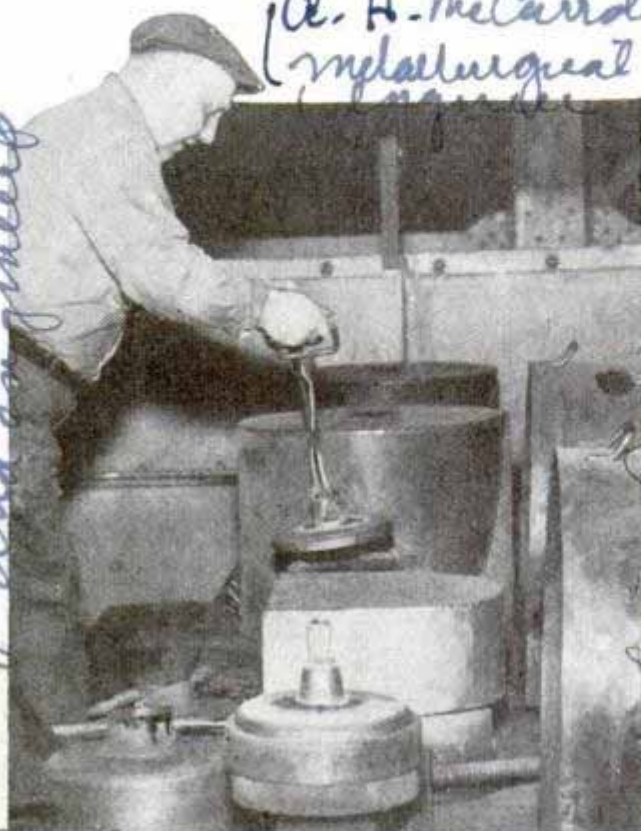

Turning out stronger steel parts for the automobile industry in centrifugal casting molds

Molds that spin at 600 to 800 revolutions per minute are being used to cast stronger steel parts for the automobile industry. The centrifugal casting turns out a lighter weight product and is economical, since the metal is brought directly from melting pot to mold while forging requires the metal to be heated three or four times. Extra strong gear blanks, free from blow holes and shrinks are produced in three minutes in the whirling mold.

"Fly Ash" Trouble Cured by Control of Fire

Constantly "feeling" the fire and balancing air delivery, a simplified mechanism is designed to control "fly ash" at its source in stokers. Measuring twelve by nine by six inches, it does not permit a sudden blast of air when the fan starts, but holds it in check until the fuel bed has reached a proper density. After the fuel bed has been established, the air is further retarded and slowly admitted to the fire so that combustion temperatures are stepped up

moderately. By this means, the loose ash is restrained until it forms into a solid clinker. The action eliminates formation of "coke" trees by creating better combustion. The device also acts as a counterbalance should the fuel bed become too thin during stoker operation, which might develop a tendency to blow out degenerated ash. The apparatus shuts down the air supply and slowly starts to rebalance it.

12527

Airplane Speed Indicator on Car Promotes Fuel Economy

See Aug. 1940 - 230

Motorists who govern their driving rate on long trips by the air speed instead of ground speed may better their fuel consumption by two miles per gallon. This can be done by using an airplane-type speed indicator, with the pitot tube on the radiator or any convenient position and the dial on the instrument board. When driving into a head wind, the air speed may register much higher than the ground speed. By driving constantly at an air-speed reading of fifty-five miles an hour, the tourist can take advantage of tail winds that may boost the actual mileage rate on the speedometer; and on encountering head winds he merely keeps to the fifty-five mile air speed and avoids part of the fuel waste in bucking a high wind at high speed.

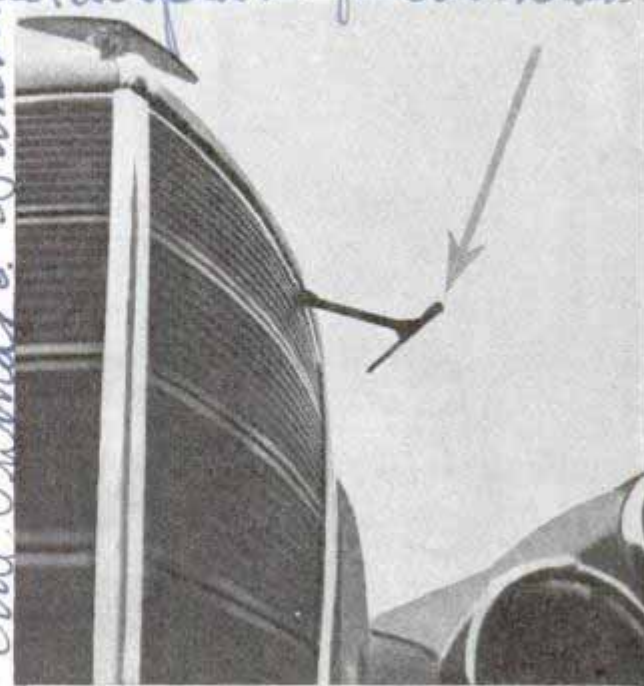

Arrow points to the airplane-type air speed indicator mounted on front of automobile

at the old plant in Dearborn developed by their metallurgists and engineers

105356 Holman Car

H 586

and Fred W. Smith

Toy Airplane Performs Stunts around Pylon



The entire family has fun with this captive stunt plane which spirals, stalls and climbs and loops around the weighted aluminum pylon. Notice the control box in "dad's" hands. Below, a closeup; the motor counterbalances the plane when in flight



By varying its speed through a rheostat button, a toy airplane can be made to loop-the-loop, spiral, stall or zoom around an aluminum pylon. The "radioplane" whirls in a full circle and maneuvers up and down approximately 100 degrees. Chromium-plated tubing which connects motor and plane through a universal joint houses a flexible drive wire, the motor being mounted as a counterbalance to the plane.

Armored Car Flies Colors of Motorized Cavalry Troop



There's plenty of power if less romance in the mechanical cavalry troops. When cavalry meant soldiers on horseback, the color guard was a dashing display of horsemen; today the national and First Cavalry regimental colors fly from staffs attached to an armored car, and their escort is a pair of motorcyclists riding behind submachine guns.

Names and addresses of manufacturers and dealers in articles described in this magazine will be furnished by our Bureau of Information upon request accompanied by stamped envelope.

Machine gunners on motorcycles escort car carrying regimental colors

Fiorello Knox Kentucky

Toy Airplane Property Property Property

International Pulverizer Corp. Condou. N. J. Trust

Wind-Tunnel Test Ends Peril of Fire as Plane Dumps Gas

into almost microscopic powder. Its industrial use will be in manufacturing finer face powder at low cost, mineral fillers for writing paper, fine insect and fungicide powder, paint and rubber pigments and powder for manufacturing plastics.

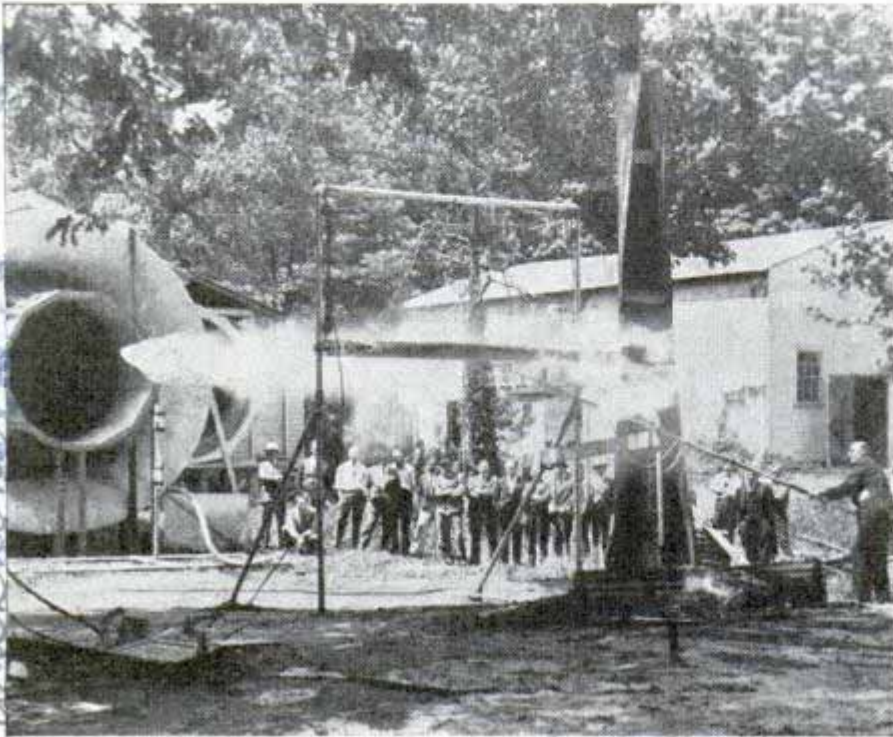

As dump valve releases gasoline in air blast from wind-tunnel blower, man at right touches it off with sparks from long pole

Dumping gasoline to lighten the load of a plane in flight has always been a hazardous operation, but safety engineers of the U. S. Bureau of Air Commerce believe they have found a way to eliminate the fire peril. They used the giant wind tunnel of the Bureau of Standards to simulate flight conditions. Releasing a gasoline dump valve over a blast of air from the wind-tunnel blower, they lit the volatile gas with sparks from a rod. But as soon as the rod was withdrawn the rush of air blew out the flames. The engineers theorized that if gasoline can be dumped directly into the slipstream of the propellers, without striking any of the plane's surfaces, the air will prevent or put out any fire.

Air-Jet Pulverizing Chamber Grinds Powder Superfine

Multiple jets of air of superheated steam shot into the walls of a pancake-shaped chamber supply the force of a pulverizing machine that grinds particles, economically, to a size corresponding to 2,500 theoretical mesh, or five microns—about two ten-thousandths of an inch. Particles one-eighth inch in diameter are placed in the unit and the jets, at pressures of 100 to 500 pounds per square inch, cause the material to whirl and grind itself by impact

Pedal Lifts Cutter of Lawn Mower to Avoid Rocks

Controlled by the operator's feet, a "floating" type cutter on a power lawn mower can be raised to avoid rocks and similar obstructions. The mower is in use on the campus of Kansas State College. Its cutters are the whirling suction-blade type, operating at speeds from 1,800 to 5,000 revolutions per minute. It has three forward and one reverse speeds, those forward ranging from one to five miles per hour. The six and one-half horsepower motor uses a half gallon of gasoline per hour, and cuts an acre every forty minutes. Old auto parts were used to build the mower. Its frame is welded.



Cutter at front of power mower is lifted by pedal controls to avoid rocks and obstacles in grass

Safety and Plaything
1145
not sold leased

International Pulverizer Corp. Condou. N. J. Trust
602
College
Kansas State
Manhattan

5/15/37
International Pulverizer Corp.

at me

RADIO



Portable BEAM-POWER AMPLIFIER

BEAM-POWER tubes now play an important part in the successful operation of modern high-gain amplifiers designed for use in homes, restaurants, hotels, schools and churches. With high-power sensitive tubes of this description, radio engineers can now design neat and compact amplifiers that no longer need be concealed under the platform, behind drapes and similar inaccessible places, inviting careless regulation of reproduction.

Although this portable amplifier is only 15 in. long, 8 $\frac{1}{4}$ in. deep and 10 $\frac{3}{4}$ in. high, it has an undistorted power out-

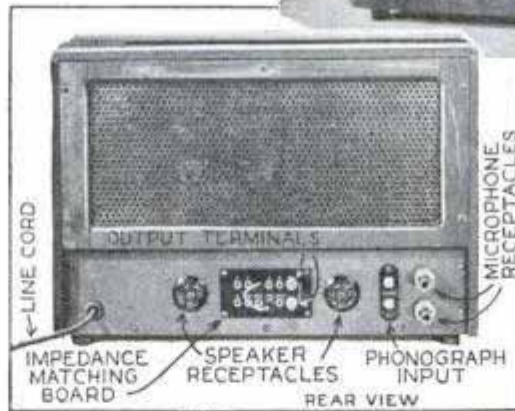

put of 25 watts, and weighs only 28 $\frac{3}{4}$ lbs. All controls are illuminated and protected by a covered compartment. Dual tone controls for treble and bass may be mixed or operated independently. The input

circuits provide two high-impedance channels for crystal, dynamic, velocity or static microphones, and one phonograph pickup channel for a crystal or magnetic pickup. All three circuits may be "mixed" or blended as desired. This blending provides for adjusting the gain of each input so that musical backgrounds can be controlled properly.

This self-contained unit employs 3 type-6J7, 1, 6C5, 1, 5Z3 and 2 type-6L6-G beam-power tubes in an inverse feedback circuit which is claimed to insure "distortionless" operation at full output and to reduce tube failures to a minimum because they are operated considerably below the maximum current and voltage ratings. The hum level is 74.5 db below maximum output.



Thordarson Electric Mfg. Co.

LOW-COST

Part I



THESE simple progressive receivers have been designed especially for the beginner. The first to be described is a crystal set that costs less than two dollars to build and can be assembled by any novice in an hour or so. Usually in progressing from one set to another there are quite a few parts wasted. This is

avoided by careful design so that the beginner can start with the crystal set, then, by adding a few parts build a 1-tube broadcast-band receiver; and finally, a very efficient short-wave set. Only one part is lost in the series, namely, the twelve-cent crystal detector.

Complete construction details for the crystal receiver are clearly shown in Figs. 1, 1-A and 1-B. The antenna coil is of the type used in midget a.c.-d.c. broadcast receivers and its primary (smallest) coil is variable by sliding it up and down over the secondary on the coil form.

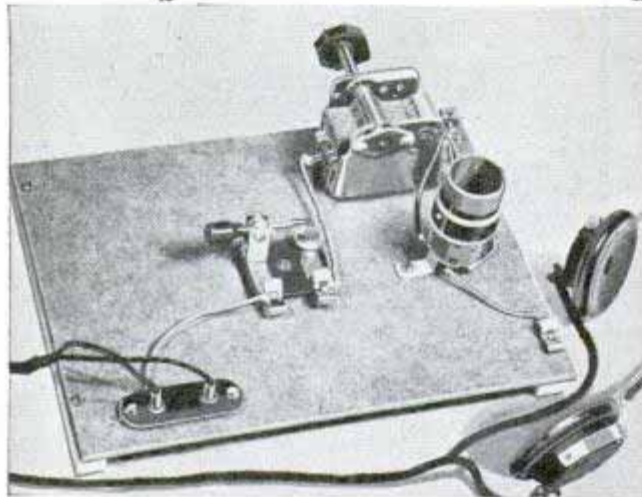

Above, photo of the completed crystal set which serves as a foundation unit for a 1-tube battery-operated broadcast receiver, and a good short-wave set

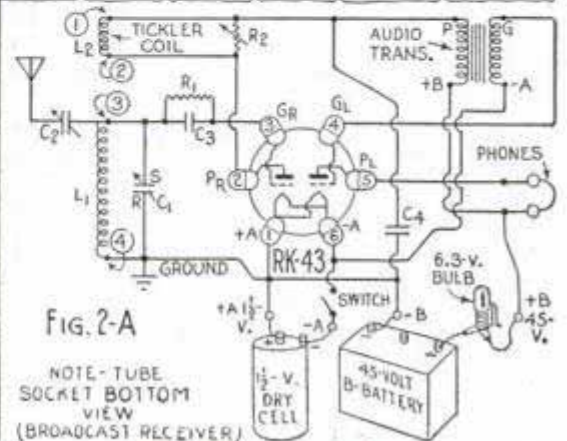
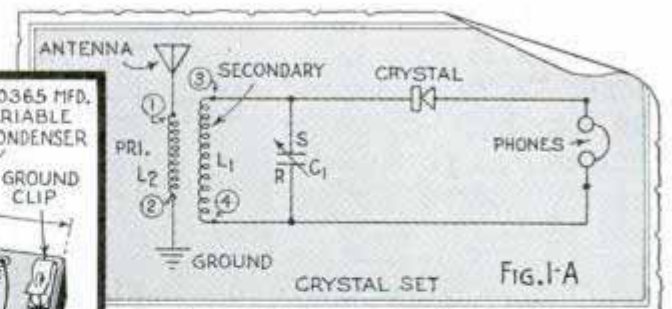
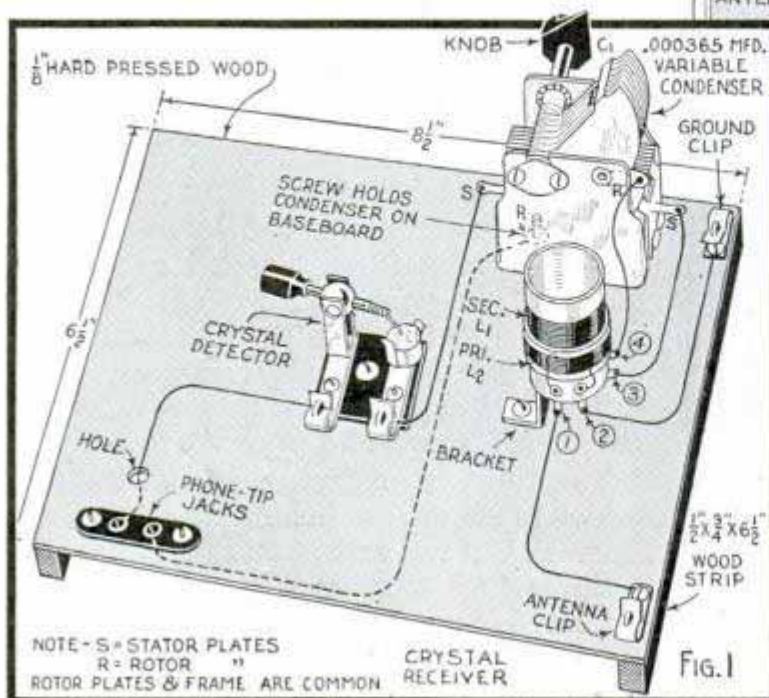

RECEIVERS *for Beginners*

THREE-IN-ONE Crystal, Broadcast and Short Wave

consistent with good signal strength. The wiring is done with No. 18 hookup wire with push-back insulation. Most of the wiring is above the baseboard except a short lead which connects the rotor (movable plates) of the variable condenser to the headphone jack terminal on the underside. The rotor plates of the condenser are common with the metal frame, therefore this connection is made at the short machine screw that holds the condenser frame to the baseboard. The stator (stationary section) has an insulated terminal lug on each side of the condens-

(Continued to page 135A)

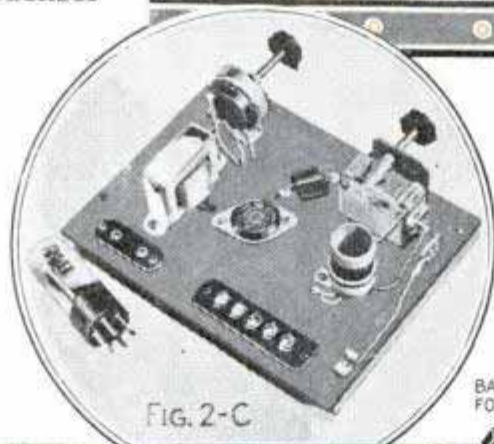
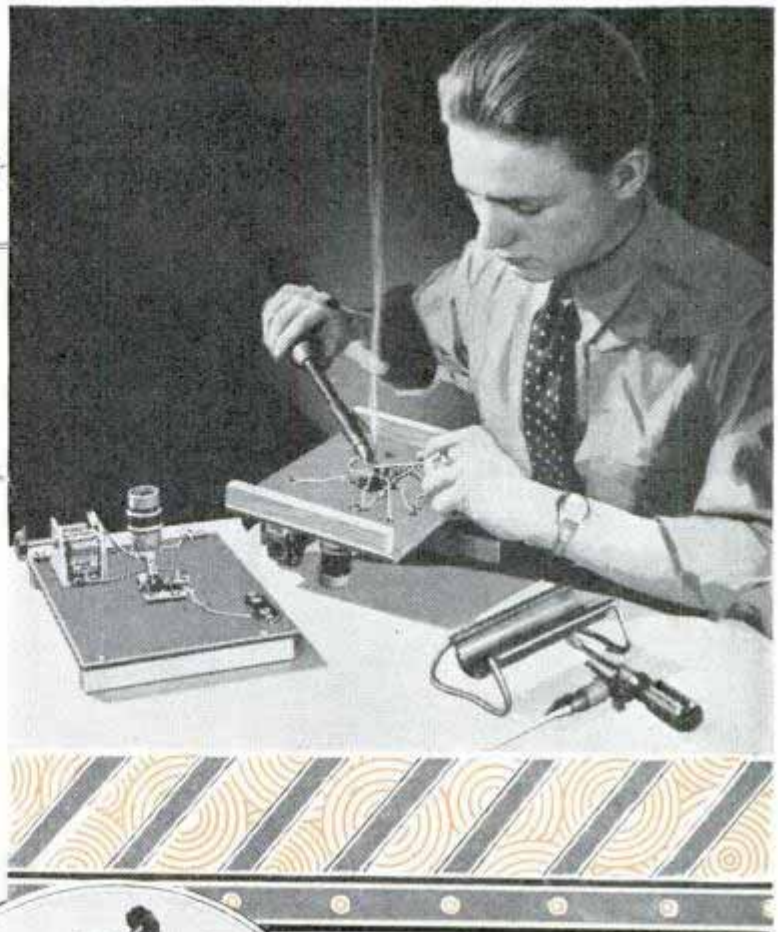
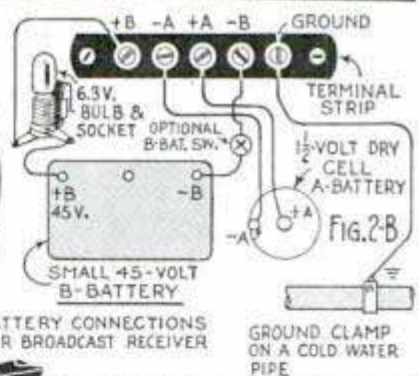

FIG. 2-C



BATTERY CONNECTIONS FOR BROADCAST RECEIVER

GROUND CLAMP ON A COLD WATER PIPE

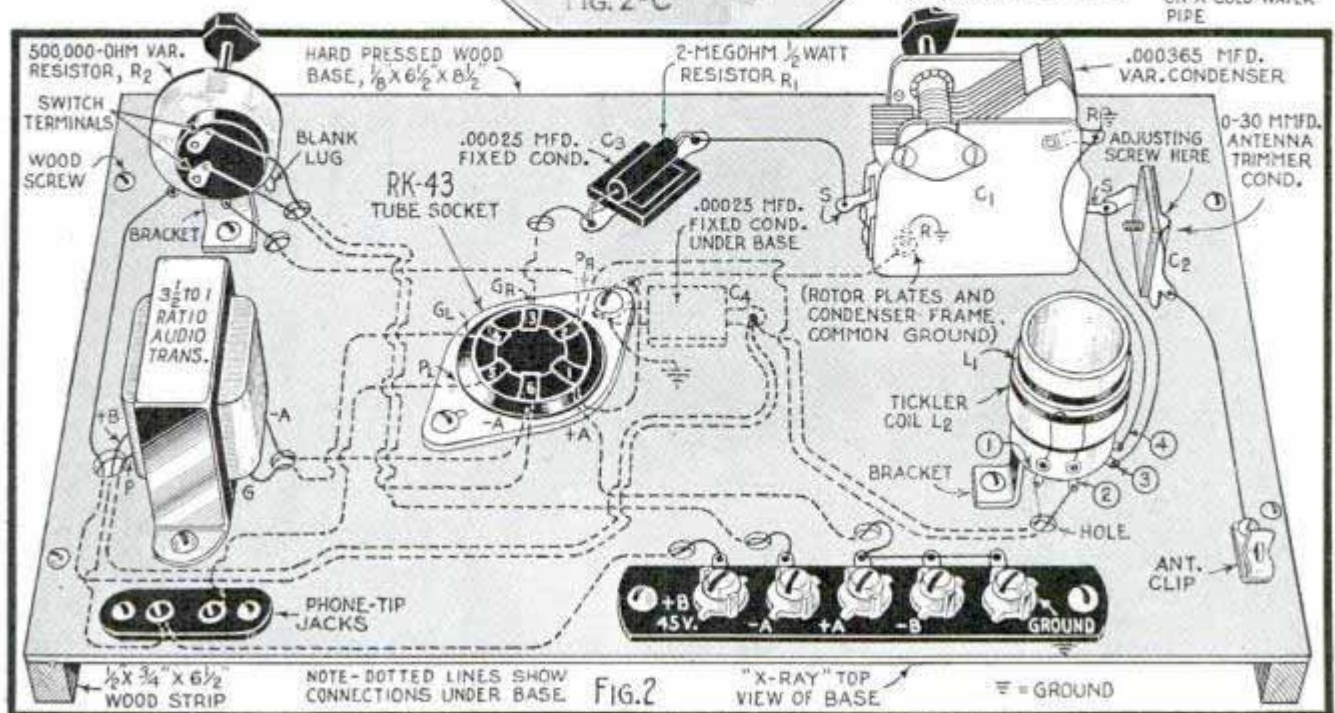

FIG. 2

"X-RAY" TOP VIEW OF BASE

☐ = GROUND

Sectional Cabinet Relay Racks for Amateurs



NOW you can build that new transmitter, amplifier or receiver in a neat black-crackle finished metal rack or cabinet of standard dimensions and obtain a compact commercial appearance heretofore only possible for those fortunate enough to have access to a well-equipped machine shop.

A screwdriver is the only tool necessary for assembling the sectional rack illustrated. The outstanding feature of a rack of this description is that the builder can assemble a complete rack starting from 3½ in. high and progressing in height in multiples of 1¾ in. until the desired height is attained. Additional sections are available for adding at any time.

The foundation unit consists of a strongly built base 20¼ by 15¾ by 2½ in. on which the side sections are mounted, and a formed top cover 19¼ by 14⅞ by ½ in.

The side-wall sections are 14½ in. deep with front and back flanges, drilled and tapped for 10-32 screws to fit both W.E. and amateur-type notched rack panels. All side sections are louvered for ventilation and are available in various heights to fit standard rack panels. Back dust covers inclose the cabinet and are made of perforated sheet steel with re-enforced edges, for additional ventilation. The Bud-type method of side-wall and panel assembly is clearly shown in the lower photos. Angle-iron brackets hold the sections rigidly and are drilled with screw holes placed to match those in the side walls.

(Continued to page 138A)

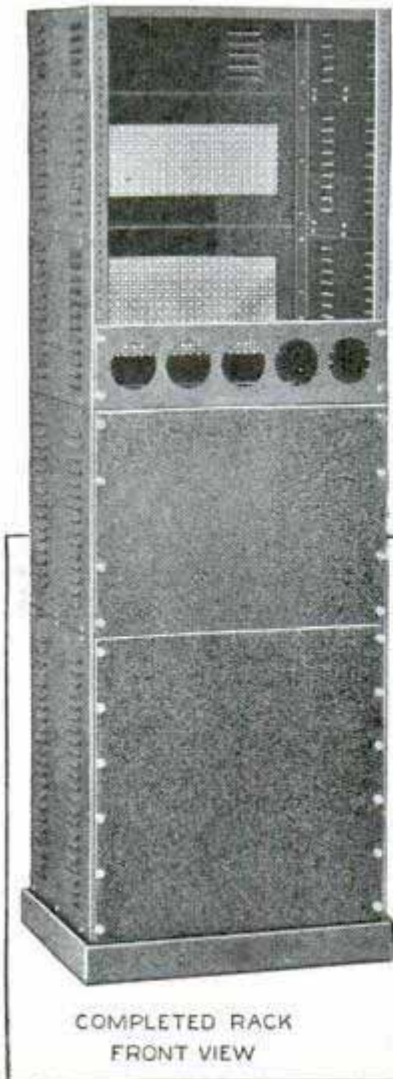

COMPLETED RACK
FRONT VIEW

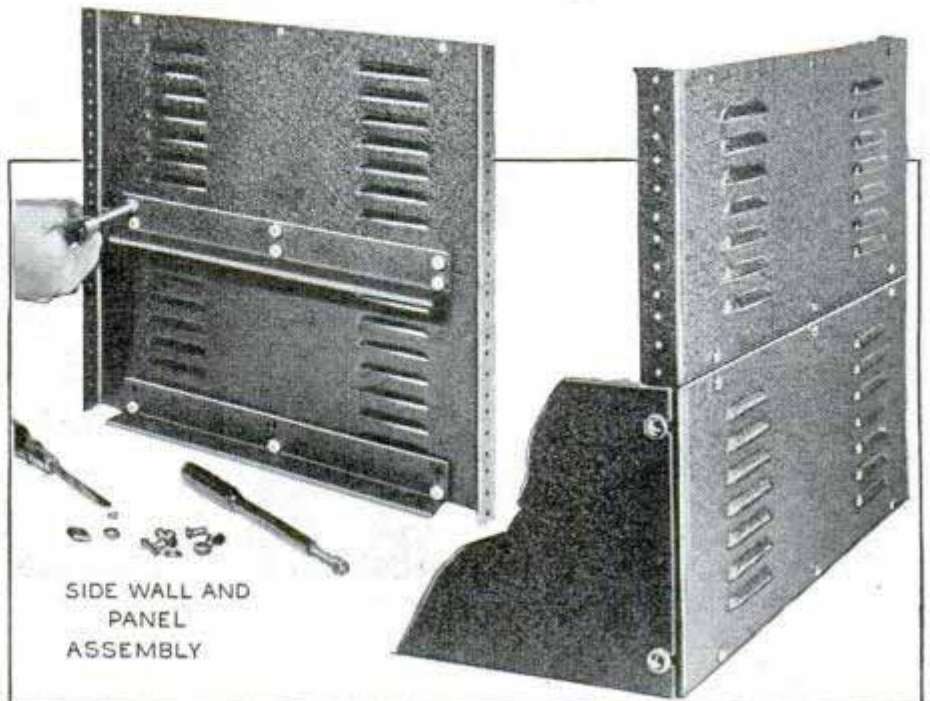

SIDE WALL AND
PANEL
ASSEMBLY

Hints for RADIO EXPERIMENTERS

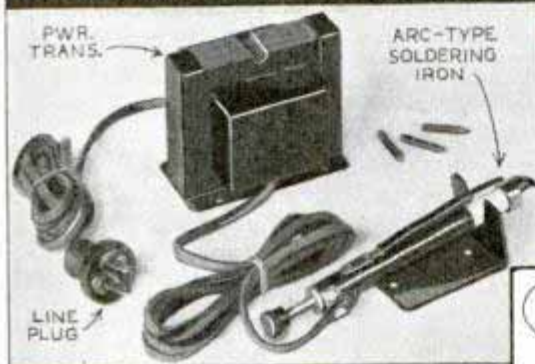

Above, small quick-heating arc-type soldering iron saves time and current as power is used only when thumb switch is depressed

Push-button switch and reel with extension cable enables listener to decrease volume of receiver to a whisper from any point in the room. Figs. 1 and 2 show standard speaker connections; switch is in series with one voice-coil lead

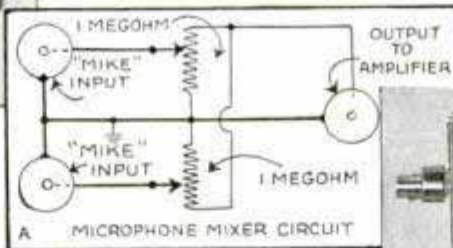
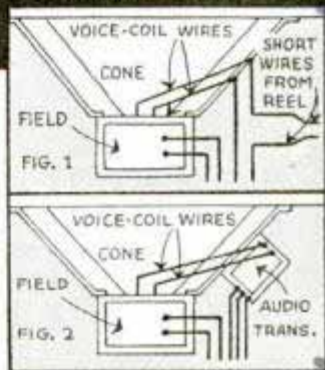

Right, simple microphone mixer unit provides for an extra "mike"; permits complete mixing of voices or instruments without adjusting the amplifier itself. Circuit diagram with parts values appears in Fig. A; photos B and C show top and bottom views of assembly in metal box 6 by 2 3/8 by 1 1/2 in.

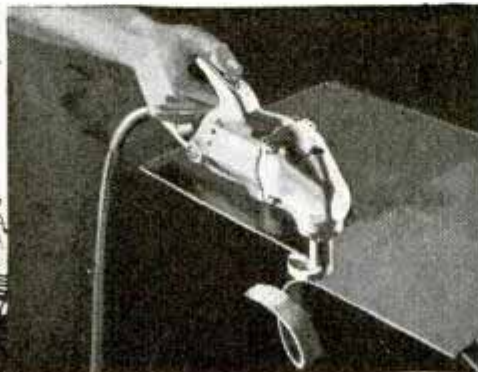
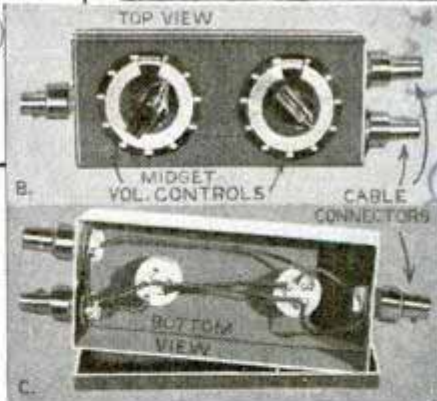

Left, ordinary wall-type toggle switch with chrome plate, for a.c. input; dresses up panel

Left, portable electric shear for metal worker; cuts all types of sheet metal up to 18 or 16 gauge; operates on a.c. or d.c. Below, variable resistor used to extend range of experimenter's low-reading voltmeter

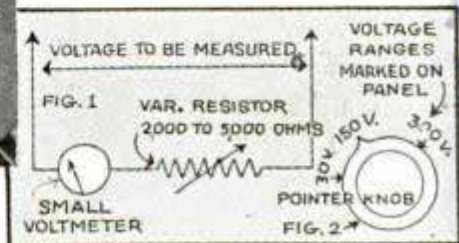

Swinging-Link Inductor Coils

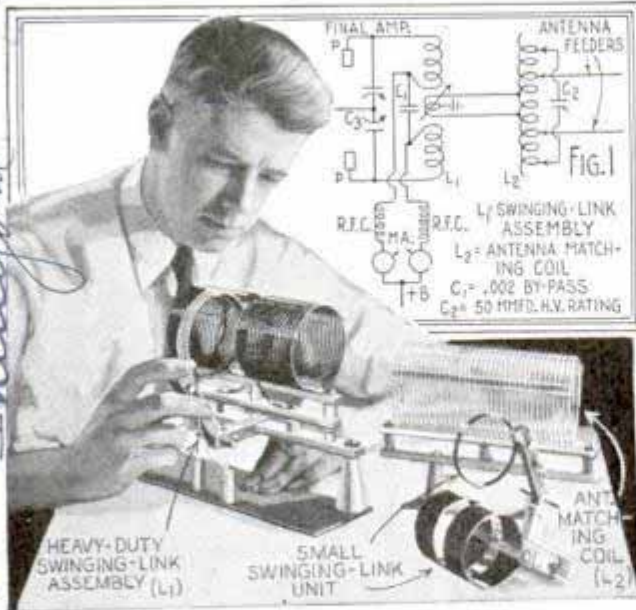

Designed to aid the amateur to obtain accurate control of loading and excitation in the final stages of a transmitter, these swinging-link coils provide an independent link and base assembly which permits front-of-panel control of coupling. This unit makes it unnecessary to resort to makeshift means of control as is necessary with ordinary link-coupled systems. Fig. 1 shows a circuit using the swinging-link assembly and a B and W type antenna-matching coil, to obtain maximum transfer of energy to the antenna.

Converter Changes D.C. to A.C.



This polarity changer converts a given voltage of direct current to the same voltage alternating current. For example,

if your house-lighting supply is 110 volts d.c., you can plug in this unit and obtain 110 volts a.c. for the operation of standard a.c. receivers and other electrical appliances designed for operation on alternating current. They are available in three 350-watt models suitable for different

home and industrial applications. Adjustable frequency control provides for the operation of electric clock motors and timing equipment, in d.c. districts.

Push-Button Radio-Phonograph

Now you can play your favorite phonograph records through a high-quality amplifier and have the kind of music you desire at any time, or, with this versatile instrument you also have a 2-band 6-tube superheterodyne radio receiver with push-button tuning. The receiver covers the range from 16 to 54 meters for important short-wave stations, and 175 to 550 meters for standard broadcast programs. This combination unit operates on 110-volt 60-cycle supply line.



Blueprints covering radio construction articles in past issues are available for 25 cents each; original material lists and additional information can be obtained from our Radio Department without charge upon receipt of postage.

NEXT MONTH—How to Build an Inexpensive Battery-Operated Electric Fence Controller. This unit operates up to 5 miles of single-wire fence and is easily assembled from ordinary radio parts. Also Part II of the article, **Low-Cost Receivers for Beginners.** Completing construction of three progressive sets

Electronic Lab. Inc. 122 W. New York Ave. New York 11

Radio Dept. Corp. 833 W. Jackson, Chicago

Corp. 833 W. Jackson, Chicago



ORNAMENTAL IRON RAILINGS

made without welding

By GEORGE B. HARRAN

HERE'S a way to make decorative iron railings right in your home shop without the use of a welding torch. The railings can be made any practical shape or length with very little time and work. Fig. 1 shows an example of what you can do. Fig. 2 gives the essential details, the dimensions being only approximate, of course. You won't have any trouble getting the materials for they are standard sizes of ornamental-iron stock.

The first thing to do is make a full-size layout of the profile of the steps and the design of the railing as in Fig. 3. Then you measure and cut all the upright members with both ends square. Allow $2\frac{1}{2}$ to 3 in. on each upright for setting in the concrete as in Fig. 2. Drill a hole for a $\frac{1}{4}$ -in. No. 20 thread in one end of each up-

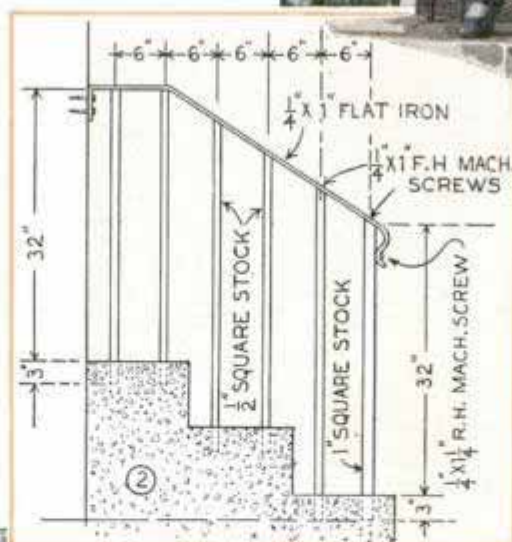

right to a depth of $1\frac{1}{4}$ in. After tapping, determine the angle of the inclined top rail and cut the tapped end of each upright to fit. Make a wooden angle gauge from your full-size layout and use it as in Fig. 4.

Now you bend the top rail to shape, proceeding with the bends as in Fig. 5. Again you have to resort to the full-size layout to get the spacing for the holes to be drilled for screws joining the rail to the uprights, Fig. 6. Notice that holes for the screws through the inclined section of the rail



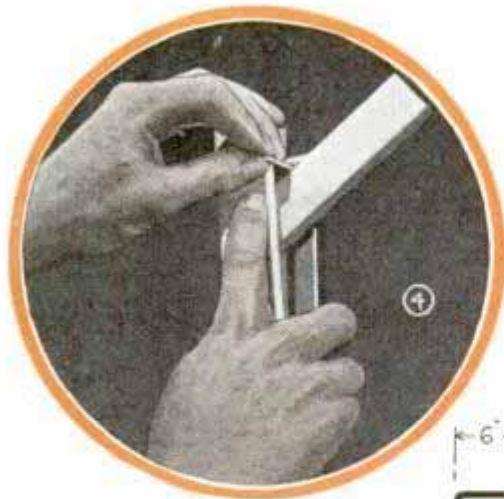

er ends of the uprights. These holes should be large enough so that you can move the uprights slightly to line them up. Set up the assembly on the steps, brace it to hold the parts plumb and in line and pour a rich cement mixture around the lower end of each upright, troweling it level with the surface of the step. Molten lead also can be used if you have the melting ladle and other necessary equipment. To finish up, apply a coat of tinner's red lead, follow

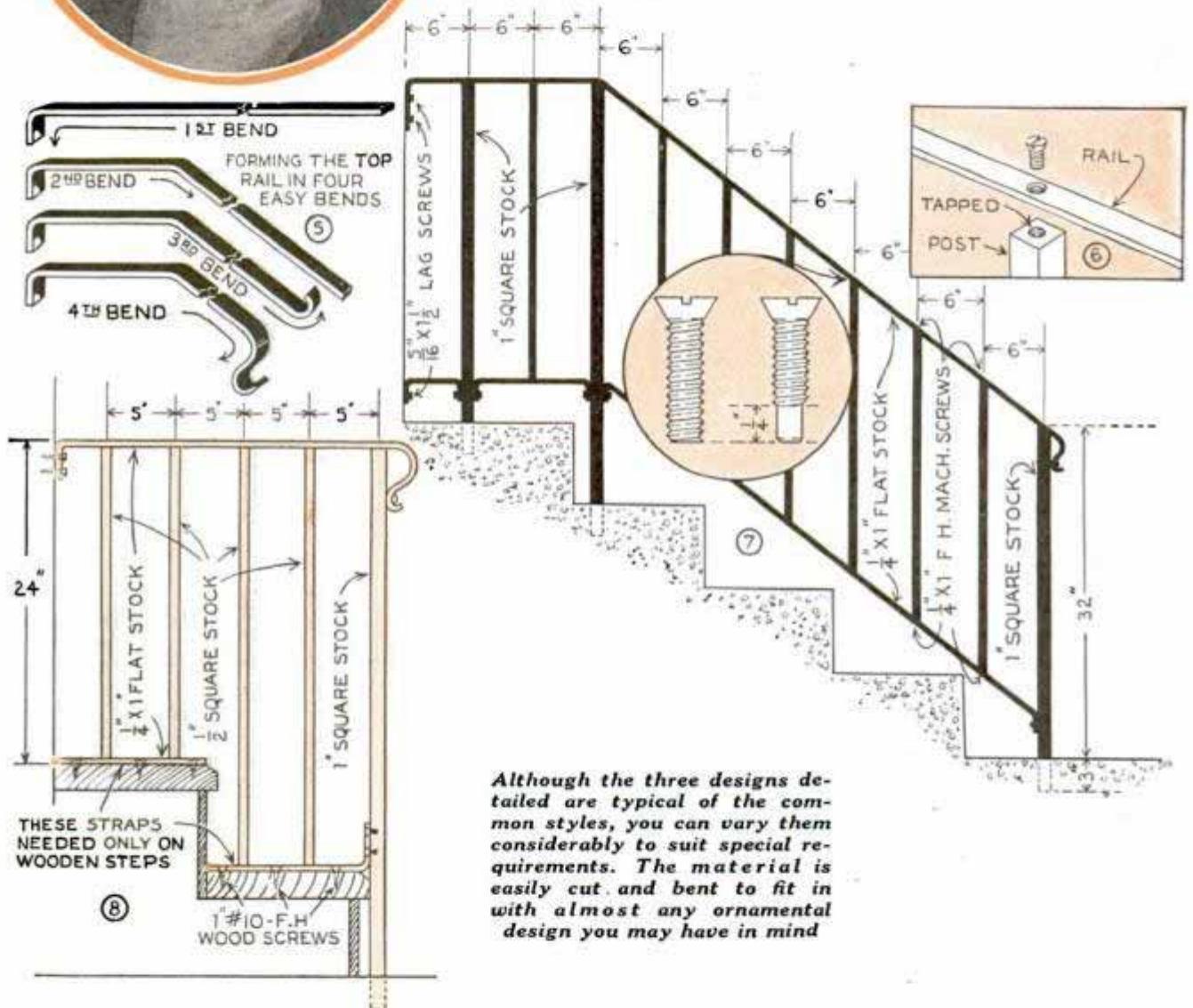

must be drilled and countersunk at an angle. File off any burrs or other irregularities that might interfere with a close fit of the parts. Grind the threads off the end of each screw as in Fig. 7 so that it will start easily in those holes which are tapped at an angle. Mix a small quantity of iron cement and apply it to the joint between the upright and the rail. Then drive the screws home.

With all this done you next chip holes in the brick or concrete steps to take the low-

with a coat of aluminum paint and finally with a coat of black or colored enamel. This finishes a railing of the type shown in Figs. 1 and 2. In Fig. 7 the construction is the same except that you use both a top and bottom rail. Fig. 8 details a simplified type of railing designed for wooden steps.

Keep a garden notebook and jot down variety of seeds planted, date of planting and first appearance of flowers; this information serves as a guide to future planting.

Carrier Transports Boat Safely on Top of Car

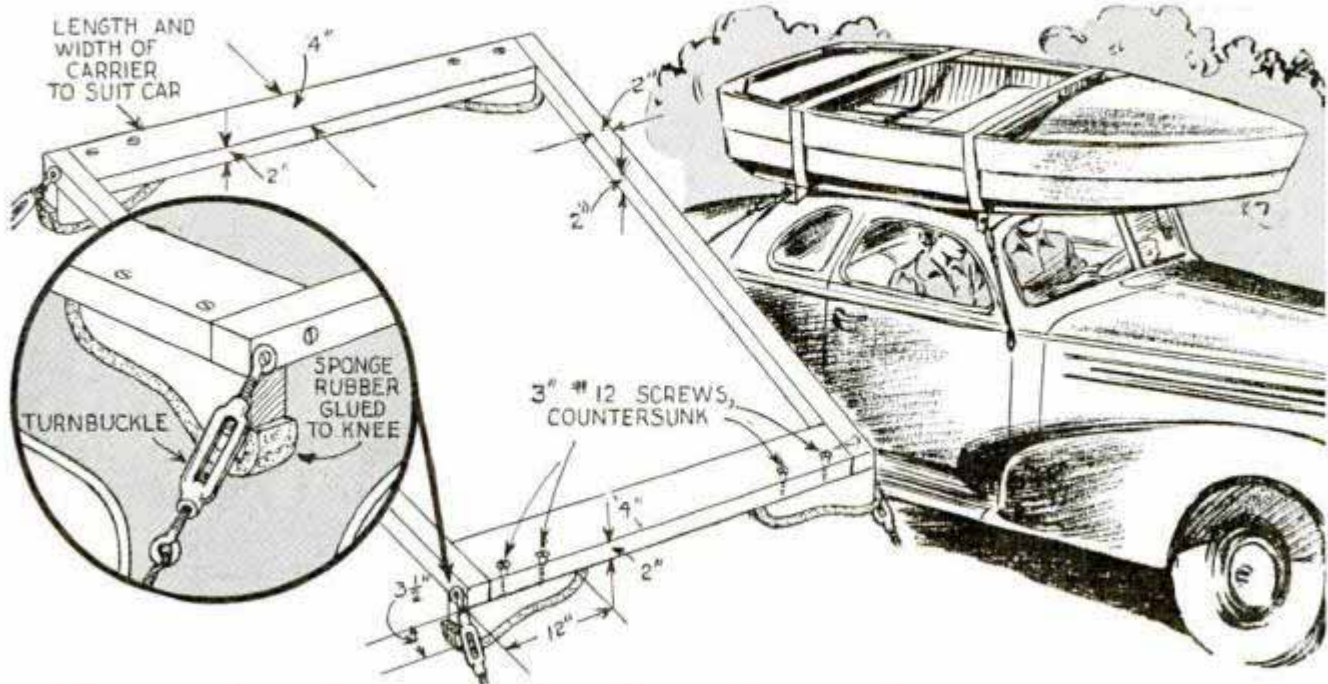

Taking your boat along is no trick at all if you spend a few minutes time to make this carrier, which fits on the top of your car. As you see, it's a very simple affair joined together with heavy screws for maximum strength, and is capable of carrying boats, kayaks and canoes up to 300 lbs. in weight. The carrier is supported at the corners by curved feet, which are cut to the contour of the car top and padded

with strips of sponge rubber to prevent marring the finish. Cradles cut to the contour of the boat bottom can be attached directly to the carrier frame with bolts. The cradles should be padded and fitted with adjustable straps of heavy webbing to hold the boat in position. Rods and turnbuckles are used to hold the carrier in place, these being cut to lengths to suit the car.—William D. Jackson, Knox, Ind.

This Self-Adjusting Sanding Block Assures Square Edges

To sand the edges of boards squarely and rapidly, one craftsman uses this unusual block. It consists of a 3 by 8-in. piece of wood to which is nailed a 2-in. strip of wood at right angles to one side. At the opposite side another piece of stock, cut to the shape shown, is pivoted to swing freely. The block is placed on the edge of the board to be sanded and the pivoted piece is pressed in against the side where it is held with the thumb as the hand grips the block in the manner indicated. The pivot block presents little friction to the work and keeps the sander from tipping so that the edge will be smoothed square.

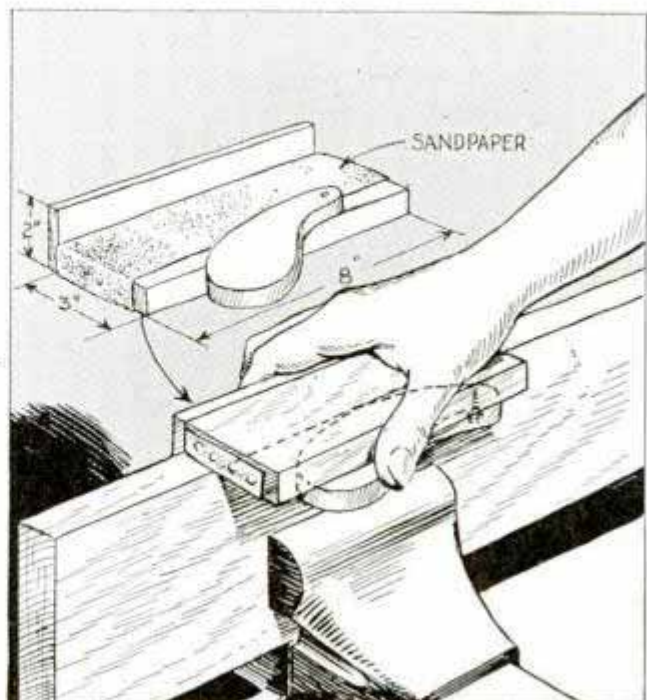

This sanding block automatically adjusts itself so the abrasive surface rides square with the work

☐ You will find that two thin coats of shellac give a hardwood floor a much better finish than one thick coat; the first one must be dried thoroughly before the second is applied.

Soap Shaver from Bottle Caps Attaches to Wash Boiler



Pulling a bar of laundry soap over the edges of the bottle caps shaves off small pieces

This simple soap shaver can be made from wood blocks of the approximate size indicated and three or four bottle caps. The blocks are nailed together with a spacer between them providing legs to slip over the side of a wash boiler. When a bar of laundry soap is drawn over the edges of the caps, shavings fall into the water.

Combination Pennant and Light for a Sailboat

This combination pennant fly and mast light for sailboats consists of a number of easily obtained units. The light is merely a gasoline sediment bowl from an old car. The excess connections are removed with a hack saw, and a miniature bayonet or

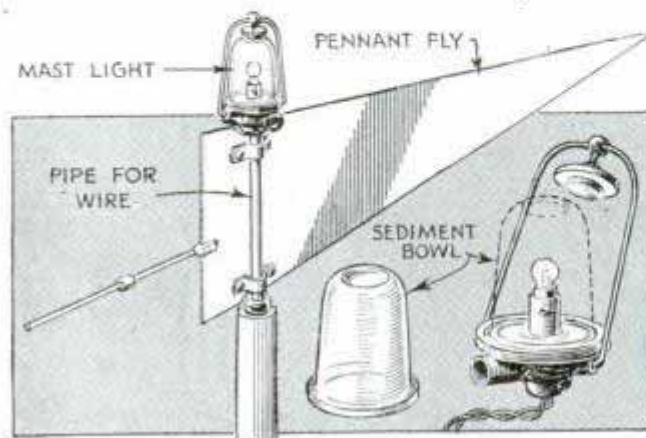

Boat light assembled easily from the gasoline sediment bowl of an old car

screw socket of the type used on some cars and many radios is attached. As the bulb is easily accessible and as it is waterproof, this light may be adapted to many other uses. The fly is made of any light metal and is attached to the mast as an assembly by using the hinge fastening taken from a lavatory cover.

—M. L. Harmon, South Bend, Ind.

Simple Electric Motor Is Built from Scrap Parts

Just to show your friends how simple it is to build a small electric motor that runs, in less than an hour, try this one. Nail together two pieces of wood to serve as a frame. The rotating part, or armature, consists of a nail serving as a vertical shaft, its pointed lower end resting in a punch mark in a small plate which is screwed to the base. Its upper end, from which the nail head is removed, passes through a hole drilled in a supporting strip. On the shaft is fitted a hardwood disk, such as a section of broom handle, drilled in the exact center to fit on the shaft snugly. Six

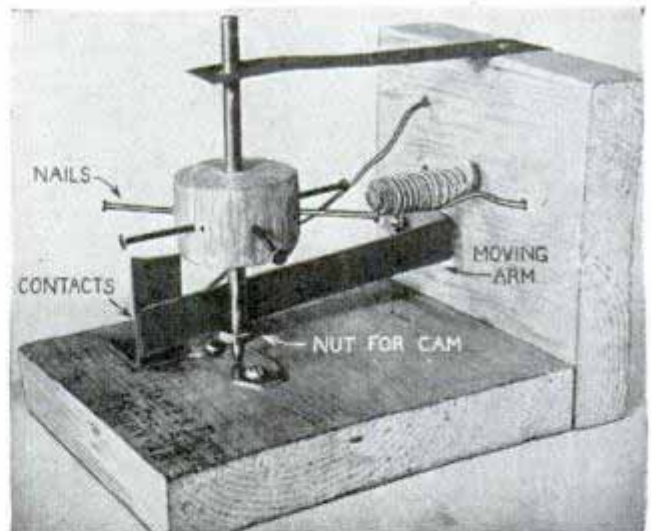

Changing the position of the nut on the armature varies the speed or reverses the motor

nails are driven into the disk to exactly the same depth and so that their heads will be equidistant. On the lower end of the shaft a hexagon nut is soldered, and a strip of tin, the moving arm, is carefully adjusted so that it contacts a smaller stationary piece only when one of the corners of the nut pushes it. The moving arm must spring free from the stationary piece when the corner of the nut recedes, but it must

not contact the flat faces of the nut. By experimenting with the position of the nut relative to the position of the nails on the armature, the speed can be varied and the direction of rotation changed. The nails on the armature rotate past a small magnet made by winding about a 10-ft. length of No. 22 insulated magnet wire on a nail driven into the side member as shown. One end of the wire is connected to the moving arm and the other to the source of current, which may be a transformer or two dry cells. The other side of the current supply goes to the stationary contact. In use, the current through the magnet attracts the nearest nail on the armature. When this nail comes opposite the magnet, the current is off, and momentum forces the nail on past the magnet. Then the nut on the shaft causes the moving arm to contact the stationary piece, allowing current to flow again, which attracts the next nail toward the magnet, and so on. Variations of the design, using as many nails as the nut has faces, may be made. A really fast motor consists of two square nuts with eight armature nails, or two hexagon nuts with twelve armature nails.

—C. E. Packer, Chicago.

Saw Converted into Disk Sander

A circular saw can be converted into an efficient sander by substituting a sanding disk for the blade. When turned on a lathe and faced with sandpaper, $\frac{1}{4}$ -in. plywood provides a good disk. It is best mounted so that the abrasive is on the side away from the bearings, a dado saw insert being used in the table to allow clearance for the disk.—H. R. Heydorf, Missoula, Mont.

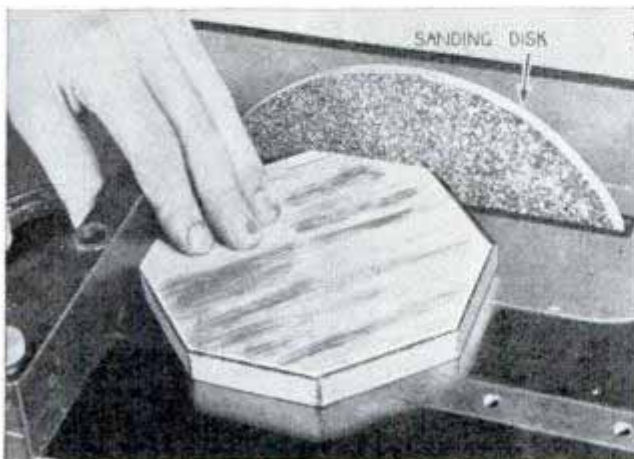

A plywood sanding disk substituted for the blade on your circular saw converts it into a sander

Picture Racks in Exhibition Hall Prevent Marred Walls

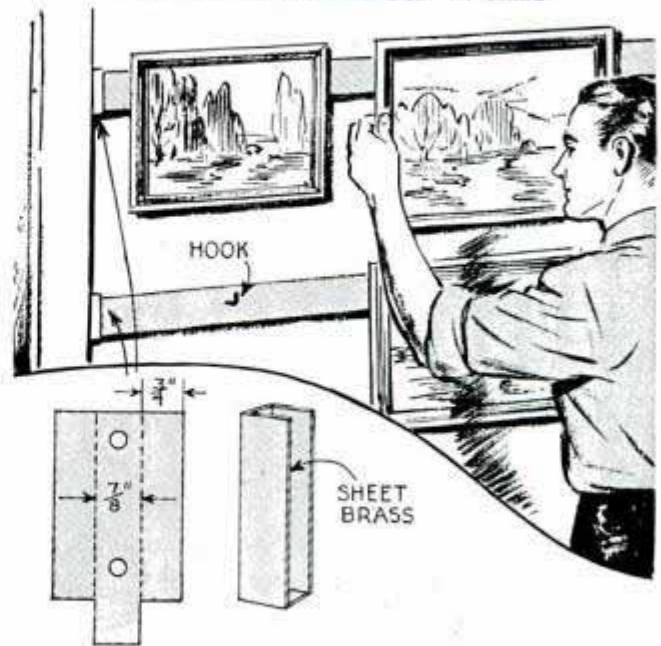

Removable wood strips between door and window casings support paintings on exhibition

Asked not to mar the newly decorated walls of a room used as a temporary exhibition hall for paintings, a group of artists employed the following method of hanging the pictures. Spaces between window and door casings were measured and lengths of $\frac{3}{4}$ by 3-in. finished pine were cut to fit between them. Then brackets of the type shown were fashioned from stiff brass and fastened to the edge of the door and window trim to support the racks.

—L. B. Robbins, Harwich, Mass.

Thin Sheet Metal Cut Easily with Aid of Razor Blades

If you have occasion to make an accurate cut along a straight line in thin metal, an easy way to do it is to employ a jeweler's saw and two single-edge razor blades to serve as guides for the fine saw blade. Clamp one blade with its unsharpened edge along the line to be cut. Lay the saw blade temporarily along the edge as a spacer, and bring the second blade up to it, and clamp.

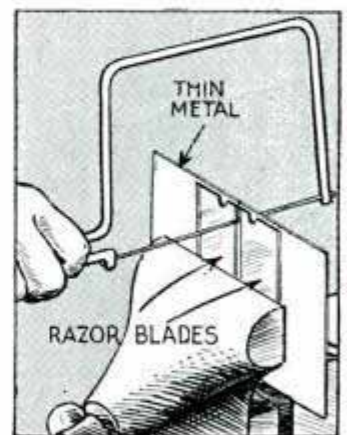

Clamp one blade with its unsharpened edge along the line to be cut. Lay the saw blade temporarily along the edge as a spacer, and bring the second blade up to it, and clamp.

SPINDLE RACKS *for*

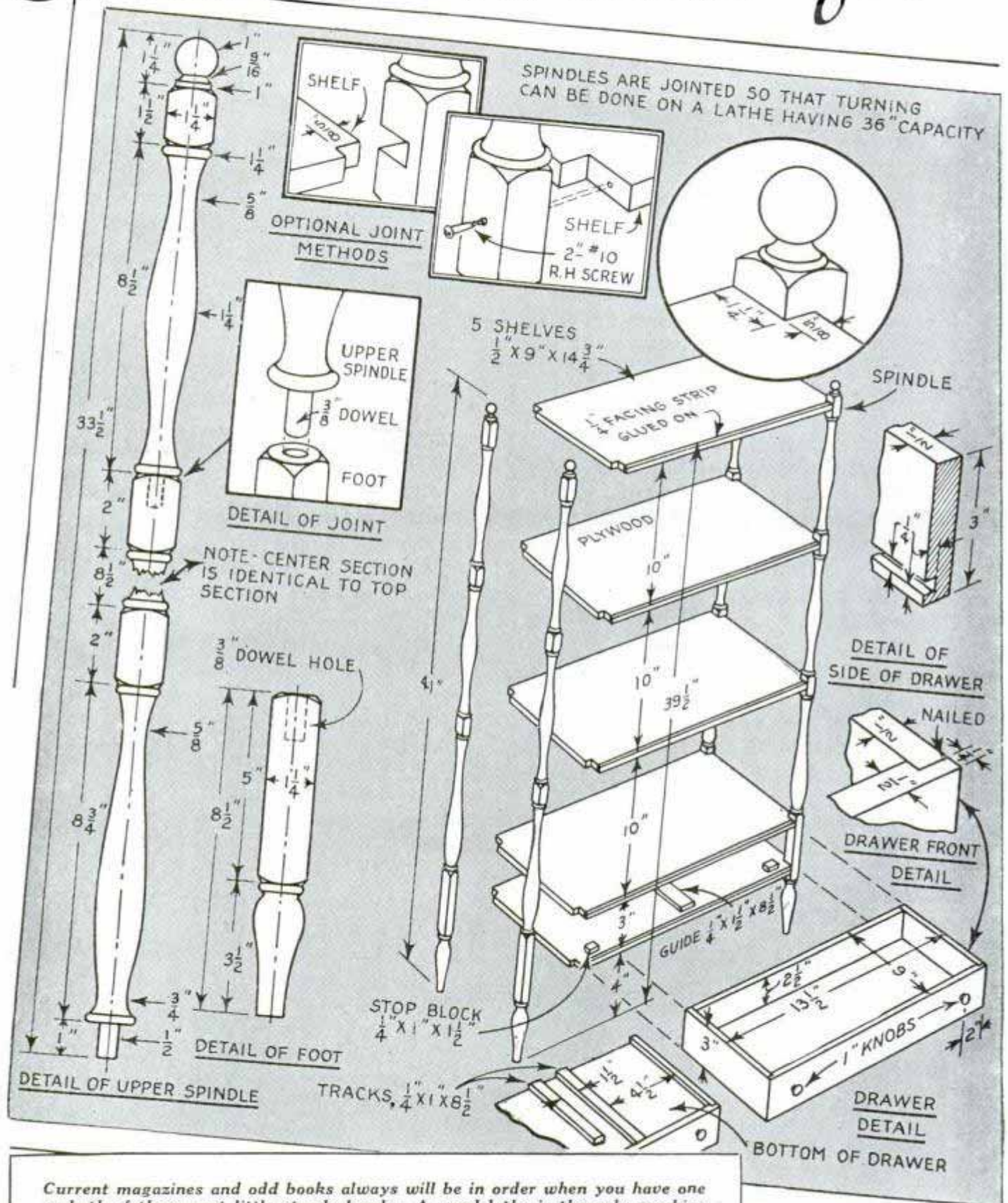

Current magazines and odd books always will be in order when you have one or both of these neat little stands handy. A wood lathe is the only machine tool you will need to build either one. Simple joinery of the cases reduces construction problems to the minimum. Although walnut and mahogany are the woods specified, you also can use maple finished "blond" or stained a honey color to match other colonial furniture which you already may have

BOOKS *and* BRIC-A-BRAC

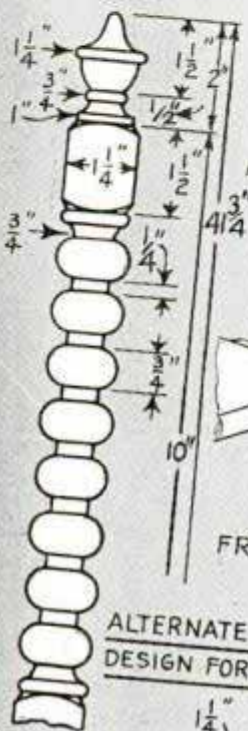

WALNUT OR MAHOGANY

FRONT

BACK BLOCK

BOTTOM

ALTERNATE SPOOL DESIGN FOR SPINDLE

THE TRIANGULAR DRAWER IS ASSEMBLED IN A VISE

SPINDLE FASTENED TO SHELVES WITH 2" #10 FH. SCREWS
BACK SPINDLE MAY BE LEFT PLAIN

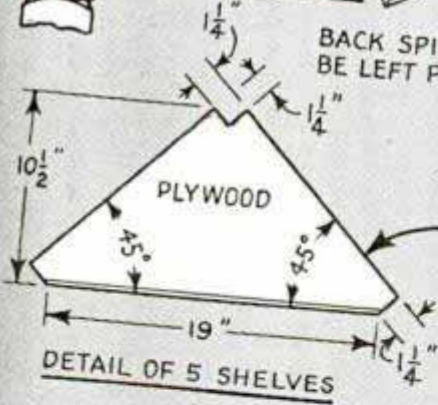

DETAIL OF 5 SHELVES

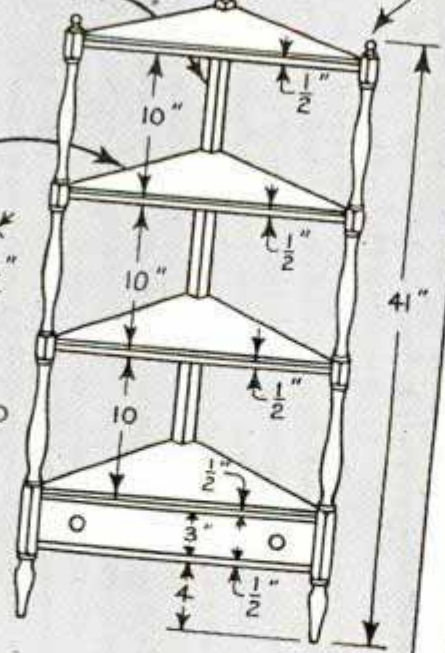

DRAWER CONSTRUCTION, TRACKS & GUIDE SAME AS FOR 4-SPINDLE DESIGN
SPINDLES ARE ALSO IDENTICAL

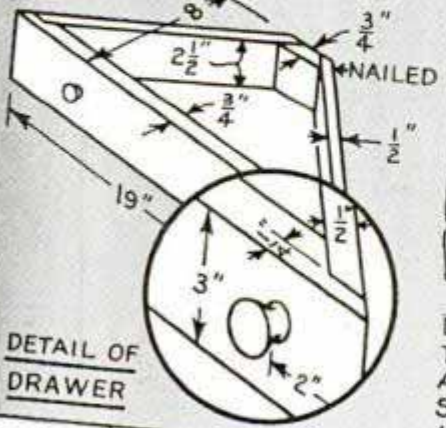

DETAIL OF DRAWER

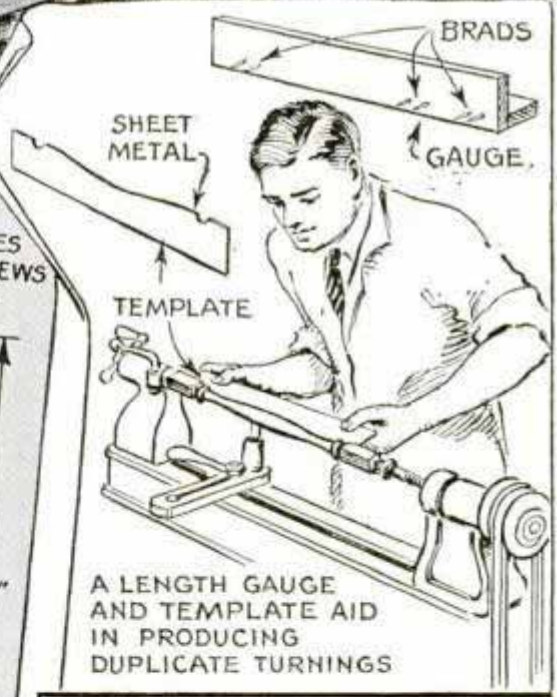

A LENGTH GAUGE AND TEMPLATE AID IN PRODUCING DUPLICATE TURNINGS

STOCK BILL

RECTANGULAR TYPE

- 4 SPINDLES $1\frac{1}{4} \times 1\frac{1}{2} \times 41$ - SOLID-TURNED
- 5 SHELVES $\frac{1}{2} \times 9 \times 14\frac{3}{4}$ - PLYWOOD
- 1 DRAWER FRONT $\frac{1}{2} \times 3 \times 13\frac{1}{2}$ - SOLID
- 2 DRAWER SIDES $\frac{1}{2} \times 3 \times 8\frac{3}{4}$ - SOLID
- 1 DRAWER BACK $\frac{1}{2} \times 2\frac{1}{2} \times 12\frac{1}{2}$ - SOLID
- 1 DRAWER BOTTOM $\frac{1}{4} \times 8\frac{3}{4} \times 13$ - PLYWOOD

TRIANGULAR TYPE

- 3 SPINDLES $1\frac{1}{2} \times 1\frac{1}{4} \times 41$ - SOLID-TURNED
- 5 SHELVES $\frac{1}{2} \times 10\frac{1}{2} \times 19$ - PLYWOOD
- 1 DRAWER FRONT $\frac{3}{4} \times 3 \times 19$ - SOLID
- 2 DRAWER SIDES $\frac{1}{2} \times 3 \times 12\frac{1}{2}$ - SOLID
- 1 DRAWER BOTTOM $\frac{1}{4} \times 7\frac{3}{4} \times 18\frac{1}{2}$ - PLYWOOD
- 2 WOOD KNOBS - 1" DIA FOR BOTH TYPES

Rubber Wheels for Model Plane from Ink Erasers



When the size of a model plane permits, use of ink erasers for wheels saves work

In some cases, round ink erasers provide good landing wheels for model planes. Simply remove the brush from the top of the eraser handle and attach the handle to the undercarriage of the plane with a small machine screw.

—E. P. Barnhart, Whittier, Calif.

Fish Cleaned with Car Valve

To quickly remove the entrails from a fish after cutting it open, one sportsman has found that an old valve from a car



An old car valve carefully cleaned will remove the entrails from a fish in a jiffy

motor is just the thing. When used as indicated, it does the work efficiently without cutting or tearing the flesh. Of course, the valve should be cleaned and polished carefully before using it.

Solder-Weight on Glass Cutter Relieves Finger Strain

Finger strain of operating a glass cutter for any length of time may be relieved considerably by attaching a weight to the cutter. A piece of bar solder attached to the flat side of the tool

by means of stout rubber bands or small bolts will make a satisfactory weight.

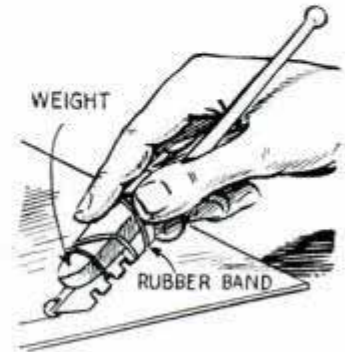

Golf Tee Cleans Camera Lenses

Some types of camera lenses, especially those on box cameras, are rather inaccessible and difficult to clean. An easy method of doing the job is to take a small wooden golf tee and cover the concave top with a bit of cotton or cleaning tissue. Holding

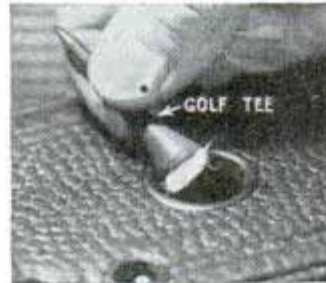

the tee against the lens and twirling it between the fingers will clean the lens.

Tap Wrench in Tight Place Turned by Screwdriver

I have found this modified tap wrench handy when tapping small holes in corners or close to the side wall of a machine. I removed the cross handle and sawed a slot across the end of the wrench to take the screwdriver blade.

—Philip A. Eyrick, Arlington, Mass.

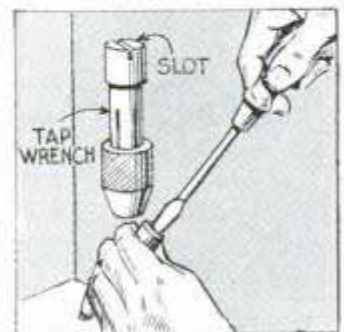

HINGED-TOP DRESSING TABLE

built with hand tools

Designed with all the common appointments of any dressing table, this one is so simple in structural details and joinery that you need only a few household tools for its construction. The whole thing is nothing more than a table with three compartments partitioned between the rails as shown. The three-section top or lid is fitted with a trio of mirrors which can be arranged for viewing the face and both sides of the head at once. Hinges supporting the wings of the lid are stiffened by hammering the sleeves so that they will hold the parts in any position desired. The mirrors are held in place by copper corner clips screwed to the lid. Mahogany or walnut plywood will do for the lid, rails and partitions but solid wood must be used for the legs

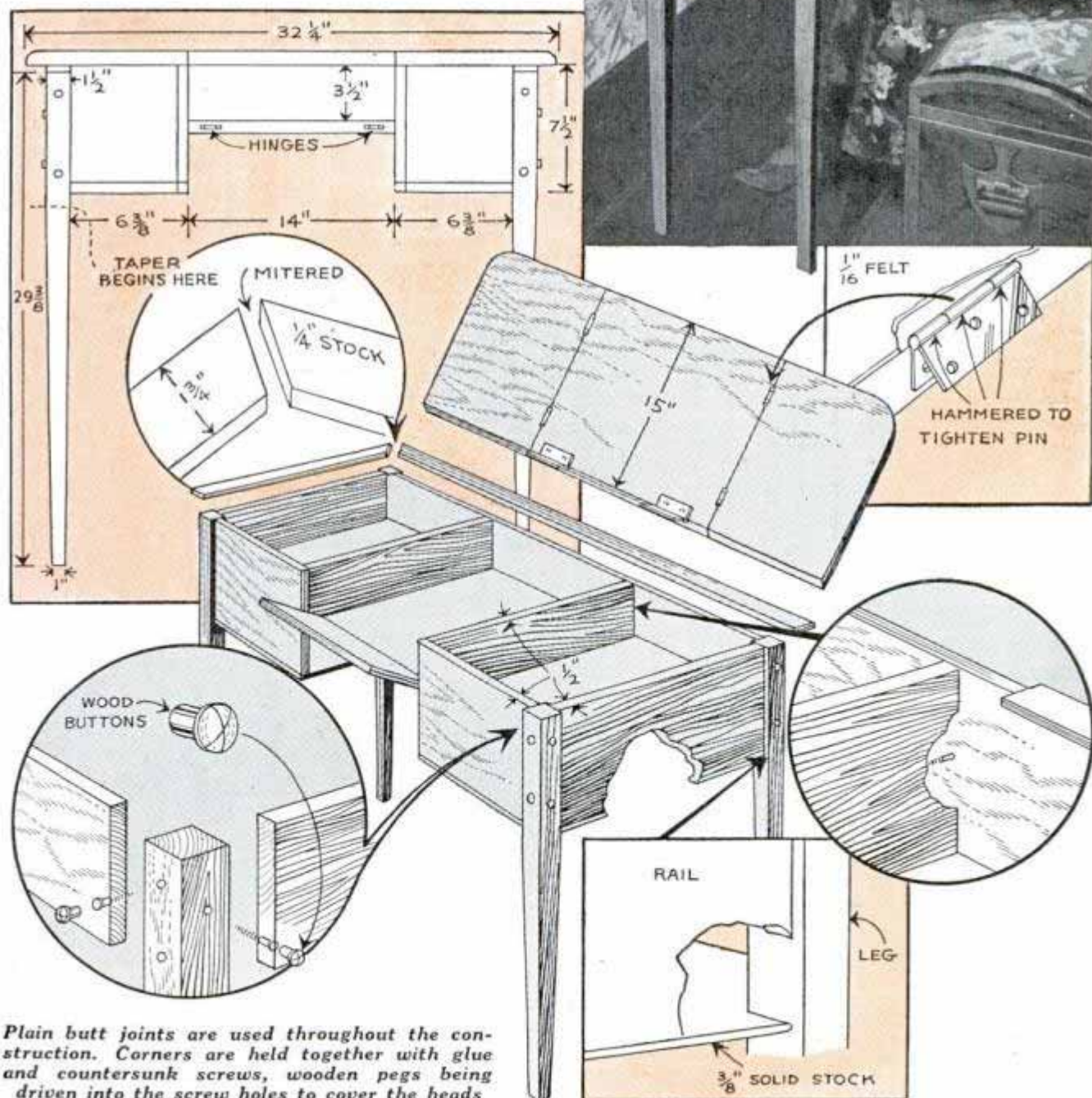
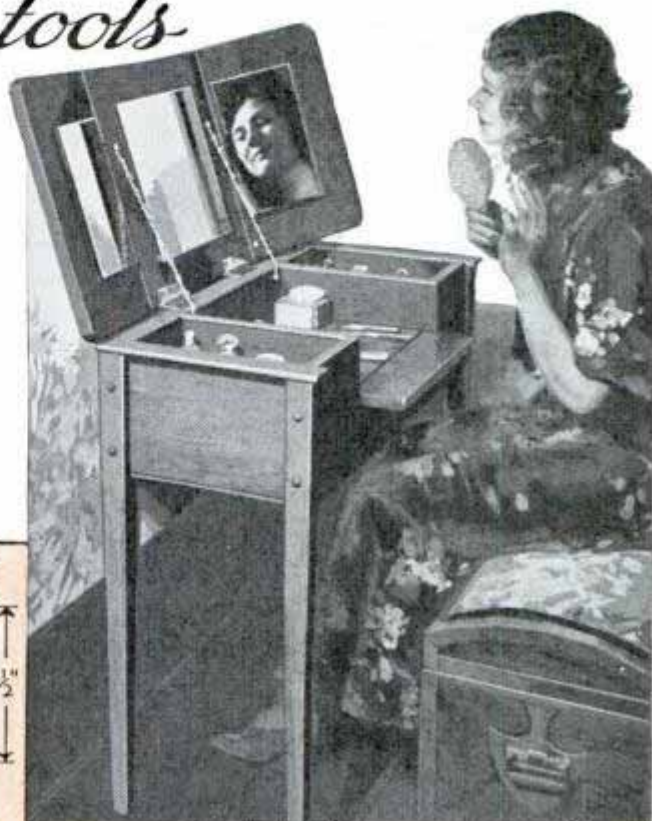

Plain butt joints are used throughout the construction. Corners are held together with glue and countersunk screws, wooden pegs being driven into the screw holes to cover the heads

Piece of Rubber Hose Protects Garment from Line Stains

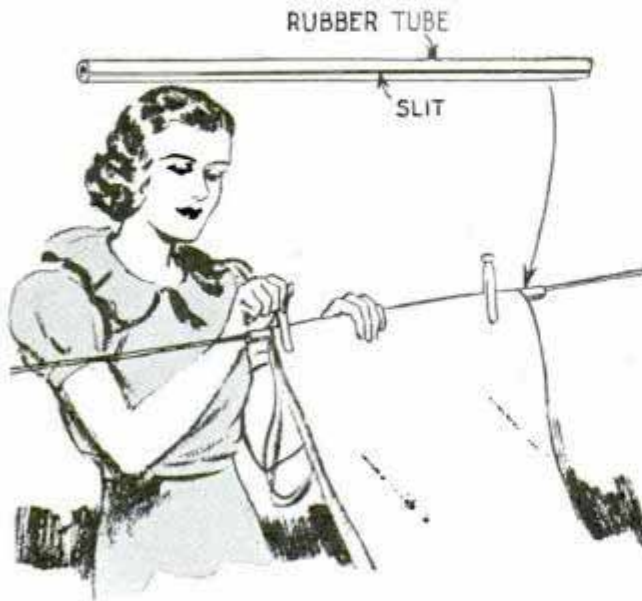

Small rubber tube slipped over clothesline protects clothes against soiling

When a delicate garment is hung on a clothesline, it may become line marked or stained where it is attached with the clothespins. To avoid this, slit a length of discarded bath hose and slip over the line.

Swinging of Screen-Door Hook Avoided by Magnet

To prevent the hook on a screen door from swinging between the frame and door when the latter closes, you can employ a small permanent magnet as indicated. Wire staples hold the magnet under the hook in the position shown.

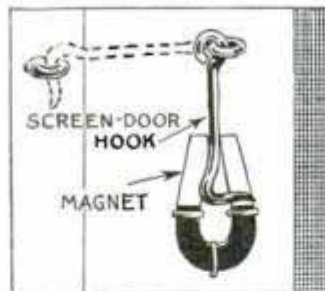

Shellac Brush Is Wrapped to Prevent Drying



When you use a shellac brush several times a day, the muss and delay of washing it out with alcohol each time can be eliminated by wrapping the bris-

les and part of the ferrule with a doubled sheet of wax paper. This should be twisted tightly about the handle to exclude air. Brushes protected in this way will remain soft overnight, despite the tendency of shellac to dry in a few minutes.

Silencing Typewriter Tables

You can silence a makeshift typewriter table by cutting sponge-rubber balls in half and attaching them to the bottom of each leg. In cutting the balls (the penny variety will do nicely), a fine-tooth saw will work better than a knife. The rubber can be attached with roofing nails, sinking the heads well into the rubber so that the latter folds over them as indicated.

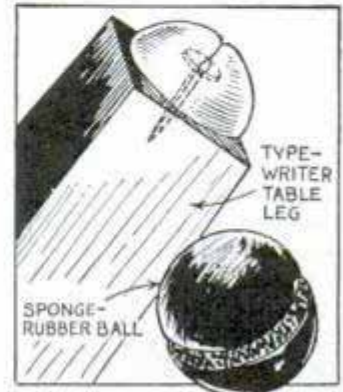

Paper Cutter from Razor Blade

A handy paper cutter is made quickly from a razor blade, a small block of wood and two thumbtacks. The blade is tacked to the block at an angle so that one corner projects slightly below the block. In use, the block is rested against a ruler and the blade itself follows the straightedge to make a clean, precise cut. The blade can be adjusted so that it cuts just through the stock but does not make a deep cut in the surface below.

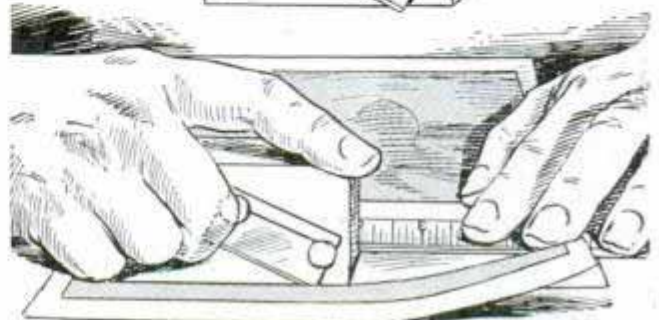
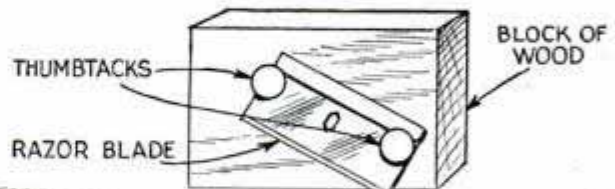

Cutter is adjusted to various depths by loosening lower tack and moving blade up or down

"Running Rastus" Never Tires in the Wind

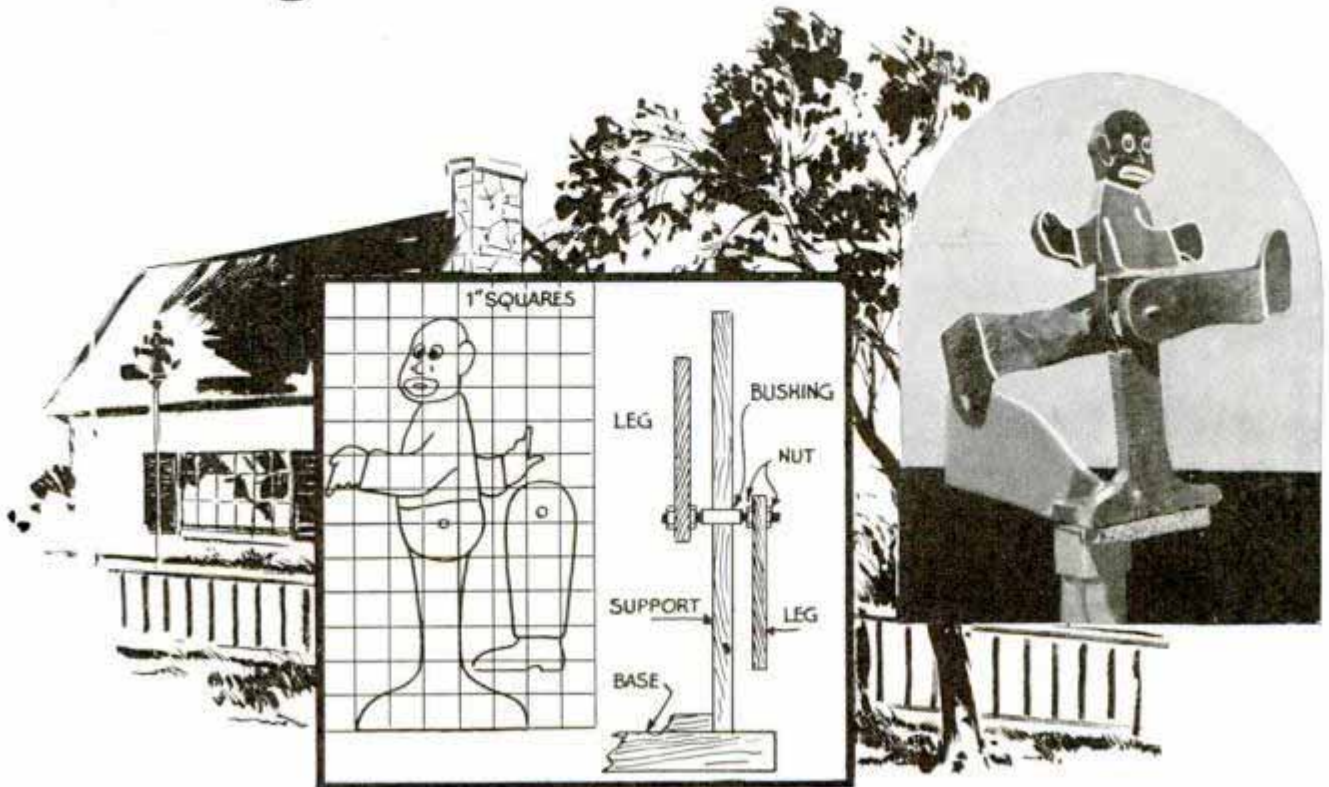

With his legs moving rapidly, "Running Rastus" is an amusing weather vane. Both the body and legs are scroll-sawed from $\frac{3}{4}$ -in. wood, after which the trailing edges of the legs are beveled like the blades of a

toy windmill, which they simulate. In assembling, the legs are locked on the threaded ends of a tiny shaft with nuts, a piece of tubing being inserted through a hole in the body to serve as a bearing.

Bending Sheets Help to Form Sheet Metal in Home Shop

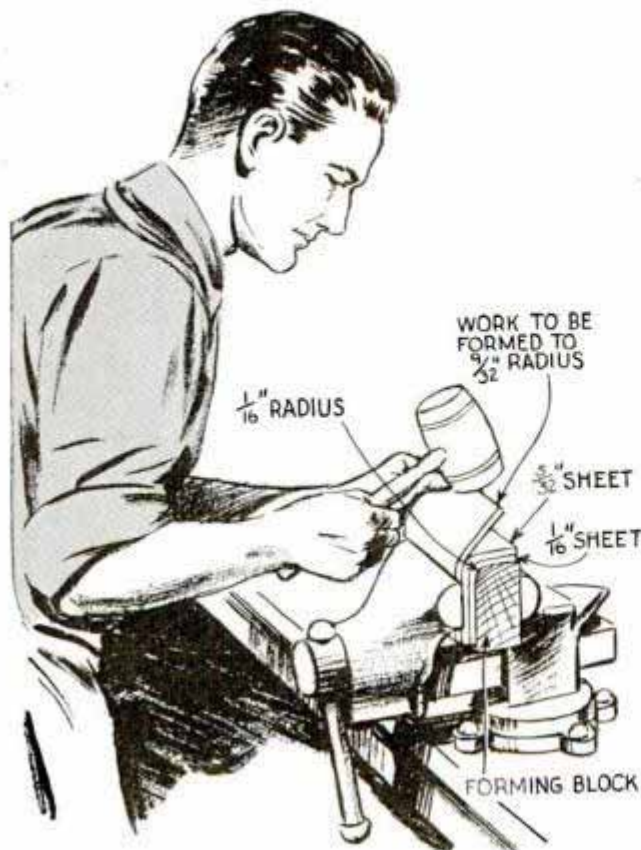

The handy man who has an occasional job of bending sheet metal can do it with fair accuracy by using a combination of bending sheets of various thicknesses. These make it unnecessary to have an individual forming block for bends of different radii. After determining the bend to be made in the work, sheets of the correct thicknesses to give the desired radius are placed on the forming block, and the assembly is clamped in a vise as indicated. The work is then bent over the assembly by tapping it lightly with a mallet. In the example given, a bend having a $\frac{9}{32}$ -in. radius was made by using two bending sheets $\frac{5}{32}$ and $\frac{1}{16}$ in. in thickness.

—Peter F. Rossman, Kenmore, N. Y.

☞ If you have over-blued your clothing and cannot remove excess color by ordinary washing with soap and hot water, soak it in a mixture of hot water, 3 qts., and vinegar, 3 tablespoonfuls.

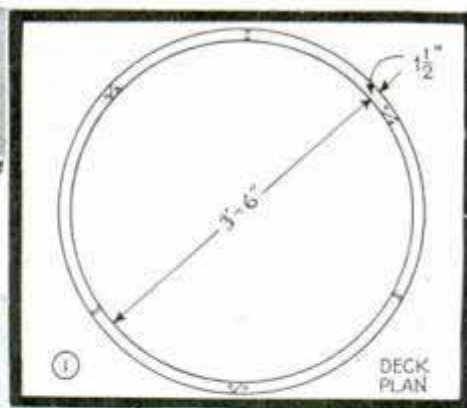

New

WATER

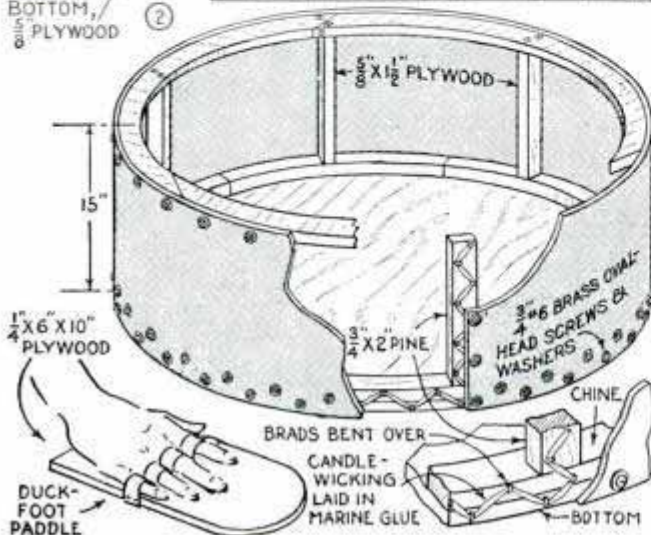
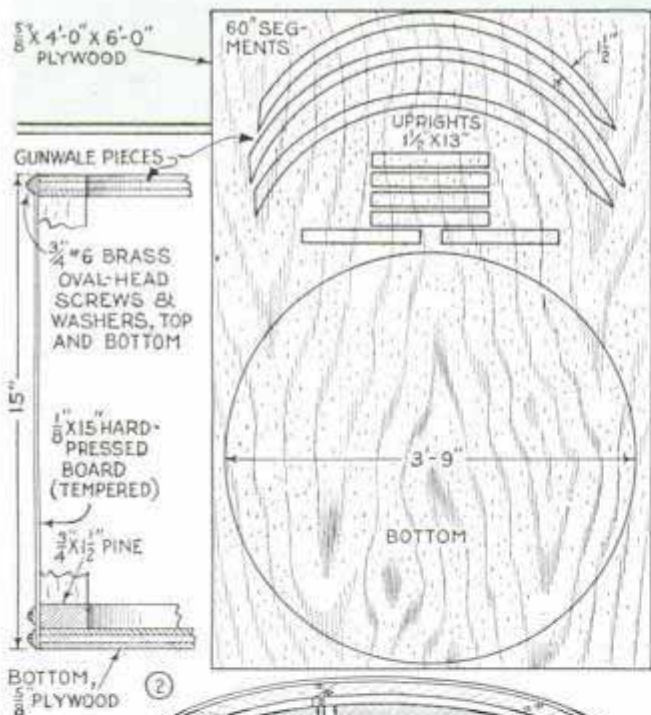

NO ONE in your beach party will be bored for want of something to do if you have several of these fun-making gadgets at hand. For example, there's, racing with the circular craft shown above, called a "Coracle" after ancient European fishing boats. This tricky craft will provide no end of sport because of the difficulty in making it follow a straight course.

Just follow the details shown in Figs. 1 and 2. You'll want to duplicate the parts, of course, so that you will have two or more completed craft. The paddle is simply a piece of 1/4-in. plywood with rubber loops for the fingers.

Then, there's "Skipperoo," strictly a water game and one that will revive memories of the fun you had as a youngster skipping flat stones across a pond. To play the game you need quiet water, a number of wooden disks, an old tennis net and a goal. The disks are turned from hardwood, making the bottom somewhat flatter than the top. Different colored disks are allotted to different players. Smooth the disk and give it a spar varnish or wax finish. The object is to skip the disk over the net into the boat

If you like a little more adventure you

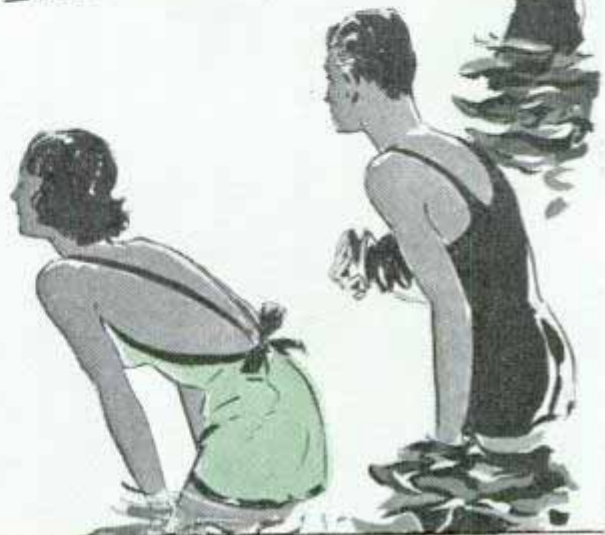
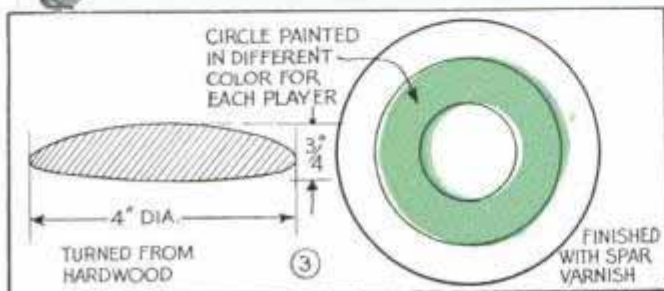
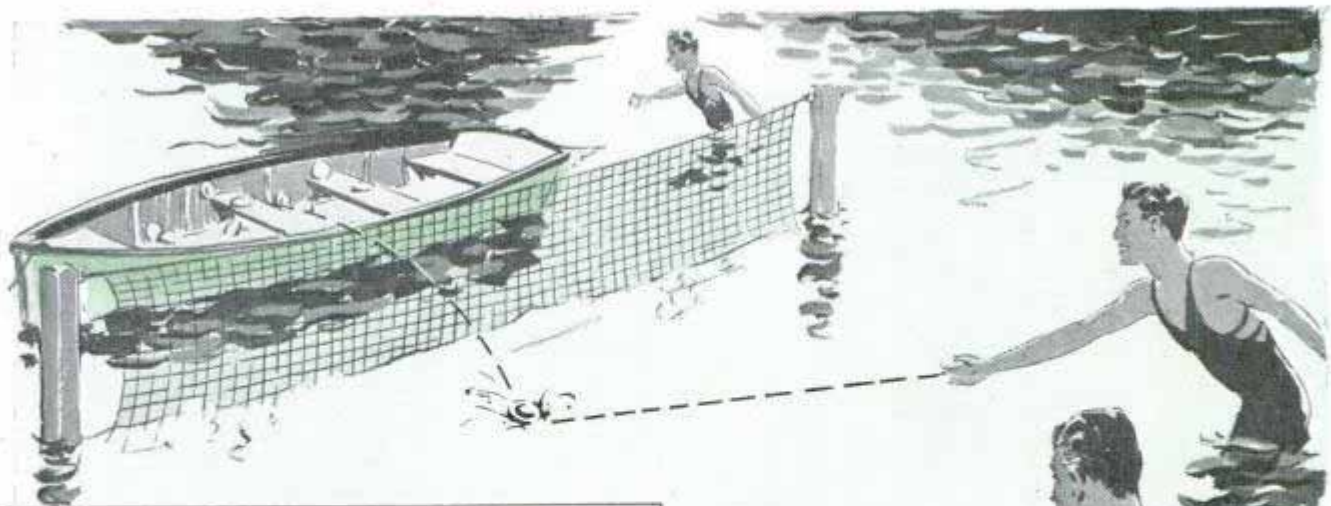

SPORTS

might try the "Sea Skis" detailed in Fig. 4. Two pontoons, linked in such a way that they are always parallel, enable one to "walk" about on smooth water.

Should you go in for log rolling, Fig. 5, you had best be prepared to swim a good share of the time. If you're an amateur at it, either you or someone else will have a lot of fun while you are learning. An artificial log can be made of a round galvanized tank covered with a wooden shell of battens bound with iron straps, as shown. Put the filler cap in the end so that buoyancy can be regulated by filling the tank with water. The log should float about three-quarters submerged. The tank must have three or more baffles inside to prevent the water ballast shifting too quickly. A satisfactory log also can be made by covering three or four Ford model-T gas tanks with battens and canvas. In this arrangement the water will need to be put in first and the tanks permanently sealed.

Another novelty is the "Tampa Tractor" detailed in Fig. 6, simply a light surfboard with a paddle wheel in front and a rudder which you control with your feet. When finished, the entire job should be painted or varnished carefully to prevent moisture

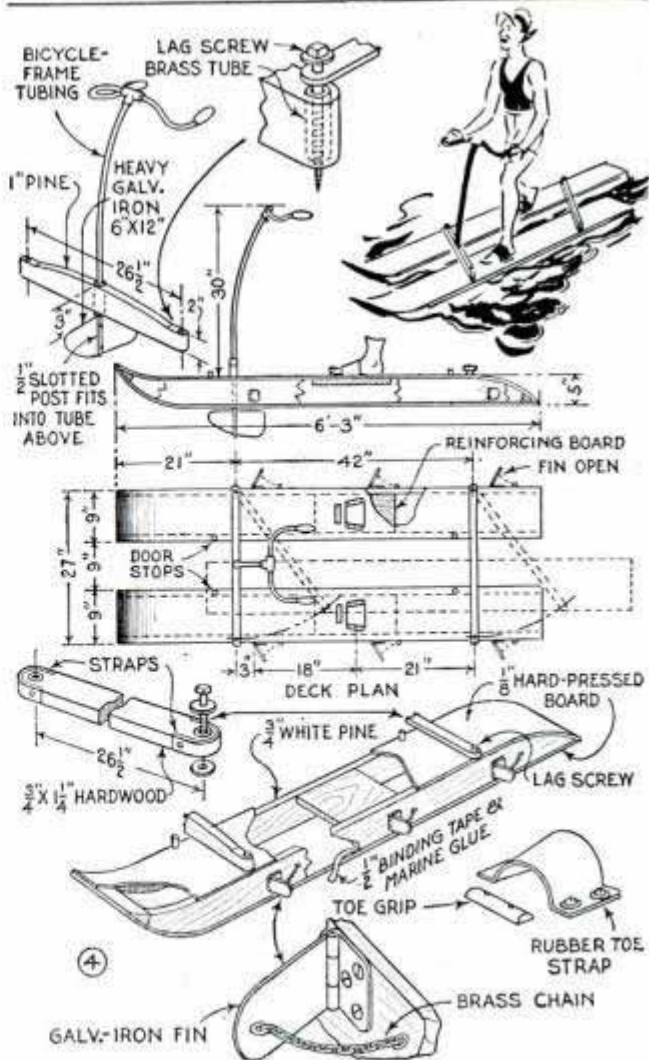

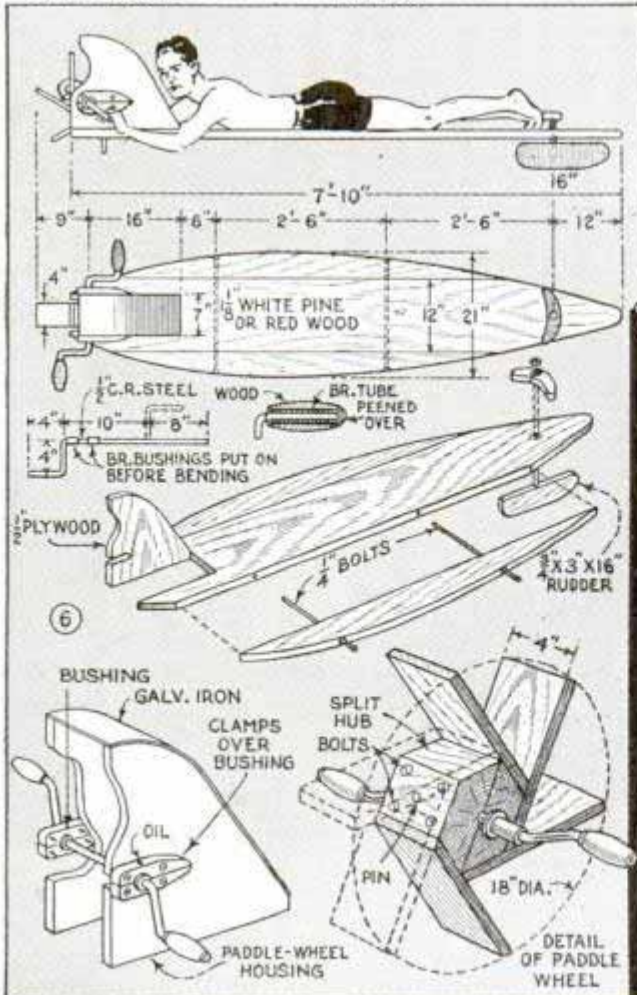

from getting in and increasing its weight.

And now a child's rowboat with a novel feature, Fig. 7. No matter how awkward the young rower may be he cannot help but make the boat go forward for the oars are made to move in a vertical plane and the hinged blade pushes the water only on the power stroke—on the return stroke the blade swings free, causing a minimum of resistance. Make the hull of two side members of light wood such as white pine or redwood, with three cross-members on the bottom and end pieces. Turn this frame upside down and lay cotton binding tape along the edges of the side boards after applying marine glue liberally. Now lay on tempered hard-pressed board 1/8 in. thick and fasten with galvanized shingle nails, staggered and about 1 in. apart. This makes a permanently water-tight joint. A keel is bolted on later. The oars are of pine, with a short piece of brass tube for a bearing on the axis or "oarlock." The fin of heavy-gauge galvanized iron swings on a bolt and rests against a stop-pin on the power stroke.

Everybody likes to fish, of course, and there are many kinds of fish including those shown in Fig. 8. Along with the varieties detailed, you add a boot or tree branch to take care of over-confident anglers. The "fish" are weighted so that they submerge with only a wire loop floating above the surface. Fishermen use the regular tackle and a small lead weight for "bait." The trick, and it's not so easy, is to

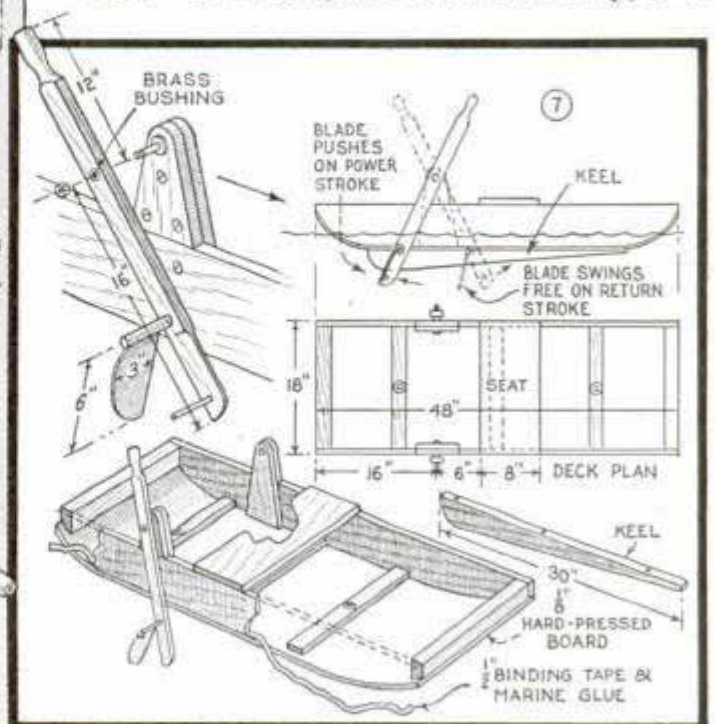

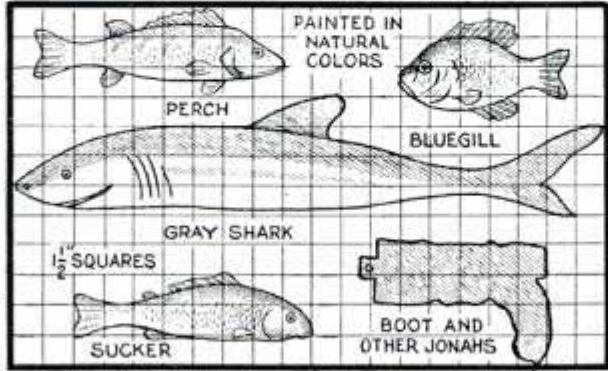
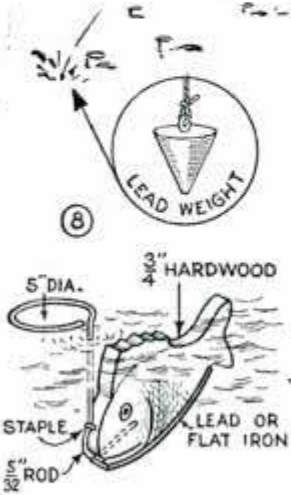
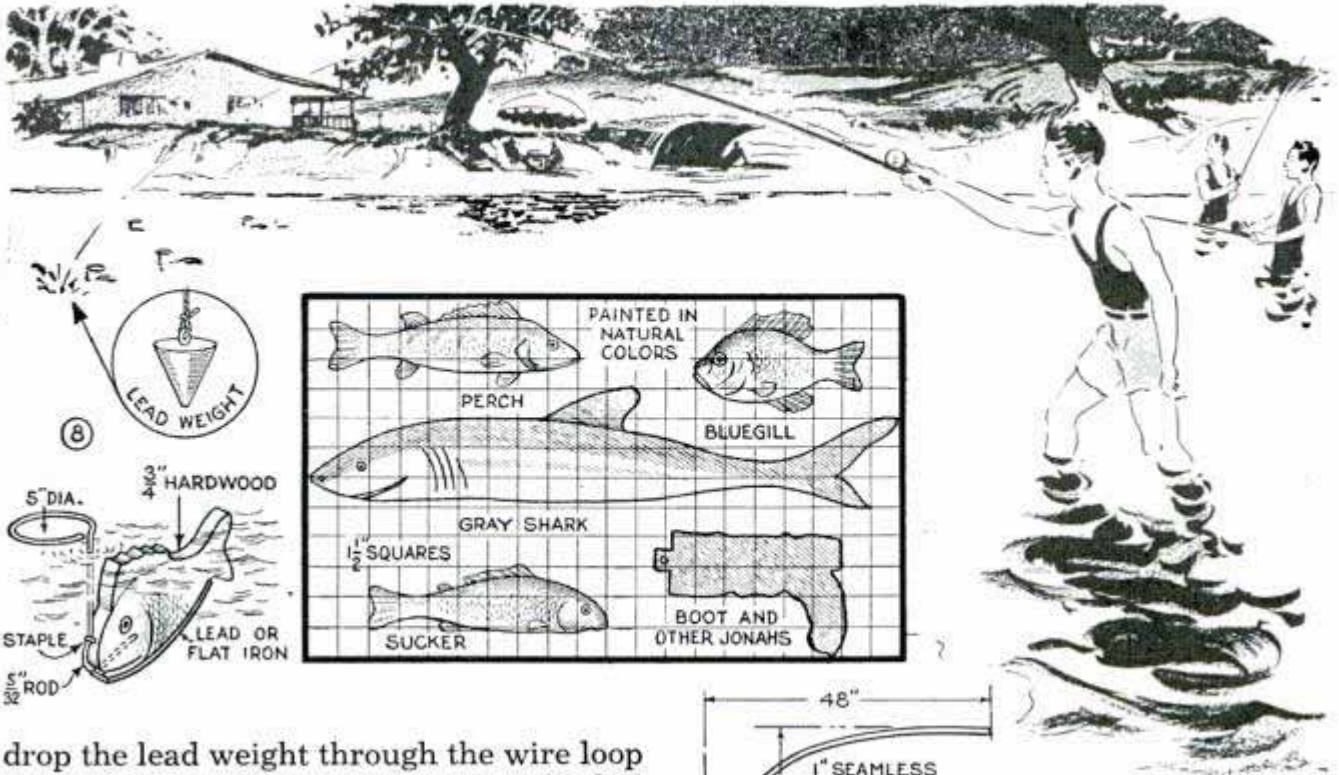

drop the lead weight through the wire loop from a distance of 20 or 30 ft. You'll find it excellent practice in plug casting. Fig. 9 details the roomy shelter you'll need between times at the beach. It's a very simple design, fully as effective as an umbrella and can be taken down easily. Lastly, there's the "turtle," made from a wash tub and a few boards, as in Fig. 10. It's easily constructed but is a most difficult affair to manage. All the floating craft described are safe if used in calm, shallow water off a sheltered beach, but don't venture out over deep, open water unless you're an expert swimmer.

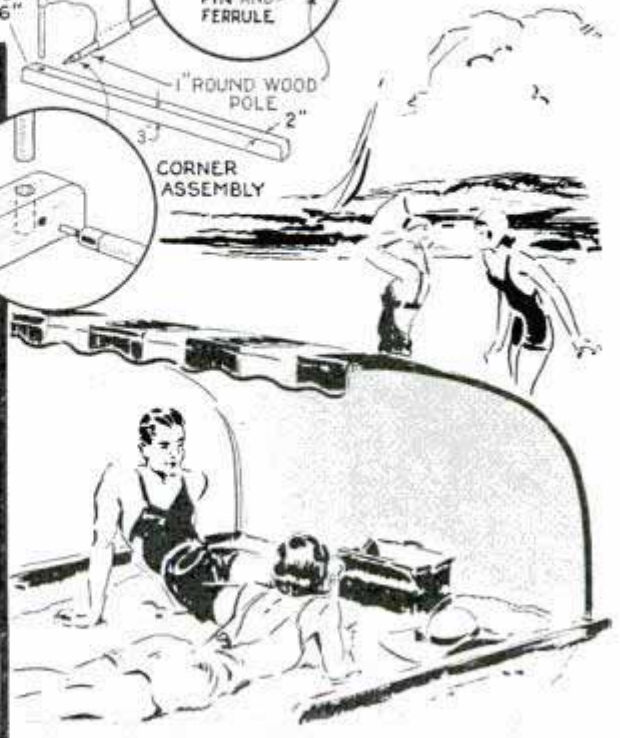
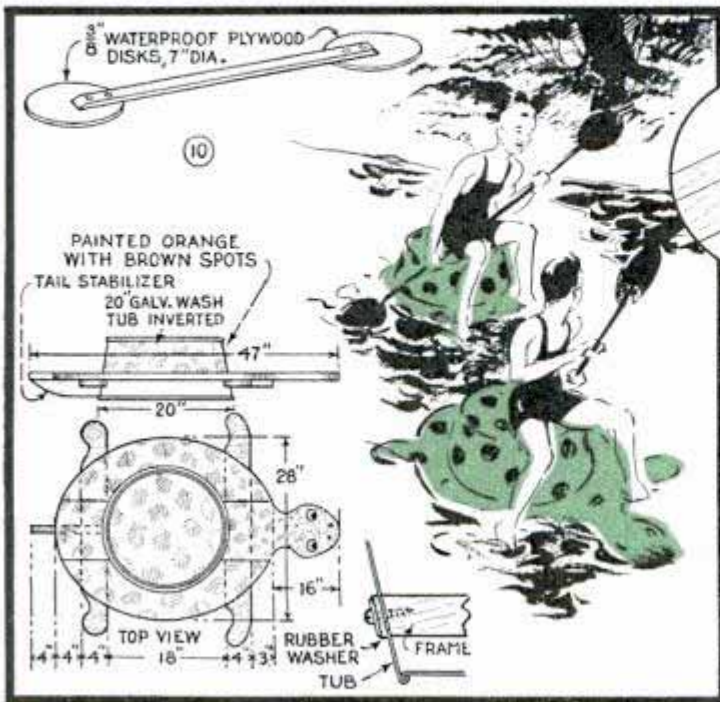
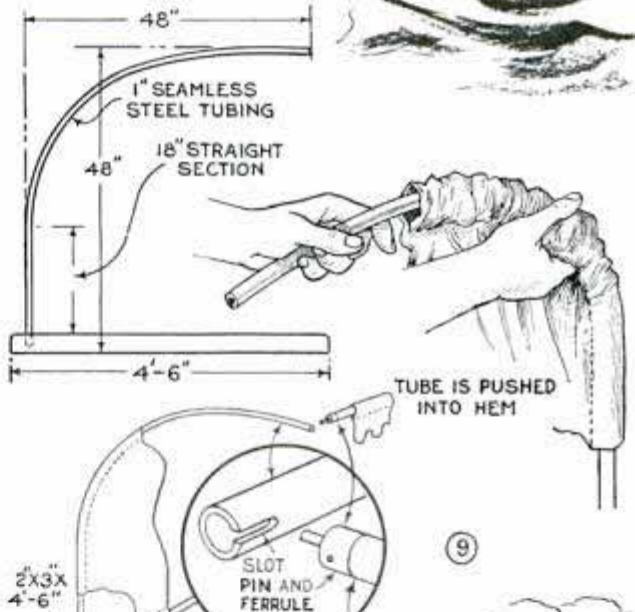

Squaring Ends of Wide Work on Circular Saw

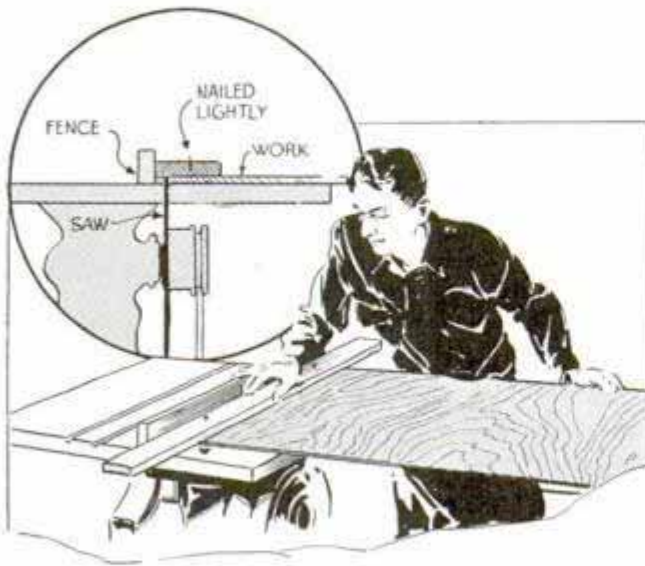

Guide nailed to edge of large work to bear against rip fence to square it on a circular saw

It's easy to square the edge of a large piece of work that cannot be held against the miter gauge of a small circular saw. Take a wood strip that is longer than the work and has one edge squared. The strip is nailed lightly to the work so that it is square with one edge, and the saw is raised to cut just through the large piece. The work is then run through the saw with the strip bearing against the ripping fence, as indicated, to serve as a guide.

—Brooks Hill, Neosho, Mo.

Metal Rods Pointed Accurately with Help of Hand Drill

You can do an accurate job of pointing metal rods on the side of a grinding wheel if the work is chucked in a hand or

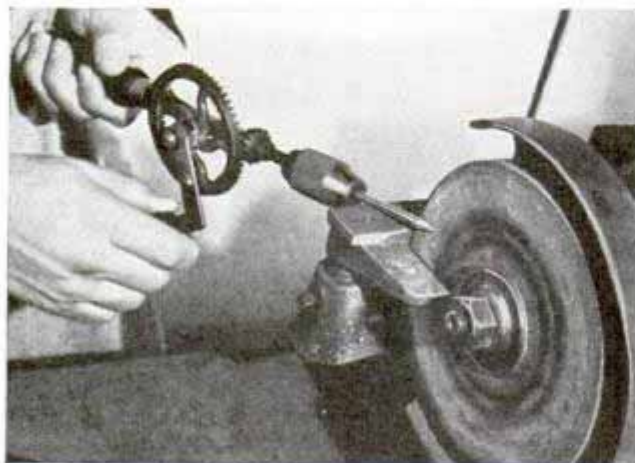

Metal rod rotated against grinding wheel with hand drill to get a point that is quite uniform

breast drill. The drill enables you to hold the work steady against the wheel and rotate it rapidly to get a uniform point.

Suction Cup Aids in Opening Can of Fruit or Vegetables

When using a can opener of the type that revolves around the can as it cuts, the top, when completely cut off, drops into the contents and has to be fished out with a fork.

To avoid this, use a small rubber suction cup as a handle for the top. When the cutter has nearly completed the circuit of the top, grasp the cup with the left hand and hold it until the top has been severed.

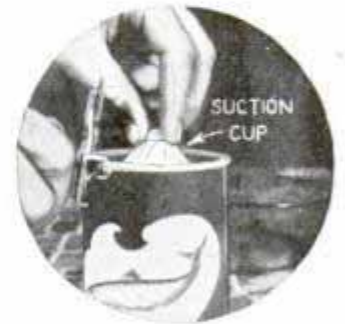

Tabs under Rim of Tin Funnel Hold Strainer Cloth



The problem of holding a cloth when liquids are to be strained through it is solved as indicated. The cloth is placed over the funnel, the sides caught under the points, after which the

center of the cloth is pressed down with one hand, tightening the cloth under each point.—H. Paisley, Edmonton, Alta., Can.

Emergency Shoestring Clasp

If you lose a clasp from the end of a shoestring, take the clamp from the bottom of an old toothpaste tube and clinch it around the string.

A few light taps with a hammer will point the end of the clamp so that it will pass through the shoe eyes easily.

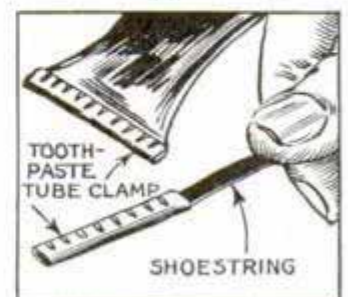

MIDGET TRAILERS



Here are two simple designs of midget trailers that can be towed by foot-operated juvenile autos or carts. The one at the right is exceptionally easy to build. Sides, seat and floor are plywood while the front and back may be sheet metal. With circular holes in the sides, and the latter cut to a pleasing contour as shown, the thing has a decided streamline effect. Still, there's no top and the rider seems to project through the roof. For the more advanced young "trailerites" the "covered wagon," shown below, may be preferred as it more closely simulates the real thing in that it has a roof and a hinged door through which riders have access to the interior. This one, also, is built mostly of plywood on suitable framing. In both cases a pair of coaster-wagon wheels, preferably of the pneumatic-tire type, are used for comfortable riding

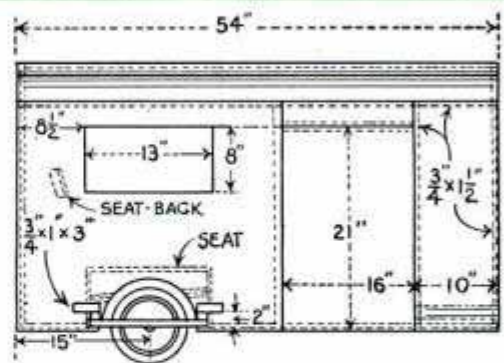
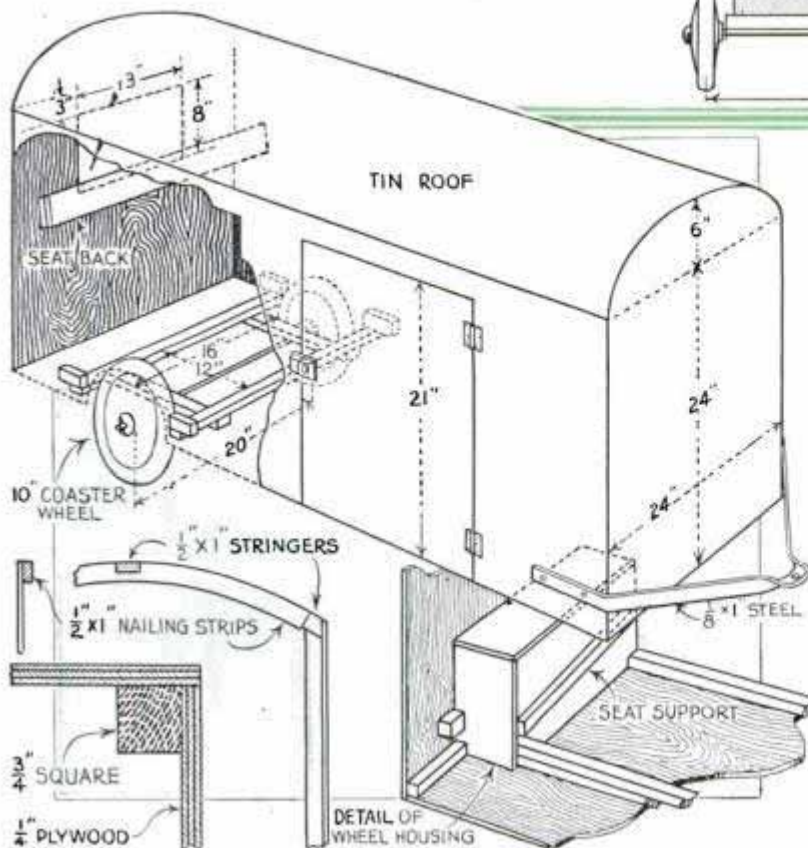
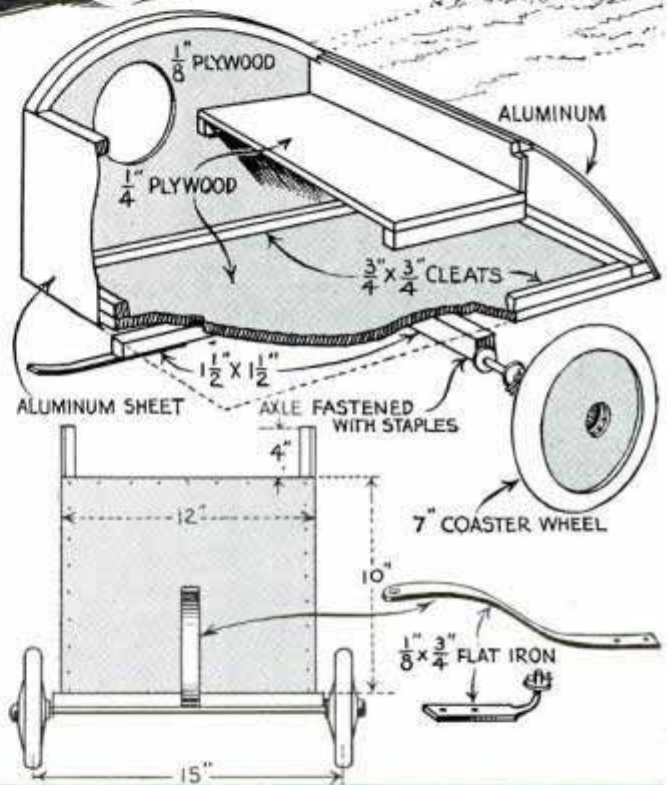

After you saw out the ends, flooring and sides, the first step in construction is to attach the nailing strips to the ends, placing them flush with the edges and reaching all the way to the bottom. In making joints use casein glue in conjunction with 3/4-in. wire nails or wood screws, the latter being preferred. The floor is in two parts, the section where the wheels are located being left open

Disk Sander Has Two Abrasives for Roughing and Finishing

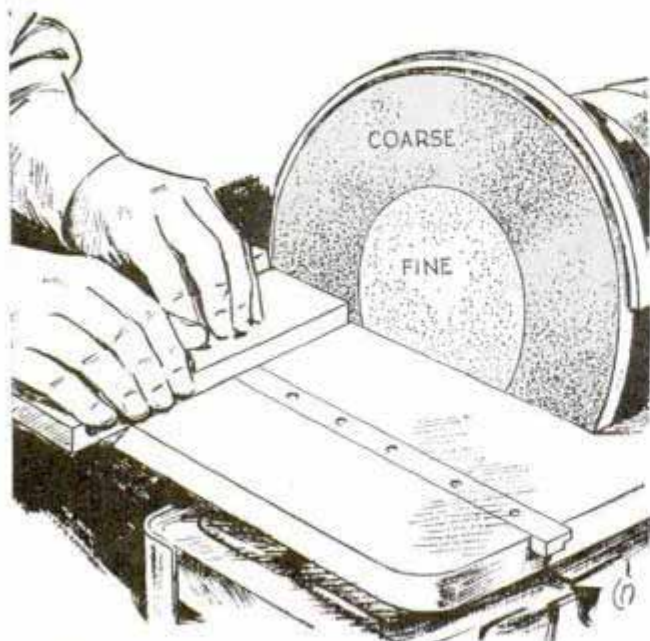

Small articles are rough sanded on the outer part of the disk and finished on the inner part

Time can be saved in finishing small objects of plastic, wood or metal if the plate of a disk sander is fitted with two abrasive disks of different grits. On the average 12-in. plate, the inner abrasive disk would measure about 6½ in. in diameter. There is no waste in abrasive papers as the unused portions of the two disks can be fitted after the first set has worn out. Best results are obtained, however, if the finer abrasive is mounted in the center. The disks can be cut easily by scoring on the back side with a pair of sharp dividers.

Culvert Edges Plainly Marked

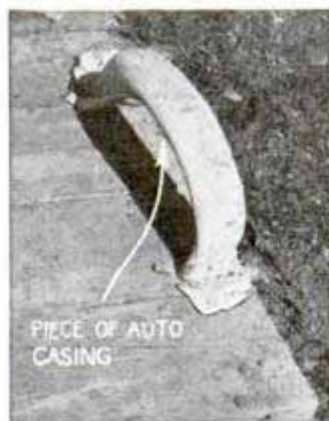

PIECE OF AUTO CASING

These simple guards for the end of a culvert have been found practical for a number of years. Slightly oxidized and whitish, they are quickly seen day or night. Each guard consists of about one-third of a small auto casing, the beads being removed back 2 or 3 in. from the ends so that the latter can be flattened and nailed to the culvert. Such guards are worth-while if for no other

reason than to prevent accidentally stepping or driving the car off the ends when turning into the drive from the highway. If black rubber is used the guards should be given a coat of white paint periodically.

Glare Shields for Sun Glasses

To prevent side glare when wearing colored glasses on excessively bright days, run the temples of the glasses through rectangular strips of dark paper or cloth as indicated. Make the strips about an inch wide.



CLOTH OR PAPER

Bottle Rack Leaves Hand Free

Bottles can't tumble off this rack because the caps are screwed firmly to the board. When it is necessary to pour out some of the contents of a bottle, it may be

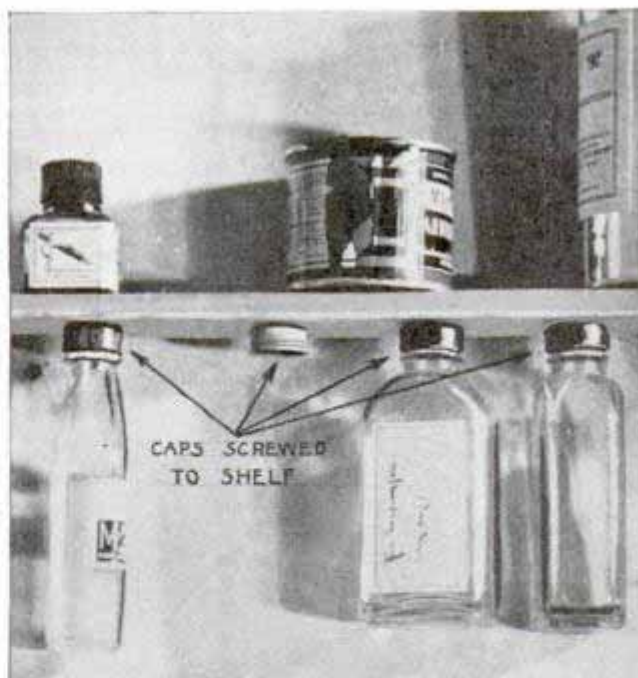

Bottles can't fall off this rack because their caps are screwed to it

unscrewed and replaced with one hand. Two screws through each cap hold it firmly and prevent turning. If air must be excluded from the contents of the bottles, put thin, rubber washers under the screw heads and draw them up tightly.

Modern Porch Furniture from Old Car Parts

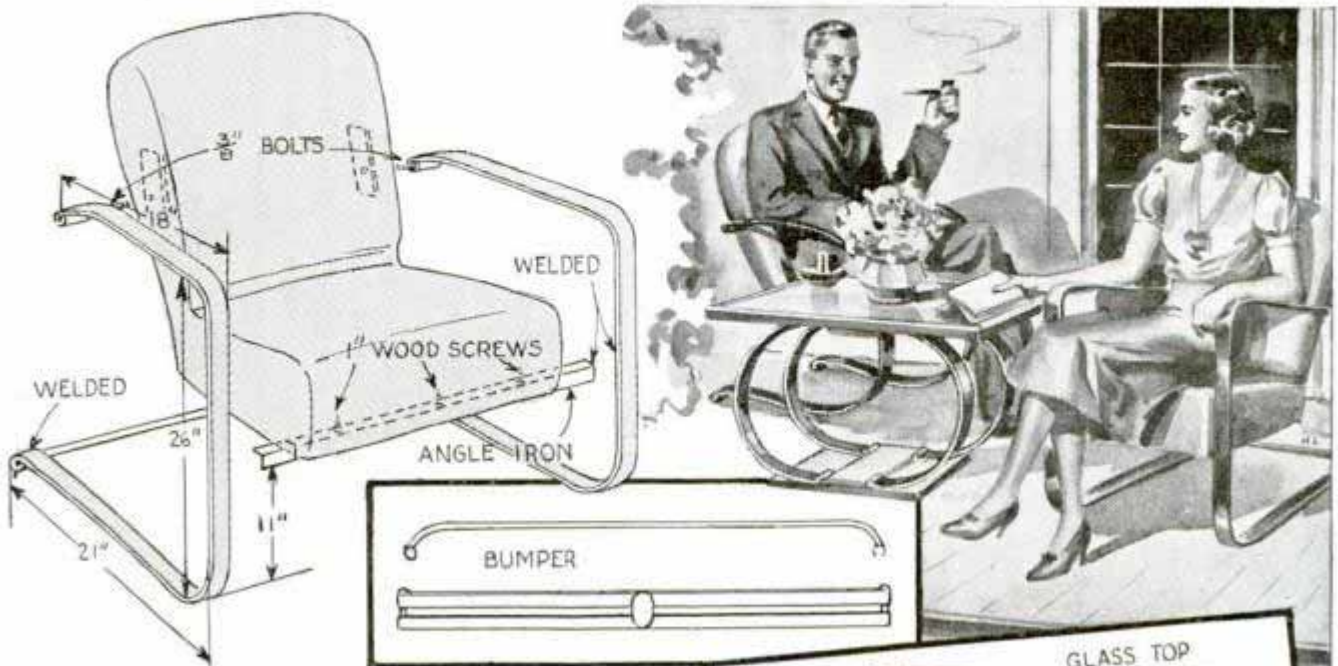

You can have a decorative table and chairs on your porch for the price of two old auto seats, three double-bar bumpers of the type shown, and a few hours of your spare time. To assemble the table, take one bumper apart, cut the bars in two and then bend them to the shape indicated, using a heavy wood block nailed to a plank and faced with sheet metal as a former. Before bending the bars, they must be heated to a cherry red where the bends are to be made. They can be re-tempered by again heating to a cherry red, allowing them to cool until the red color disappears and then plunging them into a tub of cold water. The base and table top are wood panels with the bars screwed to them, the top being covered with plate glass, which is held in place with aluminum strips around the edge of the table. One bumper is required for the two legs of each chair, the bars being heated and bent to the shape and dimensions shown, and then re-tempered. The type of seat used will determine to some extent the method of fastening it between the legs. In the original, the front was screwed to a length of angle iron, which was then welded to the legs. The metal frame of the seat back was drilled and tapped for bolts, which were run through the eyes of the bumper bars. An iron rod is welded into the eyes at the floor ends of the legs to tie them together.

—Dallas Zollinger, Providence, Utah.

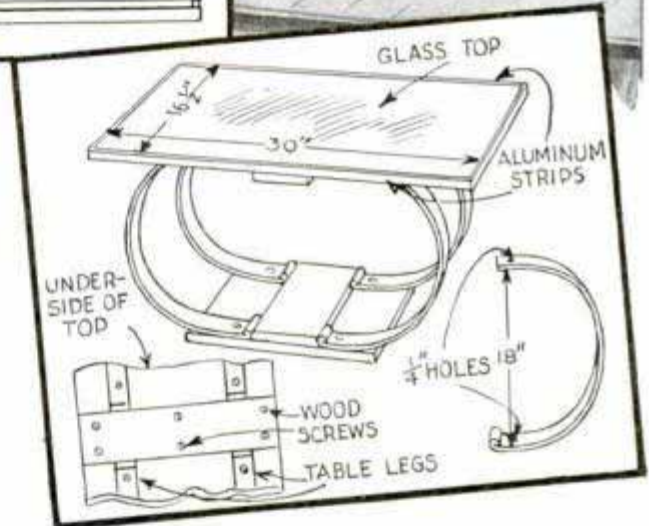

Leg Slip-Overs on Rubber Boots Keep Out Weed Seeds

Campers and fishermen who wear rubber boots through brush and tall weeds are often annoyed by having bits of broken twigs and weed seeds drop into the open boot tops.

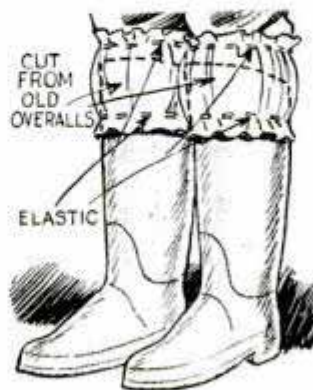

To avoid this, cut two sections from the legs of a pair of discarded duck trousers or overalls, hem the top and bottom and

thread a stout elastic through them. Then slip these over the boots. They will repay you many times for the little time and trouble necessary for their construction.

This PLAYHOUSE

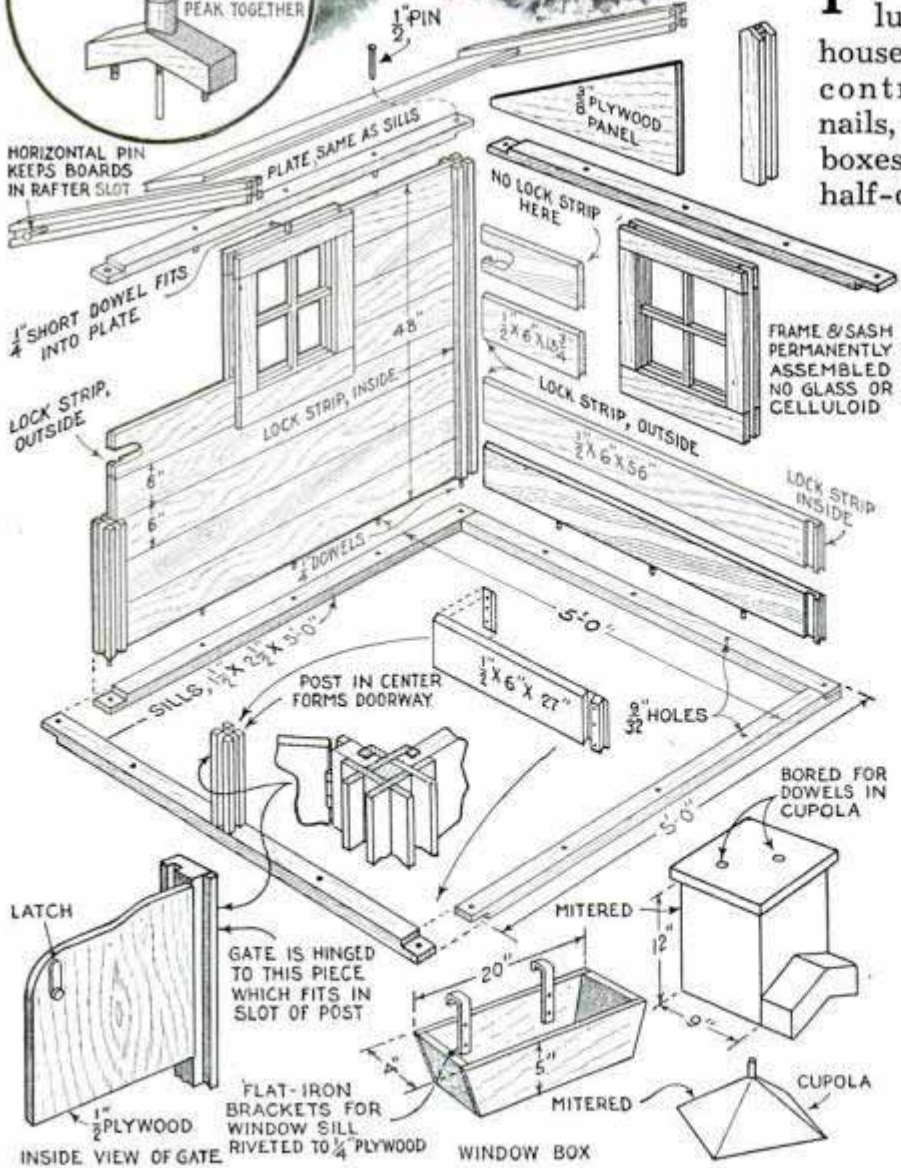
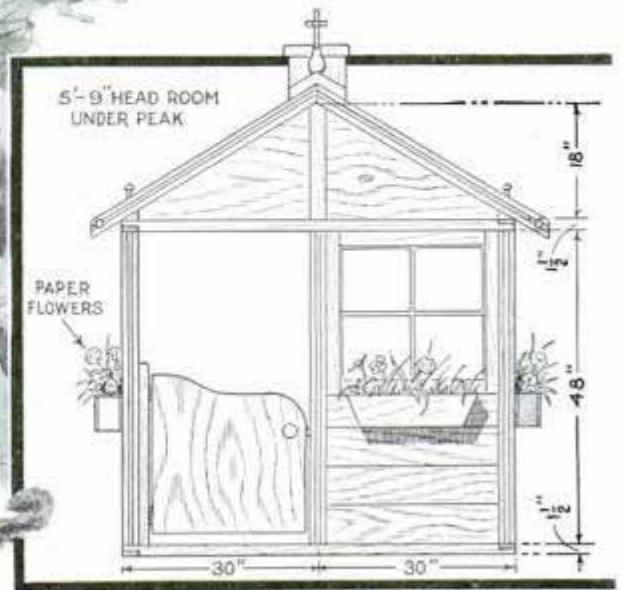
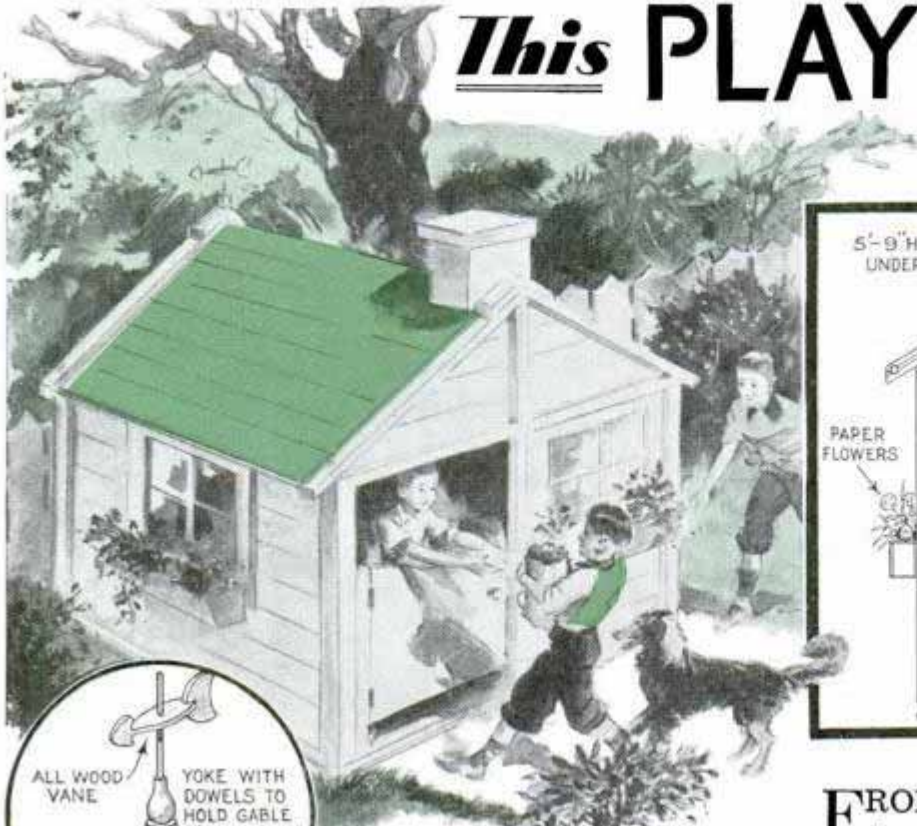

FROM a pile of specially cut lumber this trim little playhouse can be erected by young contractors without the use of nails, screws or tools. The window boxes with artificial flowers, the half-door, the weather vane all add to its attractive appearance.

Boards fitted with hardwood strips forming slots on the ends slide into grooves in corner posts and rafters, being held by a corresponding locking-strip as in the details. These corner posts are built up of $\frac{3}{8}$ -in. pine around a square core, assembled with finishing nails and casein glue. About $\frac{1}{16}$ in. clearance is allowed in the grooves for the siding, making the assembling easy.

The rafters are built up similar to the corner posts. Sills and plates are bored for dowels which are inserted in the lower siding boards. Note that the sills lap at the ends and are identical with the plates. Siding and roof

is assembled without nails

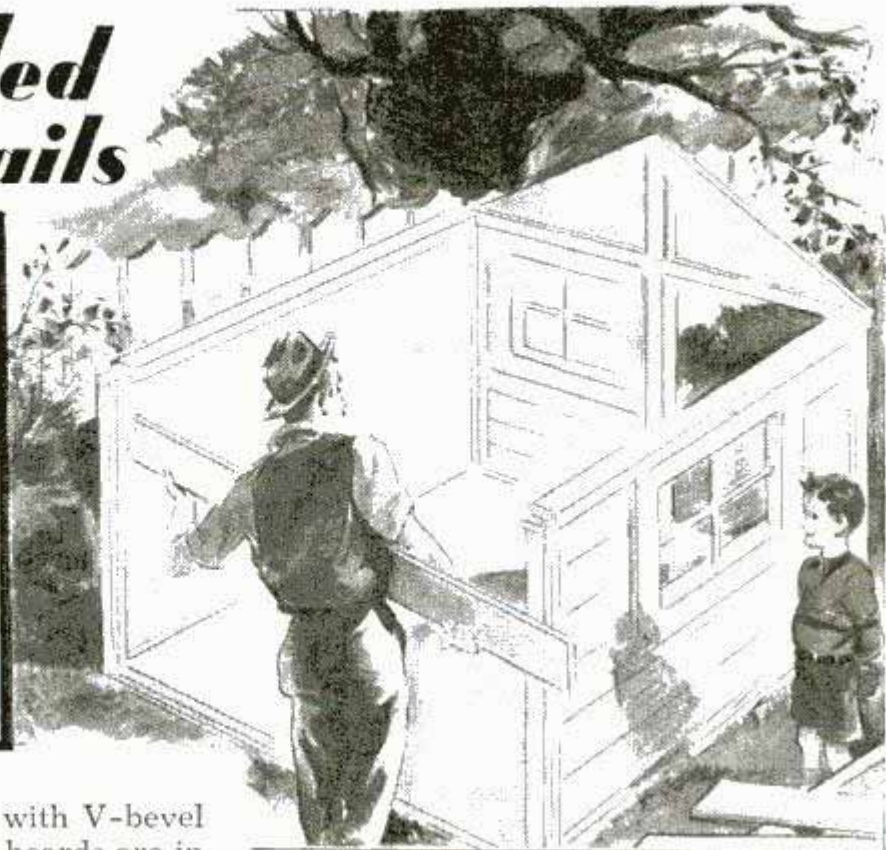
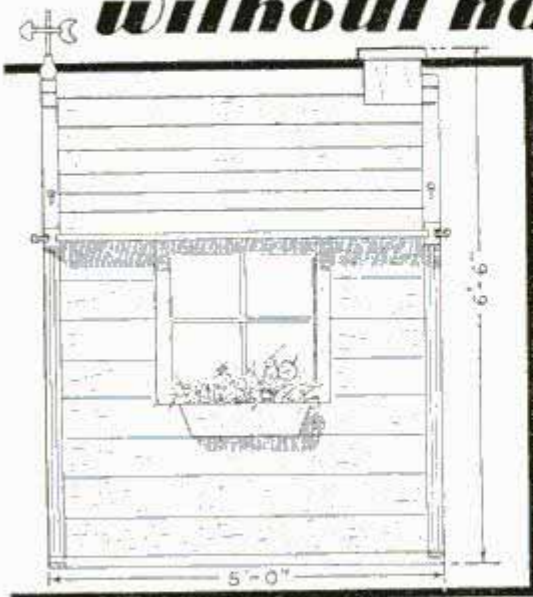

boards are $\frac{1}{2}$ by 6-in. pine, with V-bevel and groove as shown. These boards are in three lengths—for the full width of the structure, for half-widths as at the side of the door, and the short ones to go alongside the windows.

The peak of the gable is held together with a wooden yoke, which straddles the ends of the rafters. Two of these yokes are required. Window boxes made of $\frac{1}{4}$ -in. plywood are supported by two flat-iron brackets as shown. The half-door or gate is hinged to a piece which slides down in the slot of the corner post and is hung to swing out. A wooden latch, as shown, fits into the slot of the other door post.

Window frames are grooved at the sides and across the bottom to fit over the siding, and at the top a short dowel is set into a hole bored in the plate. The central framework with the mullions is of $\frac{9}{16}$ -in. material while the outside framing is of $\frac{3}{8}$ -in. stock. No glass or celluloid panes are used. Study of the details will show that the design can be changed easily. For example, you can make duplicate parts for two structures, join these end to end with a special beam under the central rafters and you have a schoolhouse. In the original design the parts were left unpainted, as the young builder usually likes to work with new boards. Of course, if the house is to be erected outdoors and exposed to wet weather, it should be varnished or painted.

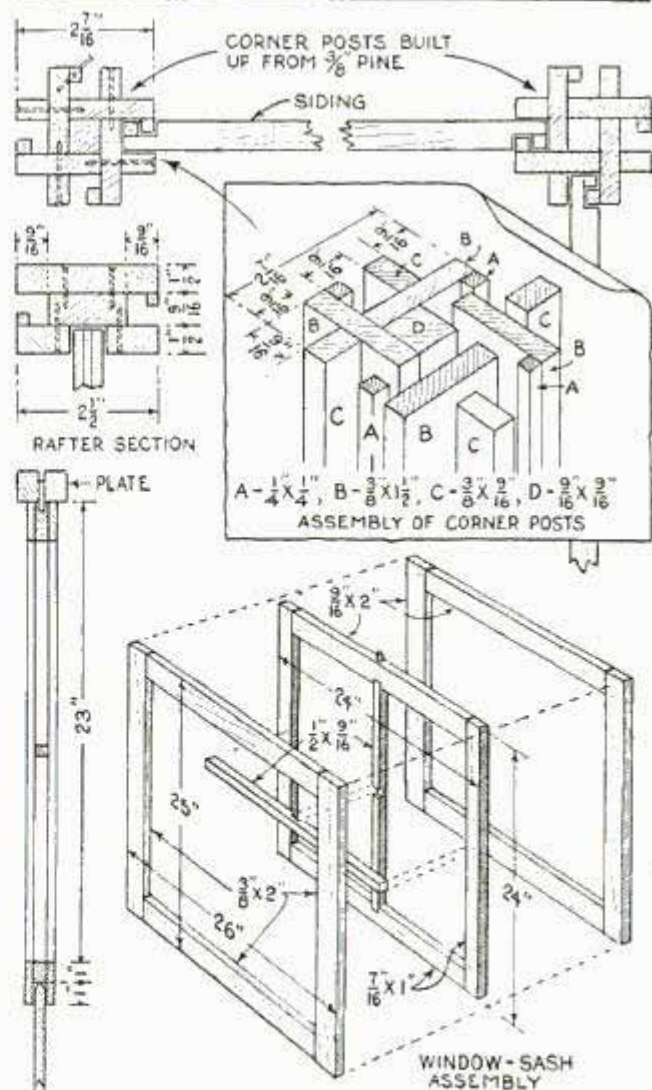

Ends of Square Work Surfaced Quickly in Jig

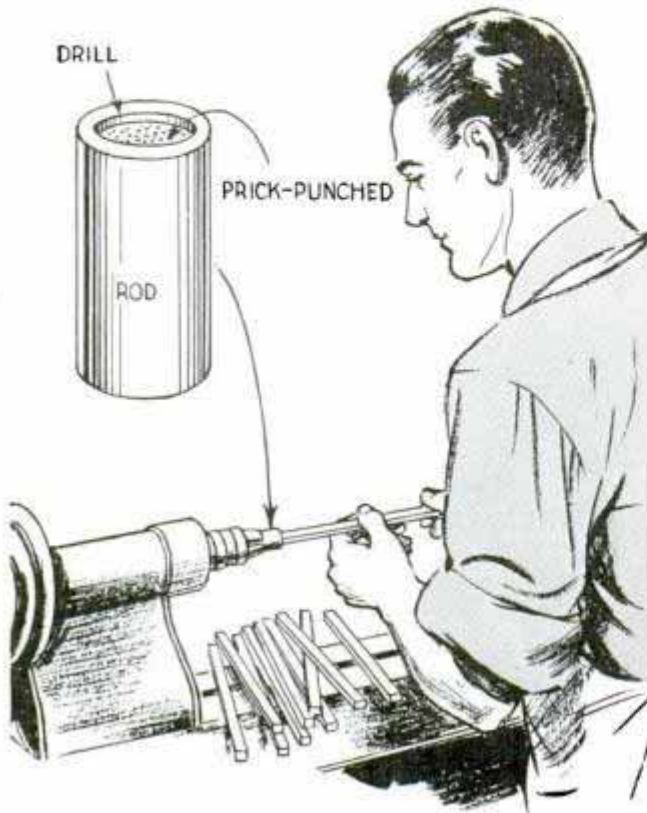

Ends of small square work rapidly finished with this jig which is rotated in a lathe

On a job of making up a number of small square sticks that had to be surfaced on one end, the work was done rapidly in a lathe with the simple jig shown, which proved better than sanding. The jig consists of a short piece of iron rod with a shallow 1/2-in. hole drilled in one end. The bottom of the hole was prick-punched to make it rough, after which it was chucked in the lathe, rotated rapidly and the ends of the work pushed into it as indicated.

Tennis Net of Chicken Wire Lasts Indefinitely

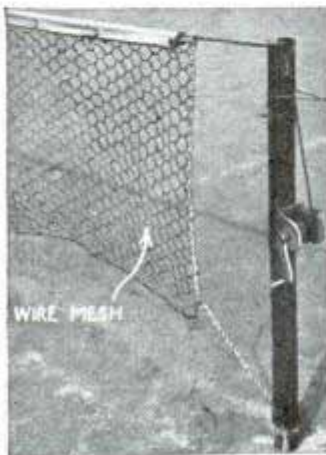

The park department of a mid-western city has reduced costs on tennis courts by substituting regular chicken wire for regulation nets. The wire is tightened occasionally. It does not shrink nor stretch with

changing weather and lasts indefinitely. The photo shows the type of pipe post with pulley and ratchet to support the wire, which is painted and then padded along the top edge with canvas.

Padded Feet on Small Boxes from Thumbtacks

Padded feet on small fancy boxes and other wooden objects are made easily from thumbtacks whose heads are covered with two small rubber bands cut from thin rubber tubing. Stretch the bands over the heads of the tacks, letting the points pierce the bands to hold them in place.



Modern-Furniture Drawer Pulls from Old Auto Pistons

Drawer pulls that go well with modern furniture can be had by sawing off the tops of auto pistons. The top is cut into three parts as indicated in the upper left-hand detail. After this has been done the pieces

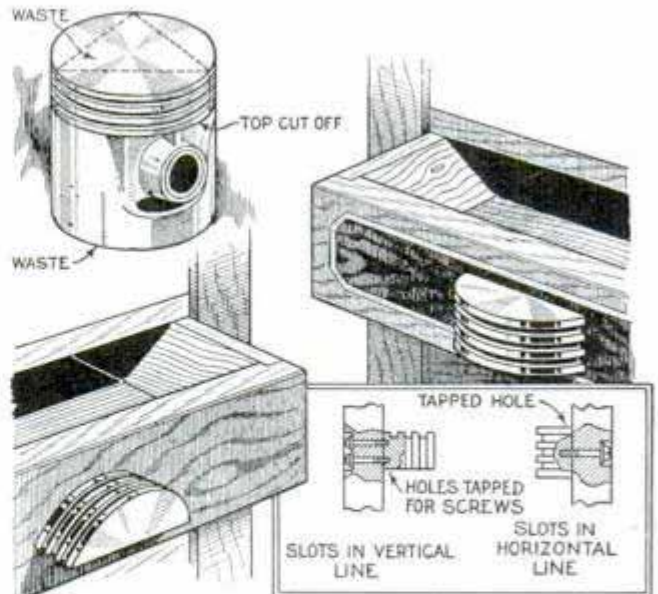

Ring groove portion of old auto piston provides modern drawer pulls when cut and given a high polish

are polished highly and drilled and tapped for attachment to the drawers with screws. The pulls can be mounted with the slots running either vertically or horizontally.

Umbrella Garden Trellis Has Luncheon Table

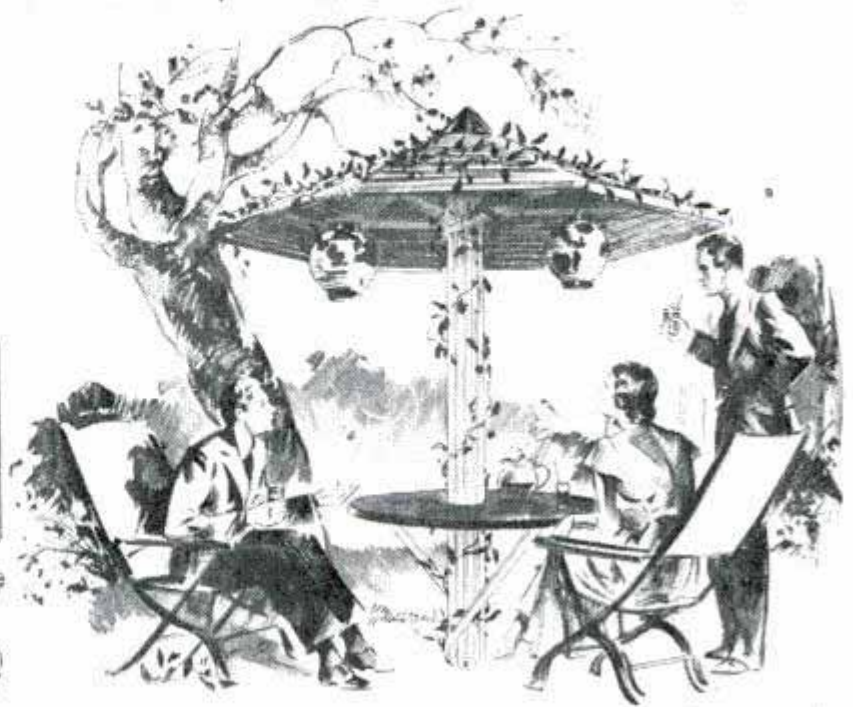
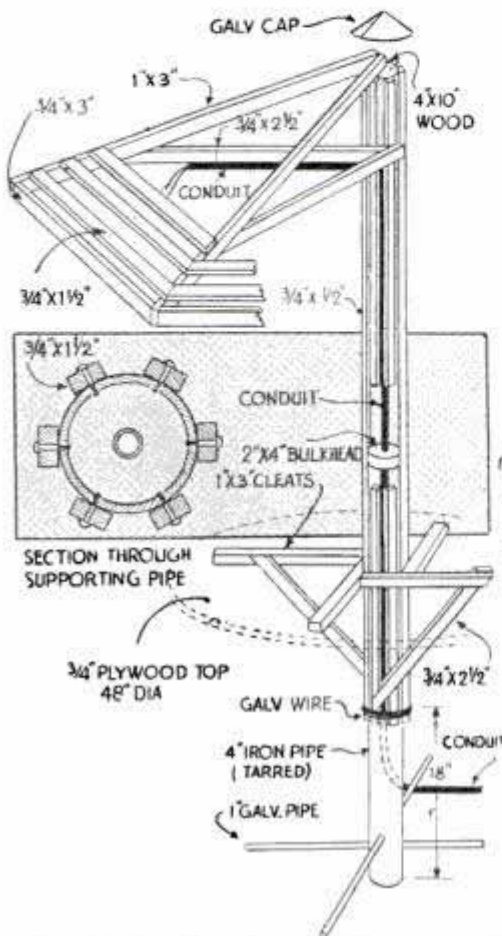

Built in the form of an umbrella, this novel garden trellis is provided with lights and a table top, and when covered with a vine, will make you feel more comfortable under it than a fabric umbrella would, because of air circulation. An iron pipe 4 in. in diameter forms the support and will last indefinitely when coated with tar paint. Crossarms of pipe underground prevent it from tilting, even in soft earth. Six evenly spaced holes drilled and tapped near the upper end, take screws, which hold upright battens that sheath the pipe. Before

these are installed, the column should be assembled with bulkheads and a wood cylinder in the top. Cleats and diagonal braces keep the table top of water-resistant plywood rigid. Galvanized screws and casein glue are used in assembly, and when completed the table should be painted, special attention being given to the edges to further prevent moisture seepage. The conduit for light wires should be installed underground at the beginning of construction, and in the column as you go along. Build the awning as shown, spacing the slats their own width apart, and capping the peak with galvanized sheet iron for protection against rain. To assure shade the first season, morning-glories can be planted while slower-growing vines are becoming established.

Shield on Photoflash Lamp Avoids Injury if Bulb Bursts

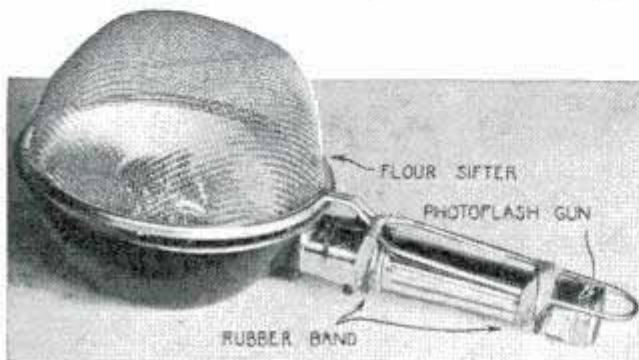

Should a photoflash bulb accidentally burst, this guard will prevent injury from flying glass

As a protection against possible bursting of a photoflash bulb, I often use a flour sifter over it as shown. Although bursting of a bulb does not happen often, I feel better when using this guard, especially when taking shots of children and babies at close range. By scattering the light rays, the screen also acts as a diffuser, resulting in a slight reduction of light intensity, which is compensated for by opening the camera lens one more stop.

—Arthur Trauffer, Davenport, Iowa.

Pipe Dropped into Deep Well Quickly "Fished" Out



Long length of pipe dropped into deep well quickly removed with this "fishing" tool

Having the misfortune to drop a 100-ft. length of 2½-in. pipe into a deep, artesian well, it was removed in one hour with this tool. It consists of a length of heavy flat iron folded in the center to provide two legs riveted together with spacers between them, width of the spacing being determined by the inside diameter of the pipe. A pointed dog pivoted between the legs of the iron with the pointed end upward as indicated, bites into the inside surface of the pipe after the tool has been lowered into it and then pulled upward. The lower ends of the tool are pointed to simplify insertion into the pipe. Before trying to remove the pipe, it's a good idea to lower a small bucket filled with rocks to locate the top of the pipe to be removed so that you can tell at what level to work with the fishing tool.

—Walter U. Akerman, Dover, N. H.

Camera Is Supported on Chair by Altered C-Clamp

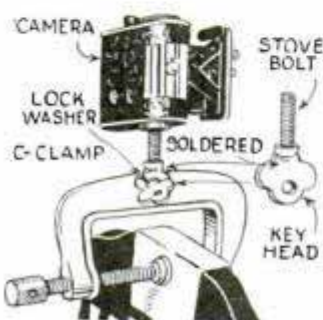

With this support, which consists of a C-clamp and two stove bolts, you can use a chair, table or other object as a substitute for a tripod to hold a small camera. Get

a small bolt that will screw into the camera socket and solder the head of a key into the slot. Then drill the clamp so that the bolt can be pivoted to it with another one fitted with a key head to provide a thumb screw, using a nut to draw it up tightly.—Dr. C. W. Clifford, Salem, Ore.

Rubber Tube over Pencil Clip Grips Pocket Tightly

If the clip of a fountain pen or automatic pencil becomes so weak that it does not hold, slip a small piece of rubber tubing over the clip as indicated in the photo. This

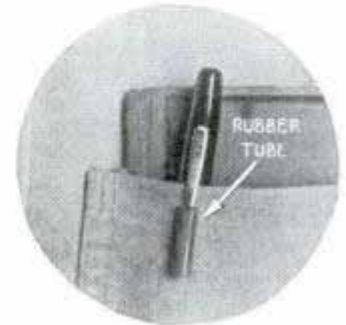

enlarges the gripping surface and provides friction so that the pen or pencil will not be dropped out of the pocket.

Corn Meal Is Good Rat Bait

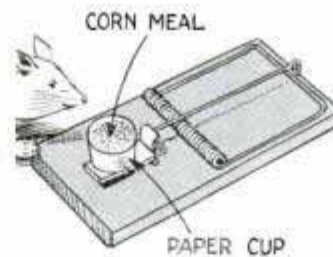

Corn meal is an excellent rat bait for traps, and is most effectively used when put in a shallow paper cup that has been fastened to the

trigger of the trap. This makes it necessary for the rat to reach up and press down on the edge of the cup.

Small Corks Removed with Screw

Amateur photographers who find that ordinary corkscrews have too coarse a thread to remove small corks from small glass vials containing developer, can use a No. 7 wood screw about 1½ in. long. A knob or handle for turning the screw is made from a piece of ½-in. round wood which is drilled to take the screw tightly.



—Sidney Pott, Victoria, B. C., Can.

"WATER BUG" a beach play boat

RESEMBLING a kayak in both appearance and construction, this canvas-covered play boat can be built by anyone—even the beginner in boatbuilding. It handles easily and will not tip over. The frames are cut from moisture-resisting plywood, Fig. 1, and assembled with the keelson and sheer battens. Note that the battens are parallel as in Fig. 4, and that the deck and bottom curves are identical in each frame as well as the transom. The frames are spaced in their relative positions along the keelson with nails that can be drawn out later, after which the sheer battens are installed temporarily. When the frames are located and squared to your satisfaction, fasten the sheer battens and keelson with 1¼-in. No. 6 brass flat-head screws, well countersunk, Fig. 2. Apply casein waterproof glue to these and all other joints, except under the canvas.

Now install deck and bottom battens with 1-in. No. 6 brass screws. Use eleven deck battens spaced uniformly. The bottom battens are butted together at the

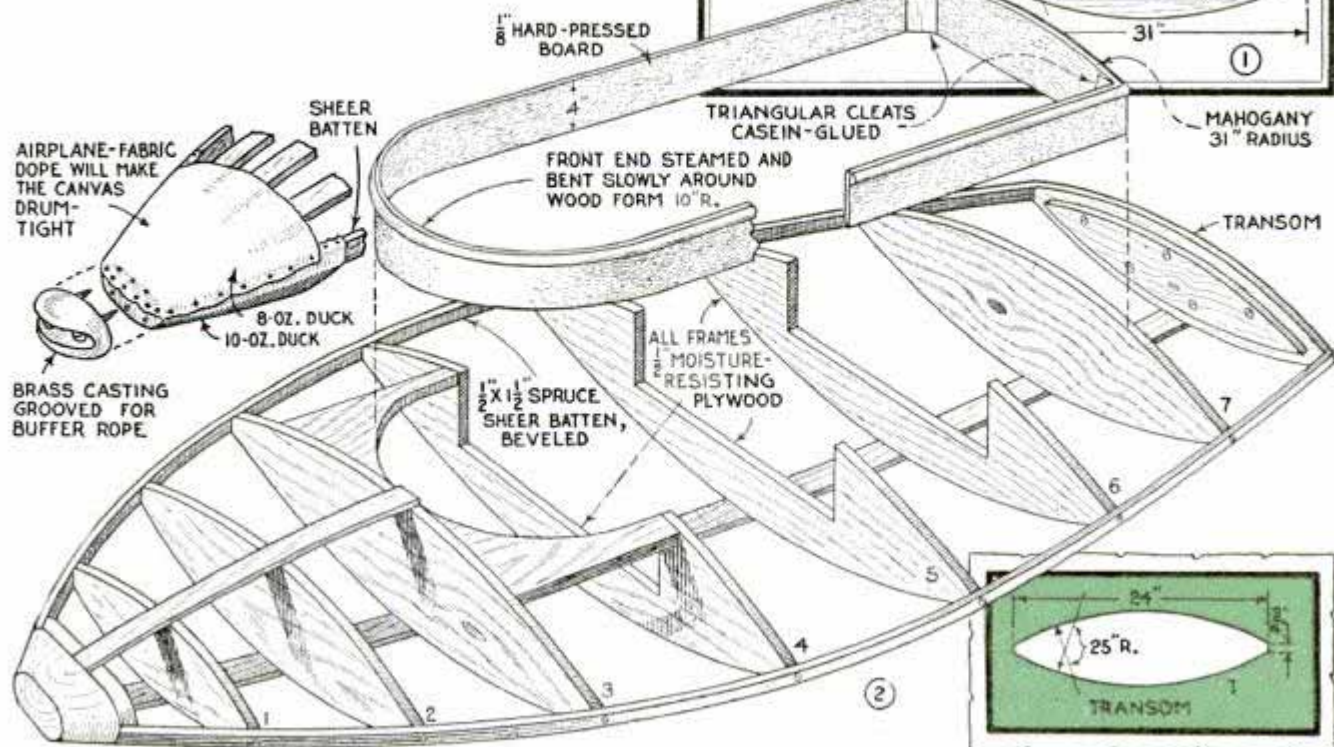
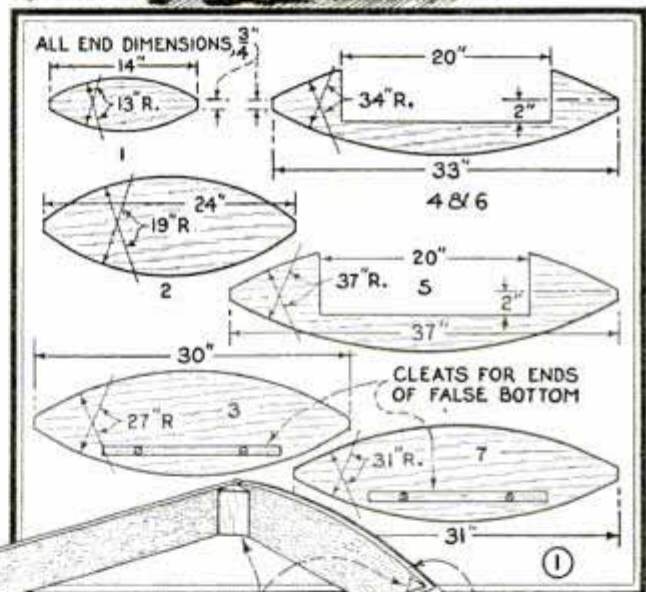
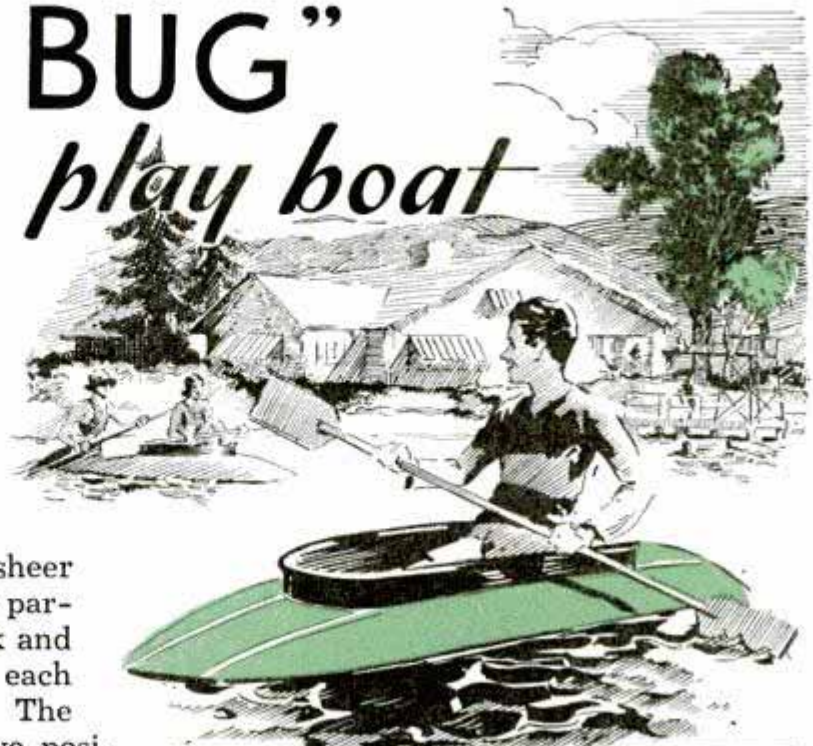

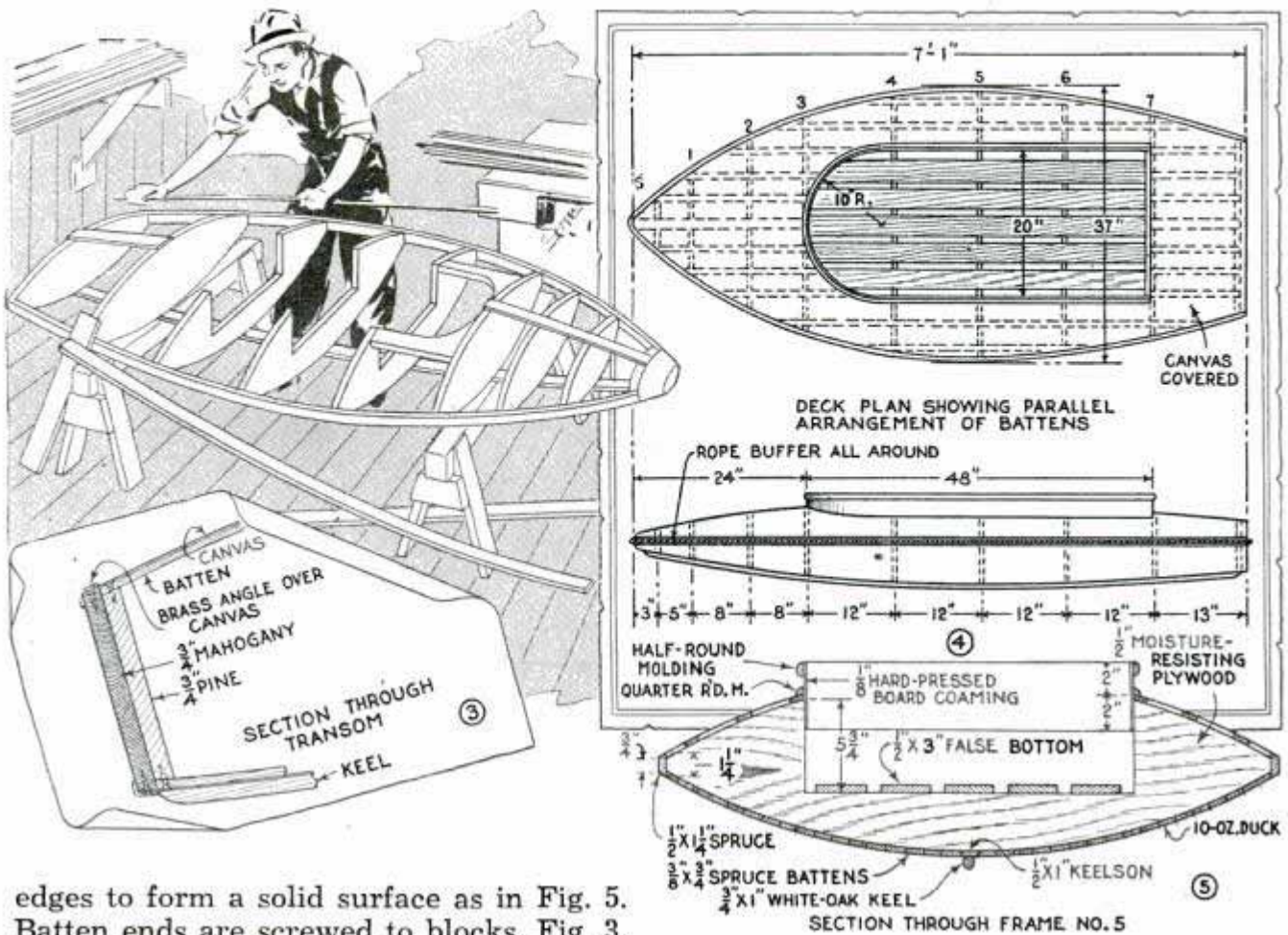

edges to form a solid surface as in Fig. 5. Batten ends are screwed to blocks, Fig. 3, so that they are flush with surfaces of stem and transom. This permits the canvas to be stretched smoothly. Before fitting the cockpit coaming, lay the bottom canvas (10-oz. duck), stretching it snugly all around and tacking along the top of the sheer batten and over the stem piece. It is also tacked over the edge of the transom. Apply marine glue along the edges of the wood, and stagger copper tacks about $\frac{1}{2}$ in. apart. The tacks are covered with a brass strip or angle, which is screwed down.

Trim away the canvas around the edge and put the deck canvas on. This laps over the sheer batten to which it is tacked after marine glue has been applied under it. Tack around the edges of the cockpit, using marine glue as before. Next, apply airplane fabric dope to deck and bottom canvas. When this is thoroughly dry the cockpit opening in the canvas can be cut out with a razor blade and the coaming fitted in place. The coaming, by the way, is a single strip of $\frac{1}{8}$ -in. hard-pressed board, which has been steamed and bent to a semicircle around a wood form. The back of the cockpit is fitted with mahogany. Molding around the top of the coam-

ing stiffens and protects the edge, and gives a finished effect.

A false bottom can be made fixed, or removable. Around the sheer batten, over the tacks, screw a hardwood strip about $\frac{3}{4}$ by $\frac{1}{4}$ in., and to this secure a rope buffer all the way around, and through the groove in the brass nosepiece. If desired, weight of the boat can be reduced considerably by sawing out some of the central area of the plywood frames; even $\frac{1}{4}$ instead of $\frac{3}{8}$ -in. batten are permissible. And to render the craft non-sinkable in case the canvas is punctured, an inflated inner tube can be put under fore and after decks. The doped canvas can be made smooth and slick by several alternate applications of paint and fine sandpaper, finishing with two coats of spar varnish.

Filling Cracks at Baseboards

If baseboards or wall molding have pulled away from a wall and cannot be renailed, fill the crack with paste wood filler mixed to the consistency of soft putty. Push it into the crack and then run the finger over the filler several times to make it smooth.

Wire Flower Basket Will Last Indefinitely

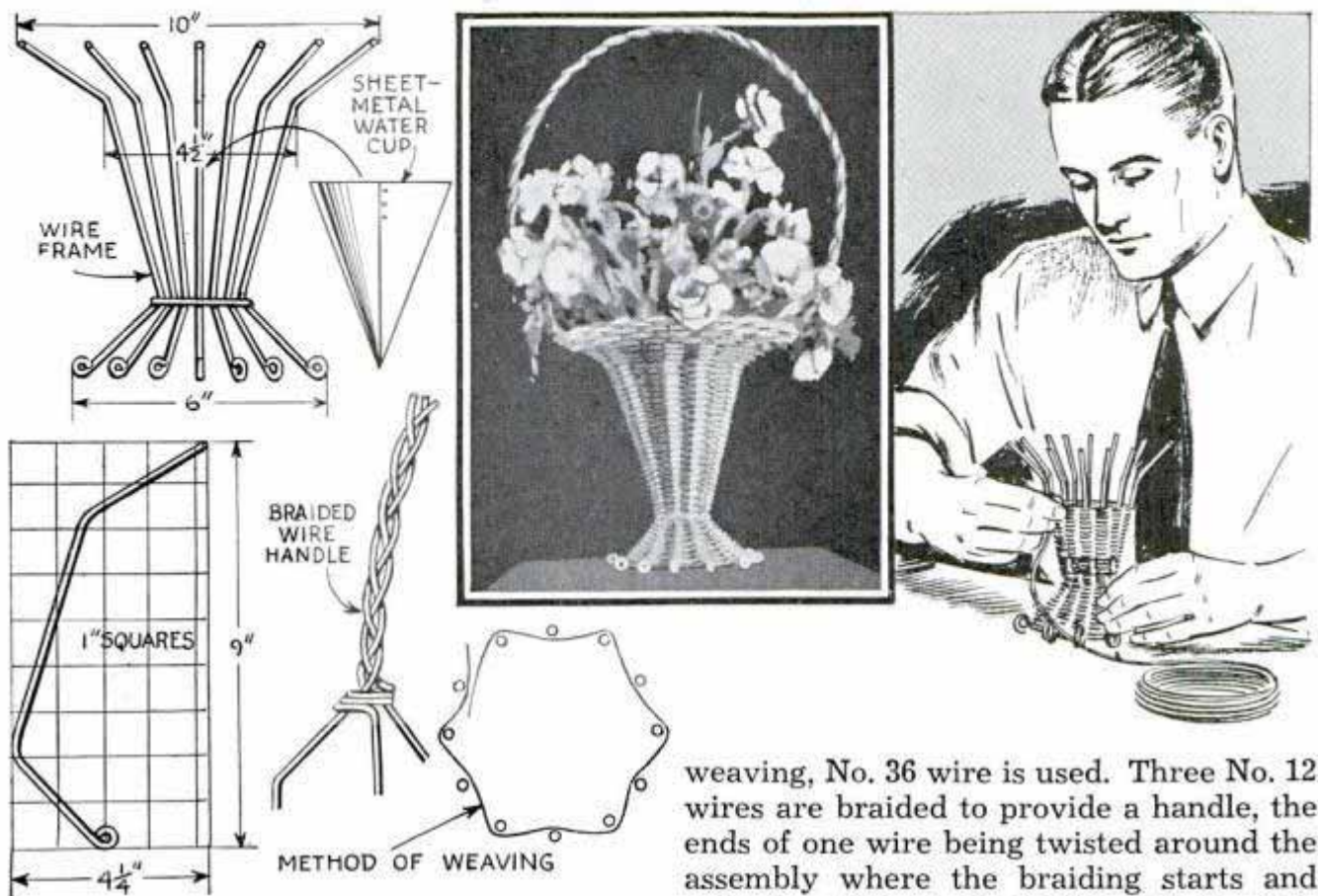

Woven from wire, this basket is easy to make and has a sheet-metal container inside to hold either cut or artificial flowers. The skeleton or frame of the basket consists of twelve lengths of No. 12 wire bent to the shape indicated in the squared detail, and soldered to the inside surface of a 2-in. wire ring near the base. For the

weaving, No. 36 wire is used. Three No. 12 wires are braided to provide a handle, the ends of one wire being twisted around the assembly where the braiding starts and ends to give a decorative effect, after which the projecting ends of the three wires are spread and soldered to three of the frame wires on opposite sides to secure the handle to the basket. The seam of the funnel-shaped container is soldered to make it watertight. The finished basket can be enameled any color.

—Harold Jackson, Kankakee, Ill.

Opening in Fence Admits People but Keeps Out Livestock

Installed in the fence around a country church, this opening allows people to walk through without bothering with a gate, but keeps out horses and cattle. Peeled cedar posts are set in two rows of three each, spacing the rows so that persons can walk between them freely.



Window Draperies Held Straight

Window draperies can be held straight by weighting them with small flat chains run through the lower hems, allowing one link to extend beyond each edge. These can be fastened over small hooks screwed into the baseboard and will prevent the draperies from blowing out the window.

Auxiliary Table on the Shaper Gives Extra Support

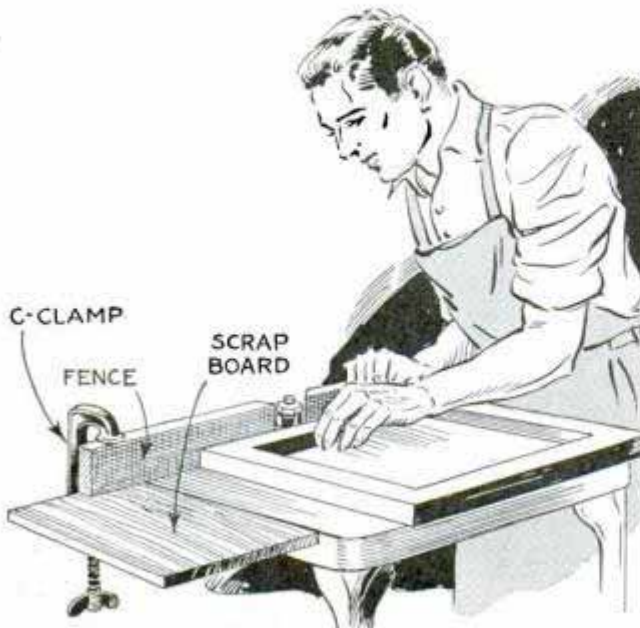

Board clamped to shaper fence flush with table top supports large work

Whenever additional table area is desired to support large work adequately while shaping it, an efficient set-up can be improvised quickly as shown. A flat board is clamped to the lower edge of the fence so that it is flush with the top of the table.

Fixture Simplifies Wire Brazing

A fixture that holds the ends of small rods or wires in alignment while soldering or brazing them can be made from a metal plate and two radio binding posts. Remove the knurled screws from the posts, and enlarge the holes through the sides slightly, unless only small wires are to be

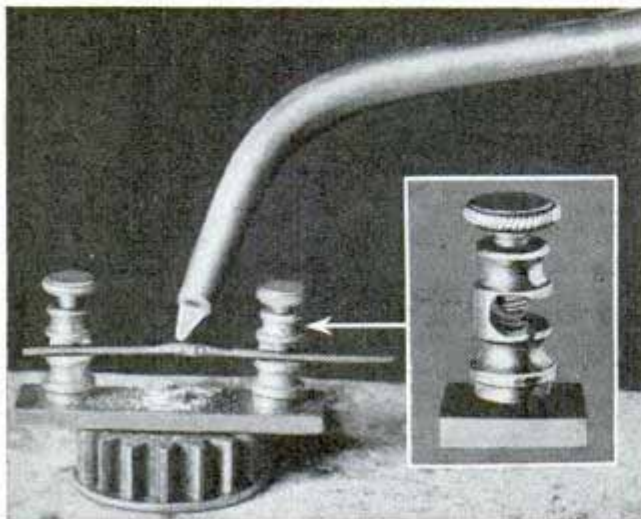

This fixture holds ends of rods or wires while soldering or brazing them together

held. Then notch one side of each post as shown in the photo, to insert or remove the work easily. The binding posts are fastened by means of their regular mounting screws to the metal plate, which is drilled to receive them. It is desirable to add a weight, such as the gear shown in the photograph, unless the plate is fastened to a bench or other support.

—Walter E. Burton, Akron, Ohio.

Blowtorch Burner Orifice Cleaned with Suction Cup

When the orifice of a blowtorch becomes clogged, a better method of removing the obstruction than poking it back with a wire or needle is to use a large suction cup. Empty the torch, leaving off the filler plug at the bottom. Then apply the cup to the bottom with edges slightly greased,

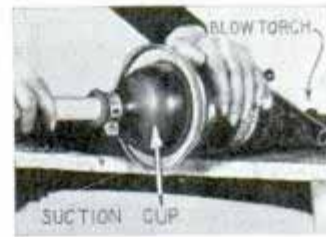

and make several strokes with the burner valve wide open. In most cases, this operation will draw the obstruction away from the orifice

and into the body of the torch where it can be flushed out. Removal of the packing nut and valve is unnecessary. This method also eliminates the possibility of enlarging the orifice.

Canvas Seats on Porch Furniture Removable for Laundering

Canvas seats on porch furniture are removed easily for laundering if the ends of the frame in which the cross rods are supported are slotted as indicated.

The ends of the canvas strips are provided with open hems to receive the rods. When reassembled, the block which was removed from the slot is replaced and a hole is drilled to receive a cotter pin. A second pin is inserted through the frame and cross rod.

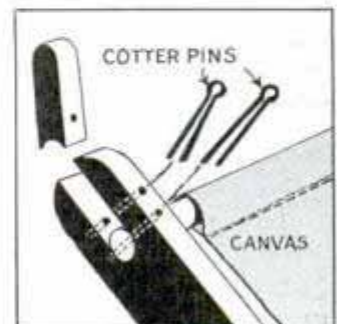

PHOTOMICROGRAPHS *through a mailing tube*

By Daniel Reynolds

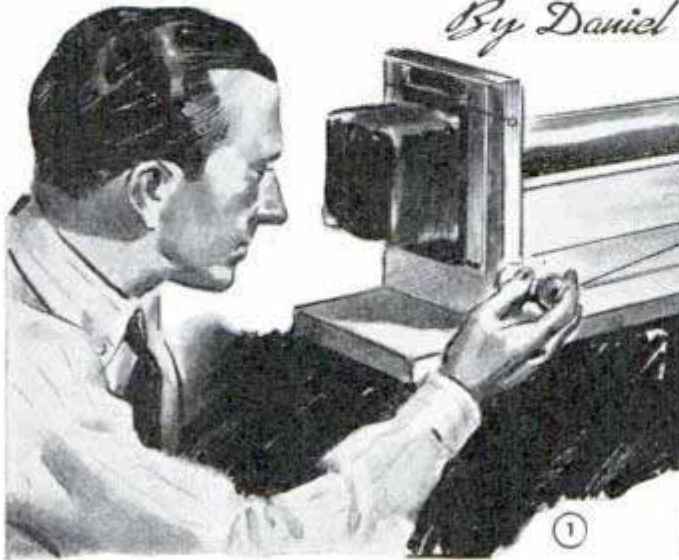

TINY details that completely escape the unaided eye can be recorded photographically with this simple outfit. For example, Figs. 3 to 6 inclusive show what you can do in making photomicrographs. They are in order: the head of a grasshopper, the seed of the common dandelion, a section of silk hose and a portion of a butterfly's wing. Fig. 1 shows the complete outfit set up and Fig. 2 the position of the easel or stage and the lighting arrangement.

Any open-back folding camera can be used. Even a box camera will give good results with some adaptations. The amount of magnification or enlargement of the subject depends upon the focal length of the lens and its distance from the plate.

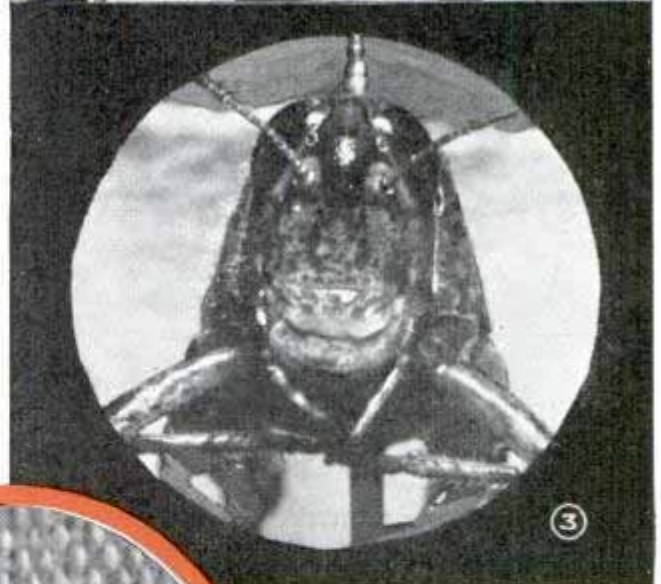

The camera shown is fitted with a 13.5 cm. focal-length lens of f.4.5 aperture. It was found that a mailing tube 3 in. in diameter and 40 in. long gave a magnification of about 10 diameters. The focusing is done with the

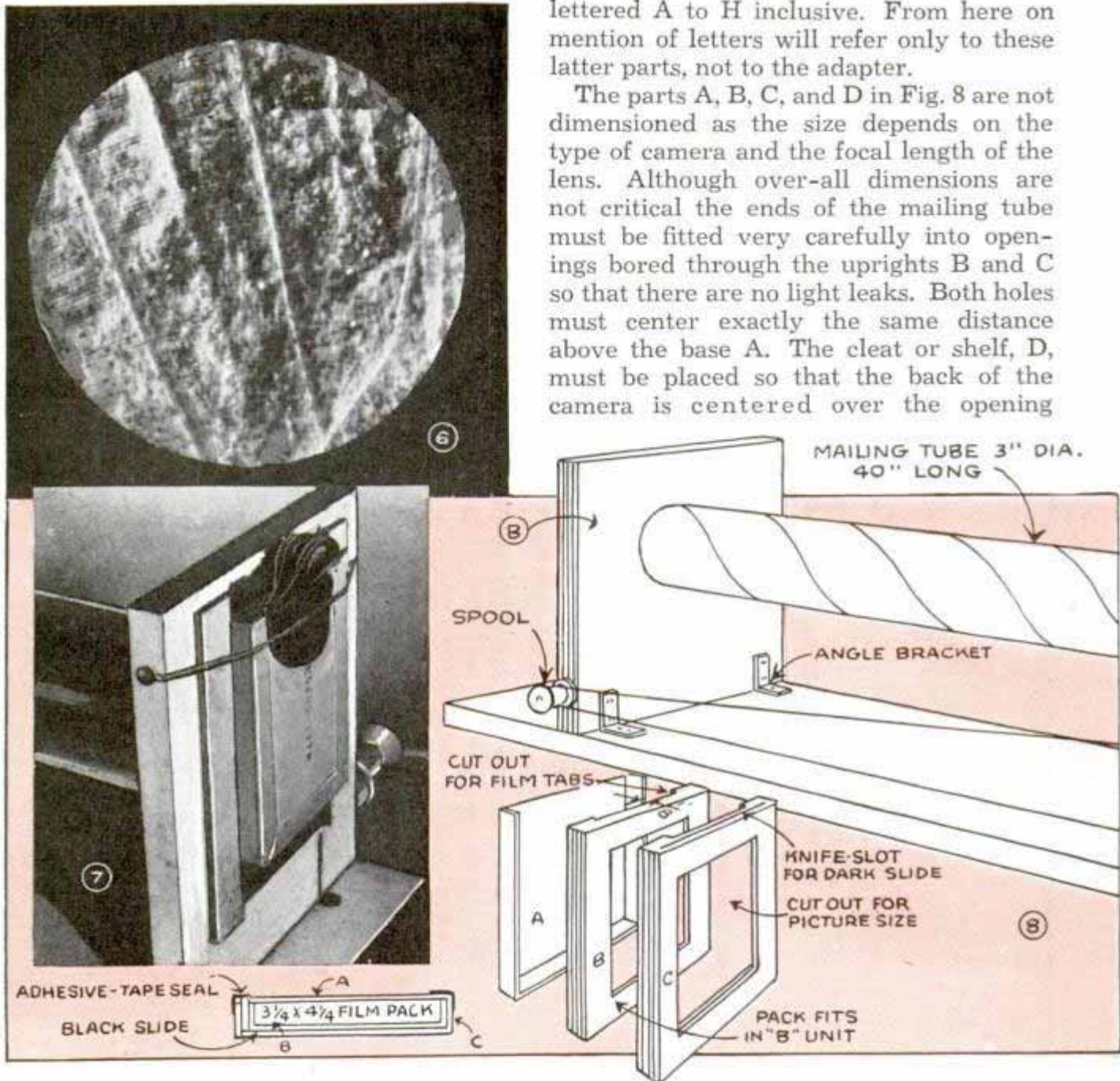

lens at its largest aperture, and once the subject is in sharp focus, the lens is stopped down to its smallest aperture, in this case f.32. To determine the time for average subjects, you multiply the normal exposure by ten. This exposure value has considerable variation, of course.

Now notice Fig. 7 and the parts A, B, and C in the two lower-left details, Fig. 8. The latter show how you can make up a film-pack adapter of odds and ends of sheet metal, plywood and tape. Fig. 7 shows the whole arrangement in place. Adapters for cut film or plates which you already may have, can be used, of course. Note also that the parts of the structure supporting the adapter, camera, and stage are

lettered A to H inclusive. From here on mention of letters will refer only to these latter parts, not to the adapter.

The parts A, B, C, and D in Fig. 8 are not dimensioned as the size depends on the type of camera and the focal length of the lens. Although over-all dimensions are not critical the ends of the mailing tube must be fitted very carefully into openings bored through the uprights B and C so that there are no light leaks. Both holes must center exactly the same distance above the base A. The cleat or shelf, D, must be placed so that the back of the camera is centered over the opening

through the tube. A curtain spring holds the camera in position as in Fig. 10. The inside of the tube and the other surfaces of the uprights B and C should be painted flat black. The inside of the tube can be painted with a cloth swab dipped in the paint and drawn through with a string. Parts E, F, G, and H comprise slide and stage on which the subject to be photographed is mounted and brought into focus. The part E is simply a 2-in. strip screwed to the base. A 6-in. arm, G, is screwed at right angles to the outer end as shown and carries two screw eyes through which the control cord passes. The stage, H, is bolted to the slide F, and is provided with a universal adjustment so that it may

be tilted or pivoted to any angle desired, as in Fig. 9. The slide carrying the stage is moved nearer or farther from the camera lens as required by means of the cord, which is attached to the slide as shown and runs back to a spool screwed to the upright B. It is looped once around the spool and then the free end is carried back through a hole in parts C and D and tied to a screw eye in the slide as shown. The cord should be taut so that the stage can be moved without taking up any slack. You substitute a small ground glass for the pack adapter when focusing.

Finally, you must have a means of light-

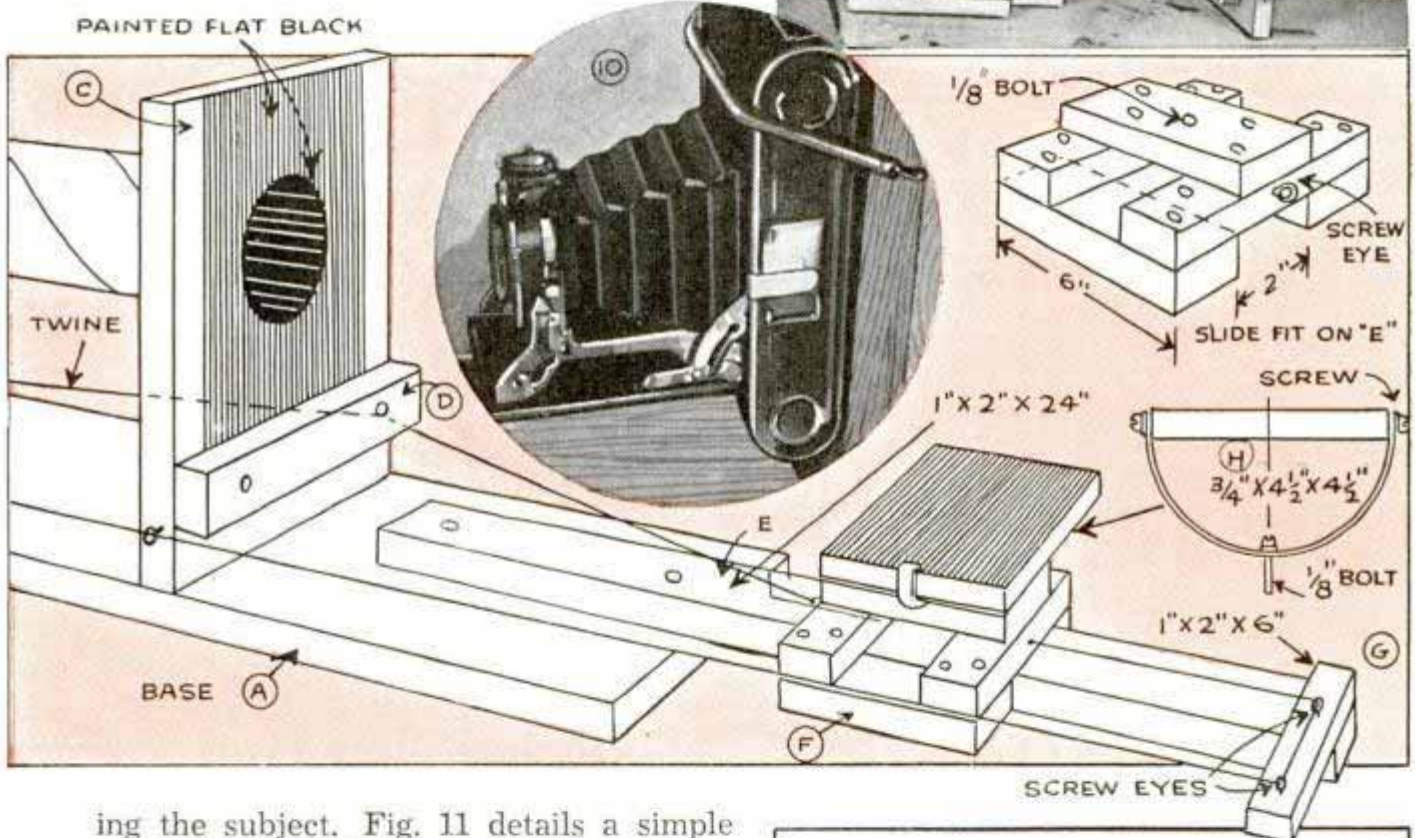
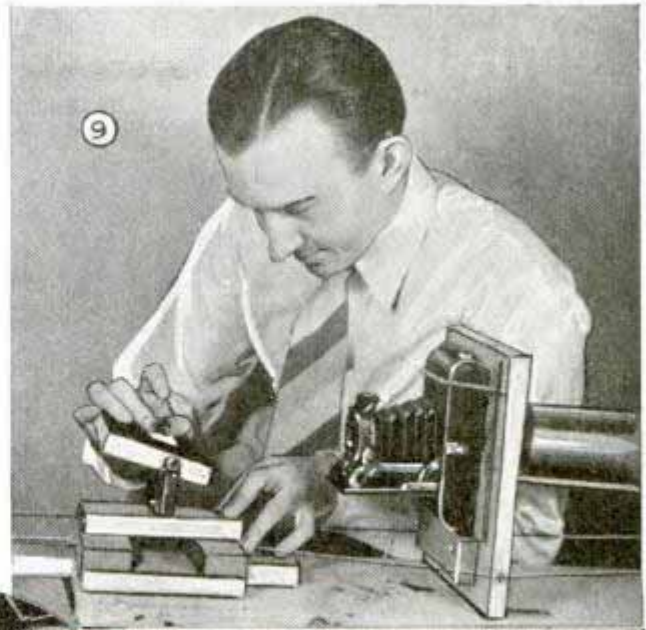

ing the subject. Fig. 11 details a simple and effective lighting arrangement. Remove the pin from an ordinary iron-strap hinge and substitute a small bolt with wing nut as shown. This provides a means of tilting the reflector to any angle. Tightening the wing nut holds it. The subject to be photographed is mounted on the stage near the front edge and the table is tilted slightly toward the camera. Certain subjects have to be outlined with small squares of white paper and often the light should be diffused with a single thickness of tracing cloth. By doing a little experimenting with various screens and colored Cellophane in front of the lamp, many novel effects can be obtained.

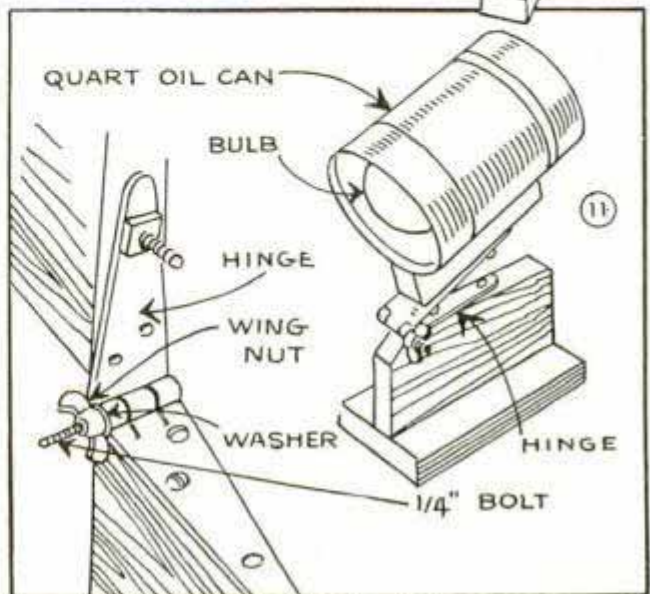

Lantern Type Sewing Basket Has Removable Cover



Lifting off the cover of this ornamental lantern exposes a convenient sewing basket

Resembling a Chinese lantern when the cover is in place, this novel sewing basket can be kept at hand on a table where it will serve as an ornament. When the cover is removed, thread, needles, thimble and scissors are all conveniently in place. The inside part is light sheet metal attached to a wood base and consists of two sides with two partitions set in some distance from the edges to provide a well in the center for scissors and similar articles. Pockets hold buttons and other small accessories while wood spindles or dowels set in the base at the sides provide a handy place for spools of thread. Two metal handles pivoted between the sides, pass through an opening in the top of the cover.

Self-Adjusting Window Silencer

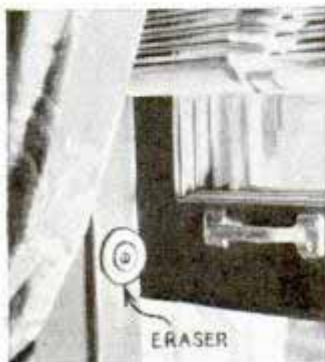

Suitable for home or car, this window silencer may be made from a pair of round typewriter erasers. These are fastened to each side of the casing with round-head screws as indicat-

ed. By pressing the edge of the eraser snugly against the sash when marking for the screw holes, adequate tension is assured when the eraser is in place. The screw should be left just loose enough for the eraser to roll freely. When the window is raised or lowered no attention or adjustment will be necessary to control all looseness. When making this installation in an automobile, extra-length sheet-metal screws will be needed and the installation should be made only where the glass edges are vertical instead of rounded and where the glass has no forward and backward movement.

Cutting Small Work on Band Saw

When sawing very small pieces on a band saw, the slot in the table insert is too wide to give good support. To remedy this, a piece of thin scrap material is clamped on the saw table as shown. This little trick also will help to avoid splitting the underside of the sawed edge.



Attractive Signs Made with Solder

With a smooth board of the desired size and a spool or two of wire solder, it is possible to make an interesting and effective sign almost as easily as one would write it with a pencil. The solder is bent according to a design previously written on a piece of paper, each word being a



Using wire solder to form lettering or writing is especially handy in photographic work

continuous piece. The pieces are held in place with short pins, placed in the folds of the letters where they are quite inconspicuous. A useful application of this type of lettering is in photographic work where it is necessary or desirable to include text on pictures and to make greeting cards or announcements photographically. The lettering can be photographed simultaneously sometimes with the subject, that is, as part of the original picture. Or, the negative of the lettering can be used in combination with the picture negative. Striking movie titles also can be made by the method described.

Top Putty Seals Camera Pinholes



Pinholes in the bellows of your camera can be sealed neatly by coating the worn spots with a thin film of black auto-top putty. This dries overnight into a tough flexible film that will fold with the bellows.

Stop Masks from Rubber Bands for Painting Objects

When you wish to paint round or square pieces of wood or metal, and the finish is to end at an even line around the work, ordinary rubber bands can be used as stop masks. Merely slip them in place, paint up to them, and when the finish is dry remove them with a pair of tweezers.

—Kenneth Murray, Sturgis, Mich.

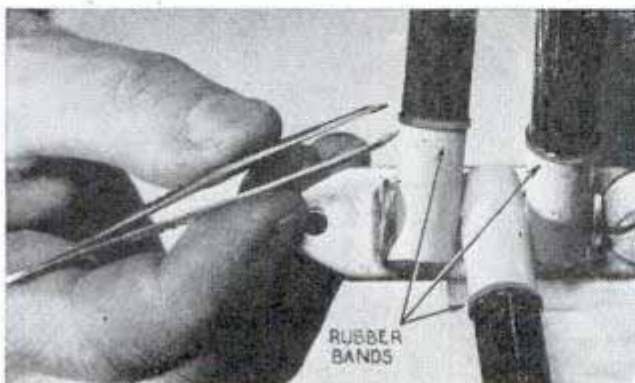

When you want a paint finish to end evenly on round or square work, try rubber bands as masks

High-Speed Flexible Polishers from Ink Erasers

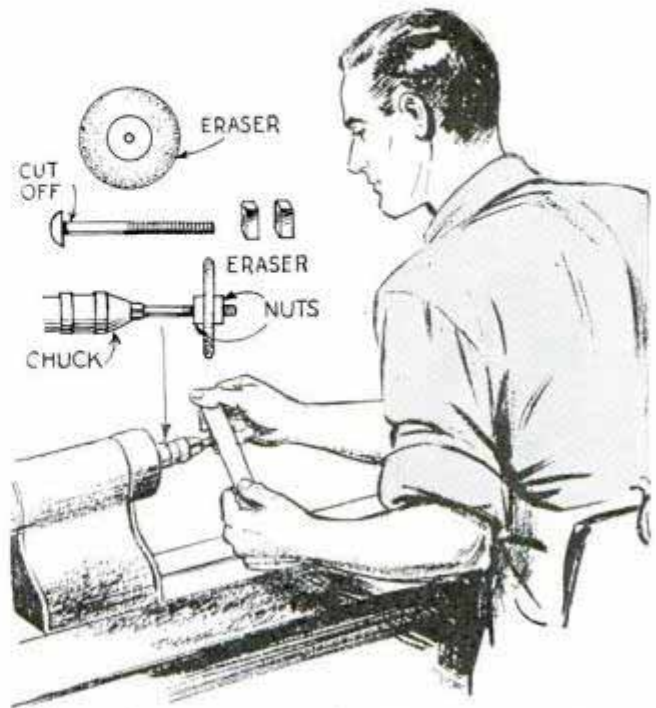

Typewriter eraser rotated at high speed in a lathe polishes light or delicate work

A high-speed polisher can be made from a typewriter eraser by removing the handle or brush portion and fitting it on a mandrel so that it can be chucked into a lathe or drill press. The mandrel consists of a short bolt small enough to pass through the center opening in the eraser. The head of the bolt is cut off and the eraser is clamped in position between two nuts. If a polisher of this type tends to vibrate because it is not perfectly round, true it up with a piece of sandpaper.

Film Rolls Used in Developer Tabulated on Bottle Neck

The use of rings on the necks of developer bottles to indicate the number of rolls of film that have been developed is much simpler than the usual constant changing of labels or figures. The rings shown are



1¼-in. conduit locknuts, but any ring will serve, even those made from wire clothes hangers.—H. J. Kennard, Gonzales, Tex.

Your HOME

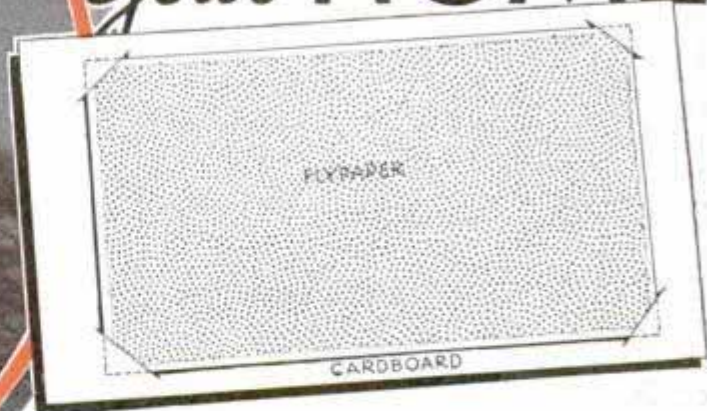

A piece of cardboard with slits cut in it to take the corners of flypaper, keeps the latter from curling. When using a can opener of the type shown at the left, tip it over the rim of the can as indicated and it will cut fast and clean

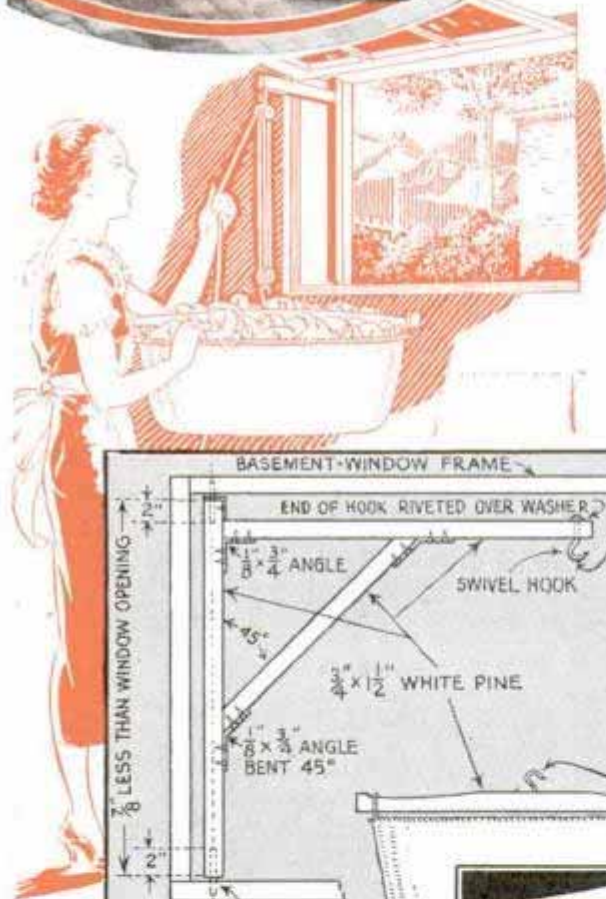

Instead of laboring to carry heavy baskets of wet clothes, ashes and rubbish up a basement stairway, install this little derrick in a window and hoist them out. The derrick is pivoted between the top and bottom of the window frame outside the sash so that the latter can be closed; it rests flatly against the window when not in use

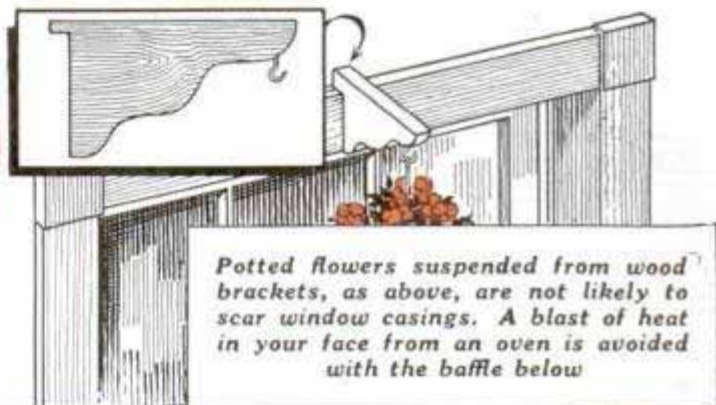

Potted flowers suspended from wood brackets, as above, are not likely to scar window casings. A blast of heat in your face from an oven is avoided with the baffle below

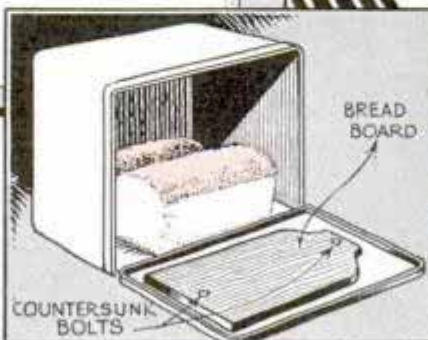

Mounting a breadboard inside the lid of a bread box saves shelf space



Rubber lamp cord wrapped around your iron handle improves the grip

PROBLEMS

Solved Easily

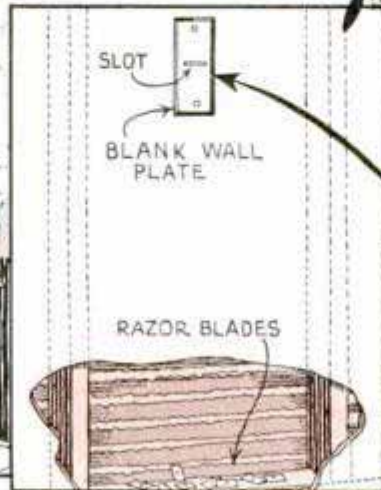

Razor blades safely disposed of by dropping them into bathroom wall as above, using a blank electric-switch cover, which has a slot cut in it. Upper left, cancelled stamps removed from a number of envelopes with a funnel and teakettle. A door stop screwed to one leg of a table as shown at the left, is adjusted quickly to level the table on an uneven floor

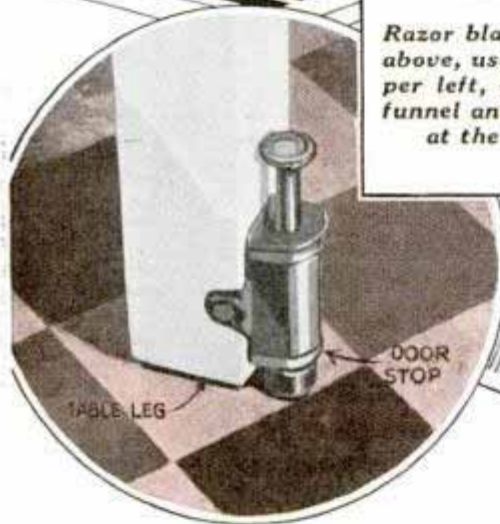

The handy man who has occasion to cut openings in sheet metal where use of a pair of shears is impossible, can do the job easily with the tool shown at the right. Lower right-hand corner, wood letters hung on water, steam and gas pipes identify them to someone not familiar with the piping system

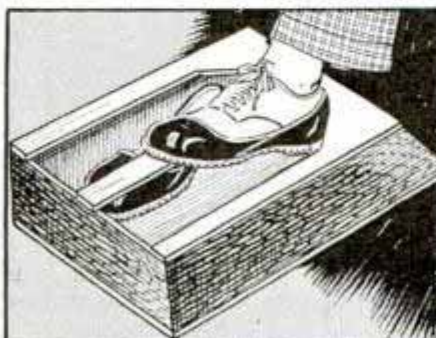

Your dirty rubbers are left right in this boot jack after removing them



Ends of asbestos electric cords coated with silicate of soda to prevent fraying



WOOD LETTER →

Capacity of Trouser Rule Pocket Increased by Wire Insert

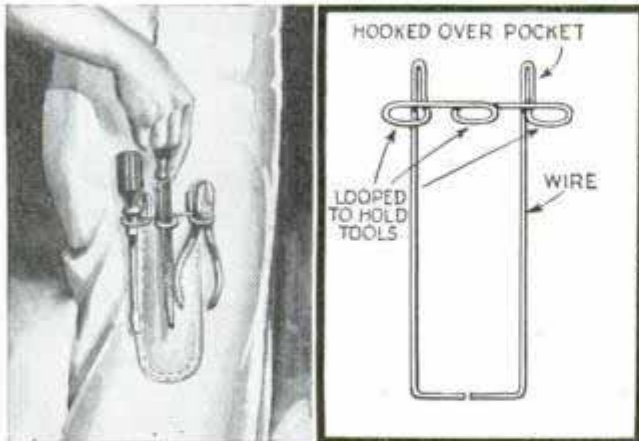

Wire insert enables you to carry several tools in the rule pocket of your overalls

To increase the capacity of the rule pocket in his overalls so that long tools such as files, screwdrivers, etc., could be carried in addition to his folding rule, an

electrician employed a wire insert bent to the shape indicated. It fits snugly into the pocket, yet is easily removed.

Port Holes for Ship Models

Modelmakers who like a finished effect on their work but have limited time and equipment, will find that shoe eyes can be used sometimes to provide realistic port holes

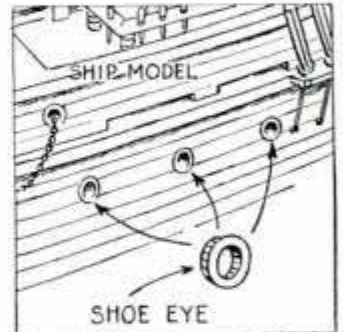

for ship models. First cut the eyes out of some old shoe. Then carefully select a drill that is just a trifle smaller than the inner rim of the eye. After boring the holes in their proper places in the hull, carefully tap the eyes in place.

Speedy Model Boat Travels Circular Course

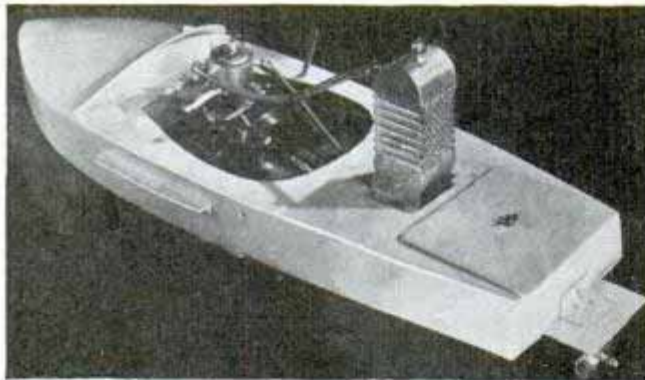

This 32-in. motorboat, powered by midget gas engine, develops speed of 20 to 25 m.p.h. on circular course. Set of four blueprints, Nos. 906 to 909 inclusive, which includes full-size frame patterns and all necessary constructional details, will be sent postpaid upon receipt of a \$1.00 remittance.

OTHER SUMMER PROJECTS

DUTCH WINDMILL AND WATER WHEEL—911: Mill, 40 in. high. Small water wheel. 25c.

16-FT. CANOE—811 and 812: Cedar planking covered with canvas. (2 prints) 50c.

12-FT. SAILBOAT—524 and 525: Flat bottom, center board type. (2 prints) 50c.

10-FT. ROWBOAT AND AUTO TRAILER—551: Wonderful combination for week-end trips. 25c.

LAWN AND GARDEN FURNITURE—920 to 922 incl.: Collection of designs for arbor and seat combination and swings. (3 prints) 75c.

LOG CABIN CONSTRUCTION—916: Two floor plans. Shows how to make corner joints. 25c.

Any six of these blueprints (not sets of prints) will be sent postpaid upon receipt of \$1.00

SECTIONAL ROWBOAT—905: Length 12 ft., beam 4 ft. Three sections occupy space only 6½ ft. long when nested. 25c.

SURFBOARDS AND SKIBOARD—701, 55 and 70 in. surfboards. Skiboard is driven by small outboard. 25c.



10-Ft. Rowboat and Trailer
Plan 551

Blueprint Department, Popular Mechanics Magazine, 200 E. Ontario St., Chicago



SHOP NOTES

WATER-OPERATED EJECTOR *drains tanks and cisterns*

WHEREVER water pressure is available, cisterns, tanks, cesspools, and the like can be drained easily and rapidly with this ejector. Steam under pressure can be used in place of water as a source of power.

Fig. 1 shows how the ejector operates on city water pressure and lifts water several feet. The operating parts are shown in Fig. 2. The water inlet nozzle is made from a length of $\frac{1}{2}$ -in. inside diameter heavy wall brass tubing. A piece 5 in. or longer should be used. The end of this tube should be hammered to shape over a form such as is shown in the upper details of Fig. 4. The hammering is started about $1\frac{1}{2}$ in. from the point, working around the tube and gradually to the tip. After the nozzle has been hammered to shape, the end is smoothed down with a file. The inside diameter of the nozzle tip should be about $\frac{1}{4}$ in. The nozzle is threaded for the greater part of its length using a $\frac{3}{4}$ -10 standard machine screw die. The nozzle is fitted into a standard 1-in. pipe tee by means of a brass bushing, which is threaded to fit the tee on the outside and drilled and tapped to admit the nozzle in the inside. The

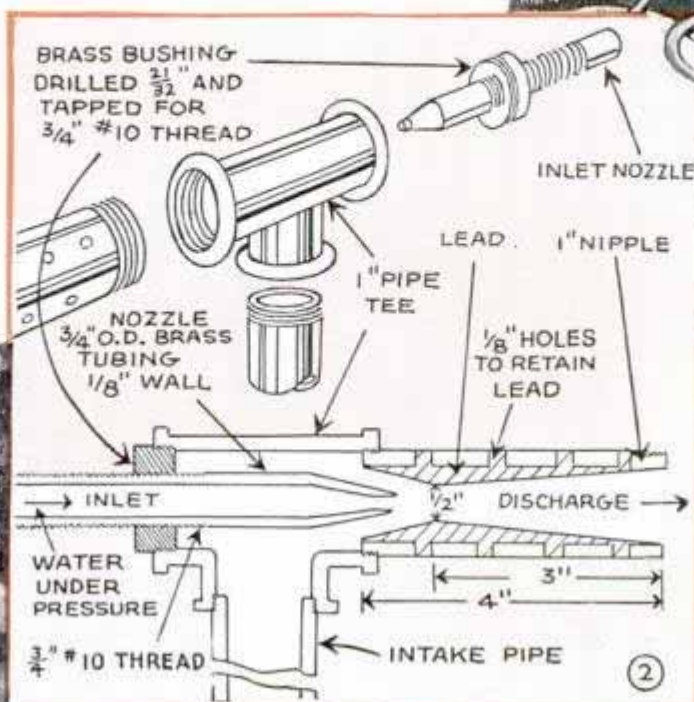
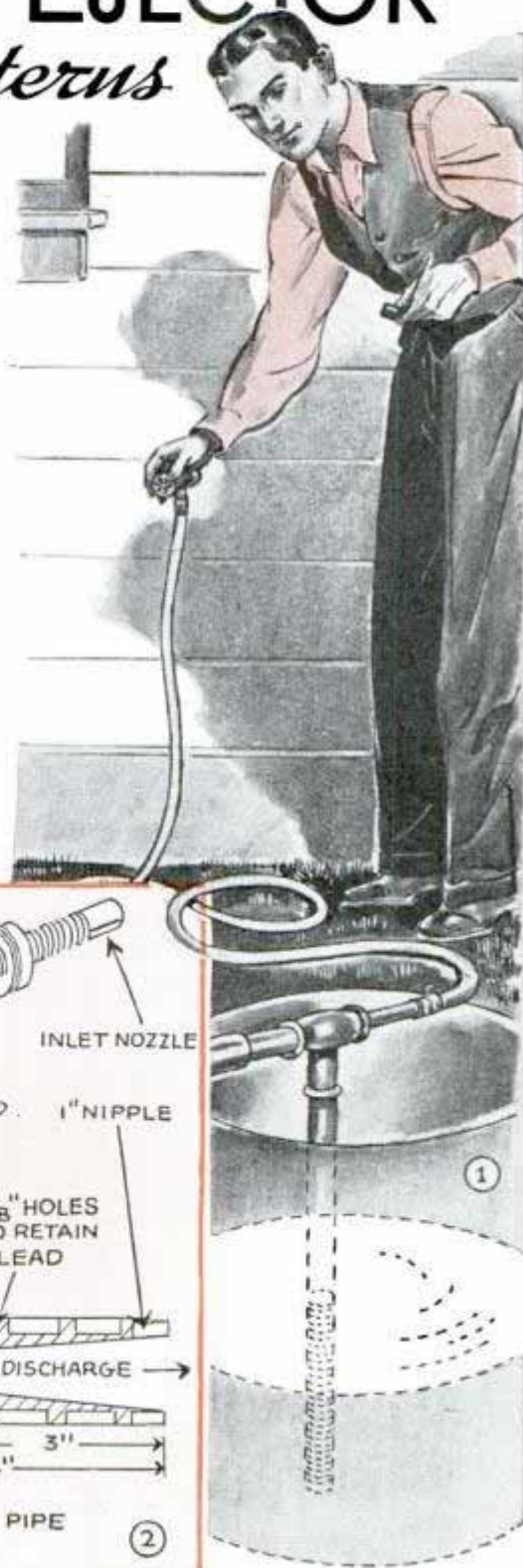

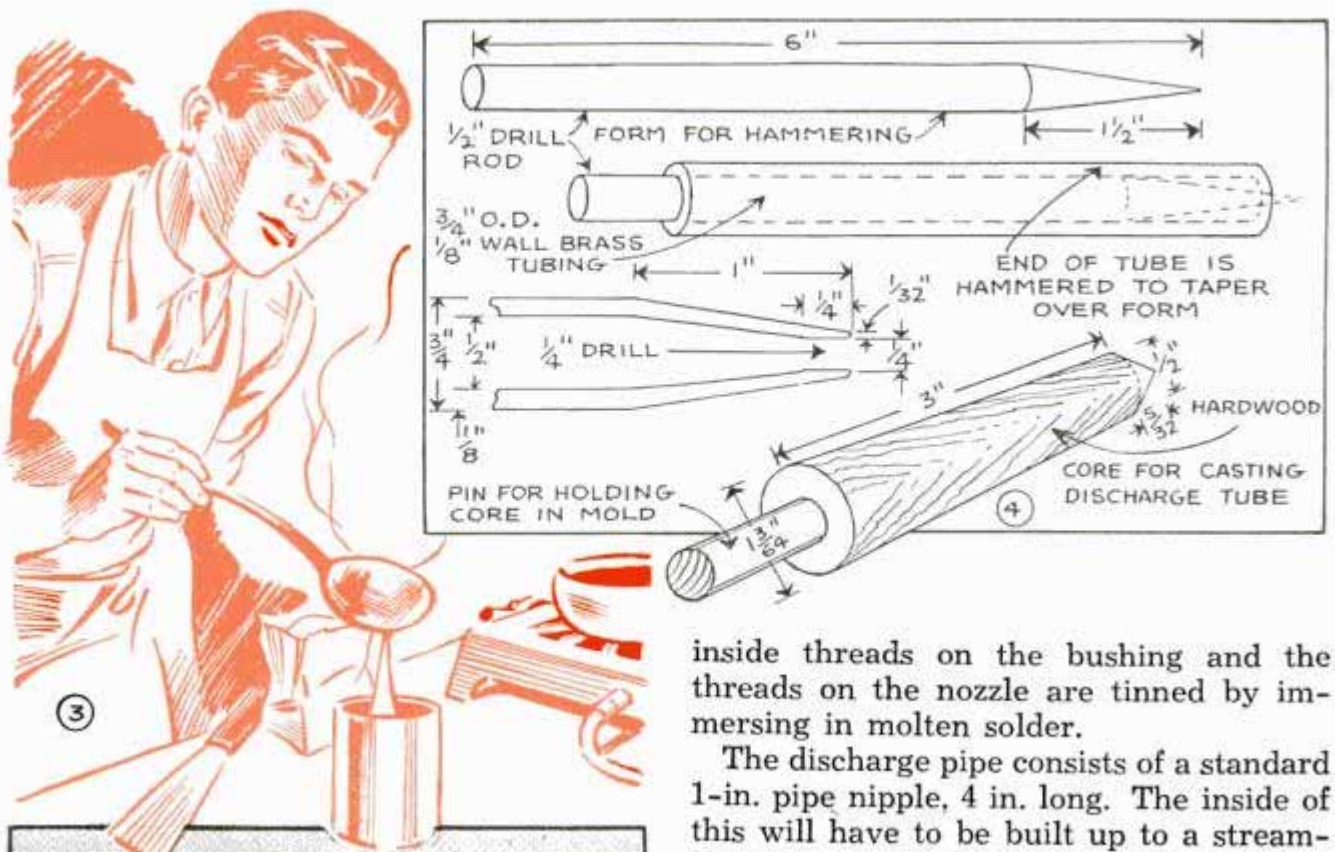

inside threads on the bushing and the threads on the nozzle are tinned by immersing in molten solder.

The discharge pipe consists of a standard 1-in. pipe nipple, 4 in. long. The inside of this will have to be built up to a streamline shape. A wooden core, 3 in. long, and conical in shape, is turned to the dimensions shown in the lower detail of Fig. 4. A number of small holes are drilled in the pipe, which is wrapped with a sheet of shim stock tied on with wire. The inside of the pipe should be clean and bright. Plaster of paris is now poured into a wooden or metal form, about 4 in. in diameter and not less than 5 or 6 in. high as in the upper detail of Fig. 5. An empty tin can will do. The core is placed vertically in the plaster before it has set. When the plaster has set, put the pipe nipple in place around the core, taking care that the core is exactly centered in the pipe. A washer cut from cardboard will serve as a spacer until the nipple is permanently located. Enough plaster of paris is then poured around the pipe to cover the threads and lock the pipe in position. When this has set, the form outside the pipe should be filled with plaster. Next mold some lead, solder, or type metal and fill the space between the pipe and core with the molten metal. These metals can be melted in a seamless iron pot on a stove or gas plate if a little borax is added to dissolve the dross. When the metal has cooled, the plaster mold is broken and the wooden plug removed. A 1/2-in. hole is drilled through the lead, starting from the mark left by the tip of the core, and then the lead is cut to the

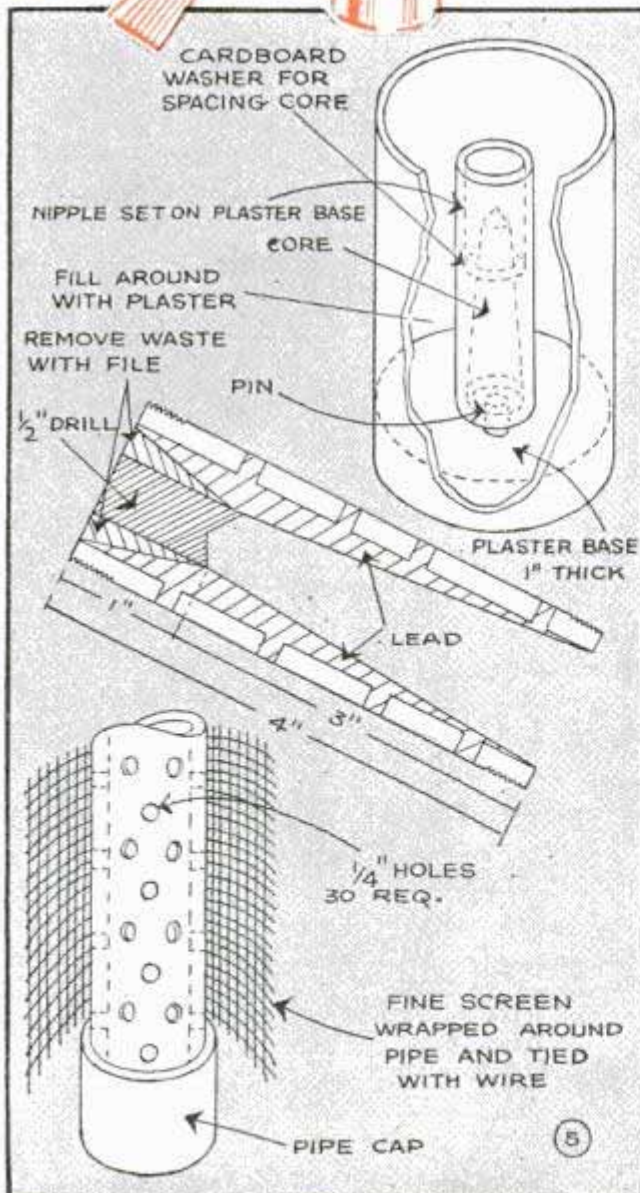

shape shown in the center detail of Fig. 5. The lead surface should be smoothed and slightly rounded, at the throat of the tube.

A length of hose or pipe having an inside diameter of not less than 1 in. should be fastened to the side arm of the tee to reach down into the sump or pit being drained. It is wise to fit the end of the intake tube with a strainer as shown in the lower detail of Fig. 5. The end of a length of 1-in. pipe is capped and not less than thirty $\frac{1}{4}$ -in. holes are drilled in the pipe. A piece of wire screen is wrapped around the pipe and tied in place with wire.

The ejector now can be tested. Work the nozzle into its bushing so that the tip of the nozzle is about $\frac{1}{4}$ in. from the lead surface in the discharge tube. The suction tube is inserted into a tank and the water inlet is connected to the water supply. The discharge pipe should be led to a suitable drain. When the water has been turned on, the position of the nozzle can be adjusted by screwing it farther in or out of the bushing until maximum flow is attained. When this point has been found, the ejector is disconnected and drained, then a blowtorch is turned on the bushing. This will sweat the nozzle to the bushing so that they will be maintained in the proper place. Be careful not to let solder flow into the threads between the bushing and the tee, as this joint is to be opened when the ejector needs cleaning.

Honey Serves as Belt Dressing



Honey provides a better belt dressing than most others of home-produced origin. It affords excellent traction, and when it eventually dries, turns to sugar and drops off the belt. This is desirable as so many home-made belt dress-

ings build up layers of material on both belt and pulley. The honey should be heated until very thin, and it is then applied sparingly and uniformly, which can be done by means of a small brush.

—R. O. Lissaman, Brandon, Man., Can.

Grocer Distributes Clothespins with His Handbills



Sales circulars folded in clothespins and distributed attract attention of women buyers

One grocery store uses ordinary wood clothespins to serve a double purpose when putting out sales circulars. The sheets are folded and tucked into the clothespins, which are distributed from house to house. The pins are prized by women, who are more likely to read the circulars than if they were passed out in the regular way. Another advantage of the pins is the weight they add to the bills which makes it easy for the delivery boy to toss them onto porches, even when it's windy.

—Dale R. Van Horn, Lincoln, Neb.

Rounding Dowel Ends Quickly

When a number of dowels have to be sanded slightly on the end to permit driving them into tight holes, operations are slowed up considerably. A fast



method is to drill a hole into an iron block, place one end of the dowel in this depression, and strike it sharply with a mallet. Any featheredge remaining after sawing the dowel will be forced inward, the dowel assuming the shape shown.

Insulation Removed from Wire by Double Saw Knife

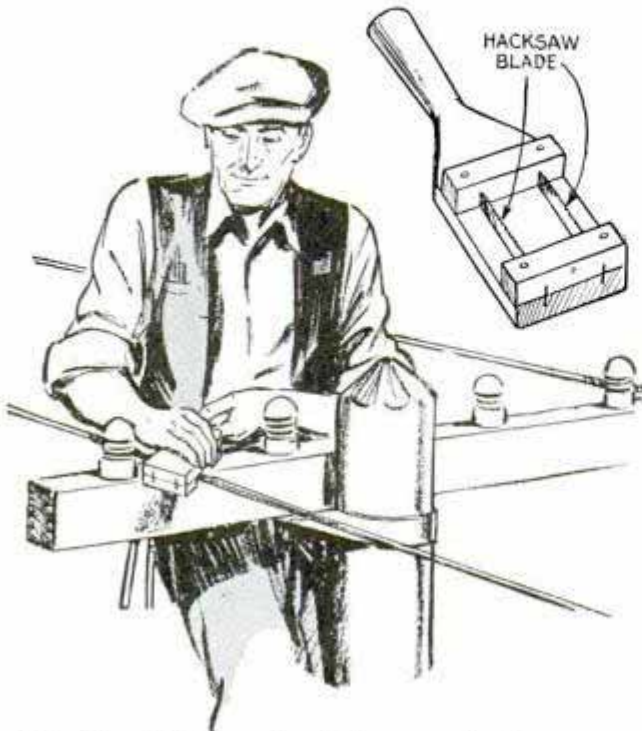

"Sawing off" heavy insulation on wire for connections is easy with this tool

Removal of heavy insulation from electric wires for soldered connections is speeded up with this tool, especially when one is working at the top of a pole. It is assembled from blocks of wood and two pieces of hacksaw blade. By using the tool as a saw at two or three angles on the wire, the insulation is rapidly severed so that it can be scraped away.

Eyes Protected with 'Cellophane' When Cutting Glass

If goggles are unavailable to protect the eyes when cutting glass, a sheet of Cellophane laid over the work while breaking the glass will do the trick. Eye protection

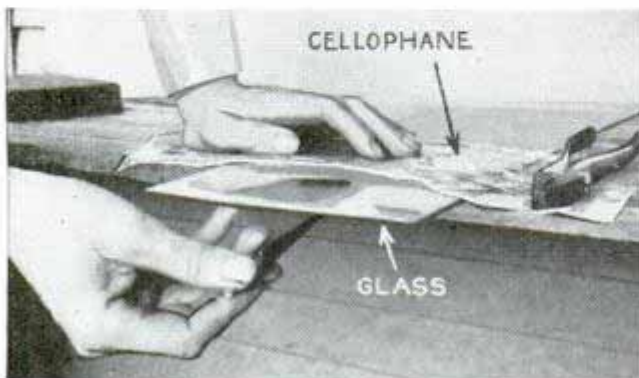

Old glass tends to "throw" slivers when cutting, thus making it advisable to protect the eyes

is especially necessary when cutting old glass, which becomes brittle with age and throws slivers upward when tapping it over a scored line to break it.

Hay Rope Kept from Twisting at the Carrier

The annoyance of having a hay rope twist between the fork and the end where it is fastened to the carrier can be avoided by using a ball-bearing at this point as indicated.

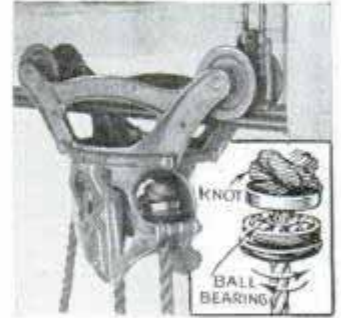

The end of the rope is run through the bearing and knotted to prevent it from pulling out. When the weight comes on the rope the bearing rests against the carrier where the knot in the rope normally rests.—I. W. Dickerson, Charles City, Iowa.

Turnbutton Locks Gate Hook



One farmer who experienced trouble by having livestock lift gate hooks with their noses, solved the problem by screwing turnbuttons to the posts just above the hooks as

indicated in the photograph. The hook can be raised when the button is in a horizontal position.

Data Sheet Handy on Drill Press

In a number of varied operations on a drill press in a small factory, a pair of clock springs and a sheet of celluloid were used to hold the data sheet on the drill-press post. This could be moved up or down to suit the operator, the celluloid keeping the sheet clean.

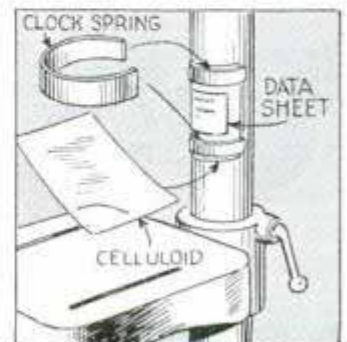

NOVEL BACKGROUNDS *for close-up photos*



In the photo above, a spotlight was set overhead and a floodlight was placed near the camera to soften the shadows



Corrugated board, dowels and coarse crepe paper lend some distinctive effects. Single-faced corrugated board in the medium green color, used for dressing store windows, is best for average work. The corrugations are run either vertically or horizontally in contrast with predominant lines of the subject. Left, dowels set in holes drilled in a board produce striking backgrounds. Below, holding a mirror almost vertically on corrugated paper to show both sides of an object

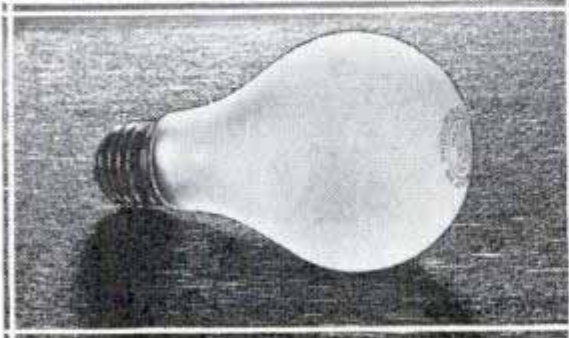
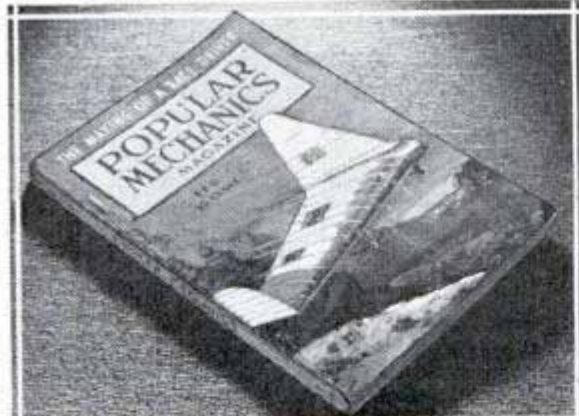

Magazine and lamp above were photographed against coarse crepe paper stretched on a table top, with a spotlight placed to partly face the camera and direct the light slightly downward on the subject. Right, size of shadows can be controlled to assume various proportions in relation to actual subjects photographed to emphasize an idea



Camera Tripod Set on Platform Is Portable in Studio

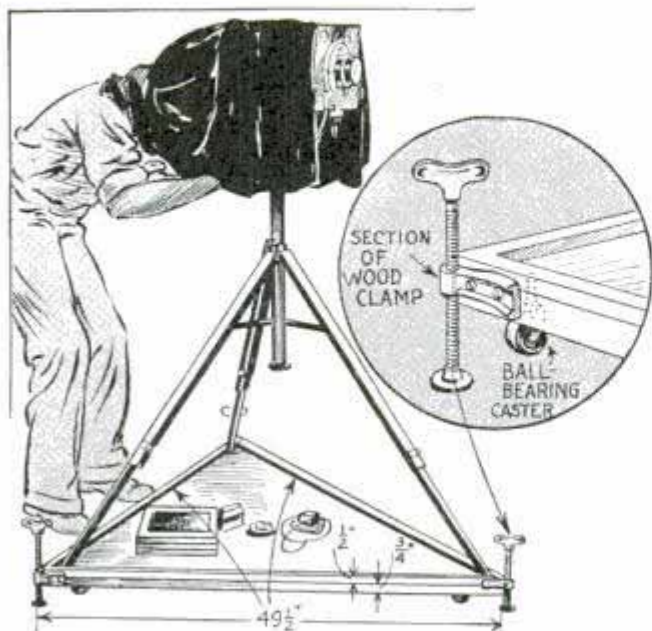

Castered platform supports camera tripod and can be moved to any part of the studio

For studio work, this triangular platform eliminates juggling of the camera as both it and the tripod can be moved. The platform consists of a bottom of $\frac{3}{4}$ -in. hard-pressed board to which $\frac{1}{2}$ -in. rails are nailed to prevent the legs of the tripod from slipping. Ball-bearing casters at each corner make the platform movable. To steady the camera while taking a picture, screw-type legs at the corners are turned down to support the weight of the entire unit. Each leg consists of a screw and part of one of the jaws of an old C-clamp or regular woodworker's clamp. The method of attaching these screws is shown in the circle.—S. J. Smith, South Bend, Ind.

Making a Boring Tool

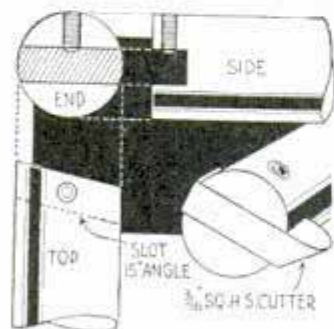

$\frac{3}{16}$ in. square. The slot should be cut at a slant of from 12° to 15° so that when the cutter bit is in place the cutting edge will have a slight lead on the bar to prevent

Here's a lathe boring tool that will make a cut $\frac{1}{8}$ in. deep without chattering. A piece of $\frac{1}{2}$ -in. cold-rolled steel is slotted on the end to receive a high-speed cutter bit

binding. A $\frac{1}{4}$ -in. setscrew locks the bit in place, the end of the bar being ground off to the same angle as the bit. A bit $\frac{3}{4}$ in. in length will be found the shortest possible as the setscrew head projects above the surface. A second bit 1 in. long will bore up to $1\frac{1}{4}$ in. If larger holes are necessary, a piece of $\frac{3}{4}$ -in. shaft should be used. The rear portion of the shaft is flattened for use in the tool post.

Jeweler's Small-Parts Holders from Tablespoons

Bent to the shape indicated, cheap tablespoons provide good holders for screws and other small parts on a jeweler's workbench. The handle ends of the spoons have V-cuts to slip under large flat-head nails driven into a rack so that they can be removed as desired.

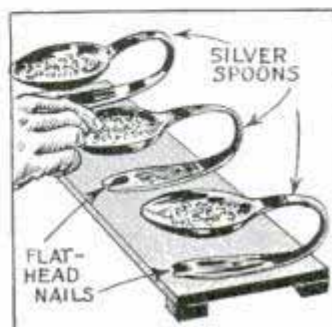

—A. S. Wurz, Jr., Rockyford, Alta., Can.

Handy Splayed-Jaw Clamp

This is an unusual type of clamp that can be applied in a jiffy over a wide surface, and often does the work of two clamps. It consists of two identical pieces, the drilling and tapping of the holes being a little different in that only one hole is tapped in each jaw, the lower one at A and the upper one at B. This permits the clamp to be adjusted rapidly as both screws are operated from one side.

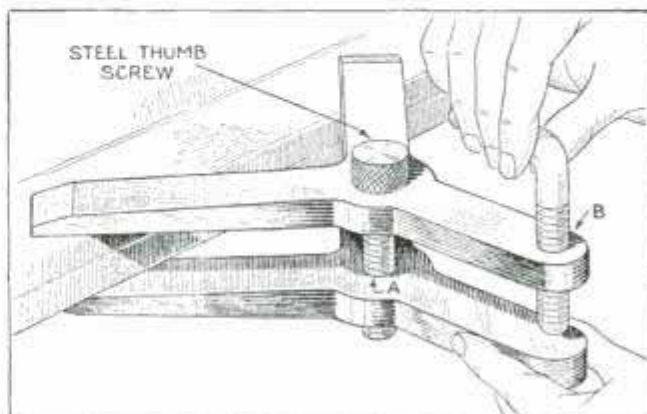

This clamp covers a wide surface, is adjusted quickly, and often does the work of two clamps

Hay Delivered from Baler Directly to Wagon

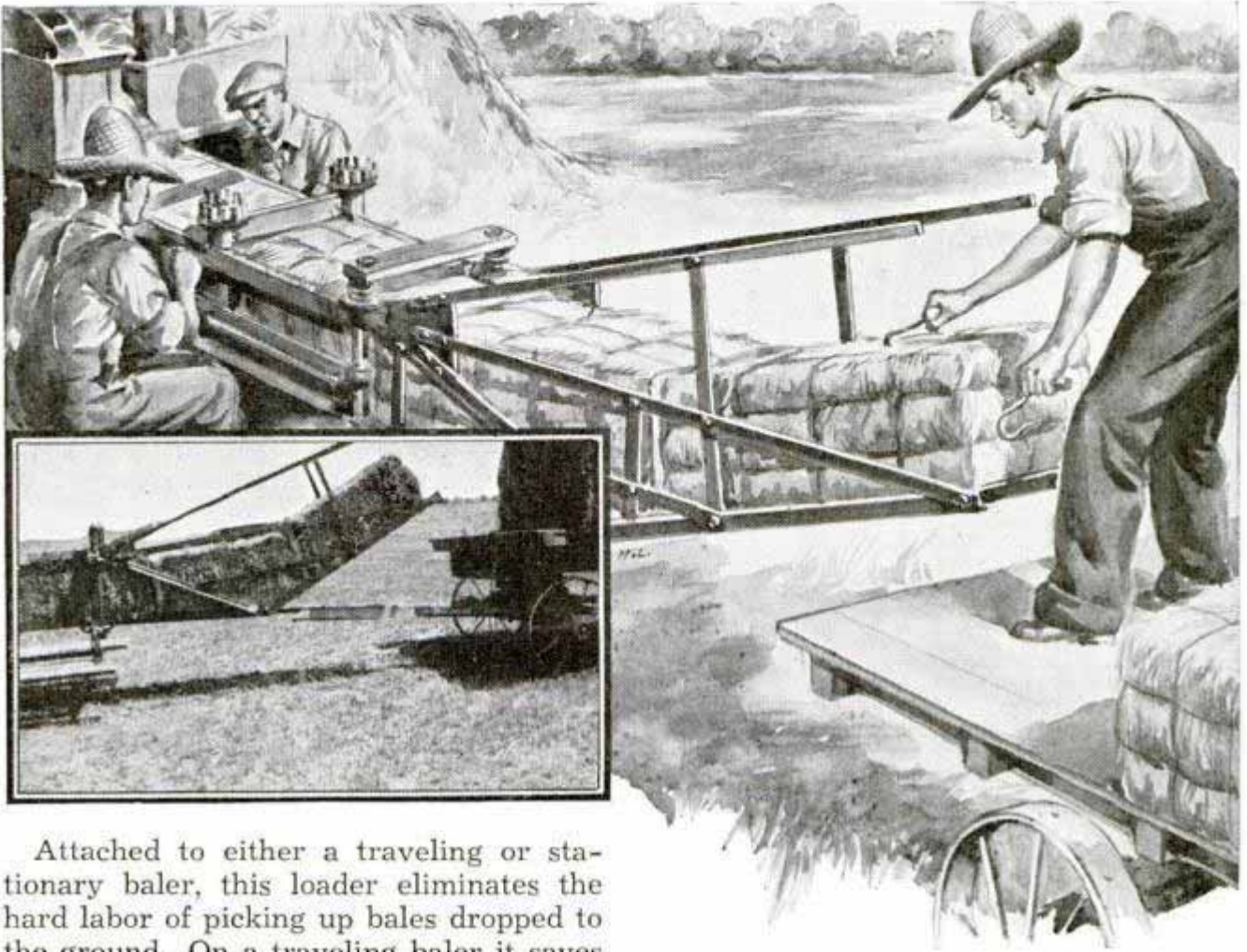

Attached to either a traveling or stationary baler, this loader eliminates the hard labor of picking up bales dropped to the ground. On a traveling baler it saves time lost in going back over the field to gather the bales, and when baling from a stack or barn, it saves labor by loading them directly onto trucks or wagons. It is constructed of flat or angle iron and includes a hitch for towing a wagon. The

divider blocks between the bales ascend the loader and the workman on the wagon returns them to the operator by sliding them down between the two top members of the loader which are converted for the purpose.—Stanley Russell, Vincennes, Ind.

Short Fence Across Creek Saves Main One During Flood

To avoid rebuilding several rods of fence across a creek after a flood, a farmer builds an individual, short fence across it as indicated. The regular fence stops at each bank of the creek and a couple of extra posts are set close to the regular end posts to support the short fence, which is all that has to be repaired after a heavy rain has raised the creek to flood stage.

—James Vick, Winterpock, Va.

☐ A dab of thick grease on the end of a matchstick will often solve the problem of replacing an awkward cotter pin as it will stick to the grease and then can be maneuvered into the hole.

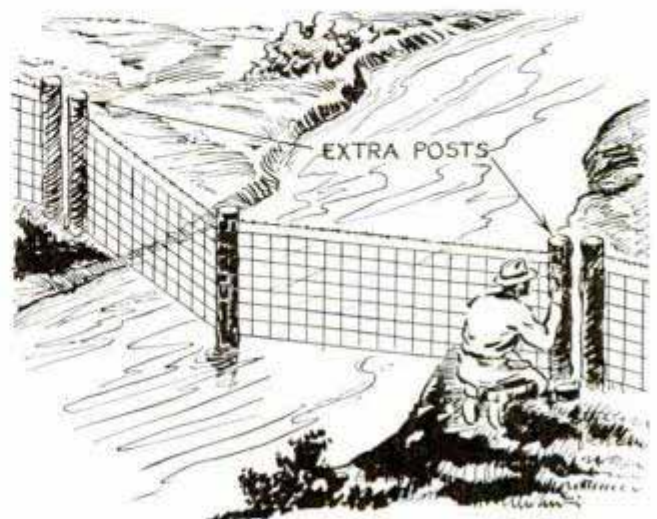

When a creek is flooded, the short section of fence washes out without damaging the main one

Tools Carried on Implements in Rubber Kits

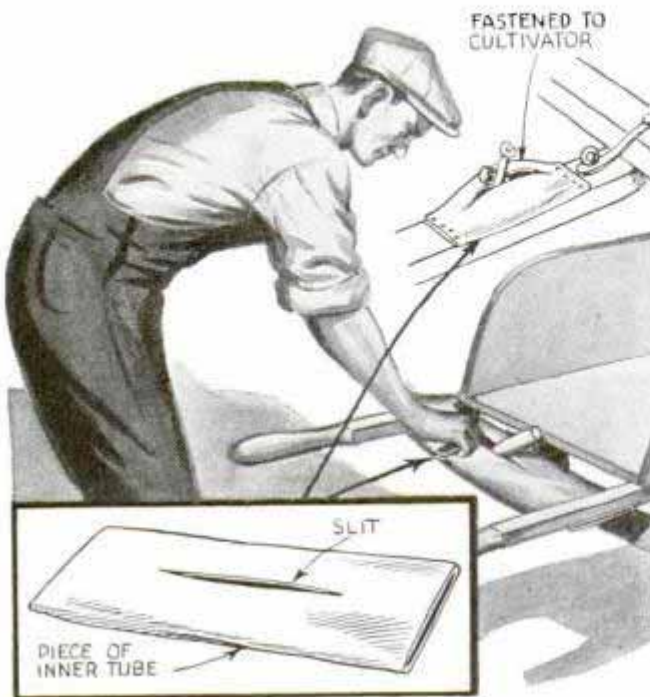

Tool kit from inner-tube on wheelbarrow or farm machinery prevents loss and costs nothing

A section of old auto inner-tube with a short slit in one side and nailed to the tongues of farm implements or stretched between the handles of a wheelbarrow, provides a dandy kit for small tools. The slit enables you to remove or replace tools quickly, yet prevents them from falling out.

Grease Fitting on Countershaft to Lubricate Loose Pulley

Difficulty of lubricating loose or idler pulleys that are constantly in motion is overcome by means of a grease fitting in the shaft. Drill a $\frac{21}{64}$ -in. hole to a depth of 1 in. in the center of the projecting shaft end, and continue the hole with a $\frac{9}{32}$ -in. drill to a point under the center of the loose-pulley hub. Then drill from the side of the shaft until both holes meet. Tap the hole in the end of the shaft with a $\frac{1}{8}$ -in. pipe tap and insert a Zerk fitting or a grease cup. The loose pulley now can be greased at will, elimi-

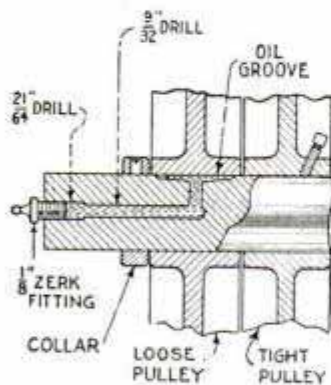

nating the possibility of machine damage due to the pulley running dry and freezing to the shaft.

—Grant O. Loader, Newcomerstown, O.

Handholes Cut in Sawhorses to Carry Them Easily

Carpenters and others who have to work with sawhorses will find that holes cut in the cross members as indicated simplify carrying them. The holes should be rounded and sanded at the edges to avoid getting splinters in the hand.

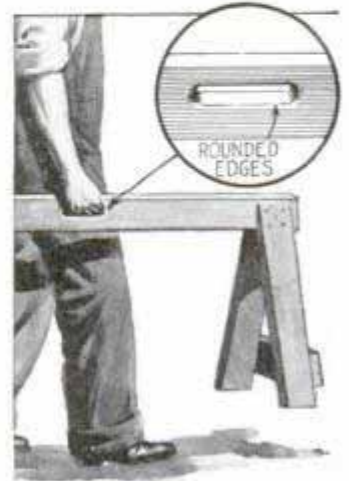

Hammer Slung from Wrist to Avoid Dropping It

When working on a building above a sidewalk or other place where it is necessary that every precaution be taken to avoid dropping a hammer, the workers of one construction company sling their hammers from their wrists with rawhide thongs. These are run through holes drilled at the end of the hammer handles, then doubled and looped around the wrist, being long enough so that they do not interfere with using the hammer.

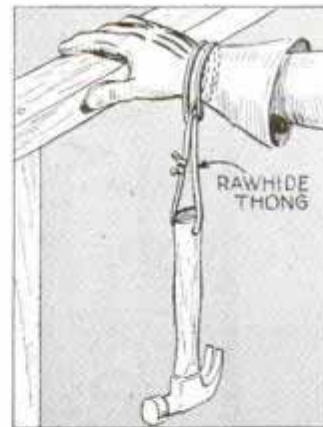

1937 INDEX

for Craftsman, Shop Notes and Radio sections is now available and will be sent upon receipt of ten cents. Please do not send coin. Address Book Dept., Popular Mechanics Magazine, 200 East Ontario Street, Chicago.

Modern PLANT STANDS in Wood, Metal and Plastic



COMBINING lustrous plastic or gleaming metal with a bone-white finish on wood, these smart plant stands add a modern touch when placed in front of a window, at either side of a bay or in a hall. While they can be assembled entirely of wood, a pleasing distinction between the legs and the bases can be had by using metal or plastic for the uprights. The stand shown in Fig. 1, and dimensioned in Fig. 2, is all wood. The legs can be turned from square stock, but it is easier to use standard 1-in. dowel rods, as turning such slender pieces is rather difficult, due to distortion, and requires a distance of at least 42 in. between centers. In joining the square ends of the legs at top and bottom to the dowels, one of two methods is used. Tenons may be formed on each end of the dowel as shown in Fig. 3, or 1-in. holes are bored to a uniform depth in the ends of the square members to take the dowels. In Fig. 3 the jointer

method of cutting tenons on round stock is used. A simple wood block clamped to the table guides the work and the machine fence sets the length of the tenon as the work is slowly rotated in the same direction as the cutter head. Top and base of the stand are wood disks attached to the legs with

screws through the ends, the screws being countersunk and puttied over with plastic wood, as in Fig. 5. The underside of the lower

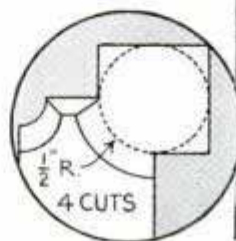
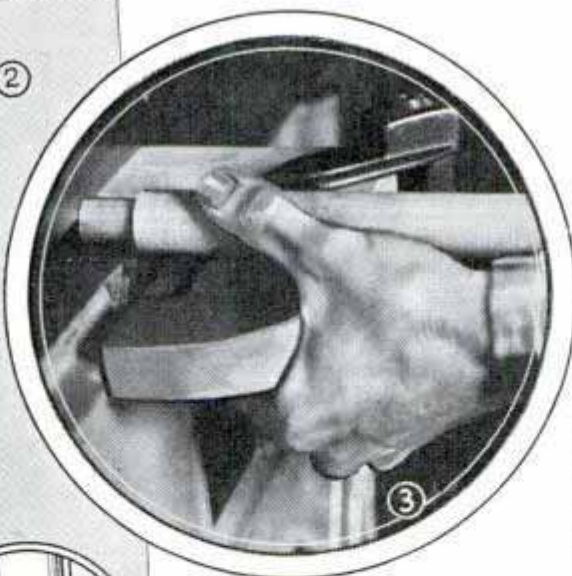
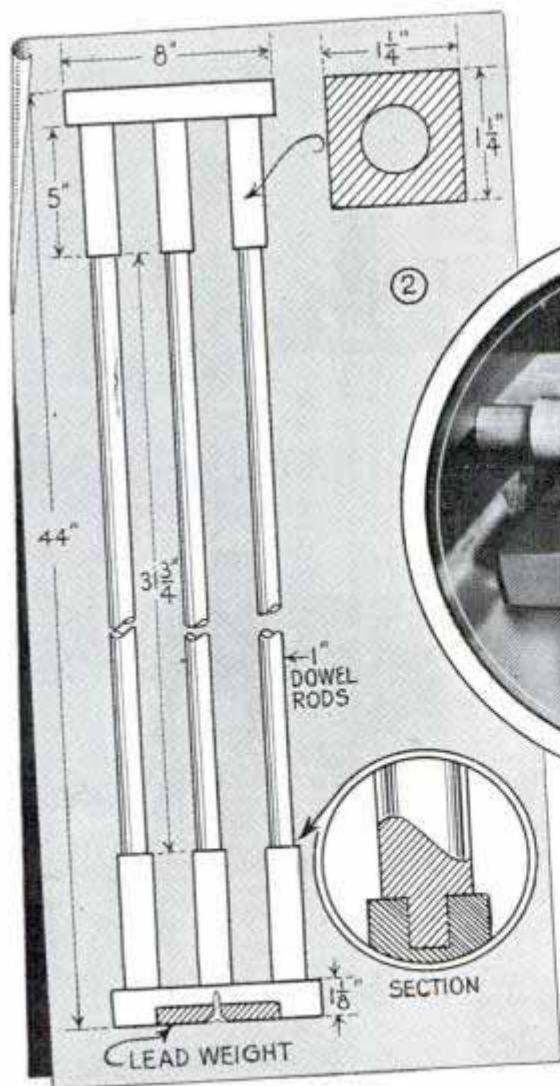



disk first should be recessed $\frac{3}{8}$ in. deep and 5 in. in diameter for the insertion of a lead weight. For this you use about 5 lbs. of molten lead poured into a sand or wood mold as shown in Fig. 7. Drill three or four holes through the weight and fasten it in place with brass screws.

The top and lower bases of the design shown in Fig. 6 consist of two disks each of $\frac{3}{4}$ -in. stock glued firmly and screwed together. Here you will need 42-in. lengths of stock for the legs. As standard dowels of this length are not available, unless you prefer to cut them on a molding head or shaper, Fig. 4, $\frac{3}{4}$ -in. chromium tubing may be used in contrast to a top and bottom of wood finished bone white. Before painting the wood, smooth it to a glasslike finish, using first medium coarse and then very fine sandpaper. Apply a light coat of thin paint as a primer, sand it lightly when dry, and follow with the finish coat. If more than two coats of paint are desired, sand lightly between each coat. If the stand is to be painted, thin-wall galvanized, electrical conduit can be used to good advantage. Vertical uprights of crystal plastic, highly polished, will produce a striking effect. Then, too, where massive lines are desired, standard $1\frac{3}{8}$ -in. curtain-pole stock provides you with material requiring nothing but cutting up to correct lengths. Pipe uprights are anchored to the wood bases simply by

boring holes $\frac{3}{4}$ in. deep, triangularly spaced, and driving finishing nails through the edge into holes drilled through the pipe as shown in the detail at Fig. 6. Also, it's a good idea to drill a small hole through the edge of the base to avoid splitting it with the nail.

The design with curved uprights, in Fig. 8, requires more time to construct. Band-sawed from $\frac{3}{4}$ -in. flat stock, the legs are supported at the bottom with a triangular-shaped stretcher and fitted at the top with either an octagonal-shaped block or one with a simple turned edge. The contour of the legs can be marked best by laying the work out on the floor where a large radius can be swung.

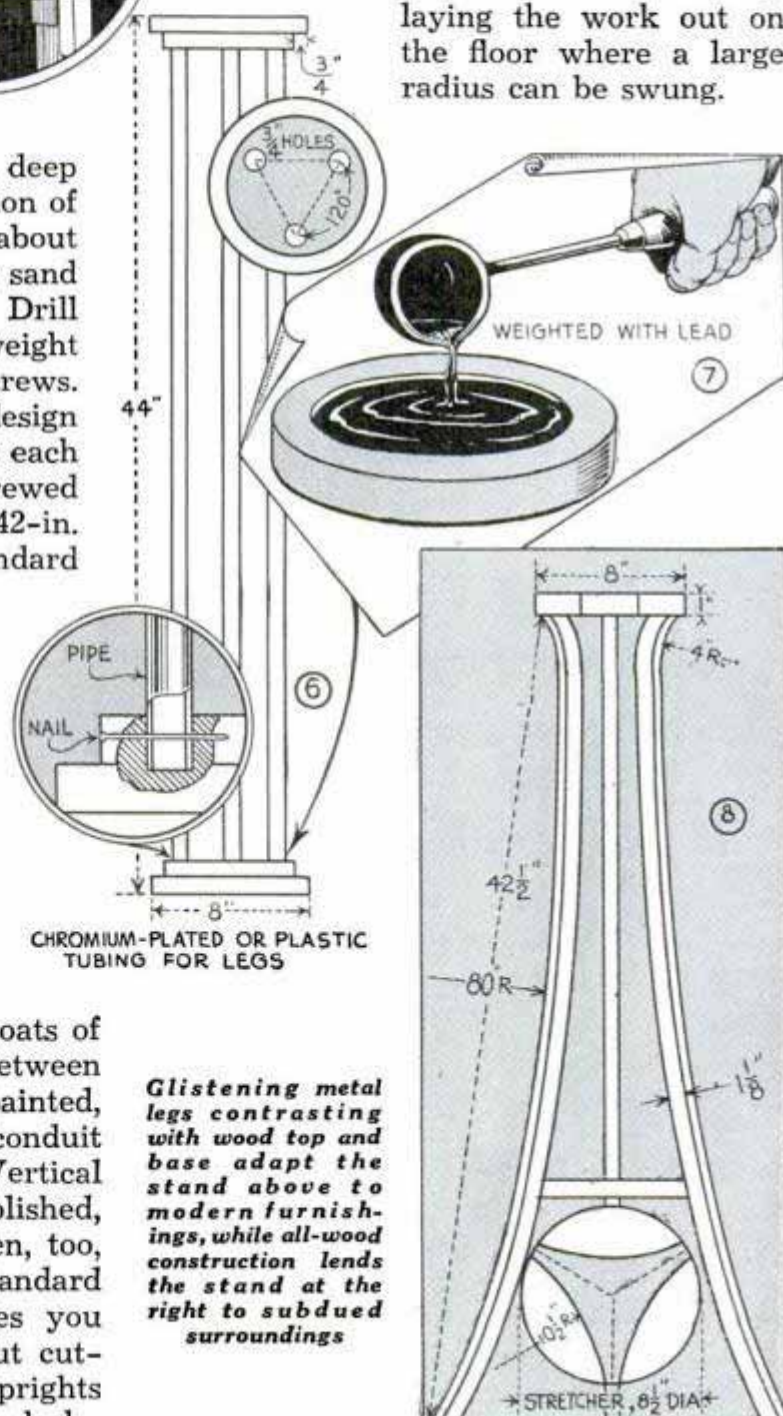

Glistening metal legs contrasting with wood top and base adapt the stand above to modern furnishings, while all-wood construction lends the stand at the right to subdued surroundings

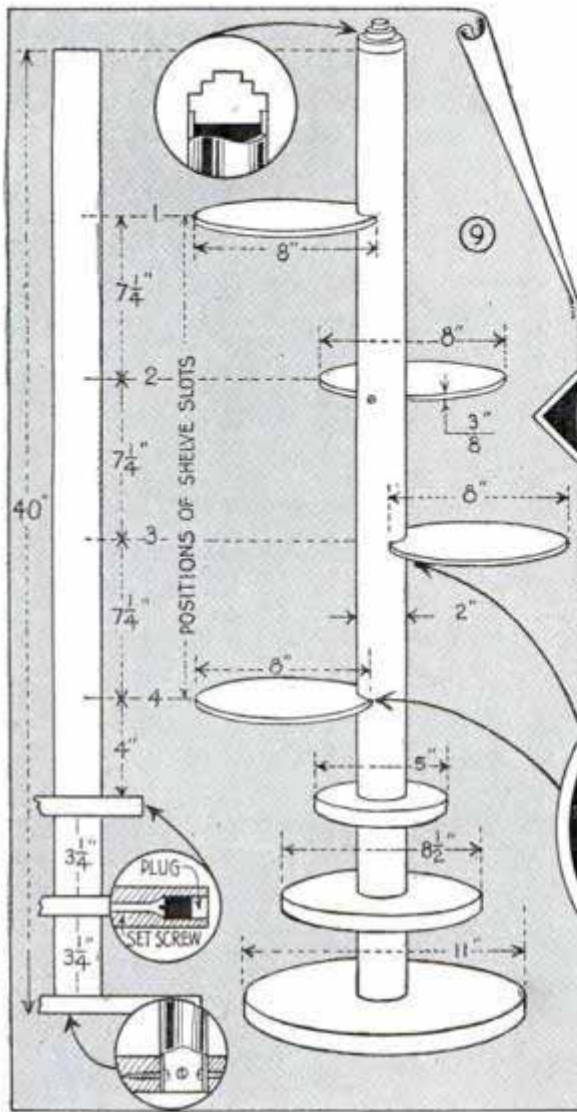

Circular, wood shelves radiating spirally from a center column of bright, chromium-plated tubing give this stand an unusual appearance that permits it to be used in any home, and it's assembled easily with simple hand tools

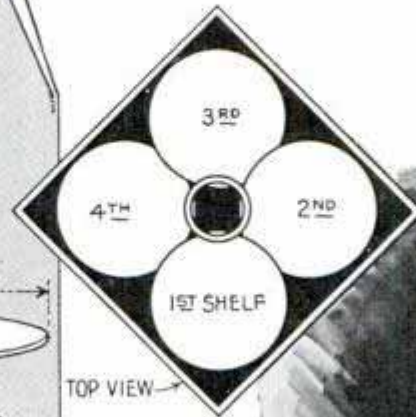

TOP VIEW

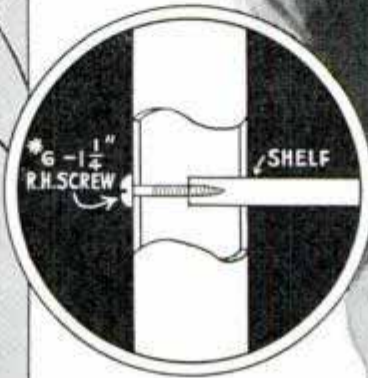

The stand in Fig. 9 provides place for a number of plants on shelves radiating spirally from a center column of chromium tubing. Slots to support the plywood shelves are cut $\frac{7}{8}$ in. deep in the column with a hack saw, and squared up with a file to take the shelves, to be inserted snugly. Screws driven in at the back hold them firmly to the column. This work must be done carefully so that the shelves fit the slots tightly, otherwise the weight of the plants may tend to pry them loose. Care must be taken when drilling the pipe behind the

slots for the anchoring screws. If the holes fail to line up with the centers of the disk edges, the screws are likely to split them. Three receding disks of $\frac{3}{4}$ -in. plywood form the base of the stand and are fastened as shown in detail. The edge of each disk is counterbored deeply, after which the hole is continued with a small drill to the hole for the column in the center. A brass wood screw is driven in to contact the column, after which the hole in the disk edge is plugged with wood. The top of the column is capped with a turned plug.

Fresh Fish Preserved in Wet Sawdust for Transporting

Fishermen, who must travel some distance to and from the lake or stream in which they wish to ply their art, often find it difficult to preserve the catch in a satisfactory degree of freshness without the use of ice. If the fish are dressed at once, after catching, and packed in wet sawdust, they will retain their freshness for several

hours, and even more. If spring water is available, the sawdust should be dampened thoroughly with this, but water of the normal temperature of the lake or stream will serve the purpose. The sawdust should be carried in some container which will exclude the air as much as possible.

—G. E. Hendrickson, Argyle, Wis.

Tracings or Blueprints Stored in Window Shades

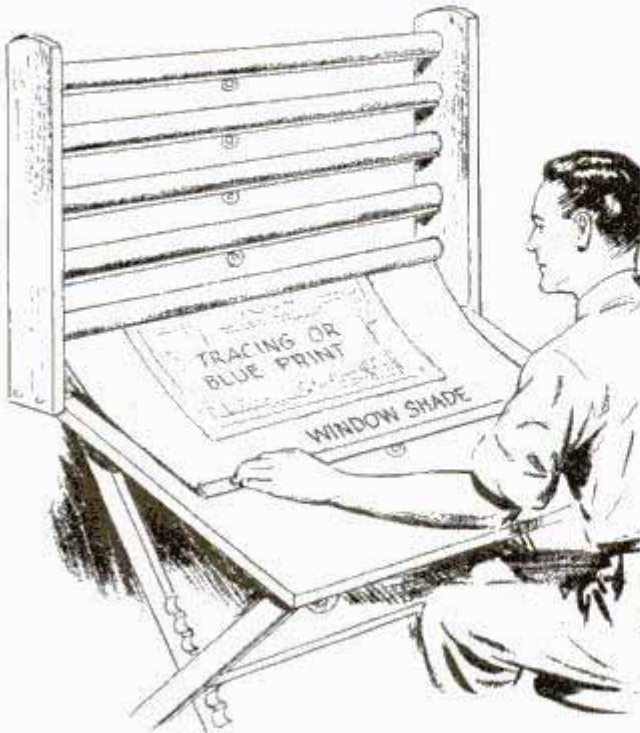

Artist keeps unfinished tracings stored safely by rolling them up in window shades

A number of window shades with their rollers mounted between vertical supports as shown, provide handy places for storing blueprints, unfinished tracings, and similar work. In use, a shade is unrolled, the tracing or blueprint laid on it and rolled up with the shade.

—D. A. Cason, Dallas, Tex.

Wheeled Feed Rack Hauls Hay Right from the Field

Resembling a regular hayrack, this feed rack can be set on the wagon, which is taken to the field, loaded and returned to the feed lots, thus saving the time to pitch

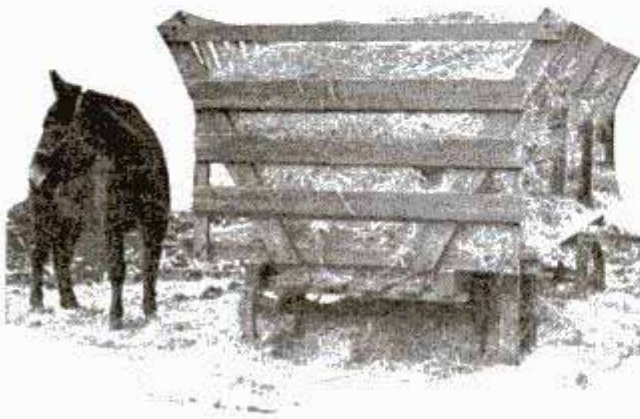

This feed rack prevents waste of hay, and also eliminates pitching feed from wagon to rack

the hay from the wagon to a regular rack. The bottom is built of solid boards which extend to the lower edges, although the sides taper inward toward the bottom at a 30° angle. The owner estimates that about one-third of the hay is saved which would ordinarily be pulled out and trampled underfoot from a regular hayrack.

Lathe Set to Cut Small Tapers with Piece of Cardboard

When a slight taper is to be cut on mandrels, etc., the lathe can be set for the job by merely inserting a strip of cardboard under one side of the tailstock. The amount of taper is determined by the thickness of the cardboard, which tilts the top of the tailstock to one side as indicated by the dotted lines.

—H. Harrison, Woodstock, Ont., Can.

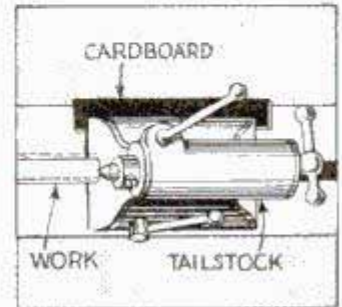

Inner-Tube Patch on Glove Palm Aids in Using Screwdriver

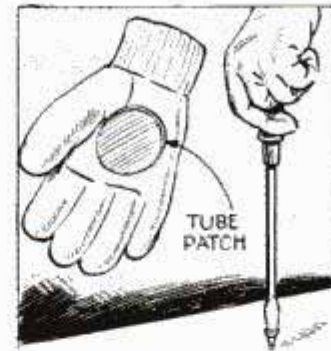

To facilitate the use of a screwdriver when wearing cotton gloves, one mechanic puts an inner-tube patch in the palm of one as indicated. The heel of the screwdriver bears against the patch

where it tends to cushion the hand and provide friction in gripping the screwdriver.

Protecting Exposed Instruments on Motorcycle

The difficult problem of preventing water from passing around the glass covers of speedometers, ammeters, and other exposed instruments on a motorcycle, is solved by coating the joint between the glass and metal with cellulose cement. The cement can be made by dissolving celluloid chips in amyl acetate to form a thick paste.—Ivan J. Stretten, Detroit, Mich.

Arrows Matched on This Homemade Tester

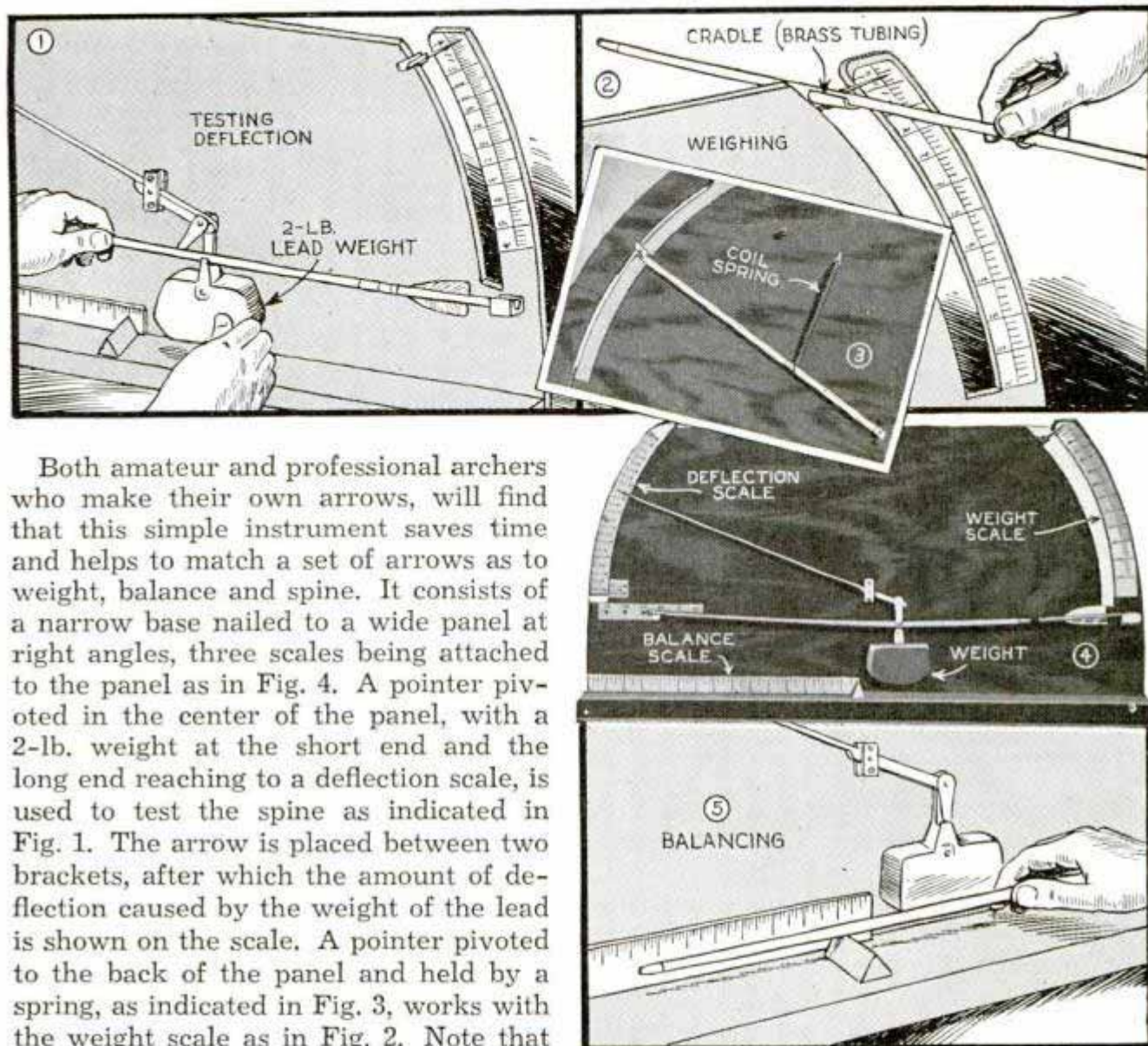

Both amateur and professional archers who make their own arrows, will find that this simple instrument saves time and helps to match a set of arrows as to weight, balance and spine. It consists of a narrow base nailed to a wide panel at right angles, three scales being attached to the panel as in Fig. 4. A pointer pivoted in the center of the panel, with a 2-lb. weight at the short end and the long end reaching to a deflection scale, is used to test the spine as indicated in Fig. 1. The arrow is placed between two brackets, after which the amount of deflection caused by the weight of the lead is shown on the scale. A pointer pivoted to the back of the panel and held by a spring, as indicated in Fig. 3, works with the weight scale as in Fig. 2. Note that the panel is slotted next to the scale and the pointer end bent to work in it so that the reading can be taken from the front. A short piece of tubing split in half and soldered to the pointer serves as a cradle to hold an arrow while weighing it. The balance scale at the bottom of the panel is merely a 1-ft. rule held beside a wedged-shape piece of wood to serve as a knife-edge pivot on which the arrow is placed to find its center of balance, Fig. 5. The rule serves as a guide in selecting arrows that balance the same distance from the pointed end. As all tests with the instrument are comparative, the scales can be calibrated as desired. To use the instrument, one arrow is tested on it, after which others are tested until a set is found that has the same weight, balance and spine.

—Clement C. Parker, Norristown, Pa.

Life of Rubber-Glove Fingers Extended with Tape

When rubber gloves are worn while picking up objects with the fingers, the balls of the fingers and thumbs wear quickly, rendering the gloves useless. In-



stead of trying to repair them, it is better to protect the finger tips beforehand by applying small pieces of adhesive tape. The tape will receive the wear and is easily replaced. This method is used regularly by a photographer who handles glass plates in developing and fixing solutions.

Sweet-Potato Vines Cut Quickly with Horse-Drawn Sled



Sled with mower-sickle sections on runners cuts sweet-potato vines for removal before digging

Cutting sweet-potato vines between the rows before digging them, is simplified with this sled, which is pulled between the rows. Sections of a mowing-machine sickle, screwed to the sides of the runners near each corner, project below them and cut the vines. The sled should be wide enough to just clear the potato hills. If necessary to weight the sled, the workman can ride on it.

Truing Lathe Center

When a lathe center has to be trued up without the use of a compound rest or when the rest has been set and cannot be disturbed, a tailstock center can be employed to guide the tool. A bent tool holder is used with the heel resting against the rear side of the tailstock center. Now if the saddle is moved up as the cross slide is moved outward, and the heel of the tool holder is kept in contact with



the tailstock center, the tool will be forced to follow the same path and produce the same taper on the center being turned.

—H. Moore, Leeds, England.

Number of Month on Calendar Saves Time

Typists, clerks and other office workers who often have to refer to a month by number, can save time by marking the number of the month in large figures on the calendar. A glance will show the number of month without having to count back as is often the case.



Armored Cable Cut Smoothly Through Tape Wrapping



To avoid ragged edges when cutting armored cable with a hacksaw, wrap a piece of friction tape around the cable at the point where it is to be severed.

Then cut through both tape and cable. The tape is removed in a moment and the edges will be found clean, which makes it easier to work with when placing an electrical fitting over the end.—H. R. Wallin, New York.

Water Will Lubricate Hack Saw for Lead Cutting

A Wisconsin plumber declares that oil never should be used to lubricate a hack saw when cutting lead. A small oil-can filled with water should be kept readily at hand for such work.



453 Westminster
Aurora, Ill.

HAND LOOM

weaves cane into webbing

By WAYNE C. LECKEY

CAPABLE of weaving strand cane into solid or open-woven webbing from 12 to 20 in. wide, this homemade loom affords the small shop in the business of chair caning a profit from weaving its own seating materials. Figs. 1 and 3 give you the general idea of assembly. The frame is made of 1 3/4 by 3-in. hardwood, mortised and tenoned throughout. In notches cut in the top of the forward legs, a half-round breast beam is fitted as in Fig. 3. Two lengths of slotted pipe, sliding on flat-iron crossbars, form an adjustable weaving bed. Cane and webbing beams are fitted to opposite ends of the loom and pivot in brackets. The webbing beam can be turned with

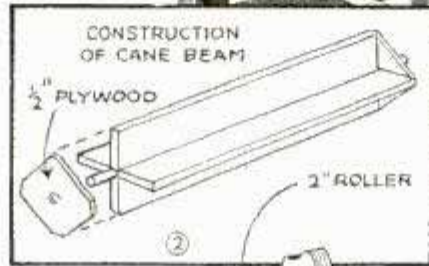
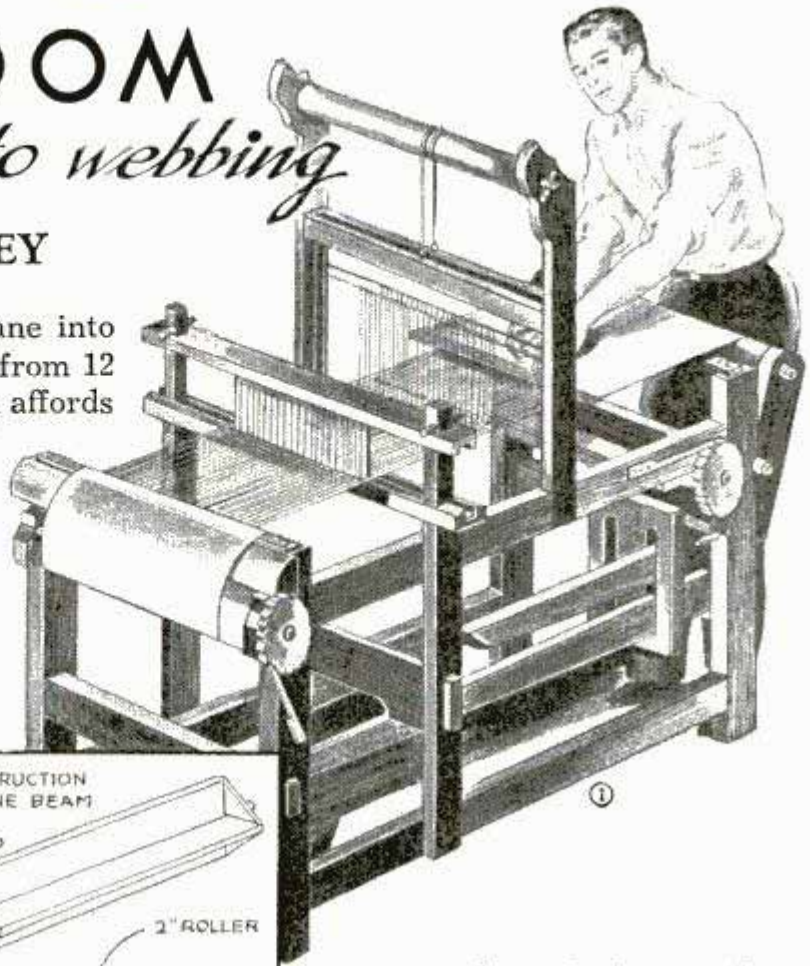

tenons sufficiently long to allow a 6-in. ratchet wheel to be pinned at one end. The cane beam or drum is constructed as shown in Fig. 2. Heavy canvas is tacked to each beam and hemmed. Then a 3/4-in. flat-iron bar is inserted in each hem and drilled with a series of holes spaced 1/2 in. apart. The canvas attached to the cane beam should be long enough to al-

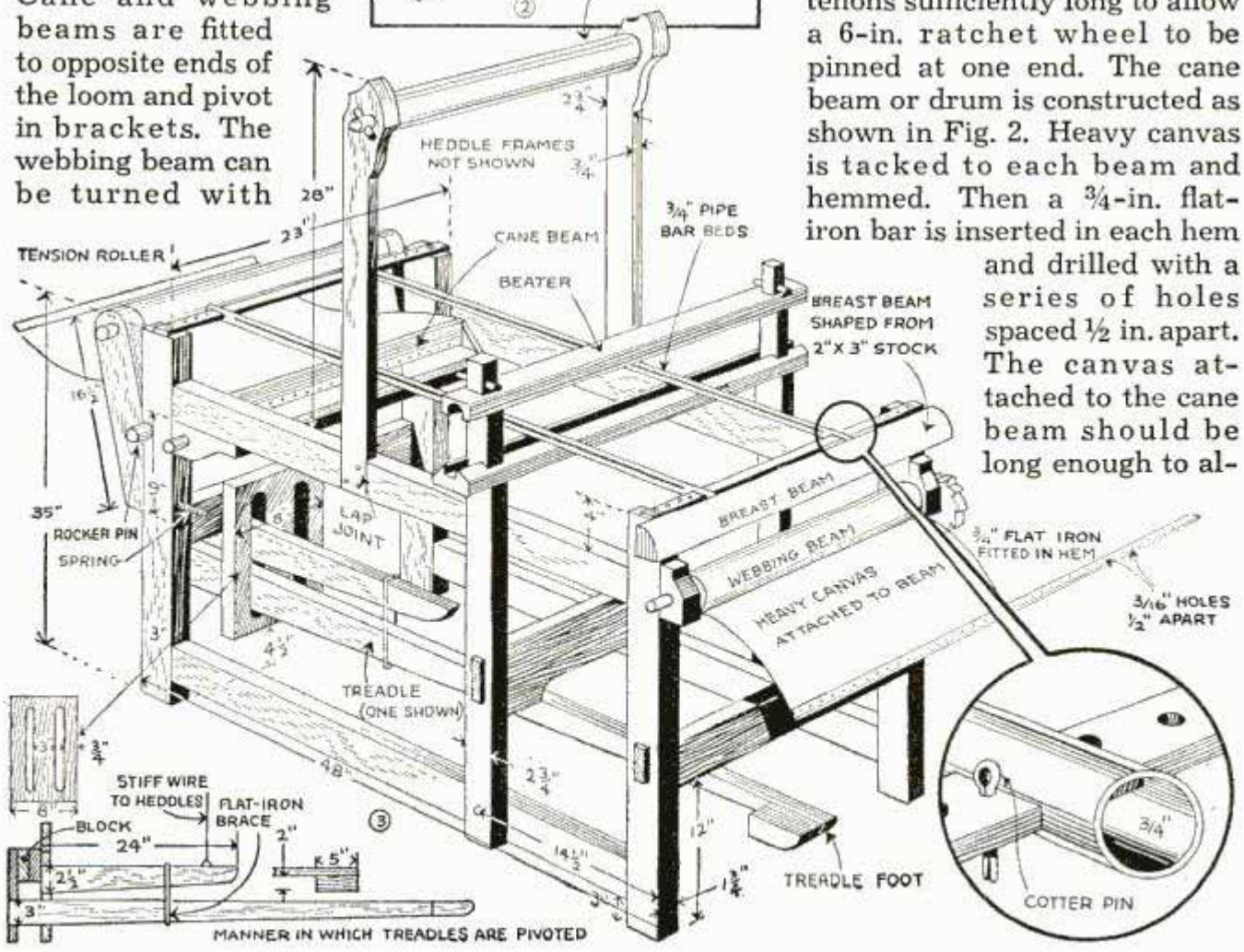

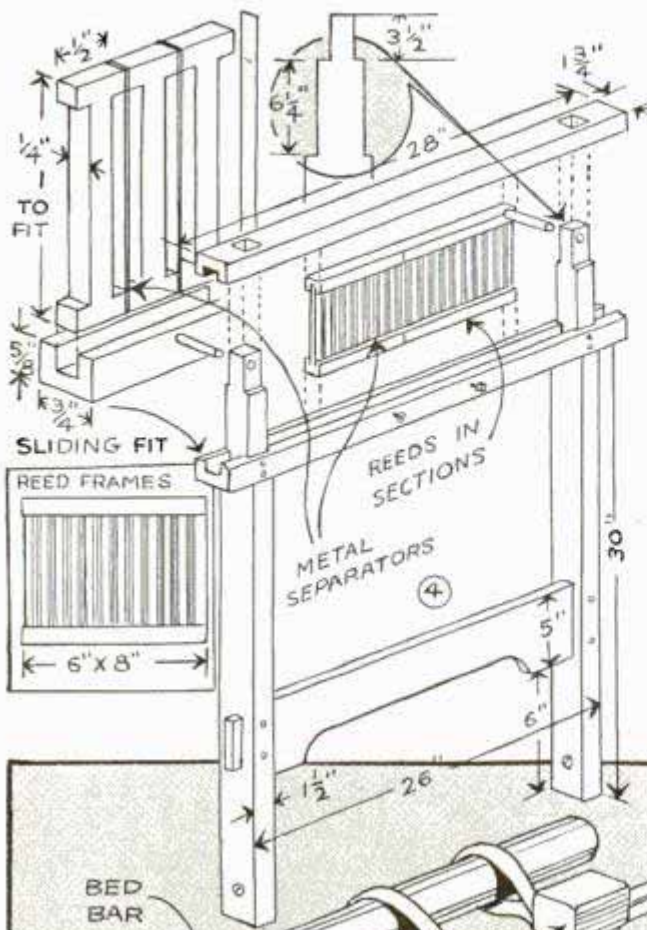

low it to return over the weaving bed as far as the heddle uprights, Fig. 1. Canvas on the webbing beam should reach at least to the top of the breast beam.

The number of reeds in the beater, Fig. 4, govern the size of the mesh. As dimensioned, the reeds are used for 1/4-in. mesh with the weave termed as "Fine." For weaving 3/8-in. mesh, "Superfine," a separate set of reeds must be made. This is true also for 7/16-in. mesh, "Fine-Fine," and 9/16-in. mesh, "Medium." The reeds are made up in 6 and 8-in. sections in order to build up to the desired width. Metal separators inserted between the reeds divide each set of horizontal strands.

The heddle frames are constructed as shown in Fig. 9. Angle-bent flat iron screwed to wood stretchers and fitted with narrow crossbars 16 in. apart forms the

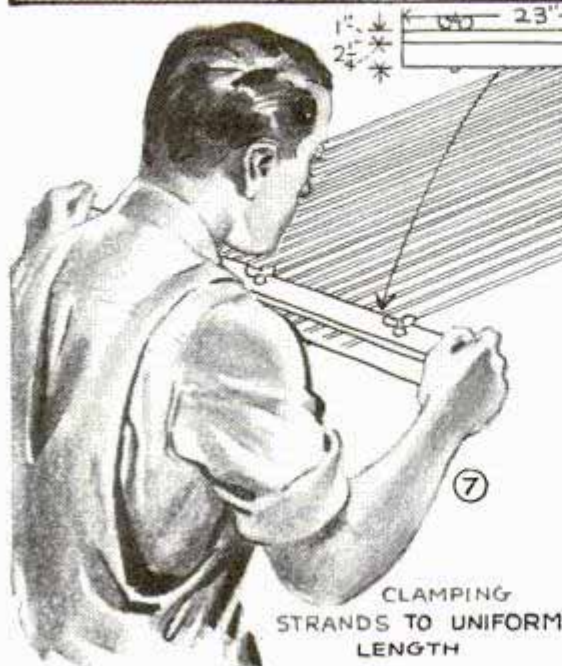
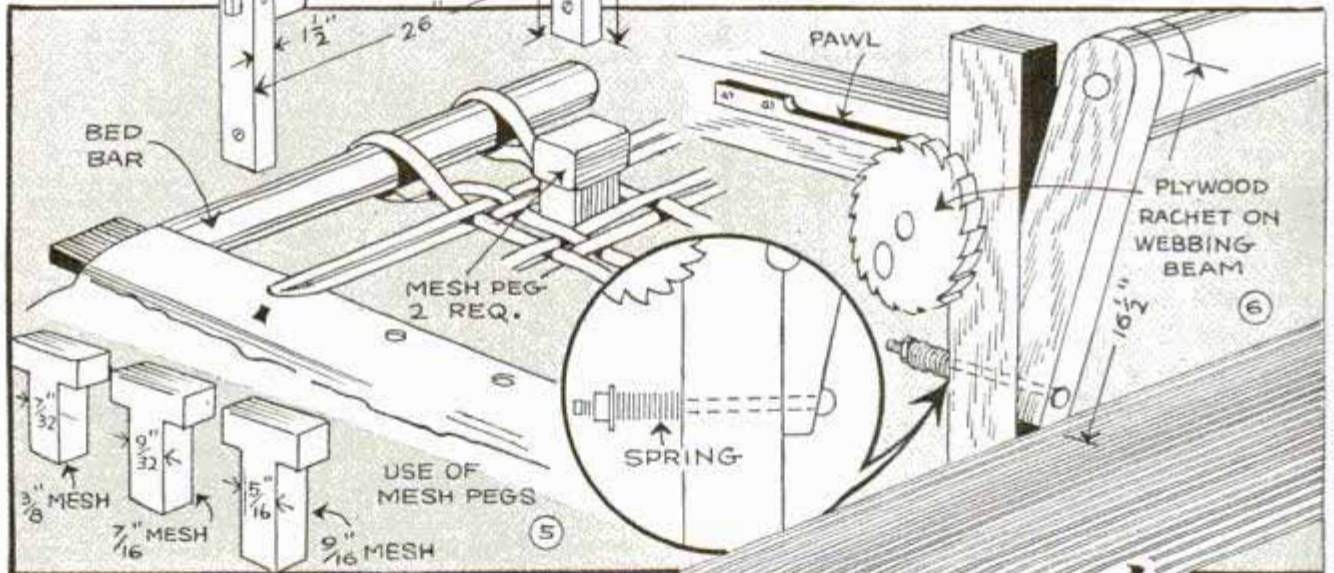

frame in which the heddles are suspended on twisted wires. The frames move up and down alternately on a roller support, Fig. 3.

A roller tension beam fitted to the rear of the frame, Figs. 3 and 6, gives, each time the strands are elevated, to prevent breakage. Fig. 3 gives dimensions for the treadles.

Begin threading up the loom by tying the strands to the canvas of the cane beam as shown in Fig. 8. Starting in the center of the beam, insert two strands through the hole and tie securely. Then thread one strand through the rear heddle and the other through the front heddle, both strands starting from the same hole in the

canvas. Proceeding forward, insert the strands through the center reed of the beater, one on each side of the separator. When the correct number of strands have been threaded through likewise, the strands are drawn out their full length, Fig. 7, and clamped. With an assistant, the cane is then reeled in on the cane beam to a point where the wooden clamp will drop down behind the breast beam. The loose ends are tied to the canvas on the webbing beam before the clamp is removed. Engage the pawl in the ratchet to bring the cane sufficiently taut, but not too great.

The loom is now set for weaving. Mesh pegs, corresponding to the size of webbing desired, are used as shown in Fig. 5. These

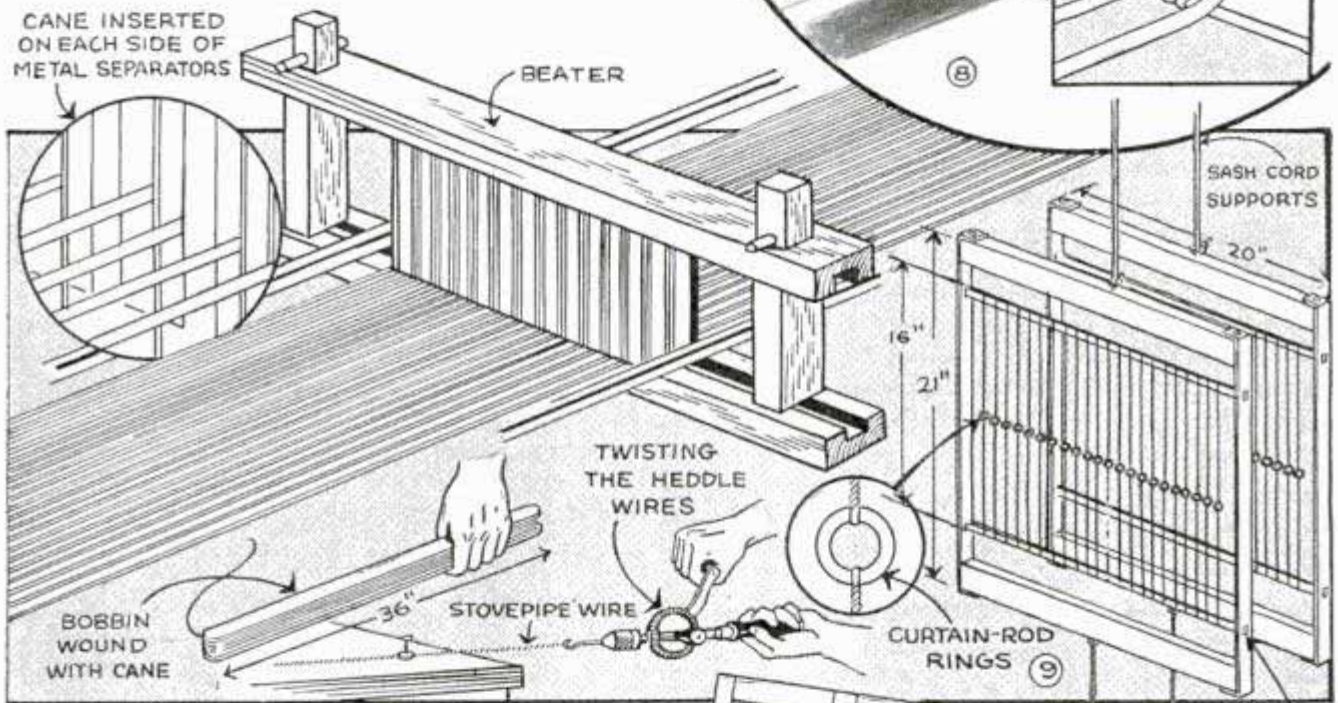

space the horizontal strands as the weaving progresses. Now to weave. First, elevate the heddle then, with the cane tied around the bed bar, pass the bobbin through between the two diverging sets of vertical strands and loop around the bed bar on the opposite side. Seeing that the glazed side of the cane is upward on the return weave, reverse the treadles and pass the bobbin through as before, looping around the pipe bars as in Fig. 5. Then with the beater, crowd the weave snugly together. The weaving of the horizontal strands is continued in this manner, using the mesh pegs, for a distance equal to the width of the webbing exclusive of its marginal ends. At this point, the diagonal strands, Fig. 10, must be woven in by hand.

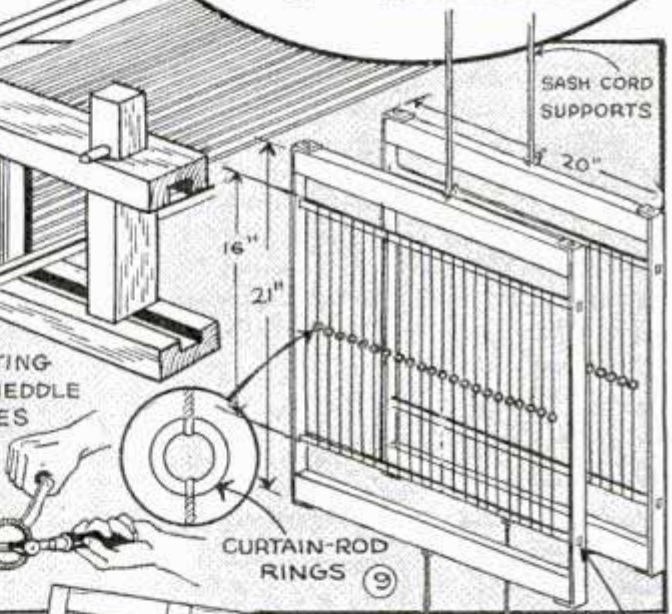
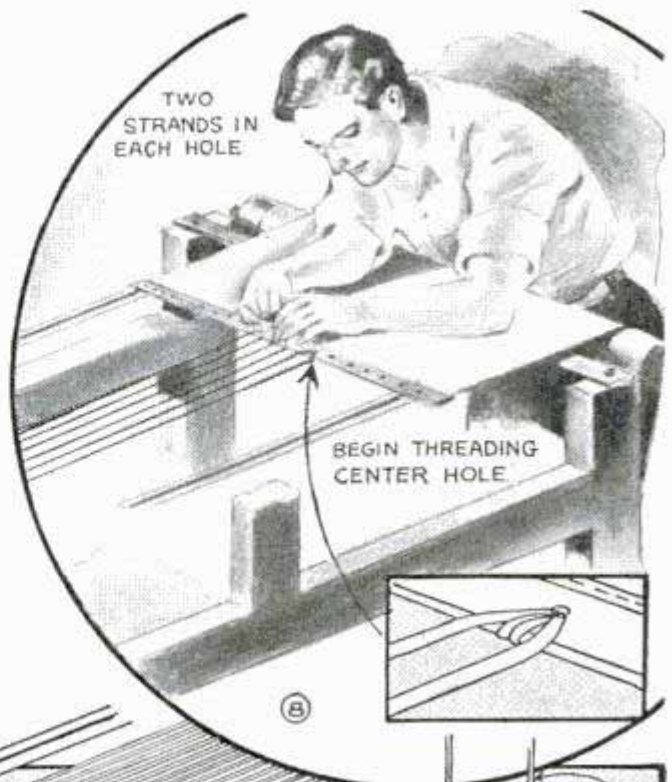

The dark lines in Fig. 10 show how this is done. When these strands are in place, the looped ends around the bars are cut and the webbing so far woven can be reeled in on the webbing beam and the operation repeated. Except for the amount of cane lost in threading the beams, there is practically no waste as short strands can be used later as weavers.

Alphabetical Bill File on Wire over Shipping Bench

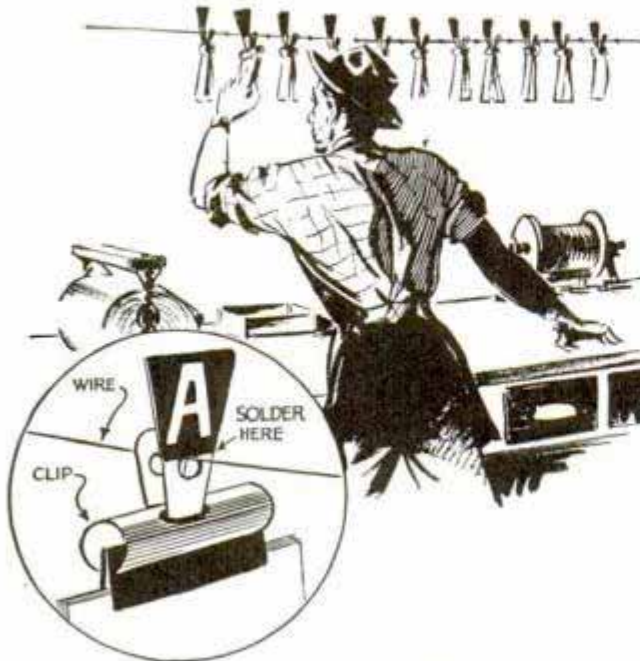

This shipping clerk has alphabetical file for bills right above his head

Shipping clerks and others who have to handle quantities of bills and invoices will find this alphabetical file convenient. It is stretched between walls above their bench where the papers can be reached instantly. The file consists simply of a number of paper clips of the type shown, which are strung on a wire. Pieces of sheet metal bearing the letters of the alphabet are soldered to one handle of the clips as indicated in the circular detail.

Holder to Clamp Screws in Vise While Shaping Ends

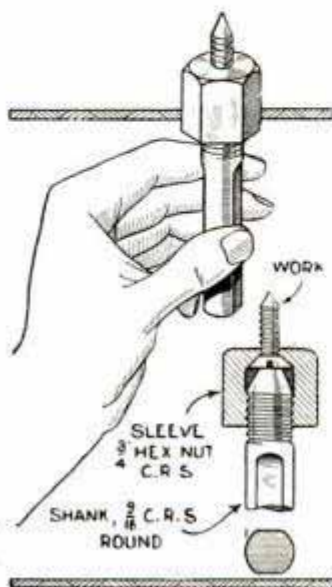

On jobs that require pointing ends of a number of machine screws, this simple holder will grip them tightly so that they can be clamped in a vise. It consists of a piece of steel rod flattened on two sides at one end and threaded at the other to take a sleeve, which is made from a short

piece of hexagon stock. The sleeve is drilled out and tapped so that it will clamp the screw head against the beveled end of the rod. The portion of the sleeve that contacts the screw head is counterbored to the same bevel as that of the head.

—Michael Wolf, Minneapolis, Minn.

Container for Soldering Flux

Welders will find this container unusually handy because it sets at an angle so that the flux can be reached easily with the welding rod. It consists of a short piece of large tubing

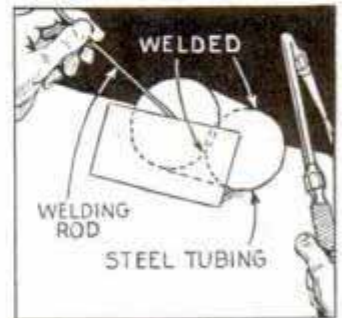

with a metal disk welded to one end to close it, and a rectangular piece welded to the other end to cover half the opening, the piece projecting over the edge to serve as a support when the container is set on a bench.

—W. R. Maddex, Richmond, Ind.

Boards Laid Across Fence Corner Provide Simple Sunshade

When there is young livestock on a farm, it will often pay to erect a number of these sunshades for use on hot days. If the fences around the cattle yards are wood, so much the better. You need only lay old boards across the corners as indicated in the photo, a single nail through the end of each board holding it in place.

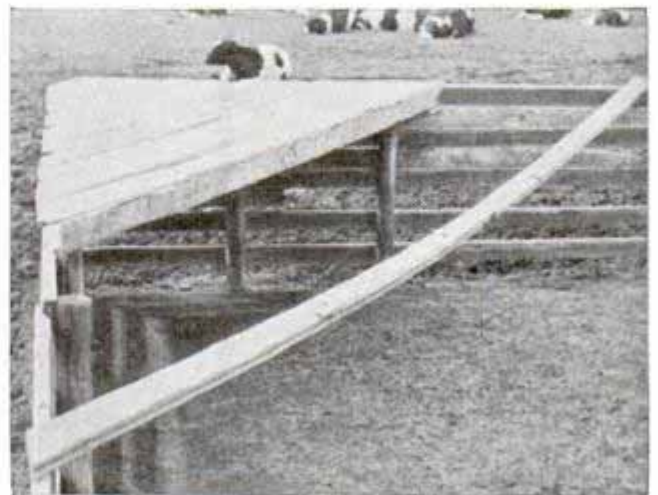

Boards laid across top of fence at corners provide ideal sunshade for young cattle

AUTO SHORTCUTS

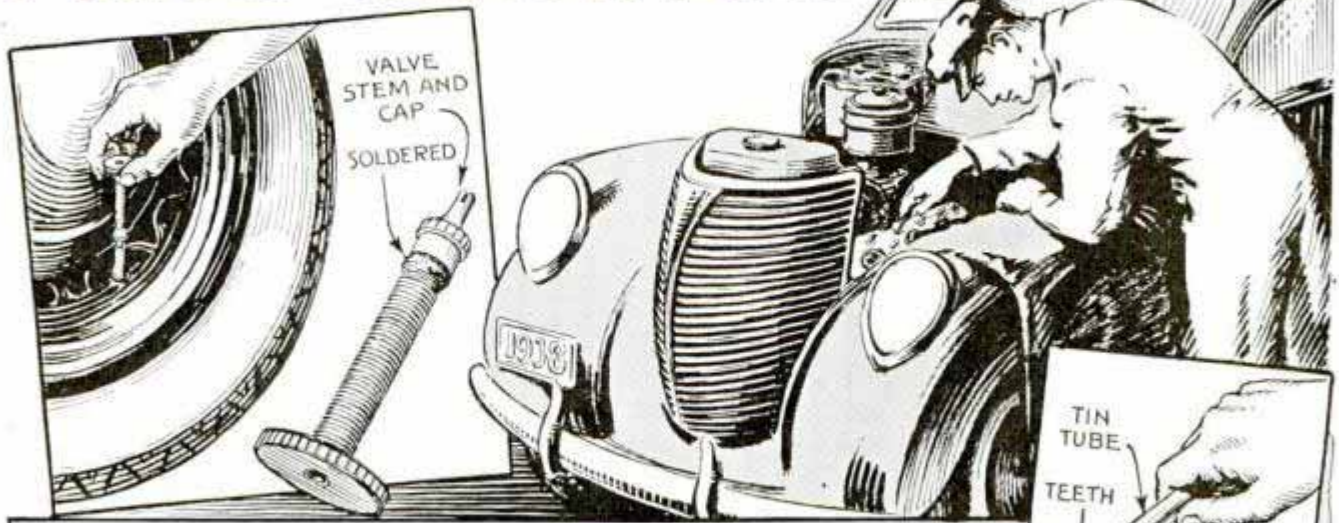

Right, aluminum heads "frozen" to studs removed easily by first cutting away corrosion around the studs with tin tube, which has sharp teeth filed on one end. Valve stem with cap soldered on, as above, removes valve cores quickly. Small holes drilled in crankcase ventilating tube often help in cases of excessive oil consumption that hasn't been reduced by reconditioning the motor

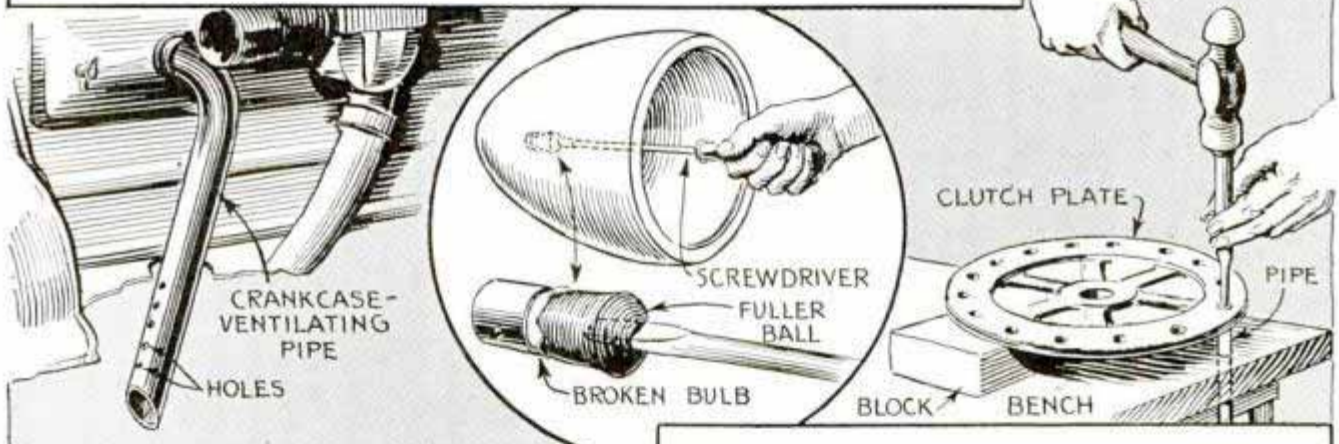

Center, fuller ball on screwdriver removes broken bulbs safely. Above, rivets driven from clutch and brake linings fall through pipe "anvil" into receptacle on floor so that they aren't scattered about. Left, mud and insects forced from radiator fins with special water nozzle, which consists of small pipe having a cap and a small hole drilled near the capped end. Below, breakage of truck-body reflectors avoided by hinging them in place so that they swing and tend to absorb the shock if struck by some object

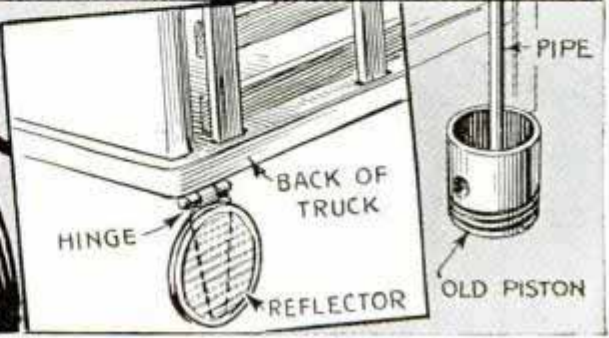
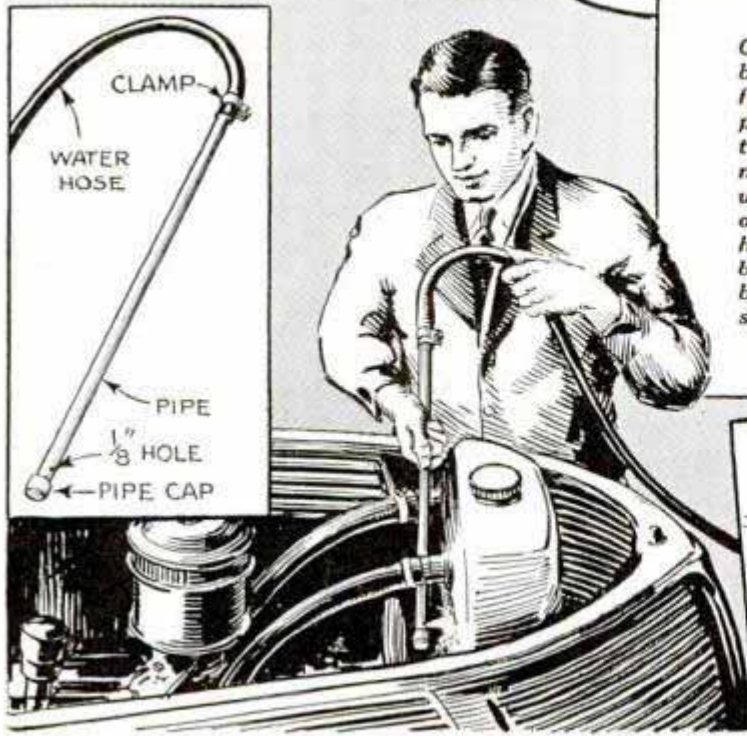

Small Funnel Holds Compound to Grind Valves



A small funnel with a cork in the spout keeps valve-grinding compound conveniently at hand

To hold valve-grinding compound conveniently at hand, one mechanic employs a small funnel. A cork closes the spout, which is inserted in one of the bolt holes of the engine block to hold the container erect and prevent it from tipping over.

Increasing Life of Mud Hooks



A good way to increase the life of mud hooks is to pry open the end links connecting the cross chains with the side plates, and turn them over when nearly worn through. Do not open the hook any wider than necessary as the metal might break when the hook is closed over the plates again.

—Henri Castonguay, Spencer, Mass.

Assorted Shoes Equalize Brakes

The effect of one brake shoe in each pair is often greater than the other, which is

due either to the lining being different, or to grease having leaked onto one and not the other. This trouble can be overcome on brakes having two interchangeable shoes. The four shoes are removed from the wheels and so assorted that one of the quick acting and one of the poorly gripping are in each drum. If the brake is of the type having the shoes mounted vertically, the good one is placed at the rear side of each drum. As the weight of the car is thrown against the front side of each drum when stopping, the good shoe in the rear half gives more friction, which is usually lacking. This plan does not increase the over-all power of the brakes. It makes all of their power usable.

—E. T. Gunderson, Jr., Humboldt, Iowa.

Tightening Tubular Terminals on Spark Plugs

For tightening or loosening long, tubular nuts on spark-plug terminals, a socket wrench of the type used to tighten knurled nuts on radios will do the job in a jiffy and without damaging the nut. This wrench is better and quicker than a pair of pliers as the knurled surface inside the socket grips the terminal nut tightly.—Emil J. Novak, Omaha, Nebr.

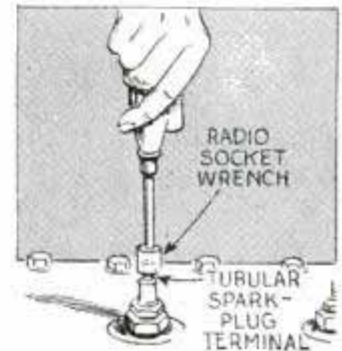

Shrunk-Fit Piston Pins Removed with a Heat Gun

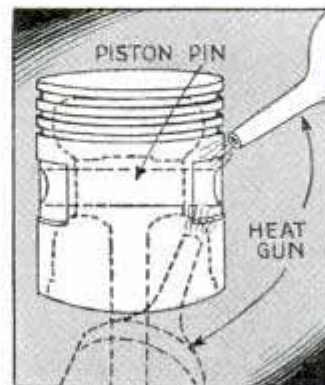

Instead of putting a piston in hot water or oil to expand the bosses so that a shrunk-fit piston pin can be removed, try using a heat gun. The heat can be applied directly to the bosses to expand them quickly

without heating the entire piston, and the job can be done in much less time than when the other methods are employed.

Bumper Vise Stand to Repair Cars on Road

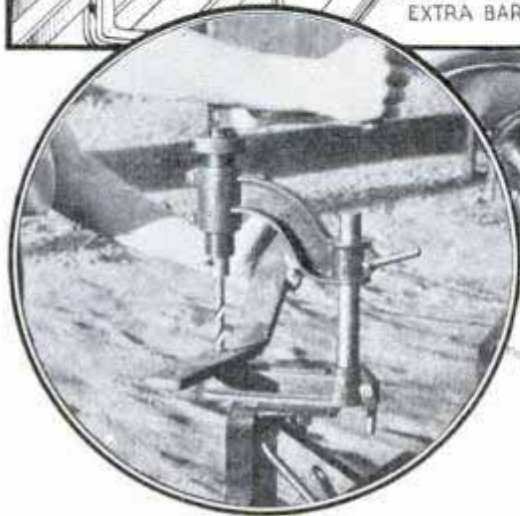
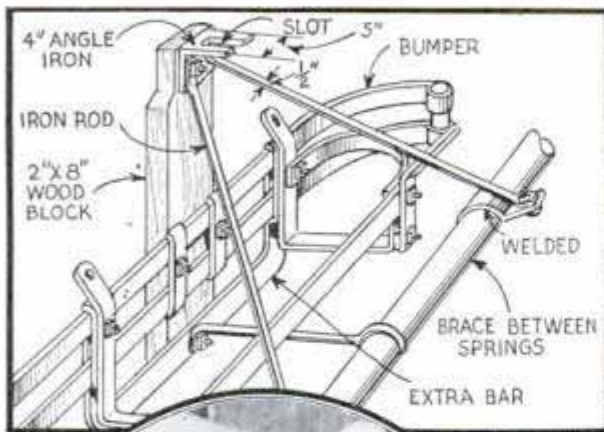

For repairing cars on the road, a California mechanic finds this bumper stand handy to hold a vise or a small hand drill press. It's just a piece of 2 by 8-in. yellow

pine or hardwood bolted to the front bumper and to an extra bar of flat stock bolted to the bumper and extending under it. Rigidity is obtained by reinforcing the entire assembly by means of three bracing rods, one end of these being fastened to clips welded to the tubular brace between the springs. A slotted piece of 4 by 4-in. angle iron, bolted to the upper end, simplifies attachment of tools.

Garage Doors Made Burglarproof by Clip on Locking Bar

Garage doors that are locked by a bar pivoted to one of them, can be made burglarproof by a spring clip as indicated. This is fastened to the bar near one end to engage a projecting iron catch, which is riveted at right angles to the regular bar bracket on the door. The catch prevents the bar from being raised by a thin piece of metal pushed between the doors.

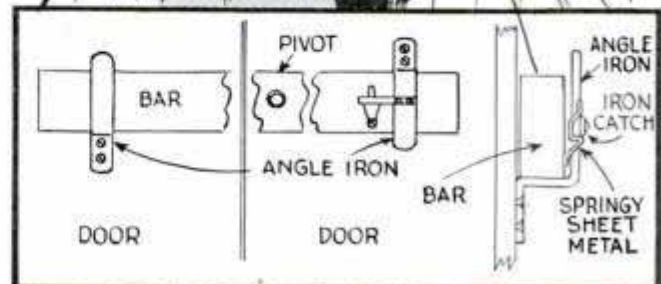

When the bar is dropped into the brackets, the catch slips over an arm so that the bar cannot be raised

Poor Free-Wheeling Adjustment Causes Noisy Gears

In many cases of complaints of transmission howl and noise on the 1934 Plymouth, while driving out of free-wheeling, the trouble was found to be caused by the free-wheeling gears not meshing fully. Shortening the control rod so the gears meshed correctly stopped the trouble.

Patching Rack for Inner Tubes from Old Spade



Old spade screwed to wall or bench provides handy support for inner tube while patching it

An old spade can be converted into a handy wall or bench support to hold inner tubes while patching them. The natural curve of the back of the blade is just right for this type of work. To attach the blade, remove the handle and, after heating the straps, bend them as shown and screw them in place. Additional rigidity can be had by riveting or welding an extra strap at an angle under the blade.

—W. C. Wilhite, Carlinville, Ill.

Lubricating Windshield Wipers

Wipers that are inclosed in panels above the windshield can be oiled by the vacuum line under the instrument panel. Put a few drops of oil into the line and with the aid of a tire pump force air up into the wiper.—Clifford Horne, Redgranite, Wis.

Storage Battery Checked for Leaks with Ordinary Compass

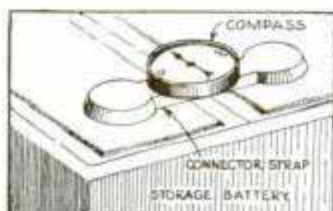

If you drop a storage battery or have other reasons to suspect that the cells might have been cracked so

that there is an electrical leak between them, an ordinary compass can be used to make a check. Just set it on one of the connectors between the cells, and if there is current flowing between them, the compass needle will be deflected at right angles to the connector. Make two or three tests with the battery in different positions to be sure the needle is not merely pointing to the earth's magnetic pole.

Bugs Removed from Windshield with Wood Block

One mechanic found that wet pine blocks kept in a bucket of water near his gasoline pumps were effective for removing bugs from windshields.



Fresh accumulations were scraped off easily with the smooth edge of a block, while dried deposits were rubbed off with the end grain.

Sliding Straps on Robe Rail Hold Your Umbrella

Carrying an umbrella in the car is usually annoying, as it is difficult to find a place where it will not be in the way. If the front seat is provided with a robe rail, two leather straps may be attached to the rail to hold the umbrella as indicated.

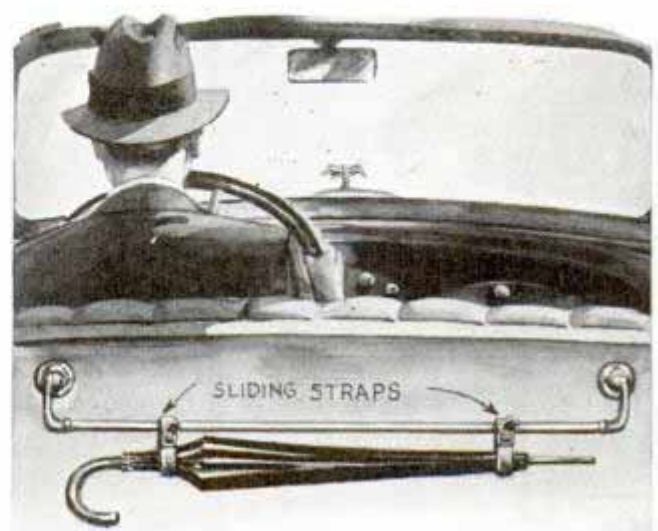

Your umbrella is always out of the way, yet is at hand when needed if it is strapped to the robe rail

Eastman's

"Miniature"

Family



KODAK RETINA II (above) . . . Lens, anastigmat $f.2.8$ or anastigmat $f.2.0$. Shutter, 1/500 Compur-Rapid. Coupled coincidence-type range finder. Body shutter release. Double-exposure prevention device. Kodak Retina II, $f.2.8$, \$115; Kodak Retina II, $f.2.0$, \$140. Prices include sportsman's field case.

KODAK RETINA I (not illustrated) . . . Lens, Kodak Anastigmat EKTAR $f.3.5$. Shutter, 1/500 Compur-Rapid. Film-measuring mechanism. Exposure counter. Depth-of-focus scale. Price, \$57.50.



KODAK BANTAM SPECIAL (above) . . . Lens, Kodak Anastigmat EKTAR $f.2.0$, extra-fast, super-corrected. Shutter, Compur-Rapid, 9 speeds to 1/500 second. Built-in coupled range finder of the split-field military type finds the range and focuses in one operation. Film-centering device locks film accurately in position for each exposure. New low price, \$87.50, includes field case.



KODAK DUO SIX-20, Series II (left) . . . The miniature that takes album-size pictures ($1\frac{5}{8}'' \times 2\frac{1}{4}''$). Lens, Kodak Anastigmat $f.3.5$. Shutter, 1/500-second Compur-Rapid. Eye-level finder frames action—makes it easy to follow. Body shutter release minimizes danger of camera movement. Bracket for Kodak Pocket Range Finder. Price, \$57.50.

Only EASTMAN makes the KODAK

LOAD WITH A WIDE RANGE OF BLACK-AND-WHITE FILM . . . Kodak Retina I and Kodak Retina II load with Kodak "SS," Panatomic, Super X, and Infra-Red Film; Kodak Bantam Special, with Kodak Panatomic and Super X; Kodak Duo Six-20, Series II, with Kodak Verichrome, "SS," and Panatomic.

ALSO LOAD WITH KODACHROME (FULL-COLOR) FILM . . . Kodak Retina I, Kodak Retina II, and Kodak Bantam Special also load with Kodachrome Film for gorgeous full-color transparencies. These may be viewed as they are, or mounted in slides for large-size projection with Kodaslide Projector. At your dealer's . . . Eastman Kodak Company, Rochester, N.Y.



KODASLIDE PROJECTOR . . . Ideal for projecting mounted Kodachrome transparencies. Built to precision standards. Yields big images of unsurpassed over-all clarity. With 8-foot cord, switch, plug, $4\frac{7}{8}$ -inch lens, \$48.50.

THIS PART OF "DUDE" IS O.K. WITH



HERE IT LOOKS MIGHTY PLEASANT being host at the Malibu "Dude" Ranch and starting guests Betty Campion and Alice Carver on the trails. But

ask Lee Thursby about the exhausting task of keeping 35 "dudes" amused and fed! You bet Lee has a favorite cigarette, and, at right, he tells why.

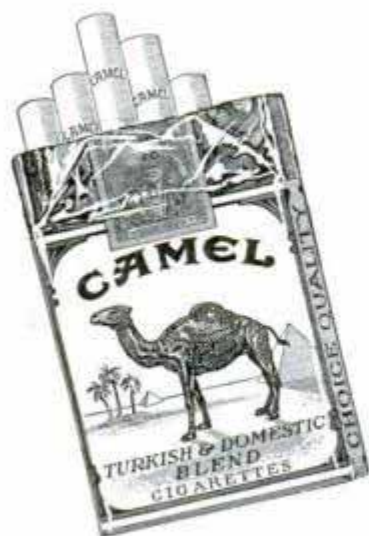

Camels are a matchless blend of finer, MORE EXPENSIVE TOBACCOS
—Turkish and Domestic

**BUT WHAT YOU DON'T SEE ABOVE
IS THE TOUGH, NERVE-STRAINING
SIDE OF KEEPING A BUSY "DUDE"
RANCH GOING**

Lee Thursby has got to have steady nerves. He smokes Camel cigarettes. He finds Camels are so mild that they never get on his nerves!

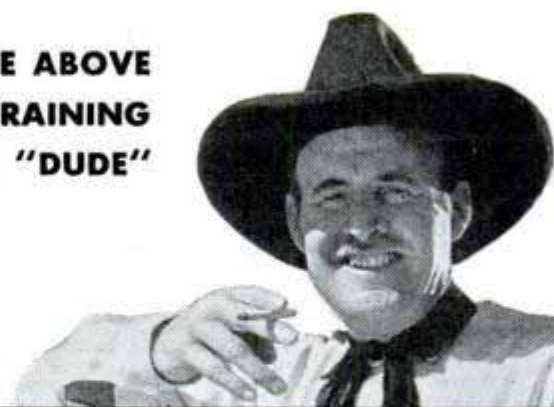

PEOPLE DO APPRECIATE THE **COSTLIER TOBACCOS** IN CAMELS

THEY ARE THE **LARGEST-SELLING** CIGARETTE IN AMERICA

**ONE SMOKER
TELLS ANOTHER: "CAMELS"**

RANCHING LEE THURSBY

"Lee, I've been trying to decide what it is I like best about Camels—their mildness, or that good Camel taste. Camels agree with me in so many, *many* ways!"



"You and me both, Miss Alice. There's so powerful many things to make Camels different. In this 'dude' ranching business I've got to have my nerves in shape *all* the time. Camels don't get my nerves ragged. When ever hustling gets me played out, a Camel gives me a swell 'lift' in energy. There's more pleasure to Camels. Our guests seem to go for Camels too!"

Copyright,
1938,
R. J. Reynolds
Tobacco Co.,
Winston-Salem,
N. C.



BACK TO THE REAL GRIND of "dude" ranching, Lee Thursby, assisted by "Shorty" Kelley, hefts another big load of grub from the chuck-wagon. Cartons of Camels too. Lee speaks for millions of smokers when he says: "I smoke Camels 'for digestion's sake.' Camels set me right! Believe me, 'I'd walk a mile for a Camel!'"

AGREE WITH ME!"

H 355
 16 277

"Gentlemen Drivers"

(Continued from page 229)

dry them out helps a balky engine, and many drivers carry an extra set of spark plugs in a dry place in case they are needed.

Three or more different shapes of propellers are in most drivers' kits. A small propeller gives the best speed in calm water but rough water, which is faster, calls for a propeller with more pitch. A propeller with plenty of pitch gives the highest speed in a straightaway dash but a larger propeller of smaller pitch is best for closed-course racing because its more positive bite on the water gives better acceleration. On rivers that contain quantities of driftwood drivers use steel propellers that can chop their way along without bending the blades.

Outboard racing is cheap in comparison with other speed sports. You can spend as much as \$1,500 for an unlimited "X"-class motor if you want a crack at the present world record of a fraction under eighty miles per hour, or you can get into the midget "M" class with a complete outfit, including motor, hull and trailer, for about \$300. If you build the hull and trailer you can clip a hundred dollars off that cost. Most drivers buy their hulls and do their own motor work. The "M" class requires a fifty-pound boat and an eight-cubic-inch motor and you will have to beat thirty-three miles per hour with that equipment if you want to hang up a new record.

The other hydroplanes graduate in size from the "A" class, with a 100-pound boat and a fourteen-cubic-inch motor, "B" class with a 100-pound boat and twenty-cubic-inch motor, "C" class with a 150-pound hull and thirty-cubic-inch engine, to the "F" class that requires a 190-pound hull and a sixty-cubic-inch engine. In the last you will have to do better than fifty miles per hour to win many races. The present record is sixty-two miles per hour. Other racing classes are the one and two man runabouts.

☐ Popular Mechanics Magazine can furnish the name and address of the maker of, or dealer in, any article described in its pages. If you wish this information, write to the Bureau of Information, inclosing a stamped, self-addressed envelope.

Thrill Hunters of the Air Lanes

(Continued from page 253)

the sake of brevity. Sometimes, two or three minutes of dialogue will have to be added to a show. Different inflections on the lines alone often will do the trick.

In the radio programs he produces, Stuart Hawkins uses his forefinger to pace a script. Not one member of a cast so much as opens his mouth until Hawkins' finger comes down. The finger uplifted means silence. Manipulated in certain ways, it signals the timing of sound effects. In a scene where there are many characters, it moves around like a baton.

Any doubt as to the reality of radio characters in the minds of the listeners vanishes after one look at the personal letters they receive daily. A kindly boarding-house owner or a country-doctor character will receive hundreds of letters asking their advice on love problems or how to secure a job. If some dashing hero is wounded in battle, he receives remedies and suggestions for taking care of his gunshot wounds. Whenever some feminine character becomes engaged to some other imaginary character, her mail is glutted with advice on husband-taming and housekeeping.

Chicago is the script capital of the radio world. There are approximately 500 radio actors engaged in radio dramatic work. Of this number, however, approximately fifteen per cent do ninety per cent of the jobs. An actor receives from fifteen to twenty-five dollars a program for an ordinary part. Some actors and actresses have worked on as many as forty script shows in a single week but ordinarily an average week is ten or twelve appearances.

A whole bagful of voice tricks must be possessed by a radio performer. Contempt, love, anger, pity—every mood requires a corresponding tonal quality in the voice. He must be adept at reading lines or his performance will sound mechanical.

Stock companies and the smaller radio stations have been the developing ground for the majority of players, particularly those who do character work. Some of these are amazingly versatile. Forrest Lewis plays the part of young men, old men, Germans, Frenchmen, Englishmen, Hindus, Orientals, and five Negro characters. On one fifteen-minute show he plays six characters.

Built by Collins Boat Works
 219 E. Lorens Avenue
 Chicago, Ill.

NEW *Non-Skid* TIRE DRIES WET ROADS

... Also Gives You Golden Ply Blow-out Protection Free



Wins "hands down" in non-skid tests
For thousands of miles over wet and dry roads the famous Pittsburgh Testing Laboratory checked the regular and premium-priced tires of America's six largest tire manufacturers to determine scientifically which tire gave greatest resistance to skids.

Read how this new tire can save your life

WITH traffic growing heavier, with long vacation trips just ahead, *right now* is the wise time to replace smooth, dangerous tires with the new Goodrich Safety Silvertowns.

This sensational Silvertown is *more* than just a new tire — it's a NEW KIND OF TIRE! *Inside* it has the famous Golden Ply blow-out protection that has already saved thousands of motorists' lives. *Outside* it has the amazing new Life-Saver Tread that actually *dries* wet roads and gives you the *quickest* non-skid stops that you've ever had. For *tomorrow's* safety—equip your car with Goodrich Safety Silvertowns *today!* They cost you not a penny extra.

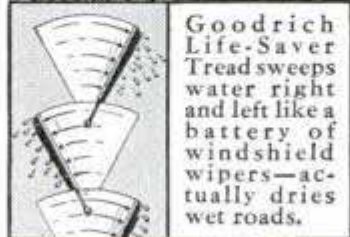

Goodrich Life-Saver Tread sweeps water right and left like a battery of windshield wipers—actually dries wet roads.

SUMMARY OF THE REPORT from America's Largest Independent Testing Laboratory

"NON-SKID—The new Goodrich Silvertown with the Life-Saver Tread gave greater skid resistance than any other tire tested including those tires listed from 40% to 70% higher in price.

"MILEAGE — The Goodrich Silvertown gave more non-skid mileage than any of the other tires tested in its own price range—averaged 19.1% more miles before the tires wore smooth.

"BLOW-OUT PROTECTION —Despite the severe nature of these tests, no Silvertown blew out, or failed from any cause, while two tires of other makes failed."

A. R. ELLIS, Pres.



PITTSBURGH TESTING LABORATORY

The new Goodrich SAFETY Silvertown

LIFE-SAVER TREAD SKID-PROTECTION  GOLDEN PLY BLOW-OUT PROTECTION

H 448

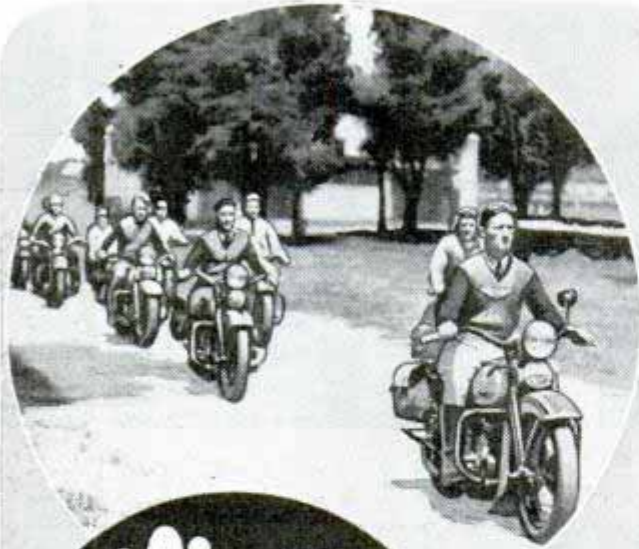

**Rolling
up
GOOD
TIMES!**

Yes, Siree — owning a motorcycle is great sport these days! No more nothing-to-do days! Enjoy plenty of action and fun every day — and make lots of new friends. Go in for gypsy tours, reliability and endurance runs, hillclimbs, tourist trophy races, and other thrill-packed motorcycle events. Join a live-wire riders' club. Visit your Harley-Davidson dealer — find out about the great fun club members everywhere are having — and get an eyeful of the latest model Harley-Davidsons. Also ask about his Easy Pay Plans — and above all, be sure to mail the coupon NOW!

Harley-Davidson
WORLD'S CHAMPION MOTORCYCLE

**MAIL THIS COUPON
NOW!**



Harley-Davidson Motor Co., Dept. P-838, Milwaukee, Wis.

Please send illustrated literature on Motorcycles and FREE copy of "ENTHUSIAST," Motorcycling Magazine. Stamp is enclosed for mailing cost.

Name.....

Address.....

The Truth about Tank Farming

(Continued from page 235)

place naturally. But in the water-culture method they must be made by the operator.

The proper preparation of seed beds, tanks and nutrient solutions is only part of the problem. Knowledge and control of light and temperature, plant diseases, insect pests, plant varieties and their climatic adaptations are equally important. In short, a successful water culturist must know as much about plants as a successful dirt farmer or an expert greenhouse man.

In the welter of confusion about water culture, promoters and profiteers have seen a chance to reap a quick fortune. Many have advertised the sale of nutrient salts for water-culture solutions, making highly exaggerated claims for these chemicals—such as the power to produce crops without regard to the season of the year. One promoter offered a package of nutrient salts for \$1.25. Purchased at a chemical supply house, the same amount of salts would cost only five or ten cents.

It would be misleading to state flatly that greater yields are possible by water-culture methods than by soil methods in the same area. Greenhouse conditions are so different from those on the farm or in the garden that no scientific or practical basis of comparison exists. Yields from water culture are not so impressive when compared with the yields from greenhouses growing tomatoes in soil. Both successes and failures have been reported from greenhouses using the water-culture method of growing tomatoes. The question resolves itself to this: Is it cheaper to grow tomatoes by water-culture methods or by soil methods?

Water culture at present is for the expert. It is still in the experimental stage, and to go at it on a commercial scale without training and experience is a gamble. Ernest W. Brundin of Montebello, Calif., is one grower who has made a success of water culture on a large-scale commercial basis. He holds a bachelor of science degree from the University of California and has been engaged in patent and irrigation engineering. He started his project three years ago with the advice of Dr. Gericke.

Mr. Brundin has about half an acre under glass. In his greenhouses are 150

H 448

chemical tanks, containing 12,000 tomato plants. Temperature, sunlight and humidity are rigidly controlled, and the nutrient solution is pumped to all the tanks from one central pumping unit. No one chemical formula is used. He tests his solution every twenty-four hours to see what adjustments should be made. The plants are fed about eight pounds of salts each day—costing about three cents per pound. On cloudy days, the plants require less food than on sunny days.

Seed is planted about the first of September and the ripe tomatoes are harvested continuously from January to August. Then the plants are removed, the houses and tanks are thoroughly cleaned, and new seed is planted. Mr. Brundin's water-culture tomatoes are in constant demand by large fancy grocery stores and are also served in the dining cars of one railroad.

Mr. Brundin reports that the 1937 crop yielded at the rate of eighty-three tons per acre and sold in the wholesale market for an average price of thirteen cents per pound. This is possibly a fifteen to twenty-five per cent greater yield than that of hothouse tomatoes grown in fertile soil. More favorable prices are obtained because the fruit is harvested during dark winter days when soil-grown, hothouse tomatoes are not available. At present, the investment required for an acre of water-culture equipment will run about \$25,000 for the hothouses, and about \$7,000 for the tanks and pumping equipment.

"The person who ventures into 'chemical farming' should be guided by dollars-and-cents facts," says Mr. Brundin. "Small-scale 'experimental' tanks, as advertised by the promoters, are more difficult to operate and control than a large commercial plant. It is essential that the grower have a knowledge of testing alkalinity-acidity and nutrient balances, and know how to make the necessary adjustments."

That is the opinion of a man who speaks from first-hand experience. The truth about water culture is this: With scientific methods and expert supervision, it may succeed on a commercial scale in luxury crop production. But the commercial grower must be prepared to invest a considerable amount of money in equipment and develop his own technique with expert advice. Otherwise he may be doomed to discouraging failure.

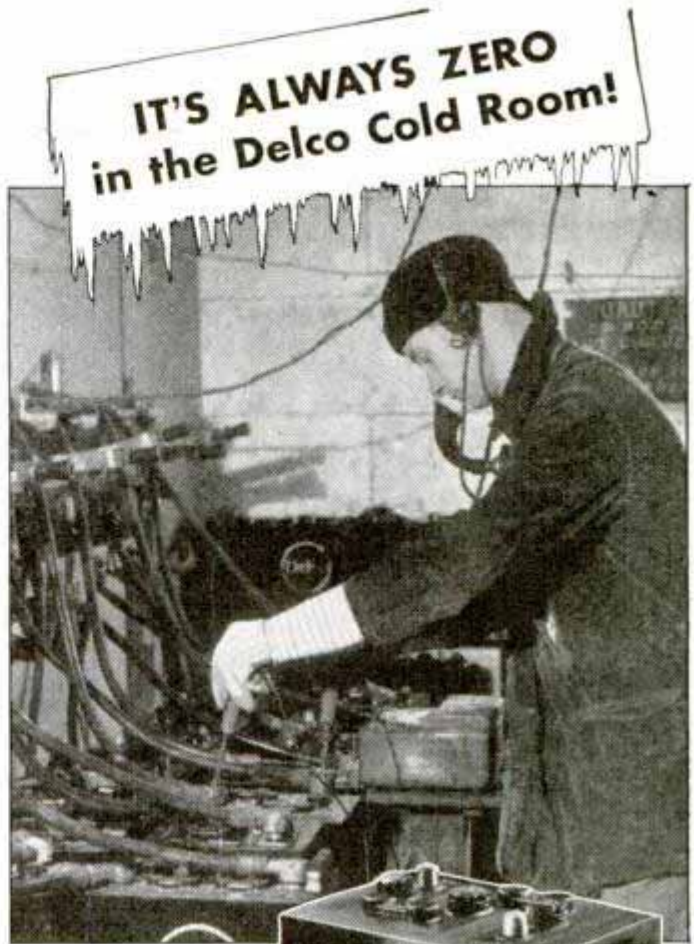

In this "cold room," where zero temperature prevails, Delco batteries are tested for performance to insure quick starting in cold weather.



In summer as well as in winter, Delco-Remy engineers and research men subject Delco batteries to cold-room tests at a temperature that never varies more than one degree from zero. Here, under approximate winter operating conditions, each part of a Delco battery is thoroughly checked, so that its cold-weather performance may be assured. It is this thoroughness in research and testing that assures battery users of quick starting, ample power, and long life from the Delco batteries in their cars, trucks, boats, and tractors.



Delco battery sales and service requirements are available at United Motors Service Stations and dealers everywhere.

Delco-Remy

ANDERSON, INDIANA

World's Largest Manufacturer of Automotive Electrical Equipment

12.398

Cloak of Fire Guards Drop of Steel

(Continued from page 203)

is delivered from a welded underground tank at the filling station through a welded pump into the welded tank of your automobile.

Arc welding for many years was prohibited, but now is almost the universal method employed for fabricating the mammoth pressure vessels used in refineries, because it allows them to treat the raw material at extremely high temperatures and pressures, and in large volume. This modern refining equipment enables the oil industry to extract fifty per cent more motor fuel from a barrel of crude oil than was possible before the days of the shielded arc. The cut in the nation's annual gasoline bill as a result of this saving in raw material has been estimated to be more than a billion dollars, or five cents a gallon on the retail price, and the gasoline itself is rated to be fifteen per cent more efficient.

In the steam-power field, temperatures and pressures took an upward surge. It is a striking contrast to compare the hesitancy toward arc welding steam pipe lines for fifteen pounds pressure in 1925, with the prevailing practice of welding pipe lines for a hundred times that pressure in 1938. The economy of it is found in the story of fuel consumption, one and five-tenths pounds of coal per kilowatt-hour in an average steam station, and eight-tenths pound of coal per kilowatt-hour in a modern high-pressure station.

Impressive also is the weight-saving advantages in shipbuilding. A 35,000-ton battleship saves a thousand tons of steel in the hull and is able to add that much to armament without sacrificing speed or violating naval building agreements. A 300-foot cargo vessel's load capacity is increased by 300 tons, thus saving her owners thousands of dollars per year, in addition to being lower in construction cost.

It is not surprising that the industrial payroll numbers increasing thousands of Class One welders. Hunched over their work like so many strangely hooded gnomes they are busy every day at fusing together some of the mightiest steel structures ever built. Often they are located behind heavy curtains to protect passers-by from exposure to the sharp glare of the arc. Their work has a peculiar simplicity



Bewise - Alkalize

An Alka-Seltzer Tablet in a glass of water makes a sparkling pleasant-tasting solution. Drink it and it gives quick relief from Headaches, Sour Stomach, Distress after meals and other common ailments. It also helps overcome excess acid condition so often associated with these troubles.

TUNE IN THE NATIONAL BARN DANCE SATURDAY NIGHT NBC - NETWORK
30¢ & 60¢ PKGS. OR BY THE GLASS AT DRUG STORE SODA FOUNTAINS



WITH ALKA-SELTZER IN OUR GRIP, WE LEAVE DULL CARE BEHIND.

GOOD BYE TO MORNING MISERY, GOOD BYE TO DAILY GRIND

GOOD BYE TO UPSET STOMACHS AND HEAD-ACHES TOO, MY DEAR

GOOD BYE TO WORK AND WORRY - VACATION TIME IS HERE

Alkalize with Alka-Seltzer AT ALL DRUGGISTS

DO YOU WANT a new business profession of your own, with all the trade you can attend to? Then become a foot correctionist, and in a few weeks earn big income in service fees,—not medical nor chiropody—easy terms for home training, no further capital needed, no goods to buy, no agency. Established 1894. Address Stephenson Laboratory, 1 Back Bay, Boston, Mass.

4-398
of design. Pipes are joined without couplings; structural steel trusses are assembled without gusset plates; boiler drums are made without butt straps. These auxiliary connecting pieces are unnecessary because the weld is fully equal in strength to the metal which it joins.

Although this process has been fitted into the production lines of many steel fabricating plants, it is not restricted to such prosaic working conditions. One master welder may apply his sputtering arc on the bracing structure of the bottom hold of a battleship. Another straddles a beam high up in the framework of a new office building. A third is busy in the maze of high-pressure piping of an oil refinery. The immediate responsibility is always the same, to guide that tiny arc along a seam, feeding the wire downward as it melts, so as to hold the arc gap at a uniform length, and guiding the milk-white drops of liquid metal accurately into the advancing crater. All this is in spite of clumsy protective clothing, heavy work gloves and a huge black fiber helmet that completely incloses his face and lets him view his work through a window of dark glass.

The very newness of the process makes for new opportunities in many branches of engineering, new worlds for science to conquer. Improvements are yet to be made in the composition of electrode coatings and methods of applying them to wire. Electric current-control devices are in their infancy and will reward inventive genius. The subject of design for welding covers a vast new area; designing to use welded metal construction so the utmost benefit is gained from the strength and soundness of the weld metal and with the greatest possible economy of material and labor. These subjects are being discussed actively at conferences and clinics held by engineering schools, universities and technical societies in all part of the country. Those closest to arc-welding developments assert that the process is on the threshold of its most flourishing period of expansion and development.

☐ Popular Mechanics Magazine can furnish the name and address of the maker of, or dealer in, any article described in its pages. If you wish this information, write to the Bureau of Information, inclosing a stamped, self-addressed envelope.



"These BIRDS were caught STEALING GAS"

All over the country, 70,000 Registered AC Spark Plug Cleaning Stations are displaying the pointed little reminder illustrated above.

In bringing dirty spark plugs to the attention of motorists, these Cleaning Stations are rendering a helpful, valuable service. For dirty spark plugs waste as much as one gallon of gas in ten, and cause hard starting and loss of power.

The dirty deposit (oxide coating, soot, and carbon) makes spark plugs misfire—especially when the engine is under load or operating at high speed. This misfiring wastes fuel, steals engine power, and delays starting. So, make it a point to have your plugs cleaned—by the AC Method—every 4,000 miles. The cost is only 5c a plug.

LOOK FOR THIS SIGN
When you need plugs or
plug service.



REPLACE WORN PLUGS
WITH AC
QUALITY
SPARK PLUGS

AC SPARK PLUG DIVISION
General Motors Corporation • FLINT, MICH.

WATCH THIS SPACE
IN NEXT ISSUE
FOR FULL PARTICULARS ON

DURO'S Heavy Duty Hand Grinder

- FULL UNIVERSAL GENERAL ELECTRIC MOTOR
- NEW DEPARTURE BALL BEARINGS
- STREAMLINE DESIGN

DURO METAL PRODUCTS COMPANY

2649 No. Kildare Ave.,

Chicago, Ill.



VEST POCKET ADDING MACHINE

IDEAL FOR BUSINESS OR PERSONAL USE: Adds, subtracts, multiplies, divides. Does work of more costly machine. Counts up to million, made of steel—weighs 8 ounces. Simple, accurate. Not a toy. Guaranteed 5 years.

— FREE TRIAL —
SEND NO MONEY!

\$2.50
Total Cost

Order from ad, not sold in stores. Just send name and address. On delivery pay postman \$2.50 (plus few cents postage). (If outside U. S. send cash.) 10¢ additional in Latherette Case. If not satisfied after 10 days' trial you get your money back. Thousands of satisfied users. Write for Agent's proposition. **CALCULATOR MACHINE CO.** (Mrs.) Dept. 108, P. O. Box 1118, Chicago, Illinois.



EARN MONEY COLOR-GLAZE POTTERY, TILES, WALLS, STATUARY

Make 2,500 designs concrete lawn pottery without molds, power or costly tools and glaze them like clayware. **Build your own equipment** from our plans. Use only sand, cement, cheap materials. No experience needed. **MEN**—Send 10¢ TODAY for colorplate, details of this money-making business.

NATIONAL POTTERIES COMPANY
Room 6, 13 W. 26th St., Minneapolis, Minn.

COLUMBIAN METAL BOATS

Light weight, durable, carefully built boats at remarkably low prices. Made of toughest galvanized copper bearing steel. Wood gun-wales. Heavy transoms for outboard motors. Two or more built-in air chambers for extra buoyancy in case of upset. Real wave riders; easy to handle. Never leak or warp. Always ready for use. Both round and flat bottom boats; all sizes and styles.

Write For Free Boat Booklet with description and prices of complete line of metal boats—knockabouts for fishermen, light weight lively boats for parks and resorts, heavy duty craft for outboard motors. **Dealers Wanted—** who can develop volume sales.

COLUMBIAN STEEL TANK COMPANY.
P. O. Box 4226A Kansas City, Missouri



H 13

Running the Electric Liners

(Continued from page 197)

other motors can be switched on at once to supplement the pumping.

Air conditioning the ship is one of the big tasks of the electrical department and usually the demand is for cold air to the fire and engine rooms and for warm air to the passenger spaces. Fifty-six large ventilating fans on the "Santa Paula" handle half a million cubic feet of air a minute in and out of the ship, electrical coils in the intake ducts heating the air that is drawn down into the cabins and public rooms.

You might think that the engine-room crew and the electricians would have lit-

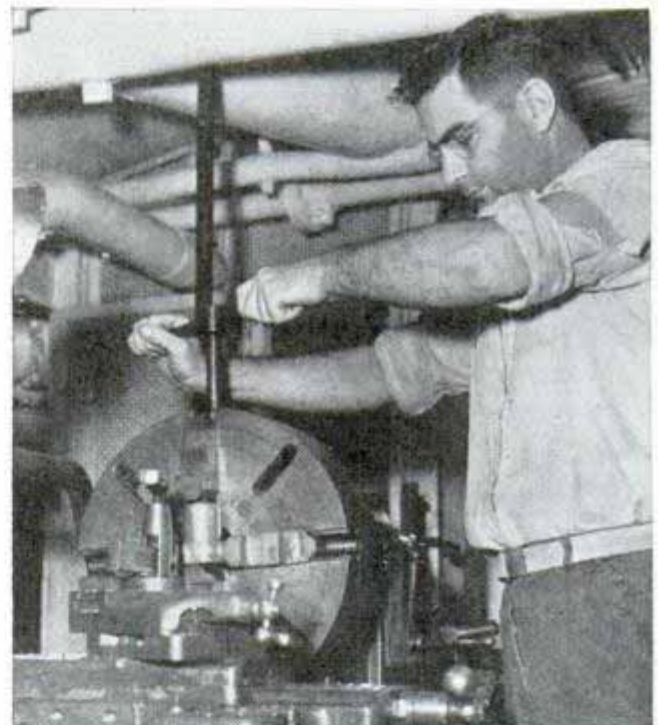

Small lathe in ship's machine shop, where emergency repairs may be made

tle to do during a voyage when everything has been shaken down after leaving port, but that is wrong. One of the goals of modern seamanship is to prevent anything from happening that might disrupt schedules or alarm the passengers. To achieve that ideal calls for a steady routine of maintenance. On every voyage, each piece of electrical gear on board is thoroughly inspected. At the first sign of wear an element is replaced and repaired. Each six months, every pump, motor, and fixture is taken apart, cleaned and oiled, and reconditioned. The ship has a stock of \$75,000 worth of spare electrical equipment on board, carrying it for thousands of miles

H 13
 on voyage after voyage on the bare chance that sometime at sea a heavy armature or some other vital part will have to be replaced in a hurry. There is no telephoning a convenient warehouse and waiting for an immediate delivery. Enough emergency cables are carried for connecting any important motor on the ship with any primary. All these spare parts are protected with heavy coats of insulating varnish to keep out corrosion and moisture.

Some large liners have electric main drives by which steam raised in the fire rooms is used to turn great turbo-generators that supply the power to big motors connected directly to the propeller shafts. But even on ships that use steam turbines for propulsion, electricity is used for practically every other purpose. Electric bake ovens and stoves in the galley, electrical refrigerating equipment, motion-picture projectors, public-address systems for musical broadcasts, and the maintenance of the different electrical fire-alarm and collision signals all must be taken care of by the seagoing electricians.

Riding Hobby Horses to Fame

(Continued from page 189)

non says, is retouching. Out of 3,800 negatives exposed during 1937, but two were perfect. This means that no retouching at all had to be done on them. Even with his vast knowledge of horses, Shannon seldom makes a shot when everything is perfect. The horse may drop one ear. Its tail may be carried to one side by the wind. The rider may be doing something awkward. All such defects have to be removed by careful retouching on both print and negative. Sometimes a horse picture has to be recopied several times. When the job finally is finished, not even an expert photographer can detect where the doctoring was done. Shannon once was called upon to remove the rider from a horse and put another person, who had recently purchased the animal, in his place. He did this so skillfully that the alteration cannot be detected.

"If I spent a year telling and showing a photographer how to take horse pictures, he would go out and fail miserably," Shannon says. "It's not a matter of photography. Anyone can learn how to make

(Continued to page 124A)

Treet Topics

IT CAN'T BUY
FLOWERS ~



NOR TICKETS
TO A
SHOW ~

BUT THAT
SAME
THIN DIME ~



WILL TAKE
YOU A
LONG WAY
ON A DATE



IF YOU
DO THIS ~



-AND TREET YOURSELF
TO A PACK OF
PERFECT SHAVES!

Treet SINGLE
EDGE
BLADES
FOR GEM AND EVER-READY RAZORS

Treet Safety Razor Corporation, Newark, New Jersey

CAN YOU BEAT THESE POWER COSTS?

Save
up to
\$293⁸⁰
Per
Month
on
power
costs

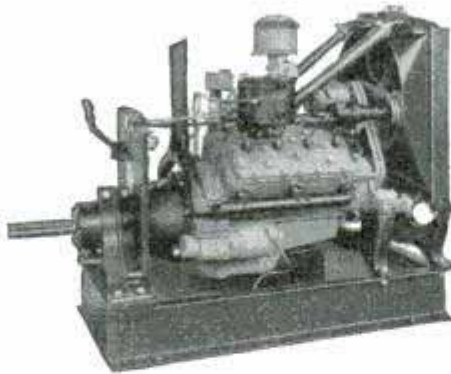

with a KRW FORD V8 Unit

50 H. P. with KRW V8 Unit using natural gas (1125 BTU) @ 30c per 1000 cu. ft. \$ 46.80 per month
50 H. P. with KRW V8 Unit using gasoline @ 10c per gal. (no tax) \$ 145.60 per month

Above figures show primary fuel costs (lubricating oil not included) for operating a KRW V8 Unit to develop 50 H. P. for 10 hours per day—20 days per month. Compare this with electricity @ 3¢ per KWH which amounts to \$340.60 per month. You can pay for a KRW Unit in a few short weeks **out of actual savings!**

KRW V8 Units are daily saving money for operators of air conditioning and refrigeration equipment, mills, factories, shops, welders, compressors, pumps, well-drilling outfits, contractors' equipment, etc., etc.

For complete information, prices and data write us. You can buy through your local Ford Dealer and benefit by local service and low-cost Ford engine replacement feature.

K. R. WILSON 17 Lock St. BUFFALO, N. Y.

Builders of Shop Equipment for Ford Dealers Since 1916

West Coast Branch: 722 Mateo St., Los Angeles.

Export Office: 90 West St., New York.



Explore NEW ROADS

You can get a thrill out of driving again. Try the less frequented highways. Let the Hull Auto Compass direct you along any unfamiliar road any time, in any weather. No worry, no delays. Only \$2.95 at your dealer. Two-piece model \$1.95. Write for circular.



HULL MFG. CO., P. O. Box 246-D4, WARREN, OHIO

60 POWER TELESCOPE . . . \$219

NEW! VARIABLE EYEPIECE 20X—40X—60X
Three telescopes in one. 3 different magnifications. 20 power for ultra-bright images with 40 and 60 power for extra long range. Guaranteed to bring distant objects, people, sports events, ships, moon, stars, etc., 60 times as close.



Most powerful made for anywhere near the money. Closes to less than a foot in length. Multiple lens system. 30 mm. objective lens. 5 sections. Directions included for using as a compound 4 lens microscope. American made. We pay the postage. Only \$2.19. Catalog of Microscopes, Binoculars, etc. FREE on request. BROWSCOPE CO., Dept. 48, 5 W. 27th St., New York, N. Y.

NO MORE Spoiled FILM!

\$1.95

NOW—PERFECT PICTURES WITH ANY CAMERA!

For movies or stills. Eliminates guesswork; insures perfect "shots," even in poor light. Automatically corrects for speeds, filters, subjects, etc. Case, 35c. At all Dealers.



Univex EXPOSURE METER

B465

(Continued from page 123A)

good pictures from a purely photographic standpoint. But to make successful horse pictures, you've got to know horses."

Some cameramen maintain that $\frac{1}{500}$ second shutter speed is fast enough to stop action. When it is pointed out that the horses' feet will be blurred at that speed, they come back with "Oh, you can't stop the feet anyway." Shannon's pictures prove otherwise. He has to stop the foot action, for that is one of the most important things to a horse fan. So he uses a shutter speed of $\frac{1}{2000}$ second. To minimize movement and obtain sufficient depth of focus with a wide-open lens, he keeps well back. His horses cover only about one-fourth the negative area. In shooting action, he follows the horse through his view finder much as a hunter follows game with the sights of his gun. It took a long time for him to learn the psychological split-second to press the shutter release in order to catch the peak of action, which means in the case of a trotting horse, when its knee is at the highest point. By keeping back with his camera, he minimizes the possibility of shooting too far ahead of, or behind, the moving horse.

He photographs, for the most part, saddle horses, jumpers or hunters, and draft horses. The first classification provides the bulk of his work. He does very little racing work. He has learned a great many inflexible rules about the way a horse should be shown in order to please the owner. For example, a saddle horse, ninety-nine times out of 100, should be taken when it is at a trot. Otherwise it will look awkward. Incidentally, a high-class saddle horse in a pose that is declared perfect by a horse expert is likely to look awkward to anyone not familiar with horse points. The neck, for example, may seem too prominent; but to a horseman, a long, fine neck is a mark of high perfection.

Saddle horses are photographed to show the peak of action, when the knee is at its highest point. There are various additional rules for photographing three-gaited horses, five-gaited ones, and so on. Horses used for hunting and jumping are shot generally at the top of their jump. Shannon uses a low camera position in such cases, to emphasize height above ground, and to keep the horse's feet from merging with the ground or background objects.

Raising Rabbits for Profit

(Continued from page 245)

removable to facilitate cleaning and disinfecting. Some rabbit raisers use two tiers of hutches, one above the other, to conserve space, but cleaning is easier in single tiers."

Greens and water are the main items of diet, any green hay such as alfalfa, clover or even peanut hay being acceptable. All hay, of course, should be well cured and never musty or moldy. Oats, barley, wheat, and corn are also fed to the animals to balance their diet, with occasional small amounts of sulphur, charcoal, and cod-liver oil. Rabbits like carrots and should receive one occasionally. A block of salt should be placed in each hutch so that the rabbit may nibble at it. Feeding instructions and other hints in caring for rabbits are contained in bulletins issued by the Department of Agriculture and by some state universities.

Given proper care, rabbits usually remain healthy and free from many afflictions that trouble other animals. Two serious diseases, however, a nasal trouble known as snuffles and a worm infection called coccidiosis, are incurable. Rabbits infected by either should be destroyed at once and their hutches thoroughly sterilized to prevent spreading the disease. Most rabbit raisers feed their animals twice a day. Their appetite is a good indication of their state of health.

There are a number of other commercial breeds aside from the white New Zealand, including the red New Zealand, Flemish, Chinchilla, and Angora. The last two are raised exclusively for their fur or wool, which is extremely high priced. "Some people who have tried to raise rabbits in the past have dropped it when they failed to make money," declares Green, "but they shouldn't blame the rabbits. Raising them is a pleasant and profitable occupation and success with them takes proper management and attention to details just the same as in any other business. The fundamentals of success are good breeding stock, proper equipment and the right care."

☐Inquiries as to makers of articles described in Popular Mechanics will be answered by our Bureau of Information upon receipt of return postage.

American Rabbit Raisers' Magazine
 will send free literature



A CLOGGED radiator may be the beginning of an expense account. The motor overheats. You lose power. Expensive repairs often result from a neglected radiator. Don't take a chance. You can keep radiators clean with SANI-FLUSH. Keep motors running cool and efficiently.

Just pour 10c worth of SANI-FLUSH in the cooling system of your car. (25c for the largest truck or tractor.) Follow directions on the can. Run the engine. Drain. Flush. Refill with clean water. It takes very few minutes and SANI-FLUSH removes rust, scale and sediment. It cannot injure motor or fittings. You'll find SANI-FLUSH in most bathrooms for cleaning toilet bowls. Sold by grocery, drug, hardware, and five-and-ten-cent stores. 25c and 10c sizes. The Hygienic Products Company, Canton, Ohio.

Sani-Flush 
 KEEPS RADIATORS CLEAN

NEW BRUSH PLATING OUTFIT
 For AUTO PARTS



Connects to a battery with no tanks necessary. Plates on iron, steel, brass, copper, etc. Almost as simple as painting. Hundreds of car owners waiting for this low-cost plating. Improves appearance and value of the car. Your opportunity to make good income plating auto parts, bathroom fixtures, reflectors, mirrors, etc.

FREE PROOF
 Write quick—big season here. Get FREE PROOF and particulars that put you in a paying business of your own.

GUNMETAL COMPANY
 AVENUE M DECATUR, ILL.

14434
The Wonders of Silent Sound

(Continued from page 213)

tric slab, repeated constrictions occur. The crystal slab and its electrodes are placed in a dielectric bath that serves to insulate the electrified plates, and the constrictions of the crystal set up vibrating waves in the liquid. Roughly speaking, a quartz disk slightly larger than a silver dollar and about three millimeters thick creates one million of such pressure waves per second. These are the ultrasonic vibrations so deadly to bacteria.

The mounting pressure waves in the dielectric bath cause the liquid to raise itself up into a solid mound above the crystal. If you should have a test tube partly full of water and insert the bottom of the tube in the mound of liquid, the water in the tube appears to boil violently, due to the jarring effect of the pressure waves. Oil and water in the test tube become so emulsified that the oil remains in suspension for days afterward. The hammering of the ultrasonic waves breaks the oil up into microscopic drops. It is this same continuous beating that shatters yeast and bacteria and that breaks starch down into dextrin.

Some of the research in supersonics is being conducted in secret because of its promising commercial possibilities. At the University of California at Los Angeles, however, Dr. Vern O. Knudsen is using the high-frequency waves purely as a scientific tool. Under Dr. Knudsen's direction the molecule is being attacked from a new front.

One of the quietest places in the world, where the silence is so oppressive that it seems to hurt, is the heavily padded "dead" room in the sub-basement of the sound laboratory on the U. C. L. A. campus. In this room sounds of different wave lengths are created, trained to travel in straight lines, pitched back and forth by huge parabolic reflectors, and are condensed and focused by means of zone plates that act as sound lenses.

The exact opposite of this dead room is a big reverberating chamber where slight sounds seem to magnify themselves to nerve-shattering intensity, bouncing back and forth between tuned metal plates and hard plaster walls, and echoing and rumbling long after the original sounds cease.



Heavy Body 3-In-One Oil is made especially for light motors, lathes, lawn mowers, washing machines, refrigerators, etc. Same uniform high quality as regular 3-In-One Oil—famous for 44 years. Triple-action—it LUBRICATES, CLEANS AND PREVENTS RUST.

HEAVY BODY 3-IN-ONE OIL

REAL MONEY RENTING OR SELLING
New RANGER SCOOTER

There's big money selling this new, marvelous improved RANGER SCOOTER to all stores needing quick, cheap delivery—or renting to riders! Good territory still open. Ranger Scooter is safe, sturdy—gets 120 miles to gallon at 30 m.p.h. Act now! Write for Free folder, Special Low Agents' Prices.

MEAD CYCLE CO.
Dept. HS-118 Chicago, U. S. A.

NEW BENJAMIN AIR PISTOLS

Powerful—Accurate—Economical—Practical—Adjustable Shooting Force—Amazing Maximum Velocity—cal. 177 or 22 and BB—For Target and Small Game—the only Genuine Compressed Air Pistol for Shooting BB on the market—Single Shot with Bolt Action—Hammer Fire—Hair Trigger—Safety. Price \$7.50.

Holster \$2.00. Also 177 and 22 Single Shot Air Rifles \$7.50—Single Shot BB Air Rifle \$6.00—25 Shot BB Repeater Air Rifle \$7.50 at Dealer or Direct—No license required—Safe for indoor use. FULL DETAILS—TARGETS—FREE—WRITE TODAY Benjamin Air Rifle Co., 891 Marion St., St. Louis, Mo.

EARN MONEY STRINGING TENNIS RACKETS

EASY—PROFITABLE—INTERESTING WORK!
It's easy to earn \$40.00 to \$80.00 a month in spare time. Many TOMGUT stringers who devote all their time to stringing, make \$200.00 and more a month.

You can too! We teach you how to string—show you how to get business—supply business-getting advertising helps. Our cooperative plan insures your success. Start your own stringing business now!

FREE

Write today and we will send you Free plan and special offer on strings and stringing equipment.

THOMPSON MANUFACTURING CO.
4535 Packers Ave., Chicago, U. S. A.
TOMGUT "Court-Tested" Tennis & Badminton Strings

Send FREE plan and special offer. Send new booklet, "400 YEARS OF TENNIS." Enclosed is 10c to cover mailing costs.

Name _____
Address _____
City _____ State _____

MAIL THIS COUPON

OTTAWA LOG SAW

only \$39

GREATEST OFFER EVER MADE

Make Money! Wood is valuable. Saw 15 to 20 cords a day. Does more than 10 men. Ottawa easily operated by man or boy. Falls trees—saws limbs. Use 4-hp. engine for other work. Write today for **FREE** book.

OTTAWA MFG. CO., 827 Wood St., Ottawa, Kansas

BILD-UR-OWN

COASTERS • MIDGET AUTOS • SCOOTERS • BIKE TRAILERS, ETC.

SAVES YOU MONEY TOO!

Want the best for your motor scooter? Then equip it with our **DISC WHEELS** and **Balloon Tires**. Your choice of famous **(GOODRICH—GOOD YEAR—FIRESTONE)**

At lowest prices. We provide Scooter Kits at big savings. Build Now! We also carry larger Tires, Wheels, Motors, etc. Write for prices.

BILD-UR-OWN DEVICES, 5237 Lake St., Dept. A-B, CHICAGO, ILL.

GET YOUR TRACTOR AT FACTORY PRICE

3 Speeds Fwd. and Reverse. Runs 4 to 8 hrs. per gallon

Amazing money maker for farms, truck gardens, orchards, nurseries, poultry ranches, country homes, etc. Plows, discs, harrows, cultivates, mows lawns, cuts weeds. Runs belt machines, 2 to 5 H.P. riding or walking types. Write for **FREE CATALOG**. Low **Factory Prices and 10 day Trial Plan**. Address **Nearest Office**.

SHAW MFG. CO. 4508 Front St., Galesburg, Kans.
130 G West 42nd St., New York, N. Y., 5812 G Magnolia Ave., Chicago, Ill., 662 G North 4th St., Columbus, O.

SHAW DU-ALL TRACTOR

Air Tires or Steel Wheels

PHOTOGRAPHIC ALMANAC

Free!

Free 1938 Almanac includes (1) Special month-by-month *Photographic Calendar*, (2) Authoritative photographic articles, (3) Handy Exposure Table, Exposure Guide, (4) 100 pages of still & movie cameras, films, lenses, enlargers, chemicals—everything photographic—many at big savings. **ALL GUARANTEED on 10 Day Money Back Trial**. (Used equipment accepted in trade.) Write for Free copy!

Central Camera Co., (Est. 1899) 230 S. Wabash, Dept. K-8, Chicago

SAVE MONEY BUILD YOUR OWN FAN

Aluminum Propellers Shipped Collect	THREE-BLADE for 1/4 H.P. Motor			TWO-BLADE for 1/4 H.P. Motor		
	Size	Shaft	Price	Size	Shaft	Price
	20 1/2"	1/2"	\$4.00	12"	1/2"	\$2.25
	24"	3/8"	4.50	16"	3/8"	2.50
	26"	1/2"	5.00	20 1/2"	1/2"	3.00

MICHAEL ELECTRIC COMPANY, Dept. P., Fort Worth, Texas

AGENTS 300% Profit SIGN LETTERS

For Store Fronts and Office Windows. Anyone can put them on. Free samples. Liberal Offer to general agents.

METALLIC LETTER CO., 438 N. Clark St., Chicago

A AND N SUPPLY CO.

Bargains—Military, Sport Goods, Firearms, Clothes, Shoes, etc. Send 10¢ for new catalog, to be redeemed on first order.

EST. 1868 A & N Supply Co., 4772 Lester St., Richmond, Va.

BURN YOUR NAME ON TOOLS WITH THE ARKOGRAF

PROTECT YOUR TOOLS FROM THEFT Write with electricity any name or design on the hardest and finest tools and instruments, or any metal, like writing on paper with pen or pencil. **Complete Outfit \$3.50—Prepaid Anywhere** Interesting illustrated circular free. Write today. Agents wanted.

ARKOGRAF PEN CO., 3927 S.E. Stark St., Portland, Ore.

ALL CLEVELAND RADIATES FROM THIS HOTEL

● Under the same roof with you are the five fine buildings of the Terminal development, and the Union Terminal itself. And rooms are luxuriantly comfortable, and meals are famous. Everyone tries to prove we're glad to have you with us.

HOTEL CLEVELAND

Cleveland

OIL OF INDIA MOSQUITOS

DON'T LET THEM TAKE THE JOY OUT OF YOUR SUMMER OUTINGS

Aromatic OIL OF INDIA keeps biting insects away! Simply apply a little to exposed skin. Everyone likes its pleasant odor. **PESTS DON'T**. Very effective and lasting. **Absolutely harmless**. Promotes outdoor comfort, insures perfect sleep. Send at once 50¢ for one bottle or \$1.00 for two.

Money Back Guarantee

OIL OF INDIA CO., 116-G West Illinois St., Chicago, Ill.

DEALERS WRITE

BRAKES—ELECTRIC, VACUUM AND AUTOMATIC—AXLES AND HITCHES FOR ANY TRAILER.

All treads, all spring spreads.

New \$3.00 House Trailer Blue Prints Free With Axle Assembly

WRITE FOR FREE LITERATURE.

HAMMER BLOW TOOL COMPANY, Dept. 108 WAUSAU, WIS.

Saw-Filing

Pays up to \$2 or \$3 an Hour in Spare Time—No experience needed

A FOLEY Automatic Saw Filer files hand, circular and band saws better than the best hand filer. Cash business, no canvassing, no eye-strain. Louis P. Wadwick, Ohio, says, "I have filed 764 saws in spare time and have earned \$850.00 in carpenter work due directly to my saw filing contracts." Send coupon for **FREE PLAN**, no obligation.

FOLEY MFG. CO., 816-K Foley Bldg., Minneapolis, Minn.

Send Free Plan on Saw Filing business.

Name.....
 Address.....

H 389

The World of Tomorrow

(Continued from Coloroto Section)

terns of nozzles, gas burners, fireworks receptacles and other equipment will be installed on a block-long platform beneath the surface of the lagoon. Two or three men will operate the show from a control room atop a near-by building. Because of the problems involved in amplifying music to a point where it can be heard above the rush of water, special musical scores must be prepared for the show.

The amusement zone spectacle will present an inferno of water, fire and color and will be staged from barges. There will be flame and water-throwing barges while light barges will bear searchlights, mercury vapor lamps and sodium floodlights, and fireworks barges will touch off the pyrotechnic displays. Others will launch silhouettes of gondolas so spectators will have a yardstick to judge the tremendousness of the scene. Captive balloons, played upon by searchlights, will provide the "ceiling" for the show.

The fair's most elaborate and costly artistic project will be a \$60,000,000, mile-long Central Mall extending like a jeweled band across the main exhibit area. This Mall will be bordered by more than a score of the largest buildings, studded with heroic sculptures, inlaid with lagoons, enlivened by waterfalls and hundreds of fountains, accentuated by huge pylons and lined with more than 1,000 trees.

Dominating one section will be the largest portrait statue fashioned by man since the Egyptians hewed the figure of Ramesses II out of rock—a sixty-five-foot figure of Washington as he appeared for his inauguration. Other huge figures, majestic murals and massive reliefs will adorn this area, as will a fifty-foot sun dial which will actually indicate time.

Not a light bulb or other visible source of illumination will be seen at night along the main section of the Mall. Instead, mercury vapor lights sunk in the ground will cast a soft glow into trees and foliage, causing the under sides of leaves to fluoresce and bathe the entire area in a luminous radiance, seemingly emanating from the trees, shrubbery and flowers.

Each exhibit zone will have its own key display, a spectacular "summary" of the

Atlas MADE THE WAY YOU WANT IT!



DELUXE SMALL LATHE \$59.50 - \$64.50

Every feature you want and expect on a small metal working lathe has been built into this sensational new Atlas machine tool. It's a backgeared screw-cutting lathe with 16 speeds, reversible power feed, V-belt drive, Timken bearings, wide thread cutting range, etc. Two sizes—12" and 18" between centers—6-inch swing. Send for new Catalog No. 29 today.

ATLAS PRESS CO.
843 N. Pitcher St., Kalamazoo, Mich.

BUILD THE CUTTY SARK

2 ft. MODEL OF THE FAMOUS CLIPPER SHIP

Everything... including CARVED WOOD HULLS, Printed-Balsa Decks, Cast-Metal Life-boats, Anchors, Bits, Steering Wheel, Chains, Mast, Spars, Rigging, Cement, Colored Lacquer—Full-Size Plans and Instructions.

Send for Catalog all Ideal's new Models...
IDEAL AIRPLANE & SUPPLY COMPANY, INC.
26 West 19th Street, New York

work faster

ALL-PURPOSE MOTO-TOOL

Everyone who works with his hands—at home, shop, school, or profession—can use the efficient, attractive Moto-Tool to advantage. Grinds, drills, routs, carves, polishes all materials. Chuck uses many tools. You do in seconds jobs that require hours of hard, hand work. Safe, thousands in use. Two fine models. No. 1 weighs 6 oz.—about 20,000 r.p.m. No. 2 weighs 13 oz.—about 25,000 r.p.m. Order on 10-day money back trial, or send for free booklet.

Dremel Mfg. Company
2832 CT., Racine, Wis.

Model 1 \$9.85 postpaid 10 Day Trial
Model 2 \$16.50 Postpaid

All Aboard!

For a Wonderful VACATION TRIP!

Auto-Glide

120 MILES PER GALLON!

Here you go!—on the most thrilling trip of your life! Travel 200 to 300 miles daily, comfortably—only 50c to 75c a day for gas! See other states, cities, mountains, lakes—at almost no cost!

The genuine Auto-Glide, made by a foremost engine builder, has the ruggedness, power and comfort for long trips. Extra strong welded frame. Powerful 1½ or 2 H.P. Cushman engine (2-speed transmission) climbs steepest hills. In high, up to 35 miles an hour. Clutch makes it easy to stop at crossings, intersections, 2 or 3-wheel models. Kari-Pac model has big luggage carrier. Magneto or battery. Starter, brake, light, hand-accelerator, balloon air tires, etc.

FREE BOOK! See your dealer or write for full details, book, Low Prices.

CUSHMAN MOTOR WORKS, Dept. A-8, Lincoln, Nebr.

14389
kind of exhibits in that area. In the transportation building, for example, the focal exhibit will include an intricate working model of an interplanetary rocketport of the future. Here visitors will see futuristic ships, planes and trains unloading passengers for a trip to Mars.

Then, as motors hum, signal lights twinkle and sirens scream, will come the breath-taking moment of departure. A crane picks up the rocketship and deposits it gently in the breach of a rocketgun. There is a brilliant flash, a muffled explosion and spectators see the rocket winging its way through the heavens.

One of the largest exposition buildings ever constructed, a modernistic S-shaped structure nearly one-fourth mile long, will house the most elaborate railroad exhibit ever assembled under one roof. Among the features will be the largest working model railroad ever built, an outdoor train display and a pageant of transportation.

In a million-dollar medical center man will see himself inside and out. Visitors will see the blood stream coursing through the body of a huge transparent man and hear his rhythmic heart beats as they enter this building. There will also be models of the human eye, the mouth and the skull so large that groups can walk inside and see what "makes the wheels go round."

In many cases, the design of a building will indicate the nature of its exhibits. A gas company building will be shaped like a huge burner, marine exhibits will be displayed in a structure whose entrance will resemble a waterfront pier flanked by the towering prows of two ocean liners, and aviation progress will be shown in a building representing a colossal plane emerging from its hangar.

Television will be demonstrated in the RCA building which will be linked directly with the NBC television transmitter atop the Empire State building, and the government's \$3,000,000 exhibit section will include nine large, semi-classic buildings dominated by an imposing federal structure. One feature will be great revolving murals, each of which will tell a story of government activity as it moves along the walls.

One of the outstanding features will be a \$1,500,000 "Town of Tomorrow," an ad-

(Continued to page 130A)

YALE OIL

Made by YALE, maker of famous locking devices



THE BETTER LUBRICANT and RUST PREVENTER

Scientific tests proved the supremacy of this heavier bodied, finer quality oil for lubricating and rust-proofing. YALE OIL has a remarkable affinity for metal. Its amazingly strong film resists "air punctures", protects longer—ideal for electric motors, tools, machines, and general home use. It stays put—does not drip from bearings. Insist upon YALE OIL.

Used for 25 years on the world's finest bank vault mechanisms!

In handy tubes, 10c, 15c and 25c. At hardware and sporting goods stores.

If your dealer can't supply you, send 10c and we will mail a tube postpaid.

Address Department O.M.

THE YALE & TOWNE MFG. CO. STAMFORD CONN.

AUTOMATIC STENCIL DUPLICATOR

Amazing new Print-O-Press Stencil Duplicator. Automatic feeding. Automatic inking. Full 8 1/4 x 14 legal size. Other models also, at world's lowest prices. Details free, also free samples of work done. User-Agents write.

Professional Products Dept. 810, Silvertown, O.



\$13.95
Complete

Order direct

RE-STRING RACKETS AT HOME



•EARN MONEY•

It's pleasant, profitable work. No experience or skill required. Easy to Learn. Full line of guaranteed stringing tools, frames, gut and silk strings for your selection. Every item highest quality. Write for complete details.

Write for our 1938 Illustrated Catalog and Instruction Book.

W. A. BICKEL & Co., Dept. A-8, 137 N. Marion, Oak Park, Ill.

DIESELECTRIC PLANTS

ELECTRIC STARTING REMOTE CONTROL

\$760 Easy Payment Plan
and up
F. O. B.
K. C., Mo.

Make your own electric light and power the "Diesel Way" with WITTE Dieselectric Plants, 2500, 4000, 8000 watts, for Less Than ONE CENT per KILOWATT on cheap non-explosive fuel. 110 volt A. C. or D.C. for direct lighting, 32 volt for battery operation. Charging costs lowered 75%. Easily installed in small space. Also stationary Diesel Engines 4, 6 and 12 H. P. Use a Diesel for Economy and Safety.



2500 Watts

174-C Oakland Ave.

Kansas City, Mo.

WITTE ENGINE WORKS

H 389

(Continued from page 129A)



CAPTURE PRECIOUS MOMENTS in a LIVING Diary!

Paragon 16 mm. Movie Camera \$29.75

Thrills of past pleasures live more vividly—on a 16 mm. Paragon Movie. Better pictures, larger projections, from the Paragon Movie Camera, give more lasting joy to movies of friends, family, vacations, parties.

Paragon 16 mm. Movie Cameras are famous for accuracy, brilliance, easy operation and light weight. Equipped with sharp view finder, F:3.5 Wollensak Lens, and many unusual features. Guaranteed, fully protected. Money Back after 10-day trial, if not satisfied.

ORDER NOW AT DIRECT-FROM-FACTORY PRICES

Paragon No. 1-S one speed
Regular price \$35.00 . . . Special \$29.75
f.o.b. Fond du Lac

Paragon No. 3-S three speed
Regular price \$42.50 . . . Special \$35.75
f.o.b. Fond du Lac

Order Today—Save Money—Enjoy Better Movies.

Free Offer If ordered within 30 days.
Beautiful \$7.50 Cowhide Carrying Case

Paragon Camera Company
P-3, Fond du Lac, Wis.



WOOD-WORKING SUPPLIES



New 100 page book contains most complete list of woodworking supplies in the world—Standard American woods cut-to-size at bargain prices. Rare imported woods, veneers, plywoods, inlays, carved legs, mouldings, decorations, special tools. Hard-to-find ornamental hardware, scroll saw patterns, wood-finishing instructions—How to make Venetian Blinds at 1/3 store prices. Send only 10c for Catalog No. 10 to Craftsmen's Wood Service Co., 2732 S. Mary Street, Chicago, Ill.

ONLY 10¢

TRAILER BUILDERS · BUYERS · OWNERS

Over 100 pages! Beautifully Printed and Illustrated! Trailer Suggestions and Ideas galore! Catalog shows America's greatest line of Trailer Parts and Equipment at lowest prices. Everything from wheels to top. Rush 25c today. Satisfaction positively guaranteed!

TRAILER SUPPLY CO.

Box 438-A

WAUSAU, WIS.



BUILD IT YOURSELF

The Jim Dandy Cabin Cruiser

The Trailer that has everything. Classy! Roomy. Easy to build in any size with my simplified Plans and Instructions—Price \$1.00. Rush dollar bill today to JIM DANDY Box 125-A WAUSAU, WIS.



MAKE MONEY IN PAINTING BUSINESS



Paint walls, ceilings, screens, furniture, radiators, machinery faster, better! $\frac{1}{4}$ H. P. motor 110 Volt 60 Cycle AC, complete with Spray Gun, 15 ft. hose. Weighs only 44 lbs. Carry anywhere. FULLY GUARANTEED. Only \$31.15 f. o. b. Chicago. \$5 Deposit, Balance COD, or SEE YOUR DEALER. Circular FREE. Get started making money NOW!

Ideal Automatic Pump Co., Dept. PM8, 801 Washington, Chicago

\$31.15 Complete

ARC WELDER FROM OLD DODGE GENERATOR

For light or heavy work 75-200 amps. 35c brings complete plans and valuable catalogue listing 500 electrical items. Over 100 other generator changes.

LEJAY MFG., 347 Lejay Bldg. Minneapolis Minn.



Earn Spare-Time Money THIS NEW PLEASANT WAY!

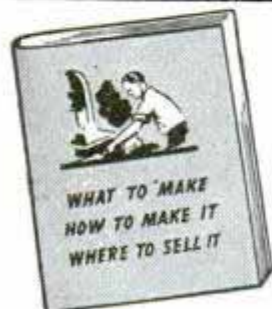

Learn how you can build up a profitable spare or full-time business in your own home. This new book "How to Make Money in Woodworking" is crammed with practical tested ideas, plans, and suggestions. Tells you exactly what to make, how to make it and how to sell it. Describes plans that have worked for others. Woodworking, the new way, is light, pleasant, and profitable. Send only 10c and complete book will be mailed postpaid. Satisfaction guaranteed or money refunded. Write to Dept. A838.

Delta Mfg Co. 600 E. VIENNA AVE. MILWAUKEE, WIS.

vanced concept of community design and housing featuring new architectural treatment and the practical use of all modern house building materials, methods and equipment, together with suggestions for home decoration.

When a Gothamite starts reeling off fair facts and figures, he sounds like an astronomer discussing distances between planets, for some of the figures are so staggering as to make even New Yorkers a bit dizzy.

"We're going to set out 1,500,000 shrubs, 10,000 trees, grow 250 acres of grass, plant millions of flowers," he begins casually, then shifts into high. "Fifteen million square feet of walls will enclose fair buildings which will be stabilized by 308 miles of pilings. Into these buildings will go 15,000,000 board feet of lumber, 28,500 tons of steel, 400,000 barrels of cement, 9,000 tons of lighting materials and 12,000 tons of plaster board.

"There will be thirty-four miles of walks about 3,000,000 square feet of building area. We expect visitors to pass through the turnstiles at the rate of three per second. We anticipate an average attendance of 250,000 a day with 800,000 on peak days. Transportation is being planned to handle 160,000 visitors an hour."

To the seasoned fair-goer, all this probably sounds like sore feet. But this fair, despite its vast proportions, expects to have fewer aching feet per acre than any previous exposition. This is because it is being zoned like a city and related exhibits will be grouped so visitors interested in any particular subject will find everything relating to it in the same general area.

The site is shaped like an airplane and exhibits will be concentrated in the 390-acre cabin section, amusements in the 280-acre fuselage, a boat basin and docks will form the propeller, and the motor and tail will form parking space for 35,000 cars.

"Every building and exhibit of the fair will tie in with the central theme," says Grover Whalen, its president. "By reviewing yesterday and studying today, by telling man of his progress in the past and showing him the tools of the present, we hope to aid millions of people in charting a better and happier future. If we can do that, the New York World's Fair of 1939 will be a success, regardless of what the balance sheet shows when it is ended."

OWN A ROYAL



Believes Royal helped him get ahead!

"The day I got my Royal I started typing my reports. The boss liked it. Soon I had a larger territory. Now I have 5 men under me."

PORTABLE ON



Glad they picked a Royal

"All of us use our Royal Portable—Junior for his homework—I to work out assignments for a correspondence course which I'm taking."

YOUR OWN TERMS



Ideas typed on Royal bring raise

"Ideas count where I work. Since I got my Royal, I've typed mine out. Already I've had one raise, and I expect another."

Only a Few Cents a Day

FREE HOME TRIAL FOR EVERY

MEMBER OF THE FAMILY! A Royal Portable will help you write faster, think faster. A practical, modern necessity—it's an opportunity for a better, brighter future! A chance to do more, *be more!*

Without risking a penny prove—right in your own home—that a Royal will help you—whatever your business or profession—help you to set down your ideas and reports *legibly, impressively*. Prove too, that it will help the children with their homework . . . *help every member of your family with their writing!*

READ WHAT ROYAL GIVES YOU! Standard, full-sized keyboard. Easy, effortless action, Touch Control, Finger Comfort Keys, Genuine Dust Protection, Automatic Paper Lock, Touch-set Tabulator and many other office typewriter features. Tested, proved, guaranteed!

FREE! Royal's Instant Typing Chart, shows you how to type **RIGHT**. INCLUDED with every Royal Portable at no extra cost—a handsome, all-weather, triple-convertible Carrying Case.

SEE what a Royal will do! Then own it on your own terms—cash or *only a few cents a day!* Mail coupon today for full details of Royal's offer—prices, terms, Free Home Trial—everything. No obligation.



ROYAL TYPEWRITER COMPANY, Inc.,
Dept. B-83, 2 Park Ave., New York, N. Y.

Tell me how I can own—for only a few cents a day—a latest model Royal Portable—with **FREE HOME TRIAL**.

(DO YOU OWN A TYPEWRITER NOW? Then make it help pay! Write Make and Serial No. on coupon margin for full trade-in value.)

NAME _____ STREET _____
CITY _____ STATE _____

TRAILER BUILDERS

Send 10c for our latest DeLuxe Trailer plans with all the modern improvements known to trailer builders. We supply everything at bargain prices. Our new 1938 trailer supply catalog (largest and most complete) is **free**, National Trailer Equipment Co., Dept. P-8, 714 W. Wisconsin Ave., Milwaukee, Wis.

PARMAK ELECTRIC FENCER

SLASHES FENCE COSTS

Now! Amazing **FLUX DIVERTER** invention gives long life to **SAFE** 6-volt batteries—unforgettable sting stops the worst fence breakers. **ONE** used **WIRE** on light stakes costs less than . . . **\$10 Per Mile**

SENT ON 30 DAYS TRIAL!

Write for **FREE CATALOG**—long time guarantee and proof from users near you. Thousands now in use. **DEALER AGENTS WANTED.** Write at once: **PARKER-MCCRORY MFG. CO., 100-K, Kansas City, Mo.**



60 SECOND DEMONSTRATION Sells Motor Conditioner

Make up to 276% profits this new way. Dip tar-coated metal in **ZEVOLENE**. Take out in 60 seconds. Tar is gone. Prospect is sold. For this astounding demonstration shows by action, not words, how **ZEVOLENE** gives motors an **INTERNAL** cleansing which quickly and harmlessly removes tarry elements (commonly referred to as gum and sludge) from piston rings, valve stems, and oil lines. Restores lost power, makes engine quieter and smoother running, increases acceleration, saves gas and oil and garage bills. Absolutely harmless. Pours in crankcase just like oil. Test records prove its value.

DISTRIBUTORS now being appointed to sell car and truck owners, dealers, filling stations, etc. Write at once for test records showing amazing results of **ZEVOLENE** and complete details of the extraordinary money-making proposition we have to offer.

ONE CAN GIVES ENGINE AN INTERNAL BATH



NEW WAY PRODUCTS COMPANY
900 Davidson Bldg., Kansas City, Mo.

Welding Business Earns \$150 to \$300 for You Each Month



"BUILD-YOUR-OWN"

Just couple your own engine to this unit, mount it on chassis and you have money making advantage of a portable welder at a saving of \$100 to \$500.



30 DAY'S TRIAL AT HOBART'S RISK AND EASY "PAYS FOR ITSELF" TERMS

Free! VALUABLE BOOKLETS ON WELDING. CHECK YOURS AND MAIL THE COUPON TODAY.
 How to Build-Your-Own
 New Profits in Arc Welding
 New Arc Welding Catalog

New low prices make this profitable welding service available to everyone. Opens doors to big pay jobs that carry real profit. Hobart Welders are easier to operate, faster, guaranteed to bring you quality welding business . . . extra profits will pay for welder without expense to you.

NO INVESTMENT TERMS — PROFITS PAY FOR IT
Extra earnings and savings possible with Hobart Welders make it easy to own without expense. You can even rent a new Hobart and later purchase it without loss. Coupon brings details.



HOBART BROS., BOX M-88, TROY, OHIO
Gentlemen: Send me information on () Build Your Own Welder () Electric Drive Welder () 30 Days Trial, Easy Terms () Rental Plan. Also send me free books I've checked.
Name _____
Address _____

HOBART
THE FASTEST SELLING ARC WELDER ON THE MARKET TODAY

H348

Making Money with Pictures

(Continued from page 221)

had missed the picture rushed his roll to the developer. In thirty minutes his best shot was on the wire to a New York picture syndicate. It was a scoop! He could name his price, in three figures; and before many minutes other newspapers and syndicates were calling for his other shots.

It isn't often you catch the cameraman napping, however. Yet the amateur who, like Mr. Kirkwood, always keeps his "picture gun" in his pocket, loaded, has as good a chance as the professional to make a "killing." A dozen photographers might

Have your Purolator serviced regularly!



KEEP your engine healthy by keeping your oil clean! Dirt, dust, carbon, sludge, tiny pieces of metal and other harmful impurities are taken out—when your Purolator is kept in good condition. Just as you recharge your battery . . . just as you buy new tires for safety's sake . . . have your Purolator serviced regularly, whenever an examination of the oil indicates the need. It will keep performance up . . . expenses down. Motor Improvements, Inc., Newark, New Jersey.

*Licensed under Sweetland patents

PUROLATOR

THE OIL FILTER ON OVER 85% OF ALL 1938 FACTORY EQUIPPED CARS

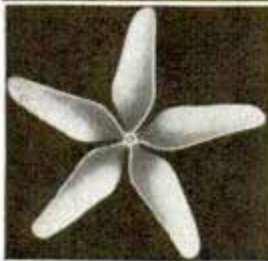

BUILD ATTIC VENTILATORS

5 Blade, 40" Cast Aluminum Blade.
12,000 CFM. Dynamically and Statistically balanced . . . \$15.00
21 1/2" Aeroplane Type . . . 3.00
24" Circulator Type . . . 4.50

ELEC. EQUIP. & FDY. CO.
PINE BLUFF, ARK.

MICROMETERS



Six piece set, in velvet lined leather case. Special price, only \$13.95. Precision machined in one thousandths, up to 4" outside and 3 3/4" inside measurements. Guaranteed accurate, easy to read and adjust. Satisfaction guaranteed or money back. This is your opportunity to get one at a Bargain Price if you act now. Shipped prepaid on receipt of remittance. On C.O.D. shipments, send deposit of \$2.00.

FREE FOLDER

MICRO PRODUCTS, 529 E. Jefferson Ave., Detroit, Mich.

Stoves AT FACTORY PRICES!



SALE CATALOG — FREE

Nearly 200 Styles and Sizes of Heaters, Ranges, Furnaces at FACTORY PRICES. Easy Terms. Write today for FREE CATALOG. New styles, new features—24-hour shipments.

Kalamazoo Stove & Furnace Co.,
391 Rochester Avenue
Kalamazoo Michigan
Over 1,300,000 Satisfied Users
39 Years in Business

"A Kalamazoo Direct to You"

Write for FREE CATALOG



Amateur scoop of 1938 is this, the only picture of the actual collapse of the Niagara Falls bridge

cover an intercollegiate foot race and only one capture the thrilling finish in the snapshot printed with this article.

What started as a routine assignment for Samuel Shere of International News Photos brought him first prize from Editor & Publisher magazine for the best news picture of 1937, a magnificent shot of the dirigible "Hindenburg" aflame at Lakehurst.

"The big ship was approaching the mast and was discharging water ballast," related Shere. "I was measuring her big hulk in my camera finder when I detected a flash of fire in her tail. Then came the first explosion that shook the ground. In that split second I pulled the trigger of my camera, recording the actual peak of the 'Hindenburg' disaster. As fast as I could, I took other shots. The flames finished her in thirty-two seconds. The heat was terrific. I ran toward the blazing ship and shot pictures of survivors. I was standing not far from the control cabin when the ship's small-arm ammunition went off. Someone yelled 'Fall down quick!' and I did until the firing ceased."

A young fellow who used to help a truck

H 348

driver bring farm produce from Michigan into Chicago heard there was pin money in pictures, so he took ten dollars out of the bank and bought a camera. The very next morning his truck swerved off the road to avoid crashing into a truck ahead. Getting out, he found a half dozen trucks "accordioned" into each other, with a passenger car in front. The first truck had been hauling four new automobiles. It was a "swell looking wreck." The problem was to get an angle that would take in the entire scene. He finally snapped a series of six pictures that could be arranged in a panorama. In Chicago he took his films to a newspaper office. They paid him twelve dollars for three prints, gave him the negatives, sent him upstairs to a wire association office where he collected fifteen dollars more. They told him where he might make some further sales, and two hours later he had sixty-five dollars.

If you had had some good exclusive pictures of the former Wallis Warfield of Baltimore at the time King Edward VIII of England abdicated to marry her, you might have sold them for \$50,000.

The highest price ever paid for news pictures for use in a single publication in the United States was for the photographs of the Byrd expedition at the South Pole. The seller was Wide World Photos; the buyer, Popular Mechanics Magazine—and the price was nearly \$4,000 for exclusive publication in the scientific field.

An English sailor on the airplane carrier "Hermes" was snapping pictures for his scrapbook while the Lindbergh seaplane, Col. and Mrs. Charles A. Lindbergh aboard, was being lowered into the floodwaters near Hankow, China, in the autumn of 1931. As the plane hit the water it capsized, hurling its famous occupants into the Yangtze river. The sailor's film-pack of twelve exposures showed the entire incident. After the rescue, the "gob" handed his negatives to his superior, who presented them to Colonel Lindbergh.

He decided to auction the pictures off to American newspaper interests, the money to be used for a home for British navy men on the Hankow waterfront. The New York Times offered \$9,000 for the pictures.

So it pays to keep your camera in your pocket, primed and ready. It need not be an expensive one. Better use one you can master. Keep it handy, keep it loaded, keep your eye open!



Make new or old buildings more attractive and waterproof. Plastic COLORCRETE fuses with any masonry surface. It fills all cracks. It can be sprayed in any thickness and in 30 colors. Fully proven by over twelve years actual use under all conditions and every climate.

Owners everywhere want to enhance values. You can supply this big waiting market with permanent COLORCRETE at amazingly low cost.

With this machine

Offers big earnings. Operators report costs of 2c and up per sq. ft. and sell up to 7c. Some have paid for their equipment from first few jobs. Machine capacity up to 1,000 sq. ft. per hour.

Get the facts. Send for book "Proven Business Opportunity." Write today. It offers big extra income.

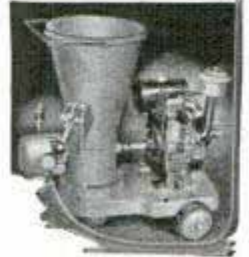

COLORCRETE INDUSTRIES, INC.
570 Ottawa Ave. Holland, Mich.

Only \$18.90 at Bass

Dollina O
Special-candid camera—with Certar Anastigmat F. 4.5 lens. Vario shutter, speeds 1/25, 1/50, 1/100, time and bulb. At Bass... \$18.90
Send for free Camera Catalogue No. 236

Bass Camera Co.
179 W. MADISON ST. CHICAGO, ILL.

HANDEE

TOOL OF 1001 USES

ACTUALLY A WHOLE SHOP FULL OF TOOLS IN ONE

Uses 200 different accessories, instantly interchangeable in easy-working chuck. For faster, better work on all materials, at home, in shop, or take to job. Plugs in any AC or DC socket, 110 volts. You'll be amazed at its unmatched performance, precision and almost human response.

**Grinds
Drills
Polishes
Engraves
Sharpens
Carves
Cleans
Sands
Cuts
Saws**

STANDARD MODEL

13,000 r.p.m. Weighs 16 oz. \$10.75 postpaid with 3 Accessories.

DE LUXE MODEL

25,000 r.p.m. Fastest, smoothest, most powerful tool for its type and weight, 12 oz. \$18.50 postpaid with 6 Accessories.

GET A DEMONSTRATION at Hardware, Tool or Dept. Stores. or let us send either model on 10-days Money-back Trial. Catalog Free.

New ROUTER and SHAPER
Convert your De Luxe Handee into an easy-to-handle Router or Shaper that will inlay, rout, carve, make molding cuts to 100th of an inch accuracy. \$12.50.

Chicago Wheel & Mfg. Co., 1101 W. Monroe St. Dept. Q, Chicago, Ill.

Send Catalog Router-Shaper Set PMS
 De Luxe Model Standard Model Send C. O. D.

Name.....
Address.....

AMERICA'S NEWEST
Mode of Transportation
ROCK-OLA
MOTOR
SCOOTER

SOLD ON
R. M. C.
EASY
TERMS!

125 MILES PER GALLON!

30 MILES PER HOUR!

Go places QUICKLY, INEXPENSIVELY!

It's loads of fun to go "scooting"! And you can easily learn to ride in one minute! Grand for going to and from work, school or shopping. Convenient to use—and parks anywhere. Safe, comfortable, and featuring the revolutionary new "FLOATING RIDE"!

Special 3-wheel delivery model for grocers, garages, printers, druggists, hundreds of businesses. Sold by your dealer on low R. M. C. time payment terms. Write for his name and literature.

DEALERS: A few valuable dealer franchises available. Write or wire.

ROCK-OLA MFG. CORP. SCOOTER DIVISION
806 NORTH KEDZIE AVENUE, CHICAGO

SLIDE-VALVE STEAM ENGINE

model SE-3, for small boat models. A complete power plant, ready to run, with two-cylinder engine (as illustrated), boiler, safety valve, denatured alcohol burner and propeller rig. Price \$3.00. Postage extra, shipping wt. 1 1/2 lb.

SHAWNEE ENGINE CO., Box 162, Station D, Cincinnati, O.



FREE 48-Page **POWER TOOL** Catalog sent to any home craftsman interested in improving his work. Full descriptions of **DRIVER** Engineered Power Tools and Accessories. Write today! Walker-Turner Co., Inc., 188 South Avenue, Plainfield, N. J.

DRIVER Engineered POWER TOOLS

HANDY TAPS and DIES . . .
Accurate—carefully hardened and tempered. Complete range of sizes at your local five and ten cent store.
HENRY L. HANSON, WORCESTER, MASS.

FREE Sensational OFFER
2 FENCING SWORDS FREE
FENCING
WORLD'S FINEST SPORT
HARMLESS-EXCITING FUN



Develops strong body and alert mind. **HARMLESS.** The spring-steel 3-foot-long foils (swords) are equipped with rubber buttons. Aluminum cup-shaped hand guards. Our De Luxe foils are built for hard usage.

Complete set of two foils (swords) and free instruction booklet, only \$1.98 postpaid. Two additional fencing swords **FREE** for limited time. (Regular price of these two sets of foils \$3.98.) **ORDER NOW.**

ALL-AMERICAN FENCERS GUILD
Dept. 8 PM 48 West 48th St., New York, N. Y.

SPARE TIME MONEY . . .

There's a big demand for the many hand-tooled articles you can make with the Esaco Leathercraft Set. Easily learn to make good money in your spare time. Complete outfit including tools, leathers, patterns, etc., and full instructions, only \$2.00—on sale at leading Department Stores or order direct and pay postman on arrival. \$2.50 outside U. S.

LEATHERCRAFT

Free When ordering direct, clip name of your Department Store to this ad, and we will include with your set, one extra free project. Illustrated catalog 10c.

E. A. SWEET CO. Dept. A-15 Binghamton, N. Y.

A 543
The Diesel in the Air

(Continued from page 163)

wind," were equipped with four 600-horsepower engines. Once again, they demonstrated the reliability of the Diesel by making fourteen trips over the same route.

Catapulting is used extensively for launching these Diesel-engined mailplanes, as Germany lacks bases from which to operate. Although this involves the use of catapult ships, it has the advantage that the plane can take to the air with full load without risking a take-off from a choppy sea. At present, catapulting is not suitable for passenger planes as the rate of acceleration is too rapid.

For long-range flights, the Diesel is particularly economical. This was demonstrated when a Dornier Do 18 flying boat made a 5,200-mile non-stop flight from the English Channel to Caravellas, in Brazil. This broke the world's long-distance sea-plane record by nearly 1,000 miles, thanks to the remarkable fuel economy of the Junkers "Jumo" 205 engines. A fuel saving of approximately twenty-three per cent, compared with gasoline operation, is now obtained under average conditions. Another advantage is the saving in fuel cost. Aviation gasoline costs about eleven cents a gallon at refinery, compared with five cents a gallon for Diesel fuel.

Perhaps the most important factor is that Diesel fuel does not give off inflammable vapor at ordinary temperatures like gasoline, so there is no danger of an explosion from this source.

The Junkers factory is engaged in the type-testing of their 1,200-horsepower "Jumo" 206 Diesel, and in the construction of a new type which is to develop 2,000 horsepower. The latter will not follow the six-cylinder, in-line construction of their other Diesels, but will be a "square" engine with four banks of six cylinders and a crankshaft at each corner. So compact will the engine be, that its diameter will not exceed thirty-nine inches. Its weight will be about one pound per horsepower.

The United States, England, France, Japan and Russia are all working with the Diesel. Next year, huge flying boats carrying passengers and mail, powered with 2,000-horsepower Diesels, may take their place for transatlantic travel. Ultimately the Diesel may become the most popular power plant for long-distance flights.

Low-Cost Receivers for Beginners

(Continued from page 259)

er for convenience. A lead is soldered to the terminal on the left side and run down to the spring clip on the crystal detector, the other spring clip on the detector being connected to the remaining phone-tip jack.

All four terminals on the antenna coil are numbered for identification in Fig. 1

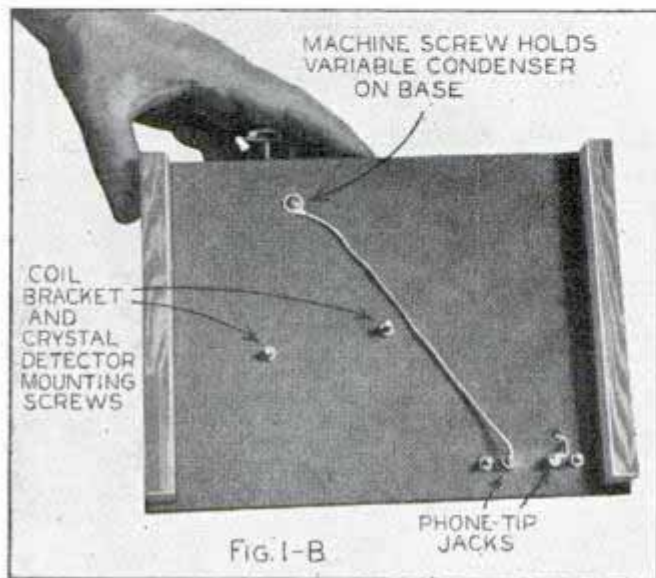

and correspond to those shown in the schematic circuit diagram Fig. 1-A. The top end of the primary is No. 1 and the bottom terminal is No. 2; looking into the coil from the top, the upper end of the secondary is No. 3 and the lower end No. 4. Solder leads to each terminal lug and connect them exactly as shown in Fig. 1.

When completed, connect the antenna and run the ground lead to a clamp on a

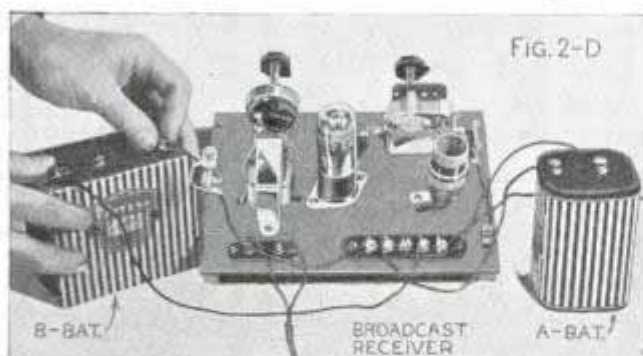

cold-water pipe. Now plug a pair of good headphones into the tip jacks, move the "cat whisker" over the surface lightly until you find a sensitive spot and then tune in stations by rotating the condenser.

A set using a tube will pick up more stations with greater volume than a crystal receiver. Figs. 2, 2-A, 2-B, 2-C, 2-D and

(Continued to page 136A)

CATALOG 72 1938

NEW FREE CAMERA CATALOG

Cameras, cameras — a thrilling parade of all the latest models in one big volume devoted exclusively to cameras and equipment. Send for this amazing FREE catalog today. See what you can save! See the wide selection of famous-name cameras and equipment, the completeness of stocks right down to the tiniest film clip. Mail the coupon NOW! Tomorrow you may forget all about it.

REFLECTA CAMERA

\$15.75

F:4.5 Lens

WHOLESALE RADIO SERVICE CO. INC.

NEW YORK, N. Y. • CHICAGO, ILL. • ATLANTA, GA.

100 SIXTH AVENUE • 901 W. JACKSON BLVD. • 205 PEACHTREE STREET

BOSTON, MASS. • BRONX, N. Y. • NEWARK, N. J. • JAMAICA, L. I.

WHOLESALE RADIO SERVICE CO., INC.

100 SIXTH AVENUE, NEW YORK, N. Y.

Rush FREE Camera Catalog No. 72-7H8

Name

Address

City

State

PASTE COUPON ON PENNY POSTCARD

LeJay Electric Troller

LIGHTWEIGHT—CLEAN—SILENT

Ideal for boats or canoes because of its variable speed from maximum to just moving. So simple a child can operate yet strong and sturdy for general use. Operates 8-12 hours on good battery. Silent operation plus use of both hands for fishing and other features make it the perfect outboard. Free details.

It's easy to build your own electric outboard from old auto generator. We show you how. Dime brings simplified plans and valuable catalog.

LEJAY MFG. CO., 547 LeJay Bldg. Minneapolis, Minn.

\$29.50

FREE BOOKLET ON FILES...

"A File For Every Purpose" gives instructions on use and care of many kinds of files — 28 pages, profusely illustrated. Write Nicholson File Co., 22 Acorn St., Providence, R. I., U. S. A.

Amazing NEW GLAZE Beautifies and Protects



Car Owners! Meet MASTER GLAZE — the sensationally different luster for new and used cars!

Not a wax — not an oil polish — not a paint — nothing that "smears" over the surface. A creamy liquid — quick and easy to apply! Gives a hard, glass-like surface. Even gasoline cannot dull it! Lasts six months to a year! Amazing luster — beautiful, sparkling clean and brilliant! Doesn't fingerprint — doesn't smear! Seals the pores — protects! Nothing like it!

FREE Write now for Free booklet and **SAMPLE OFFER**. Free Trial offer. Just send your name and address.

MASTER GLAZE CO., 7720-32 W. HARWOOD AVE., MILWAUKEE, WIS.

WRITE for this big money maker TODAY

New IRONING CORD SET

It Spins ROUND and ROUND
Cannot kink or twist.

Here is no ordinary new product. This new Wrist-Action Plug is one of the most remarkable new devices ever offered! You never saw anything like it. Housewives are fascinated—held spellbound by the instant demonstration you can give with this new electric iron cord that swings freely in any direction. Ends kinking and twisting—prevents broken wires, burned fuses. Swivel action plug spins round and round—swings from side to side—keeps cord out of the way—no wonder housewives say, "Just what I want," as soon as they lay eyes on it!

FREE Makes no difference what you have sold or if you never sold anything in your life before you are bound to be successful. Nothing on the market like it—simply show it and the sale is made. Get the facts at once. **WRITE** Learn how you can GET YOUR **TODAY** DEMONSTRATOR FREE. Write for big money making plan.

NO-TRO ELECTRIC APPLIANCE CORP.
800 N. Clark St. Dept. P-8 CHICAGO

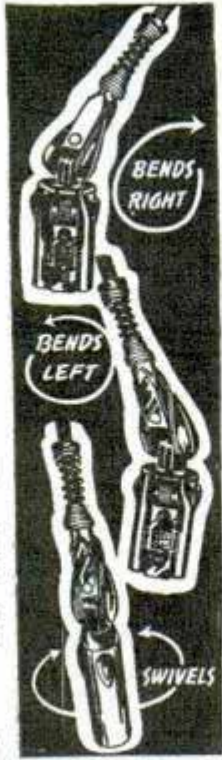

BIG MONEY BUILDING MEAD'S

New Portable OUTBOARD BOAT



IN A FEW DAYS AT HOME!
Build this light, 50 lb. tough, durable, seaworthy, portable Outboard Ki-Yak! Take it anywhere by hand or car. Safe, leakproof, trouble-free. More speed per horsepower, more miles per gallon. MEAD'S perfected aluminum-ribbed, cut-to-fit Construction Kit guarantees successful assembly, quickly, easily, economically. New 69 lb. OK-4 uses oars, sail, motors 10 h.p. or less. Also 3 "CK" paddle-sail models from 20 lbs. to 45 lbs. Rush dime for details, 36 Gift Paddle Offer!

MEAD GLIDERS 15 S. Market St., Dept. R-88 CHICAGO, ILL., U. S. A.

FREE RADIO AND PARTS CATALOG!



See the latest sensational radio developments in Allied's new 1938 Radio Catalog! 61 new KNIGHT Radios at amazingly low prices; 12,000 radio parts; 32 new Build-Your-Own kits; Amateur gear; P. A. Systems; books, tools, etc. Write today for FREE copy!

ALLIED RADIO CORP.

833 W. Jackson Blvd., Chicago, Ill. Dept. 5-H-8



PHOTO ENLARGEMENTS

Is Photography your hobby? Do you want a profitable easy business at home? Make **PHOTO ENLARGEMENTS** for yourself and others. Your cost 5c each and less. The Ideal Photo Enlarger is **AUTOMATIC**. No experience required. Also **COPIES** any picture. **\$5.94 COMPLETE**. Interesting circular **FREE**.

5¢ ANY SIZE

IDEAL-O, 122 East 25th Street, New York City

COMPLETE ELECTRIC PLANTS



Onan A.C. plants furnish same current as city lines, 110 Volt, 60 Cy. For farms, camps, construction jobs. Operate radios, water systems, all appliances. New models, 350 to 5000 watts, 6, 12, 32 and 110 volt D.C. Models \$57.50 and up. Also combination A.C.-D.C. units Shipped complete, ready to run.

Write for details.

D. W. ONAN & SONS
1024 Royalston Ave
Minneapolis Minnesota

(Continued from page 135A)

2-E show complete construction details for a one-tube receiver built up from the crystal-set parts—plus some new ones—and the cost is quite reasonable.

A low-drain tube known as the RK-43, originally developed for use in radio equipment installed in meteorologic "weather balloons," is employed in this broadcast receiver and also in the short-wave set to be described. It is a dual-purpose tube which means that it is the equal of two ordinary tubes. With only 45 volts of B-battery voltage, this set will operate a small magnetic speaker on strong locals and has plenty of headphone volume on weak distant stations. A list of the original parts used in all three sets can be obtained from Popular Mechanics radio department without charge. The blue-

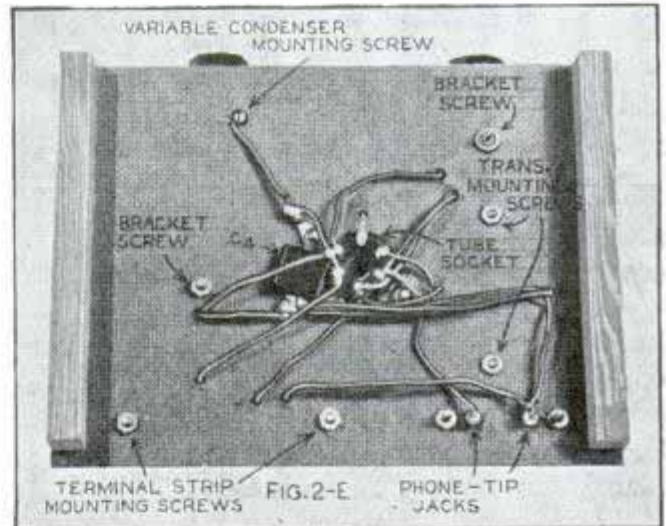

print, number R-256, however, will not be available until Part II of the article appears in the September issue. As the beginner should start with the crystal set, a complete description of the other receivers will be given later. For the broadcast set the crystal detector is removed and replaced with a 6-prong tube socket. The coil is modified slightly by removing 20 or more turns from the smallest winding (L_2) which now serves as a "tickler." This is necessary to prevent excessive oscillation. Just enough turns are removed so that the set will drop in and out of oscillation smoothly as the regeneration control (R_2) is turned. The 6.3-volt pilot-light bulb is connected in series with the positive B lead near the battery merely as a protective fuse and has no effect on the operation of the set.

(To be continued)



C. S. SPECIAL

WONDER CIGARETTE ROLLER

The New Realization. The greatest fad Hollywood ever had. Everyone is doing it, why not you? The new WONDER CIGARETTE ROLLER rolls any kind of tobacco. Now you can roll and have your own monogram on your cigarettes. Any 10c package of tobacco will make 40 to 60. Send \$1.00 and we will send prepaid Cigarette Roller and Monogram with the word "special" and your own initials.

AGENTS WANTED. Young men and women are making from \$10.00 to \$25.00 per day. Be your own boss. Address Box 487 Hollywood, California.

Metal Canoe!

UNSINKABLE! Can't sink even when filled with water. Made of "Dowmetal," the lightest of all metals. Never takes on weight. No canvas or other materials to deteriorate. Easiest of all canoes to handle. Much lighter and stronger than wood. Safe even for children. (Patented) Write today for **FREE** circular.



Lightest of All Canoes.

Strongest Canoe Ever Built.

FREE CIRCULAR

C. W. Stiver, 222 Schirmer Bldg., Saginaw, Mich.

Net wt.—10 3/4 lbs. Ship. wt.—12 lbs.

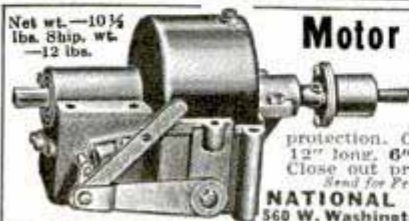
**Motor Speed Reducer**

Ratio 144 to 1; Ball Bearings; white metal housing; rating up to 1/4 H. P. Equipped with friction clutch for overload protection. Originally sold for \$25.00. 12" long, 6" wide, 5 1/2" high. Close out price... **\$3.95**

Send for Free 22 page Paint Spray Catalog. **NATIONAL ELECTRIC TOOL CO.** 560 W. Washington Blvd., Dept. 70, Chicago, Ill.

Print Your Own

Cards, stationery, circulars, tags, labels, advertising, etc. Save money. Print for Others; Big Profits; easy rules sent. Will do popular Raised Printing like Engraving. Junior outfit \$9. Senior outfits \$17 and up. Send for free catalog and all details. **KELSEY PRESSES, E-37, MERIDEN, CONN.**

BUILD CLOCKS with our help

Cash in on the demand for Mantel, Banjo, GRANDFATHER'S CLOCKS. Ask about our new, low-priced Hall Clock and Special Blue Print Offer. Send dime for illustrated working drawing of Hall Clock; 25c for plans of 16 Mantel & Banjo Clocks. Catalog **FREE.** **AMERICAN CHIME CLOCK CO.** 1672 Ruffner St. (Established 1877) Philadelphia, Pa.

FORCED TO LIQUIDATE Surplus Stock of New 1938 MODEL

All-Steel Utility Trailers. Must be disposed of immediately at way below cost of manufacture. A record breaking opportunity to buy a custom built, sturdy, all steel, ton capacity trailer for only \$69, less tires. Original price \$167.50; while they last, \$69. F. O. B. Chicago. **BELL TRAILER MFG. CO., Dept. PM-8, 2452 S. Michigan Ave., Chicago, Ill.**

CATCH FISH! minnows, eels, mink, muskrat with our folding galvanized **Steel Wire Traps, Greer Patent Lever Hooks** are so constructed that when a fish gives the slightest pull on the bait the upper hook reaches down and gets a hold that lands him. 3 for 50c. Write for descriptive catalog of Traps, Hooks, Lures, and other specialties. **Walton Supply Co., 3507B Juniata St., St. Louis, Mo.**

BUILD THESE PROJECTS

For garden or lawn. Easy to build. Easy to sell. Detailed Blueprints Model B-25 Dutch Windmill 50c; Model OM-60 Old Mill, 85c. Lawn Figure Patterns—Sunbonnet Girl, Dutch Boy, Tulip Girl, Holland Pair, 35c each all 4—\$1.00. Catalog illustrating many models, send 10c, today.

CRAFTSMAN'S MODEL CO., Dept. P-20, 2030 N. 41st St., Milwaukee, Wis.

SAVE OVER ONE-HALF!

Typewriters—Duplicators—Adders—Addressographs—Checkwriters—Dictaphones—Multigraphs for sale at less than one half manufacturer's original price. Look and operate like new. Terms as low as 10c a day. Write for money-saving information today.

PRUITT, 7 Pruitt Bldg., Chicago, Illinois

YOUR OWN MOVIES! 10¢ A DAY!

NATIONALLY ADVERTISED 8MM and 16MM Movie cameras, projectors. For home, business, church, school, club. **MONEY BACK 10 DAY TRIAL.** Payments as low as 10¢ A DAY. Satisfied customers throughout the world. **FREE details. WRITE TODAY.** Dan Elder's Home Movies, Dept. A-8, 739 Boylston St., Boston, Mass.

Earn Cash at Home!

We paid M. M. \$1174 for exceptional "cellar crop" SNOW-KING mushrooms! Big free picture book tells if your cellar, shed, barn suitable. We furnish materials, buy all crops. Write today. Est. 1908. **UNITED CO., 3848 Lincoln Ave., Dept. 306, Chicago.**

In answering an advertisement with a coupon, be sure to write name and complete address clearly. Sometimes advertisers are unable to respond to inquiries due to lack of complete information.

When writing to advertisers please mention Popular Mechanics

MODEL AIRPLANE ENGINE**NOW ONLY \$13.75**Set the Pace—with the **SYNCR O ACE**

At left, the modern, streamlined power plant, for model airplanes and boats. Immediate deliveries, with all 1938 improvements.

THE NEW Syncro BEE \$12.50

Now in production. Has 1/2" bore and 5/8" stroke. Weighs approximately 4 oz. Both models, as well as special model makers motorless electric jig saws, at your dealer's.

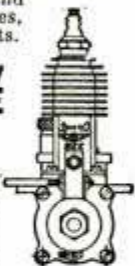
**LITERATURE FREE**

SYNCR O DEVICES, INC., 511 Boydell Bldg., Detroit, Mich.

GOVERNS SPEED OF ANY GAS ENGINE

It's easy and economical to supply your own power for operating all types of machinery, and do more work for less money. Simply remove the engine from a used automobile or truck, set it up where you like, attach a **PIERCE UNIVERSAL GOVERNOR**, start the engine and you have constantly controlled power for the operation of electric lighting plants, arc welders, refrigerating units, air compressors, feed grinders, hoists, saw mills and innumerable other applications.

The load may change but the **PIERCE UNIVERSAL GOVERNOR** will maintain a uniform engine speed. For close regulation of speed and dependable performance **PIERCE GOVERNORS** are never equalled. Installation is simple. Either V or flat belts can be used. Complete Governor outfits are also available for nearly all makes and models of industrial engines.

Write for illustrated literature and prices.

THE PIERCE GOVERNOR COMPANY 1601 Ohio Avenue, Anderson, Indiana

**PIERCE GOVERNORS THE BRAINS OF ANY GAS ENGINE****GAS MILEAGE EFFICIENCY GAUGE**

A standard Vacuum Gauge 2 1/8" diam. with easy-to-read dial Indicates:

1. HOW TO DRIVE MORE MILES PER GALLON.
2. HOW TO CHECK ENGINE PERFORMANCE.



The same type Vacuum Gauge used by Modern Service Stations—mounted on YOUR car as a **CONSTANT** indicator. Pays for itself in a few weeks by **GASOLINE SAVED.** Installed in a jiffy by anyone.

30 Day Trial, Postpaid on receipt of \$2.50 or C. O. D. plus postage.

SPEEDOMETER SERVICE CO., Inc., 281 Central Ave., Newark, N.J.

KEEP YOUR HOUSE

Don't suffer with unbearable heat in summer. Enjoy cool refreshing breezes of modern **AIR-COOLING.** Small cost. Easy and Cheap to operate. Install it yourself. Be comfortably cool in hottest weather. Write for Free Information.

International Engineering, Inc., Dept. 41, Dayton, Ohio

NOW YOU CAN GET A HEAVY DUTY INDUSTRIAL WELDER

Works ON 110-Volt Light Socket

This marvelous **DYNAMIC** Power Welder will do the work of much higher priced types. It is easily portable. **WELDS** Cylinder Blocks, Bumpers, Fenders, Tanks, Farm Machinery, and etc. Will also solder and braze on the lightest material. Works on iron, steel, tin, brass, copper and all other metals. Men without previous experience can make as much as \$5.00 on a one hour repair job. Go into business—Open a Welding Shop **NOW.**

AGENTS—Make big profits selling to garages, factories, joiners and machine shops. Write **TODAY** for our

10-DAY TRIAL OFFER. DYNAMIC WELDER CO. 2226-FA Silverton Road Chicago, Illinois

for Only **\$195**

RETAIL





U. S. Patent No. 2015459.

BUILD IT WITH DOENUTS

Build your own wheelbarrow, scooter, bicycle trailer, wagon, midget auto, street marker, boat dolly, lawn chair, etc., with Musselman DOENUT wheels. Developed and patented by the originator of the airhoop for airplanes. Sizes 10" x 2.75" and 12" x 3.30". Operate on as low as 15 lbs. air. Absorb surface obstructions. No jolting. Do not sink into sand or soft ground. Roll same load with less than **HALF THE EFFORT**. Send 25c for simple blue print drawings of any vehicle shown here or \$1.00 for all 6. For literature only send 10 cents postage. **!**

THE MUSSELMAN PRODUCTS CO.
6247-C St. Clair Ave., Cleveland, Ohio



FACTORY GUARANTEED

NEW REMINGTON NOISELESS PORTABLE

AT LAST! The famous Remington NOISELESS Portable plus Carrying Case is yours for as little as ten cents a day. Brand new. Not rebuilt. Standard keyboard and every modern feature. Free typing course. 10-Day free trial. You don't risk a penny. **WE PAY ALL SHIPPING CHARGES.** Act now! Remington Rand Inc. Dept. 152-8. 465 Washington St., Buffalo, N. Y.



AS LOW AS 10c A DAY

What! Only \$6.94 FOR THIS SILVER RADIO

Yes, it's true—just \$6.94 buys this all-electric radio complete with full size tubes and serial Rush \$1 deposit, balance C.O.D. plus postage. Money back if not satisfied.

FREE New Catalog, just off press. Models for farms, homes and cars. Radios that get Europe. Automatic tuning. Consoles and table models. Save up to 50%.

SILVER MANUFACTURING CO., Inc.
2858 Elston Ave., Dept. P-8, CHICAGO.



Send for This!

SAFE, STRONG TRAILER JACK & COUPLER

Atwood-Dayton design. Used more than any other. Extra safety factor all directions. All steel. Also new larger Disappearing Step, positive-action Diaphragm Pump. New prices 10% to 25% lower. Write TODAY!

Atwood Vacuum Machine Co., Dept. MA, Rockford, Ill.



FREE CATALOG

Showing the finest and most desirable Tool Chests ever made for Machinists and Toolmakers.

GERSTNER TOOL CHESTS
438 Columbia St. Dayton, Ohio



WORLD'S GREATEST all around ELECTRIC TOOL

The new **WHIZ ELECTRIC TOOL** is the handiest, most useful power tool ever made. Not a delicate instrument but a real rugged tool, equally effective for both power and precision work. Drills through 1/4 inch iron plate in 42 seconds or engraves intricate designs on jewelry. Handles any material: Metals-Woods-Alloys - Plastics - Glass - Steel-etc. Saves time. Eliminates tedious labor. Plug into any socket AC or DC, 110 volts. Chuck 1/4" capacity. Ball bearing thrust. Powerful, triple-gear motor. "Worth its weight in gold," to mechanic or handy man. **STANDARD MODEL** with Normal Speed (uses 50 different accessories, instantly interchangeable). Special Introductory Price for a limited time, only \$8.95.

FREE Accessory outfit (Value \$2) includes set of drills, mounted 1 1/2" grinder, sanding discs, cutting wheels, mounted brush, polishing wheel, carving bur, etc. **FREE** with each outfit ordered NOW. We pay postage on all shipments. Will send C.O.D. if desired. **10-DAY TRIAL-MONEY BACK GUARANTEE.**

Special "2-SPEED" MODEL combines Normal Speed and High Speed in one outfit (uses 200 accessories) only \$8.95 complete, with same accessory outfit (value \$2) **FREE.**

PARAMOUNT PRODUCTS CO.
Dept. 8A, 48 West 48th Street, New York, N. Y.



Sectional Cabinet Relay Racks

(Continued from page 260)

Mounting brackets enable the builder to support completed chassis bases directly on the back of each front panel. Smaller mounting brackets are available for



mounting shelves to rack panels; these appear in the photo with the box-type dust cover for small units. Inter-stage shields and many other aids to the builder who is not equipped for metal working encourage the amateur to standardize his equipment and build efficient apparatus.

Photos A, B, C and D show complete metal cabinets suitable for housing receivers, testing equipment, small transmitters



and amplifiers. Some of the smaller metal cases now available to amateurs are provided with hinged covers and handles. Thus metal replaces the wooden cabinets formerly employed for housing amateur apparatus, and gives the beginner as well as the advanced experimenter an opportunity to construct radio equipment he can be proud of.

Where Is Television Now?

(Continued from page 183)

probably has a frequency of sixty cycles per second—sixty pulses of flow in each direction—but sound broadcast stations use frequencies up to 1,500,000 cycles per second while television goes up around 50,000,000. And radio laboratories are experimenting with frequencies of more than a billion cycles per second!

Some of the most difficult problems of television result from these rapid reversals of current. We think of electricity as instantaneous but it is not. It has a speed of about 186,000 miles per second. So when we call upon a current to travel even a few feet and reverse itself—but to do this millions of times per second—we encounter limitations even in the speed of electricity.

Eighty-seven video programs were telecast by NBC last year. Only about 100 families, however, were able to enjoy these telecasts radiating from the antenna atop the Empire State building because there are only that many receivers in the New York metropolitan area, most of them in the homes of RCA and NBC engineers.

Engineers, designers, cameramen, costumers and directors work with special scene compositions, materials, colors and lighting in preparing a video performance. High-efficiency, non-glare lights have been developed for telecasting but the illumination required for a television scene is still somewhat greater than for the movies.

Most people assume television programs will be accompanied by sound but programs without sound have been found desirable in some instances. In fact, television may take up pantomime acting where Hollywood left it when the movies began recording sound with sight.

While passing through the earphone stage, television needs what radio needed in the days of crystal sets—hams and tinkers. RCA recently made available to amateurs certain specialized parts, including several Kinescopes, and before long complete television kits containing all the parts for receivers may be available. Once the art emerges from the laboratory, the nation's hams and tinkers will play an important part in its development.

And what of the hams who perform this labor of love? They will probably be the television—or video—servicemen and distributors of tomorrow.

Amazing New Invention... SAVES HOUSEWIVES ARMS! Pays YOU Big Money

NEVERLIFT IRON REST

Sell what 9 women out of 10 WANT—and the depression is over for YOU! THE NEVERLIFT IRON REST is new, patented, it does away with the drudgery in ironing! Eliminates "Ironing Day Backache"—hailed by housewives everywhere as the greatest labor saver of the age! Quick, easy, dramatic demonstration gets orders on sight. Retail only 50c, you make up to 100% PROFIT. Hand out dozens daily. One man sold 43 in 1½ hours' work—one woman sold 14 in two hours—many others doing just as well—and better. You—can get in on this big money too, so start now!

NO RISK STARTING PLAN

We can't describe the powerful appeal to women of this amazing invention. Find out for yourself—AT OUR RISK! Women in your locality will prove it with PROFITABLE ORDERS! But act now—territories going fast. Write TODAY!

THE NEVERLIFT CO., INC.

813-AL East 47th St.,

Chicago, Ill.



WOMEN LIFT 900 LBS.

Doing a
Family Ironing!

Lifting a 4½ lb. iron 200 times (average ironing) equals 900 lbs.! The sketch shows how NEVERLIFT does away with lifting. Iron slides from board to Rest in one easy stroke and slides off again—with no lifting.

In answering advertisements always write name and full address clearly.

Earn BIG MONEY MAKING ELECTRIC RAZORS at home!

BUY ALL PARTS READY FOR
INSTANT ASSEMBLY
NO TOOLS NEEDED
Make \$5 or More on Every Razor Sold

Just think, a complete \$15 type razor for \$1.95 or less. You can make \$5 or more for fifteen minutes of your spare time. Start AT ONCE, big or small—with one unit or 100—make your own electric razor or sell to others—you can profit both ways!

Costs **\$1.95** (in lots of 3) **LARGER QUANTITIES LESS**

Make your own electric razor just like the ones selling in the high price brackets. Earn money assembling electric razors for others in your spare time or full time. Buy parts from us—complete matched units. Every part standardized precision-built made by the most popular together to make one of the most popular standard super-quality Electric Razors. (The same high quality parts now used in Shavers selling for much higher prices.)

Write for information or order your first unit at once and prove the money-making possibilities to your own satisfaction.

SIMMONS MFG. CO.
128 W. North Ave., Chicago

FREE
Screwdriver and instructions with order for first unit. You need no other tools... no soldering equipment.

SIMMONS MFG. CO.
128 W. North Ave., Chicago

- Send C.O.D. 1 sample razor kit for which I will pay postman \$2.25 plus a few cents postage.
 Enclosed find \$..... for..... Electric Dry Shaver Kits including free instruction, tools and money making plans.

Name.....

Address.....

\$85⁰⁰

Less Motor Drive
Sold on Easy Payments as Low as \$5.00 a Month for 12 to 18 months.

EMPLOYED IN EVERY INDUSTRY FOR THE

Finest

METAL WORKING JOBS

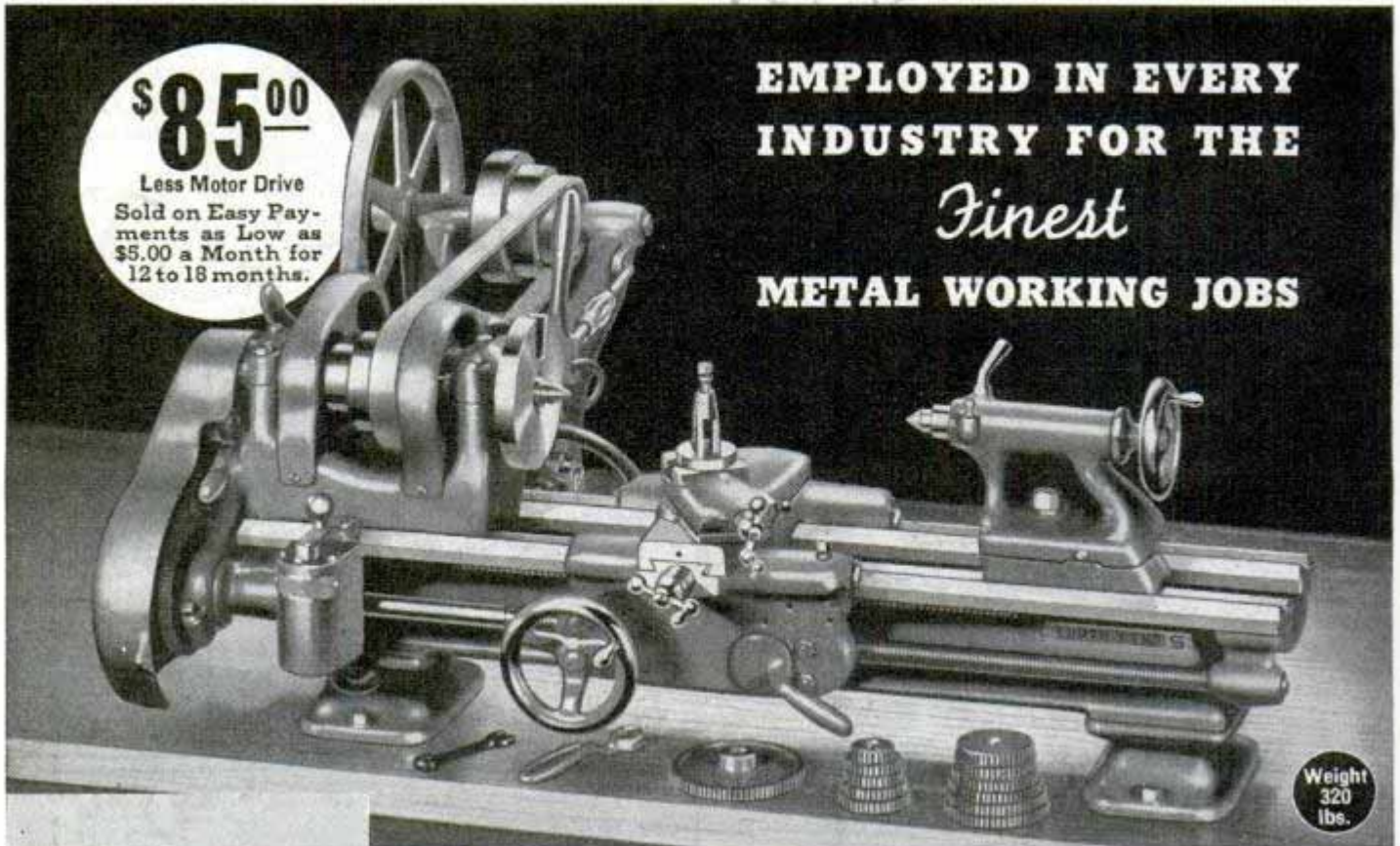

Weight 320 lbs.

SOUTH BEND BACK-GEARED SCREW-CUTTING PRECISION LATHE

This 9-inch South Bend Lathe used by:
MANUFACTURERS TOOL ROOMS LABORATORIES MACHINE SHOPS

- Automotive
- Electrical
- Gun Smiths

U. S. GOVERNMENT SCHOOLS HOME WORK SHOPS INVENTORS

The 9" x 3' South Bend Precision Lathe does these operations:

**—TURNS—BORES
—CUTS SCREW THREADS—FACES
—DOES MILLING, CHUCKING, REAMING, DRILLING, FILING AND HUNDREDS OF OPERATIONS IN STEEL, IRON AND OTHER METALS.**

There are 5 sizes of South Bend Lathes—9", 11", 13", 15" and 16" swing with bed lengths 3' to 12'. In motor or counter-shaft drives. Priced \$85 to \$1500.

No. 415-YA, 9 1/4" swing by 3' bed Workshop Bench Lathe with Horizontal Motor Drive, 1/4 h.p. Reversing Motor, Switch, Belts and Adjustable Belt Tension Countershaft. **\$117.00**
(\$15 Down—\$7 Monthly for 18 Months)

THE design and construction of the 9-inch Workshop Lathe guarantees doing jobs to the most exacting specifications. Workmanship and materials are of the highest standards that only our 32 years of manufacturing fine precision lathes can furnish. Used by every industry in the United States and abroad—the 9-inch Workshop Lathe is proving a profitable and productive investment.

Features: Precision Lead Screw for screw threads 4 to 112 per inch, Ball Thrust Bearing on spindle, Automatic Longitudinal Screw Feed, Twin Gear Reverse to Lead Screw, 3/4" spindle hole taking collets up to 1/2". Takes 38 attachments for milling, grinding, draw-in collet chuck work, taper work, and other jobs.

SOUTH BEND LATHE WORKS
632 E. Madison St., South Bend, Ind., U.S.A.

LATHES ARE STOCKED IN PRINCIPAL CITIES

Boston, Massachusetts—The MacKenzie Machinery Company, Inc., 36 Oliver Street
Bridgeport, Conn.—A. C. Bigwood Machinery & Equipment Co., 17-21 Union Square
Chicago, Ill.—C. B. Burns Machinery Company, 541 West Washington Boulevard
Cleveland, Ohio—The Reynolds Machinery Company, Inc., 2034 East 22nd Street
Dallas, Texas—The Machinery Sales and Supply Company, Inc., 2124 Main Street
Denver, Colorado—The M. L. Foss Machinery Company, Inc., 1901 Arapahoe Street
Detroit, Michigan—The Lee Machinery Company, Inc., 6318 East Jefferson Avenue
Houston, Texas—The Wessendorf, Nelms & Company, Inc., 317 Preston Avenue
Los Angeles, Cal.—Eccles & Davies Machinery Company, Inc., 1910 Santa Fe Avenue
Milwaukee, Wisconsin—W. A. Voell Machinery Company, 1833 North 16th Street
New York, New York—The A. C. Colby Machinery Company, Inc., 183 Centre Street
Philadelphia, Penn.—W. B. Rapp Machinery Company, Inc., 132 North Third Street
Portland, Oregon—The Portland Machinery Company, Inc., 208 So. West First Avenue
Providence, Rhode Island—George T. Reynolds & Son Co., Inc., 171 Pine Street
Rochester, New York—The Opden R. Adams Machinery Company, 256 State Street
St. Louis, Mo.—Colcord-Wright Machinery & Supply Co., 1223-1229 No. Broadway
San Francisco, California—The Moore Machinery Company, Inc., 550 Fifth Street
Seattle, Washington—The Star Machinery Company, Inc., 1741 First Avenue
South Syracuse, New York—H. A. Smith Machinery Co., Erie Blvd. E and So. Townsend St.
Tulsa, Oklahoma—The Machine Tool & Supply Company, 215-219 East First Street

Send Coupon
FOR THESE BOOKS

New edition "How to Run a Lathe"—with 128 pages, and over 350 illustrations on lathe operation. 1,500,000 copies of this book in use. Catalog No. 46 shows and describes the 9-inch Lathe in 3', 3 1/2', 4', and 4 1/2' bed lengths, and 8 drives.



SOUTH BEND LATHE WORKS,
632 E. Madison St., South Bend, Ind., U.S.A.

- No. 34LB, "How to Run a Lathe," 25c
- No. 46, 9" Workshop Catalog, Free
- Easy Payment Plan

Class of Work.....
Name.....
Address.....
City..... State.....

SOUTH BEND Precision LATHES

PROOF THAT EVERY CAR IS THREE-CARS-IN-ONE



THE THREE GRADES OF GASOLINE SOLD TODAY GIVE MODERN CARS A TRIPLE PERSONALITY

Automobile mechanics tell us that it's the car owner "who doesn't know what it's all about" that runs into the most trouble. Fortunately, the basic facts about what a man can expect from his car on each of the three grades of gasoline are so simple that you can easily understand them. Here they are:

THEY CAME AND SAW. At the Ethyl Motor Clinic popular makes of cars were run on the three grades of gasoline sold today. The entire audience saw the results projected on a large screen. This test, and others, definitely proved that modern cars have three grades of performance.

Poor performance

with "low-grade" gasoline



There is no anti-knock fluid (containing tetraethyllead) in "low grade" gasoline. Power is lost because the spark *must* be retarded by your car dealer to prevent "knock" or "ping."

Good performance

with "regular" gasoline



Most regular gasoline has in it anti-knock fluid (containing tetraethyl lead). The spark can be considerably advanced for more power without "knock" or "ping."

Best performance

with gasoline containing "ETHYL"



Gas "with ETHYL" is highest in all-round quality. It has *enough* anti-knock fluid (containing tetraethyl lead) to let the spark be *fully* advanced for maximum power and economy without "knock" or "ping."



Grace Moore
in Magnolia Gardens
.... *Chesterfield time is
pleasure time everywhere*

They Satisfy