

THRILL HUNTERS OF THE AIR LANES

POPULAR MECHANICS

MAGAZINE

WRITTEN SO YOU



REG. TRADE MARK GREAT BRITAIN NO. 410438

U.S. PAT. OFF.

JULY
25 CENTS



SEE PAGE 54

YOU CAN DEPEND ON CHAMPIONS



FOR MAXIMUM ECONOMY

Under the strict surveillance of the A.A.A. Contest Board, 26 stock cars recently left Los Angeles for Yosemite National Park, 314.5 miles away. Every car was carefully prepared for, and every driver was intent on, one thing only—extracting the most miles per gallon out of every gallon of gas.

This was the third annual Gilmore-Yosemite Economy Run, a real test of engine efficiency and economy. The route is not conducive to good mileage, includ-

ing as it does almost 100 miles of winding mountain highway and climbs reaching an elevation of over 6000 feet. The "stingy drivers", as they are known, furnished proof positive that engines equipped with Champion Spark Plugs get maximum miles per gallon when the Sweepstakes award and eight out of ten first places went to Champion-equipped cars.

For maximum economy in *your* car replace worn-out spark plugs with new Champions.

CHECK AND CLEAN SPARK PLUGS WHEN YOU CHANGE OIL

ACTUAL SIZE
V PLUG



V- $\frac{3}{8}$ "
24 Thread
V-2 $\frac{1}{4}$ "
32 Thread
65c

MODEL BUILDERS
—ATTENTION!

Specially designed for model gas engines giving the same dependable performance as regular Champions. Absolutely gas-tight, alloy needlepoint electrode, one-piece construction. If not available through your dealer, write Champion Spark Plug Company, 900 Upton Ave., Toledo, Ohio.

SEE HOW NEW KIND OF TIRE DRIES WET ROADS

GIVES YOU THE QUICKEST NON-SKID STOPS YOU'VE EVER SEEN

IN EVERY wet road emergency you need a tire that will turn the road under your car into a *dry* track. And now, thanks to the new Goodrich Safety Silvertown with Life-Saver Tread, you can have a *road-drying* tire that works like a whole battery of windshield wipers...sweeps away the water right and left... gives you the safest, quickest stops on wet roads you've ever seen!

Remember, this new skid-protected Silvertown also gives you the famous blow-out protection of the Goodrich Golden Ply. Thus the lives of yourself and your family are protected against *both* skids and blow-outs.

Your Goodrich dealer or Goodrich Silvertown store wants to give you a free demonstration of this new kind of tire in action. So why not go in and get first-hand the thrilling experience of a SILVERTOWN STOP? And, for safety's sake, make your next tires Goodrich Safety Silvertowns.



PROOF!

from America's
Largest
Independent
Testing Laboratory

"**B**OTH regular, and also the premium-priced tires of America's six largest tire manufacturers were submitted to a series of exhaustive road tests by us, with the following result:

"**NON-SKID**—The new Goodrich Silvertown with the Life-Saver Tread gave greater skid resistance than any other tire tested, including those tires listed at from 40% to 70% higher in price."



PITTSBURGH TESTING LABORATORY

1 LIFE-SAVER
TREAD SKID
PROTECTION

2 GOLDEN PLY
BLOW-OUT
PROTECTION



Life-saver tread dries road like a battery of windshield wipers. Sweeps the water right and left—forces it out through the deep drainage grooves.

The new Goodrich SAFETY Silvertown

SKID PROTECTION OF LIFE-SAVER TREAD ◆◆ GOLDEN PLY BLOW-OUT PROTECTION

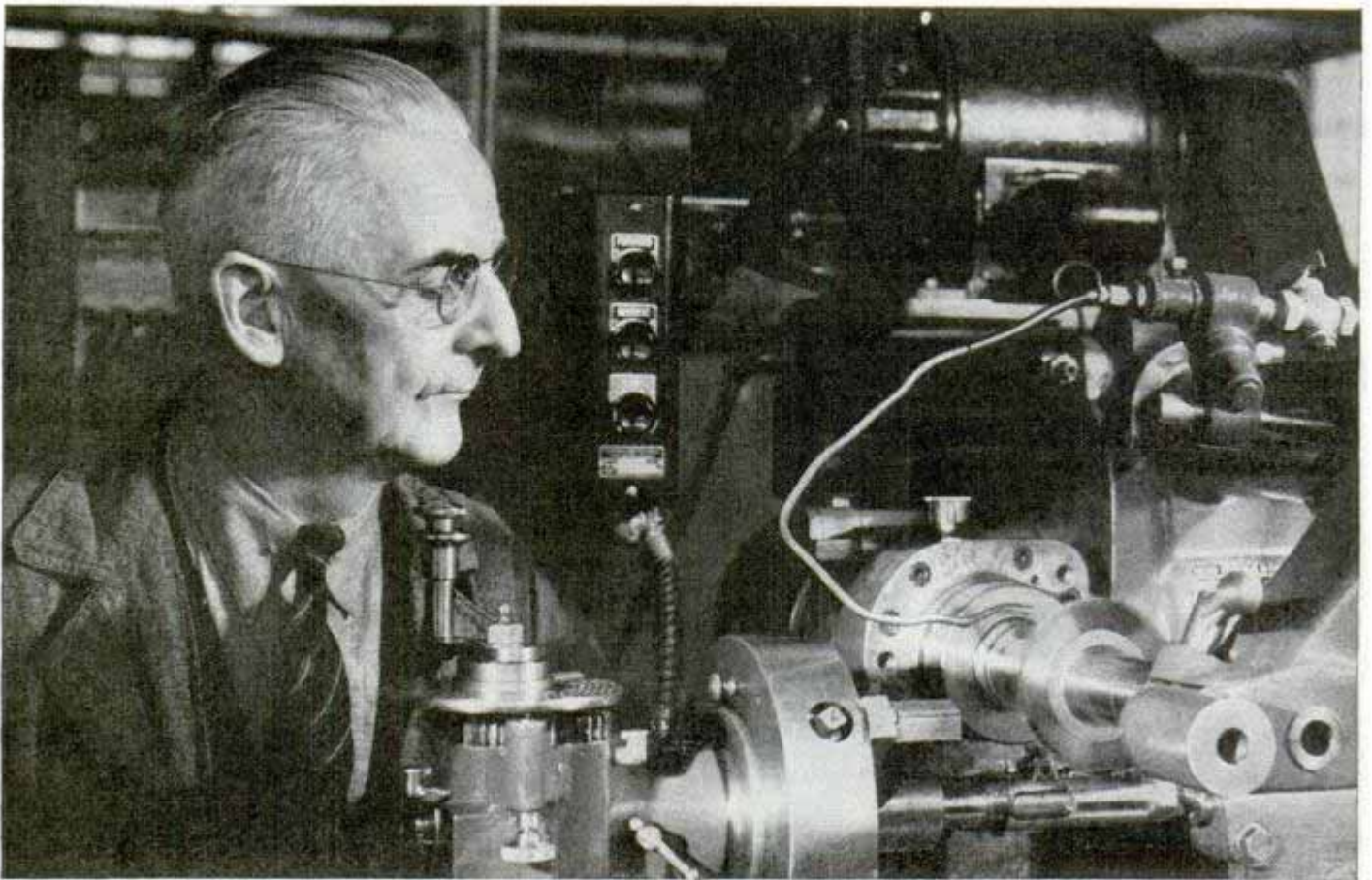

AMERICA'S ANSWER

ALL over the world, nations are struggling to obtain a higher standard of living for their people. They are resorting to conquests, boycotts, experimental forms of government. But America has its own answer to this problem—a solution which has proved its worth. This American workman and millions of his associates, aided by the scientists and engineers of industry, are raising the living standards of all of us. They are doing it by constantly developing new and better products, and then learning to make them inexpensive so that millions of people can afford them.

For instance in 1927, when an electric refrigerator cost about \$350, approximately 375,000 were purchased. In 1937, a better refrigerator cost only

\$170. And because the cost had been cut in half, *more than six times as many people* bought them.

In the same ten years the cost of a typical electric washer has been reduced from \$142 to \$72, a console radio from \$125 to \$53, and a 60-watt MAZDA lamp from 30 to 15 cents. And these new lower-cost articles, typical of hundreds of manufactured products, perform better and cost less to operate than their predecessors.

General Electric scientists, engineers, and workmen, by contributing to this progress—by helping to create more goods for more people at less cost—are hastening the day when all may enjoy the comforts and conveniences which only the rich could afford a few years ago.

G-E research and engineering have saved the public from ten to one hundred dollars for every dollar they have earned for General Electric

GENERAL  **ELECTRIC**

1938—OUR SIXTIETH YEAR OF ELECTRICAL PROGRESS—1938

Popular Mechanics Magazine

H. H. WINDSOR, Founder

H. H. WINDSOR, Jr., Editor and Publisher

July, 1938

Vol. 70, No. 1

Special Features

Built-to-Order Vegetables	1
Spectacular Fireworks Coloroto	
Fire under Your Hood (<i>Special</i>)	20
Rope Spinning for Health	26
Yachtsmen Go to School	34
Thrill Hunters of the Air Lanes	40
The Liner of the Future	46
Making Jobs for the Big Hook	50
Hay Fever and How to Escape It	55
"Beating Action" with Your Camera	60
Producing Riches from Scraps	66
Emergencies at Sea	72
Variety in Your Magic	82
Secrets of the "Singing Crystals"	90

(Continued on next page)

The Wonders of "Silent" Sound

JUST emerging from the laboratory is the brand new science of ultrasonics which deals with sound waves far above the limits of human audibility. And the most mystifying tricks of the world's greatest magicians seem simple indeed when compared with the miracles performed by men of science with "silent" sound produced by waves vibrating hundreds of thousands of times per second. With one kind of silent sound they can soft-boil an egg without raising the temperature. With another kind they can halt decay, and with a third they can kill bacteria which stubbornly resist age and heat and cold. With the aid of the waves, they can break down starch into dextrin, and speed up the maturing process of plant seeds. An article next month describes the peculiar properties of silent sound waves and indicates some of the commercial possibilities of this new science.

Next Month

AMERICA'S largest city next year will stage the world's biggest fair, a \$150,000,000 exposition three times as big and three times as costly as Chicago's famed Century of Progress. An article in the August issue describes the wonders of the New York World's Fair of 1939 and eight pages of beautiful Coloroto pictures illustrate the story.

Gardens Without Soil

IN a California greenhouse, a man grew tomato plants so tall he had to use a stepladder to pick the fruit. But it wasn't the size of the plants alone that fired the public's imagination. The plants were grown by water-culture methods—without soil. That led many to predict the end of the dirt farmer and to foresee "skyscraper gardens" for city dwellers. But it isn't quite that simple as you'll find by reading "The Truth about Water Culture" next month.

Money from Bunny

THERE'S money in rabbits, about \$5,000,000 a year to be exact. People who used to raise rabbits as a back-yard hobby, today are reaping a nice profit from their efforts. The demand for rabbits is increasing, but don't start a rabbit "farm" until you know some of the tricks of the business. An article in the August issue tells you what to do—and what not to do, which is just as important.

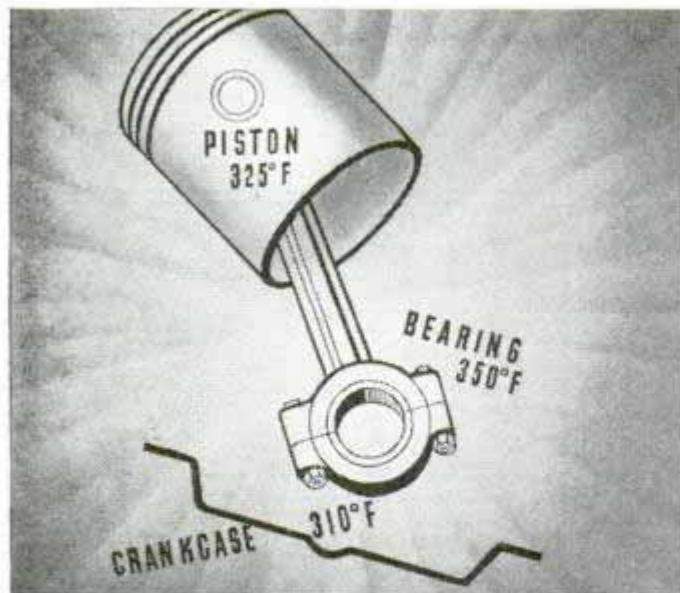

THESE EXCESSIVE SUMMER DRIVING TEMPERATURES WILL NOT BREAK DOWN PYROIL'S SAFE PROTECTION

Let Pyroil fortify your car throughout the heat of summer. This famous motor protector offsets the causes of engine overheating. It defies heat to break it down! Pyroil's super film will not easily rupture. That's why it safely shields pistons, cylinder walls, valves and bearings against lost or heat-weakened lubrication.

Pyroil is a four way protector in all weather. It reduces friction. It eliminates carbon, gum, sludge and other contaminations. It supplies unflinching lubrication in emergencies. It prevents damaging corrosive attack and early metal wear.

Pyroil's benefits give you constant smooth and powerful operation. Ask your service station salesman to add a few ounces of it to the crankcase and fuel tank of your car, today. That's all it takes. And it costs only a few cents! Manufactured and Guaranteed by Pyroil Company, W. V. Kidder, Founder, 57 Pyroil Bldg., LaCrosse, Wisconsin, U. S. A.



NOTHING FINER FOR NON-ABRASIVE NEW CAR BREAK IN!

DISTRIBUTORS:
CHECK AND MAIL COUPON FOR FRANCHISE FACTS.

SIMPLY ADD TO GAS & OIL

PYROIL COMPANY,
57 Pyroil Bldg., LaCrosse, Wis., U. S. A.
Please send complete Pyroil facts.
 Also send details of your plan for Distributors.

Name.....
Address.....
City..... County..... State.....

(Contents—Continued)

AUTOMOTIVE

Telescoping spring smooths motorcycle ride.....	17
Pistol fires paint "bullets" to check brakes.....	32
Molasses road surfacer is tested in India.....	45
Buffer cleans white side walls of tires.....	53
Racing "whale" to try for land speed record.....	59
Mirrors trace car vibrations.....	77
Miniature model of trailer home helps buyers.....	64
Sliding roof on police car for sighting rifles.....	64
Car goes 100 miles on fifty cents.....	79
Push-button electric jacks speed tire changes.....	86
Stainless steel "jungle yachts".....	94
Prism reflectors outline road at night.....	96

AVIATION

Parachute jumper sets record of 35,070 feet.....	38
Pilots cannot be acclimated to high altitudes.....	48
Winter skids fit over airplane wheels.....	65
Quick-firing aerial cannon for fliers.....	70
Window in floor of bomber.....	77
Transatlantic "flying wing" to offer luxury.....	78
"Flying tank" is mobile gun nest on land.....	87
Rifle shell warns of fire in airplane.....	95

CONSTRUCTION

Bombproof rail terminal to shelter a million.....	32
Paint bucket holder.....	80
Air analyzed at bridge for effect on paint.....	86
Funnel-faced keyhole guides key.....	89
Brick house sawed in two to insulate.....	96

FARM AND GARDEN

Porous hose waters lawn by gentle seepage.....	33
Combination spiker and tamper for garden.....	38
Tractor's wheels adjustable for any farm job.....	58
"Slip-on" edge plowshare.....	95

HOUSEHOLD

"Window box" evaporating fan for home cooling....	17
Door closer with spring latch.....	38
Furnace smokepipe jacket reduces fire hazard.....	70

MODELS

Car copied with knife, saw and file.....	38
Midget steam engine handy for model makers.....	58
Old home town lives in miniature.....	76
Building model trolley cars is latest hobby.....	95

PHOTOGRAPHY

Stop-motion film used in model city.....	25
Projector attachment feeds slides automatically....	30
Camera dolly rides the rails to "shoot train".....	31
Shutter release cable operated by lips.....	44
Pilot takes his own picture in air.....	45
Neckstrap steadies camera for time exposure.....	53
Enlarger for movie film needs no darkroom.....	70
Slotted ring on tripod holds camera at angle.....	71
"Hypo detector" tests washed negatives.....	80
Synchroflash adapted to any camera.....	81
Camera in reflector window takes shadowless picture	94

RADIO AND ELECTRICITY

Robot court reporter puts evidence on record.....	39
Glass tape to insulate electric coils.....	45
"Electric eye" guards ballot box.....	86
Pillow speaker for bed, chair or couch.....	97
How to build an armchair radio cabinet.....	98
Cathode-ray tube for visual set testing.....	100
Practical radio suggestions.....	101
Electron-coupled variable-frequency exciter unit...102	
Magic switch for window displays.....	102
Portable set tester for servicemen.....	102
Push-button console receiver for local stations....102	

SCIENCE AND INDUSTRY

Paper cup for spraying paint.....	23
Master mixing rack for measuring base paints.....	44
Food cans with silver lining kill germs.....	80
Hydraulic weight recorder aids oil driller.....	81
Glass grinder built to match earth's curvature....133A	

SHIPS AND SHIPPING

Liner of the future.....	46
Model of original steamboat antedates Fulton's ship	93
Boat paint resists growths.....	96

(Continued to page 6A)

TO EARN MORE MONEY • HAVE MORE FUN

Invest in PRACTICAL PROFITABLE Books

Whatever your interest—whatever your need—here are books that will help you. Popular Mechanics experts have selected them for you. Books to help you on your job . . . to help you to a better job . . . to help you earn extra money in spare-time work . . . to profitably develop a hobby . . . to gain advancement through home study. Other books for entertainment and recreation.

Successful businesses . . . profitable sidelines . . . doubled incomes . . . have resulted from a single idea. Popular Mechanics Books are filled with money-making ideas. Select from the list on this page. Profit with the latest and best-proven facts—ideas and information.



SELECT FROM THIS LIST

AUTO POWER: A fine, practical book on winding auto generators and converting "Model T" and other units into 110 and higher voltages. \$1.00.

EASY-TO-MAKE TOYS: 67 varied and novel designs. Just the thing for the home workshop or a guide to an interesting small business. \$1.50.

BOAT BOOK: Recently published! Second edition with six additional boats. Build your own boat. Full directions and details for all types small pleasure craft. 312 pages. Illustrated. \$3.00.

DYKE'S AUTO ENCYCLOPEDIA: World's Greatest Auto Book. New 18th edition just out. Now more than ever before the only book for auto and shop mechanics. 1396 pages. 4,600 illustrations. Cloth. \$6.00.

MODERN RADIO SERVICING: This radio man's "Book of Knowledge," by Ghirardi, covers every phase of radio servicing today. 1,300 pages. 706 illus. \$4.00.

AIR CONDITIONING: By Riesbeck. The book of the hour in this big new field. Get started in America's next big industry with this new, authoritative work. 369 pages. Illustrated. \$3.50.

DIESEL HANDBOOK: By J. Rosbloom. The standard book on modern Diesel practice. Adopted everywhere for instructions in land, marine, locomotive, automotive, aero and portable services. 544 pages. Illustrated. \$5.00.

OUTDOOR SPORTS: The one book for out of doors folks. Covers everything, including homemade equipment. For young and old. 352 pages. 650 Pictures. Cloth. \$2.00.

SHIP MODEL: Build finest ship model of them all. Sovereign of the Seas. A real masterpiece. Detailed instructions, plans, etc. Authentic design. 180 Pictures. \$1.00.

ARMATURE WINDING: New edition on construction, winding, repairing of A.C. and D.C. motors and generators. \$2.00.

FURNITURE DESIGN AND CONSTRUCTION: Shows how to design and make tables, chairs, desks, lamps, shelves, candlesticks, etc. \$2.50.

CONCRETE: 1001 Ideas for Using. New Popular Mechanics book. Just out. Most complete on subject. Covers all newest phases. Beautiful color illustrations. \$5.00.

WOOD TURNING: A real course of instruction in this fascinating art. Starts with simple operations. Includes spiral turning and complete jobs. \$1.50.

PROSPECTOR'S HANDBOOK: Tells what minerals to look for and where. How to locate, sample, test, appraise, mine and market; also prices. \$3.00.

BOOKKEEPING: New simplified book teaching how to keep personal and family records and set of books for a business concern. \$2.25.

A. C. POWER WIRING: Just published. A complete treatise on the practical applications and uses of alternating current for power. 461 pages. Illustrated. \$4.00.

2000 WAYS TO MAKE MONEY

A THOUSAND WAYS TO MAKE \$1,000: Tried and Tested Methods that Work — That You Too, Can Use. How hundreds of men made their first \$1,000 in their own business. \$2.50.

MONEY MAKING IDEAS: 1000 spare time ways to make money. Practical guide for young and middle aged men and women, students, boys, girls. \$1.00.



CARPENTRY AND JOINERY WORK: All details of house building; framing, building partitions, doors, windows, cornices, etc. \$3.00.

ELECTROPLATING: With copper, nickel and chromium. A technical bulletin of latest methods, formulas and trade secrets. Cleaning, polishing, buffing, etc. \$1.00.

SHOP NOTES LIBRARY: 5 vol. 2000 Wonderful shop ideas. Volumes reprinted annually from Shop Notes section Popular Mechanics. \$2.50.

WIRING: Approved economy methods for homes, buildings. Standard up-to-date book meets every requirement. \$2.50.

SEND NO MONEY—BOOKS SHIPPED C. O. D. IN U. S.

Select books from list above. Help yourself to more profitable—more enjoyable days. Send No Money. Pay postman above prices plus postage. (C.O.D. in U. S. and possessions only). Add ten cents for each book for postage if remittance is sent with order. Act Now.

POPULAR MECHANICS PRESS
Room 738—200 East Ontario St., Chicago, Ill.

This One



KT3H-X4N-34TD



When writing to advertisers please mention Popular Mechanics

HAVE YOU TRIED THESE PRACTICAL HOME USES OF GENUINE MASONITE?

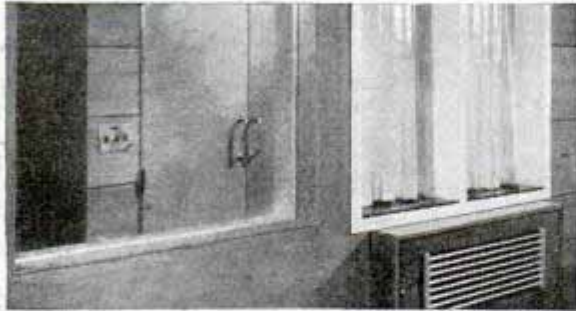

● Homecraftsmen find hundreds of ways to achieve beautiful, unusual effects in the home—with Genuine MASONITE. In the hallway shown above, the neat mirror frame is MASONITE TEMPERED PRESWOOD with sanded edges. The radiator cover, impervious to temperature changes, is MASONITE TEMPERED PRESWOOD.



● The bathroom walls are MASONITE TEMPERED PRESWOOD. Two are enameled, and two are clear-varnished to produce a smart two-tone color scheme.

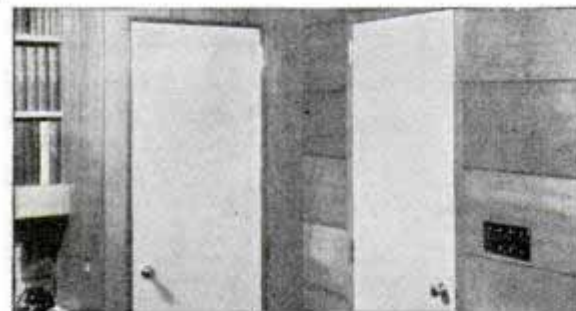

● These "flush" doors are regular doors with MASONITE TEMPERED PRESWOOD glued to each side. They not only offer a neat, modern appearance, but also provide surfaces which can easily be kept spotlessly clean.

● Why not discover the many improvements you can make in your home with Genuine MASONITE? Mail the coupon for FREE samples and details about MASONITE—THE WONDER WOOD OF A THOUSAND USES.



MASONITE CORPORATION
Department PM-7
111 W. Washington St., Chicago, Ill.

Please send me FREE samples of Genuine MASONITE and more information about THE WONDER WOOD OF A THOUSAND USES.

Name _____
Address _____
City _____ State _____

(Contents—Continued)

SPORTS

Automatic brake stops snarls on casting reel.....	18
Three-piece boat is assembled while afloat.....	18
Impact indicator shows force of golf drive.....	57
Baby's coop fitted on bike solves problem.....	58
Folding fish net fits in oarlock.....	64

TOOLS

Welding kit carried on back speeds work.....	59
Safety armored cable cutter.....	64
Rubber-clad hammer absorbs shocks.....	89

MISCELLANEOUS

Railway "dreadnaught" captured in China war.....	19
Searchlight lens magnifies hand to huge proportions.....	19
Popcorn measured for quality in glass column.....	23
Death guards lost mine on Superstition mountain.....	24
Legs of Franklin statue weigh four tons.....	25
Sound stroboscope measures musical tones.....	30
Beavers show skill damming 2,000-acre lake.....	31
Merry-go-round magazine stand.....	33
"Parking" space for river steamboats.....	39
Banana tree grows in a special house.....	44
Automatic fire detector.....	48
Lard dispenser measures exact weight.....	48
Plowing into the bottom of the sea.....	49
Crippled dog walks with aid of wheels.....	57
Mending plastic like rubber is self-curing.....	65
Paper fastener "welds" sheets between dies.....	70
Blades replace glass globe in street lamp.....	71
Life preserver inflated by squeezing one end.....	71
Safety clip for key ring or watch chain.....	71
Abrasive disk glued on wheel used immediately.....	79
Watch to fit side of wrist.....	79
Derrick drills sidewalk to reach water.....	80
"Upside-down" dam to protect from floods.....	88
Deep-sea diver's armor weighs 3,000 pounds.....	89
Fire blanket unrolls like window shade.....	93
Quick drying stamp-pad ink reduces blurring.....	93
Spotting planes by television tested in England.....	94
Hose coupling attached by pressing lever.....	96

Craftsman and Shop Notes

AUTOMOTIVE

Charging battery in car.....	155
Extra tank increases radiator capacity in car.....	155
Rubber heels cushion motor.....	158
Cleaning the upholstery in your car.....	157
Clothespin opens inner tube to release air.....	159
Parts rack made from headlamp reflectors.....	159
Protecting shackles from dust.....	159
Stopping rattles in hood hinge.....	159
Inner tube buffed with potato masher.....	160
Operating trailer stoplight with that of car.....	160
"Sandpaper block" to clean battery posts.....	160
Wall mirror guides drivers onto greasing pit.....	160

CAMPING, FISHING, HUNTING

Spring on fishhook preserves dough bait.....	106
Mounting the fish you catch.....	114
Canoe moved over beach on small tree.....	118
Roll-top picnic table.....	119
Paraffin in shotgun shell to wax fishline.....	120
Rubber reel for extra fishlines.....	129

ELECTRICAL

Electric-razor cord knotted to prevent dropping.....	120
Flashlight and mirror to inspect storage batteries.....	120
Locating breaks in electric cords.....	142

FARM

Cross strap on team prevents tangled lines.....	142
Post brace wires anchored with brake drums.....	142
Rope run in high pulley with fishing rod.....	144
New fence laid out with lime duster.....	156

HAND TOOLS

Transferring a blind hole.....	110
Jointer gauge for hand plane.....	113
Finding diameter of round work with squares.....	120
Screwdriver held in pocket by rubber tube.....	130
Novel wedge aids in ripping long boards.....	138
Drill-press vise holder eliminates adjusting table.....	141
Gauge on steel pocket rule is useful.....	145
Removable compass support fits opening.....	145
Holding attachment for screwdriver.....	156

(Continued to page 8A)

Are you, too, up against life's big question— "How Can I Make More Money?"

Every bill to be paid, every need to be met, every dream still unfulfilled—demands the answer to this question. For on its answer hang all the other answers of life: how you live, what you wear, where you go, what you do, the position you hold, the one you hope to hold in future!...

MORE than anywhere else, this question haunts you daily on the job. You want a bigger salary; more pleasant and interesting work to do; more advantages for your loved ones—recreation, travel, social activities. And so, as you keep plodding on, in between the little thoughts comes this big one, again and again: "How can I make more money?"

Well, how can you? . . . By working harder than ever, so as to attract more attention to your industry? Thousands of people are working harder than ever, these days; employers have no worries on that score. By trying to "get a stand-in" with somebody of influence? Plenty of people have tried that, too—only to fall down because they couldn't deliver. By getting "outside work" to do? Sooner or later, your regular job suffers—and then what?

Out of the corner of your eye you can see a long line of folks just waiting for the job you have now. Any time you're "out," a dozen others are ready to step in. So it's dangerous to resign and look elsewhere, isn't it? Besides, jobs in your same line elsewhere are bound to pay about what you're earning now.

What's Wrong, Anyway?

Let's be quite serious for a moment about this "money" question. Who, as you glance around the business world, are the money-makers in it? Are they the filing clerks, typists, stenographers, bookkeepers, timekeepers and routine clerical people? Or are they the expert salesmen, the accountants and C. P. A.'s, the attorneys, the traffic managers, the personnel directors, the sales correspondents, the sales managers, and other executives who give orders for other people to execute?

And how did these money-makers, with their enviable jobs and opportunities, "get that way"? Was it simply by working hard—having a "pull"—changing jobs till they found the fat salaries they wanted?

Experience says no! . . . They make more money than the rank-and-file in business for just one reason: they



have *trained* for the better-paid specialized functions that Tom, Dick and Harry, the rank-and-file, cannot discharge.

Their Answer is Yours

That is their answer to life's biggest question. It is *your* answer as well. And LaSalle has made it possible for YOU—granted a real purpose and adequate education—to train for the field in which you would prefer to earn more money. Without leaving your job, you can do what nearly a million men and women have done already: utilize your spare time for home study that definitely equips you to get your money question *answered*.

The coupon below lists a number of specialized vocations which today offer the interesting work, attractive opportunities, gratifying incomes—all the rewards that go with "bigger responsibilities." Pick out the one that most appeals to you, check it, and add your name and address. Find out the interesting facts about it which your inquiry will bring you promptly, without obligation. Send your request along NOW, and learn how to get the one right answer to this biggest of life's questions—the question of "more money."

Don't act on this advertisement unless you're really in earnest.

LASALLE EXTENSION, Dept. 764-R, Chicago

I would like to have your special booklet—without any cost or obligation to me—about my opportunities and your success training in the business field I have checked.

- | | | |
|--|--|---|
| <input type="checkbox"/> Business Management | <input type="checkbox"/> Expert Bookkeeping | <input type="checkbox"/> Business English |
| <input type="checkbox"/> Higher Accountancy | <input type="checkbox"/> C. P. A. Coaching | <input type="checkbox"/> Effective Speaking |
| <input type="checkbox"/> Traffic Management | <input type="checkbox"/> Industrial Management | <input type="checkbox"/> Office Mgm't |
| <input type="checkbox"/> Modern Salesmanship | <input type="checkbox"/> Modern Foremanship | <input type="checkbox"/> Stenotypy |
| <input type="checkbox"/> Commercial Law | <input type="checkbox"/> Business Correspondence | |
| <input type="checkbox"/> Law: Degree of LL. B. | | |

Name..... Age.....

Address.....

LASALLE EXTENSION

When writing to advertisers please mention Popular Mechanics



Making these repairs with SMOOTH-ON No. 1 is like finding money!

Stopping leaks at screw threads, gaskets, press-fit joints, seams, connections, cracks, etc., in water, steam, gas, air or smoke pipes, boilers, furnaces, fire pots, heaters, tanks, radiators, sinks, troughs, etc.

Tightening loose wood screws, bolts, nuts, handles, drawer pulls, hinges, locks, hooks, casters, stems, bases, etc.

SMOOTH-ON No. 1 has enabled thousands of householders and home mechanics to make the above and similar repairs at absurdly low cost—to restore full usefulness to many impaired household appliances that otherwise would have required expensive replacement.

Smooth-On No. 1 hardens and its adhesion and expansion in doing so effect a tightness of parts or a seal against leakage that withstands pressure, heat, cold, vibration, moisture and chemical action. The Smooth-On restores original efficiency quicker, with less effort and at less expense than by any other practical repair procedure. Try Smooth-On (no heat, special tools or previous experience required). Your worst repair becomes simple and you can make annual savings that amount to a substantial figure.

Many Smooth-On repairs can be made in various ways. The one which produces the best results most economically is easily determined from the instructions and diagrams in the free Smooth-On Home and Auto Repair Booklet.

Mail the coupon for your copy and get Smooth-On No. 1 in 7-oz. or 1 or 5-lb. can from your hardware store.



Write for **FREE BOOK**



Do it with **SMOOTH-ON**

SMOOTH-ON MFG. CO.,
Dept. 37,
574 Communipaw Ave.,
Jersey City, N. J.

Please send the free Smooth-On Repair Book.

Name.....

Address.....

7-38.....

(Contents—Continued)

HOME IMPROVEMENT

Boot scraper swings out of the way.....128
Combination shelf and towel rack.....128
Back yard fence prefabricated in spare time.....129

HOUSEHOLD

Non-drip can to water flowers.....107
Easy way to miter window-screen molding.....123
Knives stored in breadboard.....123
Chemical "servants" ease home tasks.....124
Mezzanine shelves raise small articles in cabinet.....129
Solving home problems.....136
Sponge in flower vase prevents spilling water.....138

LAWNS AND GARDEN

Garden chaise longue on wheels.....108
Outdoor living rooms.....111
Strips of tinfoil keep birds from seeds.....118
Support for nozzle of garden hose.....123

OFFICE

Paper gauge for the typist.....106
Typewriter cover folds like buggy top.....110
Electric eraser cleans fast.....123
Typewriter key padded to cut stencils.....130
Pencil pointer swings under drawing board.....142
Preventing loss of papers on desk slide.....151

PHOTOGRAPHY

Photographing tall building with small camera.....107
Photo printing press maintains even pressure.....118
Photo flashes for daytime shots.....121
Density meter gives correct exposure time.....153

POWER TOOLS

Combination grinder shield and lamp.....106
Brazing bandsaw blades.....139
Lathe gears filed in pigeonhole cabinet.....145
Using two V-blocks as drill jig.....155

STORE AND SHOP

Store your lumber flat.....143
Rack to dry price tags quickly.....152
Rolled paper kept from sticking by rubber finger.....152

TOYS AND NOVELTIES

Toy-train current collector automatically polished.....105
Propeller spins when toy is pushed on floor.....113
Simple puzzle difficult to work.....135

WOODWORKING

"Barrel" smoking set.....103
Buttons on ladder hold strips for sawing.....107
Homemade turning tool handles small work.....130
Gluing clamp costs less than half dollar.....135
Jig to cut irregular work in circular saw.....135

MISCELLANEOUS

Diving raft pushed by outboard motor.....105
Artists' brush holder suspends bristles in cleaner.....106
Drawing large hexagon figures.....106
Mosquito netting on beach umbrella.....107
Rubber cement used as an eraser.....110
Shading linoleum blocks.....110
Cleaner for white shoes.....118
Double-pointed fasteners from thumbtacks.....120
"Palm thimble" for stitching heavy cloth.....128
Strong filler cap for outboard motor.....128
Shirt serves as emergency laundry bag.....130
Your own weather bureau for a dollar.....131
Rubber washers on wallet help prevent loss.....135
Wedge stick for setting calipers quickly.....141
Painting pipe to be laid under ground.....144
Pipe used as adjustable brace.....144
Sheet metal around birdhouse standard.....144
Brake for hoisting pulley.....145
Wind-driven generator charges batteries.....146
Lip on test tube flattened to avoid rolling.....151
Folding ladder on water tower.....152
Non-tip carrier for paint can.....152
Finding thickness of shim stock with glass.....156

IMPORTANT NOTICE

It is the intention of this magazine to provide its readers with information regarding the latest developments in the mechanical arts. We take no responsibility as to whether the disclosures contained in our articles are covered by patents and advise readers to investigate this subject before making, using, or selling any of the products, machines, or processes described, in order to avoid possible liability for patent infringement.

FOOD IN BOTH HANDS!

Lunch box in one hand, I.C.S. textbook in the other—all over this country today there are men who will devote those extra moments at the lunch hour to learning something that will help them on their present jobs—something that will help them prepare for the bigger, better paying jobs up the ladder. At home, in those evening hours, these ambitious men devote themselves to mastery of I.C.S. Courses—they know that their “futures” depend upon their “presents”! When they realized it, they mailed the coupon of progress that now stares you in the face!

INTERNATIONAL CORRESPONDENCE SCHOOLS

BOX 5516-J, SCRANTON, PENNA.

★ Without cost or obligation, please send me a copy of your booklet, “Who Wins and Why,” and full particulars about the subject *before* which I have marked X: ★

- | | | | |
|---|--|--|--|
| <input type="checkbox"/> Architect | <input type="checkbox"/> Sheet Metal Worker | <input type="checkbox"/> Commercial Refrigeration | <input type="checkbox"/> Surveying and Mapping |
| <input type="checkbox"/> Architectural Draftsman | <input type="checkbox"/> Boilermaker | <input type="checkbox"/> Plumbing <input type="checkbox"/> Steam Fitting | <input type="checkbox"/> Bridge Engineer |
| <input type="checkbox"/> Building Estimating | <input type="checkbox"/> Telegraph Engineer | <input type="checkbox"/> Heating <input type="checkbox"/> Ventilation | <input type="checkbox"/> Bridge and Building Foreman |
| <input type="checkbox"/> Contractor and Builder | <input type="checkbox"/> Telephone Work <input type="checkbox"/> Radio | <input type="checkbox"/> Air Conditioning and Cooling | <input type="checkbox"/> Chemistry <input type="checkbox"/> Pharmacy |
| <input type="checkbox"/> Structural Draftsman | <input type="checkbox"/> Mechanical Engineering | <input type="checkbox"/> Steam Engineer | <input type="checkbox"/> Coal Mining |
| <input type="checkbox"/> Structural Engineer | <input type="checkbox"/> Mechanical Draftsman | <input type="checkbox"/> Steam Electric Engineer | <input type="checkbox"/> Mine Foreman <input type="checkbox"/> Fire Bosses |
| <input type="checkbox"/> Management of Inventions | <input type="checkbox"/> Machinist <input type="checkbox"/> Toolmaker | <input type="checkbox"/> Marine Engineer | <input type="checkbox"/> Navigation |
| <input type="checkbox"/> Electrical Engineer | <input type="checkbox"/> Patternmaker | <input type="checkbox"/> R. R. Locomotives | <input type="checkbox"/> Cotton Manufacturing |
| <input type="checkbox"/> Electric Lighting | <input type="checkbox"/> Diesel Engines | <input type="checkbox"/> R. R. Section Foreman | <input type="checkbox"/> Woolen Manufacturing |
| <input type="checkbox"/> Welding, Electric and Gas | <input type="checkbox"/> Aviation Engines | <input type="checkbox"/> Air Brakes <input type="checkbox"/> R. R. Signalmen | <input type="checkbox"/> Agriculture |
| <input type="checkbox"/> Reading Shop Blueprints | <input type="checkbox"/> Auto Technician | <input type="checkbox"/> Highway Engineering | <input type="checkbox"/> Fruit Growing |
| <input type="checkbox"/> Heat Treatment of Metals | <input type="checkbox"/> Auto Electrical Technicians | <input type="checkbox"/> Civil Engineering | <input type="checkbox"/> Poultry Farming |
| | BUSINESS TRAINING COURSES | | |
| <input type="checkbox"/> Business Management | <input type="checkbox"/> Bookkeeping | <input type="checkbox"/> Service Station Salesmanship | <input type="checkbox"/> Grade School Subjects |
| <input type="checkbox"/> Industrial Management | <input type="checkbox"/> Secretarial Work | <input type="checkbox"/> First Year College Subjects | <input type="checkbox"/> High School Subjects |
| <input type="checkbox"/> Traffic Management | <input type="checkbox"/> Spanish | <input type="checkbox"/> Business Correspondence | <input type="checkbox"/> College Preparatory |
| <input type="checkbox"/> Accountancy | <input type="checkbox"/> French | <input type="checkbox"/> Stenography and Typing | <input type="checkbox"/> Illustrating |
| <input type="checkbox"/> Cost Accountant | <input type="checkbox"/> Salesmanship | <input type="checkbox"/> Civil Service <input type="checkbox"/> Mail Carrier | <input type="checkbox"/> Cartooning |
| <input type="checkbox"/> C. P. Accountant | <input type="checkbox"/> Advertising | <input type="checkbox"/> Railway Mail Clerk | <input type="checkbox"/> Lettering Show Cards <input type="checkbox"/> Signs |
| | DOMESTIC SCIENCE COURSES | | |
| <input type="checkbox"/> Home Dressmaking | <input type="checkbox"/> Advanced Dressmaking | <input type="checkbox"/> Foods and Cookery | |
| <input type="checkbox"/> Professional Dressmaking and Designing | | <input type="checkbox"/> Tea Room and Cafeteria Management, Catering | |

Name.....Age.....Address.....

City.....State.....Present Position.....

If you reside in Canada, send this coupon to the International Correspondence Schools Canadian, Limited, Montreal, Canada

**You
HELPED
BUILD HER**
*Man...That's a
Real Thrill*

**That's Only One Reward of An
AIRCRAFT INDUSTRY CAREER**

There's a real thrill in viewing a great plane which you have helped create. But there's a far greater thrill in playing a part in an industry so alive, and growing so swiftly, that progress depends only on you. This is a source of real satisfaction to the man who has trained for and embarked upon an aircraft industry career.

EXECUTIVE BOARD
JOHN K. NORTHROP
 formerly Pres., The Northrop Corp., and Vice-Pres. Douglas Aircraft Company, Inc.
C. A. VAN DUSEN
 Vice-Pres. Consolidated Aircraft Corporation
ROBERT E. GROSS
 President, Lockheed Aircraft Corporation

**IT'S ANOTHER
REAL THRILL TO START
YOUR CAREER AT AERO I. T. I.**

... the only aircraft training institution under the direct supervision of leading airplane builders. Devoted solely to preparing men for aircraft industry careers, Aero I. T. I. offers these courses: Aeronautical Engineering, Design, and Drafting; Master Aircraft Mechanics; and the Combination Aircraft Mechanics Theory at Home and Shop Course. No matter where you live you can start your training at once. For complete information on the Aero I. T. I. way to an aircraft career ... send the coupon.

Aero Industries Technical Institute
 5253 W. San Fernando Rd., Los Angeles, Calif.

Please send details on Aero I. T. I. training. I am 18 years of age or over and can furnish character references.

Name _____ Age _____
 Street _____
 City _____ State _____ a-10-p

ELECTRICAL ENGINEERING

ONE YEAR Course Prepares For
 Technical Work In Electrical Field

Thorough training in principles, with practical applications in laboratory and shop. High placement record. Modern buildings, dormitory, dining hall. Campus. 46th year begins Sept. 28. CATALOG on request.



BLISS ELECTRICAL SCHOOL
 117 Takoma Avenue, Washington, D. C.

AUTOMOTIVE ENGINEERING



Bachelor of Science Degrees—in Automotive, Aeronautical, Architectural, Chemical, Electrical, Industrial and Mechanical engineering! Modern equipment. All college activities. Low tuition. Write today for Catalog.

LAWRENCE INSTITUTE OF TECHNOLOGY
 15102 Woodward Ave. DETROIT, MICH.

A NON-PROFIT COLLEGE

CATALOG ON REQUEST

THE SELF-STUDY DIESEL COURSE

(ROSBLOOM SYSTEM)

81 Books with 44 Blueprints and Color Supplements
 THE PRACTICAL COURSE ON MODERN DIESEL ENGINES
 — UNIVERSALLY USED THROUGHOUT THE WORLD —
Only Sold Complete—\$37.50 prepaid

DIESEL ENGINEERING INSTITUTE, JERSEY CITY, N. J.

LEARN WATCH REPAIRING



AT HOME You can learn by our modern and original system of instruction every part of the Watch Repairing Trade at home. You can earn money while learning and prepare yourself for a well paying position or start in business after completing our course of instruction. Good watch repairers are in demand and generally earn very good salaries. For particulars apply to the Wisconsin School of Watch Repairing
 524 E. Mason St., MILWAUKEE, WIS.

RADIO ENGINEERING

broadcasting, aviation and police radio, servicing, marine and Morse telegraphy taught thoroughly. Nine months' engineering course equivalent to three years' college radio work. School established 1874. All expenses low. Catalog free.

Dodge's Institute, Ada St., Valparaiso, Ind.

MAIL FOR FREE INFORMATION

BROOKLYN YMCA TRADE SCHOOL

1117 Bedford Ave., Dept. PM-62
 Brooklyn, New York City, N. Y.

Diesel Engines
 Diesel Technical Oil Burner
 Aviation Mechanic Welding
 Aeronautical Technical
 Auto Mechanic Talking Pictures
 Refrigeration Machine Shop
 Radio and Television Mechanic
 Air Conditioning
 Architectural-Mechanical Drafting
 Electrical Window Display
 Armature Winding

Name.....
 Address.....

Become a Draftsman



Enjoy a Real Job in Industry

Steady Work

As nearly all manufacturing—construction—building starts on the drafting table, the draftsman is one of the first to be hired and one of the last to be laid off. It is his blueprints, his specifications, that give the last word in what the workmen are to do. No article—building or construction job is started before the plans drawn by the draftsman have been officially approved.

Good Pay

The draftsman has been called the Junior Engineer which title just about describes his work—position and pay. He combines his knowledge of principles, mechanism and construction details with the ability to draw and reproduce motions and methods on paper. On the average, his salary is considerably above the wages of the mechanic and, of course, less than that of the engineer.

Chance for Promotion

Working on plans, helping design new machines or new methods of construction, the draftsman is working directly with the important men of the organization. Consequently he knows what is being considered and planned. It may be the superintendent—the engineer—or even the prospective buyer with whom he consults. Because of these contacts, his experience and knowledge of the business in general he is in an excellent position to be promoted when next there is a good opening.

Young at 40

Athletes—farmers—and factory and shop workers who rely on muscle start growing old even before they reach 40 while office workers—executives—teachers—professional men, in fact, all kinds of brain-workers are just approaching their prime at 40 to 50. Training increases your value at once and continues to help boost your earning power as you mature.

Don't Be Just Average

What happens to the average man? Not having thorough training for a worth-while job, he goes along year after year, wishing he had a good job, but wishing was never a substitute for training. \$40 a week is about his top, usually never that high. Grows old on the job, starts down at 40, finds himself slipping in speed and salary.

But the ABOVE AVERAGE MAN loses no time getting his training. Prepared for the job ahead, he is in line for RAPID PROGRESS—his WORK STEADY, his PAY GOOD. Trained, a young executive, young Draftsman drawing plans for great projects, YOUNG ON THE JOB at 40, at 45, at 50! And still has 10 or 15 years active service at good pay to which he can look forward! Training—the sooner you get it—the sooner it can help LIFT YOU ABOVE THE AVERAGE!

Don't grow old at 40. Train now for the job you want at 50. Training helps you to be independent—self-supporting. It helps you to enjoy associations that are denied the untrained man. Training helps you to increase your earning power and by so doing to offer members of your family advantages far in excess of what you could give them as an untrained man. Train and enjoy PROGRESS—CONTENTMENT—INDEPENDENCE.

American School, Drexel at 58th, Chicago

Get the Facts—Write Today

American School, Dept. DDB-45

Drexel Avenue at 58th Street, Chicago

Without the slightest obligation, send complete facts "How I can become a Draftsman" and free bulletin.

Name..... Age.....

Address.....

City..... State.....



There's QUICK, BIG MONEY to be made in POULTRY

Many earn \$1,000 to \$2,500 a Year Have a Business of Your Own!



Whether you want a job at good pay or a highly profitable business of your own—Poultry offers you many excellent opportunities. Poultry meat and eggs are always in demand, and there is frequently a shortage of trained poultrymen. My Home Study Course quickly shows you how to succeed—how to save money and make money either for yourself or for an employer.

CASH IN SPARE TIME or FULL TIME

No matter where you live or what you do now, my proved course will show you what to do to succeed right from the start. I've helped others make from \$1,000 to \$2,500 a year and UP! And, if you choose to start your own business, I'll show you how to make a small investment grow, show you how to expand. Send for the facts TODAY.

FREE Book Shows the Way to Big Pay and BIG Profits

Mail coupon below TODAY—for my Big NEW FREE Book, "How to Raise Poultry for Profit." My forty years of experience are yours. The Poultry Industry needs YOU. You need my book. Get it—and get in line for the BIG Money that can be made in POULTRY.



Mail NOW for FREE Book

NATIONAL POULTRY INSTITUTE, Dept. 33-D, Adams Center, N.Y., Attn: Harry M. Lamont, Pres

Dear Mr. Lamont: Send me your FREE Book, "How to Raise Poultry for Profit." I want to know more about my opportunity to make \$1,000 to \$2,500 a year, spare or full time.

Name.....

Address.....

Make this thorough, NEW library of electrical maintenance and repair work for YOU.

Every man concerned with the care and repair of electrical machinery should have these practical books, with their helpful tables, diagrams, data, methods, and kinks. Every one of the five volumes is jammed to the covers with sound how-to-do-it information—the kind you need when anything goes wrong on the job.



Electrical Maintenance and Repair Library

5 VOLS., 2042 PAGES, 1721 ILLUSTRATIONS

Tell you how to inspect and repair motor starters and generators—how to diagnose motor and generator troubles—how to figure new windings for old cores on induction motors—direct and alternating current windings—repair shop methods for rewinding armatures—commutator connections—testing armature windings—testing induction motors for faults, etc., etc. New trouble-shooting book now included: In addition to four well-known practical books on all details of electrical machinery, the Library now contains Stafford's Troubles of Electrical Equipment, a new book full of special trouble-shooting charts, explanations of symptoms, and causes of machinery troubles, specific remedies, etc.

No Money down—special price—easy payments

FREE EXAMINATION COUPON

McGraw-Hill Book Co., 330 W. 42nd St., New York
Send me for ten days' free examination the Electrical Maintenance and Repair Library. If satisfactory I will send you \$1.00 in 10 days and \$2.00 monthly until the price of \$15.00 is paid. If not wanted, I will return the books postpaid. (To insure prompt shipment write plainly and fill in all lines.)

Name.....
Home Address.....
City and State.....
Position.....
Name of Company..... P. M. 7-38

A GOOD JOB—A BETTER FUTURE

The increased use of metal in aircraft construction has created a steadily growing demand for specialists in sheet metal work. Take a thorough, practical, complete, specialized and proven

AIRCRAFT SHEET METAL COURSE

at Roosevelt Aviation School and you will hold the key to a good job and a better future in a great and growing industry.

Complete information without obligation. Get the facts about this and ten other courses. State age.

Write Today to Dept. P. M.

ROOSEVELT AVIATION SCHOOL

AT ROOSEVELT FIELD
MINEOLA, LONG ISLAND, NEW YORK

BE A PASSENGER Traffic Inspector

AMBITIOUS MEN... Make Your Future Secure

Specialize as trained Railway and Bus Passenger Traffic Inspector and a position is ready for you. Our graduates are in constant demand. Short, home-study course qualifies you, and upon completion we help place you at up to \$135 per month, plus expenses, to start, or *refund tuition*. Advance rapidly with experience. Men—19 to 50 eligible. Free Booklet: STANDARD BUSINESS TRAINING INSTITUTE, Div. 207, Buffalo, N. Y.

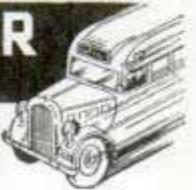

BE AN ARTIST

WE CAN TEACH YOU DRAWING in your own home during your spare time. Thirty-five years of successful teaching proves our ability. Artists receive large salaries.

Write today for Art Year Book
SCHOOL OF APPLIED ART

Dept. 108-B 10 E. Huron St., Chicago, Ill.



LEARN MECHANICAL DENTISTRY

A profession offering unlimited opportunities. Most modern and complete course embracing every branch from Platino Porcelain Work, which prepares you to work for Dentists or start your own business. Individual instruction—practical training in day or night school. No books—no classes. Catalog upon request.

Dept. 735

McCARRIE SCHOOL OF MECHANICAL DENTISTRY
207 N. Broad St. Phila., Pa.

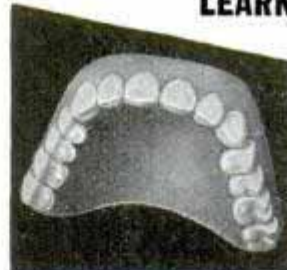

You Can Regain Perfect Speech, if you

STAMMER

Send today for beautifully illustrated book entitled "DON'T STAMMER," which describes the Bogue Unit Method for the scientific correction of stammering and stuttering. Method successfully used at Bogue Institute for 37 years—since 1901. Endorsed by physicians. Full information concerning correction of stammering sent free. No obligation. Benjamin N. Bogue, Dept. 192 Circle Tower, Indianapolis, Indiana.

Train at home for GOV'T. JOBS!

\$90 to \$175 month—Men and Women—Age 18 to 50

- () POSTMASTER
- () Auditor
- () Stenographer
- () U. S. Border Patrol
- () Telephone Opr.
- () Watchman
- () Meat Inspector
- () Secret Service Opr.
- () Ry. Mail Clerk
- () R. F. D. Carrier
- () Special Agent
- () Stock Clerk
- () City Mail Carrier
- () P. O. Clerk
- () File Clerk
- () Special Investigator
- () Typist

Good pay, steady work; pensions; vacations. Hundreds of jobs open every month. Check jobs you want. We have trained men and women for government jobs for 30 years. Get full details today.

OZMENT INSTRUCTION SERVICE

Dept. 115-A, St. Louis, Mo.

Send me FREE particulars "How to Qualify for Government Positions" marked "I." Salaries, locations, opportunities, etc. ALL SENT FREE.

Name.....
Address.....

They Needed TRAINED Diesel Men

★ INDICATES HEMPHILL DIESEL RESIDENT SCHOOLS

and H.D.S. Graduates went on the jobs!

The Nevada gold mine, the lumber camp in the far north, the big Texas refinery, the west coast Diesel manufacturing plant, the great motorship bound for the Orient . . . All needed trained Diesel men . . . and Hemphill graduates went on those jobs --- just as H. D. S. men have been called to many other interesting jobs throughout the world.

CASH IN ON THE GREAT WORLD-WIDE SWING TO DIESEL--WITH HEMPHILL DIESEL TRAINING

On the map above, you see pictured only a few of the many uses of Diesel engines . . . only a few of the types of jobs . . . only a few of the places . . . where Hemphill-trained men are to be found . . . and where future Hemphill Diesel Schools graduates may start their careers.

You, too, can qualify for Diesel opportunities . . . through the superior training given

by the eight Hemphill Diesel Schools . . . the training that has brought such calls for H.D.S. graduates as those illustrated above. Open to you are Day or Night Courses, also the Combination Home Study and Later Shop Training course, which can be started at once, no matter where you live. Send coupon for detailed information on today's great Diesel opportunities and H.D.S. training.

HEMPHILL DIESEL SCHOOLS

Located only in the cities listed below and in no way connected with any other school of even similar name.

HEMPHILL DIESEL SCHOOLS

Please send information on Diesel opportunities and Hemphill Diesel training. I am over 18 years of age.

NAME..... AGE.....

STREET

CITY..... STATE..... m-29-f

Send Coupon to Nearest Address

BOSTON, 114 Brookline Ave.
 NEW YORK, 31-26 Queens Blvd., L.I. City
 DETROIT, 2341 W. Lafayette Blvd.
 CHICAGO, 2014 Larrabee St.
 MEMPHIS, 417 Monroe Ave.
 LOS ANGELES, 2120 San Fernando Road
 SEATTLE, 501 Westlake North
 VANCOUVER, B.C., 1363 Granville St.

SEND COUPON TODAY!

MORE PAY AND A BETTER JOB

Earn better pay! Get out of overalls! Learn **PRACTICAL DRAFTING**. If you're a Shop Worker, **DRAFTING** will put you in line for quick promotion. As a mechanic, **DRAFTING** means increased earnings, more pay raises. **DRAFTING** leads in all industries. Jobs open **NOW!** **Aviation, Machinery, Automobiles, Building** must have draftsmen.



Learn Practical **DRAFTING** At Home From an **ENGINEER**

I'll train you on practical work by a method successful with thousands since 1900—and furnish you all tools; also Drawing Table. No high school or previous experience required. You must be entirely satisfied with my personal training **UNTIL COMPETENT** and assisted to a position **OR MONEY BACK**.

START NOW!

Write **TODAY** for **FREE BOOK** on "Draftsmanship." You must give your age. No obligations. Mail coupon below!

FREE BOOK

ENGINEER DOBE
Div. B-337
Libertyville, Ill.

Send me your free book, "Successful Draftsmanship" and explain how you will assist me to a good position as a draftsman.

Name..... Age.....

Address.....

Post Office..... State.....

Learn this Profitable Profession



in 90 Days at Home

Hundreds of men and women of all ages 18-50 make \$10.00 to \$20.00 in a single day giving scientific Swedish Massage and Hydro-Therapy treatments. There is a **big demand** from Hospitals, Sanitariums, Clubs, Doctors and private patients as well as opportunities for establishing your own office. Learn this interesting money-making profession in your own home by mail, through our home study course. Same instructors as in our **NATIONALLY KNOWN** resident school. A diploma is awarded upon completion of the course. Course can be completed in 3 to 4 months. High School training is not necessary. Many earn big money while learning.



Anatomy Charts & Booklet FREE

Enroll now and we will include uniform coat, medical dictionary, patented reducing roller and Hydro-Therapy supplies without extra cost. The reducing course alone may be worth many times the modest tuition fee.

Send coupon now for Anatomy Charts and booklet containing photographs and letters from successful graduates. These will all be sent postpaid—**FREE**.

THE College of Swedish Massage (Successor to National College of Massage)
Dept. 877-1601 Warren Boulevard, Chicago.

You may send me **FREE** and postpaid, Anatomy Charts, booklet containing photographs and letters from graduates, and complete details of your offer.

Name.....

Address.....

City..... State.....

PARKS AIR COLLEGE

PARKS AIRPORT EAST ST. LOUIS, ILL.

Offers YOU COLLEGE and PROFESSIONAL TRAINING Majoring in AVIATION

FOUR courses lead to B.S. degrees in Professional Piloting, Aviation Operations, Maintenance Engineering, Aeronautical Engineering.

TWELVE TRAINING PLANES are used in professional flight training which prepares graduates for airline flight operations. 74% of graduates enter air transportation in North and South America. 64,000 hours flight training given, 650 hours being flown monthly.

FACULTY of 34 specialists in various fields of aviation.

1491 graduates. Enrollment limited to a total of 300.

100-acre airport, 14 buildings devoted to school purposes exclusively. Dormitories and dining hall at the College.

Accredited by the Illinois Superintendent of Public Instruction. Government approved as a Commercial Ground and Flying School and Mechanics' School. Open to high school graduates.

Fall Term September 26th. Send postcard for new 60-page catalog.

Registrar, Dept. PM-7

11th YEAR PARKS AIR COLLEGE, East St. Louis, Ill.

ENGINEERING DEGREE IN TWO YEARS

B.S. DEGREE courses in engineering: Electrical, Civil, Chem., Mechanical, Radio and Television, or Aeronautical. 1 yr. Mech. Drafting. Intense, practical, thorough program. Prep courses without extra charge. Earn while you learn in this industrial center. Low tuition. Enter March, June, Sept., Dec. Write for Catalog. 229 E. Washington Blvd., Fort Wayne, Ind.

INDIANA TECHNICAL COLLEGE

CARTOONING

PAYS WELL Turn your talent into dollars. Develop your ability with personal instruction from an internationally-known cartoonist. His exclusive, successful method of drawing and creating ideas makes it easy to attain success. Write for Free Booklet and details of this exceptional home-study course. The National School of Cartooning, 437 Penton Bldg., Cleveland Ohio



Learn Write

Begin Today. Write for our Free Book, "How to Become a Good Penman." It contains specimens and tells how others learned to write in spare time. Your name elegantly written on a card if you enclose stamp for postage. Write today. The Tamblin School of Penmanship, 418 Ridge Bldg., Kansas City, Mo.

Operator No. 38



FOLLOW THIS MAN

Secret Service Operator No. 38 is on the job! Running down dangerous Counterfeit Gang. Tell-tale finger prints in murdered girl's room.

Free The Confidential Report Operator No. 38 made to his chief. Write for it.

Earn a Regular Monthly Salary

YOU can become a Finger Print Expert at home in your spare time, at small cost. Write for confidential full report and details. Literature will be sent only to persons stating their age.

INSTITUTE OF APPLIED SCIENCE
1920 Sunnyside Ave. Chicago, Ill.

Dept. B-135

LEARN WATCHMAKING AND ENGRAVING

BY OUR PROFIT-SHARING PLAN
OUR GRADUATES SUCCEED

One of our Iowa students started in a very small way—now doing over \$30,000 a year. Another in Wisconsin, over \$10,000 the first year. Day or night classes. Call or write for **FREE BOOK**. Chicago School of Watchmaking, Dept. 6501, 155 N. Clark St., CHICAGO.

REFINISHES AUTOS Like NEW!

PAYS UP TO \$7.00 AN HOUR

KAR-NU refinishes any color automobile easily, quickly and economically without polishing, waxing, rubbing or painting.

JUST WIPE IT ON WITH A CLOTH! Magic-like fluid covers old paint with tough, elastic coat. Absolutely transparent, self-leveling, self-polishing. Guaranteed. Lasts 8 to 12 months. Equal in beauty to repaint job costing \$10 to \$35. Write for Free Sample to prove our claims and Territory offer.

KAR-NU CO., Dept. G-30, Oakley Sta., Cincinnati, O.

"Give Me Your Measure and I'll Prove in the First 7 Days You Can Have a Body Like Mine!"

No other Physical Instructor in the World has ever DARED make such an offer!

I'LL give you PROOF in 7 days that I can turn you, too, into a man of might and muscle. Just think of it! Right in the first week under my guidance you will see and feel the improvement! Then as my weekly instructions arrive in your home you continue to rebuild, renew and "overhaul" your body. By the end of three months you are the owner of a powerful body that you will be proud to display anywhere, anytime! People will notice the ruddy glow of health in your face, the sparkle in your clear eyes, your broad shoulders and they will seek your company. You will be the fellow who will walk off with the prettiest girl and the best job while others wonder how you did it!

Write your name and address carefully on the coupon below. I'll send you absolutely free a copy of my new book, "Everlasting Health and Strength." It reveals the secrets that changed me from a 97-pound flat-chested weakling into a husky fellow who twice won the title of "World's Most Perfectly Developed Man" against all comers! And it shows how I can build you into an "Atlas Champion" the same way.

Are you underweight? I'll add pounds where they are needed! Are you fat in spots? I'll show you how to pare down to fighting trim.

And with the big muscles and powerful evenly-developed body that my method so quickly gives you, I'll also give you through-and-through health—health that digs down into your system and banishes such things as constipation, pimples, skin blotches and the hundred-and-one similar conditions that rob you of the good times and the good things of life.

I've Got No Use At All for "Contraptions"

I haven't any need for contraptions that may strain your heart and other vital organs. I don't dose you or doctor you. Dynamic Tension is all I need. It's the natural, tested method for developing real men inside and out. It distributes added pounds of powerful muscles over your body, gets rid of surplus fat, and gives you the vitality, strength and pep that win you the admiration of every woman and the respect of any man.

Get my free book, "Everlasting Health and Strength"! Mail coupon today. Gamble a stamp to prove I can make YOU a new man!

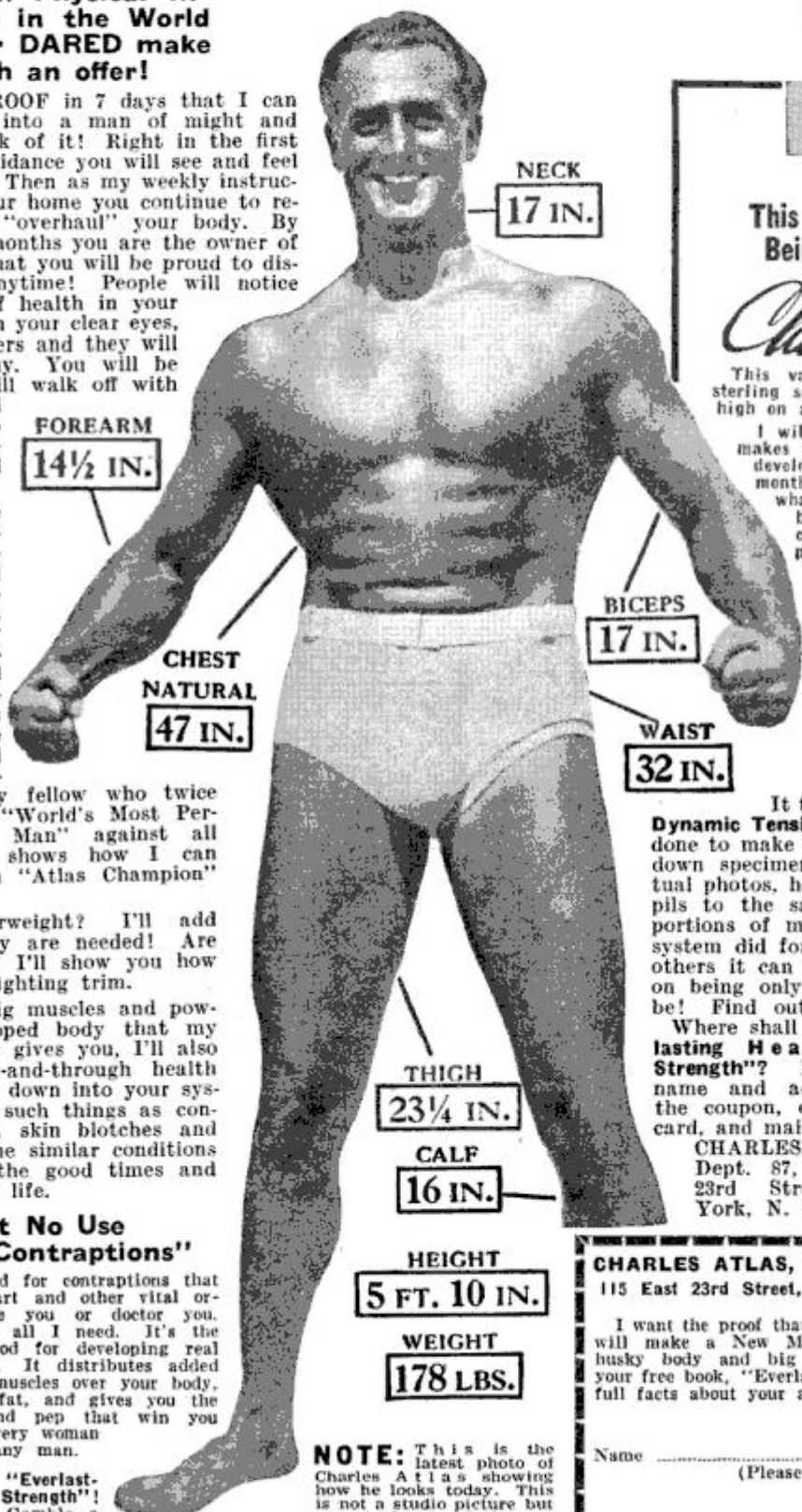

This Sterling Silver Cup Being Given Away by

Charles Atlas

This valuable cup, made of solid sterling silver, stands about 14 inches high on a black mahogany base.

I will award it to my pupil who makes the most improvement in his development within the next three months. Therefore, no matter what your measurements may be now, you have an equal chance to win this cup for permanent possession — and with YOUR name engraved on it!

Get my free book by mailing coupon below!

48-PAGE BOOK
FREE

It tells you all about my special Dynamic Tension method, and what it has done to make big-muscled men out of run-down specimens. It shows you, from actual photos, how I have developed my pupils to the same perfectly balanced proportions of my own physique. What my system did for me and these hundreds of others it can do for you too. Don't keep on being only half of the man you CAN be! Find out what I can do for you.

Where shall I send your copy of "Everlasting Health and Strength"? Put your name and address on the coupon, or a postcard, and mail it today.
CHARLES ATLAS,
Dept. 87, 115 East
23rd Street, New
York, N. Y.



CHARLES ATLAS, Dept. 87,
115 East 23rd Street, New York, N. Y.

I want the proof that your system of Dynamic Tension will make a New Man of me—give me a healthy, husky body and big muscle development. Send me your free book, "Everlasting Health and Strength," and full facts about your amazing 7-DAY TRIAL OFFER.

Name
(Please print or write plainly)

Address

City..... State.....

NOTE: This is the latest photo of Charles Atlas showing how he looks today. This is not a studio picture but an actual untouched snapshot.

MAIL COUPON FOR FREE BOOK NOW!



High School Course at Home

Many Finish in 2 Years

You can complete this simplified High School Course as rapidly as your time and abilities permit. Equivalent to resident school work—prepares you for entrance to college. Standard H. S. texts supplied—Diploma. Credit for H. S. subjects already completed. Single subjects if desired. High School education is very important for advancement in business and industry and socially.

College Entrance

During the past 14 years, our High School graduates have been admitted to 531 different Universities, Colleges, Junior Colleges and Normal Schools—80% of them without entrance examination. Course also prepares for teachers' certificate and pre-professional examinations.

Business—Industry

To get and hold a good position in Business today you must be able to write clear, accurate letters and reports—do figuring involving Algebra and Geometry—talk intelligently on matters requiring a knowledge of Geography, History, and Economics.

In Industry—Mechanical and Engineering lines—you must have at least an elementary knowledge of Physics and Chemistry—be able to figure quickly and accurately—know something of Mechanical Drawing and blueprints—and be able to talk and write accurately and clearly on both your work and ordinary topics of conversation.

Our High School course meets the preparatory educational requirements for Business and Industry.

An Educational Institution

The American School was chartered in 1897 as an educational institution, not for profit—and is exempt from paying Federal income tax, like the best resident colleges and universities.

Don't Be Handicapped—Complete Your Training Now

Be a High School Graduate! Prepare yourself for promotion in Business and Industry—

20 Other Courses

Over 150 noted Educators, Engineers, and Business Men helped prepare our special instruction material, which is used by many resident schools and colleges, U. S. Navy, and Province of Manitoba, Canada. We offer you quality training at home for the best-paying lines of Industry and Business, as listed in the coupon.

for the Professions, College Entrance and social success. No matter what line you may select, High School training will prove invaluable to you! Our moderate fees cover all instruction, standard textbooks and Diploma. Easy monthly terms. Get ahead in life. Start your training NOW!

Mail coupon for information about line that interests you
American School, Drexel at 58th, Chicago

American School, Dept. HB-45, Drexel at 58th, Chicago

Tell me how to train for success in line checked. No obligation.

- | | |
|--|--|
| <input type="checkbox"/> High School Course | <input type="checkbox"/> Diesel Engineering |
| <input type="checkbox"/> Accounting & Auditing | <input type="checkbox"/> Drafting & Design |
| <input type="checkbox"/> Architecture & B'lding | <input type="checkbox"/> Liberal Arts |
| <input type="checkbox"/> Automotive Engin'ring | <input type="checkbox"/> Private Secretary |
| <input type="checkbox"/> Business Management | <input type="checkbox"/> Hi'er Ac't'g (C.P.A.) |
| <input type="checkbox"/> Commercial Aeronautics | <input type="checkbox"/> Highway Engin'ring |
| <input type="checkbox"/> Electrical Engineering | <input type="checkbox"/> Mechanical Eng'ring |
| <input type="checkbox"/> Electrical Refrigerat'n | <input type="checkbox"/> Radio & Television |
| <input type="checkbox"/> Air Conditioning | <input type="checkbox"/> Salesmanship |
| <input type="checkbox"/> Civil Engineering | <input type="checkbox"/> Steam Engineering |
| <input type="checkbox"/> Complete Law | |

Name.....
Address.....

SEE AND TRY SLINGERLAND

RADIO KING DRUMS

MAY-BELL GUITARS

Don't buy Guitar, Mandolin, Banjo, Electric Guitars, Bugles or Drums until you have seen and tried the Slingerland May-Bells. Guaranteed More for your Money. Wonderful, snappy, powerful, pleasing tone. No equal in price. Sold on easy payments and 5 days free trial by all leading music dealers.

Cut this Adv. Out—Good for \$1.00 Credit.

Ask for Special Information on How to Organize Drum and Bugle Corps. Send for free catalog. Mention instrument wanted. Write today.

Gene Krupa

SLINGERLAND MUSICAL INSTRUMENT MFG. CO.
1330 BELDEN AVE. CHICAGO, ILLINOIS

LAW STUDY AT HOME

Legally trained men win higher positions and bigger success in business and public life. They command respect. Greater opportunities now than ever before. Big corporations are headed by men with legal training.

More Ability: More Prestige: More Money

We guide you step by step. You can train at home during spare time. Degree of LL. B. conferred.

Successful graduates in every section of the United States. We furnish all text material, including fourteen-volume Law Library. Low cost, easy terms. Get our valuable 64-page "Law Training for Leadership" and "Evidence" books FREE. Send for them NOW.

LASALLE EXTENSION, Dept. 764-L Chicago

WIN YOUR DAWN WITH THE PATROL

Unequaled advantages in location for all year flying, finest equipment, highest Government approval for obtaining license in Transport, Limited Commercial, Private Flying, Radio, Sheet Metal, Mechanical Courses. For complete illustrated catalog, write—

J. D. GREEN, Director, Dept. PMS, TULSA, OKLAHOMA

SPARTAN SCHOOL OF AVIATION

GAG-CARTOON!

AND MAKE BIG MONEY—AT HOME—BY MAIL! Magazines may up to \$200.00 per cartoon. Get in this NEW FIELD and be your own boss! My 50 lesson—1000 illustration course shows you how. **FREE LESSON—FOON MARKETS INCLUDED—\$2.80**

All for.....
Send for FREE details.

MOON GAG-CARTOON SCHOOL
Box 106 — Dept. A6, Fall Creek, Wis.

\$2 FEMALE
\$1.50 MALE

WHY NOT spend spring, summer, fall, gathering butterflies, insects.

I buy hundreds of kinds for collections. Some worth \$1 to \$7 each. Simple outdoor work with my instructions, pictures, price list. Profit—pleasure. Send 10c (not stamps) for Illustrated Prospectus before sending butterflies.

MR. SINCLAIR, DEALER IN INSECTS
Dept. 6, Box 1830 San Diego, Calif.

WILL YOU WEAR THIS SUIT and Make up to \$12 in a Day!

Let me send you a fine all-wool union tailored suit **FREE OF ONE PENNY COST.** Just follow my easy plan and show the suit to your friends. Make up to \$12 in a day easily. No experience—no house-to-house canvassing necessary.

Send for Samples—FREE OF COST

Write today for FREE details. ACTUAL SAMPLES and "sure-fire" money-getting plans. Send no money.

H. J. Collin, PROGRESS TAILORING CO., Dept. G-216, 500 South Throop Street, Chicago, Illinois.

COMPLETE ELECTRIC PLANTS



Onan A.C. plants furnish same current as city lines, 110 Volt, 60 Cy. For farms, camps, construction jobs. Operate radios, water systems, all appliances. New models, 350 to 5000 watts, 6, 12, 32 and 110 volt D.C. Models \$57.50 and up Also combination A.C.-D.C. units Shipped complete, ready to run.

Write for details.
D. W. ONAN & SONS
1022 Royalston Ave
Minneapolis Minnesota

Free AIR CONDITIONING AND REFRIGERATION TRIAL LESSON



Trained men needed. Good pay. Opportunities. Learn easily AT HOME in spare time. Write today for FREE TRIAL LESSON.

CHICAGO TECHNICAL COLLEGE
H302 Tech Bldg., 118 E. 26th St., Chicago, Ill.
If you can go away to college to learn Air Conditioning, Engineering, Architecture, Drafting, Electricity, or Radio, send for Free Blue Book.

U.S. GOV'T JOBS

Earn \$1260 to \$2100 at Start

Excellent opportunities for citizens 18 to 50. No special experience usually required. Railway Postal Clerks may earn \$155 first month; Customs Inspectors as high as \$3,000 a year. Send for FREE BOOK "How to Secure a Government Position." It tells about many good government positions and how our tested method will help you pass examinations. Write AT ONCE. Arthur R. Patterson (Former Government Examiner), Principal, PATTERSON SCHOOL, 87 Mercantile Bldg., Rochester, N. Y.

EASY TO LEARN ACROBATICS

New, fast-learning Method of Acrobatics, Hand Balancing and Tumbling fully illustrated and diagrammed. Easily understood by Beginners as well as Professionals. Natural body builder. My Acrobatic Poses and literature sent FREE.

KEN COOPER, ACROBAT
733 N. Van Buren St. Milwaukee, Wis.

STUDY ENGINEERING AT HOME

Home Study Courses leading to Degrees in Electrical; Civil; Mechanical; Diesel; Architectural; Aeronautical; Automotive; Drafting; Radio; Air Conditioning; Refrigeration. Highway, Mining, Petroleum, Industrial, Steam, Chemical Engineering; Arts; Sciences; Philosophy; Education; Writing; Psychology; Chemistry; Theology; Law; Agriculture; Business; Advertising; Sales; Accounting; Public Speaking. MCKINLEY-ROOSEVELT GRADUATE COLLEGES, 4246 Clarendon Ave., Chicago.

GUITAR

Home Study Courses leading to Degrees in Electrical; Civil; Mechanical; Diesel; Architectural; Aeronautical; Automotive; Drafting; Radio; Air Conditioning; Refrigeration. Highway, Mining, Petroleum, Industrial, Steam, Chemical Engineering; Arts; Sciences; Philosophy; Education; Writing; Psychology; Chemistry; Theology; Law; Agriculture; Business; Advertising; Sales; Accounting; Public Speaking. MCKINLEY-ROOSEVELT GRADUATE COLLEGES, 4246 Clarendon Ave., Chicago.

EARN THE DEGREE

Doctor of Psychology (Ph.D.), Philosophy, Science, General Courses—Arts, Law, Business, etc. "CHARTERED BY STATE OF MONTANA." Send for 32-page FREE Bulletin at once. No Obligation. Temple Bar College, Dept. 2-R, 213 East Main Street Missoula, Montana, U. S. A.

NEW YORK SCHOOL OF MECHANICAL DENTISTRY

Earn big money in a few months. We show you how! Real Laboratory Training. OLDEST school. Day, Eve. Easy terms. Ask for free Catalog P and tool offer. N. Y. SCHOOL OF MECHANICAL DENTISTRY, 125 W. 31 St., N. Y. C.

Correspondence Courses in RADIO and ELECTRICAL ENGINEERING

LOW AS \$25

ELECTRICAL ENGINEERING. Get good grasp of wide electrical field. Modern. Very understandable.
RADIO ENGINEERING. Extra fine course in radio, public address, photo-electric work. Trains you to be super-service man, real vacuum tube technician. Tuition ONLY \$25, either course. Deferred payment plan. Experiment kits furnished.
FREE Write for free copies of school catalog, student magazines, etc.
FREE LINCOLN ENGINEERING SCHOOL, Box 931-86, Lincoln, Nebr.

Need Money Quick?

Send me your name and I'll mail free facts about Coffee Agency Plan showing how you can make up to \$9.50 in a day for full time, up to \$5.00 for part time. Nationally known line of 250 daily necessities in big demand. No experience needed. Liberal credit plan. Limited openings. Write quick—

Albert Mills 5290 Monmouth Cincinnati, Ohio

Be a RADIO EXPERT



Learn at Home to Make \$30, \$50, \$75 a WEEK



Chief Operator Broadcasting Station
"When I completed 20 lessons, I obtained my Radio Broadcast Operator's license and immediately joined Station WMPC, where I am now Chief Operator."
HOLLIS F. HAYES, 85 Madison St., Lapeer Mich.

Do you want to make more money? Broadcasting stations employ engineers, operators, station managers and pay up to \$5,000 a year. Spare time Radio set servicing pays as much as \$200 to \$500 a year—full time servicing jobs pay as much as \$30, \$50, \$75 a week. Many Radio Experts operate their own full or part time Radio businesses. Radio manufacturers and jobbers employ testers, inspectors, foremen, engineers, servicemen, paying up to \$6,000 a year. Radio operators on ships get good pay and see the world. Automobile, police, aviation, commercial Radio, and loud speaker systems offer many good opportunities. Television promises many good jobs soon. Men I trained have good jobs in Radio.



Own Business Pays \$300 a Month
"I now have my own Radio business which shows three hundred dollars a month profit—thanks, again, to National Radio."
FRANK T. REESE, 39 N. Felton St. Philadelphia, Penna.

Many Make \$5, \$10, \$15 a Week Extra in Spare Time While Learning

The day you enroll I start sending you Extra Money Job Sheets. They show you how to do Radio repair jobs, how to cash in quickly. Throughout your training I send plans and ideas that made good spare time money for hundreds of fellows. I send special Radio equipment which gives you practical experience—shows how to conduct experiments, build circuits illustrating important Radio principles.

Find Out What Radio Offers You

Mail coupon for "Rich Rewards in Radio." It's free to any fellow over 16 years old. It points out Radio's spare and full time opportunities, also those coming in Television; tells about my Training in Radio and Television; shows you letters from men I trained, telling what they are doing, earning; shows my Money Back Agreement. MAIL COUPON NOW in an envelope or paste on penny postcard.

J. E. SMITH, President
Dept. 8GP
National Radio Institute
Washington, D. C.

Mail this Now FREE
Get 64-page Book

RICH REWARDS IN RADIO

J. E. SMITH, President, Dept. 8GP, National Radio Institute, Washington, D. C.

Dear Mr. Smith: Without obligating me, send "Rich Rewards in Radio," which points out the spare time and full time opportunities in Radio and explains your 50-50 method of training men at home in spare time to become Radio Experts. (Please Write Plainly)

AGE.....
NAME.....
ADDRESS.....
CITY..... STATE.....

When writing please mention Popular Mechanics

ENGINEERING

ELECTRICAL — MECHANICAL — ARCHITECTURAL — STRUCTURAL — CIVIL — AERONAUTICAL — HIGHWAY

Technical and applied courses — nonessentials omitted — fundamentals stressed

Chartered by the State. Recommended by graduates, endorsed by industry, approved by engineers and educators. Courses include Air Conditioning, Electric Refrigeration and Diesel. Extensive modern equipment. Low tuition. Part-time work for room and board. Degree in two years, diploma in one year. Also short intensive courses of

three and four months in Electricity, Diesel-Electric, Power Plant, Refrigeration, Air Conditioning and Drafting. One and two-year courses open in September, short courses open the year round. Thousands of successful graduates in U. S. and foreign lands. Write for catalog.

39th YEAR

FINLAY ENGINEERING COLLEGE

1001 Indiana Avenue

Kansas City, Missouri

LEARN ACCOUNTANCY SECRETARIAL AND OFFICE WORK HILL'S WAY

EARN MORE MONEY

Big pay goes to those who train for it. Hill's trains men and women quickly to fill highly paid positions. Easy to acquire, yet completely thorough. Learn at home during time now wasted. Low tuition fee; easy payments. Send today for our inspiring SUCCESS Book FREE.

HILL'S EXTENSION SCHOOL
603 West Main St., Oklahoma City, Okla. • Est. 1907

Name _____ Age _____
Address _____
City _____ State _____

CARTOON YOUR WAY TO SUCCESS!

DON'T COPY — LEARN TO ORIGINATE!

RAYE BURNS will teach you HOW to CREATE ORIGINAL CARTOONS at home that you can SELL! Course contains 26 lessons and over 600 illustrations. All for Only . . . **\$3.85**

Send name and address for free details.

RAYE BURNS SCHOOL, Dept. M, BOX 2194, Cleveland, Ohio

AUDELS Carpenters and Builders Guides 4 vols. \$6



Inside Trade Information for Carpenters, Builders, Joiners, Building Mechanics and all Woodworkers. These Guides give you the short-cut instructions that you want—including new methods, ideas, solutions, plans, systems and money saving suggestions. An easy progressive course for the apprentice and student. A practical daily helper and Quick Reference for the master worker. Carpenters everywhere are using these Guides as a Helping Hand to Easier Work, Better Work and Better Pay. To get this assistance for yourself, simply fill in and mail the FREE COUPON below.

Inside Trade Information On:

How to use the steel square—How to file and set saws—How to build furniture—How to use a mitre box—How to use the chalk line—How to use rules and scales—How to make joints—Carpenters arithmetic—Solving mensuration problems—Estimating strength of timbers—How to set girders and sills—How to frame houses and roofs—How to estimate costs—How to build houses, barns, garages, bungalows, etc.—How to read and draw plans—Drawing up specifications—How to excavate—How to use settings 12, 13 and 17 on the steel square—How to build hoists and scaffolds—skylights—How to build stairs—How to put on interior trim—How to hang doors—How to lay floor—How to paint.



THEO. AUDEL & CO., 49 W. 23rd St., New York City

Mail Audels Carpenters and Builders Guides, 4 vols., on 7 days' free trial. If O.K. I will remit \$1 in 7 days, and \$1 monthly until \$6 is paid. Otherwise I will return them. No obligation unless I am satisfied.

Name.....
Address.....
Occupation.....
Reference.....P.M.

AUTO-MECHANICS & WELDERS

Auto Mechanics and Welders are in big demand. Complete courses in arc and acetylene welding, body and fender bumping, spray painting and metal finishing. Pay after graduation plan. Special low rates. Write today.

MICHIGAN TRADE SCHOOL
3758 Woodward Ave., Detroit, Mich.

Write for FREE CIRCULAR

THERE'S MONEY IN YOUR CAMERA!

Others make good incomes selling pictures to publications. FREE BOOKLET describes home-study course (which may be paid for in easy installments) and tells how YOU can do it too! Universal Photographers, Dept. 77, 10 West 33 Street, N. Y. C.

VOICE

100% Improvement Guaranteed

We build, strengthen the vocal organs—not with singing lessons—but by fundamentally sound and scientifically correct silent exercises . . . and absolutely guaranteed to improve any singing or speaking voice at least 100% . . . Write for wonderful voice book—sent free. Learn WHY you can now have the voice you want. No literature sent to anyone under 17 years unless signed by parent.

PERFECT VOICE INSTITUTE, Studio B-135
64 E. Lake St., Chicago

In answering advertisements always write name and full address clearly.

MAKE MONEY AT HOME

RUBBER MOLDS Low as 6¢ EA.

Amazing rubber mold-making outfit makes perfect flexible molds of plaques, ash trays, book-ends, etc. Molds cost from 6c to 25c each. Each mold makes hundreds of novelties and gifts to sell up to \$1.00 apiece! No experience necessary. Quick and easy. Start profitable business in your home . . . sell to stores, gift shops, friends, resorts, road stands, by mail. Full or spare time. "Molders Handy Book" and list of buyers FREE. Write

SO-LO WORKS
Dept. G-827 Cincinnati, Ohio

AVIATION Wants More LINCOLN TRAINED MEN

This Government Approved Lincoln School wants to immediately get in touch with men interested in preparing for positions as Pilots and Airplane Mechanics. Aviation's great expansion program calls for thousands more trained men.

PILOT Training at Lincoln includes elementary flight maneuvers, night and blind flying, beam and cross-country flying. 14 Training Planes; 6 types, gives you wider Piloting experience and prepares you for your Pilot Rating.

MECHANICS Training at Lincoln includes Practical experience in Airplane and Engine Maintenance, Rebuilding, Overhaul, Repair; Sheet Metal, Welding, Radio. A few months training prepares you for Mechanics position. Advanced Training meets all requirements for your Mechanics Rating.

WRITE TODAY for complete information. Our Advisory Staff will gladly help you plan your career in Aviation.

LINCOLN AIRPLANE & FLYING SCHOOL
557 Lincoln Aircraft Bldg. Lincoln, Nebraska



Learn to MOUNT BIRDS Tan SKINS, Make Up FURS

Be a Taxidermist. We teach you at Home.

Mount Birds, Animals, Pets, common specimens. Save your hunting trophies; decorate home and den. Make genuine KROME LEATHER, tan and make up furs for sparetime profit.

FREE BOOK 48 pages—tells all about it. Hunters, get this wonderful book. Its Now Free. Send postal card Today—This Minute! State your AGE.

N. W. School of Taxidermy, 8337 Elwood Bldg., Omaha, Nebr.



NEW YORK TRADE SCHOOL

Electricity Plumbing and Heating Sheet Metal Work

One-Year Intensive Courses. Also shorter courses in Auto Mechanics and Welding. Fall term: Sept. Register now.

Oldest School of Its Kind in America

NEW YORK TRADE SCHOOL

An endowed institution not operated for profit.
306 East 67th Street. New York, N. Y.

\$40 a week JOB

Earn \$40 to \$60 a week in such active fields as Drafting, Accounting, Air Conditioning, Diesel, Architecture, Merchandising, Electricity, Refrigeration, Mechanical, Radio. We prepare you at home and then help place you in right job. Low monthly terms—satisfaction or money back. Write for facts—no obligation.

American School, Dep. GB45, Drexel at 53th, Chicago

5c TIRE MAKES \$2.00 MAT

Make springy, long-wearing Rubber Mats out of old auto tires. Any length or width. BIG sale to schools, factories, stores, homes. Think of the profit. Brand new business, fully patented. Field untapped. Reasonable investment and simple hand machine starts your local plant. Write quick for free information. Don't lose a minute—this is BIG!

FABRIX, INC.

Dept. 77

325 W. Huron St., Chicago, Ill.

\$30⁰⁰ TRADE-IN ALLOWANCE DURING THIS MIDWEST FACTORY-TO-YOU SALE



16 TUBES

TOUCH BUTTON TUNING

30 DAYS FREE TRIAL

EASY TERMS

FACTORY-TO-YOU PRICE...\$69.95

LESS \$30.00 ALLOWANCE you pay only

\$39⁹⁵ COMPLETE

SEND for this marvelous new COMPLETE 1938 Midwest 16-tube radio... on 30 days FREE Home Trial. Big beautiful console—10,000 mile range—world-wide reception—glorious new tone—and Dial-A-Matic Tuning.

Midwest Radio Corporation
Dept. WW-15 Cincinnati, Ohio

Write for FREE 1938 Factory Catalog.

When writing please mention Popular Mechanics

DIESEL POWER

A Coming American Industry



Courtesy "Diesel Progress"

The internal-combustion engine represents man's supreme triumph of machine power. Diesel engineers are in great demand. Many are acquiring necessary knowledge through spare-time study of this modern I. C. S. Course on Diesel engines. Free booklet—use coupon!

RADIO holds great



rewards for trained men

Almost in a decade radio has become a giant industry. The opportunities created will be enjoyed by trained men. The International Correspondence Schools Radio Course, prepared by leading authorities and constantly revised, will help make you a trained man! A fascinating book—FREE.

MECHANICAL ENGINEERING —A Field with a Future



This course has meant advancement to hundreds of ambitious men, mechanics, draftsmen, blacksmiths, foundrymen, patternmakers, apprentices, and mechanical engineers—men who wanted to get ahead and to earn more money. You will find, as they have found, that enrolling for an I. C. S. Course is an investment in a Bigger Future. Use the coupon! No obligation.

AIR CONDITIONING

today's big opportunity!

Air Conditioning is the next big industry. Mark that prediction! Its opportunities are as big in winter as in summer. Plumbing and heating engineers must know Air Conditioning—the field in its broader aspects invites ambitious men. And a new, up-

to-the-minute course on Air Conditioning now offered by the International Correspondence Schools is a golden avenue for success. Full information—free!

INTERNATIONAL CORRESPONDENCE SCHOOLS

Box 5517-J, Scranton, Penna.

Without obligation, send me full information on subject checked below:

- DIESEL POWER RADIO COURSE
 MECHANICAL ENGINEERING
 AIR CONDITIONING

- | | | |
|--|--|---|
| <input type="checkbox"/> Architecture | <input type="checkbox"/> Drafting | <input type="checkbox"/> Accounting |
| <input type="checkbox"/> Concrete Construction | <input type="checkbox"/> Good English | <input type="checkbox"/> Salesmanship |
| <input type="checkbox"/> Reading Shop Blueprints | <input type="checkbox"/> Advertising | <input type="checkbox"/> Show Card Lettering |
| <input type="checkbox"/> Civil Engineering | <input type="checkbox"/> Diesel Engines | <input type="checkbox"/> Civil Service |
| <input type="checkbox"/> Gas Engine Operating | <input type="checkbox"/> Refrigeration | <input type="checkbox"/> High School Subjects |
| <input type="checkbox"/> Chemistry | <input type="checkbox"/> Highway Engineering | <input type="checkbox"/> Electrical Engineering |
| <input type="checkbox"/> Poultry Farming | <input type="checkbox"/> Inventing and Patenting | <input type="checkbox"/> Aviation Engines |

Name _____

Address _____



MMOTORISTS would find a newly patented map arrangement very useful



on long trips. The device consists of a circular flexible sheet which is attached to the steering wheel, within the rim and over the horn button. A map fastened to the sheet provides easy access to road information so that the driver may follow a route by glancing at the map from time to time.

FOR observation of underwater life, a boat having a well into which persons may descend has been patented.

The well has windows through which marine animals, fish and plants may be observed. This arrangement would be useful at ocean and fresh-water resorts, providing a new attraction for sightseers.



FOR the devotee of outdoor life, the fisherman, hunter and camper, a newly patented camp stove solves the problem of how to prepare food easily.

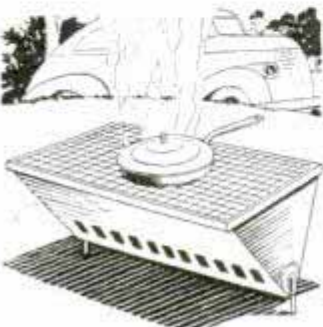

The stove is V-shaped, with a removable grill-work cover. The fire is contained in the bottom and

cooking utensils are placed on the cover. Openings in the bottom permit discharge of ashes. Supports, which are thrust into the ground, hold the stove in the proper position.

THEFT of electric-light bulbs from their sockets may be prevented as the result of a newly patented invention.

The device consists of a socket with gripping means operable by a magnet to prevent rotation, and a non-magnetic casing surrounding the locking device and the socket to prevent access when a bulb is in place.



SSCARRING of floors and of shoe heels is prevented by a quickly detachable heel plate patented recently.



The plate may be removed before entering the house. It protects heels of women's shoes from damage while driving the automobile. The protective plate may be used with either rubber or leather heels.

GREATER comfort in the automobile or other automotive vehicle is the purpose of a cooling unit patented recently. It consists of a streamline housing adapted to be mounted on the roof of the car. The housing has two compartments, one con-

(Continued to page 25A)

THOUSANDS LEARN MUSIC THIS SIMPLE EASY WAY

No Expensive Teachers . . . No
Old-time Drudgery

Beginners Learn Real Music from the Start

Yes, literally thousands of men and women in all walks of life have learned music—have won new friends, become socially popular—this quick, modern, easy as A-B-C way.

You, too, can learn to play—to entertain others—to pep up any party—just as those thousands of others are doing. And you can do this without the expense of a private teacher—right in your own home. You don't need to be talented. You don't need previous musical training. You don't have to spend hours and hours learning monotonous scales and humdrum finger exercises. You start right in learning real little tunes. And sooner than you expected you find yourself entertaining your friends—having the best times you ever had.

Easy as A-B-C

The U. S. School method is literally as easy as A-B-C. First, it tells you how to do a thing. Then it shows you in pictures how to do it. Then you do it yourself and hear it. What could be simpler? And learning this way is like playing a game. Practicing becomes real fun instead of a bore as it used to be with the old way.

Prove to yourself without cost how easily and quickly you can learn to play. Send today for Free Dem-

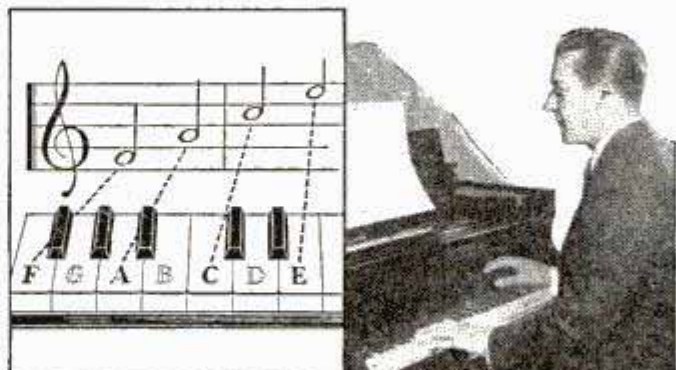

onstration Lesson and Explanatory Booklet. See the simple principles around which this method is built. If you really want to learn music—if you want to win new popularity—enjoy good times galore—mail the coupon below. Don't delay—act NOW. Instruments supplied when needed, cash or credit. U. S. School of Music, 77 Brunswick Bldg., New York City.

U. S. SCHOOL OF MUSIC
77 Brunswick Bldg., New York City

Send me your amazing free book, "How You Can Learn Music in Your Own Home," with inspiring message by Dr. Frank Crane; also Free Demonstration Lesson and particulars of your easy payment plan.

Name.....
Address.....
Instrument.....
Have you Instrument?.....

LEARN TO PLAY BY NOTE

- Piano
- Guitar
- Violin
- Saxophone
- Organ
- Mandolin
- Tenor Banjo
- Hawaiian Guitar
- Piano Accordion

Or Any Other Instrument

ELECTRICAL ENGINEERING

ONE YEAR condensed course for ambitious men. Theory and practice combined. Mathematics, mechanical drawing. Students construct motors, install wiring, test electrical machinery. Bliss men hold responsible positions. Modern buildings; campus. 46th year begins Sept. 28. CATALOG.



BLISS ELECTRICAL SCHOOL
267 Takoma Ave., Washington, D. C.

Auto-Diesel

Master a real trade. Auto Mechanics, Diesel Mechanics, Arc Welding, Acetylene Welding, etc. Let us train you to be an expert Auto-Diesel Mechanic and help you get a good job. The cost to you is reasonable. Learn on modern equipment with tools under experienced instructors. Real shop work. Steam heated buildings. Room and board in our steam heated dormitory. We pay your fare to Nashville. For free catalog write

Nashville Auto-Diesel School, Dept. 75, Nashville, Tenn.

TRAIN FOR Radio IN 12 WEEKS

BY SHOP WORK—NOT BY BOOKS
I'll Finance Your Training!

Prepare for jobs in Broadcasting, Talking Pictures, Television, Wireless, etc., by 12 weeks practical shop training in Coyne Shops. Free Employment Service. Many earn while learning. You don't need previous experience or a lot of book learning. Send coupon for BIG FREE RADIO and TELEVISION BOOK, and my "Pay-Tuition-After-Graduation" Plan.

H. C. LEWIS, President, Radio Division,
Coyne Electrical School,
500 S. Paulina St., Dept. B8-3H, Chicago, Ill.

Dear Mr. Lewis—Send me your big Free Radio Book and all details of your Special Tuition Offer—and about your "Pay After Graduation" Plan.

Name.....
Address.....
City..... State.....

DRAFTING



BOOKS SENT FREE!

ON APPROVAL
5 VOLUMES BRAND NEW EDITION

Only 15 minutes a day with these WONDER BOOKS can prepare you for a good drafting job in less than a year. Mechanical and architectural drafting from simple straight lines to important complex plans. A step at a time! Built especially for beginners, for men with only grammar schooling. Drafting room practice, PLUS ENGINEERING, made easy and clear. Includes complete course in blueprint reading.

Big Field Big Demand Big Pay

Competent draftsmen are urgently needed right now in all building and manufacturing lines at \$30.00 to \$75.00 a week. That's just the beginning—FOR DRAFTSMEN HAVE THE BEST CHANCES FOR ADVANCEMENT. Pleasant, fascinating work, easy to learn and do. Learn quickly with these books—send coupon for a set and see for yourself.

[A year's consulting membership in the American Technical Society now given to all readers of this famous encyclopedia of drafting. Many say that it is worth more than the cost of the books.]

Complete set of drawing instruments if you send for these drafting books NOW. These instruments are made of the finest of German silver, are absolutely accurate and are packed in velvet lined leatherette pocket case. Real \$10 value, but included with these books.

For Beginners or Experts

Written, so you can understand every word, by 22 well known engineers and architects. De-Luxe flexible binding, nearly 2,000 pages, 1546 blueprints, charts and diagrams; prepares you for a good drafting job in mechanical or architectural lines. Sent for 10 days' free use if you mail coupon immediately.

These Instruments Included



AMERICAN TECHNICAL SOCIETY
Dept. DB19, Drexel at 58th St., Chicago, Ill.

American Technical Society, Dept. DB19, Drexel at 58th St., Chicago, Ill. Send for 10 days' trial New 5 volume set of drafting. I will pay the few cents delivery charges. If I wish, I may return books in 10 days and owe you nothing but if I decide to keep them, I will send \$2.00 after 10 days, then only \$3.00 a month until \$24.80, the advertising price, is paid. Send latest edition and include drawing instruments and Membership Certificate.

Name.....
Address.....
Attach letter stating age, occupation, employer's name and address and that of at least one business man as a reference.

When writing please mention Popular Mechanics

A frank man to PATENTS - INVENTIONS

THE world of invention moves on. About a hundred years ago people were saying, "There's nothing left to invent"—today we know that is one of the funniest things ever said. Just think what has happened in the last hundred years! Autos, radios, airplanes, and thousands of useful, practical devices for home, shop and office have been invented and put on the market. Inventors are constantly making the world a better place to live in. Did you see a notice in the paper that an obscure worker, Hans Wach, has invented a simple device to utilize exhaust steam on steam boats? *Already, the report states, the steamship lines have saved more than \$15,000,000 in fuel bills with his invention.* Almost in the same breath the Dept. of Commerce announced that it will soon test out a new, non-crashable aeroplane, which the average man can learn to fly in a day, which will travel at 110 miles an hour and sell at the price of a cheap automobile. An unknown Seattle man has invented a robot to go 5,000 feet under the sea and recover millions and millions of dollars worth of gold lying at the bottom of the ocean since the days of the early Spaniards.

Remember this: For every outstanding big invention there are thousands of small, simple things for use in the home, the office, the factory, on the farm, on every sort of travel conveyance. Little articles like you find on the counters of a 10-cent store, hardware store, drug store, toy and novelty shop.

Many Little Ideas Have Big Commercial Possibilities

A person finds something he's using doesn't work right, or it's clumsy, or costs too much. He gets a happy thought. He improves the old Article. That's contribution to human progress. That's the way that many, many men have reached the goal of financial comfort, independence and even wealth. Most of the things millions of us use didn't come from the brains of engineers and physicists. They came from the mind and maybe the crude home work bench of Mr. Average Man, busily engaged in earning his bread and butter at whatever chance or circumstance has given him to do. The "little" man's opportunity as an inventor was never greater than it is today.

Who Are Inventors?

You'd be amazed at the men we contact in the course of a busy year. Most of them do not consider themselves inventors at all. During their work or leisure they get an idea. They work it out on paper. They get in touch with us about Protection. Did you know that a dentist invented the stock ticker, a school teacher the telephone, a farmer the typewriter, an artist the telegraph? Did you know that the crinkly hair pin—sold by millions now—came about because a husband saw his wife twisting the old-fashioned straight hair pin to make it stay in place? **Poor men who have no thought of invention now will be financially well-fixed in a few years because of a happy thought that the world could use to advantage.**



Can You Answer These Questions?

Ask yourself these questions: How do the Patent Laws protect me? What easy steps can I take, without cost, to put myself in position to support my belief that I am the first man to think of my invention? Is a Patent worth the cost? Do I need a model? Should I try to sell my invention before I have it Patented? Is there any safe, business-like way to secure financial help? If I do apply for a Patent, how shall I reach people who can market my invention? Can I protect and sell an improvement on some invention that has already been patented? These are but a few of the questions which usually confront the average man. You need the answers! **YOU CAN HAVE THEM, without cost, trouble, or delay.**

Our Business Is to Help You. Write Us Today

For more than forty years, this firm has been helping men with an inventive turn of mind. We maintain a large staff of trained, experienced specialists—**Registered Patent Attorneys, Draftsmen, and Searchers to help our clients secure all the protection to which they are entitled.** Fees are reasonable. Deferred payments frequently arranged. Questions promptly answered. Write us frankly with absolute assurance that what you say will be treated with strictest secrecy. **But FIRST, send for the FREE BOOKS shown on the opposite page.** They are filled with facts, pictures and suggestions. They tell you things about Patents, Inventions and Selling Inventions that we have learned in our long experience. **They may save you time, expense, EVEN LATER DISAPPOINTMENT.** Simply fill in the coupon. No charge, no obligation. Write us TODAY.

RUSH COUPON TO WASHINGTON, D.C. TODAY

man talk about - SELLING INVENTIONS

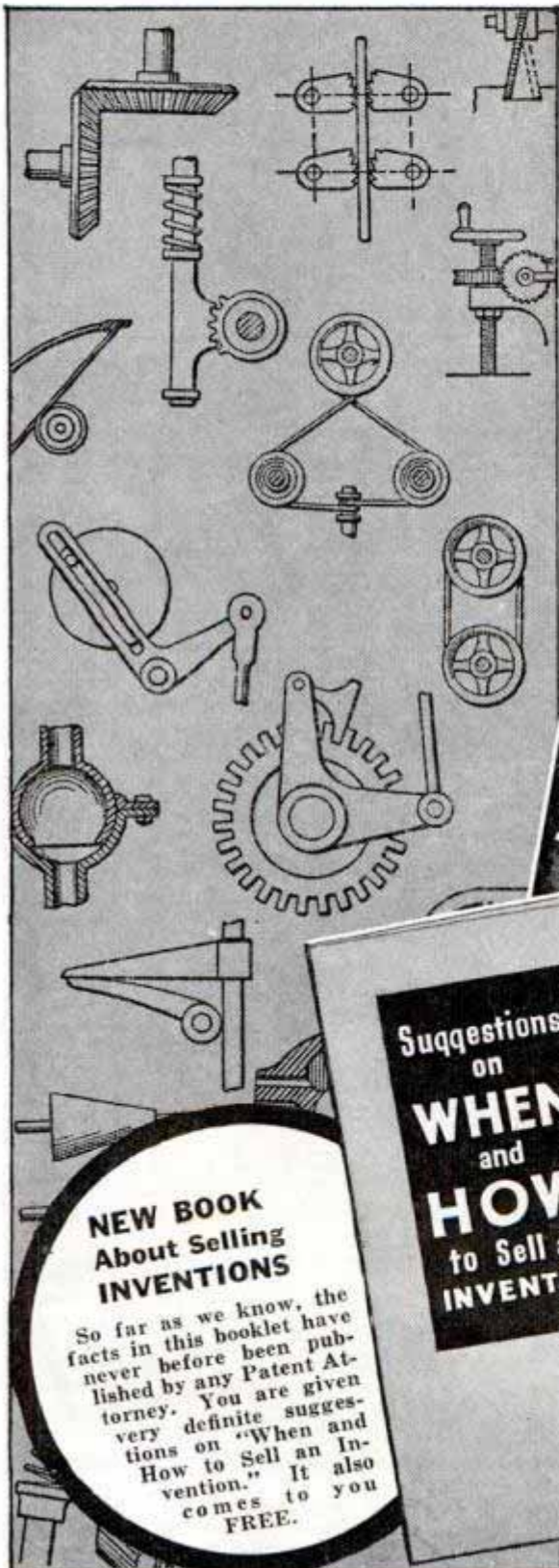

115 Mechanical Move- ments Like These

Besides many other features and facts there are 115 different mechanical movements and principles in the big 48-page Book below. Maybe there is just the idea you need to solve some mechanical problem. Use the coupon or write us a card or letter.

2 FREE BOOKS
with
68 PAGES
of Facts and Pictures!



Suggestions
on
WHEN
and
HOW
to Sell an
INVENTION

NEW BOOK
About Selling
INVENTIONS

So far as we know, the facts in this booklet have never before been published by any Patent Attorney. You are given very definite suggestions on "When and How to Sell an Invention." It also comes to you **FREE.**

VICTOR J.
EVANS & Co.

REGISTERED PATENT ATTORNEYS

- Main Office: 20-H, Victor Building,
Washington, D. C.
Other Offices: 2610-N, Singer Bldg., New York
1445-N, Monadnock Bldg., Chicago
1010-N, Hobart Bldg., San Francisco
405-N, Garfield Bldg., Los Angeles
514-N, Empire Bldg., Pittsburgh

Send me FREE copies of your books, "Patent Protection" and "When and How to Sell an Invention." (Note: Same books supplied by any of branch offices listed above.)

Name.....
Street and No.....
City or Town..... State.....

When writing to advertisers please mention Popular Mechanics

Learn this Profitable Profession



in 90 Days at Home

Hundreds of men and women of all ages 18-50 make \$10.00 to \$20.00 in a single day giving scientific Swedish Massage and Hydro-Therapy treatments. There is a big demand from Hospitals, Sanitariums, Clubs, Doctors and private patients as well as opportunities for establishing your own office. Learn this interesting money-making profession in your own home by mail, through our home study course. Same instructors as in our **NATIONALLY KNOWN** resident school. A diploma is awarded upon completion of the course. Course can be completed in 3 to 4 months. High School training is not necessary. Many earn big money while learning.



Anatomy Charts & Booklet FREE

Enroll now and we will include uniform coat, medical dictionary, patented reducing roller and Hydro-Therapy supplies without extra cost. The reducing course alone may be worth many times the modest tuition fee.

Send coupon now for Anatomy Charts and booklet containing photographs and letters from successful graduates. These will all be sent postpaid—FREE.

THE College of Swedish Massage (Successor to National College of Massage)
Dept. 864-1601 Warren Boulevard, Chicago.
You may send me **FREE** and postpaid, Anatomy Charts, booklet containing photographs and letters from graduates, and complete details of your offer.

Name _____
Address _____
City _____ State _____

Photo-Engraving

BIG PAY!
IDEAL WORKING CONDITIONS
INCREASING DEMAND

LEARN QUICKLY AT HOME BY LATEST EXPERT METHOD
An easy, quick, thorough **Home Study Course**. Oldest and largest school in the world **TEACHING PHOTO-ENGRAVING** by correspondence and residence. Many unusual features—Experimental Equipment for home use—Rare Reference Books—Camera Journalism. Plate Layout Examples, Lifetime Consulting Service. **"30 Photo-Engraving Ways to Make Money from the Day You Start Your Studies!"**. . . All included at no extra cost. Write today for free 38-page Opportunity Booklet. . . .
AURORA SCHOOL OF PHOTO-ENGRAVING
Dept. 178 AURORA, MISSOURI



CARTOONISTS! MAKE BIG MONEY!

Let a nationally known cartoonist teach you to **ORIGINATE, AND SELL YOUR CARTOONS**, by easy method at home. **J. A. PATTERSON'S MASTER CARTOON COURSE** has 35 lessons (large 10 x 14 lesson charts), and over 800 illustrations. . . . only \$3.75
Send for free details.
If you act at once I will send you my regular \$1.00 course in cartoon gag writing, including cartoon markets **FREE**.
Enclose 10¢ if you wish a big sample trial lesson.
J. A. PATTERSON SCHOOL, Dept. A, Box 590, TULSA, OKLA.

Genuine LACO Automatic OIL-BURNING HEATER



Lots of Heat—Amazing Low Fuel Cost!

Write today for free book showing LACO's new oil-burning heater for home, store, filling station, etc. No basement needed. Complete with special LACO "2-Stage" burner—and new-type Inner Heating Unit with 20% greater heating surface! Delivers big volume of heat from small amount of oil. Self-contained fuel tank. Beautiful steel cabinet. Quiet. Safe. Humidifies, circulates the air. Choice of sizes.

WRITE! Send for Free Book, photos, low prices. If you prefer furnace-type oil-burner, ask for book on Pressure-Type and Mineral-Wick models.

DEALERS: Sample burner sent new dealers for examination, no obligation. **WRITE!**

LACO OIL BURNER CO., 178 Union St., Griswold, Iowa



FOB Factory

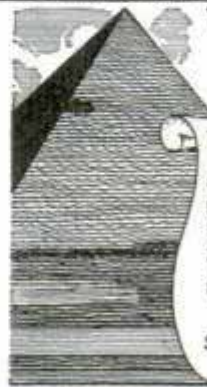

WHAT STRANGE POWERS

Did The Ancients Possess?

WHERE was the source of knowledge that made it possible for the ancients to perform miracles? These wise men of the past knew the mysteries of life and personal power. This wisdom is not lost—it is withheld from the masses. It is offered freely **TO YOU**, if you have an open mind. Write for free sealed book. Address: Scribe KZL.

The ROSICRUCIANS
San Jose (AMORC) California

AVIATION APPRENTICES



GOOD PAY

BIG FUTURE

If you are interested in training yourself for a highly paid position in the aviation industry—Write, immediately, inclosing stamp.

MECHANIX UNIVERSAL AVIATION SERVICE CO.
Strathmore Station Dept. E Detroit, Mich.

TRADES THAT PAY Auto, Diesel, Aviation Mechanics, Body, Fender Repair, Painting, Welding. Learn with a few weeks practical training. Trained men get the openings. Write for **FREE BOOK**, low tuition rate. State course interested in. **McSWEENEY SCHOOLS**, Dept. 19-55, Detroit, Mich., or Kansas City, Mo.

LIVE BODIES FOR SALE

Oh boy! Wouldn't that be swell—I'll tell you what I will do though, I will take that scrawny body of yours and whip it into shape just like I have done for myself and so many others. Do you want big muscles and a huge robust body? My book "Pulsant Body Building" is absolutely **FREE**.

TOMMY LOUGHRAN, Dept. 19, 4 S. 15th St., Philadelphia, Pa.

New York Established 1902
Electrical School
Ask for free booklet
44 West 17th St., N. Y. C.

Government Jobs
EXAMINATIONS SOON VALUABLE INFORMATION FREE
COLUMBIAN CORRESPONDENCE COLLEGE
WASHINGTON, D. C.



TRI-STATE COLLEGE

ENGINEERING DEGREE IN 2 YEARS

Courses in Civil, Electrical, Mechanical (108 weeks), Chemical, Aeronautical (108 weeks), Radio Engineering. Essentials of engineering training included and non-essentials eliminated. B. S. Degree granted upon completion of course. For ambitious, earnest students. Those who lack high school may make up required work. Graduates compete successfully with those of 4-year schools. Technical instruction at lowest cost and in least

time consistent with thorough training. Intensive instruction in accord with individual ability. Courses also in Business Administration and Accounting. Also short diploma courses (36 weeks) in Surveying and Drafting. Students from all parts of the world. Tri-State graduates make good. Tuition, living expenses low. 55th year. Enter September, January, March, June. Write for catalog. **478 College Ave., Angola, Ind.**



NEW INVENTIONS

(Continued from page 20A)

taining a condenser and the other a blower and an evaporator. Inlet and outlet ducts from the second compartment permit the unit to introduce cool air into the car and to remove warm air. Proper connections for operating the condenser and other mechanism run to the vehicle's engine.

GREATER safety through quicker stopping is the objective of a combination braking and anti-skid device just patented. It provides for installation of plates, covered with resilient material like rubber, on the automobile or bus. These plates would be lowered quickly to contact the pavement in emergencies, an electric motor controlling movement of the plates.



CONVENIENCE of entering the trailer directly from the automobile without

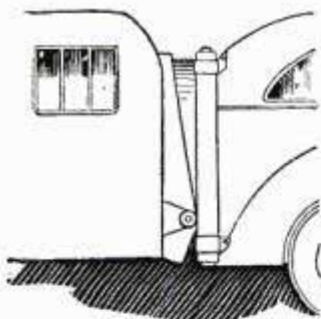

stepping to the ground is afforded by a newly patented coupling. A door in the trailer and another in the car, at their meeting ends, provide access. The coupling surrounds

and incloses the door openings and is constructed to facilitate turning corners and absorbing road shocks.

HANDY for the housewife in preparing vegetables for cooking, an easily operated cutter-grater has been patented. Vegetables are pushed in a trough until they come in contact with the cutter. The cutting-grating wheel is turned by means of a small hand crank. Feeding vegetables into the cutter is made easy by a sliding device fitting on the trough.

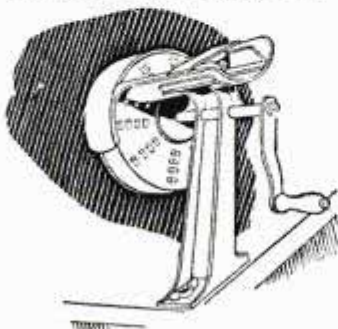

NOW YOU CAN LEARN TO DRAW AT HOME!

Learn in Your Spare Time This Simple, Practical Way Artists Earn \$30, \$50, \$75 A Week!

You can acquire the ability to enter the fascinating, profitable field of Art. It's actually fun to learn at home the proven WSA way—in your SPARE TIME. Our individualized instruction makes learning to draw easy by simple steps. No previous art training is necessary—we teach from the beginning.

Commercial Art, Cartooning and Designing, ALL in ONE Course!

WSA has been successfully training men and women for Art careers since 1914. Many of our outstanding graduates are now making good money in their own art studios, or working for newspapers, publishers, stores and advertising agencies. **TWO ARTISTS' OUTFITS** given. All details given in free book (mail coupon below).

FREE BOOK gives details!

Washington School of Art, Studio 127E
1115—15th St., N. W., Washington, D. C.

Yes! I am interested in learning to draw. Please send me your Free Book "Art for Pleasure and Profit."

Name _____ Age _____
Address _____
City _____ State _____

DO YOU LIKE RADIO DOES THE FUTURE OF TELEVISION INTEREST YOU?

Send for your free copy

You men anxious to make good in radio and related industries want the true facts,—you want to know about employment opportunities and requirements. National Schools,—a million-dollar trade school,—will supply you with a sincerely honest statement of facts on what you should do to get into the profitable radio industry. No exaggerations,—no mis-statements. Mail coupon today. Send for your free copy. Real facts on radio employment requirements. You need real experience. National offers complete training with modern equipment.

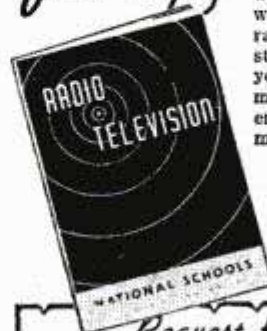

NATIONAL SCHOOLS
Los Angeles

Request for **FREE BOOK** of DETAILS

NATIONAL SCHOOLS,
Dept. PMR-7, 4000 S. Figueroa St., Los Angeles, Calif.

NAME _____ Age _____
ADDRESS _____
CITY _____ STATE _____

Train for In 12 Weeks ELECTRICITY

at Coyne

Quick, Easy Way by Practical Work on Motors, Dynamos, Etc.



I'LL FINANCE YOUR TRAINING

Send coupon today for all details of my quick easy way to train for your start in the great fascinating field of Electricity. I'll tell you how we can train you in 12 weeks by the famous Coyne "Learn By Doing" method right here in my big Chicago training shops. I will not only tell you about my training but I'll tell you how you can get this training first—then pay for it in easy monthly payments starting 60 days after your regular training period is over.

JOB HELP AFTER GRADUATION

If you need part time work to help with living expenses, we'll help you get it. After graduation you get lifetime employment service. Here at Coyne you don't need previous experience or a lot of education. Send coupon today. When I get it I'll send you my big free book and all details of my offer. Don't delay—get the facts today. Mailing the coupon today can be your first start towards a better job and a real future.

H. C. LEWIS, President COYNE ELECTRICAL SCHOOL
500 S. Paulina Street Dept. 88-72 Chicago, Illinois

Please send me your FREE book about Coyne and your training in Electricity, including Diesel, Electric Refrigeration and Air Conditioning and tell me about your sensational "Pay-After-Graduation" Plan.

NAME _____

ADDRESS _____

CITY _____ STATE _____



START \$1260 to \$2100 YEAR

Men—Boys.
GET READY
Immediately
Dependable Positions
Common Education
Usually Sufficient
Mail Coupon
Today—
SURE

Franklin Institute
Dept. T-173
Rochester, N. Y.

Gentlemen: Rush to me FREE of charge, list of U. S. Government big pay jobs. Send me FREE 32-page book describing salaries, vacations, hours and work. Tell me how to qualify for one of these jobs.

Name _____

Address _____

EXTRA MONEY

\$10 to \$85 a week
Yes, you—anybody can make a lot of money right at home, and what's more, have real fun doing it. We show you how, we furnish everything necessary on an easy basis.

COSTS NOTHING

to learn about our plan, all details are given you free. Write today for idea book full of colored pictures telling all about our methods which have made so many people independent. Learn how easy it is to make from \$10 to \$85 per week in the most delightful home work you can imagine. Don't miss this opportunity. Write Now—It's FREE!

FIRESIDE INDUSTRIES, Dept. 66-H, Adrian, Mich.

Was \$5.00
NOW \$2.75
POST PAID

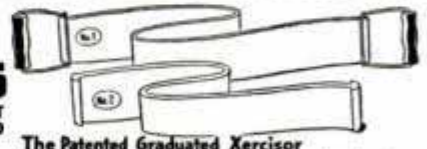

OVER 1,000,000 USERS. Here's the greatest Exercisor ever devised for developing strong, supple muscles... reducing waist line... ending constipation... building strength, health, happiness. Two interchangeable live LATEX pull bands of variable strength (not obsolete cords) A light, compact, graduated Exercisor. Complete with illustrated body building instructions. Don't take our word for it. Don't take the word of over a million users. **PROVE** it to yourself at **OUR RISK.** Send \$2.75 TODAY... or pay postman \$2.75 plus postage. Use 20 days. If not delighted with results, return and your \$2.75 will be cheerfully refunded. **BODY BUILDERS CO., Box 1244-A, Memphis, Tenn.**

"ARITH - MAGIC" 251752 x 48 = 12084096
276 x 28 = 7728 416 x 26 = 10816

makes these and thousands of others simple mental calculations. This amazing book is yours for paying the postman \$1.98 plus postage—or send \$2.00 for mailing postpaid.

ARITH-MAGIC, Dept. 50, Elmhurst, Ill.

BOOKS—FOR TODAY'S BIG OPPORTUNITIES

List sent free upon request
Popular Mechanics Press, 200 E. Ontario St., Chicago

NEW SCIENTIFIC WONDER

"X-RAY" CURIO

10c
3 for 25c

Reg. U.S. Pat. Off.

"Silver Only"
BOYS BIG FUN. You apparently see thru cloth, wood, stone, etc. **FREE PACKAGE** radio picture films, 16 pictures without camera. **IT'S GREAT SPORT!** 1 package with each 25c order.
MARVEL MFG. CO., Dept. 30-E NEW HAVEN, CONN.

DIESEL

Get BETTER training. Realize Adcox advantages. Located in Pacific Northwest, a Diesel center. Established 28 years. Modern equipment, expert instructors. Close cooperation for YOUR success. Earn room and board while learning. Send for FREE big 40-page Diesel School Catalog No. 18. Home Study and Resident Courses.
L. L. ADCOX TRADE SCHOOL
Portland Oregon

The BRISCHOGRAPH makes you an artist INSTANTLY Use any size copy. Junior covers 4 x 4 inches at one time. Projects in colors and up to life size. Comes completely wired, with lamp, lenses and transpore mirror. Dealers in principal cities and foreign countries. Send \$10. money order, try it ten days. Money back guaranteed. Commercial models \$35, \$50, and \$100.
The BRISCHOGRAPH CO., 24 W. Welshmer Rd. Columbus, O. Established 1926. Canada: Winnipeg Map & Blue Print Co., 318 Donald St.; Winnipeg, Man.

NOW YOU CAN GET A HEAVY DUTY INDUSTRIAL WELDER

Works Off 110-Volt Light Socket
This marvelous DYNAMIC Power Welder will do the work of much higher priced types. It is easily portable. **WELDS Cylinder Blocks, Bumpers, Fenders, Tanks, Farm Machinery, and etc.** Will also solder and braze on the lightest material. Works on iron, steel, tin, brass, copper and all other metals. Men without previous experience can make as much as \$5.00 on a one hour repair job. Go into business—Open a Welding Shop NOW.
AGENTS—Make big profits selling to garages, factories, junkies and machine shops. Write TODAY for our 10-DAY TRIAL OFFER.
DYNAMIC WELDER COMPANY
2226-EX Silverton Road Chicago, Illinois

for Only \$195
RETAIL

Six Big Auto Books

shipped
FREE
for
examination



Here is a wonderful offer for anyone who wants to know more about automobiles. Whether you want to keep your own car in perfect condition or make more money by learning all about design, upkeep and repair, you should have these books. Our amazing FREE SHIPMENT offer puts them into your hands for examination without paying us one cent. Read them. Look them over. Use the jiffy index which enables you to put your finger on wanted facts instantly. Then decide whether or not you want to keep them.

Practically every auto fact is covered. Diesel engines, aviation motors, outboard motors, motor cycles, tractors, superchargers and other up to date features are all included. In addition they tell you how to do every auto job RIGHT the FIRST TIME.

Make More Money

Why not qualify for a BIG PAY JOB? Be the man who knows the answers. Be a foreman, superintendent or manager. Over 23 million auto owners need men who know how, who don't have to guess to find out what's wrong and who can fix it quickly. Learn auto engineering with these wonder books without studying or memorizing. Use the jiffy index to look up the answer to any auto problem.

6 Big volumes bound in gold stamped flexible binding. Over 2600 pages, 2000 illustrations, wiring diagrams, equipment charts, etc. Printed on fine paper in extra clear type with the famous jiffy index for quick fact finding. Here are the most up to date automobile books ever published.

AMERICAN TECHNICAL SOCIETY
Drexel Ave. at 58th St., Dept. AB19, Chicago, Ill.

Can You Fix It?

Can you adjust knee action and other phases of modern automobile construction? Do you know the details of automatic gear shifts, booster brakes, and other newer items of equipment? Can you handle a DIESEL job? In short, are you up to the minute on automobile design and repair? In these days you must know the answers to make the BIG MONEY. These books which we offer to send you FREE FOR EXAMINATION cover the entire automobile field including Service Shop Management.

CONSULTING MEMBERSHIP INCLUDED If you send for these books NOW on our free examination offer we will include a consulting membership in the American Technical Society good for one year. You have the services of our staff of experts without charge. Write or wire for information on any difficult problem. A reply will be sent promptly at no cost.

AMERICAN TECHNICAL SOCIETY
Drexel Ave. at 58th St., Dept. AB19, Chicago, Ill.

I would like to see the 6-volume edition of your AUTO BOOKS. I will pay the few cents delivery charges only. If after 10 days' use I decide to keep them, I will send you \$2 and pay the balance at the rate of only \$3 a month, until \$24.80 is paid. Otherwise I will return the books and owe you nothing. Include FREE, consulting membership as per your offer above. Send BRAND NEW edition including DIESEL.

Name.....
Address.....
City..... State.....

Please attach letter stating age, occupation and name and address of employer and at least one business man as reference.

LEARN TELEVISION

... at home! Absolutely NEW kind of training. In ADDITION to text books you get complete practical Television Equipment that actually transmits and receives. Fascinating, thrilling home training. Easy time payments... only 30c a day pays for BOTH training and equipment. Write for complete details and FREE book. No obligation.

Free Book!

American Television Institute
Dept. PM 738, 433 E. Erie St. Chicago, Ill.

Know Electricity as Experts Know It—and Get an Expert's Pay!

Recovery has begun! The months ahead are charged with significance and expectation. What will you do to get the jump on the other fellow?
Thousands of men have used

The Croft Library of Practical Electricity

The Croft Library is a complete electrical educator. It is founded on practice—on 20 years of shirt-sleeve experience—on work as it is actually done. It is jammed from cover to cover with the kind of hard-headed facts you want. Written so that the beginner can easily understand it, yet so sound, so thorough, that it is the daily guide of 59,000 highly paid electrical workers and engineers. Croft tells you the things you need to know about motors, generators, armatures, commutators, transformers, circuits, switchboards, distribution systems—electrical machinery of every type—wiring for light and power—wiring of finished buildings—underwriters' and municipal requirements—illumination in its every phase—the most improved methods of lighting—lamps and lamp effects, etc.—how to do a complete job, from estimating it, to completion.

No money down—easy payments
Fill in and mail the coupon attached and we will send you the entire set of seven volumes for ten days' Free Examination. We take all the risk—you assume no obligation. If you decide to keep the books, send \$1.50 in ten days and the balance at the rate of \$2.00 a month. Send the coupon NOW and see the books for yourself.

Want a Career in photography?

Become an expert in Commercial, News, Portrait, Advertising, Candid, or Motion Picture Photography. Big money-making opportunities! Or learn for pleasure. Learn at home or in our modern, completely equipped studios. 28th year. Free booklet.

NEW YORK INSTITUTE OF PHOTOGRAPHY
10 West 33 Street (Dept. 49) New York City

ARTISTS MAKE MONEY

Find out your ability. Send name, age, occupation and address for Free Vocational Art Test.

Federal Schools, Inc., 7138 Federal Schools Bldg., Minneapolis, Minn.

HOME STUDY COURSES

Home Study Courses leading to Degrees in Arts and Sciences; Philosophy; Education; Writing; Psychology; Chemistry; Theology; Law; Agriculture; Business; Accounting; Sales; Advertising; Electrical; Civil; Mechanical; Diesel; Architectural; Aeronautical; Automotive; Drafting; Radio; Air Conditioning; Refrigeration; Highway; Mining; Petroleum; Industrial; Steam; Chemical Engineering. Chartered by State of Illinois.
McKinley-Roosevelt Graduate College, 4228 Clarendon Ave., Chicago

Learn PHOTOGRAPHY at Home

Splendid opportunities. Prepare in spare time. Easy plan. No previous experience needed, common school education sufficient. Send for free booklet "Opportunities in Photography", particulars and requirements.

American School of Photography
3601 Michigan Ave., Dept. 135-B, Chicago, Ill.

When writing please mention Popular Mechanics

FREE EXAMINATION COUPON

McGraw-Hill Book Co., 330 W. 42nd St., New York

Send me for ten days' free examination the Croft Library of Practical Electricity. If satisfactory I will send you \$1.50 in 10 days and \$2.00 monthly until the price of \$19.50 is paid. If not wanted, I will return the books postpaid. (To insure prompt shipment write plainly and fill in all lines.)

Name.....
Home Address.....
City and State.....
Position.....
Name of Company..... PM-7-38

AN AVIATION CAREER OFFERS YOU A GREAT FUTURE

Dept. P.M.7 MAJOR CAREER COURSES

AERONAUTICAL ENGINEERING

MASTER MECHANICS

NAME _____ ADDRESS _____

Demand for trained aircraftsmen in Southern California plants is increasing and already exceeds supply. Curtiss-Wright Technical Institute, Aviation's foremost and oldest school, is located in heart of this activity and specializes in Sheet Metal, Master Mechanics and Aero Engineering. (No flying involved.) Graduates are obtaining immediate employment. Write for details NOW!
MAIL THIS COUPON TODAY

CURTISS-WRIGHT TECHNICAL INSTITUTE • GRAND CENTRAL AIR TERMINAL • GLENDALE (LOS ANGELES) • CALIFORNIA



*Small
Inventions*
**THAT HAVE
BUILT BIG
BUSINESSES**

INVENTIONS do not have to be complicated to be profitable when Patented. The 5c and 10c stores flourish on simple Patented products which are commercially successful. The zipper, safety pin, thumb tack, paper clip, collar button—all simple, yet familiar inventions—brought their inventors rich rewards. If you have a Patentable invention—act to protect it. Many of the most useful, widely popular, greatly profitable, and

extremely successful inventions have been very simple ones. You have only to look at the devices we have pictured here to realize how a simple invention may become a utility bought by a hundred thousand or a million people soon after it is produced. Don't be afraid that the simplicity of your invention makes it valueless. The thing that you find so simple that you wonder why a thousand other people haven't already done it is often the invention worthwhile.

HOW OTHER INVENTORS GOT STARTED



The list of men who succeeded in invention with only a poor boy's start is a very long and noble one. Poverty, hardships, lack of friends, distance from the market—these could not hold back Bell, Edison, Eastman, McCormick, Whitney and others. Everyone cannot succeed. But every man can try. Courage, sacrifice, and hard work may bring you a measure of the success these men had. Lack of mechanical ability is not a serious drawback. You can always get someone able to build a model, draw a detailed design, or otherwise materialize your invention for you. The big drawback is discouragement.

Your invention of a practical article or an improvement upon an old one should

be patented NOW. Frequently many of the thousands of applications filed in the U. S. Patent Office each year are for the same or almost the same invention. In such a case, the burden of proof rests with the last application filed. Sometimes a delay of even a few days in filing the application means the total loss of the patent. **LOSE NO TIME.**

The entire time of this large and experienced organization is devoted exclusively to patent and trade-mark cases. We know the rules and requirements of the Patent Office. We understand the technicalities of Patent Law. We can proceed in the quickest and safest ways in preparing an application for a patent covering your invention.

FREE THE BIOGRAPHY OF GEORGE EASTMAN
Views of the man who used Patent Protection to amass millions and give perfection to a new art—*Photography*—itself one of the greatest inventions.

CLARENCE A. O'BRIEN & HYMAN BERMAN

70-K ADAMS BUILDING

WASHINGTON, D. C.

Registered Patent Attorneys Before U. S. Patent Office

When writing to advertisers please mention Popular Mechanics

Send For This
FREE BOOK

TIPS

PROTECT YOUR
INVENTIONS
WITH U.S.
PATENTS

If you have an invention that is patentable—and want to secure for yourself your inventor's sole right to profit from the invention—you can't afford to lose time in securing the protection of a U. S. Patent. Other inventors may be working on the same invention right now. Should they develop this invention and file patent application before you do—the burden of establishing priority will be upon you. Our Big Book—"Patent Guide for the Inventor"—will tell you the quickest possible way to secure Patent Protection for your invention. **SEND FOR IT TODAY!**

The **FIRST IMPORTANT STEP** in **SECURING A PATENT**—is to obtain the services of a Registered Patent Attorney. The U. S. Patent Office advises that you secure the aid of an experienced Registered Patent Attorney to prepare your statements. Establish the date of your invention as explained in our book and disclose your invention to him in correct form. He then makes a **SEARCH** of the Patent Office Records and reports to you on existing U. S. Patents which might bear on your invention, giving his opinion on the advisability of proceeding and filing formal application.

REASONABLE FEES—CONVENIENT TERMS. Don't worry about finances. Our fees are very reasonable—we can arrange convenient terms of payment. It is our custom to permit clients to pay for our services in installments as the application progresses in our office. See our Big Book for fees in obtaining Patent. It explains our arrangements clearly. Send for it **NOW!**

FREE RECORD OF INVENTION FORM—Use our **FREE** "Record of Invention" form to assist you in recording the descriptive outline of your invention and to establish the date of your invention. With it you can make a rough sketch of your invention and have it witnessed in a manner of value to you as evidence should occasion arise.

**TEAR OFF AND
MAIL NOW!**

**CLARENCE A. O'BRIEN
and HYMAN BERMAN**

70-K Adams Building, Washington, D. C.

Registered Patent Attorneys
Before U. S. Patent Office

Please send me at once your Big Free 48-Page Book, "Patent Guide for the Inventor" and your Specially Prepared "Record of Invention" form. This request does not obligate me.

Name.....

Address.....

(Please write or print plainly)

PATENTS

Booklet Free Highest References
 Promptness Assured Best Results
 Send drawing or model.

ALL BUSINESS GIVEN PROMPT AND PROPER ATTENTION

Listed Patent Lawyer in the latest editions of the Rand-McNally Directory of Bankers and Bank-Recommended Attorneys, published by Rand-McNally & Co., Chicago, Ill.; The Baggott & Ryall Directory of Guaranteed Attorneys, published by Legal Directory Corporation, Boston, Mass.; American Lawyers Annual, Cleveland, Ohio; Bankers Service Legal Directory, published by Bankers Service Co., Boston, Mass.; Eyre's Law List, 9 Park Place, New York City; Snow-Church Directory Co. Lawyers List, published in New York City, and the Central Guarantee Co., Bankers and Lawyers Directories, 630 Fifth Avenue, New York City.

WATSON E. COLEMAN, Victor Building, 724 Ninth Street, N. W.
REGISTERED PATENT LAWYER **WASHINGTON, D.C.**

INVENTORS PATENT YOUR IDEAS SEND FOR FREE BOOK



HOW TO OBTAIN A PATENT

Written by a Former Member of the Examining Corps (1922-24) of the U.S. Patent Office. If you want to profit by your idea, you should take steps to apply for a U. S. Patent at once. Your first step is to get this Free Book. This interesting illustrated book contains valuable information you should have. It tells you fully how to obtain a patent on your idea in the quickest way. With this Free Book you will also receive a "Record of Invention" form on which you can easily record your idea. Personal and Confidential Service: Your case will be personally handled only by a Registered Patent Attorney who is also a Former Member of the Examining Corps of the U. S. Patent Office. All communications confidential.

MAIL COUPON TODAY for FREE PATENT BOOK and RECORD OF INVENTION Form.

CARL MILLER
 REGISTERED PATENT ATTORNEY
 FORMER MEMBER EXAMINING CORPS U. S. PATENT OFFICE

Wentworth Bldg., 35th Floor, Dept. 78A, New York City
 MILLER BUILDING, Dept. 78A, Washington, D. C.
 Please send me your Free Book, "How to Obtain a Patent," and your "Record of Invention" form.

NAME.....
 ADDRESS.....

New Ideas now Salable Before Patenting

Practical, useful inventions may now be safely marketed without patenting expense. Write for proof that we successfully sell both patented and unpatented inventions.

Chartered Institute of American Inventors
 Dept. 4, Barrister Building, Washington, D. C.

PATENTS—TRADE MARKS

All inventions submitted held confidential and given personal attention by members of the firm. Form, "Evidence of Conception" and instructions, "How to Establish Your Rights"—FREE!

LANCASTER, ALLWINE & ROMMEL
 Patent Law Offices
 412 Bowen Bldg. Washington, D. C.

INVENTORS PROTECT & SELL

Your unpatented invention can be sold with positive safeguards under patent laws. New, low-cost procedure. Complete details, free.
AMERICAN PATENTS CORPORATION
 Dept. 4-E Washington, D. C.

ALBERT E. DIETERICH
THEODORE H. RUTLEY
 REGISTERED PATENT LAWYERS
 512 B Colorado Bldg. WASHINGTON, D. C.
Booklet on Patents sent free

INVENTORS who derive largest profits know and heed certain simple but vital facts before applying for patents. Our book, Patent-Sense, gives those facts; sent free. Trade Marks—Copyrights.
LACEY & LACEY, Est. 1869, 635 F St., N. W., Dept. 5, WASHINGTON, D. C.

No JOKE TO BE DEAF

—Every deaf person knows that—



Mr. Way made himself hear his watch tick after being deaf for twenty-five years, with his Artificial Ear Drums. He wore them day and night. They stopped his head noises. They are invisible and comfortable, no wires or batteries. Write for TRUE STORY. Also booklet on Deafness.



THE WAY COMPANY

729 McKenley Bldg. Detroit, Michigan



BUCHSTEIN'S FIBRE LIMB

is soothing to your stump—strong, cool, neat, light. Easy payments. Braces for all deformities. Agents wanted.

D. BUCHSTEIN CO.
 810 3rd Ave., So., MINNEAPOLIS, MINN.



Earn Cash at Home!

We paid M. M. \$1174 for exceptional collar crop Snow-King mushrooms! We furnish materials; buy all crops. Big FREE picture book tells if your cellar, shed, suitable. Est. 1908. Write today.
United Co., 3848 Lincoln Av., Dept. 303, Chicago



RAISE GIANT FROGS

WE BUY! Good prices year round! Other markets waiting for all you can ship. Get ready now for next spawn. Breeder lays 20,000 eggs yearly. Small pond starts you. Free book shows sketch. Send no money. Write American Frog Canning Co. (Dept. 133-M), New Orleans, La.

In answering advertisements always write name and full address clearly.

To PROTECT YOUR INVENTION Use this coupon, NOW

Delays are dangerous and may be very costly. My personal service assures prompt action, strict confidence, and a minimum of expense. I suggest that you send me a model or drawing, or sketch and description of your invention, and \$5.00. I will make a search and report

promptly as to its patentability and send you a copy of my 72-page booklet. Or, if you prefer to read my booklet first, mail the attached coupon at once. I will also send my "Record of Invention" form. (Over 38 years experience as a Registered Patent Attorney.)

L. F. Randolph, 302-D Victor Bldg., Washington, D.C.

Please send me at once, free of charge, your 72 page booklet and "Record of Invention" form.

Name.....
 Address.....

A PERSONAL CONFIDENTIAL PATENT SERVICE

WANTED Ideas

For New Uses of Cast Iron

Will Pay for Ideas Accepted

Write Giving Details But Do Not Send Models or Samples

Dept. X, 631 St. Clair St., Chicago



Only 22¢ a Day
Puts This All-Purpose
ELECTRIC ARC WELDER
IN YOUR SHOP

TEN-DAY TRIAL
Guaranteed: 10 Months To Pay

Details FREE

Now, for first time, it is EASY for every inventor, laboratory, home workshop owner, garage, repair shop, and factory to afford a complete welding service for manufacturing, maintenance, experimental, or repair work. Full size, heavy-duty Electric Arc Welder—Commonwealth Model 120-FS—yours for only 22¢ a day! Has efficiency of machines costing \$250.00 to \$1,000.00. Welds all metals and alloys. Six heats handle everything from fenders and light sheet metal to motor blocks and heavy castings. Also fine for soldering and brazing.

WORKS ON 110 OR 220-VOLT A. C.

Simply plug into 110 or 220-volt, 60-cycle A. C. electric socket. Costs only few pennies an hour to operate. Anyone can use easily. Comes complete with helmet, electrode holder, welding rods, full instructions, etc. Nothing else to buy. Fully guaranteed.

WRITE FOR 22¢ A DAY PLAN

Stop throwing away profits! Do your own welding. Get sensational facts about Model 120-FS and 22¢-a-day plan. Write today!

COMMONWEALTH MFG. CORP.

Dept. K-51 4208 Davis Lane, Cincinnati, O.

Free • DRAFTING TRIAL LESSON IN



More good jobs now in Drafting. Learn AT HOME in spare time (or at our Chicago School). Send post card for FREE TRIAL LESSON and see how easy to learn and get a good job.

CHICAGO TECHNICAL COLLEGE
H209 Tech. Bldg., 118 E. 26th St., Chicago, Ill.

If you can go away to college to learn Drafting, Engineering, Architecture, Electricity, Air Conditioning or Radio—send for Free Blue Book.

Learn Public Speaking

At home—in spare time. Many overcome "stage-fright," gain self-confidence and increase earning power, this easy way. Write for free booklet, *How to Work Wonders With Words* and requirements. North American Institute, Dept. 135B 3601 Michigan Ave., Chicago, Illinois

HOW to Protect and capitalize on your INVENTION

Get these FREE BOOKS of "IDEA" Opportunities



Is your idea patentable? Has it commercial possibilities? Those are the things you want to know--and interesting information on these questions can be found in our books "How We Protect You" and "Suggestions on How to Commercialize Your Invention". We will send you these absolutely FREE--together with our Certification of Invention form, if you mail the coupon below NOW!

OUR EXPERIENCE GUIDES YOU
You can feel perfectly sure in dealing with this reputable firm. C. A. Snow & Co. has been securing patents of every description for 63 years. Save time and expense now by getting advice based on our long patent experience.

C.A. SNOW & CO.
Registered Patent Attorneys Since 1875

MAIL NOW FOR FREE BOOKS

Dept. 178 SNOW BUILDING, WASHINGTON, D. C.

Gentlemen: Please send me absolutely free and without obligation on my part, your original document "Certification of Invention", together with your two guides for Inventors, "How We Protect You" and "Suggestions On How to Commercialize Your Invention."

Name.....
Street and No.....
City or Town..... State.....

★ GET ON "UNCLE SAM'S" PAYROLL ★

Many Appointments Each Year

\$1260 TO \$2100 FIRST YEAR

Common Education Usually Sufficient
Short Hours—Vacations With Pay
MEN—WOMEN
Mail Coupon immediately—today sure. Hurry.

FRANKLIN INST., Dept. T195, Rochester, N. Y.
Gentlemen: Rush to me, without charge, 32 page book with list of U. S. Government big paid positions obtainable. Advise me also regarding salaries, hours, work, vacation, etc. Tell me how to qualify for a position.

TEAR HERE
Name.....
Address.....

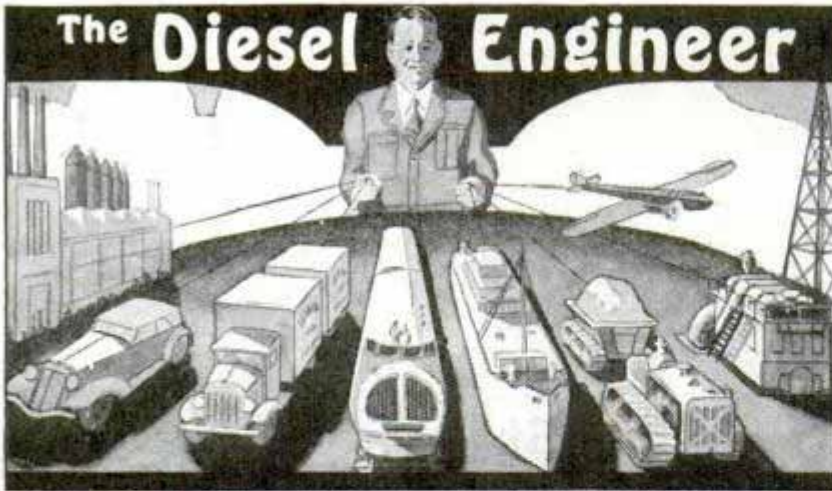

Is Your Job Safe?

Just as the gasoline engine changed the jobs of thousands who depended on horse-drawn vehicles for their living—so now the Diesel engine is fast invading both the power and transportation fields, and threatening the present jobs of thousands.

What This Field Offers You

Diesel engines are replacing steam and gasoline engines in power plants, motor trucks and busses, locomotives and ships, aircraft, tractors, dredges, pumps, etc.—opening up well-paid jobs for Diesel-trained men. You get all the latest Diesel developments in our course. Special diagrams for quick understanding of this new power.

For Men Earning Under \$40 a Week

Diesel — The New Power

Now is your chance to get into a big new industry and grow up with it to an important position. Today there is practically no competition in the Diesel field, but the increasing use of Diesel engines will result in keen competition for jobs after a few years. If you start your training now and get established in this field, you need not worry about competition.

AMERICAN SCHOOL, Dept. DB 45, Drexel Avenue at 58th Street, Chicago, Illinois

Fit Yourself For a Good Pay Job

Job Facts in Diesel

Learn how quickly you can prepare for growing opportunities in Diesel by our Job-Instruction method. Train at home for this good pay field where there is chance for rapid promotion. Free employment service to graduates. Low monthly terms. If you want a good job get FACTS! Write for booklet today!

In answering advertisements always write name and full address clearly.

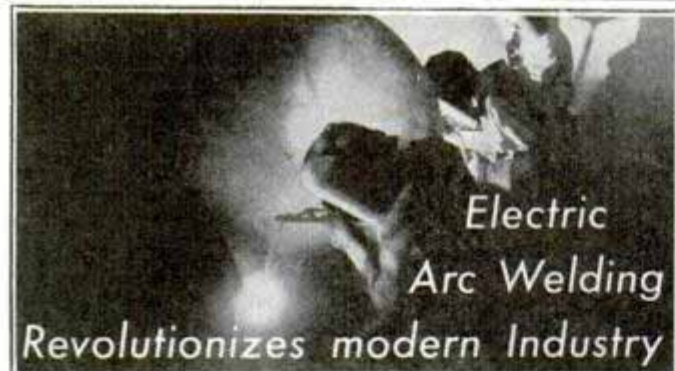

Electric
Arc Welding

Revolutionizes modern Industry

U. S. Manufacturers desire men to learn Electric Arc Welding and get practical experience under actual production conditions in the laboratories of the School of Engineering. Moderate training Fee. Accepted applicants will be fully trained until ready to pass rigid test and assisted in securing employment. presents one of the outstanding opportunities for steady income and future success. Welding is growing rapidly, replacing large and intricate castings, rivets, nuts, bolts, screws. It is commonly used in assembling cranes, hoists, bridges, structural steel work, etc. No limit to the application of welding to industry, increasing durability and reducing manufacturing costs. There is a decided shortage of properly trained Welding Operators, Technicians, and Welding Engineers. Why be content with ordinary work, hit and miss jobs and low pay when in a short time you can become a trained Specialist in Welding?

MILWAUKEE
SCHOOL of ENGINEERING
Institute of Electrotechnics

Dept. PM-738, Broadway & E. State, Milwaukee, Wis.

EXTRA!

'THE DAWN OF A GIGANTIC INDUSTRY' Seventh Edition! Just off the press! Get this new popular, fascinating large-size 68 page book, biggest ever published on Welding Training for Industry. It's free to Men of Action!

Without obligation send Free Booklet "The Dawn of a Gigantic Industry and its Outstanding Opportunity."

- Also tell me How to Become an
- Arc Welding Operator (3 1/2 mo.).....
 - Gas Welding Operator (6 wks.).....
 - Welding Technician (4 mo.).....
 - Welding Engineer (1 yr.).....
 - Electrical Engineer
 - B. S. Degree (4 yrs.).....
 - Air Conditioning & Refrig. Tech. (3 mo.).....
 - Radio Serviceman (6 mo.).....
 - Student Loan Plan.....
 - Extra Part Expense Plan.....

Name.....Age.....
City.....
State.....(PM-738)



CARTOONING

To those earnest students of this fascinating profession who realize the advantage of PERSONAL INSTRUCTION by a nationally known cartoonist, I offer a system of study recommended by America's foremost cartoonists. It's as near like private tutoring as is possible in a home study course. Write at once for free details.

DORMAN H. SMITH, Box C597, San Rafael, California

Know! YOUR CAR

ASK TO SEE IT!



GOOD NEWS—JUST OUT

1938 AUDELS NEW AUTOMOBILE GUIDE is NEW from cover to cover. Explaining the Theory, Construction and Servicing of modern motor cars, trucks and buses; and the application of auto type Diesel Engines. . . . PRACTICAL INFORMATION IN HANDY FORM, 1540 PAGES COVERING . . .

AUTO REPAIRS & SERVICE HELPS

All the Parts of an Automobile—Automotive Physics—The Gas Engine—How a Gas Engine Works—Gas Engine Principles—Multi-Cylinder Engines—Horse Power—Automobile Engines—Engines: Stationary Parts—Engines: Moving Parts—Pistons—Piston Rings—Connecting Rods—Crank Shafts—The Valves—The Valve Gear—Cams and Cam Action—Valve Timing—Cooling Systems—Gasoline—Fuel Feed Systems—The Mixture—Carburetors—Automatic Choke—Super-Chargers—Transmissions—Synchro-Mesh—Clutches—Universals and Propeller Shafts—The Differential—Rear Axles—The Running Gear—Brakes—Wheel Alignment—Knee Action—Steering Gear—Tires—Lubricants and Lubrication—Automotive Electricity—Ignition Systems—Magneto Ignition—Spark Plugs—Ignition Coils—Distributors—Automatic Spark Control—Ignition Timing—Generators—Starters—Generator and Starter Testing—Lighting Systems—Storage Batteries—Battery Charging—Battery Testing Troubles, **Automotive Diesel Engines.** Inside Views of all Automobile Parts Fully Illustrated. To Get This Assistance for Yourself Simply Fill in and Mail Coupon Today.

\$4 COMPLETE • PAY ONLY \$1. A MONTH

THEO. AUDEL & CO., 49 WEST 23rd STREET, NEW YORK Please send me postpaid AUDELS NEW AUTOMOBILE GUIDE (\$4) for free examination. If I decide to keep it, I will send you \$1 within 7 days; then remit \$1 monthly until purchase price of \$4 is paid. Otherwise, I will return it to you promptly.

Name.....
Address.....
Occupation.....
Reference.....-PM

ATHLETE GAINS 4 LBS. IN 1 WEEK

Like Thousands of Men and Women He Found Kelpamalt, the Excellent Mineral Concentrate—Rich in Sea-Plant Iodine—A Splendid Easy Way to Add Pounds, Strength and Energy!



To the right is a picture of T. P. Ryan of New York City. He writes, "I had been underweight for years. Kelpamalt quickly put on 4 healthy pounds for me the first week!" If you, too, are skinny, scrawny, run-down, pounds underweight, try Kelpamalt for one week. This excellent mineral-iodine concentrate helps the system get all the real good out of food. Your own doctor will approve this harmless way. Costs but a few cents a day to use and is sold at all good drug stores. Get SEEDOL KELPAMALT today.

AMAZING MACHINE GROWS HAIR



BEFORE



AFTER

Only \$9.95 COMPLETE

"Intermittent Vacuum" stimulates deep-lying scalp blood vessels—and GROWS HAIR in thousands of cases of baldness. Stops falling hair, Tones up scalp. New hair often in 90 days. Easy to use this amazing machine at home. Only \$9.95 complete. Write quick for FREE TRIAL OFFER. RAND, DEPT. K-1662, NEWPORT, KY.

FULLY GUARANTEED METER

Tells How to Use—

Concrete About the Home; Concrete in the Garden and Yard; Concrete About the Farm; Concrete Homes and Buildings; Making Recreation Devices; Concrete in the Workshop; Concrete Products for Manufacture; Concrete in Business and Industry, etc. Gives 146 Concrete Kinks.



The Book of the hour for the workshop fan, handy man and home owner.

Money Making Facts - Best Methods - Materials - New Colored Concrete - 146 Kinks

"1001 Ways to Use Concrete" strips the mystery from the fascinating work of making useful articles and permanent improvements with concrete. This book, just published covers every known use of concrete for the home, farm, building, business and industry, plus newer uses in decoration and arts. Includes new fast setting and gloriously colored concrete and 146 valuable usable kinks. 1001 uses of concrete including homes, garden furniture, pools, statuary, etc., recreation devices, farm improvements, driveways, walks, etc. Describes all methods and materials. Shows how to do real professional type jobs.

NEW Concrete BOOK

Makes Cement Work of All Kinds Easy

256 Pages — 16 Colored Plates, Hundreds of Pictures

Large book 7 x 10 inches. Handsome cloth binding. Sent postpaid for only \$5. Sent COD in U. S. if preferred. Order today. Make concrete work a fascinating hobby or a profitable business.

POPULAR MECHANICS PRESS - 200 East Ontario St., Dept. 730C - CHICAGO

FOR MEN WHO WANT TO LEARN A PROFITABLE TRADE

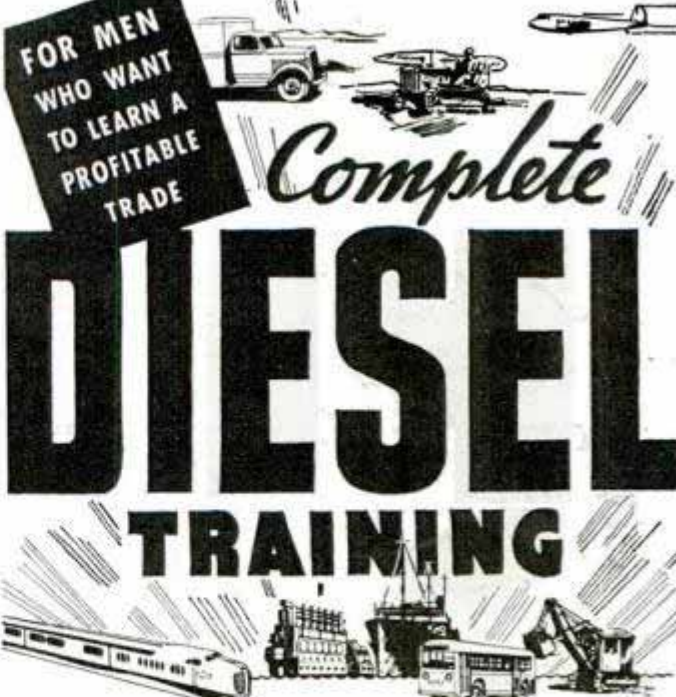

Complete DIESEL TRAINING

—with all types
INTERNAL COMBUSTION ENGINES, ELECTRIC POWER GENERATION, etc.

YOU MEN who are sincerely ambitious to make good in the Diesel and related industries, want to know the true facts—you want to know about employment opportunities and employment requirements. For 33 years, National Schools, a recognized leader in the field of trade education, has played a vital part in helping wide-awake men to qualify for success in industry. National Schools—a million-dollar trade school—will supply you with a sincere, honest statement of facts on what you should do to get into the profitable Diesel Industry. No exaggerations—no mis-statements.

YOU NEED REAL SHOP EXPERIENCE WITH TIME-TESTED TRAINING

Mail the coupon below. In the literature you will be sent, you will see exactly how other men like you are preparing themselves for success in National's modern training shops. You learn on the latest, finest equipment. You do real job work. You learn by time-tested, shop-practice methods. Your training is fascinating in every detail. You are taught how to make good, and helped to make good after you graduate. All of this and much more is clearly pictured for you in the Free Book of Facts we will send to you.

TRANSPORTATION ALLOWED TO LOS ANGELES

National Students are allowed coach railroad fare from any point in U. S. (Canadian students from nearest point of entry.) Student social life includes inspection trips, excursions, athletic activities, etc. Special doctor service. Personality coaching. **Many students are helped with spare-time jobs to earn room and board while learning.** (Canadians excepted.) Graduate employment cooperation.

NATIONAL SCHOOLS

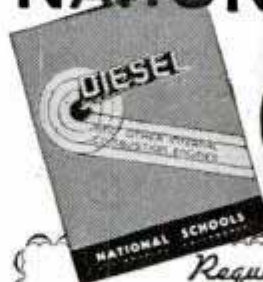

FREE BOOK

Los Angeles

Request for Free Book

NATIONAL SCHOOLS (established 1905) Dept. PMA-7
4000 South Figueroa Street, Los Angeles

Please send me, without obligation, your FREE BOOK and information regarding Diesel Employment Opportunities and Requirements.

NAME _____ AGE _____

ADDRESS _____ CITY _____ STATE _____

When writing please mention Popular Mechanics

1939 1940 1941 1942 1943 1944 1945 1946 1947 1948



The leaders of the next ten years will largely be determined in the next ten months. Will you be one of them?

Will You Be Clerk or Manager Ten Years from Now?

"SURELY, this could never happen to me," you say—"that I should be sitting at the same desk—be doing the same work—for ten straight years!"

But wait a minute—

Exactly that same thing has happened to thousands upon thousands of men. It has probably happened to men right in the company you now are working for. And—unless you fit yourself for a better job—there is a very good chance that it may happen to you!

Unthinkable? That's what J. N. Dixon of Columbus, Ohio, said to himself. Yet lack of training kept him slaving away at low wages for a long time.

TRIPLES INCOME

Here is Mr. Dixon's own story—"Just after I returned from the war, one of your representatives found me plugging away at a bookkeeper's job in Marietta, Ohio. He performed a real service and explained to me the need of further training, and induced me to take the LaSalle training in Higher Accountancy. After a few months of study, I secured a position with the Trust Department of a National Bank. This was the stepping stone I needed to various responsible positions including handling of receiverships and other important duties. That quickly boosted my income several hundred percent."

ANOTHER AMAZING SUCCESS STORY

If you think Mr. Dixon's success story unusual, please read what J. H. Krouse of Memphis, Tennessee, says. "When I decided to take your training in Higher Accountancy, I was a clerk. Today I am Chief Consultant Accountant for the U. S. Engineer's Office in Memphis, Tenn. Whatever success or recognition I have had, I owe to your training. I have had no other specialized training along this line. Your method of teaching is not only instructive but highly engaging. I have observed other courses, but firmly believe LaSalle has the best to be had anywhere."

Another bit of proof is Mr. R. P. Barthalow's experience. Mr. Barthalow is Chief of the Sales Tax Section of the Tax Commission of Ohio. A department which handles over \$50,000,000 a year. Mr. Barthalow attributes much of his success to LaSalle training.

SEND FOR These Two Books and Start Toward Bigger Success

Need you hear more before you investigate the opportunities in Accountancy?

Or will you face the problem of your future NOW—and send to LaSalle and get further facts and particulars?

Without cost or obligation, the coupon will bring you two interesting books—one a 64-page book entitled, "Accountancy, the Profession that Pays"; the other "Ten Years' Promotion in One."

How about those next ten years—will you wait or will you START TODAY to realize the tremendous opportunities that may lie ahead of you through sound and practical home-study business training?

Measure your grit and ambition by what you do with this coupon—NOW.

LASALLE EXTENSION

LASALLE EXTENSION, Dept. 764-HR, CHICAGO

Opportunities in Accountancy—Check below and we will send you a copy of "Accountancy, the Profession that Pays," also copy of "Ten Years' Promotion in One," all without obligation.

Higher Accountancy: Leading to position as Auditor, Comptroller, Certified Public Accountant, Cost Accountant, etc.

Other LaSalle Opportunities: If more interested in one of the other fields of business indicated below, check that.

- | | | |
|--|---|---|
| <input type="checkbox"/> Business Management | <input type="checkbox"/> Traffic Management | <input type="checkbox"/> Stenotypy |
| <input type="checkbox"/> Expert Bookkeeping | <input type="checkbox"/> Law: Degree of LL. B. | <input type="checkbox"/> Business English |
| <input type="checkbox"/> C. P. A. Coaching | <input type="checkbox"/> Industrial Management | <input type="checkbox"/> Commercial Law |
| <input type="checkbox"/> Modern Salesmanship | <input type="checkbox"/> Modern Business Correspondence | <input type="checkbox"/> Effective Speaking |

Name _____ Age _____

Present Position _____ Address _____

When writing to advertisers please mention Popular Mechanics





CLASSIFIED

Advertisements



Advertisements in this section, 35 cents per word, each insertion, minimum 10 words, payable in advance

To be inserted under proper classification in August issue, copy should be in our office June 8th

August issue on sale July 1st

Popular Mechanics Magazine, 200 East Ontario Street, Chicago, Illinois

YOU'LL PROFIT

By reading and answering the classified ads in this section. Hundreds of opportunities to make and save money.

Popular Mechanics,
Chicago, Ill.

Gentlemen: We have been doing a little seasonal advertising every year for about twenty years to dispose of a limited amount of ginseng seed and naturally placed these little classified ads in agricultural papers, but a few years ago tried Popular Mechanics and much to our surprise, found Popular Mechanics a better advertising medium for this special crop than any farm, agricultural or horticultural publication. We thought you might care to know this.

(Original letter on
file in our office)

Yours truly,
LAKE SARAH SPECIALTY FARM.

AUTOMOBILES

CHEVROLET Owners—Send 50c for illustrated chart and gauges, guaranteed save price daily, saves gas, oil, repairs, motor smoother, quieter, always starts cold, rain, snow. H. F. Willey Sales Co., Brookings, South Dakota.

MIDGET Racing book; facts for fans, builders, drivers; track sizes, regulations; pictures, specifications, working drawings. \$1.00 postpaid. \$1.15 C.O.D. Ray Kuns, Department 27, Madisonville, Cincinnati, Ohio.

MIDGETS! Parts, plans, building kits. New catalog, plan book, 10c. Shipps Midgets, Box 543-H, Zanesville, Ohio.

MAKE Simple, costless cylinder oil reclaimer—save hundreds. Oil doesn't wear out. Instructions 50c. Thermo Laboratory, Peoria, Ill.

MIDGET Cars, parts, plans. Catalog dime. Derby Midget Cars, Woodstock, Ill.

FORD V-8's, 1934-1938; gasoline saving device. \$1. Walert Co., 3429 No. 10th St., Milwaukee, Wisconsin.

AUTOMATIC Exhaust gas receiver on auto. Eliminating Co. Patented. Sale. Hollister, Uruapan, Mexico.

REFINISH Your car. Instruction book treats all phases of painting and refinishing autos and trucks. Written for the man who wants to renew his own car, but covers also the business end of refinishing for the professional. \$1.65 postpaid. Popular Mechanics Press, Room (C36), 200 E. Ontario St., Chicago.

AUTO SUPPLIES AND EQUIPMENT

MECHANICS: Don't turn away Ford valve work if your present refacer has no "Stem Clearance Grinder Attachment." The "Valvak" stem grinder and gauge gives proper tappet clearance in about same time taken to adjust tappets on other cars. Literature free. Valvak Sales Co., 7446 Belmont, Chicago.

TIRE Paint, gallon \$1.00. Tire strippers, dozen \$1.00. Industrial crayons, dozen \$1.00. Klondyke's, 2605-2601 Fort St. W., Detroit, Mich.

USED Midget autos, motors, parts service. Direct owner prices. Latest lists, 20c. Shipps, Box 543-H, Zanesville, Ohio.

SAVE 33-1/3%! Amazing new directional safety signal for automobiles. Flashes a brilliant warning. Easy to install. No drilling. Ornamental. Complete \$3.25. Write for circular. Direct-A-Turn, 3623 Dickens, Chicago.

AIRLOCK Stops punctures, lengthens tire life. Fully guaranteed. One tire \$1.00, four \$2.50. Airlock Laboratory, 1460 Hollywood Ave., Chicago, Illinois.

FREE 1938 Wholesale bargain catalogue auto supplies, equipment, tools. Lefte, 1189 Bedford Ave., Brooklyn, N. Y.

SAVE Half! Guaranteed reconditioned truck and auto parts. All parts, all models, makes. Catalog free. General Auto, 7008-AA Cottage Grove, Chicago.

PLATING Outfits for auto parts. Connect to a battery. No tanks used. Free particulars and proofs. Gunmetal Co., Ave. J, Decatur, Ill.

AUTO TRAILERS

BUILD The famous, low-cost Jim Dandy Cabin Trailer. Complete plans and instructions 50c. Plans to build the beautiful, streamlined Jim Dandy Cabin Cruiser, \$1.00. Trailer Builders Manual and catalog of trailer parts, supplies and equipment—over 100 interesting, illustrated pages, 25c. Order today. Satisfaction guaranteed. Trailer Supply Co., 411-A Jackson St., Wausau, Wisconsin.

LEARN Engineering facts about trailers. Build your coach from drawings in Trailer Engineering book. Choice of four plans. Order your copy now—\$1.00 postpaid; \$1.15 C.O.D. (No parts.) Ray Kuns, Dept. 7, Madisonville, Cincinnati, Ohio.

MOTORCYCLES, BICYCLES, MOTOR SCOOTERS AND SUPPLIES

SAVE. Enjoy scooters. Make your own. Plans one dollar. L. R. Bault, Spencer, Indiana.

BUILD Your own Motor Scooter. We furnish parts, drawings. Literature dime. Comet Cycle Company, Box 3032, Madison, Wis.

PERFECTED American made generator eliminates batteries for bicycle lamps. Many exclusive features. Send for descriptive circular. Bike-Lite Company, 1624 Junction Ave., Racine, Wisconsin.

SEND 10c For new 1938 Handbook of Information, listing new and used parts for all makes of motorcycles; accessories, batteries. Bootz, 622 East Grand, Des Moines, Iowa.

ALLOY Pistons—Harley, Indian, Henderson, Excelsior, Cleveland. New and used parts for less. Cylinder grinding. Catalogue and wings pin 10c. Ballak, 1115 Chestnut, St. Louis, Mo.

REBUILT Motorcycles, all makes, new and used Harley-Davidson parts. Send 10c for bulletin. Western Harley-Davidson Distributors, 914 E. 15, Kansas City, Mo.

RECONDITIONED Motorcycles. New—used parts for all makes. Authorized Harley-Davidson dealer. Whitman Motorcycle & Supply Co., 405-9 Southwest Blvd., Kansas City, Mo.

INSIDE Dealer prices. Overstocked, all models, Indians and Harleys. Rebuilt, guaranteed. Dime brings latest list. Crandall-Hicks, Boston, Mass.

SEND 15c For illustrated used motorcycle catalog. Bargains. Largest stock genuine Indian parts and motorcycles. Indian Motorcycle Sales, Kansas City, Mo.

MOTORCYCLE Bargains, lowest prices, bargain sheets for stamp. Motorcycle accessories, Rochester Harley Davidson Corp., 129 W. Main St., Rochester, N. Y.

AVIATION

INSTRUCTION For professional airmen. Transport license texts which take the drudgery out of study are published only by Thompson Aviation Publishers, 8316 Woodward Avenue, Detroit, Mich. Write for outline.

PROPELLERS: Sled, airplane. Catalog free. Woodcraft Propellers, General Delivery, Dallas, Texas.

DALLAS Aviation School, government approved. Best in the United States. Save time and money. Write for illustrated catalog. Dallas Aviation School, No. 7, Love Field, Dallas, Texas.

AVIATION Needs men. Pilots, mechanics, draftsmen, sheet metal, positions open. Learn now. Free catalog. California Flyers School of Aviation, Dept. PMC-7, Los Angeles Airport, Inglewood, California.

PROPELLERS. Quality, lowest prices, aeroplanes, sleds, fans, windchargers. Free catalogue. Standard Propellers, Fort Worth, Texas.

HOW To fly. Send dollar for student's manual. Anderson Flying Service, City Airport, Detroit, Mich.

AVIATION. "How to get into." Send stamp. Meyer, Box-8, Hempstead, N. Y.

PROPELLERS For airplanes, fans, sleds, iced blueprints. Catalog dime. Lorenzen Propellers, Niles, Michigan.

GET Into aviation. Air transport pilots get up to \$6,000 per year, mechanics \$2,500. Learn at this government approved school. Write for complete information. State age. Lincoln Flying School, 2004 Aircraft Building, Lincoln, Nebraska.

AVIATION Apprentices. Good pay—Big future. Write, immediately, enclosing stamp. Mechanix Universal Aviation Service, Strathmoor Station, Dept. E2, Detroit, Michigan.

BATTERIES, GENERATORS, ETC.

CITY Electricity from batteries. Costs nothing to operate. Wind charged. Special alternator runs radio, lights, machinery. Plans \$1.00. Harold Ramsey, Corn- ing, Ohio.

EDISON Storage batteries for light-power systems. Non-acid. Odorless. fifteen year life. Five year unconditional guarantee. Bargains in complete lighting systems. Low prices. Free illustrated literature. "See-Jay" Battery Co., 82 Sterling Ave., Yonkers, N. Y.

TWELVE Volt, 400 watt, heavy duty motor bus generators. Perfect condition. \$8.50 f.o.b. Chicago. Other units in stock. State Ignition, 52 Cullerton, Chicago.

EDISON Lifetime storage batteries for light and power. Eliminates acid battery diseases. Long guarantee. All kinds rebuilt generating plants, motors, and miscellaneous articles at bargain prices. Free interesting literature. T. Hawley Smith Co., Croton Falls, N. Y.

AIR CONDITIONING

BUILD Your own summer cooling system. Prints, plans \$2.00. Williams Engineering, 917 W. St. Joe, Lansing, Mich.

ALL Year air conditioning cabinet. Filters, heats, cools 1000 c.f.m. 15 deg. on 300 lbs. ice. Shipped knocked-down. \$95.00. Lists \$175.00. All sizes, bargains, ventilating fan, wheels, frames, guards, pedestals, blowers, air filters, save assembly costs. Texo Sales, Cincinnati.

ELECTRICAL SUPPLIES—EQUIPMENT

ULTRA Violet—Infra red. Dual ray health lamp. Two separate units in one. Promotes sun tan—vitamin "D." Automatic control. AC-DC current. \$3.90 postpaid. Details free. Beyer Mfg. Co., 4515-P Cottage Grove, Chicago.

ELECTRIC Eye catalog, and reprint "Photocell Experience in Factory" free for stamp. 32 page book "Electric Eye in Theory and Practice," 50c. Dept. 83, Photobell, 96 Warren Street, New York.

ELECTRIC Pen, engraves all metals, 50c prepaid. Hudson Bros., East Syracuse, N. Y.

ELECTRICIANS, Cut B.X. cable the easy way. Information 25c. Electric, 413 Sixth, Laramie, Wyo.

SAVE 25% On brand new nationally advertised $\frac{1}{4}$ " and $\frac{1}{2}$ " electric drills. Quantity limited. 15 Harper, Detroit, Michigan.

VACUUM Cleaners, all makes, suitable for rebuilding, etc. \$2.00 up. Talley's, 510 S. Tryon, Charlotte, N. C.

ELECTRO-SCRIBE: Electric pencil writes, engraves all metals. \$1.00 postpaid. Details free. Beyer Mfg. Co., 4515-K Cottage Grove, Chicago.

ELECTRIC FENCING

ELECTRIC Fencer—\$9.75 complete! Guaranteed. Detail free. Sentinel, Dept. K-929, Cincinnati, Ohio.

WELDING AND SOLDERING

DEMONSTRATORS, Electric arc welders. Money-saving prices. Used by the government. Trial and terms guaranteed. Hobart Welders, M-783, Troy, Ohio.

SPOT-WELDING, Soldering, brazing outfit \$2.95. Lynnpetcher, 2030 Julian, San Diego, California.

D.C. ARC-WELDER From 25-600 amperes, depending on size of d.c. motor salvaged from electric trucks, buses, automobiles, etc. Battery or generator excited. Instructive plans \$1.00. Welders Club of America, AB-3432, M-Mart, Chicago. Airmail or c.o.d. 12c extra.

ELECTRIC Arc welder, only 22c a day! Sensational commonwealth all-purpose heavy duty, continuous operation arc welder. Ten months to pay from profits. Handles all welding—lightest sheet metal to heaviest castings. Operates from electric socket. Complete, nothing else to buy. 10-day trial. Details free. Commonwealth, Dept. K-55, Cincinnati, Ohio.

LEARN Arc welding. A growing industry with great opportunities. Consult your local school, or if there is none available write The Lincoln School of Welding, Dept. A, Box 5758, Cleveland, Ohio.

MONEY Back guarantee, (if not satisfied.) Save money, buy real plans with actual proofs. Why purchase mimeographed, printed theory? Welders Club of America, AB-3432 M-Mart, Chicago.

MAKE Soldering easy. Tin and solder any metal, even cast-iron (not alum.) Money back, formula 25c, supply ready to use 50c, both 75c. Martin's Service, 1322 Potrero Ave., San Francisco, Calif.

REBUILT Electric arc welders, all sizes, a.c.—d.c. guaranteed. Lowest terms. Money-saving prices. Service Co., 3732 Cedar Ave., Cleveland, Ohio.

ELECTRIC Welders, 110-220 volt, fan-cooled, can be used for hours, \$75.00. Box 331, Hamilton, Ohio.

D.C. ARC-WELDER From 25-200 amperes using North-East (Dodge) automobile generators. Instructive plans \$1.00. Welders Club of America, AB-3432 M-Mart, Chicago. Airmail or c.o.d. 12c extra.

75-200 AMPERE Arc welder from Dodge generator. Complete plans and valuable catalog 35c. 100 other generator changes. LeJay Manufacturing, 347 LeJay Bldg., Minneapolis, Minn.

IS There money in welding? Recent book gives valuable information showing welding is a growing field offering opportunity to anyone looking for a trade. \$1 postpaid. Popular Mechanics Press, Room (C38), 200 E. Ontario St., Chicago.

ENGINES, MOTORS, DYNAMOS

ELECTRIC Drill \$3.67; shaver \$4.00; 10" oscillating fan \$4.35; candid type camera \$3.98. Home workshop tools. Bargain pricelist free. Mailorder Electric Co., 713 South Dearborn St., Chicago.

"PEPY" Gasoline engine governors: Automobile engines made power units for electric welders, saw rigs, generators, etc. Order on trial guarantee. \$7.50 postpaid. Harris Machinery, Minneapolis, Minnesota.

FOR Sale—Small elect. motors, high speed, 1/10 h.p., 115 volt, universal. Rebuilt—\$2.00 postpaid. McConnell, 1619 Edgewood, Racine, Wis.

THREE To ten KVA alternating generators. Motors, converters. Queen City Electric, 519 South California, Chicago.

GUARANTEED, Slightly used $\frac{1}{2}$ horse, 110 volt, alternating motors \$7.90. Wilmut Auto Supply, 2247 St. Paul Ave., Chicago.

BARGAIN— $\frac{1}{2}$ Hp. motors, 60 cycle, 1 phase, 110 volt, like new, guaranteed, \$8.25. Send check to Erie Electric Motor Co., 120 Church, Buffalo, N. Y.

WINDING Data, 225 motors, single and three phase. Price \$1. Motor Data Co., Box 7631, Kansas City, Mo.

MACHINERY, TOOLS AND SUPPLIES

KELLOGG Air compressors, \$6.00. Electric refrigerators, \$25.00. Lathes, Motors. Taylor, 105 East 102nd Street, New York.

BARGAINS, Demonstrators, electric arc welders, guaranteed, 30 days trial and terms. Write Hobart Welder Exchange, Box M-784, Troy, Ohio.

FAST Pumping air compressor from scrap. Large or small size. Plans \$1.00. John Merchant, Sanborn, Iowa.

STRETCH Your dollar with Atlas Shop Equipment. Metal and wood lathes, drill presses, arbor presses, shapers, vises, motors, grinders, tools, and attachments. Send for new 1938 catalog. Atlas Press Co., 1887 N. Pitcher St., Kalamazoo, Mich.

MOTOR Rails, silent, adjustable, vibrationless, fits 1/4, 1/3, 1/2 hp. electric motors \$3.00. Specialty Mfg. Co., 7520 Melrose Avenue, Los Angeles, Calif.

CONCRETE Building block machines and molds. Easy payments. Catalog free. Concrete Machine Co., 5 North Main St., St. Louis, Mo.

WANTED! Used power tools, shop equipment. Hundreds cash buyers. Write Tooling, Box 581, Zanesville, Ohio.

PAINT Sprays \$16.50 complete. Circ-lars. Burks', 1316 Prospect, Toledo, Ohio.

ATLAS Demonstrators, lathes, drill presses and accessories at big savings. 15 Harper, Detroit, Michigan.

PLASTICS, Brass, aluminum, Dowmetal, monel, stainless steel, gears, etc. Catalog 10c. Hobby Supply House, Box 2014, Pittsburgh, Penna.

SOUTH Bend 9" lathe milling attachment, universal movement, \$9; threading dial indicator, \$3; circular free. Unique Manufacturing Co., 4807 No. 31st Ave., Omaha, Nebr.

CASTINGS And blue prints for tailstock turret attachment for bench lathes—\$3.50. Milburn, Box 63, Covington, Ky.

POWER Hacksaw, three inch capacity, \$6.50. Milburn, Box 63, Covington, Ky.

12" x 6" SEBASTIAN Geared head motor drive Gold Seal lathe. Excellent condition. Write for bargain price. Cincinnati Machinery & Supply Co., 219 E. Second St., Cincinnati, Ohio.

BOATS, OUTBOARD MOTORS, ETC.

12-FOOT Flat bottom rowboat—complete plans 25c. Free boatbuilding catalog. The Rudder, 15 Murray St., New York.

BUILD A boat. Everything for building or equipping your boat. Build a boat by the Welch System. Use Welch Ready Cut parts. Inexpensive; interesting and profitable. Send 10c for catalog showing boats of many types; boat hardware; Welch White Cap motors. Welch Boat Company, Station K-1, Milwaukee, Wisconsin.

OUTBOARD Parts, new, used. Bargains new motors. Literature dime. Cramer's, 1500 N. Wells, Chicago.

SAIL Your canoe, rowboat! Complete rig \$12 to \$19. Try-sail Company, Patterson, New York.

ATTENTION! 12' Kayak kit \$10.00! Request circular. Playaks, Dedham, Mass.

FORD Marine conversion parts and kits. Models A, B, V8 (domestic or foreign). Catalogue 25c (coin). Osmitson, 3101 C Street, Philadelphia, Penna., U.S.A.

PROPELLERS, Gear pumps, stuffing boxes, bearings, etc. Wm. Baker, Pond St., Quincy, Mass.

FORD And Zephyr marine engines. Send 10c coin. Lehman Engineering Company, Newark, N. J.

ASSEMBLE Your own boat. Our finished knock-down frames and materials save you 2/3 builder's cost. All types and sizes. Send 25c for big catalog. Brooks Boat Co., Inc., D4, Saginaw, Mich.

OUTBOARDS—Save $\frac{1}{2}$. Good used parts, all makes and models. Bargains rebuilt motors. Crandall Hicks Co., 959 Commonwealth, Boston, Mass.

COMPLETE Your own boat with our pre-fabricated frames and materials. They're different. Save 2/3s and costly mistakes. Send requirements for quotations. Illustrated catalog 100 boats, 10c. Bay City Boats, Inc., Bay City, Mich., 1552 Adams St.

BOAT Designers are highly paid professionals. Complete course by mail. Catalog. Westlawn, Montville, N. J.

BUILD Your own boat—New book gives plans, methods, etc. 312 pages \$3. Popular Mechanics Press, Room (C38), 200 E. Ontario St., Chicago.

SPORTING GOODS, GUNS, FISHING TACKLE, ARCHERY

FISH Night or day. When the fish bites float lights. Dollar postpaid. Electric lighted lure, attractive to fish night or day, dollar postpaid. Fishy looking flyrod lures, indestructible, fifty cents. Satisfaction guaranteed. Dealers wanted. Free circular. Seigle's, Hinton, Oklahoma.

OIL Painting from photograph \$5. Portraiture, 826 Noble, Chicago.

FISH Bite like hungry wolves with my new amazing doughball fish bait. Tested secret formula. \$1.00. Baer, 1450 Elm-dale, Chicago.

DISGORGER You can use. Satisfaction guaranteed. Slides down line. Can't pass hook. 15c coin. C. R. Harkins, Dept. 3, 2152 Mt. Elliott, Flint, Mich.

MAGNETOS And guns skillfully repaired. Albert Schantz, Baden, St. Louis, Mo.

DIVING Helmets. Lake resorts, profitable attraction, inexpensive. Recover outboard motors. Engineering Sales, Man-kato, Minn.

TREASURE Finders? Read Goldak advertisement on page 130A.

TENNIS Rackets restrung. Genuine gut. \$2.50 postpaid. Harlan, 5307 S. Marsh-field, Chicago.

TENNIS Strings, gut, silk, tendon at sensational reductions. Write for free samples and prices. Crescent, 2535 Patricia, Los Angeles.

TENTS, Factory to you. Catalog free. Willis Co., Everett, Mass.

FLY And leader materials and tools. 24 page list free. Casting and trolling catalog free. For 104 page general fly tackle catalog full of valuable dope send 3c. Paul Young, 8065 C-6 Grand River, Detroit, Mich.

ARCHERY Headquarters—617 South State, Chicago. Catalogue free. Complete instruction book 50c.

HUDSON Bay blankets, Indian pack baskets, camp stoves, knives, compasses, outdoor equipment. Free catalog. Howe Fur Co., Box P, Coopers Mills, Maine.

FIELD GLASSES, TELESCOPES AND MICROSCOPES

TELESCOPES. Binoculars, microscopes. 10c brings catalog, coupon and money saving optical information. Hobby Man, Jefferson, Iowa.

LENS KIT makes 3" diameter 25-150 power astronomical telescope. \$1.00 postpaid. Instructions, lens list free. Optical Works, PM7B, Milton, Penna.

TELESCOPES. Microscopes, binoculars; 1938 bargain catalog free. Brownscope Company, 5 West 27th Street, New York.

FREE Instructions. Build powerful telescope. Atemsco, Box 213, Flushing, N. Y.

BUILD An astronomical telescope. Catalogue free. John Pierce, Springfield, Vermont.

TELESCOPES. Microscopes, binoculars, mineralogy, chemistry. Catalog free. Teeko, Evanston, Illinois.

ANTIQUES, RELICS, INDIAN GOODS

100 GOOD Arrows, tomahawk, \$3.00. Perfect clay pipes, \$2.50. Caddo Trading Post, Glenwood, Arkansas.

100 GOOD Arrowheads \$3. Catalog. 5c. H. Daniel, Hot Springs, Ark.

INDIAN Relics, beadwork, coins, curios, minerals. Catalog 6c. Indian Museum, Northbranch, Kansas.

TAXIDERMY

TAXIDERMY Supplies—Quality artificial eyes, teeth, genuine Jonas head forms. Tools, materials, etc. Everything for the progressive taxidermist. Send 10c for big illustrated catalogue. Jonas Bros., 1049 Broadway, Denver, Colo.

DOGS, PETS, BIRDS

REGISTERED Baby Saint Bernards. Dime brings photographic prospectus, free colored souvenir! Royal Kennels, No. 8, Chazy, N. Y.

FINEST Registered German shepherds. Roberts Pet Farm, Floyds Knobs, Indiana.

ST. BERNARDS; We want the name and address of every person who is a lover of good St. Bernards. A premium will be mailed free to everyone answering this advertisement. Lake Manitou Kennels, Watrous, Sask., Canada.

BEAUTIFUL Pure white police dogs. Ansonia Kennels, Mose, N. Dak.

POULTRY AND FARM SUPPLIES

MAKE Money with poultry. Read America's leading poultry magazine for latest information. Three years \$1.00; nine months 25c. Poultry Tribune, Dept. E-93, Mount Morris, Ill.

SEYMOUR Chicks. A grade Barred, Buff, White Rocks, Reds, Wyandottes \$6.75, pullets \$8.95; cockerels \$6.40. Leghorns \$6.25, pullets \$11.40, cockerels \$2.50. AA grade 1/2c per chick more. Seymour Hatchery, Box 36, Seymour, Indiana.

DAVIS Chicks for broilers and layers, 21 different breeds. Sexed chicks, poulters \$2.50-100 and up. Free catalog. Davis Poultry Farm, Route 34, Ramsey, Indiana.

GREENSBURG Chicks, \$2.50 per 100 and up. Also sexed checks. Greensburg Hatchery, Box 40, Greensburg, Indiana.

TREES, SHRUBS, ROOTS, HERBS

JUST Out! World's greatest "Herbalist Almanac." Beautifully illustrated in natural colors. Contains over 200 old-fashioned herb medicine recipes for home use. 10c postpaid. Worth dollars! Botanics, 145 W. 112th St., Chicago.

FARMS AND FARM LANDS

ATTENTION Iowans in California. Will sell to sportsmen, or anybody, eight acre corner plot, 14 mi. east of Ames, 1 1/2 mi. south of U.S. 30 on 2 good roads, my permanent home past 8 years, for best offer above \$5000. Location worth \$15,000, as prices of other things now stand. Complete description on request, no incumbency. Ernest L. Secor (Owner), Nevada, Iowa, R. 1, Box 99.

BARGAINS In land! Where crops are dependable. Washington, Minnesota, Montana, Idaho, Oregon and North Dakota. Literature. Impartial advice. Specify state. J. W. Haw, 119 Northern Pacific Ry., St. Paul, Minn.

FARMS That pay in the Great Northern Railway agricultural empire, Minnesota, North Dakota, Montana, Idaho, Washington, Oregon. Fertile black soil, high production crops, grain, fruit, vegetables, feed and livestock. Many kinds of farms for selection. Write for book on state you prefer. E. C. Leedy, Dept. 757, Great Northern Railway, St. Paul, Minnesota.

FLORIDA Chicken and fruit land, 2 1/2 acres \$99. \$1 down, \$1 weekly. Larsen, Bisbee Building, Jacksonville, Fla.

\$300 GETS Modern hwy. farm, splendid location for cabins, etc., on concrete highway; 2 acres in village; shade, fruit, good 5-room bungalow, bath, electricity, furnace; \$2800, only \$300 down; page 56 illus. 2000-bargain catalog free. Strout Ag'y, 255-P 4th Ave., New York City.

WANT To hear from owner of property for sale or trade. Details free. Real Estate Salesman, Desk B, Lincoln, Nebr.

40 ACRES. Near White River, unimproved; poultry land. \$175, \$5 down, \$5 monthly. Free list and literature. Hubbard, 216 Grossman Bldg., Kansas City, Kans.

PROFITABLE OCCUPATIONS

RAISE Guinea pigs. Make money, thousands needed. We supply breeders and buy the young. Write. Free information. Research Supply, 2436 W. York Street, Philadelphia, Penna.

M. M. earned \$267, three weeks, raising mushrooms in cellar! Exceptional, but your cellar, shed perhaps suitable. We buy crops. Book free. United, 3848 Lincoln Ave., Dept. 67, Chicago.

MAILORDER Profit-seekers attention! Money-making opportunities free! Jay, 6054-p Kenwood, Chicago.

"RAISE Frogs!" We buy! Good prices year round. Small pond starts you. Free book shows sketch. American Frog Raising, (153-M) New Orleans, Louisiana.

GROW Pearls—Make gold in bedroom. Postal brings information. Scientific Publishers, Woodside, New York.

TREASURE Finders? Read Goldak advertisement on page 130A.

MONEY In mail order business. Proven. Practical plans. Complete details for dime. Sasco, Box 65PM, Oakland, Calif.

CHEMICULTURED Vegetables, flowers, grown without soil are better. Full instructions, formulae and package chemicals \$1 postpaid. Chemiculture Laboratories, 2580 Venice Blvd., Los Angeles.

DISTRIBUTE Free samples, stamp appreciated. Thompson's Advertising, 440 Tusculum, Alabama.

WE Start you in business, furnishing outfits and instructions, operating Specialty Candy Factory home. Men and women, earn \$25 up to \$60 weekly, all or spare time. (Our 29th year.) Booklet free. W. Hillyer Ragsdale, Inc., Drawer 62, East Orange, N. J.

WANTED Original poems, songs, for immediate consideration. Send poems to Columbian Music Publishers, Ltd., Dept. P66, Toronto, Can.

SOILLESS Plant culture. Raise tomatoes, potatoes, flowers, etc., in shallow tank of water containing 21 chemicals. Tomato vines 20 feet, bear for year, 20 pounds per vine, quality better than soil grown. Instructions, formula \$1.00. Purdy's Chemicals, 1852 E. Slauson Ave., Los Angeles.

RAISE Rabbits and covies for us. We buy at top prices. Complete details in catalog, contract and magazine. 10 cents. Stahl, Box 1, Holmes Park, Mo.

FREE Booklet describes 107 plans for making \$20-\$100 weekly, in home or office, business of your own. Elite Co., 214 Grand St., New York.

COUNTRY Drives or movies afternoons! Work mornings home. No canvassing! Folio-H, Station D, Los Angeles.

RAISING Jumbo frogs. Interesting. Big future. Females lay 10,000 eggs. Free literature. American Frog Industries, Box 336, Rayne, La.

BOOKS, PERIODICALS, PICTURES, POSTCARDS

OLD Perfume, wine, magic and chemistry books. Catalogue dime. Carlton, Box 369, San Francisco.

MAGAZINE. Newspaper subscriptions. Money saving club prices. Castellazzo, 3717 Redwood, Oakland, Calif.

ANY Book in print. Booklet announcing current new books on request. Stenger's, 203 S. Dearborn, Chicago.

RARE Antique books. Some two hundred years old. List, ten cents. Friday, Streator, Ill.

GAMES—ENTERTAINMENT

PLAYS, Operettas, musical comedies, complete minstrel first-parts with song programs, blackface skits, vaudeville acts, monologs, dialog, recitations, juvenile plays and songs, musical readings, entertainments, make-up goods. Catalog free. T. S. Denison & Co., 203 N. Wabash, Dept. 11, Chicago.

MAGIC TRICKS, PUZZLES, JOKER NOVELTIES

ENTERTAIN—Magic, fun catalogue 6c. Postpaid. Columbia Novelty Mart, 1693 Broadway, New York City.

VENTRILOQUISM. Complete instructions and dialog \$1.00. Illustrated puppet catalog 25c. Frank Marshall, 5518 So. Loomis Blvd., Chicago, Ill.

KNIFE Throwing secrets exposed! Beginners and experts get this book now! 40 tricks and throws used by professionals. \$1.00 postpaid. Frank Dean, 1294 E. San Fernando, San Jose, Calif.

JUST Off the press! Our large catalog of magic for everyone. From the beginner to the professional magician. Send 25c for your copy. Chicago Magic Co., 2300 N. Mason Ave., Chicago.

BE A magician. Large professional magic catalogue of latest tricks 25c. Cash paid for complete Tarbell magic courses. Write. Ireland, C-109 North Dearborn, Chicago.

FREE Surprise trick. Joke novelties to everyone sending 10c for large illustrated catalog. Hobby Shop, Lorain, Ohio.

SVENGALI Magic decks, magic, magic cards, joker's novelties, puzzles, World's largest manufacturers. Catalog describing 300 items free. Adams Company, Ashbury Park, N. J.

FREE Tricks! Join Magicians' Fraternity! Monthly magazine, sample 10c. International Magicians, Mount Morris, Ill.

FREE! Magic catalog 500 tricks. Amaze. Mystify friends. Write today! Lyle Douglas, Station-A-5, Dallas, Texas.

EARN Money in any crowd. Call names of strangers, tell unspoken questions. Professional course mind reading, spirit writing, etc., \$1. Henderson, Box 341, San Bernardino, Calif.

LEARN Ventriloquism. 3c stamp brings particulars. Smith, 125 N. Jefferson, Peoria, Ill.

LARGE Professional magic catalogue, 25c. Holden, 220 W. 42nd St., New York.

MAGIC Catalogue, latest tricks, 10c. Frank Lane, Little Bldg., Boston, Mass.

RARE COINS

COIN Collectors—Read "The Numismatist." Monthly news on coins, medals, paper money. Published by American Numismatic Association. Annual dues including subscription, \$3.00; last half 1938, \$1.50. Sample copy 30c. Write for descriptive circular. Room 228, 99 Livingston St., Brooklyn, N. Y.

OLD Money wanted. Will pay fifty dollars for nickel of 1913 with Liberty head (no buffalo). We pay cash premiums for all rare coins. Send 4c for large coin folder. May mean much profit to you. Numismatic Co., Dept. 20, Fort Worth, Texas.

50 OLD Coins all different \$1.00. 100 different coins \$2.50. 20 dates large cents \$2.00. Claud Denney, Box 1825, Dallas, Texas.

INDIAN Head cent, and list 10c. Charles Banker, Salina, Kansas.

SOME Specimens 1909 cent worth \$10. We buy certain coins, common and rare. Others worth to \$6000; certain 1864-1865 Indian head cents \$100 each; dimes before 1895, \$450; Liberty head nickels before 1914, \$300; large pennies \$2000; encased postage stamps, \$13; half cents, \$275; half dimes, \$175; quarters, \$300; fractional currencies; paper money; gold dollars, \$1,500; colonial coins, \$300; silver dollars, \$4,000; 1933, 50c, \$4.00; foreign coins \$165, etc. Only certain coins worth top prices, but others have premium value too. Send 15c today for illustrated 1938 coin book, before sending coins. National Coin Corp., (82), Daytona Beach, Florida.

UNITED States commemorative $\frac{3}{8}$ s. five different, \$5.00. S. Koepfel, Merritt Bldg., Los Angeles, Calif.

UNCIRCULATED San Francisco mint cent and list 10c. 3 dates 25c. Landon, 901 Lucerne, Los Angeles.

\$5.00 TO \$2500.00 Paid for rare coins. Send 15c for 1938 latest 36 page illustrated coin buying book. Charles Fischer, (1), Chagrin Falls, Ohio.

12 DIFFERENT Dates large cents \$1. 10 different Confederate bills \$1. 50 different foreign coins \$1. New England Book Company, 1622 Hancock, Quincy, Mass.

UNITED States coins at bargain prices. 2c piece and newest 1938 selling price list 10c. Em. Cohen, Box 3507, Cleveland, Ohio.

COMMEMORATIVE Half dollars, Lincoln, Stone Mountain, Oregon, Texas, Cleveland, Kentucky, San Diego, Long Island, \$1.50 each. Illustrated catalogue No. 14, 25c. Norman Shultz, Salt Lake, Utah.

FREE! Foreign coin, banknote, and large illustrated coin catalogue. Send 4c postage. Coin approvals sent. Tatham Coinco, Springfield-125, Mass.

GET Profit and pleasure in collecting old coins. Send 10c for 56-page illustrated coin catalog. You'll be delighted with it. Send for it now. B. Max Mehl, 370 Mehl Bldg., Fort Worth, Texas. Largest rare coin establishment in U. S. Established 38 years.

\$5 TO \$500 Each paid for hundreds of old or odd coins. Keep all until posted. Many very valuable. Send 10 cents for illustrated Coin Value Book, 4x6. Guaranteed buying and selling prices. 31 years in business. Coin Exchange, Box 5, Le Roy, N. Y.

RARE U. S., foreign coins, war medals. Catalogue 10c. Mengelle, Colorado Springs, Colo.

STAMP COLLECTING

61 DIFFERENT Stamps including tiger, camel, other animal stamps, pyramids, ships, pictorials, British, French Colonials from Eritrea, Egypt, Toga, Africa, Asia, etc., 5c with approvals. American Stamp Co., Dept. 10, Frankfort, Ohio.

BEAUTIFUL Netherland triangle, jubilees, pictorials from Syria, Mexico, Australia and others only 5c with approvals. Kaiser, 302 Hurley, St. Paul, Minnesota.

SIX Cents brings set of Ecuador (U.S.) constitution stamps. Netherlands, Miner-va triangle, Von Hindenberg zeppelin and one hundred foreign stamps to approval applicants. Searle, Box 181, Mason City, Iowa.

FREE Stamp catalog: George VI issue, giant forty-page quarterly listing albums, supplies, coronations, Canadians, colonials, United States and foreign. Illustrations galore! Empire Stamp Co., Dept. P.M., Toronto, Canada.

HUNGARY St. Stephen religious stamp, unusual beauty; must be seen; set 4 different 10c. approvals. French, 1637 Superior, Cleveland.

LAST Call. The prices of the series of stamps issued by 16 nations in honor of the 150th anniversary of the U. S. Constitution are going up rapidly. Collectors who have not yet obtained all of them will do well to get them quickly or miss the greatest opportunity philatelists ever had. Already here are the U. S. Constitution stamps issued by Spain, Salvador, Guatemala, Honduras, France, Brazil, Ecuador, Poland, Dominican Republic, Nicaragua. Yet to come are Finland, Panama, Vatican City, Ireland, Haiti and Venezuela. Several of these issues are completely sold out, and most dealers can no longer supply them at any price. We, however, still have them all but will soon be compelled to raise prices. Most of these stamps are gorgeous beauties printed in many colors. Many show the American flag in red, white and blue or some other patriotic emblem. All are inexpensive. No stamps ever issued anywhere have greater beauty or will advance more rapidly in value. The Salvador stamp is the largest, showing the map of Americas with U. S. and Salvador flags in natural colors. We will send it for only 10c to approval applicants together with our free monthly bulletin, describing them all. Act now or regret later. Remember jubilees and Farleys! Approval Headquarters, Globus Stamp Company, 268 - 4th Ave., New York City, Dept. 201.

PICTORIAL Set six, 10c. Ten others free. Robert, 6864 Irwin, Montreal, Canada.

FREE Collection—25 different Portugal—for correct names and addresses of 3 active stamp collectors. Reimers, 100 Flatiron Bldg., Ft. Worth, Texas.

ECUADOR—Thousand mixed \$2.00. Ten thousand \$18.00. 75 different \$1.00. 125, \$2.00. America 500 different \$4.00. List free. Perrone and Campana, Box 749, Guayaquil.

A BIG Bargain—All for only 55c. Stamp album, providing spaces for 2200 stamps with 700 illustrations, packet of 500 different stamps, 500 hinges, and millimetre measure. Free with each order our pamphlet which tells "How To Make A Stamp Collection Properly," and our price list of albums, supplies and hundreds of bargains in sets and packets. Queen City Stamp Co., Room 36, 604 Race St., Cincinnati, Ohio.

UNPICKED Canadian mixture contains plenty coronations, new, obsolete issues, etc. \$1.00 lb. postpaid. Spier's, 975 James, Montreal, Canada.

5c BRINGS Magnificent world packet. Cat. value 65c. Approvals sent. Chautauque Stamp Company, Box 210, Jamestown, N. Y.

DIAMOND Shaped air mail—Big packet 105 all different, including air mail, commemoratives, Congo, Epirus, Manchukuo, etc.; set of two ex-King Edwards and Costa Rica diamond shaped air mail; scarce U. S. telegraph, cat. 30c; pkt. British Colonies—Gwalior, Hyderabad, Silver Jubilees; big lists. Everything for 5c to approval applicants. Send today! Mystic Stamp Co., Dept. 80, Camden, New York.

BEAUTIFUL Diamond shape stamp and nice packet, 9c to approval applicants. Filmer, 1-68, Salida, Colorado.

SEALED Sacks containing 1000 British Colonials, from empire missions, \$1. Price, 9, Blythe Street, Liverpool, England.

UNPICKED! 100 U. S. revenues on documents, 10c! 1,000, 60c. Vanvoorhis, Hyndman, Pennsylvania.

WEEKLY Stamp magazine, thirteen weeks, 10c. Stamp Journal, Kalamazoo, Mich.

100 DIFFERENT Stamps, tongs, hinges—10c. Approvals. Batson, 3125 Normount Avenue, Baltimore, Maryland.

FREE: 15 Different China 2c postage, with penny approvals. Lejac, Chowchilla, Calif.

PACKET Commemoratives, airmails, triangle, old U. S. 5c approvals. Far Seas Co., Box 2154, Houston, Texas.

1,000 GOOD Mixed foreign, 25c. Mission Mart, Brookland, D. C.

TRIANGLE, Two diamonds, only 5c with approvals. George Wentz, San Marcos, Texas.

DOLLAR Packets, 60 coronation, 175 airmail, 75 Newfoundland, 110 Canada, all different. Hamil, Beachville, Ontario.

FREE, 101 Stamps to approval applicants sending postage. Quality Stamp Shop, Englewood, Colorado.

BEST One cent approvals in America. Elvin Stanton, Niantic, Conn.

COMMEMORATIVES: Forty, 25c stamps. Botton Boite, 511, Bruxelles, Belgique.

20 DIFFERENT Dominican, 10c (stamp). Lopezmar, Box 1012, Ciudad Trujillo, Dominican Republic.

WANTED To buy. Commemorative half dollars. Other commemorative issues. L. W. Evans, 1816 E. 75 St., Kansas City, Mo.

MINT $\frac{1}{2}$ c U. S.! Surprise set! 3c approval applicants. Oriental Stamps, Box 1, Kensington Station, Brooklyn, N. Y.

FRENCH Colonies, five short sets, twenty stamps, 5c. Approvals. Woodlawn Stamp Company, Dept. 12, 1923 W. Mulberry, San Antonio, Texas.

MIXTURE—100 Stamps from 50 different countries including British Colonies, 10c. No approvals. Elsea, Bowling Green, Ohio.

STAMP Dealers: Illustrated wholesale catalogue featuring Canadians, Newfoundland, British Colonials. Free to dealers. Empire Stamp Company, Dept. 5, Toronto, Canada.

U. S.-CANADA: Revenue lot; 45 different including \$10 denomination, only 29c with approvals, where? Petersen's, Box 300, St. Paul, Minn.

1897 GRANDE Comore, Liberian Congo antelope, Turks Caicos, Cayman Islands, genuine Baden, etc. Everything 3c with approvals. Viking 1-Z Hanson Place, Brooklyn, N. Y.

PRODIGIOUS Gift! Fantastic Indochina, German state, savage Somicast, Perak, Selangor, Negri Sembilan, bicolored banana airmail, Siberia. Absolutely free with approvals! Postage 3c. Saxon Co., 408-A Jay St., Brooklyn, N. Y.

215 DIFFERENT Stamps including 15 China, coronation, jubilee, Edward only 10c to persons requesting approvals. Write today! Gem Stamp Company, 1905 Carleton, Fort Worth, Texas.

FINE Approvals, freshly filled books. Tell me the countries you prefer, and I will send just what you want. Milton Skinner, 306 East Fourth, Long Beach, Calif.

\$1.00 CATALOG Value unused U. S. stamps only 25c. A Grove, 306 Blanchard, Seattle, Washington.

PACKET U. S. cat. \$5.00 only 10c to approval buyers. Gull Stamp Company, Overlea, Md.

FREE, Ecuador "constitutions." Approvals 3c postage. Raymax, Box Blythebourne 11, Brooklyn, N. Y.

U. S. STAMPS, 273 Mounted, \$1.00. Vandal, Box 646, Stamford, Texas.

MONTHLY Stamp and coin magazine, six months and 25 foreign stamps, 25c. American Stamp Journal, Cedar Rapids, Iowa.

100 DIFFERENT U. S. including commemoratives. Cataloging between \$4-\$5. Special \$1.00. Anderson, 67 Jacob, Newark, N. J.

U. S. APPROVALS! Special discounts to serious collectors. Box 822, Minneapolis.

MEMBERSHIP Card free—The James Lee Stamp Club, 210-A North First Street, Phoenix, Arizona.

STAMPS On approval, $\frac{1}{2}$ c each. Omans, 642 Broadway, St. Paul, Minn.

AIRMAILS—Eight beauties, including Ecuador constitution, to approval applicants enclosing postage. Green & Company, Norwood, Ohio.

1000 WORLDWIDE Stamp mixture 25c. Monjar, 1542 Waverly, Cincinnati, Ohio.

FREE Transparent hinges, 100 different Austria, with approvals. Business Builders, Brentwood, Missouri.

COLLECTION Economy. Free particularly rare stamps. Box 193, Pomona, Calif.

U. S., Canada, Newfoundland, Mexico: "Four Star approvals." Nothing like them! Write today. 312 mixed U. S. only 10c. Kessels, Tucson, Arizona.

U. S. No. 703, Yorktown, mint, 5c with general approvals. Gremis, Manchester, Iowa.

U. S. Mixture, unpicked, pound 75c; 3 lbs. \$2.00. Brooks, 2502C Kenmore Place, Brooklyn, N. Y.

10 DIFFERENT U. S. Constitution commemoratives 25c. Complete set Hindenberg zeppelin airmails 13c. Splendid approvals. Moulton Stamps, Elgin, Illinois.

FREE Set with penny approvals. Irvin's Stamp Mart, 3361 Milwaukee, Chicago.

FREE Dollar packet to approval applicants. Harlan, 5307 South Marshfield, Chicago.

EXCHANGE Direct with collectors. Cheapest way to multiply your collection. Addresses of 200 stamp-clubs in over 30 different countries, colonies, etc., on the five continents. (No U.S.A.) Send one dollar for list to P. O. Box 1206, San Francisco, Calif.

FIRST Flights with the newly built Zeppelin (this summer) and European first-flight-cover-service. Interesting booklet free! Frischer, Althauptplatz 9, Vienna 9, Austria.

FREE: 5,000 Different, \$1 packet; information; 10c coin, 3c stamp. Franklin, 328 Bergen Ave., Jersey City, N. J.

SUMMER Sale. Usual dime packets now 7c. Examples—5 Armenia, 5 Mongolia, 5 Nyassa, 5 Eritrea, 5 Porto Rico, 6 Kenya, 7 Iraq. Reimers, 150 Flatiron Bldg., Fort Worth, Texas.

200 DIFFERENT (Catalog value \$4.00) and packet hinges, 10c with approvals. Scarce new triangle included free. Highland, 1616-V Sunset, Utica, N. Y.

ILLUSTRATED Album. Spaces 4000 stamps; to approval applicants 20c. Swan Stamps, 604 Swan, Dunkirk, N. Y.

15 DIFFERENT United States commemoratives 10c (dime) to approval applicants. Blue Grotto Stamp Co., Flint, Mich.

8 AIRMAILS From Syria, Lebanon, Guatemala, etc., and 55 others, 5c to approval applicants. Barker, Box 488, San Francisco.

CANNON! Set of stamps showing cannon, firing squad, cavalry charge and 200 other different stamps, only 10c to approval applicants. L. H. Reich Stamp Co., 4647 Kenmore, Chicago.

WE Buy stamps. Send description first. Leslie Stamp Co., Haverhill, Mass.

15 U. S. Commemoratives 10c. Approvals. Leader, 1550 Seward, Detroit, Mich.

WE Buy old stamps. What have you? Stampco, Box 1305A, St. Louis, Mo.

FREE—\$1 U. S. stamp with request for 52 page list of United States and foreign stamps. Stamps on approval. References necessary. 1 lb. U. S. mixed with one U. S. coin before 1850, 50c. New Hussman Stamp Co., 1122 Pine, St. Louis, Mo.

NOMAD "Bonanza"—surprise packet with stamp treasures galore, odd shapes, countries, sizes. Free to new approval applicants sending 3c postage. Nomad Stamp Company, Flint, Michigan.

SUPER-WONDER Packet offered, containing 60 different stamps from Afghanistan, Transjordan, North Borneo, Manchukuo, Sudan, Guadeloupe, Iraq, Sarawak, French and British Colonies, including natives, beasts, ships, etc. This entire packet for only 5c to approval applicants. Big illustrated lists free. Kent Stamp Company, Box 87(9), Brooklyn, N. Y.

NEW Rivera nude stamp! World's largest triangle! Congo, Sudan, South Seas, bicolored, pictorials and many others. Only 3c with approvals. Cactus Junior Approvals, Box 1870-B, Tucson, Arizona.

WORLD'S Smallest airmail, free stamp magazine, \$2.00 U. S., animals, bird, train, Indian, airplane, commemoratives, scarce stamps 25 countries, 5c with approvals. Capital Stamps, Dept. PM7, Little Rock, Arkansas.

AT 1/10 Catalog. U. S., British Colonies. Meyerowitz, 1756Y 70 Street, Brooklyn, N. Y.

FREE. U. S. \$1, \$2, \$4 and \$5 stamps. Unbeatable U. S. approvals. Nelson, 78 E. 5th St., St. Paul, Minn.

FREE—The Stamp Finder! Our new 24 page edition, fully illustrated, which will enable you to instantly identify all difficult stamps. Also fine packet of odd and unusual stamps from Bosnia-Herzegovina, Monaco, Patiala, Cyprus, etc., including maps, ships, animals and strange scenes. All free to approval applicants inclosing 3c postage. Garcelon Stamp Co., Box 900, Calais, Maine.

NEW Irish souvenir stamps. A set of beautiful and interesting souvenir stamps has been issued by Irish Hospitals' Trust Ltd. A specimen sheet of 24 of these stamps may be obtained free of charge on applying to Dept. P.M. Mr. J. O'Sheehan, 28 Earlsfort Terrace, Dublin, Ireland.

FREE! Two coronation sets. Postage 3c. Roberts, 312F Shearerbig, Bay City, Mich.

GIANT-SIZED Russian zepplin stamp, cat. val. 20c, and beautiful Lithuania air mail triangle; also big packet of 53 different stamps including Azerbaijan, Epirus, new Martinique, etc., and illustrated lists, all for 5c to approval applicants! World-Wide Stamp Co., Box 600, Camden, New York.

UNITED States—45 different, perforation gauge, hinges, bargain pricelist—all for 10c. Seidenberg, Baroda, Mich.

DIAMOND-SHAPED Stamp. Liberia gunboat triangle, two other triangles, silver jubilee, 27 others, 5c. Crowder Co., 127E North, Baltimore, Md.

LIBERIA Snake triangle, giant Spanish triangle, 50 other stamps, 5c. Wright Co., 2527 Guilford, Baltimore, Md.

4½ TRIANGLES! Guatemala bisect (diagonal half-stamp), beautiful Liberia, three additional triangles, 27 other stamps, 5c. Abell Co., 1818 St. Paul, Baltimore, Md.

ILLUSTRATED U. S. list, price 50c, large complete U. S. price list free. Send postage. Stanley Gibbons, 38P Park Row, N. Y.

PENNY Approvals that please. Haywood, 395 Adams St., Pomona, Calif.

FREE! Triangle airmail! Coronation! Pictorials! British Colonies! Wonderful packet 110 different, 5c to approval applicants. Bargain Co., Box 39P, Times Square Station, New York.

PANAMA Triangle and 50 others free to approval applicants sending 3c postage. Tatham Stampco, Springfield-30, Mass.

300 DIFFERENT Stamps 20c; 600, 50c; 1000, \$1; 2000, \$3; 3000, \$7. Fred Onken, 630 79th St., Brooklyn, N. Y.

FREE! "United States and British North America"—our valuable, complete, illustrated, 64-page catalog quoting lowest prices. Big illustrated list of foreign stamps also included. H. E. Harris & Co., 137 Transit Building, Boston, Mass.

QUEEREST Stamps packet. Receive one of world's smallest stamps; scarce Vatican City; Greek Red Cross (coiled snake in Garden of Eden!); Manchukuo; Soruth (mountain lion); Mozambique (giraffe); Palestine; many others. Also big packet 25 dif. Japan, (including earthquake stamp) and pkt. 15 dif. China. Everything for only 5c to approval applicants! R. M. Stamp Co., Box 230P, Port Chester, N. Y.

50 DIFFERENT, Fine U. S. including perforation gauge, 10c with approvals. The Stamp Shop, 809 Holland Bldg., St. Louis, Mo.

200 DIFFERENT 10c. Big 50% approvals. Covert Stamp, 39 State, Rochester, N. Y.

FREE! 110 Different stamps to approval applicants, 3c postage. Zephyr, 5124 George, Chicago.

STAMPS. A superb selection sent on approval. Quality at low prices. Fred Herzberg, Box 91-P, Elmhurst, Ill.

50 DIFFERENT British Empire including jubilee, Edwards, 50 different new, recent and pictorial world issues, 15 different airmails, 500 hinges, perforation gauge, all for 25c. Approvals sent. Lists free. Victoria Stamp Co., London, 4, Canada.

BRAZIL, 50 Different 10c with bargain approvals. Davis, Silver Lake, Ind.

ASK For our wonderful one cent approvals. Prospect Stamp Co., 225 Broadview, Toronto, Canada.

WHOLESALE Catalog for dealers. Illustrated. Postage 5c. Frank Co., 4900 Chalmers, Baltimore, Md.

PENNY Approvals, that satisfy. Neil Gronberg, Box 5441-P, Philadelphia, Penna.

30 DIFFERENT Angola, Cape Verde, Guinea, Portugal, Mozambique, St. Thomas and Prince 5c. Approvals. Depraw, Ocean Park, Calif.

STAMP Dealers, your ad here will bring wonderful returns. Ask me for proof. F. W. Johnson, Manager, Classified Advertising, Popular Mechanics Magazine, 200 E. Ontario St., Chicago.

APPROVAL Sheets. One to three cents. Frederick B. Driver, 2009 Finance Bldg., Philadelphia, Penna.

25 UNITED States, including \$4 and \$5 stamps free to approval applicants. 3c postage. Brownie Stamp Shop, Flint, Mich.

HOBBIES AND COLLECTIONS

UNUSED Book match covers, 100 all different, \$1.00. Free list. Charles Edelman, 1311C East 84, Cleveland, Ohio.

BOOK Match covers, 60 different, 25c postpaid. G. Curtis, 505 High, Oshkosh, Wis.

PHOTO FINISHING

OUR Finishing is world wide with a guarantee to "please you." 8 glossy prints and 2 double weight enlargements 25c coin. One-day service. Please U Film Service, 182-M, LaCrosse, Wis.

MAIL Your rolls to film center of the world. Any 6 or 8 exposure roll developed and printed 25c coin. DeLux enlargement coupon free! Photo Finishing Shop, Est. 23 yrs., 411-W Genesee Valley Trust Bldg., Rochester, N. Y. "The Camera City."

EXPERT Photo finishing. One day service. 8 genuine expensive Velox prints, two double weight professional enlargements 25c. Expert Studios, LaCrosse, Wis.

ENLARGEMENTS. 5x7 From 127 to 122 roll, 6 or 8 exposures, only 50c, developed free. Knickerbocker Foto Co., 129 West 27th Street, New York City.

BARGAIN, 16 Velox prints 25c or 8 Velox prints and 2 professional enlargements 25c. Snap Shot Shop, Box 26C, College View, Lincoln, Nebraska.

20 REPRINTS 25c. Films developed, two prints each negative 25c. Skruandiand, 6970-8 George, Chicago.

TWO Enlargements with each roll developed 25c. Davids Photo Service, St. Cloud, Minn.

FREE—4 Big enlargements—8 prints every roll 25c, 20 reprints \$5; 100, \$1.00. Filmeo, Albany, Wis.

FILMS Developed, eight highest quality Velox prints with wide paneled borders, mounted in deluxe album, also two enlargement coupons, all for 25c. Premium catalogue free with first order. Knickerbocker Foto Co., 129 West 27th Street, New York City.

PHOTO Mill. Immediate service! No delay! Roll developed, carefully printed and choice of two beautiful 5x7 double weight professional enlargements, one tinted enlargement, or eight reprints—for 25c coin. Reprints 2c each. The Photo Mill, Box 629-12, Minneapolis, Minnesota.

VELOX Prints, 6 or 8 exposure rolls developed and printed with one 5x7 enlargement, 25c coin. 8 exposure 127, 120, 116 rolls developed and printed double size with one 5x7 enlargement, 25c coin. All re-prints 3c ea. Same day service. Q & S Photo Service, P.O. Box 15, Sta. A, Los Angeles, California.

12 HOUR Service. Roll developed, printed, your choice two 6x8 Platesunk enlargements, one enlargement colored or etched or 8 reprints for 25c coin. The Artists, Box 230F, Minneapolis, Minnesota.

ROLLS Developed, 8 prints on Velox, 25c. Deluxe enlargement in 8" lock easel frame, 39c. 3 for \$1.00. Photoshop, Box 218, Augusta, Ga.

RUSH Service! Finest developing! Perfect prints assured. Roll developed, choice 2 gorgeous 5x7 enlargements, eight prints or 1 hand-colored enlargement, 25c coin. Reprints 2c. Gopher Photo Service, Box 3323, St. Paul, Minn.

BEAUTIFUL Oil colored enlargement in de luxe frame, with each roll developed 25c coin. Badger Studios, LaCrosse, Wis.

FILMS Developed, 16 prints, 2 enlargements, 25c. Truefoto, Dept. 30, Des Moines, Iowa.

QUICK Service—Rolls developed, 8 guaranteed prints; 2 enlargements; 25c coin. OK Photo Service, Ottawa, Kansas.

ROLL Developed and printed. Two enlargements, one of them in colors, all for 25c coin. The Photo Finisher, Station E, Box 42, Columbus, Ohio.

20 REPRINTS 25c. Films developed, 16 prints 25c. Enlargements 8x10—25c; 5x7—10c. Low Photo, M-2657 Nava, Chicago.

ROLLS Developed and printed 10c. Trial. Quality Finishers, Maywood, Ill.

HALFTONE Cut from your favorite photograph \$2.50. VanDorn's, Ottawa, Illinois.

ROLLS Developed, eight prints and two enlargements 25c. Art Photo, 1783 Delaware, Detroit.

8 ENLARGEMENTS (Instead ordinary prints) per roll for 25c. Hilo, Yale, Okla.

PROFESSIONAL Quality service. Rolls developed, 8 prints and 2 enlargements 25c. The Film Capital Service, Box 504, Rochester, N. Y.

FILMS Developed, 2 prints of each 25c. 20 reprints 25c. Pine Photo, M-5134 Nevada, Chicago.

TAKE Your pick! One master natural color enlargement, two beautiful enlargements, or 8 duplicate prints given free with roll developed and 8 high-gloss prints for only 25c coin. Reprints 3c each. Overnight service. Amazing professional quality must delight you or money back! Sixteen years experience. Sunset Service, 278 Sunset Building, St. Paul, Minnesota.

RECOGNIZED As a leader for high quality and better service. Do not be misled. It is easy to copy a name but hard to meet our superior quality. Roll developed, 8 guaranteed glistening prints and 2 enlargements 25c. The old reliable American Photo Service, 2946M Nicollet, Minneapolis, Minn.

AT Lewis' Photo Service, Box 988, Youngstown, Ohio. You get roll developed and 8 prints 25c. Reprints 3c. Prompt service.

SAMEDAY Service: Roll developed, 8 glistening prints, 2 enlargements—25c. Midwest Photo, B-54, Janesville, Wis.

ENLARGEMENTS, Colored in oils by experts, from your film or picture, 5x7, 25c; 8x10, 50c. Miller's, 84 Armbruster, Buffalo, N. Y.

"ART-OIL" Color enlargement free with 8 lifelike prints and roll developed 25c. Royal Photos, Box 5022D, St. Paul, Minn. Prompt service.

MAKE Photography Pay. New book, \$1.00. Popular Mechanics, 200 E. Ontario St., Chicago.

Conc. plan

BE Modern! Get modern service. Modern quality. Modern prices. Our modern methods give quick service and bright guaranteed neverfade pictures. Roll developed 16 prints, 25c coin. 16 reprints 25c. Enlargement coupon. Candid rolls developed fine grain. Enlarged prints 3x4 4c each. Send next roll or reprint order to Modern Finishers, 3537-C, St. Paul, Minn.

IDEAL Photos. 25c per roll, finished with round corner prints. Coupon and snapshot folder free with initial order. Ideal Photos, Box 2255, Paterson, N. J.

ROLLS Developed. 8 prints, 2 enlargements, 25c. Mayfair, Box 261-K, Toledo, Ohio.

SNAPSHOT Folder with every roll developed, 8 prints, painted enlargement—25c. Reprints 3c. Fast service. Janesville Film, A-54, Janesville, Wisconsin.

PROMPT Service—Quality work; 2 beautiful double weight gloss enlargements, 8 guaranteed neverfade prints each roll. 25c. Excel Photo Service, Dubuque, Iowa.

20 REPRINTS 25c. 100 Reprints \$1. Roll developed with 16 prints 25c. Newtowne, 4, Maywood, Ill.

SNAPSHOTS In colors—Roll developed, 8 natural color prints—25c. Natural color reprints—3c. Amazingly beautiful. Natural Color Photo, C-54, Janesville, Wis.

WILLARD'S Gives your pictures a beauty treatment—they're clear, brilliant, full of life. Roll developed, 2 prints each negative 25c. Enlargement coupon. Willard's, Box 3535-A, Cleveland Heights, Ohio.

HIGHEST Quality reprints 2c. Rolls developed, 2 sets prints, 25c. Fred Weick, 2840 Zenobia, Denver, Colorado.

ROLLS Developed and printed with two hand colored enlargements, 25c. Colorgraph, Dunning Station, Chicago.

TWENTY Reprints 25c. Roll developed and two prints each negative, 25c. Mail orders only. Star Photos, 109 N. Dearborn, Chicago.

IMMEDIATE Service! Better pictures. Two beautiful heavy-weight professional enlargements and eight guaranteed Perfectone prints 25c coin. Eight beautiful enlargements from roll only 25c. Candid rolls developed free! Prints enlarged to 3x4, only 4c each. Pictures sent back same day film is received. American Studios, Box B, LaCrosse, Wis.

ROLL Developed, 16 guaranteed prints 25c. Smart Photo, Winona, Minnesota.

GUARANTEED. Film developed, 16 prints 25c. 20 prints 25c. Quality Photo, Hutchinson, Kansas.

BE Convinced—Globe photos are unexcelled. 8 Duo-Tone prints, 2 5x7 enlargements. Send next roll 25c coin to Globe Photo Shop, La Crosse, Wis.

PROMPT Service, guaranteed work. Two beautiful portrait type double weight enlargements, eight neverfade gloss prints, each roll 25c. Dubuque Film Service, Dubuque, Iowa.

ROLL Developed and 8 guaranteed prints including two enlargements, 25c coin. Super Snapshot, Winona, Minnesota.

FILMS Developed. Two beautiful glossy, double weight, professional enlargements and 8 prints all for 25 cents coin. Reprints 3 cents. Dependable quality and service. Allied Photo Service Company, Drawer 289 I, Sparta, Wisconsin.

LATEST In photo finishing. Miniature rolls developed and printed 3x4—5c each print. Radio Film, LaCrosse, Wisconsin.

PROMPT Service! Rolls developed, two Velox prints each negative 25c. Hench Studios, Harrisburg, Penna.

PHOTO Mill. Immediate service! No delay! Roll developed, carefully printed and choice of two beautiful 5x7 double weight professional enlargements, one tinted enlargement, or eight reprints—25c coin. Reprints 2c each. The Photo Mill, Box 629-12, Minneapolis, Minnesota.

GET The best. Roll developed, beautiful hand colored enlargement, 8 neverfade border prints, 25c coin. Prompt service. Sun Photo Service, Drawer T, St. Paul, Minn.

ROLL Developed, 8 brilliant fadeproof Velox prints and two professional enlargements 25c. Overnight service. Young Photo Service, 405-C, Albany, N. Y.

TWO Prints each with every roll developed, 25c. Very finest quality. Reprints 2c each. Brown Photo Company, 1910-34 Emerson, Minneapolis, Minnesota.

ROLLS Developed, two sets prints plus enlargement coupon 25c. Reprints 3c. Over 19 reprints 2½c. Jones Studios, Davenport, Iowa. "Where the West Begins."

ROLLS Developed, 2 prints each and 2 free enlargement coupons, 25c; reprints, 2c each; 100 or more, 1c. Summer's Studio, Unionville, Mo.

ENLARGEMENTS 4x6, Five for 25c. 5x7 three for 25c. 8x10 three for 35c. Hand colored and framed each 4x6, 30c. 5x7, 35c. 8x10, 45c. Send film negatives. Enlargers, Maywood, Ill.

ROLL Developed and 8 beautiful Velox glossy prints 25c coin or stamps. Reprints 3c each. Fotoprint Service, Box E, Roanoke, Va.

FINER Finishing. Rolls developed and printed, with one colored enlargement, or two professional enlargements. All for 25c (coin). Genuine, nationally known, Moentone superior quality. Moen Photo Service, La Crosse, Wis.

TWO Glossy enlargements, 1 colored with roll 25c. Arbor Service, 10, Joliet, Ill.

ROLLS Developed—Two new Beautitone Dublute professional enlargements, 8 guaranteed fadeless Beautitone prints, 25c. Giant Snapshots, Inc., 667A, Green Bay, Wis.

BEAUTIFUL 5x7 Enlargements from your favorite negatives 17c each; three for 50c. Eight exposure roll developed and printed 25c. Work guaranteed. Jeems Service, Box 137, Ann Arbor, Mich.

FOR The discriminating amateur, roll developed and carefully printed 25c, reprints 3c. Superior workmanship, same day service. Paramount Co., 327 E. 92nd St., New York.

CAMERAS, PHOTO SUPPLIES

TODAY'S Biggest camera bargain; Sample copy of sensational 108-page new candid camera monthly, Minicam Magazine, sent you for only 10c. (Regular newsstand price, 25c.) Beautifully illustrated with prize-winning photographs. Tells how to take better pictures, answers questions on dark room technique, improves your "shooting" ability, advises where to sell photographs. Send 10c to Minicam Magazine, 6 East 12 Street, Cincinnati, Ohio.

CAMERAS—Shutters repaired. Leather bellows installed in folding and view cameras. Bellows made to order. United Camera, A-1515 Belmont, Chicago.

CAMERAS And supplies. Free illustrated Photographic Almanac listing everything photographic—still, movie cameras, films, lenses—at tremendous savings. Hundreds of bargains, new and used. All guaranteed. We take your old camera or equipment in trade. Write for free copy of new Photographic Almanac and money-saving bargain book—just out! Limited edition. Hurry! Central Camera Co., (Photographic Headquarters since 1899), 230 South Wabash, Dept. 7-K, Chicago.

MAKE Money in photography. Learn quickly at home. Spare or full time. Easy plan. Previous experience unnecessary. Common school education sufficient. Interesting booklet and requirements free. American School of Photography, 3601 Michigan Ave., Dept. 3432, Chicago.

PHOTOGRAPHERS! Learn secrets of big money! Seventeen sure-fire, unusually successful plans revealed by retired traveling photographer. Fully explained 50c. Roy Engstrom, Red Wing, Minnesota.

DUPONT Superior panchromatic, 35mm. five foot lengths, (tongued), 25' can, \$1.30. Optical Development Corporation, Larchmont, New York.

TAKE Night photographs! Hypersensitize your films 300-400% increased speed. Hypersensitizer with instructions 25c. Sameth, 45 West 97th, New York City.

NEW Unused Univex Cine 8, \$8.75. H. Bennet, Palisade, Colo., Box 59-C.

TREASURE Finders? Read Goldak advertisement on page 130A.

BASS Unusual quality values: Half or full V. P. Dolly, Corygon F:3.5 lens, Compur shutter, new, \$23.75. 2¼x3¼ Zeiss Volta F. P. and P., F:6.3 lens, automatic shutter, F. P. A. and holders, \$12.50. Sport DeFranne, full or half 2¼x3¼, F:3.8 Anastigmat with carrying case, \$29.75. Dollina II, coupled range finder, Radionar F:2.9 lens, Rapid Compur 1/500th shutter, \$49.75. Argus, F:4.5 lens, \$12.50. Above and hundreds of other bargains in Bass Bargaingram No. 235, a 52-page book. Money with a smile guaranteed. Bass Camera Company, Dept. AG, 179 W. Madison St., Chicago, Illinois.

IF You go to Mexico ask first for prices and pamphlets of finest German quality miniature and other cameras, binoculars, movie cameras and projectors. Foto Mantel Sucr. R. Rudiger, V. Carranza 11, P.O. Box 1459, Mexico City.-105. Branch Store: Tijuana, B. C.

ATTENTION Photographers! Increase profits substantially by taking photocopies (commonly called photostats) with your regular camera. No film, no prism, details free. The Barbour Manufacturing Co., Warren, Ohio.

CORONET Midget, the new "Minicam," post paid \$2.50. Film 6 exposures 15c. G. Gennert, Inc., 20 West 22nd Street, New York City, N. Y.

FREE! Book, "How to Sell Snapshots," Fomo Company, Canton, Ohio.

CAMERAS Films, paper 25% to 35% discount. Paramount Photo Division, 327 East 92nd St., New York.

INCOME From your camera instead of expense. Low cost home course teaches you to make photographs for magazines, newspapers, advertisers. Tremendous demand. Earn good money wherever you live. Free book. Universal Photographers, Dept. 104, 10 W. 33rd St., New York.

HAVE You a camera? Send ten cents for recent number of our big magazine, showing how to make better pictures and earn money. American Photography, 116 Camera House, Boston, 17, Mass.

WE Purchase and accept in trade used photographic equipment. Send for bargain list. Fotoshop, 134R W. 32nd, New York City.

MOTION PICTURES AND SOUND EQUIPMENT

MAKE Your movie titles with the Stamp-O-Title outfit manufactured, and distributed by the Stamp-O-Set Co., Inc., 329 East 116 Street, New York. Dept. P. 6. Price \$8.75.

"HERE'S News from Bass." A 52-page Cine Bargaingram No. 234. A veritable encyclopedia of motion picture apparatus, 8 mm. and 16 mm., silent and sound. Sound cameras. You must have a copy of this book. It's hot off the press. Your copy is waiting. Don't delay, and send for this valuable book. Dept. A. Bass Camera Company, 179 West Madison Street, Chicago, Illinois.

16MM. CAMERA \$19.50, 16mm. motor driven projector \$3.95, 8 and 16mm. films. Stamp for catalogue. Excel, 622 Madison, Toledo, Ohio.

CENTRAL'S Free, new, money-saving bargain book explains latest movie developments, offers money-saving bargains in cameras, lenses, projectors, films. Used equipment taken in trade. Write for free copy. Central Camera Co., (Photographic Headquarters since 1899), 230 S. Wabash, Dept. 17-K, Chicago.

BARGAINS! 8mm., 16mm., free literature. Elder, B-739 Boylston, Boston, Mass.

16MM., 8MM., Movie bargains. Free list. Victor Films, Litchfield, Minn.

PROJECTORS, Cameras, accessories. Substantial discounts. Stan's, 228 Neilson, New Brunswick, New Jersey.

CLOSE-OUTS 16mm., 8mm. Listings stamp. Cine, 151 Broadway, Paterson, N. J.

FILMS, Projectors, Sound, silent. List 10c coin. Box 6, Rosedale, Kansas.

16MM. NONHALATION Film, 110 ft., \$2.75. Two rolls \$5.00, including processing. Cope Studios, 3720 South Figueroa, Los Angeles.

AMBERTINT 16mm. Camera film \$1.85 for 100 feet including machine processing. Daylight loading. Weston Six, Hollywoodland Studios, South Gate, Calif.

8-16MM. FILMS. All subjects. Sale, exchange, films rented everywhere. Bargains in equipment. Trades accepted. Free illustrated catalogue (with sample film 10c.) Garden, 317 West 50th Street, New York.

BARGAINS. 35mm. Films. Big lists. Demsey, 1223 Berkeley, Youngstown, Ohio.

FREE! Big bargain lists 35mm. Calderara, 5119 South St. Louis, Chicago.

SCENARIOS. "Flowers Are Where You Find Them." Child 18 months to 3, \$1.00 "Stratosphere Castles," exciting mystery romance feature, adults \$5.00. Home Movie Scenarios, 1629 Telegraph, Oakland, Calif.

SOUND Film features fifteen dollars. Weidman Film Service, Weidman, Mich.

MOGULL'S Removal sale! Free removal bargaining crammed with still, silent-sound movie equipment, accessories. 68-J West 44th, New York.

"THE World's greatest of all Passion Plays," 16mm. and 35mm. 8-reels. Sound with dialogue or silent. Rent or purchase. Superior than Oberammergau stage play. Write Hemenway Film Co., 37 Church Street, Boston, Mass.

16MM. VEL-O-TEX. Perfect outdoor film. Weston 8. 50 foot daylight loading rolls \$1.29 including processing. Sample free. Vel-O-Tex Laboratories, Gary, Ind.

GENERA Film, 100 feet for Univex, \$1.00 postpaid. Processing powders. Circulars. Fromaders, Davenport, Iowa.

BEADED Screens, 30" x40" - \$3.00; beads only, \$1.00 lb., postpaid. Illinois Mail Order, 441 South Blvd., Oak Park, Ill.

PROFESSIONAL 35mm. Cameras, printers, sacrificed \$20.00. Avond, 747 6th Avenue, New York.

MOVIE Film. Develop yourself. Univex, Eastman. Raw film wholesale. Chemical samples 15c. Lake Camera Exchange, Gary, Ind.

NEW 16mm. Automatic movie cameras \$22.50. Free 16mm., 8mm. bargain lists. Home Movies, Box 216, Easton, Penna.

35MM. TALKIES For rent. Shermco, 6101 Orchard Grove Ave., Cleveland, Ohio.

LEARN Motion picture theatre business. Home-study training; management, advertising, projection. Free catalog. Give age. Theatre Institute, Elmira, N. Y.

35MM FILMS Rented, 50c weekly. Lists 3c. Hoffman Film Service, 57 Broad, Albany, N. Y.

8-16MM. TITLES, 2c Word. Catalogue. Cineshop, 1812 Piedmont, Charleston, West Virginia.

15% TO 25% Discount on still or movie cameras. Free circular. Paramount Co., 327 E. 92nd St., New York City.

RELIGIOUS Pictures for rent or sale. 16mm. and 35mm. sound or silent. All-Sacred Film Co., 50 Melrose St., Boston, Mass.

RADIOS, SUPPLIES, INSTRUCTION

LONG Distance crystal set plans 25c, materials \$1.28, wired \$2.48. Gulf Television, Seguin, Texas.

BE A radio announcer, actor, singer, writer. Learn at home. Free information. Radio Arts Academy, 3823 Wilshire, Hollywood, Calif.

RADIO Bargains, electric appliances. Save half. Free bulletin. Mack Brothers, 2045 Chicago Ave., Chicago.

SAVE Money on radio sets, parts, tubes, etc. Send for new summer catalog. United Radio Company, N-1000, Newark, N. J.

6 BEGINNER'S Plans and "Radiobuilder" year 25c, 15 for 50c. Laboratories, 7700-C East 14th, Oakland, Calif.

BARGAINS: Wholesale prices on standard make radios, refrigerators, washers, ranges, sweepers and other appliances. Write for prices. Wholesale Appliance Company, 312 - 21st, Toledo, Ohio.

RADIO Engineering, broadcasting, aviation and police radio, servicing, marine and Morse telegraphy taught thoroughly. All expenses low. Catalog free. Dodge's Institute, Ames St., Valparaiso, Ind.

MUSIC AND MUSICAL INSTRUMENTS

SONGWRITERS—Send best poems today. Remarkable offer. Free rhyming dictionary and instruction book by famous Broadway composer. Songwriters Institute, 1234-C Broadway, New York.

SONG Poems wanted to be set to music. Free examination. Send poems to McNeil, Bachelor of Music, 4153-PM S. Van Ness, Los Angeles, Calif.

SWIRK Gens violins. Five thousand dollars. Dziedzic, 2471 Denton, Detroit.

PUBLISH Your piano part. Songpoems wanted. Songland, "PM," Thomaston, Maine.

PIANO-ACCORDION—"Individualized" correspondence courses. Leland Lay Studios, Kirksville, Missouri.

PHONOGRAPHS, Supplies, repairing, motors, tone arms, speakers. Epsteins, 50 First Street, New York City.

SEND 6c For music samples. Catalogue. 212 Exchange Bldg., Spokane, Wash.

HOW To play piano by ear. Simplified method. \$1.00. Piano Shorthand Music Company, Springfield, Illinois.

MUSIC Composed to words. Rhyming pamphlet free. Phonograph recording of song free. Send poem. Just released "Joyce." Copy 25c. Keenan, 259 Beach St., Bridgeport, Conn.

SONGWRITERS Wanted immediately. Glen Warren, 1560 Broadway, New York City.

SONGWRITERS! Amazing convincing proposition. Hibbeler, C-5, 2157 No. Avers, Chicago.

SONGS And song poems bought. Published. Royalty basis. Free information. Metro Melody Pub. Co., Loew's Theatre Bldg., San Francisco, Calif.

TERRIFIC Success. New copyrighted courses. Quick, thorough. Radio Method of Piano Jazz, P.O. Box 1024, Dept. 17, San Francisco.

POEMS Set to appropriate melodies. Professionally arranged for publication. Strasser, 20 West Jackson, Chicago.

SONGS—Arranged, revised by arranger "Cherry Blossom Lane." "Gypsy Tea-room," others. Send for details. Harold Potter, 1619(P) Broadway, New York.

EARN More! Learn modern music arranging by personal correspondence. Melodic Music Methods, P. O. Box 1297, New Orleans, La.

MUSIC Composed, arranged, songs, orchestra, band. Frank Wildt, Lancaster, Pennsylvania.

PIANO By ear. Free booklet. Day-V-Way, Woolworth Building, Dearborn, Michigan.

POEMS Set to music, arranged for publication. Free examination, report. MMM Studios, Dept. 33C, Portland, Ore.

LEARN Swing piano! Self instructor makes it easy. Postal brings free folder. Christensen, 751 Kimball Hall, Chicago.

LATE Phonograph records, some new, some slightly used. Fifty—\$2.50. Davis Sales Company, Syracuse, New York.

SONGWRITERS: Send best poem today for exceptional offer. Richard Brothers, 24 Woods Building, Chicago.

SONGWRITERS Wanted, write for free book. Indiana Song Bureau, Salem, Ind.

MUSIC Composed to words. Wonderful proposition. Bauer Bros., Oshkosh, Wis.

DUO-FLEX Reeds for clarinets, and saxophones eliminate your reed troubles. Write for circular. Duo-Flex Reeds, 1204 1st Ave., Evansville, Ind.

WRITE Songs. Big money and reputation. Write for information. J. Gordon Pub. Co., 201 N. Hoyne, Ave., Chicago.

WANTED! Lyrics, melodies for songs. We arrange, publish, sell. Superior Song Studios, Passaic, N. J.

WANTED Original poems, songs, for immediate consideration. Send poems to Columbian Music Publishers, Ltd., Dept. 42, Toronto, Can.

BUSINESS OPPORTUNITIES

THOUSANDS Opportunity ads simulated to proven few; plus scores unadvertised lines. Save years, dollars. Elaborate list. First 25, 25c; 65, 50c; 150, \$1.00. Restpart, Willmanson, Mass.

"THE Knack of Making Money in Any Job," business or profession. Send stamp please. Eli Sharp, Kansas City, Kansas.

CONDUCT Your business from Chicago! Will forward your mail daily. \$1 month. General, 108x North Dearborn.

RUBBER Mold bargains! Stamp brings catalog. Colonial Art, Derry, N. H.

INVENTORS—Small ideas may have large commercial possibilities. Write us for free book, "Patent Guide for the Inventor" and "Record of Invention" form. Delays are dangerous in patent matters. Free information on how to proceed. Clarence A. O'Brien & Hyman Berman, 58-D Adams Bldg., Washington, D. C.

YOU'LL Like resilvering mirrors, autoparts, reflectors, making chipped glass signs. Write, Sprinkle, Plater, 127, Marion, Indiana.

MILLION Articles. Buy wholesale. Valuable directory 10c. Ideal Service, Park Ridge, Ill.

POPCORN, Crispette, carmelicrisp, potato chip, salted nut machines. Long Eakins, 1960 High St., Springfield, Ohio.

MAKE Money. Mail order. I do, you can. Details dime. Chapman, Victor House, Bellingham, Wash.

FASCINATING Business. Repair, adjust typewriters, adding machines. Learn easily at home from factory expert. Earn up to \$15.00 daily. Complete instructions covering all makes \$3.00 postpaid or sent C.O.D. Adding Machine Equipment Service, 3601 Michigan, Dept. 343B, Chicago.

M. M. earned \$267, three weeks, raising mushrooms in cellar! Exceptional, but your cellar, shed perhaps suitable. We buy crops. Book free. United, 3848 Lincoln Ave., Dept. 68, Chicago.

MANUFACTURE From Phospholene. Cleaning fluid 1c gallon; bleach 2c gallon; hand soap 2c pound; and ten fast sellers. Sample 25c. Details free. Western, 6615 Denison Ave., Cleveland, O.

TWELVE (12) Money making plans, "including free plans," for 50c. United Distributors, 32 Everett Street, Lynbrook, N. Y.

AMERICAN Homemaker Magazine—sample, unusual profit details, 10c. Challenge, 31, St. Petersburg, Florida.

MILLIONS Jobless! Sell amazing, practical job-getting information by mail. Write, Cormack, 8 Hazel, Norwalk, Conn.

TYPISTS! Get free details on starting an independent typing business of your own. White's Business Service, 114 W. Henry, Elmira, N. Y.

87 MEANS To financial success. Particulars free. Wm. Strauss, Owings, W. Va.

STOP Experimenting. I'll show you how to make a fortune without capital. I did. You can. Stamp appreciated. Peris, 107-G, East Rochester, N. Y.

RESULT Getter, magazine of money-making opportunities. Copy 10c. George Fenner, 1618 Lucia, Louisville, Ky.

NO Depression when you read New England Progress Magazine. Copy 10c. Victors Printery, Exeter, N. H.

FORMULAS—Fast selling products. Guaranteed. Laboratory tested. Lowest prices. Catalog free. Kemico, 55G, Park Ridge, Ill.

\$250 STARTS "Chain" of penny gum and confection vending machines. Steady cash income. Details free. Robbins Co., 1141P DeKalb Ave., Brooklyn, New York.

"SUCCESS Beacon," 52 pages! Money-making schemes, ideas, opportunities. Dime. Jay, Publishers, 6054-p Kenwood, Chicago.

NEW Popcorn Cheese-O-Corn machines. Happy Days products sell. Big money. Write today. Barnard's, Omaha, Nebr.

OPERATE Profitable "route" four compartment vendors. Small investment. Penny King, 1233D Chouteau, St. Louis.

FREE Circulars describing money making opportunities. Rogers Publishing Company, 321 Chamber Commerce Building, Los Angeles, California.

OVER 20 Ways to make money. With this valuable information get details of amazing all-profit mallorder business. Brings dollars daily. Dime and stamp. None free. Johnson, 126-M Lexington Avenue, New York.

"MAKE Mirrors at home." Big profits. Little outlay. Also emboss, grind—foil, gold leaf, frost, chip and make imitation stained glass. Instruction course \$1.00. Bestovall, 4047-M N. Whipple, Chicago.

WHERE To buy at lowest wholesale prices. Information free. Yorena, Box P-312, Bayonne, N. J.

BUY Sweet Meats. It's a book you should own. Price \$1.00. E. Guncelle, Mgr., Westhampton, L. I., N. Y.

HUMAN Efficiency. This surprising little book actually helping workers. \$1. Shertzer, 970 Weber, Pomona, Calif.

MAKE Money growing vegetables, fruits, flowers, plants without soil. Use only water and chemicals. Complete formula and process \$1.00. Kemixal, 179, Park Ridge, Ill.

UNBELIEVABLE Profit. Unlimited market. Instructions for making simple beauty and health product. Dollar. Essaness Company, Beaverton, Oregon.

MAKE Artificial marble, glazed tiles, uncanny. Tabletops, plaques, floors, hones, novelties. Hard, fireproof, inexpensive, cement secrets. Brilliant tile and liquid rubber samples 3c. John A. Payn, 945 Grande Vista Avenue, Los Angeles, Calif.

START Profitable mail order business. "Mail Order Success," 28 pages, facts, ideas, methods of getting profitable returns on every dollar invested. Dime. Mail Plan Bureau, Fillmore, N. Y.

LEARN The answers and make big money. Inside legal information. 25c. Dept. B, 234 Hurst Bldg., Buffalo, N. Y.

MAKE Your own rubber molds. Details free. June, 101-B Beech, Holyoke, Mass.

\$50.00 WEEKLY! Operate mail order business for us. Product furnished. Iron-So-Ezee, Mt. Washington, Ohio.

MAKE Colored pottery, statuary, novelties, souvenirs. Write. Colorcraft, 489 Arcade Bldg., St. Louis, Missouri.

OPPORTUNITIES Plenty! Money-makers that "click"! Unusual "idea" service! Bulletin free! Cee-Tee Company, P-1079 Madison St., Brooklyn, N. Y.

NEW York world's fair. Complete information regarding concessions, exhibits, royalties, licensing costs for any product, mailed on receipt of \$1 service fee. Apparel Fair Exhibits, Empire State Building, New York.

BUSINESS Beginners, home sparetime workers write for "Road Map to Business Success." It's free "starter" to business of your own. Formula Bureau Club, Midlothian, Illinois.

KAR-O-MEL. Ten other popcorn formulas, including cheese, directions, etc. \$1.00. Dietz, Toledo, Ohio.

BE Successful in business. Learn elementary and guiding principles from expert. Don't lose time and money experimenting; study and win. Complete course reasonable. Free booklet. Gardner & Gardner, 212-A Eighth, S.W., Cedar Rapids, Iowa.

START Now, make money manufacturing art objects, book ends, artificial marble, rubber molds that need no greasing, free particulars. Plastic Arts, Homewood, Ala.

PROFITABLE Moneymaking plans, ideas. Literature free. Silvester, BX217, Old Bridge, N. J.

6 MAIL Order magazines including all you must know about mail order business 10c. Armand Cartier, 31 Cumberland St., Woonsocket, R. I.

RESILVER Mirrors—Plate tableware, metalware, tools, auto parts, reflectors. Write. Rapido Service, Edwardsville, Ill.

AUTOMOBILE Speed limiter, electric lawnmower. Attractive proposition. Request literature. Owen, 830-W Euclid, Detroit, Michigan.

CERTIFIED Formulas duplicating agents most popular specialties. All lines. No service like this. Stamp brings interesting information. Miller, Jetton, Tampa, Fla.

HERE'S Your chance! "Millions becoming Health-Minded!" Health foods, (your labels) instructions, furnished to 500 members. Hurry! Samples, dime. Gardena M. System, Station "S," Los Angeles.

DOLLAR Profit on dollar mail sale. Sales guaranteed. Stamp brings details. Adams, 85 Stealawanna, Lackawanna, N. Y.

FREE—New profitable money-making plan, build your own business with small capital, spare time. \$1.00 starts you making \$25.00. Pm. Kohn, 506 W. 45th St., Chicago.

TYPEWRITER Repairing taught on real machines. Earn while learning. Our instructors show you how. \$1 brings plan and first three lessons. School of Applied Mechanics, 1085-p White St., Far Rockaway, N. Y.

PROFIT With new products. Make, sell, repeat. Analysis. Research. Guaranteed formulas. Biggest catalog free. Special prices, leads. Gibson Laboratory, Chemists, BD-1142 Sunnyside, Chicago.

OPERATE Electric Simonizing station. Cash in on labor-saving invention. Only \$29.50. Should net you approximately \$300-\$400 month. Write Bissell's Manufacturing, 3320-P Archer, Chicago. Dealers wanted.

WORLD'S Fair preview, free. Employment opportunity; enclose stamp. Richards, 280 Broadway, New York.

CONVERT Newspapers into saleable products. Instructions, formulas, complete, \$1. Long. 818 Wyandotte, Kansas City, Mo.

DATA On South American employment. If you are interested in South American employment remit \$1 in cash or money order for general information and list of foreign operating concerns. Capital Listing Service, Franklin P. O. Box 466, Washington, D. C.

MONEY In butterflies, moths. See Sinclair Display Advertisement on page 16A.

PLASTEX Industries offers industrious men an opportunity to start a business of their own, manufacturing art goods, novelties, souvenirs, etc., in Plastex and marble imitation. 5c material makes \$1 articles. Rubber moulds furnished for speed production. Small investment brings big returns. You are just in time for big wholesale season now starting. Write for interesting booklet mailed free. Plastex Industries, Dept. A, 1085 Washington Ave., New York.

TREASURE Finders? Read Goldak advertisement on page 130A.

RESPECTABLE Business, good profits, no investment, no selling. Plan complete, 55c. 227 Franklin St., Franklin, N. H.

START A business for \$1.00. Fast selling necessity that "sells on sight" to every business and professional man. 700% profit for salesmen. Copyrighted. Write today for particulars and prove to yourself how this new specialty will make you big money quick. M. J. Cook, Dept. B-1, Everson Bldg., Syracuse, N. Y.

PROFITABLE Home mail business, fully equipped, \$2.95. (\$15.00 value). Enormous returns. Product details 25c. Thompson, Box 241, Duluth, Minn.

COLOR-GLAZED Concrete pottery, tiles, walls. Make glazed concrete lawn pottery without molds, power or costly tools. Cheap materials. Build own equipment from our plans. Giftware, statuary. Money-making business for men. Booklet, colorplate, details 10c. National Potteries, 13 West 26th, Minneapolis, Minn.

HOW And where to obtain capital fully explained, free particulars. Star Service, Wapakoneta, Ohio.

PROFITUNITIES In mail order, three months 25c (coin). Circular "Truth about Business Plans" included. Otanko, Box 114, East Akron, Ohio.

PROFITS And pleasure making shell jewelry, novelties—newest field! Stamp appreciated. Challenge, A-11, St. Petersburg, Florida.

"INCREASE Your Earnings." Send for free budget of moneymaking opportunities. Bernie Pyles, 1566 Jones Street, San Francisco, Calif.

UP To \$300 week being earned putting on movie shows in small towns, at lodge meetings, churches, schools, fairs, etc. Our new 16mm. sound-movie projector offers you big opportunity. Write Wenzel Co., 2509 So. State, Chicago.

FREE Circulars describing hundreds of moneymaking opportunities by mail. Newest methods. Pleasant surprise. Write now. Progress Publishing Co., 2513A N. 9th St., Milwaukee, Wis.

HUGE Profits growing plants without soil. Produce flowers, fruits, vegetables anywhere year round with chemicals. Season's supply, directions, \$2.00. Formula, bibliography, \$1.00. Both \$2.50. Chemiculture, 4701 Sheridan, Chicago.

EARN \$25.00 Weekly working two hours daily. No canvassing or manufacturing. Business Opportunities, St. Paul, Minn.

COLOR Concrete surface with chemical solutions. Beautiful pottery without molds. Garden wishing-wells, Stucco rock. Glazing concrete. Sample 10c. Hollywood Cement Craft, 8527 Wonderland, Hollywood, California.

LIQUID Marble—anyone can make! Colorful, glazed! Moulded, brushed, sprayed. Rubberlastic moulds. Composition flooring. Big money in these! Particulars free. Marbleizing Service, Edwardsville, Ill.

107 WAYS To make money, in home or office, business of your own. Full particulars free. Elite Co., 214 Grand St., New York.

AFTERNOONS Free for outdoors, shows, \$340 month home. Unique plans. No canvassing. Prepare for surprise. Folio-F, Station D, Los Angeles.

ADDED Income ideas. Mail Sales News magazine, copy 10c. Katz, 4254 No. Kimball, Chicago.

DONUT, Potato chip, cheezed pop corn. Home made. Big profits. Vanderpol, Springfield, Ohio.

WE Start you in business, furnishing outfits and instructions, operating Specialty Candy Factory home. Men and women, earn \$25 up to \$60 weekly, all or spare time. (Our 29th year.) Booklet free. W. Hillyer Ragsdale, Inc., Drawer 4, East Orange, N. J.

SUCCEED With your products. Make-sell them. Formulas, Processes. Accurate analyses. Catalog free. B. Thaxly Co., Washington, D. C.

PROFITABLE Home business. Legitimate. No canvassing. Maywood Publishers, P-923 Broadway, New York.

SELL By mail. Books, novelties. Bargains! Big profits! Particulars free. B. Elfco, 438 N. Wells, Chicago.

FREE Booklet describes 107 plans for making \$20-\$100 weekly, in home or office, business of your own. Elite Co., 214 Grand St., New York.

I WANT To send you proof of the wonderful pulling power of Popular Mechanics Magazine's classified pages. What's your proposition? Write me today. F. W. Johnson, Manager Classified Advertising, 200 E. Ontario St., Chicago, Ill.

CHARTERS: Delaware; best, cheapest; free forms. Colonial Charter Co., Wilmington, Del.

CASH Every week clipping and preparing news items for publishers. Simple, fascinating work. Experience unnecessary. Stamp brings information. Division 55, National Press, 3923 W. Sixth, Los Angeles, Calif.

DELAWARE Charters: Complete service \$35. Submitted forms. Chas. G. Guyer, Inc., Wilmington, Del.

ARTIFICIAL Marble sanitary flooring, instruction covering wood or cement flooring 1/2 inch thick, fireproof, all colors, low cost, ornamental casting, concrete, plaster, papier-mache, garden furniture, statuary, flexible molds, particulars free. Chris Mahler, Elmont, N. Y.

MAIL Order business is your opportunity. Many began small, now earn thousands yearly. No personal contact. Boundless opportunities. Have had over 30 years experience; will help you succeed. Send 25c for valuable booklets, none free. B. Brenner, 257 S. 21st, Philadelphia.

100 PROFITABLE Mail order and local plans. Gilbert Supply, 1107 Broadway, New York.

MONEYMAKING OPPORTUNITIES

YOUR Name—5,000 mailing lists—25c. Get samples, opportunities galore from all over world. Pines, 583-P Monroe, Brooklyn, N. Y.

MIRROR Silvering formula 35c. Worth \$5.00. Hobby Man, Jefferson, Iowa.

NU-SHINE, Startling new discovery. Moneymaker. Formula 10c. Holgeron, Canton, Kansas.

START A business of your own. 22 new business opportunities. Particulars free. W. Strauss, Owings, W. Va.

START Mailorder business. Details free. Pederson, 1609 1/2 East Fifth, Duluth, Minn.

YOU'LL Like resilvering mirrors, auto-parts, reflectors, making chipped glass signs. Write, Sprinkle, Plater, 287, Marion, Indiana.

YOU Can be independent. Booklet on successful tested home and office businesses free. No investments required. Literary Sales, 168 Market, Hamilton, Canada.

"RESILVERING Mirrors" and 50 other moneymakers 10c. Ideal Service, 179-M, Park Ridge, Ill.

MAKE, Sell, men's washable ties, easy to make, sell. Materials cheap. Pattern, sales plan, tie, cut out, not sewed, 25c. pkg. needles, \$1.00 postpaid. Walter Journey, Orange, Texas.

FIVE Dollars made daily with your own simply made cleaner for painted woodwork, varnish, linoleum, etc. Every home prospect. Formula, full directions, one dollar. Marvoclean, 736 West Main, Richmond, Ind.

GROW Without soil—Flowers, vegetables, plants. Year round, anywhere. Only water and common chemicals used. Formula \$1.00. Bestovall, 4047-W North Whipple St., Chicago.

OPPORTUNITIES, Money making plans, profitable ideas, formula and trade secrets, choice selection, local or mailorder. Farm and Home Industries, 56 Seneca, Gardenville, N. Y.

FREE Details. Unique mail order opportunity. Act quick! Donner Company, Box 396, Far Rockaway, N. Y.

EASY Money! Moneymaking opportunities, many of them; anyone can work them spare or full time. Details free. Lewis Co., 828-A Carpenter, Oak Park, Ill.

FREE! Extraordinary opportunities! Mailorder and locally! Evers, Box 66PM, Elmhurst, N. Y.

MONEY Making plans! Over 100! Free details. Rogers, Waverly, Va.

BRUSHLESS Palseteeth cleaner formula \$1.00, large sample 25c silver. Walsh, 248 Whittenton St., Taunton, Mass.

CHEMICAL Culture. Grow flowers and vegetables without soil. 2 sample outfits for \$1.00. Distributors make 200%. Little Planters Club, 4111 S. Broadway, Los Angeles.

PEANUT Venders \$2.35 each. Davis Metal Fixture Co., Lansing, Mich.

TURN Spare time into cash with typewriter! Addressing envelopes, mailing circulars, typing! Dime brings information, none free. Ace-PME, 322 Empire, Birmingham, Ala.

\$40 WEEKLY At home making "Specialty Doughnuts," complete instructions 50c. Freeman, 118 Oak, Porterville, Calif.

ANALYSIS. Research. Newest guaranteed formulas. Biggest catalog free. Special prices, leads. Gibson Laboratory, Chemists, BD-1142 Sunnyside, Chicago.

MONEY In butterflies, moths. See Sinclair Display Advertisement on page 16A.

TREASURE Finders? Read Goldak advertisement on page 130A.

FREE! Send for booklet of special opportunity offers, if you are really looking for opportunities. Hughes Studio, Shillington, Penna.

"PROFITS." Stamping keychecks. Outfits furnished. Name-address on sample 25c. Bohn Co., Box 86-B, Wilkes-Barre, Penna.

MONEY Making propositions, practical and legitimate. Free particulars. Schembri, P.O. Box 1271, Detroit, Mich.

NOW Make money! A \$1.00 magazine (40th year), filled with schemes, tips, business opportunities, formulas, sent six months for only 30c. "Schemer Monthly," Alliance, Ohio.

STOP Squealing—Start crowing! Work mornings home—country drives or movies—afternoons! No canvassing! Polio-A, Station "D," Los Angeles.

MILLIONS Jobless! Get dollars in mail daily, like we do, for amazing employment information. Keep money; we fill your orders free. Stamp brings details. Co-Operative Service, 77 Swan, Buffalo, N. Y.

MAN In each town to plate auto parts, reflectors, bicycles, fixtures, mirrors, by late method. Simple plan of manufacturing at home starts you in good paying business. Free particulars and proofs. Gunmetal Co., Ave. N. Decatur, Ill.

RAISE Earthworms for profit. Information free, stamp appreciated. Bureau Zoological Research, 106A Broadway, Peoria, Ill.

MOULDS. Guaranteed, for casting toy soldiers, Indians, trappers, warships, sinker moulds, 244 kinds. Send 5c for illustration-catalogue. Henry C. Schiercke, 645 Spencer, Ghent, N. Y.

107 PLANS For making \$20-\$100 weekly in home or office business of your own. Descriptive booklet free. Elite Co., 214 Grand St., New York.

WHOLESALE Sources, 500,000 articles. Free directory. Maywoode, 925 Broadway, New York.

FORMULAS, PLANS, ETC.

100 MONEYMAKING Formulas 25c. Descriptive literature free. Harvey Teeple, Decatur, Ind.

MAKE Spare hours profitable with tested formulas. 50c each. Dean Formula Service, Box 101, Arlington, N. J.

GUARANTEED Formulas—New fast sellers. None better. Lowest prices. Catalog free. Kemico, 49G, Park Ridge, Ill.

MANUFACTURE Technikum fast selling products. Immediately successful. Very little equipment required. Enormous profits. 200 reliable formulas 50c. Technikum Laboratories, 210 5th Ave., New York.

NEWEST Formulas, all lines. Catalog free. Hodge Lab., Elkhart, Ind.

TESTED Plantculture formulas for sand, water. New simple method. Instructions. Bulletin list. \$1. Sell inexpensive mixtures. Plantculture, B601, Bryan, Texas.

INDUSTRIAL. Formula consultants. Alembic Laboratories, Chemists and Chemical Engineers, Box 1277, Chicago, Illinois.

POLISH Out stains and scratches from furniture, good for all metal. Formula \$1.00. Box 101, Flint, Mich.

ICELESS Ice! Colder! Cleaner! Cheaper! Instructions, 25c. Duffy, Covington, Ky.

FORMULA Book! Largest! Best! Send name-postal. Rokemko, Waverly, Va.

FOR 25c Or 3 for 50c we develop any formula desired. Here are a few: Veterinary remedies, vermin killers, cosmetics, dyes, etc. Abros Process Co., Box 733, Brockton, Mass.

MECHANICS Soap (1938) inexpensive. Formula 25c. Tom Moore, Chemist, Waterloo, Iowa.

110 EXCELLENT Formulas \$1. Mail-order, manufacturing. Acne Remedies, tonics, perfumes, etc. Interstate Laboratories, 210 Fifth Ave., New York.

ANALYSIS. Research. Newest guaranteed formulas. Biggest catalog free. Special prices, leads. Gibson Laboratory, Chemists, BD-1142 Sunnyside, Chicago.

WATERLESS Soap guaranteed, clean dirtiest hands in America. Formula \$1. Jerome Jones, Hollins, Alabama.

FORMULAS: 15 Proven moneymaking formulas \$1.00. (Not stock-formula catalogue stuff), real unusual offers. List free. Marvel Laboratories, 6629 No. Maplewood, Chicago.

NO Service like this! Certified formulas based on guaranteed chemical analyses of today's most popular specialties! Stamp brings valuable information. Miller, 1705 Jetton, Tampa, Florida.

THAXLY Formulas for perfect products. Accurate analysis assured. Resultful research. Catalog free. B. Thaxly Co., Washington, D. C.

FORMULAS. Latest money makers. Literature free. Belfort, 4042 N. Keeler, Chicago.

SILVERING Mirrors made easy and 460 other useful articles in Shop Notes, Vol. 28—50 cents postpaid. Popular Mechanics Press, Room (C38), 200 E. Ontario St., Chicago.

CHEMISTRY

CHEMICAL Analysis and testing. Send stamped envelope for details. S & W Laboratory, 701 N. Hickory St., Joliet, Ill.

ANALYSIS. Research. Newest guaranteed formulas. Biggest catalog free. Special prices, leads. Gibson Laboratory, Chemists, CT-1142 Sunnyside, Chicago.

CHEMICALS. Laboratory glassware, apparatus. Send 3c for catalog CP1. Biological Supply Company, 1176 Mt. Hope Avenue, Rochester, N. Y.

CHEMISTRY. Biology, mineralogy supplies, microscopes, telescopes. Catalog free. Teeko, Evanston, Ill.

HANDBOOK For chemical experimenters, hundreds of experiments, illustrated, 50c. Experiment booklet, 15c. Chemical catalogue, 10c. Reading Scientific Co., Reading, Penna.

FREE Chemistry catalog. Supplies at 5c! Equip complete laboratory. Send 3c for postage. Kemkit Scientific Corp., 397P Bridge St., Brooklyn, N. Y.

TECHNICAL Bulletin. Many subjects. List free. Popular Mechanics, 200 E. Ontario St., Chicago.

AGENTS WANTED

REPRESENTATIVE In each section to introduce greatest toy sensation of all times. Sells on sight. Large orders from variety stores. \$20 day easy. Agents proposition, instructions and prepaid sample 25c. Joy Toy Co., 1325 Stadium Ave., New York City.

COUNTY Agents wanted: "Snap-Up" keyless, electric, gasoline caps for automobiles. Exclusive county rights granted. Territory going rapidly. Write "Snap-Up," Box 830, Ashland, Kentucky.

200% PROFIT. Magic disc, needed every home. Amazing demonstration makes sales easy. Sample and plans 10c. Jaybe, Box 944, Altoona, Penna.

FAST Selling specialty, guaranteed product, large profits, great repeater. Exclusive territory. Details free. Nu-Way Products Co., 302½ E. So. Front St., Mankato, Minn.

SUBSTANTIAL Profits. Beautifully lighted house numbers. 3" black castiron, opal glass, switch, wire, Mazda bulbs, 10" x 4" x 1½". Easy installation. Sample \$2.59 complete. George Kelly, 5958 Washington Chicago.

DU SONNE Now gives you perfumed earrings. The year's biggest winner. Sample pair 25c. Attractive proposition awaits you. Chaperone Products Company, 17 State Street, New York City.

NEW. Streamlined writing set. Not a fountain set. The pen that fills itself. Low cost necessity. Unlimited field. Big money now. Write Inkflo, Dept. B, Los Angeles, Calif.

MAKE Good money trading new fountain pens for old discarded pens. Send old pen with 50 cents for sample and particulars. Fountain Pen Exchange, Flagler, Colo.

SIX Razor blades free. Make big money weekly giving away razor blades. Exclusive territory. Write immediately. R. Trego, 226 First Ave., Phoenixville, Penna.

AGENTS: Smash go prices! Santos coffee 12c lb. 4-oz. vanilla 8½c. Razor blades 10 for 8½c. 100 sticks chewing gum 12c. Christmas cards, 21 in box 14c. 150 other bargains. Premiums. Experience unnecessary. Carnation Co., PO, St. Louis, Mo.

AT Home, your own manufacturing business, making popular \$1 novelties. Cost you 3c to 15c. Everything supplied. Write So-Lo Works, Dept. G-842, Cincinnati, Ohio.

NEW Kind of heat boils water instantly. Make to \$30 daily. Pocket size minute demonstration. No installation. Free offer. No investment. Write the Lux Co., Dept. B-207, Elkhart, Indiana.

450% PROFIT Quick-Action automatic gas lighter. No flint. 25c seller to every home, office and restaurant. Sample 10c. New Method Co., Box PMG-67, Bradford, Penna.

STARTLING Invention—Pocket adding machine. Nationally advertised \$2.50. Whirlwind seller. Big profits. Baby Calculator Co., Box 1118, Chicago.

NEW Sensation craze, the Photo Ring, is sweeping the country. Make sensational profits for Photo Ring salesmen. Monarch Distributing Co., Box 46, Anderson, Ind.

ENAMEL Protection pads 20c. Foley, 517 Cloverdale St., Seattle, Washington.

SENSATIONAL New sellers. Free catalogue, samples. Paty Company, Somerville, Mass.

SELL Pal metal polishing cloth. Fast 25c seller. Sample 10c. Albert Nahabit, 116 Sylvian, Central Falls, R. I.

MAKE Artificial flowers, 40 different flower patterns and materials to make six dollars worth. Sent prepaid \$2. Zanone, 308 Van Buren Street, Chicago.

ABLE Man to distribute samples, handle coffee route. Up to \$45 first week. Automobile given as bonus. Write Albert Mills, 6225 Monmouth, Cincinnati, Ohio.

YOU Can have a cedar closet in your home for \$2.50. Agents wanted. Churchill Cedar Co., Box 731, Kellogg, Idaho.

SELL Business cards \$1.00—1,000. Liberal commission. Castellazzo, 3717 Redwood, Oakland, Calif.

WANTED—District purchasing agents. No experience or money required. Write Purchasing Manager, 174 N. Halsted, Chicago.

BIG Profits. The perfect eyeglass cleaner. Prevents steaming. Sample 15 cents. Shurberg Chemical, Hartford, Conn.

WHOLESALE Catalog. Razor blades, hosiery, soaps. Bulger, 147A Pemberton, Cambridge, Mass.

HELP Organize Little Coin Clubs. New, novel, profitable. Details 10c. James A. Ross, Balter Bldg., New Orleans.

HYATT 1938 New fast selling deals. Sample 25c. Orahood Sales, West Mansfield, Ohio.

"HOLDIT" Rug coating. Prevents slipping, wrinkling, etc. Good opportunity. Sample and details, 25c (coin). Wildon Co., Metropolitan Box 5032, Los Angeles, Calif.

RELIGIOUS Mottoes, sell fast at dime. Novelty Signs, Stryker, Ohio.

100% PROFIT. Millions need 25c eyeglass cleaner. Details free. Box 107, Seward, Nebr.

NEW Guaranteed electric dry shavers, reduced prices, easy payments. Reynolds, 5510 LeMoyné, Chicago.

AGENTS—Every auto owner wants new reversible sheep skin auto washing mitt. Big profit. No competition. Easy fast sales. Write quick. Be first in your territory. Blue Bonnet, Gainesville, Texas.

OUTSTANDING Opportunity. Agents wanted for Self-Adjustable Arch Support (patents pending). New England states already taken. Samples and details \$1.25 postpaid. Box 451, Leominster, Mass.

MONEY In butterflies, moths. See Sinclair Display Advertisement on page 16A.

SEPPA-FILE—New. Every factory, office and home a prospect. Introductory, dozen \$1.00 prepaid. Brings nice profit. Single sample 20c currency. Labahn, National Specialties, Evanston, Illinois.

PROFIT With new products. Make, sell, repeat. Analysis. Research. Guaranteed formulas. Biggest catalog free. Special prices, leads. Gibson Laboratory, Chemists, BD-1142 Sunnyside, Chicago.

SENSATIONAL Plan. Give free can of baking powder with each purchase. Write, Blako, 9459 Alstyn Ave., Elmhurst, New York.

A BUSINESS Of your own, making Palmer's original chipped glass name plates, numbers, mirrors, signs. Illustrated literature and sample free. E. Palmer, 512, Wooster, Ohio.

400% PROFIT—The Perennio Calendar 640 years. Vest pocket size, 24 pages. \$5.75 hundred. Sample 10c. Box 388, Baltimore, Md.

AGENTS Sell water and oil painted portraits. Large commission daily. New York Art Studio, Syracuse, N. Y., Elmwood Station, Dept. 3-A.

FREE! Mexican framed feathered pictures. 5½x8½ costs 49c, retails \$1.00. Sample 50c stamps, refunded first order. Marquez-P, Apartado 1176, Mexico City.

DO You want agents for your proposition? Your ad in this space will place your message before hundreds of men seeking fast-selling products. My folder "How to Secure Agents," is filled with proof. I'll gladly send you a copy free. P. W. Johnson, Manager Classified Advertising, Popular Mechanics Magazine, 200 E. Ontario St., Chicago.

SELL Beautiful 1939 art calendars low as 100 for \$3.95. Every business buys. Orders being placed; start quick! Big commissions daily. Write! New England Art Publishers, North Abington, 36, Mass.

AGENTS Make bigger profits on food products—bargain deals. Low wholesale prices. Big display case sent on trial. Ho-Ro-Co, 2810-R Dodier St., St. Louis, Mo.

BIG Money applying initials on automobiles. Write for particulars and free samples. American Letter Company, Dept. 40, Dunellen, New Jersey.

ATLAS Window sign letters. Large sizes, penny each. Beautiful free samples. Atlas, 7941 Halsted, Chicago.

BIG Money applying initials on automobiles. Easiest thing today. Free samples. Also, sideline salesmen for name plates and tire cover transfers. "Ralco," 1305 Washington, Boston, Mass.

500% PROFIT! Gold and colored sign letters for windows, offices, trucks, signs. Auto monograms. Easily applied by agent or customer. Neonite, Akron, Ohio.

BIG Money taking orders; shirts, ties, hosiery, underwear, raincoats, pants, uniforms, etc. Sales equipment free! Experience unnecessary. Write Nimrod, Dept. 8, 4922-28 Lincoln, Chicago.

GUARANTEED Gold leaf letters for store and office windows. 500% profit. Free samples. Metallic Co., 438-B N. Clark, Chicago.

MAN In each town to plate auto parts, reflectors, bicycles, fixtures, mirrors, by late method. Simple plan of manufacturing at home starts you in good paying business. Free particulars and proofs. Gunmetal Co., Ave. H, Decatur, Ill.

AGENTS—To mail our literature. Good profits. Home business. Maywood, 149 Fifth Ave., New York.

SUCCEED With your products. Make-sell them. Formulas. Processes. Accurate analyses. Catalog free. B. Thaxly Co., Washington, D. C.

AGENTS—Opportunity to make money; book containing 107 successful business plans; home or office; send for free introductory booklet. Elite Co., 214 Grand St., New York.

FREE Sample—Amazing cleaner; sells homes, taverns, everywhere. Big profit—fast repeater. Betco, 5007 Irving Park, Chicago.

AGENTS: Stamping names on pocket-key protectors. Sample check with your name, address, 25c. Stamping outfits. Emblem checks, check-fobs, name plates. Hart Mfg. Co., 303 Degraw St., Brooklyn, N. Y.

MANUFACTURE Specialties, hire agents yourself. Big money. Free literature. Gilbert Supply, 1107-P Broadway, New York.

ENGRAVED Name plates, numbers, signs, etc., easily sold, profits large. Brett Bros., Winthrop, Mass.

HIGH-GRADE SALESMEN

CALLING All brush salesmen. Make 100% profit selling the newest Magnetic Electric Brush, attractive sponge rubber brushes and other rubber items. Household chemicals, polishes, waxes, silver cloths, fly sprays, moth destroyers, kitchen aids, plus a wonderful complete line of quality brushes, mops, brooms, etc., tested and approved by Good Housekeeping Institute. All salesmen make 100% profit plus an immediate opportunity to become manager with a company established fifteen years. Write Advertising Department, Donald Brush Company, Camden, N. J.

SALESMEN—Sell business stationery, book matches, advertising gummed tape, advertising pencils, shelf moulding, labels, salesbooks, rubber stamps. Business cards \$1.50 thousand. 35% comm. daily. Free deals. Sales portfolio free. David Lionel Press, 312 So. Hamilton, Dept. J, Chicago.

SALESMEN Distributors, 200 items brushes mops. Marvelous Magnetic Brush excels vacuum cleaner. Big profits. Neway Brush Co., Hartford, Conn.

SELL Starbrite signs, religious mottoes. Schaffner, 1336 W. Rush, Philadelphia, Penna.

SELL Nothing. \$95.00 weekly. \$500,000 punchboard firm announces new, no investment plan. Season starting. K&S, Dept. C127, 6227 Broadway, Chicago.

EXPERIENCED Salesmen. Home study courses of higher learning in law, arts and sciences, engineering, vocational. Highest commissions. McKinley Graduate College, Chicago.

BIG Commission selling celluloid pricing tickets, metal shelf moulding, menu covers, signs, celluloid buttons, cards. P. Pricing Tickets, 124 White Street, New York.

DID You make \$50 last week? Does your job offer you real future? If not, why not start a wholesale business of your own? Little or no capital needed. Handle line 200 nationally advertised 5c-10c products. Show merchants new plan for increasing sales and profits. Handle everything from your home at start. Chance to operate one of our Silver Fleet service trucks. Facts free. World's Products Co., Dept. 7810, Spencer, Ind.

IF You are ambitious you can make good money with a Rawleigh route. We help you get started. No capital or experience needed. Steady work for right man. Write Rawleigh's, Box G-2-PPM, Freeport, Ill.

JUST Out. New invention sells fast to service stations, garages. 4 easy sales daily makes \$75.00 weekly. Vernon Co., Newton, Iowa.

SELL America's most complete line of business necessities. Regular and novelty size book matches, gummed labels, political items, pricing sets, restaurant supplies, salesbooks, engraved lake stationery, shipping room supplies, office supplies, printed gummed tape, advertising chewing gum, advertising pencils, thermometers, business stimulators. Complete line printed business forms and hundreds of other fast sellers. Business cards \$1.50 thousand. Stationery \$2.70 thousand. All competition undersold. Cash commissions advanced daily, extra bonus. Experience unnecessary. Complete sales outfit free. Federal, AL-301 South Desplaines, Chicago.

SALESMEN—Distributors. Unlimited money making opportunity selling the new, universally needed Sentry Stop-a-Draft (see page 879 June issue Popular Mechanics). No competitors. Every home, office, store, factory, hotel, hospital and building a prospect. Protected territory available on attractive, small deposit basis. Ray-steel Specialties, Inc., Terminal Tower, Cleveland, Ohio.

MAKE Up to \$50.00 weekly part time selling top quality advertising book matches at low prices. Experience unnecessary. Full time profits unlimited. Free sales kit and zipper case. Match Corporation of America, Dept. E-7, 6041 West Grand, Chicago.

MAKE Up to \$1200 per month. Exceptionally high grade big money making opportunity. Write quick. Charles Kopp, Mansfield, Ohio.

SALESMEN—Sell calendars, complete line, all sizes, including jumbos; beautiful subjects. Samples free! Fleming Calendar Co., 6539 Cottage Grove, Chicago.

317% PROFIT Selling soilless plant grower. Sample 50c. Details free. Soilless Growers, 1570 South First, Milwaukee, Wisconsin.

YOUNG Men! Here is your opportunity. Sell guaranteed tires wholesale. Large profits. Unlimited field. Details free. No experience or money necessary. Auto Tire Co., 4602-A So. Ashland, Chicago.

BLADES, Factory prices. Free delivery. Ace Blades, Dept. 5-E, Rochester, N. Y.

"KWIK-N-EASY Bug Remover" dissolves insects and splashes on automobiles. Sales possibilities unlimited. Constant repeater. Sample 25c. Chemical Industries, San Francisco, Calif.

BEAUTIFUL Line advertising book matches; salesmen's catalogs. Sander-son's, Ottawa, Illinois.

BUILD Steady year round business calling on beauty shops. Complete line. Send \$1.00 for instructions and material. Century Chemists, Williamstown, Ky.

AGGRESSIVE Salesmen for exclusive sales rights on famous, Proven King Products. Constant money-maker. Fast repeater. 100% profit. Earn \$5000 up yearly. Successfully sold for years. Don't waste time. Pick a winner. Write King Mfg. Co., 1701 Maplewood Ave., Flint, Mich.

SELL Fans, calendars to merchants. Free samples to producers. Casey Calendar Co., Knoxville, Iowa.

SALESMEN: Sell advertising novelties, calendars, fans, thermometers, etc., for nationally known firm. Liberal commissions. Stanwood Hillson Corp., 21 Station St., Brookline, Mass.

BIG Money taking orders; shirts, ties, hosiery, underwear, raincoats, pants, uniforms, etc. Sales equipment free! Experience unnecessary. Write Nimrod, Dept. 65, 4922-28 Lincoln, Chicago.

ATLAS Window sign letters. Large sizes. Penny each. Beautiful free samples. Atlas, 7941 Halsted, Chicago.

OUR New 1938 complete line of brushes now ready. Largest commissions. Write for sales plan. Wire Grip Sanitary Brush Company, 2300 5th Ave., New York.

NEW Specialty—Sells every business and professional man. Four \$15 sales daily pay \$280 weekly. Farrell cleared over \$1,000.00 monthly. Write, F. E. Armstrong, President. Dept. PM, Mobile, Ala.

GUARANTEED Gold leaf letters for store windows. Free samples. Liberal offer to car owners. Metallic Co., 438-A N. Clark, Chicago.

MAKE More money with Red Comet Automatic Fire Extinguishers. Low price. Proved seven years. Splendid sales outfit free. Some good territory open. Exclusive. Write quick. 704 Red Comet Bldg., Littleton, Colo.

FREE Booklet describes 107 plans for making \$20-\$100 weekly, in home or office, business of your own. Elite Co., 214 Grand St., New York.

HELP WANTED

LOCAL Agents wanted to wear and demonstrate suits to friends. No canvassers. Up to \$12 in a day easy. Experience unnecessary. Valuable demonstrating equipment, actual samples free. H. J. Graves, 1300 Harrison, Dept. G-817, Chicago.

STORIES, Cartoons, photos wanted. Instructions, sample magazine 20c. Box 280, Mansfield, Ohio.

WEAR Fine hose I send without cost with outfit while taking orders for amazing new hosiery. Replacement guaranteed against holes, snags, and runs. Rush name and hose size. Wilknit, Desk 37-G, Greenfield, Ohio.

I'LL Give you groceries at wholesale besides splendid opportunity to make up to \$45.00 in a week. Brand new Ford sedan given as bonus. Details free. Albert Mills, 6219 Monmouth, Cincinnati, Ohio.

EDUCATIONAL AND INSTRUCTION

AUTOMOTIVE Home study courses. Many good jobs for trained men in automobile, mechanics, aviation. McKinley-Roosevelt College, Chicago.

DRIVING Easily learned with simple illustrated instructions. Free details. Educational Service, 261 Boerum St., Brooklyn, N. Y.

FOR An extremely profitable lifetime business, operate a collection-credit agency. Free folder. Cole Associates, Syracuse, N. Y.

MAKE More money. Get a U. S. government job. Get our new plan for obtaining one—no obligations. Age 18-50. Write Ozment Instruction Service, 101, St. Louis, Mo., immediately.

SELL Insurance. All kinds. Training and placement. Vocational Institute, Boonton, New Jersey.

GET A government job. \$105-\$175. Prepare immediately for next examinations. List positions, full particulars, free. Write today. Franklin Institute, Dept. T3, Rochester, N. Y.

1938 GOVERNMENT Exams. Fingerprint classifier, customs aid, auditor, elevator conductor, \$1.10 each. Complete practice examinations, answers. List 50 jobs, previous examination questions free. Write today. Pergande, Publishers, Milwaukee, Wis.

UNEMPLOYED? Business improving. Thousands job opening. Instructive information free. Write. Employment Counsellors, Box 1283-K, Milwaukee, Wisconsin.

STUDY For a degree in psychology, metaphysics, truth, theology. Home study. Chartered college. Free catalog. College of Universal Truth, 1100 N. Dearborn, Chicago.

LEARN To dance. Complete instructions \$1.00. Deluxe Co., Box 512, Des Moines, Iowa.

SUCCESSFUL Men are "realists." Treatise on realism sent free. Realist League, 45 Abbey Court, Brooklyn, N. Y.

BECOME Practical scientific investigator. Modern, illustrated course. Thorough training by former agent U. S. secret service. Particulars free. International Secret Service Institute, PM-78, Hoboken, N. J.

"SHORTHAND Simplified" complete \$1.00. Lesson 10c. Opportunities. Simmons, Rocky Hill, Conn.

MATHEMATICS. Arithmetic, algebra, geometry, trigonometry, physics, drafting, airplane, mechanical, electrical, ship, structural, surveying, blueprint reading, building estimating, preparation licenses, civil service engineering examinations. Mondell Institute, 112 W. 42d, New York.

TELEGRAPHY Taught thoroughly. New railroad retirement act creating renewed openings for operators. Enroll now. Expenses low. Catalog free. Dodge's Institute, Hiatt Ave., Valparaiso, Ind.

MASSAGE. Hydrotherapy, dietetics, drugless therapeutics, chiropody, taught by mail. Evans Correspondence School, Montgomery, Ala.

GOV'T Jobs start \$1260-\$2100 year. Men-women age 18-50. Former examiner's tested method helps qualify you. Particulars, list jobs free. Write today. Patterson School, 8C Mercantile Bldg., Rochester, N. Y.

DEGREES Earned by home study in arts, sciences, philosophy, education, psychology, theology, law, chemistry, engineering, business, agriculture. McKinley-Roosevelt College, Chicago.

EARN Extra money! Clipping and preparing newspaper articles for publishers. Simple; fascinating; profitable. Send stamp. Division 55A, National Press, 3923 W. Sixth, Los Angeles, Calif.

LEARN Machinist trade, tool, die making. Automatic and hand screw machines. Modern shop methods. Actual work. Jobs open for trained men. Employment help. Illustrated booklet free. Allied Screw Machine Co., 601 Lake St., Chicago.

LEARN Auto mechanics, body, repairing, welding, electricity, refrigeration. Diesel. Stevenson's, 208A Main, Kansas City, Mo.

"1,000 WAYS To Make \$1,000." You can do it—others have. This amazing book will startle you. 475 pages, only \$2.50. Popular Mechanics Press, Room (C38), 200 E. Ontario St., Chicago.

CARTOONING, COMMERCIAL ART, SHOWCARD WRITING, SIGN PAINTING

ART. Sell oil paintings for well known artist. Tremendous profit, sell on sight. Send \$1 for large painting, particulars. Photoart, 857 S. 89 St., Wauwatosa, Wis.

NEW, Profitable industry for artists and cartoonists! Write Hartman, 2438 W. Lincoln, Nebr.

SELL Cartoons. Templetons Cartoonist Monthly tells where. Two issues 25c. Lavalette, W. Va.

CHALK Talks. Laugh producing program, \$1.00. Catalog 10c. Balda, the Cartoonist, Oshkosh, Wisconsin.

EARN cash income, copying and duplicating simple cartoons for advertisers. 3-M Service, Argyle, Wis.

MAKE Art Pay. Advanced art students. \$1.00. Popular Mechanics, 200 E. Ontario St., Chicago.

PLAYS, STORIES, MANUSCRIPTS

RADIO Scripts professionally prepared for broadcast and sale. Weston Studios, 709 Broad, Endicott, N. Y.

WANTED—Authors' manuscripts. Immediate marketing. Revel, 73 West 44th, New York.

STORIES Revised; placed on market. Write: Hursh, Box P-1013, Harrisburg, Penna.

WANTED, Original poems, songs, for immediate consideration. Send poems to Columbian Music Publishers, Ltd., Dept. 209, Toronto, Can.

ADVERTISING AGENCIES, LETTER WRITERS, FOR ADVERTISERS

LEARN Advertising quickly at home. Easy practical plan. No text books. Common school education sufficient. Interesting booklet and requirements free. Page-Davis School of Advertising, 3601 Michigan Avenue, Dept. 3432, Chicago.

ADVERTISING Placed over 3700 weekly newspapers. Castellazzo, 3717 Redwood, Oakland, Calif.

ADVERTISE In Sunday newspapers reaching 1,500,000 homes throughout United States. \$15.40 inch. Ratebook all leading newspapers, magazines, free. Chicago Union Agency, 20-P West Jackson, Chicago.

24 WORDS 65 Newspapers, magazines \$3.00. Goodall, 742 Market, San Francisco.

INCH Display advertisement 30 magazines year \$24. Wood's Popular Services, Atlantic City, (N. J.)

TELEPHONE Directory names, addresses \$1.00 per 200, \$4.00 per 1000. W. Grasons, 2817 "C" St., Toledo, Ohio.

ADVERTISE: 24 Words in 250 newspapers \$10. Lists free. Advertising Bureau, 4515-C Cottage Grove, Chicago.

FREE—New Advertisers Rate Guide, 44 pages. Includes everything. Lowest rates. E. H. Brown Advertising Agency, 140 S. Dearborn, Chicago.

ADVERTISING Placed anywhere. Helpful, free service. Rate guide book free. Baker Advertising Agency, 189 W. Madison, Chicago. Successors to Ankrum Advertising Agency. Established 27 years.

BUSINESS SERVICE

INFORMATION—Where to buy anything. Manufacturers, wholesalers addresses. Unusual articles our specialty. Reasonable rates. Universal Buyers Service, Box 134, Lakewood, New York.

CHICAGO Mail address; business, personal. Mail reforwarded to you. \$1 monthly. General, 56 West Washington.

BRANCH Office mail address representation; efficient service. Brockington, Chazy, N. Y.

\$2.00 MONTHLY Maintains Washington, D. C. office, business or personal purposes. Hawkins Mail Service, 817 Fourteenth.

MESSAGE Bureau. Mail forwarded daily. 200 Lumber Exchange, Minneapolis, Minn.

RUBBER STAMPS AND OFFICE SUPPLIES

CUSHION Mounted one, two lines, 25c; 3 lines, 35c. Stamp Works, Hastings, Nebraska.

2 LINES 25c, 3 Lines 35c, signatures \$1.50. Stamp Works, Centerport, N. Y.

BRONZE Signs. Made to your order. Write for estimate. Randale Co., 118 Walker St., New York, N. Y.

NAME Address, 2 lines 25c; 3 lines 35c. Stamp Works, Auburn, Nebr.

CUSHION Mounted one-two lines 25c; three 35c. 100 letterheads, 100 envelopes \$1.00. Hauer Press, 1314 Ford, Youngstown, Ohio.

ORIGINAL, Cushion mounted. One, two lines 25c; three 35c; four 45c. Facsimile signature \$1.50. Stamp Works, 814 Bradley, Peoria, Illinois.

TYPEWRITERS, DUPLICATORS, OFFICE DEVICES

TYPEWRITERS, Duplicators, multi-graphs. Write for free list office machine bargains. Save half. Pruitt, 518 Pruitt Bldg., Chicago.

STENCIL Duplicator—Anyone can make! Particulars free. Rapidee Service, Edwardsville, Illinois.

INCREASE Business now. "Excello-graph" Rotary Stencil Printer reprints thousands everything you typewrite, hand-write, draw or trace. Colors, \$19.75 to \$44. Terms. Illustrated literature free to business or professional men. Pittsburgh Typewriter Supply, Department K-2, Pittsburgh, Penna.

PRINTING, MULTIGRAPHING, MIMEOGRAPHING, GUMMED LABELS

95c EACH 250 Letterheads, envelopes, statements, 1000 cards or tickets. 100 chance books \$2.50. Postpaid. C. J. P. Printing, 2617 Ann Street, Philadelphia, Pennsylvania.

OFFICE Supplies, labels, envelopes, etc. Free samples. Okayprint, Martins Ferry, Ohio.

MODERN Letterheads in good taste inspire confidence. Special—500 white Hamilton (new) bond letterheads, envelopes, \$3.75. Colors, finishes. Folders. Croydon Press, 108 Fourth Avenue, New York.

PRINTING—Rubber stamps, office supplies, illustrated price list free. Edgewood Press, Edgewood, Maryland.

PRINTING—Complete line. Low prices. Estimates given. Castellazzo, 3717 Redwood, Oakland, Calif.

500 STICKERS, Four lines, 25c. Fine labels. Cott's, Spickard, Missouri.

1000 2 1/2 x 4 LABELS \$1.50; 2 1/2 x 3, \$1.25. 100 8 1/2 x 11 letterheads 50c; 6 3/4 envelopes 60c. Paramount Press, Atlanta, Missouri.

MULTIGRAPHED Letters that look typewritten. Hundred \$1.30. Additional hundreds 10c. (20-line-limit). Box 304, Columbus, Ohio.

LABELS For shipping, packaging, advertising. Samples. Aircraft Label Company, Asheville, N. C.

TYPEWRITTEN Letters duplicated; overnight service! Submit copy for quotations. Brockington, Chazy, N. Y.

\$1.00 POSTPAID—125 8 1/2 x 11 Letterheads and 125 envelopes. Benneville, 907 West Roosevelt, Philadelphia.

1000 BUSINESS Cards \$1.00; cash; postpaid. Brower Press, Sandwich, Ill.

500 QUALITY Business cards \$1.50. Postpaid. Capitol Stationery Company, PM-285, East Williston, New York.

HAMMERMILL Letterheads, 300 8 1/2 x 11, any color paper and ink, \$1.48 postpaid. Free particulars. Woodruff's, 217A Lewis, Duluth, Minn.

1000 6 x 9 CIRCULARS, Letterheads, envelopes, postcards, \$2.95; 5000, \$9.45. All printing reasonable. Samples. Cuts. Goodprint, Harrisonburg, Va.

GET Our prices for distinctive printing. The Delavan Printery, 177 Freund St., Buffalo, N. Y.

FREE Pricelist, samples. Hammermill letterheads, statements, 6 3/4 envelopes, \$3.89—1000. McCall Press, 1326 So. 27th, Omaha, Nebr.

EXTRA—1000 Letterheads, envelopes, 6x9 circulars, postcards, statements, \$2.25; 5000, \$8.00 postpaid. Guaranteed. Sudden service. Reasonable in all printing. Try and be convinced. Established 1899. Hustler, Advance, Indiana.

ZINC Line cuts \$1.00 up. Halftones \$1.35. Printwell, Wyoming, Penna.

SNAPPY Modern printing. Lowest prices. Mellenshel Printers, 3717 Lexington, Chicago, Illinois.

BEST Quality envelopes, thousand, \$1.75, 5000, \$6.75. Samples. Hemphill, Kenilworth, Illinois.

HARVEY Labels—Sensational values. Samples free. 6618T Quimby, Cleveland, Ohio.

1,000 BOND Letterheads or envelopes, \$2.85. Moyer, B-241-P, Milton, Penna.

MATCHES—Advertising book matches. Extraordinary! (Salesmen wanted). Sanderson's, Ottawa, Illinois.

PRINTED Envelopes \$1.10 M. Letterheads, statements. Maloney Sales, Box 182, Rochester, N. Y.

LETTERHEADS, Envelopes, cards, 250, \$1.25; 500, \$1.95. Circulars 1000, \$1.85. Samples. B. Wilson, 1724 Monroe, Madison, Wisconsin.

200 8 1/2 x 11 BOND Letterheads, 100 envelopes \$1.00. Times, Warrensburg, Ill.

SEND Dollar bill for 1000 business cards. Woodprint, Woodstock, Virginia.

500 LETTERHEADS. Statements, envelopes, or 1000 business cards \$1.00. Carter, Box 52, Orange, Calif.

NEARGRAVURE Stationery! Distinctive, striking, different. Solldays, Letterhead Specialists, Knox, Indiana.

LABELS: All kinds. Write, samples. JBSCO, Box 93, Holyoke, Mass.

500 3/4x2 1/4 FOUR Line gummed stickers, 25c. Moritz Printery, Saginaw, Mich.

PRINTING OUTFITS AND SUPPLIES

HAND Press, type and complete printers' supplies. Advise equipment you need and we quote prices; or send stamp for catalog. P. Peiffer, 10-C; 6 Columbia St., Newark, N. J.

PRINT Your own cards, stationery, circulars, advertising. Save money. Easy rules furnished. Print for others, big profits. Junior outfit \$9.00; job presses \$11 up. Details free. Kelsey Presses, E-11, Meriden, Conn.

BARGAIN: (Chandler) Gordon press. Size 8x12. Excellent condition. Must sell to settle estate. \$48.00 f.o.b. Chicago. E. Kelsey, 645 W. 64th St., Chicago.

LEARN Silk screen process. Information free. Or, send 25c for complete instructions. Process Division, 86 St. Paul Street, Rochester, N. Y.

SUPPLY Sources, everything. Printers co-operate. Sharra, 325 Atwood, Pittsburgh, Penna.

HAND Presses, type, supplies. Big lists 3c. Landis, Richland, Penna.

STOCK Cuts 40c up. Catalog 10c. Gregor's, 79-N Main Street, Belleville, N. J.

BARGAINS, Presses, type, List 3c. Exchange D-15, 22 Orient, Meriden, Conn.

BARGAINS — Presses, type, supplies. Send stamp. 159 Harvard, Cambridge, Mass.

PATENT ATTORNEYS

WHAT To do with your invention? Free books tell all. Patent facts clearly explained. 63 years' experience at your immediate service on easy budget payment plan. Write today for free copies of our booklets and "Certification of Invention" form. C. A. Snow & Co., 175 Snow Building, Washington, D. C.

INVENTORS: Send immediately for your copies of our new free books, "Patent Protection" and "Suggestions on Selling an Invention." Sixty-eight pages of interesting facts. They tell how patent laws protect you; kind of sketch or model needed; simple steps to take without cost; how successful inventors have secured financial assistance; show interesting inventions; illustrate important mechanical movements. With books we also send free Evidence of Invention form to help establish date of disclosure. Prompt service, reasonable fees, special deferred payment plan. Strictest secrecy. Thirty-nine years experience. Highest references. Write us today. The facts in our books, are worth money to the man with a good invention. Address: Victor J. Evans & Co., Registered Patent Attorneys, 12-H Victor Building, Washington, D. C.

INVENTORS—Small ideas may have large commercial possibilities. Write us for free book, "Patent Guide for the Inventor" and "Record of Invention" form. Delays are dangerous in patent matters. Free information on how to proceed. Clarence A. O'Brien & Hyman Berman, 58-D Adams Bldg., Washington, D. C.

PATENTS—Best service, free opinion. Expert Washington associates. Address: David P. Dellinger, Attorney, Cherryville, N. C.

WE Successfully sell inventions, patented and unpatented. Write for proof, and tell us what you have for sale. Chartered Institute of American Inventors, Dept. 4-C, Washington, D. C.

"INVENTOR'S Guide." 100 mechanical movements, free; advises on patenting, selling inventions. Frank Ledermann, Tribune Bldg., New York.

PATENTS. Instructions "How to Establish Your Rights" and form, "Evidence of Conception"—sent free! Lancaster, Allwine & Rommel, 411 Bowen Bldg., Washington, D. C.

PATENTS. Booklet free. Highest references. Best results. Promptness assured. Watson E. Coleman, Patent Lawyer, 724 Ninth St., Washington, D. C.

L. F. RANDOLPH, 302-B Victor Bldg., Washington, D. C. Low cost. Book and information free.

INVENTORS—Send for free booklet "Patent-Sense." Information based on 64 years experience. Lacey & Lacey, Dept. 5A, 635 F St., Washington, D. C.

PATENTS—Trade marks. Preliminary advice, book and disclosure form free. Personal service. Irving L. McCathran, 1060 International Bldg., Washington, D. C. Registered Patent Attorney.

PATENTS. Protect your idea by securing free "Proof of Invention" folder. Exceptional personal service. Established 1906. E. E. Vrooman, 871 Woodard Bldg., Washington, D. C.

FOR INVENTORS

INVENTORS: Send immediately for your copies of our new free books, "Patent Protection" and "Suggestions on Selling an Invention." Sixty-eight pages of interesting facts. They tell how patent laws protect you; kind of sketch or model needed; simple steps to take without cost; how successful inventors have secured financial assistance; show interesting inventions; illustrate important mechanical movements. With books we also send free Evidence of Invention form to help establish date of disclosure. Prompt service, reasonable fees, special deferred payment plan. Strictest secrecy. Thirty-nine years experience. Highest references. Write us today. The facts in our books are worth money to the man with a good invention. Address: Victor J. Evans & Co., Registered Patent Attorneys, 13-H Victor Building, Washington, D. C.

MODELS, Dies, metal stampings of patent articles. Mail 3c for catalog of model supplies. Pierce Model Works, 28 North Clinton St., Chicago, Illinois.

WORKING Models built. Tools, dies and experimental work. Engineering service. Ask for estimate. Esquire Tool and Die Corp., 3115 W. Cameron Ave., Milwaukee, Wis.

INVENTORS—Small ideas may have large commercial possibilities. Write us for free book, "Patent Guide for the Inventor" and "Record of Invention" form. Delays are dangerous in patent matters. Free information on how to proceed. Clarence A. O'Brien & Hyman Berman, 58-D Adams Bldg., Washington, D. C.

INVENTIONS. Financed, patented, marketed. Inventors Limited, 6556 S. Halsted, Chicago.

WILL Consider purchasing patent having possibilities for me to manufacture and market. Write full details. Box 138, West Hartford, Conn.

PROTECT Manuscripts, songs, ideas against plagiarism. Details \$1. Box 304, Columbus, Ohio.

BUYERS Located meritorious patented, unpatented inventions. Descriptive booklet, disclosures form free. If will sell, write us immediately. Invention Reporter, M-11236 So. Fairfield, Chicago.

SELL Your patent through a small classified ad in Popular Mechanics. Many inventors have found buyers in this way. Ask me for proof—I'll gladly send it to you. F. W. Johnson, Manager Classified Advertising, 200 E. Ontario St., Chicago.

PENDING Patent applications can be brought before thousands of manufacturers, free of charge, through Invention Magazine. Write for details. Invention, Inc., 635 F Street, Washington, D. C.

UNPATENTED Ideas can be sold. I tell you how and help you make the sale. Particulars with list of manufacturers and wanted inventions, sent free on request. Write Wilson Holmes, 907-A Barrister Building, Washington, D. C.

INVENTORS—Send for 72-page book on patents. Reasonable terms. Conscientious treatment to inventors. L. F. Randolph, Registered Patent Attorney, 302-E Victor Bldg., Washington, D. C.

INVENTORS: "Making Inventions Pay," our 32-page illustrated book, mailed upon receipt of 3c postage. Crescent Tool Co., Dept. Z, Cincinnati, Ohio.

I SELL Patents. Established in 1900. Charles A. Scott, 773PM Garson Ave., Rochester, N. Y.

INVENTOR'S Universal Educator: contains 900 mechanical movements; 50 perpetual motions; instruction on procuring and selling patents and selecting an attorney, etc. Suggests new ideas. Price \$1 postpaid in U.S.A. Address Albert E. Dietrich, 511-B Colorado Bldg., Washington, D. C.

HAVE You a sound, practical invention for sale, patented or unpatented? If so, write Chartered Institute of American Inventors, Dept. 4-A, Washington, D. C.

INVENTIONS WANTED

SMALL Inventions wanted by manufacturers. I'll help you sell your invention. Write for free circular. Stanley Hull, 7829-K Euclid Ave., Cleveland, Ohio.

CASH For unpatented ideas. Stamp for particulars. Mr. Ball, 9441-A Pleasant, Chicago.

INVENTIONS Quickly commercialized. Unpatented, protection guaranteed. Pacific Inventors Agency, 2236 Post, San Francisco, Calif.

WANTED — Prominent manufacturer wants ideas or inventions pertaining to automatic coin-operated devices of all descriptions. All correspondence confidential. Western, 925 W. North Ave., Chicago.

SIMPLE, Practical inventions wanted by manufacturers, patented or unpatented. For information write Chartered Institute of American Inventors, Dept. 4-D, Washington, D. C.

PATENTS FOR SALE

HOT Specialty and premium. Paul DeMartini, 75 Rico Way, San Francisco, Calif.

MANUFACTURING

MANUFACTURERS — Confidential development, models, special tools, complete engineering, machinist, service production, twenty years experience. St. Louis Tool, St. Louis, Mo.

ANALYSIS. Research. Newest guaranteed formulas. Biggest catalog free. Special prices, leads. Gibson Laboratory, Chemists, DS-1142 Sunnyside, Chicago.

DIES, Stampings, wire forming, complete manufacturing. Southern Products, Independence, Missouri.

INVENTIONS Manufactured in any quantity at low cost. Stampings, dies, models, etc. Estimates and free catalog. Crescent Tool Co., Dept. X, Cincinnati, Ohio.

MANUFACTURING. Dies, machinery, models, brasswork, white metal casting moulds. Catalog 3c. Baum's Metal Specialties, Kansas City.

DIES, Models, engineering, drafting, inventions perfected, catalog house connections, metal stampings, manufacturing specialists. Honeycutt Mfg. Co., Kansas City, Mo.

MODELS AND MODEL SUPPLIES

SPEED Boat engines, boilers, torches, hulls. Write for list. Worthington Engines, 7817 Grove Ave., Webster Groves, Mo.

GAS Model airplane catalog 5c. GMS, 314 Second North, Syracuse, N. Y.

INVENTORS—Small ideas may have large commercial possibilities. Write us for free book, "Patent Guide for the Inventor" and "Record of Invention" form. Delays are dangerous in patent matters. Free information on how to proceed. Clarence A. O'Brien & Hyman Berman, 58-D Adams Bldg., Washington, D. C.

MODEL Railroad supplies catalog 10c. Box B, Dunellen, New Jersey.

CATALOGUE Of over 40 engines, castings, supplies, 25c. Refunded. Howardco, A-2417 North Ashland, Chicago.

MODEL Railroad supplies catalog 10c. Box PM, Dunellen, New Jersey.

MODEL Making machinery, precision built, reasonably priced. Write for circular. William Romer, 656 Winthrop Ave., New Haven, Conn.

GAS Motors for model airplanes, boats, Circular 10c. Anton Bohaboy, Rahway, New Jersey.

SHIP And yacht model fittings; construction sets; model yacht sails; illustrated catalog 20 cents. A. J. Fisher, 1002-1 Etowah Avenue, Royal Oak, Mich.

MODELS—Your ideas developed into practical working models. 30 years' successful experience; thousands of satisfied customers. Confidential service guaranteed. Bank references. Send 3c postage for 32-page book—"Making Inventions Pay." Crescent Tool Co., Dept. Y, Cincinnati, Ohio.

MODEL Supplies for the inventor. Send 3c stamp for catalog. Pierce Model Works, Tinley Park, Ill.

RAILWAY Models. Catalog handbook 25c. Walthers, 247 E. Erie, Milwaukee.

BLUEPRINTS AND PLANS

LAWN Mower sharpener blue prints \$3.50. Build it yourself. Adolph Auch, 1110 N. Hamilton Avenue, Indianapolis, Indiana.

COMPLETE Solar heater plans \$2.00. Sunshine will heat water for your home. Emerson Solar Heater, Escondido, Calif.

HOME CRAFTSMEN

WILD Bird nesting houses. Blueprint and assorted sketches 15c. Garden Woodcraft Studio, 2032 Broadway, San Diego, California.

MEXICAN Designs for making artistic wall plaques. 20 patterns and instructions 25c (coin). Mexican Arts and Crafts, Box 332, Eagle Pass, Texas.

LEATHERCRAFTSMEN—Write for free instructions and price list of leather, tools, etc. Sample cards 5c. Wilder & Co., Dept. F, 1038 Crosby St., Chicago, Ill.

DESIGN Your own furniture. Our complete course shows you how. Only \$8.50. Invaluable to home craftsmen. Write for descriptive folder. Klok Institute, 430 Lyon, Grand Rapids, Mich.

HEAVY-DUTY Jigsaw, home workshop shaper, drum sander and 458 other practical articles in Vol. 28 Shop Notes only 50c postpaid. Popular Mechanics Press, Room (C38), 200 E. Ontario St., Chicago.

OLD GOLD, WATCHES, JEWELRY, PRECIOUS STONES

HIGHEST Prices for old gold, teeth watches, jewelry. Full cash value mailed day shipment received. Satisfaction guaranteed or articles cheerfully returned. Information free, or ship today. Chicago Gold Smelting Co., 300-P Champlain Bldg., Chicago.

GOLD \$35 Ounce. Ship old gold teeth, crowns, jewelry, watches—receive cash by return mail. Satisfaction guaranteed. Free information. Dr. Weisberg's Gold Refining Co., 1500-4 Hennepin, Minneapolis, Minn.

AUSTRALIA'S Lovely opals. Illustrated catalogue free. Good selection \$5. Norman Seward, Melbourne, Australia.

ELGIN, Waltham wrist or pocket watches, 7 jewels only \$3.98, 15 jewels only \$4.98, 17 jewels only \$6.98 sent C.O.D. All watches fully guaranteed. R. A. Press, Inc., 812 Sansom, Philadelphia, Penna.

RING Catalog free. Wholesale Distributors, 703 West State, Jefferson, Iowa.

5000 REBUILT Elgin, Waltham, Hamilton watches. Also ladies, gents wrist watches. Make big money! 12 size, 7 jewel, Elgin or Waltham, \$4.75; 16 size, 17 jewel, \$7.50. Send for free watch and diamond catalogue. The New York Jobbers, Dept. M, 74 Bowery, New York, N. Y.

HOW To identify and determine value of old precious metals. Where to buy. To whom to sell. Reliable and up-to-date information. Complete instructions only \$1 postpaid. Popular Mechanics Press, Room (C38), 200 E. Ontario St., Chicago.

TOBACCO

GUARANTEED: Cigarette, pipe or chewing. 5 lbs., \$1.00; ten, \$1.75. Pay when received. Pipe and box cigars free. Rives Tobacco Co., Paducah, Ky.

PREPAID, Long, clean, juicy red leaf, mild and sweet chewing 10 lbs. \$1.20. Mild smoking, 10 lbs. \$1.10. Pkg. twist free with each order. Collier Tobacco Pool, Martin, Tennessee.

FREE Book—Blending fine tobaccos. Varsity Cigar Shop, Evanston, Illinois.

CIGARETTES—40 For 10c using guaranteed pocket device. Makes your own exclusive monogrammed brand. Free particulars. Berkeley, 1704 Stephen Street, Brooklyn, N. Y.

TOBACCO Users: Answer this ad—it means something for you. Bargain prices, generous trial sample 10c. Trout Farms, D58PM, Hickory, Ky.

CIGARETTES—Roll 'em for 15c hundred. Samples both hand and machine rolling tobaccos 10c. Postal Tobacco, Box 1045, Owensboro, Kentucky.

FOR THE HOME

BUILD Your own power mower with Electromower Kit. Converts any standard lawnmower to a power operated, self propelled unit. Details free. Electromower, Channahon, Ill.

1001 WAYS to Use Concrete. Send for large free illustrated folder describing new Popular Mechanics book covering every known use of concrete for the home, farm, building, business and industry. Popular Mechanics Press, Room (C38), 200 E. Ontario St., Chicago.

RAZORS—BLADES—SHARPENING

ELECTRIC Shaver. Streamlined; powerful motor; \$15.00 performance; leather case; guaranteed. \$4.75 prepaid. Fleischman, 611 Madison, Chicago.

50 HIGH Quality blue steel razor blades 49c. Free with each 49c order. One rust-proof safety razor. Blades 90c 100. A. Goldstein, Jr., 2807 Allendale Rd., Baltimore, Md.

GILLETTE Razor with 50 blue blades, \$1.00. Postpaid anywhere. Relinco, Rochester, N. Y.

SPECIAL 100 Finest quality "Double-edge" razor blades, one large tube shaving cream, one large tube tooth paste, one styptic pencil and one pocket comb, all for \$1.00 prepaid. Satisfaction guaranteed or money refunded. Delta Distributors, 832 Francisco St., Los Angeles.

RAZOR Blades last months with sharpening compound, 25c. G. Banks, Holliston, Mass.

10 GUARANTEED Double-edge razor blades and Goodrich sharpener, 25c. Master Distributors, P.O. Box 1223, Chicago.

SURVEYING INSTRUMENTS

GUARANTEED Factory rebuilt transits and levels for rent (with purchase option) or sale (cash or terms). Order now before prices advance. We will repair, trade in, or buy your old instruments. Ship prepaid for estimate and valuation. Write for List M-37 and complete information to Warren-Knight Co., 136 N. 12th St., Philadelphia, Penna.

FOR SALE OR EXCHANGE

TRADERS Bulletin hundreds of trades and bargains. Mack Brothers Exchange, 2041 Chicago Ave., Chicago.

WANTED—MISCELLANEOUS

WANTED: For exclusive national sales promotion or distribution: Any new 10c to \$1.00 retail articles novelties, household gadgets, stationery or office specialties. Send sample stating definite facts and terms of your proposition. A. H. Labahn, National Specialties, Evanston, Illinois.

NEED Money to promote mechanical invention. Ray Scott, Route 4, McAlester, Okla.

CASH For used microscopes, binoculars, cameras, slide rules, drawing sets, surveying, scientific instruments, mechanical and electrical hand tools. Highest prices paid day shipment received. Satisfaction guaranteed or shipment promptly returned. Elman's, 2302 VanBuren, Chicago.

PERSONAL

FOOT Remedy guaranteed to stop offensive perspiration. \$1.00. Noxodor, Box 384, Ypsilanti, Michigan.

WIN Prize money: Booklet—"Successful Contesting"—shows how. 10c postpaid. Bulletin listing \$200,000.00 prizes included free! World Publishers, 4515-B Cottage Grove, Chicago.

ATHLETE'S Foot cured quickly, easily, permanently. \$1. Box 188-A, Station 8, Los Angeles.

GUMS Bleed? Teeth infected? 10c for trial bottle "Gimp." Link, Emporia, Kas.

WALK Or stand much? Try Self-Adjustable Arch Support. Every user satisfied. Made to order. \$1.25 postpaid. Details free. Box 451, Leominster, Mass.

TREASURE Finders? Read Goldak advertisement on page 130A.

TOE Itch stopped one treatment. 10c for trial bottle "Gimp." Link, Emporia, Kansas.

INTERESTING Success booklet free! Johnston, PM-257 North Washington, Tiffin, Ohio.

WANTED. Original poems, songs, for immediate consideration. Send poems to Columbian Music Publishers, Ltd., Dept. 33, Toronto, Can.

STUTTERING And stammering corrected at home. Descriptive booklet free. Paul J. Wolfe, Box 52, Pittsburgh, Penna.

MISCELLANEOUS

FINE Large colored pen and ink drawing of your favorite portrait, scene, etc. \$2. Send clear photo; will return. Hanousek, 2542 - 42 Street, Long Island City, New York.

WANTED—An inventor with some practical knowledge of slaughter houses to help us with a device for humane slaughtering. Box 94, Pikeville, Maryland.

BOOK Matches, complete, unused. 50 different for 50c. Excellent collector's item never before offered. Post Office Box 864, Rockford, Illinois.

ENGRAVED Metal name plates. Rust proof. No polishing. Circular. Lock 1476, Washington, D. C.

BUSINESS Proposition resilvering mirrors, autographs, reflectors, making chipped glass signs. Write Sprinkle, Plater, 283, Marion, Indiana.

SWAPPERS, Collectors, investigate free trading service. Exchange, Box 425, Detroit.

NEW-CITY—Help plan and build new, scientific, co-operative city, Pacific coast. Join national movement now organizing. Educational, inspiring. Booklet, 25c; folder, 3c. Terminal, Box 3043, Seattle, Wash.

QUALITY Painting and decorating. Floyd Weaver, Route 2, Rockford, Ill.

MEXICAN Legal matters. American Attorney, Box 1736, El Paso, Texas.

MINIATURE Bristle brushes for cleaning smoking pipes, electric razors, hundreds of practical uses. 10c per set. Busch Brush, 740 - 8th Avenue, New York City.

FIREWORKS. Wholesale prices. Free catalogue. Leon Bresky, 1610 1/2 Hamilton, Houston, Texas.

"NITE-LITE" New luminous wonder paint. Brilliant, lasting. Ounce jars, violet \$1.00, green \$3.00. Luminart Co., Box 494-A, Hoboken, N. J.

COCONUTS Just as they fall from the palm. Wonderful souvenirs of the tropics. Postpaid 50c. Kyle's Curios, 218 Harvey Bldg., W. Palm Beach, Fla.

COATS-OF-ARMS And crests correctly rendered in colors or black and white. Highest grade. Estimates free. Heraldic Studios, 1914 Oakdale Ave., Chicago.

IF You have something to trade send ten cents to Dept. PM, Swapper's Guide, Delphos, Ohio.

SPECIAL Introductory offer. Regular 8" slide rule, only 30c prepaid. Labahn, National Specialties, Evanston, Illinois.

MONEY In butterflies, moths. See Sinclair Display Advertisement on page 16A.

TREASURE Finders? Read Goldak advertisement on page 130A.

FREE Typewriter. Outfit 25c. Details free. Associated, Southside, Oil City, Pennsylvania.

SWAPPER'S Friend, R4, Saline, Mich. Interests swappers, mail order. 50c year, sample 10c.

ARTISTIC Bird pictures, framed, hand-made with genuine feathers. Unequaled, beautiful ornament! Size 5 1/2 x 8 1/2, \$1.00 postpaid. Agents wanted. Marquez-GA, Apartado 1176, Mexico City.

NATIONALLY Advertised electrical appliances, radios. Any make. Any model. 20% to 50% discount. Brennen Distributing Company, 228 Seeley St., Brooklyn, N. Y.

STANDARD Electric lamp insect killer, \$2.00 up. Literature free. Sauer Bros., San Leandro, Calif.

WATERPROOF Leaky basement walls, floors. Inexpensive. F. Gerwin, Meeker, Oklahoma.

AMATEUR Tattooing outfits, illustrated catalog 6c. "Tatuco," 651A S. State, Chicago.

MAKE It Yourself—Hundreds of practical and useful devices described in our big book. Plain instructions and illustrations show you how. Save money on things for yourself or make profit selling to others. 900 articles. 480 pages. 823 illustrations. \$3 postpaid. Popular Mechanics Press, Room (C38), 200 E. Ontario St., Chicago.

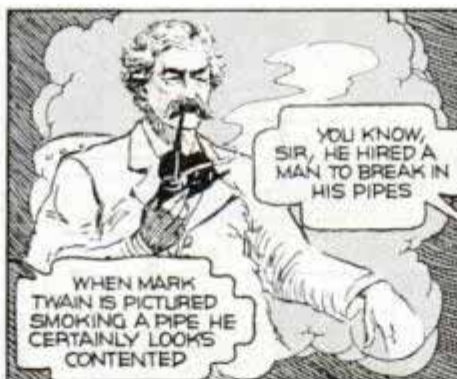

Copyright, 1938, R. J. Reynolds Tobacco Company

TASTE THAT RICH TASTE!
MARVEL AT THAT EXTRA MILDNESS!

PUT THAT P.A. CRIMP CUT TO WORK FOR YOU. SEE HOW MUCH BETTER IT PACKS, DRAWS—HOW MUCH COOLER IT SMOKES!



FATHER'S DAY
JUNE 19th

Is dad a pipe-smoker? Here's the ideal gift for him—a pound or half-pound of extra-mild, extra-tasty Prince Albert, in a neat red tin. Will dad be mighty pleased with that? Just try it and see!

SO MILD!



PRINCE ALBERT
 THE NATIONAL JOY SMOKE

PERFECT SMOKES—OR NO PAY!

Smoke 20 fragrant pipefuls of Prince Albert. If you don't find it the mellowest, tastiest pipe tobacco you ever smoked, return the pocket tin with the rest of the tobacco in it to us at any time within a month from this date, and we will refund full purchase price, plus postage.

(Signed) R. J. Reynolds Tobacco Co., Winston-Salem, N. C.
 ALSO FOR FASTER-ROLLED, NEATER "MAKIN'S" CIGARETTES.

50 pipefuls of fragrant tobacco in every 2-ounce tin of Prince Albert

Popular Mechanics Magazine

REGISTERED IN U. S. PATENT OFFICE AND CANADA

WRITTEN SO YOU CAN UNDERSTAND IT

Vol. 70

JULY, 1938

No. 1

MADE-TO-ORDER PLANTS

FIVE years from now a variety of wheat that no one has ever seen is going to be in the hands of western farmers for planting. The new wheat doesn't even exist today, yet plant scientists already know as much about it as if they had been growing it for years.

For one thing, the new variety will be resistant to three wheat destroyers, stem rust, smut and Hessian fly.

The plant breeders know exactly what the new wheat will look like,



Above, measuring tomato's puncture strength to determine fitness for canning. Left, large potatoes and pears produced by plant breeding

12490
Curb. Thomas G. Steinson, Jr. Los Angeles, Calif.
105 55 Holman, Inc.



each generation are allowed to self-fertilize themselves, but in backcrossing the plants are crossed back with one of the original parent varieties so as to breed in more completely the qualities to be perpetuated.

"Suppose we wish to combine the high yield and quality of one variety of wheat with the disease-resisting qualities of another variety," Dr. Briggs explains. "We start out by crossing them. If there happen to be twenty-one different pairs of factors in the parents influencing color, adaptation, quality, yield, and so on, the type desired would occur only once in 4,398,046,511,104 individ-



Top, samples of wheat, one infected with stem rust which prevents grains from maturing, and the other with rust-free stems. The poor sample was one of the healthy sample's parents. Bottom, spraying onions affected by wilt is necessary when disease resistance has not been built up by breeding

what its yield will be, how it will mill, and where it will grow best. It will be unnecessary to grow several crops to prove its worth. This tailor-made wheat, built to exact specifications, is possible because of a new development in plant breeding. Selection and hybridization, the two mainstays of plant breeders in the past, have led to many improvements in commercial crops but the trouble has been that these methods are of a hit-or-miss nature. The mixed characteristics of hybrid generations are so extensive that picking out the best plants is uncertain and sometimes impossible.

This uncertainty is avoided by backcrossing, an old but comparatively unknown method of plant breeding that has been developed into a recognized and reliable system by Dr. Fred N. Briggs, agronomist at the Davis agricultural experiment station of the University of California. In ordinary hybridizing, plants of

uals in the second generation. To grow such a population would require 50,000,000 acres of land and then we would have the impossible job of selecting from the acreage the one individual plant having the exact qualities we seek. In practice, that is impossible, so we select plants that ap-

H 490
 2
 100 e 2
 Davis, Calif

H 490

Sorbelman Syndicate
6 d W. 4 St. N. York

Boards Make Better Shoes for Tramping in the Mud

pear to be nearly what we are looking for.

"However, if each generation is bred back to the most desirable parent instead of being self-fertilized, the problem is far simpler. The desirable characteristics of the recurrent parent are preserved automatically and the factors desired from the other parent are maintained by selection. In the above cross the recurrent parent combination occurs 2,097,152 times more often than in the straight cross. After the fifth or sixth backcross the offspring may be considered identical with the recurrent parent except that the selected characteristic of the other parent has been adopted. That means, using the two varieties of wheat for example, that the hybrid will be identical with the parent that has high yield and quality and that it will have inherited the disease resistance of the other parent.

"Backcrossing does not necessarily speed up the creation of a new variety but it does permit predicting just what we are going to get. It is a means of changing one characteristic of a plant without affecting any of the others. In its field it takes the guesswork out of plant breeding. Ordinary hybridizing is still the approved way of experimenting with crops on which little work has been done, but with crops that have already been the subject of improvement, backcrossing is a means of combining into one variety desirable characteristics that may be selected from other varieties."

Already, many varieties of wheat and other grains have been improved by backcrossing. One interesting example is in barley. Atlas is the most important of all barleys grown in California but after threshing it is impossible to distinguish Atlas grains from the grains of two other varieties. A long-haired rachilla, a small appendage at the base of the kernel, is being transferred to Atlas to "trademark" that variety so that it can be recognized at a glance.

A good instance of how backcrossing compares with ordinary crossing is found in a tomato-breeding program being conducted at the experiment station by Dr. D. R. Porter. The work was started in 1929 when the Marglobe tomato, an ideal 150-gram shipping and canning variety, proved

(Continued to page 139A)



Here is a different kind of board walk. The wooden shoes proved helpful in walking through mire

If snowshoes help you stay on top of a drift, why not boards for walking on the mud? A young member of a gypsy encampment in Kent, England, contrived a pair of board shoes and found they not only enabled him to walk on top of deep mud but kept his feet dry, too.

H 488

Cardboard Practice Golf Ball Shows Where Club Strikes

To sharpen the golfer's eye, a practice kit provides cardboard balls that show exactly where the club strikes. The golf club head is rubbed with a grease-marking crayon, which registers on the target ball and tells whether the golfer is topping or undercutting. This home practice set has a rubber tee, and the cardboard ball is mounted in a slot on a picture of another ball which gives a three-dimension effect.

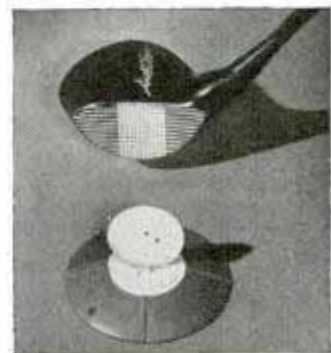

Keith Golf Practice

4 502
**Octopus Brought in Alive
 Weighs 200 Pounds**



This octopus had a spread of seventeen feet from tip to tip and weighed 200 pounds when captured

Catching an octopus by hand and bringing it back alive is risky business if you don't know the octopus. An Oregon youth does, and makes a business of furnishing live octopodes to aquariums. By studying the deadly creature he has learned where to apply pressure to the body of the octopus to break its grip under water. The catch with which he is pictured here weighed more than 200 pounds and had a spread of nearly seventeen feet from tip to tip of opposite tentacles.

4 508
**Five Tons of Silver Each Week
 Used in One Photo Factory**

Second only to the United States mint in its consumption of silver, the Eastman Kodak plant at Rochester, N. Y., uses five tons of the metal every week. Back in 1885 the factory required just forty pounds a week for making the light-sensitive emulsion. Eighty per cent of the silver mined

today comes from Mexico, Canada, Peru and the United States, but—except for that produced in Mexico—most of the new silver comes not from silver mines but as a by-product from lead, copper and zinc mines. Last year a record output of 276,000,000 ounces was mined.

H 513
**Adjustable Flasher for Signs
 Run by Reversible Motor**

Operated by a small, reversible variable-speed induction motor, an adjustable flasher for display signs is on the market. The motor drives adjustable cams which break the circuits at the switch points. The compact flasher unit may be equipped with two, four, six or eight convenient outlet receptacles with switches for stopping the flashing when desired at the different outlets. The unit is handy for flashing lamp loads, for the primary side of neon sign transformers and for controlling magnet switches, amusement devices, warning signals or relays where heavy loads are to be handled. Easy to install and to adjust on the job, the unit has a convenient lever that permits instant speed adjustment.

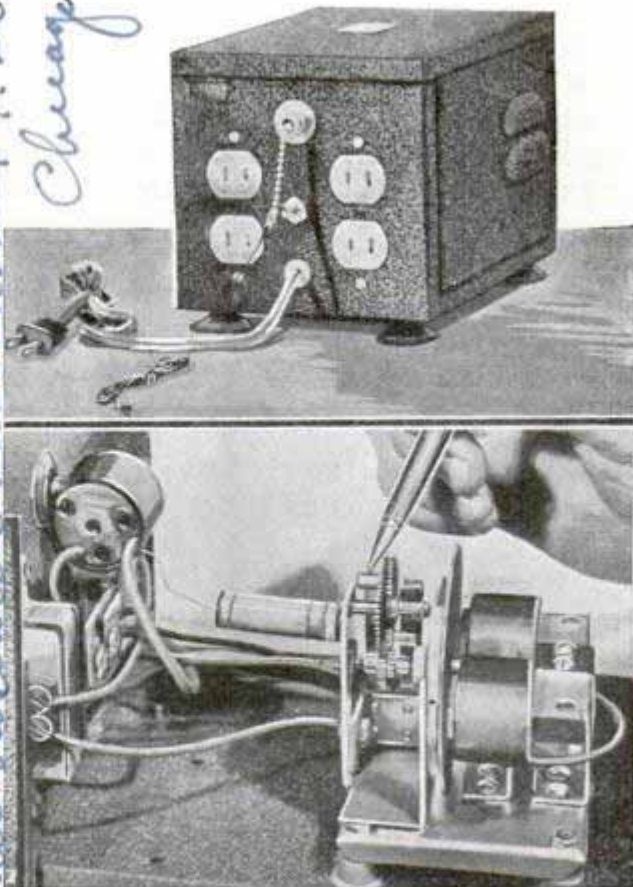

Top, flasher unit. Bottom, mechanism and wiring of handy sign lamp control

Arden Award Deep Sea Bay Oregon

James Research Laboratories, 120 Avenue Chicago

A 472

Reading

Sharp Eye of Locomotive Is Precision-Ground

When railroading was young, the locomotive's eye was all but sightless. Trains ran mostly by day, anyway, and the headlight was no more than an oil lantern perched on the engine's nose for the same reason carriages carried lamps. It was not to see with, but to be seen. Today the eighty-mile-an-hour limited requires a far-seeing fog-piercing



original Broadway Limited or Pennsylvania Express
No 2

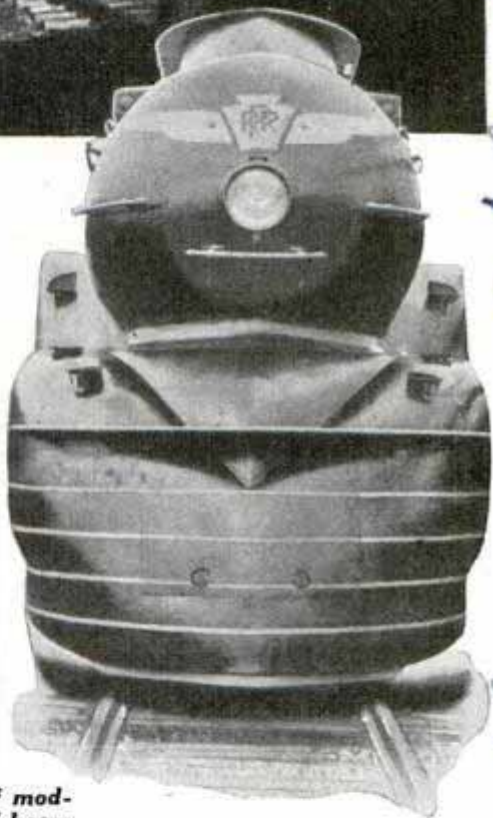
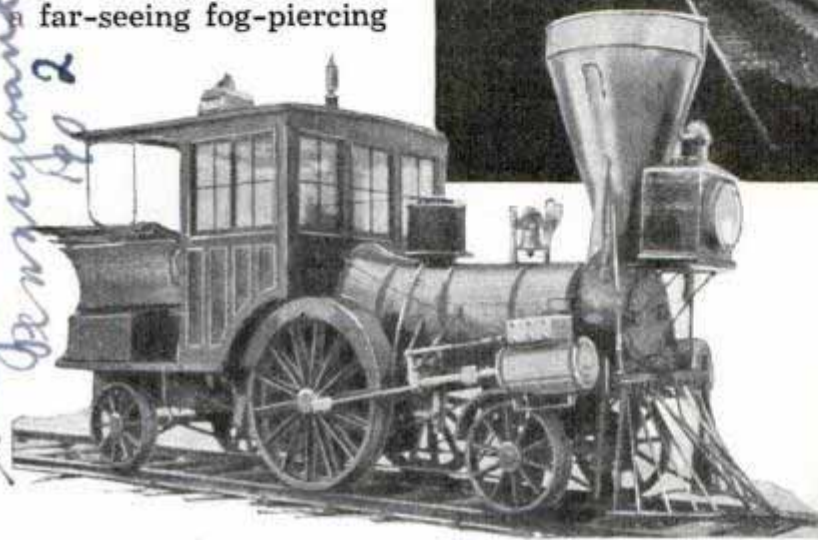

Reading
Cnd. George W. Eckhardt
2047 N. Park Ave Phila



Top, a 700,000-candlepower eye looks ahead. Compare headlight of modern locomotive at right with lantern of old timer. Below, diagram of beam

eye, its 700,000-candlepower beam lighting the track distinctly a third of a mile ahead. A 250-watt bulb furnishes the light, but it is the lenslike reflector of silvered glass behind the bulb, ground with astronomical precision, that levels the rays into a sharp pencil of light, making plainly visible at 1,500 feet distance a dark object such as a man walking the track. The front of the headlight is not a lens, merely a colorless glass shield curved enough to withstand pressure. One of the latest headlights, used on the Reading railroad, emits a penetrating yellow-green beam which is less tiring to the engineer's eyes, is relatively

non-blinding to the approaching engineer and in fog does not "kick back" against the driver's eyes as ordinary white light does. The yellow light is obtained by making the reflector of glass containing a trace of uranium. After the glass form is pressed and annealed, the back of the reflector is ground in a mathematically precise parabola. Then silver is deposited on the back, and over the silver a layer of copper is deposited electrolytically, then two more coats of a protective asphalt-base substance. Light which "spills" directly in front of the locomotive, without striking the yellow reflector, is white light.

Isolder glass type headlights Electric Co
Cambria, Philadelphia

A 445.

Conical Air-Raid Chamber Shelters Three Hundred



Berlin's air-raid refuge made of concrete. It has space for 300 persons

Closely resembling the shell for some giant war gun, a conical air-raid chamber has been erected in Berlin. It stands about sixty feet high and has room for 300 persons. The chamber is made of concrete and is painted green. During air raids, it can be sealed against gas. Its unique shape makes it a difficult target for enemy pilots.

Glasslike Springs of Quartz Replace Steel in Weighing

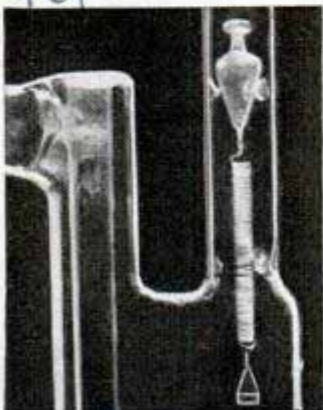

Because it excels the best spring steel in some respects, glasslike fused quartz is being used as springs to indicate minute differences in weight, in the General Electric research laboratory. Springs made of

hairlike filaments of quartz can be stretched to ten times or more their original length and will return exactly, compared to steel springs which would undergo a permanent stretching. Quartz has an extremely high melting point and quartz coils can be used at elevated temperatures, while steel springs lose their temper at relatively low temperatures. Quartz spirals are not affected by any degree of humidity, and are practically invulnerable to the multitude of chemicals used in a laboratory, and quartz coils weigh far less than steel springs. In the laboratory the quartz springs usually are suspended within a glass tube which is maintained at the temperature desired by immersion in an oil bath. A small glass "boat" suspended from the coil holds the sample under investigation. As the sample varies in weight, so does the length of the quartz spring, and since the length of the spring is proportional to the weight, readings of length give accurate weight values. Measurements are made within an accuracy of a milligram, or 1/28,350 of an ounce.

A 330

Knee Accelerator Frees Foot for Brake Operation

Greater safety is claimed to result from use of a knee-operated accelerator which leaves the foot free to control the brake pedal. If the driver should become drowsy, the accelerator closes gradually as knee pressure is relaxed.



Arrow points to accelerator which leaves right foot free to operate brake pedal

A 461

Schenectady, NY

Safety Motor Control
Blaswood, S. H.

*H 4970 Mack Truck & Motor Truck Corp
 International. Motor Truck Corp
 48th Ave and 34th St. Long...*

Smoke-Eaters Ride Streamline Pumper 'Sedan'

It is a long way in safety, speed and power from the dashing three-horse fire engines of a generation ago to the streamline pumpers just added to the Chicago fire department. The driver, an officer and six men ride comfortably to the blaze in the new "sedan" cab, protected from weather and accidents. Outside, there is room for two to stand at the rear, ready to haul out the hose from its compact compartments the moment the fire is reached. On each side of the car are hose outlets

Island City, N.Y.



Chicago's "sedan" fire engine seats eight men inside and two ride at rear. Left, below, pump connections and pressure dials

OFFICER AND DRIVER IN FRONT ROOM FOR SIX MEN IN REAR

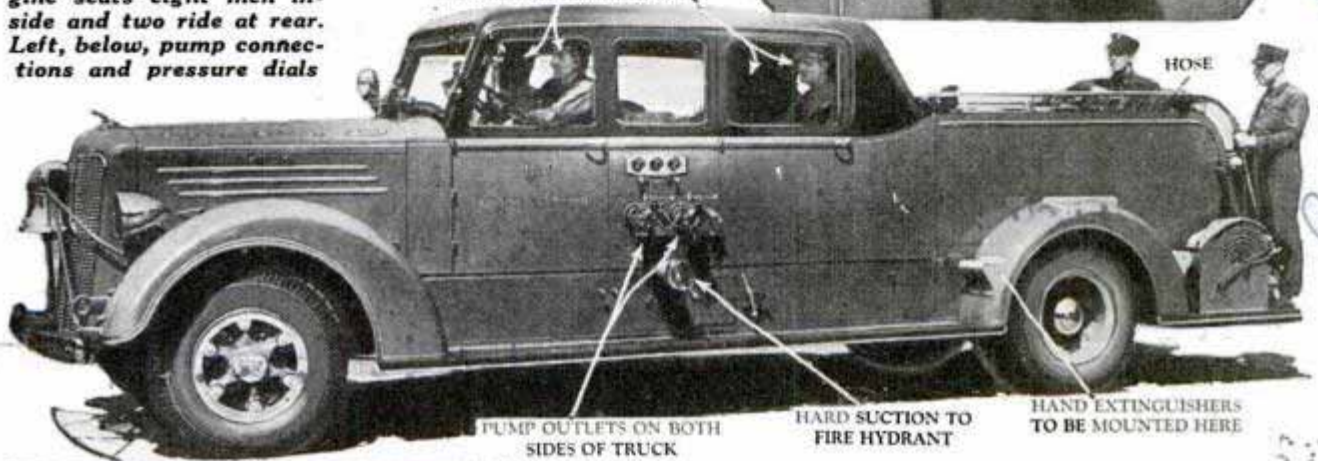

PUMP OUTLETS ON BOTH SIDES OF TRUCK

HARD SUCTION TO FIRE HYDRANT

HAND EXTINGUISHERS TO BE MOUNTED HERE

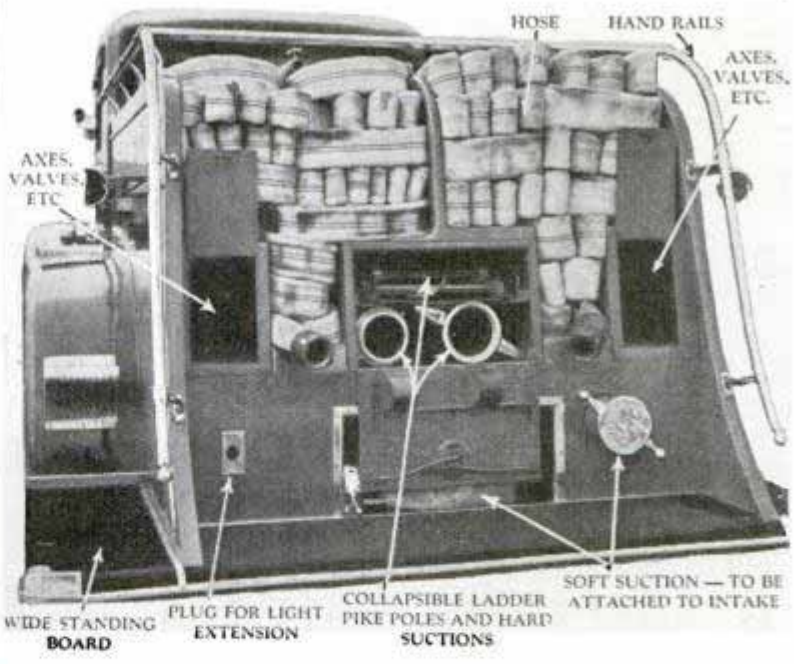
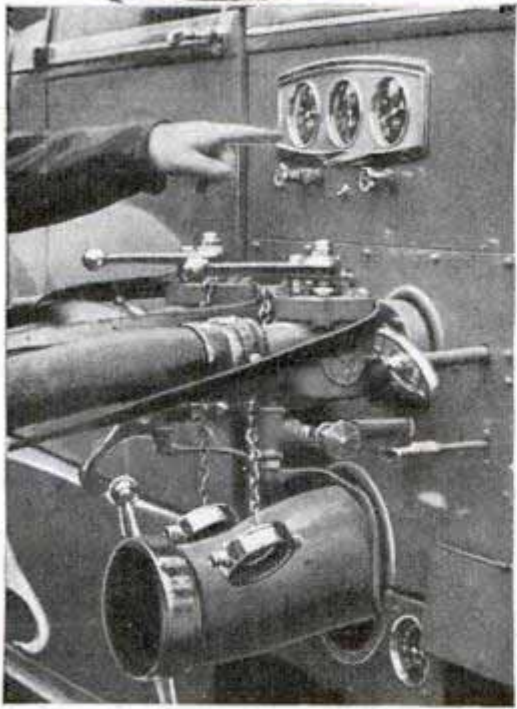

AXES, VALVES, ETC.

HOSE HAND RAILS

AXES, VALVES, ETC.

WIDE STANDING BOARD

PLUG FOR LIGHT EXTENSION

COLLAPSIBLE LADDER PIKE POLES AND HARD SUCTIONS

SOFT SUCTION — TO BE ATTACHED TO INTAKE

connected to the powerful pumps beneath the cab; they can deliver 1,500 gallons of water a minute at 120 pounds pressure. As the driver leaps from his cab he throws a lever disconnecting the six-cylinder, 225-horsepower-motor from its drive shaft

and a clutch at the pump outlet hooks the motor up to the pump. Gauges on both sides show pressure and volume of water going through the pumps. At the rear, in addition to hose storage, are compartments for axes, and an electric outlet.

*Peter Pirsch & Sons
 Chicago, Wis*

Five-Deck Streamline Boat on the Mississippi

Handwritten notes:
Mississippi
River
Boat
Co.
St. Louis
Mo.



Wide World

Mississippi skippers of the Mark Twain era would be amazed at this new streamline style river boat of 1938

Far removed from traditional river boats of the early days is the streamline ferry

just completed. The five-deck vessel carries passengers across the Mississippi.

out of St. Louis.

Abandoned Railroad Tunnel Used for Mushroom Farm

Handwritten: 7482



Wide World

Fifty-five-year-old tunnel through which Frisco railroad trains once passed is now a mushroom farm

Long since abandoned, an old railway tunnel near Kirkwood, Mo., is the site of a profitable mushroom farm. Henry Eisenreich happened upon the 475-foot bore once used by the Frisco line and saw the opportunity for raising mushrooms in its cool, moist darkness. Today Mr. Eisenreich, his wife and four children keep busy on the project and have developed one of the largest "farms" in the St. Louis area.

Handwritten: 7489

Collapsible Fishing-Line Drier Takes Little Space in Kit

Extending in two directions to form a square, a fishing-line rack accommodates 500 yards of line for drying. Rustless, it can be clamped on the side of the boat, and when folded up it can be packed away in a very small space in the fishing kit.

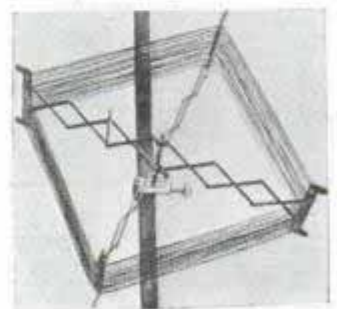

Handwritten: Ed W. Simon & Co. Broadway, N.Y.

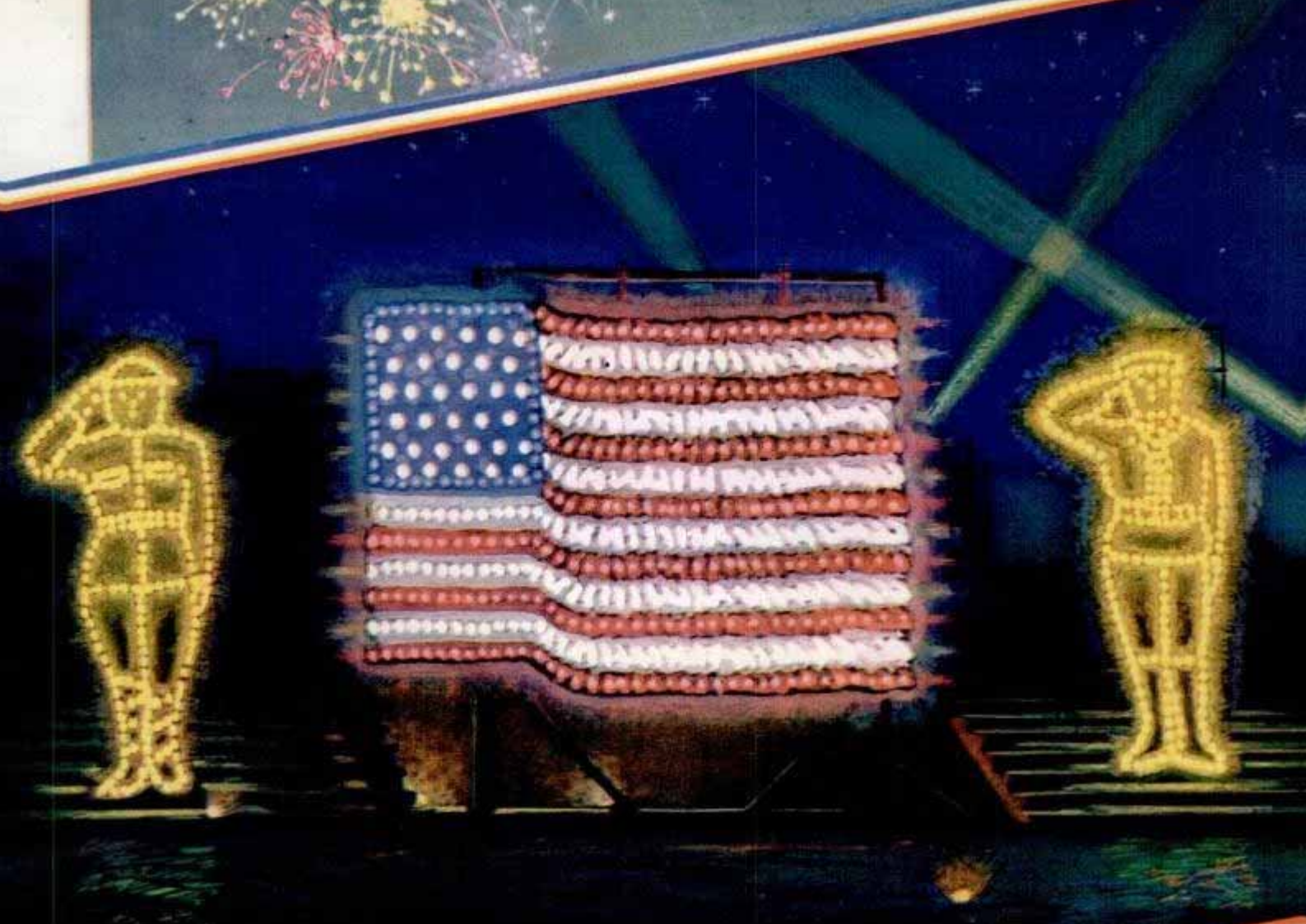

SPECTACULAR FIREWORKS

Turn NIGHT *into* BEAUTY



THE AMERICAN flag and a soldier and sailor produced in fire. Each of the spots of colored fire is made from a lance.

Cont. Mel Wharton,
1144 S. Grandview Ave

Lucas Jules

H122
9

Hercules Powder Co 908
Market St. Wilmington Del.

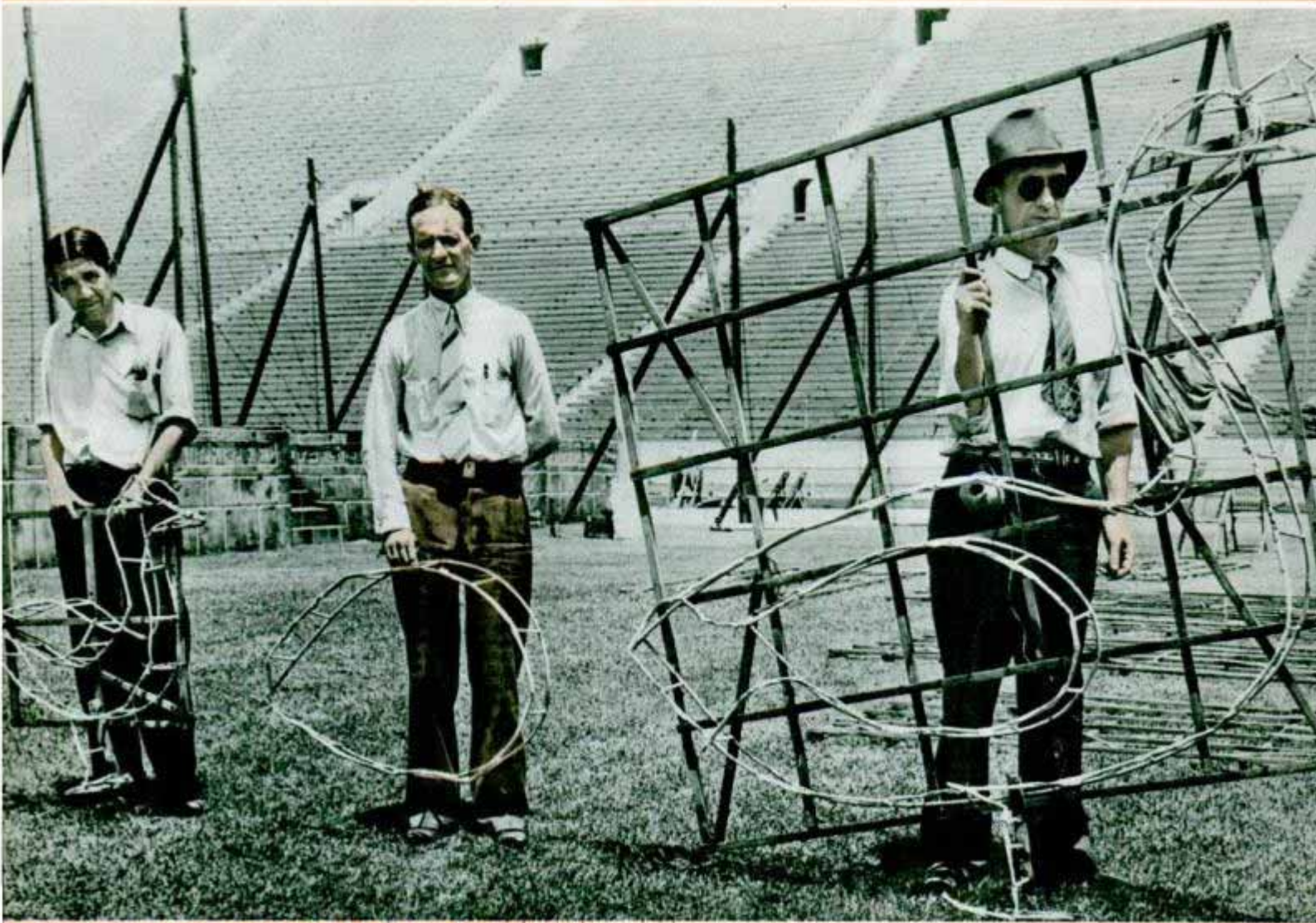

THIS FIREWORKS set is always good for a laugh. It depicts a waddling goose which halts to lay an egg which in turn is hatched into a gosling.

10

THE American fireworks scene is changing.

The barefoot boy a few years ago lit fuses on the Fourth of July and exulted to the din of exploding firecrackers from dawn until late at night. Today fireworks fetes are being placed in the hands of civic, patriotic and fraternal groups where experts, skilled in the intricacies of decorative effects, stage and direct the marvels which constitute modern pyrotechnic wonders.

Meanwhile fireworks casualties decrease yearly, even though about \$15,000,000 is spent for fireworks by the nation annually, and more people—the number is estimated at over 100,000,000—view pyrotechnic displays than ever before. Indeed it is difficult to find a

mature person who has not at some time sat enthralled at the colored trails of soaring rockets, the plumes of feathery fire scattered afar upon the heavens by bursting bombs and the luminous ingenuity of unique set pieces.

Although the Fourth of July is the big fireworks day in this country, there is not a month in the year when similar demonstrations are not casting their weird beauty upon the night air at conventions and other public and private celebrations. In the Southern states Christmas is an occasion for the popping of firecrackers, the spurting of pinwheels and general fireworks displays.

The pyrotechnic bomb is replacing the skyrocket at fireworks shows. A bomb bursts into a million harmless bits of

THE FIREWORKS SET
 BY THE AUTHOR

paper, while rockets, with their long, heavy wooden guide-sticks, have been known to fall among crowds. Furthermore, bombs can be packed to create scores of colored fire patterns in the sky better than rockets and, in the hands of experts, are safer and easier to handle.

Display bombs are cylindrical-shaped packages of powder, fireballs and other pyrotechnic devices, wrapped in papier-mache. A long fuse, strapped to the side, connects with a propelling powder charge in the base for hurling the bomb, which may weigh as much as twenty pounds, high into the air from a mortar.

Mortars are hollow steel pipes about two or three feet long, buried in the ground to lend direction to the flight of the projectiles. They are the cannon for the bombs. A row of sandbags usually is built



CLOSE-UP of lances, which look like packages of cigarettes, and fuses. The fuse is made by soaking a wet string in powder and wrapping it in heavy paper. The fuses and lances are the secrets of fireworks set pieces.

BUILDING a set piece to represent an American flag. The quick fuse, known as a "match," leads to hundreds of lances which, burning in colored brilliance, set off the spectacle. This is a "six frame" piece.





ELEPHANT squirting a shower of fire over his keeper and, below, Roman candles are employed to depict this naval bombardment.

between the line of mortars and the operators. After igniting the fuse with a torch attached to the end of a long stick, the operator either runs a safe distance away, or crouches behind the sand barrier until the earth-shaking detonation.

Some bombs are hurled up 1,000 feet,

where they explode by means of a timing device actuated to the split-second nicety of an artillery shell. Whang! They burst, scattering their carefully set contents over the heavens, often covering as much as a full acre of aerial space! Bombs are packed for multiple "bursts" of two, three, four, five and

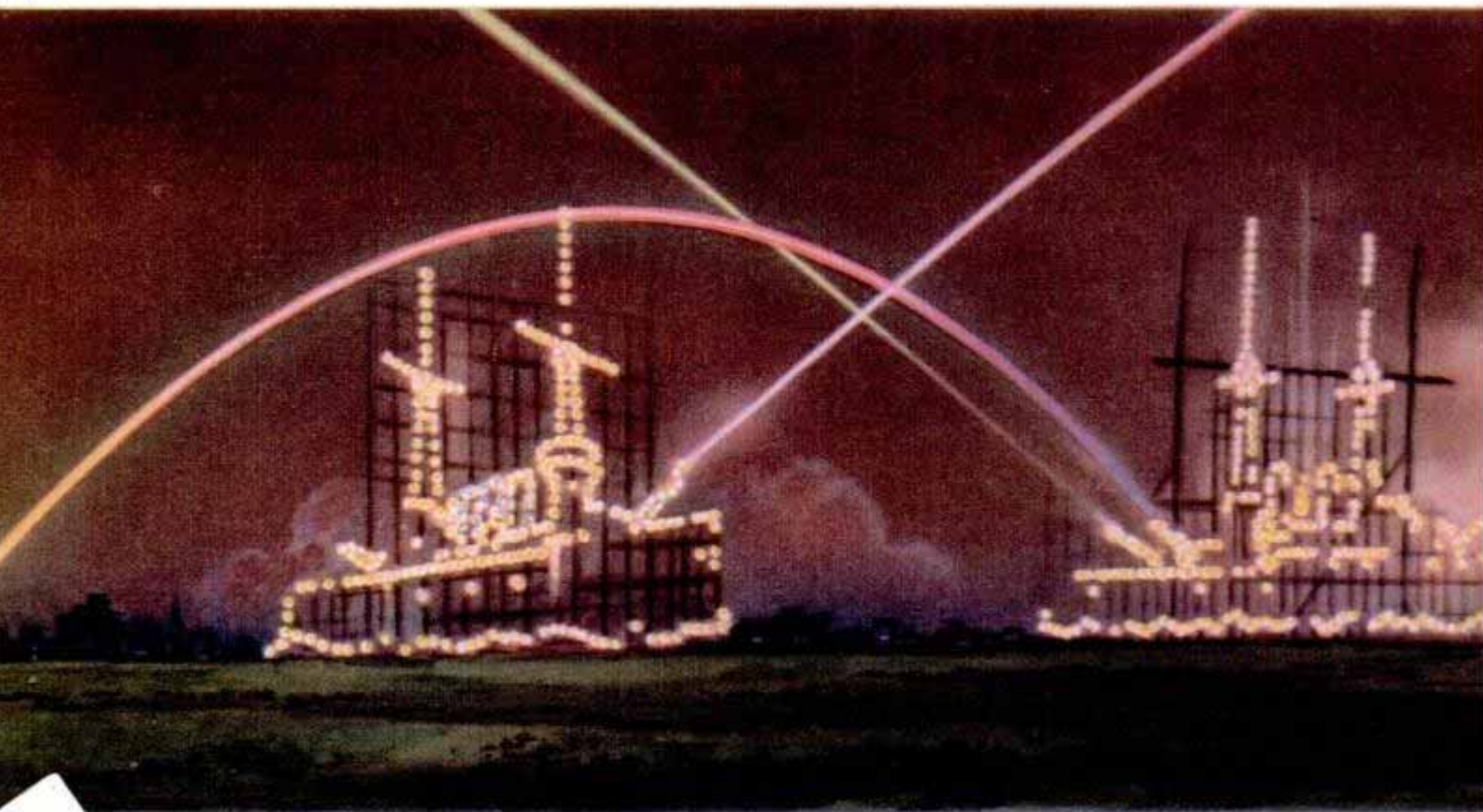

R 12 2



even six times, each explosion releasing new patterns of fiery glory. Pompons, weeping willows, star chains, colored drops and feather sprays are among the awe-inspiring luminous designs achieved by pyrotechnic engineers.

Set pieces are made to order for occasions and are the only widely known branch of display fireworks that cannot be bought over the counter. The "behind-the-scenes" activity in set-piece preparation is one of the most interesting in the world of fireworks. It begins when the salesman and celebration manager put their heads together and select the kind and quantity of pieces they want.

The designs are then drawn, made into blueprints and built. One reason the public seems never to tire of set works is that no two are exactly the same, and they can be made to fit in with current events. Special creations are manufactured for the American Legion, lodges, and other conventions and events. Many are highly unique and ornate



THIS set piece combines motion in the flying windmill with the static figures of the two Dutch housewives.

18122



THIS fireworks expert is showing how bomb fuses are touched off at fireworks exhibitions with the aid of a torch of fire held on the end of a stick.



14

and perhaps exemplify the greatest advance in exhibition pyrotechnics.

The patterns are placed on a framework and usually fused the day of the celebration, although the frames can be made up weeks prior, and even held over from one year to the next. The framing consists of standard sections five feet by ten feet in size, and, like billboard posters, any size can be built up from multiples. Wood, seldom metal, is used. Bamboo sometimes is employed because it combines lightness with good tensile strength. Props hold the sections upright and enable them to withstand wind pressures.

The design is fastened on the framework with strips of rattan. The fuses follow the outline of the picture, their purpose being to carry ignition to the

lances—the heart of the pieces—and set them in action. Lances are cigarette-like sticks of fireworks compounds which, when lit, emit light or fire of different colors. They can be measured to last for a few seconds or longer than two minutes.

Amazingly intricate and beautiful decorations such as bouquets, flags, fountains, animals and comics are done in this manner. Strontium is often used for red color, barium for green, a sodium compound for yellow, copper compounds for blue, while magnesium is used for white light. Sometimes a background of colored fire is used to heighten an effect. This is done by touching off pads of ex-



celsior saturated with alcohol or coal oil and sprinkled with a chemical to give the wanted color—one of the tricks of the profession.

Shells from fireworks cannon are nothing more than fireballs from Roman candles. Candles and gerbes throw sprays of fire and are used to simulate fountains or an elephant squirting water from his trunk upon his keeper. A composition of flame material that drops heavily creates the illusion of Niagara Falls, a prize effect of pyrotechnicians. Bicycle riders, Zeppelins, airplanes, ships, sprinters, auto races and other moving pieces are often moved about by human operators hidden behind the brilliant barrage of front light. Mechanical power is sometimes used to operate sets where rapid movement such as high rotational speed or the steady motion of the pendulum of a grandfather's clock, is demanded.

The popularity of fireworks displays is due not only to their spectacular beauty but also to low cost.



15



BOTH candles and bombs are fired from mortars. The candles shown here are propelled from the mortars by three ounces of powder and, when set off, create showers of fire.



UNEXCELLED for beauty and magnificence are the aerial bombs which burst into dazzling colors after being hurled to great heights.

16

Probably no fireworks exhibition ever held in the United States cost more than \$10,000. No convention has yet spent that much. And the expenditure for the display at the opening of Golden Gate bridge over San Francisco Bay, a four-day celebration that has seldom been equaled anywhere, cost only \$7,000. The average is, of course, much less.

Actually fireworks are one of the oldest forms of amusement. The Chinese, it is thought, were the inventors and first exploiters. Their records antedate any others, for mandarins enjoyed pyrotech-

nic nearly 4,000 years ago. The Chinese gave romantic names to fireworks. They called rockets "arrows of flaming fire"; bombs were "heaven-shaking thunder," and they spoke of Roman candles as "lances of storming fire."

Even set pieces were old when Rome was new. Before the Christian era, during the reign of Emperor Augustus in 27 B.C., pyrotechnic designs were used, and their stage of development was so advanced that the real beginnings of set works must have been centuries previous. Even (*Continued to page 128A*)

H 475

Wagner Electric Corp. 76
POPULAR MECHANICS 17
Munich 1:3
Germany

Telescoping Spring Smooths Motorcycle Ride

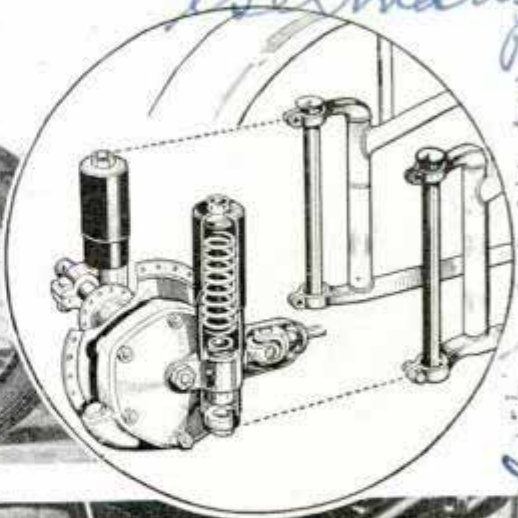
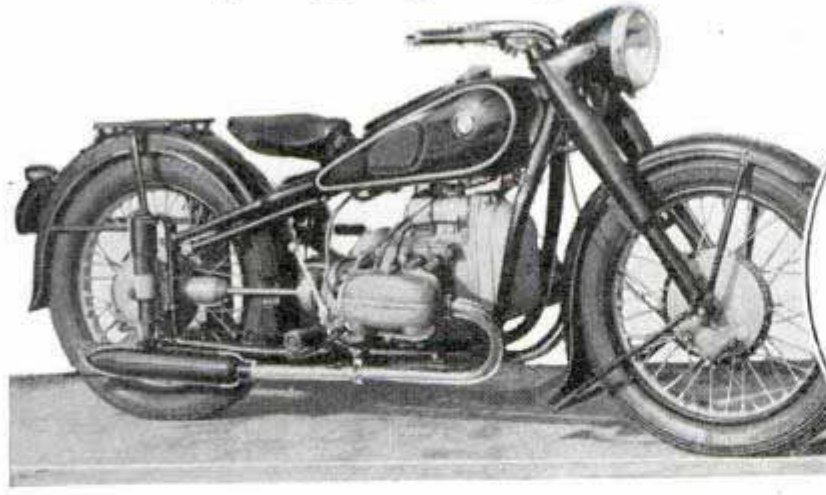

Above, German-built motorcycle with rear wheel suspension, which is also incorporated in front wheel fork. Right, phantom drawing and close-up of spring

Rear wheel suspension that operates like a telescope, absorbing every shock and jar of the road, is incorporated in a 1938 model motorcycle built in Germany. The same telescopic suspension is built into the front wheel fork. The "bike" can be driven at high speed regardless of the condition of the road, and has a two-cylinder thirty-horsepower engine with top speed of more than eighty-seven miles an hour.

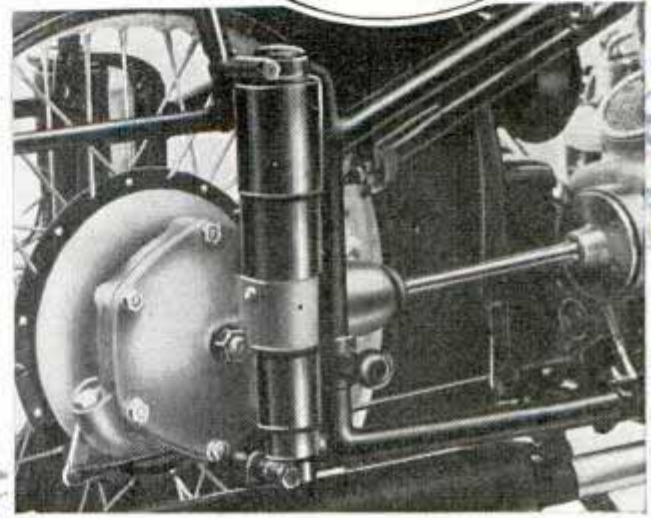

'Window Box' Evaporating Fan Cools Air in Dry Region

Installation of a "window box" evaporating system for summer cooling in hot, dry areas can lower the indoor tempera-

ture as much as twenty to thirty-five degrees. It operates on the simple principle of the absorption of heat by evaporation of water. A vertical mat made of excelsior or fiber two or three inches thick is placed outside a window, and water is allowed to flow downward through the mat while a fan draws a large volume of air through the moist mat and into the house. Another window, properly situated to provide cooling circulation through the entire house, is used as an outlet. Air delivery of the intake fan must provide a complete change of air in the house every two or three minutes. Efficient evaporative cooling systems of this type have been developed and are used to make homes and business places comfortable in western states.

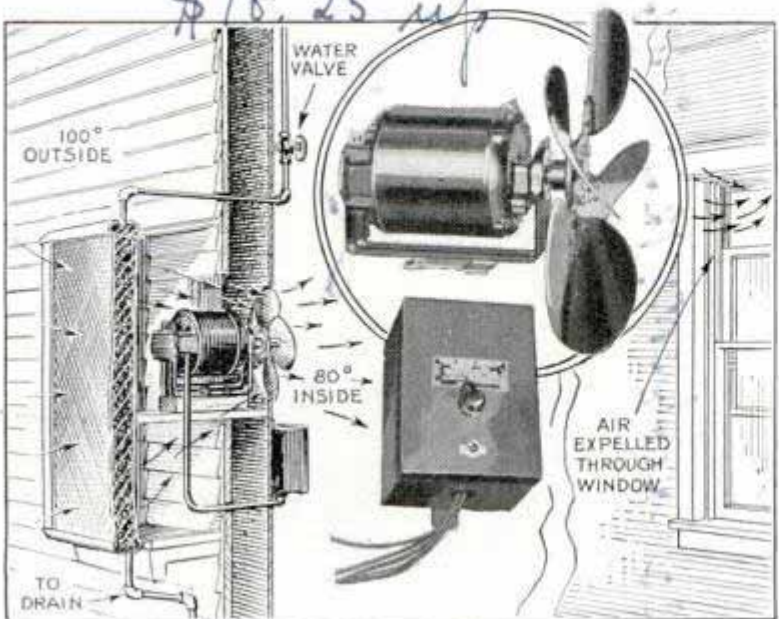

Sectional drawing shows how air drawn into house by fan is cooled by first passing through moistened mat

Wagner Electric Corp. Plumett Ave.

H 48 4

Three-Piece Boat Is Assembled While Afloat

Joe Boat Manufacturers
Bass Lake, King Island

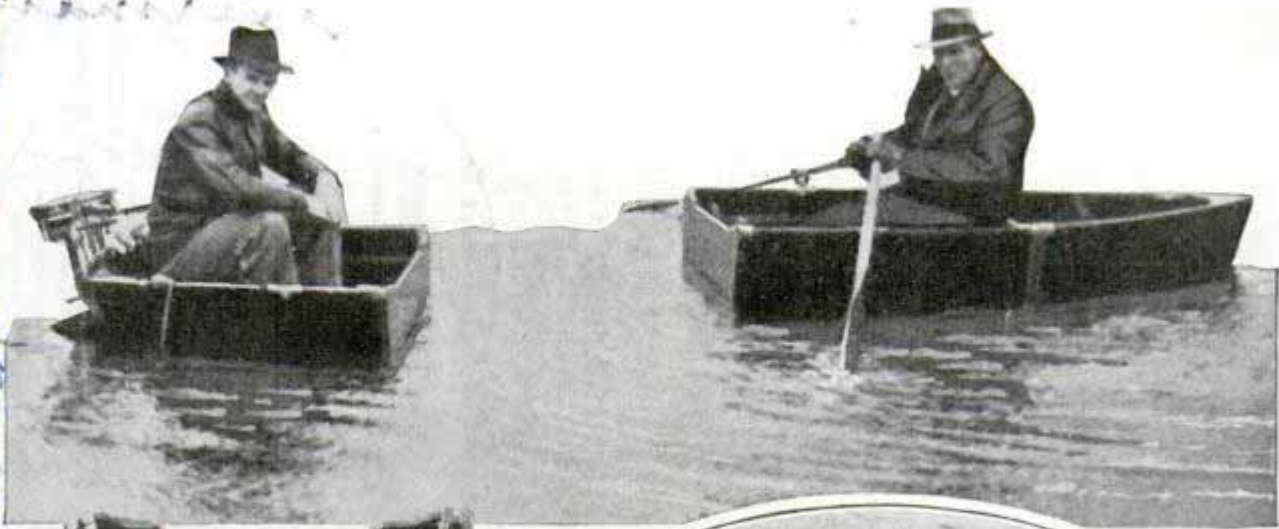

Top, two fishermen take separate sections and fish by themselves, then bring the boat together again. Below, the three-piece boat "nested" for transportation by auto or plane and afloat with outboard motor

Nesting so compactly you can load it into your automobile trunk, trailer or plane, a three-piece folding boat is assembled or dismantled in less than a minute. In fact it can be taken apart while in the water, each occupant taking a separate section, and then reassembled before rowing home. No flimsy craft, it is built of a hard composition board impervious to rot and water absorption, leakproof and able to withstand rough usage over bottom rock, gravel or coral without puncturing. Longitudinal oak strips reinforce the bottom. It seats three persons, and is equipped with folding oars, but also can be propelled by an outboard motor. If more than six-horsepower propulsion is desired, flotation tanks which fit into the nested hull are attached for better stability. The boat is ten feet long and weighs ninety-eight pounds. Dismantled, it measures seventeen by thirty-five by forty-one inches.

H 468 Automatic "Brake" Stops Snarls of Fishing Line on Reel

Snarled lines on the casting reel, not only time-wasting to the fisherman but a source of exasperation, are prevented by an automatic "brake" that can be attached to your reel with a screwdriver. Most loop

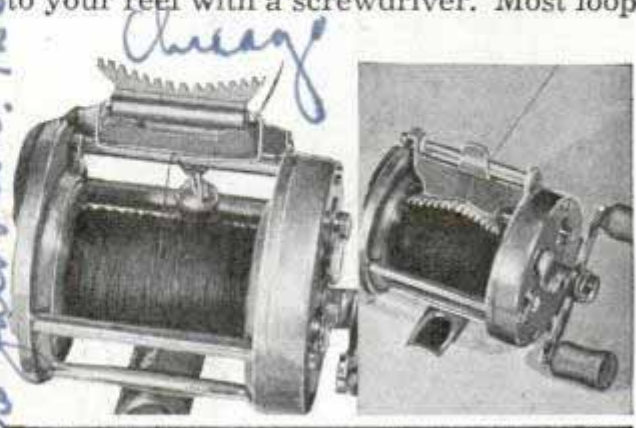

Right, the teeth set to catch snarls; left, in position for taking up slack after "brakes" are applied

Also Jacobsen 12.50 Clyburn 1.25

Chicago
DeLange
H. DeLange

snarls are caused by the spool overrunning—the spool turns faster than the line can leave it. The toothed attachment prevents this by catching the snarl as it starts and stopping the spool instantly. When properly attached to the reel, the brake operates automatically. It does not interfere in any way with the free action of the spool and does not reduce casting distance.

H 487

Rail 'Dreadnaught' Is Heavily Armed Fortress

Heavily armed for attack or defense, a "dreadnaught" railway car on the Tientsin-Pukow line in China was captured by Japanese troops. At each end of the mobile fortress was a revolving turret carrying big guns, and between them a company of soldiers, well shielded by a vaulted roof of thick steel, could man small arms and machine guns through sliding doors and slots in the wall.

Searchlight Lens Magnifies Hand to Giant Proportions

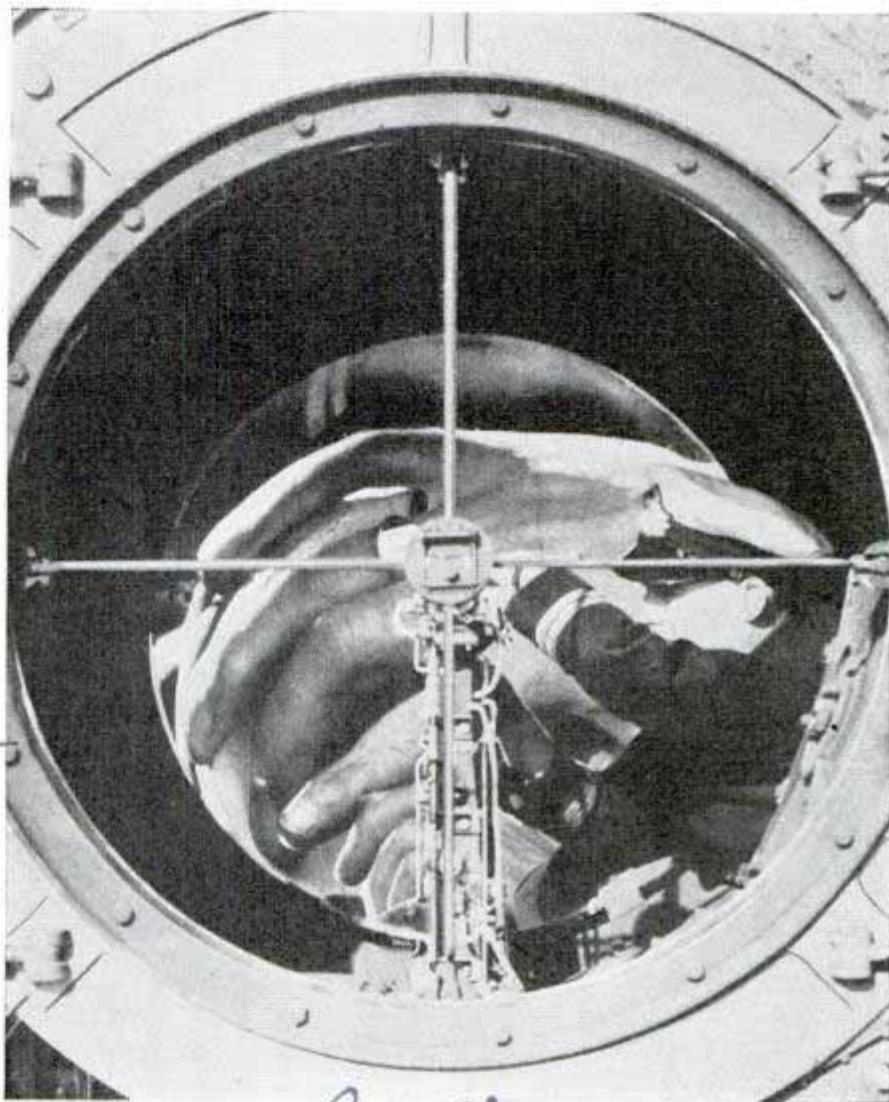

Unusual photo of giant searchlight shows greatly magnified hand of the officer testing the mechanism on board ship

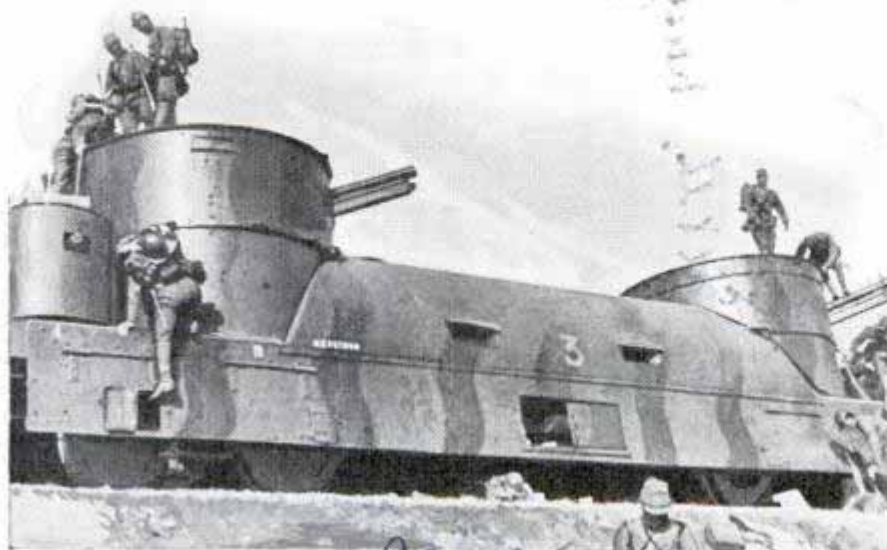

Japanese troops inspecting armored car captured on Chinese railway. Notice heavy guns in turrets, and machine gun slots along side of "tank"

When a ship's officer recently was testing the searchlight aboard H.M.S. "Cornwall," a photographer snapped a picture that showed an unusual enlargement of the man's hand. Magnification was caused by the convex mirrors of the searchlight.

☐ Inquiries as to makers of articles described in Popular Mechanics, will be answered by our Bureau of Information upon request, accompanied by return postage.

18267

FIRE UNDER

*Electro. Inotive Corp
La. Lorange. D. U.*

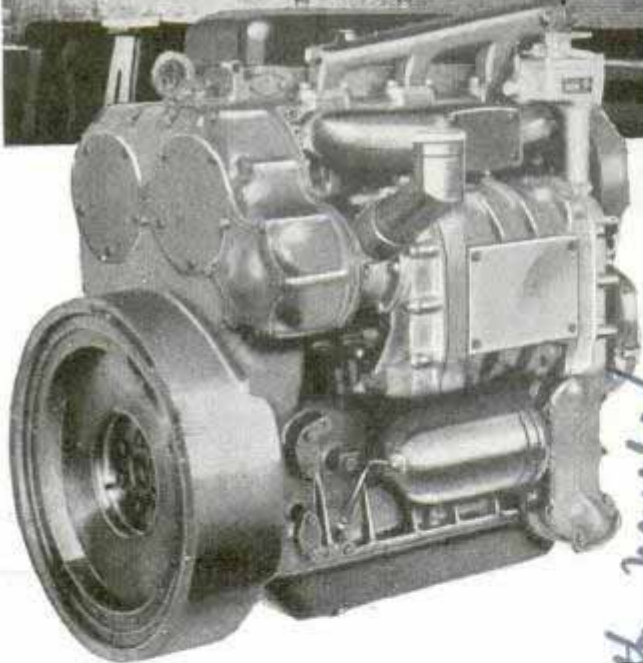
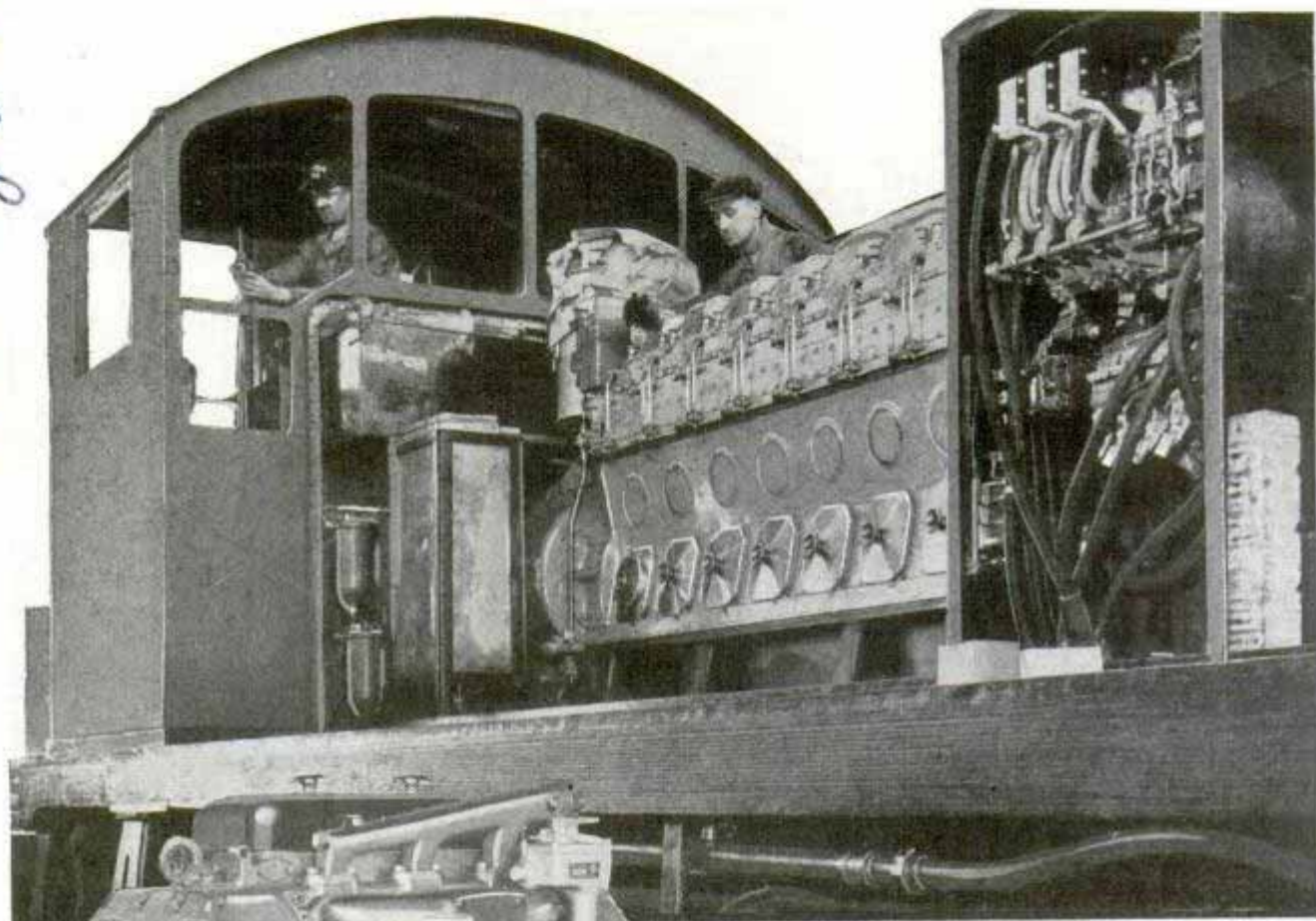

Top, closeup of Diesel-powered switch engine. Bottom, latest type of Diesel power plant, fully equipped

is also the working principle of matches. Or you can strike fire off flint or other stones, as with the old flintlock gun or the modern cigarette lighter. The automobile engine also uses sparks to start its fires.

You can start fires by compression also. This method apparently developed in the rainy tropics of Burma or Samoa. The native tool is a fire gun or syringe, really a primitive popgun. You take out the piston, put in a little punk or dry moss, push the piston in hard and you have a fire. That is because when you compress air quickly its temperature goes up. Get the temperature of the cylinder above the combustion point of the fuel and the fire begins. These fire guns are operated much like the Diesel engine, which compresses air quickly to an extremely high pressure, then injects a fuel. No carburetor is necessary.

Dr. Rudolph Diesel of Munich began by devising a coal-burning engine. He found that powdered coal thrown into the hot air of the compression chamber burned quite

By Charles Morrow Wilson

Hotel Brevoort. 5th Ave

THE story of the compression engine is really a story of starting fires. When you drive an automobile or motorcycle you are starting another fire every three to six inches of the way.

In nature there are three principal ways of starting fires. The first is by friction. This is how the Boy Scout starts a fire when he rubs sticks of wood together. It

at the New York

vice president in charge of
research, General Motors Corp

YOUR HOOD

Verbus Crystal engine at Berlin motor show

Scale model of a German automobile engine built in transparent material to demonstrate how all the parts work

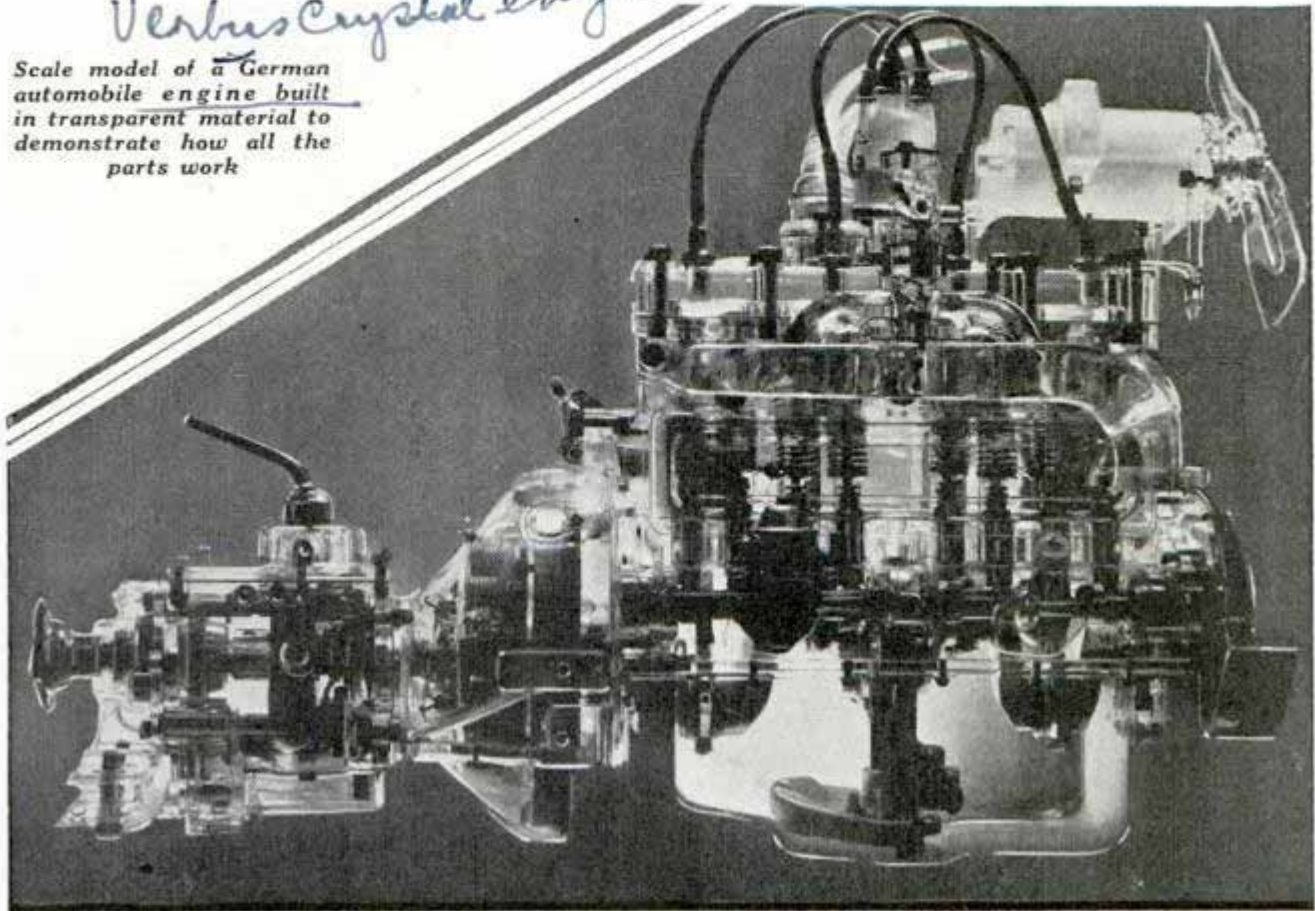

well. The trouble was that coal ashes are abrasive to cylinder walls. If we could ever develop an ashless coal, we may still find ourselves driving to work with a tray of coal in place of a tank of gasoline.

Diesel engines have opened up an entirely new field of power development. The first important issue with Diesel power is accurate timing of the fuel injection. When this is correct there is no real reason why a combustion engine couldn't be operated on a wide range of burnable materials. In fact you can imagine a day when a housewife may drive down to market and, finding herself stalled because her car has run out of fuel, she might just clip off a half-pound of butter, slap it in the fuel box, and drive home. Practically this is a long way from fact, as we now reckon fact. Just now we use crude-oil distillate in the Diesel merely because it is a cheap and convenient fuel. Some day we may hit upon other fuels which are still cheaper and more convenient.

The greater part of Diesel engineering has thus far been concerned with the in-

jector, the device which puts fuel into the cylinders. Most Diesel patents relate to the shape of the combustion chambers inside the cylinders and to the injector.

Dr. Diesel's own invention met with immediate success. But the engine's use of extremely high compression, four or more times that of the ordinary gasoline engine, required the use of strong heavy cylinder walls and parts which made the Diesel big and bulky. This made it a more or less standard stationary engine and a logical power for ships, since ship engines can be both big and heavy.

As the automobile industry came along and the spark-ignition gasoline engine developed, Diesel, as originally designed, was too heavy for light auto use. So engineers tried to make the Diesel over to match the gasoline engine. Now they are becoming reconciled to letting the Diesel be itself.

With this state of mind there now seems to be a first-rate chance that the Diesel will develop into a really important industry, one which will put a great many

Cleveland Diesel engine dis.

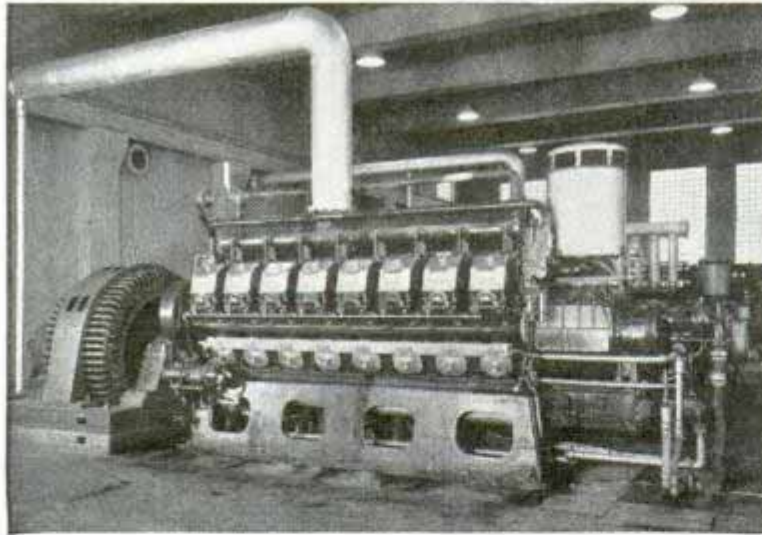

Top, Diesel engine assembly department in a General Motors plant. Bottom, sixteen-cylinder Diesel operating a 1,000-kilowatt generator

more men to work and one which will expand our ideas of the uses of power far beyond anything we now know.

The Diesel is actually about as old as the gasoline engine and its reception was more instant. The first American Diesel was installed in a St. Louis powerhouse in 1898. While visiting the United States in 1912, Rudolph Diesel predicted that the

Diesel engine would ultimately find its greatest usefulness here in America. Meanwhile his engine was already playing an important part in power-plant industries and shipping lines throughout west Europe. It made possible the submarine and other outstanding World War equipment.

Several American firms began manufacturing the larger-unit Diesels and American engineering talent has improved the equipment year after year. Our manufacturers have developed Diesel models for effective use in tractors, trucks and buses, as well as in modern streamline trains. But the Diesel's place in the routine auto industry remained largely in the laboratories.

With the development of the spark-combustion gasoline engine, the Diesel became a sort of scientific whipping boy. General Motors' entrance into the Diesel field was a by-product of experiments with motor fuels. For years engineers

Ultron Diesel engine (L.V.)

have been studying combustion and fuel burning in connection with motorcar ignition and "knocks." In this study of motor fuel it was found that whatever you do to make a gasoline engine run smoothly makes a Diesel engine run rough.

Tetraethyl lead was put in gasoline to slow down the combustion. But in a Diesel engine you want the fuel to start burning the instant the first molecule of fuel gets its head inside the cylinder. If you add something to slow down the burning you get a lot of fuel in before it starts to burn, and your Diesel knocks. So the next question was: "What can be done to make this engine independent of the character of the fuel?"

The method of injecting fuel always has been one of the foremost Diesel problems. The underlying idea is to get the fuel into the cylinder in the finest possible state. From a standpoint of combustion the air injector has been satisfactory but it requires an extremely high pressure.

Normal injection pressures are from 4,000 to 5,000 pounds per square inch at the injector head. Engineers began by supposing that if one raises the poundage of pressure he can break up the fuel still finer and better control the rate of burning. They went as high as 25,000 and 30,000 pounds per square inch. Injectors for locomotive Diesels now run pressures of about 20,000 pounds.

It was found that efficiency goes up with compression pressures. The pressure necessary to ignite fuel in a Diesel cylinder chamber is around 650 pounds as compared with about 125 pounds for an ordinary gasoline engine. So, in any case, the working efficiency of a Diesel is higher than that of an ordinary gasoline engine. Also at retarded speeds the gasoline engine loses efficiency while the Diesel tends to increase efficiency.

Engineers figured that they couldn't get very far with Diesel improvement until they could make it about twice as efficient as a gasoline engine. But they still faced weight and design problems. Because of higher cylinder pressures the Diesel must be heavier than the ordinary gasoline engine. It also was plain that if the Diesel was to be of importance to the automobile industry, there must be a limit on weight.

(Continued to page 126A)

Popcorn Measured for Quality in Glass Column

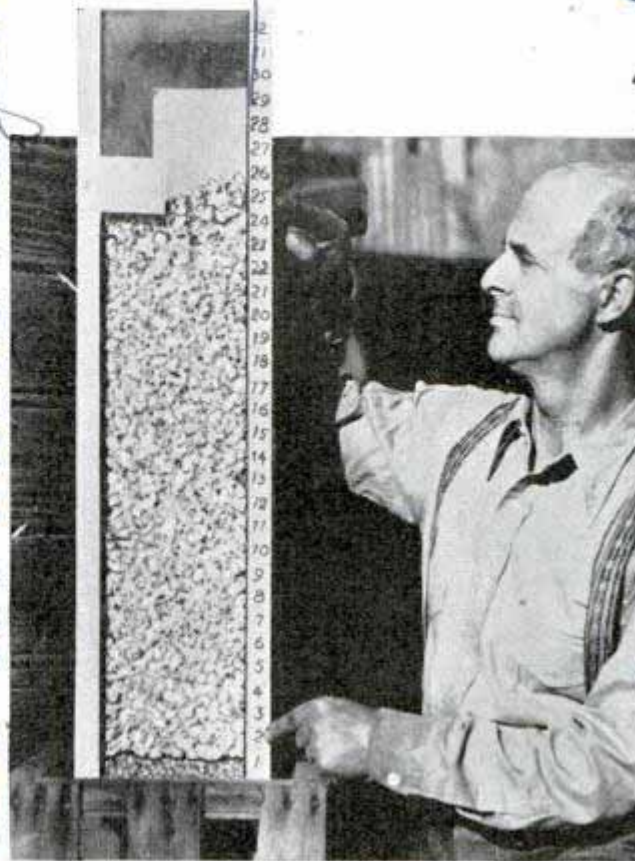

Popcorn measuring device which shows quality based on popping characteristics

Standardization of popcorn may be made possible by a measuring device designed to show the quality of the kernels. It is a square glass column graded in pounds. For the corn to be graded as standard, one pound of kernels, after being popped, should fill the measure to scale twenty-five. Twenty-one is passable, while thirty-one means the corn is excellent.

Paper Cups for Spraying Paint Are Discarded after Use

Less costly than cleaning the conventional metal can, a paper cup for paint spraying is discarded after use. It is made of three-ply paper with a metal bottom, and also can be used for storing paints and lacquers.

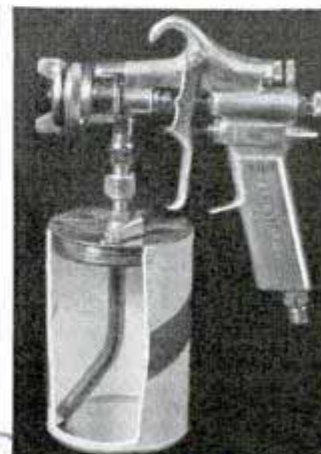

J.C. [unclear] President
H-362
cm. for dead 60's also H. [unclear]
Southern California Popcorn Growers' Assn. no address
H 467
Stiles. Paper cups. 2741 Washington
St. Louis, Mo.

see March 1935 392

Death Guards Lost Gold of 'Dutchman' Mine

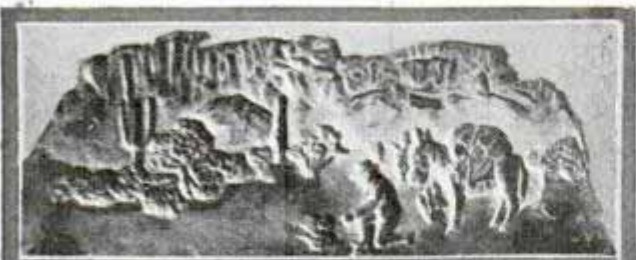

HERE LIE THE REMAINS OF
SNOWBEARD
THE
DUTCHMAN

WHO IN THIS MOUNTAIN SHOT
THREE MEN TO STEAL A RICH GOLD
MINE FROM SPANISH PIONEERS,
KILLED EIGHT MORE TO HOLD HIS
TREASURE, THEN HIMSELF DIED IN
1892, WITHOUT REVEALING ITS
LOCATION. DOZENS OF SEARCHERS
HAVE MET MYSTERIOUS DEATH IN THE
CANYONS THERE, YET THE ORE LIES
UNREVEALED. INDIANS SAY THIS IS
THE CURSE OF THE THUNDER GODS
ON WHITE MAN IN WHOM THE
CRAVING FOR GOLD IS STRONG.
BEWARE, LEST YOU TOO SURRENDER
TO THE LURE OF THE LOST DUTCH-
MAN MINE IN SUPERSTITION
MOUNTAIN.

ERECTED BY

1938



Above, plaque over "Snowbeard's" grave. Right, panning pay dirt; Weaver's Needle in distance. Nugget and cuff links are of gold from Dutchman mine

For nearly a century, violent and often mysterious death has guarded the hidden gold in Superstition Mountain. Once the rich vein in the mountain east of Phoenix, Ariz., was the property of a Spanish rancher in Sonora; he worked it for years until Indians raided his last big ore train and the United States acquired the territory in which the mine lay. Years afterward Jacob Walz, known as Snowbeard the Dutchman, murdered three of the Spaniard's heirs and stole the mine. For a decade or more he worked it alone, then re-

vealed its secret site to his nephew, and finally murdered the nephew when he grew suspicious of him. A few Phoenix residents still remember the old Dutchman coming to town with a bag of nuggets, trekking back to Superstition Mountain a week later, alone. When men tried to follow him he slipped back and shot them. Eight men, in all, were killed in this manner. The three Spanish Mexicans and two others, Snowbeard hurled into a crevasse and heaped stones upon them—a private graveyard of which he often boasted. Dy-

Phoenix, Ariz.
44 Rancho
Capt. Aron Arnold

Hydro
38

Nov 11 31

H 463

Four Tons of Marble Legs Carved for Franklin Statue

ing, the Dutchman told two men and a woman of his mine and his murders; he gave Dick Holmes samples of the ore and directions to the mine, but Holmes never found it. Snowbeard had said it was "within half a mile of Weaver's Needle," the central, highest peak of Superstition Mountain, a wild, rugged wilderness ten miles by thirty. Since then the search has gone by, with frontier-day and modern methods, but death still guards the secret. Adolf Ruth of Washington acquired a map in Mexico in 1930 and went up to the mountain alone. He never returned. Six months later archaeologists accidentally found his skull; his murder was never solved. Bones of other men have been discovered. Two years ago 600 searchers hunted a lost prospector in vain; but after a blizzard he came out alone with a handful of gold found in a cave, a relic of Spanish days. A bronze tablet recalling the mysteries of the lost mine has just been erected over Snowbeard's grave on Superstition Mountain.



Marble legs of Benjamin Franklin statue, weighing four tons, were brought by truck from Long Island studio to Philadelphia

It took fifteen workmen to move the crated marble limbs of the new Benjamin Franklin statue from the loading platform to Franklin Hall in Philadelphia recently. The legs alone weigh four tons. The heroic statue was brought from the Long Island studio of James Earle Fraser, the sculptor.

H 471

Stop-Motion Film Brings Traffic to Life in Miniature City



Moving miniature truck a tiny fraction of an inch between "frames" of movie. Each vehicle is moved twenty-four times for each foot of film

Model cities can be made deceptively alive by the "stop-motion" process of filming. This method is used for realistic action, the tiny figures or vehicles being moved a fraction of an inch by hand after every "take" of the movie camera. In one film made for advertising purposes nine miniature trucks and buses were used, and each had to be moved twenty-four times for each foot of film. Since it takes one minute to show ninety feet of film, production of the one-minute scene involved 19,440 carefully calculated hand moves.

Acme Institute
 I. S. Easton, Newark, N. J.
 Lane Handy Picture Service, Inc.

es 942

Cont. James Mc Sweeney,
334 J Ave.
Carmichael, Calif

ROPE SPINNING

Olaf Clark.
Serry Boardali

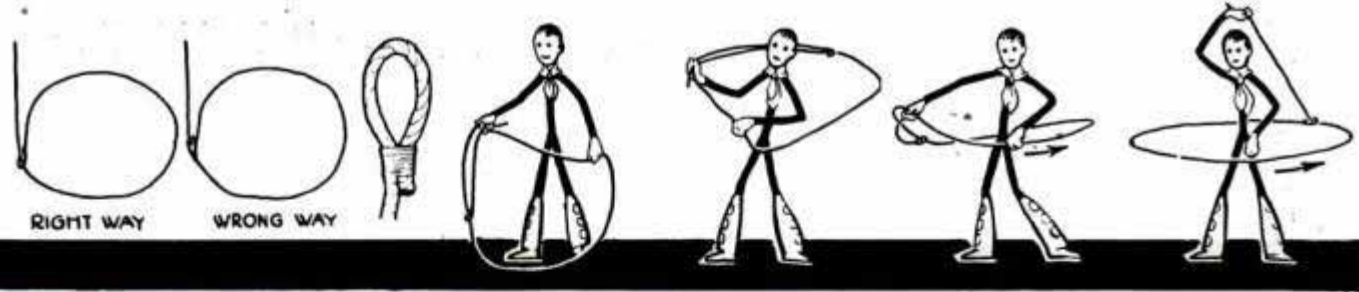
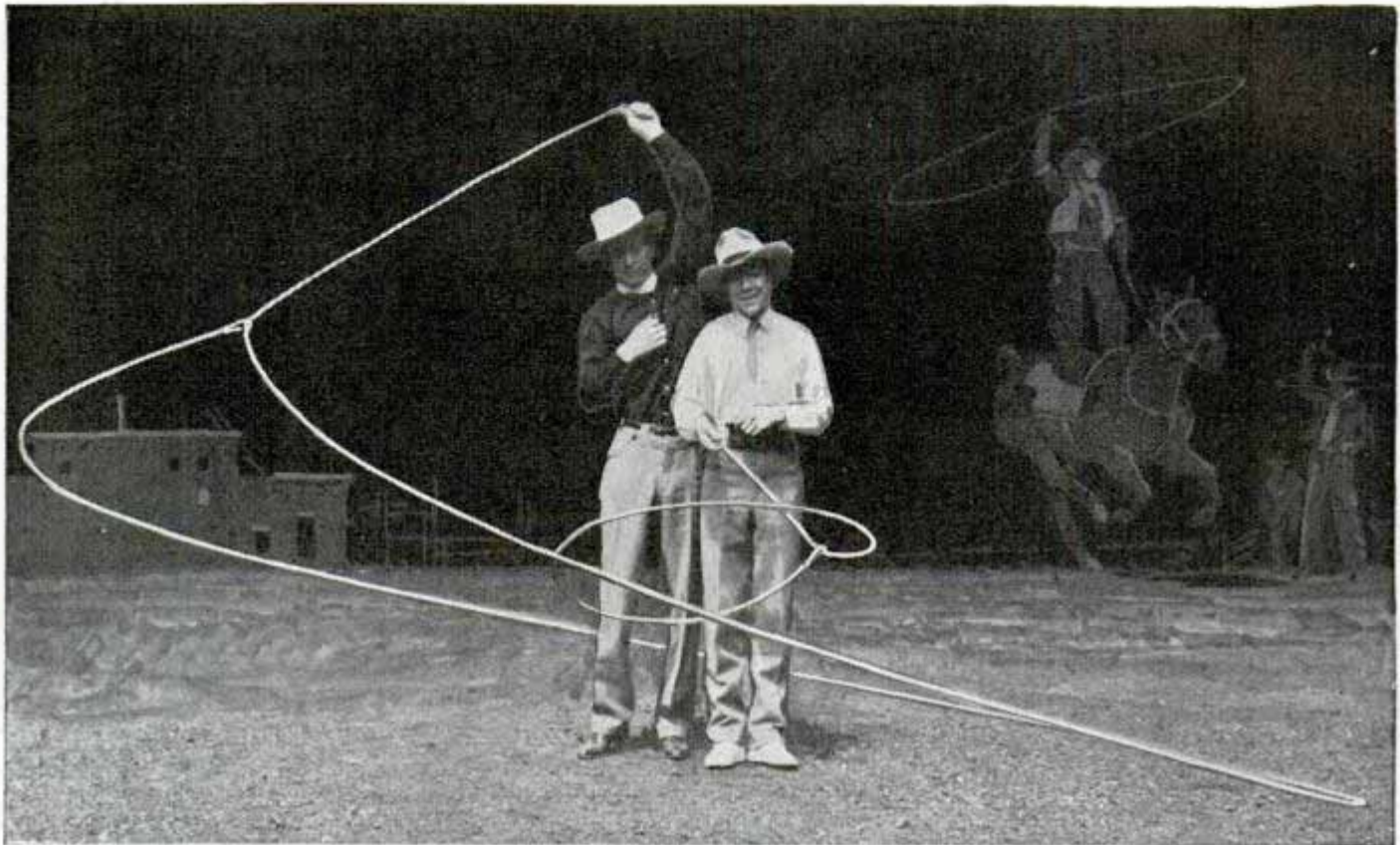

Top, two exponents of famed cowboy sport. Bottom, right way and wrong way of putting spoke through the honda. Other figures illustrate simplicity of starting loop about the body

TRICK roping, a cowboy pastime that is gaining favor as a sport, offers a pleasant blend of exercise and amusement.

There is no expense connected with this form of recreation nor are there seasonal limitations. The rope spinner may take his exercise to suit his convenience, indoors or out. Because it brings into play the trunk muscles as well as others, many men have taken up the sport as an aid to waistline control.

The fascination of the lariat is comparable to golf, tennis, or any major sport. Once a person acquaints himself with a few simple fundamentals he is anxious to learn all there is about roping, which is a life-time assignment, any veteran will tell

you. The fundamentals are easily mastered, however.

The correct type of lariat is important, according to Ray Berwick, professional roper who has entertained rodeo and vaudeville audiences all over the world. A rope no less than fifteen feet in length is recommended. Because it can be handled easily and does not kink readily, braided cotton sash cord, size No. 10, is preferred by the top-notchers. One end of the rope should be wired in such a way that it will not ravel and to the other should be attached a thin brass or aluminum eyelet with a groove, permitting the rope to be placed around it. This is called a honda and furnishes an opening of constant size

Indian Archery
and Fry Corps
610

Do 942
Hulten &
Evansville, Ind

for HEALTH

through which the free end of the rope is threaded. If the metal eyelet is not used a honda can be made by bending back five inches of the rope and reenforcing it with copper wire or tape. After a time, the roper will add additional wire to the honda as the extra weight expedites the handling of a loop in some of the more subtle routines.

Rope spinners call the free end of the rope the spoke. It's the friction of the spoke against the honda that prevents a loop from closing.

A small flat loop is the logical starting point.

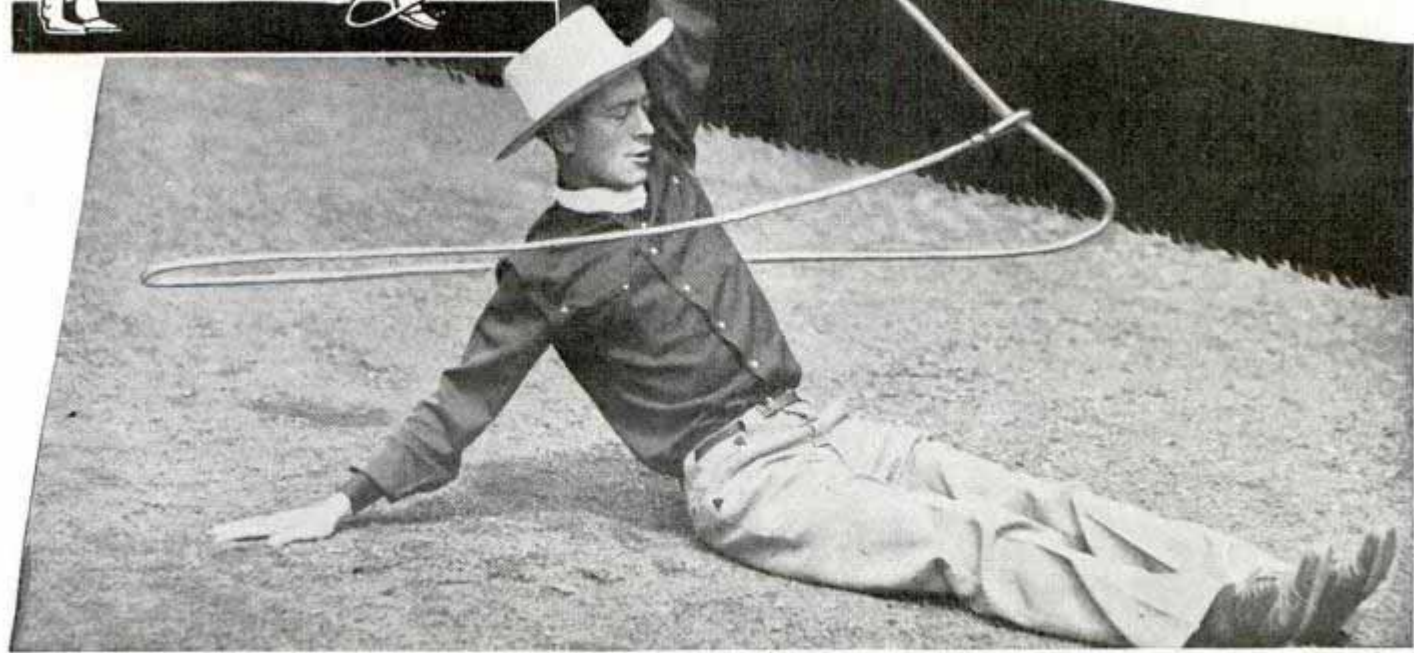
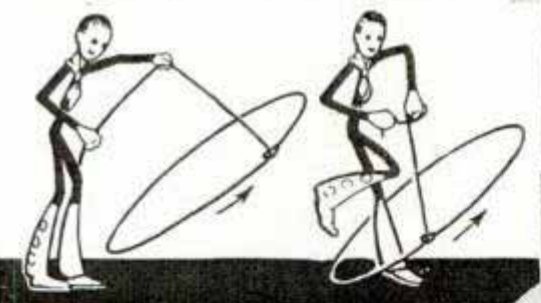
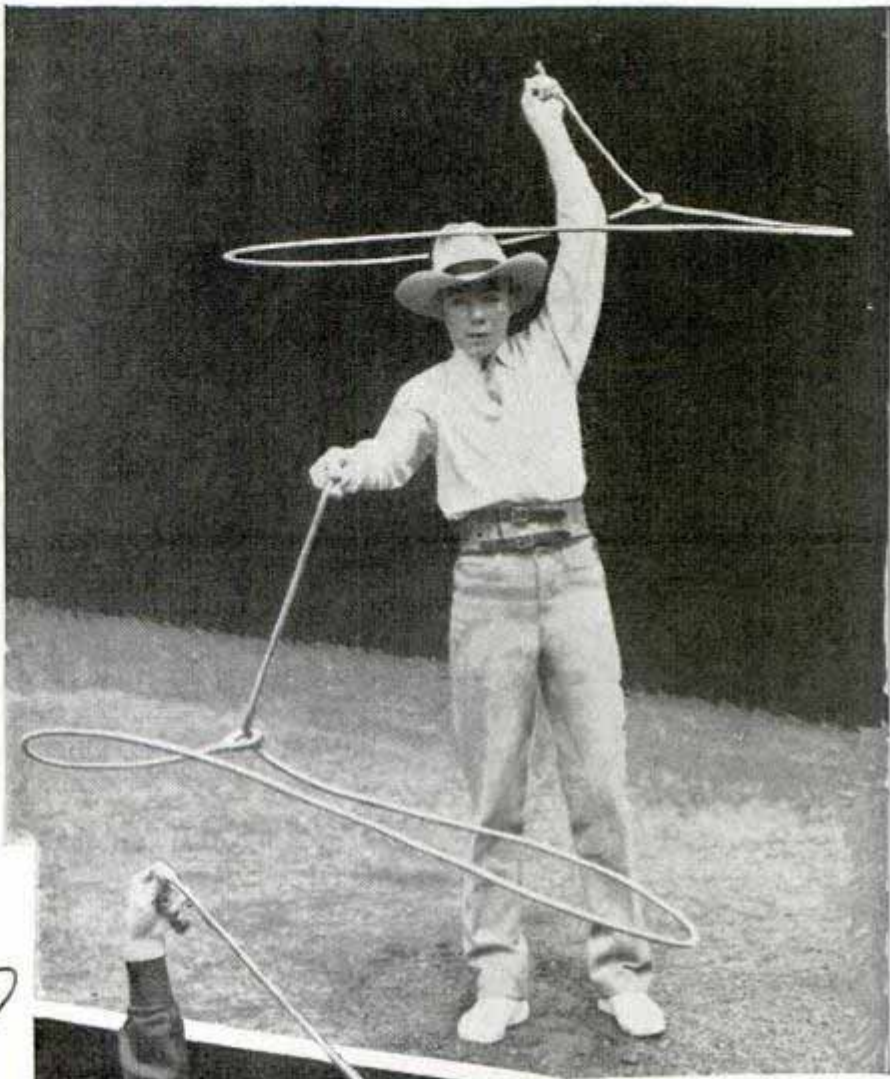

Top, right, some of the more spectacular phases of trick roping. Left, figures showing how to step into loop. Bottom, there are hundreds of variations of simple routines, as expert demonstrates in this photograph

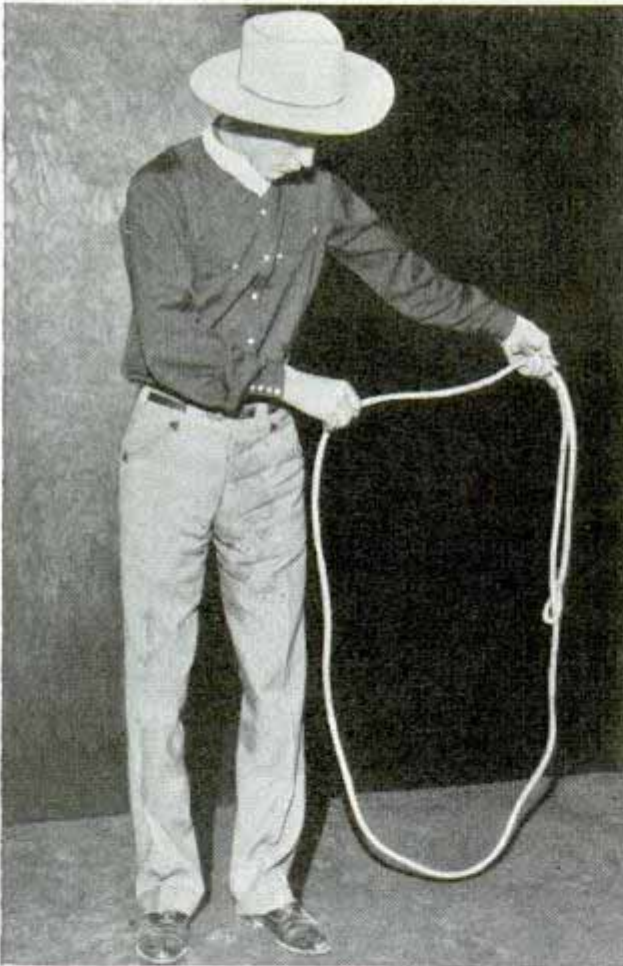
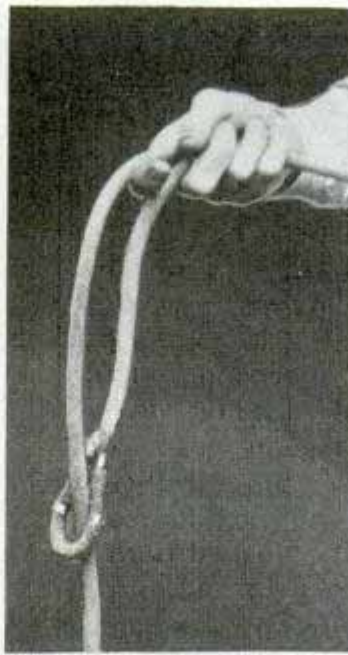
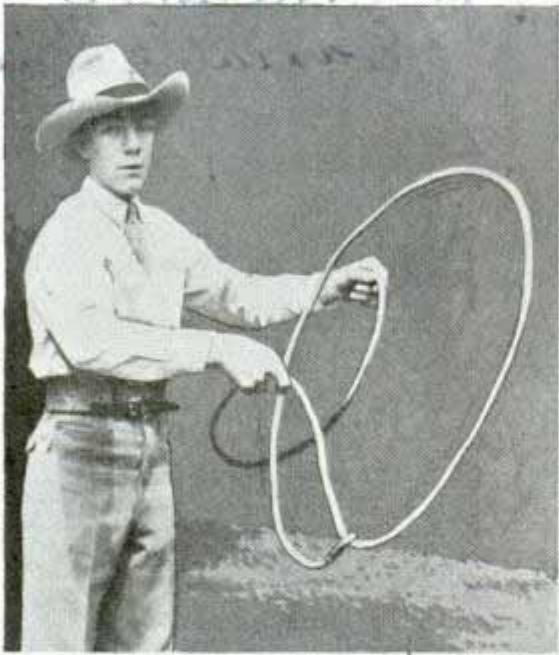

Top, left, sense of rhythm is important in spinning small loops over free end of rope. Center, how rope should be held at start. Right, vertical loop requires a heavier honda than lateral loop. Bottom, demonstrating start of a lateral loop from the left side

stance with the body bent slightly forward and the feet apart. He explains the technique:

"With the right hand grasp the two ropes. The thumb should be over the free end and the index finger in between the loop and the free end so as to separate them. The closed palm is held in an upright position and the rope to your right. The fingers of the left hand, which hold the loop and the free end, should be relaxed so that the rope can be dropped quickly as the whirling starts.

"Here is how the loop is set in motion. With a sweeping motion toward the body turn your hand over. When your hand reaches a point directly in front of you, release the loop part and begin a circular motion with the spoke that has been retained in your right hand. This movement is done with the wrist, not by twisting the arm.

"The loop should be thrown from the hand in such a way that it starts twirling before it touches the ground. In order to keep the loop from striking the legs, hold it out from the body.

"The right hand makes a revolving forward motion and by speeding up the wrist and letting out on the rope, the loop is opened by centrifugal force and may be increased to any size the lariat spinner feels capable of handling.

Here the rope can be revolved to the left or to the right, the former being the more practical as there is less possibility of the rope kinking. The beginner can use his own judgment as to the size of his loop. It is best to start with a small one and enlarge it by degrees.

According to Ralph Clark, circus roper, the beginner should assume a natural

2942

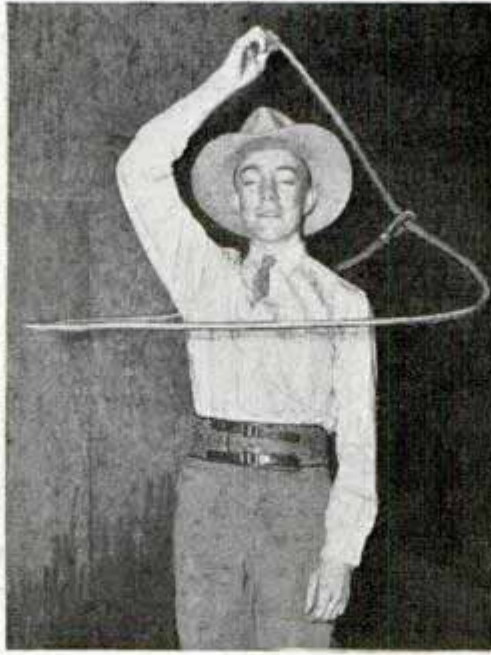

"While the loop is revolving the spoke should be turned in the fingers of the right hand. Likewise, the left hand should be kept busy unkinking the rest of the rope."

Naturally, a few false starts must be expected before the proper technique is mastered. Once you get a loop started, however, you will experience little difficulty in keeping it going. The secret of rope spinning is getting the proper rhythm into the loop. Once this has been learned, the lariat spinner is well on his way to success.

The backward loop is essentially the same as the forward one except that it is revolved to the right instead of the left. When this has been mastered the spoke should be transferred from the right hand to the left. A good roper is proficient with either hand.

When a beginner can control a loop approximately six feet in diameter he is ready to try a few of the more difficult

(Continued to page 116A)

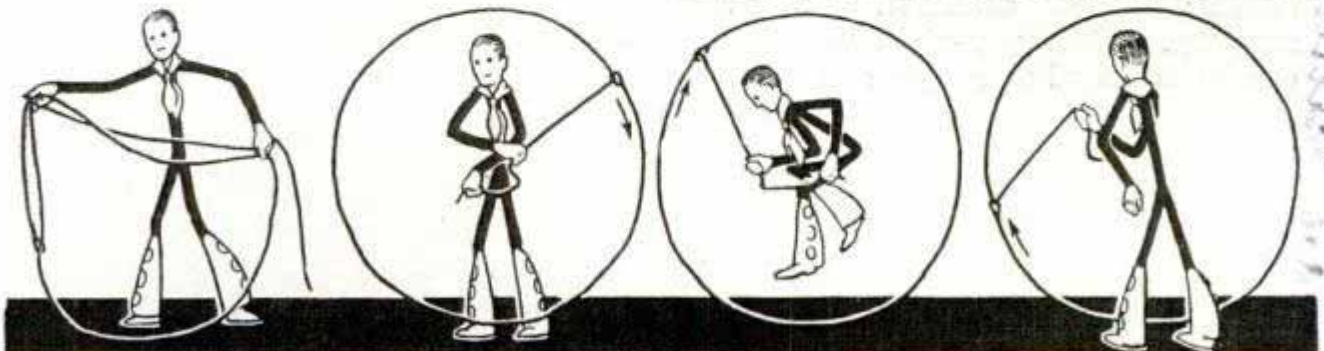
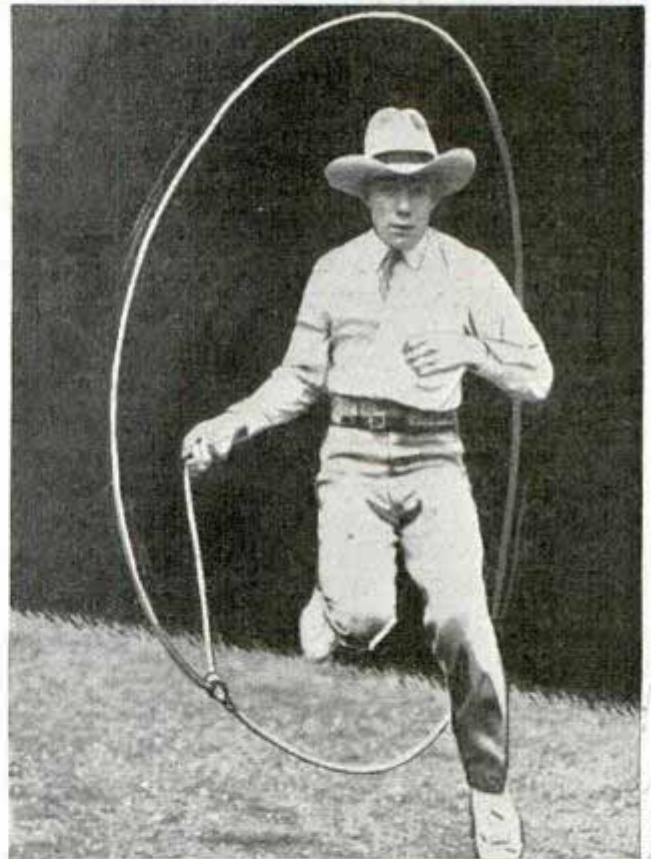

Top, left, rope spinning is lively exercise. Center, spinning rope around body. Right, while loop revolves, free end should be turned in the fingers. Center, jumping through vertical loop. Bottom, figures illustrate jumping through vertical loop

Measuring Musical Tones with the Sound Stroboscope



Testing tone of a wood-wind instrument with chromatic stroboscope. Inset shows pattern of one of the lighted windows seen in unit at left

Sing or play to the chromatic stroboscope and it will show you, by a pattern in a lighted window, exactly how far you deviate from the true key. The instrument was developed as a means of measuring in a visual, foolproof way the intonation of wind instruments. The player might "fool" the tuning bar by his way of "lipping" the tone, but he cannot fool the stroboscope. Two units and a microphone form the complete instrument. One unit has twelve windows in the relative positions of the

twelve white and black keys of the piano starting with C. Behind each window is a rotating disk imprinted with a pattern of seven rings of alternate light and dark segments, each ring progressing outward having twice the number of segments of the inner ring. The disks are lighted by a gas tube flashing in accordance with the pulsations of the sound reaching the microphone. When the number of light pulses per second equals the number of dark segments passing per second on one of the rings of a disk, that disk appears to stand still. If the same note is sounded an octave higher, the same pattern appears with twice the number of bars, for the frequency is doubled. If the pattern remains stationary, the tone sounded is correct; if the tone is sharp, the pattern moves to the right; if flat, it moves toward the left. To find exactly how sharp or flat the tone, the operator turns a knob on the second unit until the pattern stands still. A dial shows the degree of deviation from correct tuning. The instrument may be used in testing musical performance, tuning organs and pianos, and teaching.

Self-Changing Slide Projector Is Run by Remote Control

Any picture slide projector can be made to operate automatically by a self-feeder attachment now available. The rotary magazine holds forty-eight slides which can be arranged in proper sequence; the attachment is then connected to the regular projector and the viewing time regulated by a switch for rapid or slow change, or remote control. Change from one slide to the next takes three seconds. When remote control is used the operator changes the view by pressing a switch.

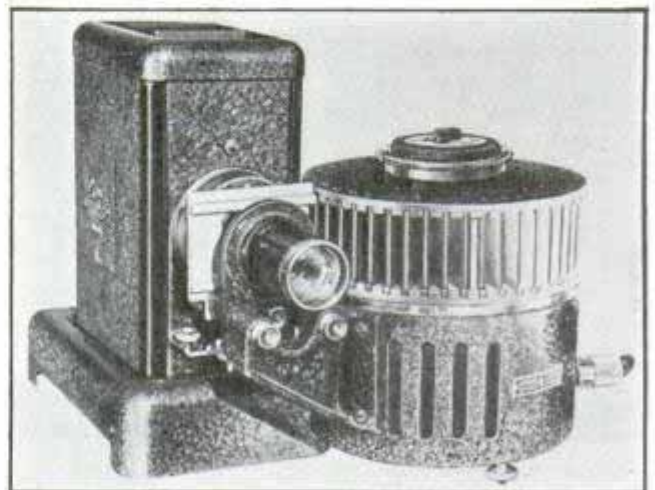

Forty-eight slides arranged in proper sequence in rotary magazine are fed automatically to projector

Send return postage to our Bureau of Information to learn the name of the maker of any device described in this magazine.

C. S. Conn, Ltd., Elkhart, Ind.
 H 476.
 Spindler & Suplee, Inc.
 86 Third St., San Francisco, Cal.
 H 469

H 443

Carl James the Queeny 4 31 0
60th Terrace
Kansas City, Mo
Paramount Studios.

Camera Dolly Rides the Rails to 'Shoot' Train

Ordinarily a camera dolly is a low-wheeled truck that carries the camera and crew along with the action. But an ordi-

nary dolly wouldn't do for one scene recently, when the script called for a movie of a string of railway flat cars carrying a shipment of new automobiles. A stranded orchestra was to discover the cars, climb aboard and ride to town in style. Several dollies were tried, but they were unsatisfactory and finally the director ordered a special camera truck fitted with railroad car wheels and the scene was "shot" from an adjoining parallel track.

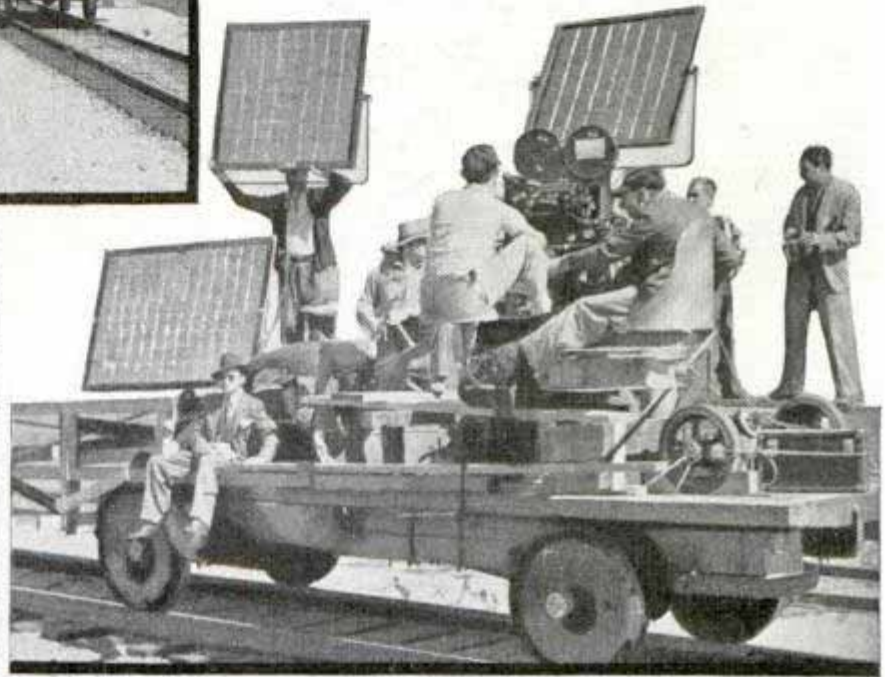
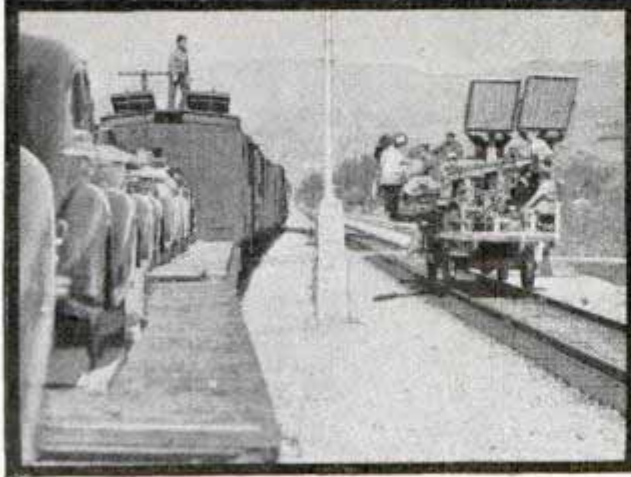

Film director's problem was to grind out scene of stranded orchestra "hitching" ride in shipment of new automobiles on passing freight. It was solved by fitting camera dolly with railway car wheels and shooting while dolly traveled on adjoining track, as shown above and at left

H 474

Beaver Engineers Show Skill Damming 2,000-Acre Lake

Human engineers are getting plenty of competition from the beavers. In Glacier National Park a small colony of beavers has built a dam across the outlet to Bowman Lake, backing up nearly 2,000 acres of water. Although the dam itself is not large, it has impounded a tremendous volume of water and raised the level of the

lake ten inches. The beavers swim a quarter mile to work daily at dusk. Last spring the beaver colony numbered only six, and is still small with the addition of this year's young. Beavers are being encouraged because of the effectiveness of their dams in aiding man's water-conservation and erosion-prevention programs.

Reported by Ranger C. E. Croghan

Scene done 4/19/38

H 483

Bombproof Rail Terminal to Shelter a Million

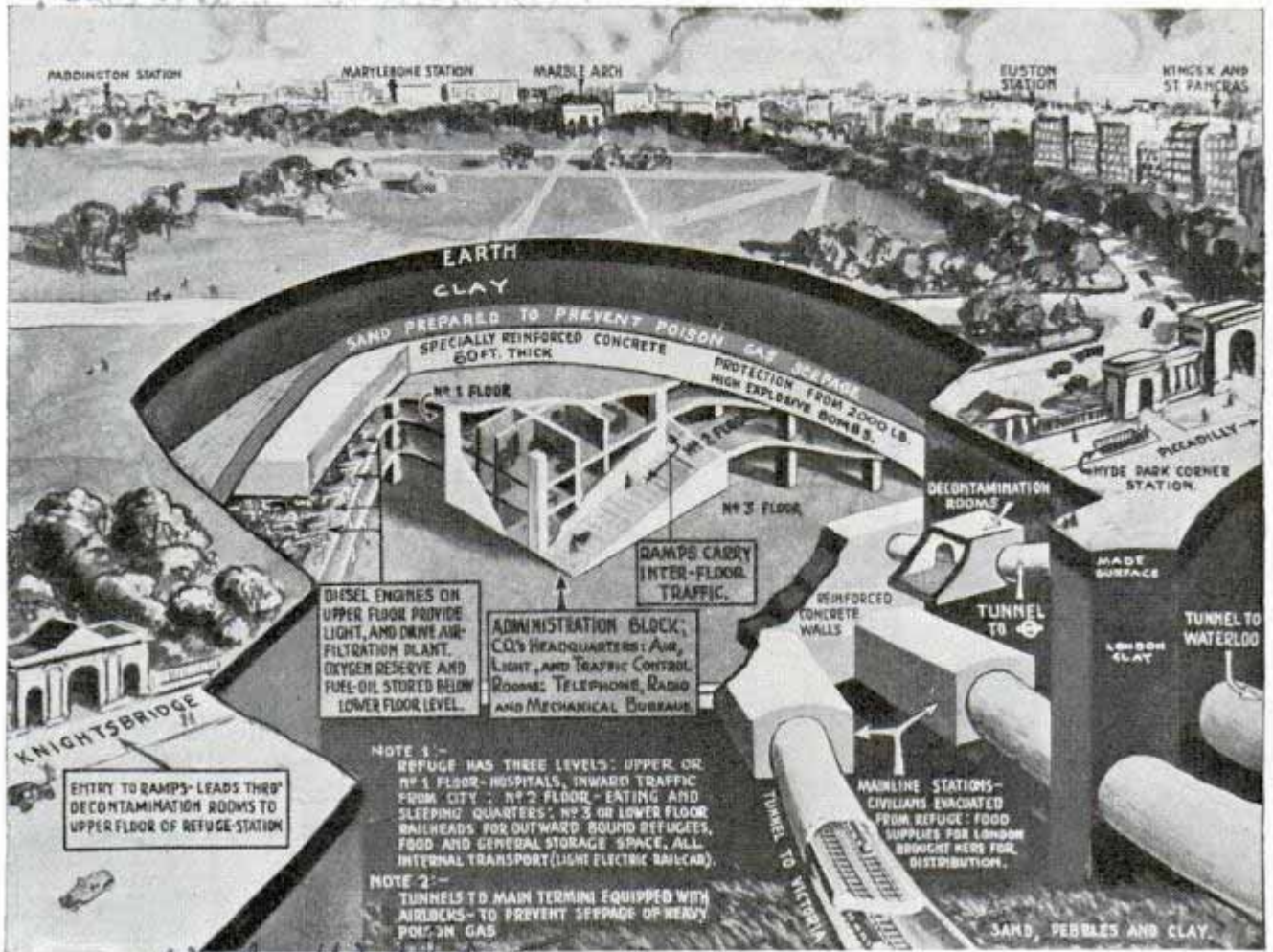

Artist's sketch of tremendous refuge chamber which it is suggested could shelter a million Londoners during air raids, besides providing bombproof rail tunnels to bring in supplies and evacuate refugees

Deep underneath Hyde Park in London a vast bombproof railway terminal is proposed to shelter a million persons in wartime air-raid emergencies and at the same time coordinate traffic. Refugees could be evacuated quickly to the relative safety of the surrounding countryside, and food and fuel could be brought into the city underground. An artist has sketched the project in cross-section, showing rail and traffic tunnels leading to various sections of the city, and all entrances guarded by decontamination chambers to prevent poison gas from entering the refuge. Beneath the thick surface covering of earth and clay would be a layer of sand prepared to stop gas seepage, then a sixty-foot layer of reinforced concrete which would shield the subterranean chamber from bombs.

Send return postage to our Bureau of Information to learn the name of the maker of any device described in this magazine.

H 466

Pistol Fires Paint "Bullets" to Check Auto Brakes

Firing cartridges loaded with paint pigment, a pistol-like device shows the distance necessary to bring an automotive vehicle to a stop after the brake has been applied. An electrically operated contact switch which causes the pistol to fire is attached to the brake pedal.

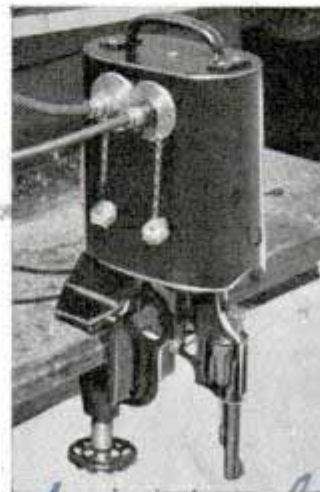

After the car is brought to a stop, a tape is used to measure the distance from the marked spot on the pavement where the brakes were applied to the point where the car stopped.

Triangle Associates
1033 Cathedral

Homemade Merry-Go-Round Sells Magazines

Whirling at the touch of a finger, a merry-go-round newsstand was built by a sidewalk dealer at El Paso, Tex., to display his magazines. It has ample display space, with racks pyramiding up the center pole which supports the rainproof canopy, and it revolves smoothly on ball bearings in either direction. The stand is supported by a four-inch pipe sunk in concrete two and one-half feet in the ground. The main post is an old automobile drive shaft extending from the bottom of the pipe to a point five feet above ground. The bearings at top and bottom of the four-inch pipe were taken from a truck wheel. The canvas, which covers the stand at night, is raised and lowered by ropes and pulleys.

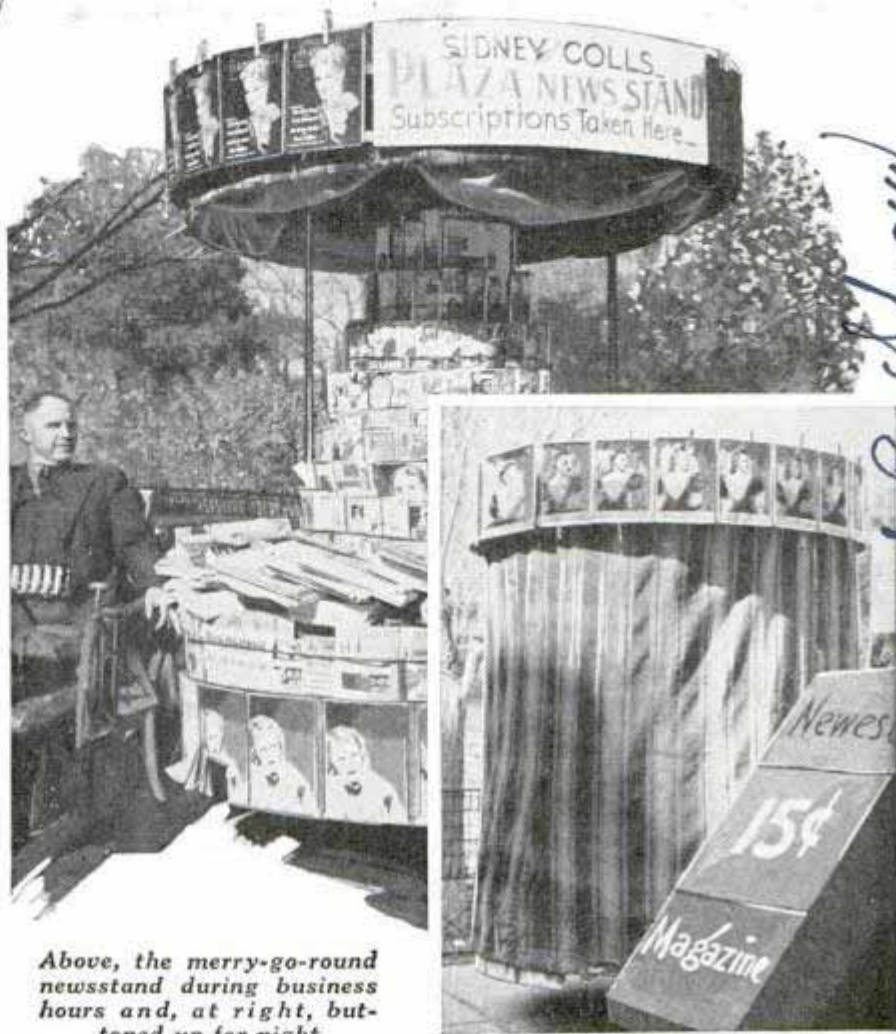

Above, the merry-go-round newsstand during business hours and, at right, buttoned up for night

Sidney Colls.
Con. J. P. Shaw
General Delivery
El Paso, Tex.

Porous Hose Waters Lawn Properly by Gentle Seepage

Soil Soaker about \$2.00

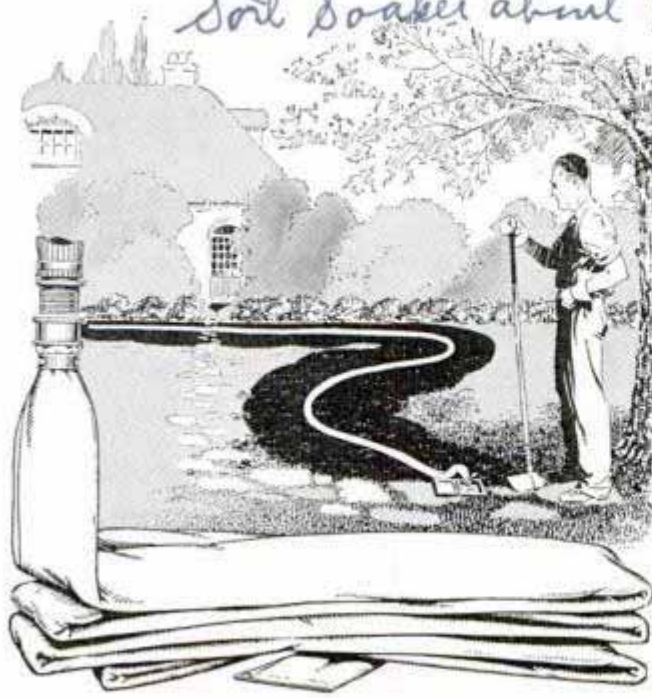

Proper watering of the lawn is made easy by using a porous section of hose which is attached to the end of the garden hose in place of the sprinkler. It is eighteen feet long. Water seeps gently through thousands of pores in the canvas, eliminating spray, soil washing and running off. Every drop of water is placed where desired, even in narrow parkings, narrow flower beds, on terraces and under hedges. The hose may be moved without shutting off the water. It makes possible the employment of the deep-soaking method recommended by experts as more beneficial than surface sprinkling.

Black area shows how seepage hose waters lawn. Below is the folded hose

Names and addresses of manufacturers and dealers in articles described in this magazine will be furnished by our Bureau of Information upon request accompanied by stamped, self-addressed envelope.

Hastings Carvas Co
Hastings Neb.



YACHTSMEN *Go to*

YACHTING no longer is a rich man's sport. It's possible to become a yachtsman on a very limited budget. Yacht clubs blanket the country. Thousands of persons are sailing boats in fresh-water lakes, tens of thousands in salt water.

And what's more, you can advance much more rapidly in the sport than ever before, thanks to the yachting schools being conducted in many sections. There are courses for yachtsmen of every grade, from the beginner who aspires to be skipper of a snipe to the old salt in search of charts and sailing directions for a voyage around the world.

With a pair of bell-bot-

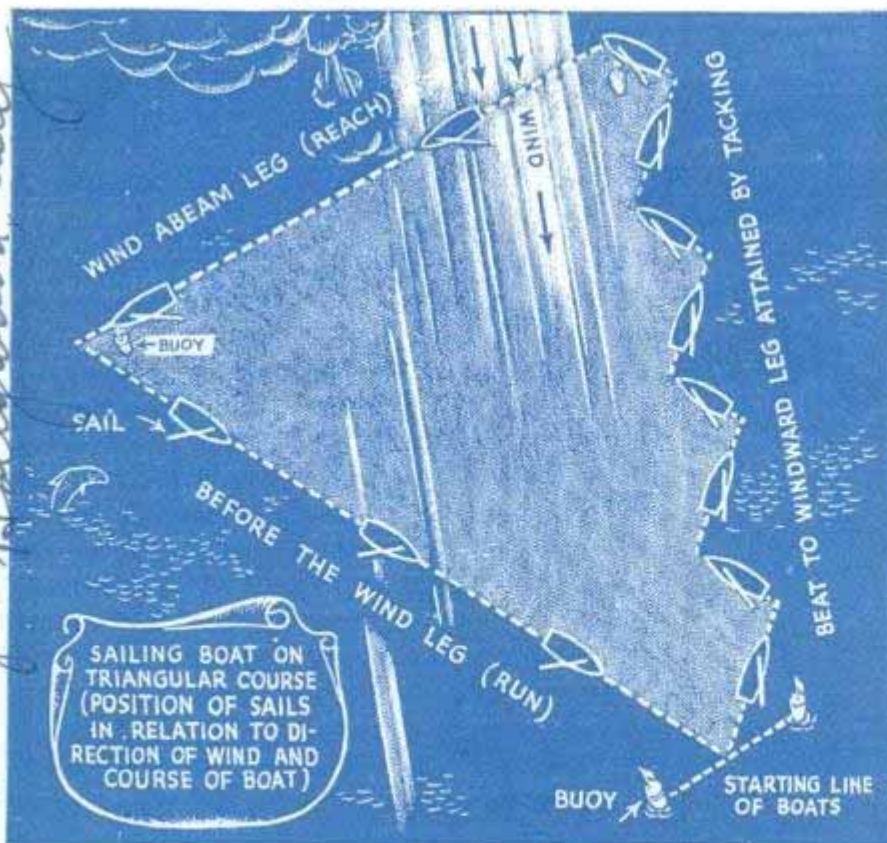

Top, typical summer afternoon on the club float at Massachusetts Institute of Technology. Bottom, example of instruction given the student in yachting schools

H209
 Capt. James Mc Duening
 % Hollywood - Adverse to
 Millward Call

Carriage man

602 PL

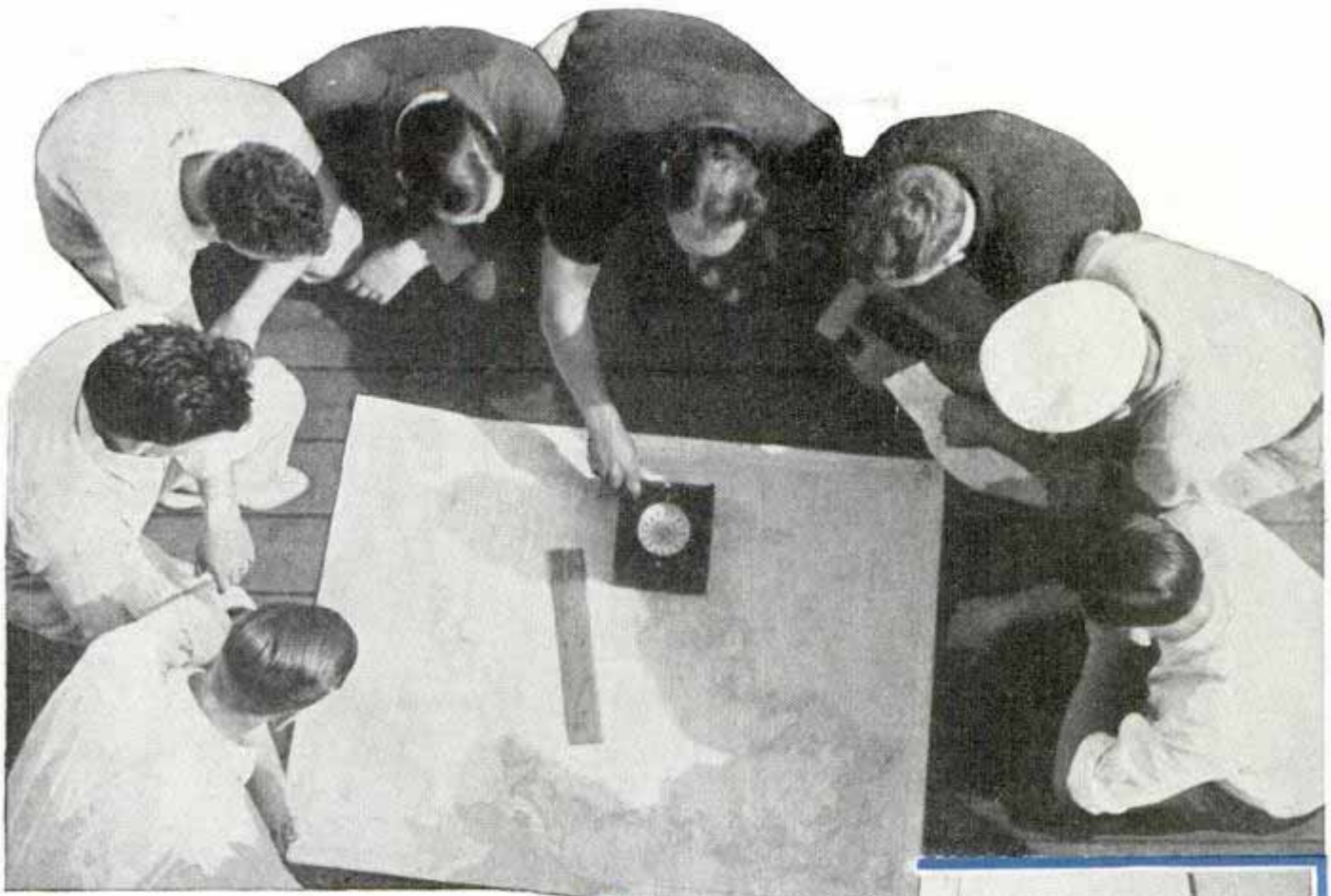

SCHOOL

tom dungarees, some low-heeled tennis shoes and a sailing cap, you're all set. There's no trouble learning to sail. You can declare your intentions to the commodore of the nearest yacht club, or, if you live in a large city, to a department-store floor walker.

A New York store first experimented with classes in sailing last spring. A sailing expert was brought in to instruct 400 beginners in handling the tiller and when and when not to use the centerboard. A twenty-three-foot senior knockabout boat was put up in the classroom and the pupils were taught how to tack, trim the jib, and other points before going out to Milton Point, Rye, N. Y., for three sailing lessons. So enthusiastic was the response to these classes that similar ones are being arranged by boat builders in other stores through-

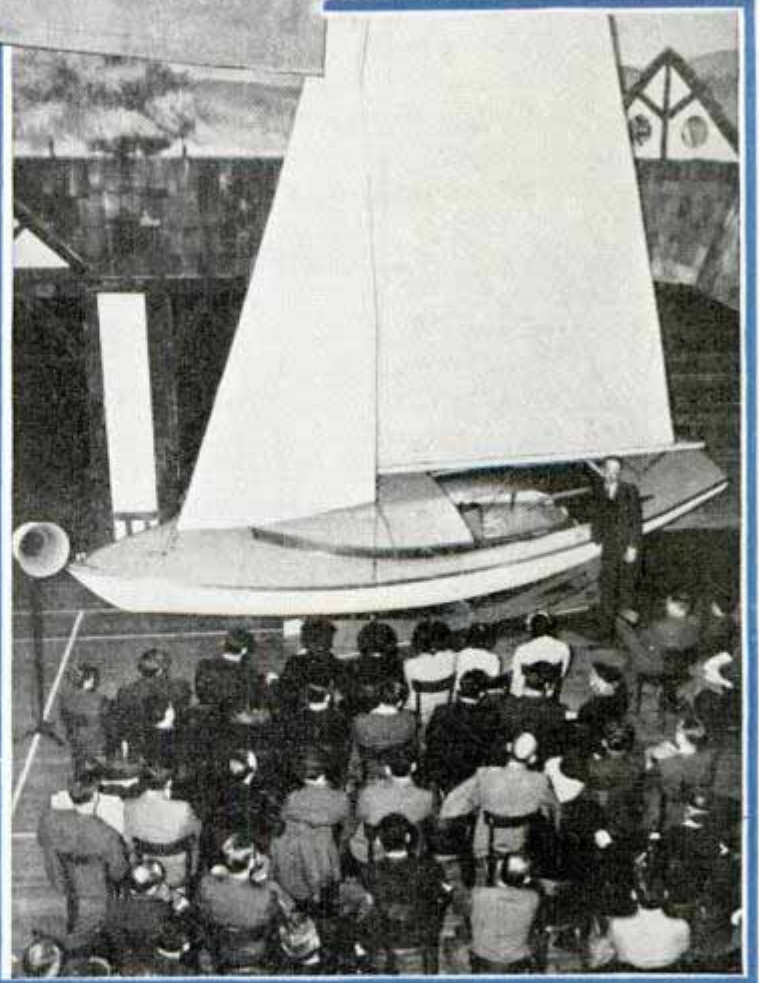

Top, students learning fine points of navigation. Bottom, sailing class in New York department store which was attended by more than 400 beginners

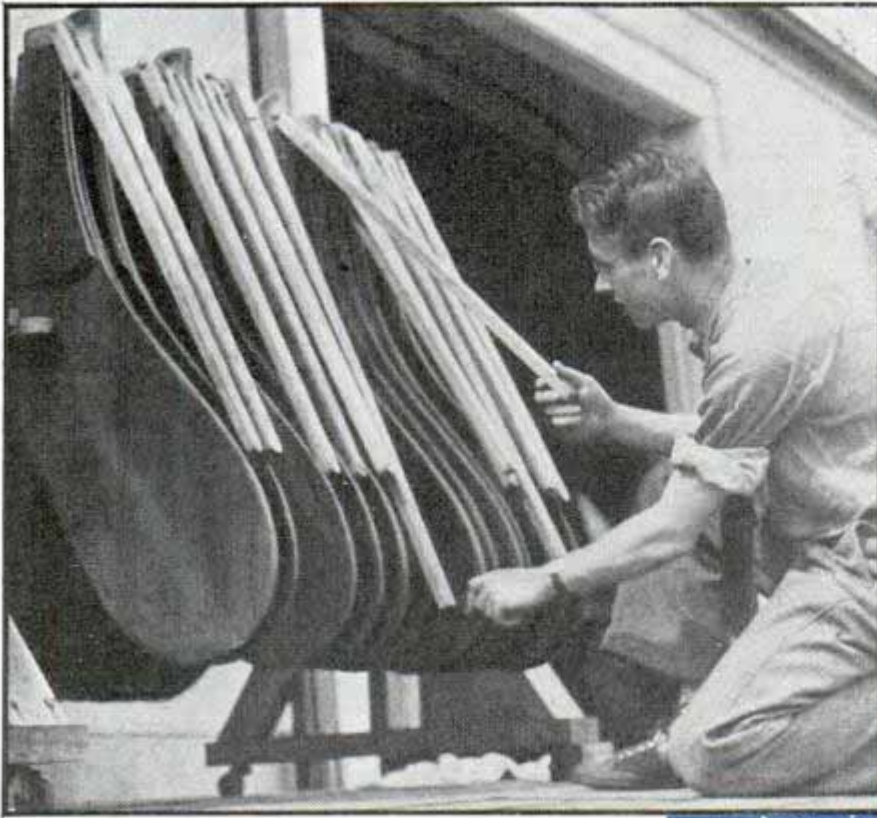

The thirty-eight boats owned by the group are a modification of the regular "frost-bite" dinghy and were designed by M.I.T.'s department of naval architecture to meet the student's requirements. It was necessary that these boats be sporty, yet safe, roomy and designed so they easily could be dismantled of rig and sails and stowed in racks in the clubhouse. Since the students have only a limited number of hours of recreation, it also was essential that the boats could be placed in operation within a few

out the country. The lack of a membership in a yacht club need not deter you from learning the sport. Commodores of public rental fleets offer well-planned courses that compare favorably with those offered by private clubs.

Sailing has returned to favor in intercollegiate sport circles and extracurricular studies in all phases of yachting may be found at Brown, Harvard, Cornell, Dartmouth, and Massachusetts Institute of Technology. With more than forty small sailing craft, excellent water facilities, sailing pavilion with classrooms, workshops, recreation rooms, and instruction covering the whole field from rudiments to advanced navigation, yacht design, and marine engineering at its disposal, M.I.T. has become the greatest incubator of sailing interest in the country.

Since the project was started two years ago, the students have turned in more than 16,000 sailing hours, according to Walter C. Wood, who serves as sailing master. Last year, his records show, 691 students and faculty members were taught how to sail. More than eighty per cent of these were from inland cities and had to be put through the shore school before being allowed to take out the boats. Everyone who signs up for the sport is given a test and his basic rating is determined.



Top, student picking rudder for a race. Bottom, another example of yachting instruction

minutes so their pilots would have a maximum sailing time. These dinghies are twelve and one-half feet long, five feet wide, and have sixty-nine square feet of sail when cat-rigged and ninety square feet when sloop-rigged. They weigh 175 pounds and may be lifted easily by two men. Of lapstream construction, they have cedar planking and mahogany trim.

Shore school is conducted several afternoons weekly, not unlike a regular college course. The first step in the beginner's training is to study for a crew rating. In order to pass this test, he must be able to tie nine different knots, make four types of splices, know the nomenclature of cordage, belay to a cleat or pin, coil halyards, heave a line, know the principles of anchoring and mooring a boat, understand

14 209

and use blocks and tackles, and know something of vessels. In addition, he must be a good swimmer and versed in the rules of the road.

Classroom work coupled with actual sailing experience is the plan of the second group, the helmsmen or skippers. To earn this rating, a sailor of crew rank must be capable of launching, rigging, hauling and stowing his dinghy without assistance, learn how to set and trim sails and his boat, and demonstrate a beat, reach, run, tack, jib, and luff, make a float landing on leeward and windward sides of the dock, furl and stop sail, pick up a moor-

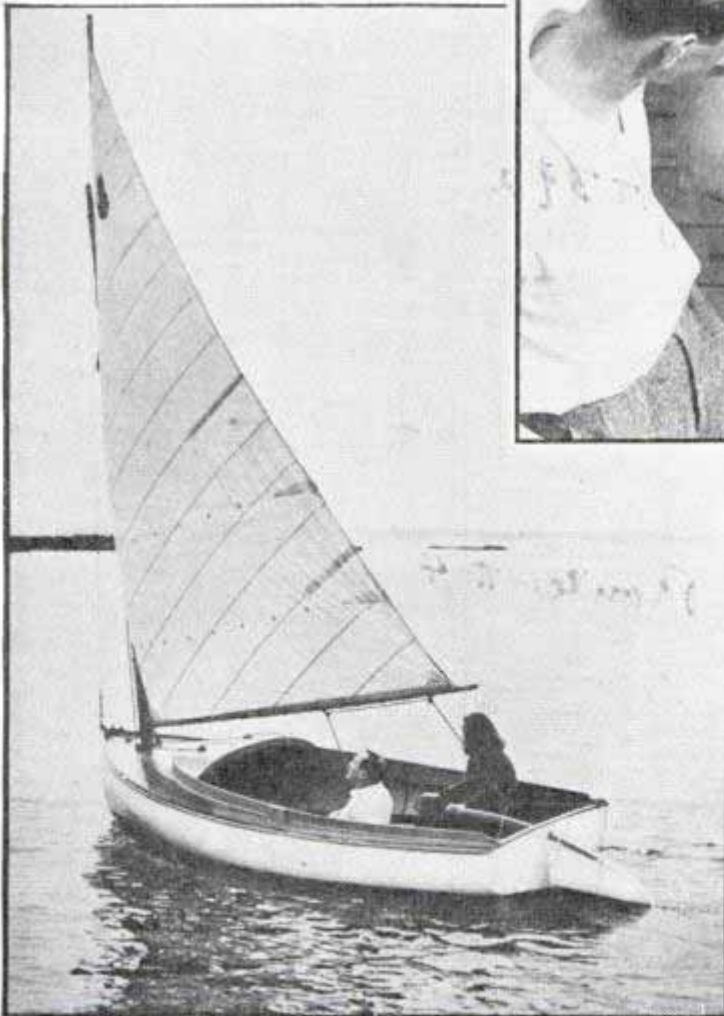

ing, and be able to give orders to a crew during these maneuvers. After he has successfully passed this test, the skipper can take out a boat at any time but he still must qualify in more examinations before he is eligible to compete in races. There are two additional rankings, coxswains and boatswains, and those who qualify for them assist in the instruction, the conduct of races and regattas, and other activities of the organization.

The yachting schools for seasoned veterans are typified by Frank Benham's University of Navigation at the San Diego Yacht club. Its graduates are conspicuous in racing and cruising activities in the Pacific. They have raced to Honolulu and the

(Continued to page 138A)

Top, another step in sailing lessons. Center, explaining intricacies of "Spanish bowline." Bottom, doctors prescribe sailing as a tonic for jangled nerves

Seven-Mile Parachute Jump Sets a New Record



Parachute jumper in complete outfit just before making record leap from plane

Leaping from an airplane at an altitude of 35,075 feet, nearly seven miles up, James Williams, a Frenchman, recently established a new record for parachute jumping. Although he carried two parachutes, Williams did not open either of them until he had dropped to within 650 feet of the ground. He wore an oxygen mask and carried recording instruments.

Spring Latch Grips Small Door and Holds It Shut

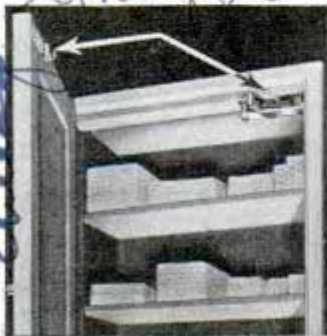

Intended for use on small or medium-sized cabinets and cupboards, wardrobes and closet doors, a door closer with a strong spring grips the door and holds it snug. Even warped doors are pulled tight. No mortising is required. A hook is screwed to the inside of the door,

and the housing containing the finger grip is installed on the door jamb. When the door is open this finger grip reaches out a half inch and actually grabs the door and pulls it shut with a four-pound pull that prevents rebound or rattling.

Spike-Studded Garden Cultivator Is Reversible for Tamping

Spiker and tamper are combined in a garden tool useful for various operations in lawn-making and maintenance. Attached to its four-foot handle is a metal plate nine inches square, one surface studded

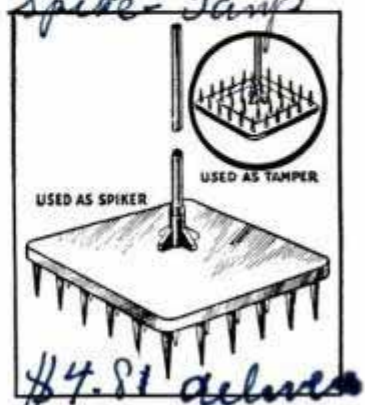

with thirty-six spikes an inch and three-quarters long, for use in perforating the sod to admit air, water and fertilizer, or for breaking up clods. The other surface is smooth, for use in tamping the earth. The handle is changed from one side to the other simply by turning a nut.

Tiny Car Copied from Pictures with Knife, Saw and File

With only photographs to guide him, Paul Jones, Jr., an eighteen-year-old high school graduate of Winters, Tex., has built a miniature model of a 1938 Chevrolet cabriolet, complete to its driving controls and clear-vision dials on the instrument board. His only tools were knife, saw, file and



Here is the young Texan and his handmade copy of a Chevrolet, complete in every detail

at Charles France
Case ment Hardware Co
406 N. Wood St

break hugg. at 10 4 7-8th heler
10 4 7-8th heler
10 4 7-8th heler

H 446

H 392

Route # 4

406

Springer

sandpaper. He had no training in woodwork, nor any electrical tools. The tiny car is twenty-five inches long and nine inches wide. The entire model comprises 668 pieces, and the body itself, which is supported by leaf springs made from a clock spring, consists of 426 separate pieces. Its doors open to reveal a front seat upholstered, like the rumble seat, with imitation leather, and there is a package ledge back of the driver's seat. The windshield wiper blade lies snugly against the lower molding of the V-shaped windshield. The running boards have tread edged with extra-deep rubber molding. The windows provide typical "no-draft" ventilation, and even the rubber tires, the radio antenna and fender guides are faithful copies of the originals.

'Parking Space' for Steamers Has Concrete Hitching Posts

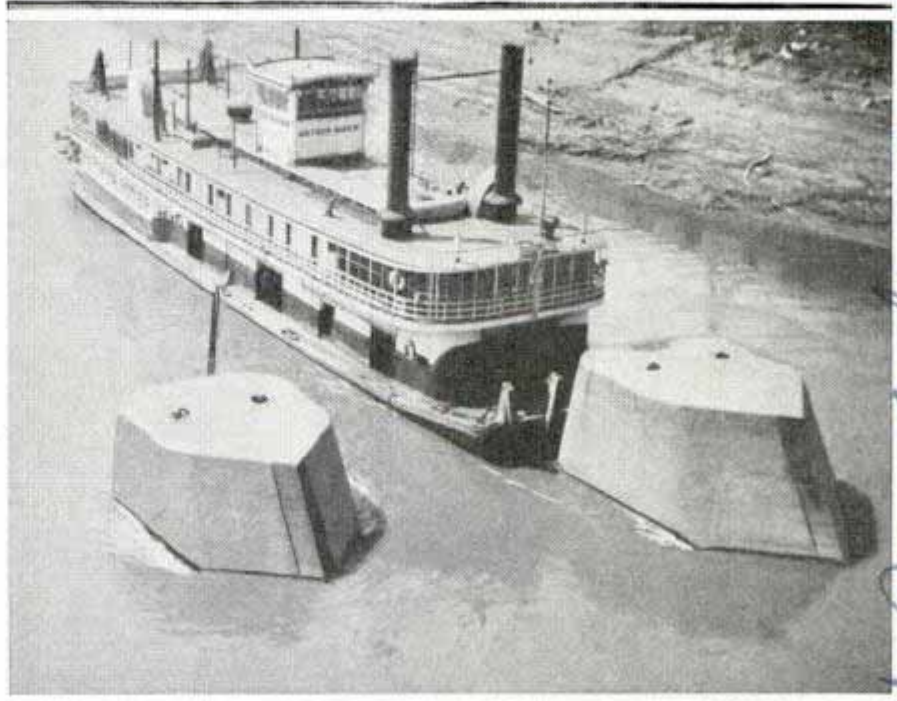

Parking is no problem to pilots of Ohio river boats at Cincinnati. The city has provided these huge concrete "hitching posts" for steamers

Cincinnati has provided a special "parking lot" for steamboats. When the Ohio river boats come to town they can tie up on the downstream side of one of the huge concrete hitching posts lined up near the shore.

Robot Court Reporter Takes Trial Evidence for Typist

In place of the shorthand reporter, an electric robot took down the testimony at a recent courtroom hearing in Yakima,

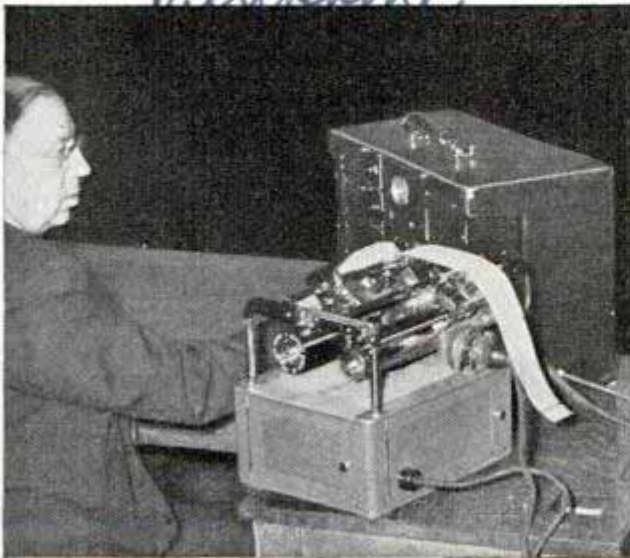

Microphones in courtroom pick up testimony during trial and this robot reporter records it on wax

Wash. Tireless and accurate, this robot court reporter has the advantage of catching the vocal inflections of judge, witness or attorney and being able to play back immediately any testimony it has recorded. A sensitive microphone picks up the proceedings without loss of volume or detail, and can make the permanent record if desired, miles away from the courtroom. This record is made on wax cylinders, and the device has two drums; as soon as one is completed the second automatically takes up the recording, so that there is no interruption in change-over. The cylinders can be delivered to typists as rapidly as they are filled, thus speeding up transcription. The records are played back through earphones or a loud speaker, the equipment operating on ordinary 110-120 volt current. Construction is so simple that any radio man could repair the machine quickly should a breakdown occur.

cont. Roy Tichenor, 1404 Walnut Cincinnati
 I mention it to name Moberg
 Seattle Wash.

1438

Herikshio

H 276 Mr. James M. Sweeney
431 W 60th Terrace
Kansas City, Mo

THRILL HUNTERS



This crowd around the microphone shows the popularity of radio programs in which any one may participate

PART I

VARIETY is the spice of radio. The national appetite for the man-bites-dog brand of loud-speaker entertainment is insatiable and an army of idea men, oddity hunters, curio seekers and news hawks constantly is devising new thrills to please jaded radio ears.

The one-armed paper hanger with hives, the talking dog, the singing mouse—all are grist for the radio mills. So is the engineer's first-person account of how he amputated his own leg to prevent the explosion of a wrecked locomotive boiler, or an informal glimpse into the life of a flag-pole sitter or the town crier.

There has been a growing desire on the part of listeners to have a hand in the programs. Consequently, the program

makers have hatched hobby programs, curbstone interviews, old-time spelling bees, telepathy tests, puzzle programs and other audience-participation features. Even the old New England town meeting has been revived to reawaken the individual citizen's political consciousness by an uncensored broadcast of conflicting political views.

Behind-scenes operations of radio's thrillhunters show much spade work must be done in order to assemble sufficient data for a typical program. They make a careful check of the suggestions the postman dumps into their laps each morning. That is no small task, for if all the requests made to appear on "We, the People" were granted, approximately thirty-seven hours of radio time would have to be devoted

to this single show each week.

While these suggestions are being culled, staff workers study books and magazines for potential air sensations. Newspaper clipping bureaus have a regular service dealing with human-interest items for the radio specialists. Libraries are probed for material on amazing lives, incredible adventures, and forgotten heroes.

Of course, the leader of the oddity hunting guild is Robert L. Ripley, who generally climaxes a bizarre air skit with proof in the form of the person around whom the incident has been patterned. For example, one of his thrills concerned a wealthy Indian maharajah who had been living incognito near Sturgis, Miss. The maharajah related how he once had grieved because specialists told him he could not survive an operation to clear a brain in-

Clem
McCarthy

A 296

of the AIR LANES



fection. Bent on taking his own life, he fired a suicide bullet into his head. Instead of killing him, the bullet cleared away the infection, enabling him to regain good health.

Another guest was a Cleveland workman who fell from a building scaffold and cracked a concrete sidewalk with his head. They rushed him to a hospital but his two-inch skull was still intact. Another believe-it-or-notter, an officer of the United States navy, fell from a balloon, directly into the path of an oncoming battleship. He was run over by the man-o'-war and given up for lost until a searching party espied him clinging to some anchor buoys.

Anyone who follows an unusual line of work is greeted with open arms by the broadcasters. A Philadelphia professional blood donor who has undergone 324 transfusions aired his experiences on a



Prof. Charles Weidenman
Ohio State University
Columbus, Ohio

Top, here the news-caster is telling the thrilling story of a track event while his microphone picks up the sound of drumming hoofs. Bottom, playing a strange-looking instrument

Kentucky seeking news.

Columbia Radio Playhouse
Hammerstein Theatre
Collegiate

Major Bowes

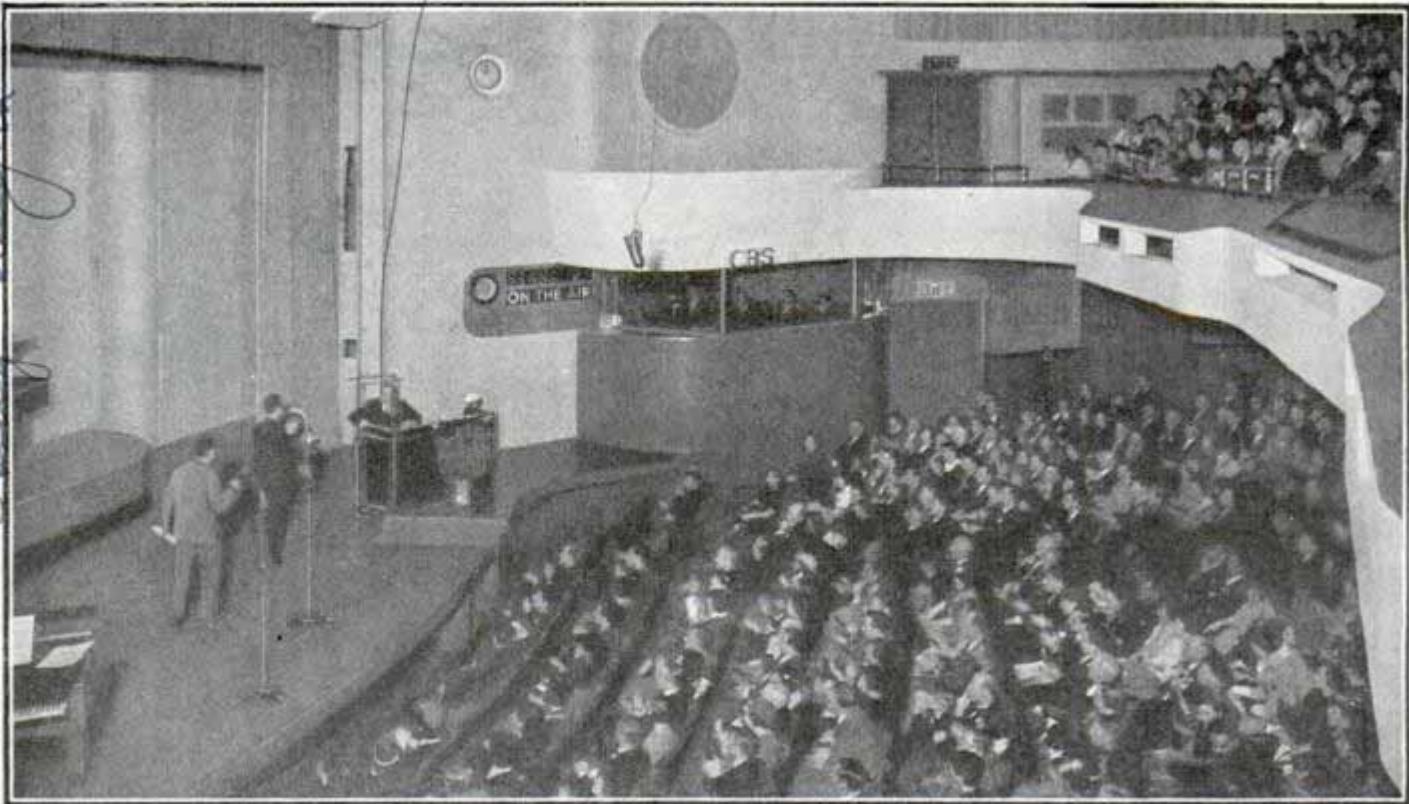

On the air with Major Bowes and his amateurs. The major is sitting behind the desk at left of stage, while the audience of about 1,300 is shown facing him and two performers

Stella Bird

national broadcast as did the man who rides a pony in front of every New York Central freight train as it enters the heart of New York City. The latter's listeners were puzzled until he explained the ride is made to keep the railroad company's franchise intact.

Another commentator, John Nesbitt, ferrets out hard-to-believe incidents connected with the lives of celebrities and private citizens. One of his findings concerned a Philadelphia invalid who, during the past six years, has made 30,000 personal telephone calls from her bed. She calls hospital internes, police desk sergeants, hotel clerks, watchmen, and other night workers, greeting them in a soft pleasant voice with, "How are you getting along? This is the Duchess."

Phillips H. Lord contends every man or woman is a good actor if given the assignment of telling his or her own life story. He has proved this point repeatedly in the presentation of such personalities on his police dramas, as the paroled North Carolina convict who

told a coast-to-coast audience how it felt to be condemned to the electric chair seven times and then finally pardoned for a crime in which he had no part.

Almost six million brain teasers have been mailed to "Professor Quiz" by radio enthusiasts. On each broadcast, five persons are selected from the studio audience to come before the microphone and test



Robert L. Ripley in the Garden of Eden. Believe it or not, there's not an apple tree in sight, says Mr. Ripley

H276

Gomez African Gray parrot 43

their skill in quick thinking. Whenever the air "prof" misses on a question, it becomes a dinner-table topic of conversation for the nation. The monkey-on-the-rope problem, probably the most famous question of the series, stumped him. The problem was: A rope is hanging over a pulley; on one end hangs a certain weight. On the other end is a monkey of exactly the same weight. The monkey starts to climb the rope. What happens to the weight on the other end?

Prominent scientists became involved in the battle after the professor stated the weight would remain on a level with the monkey. To settle the argument, the experiment was performed with the help of a circus monkey and a weight. The weight went up.

(Continued to page 130A)

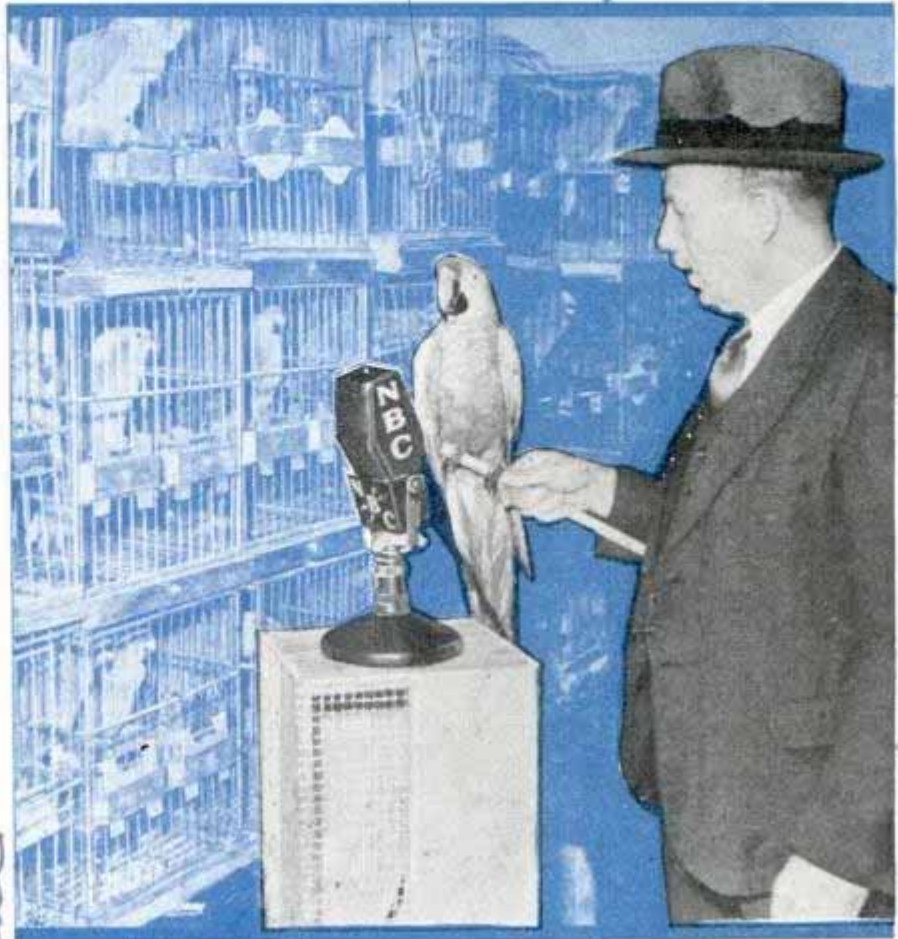

bird collector



Philip



Top, putting parrot through paces in radio's hunt for best talker. Bottom, left, costly gems used in radio dramatization of a big jewel robbery. Right, telephone exchange during a Howes program

Rosewater's shop.

Lips Operate Shutter Cable Leaving Hands Free

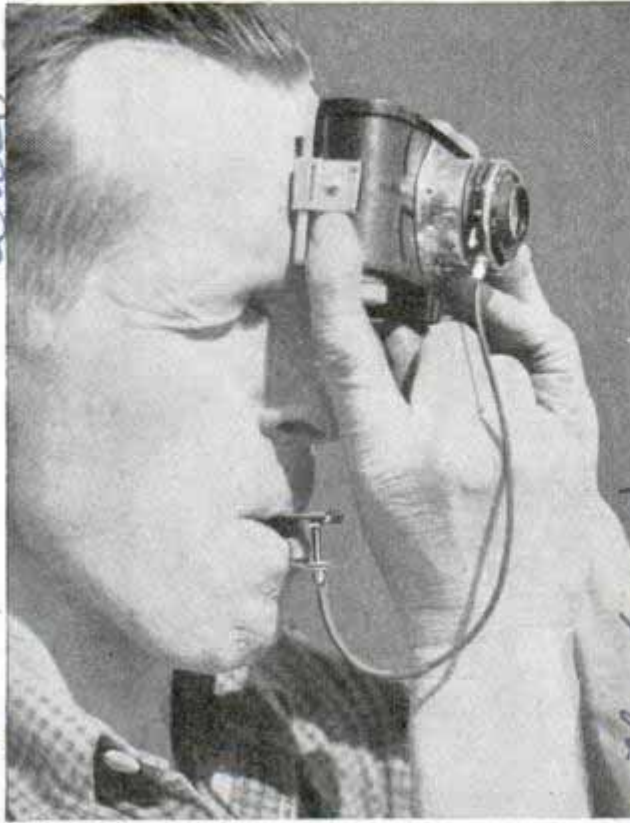

Using both hands to focus and steady the camera, the photographer releases shutter with his lips

Both hands can be freed to focus and steady the camera by using a mouth-operated shutter release cable just put on the market. Simply closing the lips trips the shutter. This method avoids jarring the camera and makes for sharper pictures. The attachment can be used with any cable release camera.

Master Mixing Rack for Paints Measures Out Base Colors

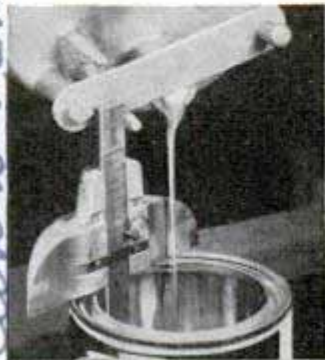

Sixteen one-gallon cans mounted on a simple rack hold all the essential base colors for convenient and accurate mixing of paints to match automobile body tints. Each can is fitted with a special lid designed for easy agitation by hand or electricity, and for rapid, easily controlled flow. The empty can is placed

on a sliding tray which travels along either row of cans. One of the four micromatic gauges (for pint, quart, half-gallon or gallon cans) is attached to the can and set for the quantity called for by the master formula book, the valve gate is opened and the required amount poured. In this manner a pint of any shade, exactly matching the original factory color, can be prepared in a few minutes and the need for a large inventory of mixed colors is eliminated.

Banana Tree Grows in House to Twenty-Foot Height

Constructed to keep out cold, a special house protects a banana tree being grown in Tennessee, far from its native soil. The tree, measuring twenty feet in height and thirty-one and one-half inches in circumference, grew from a three-foot sprout in about eleven months. The house around the tree is twenty feet high and six feet square. Building paper on the sides keeps out the cold air, while glass panes on the front allow the sunlight to reach the tree.

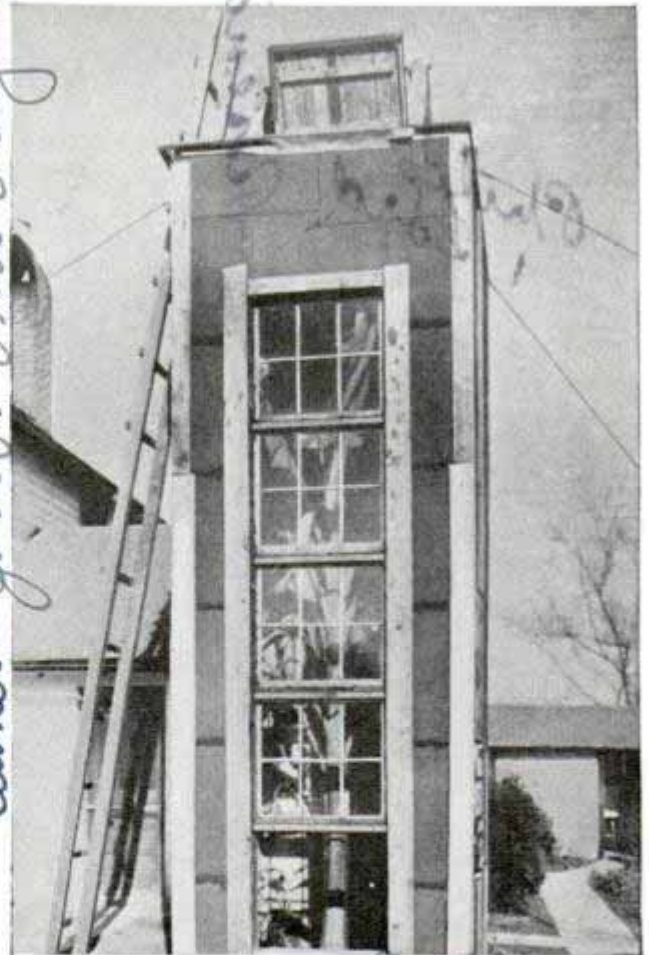

Banana tree is visible through window of shelter built to guard against cold weather

Robt. J. Reynolds
Box 26, Hollywood, Fla.
A 295
Esco Co
7301 Bessemer Ave
Cleveland Ohio

A 394
Camer - John H. Fells Fayetteville, Tenn.

data statement

H 378.

Flier Takes His Picture with Camera on Wing

By attaching his camera to the left wing of his small cabin plane, a Rochester, N. Y., pilot was able to take his own picture while flying above his home city. The folding camera was screwed inside a cigar box, which in turn was screwed to a post fastened beneath the wing. At the right moment the flying photographer pulled the string and the shutter clicked.

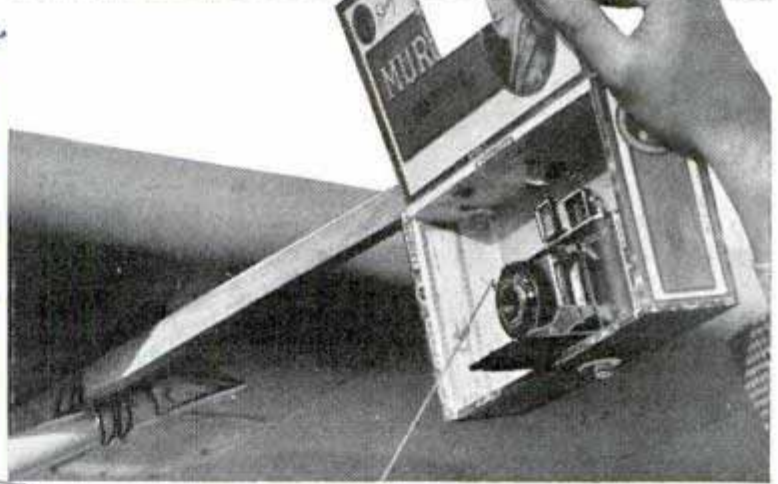

Top, pilot pulls cord tripping shutter of camera to take his picture. Below, camera mounted in cigar box fastened to wing

Molasses Road Surfacers Is Tested in India

Experiments in India have revealed the practicability of converting molasses into an insoluble resinous product suitable for use as road-surfacing material. The process involved the resinification of molasses with a mixture of coal tar and asphalt in presence of acids. The cost is said to be about one-third that of asphalt. The new product is liquid at the time of application and does not melt in hot weather after being spread on the road. The surface of the molasses-covered road sometimes shows signs of peeling after two or three months, which necessitates application of a seal-coating material to restore the surface to proper condition. The surfacing material and the coating are patented in India.

Quest 793 P. 846
see

Technology
Sugar
Improved nature of

H 418

Tape Spun from a Glass Marble to Insulate Electric Coils



Insulating tape is woven of glass thread so fine a strand 150 miles long is drawn from small marble

Glass tape to insulate the coils of electric motors is being woven from strands only one-eighth as thick as a human hair. From glass marbles three-quarters of an inch in diameter these strands are drawn, each marble yielding a strand more than 150 miles long. Strands are then twisted into thread, 204 strands to each thread, and the thread is woven into tape that is fireproof, has high dielectric and mechanical strength and does not absorb moisture. Westinghouse engineers are experimenting with this tape to increase the power and efficiency of electric motors.

Westinghouse Electric & Mfg. Co., Inc.

388
C.H. Parsons, Photo-plate
London, W.C. 2, England
Cnd. / Odham Press, Ltd. (C.H. Parsons) / 93. Long acre, London, W.C. 2, England

THE LINER

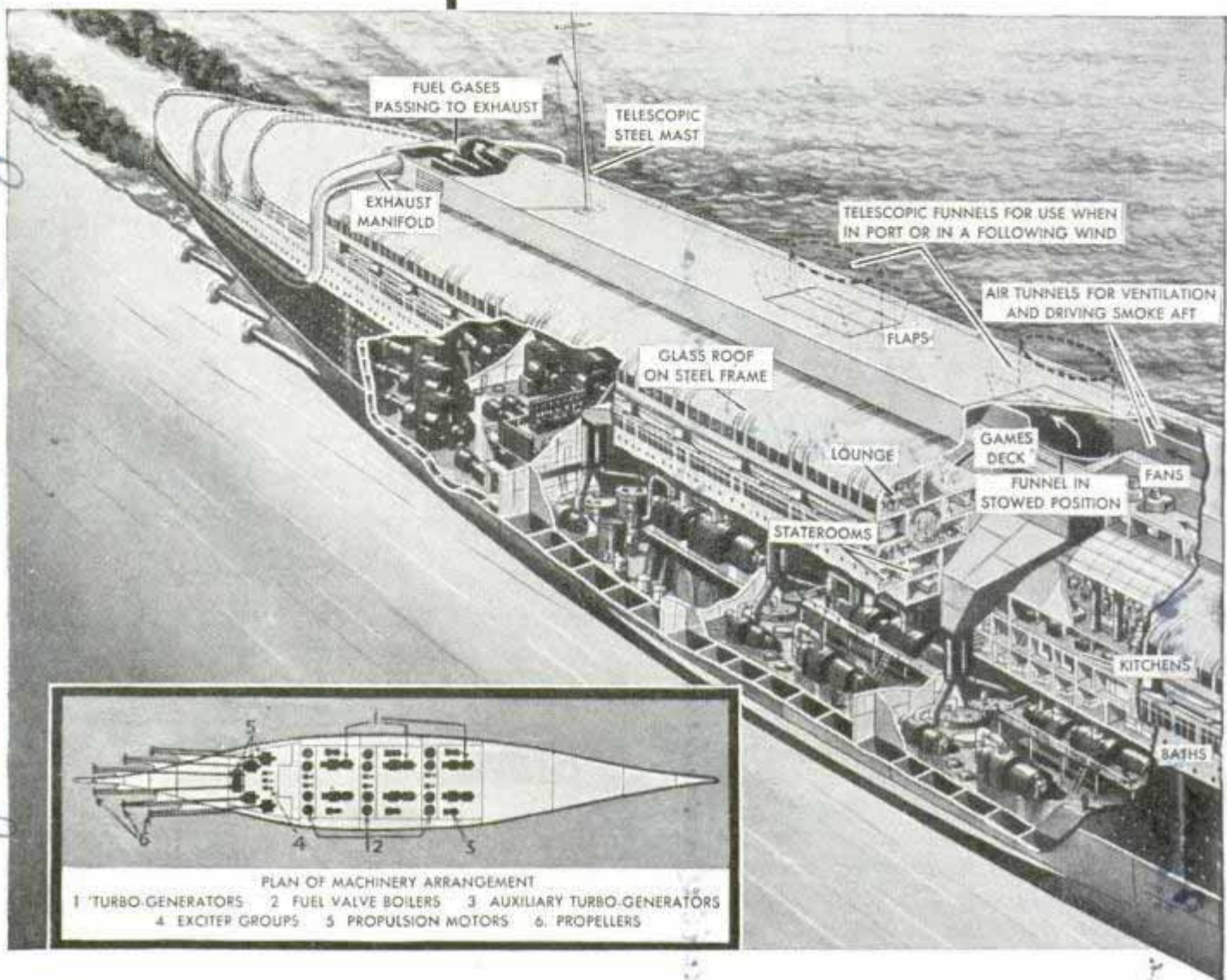

AERONAUTICAL designers already are putting on paper their plans for hundred-passenger air leviathans that will shorten the gap between Europe and America. Transatlantic air liners soon will be in real competition with ocean liners, and now marine engineers have begun to sketch plans for ships that can stay in competition with the fliers. One design proposes a six-screw vessel that could cross the Atlantic in three and one-half days, driven by six main propulsion motors of at least 66,000 horsepower each. Their current would be supplied by six turbo-generators with a capacity of 51,000 kilowatts each. Such a power plant, developing a total of around 400,000 horsepower—the "Queen Mary" rates about 200,000 horsepower—would consume 2,150 tons of fuel oil a day, requiring vast storage tanks and some method of ballasting to maintain

equilibrium as the oil is consumed. The engineers figure this huge streamline vessel could run five or six knots faster than any present ship, and more time could be made up by landing passengers at Montauk Bay and putting them on a fast "boat train" down Long Island to New York. This would save about ten hours, eliminating about 170 miles from the ship journey, besides the slow process of docking in New York harbor.

During a voyage, the fuel gases would be exhausted from vents at the stern. However, in harbor or in case of a strong following wind the gas would be diverted to two funnels, situated in the conventional place amidships but telescoping, when not in use, through flaps in the top deck. Another suggested innovation is a control bridge provided with movable wings which can be extended from either side for a

H 3 88

of the FUTURE

see June 1938. 887

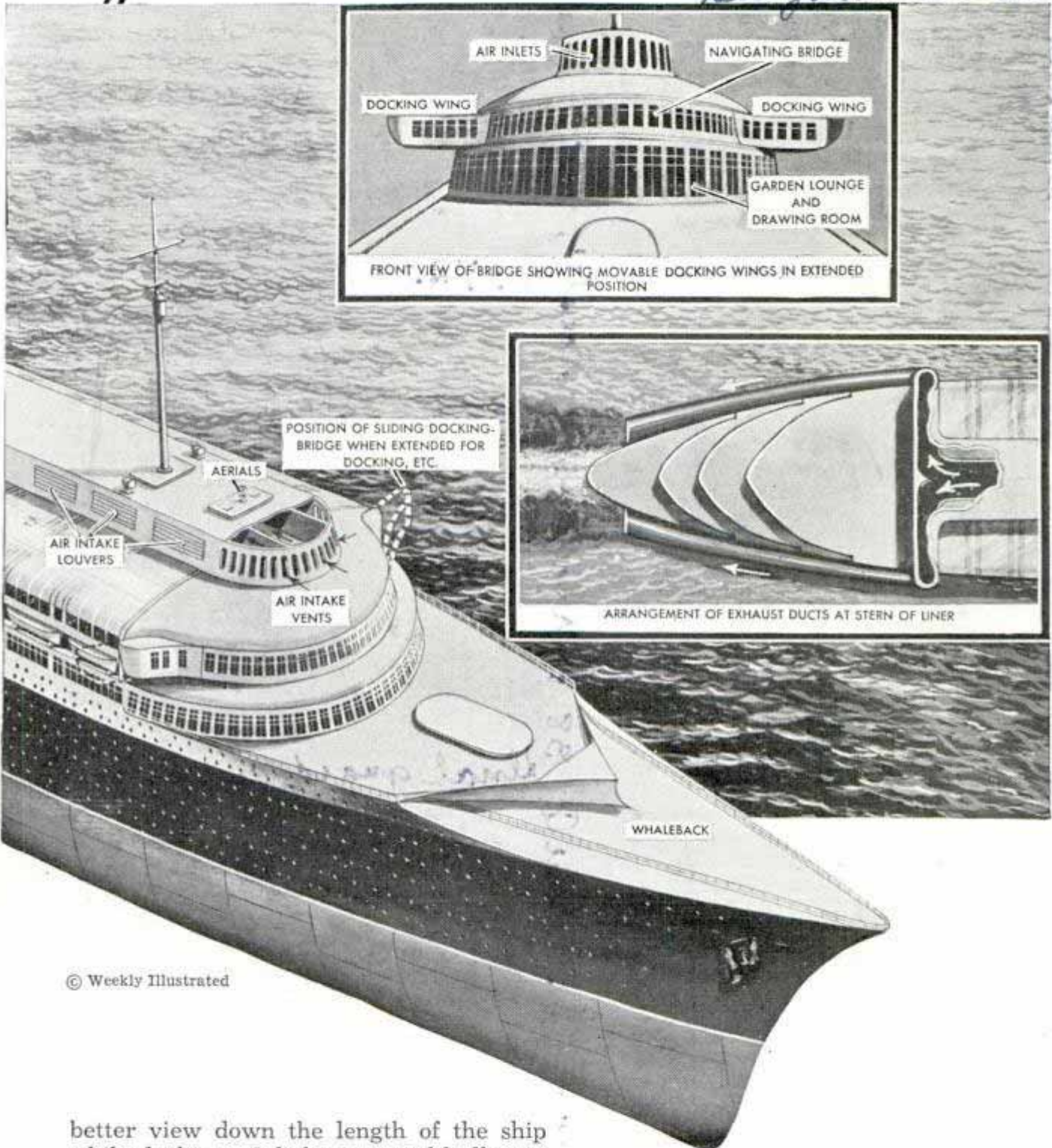

© Weekly Illustrated

better view down the length of the ship while docking. A light, inverted hull over the main deck would provide a streamline superstructure. As much as possible, the designers propose to eliminate external gear; the lifeboats are under cover, and the steel masts telescope into the deck. The glass roof of the top deck is strong enough to resist the battering of Atlantic gales.

The superliner as planned by A. C. Hardy and Pierre de Malglaive would be

about 1,350 feet from bow to stern, compared with the 1,108-foot length of the "Queen Mary." Its cost has been estimated between forty and fifty million dollars—considerably under the figure to be spent on each of the superdreadnaughts projected for the U. S. navy. Construction would take three years or more, and provide work for thousands of men.

Science Service 4/1/38

Lard Dispenser for Grocery Measures Correct Weight



Cranking out lard to the penny's worth with dispenser which replaces old scoop-and-weigh method

Measuring out lard like the fuel pump at a gasoline station, a dispenser eliminates waste and assures cleanliness. It is accurate, measuring lard to the exact penny's worth. When the 110-pound lard can arrives, the grocer removes the lid and fits over the lard a rubber diaphragm. A jack pushes the container upward, and pressure forces the lard into the measuring block. Having figured how much pressure it takes to eject a pound, the inventors calibrated a scale so that the grocer knows the proper pressure to deliver the weight of lard desired. By turning a crank, the lard is poured into a wrapper.

Pilots Cannot Be Acclimated to High-Altitude Flying

Unlike mountaineers, aviators do not become acclimated to high altitudes. Experiments conducted by Capt. H. G. Armstrong of the army medical corps indicate

that short periods of flight at high altitudes have a dangerous cumulative effect of diminishing the oxygen in the tissues, and pilots flying only three hours a day complain of chronic fatigue. Rabbits can stand altitudes one and one-half times higher than man, and for two weeks of daily experimental four-hour "flights" in 18,000-foot atmosphere, corresponding to 12,000 feet for man, they stood up well; then they suddenly began to lose weight, became anemic and paralyzed, and most of them did not survive four weeks.

#372.

Fire Detector Closes Windows, Turns on Water Curtain

Protection of buildings from fire in a structure near by is afforded by automatic equipment now on the market. The apparatus detects heat from a fire in an adjoining building before it becomes serious and automatically closes windows in the building it protects. Then it releases a water curtain. Heretofore it has been necessary to close windows manually and to turn on the water curtain from some central source. The automatic equipment saves time and reduces loss by operating in many cases before persons in the building are aware that a fire has started.

Alnal guard control

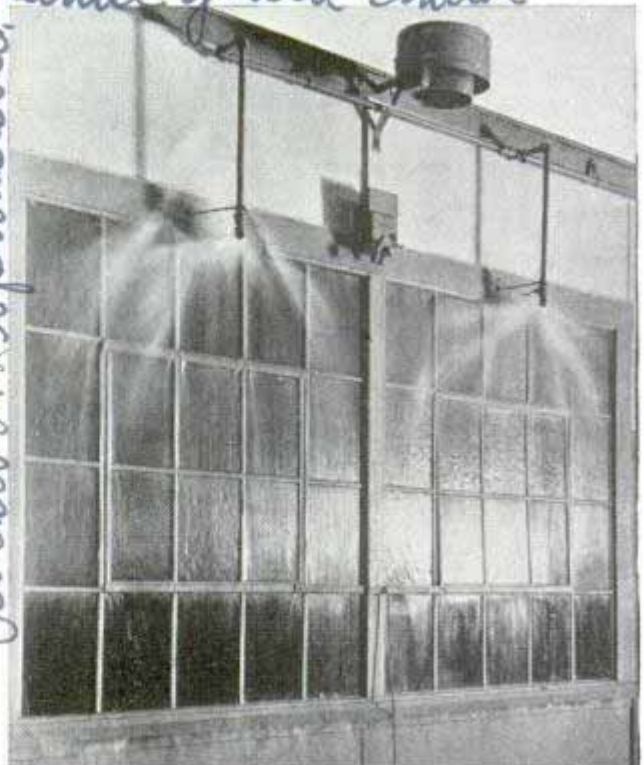

Automatic sprays in action to protect windows against heat from fire next door

*Cl nos. martiny L. Jackson / 1519 Garvie St
and John D. Carter - Boston - Mass. #403*

*Harlow B. Woodruff, Mass
Rockwood Sprinkler Co. #424*

1450 W. 45th St. New York

PLOWING into the Bottom of the SEA



OTTER
BOARDS OF
NETS INJURE
THE CABLE



WHERE PLOWING
PROJECT
BEGINS

OPERATING OFF THE COAST OF IRELAND, TRAWLERS, DRAGGING THEIR NETS, HAVE DAMAGED THE TRANS-ATLANTIC CABLES TO THE EXTENT OF \$800,000 YEARLY. BURYING A CABLE IN THE FURROW MADE BY A SUBMARINE PLOW WILL, IT IS BELIEVED, PROTECT IT FROM FUTURE HARM... THE DARING PLAN OF "WESTERN UNION."

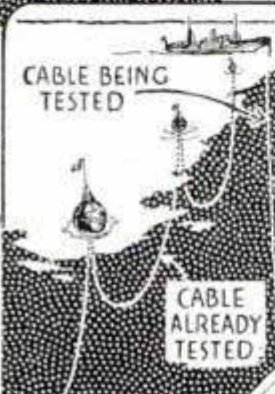

CABLE BEING TESTED

CABLE ALREADY TESTED

EXAMINING A CABLE TO FIND POINT OF INJURY

THE CABLE SHIP LORD KELVIN, WITH A STORAGE OF 700 MILES OF DEEP-SEA CABLE, PREPARING TO PLOW THE CABLE INTO THE SEA-BOTTOM... HOW CABLE IS PAID OUT FROM AN AFT TANK

THE LUCAS GRAPNEL FOR GRAPPLING THE CABLE FROM THE DEEP SEA BOTTOM

DYNAMOMETER - ESSENTIAL IN REGISTERING CABLE'S PULL

CHAIN LOCKER

SHEAVES OVER WHICH CHAIN, LINES OR CABLES ARE RUN

CABLE AS USUALLY PAID OUT FROM DRUMS TO SHEAVES

WORLD'S LONGEST CHAIN - 4200 FT. PLOW AS SWUNG OUT. LATER, IT IS LOWERED FROM THE SHIP'S BOW

DRUMS ON WHICH CABLE UNITS ARE WOUND

RANGE FINDER USED IN CHECKING BUOY POSITIONS

ROOM FOR CABLE TESTING

BUOYS

FORWARD CABLE TANKS

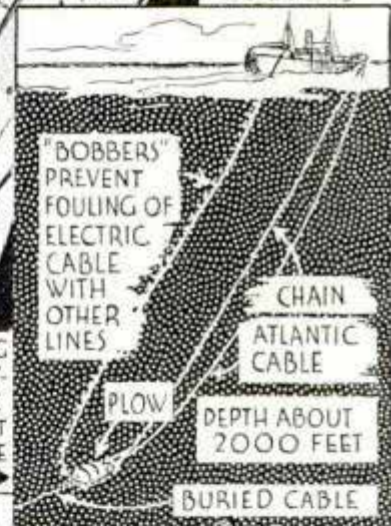

"BOBBERS" PREVENT FOULING OF ELECTRIC CABLE WITH OTHER LINES

CHAIN

ATLANTIC CABLE

PLOW

DEPTH ABOUT 2000 FEET

BURIED CABLE

PLOWING AND LAYING THE CABLE AT THE SAME TIME

ELECTRIC CABLE AND BUOYANT "BOBBER"

PLOW'S ROLL OR PITCH RECORDED BY PENDULUMS AND DATA TRANSMITTED BY ELECTRIC CABLE

TUBULAR STEEL RIBS

CHAIN

ATLANTIC CABLE

MESH

FREES DECK FROM STONES, ETC.

STEEL SHARE WHICH MAKES 18-IN. DEEP FURROW

WHEEL WITH SHARE GUIDES CABLE INTO FURROW

ELECTRIC CABLE CONNECTING PLOW'S PENDULUMS WITH INSTRUMENTS ON SHIP'S BRIDGE

To protect their submarine transatlantic cable from continual damage by fishermen's dragnets, the Western Union Telegraph company plans literally to "plow under" the cable. A steel plow weighing more than eleven tons and dragged by a chain made of 12,500 nickel steel links capable of withstanding 65,000 pounds stress will turn up an eighteen-inch deep furrow and bury the cable in the ocean bed. Site of project is off the Irish coast

H 205
426
Capt. Jay Earle Miller
Surf St. apt. 307, Chicago

MAKING JOBS

Junior Chamber of Commerce
at Atlantic City



by motorists is growing every year. Just recently a train in Arkansas hit an empty automobile abandoned on the tracks and the engine, two baggage cars, four day coaches and two Pullmans were derailed, killing three trainmen and three passengers. In a similar accident in Kansas, no one was killed or seriously hurt, but more than \$100,000 damage was done when the locomotive and two baggage cars turned over, another car stood on end and a fourth left the rails.

The Arkansas accident was the exception to the

ONE thousand three hundred and five people were killed and 3,266 injured during the first nine months of 1937 at highway grade crossings in the annual meeting between careless motorists and fast trains.

Just 3,094 motorists, an average of more than eleven per day, participated in the casualty roll. No automobile has yet won the right-of-way argument with a train, though plenty of trains have lost it, thereby making more jobs for the men who man the big hook with which wreckage is removed from the tracks and who answer the screaming whistle for the wrecking train.

Damage done to American railway trains



Top, safety exhibit in a Parade of Horrors urges the motorist to stop, look, listen—and think. Bottom, ruins of oil truck after crash at crossing. The oil tank, ignited in the accident, was carried 1,000 feet down the track

Richville R.I. N.Y.

rule that modern railroad passenger trains are the safest form of mass transportation. All-steel cars do not telescope, as their wooden predecessors did. Neither do they burn, as cars did in the days of wood construction, coal-burning heating stoves and gas lighting. About the worst injuries a passenger can expect normally are bruises or cuts from flying glass.

74 2 33

for the BIG HOOK

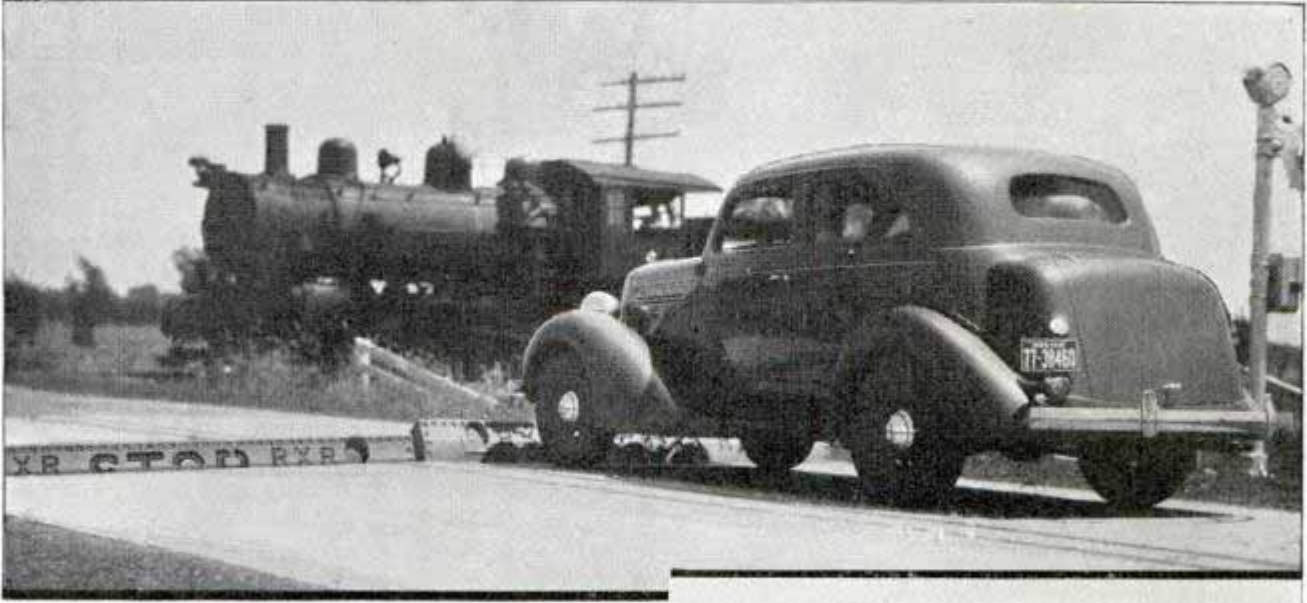

For the trainmen who sit in the cab watching a speeding motorist trying to race the train to a crossing, the case is far different. With an intense fire in the firebox at their feet, ready to ignite the gasoline from a wrecked automobile, with hundreds of tons of speeding train at their backs, ready to climb over a wrecked engine, and with tons of coal waiting to pour down into the cab and bury them against the hot boiler head, their chance of escape is little better than that of the foolish automobile driver speeding to cross the tracks in front of them.

What does an engineer think about while his train is being knocked off the track by an automobile? the Kansas engineer was asked as he sat on the side of his overturned locomotive, half buried in the mud and water beside the track.

"There isn't time to think until after it is all over," he explained. "We were almost on top of the automobile when we came around the curve and sighted it. The train traveled thirteen car lengths from that spot until the engine turned over. We were doing fifty miles per hour when I saw the stalled auto, so it was only a matter of seconds until we were in the ditch.

"In that time the fireman shut off the oil feed to the firebox to prevent a fire. We could smell the gasoline from the automobile's fuel tank, for the wreckage was mostly wrapped up around the trailing trucks right under us. I had shoved the

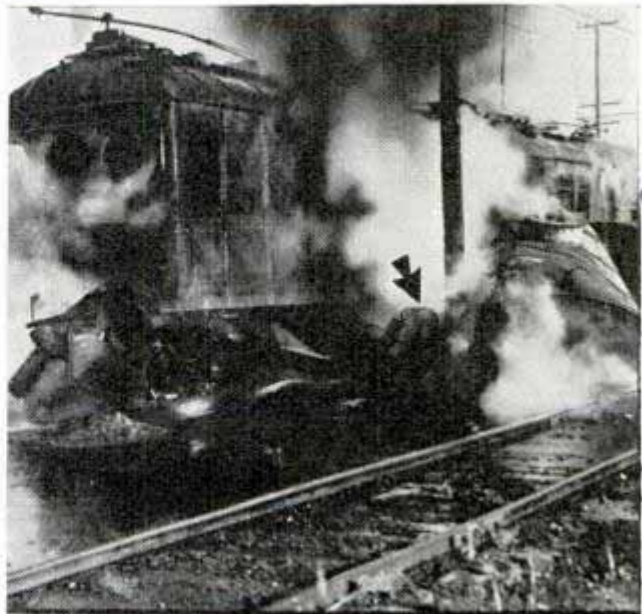
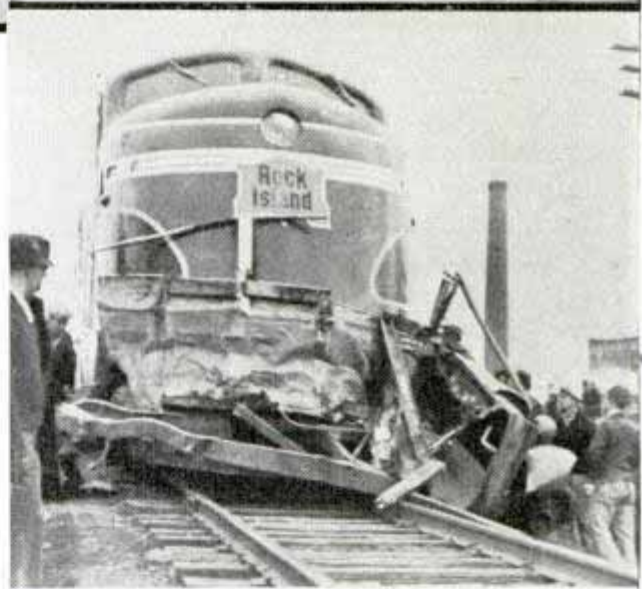

Top, steel barrier rising out of pavement to halt autos. Center, train-school bus wreckage. Bottom, arrow points to body of truck driver killed in wreck

*Rock Island
5569
Pacific Electric market*

Retriev. d 51

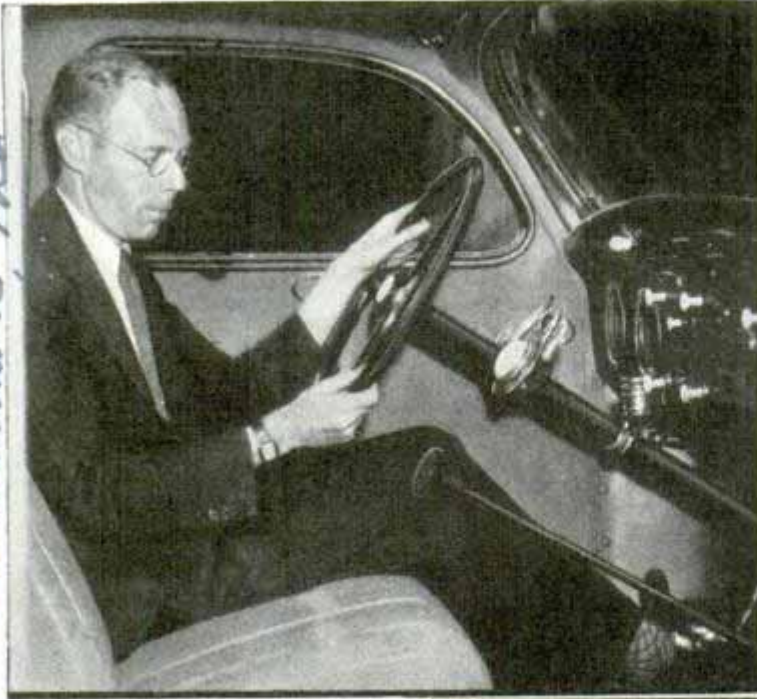

Charles Adler, Jr.
— Baltimore, Md.

sentative of the average railroad accident of that type.

In front was a high-wheeled locomotive, followed by two baggage cars, a combination baggage-dormitory car for use of dining-car waiters, two Pullmans, a diner, a lounge car, four Pullmans and an observation car.

The locomotive and tender, fully loaded, weighed 573,000 pounds. That includes 3,600 gallons of fuel oil, at seven pounds to the gallon, and 10,000 gallons of water, figured at seven and one-half pounds per gallon, so the variation between full load and empty is only

brake lever over to full service application and shut off the emergency fuel oil valve in the tender head, back of me, to keep the 1,500 gallons of fuel in the tank from feeding down if fire did break out. Then I tried to apply the emergency brake, after the speed had dropped enough to make it safe. Next thing we turned over. My side was on top and I told the fireman, 'I think we can get out here' and he said, 'Well, get out of the way and I'll try it.'"

The engine crew probably owed their escape to the use of oil fuel. The firebox blaze was extinguished when the fireman closed the valve, and there was not sufficient heat in the metal to explode the gasoline vapor from the wrecked automobile. Likewise there was no coal to crush them, and the tender fuel tank held together, so no oil was spilled into the wreckage. Although they rode 286 tons of engine into the ditch, with 835 tons of train pushing it on, their injuries were limited to bruises and cuts.

What happened to the Kansas train, a standard transcontinental flier, is repre-

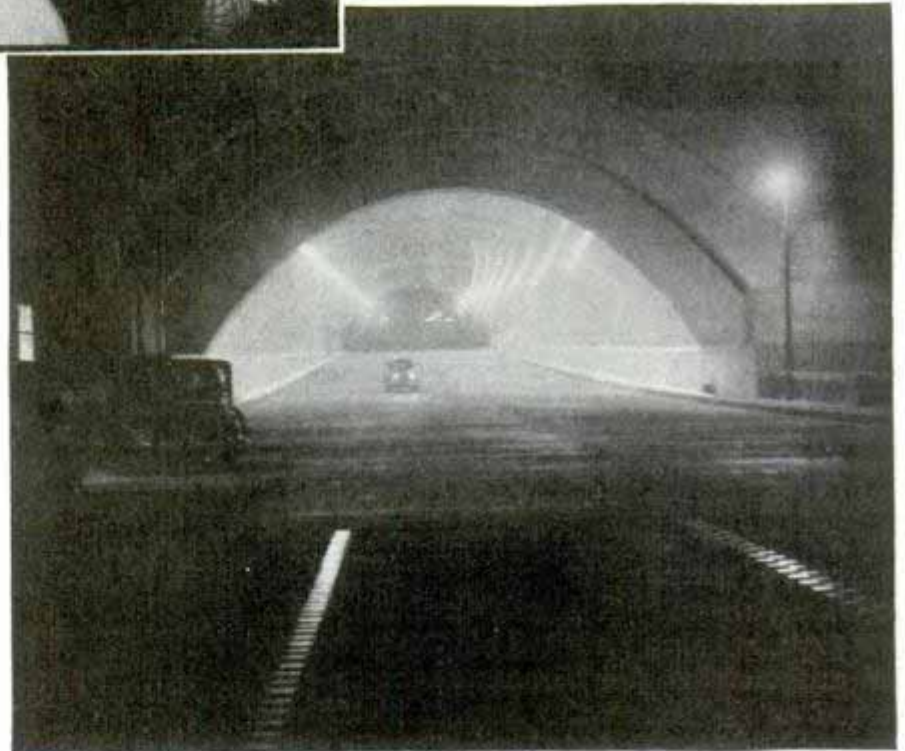

Top, auto equipped with automatic signal mounted on steering column which warns of danger as it is actuated by magnetized steel plates beside highway, near a crossing or similar hazard. Bottom, San Francisco-Oakland Bay bridge tunnel is free from crossing peril, since interurban trains run on a deck below

fifty of the locomotive and tender's 286½ tons. The six Pullmans, at seventy tons each, weighed 420 tons, the two baggage cars totaled 120 tons, the baggage-dormitory car seventy-five tons, the diner eighty tons, the lounge seventy-two tons and the observation car sixty-eight tons, or a total for cars of 835 tons and for complete train of 1,121½ tons. The train was about 1,121 feet long.

At fifty miles per hour that 2,243,000 pounds of train was traveling 4,400 feet

2206 South
— Road.

per minute, or $73\frac{1}{2}$ feet per second, and the engineer estimated that when the stalled automobile first came into view it was not more than fifty feet from the engine, so there was less than five-sevenths of a second between first sight and crash. The light automobile was shoved ahead of the train, parts of it catching on the roadbed and between the crossties and the rest being forced back under the pilot. When the locomotive came to rest the auto radiator was still hanging on the engine pilot, a portion of one auto wheel was lying beside the locomotive, and the rest of the vehicle was crushed in an unrecognizable mass under the engine firebox.

A simple multiplication shows that 2,243,000 pounds of train multiplied by a speed of 4,400 feet per minute strikes a blow of 9,869,200,000 foot-pounds—so it is not surprising that an automobile weighing a couple of tons can't win an argument with a train. Surprisingly enough, all that energy can be used up and the train brought to a standstill without serious damage to equipment or passengers. To the passengers in the big steel cars the stoppage is just a succession of minor shocks. The first shock is felt when the brakes go on, the next one when the train leaves the track and begins bumping over the ties, and finally a series as cars and engine turn over and are pushed ahead by the still unexpended momentum of the train. If the couplers hold together for a few seconds the cars usually begin to fold up like an accordion, and come to rest back and forth diagonally across the track.

Engineer Harry Clewer, Rock Island railroad veteran, suggests that train derailments in crossing accidents usually occur when the locomotive pilot hits the front portion of the automobile, where the weight of the engine makes it more apt to be dragged under the wheels. When automobiles are hit back of the hood, he observes, they usually are thrown clear.

Superintendents of motive power on various railroads believe the steam-engine pilot design is a contributing factor, and point out that there is no record of any streamline electric locomotive ever being derailed by a crossing obstruction. The smooth, sharply sloping nose of the streamliner either throws an obstruction aside,

(Continued to page 125A)

Neckstrap Steadies Camera for Movie or Time "Still"



Post is adjustable to bring camera to eye level, and is supported by strap hanging from neck

Camera fans who want rock-steady movies or still pictures can use a neckstrap support. The camera is screwed to an adjustable post instead of the usual tripod, and this post rests on the base of a strap hung around the neck. The post can be raised or lowered to put the view finder at eye level. With care, a camera can thus be held steady for a time exposure of as long as two seconds.

N 447

Buffer Disk Cleans Side Walls of White-Rubber Tires

White side walls of automobile tires can be cleaned with a rubber buffer disk when ordinary cleaning methods are ineffective. The buffer is mounted on a flexible shaft. Guided smoothly by hand over the side-wall surface it takes off grease spots, stains and curb scuff marks.



Goodyear Rubber Co. Akron Ohio

Memoria American Corp. 4.85.55, 1st Ave. New York

14382

Complete Model Railway Is Built for Movie



Circle, oiling one of the small locomotives in the miniature railroad system. Bottom, general view of the system, showing two trains meeting at a signal board
*Lionel Corp
 158 26th
 newport*



Temature name "Three a Crowd" ...

Warner Bros

Laid out over 2,400 feet of landscaped floor space inside a Hollywood sound stage, one of the most complete model-railway systems ever built was used in a recent motion picture. The double-track system crosses thirteen bridges and there is a multiplicity of switches, crossings, culverts, signal stations, sidings, towers, cut-offs, and cross lines. The track is between

600 and 700 feet long. Fifteen electric circuits are centered at an elevated operating platform located at one end of the system. From this platform it is possible to start, switch and stop the miniature trains at any point. The model railway is the main feature of a film having as its central character an eccentric millionaire with railroading as a hobby.

*James Mc Luey, 931 W
60th Terrace,
Kansas City
Mo*

HAY FEVER And How To Escape It

EVERY year a strange storm sweeps across America. No one sees it but millions feel its effect. Originating in Montana and along the Canadian border early in August, great clouds of microscopic dust sweep east and south during the next three months at the rate of thirty-five miles a day.

These particles, yellow in color under a microscope, are pollen granules from the ragweed which causes more than four-fifths of the hay fever cases. By the billions they are picked up by air currents, carried for days across fields, forests and rivers into homes, thea-

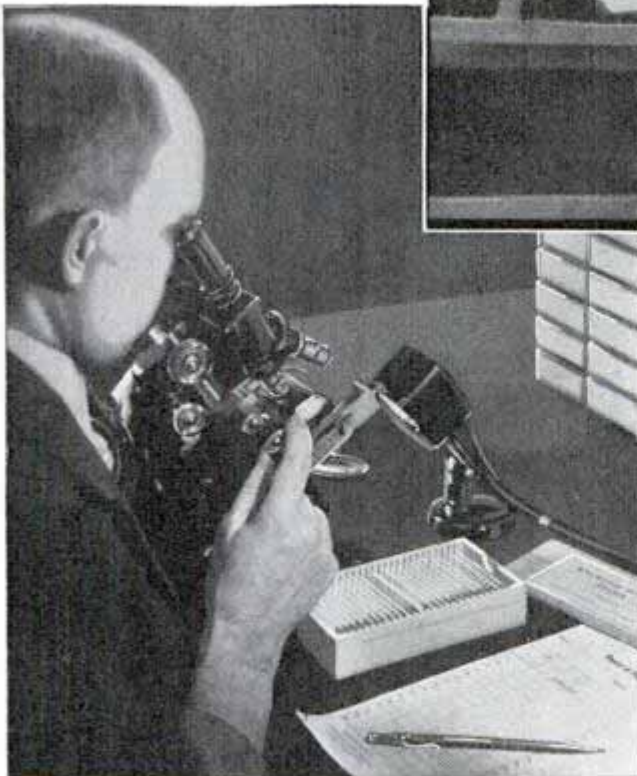
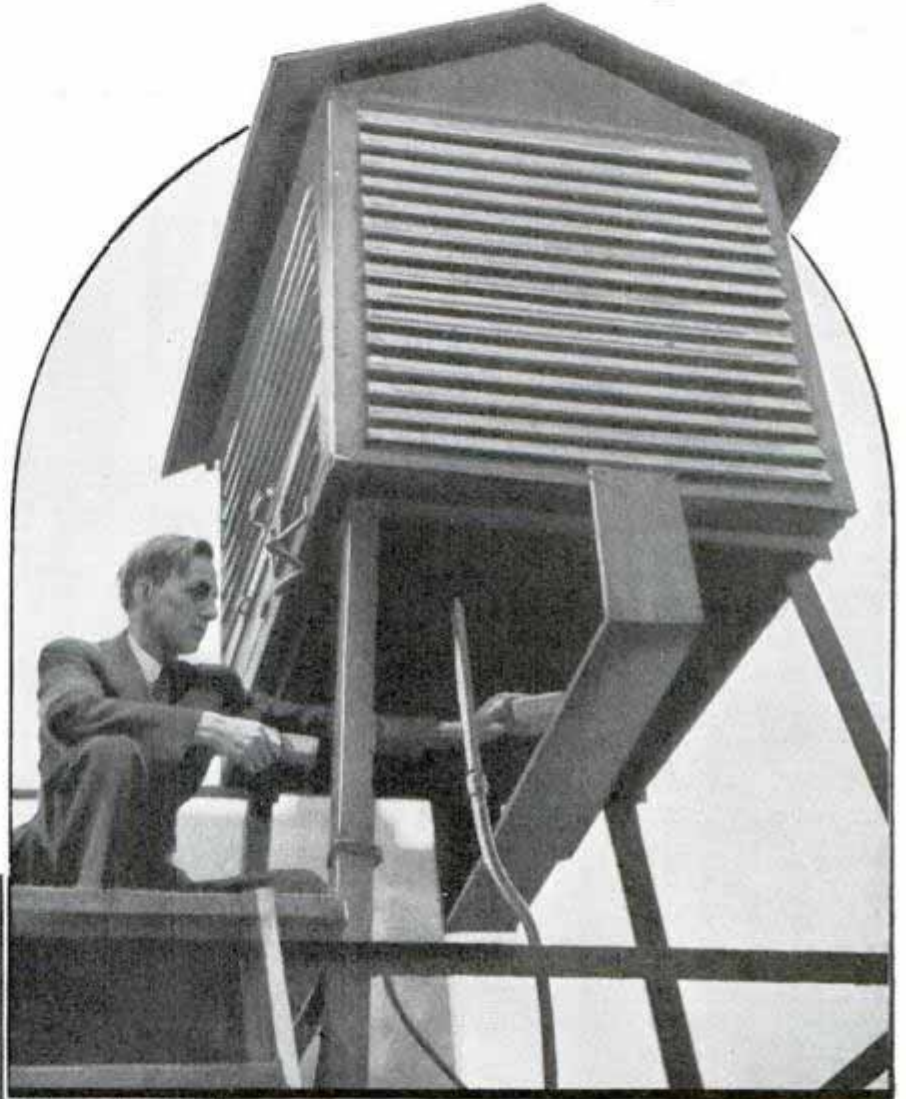

Top, exposing pollen slides under shelter which keeps out rain and dirt. Bottom, studying slides for use in compiling national pollen map

ters and office buildings to start the sneezing and weeping that do not abate until the first killing frosts.

For twenty years Oren C. Durham, Chicago botanist, has been studying these pollen storms. A pollen hunter, a pollen counter, he has pursued the yellow dust all over America. His research has been of practical benefit to the hay fever specialists and sufferers.

Medical authorities for a time disagreed as to the weed source responsible for the greatest number of hay fever cases. An accusing finger was pointed at the golden rod. But that notion was dispelled as soon as a scientific investigation had been made. Now it is regarded only as a minor offend-

World Chicago City

B. Danneal Laboratories

Abbott Laboratories

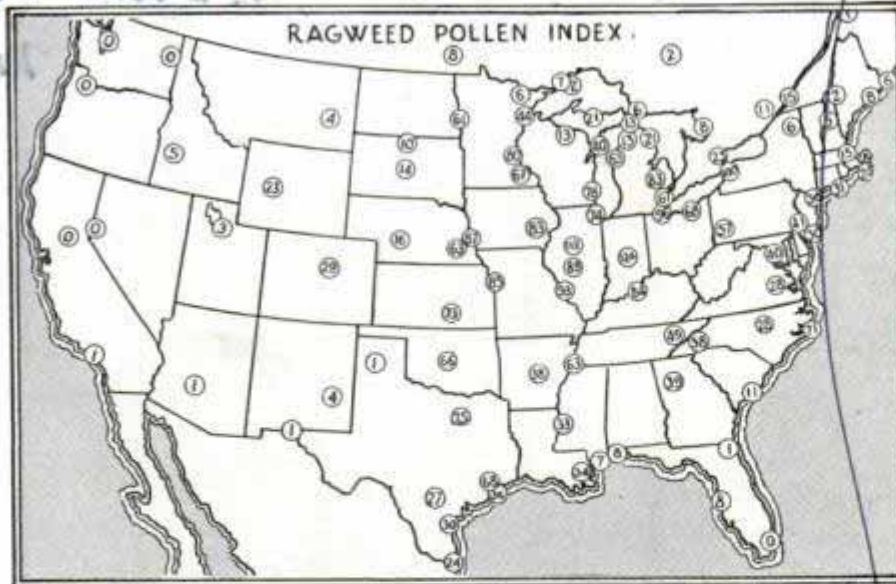

er. The ragweeds are the real culprits east of the Rockies. Wormwoods and Russian thistles are the troublemakers along the Pacific coast and in Rocky Mountain regions.

The ragweed pollen output of North America is at least a million tons, Durham estimates. Of this amount, approximately 275,000 tons get into the air. It takes a billion granules of ragweed pollen to fill an ordinary teaspoon, but six or seven granules are enough to give the ragweed-sensitive person watering, itching eyes, running nose, and all the symptoms of hay fever. With an annual fall of pollen as high as half a ton per square mile in some sections, it is little wonder that hay fever is on the increase. The number of watery, raw noses cannot be gauged accurately, but experts say it's not fewer than one in twenty.

Because the susceptible differ in their degree of sensitiveness and in the types of pollen to which they are allergic, it is important that the sufferer and his physician know the kinds of pollen to be encountered in a certain locality at a specific time. Here is where Durham fits into the picture. He has been responsible for the first pollen map of the United States. This map represents the compilation of accurate pollen information from nearly 100 cities. More than twenty thousand individual air tests have been made and the results carefully tabulated. Small pieces of glass covered with a thin film of vaseline are exposed face up in a horizontal position for a number of hours. They are covered by shelters to keep out rain and particles of

soot, sand and dirt. A cover eight or ten inches above the slide does not interfere with the deposit of pollen.

Throughout the late summer and fall these slides are exposed from coast to coast by the observers of the United States weather bureau,



Top, ragweed pollen map, with points free from the pollen being marked zero. Bottom, room air filter for removing pollen from the air

then sent in to the Abbott Laboratories where Durham checks them.

By calculating the rate of fall of the pollen on the slide, Durham is able to determine the intensity of the toxic dust in the air over that city. The slide is approximately one-fourth square inch and as soon as the pollen count is completed he can calculate the amount that falls on a large area such as a square yard or square mile. By averaging the amount found at a representative number of points, he arrives at a fair estimate of the total fall of a particular type of pollen.

Pollen grains vary in size and shape. Under a microscope a ragweed granule resembles a battered golf ball. These grains measure twenty microns, a micron being one-thousandth of a millimeter. Forty of these granules placed side by side would

scarcely reach across the center of an ordinary pinhole. As long as the granules are kept dry they retain their power to cause hay fever symptoms indefinitely. Fifteen-year-old pollen is virtually as active as grains freshly gathered.

The distances that pollen travels vary. Some only an inch or so, others blocks or even miles. The rate of fall of single grains in perfectly still air is only about ten feet per minute. Because of the columns of heated air that rise from the earth to heights of four to five thousand feet, pollen dust is often carried great distances. By tests made from airplanes, Durham has found that the air thirty miles from the shore of Lake Michigan contained on some days almost as much pollen per cubic yard as that at the same altitude over land.

First as a hobby and later as a business, Durham has been making field surveys since 1924 when he collaborated with Dr. W. W. Duke, a hay fever specialist, in classifying and checking weeds in the vicinity of Kansas City, Mo. The move toward a national pollen survey was started in 1928.

Of the localities studied only Portland and Seattle have been found free of ragweed pollen. The plants do not grow in this area and the Cascade Mountains serve as a barrier against the yellow dust storms from the intermountain region. California and the southwest do not have ragweed but there are local equivalents. Parts of Florida and Alabama, Prince Albert and a few Canadian points have clean slates.

Of course, there are persons who are sensitive to other things besides pollen. The dander of animals frequently causes an allergic condition. So do the minute hairs and scales from butterflies, moths, and some insects. Foods, too, can cause hay fever.

"Modern preventive pollen treatment," Durham explains, "is carried out with pollen extracts, the soluble part of the pollen grains in a preservative solution. Treatment usually starts a month or so before the season begins and after ten or twenty inoculations in increasing doses immunity generally results."

Air filters that fit into home and office windows have been developed that will remove between ninety-eight and ninety-nine per cent of the pollen in a room.

Dog Rides His Own Trailer Supporting Broken Back



Pete has lost the use of his hind legs, but gets around nicely with this two-wheeled "trailer" cradle

Despite a broken back, Pete, a Welsh terrier in San Francisco, manages to get around quite well with the aid of two wheels. Pete fell from a third-story window and the injury to his back resulted in paralysis of his hind legs. He might never have walked again—but he does, for a stretcher-like cradle supports his hind quarters while he pulls himself along on his front paws. Meanwhile two-wheeled Pete is being treated and there is hope he may recover the use of his legs.

Impact Indicator on Face of Club Shows Force of Golf Drive

To "meter" the power behind a golfer's drive, a Long Island dentist has invented an impact indicator which is built into the face of the club.



A small disk at the point of impact is the head of a piston which absorbs the force of the stroke, causing a pointer to move across the dial on top of the club.

es 6 8 0
H 4 2 3
owner - Mrs. Tony Curro
San Francisco, Calif.
Dr. Michael J. Glees
Amityville, L.I. New York

Ben's Indicator Co
Philadelphia

Baby's Coop Fitted on Bike Solves Family's Problem



Handlebar coop takes the baby for an outing on dad's bicycle, safe from wind and dust

What to do with the baby when father and mother wish to go cycling has been solved by a Melbourne, Australia, couple. The baby is placed in a neat, glass-inclosed coop fitted on the handlebars of the father's bicycle. The small compartment protects the child from dust and weather.

Midget Steam Engine Handy for the Model Maker

Seven inches long and slightly less than three inches high, a miniature steam engine now on the market can be used to drive small working models, boats and toy mechanisms. It is a precision product, being die cast of a zinc base alloy of high

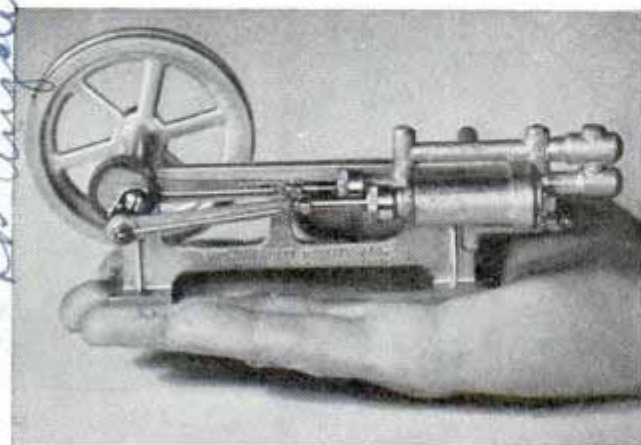

Tiny engine run by steam, water or air pressure is used to drive boats, toys and small working models

tensile strength. The main shaft, valves and piston are ground to size within very close limits. Valve action is positive, allowing very slow and high speeds. The engine may be operated on steam, air or water pressure. Speeds ranging from 2,000 to 4,000 revolutions per minute have been developed on pressures from two to fifteen pounds. Speeds as low as fifty revolutions per minute can be maintained by using less than two pounds. The engine will run in either direction by changing intake and exhaust lines. It can be taken apart and reassembled easily.

H380 Tractor's Wheels Adjustable to Any Farm Job

Built to perform all kinds of work on the farm, a new six-cylinder tractor has wheels which may be adjusted for different jobs. The rear wheels are adjustable from fifty-six to eighty-four inches, four inches at a time, and the front wheels may be set from fourteen to fifty-six inches. No

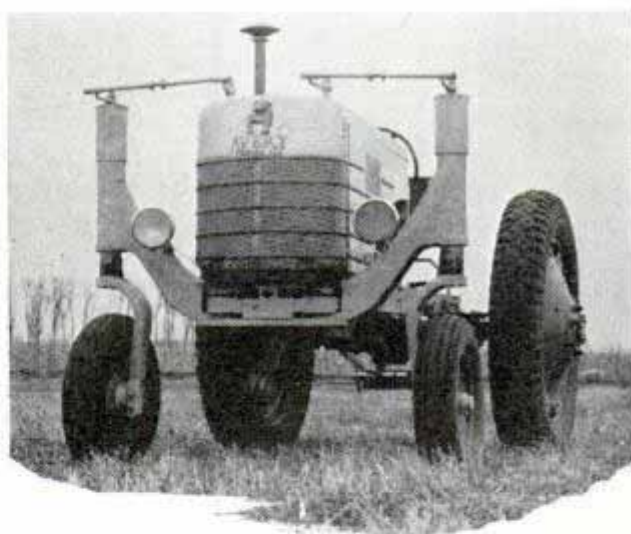

Wheelbase and tread of this farm tractor can be changed for road work or cultivating row crops

special tools are needed for setting the wheels. Front and rear wheels may be changed from standard fifty-six inch tread for road work to any setting desired for row crops planted from fourteen to sixty inches apart, including listed crops. As the front wheel setting is changed, the wheel base is lengthened or shortened. The tractor has three speeds forward, from two to eighteen miles per hour, and is equipped with automotive headlights, adjustable so that one may be reversed for night work.

Avery Farm Machinery Co.

*Prueitt Novelty Works
1828 W 43rd Place
Los Angeles Calif*

H 459

Brooklands, England

Turreted 'Whale' Tries for Land Speed Title

Beneath the "blister" turret that protrudes above the sleek steel nose of a land-going whale, John Cobb will grip the wheel next August as he roars across the Utah salt flats toward a new land speed record. The low-built racer has remarkably clean lines, broken only by the driver's turret and the four wheels set in slots through the body; it tapers to a beaver-tail rear end. Designed by Reid Railton, the superspeedster is powered by twin engines of 1,250 horsepower each, driving the front and rear axles independently. Thus the three-ton monster is really two racing cars in one. Lacking the conventional radiator in front, the engines are cooled by water and ice in a seventy-five gallon tank. The wheelbase is thirteen and one-half feet; the car is only fifty-one inches high. Its front wheel track measures five and one-half feet, the rear three and one-half feet.

no price

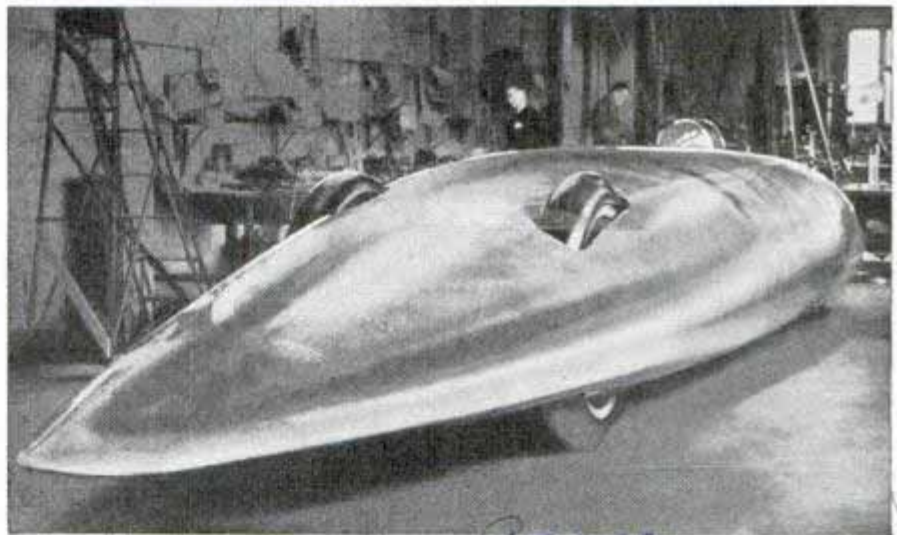
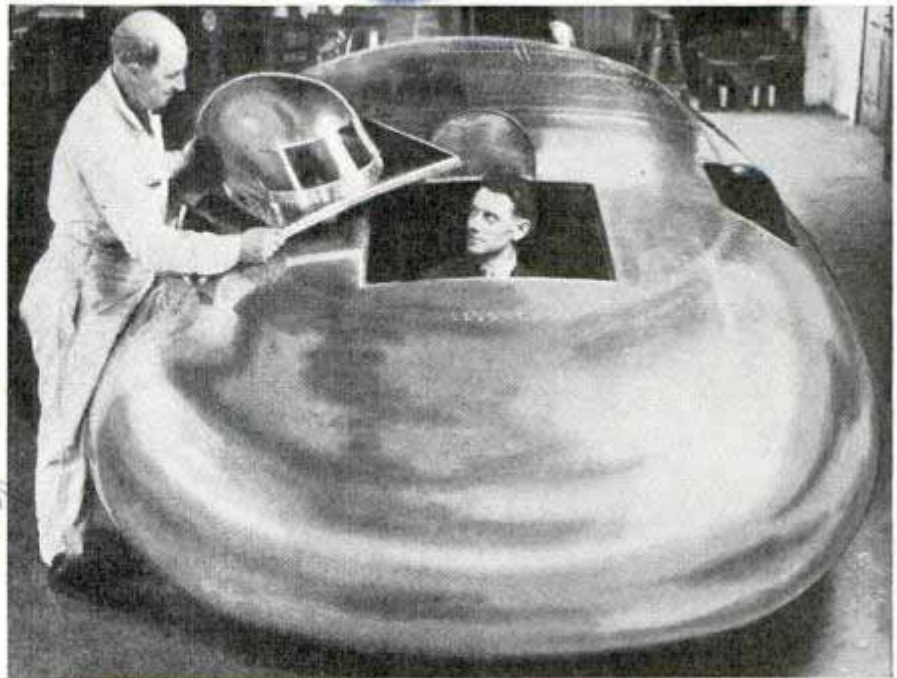

Top, fitting protective turret over driver's cockpit in nose of racer. Below, a rear view showing the clean lines and tapering "beaver tail"

acme

Forty Pound Welding Kit Carried on Back Speeds Work



Carried on the back of the operator, a portable welding outfit speeds up work at Grand Coulee dam. The outfit consists of a midget gas tank and the welding equipment, weighing about forty pounds complete. In comparison, the ordinary gas tanks used in welding weigh about 150 pounds. With the outfit on his back, the welder may go from one job to another, even climbing ladders if necessary.

Send return postage to our Bureau of Information to learn the name of the maker of any device described in this magazine.

Cont. Daniel Mc Farland
Box 10 24 Mason's Cate 16/16/1

"BEATING ACTION" ^{ing} with



YOU'RE out to trap action in pictures? There's more than one way to do it; but whatever way you choose, it will call for speed. Action in front of the camera demands action inside the camera—or behind it.

A quick trigger finger and an eye alert to catch pauses in action can make up for slowness of lens or shutter. Or, to borrow the method popular abroad, you can "swing it" and freeze the action while you blur the background.

Of course, the best camera to use is an action camera: one with high-speed lens and extra-rapid shutter. That combination carries an invaluable "margin of safety." The camera helps make up for your own deficiencies, possible small errors in "timing," and occasional unsteadiness of the hand. In brief, it makes action snapshooting easy.



Even a slow camera can catch a diver at top of his bounce from springboard, for he is momentarily motionless in mid-air. But it took a fast shutter to snap this angle view of the skiers at 1/800 second

Your CAMERA

"But," you may reply, "I haven't a speedy camera. Can I still get action pictures—of a sort?" The answer is that you can, and very good ones—not just pictures "of a sort."

In action snapshotting, the difference between a fast camera and one with slow lens and shutter is that the slow camera puts more responsibility on you. It has less margin of safety than the better instrument. Your timing must be more accurate, your judgment keener and the light must be good. You must give more thought to viewpoint and angle. In brief, you must use your head as well as your lens, and light conditions must

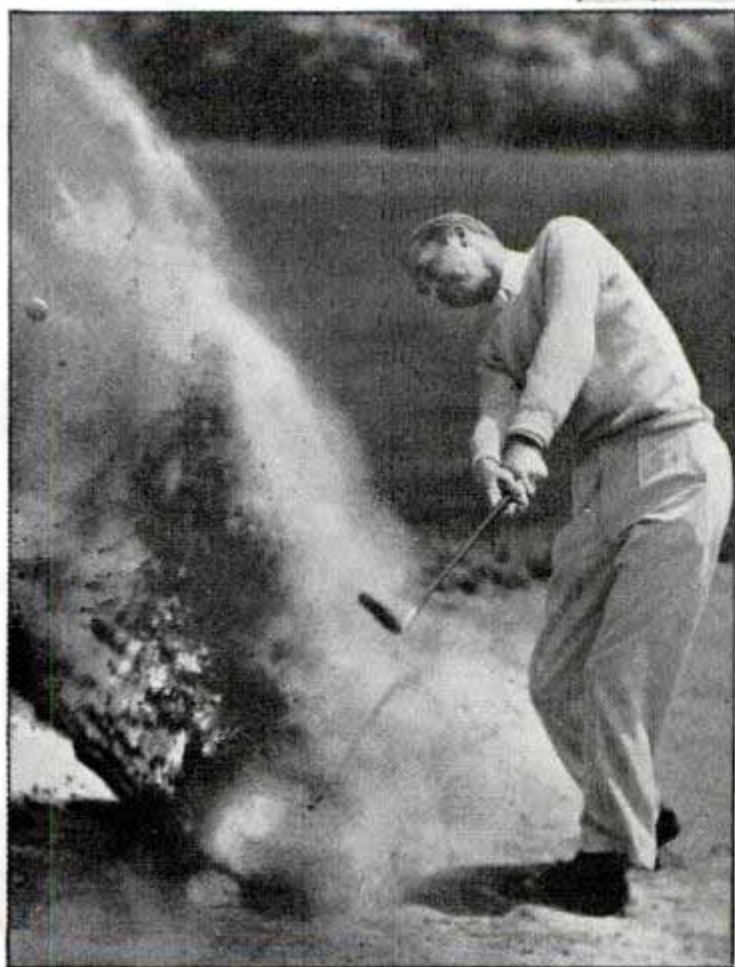

If shutter is slow, the eye must be quick to catch the pause at top of swing, above. Notice how sharply the speed camera caught ball and club in lower photo

be "with you." Most box cameras have lenses with speed of about f.12.5 and shutter speed averaging between one-thirtieth and one-fiftieth second. Miniatures with lenses as rapid as f.2—thirty-nine times as "fast" as the box-camera lens—and shutters that adjust up to $\frac{1}{500}$ second can take pictures many times as fast as the box camera; or, with the same shutter speed as the box camera, get a picture at f.2 in light about one-fortieth as strong.

This gives a decided advantage to the owner of the speed camera, especially when light is weak. But, when light is good, there are a number of tricks and dodges that permit the slow camera to obtain effective action pictures.

Four of these "dodges" are especially useful: the head-on viewpoint, the "momentary pause," simulated action, and the "swing" technique used frequently by British and Continental sports photographers.

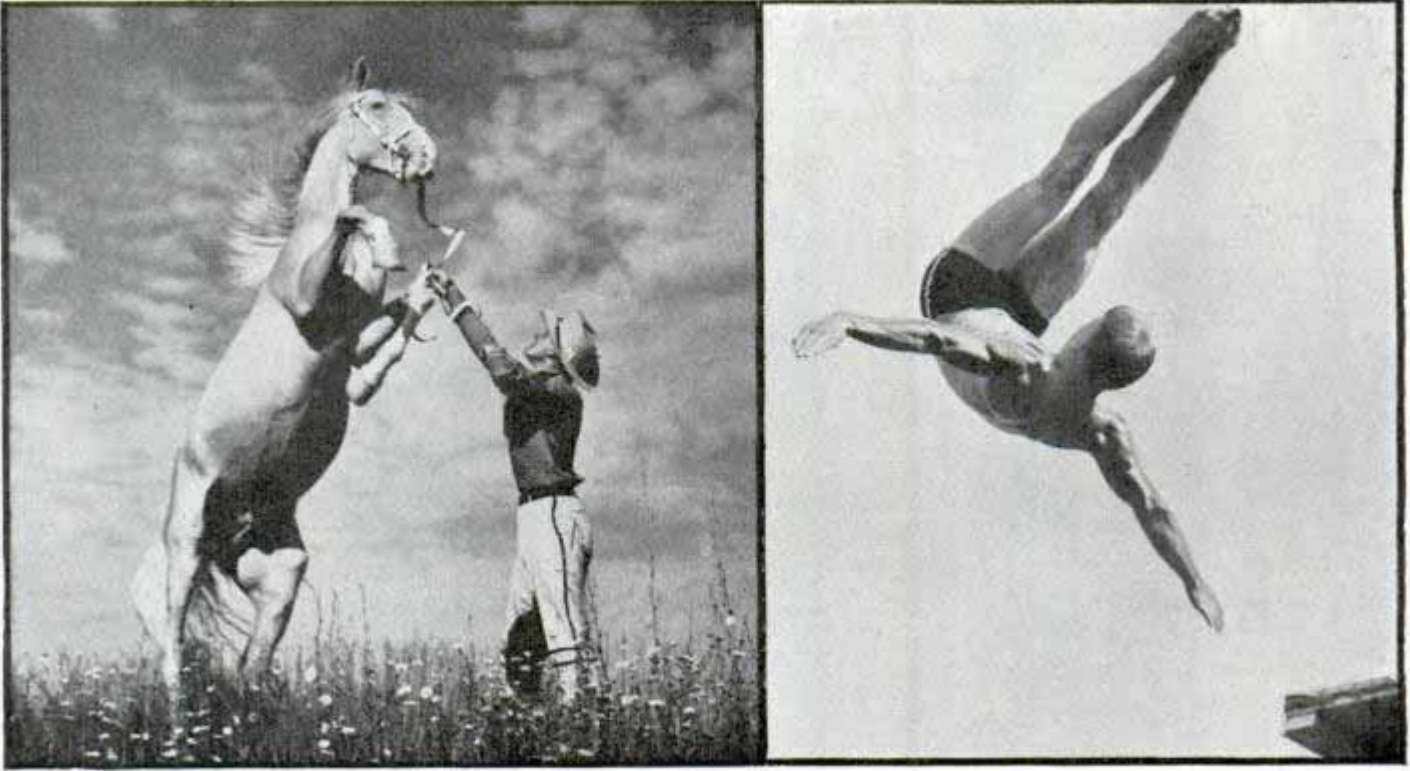

The head-on viewpoint is advantageous when one is picturing an object that is speeding rapidly in a straight line—a racing horse, automobile, motorcycle, train, or runner. Such objects as these, pictured head-on, move quite slowly as far as the camera is concerned—until they get near the camera. The nearer they get, the less your view is “head-on”—for naturally, you will not be standing in the center of the railway track or the motor speedway, but

a bit to one side. At the same time, as the moving object nears the camera, it grows rapidly in size, and this swift expansion tends to blur your picture. So, your rule should be, snap the picture while the object is still some distance away, before you begin to lose the true head-on viewpoint.

Slowly moving objects can be snapped with reasonable assurance of success even when you diverge from the head-on viewpoint as much as thirty to forty-five degrees. The average speed of a box-camera shutter is one-thirtieth to one-fiftieth second, and with a thirty-degree-angle viewpoint, this speed will “stop” a person walking at the rate of three to four miles an hour, when he is twenty-five feet from the camera.

The required shutter speeds increase rapidly as your angle of view increases, and most things taken at an angle fall into the high shutter speed class. For instance, at a forty-five-degree angle and twenty-five-foot distance, a person walking four miles an hour requires at least one-fiftieth second; horses traveling at eight miles an hour require $\frac{1}{150}$, and horse races and bicycle races demand $\frac{1}{500}$.

Doubling of the distance between the object and the camera permits you to give twice the shutter time. For instance, at a horse race or bicycle race, where shutter speed of $\frac{1}{500}$ would be necessary with a



Stopping action of horse or head-on view of boat is easy, but spinning dive calls for a fast shutter



subject twenty-five feet away, you can give $\frac{1}{250}$ second if the subject is fifty feet from the camera. These figures are worth memorizing if you want successful action pictures.

Next in importance to the head-on viewpoint is the momentary pause. Consider, for instance, what happens when a person is swinging in a rope swing. His movement is that of a pendulum—the swing travels upward toward the peak of its sweep, slows down as it nears the top, makes a complete halt, starts down slowly and gathers momentum as it goes. At the top, it is motionless—and if your shutter is snapped just at the moment the peak is reached, swing and swinger will be “frozen” in mid-air. This calls for practice, careful judgment—and yes, luck—but the results are worth the effort.

Study this same sort of phenomenon in the high-jumper, the pole-vaulter, the javelin-thrower, and on the tennis court. You will find that at certain points there is enough “freezing” of motion to permit sandwiching in a snapshot, even with the slow shutter speeds available on inexpensive cameras. Proper choice of viewpoint lengthens the pause. For instance,

the javelin-thrower at the end of, or just before, his throw will, for the camera, be frozen longer with a viewpoint directly behind him or directly in front, than from a side view.

Some of the best “action” pictures one sees actually contain no action—they could have been made even with a short time exposure. The action effect of such pictures depends on their arrangement and subject matter. Straining muscles, tense

(Continued to page 123A)



Fast train was caught in one twenty-fifth second. Blur in tennis scene and tenseness of fisherman heighten effect of action

Mechanical & Electrical
Corp. Post Chester
N.Y.

H 425

Police Car Has a Sliding Roof for Sighting Rifle in Chase



Police officer illustrates how sliding roof panel permits him to stand up and take aim at fugitive

When the roving police squad in Maywood, Calif., engages in a running battle with a fleeing criminal, a panel in the car roof slides back and an officer stands up and sights his rifle with unobstructed view. Seated back of the windshield, the police are at a disadvantage in aiming and firing. With the sliding roof, however, the police can use the rifle to cover a dangerous situation from the start.

Emil Marshall Perham 11/28
Seamus Elvire Los Angeles Calif

in every detail. The models are sent also to prospective buyers living in regions far from any dealer. The top of the model is removable to show the arrangement and furnishing of the two-room trailer.

H. 441 ~~AFB~~ pens.

Safety Armored Cable Cutter Used in Any Position

Lending itself to use in any position, close to wall outlets, on the floor or very near the ceiling, an armored cable cutter is handy for the tool bag. It is safe, since there is no danger of cutting insulation, causing short circuits and incurring injury to hands, knees or clothing. The cutter can be clamped on the workbench. It handles armored electrical cable and Greenfield.



H 369

Folding Net Fits in an Oarlock and Keeps the Fish Alive

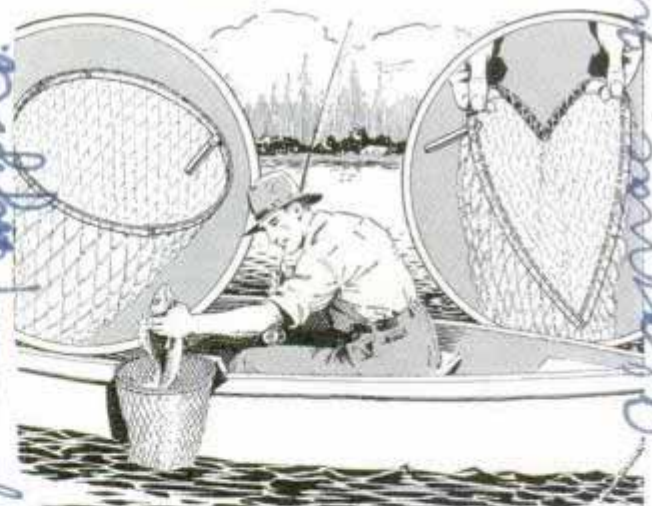

Fish net, shown open and folded, can be attached to oarlock, thus leaving both hands of fisherman free

Fish can be kept alive alongside the boat in a net, being introduced this year, which has an attachment that fits into the oarlock. The net need not be lifted while trolling, and thus it is always ready for use and requires no extra hand to hold it. The metal hoop folds up when not in use.

H 451

Miniature Trailer Home Model Helps Interest Buyers

To interest prospective buyers and help the salesman close deals, one trailer manufacturer supplies its agents with a miniature model of a trailer home, built to scale

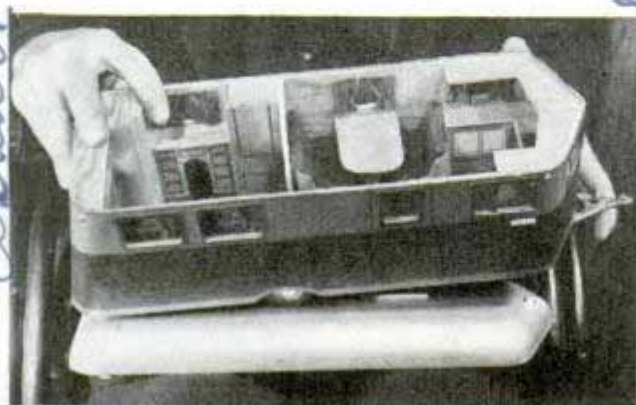

With roof removed, interior of model is seen to be furnished exactly like the trailer itself

Chert Trainers. Ave.
1930 S. Main St.
Gilbert Ariz.

Wallace Specialty Supply Co.

Send return postage to our Bureau of Information to learn the name of the maker of any device described in this magazine.

File - Q. Fix.
Mending Plastic Like Rubber Is Self-Curing

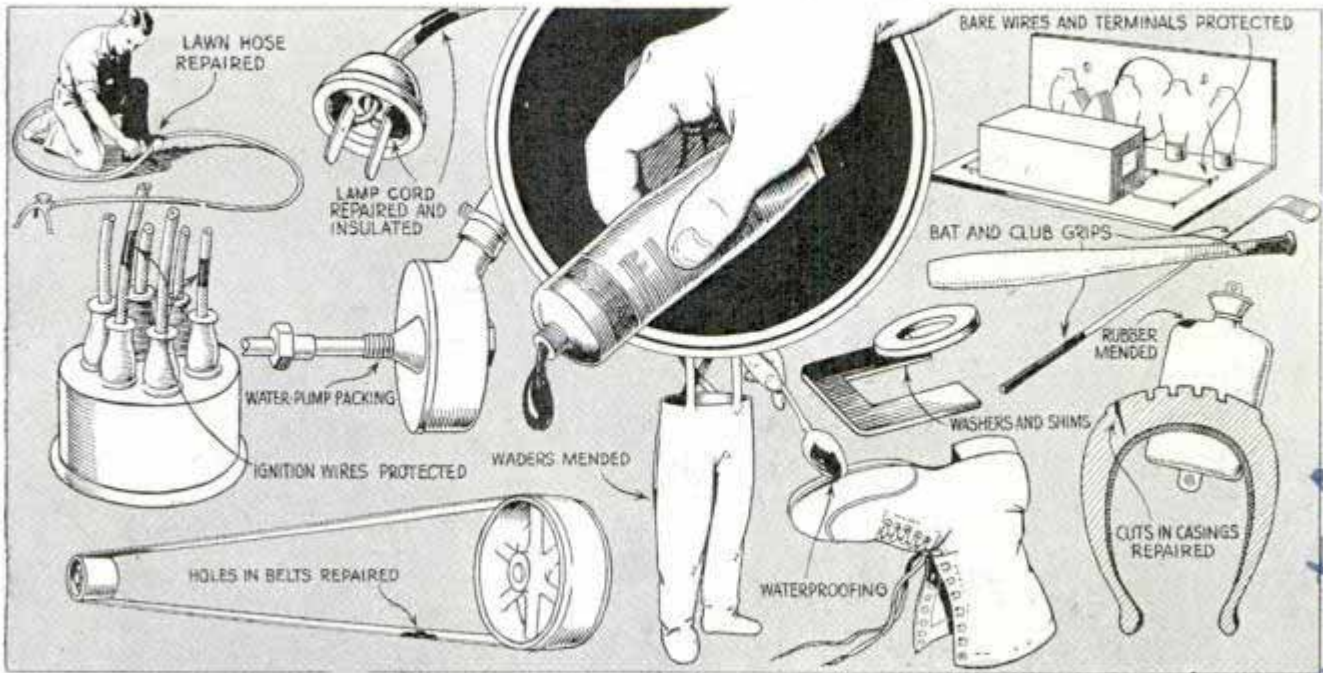

SELF-CURING and possessing adhesive properties, a new black-plastic compound fulfills the need for a means of mending and repairing. After being spread on, shaped as desired and allowed to dry, the compound forms a tough, elastic, waterproof patch, resembling vulcanized rubber. Old insulation can be repaired easily or new insulation made for lamp cords, radio wires, auto ignition or electric wires. No tape is required to complete the job, since the compound dries into a firm protective coating. Due to its properties of elasticity and toughness, the compound, which comes in tubes, is an ideal adhesive where resiliency is required. Leaky hose can be mended by applying

the paste to the hole, or holes, and permitting it to dry. Rubber wading boots may be repaired, shoes may be waterproofed, shoe heels may be built up, hot-water bottles mended, conveyor belts made almost like new by building up damaged areas with the plastic. Around the automobile, the compound finds dozens of uses, such as repairing cuts in treads and sidewalls and holes in tire casings, stopping leaks in top, window and windshield, eliminating body rattles and squeaks, mending tears or holes in seat covers and upholstery, and forming efficient waterproof packing for the pump. Many other uses for the plastic can be found around the home, office, boat, camp, workshop and other places.

H 374.

Winter "Overshoes" for Plane Are Fitted over Wheels

Quick changeover from summer to winter "overshoes" on an airplane is facilitated by a skid developed by a pilot at Regina, Sask. Instead of supplanting the airplane's wheel, this skid fits over the wheel. The flier built the skids in his own shop, using thirty-eight feet of one-inch chrome alloy tubing. Each skid is hinged at both bases and at the top of the wheel; tubes fore and aft and a cotter pin hold it securely. It takes but a few moments to remove the cotter pin and tubes and stow the skids away in the cabin.

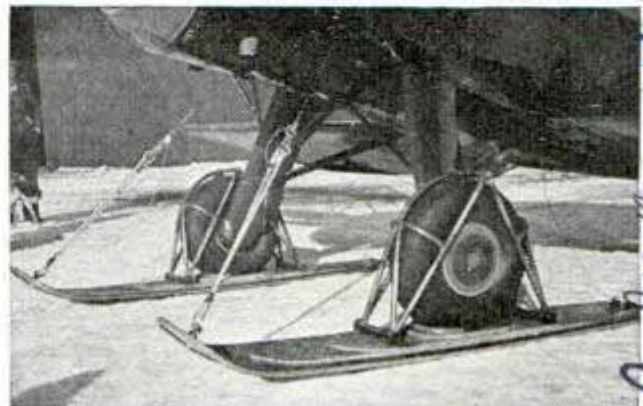

Frame of chrome alloy tubing, quickly installed, puts winter skids on plane without removing wheels

Charlie Skinner

*Products Co. 438 Chicago
 New York - 50 Pine St. Chicago
 The Skid most
 Regina Sask
 Regina. Sask Can.*

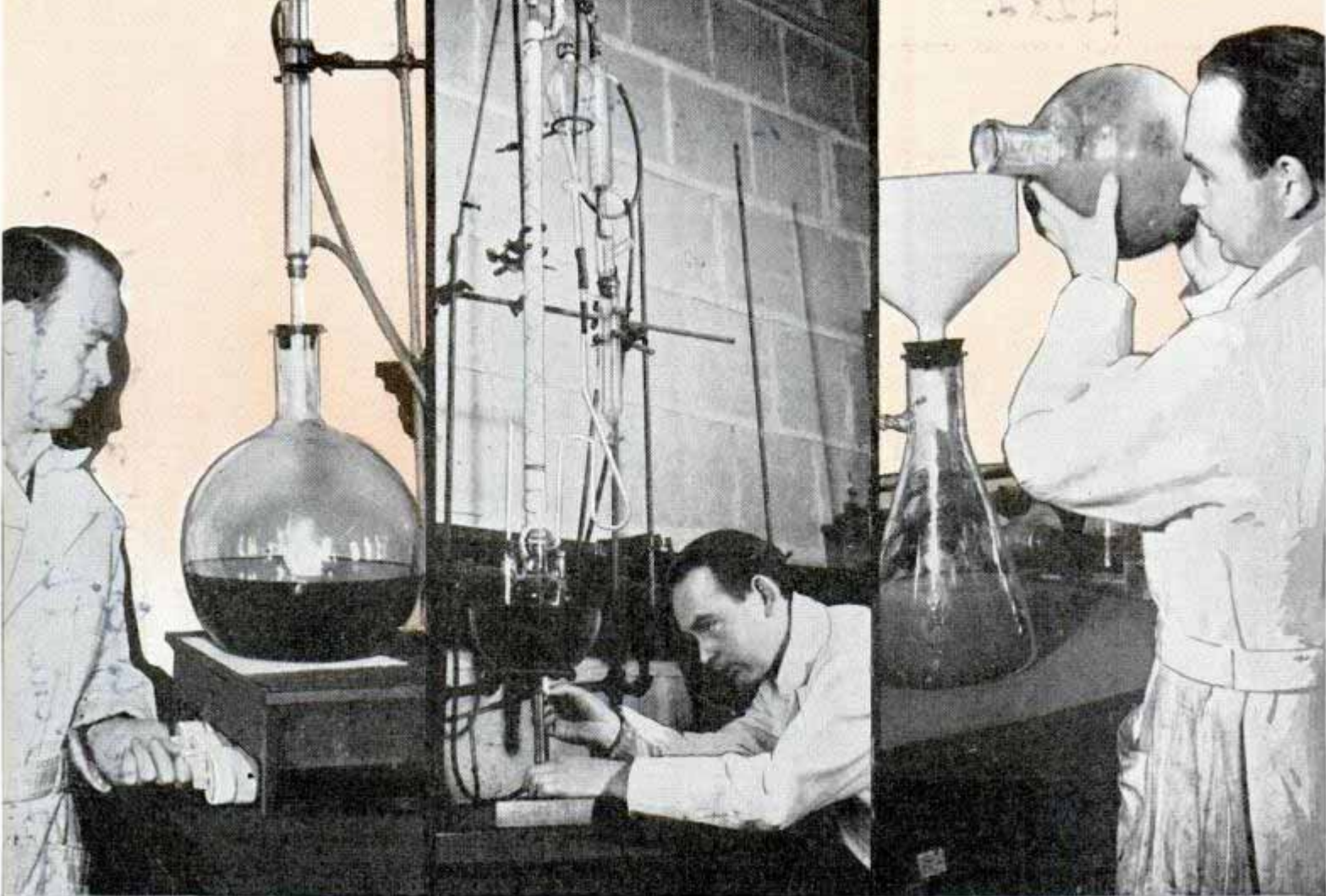

MODERN ALCHEMISTS

Top, left, cooking mixture of casein and concentrated hydrochloric acid, first step in producing amino acid known as 1-leucine. Center, drawing off leucine in solution. Right, purifying the leucine. Bottom, weighing pure 1-leucine on balance that measures weights down to 1/4,500,000 of a pound

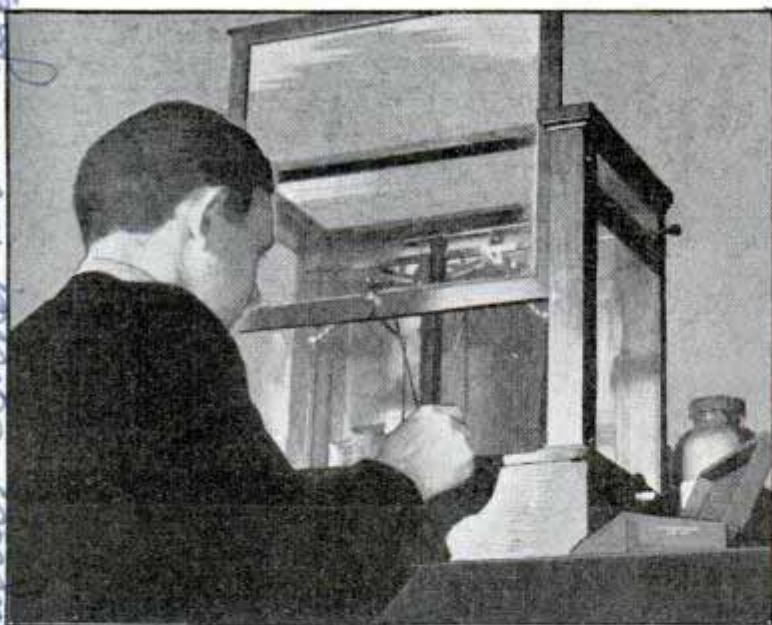

Today, white-smocked scientists in chemical laboratories are using such things as dried blood, chicken feathers, sunflower seeds, cottage cheese, gelatin and sweepings from the barber shop to produce crystals worth twice their weight in gold.

These tiny, jewellike crystals are known as amino acids, and some kinds sell for 1,000 dollars a pound. To the naked eye, amino acids look like uncolored bath salts or white talcum powder; under the microscope, the beauty of their crystalline structure is seen.

One of the few places in the United States where you can purchase amino acids is the chemistry department of the University of California at Los Angeles. Dr. Max Dunn is the twentieth century

DURING the Middle Ages, the dream of every alchemist was to convert baser metals into gold. Employing the closely guarded secret of the "philosopher's stone," those early experimenters mixed smelly concoctions, let them simmer and stew, bubble and boil, but they could not produce riches.

H262
 Carl Anderson, Hammett
 w/le. Spindley, W. Payne, L. S. Dainton
 Carl Anderson, Hammett

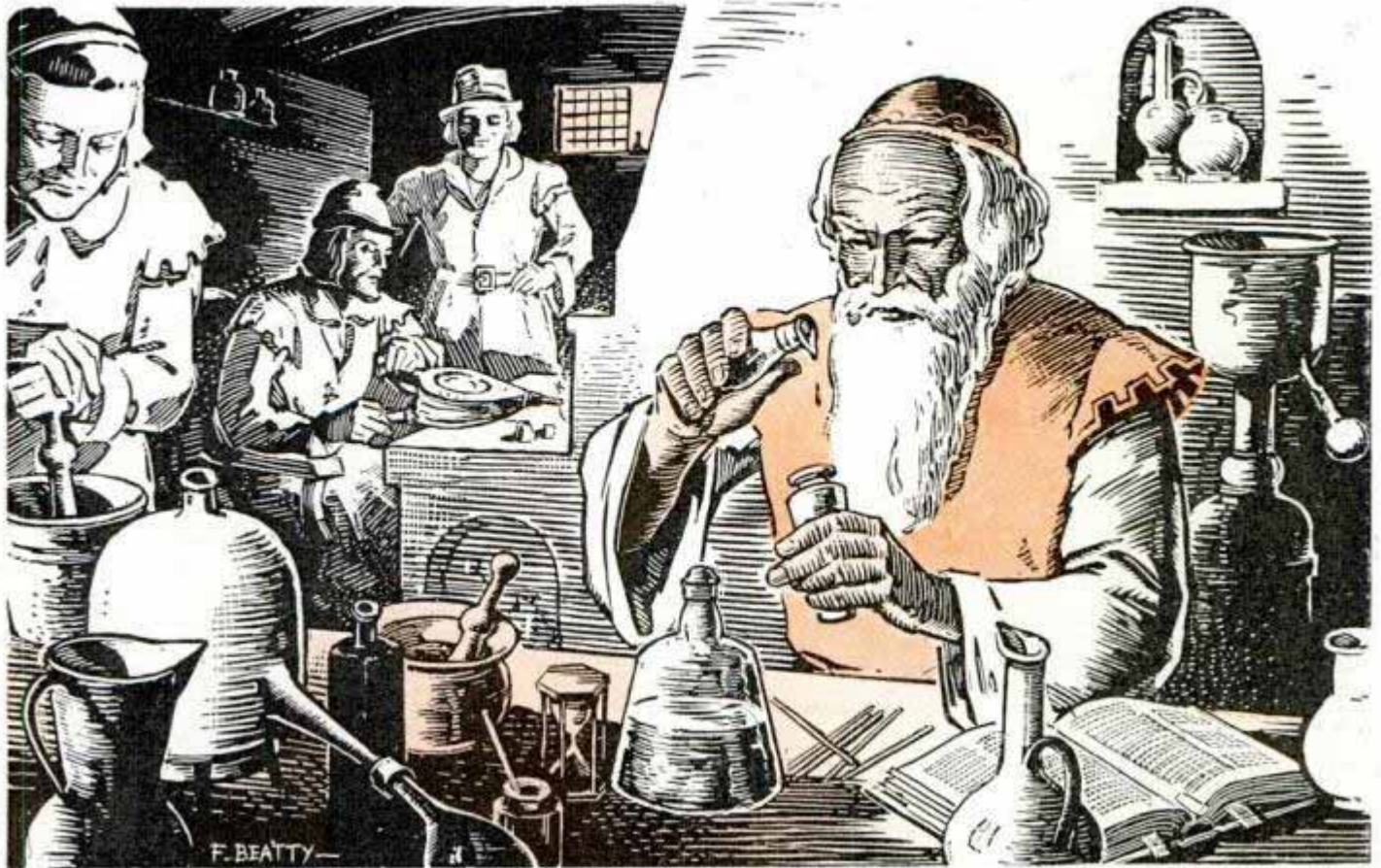

Produce RICHES from SCRAPS

magician who is directing students in the manufacture of these acids to be sold to universities, hospitals, and research laboratories in all parts of the world.

Amino acids are rare chemical substances that seldom occur in a free state. Twenty-two have been discovered and named. They exist in long strings, like beads on a thread, to make up one of the chief constituents of living matter, the protein.

The reducing specialist tells plump young ladies to eliminate fats and carbohydrates from their diets and to eat more protein food. He prescribes lean meat, fish, eggs, fresh vegetables and fruit. Since proteins form an essential part of our diet, it is only natural that they should be transformed into an important part of our bodies. Look at your hands: all that you can see is protein—skin, fingernails, hair. Much of our muscular structure is protein.

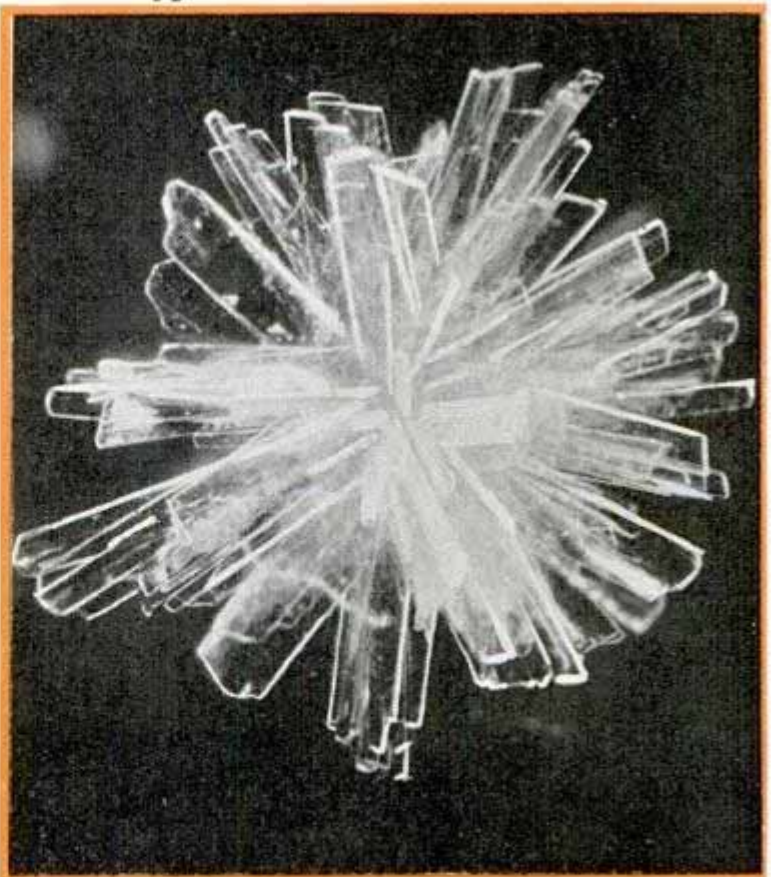

Top, alchemists of old vainly sought to convert baser metals into gold. Bottom, amino acid crystals as photographed through the photomicrograph



So complicated is the chemical structure of a protein that no scientist has succeeded in creating a single one. Instead, they have taken it apart and found it to be composed of various kinds of amino acids. Dr. Dunn's first attempt to buy amino acids from commercial drug supply houses proved futile. Of the twenty-two amino acids, only a few were being sold for research purposes. The price was exorbitant, near the cost of platinum. So Dr. Dunn decided to manufacture amino acids in order to obtain invaluable information concerning their physical properties, their structure, and their solubility. Thus began a project

known today as Amino Acids Manufactures, a non-profit venture of the University of California which has been operating on a commercial scale since 1935.

One by one the amino acids began to be manufactured. Price lists were computed and they were sent to universities, clinics, and laboratories throughout the world. Orders poured in. Today, sixteen of the twenty-two amino acids are offered for sale. Even though the project is run on a non-profit basis, so difficult are some of these amino acids to produce that they

sell for more than 1,000 dollars a pound. Others range from five dollars to 800 dollars a pound.

Some kinds of amino acids are made directly from chemical elements by synthetic processes. Others are broken down from animal and vegetable proteins. The meth-

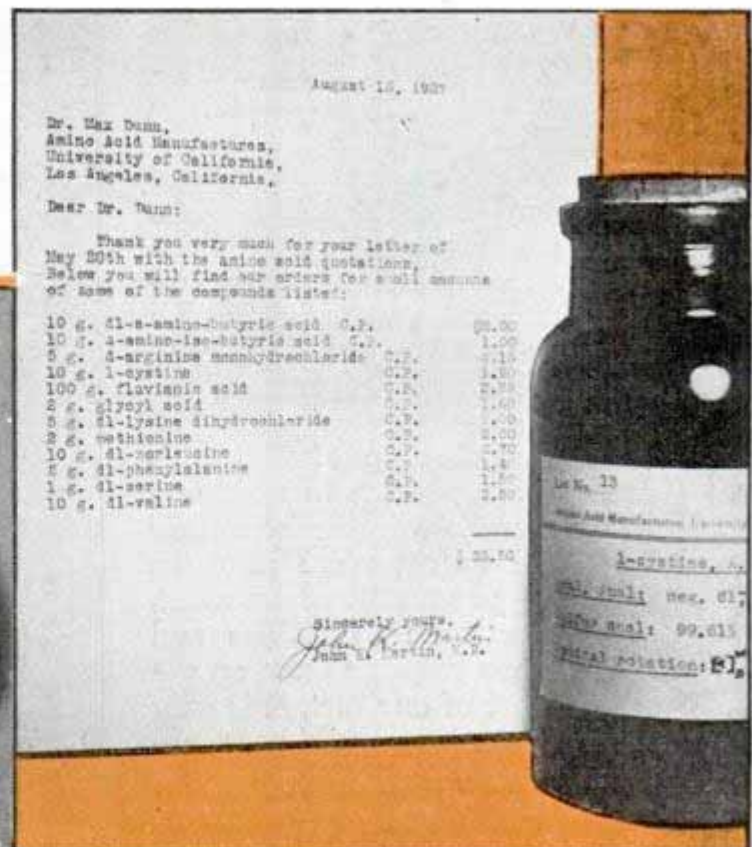
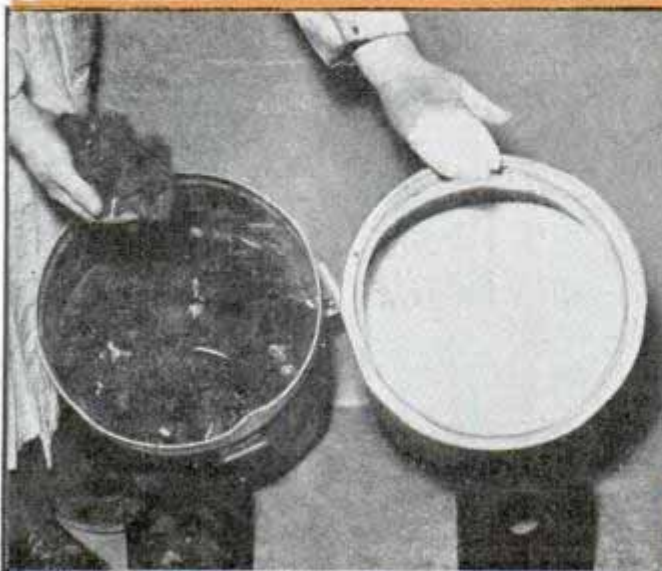

Top, sixteen kinds of amino acids. Bottom, left, can of hair and another of dried cottage cheese, two raw materials from which amino acids are manufactured. Right, sample order for acids, with bottle of L-cystine ready for shipment

od by which these proteins are given the chemical "third degree" is interesting. According to the type of amino acid desired, dried blood, cottage cheese, sunflower seed, wheat, gelatin, or hair sweepings are put in a large flask, mixed with strong sulphuric or hydrochloric acid and heated for twenty-four hours or more. Other chemicals are added and then drawn off by evaporation and filtering. With infinite slowness and precision, superfluous substances are drawn off until all that remains is a bit of precious powder or tiny crystals. These are the amino acids. They are carefully analyzed, bottled and labeled.

According to Dr. Dunn, entirely new processes have been developed. For the first time in chemical history these acids have been reduced to beautiful transparent crystals, looking like rare jewels. Crystallization is a sign of high purity, which is important to the research scientist.

Amino acids are invaluable to man in many ways. If we were deprived of a constant supply of them in the form of proteins, life would soon depart. Man must depend upon plants or plant-eating animals for this supply. Plants are the only living things on earth that can absorb chemical salts from the earth and, with the energy from sunlight, combine them with

carbon dioxide and water to produce proteins. When you eat meat or spinach, the digestive fluids in your stomach immediately go to work on the proteins and break them down into amino acids. The blood stream distributes them to all parts of your body. Here they are used as raw materials to rebuild tissues that have been

(Continued to page 124A)

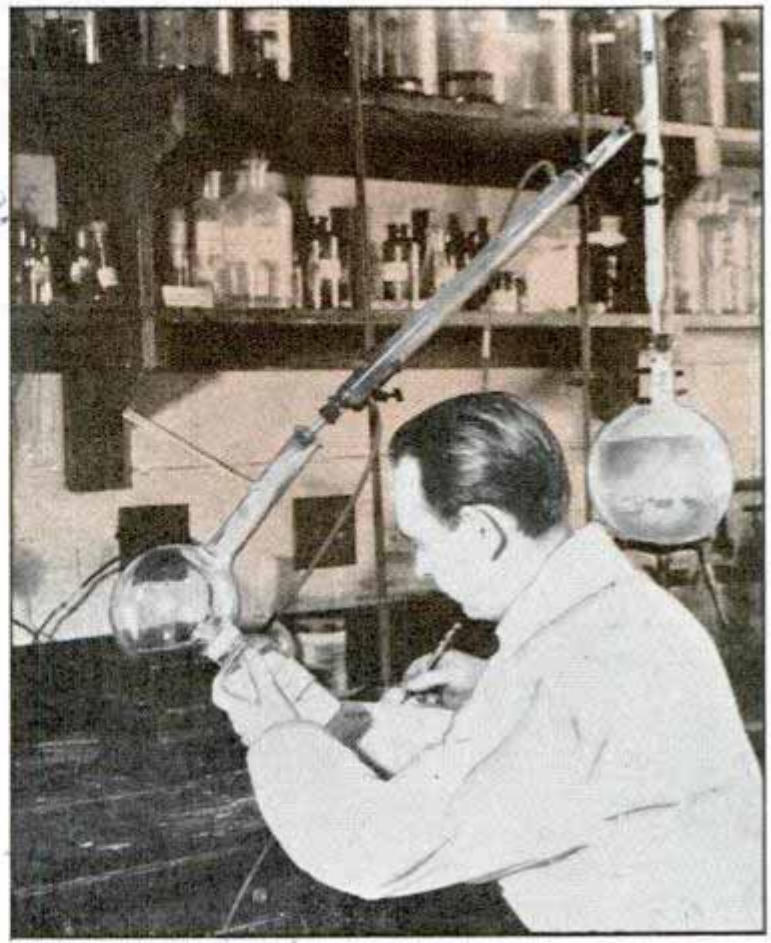

Top, bottling and labeling an acid. Bottom, left, one kind of amino acid closely resembles a diamond in shape. Right, purified 1-leucine, which sells for about \$400 per pound

Quick-Firing Aerial Cannon Latest Weapon for Fliers

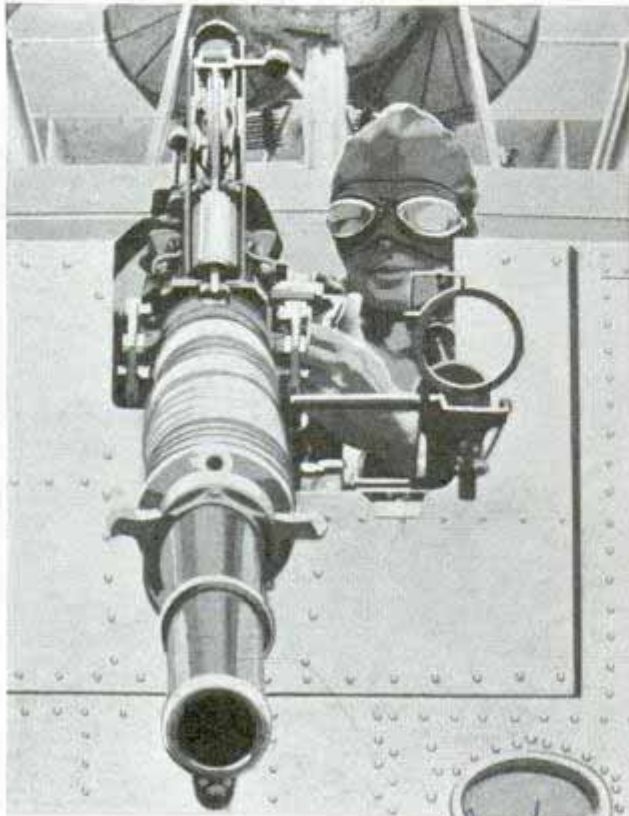

Aerial gunner is shown training a new type cannon developed for English aircraft

In Europe's rush to rearm, many new weapons are being developed for warfare on the ground, in the air and on the sea. Among them is a quick-firing aerial cannon for England's flying fighters. The cannon is manned from the cockpit of aircraft. It is expected to find wide use in the 400 new fighting planes which England is adding to her air force.

Furnace Smoke-Pipe Jacket Reduces Fire Hazard

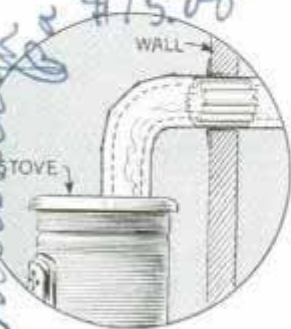

By covering furnace smoke pipes or stovepipes with a galvanized steel jacket and sleeve, building owners can reduce fire hazards materially. An air space between the jacket and the smoke pipe prevents overheating. When smoke pipes become corroded and rust through, the jacket prevents

sparks from escaping. The jacket also affords protection in buildings where smoke pipes have been installed so close to wooden joists and flooring that there is danger of fire from overheating.

sparks from escaping. The jacket also affords protection in buildings where smoke pipes have been installed so close to wooden joists and flooring that there is danger of fire from overheating.

H 352. Paper Fastener "Welds" Sheets between Corrugated Dies

Using no pins or staples, a paper fastener just put on the market binds the sheets together by pressing them between corrugated dies. The device weighs less than two pounds and is operated simply by pressing a hand lever. It forms a strong enough adhesion to be used for closing leaflets or envelopes for mailing.



H 401 Enlarger for Home Movie Film Requires No Darkroom

No darkroom is necessary for making enlargements from sixteen-millimeter motion-picture film with the compact enlarger just announced. Enlarged negatives can be made in a few seconds from either black-and-white or color film, and so simple is the process that error is almost impossible. The device resembles an ordinary folding camera, but in place of the usual

\$ 15.00



Movie film is locked in gate at front of enlarging camera and photo flood projects image on roll film

Smith Industries, Dept. H 352
Middleport, N. Y.

Custom Kodak Co Rochester, N.Y.

Messer Brothers
7026 Kelly St.
Butte, Pa.
H 405

front lens is a film gate where the movie film is locked over the particular frame to be enlarged. For the average picture, a five-second exposure would produce a good negative on supersensitive panchromatic film with the light of a photoflood lamp held five inches from the film gate. Since the enlarger is loaded with eight negatives in a roll, each picture two and one-half by three and three-eighths inches, immediate processing of the enlarged negatives is unnecessary.

Safety Catch for Keys or Watch
 Fastens Securely on Belt

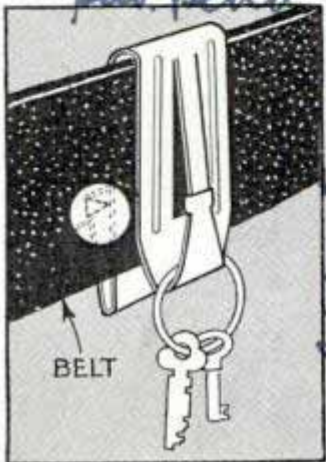

Key ring or watch chain can be held securely on a safety catch just invented. It is made of spring steel, and, once clamped on your belt or the edge of a pocket, it stays. The ring can be slipped on or off with one hand.

Tiny Life Preserver Inflated
 by Squeezing One End

Weighing only six ounces, the latest life preserver is inflated by squeezing one end of a small rubber sack. The pressure and heat act on chemicals instantly, releasing buoyant gas. The preserver will keep the average person afloat for sixteen hours.



Swimmers supported in water by life preservers weighing only six ounces

Slotted Ring on the Tripod
 Holds Camera at Angle



Adjustment of two thumbscrews on slotted ring allows camera to be mounted on tripod at any angle

By simply mounting a slotted ring on top of your camera tripod, you can take pictures at any angle, vertical or horizontal. The ring is four inches in diameter, weighs four ounces and easily fits into your pocket. Two thumbscrews fasten it to the tripod and the camera at the desired angle.

Blades Replace Glass Globe
 in Latest Street Lamp

Reflecting blades replace the glass globe in the latest street lamp. With the light bulb inserted into the top of the lamp, the blades reflect light in all directions. Danger of breakage and the constant replacement of globes has been eliminated.



Clm. W. K. Morrison

See No. 1938-647

Lyons 236 State St. Schenectady, N.Y.

Mr. Lige Inland Co. Milwaukee, Wis.

Clm. Clarence V. Inouere
 Suisse Pointe, Mich.

Art 69
Carl Thomas & Co. Insurance
10555 Holman Ave
Los Angeles, Calif

EMERGENCIES *at*

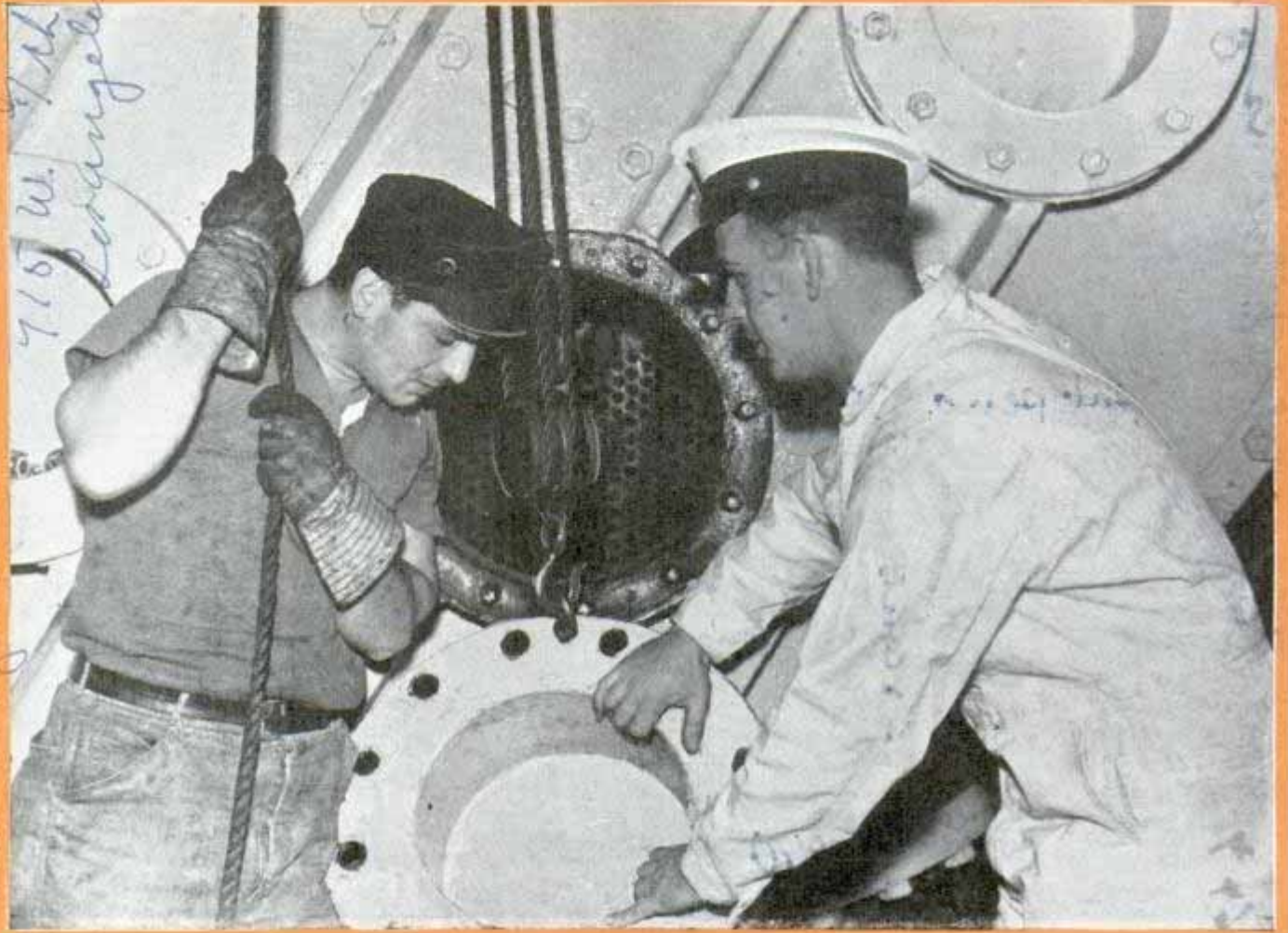

Removing heavy door from main condenser of ship's engine to inspect interior. Careful inspection frequently discloses trouble that might create an emergency at sea

LOOKOUTS at the bow, in the crow's-nest and on the wings of the bridge strain their eyes for hidden dangers when a big ship steams along in the fog. Sound as well as sight is crippled and the warning blasts of a near-by ship seem muffled and far away.

Down in the humid heat of the engine room, the engineers are ready for any emergency command. The chief engineer gave the "stand by" order when the fog first closed down and now four men, instead of the customary two, are at the controls on the operating platform. Shutting down the big steam plant is a delicate job and when it has to be done in a hurry nothing must go wrong. Even at best, reversing the engines of a big liner at emergency speed is a nerve-racking ordeal. Chaos seems to take charge as the engines rumble and pound on their supports.

On the instant that the warning bell sets up its clamor and the pointers on the brass telegraph dials swing to "Full Speed Astern" the men at the throttle wheels spin them shut and open up the reversing throttles. The propeller shafts come to a full stop and then reverse. The great propellers start tearing at the water that is flowing past them. The strain of trying to check the momentum of 20,000 tons or more of ship, the bucking of the propellers as they thrash the water, make it seem as if the propellers are going to pull the engines from their bases. Steel floors buckle and vibrate. Metal columns jiggle. Motors and generators dance on their bases. Meanwhile every man below holds on to something solid, for the emergency command may mean that a collision is coming.

It takes only a second or two to spin the throttles from full speed ahead to full speed

H269

SEA

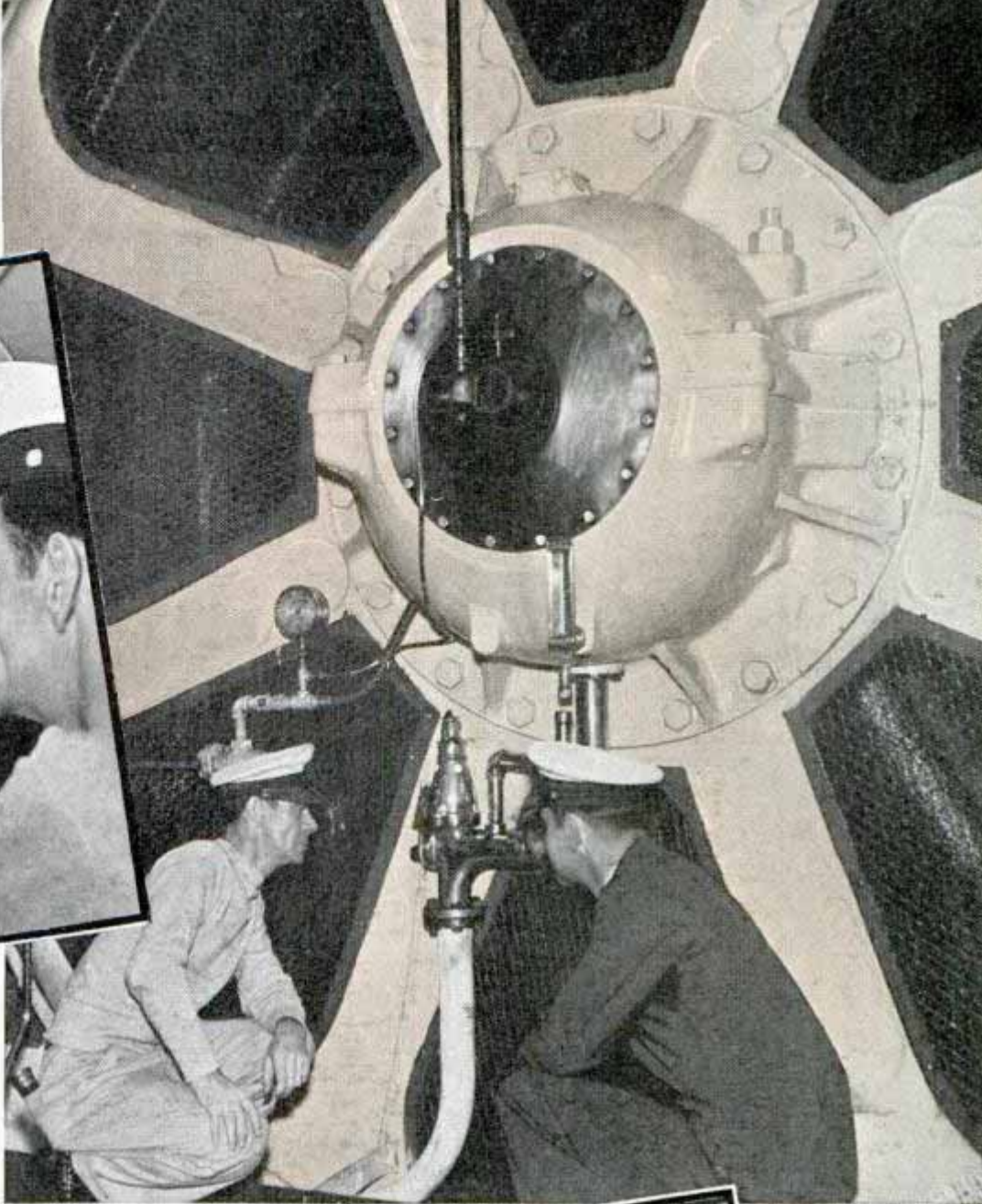
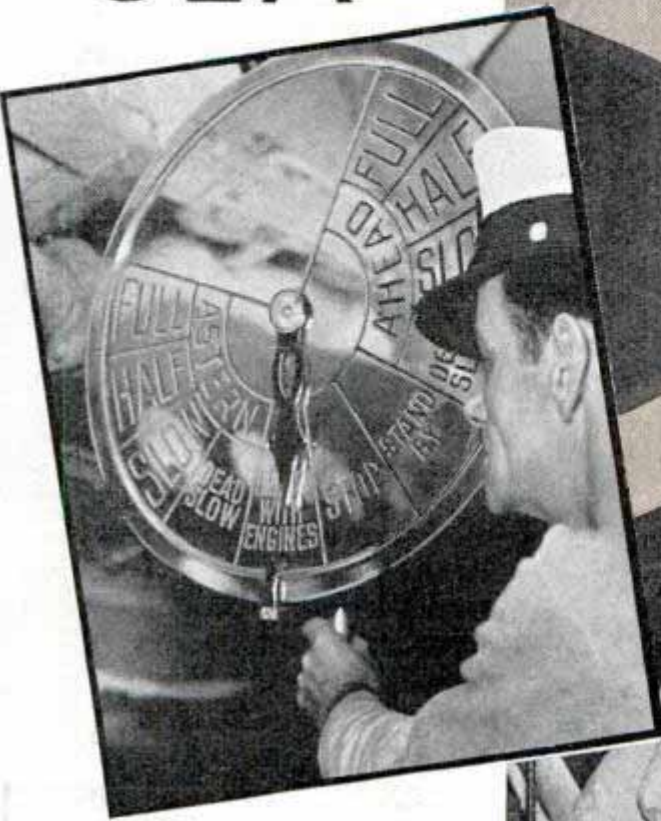

astern but a ship will slide through the water five or six times her own length before coming to a stop. A big vessel 500 feet long or more must begin to stop at least half a mile before she comes to a halt. Even at reduced speed in fog a ship's way is not checked at once. That's why, when orders come from the bridge, the engineers must execute them instantly.

Steam still rules in the big ships, whether reciprocating engines, turbines, or electric drives actually turn the shafts. All such engines are moved by steam raised in the boilers of the fire-room. In an electric-drive ship the steam operates turbines and the turbines turn generators that create the electric current that in turn operates

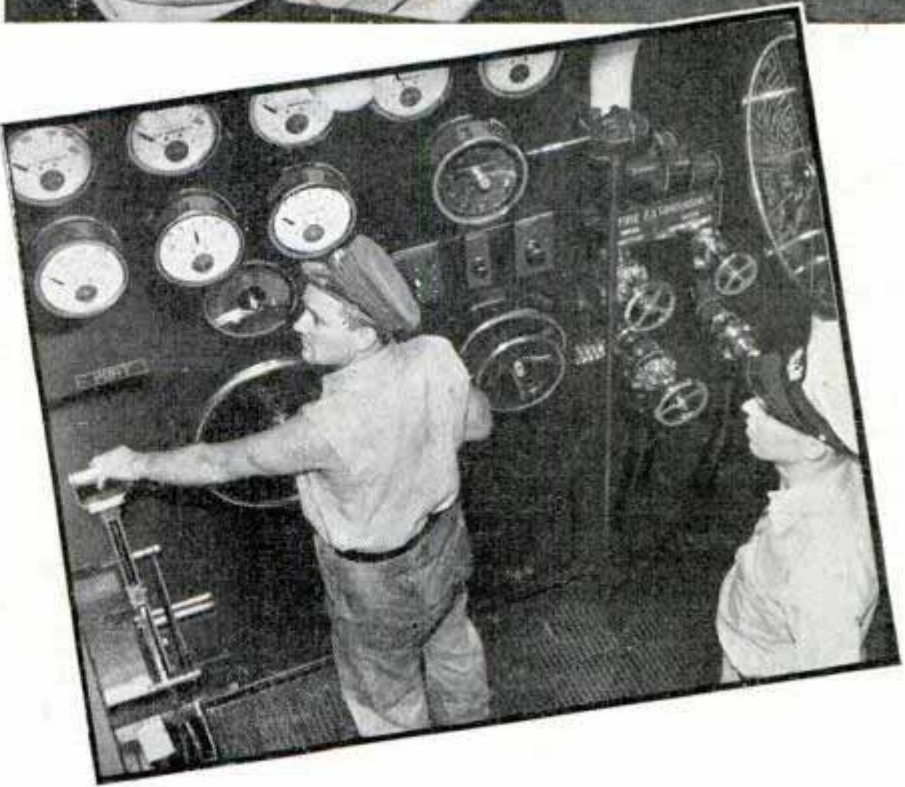

Top, left, engineer answering bells on ship's telegraph. Right, inspecting oil flow from main bearing of motor. Bottom, engineers at bridge telegraph and throttles of electric liner

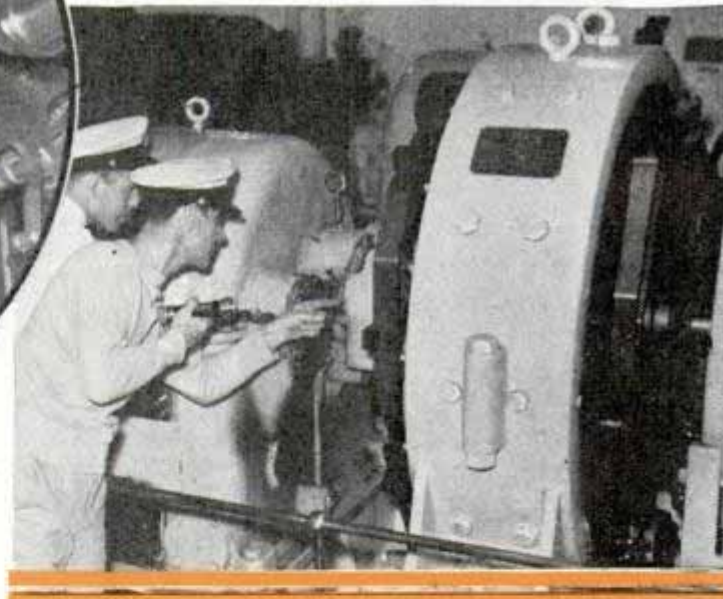
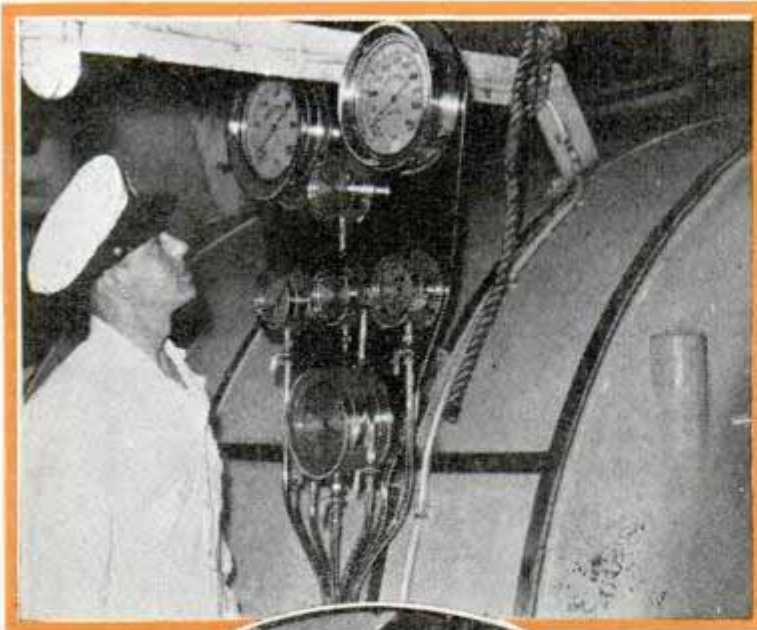

need half an hour to slow down and stop. The way to halt it at once without damage is to reverse the motor that the generator is driving. That heavy load is too much and the generator stops right then.

Such vital auxiliaries to the big engines as feed pumps and circulating pumps are installed in duplicate so that if one breaks down the other can be started up at once. Tons of spare bearings and other equipment are carried by all big ships so that repairs can be made at sea when necessary.

These days the tendency is to do most overhaul and repair work at shipyards where facilities for doing each job right are available. But in emergencies the engineers resort to ingenious ways to keep their engines going, even when there are not the proper spare

huge motors attached to the propeller shafts.

Each kind of power plant has its own problems. The first maxim of sea-going engineers is to prevent breakdowns and emergencies by scrupulous inspections. Trouble often can be caught before it actually happens. Usually the engines have to be stopped at once because a breakdown can become progressively worse if the engines keep turning. Reciprocating engines and turbines can be stopped by yanking the emergency steam trip but even when the turbine is stopped, the huge, perfectly balanced rotor of a big generator of an electric-drive plant keeps spinning at top speed. By itself it would

Top, watching gauge that shows condition of steam in different stages of big turbine. Circle, throwing switches that divert lighting circuits to stand-by generator. Right, engineers inspecting operation of small steam dynamo

parts on board. Strands of rope make a good hydraulic packing in a pinch. Babbitt metal poured into the grooves of a piston and smoothed off will serve for a while if the piston rings of a small steam dynamo fail. Properly supported, hard wood has been used as a piston head when the piston of a small steam engine shattered.

Few people ever heard of a ship running

out of fuel at sea yet this has happened more often than you might think. Normally the chief engineer puts more than enough fuel on board to last the length of the trip plus any emergency delays that could be expected. Not so many years ago a Chinese ship left port with enough coal for five days, more than enough for her three-day trip. But the chief engineer hadn't figured on fighting a steady storm. Rough weather ran up fuel consumption and with only a few miles to go the last shovelful of coal was thrown into the furnaces. The ship was within sight of her destination but she started to drift away. There was no wireless on board. Wind and current drifted the helpless vessel 1,000 miles in the next month, until she was sighted by an American ship. The crew was on the verge of starvation when rescued.

Even more recently a tanker sighted a freighter drifting without lights just at dusk 100 miles off the Florida coast. Questions by radio brought a weak reply. The freighter had run out of fuel

(Continued to page 114A)

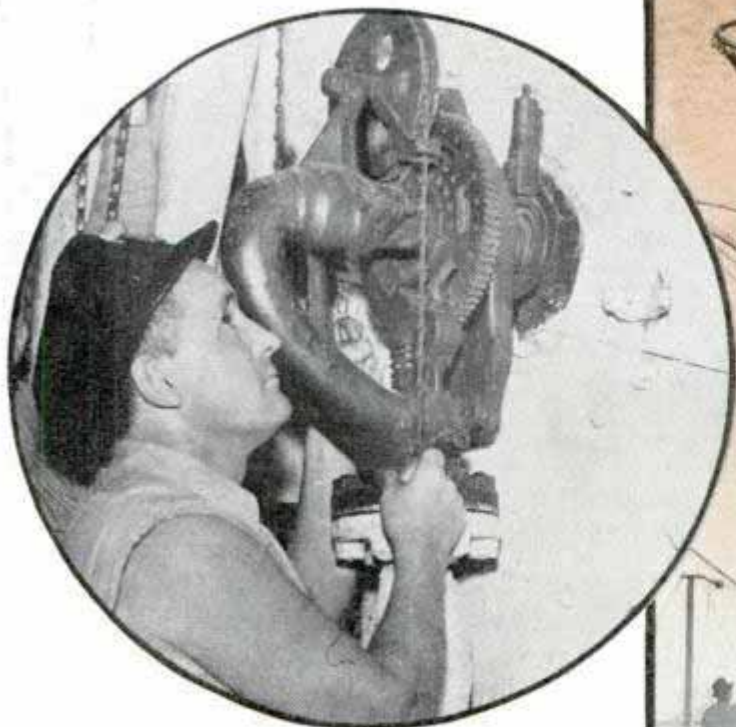
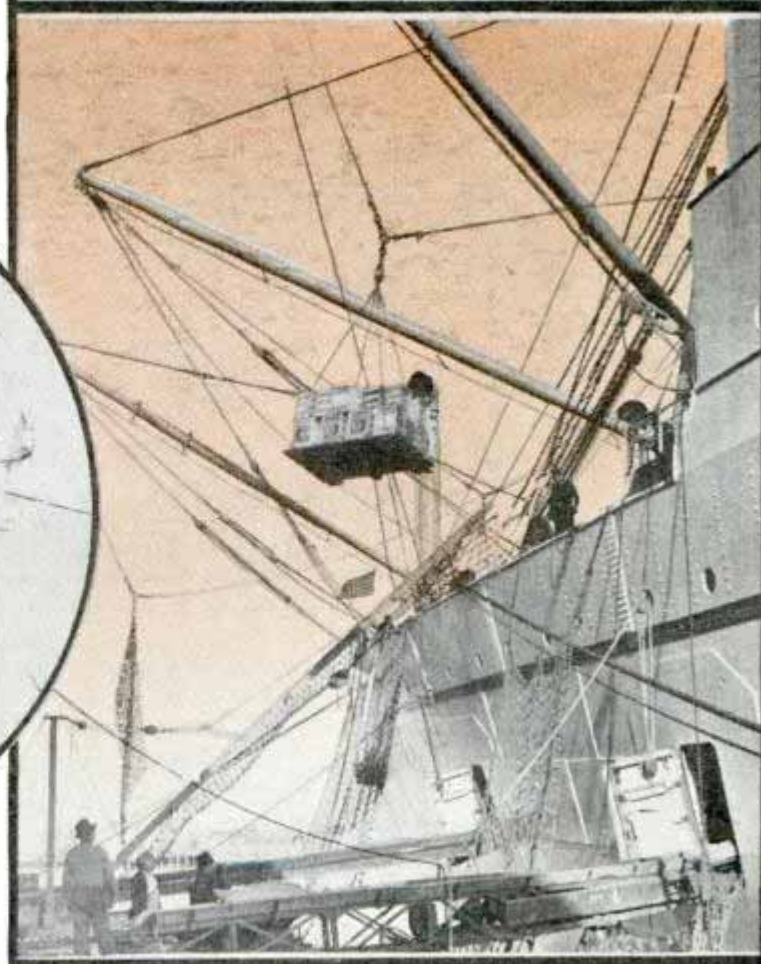

Top, engineer at throttle. Bottom, working cargo in port. Circle, opening valve to blow out tubes of boiler to remove scale

H 364

Old Home Town Returns to Life in Miniature



Top, model of old New England town as it was a generation ago, rebuilt in Californian's back yard. Center, western tank town, and below, miniature streamliner passes an old Spanish mission

Living again in miniature as it was twenty-five years ago is the old home town of H. R. Howard, a Pomona, Calif., resident who has reconstructed his former New England community as a model city in his back yard. A real forge in the tiny blacksmith shop sends smoke curling up the chimney, organ music (from a radio

set) emanates from a little church, flowing water turns the old mill wheel and a covered bridge crosses the stream. White-washed desks in the little red schoolhouse, buggies and surreys, sawmill and graveyard and bandstand all are reminiscent of the town a generation ago. The home town is but one of the scale model groups built

232 Jefferson St.

by Mr. Howard as a hobby. There is also a western tank town with a gas-electric train operated by a one-fifth horsepower motor, obeying automatic signals. Every chair and table is in its proper place inside the tiny buildings; real miniature trees and green grass, cut by shears, add to the landscape. There is a "ghost town" with an old stagecoach in front of the crumbling general store. Streamline trains roll past models of the old Spanish missions and modern California homes. The railway cars, buildings and streets are all lighted, producing a striking effect at night. Even the several trains on the miniature railroad are furnished, the club and chair cars done in leather, blue corduroy, red plush and imitation walnut; a dining car, with two tables set for dinner, has kitchen, pantry and four real refrigerators storing ice, and a motor fans air over the ice to cool the dining section. Air pressure delivers water to a shower in the observation-buffet car. The observation room is finished in walnut and green plush and one stateroom bed is made up for the night.

"Bird's-Eye" View of Target Seen through Bomber's Floor



Lying prone in nose of British training craft, bomb operator sights his target through a window in the floor

From a window in the nose of Britain's "Oxford" training bomber the crew has a veritable "war bird's-eye" view of the target. The window is used for bomb sighting, the bomb operator lying prone and training his eyes on the objective.

Mirrors Trace Car Vibrations and Help Eliminate Source

Through an arrangement of mirrors inside a portable deflection indicator, Cadillac



Tracing vibrations in automobile by means of small deflection indicator

lac engineers can locate sources of vibration in automobiles. A mirror is attached to the needle in the barrel of the instrument which registers the reflection of a beam of light on a second, eight-sided mirror. The second mirror revolves at high speed so that the light beam plots a curve against a transparent screen on the face of the indicator. Any deflection or vibration by the automobile part under test is exaggerated 250 times on the screen. A typical test is that for vibrations on an air cleaner. Readings with the instrument on vertical and horizontal planes disclose the direction of the vibration, and further similar tests reveal the source. The instrument is used in precision manufacturing, being employed to test parts. Minor flaws in the weight of rotating parts destroy balance and create major vibrations.

Cordillae Motor Car Co

much pleasant.

Transatlantic 'Flying Wing' to Offer Luxury

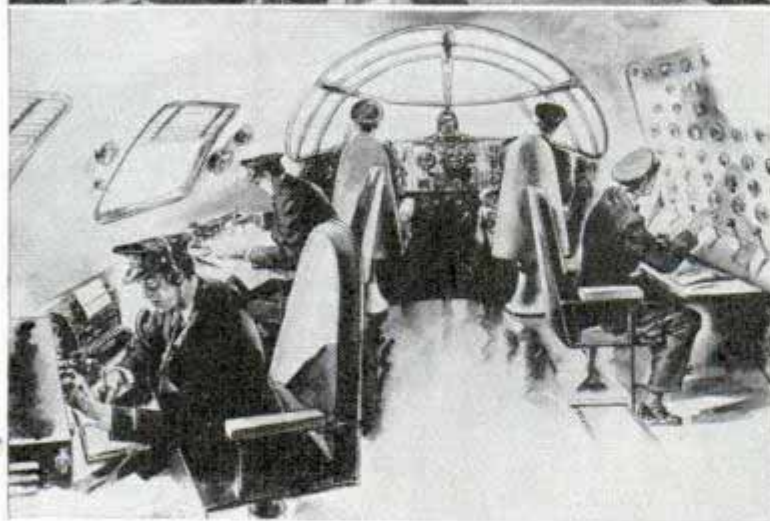
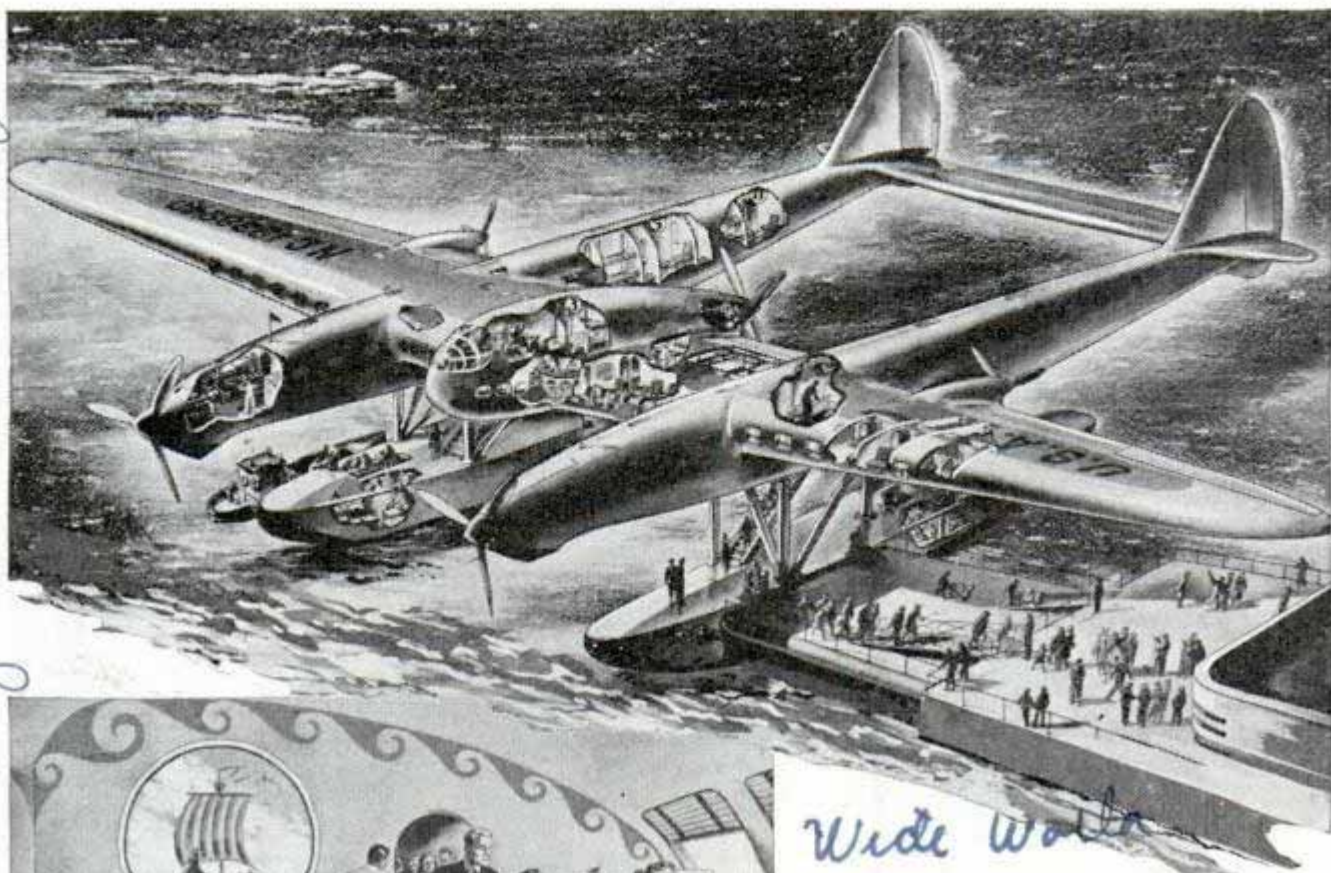

Wide Walk

Cut-away drawing indicates ample accommodations in twin fuselages and wings for 120 passengers. This is the superliner proposed by Maj. Alexander P. de Seversky for transatlantic travel. Below are the lounge-observation room in leading edge of "flying wing," affording direct view ahead for passengers, and control room in central gondola

Passenger accommodations aboard a super-clipper planned for transatlantic service will offer new luxury in air travel. The huge plane, literally a flying wing, will have dining saloon and promenade in two sections, each connected by a cocktail lounge and an observation deck. Observation windows in the leading edge of the wing will afford an excellent forward view. The two sections will have comfortable accommodations for fifty people, so that meals may be served quickly. The clipper is designed to carry a payload of 43,000 pounds and to accommodate 120 passengers. A crew of sixteen will operate the great craft, which will have a cruising range of more than 5,000 miles and a minimum cruising speed of 250 miles per hour. Supercharging will permit flight at high altitude. Passengers will be housed in the 250-foot wing, which is large enough to afford particularly spacious quarters. Attached to this wing will be two

Seversky Aircraft Corp. L.I. N.Y. Farmingdale, L.I. N.Y.

large fuselages or outriggers for housing retractable landing pontoons and supporting the tail surfaces. Hydraulic mechanism of the pontoons will perform the dual function of a retractable device and a shock absorber, so that the ship will be able to weather seas that would be disastrous to the conventional flying boat. Eight engines will propel the plane. The control room will be situated in the central gondola, permitting full view for captain and pilots and affording ample working space on the bridge for radio officer, navigation officer, captain, first officer and chief engineer. Plans for the super-clipper have been submitted by Major Alexander P. de Seversky to Pan American Airways. Major de Seversky recently was granted patents on an ingenious method for simultaneously slowing the landing speed of a plane and for increasing the lift of its wings. The method calls for ports to be placed near the leading edge of the wing and to be connected with suction ports on the under side of the wing toward the rear. Suction thus created simultaneously slows the ship and cuts turbulence on the upper side of the wing, thus increasing lift. The invention may solve the problem of how to slow extremely high landing speeds of military aircraft.

H 377
**Wood-Burner Drives a Car
 100 Miles for Half Dollar**



Boiler rack is mounted in place of trunk on rear of this economical wood-burning French automobile

Instead of a trunk rack, the French minister of agriculture has a boiler rack on his wood-burning automobile. Because of the high cost of gasoline in Europe, manufacturers are constantly experimenting with other fuels, such as wood, charcoal and coal. This car travels 100 miles on fuel costing fifty cents, and is said to be capable of the same speed as gasoline cars.

H 340
**Watch to Fit Side of Wrist
 Gives Quick View of Dial**

So curved that it is worn on the side, instead of the back, of the wrist, the latest watch for men affords full view of the dial without the usual turning of the arm. Tests indicate that it is subject to less bumping and scratching than wrist watches worn in the ordinary manner.



Wrist watch with patented curved movement is worn on side of wrist, protected from jars and scratches

H 407
**Abrasive Disk Glued on Wheel
 Can Be Used Immediately**

Abrasive disks made of paper or cloth may be applied with a fast-drying glue which does not require clamping. The wheel can be used immediately after applying the disk and glue. The glue

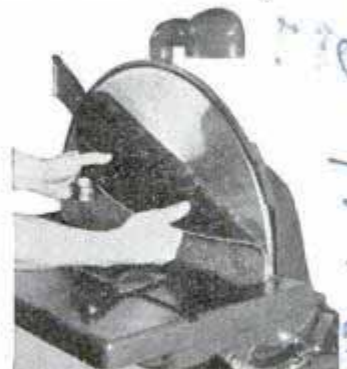

is brushed on both the disk and metal wheel, but when removed the glue adheres only to the worn disk.

Send return postage to our Bureau of Information to learn the name of the maker of any device described in this magazine.

Curver, \$50.00
 The Watch Co.
 13697 Glenwood Ave.
 Chicago, Ill.

The Watch Co.
 13697 Glenwood Ave.
 Chicago, Ill.

H 426

Bucket Held on Slant Roof by Adjustable Legs



Working on a gable roof, the painter adjusts the legs of bucket holder to keep the can level

No matter what the angle of roof or ladder, there is a paint-bucket holder that will keep the can level and steady. When the bucket is needed on a slanting roof, the adjustable legs extend downward on the outer edge like the props of a mountainside cabin. It will perch on chimney top or ladder equally well, and is adaptable to paint cans of four sizes.

Meter Tests Washed Negatives to Detect Any Hypo Left

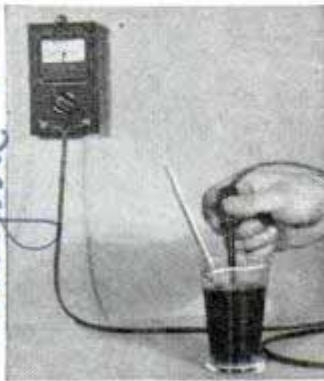

If photographic prints are to keep their original brilliance and not turn yellow, the hypo must be washed off thoroughly during the developing process. A "detector" just brought out will show the presence of one part of hypo in 10,000 parts of water and thus assure clean negatives. The drip-

pings from negatives or prints are poured into a graduate or glass tube and the test electrode immersed in the liquid. The meter instantly indicates the amount of hypo remaining in the water.

Food Cans with a Silver Lining Deal Death to Germs

Tin cans with a silver lining soon may be used by the food-packing industry. Silver-lined cans would have an added safety value because of the germ-killing property of silver. The research division of the national Bureau of Standards has developed a can that could be produced at relatively low cost. Twelve-ounce solderless containers have been produced from silver clad copper and steel sheets, the base metal being twelve-thousandths of an inch thick with a silver coating one-thousandth inch thick.

Derrick Drills City Sidewalk to Reach Water

Set up on the street in a busy southern city, a small oil derrick recently was used to drill through the sidewalk to reach water. Installation of an air-cooling system in a bank near by made necessary the drilling of a well to obtain a water supply.



Here is a derrick set up in a busy city street to drill for water

Wm. A. Bergstrom
Vineyard Blvd. N.Y.
Tulavite

Subm: 2/29/38

Applied in the State of America

H 387
Haynes Products Co.
36 Liberty St.
New York

Carandeled St

Hamilton, N.Y. a derrick 25 ft
with a derrick

Hebering Bank + Trust Co. Foundation

H 437

Harold Haphack
Bellflower, Calif.

Hydraulic Dial Shows Pressure on Oil Drill

Sensitive to every change in pressure as the bit sinks into hard or yielding rock strata far underground, a hydraulic weight recorder invented by an oil worker in California permits the well driller to keep constant watch on the course of his drill. If pressure on the bit is not relaxed when the bit encounters a tough layer of rock it may slant off on the line of least resistance. By watching the dial of the automatic recorder the operator can lessen pressure when needed and let the bit continue to bore straight down. The inventor connected a drumlike device to a steel line fastened stationary at the derrick end, and connected to the well pipe and drilling tools. Tension on the steel line compresses the drum, which contains a hydraulic system, and fluid is forced through a tube to the gauge located at the drill controls. By recording the weight of the suspended pipe, drilling bits, etc., in

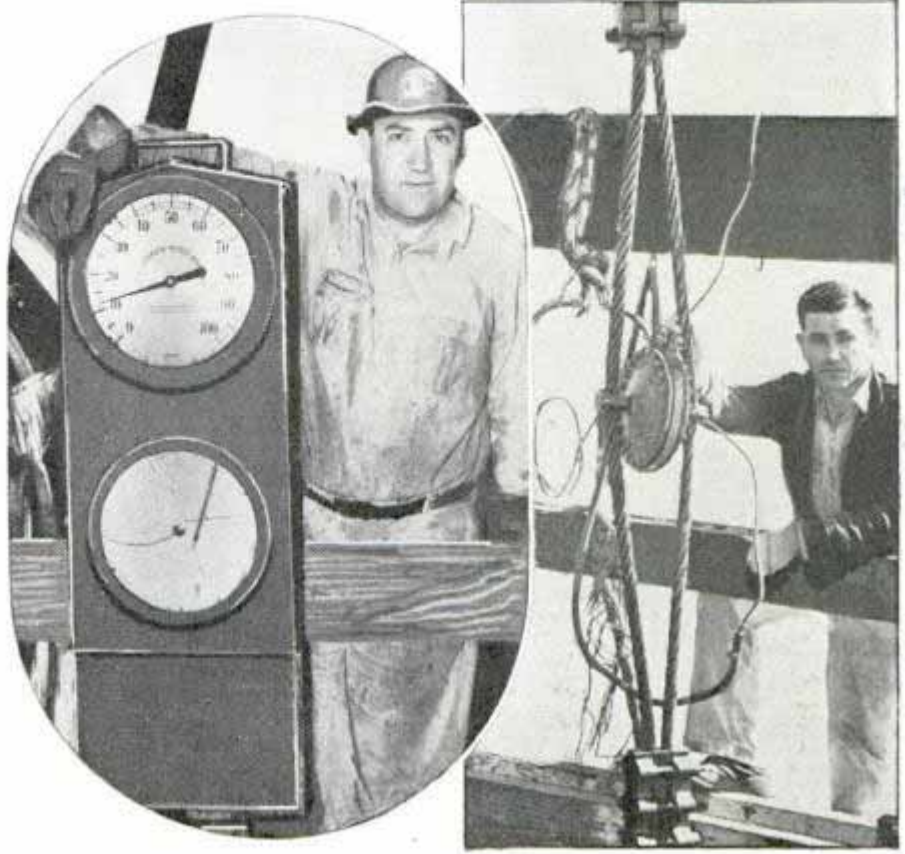

Tension on steel line and drum, right, is transmitted by hydraulic line to dial at left which shows pressure on drill in oil well

the well hole the degree of pressure exerted by the drill bit on the rock can be determined. The more resistance met, the less weight is recorded. The inventor expects to adapt the device to weight-recording machines in other lines of industry.

H 368.

Synchronizer for Photo Flash Is Adapted to Any Camera

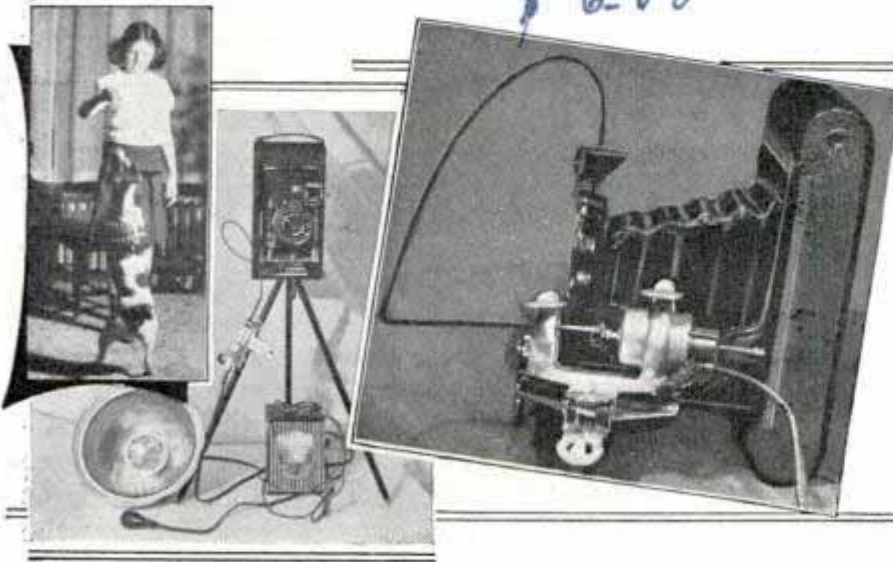

Adaptable to practically any camera, a synchronizer just offered makes it possible for the amateur photographer to time his flashlight and his shutter simultaneously by closing an electric circuit. It is easily attached, weighs only ten ounces and can be operated by battery or house current. Synchronizer and flash bulbs are put in the same circuit and neither can work without the other. A clamp holds the device on camera or tripod.

Synchronizer, shown attached to ordinary folding camera at right, trips shutter and flash bulb simultaneously as electric circuit is closed

S. W. Duncan, c/o Auto Power
12401st Ave

Vertical handwritten text on the right margin, possibly a page number or reference.

Mr. James M. Sweeney
 431 W 60th Terrace
 Kansas City, Mo

H 103

H Claude Enslow, 2940 Forest, Kansas City, Mo

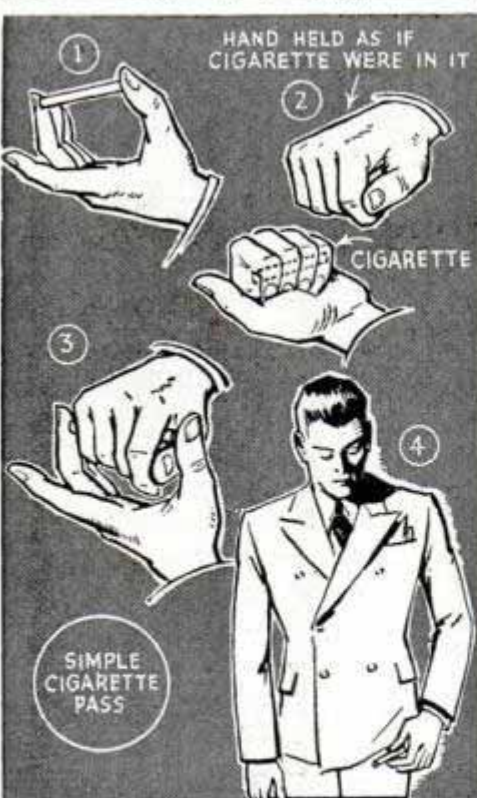

VARIETY

By Claude Enslow
 Professional Magician

2940 Kansas City, Mo

THE professional magician usually garnishes his card tricks with trimmings such as fans, flourishes, riffles and one-hand cuts. Although such movements may have no direct bearing on the tricks, they are spectacular, and by applying a few secrets of the professional, the amateur entertainer can dress up his own stunts.

Soaping a deck is a big aid in achieving dexterity because it makes the cards smoother and easier to handle. Dip a flannel cloth into fine powdered soap and rub both sides of each card. At first the cards may stick together but this tendency will disappear. By idly flipping the deck in spare moments, you will acquire digital nimbleness in a few weeks.

Variety is the spice of magic and even in impromptu exhibitions, you should strive for a well-balanced program of card, rope, coin and cigarette tricks. Changing the color of a card is an excellent introductory stunt for any gathering. Holding the deck so spectators can see the top card, announce you are going to pass your right hand over the deck

Top to bottom at left, various steps in rising cigarette trick in which cigarette eventually disappears. Above, at right, pulling cigarettes out of the air and placing them in hat. Insets show props

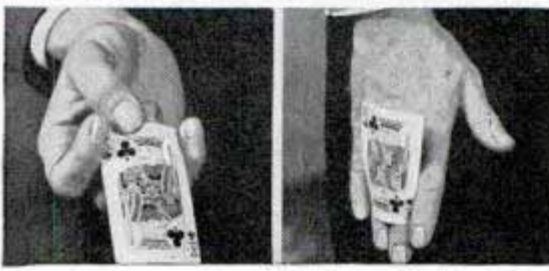

in YOUR MAGIC

slowly to change the card's spots. You do this and then allow your right hand to drop to your side. By the rigid way in which you hold it the audience suspects you are concealing a card in it. When you feel certain the eyes of the crowd are glued upon it, turn your hand slowly to show it empty.

When performing this trick, make a few preliminary passes over the deck with your hand. When ready to change the color, place the thumb of your right hand behind the deck and your hand will naturally cover the deck just as it did on the preliminary gestures. It's a good idea to moisten your thumb. This will enable you to slip the card off the back and grip it between thumb and finger. Without any hesitancy take the card off the back and place it on the top. Then again bring your



Soaping cards to make them smoother. Top, close-up of the back palm, the basis for many disappearing card tricks, including the one illustrated in which the card disappears as it is passed back of the trouser leg of the magician

14 105



In picking up the card, hold it between the two middle fingers and thumb of your right hand with the former bent down so the two nails are against the back of the card, the thumb holding it from the opposite side. While the "rubbing in" is being done, the first and little fingers grip the card so as to curve it. When the hand is opened the card goes to the back, revolving between the first and fourth fingers as though on an axis. As the card

Above and right, start and finish of trick by which magician changes spots on card. Close-up shows how he does it. Below, burr makes coin stick to wall. Bottom, how coin is passed through a hole of smaller diameter

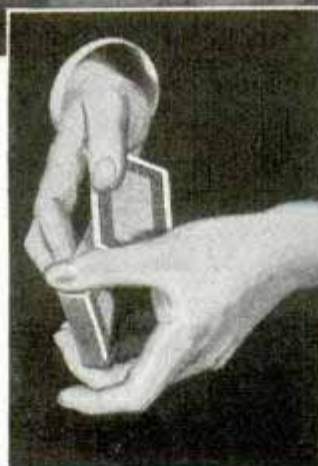

hand slowly over the deck as you did at first. Be deliberate about dropping your hand to your side to arouse the spectators' suspicions. Practice in front of a mirror until you fool yourself. Then you are ready to perform it.

Go into your second trick by accidentally dropping one card from the pack. When you stoop to pick it up, pass it back and forth behind your trouser leg as if you were trying to rub it into the calf of your leg. The card vanishes and you show both sides of your hand to prove it is gone. A simple back-palm is the basis of this stunt. A half hour spent in its mastery will be amply rewarded as palming of this type enters into many tricks.

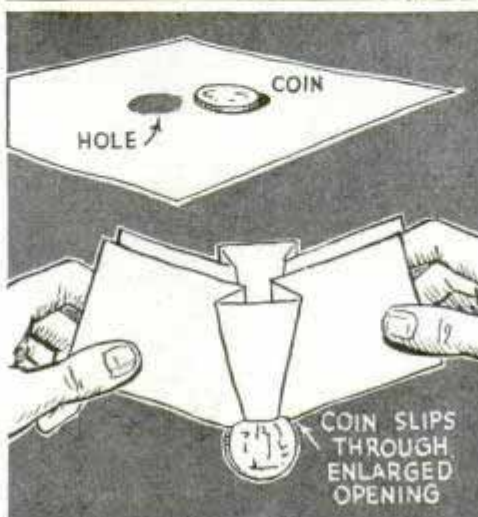
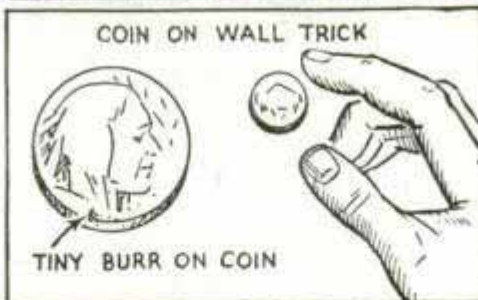

is now on the back of the hand, the palm is shown to be empty and then the whole body wheels to the left in a sweeping motion. Pivoting on your left foot, turn your right leg over to show it to your audience. While doing this your right hand goes quickly to the pack to place the card on it. The spectators do not see you do this because your body is turned away from them, and besides, their attention is riveted on the back of your leg where they think the card is concealed. After depositing the card on the deck, the right hand comes back and brushes across

the trouser leg to show the card has vanished. This time, both sides of the hand can be shown.

The rising cigarette is a clever stunt. An ordinary cigarette is held in the fingers of the left hand. The fingers are then closed over it and the hand is turned over so the back of it faces the audience and the cigarette is seen to rise slowly from the hand. You start to repeat the trick but the second time seem to encounter difficulty. When you open your hand the cigarette has disappeared. Here is the secret. As the cigarette is held in the fingers of the left hand the right hand closes them over it. The left hand is then turned over with the fingers of the right hand being held to conceal the movement of the left-hand thumb as it pushes the cigarette upward.

On your second attempt, the start is the same but as the fingers are being closed over the cigarette, it is gripped by the second finger and heel of the right hand. The left hand is turned over, leaving the cigarette in the right hand. While you are showing your empty left hand, your right hand can "discover" the cigarette under someone's coat.

Picking cigarettes out of thin air is spectacular but requires very little skill. As you pick the cigarettes out of the air you place them in a hat then distribute them among the crowd. The secret of this trick is a fake "cigarette" that is placed on the back of the second finger. This fake can be cut from a tin can, soldered, and then painted. The "cigarette," about two inches long, should be painted flat white. The clamp should be flesh color. Another variation is to solder a pin on a clamp, then slip a cigarette onto it.

(Continued to page 132A)

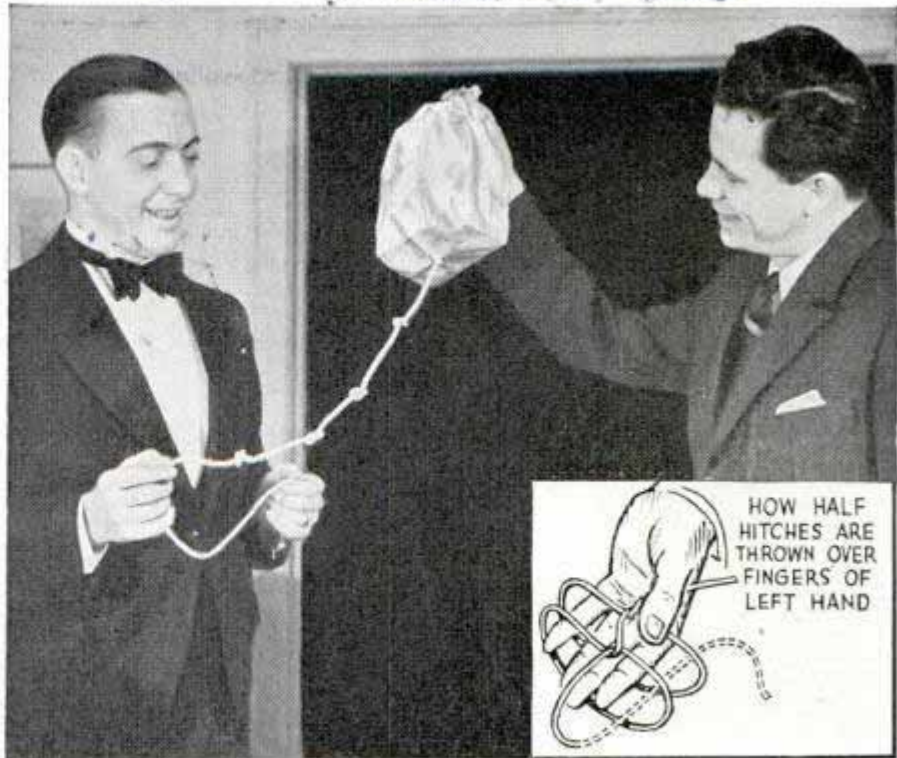

Details of "spooky knots" trick, top, in which a rope appears to tie knots in itself. Below, a trimming of magic—a riffle. Inset shows start of the riffle

Editor, San Francisco.

86 465 *Caplan* POPULAR MECHANICS *Rudge*

Air Is Analyzed at Bridge for Its Effect on Paint

San Francisco



Four-cup fan pumps sample of air into bottle of distilled water for analysis of elements

Because of its effect on paint, engineers are testing the air "breathed" by the San Francisco-Oakland Bay bridge. Just below the lower deck of the bridge at one of its towers they have mounted a four-blade cup vane fan which turns in the wind, operating a pump that sucks air into a bottle of distilled water. For every thirty fan revolutions the pump turns once, scooping up seventy-five cubic centimeters of air. When the pump counter shows 99,999 revolutions the bottle is sealed and sent to a laboratory for analysis of the air sample. Tests have disclosed sulphates, salt, coffee chaff, soot and other elements in the air.

"Electric Eye" Counts Ballots and Guards against Stuffing

There's no stuffing of the ballot box when the "electric eye" is on guard. An automatic count of ballots by means of a photoelectric cell was employed during an election at a recent Chicago bowling meet. A vote was registered each time the light

beam was broken as a ballot dropped into the box. Even if several ballots had been stuffed in at once, only one would have been counted. To falsify the vote, a person would have had to drop extra ballots in separately, and election officials could easily detect that.

H 402

Push-Button Electric Jacks Speed Up Tire Changes

Designed for permanent installation on the automobile, electric jacks speed up tire changes. A push button on the dash sets the jacks in motion and they automatically raise the car to a height that gives ample ground clearance for changing a flat tire. Pressing the same button restores the jack to driving position. The system contains two jacks, one on each side, and the push-button unit. Only one jack can be operated at a time. Electrically operated like the self-starter, the jacks use approximately the same amount of current for raising the car twelve times as the starter does for starting the engine once.

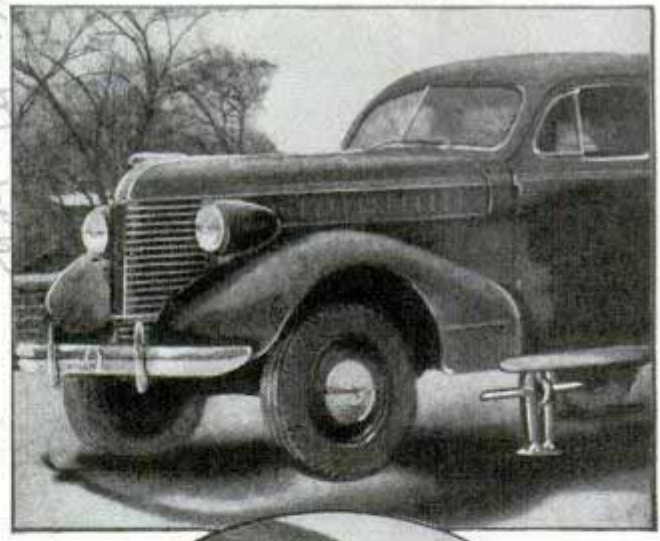

Two views of electric jack in use. Top, raising auto. Bottom, supporting trailer

Sacramento Laporatoris, Div. of Highways.

General Electric

American Bowling Congress

Liftomatic, Inc.

'Flying Tank' Is a Mobile Gun Nest on Land

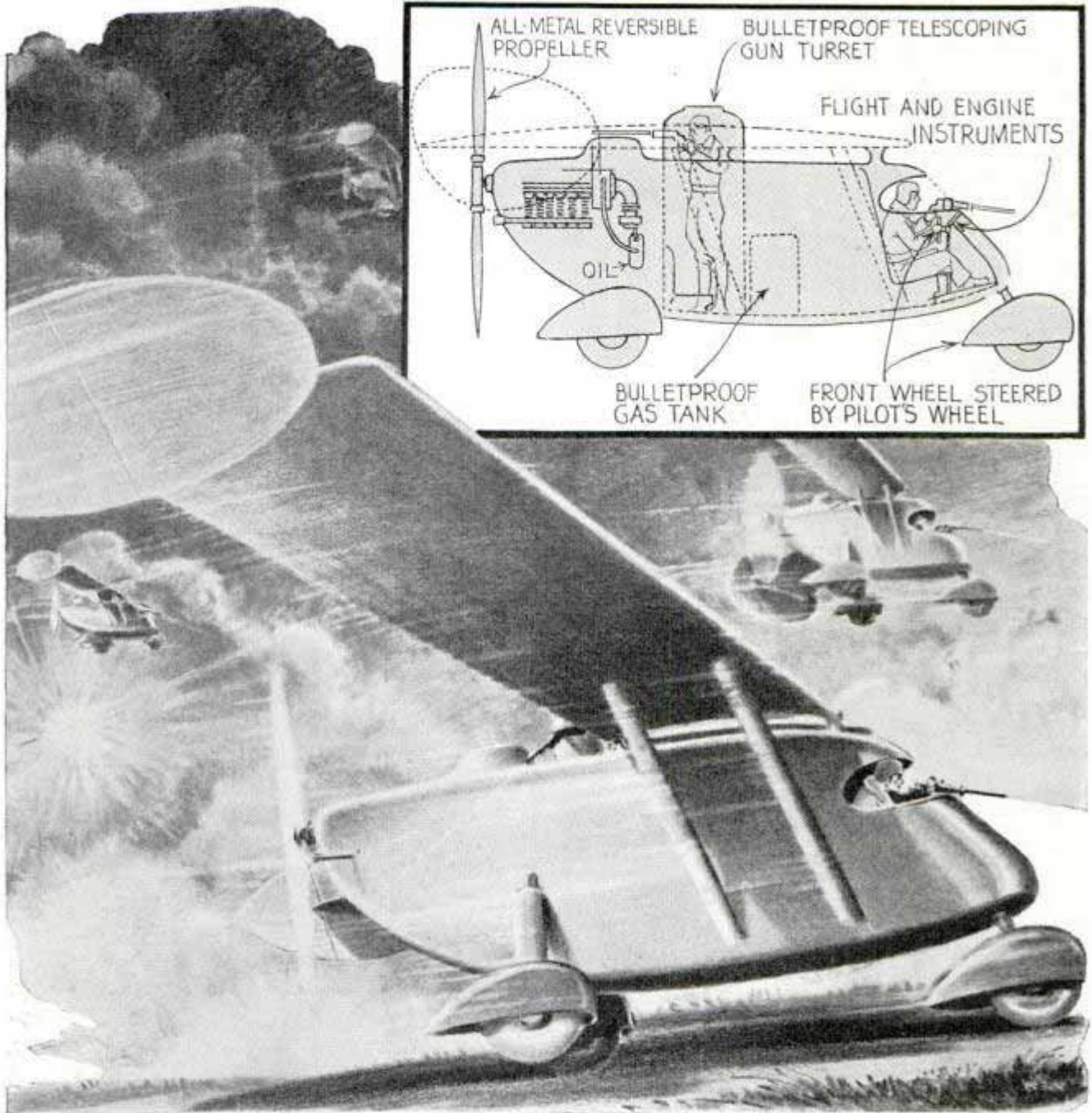

Ready to fight on land or in the sky, this two-gun craft can shed its wings in two minutes and take to road. Phantom drawing at top shows arrangement of cockpit, gun turret and removable wings

Detach the single V-shaped wing of the "flying tank" and you have a swift, mobile machine-gun nest whose reversible propeller can drive it seventy-five miles an hour in land-battle maneuvers. Plans for this versatile little fighter have been developed by Waldo Waterman, previously designer of a convertible airplane-automobile. In the air his flying tank would cruise at 160 miles an hour, spurt to 180, the pilot manning one machine gun from his steel-armored forward cockpit—engine and propeller are at the rear—while a sec-

ond gunner operates in a revolving, bullet-proof gun turret. The plane could take off or land in a small space. Its wing span is only thirty-seven feet and the "capsule" cockpit only fourteen feet four inches long. A fleet of these tiny ships could land behind enemy lines, drop their wings in two minutes and operate against land troops. They could be stored compactly on an aircraft carrier and make swift raids against inland cities, then return and stack their wings below decks on the ship. The pilot's wheel steers the front wheel on land.

Aviation Engineer, Santa Monica Calif

"Upside-Down" Dam Cuts Floods in Middle

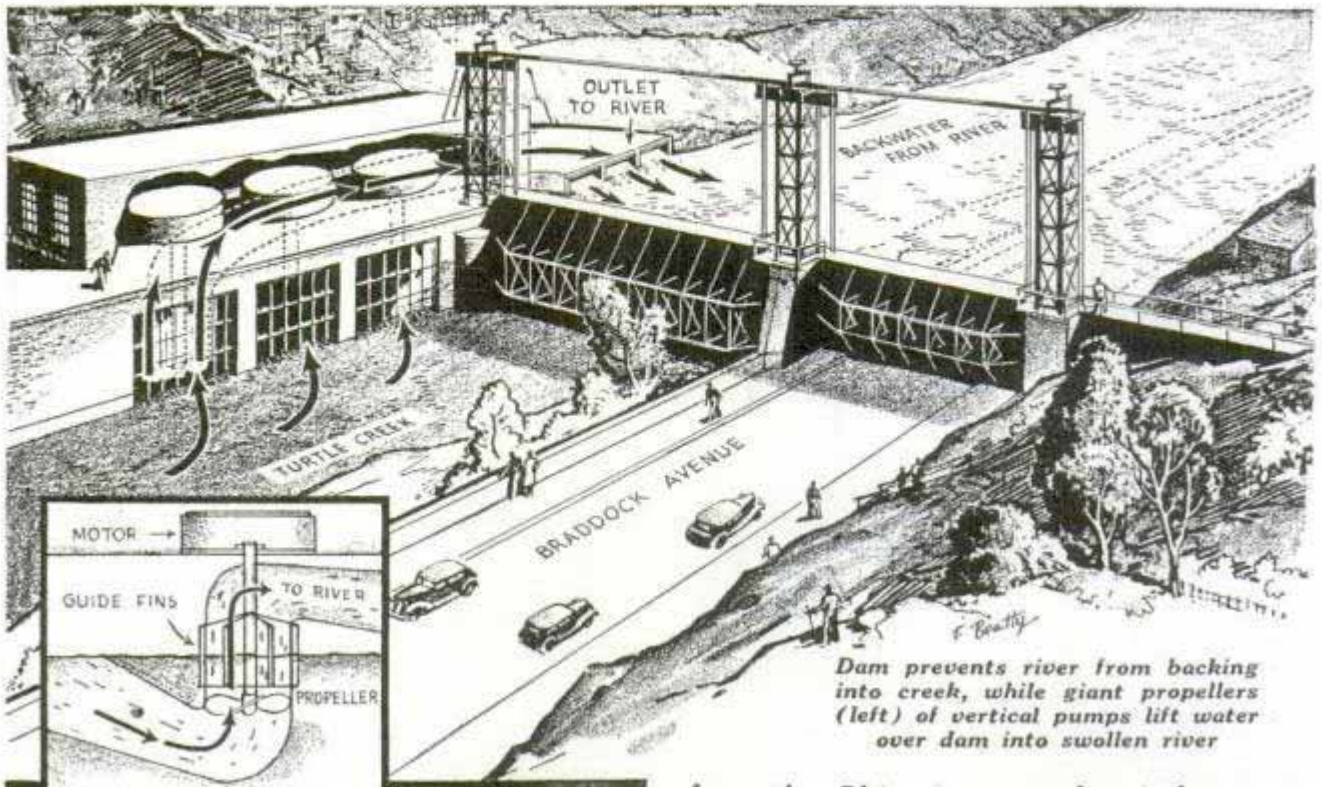

Dam prevents river from backing into creek, while giant propellers (left) of vertical pumps lift water over dam into swollen river

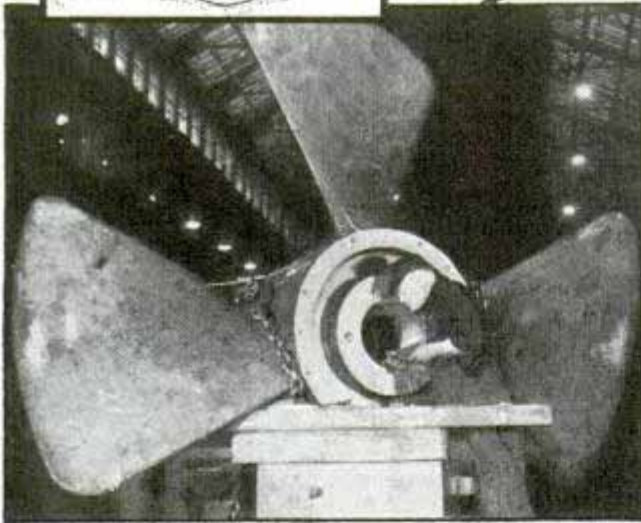

DESIGNED to protect the industrial valley of Turtle Creek against floods, a novel structure near Pittsburgh, Penna., is described by engineers as an upside-down dam. As the result of preliminary tests, Westinghouse Electric and Manufacturing company engineers expect the dam will be capable of pumping enough water out of the valley every twenty-four hours to fill a large city block to a height of 648 feet. The effectiveness of the dam depends upon its three giant vertical pumps to keep the flood waters of Turtle Creek flowing downstream, while two massive steel gates shut out water of the Monongahela river as it strives to back up

from the Ohio river at what is known as the "Point" at Pittsburgh. Actually it will cut two floods in the middle. First, the down-flooding water of Turtle Creek will be walled in; then, the backed-up water from the Monongahela will be walled out before it starts a counterattack up the valley. History has taught the engineers that about twenty-four hours after Turtle Creek has carried the crest of its own flood waters, it is piled back upon itself by the Monongahela, into which it flows about one and one-half miles below East Pittsburgh. With the gates closed during a flood, the pumps in the dam will quicken the flow of the creek through tunnels around the barricade. With the approach of the next flood, the larger of the steel gates, eighty feet long and thirty feet high, will be lowered across the creek. The smaller gate, forty feet long and twenty feet high, will close off Braddock avenue, which parallels the creek at the low point of the valley. Three ten-ton propellers will force the water around the east end of the dam through three tunnels large enough for a locomotive to pass through. Three 5,000-horsepower electric motors rotate the pumps 112 times a minute. Each motor is twenty-three feet in diameter. From the creek above the dam, the flood water will pour into three entrance ducts

and rush down a sharp incline to pumping pits eleven feet below the creek's normal surface. The propellers will spin the water upward through vertical wells from which it will be deflected into horizontal chambers which permit the flow to expand gradually and reduce its velocity before it is emptied on the downstream side of the dam. A metal guide vane of four six-foot blades, placed above each pump, breaks up the stream of water into four paths to prevent eddies and increase the efficiency of the pumps. Each vane weighs 47,000 pounds. By first lifting the water up the pump shafts sixteen feet above the outlets, the pumps will create a siphoning effect, helping to pull additional flood water up through the chambers. The effect of the barricade will be that by pumping the flow beyond the gates, more water will be put into the Monongahela during the time its stage is rising, bringing the river to its crest a few minutes earlier than normally. The dam was built by Westinghouse as flood protection for its East Pittsburgh works.

Diver Puts on 3,000 Pounds of Armor for Deep-Sea Trip

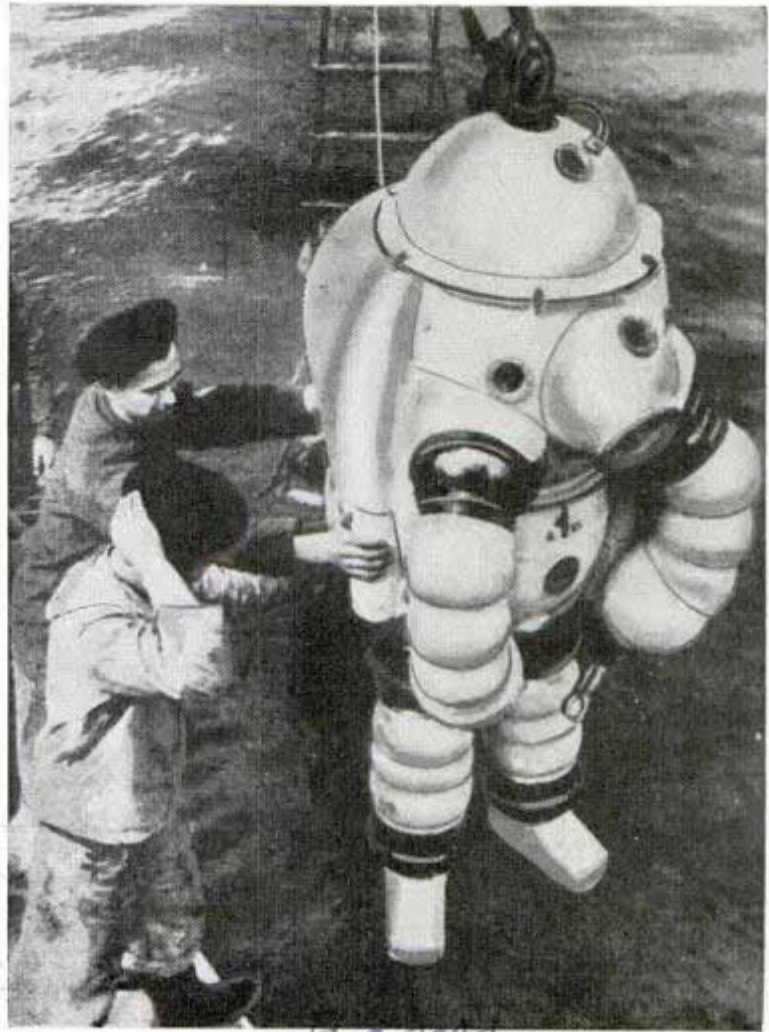

Encased in a 3,000-pound shell, diver is lowered for deep-sea test. The armor was designed to stand pressure 800 feet deep

Keyhole with 'Funnel' Face Guides Key to Opening

Fumbling at keyholes in the dark is a nuisance made unnecessary by a "funnel-faced" lock just invented. No matter where the key strikes the face, the inward slant of the surface guides the key easily to its slot.



Deep-sea fish living in the terrific pressure that exists 800 feet beneath the ocean surface are to be introduced to a grotesque new monster. A diver's suit of armor weighing a ton and a half has been invented by Cavalier Roberto Galeazzi of Italy and has met its tests successfully. Equipped with articulated limbs, it is designed for 800-foot descents—nearly double the depth previously reached by a diver—and thus opens a new and unknown field.

Rubber-Clad Hammer Absorbs Shock

Live rubber, surrounding the end of the handle extending through the eye of a new hammer absorbs much of the shock resulting from blows with the tool. Forced into place under pressure, the rubber is held by special cement.

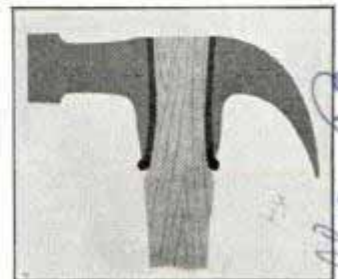

Write care of inventor, Congress

H 419

H 3 58.

Max Lowenthal

1 seller P. S. ...
 879 ...
 Newark, N.J.

A174

SECRETS of the

high fidelity headphone
P.S. 7. 18
\$7.50

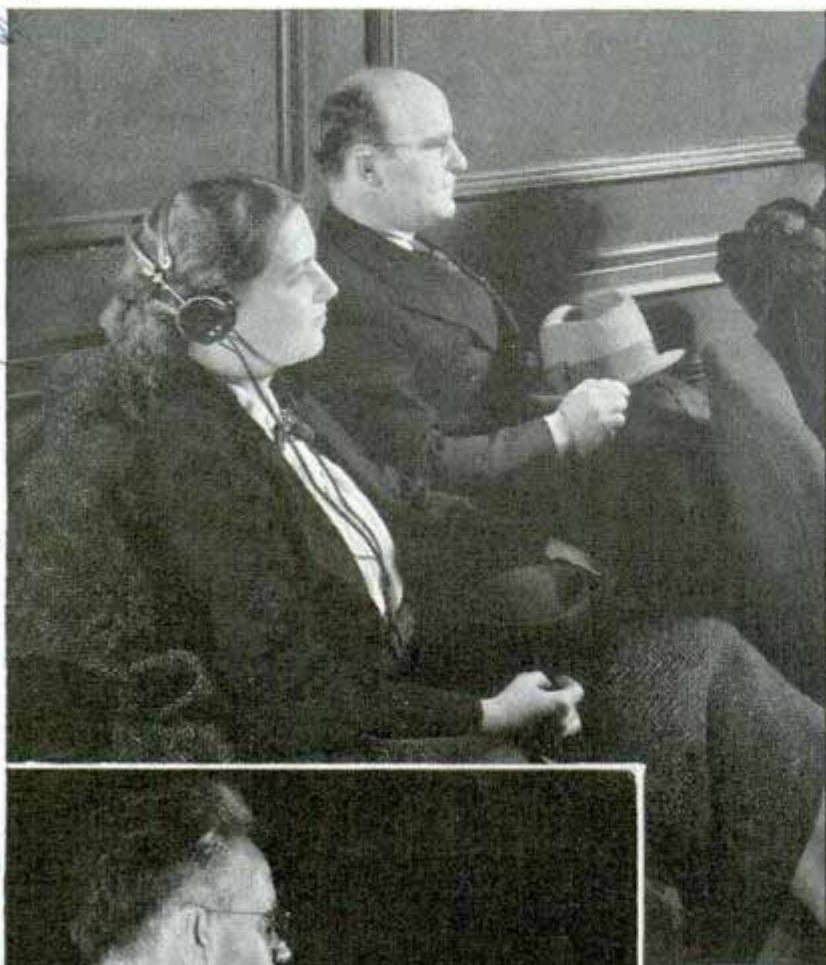

\$30.00
\$26.50

see manual
1952-362
P.S. 7. 18
\$7.50



By H. W. Magee

TWO uncanny feats of magic performed by a glasslike material called Rochelle salt crystal rank this man-made substance as one of the world's modern wonders and also as one of its great mysteries.

This "singing" crystal which is "grown" by a chemical process not only does two astonishing things, but does both of them about one thousand times better than any other known material. First of all, if squeezed or placed under strain, it becomes electrified, instantly converting the pressure into a corresponding amount of electrical energy.

Twisting or bending such a crystal, for example, may produce enough electricity to cause a neon tube to glow and even produce a very small jump spark in the air. Thus the crystal is a generator. But that is not all. If it is electrically charged, it just as quickly changes the electrical energy into mechanical motion by vibrat-

Sound-cell "mikes," bottom, in use in auditorium. Top, left, girl wearing crystal headphone for hard of hearing in theater. Right, high output sound-cell microphone, lapel "mike" and crystal heart-beat pickup

3311 Perkins Ave.
Cleveland, Ohio

12/194

"SINGING CRYSTALS"

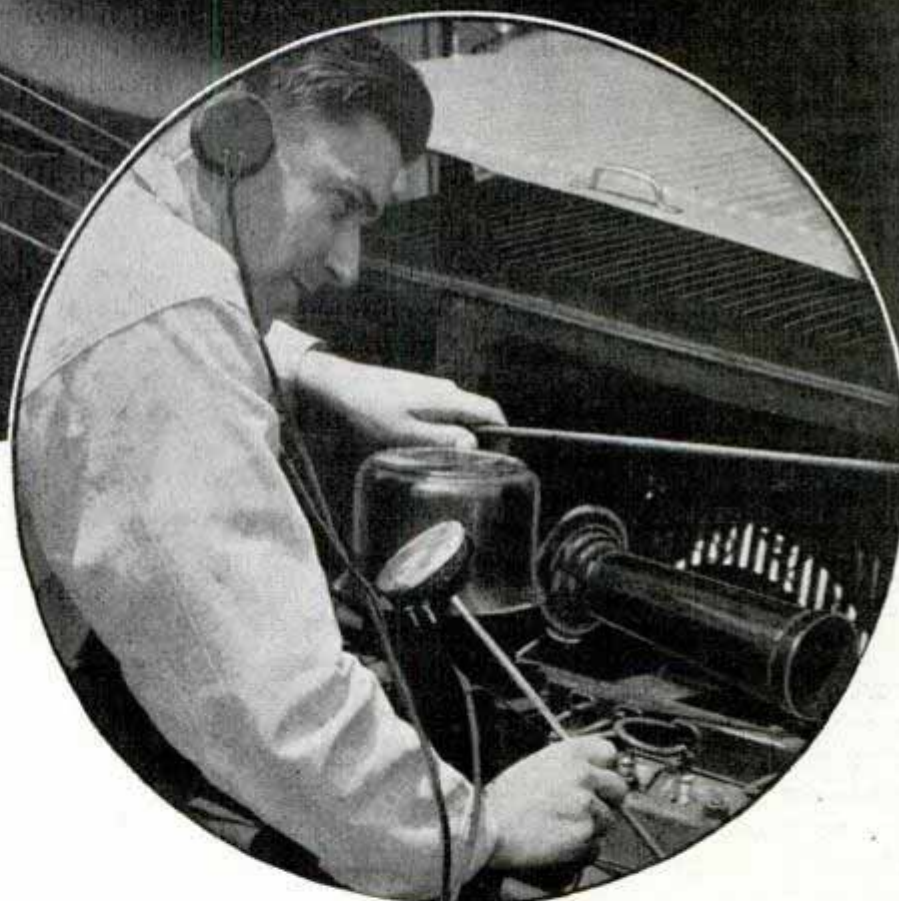
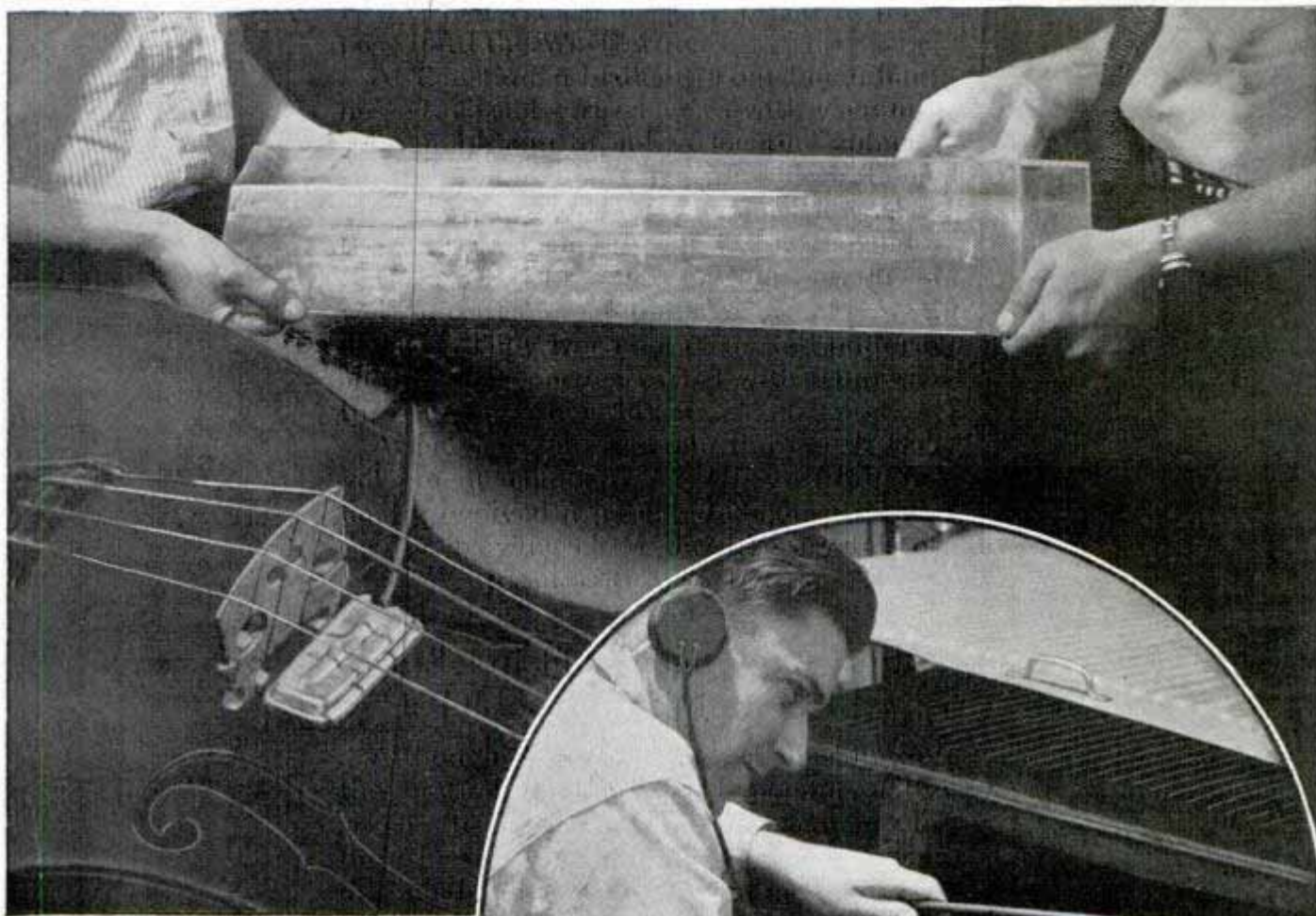

Photos courtesy
Brush Development Company

\$ 25 00
\$ 4 250

Musical pickup mounted on violin for reproduction through amplifier and loud-speaker system, and large Rochelle salt crystal produced by Brush Development company. Right, locating motor noise with vibration pickup and headphones

ing or twisting or bending. Hence it then becomes a driver or sort of crystal motor.

Why this particular substance can instantly change pressure into electricity, or transform electrical energy into mechanical energy, no one knows exactly. But in its raw state, the crystal is soluble in water and melts at 165 degrees, so one theory is that the material is so unstable that even a little pressure, as from sound waves, causes the molecules to slide over each other and build up an electrical charge.

While the reason it reacts in this way is a mystery, the fact that it does has enabled man to harness its unusual properties and put the crystal to work at dozens of tasks, some of them as unusual as the remarkable traits of the crystal itself—tasks like detecting the presence of insect pests by the faint noise they make in a field, and making a visual record of human heart beats. But perhaps the widest and most unusual application of all is in radio.

Almost as amazing as radio itself is the



role played by a few bits of this substance sealed in the heart of the modern crystal microphone and headphone. When an opera singer hits C above high C, you actually hear the note over your radio a brief instant before the sound reaches the ears of her audience because radio waves outrun sound waves.

But before you hear her voice, the sound energy must be changed to electrical energy, the electrical energy must be amplified and transmitted through space, and your receiver must convert it back to sound—all in a split-second. The beginning and end of this near-miracle, changing sound waves into electricity, then reversing the process, is accomplished in the twinkling of an eye, in the case of the crystal "mike" and headphone, by some little "sandwiches" of Rochelle salt crystal.

The magic properties of this crystal have been known for years but until recent times no one knew how to harness them and put them to work. A century before the Revolutionary war, an apothecary at Rochelle, France, obtained a powdery substance, sodium potassium tartrate, from a chemical solution. It was used for me-

dicinal purposes like Epsom salts and came to be known as Rochelle salts.

A century passed, then someone found that certain substances, if subjected to pressure or strain, develop electric voltages on opposing surfaces. Such materials are said to have piezoelectric activity. Another century passed, during which this phenomenon was considered as little more than a scientific curiosity. Then, in 1880, the Curies of radium fame measured the piezoelectric activity of some thirty substances.

Quartz crystals, they found, possessed this property to a greater extent than any other natural product. But man-made crystals of Rochelle salt, they discovered, were about one thou-

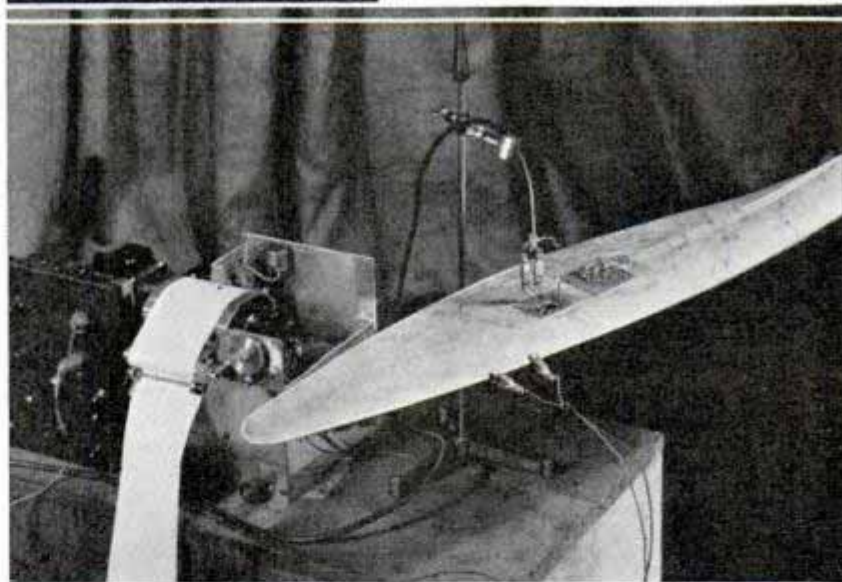

Apparatus, top, for calibrating and testing microphones. Center, sound-cell mounting in microphone. Bottom, measuring bending and torsional strains with aid of crystals and pen recorder

sand times more active than quartz. They also learned that the electric potential between opposing surfaces varied with the pressure and established that, in accordance with the law of the conservation of energy, any substance which generates electricity in response to mechanical motion will act conversely, transforming electrical energy into mechanical energy.

Roentgen, who developed the X-ray, predicted that pressure electricity would some day be applied in the field of acoustics but it was never used for any practical purpose until the World War.

At that time a brilliant Frenchman harnessed piezoelectric devices with vacuum-tube amplifiers to aid in locating submarines through supersonic water vibrations. The submarine detector demonstrated that the same idea could be applied in the audible range. But crystals then produced were unsatisfactory for pressure electrical devices. They were not clear and uniform and their properties varied with temperature, among other things.

After years of research, the Brush Development company of Cleveland, O., finally evolved a patented chemical process for growing clear glasslike crystals of

(Continued to page 118A)

Model of First Steamboat Built Is Older than Fulton's Ship

Although Robert Fulton's steamship was the first of its kind to be commercially successful, it was not the first steamer. In the American Philosophical Society rooms in Philadelphia is the original model of the steamship built by John Fitch in 1785, credited with being the original steamship. Fulton's boat went into operation in 1807, and even before that an English inventor, William Symington, had constructed a steamship.



Original model of the first steamship, built in 1785 by John Fitch. Notice side paddles on belt

Fire Blanket Unrolls Like Shade to Wrap Flaming Clothes



Worker saves himself from flames by wrapping in emergency blanket, which unrolls from wall bracket

Unrolling like a window shade hung on the wall vertically, an emergency fire blanket is always ready to smother flames. If a workman's clothes catch fire, he can wrap himself snugly in the blanket with a twist of his body, without help from others. It can be used, too, to extinguish small fires and protect persons who are forced to run through flames.

Quick-Drying Stamp-Pad Ink Reduces Blurring

Impressions made with a new stamp-pad ink dry so rapidly that they may be rubbed with the fingers immediately with little or no blurring. One pad filled with the ink was in steady use for three months with only one re-inking, in spite of the fact that the pad box was left open most of the time. The ink did not lose its property of drying quickly. A special organic liquid in the ink is much less volatile than water, explaining its unusual properties.

H 194

H 404

H 376

H 349

Dept. of Commerce

Emergency Equipment Co. 55 W. 4th St. New York City
Developed by Dr. J. H. Waters Chemist
Duxey of Standards
Was Symington, S. C.

Explorer Rides Stainless Steel "Jungle Yacht"

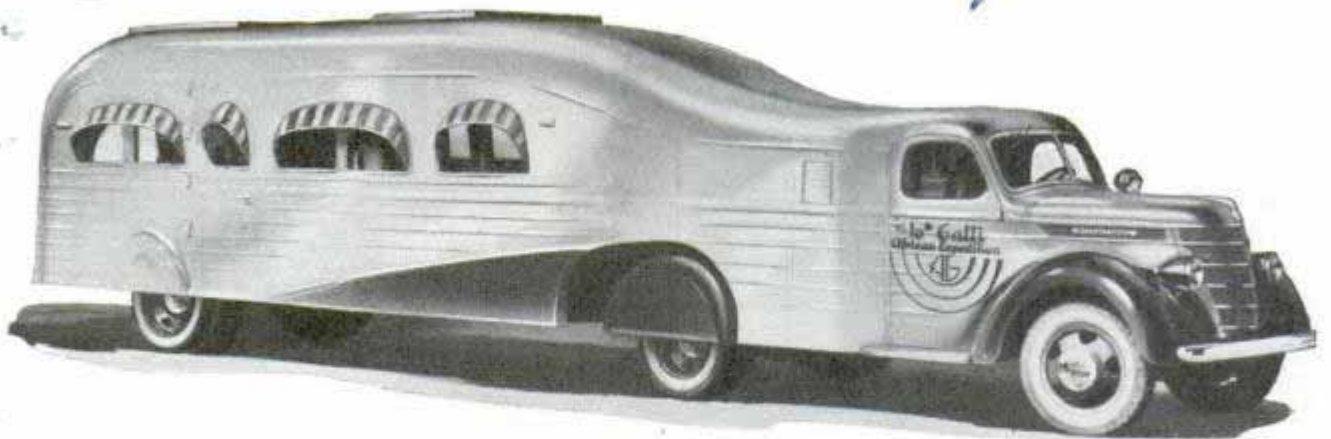

One of two air-conditioned, stainless steel truck-trailers built for Congo expedition. It includes lounge, library, observation-dining room, bedrooms, tile bath with full-length tub and electric kitchen

Comforts, even luxuries, of home are offered the explorer in two stainless steel "jungle yachts" which Commander Attilio Gatti will use in a trip through Africa. The vehicles are powered by truck engines. Each is a roomy, streamline trailer, carefully insulated, fitted with a variety of custom-built refinements and air-conditioned. Appointments include two bedrooms, bathroom with full length tub in black tile, living room and observation dining room, with library and bar, and electric kitchen. Two-way radio with sixty-mile range provides for intercommunication. Protection is provided against wild-

animal assault, while screening and insulation guard against heat, cold, humidity, insects and the pollen of certain tropical flowers which cause deadly fevers. Overall length is forty feet. Commander Gatti also will use a station wagon and two supply trucks on his expedition. One of the trucks is a one-ton unit with special platform top for motion-picture work. It also will pull a photographic laboratory trailer. The expedition will make surveys, gather material and study itineraries for further colonial development of the Congo country; gather rare animals, and take still, motion and color pictures.

Camera in Reflector Window Takes Shadowless Picture



Camera shoots through window of four-bulb reflector

For color photography and other work demanding flat, shadowless lighting, a light reflector with a window at its center has been developed. The camera is mounted on a platform so that it can peer through the window from directly behind the light source. The reflector accommodates four light bulbs. The platform is adjustable to fit any camera, and tilts for angle shots.

Spotting Planes by Television Is Tested in England

Use of television receivers as "spotters" of airplanes is in the test stage in England, and secret research is under way in the United States to find other ways of spotting airplanes than by the present sound-detection methods. Since television broadcasts have been in progress over London, it has been noted that when airplanes are

Camera Research Laboratories
Springfield, N. P. 111
7240

H 436

International Harvester Co.
180 N. Michigan

H 432

H 454

flying in the vicinity, "ghost" images are produced in the receivers. These ghosts are caused by reflection of the television waves from the metal-airplane surfaces, according to technicians. Thus, the reflected waves arrive at the television receivers at a slightly different time than the ordinary waves. The result is a dual image of the scene being transmitted. The image of the plane is not received. The displacement of the ghost image has been correlated with the distance of the plane from the television receivers and a system has been worked out whereby television receivers on England's coast could spot approaching planes in time of war.

H 453

Building Model Trolley Cars for Home Electric Railway

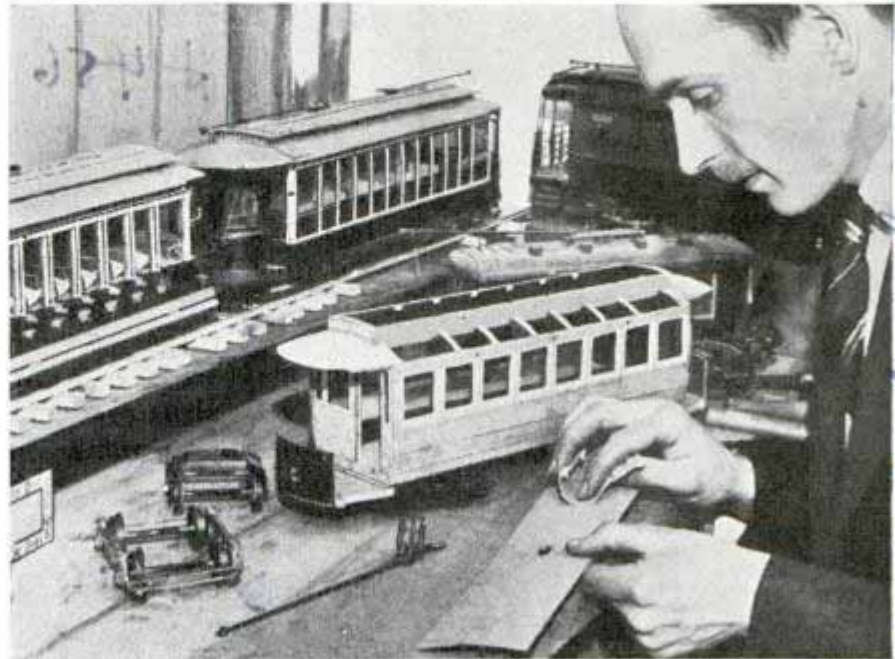

"Early American" trolley cars, including some of the obsolete open types, are among the collection of this New York model builder

Building, operating and collecting all types of model trolley cars is the hobby of a New Yorker, one which he finds fascinating and practical. Smaller space is required for the trolley cars than for model trains, due to the fact that each car operates as a unit. The collector-builder warns that once the model maker becomes interested in the little cars, he becomes an ardent operator and collector. He finds it fascinating to watch the miniature trolley poles pick up current as they slide along the overhead wire and to observe other phases of operation. He also finds the construction of old-fashioned and modern cars thoroughly interesting.

H 455

Rifle Shell Warns of Fire in Airplane Engine

Warning of the outbreak of fire in the airplane engine, the latest detector unit employs a blank twenty-two caliber rifle shell. The explosion of the shell lights a signal on the instrument panel and sounds an electric alarm. Several shells are mounted at strategic points about the engine and attached to tubes leading to the instrument panel. Flame or heat of 250 degrees will fire the shell, causing the alarm to sound. The pilot then releases a container of carbon dioxide gas which envelops the engine, snuffing out the fire.

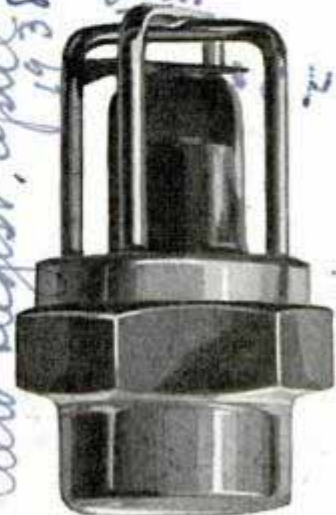

H 390

'Slip-On' Plowshare Edge Sharpens Self with Use



It takes but a few minutes to put a new edge on the plowshare now, for a "slip-on" edge of durable steel is available to fit over any general purpose plowshare. The edge stays sharp until worn out, its design making the blade self-sharpening with use. It tightens with use, too, and will not pull loose even when backing.

Handwritten notes on the right margin include:
 Robert Brahan, 2810 Avenue C, Washington, N.Y.
 Walter Kidde, 160 Elm St., New Haven, Conn.
 W. L. Well, 3 Weill St., New Haven, Conn.

Slip-On Plowshare
 Box 248, C.I.

Brick House Sawed in Two to Insulate against Damp



After sawing out one layer of mortar with crosscut saw, copper sheet is inserted for insulation

When an old brick house in Alexandria, Va., began to suffer from "old age," its bricks and mortar drawing moisture up from the earth like a wick and thus threatening the woodwork with decay, an architect and builder decided to saw it in two to save it. A crosscut saw was used to saw out the mortar between two layers of bricks near the ground, and sheet copper was inserted in the joints for insulation. The house had no basement. The slight clearance remaining after insertion of the copper strips was closed by letting the building settle, which involved no injury to the structure above.

Hose Coupling Attached Quickly by Pressing a Lever



Ease of coupling garden hose to the faucet is a feature of a new hose connector. By pressing a lever, the connector firmly couples the two parts together,

saving time and providing a non-leak connection. The connector consists of two parts, one of which is attached permanently to the faucet and the other to the hose. When the two are brought together, the lever locks them in place quickly.

Prism Reflectors Outline Road with "Fence of Light" at Night

Prismatic reflectors mounted on posts set at 100-foot intervals make driving safer at night along U. S. Highway 16 between Detroit and Lansing, Mich. They form a "fence of light," visible far ahead, etching the outline of the road and its hills and curves against the darkness. Three reflectors made of the plastic "Lucite" are installed on each post. They are clear, flexible, non-shattering and highly reflective.

Boat Paint Resists Growths and Is Easy to Apply

Unusual protection against marine growths is afforded by a boat bottom paint which brushes on as easily as grease. The paint is virtually free of the disagreeable odors usually found in such mixtures. It never settles out hard, but remains a soft, mushy mass in the bottom of the can, easily stirred into complete suspension.



Two photographs compare boat bottoms; one at top is painted with resistant liquid

Horace L. Woodward
413
20 E. Hector Bldg. 9th. and 10th
Place N.W. Washington, D.C.
Ever. Jato Coupling Co.
254 W. 54th St. N.Y.C.
useful
Alexander St. Yonkers New York
press paint Co. 69 Alexandria St.
439

1029 Newark Ave
Elizabeth N.J.
Special plastic used
de 10 ans de l'experience

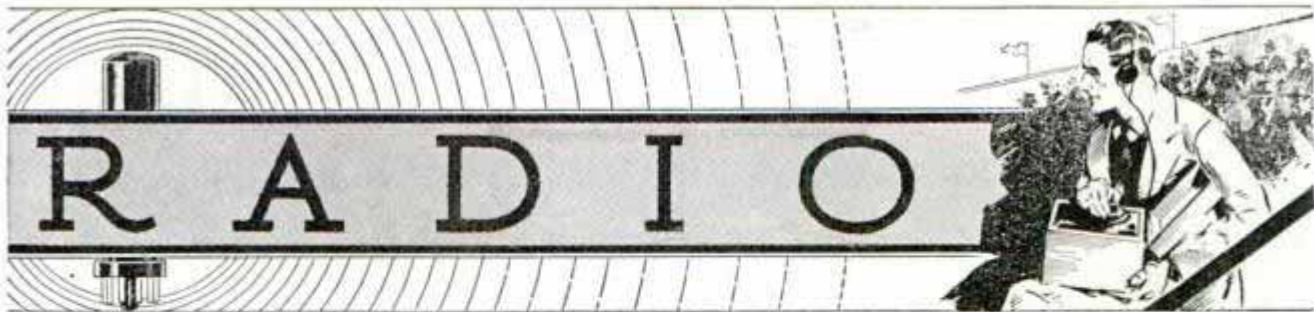

PILLOW SPEAKER

for bed, chair or couch

PERHAPS you often have denied yourself the pleasure of listening to some favorite radio program because others near you were not interested. This thin pillow speaker is a high-impedance, voltage-operated crystal device intended to be used with most any radio receiver, particularly the portable or personal A.C.-D.C. sets. Patients in homes or hospitals can each enjoy their own radio programs without disturbing others and need no longer use uncomfortable headphones.

A few simple connections are necessary to install the unit; if your set employs a speaker of the dynamic type, follow the connections indicated in Fig. 1, or, if a magnetic speaker is used, connect as shown in Fig. 2. In either case a switch is required which "breaks" the speaker circuit and "makes" the "pillow-speaker" circuit simultaneously. With a magnetic speaker, a plate-circuit choke coil of about 10 henries must be used. If the set employs an electrodynamic or permanent-magnet type of speaker with a conventional output transformer, the speaker unit is connected across the primary of the transformer and it is only necessary to supply the "make" and "break" switch.



Hushatone

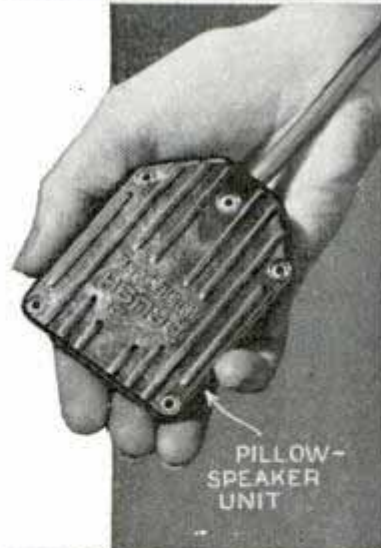

PILLOW-SPEAKER UNIT

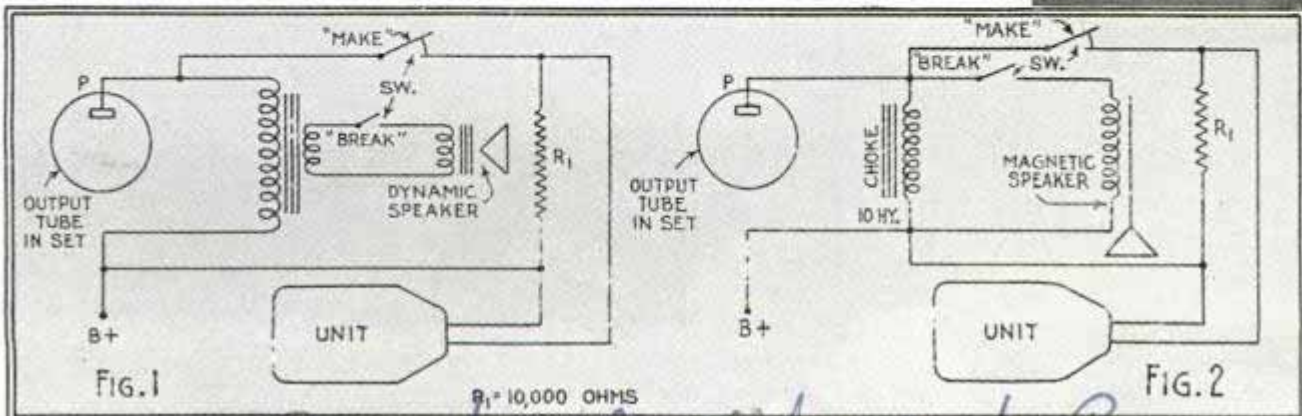

*Brush Development Co.
3311 Perkins Ave.
Phila.*

TUNE with

By Wayne C. Leckey

NOW you can build your own armchair cabinet to house any four or five-tube radio receiver chassis in a position where it can be tuned with ease and comfort without getting up from your chair. This practical and smartly styled cabinet also serves as an end table and bookcase.

Although the design is modern and up-to-the-minute in every detail, it is not expensive to build. Reasonable changes may be made in the dimensions to meet individual requirements. For example, the size of the tone chamber may be increased if necessary, and methods of joining the various parts will depend to some extent on the tools at hand.

Complete constructional details are clearly shown in the cutaway drawings Figs. 3, 4 and 5. With proper equipment, tongue-and-groove joints should be used throughout; however, plain butt joints nailed, glued and blocked will do in the absence of such machines.

Solid wood stock is recommended for a fine cabinet finish, but the use of veneer-faced plywood will simplify construction since the front and back pieces can be cut from single panels, using the waste material for the shelves. In this case exposed edges would be painted black to conceal the laminations, and the rounded edges would be left square.

Ventilation is provided in the back of the cabinet by means of narrow slots cut as shown in photo Fig. 2. These slots are located just about opposite the tubes in the set chassis. This photo and sketch also illustrate the method of mounting the receiver chassis and

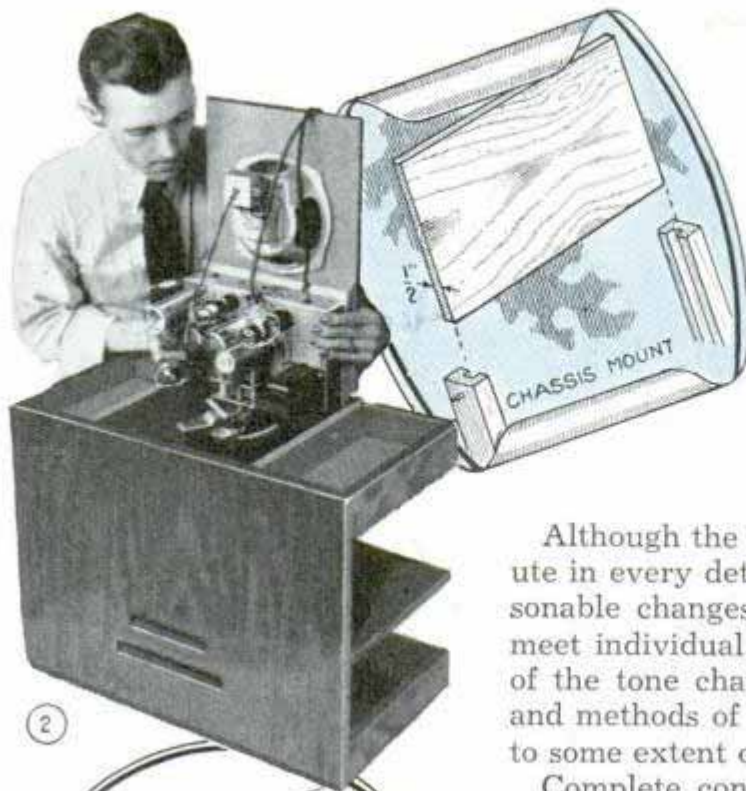

2

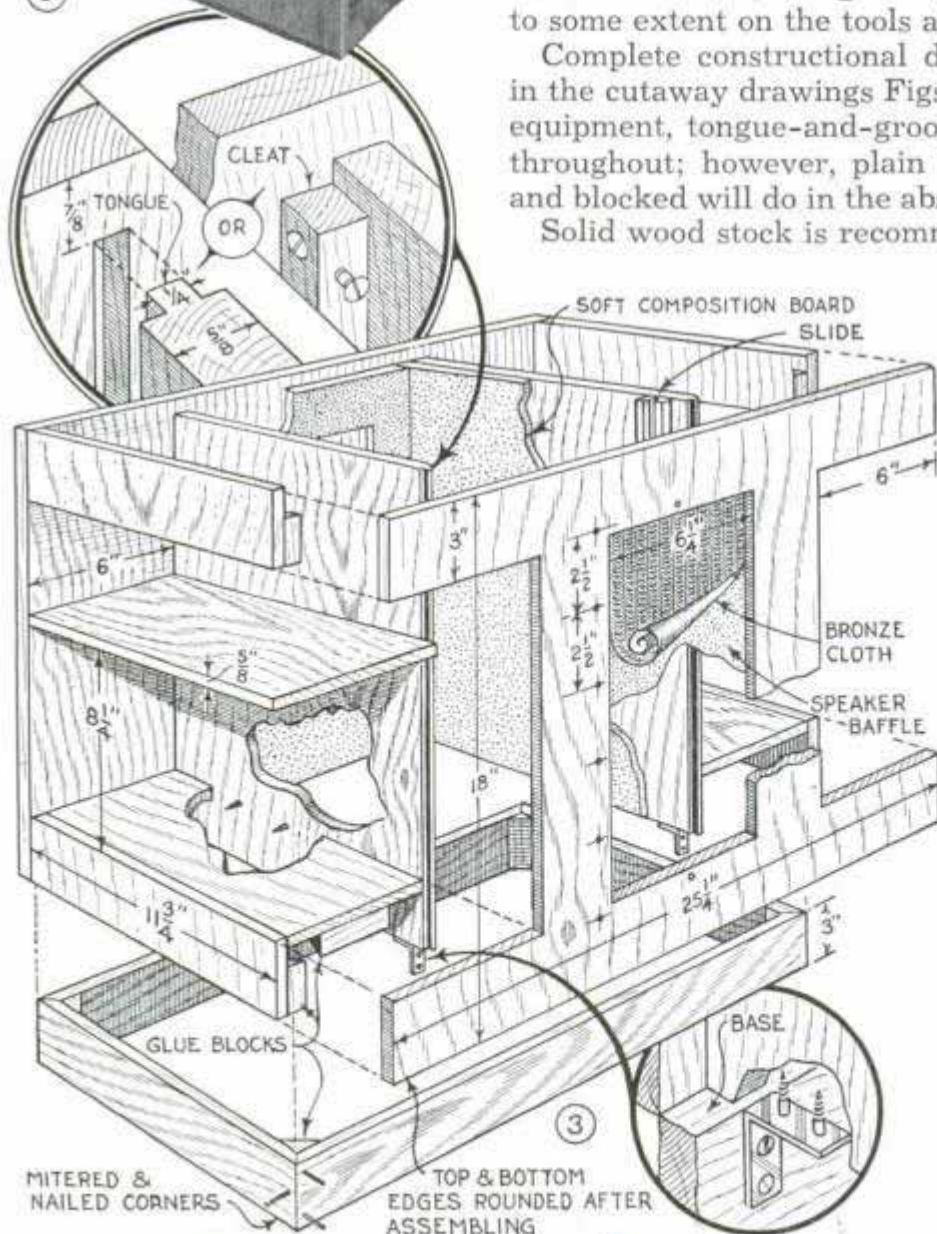

3

COMFORT -- an armchair cabinet that you can build

speaker. The semi-circular fins forming the speaker grille appear in photo Fig. 6; these are simply lathe-turned disks shaped as indicated in Fig. 7, and cut in half by tacking to a straight edge as shown in Fig. 8. The fins are equally spaced and fastened with small screws from the back. All material dimensions are given in Figs. 3, 4 and 5. Please note the over-all size of the framework, Fig. 4, is made to overlap the edge of the cabinet $\frac{3}{16}$ in. The inner cuts of the molding are made with a circular saw before mitering to size and gluing. The outer cuts are then made to seat the frame snugly $\frac{7}{8}$ in. down in the top of the cabinet. Before fastening in place with slim screws driven through the edge, suitable notches must be made in the front edge of the frame for the insertion of the narrow, chrome molding flanking the speaker grille.

A $\frac{1}{4}$ -in. fancy-figured panel equaling the size

(Continued to page 137A)

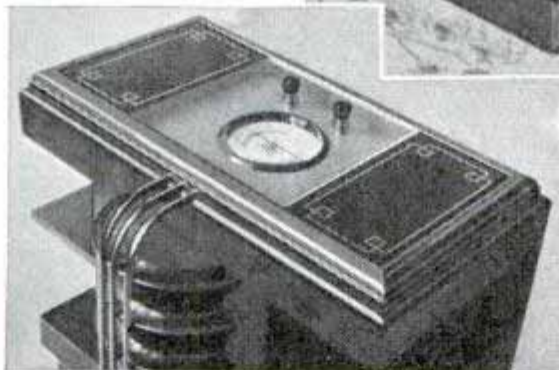

GLASS PAINTED
BLACK & STRIPED
WITH GOLD ON
UNDERSIDE

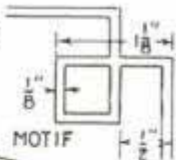

GLASS DRILLED
FOR SHAFTS

BIRD'S-EYE OR LACE-
WOOD DIAL PANEL

CORNER BLOCK

CORNERS GLUED,
NAILED & BLOCKED

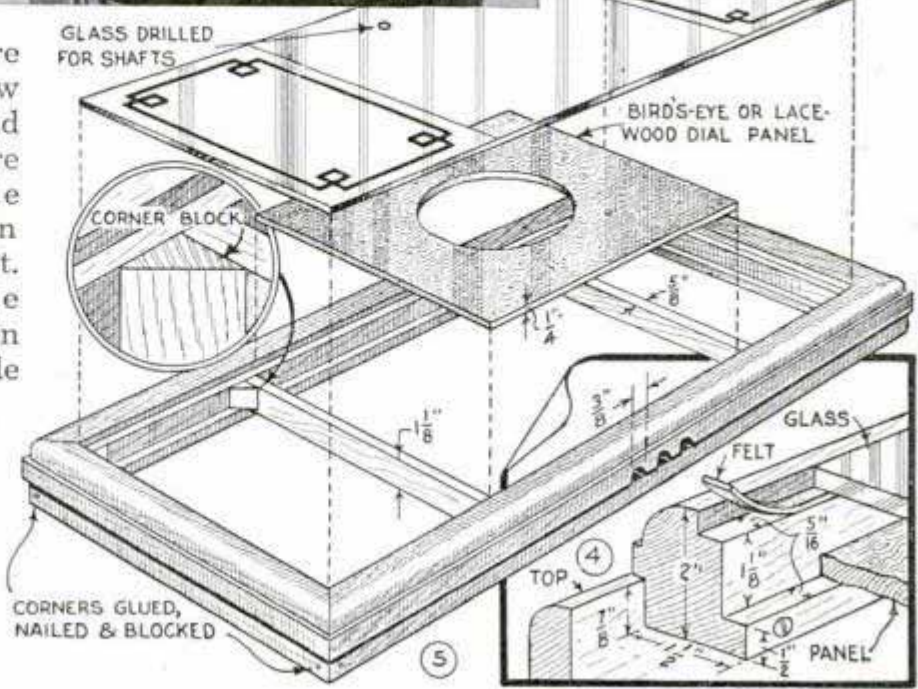

Cathode-Ray Tube for Visual Radio Set Testing



PERHAPS one of the most useful applications of the cathode-ray tube at the present time is the cathode-ray oscillograph for visual radio set testing. Servicemen and experimenters at first were slow in taking advantage of this modern method of radio trouble shooting. The early equipment was rather bulky and expensive but this is no longer a stumbling block in the path of progress.

The RCA type-913 all-metal cathode-ray tube, having a fluorescent screen about one inch in diameter, provided a low-voltage tube that made a comparatively low-cost portable oscillograph practical and the serviceman can now see what he is doing thus eliminating much of the guesswork and former cut-and-try methods commonly employed. With this modern "X-ray" of radio the operator can not only line up receivers visually but also actually see distortion and hum. For example, photo A at lower left shows what can happen when an I.F. amplifier is alined with an output meter; photo B indicates the proper alinement obtainable with the oscillograph. The proper alinement of an amplifier that is overcoupled, showing a broad peak, appears in photo C. When seeking for the results illustrated in C with an output meter you are quite likely to peak the transformers at different frequencies, as clearly shown in photo D.

Progressive servicemen can make convincing demonstrations to customers, and experimenters and students can develop special circuits and have a visual record of their progress, by learning to

(Continued to page 134A)

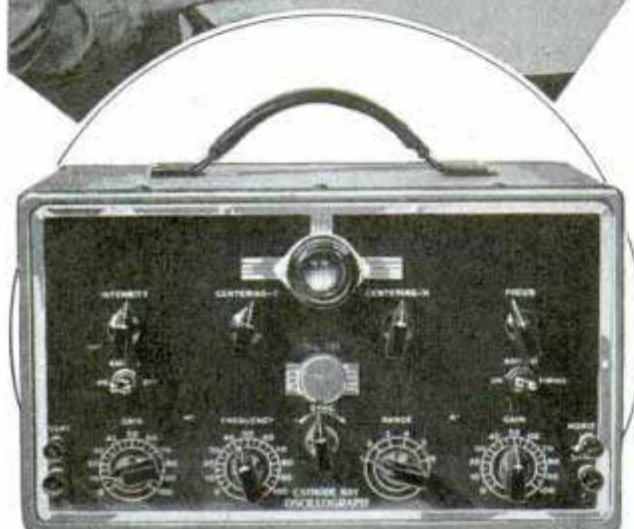

CATHODE-RAY OSCILLOGRAPH

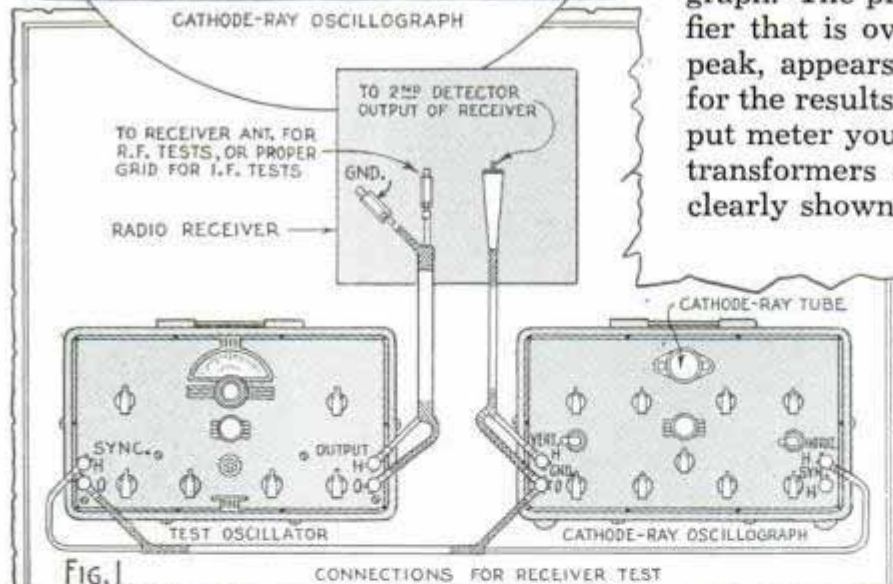
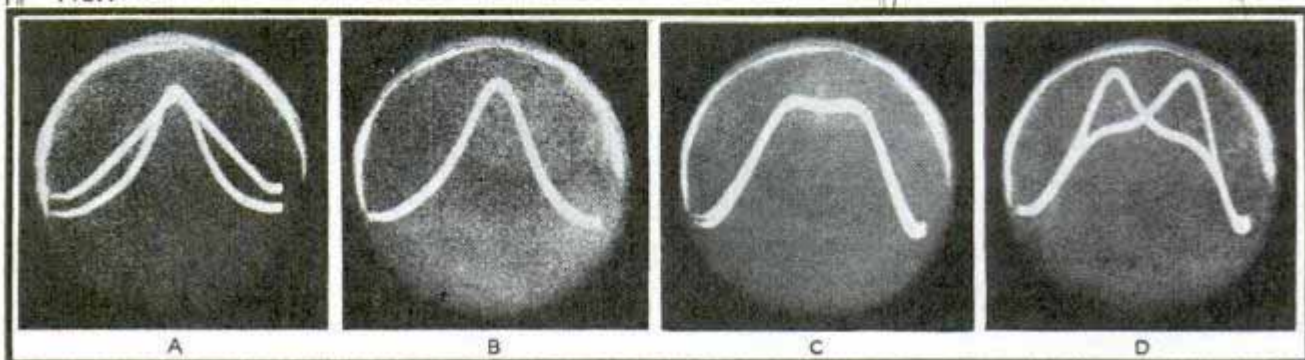

Fig. 1

CONNECTIONS FOR RECEIVER TEST



Practical RADIO SUGGESTIONS

*Hytron Corp
76 Lafayette Salem, Mass*

Bantam
Miniature tubes with octal bases, for use in compact receivers, these "bantam" tubes measure 1 1/4 in. in diameter and from 2 1/4 to 3 3/4 in. over-all. Characteristics same as larger glass types



Below, handy method for mounting a.c. toggle switch on transformer; makes husky shakeproof mounting for small power-pack assembly or similar experimental hook-up

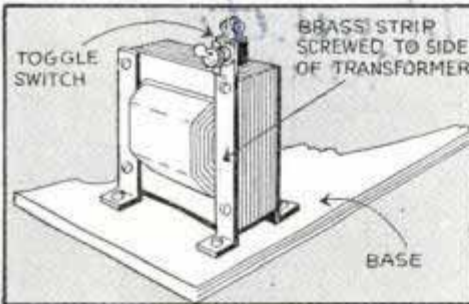

Below, C-clamp and brass angle used to flatten soft copper tubing for making solid bolted connections

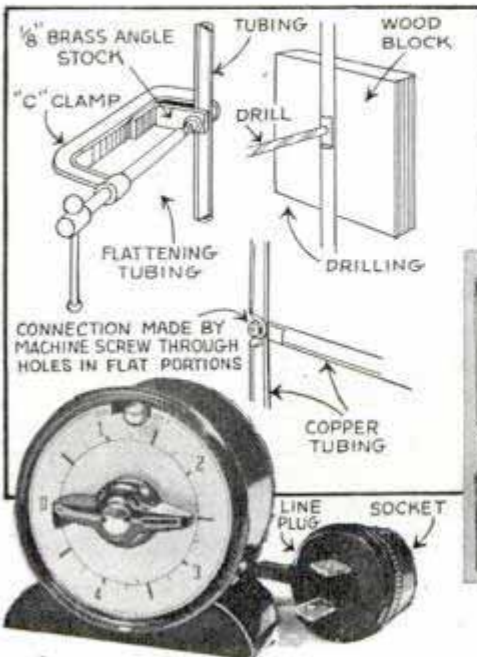

Right, homemade electric drill made from sewing-machine motor, dime-store chuck and suitable thrust bearings. Grip may be of wood or metal; will handle up to 1/4-in. drill in brass

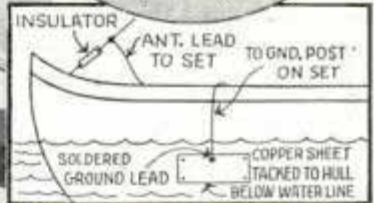
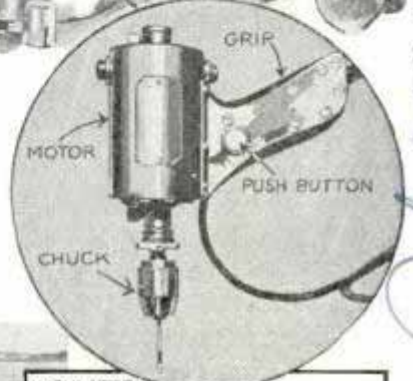

Above, ground plate improves performance of receiver in boat. Below, metal tubes may be checked with ohmmeter; open circuit shows burned-out filament

Below, compact "A," "B" and "C" batteries suitable for portable receivers and test sets. Fig. A replaces old type No. 6 dry cells; Fig. C is a small 45-volt B-battery; Figs. B and D are 4 1/2 and 7 1/2-volt C-bias batteries; Fig. E is a 3-volt "pen-light" battery consisting of two 1 1/2-volt cells in series. Lower left, automatic switch turns your set "on" or "off" at any time up to a maximum of 5 hours



*Chapman & Co. Radio Receiver Center
New York*

Burgess Battery Co. 101

*Crumpen
4017 W. Lake
Chicago*

Electron-Coupled Exciter Unit

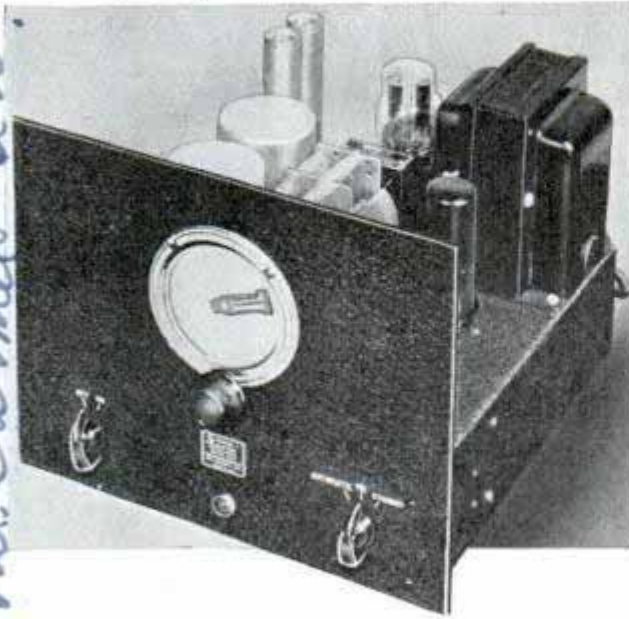

This variable-frequency control unit includes ganged buffer stages and enables the amateur operator quickly to shift his signal to another channel in the same band when he receives reports that he is being covered by severe interference. Ganged tuning adjustment provides single-dial control from the operating desk.

Push-Button Console for Locals

Designed for high-quality reception in metropolitan areas served by powerful high-fidelity radio stations, this 8-tube set covers the standard broadcast band, has



12-in. speaker, and gives uniform reproduction in frequency range of from 50 to 7,000 cycles, with output of 12 watts. Additional features include "magic eye" for tube alinement, 8 stations pretuned, and there are no dials.

Complete Portable Set Tester

All instruments necessary for complete set testing are included in this combination portable radio laboratory. The separate units consist of an all-wave signal generator; a 5,000 ohm per volt multirange meter and a tube tester. A roller index carries a list of tubes and testing procedure.



Magic Switch for Window Display

As this capacity-operated switching system works only when a prospective customer is in front of the show window it is unnecessary to leave the window lighted continuously. The photo is self-explanatory. It also may be used to start action displays and turntables and to operate radio, phonograph, or spotlights.



Blueprints covering radio construction articles in past issues are available for 25 cents each; original material lists and additional information can be obtained from our Radio Department without charge upon receipt of postage.

NEXT MONTH—Three Simple Receivers for Beginners. A two-part step-by-step construction article for a low-cost crystal set; a one-tube broadcast-band battery-operated receiver and a one-tube short-wave battery set. Same parts, with additions, used for all three sets. Actually a beginner's course in radio building

*Mississauga N.Y. Co.
Mt. Carmel Ill.
A.C.A. N.Y. Co.
Carmel Ill.*

magic mirror

*37 W. 54 St
New York*



"BARREL" SMOKING SET

TRULY an unusual and novel addition to your den, home or cabin, this smoking set, Fig. 1, is modeled after grandmother's washing equipment—brass-bound bucket, tubs and rain barrel, complete to the spigot. If you have a four-jaw chuck for your lathe, the entire set can be turned from one piece $3\frac{1}{2}$ in. square and 10 in. long. Otherwise the pieces will have to be turned separately on a faceplate.

Using a chuck, turn the outsides of both tubs, Fig. 3, and the inside of the first one to the dimensions given in Fig. 4, adding a cut-off allowance between the tubs. Sand the work and score twelve stave joints. If

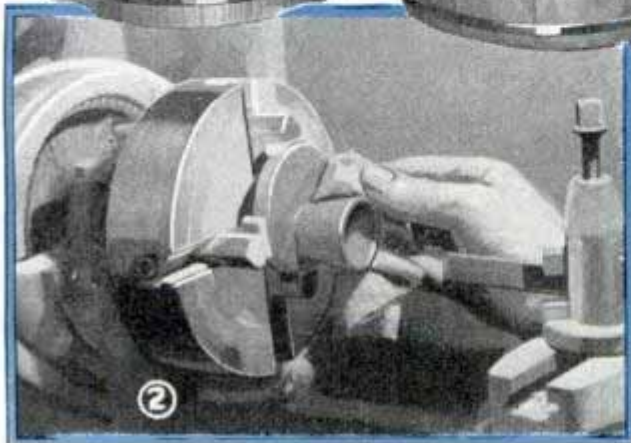

a wax finish is desired, apply it now. Mark off the handles and cut out later, or use a hand grinder as in Fig. 6. Now cut off the first one and complete the second one. Next comes the barrel. When the

outside has been turned and sanded to size, turn the inside, forming a recess on the inside surface at the mouth to take the barrel head. Then wax the barrel and cut it off. The bucket and barrel head are turned in one piece from the remaining stock. Notice in Fig. 2, that the bucket sets to one side of the center of the head. Turn the head portion first, reverse the stock and clamp it in the chuck $\frac{1}{2}$ in. off center to turn the bucket. Hoops for the tubs, bar-

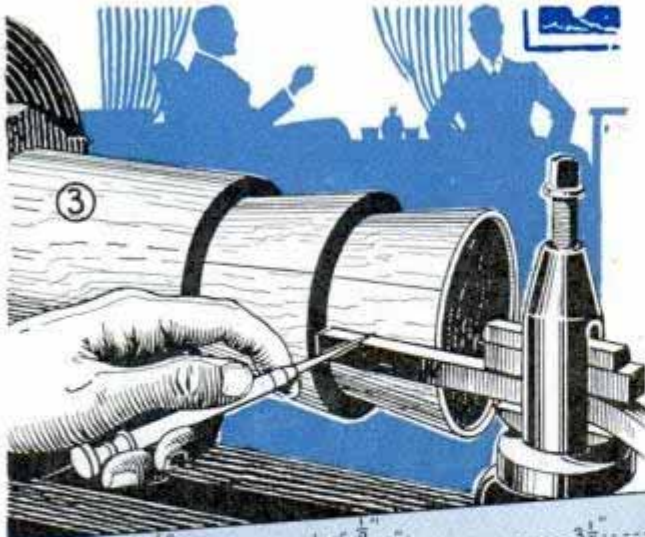

Allow about $\frac{3}{16}$ in. for lap. Solder the hoops together, burr side in. Force them in place with a blunt-end screwdriver and fasten them in place with four pins cut to the right length, polishing off the finish on the heads to expose the brass underneath.

The bucket is hooped in a similar manner, except that the bands must be soldered together around it as they cannot be slipped in place. A folded piece of paper under the joint will keep the wood from being scorched by the soldering iron. A

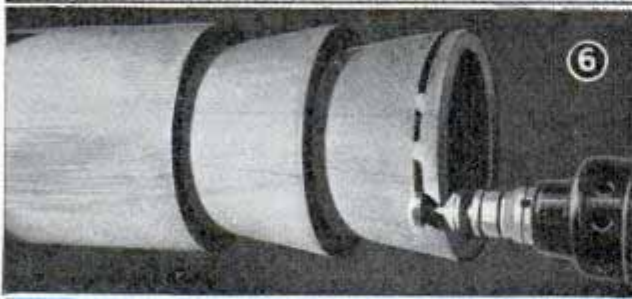
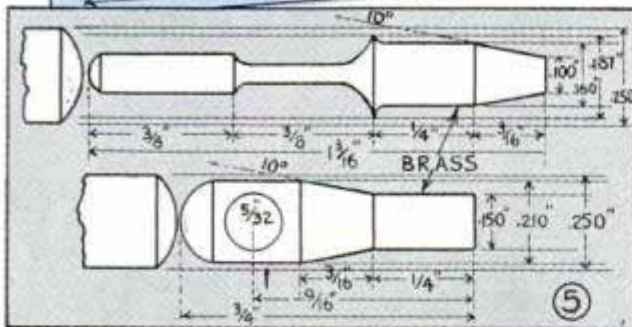
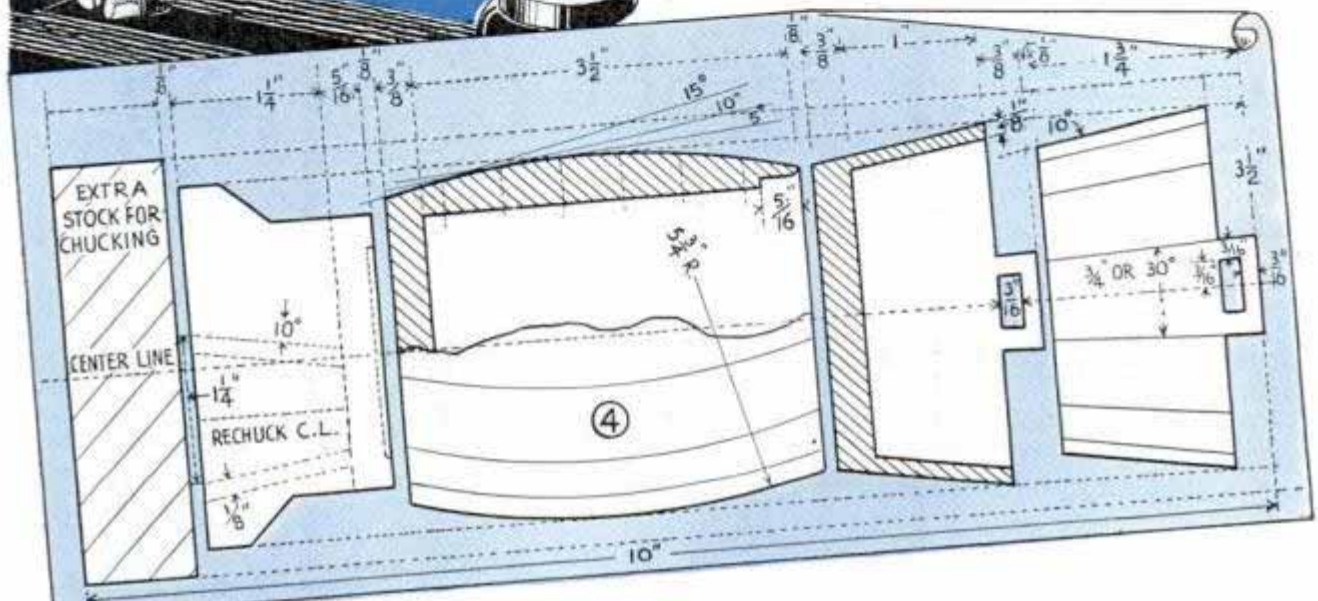

rel and bucket are $\frac{1}{8}$ in. wide and are cut from sheet brass or copper. Cut the strips from alternate ends of the sheet so that burrs will be on the same side of the strips. File off the burrs and measure the hoops for length by placing the strips around the tub or barrel $\frac{1}{4}$ in. below the final position.

bail for the bucket is formed from a piece of wire and is attached through small holes in the sides. A spigot for the barrel is turned from $\frac{1}{4}$ -in. rod as shown in Fig. 5. If a metal-turning lathe is not at hand, it may be filed out on a drill press or slightly enlarged and turned from wood.

Bobby Pin Serves as Bodkin

When you have to thread a tape, ribbon or elastic through a hem in a garment, and a bodkin is not at hand, a bobby pin from your hair provides a good substitute. Run the end of the tape or elastic through the looped end of the pin and use it as shown.

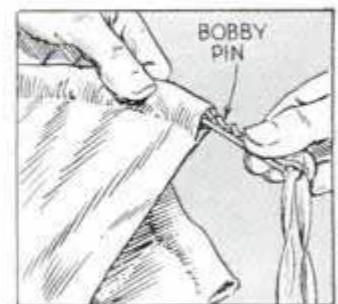

☐ When slicing hard-boiled eggs, the yolks can be prevented from crumbling by wetting the knife before each cut.

Diving Raft Is Pushed by Outboard Motor

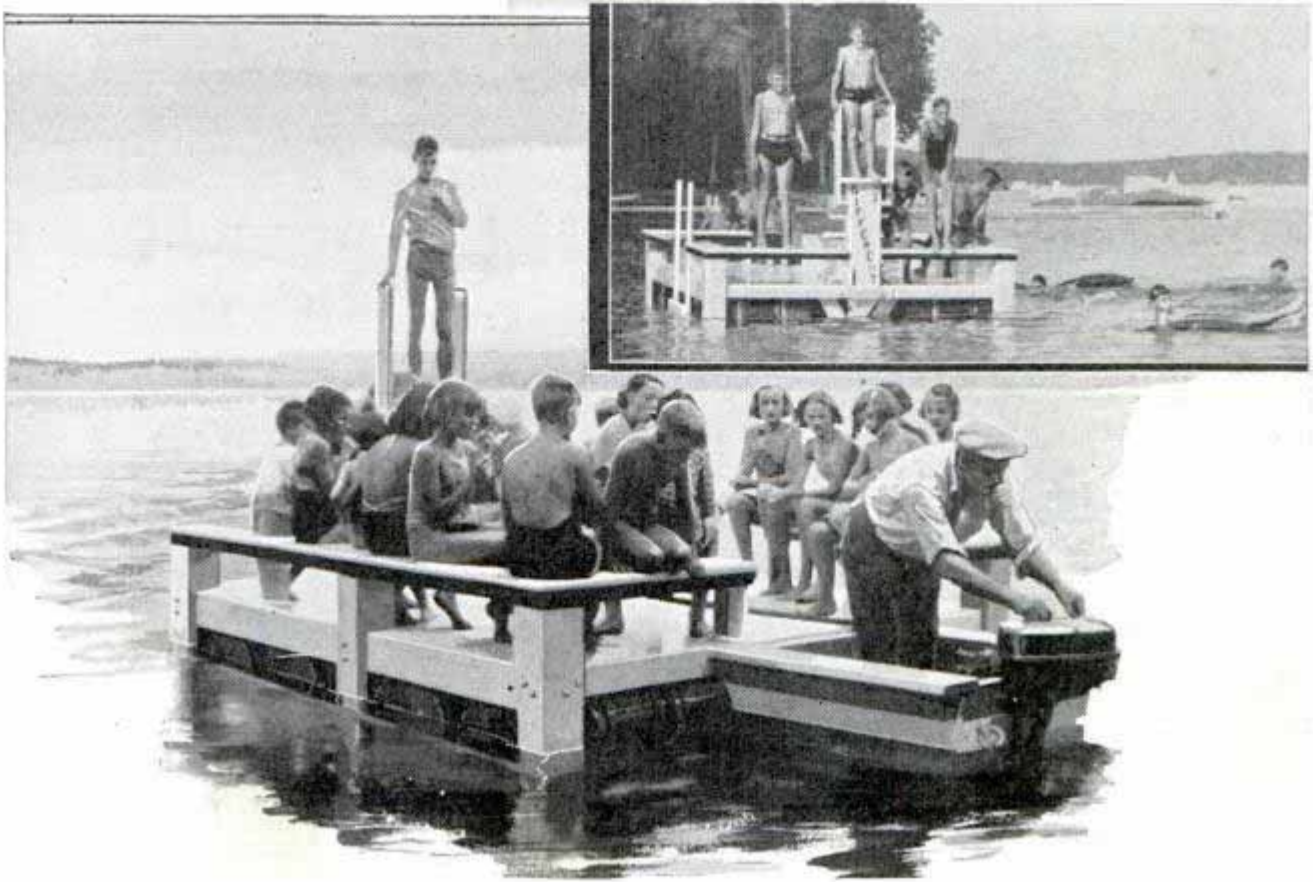

Carrying as many as twenty swimmers, this raft is pushed to any spot in a lake or river by an outboard motor. It has a ladder from the water to the deck and a diving platform, in addition to seats which serve as a railing around the edges of the

raft. It is constructed of strong timbers and is floated on airtight oil drums. At the stern of the raft is a small projection which carries the motor and provides a well in which the operator of the raft rides.

—F. J. Burr, Rockford, Ill.

Current Collector on Toy Train Is Polished Automatically

To assure good electrical contact between the current collector and the third rail of a toy train, attach a short strip of emery cloth to the rail as indicated, slipping the edges under the tabs that clamp the rails to one of the ties. The strip should be a little shorter than the distance between the two shoes or rollers of the collector so that the current will not be interrupted entirely. The collector slides over the abrasive each time the train goes around the track and removes film, dirt or oxide that may form on the collector.

☐ A mixture of equal parts of thick, boiled starch and thick, warm soapsuds is a good polish for linoleum; the mixture preserves the finish of the linoleum and makes it resistant to soiling.

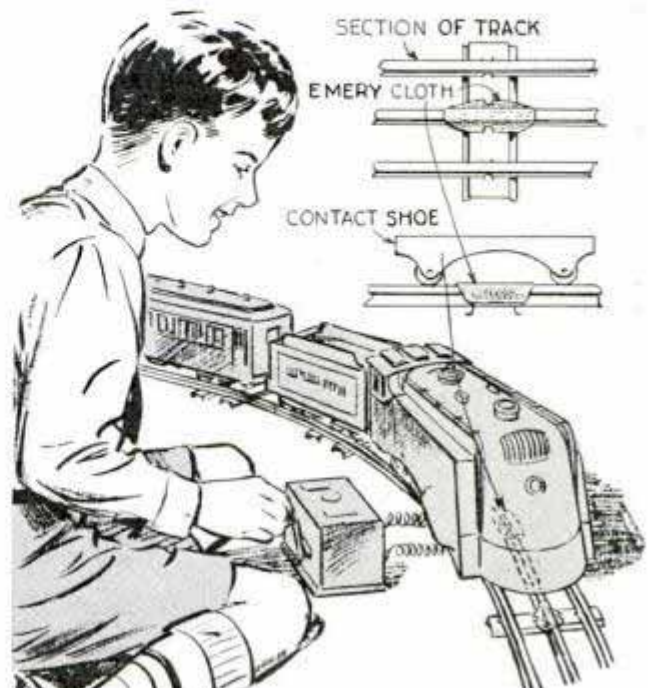

Shatterproof Eye Shield and Lamp for Your Bench Grinder



Providing eye safety against flying particles, this shield also illuminates the work

Used successfully in high-school shops, the grinder shield shown in the photo combines shatterproof glass to protect the eyes along with a lamp that provides good illumination for the work. Simple to make, the shield consists of a small board with openings cut near the ends, the edges being rabbeted to take glass, which is supported directly over the wheels. A bulb under the opaque center section of the shield provides plenty of light.

Drawing Large Hexagon Figures

When you want to draw large hexagon figures, and there is no compass or square at hand, use a castellated nut. Using the

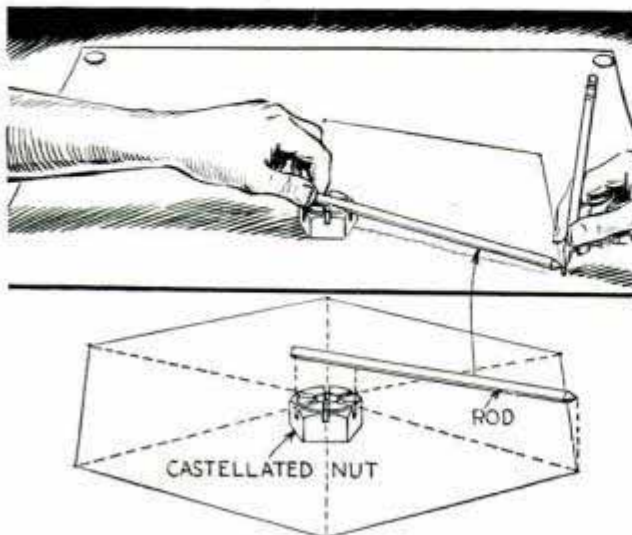

It's a simple trick to draw a large hexagon figure with the aid of a rod and castellated nut

nut as a center, place a rod, pencil or similar object in two slots of the nut and mark the work at the end of the rod. Repeat this operation for each of the six slots, taking care that the rod projects the same distance from the nut each time. Connecting the marks with lines completes the figure.—W. C. Wilhite, Carlinville, Ill.

Small Coil Spring on Fishhook Preserves Dough Bait

When fishing with dough bait, get a small coil spring, bend it into a loop and run the hook through it as indicated. Then mold the bait around the spring and hook.



This arrangement will help prevent the water from washing off the bait.

Paper Gauge for the Typist

To avoid typing too near the lower edge of a sheet of paper, cut a ½-in. strip from the bottom of the carbon sheet. This edge will show through the original copy when you are near the bottom of the paper. The carbon can be seen best through light-weight papers, but no trouble has been experienced on paper even of 20-lb. weight.

—W. Melzian, Los Angeles, Calif.

Artists' Brush Holder Suspends Bristles in Cleaner

Bristles of your brushes will always be soft and will last longer than normally if you use a holder like the one shown, because it keeps the brushes suspended in a glass of cleaner. The holder consists of a length of wire bent to a U-shape and soldered to a can lid with a coil spring soldered to the hori-

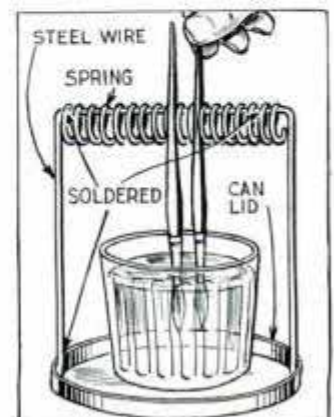

zontal part.

zontal part to hold the brush handles. A glass of cleaning fluid is set in the lid so that the entire assembly can be picked up and moved at will.

—C. A. Adams, Saskatoon, Sask., Can.

Turn Buttons on Sides of Ladder Hold Strips for Sawing



For putting up picture molding, fitting window stops, etc., a pair of wooden turn buttons attached to the sides of the stepladder will be found handy to support the work while sawing it.

The buttons should fit snugly so that they will remain in position when opened for use or folded out of the way.

Mosquito Net on Beach Umbrella Keeps Insects Away

Sew a few dress hooks around the edge of your beach umbrella and when you go to the beach, mosquito netting can be fastened to them to keep insects from bothering you. A strip of cloth binding can be sewed to the edge of the netting to reinforce it so that the eyes of the hooks can be attached to it.



Mosquito netting hung from your umbrella provides a retreat from insects when you are at the beach

Camera Bed Held at Angle Rigidly to Photograph Tall Buildings



Bed of small folding camera tilted and locked rigidly to take picture of tall object without distortion

You can photograph a tall building or other object with a small folding camera almost as good as the job can be done with a commercial camera that has a swing back, if the bed of the small camera is tilted as indicated. After tilting the bed at the desired angle, a C-clamp is used to hold it rigidly in place while taking the photo.—Kenneth Murray, Sturgis, Mich.

Non-Drip Can to Water Flowers

When you use a sprinkling can to water potted flowers, cut a large washer from an old inner tube and slip it over the can spout as indicated to catch water that drips from the end. The washer will assume a cup shape if the hole in the center is slightly smaller than the diameter of the spout.



☞ The next time you poach eggs, add a tablespoonful of vinegar to the water, and the whites will set without spreading.

Garden CHAISE LONGUE

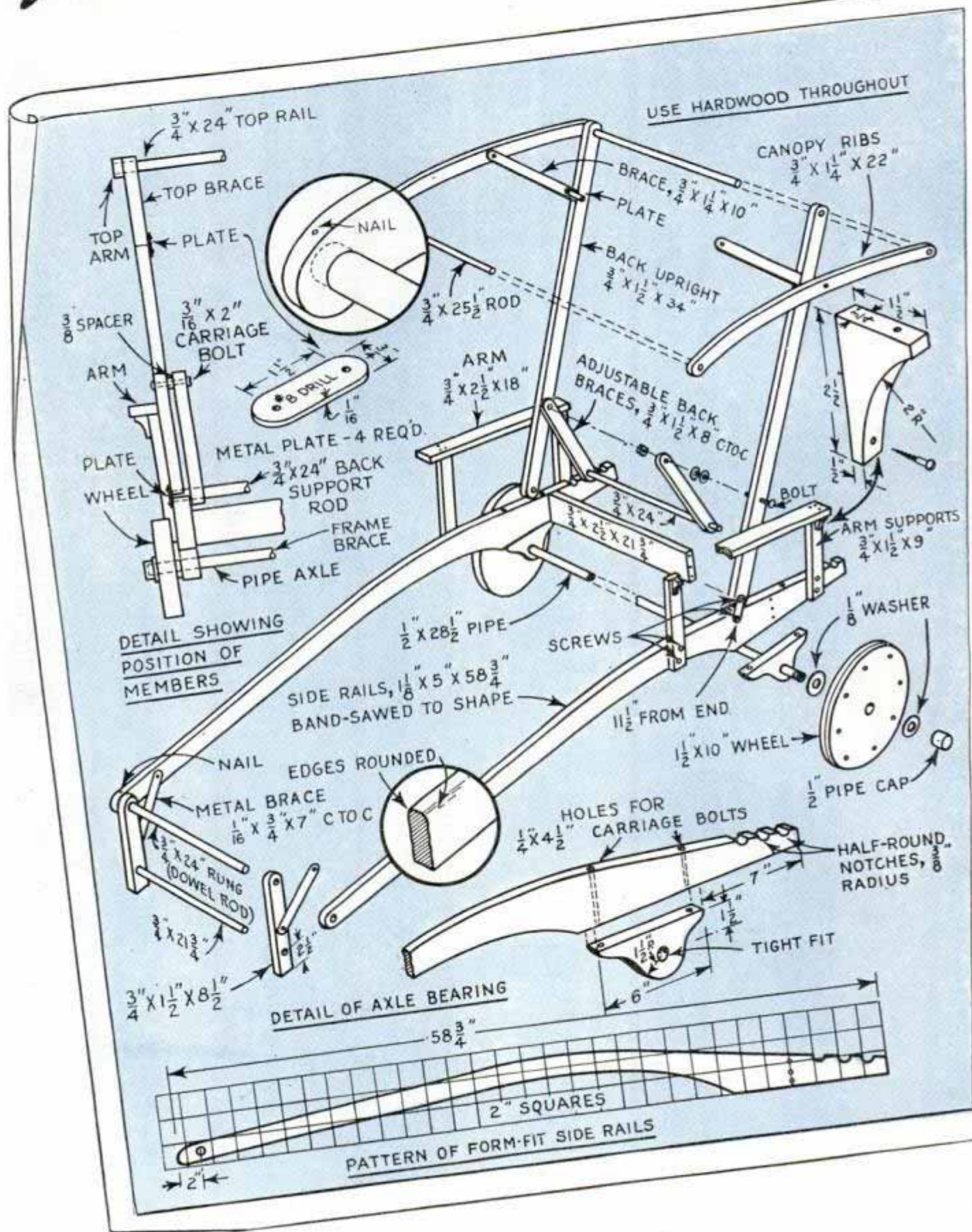

On Wheels

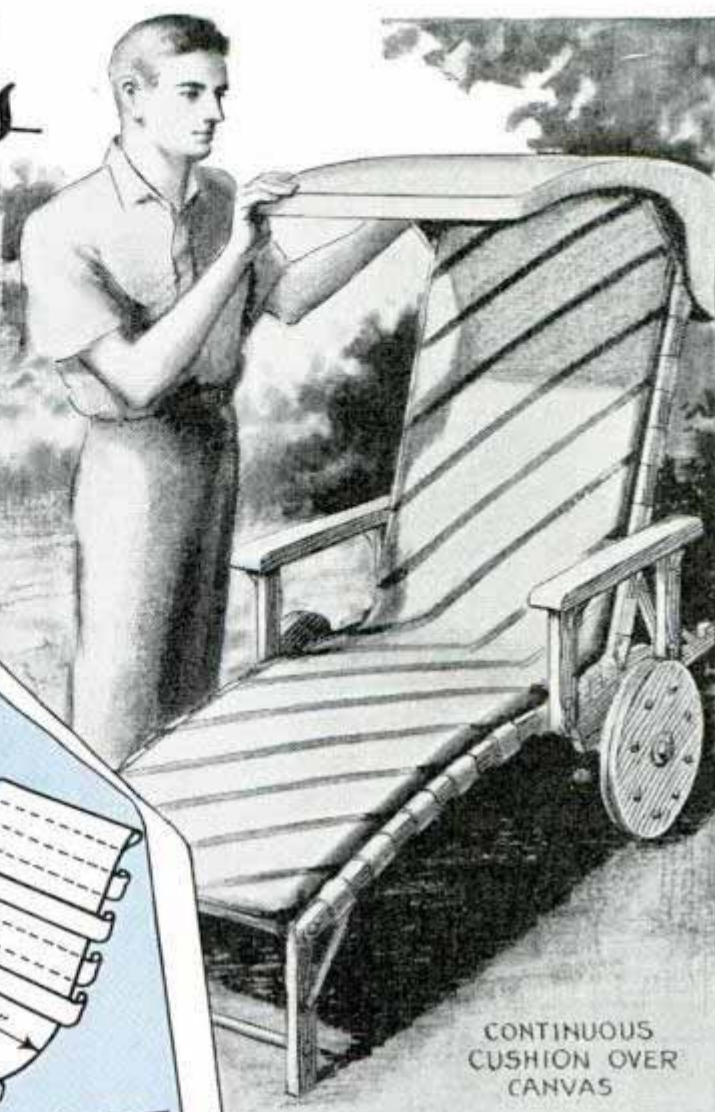
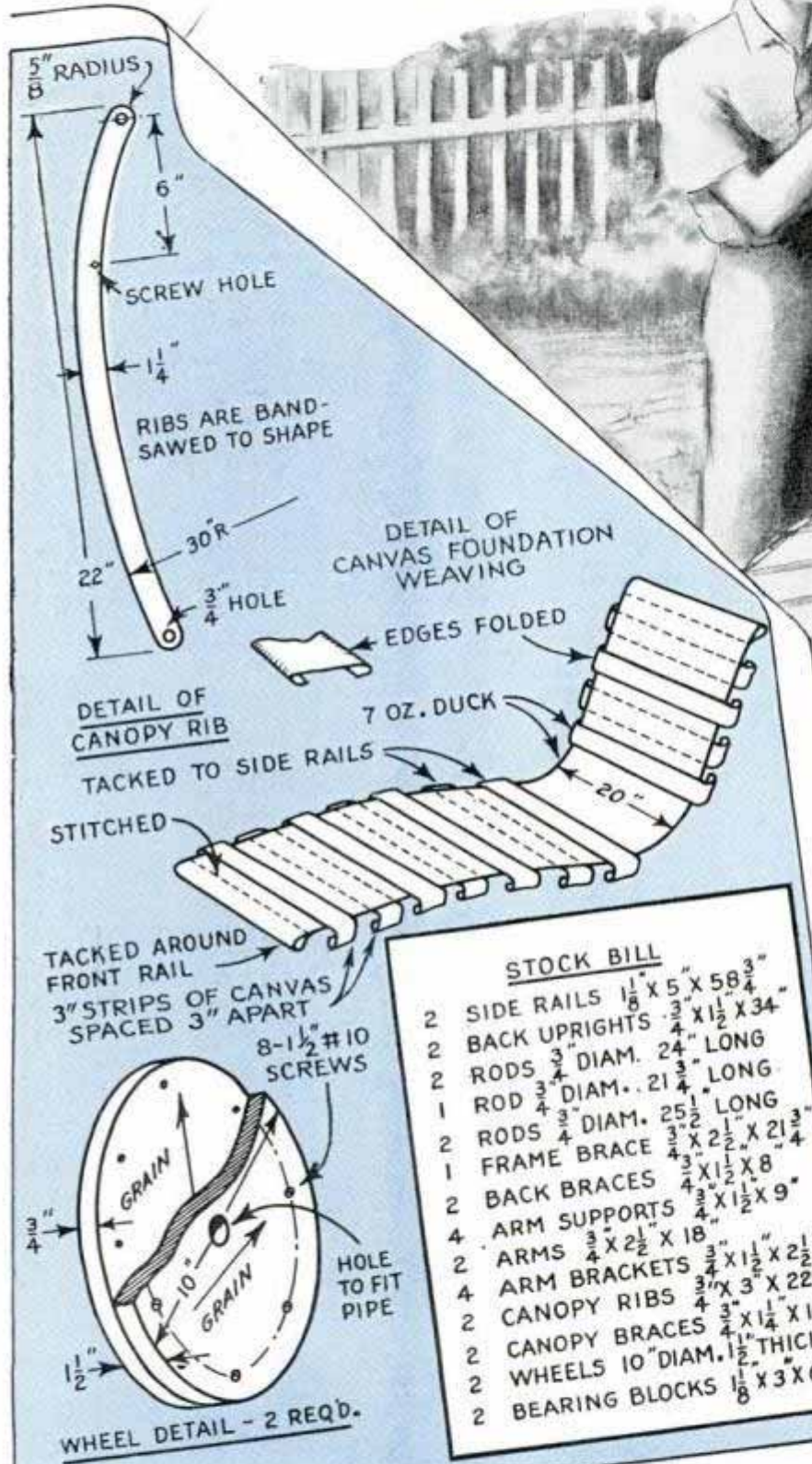

CONTINUOUS CUSHION OVER CANVAS

STOCK BILL

2	SIDE RAILS	1 1/8" X 5" X 58 3/4"
2	BACK UPRIGHTS	3/4" X 1 1/2" X 34"
2	RODS	3/4" DIAM. 24" LONG
1	ROD	3/4" DIAM. 21 3/4" LONG
2	RODS	3/4" DIAM. 25 1/2" LONG
1	FRAME BRACE	3/4" X 2 1/2" X 21 3/4"
2	BACK BRACES	3/4" X 1 1/2" X 8"
4	ARM SUPPORTS	3/4" X 1 1/2" X 9"
2	ARMS	3/4" X 2 1/2" X 18"
4	ARM BRACKETS	3/4" X 1 1/2" X 2 1/2"
2	CANOPY RIBS	3/4" X 3" X 22"
2	CANOPY BRACES	3/4" X 1 1/4" X 10"
2	WHEELS	10" DIAM. 1 1/2" THICK
2	BEARING BLOCKS	1 1/8" X 3" X 6"

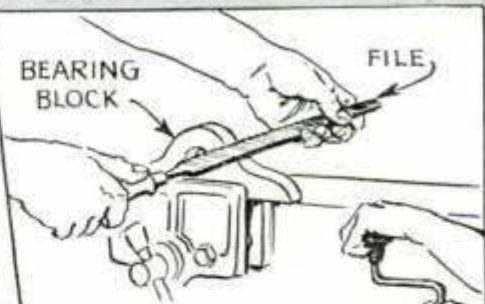

CONCAVE CURVES ARE SMOOTHED WITH A FILE

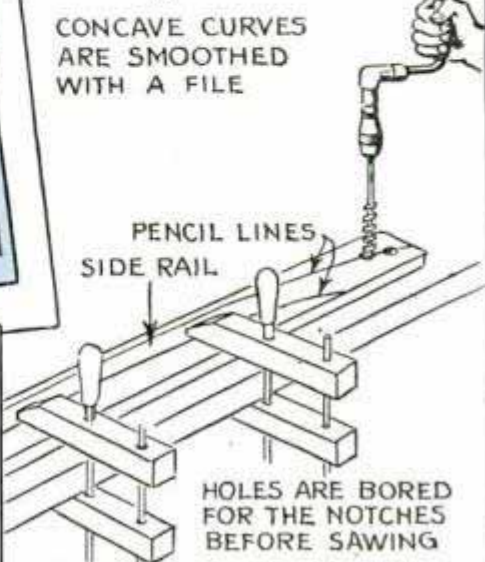

Light in weight but sturdy in construction, this comfortable garden chair is easy to wheel to any desired location in "wheelbarrow fashion." Interlaced canvas strips across the rails prevent sagging and provide a strong foundation for a one-piece cushion, which extends over both seat and back. The latter is adjustable to three positions to suit the user

B.P. 998

Linoleum Blocks Shaded Easily with Hot File



Hot file pressed into surface of linoleum block to produce dots, which shade your prints

Anyone who works with linoleum blocks can produce shading on his prints by "etching" the blocks with an old file. Use one that is bent at right angles near the end. Then heat it and press it against the parts of the block to be shaded. This produces a series of parallel lines in the linoleum. Next go over the work again, holding the file at right angles to the first lines, which will produce small dots in the surface of the block similar to "Ben Day" effects. This work must be done carefully, and the iron must not be too hot or the dots will be burned.

—Kenneth L. Wilson, Houghton, N. Y.

Transferring a Blind Hole

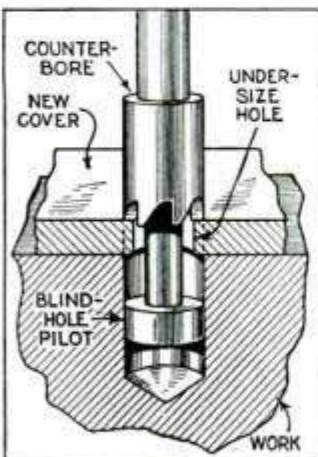

make a pilot with a head that is a sliding fit in the blind hole and a shank much smaller to pass through the small hole in

the new work and into the counterbore, which is the same size as the blind hole. The pilot will guide the counterbore, which is used to enlarge the hole in the new work to size.

'Buggy-Top' Cover for Typewriter Is Closed Quickly

Opened or closed just like a buggy top, this typewriter cover is always at hand, yet is out of the way when working with the machine. The cover is sewed to two

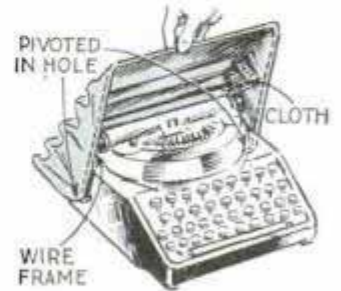

U-shaped wire frames, which are bent at right angles about an inch from the ends to pivot in two holes drilled in the sides of the typewriter near the bottom.

Rubber Cement Used as Eraser

Rubber cement serves nicely in cleaning smudged work where the abrasiveness of a regular rubber eraser might cause damage. The cement is spread generously over



the area to be cleaned, allowed to dry and is then rubbed off with a clean cloth. White rubber cement is preferable, although the kind used in repairing inner tubes will do.

OUTDOOR LIVING ROOMS



By FRANK E. BROWN

PLANNING your back yard for the full enjoyment of an outdoor living room requires a generous bit of time and thought. The materials alone usually require only a small cash outlay. Often you can make use of items already at hand and those which must be purchased need not be expensive.

Take the two suggestions on this page, for example. Either design can be built

into the landscaping scheme on a small lot and anyone handy with tools can do practically all the structural work. Both designs combine a shelter with an outdoor fireplace, the first being simply a framework of rustic timbers supporting a roof thatched with material appropriate to the locality in which it is built. The walls and fireplace are of cobblestones laid in cement. Where cobblestones are not obtainable or are too costly, very attractive work can be done with brick or pieces of broken concrete. Decorative items might be gourds, charm strings of brightly colored

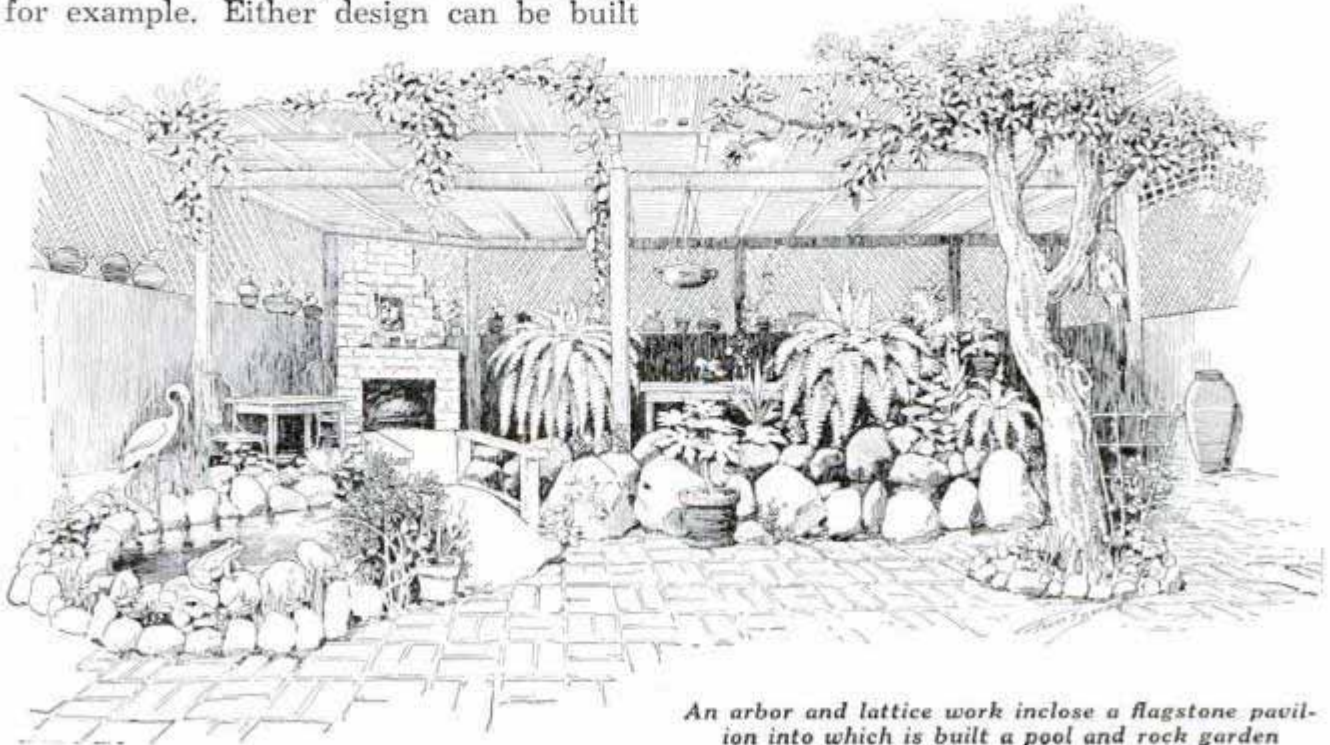

An arbor and lattice work inclose a flagstone pavilion into which is built a pool and rock garden

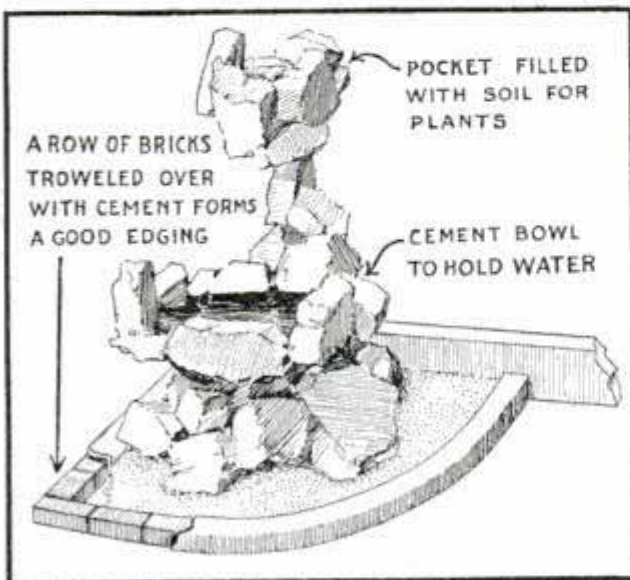
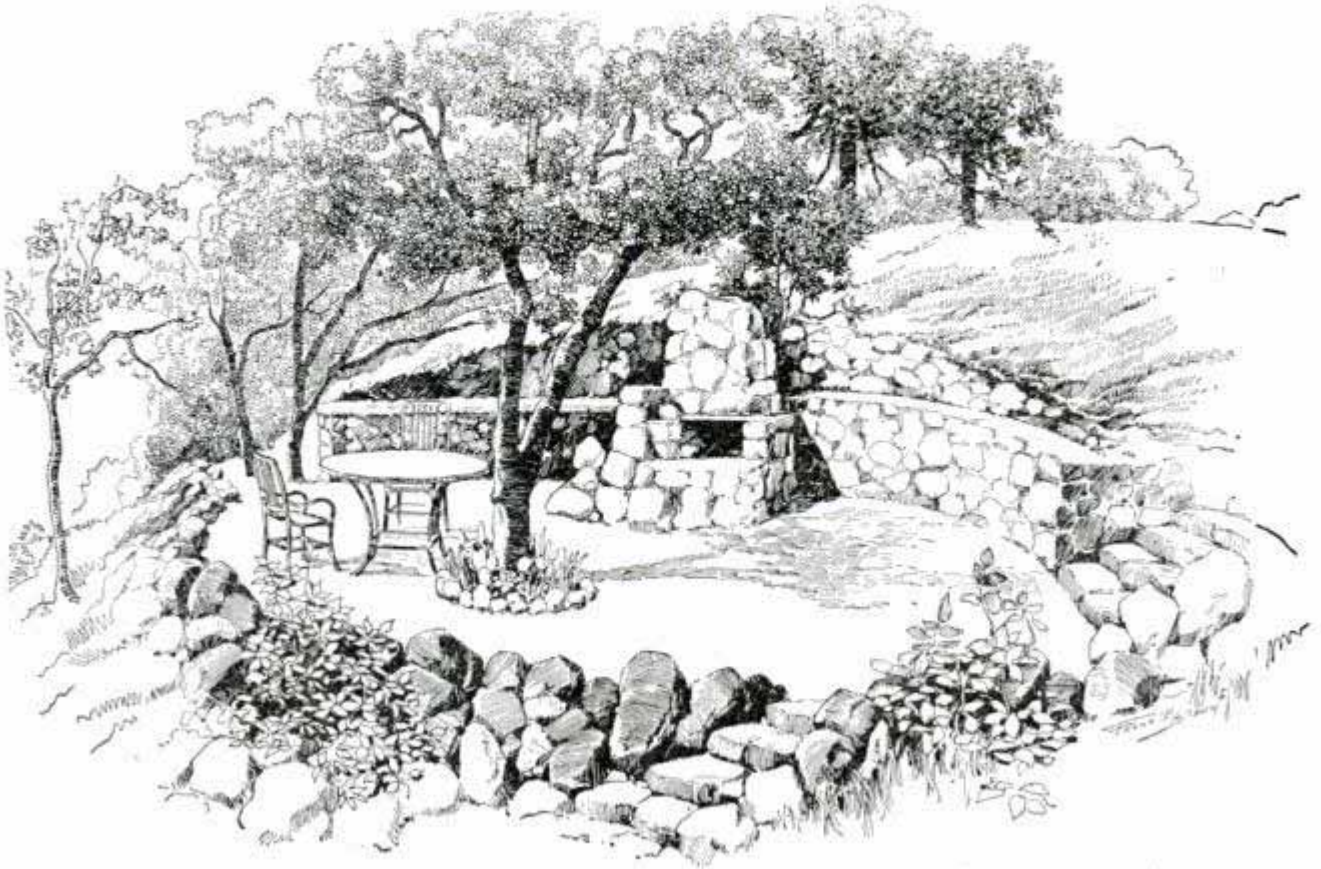

A ROW OF BRICKS
TROWELED OVER
WITH CEMENT FORMS
A GOOD EDGING

POCKET FILLED
WITH SOIL FOR
PLANTS

CEMENT BOWL
TO HOLD WATER

Pods, and flowerpots of unusual shapes. The furnishings may be an enameled table and benches with several chairs of rustic style. The second design is really an arbor sheltering a flagstone pavilion into which is built a pool and rock garden. Of course, such a construction offers almost unlimited opportunity for unusual lighting effects and novel arrangement of the furnishings.

In the third design, which goes well on a sloping lot, the nearest approach to formal treatment is the curved cobblestone wall around the back of the fireplace. The lower wall is simply loosely laid field stones of assorted sizes. The sloping floor might be of colored concrete or flagstones. This particular design is perhaps more flexible in its possible adaptations than any of the others. The next suggestion is especially suited to the small lot and consists of a simple vine-shaded arbor, with a stone fireplace. This style is unusually effective when placed at the back of the small lot and fronting on a fairly large pool. The final suggestion shows what can be done with broken concrete, the design being suitable as a corner piece for a small stone court. A soil pocket for plants and a concrete bowl to hold water are possible elaborations of the idea.

Propeller Spins When Toy Is Pushed on Floor

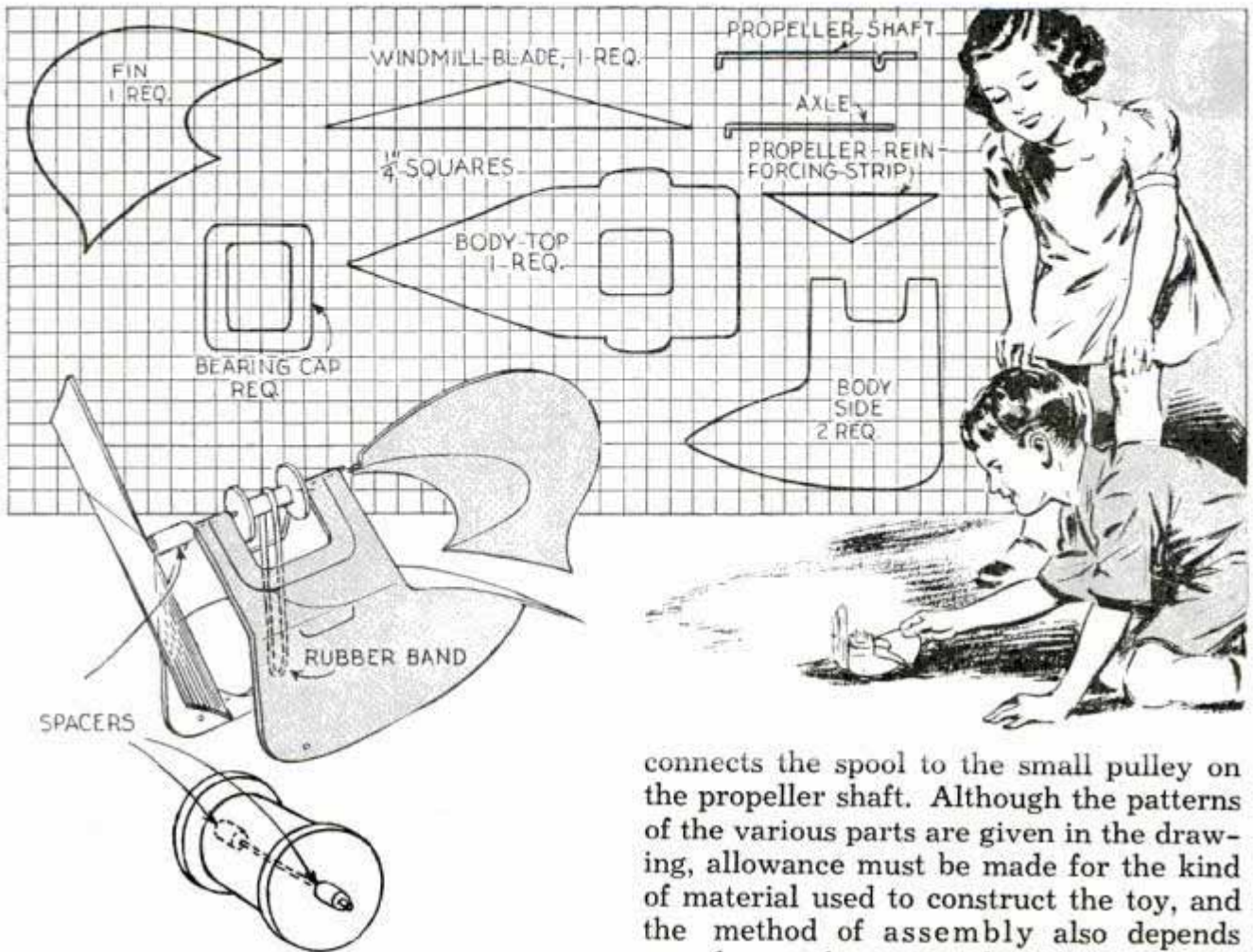

Here's a simple toy that fascinates two or three-year children because pushing it over the floor or table top slowly causes the propeller to spin. An ordinary thread spool contacts the floor and a rubber band

connects the spool to the small pulley on the propeller shaft. Although the patterns of the various parts are given in the drawing, allowance must be made for the kind of material used to construct the toy, and the method of assembly also depends greatly on the material. While this toy originally was built of cardboard, this is rather fragile and one made of thin sheet metal or even hard-pressed board is suggested for greater durability.

—Glenn Bryant, Cleveland Heights, Ohio.

Jointer Gauge for Hand Plane to Square Edges of Stock

This gauge will enable you to joint the edges of work squarely. Two pieces of angle brass are fastened together with machine screws as indicated. Piece A serves as a fence or guide against the work, while piece B carries the plane. It is advisable to set piece A at a slight angle so that the plane iron cuts the work with a shearing action. Two bolts with large washers under the heads clamp the gauge to the plane, the washers merely overhanging the top edge of the plane sides. This makes it unnecessary to drill holes in the plane. Wing nuts on the bolts facilitate attaching or removing.

—S. J. Gancher, Richmond Hill, N. Y.

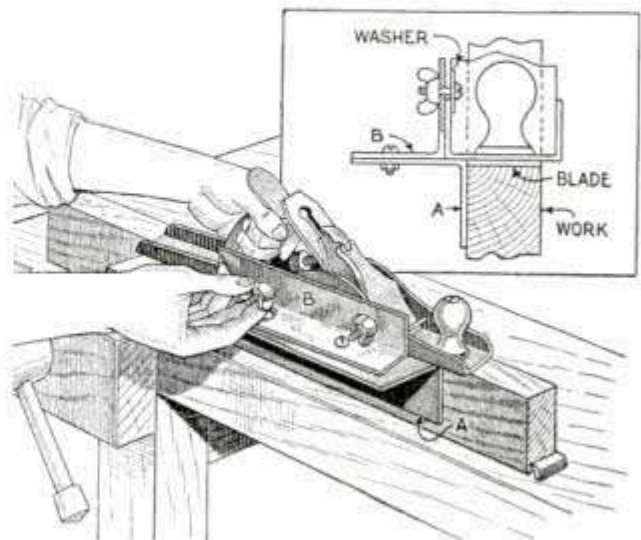

Hold the plane with the fence of the gauge flat against the side of the work

MOUNTING

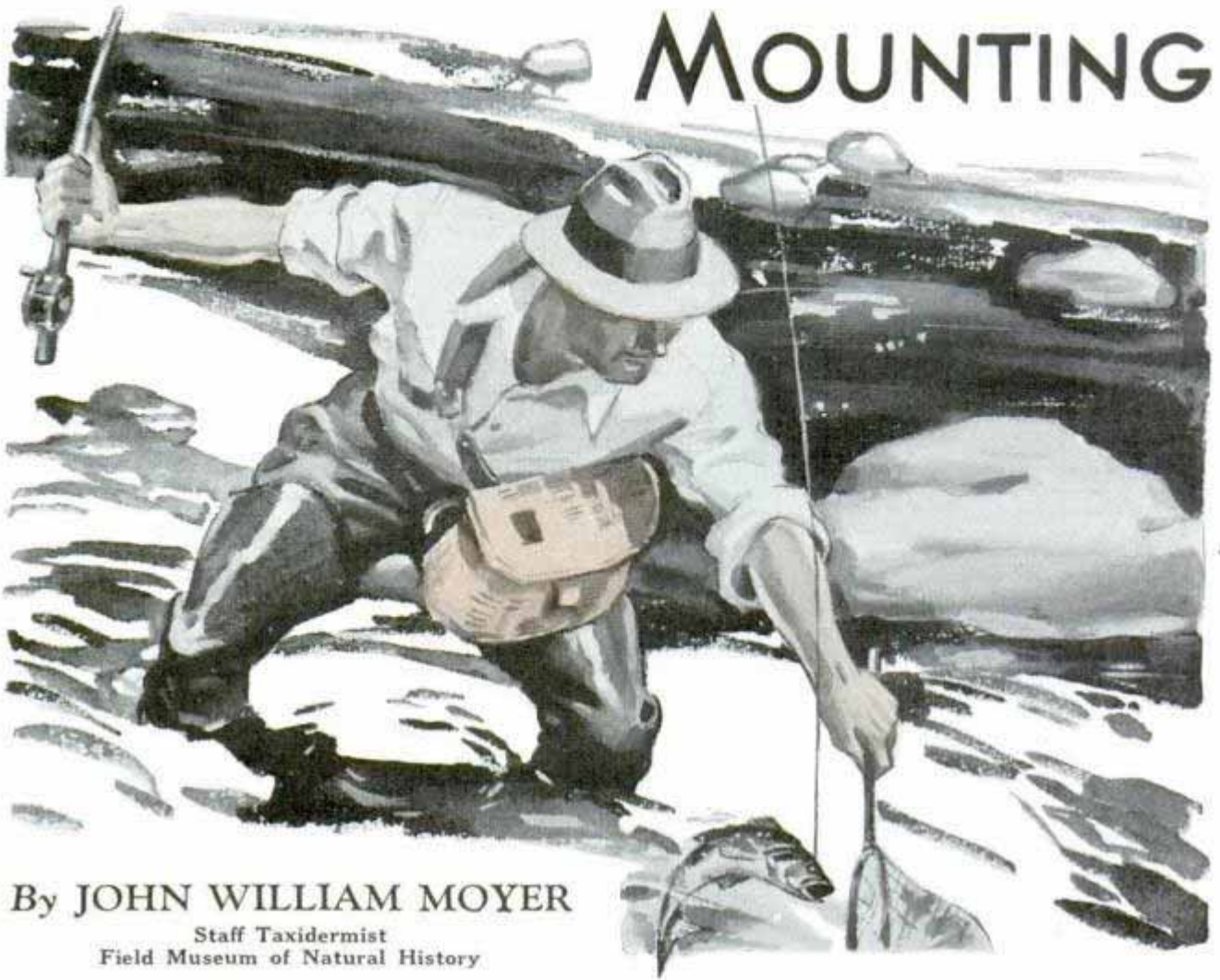

By JOHN WILLIAM MOYER

Staff Taxidermist
Field Museum of Natural History

THE supreme moment in fishing—landing the king of all fighters—is given an added thrill if you can mount the fish as proof of your skill. The first step after the fish has been taken from the water, and even before it is dead, if possible, is to take accurate color notes. It is important that this be done, as fish begin to lose their colors immediately after leaving the water. A drawing, or outline, of them can be made and the proper colors marked in, using

wax-crayon pencils or just writing in the correct colors. Make a note of the eye color so the proper colored glass eyes can be inserted in the specimen later. The best way to keep a fish, if it is necessary to preserve the specimen several hours, possibly several days, before mounting, is to wrap it tightly in wet moss, or a wet towel and pack in cracked ice. Replace the ice as it melts and mount the specimen as soon as possible.

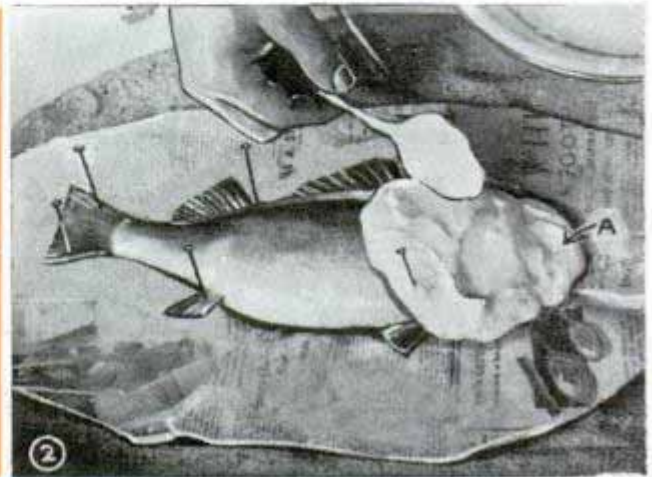
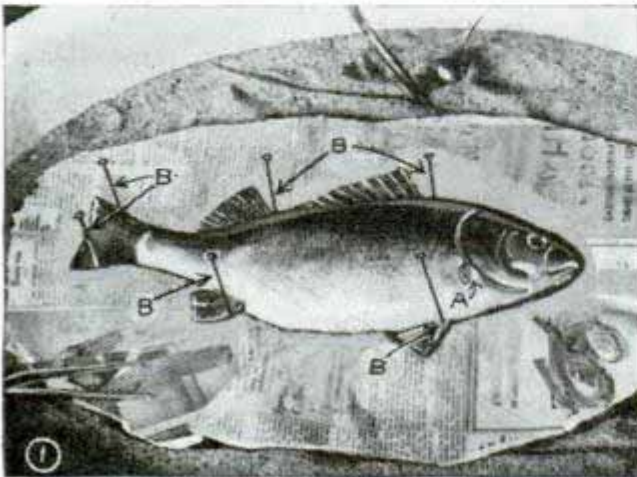

THE FISH YOU CATCH

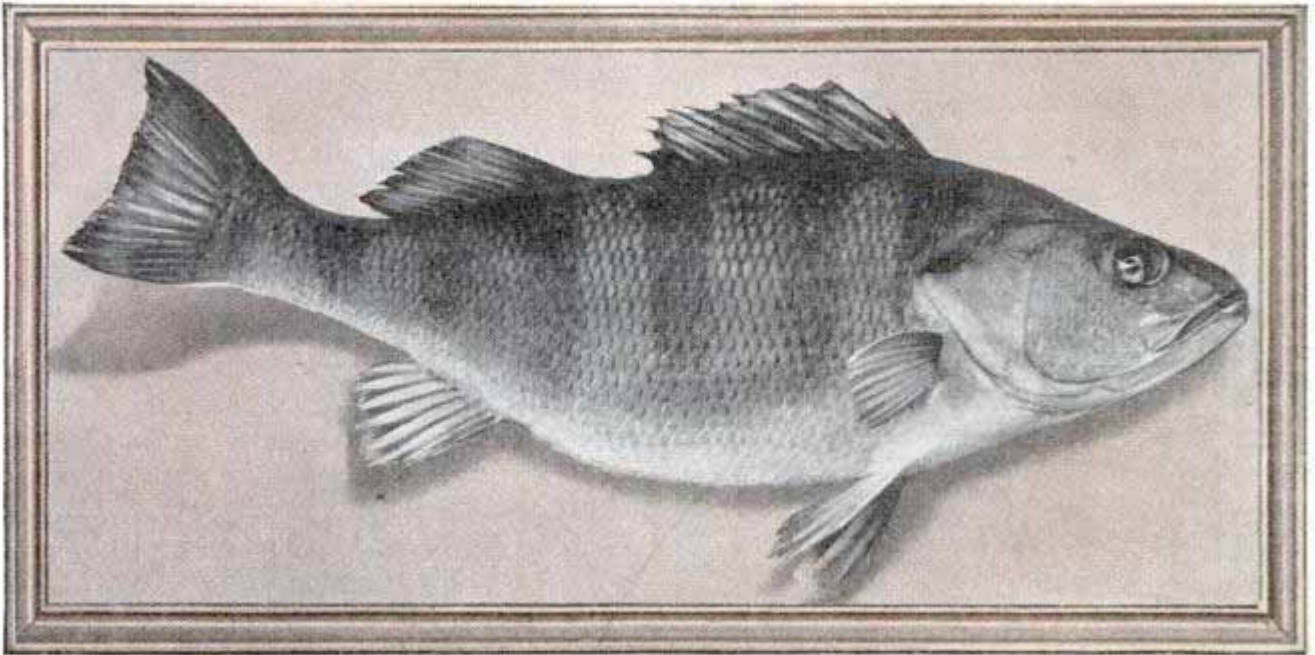

When you are ready to prepare the specimen, wash it well in cold, running water, taking care that the inside of the mouth and gills is thoroughly clean. Now sponge off the side of the fish that is to show with alum water (about a teaspoonful of alum to a gallon of water). This will set the mucus with which all fish are covered. Cut off the pectoral fin A, Fig. 1, from the show side and keep this fin wet so it will stay relaxed until used later. Lay the fish in a box of sand, first putting a piece of newspaper on top of the sand and the fish on this; the paper to keep the sand from sticking to the specimen. The fish is buried about halfway in the sand in the pose wanted in the finished mount. The fins and tail are now spread and held in position with large pins, B, in Fig. 1.

Now mix up a batch of plaster of paris, making it quite thick so it will set quickly, and pour this over the fish. Start at the head and work back toward the tail, as at A in Fig. 2, but do not cover the fins and tail any more than shown in Fig. 3. Leave the pins in until the plaster has set and then remove them, after which the cast is turned over and, grasping the fish by the tail, it is removed from the mold, Fig. 4. Lay the mold aside for the time being and wash all plaster particles from the fish.

Skinning of the specimen is next. Lay it on the show side and with a sharp knife make an incision along the lateral line on the off side, A to B, Fig. 5. Cut through the scales and skin, but not any deeper. Separate the skin from the body, Fig. 6, being careful not to leave any more flesh

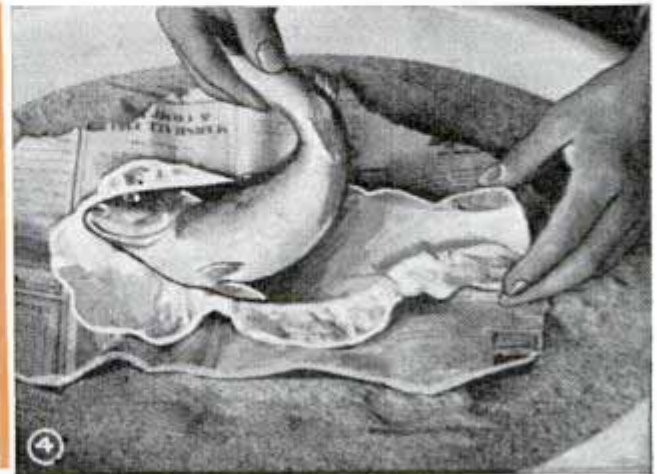
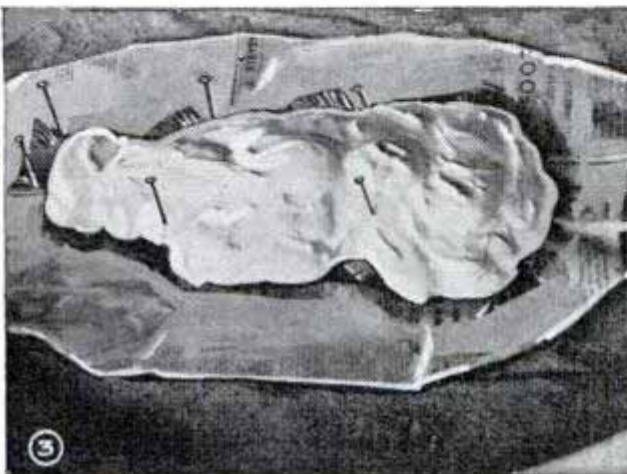

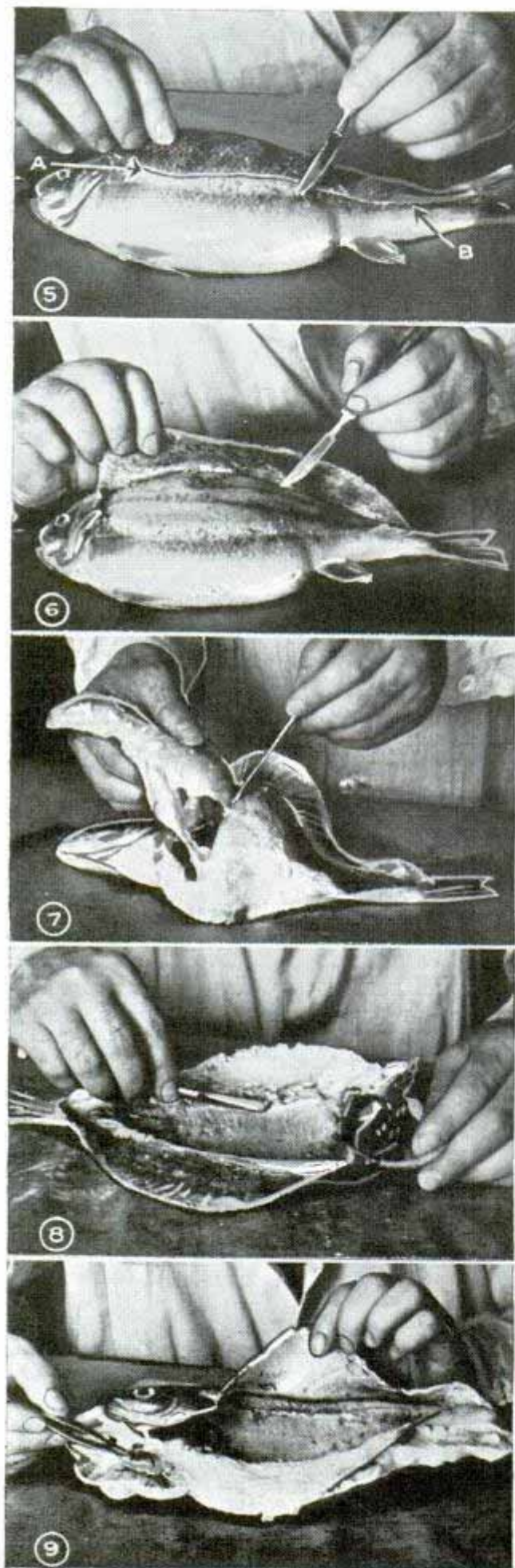

attached to the skin than necessary. When the base of the fins and tail is reached, use a heavy pair of scissors to cut loose from the body. Skin down over the back until the head is reached and sever the body from the head and skin as in Fig. 7. The skin is next cleaned of all remaining flesh with a dull knife, taking care not to injure the silvery lining next to the skin, Fig. 8. Clean the head thoroughly, removing the eyes and flesh in the cheeks (which can be removed through the eye cavity) and around the head; do not remove the gills. Cut away all flesh around the fins and tail, but be careful and do not cut through the skin. After the skin is thoroughly cleaned, wash it off in cold water and allow to drain. Now dip the skin in alcohol, which acts as a preservative and also "sets" it. Around the base of the fins and tail, use some formaldehyde to act on any particles of flesh that could not be removed. Also use formaldehyde in the head and around the gills. Keep fins and tail wet at all times, so they will stay relaxed.

The fish skin is now laid into the plaster-of-paris mold and pressed into the correct shape, the mold acting as a guide, Fig. 9. See that the head and tail fit in their correct places. Now mix up a batch of any quick-setting papier-mache (any number of brands of papier-mache can be bought from taxidermy supply houses) and flow in a layer of this on the skin. Cut a small block of wood, A in Fig. 10, and set this into place. Now make the papier-mache thicker and fill up the rest of the skin. As this is being done, start at the tail and sew up the specimen, taking care to get in just the proper amount of papier-mache. After the specimen is sewed up and while the papier-mache is still soft, press the fish firmly into the mold and model into shape as in Fig. 11. Allow the papier-mache to set thoroughly, but keep the fins and tail wet and relaxed.

Then remove the fish from the plaster mold, Fig. 12. Now fasten the fish to a temporary piece of wood by driving screws into the block of wood previously placed inside the specimen, and allow to dry thoroughly. Give the fins and tail the correct spread and angle and hold them in position by pinning between two pieces of cardboard. Pin down the gill coverts and either close or open the mouth, filling in

the cheeks with papier-mache as in Fig. 13. After four to six hours, give the body a thin coat of white shellac to prevent the scales, in some specimens, from curling.

Allow the work to dry for several weeks, depending on the size of the specimen, and then remove the cardboard from the fins and tail. They should be reinforced on the underside with a piece of thin cloth glued in place, and on the top side with tissue paper as in Fig. 14. Use what is known as carpenter's glue for this work and add some glycerin to it to keep the fins and tail flexible, Fig. 14.

After the glue has dried, the fins and tail are trimmed using a sharp pair of scissors; trim according to the natural shape of the fins and tail. The pectoral fin is now fastened into place. Fill in any depression around the fins, tail or head caused by the skin shrinking in the drying, with modeling wax, or a smooth papier-mache. Glass eyes, which can be bought from a taxidermy supply house, either colored or clear eyes that one can color from the notes taken, are next set into place with the wax or mache. The specimen is now given a light coat of white shellac to form a base for our coloring.

Following the color notes taken when the fish was first caught, the true colors are applied to the specimen, making it look as natural as possible. Do not use the colors too heavy and do not brush them on; stipple them as a sort of color tints. After the specimen is colored, allow to dry and then give it a light coat of a good varnish.

Firm Angle Worms Assure a Big String of Fish

When using angle worms for fish bait, anglers will find that trout and bass are more apt to strike them if they are kept fresh and firm. This is best done by lining the bottom of your bait box with swamp moss, which can be found in marshy woodlands. If the moss is not available in the woods, it can be obtained at your nearest florist. After covering the bottom of the bait box with moss, dampen it, place the day's supply of worms inside and cover them with more moss. The worms will be firm and fresh when the stream or lake is reached and they will remain in good condition for a full day's fishing.

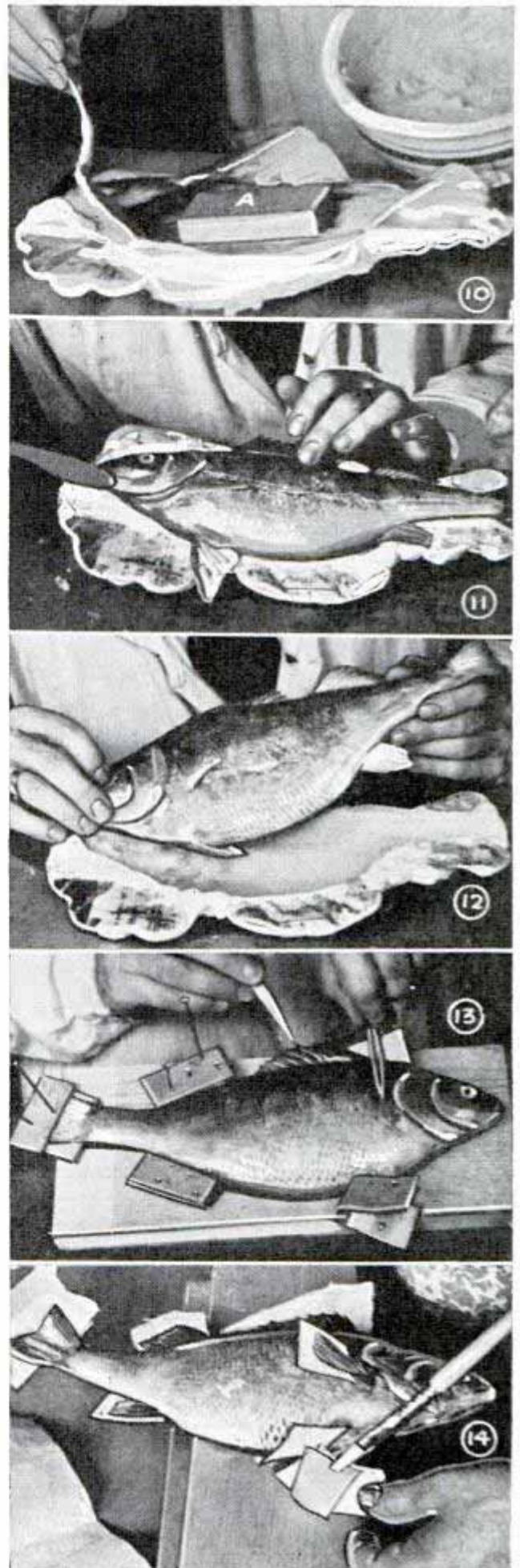

Springs in Photo Printing Frame Maintain Even Pressure

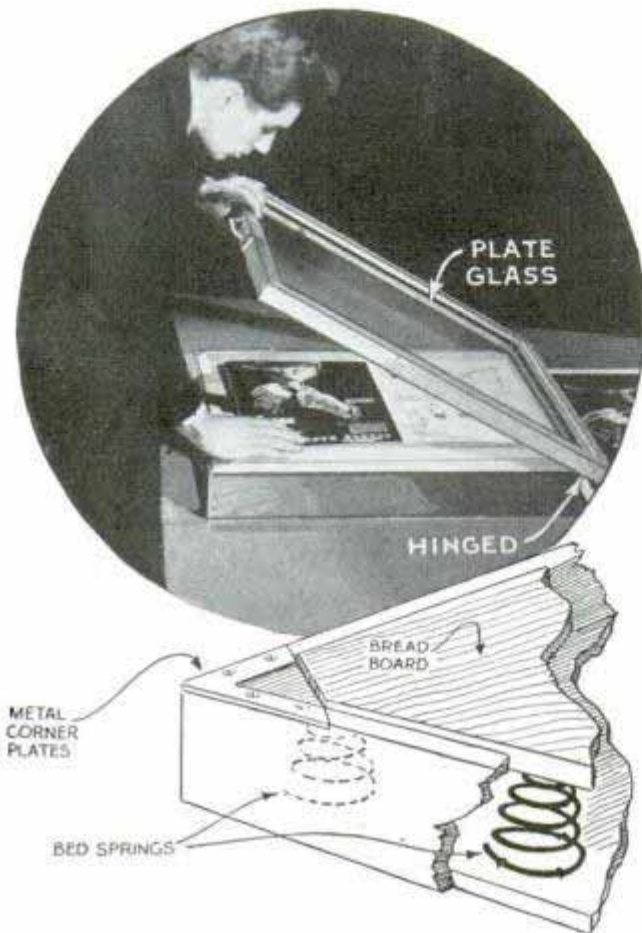

Large size frame has a resilient bed that holds the work in contact with the glass uniformly

Useful in either an amateur or commercial photo studio, this frame serves for printing large sizes of paper, flattening prints or copying. It consists of two parts hinged together, the top part having a piece of plate glass flush with its lower surface, and a hand grip for easy manipulation. The glass presses tightly against the wood top of the lower part, which floats on coil springs and is retained by metal corner plates. The floating piece may be an ordinary breadboard and it should fit loosely, permitting up-and-down movement. The board should be recessed at the corners to assure contact with the glass at all points.

Cleaner for White Shoes

An excellent cleaner for white shoes can be made as follows: Dissolve soda ash, $1\frac{1}{2}$ oz., and soap flakes, 6 oz., in hot water, 3 qts. When partly cooled, add a solution, which has been made by soaking powdered

gum arabic, 2 oz., in water, 2 fluid oz., for 15 min. and then shaking or stirring until dissolved. When the mixture has cooled, vigorously stir in titanium dioxide (white), $4\frac{1}{2}$ lbs. The finished cleaner is bottled while being stirred and the directions should indicate that the product is to be shaken before applying.

Tinfoil Strips Keep Birds Away from Flower Beds

Birds will not scratch out seeds, tiny plants or eat your strawberries if you suspend narrow strips of tinfoil from wire stakes set in the garden. The tinfoil strips have the advantage over cloth or paper in that they flutter in a lighter breeze and crackle quite loudly.

—W. L. Wernicke, Valley Stream, L. I.

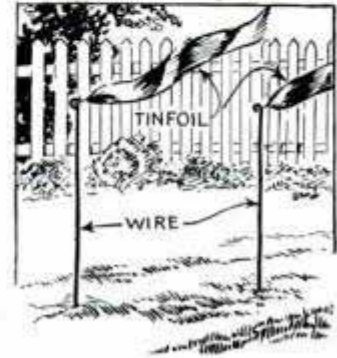

Canoe Skidded Safely over Beach on Tree Bough

When a canoe must be transported some distance from camp to the water, one fisherman lashes a pine sapling or tree bough to the thwart at either side to serve as a skid. The bow of the canoe is thus protected so that the opposite end may be raised and the craft pushed over fairly rough surfaces without damage.

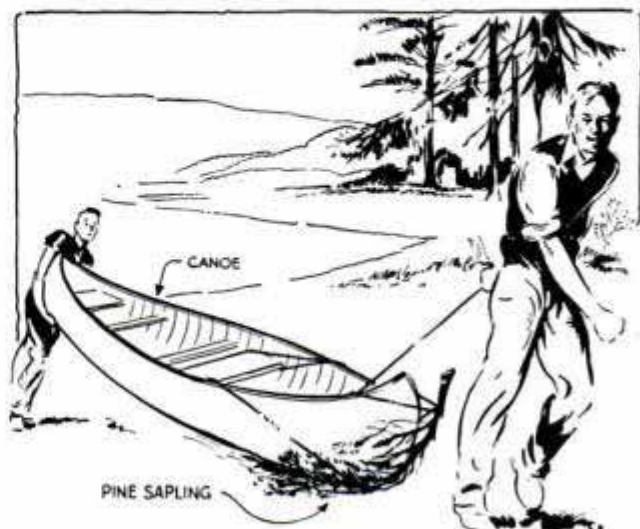

Small tree lashed to bow of canoe serves as skid to move craft over beach or around rapids

ROLL-TOP PICNIC TABLE

Here's a folding table that solves the chief problem of picnic parties for it can be set up anywhere in less than a minute's time. Just unroll it, swing the legs and pivoted cross members into position, tighten the thumbscrews that hold the braces and there you are. The top, as you will see, consists of a number of hardwood strips glued to a piece of heavy canvas. The best way to do this is to improvise a jig to hold the strips firmly in position. Then spread the glue in a line down the center of each strip, lay the canvas on top and roll the whole surface to spread the glue uniformly

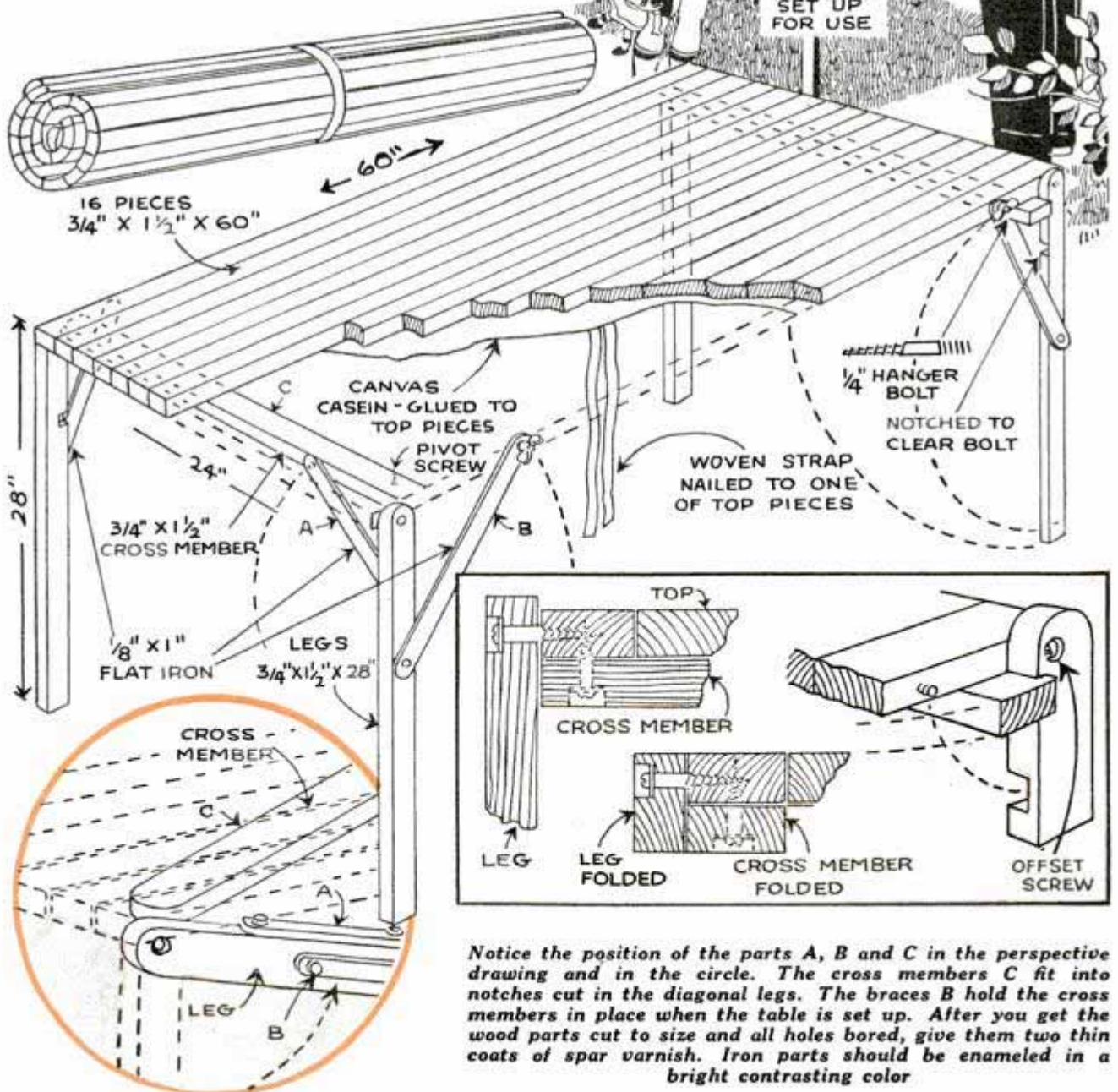

Batteries Are Quickly Inspected with Flashlight and Mirror

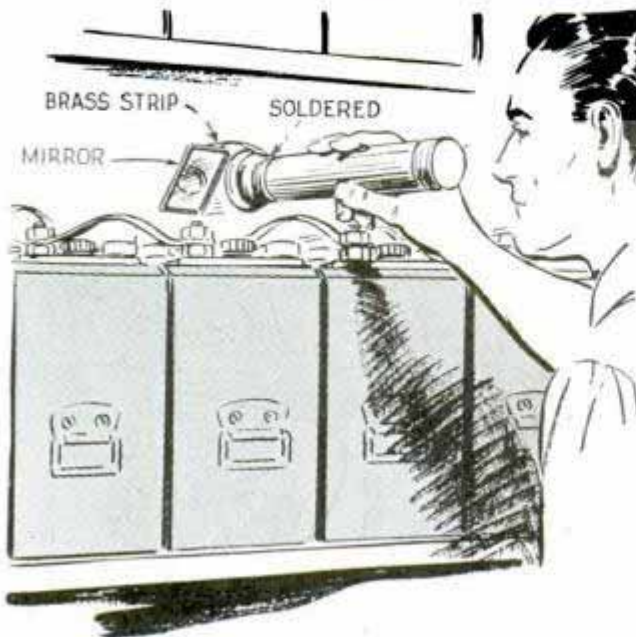

Flashlight with mirror attached permits you to see into openings that are usually difficult to reach

When storage batteries are set on shelves where it is difficult to inspect them, a flashlight with a mirror attached in front of the lens will save time and trouble. A small pocket mirror that has a metal frame is best as a brass strip can be soldered to both it and the flashlight case. When the flashlight is held as indicated, light is reflected into the battery so that the image of the interior can be seen in the mirror. Plumbers and electricians will find this idea handy when looking between wall partitions by inserting the mirror into a small opening so that light can be reflected between the walls.

—Vincent F. Cipolle, Los Angeles, Calif.

Double-Pointed Fasteners Made from Two Thumbtacks

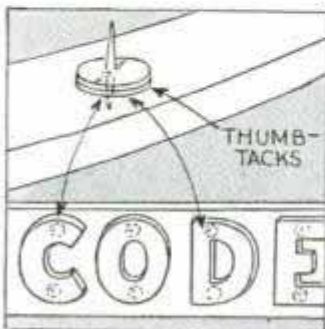

Thumbtacks of the type that have slots in the heads can be used double where a quick fastener is needed. The point of one tack fits through the slot in the other, providing a double-pointed tack that is useful for fastening pictures to a wall or for hanging up any light object. Such fasteners have been

used for pinning wooden letters onto a board to provide signs that are changed quickly.—John G. Roberts, Chicago.

used for pinning wooden letters onto a board to provide signs that are changed quickly.—John G. Roberts, Chicago.

Diameter of Round Work Found with Two Squares

Two squares provide a quick means of finding the diameter of round work. Just place it on one square as indicated, and then butt the other tightly against it. The dimension on the first opposite the edge of the second square is the diameter of the work in inches.—R. L. Allen, Dothan, Ala.

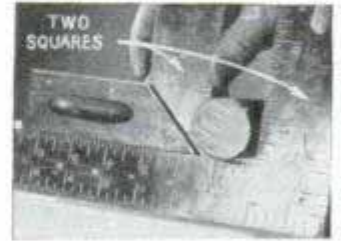

Shotgun Shell Holds Paraffin to Wax Fishline



A handy method of waxing your fishline to preserve it, is to carry a discharged shotgun shell that has been filled with melted paraffin. A deep slot in the end of the shell

permits the line to be drawn over the wax quickly.—G. E. Hendrickson, Argyle, Wis.

Cord of Electric Shaver Knotted to Avoid Dropping

Instead of taking a chance of dropping an electric shaver, which might result in a broken case or damaged cutting head, knot the cord as indicated and slip the resulting loop over your wrist. There is no possibility of

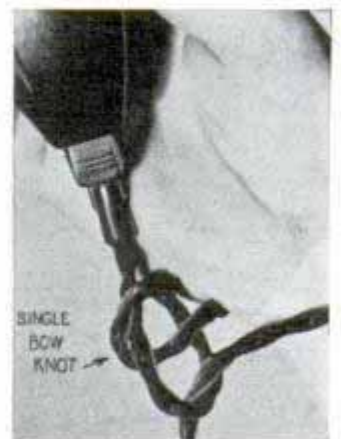

the shaver reaching the floor if it is dropped and you don't have to remove the knot when you have finished shaving.

PHOTO FLASHES *for* DAYTIME SHOTS

HOW would you take the type pictures shown in Figs. 2, 4 and 6? Not many years ago probably it would have been wise to give up the idea entirely but now, with the photoflash lamp and the synchronizer, Fig. 1, you can handle these tricky daylight shots. A moment's study of the three compositions will show you why they used to be considered extremely difficult. In the first two, Figs. 2 and 4, you have the problem of a bright blue sky with scattering clouds, and a foreground composed of considerable essential detail. To secure balance it is necessary that you catch this foreground detail with a comparatively short exposure. This must be done in order to render the sky properly. Normally if you increase the exposure sufficiently to assure foreground detail, even with a filter

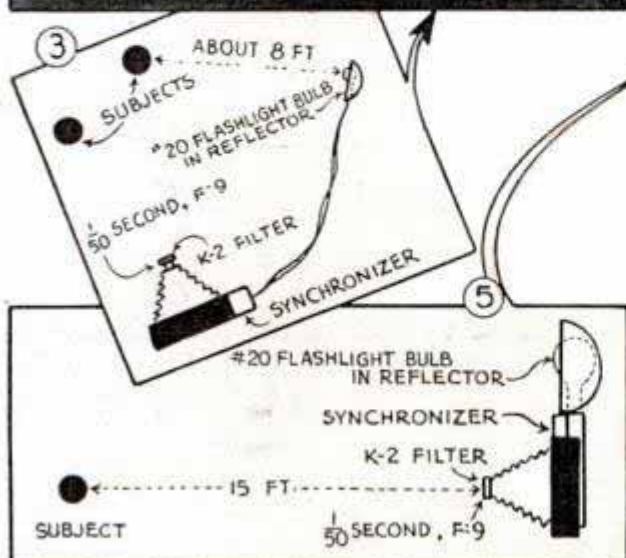

over the lens, you will overexpose the sky so greatly there will be little or no cloud detail recorded. The result will be a negative badly out of balance. Figs. 3 and 5 show how the two shots in question were taken, using photoflash lamps and a synchronizer. Notice especially how the bright light from the sky was utilized to backlight the figures in both shots and that the photoflash gave the necessary frontal detail in the faces to assure a pleasing and striking composition. In taking the photo Fig. 2, the natural lighting made it necessary to have the synchronizer fitted with an extension socket and reflector unit so that



the light from the flash lamp. Of course, there are many factors to consider in taking any similar photo as the actual conditions will never be exactly the same. A good exposure meter will eliminate much of the guesswork. Sometimes it is desirable to make a photograph of a subject out of doors without showing any background. Fig. 7 is an example of this. To eliminate strong shadows and show detail in the camera and the dark clothing of the figure, the flash lamp was used, in this instance being fired from the camera.

The portrait of the puppy, Fig. 8, and the detail, Fig. 9, indicate how a somewhat different problem in lighting was handled. In order to backlight the subject and sharpen the profile, a spotlight was placed as in Fig. 9. Then to catch all details of pose, expression, and body contour a photoflash was fired from the camera, using a medium stop opening and a comparatively short exposure.

the latter could be located some distance from the camera as shown in Fig. 3. In shooting the second photo, Fig. 4, the flash unit was used attached to the camera as you see it in Figs. 1 and 5.

Fig. 6 is another example of how the flash lamp can be used to control the lighting in daytime photography of a difficult subject. Here again you have the problem of effectively rendering near and distant detail. With the flash unit you photograph the landscape by the light of the sun, and the near side of the arch and the figure by

Lacquer Avoids Spotty Photos

When touching up an enlargement from a miniature negative, the difficulty of matching the luster of the retouched surface with the rest of the print to avoid spottiness, is overcome by applying clear lacquer. This is brushed on in the usual manner, a large brush being preferred. Absorbent surfaces may require two coatings, but usually one will suffice.

—John G. Roberts, Chicago.

Support for Garden-Hose Nozzle

Permanently attached to your garden hose, this metal stake or support is always at hand to push into the ground and support the nozzle in a vertical position. When not in use, it lies close to the hose out of the way when holding the latter in your hand. The support is a piece of sheet metal cut and bent to the shape shown. It is clamped around the hose just back of the nozzle.

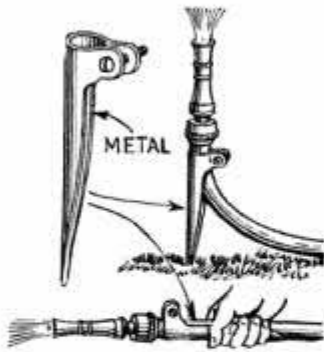

Electric Eraser Cleans Fast and Smooth

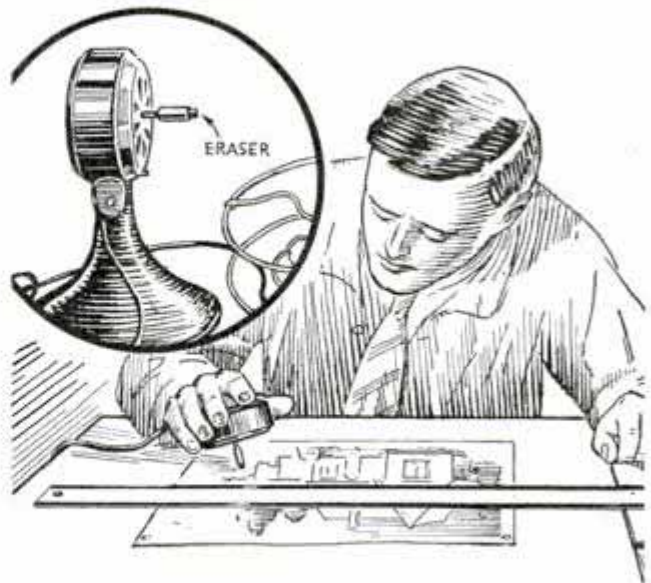

Cleaning or erasing portions of drawings is done quickly with this electric eraser

Especially useful for erasing in restricted spaces, this power eraser will save time and enable you to do a neat job. It consists of a tiny electric motor, such as used on small electric fans, the abrasive rubber being attached to the armature shaft by means of a wood or metal sleeve. When the eraser becomes dirty, a piece of fine sandpaper held lightly against it while rotating will clean it quickly.

—Frank W. Bone, Adrian, Mich.

Knives Stored in Breadboard

Here's a breadboard that should be doubly welcome in your kitchen as it keeps the bread knives handy and there is no possibility of the edges being damaged. The board consists of two parts, grooves being cut in one surface of each one to form narrow knife slots when they are

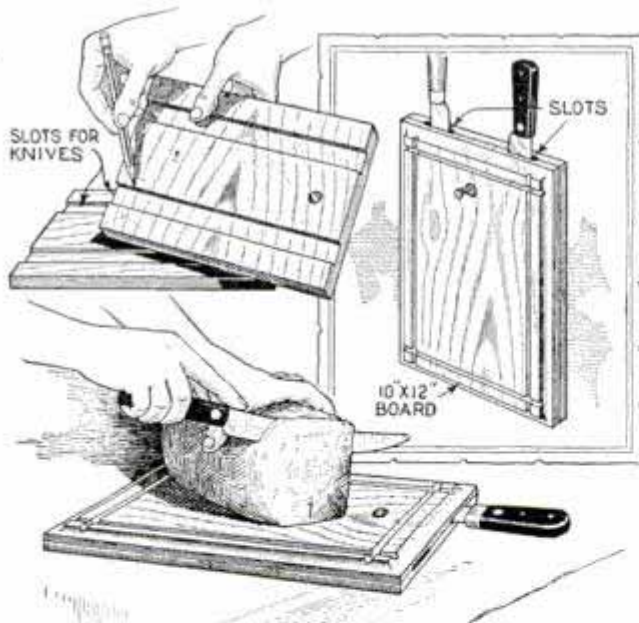

Your bread knives are always at hand and the cutting edges are well protected in this board

glued together. Use waterproof glue, and apply several coats of raw linseed oil, allowing each coat to dry two days before the next is applied. The oil tends to make the board resistant to water and helps to prevent excessive warping.

—Burl Knutson, Bismarck, N. D.

Easy Way to Miter Molding on Window Screens

Instead of carefully measuring and then mitering the ends of window-screen moldings, I nail them in place, allowing the ends to overlap slightly at the corners. Then I

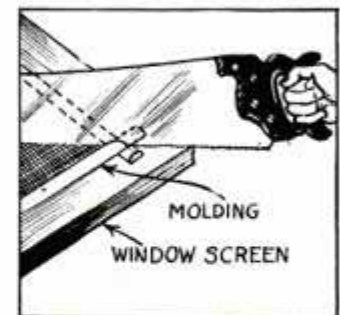

saw through both pieces at an angle. This method gives me a tight-fitting joint and saves a lot of time. A little care must be taken not to cut the wire or saw into the screen frame.—A. L. Toews, Angwin, Cal.

☞ When a sewing-machine belt loosens enough to slip, a few drops of castor oil applied to it usually will stop the trouble.

CHEMICAL "SERVANTS"



WINDOW - CLEANING PASTE

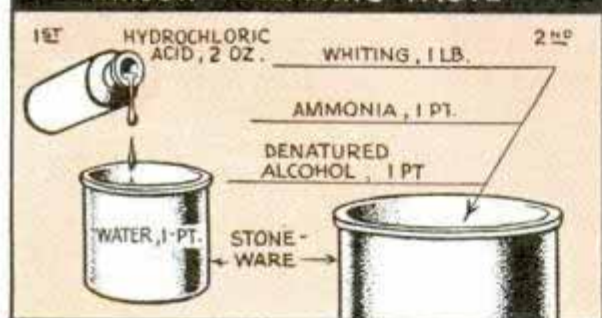

By J. B. MULLEN

IN THE accomplishment of everyday household tasks, it is often possible to minimize hard and tedious labor by the expedient use of simple chemical solutions, which can be prepared easily by anyone.

For example, after long exposure to the elements, window glass becomes dull and opaque. To renew the glass, it is washed first with water, and then with a solution made by slowly pouring hydrochloric (muriatic) acid, 2 oz., into water, 1 pt., in a stoneware or glass container. Apply this solution as shown in Fig. 1. Care should be taken to wear rubber gloves and not to splash the acid solution on the clothing or skin. After washing away the acid with water, the glass may be polished with a paste made from precipitated chalk, 1 lb., in ammonia, 1 pt., and denatured alcohol, 1 pt. The paste is rubbed on the glass and

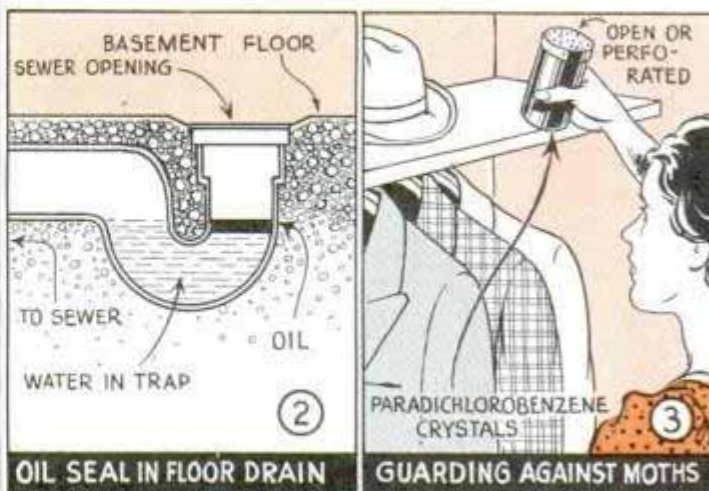

allowed to dry, after which the white coating is rubbed off with a clean, soft cloth.

Sewer traps, such as those in the floors of basements, become dry, if they are not used frequently, and allow dangerous and unpleasant gases to enter the house. To prevent this, flush the trap and then pour a small quantity of oil, such as used motor oil, into the trap as in Fig. 2. The oil will float on top of the water and prevent evaporation. If a building is vacant during freezing weather, sufficient kerosene should be poured into all traps to replace the water and thus prevent bursting of the pipes.

Paradichlorobenzene crystals make a good moth repellent if placed in an open container in a tightly sealed closet as in Fig. 3. Gummed tape around the edges of the door makes an effective seal. The crystals change to a vapor which is poisonous to moths but relatively non-injurious to human beings.

Chimneys which have become clogged with soot may be cleaned easily by throwing $\frac{1}{4}$ lb. or more of a cleaning compound into the stove or furnace on top of a hot bed of coals, as in Fig. 5, and the door closed quickly so that the full draft will be available when the compound takes fire. A good compound is made from ordinary table salt, 7 lbs., potassium nitrate (salt-peter), 4 lbs., flowers of sulphur, 7 lbs., copper sulphate, 7 lbs., ammonium chloride, 8 lbs. The chemicals are thoroughly mixed together until a uniformly colored powder is obtained. This must be kept in

Ease HOME TASKS

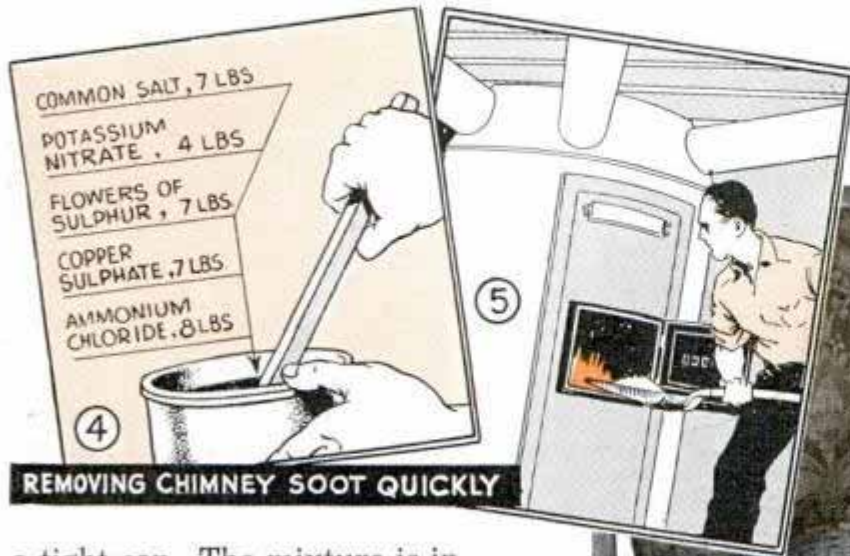

REMOVING CHIMNEY SOOT QUICKLY

a tight can. The mixture is inflammable and should be handled accordingly. When a chimney is overloaded with soot and catches fire, it can be extinguished by throwing two or three large handfuls of salt onto the fire and closing the door quickly.

Upholstered furniture which has become infested with moths may be cleared of them by spraying the furniture as indicated in Fig. 6, with a solution made by dissolving paradichlorobenzene, 1 oz., in ethylene dichloride, 4 pts. 11 oz., and carbon tetrachloride, 1 pt. 9 oz. This solution is non-flammable and will not leave a stain on upholstery or clothing. An effective deodorant and disinfectant is made from pine oil, rosin, lye and water. The concentrated disinfectant from which the spray is made as needed, is prepared by heating together steam-distilled pine oil, 5 lbs., and water-white wood rosin, 2 lbs., in a kettle, preferably over a water bath as in Fig. 7. The mixture should be stirred while heating and should be watched carefully so that the temperature does not rise above 176° F. The heating and stirring are continued until the rosin has all melted and mixed to an even, oily consistency. Care must be taken to prevent the mixture catching fire. When dissolved, the mix is allowed to cool

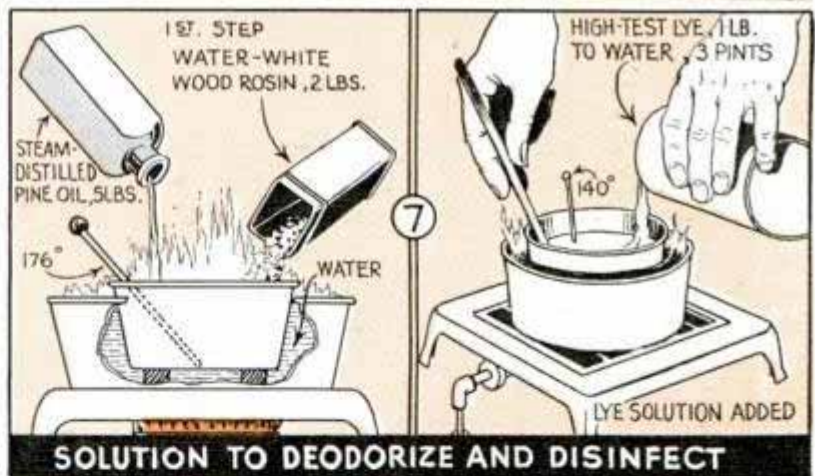

SOLUTION TO DEODORIZE AND DISINFECT

until the thermometer reads 140° F. At this temperature 1 pt. of a lye solution, made by dissolving high-test lye, 1 lb., in water, 3 pts., is added slowly while stirring gently. If the lye is added too fast the batch may foam over the sides of the kettle. When all the lye has been added the heat should be regulated so as to keep the batch at about 140° F. for a half hour. During this time it should be stirred slowly.

For use, the clear amber solution made as above is poured into water while stirring briskly with a paddle as in Fig. 8. As a wash for deodorizing and disinfecting bathroom fixtures, Fig. 12, one part of the



concentrated disinfectant is stirred into 40 parts of water. This will produce a milky solution which is an excellent disinfectant and deodorant, but which will not burn the hands and is non-corrosive and non-toxic. The same solution may be used as a spray to destroy musty odors in basements, to disinfect garbage cans, and as a spray for out-buildings and poultry houses.

Very often a screw or nut which has been in place for a long time is rusted or corroded to such a degree that removal is impossible without the use of an effective penetrating oil. This is made by mixing together thoroughly secondary butyl alcohol, 15 fl. oz., light mineral oil, 4 pts., and kerosene, 30 fl. oz., Fig. 9. The oil is sprayed or dropped on the parts, and allowed to stand for a few minutes.

A brush-cleaning solution that is really effective can be made by mixing kerosene, 1 gal., and oleic acid, $\frac{1}{2}$ gal., in a large container. In another container, 28 per cent ammonia water, 1 pt., and denatured alcohol, 1 pt., are mixed as in Fig. 10. The ammonia-alcohol mixture is stirred into the kerosene solution until a smooth prod-

uct results. The mixture is kept in a tightly corked container to prevent evaporation. To use the solution, the brushes are allowed to stand in the mixture overnight, after which they are washed out with warm water. It is best to soak the brushes in the mixture in a covered can, as in Fig. 11.

Old grease spots on cloth or paper may be removed by rubbing them with a mixture of calcined magnesia and benzene, rubbed to a paste, Figs. 14 and 15. The benzene dissolves the grease and the magnesia absorbs it. While it may be necessary to make several applications, the advantage of this cleaner is that it does not leave a ring. It may be preserved in a large bottle if the latter is tightly corked.

Paradichlorobenzene is effective as an ant exterminator. For this purpose 1 lb. of the crystals is dissolved in carbon tetrachloride or kerosene, 2 qts., Fig. 13, and the solution is poured into the ant holes as shown. The carbon-

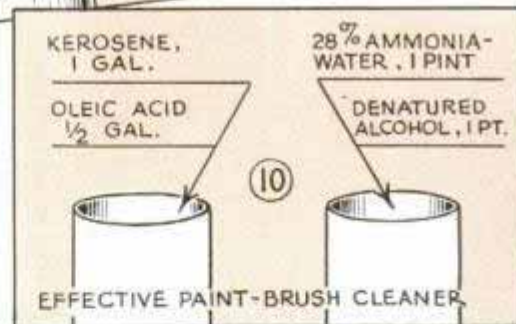
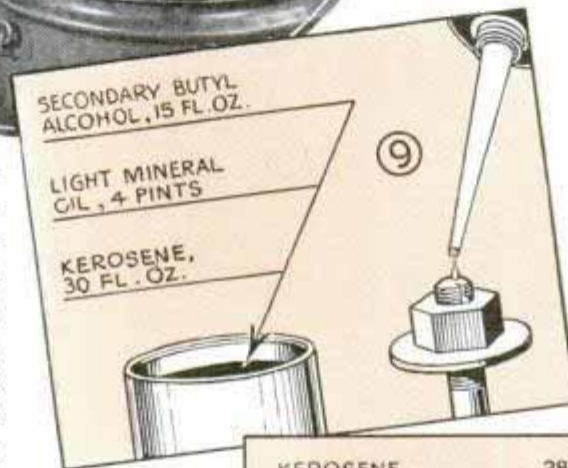

tetrachloride solution has the advantage of being non-inflammable. Ants may be prevented from entering a building by sprinkling oil of sassafras about the doors and any other place where the insects are gaining entrance.

Books that have been on the shelves or in cases for a long time become quite dusty and dirty along the edges of the pages. Ordinary dusting fails to remove this accumulation. The dust and dirt can be removed by rubbing with bread. The best substance to use is the well-cooked but doughy bread inside the crusts of fresh rolls. In applying, the soiled book is rubbed with a ball of the dough as shown in Fig. 16. The ball may be used until it is saturated with dirt.

Odors from vegetables kept in the refrigerator may be prevented from contaminating other foodstuff kept in the same compartment by including a perforated can containing charcoal. The can should be of aluminum so that it will not corrode. It should have a capacity of about 1 qt. for a 3-cu.-ft. refrigerator. Small holes should be punched into the sides and top of the can as close together as possible so that the charcoal will absorb the odors. The charcoal used may be from willow or other fine-grained wood. It should be pulverized as fine as possible to retain in the perforated can. Before using, the charcoal should be heated in an open pan to just under the point where it starts to glow, to free it from any gases which it may contain. The charcoal should be removed and reheated in the same manner about once a week to keep it in good active condition. In order to make the charcoal of the utmost effectiveness, the entire interior of the refrigerator compartment should be kept scrupulously clean. It's a good idea to do this each time the charcoal is taken out to heat it.

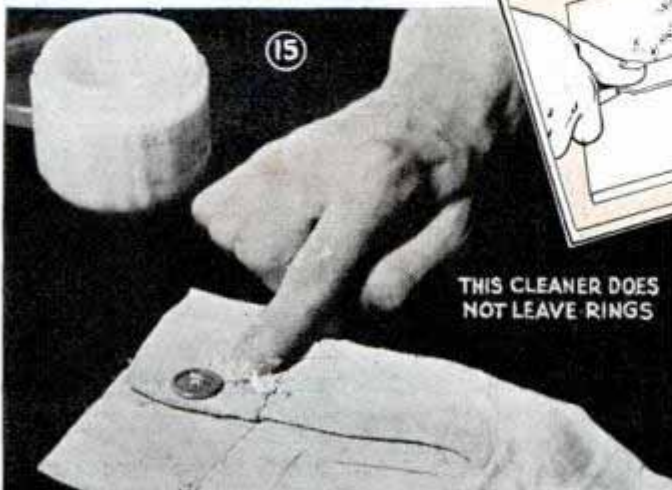
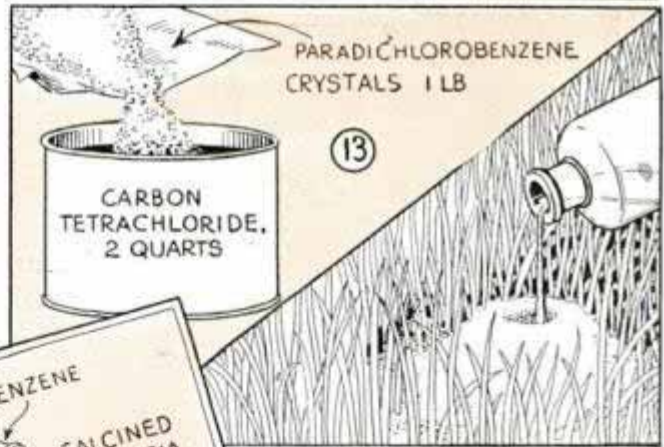

Combined Shelf and Towel Rack for Bath or Dressing Room

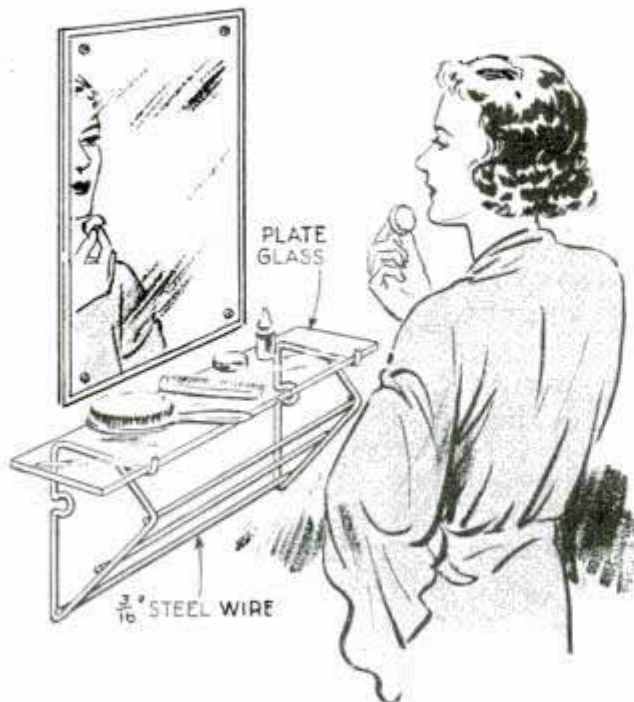

Bathrooms and dressing rooms without adequate shelves are improved with this combination

Neat and attractive, this combination greatly improves a bathroom or dressing room that is not adequately equipped, or one that is used by more than one person at a time. The glass shelf provides plenty of space for combs, brushes and other toilet articles while the rack underneath is ideal for towels. The shelf supports and the towel bars are made of heavy wire, the supports being bent to the shape indicated and the bars soldered to them. Screw eyes driven into the wall with the eyes opened and then closed over the supports, hold the assembly in place.

—David E. Anderson, Alhambra, Calif.

Improving Filler Hole in Gas Tank of Outboard Motor

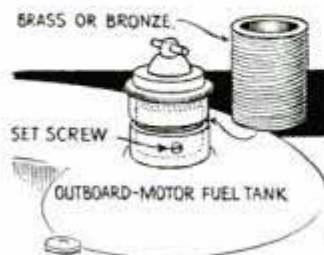

Due to the soft metal often used in the manufacture of gas tanks on outboard motors, the threads around the filler hole and the cap are damaged easily so that the tank can't be sealed against leaks. This trouble can be avoided by screwing a threaded sleeve of brass or bronze into the opening to take

a brass cap. A small set screw in the shoulder of the tank locks the sleeve in place, and a vent valve from a car hot-water heater set into the cap serves as a tank vent.

—Myron L. Harmon, South Bend, Ind.

Needle Pushed in Heavy Cloth with Bent Spoon

When stitching canvas or other heavy material with a large needle, sore fingers may be avoided by using a spoon, bent to the shape shown, as a "palm thimble." The spoon bowl rests



comfortably in the palm of the hand where it is securely supported in place by the bent portion of the handle, which hooks over the side of the hand.

Strap Hinge Forms Boot Scraper That Swings Out of Way

A boot scraper that may be swung out of the way is provided by screwing a large strap hinge to the side of a step as indicated. When open, the loose half of the hinge assumes a horizontal position for scraping the shoes, while a kick of the foot swings it quickly to one side.

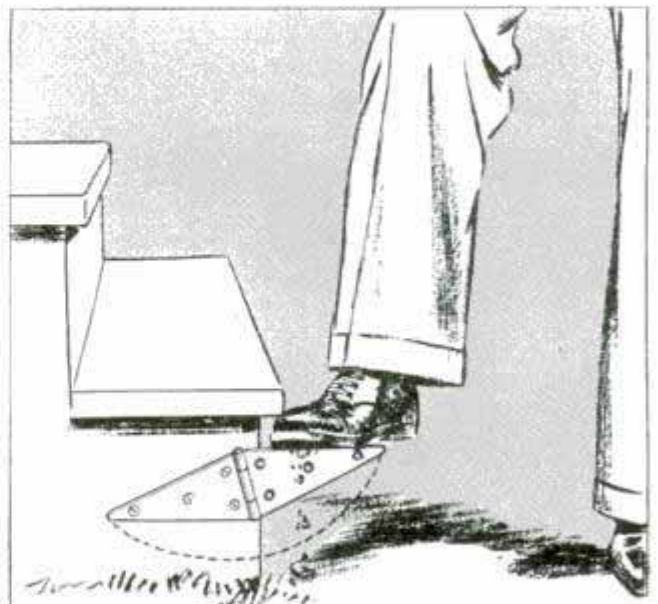

A kick of the foot swings this scraper to one side after you have cleaned your shoe soles

Back-Yard Fence Prefabricated in Spare Time

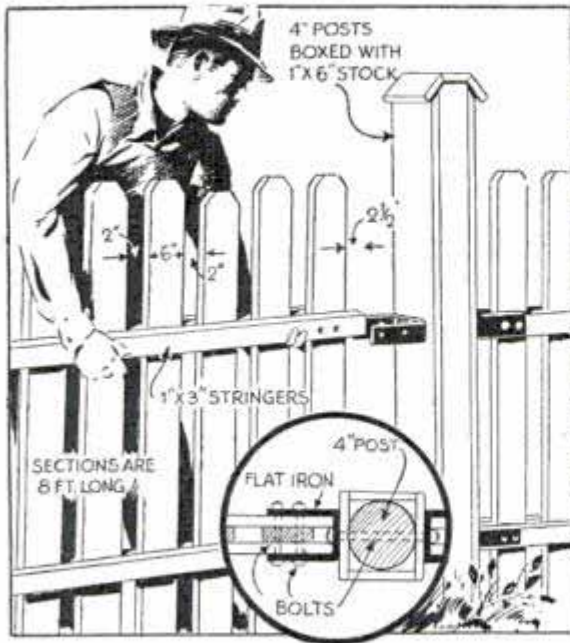

Inexpensive because it will outlast several fences built of pine, this pecky-cypress fence has withstood the weather for twelve years and is still sound. It was put together during spare time, being built up in 8-ft. sections, and attached to posts by means of U-shaped brackets as indicated. This method of construction is espe-

cially handy on fences made from wood that requires painting frequently, as it is possible to take the fence apart and re-finish it indoors at night and during the winter months when the work cannot be done outside. A cheap grade of swamp cypress has the rot-resisting qualities of better cypress, and, when stained, is capable of withstanding the elements, yet takes on a weatherbeaten effect. Fir posts, set in concrete, were boxed in with the same wood and were capped as shown.

“Mezzanine” Shelves in Cabinet Show Articles at the Rear

Pantry and cabinet shelves that are so deep that articles at the rear are screened from view by those in front, can be improved with “mezzanine” shelves as indicated. These are $\frac{1}{2}$ -in. plywood with a section cut out of the center to provide space for tall pieces.



Rubber Reel for Extra Fishline

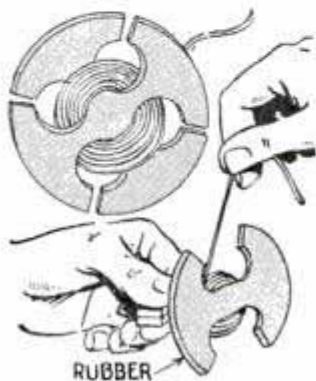

Fishermen who carry extra fishlines in their pockets will find that a reel cut from a piece of heavy inner tube as indicated, is lighter and less bungle-some than reels of wood or steel. The

line is wound through the slots, which close automatically to prevent unwinding.

Soiled Shirt Serves as Laundry Bag in Emergency



You can improvise a laundry bag quickly by pinning a shirt to a coat hanger as shown above

When traveling and there is no laundry bag at hand, a soiled shirt can be converted quickly to serve as an emergency one. Just pin the collar together with a safety pin, knot the sleeves and pin the tail of the shirt to a coat hanger.

This Homemade Turning Tool Handles Small Work

On a job of turning a quantity of miniature thole pins from hardwood, I found

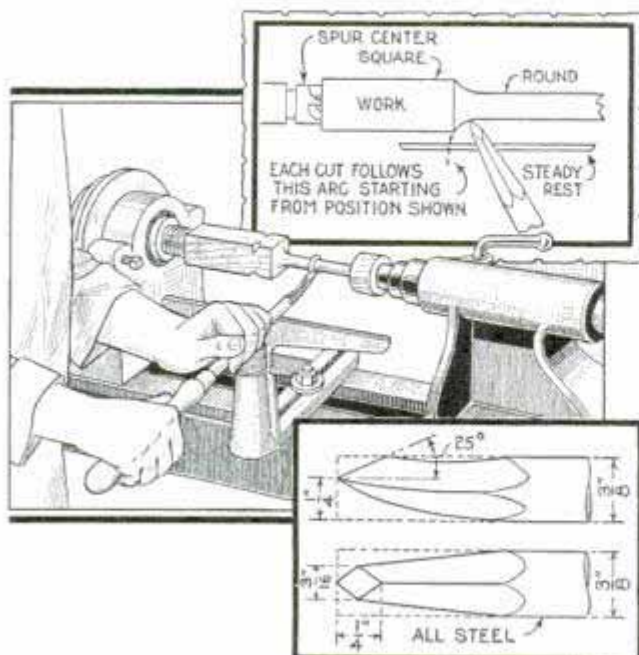

Modelmakers will find this tool just the thing when shaping tiny turnings in a lathe

this specially shaped tool ideal for the work, especially in the initial rounding from the square stock. Ground to shape from round tool steel, the tool is strong and sturdy, is easily sharpened and may be used straight up, sideways or upside down without digging-in even in open-grain woods. When using the tool for rounding square stock turn a groove to the round at the extreme right side of the work and then hold the point at the angle shown, applying pressure toward the left or live center rather than straight against the turning. This gives a minimum of shock and vibration and a fast clean job.

-Harold Thompson, Westfield, N. J.

Screwdriver Held in Pocket by Rubber Tube

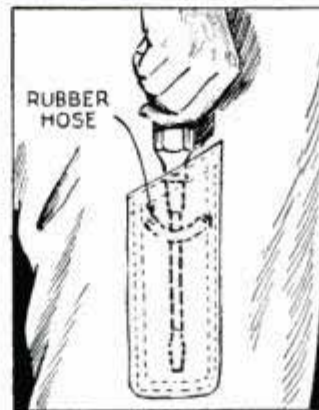

Electricians and others who carry a screwdriver in the leg pocket of their overalls, can avoid loss of the tool when climbing poles or ladders by slipping a piece of rubber tubing over it as indicated. The hose is slit in the

center and is impaled on the shaft of the tool and pushed into the pocket as shown.

Typewriter Key Padded to Avoid Damaged Letter on Stencil

Typists who cut mimeograph stencils, and have trouble with some of the letters being cut so that they fall out of the stencil, will find that padding the keys that control these letters helps to solve the problem.



A disk of sponge rubber provides a good pad that is resilient and helps to absorb the pressure when the "touch" on the key is too hard. Rubber bands can be used to fasten the rubber temporarily in place.

Your Own WEATHER BUREAU for a Dollar

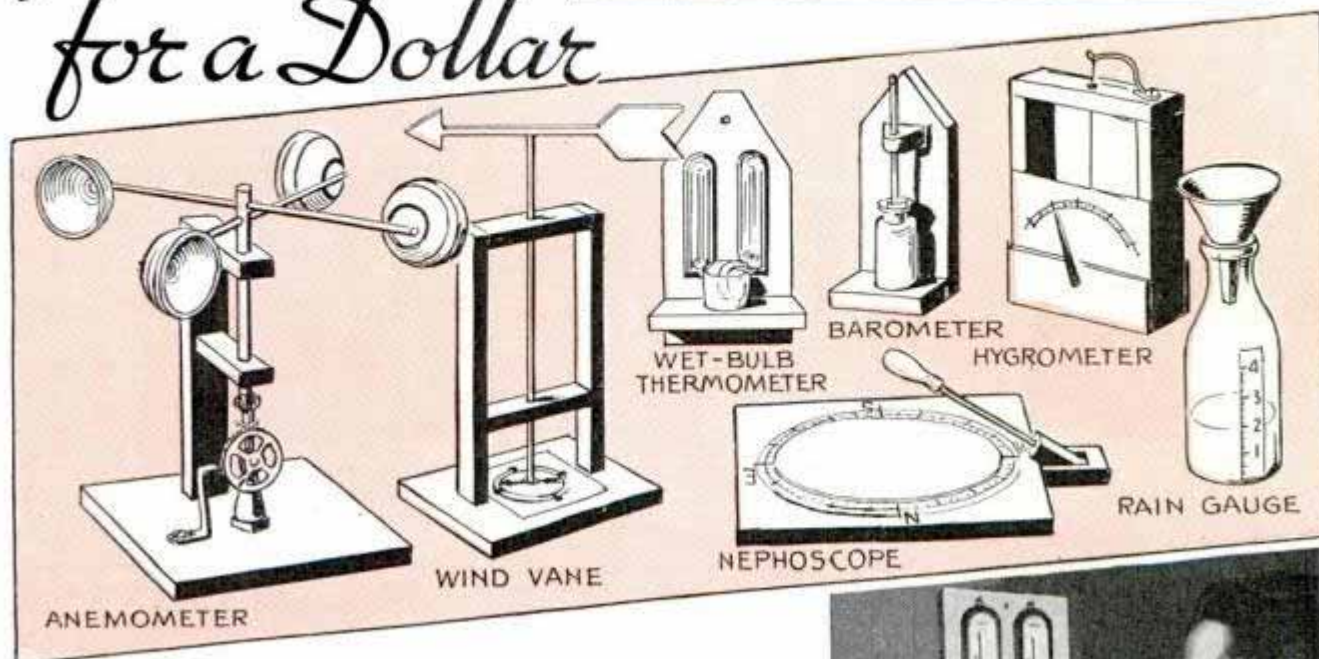

By JOSEPH P. DRISCOLL

FUN, useful information and even valuable data may be had with this easily made weather bureau. Although greatly simplified, the instruments combine practically all the essentials of professional equipment. With them you can make records of temperature, barometric pressure, rainfall, humidity, wind velocity and prevailing direction, measure the speed and drift of clouds, etc. Standard textbooks on the fundamentals of meteorology will be of help in reading the instruments, making up the proper scales, and arranging your records.

The accurate determination of temperature is one of the first essentials of good forecasting. Here, in place of investing in an accurately calibrated instrument, you employ three 10-cent thermometers, Fig. 2, and average their readings by totaling and dividing the sum by three. Make sure when taking the readings that your eye is level with the liquid in the tubes so that an accurate value will be recorded.

Moisture content is best determined by a wet-bulb thermometer, Figs. 1 and 3. The ability of the atmosphere to absorb moisture depends upon how much it already holds. Then evaporation is always attended by a lowering of temperature as

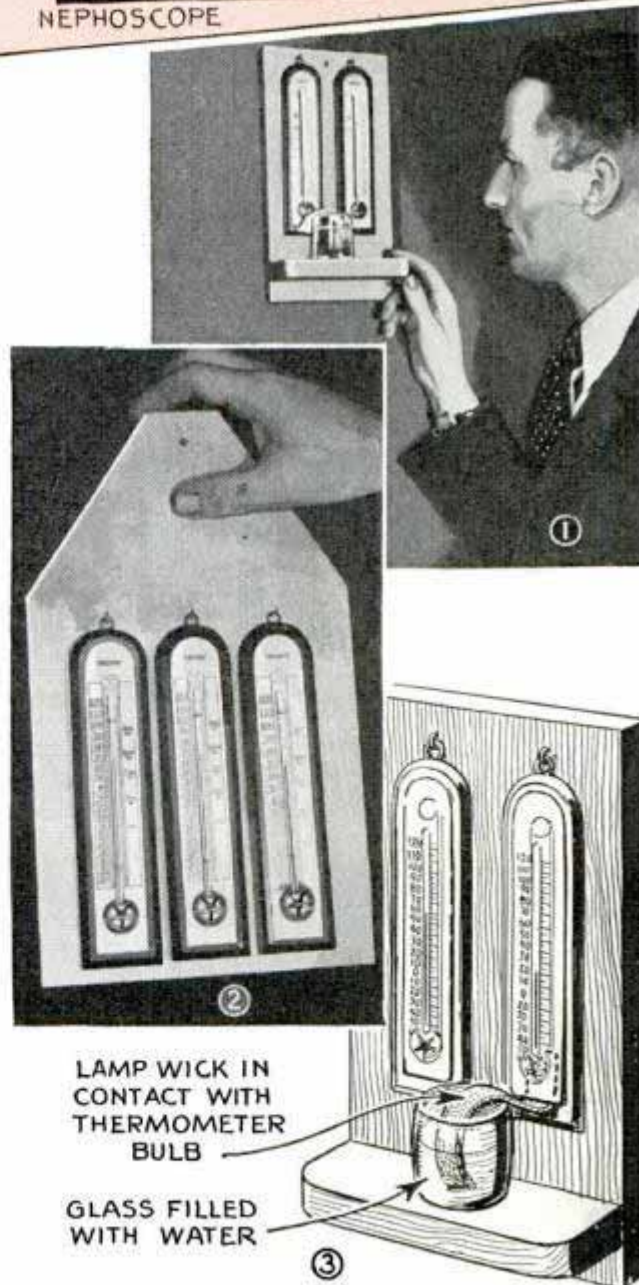

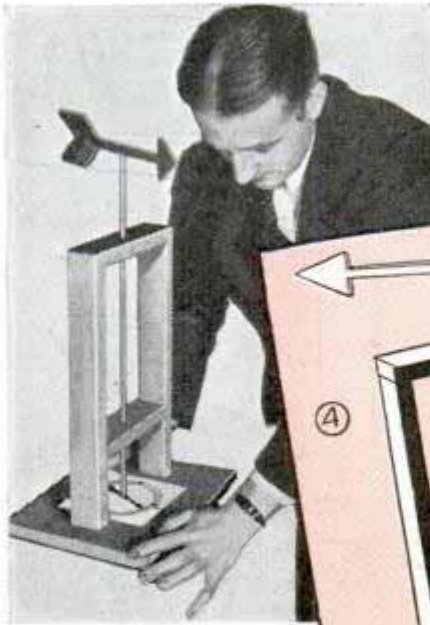

WIND VANE

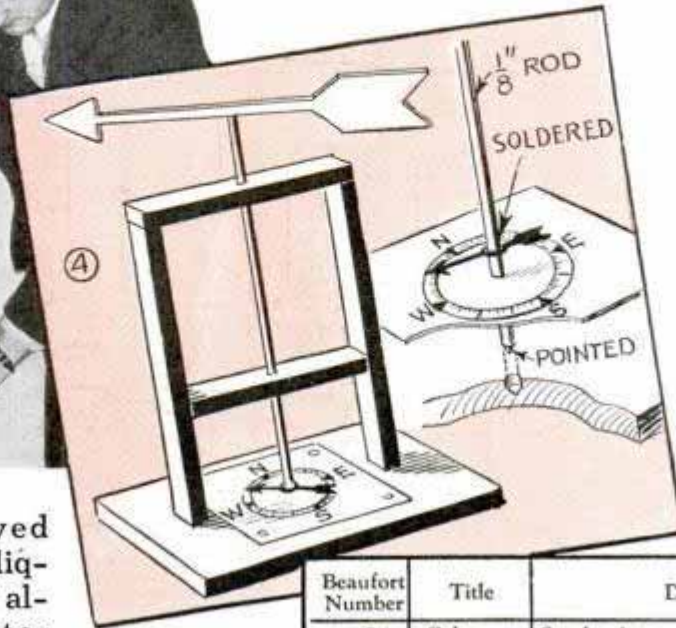

is amply proved when a volatile liquid like ether or alcohol evaporates from the palm of the hand. Therefore when a wick soaked in water is permitted to contact the bulb of a thermometer, the reading of that thermometer will always be slightly lower than that of one not fitted in this manner. If the air is dry, evaporation will be high and the temperature of the wet-bulb instrument will be much lower than an ordinary thermometer. As you will see from Fig. 3, the wet-bulb thermometer has a clean lamp wick in contact with the bulb. The free end of the wick is submerged in a small glass filled with water as shown. Any book devoted to the weather will supply the proper scale to use with such an arrangement. The evaporimeter, Fig. 7, is also an instrument used to check humidity but here only the amount of water that escapes into the air is recorded. An inverted test tube provided with a cork to which is attached a small piece of blotting paper comprises the instrument. A small needle hole is punched through the center of the cork to permit the water to reach the blotting paper which is in contact with the air.

Fig. 4 shows how you can make a calibrated wind vane for the purpose of recording the direction of the wind. This vane is intended only for occasional or pe-

riodic outdoor use. If the amateur weatherman wishes, he may build himself an instrument that can be left outside at all times although there is little use of this unless an inside recording mechanism is also included. The vane is provided with an accurate, eight-point scale and when used, the N or north point on the scale should be pointed due north. Along with the wind vane you need the anemometer to measure the velocity of the wind. Although these instruments are

Beaufort Number	Title	Determination	⑤	Speed in m.p.h.
0	Calm	Smoke rises vertically		0
1	Light air	Slight smoke drift		2
2	Slight breeze	Leaves rustle		5
3	Gentle breeze	Wind extends light flag		10
4	Moderate breeze	Raises dust and light paper		15
5	Fresh breeze	Crested waves, trees sway slightly		21
6	Strong breeze	Large branches in motion, whistling wires		27
7	High wind	Whole trees in motion, difficult walking		35
8	Gale	Breaks twigs off trees		42
9	Strong gale	Slight damage, shingles, etc.		50
10	Whole gale	Trees uprooted, structural damage		59
11	Storm	Widespread damage		68
12	Hurricane	Great damage, building destroyed		75 up

costly the amateur can make a good substitute with a 10-cent egg beater and two 10-cent rubber balls having a diameter of about 3 in. The balls are cut in half and mounted on the cross members with small machine screws, the whole thing being set up as in Fig. 8. The ratio of the gearing on the egg beater will have to be determined by counting the number of times the smaller gear turns during a single revolution of the larger gear. Then, if the large gear is marked with a black line, the user may, by the use of a watch, count the r.p.m. of the rotating rubber cups. The shaft is a 1/2-in. dowel soaked in hot paraffin to make it revolve in the wooden

bearings with a minimum of friction. It will be found necessary to cut half of the handle of the beater off after which it may be held to the baseboard with a wood screw. The instrument is not made for continuous outdoor service. Rather it should be carried out only when readings are to be taken. Velocities may be comparative or the builder may consult a book on the weather and employ a comparative table. The Beaufort scale, Fig. 5, is based on anemometer readings taken at a height of 33 ft. However, good comparisons may be had at lower levels if the readings are taken in open spaces. Under no circumstances should the anemometer be used in a sheltered spot near a building. Errors as high as 80 per cent would result.

The rain gauge, Fig. 6, is an exceptionally simple instrument but here the builder must be sure to employ a catch basin with a diameter the same as the large end of the funnel. A quart-size milk bottle will do very well if the diameter of the funnel at the top is the same as the inside diameter of the bottle. Even then a correction factor of 10 per cent must be added to compensate for the rain that splashes outside the funnel when it strikes. After each rain the contents should be measured and emptied. The figures should be placed in a notebook and totaled at the end of a season. The result will be surprisingly accurate and it should prove interesting to check with the local weather bureau.

Atmospheric pressure is of great importance. The pressure on the surface of the

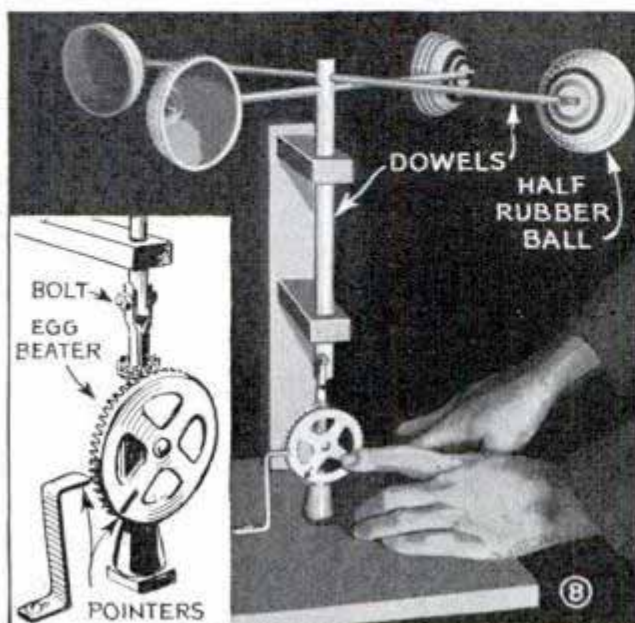
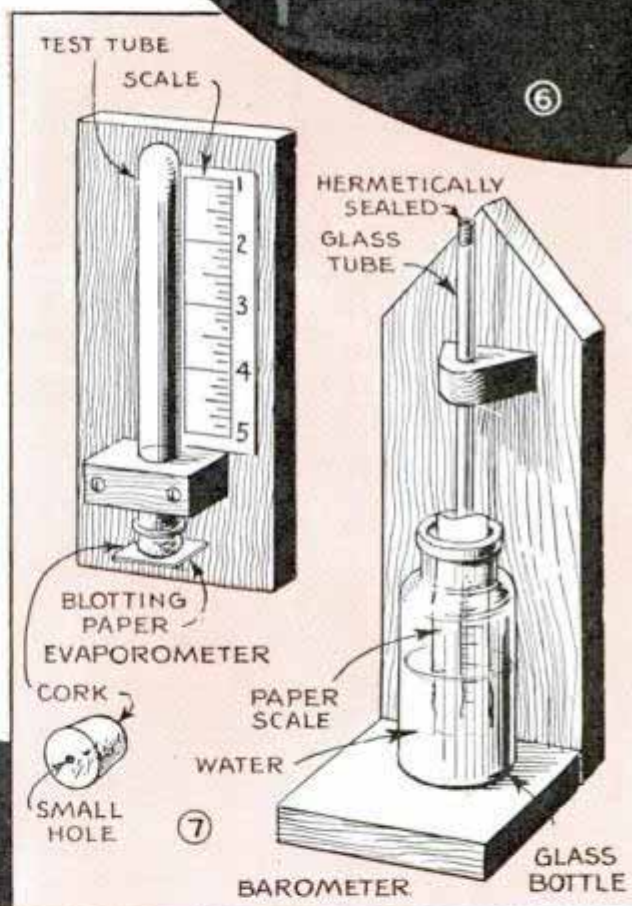

earth varies widely and hence must be measured, at least in a comparative way. The weatherman calls it barometric pressure and he checks its variations from day to day with a sensitive instrument. However, the amateur can make a practical barometer as in Fig. 7. A small glass tube with a $\frac{1}{4}$ or $\frac{1}{8}$ -in. bore, a bottle and two pieces of stock are all that is needed in the way of materials. One end of the tube is sealed either by melting the glass together or by the use of a cork and sealing wax.

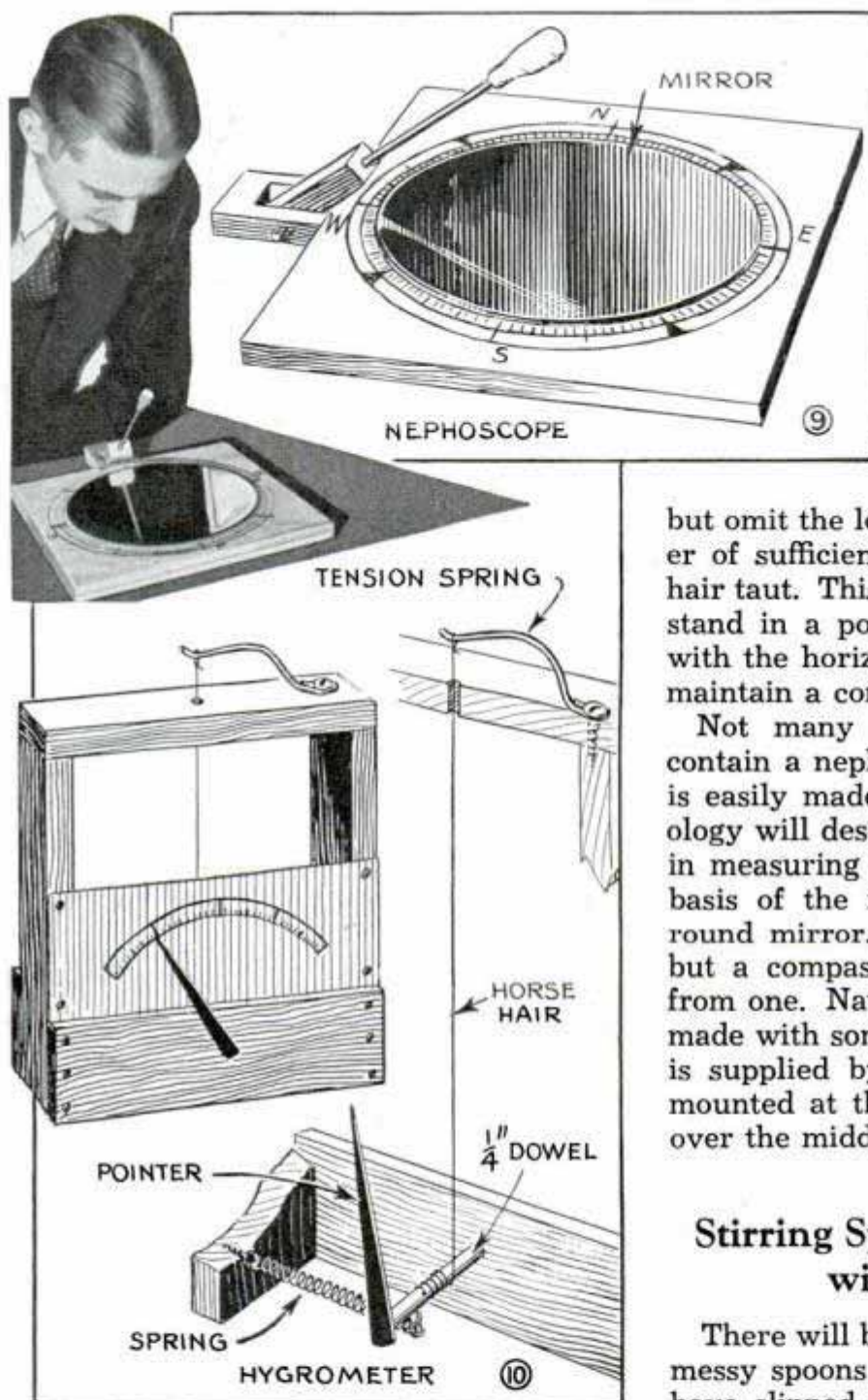

When in position in the holder, the open end of the tube is held under the surface of the water in the bottle and the changing pressure forces the water up into the tube to a degree depending upon the change. Comparative readings are taken by the use of a small scale calibrated in millimeters. Evaporated water should be replaced.

Changes in barometric pressure are invariably followed by changes in humidity and this is measured with a hygrometer, Fig. 10. Here a horse hair is used because of its sensitivity to changes in the moisture content of the air. The mechanical construction of the instrument is very

clearly shown in the detail. The hair is wound around a small dowel (several turns will do) which is free to turn and which carries a pointer running over a scale. The spring should be just strong enough to keep the hair gently taut. Another simpler way of making this instrument is to suspend the horse

hair in the same manner but omit the lower spring and use a pointer of sufficient weight to keep the horse hair taut. This means that the pointer will stand in a position of approximately 45° with the horizontal so that its weight will maintain a constant tension on the hair.

Not many amateur weather bureaus contain a nephoscope, yet this instrument is easily made and any book on meteorology will describe its use and importance in measuring the velocity of clouds. The basis of the instrument involves a 9-in. round mirror. The scale used is nothing but a compass scale and may be copied from one. Naturally comparisons must be made with some stationary object and this is supplied by a wooden or metal knob mounted at the end of a rod and resting over the middle of the mirror as in Fig. 9.

Stirring Spoon Clipped on Pan with Clothespin

There will be no messy spoons that have slipped into a hot kettle of preserves or jelly, if you use this holder, which clips right over the edge of the container.

It's an ordinary spring-type clothespin which has the upper ends of the legs notched to support a spoon as shown in the photo.



☛ The odor of stale tobacco smoke can be removed from a room by placing a few drops of oil of lavender in a bowl and adding two or three cupfuls of hot water.

Can You Solve This Puzzle?

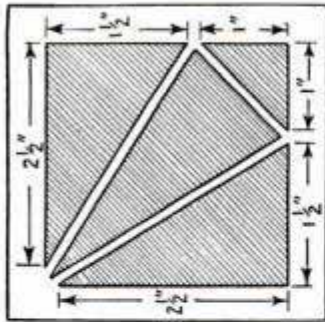

Take a piece of thin wood or heavy cardboard 2½ in. square and saw it into four pieces as indicated. Then jumble the pieces and see how many of your friends can put

them together. You will be surprised at what a sticker it is for someone who does not know the secret.

—O. M. Chase, East St. Louis, Ill.

Jig to Cut Irregular Work in Circular Saw

Serving as a straightedge in lining up work with irregular edges in a circular saw, this jig will enable you to make cuts accurately that were usually a matter of guesswork. The jig consists of a piece of plywood to which is nailed a strip of ½-in. stock so that it can be clamped to the rip fence of the saw, raising the jig above the table sufficiently to allow the work to pass under it. In use, the outer edge of the jig

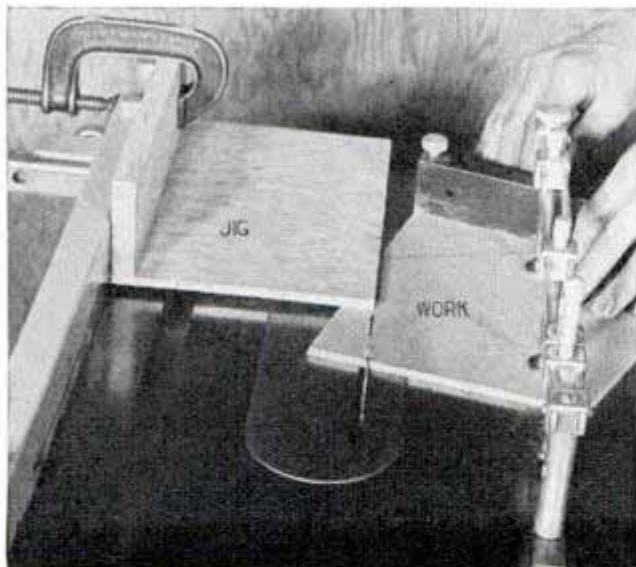

There's no guesswork with this jig when work having irregular edges is cut in a circular saw

is alined with the saw blade, after which the mark on the work indicating the cut to be made is placed directly under the edge of the jig. Then the work is clamped in the miter gauge in this position and run through the saw.

Four-Foot Woodworkers' Clamp for Less Than Half Dollar

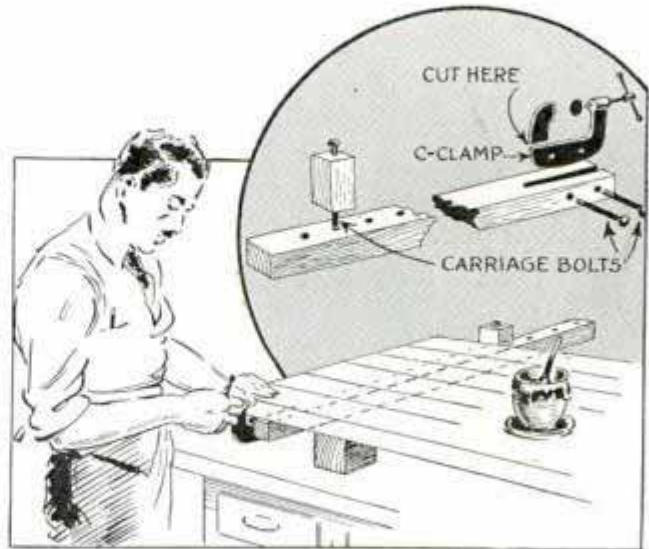

Clamps of this type are so inexpensive that you can make several for the cost of one of the usual type

A C-clamp from the dime store, a piece of fir wood 1¾ in. square by 4 ft. long and a few carriage bolts comprise this clamp. Saw off the lower jaw of the C-clamp and drill two holes in the remaining portion. Then fit it in a slot in the end of the wood and bolt it in place. The adjustable end of the clamp consists of a bolt run through a block of wood, which is set in one of several holes drilled in the fir stock to get the desired width.

—Henry Sauer, Rochester, N. Y.

Rubber Washers on Billfold Help Prevent Loss

Cemented to one side of a billfold or wallet, several rubber washers uniformly spaced will help prevent it from accidentally slipping out of your pocket when you run or stoop. The surfaces of the washers provide friction against the pocket lining. When using rubber cement for the purpose, apply a thin coat to both purse and washers and when this is dry apply another coat, allowing this to dry partly before pressing the washers in place.

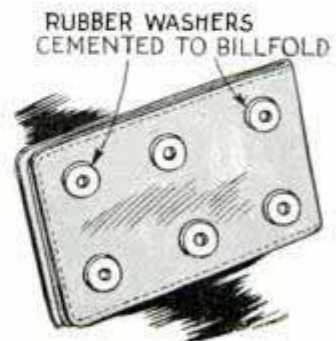

—Opie Read, Jr., Chicago.

Solving HOME

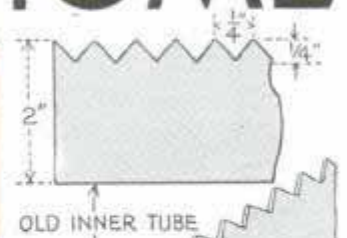
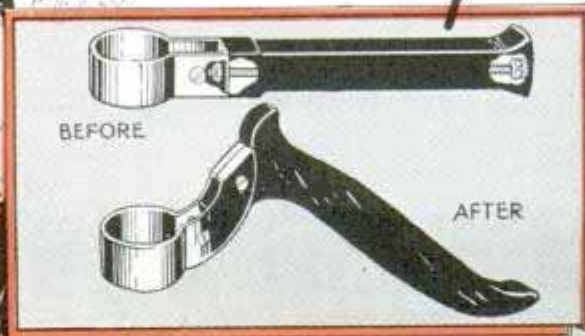

OLD INNER TUBE

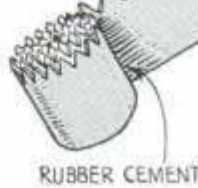

RUBBER CEMENT

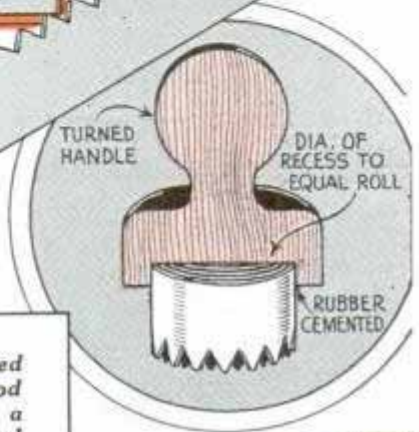

Straight handles on the old-style vacuum coffee makers can be changed easily to the newer curved type by shaping the latter from hardwood and attaching it with a band of sheet metal and stove bolts. Right, a notched strip of inner tube fitted into a holder makes a good scouring pad

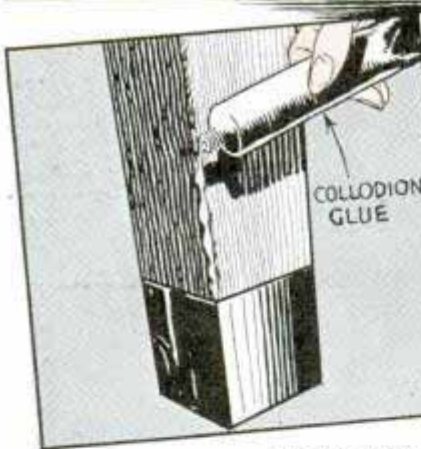

COLLODION GLUE

Collodion applied to sli-
ered corners of desk and
chair legs prevents dam-
age to silk hosiery



Dents in aluminum pans
and kettles can be rolled
out with a chair caster
fitted with a handle

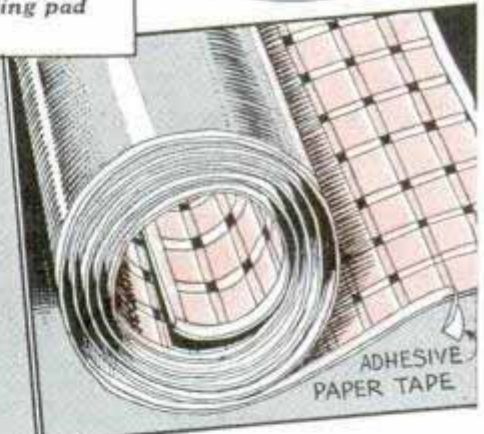

ADHESIVE
PAPER TAPE

When you roll up linoleum
the edges may be pro-
tected against tearing by
applying paper tape

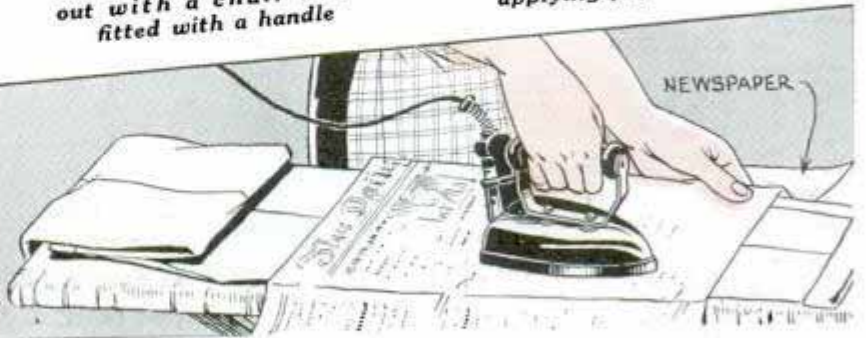
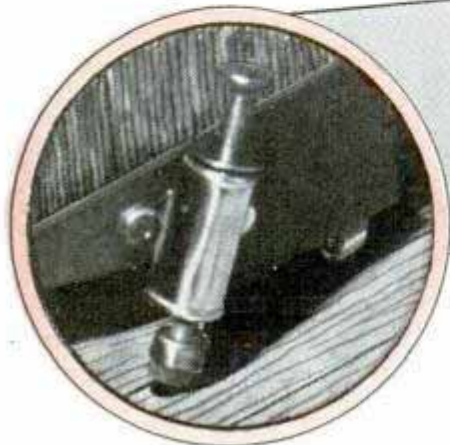

NEWSPAPER

To keep a studio couch in place against the wall fit a doorstop of the foot-operated type at each end as shown at the left. The stop should be screwed to the frame at an angle. To press trousers without danger of scorching, use a newspaper as shown above. The iron slides much easier over the paper than over a damp cloth. When pressing light-colored trousers use a sheet of plain paper

PROBLEMS

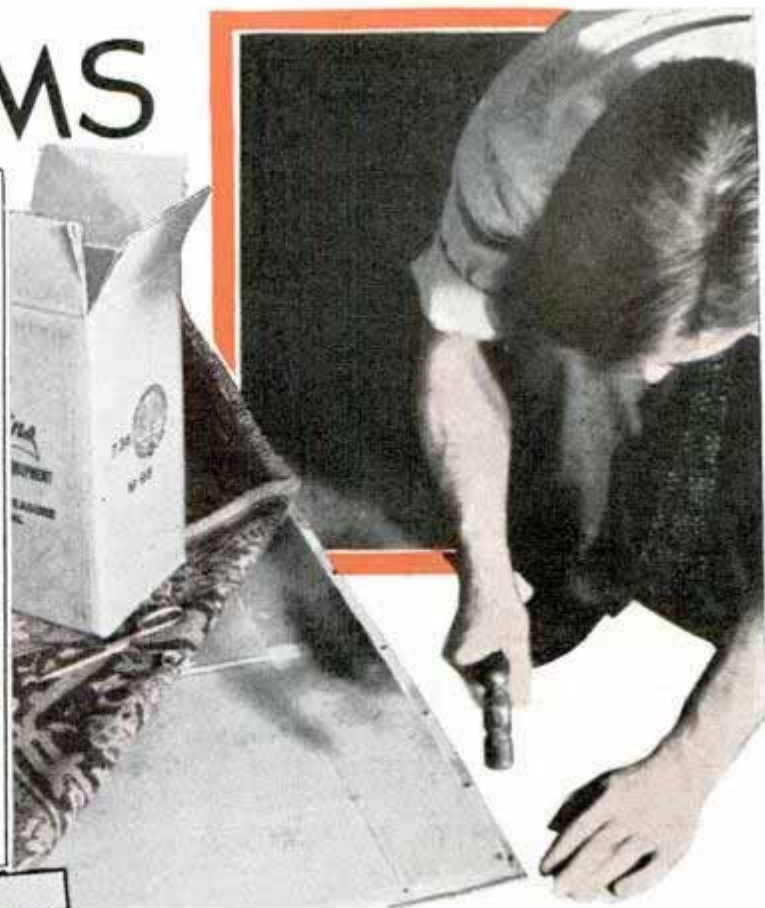
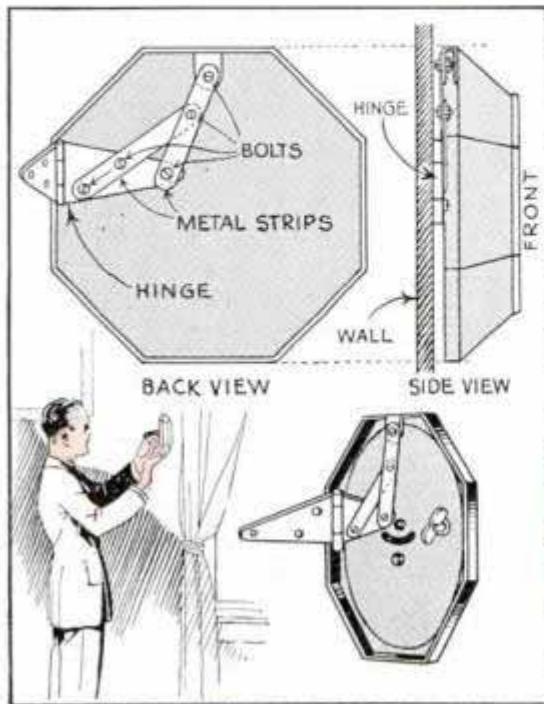

A simple way of hanging a kitchen clock is shown above at the left. Two pieces of flat iron are bolted to one leaf of a hinge as indicated to form the swinging bracket. Above, paper cartons cut apart and laid flat make good rug pads

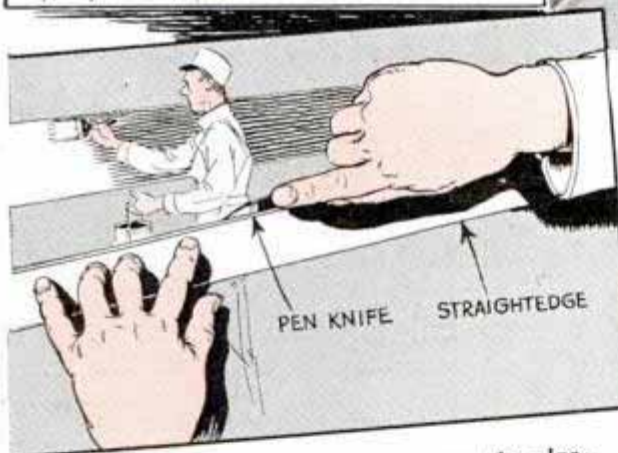

To paint a true line on a wall, score the plaster lightly along a straightedge with a penknife. The paint will not flow beyond the scored line

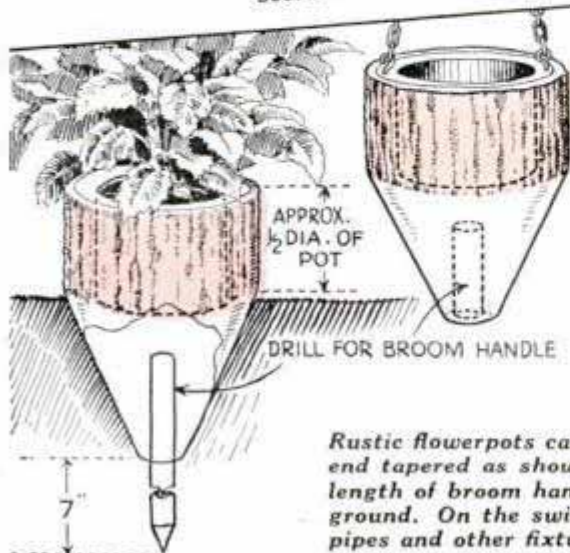

Rustic flowerpots can be turned from medium-sized logs or cedar posts with one end tapered as shown at the left. The tapered end is drilled for insertion of a length of broom handle which serves to anchor the pot when it is placed in the ground. On the swinging type the hole may be omitted. Above, "sweating" of pipes and other fixtures in hot weather can be prevented by installing a tank in the basement as shown

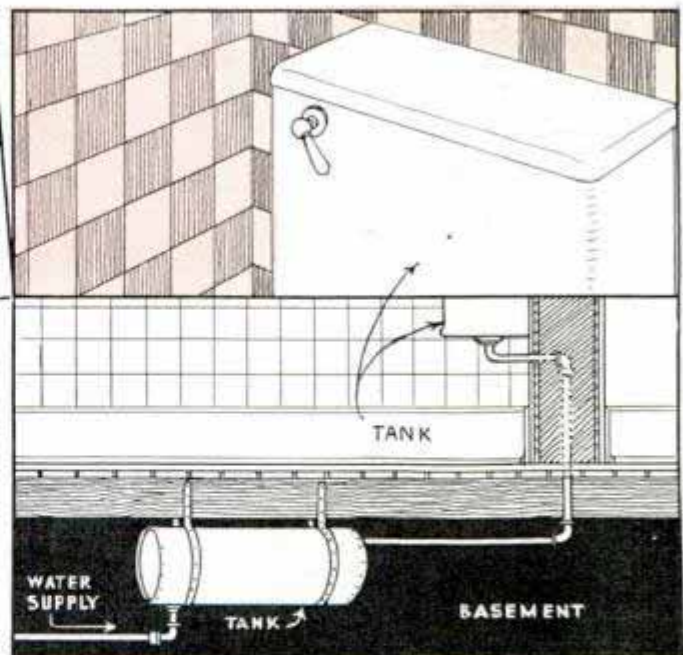

Wire Wedge Spreads Saw Cut When Ripping Long Work



To spread the saw cut when ripping long work is a simple matter of swinging the tool to one side

Bent to the shape indicated and fitted with a handle, a length of heavy wire provides a handy follower wedge to spread

the saw cut and prevent binding when ripping long boards. The end of the wedge is slipped into the cut and the handle is moved to one side until the loop can be slipped over the edge of the work.

Sponge in Neck of Flower Vase Prevents Spilling Water

When a bunch of long-stemmed flowers is put in a vase, it's a good idea to work a small sponge down into the neck of the vase around the stems. Then if the container is upset, the sponge will tend to keep the water from spilling. Use a dry sponge so air can circulate through it.

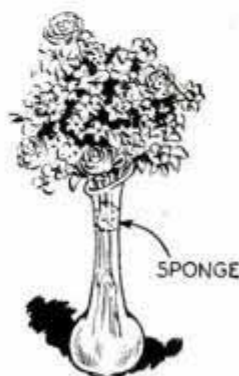

Venetian Blinds to Dress Up Your Windows



SAND BOX AND WADING POOL—708: Pool is canvas-lined, 12 by 36 by 45 in. Great fun for children. 25c.

TRELLIS SUGGESTIONS—639: Six types that will help beautify your home. 25c.

Any six of these blueprints will be sent postpaid upon receipt of \$1.00

Tilted slats let in air and light without glare. They provide pleasant shade in summer, draft-free windows in winter and privacy the year 'round. Our blueprints 926 and 927 cover the construction of three different types of Venetian blinds and will be sent postpaid upon receipt of a 50c remittance.

MORE BLUEPRINTS ON GOOD SUMMER PROJECTS

"ZIP," MODEL RACING YACHT—880 to 884: 50 in. long. Plans include full-size lift templates. Four prints \$1.00.

"SEA SAUCER"—893: 9½-ft. sail boat. Built of 3/16-in. plywood. Just the thing for small lakes. 25c.

15-FT. ROWBOAT—644: Flat bottom, all purpose craft. Heavy transom provided for outboard motor. 25c.

CHILD'S PLAYHOUSE—925: Wood frame covered with wall board. Has floor space 10 by 12 ft. 25c.

OUTDOOR FIREPLACES—917: Several simple, but practical types, to match other items in rock garden. 25c.

MIDGET AUTO—906 to 909: Small car having a 58-in. wheelbase and 28-in. tread. Powered by small gas engine of the washing-machine type. Four prints \$1.00.

Blueprint Department, Popular Mechanics Magazine, 200 E. Ontario St., Chicago



Brazing BANDSAW BLADES

By WAYNE C. LECKEY

BY USING an ordinary blowtorch to furnish the required heat, the home craftsman easily can do a good job of bandsaw brazing right in his own workshop at a considerable saving of both time and expense. Just about the minimum of equipment is needed, a torch, clamping jig, soft, fusible spelter and borax for flux.

First of all, a jig must be made to hold the blade in perfect alignment while brazing the ends. This can be improvised readily from a block of hardwood as shown in Fig. 1. The block is grooved lengthwise to take the blade flush with the surface. A large hole is bored through the center of the block to allow the flame to pass around the blade without burning the wood. The jig is then mounted as shown, and small blocks drawn down with screws hold the ends of the blade securely in place. A more serviceable clamp for heavier blades which tends to hold

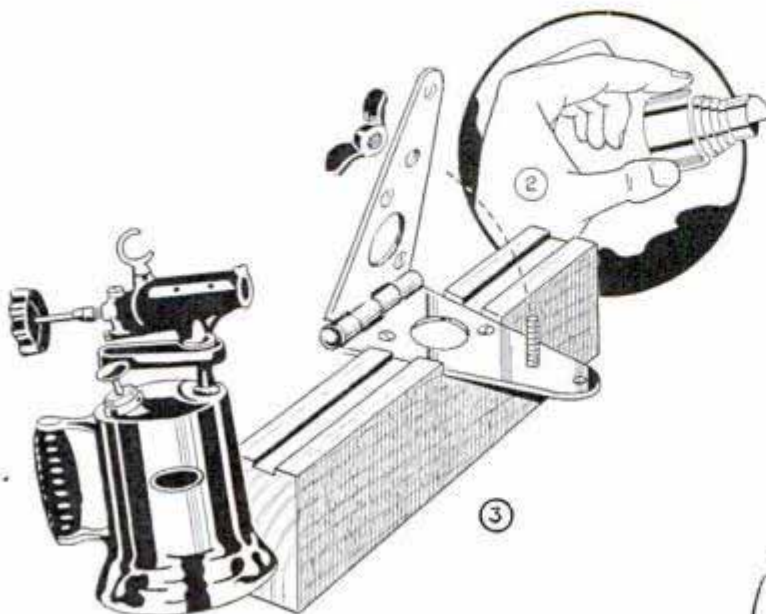

the work securely near the braze is shown in Fig. 3. As you can see, this makes use of a common strap hinge set at right angles to the groove for the blade in a larger block of wood with openings provided to admit the flame. The ends of the blade are held by the two leaves of the hinge.

The broken blade is made ready for brazing by squaring the ends and beveling each the distance of one tooth as shown in Fig. 7, so that when lapped they will match to form a single tooth. As it is important that the work be thoroughly clean, avoid touching the surfaces with your fingers once they are ground. Bandsaw blades should be brazed with silver solder which melts at a low temperature. This is available in a thin foil and is used from the center of the

C & E Marshall
139

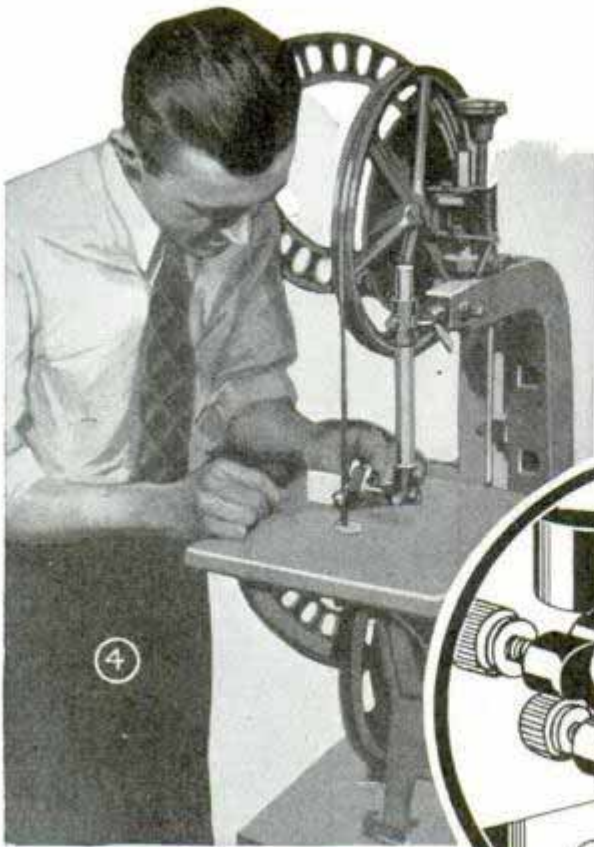

excess solder is removed and the joint is ground down to a thickness identical to the blade gauge. To check this accurately, place the blade on the machine, Fig. 4, and with a piece of paper between the guides as in Fig. 5, see if the joint will pass between, turning the wheels slowly by hand. If not, the joint is still too thick and must be ground down still more. The grinding must be done carefully so that the blade is brought to a uniform thickness. It is also very important that

the single tooth at the lap be reground to the same thickness and then shaped, filed and set to correspond to adjacent teeth. Variation in the shape or set of this one tooth is likely to set up strains that will cause breakage.

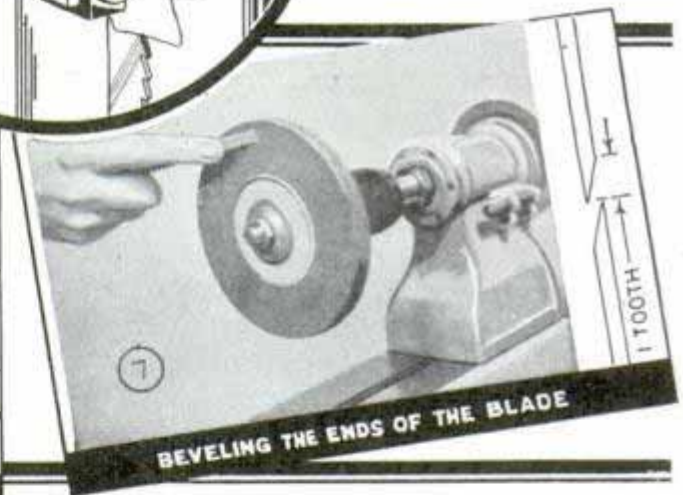
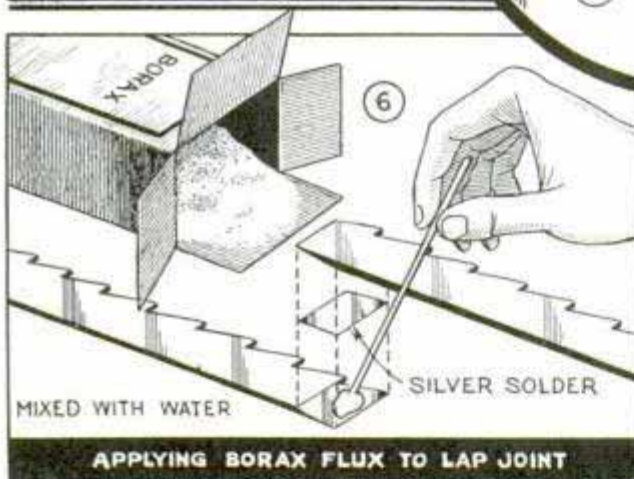
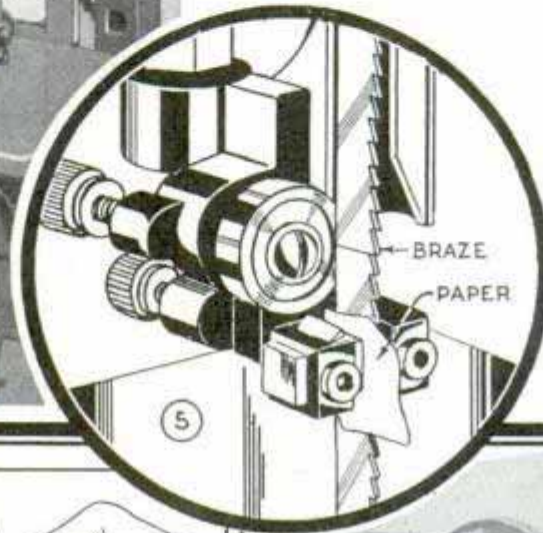

roll as in Fig. 2. With the blade in the clamping jig, dissolve some borax crystals in a glass of water and paint the joint with this solution. A piece of silver solder a trifle larger than the lap is placed between as in Fig. 6. Keep this free of oil by handling it on the edges. Pump the torch with sufficient air to give a strong, hot flame and direct the latter onto the joint as in Fig. 1. When the blade becomes a cherry red in color, you will notice the edges of the solder begin to curl and melt an instant before the center softens. When the solder runs out of the joint, draw the torch flame away slowly. Removing the heat suddenly is apt to harden the blade and cause it to break. When the work cools,

Glue Brush from Pencil Eraser

A handy brush for spreading glue is made easily by cutting a number of notches in the end of a pencil eraser of the type shown. This gives you a toothed edge

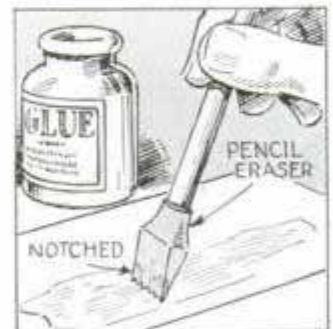

and helps avoid the tendency to apply too much glue as only the ends of the teeth are in contact with the work. The same idea is also applicable as an acid swab when soldering.

Wedge Stick for Setting Your Calipers Quickly

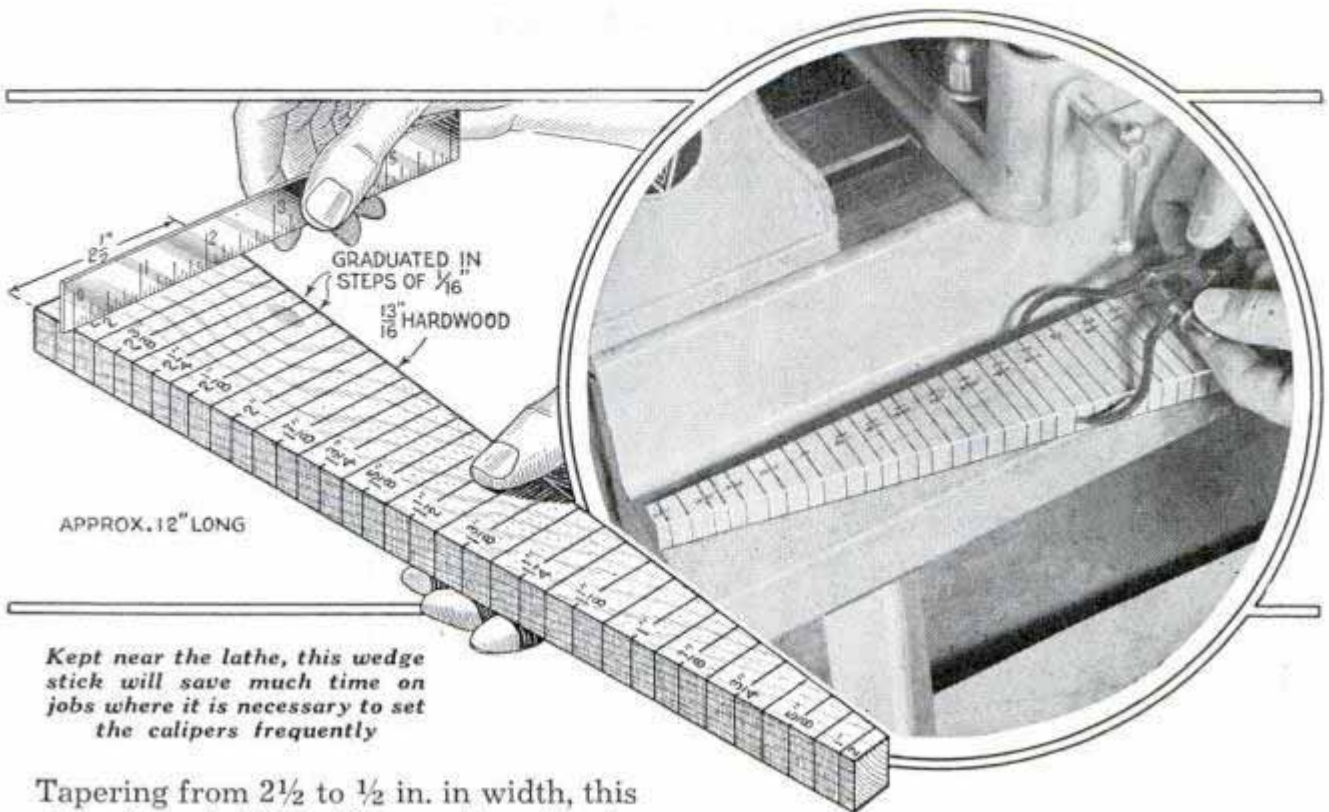

Kept near the lathe, this wedge stick will save much time on jobs where it is necessary to set the calipers frequently

Tapering from $2\frac{1}{2}$ to $\frac{1}{2}$ in. in width, this wedge-shaped stick will save time in setting calipers as all you do is to hold the legs at the desired division line and tighten them against the sides of the stick. It is made of hardwood and the division lines

are spaced so that they vary progressively $\frac{1}{16}$ in. in length, the lines being drawn with black waterproof ink.

—Howard R. Heydorf, Missoula, Mont.

Drill-Press Vise Holder Eliminates Adjusting the Table

Here's a holder for a drill-press vise that enables you to drill a number of holes in line without shifting the work in the vise jaws. Both the vise and work are moved as a unit along the holder. This saves time, especially when drilling work that has bosses, shoulders or other projections so that it's difficult to reset the work, making it necessary to adjust the table after drilling each hole. The holder is a piece of flat iron bent as indicated and bolted in the slots of the table. Both the holder and work are clamped in the vise, the jaws of which are loosened slightly to shift the assembly. If the number and location of the table slots permit, the work can be moved to and from the operator by slightly loosening the bolts.

☐ You can tighten the springs in window-shade rollers with a table fork; just slip the flattened end of the spring roller between two tines and turn the fork.



Once work is clamped in this vise, adjustments for various holes are made by shifting the assembly

Brace Wires on Corner Posts Anchored to Brake Drums



Brake drums provide good anchors for fence-post brace wires as they do not pull out of the ground

Fastened to the brace wires of corner fence posts and buried in the ground, old auto brake drums provide better anchors than stakes or stones. The drums do not pull out of the ground, do not decay rapidly and are little affected by alternate freezing and thawing of the ground.

Locating Breaks in Electric Cords with a Spark Coil

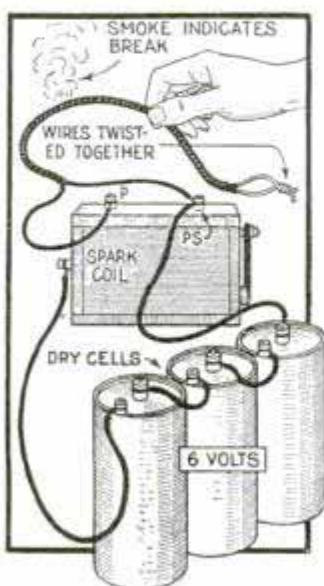

When one of the wires of an electric cord is broken, the break can be found often by twisting the wires together at one end of the cord and connecting the other end to a vibrator coil, such as used on model-T Fords. The connection is made as indicated, using three or four dry

cells or a storage battery. The high-tension current passing through the cord will arc across the break

in the wire, heating the insulation and causing it to smoke.

—W. C. Wilhite, Carlinville, Ill.

Pencil Pointer Swings under Your Drawing Board

Rather than have a sandpaper pencil pointer lying on his drawing board, where it is likely to soil papers, one draftsman finds a piece of sandpaper glued to a strip of wood and pivoted to the underside of the drawing board handy. It swings out of the way when not in use so that there is no possibility of it soiling the work.

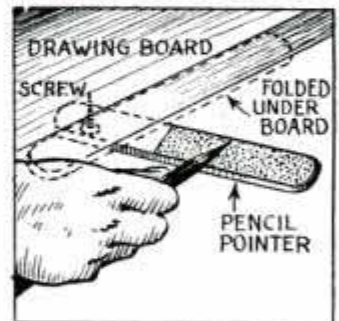

Rubber Strap Between Horses Prevents Tangled Lines

When a team of horses are used to move loads by means of a cable attached to the doubletrees, there is constant danger of the lines dropping down between the

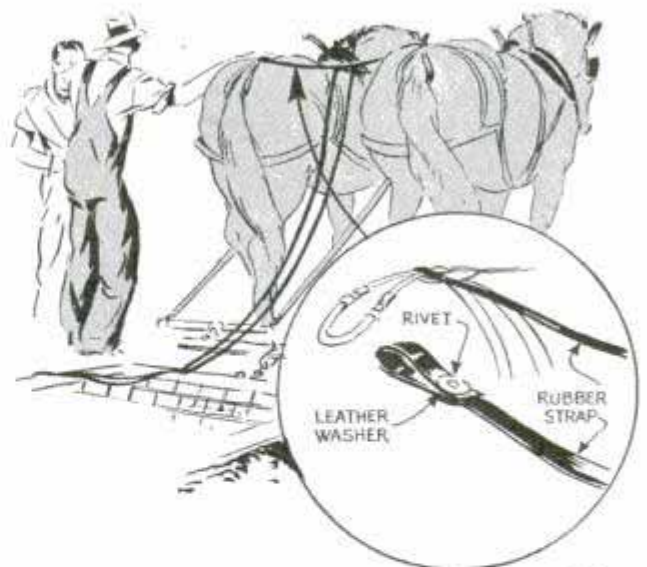

Lines can't drop between team and get tangled under the singletrees when this cross strap is used

horses, when not in use, and becoming tangled. If a strip of rubber cut from an inner tube is attached to the back strap of each harness, the lines will rest on this. The elasticity of the strap prevents dislodgment of the harness straps should the team spread apart slightly.

Store Your LUMBER Flat

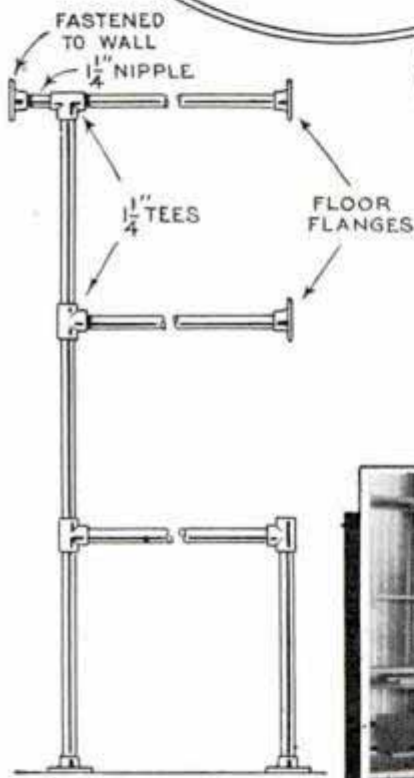

OPEN FACE WALL TYPE

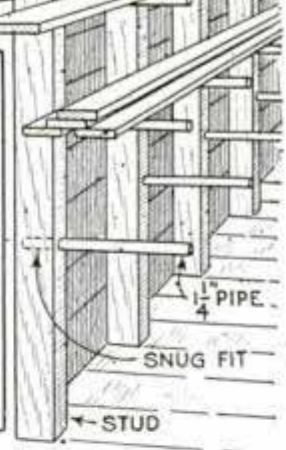
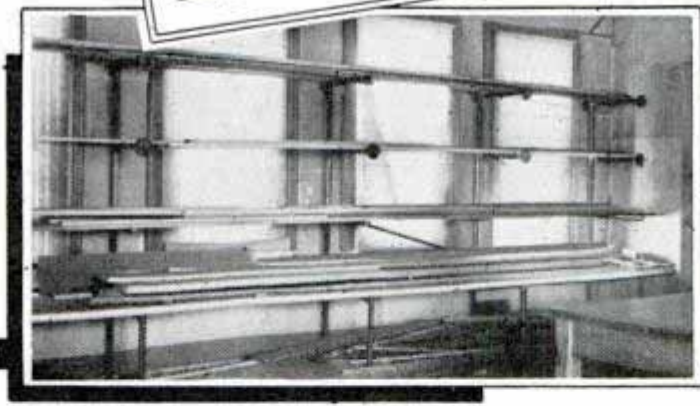
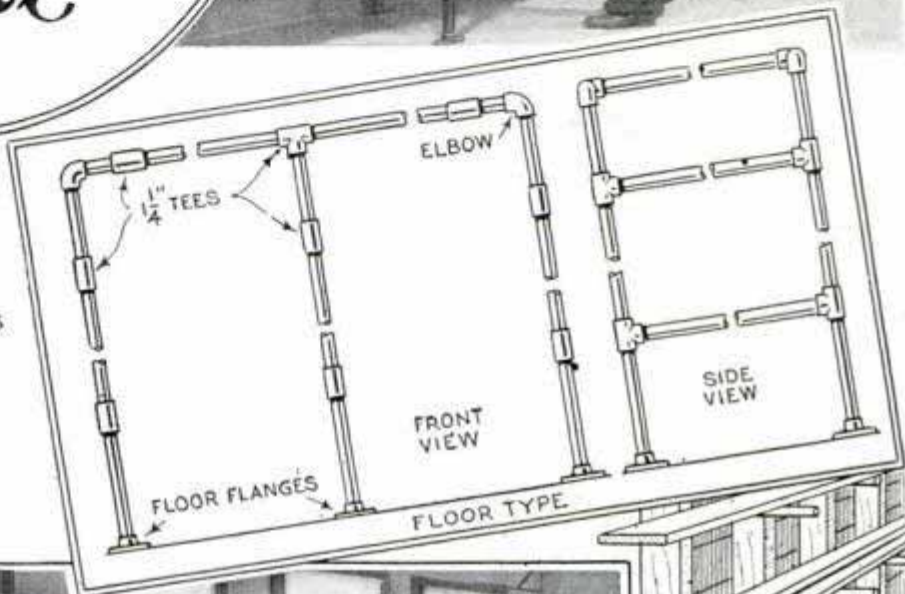

A sturdy storage rack suspended from the ceiling or placed against a wall in your shop where there is adequate circulation of air will aid greatly in keeping your cabinet lumber in perfect condition. Old pipe, which is usually easy to obtain most anywhere, together with standard fittings, is ideal for construction. Of course, the size of the racks will be determined by the available space and the average length of stock ordinarily kept on hand. Supports should be placed not more than 3 ft. apart to prevent warping of stock. If you have a basement workshop, use expansion sleeves for fastening the floor flanges to the concrete. In storing the wood, place spacer blocks between each layer of stock to permit air to circulate properly. Where there are a number of long pieces stored together the blocks should be located over each crosspiece of the frame

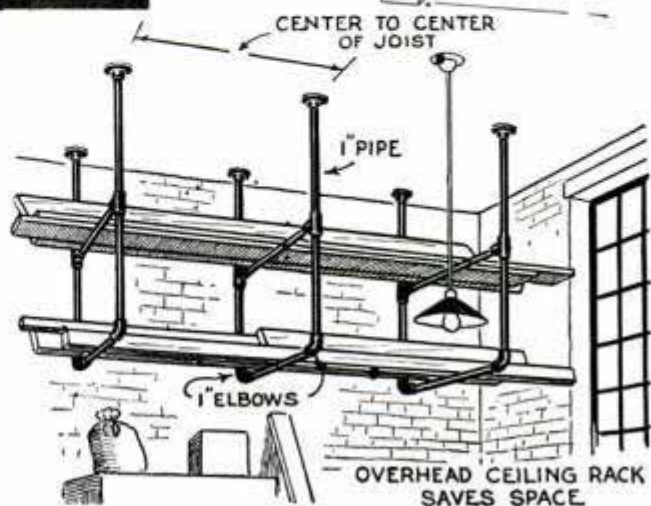

Simple Method of Painting Pipe to Be Laid Underground

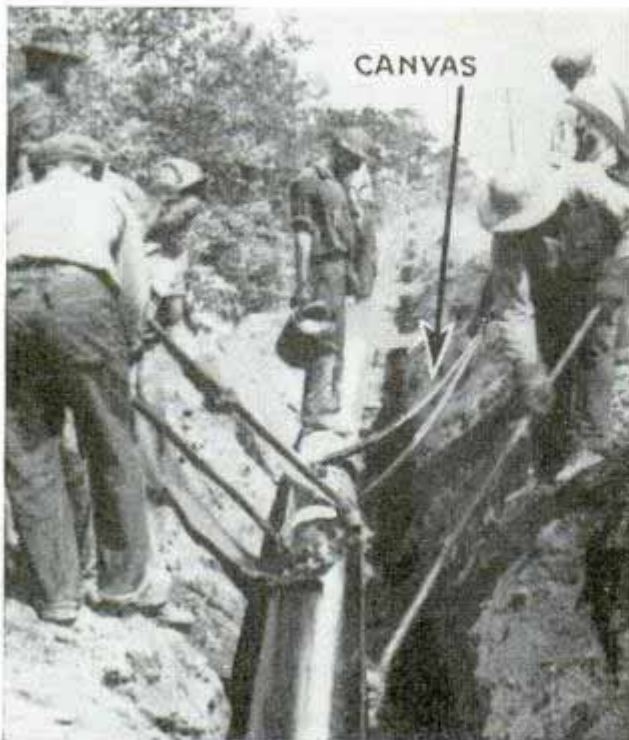

Strips wrapped once around pipe and pulled back and forth apply paint poured from can

A good way to paint large pipe cheaply and quickly, before putting it underground, is to use two strips of canvas about 15 in. wide and as long as convenient to handle. Pieces of wood fastened to the ends serve as hand grips. One strip is thrown over the top of the pipe with the ends passing underneath, and the other strip is put on in a reverse position. A man with a spout-can applies paint to the strips and to the pipe. As the ends of the strips are moved back and forth the pipe is painted.—W. V. Garrett, Norwood, Pa.

Keeping Cats Out of Birdhouse



When cats climb up a birdhouse standard or tree to get at the nests, take a length of stovepipe and slip it over the standard or tree trunk as indicated. As the surface of the pipe is hard, a cat cannot use its paws to climb it.

If the standard is too large or too small for the pipe, a piece of sheet metal may be substituted.

—August Karvonen, Wainola, Mich.

Adjustable Brace Has Many Uses

Lengths of pipe with nuts welded over the ends and bolts threaded into them make handy braces for the interior of concrete forms, braces for mine timbers and similar uses. The braces are adjusted by running the bolts in or out of the nuts, and if stud bolts are used, two lengths of pipe can be connected by screwing two nuts onto one bolt.

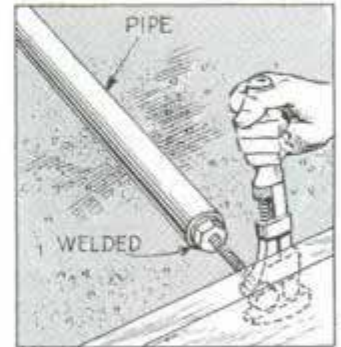

—Jos. C. Coyle, Yuma, Ariz.

Rope Run Through High Pulley with Aid of Fishing Rod

When a hay rope breaks and slips from a pulley which is suspended outside the gable of the barn room, don't endanger your life and limb trying to climb up and rethread it. Instead, obtain a long fishing



Push end of rod through pulley, unreel line to the ground and tie rope end to it and reel in the line

rod with reel and line attached. Push the rod through the pulley, unreel the line to reach the ground and tie the rope end to it. Then reel in the line, pulling the rope through the pulley.

Brake for Hoisting Pulley

On roof repair jobs, one workman usually operates a hoist, which makes it advisable to have a brake on the pulley to prevent possible accidents should the rope slip from the hands of the operator. One of the simplest brakes consists of a tapered block which fits in the pulley as indicated. A stout rubber band cut from an old inner tube holds the block in place. A facing of rubber will make the brake more effective.

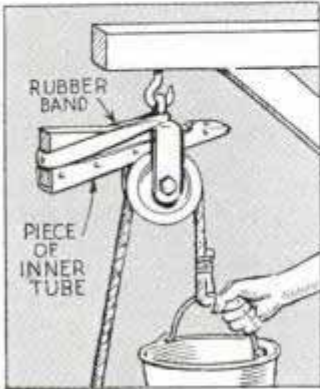

Removable Center for Large Hole Supports Compass or Dividers

As an improvement over the usual method of providing a hole with a removable center by using a square piece of wood which is driven into place snugly, this T-shaped center is easily put in position or removed. It consists of two pieces of wood, a length of square stock and a springy crosspiece, nailed or screwed together. In use, the thin piece is placed in the hole first, and is pressed back until the square piece enters.

—Harry Moore, Leeds, England.

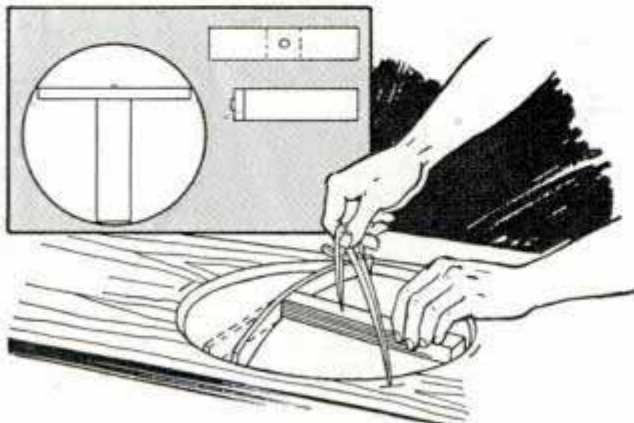

When it is necessary to rest one leg of a compass in the center of a hole, this removable support is useful

Gauge on Steel Pocket Rule Has Several Uses

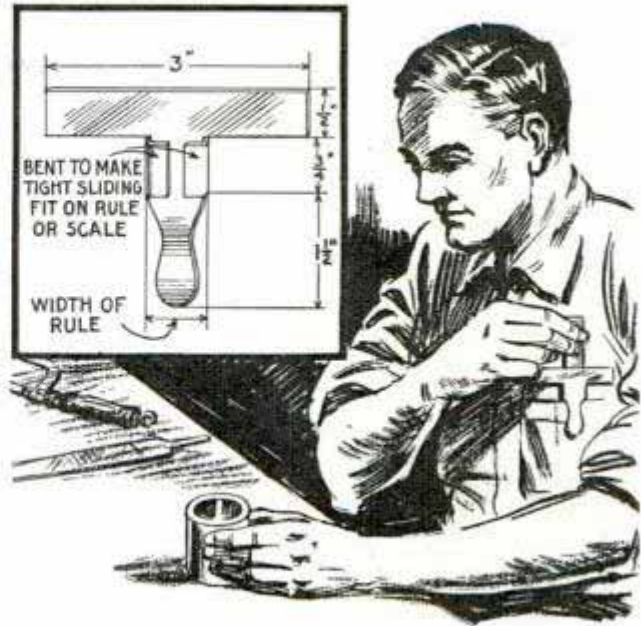

When fitted to your steel pocket rule, this sliding metal "T" serves as a depth gauge, square and clip

By cutting and bending a piece of mild spring brass as shown in the detail, you can make a sliding fixture for a steel pocket rule which will act as a depth gauge, a square and a pocket clip. The sheet brass is cut in the form of a T with two short projections, or "ears," which are bent to make a tight, sliding fit over the rule. The leg of the T is trimmed to the shape indicated and serves as a pocket clip.

—A. H. Waychoff, Tempe, Ariz.

Lathe Gears Stored in Pigeonhole Cabinet Are Quickly Selected

If your lathe is of the standard-gear type, and you find that the usual gear bracket is an inconvenient method of handling the gears, build a small cabinet having a number of pigeonholes, one for each gear. The gear numbers can be typewritten on slips of paper and tacked or glued to the edges of the compartments, covering them with clear varnish to protect the lettering against obliteration by grease and dirt.—Lewis Condon, Brookfield, Mo.



X796

Wind-Driven GENERATOR



parts of the generator. The first step is to remove the gear. Next, remove the screws that hold the end plate, and remove in turn the armature or rotating part, the field coils and pole pieces, and the brush assembly. The armature must be stripped entirely of its wiring. To remove the fiber wedges that hold the armature coils in place, first tap them against the wire to loosen them and then drive them out with a hammer and a blunt piece of wood or metal. Cut all the wires near the commutator, and then locate the coil that was wound last, which is the only coil that is not covered by some of the other winding. Remove this coil, one turn at a time, and proceed to remove the other coils, one after the other, in the same way. After all the wire has been removed, pull the old insulation from the slots and saw the wire and solder from the commutator bars, as in Fig. 6. This is done with a short piece of a hacksaw blade. A convenient jig for holding the armature while it is

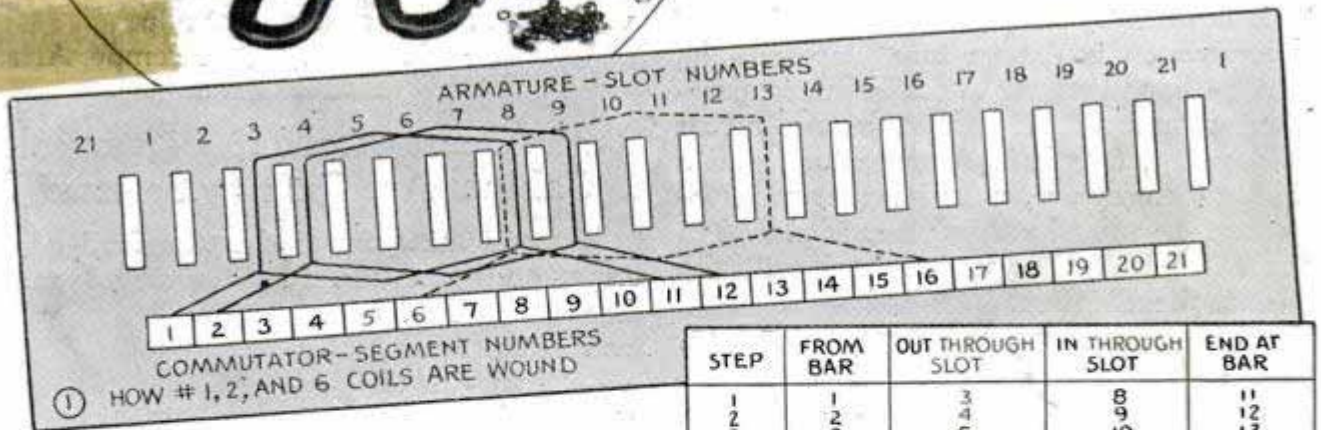

By C. A. CROWLEY

COSTING little to build and practically nothing to operate, this power plant charges radio batteries. A 6-ft. propeller is coupled to a rebuilt Ford model-T generator, which is rewound so that it will start charging at about 290 r.p.m. The use of a simple governing device prevents excessive speed.

The photo above shows the various

CHARGES BATTERIES

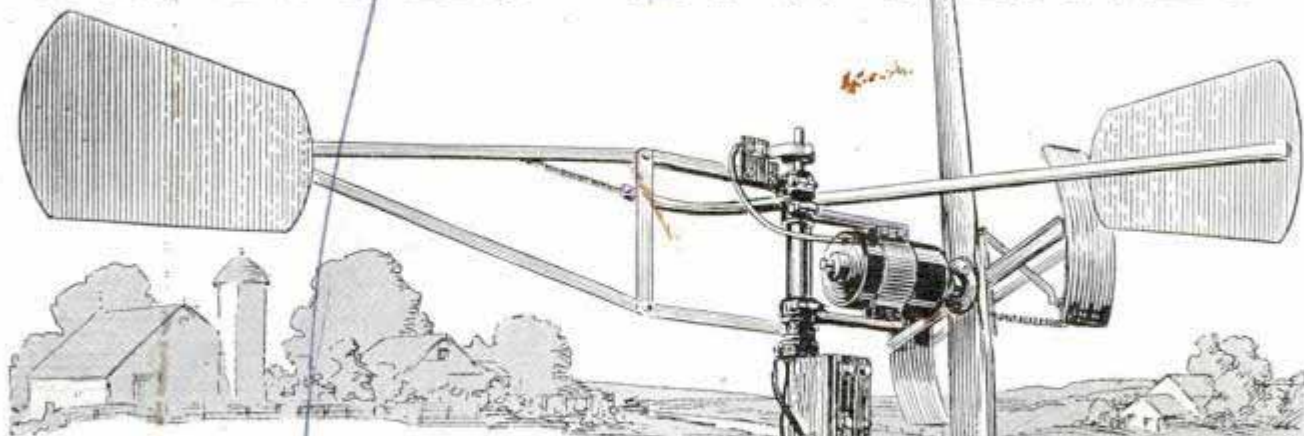

being stripped and rewound is also shown. Number the commutator bars and the corresponding slots consecutively, going clockwise around the commutator.

The material needed includes a pair of slotted-fiber end laminations, sheet-fiber insulation for the slots, wedges to hold down the windings, brushes, cotton tape, and shims for the field pole pieces. The wire needed is 1¼ lbs. of No. 19 "Celenamel" (Cellophane-covered-enameled) magnet wire for the armature, and 2 lbs. of No. 18 enameled wire for the field coils. Cut through the slotted-fiber end laminations and slip them into place, as shown in Fig. 3. Insulation papers are inserted into each of the slots in the armature, as in Fig. 4. These papers can be purchased cut to size, or they can be made by cutting insulating paper .007 in. thick into pieces 2½ by 1¾ in. in size. The insulation will extend somewhat higher than the slots so that the fiber can be turned down to protect the top of the coils. Cotton tape is then wrapped around the shaft between the commutator and the armature. One

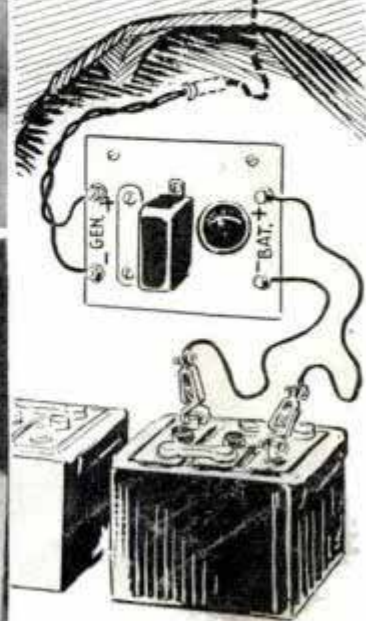
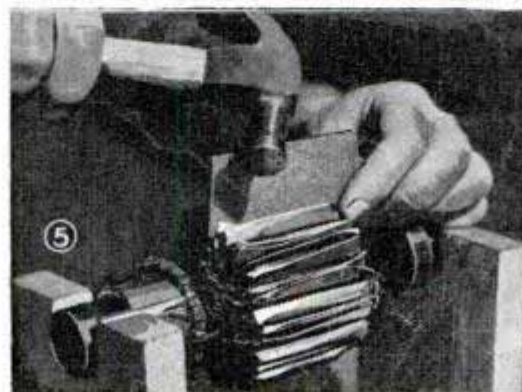
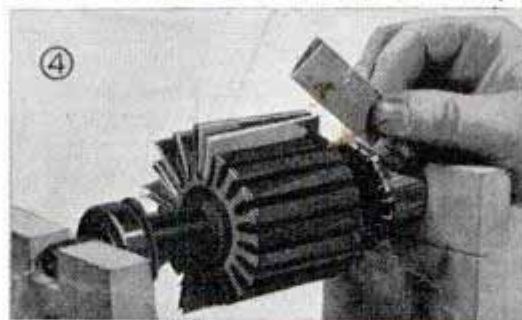
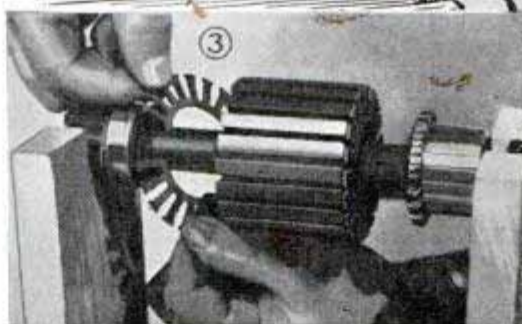

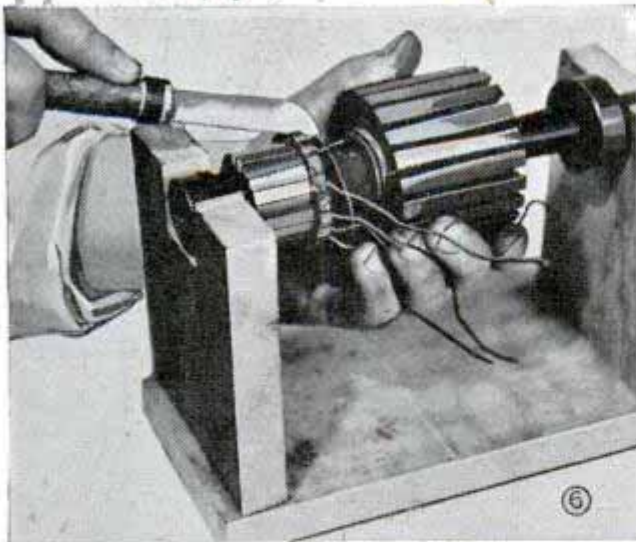

coils have been wound. When winding the sixth and following coils, you will be laying wire on top of a finished coil. It may be necessary in these cases to press down the original coil to make room. This is done as shown in Fig. 5, by pressing down with a blunt piece of $\frac{1}{8}$ -in. hard-pressed board or fiber. After laying the second coil in each slot, press down the wire, fold over the insulation, and insert a wooden slot wedge such as was removed when clearing the armature of its original winding. Continue winding until all the coils have been completed. As each coil is finished, it is wise to test it for grounds and shorts, using the methods indicated in Fig. 7.

When all the coils have been wound and tested, the moon-

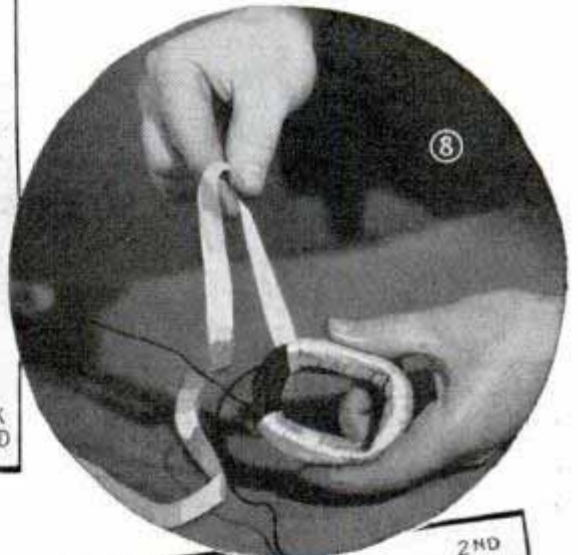
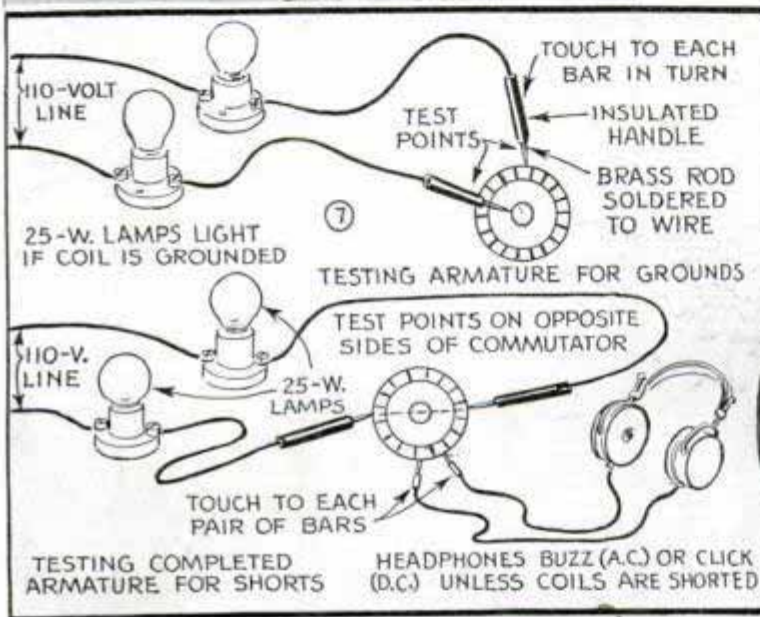

or two layers of the tape will be sufficient.

The loose end of the Celenamel No. 19 wire is inserted into the slot of commutator bar No. 1, so that the wire extends outside the riser of the commutator about an inch for convenience when attaching this wire permanently. As shown in Fig. 1, this wire is now led out through slot 3, back through slot 8, out again through slot 3, continuing until exactly seventeen turns have been laid in these two slots. The loose end of the wire is then brought over to commutator bar 11, and cut off, allowing about 4 in. excess. It now should be folded temporarily on top of the coil just wound and tagged as No. 11. Next start with bar 2, wind 17 turns in slots 4 and 9, and lead the loose end to bar 12, where the wire is cut and folded back out of the way and labeled No. 12. Continue in this manner, as indicated in the winding diagram, Fig. 1, and in the chart Fig. 2, until all the

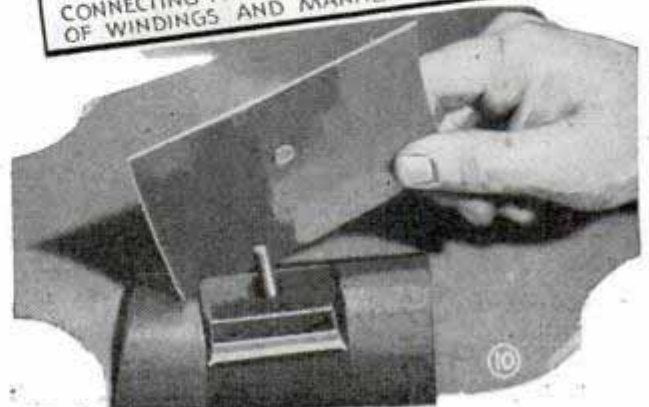
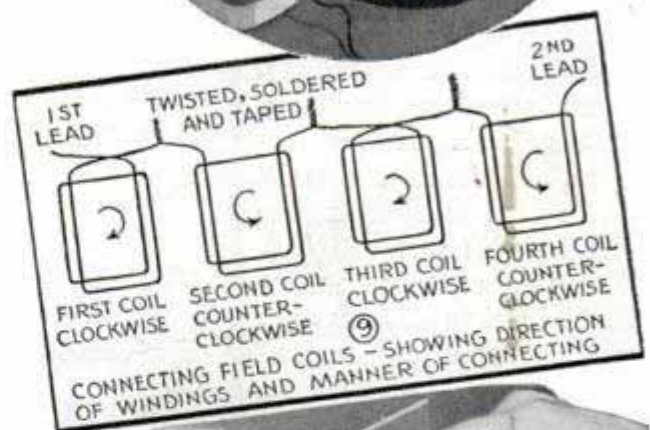

shaped end insulation paper is laid over the ends of the coils at the commutator. The loose ends of the coils are placed in the proper grooves in the commutator bars, and a few turns of twine are wrapped around the wires a little back of the commutator to hold them in place. The wires are then soldered to the commutator bars. Test the armature again for grounds and shorts. The entire assembly is now saturated with insulating varnish or shellac and allowed to dry.

The field coils are wound on a rectangular form, Fig. 10, the size of which will be the same as the inside dimensions of the old field coils. Four coils of 125 turns each of No. 18 enameled wire are required. When each coil is finished, remove it from the form and bind it with cotton tape, as shown in Fig. 8. Shape the coils to fit the contour of the frame by inserting them

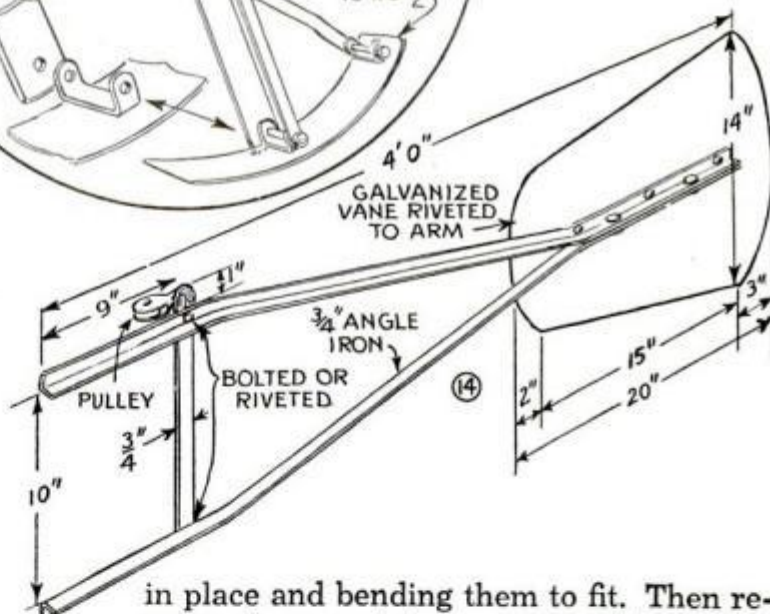
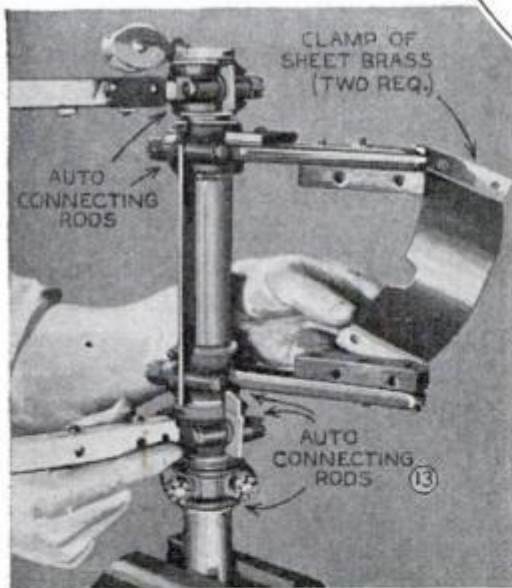
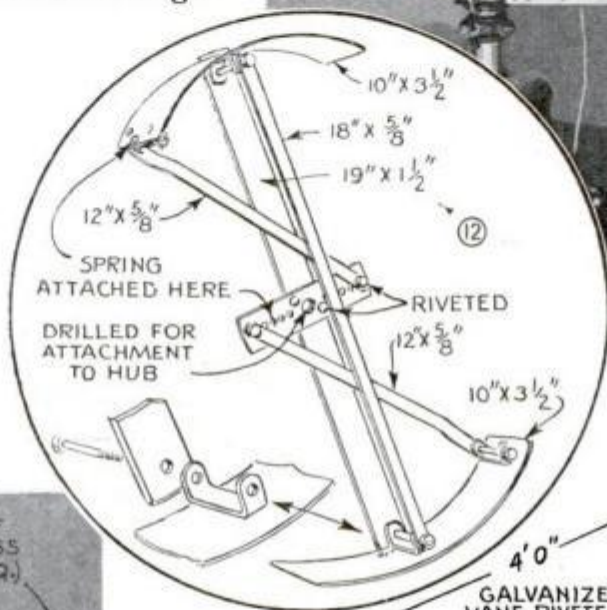
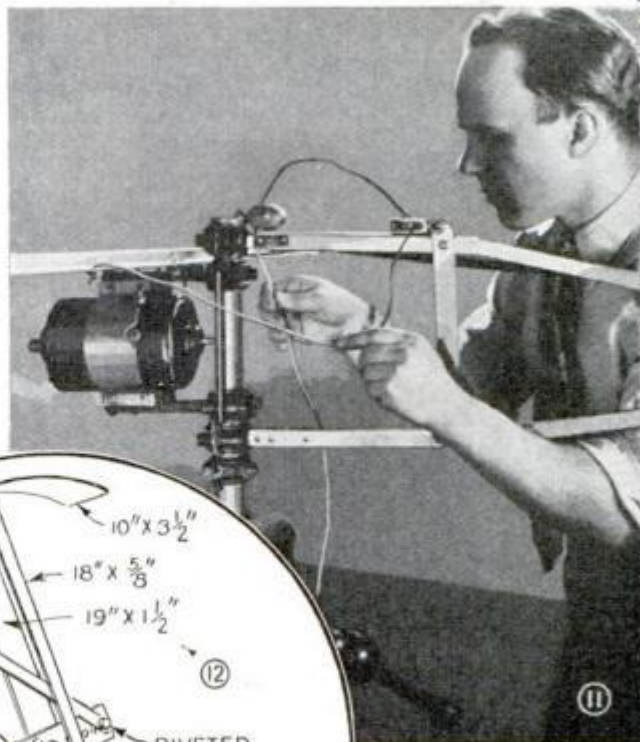

in place and bending them to fit. Then remove them and impregnate with varnish or shellac. When dry, connect them in series as indicated in Fig. 9 and put them in position, inserting the pole pieces and shims. The first and third coils are to be connected so that their turns are wound clockwise and the second and fourth counterclockwise. The generator now can be assembled with new brushes in the positions occupied by the old brushes. The ungrounded generator terminal is connected to the main insulated brush. One field lead, either one, is connected to the third brush, and the other field lead to the grounded main brush. Connect the gen-

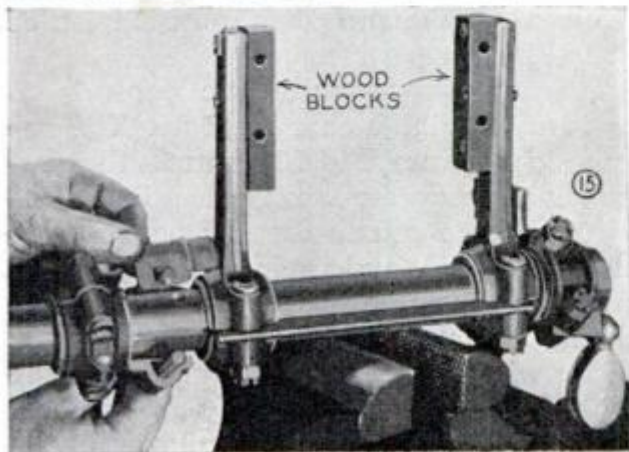

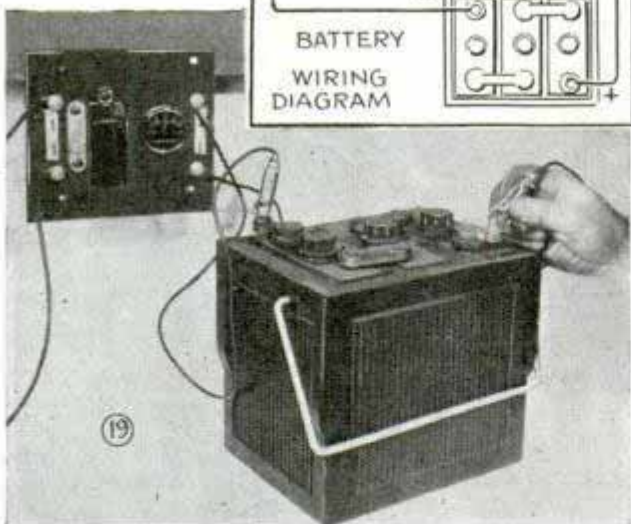
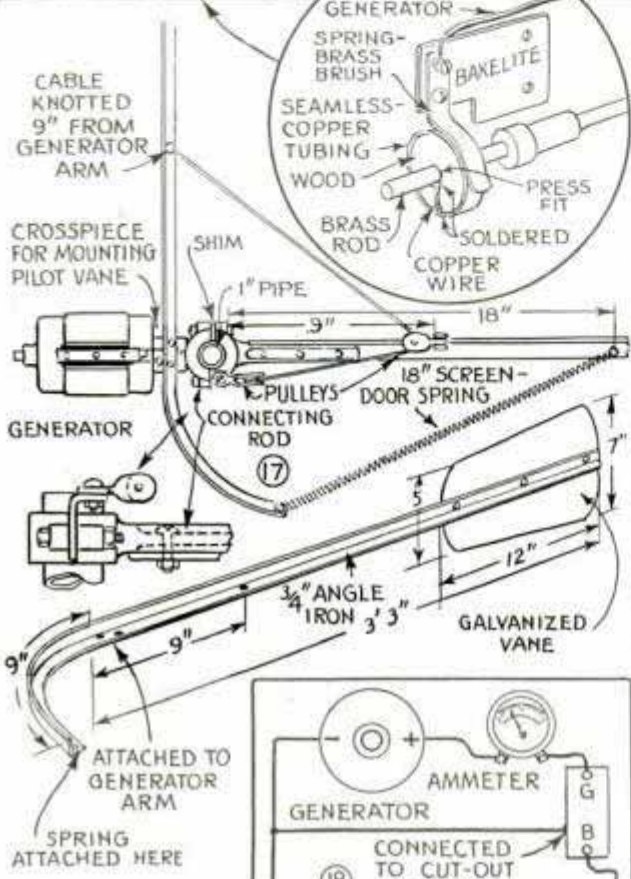
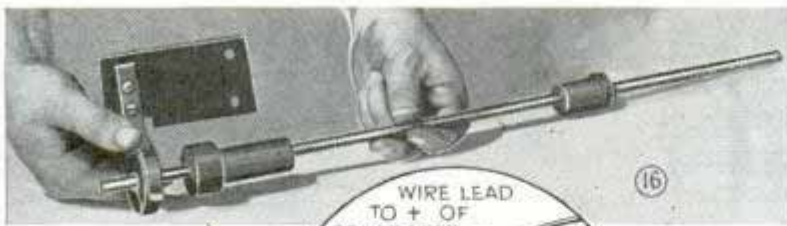

erator to a power supply and run it for a moment as a motor, noting the direction of rotation. If it rotates clockwise, viewed from the front, leave the connections as they are. If it rotates counterclockwise, reverse the field lead connections, so the lead which had been grounded is connected to the third brush, and vice versa.

The shaft on which the outfit is mounted is an 18-in. length of 1-in. pipe. The arms on which the generator and the vanes swing are fastened to the shaft with Ford model-T connecting rods, which serve as swivels. The small

bearing is sawed off and the large bearing is reamed or filed out to fit the pipe. The large end of one connecting rod is sawed off and tightly bolted around the shaft at a point 11 in. from the top. This will serve as a bearing for the swivel arms above it. The main vane is cut from galvanized sheet metal to the dimensions shown in Fig. 14. The arm is 4 ft. long and is made as shown from $\frac{3}{4}$ -in. angle iron. The vane is riveted to the arm, which is fastened later to the connecting-rod swivels with $\frac{1}{4}$ -in. bolts. Blocks of wood, $\frac{5}{8}$ by $3\frac{1}{2}$ in., are bolted to the other two connecting rods as in Fig. 15. The generator will be attached to these blocks with two sheet-metal bands, as shown in Fig. 13, which are $2\frac{1}{2}$ in. wide and shaped to fit the generator. The generator swivel arms now can be mounted on the shaft and the bolts drawn tight, using shims to permit the assembly to revolve freely. Strap-iron strips, $\frac{1}{8}$ by $7\frac{1}{2}$ in., are used as shims, as can be seen in Fig. 15. Additional shims cut from light-gauge metal can be used as needed. The lower end of the heavy shim extends a little below the bottom of the lower swivel and acts as a stop to hold the generator and the main vane in the proper relative positions. The vane swivel arm is mounted in the same manner. A piece of $\frac{1}{8}$ -in. metal, bent as shown in Fig. 15, is used as the shim on the lower right-hand joint. This engages the long shim on the generator frame and holds the generator and the vane in alignment in a moderate wind. The vane and generator next can be bolted in place.

There are two automatic controls to prevent too high a charging rate. The automatic governor, Fig. 12, controls the generator at moderate wind velocities. Centrifugal force causes the curved vanes to move outward, and their wind resistance prevents excessive speed. The mechanism should be balanced accurately at the hub. When wind velocities get too high for the centrifugal governor to be effective, the pilot vane control comes into play. The di-

mensions of the vane and the angle-iron support are given in Fig. 17. This assembly is rigidly attached to the upper generator arm with two bolts or machine screws. The short end of the angle-iron support is fastened to the main vane arm with an 18-in. spring. A flexible steel cable is fastened to the pilot-vane support 9 in. from the generator and run over the two pulleys as shown in Figs. 11 and 17. When the wind gets strong, its force against the pilot vane will be so great that the vane will be forced back and will pull the generator and propeller partly out of the wind, or even at right angles to a violent wind. When the batteries are fully charged, pulling the cable will also take the propeller out of the wind.

Electric current is conducted from the rotating generator assembly to stationary wires by means of slip rings. A 2-ft. length of $\frac{3}{8}$ -in. brass rod is run up the center of the main shaft. Turned plugs, of hardwood or preferably Bakelite, at the top and bottom of the pipe hold the rod in place. See Fig. 16. If the plugs are wood, they must be waterproofed by soaking them in melted paraffin wax for an hour. Rubber stoppers, such as are used in chemical laboratories, can be substituted. A copper disk, about 1 in. in diameter and $\frac{1}{2}$ in. thick, and drilled to admit a press fit of the brass rod, will serve as a slip ring. This must fit tightly on the rod as shown in Fig. 16. The disk may be wood covered with a ring of 16-gauge or heavier copper. A brush of 16-gauge spring brass, $\frac{1}{2}$ in. wide and curved to fit the slip ring, and mounted on Bakelite, carries the current from the generator to the slip ring. The other side of the generator circuit is grounded to the frame.

The wiring diagram is shown in Fig. 18. Heavy insulated wires should be used and all connections should be soldered to insure permanence. The ammeter and cut-out can be mounted at any convenient point. The cutout can be one from an automobile, or better, a special cutout designed for a wind-generator system. A panel board as seen in Fig. 19 is a convenient means for mounting cutout, ammeter and binding posts. When everything is ready, mount the propeller on the generator shaft and install the governor, and the system is ready to operate.

Loss of Papers on Desk Slide Is Easily Prevented



CREASED AND FOLDED PAPER FLAP

The folded paper will keep the work on the desk slide from dropping into a drawer below

Loss of papers by leaving them on a desk slide when it is pushed in so that they drop into a drawer or compartment below, when it is pulled out, can be prevented with a folded piece of paper. This is glued to the slide near the rear edge so that it keeps the papers from slipping off.

Lip on Test Tube Flattened to Avoid Rolling

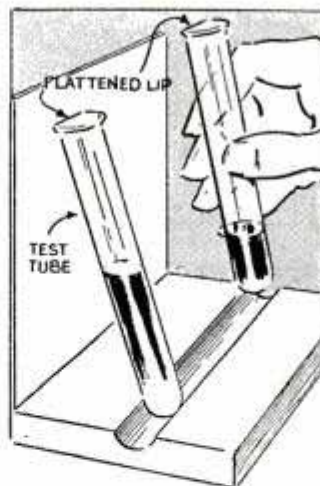

If the lip of a test tube is flattened slightly, it may be leaned against a vertical surface or laid on a flat one without rolling. The lip can be flattened by heating the glass in a gas flame and then pressing it against a flat metal surface, preferably one

that is hot. Do not bend the lip so much that it is impossible to fit a cork into the mouth of the tube.

☞ Brightly colored fingernail polish is excellent for marking dishes and pans that are to be sent out of the home; when the utensils are returned, the markings can be taken off with polish remover.

Price Tags Held in Coil Spring Are Dried Easily

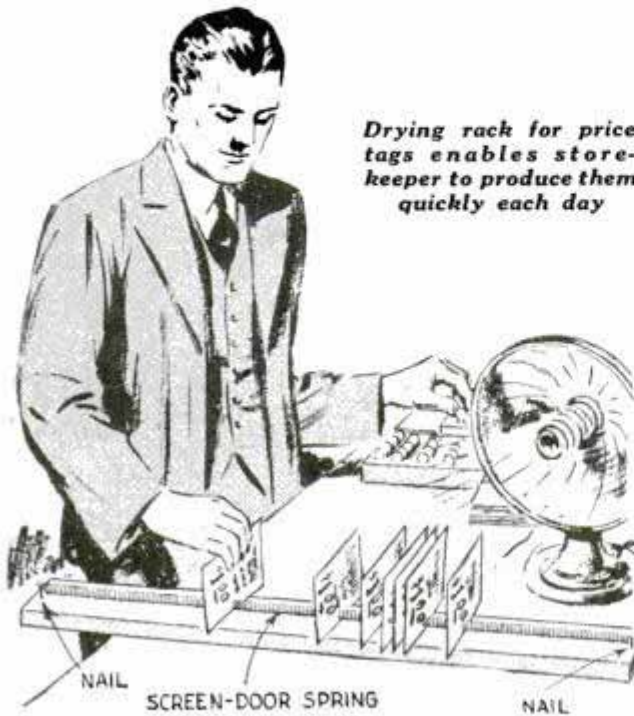

Drying rack for price tags enables storekeeper to produce them quickly each day

In order to dry price tags quickly after printing them, one storekeeper stretched a screen-door spring between two nails driven into a board and inserted the cards between the coils of the spring. This kept the cards separated so that heat from an electric radiant heater quickly dried them. The board and spring also enabled him to carry the entire bunch of cards around the store and select the ones needed at a glance.—E. S. Newlon, Council Bluffs, Ia.

Rubber Finger Lifts End of Paper from Roll in Rack

Tendency of the end of paper to stick to the roll, when mounted in a rack as indicated, can be avoided with this rubber

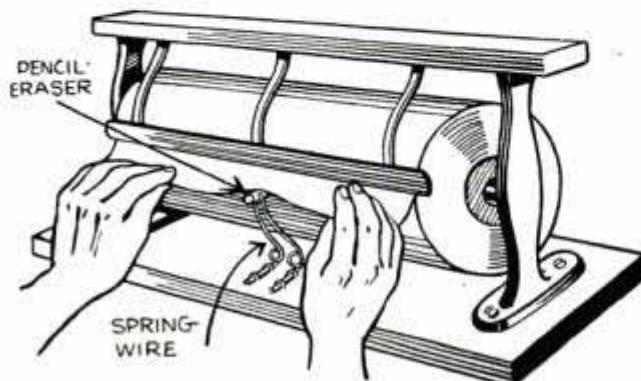

Storekeepers can save time by using this rubber finger to keep the end of wrapping paper from sticking

finger, which bears against the roll and forces the paper end away as the roll is rotated. The finger is merely a length of spring wire pushed through a rubber pencil eraser and then bent to the shape indicated, after which it is attached to the base of the rack with staples.

Non-Tip Carrier for Paint Can

Any danger of tipping over a small paint can is minimized if you support it with this simple holder. It consists of a small board in which two nails are driven 7 or 8 in. apart, the nails projecting to take a wide rubber band cut from an old inner tube. When a can is set between the nails, the band grips it.



Folding Ladder on Water Tower to Keep Children Off

To prevent children from climbing to dangerous heights on a municipal water tower, one local official recommended al-

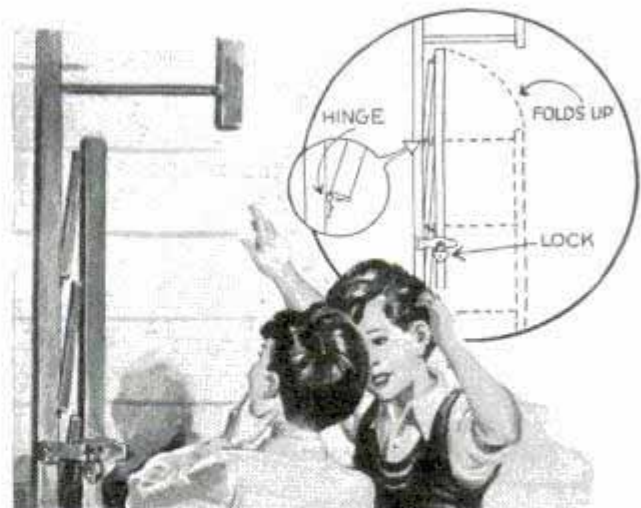

Lower portion of ladder on water tower folds up so that small children can't climb it

tering the ladder on the tower so that the lower part could be folded. This was done by using steps in place of rounds, each one being hinged at both ends so that one side could be lifted and locked to the other side as shown in the sketch.

DENSITY METER

*gives exposure time
from color negatives*

By WILLIAM MAYOH

GETTING the correct exposure time for prints that are to be made from three-color separation negatives is a simple and accurate process with this density meter, which eliminates all guesswork. It may be used in making bromides for the carbonyl process, positives for wash-off reliefs, chromatone prints, etc. Anyone having a good photoelectric exposure meter can build the outfit at home in spare time at slight expense.

It consists essentially of a box containing an electric lamp the brilliancy of which can be controlled by means of a dimmer socket. The hinged lid of the box has a small hole in the center, over which the exposure meter can be brought by swinging down a hinged arm to which the meter is attached. A pivoted fiber, Bakelite or metal disk on the lid has a num-

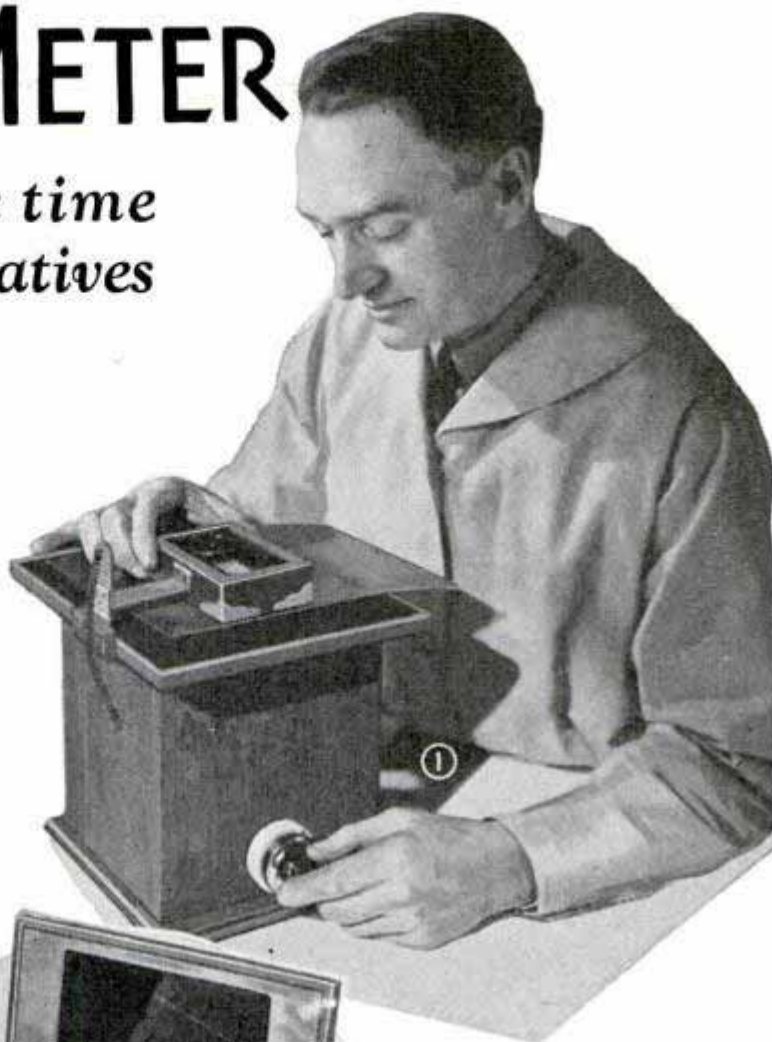

ber of holes of graduated sizes ranging from $\frac{1}{16}$ to $\frac{3}{8}$ in. in diameter, all of the holes being centered on a circle scribed from the center of the disk. The disk is located so that turning it will bring each hole directly over the hole in the lid, thus controlling the amount of light striking the face of the exposure meter. A snap switch

should be mounted in a convenient position on the outside of the box. A careful study of the illustrations will show the exact arrangement. Fig. 1 shows the exposure meter brought down on a negative while Fig. 2 displays the interior of the light box showing a lamp housed in a small reflector; also the hole in the center of the lid and two lengths of chain from the dimmer socket projecting from the front of the box. Fig. 3 shows the expo-

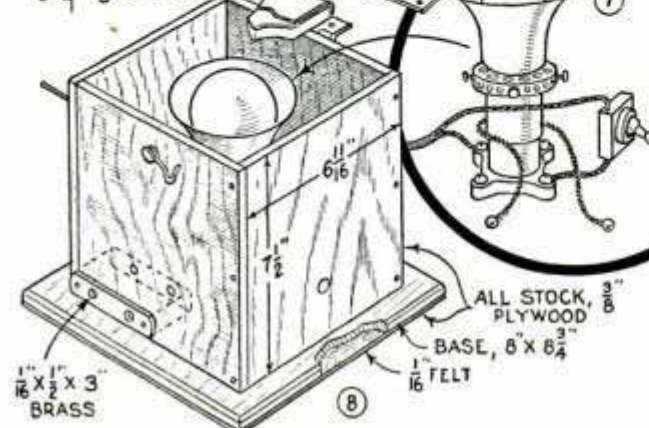
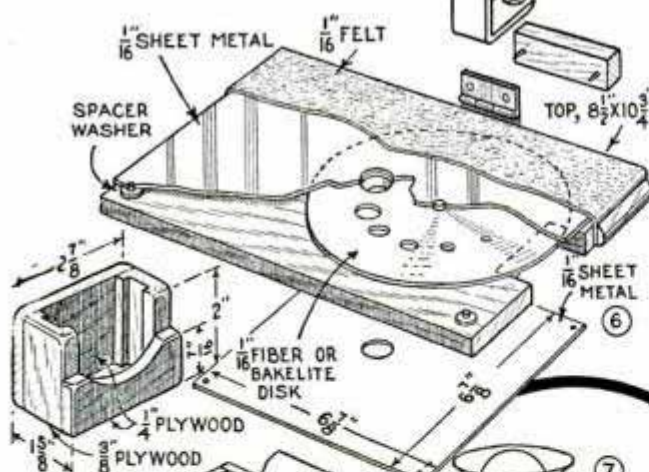
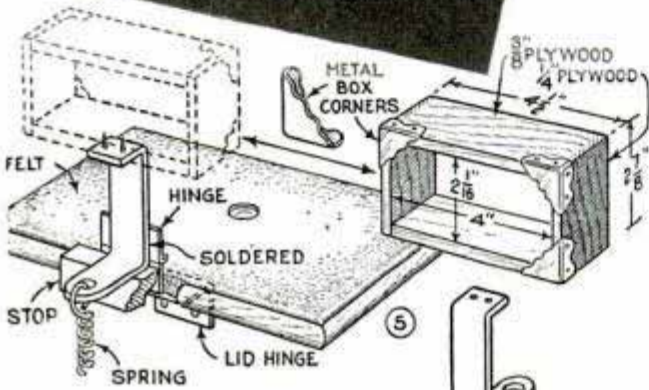

sure meter held out of the way on the hinged arm.

Figs. 5 to 8 inclusive show constructional details. Any high-quality exposure meter of the photoelectric cell type will serve. It is held in a wooden frame attached to the hinged arm. Fig. 5 shows a dimensioned frame designed for one type of exposure meter, while at the left of Fig. 6 a frame designed to hold another type is shown. The arm that holds the meter has a small coil spring attached to keep it in a vertical position when released. Plywood is handy material from which to make the box and lid. The latter has a notch on one side so that the operator can insert his finger here to turn the disk. A piece of sheet metal is tacked or screwed to the underside of the lid to dissipate heat from the lamp. Also, a piece of sheet metal is mounted on the lid and spaced above the latter by means of washers to permit the disk to turn freely. Then, a piece of felt is glued to the metal so that negatives can be slid over it without scratching the emulsion side.

In taking photos for color work, every negative should include a gray scale somewhere to one side as indicated in Fig. 4. The scale is placed directly over the hole in the lid of the light box and then the disk is revolved until you arrive at the right opening to match your gray scale on the negative, after which the meter is lowered directly on the negative and the brilliancy of the light is increased or decreased by means of the dimmer socket until the meter reads, let us say, 65. You now place the negative between the meter and the cabinet and take two readings, one from the dense end of the gray scale and one from the light end. Make a note of this and do the same with the red and yellow printer negatives. As an example let us say that your readings are somewhere in this order as you read them: Blue negative, 6 and 30; red negative, 10 and 40; yellow negative, 8 and 24. You now have all the information you can obtain from the density meter, providing your light did not fluctuate. This you can control by reading the meter only between the reading of your negatives and keeping it at the same value with the aid of the dimmer socket.

And now for the benefit of those who

do not understand how to get exposures on bromide paper from these readings: Take your blue negative first and make a test print in your enlarger. We will say your exposure was 5 seconds at f:8. This test determines the exposures of the red and yellow negatives. For instance, with the blue negative meter reading at 6 and 30, the red negative reading being 10 and 40, and the yellow negative reading being 8 and 24, you subtract the reading of the dense end of the scale from that of the light end and you get these figures: 24 for blue, 30 for red, and 16 for yellow. Now multiply 24 on blue by 5 seconds which gives you 120. Now divide 120 by the 30 for the red and you have 4 seconds as your exposure for red, and similarly divide 120 by the 16 for the yellow, which gives $7\frac{1}{2}$ seconds as the exposure for yellow.

Using Two V-Blocks as Drill Jig

Whenever I have a hole to drill in round stock, I set up a pair of V-blocks as indicated. This method does away with both difficulties connected with the use of

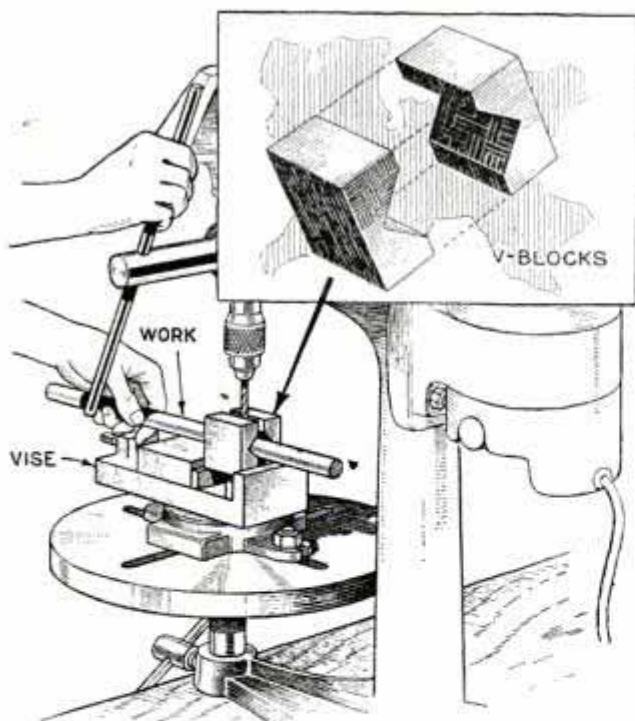

Two V-blocks clamped in vise hold rough work so it can be drilled through without damaging blocks

V-blocks—centering the work under the drill and providing clearance underneath so that the hole can be drilled right through without drilling into the blocks.

—H. Moore, Leeds, England.

Car Pulling Heavy Trailer Cooled by Additional Water Tank

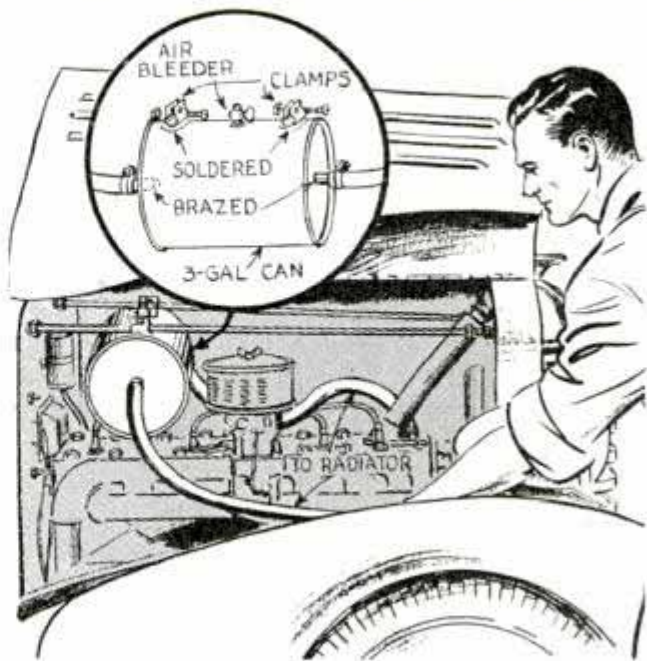

Auxiliary tank increases radiator capacity of car when pulling trailer over mountain roads

Before making a trip with a house trailer behind my car, which has always had a tendency to run hot, I installed an extra water tank, which was a 3-gal grease can. Two pipes were brazed to the ends to take the hoses which were disconnected from the hot-water heater. A bleeder pet cock is necessary in the top to drain off the air so the tank will fill with water completely. The tank can be clamped to the radiator braces or installed any place under the hood where there is room. I pulled a heavy trailer over 300 miles of steep mountain roads in the hottest weather without the radiator boiling. Before the tank was installed the car would boil quickly when pulling no trailer. The water hoses can be returned to the heater in the fall when the extra cooling is not needed.

—G. L. Beck, Tacoma, Wash.

Charging Battery in Car

To recharge a car battery without removing it from the car, mount a $\frac{1}{4}$ -hp. alternating current motor so the fan belt can be used to connect this motor to the car generator. A washing-machine motor generally is equipped with a pulley for a V-belt. If the motor speed is too high, obtain a smaller motor pulley.

—A. E. Torell, Everett, Wash.

Position of Fence Posts Marked with This Lime Duster

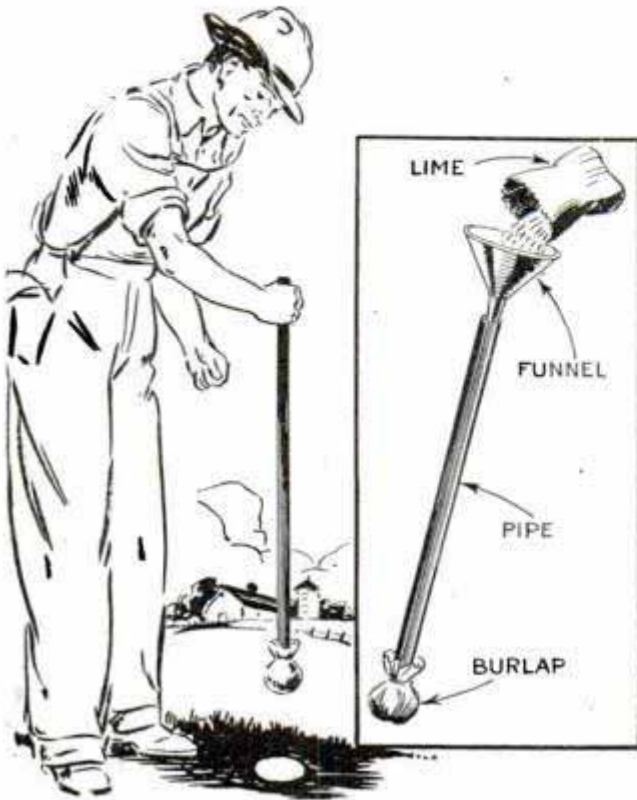

You can save labor and time by using this lime duster instead of stakes to locate fence posts

Instead of laying out the locations of posts in a new fence by driving stakes into the ground, use this lime duster, which saves time and labor. It consists of a length of pipe with a piece of burlap tied tightly over one end to form a small bag. In use, the pipe is filled with lime, and the workman walks along and taps the ground where a post is to be set. The lime sifts through the cloth and leaves a white spot on the ground.

Rubber Heels Cushion Motor

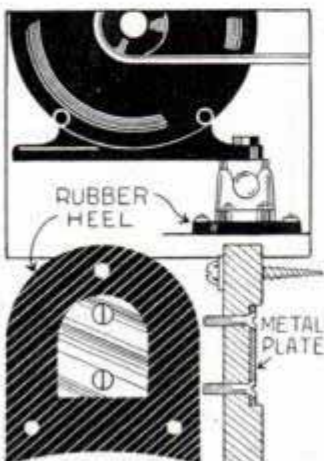

To reduce vibration of electric motors to a minimum, shock-absorbing motor mounts for floating-type rails can be made from a pair of rubber heels. Cut a metal plate to fit the recess in the top of the heel and drill

two holes through the heel and plate to line up with rail clips. Countersink the flat-head bolts in the plate and bolt the three together. Fasten the heels to the bench with three screws or bolts, using washers under the heads.

—F. W. Coates, Brooklyn, N. Y.

Screw Holder for Screwdriver

Shaped from a piece of thin spring steel, this attachment will enable you to start screws in places where it is impossible to reach with the hands. A slot with a hole at one end permits a screw head to be inserted and held true for starting it straight.

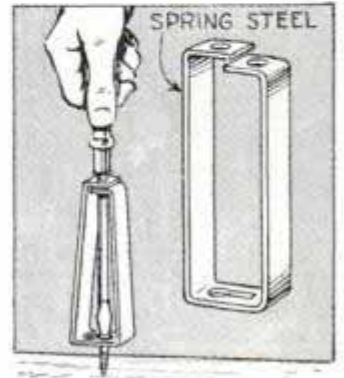

—Chas. H. Willey, Penacook, N. H.

Thickness of Shim Stock Gauged Between Sheets of Glass

When a micrometer is not at hand to find the thickness of a piece of shim stock and the thickness is not too critical, an emergency method of gauging the stock is to place it between two pieces of glass, press-

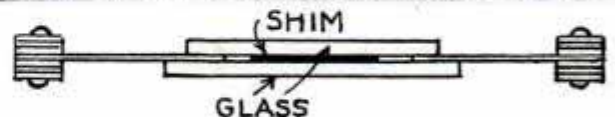
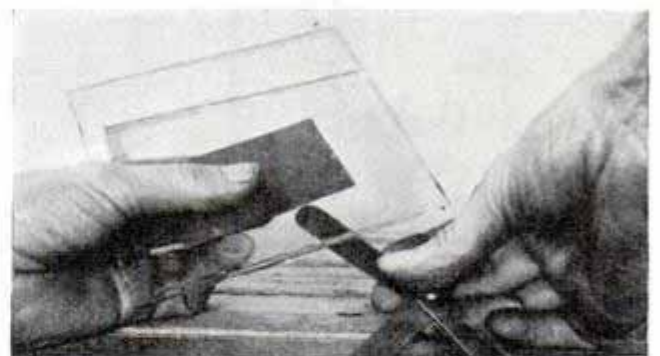

Place shim stock between two pieces of glass, press tightly and insert thickness gauge between the sheets

ing the pieces tightly. The distance between them, as measured with a thickness gauge, will equal the thickness of the stock. Glass from a broken windshield is best as it is usually perfectly true. Do not use window glass as it often has a wavy surface.

CLEANING the UPHOLSTERY *in Your Car*

CAREFUL, periodic cleaning of the upholstery on your car will not only help to maintain the beauty of the interior, but will prolong the life of the cloth. Upholstery fabrics that are cleaned regularly will not wear out as quickly as those left untidy.

A thorough brushing with a whisk broom twice a month will do wonders. If ordinary spots appear, go over them with a wet cloth and any regular cleaner at once. Should holes be burned in the cloth, it is best to have an experienced upholsterer make the repairs. Ordinary candy stains, except chocolate, can be removed by simply rubbing the discolored areas with a cloth soaked in very hot water. Start the cloth moving in a circular motion, working from the outside toward the center of the spot. Candy stains that result from fruit-filled chocolates should be rubbed with a cloth soaked in lukewarm, soapy water. Scrape with a dull knife while rubbing. Then rinse by rubbing the spot with a cloth soaked in cold water. Milk-chocolate stains are best removed by rubbing with a cloth soaked in lukewarm water and, after the surface is dry, sponging with a cloth dampened with chloroform.

Paint stains should be cleaned as quickly as possible after they are discovered. The older they are, the harder they will be to clean. For dry stains, use a cloth soaked with a mixture of denatured alcohol, 1 part, benzene, 1 part, acetone, 1 part, amyl acetate, 1 part. Rub the spot with a circular motion, starting 3 or 4 in. outside the actual spot and working toward the center. A dull knife should be used as much as possible. For spots that have not dried, you can probably get them out by rubbing with a cloth that has been soaked in turpentine.



A special technique is required to remove grease spots. Take a dull knife and get off as much grease as possible without harming the fabric. Then sponge with chloroform, ether, gasoline, benzene or any good solvent. Carbon tetrachloride is probably the best. It's a good idea to start well outside the stains. Spots made by ice cream will respond to the same treatment as stains made by fruit-filled chocolates. Hot water first with soap or warm soap-suds and then, after the area is dry, a sponging with carbon tetrachloride will remove the fatty matter.

There are many types of lipstick stains, but, in general, a solution of carbon tetrachloride or chloroform will remove them,

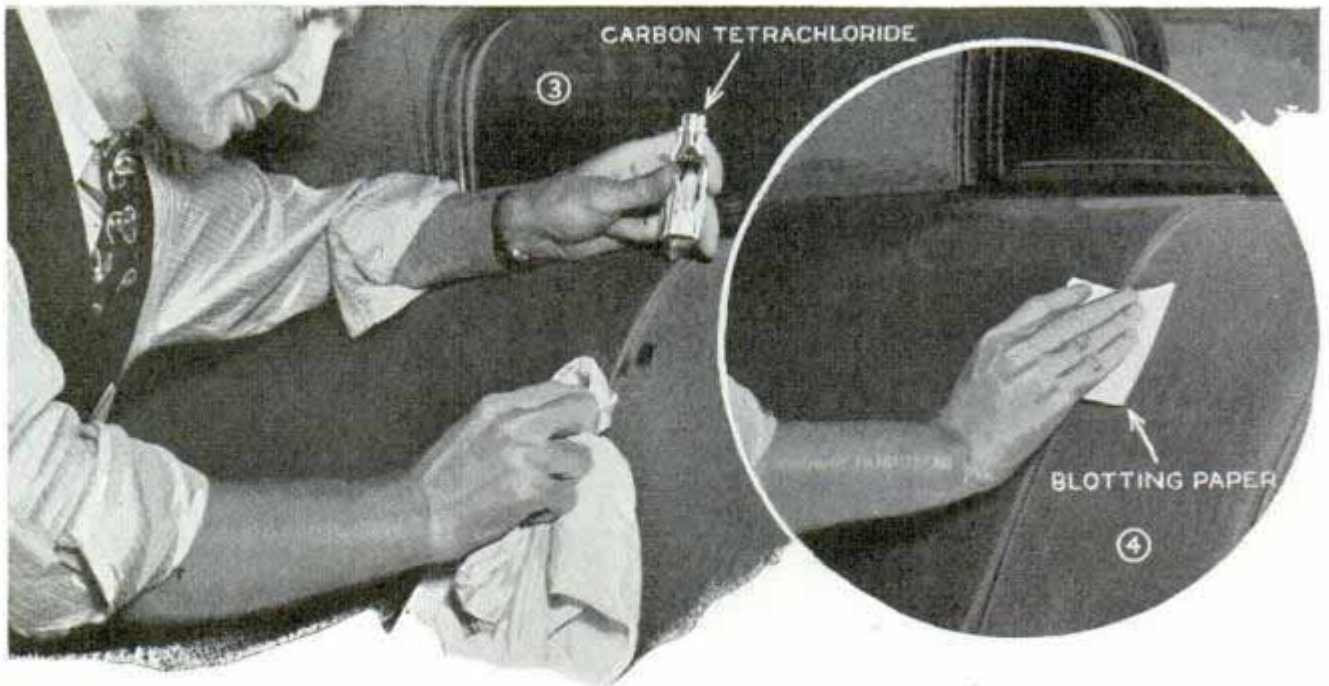

especially if you press a blotting paper firmly on the spot after applying the mixture. Repeat as often as necessary to remove stain, using a new surface of the blotter each time. Fresh mildew can be removed by rubbing vigorously with a cloth thoroughly wet with warm soapsuds, followed by rinsing with cloth wet with cold water. In old mildew you may find that spots remain after you have removed their cause, but a 10-per-cent solution of oxalic acid may eliminate them.

Warm soapsuds, followed by a rinse with cold water, usually does the job on rust. For tar, dampen slightly with chloroform and scrape with a dull knife. Follow this by rubbing with a cloth wet with benzene

or carbon tetrachloride. It's not wise to use soapsuds on fruit stains. They can best be taken out by treating them with very hot water. If possible, apply boiling water on the spots and scrape as clean as possible without injuring the fabric. Then rub with a cloth soaked in hot water. Sometimes it is necessary to sponge, after drying, with a cloth dampened with carbon tetrachloride.

A clean cloth soaked in lukewarm soapsuds will do wonders on spots made by dogs, particularly if you rub the stain afterwards with a clean cloth soaked in cold water. You can then pour a weak solution of strong ammonia and water on the spot and rinse with a clean wet cloth.

Punctured Gasoline Tank on Car Repaired with Rubber Plug

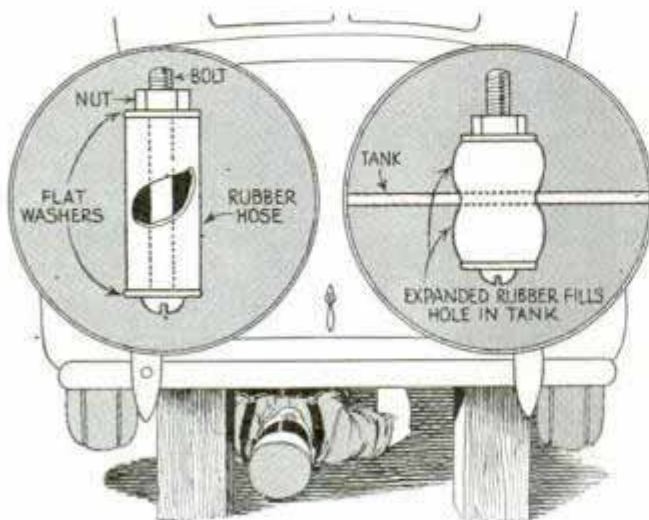

Expansive rubber plug seals puncture in gasoline tank until permanent repair can be made

If you accidentally puncture the bottom of a gasoline tank, it can be repaired temporarily as follows: First round out the hole, then slip a piece of rubber hose or tubing over a small bolt, with a washer at each end. Insert the assembly into the opening and drive on a nut, tightening it to expand the rubber tightly in the hole. The gasoline will tend to swell the rubber and make it still tighter.

Use a piece of copper or aluminum filed to the desired shape when scraping carbon from an aluminum piston; if a steel scraping tool is employed, there is danger of damaging the piston.

Stopping Rattles in Hood Hinge

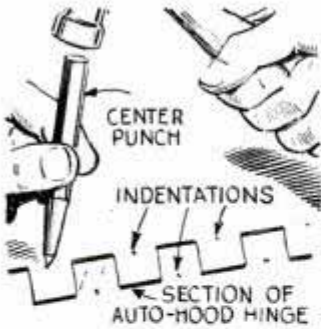

Some cars develop annoying rattles that are often caused by looseness in the piano hinge of the hood. A simple way of tightening the hinge is to make an indentation with a center punch on each section or tab directly over the rod passing through it, thus tightening the section on the rod.

—Richard A. Ehrmin, Toledo, Ohio.

Clothespin Opens Inner Tube to Release Air

To release air quickly from a punctured inner tube, one mechanic devised this simple device. It consists of a spring clothespin, the open ends of which are sharpened and notched, as shown. In use, the sharpened ends are pushed together for insertion into the puncture to the depth of the notches. When released, the spring spreads the pin to enlarge the opening so that the air escapes rapidly without further attention of the operator.

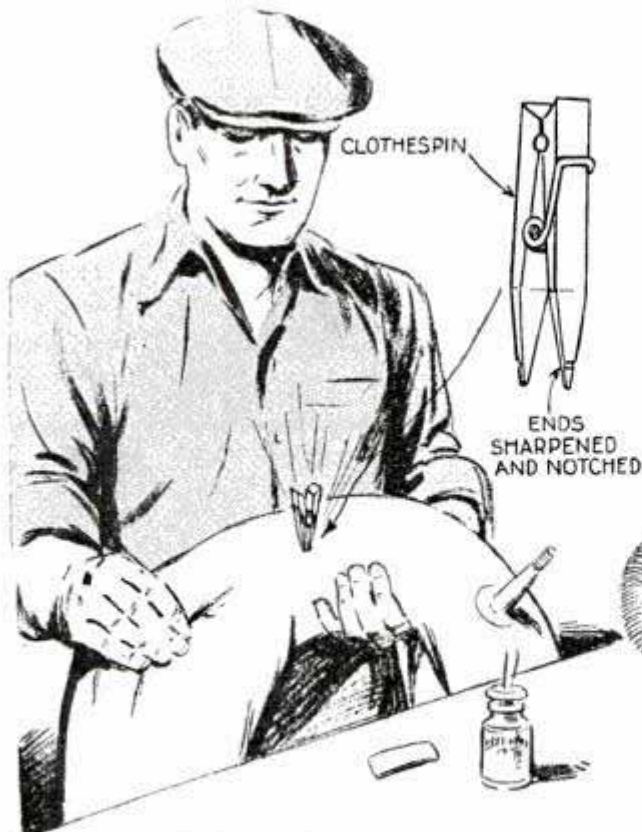

Spring-type clothespin altered to insert into puncture of inner tube to release air quickly

Parts Rack Made from Reflectors of Old Car Headlamps

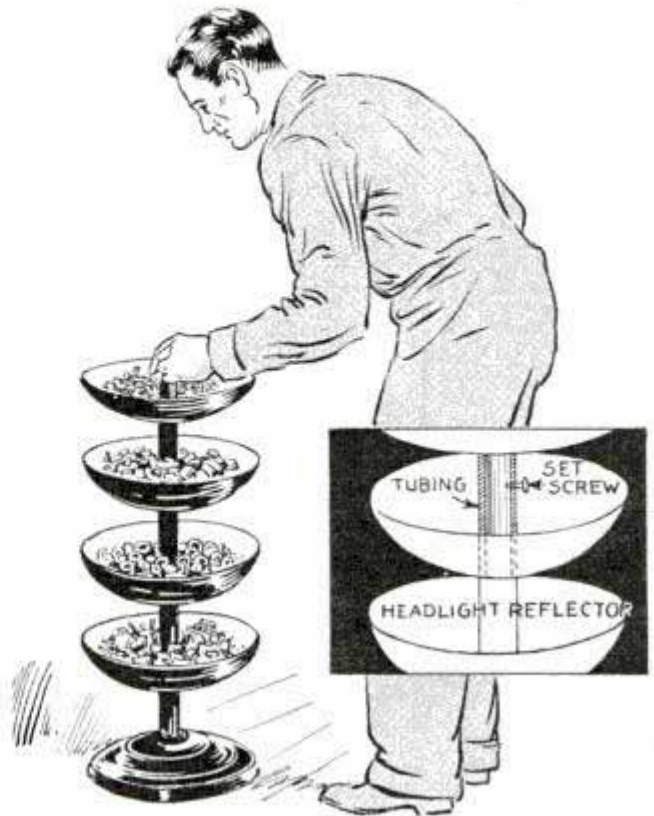

Small parts such as screws and nuts can be picked at a glance in this rack

Neat and handy for the bench in a small shop or garage is this screw and bolt rack which utilizes old headlamp reflectors as the containers. An iron rod or pipe is mounted on a heavy base and the reflectors are slipped over it and separated by 4-in. sections of pipe or tubing which fit over the central rod. The resulting trays are held rigidly in place either by soldering them to the shaft or by drilling and tapping each separating tube and providing it with a set screw.

—W. C. Wilhite, Carlinville, Ill.

Protecting Shackles from Dust

When trucks work in dust and mud, it's a good idea to cover the spring shackles. After washing off the parts, lubricate them as usual, then take a piece of burlap and, after soaking it in oil, wrap it around the shackle, tying it in place with a piece of wire. This not only prevents the dust from accumulating directly on the shackles and the fittings but also prevents the dust from working into the shackles with resultant wear.

—Emil J. Novak, Omaha, Nebr.

Inner Tube Buffed on Grinder with Aid of Potato Masher



Accidental injury to the fingers, when buffing inner tube, avoided by stretching it over potato masher

To avoid any chance of injury to his fingers from a buffing wheel, when roughening the surface of an inner tube before a patch is applied, one mechanic stretches the damaged portion of the tube over the end of a wooden potato masher, and holds it in place with a rubber band.

Rear Signal Lights on Trailer Plug into Car Circuit

Operating a trailer tail lamp and stop light in conjunction with those on your car is accomplished easily when an electrical plug of the

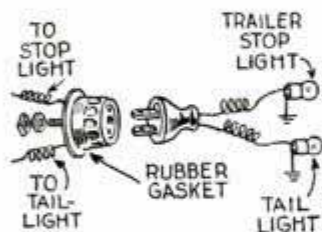

type shown is used as a connector, which permits the circuits to be broken quickly when the trailer is unhooked from the car. The diagram

shows how the wiring is done. A small bolt will have to be substituted for the screw in the plug, which must be insulated from the car where it is mounted. Also, the tongue and hitch of the trailer must be metal to complete the circuit from trailer to car battery, otherwise a jumper wire

will have to be connected between the trailer and car frames. The same idea can be used when the trailer is to be lighted from the car battery.

"Sandpaper Block" to Clean Battery Posts

Cleaning corrosion from storage-battery posts is done in a jiffy with this sandpaper block. It consists of a short piece of garden hose, which is split along one side to take a piece of

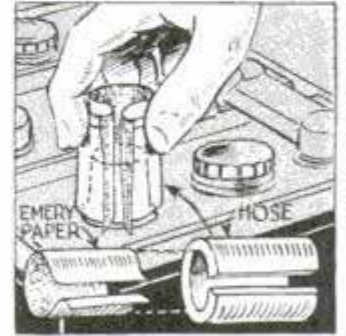

sandpaper, inserted on the inside. In use, the hose and paper are slipped over the post and twisted from side to side.

Wall Mirror Guides Drivers onto Greasing Pit

To protect customers at a lubricating station from driving their cars into pits or against hoists, a wall mirror can be mounted as shown, so that the driver can watch his front wheels. The mirror should be of large size and it should be mounted firmly to prevent swaying or shifting. Such precaution for your patrons may serve as valuable court evidence that you use "reasonable care" in the protection of your customers and their cars, in addition to preventing accidents that might be very expensive.—C. E. Packer, Chicago.

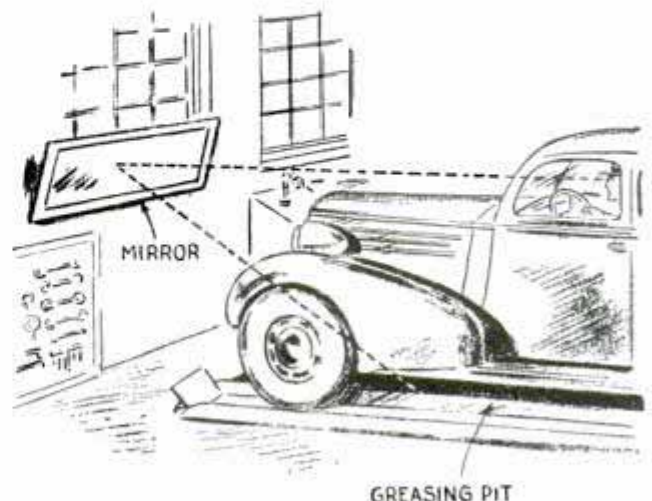

Driver seeing image of front wheels in mirror is able to steer safely onto lubricating pit or rack

Famous KODAK BANTAM SPECIAL

now \$87.50



FEATURES

LENS—Kodak Anastigmat EKTAR *f.2.0*, extra-fast, super-corrected.

SHUTTER—Compur-Rapid, 9 speeds to 1/500 second.

COUPLED RANGE FINDER—Military type; split-field; finds the range and focuses in one operation.

FILM-CENTERING DEVICE—Locks film accurately in position for each exposure.

KODAK BANTAM SPECIAL'S great reception by camera fans permits a substantial price cut. "Buy of the year" at \$115, now only \$87.50, with field case.

If that's about your price, this is certainly your miniature. Extra-fast lens. High-speed shutter. Built-in range finder. Handles with delightful ease. Master of every miniature shot. See it at your dealer's.

TAKES PICTURES IN FULL COLOR . . . Load Kodak Bantam Special with Kodachrome Film and get gorgeous full-color transparencies, to be viewed as they are, or mounted in slides for large-size projection in the Kodaslide Projector . . . Eastman Kodak Co., Rochester, N.Y.

FIELD CASE

Kodak Bantam Special's new low price includes a tan sole leather sportsman's field case which allows you to carry the camera on a neck strap—ready for use without complete removal from the case. A great convenience for "rapid-fire" picture taking.



KODAK MINIATURE ENLARGER, MODEL B, is a useful miniature camera accessory. Blows up your miniature negatives to 100 times original negative area, or to even greater proportions. Has an *f.4.5* Kodak Anastigmat lens and many outstanding features, yet is priced as low as \$52.50. Ask your Kodak dealer for complete details.



For BLACK-AND-WHITE, Kodak Bantam Special loads with Kodak Panatomic or Kodak Super X Film—the former for negatives of exceptionally fine grain that permit an astonishing degree of sharp enlargement; the latter for indoor shots, or short exposures outdoors, where high film speed is essential. **For FULL-COLOR**, you choose from two types of Kodachrome Film—regular, for daylight; Type A, for Photoflood or Photoflash exposures.

*Only EASTMAN
makes the KODAK*

Emergencies at Sea

(Continued from page 75)

oil and was using her emergency radio generator. She had had plenty of fuel the day before when the engineer decided to pump over the side a lot of water that had settled at the bottom of the fuel tank. Unfortunately, when the water was pumped out and the pump was shut down a valve didn't seat properly and the pump kept on unnoticed, discharging good fuel oil over the side until the tank was dry. The tanker was loaded with Diesel oil, so the two ships tied themselves together and fire hoses were coupled together to transfer some of the tanker's cargo.

Losing a propeller is not very common but when it does happen it almost always



One of bank of four huge refrigerating engines used on a modern steamship

occurs in port instead of out at sea. Just as long as a ship is steaming ahead the back pressure on a loose propeller keeps it attached firmly to the shaft. Maneuvering into a dock, the propeller direction may be reversed for backing the ship, and the propeller is pulled right off the shaft. Occasionally a ship loses one blade from a propeller. When that happens the engines are slowed down to prevent too much vibration and the ship keeps on her way. Most ships carry at least one spare propeller blade and a replacement could be made at sea, although an engineer likes to wait until he dry-docks or at least is tied up to a wharf in quiet water. Tied up to a wharf, he can tip his ship by trimming the

ballast tanks until the propeller hub is out of water. Once after a rough voyage across the Pacific the chief engineer of a tanker decided to tip his ship for an inspection. His inspiration was a lucky one for he found that the high following sea that had accompanied them most of the way across had unscrewed four of the six bolts that held the rudder to the rudder stock and that the fifth bolt was nearly ready to drop off.

Many ships carry a spare tail shaft and in an emergency an engine room staff could unship a broken tail shaft and replace it with the spare. This is really a shipyard job and few chiefs like the idea of doing it with their own men because of the grave danger of serious accidents. The solid steel shaft, a foot or more in diameter and possibly twenty feet long, could easily crush several men if it broke away while being moved into place.

If a ship loses a rivet from her bottom the leak is usually not very serious and a soft metal plug can be driven into the hole to keep the water out. But if loss of the rivet is likely to open a seam it can be replaced at sea by dropping a weight attached to a thin line down through the hole. This weight, dropped into the ocean, is then retrieved from outside the hull by looping a rope around the hull from the bow and drawing it aft. The loop catches the line that holds the weight and it can be drawn up on deck. Then a patch bolt is substituted for the weight and the line is tossed overboard. Pulling the line back up through the rivet hole draws the patch bolt right into the hole. A nut placed on the bolt from inside the ship is tightened and the job is finished.

Boilers are watched constantly at sea for the first sign of cracks or corrosion. One of the most disagreeable jobs in a fireroom is blocking off a leaking tube in a boiler. After the fires have been turned off the temperature inside the boiler is around 200 degrees and if the repair has to be made at once a fireman bundles up in all the clothing he can get and climbs in through the door, walking on planks to keep the hot metal from buckling his shoes. He has to work fast to finish the job before he is overcome by the heat.

*“Velvet’s
the name*

**..get out your
pipe and
put ‘er there!”**



*Better
smoking
tobacco*

Velvet
—the **MILDNESS**
of fine old
Kentucky Burley
aged in wood
—the **FLAVOR**
of pure maple
sugar for extra
good taste

*Velvet packs easy in a pipe
Rolls smooth in a cigarette
Draws right in both*

es 942

*"I'd marry you
in a minute—*



...if you had a Barbasol Face™

A SMOOTH, firm, youthful-looking skin has a lot more lure for a lovely lady than a rough, leathery hide.

That's why a Barbasol Face is such an asset. For Barbasol contains certain oils that help keep the skin fresh and youthful-looking.

None of those harsh irritants that tend to bite and burn and coarsen the skin and make you look older. No sandpaper face or stubbly chin from a shave that doesn't cut the whiskers off close enough.

Barbasol is the modern way to shave—the cleanest, sweetest shave you ever had.

Buy a thrifty big tube of Barbasol today. Try it for just ten days. Note how nice the skin feels—softer and smoother—thanks to the beneficial oils in Barbasol. When you see how it seems to shave the years away with your beard, you'll help to make America's fastest-selling shaving cream even a faster seller. At all drug stores, large tube, 25¢. Giant tube, 50¢. Family size jar, 75¢. Five Barbasol Blades for 15¢.



Rope Spinning for Health

(Continued from page 29)

stunts. At this point, however, it might be well to point out that loops of this size should be kept in the same position as the smaller ones. When attempting the larger loops, many beginners try to speed up, forgetting that the spoke must turn in the hand to keep the rope from snarling.

With a little practice and patience, the neophyte can learn to jump in and out of a lateral loop. In doing this routine, Terry Bardole, youngest of the big timers, starts

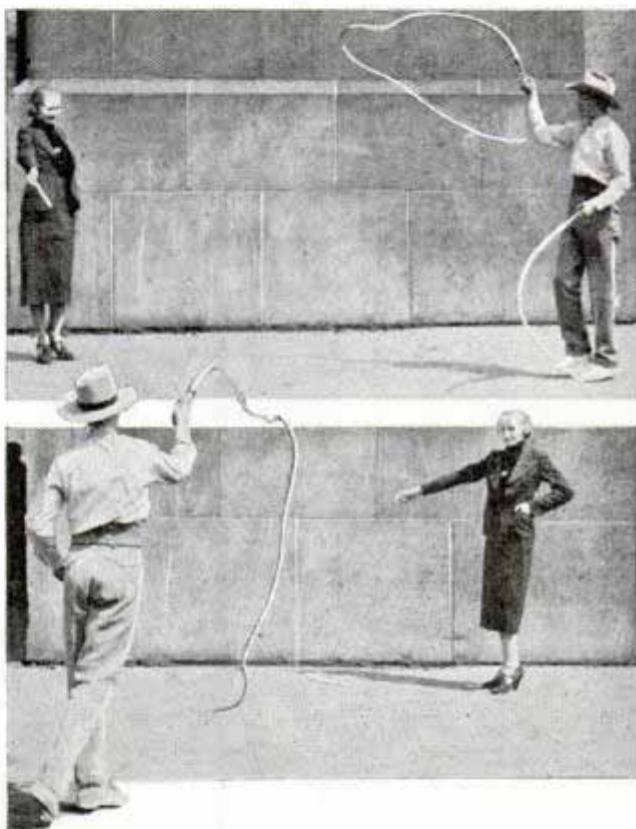

Top, whip cracking goes hand in hand with rope spinning. Here an expert prepares to snip roll of paper from girl's hand. Bottom, completion of the trick. Note short piece of paper left in girl's hand

a medium-sized flat loop rotating to the left, about five or six inches off the ground. When the loop is going at average speed, the spinner steps briskly into the circle with his right foot just as the spoke passes. His weight is thrown to the right foot on which he is standing and before the spoke has a chance to come in contact with his right leg, he makes a backward step and the spoke is allowed to pass under. The routine should be tried on the left side after the above procedure has been mastered.

A variation of this stunt is to step into the loop with the right leg closely followed by the left just as the spoke passes the

right leg. With a quick, rhythmical movement, the hand is turned from a downward to an upward position, thus pulling the loop around the body. The action is reversed if the spinner wants to get out of the loop without stopping it. Just as the spoke passes the right shoulder, the hand is dropped to a downward position. The roper then steps backward out of the loop with his left foot first, followed by his right.

In order to spin a loop around you, the loose end of the rope should be fed into the honda until there is just a little over two feet remaining outside it. Grasping the left side of the loop with the left hand and holding the right in the same position as before, you are in position for the spectacular stunt. The hands should be about two and one-half feet apart and the left arm should be held rigid, almost even with the waist. The right arm sweeps on an upward curve around the body toward the left. The loop is released when your hand is just above your head.

Using the arm and wrist, the spoke is revolved in a circle approximately one foot in diameter. The size of the loop can be regulated by the area in which the spoke travels and the speed of the wrist.

Spinning small loops around the outside of your body is another feature stunt. Here the sense of swing is of great importance. The vertical loops then may be tackled. They represent a separate field. In the flat loops it was centrifugal force that carried the loop outward while gravity was pulling downward on the entire noose. This is not the case in the vertical loops. Hence, a heavier honda is necessary.

From here the roper can use his own imagination. There are hundreds of variations of the simple fundamentals.

Lampblack Helps Break the Ice to Open Navigation in Yukon

Up in the Yukon, shipping men hasten the spring thaw on Lake Laberge by marking the ice with lampblack. A wide path of oil and lampblack is spread over the ice along the route the ships will follow. The sun's rays penetrate the black strip, the oil helps to keep the day's melting from freezing again at night, and day by day the sun cuts deeper. Long before a ship could ram through adjoining ice, a steamer can aim for the black strip and open a channel.

Cub. Francis Miller's, which says B.C. Canada

23942

1-501

White Pass Yukon Route

Treet Topics

SPEND LESS TIME
HISSING--



SPEND MORE
TIME
KISSING



BY SPENDING
JUST ONE
THIN DIME

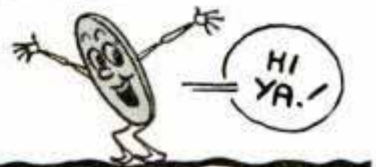

THIS
WAY:



-AND TREET YOURSELF
TO A PACK OF
PERFECT SHAVES!



4 FOR 10¢

BLADES

Single-Edge

FOR GEM AND EVER-READY RAZORS

Treet Safety Razor Corporation, Newark, New Jersey

12-94

What - NO ALKA-SELTZER IN THE HOUSE!

Don't LET THIS HAPPEN IN YOUR HOME

It certainly is disappointing to wake up with a headache or an upset stomach, and find there are no Alka-Seltzer Tablets in the house. This often means having to start the day feeling miserable, when, had Alka-Seltzer Tablets been available, you could just drop one in a glass of water and quickly have a sparkling glass of Alka-Seltzer that would relieve your trouble promptly.

Alka-Seltzer gives relief in TWO ways — its analgesic properties promptly relieve the pain and because it is one of the best alkalizers known, it helps correct the excess acid condition so often associated with common ailments. Sold by all druggists in 30c and 60c packages.

BE WISE-ALKALIZE WITH Alka-Seltzer

DO YOU WANT a new business profession of your own, with all the trade you can attend to? Then become a foot correctionist, and in a few weeks earn big income in service fees,—not medical nor chiropody—easy terms for home training, no further capital needed, no goods to buy, no agency. Established 1894. Address **Stephenson Laboratory, 1 Back Bay, Boston, Mass.**

Secrets of the "Singing Crystals"

(Continued from page 93)

nearly uniform size and found ways to overcome the other difficulties. As produced by this company today, these crystals are about twenty-two inches long, three and one-half inches wide and two inches high. Each is shaped like a gambrel roof and weighs about five pounds.

Small segments are carefully sawed or cut from the large crystal and then ground. These segments become the generators and drivers, their characteristics depending on the angle at which they are cut, and the manner in which they are ground and combined with each other. When two segments or crystal plates with electrodes attached are cemented together, and a voltage is applied to the electrodes, one plate

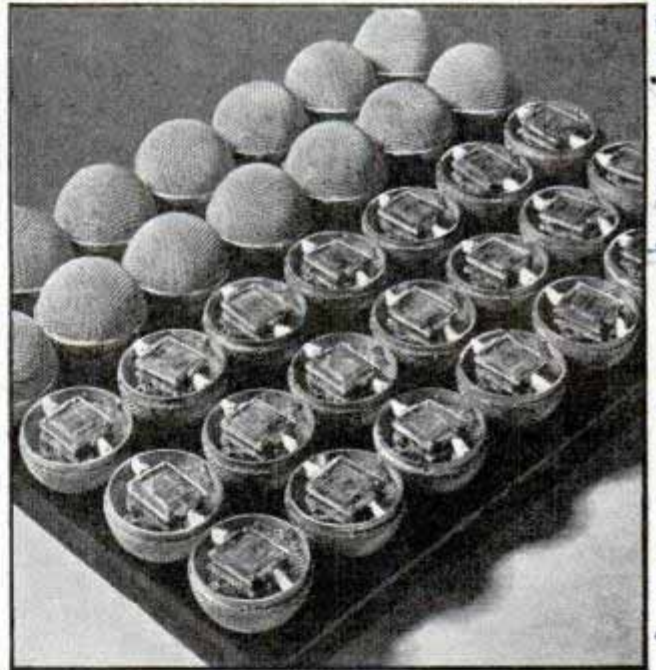

A tray of sound-cell microphones on the production line at the Brush Development company plant

expands while the other contracts, thus causing a bending of the entire unit similar to the action of a bimetallic thermostat. Such an assembly is called a bimorph element and it can be made to exert either a bending or twisting force. If three corners of a twister element are held in a fixed position, the fourth corner exhibits greater activity than it otherwise would.

A sound cell is an assembly of two of these bimorph elements, sensitive to bending, in a little case. The elements are supported at two points and a space is left between them so the plates are easily distorted by variations in sound pressure.

Copyright © 1934 by The McGraw-Hill Companies, Inc.

Electrodes extend from each element and the assembly is impregnated in wax to provide an airtight and moistureproof box. The result is a small, flat, hollow case, the two major surfaces of which generate voltage in response to acoustical pressure, the voltage generated by one side being in phase with that of the other when caused by sound, but out of phase—thus tending to cancel each other—when caused by mechanical shock or vibration. Several sound cells can be connected together. Such an assembly is a pressure-operated device, entirely self-energizing, and will respond as well at one cycle as at one thousand.

In a microphone, the crystal acts as a generator; in a receiver, it is a driver. A little device known as a heart-beat pickup accomplishes electrically what the stethoscope does acoustically. There is also available a recorder mechanism in which a crystal motor is employed to actuate a pen which makes a visual record on a moving roll of paper of heart sounds or the bending and twisting strains to which a test part, such as an airplane propeller, may be subjected. This equipment also is used in recording other low-frequency electrical alternations or mechanical vibrations.

The crystal vibration pickup is a device which, when applied to any body having vibratory motion, converts that motion into an electrical potential of similar characteristics. It is employed in locating the source of noise or vibration in reciprocating or rotating machines, in measuring the transmission of vibration through different materials, recording the vibration of airplane wings, automobile bodies or pipelines and in the production testing of bearings, crankshafts, generators, motors, gear trains, transformers and other parts. A crystal musical pickup also has been developed to amplify the tone of any musical instrument to which it is attached.

Crystal oscilloscopes in which the crystal motivates a light beam as it passes from its source to a moving film or rotating mirror are employed for recording and studying wave forms and for such purposes as recording the time required to flash a photo bulb or to produce timing waves on film. There are crystal headphones for the use of the hard of hearing in theaters, tiny lapel "mikes" for the use of public speakers, combination crystal mikes and receivers.

(Continued to page 120A)

*I've Always Wanted
A Movie Camera—
NOW I'VE
GOT ONE!*



**UniveX Takes
Movies At Less
Cost Than
Snapshots!**

There's no thrill to compare with taking your own movies. *Now you can afford it!* Here's the only precision-built, lifetime 8 mm. movie camera in the world under \$30—the only one that uses the inexpensive 69¢ UniveX Film. Compact...easy to load and

operate — the UniveX Cine "8" will bring you a lifetime of pleasure and enjoyment! Ask your dealer for free showing or send for illustrated booklet, Universal Camera Corp., Dept. 69, New York City.



\$9.95 Prices higher outside U. S. A.

With F3.5 Lens \$19.95

UniveX CINE "8" **AMERICA'S No. 1
MOVIE CAMERA**

12194

(Continued from page 119A)

SOME TWOSOME!

A BICYCLE... A RIFLE... THESE TWO IVER JOHNSON LEADERS HAVE BEEN FIRST CHOICE WITH AMERICAN BOYS FOR YEARS AND YEARS

A bicycle—your two-wheeled roadster until you own a car! Iver Johnson bicycles have the looks, speed and all round perfection that only real engineering skill builds into a bike. Streamlined—2- or 3- speed gearshift if you wish—fully equipped for “tops” in driving power and endurance. A bicycle is an important “buy.” Look beyond flashy paint. Get real value—guaranteed. See an Iver Johnson first! Ask for Folder 66B.

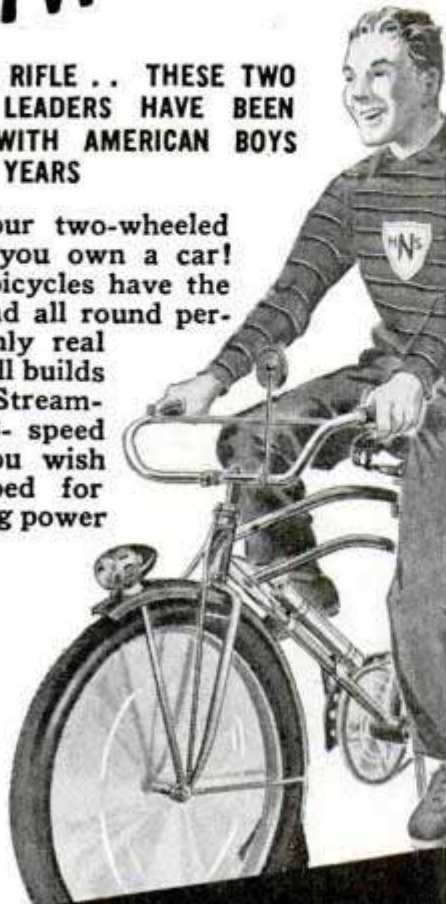

Iver Johnson

Model 2-X
\$5.75



Draw a bead and drill the bull's-eye—that's Iver Johnson action! Hundreds of boys have become crack-shots with the fine balance and accuracy our experts put into Iver Johnson .22 Bolt Action Safety Rifles. The “action area” is finest rifle steel, machined to precision and guaranteed. Let us tell you more about it. Ask for Folder 66A.

**IVER JOHNSON'S
ARMS & CYCLE WORKS**

21 River St., Fitchburg, Mass.

85 Chambers St., New York

ers for use in intercommunicating systems and even a “pillow speaker” which enables a hospital patient to enjoy a radio program although the sound is inaudible to others in the same ward.

Some of the applications of crystal equipment are so unusual as to seem fantastic. The owner of a fox farm has crystal microphones in the nest houses. Instead of patrolling the grounds at night to watch for disturbances, the watchman now listens from a central point. In somewhat similar fashion, Hawaiians listen for the presence of insects in growing crops. A crystal contact microphone, crystal receivers and amplifying equipment enable listeners to detect the slightest sounds—even the faint sounds of insects in a distant field.

Crystal mikes are also finding a wide application in crime-detection work because they are small and inconspicuous and pick up even the faintest whisper. Contact microphones placed against a wall or door will pick up conversation in the next room, it has been found. Hence, it is not even necessary to conceal the equipment in the room of those under surveillance.

So sensitive are the crystal vibration pickups that one was developed for use in regulating tiny wrist watches whose ticks are hardly audible. The moving parts are very small and light in weight and the vibration produced is almost infinitesimal but it is enough to cause the crystal element to generate electricity.

Each year new tasks are being found for these man-made crystals with the peculiar ability to change pressure into electrical energy. No one can predict all the tasks the “singing” crystals eventually will perform but those familiar with their properties already foresee the day when pressure electricity will be applied to an instrument of communication which most of us use several times daily—the telephone.

Our Bureau of Information keeps on file the names and addresses of makers of, and dealers in, all devices described in the pages of Popular Mechanics Magazine. We are glad to furnish this information to our readers upon request, accompanied by stamped, self-addressed envelope.



Feed Karbout into intake manifold



GET RID of that "Motor Ping" —Today!

• Just go to the service station or garage displaying the KARBOUT sign—ask for a KARBOUT Clean-out Treatment.

This is the story spreading over the country like wild-fire, from motorist to motorist.

KARBOUT Goes In—Carbon Out!

Fed into the intake manifold, KARBOUT loosens the gums to which carbon adheres—like a ferret chasing out rats, KARBOUT chases carbon out. Just watch the exhaust. **All for \$1.00** your service station or garage will treat your engine with KARBOUT to dissolve all types of motor gums—eliminate



carbon formations—free all sticky valves—equalize compression in all cylinders—restore lost power—improve acceleration and stop "motor ping" . . . And you'll like the new smoothness and quietness of your motor. **THE SHALER COMPANY, Waupun, Wisconsin.**

Ask for a

SHALER KARBOUT

MOTOR CLEANOUT

EARN MONEY COLOR-GLAZE POTTERY, TILES, WALLS, STATUARY

Make 2,500 designs concrete lawn pottery without molds, power or costly tools and glaze them like clayware. **Build your own equipment** from our plans. Use only sand, cement, cheap materials. No experience needed. **MEN—Send 10c TODAY** for colorplate, details of this money-making business.

NATIONAL POTTERIES COMPANY
Room 6, 13 W. 26th St., Minneapolis, Minn.

AGENTS 500% Profit SIGN LETTERS

For Store Fronts and Office Windows. Anyone can put them on. Free samples. Liberal Offer to general agents. **METALLIC LETTER CO., 438 N. Clark St., Chicago**

BURN YOUR NAME ON TOOLS WITH THE ARKOGRAF

PROTECT YOUR TOOLS FROM THEFT
Write with electricity any name or design on the hardest and finest tools and instruments, or any metal, like writing on paper with pen or pencil. **Complete Outfit \$3.50**—Prepaid Anywhere. Interesting illustrated circular free. Write today. Agents wanted. **ARKOGRAF PEN CO., 3927 S.E. Stark St., Portland, Ore.**

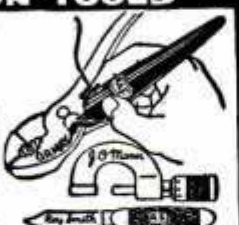

OTTAWA LOG SAW

only \$39
GREATEST OFFER EVER MADE
Make Money! Wood is valuable. Saw 15 to 20 cords a day. Does more than 10 men. Ottawa easily operated by man or boy. Falls trees—saws limbs. Use 4-hp. engine for other work. Write today for **FREE** book.

OTTAWA MFG. CO., 727 Wood St., Ottawa, Kansas

BILD-UR-OWN

COASTERS • MIDGET AUTOS • SCOOTERS • SAVES YOU MONEY TOO!
Want the best for your motor scooter? Then equip it with our **DISC WHEELS** and **Balloon Tires**. Your choice of famous **(GOODRICH—GOOD YEAR—FIRESTONE)**
At lowest prices. We provide Scooter Kits at big savings. Build Now! We also carry larger Tires, Wheels, Motors, etc. Write for prices.
BILD-UR-OWN DEVICES, 5237 Lake St., Dept. A-7, CHICAGO, ILL.

More Fun Than a Candid! Take Movies!

SAVE MIDDLEMAN'S PROFIT - BUY DIRECT from FACTORY

Enjoy thrilling MOVIES of your vacation, your family, friends, special events, parties and sports,—with the **PARAGON 16 mm. MOVIE CAMERA**. Latest models,—lightweight, aluminum—small—compact—**attractive—easy to operate—with telescopic view finder, and many more outstanding features. Guaranteed. Perfect-feeding film movement. Fully protected. Fool-proof working parts. A great value at the price. Instruction book free.**

Paragon Model 3-S, 16 mm. with F3.5 lens, three speeds, 100 ft. film capacity. (10 days money-back trial.) F. O. B. Fond du Lac, Wis.

\$35.00

SPECIAL FACTORY PRICES . .

FREE OFFER WITH ORDER

Order from this Ad and get a Beautiful Cowhide Carrying Case **FREE**, with hand strap and shoulder strap. Regularly priced at \$7.50 For free gift, send money order **NOW** to **PARAGON CAMERA COMPANY, P-2, Fond du Lac, Wisconsin** Reference: National Exchange Bank, Fond du Lac.

Paragon Model 1-S, 16 mm. with F3.5 lens, one speed, 100 ft. film capacity. (10 days money-back trial.) F. O. B. Fond du Lac, Wis.

\$29.75

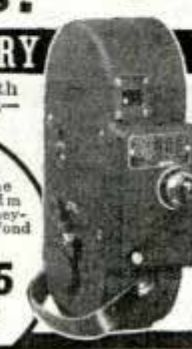

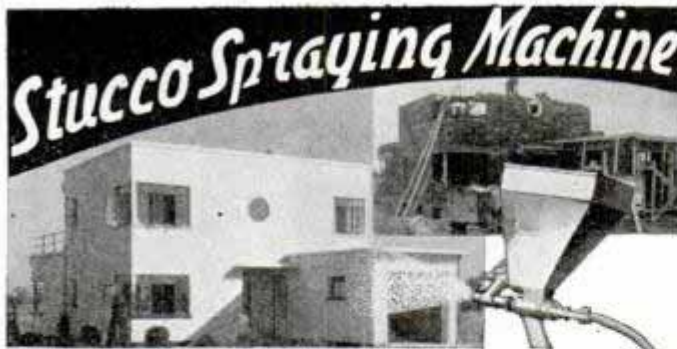

Renew old buildings. Make new construction more permanent and attractive. Plastic Colorcrete is waterproofed. It fuses with any masonry surface. It fills all cracks. It can be applied in any thickness and in 30 colors. Fully proven by over 12 years actual use under all conditions and every climate.

OFFERS BIG EARNINGS

Owners everywhere want to enhance present values. With this machine you can supply this big waiting market with permanent Colorcrete at amazingly low cost. Operators report cost of 2c and up per sq. ft. and sell up to 7c. Some have paid for their equipment from first few jobs. Machine capacity up to 1,000 sq. ft. per hour. Get the facts. Send for books, "Proven Business Opportunity." Write today. It offers you big extra income.

COLORCRETE INDUSTRIES, INC.
570 Ottawa Ave. HOLLAND, MICH.



Thompson BEATS the World on BOATS



Better Built Lower Prices

Only Boats With Full Length Spray Rails

Keep passengers perfectly dry—even at high speeds. Catalog also shows today's five most popular models of sailboats. Two big factories. Prompt shipment.

CATALOG FREE
Write for your copy. State kind of boat in which you are interested.

THOMPSON BROS. BOAT MFG. CO. (87)
213 Ann St., PESHIGO, WIS. (Write to either place) 113 Elm St., CORTLAND, N. Y.



Canoes \$64 and up

Rowboats \$42 and up

Outboards \$42 and up

Very fast utility model

EARN MONEY Stringing TENNIS RACKETS



An opportunity to earn as much as \$3.50 for a few minutes of your spare time. String your own racket and save money. Tennis players buy restringings frequently. Every restringing means profit for you. No experience needed—we teach you how. TOMGUT Equipment makes it easy. Costs practically nothing to start. Easy work. Begin NOW!

FREE Write today and we will send you Free plan and special offer on strings and stringing equipment.

THOMPSON MANUFACTURING CO.
4535 Packers Ave., Chicago, U. S. A.
TOMGUT "Court-Tested" Tennis & Badminton Strings

Send FREE plan and special offer. Send new booklet, "400 YEARS OF TENNIS." Enclosed is 10c to cover mailing costs.

Name.....
Address.....
City..... State.....

MAIL THIS COUPON



NEW BRUSH PLATING OUTFIT For AUTO PARTS

Connects to a battery with no tanks necessary. Plates on iron, steel, brass, copper, etc. Almost as simple as painting. Hundreds of car owners waiting for this low-cost plating. Improves appearance and value of the car. Your opportunity to make good income plating auto parts, bathroom fixtures, reflectors, mirrors, etc.

FREE PROOF

Write quick—big season here. Get FREE PROOF and particulars that put you in a paying business of your own.

GUNMETAL COMPANY

AVENUE M DECATUR, ILL.

\$1.50 At Electrical Stores or Post-paid



"THE NEON LIGHT sets you RIGHT" TEST-O-LITE

Handiest electrical tester made; quickly locates trouble in electric circuits, fuses, cut-outs, motors, radios, etc. Has 1,001 uses for electricians or home. Tests any voltage 110 to 550; tells A.C. from D.C. Exceeds ordinary clumsy test bulb. Fountain-pen size; with pocket clip. Lifetime guarantee.

L. S. BRACH MFG. CORP.
55 Dickerson St. Newark, N. J.

BUILD THE CUTTY SARK

2 FT. MODEL OF THE FAMOUS CLIPPER SHIP



Complete kit includes perfect building plans \$2.50 plus 13¢ postage

Everything...including CARVED WOOD HULLS, Printed-Balsa Decks, Cast-Metal Life-boats, Anchors, Bitts, Steering Wheel, Chains, Mast, Spars, Rigging, Cement, Colored Lacquer—Full-Size Plans and Instructions.

Send for Catalog all Ideal's new Models...10¢ IDEAL AIRCRAFT & SUPPLY COMPANY, INC. 28 West 19th Street, New York

"Tops" FOR FUN!



Always some place to go—something thrilling to do! Fun, excitement, new friends, fine pals! That's motorcycling—today's greatest outdoor sport. Get into it—NOW! See 1938 models at nearest Harley-Davidson dealer. Write for FREE copy of motorcycling magazine, "The ENTHUSIAST."

Harley-Davidson Motor Co., Dept. P-738, Milwaukee, Wis.

HARLEY-DAVIDSON
MOTORCYCLES

TRAILER BUILDERS · BUYERS · OWNERS

Over 100 pages! Beautifully Printed and Illustrated! Trailer Suggestions and Ideas galore! Catalog shows America's greatest line of Trailer Parts and Equipment at lowest prices. Everything from wheels to top. Rush 25c today. Satisfaction positively guaranteed!

TRAILER SUPPLY CO. Box 438-A WAUSAU, WIS.



BUILD IT YOURSELF



The Jim Dandy Cabin Cruiser

The Trailer that has everything. Classy! Roomy. Easy to build in any size with my simplified Plans and Instructions—Price \$1.00. Rush dollar bill today to **JIM DANDY** Box 125-A WAUSAU, WIS.

MAKE MONEY IN PAINTING BUSINESS



Paint walls, ceilings, screens, furniture, radiators, machinery faster, better! 1/4 H. P. motor 110 Volt 60 Cycle A.C. complete with Spray Gun, 15 ft. hose. Weighs only 44 lbs. Carry anywhere. FULLY GUARANTEED. Only \$31.15 f. o. b. Chicago. \$5 Deposit, Balance COD, or SEE YOUR DEALER. Circular FREE. Get started making money NOW!

Ideal Automatic Pump Co., Dept. PM7, 801 Washington, Chicago **\$31.15** Complete

PLASTEX



The Plastex Industry needs manufacturers on small scale and for big production of Lamp and Clock Stands, Art Goods & Novelties in Plastex and Marble imitation. Experience unnecessary. 1/2c material makes regular 10c store sellers. Rubber moulds furnished for speed production. Small investment brings big returns. Ambitious men have chance for real prosperity. Our free booklet will interest and benefit you. Plastex Industries, Dept. "P," 1085 Washington Avenue, New York, N. Y.



"Beating Action" with a Camera

(Continued from page 63)

facial expression, pose that is actually balanced but looks unbalanced, such as a body leaning far forward, suggest movement often more effectively than if the subject were really in rapid motion. In such simulated action pictures, there is opportunity for dramatic creative work that should appeal to the serious camera user.

Where one must use a slow camera or slow shutter speed to "stop" rapidly moving objects, and cannot choose a head-on or close-angle viewpoint, he can often make effective use of the "swing" or "panoram" technique, in which the camera is moved to follow the moving object.

This method is one developed by press photographers who must bring back pictures regardless of weather and light conditions. The picture subject is centered in the camera view finder, and kept there by moving the camera as the subject—racing car, motorboat, or athlete—passes. With camera and subject movement thus "synchronized" the subject is sharp, but the background is drawn out into a long blur that fairly whizzes across the picture and heightens the effect of action.

With ordinary cameras this swing method can be used effectively only if the camera has an eye-level view finder. The movement must be carried through smoothly, and the shutter snapped at the proper point without a jerk.

In many of your action pictures, particularly of athletes and horse races, you may find that there are blurred details—a hand that moved too rapidly, a foot too swiftly swung. These will be found even at high shutter speeds, and if not too fuzzy, should be welcomed. A picture in which every detail is hairline sharp is likely to look "dead" or unreal. The small blurred details give life; they highlight the action. This rule is true even of inanimate things. If you snap rippling water at too high a shutter speed, it looks still and brassy. Absolute freezing of motion is of value only in scientific work.

Do not overlook the advantage of the low viewpoint. Those dramatic football pictures with figures looming up against the sky, are made with the camera almost on the ground. The sky provides a simple, effective background. Make full use of it, and watch your pictures gain drama.



Rust and scale are enemies of your motor. They clog the cooling system. The engine overheats. Power is lost. Costly damage may result. Get rid of these dangers in ten minutes—with 10c worth of SANI-FLUSH. (25c for the largest trucks and tractors.)

Just pour a little of this safe powder in the radiator. Follow directions on the can. Run the motor. Drain. Flush. Refill with clean water. Rust, scale and sediment are flushed away. The water circulates freely. Motors run cool and efficiently. And you don't take any chances on scored cylinders or "frozen" pistons. SANI-FLUSH cannot injure motor or fittings. You'll find SANI-FLUSH in most bathrooms for cleaning toilets. Sold by grocery, drug, hardware, and five-and-ten-cent stores. 25c and 10c sizes. The Hygienic Products Company, Canton, Ohio.

Sani-Flush **Safe**
NOT CAUSTIC
KEEPS RADIATORS CLEAN

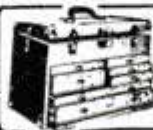

TOOL CHESTS

The finest and most desirable chests ever made for machinists and toolmakers. Free Catalog.
GERSTNER TOOL CHESTS
438 Columbia St. Dayton, Ohio

WOODSTOCK
TYPEWRITERS

FAMOUS AUTHOR SAYS:



AMAZING NEW ONE-PIECE
GILLETTE RAZOR 69¢
 COMPLETE WITH FIVE BLADES

..A TWIST—it's open!



A TWIST—it's closed!



WITH a 30-year background of Gillette shaving satisfaction, Albert Payson Terhune speaks from experience when he calls this Gillette One-Piece Senator "the greatest razor of them all!" At 69 cents, including five Gillette Blades, here's the most amazing value in Gillette history. You change blades in three seconds! Twist the handle—and it's open. Another twist—it's closed, ready for use. Sturdily built, heavily nickel-plated, it's designed to hold Gillette Blades in perfect alignment and give you clean, comfortable shaves that last!

More Comfort For Your Money

Gillette has invested millions in equipment to produce uniform blades that fit your Gillette Razor accurately. Always insist on Gillette Blades. They give you the world's best shaves for less than 1¢ a day.



Gillette's New Brushless Shaving Cream
 Prepare your beard for perfect shaves with Gillette's New Brushless Cream. Made with peanut oil, it softens wiry whiskers, stays moist, speeds shaving, won't clog your razor. Try a tube. You'll like it! Large tube only 25¢.

Gillette
RAZORS AND BLADES

MORE SHAVING COMFORT FOR YOUR MONEY

Modern Alchemists

(Continued from page 69)

4267
 torn down by work and play. Amino acids also help to regulate the bodily functions. They influence your size, your rate of growth, the amount of fat that you carry, the color of your eyes and hair, and even your personality. It has been estimated that $\frac{1}{1000}$ of a gram of an amino acid known as thyroxin, concentrated in the thyroid gland, stands between a happy, normal existence and death or imbecility.

Knowledge of these strange substances has already been put to commercial use. The salt of one kind of amino acid known



Dr. Dunn with photomicrograph, with which amino acid crystals are photographed

as glutamic acid is manufactured and sold as a condiment. It has a surprisingly natural meaty taste.

Another amino acid known as cystine is found most abundantly in human hair. Some scientists believe that experiments with this amino acid may lead to a solution of the problem of baldness. One called glycine has been found valuable in the treatment of muscular disorders. Histidine is being used in the treatment of stubborn gastric ulcers. Scientists at the University of California are using amino acids as an approach to the problem of cancer.

H-2-3-5
Making Jobs for the Big Hook

(Continued from page 53)

or hurls it high into the air. Railroad men say this is because there is no coupler projecting in front and no pilot beam to catch and hold the wreckage. It is possible that steam trains of the future will be equipped with some form of smooth covered pilot, resembling a snowplow in shape. Such an arrangement, railroad officials say, might save the railroads costly wrecks and loss of life among passengers and engine crews.

The lot of the engineer and fireman when a motorist comes roaring down a cross roads is not a happy one. The motorist can always stop, but the train can not, so the engine crew sits helpless.

"Sitting in the cab watching one of those careless motorists gives you the chills," says Engineer Clewer. "You wonder what he is going to do—and you never know. You can't do anything yourself. You pull the whistle cord as you pass the regular whistle post, and, in open country, you are sure he sees and hears you. But he speeds up to make the crossing, and then he slows down and acts like he is going to stop. And then, at the last minute, he steps on the gas and races across in front of you. By that time you are so close you can't see past the boiler and running board to watch his progress the last few feet. You sit and wait for the 'clunk' of metal if your pilot hits him. If you don't hear the 'clunk' you look out the other window in time to see him highballing down the highway. Then you settle back and wait for the next crossing."

In 1936, 1,786 motorists were killed at grade crossings, amounting to thirty-four and five tenths per cent of all fatalities in railroad operations for the year, according to the Western Railways Committee on Public Information. The Department of Commerce reports 1305 killed during the first nine months of 1937, or at the rate of 1,740 per year. Owing to an increase in the number and seriousness of accidents during the last quarter of 1937, however, the National Safety Council estimates the total was considerably larger. The final quarter usually is the worst each year.

If you don't want to make a job for the big hook, it behooves you to slow down, look and listen at every railroad crossing.



**have something
 you want inside that no
 other pipe can give you**

See that little steeple with the sphere on top of it? It does a whale of a lot for smoking enjoyment. How? This way. First, the smoke, on its way from the bowl to your mouth, passes through the cross-holes in the ball. Particles of tobacco, however, trying to sneak through, are trapped right there, can't get by! Also, *tobacco tar*, being heavier than the smoke, condenses and deposits on the steeple walls. Result: no bitter taste, and a sweet, dry smoke, *actually cooler* than mouth temperature! Give yourself a break: get a Kaywoodie. Kaywoodie Company, New York and London.



JAMESTOWN KAYAKS

Knockdown kits or assembled lengths from 9 feet to 13½ feet. Prices from \$9.95 to \$34.50.
CANVAS CANOE complete ready to ride. \$39.50.
 Rubber boats and mattresses from \$12.00 to \$80.00.
 Send dime for beautifully illustrated catalogue.
JAMESTOWN SPECIALTY CO., Titusville, Pa., Box 377, P.M.

BIG OPPORTUNITIES MANUFACTURING MATERIALS FOR LOW COST BUILDING



CASH IN BIG on the great building upturn under way. Make a superior, more permanent material—the kind demanded by your trade—lighter weight, and offering big savings in construction. Sells easily up to 100% over manufacturing costs.

WE EQUIP YOU with line production machinery requiring only modest investment. Raw materials enter at one end—finished products emerge from other end. Big daily production with one to three men. You make common brick—face brick—in over 40 beautiful colors—also DUNSTONE in 9 sizes.

INVESTIGATE NOW. Send for "4 Keys to Success." It tells the complete story—how present manufacturers are making outstanding progress in a business offering unlimited opportunity for growth, expansion and profit. Write today.

W. E. DUNN MFG. CO.
600 W. 24th St. Holland, Mich.



CAPE COD CHAIRS

Style "B"—"C"—
"A". Blueprint
50c. All 3 for
\$1.00.

For catalog illustrating over 75 practical projects, send 10c. Free with order. "Over 35,000 Satisfied Customers."

CRAFTSMAN'S MODEL CO., Dept. P-19, 2030 N. 41st Street, Milwaukee, Wisconsin

BABY CALCULATOR
CHICAGO, ILL. U.S.A.
PATENT APPLIED FOR

ADDITION
SUBTRACTION
MULTIPLICATION
DIVISION

VEST POCKET ADDING MACHINE

IDEAL FOR BUSINESS OR PERSONAL USE: Adds, subtracts, multiplies, divides. Does work of more costly machine. Counts up to million, made of steel—weighs 8 ounces. Simple, accurate. Not a toy. Guaranteed 5 years.

— FREE TRIAL —
SEND NO MONEY!

\$2.50

Total Cost

Order from ad, not sold in stores. Just send name and address. On delivery pay postman \$2.50 (plus few cents postage). (If outside U. S. send cash.) 10c additional in Leatherette Case. If not satisfied after 10 days' trial you get your money back. Thousands of satisfied users. Write for Agent's proposition. **CALCULATOR MACHINE CO.** (Mfrs.) Dept. 167, P. O. Box 1113, Chicago, Illinois.

60 POWER TELESCOPE . . . \$2 19

VARIABLE EYEPIECE 20X—40X—60X
NEW! Three telescopes in one. 3 different magnifications. 20 power for ultra-bright images with 40 and 60 power for extra long range. Guaranteed to bring distant objects, people, sports events, ships, moon, stars, etc., 60 times as close.



Most powerful made for anywhere near the money. Closes to less than a foot in length. Multiple lens system. 30 mm. objective, in heavy brass mount. Directions included for using as a compound 4 lens microscope. American made. We pay the postage. Only \$2.19. Catalog of Microscopes, Binoculars, etc. **FREE** on request. **BROWNSCOPE CO., Dept. 47, 5 W. 27th St., New York, N. Y.**



Auto-Glide Make Thrilling Trips -or Cheap Deliveries

Keen fun for the whole family—at amazingly low cost! Picnics, trips—100 miles for 50c! Great delivery rig, too—cuts costs, increases delivery volume. Gives you most downright ruggedness and carefree service for lowest cost—powerful 1½ or 2 H. P. engine, strong frame, 2-speed transmission, clutch, brake, balloon tires. Trunk has removable cover, lock. Side-Kar and 3rd wheel on or off quickly. Other models.

DEALERS: Write for June Offer!

THE CUSHMAN MOTOR WORKS, Dept. V-7, Lincoln, Nebr.

WRITE for photos, complete details and the very Low Price. Send postcard or letter today.

Fire Under Your Hood

(Continued from page 23)

A whole flock of "shouldn'ts" began annoying their noses at the engineers. The Diesel shouldn't be any bigger, or less flexible or much heavier than the corresponding gasoline engine. It shouldn't be wholly dependent upon any one type of fuel or lubrication.

The work began by shifting from the four-cycle to the two-cycle. The latter fires every time the piston comes up. This gives approximately the same power with only half as much engine material, which in turn allows big reduction in weight. Twenty-two of the nation's great railroads now use Diesel locomotives.

This leads to the question: "When are they going to put Diesel engines in automobiles?"

The only answer is "When they get them good enough." For big commercialized vehicles—trucks, buses and tractors—the day of Diesel is here, and that is a big field.

It appears that the Diesel always is going to cost more than the ordinary gasoline engine because the injectors are so difficult to make. The dimension variable of the pumps, because of the extremely high pressures at which they operate, can't be more than one ten-thousandth of an inch. That's about the thickness of a human hair that has been sliced into 120 equal pieces!

In developing the modern Diesel, engineers have been forced to develop equipment which can measure accurately to one ten-millionth of an inch. Diesel power raises a new peak in the demand for manufacturing accuracy.

From an engineering standpoint the Diesel development seems to be opening a new highway into the land of accuracy. This is evident in the new General Motors Diesel plant at Detroit, where a laboratory has been adapted to a central testing set-up, serving all the Diesel engine divisions. In building the plant, architects created a set-up which subdues noise and vibration so much that you can stand outside the building and not hear the engines running inside. Inside, the quiet enables an engineer observing a particular engine to be free from the human error possibility which comes of hearing and feeling the operation of engines near by.

COMPLETE ELECTRIC PLANTS



Onan A.C. plants furnish same current as city lines, 110 Volt, 60 Cy. For farms, camps, construction jobs. Operate radios, water systems, all appliances. New models, 350 to 5000 watts, 6, 12, 32 and 110 volt D.C. Models \$57.50 and up. Also combination A.C.-D.C. units Shipped complete, ready to run.

Write for details.
D. W. ONAN & SONS
1023 Royalston Ave
Minneapolis Minnesota

Make "BIG TIME" BOW AND ARROW SET

Fun. Easy to make your own BIG TIME bow and arrow set at home. Kit includes select, well seasoned Hickory stave, cut to shape, to make 5/4 FOOT BOW! Everything needed sent—7 Port Orford Cedar arrow shafts, prepared feathers, points, string, glue, wax, full instructions with illustrations. Complete \$2.35 prepaid. Satisfaction Guaranteed. ARCHERY CATALOGUE sent for 10c.

\$2.35

Bows and Arrows of Excellence
Ben Pearson, Inc. Dept. 77, Pine Bluff, Ark.



\$22.50 at Bass

DE FRANNE REFLEX
Twin lens Reflex... takes 12 2 1/4 x 2 1/4 shots on film. Triolar F:4.5 Anastigmat... automatic shutter. Eveready leather case \$4.50. Free: Big Camera Catalog - Write Dept. P.

BASS CAMERA CO.
179 W. MADISON STREET CHICAGO, ILL.

RE-STRING RACKETS AT HOME



Instructions FREE

• EARN MONEY •

It's pleasant, profitable work. No experience or skill required. Easy to Learn. Full line of guaranteed stringing tools, frames, gut and silk strings for your selection. Every item highest quality. Write for complete details.

W. A. BICKEL & Co., Dept. A-7, 137 N. Marion, Oak Park, Ill.

Power Pays a Big Profit with a



Red Universal Tractor

Does all field and belt work. Handles easily. Absolutely safe. Operates for 33c a day. Hundreds in use. Buy direct at low factory price. Two weeks trial—satisfaction guaranteed. Write for your free colorful catalog.

PIONEER MFG. CO.
DEPT. V-78 WEST ALLIS, WIS.



A AND N SUPPLY CO.

Bargains—Military, Sport Goods, Firearms, Clothes, Shoes, etc. Send 10¢ for new catalog, to be redeemed on first order.

EST. 1869 A & N Supply Co., 4772 Lester St., Richmond, Va.

BARGAINS GALORE! SAVE HALF!

TYPEWRITERS — DUPLICATORS — ADDERS FOLDERS — ADDRESSOGRAPHS

FREE TRIAL! MONEY BACK GUARANTEE! Typing Course & Table Free. Write for Bargains! Name what you want. Send No money! Low as 10c a day!

PRUITT CO., 992 PRUITT BLDG., CHICAGO



SAVE MONEY

BUILD YOUR OWN FAN

THREE-BLADE for 1/4 H.P. Motor			TWO-BLADE for 1/4 H.P. Motor		
Size	Shaft	Price	Size	Shaft	Price
20 1/2"	1/2"	\$4.00	12"	1/4"	\$2.25
24"	3/8"	4.50	16"	3/8"	2.50
26"	1/2"	5.00	20 1/2"	3/4"	3.00

MICHAEL ELECTRIC COMPANY, Dept. P., Fort Worth, Texas

WRITE for this big money maker TODAY



Women ARE GOING WILD ABOUT THIS New WRIST-ACTION CORD!

It Spins ROUND and ROUND and Swings from SIDE to SIDE

Here is no ordinary new product. This new Wrist-Action Plug is one of the most remarkable new devices ever offered in the Direct Selling Field! You never saw anything like it. Housewives are fascinated—held spellbound by the instant demonstration you can give with this new electric iron cord that swings freely in any direction. Ends kinking and twisting—prevents broken wires, burned fuses. Swivel action plug spins round and round—swings from side to side—keeps cord out of the way—no wonder housewives say, "Just what I want," as soon as they lay eyes on it!

'FREE

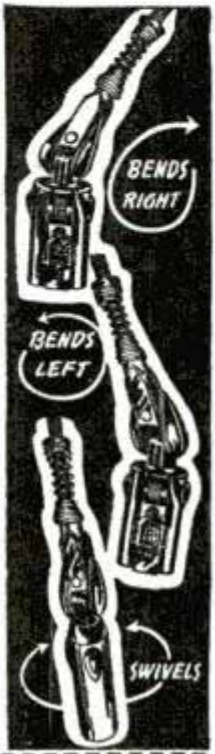
Sales are instant—sure! Nothing like it ever before. Here is the self selling big money maker you can clean up with. Get the story at once. Learn how you can GET YOUR DEMONSTRATOR FREE. All territories virgin—wide open. Write immediately for sensational money making plan. Mail the coupon today.



NO-TRO ELECTRIC APPLIANCE CORPORATION
800 North Clark St. Dept. P-7 Chicago, Ill.

FREE SAMPLE OFFER COUPON

NO-TRO ELECTRIC APPLIANCE CORP.
800 North Clark St., Dept. P-7, Chicago, Ill.

Please rush me FREE information and sample offer at once.

NAME.....

ADDRESS.....

CITY..... STATE.....

ENGINES

Enclosed, Self-Oiling, Roller-Bearing

Cheapest reliable power for farm or factory. Uses all fuels for pumping, sawing, etc. Best engine for the money. You Pay Less to Own It—Less to Run It. Cash—Terms—Catalog FREE.

WITTE ENGINE WORKS
174-B Oakland Ave., KANSAS CITY, MO. 215-F Mulberry St., HARRISBURG, PA.

Saw-Filing

Pays up to \$2 or \$3 an Hour in Spare Time—No experience needed

A FOLEY Automatic Saw Filer files hand, circular and band saws better than the best hand filer. Cash business, no canvassing, no eye-strain. Louis P. Wadwick, Ohio, says, "I have filed 764 saws in spare time and have earned \$850.00 in carpenter work due directly to my saw filing contracts." Send coupon for FREE PLAN, no obligation.

FOLEY MFG. CO., 716-B Foley Bldg., Minneapolis, Minn.

Send Free Plan on Saw Filing business.

Name.....

Address.....

122



ONLY with a Johnson Sea-Horse can you steer in *any* direction, go forward or backward—stop quick!—pull away from a dock

New
BANTAM WEIGHT M S
\$49.50
See this new bantam weight sensation with REVERSE, underwater exhaust, synchro-control, patented co-pilot—the QUALITY of the motor of the low price field!

sidewise or astern. Johnson gives you Full Pivot Reverse, as well as Underwater Exhaust and Alternate Firing—the "big three" of outboard motoring—and only Johnson has all three!



FREE!

WRITE for the Sea-Horse Handy Chart of motor sizes and specifications describing all nine models of the '38 line. Packed with new developments!

JOHNSON MOTORS
400 PERSHING ROAD WAUKEGAN, ILLINOIS

work faster
ALL-PURPOSE MOTO-TOOL

Everyone who works with his hands—at home, shop, school, or profession—can use the efficient, attractive Moto-Tool to advantage. Grinds, drills, routs, carves, polishes all materials. Chuck uses many tools. You do in seconds jobs that require hours of hard, hand work. Safe, thousands in use. Two fine models. No. 1 weighs 6 oz.—about 20,000 r.p.m. No. 2 weighs 13 oz.—about 25,000 r.p.m. Order on 10-day money back trial, or send for free booklet.

Dreme Mfg. Company
2831 CT., Racine, Wis.

Model 1
\$9.85 postpaid
10 Day Trial

Model 2
\$16.50 Postpaid

7¢ A DAY! BUYS THIS AMAZING NEW **ELECTRIC SHAVER!**



Close, quick shaves with the Hunter Electric Dry Shaver! Operates on sensational "vibrator" principle. Just plug into A. C. Outlet and it starts! Pays for itself in a dozen ways by saving on blades, brushes, soaps, lotions, etc. Many unusual features—self-starting, self-cleaning, self-sharpening, self-oiling. Priced amazingly low. Plus easy-payment terms of only 7¢ a day! Now everyone can afford to shave by electricity!

Earn Your Own Shaver FREE!

Get full details of our Free Shaver Plan for user-agents. Demonstrate to your friends—collect enormous profits. All shavers sold on 20 Day Free Trial, plus 1 year guarantee. Write this minute while your territory is open. For all particulars, address **HUNTER SHAVERS CO., 790 Broad St., Dept. H-50, Newark, N. J.**

HUGE PROFITS FOR SALESMEN

Spectacular Fireworks

(Continued from Coloroto Section)

moving sets were common. The Florentines erected figures of heroic size, outlining them with fireworks. The figures were fashioned of plaster, covering a wooden form that was later removed. Each stood by itself on a high platform visible at a great distance, the stage mounted on wheels so it could be moved from place to place by pulleys and ropes. The scenes were usually garnished balls of fire and streams of flame gushing forth from pipes.

Yet despite the old age and respectability of the art of fireworks, it is known that the early displays were often hit or miss, marked by nearly as many failures as successes. Today's fireworks, on the other hand, have achieved a degree of timing, calibration, color, stability and magnificence in keeping with the pace of modern science.

The motion-picture industry uses fireworks to gain startling effects and to create light for shooting night scenes. Flares that emit intense white light are ignited for taking out-of-doors shots after dark when other light is not available. The common movie flare develops from 40,000 to 50,000 candlepower. The time element can be indefinitely extended by lighting the flares in sequence.

Fog scenes are produced by deftly placed smoke pots, their heavy smoke being drifted before the lens by wind machines. A house in a populous neighborhood may be isolated, as if on a desert, by the simple expedient of placing pots back of the house and in front of the unwanted background. Such smoke registers on film as blue sky. Pots are standardized in several sizes and colors, the largest emitting smoke for more than two minutes. White, gray, black and yellow are the colors most in demand for movie making. As many as 300 dozen smoke pots have been used in filming a single screen sequence.

Movie photographers have found that colored fire registers brilliantly on professional emulsions, and at this time technicians and fireworks experts are putting their heads together in an effort to devise new and yet more thrilling and beautiful effects. Many believe the next great forward step in the development of fireworks will come from the imprint of the motion-picture industry upon this ancient art.

New Tool Cuts Threads 50% Faster

Save Time and Money
Cut More Accurate Threads
with the
LUERS THREADING TOOL

You can chase better threads, from 25 to 50% faster, no matter whether you're an apprentice or an expert mechanic. Holder and parts are drop forged of finest alloy tool steel, carefully heat treated for long, hard use. Cutters are of best, hammered, high-speed steel, hardened and tempered; ground to correct thread angle, and inspected.

YOU NEED THIS TOOL BECAUSE

- You have 4 3/4" cutting edge on the 2 cutters.
- One cutter chases threads close to a shoulder, USS 64 to 9P; the other USS 9 to 4P.
- Cutters sharpened in half the time.
- Three-in-one shank (3/8" x 3/4", 1/2" x 1 1/4", 1/2" x 1 3/4"). Adaptable for tool post on all lathes from 9" swing, up.
- Shank block makes excellent holder for 3/8" to 1/2" boring bars.
- Gauge automatically indicates correct radial plane for sharpening cutters. It also lets you set tool at right angles to work, eliminating the conventional 60° V gauge.
- Two cutting points are always ready. To finish thread with a sharp point you can change the point in 5 seconds—just release cutter, turn, set with gauge and lock. No aligning or correction of feed graduation necessary. Should both points become dull the cutter may be removed, sharpened and reset by gauge. It will be in exactly the same position, with no realignment necessary.

The slight spring action of the tough alloy steel holder makes for better threads. The frictionally held cutters will slip before they will jam and spoil the job or the point.

Replacement cutters and pins are inexpensive. The entire tool weighs but 12 oz.

YOUR MONEY BACK IF NOT SATISFIED

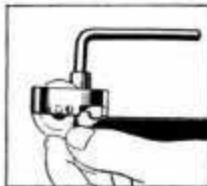
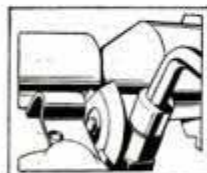

Patented

SPECIAL INTRODUCTORY OFFER

One Luers Threading Tool complete—with 3-in-1 shank, holder, gauge and 2 high speed cutters, only \$5.00. This offer is good in the United States only. On foreign orders the price is \$10.00.

MAIL THIS COUPON

J. Milton Luers, 3211 Bellvue Ave.
Detroit, Mich.

- I enclose \$5.00. Ship me your Special Introductory offer as outlined above, transportation prepaid.
- I enclose \$1.00. Ship C. O. D. for balance plus transportation.

Name.....

Address.....

REAL MONEY RENTING OR SELLING
New RANGER SCOOTER

There's big money selling this new, marvelous improved RANGER SCOOTER to all stores needing quick, cheap delivery—or renting to riders! Good territory still open. Ranger Scooter is safe, sturdy—gets 120 miles to gallon at 30 m.p.h. Act now! Write for Free folder, Special Low Agents' Prices.

MEAD CYCLE CO.
Dept. FS-118 CHICAGO, U. S. A.

Fun with a Sidecar!

Get a Goulding Sidecar and have company when you go motorcycling. Remarkably easy to handle. No shocks to wrists. Holds to ground. Rides smoothly and comfortably—even on rough roads. Made for any motorcycle specified. Also police sidecars and package delivery models. Light, strong wheels (complete) for light trailer use. Wheel fittings.

Write for circular today!

FREE CIRCULAR

Goulding Mfg. Co., 306 Mackinaw, Saginaw, Mich.

LAWNMOWER PARTS

all makes of mowers—Write for FREE catalogue COLLOT
SUPPLIES: 1207 Bedford Ave., Brklyn, N. Y., 438 Dead-
erick St., Nash., Tenn., 19 N. W. Miami Ct., Miami, Fla.

LeJay Electric Troller
LIGHTWEIGHT—CLEAN—SILENT

Ideal for boats or canoes because of its variable speed from maximum to just moving. So simple a child can operate yet strong and sturdy for general use. Operates 8-12 hours on good battery. Silent operation plus use of both hands for fishing and other features make it the perfect outboard.

29.50

Free Details.

It's easy to build your own electric outboard from old auto generator. We show you how. Dime brings simplified plans and valuable catalog.

**LEJAY MFG. CO., 1547 LeJay Bldg.
Minneapolis, Minn.**

HANDEE
TOOL OF 1001 USES

ACTUALLY A WHOLE SHOP FULL OF TOOLS IN ONE

Uses 200 different accessories, instantly interchangeable in easy-working chuck. For faster, better work on all materials, at home, in shop, or take to job. Plugs in any AC or DC socket, 110 volts. You'll be amazed at its unmatched performance, precision and almost human response.

STANDARD MODEL
13,000 r.p.m. Weighs 16 oz. \$10.75 postpaid with 3 Accessories.

DE LUXE MODEL
25,000 r.p.m. Fastest, smoothest, most powerful tool for its type and weight, 12 oz. \$18.50 postpaid with 6 Accessories.

GET A DEMONSTRATION at Hardware, Tool or Dept. Stores, or let us send either model on 10-days Money-back Trial. Catalog Free.

New ROUTER and SHAPER
Convert your De Luxe Router Handee into an easy-to-handle Router or Shaper that will inlay, rout, carve, make molding cuts to 100th of an inch accuracy. \$12.50.

Chicago Wheel & Mfg. Co., 1101 W. Monroe St. Dept. Q, Chicago, Ill.

Send Catalog Router-Shaper Set De Luxe Model Standard Model Send C. O. D.

Name.....

Address.....

CAN YOU BEAT THESE POWER COSTS?

SAVE
up to
\$293⁸⁰
Per
Month
on
power
costs

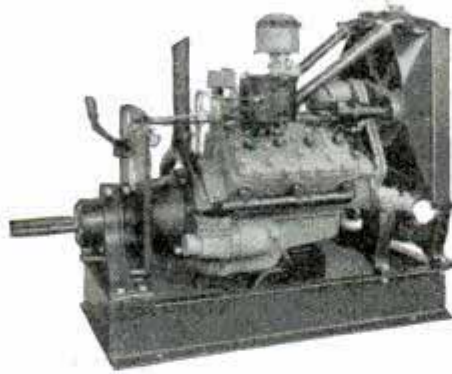

with a KRW FORD V8 Unit

50 H. P. with KRW V8 Unit using natural gas (1125 BTU) @ 30c per 1000 cu. ft. \$ 46.80 per month
50 H. P. with KRW V8 Unit using gasoline @ 10c per gal. (no tax) \$ 145.60 per month

Above figures show primary fuel costs (lubricating oil not included) for operating a KRW V8 Unit to develop 50 H. P. for 10 hours per day—26 days per month. Compare this with electricity @ 3¢ per KWH which amounts to \$340.60 per month. You can pay for a KRW Unit in a few short weeks **out of actual savings!**

KRW V8 Units are daily saving money for operators of air conditioning and refrigeration equipment, mills, factories, shops, welders, compressors, pumps, well-drilling outfits, contractors' equipment, etc., etc.

For complete information, prices and data write us. You can buy through your local Ford Dealer and benefit by local service and low-cost Ford engine replacement feature.

K. R. WILSON 17 Lock St. BUFFALO, N. Y.

Builders of Shop Equipment for Ford Dealers Since 1916
West Coast Branch: 722 Mateo St., Los Angeles.
Export Office: 90 West St., New York.

FINDS BURIED TREASURE! NEW GOLDAK RADIOSCOPE

Most efficient metal and mineral ore locator ever known. Money-back guarantee to detect buried GOLD, SILVER, or any other metal. Extremely powerful new models. Put your prospecting on a scientific basis. If you know of buried treasure, find it with the new Goldak. Write world's largest manufacturer of successful mineral locators for information.



THE GOLDAK CO., Dept. P
1031 South Broadway, Los Angeles, Calif.

NEW BENJAMIN AIR PISTOLS

Powerful - Accurate - Economical - Practical - Adjustable Shooting Force - Amazing Maximum Velocity - 177 or 22 and BB - For Target and Small Game - the only Genuine Compressed Air Pistol for Shooting BB on the market - Single Shot with Bolt Action - Hammer Fire - Hair Trigger - Safety. Price \$7.50. Holster \$2.00. Also 177 and 22 Single Shot Air Rifle \$7.50 - Single Shot BB Air Rifle \$6.00 - 25 Shot BB Repeater Air Rifle \$7.50 - at Dealer or Direct - No license required - Safe for indoor use. **FULL DETAILS - TARGETS - FREE - WRITE TODAY** Benjamin Air Rifle Co., 831 Marion St., St. Louis, Mo.



Amazing NEW GLAZE Beautifies and Protects



Car Owners! Meet MASTER GLAZE - the sensationally different luster for new and used cars!

Not a wax - not an oil polish - not a paint - nothing that "smears" over the surface. A creamy liquid - quick and easy to apply! Gives a hard, glass-like surface. Even gasoline cannot dull it! Lasts six months to a year! Amazing luster - beautiful, sparkling clean and brilliant! Doesn't fingermark - doesn't smear! Seals the pores - protects! Nothing like it!

FREE Write now for Free booklet and **SAMPLE OFFER**. Free Trial offer. Just send your name and address.

MASTER GLAZE CO., 7720-31 W. HARWOOD AVE., MILWAUKEE, WIS.

Thrill Hunters of the Air Lanes

(Continued from page 43)

Spelling bees for children and grown-ups have become standard radio fare.

Major Bowes first saw the vast possibilities in audience-participation shows. He has presented more than 10,000 untested entertainers over the air, ranging from five to 110 years old. Not all the thrills of the amateur series have been supplied by the aspiring musicians, he admits. One night just before the veteran showman was ready to go on the air, he heard that a youngster was dying of an infection in a New York hospital. A transfusion was needed to save the boy's life. As soon as Major Bowes was on the air, he made an appeal for the type of blood needed and within three hours 600 persons thronged the hospital corridors, eager to be of assistance. Tests were made rapidly, the right type of donor was found and the boy's life was saved.

Extraordinary hobbies of ordinary persons have been found particularly appetizing by audiences. From all parts of the country people have come to tell of the thrills connected with their particular diversion. A Panama City, Fla., man related over the air how he once became annoyed at a shark that was tearing his fishing nets to shreds and decided to do something about it. Slipping a knife between his teeth, he dived into the water and killed the shark. Since then he has been fighting sharks for fun and profit. Another bizarre hobbyist was uncovered in Newton, Pa., a man who trains roosters. His proteges crowded into the microphone on command and then completed their turn with such amazing bits as playing dead and roller skating across the stage. An Ohio professor contributed a thrill to radio when he explained his hobby of mastering musical instruments made of bones, stones, and fossilized ribs. He demonstrated a mophone from his mother's kitchen; a set of musical stones, which he calls the stonario, collected from southeast Nebraska. Other items in his collection include a tuned pokeweed flute, gathered from the Strawberry canyon on the campus of the University of California; a set of Pan's pipes from the drumstick bones of turkeys, and a rhinotone, consisting of fossilized ribs from a prehistoric animal which lived from fifty to 100 million years ago. A man with

H 296
 the largest collection of World War posters in existence and another with a \$50,000 collection of roots that resemble humans and animals, shared program honors with a map builder who gives them an unusual fillip by covering them with dirt samples sent from every part of the globe.

How unusual does a hobby have to be before it is considered program material? That question may be answered by a glance at the following hobbyists, which have been featured: a New Yorker who saves pieces from wedding cakes, some of which are more than fifty years old; the home workshop worker who pinch-hits for Santa Claus by repairing broken toys and distributing them among poor children; harp, hairpin, and corset collectors; the owner of the most famous collection of telegrams in existence; a relic hunter whose exhibit is made up of items salvaged from famous sea disasters; a feminine deep-sea diver, and a collection of newspaper misprints and old-time clown songs.

Radio has been responsible for bringing to light a handwriting expert who finds recreation in studying scribbles and explaining their subconscious meanings. A comic, yet profitable hobby of buying mislaid trunks at auctions was outlined over the air by a well-known writer. His hobby of attending trunk auctions and the purchase of mislaid or abandoned baggage has been the mainspring for some sixty-two books and 500 short stories. The contents of the trunks often have opened up possible fiction avenues beyond the imagination of the average writer.

The radio audience has been converted into one big laboratory to determine whether telepathy exists as an extra sensory power. The tests consist of the selection of various objects, designs, and colors quickly identifiable by the mind by a mechanical device, the action of which is unpredictable. Ten selected telepathic senders then concentrate on the machine's selection and attempt to project the thought to the listening audience.

It was the "Vox Pop" program that focused attention on the wonder man whom writers have joked about because they believed he was non-existent—the one-armed paper hanger. When the radio hunt was started, not one, but twenty-three turned up. And most of them had had the hives.

(Concluded next month)

NEW LIQUID WAX -MADE BY DUPONT

WAXES CARS IN HALF THE TIME



SPEEDY WAX CLEANS AS IT WAXES..
LEAVES THE FINISH SPARKLING LIKE NEW

CUTS OUT ONE OPERATION



YOU DON'T HAVE TO USE A CLEANER
BEFORE YOU APPLY SPEEDY WAX



Now say good-bye to long hours of car polishing. For the new Du Pont Speedy Wax *cleans* as it *waxes*. It saves time and labor—and what a shine it leaves! Try it today!

SAMPLE FOR YOU. Send 6¢ for postage and get a sample can of Speedy Wax—enough for fenders and hood. (Offer good in U. S. only.) Write Du Pont, Dept. PM-3, Wilmington, Del.

DUPONT
REG. U. S. PAT. OFF.

SPEEDY WAX

8705

Earn BIG MONEY MAKING ELECTRIC RAZORS at home!

BUY ALL PARTS READY FOR INSTANT ASSEMBLY NO TOOLS NEEDED

Make \$5 or More on Every Razor Sold

Just think, a complete \$15 type razor for \$1.95 or less. You can make \$5 or more for fifteen minutes of your spare time. Start AT ONCE, big or small—with one unit or 100—make your own electric razor or sell to others—you can profit both ways!



Costs \$1.95 (in quantities less) TO START IN BUSINESS

Make your own electric razor just like the ones selling in the high price brackets. Earn money assembling electric razors for others in your spare time or full time. Buy parts from us—complete matched units. Every part standardized precision-built made by us ready to be put together to make one of the most popular standard super-quality Electric Razors. (The same high quality parts now used in Shavers selling for much higher prices.) Write for information or order your first unit at once and prove the money-making possibilities to your own satisfaction.

SIMMONS MFG. CO.
120-124 W. North Ave., Chicago, Ill.

FREE
Screwdriver and instructions with order for first unit. You need no other tools... no soldering equipment.

SIMMONS MFG. CO.
120-124 W. North Ave., Chicago

- Send complete details about your Electric Dry Shaver Kit and money-making plans.
- Enclosed find \$..... for..... Electric Dry Shaver Kits including free instruction, tools and money making plans.

Name.....
Address.....

Variety in Your Magic

(Continued from page 85)

When reaching into space for a cigarette, the hand is closed and the thumb brought over the base of the fake, thus giving the appearance of catching a cigarette. It is placed in the hat and before the hand is brought into the open the fingers are spread apart. The fake cannot be seen because it is on the back of the second finger. This procedure can be repeated as many times as you wish. If you are going to give out cigarettes, hold them in your left hand as you show the hat to be empty. Upon completing this, drop the cigarettes in the

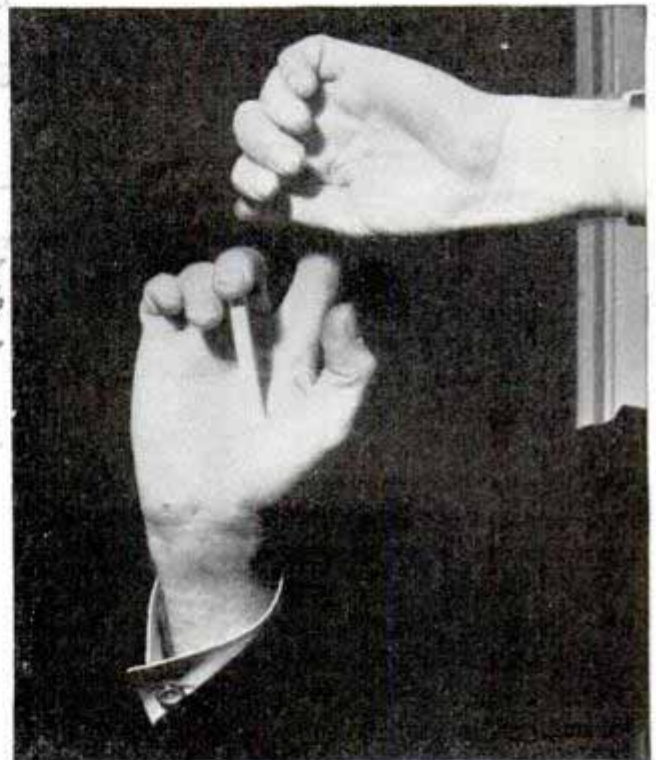

One step in cigarette trick. Left hand is turned over, leaving cigarette in right hand

hat and proceed with the trick, making certain the hat is held above the eye level of the audience.

Another method of making a cigarette vanish is to hold it between the thumb and second finger of the left hand. The right hand covers the cigarette as if it were taking it but in reality it drops into the palm of the left. The right hand is then closed as if it is holding the cigarette and with a flourishing gesture it is opened—empty. The left hand can then pull the cigarette out from under your coat.

The "spooky knots" is the expressive term given a clever rope trick. Coil an ordinary rope around your hand several times and place it in an ordinary paper

PHOTO ENLARGEMENTS

Is Photography your hobby? Do you want a profitable easy business at home? Make **PHOTO ENLARGEMENTS** for yourself and others. Your cost 5¢ each and less. The Ideal Photo Enlarger is **AUTOMATIC**. No experience required. Also **COPIES** any picture. **\$5.94 COMPLETE**. Interesting circular **FREE**.

IDEAL-O, 122 East 25th Street, New York City

5¢

ANY SIZE

WORLD'S GREATEST all around ELECTRIC TOOL

- DRILLS
- GRINDS
- SANDS
- SAWS
- POLISHES
- SHARPENS



ONLY 6.95

POSTPAID

The new **WHIZ ELECTRIC TOOL** is the handiest, most useful power tool ever made. Not a delicate instrument but a real rugged tool, equally effective for both power and precision work. Drills through 1/4 inch iron plate in 42 seconds or engraves intricate designs on jewelry. Handles any material: Metals-Woods-Alloys - Plastics - Glass - Steel - etc. Saves time. Eliminates tedious labor. Plug into any socket AC or DC, 110 volts. Chuck 1/2" capacity. Ball bearing thrust. Powerful. "Worth its weight in gold," to mechanic or handy man. **STANDARD MODEL** with Normal Speed (uses 50 different accessories, instantly interchangeable). Special Introductory Price for a limited time, only \$6.95.

FREE Accessory outfit (Value \$2) includes set of drills, mounted 11/2" grinder, sanding discs, cutting wheels, mounted brush, polishing wheel, carving bur, etc. **FREE** with each outfit ordered **NOW**. We pay postage on all shipments. Will send C.O.D. if desired. **10-DAY TRIAL—MONEY BACK GUARANTEE.**

Special "2-SPEED" MODEL combines Normal Speed and High Speed in one outfit (uses 200 accessories) only \$8.95 complete, with same accessory outfit (value \$2) **FREE**.

PARAMOUNT PRODUCTS CO.
Dept. 7A, 48 West 48th Street, New York, N. Y.

4105
sack that has a small hole cut in the bottom. The loose end of the rope is allowed to hang through this hole. After a few mystic words, you pull the rest of the rope through the hole and several knots are seen tied in it.

In starting, coil the rope around your hand and then, on the pretext of starting over, repeat the process, this time tossing it into half hitches around the fingers of the left hand. The loose end of the rope is then placed through the hole in the bottom of the sack. As the rope is drawn through the hole, the half hitches are tightened.

Two simple coin tricks can be used to conclude your performance. Ask your audience if anyone can hang a coin on the door, then show them how. The piece must be prepared in advance. A small cut is made on the edge of the coin so as to project from the coin's surface. By pushing the coin firmly against wood it will adhere. This cut or burr is so small it will not be detected easily.

For the concluding trick, cut a hole in a piece of paper slightly smaller than the coin to be used and explain you can make a coin pass through this opening without increasing its size. Fold the paper in half and hold it upright so the hole becomes a semicircle. Then place the coin between the halves of the paper as far as it will go. By bending each side of the paper as illustrated, the hole will spread and become wide enough for the coin to pass through. At the conclusion of the stunt, you can flatten the paper out to its original size to show it has not been torn.

4492.
Glass Grinding Machine So Big It Matches Curve of Earth

Jord. plant
Tremendous grinding machines built on such a scale that the curvature of the earth was taken into account in their construction are used to grind and polish safety glass for a leading automobile manufacturer. Engineers computed the earth's curvature each way from the center of the 600-foot bed of the machine at one-fortieth of an inch, even allowing for the effect of light refraction on their readings in making the measurement. The precision was required for maximum uniformity in thickness of the glass.

Jord Dealers news
4/16/58

The Most Marvelous Invention In the History of Bicycles



RIDE THE HILLS WITH EASE
FITS ALL
MUSSELMAN—MORROW
—NEW DEPARTURE & ELGIN BRAKES

Now you can quickly make a 2-speed out of any American made coaster brake with the original MUSSELMAN 2-SPEED CONVERSION UNIT. With its handy auto type gear shift lever, you can shift from low to high or from high to low while coasting, pedaling or braking. The shifting action is positive, smooth and a thrill to operate. The construction is rugged and fool-proof. Over 7,000 riders already praise it for taking the leg strain grind out of pedaling.

Think of it! This invention actually makes your bicycle pedal 28% easier uphill and against the wind. A year ago no one dreamed it was possible. Today it is a fact! You can make this 2-speed unit part of your own bicycle in only 20 minutes time. Makes your bicycle pedal uphill almost as easily as on the level!

The inventor of this amazing 2-Speed is A. J. Musselman, the man who invented the first Musselman coaster brake in 1905. The man who also invented the airplane brake, the Doenut tire and the famous air wheel for airplanes used the world around. Now comes this 2-Speed unit for bicycles, which is the latest and most ingenious invention of his career. Never can you appreciate the greatest thrill of cycling until you have the Musselman 2-Speed.



SPECIAL OFFER: If your dealer cannot supply you, use the quick action coupon below. Send it in today, then install the Musselman 2-Speed complete with the handy gear shift control, at the special price of \$5.00 prepaid. Ride it every day for 10 days. Then if you are not entirely delighted with it, return it for full refund and no questions asked. Be sure and mark the make of your coaster brake on the coupon below. Mail it in today—your 2-Speed unit will be on its way to you within 24 hours.

THE MUSSELMAN HUB BRAKE CO., 6227-E St. Clair Ave., Cleveland, Ohio
Please ship me prepaid, one 2-Speed Unit complete with gear shift control for my bicycle. My coaster brake is () Musselman; () Morrow; () New Departure; () Elgin. An enclosing complete cost of \$5.00 () or am enclosing a \$1.00 deposit, balance C.O.D. It is understood that if for any reason whatever I am not satisfied, I may return it in ten days and my full purchase price will be refunded.

NAME
STREET OR R.F.D.
CITY STATE



GREATER POWER—OVER 5 WATTS OUTPUT
SMOOTHER RUNNING—QUIET AND VIBRATIONLESS
NO HEAT—RUNS COOL INDEFINITELY

The new Duro Grinder, completely redesigned is a revelation in power, speed and ability to run cool for hours. We believe you will be amazed at the power output and efficiency of this Grinder. Compare it with others at even higher prices. Power output is the power delivered at the spindle and should not be confused with power input.

COOL—ABSOLUTELY—We ran a quantity of these Grinders continuously for 18 hours and every one could be held comfortably in the hand. Ask your dealer to show you and tell you about this wonderful new Duro Grinder.

DURO METAL PRODUCTS Co.

2659 N. KILDARE, CHICAGO, ILL.
 NEW YORK DISPLAY, 258 BROADWAY, N. Y.

FREE RADIO AND PARTS CATALOG!



See the latest sensational radio developments in Allied's new 1938 Radio Catalog! 61 new KNIGHT Radios at amazingly low prices; 12,000 radio parts; 32 new Build-Your-Own kits; Amateur gear; P. A. Systems; books, tools, etc. Write today for FREE copy!

ALLIED RADIO CORP.

833 W. Jackson Blvd., Chicago, Ill. Dept. 5-G-8

FOR YOUR OUTING AND TOURS!

ALL PURPOSE VARIABLE VARIOSCOPE AMERICAN TELESCOPES \$7.50 Up

Large achromatic lenses, clear and sharp. Felt mounted draw tubes, chromium plated, plainly marked power, set instantly for every use—sports, target work, hunting, marine or astronomical. Made in three sizes. Guaranteed.

10 to 20X—\$7.50; 10 to 30X—\$10; 10 to 40X—\$12.50

Baron's catalog: Air Guns, Rifles, Firearms, Binoculars; Micro and Telescopes, Police Goods, Badges, etc. Send no stamp.

LEE SALES CO. (Dept. WM), 35 West 32nd St., N. Y. City

Earn Spare-Time Money THIS NEW PLEASANT WAY!



Learn how you can build up a profitable spare or full-time business in your own home. This new book "How to Make Money in Woodworking" is crammed with practical tested ideas, plans, and suggestions. Tells you exactly what to make, how to make it and how to sell it. Describes plans that have worked for others. Woodworking, the new way, is light, pleasant, and profitable. Send only 10c and complete book will be mailed postpaid. Satisfaction guaranteed or money refunded. Write to Dept. A738.

Delta Mfg Co. 600 E. VIENNA AVE. MILWAUKEE, WIS.

Cathode-Ray Tube

(Continued from page 100)

use the oscillograph in connection with a good test oscillator having a suitable sweep circuit. Sketch Fig. 1 shows a model-150 RCA test oscillator, or signal generator, of this description and all shielded connections to a model-151 cathode-ray oscillograph necessary for complete visual set testing. These units are both easily portable and weigh approximately 15 pounds each; all controls are on the front panels. The tubes employed in the oscillograph and the arrangement of the various controls will be noted in the rear view photo.

Fundamentally, a cathode-ray tube consists of (1) an electron-beam source, (2) provision for deflecting the beam, (3) provision for focusing the beam on a screen,



and (4) a fluorescent screen for visibly indicating the position of the beam. In the type-913 tube the electron source is an indirectly heated cathode; the cathode, control grid, and focusing electrodes constitute an electron gun, used to project a beam of electrons. This beam is deflected by two sets of plates placed at right angles to each other. Focusing is accomplished by adjusting the ratio between the voltages on the two groups of plates. In practice, the anode group No. 2 voltage is generally held constant and the anode No. 1 voltage is varied since it is the smaller potential to control. A screen forms one end of the tube. It is one inch in diameter, and the inside is coated with material which emits light when struck by the electron beam. The control grid provides a means for controlling the quantity of electrons admitted into beam stream, thus permitting control of spot intensity, usually referred to as "brilliancy."

OWN A ROYAL PORTABLE ON YOUR OWN TERMS



Take advantage of Royal's FREE HOME TRIAL offer. Send in the coupon below.

GET A FREE HOME TRIAL!

Without risking a penny—prove that a Royal Portable will help you think faster, write faster—get your ideas, letters and reports down on paper easily—in modern, readable, saleable form.

EARN MORE MONEY

... GET AHEAD FASTER!

Whatever your job—salesman, executive, inventor, engineer, teacher, student—prove that it will pay you (your family, too—if you are a family man) to own a Royal Portable!



READ WHAT ROYAL GIVES YOU: These great features explain why so many thousands of families are Royal owners. Built by the world's largest company devoted exclusively to typewriters—with standard, full-sized keyboard and easy, effortless action: Touch Control, Finger Comfort Keys, Genuine Dust Protection, Touch-set Tabulator and numerous other "big machine" features. Royal Typewriter Company, Inc., New York:

ONLY A FEW CENTS A DAY!

ACT NOW! SEE what a latest model, factory-new Royal Portable can do for you—your family. Then own it on your own terms—cash or only a few cents a day. Mail coupon today for details of offer.

FREE! ALSO!

Royal's Instant Typing Chart—it shows you how to type right, no extra cost!

Included with every Royal Portable—at no extra cost—a handsome carrying case.

ROYAL TYPEWRITER COMPANY, Inc.
Department B-87, 2 Park Avenue, New York, N. Y.

Please tell me how I can own—for only a few cents a day—a latest model Royal Portable with Free Home Trial. I now own a _____ Typewriter, Serial No. _____. Tell me how much you will give on it as CASH allowance on a Royal Portable.

NAME _____ STREET _____
CITY _____ STATE _____



BRAKES—ELECTRIC, VACUUM & AUTOMATIC—AXLES & HITCHES FOR ANY TRAILER.

All treads, all spring spreads. WRITE FOR FREE LITERATURE.

HAMMER BLOW TOOL COMPANY, Dept. 107

WAUSAU, WIS.

PHOTOGRAPHIC ALMANAC

Free!



Free 1938 Almanac includes: (1) Special month-by-month *Photographic Calendar*. (2) Authoritative photographic articles. (3) Handy Exposure Table, Exposure Guide. (4) 100 pages of still & movie camera, films, lenses, enlargers, chemicals—everything photographic—many at big savings. ALL GUARANTEED on 10 Day Money Back Trial. (Used equipment accepted in trade.) Write for Free copy! Central Camera Co., (Est. 1899) 230 S. Wabash, Dept. K-7, Chicago

SHAVING BARGAIN

125 double edged blades \$1 made of finest chrome surgical steel. Users report ten shaves per blade. Cannot be duplicated elsewhere. Sent postpaid with money back guarantee —\$1. Anstell Products, 654 East 49th St., Brooklyn, N. Y.

PARMAK ELECTRIC FENCER

SLASHES FENCE COSTS

Now! Amazing FLUX DIVERTER invention gives long life to SAFE 6-volt batteries—unforgettable sting stops the worst fence breakers. ONE used WIRE on light stakes costs less than... **\$10 Per Mile**



SENT ON 30 DAYS TRIAL! **\$12.50**
Write for FREE CATALOG—long time guarantee and proof from users near you. Thousands now in use. DEALER AGENTS WANTED. Write at once—PARKER-McCRODY MFG. CO., 100-J, Kansas City, Mo.

When writing please mention Popular Mechanics



BE at Home ON STRANGE ROADS

With a Hull Auto Compass you never get confused on strange country roads or city streets. It always tells your direction of travel, saving you miles, money, worry and delays at a cost of only \$2.95 at your dealer. Two-piece model \$1.95. Write for circular.

HULL MFG. CO., P. O. Box 246-D3, WARREN, OHIO

Net wt.—10 1/2 lbs. Ship. wt.—12 lbs.

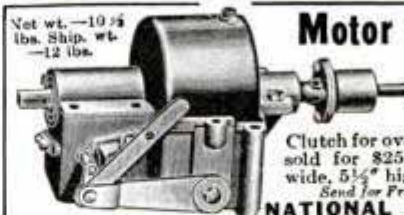

Motor Speed Reducer

Ratio 144 to 1; Ball bearing; white metal housing; rating up to 1/2 H. P. Equipped with friction

Clutch for overload protection. Originally sold for \$25.00. 12" long, 6" wide, 5 1/2" high. Close out price **\$3.95**

Send for Free 58 page Paint Spray Catalog. **NATIONAL ELECTRIC TOOL CO.** 560 W. Washington Blvd., Dept. 58, Chicago, Ill.



TRAILER PARTS

New catalog of trailer parts at bargain prices. Axles, straight, \$4. Drop center axle, \$7.50. Drop center axle undercarriage, \$19.50, complete less tires. Cable-controlled brakes on axle, \$15 extra. Electric brakes—prices on request. Send for FREE Catalog today.

SHAMROCK TRAILER PARTS, 12321 Turner, DETROIT, MICH.

NOW AT BIKE COST!

The Sensational Full Sized HEAVY DUTY Motorized Scooter.

Has Unique Mechanical Features exclusive to **CONSTRUCTA-SCOOT**
Bates Multimotor Clutch—Auto Type Pedal Controls—Cushion Spring Fork—Silent Chainless Drive—Oversize Brakes—Safety Fuel System—12 x 3.00 Lug Balloons—Briggs, Lauson, Iron Horse, etc., Engines—Beautiful Colors.

Priced From **\$29.50 to \$59.50**
Address **CONSTRUCTA-SCOOT** 4577 W. Armitage Ave., CHICAGO



Atlas MADE THE WAY YOU WANT IT!



DELUXE SMALL LATHE \$59.50 - \$64.50

Every feature you want and expect on a small metal working lathe has been built into this sensational new Atlas machine tool. It's a backgeared screw-cutting lathe with 16 speeds, reversible power feed, V-belt drive, Timken bearings, wide thread cutting range, etc. Two sizes—12" and 18" between centers—6-inch swing. Send for new Catalog No. 29 today.

ATLAS PRESS CO.
743 N. Pitcher St., Kalamazoo, Mich.

Assemble This KI-YAK AT HOME FOR VACATION OR PROFIT



Weights only 20 lbs. Carry It On Bike or By Hand.

5 1/2 YEAR OLD BOY

\$6 PADDLE GIVEN with your CK Ki-Yak—if you hurry!

BOYS—see how easily this 5 1/2 year old youngster carries his MEAD KI-YAK! What fun you'll have with one—AND—you can assemble it YOURSELF at home in a few hours from our numbered, cut-to-fit Construction Kit—and SAVE HALF the factory-built cost. Tell DAD about this educational project—and the FUN it will bring you during VACATION! 3 paddle-sail models weighing 20 to 45 lbs.—2 portable outboard motor, sail, oars models 50 and 69 lbs. RUSH 10c NOW for illustrated Circulars. Low Introductory Prices, \$6 Gift Paddle Offer. HURRY! MEAD GLIDERS, 15 S. Market, Dept. B-78, CHICAGO.

NEW TYPE CHEAP OIL BURNER

WHY COOK OR HEAT with COAL or WOOD
Quick heat at turn of valve—over 40,000 sold, no dirt, ashes or drudgery. Burns cheap oil new way—no clogging up or carbon. Slips into Any STOVE, RANGE or FURNACE.

WRITE FOR CIRCULAR and AGENTS PLAN—Let us show you how it ends work and dirt of coal and wood.

AGENTS—Wonderful money-maker, spare or full time. Write quick for details—a postal card will do.

UNITED FACTORIES, J-751 Factory Building, Kansas City, Mo.

Welding Business Earns \$150 to \$300 for You Each Month

30 DAY'S TRIAL AT HOBART'S RISK AND EASY "PAYS FOR ITSELF" TERMS

New low prices make this profitable welding service available to everyone. Opens doors to big pay jobs that carry real profit. Hobart Welders are easier to operate, faster, guaranteed to bring you quality welding business . . . extra profits will pay for welder without expense to you.

NO INVESTMENT TERMS—PROFITS PAY FOR IT

Extra earnings and savings possible with Hobart Welders make it easy to own without expense. You can even rent a new Hobart and later purchase it without loss. Coupon brings details.

"BUILD-YOUR-OWN"

Just couple your own engine to this unit, mount it on chassis and you have money making advantage of a portable welder at a saving of \$300 to \$500.

"Build-Your-Own" Unit

Free! VALUABLE BOOKLETS ON WELDING. CHECK YOURS AND MAIL THE COUPON TODAY.

How to "Build-Your-Own"

New Profits in Arc Welding

New Arc Welding Catalog

HOBART BROS., BOX M-78, TROY, OHIO
Gentlemen: Send me information on () Build Your Own Welder () Electric Drive Welder () 30 Days Trial, Easy Terms () Rental Plan. Also send me free books I've checked.

Name.....
Address.....

HOBART
THE FASTEST SELLING ARC WELDER ON THE MARKET TODAY

Gas Engine Drive
Electric Drive

FIREWORKS

1¢ POSTCARD will Save YOU many DOLLARS

FREE! LOOK! FREE!

100 Fort McHenry SALUTES \$3.25 worth of FIRECRACKERS for only \$1.50

Full of LOWEST PRICES on America's Best Fireworks!

GUARANTEED SAVINGS ON EVERY ITEM AT

BALTIMORE FIREWORKS CO., INC.
6900-02-04-06-08 EASTERN AVE., BALTIMORE, MARYLAND

In answering advertisements always write name and full address clearly.

Build a BOAT FOR PLEASURE OR PROFIT



EASY—LOW COST with POPULAR MECHANICS BOAT BOOK

Shows EXACTLY HOW TO BUILD 15 DIFFERENT BOATS

Build a boat at home! You can do it. Just the kind you've wanted—power, sail, or row boat. The "Boat Book" shows you how in simple step-by-step directions. Specially prepared for those with limited tools, little skill and money. Build boats to sell for profit too. Book tells how.

GIVES PLANS, METHODS AND MATERIALS

Actual working plans and photos of real boats under construction makes building easy. Shows materials needed and rock-bottom costs. Hundreds of pictures. No chance for mistake. Includes also, navigation and pilot rules, handling sailing craft, boat kinks, boating terms. Everything a boat enthusiast should know. Size 7x10 inches. 312 pages. Fine cloth binding.

SEND NO MONEY

Write for new edition of Boat Book today! Sent anywhere. Pay postman \$3.00 plus few cents postage. Outside U. S. and possessions remit with order. Money refunded if not satisfied.

POPULAR MECHANICS PRESS—Room 536A
200 East Ontario St., Chicago

Tune with Comfort

(Continued from page 99)

of the tone chamber is cut to rest on the lower rabbet of the frame between two narrow strips glued and blocked as shown in Fig. 5. Locating the dial opening in the figured panel is done most accurately after sliding the chassis in place on the grooved slides. These slides are stopped at one end and screwed in place to bring the condenser shaft of the set in the center of the panel. A pane of single-strength plate glass covers the dial and is drilled for standard shaft extensions to bring the control knobs above the glass, thus form-

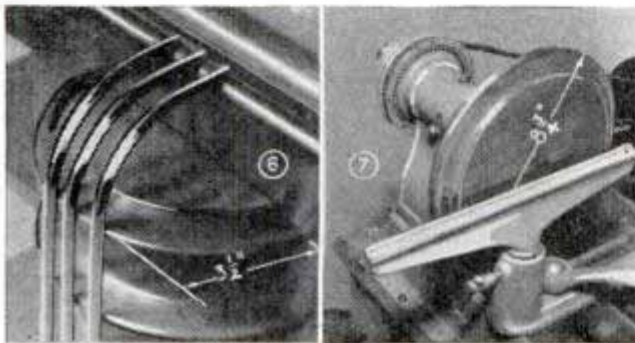

ing a practically unobstructed, flat top. Strips of masking tape are cut $\frac{1}{8}$ in. wide and pressed firmly to the underside of the glass to form the suggested pattern shown in the

motif. This masking tape permits the glass to be painted black and later striped with gold paint by carefully removing the tape when dry. A list of the original materials used can be obtained from Popular Mechanics radio department without charge. The blueprint number is R-255. Soft composition board is used to line the chamber and also for a baffle board for the speaker. A hole is cut in the board for the speaker and baffle is covered with bronze metallic cloth before fitting in position.

Antenna, ground and power leads from the receiver chassis may be brought out through the ventilating slots in the back of the cabinet, or, if the cabinet is mounted on fairly large rubber feet the leads can be run out under the bottom. Flat rubber-covered cable containing these leads is available for running under rugs if desired.



N-Type Purolator
the clear oil
filter

The new N-Type Purolator keeps oil clean and clear . . .

Keep repair bills down—by keeping your motor oil free from harmful impurities. Install a Purolator today! With the new N-Type Purolator, you know your oil is clean because you see it's clear. When the oil on the measuring stick no longer shows clear, you know it's time for N-Type Purolator cartridge replacement—an inexpensive job the service man can do in a jiffy. Motor Improvements, Inc., Newark, New Jersey.

PUROLATOR

THE OIL FILTER ON OVER 85% OF ALL 1938 FACTORY EQUIPPED CARS

CAMERA AND RADIO CATALOG

FREE

Featuring all makes of cameras, films, and supplies. Everything you need in photography at new low prices. Plus great money saving values in 1938 Lafayette Radios, famous make parts, tubes, equipment. Send for Catalog 71-7G8 today! It's your guide to real "buys" in cameras and radio.

SPECIAL:
REFLECTA
REFLEX
CAMERA
F.4.5 3" LENS \$15.75

IT'S
FREE!
WRITE
NOW



WHOLESALE RADIO SERVICE COMPANY, Inc.
105 Sixth Avenue • New York, N. Y.

GOVERNS SPEED OF ANY GAS ENGINE

It's easy and economical to supply your own power for operating all types of machinery, and do more work for less money. Simply remove the engine from a used automobile or truck, set it up where you like, attach a PIERCE UNIVERSAL GOVERNOR, start the engine and you have constantly controlled power for the operation of electric lighting plants, are welders, refrigerating units, air compressors, feed grinders, hoists, saw mills and innumerable other applications.

The load may change but the PIERCE UNIVERSAL GOVERNOR will maintain a uniform engine speed. For close regulation of speed and dependable performance PIERCE GOVERNORS are never equalled. Installation is simple. Either V or flat belts can be used. Complete Governor outfits are also available for nearly all makes and models of industrial engines.

Write for Illustrated literature and prices.

THE PIERCE GOVERNOR COMPANY
1601 Ohio Avenue, Anderson, Indiana

PIERCE GOVERNORS
THE BRAINS OF ANY GAS ENGINE



**I'M HANDY
ANDY NOW**



**THIS CANNED WOOD MAKES
ALL HOME REPAIRS EASY**

- broken chair
loose casters
- holes in floor
floor cracks
- loose drawer pull
screw holes

With PLASTIC WOOD—the discovery that handles easy as putty and quickly hardens into wood you can drive nails and screws into, paint, carve—you can do an expert job of repairing. A permanent job you'll be proud of. It's amazing. Try it. Paint, hardware stores sell PLASTIC WOOD. 25¢ a tube, 35¢ a can.



PLASTIC WOOD



**HERE'S THE
MASTER
FIXER**

Quickly, permanently joins and repairs china, glass, wood, celluloid, etc. Transparent — or Metal color. Get it at paint, hardware or 10¢ stores.

**Old English
CEMENT**

HANDY TAPS and DIES . . .
 Accurate—carefully hardened and tempered. Complete range of sizes at your local five and ten cent store.
HENRY L. HANSON, WORCESTER, MASS.

**BUILD YOUR OWN
AIR-CONDITIONING OUTFIT**

Have "mountain air", year-around health and comfort in your home, store, office, workshop. Seven Units — Summer, Winter, year-around. Materials picked up at small cost. Complete diagrammed instructions, seven blueprints, make construction simple and easy. Worth full cost educationally alone — offers good income opportunity. Written money-back guarantee. Send \$1.00 (or pay postman \$1.15).

Send \$1 today!
SERVATEX COMPANY, 895-PMD Madison Bldg., Milwaukee, Wis.

H 207
Yachtsmen Go to School

(Continued from page 37)

South Seas as well as Santa Barbara and Santa Catalina Island. When they learn how to use sextants, protractors, parallel rulers, dividers, and have a thorough grounding in navigation, they get diplomas and become recognized masters of vessels up to eighty feet in length.

The sailing enthusiast who has grown weary of cruising generally takes a whirl at racing and furthers his education by studying under the masters of speed that frequent the lakes of Wisconsin and Minnesota. On the inland lakes of these two states may be found some of the most highly developed racing boats in the world. They are a revelation to keel-minded yachtsmen who have little acquaintance with the capabilities of the scows. Of light displacement, drawing but a few inches of water, these boats carry up 500 measured feet of sail and with only the crew for ballast. Under certain conditions they climb out of the water and plane for short stretches with speeds up to thirty-five miles an hour being reported. When they are scudding along at twenty and twenty-five miles an hour, a speedboat is needed to keep up with them.

Unlike most sports, sailing is rich in its rewards to the beginner. Another point in its favor is that it provides a cheap, fascinating escape from business cares and daily problems. The initial cost of a new boat is not out of reason and the upkeep is small. In the case of a home workshop worker with the proper tools and two weeks' time at his disposal, a twelve-foot catboat with a five-foot beam can be built for around fifty dollars. Or the sailor with an ear to the ground can always pick up a "buy" in a used boat.

Mooring and club fees are the principal other items of expense. In yacht clubs where the accent is on sailing these are within reach of the average boat owner. Some eliminate these costs entirely by loading their boats onto skeleton trailers after the day's sailing is over.

Boat yards all over the country are in the midst of a boom exceeding even that of the lush years. There is a lively demand for used boats, and home workshop workers are planning to launch a flotilla that will dwarf any of recent years.

Made-to-Order Plants 490

(Continued from page 3)

to have very little resistance to the spotted wilt disease. It was decided to cross the Marglobe with the Red Currant, a variety that resists disease, but which weighs only half a gram and is about the size of a grape. The problem was to extract from the Red Currant its disease resistance alone and implant this in the Marglobe.

The program was carried through five generations by ordinary selection and self-fertilization, but at the end of the work the fruit averaged eighty grams in weight, considerably under the 150-gram weight of the Marglobe. The plant breeders dropped the strain and started in all over again, this time using the backcross method. The first generation after the original cross was backcrossed with Marglobe. Fruit of the third backcross averaged 126 grams in weight, a vast improvement in comparison with the fifth generation in self-fertilization. This year the breeders expect that they will have tomatoes that weigh 150 grams each or more and that will be identical with the original Marglobe except that they will have the disease resistance of the other parent.

Perfecting and fixing a new strain requires from three to fifteen years, depending upon the particular type of plant and the number of generations that can be raised per year.

Vanquishing plant diseases is one of the most important fields of modern plant breeding and each year disease-resistant varieties that have been "vaccinated" against various afflictions come on the market.

In the past, one crop of watermelons seemed to ruin a field forever as far as watermelons were concerned. The land became "wilt sick" and the melon vines would wilt before producing fruit. Today the plant breeders have perfected wilt-resistant varieties that flourish in infested land, enabling farmers to grow melons in the same fields year after year.

Nematodes, a plant-stunting disease that attacks many crops, is headed toward extinction because the plant scientists have found that resistance to the condition can usually be created. Soy beans and lima beans have already been improved against

(Continued to page 140A)

MORE POWER GREATER ACCURACY FOR YOUR .22 RIFLE



Super-X and Xpert

WESTERN SUPER-X .22's will give you a new conception of long-range power and accuracy. The LUBALOY coated bullets strike a CRASHING blow! Expend all their energy *within* the object, with 50% more power! They're 26% faster!... For all-purpose accurate shooting, use XPERT .22's. Both cartridges are SMOKELESS and NON-CORROSIVE! Mail the Coupon for FREE handbook!



WESTERN CARTRIDGE COMPANY,
Dept. G-46, East Alton, Ill.

Send your free rifle, pistol and shotgun shooting guide, the Western Ammunition Handbook containing full particulars of the World Champion Ammunition.

Name

Address

Post Office State

VENETIAN BLINDS

Make your own at low wholesale cost. It's easy under our unique plan. All materials supplied. Send 20c for circular and samples of Ladder Tape, Cord, Rails, Slats. 15 color samples of tape and chart listing mos. decorative color combinations

VENETIAN BLIND MFG. & SUPPLY CO.
Dept. 2, 1760 Lunt Ave., Chicago, Ill.

MAKE BIG MONEY DAILY SUPPLY STORES WITH NEW CIGARETTE STAIN REMOVER



NICOLENE Daily Necessity For Smokers

Self-Selling
Counter Display
Makes Your Sales
FREE Selling
Plan

Full or Spare Time

NICOLENE—a harmless preparation that removes ugly, yellow nicotine stains from fingers—is taking smokers by storm! Simple to apply. Nothing like it! Just what millions of cigarette smokers—men and women—are looking for. Snappy blue and yellow counter display of 24 purse size 10c bottles. Sells fast—repeats quick. Drug, department, cigar stores, beauty shops—all kinds of stores—buy on sight. Chance to earn up to \$60 and more weekly. Get our BIG PROFIT DEAL—\$1 starts you. Write TODAY!

NEVERLIFT CO.,
813-W East 47th St., Chicago, Ill.



TAKE-ABOUT SANDERS

Give every job an expert finish in minutes instead of hours

Don't let slow, tiresome, tedious hand sanding and scraping spoil your finishing and refinishing pleasure. Do it this modern, efficient way with a Take-About. No experience necessary, just plug it into the nearest light socket and it will do your job in a jiffy. Use it on straight or slightly curved surfaces. Use the front pulley as a spindle sander on curved work.

Used in thousands of schools for instruction and refinishing desks and other maintenance work.

WRITE FOR DETAILS, PRICES AND TERMS TODAY

PORTER-CABLE-MACHINE CO.

Precision Tools Since 1906

2000-7 N. SALINA ST.

SYRACUSE, N. Y.

MODEL AIRPLANE ENGINE

Set the Pace—with the SYNCRO ACE

The Modern Streamlined Power Plant, for model airplanes. Immediate deliveries, with all 1938 improvements.

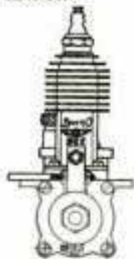

NOW
Only \$13.75
At your dealers



The NEW SYNCRO BEE

This tiny gasoline engine will be ready June 20. Smallest! Lightest! Only 1/4" bore and 3/8" stroke. Weighs approximately 4 oz. You've waited for this little engine. Here it is. At your dealer, only \$12.50.

LITERATURE FREE

Contains complete technical specifications. Write today.

SYNCRO DEVICES, INC., 511 Boydell Bldg., Detroit, Mich.

What! Only \$6.94 FOR THIS SILVER RADIO

Yes, it's true—just \$6.94 buys this all-electric radio complete with full size tubes and serial. Rush \$1 deposit, balance C.O.D. plus postage. Money back if not satisfied.

FREE New Catalog, just off press. Models for farms, homes and cars. Radios that get Europe. Automatic tuning. Consoles and table models. Save up to 50%.

SILVER MANUFACTURING CO., Inc. 2868 Elston Ave., Dept. P-7, CHICAGO.



Send for this!

NOW The Challenger \$69.50 WHY WALK!

when you can ride 120 miles on a gallon of gasoline at 35 miles per hour, on the Challenger, costs only \$69.50 delivered. Nothing like it for thrills, recreation, convenience or getting places.

The "Challenger" designed and built by the Makers of "MOTO-SCOOT," to meet the definite demand of an exceptionally low priced vehicle with an exceedingly low maintenance cost. The "Challenger" has been tested and approved you will be amazed at its outstanding performance.

MOTO-SCOOT MFG. CO.

227 S. Western Ave. Chicago, U. S. A.



(Continued from page 139A)

it-and similar development is going forward in tomatoes, cantaloupes, peppers, and garlic. The mildew disease that strikes onions is also being attacked. Twenty-two varieties of onions have been tested for their resistant qualities and the best of these are being backcrossed with varieties that excel in other good qualities.

A number of years ago the flourishing sugar-beet industry came to an abrupt end on the west coast because of the spread of "curly top," a disease that swept through the fields almost like an epidemic. Sugar-beet growers gave up but the fight was carried on by plant breeders who hoped to produce strains that were vaccinated against the disease. They succeeded a short time ago and now sugar beets are coming back in that area again.

Plant breeders have imparted wilt resistance to flax, have perfected odorless cabbage, have removed the objectionable odor from marigolds, and have altered the shapes of many vegetables. Smaller Hubbard squashes are grown today simply because they are more convenient for a small family than the large squashes.

All down the line, the plant scientists are improving vegetables, fruits, and flowers. Their work ranges from producing "streamline" potatoes to developing hardy lemon trees that will flourish under temperate conditions. Streamlining potatoes, already partly accomplished, is intended to do away with deep eyes so as to reduce waste and permit greater peeling speed.

412.

Outboard Bracket for Canoe Adaptable to Any Motor

Adaptable to any outboard motor, a new bracket fits any canoe. It is constructed so that the large bearing surfaces do not permit scuffing of the canoe. The bracket can be taken down and packed for portaging and shipping.



\$8.50 Job factory

Little Giant

Many pole boats and motors



Easy

YOU'LL advance faster with an easy playing Conn. Choice of world's greatest artists. Many exclusive features yet they cost no more. Home trial. Easy payments. See your dealer or write for freebook. Mention instrument. C. G. CONN, Ltd. 731 Conn Bldg. ELKHART, IND.



OIL OF INDIA MOSQUITOS DON'T LET THEM TAKE THE JOY OUT OF YOUR SUMMER OUTINGS

Aromatic OIL OF INDIA keeps biting insects away! Simply apply a little to exposed skin. Everyone likes its pleasant odor. PESTS DON'T. Very effective and lasting. Absolutely harmless. Promotes outdoor comfort, insures perfect sleep. Send at once 50c for one bottle or \$1.00 for two.

OIL OF INDIA CO. 116-G West Illinois St., Chicago, Ill. DEALERS WRITE

FREE FOLDER MICROMETERS SPECIAL \$13.95

Six piece set, in velvet lined leather case. Precision machined in one thousandths, up to 4" outside and 3/4" inside measurements. Easy to read, adjust and accurate—complete satisfaction or money back. Buy now at bargain price. Shipped prepaid on receipt of remittance. On C.O.D. shipments, send deposit of \$2.00. Foreign deliveries cash with order.

CARSTON SALES CO., Dept. 107, 5431 W. Harrison St., Chicago, Illinois

TWO-CYLINDER STEAM ENGINE

for small boat models complete with propeller, shaft, fire screen, denatured alcohol torch and fuel tank. Torch will start cold engine in 2 minutes, run it for 12 minutes. Price complete as described \$3.00 postpaid. Shawnee Engine Co., Box 162, Station D, Cincinnati, O.

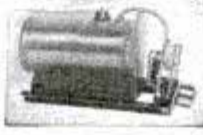

TRAILER BUILDERS

Lowest prices in the industry for windows, couplers, lifting devices and other items. Send 10c for 40 page illustrated catalog. MARVEL TRAILER PARTS CO. Detroit, Mich. 19020 Celestine

BUILD CLOCKS for PLEASURE—PROFIT Hall clocks are high priced in stores—you can make good money building them or electrifying spring clocks. Dime brings drawing of easily built Grandfather Case with "HOW" Book pricing banjo, desk, mantle, spring. ELECTRIC chime. BATTERY CLOCKS from \$1.40. Hall clock. Brass weight chime movements from \$16.95. Start now. KUEMPEL CHIME CLOCK CO. Building 18 Guttenberg, Iowa

BUILD ELECTRIC FENCE FROM OLD FORD T COIL

Costs nothing to build. Operates on car battery or hot shot. 35c brings complete plans and valuable catalog listing over 500 electrical items. LEJAY MFG., 847 LeJay Bldg., Minneapolis, Minn.



MONUMENT \$11.00 Freight Paid or UP Erected.

Genuine Marble, also Granite. Lettered Free. Freight paid. Erected if desired. Thousands satisfied customers. FREE Catalog and samples. U. S. MARBLE & GRANITE CO. A-18 Oneco, Fla.

QUICK CASH IN NEW POTATO CHIPS

START AT HOME
Here's your chance—a money-making business of your own. Turn potatoes into cash by making new kind of Potato Chips with my improved outfit. Makes delicious, superior, "NON-GREASY" Chips at low cost. A few hours' practice does it. Begin anywhere—city, village, town. Potatoes cheap and plentiful. Wholesale or retail. Steady year 'round business. Groceries, markets, restaurants, taverns, do the retailing for you. **WE HELP START YOU IN BUSINESS.** Great quantities of Chips are eaten daily. Profit large—unusually so. You can start this money-making business on a "next to nothing" outlay of cash. Write for Potato Chip Booklet. **LONG-EAKINS COMPANY** 728-S High St., Springfield, Ohio



Attention: Compressor Users THE SMITH AIR COMPRESSOR cuts the cost of compressed air

If you use a compressor, by all means, investigate THE SMITH. Powered by a FORD MOTOR it gives smooth, low-cost performance. Used the world over to replace large, cumbersome compressors in a majority of work such as drilling rock, breaking pavement, riveting, sand blasting, spray painting, metallizing, and general use with pneumatic tools.

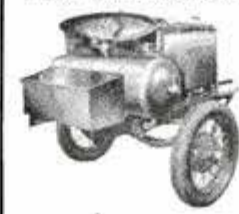

With a Ford Motor and shop facilities you can assemble your own compressor. We will furnish a Smith Compressor Head and Accessories with instructions for mounting. Write Dept. D for details stating the use you have in mind. **GORDON SMITH & CO., INC.** Bowling Green, Ky.

YOUR YOUTHFUL SKIN A MASS OF PIMPLES?

Take steps now to help keep your blood free of skin-defiling poisons

Stop being an object of shame and scorn among your friends. Find out what often causes those repulsive-looking pimples . . . and get rid of them.

Between the ages of 13 and 25 your body is changing rapidly. Important glands develop. These gland changes upset your system. Waste poisons from the intestines are often thrown into the blood stream and are carried to your skin, where they may bubble out in ugly, shameful hickies.

You must help keep your blood free of these skin-irritating poisons. Thousands have done so, just by eating Fleischmann's Yeast. The millions of tiny, living plants in each cake of this fresh food act to help you fight pimple-making poisons at their source—in the intestines, before they can get into the blood. Many get amazing results in 30 days or even less! Get Fleischmann's Yeast now. Eat 3 cakes a day—one before each meal—until your skin is clear and fresh again.

A. C. - D. C. ELECTRIC DRY SHAVE RAZOR COST \$3.00. A BIG \$2.00 PROFIT FOR YOU

At last a Guaranteed streamlined precision-built Head and Motor Electric Dry Shave Razor at the world's lowest price that makes selling a cinch! We welcome comparison to \$15.00 competition. But don't wait! Get complete facts quick—Hurry! "Yours Free" plan tells all!

UNIVERSAL INDUSTRIES, 6227 BROADWAY, DEPT. 127, CHICAGO

3 IN 1 Electric TORCH

WELDS BRAZES SOLDERS



Now, an electric welding, brazing & soldering torch complete with inbuilt power unit, goggles and supplies. Works instantly off any light socket. Does a thousand and one repair jobs at an amazingly low cost on aluminum, iron, steel and other metals. Indispensable in auto shops for fender and body repairs. Unbeatable for home repairs, shop, factory, farm, engineer, janitor, sheet metal, radio and bicycle repairs. Anyone can handle without previous experience with our simple instructions. Does many industrial and production jobs.

COMPLETE TO YOU \$6.95

10-DAY HOME TRIAL
You can try 3-in-1 Electric Torch for 10 days at our risk or get one absolutely free by helping to introduce it. Write for Free particulars.

ELECTRO-TORCH CO.
2613-AC Michigan Ave., Chicago

FACTORY GUARANTEED

NEW REMINGTON NOISELESS PORTABLE

AT LAST! The famous Remington NOISELESS Portable plus Carrying Case is yours for as little as ten cents a day. Brand new. Not rebuilt. Standard keyboard and every modern feature. Free typing course. 10-Day free trial. You don't risk a penny. WE PAY ALL SHIPPING CHARGES. Act now! Remington Rand Inc. Dept. 152-7. 465 Washington St., Buffalo, N. Y.



AS LOW AS
10c A DAY

Midget Portable

ELECTRIC OR BATTERY Radios

WORLD'S SMALLEST RADIOS

Just a handful—Wt. only 2 lbs. Size 3 1/4 x 5". 4 tube performance! Midget BUILT IN LOUD-SPEAKER and AERIAL. Has Broadcast and Short Wave bands! Simple to operate. Ideal Radio for Office, Apts., Bed-rooms, Colleges, Camps, Trailers, etc. Battery model has batteries inside case for use on Farms, Boats, Autos, etc. Electric model uses 110 Volts A.C. D.C. Either model kit of parts for \$6.49. Wired and tested 50c extra. \$6.99 complete ready to listen! (Batteries for Battery model \$1.79 extra). SEND ONLY \$1.00 and pay postman balance on delivery. ORDER NOW! GUARANTEED.

TINYTONE RADIO CORPORATION. Dept. P-7, Kearney, Nebr.



AUTOMATIC STENCIL DUPLICATOR

Amazing new Print-O-Press Stencil Duplicator. Automatic feeding. Automatic inking. Full 8 1/4 x 14 legal size. Other models also, at world's lowest prices. Details free. Also free samples of work done. User-Agents write.

Professional Products Dept. 710, Silvertown, O.

\$13.95 Complete



Order direct

One Wire Electric FENCE

Fencing Cost Only \$5 Mile

Complete Electric Fence—only \$9.75 complete with insulators! Sharp but harmless electric "sting" holds all live stock safely and securely. Three dry cells last many months. Satisfaction guaranteed. Details free. SENTINEL, Dept. K-949, 4220 Davis Lane, Cincinnati, Ohio.

Only \$9.75 COMPLETE



"I WANT TO TAKE THIS OPPORTUNITY TO THANK YOU FOR DOING ME A FAVOR BY SELLING ME MY HOBART WELDER. I CERTAINLY AM WELL PLEASED WITH IT AND IT HAS HELPED ME BUILD MY BUSINESS MORE THAN I CAN SAY"

DANBURY, CONN.

SIMPLIFIED ARC WELDING BRINGS BIG PROFITS EVERY MONTH

New low prices make this profitable welding service available to everyone. Opens doors to big pay jobs that carry real profit. Hobart welders are easier to operate, faster, guaranteed to bring you quality welding business... extra profits will pay for welder without expense to you.

NO INVESTMENT TERMS—PROFITS PAY FOR IT

Extra earnings and savings possible with Hobart Welders make it easy to own without expense. Write for details.

HOBART BROS., Box M-781, TROY, OHIO



BIG MONEY-MAKERS THAT WORK

FIFEL-GEARED PLIERENCH KIT-7" & 8 1/2"

"Pocket Machine Shops" that Do the work of 550 worth of Other tools. Amazingly Quicker, Better... Easier!

- Now of ALLOY Steel—65% Stronger!
- NEW PLANT.. Quadrupled Capacity.
- Now have your Own Business in a New Selling Case. Full-time men making \$1,500 to \$4,000 Yearly..Part-timers in proportion. We need Many More! FREE

Mail Your Address Today (on a post card will do) Get FREE—this 7-Edge-End-&-Angle Screw-driver and 101-Picture Manual of Mechanics, with... User Offers; or, with... DISTRIBUTOR, Territory, Demo. and SELLING KIT Offers!

AMERICAN PLIERENCH CORP PMG-4511 N. RAVENSWOOD AV. CHICAGO, ILL.





WOOD-WORKING SUPPLIES

New 100 page book contains most complete list of woodworking supplies in the world—Standard American woods cut-to-size at bargain prices. Rare imported woods, Veneers, ply-woods, inlays, carved legs, mouldings, decorations, special tools, Hard-to-find ornamental hardware, scroll saw patterns, wood-finishing instructions—How to make Venetian Blinds at 1/3 store prices. Send only 10c for Catalog No. 10 to Craftsmen's Wood Service Co., 2731 S. Mary Street, Chicago, Ill.

EVERYTHING THE CRAFTSMAN NEEDS ONLY 10c



CATCH FISH!

Minnesota sea, mink, muskrat with our folding, galvanized Steel Wire Traps. Greer Patent Lever Hooks are so constructed that when a fish gives the slightest pull on the bait the upper hook reaches down and gets a hold that lands him. 3 for 50c. Write for descriptive catalog of Traps, Hooks, Lures, and other specialties. Walton Supply Co., 3507 1/2 Juniata St., St. Louis, Mo.



BUILD CLOCKS with our help

Cash in on the demand for Mantel, Banjo, GRANDFATHER'S CLOCKS. Ask about our new, low-priced Mantel Clock and Special Blue Print Offer. Send dime for illustrated working drawing of Mantel Clock; 25c for plans of 16 Mantel & Banjo Clocks. Catalog FREE.

AMERICAN CHIME CLOCK CO.
1671 Ruffner St. (Established 1877) Philadelphia, Pa.



Print Your Own

Cards, stationery, circulars, tags, labels, advertising, etc. Save money. Print for Others; Big Profits; easy rules sent. Will do popular Raised Printing like Engraving. Junior outfit \$9. Senior outfits \$17 and up. Send for free catalog and all details. KELSEY PRESSES, F-37. MERIDEN, CONN.



WIND ELECTRIC PLANT

Build Your Own—We Show You How! Easily made from old auto generator. Dime brings complete plans and 1938 catalog. 100 other generator changes to 6, 12, 32, 110 volt plants, motors, welders, elec. fence, etc.

LeJay Mfg., 447 LeJay Bldg., Minneapolis, Minn.



Earn Cash at Home!

We paid M. M. \$1174 for exceptional cellar crop Snow-King mushrooms! We furnish materials; buy all crops. Big FREE picture book tells if your cellar, shed, suitable. Est. 1902. Write today. United Co., 3848 Lincoln Av., Dept. 304, Chicago



FREE 48-Page POWER TOOL Catalog sent to any home craftsman interested in improving his work. Full descriptions of DRIVER Engineered Power Tools and Accessories. Write today! Walker-Turner Co., Inc., 178 South Avenue, Plainfield, N. J.

DRIVER Engineered POWER TOOLS

NEW BIG TRAILER PARTS CATALOG

Shows hundreds of house trailer items. Build your own trailer or re-condition the one you have. Wholesale prices. Quality merchandise. Prompt shipment. Send 10c for this money saving catalog today.

C. M. Hoof Company, 1736 S. Michigan Ave., Dept. P-7, Chicago, Ill.



YOUR OWN MOVIES! 10c A DAY!

NATIONALLY ADVERTISED 8MM and 16MM Movie cameras, projectors. For home, business, church, school, club. MONEY BACK 10 DAY TRIAL. Payments as low as 10c A DAY. Satisfied customers throughout the world. FREE details. WRITE TODAY. Don Elder's Home Movies, Dept. A-7, 739 Boylston St., Boston, Mass.



ALL THE IMPRINTED CARDS YOUR CUSTOMER NEEDS FOR \$1.99

CHRISTMAS CARD SENSATION

Make more money with this revolutionary new way of selling imprinted cards. Give customer all he needs for \$1.00. Also offer superb 25-card Box Assortments for 50¢. Exclusive Everyday Cards and Artistic Gift Wrappings. Up to 100% profits. Write today for Elaborate Saleable Assortment sent AT ONCE on approval. ACT NOW!

CARDINAL GREETINGS, Dept. 97, Cincinnati, Ohio

BUILD AND SAIL THIS YACHT
LENGTH 22" HEIGHT 28" BEAM 4"

Complete Kit - hull finished inside and out—Deck shaped. Keel, rudder, mast, spars, sails, ready to assemble. All necessary fittings. Patent automatic steering device. Plans and instructions - \$2.50 P. P. Send 10c for catalog of planes, boats, motors and charts.

INT'L MODELS KIT DIV. 251 West 55 St., N. Y. C.

MODEL MAKERS, PRECISION workers like Nicholson X. F. Knurled Handle Needle Files! Box of dozen different shapes, at your dealer's, or write Nicholson File Co., 22 Acorn St., Providence, R. I., U. S. A.

TRAILER BUILDERS

Send 10c for our latest DeLuxe Trailer plans with all the modern improvements known to trailer builders. We supply everything at bargain prices. Our new 1938 trailer supply catalog (largest and most complete) is free. National Trailer Equipment Co., Dept. P-7, 714 W. Wisconsin Ave., Milwaukee, Wis.

BOOKS—FOR TODAY'S BIG OPPORTUNITIES

List Sent Free Upon Request

POPULAR MECHANICS PRESS-200 E. ONTARIO ST. CHICAGO

OFFICE MACHINES—Care and operation of 29 different makes. Typewriters, adding machines, duplicators, etc. Only book on subject. 384 pages, illustrated. \$2.50 postpaid.

POPULAR MECHANICS PRESS
200 East Ontario Street Chicago

Extra Money From Books

SEND NO MONEY • Books Sent C.O.D. Anywhere in U. S. These famous Pay-Raising, Extra Money Books have helped thousands of others. Let them help you too. Check this list and mail with your name and address. Pay postman on delivery plus few cents postage. Send 3c stamp to cover postage and ask for catalog of other books.

SELECT FROM THIS LIST

AIR CONDITIONING
Furnaces, Unit Heaters \$3.00

ARMATURE WINDING
For A.C. and D.C. Machines. \$2.00

AUTO REFINISHING
Duo With Spray Gun \$1.50

BLUEPRINT READING
For Machine Trades \$1.50

BRICKLAYING
Plain and Fancy \$1.50

CARBURETORS (All Makes)
New, Revised Edition \$3.00

CHEVROLET SIX
Car, Truck, Operation Repair \$2.50

COLONIAL FURNITURE
Making, 95 Pieces \$3.50

DANCE
Learn at Home Without Music or a Partner \$2.00

DIE CASTING
Machines, Dies, Alloys \$3.00

ELEMENTS DIESELS
Engineering Questions and Answers \$4.00

FOUNDRY WORK
Molding, Casting, etc \$2.00

FURNITURE REPAIRING
Finishing and Decoration \$3.00

HIGH-SPEED DIESELS
New, practical, non-technical \$2.50

HOME GROUNDS FURNISHINGS
1500 Needed \$2.50

LEATHER MAKING and Home Tanning \$1.00

MACHINE SHOP WORK
Tools and Methods \$2.50

METAL SPINNING
Practical New Book \$1.00

MONEY-MAKING FORMULAS
10,000 Practical \$4.00

PLASTERING
Best Instruction Manual \$1.25

RADIO PHYSICS COURSE
New edition. Everything about Radio \$4.00

SHEET METAL
Construction Work \$2.50

STEAM ENGINEER'S LICENSE
How to Obtain \$2.00

STEEL SQUARE
Hodgson, 500 pp. 300 Illustrations \$2.00

TAXIDERMY, HOME
Mount Trophies Profit, Pleasure \$1.50

WOOD TURNING
Course In \$1.50

WROUGHT IRON WORK
Practical \$1.35

POPULAR MECHANICS PRESS
Room 738A 200 E. Ontario St., Chicago

AIR COOL YOUR HOME at Small Cost

Glorious Cooling Comfort is now yours to enjoy in the hottest weather. Let an INTERNATIONAL UNIT change the hot stuffy air in your home to a cool refreshing place in which to work, play and sleep.

QUICKLY INSTALLED—In any Home, Store or Building old or new. You can easily install it yourself. We furnish plans and instructions Free. **CHEAP TO USE**—Due to the scientific circulating air principle, cost of operation is very low. Pays Big Dividends in Refreshing Comfort.

HOME OWNERS and BUILDERS write today for Free Illustrated Bulletin. State size of house or building to be cooled. **DEALERS WANTED.** Please address Dept. 30.

INTERNATIONAL ENGINEERING, INC., Dayton, Ohio

DO TIRE GROOVING

Go into Business for Yourself. Make 300% to 500% PROFIT!

Buy up good used tires—Re-groove them—Sell to used car dealers, car owners.

Expert tire groovers always have work. Big demand for men who know this new trade. Auto dealers, tire dealers, service stations, fleet operators pay more money to men who can groove tires. Depression helps this business. No rubber added. You ENGRAVE the smooth tire, make it look like new.

Easy to learn how. Send 25c stamp for complete instructions.

KWICK-KUT COMPANY, 3830 Arsenal Street, St. Louis, Missouri

SPORS 4000 MONEY MAKERS

FREE! WHOLESALE CATALOG

Has: 15 selling plans; 30 money making ideas; 4000 world wide bargains; 260 pages of big values. Also shows top-notch prizes; business stimulators. All at rock bottom wholesale prices. Salesmen-Dealers. Obtain this fascinating Book Of Opportunity FREE. Write for it today, to

SPORS CO., 5-38 Main St., LeCenter, Minn.

GET YOUR TRACTOR AT FACTORY PRICE

3 Speeds Fwd. and Reverse. Runs 4 to 8 hrs. per gallon

Amazing money maker for farms, truck gardens, orchards, nurseries, poultry ranches, country homes, etc. Plows, discs, harrows, cultivators, mows lawns, cuts weeds. Runs belt machines 2 to 3 H.P. riding or walking tractors. Write for FREE CATALOG. Low Factory Prices and 10 Day Trial Plan. Address nearest office.

SHAW MFG. CO. 4507 Front St., Galiesburg, Kans.
130 G West 42nd St., New York, N. Y., 5812 G Magnolia Ave., Chicago, Ill., 668 G North 4th St., Columbus, G.

SHAW DU-ALL TRACTOR

★ More FUN at CAMP ★

This summer, Leather Craft is the rage . . . it's America's fastest growing hobby. You can begin to enjoy an EASCO Leather Craft Set the minute you open it. Complete outfit, including tools, leathers, patterns, etc., and full instructions, only \$2.00—on sale at leading Department Stores or order direct and pay postman on arrival. \$2.50 outside U. S.

LEATHERCRAFT

Free When ordering direct, clip name of your Department Store to this ad, and we will include with your set, one extra free project. Illustrated catalog 10c.

E. A. SWEET CO. Dept. A-14 Binghamton, N. Y.

**DISTINCTIVE . .
IN FINE
WORKMANSHIP
AND DESIGN**

\$85⁰⁰

Less Motor Drive
Sold on Easy
Payments as
Low as \$6.00 a
Month for 12
to 18 Months.



No. 415-YA, 9 1/4" swing by 3' bed Workshop Bench Lathe with Horizontal Motor Drive, 1/4 h.p. Reversing Motor, Switch, Belts and Adjustable Belt Tension Countershaft **\$117.00**
(*\$15 down—\$7 Mo. for 18 Mo.*)

Weight
320
lbs.

NO METAL working machine has ever before been offered to equal the high quality and low price of the 9-inch Workshop South Bend Lathe. This lathe is capable of doing the finest work on tools, dies, jigs, and fixtures. Its new features and construction insure accuracy and maintain it over a long period of years. The exacting requirements to which this lathe is held in thousands of industries is guarantee and proof of its precision.

Manufacturing plants, machine shops, tool rooms, laboratories, automotive repair shops, home workshops—all are installing the 9-inch Workshop Lathe. Choice of engineers and mechanics everywhere.

Features insuring the 9-inch Workshop Lathe a precision lathe are: V-ways on the lathe bed, Precision Lead Screw for cutting screw threads from 4 to 112 per inch, Ball Thrust Bearing on Spindle, Automatic Longitudinal Screw Feed, Twin Gear Reverse to Lead Screw, 3/4-inch hole through spindle taking collets up to 1/2-inch, Precision cut steel gears.

38 attachments are available for milling, grinding, draw-in collet chuck work and many other operations. Made in 3', 3 1/2', 4' and 4 1/2' bed lengths. Powered by 1/4 h.p. motor from ordinary lamp socket.

SOUTH BEND LATHE WORKS

631 East Madison Street
South Bend, Indiana, U.S.A.

**SOUTH BEND
BACK-GEARED
SCREW-CUTTING
PRECISION LATHE**

This 9-inch South Bend Lathe used by:
**MANUFACTURERS
TOOL ROOMS
LABORATORIES
MACHINE SHOPS**

- Automotive
- Electrical
- Gun Smiths

**U. S. GOVERNMENT
SCHOOLS
HOME WORK
SHOPS
INVENTORS**

The 9" x 3' South Bend Precision Lathe does these operations:

- TURNS—BORES**
- CUTS SCREW**
- THREADS—FACES**
- DOES MILLING,**
- CHUCKING, REAM-**
- ING, DRILLING,**
- FILING AND HUN-**
- DREDS OF OPERA-**
- TIONS IN STEEL,**
- IRON AND OTHER**
- METALS.**

There are 5 sizes of South Bend Lathes—9", 11", 13", 15" and 16" swing with bed lengths 3' to 12'. In motor or countershaft drives. Priced \$85 to \$1500.

Write

FOR THESE BOOKS "How to Run a Lathe"—160 pages, over 300 illustrations on lathe practice and operation. Catalog No. 46 shows, describes 9-inch lathe in all sizes. *Use Coupon.*

LATHES ARE STOCKED IN PRINCIPAL CITIES

- Chicago, Ill.—C. B. Burns Mchry. Co., 541 W. Washington Blvd.
- New York, N. Y.—A. C. Colby Mchry. Co., 183 Centre Street.
- Philadelphia, Pa.—W. B. Rapp Mchry., 132 No. Third Street.
- Los Angeles, Cal.—Eccles & Davies Mchry., 1910 Santa Fe St.
- Detroit, Michigan—Lee Mchry. Co., 6318 E. Jefferson Avenue.
- Milwaukee, Wisconsin—Voell Mchry. Co., 1533 No. 16th Street.
- Boston, Mass.—The MacKenzie Mchry. Co., 36 Oliver Street.
- Cleveland, Ohio—Reynolds Mchry. Co., 2034 E. 22nd Street.

SOUTH BEND LATHE WORKS,
631 E. Madison St., South Bend, Ind., U.S.A.

- No. 33LB "How to Run a Lathe," 25c
- No. 46, 9" Workshop Catalog, Free
- Easy Payment Plan

Class of Work.....
Name.....
Address.....
City..... State.....



SOUTH BEND Precision LATHES

32 M. P. H. STANDING STILL



THIS DYNAMOMETER TEST at the Ethyl Motor Clinic clearly shows the three grades of performance. Illustrated below is the rear wheel of a popular make of car on the dynamometer rollers. Three grades of gasoline are used and the differences in power and speed indicated on sensitive instruments. This test leaves no doubt that every car has three grades of performance.

BUT IT PROVES THAT MODERN CARS HAVE 3 GRADES OF PERFORMANCE

You don't really buy gasoline... you buy performance and mileage. That's why you'll be doing yourself a real favor to read the basic facts about gasoline and performance. Here's what you can expect from each grade of gasoline:—

Poor performance

with "low-grade" gasoline



There is no anti-knock fluid (containing tetraethyllead) in "low grade" gasoline. Power is lost because your car dealer *must* retard the spark to prevent "knock" or "ping."

Good performance

with "regular" gasoline



Most regular gasoline has in it anti-knock fluid (containing tetraethyl lead). The spark can be considerably advanced for more power without "knock" or "ping."

Best performance

with gasoline containing "ETHYL"



Gas "with ETHYL" is highest in all-round quality. It has *enough* anti-knock fluid (containing tetraethyl lead) to let the spark be *fully* advanced for maximum power and economy without "knock" or "ping."

Henry Picard LOOKS THE SITUATION OVER



"I've never favored one particular cigarette, Mr. Picard. I can see *you* do though. Do you find Camels *different*?"

"Camels are *distinctly* different, Mr. Stahl—different in many ways. The longer I smoke Camels, the more I appreciate their natural smoothness and mildness—the real mildness that's easy on the throat. Camels never tire my taste. Camels *agree* with me. They *do*—from *all* angles. I hear many golfers praise Camels. Camels never get on your nerves. Most top-flight golfers I know smoke Camels. Camels set you right!"

Picard — a heady strategist in a tight spot — says: "A cigarette, too, has to be sized up from a lot of angles."

WORLD-FAMOUS golfers—men who need iron nerves and steady hands for that winning stroke—and millions of other people under the strain of everyday life, all appreciate this fact: **CAMELS SET YOU RIGHT!** Smoke Camels and see for yourself why they are so different from other cigarettes. Note particularly the greater pleasure you get from Camel's *costlier tobaccos!*

**On the Air Monday Nights
E-D-D-I-E C-A-N-T-O-R**

America's great fun-maker and personality brought to you by Camel cigarettes. Over Columbia Network. See your local newspaper listing for correct time.

**On the Air Tuesday Nights
BENNY GOODMAN
THE "KING OF SWING"**

Hear the great Goodman Swing Band "go to town." Every Tuesday at 8:30 pm E. S. T. (9:30 pm E. D. S. T.), 7:30 pm C. S. T., 6:30 pm M. S. T., 5:30 pm P. S. T., over Columbia Network.



HELEN STANSBURY, United Air Lines' Director of Women's Traffic, speaking: "I choose Camels for mildness. They're never harsh. When the pace I go fatigues me, a Camel gives me a 'lift.'"



A matchless blend of finer, MORE EXPENSIVE TOBACCOS — Turkish and Domestic

PEOPLE DO APPRECIATE THE **COSTLIER TOBACCOS** IN CAMELS

THEY ARE THE **LARGEST-SELLING** CIGARETTE IN AMERICA

Copyright, 1938, R. J. Reynolds Tobacco Co., Winston-Salem, N. C.

ONE SMOKER TELLS ANOTHER.. **"CAMELS AGREE WITH ME!"**