

U. S. DRIVERS AGAINST THE WORLD

# POPULAR MECHANICS

★

## MAGAZINE

WRITTEN SO YOU CAN UNDERSTAND IT

DC MADE, GREAT BRITAIN, NO. 40429

REG. U.S. PAT. OFF.

JUNE  
25 CENTS



SEE PAGE 840



# The Test that Says...

## **No Acid Here**

Even the most super-sensitive test can't find a trace of acid in Quaker State Motor Oil. Quaker State is made only of the finest Pennsylvania crude oil . . . scientifically freed of all impurities in four great, modern refineries. The common ailments of sludge, carbon and corrosion are wholly overcome by *Acid-Free Quaker State*. Your car will run better, last longer. Retail price, 35¢ a quart. Quaker State Oil Refining Corporation, Oil City, Pennsylvania.



# NEW TIRE WINS IN SENSATIONAL NON-SKID TESTS!

YOU NEED THIS NEW KIND  
OF TIRE IN WET WEATHER  
EMERGENCIES LIKE THIS



## Stops Quicker, Safer Than Tires Costing up to 70% More!

HERE, at last, is a tire so utterly different in action that, at the first sign of a skid, it turns the wet road under your car into a "dry" surface.

In exhaustive road tests made by the largest independent testing laboratory in the country, against regular and premium-priced tires of America's six largest tire manufacturers, no tire tested, regardless of price, came up to this new tire in non-skid action.

For safety's sake, ride on Goodrich Safety Silvertowns. See your Goodrich dealer or Goodrich Silvertown Store now.

### READ THE REPORT— from America's Largest Independent Testing Laboratory

"BOTH regular, and also the premium-priced tires of America's six largest tire manufacturers were submitted to a series of exhaustive road tests made over a three months' period by us, to determine their resistance to skidding and wear, with the following results:

"NON-SKID—The new Goodrich Silvertown with the Life-Saver Tread gave greater skid resistance than any other tire tested, including those tires listed at from 40% to 70% higher in price.

"MILEAGE—The Goodrich Silvertown gave more non-skid mileage than any of the other tires tested in its own price range—averaged 19.1% more miles before the tires wore smooth."



PITTSBURGH TESTING LABORATORY

### 2 LIFE-SAVING FEATURES . . . AT NO EXTRA COST!



The never-ending spiral bars of the Life-Saver Tread act like a battery of windshield wipers—sweep the water right and left—force it out through the deep grooves . . . give the rubber a dry track to grip.



Don't gamble on blow-outs. Every new Goodrich Safety Silvertown is constructed with the now famous heat-resisting Golden Ply that gives you real protection against high-speed blow-outs.



# The new Goodrich SAFETY Silvertown

SKID PROTECTION OF LIFE-SAVER TREAD ◀▶ GOLDEN PLY BLOW-OUT PROTECTION

# THE BIGGEST TELEPHONE VALUE FOR YOUR MONEY

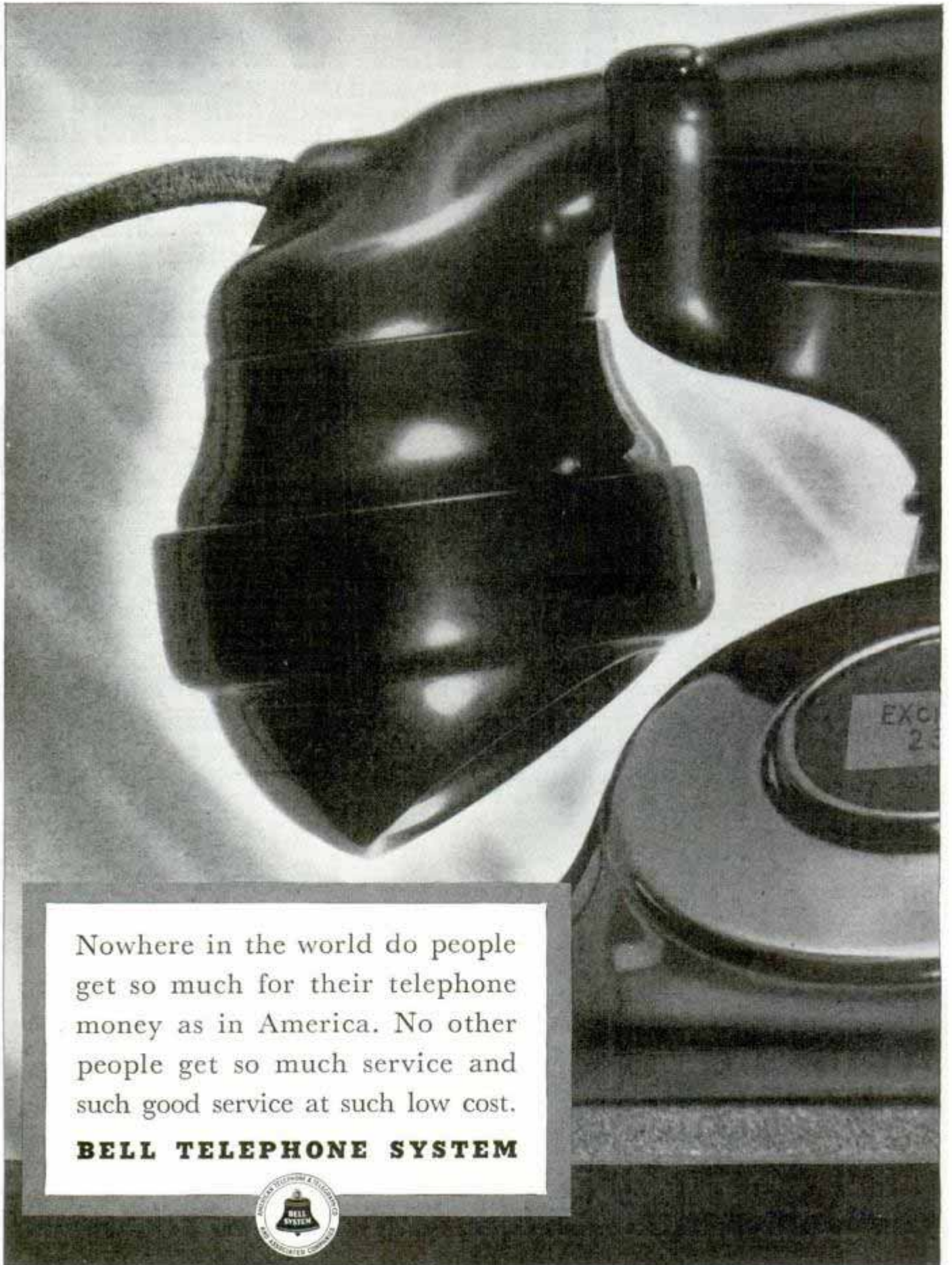

Nowhere in the world do people get so much for their telephone money as in America. No other people get so much service and such good service at such low cost.

**BELL TELEPHONE SYSTEM**



# Popular Mechanics Magazine

H. H. WINDSOR, Founder

H. H. WINDSOR, Jr., Editor and Publisher

June, 1938

Vol. 69, No. 6

## Special Features

Wings for Policemen . . . . .	801
Don't Pity the Poor Fish . . . . .	Coloroto
The Latest Movie Thrills . . . . .	818
The Advance of Diesel . . . . .	826
Brute Force vs. Engineering Skill . . . . .	834
Age of the Aerial Monsters . . . . .	840
Electric Plants Offer Power to All . . . . .	850
Phantom Fleet of the Highway, Part II	858
American Drivers against the World	866
Riches from the Air . . . . .	872
Nature Photos in Your Back Yard . . . . .	882
Dress Up Your Magic Tricks . . . . .	890

(Continued on next page)

## Hunting Thrills for the "Mike"

**I**F YOU have an unusual job, own a singing mouse, collect sharks' teeth as a hobby or possess any other qualification which sets you apart from your fellows, you are likely to be yanked before a microphone to tell the world about it. For radio constantly is seeking new thrills for your jaded ears and the entire world is being combed to find new material for the "mike." Talking dogs, one-arm paper hangers, flag-pole sitters, performing robots and roller-skating roosters all have provided grist for the radio mill. And what new sound you may hear when you twist your dials tomorrow, even the men who seek and find the thrills don't know. But this continual search for radio variety is an interesting business and the tale of what the searchers find makes interesting reading. The first of two articles on this subject appears in the July issue.

## Next Month

**L**ITTLE boys armed with punk used to set off the Fourth of July fireworks, often with tragic results. Today experts, skilled in producing spectacular displays, touch off the pyrotechnic wonders which turn night into beauty. An article next month, illustrated with eight pages of Coloroto pictures, explains how modern fireworks spectacles are produced.

## Work for the Big Hook

**N**O automobile has yet won a right-of-way argument with a train, but plenty of trains have lost it, thereby making more work for the big hook which snakes the wreckage off the track. If you've ever wondered what a helpless engineer thinks about as he watches a reckless motorist racing him to a crossing, you'll want to read "More Jobs for the Big Hook" in the July issue.

## Wealth from Waste

**A**LCHEMISTS of the middle ages brewed strange concoctions of pigeons' blood and lichens in a futile attempt to create riches. Where they failed, modern chemists have succeeded. Today they are using such things as dried blood, chicken feathers, sunflower seeds and sweepings from barber shops to produce crystals worth twice their weight in gold. These crystals are vital to your existence as you'll discover by reading this wonder story next month.

## (Contents—Continued)



## MANY A REPAIR DOLLAR IS SAVED THIS WAY

Pyroil is made for the express purpose of *keeping engine operation efficient—by eliminating contaminations that foul both new and old car performance.* In this way, Pyroil offsets many costly repairs. It saves you *dollars* of ordinary repair or overhaul expense!

Pyroil keeps out sludge, gum and hard carbon. It prevents combustion acids and corrosion from attacking pistons, valves and bearings, and from causing early wear. These are the things that gradually steal power away.

Pyroil keeps valves and rings from sticking, too. Cuts down friction and overheating. Yet you need only a *few inexpensive ounces* of Pyroil in gas tank and crankcase at intervals, to do all of this!

Better have your service station salesman give your car a money saving Pyroil treatment, today! Mail Coupon. Manufactured and Guaranteed by Pyroil Company, W. V. Kidder, Founder, 56 Pyroil Bldg. LaCrosse, Wisconsin, U. S. A.

**NOTHING FINER FOR  
NON-ABRASIVE NEW  
CAR BREAK IN!**

**DISTRIBUTORS:  
CHECK AND MAIL  
COUPON FOR FRAN-  
CHISE FACTS.**



**SIMPLY  
ADD TO  
GAS & OIL**

**PYROIL COMPANY,  
56 Pyroil Bldg., LaCrosse, Wis., U. S. A.**

Please send complete Pyroil facts.  
 Also send details of your plan for Distributors.

Name.....  
Address.....  
City..... County..... State.....

AUTOMOTIVE	
Light on sun visor aids in reading maps .....	823
Safety grip holds car on hoist .....	824
Crashproof gas tank for trucks .....	831
Highway striper covers twenty-five miles daily .....	833
"Wigglebug" saves time in lubrication .....	848
Oil leak detector shows condition of bearings .....	849
Special soap cleans off dirt and oil .....	856
Vacuum truck collects garbage .....	856
Bike turned into motorcycle .....	865
Skidding trailer helps to build safer tires .....	870
Eighteen-pound Diesel engine .....	879
Ignition analyzer tests parts in thirty seconds .....	886
Cabless tractor hauling bus .....	887
Double-piston engine for racing motorcycles .....	888
Signal warns of waste and saves gasoline .....	894
Aerial bridge on truck reaches street lamp .....	895
Wheel chair "coupe" driven by lawnmower engine .....	895
"Death at the wheel" photo warns motorists .....	896

AVIATION	
Steel is seventeen per cent of plane's weight .....	817
Plane image on dial shows position of wheels .....	824
Decoy planes made of matting and reed .....	825
Four-crankshaft air engine fast without vibration .....	832
Children study bombing plane from chart .....	839
Lights in cockpit guide pilot through fog .....	855
Plane burning liquid hydrogen could circle earth .....	856
Midget radio planes test gunner's accuracy .....	857
Air line accidents in U. S. .....	862
Flying fortresses set record on long journey .....	865

CONSTRUCTION	
Glass "pool" has windows in floor .....	822
Slate and asbestos cutter speeds roofing work .....	825
Fast-drying cement sets in two hours .....	846
Camera helps road builder project future highway .....	854
Automatic strip stops draft under door .....	879
Burglarproof window opened and shut by crank .....	880
Elevator takes tourists to mountain top .....	880

FARMS	
Planes scatter grass seed after forest fire .....	838
Waste pumped from barn to fertilize farm .....	839
Baby mules put to bed in farm hospital .....	855

HOUSEHOLD	
Metal stand saves lifting iron .....	846
Small capacity humidifier operates automatically .....	864
Short waves cook ham .....	876

PHOTOGRAPHY	
"Sight test" wall chart for cameras .....	830
Oil pool used in movies for reflection shots .....	833
Magnifier permits sharp focusing in enlarging photo .....	838
Salesman projects rug pattern on floor .....	839
Mercury vapor kit increases photo film speed .....	848
"Probability machine" to reduce graininess of film .....	863
Aerial camera lens sees details a mile below .....	871
Speed camera splits lightning into eleven strokes .....	871

RADIO AND ELECTRICITY	
Radio newspaper system in first tests .....	886
Compact push-button receivers in table models .....	897
How to build a three-tube radio direction finder .....	898
Simplified condenser substitution tester .....	900
Practical radio hints .....	901
All-purpose portable vacation receiver .....	902
Amateur transmitter on "add-a-unit" principle .....	902
Five-station safety tuning for auto set .....	902
Radio test set fits your pocket .....	902

SCIENCE AND INDUSTRY	
Wildcat drillers use latest methods .....	830
Making baseballs and bats is big business .....	847
Prism and lens weave weird light patterns .....	862

SHIPS AND SHIPPING	
Firemen wear asbestos suits and oxygen masks .....	855
Latest radiophone speeds calls from small craft .....	878
Satan is emblem on funnel of steamer .....	880
Six-screw liners to be built .....	887
New passenger ship for U. S. lines .....	889

SPORTS	
Mechanical batter tests liveliness of balls .....	817
Tennis on roller skates requires real skill .....	825
Outboard motor has flexible shaft .....	864
Shorter travel for firing pin .....	878

TOOLS	
Floor sander has stool attached .....	830
"Fountain pen" oil can ejects a tiny drop .....	846
Tool beads tubing to provide tighter connection .....	848
Low-voltage drill run by auto battery .....	863

(Continued to page 6A)

# "THEY BOLTED ME IN, TURNED ON THE WATER!"



JAMES ELWOOD

"I ordered the fire pulled on the No. 7 boiler as we steamed into port," writes Second Engineer James Elwood of 216 East 19th St., New York.

CARELESS FIREMAN TURNS ROUTINE  
TASK INTO NIGHTMARE



"Soon as she was cool, I was in there with my flashlight and chipping hammer looking for the trouble. I must have been too quiet about it, for..."

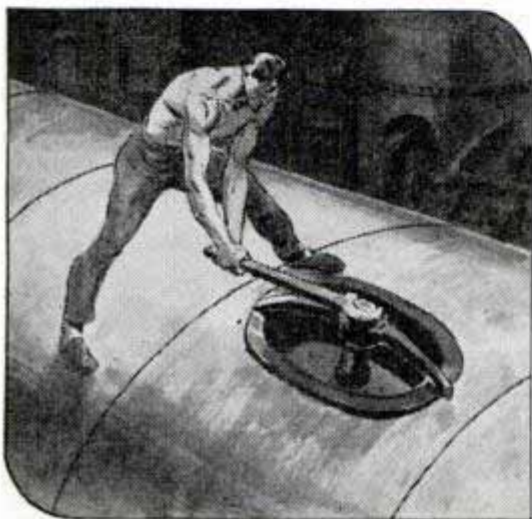

"I heard the clank of the steel manhole cover slam into place! The fireroom crew thought I was out of the boiler. A rush of water told me they were filling her up again!"

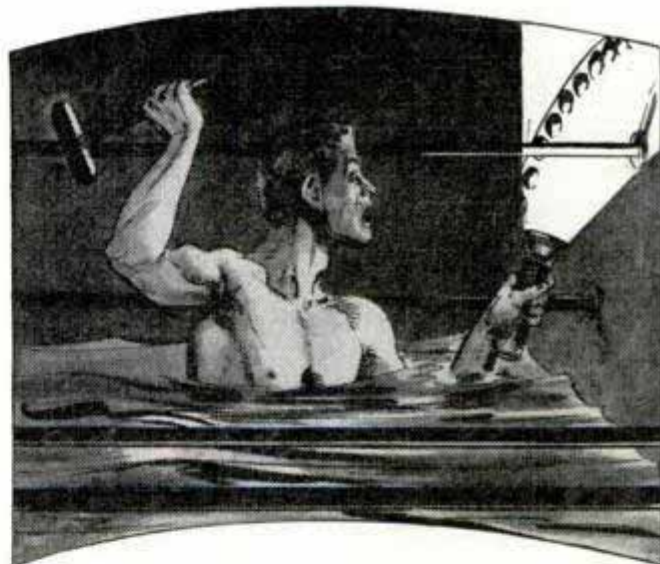

"As panic seized me, I dropped my hammer, the only possible means of being heard out there in the fireroom. But I did hang onto my flashlight and those *fresh* DATED 'Eveready' batteries kept on doing their stuff ... so, when I pulled myself together, I found the hammer and pounded mightily for aid as the water crept higher and higher.

"Yes, they heard me, or I never would have come out of that boiler alive ... so I'm thanking fresh 'Eveready' batteries for being here today.

(SIGNED)

*James Elwood*

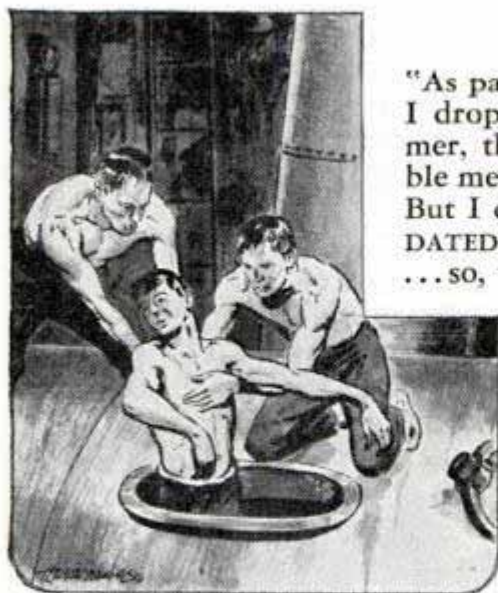

**FRESH BATTERIES LAST LONGER... Look for the DATE-LINE**

NATIONAL CARBON COMPANY, INC., 30 EAST 42nd STREET, NEW YORK, N. Y.

When writing to advertisers please mention Popular Mechanics



## CLEAN PLUGS PEP UP YOUR CAR and save 10% on gas

The statement that dirty spark plugs waste gasoline is based upon fuel consumption tests observed and verified by the Department of Engineering Research of the University of Michigan. The reason why this waste occurs is the fact that dirty plugs misfire intermittently, especially at high speeds and on hard pulls. Dirty plugs behave that way because the dirt (oxide coating) acts as an electrical conductor when hot. Obviously, fuel not ignited is wasted. Misfiring also steals engine power, and causes hard starting. So, in the interests of economy and of engine performance, it is good practice to have your spark plugs cleaned every 4,000 miles and to replace those that are badly worn. There are 70,000 Registered AC Cleaning Stations waiting to serve you. Their charge is only 5c a plug.



Look for this  
SIGN  
When you need plugs  
or plug service.



REPLACE PLUGS  
THAT ARE WORN  
WITH AC  
QUALITY  
SPARK PLUGS

AC SPARK PLUG DIVISION  
General Motors Corporation • FLINT, MICH.

## (Contents—Continued)

Transparent oilcan .....	864
Double wrench for hub bolts of dual wheels .....	880
Hydraulic power for small shops .....	894

### MISCELLANEOUS

Boy's hobby pays way through school .....	817
Shooting gallery uses movie of game as target .....	823
Streamline locomotive latest on foreign road .....	823
Cable car rides above flooded canyon .....	824
Hand tool pulls railroad ties .....	824
"Death rays" sterilize air, stop mold growth .....	831
Homemade bicycle trailer aids newspaper carriers .....	832
Lamp giving polarized light .....	838
Making navy's big guns calls for precision .....	845
Big shoe on auto latest in advertising .....	846
Compass mounted on handlebar of bicycle .....	848
Humane muzzle for the dog .....	849
Science probes secrets of Stradivarius violin .....	853
War tanks ineffective against trained troops .....	854
Long-burning super-match starts fire easily .....	864
Coal heater in trailer converted into oil burner .....	871
Emergency lamp burns in a bucket of water .....	876
Submarine micro-telescope reveals underwater life .....	876
Anti-aircraft gun sprays sky with steel .....	877
Giant bearing to support largest telescope .....	877
Law violators take lesson from model city .....	879
Tagging of sardines solves migration puzzle .....	881
Paint container and cover fit spray gun .....	886
Stratosphere rocket is latest of thrill rides .....	887
Dental patient administers own gas .....	888
Locks made non-pickable by special cylinder .....	888
Odd restaurant like zeppelin attracts tourists .....	889
Dolls from scrap metal latest of hobbies .....	896
Meteorites are worth cash to finder .....	896

## Craftsman and Shop Notes

### AUTOMOTIVE

Emery stop for sharpening tire-patching knives .....	958
False bottom in cupboard to store valuables .....	958
Storage batteries dismantled with heat gun .....	958
Car lock lubricated with insect-powder blower .....	959
Cars parked in garage at an angle .....	959
Pinion gear serves as funnel strainer .....	959
Three-way tool to lift cylinder heads .....	959
Inside door handles removed with aid of washer .....	960
Jig to clean piston-ring grooves .....	960
Lamp for examining interior of storage battery .....	960
Windshield wiper operated by vacuum cleaner .....	960

### BOATS

Adjustable footrest for boat .....	920
Rubber holders support oars while fishing .....	922
Non-slip covering for boat seat .....	924
Before launching your boat—Part II .....	931
Outboard motor moved on detachable wheels .....	936

### CAMPING, FISHING, HUNTING

Camper's potlids have removable finger grips .....	910
Tin cans protect legs of picnic table .....	915
Two ideas for camping trip .....	915
Clothespins hold picnic cloth to ground .....	922
Emergency dipper from tin can .....	930
Emergency vise for fishermen .....	940
Springs keep tent taut .....	940
Supports for carrying fishing rod in boat .....	943

### ELECTRICAL

Christmas-tree lamps used in railroad signals .....	925
Portable alarm unit for icebox drip pan .....	942
Automatic signal for filling station .....	958

### FARM

Adjustable ropes to support fruit-tree limbs .....	920
Chicken coops made from oil drums .....	944
Singletree hooks that hold harness traces .....	954

### FURNITURE

Utility racks for bath room .....	903
"Peg-leg" coffee table with drop leaves .....	908
Bookcase table and filing cabinet combined .....	923
Doors and lids that roll .....	941

### HAND TOOLS

Protecting hand plane on bench .....	906
Mallet given soft nose by rubber band .....	925
Corner angle improves pocket tape .....	928
Hack-sawing large work .....	934

(Continued to page 8A)





C. E. VETH

*Gets SACCO products on the way to customers for less money . . .*

# How dare you say, "I have no opportunity"

—when men and women, thru the  
new home-study training, are mak-  
ing records such as these?



B. J. MERTZ

*Not content, he, to remain a teacher at low pay.*

**Y**OU seek a better opportunity to get ahead in business—and you don't want "promises"; you want a definite program for advancement, backed by positive proof that that program *works!*

Listen, then, to these actual experiences—and when you have heard them, tell us, if you can, how you *dare* to say, "I have no opportunity!"

## Earns Raises Totalling 324%

Take the case of C. E. Veth, holding a good job as traffic manager. Many a man would have rested content. Not Veth! Not while it was possible to keep right on moving up in his firm—the Smith Agricultural Chemical Co. of Columbus and Indianapolis. Note what Veth did:

"How," he asked himself, "can I get *more* money? What will *make* me worth more to them? I'm already giving them full value in time and hard work. But if only I could . . ."

And then he saw the way! *He would save them so much money that they could easily give him a fine raise yet still be money ahead!*

So, Mr. Veth watched for ways to do it. He found a few. But his knowledge of the possibilities was limited. At length, a day came when he realized that he needed to *know* more before he could *earn* more. That day he sent us just such a coupon as you see on this page!

What happened? In a single year he detected \$10,600 worth of mistakes in charges that his LaSalle training enabled him to correct—to *save* for his firm. Yes, he got his raise. And another. And still others. *324% at latest report to us.*

## 700% Increase in 7 Years

From teacher in a rural Texas school to foundry Office Manager and Acting Secretary *in four years*—at a salary *five times* his former one! And in three years more, B. J. Mertz had become Comptroller and a Director in the Buckeye Union Casualty Co. with a *yearly income 700%* greater than when he mailed the LaSalle coupon. Higher accountancy *training* did it for Mr. Mertz—yes, training plus the *backbone* to get out of an ill-paid rut into the "big time."



BERNICE ROACH

*No single diploma would satisfy when several would win bigger success . . .*

## Women, Too, Increase Their Success

For instance, Miss Bernice Roach! Already well paid, she nevertheless *doubled* her income, *quickly*—three months after winning her LaSalle diploma and passing her Certified Public Accountant's examination! "A lucky day for me," she says of the day she enrolled for LaSalle accountancy. Yet what she did, others can do—and *are* doing!

## Send for These Free Books

You, too, are eager to get ahead? Then you will find it of vital importance to learn more of the success-methods which Veth, Mertz, Miss Roach and many others have employed so profitably.

We have therefore prepared a special 64-page book which outlines these methods in detail. It also points out the big opportunities in the field you are in or wish to enter—shows you how you may fit yourself to *grasp* them!

The coupon brings this book to you without cost or obligation.

Measure your will to succeed by what you do with this coupon—NOW!

LASALLE EXTENSION—Chicago

Dept. 664-R

Chicago

I would like to have your special booklet—without any cost or obligation to me—about my opportunities and your success training in the business field I have checked below.

- Higher Accountancy
- Business Management
- Modern Salesmanship
- Traffic Management
- Law: Degree of LL. B.
- Commercial Law
- Industrial Management
- Business Correspondence

- Stenotypy
- Credit and Collection Correspondence
- Modern Foremanship
- Expert Bookkeeping
- C. P. A. Coaching
- Business English
- Effective Speaking
- Office Management

Name.....

This One

Present Position....



6APX-D7N-UFTD

Address.....

**LaSalle Extension** Adult Business Training

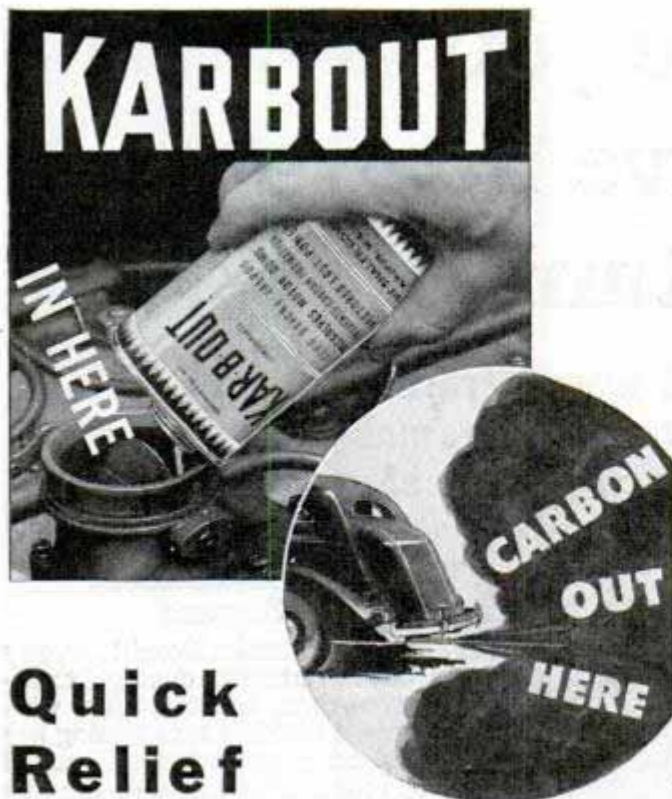

## Quick Relief Lost Power Restored

KARBOUT dissolves the gums and frees carbon which forms on piston heads, in piston ring grooves and on valve stems—allowing it to pass off with the exhaust.

This concentrated Gum Solvent dissolves all types of motor gums—frees your engine of sticky valves—eliminates carbon formations—equalizes compression in all cylinders—restores lost power—snaps up acceleration—stops “motor ping”—and makes your engine quieter and smoother running.

### Get a Karbout Clean-out

Over 100,000 garages and service stations carry Karbout—and can give you a clean-out treatment *while you wait*, for only \$1.00, or you can buy handy 8-oz. cans for giving your motor a treatment—and by regular use in your gasoline prevent further gum and carbon formations that rob you of power.

For Quick relief, give your motor a Karbout clean-out today . . . Descriptive pamphlet sent on request.

**THE SHALER COMPANY**  
Waupun, Wis.

### Try This Saucer Test



Take an old piston ring on which there are heavy gum and carbon formations, and place it in an ordinary saucer, covering the ring with KARBOUT. In a

short period of time you will find that with the whisk from a broom, you will be able to clean out the oil ring slots of gum and carbon formations. KARBOUT is guaranteed not to attack or corrode any part of the engine or carburetor.

**SHALER KARBOUT**

## (Contents—Continued)

Sheepskin on workbench oils hand plane . . . . .	934
“Fur-lined” screwdriver protects finished work . . . . .	936
Counting threads in tapped hole . . . . .	944
Rack holds small tools for easy selection . . . . .	952
Lid on toolbox serves as handle . . . . .	952

### HOME IMPROVEMENTS

Kitchen knife and brush holders . . . . .	907
Extra rooms in the attic . . . . .	917
Sewing nook sets any place in home . . . . .	924
Patching plastered walls . . . . .	928
Sidewalk decorated with tree leaves . . . . .	934
Iron handle kept cool with cardboard . . . . .	934
Chinese banjos add decorative touch to den . . . . .	935
Clothespins on hooks to hang garments . . . . .	936
Home problems easily solved . . . . .	938

### LAWN AND GARDEN

“Check-row wire” assures uniform garden planting . . . . .	906
Creeping weeds pulled with aid of shoehorn . . . . .	910
Growing plants in a window box . . . . .	911
Emergency garden-hose nozzle from sprinkler can . . . . .	920
Empty seed packages mark garden rows . . . . .	920
Decorative feudal castle for your fish pool . . . . .	937

### METAL WORKING

Foot scrapers of heavy sheet metal . . . . .	905
Turning in a drill press . . . . .	944
Metals in color . . . . .	947

### PHOTOGRAPHY

Negatives dried on towel rack . . . . .	904
Printing photos on glossy paper . . . . .	915
Exposure time marked on negative with needle . . . . .	920
Improving cable release on camera . . . . .	928
Getting exposure time for photo filter . . . . .	930
Cleaning miniature-camera film . . . . .	936

### POWER TOOLS

Depth gauge for setting circular saw . . . . .	913
Eccentric tool-post holder for lathe . . . . .	945
Supporting long lathe turning tool . . . . .	954

### STORE AND SHOP

Paper gauge for the typist . . . . .	905
Diluting showcard colors . . . . .	937
Funnel on glue brush keeps handle clean . . . . .	944
Cutting wrapping paper into sheets . . . . .	946
Saddle holds milk cans while being repaired . . . . .	946
Linoleum unrolled to show customer pattern . . . . .	951

### MISCELLANEOUS

Canvas drawer catches parts dropped from vise . . . . .	905
Clothespin lock opened with match . . . . .	906
Drying rubber boots quickly . . . . .	906
Gauge assures uniform lettering . . . . .	907
Chicken hobbles from clothespins . . . . .	910
Flat boat inverted on oil drum for diving board . . . . .	910
T-square carried on underside of drawing board . . . . .	910
Large rock broken with water . . . . .	913
Cushion feet for glass graduates . . . . .	922
Handkerchief in pocket shaped with cardboard . . . . .	922
Keeping slide-rule case closed . . . . .	922
Non-sag support arm for workbench lamp . . . . .	924
Rubber hose on stirring rod . . . . .	924
Simple miter box for workshop . . . . .	925
Novelties from Cellophane straws . . . . .	926
Cutting tenons for ship models . . . . .	928
Windmill pump aerates outdoor fish pool . . . . .	929
Invisible support for flowers . . . . .	930
Water gauge made easy to read . . . . .	930
Clothesline kept taut with auto spring . . . . .	934
Tumbling-acrobat toy . . . . .	937
Electrical trimmer shapes arrow feathers . . . . .	943
Loop hinge to open stepladder . . . . .	944
Spanish flat-tile roof imitated with cement . . . . .	945
Drawing parallel lines that are equally spaced . . . . .	946
Emergency door stop and bumper . . . . .	951
Adjustable arbor catcher . . . . .	952
Sanders for the modelmaker . . . . .	952
Circles quickly divided into number of parts . . . . .	953
Extra current for engines having flywheel magnetos . . . . .	953
Drill gauge shows size at a glance . . . . .	954
Long spout on tube of cement . . . . .	954
Printing pictures on aluminum foil . . . . .	955

### IMPORTANT NOTICE

It is the intention of this magazine to provide its readers with information regarding the latest developments in the mechanical arts. We take no responsibility as to whether the disclosures contained in our articles are covered by patents and advise readers to investigate this subject before making, using, or selling any of the products, machines, or processes described, in order to avoid possible liability for patent infringement.



## "SHOP PRACTICE & HOME STUDY - brother, they go together!"

● "I work in the shop every day. And a couple of hours every evening, I study. Study what? I don't mind telling you — an I. C. S. Course! Take it from me, shop practice and home study go together. When you combine them you are headed toward more pay — provided you do the same thing I did by mailing a coupon like the one below."

### INTERNATIONAL CORRESPONDENCE SCHOOLS

BOX 5515-J, SCRANTON, PENNA.

★ Without cost or obligation, please send me a copy of your booklet, "Who Wins and Why," and full particulars about the subject *before* which I have marked X: ★

- |  |   |   |  |  |
|--|---|---|--|--|
| <input type="checkbox"/> Architect                 | <input type="checkbox"/> Sheet Metal Worker       | <input type="checkbox"/> Plumbing                               | <input type="checkbox"/> Steam Fitting                               | <input type="checkbox"/> Bridge Engineer             |
| <input type="checkbox"/> Architectural Draftsman   | <input type="checkbox"/> Boilermaker              | <input type="checkbox"/> Heating                                | <input type="checkbox"/> Ventilation                                 | <input type="checkbox"/> Bridge and Building Foreman |
| <input type="checkbox"/> Building Estimating       | <input type="checkbox"/> Telegraph Engineer       | <input type="checkbox"/> Air Conditioning and Cooling           | <input type="checkbox"/> Steam Engine                                | <input type="checkbox"/> Chemistry                   |
| <input type="checkbox"/> Contractor and Builder    | <input type="checkbox"/> Telephone Work           | <input type="checkbox"/> Marine Engineer                        | <input type="checkbox"/> Steam Electric Engineer                     | <input type="checkbox"/> Pharmacy                    |
| <input type="checkbox"/> Structural Draftsman      | <input type="checkbox"/> Mechanical Engineering   | <input type="checkbox"/> R. R. Locomotives                      | <input type="checkbox"/> R. R. Section Foreman                       | <input type="checkbox"/> Coal Mining                 |
| <input type="checkbox"/> Structural Engineer       | <input type="checkbox"/> Mechanical Draftsman     | <input type="checkbox"/> Air Brakes                             | <input type="checkbox"/> R. R. Signalmen                             | <input type="checkbox"/> Mine Foreman                |
| <input type="checkbox"/> Management of Inventions  | <input type="checkbox"/> Machinist                | <input type="checkbox"/> Highway Engineering                    | <input type="checkbox"/> Civil Engineering                           | <input type="checkbox"/> Fire Bosses                 |
| <input type="checkbox"/> Electrical Engineer       | <input type="checkbox"/> Patternmaker             | <input type="checkbox"/> Surveying and Mapping                  | <input type="checkbox"/> Agriculture                                 | <input type="checkbox"/> Navigation                  |
| <input type="checkbox"/> Electric Lighting         | <input type="checkbox"/> Diesel Engines           | <input type="checkbox"/> Commercial Refrigeration               | <input type="checkbox"/> Fruit Growing                               | <input type="checkbox"/> Cotton Manufacturing        |
| <input type="checkbox"/> Welding, Electric and Gas | <input type="checkbox"/> Aviation Engines         | <input type="checkbox"/> Business Training Courses              | <input type="checkbox"/> Poultry Farming                             | <input type="checkbox"/> Woolen Manufacturing        |
| <input type="checkbox"/> Reading Shop Blueprints   | <input type="checkbox"/> Automobile Mechanic      | <input type="checkbox"/> Service Station Salesmanship           | <input type="checkbox"/> Grade School Subjects                       | <input type="checkbox"/> Agriculture                 |
| <input type="checkbox"/> Heat Treatment of Metals  | <input type="checkbox"/> Commercial Refrigeration | <input type="checkbox"/> First Year College Subjects            | <input type="checkbox"/> High School Subjects                        | <input type="checkbox"/> Fruit Growing               |
|  |   | <input type="checkbox"/> Business Correspondence                | <input type="checkbox"/> College Preparatory                         | <input type="checkbox"/> Poultry Farming             |
|  |   | <input type="checkbox"/> Stenography and Typing                 | <input type="checkbox"/> Illustrating                                |  |
| <input type="checkbox"/> Business Management       | <input type="checkbox"/> Bookkeeping              | <input type="checkbox"/> Civil Service                          | <input type="checkbox"/> Cartooning                                  |  |
| <input type="checkbox"/> Industrial Management     | <input type="checkbox"/> Secretarial Work         | <input type="checkbox"/> Railway Mail Clerk                     | <input type="checkbox"/> Lettering Show Cards                        | <input type="checkbox"/> Signs                       |
| <input type="checkbox"/> Traffic Management        | <input type="checkbox"/> Spanish                  |   |  |  |
| <input type="checkbox"/> Accountancy               | <input type="checkbox"/> French                   | <input type="checkbox"/> Domestic Science Courses               |  |  |
| <input type="checkbox"/> Cost Accountant           | <input type="checkbox"/> Salesmanship             | <input type="checkbox"/> Home Dressmaking                       | <input type="checkbox"/> Foods and Cookery                           |  |
| <input type="checkbox"/> C. P. Accountant          | <input type="checkbox"/> Advertising              | <input type="checkbox"/> Professional Dressmaking and Designing | <input type="checkbox"/> Tea Room and Cafeteria Management, Catering |  |

Name.....Age.....Address.....

City.....State.....Present Position.....

If you reside in Canada, send this coupon to the International Correspondence Schools Canadian, Limited, Montreal, Canada

When writing to advertisers please mention Popular Mechanics



# There's Quicker, Bigger MONEY for YOU-in POULTRY

**Earn \$1,000 to \$2,500 a Year or Have a Business of Your Own!**



Whether you want a job at good pay or a highly profitable business of your own—Poultry Raising offers you more than any other easily-learned trade or profession. Poultry meat and eggs are always in demand—and there is a shortage of trained poultrymen. My Home Study Course trains you quickly to fill a good job in poultry—and my Personal Employment Assistance will help you get one!

**FREE Book Shows the Way to Big Pay and BIG Profits**

Mail coupon below TODAY—for my Big NEW FREE Book, "How to Raise Poultry for Profit." My forty years of experience are yours. The Poultry Industry needs YOU. You need my book. Get it—and get in line for the BIG Money that's waiting for you in POULTRY.

**Spare Time or Full Time YOU CAN Cash-in BIG**

No matter where you live—city, town or country—or what you do now, my proved methods will assure your success right from the start. I'll help you make from \$1,000 to \$2,500 a year and UP! And, if you choose to start your own business, I'll show you how to make your tiny investment multiply itself automatically. What I've done for thousands of others—I can do for you.

**Mail NOW for FREE Book**

**NATIONAL POULTRY INSTITUTE, Dept. 32-D, Adams Center, N.Y., Attn: Harry M. Lamon, Pres.**

Dear Mr. Lamon: Send me your FREE Book, "How to Raise Poultry for Profit." I want to know more about my opportunity to make \$1,000 to \$2,500 a year, spare or full time.

Name.....

Address.....

# Learn this Profitable Profession



**in 90 Days at Home**

Hundreds of men and women of all ages 18-50 make \$10.00 to \$20.00 in a single day giving scientific Swedish Massage and Hydro-Therapy treatments. There is a big demand from Hospitals, Sanitariums, Clubs, Doctors and private patients as well as opportunities for establishing your own office. Learn this interesting money-making profession in your own home by mail, through our home study course. Same instructors as in our **NATIONALLY KNOWN** resident school. A diploma is awarded upon completion of the course. Course can be completed in 3 to 4 months. High School training is not necessary. Many earn big money while learning.



**Anatomy Charts & Booklet FREE**

Enroll now and we will include uniform coat, medical dictionary, patented reducing roller and Hydro-Therapy supplies without extra cost. The reducing course alone may be worth many times the modest tuition fee.

Send coupon now for Anatomy Charts and booklet containing photographs and letters from successful graduates. These will all be sent postpaid—FREE.

**THE College of Swedish Massage (Successor to National College of Massage) Dept. A77—1601 Warren Boulevard, Chicago.**

You may send me **FREE** and postpaid, Anatomy Charts, booklet containing photographs and letters from graduates, and complete details of your offer.

Name.....  
Address.....  
City..... State.....

# PARKS AIR COLLEGE

PARKS AIRPORT EAST ST. LOUIS, ILL.

**Offers COLLEGE and PROFESSIONAL TRAINING Majoring in AVIATION**

FOUR courses lead to B.S. degrees in Professional Piloting, Aviation Operations, Maintenance Engineering, Aeronautical Engineering.

TWELVE TRAINING PLANES are used in professional flight training which prepares graduates for airline flight operations. 74% of graduates enter air transportation in North and South America. 64,000 hours flight training given, 650 hours being flown monthly.

FACULTY of 33 specialists in various fields of aviation.

1477 graduates. Capacity enrollment of 302 for Fall term.

100-acre airport, 14 buildings devoted to school purposes exclusively. Dormitories and dining hall on the Field.

Accredited by the Illinois Superintendent of Public Instruction. Government approved as a Transport Ground and Flying School and Mechanics' School. Open to high school graduates.

Summer term July 5th. Send postcard for new 60-page catalog.

Registrar, Dept. PM-6

**11th YEAR PARKS AIR COLLEGE, East St. Louis, Ill.**

# AUTO-MECHANICS & WELDERS

Auto Mechanics and Welders are in big demand. Complete courses in arc and acetylene welding, body and fender bumping, spray painting and metal finishing. Pay after graduation plan. Special low rates. Write today.

**MICHIGAN TRADE SCHOOL**  
3758 Woodward Ave., Detroit, Mich.

Write for FREE CIRCULAR

# LEARN RADIO TELEVISION

**Midland's** Color-Coded Extension Training fits you for better radio jobs—prepares for future television opportunities. Backed by 5000-watt Columbia basic network broadcasting station, KMBC. Graduates qualified to take Government operator's license exams. Lifetime employment service. All necessary equipment for "home laboratory" experiments furnished; 90 illustrated lessons, 10 laboratory manuals. After "home training," bus ticket to Kansas City for 4 weeks' intensive training in laboratories. Get facts—write for free catalog.

**MIDLAND TELEVISION, Inc., Power & Light Bldg., 106-F W. 14th St., Kansas City, Mo.**

# GAG-CARTOON!



AND MAKE BIG MONEY—AT HOME—BY MAIL! Minimum pay up to \$200.00 per cartoon. Get in this **NEW FIELD** and be your own boss! My 50 lessons—1000 illustrations course shows you how. **FREE CARTOON MARKETS INCLUDED—\$280**

Send for FREE details,  
**MOON GAG-CARTOON SCHOOL**  
Box 106—Dept. A6, Fall Creek, Wis.

# I WANT MEN

FORDS GIVEN

**TEA AND COFFEE ROUTES PAYING UP TO \$60.00 IN A WEEK**



National company needs more men at once to make regular calls on local routes. No experience needed. Operate on our capital. I give producers brand-new Ford cars as bonus. Rush name on postcard for FREE facts.

**ALBERT MILLS**  
5250 Manmuth Cincinnati, Ohio

**MAIL FOR FREE INFORMATION**

# BROOKLYN YMCA TRADE SCHOOL

1117 Bedford Ave., Dept. PM-61  
Brooklyn, New York City, N. Y.

- Diesel Engines
- Diesel Technical
- Aviation Mechanic
- Aeronautical Technical
- Auto Mechanic
- Refrigeration
- Radio and Television Mechanic
- Air Conditioning
- Architectural-Mechanical Drafting
- Electrical
- Armature Winding
- Oil Burner
- Welding
- Talking Pictures
- Machine Shop
- Window Display

Name.....

Address.....

# Become a Draftsman

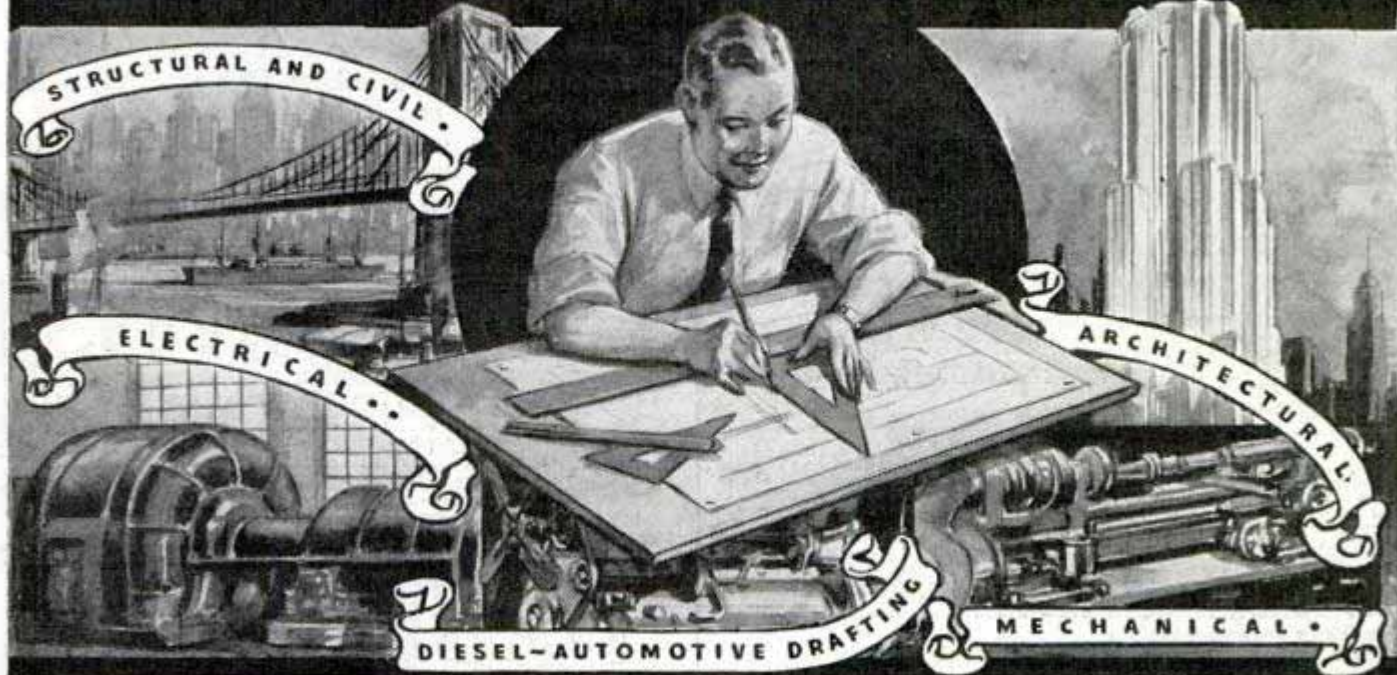

## Enjoy a Real Job in Industry

### Steady Work

As nearly all manufacturing—construction—building starts on the drafting table, the draftsman is one of the first to be hired and one of the last to be laid off. It is his blueprints, his specifications, that give the last word in what the workmen are to do. No article—building or construction job is started before the plans drawn by the draftsman have been officially approved.

### Good Pay

The draftsman has been called the Junior Engineer which title just about describes his work—position and pay. He combines his knowledge of principles, mechanism and construction details with the ability to draw and reproduce motions and methods on paper. On the average, his salary is considerably above the wages of the mechanic and, of course, less than that of the engineer.

### Chance for Promotion

Working on plans, helping design new machines or new methods of construction, the draftsman is working directly with the important men of the organization. Consequently he knows what is being considered and planned. It may be the superintendent—the engineer—or even the prospective buyer with whom he consults. Because of these contacts, his experience and knowledge of the business in general he is in an excellent position to be promoted when next there is a good opening.

### Young at 40

Athletes—farmers—and factory and shop workers who rely on muscle start growing old even before they reach 40 while office workers—executives—teachers—professional men, in fact, all kinds of brain-workers are just approaching their prime at 40 to 50. Training increases your value at once and continues to help boost your earning power as you mature.

### Don't Be Just Average

What happens to the average man? Not having thorough training for a worth-while job, he goes along year after year, wishing he had a good job, but wishing was never a substitute for training. \$40 a week is about his top, usually never that high. Grows old on the job, starts down at 40, finds himself slipping in speed and salary.

But the ABOVE AVERAGE MAN loses no time getting his training. Prepared for the job ahead, he is in line for RAPID PROGRESS—his WORK STEADY, his PAY GOOD. Trained, a young executive, young Draftsman drawing plans for great projects, YOUNG ON THE JOB at 40, at 45, at 50! And still has 10 or 15 years active service at good pay to which he can look forward! Training—the sooner you get it—the sooner it can help LIFT YOU ABOVE THE AVERAGE!

**Don't grow old at 40.** Train now for the job you want at 50. Training helps you to be independent—self-supporting. It helps you to enjoy associations that are denied the untrained man. Training helps you to increase your earning power and by so doing to offer members of your family advantages far in excess of what you could give them as an untrained man. Train and enjoy PROGRESS—CONTENTMENT—INDEPENDENCE.

**American School, Drexel at 58th, Chicago**

### Get the Facts—Write Today

**American School, Dept. DDA-45**  
Drexel Avenue at 58th Street, Chicago

Without the slightest obligation, send complete facts "How I can become a Draftsman" and free bulletin.

Name.....Age.....

Address.....

City.....State.....

# Air-Conditioning Books

shipped **FREE** on approval

Grab this opportunity to get the most up to date information on this new profession, which is bound to revolutionize building. From start to finish these 6 great books cover the whole field, from air conditioning old houses, converting old heating systems to the proper method of design and installation for use in the most modern buildings. It won't be long before every carpenter, every architect, every plumber or anyone who has anything to do with building will be expected to be fully familiar with the science of air conditioning. Here is your opportunity to get this information FREE for trial.

## Over 2000 Pages - 800 Illustrations

These books are beautifully bound in modernistic binding simulating leather and are chock full of invaluable information for any one in the building field. Whether you are a beginner or an expert, you should have a set of these books which will be sent to you upon your FREE examination offer. Send the coupon—the full set of 6 big volumes will be forwarded promptly.

### Membership

#### FREE

Send now and we will include a membership in the American Technical Society giving privilege of consultation with our engineers for one year on any difficult problem without cost.

### New Money Making Profession

Air conditioning is new but it is already in great demand and men who are smart enough to get into this work now are bound to profit by their foresight. Up to now very little information has been available. Men who knew much about the subject have guarded this information jealously, but here is the most up-to-date information and it all comes to you without any obligation other than to examine it before you decide whether or not you want to keep the books. Don't delay. Be the first in your locality to fit yourself for a profession which will probably grow like wildfire as soon as the coming building boom gets under way. Send the coupon today.

American Technical Society  
Drexel Ave. & 58th St., Dept. KA19, Chicago, Ill.

I would like to see the new 6-volume edition of your Air Conditioning Books. I will pay the few cents delivery charges only, but if I choose to, I may return them express collect. If after 10 days use I prefer to keep them, I will send you \$2 and pay the balance at the rate of only \$3 a month, until \$24.80 is paid. Please include free consulting membership as per your offer above.

Name .....

Address .....

City .....

State .....

Attach letter stating age, occupation and name and address of employer and that of at least one business man as reference.



## Know Electricity as Experts Know It—and Get an Expert's Pay!

Recovery has begun! The months ahead are charged with significance and expectation. What will you do to get the jump on the other fellow? Thousands of men have used

## The Croft Library of Practical Electricity

The Croft Library is a complete electrical educator. It is founded on practice—on 20 years of shirt-sleeve experience—on work as it is actually done. It is jammed from cover to cover with the kind of hard-headed facts you want. Written so that the beginner can easily understand it, yet so sound, so thorough, that it is the daily guide you need to know about motors, generators, armatures, commutators, transformers, circuits, switchboards, distribution systems—electrical machinery of every type—wiring for light and power—wiring of finished buildings—underwriters' and municipal requirements—illumination in its every phase—the most improved methods of lighting—lamps and lamp effects, etc.—how to do a complete job, from estimating it, to completion.

### No money down—easy payments

Fill in and mail the coupon attached and we will send you the entire set of seven volumes for ten days' Free Examination. We take all the risk—you assume no obligation. If you decide to keep the books, send \$1.50 in ten days and the balance at the rate of \$2.00 a month. Send the coupon NOW and see the books for yourself.

### FREE EXAMINATION COUPON

McGraw-Hill Book Co., 330 W. 42nd St., New York  
Send me for ten days' free examination the Croft Library of Practical Electricity. If satisfactory I will send you \$1.50 in 10 days and \$2.00 monthly until the price of \$19.50 is paid. If not wanted, I will return the books postpaid. (To insure prompt shipment write plainly and fill in all lines.)

Name .....

Home Address .....

City and State .....

Position .....

Name of Company .....

## ELECTRICAL ENGINEERING ONE YEAR CONDENSED COURSE

Prepares for technical work in the electrical field. Thorough training in principles, with practical applications in laboratory and shop. High placement record. Modern buildings, dormitory, dining hall. Campus. 46th year. Catalog on request.



**BLISS ELECTRICAL SCHOOL**  
116 Takoma Ave., Wash., D. C.

## AVIATION APPRENTICES



**BIG PAY GOOD FUTURE**  
IF YOU ARE INTERESTED IN WORKING YOURSELF INTO A HIGHLY PAID POSITION IN AVIATION—Write, immediately, enclosing stamp—  
**MECHANIX UNIVERSAL AVIATION SERVICE CO.**  
Dept. E  
Strathmoor Station Detroit, Mich.

## TRAIN FOR Radio IN 12 WEEKS

BY SHOP WORK  
I'll Finance Your Training  
Prepare for jobs in Broadcasting, Talking Pictures, Television, Wireless, etc., by 12 weeks practical shop training in Coyne Shops. Free Employment Service. Many earn while learning. You don't need previous experience or a lot of book learning. Write for **BIG FREE RADIO and TELEVISION BOOK**, and my "Pay-Tuition-After-Graduation" Plan.  
H. C. LEWIS, Pres., RADIO DIV., Coyne Electrical School  
500 S. Paulina Street Dept. AS-3H Chicago, Illinois

## CARTOONING

**PAYS WELL** Turn your talent into dollars  
Develop your ability with personal instruction from an internationally-known cartoonist. His exclusive, successful method of drawing and creating ideas makes it easy to attain success. Write for Free Booklet and details of this exceptional home-study course.  
The National School of Cartooning, 437 Penton Bldg., Cleveland, Ohio



*Learn to Write*

Begin Today. Write for our Free Book, "How to Become a Good Penman." It contains specimens and tells how others learned to write in spare time. Your name elegantly written on a card if you enclose stamp for postage. Write today. The Tamblyn School of Penmanship, 418 Ridge Bldg., Kansas City, Mo.

## AUTOMOTIVE ENGINEERING



Bachelor of Science Degrees—in Automotive, Aeronautical, Architectural, Chemical, Electrical, Industrial and Mechanical engineering! Modern equipment. All college activities. Low tuition. Write today for Catalog.

A NON-PROFIT COLLEGE

LAWRENCE INSTITUTE OF TECHNOLOGY  
15102 Woodward Ave.  
DETROIT, MICH.

CATALOG ON REQUEST

## MAKE MONEY AT HOME

**RUBBER MOLDS** Low as 6¢ EA.

Amazing rubber mold-making outfit makes perfect flexible molds of plaques, ash trays, book-ends, etc. Each mold makes hundreds of novelties and gifts to sell up to \$1.00 apiece! No experience necessary. Start profitable business in your home... sell to stores, friends, resorts, road stands or by mail—NOW! Full or spare time. "Molder's Handy Book" and list of buyers FREE! Write



**SO-LO WORKS**  
Dept. F-827 Cincinnati, Ohio

# MASS PRODUCTION

# DIESEL ENGINES

## Sweeps THE COUNTRY

★ HEMPHILL DIESEL  
RESIDENT SCHOOLS

### GREATER OPPORTUNITIES THAN EVER BEFORE NOW OPENING TO HEMPHILL DIESEL TRAINED MEN

Millions have been poured into modern mass production plants. New type Diesels are now on the market for automotive and many uses never before considered practical. NATION-WIDE DIESELIZATION IS HERE.

Five years ago Hemphill Schools predicted leading automotive builders would enter the Diesel field. Hemphill training anticipated these history making advances. Shops, laboratories and theory offered in the Day, Night, and Combination Home Study with later Shop Training Courses, have been kept up to the minute.

Never before have Hemphill Diesel Schools' students had greater opportunities before them. Eight completely equipped practical training schools are located in important marine, automotive and industrial centers—in U.S. and Canada—ready and thoroughly able to train men for this specialized field.

No matter where you live, if you are interested in training that will qualify you for this growing, fascinating industry, send for details on WHAT MASS PRODUCTION OF DIESEL ENGINES MAY MEAN TO YOU. Use coupon, no obligation.

## HEMPHILL DIESEL SCHOOLS

*Send Coupon Today*  
TO NEAREST ADDRESS

BOSTON, 114 Brookline Ave.  
NEW YORK, 31-26 Queens Blvd., L.I. City  
DETROIT, 2341 W. Lafayette Blvd.  
CHICAGO, 2014 Larrabee St.  
MEMPHIS, 417 Monroe Ave.  
LOS ANGELES, 2120 San Fernando Road  
SEATTLE, 501 Westlake North  
VANCOUVER, B.C., 1363 Granville St.

HEMPHILL DIESEL SCHOOLS (addresses at left)

Please rush information on how I may qualify for the Diesel field, and details on your Courses. I am over 18.

NAME \_\_\_\_\_ AGE \_\_\_\_\_

STREET \_\_\_\_\_

CITY \_\_\_\_\_ STATE \_\_\_\_\_

Notwithstanding representation to the contrary, the Hemphill Diesel Schools are in no way associated with any other school of even similar name.

When writing to advertisers please mention Popular Mechanics

# Be on the Payroll... Train at Home as a DRAFTSMAN



If you want to learn drafting as a profession—or if you want to learn drafting to advance in your present work—Engineer Dobe can train you at home in your spare time by his long established, proven-practical "Work-Job" Method.

You'll be amazed at the speed with which you can learn in your spare time by Engineer Dobe's Practical Method.

Send coupon TODAY for free book entitled "Success in Draftsmanship."

**DRAFTING  
Means a  
BETTER JOB-  
MORE PAY-  
ADVANCEMENT**

Engineer Dobe can prepare you just as he has trained thousands of successful students, aged 16 to 18 to past 50. His practical "Work-Job" method requires no previous experience. High school education not needed. He offers you a real opportunity to get a complete training in drafting right in your home in a surprisingly few months. Engineer Dobe teaches his students until thoroughly trained and until holding a good paying job.

## Send for FREE BOOK

The draftsman has rich opportunities for advancement and better pay in scores of fields. In Machinery, Building, Aviation, Electricity, Transportation, Automotives—draftsmen must be used. Many trained draftsmen will be needed on better jobs at better pay and shorter hours.

Mail the coupon today for FREE illustrated book "Successful Draftsmanship" and full details of Engineer Dobe's remarkable offer that includes all necessary tools and equipment. Learn just how you can be trained successfully at home in your spare time. Now is the time to prepare. Send the coupon NOW.

Complete Outfit  
Furnished



**ENGINEER DOBE, Div. A337, Libertyville, Ill.**

Send me your free book "Successful Draftsmanship." Please explain how you assist your graduates to good positions as draftsmen.

Name \_\_\_\_\_

Address \_\_\_\_\_

Town \_\_\_\_\_

State \_\_\_\_\_ Age \_\_\_\_\_

# ENGINEERING

**DEGREE  
IN TWO  
YEARS**

TECHNICAL AND APPLIED COURSES. Nonessentials omitted. TIME AND MONEY SAVED. DEGREE 2 YEARS, DIPLOMA 1 YEAR. Electrical, Mechanical, Architectural, Structural, Civil, Aeronautical, Highway. All courses include Air Conditioning, Electric Refrigeration and Diesel. Short intensive courses 3 and 4 months in Electricity, Power Plant, Diesel, Air Conditioning, Electric Refrigeration, Drafting, Extensive modern equipment. LOW TUITION. Part-time work for room and board. Thousands of successful graduates in U. S. and foreign lands. Approved by Industry, endorsed by educators, recommended by graduates. One and two year courses open in September, short courses open year round. 39th YEAR. Catalog free.

**FINLAY ENGINEERING COLLEGE**  
1001 Indiana Avenue Kansas City, Mo.



**BE A RAILWAY  
TRAFFIC INSPECTOR** WRITE TODAY  
**A GOOD PAYING POSITION  
WITH OUR TRAINING**

ACTIVE MEN—19 to 50—trained as Railway and Bus Passenger Traffic Inspectors earn up to \$135 per month, plus expense, to start, upon completion of our simple, home-study course. We help place graduates or refund tuition. Interesting work; steady pay; splendid opportunities for advancement. Get Free Booklet.

**STANDARD BUSINESS TRAINING INSTITUTE**  
Buffalo, N. Y.



## FOLLOW THIS MAN

Secret Service Operator No. 38 is on the job! Running down dangerous Counterfeit Gang. Tell-tale finger prints in murdered girl's room.

**Free** The Confidential Report Operator No. 38 made to his chief. Write for it.

Earn a Regular Monthly Salary

YOU can become a Finger Print Expert at home in your spare time, at small cost. Write for confidential full report and details. Literature will be sent only to persons stating their age.

**INSTITUTE OF APPLIED SCIENCE**  
1920 Sunnyside Ave. Chicago, Ill.

## You Can Regain Perfect Speech, if you STAMMER

Send today for beautifully illustrated book entitled "DON'T STAMMER," which describes the Bogue Unit Method for the scientific correction of stammering and stuttering. Method successfully used at Bogue Institute for 37 years—since 1901. Endorsed by physicians. Full information concerning correction of stammering sent free. No obligation. Benjamin N. Bogue, Dept. 191 Circle Tower, Indianapolis, Indiana.

## BE AN ARTIST

WE CAN TEACH YOU DRAWING in your own home during your spare time. Thirty-five years of successful teaching proves our ability. Artists receive large salaries.

Write today for Art Year Book  
**SCHOOL OF APPLIED ART**  
Dept. 108-A 10E. Huron St., Chicago, Ill.



## LEARN WATCHMAKING AND ENGRAVING

BY OUR PROFIT-SHARING PLAN  
**OUR GRADUATES SUCCEED**  
One of our Iowa students started in a very small way—now doing over \$30,000 a year. Another in Wisconsin, over \$10,000 the first year. Day or night classes. Call or write for FREE BOOK.  
**Chicago School of Watchmaking, Dept. 6401, 155 N. Clark St., CHICAGO.**

## REFINISHES AUTOS Like NEW!



**PAYS UP TO \$7.00 AN HOUR**

**KAR-NU** refinishes any color automobile easily, quickly and economically without polishing, waxing, rubbing or painting. JUST WIPE IT ON WITH A CLOTH! Magic-like fluid covers old paint with tough, elastic coat. Absolutely transparent, self-leveling, self-polishing. Guaranteed. Lasts 8 to 12 months. Equal in beauty to repaint job costing \$10 to \$35. Write for Free Sample to prove our claims and Territory offer.  
**KAR-NU CO.** Dept. F-30, Oakley Sta. Cincinnati, O.



# AUDELS NEW 1938 AUTO GUIDE ANSWERS YOUR QUESTIONS!

Practical Information in  
Handy Form, 1540 Pages  
—1540 Illustrations.

**KNOW  
YOUR  
CAR!**

**AUTO REPAIRS & SERVICE HELPS**

All the Parts of an Automobile—Automotive Physics—The Gas Engine—How a Gas Engine Works—Gas Engine Principles—Multi-Cylinder Engines—Horse Power—Automobile Engines—Engines: Stationary Parts—Engines: Moving Parts—Pistons—Piston Rings—Connecting Rods—Crank Shafts—The Valves—The Valve Gear—Cams and Cam Action—Valve Timing—Cooling Systems—Gasoline—Fuel Feed Systems—The Mixture—Carburetors—Automatic Choke—Super-Chargers—Transmissions—Synchro-Mesh—Clutches—Universals and Propeller Shafts—The Differential—Rear Axles—The Running Gear—Brakes—Wheel Alignment—Knee Action—Steering Gear—Tires—Lubricants and Lubrication—Automotive Electricity—Ignition Systems—Magneto Ignition—Spark Plugs—Ignition Coils—Distributors—Automatic Spark Control—Ignition Timing—Generators—Starters—Generator and Starter Testing—Lighting Systems—Storage Batteries—Battery Charging—Battery Testing Troubles.

**AUTOMOTIVE DIESEL ENGINES  
Including Questions and Answers**

The contents is progressively arranged; thus making it a text book and a reference book, to which you will refer again and again.

**INSIDE VIEWS OF ALL AUTOMOBILE PARTS FULLY ILLUSTRATED.  
GOOD NEWS—JUST OUT**

AUDELS NEW AUTOMOBILE GUIDE is NEW from cover to cover. Explaining the Theory, Construction and Servicing of modern motor cars, trucks and buses; and the application of auto type Diesel Engines.

Written by an engineering authority and presented with forceful directness in plain language and simple terms, generously illustrated. It is an up-to-date authoritative book of instructions giving a new vision of the automotive field. Covers the entire subject in every detail. Does not deal in idle theories, but gives definite directions telling exactly what to do and how to do it. It is packed full with important information, indispensable to auto mechanics, service men and owners.

**TO GET THIS ASSISTANCE FOR YOURSELF SIMPLY FILL IN AND MAIL COUPON TODAY**

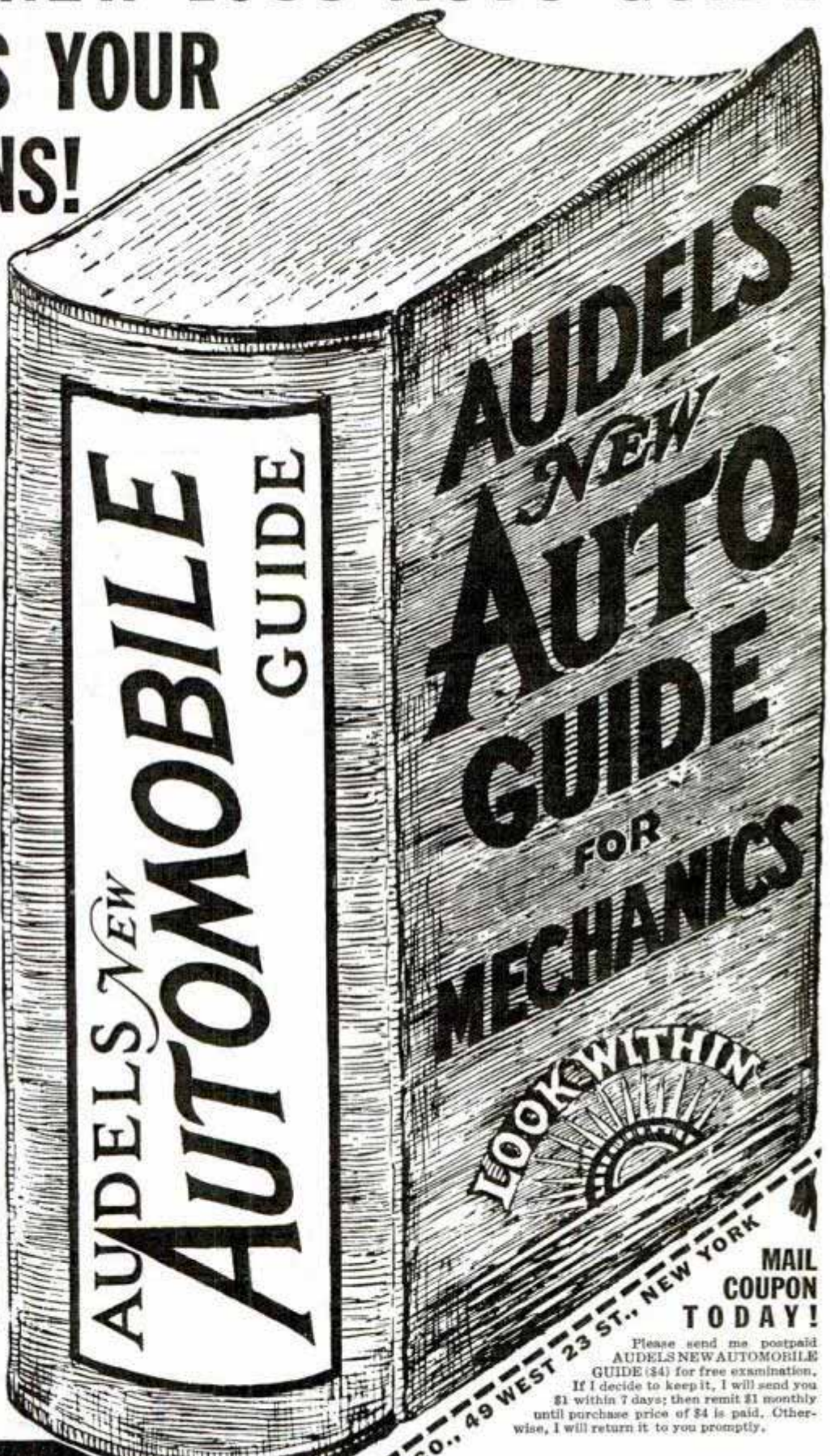

AUDELS <sup>NEW</sup> **AUTOMOBILE** GUIDE

AUDELS <sup>NEW</sup> **AUTO** GUIDE FOR MECHANICS



**MAIL COUPON TODAY!**

Please send me postpaid AUDELS NEW AUTOMOBILE GUIDE (\$4) for free examination. If I decide to keep it, I will send you \$1 within 7 days; then remit \$1 monthly until purchase price of \$4 is paid. Otherwise, I will return it to you promptly.

**FOUR DOLLARS COMPLETE**  
\$4 **1540 PAGES** \$1 PER MO.  
**1540 ILLUSTRATIONS**  
FLEXIBLE BOUND-HANDY SIZE

**ASK TO SEE IT!**

AUDEL, PUBLISHERS, 49 West 23rd Street, New York City

THEO. AUDEL & CO., 49 WEST 23 ST., NEW YORK

Name.....  
Address.....  
Occupation.....  
Reference..... P.M.



## High School Course at Home

### Many Finish in 2 Years

You can complete this simplified High School Course as rapidly as your time and abilities permit. Equivalent to resident school work—prepares you for entrance to college. Standard H. S. texts supplied—Diploma. Credit for H. S. subjects already completed. Single subjects if desired. High School education is very important for advancement in business and industry and socially.

### College Entrance

During the past 14 years, our High School graduates have been admitted to 531 different Universities, Colleges, Junior Colleges and Normal Schools—80% of them without entrance examination. Course also prepares for teachers' certificate and pre-professional examinations.

### Business—Industry

To get and hold a good position in Business today you must be able to write clear, accurate letters and reports—do figuring involving Algebra and Geometry—talk intelligently on matters requiring a knowledge of Geography, History, and Economics.

In Industry—Mechanical and Engineering lines—you must have at least an elementary knowledge of Physics and Chemistry—be able to figure quickly and accurately—know something of Mechanical Drawing and blueprints—and be able to talk and write accurately and clearly on both your work and ordinary topics of conversation.

Our High School course meets the preparatory educational requirements for Business and Industry.

### An Educational Institution

The American School was chartered in 1897 as an educational institution, not for profit—and is exempt from paying Federal income tax, like the best resident colleges and universities.

### Don't Be Handicapped—Complete Your Training Now

Be a High School Graduate! Prepare yourself for promotion in Business and Industry—for the Professions, College Entrance and social success. No matter what line you may select, High School training will prove invaluable to you! Our moderate fees cover all instruction, standard textbooks and Diploma. Easy monthly terms. Get ahead in life. Start your training NOW!

### 20 Other Courses

Over 150 noted Educators, Engineers, and Business Men help prepare our special instruction material, which is used by many resident schools and colleges, U. S. Navy, and Province of Manitoba, Canada. We offer you quality training at home for the best-paying lines of Industry and Business, as listed in the coupon.

Our moderate fees cover all instruction, standard textbooks and Diploma. Easy monthly terms. Get ahead in life. Start your training NOW!

Mail coupon for information about line that interests you  
**American School, Drexel at 58th, Chicago**

**American School, Dept. HA-45, Drexel at 58th, Chicago**

Tell me how to train for success in line checked. No obligation.

- |  |   |
|--|---|
| <input type="checkbox"/> Accounting & Auditing   | <input type="checkbox"/> Diesel Engineering     |
| <input type="checkbox"/> Architecture & B'lding  | <input type="checkbox"/> Drafting & Design      |
| <input type="checkbox"/> Automotive Engin'ring   | <input type="checkbox"/> Liberal Arts           |
| <input type="checkbox"/> Business Management     | <input type="checkbox"/> Private Secretary      |
| <input type="checkbox"/> Commercial Aeronautics  | <input type="checkbox"/> H'l'er Ac't'g (C.P.A.) |
| <input type="checkbox"/> Electrical Engineering  | <input type="checkbox"/> Highway Engin'ring     |
| <input type="checkbox"/> Electrical Refrigerat'n | <input type="checkbox"/> Mechanical Eng'ring    |
| <input type="checkbox"/> Air Conditioning        | <input type="checkbox"/> Radio & Television     |
| <input type="checkbox"/> Civil Engineering       | <input type="checkbox"/> Salesmanship           |
| <input type="checkbox"/> Complete Law            | <input type="checkbox"/> Steam Engineering      |

Name.....  
 Address.....

When writing please mention Popular Mechanics

## A GOOD JOB—A BETTER FUTURE

The increased use of metal in aircraft construction has created a steadily growing demand for specialists in sheet metal work. Take a thorough, practical, complete, specialized and proven

### AIRCRAFT SHEET METAL COURSE

at Roosevelt Aviation School and you will hold the key to a good job and a better future in a great and growing industry.

Complete information without obligation. Get the facts about this and ten other courses. State age.

Write Today to Dept. P. M.

### ROOSEVELT AVIATION SCHOOL

AT ROOSEVELT FIELD  
 MINEOLA, LONG ISLAND, NEW YORK

## ENGINEERING DEGREE IN TWO YEARS

B. S. DEGREE courses in engineering: Electrical, Civil, Chem., Mechanical, Mech. Drafting, Radio and Television, or Aeronautical. Intense, practical, thorough program. No extras for prep. or review. Earn while you learn in this industrial center. Low tuition. Enter March, June, Sept., Dec. Write for catalog. 229 E. Washington Blvd., Fort Wayne, Ind.

### INDIANA TECHNICAL COLLEGE

## Be a DENTICIAN

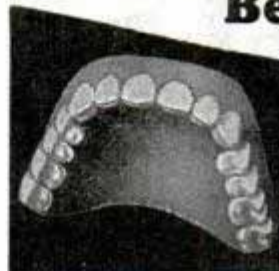

Learn at home to make Crowns, Plates, Bridgework, etc., for Dentists. Easy, practical way to learn mechanical dentistry at home in spare time. Full Equipment of Tools and Materials Included with Course. Low tuition. Easy terms. Write for FREE BOOK about this money-making profession that is not affected by "machine age."

McCARRIE SCHOOL OF MECHANICAL DENTISTRY  
 207 No. Broad St., Dept. 734, Philadelphia, Pa.

## LEARN WATCH REPAIRING



AT HOME You can learn by our modern and original system of instruction every part of the Watch Repairing Trade at home. You can earn money while learning and prepare yourself for a well paying position or start in business after completing our course of instruction. Good watch repairers are in demand and generally earn very good salaries. For particulars apply to the Wisconsin School of Watch Repairing 524 E. Mason St., MILWAUKEE, WIS.



## WILL YOU WEAR THIS SUIT

and Make up to \$12 in a Day!

Let me send you a fine all-wool union tailored suit FREE OF ONE PENNY COST. Just follow my easy plan and show the suit to your friends. Make up to \$12 in a day easily. No experience—no house-to-house canvassing necessary.

Send for Samples—FREE OF COST

Write today for FREE details. ACTUAL SAMPLES and "sure-fire" money-getting plans. Send no money. H. J. Collin, PROGRESS TAILORING CO., Dept. F-216, 500 South Throop Street, Chicago, Illinois.

## GOV'T. JOBS

SALARY TO START \$90 to \$175 MONTHLY MEN.. WOMEN Age Range 18 to 50

- |   |  |
|---|--|
| <input type="checkbox"/> Railway Mail Clerk   | <input type="checkbox"/> POSTMASTER          |
| <input type="checkbox"/> P. O. Laborer        | <input type="checkbox"/> Elev. Conductor     |
| <input type="checkbox"/> R. F. D. Carrier     | <input type="checkbox"/> Auditor             |
| <input type="checkbox"/> Special Agent        | <input type="checkbox"/> Stenographer        |
| <input type="checkbox"/> Statistical Clerk    | <input type="checkbox"/> U. S. Border Patrol |
| <input type="checkbox"/> City Mail Carrier    | <input type="checkbox"/> Telephone Opr.      |
| <input type="checkbox"/> P. O. Clerk          | <input type="checkbox"/> Watchman            |
| <input type="checkbox"/> Stock Clerk          | <input type="checkbox"/> Meat Inspector      |
| <input type="checkbox"/> Special Investigator | <input type="checkbox"/> Secret Service Opr. |
| <input type="checkbox"/> Typist               | <input type="checkbox"/> File Clerk          |

GOVERNMENT INSTRUCTION SERVICE, Dept. 111, ST. LOUIS, MO.

Send me FREE particulars "How to Qualify for Government Positions" marked "X". Salaries, locations, opportunities, etc. ALL SENT FREE.

Name.....  
 Address.....

# ARE YOU A "Beach-Rabbit"?

ARE YOU *glad* to be seen in a bathing suit? Or are you a "beach-rabbit"—secretly wanting to scurry under the sand or into the water—so that people won't "kid" you about your flat chest, skinny arms or legs, or shoulder blades and ribs that "show through your skin"?

Send the coupon for my **FREE BOOK**. You'll see actual **PICTURES** and **PROOF** showing how I've built men of might and muscle out of fellows who have been ashamed and embarrassed to be seen in a bathing suit! And you'll read how—right in the first 7 days—I'll give YOU the kind of **PROOF** that you can **SEE, FEEL, and MEASURE** with a tape!

### Amazing 7-Day Trial Offer

Yes, in even the first seven days you'll begin to *feel* the new muscles starting to bulge! Then, as my weekly instructions arrive in your home, you continue to re-build, renew and "overhaul" your body. I'll trim your waistline into shape. Across your stomach I'll stretch layers of tough yet limber sinew that will be a real guard of manly protection. Your arms, shoulders, legs will be quickly toned into tireless dynamos of **POWER!**

I know what it means to have the kind of body that you have to find excuses for. I *used* to be a 97-pound weakling. A nervous, tired, anaemic runt. Something had to be done. And **THEN**—I discovered **DYNAMIC TENSION!** I built *my* body into the picture of health and



strength you see here—and won the title, "World's Most Perfectly Developed Man"! And now I'm ready to show YOU my secret.

### No Apparatus, Pills or Diets

I have no use for pills, freak diets, or apparatus that might strain your heart or other vital organs. **DYNAMIC TENSION** is a *natural* way to build up your body, strengthen you inside and out. It not only makes you an "Atlas Champion," but goes after constipation, pimples, skin blemishes, and other weaknesses.

### Actual Photographs Will Show You

Let my **FREE BOOK**—"Everlasting Health and Strength"—show you photographic proof of what **DYNAMIC TENSION** has done for others. It tells about my amazing secret of physical development. It tells you how to develop courage, confidence, and will-power—and how I can make you **THE MAN YOU WANT TO BE!** . . . This valuable book is absolutely **FREE!** Send for it **TODAY!** Address me personally: **CHARLES ATLAS, Dept. 86, 115 East 23rd Street, New York, N. Y.**



**Would YOU Like to Win One of These Sterling Silver Cups?**

A sterling silver cup, 14 in. high on mahogany base is awarded each 3 months to my student who makes most improvement in that time.

### Mail Coupon for FREE BOOK

**CHARLES ATLAS,**

**Dept. 86, 115 East 23rd Street, New York, N. Y.**

I want the proof that your system of Dynamic Tension will make a New Man of me—give me a healthy, husky body and big muscle development. Send me your free book, "Everlasting Health and Strength"—and tell me all about your 7-DAY TRIAL OFFER.

Name..... (Please print or write plainly)

Address.....

City..... State.....

**I'LL PROVE IN ONLY 7 DAYS I CAN MAKE YOU A NEW MAN!**

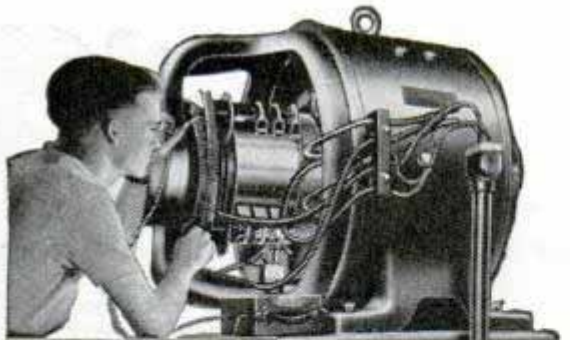

**TRAIN FOR  
A GOOD PAY JOB IN  
ELECTRICITY**  
ON REAL MOTORS, GENERATORS, ETC.

**PAY TUITION AFTER GRADUATION**

Practical training on full size electrical equipment. **"Learn by Doing" in 12 short weeks.** No previous experience or advanced education needed. Send the Coupon NOW for Big Free Illustrated Book.

Learn about the "Pay Tuition After Graduation Plan," "Part Time Employment Plan," "Job After Graduation Service." NOW... Diesel, Air Conditioning and Electric Refrigeration at no extra cost.

**MAIL THIS COUPON TODAY**

H. C. LEWIS, President  
COYNE ELECTRICAL SCHOOL  
500 S. Paulina St., Dept. A8-72, Chicago, Ill.

Please send me your Big Free Book and details of your "Pay Tuition After Graduation Plan."

Name.....  
Street.....  
City..... State.....

**Learn this  
Profitable  
Profession**



**in 90 Days at Home**

Hundreds of men and women of all ages 18-50 make \$10.00 to \$20.00 in a single day giving scientific Swedish Massage and Hydro-Therapy treatments. There is a big demand from Hospitals, Sanitariums, Clubs, Doctors and private patients as well as opportunities for establishing your own office. Learn this interesting money-making profession in your own home by mail, through our home study course. Same instructors as in our NATIONALLY KNOWN resident school. A diploma is awarded upon completion of the course. Course can be completed in 3 to 4 months. High School training is not necessary. Many earn big money while learning.



**Anatomy Charts & Booklet FREE**

Enroll now and we will include uniform coat, medical dictionary, patented reducing roller and Hydro-Therapy supplies without extra cost. The reducing course alone may be worth many times the modest tuition fee.

Send coupon now for Anatomy Charts and booklet containing photographs and letters from successful graduates. These will all be sent postpaid—FREE.

THE College of Swedish Massage (Successor to National College of Massage)  
Dept. A64-1601 Warren Boulevard, Chicago.

You may send me FREE and postpaid, Anatomy Charts, booklet containing photographs and letters from graduates, and complete details of your offer.

Name.....  
Address.....  
City..... State.....

When writing please mention Popular Mechanics

**TO YOUNG MEN—  
STENOTYPY THE WAY  
TO SUCCESS**

Stenotypy, the new profession, offers unusual opportunities to ambitious young men. It's a man's way of recording speech in this machine age — a silent little machine that types plain print letters faster than anyone can talk. It opens up preferred jobs now — leads to executive careers later. One of the surest, quickest ways to get into Business on the right basis.

Now you can learn Stenotypy in your spare time. Low cost — convenient terms. Get full details. Write for valuable free booklet, "Advantages to You in Stenotypy," describing the unusual opportunities for young men in this growing field and telling how you may enter it successfully. Write Dept. 664-ST.

THE STENOTYPE COMPANY  
4101 S. Michigan Ave., Chicago, Ill.



**VOICE**

**100% Improvement Guaranteed**

We build, strengthen the vocal organs — not with singing lessons — but by fundamentally sound and scientifically correct silent exercises... and absolutely guarantee to improve any singing or speaking voice at least 100%... Write for wonderful voice book — sent free. Learn WHY you can now have the voice you want. No literature sent to anyone under 17 years unless signed by parent.

PERFECT VOICE INSTITUTE, Studio A-135  
64 E. Lake St., Chicago



**THE SELF-STUDY DIESEL COURSE**

(ROSBLOOM SYSTEM)

81 Books with 44 Blueprints and Color Supplements

THE PRACTICAL COURSE ON MODERN DIESEL ENGINES  
— UNIVERSALLY USED THROUGHOUT THE WORLD —

Only Sold Complete — \$37.50 prepaid

DIESEL ENGINEERING INSTITUTE, JERSEY CITY, N. J.

**EASY TO LEARN ACROBATICS**

New, Fast-learning Method of Acrobatics, Hand Balancing and Tumbling fully illustrated and diagrammed. Easily understood by Beginners as well as Professionals. Natural body builder. My Acrobatic Poses and literature sent FREE.

KEN COOPER, ACROBAT Milwaukee, Wis.  
733 N. Van Buren St.

**Learn  
Public  
Speaking**

At home — in spare time. Many overcome "stage-fright," gain self-confidence and increase earning power, this easy way. Write for free booklet, *How to Work Wonders With Words* and requirements.

North American Institute, Dept. 135A  
3601 Michigan Ave., Chicago, Illinois



**LOOK! Baby Chicks**

THOUSANDS WEEKLY ALL YEAR

Finest quality & Layers in 40 breeds. Hybrid Baby Pullets and Cockerels, B. W. D. Tested. Ducklings, Goslings, Baby Turkeys, Guinea. In business 28 years. Catalog free. Nabob Hatcheries, Box M, Gambier, Ohio.



**WHY NOT** spend spring, summer, fall, gathering butterflies, insects.

I buy hundreds of kinds for collections. Some worth \$1 to \$7 each. Simple outdoor work with my Instructions, pictures, price list. Profit — pleasure. Send 10c (not stamps) for Illustrated Prospectus before sending butterflies.

MR. SINCLAIR, DEALER IN INSECTS  
Dept. 6, Box 1830 San Diego, Calif.



**The BRISCHOGRAPH makes you an artist INSTANTLY**

Use any size copy. Junior covers 4 x 4 inches at one time. Projects in colors and up to life size. Comes completely wired, with lamp, lenses and transparent mirror. Dealers in principal cities and foreign countries. Send \$10, money order, try it ten days. Money back guaranteed. Commercial models \$25., \$50. and \$100.

The BRISCHOGRAPH CO. 24 W. Welschimer Rd. Columbus, O. Established 1926. Canada: Winnipeg Map & Blue Print Co., 318 Donald St.; Winnipeg, Man.

**Learn  
PHOTOGRAPHY  
at Home**

Splendid opportunities. Prepare in spare time. Easy plan. No previous experience needed, common school education sufficient. Send for free booklet "Opportunities in Photography", particulars and requirements.

American School of Photography  
3601 Michigan Ave., Dept. 135-A, Chicago, Ill.

**NEW YORK SCHOOL OF MECHANICAL DENTISTRY**

Earn big money in a few months. We show you how. Real Laboratory Training. OLDEST school. Day, Eve. Easy terms. Ask for free Catalog P and tool offer.

N. Y. SCHOOL of MECHANICAL DENTISTRY, 125 W. 31 St., N. Y. C.

# Photo-Engraving

**BIG PAY!**  
IDEAL WORKING  
CONDITIONS  
INCREASING  
DEMAND

**LEARN QUICKLY AT HOME BY LATEST EXPERT METHOD**

An easy, quick, thorough Home Study Course. Oldest and largest school in the world TEACHING PHOTO-ENGRAVING by correspondence and residence. Many unusual features—Experimental Equipment for home use—Rare Reference Books—Camera Journalism. Plate Layout Examples. Lifetime Consulting Service "30 Photo-Engraving Ways to Make Money from the Day You Start Your Studies!"... All included at no extra cost. Write today for Free 38-page Opportunity Booklet. **AURORA SCHOOL OF PHOTO-ENGRAVING** Dept. 168 AURORA, MISSOURI



## Genuine LACO Automatic OIL-BURNING HEATER

**Abundant Heat—Amazing Low Fuel Cost!** Write today for free book showing LACO's new complete home heater with (1) Famous LACO "2 Stage" burner! (2) New-type Inner Heating Unit with 20% extra heating surface—users say it delivers 20% to 40% More Heat! (3) Self-contained fuel tank! (4) Beautiful steel cabinet. ALL at an amazing Low Price. No basement needed—place in any room. Quiet. Safe. Humidified, circulates the air. Simple heat adjustment. Choice of sizes.

**WRITE!** Send for Free Book, photos, low prices. If you prefer furnace-type oil-burner, ask for book on Pressure-Type and Mineral-Wick models.

**DEALERS:** Sample burner sent new dealers for examination, no obligation. **WRITE!**



FOB Factory

**LACO OIL BURNER CO., 168 Union St., Griswold, Iowa**

# Want a Career in photography?

We give you personalized training. Commercial, News, Portrait, Advertising, Candid or Motion Picture Photography. Big money-making opportunities. Or learn for pleasure. Personal Attendance and Home Study courses, 28th year. Write for Free booklet.

**NEW YORK INSTITUTE OF PHOTOGRAPHY**  
10 West 33 Street (Dept. 49) New York City

# AUDELS Carpenters and Builders Guides 4 vols. \$6



**Inside Trade Information** for Carpenters, Builders, Joiners, Building Mechanics and all Woodworkers. These Guides give you the short-cut instructions that you want—including new methods, ideas, solutions, plans, systems and money saving suggestions. An easy progressive course for the apprentice and student. A practical daily helper and Quick Reference for the master worker. Carpenters everywhere are using these Guides as a Helping Hand to Easier Work, Better Work and Better Pay. To get this assistance for yourself, simply fill in and mail the FREE COUPON below.

### Inside Trade Information On:

How to use the steel square—How to file and set saws—How to build furniture—How to use a mitre box—How to use the chalk line—How to use rules and scales—How to make joints—Carpenters arithmetic—Solving mensuration problems—Estimating strength of timbers—How to set girders and sills—How to frame houses and roofs—How to estimate costs—How to build houses, barns, garages, bungalows, etc.—How to read and draw plans—Drawing up specifications—How to excavate—How to use settings 12, 13 and 17 on the steel square—How to build hoists and scaffolds—skylights—How to build stairs—How to put on interior trim—How to hang doors—How to lay floor—How to paint.



**THEO. AUDEL & CO., 49 W. 23rd St., New York City**

Mail Audels Carpenters and Builders Guides, 4 vols., on 7 days' free trial. If O.K. I will remit \$1 in 7 days, and \$1 monthly until \$6 is paid. Otherwise I will return them. No obligation unless I am satisfied.

Name.....  
Address.....  
Occupation.....  
Reference.....P.M.

# Learn at Home to MAKE MORE MONEY

I'll train you Quickly for Good Spare Time and Full Time Jobs in RADIO...



Mail Coupon for FREE Information

Do you want to make more money? Radio offers you many opportunities for well-paying spare time and full time jobs. And you don't have to give up your present job, leave home or spend a lot of money to become a Radio Expert.

**Many Radio Experts Make \$30, \$50, \$75 a Week!**

Radio broadcasting stations employ engineers, operators, station managers and pay up to \$5,000 a year. Spare time Radio set servicing pays as much as \$200 to \$500 a year—full time Radio servicing jobs pay as much as \$30, \$50, \$75 a week. Many Radio Experts own and operate full time or part time Radio businesses. Radio manufacturers and jobbers employ testers, inspectors, foremen, engineers, servicemen, paying up to \$6,000 a year. Automobile, police, aviation, commercial Radio, and loud speaker systems offer good opportunities now and for the future. Television promises many good jobs soon. Men I have trained at home have good jobs in all these branches of Radio.

**Many Make \$5, \$10, \$15 a Week Extra in Spare Time While Learning**

Almost every neighborhood needs a good spare time serviceman. The day you enroll I start sending Extra Money Job Sheets showing how to do Radio repair jobs. Throughout your Training I send plans and ideas that made good spare time money for hundreds. I send Special Equipment to conduct experiments, build circuits, get practical experience. I ALSO GIVE YOU A COMPLETE, MODERN, PROFESSIONAL ALL WAVE, ALL PURPOSE RADIO SET SERVICING INSTRUMENT TO HELP SERVICE SETS QUICKER—SAVE TIME, MAKE MORE MONEY.

**Find Out What Radio Offers You**

Mail the coupon now for "Rich Rewards in Radio." It's free to anyone over 16 years old. It points out Radio's spare time and full time opportunities and those coming in television; tells about my Training in Radio and television; shows you letters from men I trained, telling what they are doing and earning; tells about my Money Back Agreement. MAIL THE COUPON in an envelope, or paste it on a penny postcard—NOW!

**J. E. SMITH, President National Radio Institute Dept. 8FP Washington, D. C.**



Works for State of Illinois

"If I had not taken your Course I would still be digging ditches. I am working for the state of Illinois, operating the 1,000 watt transmitter. If anyone wants to write me about your Course, I shall be glad to answer. R. S. LEWIS, State Police Radio Station, WQPM, Macomb, Ill.

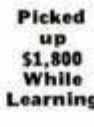

Picked up \$1,800 While Learning

"I picked up \$1,800 while studying. I call that easy money—the time I gave my Radio work did not interfere with my other business." OTIS DENTON, 14105 Lorain Avenue, Cleveland, Ohio.

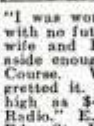

Made Up to \$400 a Month

"I was working in a garage with no future in sight. My wife and I decided to put aside enough to pay for my Course. We have not regretted it. I have made as high as \$400 a month in Radio." E. G. WOLFE, 1202 Eden St., Elkhart, Ind.

Mail this Now FREE Get 64-page Book



**J. E. SMITH, President, Dept. 8FP National Radio Institute, Washington, D. C.**

Dear Mr. Smith: Without obligating me, send "Rich Rewards in Radio," which points out the spare time and full time opportunities in Radio and explains your 50-50 method of training men at home in spare time to become Radio Experts. (Please Write Plainly.)

AGE.....  
NAME.....  
ADDRESS.....  
CITY..... STATE.....

When writing please mention Popular Mechanics



**I**LLUMINATION and magnification of an object at the same time are provided



by a device designed for the dentist's use. Attached to the frame holding a magnifying glass is a small electric lamp which illuminates the patient's mouth. The

apparatus is mounted on an adjustable arm or support and may be pushed out of the way when not in use.

**H**ANDY for reading in bed is a collapsible universal book support patented recently. To an upright member hinged to the base is attached an arm holding the book-rest. This arm extends over the bed. An electric lamp attached to the top of the bookrest provides illumination. The stand is adjustable to any reading position.



**B**Y DETACHING the trucks of a newly patented roller skate and clamping them on the runners of a sled, something different in sidewalk vehicles may be created. This permits the young owner to use his sled the year around, if he



wishes. Then, when he tires of playing with the roller sled, the trucks may be returned to the skate undamaged. Attachment of the trucks to the sled is accomplished with the skate key.

**H**ANDLING the big steel rails with which railroads are constructed is made easier for the maintenance crew by a hydraulic rail bender patented recently. The machine may be operated easily by one man. Rails may be bent by applying the machine at the point desired and by working a pump handle up and down, forcing oil from a reserve tank into the main cylinder and creating great pressure. The bender is intended to replace screw machines which required considerable manual labor to operate.

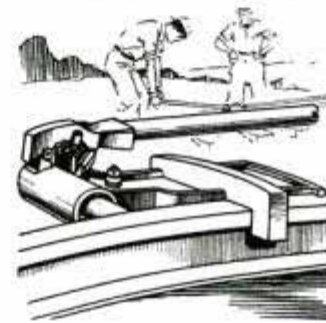

**A**DDITIONAL protection of banks against bandits is the purpose of an alarm system patented recently. It is arranged so that the alarm is set off when the operator raises his arms, in response to a command, or when he presses his arms closely to his body. The alarm also is set off when the operator raises either arm and presses the other against his body. The signal harness, concealed by the operator's clothing, is con-



(Continued to page 33A)

**"FEELS LIKE  
A NEW  
MOTOR"**



**NEW AUTO-LITE  
SPARK PLUGS**  
—MAKE STARTING EASIER  
—GIVE FASTER TOP SPEED  
—STOP GASOLINE WASTE

## NEW KIND OF SPARK PLUG DEVELOPED BY IGNITION ENGINEERS

### *Puts New Life in Car Performance*

**T**ruly on a par with the striking advances in motor car engineering during the past few years is the spark plug engineering in the new Auto-Lite spark plug. The new Auto-Lite Konium Electrode and the new Auto-Lite Ziramic insulator are the *first* significant spark plug improvements in many years.

The 'Auto-Lite Konium Electrode reduces electrical stress, produces a spark at reduced voltages. Because of it, motors with Auto-Lite plugs start easier—give improved gasoline mileage—show higher top speed! And the new Ziramic insulator provides greater electrical strength, resists breakage and heat shock as no other commercial spark plug insulator ever has.

Throw away your old spark plugs and install a complete new set of Auto-Lites. You'll be money ahead!



**EXCLUSIVE  
ZIRAMIC INSULATOR**  
Resists Breakage,  
Provides Greater  
Electrical Strength

**EXCLUSIVE  
KONIUM ELECTRODE**  
Provides Spark at  
Reduced Voltage—Steps  
Up Action of Entire  
Ignition System

Ask for **AUTO-LITE**  
SPARK PLUGS

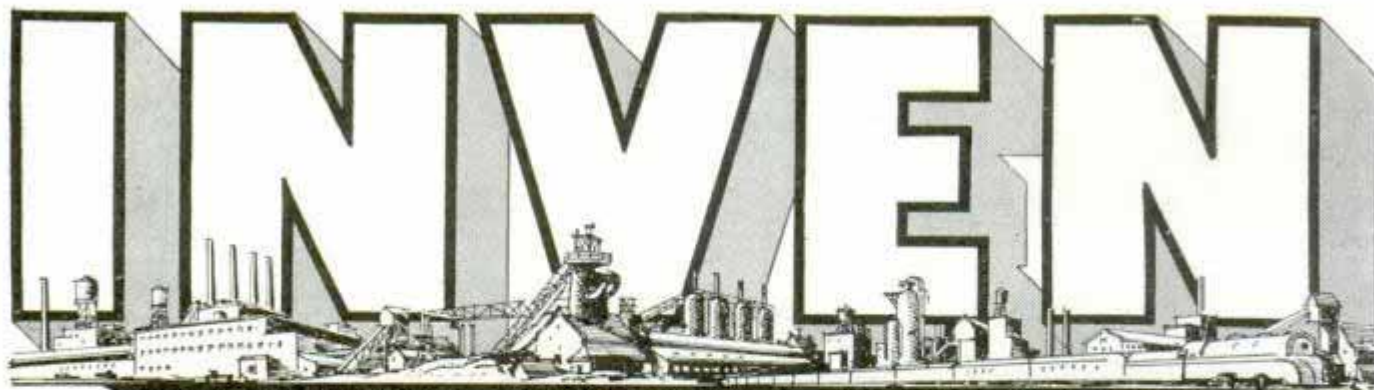

## How to Determine The Patentability Of Your Invention

Before you spend money in making a model, or spend weeks in its design, we advise you first to have a preliminary search made through U. S. Patents in the U. S. Patent Office to see if there are inventions like yours already on record; and, if so, let us give you our opinion as to the patentability of what you have.

We employ experienced searchers to perform this service for you. From the reports of our searchers we can quickly form our opinion as to whether your invention is confronted with obstacles in the form of already granted patents. First get our FREE BOOK and read the chapter on "How Can I Know Whether My Idea is Patentable?"

## HOW WE SERVE THE INVENTOR

We have secured patents for inventors located in every state in the Union. Our organization is a large and efficient one. Our practice is confined entirely to Patents, Trade-Marks, and Copyrights. We have had years of experience in Patent Matters. When you place your invention in our hands, we are in position to proceed at once to secure protection for you.

Learn How To Get Your  
**THIS FREE BOOK**  
 FROM THE CRUDE INVENTOR'S SKETCH TO THE

Our fees are reasonable, and, if you desire, we can arrange convenient terms of payment.

## WHAT HELP IS THE PATENT ATTORNEY?

Your invention may provide your life's greatest opportunity. If it is to bring income to you it should be legally yours. Upon your patent attorney's skill rests how completely your patent covers all the protectable points in your invention. The inventor may actually lose money on his invention by overlooking a single claimable point that a skilled patent attorney would not miss.

## WHAT THE INVENTOR MUST KNOW

In order to proceed successfully, the inventor must follow certain definite steps that precedent has established as the quickest way to reach his goal. Our FREE BOOK, "Patent Guide for the Inventor," gives a concrete, logical, and thorough resume for the inventor to follow. It takes him, through 48 pages, from the crude first model to the finished commercial product. It shows the inventor how to avoid mistakes, how to shorten the road in getting his invention ready for market; it also points out how to save money and avoid the errors of inexperience in applying for patent. Getting our FREE BOOK should be the first step in definitely declaring yourself an inventor. After you get this illustrated, clearly worded guide of carefully compiled patent knowledge you will know how to proceed without expensive mistakes and discouraging setbacks from "wrong-track" methods.

# CLARENCE A. O'BRIEN & HYMAN BERMAN

70-H ADAMS BUILDING, WASHINGTON, D. C.  
 Registered Patent Attorneys before U. S. Patent Office

When writing to advertisers please mention Popular Mechanics



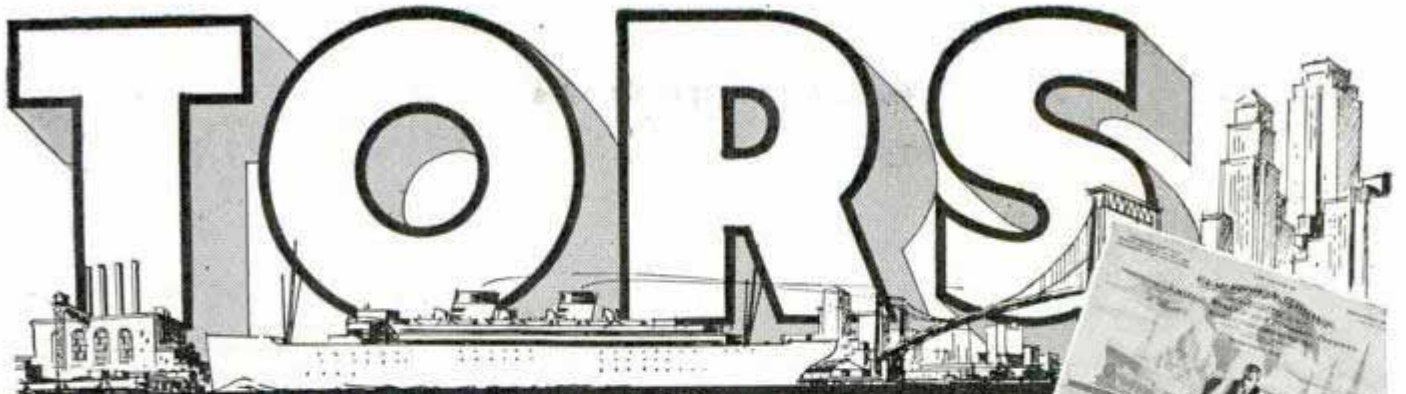

*Invention Ready For These Waiting Markets*

Keen competition in every form of industry has put manufacturers feverishly at work trying to speed up output, reduce overhead, save on materials, outsell trade opponents. The inventor is the key-man in making advancement possible to any business. Upon the inventor rests the success of many enterprises.

**FREE RECORD OF INVENTION FORM.**

This FREE Record of Invention Form enables you to make in convenient form a sketch of your invention and have it witnessed in a manner of value to you should the occasion for evidence arise. MAIL THE COUPON TODAY and obtain our FREE BOOK and Record of Invention Form.

This does not mean that you must have something gigantic to win commercial success. A new way to open a door or button up a shirt may be the very thing hundreds of manufacturers are looking for. If you have something novel—if it is practical to manufacture—no matter whether it be an improved rattle for a child or a whistle for a mechanical automobile, there is likely a waiting market.

**WILL SHOW YOU** *Every Step of the Way*  
**FINISHED COMMERCIAL PRODUCT**



**THE IMPORTANCE OF IMMEDIATE ACTION**

In making application for patent it is important to be first. Even if your application is delayed by a few days you may be placed at a disadvantage. The short time that elapsed between Elisha Gray's application for his telephone patent and the application of Alexander Graham Bell probably cost Gray the rights to the telephone.

**TEAR OFF AND MAIL NOW!**

**COUPON**

**CLARENCE A. O'BRIEN and HYMAN BERMAN**

**70-H Adams Building WASHINGTON, D. C.**

*Registered Patent Attorneys Before U. S. Patent Office*

Please send me at once your Big FREE 48-Page Book, "Patent Guide for the Inventor" and your Specially Prepared "Record of Invention" form. This request does not obligate me.

NAME.....

ADDRESS.....

(Please write or print plainly)

# DO YOU LIKE RADIO DOES THE FUTURE OF TELEVISION INTEREST YOU?



Send for  
your  
free copy

You men anxious to make good in radio and related industries want the true facts,—you want to know about employment opportunities and requirements. National Schools,—a million-dollar trade school,—will supply you with a sincerely honest statement of facts on what you should do to get into the profitable radio industry. No exaggerations,—no mis-statements. Mail coupon today. †Send for your free copy. Real facts on radio employment requirements. †You need real experience. National offers complete training with modern equipment.



**NATIONAL  
SCHOOLS**  
*Los Angeles*

Request for **FREE BOOK** of DETAILS

NATIONAL SCHOOLS,  
Dept. PMR-6, 4000 S. Figueroa St., Los Angeles, Calif.

NAME \_\_\_\_\_ Age \_\_\_\_\_

ADDRESS \_\_\_\_\_

CITY \_\_\_\_\_ STATE \_\_\_\_\_



**START**

**\$1260 to \$2100 YEAR**

**MEN—WOMEN**

42,766 appointments  
last fiscal year. Short  
hours. Depend-  
able jobs.

Common Education  
Usually Sufficient  
Mail Coupon  
Today—  
**SURE**

**Franklin Institute**  
Dept. S195  
**ROCHESTER, N. Y.**

Gentlemen: Rush to me, FREE of charge, list of U. S. Government big pay jobs. Send me FREE 32-page book describing salaries, vacations, hours, work, and full particulars telling how to qualify for one of these jobs.

Name.....

Address.....

## Monastery Secrets

... THE FORBIDDEN  
KNOWLEDGE OF TIBET

What strange secrets of nature are locked within the mountain fastness of Tibet? What control over the forces of the Universe do these cloistered sages exercise? For centuries the world has sought to know the source of their power—to learn their mastery of life, and their faculty for overcoming problems with which the masses of mankind still struggle. Have they selfishly deprived humanity of these rare teachings?

WRITE FOR THIS  
FREE BOOK

Like the streams that trickle from the Himalayan heights to the plateaus below, the great truths of these brotherhoods have descended through the ages. One of the preservers of the wisdom of the Orient is the Rosicrucian Brotherhood (not a religious organization). They invite you to write today for their FREE Sealed Book, with its amazing revelations about these mysteries of life. Address: Scribe B.X.W.

The ROSICRUCIANS  
AMORC  
San Jose, Calif.  
U. S. A.



## LAW STUDY AT HOME

Legally trained men win higher positions and bigger success in business and public life. They command respect. Greater opportunities now than ever before. Big corporations are headed by men with legal training.

More Ability: More Prestige: More Money

We guide you step by step. You can train at home during spare time. Degree of LL. B. conferred. Successful graduates in every section of the United States. We furnish all text material, including fourteen-volume Law Library. Low cost, easy terms. Get our valuable 64-page "Law Training for Leadership" and "Evidence" books FREE. Send for them NOW. LASALLE EXTENSION, Dept. 664-L Chicago

## Correspondence Courses in RADIO and ELECTRICAL ENGINEERING

LOW AS  
**\$25**



**ELECTRICAL ENGINEERING.** Get good grasp of wide electrical field. Modern. Very understandable.  
**RADIO ENGINEERING.** Extra fine course in radio, public address, photo-electric work. Trains you to be super-service man, real vacuum tube technician. Tuition ONLY \$25, either course. Deferred payment plan. Experiment kits furnished.  
**FREE LINCOLN ENGINEERING SCHOOL, Box 931-81, Lincoln, Nebr.**

## U.S. GOV'T JOBS

**Earn \$1260 to \$2100 at Start**

Excellent opportunities for citizens 18 to 50. No special experience usually required. Railway Postal Clerks may earn \$155 first month; Customs Inspectors as high as \$3,000 a year. Send for FREE BOOK "How to Secure a Government Position." It tells about many good government positions and how our tested method will help you pass examinations. Write AT ONCE. Arthur R. Patterson (Former Government Examiner), Principal, PATTERSON SCHOOL, 86 Mercantile Bldg., Rochester, N. Y.

# MEASURE YOUR AIRCRAFT TRAINING



## by CAREER VALUE

And You Will Choose  
**AERO I.T.I. - Where**

- the training program is under the supervision of an Executive Board of leading aircraft builders.
- the largest, finest, and most modern educational plant of its kind is solely devoted to preparing men for aircraft industry careers.
- the most extensive, most complete assemblage of modern airplane manufacturing equipment for training purposes is to be found.
- the whole training program is so authoritative, so practical, so thorough that actual experience in an aircraft plant itself could not equal it in career-value.

### EXECUTIVE BOARD

**C. A. VAN DUSEN**  
Vice-President Consolidated Aircraft Corp.

**JOHN K. NORTHPROP**  
Formerly-President The Northrop Corporation; Vice-President, Douglas Aircraft Company, Inc.

**ROBERT E. GROSS**  
President, Lockheed Aircraft Corporation

## AERO INDUSTRIES TECHNICAL INSTITUTE

5253 West San Fernando Road, Los Angeles, California

If you are interested in an aircraft industry career through the Master Aircraft Mechanics Course, the Aeronautical Engineering, Design and Drafting Course, or the Combination Aircraft Mechanics Theory at Home and Shop Course... send this coupon *Today*

Please send information on Aero I.T.I. training. I am 18 years of age or over and can furnish character references.

NAME \_\_\_\_\_ AGE \_\_\_\_\_

ADDRESS \_\_\_\_\_

CITY \_\_\_\_\_ STATE \_\_\_\_\_ a-s-p

## Free • DRAFTING



More good jobs now in Drafting. Learn AT HOME in spare time (or at our Chicago School). Send post card for **FREE TRIAL LESSON** and see how easy to learn and get a good job.

**CHICAGO TECHNICAL COLLEGE**  
G209 Tech. Bldg., 118 E. 26th St., Chicago, Ill.

If you can go away to college to learn Drafting, Engineering, Architecture, Electricity, Air Conditioning or Radio—send for **Free Blue Book**.

## LEARN TELEVISION

... at home! Absolutely NEW kind of training. In ADDITION to text books you get complete practical Television Equipment that actually transmits and receives. Fascinating, thrilling home training. Easy time payments... only 25c a day pays for BOTH training and equipment. Write for complete details and **FREE** book. No obligation.

**American Television Institute**  
Dept. PM 638, 433 E. Erie St., Chicago, Ill.



## STUDY ENGINEERING AT HOME

Home Study Courses leading to Degrees in Electrical; Civil; Mechanical; Diesel; Architectural; Aeronautical; Automotive; Drafting; Radio; Air Conditioning; Refrigeration; Highway; Mining; Petroleum; Industrial; Steam; Chemical Engineering; Arts; Sciences; Philosophy; Education; Writing; Psychology; Chemistry; Theology; Law; Agriculture; Business; Advertising; Sales; Accounting; Public Speaking. **McKINLEY-ROOSEVELT GRADUATE COLLEGES, 4246 Clarendon Ave., Chicago.**

## SALES MANAGERS WANTED

Large Industrial Training Organization specializing Diesel, Auto, Aviation, Air Conditioning, Refrigeration, Correspondence and Practical Courses requires aggressive Sales Managers, U. S. Territories. Possible earnings \$20,000 year. Must show successful record selling Vocational Training and developing sales organization, etc. Give full details first letter. Write: Chicago Vocational, 703 Hennepin Ave., Minneapolis, Minn.

## EARN MONEY at Home

Make delicious, new "NON-GREASY" Potato Chips at low cost. We furnish equipment and instructions. Potatoes plentiful and cheap. Groceries, markets, restaurants, taverns do the retailing for you. Profit large—unusually so. You can start this money-making business on a "next to nothing" outlay of cash. Write for Potato Chip Booklet.  
**LONG-EAKINS CO., 628-S. High St., Springfield, O.**



# AUTO

BOOKS SENT FREE



on approval. Just mail the coupon and we'll send you a set of these remarkable auto books, just off the press. Whether you are a mechanic or helper, expert or apprentice, auto owner or driver, if you're interested in knowing all about automobile mechanics, take advantage of this **FREE OFFER**.

### GET A BETTER JOB

A better job—in the gigantic auto industry. **BIGGER PAY**—a chance to go into business for yourself and get a share of the huge profits, are waiting for any man who even half tries to improve himself. Learn auto engineering with these wonder books a new way—without studying or memorizing. Simply use the **JIFFY INDEX** to look up the answer to any auto problem. Built by eleven of America's greatest automobile engineers, and written in simple language so you can understand it. Very newest cars, all covered.

### CAN YOU FIX IT?

These wonder books tell step by step HOW to take out "play" in differential — to kill the shimmy in steering—to set **TIMING**—how to put your finger instantly on engine trouble and then the quick expert way to **FIX** it. Newest improvements fully covered. Equal to a complete trade course at less than a fourth the cost.

**6 BIG VOLUMES**  
Brand New Edition  
2500 pages, 2000 illustrations, wiring diagrams, etc., including Marine Engines, Aviation Motors, Diesel engines, etc. De Luxe edition, gold-stamped flexible binding.

**[ FREE Privilege of consulting Automobile Engineers of American Technical Society for one year without cost if you mail coupon immediately ]**

Books also include valuable articles on **Service Shop Management**.

**AMERICAN TECHNICAL SOCIETY,**  
Dept. AA19, Chicago, Ill.  
I would like to see the new 6-volume edition of your **AUTO BOOKS**. I will pay the few cents delivery charges only, but if I choose to, I may return them express collect. If after 10 days use I prefer to keep them, I will send you \$2 and pay the balance at the rate of only \$3 a month, until \$24.80 is paid. Please include free consulting membership as per your offer above.  
Name \_\_\_\_\_  
Address \_\_\_\_\_  
City \_\_\_\_\_ State \_\_\_\_\_  
Attach letter stating age, occupation and name and address of employer and that of at least one business man as reference.

When writing please mention Popular Mechanics

**FOR MEN WHO WANT TO LEARN A PROFITABLE TRADE**

**Complete DIESEL TRAINING**

**—with all types INTERNAL COMBUSTION ENGINES, ELECTRIC POWER GENERATION, etc.**

YOU MEN who are sincerely ambitious to make good in the Diesel and related industries, want to know the true facts—you want to know about employment opportunities and employment requirements. For 33 years, National Schools, a recognized leader in the field of trade education, has played a vital part in helping wide-awake men to qualify for success in industry. National Schools—a million-dollar trade school—will supply you with a sincere, honest statement of facts on what you should do to get into the profitable Diesel Industry. No exaggerations—no mis-statements.

**YOU NEED REAL SHOP EXPERIENCE WITH TIME-TESTED TRAINING**

Mail the coupon below. In the literature you will be sent, you will see exactly how other men like you are preparing themselves for success in National's modern training shops. You learn on the latest, finest equipment. You do real job work. You learn by time-tested, shop-practice methods. Your training is fascinating in every detail. You are taught how to make good, and helped to make good after you graduate. All of this and much more is clearly pictured for you in the Free Book of Facts we will send to you.

**TRANSPORTATION ALLOWED TO LOS ANGELES**

National Students are allowed coach railroad fare from any point in U. S. (Canadian students from nearest point of entry.) Student social life includes inspection trips, excursions, athletic activities, etc. Special doctor service. Personality coaching. **Many students are helped with spare-time jobs to earn room and board while learning.** (Canadians excepted.) Graduate employment cooperation.

**NATIONAL SCHOOLS**

**Los Angeles**

**FREE BOOK**

*Request for Free Book*

NATIONAL SCHOOLS (established 1905) Dept. PMA 5  
4000 South Figueroa Street, Los Angeles

Please send me, without obligation, your FREE BOOK and information regarding Diesel Employment Opportunities and Requirements.

NAME \_\_\_\_\_ AGE \_\_\_\_\_

ADDRESS \_\_\_\_\_ CITY \_\_\_\_\_ STATE \_\_\_\_\_

When writing please mention Popular Mechanics

**AIR CONDITIONING AND ELECTRIC REFRIGERATION INDUSTRY NEEDS TRAINED MEN**

34 year-old organization now receiving applications of men to prepare for positions in Air Conditioning and Electric Refrigeration. Quality in 3 months for Estimating, Installation, Service, Maintenance and Sales positions. No experience needed—we train you under actual working conditions in our own air conditioned laboratories. Free employment service. Get illustrated book "Step Up to Success" — it's free! Write

**MILWAUKEE SCHOOL of ENGINEERING**  
Institute of Electrotechnics  
1020-D North Broadway, Milwaukee, Wis.

**New York Electrical School** Established 1902

Ask for free booklet  
44 West 17th St., N. Y. C.

**START EARNING IN 3 DAYS**

"Made \$16.50 and have finished only 3 lessons," says Mrs. Ellen V. Bailey of Pennsylvania. Decorate giftware. We supply everything and teach you how. Easy, fascinating work—full or spare time. A big income possible every month! No selling experience needed. Thousands of Fireside Members now make good money right at home. Write today for new membership plan. It is FREE. Send no money.

**FIRESIDE INDUSTRIES Dept. 66-G Adrian, Mich.**

**DIESEL**

Get BETTER training. Realize Adcox advantages. Located in Pacific Northwest, a Diesel center. Established 28 years. Modern equipment, expert instructors. Close cooperation for YOUR success. Earn room and board while learning. Send for FREE big 40-page Diesel School Catalog No. 18. Home Study and Resident Courses.

**L. L. ADCOX TRADE SCHOOL** Portland Oregon

**AGENTS! BIG PROFITS! NEW 10-IN-1 GARDEN TOOL!**

Wonder Cultivator! 10 labor-saving, money-saving tools in one! Does ALL work easier, quicker, better—spading, hoeing, trimming, raking, plowing, clearing. Sells to homes, farms, parks, cemeteries, golf courses, etc., etc., on sight. Amazingly low priced! Big profits! Send for details—NOW.

**WONDER MFG. CO., 325 W. Huron St., Dept. 116, Chicago, Ill.**

**GUITAR**

You'll enjoy learning for less than 2c a day. Full particulars Free. Write today.

**HAMANN INSTITUTE, 3016 N. 24th Place, R-6, MILWAUKEE, WIS.**

**ARTISTS MAKE MONEY**

Find out your ability. Send name, age, occupation and address for Free Vocational Art Test.

**Federal Schools, Inc., 8138 Federal Schools Bldg., Minneapolis, Minn.**

**Earn Cash at Home!**

**M.M. EARNED \$1174!** of Home!

We paid M. M. \$1174 for exceptional "cellar crop" SNOW-KING mushrooms! Big free picture book tells if your cellar, shed, barn suitable. We furnish materials, buy all crops. Write today. Est. 1908, UNITED CO., 3848 Lincoln Ave., Dept. 302, Chicago.

**EARN THE DEGREE**

Doctor of Psychology (Ph.D.), Philosophy, Science. General Courses—Arts, Law, Business, etc. "CHARTERED BY STATE OF MONTANA." Send for 32-page FREE Bulletin at once. No Obligation.

**Temple Bar College, Dept. 2-R, 213 East Main Street Missoula, Montana, U. S. A.**

**NEW SCIENTIFIC WONDER**

**"X-RAY" CURIO**

10c  
3 for 25c

"Silver Only"

**BOYS BIG FUN.** You apparently see thru cloth, Wood, Stone, any object. See Bones in Flesh. FREE PACKAGE radio picture films, take pictures without camera. IT'S GREAT SPORT! 1 package with each 25c order.

**MARVEL MFG. CO., Dept. 80-D NEW HAVEN, CONN.**

# THOUSANDS NOW PLAY *who never thought they could!*



**SURPRISED FRIENDS**

My friends are surprised at the different pieces I can already play. I am very happy to have chosen your method of learning.\* B. F., Bronx, N. Y.



**LEARNED QUICKLY AT HOME**

I didn't dream I could actually learn to play without a teacher. Now, when I play for people they hardly believe that I learned to play so well in so short a time. \*H.C.S., Calif.



**WOULDN'T TAKE \$1000 FOR COURSE**

I have learned to play by note in a little more than a month. I wouldn't take a thousand dollars for my course.\* S.E.A., Kansas City, Mo.

## You, too, can play any instrument by this EASY A-B-C Method

YOU think it's difficult to learn music? Thousands of others have, too! Like you, they longed to play some instrument, but they thought it took years of tedious study and practice to learn.

Then they made an amazing discovery! They learned about a wonderful way to learn music at home—without a private teacher—in a surprisingly short time. They wrote to the U. S. School of Music for the facts about this remarkable short-cut method. The facts opened their eyes! And, in addition, a free Demonstration lesson showed them how easy it was to learn.

**LEARN TO PLAY BY NOTE**  
**Piano Guitar**  
**Violin Saxophone**  
**Organ Mandolin**  
**Tenor Banjo**  
**Hawaiian Guitar**  
**Piano Accordion**  
**Or Any Other Instrument**

Thus thousands of men and women have studied music at home this simple, A-B-C way. Now, everywhere music-lovers are enjoying the thrilling satisfaction of creating their own music. They have found the key to good times, popularity and profit.

You can do the same. Simply mail

the coupon below now. See how you, too, can learn to play your favorite instrument—in your spare time at home. Never mind if you have no musical knowledge or training. Just read the illustrated booklet—examine the demonstration lesson. (Instruments supplied when needed, cash or credit.) U. S. School of Music, 76 Brunswick Building, N. Y. C., N. Y.  
 \*Actual pupils' names on request. Pictures by professional models.

**FREE DEMONSTRATION LESSON AND BOOKLET**

**U. S. SCHOOL OF MUSIC**  
 76 Brunswick Bldg., New York City, N. Y.

Send me your amazing free book, "How You Can Learn Music in Your Own Home," with inspiring message by Dr. Frank Crane, also Free Demonstration Lesson and particulars of your easy payment plan.

Name.....  
 Address.....  
 Instrument..... Have you Instrument?.....



**THERE'S MONEY IN YOUR CAMERA!**

Others make good incomes selling pictures to publications. **FREE BOOKLET** describes home-study course (which may be paid for in easy installments) and tells how YOU can do it too! **Universal Photographers, Dept. 76, 10 West 33 Street, N. Y. C.**

**REAL JOBS OPEN** Auto, Diesel, Aviation mechanics, Body, Fender repair, Painting, Welding. Learn with few weeks practical training. Write for **FREE BOOK**, low tuition rate, and course interested in. **McSWEENEY SCHOOLS, Dept. 10-54, Detroit, Mich., or Kansas City, Mo.**

**RADIO ENGINEERING**, broadcasting, aviation and police radio, servicing, marine and Morse telegraphy taught thoroughly. Nine months' engineering course equivalent to three years' college radio work. School established 1874. All expenses low. Catalog free. **Dodge's Institute, Ada St., Valparaiso, Ind.**

**CARTOONING AND SEMI-ILLUSTRATING** Elementary and advanced course of Motion Picture animation, newspaper and magazine work. Latest methods just released \$1.00 per lesson. Children & adults. This field needs you. Write now. Free charts from Studio No. 2, Canton, Ohio. **HOLLYWOOD-CANTON-SCHOOL OF CARTOONING**



**Learn AVIATION**

**Come to LINCOLN** Train at this Government Approved School for Good-Pay position as



**Pilot or Mechanic.** Air lines need Trained Pilots and Maintenance Men. Airplane Manufacturers need skilled Mechanics. Lincoln Trained Men in demand. **Be a Pilot.** Lincoln Training prepares you for Government Rating as Private, Limited Commercial or Transport (Commercial) Pilot. 14 Modern Training Planes.

**Be an Airplane Mechanic.** Lincoln Training prepares you for Government Mechanic's License. You get Practical experience in Airplane and Engine Maintenance, Overhaul, Assembly, Repair, Sheet Metal, Welding, Radio.

Aviation is Calling You. Now is the time to train at Lincoln. Write Today for Complete information.

**LINCOLN AIRPLANE & FLYING SCHOOL**  
 556 Aircraft Bldg. Lincoln, Nebraska

**Get More MEMORY POWER**  
 Nothing to learn or study. Secret of thinking clearly. Overcomes fear. Gives you poise. Confidence. Most simple MIND assisting method ever discovered. 15 minutes examination proves it, or money refunded. \$2.00 or C.O.D. plus postage. Nothing further to buy. **SAMUEL D. GATES, St. A21, 207 N. Michigan Av., Chicago, Ill.**

## TRI-STATE COLLEGE

### ENGINEERING DEGREE IN 2 YEARS

55th YEAR

Courses in Civil, Electrical, Mechanical (108 weeks), Chemical, Aeronautical (108 weeks), Radio Engineering. Essentials of engineering training included and non-essentials eliminated. B. S. Degree granted upon completion of course. For ambitious, earnest students. Those who lack high school may make up required work. Graduates compete successfully with those of 4-year schools. Technical instruction at lowest cost and in least

time consistent with thorough training. Intensive instruction in accord with individual ability. Courses also in Business Administration and Accounting. Also short diploma courses (36 weeks) in Surveying and Drafting. Students from all parts of the world. Tri-State graduates make good. Tuition, living expenses low. 55th year. Enter September, January, March, June. Write for catalog. **468 College Ave., Angola, Ind.**

PATENT YOUR INVENTION >>>

MECHANICS



STUDENTS



FARMERS



ARTISTS



# PATENT

*your ideas*

**TAKE STEPS NOW TO PROTECT YOUR RIGHTS**

A FORMER First Assistant Commissioner of Patents once said, "... the shed mechanic, printer's devil, housewife and small town cobbler have yielded almost all the basic inventions of the last twenty-five years." Men in many different positions and trades have worked out worthwhile inventions: A portrait artist who studied electricity invented the telegraph; a poet who had mechanical leanings made important improvements relating to the sewing machine; a man who

specialized in teaching the deaf and dumb developed the telephone; a bank clerk whose hobby was amateur photography invented the hand camera; a farm boy who was studying radio distinguished himself for his inventions in television; a man who gained most of his education from correspondence schools has made important contributions to the efficiency of the modern radio. If you have a good invention, you should learn how to protect your rights to it.

**READ ABOUT THIS Man**

SEND SKETCH OR MODEL TO-DAY >>

# PATENT YOUR INVENTION >>>

## IMPORTANT TO INVENTORS Your Next Step

Your invention may be simple—but it may be patentable. And many small inventions for the household, the office, or the shop have been very successful. But whether it is large or small, simple or complicated, there is one definite step you should take at once: You should make out a properly dated and witnessed disclosure of your invention. This evidence may be of great importance.

### Free "Evidence of Invention" Form

To help you right at the start, we will send you a FREE Evidence of Invention form on which you may make out a full sketch and description of your invention, and then have it witnessed by one or more of your friends. This may be the very thing that spells the difference between success and failure.

Just a few years ago, during the depression, a man named Charles Brace Darrow, of Philadelphia, Pa., found himself out of a job. He started tinkering and thinking, using the kitchen table for a workshop. In the course of a few months he had developed a new kind of parlor game. His friends tried the game, and liked it, so Darrow applied for a patent. The name of Darrow's game was "MONOPOLY"—and it is said that he has made a substantial fortune from it. The procedure followed by Darrow was correct. First, develop your idea. Then make a record of it, show and explain it to friends whom you can trust. Then move to seek the protection of a U. S. Patent. Our book "Patent Protection" explains all this procedure fully. It is interesting. It is instructive. And, if you have what may be a valuable invention, it is important to you.

We also want to send you a FREE copy of our smaller booklet that tells when and how to offer your invention for sale. Gives definite facts about selling and marketing. Invention isn't enough. A patent isn't enough. You must know how to cash-in. This booklet deals with that subject.

### 40 Years of Experience

Our firm has been helping inventors for 40 years. A large staff of expert draftsmen and registered patent attorneys gives you expert service. Fees are reasonable. Deferred payments arranged when desired. Questions answered. First class facilities for service.

# VICTOR J. EVANS & CO.

REGISTERED PATENT ATTORNEYS

MAIN OFFICE: 20-G VICTOR BUILDING WASHINGTON, D. C.

Other Offices: 2610-N, Singer Bldg., New York  
1445-N, Monadnock Bldg., Chicago  
1010-N, Hobart Bldg., San Francisco  
405-N, Garfield Bldg., Los Angeles  
514-N, Empire Bldg., Pittsburgh

Send me FREE copies of your book, "Patent Protection" and "When and How to Sell an Invention." Also Free "Evidence of Invention" form. (Note: Same books supplied by any of the other offices listed above.)

Name .....  
Street and No. .... State .....  
City or Town .....>>>



### Don't Delay—Act Now!

Do not delay needlessly. The patent laws favor the man who is prompt and diligent. Therefore, write us a letter, mail us a postcard, or use this handy coupon.... Whatever you do, **DECIDE YOU WANT THE FACTS NOW!**

# SEND SKETCH OR MODEL TO-DAY >>

# SEND FOR FREE BOOKS >>

# PATENTS

**Booklet Free      Highest References**  
**Promptness Assured      Best Results**

Send drawing or model.

## ALL BUSINESS GIVEN PROMPT AND PROPER ATTENTION

Listed Patent Lawyer in the latest editions of the Rand-McNally Directory of Bankers and Bank-Recommended Attorneys, published by Rand-McNally & Co., Chicago, Ill.; The Baggott & Ryall Directory of Guaranteed Attorneys, published by Legal Directory Corporation, Boston, Mass.; American Lawyers Annual, Cleveland, Ohio; Bankers Service Legal Directory, published by Bankers Service Co., Boston, Mass.; Eyre's Law List, 9 Park Place, New York City; Snow-Church Directory Co. Lawyers List, published in New York City, and the Central Guarantee Co., Bankers and Lawyers Directories, 630 Fifth Avenue, New York City.

**WATSON E. COLEMAN,** Victor Building, 724 Ninth Street, N. W.  
**REGISTERED PATENT LAWYER      WASHINGTON, D. C.**

## INVENTORS PATENT YOUR IDEAS SEND FOR FREE BOOK



### HOW TO OBTAIN A PATENT

Written by a Former Member of the Examining Corps (1922-24) of the U. S. Patent Office. If you want to profit by your idea, you should take steps to apply for a U. S. Patent at once. Your first step is to get this Free Book. This interesting illustrated book contains valuable information you should have. It tells you fully how to obtain a patent on your idea in the quickest way. With this Free Book you will also receive a "Record of Invention" form on which you can easily record your idea. Personal and Confidential Service: Your case will be personally handled only by a Registered Patent Attorney who is also a Former Member of the Examining Corps of the U. S. Patent Office. All communications confidential.

MAIL COUPON TODAY for FREE PATENT BOOK and -RECORD OF INVENTION Form.

### CARL MILLER

**REGISTERED PATENT ATTORNEY**  
**FORMER MEMBER EXAMINING CORPS U. S. PATENT OFFICE**

Woolworth Bldg., 35th Floor, Dept. 68A, New York City  
MILLER BUILDING, Dept. 68A, WASHINGTON, D. C.

Please send me your Free Book, "How to Obtain a Patent," and your "Record of Invention" form.

NAME.....

ADDRESS.....

## PATENTS—TRADE MARKS

All inventions submitted held confidential and given personal attention by members of the firm. Form, "Evidence of Conception" and instructions, "How to Establish Your Rights"—FREE!

**LANCASTER, ALLWINE & ROMMEL**

Patent Law Offices

412 Bowen Bldg.      Washington, D. C.

## PATENTS      47 years actual experi- TRADE MARKS      ence before the U. S. Patent Office and courts.

Personal attention to inquiries. All matters held strictly confidential. Write to-day for free information regarding your problems and patent procedure.

**GOULD & GOULD**      MUNSEY BLDG.,  
WASHINGTON, D. C.

## Inventions Wanted Patented or Unpatented

We have been successfully selling inventions, patented and unpatented, since 1924. Write for proof, and tell us what you have for sale.

**Chartered Institute of American Inventors**  
Dept. 4, Barrister Building, Washington, D. C.

**INVENTORS** who derive largest profits know and heed certain simple but vital facts before applying for patents. Our book, Patent-Sense, gives those facts; sent free. Trade Marks—Copyrights.  
LACEY & LACEY, Est. 1869, 635 F St., N. W., Dept. 5, WASHINGTON, D. C.

### ALBERT E. DIETERICH

### THEODORE H. RUTLEY

REGISTERED PATENT LAWYERS

512 B Colorado Bldg.      WASHINGTON, D. C.

Booklet on Patents sent free



### BUCHSTEIN'S FIBRE LIMB

is soothing to your stump—strong, cool, neat, light. Easy payments. Braces for all deformities. Agents wanted.

**D. BUCHSTEIN CO.**

610 3rd Ave., So., MINNEAPOLIS, MINN.

Send for Catalog Today

## No JOKE TO BE DEAF

—Every deaf person knows that—

Mr. Way made himself hear his watch tick after being deaf for twenty-five years, with his Artificial Ear Drums. He wore them day and night.

They stopped his head noises. They are invisible and comfortable, no wires or batteries. Write for TRUE STORY. Also booklet on Deafness.



Artificial Ear Drum

**THE WAY COMPANY**

729 McKerley Bldg.

Detroit, Michigan

## Print Your Own

Cards, stationery, circulars, tags, labels, advertising, etc. Save money. **Print for Others; Big Profits;** easy rules sent. Will do popular Raised Printing like Engraving. Junior outfit \$9. Senior outfit \$17 and up. Send for free catalog and all details. **KELSEY PRESSES.      D-37      MERIDEN, CONN.**

## FREE BOOK      RAISE GIANT FROGS

**WE BUY!** Good prices year round! Other markets waiting for all you can ship. Get ready now for next spawn. Breeder lays 20,000 eggs yearly. Small pond starts you. Free book shows sketch. Send no money. Write American Frog Canning Co. (Dept. 133-H), New Orleans, La.

## To PROTECT YOUR INVENTION—Use this coupon, NOW

Delays are dangerous and may be very costly. My personal service assures prompt action, strict confidence, and a minimum of expense. I suggest that you send me a model or drawing, or sketch and description of your invention, and \$5.00. I will make a search and report

promptly as to its patentability and send you a copy of my 72-page booklet. Or, if you prefer to read my booklet first, mail the attached coupon at once. I will also send my "Record of Invention" form. (Over 38 years experience as a Registered Patent Attorney.)

**L. F. Randolph, 302-D Victor Bldg.,**  
**Washington, D. C.**

Please send me at once, free of charge, your 72 page booklet and "Record of Invention" form.

Name.....

Address.....

## A PERSONAL CONFIDENTIAL PATENT SERVICE



# Auto-Diesel

Master a real trade. Auto Mechanics, Diesel Mechanics, Arc Welding, Acetylene Welding, etc. Let us train you to be an expert Auto-Diesel Mechanic and help you get a good job. The cost to you is reasonable. Learn on modern equipment with tools under experienced instructors. Real shop work. Steam heated buildings. Room and board in our steam heated dormitory. We pay your fare to Nashville. For free catalog write

Nashville Auto-Diesel School, Dept. 75, Nashville, Tenn.

## WIN YOUR DAWN WITH THE PATROL

Unequaled advantages in location for all year flying, finest equipment, highest Government approval for obtaining license in Transport, Limited Commercial, Private Flying, Radio, Sheet Metal, Mechanical Courses. For complete illustrated catalog, write—



J. D. GREEN, Director, Dept. PMS, TULSA, OKLAHOMA  
**SCHOOL OF AVIATION**

## Free AIR CONDITIONING AND REFRIGERATION TRIAL LESSON



Trained men needed. Good pay. Opportunities. Learn easily AT HOME in spare time. Write today for FREE TRIAL LESSON.

CHICAGO TECHNICAL COLLEGE  
6302 Tech Bldg., 118 E. 26th St., Chicago, Ill.  
If you can go away to college to learn Air Conditioning, Engineering, Architecture, Drafting, Electricity, or Radio, send for Free Blue Book.



## CARTOONING

You can now get personal instruction in this fascinating and well paid profession by one of America's leading cartoonists. Why be satisfied with less? It costs no more. Approved by the nation's foremost cartoonists. Write for free details about this "easy to learn" home study course.

DORMAN H. SMITH, Box C597, San Rafael, California

## Extra Money From Books

SEND NO MONEY • Books Sent C.O.D. Anywhere in U. S. These famous Pay-Raising, Extra Money Books have helped thousands of others. Let them help you too. Check this list and mail with your name and address. Pay post-name on delivery plus few cents postage. Send 3c stamp to cover postage and ask for catalog of other books.



SELECT FROM THIS LIST

- AIR CONDITIONING Furnaces, Unit Heaters \$3.00
- ARMATURE WINDING For A.C. and D.C. Machines... \$2.00
- AUTO REFINISHING Duco With Spray Gun \$1.50
- BLUEPRINT READING For Machine Trades... \$1.50
- BRICKLAYING Plain and Fancy... \$1.50
- CARBURETORS (All Makes) New, Revised Edition... \$3.00
- CHEVROLET SIX Car, Truck, Operation Repair... \$2.50
- COLONIAL FURNITURE Making, 95 Pieces... \$3.50
- DANCE Learn at Home Without Music or a Partner... \$2.00
- DIE CASTING Machines, Dies, Alloys \$3.00
- ELEMENTS DIESELS Engineering Questions and Answers... \$4.00
- FOUNDRY WORK Molding, Casting, etc. \$2.00
- FURNITURE REPAIRING Finishing and Decoration... \$3.00

- HIGH-SPEED DIESELS New, practical, non-technical... \$2.50
- HOME GROUNDS Furnishing... \$0.80
- INVENTIONS 1500 Needed... \$2.50
- LEATHER MAKING and Home Tanning... \$1.00
- MACHINE SHOP WORK Tools and Methods... \$2.50
- METAL SPINNING Practical New Book... \$1.00
- MONEY-MAKING FORMULAS 10,000 Practical... \$4.00
- PLASTERING Best Instruction Manual... \$1.25
- RADIO PHYSICS COURSE New edition. Everything about Radio... \$4.00
- SHEET METAL Construction Work... \$2.50
- STEAM ENGINEER'S LICENSE How to Obtain... \$2.00
- STEEL SQUARE Hodgson, 500 pp. 300 Illustrations... \$2.00
- TAXIDERMISTRY, HOME Mount Trophies Profit, Pleasure... \$1.50
- WOOD TURNING Course In... \$1.50
- WROUGHT IRON WORK Practical... \$1.35

POPULAR MECHANICS PRESS

Room 638A

200 E. Ontario St., Chicago

## HOW to Protect and capitalize on your INVENTION

Get these FREE BOOKS of "IDEA" Opportunities



Is your idea patentable? Has it commercial possibilities? Those are the things you want to know--and interesting information on these questions can be found in our books "How We Protect You" and "Suggestions on How to Commercialize Your Invention". We will send you these absolutely FREE--together with our Certification of Invention form, if you mail the coupon below NOW!

### OUR EXPERIENCE GUIDES YOU

You can feel perfectly sure in dealing with this reputable firm. C. A. Snow & Co. has been securing patents of every description for 63 years. Save time and expense now by getting advice based on our long patent experience.

**C.A. SNOW & CO**  
Registered Patent Attorneys Since 1875

MAIL NOW FOR FREE BOOKS

Dept. 168 SNOW BUILDING, WASHINGTON, D. C.

Gentlemen: Please send me absolutely free and without obligation on my part, your original document "Certification of Invention", together with your two guides for inventors, "How We Protect You" and "Suggestions On How to Commercialize Your Invention."

Name.....  
Street and No.....  
City or Town..... State.....



## WANT A GOVERNMENT JOB START \$1260 to \$2100 YEAR

MEN—WOMEN

- File Clerks
- Postoffice Clerks-Carriers
- Railway Postal Clerks
- Customs Inspectors
- Stenographers-Clerks
- Many Other Jobs

Franklin Institute  
Dept. S173  
ROCHESTER, N. Y.

GET READY IMMEDIATELY Common Education Usually Sufficient

Mail Coupon TODAY

Gentlemen: Rush to me, FREE of charge, list of U. S. Government big pay jobs. Send FREE 32-page book describing salaries, vacations, hours, work, etc. Tell me how to qualify for one of these jobs.

Name.....

Address.....

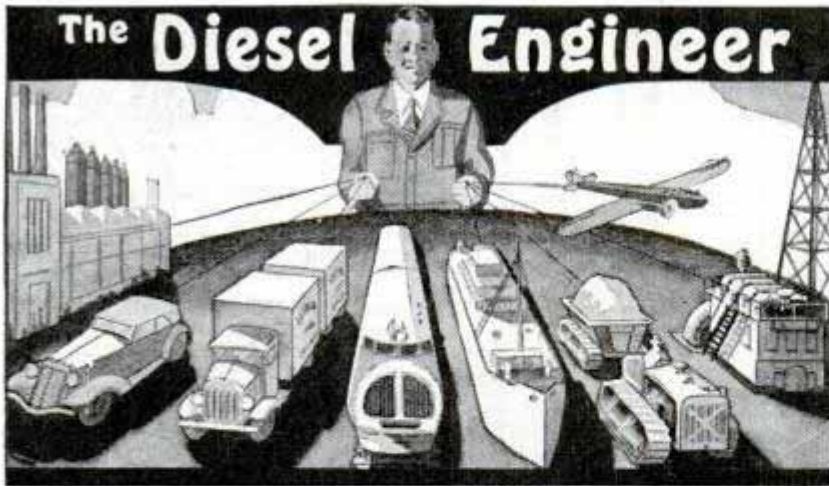

# The Diesel Engineer

## Is Your Job Safe?

Just as the gasoline engine changed the jobs of thousands who depended on horse-drawn vehicles for their living—so now the Diesel engine is fast invading both the power and transportation fields, and threatening the present jobs of thousands.

### What This Field Offers You

Diesel engines are replacing steam and gasoline engines in power plants, motor trucks and busses, locomotives and ships, aircraft, tractors, dredges, pumps, etc.—opening up well-paid jobs for Diesel-trained men. You get all the latest Diesel developments in our course. Special diagrams for quick understanding of this new power.

## For Men Earning Under \$40 a Week

### Diesel — The New Power

Now is your chance to get into a big new industry and grow up with it to an important position. Today there is practically no competition in the Diesel field, but the increasing use of Diesel engines will result in keen competition for jobs after a few years. If you start your training now and get established in this field, you need not worry about competition.

### Job Facts in Diesel

Learn how quickly you can prepare for growing opportunities in Diesel by our Job-Instruction method. Train at home for this good pay field where there is chance for rapid promotion. Free employment service to graduates. Low monthly terms. If you want a good job get FACTS! Write for booklet today!

**AMERICAN SCHOOL, Dept. DA 45, Drexel Avenue at 58th Street, Chicago, Illinois**

Fit Yourself For a Good Pay Job

## LEARN ACCOUNTANCY SECRETARIAL AND OFFICE WORK HILL'S WAY

### EARN MORE MONEY

Big pay goes to those who train for it. Hill's trains men and women quickly to fill highly paid positions. Easy to acquire, yet completely thorough. Learn at home during time now wasted. Low tuition fee; easy payments. Send today for our inspiring SUCCESS Book FREE.

**HILL'S EXTENSION SCHOOL**  
603 West Main St., Oklahoma City, Okla. • Est. 1907

Name \_\_\_\_\_ Age \_\_\_\_\_  
Address \_\_\_\_\_  
City \_\_\_\_\_ State \_\_\_\_\_

## CARTOON YOUR WAY TO SUCCESS!



DON'T COPY — LEARN TO ORIGINATE!

RAYE BURNS will teach you HOW to CREATE ORIGINAL CARTOONS at home that you can SELL! Course contains 26 lessons and over 600 illustrations. All for Only **\$3.85**

Send name and address for free details.  
**RAYE BURNS SCHOOL, Dept. M, BOX 2194, Cleveland, Ohio**

## MONEY-MAKING OPPORTUNITY

For men of character. Over \$1,600 per month earned by California man. Over \$400 a week by Georgia man. \$1,000 in a month by Delaware man. Exclusive franchises available for an investment expected to replace a multi-million dollar industry. Install on free trial. Sells itself. Repeats. Exclusive proposition. Write **F. E. Armstrong, Dept. 1112-F, Mobile, Alabama**.

### STRANGE DEVICE WELDS BRAZES and SOLDERS

**\$3.75 RETAIL**

WITH POWER From YOUR AUTO BATTERY... This Amazing NEW Arc Welder uses about the same current as four headlight bulbs. Can be used on 110 Volt electric light socket or 32 Volt electric light plant by using a Trindl Converter in place of battery. **MELTS** iron and steel almost instantly. Welds fenders, radiators, holes in bodies and milk cans, tanks and brazes broken castings. **WORKS ON ANYTHING** iron, steel, copper, brass, tin or galvanized metal. Permanent repairs made for almost nothing. Used by factories in many operations. Positive money back guarantee. **AGENTS WANTED.** Write Today for FREE Particulars. **TRINDL PRODUCTS, 2227-CX, CALUMET AVE., CHICAGO, ILL.**

**\$30.00 TRADE-IN ALLOWANCE DURING THIS MIDWEST FACTORY-TO-YOU SALE**

**16 TUBES** **FACTORY-TO-YOU PRICE: \$69.95**  
**TOUCH BUTTON TUNING** **LESS \$30.00 ALLOWANCE you pay only**  
**30 DAYS FREE TRIAL** **\$39.95 COMPLETE**  
**EASY TERMS**

SEND for this marvelous new COMPLETE 1938 Midwest 16-tube radio... on 30 days FREE Home Trial. Big beautiful console—10,000 mile range—world-wide reception—glorious new tone—and Dial-A-Matic Tuning.

**Midwest Radio Corporation** Write for FREE 1938  
Dept. TT-15 Cincinnati, Ohio Factory Catalog.

## AN AVIATION CAREER OFFERS YOU A GREAT FUTURE

Demand for trained aircraftsmen in Southern California plants is increasing and already exceeds supply. Curtiss-Wright Technical Institute, Aviation's foremost and oldest school, is located in heart of this activity and specializes in Sheet Metal, Master Mechanics and Aero Engineering. (No flying involved.) Graduates are obtaining immediate employment. Write for details NOW! **MAIL THIS COUPON TODAY**

Dept. P.M.6 **MAJOR CAREER COURSES**

AERONAUTICAL ENGINEERING  MASTER MECHANICS

NAME \_\_\_\_\_  
ADDRESS \_\_\_\_\_

## NEW INVENTIONS

(Continued from page 20A)

nected to the alarm system by a cord which is plugged into a wall socket.

**M**OTHERS may eliminate worry over whether the baby is covered up at night by using a newly patented sleeping garment. The child is placed inside the garment, which somewhat resembles a small blanket, and buttoned in for the night.



Means of buttoning are provided on the back and front of the garment so that the child may be prevented from throwing or kicking off the cover.

**M**EANS for warning the driver that his automobile is traveling at a dangerous speed is provided in a speedometer patented recently. The speedometer has an opaque dial on which the lower speed numerals are printed, as usual. The high speed numerals, however, are perforated and an electric bulb behind the speedometer illuminates the perforations when the car's speed causes the pointer to move that far around the dial. The high speed numerals are illuminated, warning the driver, until the speed drops below that indicated by the perforated numerals. The speedometer pointer switches the electric bulb on and off.

**O**FFERING a new means of watering the roots of large plants or trees, a subirrigation device has been patented. It consists of a flexible circular conduit which is buried in the ground surrounding the tree or shrub. A funnel attached to the conduit extends above ground to provide a means of conducting water to the conduit. Openings in the conduit permit the water to seep into the soil.

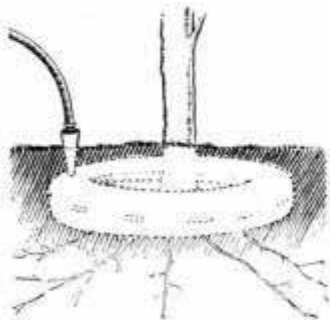

(Continued to page 54A)

 A black and white photograph of a welder in a dark mask, working on a piece of metal. The image is part of an advertisement for Electric Arc Welding.
 

**Electric  
Arc Welding  
Revolutionizes modern Industry**

**U. S. Manufacturers** desire men to learn Electric Arc Welding and get practical experience under actual production conditions in the laboratories of the School of Engineering. Moderate training Fee. Accepted applicants will be fully trained until ready to pass rigid test and assisted in securing employment. **ARC WELDING** presents one of the outstanding opportunities for steady income and future success. Welding is growing rapidly, replacing large and intricate castings, rivets, nuts, bolts, screws. It is commonly used in assembling cranes, hoists, bridges, structural steel work, etc. No limit to the application of welding to industry, increasing durability and reducing manufacturing costs. There is a decided shortage of properly trained Welding Operators, Technicians, and Welding Engineers. Why be content with ordinary work, hit and miss jobs and low pay when in a short time you can become a trained Specialist in Welding?

**MILWAUKEE  
SCHOOL OF ENGINEERING**  
Institute of Electrotechnics

Dept. PM-638, Broadway & E. State, Milwaukee, Wis.

### EXTRA!

'THE DAWN OF A GIGANTIC INDUSTRY' Seventh Edition! Just off the press! Get this new popular, fascinating large-size 68 page book, biggest ever published on Welding Training for Industry. It's free to Men of Action!

Without obligation send Free Booklet "The Dawn of a Gigantic Industry and its Outstanding Opportunity."

Also tell me How to Become an  
**Arc Welding Operator** (3 mo.).....  
**Gas Welding Operator** (6 wks.).....  
**Welding Technician** (6 mo.).....  
**Welding Engineer** (1 yr.).....  
**Electrical Engineer**  
**B. S. Degree** (4 yrs.).....  
 Air Conditioning & Refrig. Tech. (3 mo.)  
 Radio Serviceman (6 mo.).....  
 Student Loan Plan.....  
 Earn Part Expense Plan.....

Name.....Age.....

City.....

State..... (PM-638)

## HOME STUDY COURSES

Home Study Courses leading to Degrees in Arts and Sciences; Philosophy; Education; Writing; Psychology; Chemistry; Theology; Law; Agriculture; Business, Accounting, Sales; Advertising; Electrical, Civil, Mechanical, Diesel, Architectural, Aeronautical, Automotive, Drafting, Radio, Air Conditioning, Refrigeration, Highway, Mining, Petroleum, Industrial, Steam, Chemical Engineering.

**McKinley-Roosevelt Graduate College, 4228 Clarendon Ave., Chicago**

 A large black and white photograph of a Slingerland guitar. In the background, there is a smaller image of Gene Krupa playing drums.
 

**SEE AND TRY  
SLINGERLAND  
RADIO KING DRUMS  
MAY-BELL  
GUITARS**

Don't buy Guitar, Mandolin, Banjo, Electric Guitars, Bugles or Drums until you have seen and tried the Slingerland May-Bells. Guaranteed More for your Money. Wonderful, snappy, powerful, pleasing tone. No equal in price. Sold on easy payments and 5 days free trial by all leading music dealers.

Cut this Adv. Out—Good for \$1.00 Credit.  
 Ask for Special Information on How to Organize Drum and Bugle Corps.  
 Send for free catalog. Mention instrument wanted. Write today.

**SLINGERLAND MUSICAL INSTRUMENT MFG. CO.**  
 1330 BELDEN AVE. CHICAGO, ILLINOIS

# Accountancy Home-Study

## made interesting and practical thru problem method

**Y**OU know as well as we do that Accountancy fits many men for positions that pay three and five and ten thousand dollars a year—gives many other men unusual opportunity to start a profitable growing business of their own.

You probably realize also that—because of the new state and federal legislation—the accounting profession faces now and for the next few years the greatest opportunity it has ever had.

The only question is—just how practical is it for *you* to train yourself adequately in Accountancy through home study?

And the answer lies in the LaSalle Problem Method.

For this modern plan of training not only makes Accountancy study at home thoroughly practical but makes it interesting as well.

And here's how:

### You Learn by Doing

Suppose it were your privilege every day to sit in conference with the auditor of your company or the head of a successful accounting firm. Suppose every day he were to lay before you in systematic order the various problems he is compelled to solve, and were to explain to you the principles by which he solves them. Suppose that one by one you were to work those problems out—returning to him every day for counsel and assistance—

Granted that privilege, surely your advancement would be faster by far than that of the man who is compelled to pick up his knowledge by study of theory alone.

Under the LaSalle Problem Method you pursue, to all intents and purposes, that identical plan. You advance by solving problems.

Only—instead of having at your command the counsel of a single individual—one accountant—you have back of you the organized experience of a great busi-

ness training institution, the authoritative findings of scores of able accounting specialists, the actual procedure of the most successful accountants.

Thus—instead of fumbling and blundering—you are coached in the solving of the very problems you must face in the higher accounting positions or in an accounting practice of your own. Step by step, you work them out for yourself—until, at the end of your training, you have the kind of ability and experience for which business is willing and glad to pay real money—just as it was glad to pay these men.\*

### Five Men Who Tested and Proved It for You

For instance, there was the man who started Accountancy training with us in 1916. After a short period of study, he took a position as bookkeeper for a year, and then became accountant for a leading automobile manufacturer—with two bookkeepers under him. He became auditor of one of the foremost banks in his state with a salary 325 percent larger than when he started training.

He wrote, "My training is the best investment I've ever made, showing a cash value running into five figures."

And the young clerk, earning \$75 a month eleven years ago and later getting many times that as general auditor for an outstanding, nation-wide organization. Within six months after he began our training, he was earning \$125 a

month and within four years, he was earning \$250.

Do you wonder that he wrote, "While LaSalle ads once seemed like fairy tales to me, now I know from personal experience that they are true."

Or let us tell you about two men—one a stenographer and the other a retail clerk—neither of whom knew more than the simplest elements of bookkeeping. One became the comptroller and the other the assistant comptroller of a large company.

"LaSalle training in Higher Accountancy," wrote both, "was the important factor in our rapid climb."

And if you are thinking about the C. P. A. degree and a public accounting business of your own, read about the pharmacist who was earning \$30 a week some years ago when a LaSalle registrar secured his enrollment for Accountancy training. Eight months later he left the drug store to take a bookkeeping job at \$20 a week—less money but larger opportunity. Three years later he passed the C.P.A. examination and a year later yet he was earning \$5,000 a year. Now he has his own highly successful public accounting firm for which he says, "My LaSalle training has been largely responsible."

### One-Tenth of All C. P. A.'s Are LaSalle Trained

If you want still more proof, remember that 1600 C.P.A.'s—approximately one-tenth of all those in the United States who have ever passed the difficult examination for this coveted degree—are LaSalle trained.

And knowing these facts, ask yourself if there can be any further question about the practicability of this training for you—ask rather if the real question is not about the size of your own ambition and the quality of your determination.

For Accountancy is no magic wand for the lazy or the fearful or the quitter—it offers success only to the alert adult who has the courage to face the facts and the will to carry on till the job is done.

If you are that individual, the coupon below, filled out and mailed, will bring you free the information that can open up to you the future of which you have dreamed—ability and income and success.

Is it not worth getting that information?



Send for  
This Book

\*Names and addresses given on request.

## LaSalle Extension

LASALLE EXTENSION, Dept. 664-HR, Chicago, Ill.

Please send me, free of all cost or obligation, your 64-page, illustrated book, "Accountancy, the Profession That Pays," telling about the profession of accountancy and your training for success in that field.

Name.....

Address.....City.....

Position.....Age.....

When writing to advertisers please mention Popular Mechanics





# CLASSIFIED

## Advertisements



Advertisements in this section, 35 cents per word, each insertion, minimum 10 words, payable in advance

To be inserted under proper classification in July issue, copy should be in our office May 8th

July issue on sale June 1st

Popular Mechanics Magazine, 200 East Ontario Street, Chicago, Illinois

## YOU'LL PROFIT

By reading and answering the classified ads in this section. Hundreds of opportunities to make and save money.

Popular Mechanics Magazine,  
200 E. Ontario Street,  
Chicago, Ill.

Gentlemen: There is no other publication like the Popular Mechanics. We have been getting orders from Belgium, France, Australia, South Africa, the Philippine Islands and many other countries too numerous to mention. Our average cost per advertisements, which appear in your publication is one-eighth of a cent per reply, which is better than any other publication we are doing business with.

(Original letter on  
file in our office)

Very truly yours,  
NATIONAL TRAILER EQUIPMENT CO.

### AUTOMOBILES

**TIREX.** The new tire protective product, opens huge servicing market. Amazing demonstration wins motorists and truck owners. Sales and servicing increasing phenomenally. Attracting unusual attention in U. S. and foreign countries. Own and manage a Tirex National Safety Service in your city. Small capital required. Write for copy of Franchise. Tirex Corporation, 720 North Michigan, Chicago.

**MIDGET** Racing book; facts for fans, builders, drivers; track sizes, regulations; pictures, specifications, working drawings. \$1.00 postpaid. \$1.15 C.O.D. Ray Kuns, Department 26, Madisonville, Cincinnati, Ohio.

**MIDGET** Cars, parts, plans. Catalog dime. Derby Midget Cars, Woodstock, Ill.

**FORD V-8's, 1934-1938;** gasoline saving device. \$1. Walert Co., 3429 No. 10th St., Milwaukee, Wisconsin.

**MIDGETS!** Plans, parts, building kits. Modern designs, easily built, lowest cost. Catalog—containing full construction details latest sport midgets, racers, etc.—25c. Circulars free. Shippo Midgets, Box 543-H, Zanesville, Ohio.

**AUTOMATIC** Exhaust gas receiver on auto. Eliminating Co. Patented. Sale. Hollister, Uruapan, Mexico.

**AUTOMATIC** Safety control for hydraulic brakes. Fleets report saving gasoline, repairs, adjustments, preventing accidents. Soon repays cost, \$15.00 C.O.D. Ten day free trial. Money back guarantee. Sells on sight. Big profits for hustling agents. Hook, One Bank Street, New York City.

**OIL** Pumping positively controlled, any motor. No reboring dope or trick rings. Proven method. \$1.00. E. Ferris, Hazel Park, Mich.

**SUPERCARGING!** Receive laboratory information, installation, methods. Complete \$1.00. Technical Advisors, 2700 Idlewood, Richmond, Virginia.

**NEW** Discovery saves gas, increases power, smoother performance. Parts under 50c. Valuable information for dime. Community, 621 Hamilton, Farrell, Penna.

**1938 IGNITION** Supercharger. Quick starting, wet or cold. Mileage, pep, power, less carbon. \$1.25. E. G. Sales Co., 321 Broadway, New York.

### AUTO SUPPLIES AND EQUIPMENT

**FREE** 1938 Wholesale bargain catalogue auto supplies, equipment, tools. Leffe, 1189 Bedford Ave., Brooklyn, N. Y.

**AIRLOCK** Stops punctures, lengthens tire life. Fully guaranteed. One tire \$1.00, four \$2.50. Airlock Laboratory, 1460 Hollywood Ave., Chicago, Illinois.

**GASOLINE** Mileage gauge, with electric dash meter. Econometer, Plain, Wis.

**SAVE** Half! Guaranteed reconditioned truck and auto parts. All parts, all models, makes. Catalog free. General Auto, 7008-AA Cottage Grove, Chicago.

**MAKE** Automobile polish, etc. Our ten selected formulas \$1.00. Guaranteed. Variety Company, Saint Andrew, Florida.

**USED** Midget autos, motors, parts service. Direct owner prices. Latest lists, 20c. Shippo, Box 543-H, Zanesville, Ohio.

**PLATING** Outfits for auto parts. Connect to a battery. No tanks used. Free particulars and proofs. Gunmetal Co., Ave. J, Decatur, Ill.

### AUTO TRAILERS

**BUILD** Your own house trailer for less than \$100, including factory built chassis. Plans and drawings, 50c. Hildman, Inc., 459 Irvin Ave., Rochester, Penna.

**BUILD** The famous, low-cost Jim Dandy Cabin Trailer. Complete plans and instructions 50c. Plans to build the beautiful, streamlined Jim Dandy Cabin Cruiser, \$1.00. Trailer Builders Manual and catalog of trailer parts, supplies and equipment—over 100 interesting, illustrated pages, 25c. Order today. Satisfaction guaranteed. Trailer Supply Co., 411-A Jackson St., Wausau, Wisconsin.

### MOTORCYCLES, BICYCLES, MOTOR SCOOTERS, AND SUPPLIES

**LIGHTS** Bicycle lamps as you ride. No batteries. Dynamo, head and tail lights attachments chromium plated. Complete \$3.98. Folder on request. Ride safely at night. Guerrieri, 911 West Wellington, Chicago, Ill.

**MOTORCYCLE** Parts, accessories. Lowest prices. Lists 10c. Comiskey, 3852 Addison, Chicago.

**PERFECTED** American made generator eliminates batteries for bicycle lamps. Many exclusive features. Send for descriptive circular. Bike-Lite Company, 1624 Junction Ave., Racine, Wisconsin.

**SEND** 10c For new 1938 Handbook of Information, listing new and used parts for all makes of motorcycles; accessories, batteries. Bootz, 622 East Grand, Des Moines, Iowa.

**ALLOY** Pistons—Harley, Indian, Henderson, Excelsior, Cleveland. New and used parts for less. Cylinder grinding. Catalogue and wings pin 10c. Ballak, 1115 Chestnut, St. Louis, Mo.

**REBUILD** Motorcycles, all makes, new and used Harley-Davidson parts. Send 10c for bulletin. Western Harley-Davidson Distributors, 914 E. 15, Kansas City, Mo.

**RECONDITIONED** Motorcycles. New—used parts for all makes. Authorized Harley-Davidson dealer. Whitman Motorcycle & Supply Co., 405-9 Southwest Blvd., Kansas City, Mo.

**INSIDE** Dealer prices. Overstocked, all models, Indians and Harleys. Rebuilt, guaranteed. Dime brings latest list. Crandall-Hicks, Boston, Mass.

**SEND** 15c For illustrated used motorcycle catalog. Bargains. Largest stock genuine Indian parts and motorcycles. Indian Motorcycle Sales, Kansas City, Mo.

**MOTORCYCLE** Bargains, lowest prices, bargain sheets for stamp. Motorcycle accessories. Rochester Harley Davidson Corp., 129 W. Main St., Rochester, N. Y.

### AVIATION

**NEW** 1938 Illustrated catalog of new and used firearms, send coin, 25c. Aviation parachute, cost \$300.00, slightly used, bargain \$47.50. Aviators fur lined suit, cost \$75.00, bargain \$19.50. Public Sport Shops, 13 No. 16th Street, Dept. M-1, Philadelphia, Penna.

**PROPELLERS** For airplanes, fans, sleds, iceled blueprints. Catalog dime. Lorenzen Propellers, Niles, Michigan.

**HELICOPTER** Aircraft—Patent ideas offered. Walter Ellis, National City, Calif.

**PROPELLERS.** Sled, airplane, illustrated catalog free. Woodcraft Propellers, Dallas, Texas.

**AVIATION.** "How to get into." Send stamp. Meyer, Box-8, Hempstead, N. Y.

**GET** Into aviation. Air transport pilots get up to \$6,000 per year, mechanics \$2,500. Learn at this government approved school. Write for complete information. State age. Lincoln Flying School, 2004 Aircraft Building, Lincoln, Nebraska.

**AVIATION** Apprentices. Good pay—Big future. Write, immediately, enclosing stamp. Mechanix Universal Aviation Service, Strathmoor Station, Dept. E2, Detroit, Michigan.

**SENSATIONAL** Aeroplane with motor purchase. Terms. Propellers, 98c up. Information. 25c. Universal Aircraft, Ft. Worth, Texas.

### BATTERIES, GENERATORS, ETC.

**BUILD** Wind light plant. Complete plans and valuable catalog 10c. Wind plant parts, welders, electric fences. LeJay Manufacturing, 447 LeJay Bldg., Minneapolis, Minn.

**TWELVE** Volt, 400 watt, heavy duty motor bus generators. Perfect condition. Usable for welding or windmill generators. \$8.50 each f.o.b. Chicago. Other units in stock. State Ignition Service, 52 Cullerton St., Chicago.

**EDISON** Lifetime storage batteries for light and power. Eliminates acid battery diseases. Long guarantee. All kinds rebuilt generating plants, motors, and miscellaneous articles at bargain prices. Free interesting literature. T. Hawley Smith Co., Croton Falls, N. Y.

A. C. Generators, hand-driven, generates 110 volts, original price \$5.50. Special 98c. Electrical Salvage, Box 524-83, Lincoln, Nebr.

EDISON Storage batteries for light-power systems. Non-acid. Odorless. fifteen year life. Five year unconditional guarantee. Bargains in complete lighting systems. Low prices. Free illustrated literature. "See-Jay" Battery Co., 82 Sterling Ave., Yonkers, N. Y.

#### AIR CONDITIONING

AIR-CONDITIONING Outfits: easily built! Home, work-shop, stores, offices! Enjoy "mountain air," year-around health and comfort. Complete instructions. Seven different blueprints. 5-days approval. Return or remit \$1.00. Servatex Company, 895-PM Madison Building, Milwaukee, Wisconsin.

AIR Conditioning cabinet, filters, cools 1000 CFM 15 deg. on 300 lbs. ice. Lists \$150.00 erected. 12 mo. use. 12" to 30" fan wheels and motors for ventilation. Texo, 204 W. 3rd, Cincinnati, Ohio.

KEEP Cool. Large floor stand circulator \$23.50. Kitchen fan 12", \$12.50. International Engineering, Inc., Dayton, Ohio.

#### ELECTRICAL SUPPLIES—EQUIPMENT

FIRE Warning. Thermostatic contactor installs in bell wiring 50c. Unassembled, 25c. Thermostatic metal 10c. Balco, 1611 N. Wells, Chicago.

ELECTRO-SCRIBE: Electric pencil writes, engraves all metals. \$1.00 postpaid. Details free. Beyer Mfg. Co., 4515-K Cottage Grove, Chicago.

ULTRA Violet—Infra red. Dual ray health lamp. Two separate units in one. Promotes sun tan—vitamin "D." Automatic control. AC-DC current. \$3.90 postpaid. Details free. Beyer Mfg. Co., 4515-P Cottage Grove, Chicago.

ELECTRIC Pen, engraves hardest steel. Dollar prepaid. Hudson Bros., East Syracuse, N. Y.

#### ELECTRIC FENCING

ELECTRIC Fencer, \$9.75 complete. Guaranteed. Agents wanted. Sentinel, Dept. P-949, Cincinnati, Ohio.

MAKE Electric fencer. It's easy with our simple plans to convert Ford T coil. No further costs. Complete plans 35c. LeJay Mfg., 847 LeJay Bldg., Minneapolis, Minn.

#### WELDING AND SOLDERING

MAKE Soldering easy. Tin and solder any metal, even cast-iron, (not alum.) Money back, formula 25c, or supply ready to use 50c. Martin's Service, 1322 Potrero Ave., San Francisco, Calif.

NOTICE! Shop-men! Mechanics! Guaranteed 110 volt a.c. arc welder plans. Uses up to 5/32 rod. Easily built for less than \$10.00. Guaranteed plans \$1.00. Hansen Bros., Filer, Idaho.

ARC-WELDERS. Build your own 110 volt, 50-150 ampere welder. Instructions, drawings, 50c coin. Hildman, Inc., 459 Irvin Ave., Rochester, Penna.

DODGE Arc-welder, 40 volts, d.c., 25-200 amperes. Positively no armature winding. Certified instructive plans \$1.00 C.O.D. \$1.12, airmail 12c extra. Welders Club of America, AB-3432 M-Mart, Chicago. (Special: All plans sold on money back guarantee, if not satisfied.)

ELECTRIC Arc welder, only 22c a day! Sensational commonwealth all-purpose heavy duty, continuous operation arc welder. Ten months to pay from profits. Handles all welding—lightest sheet metal to heaviest castings. Operates from electric socket. Complete, nothing else to buy. 10-day trial. Details free. Commonwealth, Dept. J-55, Cincinnati, Ohio.

ARC-WELDER, D.C., 25-600 amperes, Dodge excited, built from d.c. motors of electric trucks, mules, autos, etc. Low cost. Easy method. No rewinding plans \$1.00. Welders Club, AB-3432, M-Mart, Chicago.

DEMONSTRATORS, Electric arc welders. Money-saving prices. Used by the government. Trial and terms guaranteed. Hobart Welders, M-683, Troy, Ohio.

GENUINE Dodge arc-welder (no rewinding). Plans \$1.00. Welders Club, AB-3432 M-Mart, Chicago.

ARC Welder bargains. Used, trade-ins, rentals, demonstrators. Write for price list. The Lincoln Electric Co., Room 21, Cleveland, Ohio.

110 VOLT ac. dc. Electric brazing torch. Produces 3 inch flame similar to acetylene. Complete \$12.50. 110 volt ac. heavy duty arc welder. Complete \$19.50. Apollo Mfg. Co., 319 Union, Memphis, Tenn.

75-200 AMPERE Arc welder from Dodge generator. Complete plans and valuable catalog 35c. 100 other generator changes. LeJay Manufacturing, 247 LeJay Bldg., Minneapolis, Minn.

REBUILT Electric arc welders, all sizes, a.c.—d.c. guaranteed. Lowest terms. Money-saving prices. Service Co., 3732 Cedar Ave., Cleveland, Ohio.

ARC-WELDING Outfit \$1.25. Weld fenders, braze, solder. Lavrow, 4368-W. Warren, Detroit.

ELECTRIC Welders, 110-220 volt, fan-cooled, can be used for hours, \$75.00. Box 331, Hamilton, Ohio.

#### ENGINES, MOTORS, DYNAMOS

ELECTRIC Drill \$3.67; shaver \$4.00; 10" oscillating fan \$4.35; candid type camera \$3.98. Home workshop tools. Bargain pricelist free. Mallor Electric Co., 713 South Dearborn St., Chicago.

MAKE Money, rewind washing machine motors, auto generators. Each book \$1.00. 10c coin brings particulars, catalog of winding materials, tools. Ernest Knight, LaSalle, Illinois.

FOR Sale—Small elect. motors, high speed, 1/25 h.p., 115 volt, universal. Rebuilt—\$1.50 postpaid. McConnell, 1619 Edgewood, Racine, Wis.

GOVERNORS For all makes auto engines. Circulars. 30 days free trial. Candee-Smith Governor, 445 E. 3rd St., Los Angeles, Calif.

THREE To ten KVA alternating generators. Motors, converters. Queen City Electric, 519 South California, Chicago.

GUARANTEED. Slightly used 1/2 horse, 110 volt, alternating motors \$7.90. Wilnot Auto Supply, 2247 St. Paul Ave., Chicago.

BARGAIN—1/2 Hp. motors, 60 cycle, 1 phase, 110 volt, like new, guaranteed, \$8.25. Send check to Erie Electric Motor Co., 120 Church, Buffalo, N. Y.

WINDING Data, 225 motors, single and three phase. Price \$1. Motor Data Co., Box 7631, Kansas City, Mo.

#### MACHINERY, TOOLS AND SUPPLIES

NEW Drill presses, wholesale price, all sizes. Write for circular. Peerless Machinery, 2020 E. 12 Street, Oakland, Calif.

KELLOGG Air compressors, \$6.00. Electric refrigerators, \$25.00. Bench lathes, \$15.00. Taylor, 105 East 102nd Street, New York.

10" x 5" SIDNEY Quick change lathe, three step cone drive, double back geared, excellent condition. No. 0 Cincinnati plain millers. Write for particulars. Cincinnati Machinery & Supply Company, 223 E. Second St., Cincinnati, Ohio.

CONCRETE Building block machines and molds. Easy payments. Catalog free. Concrete Machine Co., 5 North Main St., St. Louis, Mo.

REAMERS, Huge assortment. All new, first quality. No junk. Money saving prices. Shaw, Temple, New Hampshire.

WHOLESALE Prices! Tools, supplies, motors, speedreducers, pumps, gears. Catalog 10c. Kostka, 2348-F South Crawford, Chicago.

SOUTH Bend 9" lathe milling attachment, universal movement, \$9; threading dial indicator, \$3; circular free. Unique Manufacturing Co., 4807 No. 31st Ave., Omaha, Nebr.

1/4" SET Screws \$1.00 per hundred. Stern, 7401 Sangamon, Chicago.

BARGAINS. Demonstrators, electric arc welders, guaranteed, 30 days trial and terms. Write Hobart Welder Exchange, Box M-684, Troy, Ohio.

MECHANICS, Amateur, professional, handy hints booklet, 10c (coin). S. Lefe, 1189 Bedford Ave., Brooklyn, N. Y.

CASTINGS And blue prints for tallstock turret attachment for bench lathes—\$3.50. Milburn, Box 63, Covington, Ky.

POWER Hacksaw, three inch capacity, \$6.50. Milburn, Box 63, Covington, Ky.

TREMENDOUS Surplus of factory tools selling out. Drills, taps, files, hacksaws, etc. Send for free lists, include six cents postage. Travers Tool Co., 264 Jackson Ave., Long Island City, N. Y.

12" x 6" SEBASTIAN Geared head motor drive Gold Seal lathe. Excellent condition. Write for bargain price. Cincinnati Machinery & Supply Co., 219 E. Second St., Cincinnati, Ohio.

#### BOATS, OUTBOARD MOTORS, ETC.

KAYAK Construction kits. New designs in lightweight canvas kayaks and canoes. Nine to fifteen feet from \$9.95 to \$39.50. Also sold assembled. Mail dime for literature. Jamestown Specialty Co., Dept. P638, Titusville, Penna.

SAIL Your canoe, rowboat! Complete rig \$12 to \$19. Try-sail Company, Patterson, New York.

COMPLETE Plans and drawings for building three, easily built, inexpensive, speedy boats—50c. Hildman, Inc., 459 Irvin, Rochester, Penna.

14-FOOT Inboard-outboard rowboat—complete plans May Rudder 35c. Free boatbuilding catalog. Rudder, 15 Murray St., New York.

ATTENTION! 12' Kayak kit \$10.00! Request circular. Playaks, Dedham, Mass.

BOAT Lights. New low prices. Literature on request. Armington, Sycamore, Illinois.

CLEARANCE. Marine hardware, paints, etc. Varnish, \$1.39 gallon. Brand new 1937 Elto Ace motors, \$35.95. Send for complete list. H. Fletcher, Palisade, New Jersey.

FORD Marine conversion parts and kits. Models A, B, V8 (domestic or foreign). Catalogue 25c (coin). Osmithson, 3101 C Street, Philadelphia, Penna., U.S.A.

PROPELLERS. Gear pumps, stuffing boxes, bearings, etc. Wm. Baker, Pond St., Quincy, Mass.

BUILD A boat by the Welch System. Save on the cost. Send 10c for 32 page catalog of boats, motors and marine equipment. Welch Boat Company, Station K-1, Milwaukee, Wisconsin.

BOATS and surfplanes, \$18.95 up. "Brainard Bilt," Trumansburg, N. Y.

FORD and Zephyr marine engines. Send 10c coin. Lehman Engineering Company, Newark, N. J.

BUILD 12' Outboard rowboat. 12' Kayak. Patterns, each \$1.00. Circular, dime. Henry Bakewell, 44 Billings St., Lowell, Mass.

ASSEMBLE Your own boat. Our finished knock-down frames and materials save you 2/3 builder's cost. All types and sizes. Send 25c for big catalog. Brooks Boat Co., Inc., D4, Saginaw, Mich.

OUTBOARDS—Save 1/2. Good used parts, all makes and models. Bargains rebuilt motors. Crandall Hicks Co., 959 Commonwealth, Boston, Mass.

COMPLETE Your own boat with our pre-fabricated frames and materials. They're different. Save 2/3s and costly mistakes. Send requirements for quotations. Illustrated catalog 100 boats, 10c. Bay City Boats, Inc., Bay City, Mich., 1552 Adams St.

BOAT Designers are highly paid professionals. Complete course by mail. Catalog. Westlawn, Montville, N. J.

#### SPORTING GOODS, GUNS, FISHING TACKLE, ARCHERY

BOWS, Arrows, raw material. Lowest prices. Lloyd Morrison, Waldport, Ore.

3,000 GOLF Clubs, bankrupt stock. Five club set \$2.50. Lincoln Surplus, 123 S. Galena, Freeport, Ill.

CAMP Stove. Revolutionary. Folds 20x10x4. Free circular. Recreational Equipments Co., Lexington Building, Detroit, Michigan.

GUNS, Binoculars, outboards! Lowest prices! Easy payments! Catalog dime. Zeppelin Arms, PM6, Akron, Ohio.

SWAP Used sporting goods, tools, etc. Information 10c. Cassidy, 4518 Huntington, Covington, Kentucky.

NATIONALLY Known and advertised fishing tackle at bargain prices. Catalogue free. Tackle Store, Sac City, Iowa.

TENTS, Factory to you. Catalog free. Willis Co., Everett, Mass.

FLY and leader materials and tools. 24 page list free. Casting and trolling catalog free. For 104 page general fly tackle catalog full of valuable dope send 3c. Paul Young, 8065 C-6 Grand River, Detroit, Mich.

ARCHERY Headquarters—617 South State, Chicago. Catalogue free. Complete instruction book 50c.

RIFLES, Shotguns, S&W, Colts, target pistols, air rifles, hunting knives, binoculars, telescopes, police goods, badges, holsters, etc. Bargain catalog 3c. Lee Sales, (Dept. W), 35 West 32nd St., New York.

**HUDSON** Bay blankets, Indian pack baskets, camp stoves, knives, compasses, outdoor equipment. Free catalog. Howe Fur Co., Box P, Coopers Mills, Maine.

### FIELD GLASSES, TELESCOPES AND MICROSCOPES

**TELESCOPES**, Binoculars, microscopes. Free 1938 catalog. Hobby Man, Jefferson, Iowa.

**METAL** Staining pan 35c postpaid. List of stains free. Shumer, 414 West Broadway, New York City.

**LENS Kit**—Makes 3" diameter 75-150 power telescope. \$1.00 postpaid. Optical Works, PM6C, Milton, Penna.

**FREE** Instructions. Build powerful telescope. Atmsco, Box 213, Flushing, N. Y.

**EXPERIMENTERS**—Assortment 18 unmounted lenses. Suitable telescopes, microscopes, etc. \$1.00 postpaid. Optical Works, PM6A, Milton, Penna.

**BUILD** An astronomical telescope. Catalogue free. John Pierce, Springfield, Vermont.

**TELESCOPES**, Microscopes, binoculars; 1938 bargain catalog free. Brownscope Company, 5 West 27th Street, New York.

**USED** Microscopes, binoculars, astronomical telescopes—Bought, sold, repaired. Send 10c for list. Rasmussen, P. O. Box 294, Amsterdam, N. Y.

**TELESCOPES**, Microscopes, binoculars, mineralogy, chemistry. Catalog free. Teeko, Evanston, Illinois.

### ANTIQUES, RELICS, INDIAN GOODS

20 **TEXAS** Arrowheads, \$1.00. Birdpoint 10c. Paul Summers, Stamford, Texas.

100 **GOOD** Arrowheads \$3.00 postage paid. George Holder, Glenwood, Ark.

100 **GOOD** S.C. arrowheads \$2.75. Satisfaction guaranteed. W. B. Robinette, Paolet, S. C.

100 **GOOD** Arrowheads \$3. Catalog. 5c. H. Daniel, Hot Springs, Ark.

**INDIAN** Relics, beadwork, coins, curios, minerals. Catalog 6c. Indian Museum, Northbranch, Kansas.

40 **ASSORTED** Arrows, tools, Saskatchewan beauties, \$3.25. Don McKillup, Regina, Sask.

### TAXIDERMY

**TAXIDERMY** Supplies—Quality artificial eyes, teeth, genuine Jonas head forms. Tools, materials, etc. Everything for the progressive taxidermist. Send 10c for big illustrated catalogue. Jonas Bros., 1049 Broadway, Denver, Colo.

### DOGS, PETS, BIRDS

**BIRDS?** Get American Canary Magazine monthly. Year, \$1.00. 2839-P North Halsted, Chicago.

**ST. BERNARDS;** We want the name and address of every person who is a lover of good St. Bernards. A premium will be mailed free to everyone answering this advertisement. Lake Manitou Kennels, Watrous, Sask., Canada.

**PEDIGREED** Baby dogs! Money-back guarantee! Dime brings illustrated details. Royal Kennels, No. 8, Chazy, N. Y.

**BEAUTIFUL** Pure white police dogs. Ansonia Kennels, Mose, N. Dak.

### POULTRY AND FARM SUPPLIES

**BUY** Seymour chicks and see more profits this year. AA grade Barred, Buff, White Rocks, Reds, Wyandottes \$6.90, pullets \$8.95; cockerels \$6.90. Leghorns \$6.45, pullets \$12.90, cockerels \$3.00. AA grade \$1.00-100 more. Free catalog. Seymour Hatchery, Box 36, Seymour, Indiana.

**DAVIS** Chicks for broilers and layers. 21 different breeds. Sexed chicks. Poults \$3.50-100 and up. Free catalog. Davis Poultry Farm, Route 34, Ramsey, Indiana.

**FREE** Catalog describing Greensburg electric hatched chicks from big egg thoroughbred stock. Chicks, sexed chicks, turkey poults \$3.00 per 100 and up. Write Greensburg Hatchery, Box 40, Greensburg, Indiana.

**MAKE** Money raising poultry. Always a demand for eggs. Read America's leading poultry magazine, learn how others succeed. \$1.00 for 3 years; 25c for 9 months' trial. Poultry Tribune, Dept. E-93, Mount Morris, Ill.

### TREES, SHRUBS, ROOTS, HERBS

**JUST Out!** World's greatest "Herbalist Almanac." Beautifully illustrated in natural colors. Contains over 200 old-fashioned herb medicine recipes for home use. 10c postpaid. Worth dollars! Botanics, 145 W. 112th St., Chicago.

### FARMS AND FARM LANDS

**FARMS** That pay in the Great Northern Railway agricultural empire, Minnesota, North Dakota, Montana, Idaho, Washington, Oregon. Fertile black soil, high production crops, grain, fruit, vegetables, feed and livestock. Many kinds of farms for selection. Write for book on state you prefer. E. C. Leedy, Dept. 657, Great Northern Railway, St. Paul, Minnesota.

**SALT** Water farm, sand beach, 40 acres, handy village and cannery, ideal spot for farming and salt water sports; 800 ft. beach, 15 acres tillage, lot wood, fruit, cozy 5-room home, other bldgs., beautiful shade; only \$1200, \$450 down; picture page 84 illustrated catalog 2000 bargains. Free. Strout Ag'y, 255-P 4th Ave., New York City.

**BARGAINS** In land! Where crops are dependable. Washington, Minnesota, Montana, Idaho, Oregon and North Dakota. Literature. Impartial advice. Specify state. J. W. Haw, 119 Northern Pacific Ry., St. Paul, Minn.

**WANT** To hear from owner of property for sale or trade. Details free. Real Estate Salesman, Desk B, Lincoln, Nebr.

40 **ACRES**, Near White River, unimproved; poultry land. \$175, \$5 down, \$5 monthly. Free list and literature. Hubbard, 216 Grossman Bldg., Kansas City, Kans.

### PROFITABLE OCCUPATIONS

M. M. earned \$267, three weeks, raising mushrooms in cellar! Exceptional, but your cellar, shed perhaps suitable. We buy crops. Book free. United, 3848 Lincoln Ave., Dept. 66, Chicago.

**RABBIT** Raising. We pay to \$7.00 each. Catalogs 10c. Rabbitries, Bowling Green, Ky.

"\$35 WEEKLY From 3 hours homework." 204 other moneymaking plans. Particulars free. Stamford, 826-F Riverside Drive, New York.

"**RAISE** Frogs!" We buy! Good prices year round. Small pond starts you. Free book shows sketch. American Frog Canning, (153-H) New Orleans, Louisiana.

**WANTED** Original poems, songs, for immediate consideration. Send poems to Columbian Music Publishers, Ltd., Dept. P66, Toronto, Can.

**RATS**. Raise albino rats for research laboratories. Pair breeders \$1.00. Details stamp. Thompson, Noyes, Minn.

**MONEY** In minks: Wild minks almost extinct. Extra dark ranch-raised pelts bringing up to \$30. Spring kits pelted in fall. One to 11 in litter. Easy to raise in back yard. Low pen and feed cost. We train you. Pedigreed Yukon and Eastern breeders \$50 up. Terms. Send 10c for illustrated mink book. Washington Minkery, Box 87, Kelso, Washington.

**TRY** Window-sill farming, it pays. California Earthworm Farms, Highland Park, Los Angeles.

**FUR** Farming—Profitable business. 60c book, now 25c. Fur Farms Publishing Co., Karcade, Utica, N. Y.

**SOILLESS** Plant culture. Raise tomatoes, potatoes, flowers, etc., in shallow tank of water containing 21 chemicals. Tomato vines 20 feet, bear for year, 20 pounds per vine, quality better than soil grown. Instructions, formula \$1.00. Purdy's Chemicals, 1852 E. Slauson Ave., Los Angeles.

**RABBIT** And Cavy Magazine and illustrated book 10 cents. Monthly for one year 25 cents. A Stahl, New York, N. Y.

**We** Start you in business, furnishing outfits and instructions, operating Specialty Candy Factory home. Men and women, earn \$25 up to \$60 weekly, all or spare time. (Our 29th year.) Booklet free. W. Hillyer Ragsdale, Inc., Drawer 62, East Orange, N. J.

**RAISE** Rabbits and cavies for us. We buy at top prices. Complete details in catalog, contract and magazine. 10 cents. Stahl, Box 1, Holmes Park, Mo.

**FREE** Booklet describes 107 plans for making \$20-\$100 weekly, in home or office, business of your own. Elite Co., 214 Grand St., New York.

**COUNTRY** Drives or movies afternoons! Work mornings home. No canvassing! Follo-H, Station D, Los Angeles.

**RAISING** Jumbo frogs. Interesting. Big future. Females lay 10,000 eggs. Free literature. American Frog Industries, Box 336, Rayne, La.

**DIME** Brings copy National Mail Order News. Box 1773PM7, Roanoke, Virginia.

### BOOKS, PERIODICALS, PICTURES, POSTCARDS

**MAGAZINE** Subscriptions. Attractive club prices. Castellazzo, 3717 Redwood, Oakland, Calif.

**BOOKS**—Six cents each postpaid. List free. Write P. Geiger, 6538 North Maplewood, Chicago, Ill.

**HUMAN** Efficiency. Let this attractive 76p. book help you do better work. \$1. Shertzer, 970 Weber, Pomona, Calif.

**YOUR** Favorite magazines—Half price. Catalog, 10c. Magazine Exchange, Baseline, San Bernardino, Calif.

**RARE** Antique books. Some two hundred years old. List, ten cents. Friday, Streator, Ill.

### GAMES—ENTERTAINMENT

**PLAYS**, Operettas, musical comedies, complete minstrel first-parts with song programs, blackface skits, vaudeville acts, monologs, dialogs, recitations, juvenile plays and songs, musical readings, entertainments, make-up goods. Catalog free. T. S. Denison & Co., 203 N. Wabash, Dept. 11, Chicago.

### MAGIC TRICKS, PUZZLES, JOKER NOVELTIES

**VENTRILOQUISM**—"How to Become a Ventriloquist." 12 simple lessons. Anyone can learn. 25 cents postpaid. Darvill, 54 McAllister Street, San Francisco, Calif.

**SVENGALI** Magic decks, magic, magic cards, joker's novelties, puzzles. World's largest manufacturers. Catalog describing 300 items free. Adams Company, Ashbury Park, N. J.

**LARGE** Illustrated magic catalogue 25c. Lynn, Midland Ave., Paramus, N. J.

**FREE** Tricks! Join Magicians' Fraternity! Monthly magazine, sample 10c. International Magicians, Mount Morris, Ill.

**JUST** Off the press! Our large catalog of magic for everyone. From the beginner to the professional magician. Send 25c for your copy. Chicago Magic Co., 2300 N. Mason Ave., Chicago.

**SEND** Stamp for unusual magic list. Wallace, Box 105, Durham, N. Car.

**SEND** 25c. Whoopee-Seat; Dancing-Platelifter; Foo-Yu-Too; Mystery-Pig; seventeen novelties package. Leonard, 161 Greenwich St., New York.

**VENTRILOQUISM**. Complete instructions and dialog \$1.00. Illustrated puppet catalog 25c. Frank Marshall, 837 No. State St., Chicago, Ill.

**FREE!** Magic catalog 500 tricks. Amaze. Mystify friends. Write today! Lyle Douglas, Station-A-5, Dallas, Texas.

**BE** A magician. Large professional magic catalogue of latest tricks 25c. Cash paid for complete Tarbell magic courses. Write, Ireland, C-109 North Dearborn, Chicago.

**EARN** Money in any crowd. Call names of strangers, tell unspoken questions. Professional course mind reading, spirit writing, etc., \$1. Henderson, Box 341, San Bernardino, Calif.

**LEARN** Ventriloquism. 3c stamp brings particulars. Smith, 125 N. Jefferson, Peoria, Ill.

**LARGE** Professional magic catalogue, 25c. Holden, 220 W. 42nd St., New York.

**MAGIC** Catalogue, latest tricks. 10c. Frank Lane, Little Bldg., Boston, Mass.

### RARE COINS

**OLD** Money wanted. Will pay \$100.00 for 1894 dime, S. mint, \$50.00 for 1913 Liberty head nickel (not buffalo). Big premiums paid for all rare coins. Send 4c for large coin folder. May mean much profit to you. Numismatic Co., Dept. 20, Fort Worth, Texas.

**UNITED** States coins at bargain prices. 2c piece and newest 1938 selling price list 10c. Em. Cohen, Box 3507, Cleveland, Ohio.

33 **COINS**, Bills, tokens, 25c. Otto Oddehon, 106E8, Kansas City, Mo.

20 **DIFF.** Fine coins, 25c. Bishoff, 500 E. 8th, Kansas City, Mo.

**SOME Specimens 1909 cent worth \$10.** We buy certain coins, common and rare. Others worth to \$6000; certain 1864-1865 Indian head cents \$100 each; dimes before 1895, \$450; Liberty head nickels before 1914, \$300; large pennies \$2000; encased postage stamps, \$13; half cents, \$275; half dimes, \$175; quarters, \$300; fractional currencies; paper money; gold dollars, \$1,500; colonial coins, \$300; silver dollars, \$4,000; 1933, 50c, \$4.00; foreign coins \$165, etc. Only certain coins worth top prices, but others have premium value too. Send 15c today for illustrated 1938 coin book, before sending coins. National Coin Corp., (80), Daytona Beach, Florida.

**FREE** Coin or stamp list. Hussman, 207 South Seventh, St. Louis, Mo.

**2 1/2c COIN** And note 10c. Maurice Gould, 73, Brighton, Mass.

**AMERICAN COIN** manual 50c. Genung, Box 250, Ithaca, N. Y.

**13 LARGE CENTS** \$1.15. Radtke, 56 Dale, Rochester, New York.

**50 OLD COINS**, all different, \$1.00. 100 different coins \$2.50. 20 dates large cents \$2.00. Trade dollar \$1.25. Claud Denney, Box 1825, Dallas, Texas.

**NEW**, Old money wanted. Send dime for latest buying booklet. 1 1/2c for selling list. A French, R. D. 1, Troy, N. Y.

**INDIAN** Head pennies wanted. Send 10c for buying list. Lee's Stamp & Coin Shop, 210 North First, Phoenix, Arizona.

**COMMEMORATIVE** Half dollars. Lincoln, Stone Mountain, Oregon, Texas, Cleveland, Kentucky, San Diego, Long Island, \$1.50 each. Illustrated catalogue No. 14, 25c. Norman Shultz, Salt Lake, Utah.

**\$5.00 TO \$2500.00** Paid for rare coins. Send 15c for 1938 newest 36 page illustrated coin buying book. Charles Fisher, (1) Chagrin Falls, Ohio.

**FREE!** Foreign coin, banknote, and large illustrated coin catalogue. Send 4c postage. Coin approvals sent. Tatham Coinco, Springfield-125, Mass.

**GET** Profit and pleasure in collecting old coins. Send 10c for 56-page illustrated coin catalog. You'll be delighted with it. Send for it now. B. Max Mehl, 370 Mehl Bldg., Fort Worth, Texas. Largest rare coin establishment in U. S. Established 38 years.

**\$5 TO \$500** Each paid for hundreds of old or odd coins. Keep all until posted. Many very valuable. Send 10 cents for illustrated Coin Value Book, 4x6. Guaranteed buying and selling prices. 31 years in business. Coin Exchange, Box 5, Le Roy, N. Y.

**RARE U. S.**, foreign coins, war medals. Catalogue 10c. Mengelle, Colorado Springs, Colo.

**UNITED States**. Large cent, 2c bronze, 3c nickel and bargain list, 25c. Eleven dates large cents, \$1. George P. Coffin Co., Augusta, Maine.

### STAMP COLLECTING

**FREE**—New Nicaragua commemoratives with 1938 Panama Olympic airmail set 10c plus general approvals. Wehrle, 875 Main, Passaic, New Jersey.

**U. S. Comm.** 35 diff. 20c. Dominican Rep. 15 diff. 10c. Paul's Stamps, 4550 N. Mobile, Chicago.

**UNITED States**, 50 obsolete varieties (catalogs \$2.50)—50c. 50 different commemoratives—40c. Approvals. W. Torgesen, Teaneck, N. J.

**THE** Stamps of Austria. Now that Austria is no longer a nation the stamps from that country will go up by leaps and bounds for two reasons. First, the demand for Austrian stamps has become terrific over night. Second, from Austria nothing will be shipped due to exchange restrictions. Fortunately, we have on hand a large supply of all Austrian stamps, both singles and sets, and will send same "on approval" at our old prices as long as they last. One of the outstanding Austrian sets is the war issue of 1915, Nos. 803-806. These stamps show, respectively, Infantry on firing line, cavalry in action, Austrian siege gun and Austrian battleship. We will send these 4 stamps mint in excellent condition for only 10c to approval applicants. Approval Headquarters, Globus Stamp Company, 268 Fourth Ave., New York City, Dept. 201.

**PRODIGIOUS Gift!** Fantastic Indochina, German State, savage Somalicoast, Perak, Selangor, Negri Sembilan, bicolored Banana airmail, Siberia. Absolutely free with approvals! Postage 3c. Saxon Company, Dept. 65, Albee Bldg., Brooklyn, N. Y.

**THE** World in a packet—100 different stamps from 100 different countries, including Abyssinia, Afghanistan, Brunel, Falkland, Zanzibar, and others from Africa, Asia, South America, West Indies, etc. Our pamphlet which tells "How to Make a Stamp Collection Properly," together with our large bargain list of albums, packets, sets, etc., all for only 20c. Queen City Stamp Co., Room 36, 604 Race St., Cincinnati, Ohio.

**200 DIFFERENT** (Catalog value \$4.00) and packet hinges, 10c with approvals. Scarce new triangle included free. Highland, 1616-V Sunset, Utica, N. Y.

**1897 GRANDE Comore Islands**, Liberian Bongo antelope, rare old genuine Baden, Turks Caicos, \$5 U. S., British Colony map stamp, etc. Everything 3c with approvals. Viking, 1-Z Hanson Place, Brooklyn, N. Y.

**FALKLAND Coronation** 8c (coin), complete unused. Nauru coronation 28c (coin), complete unused. Approvals. L'Americque, 2215A West Cherry, Milwaukee, Wisconsin.

**BUILD** Your collection economically with "personal packets" assembled to your order. Send for selection sheets. Mitchell, Box 23, Jersey City.

**FREE**—Twenty beautiful commemoratives. Approvals. Louis Morrison, East Elbon, Chester, Penna.

**ROUMANIAN** Boy Scout issue set of five unused stamps 10c to approval applicants. Burton, Baltimore, Ohio.

**REMARKABLE Offer!** 100 stamps including commemoratives, triangles, airmails, pictorials, colonials, all only 5c to approval applicants. Leo, 853 North Martel, Los Angeles, California.

**DIAMOND** Shaped air mail—Big packet 105 all different, including air mail, commemoratives, Congo, Epirus, Manchukuo, etc.; set of two ex-King Edwards and Costa Rica diamond shaped air mail; scarce U. S. telegraph, cat. 30c; pkt. British Colonies-Gwallor, Hyderabad, Silver Jubilee; big lists. Everything for 5c to approval applicants. Send today! Mystic Stamp Co., Dept. 80, Camden, New York.

**200 DIFFERENT** including fine United States, Canada; commemoratives, old issues, airmail, 15c. Richert, 167 Pine, Jersey City, New Jersey.

**FREE!** Packet and premiums with superb approvals. Haskins, 701 Monroe, Spokane, Washington.

**FREE** Treasure packet. 3c please. Oro-motto Stamps, Kitchener, Ontario, Canada.

**ILLUSTRATED** Album. Spaces 4000 stamps; to approval applicants 30c. Swan Stamps, 604 Swan, Dunkirk, N. Y.

**FIFTY** U. S. before 1912, 15c. Box 775, Ponca City, Okla.

**EXCHANGE** Stamps, postcards. Universe. "Exchangers," Bry 226 pres, Paris, France. Particulars free.

**SOUVENIR** Mint sheets: Tipex 22c, S.P.A. 13c, Byrd 40c. Putzer, 137 Sterling Street, Brooklyn, New York.

**SAVE** On stamp purchases! Details with premium 10c. Aaron Grove, 306 Blanchard, Seattle, Washington.

**15 DIFFERENT** United States commemoratives 10c (dime) to approval applicants. Blue Grotto Stamp Co., Flint, Mich.

**BOYS**—Join our organization. Earn stamps and cash. For full details address Buick, 17393P Kentucky, Detroit, Mich.

**8 AIRMAILS** From Syria, Lebanon, Guatemala, etc., and 55 others, 5c to approval applicants. Barker, Box 488, San Francisco.

**ECUADOR** Darwin commemorative and Ceylon pictorial sets five cents. Approvals. Far Seas Stamp Co., Box 2154, Houston, Texas.

**HONDURAS** Direct to collectors! Famous airmail commemorating U. S. Constitution 32c postage paid. Pricelist free. R. C. Woodville, Ceiba, Honduras.

**FREE!** 125 Stamps to approval applicants sending 5c postage. Quality Stamp Shop, Englewood, Colorado.

**GIVEN**, 25 French Colonies, 4c with penny approvals. Lejac, Chowchilla, Calif.

**UNPICKED!** 100 U. S. revenues on documents—10c! 1,000—60c! Vanvoorhis, Hyndman, Pennsylvania.

**U. S. Mission** mixture 40c pound post-paid. Reed, 415 Grove, East Chicago, Indiana.

**50 DIFFERENT** U. S. commemoratives \$1.00; surprise gift. Clark, 1612 Dial, Springfield, Illinois.

**100 DIFFERENT**, 9c to approval applicants. Filmer, 1-68, Salida, Colorado.

**MY** Bargain approvals sent for 3c. Olivo Alvos, Guadalupe, Calif.

**111 DIFFERENT** United States 40c. Reitter-Imhoff, 111 West Jackson, Chicago.

**CANNON!** Set of stamps showing cannon, firing squad, cavalry charge and 200 other different stamps, only 10c to approval applicants. L. H. Reich Stamp Co., 4647 Kenmore, Chicago.

**DIME** Brings Costa Rica's imperforate triangle. Blocks; lists. Win Burbank, Hanover, N. H.

**BEST** One cent approvals in America. Elvin Stanton, Niantic, Conn.

**CHINATOWN** Souvenir and 125 different 10c. R. & M. Harris, 560 27th Ave., San Francisco.

**FREE** 25 World-wide approvals sent. George Talady, New London, Wis.

**THIS** Ad and 10c is worth 25c on approvals. Jack Reed, Houtzdale, Penna.

**BRITISH** Colonials, Newfoundland superb stamps and covers. Let us fill your spaces. Reference please. No. 123 Granville Ferry, N.S. Canada.

**COMMEMORATIVES**, Airmails, etc. Cataloging \$5.00—\$1.00. Raymax, Box Blythebourne 11, Brooklyn, N. Y.

**WE** Buy stamps. Send description first. Leslie Stamp Co., Haverhill, Mass.

**15** U. S. Commemoratives 10c. Approvals. Leader, 1550 Seward, Detroit, Mich.

**EXCHANGE** Duplicates the new way. Particulars free. Gage, Arcade Building, Pasadena, California.

**TEN** Different bicent. precancels, quarter. Judd, 661 Platt, Toledo, Ohio.

**1938 REVISED** Stamp annual free. Describes and illustrates albums, supplies, United States, coronations, British Colonials, Canadians, foreign stamps. This fifty-page catalogue free. Gray Stamp Company, Dept. P.M., Toronto, Canada.

**250** U. S. 10c with approvals. Killam, 106 Onondaga Rd., Syracuse, N. Y.

**WE** Buy old stamps. What have you? Stampco, Box 1305A, St. Louis, Mo.

**1000** WORLDWIDE Stamp mixture 25c. Monjar, 1542 Waverly, Cincinnati, Ohio.

**UNITED States** approvals! Lowest prices! Adult collectors! Box 822, Minneapolis.

**118 DIFFERENT** Stamps, catalog \$3.00. Includes Azerbaijan, Epirus, Liechtenstein, Ukraina, etc. 10c. Approvals. Matthews, Washougal, Wash.

**JOIN** Big stamp club. Camel stamp and airmail together with mammoth world stamp packet. Approvals. 10c. Atlas Stamps, Little Rock, Arkansas.

**ECUADOR'S** Constitution commemoratives; 100 others, 10c. Distinctive approvals. Woodlawn Stamp Company, 1923 W. Mulberry, San Antonio, Texas.

**FREE**—\$1 U. S. stamp with request for 52 page list of United States and foreign stamps. Stamps on approval. References necessary. 1 lb. U. S. mixed with one U. S. coin before 1850, 50c. New Hussman Stamp Co., 1122 Pine, St. Louis, Mo.

**HERE** is Spain's complete Columbus Santa Maria set. Eight ship pictorials, only 5c with approvals. Royal Stamp Co., Box 5944, Kansas City, Missouri.

**COSTA** Rican diamonds, triangle, airmails—3c. M. Suroveik, 5342 South Fairfield, Chicago, Illinois.

**EARN** Cash, stamps. Sell my approval books—nickel packets. Ellison, 2841 West 37th Street, Brooklyn, New York.

**WORLDWIDE** Mixture — 50 different countries—Asia, Europe, British Colonies—100 stamps 10c; 300, 25c. No approvals. Elsea, Bowling Green, Ohio.

**NOMAD** "Bonanza"—surprise packet with stamp treasures galore, odd shapes, countries, sizes. Free to new approval applicants sending 3c postage. Nomad Stamp Company, Flint, Michigan.

**15 AIRMAILS** 7c. Airmail, U. S. approvals. George Davis, Webster, Mass.

**LARGE** Columbus triangle and fine packet of 55 different stamps including valuable coronation stamp; odd Turks Is. and Leeward Is., birds, ships, etc. Only 5c to approval applicants. Potomac Stamp Co., Dep't. 105-C, Washington, D. C.

**COMPLETE** Set (12) 1923 mint blocks only 10c with approvals. Max Pyka, 3118 Fullerton, Chicago, Illinois.

**CASH** For stamp collections, accumulations. Jennie Graves, Phoenix Building, Holyoke, Mass.

**CHEAPEST** Market for African stamps. F. C. Baumann, Box 349, Johannesburg, South Africa.

**SPECIAL** 1000 All different stamps 65c. Dutton Efker, Anaheim, California.



UNITED States commemorative \$1<sup>25</sup>s, five different, \$5.00. S. Koeppel, Merritt Bldg., Los Angeles, Calif.

FREE: Stamp wallet, with packets. Francis Thiese, 10526 Anzac Ave., Los Angeles, Calif.

WHOLESALE Closeout. Large approval selection stamps, 1c each. Harlan, 5307 South Marshfield, Chicago.

250 MIXED World-wide, 3c. Stamp club literature free. Approvals. Laffal, 91-01-Z 102nd St., Richmond Hill, New York.

50 DIFFERENT United States 20c. Approvals. Dewey, 1265 Broadway, New York.

25 DIFFERENT Canada 3c to approval applicants. Maynard Sundman, D95, Bristol, Conn.

JOIN! World-wide stamp club. Send stamp for details. Buy-Mor, Box 33, Flint Station, Fall River, Mass.

SUPER-WONDER Packet offered, containing 60 different stamps from Afghanistan, Transjordan, North Borneo, Manchukuo, Sudan, Guadeloupe, Iraq, Sarawak, French and British Colonies, including natives, beasts, ships, etc. This entire packet for only 5c to approval applicants. Big illustrated lists free. Kent Stamp Company, Box 87(9), Brooklyn, N. Y.

1000 CANADA \$1.00. Wonderful mixture. Canadian Philatelist, 1084 Drummond, Montreal, Canada.

7 TRIANGLES 10c. Approvals. Goldman, 113-14 Jerome Avenue, Richmond Hill, N. Y.

WANTED You to know that many foreign governments will sell mint stamps by mail. Some over fifteen years old. Many cost a fraction of a cent. Information, procedure and address of more than 150 governments for \$1.00. Rosebraugh, Lyons, N. J.

CHINESE Airmail, etc., 5c. Southwest Stamps, 727 Story Bldg., Los Angeles, Calif.

SENSATIONAL Offer! Real old United States stamps. 20 different before 1900 10c. Approvals included. Franklin, 225 Franklin, Rochester, N. Y.

500 DIFFERENT Foreign 30c with approvals. Hecht Co., Belle Plaine 2, Iowa.

7 DIAMOND And triangle stamps, 10c. Approvals. Gaydos, Box 123, Kenosha, Wis.

FREE Particulars rare stamps. Collection economy. Box 193, Pomona, Calif.

100 U. S., Commemoratives, airmails, Virgin Island, scarce triangle, only 10c mailing charges. (Approvals). Gelburn Stamps, 1180 Gerard Ave., New York.

FREE \$10 United States stamp, with approvals. Postage 3c. Petersen, Box 300, St. Paul, Minn.

"GOYA Nude stamp"—5c to approval applicants. Jewells, Tamaqua, Penna.

COSTA Rica triangles, etc., free. Send return postage. Clyon, Clifton, New Jersey.

NEW Rivera nude stamp! World's largest triangle! Congo, Sudan, South Seas, bicolors, pictorials and many others. Only 3c with approvals. Cactus Junior Approvals, Box 1870-B, Tucson, Arizona.

WORLD'S Smallest airmail, free stamp magazine, \$2.00 U. S., animals, bird, train, Indian, airplane, commemoratives, scarce stamps 25 countries, 5c with approvals. Capital Stamps, Dept. PM7, Little Rock, Arkansas.

AT 1/10 Catalog. U. S., British Colonies. Meyerowitz, 1756Y 70 Street, Brooklyn, N. Y.

VALUE Extraordinary! 100 different U. S. stamps. Total catalog value over \$3.00. Nice clean copies, none damaged. 55c postpaid. A Grove, 306 Blanchard, Seattle, Washington.

FREE. U. S. \$1, \$2, \$4 and \$5 stamps. Unbeatable U. S. approvals. Nelson, 78 E. 5th St., St. Paul, Minn.

FREE—The Stamp Finder! Our new 24 page edition, fully illustrated, which will enable you to instantly identify all difficult stamps. Also fine packet of odd and unusual stamps from Bosnia-Herzegovina, Monaco, Patiala, Cyprus, etc., including maps, ships, animals and strange scenes. All free to approval applicants inclosing 3c postage. Garcelon Stamp Co., Box 900, Calais, Maine.

NEW Irish souvenir stamps. A set of beautiful and interesting souvenir stamps has been issued by Irish Hospitals' Trust Ltd. A specimen sheet of 24 of these stamps may be obtained free of charge on applying to Dept. P.M. Mr. J. O'Sheehan, 28 Earlsfort Terrace, Dublin, Ireland.

FREE! Two coronation sets. Postage 3c. Roberts, 312F Shearerblg, Bay City, Mich.

1/5 CATALOG Approvals, no German, sent with 250 different; or 150 (no German) choose—10c postage.. Booher, Lomita, California.

GIANT-SIZED Russian zeppelin stamp, cat. val. 20c, and beautiful Lithuania air mail triangle; also big packet of 53 different stamps including Azerbaijan, Epirus, new Martinique, etc., and illustrated lists, all for 5c to approval applicants! World-Wide Stamp Co., Box 600, Camden, New York.

FREE. Beautiful loose-leaf album to approval customers. Freeman, Tobey Road, Belmont, Mass.

UNITED States—45 different, perforation gauge, hinges, bargain pricelist—all for 10c. Seidenberg, Baroda, Mich.

FREE—Eight beautiful airmails including triangle, to approval applicants enclosing postage. Green and Company, Norwood, Ohio.

DIAMOND-SHAPED Stamp, Liberia gunboat triangle, two other triangles, silver jubilee, 27 others, 5c. Crowder Co., 127E North, Baltimore, Md.

LIBERIA Snake triangle, giant Spanish triangle, 50 other stamps, 5c. Wright Co., 2527 Guilford, Baltimore, Md.

4 1/2 TRIANGLES! Guatemala bisect (diagonal half-stamp), beautiful Liberia, three additional triangles, 27 other stamps, 5c. Abell Co., 1818 St. Paul, Baltimore, Md.

ILLUSTRATED U. S. list, price 50c, large complete U. S. price list free. Send postage. Stanley Gibbons, 38P Park Row, N. Y.

PENNY Approvals that please. Haywood, 395 Adams St., Pomona, Calif.

FREE! Triangle airmail! Coronation! Pictorials! British Colonies! Wonderful packet 110 different, 5c to approval applicants. Bargain Co., Box 39P, Times Square Station, New York.

PANAMA Triangle and 50 others free to approval applicants sending 3c postage. Tatham Stampco, Springfield-30, Mass.

FREE! "United States and British North America"—our valuable, complete, illustrated, 64-page catalog quoting lowest prices. Big illustrated list of foreign stamps also included. H. E. Harris & Co., 137 Transit Building, Boston, Mass.

300 DIFFERENT Stamps 20c; 600, 50c; 1000, \$1; 2000, \$3; 3000, \$7. Fred Onken, 630 79th St., Brooklyn, N. Y.

QUEEREST Stamps packet. Receive one of world's smallest stamps; scarce Vatican City; Greek Red Cross (coiled snake in Garden of Eden!); Manchukuo; Soruth (mountain lion); Mozambique (giraffe); Palestine; many others. Also big packet 25 dif. Japan, (including earthquake stamp!) and pkt. 15 dif. China. Everything for only 5c to approval applicants! R. M. Stamp Co., Box 230P, Port Chester, N. Y.

50 DIFFERENT. Fine U. S. including perforation gauge, 10c with approvals. The Stamp Shop, 809 Holland Bldg., St. Louis, Mo.

200 DIFFERENT 10c. Big 50% approvals. Covert Stamp, 39 State, Rochester, N. Y.

FREE! 110 Different stamps to approval applicants. 3c postage. Zephyr, 5124 George, Chicago.

FREE—\$2 And 15 other U. S. Foreign approvals. Postage 3c. Wm. Clatworthy, Upland, Calif.

STAMPS. A superb selection sent on approval. Quality at low prices. Fred Herzberg, Box 91-P, Elmhurst, Ill.

50 DIFFERENT British Empire including jubilee, Edwards, 50 different new, recent and pictorial world issues. 15 different airmails, 500 hinges, perforation gauge, all for 25c. Approvals sent. Lists free. Victoria Stamp Co., London, 4, Canada.

BRAZIL, 50 Different 10c with bargain approvals. Davis, Silver Lake, Ind.

ASK For our wonderful one cent approvals. Prospect Stamp Co., 225 Broadview, Toronto, Canada.

WHOLESALE Catalog for dealers. Illustrated. Postage 5c. Frank Co., 4900 Chalmers, Baltimore, Md.

PENNY Approvals, that satisfy. Neil Gronberg, Box 5441-P, Philadelphia, Penna.

30 DIFFERENT Angola, Cape Verde, Guinea, Portugal, Mozambique, St. Thomas and Prince 5c. Approvals. Depraw, Ocean Park, Calif.

STAMP Dealers, your ad here will bring wonderful returns. Ask me for proof. F. W. Johnson, Manager, Classified Advertising, Popular Mechanics Magazine, 200 E. Ontario St., Chicago.

FREE, 50 Stamps, Manchukuo, etc. Postage 1c. Album 3c. U. S. bargains. Bulard, 268 Northampton, Boston, Mass.

APPROVAL Sheets. One to three cents. Frederick B. Driver, 2009 Finance Bldg., Philadelphia, Penna.

25 UNITED States, including \$4 and \$5 stamps free to approval applicants. 3c postage. Brownie Stamp Shop, Flint, Mich.

EXTRAORDINARY! Free collection! Azerbaijan, Tanganyika, Belgian Congo, including approvals. Rosenberg, 3544 12th Place, Chicago.

CASH Or select foreign for precancel accumulations. Moore, Box 646, Little Rock, Ark.

## HOBBIES AND COLLECTIONS

JUST Published: 1938 Directory of Hobbies and Spare-Time Opportunities. The guide for amateur and professional hobbyists. 25c. Park City Book Supply, 1078 Pembroke Street, Dept. S-1, Bridgeport, Connecticut.

MASTER Albums for match book covers. Hold 450, five sizes. Deluxe permanent binding. Prepaid \$2.00. Matchless Album, G.C.P.O. Box 120, New York.

CHOOSE A hobby. Booklet of 500, 15c. Zak, 2824 West Cermak, Chicago.

FREE Samples cellophane envelopes for stamps, coins, covers, photographs. Wetzel, Box 235, North Bergen, N. J.

## PHOTO FINISHING

AT Lewis' Photo Service, Box 988, Youngstown, Ohio. You get roll developed and 8 prints 25c. Reprints 3c. Prompt service.

PHOTO Mill. Immediate service! No delay! Roll developed, carefully printed and choice of two beautiful 5x7 double weight professional enlargements, one tinted enlargement, or eight reprints—for 25c coin. Reprints 2c each. The Photo Mill, Box 629-12, Minneapolis, Minnesota.

SAMEDAY Service: Roll developed, 8 glistening prints, 2 enlargements—25c. Midwest Photo, B-54, Janesville, Wis.

ENLARGEMENTS, Colored in oils by experts, from your film or picture, 5x7, 25c; 8x10, 50c. Miller's, 84 Armbruster, Buffalo, N. Y.

MAIL Your rolls to film center of the world. Any 6 or 8 exposure roll developed and printed 25c coin. DeLuxe enlargement coupon free! Photo Finishing Shop, Est. 23 yrs., 411-V Genesee Valley Trust Bldg., Rochester, N. Y. "The Camera City."

"ART-OIL" Color enlargement free with 8 lifelike prints and roll developed 25c. Royal Photos, Box 5022D, St. Paul, Minn. Prompt service.

BE Modern! Get modern service. Modern quality. Modern prices. Our modern methods give quick service and bright guaranteed neverfade pictures. Roll developed 16 prints, 25c coin. 16 reprints 25c. Enlargement coupon. Candid rolls developed fine grain. Enlarged prints 3x4 4c each. Send next roll or reprint order to Modern Finishers, 3537-C, St. Paul, Minn.

IDEAL Photos. 25c per roll, finished with round corner prints. Coupon and snapshot folder free with initial order. Ideal Photos, Box 2255, Paterson, N. J.

ROLLS Developed, 8 prints, 2 enlargements, 25c. Mayfair, Box 261-K, Toledo, Ohio.

ROLLS Developed—One print and one enlargement of each exposure 25c. Trial. Reprints 30 for 25c. Henry, 25 River Grove, Illinois.

BEAUTIFUL Statuette, hand-colored in oils, from your favorite film or picture. Stands 8" high. \$1.00. Miller's, 84 Armbruster, Buffalo, N. Y.

SNAPSHOT Folder with every roll developed, 8 prints, painted enlargement—25c. Reprints 3c. Fast service. Janesville Film, A-54, Janesville, Wisconsin.

PROMPT Service—Quality work; 2 beautiful double weight gloss enlargements, 8 guaranteed neverfade prints each roll, 25c. Excel Photo Service, Dubuque, Iowa.

BEAUTIFUL Oil colored enlargement in de luxe frame, with each roll developed 25c coin. Badger Studios, LaCrosse, Wis.

20 REPRINTS 25c. 100 Reprints \$1. Roll developed with 16 prints 25c. Newton, 4, Maywood, Ill.

SNAPSHOTS In colors—Roll developed, 8 natural color prints—25c. Natural color reprints—3c. Amazingly beautiful. Natural Color Photo, C-54, Janesville, Wis.

**WILLARD'S** Gives your pictures a beauty treatment—they're clear, brilliant, full of life. Roll developed, 2 prints each negative 25c. Enlargement coupon: Willard's, Box 3535-A, Cleveland Heights, Ohio.

**ROLL** Developed with eight prints and two 5x7 super-value enlargements 25c. Stafford Studios, Wheaton, Ill.

**HIGHEST** Quality reprints 2c. Rolls developed, 2 sets prints, 25c. Fred Weick, 2840 Zenobia, Denver, Colorado.

**ROLLS** Developed, 8 prints 25c. Reprints 3c. Earl's Service, Salisbury, N. C.

**ROLLS** Developed, 8 prints on Velox 25c. 5x7 enlargement in handsome easel mount, 49c; 3 for \$1.25. Photoshop, Box 218, Augusta, Ga.

**ROLLS** Developed and printed with two hand colored enlargements, 25c. Colorgraph, Dunning Station, Chicago.

**35MM. FILM** Furnished and developed free. Enlargements 6c. Sackett Photo Service-A, Warren, Ohio.

**35MM. ROLLS** Developed and each shot enlarged to 3 1/2 x 4 1/2, \$1.00. Ideal Films, Birmingham, Ala.

**ROLLS** Developed, eight prints, plus two enlargements 25c. Art Photo, 1783 Delaware, Detroit.

**FREE**, Two sample reprints. Send negative. 3c postage. Midwest, Humboldt, Iowa.

**TWENTY** Reprints 25c. Roll developed and two prints each negative, 25c. Mail orders only. Star Photos, 109 N. Dearborn, Chicago.

**PHOTOGRAPHS**, Enlargements. Snapshots oil painted. Stamp for particulars. Mumberson Color Service, P-5410 Wellington, Chicago.

**ROLL** Developed, 8 quality prints 25c. Two enlargement coupons free. Quick service. Knickerbocker Foto Co., 129 West 27th Street, New York City.

**20 REPRINTS** 25c. Films developed, 16 prints 25c. Enlargements 8x10—25c; 5x7—10c. Low Photo, M-2657 Neva, Chicago.

**IMMEDIATE** Service! Better pictures. Two beautiful heavy-weight professional enlargements and eight guaranteed Perfectone prints 25c coin. Eight beautiful enlargements from roll only 25c. Candid rolls developed free! Prints enlarged to 3x4, only 4c each. Pictures sent back same day film is received. American Studios, Box B, LaCrosse, Wis.

**EXPERT** Photo finishing 8 genuine expensive Velox prints, two double weight professional enlargements 25c. Expert Studios, LaCrosse, Wis.

**SPECIAL** Enlargement offer! Ten 5x7 enlargements 50c with this ad only. Enlarging Company, 6444 Diversey, Chicago.

**ROLL** Developed, 16 guaranteed prints 25c. Smart Photo, Winona, Minnesota.

**GUARANTEED**, Film developed, 16 prints 25c. 20 prints 25c. Quality Photo, Hutchinson, Kansas.

**FILMS** Developed 2 prints of each 25c; 20 reprints 25c. Pine Photo, M-5134 Nevada, Chicago.

**BE** Convinced—Globe photos are unexcelled. 8 Duo-Tone prints, 2 5x7 enlargements. Send next roll 25c coin to Globe Photo Shop, La Crosse, Wis.

**PROMPT** Service, guaranteed work. Two beautiful portrait type double weight enlargements, eight neverfade gloss prints, each roll 25c. Dubuque Film Service, Dubuque, Iowa.

**DEVELOPING**, Printing, enlarging for the discriminating. Any roll developed and printed. Eight prints 25c roll. (127 to 122 eight exposures) developed and 5x7 enlargements of each negative 50c. Knickerbocker Foto Co., 129 West 27th Street, New York City.

**ROLL** Developed and 8 guaranteed prints including two enlargements, 25c coin. Super Snapshot, Winona, Minnesota.

**ROLL** Film developed and one print each in individual album 25 cents coin. High class work, fast service. King's Photo, Box 447, Rockford, Illinois.

**FILMS** Developed, Two beautiful glossy, double weight, professional enlargements and 8 prints all for 25 cents coin. Reprints 3 cents. Dependable quality and service. Allied Photo Service Company, Drawer 289 I, Sparta, Wisconsin.

**LATEST** In photo finishing. Miniature rolls developed and printed 3x4—5c each print. Radio Film, LaCrosse, Wisconsin.

**PROMPT** Service! Rolls developed, two Velox prints each negative 25c. Hench Studios, Harrisburg, Penna.

**PHOTO** Mill. Immediate service! No delay! Roll developed, carefully printed and choice of two beautiful 5x7 double weight professional enlargements, one tinted enlargement, or eight reprints—25c coin. Reprints 2c each. The Photo Mill, Box 629-12, Minneapolis, Minnesota.

**GET** The best. Roll developed, beautiful hand colored enlargement, 8 neverfade border prints, 25c coin. Prompt service. Sun Photo Service, Drawer T, St. Paul, Minn.

**INTRODUCTORY** Offer. Beautiful Platesunk etched enlargement free with roll developed printed 25c coin. 24 hour service. The Artists, Box 230, Minneapolis, Minn.

**ROLL** Developed, 8 brilliant fadeproof Velox prints and two professional enlargements 25c. Overnight service. Young Photo Service, 405-C Albany, N. Y.

**MILLIONS** Now know "Hollytints Means Better Prints." Two professional enlargements with trial roll—25c. Fascinating premiums. Unequaled service. Hollytints, P-1350, Hollywood, California.

**TWO** Prints each with every roll developed, 25c. Very finest quality. Reprints 2c each. Brown Photo Company, 1910-34 Emerson, Minneapolis, Minnesota.

**LARGEGRAPH** Reprints: Five 5x7 enlargements 25c. Cardinal Photoers, Summit, N. J.

**ROLLS** Developed, two sets prints plus enlargement coupon 25c. Reprints 3c. Over 19 reprints 2 1/2c. Jones Studios, Davenport, Iowa. "Where the West Begins."

**ROLLS** Developed, 2 prints each and 2 free enlargement coupons, 25c; reprints, 2c each; 100 or more, 1c. Summer's Studio, Unionville, Mo.

**ENLARGEMENTS** 4x6, Five for 25c. 5x7 three for 25c. 8x10 three for 35c. Hand colored and framed each 4x6, 30c. 5x7, 35c. 8x10, 45c. Send film negatives. Enlargers, Maywood, Ill.

**ROLL** Developed and 8 beautiful Velox glossy prints 25c coin or stamps. Reprints 3c each. Fotoprint Service, Box E, Roanoke, Va.

**FINER** Finishing. Rolls developed and printed, with one colored enlargement, or two professional enlargements. All for 25c (coin). Genuine, nationally known. Moentone superior quality. Moen Photo Service, La Crosse, Wis.

**TWO** Glossy enlargements, 1 colored with roll 25c. Arbor Service, 10, Joliet, Ill.

**ROLLS** Developed—Two new Beautitone Dubluate professional enlargements, 8 guaranteed fadeless Beautitone prints, 25c. Giant Snapshots, Inc., 667A, Green Bay, Wis.

**BEAUTIFUL** 5x7 Enlargements from your favorite negatives 17c each; three for 50c. Eight exposure roll developed and printed 25c. Work guaranteed. Jeems Service, Box 137, Ann Arbor, Mich.

**FOR** The discriminating amateur, roll developed and carefully printed 25c, reprints 3c. Superior workmanship, same day service. Paramount Co., 327 E. 92nd St., New York.

**MAKE** Photography Pay. New book. \$1.00. Popular Mechanics, 200 E. Ontario St., Chicago.

#### CAMERAS, PHOTO SUPPLIES

**BASS** Unusual quality values: Half or full V. P. Dolly, Corygon F:3.5 lens. Compur shutter, new, \$23.75. 2 1/4 x 3 1/4 Zeiss Volta F. P. and P., F:6.3 lens, automatic shutter. F. P. A. and holders, \$12.50. Sport DeFranne, full or half 2 1/4 x 3 1/4, F:3.8 Anastigmat with carrying case, \$29.75. Dollina II, coupled range finder. Radionar F:2.9 lens, Rapid Compur 1/500th shutter, \$49.75. Argus, F:4.5 lens, \$12.50. Above and hundreds of other bargains in Bass Bargaingram No. 235, a 52-page book. Money with a smile guaranteed. Bass Camera Company, Dept. AG, 179 W. Madison St., Chicago, Illinois.

**CAMERAS** And supplies. Free illustrated Photographic Almanac listing everything photographic—still, movie cameras, films, lenses—at tremendous savings. Hundreds of bargains, new and used. All guaranteed. We take your old camera or equipment in trade. Write for free copy of new Photographic Almanac and money-saving bargain book—just out! Limited edition. Hurry! Central Camera Co., (Photographic Headquarters since 1899), 230 South Wabash, Dept. 6-K, Chicago.

**PHOTOGRAPHY** Self-taught, twenty-five cents. Make money. Hobby Man, Jefferson, Iowa.

**IF** You go to Mexico ask first for prices and pamphlets of finest German quality miniature and other cameras, binoculars, movie cameras and projectors. Foto Mantel Sucr. R. Rudiger, V. Carranza 11. P.O. Box 1459, Mexico City.-105. Branch Store: Tijuana, B. C.

**MAKE** Money in photography. Learn quickly at home. Spare or full time. Easy plan. Previous experience unnecessary. Common school education sufficient. Interesting booklet and requirements free. American School of Photography, 3601 Michigan Ave., Dept. 3432, Chicago.

**ARGUS** Owners: Don focusing mount reduced to \$2.50. Focuses infinity to 3 feet. Pattee Scientific Development Company, Niantic, Conn.

**ATTENTION** Photographers! Increase profits substantially by taking photocopies (commonly called photostats) with your regular camera. No film, no prism, details free. The Barbour Manufacturing Co., Warren, Ohio.

**PRINT** Your own pictures direct from any negative on plain paper, fabrics, rubber, wood, porcelain, etc. Experience unnecessary. Prints indoors, outdoors, day or evening. No dark room required. Prints in 3 minutes. Harmless to negatives. This sensational outfit prepaid for only 50c. Makes over 50 prints. Transfoto, 930 W. Roosevelt, Dept. 11, Chicago.

**ARGUS**, 35mm. owners. Print, color your own positives, project brilliantly—1c per picture! Powerful projector, \$9.50. Combined projector-enlarger, \$12.50. Quality positive film printing 80c roll. Details. Photo Products, 1261 Beaconsfield, Detroit, Mich.

**ABSOLUTELY** Free! During this advertising campaign! New Moviematic, all purpose, 3-in-1 camera. Included with this camera, a Keystone motor driven projector at no cost to you. Write today! Right now! Enclose 3c stamp for details of this amazing offer. Master Distributing Corp., 18 East 48th St., New York, N. Y.

**DUPONT** Superior panchromatic, (guaranteed), 35mm.; 25 foot roll, \$1.30. Optical Laboratories, Larchmont, N. Y.

**WANTED!** View photographers. Samples, details 10c. National View, Winona, Minn.

**SELL** Your kodak and candid camera shots. Details one dime. Hocker Distributing Co., P.O. Box 1423, Wichita Falls, Texas.

**SUBSTANTIAL** Profits making film exposure meters. Initial capital 40c. Experience unnecessary. Full instructions 10c. Frahm, Fulford Ave., Belair, Maryland.

**MINICAMERS**—Sensational offer, any 36 exposure roll developed and each good negative enlarged to 3"x4" for only \$1.00. Prompt, guaranteed service. Minilabs, Box 485K, Madison Sq. Sta., New York.

**CORONET** Midget, the new "Minicam," post paid \$2.50. Film 6 exposures 15c. G. Gennert, Inc., 20 West 22nd Street, New York City, N. Y.

**FREE!** Book, "How to Sell Snapshots." Fomo Company, Canton, Ohio.

**ARGUS** Camera Ever-Ready cases with shoulder strap, genuine leather, very special \$1.89. Mirotext, 6241 Southwood, St. Louis, Mo.

**MANY** Makes of candid cameras delivered at cut prices. Catalogue free. Camera Store, Sac City, Iowa.

**CAMERAS** And shutters repaired. Leather bellows installed in folding and view cameras. Bellows made to order. United Camera Company, Inc., A-1515 Belmont, Chicago.

**CAMERAS** Films, paper 25% to 35% discount. Paramount Photo Division, 327 East 92nd St., New York.

**INCOME** From your camera instead of expense. Low cost home course teaches you to make photographs for magazines, newspapers, advertisers. Tremendous demand. Earn good money wherever you live. Free book. Universal Photographers, Dept. 104, 10 W. 33rd St., New York.

**HAVE** You a camera? Send ten cents for recent number of our big magazine, showing how to make better pictures and earn money. American Photography, 116 Camera House, Boston, 17, Mass.

**WE** Purchase and accept in trade used photographic equipment. Send for bargain list. Fotoshop, 134R W. 32nd, New York City.

**MAKE** Money with your camera. New book tells how. 46 pages, 50c. Popular Mechanics Press, Room (C38), 200 E. Ontario St., Chicago.

### MOTION PICTURES AND SOUND EQUIPMENT

**AMBERTINT** 16mm. Camera film, \$2.00 for 100 ft. including processing. Daylight Loading Weston Six. Box 366, Lynwood, Calif.

**CENTRAL'S** Free, new, money-saving bargain book explains latest movie developments, offers money-saving bargains in cameras, lenses, projectors, films. Used equipment taken in trade. Write for free copy. Central Camera Co., (Photographic Headquarters since 1899), 230 S. Wabash, Dept. 16-K, Chicago.

**BARGAINS!** 8mm., 16mm., free literature. Elder, B-739 Boylston, Boston, Mass.

**OIL** Painting from photograph, \$5. Portraiture, 826 Noble, Chicago.

**PROJECTORS.** Cameras, accessories. Substantial discounts. Stans, 228 Neilson, New Brunswick, New Jersey.

**TITLERS.** Tinting film, titling film developing outfits. Send for booklet. "Amateur Movie Tinting," 10c coin or stamps. Catalogs of 8mm.-16mm. films, home movie equipment free! Holly'd Cine Film Distrib., Dept. P-6, 1431 No. Highland Ave., Hollywood, Calif.

**CLEARANCE** Sale 16mm. projectors, films, accessories. Free list. Lewis Films, 105 East First, Wichita, Kansas.

**PORTABLE** Projector, 32 volt, 35mm., motor suitable connection farm or camp generator, reasonable. Portable sound-on-film 35mm. complete with microphone, third original price. Few good used Victor 16mm. Box 633, Morgantown, W. Va.

**35MM. BARGAINS.** Shorts, features. Lists. Floyds, 36 Franklin, Sloan, N. Y., Station F.

**DEVELOP** Your own 16mm. films. Instructions and formulas, for making complete outfit, 50c. Hildman, Inc., 459 Irvin Ave., Rochester, Penna.

**FREE** And rental non-theatrical motion picture directory. 3000 subjects 16mm and 35mm fully described. Rates, terms of U. S. distributors. Subscriber writes, "The best non-theatrical directory I have ever seen." Subscription \$2.00 year. Free literature. Motion Pictures of the World, 40 Mt. Vernon St., Boston, Mass.

**UNIVEX** Movie film—develop your own. Simple method. Pull instructions and formulas \$2.00. Hobby Corner, 687-D Cheshire Ave., Eugene, Ore.

**WHOLESALE** 16mm, 8mm. Listings stamp. No-Wat-Ka, 151 Broadway, Paterson, N. J.

**8-16MM. FILMS.** "All subjects" for sale, rent, exchange. Bargains in equipment, trades accepted. Free illustrated catalogue (with sample film 10c.) Garden Camera, 317 West 50th, New York.

**35MM. PROJECTORS.** Time payments. Free! Film list. Calderara, 5119 South St. Louis, Chicago.

**NEW** 16mm. Automatic movie cameras \$22.50. Free 16mm., 8mm. bargain lists. Home Movies, Box 216, Easton, Penna.

**16MM. VEL-O-TEX.** Weston 8. Perfect outdoor film. 50 foot rolls \$1.29 including processing. Your dealer or direct postpaid. Samples 6c. Vel-O-Tex Laboratories, 600, Gary, Indiana.

**35MM. TALKIES** For rent. Shermco, 6101 Orchard Grove Ave., Cleveland, Ohio.

**GENERA** Film, any 8mm. camera. 200 feet. \$1.95 postpaid. Separates without slitting. Processed with powders. Sample free. Promaders, Davenport, Iowa.

**"HERE'S** News from Bass." A 52-page Cine Bargaining No. 234. A veritable encyclopedia of motion picture apparatus, 8 mm. and 16 mm., silent and sound. Sound cameras. You must have a copy of this book. It's hot off the printer's. Your copy is waiting. Don't delay, and send for this valuable book. Dept. A. Bass Camera Company, 179 West Madison Street, Chicago, Illinois.

**LEARN** Motion picture theatre business. Home-study training; management, advertising, projection. Free catalog. Give age. Theatre Institute, Elmira, N. Y.

**COMPLETE** 16mm. And 8mm. rental library. Films shipped anywhere. Include postage for free catalogue. National Cinema Service, 3 West 29th Street, New York.

**"THE** World's greatest of all Passion Plays," 16mm. 8 reels. Sound with dialogue or silent. Rent or purchase. Superior than Oberammergau stage play. Write Hemenway Film Co., 37 Church St., Boston, Mass.

**MOGULL** 16mm. 100 ft. film with processing \$2.39. Super sensitive \$4.85. Like new Eastman 16mm. camera \$14.50. Model M with case \$33.50. Keystone library motor projector \$11.50. Victor or Bell & Howell Turret camera \$65. Camera, projector lenses large variety, priced low. Victor, R.C.A. Edco sound on film projector complete \$149.50 each. 4x6" screen \$6.50. 35mm. Universal camera with 2-400 ft. self-contained magazines—2" f3.5 lens, complete \$45.00. DeVry 35mm. silent projector \$29.50. Acme \$32.50. Holmes \$48.50 all complete, 1000 foot capacity. 35mm. portable sound on film projector with 15 watt amplifier, speaker, complete \$189.50. Silent, sound on film 8, 16, 35mm. shorts, features, \$1.00 reel up. Send for our latest catalogues. We maintain a national film library, sent anywhere. Join now. Trades accepted, bought. Complete repair department for movie, still work. Parts, accessories, laboratory work in all its branches. Mogull's, 1944J Boston Road, New York City.

**35MM FILMS** Rented, 50c weekly. Lists 3c. Hoffman Film Service, 57 Broad, Albany, N. Y.

**8-16MM. TITLES.** 2c Word. Catalogue. Cineshop, 1812 Piedmont, Charleston, West Virginia.

**15% TO 25% Discount** on still or movie cameras. Free circular. Paramount Co., 327 E. 92nd St., New York City.

**DIME** Brings usable title letters. Lionel, 224 North Desplaines Street, Chicago.

**RELIGIOUS** Pictures for rent or sale. 16mm. and 35mm. sound or silent. All-Sacred Film Co., 50 Meirose St., Boston, Mass.

**MOVIE** Films. Develop yourself. Univex, Eastman, etc. Movie films wholesale. Chemical samples 15c. Lake Camera Exchange, Gary, Indiana.

### RADIOS, SUPPLIES, INSTRUCTION

**QUALITY** Bakelite. Panels, tubing, strips and rod. Write Hackbush, 29 Linwood, Tonawanda, N. Y.

**BOYS.** Complete plans for crystal set, dime. Case, 5213 Perkins, Cleveland, Ohio.

**BARGAINS:** Wholesale prices on standard make radios, refrigerators, washers, ranges, sweepers and other appliances. Write for prices. Wholesale Appliance Company, 312 - 21st, Toledo, Ohio.

**RADIO** Bargains. Electric appliances. Save half. Free bulletin. Mack Brothers, 2045 Chicago Ave., Chicago.

**PLANS** 18 Distance record crystal sets, with "Radiobuilder" year—25c. Laboratories, 7700-C East 14th, Oakland, Calif.

**TELECHART!** Learn radio code by quick, easy, copyrighted method. One dollar. Telechart, Dept. 11, Box 25, Knoxville, Tenn.

**RADIO** Engineering, broadcasting, aviation and police radio, servicing, marine and Morse telegraphy taught thoroughly. All expenses low. Catalog free. Dodge's Institute, Ames St., Valparaiso, Ind.

### MUSIC AND MUSICAL INSTRUMENTS

**SONGS**—Arranged, revised by arranger "Cherry Blossom Lane," "Gypsy Tea-room," others. Send for details. Harold Potter, 1619(P) Broadway, New York.

**EARN** More! Learn modern music arranging by personal correspondence. Melodic Music Methods, P. O. Box 1297, New Orleans, La.

**SONGWRITERS**—Free rhyming dictionary and instruction book by famous composer. Send poems now. Free marketing advice. Songwriters Institute, 1234-C Broadway, New York.

**MUSIC** Composed to words. Rhyming pamphlet free. Phonograph recording of song free. Send poem. Keenan, 259 Beach St., Bridgeport, Conn.

**MUSIC** Composed, arranged, songs, orchestra, band. Frank Wildt, Lancaster, Pennsylvania.

**SONGS,** Orchestration printed \$5. Composing, arranging. Auto-Litho Co., Jensen, Fla.

**PIANO** By ear. Free booklet. Day-V-Way, Woolworth Building, Dearborn, Michigan.

**POEMS** Set to music, arranged for publication. Free examination, report. MMM Studios, Dept. 33C, Portland, Ore.

**WRITERS,** Arrangers, copyists music slide scale. Transposes both treble and bass accurately from or to any key simultaneously. Price \$1.50 postpaid. Wallee Brown Music Print, Box 70, Maywood, Ill.

**VIOLINS**—Genuine old Italian, French, German. Soprano saxophone. Baritone horn. Trombone. Phipps, 3225 Southport, Chicago.

**BAND** Instruments, cut rate prices, popular makes, state make, model. Damon Co., Geneseo, Ill.

**TERRIFIC** Success. New (copyright) courses. Quick, thorough. Radio Method of Piano Jazz, P.O. Box 1024, Dept. 17, San Francisco.

**LEARN** Swing piano! Self instructor makes it easy. Postal brings free folder. Christensen, 751 Kimball Hall, Chicago.

**MELODY** Composing course! \$5.00. Littig, 215 Mason Theatre, Los Angeles, California.

**SONG** Writers. Send for publishing agreement. McKinley Music Publishers, 1501 E. 55th St., Chicago.

**LATE** Phonograph records, some new, some slightly used. Fifty—\$2.50. Davis Sales Company, Syracuse, New York.

**SONGWRITERS:** Send best poem today for exceptional offer. Richard Brothers, 24 Woods Building, Chicago.

**SONGWRITERS!** Marvelous opportunity. Investigate. Standard Song Service, 1412 Great Northern Bldg., Chicago.

**SONGWRITERS** Wanted, write for free book. Indiana Song Bureau, Salem, Ind.

**MUSIC** Composed to words. Wonderful proposition. Bauer Bros., Oshkosh, Wis.

**DUO-FLEX** Reeds for clarinets, and saxophones eliminate your reed troubles. Write for circular. Duo-Flex Reeds, 1204 1st Ave., Evansville, Ind.

**WRITE** Songs. Big money and reputation. Write for information. J. Gordon Pub. Co., 201 N. Hoyne Ave., Chicago.

**WANTED!** Lyrics, melodies for songs. We arrange, publish, sell. Superior Song Studios, Passaic, N. J.

**WANTED** Original poems, songs, for immediate consideration. Send poems to Columbian Music Publishers, Ltd., Dept. 42, Toronto, Can.

### BUSINESS OPPORTUNITIES

**BIG** Profits making monogram stationery at home. Looks engraved. Andercamco, 1248 West 102nd Place, Chicago.

**INCORPORATE** In Delaware. Special low rates to investors forming small companies. Free information. Corporation Registration and Trust Company, 927 Market Street, Wilmington, Delaware.

**GET** Cream of radio business. Stamp brings latest radio "kink" and further particulars. Boyles Radio Service, Box 508, Winfield, Kansas.

**FORMULAS**—Fast selling products. Guaranteed. Laboratory tested. Lowest prices. Catalog free. Kemico, 55F, Park Ridge, Ill.

**"SUCCESS** Beacon." 52 pages! Money-making schemes, ideas, plans. Dime. Jay, Publishers, 6054-p Kenwood, Chicago.

**PLASTEX** Industries offers industrious men an opportunity to start a business of their own, manufacturing art goods, novelties, souvenirs, etc. in Plastex and marble imitation. 5c material makes \$1 articles. Rubber moulds furnished for speed production. Small investment brings big returns. You are just in time for big wholesale season now starting. Write for interesting booklet mailed free. Plastex Industries, Dept. A, 1085 Washington Ave., New York.

**YOU'LL** Like resilvering mirrors, auto-parts, reflectors, making chipped glass signs. Write, Sprinkle, Plater, 127, Marion, Indiana.

**ELECTRIC** Dry shavers at 62% off popular prices. New. Year guarantee. Enormous possibilities. Write: Wholesale Terminal, Norwood, Mass.

**M. M.** earned \$267, three weeks, raising mushrooms in cellar! Exceptional, but your cellar, shed perhaps suitable. We buy crops. Book free. United, 3848 Lincoln Ave., Dept. 65, Chicago.

**BOYS** Clubs—Finance your activities. No selling. Davis Metal Fixture Co., Lansing, Mich.

**INVENTORS**—Small ideas may have large commercial possibilities. Write us for free book, "Patent Guide for the Inventor" and "Record of Invention" form. Delays are dangerous in patent matters. Free information on how to proceed. Clarence A. O'Brien & Hyman Berman, 584 Adams Bldg., Washington, D. C.

**ELECTRIC** Lawnmower. Attractive proposition. Request literature. Owen, 830-W Euclid, Detroit, Michigan.

**FASCINATING Business.** Repair, adjust typewriters, adding machines. Learn easily at home from factory expert. Earn up to \$15.00 daily. Complete instructions covering all makes \$3.00 postpaid or sent C.O.D. Adding Machine Equipment Service, 3601 Michigan, Dept. 343-A, Chicago.

**COLOR-GLAZED** Concrete pottery, tiles, walls. Make glazed concrete lawn pottery without molds, power or costly tools. Cheap materials. Build own equipment from our plans. Giftware, statuary. Money-making business for men. Booklet, colorplate, details 10c. National Potteries, 13 West 26th, Minneapolis, Minn.

**BOOKS** Full of money making plans, formulas. Literature free. Pyramid Sales, Pulaski, Tenn.

**NEW** Powerful projects for profitable mail selling. Particulars free. Harrigan, Box 97, Drexel Hill, Penna.

**MONEY** Making secrets exposed. Shows the way to freedom from wage slavery. Points the way to prosperity. Particulars, stamp. W. Strauss, Owings, West Virginia.

**HOW** And where to obtain capital fully explained, free particulars. Star Service, Wapakoneta, Ohio.

**"\$35 WEEKLY** For 3 hours homework." 204 other moneymaking plans. Particulars free.. Stamford, 826-F Riverside Drive, New York.

**OPPORTUNITIES** Aplenty! Money-makers that "click"! Unusual "idea" service! Bulletin free! Cee-Tee Company, P-1079 Madison St., Brooklyn, N. Y.

**OVER 600%** Profit making at home marvelously effective new cleaner for paint, varnish, walls, floors, linoleum, etc.; no rubbing; sell to homes, stores, shops, others; money back guarantee; full instructions five dollars. Marvoleon, 736 West Main, Richmond, Ind.

**PATENTED** Screw-holding screw drivers! Factories, hardware stores buy quantities. Big profits. Foreign territories open. Toolco, 5089 Journal Bldg., Boston, Mass.

**\$250 STARTS** "Chain" of penny gum and confection vending machines. Steady cash income. Details free. Robbins Co., 1141P DeKalb Ave., Brooklyn, New York.

**OUR** Formulas are money makers. Latest, special prices. Catalog free. Industrial Laboratories, 1200 Niagara, Buffalo, N. Y.

**VALUABLE** Mail selling distributorships. Small investment. Enormous profits. Product details 25c. Thompson, Box 241, Duluth, Minn.

**START** Profitable mail order business. "Mail Order Success," 28 pages, facts, ideas, methods of getting profitable returns on every dollar invested. Dime. Mail Plan Bureau, Fillmore, N. Y.

**MAKE** \$15-\$75 Weekly; home business. Over 100 plans. Century, 1261-P Broadway, New York.

**SCALLOPING** Signs booklet. Free sample. Beveridge, 160-22 Y Locust, Jamaica, N. Y.

**RUBBER** Molds easily made. Stamp brings sample mold and directions. Vosburg Laboratory, Austin, Texas.

**HUNDREDS** Ideas, plans, formulas. Schor, 2082 Crotona Parkway, Bronx, N. Y.

**TYPISTS!** Make your typewriter pay you extra money. "49 Golden Keys to More Money" tells how. White's Business Service, 114 W. Henry, Elmira, N. Y.

**PROFITUNITIES** In mail order, three months 25c (coin). Circular "Truth about Business Plans" included. Otanko, Box 114, East Akron, Ohio.

**FUN!** Profits! Make and sell colorful lawn ornaments. 25c buys 20 novel designs, full instructions. Wickman, 738 Brooklyn Ave., Dayton, Ohio.

**PROFITS** And pleasure making shell jewelry, novelties—newest field! Stamp appreciated. Challenge, A-11, St. Petersburg, Florida.

**AMERICAN** Homemaker Magazine—sample, unusual profit details 10c. Challenge, 31-St. Petersburg, Florida.

**WORLD'S** Best seller—barring none. Postal brings particulars. George Andree, Woodside, N. Y.

**EARN** While learning marblizing, rubber mold making. Send dime for samples. Cowell Institute, Grayling, Michigan.

**NEW** Popcorn Cheese-O-Corn machines—Sensational new popcorn. Happy Days products sell. Big money. Write today. Barnard's, Omaha, Nebr.

**BIG** Profits with "Golden Magic." Locally; mail order. Details free. Sample 25c. Williams, Box 4100, Portland, Oregon.

**MAKE** Artificial marble, glazed tiles, uncanny. Tabletops, plaques, floors, hones, novelties. Hard, fireproof, inexpensive, cement secrets. Brilliant tile and liquid rubber samples 3c. John A. Payn, 945 Grande Vista Avenue, Los Angeles, Calif.

**MAKE** Money at home! Grow mushrooms in cellar or shed, with Ami Spawn and easy-to-follow instructions. Book free. Write today. Anglo-American Mushroom Industries, Dept. 25, Toronto, Ont.

**MONEY** Talks! Famous book "Start Your Own Business" starts thousands on road to success. Praised by leading newspapers. Free trial offer. Stamp brings details. Mail Order Book Service, 424 Madison Avenue, New York City.

**BIG** Money in junk storage batteries. Details free. Write Ruproco, 5656 N. Hermitage, Chicago.

**MAKE** Money growing vegetables, fruits, flowers, plants without soil. Use only water and chemicals. Complete formula and process \$1.00. Kemixal, 179, Park Ridge, Ill.

**HERE'S** Your chance! "Millions becoming Health-Minded!" Health foods, (your labels) instructions, furnished to 500 members. Hurry! Samples, dime. Gardena M. Institute, Station "S," Los Angeles.

**1c DAILY.** Establishes personal mail address. For business purposes 2c daily. Both services, include forwarding and post-marking from New York. Co-operative Mail Service, 128P Lexington Avenue.

**MONEY** Making mail order business for sale. Good for \$5000.00 per year. \$1500.00 required. Box 27, Boston, Mass.

**"INCREASE** Your Earnings." Send for free budget of moneymaking opportunities. Bernie Pyles, 1566 Jones Street, San Francisco, Calif.

**DOLLAR** Kit makes three rubber molds. Colonial Art, Derry, N. H.

**ESTABLISH** Yourself in a profitable mail order business. No goods to buy. No orders to fill. 300% profit. Send dime for "Opportunities." Camden, New Jersey.

**EARN** Up to \$50 daily with amazing penny embossing machine. Engraves Lord's Prayer, Ten Commandments, American Legion, etc., on pennies. Sensational souvenir. Send 25c and birthdate for horseshoe and 5 assorted engravings on genuine pennies (\$1 value). Literature free. Ray Mfg. Co., D-168, 2250 Clybourn, Chicago.

**FREE!** Instructions for making fastest-selling, big profit products. \$1.00 pays \$30.00. Sales Manager, Box 1591, Tampa, Florida.

**START** Making money now with this new liquid hair tonic. Stops dandruff, itching scalp and excessive falling hair. First week three applications. Costs you very little to make. Investment made back with first quart. Drug stores and barber shops can handle. Commercial and personal use. Formula \$1.00. Pancher & Sons, 612 Freeman Ave., Flint, Mich.

**INCREASE** Your income. Operate locally or by mail. Complete plan 25c. Mail Bureau, 87P Somerset St., Springfield, Mass.

**"MAKE** Mirrors at home." Big profits. Little outlay. Also emboss, grind—foil, gold leaf, frost, chip and make imitation stained glass. Instruction course \$1.00. Bestovall, 4047-M N. Whipple, Chicago.

**MONEY** With our plan! No investment or experience. \$1.00 brings it. Regal Printers, 1828 Western, Cincinnati, Ohio.

**UP** To \$300 week being earned putting on movie shows in small towns, at lodge meetings, churches, schools, fairs, etc. Our new 16mm. sound-movie projector offers you big opportunity. Write Wenzel Co., 2509 So. State, Chicago.

**MONEY** In butterflies, moths. See Sinclair Display Advertisement on page 18A.

**EXTRA** Money making chocolates and bon-bons. Practical home study course \$5.00. L. Klose, East Aurora, N. Y.

**SUCCESSFUL** New business opportunities, 10c copy. Lessler, Box 44, Clifton, N. J.

**LEGITIMATE** Business chain store item. Artist Color Co., Detroit, Mich.

**DON'T** Buy formulas until I've sent you valuable information about this new service that may make you thousands of dollars. Stamp brings everything. Miller, 1706, Tampa, Florida.

**START** Own manufacturing business. Millions need product. Up to 1,500% profit. Particulars free. Thermo D-X, Peoria, Ill.

**MEN—**Women interested in an honest proposition, with good income possibilities, write Homecraft Arts, Lakeside, Calif.

**FREE** Circulars describing hundreds of moneymaking opportunities by mail. Newest methods. Pleasant surprise. Write now. Progress Publishing Co., 2513A N. 9th St., Milwaukee, Wis.

**MAKE** More money—on the side in your spare time. Inexpensive way to get the low-downs. Small capital starts you. Steady income. Literature free. Milton, Box 772-P, San Jose, Calif.

**HUGE** Profits growing plants without soil. Produce flowers, fruits, vegetables anywhere year round with chemicals. Season's supply, directions, \$2.00. Formula, bibliography, \$1.00. Both \$2.50. Chemiculture, 4701 Sheridan, Chicago.

**PROFIT** With new products. Make, sell, repeat. Analysis. Research. Guaranteed formulas. Biggest catalog free. Special prices, leads. Gibson Laboratory, Chemists, BD-1142 Sunnyside, Chicago.

**EIGHTEEN** Money making automobile specialty formulas, including the celebrated petrolube gas saving formula with complete plan for selling by mail, all for only 63 cents. A. Bucknam, 177 State St., Boston, Mass.

**\$1.90** PROFIT On each \$2.00 order. Selling by mail. Details stamp. Ralph Brooks, Arkansas, Wis.

**ROBERTS** Borrowed \$50, paid back \$500, pocketed \$1,000 and established a paying business! How? Write "Banco Games," 414 East 52 St., Los Angeles.

**GET** Money daily by mail. We do. 4500 word brochure tells how. Quarter. Thomasson's, Minneapolis, Minnesota.

**TIREX** National Safety Service opens huge field. See advertisement under Automobiles.

**EARN** \$25.00 Weekly working two hours daily. No canvassing or manufacturing. Business Opportunities, St. Paul, Minn.

**MANUFACTURE** Writing inks. Tremendous profits. 15 gallon size \$1.50. Labels free. Samples 25c. Pilgrim-Atlas, Maiden, Mass.

**OPERATE** Home mail business. Plans, instructions, formulas. Complete 25c. Steitlee, 6605 Murray, Mariemont, Ohio.

**SELL** Books, plans, folios by mail. Plan and details 10c (coin). Tillberg, 126 Lexington Ave., New York.

**DOLLARS** And leisure on few cents capital! Make alluring enduring marble, granite, flooring, roofing, wallboard, tile, etc., at home. Sell on sight. Free information. Cement Arts, 514 Davis Building, Portland, Oregon.

**COLOR** Concrete surface with chemical solutions. Beautiful pottery without molds. Garden wishing-wells. Stucco rock. Glazing concrete. Sample 10c. Hollywood Cement Craft, 8527 Wonderland, Hollywood, California.

**LIQUID** Marble—anyone can make! Colorful, glazed! Moulded, brushed, sprayed. Rubberlastic moulds. Composition flooring. Big money in these! Particulars free. Marbleizing Service, Edwardsville, Ill.

**107** WAYS To make money, in home or office, business of your own. Full particulars free. Elite Co., 214 Grand St., New York.

**AFTERNOONS** Free for outdoors, shows. \$340 month home. Unique plans. No canvassing. Prepare for surprise. Folio-P, Station D, Los Angeles.

**ADDED** Income ideas. Mail Sales News magazine, copy 10c. Katz, 4254 No. Kimball, Chicago.

**MANUFACTURE** From Phospholene. Cleaning fluid 1c gallon; bleach 2c gallon; and ten fast sellers. Sample 25c. Details free. Western, 6615 Denison Ave., Cleveland, Ohio.

**DONUT.** Potato chip, cheezed pop corn. Home made. Big profits. Vanderpol, Springfield, Ohio.

**WE** Start you in business, furnishing outfits and instructions, operating Specialty Candy Factory home. Men and women, earn \$25 up to \$60 weekly, all or spare time. (Our 29th year.) Booklet free. W. Hillyer Ragsdale, Inc., Drawer 4, East Orange, N. J.

**SUCCEED** With your products. Make-sell them. Formulas, Processes. Accurate analyses. Catalog free. B. Thaxly Co., Washington, D. C.

**PROFITABLE** Home business. Legitimate. No canvassing. Maywood Publishers, P-923 Broadway, New York.

**SELL** By mail. Books, novelties. Bargains! Big profits! Particulars free. B. Elfcoc, 438 N. Wells, Chicago.

**FREE** Booklet describes 107 plans for making \$20-\$100 weekly, in home or office, business of your own. Elite Co., 214 Grand St., New York.

**I WANT** To send you proof of the wonderful pulling power of Popular Mechanics Magazine's classified pages. What's your proposition? Write me today. F. W. Johnson, Manager Classified Advertising, 200 E. Ontario St., Chicago, Ill.

**CHARTERS:** Delaware; best, cheapest; free forms. Colonial Charter Co., Wilmington, Del.

**CASH** Every week clipping and preparing news items for publishers. Simple, fascinating work. Experience unnecessary. Stamp brings information. Division 55, National Press, 3923 W. Sixth, Los Angeles, Calif.

**DELAWARE** Charters: Complete service \$35. Submitted forms. Chas. G. Guyer, Inc., Wilmington, Del.

**ARTIFICIAL** Marble sanitary flooring, instruction covering wood or cement flooring 1/2 inch thick, fireproof, all colors, low cost, ornamental casting, concrete, plaster, papier-mache, garden furniture, statuary, flexible molds, particulars free. Chris Mahler, Elmout, N. Y.

**MAIL** Order business is your opportunity. Many began small, now earn thousands yearly. No personal contact. Boundless opportunities. Have had over 30 years experience; will help you succeed. Send 25c for valuable booklets, none free. B. Brenner, 257 S. 21st, Philadelphia.

**100 PROFITABLE** Mail order and local plans. Gilbert Supply, 1107 Broadway, New York.

**SILVERING** Mirrors made easy and 460 other useful articles in Shop Notes, Vol. 28—50 cents postpaid. Popular Mechanics Press, Room (C38), 200 E. Ontario St., Chicago.

#### MONEYMAKING OPPORTUNITIES

**OUR** Own original formulas, all repeaters, little capital, success is yours. 5 formulas and samples \$1.00. So-Eez Products, 14512 Savannah Ave., East Cleveland, Ohio.

**NO** Peddling—Free booklet describes 107 money-making opportunities for starting own business, home, office. No outfits. Lee Griffith, Box 43, Franklin, Mass.

**TAKE** In the dollars with the "Money by Mail" system. Particulars free. Key Systems, Box 323, Jeannette, Penna.

**YOU'LL** Like resilvering mirrors, auto-parts, reflectors, making chipped glass signs. Write, Sprinkle, Plater, 287, Marion, Indiana.

**"\$35 WEEKLY** From 3 hours homework." 204 other moneymaking plans. Particulars free. Stamford, 826-F Riverside Drive, New York.

**BIG** Profit formulas and trade secrets. Lists free. Hayes, 60 E. 18th, Chicago.

**1,000,000** ARTICLES Wholesale. Directory 10c. Jelsmith, 163 Myrtle, Waltham, Mass.

**SWEET** Potato chips, sensational sellers to stores. Manufacture in home, original process. Bard, 2614 Capitol, Omaha, Nebr.

**CASH** In. 300 tested moneymakers. 68 page book, over 40,000 words. 10c postpaid. Business secrets, formulas, wholesale supply sources galore, no ads, meat only. Moneyback if dissatisfied. National Plans Institute, 246M Fifth Ave., New York.

**NEW** "Ride-Em Puzzle." Over 300% profit. Dime brings sample and dealer's offer. Coleman's, Smithboro, N. Y.

**MAKE** Perfect architectural models. Inexpensive. High profit. Free details. Weidner, 4589 Lexington, Hollywood, Calif.

**50** LETTERHEADS. Envelopes and cards or stickers, printed in two colors \$1.00. Sicoan, 2038 Obeart, St. Louis, Mo.

**"DUTCH** Holland" hamburgers—hot-dogs! Goldmine! Taverns, restaurants, roadstands. Details stamp. Davis, Box 1484-MP, Clarksburg, W. Va.

**"PROFITS."** Stamping keychecks. Outfits furnished. Name-address on sample 25c. Bohn Co., Box 86-B, Wilkes-Barre, Penna.

**SELL** By mail, proven plan, copy of circulars, advertisement, full information that gets orders, mail dollar bill. Plan Distributors, 900A Faxon, Memphis, Tenn.

**GROW** Without soil—Flowers, vegetables, plants. Year round, anywhere. Only water and common chemicals used. Formula \$1.00. Bestovall, 4047-W North Whipple St., Chicago.

**MAIL** Money-making. How? Read "Inner Circle." 6c. Warden, Box 7620, Kansas City, Mo.

**TURN** Spare time into cash with typewriter! Addressing envelopes, mailing circulars, typing! Dime brings information, none free. Ace-PMD, 322 Empire, Birmingham, Ala.

**EARN** Money collecting reptiles, toads, frogs for us. For particulars send dime. Biological Research Laboratories, Dept. 14, Springfield, Missouri.

**MONEY** Making plans. No house to house selling. Particulars free. Box 181, Barberton, Ohio.

**BARGAIN** Buyers' Guide. Tells you where all the best bargains are. Information free. Write E. D. Bebout, Box 62-P, Marion, Ky.

**MONEY** In butterflies, moths. See Sinclair Display Advertisement on page 18A.

**SALESMEN.** Get set with Mechanical Cement now. Calling on garages, etc. Trial size \$1.00. Write for literature. Lecroy Mfg. Company, Hot Springs Nat'l Park, Ark.

**"AMAZING** Opportunities" by mail. Spare time. Big profits. Write L. Process, 4437 Lincoln Ave., Chicago, Ill.

**EASY** Money! Moneymaking opportunities, many of them; anyone can work them, spare or full time. Details free. Lewis Co., 828-A Carpenter, Oak Park, Ill.

**VALUABLE** Money-making opportunities, home work. Dison, 4825 St. Lawrence, Chicago.

**NEED** Money? Free gift, details. Stamp. King Products, Ahwahnee, Calif.

**IMMEDIATE** Cash income, advertising! Particulars dime. M. Benton, Liberty, Ky.

**BE** Progressive. Start full or spare time business of your own. Convert used motor oil into valuable by-product worth 35c pound. Experience not necessary. No extra capital or labor required. Plan sent postpaid. \$1.00. Aero Electric Sales, Hart, Michigan.

**ADVERTISING.** Chance to make more money. Send 50c for promotion plans. Chippewa Advertising Company, 612 South Franklin, Mount Pleasant, Michigan.

**MONEY** Making propositions, practical and legitimate. Free particulars. Schembri, P.O. Box 1271, Detroit, Mich.

**WANT** Money? Send your address. Enclose stamp. Steitlee, 6605 Murray, Mariemont, Ohio.

**NOW** Make money! A \$1.00 magazine (40th year), filled with schemes, tips, business opportunities, formulas, sent six months for only 30c. "Schemer Monthly," Alliance, Ohio.

**STOP** Squealing—Start crowing! Work mornings home—country drives or movies—afternoons! No canvassing! Folio-A, Station "D," Los Angeles.

**MILLIONS** Jobless! Get dollars in mail daily, like we do, for amazing employment information. Keep money; we fill your orders free. Stamp brings details. Co-Operative Service, 77 Swan, Buffalo, N. Y.

**PROFIT** In vegetables, flowers, using chemicals. Remarkable yields. Proven formulas. Chemicals for 48 gallons solution. Instructions \$1.00 postpaid. Quick Growth, Hollywood Sta., Box 648, California.

**MAN** In each town to plate auto parts, reflectors, bicycles, fixtures, mirrors, by late method. Simple plan of manufacturing at home starts you in good paying business. Free particulars and proofs. Gunmetal Co., Ave. N. Decatur, Ill.

**RAISE** Earthworms for profit. Information free, stamp appreciated. Bureau Zoological Research, 106A Broadway, Peoria, Ill.

**MOULDS.** Guaranteed, for casting toy soldiers, Indians, trappers, warships, sinker moulds, 244 kinds. Send 5c for illustrative catalogue. Henry C. Schiercke, 645 Spencer, Ghent, N. Y.

**107** PLANS For making \$20-\$100 weekly in home or office business of your own. Descriptive booklet free. Elite Co., 214 Grand St., New York.

**WHOLESALE** Sources, 500,000 articles. Free directory. Maywoode, 925 Broadway, New York.

**LIKE** To draw? Earn steady income tracing and duplicating advertising cartoons. Ad-Service, Argyle, Wis.

**INVESTIGATE** Frog raising—a profitable side line. Valuable book explains and illustrates every phase of subject. Covers very latest developments. \$1 postpaid. Popular Mechanics Press, Room (C38), 200 E. Ontario St., Chicago.

#### FORMULAS, PLANS, ETC.

**MAKE** Bleach water formula 50c. Capotosto, 1707 Cranston St., Cranston, R. I.

**GUARANTEED** Formulas—New fast sellers. None better. Lowest prices. Catalog free. Kemico, 49F, Park Ridge, Ill.

**FORMULAS:** 15 Proven moneymaking formulas \$1.00. (Not stock-formula catalogue stuff), real unusual offers. List free. Marvel Laboratories, 6629 No. Maplewood, Chicago.

**EIGHTEEN** Money making automobile specialty formulas including the celebrated Petrolube gas saving formula with complete plan for selling by mail. All for only 63 cents. Bucknam, 177 State Street, Boston, Mass.

**FORMULAS** That please! Let us send proof. World's most popular food flavor. Formula and other details 25c. Rokemko, Waverly, Va.

**LATEST** Research formulas. Literature free. Research Bureau, 100 Chelsea, Charlestown, Massachusetts.

**PERFECTED** Formulas with service and problems solved, 25c. Alembic Laboratories, Chemists and Chemical Engineers, Box 1277, Chicago, Illinois.

**NO** Service like this! Certified formulas based on guaranteed chemical analyses of today's most popular specialties! Stamp brings valuable information. Miller, 1705 Jetton, Tampa, Florida.

**ANALYSIS.** Research. Newest guaranteed formulas. Biggest catalog free. Special prices, leads. Gibson Laboratory, Chemists, BD-1142 Sunnyside, Chicago.

**SENSATIONAL** Discovery. Remarkable hair grower. Results guaranteed. Ingredients inexpensive. Positive money maker. Prospects everywhere. Formula, complete manufacturing, selling instructions only \$1.00. Never bald, never grey hair secrets free. Unity Service, 2133 N. Third, Milwaukee, Wis.

**LUCKY** Seven money making formulas, own your own business, become independent, money back guarantee. Send 25c silver. Plan Distributors, 900A Faxon, Memphis, Tenn.

**ELEVEN** Laboratory tested formulas. Guaranteed moneymakers 25c. Pacific Laboratories, San Pablo, Calif.

**POLISH** For floor, furniture, formula 50c. Fred Burns, Missoula, Mont.

**BEAT** Depression. Start manufacturing business. Enormous profits. Send 50c for 200 reliable formulas fast selling products. Technikum Laboratories, 210 5th Ave., New York.

**FIFTEEN** Best formulas cosmetics, etc., 35c. Master Manufacturing, Boonville, Missouri.

**MEN!** Shave without razor! Send 25c for formula for self-shaving soap. Carl Greiner, 5112 N. Oakley Ave., Chicago, Ill.

**ICELESS** Ice! Colder! Cleaner! Cheaper! Instructions, 25c. Duffy, Covington, Ky.

**BRUSHLESS** Falseth cleaner 15c. Makes 1 gallon. Formula \$1.00. Walsh, 248 Whittenton St., Taunton, Mass.

**THAXLY** Formulas for perfect products. Accurate analysis assured. Resultful research. Catalog free. B. Thaxly Co., Washington, D. C.

**FORMULAS.** Latest money makers. Literature free. Belfort, 4042 N. Keeler, Chicago.

**10,000** MONEY-MAKING Formulas. Tells you how to make and sell almost everything under the sun; cosmetics, mucilage, anti-freeze solutions, battery solution, beverages, cheese, chewing gum, cleaning preparations, extracts, hair preparations, inks, bluing, leather polish, mirrors, perfumes, polishes, typewriter ribbons, carbon paper, washing powders, liquid soap, and hundreds of other profitable articles. \$4 postpaid. Popular Mechanics Press, Room (C38), 200 E. Ontario St., Chicago.

#### CHEMISTRY

**RUBBER** Latex. Dime brings literature, twenty experiments. Eastern Latex Labs., Box 53, Canton, Mass.

**ANALYSIS.** Research. Newest guaranteed formulas. Biggest catalog free. Special prices leads. Gibson Laboratory, Chemists, CT-1142 Sunnyside, Chicago.

**AMATEUR** Bacteriologists—Culture media capsules lists, samples 15 cents. Living amoeba, paramecia 50 cents. Culture Media Laboratories, 136-04 North Hempstead Turnpike, Flushing, New York.

**CHEMICALS.** Laboratory glassware, apparatus. Send 3c for catalog CP1. Biological Supply Company, 1176 Mt. Hope Avenue, Rochester, N. Y.

**RARE Chemicals.** Sample, dime or stamps. Ernest Snow, Lexington, Mass.

**CHEMISTRY.** Biology, mineralogy supplies, microscopes, telescopes. Catalog free. Teeko, Evanston, Ill.

**HANDBOOK** For chemical experimenters, hundreds of experiments, illustrated, 50c. Experiment booklet, 15c. Chemical catalogue, 10c. Reading Scientific Co., Reading, Penna.

**FREE** Chemistry catalog. Supplies at 5c! Equip complete laboratory. Send 3c for postage. Kemkit Scientific Corp., 397P Bridge St., Brooklyn, N. Y.

#### AGENTS WANTED

**100% PROFIT** In new perfected (1938) quick-action self-starting cigar lighter. No flint or friction. No wind can blow it out. Retail 25c. Costs you \$1.75 dozen. Sample and can fluid 25c. New Method Co., Box PM-66, Bradford, Penna.

**A BUSINESS** Of your own, making Palmer's original chipped glass name plates, numbers, mirrors, signs. Illustrated literature and sample free. E. Palmer, 512, Wooster, Ohio.

**400% PROFIT**—The Perennio Calendar 640 years. Vest pocket size, 24 pages. \$5.75 hundred. Sample 10c. Box 388, Baltimore, Md.

**UP To \$6.00** an hour. Amazing Karnu refinishes autos like new without rubbing, polishing, waxing or painting. Inexpensive—costs little. Wipes on with cloth. Lasts 8 to 12 months. Free sample. Karnu, Dept. F-8, Cincinnati, Ohio.

**AT Home,** your own manufacturing business, making popular \$1 novelties. Cost you 3c to 15c. Everything supplied. Write So-Lo Works, Dept. F-842, Cincinnati, Ohio.

**BUSINESS Proposition:** Resilvering mirrors, autoparts, reflectors, making chipped glass signs. Write, Sprinkle, Plater, 128 Marion, Indiana.

**WHOLESALE** Catalog free. Razor blades, notions. Bulger, 147C Pemberton, Cambridge, Mass.

**JUST Out!** Amazing fast selling 25c household necessity. Saves hundreds of dollars. Sell 3 to 4 each home. Make up to \$6 daily. Free sample. Puro, 3107 Pine, Dept. H-298, St. Louis, Mo.

**\*AGENTS Wanted,** nationally advertised radios, Philco, GE, RCA, Zenith, etc., send for bargain set and part catalog. United Radio, N-Newark, N. J.

**"\$35 WEEKLY** From 3 hours homework." 204 other moneymaking plans. Particulars free. Stamford, 826-F Riverside Drive, New York.

**SCIENTIFIC** Gas Economizer, increases mileage 25-40%. Generous sample and exclusive agents proposition for 3 dimes. Norsemen Chemicals, Crete, Nebraska.

**NEW Kind** of heat boils water instantly. Make to \$30 daily. Pocket size minute demonstration. No installation. Free offer. No investment. Write the Lux Co., Dept. B-206, Elkhart, Indiana.

**NEW Summer** deal for red hot immediate action. Mail postcard to nearest office today. Salesmanager, 418 Kasoto Bldg., Minneapolis, Minn. or 407 Victory Bldg., Philadelphia, Penna.

**AGENTS** Sell water and oil painted portraits. Large commission daily. New York Art Studio, Syracuse, N. Y., Elmwood Station, Dept. 3-A.

**GOLD Mine** for agents. Up to 200% profit. IMP rings cut gas bills in homes, restaurants, 25% to 50%. Money back guarantee insures quick sales. Rush name for full particulars. Economy Appliances, 2300 W. Van Buren, Chicago.

**GET** An Esquire electric razor without cost. Earn to \$30 weekly and more spare time. Nothing to sell. Earn-A-Gift, 4942 N. Kedzie, Chicago.

**FREE!** Mexican framed feathered pictures. 5 1/2 x 8 1/2 costs 49c, retails \$1.00. Sample 50c stamps, refunded first order. Marquez-P, Apartado 1176, Mexico City.

**SELL** Patented key holder. Takes no room in pocket. Excellent premium item. Send ten cents for three samples. Jay J. Sindler, Malden, Mass.

**AUTOMOTIVE** Specialty. Tremendous appeal. Repeater. Get big money facts. Eagle Mfg., 2020 S. 18, Lincoln, Nebr.

**BOYS! Girls!** Sell vanilla flavoring. Details free. General Products, 776D, Springfield, Mass.

**200% PROFIT.** Noknot clothes line reel sells on sight at 25c. Carl Clouser, 11 Glynn Terrace, Quincy, Ill.

**DO** You want agents for your proposition? Your ad in this space will place your message before hundreds of men seeking fast-selling products. My folder "How to Secure Agents," is filled with proof. I'll gladly send you a copy free. F. W. Johnson, Manager Classified Advertising, Popular Mechanics Magazine, 200 E. Ontario St., Chicago.

**SENSATIONAL** Guaranteed flavoring extracts! Four bottle—24 ounce assortment worth \$3.20, sells 99c. 100% clear profit! Prepaid freight! Free merchandise! 100 fast selling repeaters! Premiums. Waldorf Products, 1615 Donalson, Los Angeles, California.

**MAKE** Money selling guaranteed burglar alarms. Fast selling dollar item. Write Sentinel, 216 W. Jackson, Chicago.

**BIGGEST** Profits! Sell beautiful new household necessity. Women buy on sight. Darco, 5009 North Harding, Chicago.

**NEW** Amazing product. Sell locally or by mail. Pays splendid profits. Surprise in store for hustlers. Write immediately. Universal Sales, Sta. D, Box 24, Cincinnati, Ohio.

**SELL** Slogan signs. Carson's Signs, 210 1/2 East James, Flint, Mich.

**PROFIT** With new products. Make, sell, repeat. Analysis. Research. Guaranteed formulas. Biggest catalog free. Special prices, leads. Gibson Laboratory, Chemists, BD-1142 Sunnyside, Chicago.

**HIGHLY** Profitable sideline for men selling hotels, restaurants, hospitals, etc. State lines now representing. Milrox Laboratories, 845 So. Wabash, Chicago.

**SIDEL'S** Universal polishing cloths. Fast 25c sellers. Sample 10c. Scruggs Company, Box 3023, Chattanooga, Tenn.

**CERTIFIED** Formulas duplicating agents most popular specialties. All lines. No service like this. Stamp brings interesting information. Miller, Jetton, Tampa, Fla.

**SELL** New sheepskin auto washing mitts. Write: Maupin, Gainesville, Texas.

**AGENTS**—New greeting card sales plan. Particulars free. Box 198, Pottstown, Penna.

**MONEY** In butterflies, moths. See Sinclair Display Advertisement on page 18A.

**I'LL** Give you groceries at wholesale besides splendid opportunity to make up to \$45.00 in a week. Brand new Ford sedan given as bonus. Details free. Albert Mills, 6224 Monmouth, Cincinnati, Ohio.

**EARN** Easy money giving away Packard Lektro Shavers. Free sample sales card and full particulars. Distributors, Box 285, Altoona, Penna.

**SELL** Beautiful 1939 art calendars low as 100 for \$3.95. Every business buys. Orders being placed; start quick! Big commissions daily. Write! New England Art Publishers, North Abington, 36, Mass.

**DISTRIBUTORS** To sell fast moving items direct to housewife. Good opportunity. Write for particulars. Polyshine, Inc., Rochester, New York.

**NEW** Invention! Sanitary toilet seat lifter. Unlimited sales bringing large daily profits to agents. Sample 25c. Security Products, Box 134, Sacramento, California.

**AGENTS** Make bigger profits on food products-bargain deals. Low wholesale prices. Big display case sent on trial. Ho-Ro-Co, 2610-R Dodier St., St. Louis, Mo.

**AMAZING** Sharpener—100 shaves from same blade. 400% profit. \$1.00 sample 25c. Dallas Ruth, Wheelersburg, Ohio.

**BIG** Money applying initials on automobiles. Write for particulars and free samples. American Letter Company, Dept. 40, Dunellen, New Jersey.

**AGENTS** Wanted. Razor blades. Big profit. Louis Eugene, 277 Broadway, New York.

**FREE** Typewriter. Outfit 25c. Details free. Associated, Southside, Oil City, Pennsylvania.

**STARTLING** Invention—Pocket adding machine. Nationally advertised \$2.50. Whirlwind seller. Big profits. Calculator Mfg. Co., Box 1118, Chicago.

**PRIVATE** Brand cosmetics and toilet preparations. We print your name on the labels. 200% to 400% profit. Send for complete details and prices. National Scientific Laboratories, 1910W Broad, Richmond, Va.

**ATLAS** Window sign letters. Large sizes, penny each. Beautiful free samples. Atlas, 7941 Halsted, Chicago.

**BIG** Money applying initials on automobiles. Easiest thing today. Free samples. Also, sideline salesmen for name plates and tire cover transfers. "Ralco," 1305 Washington, Boston, Mass.

**BIG** Money taking orders; shirts, ties, hosiery, underwear, raincoats, pants, uniforms, etc. Sales equipment free! Experience unnecessary. Write Nimrod, Dept. 8, 4922-28 Lincoln, Chicago.

**500% PROFIT!** Gold and colored sign letters for windows, offices, trucks, signs. Auto monograms. Easily applied by agent or customer. Neonite, Akron, Ohio.

**AGENTS:** Smash go prices! Santos coffee 12c lb. 4 oz. vanilla 8 1/2c. Razor blades 10 for 8 1/2c. 100 sticks chewing gum 12c. 150 other bargains. Premiums. Experience unnecessary. Carnation Co., PO, St. Louis, Mo.

**GUARANTEED** Gold leaf letters for store and office windows. 500% profit. Free samples. Metallic Co., 438-B N. Clark, Chicago.

**MAN** In each town to plate auto parts, reflectors, bicycles, fixtures, mirrors, by late method. Simple plan of manufacturing at home starts you in good paying business. Free particulars and proofs. Gunmetal Co., Ave. H. Decatur, Ill.

**AGENTS**—To mail our literature. Good profits. Home business. Maywood, 149 Fifth Ave., New York.

**SUCCEED** With your products. Make-sell them. Formulas. Processes. Accurate analyses. Catalog free. B. Thaxly Co., Washington, D. C.

**AGENTS**—Opportunity to make money; book containing 107 successful business plans; home or office; send for free introductory booklet. Elite Co., 214 Grand St., New York.

**FREE** Sample—Amazing cleaner; sells homes, taverns, everywhere. Big profit—fast repeater. Betco, 5007 Irving Park, Chicago.

**AGENTS:** Stamping names on pocket-key protectors. Sample check with your name, address, 25c. Stamping outfits. Emblem checks, check-fobs, name plates. Hart Mfg. Co., 303 Degraw St., Brooklyn, N. Y.

**MANUFACTURE** Specialties, hire agents yourself. Big money. Free literature. Gilbert Supply, 1107-P Broadway, New York.

**ENGRAVED** Name plates, numbers, signs, etc., easily sold, profits large. Brett Bros., Winthrop, Mass.

**LUREX** Quickly removes lime and rust stains from both tubs and sinks. Sells to homes, hospitals, apartments. Sample 25c. Lurie Company, Indianapolis, Indiana.

**200% PROFIT** On telephone call counters at 5c each. Monthly repeat sales or saleable in multiple. Samples: 2-10c; 12-25c; 100-\$1.75; 1000-\$16.66. Tele-Tally, 1614 65th Avenue, Oakland, California.

#### HIGH-GRADE SALESMEN

**BIG** Cash daily; cash bonuses regularly. Sell Sanforized shirts, ties, hose; underwear direct to wearer. Guaranteed full year. Sensational style and quality features. Sales outfit free. Write today Dept. PM-6, Rosecliff-Quaker, 1239 Broadway, New York.

**AGGRESSIVE** Salesmen for exclusive sales rights on famous, Proven King Products. Constant money-maker. Fast repeater. 100% profit. Earn \$5000 up yearly. Successfully sold for years. Don't waste time. Pick a winner. Write King Mfg. Co., 1701 Maplewood Ave., Flint, Mich.

**DID** You make \$50 last week? Does your job offer you real future? If not, why not start a wholesale business of your own? Little or no capital needed. Handle line 200 nationally advertised 5c-10c products. Show merchants new plan for increasing sales and profits. Handle everything from your home at start. Chance to operate one of our Silver Fleet service trucks. Facts free. World's Products Co., Dept. 6810, Spencer, Ind.

**SELL** America's most complete line of business necessities. Regular and novelty size book matches, gummed labels, political items, pricing sets, restaurant supplies, salesbooks, engraved like stationery, shipping room supplies, office supplies, printed gummed tape, advertising chewing gum, advertising pencils, thermometers, business stimulators. Complete line printed business forms and hundreds of other fast sellers. Business cards \$1.50 thousand. Stationery \$2.70 thousand. All competition undersold. Cash commissions advanced daily, extra bonus. Experience unnecessary. Complete sales outfit free. Federal, AH-301 South Desplaines, Chicago.

**PATENTED Zipper "Money Safe"** inside our genuine cowhide monogrammed trouser belts. Pockets pickpockets. Saves cash. Take orders. Collect big cash profits immediately. We deliver. Write for free demonstrator sample offer. Initial-It, 508 North Dearborn, Chicago.

**SALESMEN, Distributors**—Established company. New automotive system all car and fleet owners vitally need. Sells for only \$2.95. Lloyds of London insurance up to \$5,000.00. Makes quick convincing demonstration. Large repeat business. New proven merchandising plan to dealers carries 100% insurance protection for you. Profits up to \$600.00 per month. Exclusive territories. Guaranteed sales or money back under Plan A. Write today for details of full-size test sample and all facts. No obligation. Craver-Jay Corporation, 105, Kansas City, Missouri.

**SANDERSON'S Book matches** (Ottawa, Illinois) offer salesmen best proposition.

**SELL Fans, calendars to merchants.** Free samples to producers. Casey Calendar Co., Knoxville, Iowa.

**IF You are ambitious you can make good money with a Rawleigh route.** We help you get started. No capital or experience needed. Steady work for right man. Sales way up this year. Write Rawleigh's, Box P-2-PPM, Freeport, Ill.

**SALESMEN:** Sell business stationery, book matches, advertising gummed tape, advertising pencils, shelf moulding, labels, salesbooks, rubber stamps, tags, office supplies. Business cards \$1.50 thousand. 35% comm daily. Free deals. Sales portfolio free. Willens, 2130 Gladys, Dept. ZX, Chicago.

**UP TO \$95.00 weekly.** Also open to side line men. \$500,000 punch board firm announces new items. No investment. Complete sales kit free. K&S Sales Co., 6227 Broadway, Dept. C126, Chicago.

**BIG Commissions selling stores celluloid pricing tickets, metal shelf moulding, menu covers, signs, chrome changeable letters.** P. Pricing Press, 124 White St., New York.

**CALLING All brush salesmen—Make 100% profit selling the newest magnetic electric brush, attractive sponge rubber brushes and other rubber items.** Household chemicals, polishes, waxes, silver cloths, fly sprays, moth destroyers, kitchen aids, plus a wonderful complete line of quality brushes, mops, brooms, etc., tested and approved by Good Housekeeping Institute. All salesmen make 100% profit plus an immediate opportunity to become manager with a company established fifteen years. Write Advertising Department, Donald Brush Company, Camden, N. J.

**20,000 MILES From weak, discarded tires with Tire Armor—a selling sensation!** We deliver. Liberal commission. Motor Products, 1760-H Lunt, Chicago.

**"\$35 WEEKLY From 3 hours homework."** 204 other moneymaking plans. Particulars free. Stamford, 826-F Riverside Drive, New York.

**UNLIMITED Profits.** Granite monuments. Lettered. Prepaid. \$9.90 up. Free catalog. Mikelich Company, St. Cloud, Minnesota.

**STORES Clamoring for soilless plant grower.** Sell Graft. Tremendous profits. Barter, 3937 Tracy, Kansas City, Mo.

**\$9,999.99 CAPACITY Pocket size calculator.** Retail price only \$1.00! Get agents offer. Lundgren, 332-S Neville Bldg., Omaha, Nebraska.

**BLADES.** Factory prices. Free delivery. Ace Blades, Dept. 5-D, Rochester, N. Y.

**STEADY Repeat:** Guaranteed lubricants, soaps, cleaners, waxes, disinfectants, auto chemicals. Old reliable manufacturers. Liberal commissions weekly. Big market. Selling equipment free. Let us explain. Baum's Castorine, Rome, N. Y.

**SELL The Driving Master.** Shows miles per gallon when driving. Analyzes motor troubles. September, 1936. Popular Mechanics described fully. Driving Master Company, Sioux City, Iowa.

**OPPORTUNITY.** Make up to \$95 weekly with astounding new product needed in every home. Gold mine for state, county, local distributors. Sensational sales. No competition. Nothing like it. Free gift plan gets automatic repeat orders. Write quick. Arwell, Inc., Dept. 56, Waukegan, Ill.

**LIVE Distributors wanted for new food sensation.** Selling like wildfire to stores, cafes. \$5.87 profit per case. Wire or airmail for exclusive territory. Minute Foods, 257-ED Werdin Pl., Los Angeles.

**MAKE Up to \$50.00 weekly part time selling Top Quality advertising book matches at low prices.** Experience unnecessary. We train you. Full time profits unlimited. Free sales kit. Match Corp. of America, Dept. E-6, 6041 W. Grand, Chicago.

**TIRE Accessories.** Guaranteed 10,000 mile Tiger Grip Tire Patch, and complete fast-selling line auto accessories. Salesmen-distributors easily make up to \$75 weekly, and over. Protected territory. Economy Rubber Products Co., 628 Burkhardt, Dayton, Ohio.

**DISTRIBUTORS For electric dry shaver retailing \$5.95.** No stock investment. Allen Razor Company, 2321 Allen, Allentown, Penna.

**SALESMEN'S Paradise—New electric guaranteed dry shave razor.** Cost \$3—Big \$2.00 profit for you. Write, wire Universal Industries, 6227 Broadway, Dept. C126, Chicago.

**MANAGERS Wanted in every city and town.** Small investment will realize \$100.00 weekly. Sayers Systems, 2801-03 Sheffield Ave., Chicago, Ill.

**CANVASSERS.** Fast selling pictures. Mexart Company, 102 Lewis, San Antonio, Texas.

**SELL New sheepskin auto washing mitts.** Write: Maupin, Gainesville, Texas.

**SPARKLING Glo-Brite signs sell fast to stores, restaurants, taverns.** Lasting gold finish. Religious mottoes. J. A. Baxter, Cambridge, Ohio.

**SALESMEN:** Sell advertising novelties, calendars, fans, thermometers, etc., for nationally known firm. Liberal commissions. Stanwood Hillson Corp., 21 Station St., Brookline, Mass.

**BIG Money taking orders; shirts, ties, hosiery, underwear, raincoats, pants, uniforms, etc.** Sales equipment free! Experience unnecessary. Write Nimrod, Dept. 65, 4922-28 Lincoln, Chicago.

**WANTED.** Monumental salesman everywhere. Marble-Granite Company, A-17, Oneco, Fla.

**ATLAS Window sign letters.** Large sizes. Penny each. Beautiful free samples. Atlas, 7941 Halsted, Chicago.

**OUR New 1938 complete line of brushes now ready.** Largest commissions. Write for sales plan. Wire Grip Sanitary Brush Company, 2300 5th Ave., New York.

**NEW Specialty—Sells every business and professional man.** Four \$15 sales daily pay \$280 weekly. Farrell cleared over \$1,000.00 monthly. Write, P. E. Armstrong, President, Dept. PM, Mobile, Ala.

**GUARANTEED Gold leaf letters for store windows.** Free samples. Liberal offer to car owners. Metallic Co., 438-A N. Clark, Chicago.

**MAKE More money with Red Comet Automatic Fire Extinguishers.** Low price. Proved seven years. Splendid sales outfit free. Some good territory open. Exclusive. Write quick. 704 Red Comet Bldg., Littleton, Colo.

**FREE Booklet describes 107 plans for making \$20-\$100 weekly.** In home or office, business of your own. Elite Co., 214 Grand St., New York.

**DISTRIBUTORS Making big money introducing latest sensation—Chemical Growing.** Produces larger flowers, vegetables, indoors, outdoors, without soil. Good territory still open. Wire, airmail. Chemi-Grow, 257-HU Werdin Pl., Los Angeles.

#### HELP WANTED

**WEAR Fine hose I send without cost with outfit while taking orders for amazing new hosiery.** Replacement guaranteed against holes, snags, and runs. Rush name and hose size. Wilknit, Desk 37-F, Greenfield, Ohio.

**WANTED—Men to represent large shoe company.** Good pay every day. No experience needed. Complete sales outfit sent free. Write Consolidated Shoe System, Dept. S31, Chippewa Falls, Wisconsin.

**LOCAL Agents wanted to wear and demonstrate free suits to friends.** No canvassing. Up to \$12 in a day easy. Experience unnecessary. Valuable demonstrating equipment, actual samples free. H. J. Graves, Pres., 1300 Harrison, Dept. F-817, Chicago.

**"ANT Buttons" kills thousands ants, roaches, flies, wasps, silverfish, waterbugs, insects, rats, mice.** Guaranteed! Send 40c samples. P.O. Box 4, Miami Beach, Fla.

**MEN Wanted for coffee routes.** Earnings up to \$42.50 first week. Brand new Ford sedan given you as bonus. I send everything; you don't risk a penny. Details free. Albert Mills, 6218 Monmouth, Cincinnati, Ohio.

#### EDUCATIONAL AND INSTRUCTION

**LEARN Fascinating, profitable profession of Swedish massage at home in 90 days.** Make up to \$70 weekly. Write for free anatomy charts and details. The College of Swedish Massage, 1601 Warren Blvd., Dept. A44, Chicago, Ill.

**"SHORTHAND Simplified" \$1.00.** Lesson 10c. Teaching opportunity. Simmons, Rocky Hill, Conn.

**DON'T Be afraid of the holdup man, or the bully just because you are below the average in size or strength.** You can make up for this deficiency with a little scientific instruction in Jiu-Jitsu which will be sent to you for only \$1.00. James Cole's Jiu-Jitsu Instructor, Box 6095, Cleveland, Ohio.

**INDIVIDUAL Dancing instruction by mail.** Beginners, advanced. Latest steps. Stamp brings personal fault-finding chart. Box 66, Sta. W, Brooklyn, N. Y.

**FOR An extremely profitable lifetime business,** operate a collection-credit agency. Free folder. Cole Associates, Syracuse, N. Y.

**\$105-\$175 MONTH.** Get U. S. government job. Try next examinations. Common education sufficient. Full particulars, list jobs, sample coaching, free. Write today. Franklin Institute, Dept. S3, Rochester, N. Y.

**BECOME An Investigator.** Remarkable "Test Question, Problem and Lesson Correction Method." Modern, practical, thorough. Profusely illustrated. Particulars free. International Secret Service Institute, PM 68, Hoboken, N. J.

**LEARN Electric welding.** Modern trade, jobs everywhere; good money. Our short practical shop course trains you. Established 1918. Welding Company, 4100 Paul Street, Philadelphia, Penna.

**STUDY For a degree in psychology, metaphysics, truth, theology.** Home study. Chartered college. Free catalog. College of Universal Truth, 1100 N. Dearborn Chicago.

**TELEGRAPHY Taught thoroughly.** New railroad retirement act creating renewed openings for operators. Enroll now. Expenses low. Catalog free. Dodge's Institute, Hiatt Ave., Valparaiso, Ind.

**BUSINESS Improving.** Thousands positions opening. Land good job now. Write. Employment Counsellors, Box 1283K, Milwaukee, Wisconsin.

**BECOME A columnist.** Pamphlet free. 10 years experience. Ben Arid, Station D, Los Angeles, Calif.

**SELL Insurance.** All kinds. Training and placement service. Vocational Guidance Institute, Boonton, New Jersey.

**SUCCESSFUL Men are "realists."** Send 10c and learn to become one. Realist League, 45 Abbey Court, Brooklyn, N. Y.

**MESSAGE, Hydrotherapy, dietetics, drugless therapeutics, chiropody,** taught by mail. Evans Correspondence School, Montgomery, Ala.

**MAKE More money.** Get a U. S. government job. Get our new plan for obtaining one—no obligations. Age 18-50. Write, Instruction Service, 101, St. Louis, Mo., immediately.

**GOV'T Jobs start \$1260-\$2100 year.** Men-women age 18-50. Former examiner's tested method helps qualify you. Particulars, list jobs free. Write today. Patterson School, 8C Mercantile Bldg., Rochester, N. Y.

**DEGREES Earned by home study in arts, sciences, philosophy, education, psychology, theology, law, chemistry, engineering, business, agriculture.** McKinley-Roosevelt College, Chicago.

**EARN Extra money!** Clipping and preparing newspaper articles for publishers. Simple; fascinating; profitable. Send stamp. Division 55A, National Press, 3923 W. Sixth, Los Angeles, Calif.

**LEARN Machinist trade, tool, die making.** Automatic and hand screw machines. Modern shop methods. Actual work. Jobs open for trained men. Employment help. Illustrated booklet free. Allied Screw Machine Co., 601 Lake St., Chicago.

**LEARN Auto mechanics, body, repairing, welding, electricity, refrigeration.** Diesel. Stevinson's, 2008A Main, Kansas City, Mo.

**CARTOONING, COMMERCIAL ART, SHOWCARD WRITING, SIGN PAINTING**

**PAINT** Signs for profit. Fine lettering fast with Speedway Patterns. Modern styles, many sizes. Unique method. Free samples, literature. Enclose 6c stamps for valuable 3-in. alphabet. Display-Letters Co., Station 235-G, New York.

**LETTERING** Made easy. "A to Z." Two volumes. \$2.00. Guaranteed. Samples. Stein Studios, Flatiron Building, New York.

**ART.** Large beautiful oil painting on black velvet \$1. Satisfaction guaranteed. Photoart, 857 S. 89 St., Wauwatosa, Wis.

**CHALK** Talks. Laugh producing program. \$1.00. Catalog 10c. Balda, the Cartoonist, Oshkosh, Wisconsin.

**BECOME** Artists overnight. New deluxe Mur-O-Graph enables one to draw excellent cartoons, portraits, posters, etc., without training. Enlarge pictures from one up to thirty inches. Not a toy. Simple, durable, accurate. Guaranteed. Thousands in use. One dollar postpaid. Literature free. Mur-O-Graph Company, Irving, Texas.

**CARTOONING**, Sketching, etc.—46 lessons, 600 illustrations, including drawing paper, pens, pencils. \$1.00 complete. Fraba Service, Cashton, Wisconsin.

**MAKE** More money making signs and showcards! Easy simplified system \$2 postpaid. Write Silvo Signs, B-1821, San Antonio, Texas.

**ARTISTS**—Increase your earnings. Latest money making plans \$1.00. Particulars free. Publishers' Xchange, Bedford Bldg., Chicago.

**EARN** cash income, copying and duplicating simple cartoons for advertisers. 3-M Service, Argyle, Wis.

**MAKE** Art Pay. Advanced art students. \$1.00. Popular Mechanics, 200 E. Ontario St., Chicago.

**PLAYS, STORIES, MANUSCRIPTS**

**STORIES** Revised, rewritten if necessary, and typed for market. Welton Tinney, Winnsboro, Texas.

**STORIES** Revised; placed on market. Write: Hursh, Box P-1013, Harrisburg, Penna.

**ACTUALLY** Make money writing. Sure sales. Box 49, Glendale, Calif.

**STORIES**, Cartoons, photos, jokes, poem, bought. Send card, Box 280, Mansfield, Ohio.

**WANTED**—Authors' manuscripts. Immediate marketing. Revel, 41 West 45, New York.

**WANTED**, Original poems, songs, for immediate consideration. Send poems to Columbian Music Publishers, Ltd., Dept. 209, Toronto, Can.

**ADVERTISING AGENCIES, LETTER WRITERS, FOR ADVERTISERS**

**DOES** Writing letters bother you? Let us write them, with results—getting pep and punch. Better Letters Bureau, 508 Railway Exchange, Milwaukee, Wis.

**ADVERTISE!** Advertise! Advertising-pencils at factory prices. Novelities, Lebanon, Indiana.

**AGGRESSIVE** Sales letters \$10, 3 for \$25. Classified and display advertising placed—no service charge. Julian J. Behr Co., Cincinnati.

**LEARN** Advertising quickly at home. Easy practical plan. No text books. Common school education sufficient. Interesting booklet and requirements free. Page-Davis School of Advertising, 3601 Michigan Avenue, Dept. 3432, Chicago.

**ADVERTISING** Placed. Over 3,700 weekly papers. Lists free. Castellazzo, 3717 Redwood, Oakland, Calif.

**SALES**, Collection letters persuasively written. Fugill, 12 Garrow, Auburn, N. Y.

**ADVERTISING** Placed; any publication, anywhere. Copy written. No service charge. Free rate guide. LeGrand Agency, W 34 West 33rd Street, New York City.

**ADVERTISE** 30 Magazines, 3 months, \$3.00 inch, 25 words \$1.50. List special offers free. Bucknam, 177 State Street, Boston, Mass.

**24 WORDS**, 40 Newspapers, \$2.00. Good-all Agency, 742 Market, San Francisco.

**ADVERTISE:** 24 Words in 250 newspapers \$10. Lists free. Advertising Bureau, 4515-C Cottage Grove, Chicago.

**YOUR Ad** in 1,500,000 Sunday newspapers (guaranteed, national circulation) \$15.40 inch. Ratebook all leading newspapers, magazines, free. Chicago Union Agency, 20-P West Jackson, Chicago.

**FREE**—New Advertisers Rate Guide, 44 pages. Includes everything. Lowest rates. E. H. Brown Advertising Agency, 140 S. Dearborn, Chicago.

**ADVERTISING** Placed anywhere. Helpful, free service. Rate guide book free. Baker Advertising Agency, 189 W. Madison, Chicago. Successors to Ankrum Advertising Agency. Established 27 years.

**BUSINESS SERVICE**

**LOOKING** For certain products? We find them. Write requirements. Sunrise Sales, 301 S. Main, Freeport, New York.

**EASY** Bookkeeping for small business, economical. Counsel Associates, Douglas, Georgia.

**PHILADELPHIA**, Pa., mail address \$1.00 monthly. National Service, 217 South Front, Office B.

**\$2.00 MONTHLY** Maintains Brooklyn, New York, address. 39 Pine St.

**CANADIAN** Mailing address. \$2.00 monthly. Box 502, Station F, Toronto.

**INFORMATION** Any question \$1. Speeches, etc., written. Galvin, 207 E. 84, New York.

**CHICAGO** Mail address; branch office; representation; \$1 monthly. Letters, etc. forwarded daily. Established 1919. General Service, 56 West Washington.

**MESSAGE** Bureau. Mail forwarded daily. 200 Lumber Exchange, Minneapolis, Minn.

**RUBBER STAMPS AND OFFICE SUPPLIES**

**2 LINES** 25c, 3 Lines 35c, signatures \$1.50. Stamp Works, Centerport, N. Y.

**METAL** Signs. Made to your order. Write for estimate. Randal Co., 118 Walker St., New York, N. Y.

**NAME**, Address, 2 lines 25c; 3 lines 35c. Stamp Works, Auburn, Nebr.

**CUSHION** Mounted one-two lines 25c; three 35c. 100 letterheads, 100 envelopes \$1.00. Hauer Press, 1314 Ford, Youngstown, Ohio.

**ORIGINAL**, Cushion mounted. One, two lines 25c; three 35c; four 45c. Facsimile signature \$1.50. Stamp Works, 814 Bradley, Peoria, Illinois.

**TYPEWRITERS, DUPLICATORS, OFFICE DEVICES**

**GEM** Post card stencil duplicators complete with supplies \$7.50. Bond Equipment Co., Commercial Bldg., St. Louis.

**TYPEWRITERS**, Duplicators, multi-graphs. Write for free list office machine bargains. Save half. Pruitt, 518 Pruitt Bldg., Chicago.

**INCREASE** Business now. "Excello-graph" Rotary Stencil Printer reprints thousands everything you typewrite, hand-write, draw or trace. Colors. \$19.75 to \$44. Terms. Illustrated literature free to business or professional men. Pittsburgh Typewriter Supply, Department K-2, Pittsburgh, Penna.

**PRINTING, MULTIGRAPHING, MIMEOGRAPHING, GUMMED LABELS**

**HAMMERMILL** Letterheads, 300 8 1/2 x 11, any color paper and ink; 6 lines; \$1.48 postpaid. Free particulars. Woodruff's, 217A Lewis, Duluth, Minn.

**BUSINESS** Cards. Thin superfine. Set modern. 1000 \$1.95 delivered. Udelco, 5455 Virginia, Hollywood, Calif.

**250 LETTERHEADS**, Envelopes, statements, \$1.00 each. Keystone Press, Andalusia, Penna.

**FINE** Value. Printed stationery. 300 Maxwell bond letterheads 6x7, 150 envelopes to match. Send \$1.00 postpaid. Established 1927. Franklin Printing Company, Franklin, Ohio.

**SNAPPY** Modern printing. Low prices. Mellenshet Printers, 3717 Lexington, Chicago, Illinois.

**500 LETTERHEADS**, Statements, envelopes, or 1000 business cards \$1.00. Carter, Box 52, Orange, Calif.

**\$1.00 POSTPAID**, 125 Letterheads 8 1/2 x 11 and 125 envelopes 6 3/4. Benneville, 907 West Roosevelt, Philadelphia.

**1,000 BOND** Letterheads or envelopes \$2.85. Moyer, B-241-P, Milton, Penna.

**SANDERSON'S** Book Matches (Ottawa, Illinois)—most attractive designs; lowest prices.

**QUALITY** Printing. Complete line—low prices. Send order for estimate. Castellazzo, 3717 Redwood, Oakland, Calif.

**MIMEOGRAPHING**—Cheaper than printing. Circulars, letters, etc. Low prices. Ruth Brown, Waseca, Minn.

**500 TWO** Color business cards \$1.50. Vidapress, 6261 N. Clark, Chicago.

**FREE** 1938 Pricelist and samples letterheads, envelopes, statements, blotters. McCall Press, 1326 So. 27th, Omaha, Nebr.

**500 GUMMED** Stickers, 1/2 x 2 1/2, four lines, 25c. Reed, Box P326, Spiro, Okla.

**LETTERS**, Exactly like typewritten. 100—\$1.30 (20 lines), additional hundreds 10c. Multigraphers, 211a Capital, Jefferson City, Missouri.

**DELUXE** Printing—Letterheads, envelopes, statements, 1000, \$2.45. Printkraft, Willernie, Minn.

**150 LETTERHEADS**, 8 1/2 x 11, and 150 envelopes, \$1.00 postpaid. Eckholm, Shelby, Mich.

**500 8 1/2 x 11** LETTERHEADS \$1.25. 500 6 3/4 Envelopes \$1.25. Victors Printery, Exeter, N. H.

**ENGRAVURE** Printing, lowest possible prices. Samples free. Sunco, Mohawk, N. Y.

**\$2.25—1000; LETTERHEADS**, Envelopes, statements, circulars. Samples. Midwest Printing, 514P Huron, Minneapolis, Minn.

**65c—50 EACH**—Envelopes, sheets, cards, (3 lines). (Coin) postpaid. (Samples 5c.) Arrowprint, Waterbury, Conn.

**RULED** Forms. Divide-the-profit-plan. Feld, Elmwood Place, Ohio.

**50 LETTERHEADS** 8 1/2 x 11, (10 each 5 colors bond paper), five lines black printing. 25c postpaid. If you like them order 1000 assorted as desired for \$2.25 postpaid. Shorite Press, 27-B Northend Station, Detroit, Mich.

**300 BOND** Letterheads, 6x7, 150 envelopes, neatly printed blue, gothic type. \$1.00 postpaid. Edgewood Press, Edgewood, Maryland.

**5,000 LABELS**, \$1.95 Postpaid. Okay Printing, Martins Ferry Ohio. Samples.

**REASONABLE**, Reliable printing. Free layout, estimating service. Irelan Printing Co., Berkeley Heights, Route 7, Dayton, Ohio.

**NAME** Cards 39 cents hundred. Prompt. Lewis Press, Malvern, Ohio.

**NEARGRAVURE** Stationery! Distinctive, striking, different. Solidays, Letterhead Specialists, Knox, Indiana.

**1000 6 3/4** ENVELOPES \$1.75; 5,000, \$7.00. Hunt, Printer, Morrisville, Penna.

**TWO** Day service envelopes, statements, letterheads. 250—\$1.00. Feld, Elmwood Place, Ohio.

**3"x6"** CIRCULARS 1000, \$1.00; 5000, \$3.50 prepaid. Keelerprint, 4237 West Cermak, Chicago.

**250 5 1/2 x 8 1/4** BOND Letterheads, 125 envelopes, \$1.25 postpaid. Universal Supply, Orange, Mass.

**SEND** Dollar bill for 1000 business cards. Woodprint, Woodstock, Virginia.

**LABELS:** All kinds. Write, samples. JBSCO, Box 93, Holyoke, Mass.

**BETTER** Grade printing, reasonable priced. Free samples. Economic Press, Leonia, N. J.

**500 3/4 x 2 1/4** FOUR Line gummed stickers, 25c. Moritz Printery, Saginaw, Mich.

**PRINTING OUTFITS AND SUPPLIES**

**MAKE** Cuts cheap, easy. Line-cuts, reverse plates, halftones. Andercamco, 1248 West 102nd Place, Chicago.

**PRINT** Your own cards, stationery, circulars, advertising. Save money. Easy rules furnished. Print for others, big profits. Junior outfit \$9.00; job presses \$11 up. Details free. Kelsey Presses, F-11, Meriden, Conn.

**HAND** Presses, type, supplies. Big lists 3c. Landis, Richland, Penna.

**PRESSES** \$5.00. Type 30c. Bargain catalog. Stamp please. Bradshaw, 3214-P Huron, Chicago.

**HAND** Press, type and complete printers' supplies. Advise equipment you need and we quote prices; or send stamp for catalog. P. Peiffer, 9-C; 6 Columbia St., Newark, N. J.

**MAKE** Screen printing outfit. Instructions 25c. Lininger, 1157-L E113th, Cleveland, Ohio.



**BUILD 9"x15"** Printing press. Details free. Huebl Coaches, LeSueur, Minnesota.

**STOCK Cuts 40c up.** Catalog 10c. Gregor's, 79-N Main Street, Belleville, N. J.

**BARGAINS, Presses, type.** List 3c. Exchange D-15, 22 Orient, Meriden, Conn.

**BARGAINS—Presses, type, supplies.** Send stamp. 159 Harvard, Cambridge, Mass.

#### PATENT ATTORNEYS

**INVENTORS:** Send immediately for your copies of our new free books, "Patent Protection" and "Suggestions on Selling an Invention." Sixty-eight pages of interesting facts. They tell how patent laws protect you; kind of sketch or model needed; simple steps to take without cost; how successful inventors have secured financial assistance; show interesting inventions; illustrate important mechanical movements. With books we also send free Evidence of Invention form to help establish date of disclosure. Prompt service, reasonable fees, special deferred payment plan. Strictest secrecy. Thirty-nine years experience. Highest references. Write us today. The facts in our books are worth money to the man with a good invention. Address: Victor J. Evans & Co., Registered Patent Attorneys, 12-G Victor Building, Washington, D. C.

**INVENTORS—Small ideas may have large commercial possibilities.** Write us for free book, "Patent Guide for the Inventor" and "Record of Invention" form. Delays are dangerous in patent matters. Free information on how to proceed. Clarence A. O'Brien & Hyman Berman, 584 Adams Bldg., Washington, D. C.

**SELL Your unpatented ideas.** I tell you how and help you make the sale. Particulars free. Write Wilson Holmes, 907 Barrister Bldg., Washington, D. C.

**PATENTS—Best service, free opinion.** Expert Washington associates. Address: David P. Dellinger, Attorney, Cherryville, N. C.

**PATENTS—Personal, confidential services for protection of your invention at reasonable cost.** Preliminary information and approximate cost of patent furnished without obligation. John B. Thomas & Co., 902 F St., N. W., Washington, D. C.

**DIETRICH & Rutley, Registered Patent Lawyers, 512 Colorado Bldg., Washington, D. C.**

**WE Successfully sell inventions, patented and unpatented.** Write for proof, and tell us what you have for sale. Chartered Institute of American Inventors, Dept. 4-C, Washington, D. C.

**"INVENTOR'S Guide," 100 mechanical movements, free; advises on patenting, selling inventions.** Frank Ledermann, Tribune Bldg., New York.

**PATENTS. Instructions "How to Establish Your Rights" and form, "Evidence of Conception"—sent free!** Lancaster, Allwine & Rommel, 411 Bowen Bldg., Washington, D. C.

**PATENTS. Booklet free. Highest references. Best results. Promptness assured.** Watson E. Coleman, Patent Lawyer, 724 Ninth St., Washington, D. C.

**L. F. RANDOLPH, 302-B Victor Bldg., Washington, D. C. Low cost. Book and information free.**

**INVENTORS—Send for free booklet "Patent-Sense." Information based on 64 years experience.** Lacey & Lacey, Dept. 5A, 635 F St., Washington, D. C.

**PATENTS—Trade marks. Preliminary advice, book and disclosure form free. Personal service.** Irving L. McCathran, 1060 International Bldg., Washington, D. C. Registered Patent Attorney.

**PATENTS. Protect your idea by securing free "Proof of Invention" folder. Exceptional personal service. Established 1906.** E. E. Vrooman, 871 Woodard Bldg., Washington, D. C.

#### FOR INVENTORS

**INVENTORS—Small ideas may have large commercial possibilities.** Write us for free book, "Patent Guide for the Inventor" and "Record of Invention" form. Delays are dangerous in patent matters. Free information on how to proceed. Clarence A. O'Brien & Hyman Berman, 584 Adams Bldg., Washington, D. C.

**SELL Your patent through a small classified ad in Popular Mechanics.** Many inventors have found buyers in this way. Ask me for proof—I'll gladly send it to you. F. W. Johnson, Manager Classified Advertising, 200 E. Ontario St., Chicago.

**INVENTORS:** Send immediately for your copies of our new free books, "Patent Protection" and "Suggestions on Selling an Invention." Sixty-eight pages of interesting facts. They tell how patent laws protect you; kind of sketch or model needed; simple steps to take without cost; how successful inventors have secured financial assistance; show interesting inventions; illustrate important mechanical movements. With books we also send free Evidence of Invention form to help establish date of disclosure. Prompt service, reasonable fees, special deferred payment plan. Strictest secrecy. Thirty-nine years experience. Highest references. Write us today. The facts in our books are worth money to the man with a good invention. Address: Victor J. Evans & Co., Registered Patent Attorneys, 12-G Victor Building, Washington, D. C.

**FREE Booklet (copyrighted) for inventors explains selling facts and buyer locating method that may save you costly mistakes and lead to profitable sale of your patented, unpatented invention.** For free copy write, Invention Reporter, F-11236 So. Fairfield, Chicago.

**INVENTORS! Get our plan.** Wm. L. White, Vineland, N. J.

**PENDING Patent applications can be brought before thousands of manufacturers, free of charge, through Invention Magazine.** Write for details. Invention, Inc., 635 F Street, Washington, D. C.

**UNPATENTED Ideas can be sold.** I tell you how and help you make the sale. Particulars with list of manufacturers and wanted inventions, sent free on request. Write Wilson Holmes, 907-A Barrister Building, Washington, D. C.

**INVENTORS—Send for 72-page book on patents. Reasonable terms. Conscientious treatment to inventors.** L. F. Randolph, Registered Patent Attorney, 302-E Victor Bldg., Washington, D. C.

**INVENTORS: "Making Inventions Pay," our 32-page illustrated book, mailed upon receipt of 3c postage.** Crescent Tool Co., Dept. Z, Cincinnati, Ohio.

**I SELL Patents. Established in 1900.** Charles A. Scott, 773PM Garson Ave., Rochester, N. Y.

**INVENTOR'S Universal Educator; contains 900 mechanical movements; 50 perpetual motions; instruction on procuring and selling patents and selecting an attorney, etc. Suggests new ideas. Price \$1 post-paid in U.S.A.** Address Albert E. Dietrich, 511-B Colorado Bldg., Washington, D. C.

**HAVE You a sound, practical invention for sale, patented or unpatented? If so, write Chartered Institute of American Inventors, Dept. 4-A, Washington, D. C.**

#### INVENTIONS WANTED

**SMALL Inventions wanted by manufacturers. I'll help you sell your invention.** Write for free circular. Stanley Hull, 7829-K Euclid Ave., Cleveland, Ohio.

**INVENTIONS Wanted. Patented, unpatented. Cash in now!** Northlake, Peoria, Ill.

**INVENTIONS Quickly commercialized. Unpatented, protection guaranteed.** Pacific Inventors Agency, 2236 Post, San Francisco, Calif.

**WANTED—Prominent manufacturer wants ideas or inventions pertaining to automatic coin-operated devices of all descriptions. All correspondence confidential.** Western, 925 W. North Ave., Chicago.

**CASH For unpatented ideas. Stamp for particulars.** Mr. Ball, 9441-A Pleasant, Chicago.

**SIMPLE. Practical inventions wanted by manufacturers, patented or unpatented.** For information write Chartered Institute of American Inventors, Dept. 4-D, Washington, D. C.

#### PATENTS FOR SALE

**OUTRIGHT: Small foot exerciser.** Chester Adams, Fayette Building, Lexington, Ky.

**WANTED—Partner to manufacture new designed educational puzzle game. Real moneymaker.** Write to Alfred Hirschi, 1027 North 13 Street, Milwaukee, Wisconsin.

**FOR Sale, socket wrench with new drive, or shank, for operation in close quarters. Strength, compactness and simplicity of standard wrench. Not a ratchet. Good item for farmers and others who want their tools to cover the greatest possible range of work. Patent applied for.** J. L. Foust, 2628 Rosemary Ave., Madison, Wis.

**\$750 CASH. Patent 2,038,915. Ketchup dispenser.** E. J. Unger, Black Moshannon, Phillipsburg, Pennsylvania.

**RECENTLY Patented garment hanger. Sale outright. Any reasonable offer accepted.** S. W. Willey, Newport, Vt.

**UNPATENTED Idea. Brass. Valve fitting manufacturers, attention.** Box 115, Sterling, Ill.

**HOT Specialty and premium.** Paul DeMartini, 75 Rico Way, San Francisco, Calif.

**PATENTS 1832114. Tire gauge; 1748338, spark plug; each \$750 cash.** Georgias, 194 Silver Street, South Boston, Mass.

#### MANUFACTURING

**MANUFACTURING Tools, dies, models, metal stamping.** Federich Tool Co., Box 12, East McKeesport, Penna.

**STAMPINGS, Dies, models, screw machine products.** Porsberg Engineering, Northfield, Ohio.

**ANALYSIS. Research. Newest guaranteed formulas. Biggest catalog free. Special prices, leads.** Gibson Laboratory, Chemists, DS-1142 Sunnyside, Chicago.

**RELIABLE National company will manufacture your products complete or will finance, manufacture and market sound useful articles or proven saleable patented products.** National Die Casting Company, 612 North Albany, Chicago, Illinois.

**DIES, Stampings, wire forming, complete manufacturing.** Southern Products, Independence, Missouri.

**INVENTIONS Manufactured in any quantity at low cost. Stampings, dies, models, etc. Estimates and free catalog.** Crescent Tool Co., Dept. X, Cincinnati, Ohio.

**MANUFACTURING, Dies, machinery, models, brasswork, white metal casting moulds. Catalog 3c.** Baum's Metal Specialties, Kansas City.

**DIES, Models, engineering, drafting, inventions perfected, catalog house connections, metal stampings, manufacturing specialists.** Honeycutt Mfg. Co., Kansas City, Mo.

**TECHNICAL Bulletin. Many subjects. List free.** Popular Mechanics, 200 E. Ontario St., Chicago.

#### MODELS AND MODEL SUPPLIES

**MODEL Making machinery, precision built, reasonably priced.** Write for circular. William Romer, 656 Winthrop Ave., New Haven, Conn.

**INVENTORS—Small ideas may have large commercial possibilities.** Write us for free book, "Patent Guide for the Inventor" and "Record of Invention" form. Delays are dangerous in patent matters. Free information on how to proceed. Clarence A. O'Brien & Hyman Berman, 584 Adams Bldg., Washington, D. C.

**POWER Tools, small bench type. Send 10c for illustrated folder.** Gardner Electrical Supply, Defiance, Ohio.

**CATALOGUE Of over 40 engines, castings, supplies, 25c. Refunded.** Howardco, A-2417 North Ashland, Chicago.

**HO Model railroading! Information, list 10c.** Reidpath, 2918 Bertrou, Chicago.

**MODEL Makers, make your own engines for model airplanes and boats. Use our castings.** S. Ben Hansen, 239 W. 22nd St., New York, N. Y.

**GAS Motors for model airplanes, boats. Circular 10c.** Anton Bohaboy, Rahway, New Jersey.

**RAILROADERS—44 Copiously illustrated pages for model railroaders each month. Sample 20c, year \$2.00.** Model Railroader, 7603 State, Wauwatosa, Wis.

**ENGINE Catalog 20c. Particulars free.** Evraymesco, 28 N. Clinton, Chicago.

**SHIP And yacht model fittings; construction sets; model yacht sails; illustrated catalog 20 cents.** A. J. Fisher, 1002-1 Etowah Avenue, Royal Oak, Mich.

**MODELS—Your ideas developed into practical working models. 30 years' successful experience; thousands of satisfied customers. Confidential service guaranteed. Bank references. Send 3c postage for 32-page book—"Making Inventions Pay."** Crescent Tool Co., Dept. Y, Cincinnati, Ohio.

**MODEL Supplies for the inventor. Send 3c stamp for catalog.** Pierce Model Works, Tinley Park, Ill.

**RAILWAY Models. Catalog handbook 25c.** Walthers, 247 E. Erie, Milwaukee.

## BLUEPRINTS AND PLANS

**PURPLE** Martin birdhouse blueprints. Twelve \$1.00. Albert Publishers, Des Plaines, Ill.

**SUMMER** Cottages. Roadside stands. Build yourself. Illustrated brochure 25c. Includes charming bungalow blueprint, alone regularly \$1.00. Charterock, 79 Madison Avenue, New York.

**COMPLETE** Solar heater plans \$2.00. Sunshine will heat water for your home. Emerson Solar Heater, Escondido, Calif.

**MAKE** Read blueprints. Particulars free. Dorris Blueprint Co., Moorcroft, Wyoming.

## HOME CRAFTSMEN

**SQUAREKNOTTERS!** Make belts, handbags, etc. Quality cord samples with catalog, free. Beginners book, catalog and samples, 10c. Special! Regular \$1 book with 50c beginners outfit, all for \$1. P. C. Herwig Co., Dept. J-6, 121 Sands St., Brooklyn, N. Y.

**WOOD** Stains, aniline dyes for home-crafters. Details stamp. Lincoln Products, 161, Fort Wayne, Ind.

**DOWELS**—Hardwood sample assortment. 26 dowels, 16" lengths. 50c postpaid 1000 miles. Free catalog. Englewood Dowel, 6319 Yale, Chicago.

**KNOCKDOWN** Furniture for entire home. Lumber, plywood, veneers. Illustrated catalog 10c. Giles-Kendall Co., Decatur, Alabama.

**20 FULL-SIZED** Lawn ornament patterns of animals, bird, etc., 25c. 20 full-sized silhouette patterns all different scenes, 25c. 20 full-sized novelty patterns of door stops, book ends, etc., 25c. Modern Woodcraft, Saginaw, Michigan.

**LEATHERCRAFTSMEN**—Write for free instructions and price list of leather, tools, etc. Sample cards 5c. Wilder & Co., Dept. F, 1038 Crosby St., Chicago, Ill.

**DESIGN** Your own furniture. Our complete course shows you how. Only \$8.50. Invaluable to home craftsmen. Write for descriptive folder. Klok Institute, 430 Lyon, Grand Rapids, Mich.

## OLD GOLD, WATCHES, JEWELRY, PRECIOUS STONES

**UNCUT** Arizona smoky topaz, \$1.00. Other semiprecious stones. 8 Main St., Miami, Arizona.

**ELGIN**, Waltham, Hamilton watches. Make big money. Send for illustrated catalog. Plymouth Jewelry Exchange, 163-B Canal Street, New York.

**POLISH** Stones for jewelry and specimens. Book how to build and operate machine \$1.00. Stamp information. Home Lapidary Shop, Madera, Calif.

**5000 REBUILT** Open face Waltham, Elgin watches. New chromium open face cases. Make big money! 12 size, 7 jewel, \$4.75; 16 size, 17 jewel, \$7.50. Send 3c stamp for free watch and diamond catalog. The New York Jobbers, Dept. M, 74 Bowery, New York, N. Y.

**HIGHEST** Prices for old gold, teeth, watches, jewelry. Full cash value mailed day shipment received. Satisfaction guaranteed or articles cheerfully returned. Information free, or ship today. Chicago Gold Smelting Co., 300-P Champplain Bldg., Chicago.

**GOLD** \$35 Ounce. Ship old gold teeth, crowns, jewelry, watches—receive cash by return mail. Satisfaction guaranteed. Free information. Dr. Weisberg's Gold Refining Co., 1500-Q Hennepin, Minneapolis, Minn.

**AUSTRALIA'S** Lovely opals. Illustrated catalogue free. Good selection \$5. Norman Seward, Melbourne, Australia.

## FOR THE HOME

**BUILD** Your own power mower with Electromower Kit. Converts any standard lawnmower to a power operated, self propelled unit. Details free. Electromower, Channahon, Ill.

## TOBACCO

**GOOD** Chewing and smoking tobacco. Mild or strong. Bulk sweetened, 14 lbs., \$1.00. Package twist free. Remit with order. O. D. Collier, Martin, Tennessee.

**GUARANTEED:** Cigarette, pipe or chewing, 5 lbs., \$1.00; ten, \$1.75. Pay when received. Pipe and box cigars free. Rives Tobacco Co., Paducah, Ky.

**CIGARETTES**—40 For 10c using guaranteed pocket device. Makes your own exclusive monogrammed brand. Free particulars. Berkeley, 1704 Stephen Street, Brooklyn, N. Y.

**PREPAID** Long, clean, juicy, red leaf mild and sweet chewing, 10 lbs. \$1.30. Mild smoking, 10 lbs. \$1.20. Package twist free with each order. Collier Tobacco Pool, Martin, Tennessee.

**PIPE** Smokers—Enjoy refreshing mildness, better flavor of natural tobaccos. Name favorite brand, send 10c for liberal samples. Free jug humidifier offer. Pete Moberly, Box 1151, Owensboro, Kentucky.

**TOBACCO** Users: Answer this ad—it means something for you. Bargain prices, generous trial sample 10c. Trout Farms, D58PM, Hickory, Ky.

**BRIAR** Pipe bowls refinished, factory original lustre. 35c or C.O.D. Duro Company, Route 6, Cincinnati.

**CIGARETTES**—Roll 'em for 15c hundred. Samples both hand and machine rolling tobaccos 10c. Postal Tobacco, Box 1045, Owensboro, Kentucky.

## RAZORS—BLADES—SHARPENING

**ONE** Hundred high quality double-edge razor blades 85c postpaid. Fifty, 55c. Hosier, 2845 Carmel St., Oakland, Calif.

**SPECIAL**, 25 Double edge blades 25c postpaid. Edwards, Box 2242, Cleveland, Ohio.

**100 BLADES**, Razor, blade sharpener, styptic, \$1, postpaid. Fresh, quality stock. John Wilson, 13641 Ellar, Dearborn, Mich.

**10 GUARANTEED** Double-edge razor blades and Goodrich sharpener, 25c. Master Distributors, P.O. Box 1223, Chicago.

**100 KEENESE** Razor blades, 50c up. Finest grade, 90c. Postpaid anywhere. Special prices for dealers. Louis Eugene, 277 Broadway, New York.

## SURVEYING INSTRUMENTS

**GUARANTEED** Factory rebuilt transits and levels for rent (with purchase option) or sale (cash or terms). Order now before prices advance. We will repair, trade in, or buy your old instruments. Ship prepaid for estimate and valuation. Write for List M-36 and complete information to Warren-Knight Co., 136 N. 12th St., Philadelphia, Penna.

## FOR SALE OR EXCHANGE

**TRADERS** Bulletin, hundreds of trades and bargains. Mack Brothers Exchange, 2041 Chicago Ave., Chicago.

## FOR SALE—MISCELLANEOUS

**USED** 32 V. light plant, \$80 complete, including radio. Arthur Ohlendorf, Crete, Illinois.

**TELESCOPE** Mirror just aluminumized. 6" diameter. Excellent condition. \$20.00. A. Pardi, 3010 Vine St., Cincinnati, Ohio.

## WANTED—MISCELLANEOUS

**CASH 'EM**. Sell us your excess unused postage. Small discounts. Mint Sheet Brokerage Company, 418 Caxton Building, Cleveland, Ohio.

**CASH** For used microscopes, binoculars, cameras, slide rules, drawing sets, surveying, scientific instruments, mechanical and electrical hand tools. Highest prices paid day shipment received. Satisfaction guaranteed or shipment promptly returned. Elman's, 2302 VanBuren, Chicago.

## PERSONAL

**ATHLETES** Foot. Itching, burning, sweating, odorous feet, cured quickly. Send fifty cents for complete treatment. Box 1012-C, Chicago.

**ATHLETE'S** Foot remedy. Cured thousands. Guaranteed. \$1.00 bottle prepaid. Dr. W. J. Renz, D.S.C., Room 3, Chavanne Bldg., Lake Charles, La.

**INTERESTING** Success booklet free! Johnston, PM-257 North Washington, Tiffin, Ohio.

**PSORIASIS** (Scaly skin disease) treatment, \$1.00. Applied externally. Stainless. Sterling Products Co., Box 83-A, Springfield, Ill.

**WANTED**, Original poems, songs, for immediate consideration. Send poems to Columbian Music Publishers, Ltd., Dept. 33, Toronto, Can.

**"SO-LONG-BUGS"** Is a sure cure for bed bugs, cockroaches, and other insects. Large sample 25c. Walters, 37 Milburn Ave., Maplewood, N. J.

**NERVOUSNESS**, Nervous fear! Afflicted? Free, interesting information. Investigate! John Englund, Ontonagon, Mich.

**WIN** Prize money: Booklet—"Successful Contesting"—shows how. 10c postpaid. Bulletin listing \$200,000.00 prizes included free! World Publishers, 4515-B Cottage Grove, Chicago.

**STUTTERING** and stammering corrected at home. Descriptive booklet free. Paul J. Wolfe, Box 52, Pittsburgh, Penna.

## MISCELLANEOUS

**COATS-OF-ARMS** And crests correctly rendered in colors or black and white. Highest grade. Estimates free. Heraldic Studios, 1914 Oakdale Ave., Chicago.

**MAGNET**—Lifts 50 times its weight. Wonderful for repairmen, machinists, etc. Write for information. Robt. C. McCloy, Oreland, Penna.

**FIREWORKS** For July Fourth. Wholesale prices. Free catalogue. Leon Bresky, 1610 1/2 Hamilton, Houston, Texas.

**QUALITY** Painting and decorating. Floyd Weaver, Route 2, Rockford, Ill.

**SWAPPERS**, Collectors, investigate free trading service. Exchange, Box 425, Detroit.

**TATTOOING** Outfits, supplies, illustrated list free. "Waters," 965 Put-nam, Detroit.

**MONUMENTS**, Reasonable. Lettered. Delivered. Guaranteed. Reliable Granite Company, A17, Oneco, Florida.

**SWAPPER'S** Friend, R4, Saline, Mich. Interests swappers, mail order. 50c year, sample 10c.

**"RACKETS** That Swindle You," 15,000 words, 10c. "The Racket Series" (reprinted from Readers Digest) 30,000 words, 25c postpaid. Authoritative expose of non-violent frauds. Brock, 34-15 31st Ave., Astoria, N. Y.

**BUSINESS** Proposition resilvering mirrors, autoparts, reflectors, making chipped glass signs. Write, Sprinkle, Plater, 288, Marion, Indiana.

**HEAD** Scratcher, dandruff loosener. Cholly St. Moritz, 875 Chancellor Ave., Irvington, N. J.

**ARTISTIC** Bird pictures, framed, handmade with genuine feathers. Unequaled, beautiful ornament! Size 5 1/2 x 8 1/2, \$1.00 postpaid. Agents wanted. Marquez-GA, Apartado 1176, Mexico City.

**INFORMATION**, Any subject. Minimum fee \$1.00. International Research, 952 Magnolia Ave., Los Angeles.

**NATIONALLY** Advertised electrical appliances, radios. Any make. Any model. 20% to 50% discount. Brennan Distributing Company, 228 Seeley St., Brooklyn, N. Y.

**MECHANICAL** Projects laid out, detailed, ready for construction. Send sketches for estimate. Drafting Service, Box 554, Pontiac, Michigan.

**ENGRAVED** Metal name plates for the home and business man. Rust proof. Free circular. Edward Lock, 1476, Washington, D. C.

**WE** Nickel plane anything. Prices reasonable. Globe Company, Fitzgerald, Ga.

**ZINC** Cuts for few cents without acids, chemicals. Guaranteed. Illustrated instruction folio \$1.00. Hendrixon, Argyle, Wisconsin.

**MONEY** In butterflies, moths. See Sinclair Display Advertisement on page 18A.

**STANDARD** Electric lamp insect killer. \$2.00 up. Literature free. Sauer Bros., San Leandro, Calif.

**INSIDE** Legal information. Keep out of trouble. Make money by knowing the answers. Price 25 cents. Dept. B, 234 Hurst Bldg., Buffalo, N. Y.

**WATERPROOF** Leaky basement walls, floors. Inexpensive. F. Gerwin, Meeker, Oklahoma.

**AMATEUR** Tattooing outfits, illustrated catalog 6c. "Tatuco," 651A S. State, Chicago.

**MEXICAN** Legal matters. American Attorney. Box 1736, El Paso, Texas.

**GOOD** Eyesight without glasses. No drugs. Representatives wanted. Arthur Jacobson, Upsala, Minnesota.

**LIKE** To draw? Earn steady income tracing and duplicating advertising cartoons. Ad-Service, Argyle, Wis.



# Easy

**YOU'LL advance faster with an easy playing Conn. Choice of world's greatest artists. Many exclusive features yet they cost no more. Home trial. Easy payments. See your dealer or write for freebook. Mention instrument.**  
**C. G. CONN, Ltd., 631 Conn Bldg. ELKHART, IND.**



# CONN

BAND INSTRUMENTS

**NEW! Complete and Up to the Minute Book on SHEET METAL WORK — WELDING — PATTERN DRAFTING**

"Sheet Metal Workers' Manual" by Broemel . . . 542 pages—400 illustrations . . . used as text by U. S. Naval Training and many other schools. Covers Electric and Oxy-acetylene welding . . . Pattern Drafting . . . Metal Working machinery and tools . . . forging—brazing . . . useful tables. Only \$2.00 postpaid . . . 5 day money-back guarantee. Send for our FREE Catalog on Allied Subjects.

**FREDERICK J. DRAKE & CO.**

M-179 N. Michigan Avenue,

Chicago, Ill.

**WE CAN TEACH YOU TO MOUNT BIRDS**

**Squirrel Lighter** **ANIMALS, HEADS, FISH**

Also to tax skins and FURS. Easily learned **AT HOME BY MAIL**. Wild game growing scarcer—big demand. Be a taxidermist. Mount for others. Big Fun, Real Hobby. Mount common specimens—no wild game needed. **REAL PROFITS IN SPARE TIME.**

**FREE BOOK** Men, Boys, get wonderful **FREE BOOK**—tells how **YOU** can learn this fine art quickly. Investigate. Send this minute. State **AGE**. **N.W. School of Taxidermy, Dept. A337-OMAHA, NEB.**



# ROMANCE WRECKED BY UGLY PIMPLES?

**Here is how to help keep skin-irritating poisons from your blood**

Don't let repulsive-looking hickies rob you of charm . . . ruin your chances for friendship and affection . . . spoil your good times. Find out what the trouble may be, and take steps to correct it.

During the years of adolescence, from 13 to 25, important glands are developing. These gland changes upset your system.

At the same time intestinal waste poisons are often deposited in the blood stream, and may irritate the sensitive skin of your face and shoulders. Pimples break out.

Fortunately, there is a way to help keep these skin-irritating poisons out of your blood. Eat Fleischmann's Yeast, 3 cakes a day. The millions of tiny, living plants in each cake of this fresh food help to remove the wastes the natural way and clear the skin of pimples. Thousands of young people get results in 30 days or less. Act now. Get Fleischmann's Yeast and eat it faithfully. See how your skin clears up.

# Amazing Invention GROWS HAIR



**in Many Thousands of Cases**

For many years hair and scalp specialists have known that inner stimulation of blood circulation in deep-lying scalp blood vessels stimulates growth of hair. Here is an amazing machine which, through principle of "Intermittent Vacuum," actually pumps blood to starved and stunted hair roots, stops falling hair, and results in new growth of hair. Yes, results are obtained even in many so-called hopeless cases of baldness.



**Amazing Reports from Users**

The Rand is simple to use. Hook up to any faucet — place helmet over head — turn on water — that's all! No water touches your head or you. Only power of water is used to create intermittent vacuum.

**Results!**

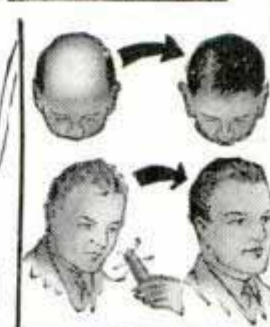

**GUARANTEED TRIAL OFFER**

You men who have tried everything else — you men who are losing your hair and are rapidly approaching embarrassing baldness — you men who have given up hope of ever regaining your hair — **YOU are invited to try the Rand Hair Growing Machine on our amazing Guaranteed Offer.** Stop being laughed at behind your back! Stop being called "Baldy"! Stop looking old before your time!

**FILL OUT AND MAIL COUPON RIGHT NOW!**



The illustrations above explain the Rand principle of growing hair. At left is a starved hair root—too weak to shoot hair through the scalp. At right is a strong, active hair root—**GROWING HAIR**—because it is properly nourished by rich blood supply.

**NEW HAIR IN 90 DAYS!**

The exact time it takes for the hair to appear varies with the individual case, but in many cases new hair appears in as little as 90 days. Usually hair stops falling out after first few treatments, scalp glows and tingles with new vigor due to stimulated circulation. Often results are quick and startling. You use the Rand at home, while resting or reading. Several 15-minute treatments per week are sufficient.

# PRICE Only \$9.95

**SEND NO MONEY—YOU PAY ONLY IF SATISFIED**

You may have spent hundreds of dollars to regain your hair. The Rand costs you only \$9.95, complete, but you pay this only if you are satisfied with results. Send no money with coupon below. Pay postman small deposit of only \$5.00 plus postage on arrival of the Rand. Then use it for 30 days according to directions. If you are then convinced that it is helping you, pay balance of only \$4.95. Otherwise return the Rand to us for full refund. You risk nothing and you may again enjoy a thick, luxuriant growth of hair! Hurry—rush coupon below today.

**RAND HAIR GROWER CO., Dept. J-1662, 402 E. 4th St. Newport, Ky.**

# Rush this Coupon SEND NO MONEY!

Rand Hair Grower Company, Dept. J-1662  
 402 East 4th St., Newport, Ky.  
 Please ship the Rand, complete, to me C.O.D. for \$5.00 plus postage. I agree to pay balance of \$4.95 if after 30 days, I am satisfied with results. Otherwise I may return the Rand to you and you will refund my money.

Name .....

Address .....

City..... State.....

# FREE WHOLESALE CATALOG



Shows 4000 World Wide Bargains, 260 pages of Big Values, 15 selling plans. This fascinating Book of Opportunity is FREE. Write for a copy today.

### GUARANTEED FOR LIFE PEN

No. R317. Pump filler fountain pen. Fitted with the new improved, stainless durium point. Has large transparent ink reservoir, holds many days supply of ink—always visible. Comes in popular, pearl-effect colors. Guaranteed to satisfy or money back. Suggested Selling price 59c. Sample, 25c Dozen, \$2.80



No. H5 Guaranteed, double edge razor blades. First quality.



Makes shaving a pleasure. Must please or money back. 15 blades 20c 100 blades 69c

### GUARANTEED WRIST WATCH \$1.59



No. V301. Fitted with unbreakable crystal; has adjustable metal band; chromium finish case. 3 year guarantee with each watch. A dependable time-keeper at a low price. Suggested selling price \$3.45

Spors Co. 4-38 Main St., Le Center, Minnesota

# LIVE BODIES FOR SALE



Oh boy! Wouldn't that be swell—I'll tell you what I will do though, I will take that scrawny body of yours and whip it into shape just like I have done for myself and so many others. Do you want big muscles and a huge robust body? My book "Puissant Body Building" is absolutely FREE.

**TOMMY LOUGHRAN**  
Undeclared World Champion

**TOMMY LOUGHRAN**  
Dept. 55, 4 S. 15th Street, Philadelphia, Pa.

**FREE**  
"Puissant Body Building"  
Sign here →  
Postal card will do.

Name.....  
Street.....  
City..... State.....

**RED GRANGE WILL SEND YOU AN AUTOGRAPHED COPY OF HIS GREAT FOOTBALL BOOK**  
Every boy who wants to star in football should own Grange's story of "Zupke of Illinois." Regular price \$2. Send dollar bill. No more. **FOR \$1.00**  
Address Red Grange, 333 N. Michigan, Chicago, Ill.

# EARN BIG MONEY IN AIR CONDITIONING

Get into Air Conditioning. Big Corporations have already hired hundreds of men for service and installation jobs. Thousands of trained men will be needed in the future. Write quickly for complete information on money making opportunities on our, "pay as you learn," plan. Address—

**Air Conditioning Training Corporation**  
Youngstown, Ohio Dept. 6-PM

When writing please mention Popular Mechanics

## COMPLETE ELECTRIC PLANTS

AC DC

Onan A.C. plants furnish same current as city lines, 110 Volt, 60 Cy. For farms, camps, construction jobs. Operate radios, water systems, all appliances. New models, 350 to 5000 watts, 6, 12, 32 and 110 volt D.C. Models \$57.50 and up Also combination A.C.-D.C. units Shipped complete, ready to run.

Write for details.  
D. W. ONAN & SONS  
1020 Royalston Ave  
Minneapolis Minnesota

## WELDERS WANTED!

**ELECTRIC ARC - OXY-ACETYLENE**  
Skilled Welders earn \$8 to \$15 a day. The demand now greater than the supply. Learn this highly paid trade in 4 weeks by actual shop work. One of America's leading schools. Established 1902. 7 floors of shops. Endorsed by welding industry. Limited number of students. 4 weeks course in Electric Arc or Acetylene Welding, including room and board, only \$159. Write or wire for reservation. Ask for "Welding Facts." State age.

**GREER COLLEGE, Dept. 168, 2024 S. Wabash Ave., Chicago**

## Government Jobs

EXAMINATIONS SOON VALUABLE INFORMATION FREE  
**COLUMBIAN CORRESPONDENCE COLLEGE**  
WASHINGTON, D. C.

## LAW HIGH-GRADE INSTRUCTION BY CORRESPONDENCE

College, Post, Grad. and Bar Ex. Rev. Courses. Law has attracted more keen, brainy men than any other calling. Send today for catalog. Low cost, easy terms. Text books loaned free.

**Chicago School of Law Dept. 301, Reaper Block CHICAGO, ILL.**

# \$ MONEY-MAKING \$ OPPORTUNITIES

For those who need larger incomes or must seek new occupations. The following workable, tested plans are adaptable both to the needs of the country or city dweller either for part time development or principal income source.

Every idea set forth in these books has been used by others for profit. They are well worth your consideration.

**Plan No. 1—1000 Ways to Make \$1,000.** Practical new book of tried, tested methods that work that you too, can use. Price \$2.65.

**Plan No. 2—Radio Servicing.** Let an expert teach you how to engage in this money making business. Price \$4.15.

**Plan No. 3—Refrigeration Service.** Official manual covers all makes. Good service men are needed. Price \$5.00.

**Plan No. 4—Automobile Refinishing.** Start a lucrative business of your own. Fine possibilities here. Excellent new instruction book. Price \$1.50.

**Plan No. 5—Outdoor Opportunities.** The raising of small animals, birds and plants for profit. Price \$2.00.

**Plan No. 6—10,000 Money-Making Formulas.** Complete instructions for the making of commodities at small cost that may be sold at a handsome profit. Price \$4.00.

**Plan No. 7—1000 Spare Time Money Making Ideas.** A job for everybody. 146 page book tells how. Price \$1.00.

**Plan No. 8—100 Civil Service Examinations.** Covering steady Government jobs. All types of positions. Better business means thousands of new jobs. Prepare now by studying this new book. Price \$2.50.

**Plan No. 9—Making Poultry Pay.** The proper breeding and management of fowls for higher egg production. Price \$2.00.

**Plan No. 10—A Living from the Land.** Answers the question "How can I successfully get established in the country?" Price \$1.50.

**Plan No. 11—Rabbits for Food and Fur.** A complete guide to the successful rearing and breeding of rabbits. Price \$2.00.

**Plan No. 12—The Frog Industry.** Should be considered more as a side line than as a major means of income. Price \$1.00.

**Plan No. 13—Is There Money in Welding?** Factual information shows welding is a growing field offering opportunity to anyone looking for a trade. Price \$1.00.

**Plan No. 14—Auto Service Shop Management.** Money-saving and business-producing ideas by two men who know just what is essential to a profitable service shop business. Price \$1.50.

Any of the above mailed postpaid upon receipt of price or sent C.O.D. anywhere in U. S. Pay postman price and few cents postage.

**POPULAR MECHANICS PRESS**  
Room 638 200 E. Ontario St. Chicago, Illinois

NOW I KNOW WHAT FRED MEANT WHEN HE SAID HE GOT HIS PAY BOOST OUT OF A TWO DOLLAR BOOK.



## PAY RAISING EXTRA MONEY BOOKS THAT WILL HELP YOU WIN SUCCESS

You, too, will find the selected list of practical books below just what you need to help you improve your job, prepare for a better one, or add to your income through spare time earnings. Thousands give these books credit for their success.

**SEND NO MONEY!** Use this advertisement as an order blank. Check books wanted. Add name and address and mail. Just pay postman price plus few cents postage. (In U. S. and possessions.) Or remit with order and add 10 cents per book for postage.

**POPULAR MECHANICS PRESS**

Room 638B 200 East Ontario Street Chicago

- AIR CONDITIONING**  
Live Field; Great Future.....\$3.50
- ALUMINUM WORKING**  
For School and Home Shops. Just Out. 295 pp., illus.....\$3.00
- AUTO ENCYCLOPEDIA**  
The Famous Dyke's Latest Edition.....\$6.00
- 110-V. GENERATORS**  
Made From Old Auto Units.....\$1.00
- BIRD HOUSES**  
Build to Sell; Easy Designs.....\$1.00
- BLUEPRINT READING**  
for the Building Trades.....\$1.25
- BOAT BOOK**  
Power, Sail, Rowing, Paddle Plans.....\$3.00
- BOY MECHANIC**  
Hundreds Things Boys Can Make.....\$2.00
- CARPENTRY, PRACTICAL**  
Complete 436 pages. Revised Edition...\$2.00
- CIVIL SERVICE**  
Home Study Courses Federal, State, City Positions.....\$1.00
- CONCRETE**  
1001 Ideas for Using. New Popular Mechanics Book...\$5.00
- DIESEL HANDBOOK**  
New! Latest Information.....\$5.00
- ELECTROPLATING**  
With Copper, Nickel and Chromium Technical bulletin.....\$1.00
- FORD V-8 CARS, TRUCKS**  
New, 700 Pages. Includes Details 1937 Cars.....\$2.50
- FORMULAS**  
1059 Money Making. Start a Business...\$1.25
- A.C. POWER WIRING**  
Covers all uses of a.c. for power.....\$4.00
- FURNITURE MAKING**  
Tools, Materials, Design.....\$2.50
- HOUSES, SMALL**  
Book of, for Home Builders.....\$2.00
- HYPNOTISM**  
How to Become an Expert.....\$2.00
- LOCOMOTIVE**  
Folding Chart Shows all Parts.....\$1.00

- LOG CABINS**  
Easy Plans; Build for Profits, Value!.....\$3.00
- MACHINE WOOD-WORKING**  
First Complete Book on Subject.....\$3.25
- MATHEMATICS**  
Easy Guide for the Practical Man.....\$1.50
- MECHANICAL DRAWING**  
Learn Drafting; Good Salaries.....\$1.00
- MONEY MAKING IDEAS**  
1000 Ways to Make \$1000.....\$2.50
- OFFICE MACHINES**  
All Makes. Care and Operation.....\$2.50
- PLUMBING**  
500 Facts Every Homeowner Should Know.....\$1.50
- TEST GOLD—PLATINUM**  
Identify—Buy—Sell, By C. M. Hoke...\$1.00
- POWER TOOLS**  
For home workshop...\$1.75
- PROSPECTORS' HANDBOOK**  
How to Mine, Appraise, Equip.....\$3.00
- RADIO SERVICING**  
Profit by Knowing Costs, Kinks, Etc!.....\$4.00
- REFRIGERATION**  
Electric, Gas. Be a Service Expert...\$5.00
- REWINDING ELECTRIC MOTORS**  
Fractional Sizes. Value!.....\$2.50
- SHIP MODEL**  
Entire Text, Famous "Sovereign" of 1637 \$1.00
- SHOP NOTES LIBRARY**  
5 Vol. 2000 Wonderful Shop Ideas.....\$2.50
- STAMP ALBUM**  
Modern, 400 Pages...\$1.00
- STEEL SQUARE**  
How to Figure Angles of Rafters, Roofs, Etc.....\$1.00
- TOYS**  
For Amusement or Profit, Saleable Designs...\$1.50
- TRAILER BUILDING**  
New Book.....\$1.00
- UPHOLSTERY**  
Always a Big Market. Start Own Business \$2.00
- WOOD FINISHING**  
Methods, Tools, Materials.....\$2.00

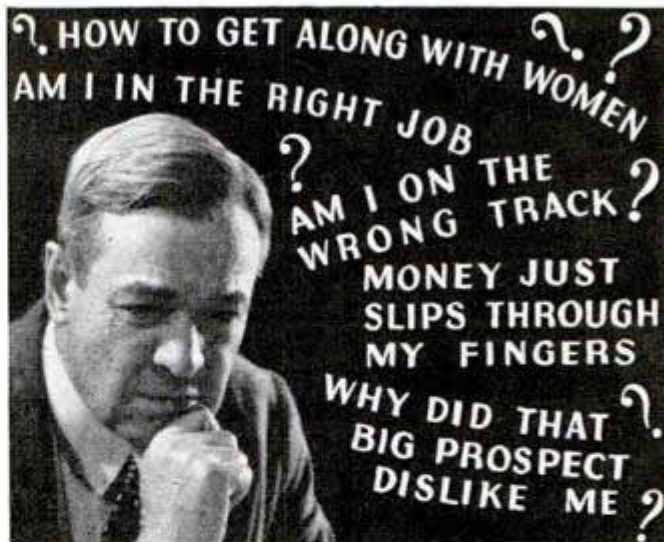

## You'll never get ahead until you understand yourself!

Out of 100 successful men, no two follow the same methods in winning friends and business or professional victories. Some thrive on contact with fellow men, others create in private; some must overcome timidity, while others must temper natural boldness with gentler approaches.

The Self-Study Foundation was organized to help men apply their education and their natural powers to best advantage. The first step is to learn what type you are—then you plan your life accordingly. Our FREE Test will point the way clearly.

### Success is not the result of good luck, but intelligent planning

No school, college or university has ever given a course that covered all the subjects embraced in this unique set of discussions organized under the title, "Getting Set for Success."

That is why men of education and successful experience declare that the Self-Study Foundation has made a priceless contribution to self-development by offering these 10 discussions.

### Here are "The 10 Milestones to Success"

1. Know How to Change in Order to Progress.
2. Get Rid of Fears That Cause Conflict.
3. Get Rid of Personal Handicaps That Hold You Back.
4. Learn the Technique of Successful Action.
5. Know How to Get Along With People in Business and at Home.
6. Know How to Get Along With Women.
7. Know How to Make Your Job Grow.
8. Know How to Act and Dress Correctly.
9. Know How to Handle Money Wisely.
10. Know How to Plan Your Future Constructively.

**SELF-STUDY FOUNDATION INC.**

### SEND FOR FREE TYPE ANALYSIS TEST

**SELF-STUDY FOUNDATION, Inc.**  
30 N. Michigan Ave., Dept. A-19, Chicago, Ill.

Please send me, free of charge, your instructions for analysis of my personality and capabilities. I understand this will place me under no obligation or expense.

Name.....  
Address.....  
City..... State.....

**Only 22¢ a Day**  
**Puts This All-Purpose ELECTRIC ARC WELDER IN YOUR SHOP**

**TEN DAY TRIAL GUARANTEED**



**STOP THROWING AWAY PROFITS! DO YOUR OWN WELDING!** That's the modern way to increase income and customer satisfaction. And, it takes only 22c a day to do it. Yes, you get the sensational, professional, ALL-PURPOSE, Commonwealth Arc Welder—Model 120-FS, for only 22c a day. Ten whole months to pay out of profits. Now, for the first time, it is EASY for every inventor, laboratory, home workshop owner, garage, repair shop, and factory to afford a complete welding service for manufacturing, maintenance, experimental or repair work.

**Details FREE**

**Works on 110 or 220-Volt A. C.**  
 Simply plug into a 110 or 220-volt, 60-cycle A.C. line. Economical—costs only a few pennies an hour to operate. Often pays for itself on first or second job. Portable—can be carried right to outside jobs in auto, truck, or side car. Anyone can weld with its easy-striking, automatically-stabilized arc. Comes complete with helmet, electrode holder, welding rod, etc. Nothing else to buy. Fully Guaranteed. Breath-taking low price! Saves and makes hundreds of dollars.



**Handles ALL Welding Sheet Metal to Heavy Castings**  
 Model 120-FS is a big, 110-pound, man sized, heavy-duty welder with efficiency of machines costing many dollars more. Welds iron, steel, cast iron, cast steel, and alloys of them. Six heats handle everything from fenders and light sheet metal to motor blocks and heavy castings. Also fine for soldering and brazing. Uses standard welding rods. No experience or special training needed to operate. Simple, complete instructions for doing all kinds welding jobs included. MAIL COUPON BELOW for complete FREE details.

**COMMONWEALTH MFG. CORP.**  
 Dept. J-51, Cincinnati, Ohio

**MAIL COUPON FOR DETAILS GET 22¢ A DAY PLAN**

Commonwealth Mfg. Corp., Dept. J-51, 4208 Davis Lane, Cincinnati, Ohio.

Please rush me at once, FREE, all details about Model 120-FS Electric Arc Welder with DeLuxe Accessories and your 22c-a-day plan.

Name.....  
 Address.....  
 Town..... State.....

**BOOKS — FOR TODAY'S BIG OPPORTUNITIES**

**List Sent Free Upon Request**

**POPULAR MECHANICS PRESS—200 E. ONTARIO ST. CHICAGO**

**PLAY AN EPIPHONE**

The instrument that is most popular with the stars of orchestra, stage, screen and radio... Write for catalog P-1, featuring Guitars, Singing Guitars, Mandolins, Banjos, etc...



**WORLD'S LARGEST FIRST GRADE INSTRUMENT BUILDERS**  
**EPIPHONE, INC.**  
 142 WEST 14 STREET, NEW YORK, N. Y.

**PROCEDURE HANDBOOK OF ARC WELDING DESIGN AND PRACTICE**

**ONLY \$1.50 in U.S.A. POSTPAID**  
 Elsewhere \$2.00

**1012 PAGES**  
**1243 ILLUSTRATIONS**

● The big new fifth edition Procedure Handbook gives you valuable, up-to-date information that will enable you to improve your position and increase your earning power. This complete, authoritative Handbook gives you quickly the right answers to problems in the development, production or utilization of steel products. It is one of the wisest investments you can make for your future welfare. Order your copy today.

**POPULAR MECHANICS PRESS**  
 CHICAGO, ILLINOIS

**STREAMLINE Your Effects for Better Results—Bigger Pay**

Cut down the resistance and friction that keeps you from success. Learn the best, easiest and most practical ways of doing things. Use modern STREAMLINED ideas. Cash in with

**318 Money-Making and Time-Saving Articles Including:**

Auto Kinks	Lathe Operation
Auto Trailer	Tool Kinks
Comfort	Electrical Kinks
Workshop	Helps

**SHOP NOTES FOR 1938**

Popular Mechanics Shop Notes for 1938 gives you 318 helpful, handy, money-making ideas, short cuts and practical plans. 324 pages of usable information. 645 illustrations. Specially prepared for mechanics, handymen, home workshop fans, farmers—for everyone who uses tools to make things and do things. Order today! Get also 1937 Shop Notes with 357 different articles. Send 50 cents for either book. Both books sent postpaid for \$1.

**World's Biggest 50c Worth**



Popular Mechanics Press, Room 436-B, 200 E. Ontario St., Chicago

**OFFICE MACHINES—Care**

and operation of 29 different makes. Typewriters, adding machines, duplicators, etc. Only book on subject. 384 pages, illustrated. \$2.50 postpaid.

**POPULAR MECHANICS PRESS**  
 200 East Ontario Street Chicago

**SIMPLIFIED ARC WELDING BRINGS BIG PROFITS EVERY MONTH**



"I WANT TO TAKE THIS OPPORTUNITY TO THANK YOU FOR DOING ME A FAVOR BY SELLING ME MY HOBART WELDER. I CERTAINLY AM WELL PLEASED WITH IT AND IT HAS HELPED ME BUILD MY BUSINESS MORE THAN I CAN SAY"

DANBURY, CONN.

New low prices make this profitable welding service available to everyone. Opens doors to big pay jobs that carry real profit. Hobart welders are easier to operate, faster, guaranteed to bring you quality welding business... extra profits will pay for welder without expense to you.

**NO INVESTMENT TERMS—PROFITS PAY FOR IT**  
 Extra earnings and savings possible with Hobart Welders make it easy to own without expense. Write for details.

**HOBART BROS., Box M-681, TROY, OHIO**



# Increase Your Earning Power

Apply time and labor-saving kinks to your work. Your efficiency will soon be recognized and you will be in line for advancement.

If you do machine shop work of any kind, sheet-metal work, painting, carpentry, auto repairing, farming, concrete work, plumbing, electrical work, welding, building-glass work, general repairing, tool-making, poultry raising, masonry or home repair work, get this

## LIBRARY OF 2000 TIME AND LABOR SAVING IDEAS FOR SHOPMEN AND HANDYMEN

RECENTLY PUBLISHED

### SHOP NOTES for 1938

318 Articles  
645 Illustrations  
224 Pages  
Price 50c  
See partial list of contents below

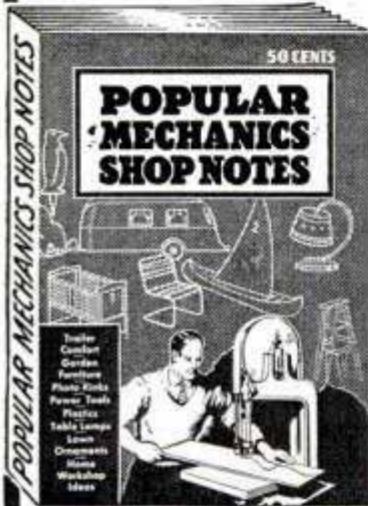

Including the new 1938 issue illustrated above, there are five volumes in the Shop Notes Library of 2000 easily understood short cuts to every-day jobs. Here are just a few of the subjects taken from the latest issue:

- |  |   |   |
|--|---|---|
| Are Welder, Auto Motor Runs                        | Garden Furniture, Metal Gas Engine Midget | Plastic Ornaments - Sail Rig, Airstream                     |
| Bite, Wood-boring Cabinet Humidifier over Radiator | Hacksaw, Electrically Driven              | Sander, Oscillating Saw, Power-Driven Table                 |
| Carpenters, Hints for Child's Crib                 | Hydraulic Rams for Country Homes          | Shaper Projects   |
| Corrosion, Guarding Against                        | Jigs for Belt Sander                      | Snow Flow, Small Rotary Table Lamps from Plastics and Metal |
| Drilling, Safe Drills, Using                       | Jigs for the Shaper                       | Temperature Indicator, Electric                             |
| Driveways, Durable                                 | Kinks for Photographers                   | Trailer Brakes, Vacuum Trailer Comfort                      |
| Electroplating                                     | Ladder Chair                              | Torch, Electric Arc   |
| Frozen Water Pipes, Thawing Electrically           | Laundry Cart                              | Wood Turning Kinks  |
| Garage, Profit Makers for                          | Lawn Ornaments                            |   |
|  | Movie Film, Power Reel for Developing     |   |
|  | Photographic Equipment                    |   |

Each volume contains approximately 400 articles and 600 illustrations and has 200 or more pages. This unrivaled library of shop helps may be secured for a limited time only. After the present supply of books is exhausted the offer must be withdrawn.

**\*Send No Money**

POPULAR MECHANICS PRESS, 200 E. Ontario St., Room 638, Chicago, Ill.

Send me, as per your offer, the following books. I will pay postman price and small amount of postage. My money will be refunded if I am not satisfied. (Check what you want.)

- 1938 Shop Notes and Lathe Handbook (Metal Working), both for 98c.
- Shop Notes Library (5 vols.) \$2.50.

Name.....  
Street and No.....  
City..... State.....

\*C. O. D. applies to U. S. and possessions only. If you reside elsewhere, remittance must accompany order.

# YOU CAN LEARN TO DRAW

—AT HOME—IN YOUR SPARE TIME



There's no mystery in learning to draw. Our practical method of instruction makes it fun to learn COMMERCIAL ART, ILLUSTRATING, CARTOONING. A few pleasant hours a week in your own home should start you on the road to earning money in the fascinating Art field.

## Trained Artists Are Capable of Earning \$30 - \$50 - \$75 A Week

Many of our graduates never studied Art before enrolling with W. S. A., yet today are successful Artists with good incomes and enjoying the finer things of life. YOU have the same opportunity to "make good." Since 1914 we have trained ambitious men and women. Read our booklet —see the TWO complete artists' outfits we give each student.



FREE BOOK gives details!

WASHINGTON SCHOOL OF ART  
Studio 126E, 1115—15th Street, N. W.  
Washington, D. C.

Yes! I am interested in learning to draw, please send me a FREE copy of your Book, "Art for Pleasure and Profit."

Name..... Age.....  
Address.....  
City..... State.....

# MILLIONS AND MILLIONS

Of Kelpamalt Tablets—The Excellent Mineral-Iodine Concentrate—Used by People The World Over! Thousands Report New Pounds, New Strength, New Energy.

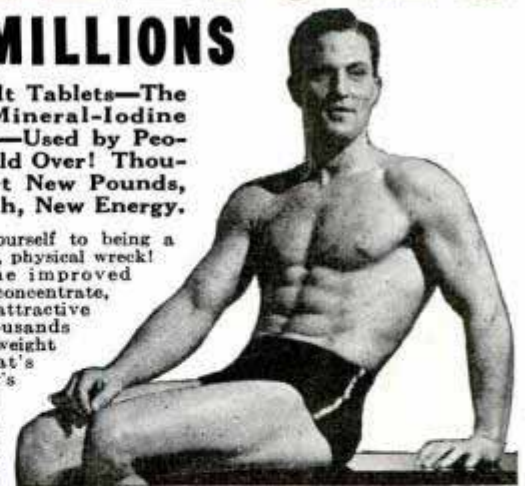

Don't resign yourself to being a skinny, scrawny, physical wreck! Kelpamalt, the improved mineral-iodine concentrate, has put solid, attractive pounds on thousands who were underweight for years. That's because the body's normal chemical processes, which change digested food into rich blood and firm flesh, require certain minerals —elements often deficient in the daily diet. Without them, good nourishment may be wasted. KELPAMALT HELPS PROVIDE THESE NUTRITIONAL ELEMENTS. Its iron, copper, calcium and other minerals, together with its natural, sea-plant iodine, help the system get the real good out of food. Try it. Thousands are amazed at quick gains of solid, "stay-there" flesh often in a few weeks. They say they eat better, sleep better, look better, feel better, too. Kelpamalt costs but little to use. Your own Doctor will approve this harmless way. Get Seedol Kelpamalt today.

Posed by Professional Model

Without them, good nourishment may be wasted. KELPAMALT HELPS PROVIDE THESE NUTRITIONAL ELEMENTS. Its iron, copper, calcium and other minerals, together with its natural, sea-plant iodine, help the system get the real good out of food. Try it. Thousands are amazed at quick gains of solid, "stay-there" flesh often in a few weeks. They say they eat better, sleep better, look better, feel better, too. Kelpamalt costs but little to use. Your own Doctor will approve this harmless way. Get Seedol Kelpamalt today.

### SPECIAL FREE OFFER

Send for Free, fascinating, instructive, 30-page booklet on How to Build Strength and Add Weight. Information on Minerals, Iodine and Vitamins, and their effects on the human body. Weight and Measurement Charts. Daily menus. No obligation. Kelpamalt Co., Dept. 1437, Borden Ave. and 21st St., N. Y. C.



# NEW INVENTIONS

(Continued from page 33A)

**U**LTRASHORT radio waves are employed in a new system of signaling.

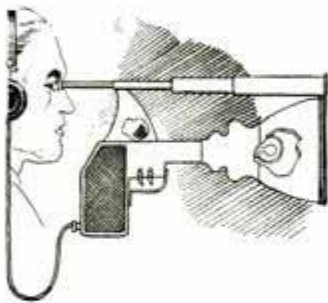

The outfit is a lightweight transmitter capable of being operated by one man. It consists of an elongated casing provided at its forward end with a concave mirror

and at its rear end with a hand grip and a microphone. It also has an ultrashort wave oscillator in the mirror, and switch-controlled lead-in wires arranged to form a tunable Lecher system within the casing properly connected to a source of current, the microphone and the oscillator. The outfit is used for signaling over relatively short distances.

**M**IXING summer drinks would not be such a task if the kitchen equipment included a newly patented ice-cube crusher. The device consists of a pair of crushing jaws pivoted and extending to form a handle. A spring holds the jaws apart until the ice cube is inserted, and pressure is applied to the handle in the manner of using a nutcracker. Small ice picks on the inside of the jaws help to crush the cube.



**W**OODSMEN would find a newly patented tool handy. It is a combination ax and pick and its handle contains a hunting knife. The knife is firmly held within the handle until its release for use is desired. The pick may be folded against the handle when not in use.



**R**EDUCING work for the farmer is the purpose of a combined cultivator and weed cutter patented recently.



The implement has a pair of rearwardly diverged blades having their rear ends rigidly connected with a U-shaped member. A gauge

wheel is adjustably mounted on the frame in advance of the blades. By cutting the weeds and cultivating the soil the implement serves a double purpose.

**O**PERATED by an electromagnet, a simple fret saw has been introduced in Germany. The electromagnet is located below a steel diaphragm supported in rubber holders. On the upper side of the diaphragm, in the center, is a clamp in which the lower end of the fret saw is fixed, while the upper end of the saw is fixed to a flexible bow. The coil of the electromagnet is connected to an ordinary a.c. lighting circuit, and the alternating field produced results in the upward and downward deflection of the diaphragm at each half period. With a periodicity of fifty, the diaphragm makes 6,000 vibrations per minute. The length of the strike may be varied by altering the vertical position of the electromagnet by means of a screw. The saw may be started or stopped by pedal or hand switch.

**F**OR the radio enthusiast, an antenna belt patented recently offers the means

for new experiment with the small receiver. The antenna is fastened around the waist. A special harness, which is worn like a cap, is connected to the receiver. Headphones attached to the harness, on each side of the head, provide for reception of signals.





# VACU-MATIC SCORES AGAIN!

**BOB McKENZIE**  
 TRANSCONTINENTAL AUTOMOBILE CHAMPION  
 COAST TO COAST

Vacu-matic Carburetor Co.  
 7617 W. State St.  
 Wauwatosa, Wisconsin

Dear Sirs:

Having just completed a new speed record between Los Angeles and Chicago, driving a 1936 Chevrolet equipped with a Vacu-matic carburetor control, I thought you might be interested in knowing some of the facts and the important part Vacu-matic played in the success of the run.

The distance covered was 2322 miles in thirty nine hours and forty-two minutes, officially timed by Western Union, which gave me an average speed of 59.7 M.P.H. based on elapsed time and with the Vacu-matic averaged 18 1/2 miles per gallon on gasoline.

Before leaving Los Angeles, we made several test runs both with and without the Vacu-matic, and the tests proved that Vacu-matic increased my gas mileage 3 1/2 miles per gallon at the driving speed of 60 M.P.H. and also very noticeable increase in both acceleration and power.

After this experience with Vacu-matic, you can depend that on my future speed runs across country that I will be depending on Vacu-matic to give me the same added performance it has proven on this last record breaking drive.

Yours very truly,

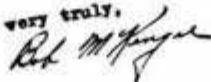

**Sets New Coast-to-Chicago Record**

**New Supercharge Principle SAVES GAS**

**MORE POWER - MORE SPEED  
 FASTER PICK-UP - NEW LIFE**

WESTERN UNION  
 TIMED

NEW YORK

TO LOS ANGELES

34 hrs-40 min

LOS ANGELES

TO NEW YORK

37 hrs-38 min

CANADA

15,000 Miles

18 days

LOS ANGELES

TO NEW YORK

AND RETURN

43 hrs-22 min

WASHINGTON, D. C.

TO MEXICO CITY

22 hrs-27 min

LOS ANGELES

TO PHOENIX

8 hrs-18 min

MURKOC DRYLANE

1947 M. M. 1 DAY

LOS ANGELES

TO SAVANNAH, GA.

10 hrs-17 min

LIPSA, MS.

TO TULSA, S. C.

4 hrs-21 min



**ESTABLISHING** new mileage records on cars in all sections of the country, the Vacu-matic again scores in a new speed record established by Bob McKenzie transcontinental automobile champion. Los Angeles to Chicago—2,322 miles in 39 hours and 42 minutes—driving 75 and 80 to maintain a speed average of 59.7 miles per hour!

Here is speed—a gruelling grind—where quick acceleration, greater top speed — and less stops for gasoline mean those precious moments saved that make new speed records possible. The same Vacu-matic that helped Bob McKenzie establish this speed record and gave him such fine gas savings is now available for all car owners. It is positively automatic—simple to install—inexpensive—and pays for itself many times over in gas savings.

**Automatic - - Nothing Like It!**

Vacu-matic is *entirely different!* It operates on the supercharge principle by automatically adding a charge of extra oxygen, drawn free from the outer air, into the heart of the gas mixture. It is entirely AUTOMATIC and allows the motor to "breathe" at the correct time, opening and closing automatically as required. No idling troubles—no carburetor adjustments necessary. It is so simple it will amaze you—so practical it will save you many dollars on gas costs.

**Fits All Cars**

VACU-MATIC is constructed of six parts, assembled and fused into one unit, correctly adjusted and sealed at the factory. Nothing to regulate. Easily attached in ten minutes.

**Agents and Salesmen**

VACU-MATIC offers a splendid opportunity for unusual sales and profits. Valuable territories now being assigned. Check and mail coupon.

**The VACU-MATIC Co. Wauwatosa, Wis.**

**Guaranteed Gas Savings**

VACU-MATIC must prove itself on every car. It is guaranteed to give worthwhile gas savings, quicker pick-up and more power, or it costs you nothing. "On my V-8 Ford it works miracles", says Ralph Fields. James Seeley—"On an International Truck on a round trip to Cleveland, 385 miles, it saved 19 gallons of gas." A. V. Grove—"On the Buick it showed 5 miles more per gallon." F. S. Peck—"I average 22 miles per gal. on my Plymouth, an increase of 7 miles, for a saving of \$15.00 a month, or \$180.00 a year." Wm. Lyons—"Averaged 25 miles on a gal. with a Model A Ford at 40 miles per hour."

**Free Details**

You owe it to yourself to know all about this remarkable discovery. Mail the coupon below. Start saving gas with VACU-MATIC and enjoy a new driving thrill! There's no obligation—so get the facts now! Write today!

**--- FREE OFFER COUPON ---**

THE VACU-MATIC COMPANY  
 7617-390 W. State St., Wauwatosa, Wis.

Gentlemen: Please send me full particulars concerning the Vacu-matic and details of your Free Offer. This of course does not obligate me in any way.

Name .....

Address .....

City ..... State .....

Check here if interested in selling proposition.

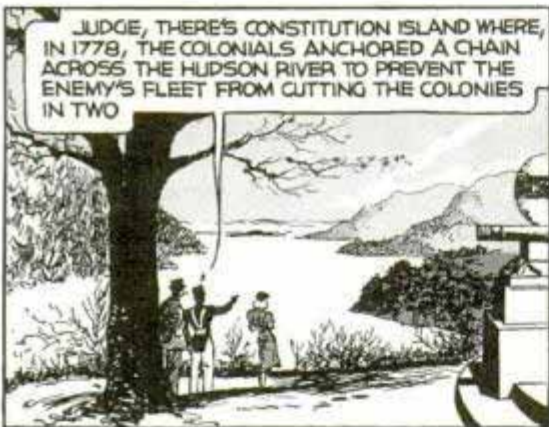

Copyright, 1938, R. J. Reynolds Tobacco Co.

★ **JOIN THE ARMY OF JOY-SMOKERS!** Here's the ★  
 ★ **world's favorite pipe tobacco for MILDNESS and RICH TASTE** ★



DOES PRINCE ALBERT  
**PACK AND DRAW  
 BETTER—SMOKE  
 COOLER AND  
 MELLOWER? YOU BET!**  
 TRY IT AND SEE!

**INSTRUCTOR**



IT'S BETTER TOBACCO.  
 THAT'S WHY PRINCE  
 ALBERT HAS THAT  
**FULL, RICH TASTE,  
 AND THERE'S NO  
 RAWNESS—P.A.'S  
 NO-BITE TREATED!**

**CAPTAIN**

**MONEY-BACK OFFER**

Smoke 20 fragrant pipefuls of Prince Albert. If you don't find it the mellowest, tastiest pipe tobacco you ever smoked, return the pocket tin with the rest of the tobacco in it to us at any time within a month from this date, and we will refund full purchase price, plus postage. (Signed) R. J. Reynolds Tobacco Co., Winston-Salem, N. C.

P. A. IS MADE TO ORDER FOR  
 BETTER "MAKIN'S" SMOKES TOO!

**50** pipefuls of fragrant  
 tobacco in every 2-oz.  
 tin of Prince Albert

THE **2** OZ.  
 BIG TIN  
**SO MILD  
 SO TASTY**

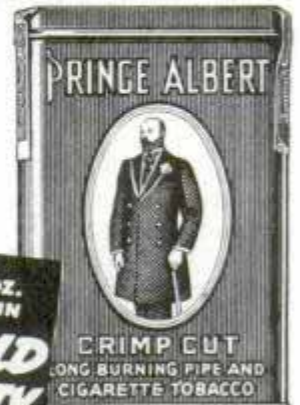

**PRINCE ALBERT**  
 THE NATIONAL JOY SMOKE

# Popular Mechanics Magazine

REGISTERED IN U. S. PATENT OFFICE AND CANADA

WRITTEN SO YOU CAN UNDERSTAND IT

Vol. 69

JUNE, 1938

No. 6

## WINGS <sup>14 285</sup> for CRIME HUNTERS

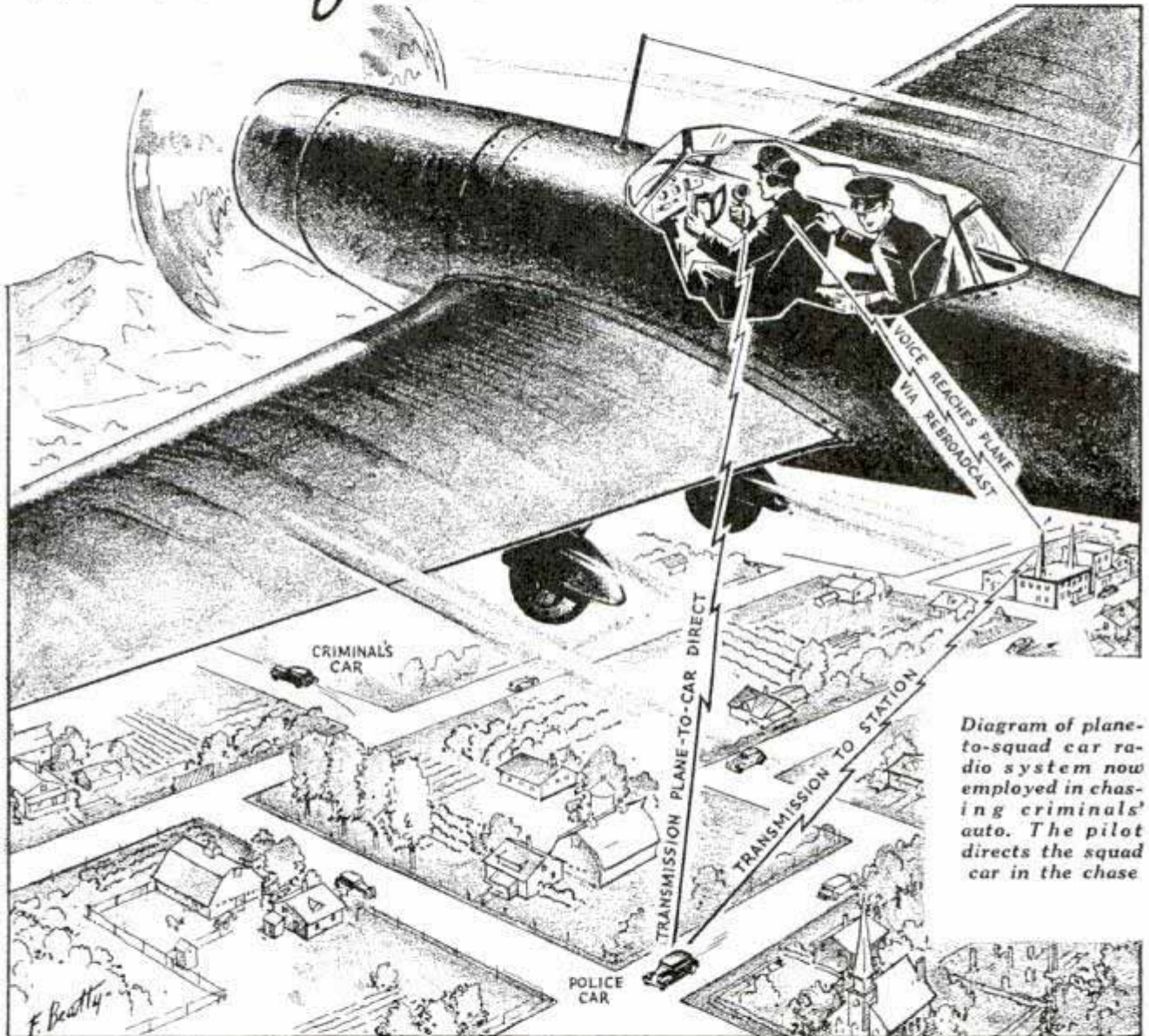

Diagram of plane-to-squad car radio system now employed in chasing criminals' auto. The pilot directs the squad car in the chase

THE picturesque, gun-toting sheriff of the old west is fast fading. The sheriff's department of San Diego county, Calif., has perfected and put into use "plane-to-car" radio communication, the culmination of several months' experimentation.

On the regular staff of the department, and in charge of the bureau of identification, is Lieutenant John Dougherty, licensed pilot and airplane owner, who on

many occasions has been called upon to direct rescue work, run down fugitive criminals and head searching parties from the sky. Until recently, his only means of communication with the ground forces has been a pre-arranged set of maneuvers, indicating the positions of the parties when located.

After much trial and error experimenting with different types of radios, both

3568 Keating St.  
San Diego Calif



aircraft and ground conversion sets, a popular type of short-range aircraft receiver and transmitter, designed primarily for "radio beam" instrument flying, has been installed and proved satisfactory. Simplicity in changing to the desired frequencies while in flight is obtained with this set, the conversion taking less than three minutes.

For example, the local department of commerce weather forecast for pilots is broadcast on 224 kilocycles, while the sheriff's radio station uses the 2,490-kilocycle band. An exchange of one compact bank of receiver coils in the receiving set is made and with the proper dial adjustment to 2,490 kilocycles, the pilot then receives the sheriff's calls from the radio cars as they are "fed back" through the main station microphone, situated in front of the station receiver. The plane trans-



mitter conversion is made with an exchange of one transmitter induction coil and a dial adjustment of the lining condenser, tuning the transmitter to the proper frequency. No change is necessary in the radio cars and they transmit and receive in the orthodox manner.

Conversation is carried on between pilot and radio-car officer, the pilot directing the car over hazardous roads, advising cutoffs to be made by the car to head off fugitives, or to direct officers on the ground in rescue work or searching parties. Radio-car officers are able to talk to the plane, requesting any needed information.

During a recent flood, a marooned family in the Tijuana river was located by the sheriff's plane. The family's position was radioed to rescue parties on the banks of the mile-wide river, whose view

(Continued to page 155A)

Top, pilot ready for reception and transmission. Center, numbers on squad cars aid the pilot. Bottom, receiver and transmitter in plane. Exchanging coils adapts equipment for police broadcast band

*Handwritten notes in blue ink:*  
 ... unit ...  
 ...  
 ...

H 373

London England

# Speeding Model Autos Thrill Racing Fans

Latest thrill for the racing fan is that experienced in watching model autos speed along a miniature track at a pace of forty miles per hour. The small speedsters, weighing four and one-half pounds, are replicas of noted racing cars. Each is propelled by rubber bands. Pillows are used to stop the little automobiles.

Center, ready for the starter's flag. Top, pillows halt the cars and end race. Bottom, preparing one of the cars for a race



*I'll include a number of four model for my auto  
Feb 23 296*

*acme*

*Hi 19 20 years 5*

*Reported by Guinness  
Council at Leipzig 1914*

## Black Radiator Saves No Fuel but Gives More Heat

Heating-plant radiators may be painted any color without running up the coal bill, according to Cornell University experts. A black radiator will radiate more heat than a red one. A white radiator radiates the least, about twenty-five per cent slower than the black. It is a seeming paradox that this makes no difference in fuel bills. If a radiator is painted so that it emits heat more rapidly, it will cool off that much more rapidly, unless additional heat is continually supplied. If the furnace supplies a certain amount of heat, the white radiator might take an hour to emit it into the room, and the black radiator only three-quarters of an hour. The amount of coal burned would be the same.

*Chas. H. ... ref*



## Printing Type Made of Plastic Can Be Remelted for Use

Plastic printing type has been developed in practical form. A ~~Leipzig~~ Germany, printing firm succeeded in making movable type from a plastic known as Polystrol. The new material is much lighter than lead and zinc and can be remelted and used over and over again!

*Deutscher Verlagsgesellschaft*

*Christian ...  
3/17/28*

*impressed 4/30*

H 371

18 409

# Aerial Mailbox Is Driven by Electric Trolley

*Capt. Lons Head; 605 Alameda St. Downey, Calif.*



Instead of walking the equivalent of a city block to his roadside mailbox, R. H. Bess of Downey, Calif., throws a switch on the front porch and the mailbox travels up to the door on an aerial cableway. An old sewing-machine motor in the top of the box drives it, picking up power from two suspended wires connected with the house electric circuit. The four wheels of the mailbox, which is made of wall-board for insulation, run on the wires, hung from poles erected on a direct line from porch to road. Forward and reverse gears permit two-way travel. A red light on the roadside post lights up when the box arrives there, signaling for the operator to turn off the current and halt the box.

*The mailbox of R. H. Bess at Downey, Calif., is really an electric trolley car. In the center it is seen traveling its aerial cable route from roadside terminal (upper right) to bring mail to front door, below*

*4397*

# Luggage Bag for Top of Automobile Has Large Capacity

*Can make for other in order*

Having a capacity of eleven cubic feet, a baggage carrier for the top of the automobile is handy for the tourist. The bag is sixty-two inches long, twenty-eight inches wide and thirteen inches deep. It has ample space for suitcases, bags, parcels, guns, fishing tackle, golf clubs and other baggage. Freshly cleaned and pressed garments may be carried without folding. The carrier may be installed on the car's roof in three minutes or removed in one minute. Stormproof and made streamline to reduce wind resistance, the bag fits the roof closely to eliminate friction and to prevent scarring. A separate bag, triangular in shape to fit into the streamline contour of the front of the other bag, provides space for odds and ends.



*Top, luggage ready to be packed in car. Bottom, packing bag on top of the automobile*

Send return postage to our Bureau of Information to learn the name of the maker of any device described in this magazine.

*Made by W.A. Rush, Arcade Bldg. Beatrice, Neb. for an auto*

# 'Mother' Plane Launches Small Ship in Midair

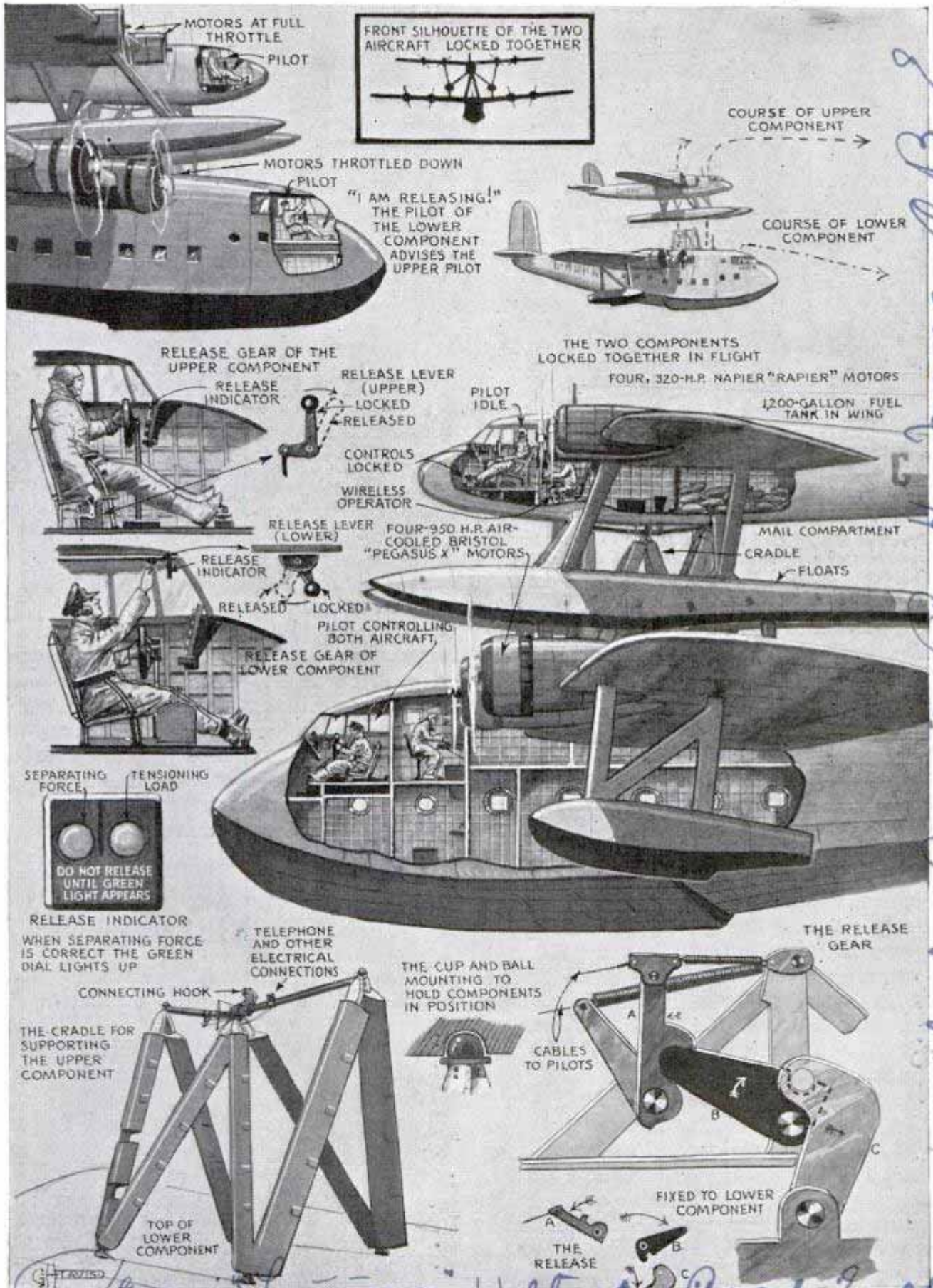

H. 29  
 Major G. H. Mayo  
 Technical Advisor  
 British Air Force



RELEASE INDICATOR  
WHEN SEPARATING FORCE IS CORRECT THE GREEN DIAL LIGHTS UP

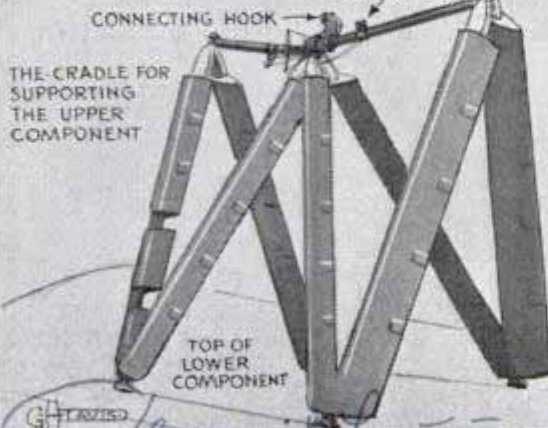

THE CRADLE FOR SUPPORTING THE UPPER COMPONENT

THE CUP AND BALL MOUNTING TO HOLD COMPONENTS IN POSITION

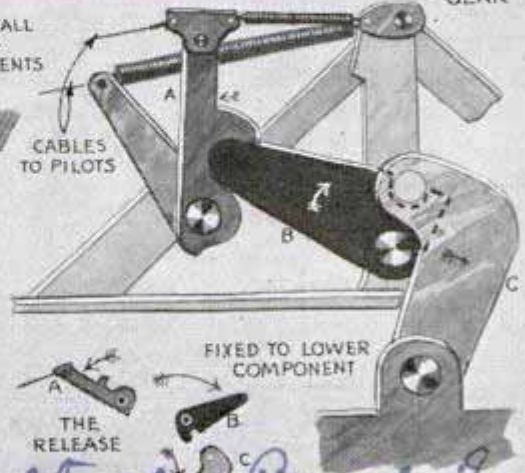

THE RELEASE GEAR

Drawings show how Mayo composite aircraft takes off as one, then separates into two planes, the smaller being launched from back of the "mother" ship. Tests of the British aircraft have been successful

Lt. J. G. Lemmers  
 141st St. Road, Cold  
 Surrey,  
 England

# Giant Floating Bridge to Carry Lake Traffic

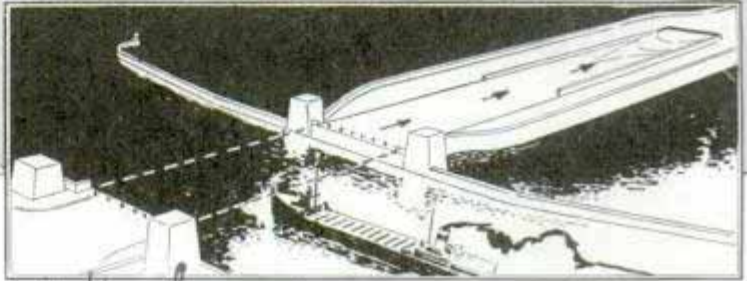
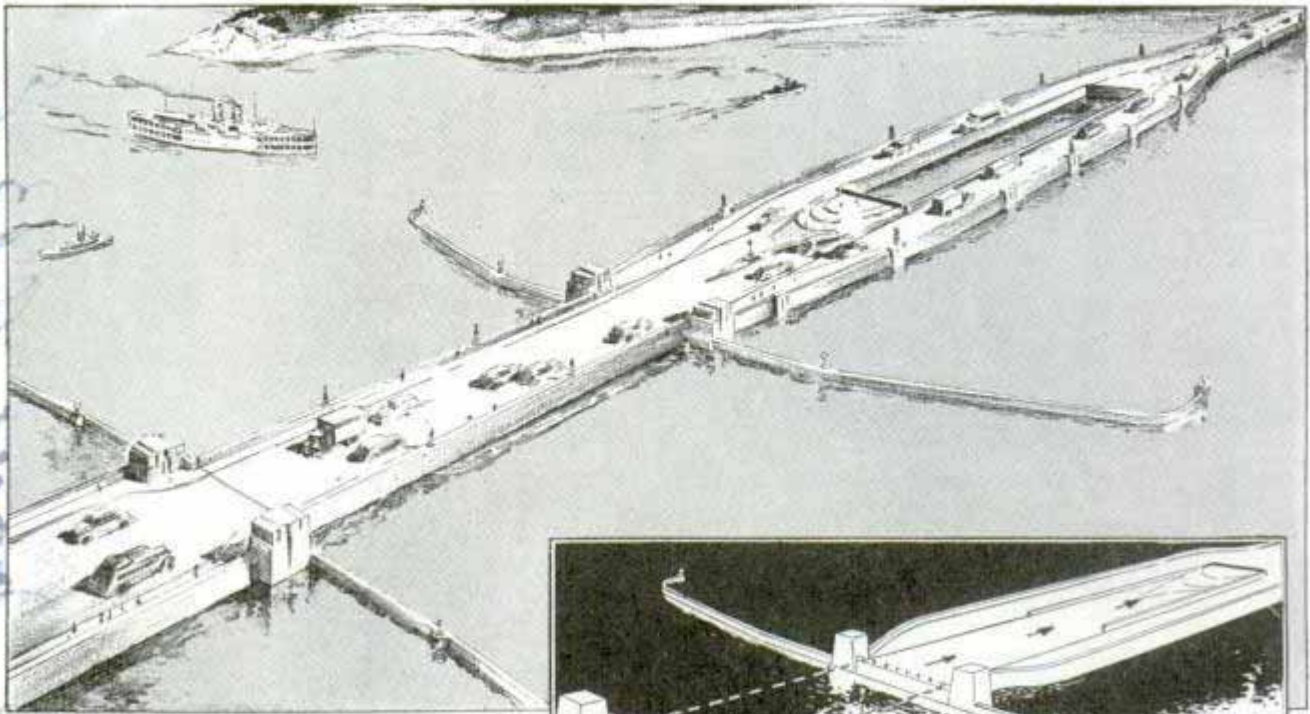

Sketch of the floating bridge. Inset, movable span drawn back. Arrows mark direction in which span is moved

Designed to carry four lanes of automobile traffic across Lake Washington at Seattle, a giant floating bridge is planned by the Washington State highway department. Because of the lake's depth of more than 200 feet and its soft muck bottom of fifty to 100 feet, engineers recommended the floating bridge as the only practical method of spanning the lake. The bridge will be 8,733 feet long, of which 5,671 feet will be composed of floating concrete pontoons, connecting Seattle on the west with Mercer island near the east shore. Each pontoon will be sixty feet wide and 310 feet long, with a draft of ten feet and a height of six feet from water line to deck. The concrete shell will be eight inches thick with six-inch intermediate walls dividing the pontoon into eighty sections. The pontoons will be anchored to concrete "dead men" in the lake bottom and connected so as to allow expansion and contraction of the concrete, but prevent vertical action. Engineers say there will be no appreciable movement, even under the most unusual conditions. Three or four wider pontoons will permit parking of automobiles without interfering with the flow of traffic. One feature of the bridge will be a 200-foot movable span that may be drawn back

into the structure to permit passage of large ships. Small craft will be able to pass beneath the bridge near the shore where approaches will have a horizontal clearance of about 150 feet. Articulation of the approaches with the first pontoons will be accomplished through water ballast kept at proper level within the pontoons by automatic electrically driven pumps.

H 386

## Bulk Film Winder for Camera Loads Strip in Daylight

Miniature camera owners can make use of the low-priced bulk film by loading it with a daylight film winder. It holds a 100-foot roll of bulk film, which must be put into the winder in the darkroom, but the transfer of ten, eighteen or thirty-six "frames" into the camera can be made in daylight. This winding device is dust-proof, and eliminates any danger of getting fingermarks or scratches on the film while it is being loaded.

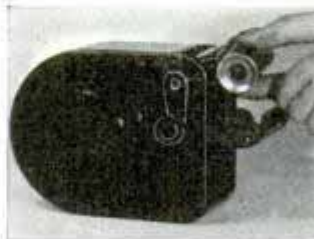

Washington Tollway Authority  
 Chief Engineer  
 Charles E. Anderson  
 H 383  
 Mr. Frank C. Hoag  
 2500 Smith Tower  
 Seattle, Wash.

Hortydale Stamps  
 Wash Hortydale Pa.



Cont. Emile C. Schürmacher

#341 727 Park Ave. New York City.

# NEWSPAPERS that TALK

Pat. # 2,063,870

"HURRY to Police Headquarters with the sound box. Get every word of that murderer's confession so our readers will be able to play it tonight when they see the pictures!"

Such assignments may become routine to the newspaper reporter and photographer of the future who will carry a portable recording device when he covers an important story. Every word of sound will be recorded on a film

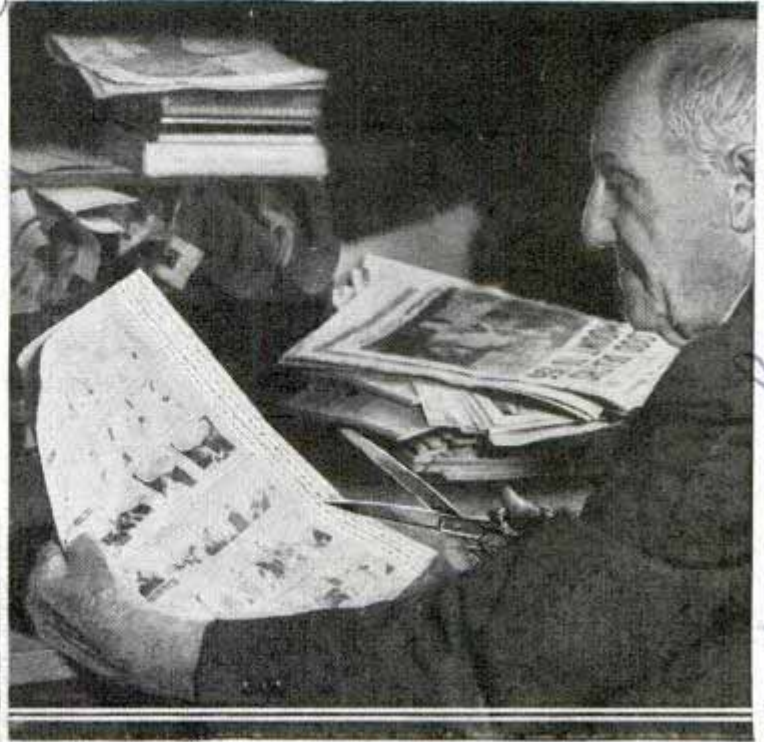

Top and bottom, cutting out sound track and pasting it into strip for reproducer. Center, typical sound feature page from which sound track would be taken

track which will be rushed to the newspaper office to be developed and printed. When the newspaper is bought that evening, it will have not only pictures and type matter but also a series of wavy lines constituting sound tracks, along the margin and, in some cases, on the page itself.

Cutting these sound tracks apart and pasting them together in a continuous strip, the reader will put them in an inexpensive reproducing device attached to his loud speaker. Then he will hear the murderer's confession—his children will hear the comic characters in the funny section talk, bark, quack and mew, and his wife, reading a travel article about Hawaii, will hear the soft accompaniment of guitars and ukuleles providing appropriate atmosphere.

Such will be the talking newspaper of the future as visualized by W. G. H. Finch, who has patented sound devices which will make possible the talking newspaper.

Repeated requests of young children to "please read me the funnies" and the desire to find a means whereby the blind could "read" a newspaper without setting it in Braille type were responsible largely

Telecommunicating Laboratories  
37 W. 57 St. New York

see March 1937 - 377

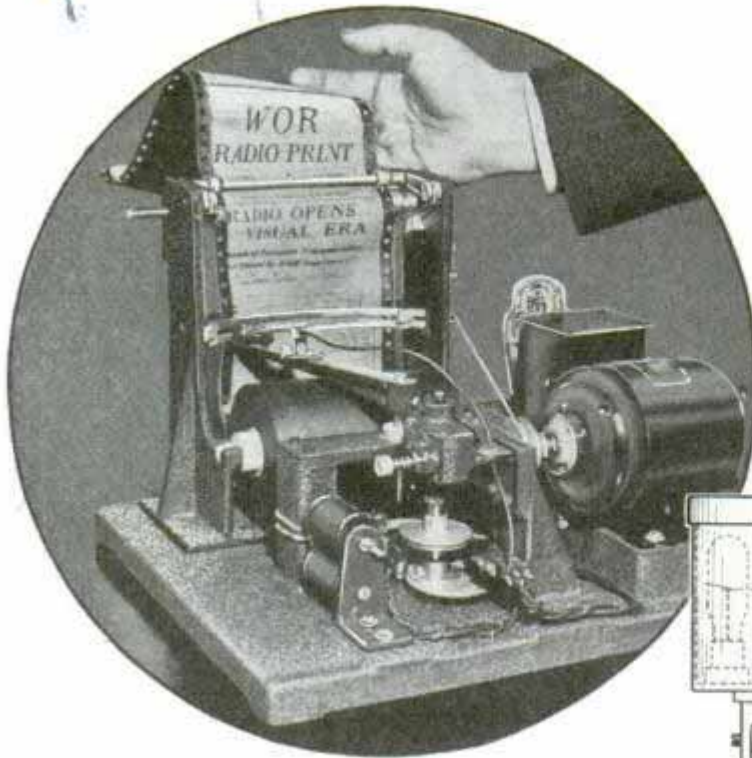

Left, facsimile recorder by which pictures and reading matter may be taken from the air and reproduced in home. Below, diagram of home reproducer. Bottom, another type of reproducer which handles sound track in spiral form

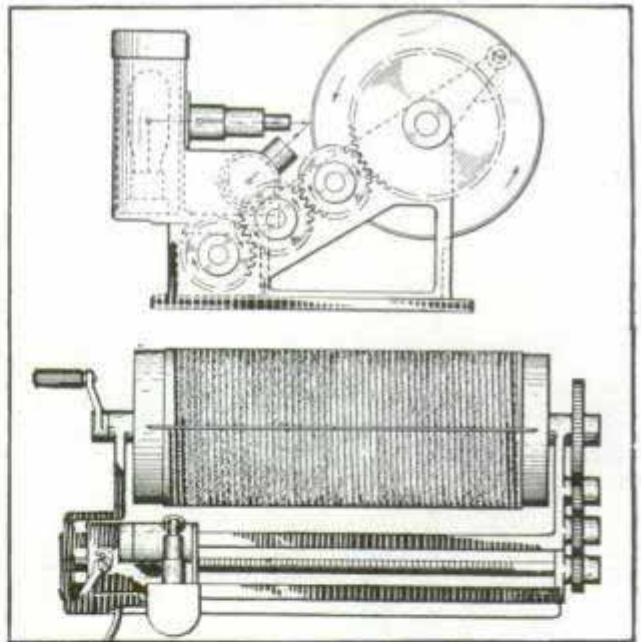
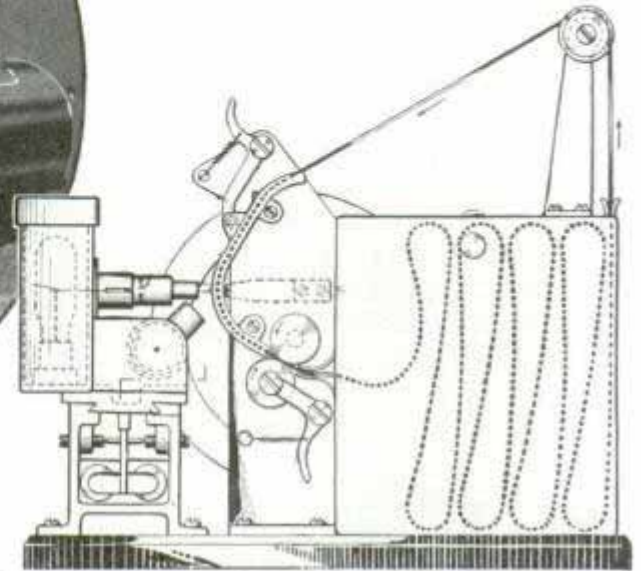

for the invention of the talking newspaper.

"The printing of the sound-track strip upon the newspaper itself is similar to the printing operation of any picture in the paper," Mr. Finch explains. "A zinc plate is made from the original sound track and the steps of printing a facsimile of the sound tracks upon the sheet is similar to the well-known practice.

"I prefer to provide perforations upon the border of the strip to define and simplify their removal more accurately. Although a single length of the strip may be employed for reproduction of the feature, modifications are provided whereby a series of strips are attached end to end to form a continuous belt of the sound tracks.

"A further modification employs sound tracks, arranged at an angle to the sheet, which are formed into a cylindrical sheet for reproduction whereby a continuous helical scanning operation is used for the reproduction. This modification may take the form of either a strip or sheet record."

According to Frederick Ehlert, Mr. Finch's associate, the home reproducing equipment may be sold for a surprisingly low price. A newspaper that adds talkies to its printed words may purchase a master recorder for \$1,000 to \$1,500. As the editorial talkie assignments begin to cover sensational news and features not recorded in the office, portable recorders will be added for reporters and photographers to

carry, just as photographers for news picture services now take picture-sending devices, enabling them to wire their pictures back to the office.

Mr. Finch foresees the need of a similar service and intends to try sending facsimiles of sound waves. If this proves practical, it will be possible for a newspaper photographer and reporter covering an earthquake in California to send to a New York newspaper, by radio or telephone,

(Continued to page 153A)

434  
 1934  
 21.00.12  
 1934

Es 1550 Cmt. Charles Morrow Wilson  
Hotel Brevoort, 5th Ave and 8th St New York



# DON'T PITY *the* POOR FISH

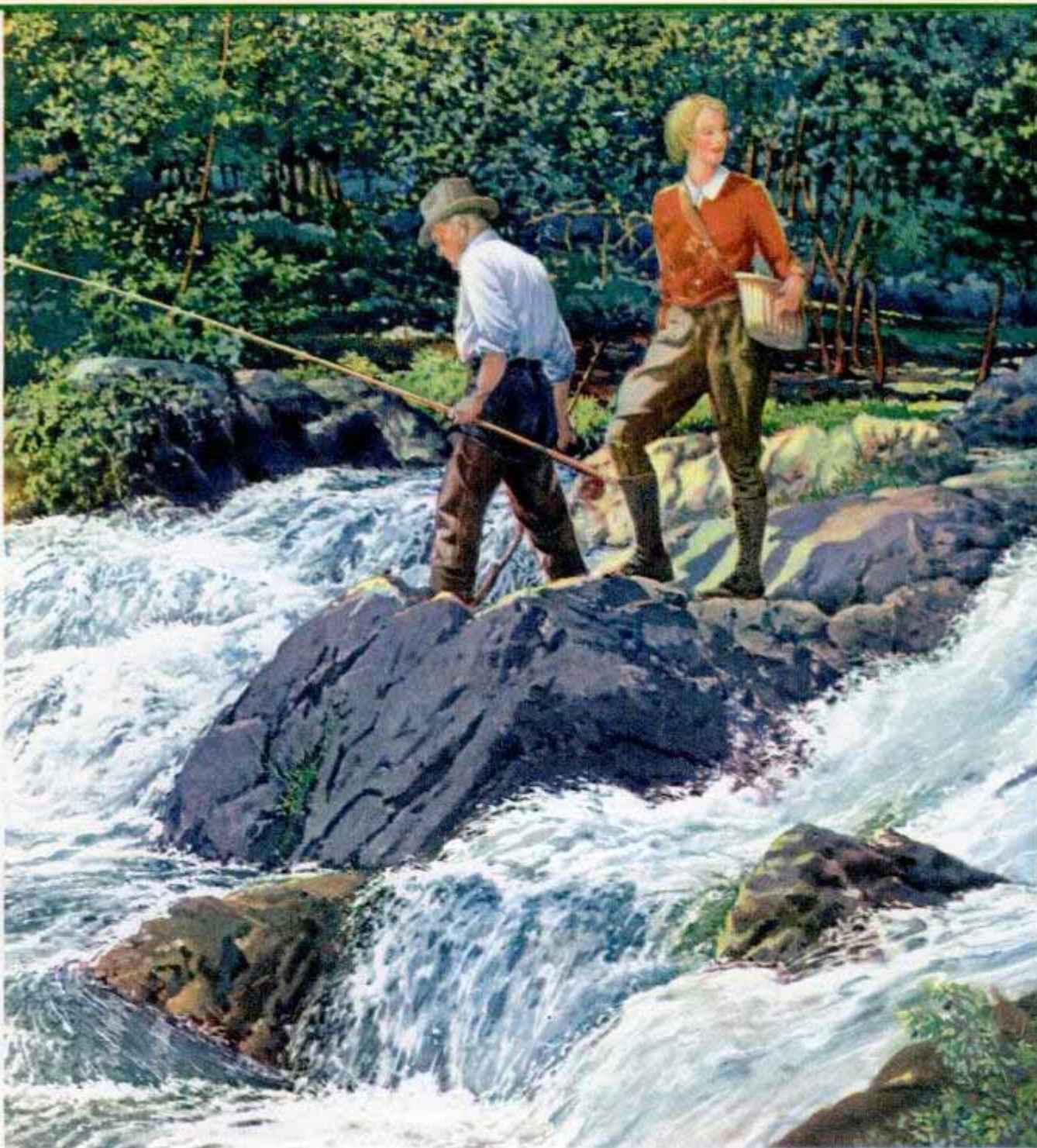

809

COLD, swift water like this with a temperature ranging between fifty-five and sixty degrees is ideal for trout.



**DON'T** be surprised when you catch a trout with a "calling card," an identification tag attached at the hatchery.

By Charles Morrow Wilson

**T**HERE is no longer any need to pity the "poor fish" because today there are fish with calling cards, fish doctors, surgeons, and dieticians, water-conditioned buses for fish, trout engineers and architects, fish elevators, modern rest rooms or pools for trout and home-coming days for wandering salmon.

These are a few of the piscatorial wonders which meet the opening of what will probably be the greatest angling season in history. Taxpayers are handing out tithe to trout whether they fish or don't fish. Each year anglers pay about \$100,000,000 for fishing licenses, rods and tackle. But that's only part of the story.

Federal and state governments now maintain about 469 trout hatcheries or rearing stations in thirty-one states.

Public money pays for these and the fish produced are planted in more than 91,000 fresh-water rivers, streams, ponds and lakes. Private trout-growing establishments have become a \$50,000,000 industry.

Maine, with more than 7,500 inland bodies of water, now leads the world in state rearing and hatching of trout. Maine's cash income from trout fishing is estimated as \$30,000,000 a year. In order to keep up this resource Maine operates fourteen trout hatcheries and twenty-six rearing stations to raise and "plant" about 20,000,000 trout a year—supposedly enough fish to supply the maximum catch to 4,000,000 anglers. The trout average about five inches in length, minimum catch size, when taken from the rearing pools. Production cost is about one cent an inch.

277330

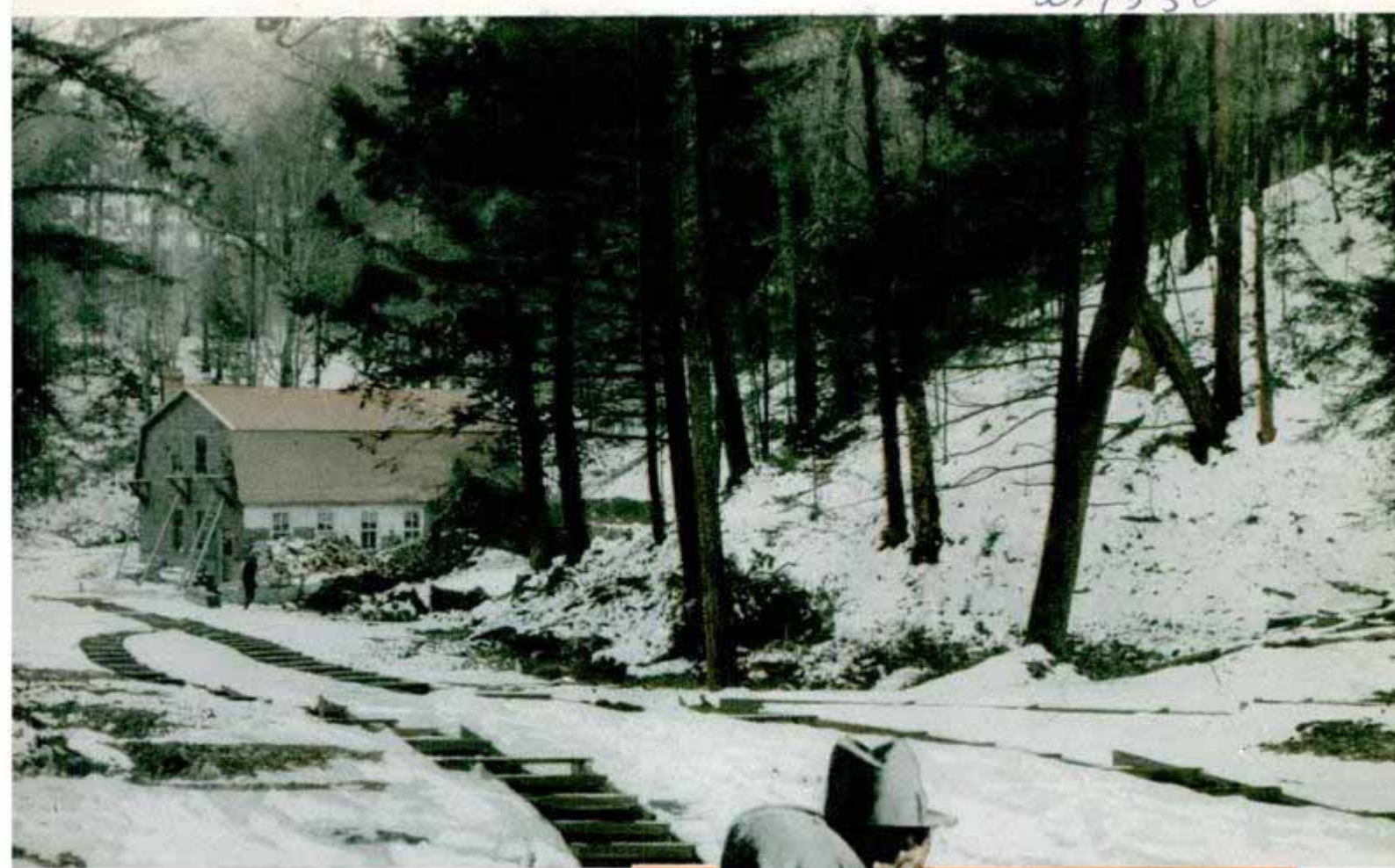

Modern hatcheries produce good minnows from seventy to eighty-five per cent of the eggs. In natural surroundings only ten to fifteen per cent of trout eggs ever hatch. Trout hatchery losses of minnows from disease and suffocation now average about five per cent. Natural losses from these same causes are thought to be about fifty per cent. Carl H. Crane, directing architect for the Maine trout stations, is perhaps the first to earn the title of professional fish architect. Both our government and Canada have requested permission to copy his designs, which include five-million-egg hatcheries and more than thirty miles of sand-bottom spillways.

Dr. E. B. Mann of Maine University is probably first to rate the title of physician and surgeon of trout. He supervises trout health and sanitary conditions, isolates contagious trout diseases, and directs autopsies on fish which die in the rearing pool. Hatchery-raised trout are far healthier than the native or "wild" fish which are the principal source of disease.



8/1

*Esray,*  
**STRIPPING** eggs from fish for later hatching. State trout hatchery in Maine, above, where about 5,000,000 trout are produced each year.

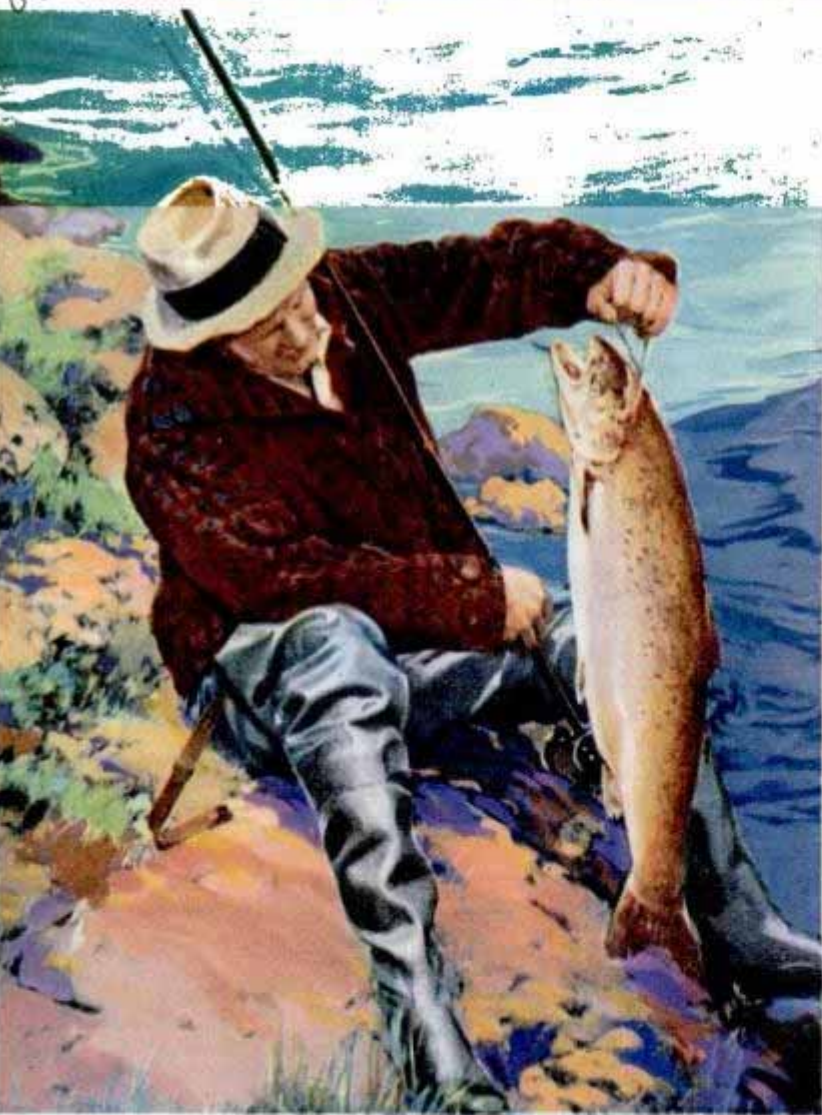

**A SALMON** like this is a worthy foe for any angler. Top, the government and the various states spend millions each year to further this sport.

Trout dieticians are extremely busy selecting the right vitamins for these fish. In earlier days, ground liver and wheat bran were thought to be an ideal feed. This ration is now largely discarded.

The modern menu for trout starts the young minnows on a straight diet of ground beef and pork liver, followed by ground beef heart and "melts" and salmon egg meal, imported largely from Japan. Protein content must be high—from twenty-two to twenty-six per cent of volume—the fat content must be low, and the water content must be at least seventy per cent of volume.

Feeding baby trout the modern way is more detailed and exacting than feeding human babies. After three months the ration begins shifting to sea foods. The trout is a cannibal by nature. He grows big by eating smaller fish. Heretofore it had been thought that no fresh-water fish could thrive on salt-water fish. Modern trout dieticians are disproving this belief. After the third month the ration includes such seafish as whiting, cod, sole, and herring. These are ground or chopped.

201550



The seafood ration grows a five-inch trout in nine or ten months. Successful use of seafood for fresh-water fish is of particular interest to naturalists. Some believe it indicates that all fish life came originally from a salt-water source and that by degrees certain salt-water fish may be adapted to fresh water for the benefit of inland anglers. The salmon which, next to trout, is our most valuable fish, is an instance of a great sea crop which migrates hundreds of miles to spawn in fresh water, often far inland.

Modern quality standards for trout feeding puts the average commercial restaurant or hotel to shame. Sea fish must be iced on the fishing boats and as soon as the boat is docked they must be transferred to refrigerating plants where the food is frozen and held at sub-zero temperatures until feeding time. Beef and other animal meats must also pass the standard packing inspection and remain closely covered in cold storage until use. Maine now owns and operates a modern refrigeration plant for exclusive use of the trout crop.

Mr. Trout is subject to more respiratory diseases than



**TRANSFERRING** trout from oxygen-charged tanks on truck to Maine lake after checking to see that tank and stream temperatures are the same.



27530  
 seem to result merely from warm water, or abrupt changes in stream temperatures. Expert nursemaids to trout are therefore never without thermometers. In taking trout from the hatchery to open streams workmen first check the temperature of the tank in which the live fish are shipped, then check the temperature of the open stream, then heat or cool the tank until the two temperatures check.

State fishery departments of Wisconsin, Michigan, and Maine, co-operating with the U. S. Bureau of fisheries, use a type of oxygen-tank truck for transporting planting stock from hatcheries to streams. These trucks carry a central tank made up of from twelve to twenty watertight cylinder berths which are made of non-tarnishing metal and connected with overhead oxygen hoses.

814  
 TRAPPING fish, above, to be used for breeding purposes. Right, spillway system at Maine trout hatchery.

*dry mills*

a human and to contagions which can destroy an entire trout population within a few days. So fish physicians are studying problems of temperature and channels. It is now a known fact that trout do not thrive in water with a temperature higher than sixty-eight degrees. But fifty-five to sixty degrees is the ideal trout temperature, and winter and summer averages should never vary more than five degrees. This is why the best trout streams should be fed by numerous surface springs which are nature's own thermostats.

So here's a good trout-catching tip. When you go fishing, take a liquid thermometer and check stream temperatures. Also remember that a trout judges bait or tackle more by color than by odor or taste. His eye is his best developed organ.

Many trout diseases and infections

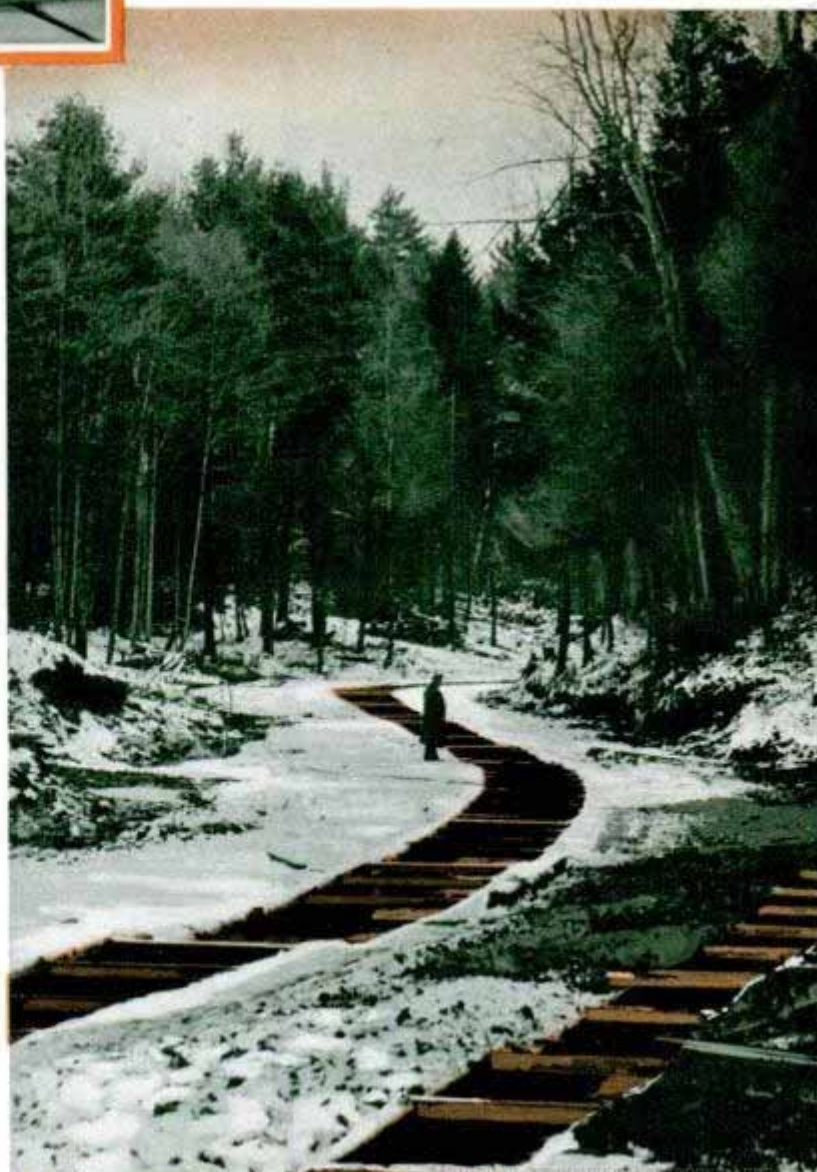





2  
6  
815

Oxygen chambers are stored at the base of the tank and a compressor attached to the truck motor keeps fresh oxygen circulating continuously in all vats.

In this way the planting stock can be shipped for several hours without suffocation losses, which would otherwise be ruinous. But there is still demand for improvement. Chunky, highly muscular fish such as bass, literally pound themselves to death in their anxiety to break free.

Oxygen is at a premium with trout and with practically all game fish. Rapid currents and small waterfalls tend to keep up the oxygen content. This introduces the rest room for trout. At the base of each spillway in the new-style rearing station is a pool of quiet water where the trout can "linger a while" before taking the next lap upstream. It has been discovered that a continuous strong current can literally tire a young trout to death.

Trout experts are now returning to natural sand bottoms for spillways and rearing pools. There's no cement channel in Maine's new super-stations for trout. Spillways are dug in native sand

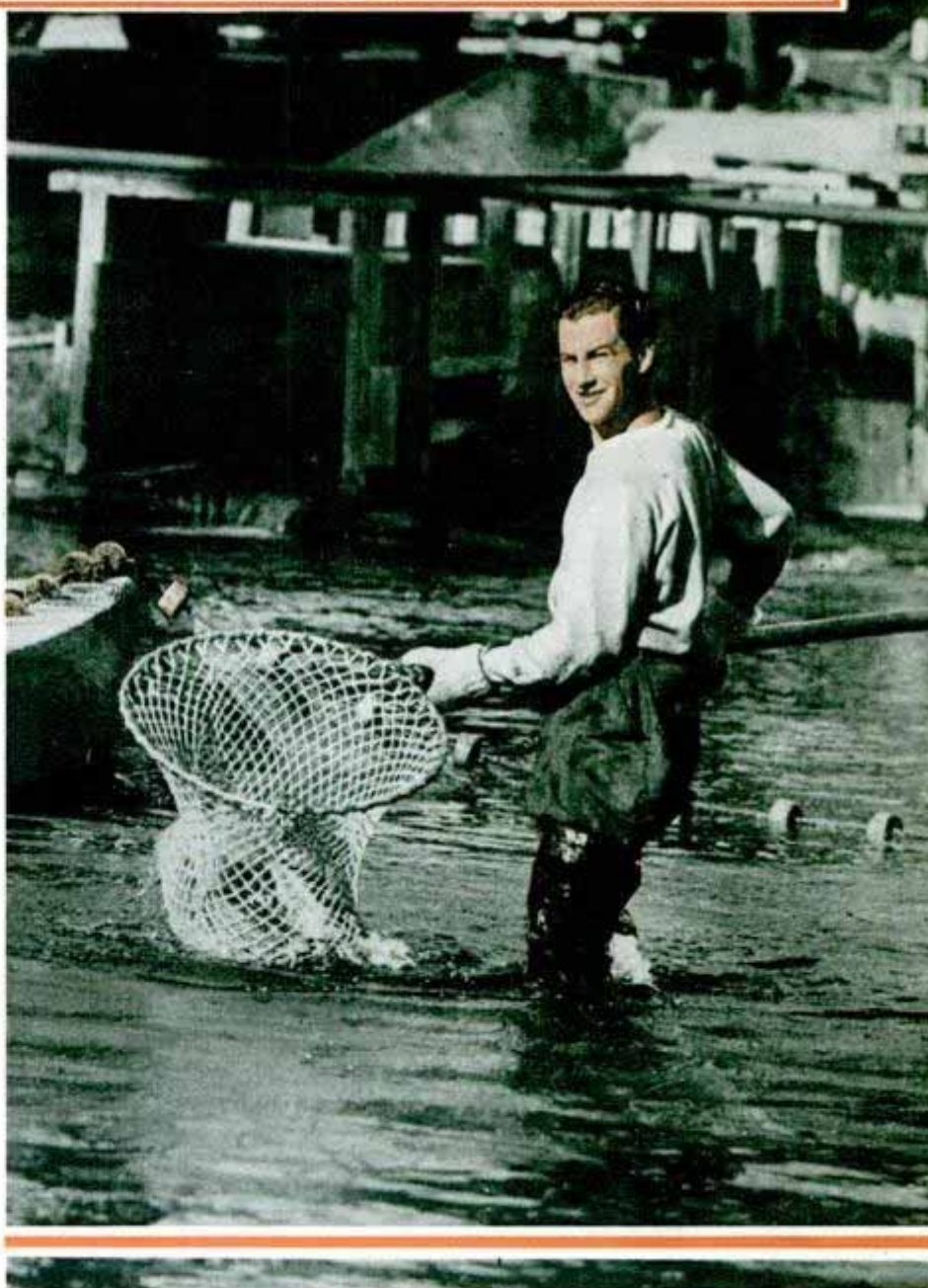

**SELECTING** fish to be used for breeding purposes at a hatchery. Above, setting a "weir" to trap wild trout for later propagation at a state hatchery.

85918

876

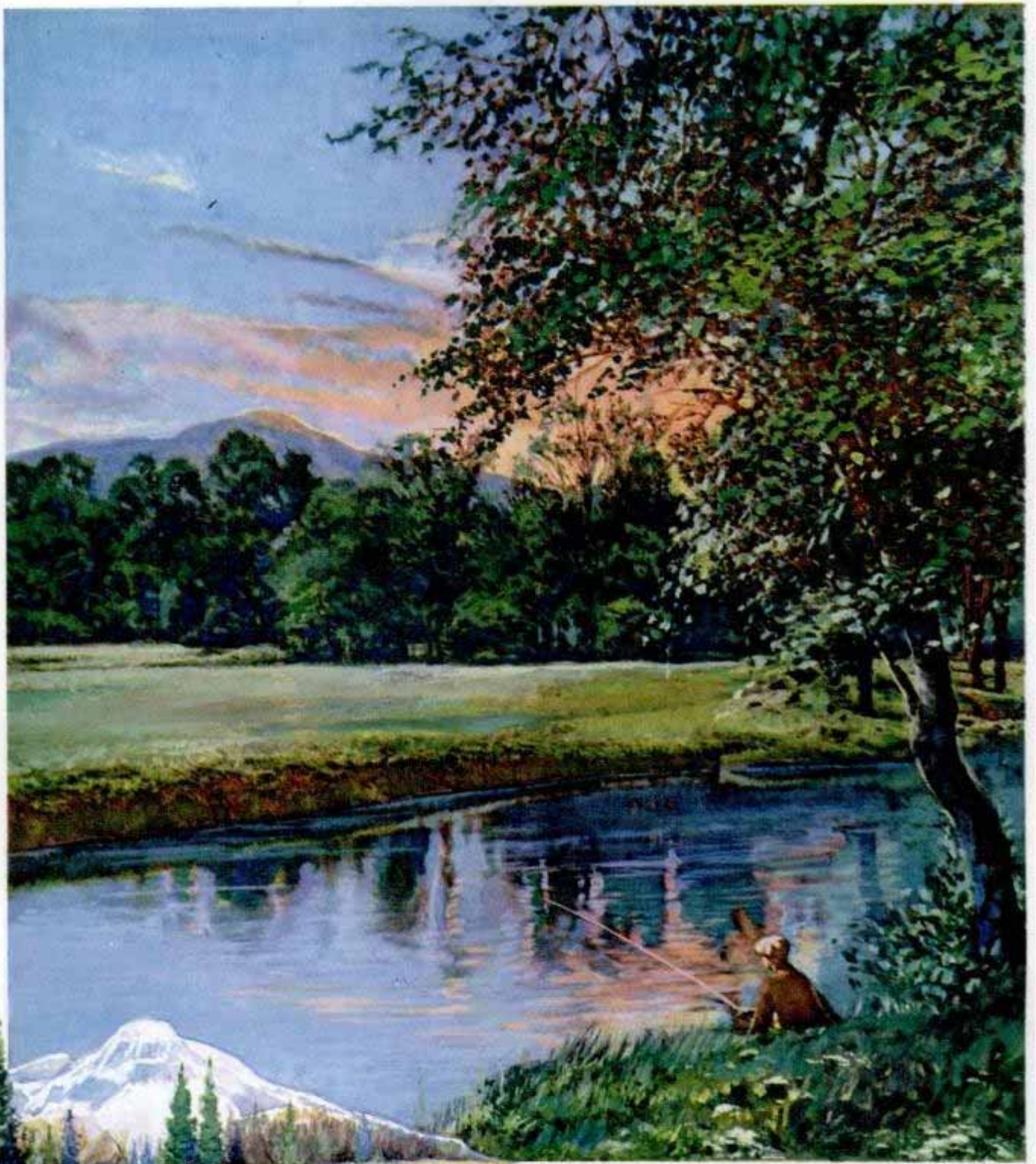

ONE of the 92,000 rivers and streams of the United States now being stocked with game fish from either federal or state hatcheries.

and gravel and fed by surface springs. Systems of gate-locks keep trout of approximately the same age and size in a given spillway—about 5,000 fish to the "block." This prevents cannibalism.

The earlier practice of stocking trout streams with fifth-stage minnows or "fingerlings" is also outdated. Experiment has proven that such planting does

little more than provide the adult trout with a good meal. The five-inch size, however, succeeds reasonably well in taking care of itself in open water, particularly when planted in the spring-time. Experts believe that about sixty per cent of possible trout streams of the United States are now contaminated by sewage or (Continued to page 128A)

# Mechanical Batter Tests Liveliness of Balls

There was no cheering from crowded grandstands when the first home runs of the year soared over the center field wall. A baseball "cannon" was the batter. The American and National leagues wanted an accurate check on the relative liveliness of the official baseballs, and the U. S. Bureau of Standards devised a mechanical batter to make the tests. It smacked a couple of balls more than 530 feet. The series of tests proved that the National League ball was quite as lively as the American League ball.

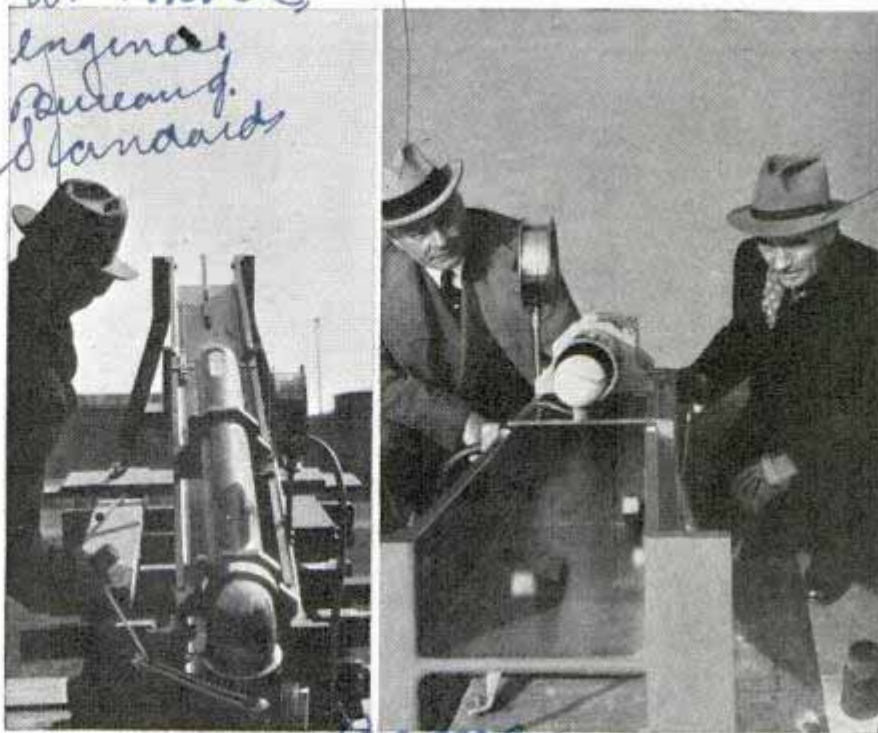

Baseballs are the bullets fed to this cannon, developed at the Bureau of Standards to test the liveliness of balls used in the big leagues this year

# Boy's Hobby of Bottling Snakes Pays Way through School

Six years ago a Chicago schoolboy began collecting snakes, frogs and insects. He did it purely as a hobby at first, hunting the specimens and preserving them. When

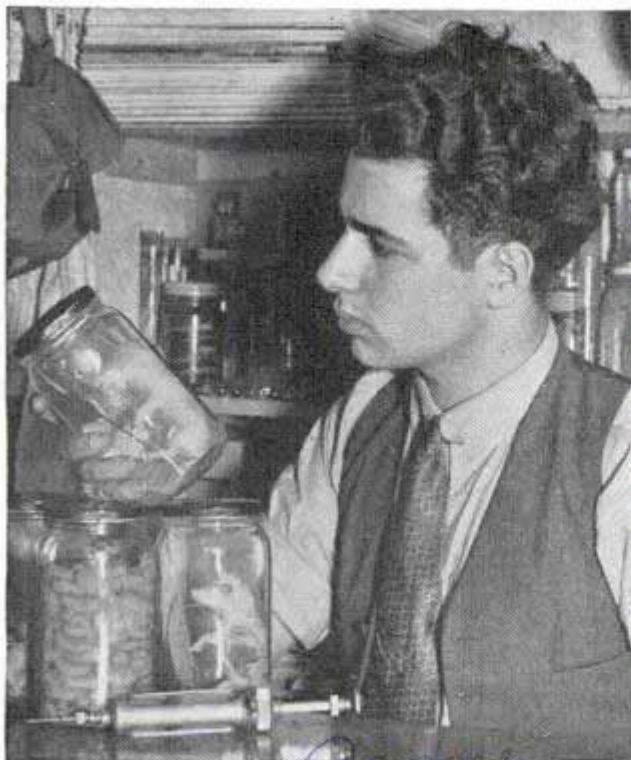

This Chicago schoolboy made a paying business of collecting and preserving animal specimens for sale

he entered high school he found there was a market for these preserved specimens in schools, colleges and scientific institutions, and he began selling them. Later he added animal embryos to his stock, obtaining them from the stockyards, and now he has banked enough money to pay for a college education and is earning his living at what used to be his hobby.

# Sky Liner Contains Ton of Steel Despite New Light Alloys

Construction of today's giant air transports has gone hand in hand with the development of light alloys, but steel has by no means been eliminated. More than seventeen per cent of the basic weight of the big planes consists of steel. There is about a ton of steel in the twenty-one passenger liner, appearing in more than a score of alloys. Aluminum and magnesium find increasing uses in the airplane factories, magnesium alloys going into landing wheels and engine parts. As much as 150 pounds—the weight of a passenger—can be saved by using magnesium alloys in the landing wheels of the largest planes.

Samuel Sorkin  
3444 Dr. P. S.

How Chemical Co.  
Midland Mich.

*H 328*  
*Secretary, Treasurer, Eddie Lyndon, Senators*  
*W.C. Mack, Engineer, Bureau of Standards*  
*H 344*  
*tested at Russell Hudson*  
*H 351*  
*Ref: J. Richardson Langley Aircraft Co. Coldwater, Mich.*  
*Sept 11/18*

H 3 20  
McNamee newspaper  
220 E 42nd, New York  
photos.

# The LATEST

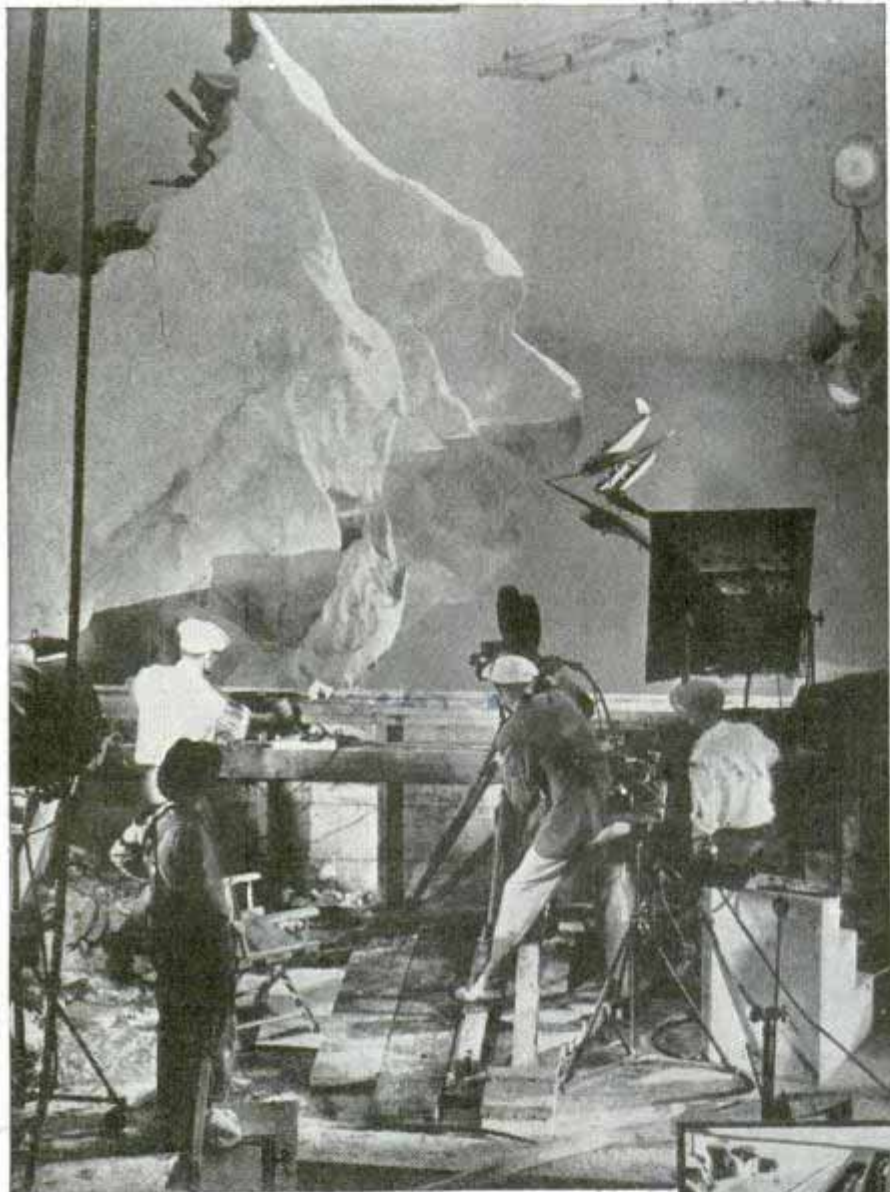

tion room. One scene showed an airplane landing on a plantation field after dark and then taking off again.

"That's real," the aviator decided. "It was made with a real airplane because you could see what the pilot was doing. Did you notice how he leveled off too soon for his landing and then nosed down again? And on the take-off, how the wing tilted over and he corrected it with his stick?"

"Sure, I did," Fulton answered, "and believe me, it was hard to get those little touches of realism into the picture. That airplane was really a four-foot model moved by invisible wires that also carried the current to blink the lights and spin the motor. We handled the airplane like a marionette on strings. All

AT THE movies a few years ago you saw many scenes so crude that you could tell they had been filmed in miniature or by some other trick process. Today more scenes than ever are being manufactured instead of acted, but audiences rarely can pick them out. Motion-picture trick men are fooling the experts.

Recently naval aviators were discussing trick work with John P. Fulton, motion-picture special effects director. One of them declared that he could spot fake airplane shots by little flaws apparent to any flyer.

"All right," Fulton said, "let's see how good you are." From the studio's film library he obtained a print of "Wings Over Honolulu" and had it run off in a projec-



Top, filming miniature plane gliding into water out of control. Bottom, dummy to be used in filming delayed parachute jump

# MOVIE THRILLS

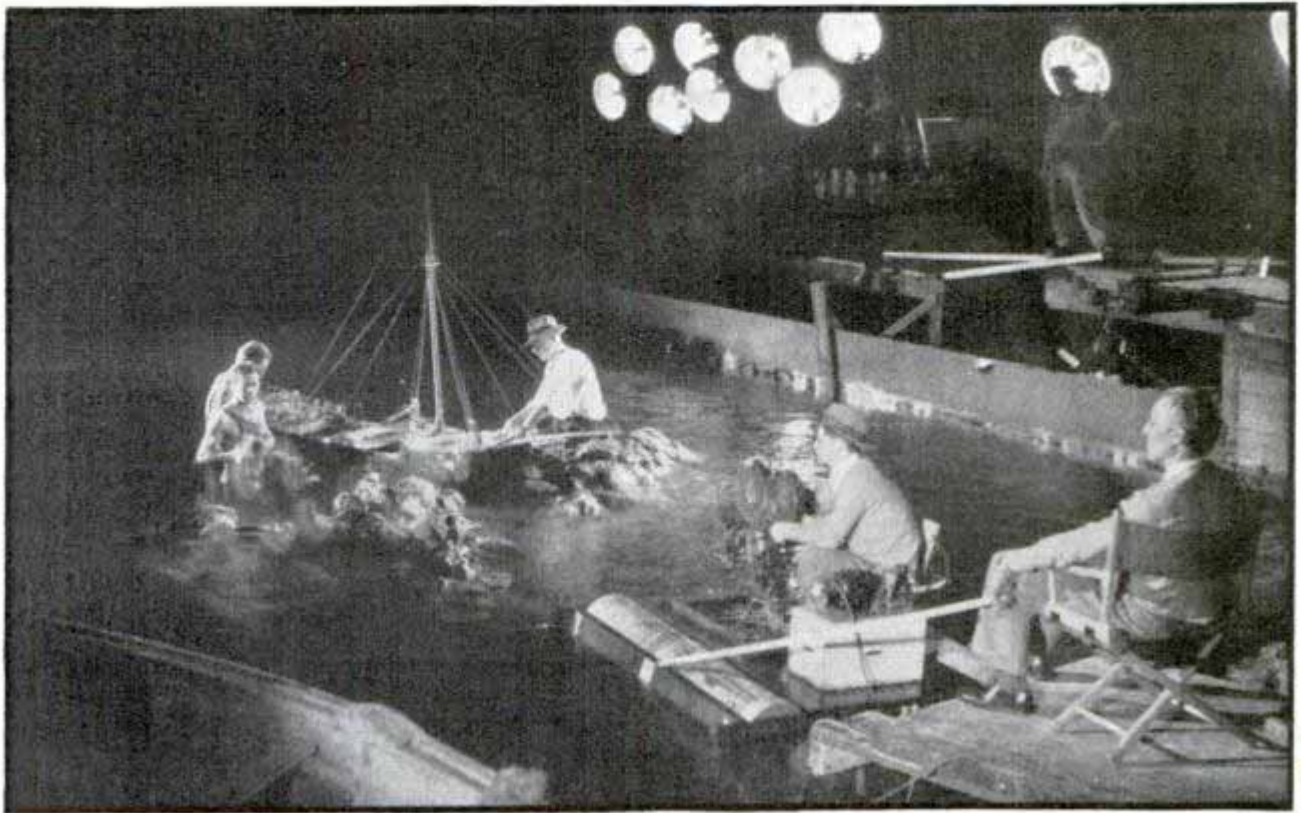

the scenery that you saw was made to the same scale and we put the camera lens right down on the ground to get the right perspective."

Another scene showed an amphibian, out of fuel in the fog, crash into a wharf while making a forced landing. The aviators held their breaths when the plane crashed and then decided that the studio had hired

a stunt pilot to wreck the plane. But, Fulton explained, it was far too dangerous for a stunt man and besides, there wouldn't be enough light in a real fog for the camera to record the crash. The amphibian was another model. Before the picture was filmed parts of the airplane and parts of the wharf were broken off and then lightly glued back into place. When ev-



Top, preparing model ship for wreck scene in tank. Bottom, left, movie of ocean used as background for beach scene. Right, set complete except for ocean, which is provided by movie projected on background screen covering black area

Reference: John D. Fulton's movie 15-21 most things for aviators.

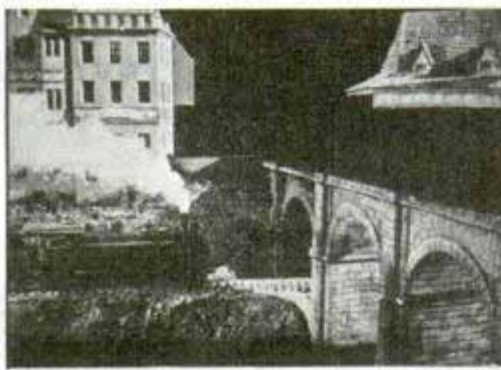
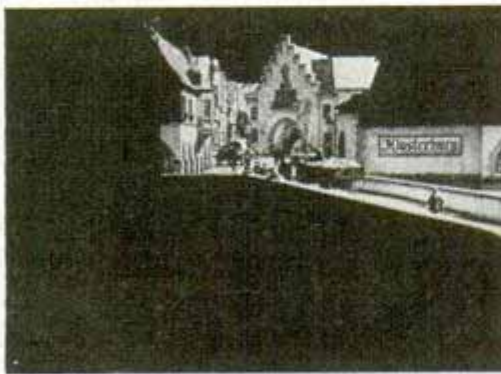

everything was ready, men on an overhead carriage lowered the miniature amphibian into the scene by its wires. To the camera it looked like the pilot was circling down through the fog to the water.

Fulton wanted a realistic crash but the wires holding up the plane interfered with it, so he stretched another thin wire across the flight path, charged with the same current as the wires holding up the plane. The short circuit that resulted when the wires touched blew out a fuse inside the model, releasing its suspension wires and allowing it to continue its glide in free flight. That let it crash into the wharf realistically. The "break-away" parts and timbers flew into the air and then the plane flipped over on its back in the water exactly as planned.

Trick work is necessary in pictures because many scenes would be impossible to catch otherwise. Another airplane picture called for a close-up shot showing the crumpling of a big transport's landing gear as it came in contact with the top of a telephone pole. To do that in real life would mean wrecking a big airplane, yet Fulton produced a perfect picture in a couple of days. On the floor of a stage he erected a small telephone pole and beneath an overhead carriage that traveled past the pole he constructed an airplane landing gear, wheel and part of the wing. Everything was built to one-quarter scale. An automatic camera was tied to the overhead carriage and the carriage was moved across the stage at twenty-five miles per hour. The wheel crashed into the top of the pole, splintering the pole and damaging the landing gear, and the crash tripped the locks that held the carriage in the



Left, top to bottom, strip showing how composite motion picture is created by using parts of a number of different scenes. The bottom scene is the composite. Right, preparing to film take-off of miniature plane controlled by overhead wires

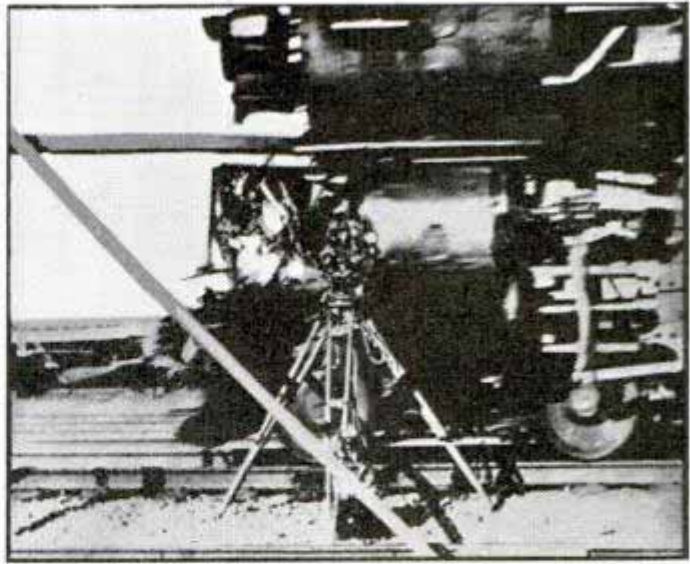
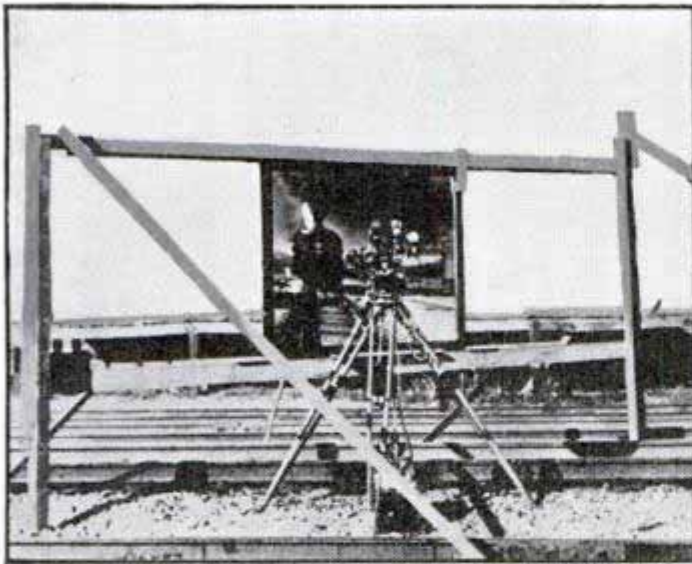

air. The whole assembly fell to the floor where the landing gear crumpled up and broke, just as it would have on a real airplane. The camera caught every detail.

Crashing an airplane or sinking a ship sometimes is best done with models but other times full-scale sections are built and rocked on the stage while actors go through their work. Some scenes that you see on the screen are composites manufactured in the laboratory by joining together parts of scenes taken from different strips of film. A good example appeared in "The Road Back." The script called for a scene showing part of a German town, with a train passing under a bridge in the foreground. To have built the full set would have cost much more than the scene was worth, so Fulton created it by combining five different strips of film. One strip was made of part of a set showing a street and buildings. Frame by frame, all of the scenery in the film

(Continued to page 132A)



Top, two views showing how locomotive is filmed close up with mirror. Center, spectacular crash of two miniature planes. Bottom, realistic appearance of planes after crash

# Glass Swimming Pool Has Windows in Floor

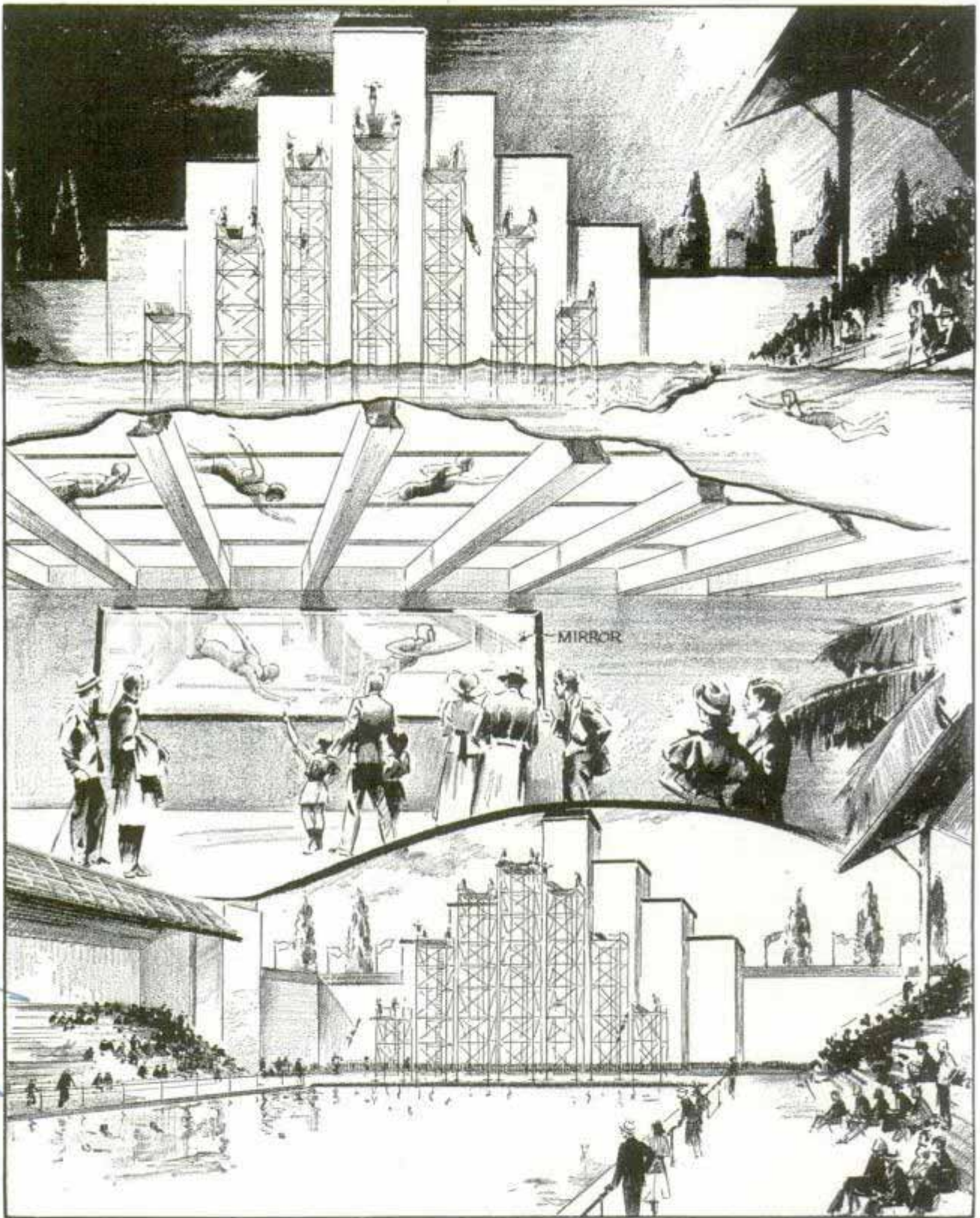

*Underwater galleries will permit spectators to watch diving and swimming exhibitions from beneath the pool to be built at the San Francisco fair in 1939. Diving towers will have springboards of plastic glass*

Visitors to the glass "swimming bowl" planned for the Golden Gate exposition in 1939 will watch speed stars and divers from beneath the windowed floor and from gal-

leries along the sides of the pool. Six-foot square panels of glass an inch thick will form the bottom, and tilted mirrored walls will allow full vision of the tank above. The

585 Beach St. San Francisco, Calif.  
 Architect - Mark Hamble, San Francisco

H 3 7 6



entrance foyer will be under the shallow end of the pool. From there the visitor proceeds to the mezzanine, with its observation galleries providing a view under the water through glass panels five feet high and sixty feet long. The pool itself will be fifty-five by 110 feet, fourteen feet deep at the diving end. There will be five towers and seven diving boards of plastic glass which must meet all the standard requirements for intercollegiate diving events. Even the backdrops behind the diving platforms will be made of glass, dramatically lighted by neon tubing. There will be seats for 2,000 spectators, who can be protected from rain by a movable glass roof.

## Streamline Rail Speedster Latest on Foreign Railways

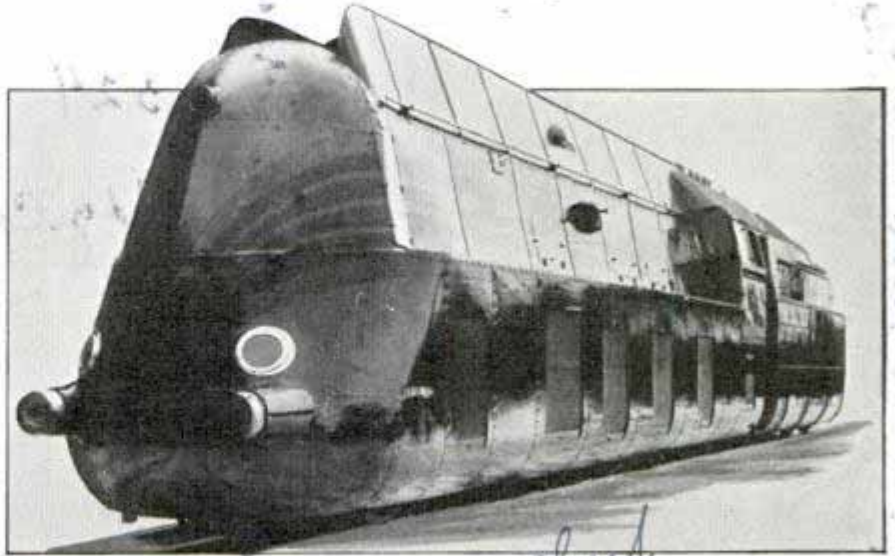

Latest of the foreign-made streamline locomotives. Note how the wheels have been covered and the pilot eliminated

Constructed with the smoothly flowing lines of many locomotives in the United States, a giant locomotive was placed in operation recently in Czechoslovakia. A hood or cover conceals practically all working parts, giving the locomotive a streamline appearance. This is the first streamliner to be put in service by the Czechoslovakian State railway.

## Shaded Light on Car Sun Visor Aids in Reading Maps



Two views of sun visor light in use. Its rays can be directed by moving the sun visor

Ease in reading road maps at night is afforded the motorist by an electric lamp attached to the sun visor of the car. The light is controlled by a switch on the instrument panel. Shaded to direct illumination where desired, the lamp also is a convenience to the woman driver in arranging her hair or applying cosmetics.

## Shooting Gallery Uses Movie of Game as Target

Original motion-picture film showing game in the forest is used in a shooting gallery introduced in Germany. The device is so constructed that when a shot is fired, the film stops and a bright light appears where the bullet hit. The film targets are being used by police and army shooting schools.

Send return postage to our Bureau of Information to learn the name of the maker of any device described in this magazine.

*W. Herman L. Gallup,  
530 Leades Bldg. Cleveland, Ohio*

*International Trucking  
Exhibition Berlin*

*copy of comment  
memo  
12/12/38*

*H 3 2 7*

*H 3 4 3*

*H 2 4*

### Grip on Hoist Holds Auto as Service Man Works



Top, showing how firmly auto is held. Bottom, preparing to hoist the car

While the automobile is elevated on the lubrication or servicing hoist, it may be held safely by a new gripping device. After the car is driven on the hoist, the clamps or jaws of the grip are turned up and clamped on the rear axle. A long-handled crank is used, making it unnecessary for the operator to crawl under the car. When the hoist is raised, the automobile may be rocked with a pry bar, in forcing grease through bearings and springs, without danger of the car falling.

### Plane Image on Dial Shows Pilot Position of Landing Wheels

Glancing at a picture of his ship on its own instrument board, an airplane pilot can see the exact position of his landing gear and wing flaps. This latest type of dial outlines the plane in white against a

black background. As the pilot approaches an airport and lowers the wheels and flaps to landing position, the wheels and flaps of the phantom plane on the indicator follow an identical course and the pilot can visualize their position.

### Hand Tool Pulls Railroad Ties Like Opening Desk Drawer

Railroad ties are pulled out for replacement today almost as easily as you pull open a desk drawer. Instead of the old method of digging out the roadbed, lifting the rail and removing the tie, a hand lever operated by one man does the job without disturbing the track. It is butted to the lower part of the rail, and a set of bull teeth bite into the tie. When the lever is pulled on a pawl ratchet system the tie is drawn out, leaving a clean hole into which the new tie can be slipped, and only the spikes and plates need to be replaced.



### Cable Car Rides above Flood in California Canyon

Floods may come but rarely in the canyons that empty into the San Fernando valley of California, but there is always a



Crossing the flooded Big Tujunga canyon above Sunland, Calif., in cable car well protected from rain

H 291  
 Eng. 973 d  
 Toward of  
 main St. All Lake City Utah

H 329  
 Oddy Chess  
 Track Equipment Corp. 640 McCormick

General Electric  
 Renewed  
 Schenck & Co. by

H 332

clad

cable car ready for emergency crossings when high water hits the Big Tujung canyon above Sunland. With a raging river below and a torrent of rain overhead, it is still snug and dry inside the glorified "breeches buoy" swinging across from bank to bank with passengers.

*H 325*  
**Slate Cutting Tool  
 Speeds Work  
 of Roofers**

Roofing work is simplified and speeded up by a new combination slate and asbestos shingle cutter and punch. Weighing five and one-half pounds, the tool cuts roofing slate



and asbestos any length or width and cuts up to and including one-quarter inch thickness. It cuts round corners and right angles, utilizing all pieces. Any carpenter or laborer, using the tool, can cut slate on the job and place it on the roofs of buildings under construction. Little experience is necessary for handling the cutter efficiently. It is made for long wear and service, its frame being malleable iron and the knife and punch point made of special selected steel, heat treated.

*H 311*  
**Decoy Plane to Fool Enemy  
 Is Made of Matting and Reeds**



*Gene*  
 Japanese soldiers examining dummy airplane left by the Chinese troops

Made of Chinese reed and matting, decoy planes to fool enemy air raiders were found recently when Japanese soldiers captured Pengpu airdrome, Anhwei province, China. The dummy aircraft were intended to draw Japanese aerial bombardment away from the airport.

*A 265*  
**Tennis Game Played on Roller Skates  
 Requires Exceptional Skill**

Introduced at a western college, tennis on roller skates is the latest game. Besides adding excitement to the game of tennis, it calls for real skill. Players must be able to maintain their balance on the skates and also to hit the ball as they race from side to side or from backcourt to the net.

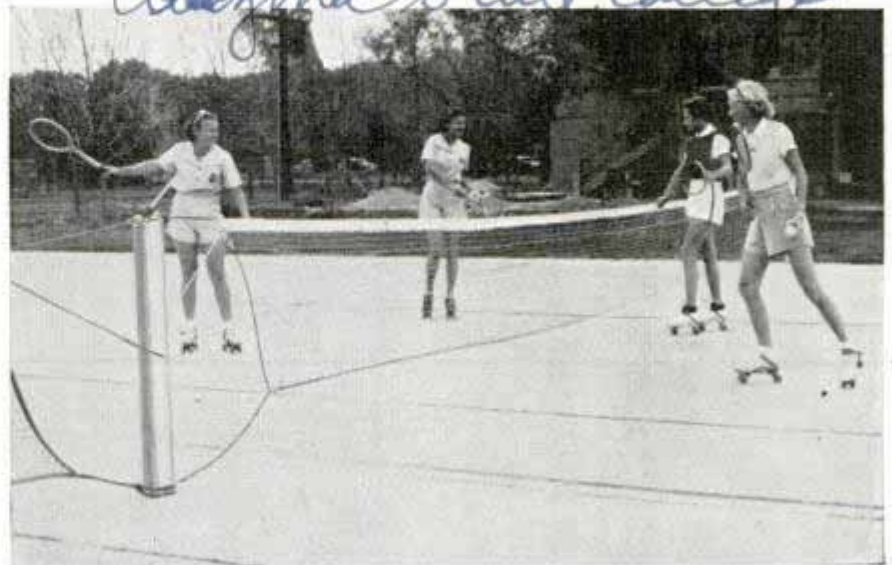

Note that the participants in this tennis game are wearing roller skates

*Parsons Bros  
 Slate Co. Pen  
 Tempe, Ariz.*

# 266  
 Capt. Charles Morgan Wilson  
 Hotel Brevoort  
 5th Ave and 8th St  
 New York

no price  
 difference  
 paid

# The

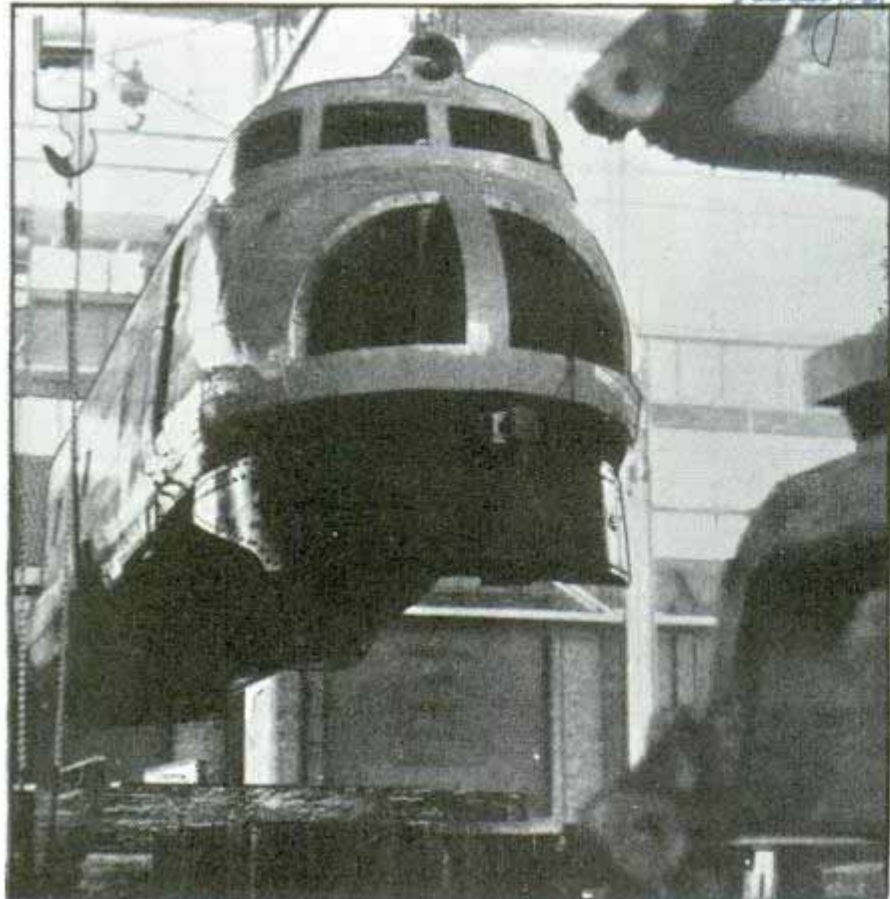

costs as low as five dollars per kilowatt capacity. Cheap power independent of high lines and expensive copper channels.

These are some American power notes of today's and tomorrow's headline news of the new small-unit two-cycle Diesel engines which our largest manufacturer of automobiles now begins in mass production.

This year marks the forty-first birthday of a combustion engine invented by Dr. Rudolph Diesel, to whose doorway in Munich the mechanical world beat not only a footpath, but a six-lane boulevard. This year

**TWICE** as much horsepower per American. An increase of from ten to 200 per cent in efficiency of compression motors with a new accuracy of motor control. An entirely new principle of "power in a package" which eventually may cut power bills to half of present levels. Complete installation of home power units for

brings the Diesel hot off the assembly line, in home-sized units of twenty-two to 160 horsepower. These midget Diesels are "little brothers" of the streamline-train Diesels which have rolled up more than eight million miles of railroad service. But the new small Diesel is more than just an engine. It is a power package equipped



HERO'S  
 AEOLIPILE



WATT'S FIRST  
 STEAM ENGINE



HUYGHENS'  
 GUN POWDER  
 ENGINE

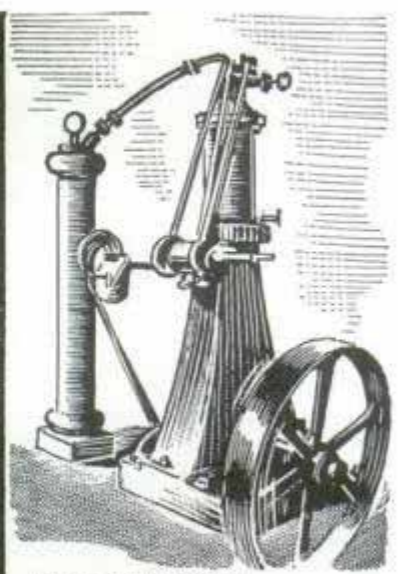

FIRST SUCCESSFUL  
 DIESEL ENGINE

Top, streamline power car ready to be lowered onto its trucks. Bottom, left, steam engine built by Hero in 130 B.C. Center, two other engines. Right, Dr. Diesel's first successful engine

7-2-66

# ADVANCE of DIESEL

*electro. motor parts, La lorange c ll.*

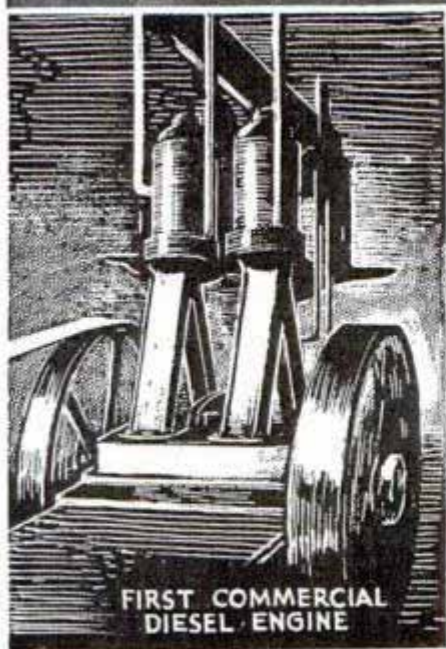
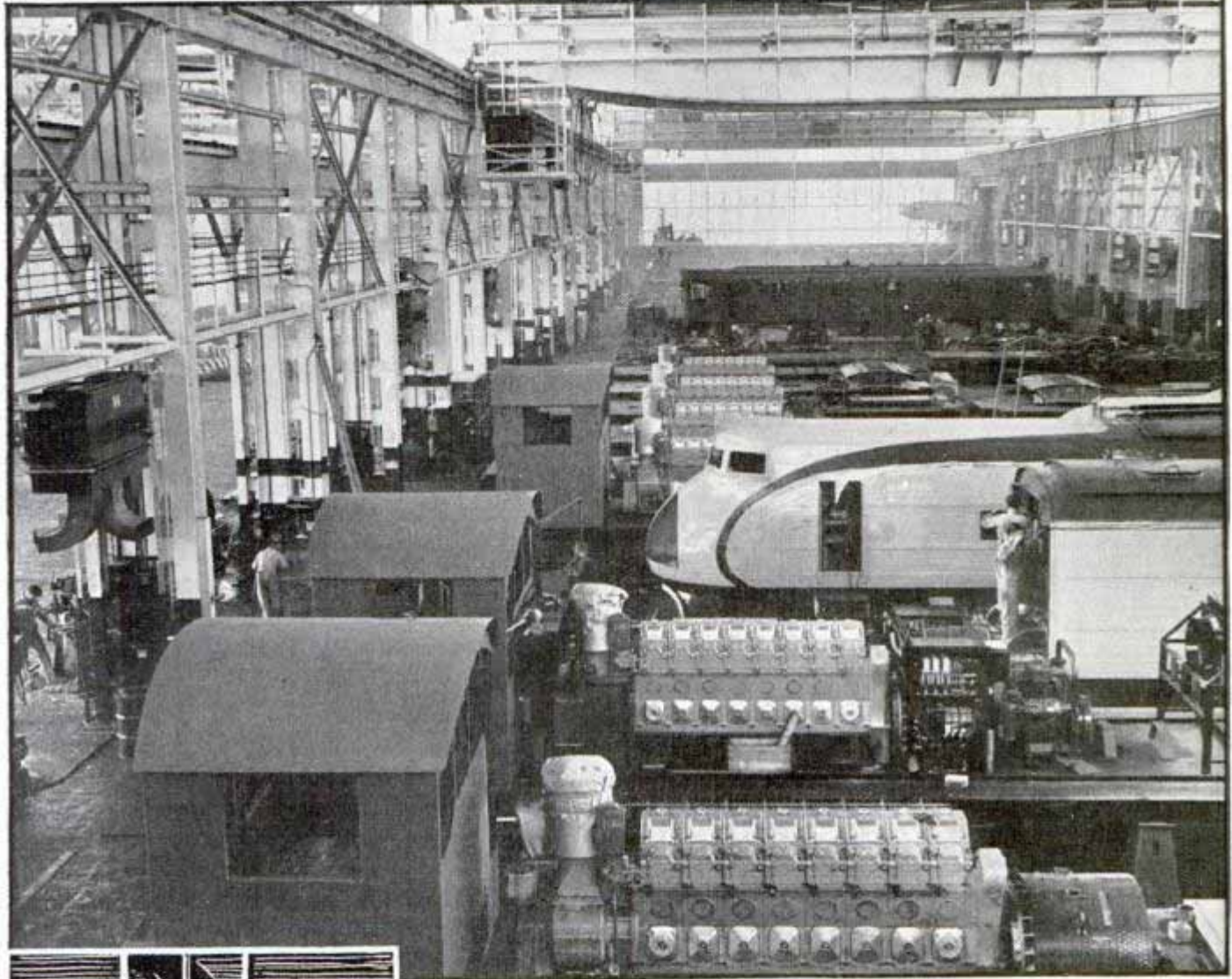

**FIRST COMMERCIAL DIESEL ENGINE**

*Top, general view of plant building Diesel engines for railroad trains. Below, first commercial Diesel engine*

with all accessories needed to start its job. In the case of the miniature stationary electric power plant the package includes the engine, generator, fuel-supply equipment, switch-board, etc.

A million square miles of our country are still beyond electrical service from central power plants or high lines. At least one million rural homes in the United States still do not have access to power lines. Power rates of different sections still range more than 700 per cent from a base average price. Though almost 37,000 miles of additional rural power lines have been built or contracted for in the past three years, studies made by the government show that no power-line mile which yields less than thirty-two dollars per year in kilowatt income can be a profitable investment. This limits the number of miles of copper channels which can be operated under present conditions.

Perfection of a small-unit Diesel generator suggests that in thousands of rural communities it may be possible to make electricity at home cheaper than it can be bought from power

*Illustration  
of  
Detroit  
Diesel  
Engine  
etc.*

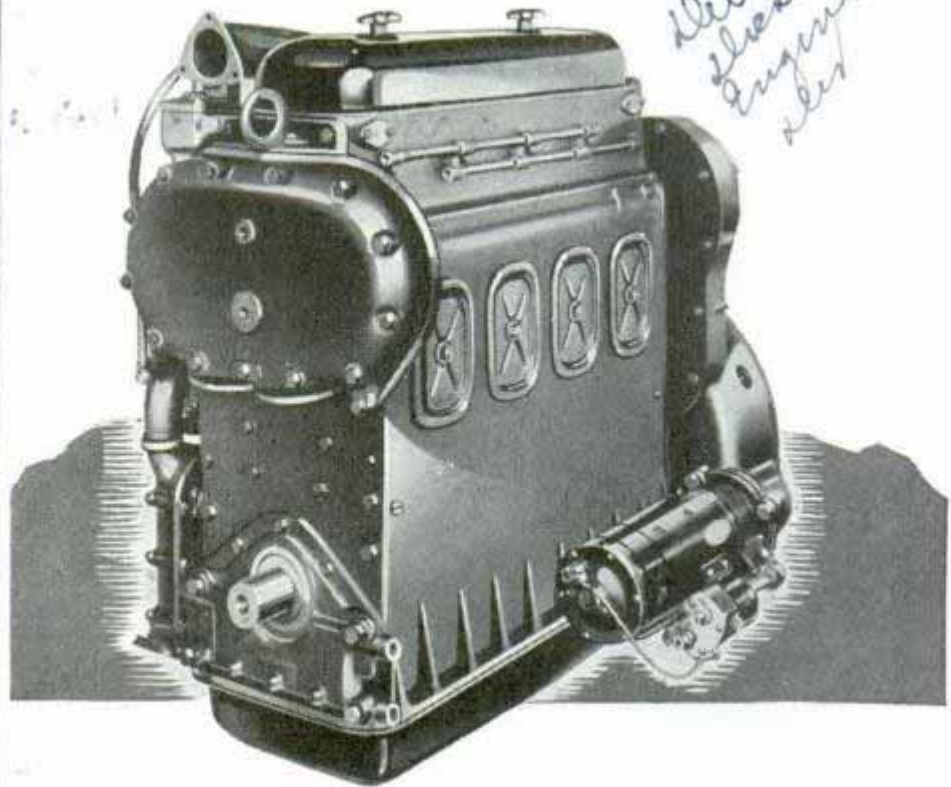
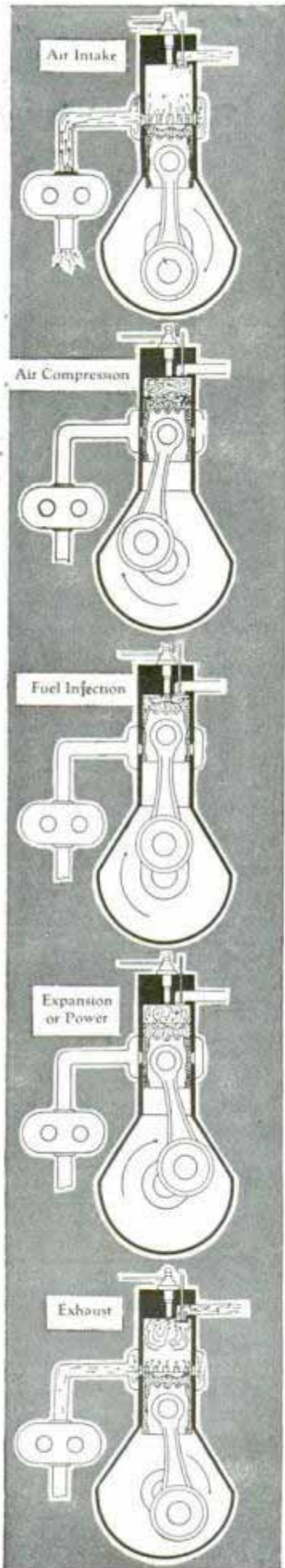

lines. Also that in remote areas power companies may be able to establish small Diesel plants to serve from one to a dozen families living beyond reach of power lines, hiring a resident farmer or workman to tend and fuel the equipment. Or an individual could install his own power plant and, if local laws allow, sell power to his neighbors.

Thus packaged power may serve to increase the uses of electrical equipment upon many thousands of farms. It may give birth to hundreds of new enterprises such as roadstands, rural amusement centers, billboard lighting, outlying theaters, parking lots, new vacation and resort projects. New progress in Diesel development unquestionably will take a still more important role in American timber industries, railroads, commercial fishing and marine shipping, as well as in further developing radio and electrical refrigeration. Almost certainly it will be of great importance to continued progress in farming, where it will power more and heavier equipment. Already city buildings are being equipped with private Diesel-generator power plants. The famous Singer Tower

## FOUR STROKE CYCLE

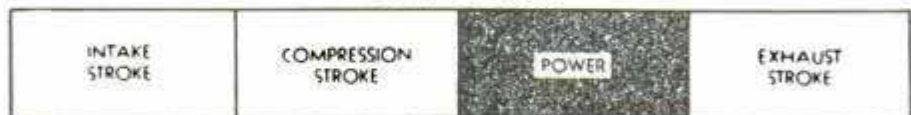

## TWO-STROKE CYCLE



*Strip at left shows how the two-cycle Diesel works. Note that it has one power impulse for each two strokes of piston. Diagram, bottom of page, compares two-stroke with four-stroke cycle, showing that two-stroke cycle produces twice as much power as the four-stroke because it has two power impulses instead of one. Photo at top, "power in package" Diesel engine*

*Esreen Steamend.*

of New York is a typical instance.

Wider distribution and use of small generator units may have a profound effect upon our manufacturing setup. "Power in a package" gives a new advantage to the home workshop and small factory. For years many of our big industries have been breaking into smaller working units. Cheap and dependable source of power has been the greatest obstacle to this decentralization.

F. G. Shoemaker, chief engineer of the Diesel engine division of General Motors tells you that a Diesel uses less fuel per horsepower than any other practical engine known. If two engines of the same size are placed side by side, one a Diesel and the other a gasoline engine, you notice that they look much alike. The first difference is that the gasoline engine mixes fuel and air before drawing the fuel into the cylinder, while in the Diesel fuel and air are mixed inside the cylinder. The Diesel has no carburetor. Instead it uses a fuel injection system to blow or force the fuel into the compression-heated air chambers just before the piston reaches the top of its stroke.

(Continued to page 131A)

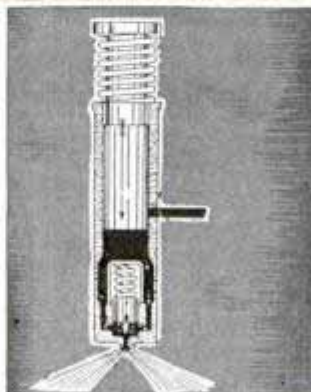
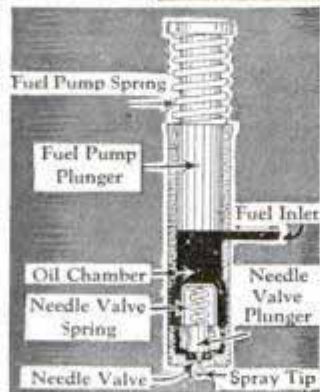
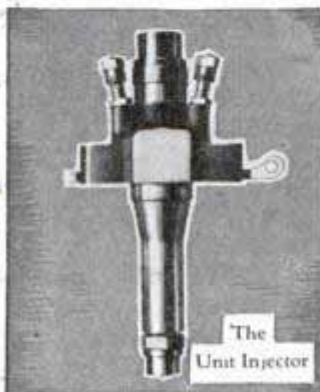
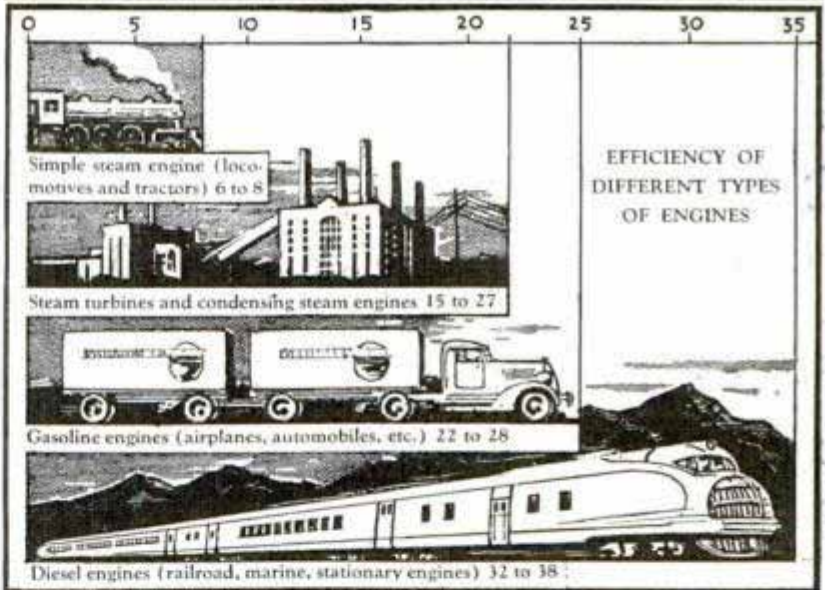
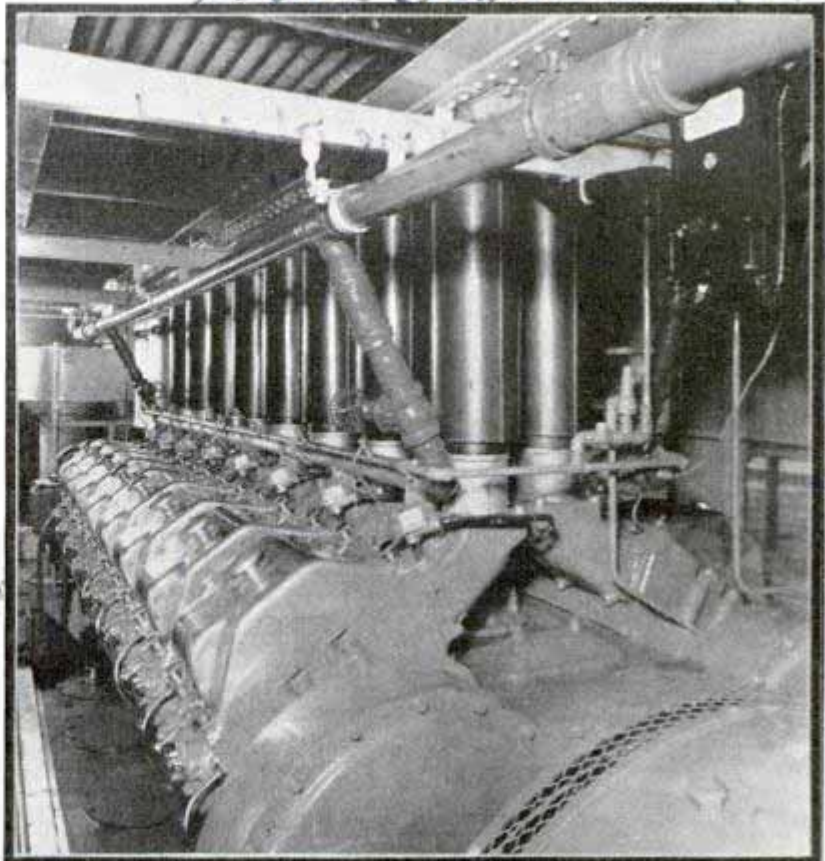

Top, view of the great Diesel plant which drives one of the rail streamliners. Center, drawing compares efficiency of different engines. Bottom, fuel injector, its essential parts, how it injects the fuel and how spray is forced out at high speed

Scene Service  
3/16/38

H 347

### Camera Takes "Sight Test" with Four-Color Wall Chart

if they are adjusted  
necessary

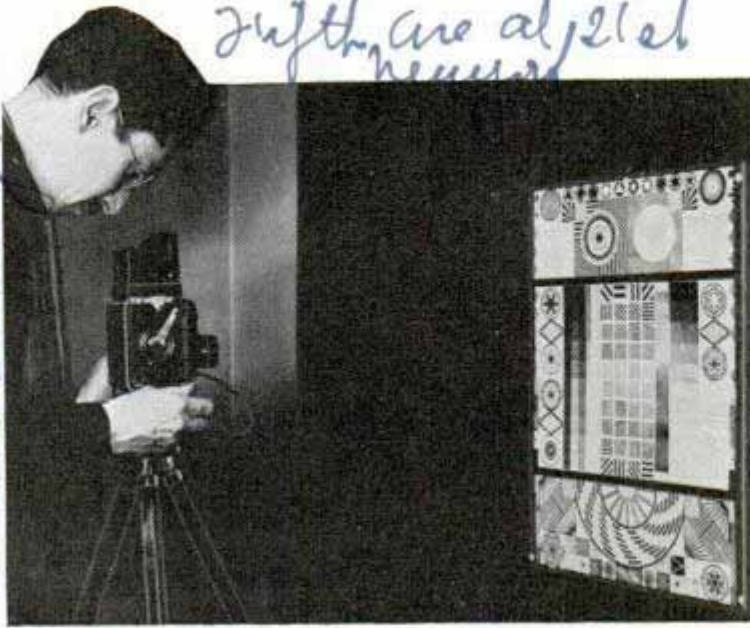

Testing the camera's eye with the "vision" chart printed in four colors. It shows up errors in photographic equipment

Like the vision test cards in the oculist's office, a wall chart has been developed for checking the camera's "eye." With it you can test your camera, enlarger, lenses and filters at home, and discover any errors in the use of films, filters, exposures, developing or printing. The chart is printed in four colors, and so can be used to study color response, as well as demonstrating lens aberrations, depth of field, astigmatism, emulsion and developer characteristics and checking exposure meters.

H 357

### Wildcat Drillers Get More Oil by Using Latest Methods

Modern methods of exploration and drilling have improved the batting average of wildcat drillers who search for oil in areas far from proved producing structures. Twelve per cent of all wildcat wells drilled in the southwest last year were producers of oil, gas or both, Dr. Frederic H. Lahee, geologist, reports. About one well in nine, drilled on geological information alone, was a producer in 1937, says Dr. Lahee, while the chances of getting production from a well located on geophysical evidence are better than one in four. Drillers who put down wells on a "hunch" location were successful only once in about fifteen attempts in 1937. New methods of exploring for oil, adopted

by many drillers, have reduced costs greatly. Instead of putting down a full-size hole, eight to ten inches in diameter, in exploratory work the drillers now use small holes, usually five or six inches in diameter, costing less to drill. Later, if the field shows promise, a full-size hole is drilled. Last year, with 4,096,990 feet of dry holes and 765,690 feet of producing wells drilled, costs under the old method would have been \$34,000,000, while by the new method they would have been only about half that much.

H 339

### Detachable Stool on Sander Makes Work Easier

Sanding floors is a more comfortable task with the latest type sander, which has a detachable stool for the operator. The sander is adjustable for floor tilt and picks up the dust by vacuum. It can be detached from its floor mountings for hand use. A searchlight-type bulb throws a spotlight on dark corners.

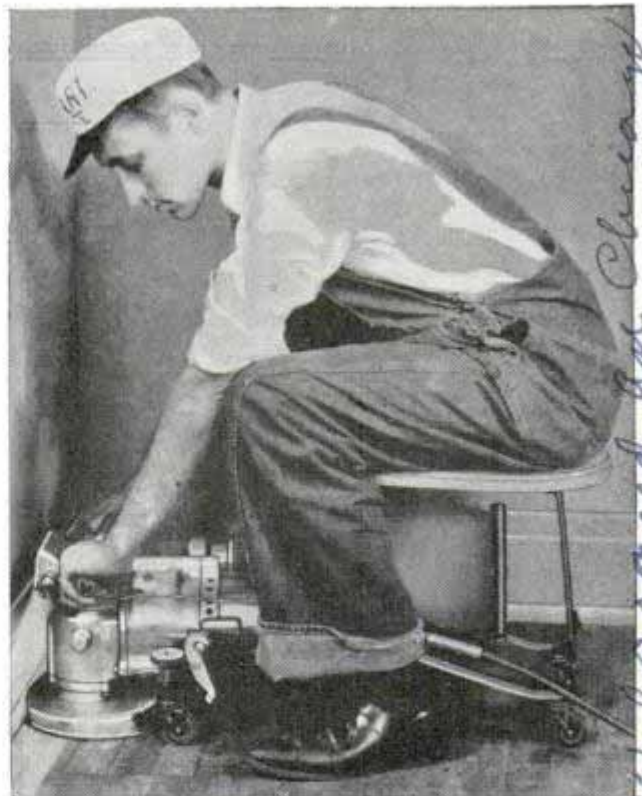

Detachable seat allows worker to sand floors in comfort, and vacuum bag collects the dust

Lincoln-Schlueter  
Floor Machy Co.

213

Cheese United Co  
Mahaw's Bldg.

Chief geologist Sun Oil Co.  
Dallas Texas

W. Esward in Chicago



H 318

Dr. Harvey C. Kentschler  
Director of Research  
POPULAR MECHANICS  
Westinghouse Lamp Div. Philadelphia 831  
"Sterilamps"

# 'Death Rays' Sterilize Air, Stop Mold Growth

Complete sterilization of the air, food and utensils with a "death-ray" lamp is the latest accomplishment of scientists. The process requires a few seconds to a few minutes to kill bacteria within range of the lamp, at a cost of about one-third that of operating an ordinary twenty-five-watt electric bulb. The "death rays" are taken from one part of the ultraviolet spectrum and projected by the lamp. Extensive experiment revealed the deadly effect of these particular rays on microbes. Today there are experimental installations of the lamp in hospitals, banks, drugstores, soda fountains, restaurants, dairies, manufacturing plants and elsewhere. Of especial interest are the tests which indicate that the lamp may be the means of controlling epidemics of colds, pneumonia, infantile paralysis and other air-borne diseases, since its ability to destroy bacteria afloat in the air has been demonstrated. The need for a sterilizing tool of this nature has been nowhere so pressing as in surgical operating rooms, where air-borne bacteria sometimes cause post-operation infections. The variety of fields in which the lamp may be applied appears to be almost unlimited.

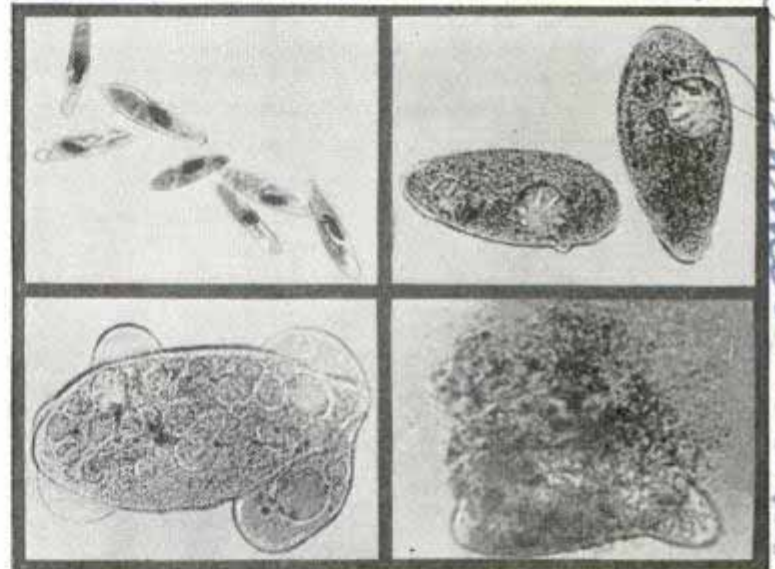

Top, white lines in display case mark location of sterilizing lamps. Bottom, steps in destruction of minute organism

see Seph 19 36-353

H 317

# Spill-Proof Gas Tank for Trucks Averts Fire in Crash

To lessen the danger of explosion and fire after highway accidents, a safety gasoline tank has been developed for trucks. Ruggedly built, with electrically welded seams, it is designed to resist battering in a collision or rupture from internal pressure. Gasoline cannot escape if the truck tips over, for the intake and air "breather" pipes both extend across the tank; tipped with the tank cap down, the pipe ends are out of the gasoline;

tipped to the other side, the tank cap is above the fuel; upside down, a check ball in the air vent prevents leakage. The tank cannot be filled deeper than the level of the breather pipe, and thus there is always an air space providing for expansion of twelve to fifteen per cent. Explosion is prevented by a fusible alloy plug in the cap. Because of the length of the intake pipe, theft of gasoline is exceedingly difficult. The tank can be installed on any truck.

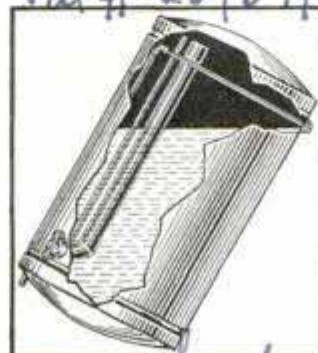

American Safety Tank Co.  
Kansas City Mo.

# Four-Crankshaft Air Engine Is Fast Without Vibration

*Los Angeles, Calif*

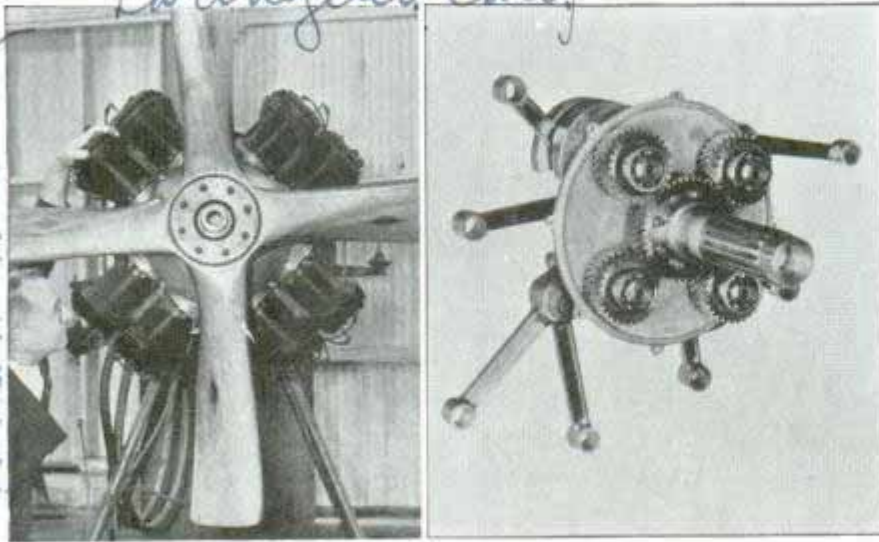

Left, motor with propeller in place. Right, view of the propeller shaft being driven by the engine's four crankshafts

terbalancing weights are provided on the short crankshafts and in addition the inertia of each piston is counterbalanced by the opposite pistons, which are traveling in the same directions simultaneously. The reciprocating rod and gear masses serve as a flywheel to prevent push and pull strains on the gears. Test stand runs up to 5,200 revolutions per minute have been made without development of vibrating periods. The greater horsepower obtained at such high engine speeds can be reduced to lower propeller speeds by selection of the

Designed with four crankshafts instead of one, a new 180-horsepower radial aircraft engine is high speed without vibration. The crankshafts are spaced around a master propeller shaft and operate the propeller shaft by means of herringbone gears. Cylinders of the eight-cylinder engine are mounted in pairs, the four sets being at right angles to each other. Each piston in each pair drives one of the crankshafts through a separate connecting rod. The cylinders may be fired in various orders. Since the design virtually eliminates vibration, greater power output through increased engine speed is attained. Coun-

proper gear ratio between the crankshafts and the propeller shaft. One advantage of the straight, hollow tubular propeller shaft is that as many as three 500-horsepower units may be mounted on the same shaft without building up excessive stresses, providing 1,500 horsepower to the propeller and at the same time eliminating total failure of power in case any one unit goes out. The straight hollow propeller shaft permits gunfire through it without synchronization with the blades, and allows installation of a direct controllable pitch mechanism. The engine employs a simplified oiling system.

# Homemade Bicycle Trailer Aids Newspaper Carriers

Unable to cover their fourteen-mile newspaper route by bicycle alone, due to the weight of the papers, two New Jersey boys constructed a bicycle trailer. They purchased two bicycle wheels on which the trailer body was mounted. The body has a capacity for a large number of newspapers. Construction of the trailer was accomplished with a combination jig saw, sander and lathe. The boys now cover the route in one-third the time required before they built the handy trailer.



*Wabewell mfg Co # 371  
2427 E. 14th  
Los Angeles, Calif*

*Martins and Edward Loring  
10 Lois Place  
Bloomfield N.J.*

*Cont. Williams M. Myers Caldwell  
66. Island Place*

# Oil Pool Used in Movies for Reflection Shots



This scene from "Heidi" illustrates the use of oil pools for reflection shots. Note the clarity of the reflection. The camera crew is shown riding a boom over the pool

Found to have a better reflecting surface than water, crude oil is being used in pools for reflection shots in movie studios. Camera crews, riding a boom over an oil

pool built on the huge sound stages, get unusual reflection shots. The picture above, made during the filming of "Heidi" clearly outlines all reflections.

## Fast Highway Striper Covers Twenty-Five Miles Daily

Laying down twenty to twenty-five miles of striping per day, a new mechanical marker for applying the white stripe to divide highway traffic lanes is in use in California. It supplants hand-propelled machines that covered a fraction of the distance in the same time. The striper applies either a four-inch white stripe or two three-inch stripes, divided by one of black. It is specially built, a four-wheel, motorless chassis, equipped with spray guns and a device extending well in front and connected with the steering gear to fix the position of the stripe. The machine is pushed ahead of a truck mounting the compressor and paint tanks.

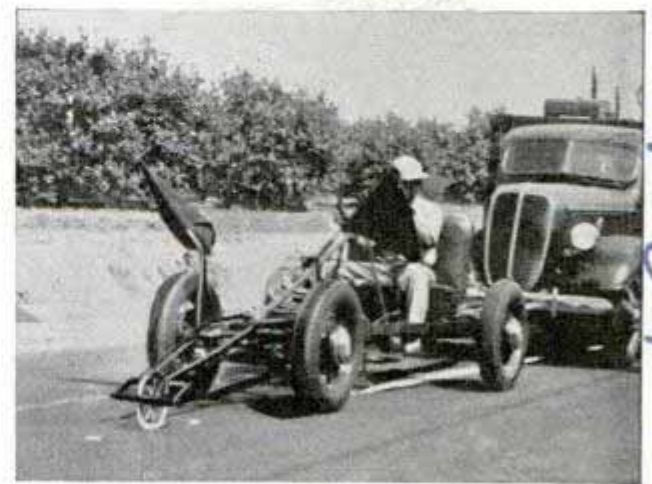

This motorless striping machine covers many miles of road during the day

Designed by engineers, Division of Highways, Dept. of Public Works, Sacramento, Calif.

cont. Tom White Box 44 Alameda Calif.

State of California, Sacramento, Calif.

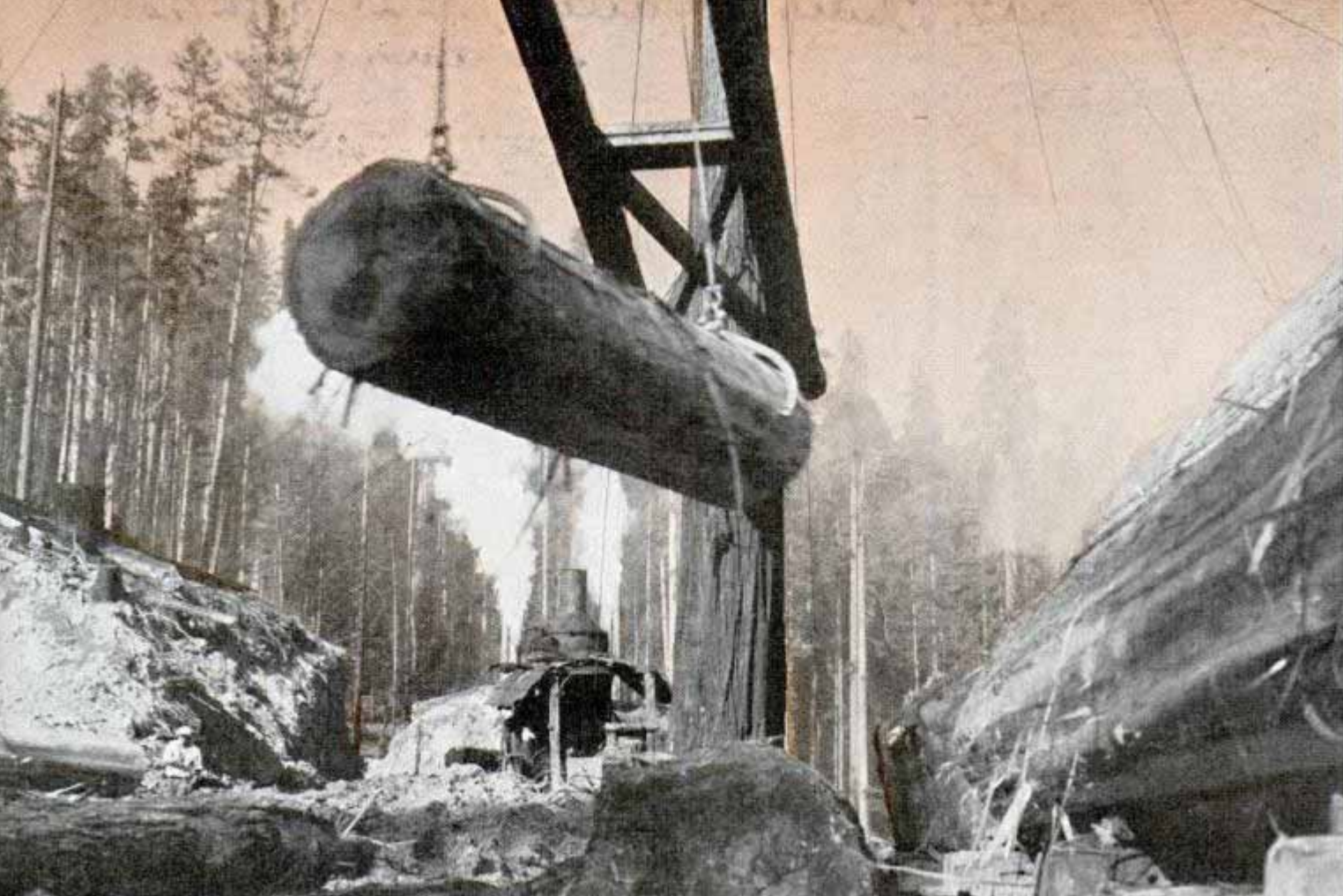

# BRUTE FORCE *Loses out*

*Thomas G. Symson, Jr.*  
*10555 Holmwood Ln Angeles*  
 By Charles Morrow Wilson



CABLE-DRIVEN hoist drums capable of a fifty-ton straight lift, tractors instead of horses, electrically operated log carriages, automatic log skidders, giant Diesel-driven logging trucks with power-operated hoists.

These are a few of the things which are changing the American lumberjack of old to a forest technician and which are helping to conserve American timber resources.

Paul Bunyan, legendary figure of the big woods, was pictured as a superman who singlehanded mowed down forests, scooped out lakes, dug river channels, and snapped off giant trees as if they were toothpicks.

Today a lone woodsman can literally fell a forest giant and drag it to market. But his power is not superhuman. It is the result of rapid and ingenious growth of mechanical equipment.

The tractor is actually the basis of the new age of American forestry known as "selective logging," upon which timber conservation now depends most heavily.

Top, great log being lifted onto flatcar. Bottom, sighting direction in which tree will fall

*Calypso & Pennington*

H/182

Cluner - The Pas Lumber Co Ltd.



The Pas, Manitoba, Canada

In the former steam and horse era of woods operation "universal logging" was standard practice. This meant destruction of all trees.

Besides wiping out millions of acres of the best forests, universal logging showed other serious faults. Its use of steam railways with wood-burning locomotives and its practice of quartering great numbers of workmen in woods caused forest-fire losses to increase from a few thousand

acres a year to a high of thirty-three million acres. Today modern fire-prevention methods, including fire lanes, towers and airplane patrol have succeeded in cutting losses from forest fires to about half.

This is one reason why we find that healthy, protected trees are growing more rapidly than timber is being used. Another reason is that truck and tractor logging, with modern mechanical accessories, has outdated the earlier practice of "clear

# to ENGINEERING SKILL



Top, Diesel tractor hauling log train on icy road. Bottom, tractor pulling, or "skidding," logs through woods. This equipment handles giant logs with unusual ease

Redwood

Willamette single drum winch

Cluner - 6 No. 10 logs! Little Quince Redwood Co. 100% Laminations - 100%

Westerly Diesel R 12 8

*Blentwood, Washington County Oregon*



cutting" or removal of all timbers.

With the efficient new equipment, logging operators can now afford to go into a given forest area and take out only the particular type of timber desired for a given market. The importance of this method is evident when one realizes that present industrial demand for timber has grown highly specialized. There are now 1,770 different kinds of trees in American woods and more than 100 varieties meet particular demands in timber industry. Our commercial uses for wood have increased from about 2,000 to more than 4,500 within the past ten years.

We still have almost half as much timber fit for sawing into lumber as when the first Pilgrim chopped his first tree in New England. The total U. S. forest acreage is still more than a fourth of the entire nation—actually more land for growing trees than for all crops, pastures and ranges combined. If gathered together our remaining forests would make a 225-mile-wide tree belt entirely across the continent.

Use of our forests represents a ten-billion-dollar investment of capital, jobs for more than a million men and women and a yearly money return half as great as total earnings from farms. This timber is our one basic resource ideally suited to conservation practice, since forests can be replaced as they are used. With the practice of selective logging there is every reason to believe

Top, tractor pushing logs into river. Center, spar pole on flatcar speeds up logging. Bottom, eighteen-wheel truck used for hauling logs to sawmill over board road

*Calapellay "Sleeve" R. Del & Le Tourneau Bulldozer  
 Pyl: James Stevens, West Coast Heatter  
 Timberline is Aisen. Stear's Oldy West*

12182

*on way to Seattle*



that American forests will be more productive a century from now than they are today.

The nation has individual mills capable of turning out a million board feet of lumber a day. Back of the 20,000 lumber mills now in operation in the United States are forests equipped with more than 30,000 miles of logging railroads, with thousands of tractors, chutes, flumes, dams, canals, tugboats, rafts, cableways, aerial trolleys and other log-moving equipment which requires about 200,000 workmen to operate.

The new story of American timber is becoming a story of transportation as well as conservation. Logging used to be almost entirely a local enterprise. Now the development of great timber areas and more specialized industrial demands for the different woods make transportation the number-one cost and problem in timbering. Seventy years ago timber sources were largely local. By 1914 the average haul necessary was 360 miles. In 1924 it was 725

miles. In 1938 it is about 1,100 miles. In the Northeastern states logs must travel an average distance of 840 miles; to the Lake states 910 miles; to Central states 1,515 miles. From the Pacific Northwest to the consuming markets of the east the average rail haul is 2,600 miles and the average water haul is 6,000. Eighty-eight per cent of the soft-wood timber used grows on the west side of the continent,

(Continued to page 124A)



Top, load of huge fir logs on flatcar ready for shipment. Bottom, tractor with equipment powerful enough to lift fifty-ton load of logs off ground

*Don't County dollar can*

*Callahooma River*

*Don't County dollar can*

*Callahooma River  
with Willamette rich*

# Lamp Gives Polarized Light Free from Glare

247 \$16.50

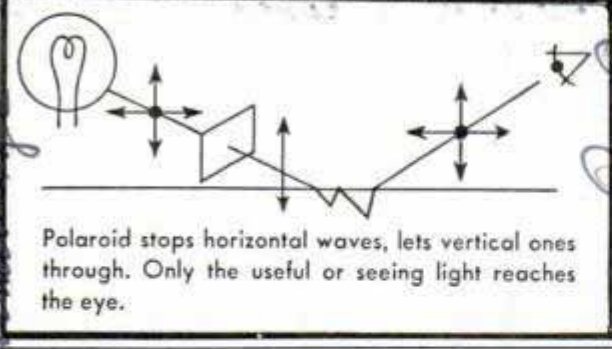
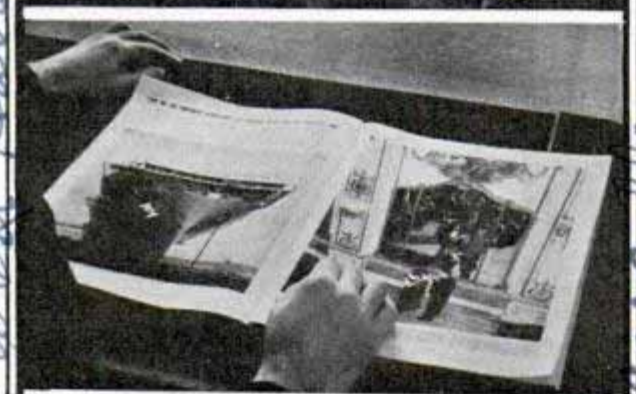

Top, ordinary light on magazine pages. Below, using polarized light. Note clarity

Providing illumination free from reflected glare, a new type of lighting unit was demonstrated recently. It was a desk lamp arranged so that light from an ordinary bulb was passed through a sheet of Polaroid, a transparent material, to remove the light waves that cause reflected glare. Those waves or vibrations of light useful for seeing were not affected, but

the waves ordinarily reflected as white specular light or glare were eliminated. The effect on the printed page was a startling clarity of detail unobscured by reflections. With glare eliminated, other lighting problems may be solved. Intensities can be increased to desired levels without the otherwise proportionate increase in reflected glare frowned upon by optical authorities. The light source may be placed directly in front of the reader, thus assuring even distribution of light across the page without concern as to reflections. While the reader has no sense of brightness with polarized illumination, much higher intensities can be maintained. Glare, according to optical experts, impairs the visual function because it bleaches out the visual purple faster than it can be regenerated by the human system.

# Magnifier for Photo Enlarging Permits Sharp Focusing

Sharply focused enlargements result when the photographer uses a vest pocket ground-glass magnifier now available. It takes the guesswork out of focusing on the enlarging table. Mounted on a metal base and angular support are a mirror, a ground glass and magnifying element. Light from the negative is transmitted through the enlarging lens to the mirror which reflects the magnified image through the glass screen.

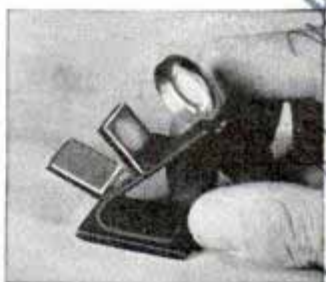

# Grass Seed Scattered by Planes after Fire Destroys Forest

Forest fire devastated a vast area of timberland in Coos County, Ore., in the fall of 1936, but today, thanks to the airplane, sheep and cattle graze on 12,000 acres of luxuriant grass where the forest stood. Grass seed must be planted quickly over a burned area, for delay would give fireweed a chance to get started. To save those acres from total loss, the county bought an airplane, equipped it with seed hoppers and sent it over the charred

Polaroid Lightly Inc. West Garden City N.Y. 285  
this all my in glasses

118  
118  
118



acres. It carried 1,200 pounds of grass seed each trip, seeding fifteen acres a minute, 150 acres each trip. The plane saved time, saved cost, for the seeding was figured at twenty-one cents an acre, and a healthy stand of grass was given a start promptly. Rice fields in California are being seeded by plane, too, and airplanes are being put to a variety of work over the western states—hunting coyotes, patrolling national forests, surveying for mountain highways, mapping timber and mineral areas, locating salmon schools for fishermen, dusting crops with insecticide, spreading smoke screens to protect citrus orchards from frost, and feeding wild life during the winter.

## Children Study Bombing Plane from Cross-Section Drawing



Austrian child learns about bombing plane from drawing showing pilot, gunners and cameraman

Sectional charts showing the "works" of an air bomber are used in Austria to teach the construction and uses of this type of fighting machine. The diagram shows machine guns mounted in the nose, and both above and below at the rear of the cabin. The bomb racks are seen at the center.

## Salesman Projects Rug Pattern on Floor of Tiny Room



Customer visualizes appearance of room as salesman operates projector throwing rug pattern on floor

To demonstrate patterns in linoleum floor coverings, a manufacturer has developed a special projector which throws the designs on the floor of a tiny three-walled room. The film is run through a projector housed in the top, and can show as many as 160 different patterns while the customer watches.

## Waste Piped from Dairy Barn to Fertilize the Farm

To make use of the waste from his cattle barn as fertilizer, a Tennessee farmer collects the waste in a concrete reservoir ten feet by twenty, and five feet deep, then pumps it through 370 feet of two-inch pipe to a hilltop. From there the fertilizer flows on the ground or in wooden troughs to any part of the farm it is directed. The floors of the dairy barn are regularly flushed clean with water, and the waste drains into the reservoir. A heavy mesh screen at the pump prevents clogging.

Armstrong Carb Co  
Lancaster Pa

Cameron motor pumps -  
Ingersoll Rand Co. -  
W.C.P.

# AGE of the AERIAL

FOR years aviation engineers have been discussing giant airplanes of the future. This year they have caught up with their prophecies and the day of the aerial monsters is here.

One thing that has helped make the dream come true is the perfection of aviation engines far more powerful than any of the past. One engine of a 1938 four-motored airplane develops more power than the total horsepower of a tri-motored transport of ten years ago. Four such engines provide as much as 6,000 horsepower for take-offs, more power than is required by a streamline engine to pull twelve railroad coaches.

These tremendous air-cooled motors, the latest developments of the engine manufacturing companies, are on the "military secret" list and are not available to everyone, nor may they be exported abroad. They are twin-row radials of improved design, consisting essentially of two radial engines, one placed right behind the other, and attached to a common crankshaft. They develop one horsepower for every pound and a quarter of weight.

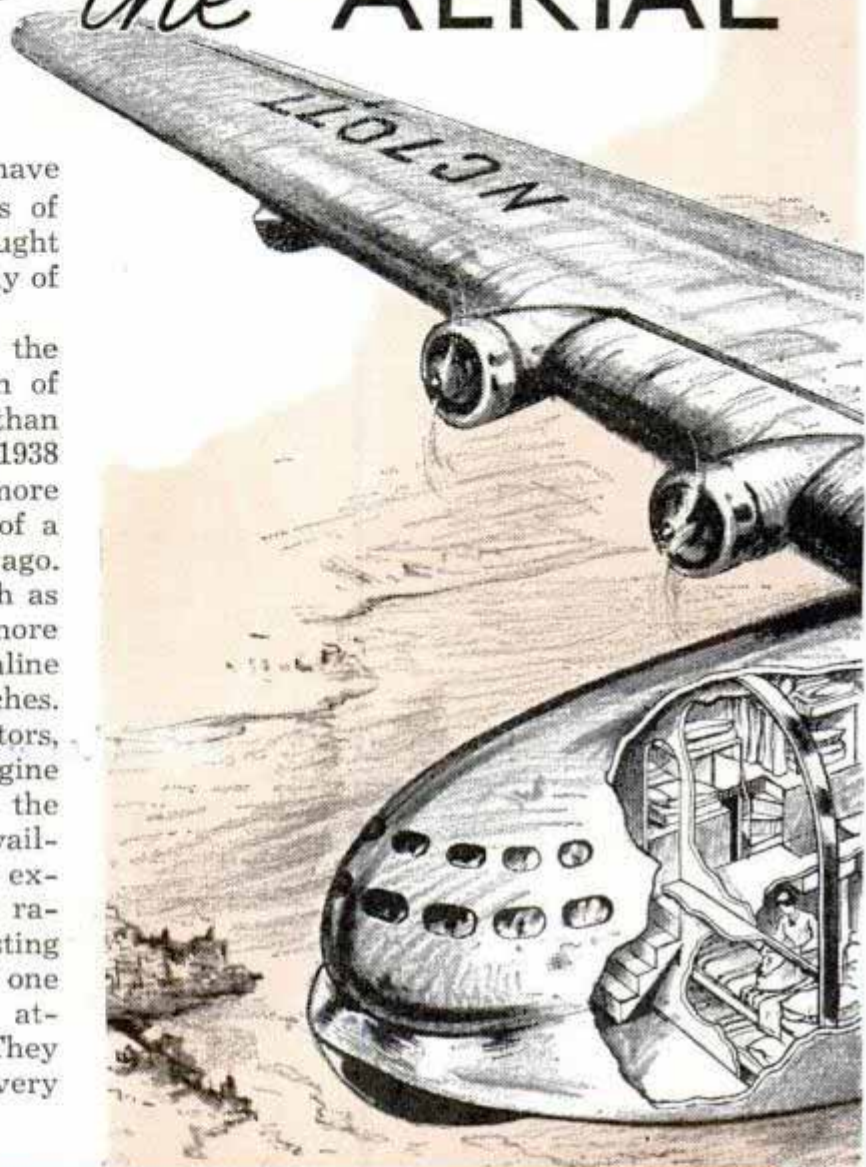

Bottom, view of workmen busy on giant fuselage and wings of Douglas transport, DC-4. The scaffolding forms a sort of dry dock in which the plane was assembled like a ship

# MONSTERS

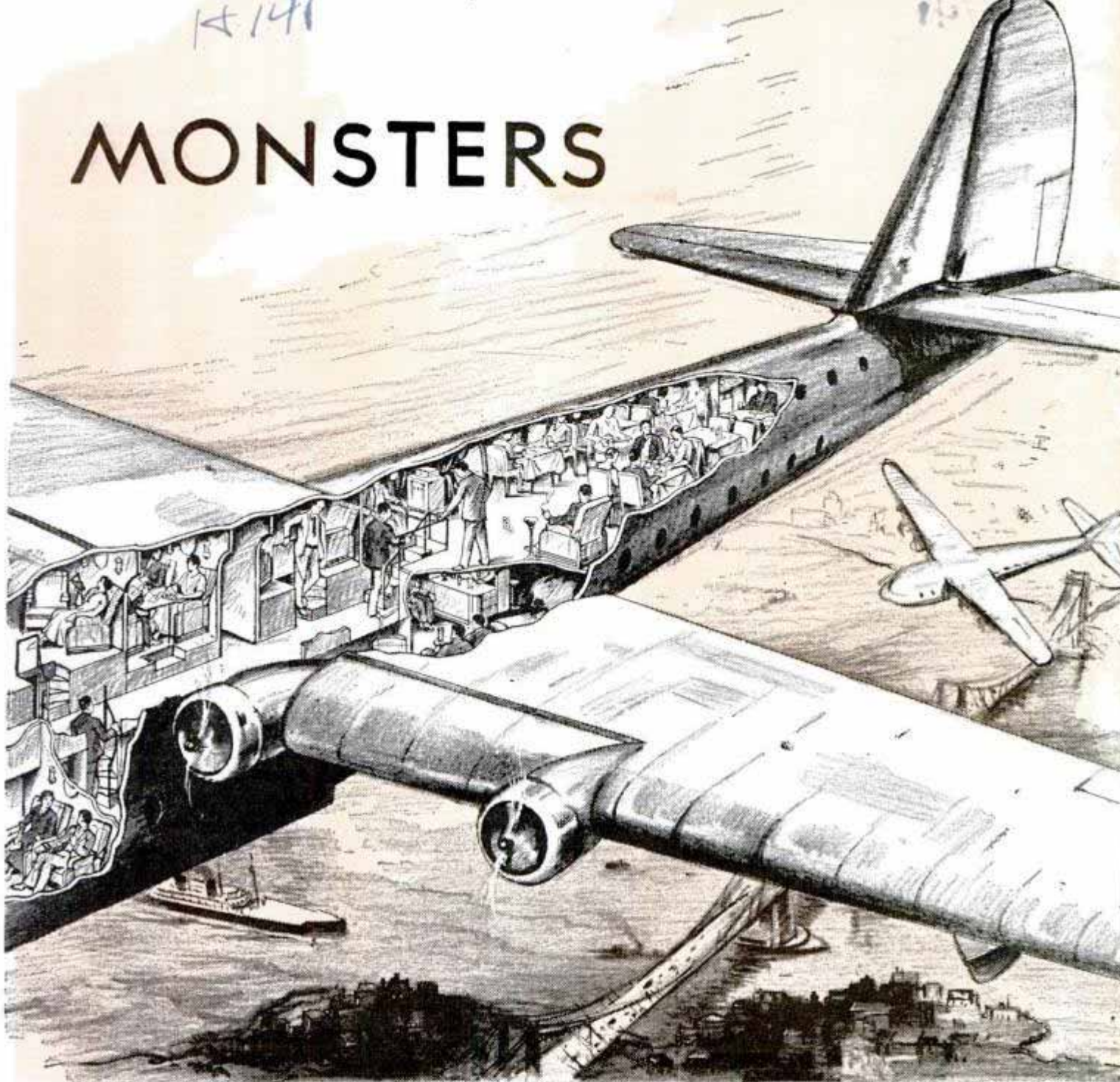

*Drawing of interior of Consolidated's version of transoceanic air liner. Note the double-deck arrangement and luxurious accommodations, very similar to those of ocean liners*

The new airplanes made possible by these engines actually dwarf the present giants of the airways. The new DC-4, to be launched soon by the Douglas Airplane company, was assembled like a ship, in a sort of dry dock.

The DC-4 has nearly three times the gross weight of the big Douglas transports now in service. The four-motored plane has a wing spread of 139 feet. Its fuselage is ninety-seven feet long and it stands twenty-four feet high. It will carry forty-two passengers and a crew of five, as well as three and a half tons of mail and express. The plane will have a top speed of around 237 miles per hour at 8,000 feet, a

cruising radius of 2,200 miles, and a service ceiling of around 23,000 feet. The plane weighs 65,000 pounds fully loaded and will be able to cross the continent with only one stop. Research, engineering, and construction costs on this first giant amount to one and a half million dollars. The plane was built at the joint order of the five leading domestic air lines. The idea of this united action is to develop a standard type of super-transport.

Instead of settling down on a tail wheel in landing, the DC-4 will land level with the ground with its tail remaining in the air. The plane uses a retractable tricycle type of landing gear that employs a nose

*A. M. Kochler  
Public Relations Sec.*

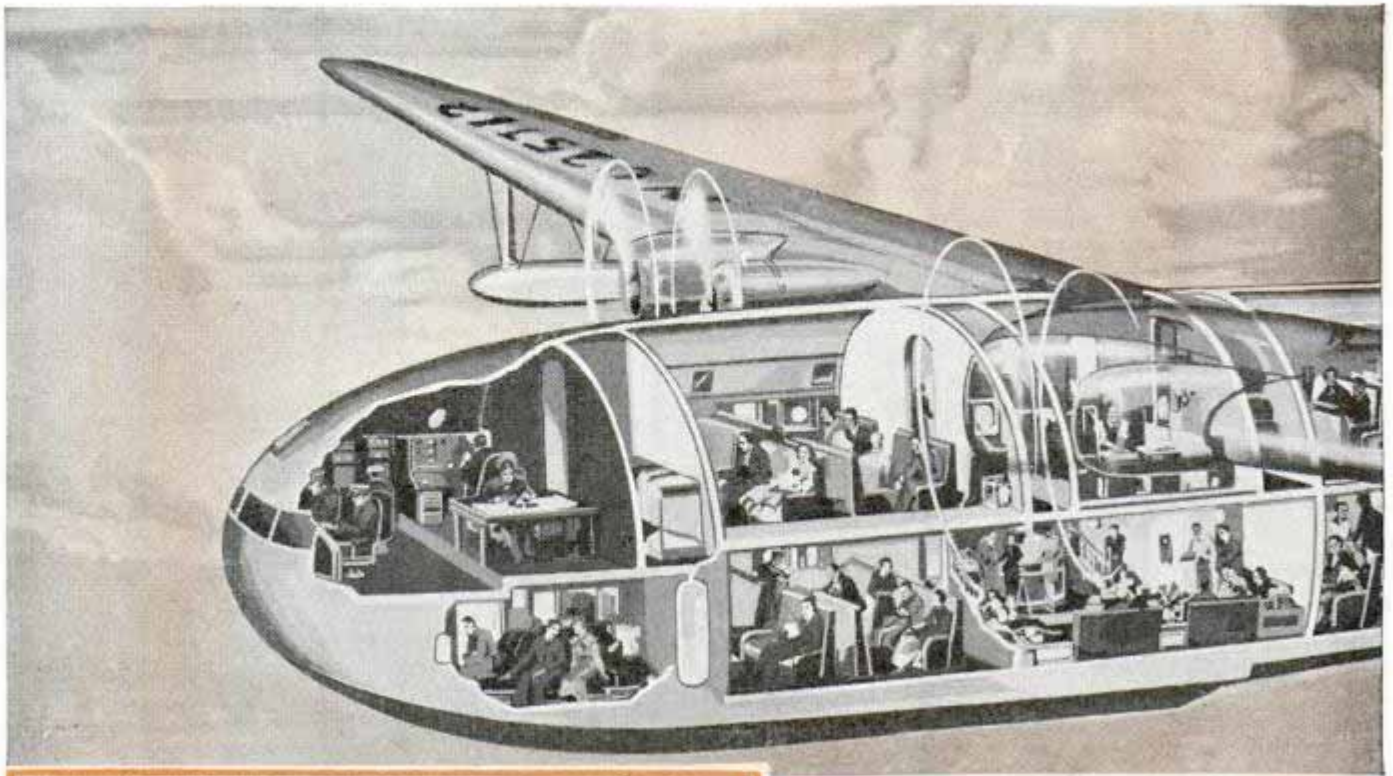

*Top, nose of Martin's concept of transatlantic air liner. Bottom, mock-up of DC-4 passenger compartment*

wheel instead of a tail wheel. The two huge main landing wheels are twenty-six feet apart.

Instead of a conventional tail the plane has triple vertical tail surfaces. The new arrangement allows better control with half the power plants not operating. The horizontal airfoil surface of the tail group is about the size of the wing of a small bomber. Control surfaces are so large that manual control by the pilot is augmented by hydraulic booster pumps. Some of the control cables are nearly one-half inch in diameter. For the first time in a large airplane, flat flush-type rivets are used in fastening the outer metal skin, materially reducing resistance.

To make sure their calculations provide

the needed safety factors Douglas engineers performed more than 300 major physical tests and approximately 1,000 minor tests before construction really started. Hundreds of thousands of dollars were spent on building up vital parts of the plane and then testing them to destruction. The special anti-frost laminated glass for the cockpit windows was subjected to temperatures of forty degrees below zero to make certain that it remain transparent under extreme conditions.

Approximately 20,000 pieces of metal, fittings, and sheets, exclusive of rivets, were used to build the plane and inspectors stationed in the dry dock approved every part before it could be added to the structure.

The lighting and other secondary power requirements are so heavy that auxiliary engines instead of batteries are used for the circuits. These air-cooled auxiliary engines drive alternators furnishing enough 800-cycle 110-volt current to light a huge office building. They also operate vacuum pumps for instrument-operating vacuum, provide pressure for the de-icers, run a hydraulic pump for the autopilot, and furnish pressure for the main hydraulic system that operates the air flaps, landing gear, and the minor hydraulic units. The

14141

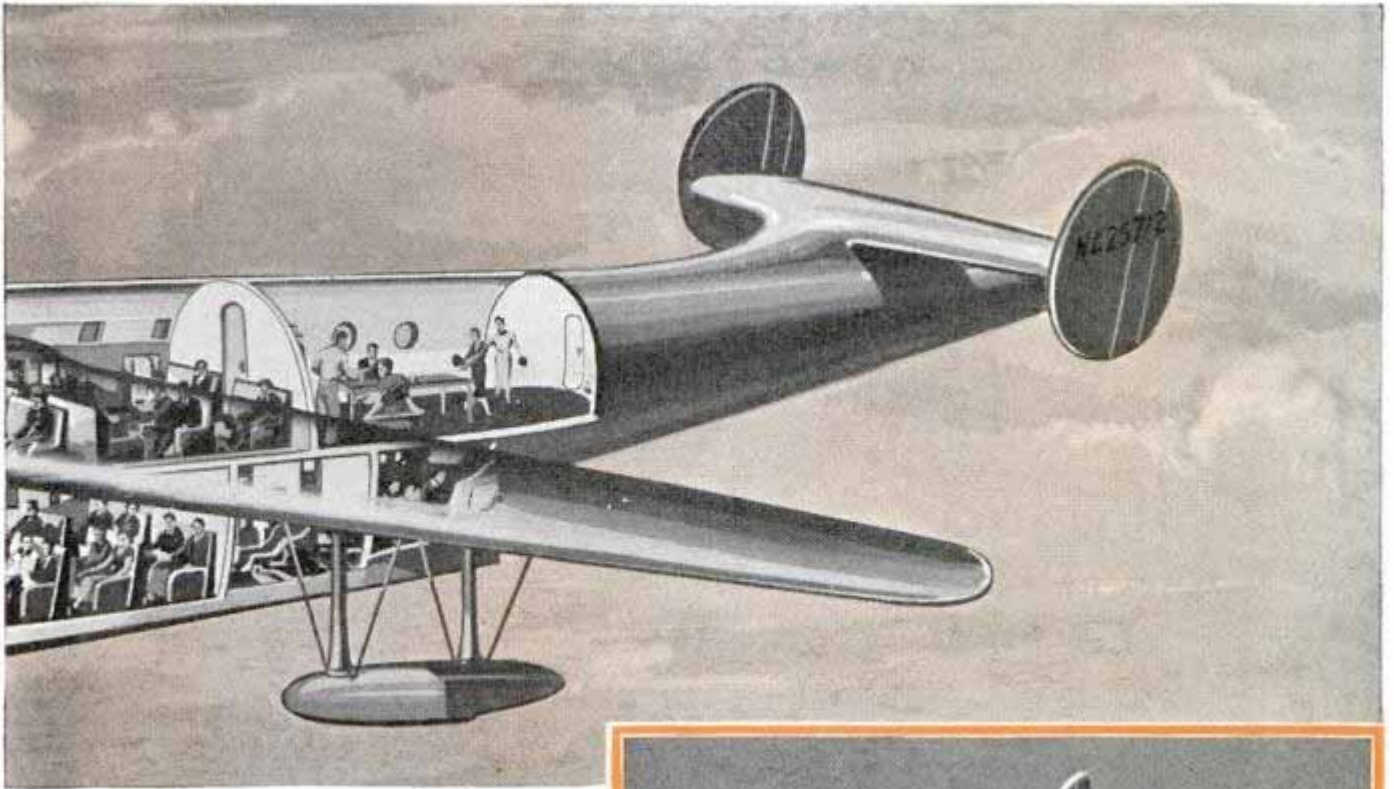

exhaust systems of these engines pass into the exhaust pipes of the propelling engines, being located so as to pass through steam boilers for cabin heating, making heat for the boilers available even when the plane is standing on the ground with the main propelling engines not operating.

Inside the huge cabin various arrangements of comfortable lounge chairs, reclining chairs, or sleeping berths are to be installed according to the desires of the different air lines. The different plans all include dressing rooms and a large galley under the care of a steward and stewardess. There are thirty-two windows in the

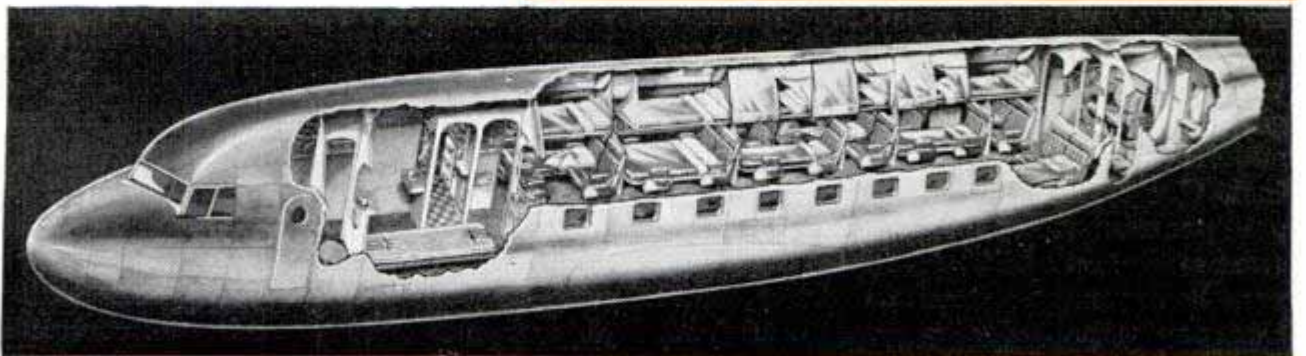

*Top, interior of Martin plane shows passengers at play. Center, model of the DC-4. Bottom, interior arrangement of DC-4, showing deep, comfortable berths for traveling at night*

main cabin space, sixteen upper skylights, and two portholes. Space beneath the cabin floor is used for baggage and express, providing more room than is available in many large sized trucks. Provisions are to be made for installing air-compressing gear and for sealing the cabin and cockpit for substratosphere flying.

In the cockpit the pilot and co-pilot sit farther apart than in present transports, the space between them being taken up by a wide control stand upon which

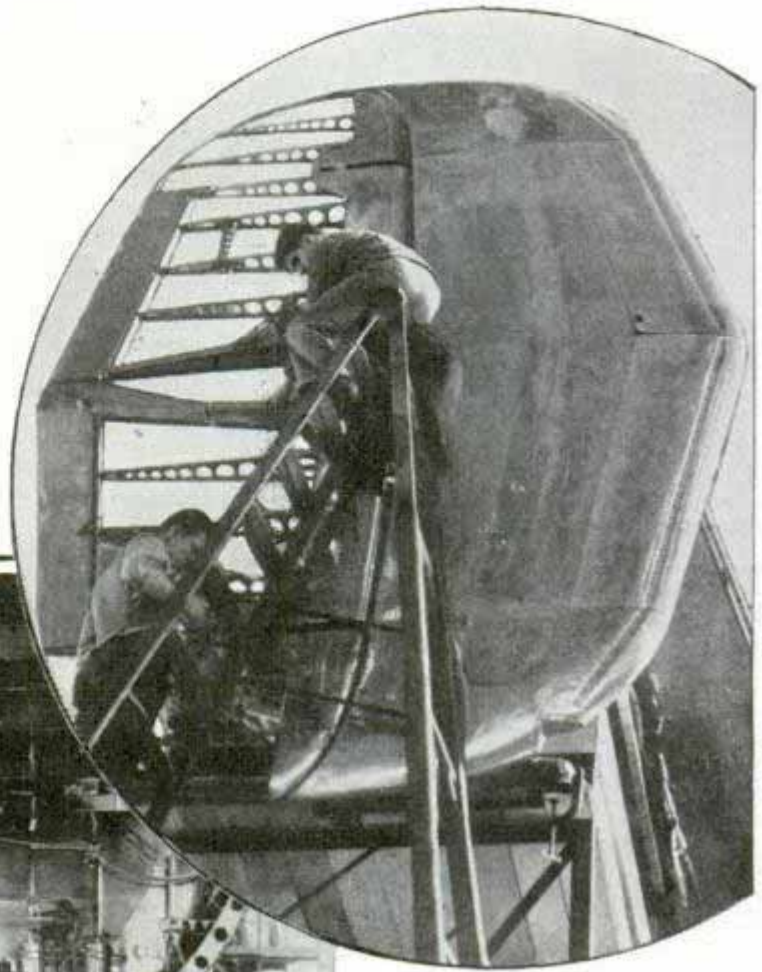
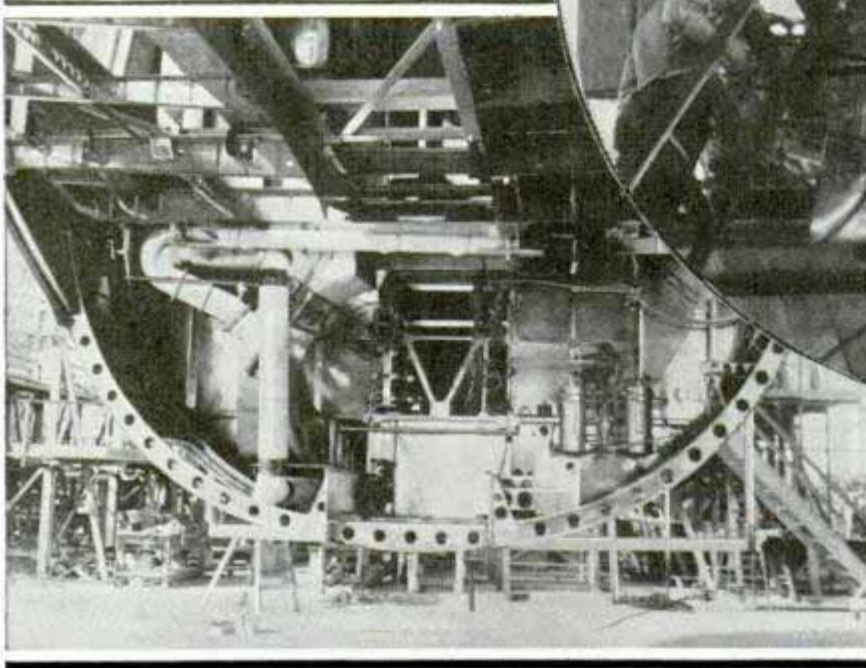

*At the left is a view of the "basement" of a super-airliner. Here, under the floor, may be seen in process of completion the maze of controls, heating, electric and ventilating systems. Above is the rudder*

are mounted all engine operating levers. Throttles are duplicated on each side of this pedestal so that it is not necessary for either man to reach across it. A third seat behind the pilots is provided for a flight engineer, who also has access to all engine controls and who thus can relieve the flying crew of all engine operating problems.

Four single engine fuel systems are provided, each engine having its own 100-gallon tank of high octane take-off fuel and its own 300-gallon tank of cruising fuel. One main selector switch on the engine pedestal changes over all the tanks in one motion. In addition, supplemental bypass levers make it possible to route fuel from any of the tanks to any of the engines. Engine-driven fuel pumps are supplemented by hand pumps in the cockpit. To make certain that this large fuel-delivery

system is foolproof in every respect, the engineers conducted comprehensive tests with a full-scale mock-up. They even had to make allowances for such conditions as the rearward acceleration of fluid in the fore and aft fuel lines during take-off, which in some systems results in a temporary drop in fuel pressure at the carburetors.

One problem magnified by the size of the plane had to do with the engine control system arrangement. Each of the out-board engines is seventy feet away from the cockpit, yet it must respond to control adjustments as rapidly and easily as if it were only a few feet away. A combination of push-pull rods at each end, connected by cables stretching through the wing, was found to be the answer. In cases where

(Continued to page 127A)

# Making Navy's Big Guns Calls for Precision

Circle, right, taking inside measurements of sixteen-inch gun with star gauge. Left, parking navy rifle after its completion in Washington navy yard. Bottom, left, machining outside of gun. Right, checking bore and inside measurements of a gun

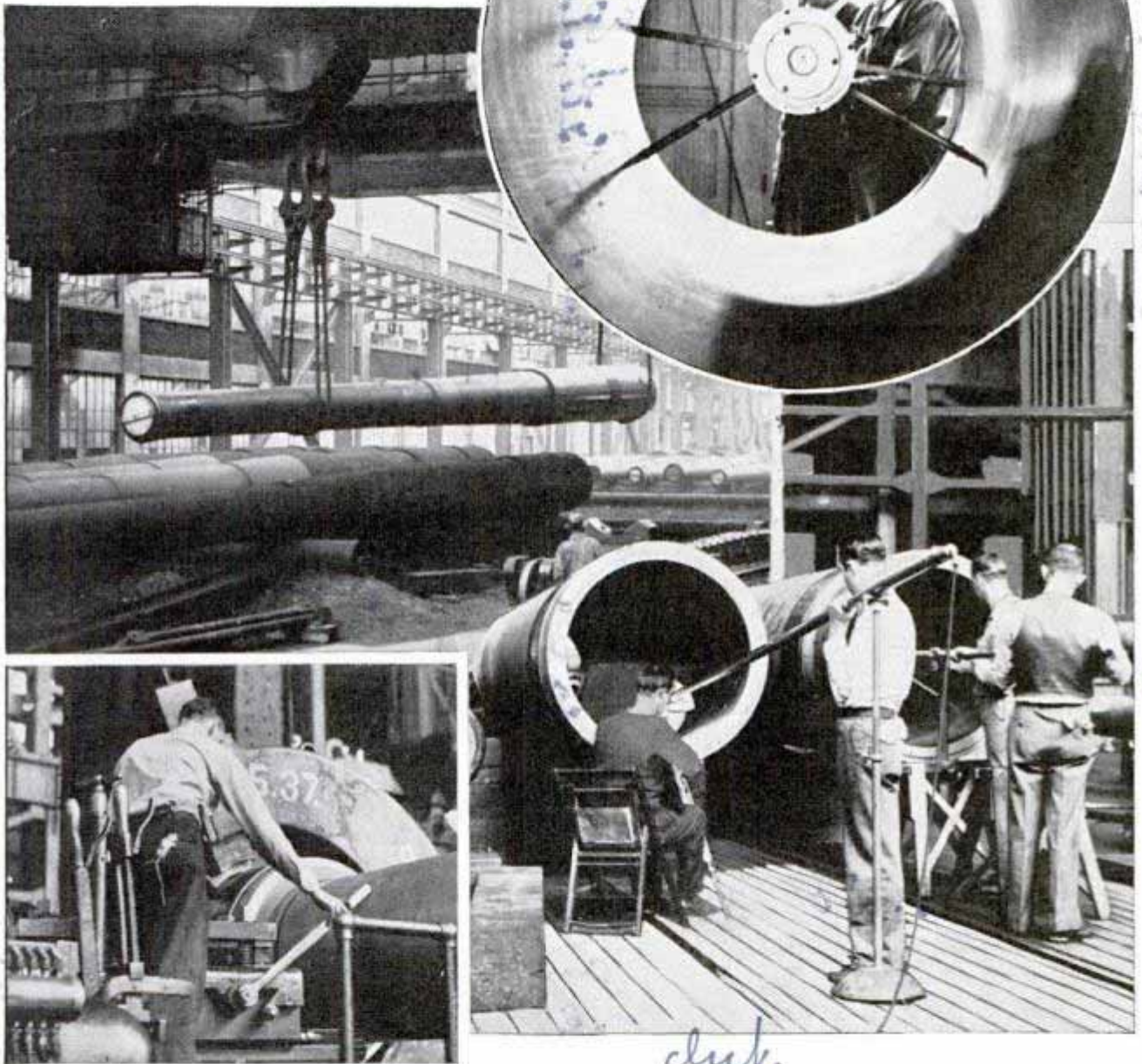

*club.*

Building big guns for the United States navy is a job calling for extreme precision, because one little flaw in a gun barrel might easily cost the lives of the gun crew on the first occasion the weapon was fired. When the casting of a big gun is sufficiently cool, it is taken from the mold and placed in the hands of machinists. The barrel goes into a giant lathe and the machinists, all experts at their job, turn the

inside and outside diameters. As the work progresses, measurements are taken on the inside with a star gauge. The finest precision is necessary at this point, for on it depends the accuracy of the gun. In addition, experts examine the bore for material defects. When the gun is completed, a big traveling crane picks it up and transports it to the gun park where the naval rifles are stored.

H 278

# Big Shoe Built on Car Body Latest in Advertising



View of giant shoe constructed on the body of auto.  
The shoe weighs 1,000 pounds

Designed as a means of advertising, a giant shoe built on an automobile body tours the country. It is size EEEEEEEEE-EEEE, and is fifteen feet four inches long, five feet four inches wide, five feet high. It weighs 1,000 pounds. Built into the shoe is a loudspeaker which is used for advertising purposes.

made by mechanics of  
Dona Allen, Inc.  
Bufford, Ia.

drop when its steel point is pressed. No oil is wasted, no part is drenched with oil, for the amount ejected at each application is about one-tenth of an average drop. It is designed for oiling office machines, clocks, guns and fishing reels, electric appliances and similar machinery.

H 310

## Fast-Drying Cement for Walls Sets within Two Hours

Unusual strength is claimed for a new type of fast-drying gypsum cement just developed. Highly resistant to weather, acid and mechanical wear, it sustained 600 to 1,200 pounds tension per square inch in tests, and ten times that strength in compression. Used for plastering walls and ceilings, this hydraulic cement can be controlled so that the first coat sets within one to two hours, making it possible to apply two or three coats in a day.

H 160

## Metal Stand on Ironing Board Saves Lifting of Iron

Considerable effort in lifting a heavy iron repeatedly can be saved by using a metal rest which is fastened to the ironing

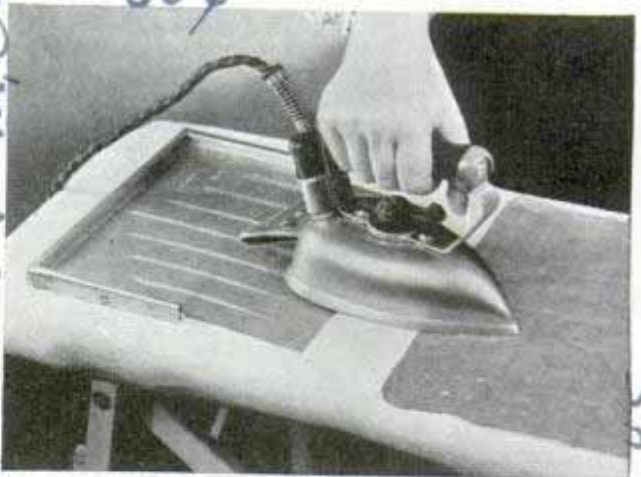

Asbestos lined, the metal pan provides resting place for iron which slides on without being lifted

## "Fountain Pen" Pressure Oiler Ejects a Tiny Drop of Oil

"Nosing" into out-of-the-way places that are hard for the ordinary oil can to reach, a "fountain pen" oiler ejects a tiny

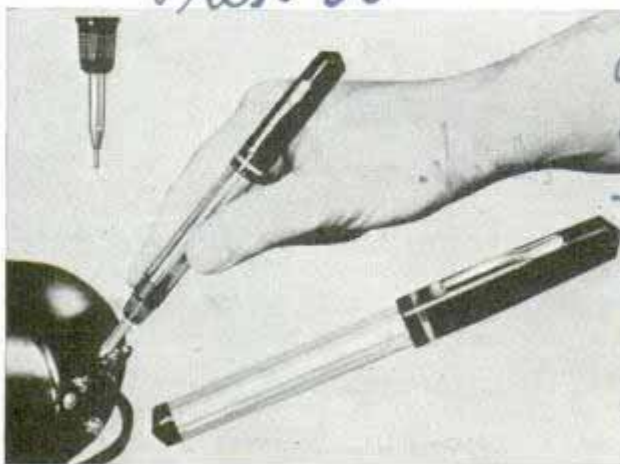

When steel point of "fountain pen" oil can is pressed, a drop of oil is ejected just where it is wanted

board, its edge flush to the board so that the iron slides on it easily. The rest, just put on the market, is lined with asbestos to prevent scorching the board cover.

Four parts of molasses, two of slaked lime, and one of charcoal powder is the recipe for a road surface that sets in four hours, is ready for traffic in twenty-four.

The Bell Mfg Co  
687 E. 82nd Cleveland

Compressed Air May  
Feb 19 38

Patd by W. D. Hayward  
Development Engineer  
Everest Co. 806  
7th Chicago

Sumford Chemical  
Sumford R.T

July 19 37-38



H 2 3 4 G. L. S. Palding & Straub  
 105 Nassau Street

# Making Baseballs and Bats Is Big Business



Since America's pastime provides an income for more people than does the real diamond industry that puts jewels on milady's fingers, manufacturing baseballs and bats for the game is big business.

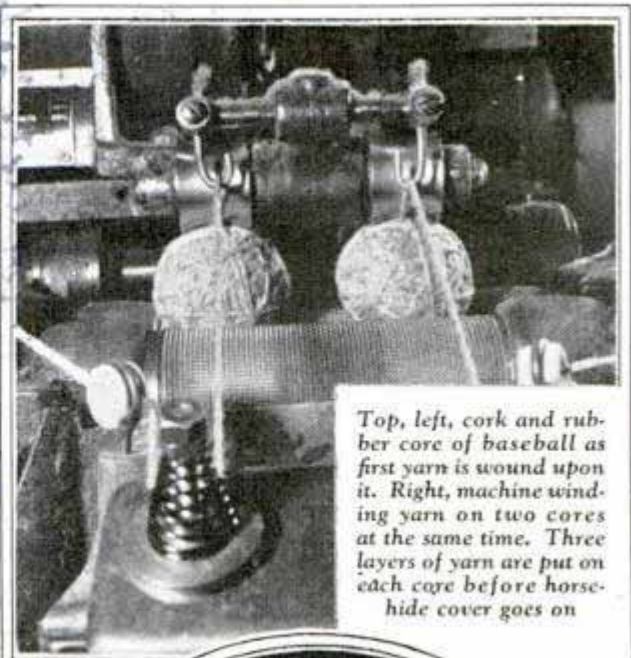

Top, left, cork and rubber core of baseball as first yarn is wound upon it. Right, machine winding yarn on two cores at the same time. Three layers of yarn are put on each core before horsehide cover goes on.



Center, left, after third layer of yarn is wound on the ball, it is weighed to conform to big league specifications. Right, horsehide covers cut in the peculiar shape to get a perfect fit.



Left, stitching on the covers, the final stage in production. Right, angle view of spraying racks where the completed bats are coated with lacquer. When the peculiar looking knobs are cut off, the bats are ready for sandlot, bush-league or big time player.

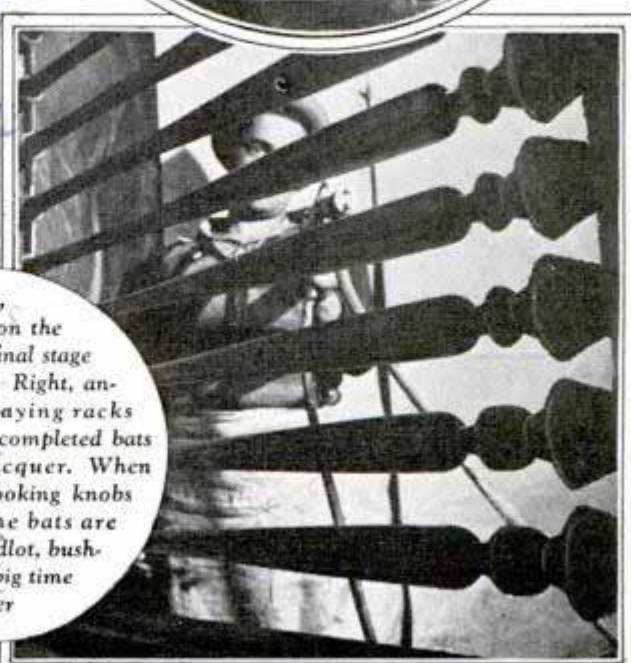

### Compass on Handlebar Post Adds Fun to Bike Riding

\$1.60



Compass, shown in circle, is mounted in streamline housing on post attached to bicycle handlebars

Watching a compass brings extra fun on a bicycle ride. A compass designed especially for bikes is being offered, housed in a streamline mounting at the top of a post that clamps over the handlebar.

### Film Speed Increased by Bath in Mercury Vapor Kit

Photographic film speed can be stepped up by a "mercury bath" kit now available for the amateur cameraman. The fact that



mercury vapor increases the sensitivity of film has long been known. This hypersensitizing kit consists of a lightproof, airtight container in which miniature films or short reels of amateur movie film can be stored for two or three days with a small glass capsule containing liquid mercury, increasing the speed of the film by seventy-five to 150 per cent. Even if left in the original package, film is speeded up by the

same percentage when exposed to the mercury twice as long. Film hypersensitized before and after use in the camera showed increases from 125 to 150 per cent. When the mercury discolours from oxidation a new capsule can be inserted.

### Tool Beads Tubing to Provide a Tighter Connection

To provide tighter connection of tubing, a new tool swedges a bead on the tubing. The bead prevents the tubing from pulling out at its connection. The device accommodates one-quarter, five-sixteenths and three-eighths inch tubing.

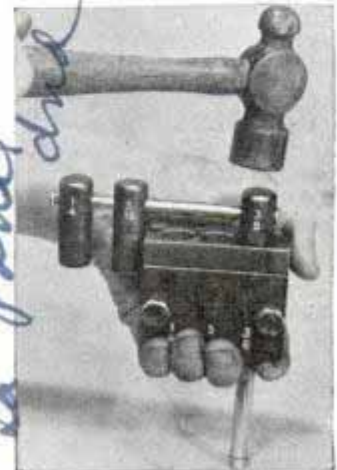

### "Wigglebug" Rocks Car to Save Time in Lubrication

Time may be saved in lubricating the automobile if a new "wigglebug" is used for rocking and shaking the car to get grease into frozen or dry bearings and springs. The device makes contact with

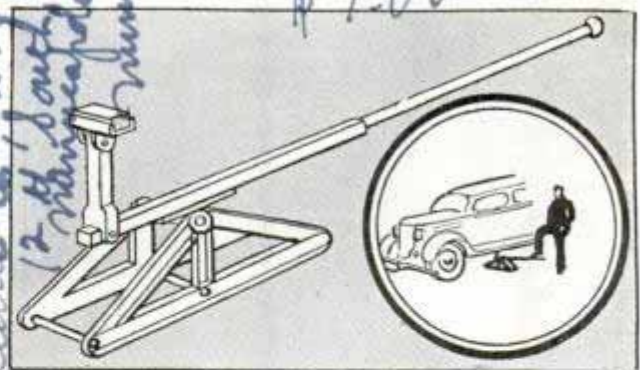

Here's the "wigglebug." Circle, how it is used to rock the car

the brace under running boards or with the bumper. A three-inch adjustment in the contact post permits use of the device on any car manufactured.

Send return postage to our Bureau of Information to learn the name of the maker of any device described in this magazine.

Handwritten notes on the left margin: 'Hull Mfg Co. Port 246', 'Warren, Ohio', 'Central Camera Co. 2300 Wabash Chgo', 'A296', '12th South', '12th Street', 'Richmore Electric Co. 245'.

Handwritten note: 'The Bee Jar & Product Corp'.

Handwritten note: 'A226'.

Handwritten note: 'A279'.

Handwritten price: '\$7.00'.

# Oil Leak Detector Shows Bearings' Condition

Above, two views of oil leak detector. Upper right, detector in use, analyzing oil being taken from the motor to show condition of bearings

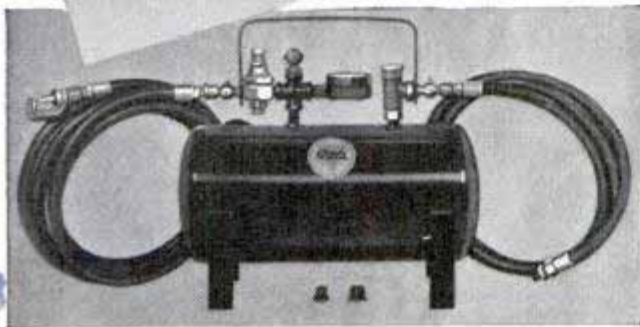
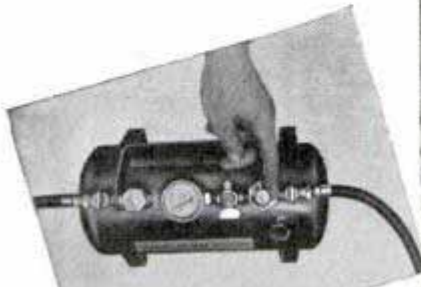
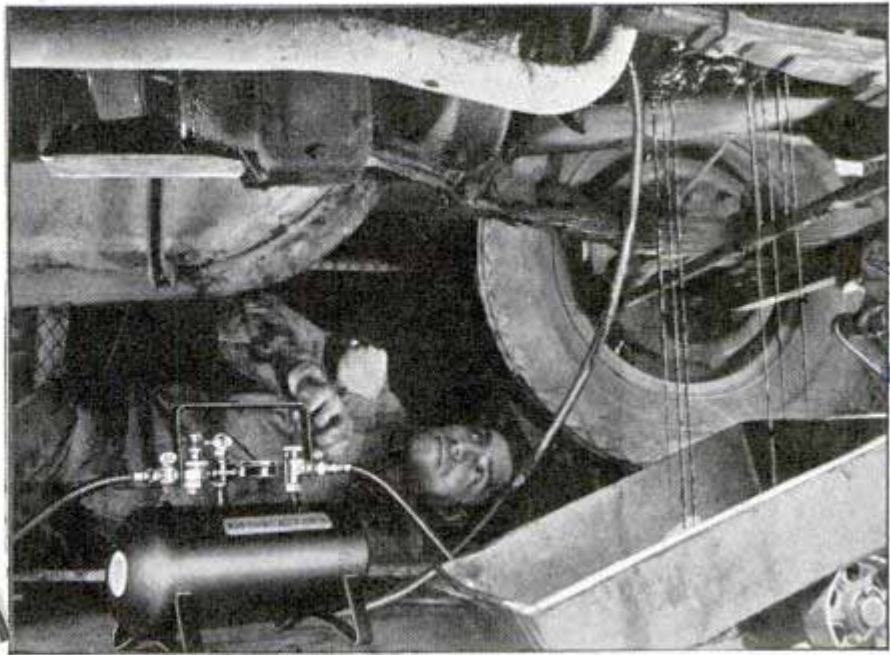

Bearings may be tested quickly for wear without tearing down the engine by using a new oil leak detector. Compact, lightweight and portable, it works with scientific accuracy and uniformity in tests of full-pressure lubrication systems. The detector consists of a small tank, equipped with the necessary gauges, and a convenient oil filter top, with two hose connec-

#313

tions, one to the air line and the other to the engine. After the oil pan is dropped, the detector is hooked up and with controlled air pressure, oil of the correct viscosity is passed into the engine under maintained and accurate air pressure to all bearings and oil lines. The tank is fitted with a pressure control valve which maintains twenty-five pound air pressure, regardless of air pressure at the air line. It also has suitable means for keeping oil and air separate, so that oil viscosity is correct and the oil does not become a foam. A screen assures passage of only clean oil into the engine. Used in the automobile owner's presence, the device will show whether new bearings are needed and whether all oil lines and headers into the engine are functioning properly.

## Humane Muzzle for Dog Permits Animal to Eat and Drink

While a new type of muzzle makes the most vicious dog harmless, it does not prevent him from eating ordinary food nor drinking. Known as the humane muzzle, it is made of a rustproof plastic material and consists of a ring that fits over the dog's nose and a small rod that goes through the mouth, back of the eye teeth. The ring prevents the dog from opening his mouth far enough to let the rod slip out. The muzzle is fastened with a small, lightweight padlock.



Two views of the humane muzzle. Left, as muzzle appears before being locked on dog

J. B. White, 110 31st Ave., Astoria, Ore.

N.Y.

Mr. Fred J. Greene, National Sportsman, Editor

Federal - May 11, 1931  
110 31  
Electronics

es 1356 Mr. J. O. Blackburn  
1224 d sabella St  
Walmette Ill

# ELECTRIC PLANTS Offer

Wind Charger Corp. 2700 Hawkins  
St. Louis, Mo.



Electricity from a power company than to make it yourself, it is no longer necessary to wait for the coming of the high lines to get it. About 800,000 rural homes today enjoy some sort of homemade current produced by plants ranging all the way from little wind chargers selling for less than \$50 up to big 5,000-watt systems which supply all the current needed for a home and make enough extra to light the barn and other outbuildings and run a lot of stationary farm machinery besides.

If you can't hook up to a high line, there is just one way to get electric light and power. That is to make it yourself. In making your own juice, you have a choice of

Princeton Engine Corp.  
1100 Broadway  
New York, N.Y.

**A**BOUT one-third of America's 31,000,000 homes still are unconnected to electric power lines. Of almost 10,000,000 homes without central station service, about half are on farms.

Thousands of these rural homes will never enjoy the blessings of electricity if they wait for the high lines to bring it because they are in areas so sparsely populated that power lines cannot be made to pay for themselves. Even where the high lines reach out into the country, the outlook for wholesale rural electrification has not been encouraging. During the three years ending with 1936, it is estimated that less than 400,000 farm homes were hitched to the electric lines, bringing the total to 1,128,000.

While it usually costs less to buy elec-



Wind charger, top, which runs radio and two lights. Below, small gasoline-engine generator

Princeton Gen. &  
Motor Corp.

Wind Power Corp  
 Newton, Iowa.

es 1356

# POWER to EVERYONE

three systems. You can use a wind charger and let the wind do it for you, you can run a generator with an engine which uses gasoline or kerosene as fuel, or you can employ a small Diesel plant for the same purpose.

Like everything else, the amount of power you get depends to a great extent on how much you spend for a power plant. The larger the plant, the greater its capacity. An Oklahoma farmer, for example, enjoys a few of the advantages of electricity with the aid of a wind charger costing less than \$50. The outfit is intended to keep his radio batteries charged, but he has enough extra juice to run two lights, one in the kitchen and one in the living room.

The great advantage of the wind charger is that it offers current at low operating cost, since the wind is free. The disadvantage of a



## POWER AVAILABLE ON FARMS IN 1930



EACH SYMBOL REPRESENTS 2,000,000 H.P.

Electricity can milk, hoist hay, pump water, do the washing, supply light and ice and do scores of other farm tasks if it were generally available

wind-driven outfit, of course, is that the amount of power is dependent on the amount of wind. In sections of the country where the wind averages ten miles an hour or more, air-driven electric plants usually are quite satisfactory.

For less than \$100, a six-volt wind charger, a battery and the necessary materials for wiring can be obtained. Such an outfit should run a radio and a few small lights and perhaps turn an electric fan of the automobile type. For a little extra, it can operate an intercommunicating system between house and barn and a loudspeaker in the latter building.

A thirty-two-volt air-driven electric plant, including generator, batteries and

D. Ngoy + Stratton Co, 2711 N. 13th St, Milwaukee, Wis. 851



wiring, may cost several times as much, but it will supply an average home with all the current needed except for cooking or water heating. Such a plant not only takes care of the lighting and runs the electric household appliances on one Illinois farm, but also supplies power to run a washer, a refrigerator, an iron, a churn, an emery wheel, a forge blower, a soldering iron, a band saw, a rip saw, a planing mill, an air compressor, a rotary pump and a car battery charger.

For those who want to be independent of the wind and who desire a plant which may be operated continuously at or near its full capacity, a generator driven by an engine burning gasoline, kerosene or perhaps fuel oil meets all requirements. Engines are now produced which will run 4,000 or 5,000 hours without much attention, and the cost of operating some of them is estimated at less than five cents per kilowatt-hour. With the muffler buried in a barrel of stones or otherwise sound-insulated, the engine makes little noise.



Such a charger developing up to 100 watts at six volts may cost about \$35 and will run eight or ten lights and charge the radio batteries. For around \$60 a charger which develops 200 watts at six volts can be obtained. This outfit will take care of the radio and run the lights in a small home. A six-volt charger also is combined with a gasoline-powered washing machine, permitting battery charging while the family washing is being done. The system also can be run continuously, if desired.

A 400-watt system supplies all the lights needed for a small home and will also take care of the ordinary household appliances which are operated intermittently. For a medium size home, an 800-watt plant will furnish light and power for most ordinary purposes. For larger places, a 1,500-watt plant or even a 3,000-watt one may be needed to electrify the home and also provide enough power for pumping water, running a heating plant and perhaps operating some stationary farm machinery.

By using a 110-volt system ranging from

(Continued to page 136A)

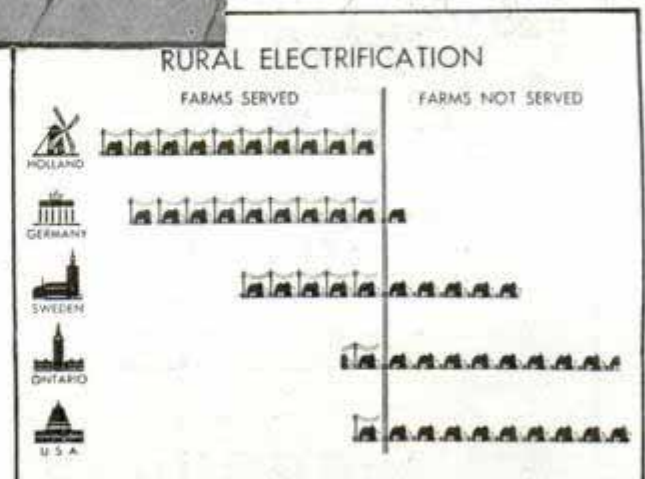

Wind charger, top, which runs radio and small lights. Center, battery and engine belted to motor generator. Bottom, rural electrification is much further advanced in some foreign countries than in the United States

H 299

# Science Probes Secrets of Stradivarius Violin

For two hundred years violin makers have tried to match the beauty of tone and form wrought by Antonio Stradivari, the Italian craftsman, in his violins. Chemists have tested the old violins to learn whether the wood had been subjected to some treatment, and have even analyzed the veneer, without uncovering any secrets.

But today the violin makers by applying mathematics and precision measurements to the task are producing instruments that really rival the famed Stradivarius. The violin is first laid out on the drawing board, following mathematical calculations carefully derived from the original. These calculations take in not only the contours

but the thickness of the wood; delicate instruments are used to record the strength and measure the curves of both top and bottom, precise to a fraction of a millimeter. It is believed now that the success of the ancient craftsmen depended on their exact calculations before actual manufacture of the instrument, and this is the method followed by the master violin makers of today. The result of this process is the production of instruments so beautiful in form and tone that some critics cannot distinguish the new violins from those made by the old master.

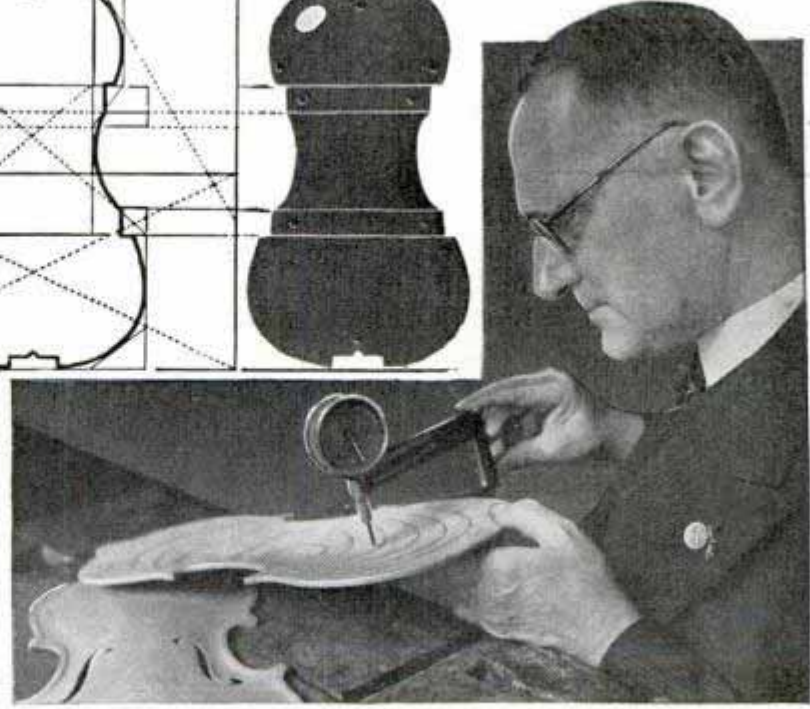
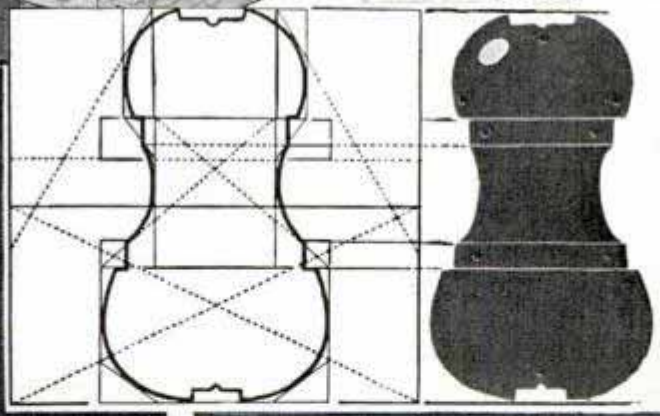
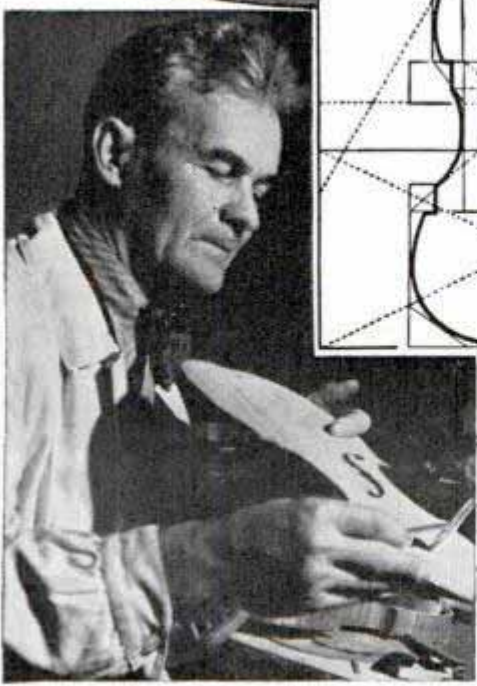
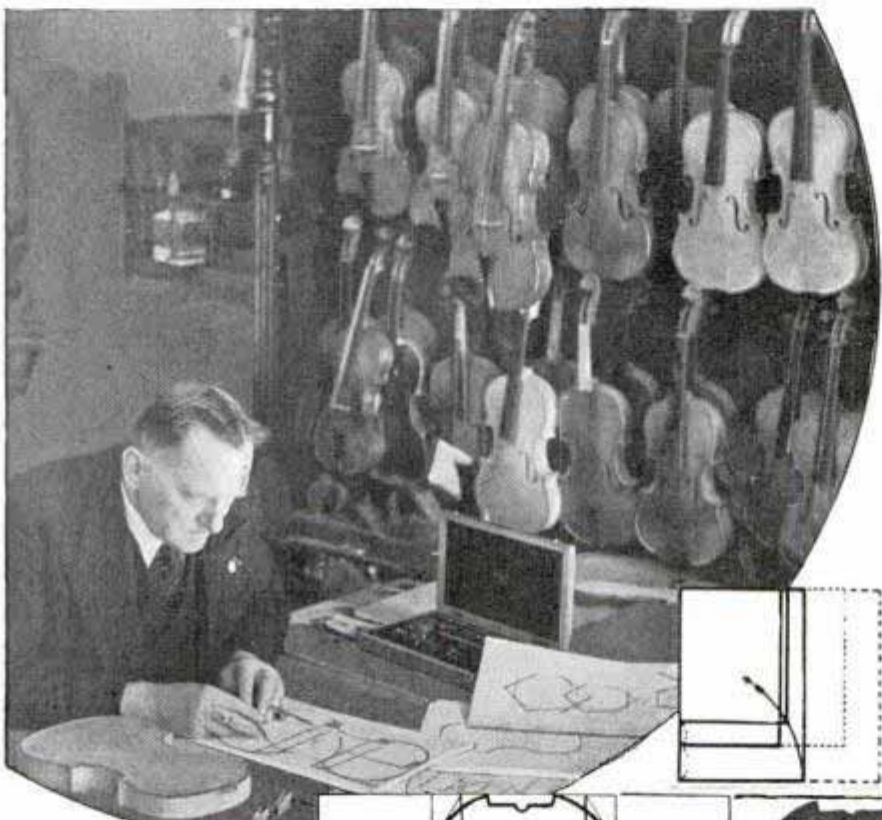

Violins rivaling the famed Stradivarius instruments are made today by laying plans on drawing board, above, with mathematical precision. Below, delicate instruments measure thickness and contours of wood

no further information  
6/28/39

# Camera Helps Builder Project Future Road

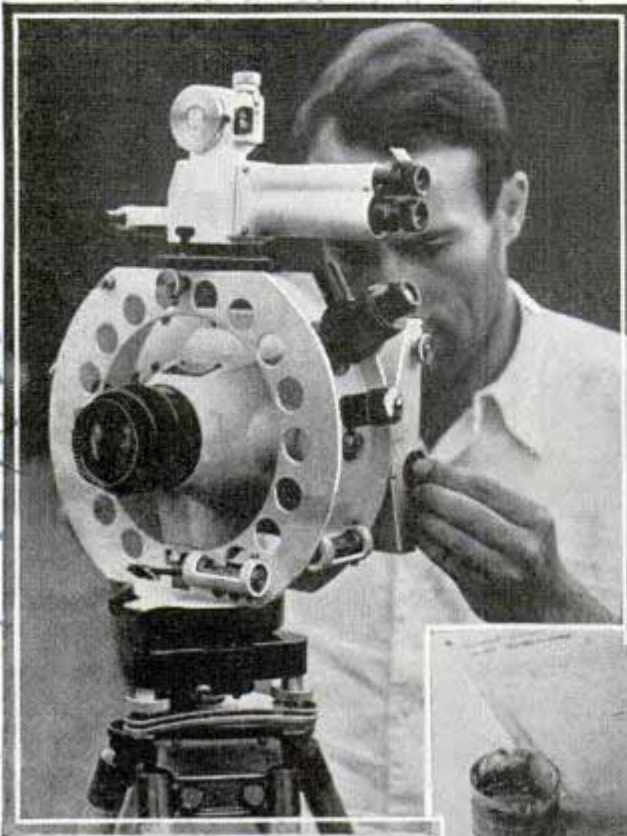

One of the problems of the highway builder, that of fitting the road into its environment, is being solved with the aid of the camera. Photographs are made of the route of the projected street or road, the planner sketches on the photograph his idea of the completed highway, in perspective, and then the plan can be visualized and criticized before construction begins. For example, one project called for a highway cutting through woods and across valleys. Panoramic photographs were made, enlarged and fitted together; bridges were painted over the photograph and the composite picture itself was photographed. The result was a picture deceptively like the finished work.

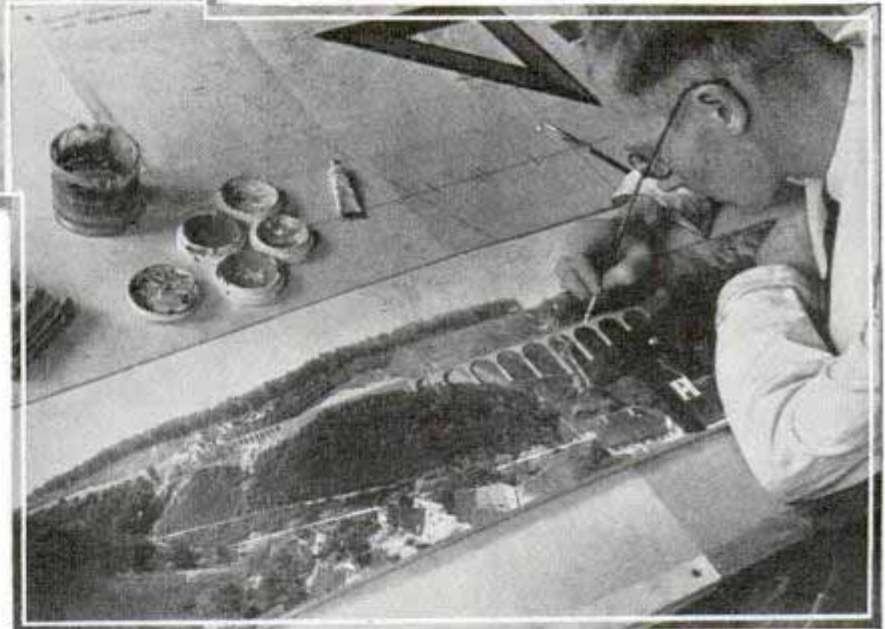

Above is the photographic "eye" with which the highway engineer sees his project. Photographing the locale of road or bridge in panorama, he lays out his perspective drawing, shown at right, then photographs the finished picture

# War Tanks Found Ineffective Against Trained Troops

In the opinion of Lieut. Col. Emilio Canevari, Italian writer on military subjects, in the journal, "Army Ordnance," war tanks are ineffective against trained troops. Tanks scored their success against the Germans in the world war, the writer holds, because German manpower had been depleted badly and what was left was of inferior quality and shaken in morale. But in the Spanish civil war, the tanks have been getting the worst of the argument since the government militia learned the business of fighting. Light tanks, that can make speed and get into places, are mere traveling tinpots, easily

subject to fatal puncture by heavy machine guns firing armor-piercing ammunition, according to the writer. Heavy tanks have to keep moving, for as soon as a tank stops, field guns find it promptly and end its career. Even while the big tanks are under way, they can be put out of action by thirty-seven millimeter guns and even by new anti-tank guns of about half that caliber. Furthermore, a moving heavy tank is of little effectiveness, except as a flame thrower, because it shakes and lurches so much that its machine guns and light cannon lose most of their ammunition in either air or earth. Infantry have

H 298  
 further information  
 2/23/38

H 293

scene service  
 2/23/38

60 at 45 ch. new York



learned that at close range a heavy tank need not be feared, the writer points out, and in Spain the government troops have found they can ruin them either by exploding grenades in their tractor treads, or by pouring gasoline on them and igniting it.

## Firemen Enter Blazing Ship in Asbestos Suits and Masks



Carrying their own oxygen supply and protected from fire, these men are equipped to attack flames in heart of blazing liner

Ready for the peril of fire at sea, the fire fighters aboard a North German Lloyd liner are provided with overall asbestos suits and helmets. They also carry electrical equipment, and wear oxygen masks to aid them in penetrating the smoke-filled interior of the ship in case fire breaks out.

## Landing Lights in Cockpit Guide Pilot through Fog

Three bright dots shining in the cockpit of the plane are the fog-piercing "eyes" of a blind landing system now being developed. It makes use of ultra-short radio waves, a cathode-ray tube and the plane's "artificial horizon" to reproduce before the pilot's eyes the equivalent of landing lights on the hidden airport. Inside the cathode-ray tube, three electron "guns" shoot electrons and produce three light spots on the tube's fluorescent screen. When the dots are lined up horizontally, the pilot knows he is on the right glide path to the field. If he is off course, the dots move in the direction the plane has veered, up, down, to right or left. Four antennas fed by one radio transmitter send out the signals which, in conjunction with the artificial horizon, aim the electron guns and thus show the pilot his position with relation to the proper landing course.

## Mule Put to Bed in 'Hospital' to Let Broken Leg Mend



Injured baby mule rests on bed in farm "hospital" while its broken leg mends

There is a three-bed "hospital" for mules on the farm of a stock raiser near Harrington, Wash. Until the hospital was installed the farmer lost several baby mules each year due to broken legs and other injuries when trampled. Now, after a veterinary sets the broken limb, the disabled baby mule is allowed to rest on one of the three old beds set aside for the hospital.

Freight trains in the United States traveled an average of 386.4 miles a day in the first half of 1937, a new record.

Railway Age  
March 19 38

H 3 4 5

H 3 3 4

Science & Service 3/11/38

Illustrated London News 2/19/38

# Vacuum Hose Sucks Waste into Refuse Truck



Driver dips lightweight hose into refuse can and vacuum sucks garbage into airtight container on truck

Clean, fast collection of garbage and refuse is provided by a vacuum truck that sucks the waste materials through a flexible, wire-reinforced rubber hose into a pressure-tight compartment. The tremendous volume of air created by the centrifugal exhaust aerates the garbage can and leaves it clean.

# Plane Burning Liquid Hydrogen Could Circle Earth Non-Stop

When some inventor develops a safe, economical method of producing and handling liquid hydrogen, he will probably revolutionize air transport. Igor Sikorsky, aircraft engineer, says that an airplane using liquid hydrogen could circumnavigate the earth along the equator in a non-stop flight without refueling. Barring such revolutionary developments as that, however, Mr. Sikorsky believes the aircraft of the future will find a practical limit of 500 to 600 miles per hour and a top altitude of 75,000 to 90,000 feet. Air speed records have advanced from forty-seven miles an hour in 1909 to 162 in 1919, 357 in 1929 and 440.62 in 1938, and predictions of 1,000-mile speeds in the next generation have been made. Mr. Sikorsky, however, doubts that this speed will be reached. Experiments

show a change in the streamline flow around a wing and considerable increase in resistance to the moving body when it approaches the velocity of sound, about 760 miles per hour, and propeller efficiency diminishes above 500 miles per hour. The very near future, Mr. Sikorsky feels, will see a practical test of high-altitude air-line operation, with passengers riding above the weather in supercharged cabins at 300 miles an hour or faster. But he points out that a plane capable of flying at fifty miles an hour at sea level would have to fly 500 miles an hour at 100,000 feet altitude to stay aloft because of the difference in air density. Such a speed is too high for efficient operation of wings and propeller. Flight above 75,000 feet and 500 miles an hour therefore awaits development of a new method of propulsion and a new source of energy with more power per weight. Mr. Sikorsky predicts for the immediate future 100-ton flying boats crossing the Atlantic in twenty hours, and anticipates that these ships will be too vast for manual control by the pilot and must have mechanically operated controls.

# Special Soap in Motor Sprayer Cleans Off Dirt and Oil

Dirty motor or chassis can be cleaned easily with a hand-pump sprayer now on the market. A special soap, soluble in water or kerosene, is used in the sprayer to take the "cling" out of oil, grease and dirt. The solution, with the accumulated dirt, is removed by water pressure.



Spraying soap solution on automobile motor to remove dirt and grease

Magnus Chemical Co., 22 South Ave.

Pneumatic Truck Body Co. Inc. 176 35th St. Detroit Mich. Chief Designing Engineer, I 360 Strayford Conn. Strayford Aircraft Corp. 176 35th St. Detroit Mich.

H 320

General Electric Aircraft March 1938

176 35th St. Detroit Mich.

H 302

# Midget Radio Planes Test Gunners' Accuracy

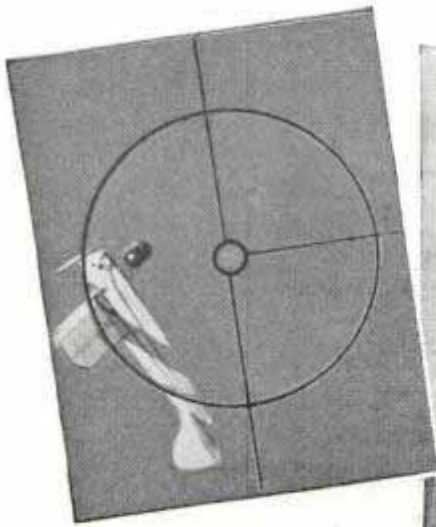

Midget planes controlled by radio are being used in army target practice. Movie cameras mounted on guns automatically register hits and misses as dummy shells pour through the anti-aircraft weapons

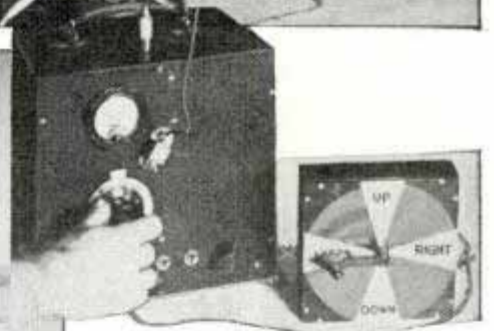

Below, gun crew ready to "fire" at radio plane. Heretofore, targets were towed by full-size planes at several hundred dollars per hour. Inset, camouflaged gun

Top, left, photo showing a direct "hit." The film is thirty-five millimeter. Anything in the circle is a direct hit. Right, explaining how the plane is controlled by ground transmitter. Center, left, range finder with which the midget plane is sighted and its range established for the gunners. Center, right, ground transmitter and controls for manipulating the plane in the air. The little ships, built by Reginald Denny and Paul Whittier, have a top speed of seventy miles per hour and a ceiling of 9,000 feet



5751 Hollywood Blvd. Los Angeles Calif  
Will you give

1715.

Blade on

# The PHANTOM FLEET

Chrysler

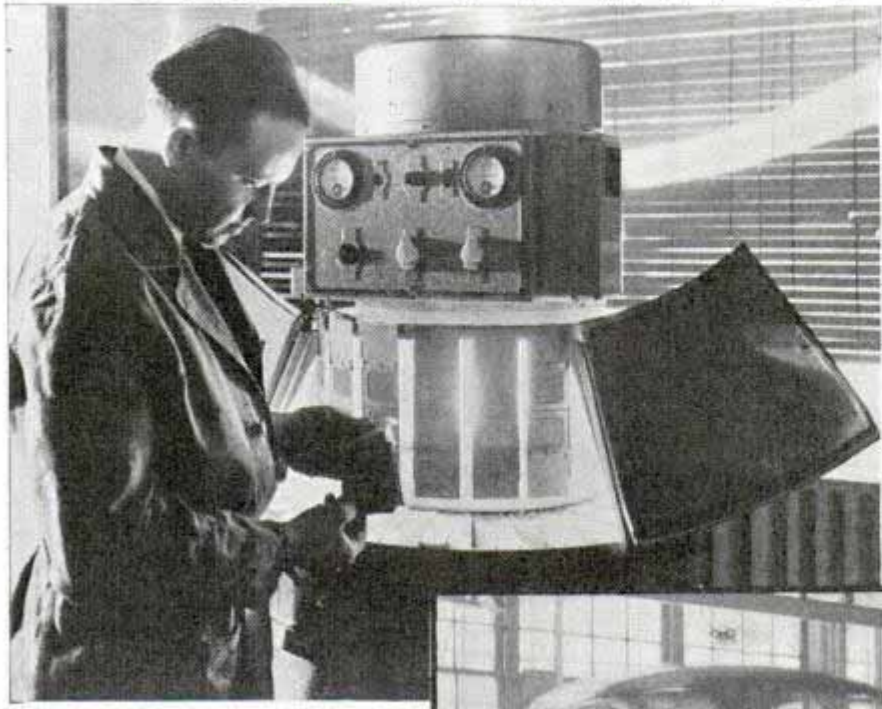

production. To keep ahead of the times, such a laboratory must be rebuilt and completely changed almost from day to day in order to offer new or more severe forms of torture for car parts.

Nothing is too small, nothing too large for the mechanical laboratory to tackle. The one at the Chrysler Engineering building, for example, is

By H. W. Magee

## PART II

**B**EHIND all the road testing of new parts and new cars is the greatest automobile "proving ground" of all—the laboratory.

Without it, frequent changes and improvements in design would be all but impossible because an accelerated laboratory test quickly reveals facts which could be obtained only after months of road testing. In addition, many tests which can be conducted quickly in a laboratory could not be performed at all on the road.

Every new automotive development must survive a laboratory beating, but new devices are not the only graduates of this proving ground. Through this chamber of horrors for cars eventually pass most of the 35,000 individual pieces which go into some modern cars.

The many kinds of steel and other materials are checked here, and there are also constant breakdown and endurance tests for experimental parts and for parts in

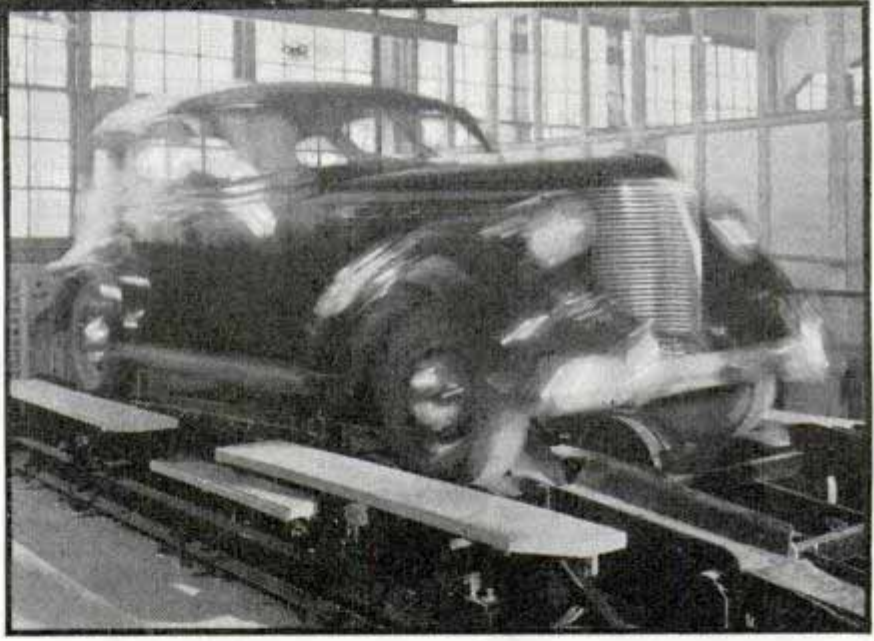

*Chrysler car dancing on the Belgian roll. Above, arc lights which approximate bright sunlight test fading qualities of upholstery*

equipped to test the performance of anything from a carburetor to a complete car. A walk through this laboratory shows every part of an automobile undergoing some form of punishment.

Perhaps the most spectacular test apparatus is the Belgian roll, a shimmy machine which shakes a car like a terrier might shake a rat. It consists of motor-driven rollers which impart a jolting impact to the car resting on them and was developed years ago to test cars which seemed to fall apart when pounded over the stone blocks of Belgium's roads. When running at full speed, the rollers shake the car until it dances and, in a few hours,

H/15

# of the HIGHWAY



give it more jolting, bumping, bouncing and vibration than it would receive in thousands of miles of driving over the roughest roads.

Bolts, nuts, screws, license plate holders, bumpers and even doors used to rain from cars like hail after they had been in the grip of the roll for a short time. But cars are built better today. A modern automobile will waltz and shimmy for hours and, after tightening, be ready for more torture.

The engines on the test blocks receive the same punishment which complete cars get on the Belgian roll. In the bedlam of the motor test room, engines are running at full throttle, their exhaust manifolds glowing red. In twenty hours on the block an engine is given the equivalent of 1,800 miles of travel at ninety miles an hour—without a stop. That's like running three or four Indianapolis races.

Here modern aids of science help expose



Photos courtesy Chrysler Corporation

Test driver, above, giving some experimental parts a workout. Below, test driver reading thermometer which gives temperature of air outside the car

841 Massachusetts

are Detroit Mike

the innermost secrets of cars and parts. Cathode-ray tubes, similar to those used in television receivers, magnify vibration in crankshafts, drive shafts and transmission parts 10,000 times, enabling engineers to see and study the vibration and eliminate the causes of the trouble.

Chrysler

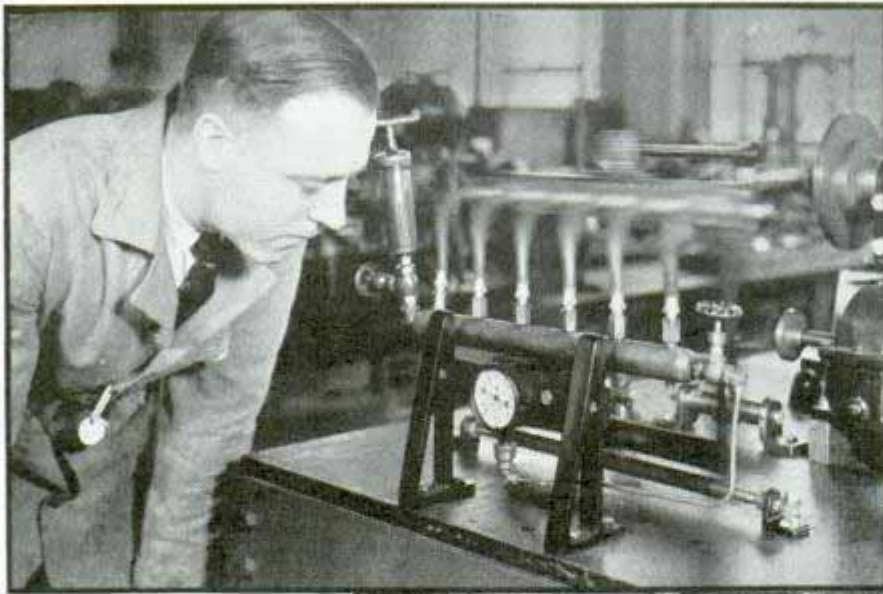

*Machine which tests durability of gasoline lines, above. Right, miniature sandstorm, above, which tests efficiency of tie rod seal, below*

And the same spectrograph which enables astronomers to probe millions of miles into the sky and tell what stars are made of also tells engineers in the laboratory what metals are made of. The spectrum of a piston heated to incandescence reveals the elements which compose the metal. There's no guesswork any more about metal structure in your automobile.

In an oversize refrigerator big enough to accommodate an automobile a test crew is "doing a stretch in Siberia." Dressed in fur-lined suits, these men are checking the starting characteristics of motors in cold weather. The thermometer registers forty degrees below zero but the engines seem to be standing the Arctic weather better than the testers.

On a full size dynamometer other engineers are giving a full size car the third degree, forcing it to disclose the exact number of "horses" hidden under its glistening hood. Near by is a carburetor test

stand where these units are being checked to determine the most efficient type and the most economical fuel mixture. Here the volume, motion, temperature and humidity of the air are under perfect control, something impossible in a road test.

Like physicians conducting a metabolism test on a patient, two engineers are making each cylinder of an engine "exhale" through an exhaust analyzer which is so sensitive that it detects one part of unused fuel in a million parts of waste gas—another experiment designed to save you fuel.

Here a man checks the balance of a propeller shaft with his ears—something no test driver could do with ears or anything else. The support at each end of the shaft is pivoted and held in a hori-

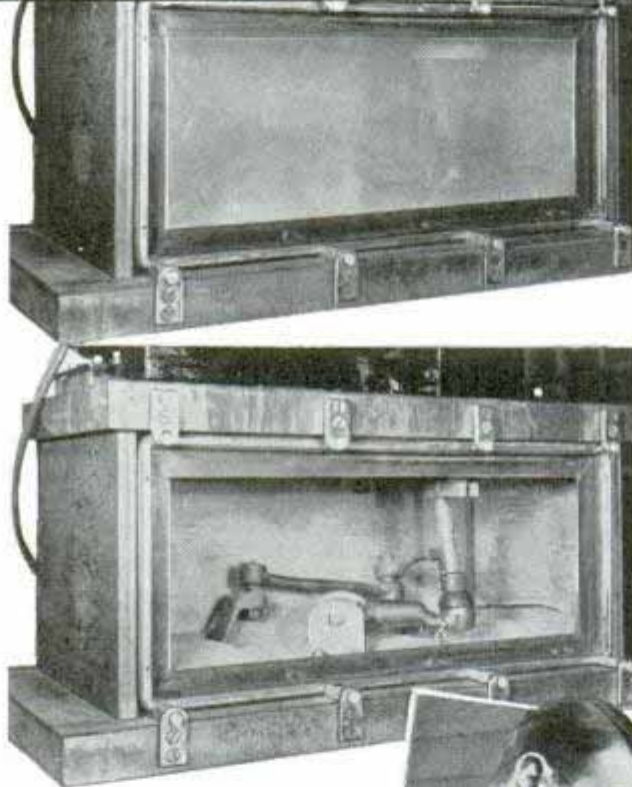

*Checking silver surface coating of Plymouth headlamp. Silver is stripped off, precipitated and weighed*

zontal plane by calibrated coil springs. The shaft is rotated at various speeds and the spring load is adjusted to equal the out-of-balance force of the shaft. This allows the supports to move away and break an electrical contact. A click in his headphones tells the test man when this occurs, or he can watch neon lights.

In a box with a glass front a miniature sand-storm rages as the end of

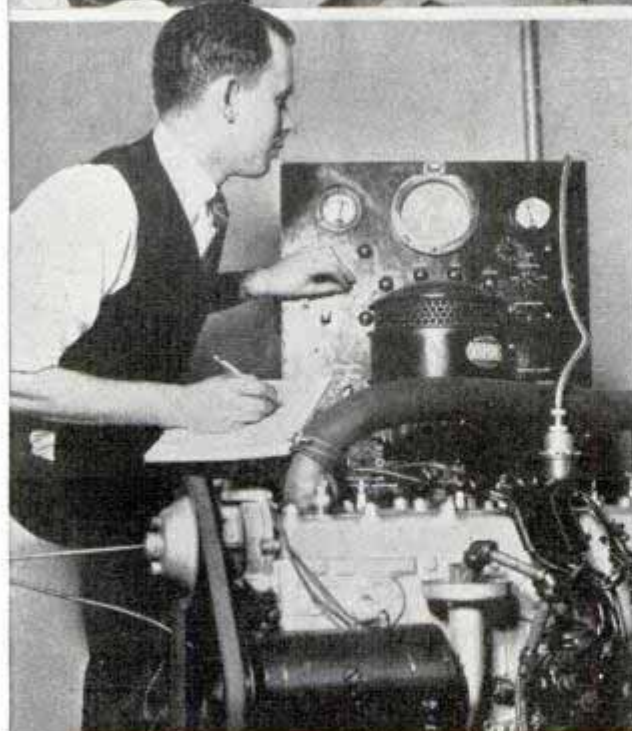
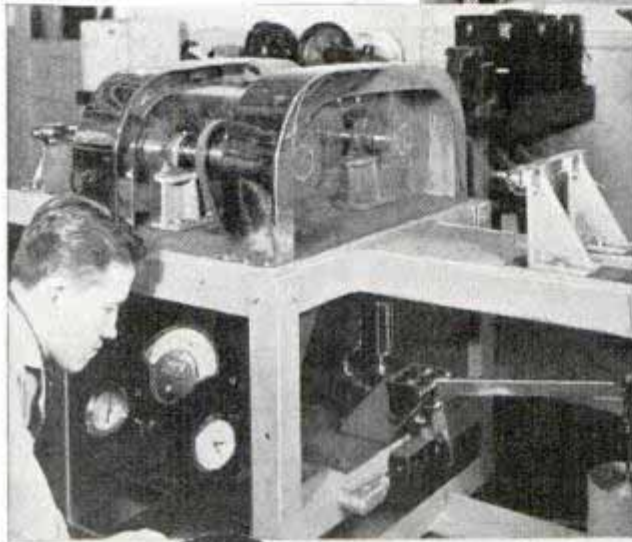

Checking propeller shaft balance, top. Center, machine which flexes hydraulic brake hose. Bottom, cathode-ray tube aids in engine tests

a tie rod operates, a quick way to find out just how efficient is the tie-rod seal. Near by a forty-mile gale of fuller's earth tests shock-absorber seals in similar fashion.

A hundred-pound hammer bangs merrily away on a rubber bumper block mounted on a little anvil while a counter records each bang and the endurance of a new type of exhaust pipe hanger is being tested by a rod which strikes the pipe at regular intervals, causing the hanger to flex just as it will when the driver hits a bump.

One machine clatters away jiggling gasoline lines until they fail, another is flexing brake hose to determine its endurance and a third is testing the expansion of the brake hose under pressures as high as 1,500 pounds per square inch. Here are armored chambers where propeller shafts and fly wheels can be revolved at speeds so high they explode and here are twin dynamometers to determine friction loss in transmissions. Right next door is a set-up where clutch spin is being investigated.

Fan belts are tested by running them under load. Belts which used to fail after twelve or fifteen hours now stand up for 300 hours on the same machine, due to better construction. Soon a new apparatus must be built to give the belts an endurance test in a shorter period because hours count in the laboratory. The efficiency of various types of oil filters is tested by pumping oil through each and adding carefully measured amounts of sludge at reg-

(Continued to page 145A)

Plymouth

# Prism and Lens Weave Weird Light Patterns

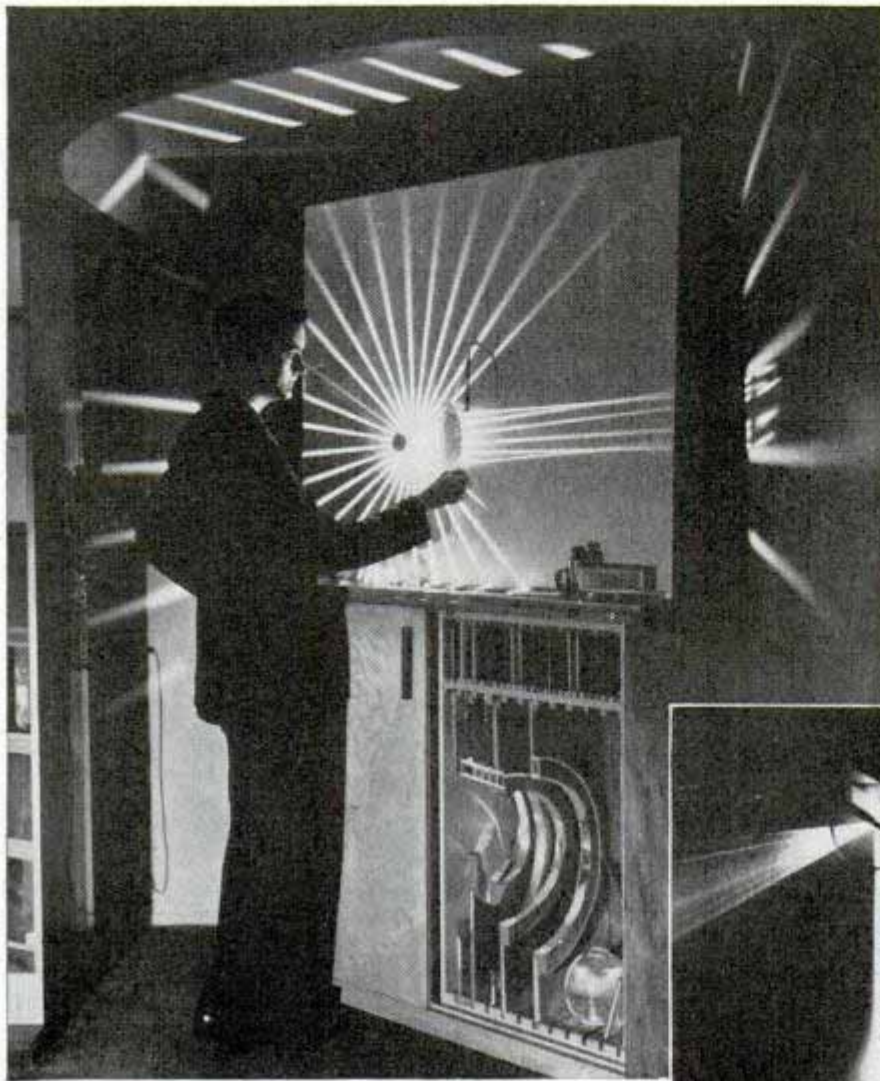

*At the left a General Electric Institute demonstrator at Nela Park, in Cleveland, is bending light beams across a white mat with a lens. The demonstration shows the infinite possibilities of light control with lenses, prisms, mirrors and various curved reflectors. Below are a few of the fantastic patterns that can be woven with these simple instruments*

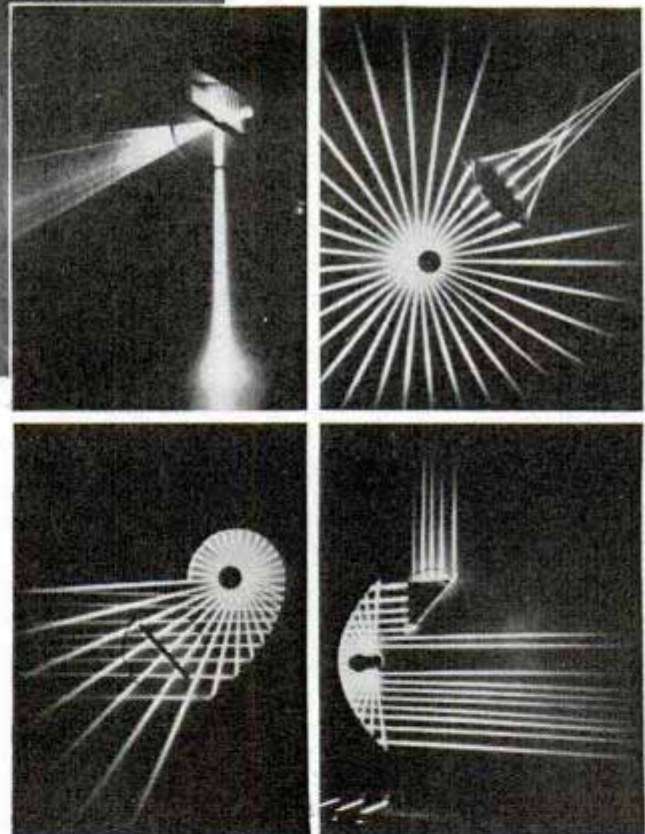

How man can twist and bend light into a myriad shapes and patterns to fulfill his purpose or his whim is shown by a light-control demonstration of the General Electric Institute at Nela Park, Cleveland. Light beams are projected across a vertical white mat and then, by means of prisms and lenses, mirrors and various curved reflectors, the beams are scattered into fantastic fingers of light, focused into parallel lines or pyramids, and woven into weird patterns of high-light and shadow.

## One Accident in 2,000,000 Miles on Air Lines of U.S.A.

There were seventeen accidents in 34,923,731 miles of flight on the scheduled air lines within the United States during the last half of 1937—one accident in every 2,054,337 miles. Only two resulted in deaths, however. In the same period of 1936 there had been twenty-six accidents,

four of them fatal. Nineteen passengers lost their lives in the last six months of 1936, and eighteen in the final half of 1937; since the domestic air lines rolled up 272,086,961 passenger miles in the latter period there was one passenger death every 15,115,942 passenger miles. Including the

15326  
# 3979  
Dept. of Commerce, Bureau of Air Commerce,  
Mar. 8, 1938.



foreign extensions of American air lines, twenty-nine passengers, three pilots, three co-pilots and two crew members died in the three fatal crashes from July to December last year. Weather was the leading cause of air-line mishaps, receiving the blame for 25.45 per cent of the accidents on domestic and foreign extensions; personnel errors were the cause of 24.54 per cent, airplane failure 22.73 per cent, airport and terrain 15.91 per cent, other causes 9.09 per cent and undetermined, 2.28 per cent.

## Less Grainy Film Is Sought with "Probability Machine"



Photoelectric device with which two California scientists are trying to discover means of reducing graininess of film

*W. O. Howard*  
*W. C. Parodena*

### Low-Voltage Drill Is Run by Automobile Battery

Taking its power from an automobile or truck battery, a low-voltage drill and grinder makes itself useful far from the power line on farm, highway and field. It operates on six to twelve volts, and its speed, regulated merely by the pressure applied, can be high enough for grinding or drilling wood or slow enough for boring large holes in iron. The chuck takes up to a half-inch drill. It has no gears.

Two scientists at California Institute of Technology were asked to see what they could do about reducing the graininess of motion-picture film. The "probability machine" they built for that purpose turned out to be a versatile instrument; not only does it aid in the study of film grain, but it can be used in bacteria tests, or in the statistical field to smooth out the curves of a sharply fluctuating graph. Film grain consists of tiny particles of silver, which under the microscope are shown to be grouped in spots. The California scientists are trying to learn why. They pass a small section of movie film slowly under the microscope of their machine; light passing through film and microscope is reflected to a photoelectric cell whose fluctuations of light are photographed on movie film. The movie is then put on a slitted drum in the integrator, and light passed through the slit reaches another photoelectric cell. As the cell moves across the film, the light beam falls on a scale indicating the graininess.

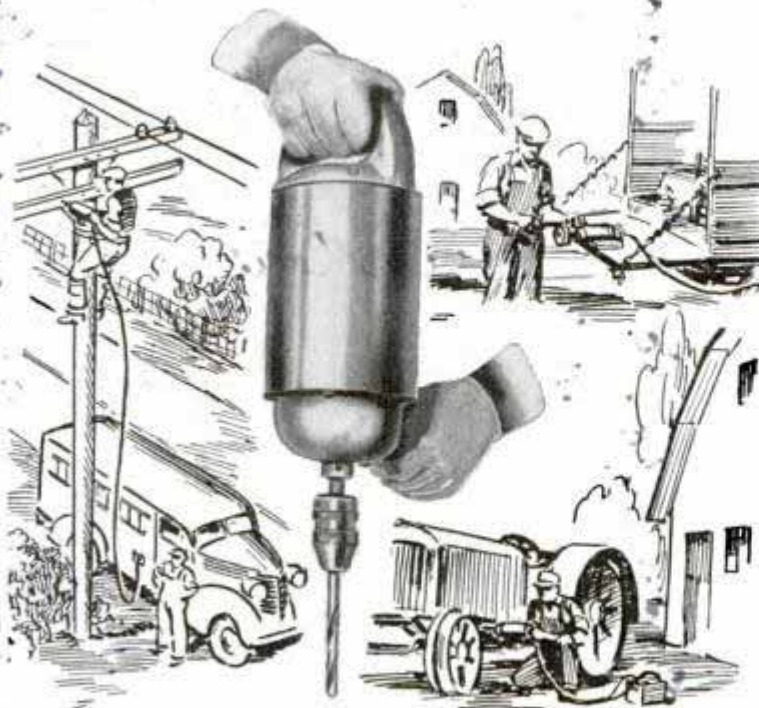

Linemen, farmers, machinists can work far from power line with this gearless, low-voltage drill run by a battery

*Le Jay Refg. Co. #406 W. Lake St. Minneapolis*

# Flexible-Drive Outboard Abolishes Gears



With no interference in front of it, propeller driven by flexible shaft obtains full thrust in water

Higher propeller efficiency is claimed for an outboard motor that delivers power through a flexible drive shaft. This not only eliminates the underwater gear box, but it lowers the disturbance of water in front of the blades and thus enhances their efficiency. The two-cycle engine is air-cooled, weighs only twelve and one-half pounds and develops two horsepower at 3,400 revolutions per minute. A racing model of similar type develops eight horsepower and weighs twenty pounds.

## Long-Burning Super-Match Starts Fire Easily

For starting fires in locomotives, furnaces and similar places, a special fusee, similar to those used on railroads for signaling, has been developed. The match burns for two and one-half minutes with an intense flame, sufficiently long to ignite

oil or other fuel. The fusee has a head so fitted that it may be removed. When scratched against an inner head, it ignites the fusee, which is thrown into the furnace. The match is regarded as an improvement over the lighting of oily waste.

## Small Capacity Home Humidifier Operates Automatically

With a capacity of one and one-half pints per hour, a small-size humidifying unit now on the market has many adaptations in industrial and domestic fields. The unit, which operates automatically, can be tapped into the regular supply or storage tank, eliminating the necessity for installing equipment to handle the water.



Mounted inside a spun-copper bowl, which forms the housing, is a waterproof motor which drives a mechanism to break water in the bowl into a fine mist and mixes it for delivery into the air.

## Transparent Plastic Oilcan Shows Contents at a Glance

Contents of an oilcan, both as to quantity and grade, can be seen at a glance in the transparent can just developed. It is made of an unbreakable plastic material and has a copper-plated flexible bottom that will not leak.

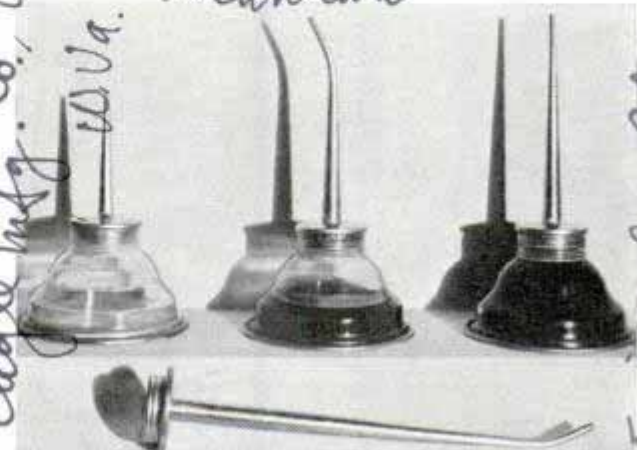

Grade and quantity of oil are always visible when the new transparent plastic oilcan is used

*Marvel Engineering Co.*  
*Los Angeles, Calif.*  
*220 East Alameda*  
*Downey Calif.*

*52 Beardsley Ave*  
*Alhambra, Cal.*  
*H 239*  
*\$75.00*  
*H 87*  
*Scanlon*  
*Universal Plastics Corp. 235 Jersey Ave.*  
*10 Avenue N.B.*

*Samuel Jackson's Sons*  
*Chemical Dept*

A 250

# Flying Fortresses Set Record on Long Journey

Six U. S. army "flying fortresses" recently set an unofficial world record for combined speed and range of flight in the large airplane class on a one-stop trip from Miami, Fla., to Buenos Aires, Argentina. The mass flight, longest and most dramatic ever undertaken by the army air corps, covered a distance of 5,260 miles. It required twenty-seven hours fifty minutes flying time and thirty-four hours fifteen minutes elapsed time, including a six and one-half hour stop at Lima, Peru. Average speed for the trip was 189 miles per hour. Average speed on the 2,565-mile hop from Lima over the towering Andes to Buenos Aires was 209.5 miles per hour.

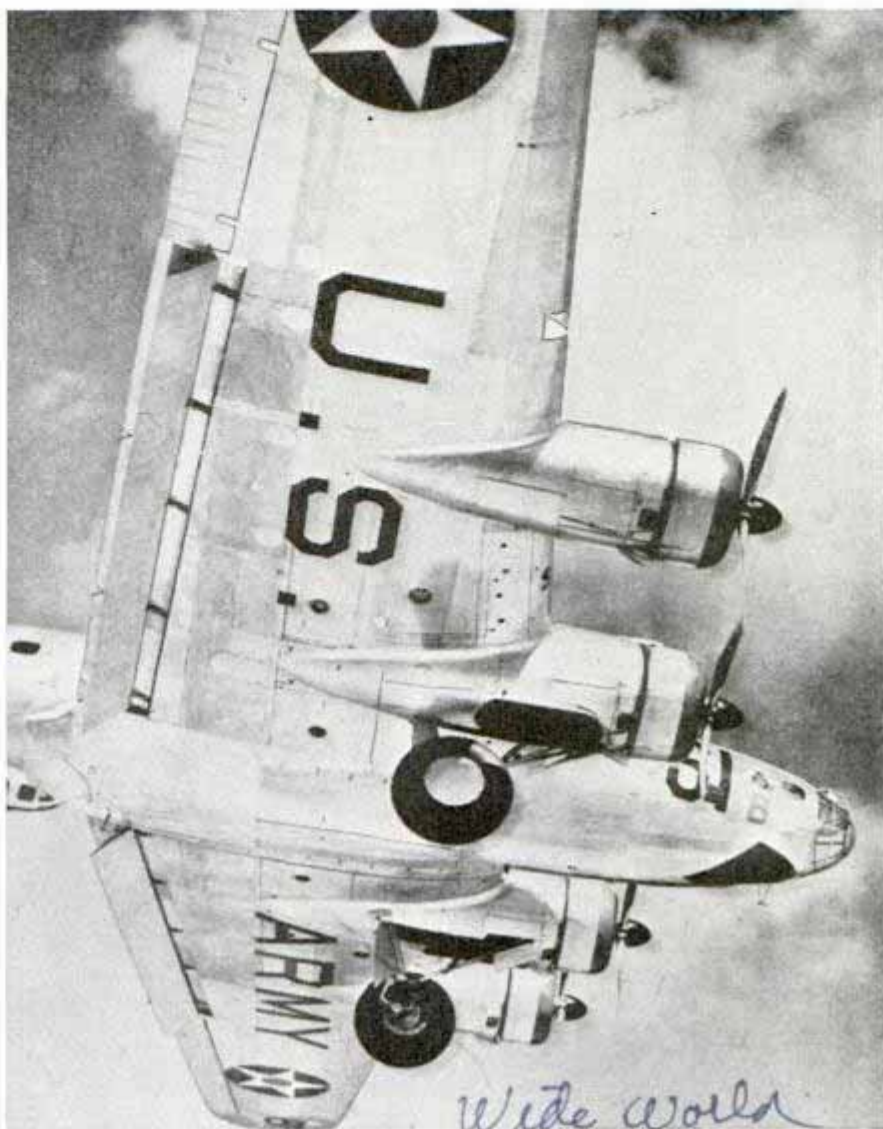

Right, view from beneath soaring army plane. Note the four engines which drive the giant craft

*Wide world*

A 200

## Bike Turned into Motorcycle by Heavy Fork and Engine

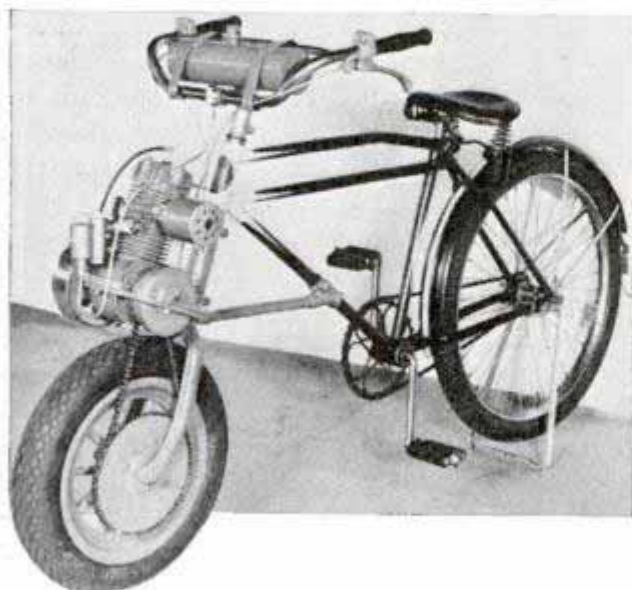

Bicycle with special fork, front wheel and light-weight engine. Note frame brace

Conversion of the new or old bicycle into a motor-driven cycle is made possible by a special front fork which replaces the conventional fork. The fork comes complete with a heavy front wheel, fitted with a tire eighteen inches in diameter and three inches across. The motor and controls are attached to the fork, which is made of extra heavy metal to take care of strain imposed by the engine. Bore of the two-cycle motor is two and one-half inches and the stroke three and one-fourth inches. The motor is equipped with annular ball bearings. The same power unit may be placed in a specially designed frame with two wheels behind. In the V-shaped area is a floor space six feet long and thirty inches wide for delivery service.

*Chas. E. Miller Corp. Anderson, Ind.*

14113

Mr. Thomas G. Stinson, Jr.  
10555 Holman Ave  
Los Angeles, Calif

# AMERICAN DRIVERS



Top, race cars bunched at turn. Bottom, breather screen helps cool the brakes

**F**OREIGN cars and drivers this year are going to use American race tracks as battlefields upon which to fight for the prestige of their governments. Automobile racing has gone international. European factories devoted to building high-speed racing machines and backed by government funds have spent long months creating the finest cars possible for the coming campaign. Each team will have spare engines, spare parts, and every aid that money can buy.

Pitted against this invasion are several dozen American cars that have been built part by part in machine shops and assembled in back-yard garages. In some cases the engines and bodies are several years old and have been rebuilt to meet the new challenge. In other cases owners and drivers have pooled their funds to put together new automobiles. If anything cracks in the trial heats they may not have time or money enough to obtain replacement parts.

Thorne Engineering Co #1731  
5842. do not keep Geo.  
Los Angeles, Calif

# Against the WORLD

Top, celluloid model of driver's body on drawing board shows proportions for cockpit. Center, shaping racing model. Bottom, marking openings in body for radiators

*Perkins*

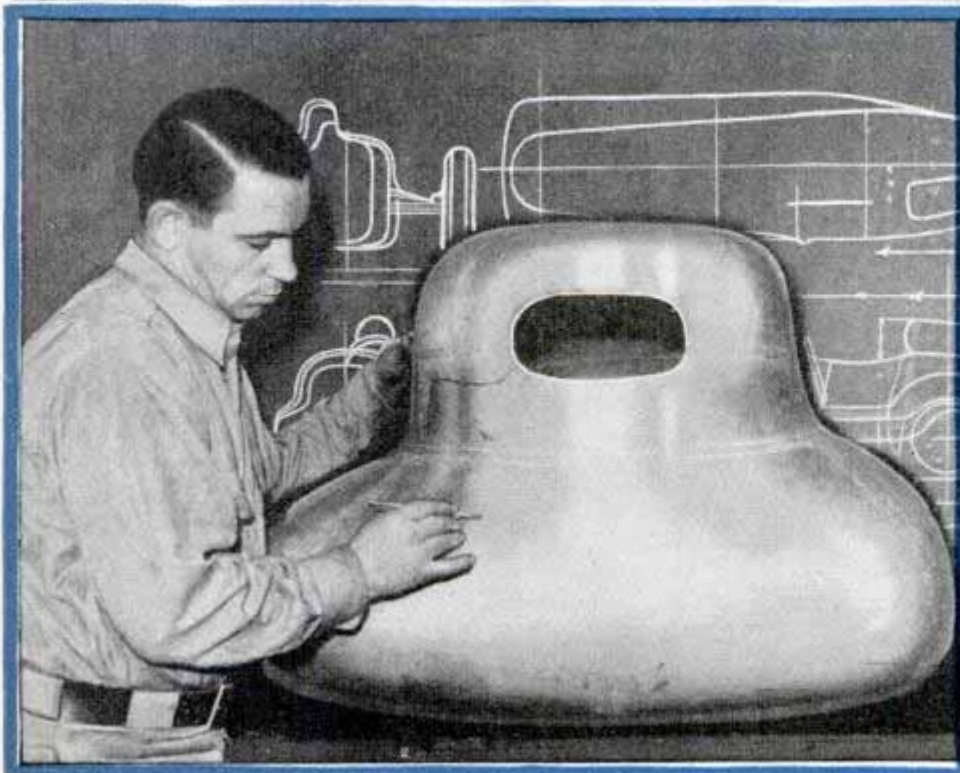
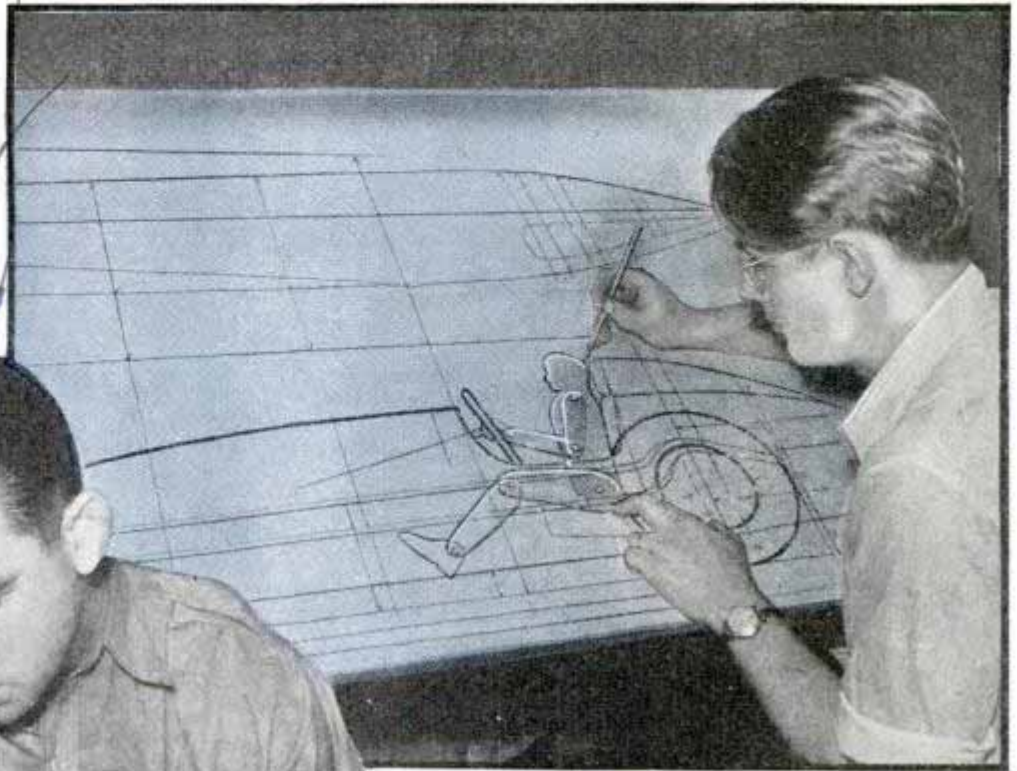

Unequal as the competition appears, almost anything can happen. Car for car, the American entries usually have been fastest in speedway racing in the past. In road racing they have been woefully slow. The reason is that America always has been interested in speedway racing while in Europe road racing with its rougher stretches and trickier turns has been more popular. Each continent specialized in the kind of car best for its kind of track. America put a premium on speed, while Europe generally favored good brakes, good springing, and good shifting, as well as a good engine.

These two brands of racing have been brought together by new rules and specifications that are intended to give every

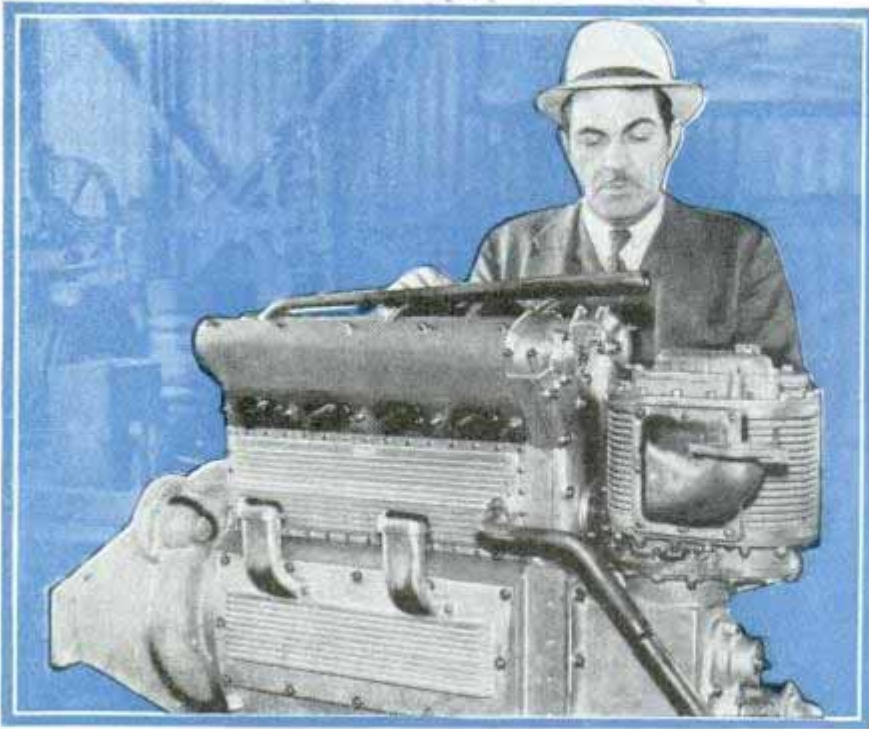

Indianapolis. Year by year, speeds have been climbing. This year the leading drivers agree that the winner will have to drive faster than ever. Barring accidents that would slow the pace, they think that the winner will have to average at least 115 miles per hour and that he may have to drive 120 miles per hour for the 500 miles. Counting pit stops, this means that he will have to drive about five miles per hour faster than his average while he is on the track.

Big time racing psychology is not to drive as fast as you can, but as

fast as you must. The man who gets in front tries to stay in front by increasing his pace when he is challenged. Instead of racing against time he races against competition. The reason, of course, is that every extra mile per hour added to high

driver a more even chance on either kind of track. This year riding mechanics are not required, hence drivers will ride alone to save the weight. Drivers using old two-man cars will deck the mechanic's seat over and those building new cars are using one-man bodies. The international rules require that the body be thirty-three and one-half inches wide. Motors may be as large as 274 cubic inches, if unsupercharged, or are limited to 181 cubic inches with supercharging. There are no restrictions on the kind or amount of fuel.

In the case of either type of engine, pressures are going to be so high that some of the drivers are planning to use new mixtures of alcohol and benzol as fuel. Compression ratios as high as sixteen to one may be tried in some of the unsupercharged engines, resulting in such extreme pressures that high-grade gasoline is no longer a suitable fuel, even when held down with copious amounts of lead.

The first battle of the season is scheduled Memorial Day at Indianapolis, the annual 500-mile classic of the racing world. Any of a dozen American veterans of this race stand an excellent chance of winning, or the checkered flag may record a European victory. At Roosevelt Raceway, the Long Island road course, Europeans are given high chances of winning the races usually held later in the year.

But the highest speeds will be made at



Top, Duray and four-cylinder engine he will place in his car. Bottom, Petillo, right, examining new crank shaft for engine

Kelly

see Feb. 19 38 - 178.

14119 Del. Charles Allan, 3212 - 545  
 Maurice are  
 POPULAR MECHANICS  
 Los Angeles Belanger Special 869

speed increases the chances of mechanical failure. No driver wants to break down and drop out of the race because he was showing off, when he might have been able to hold his lead by playing as safely as he could.

Every driver has his own peculiar driving habits on the track. Lap after lap you will see a certain car swing close to the outer wall and then recover as it comes down the stretch. On the turns you will observe that one driver always hits the "corner" low at the same place and then guns the motor as he gets half way through. The fastest way to get around at Indianapolis, taking about seventy-three seconds to lap the two and a half miles, is to go down the stretch with the motor wide open, turning up to 140 miles per hour or better. Then, just as the car starts entering the turn and the driver has started cocking the wheels around, he backs off the



Top, streamline body of racing car. Center, smoothing off cooling fins projecting from oil tank. Bottom, oil tank slung under car

throttle far enough to drop his engine down to almost half speed. Right now the car is traveling far too fast for safety and has started to drift up toward the outer rail. In ordinary hands it would be impossible to prevent a crash. But as the car starts to drift, carried along by its own centrifugal force, the driver clamps down on the accelerator again and fights this force with more power, overcoming it with the driving force of his rear wheels. Stepping on the gas keeps the car on the track and al-

(Continued to page 149A)

H 242. O.S. J. Goodrich Co.

*Abram Chas.*

# Skidding Trailer Helps to Build Safer Tires

**D**ANGER of skidding is about to be lessened for millions of motorists as the result of a two-year trailer trip over a route only two miles long. This trailer was designed and built for the purpose of studying the skidding action of automobile tires. Engineers started at rock bottom, with an absolutely bald tire, smooth as glass and about as resistant to skidding on a wet pavement. They ended with a brand new tire tread design which, they believe, represents more really scientific knowledge about skidding than



Top, watching result of a skid test. Center, truck and trailer hookup. Bottom, left, tread developed by tests. Right, sketch of test equipment

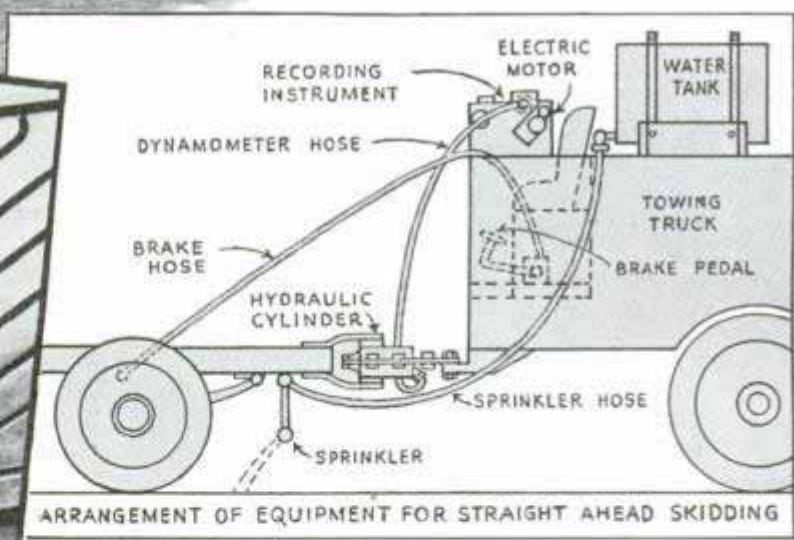
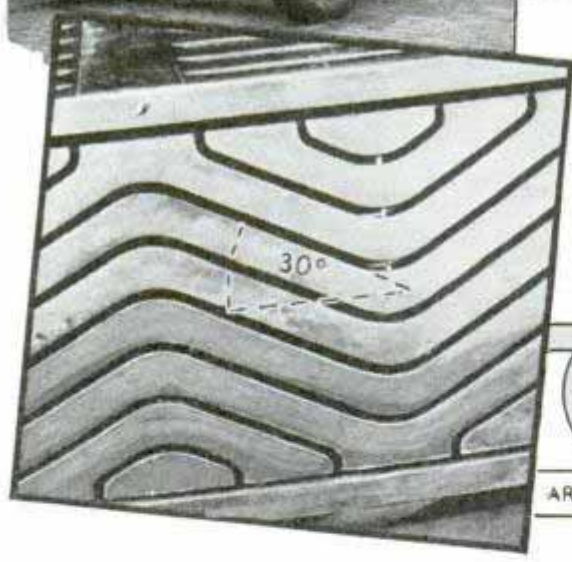

*cont. Walter E. Co. written, 1932 Florida Ave, Akron, Ohio*

any previous tread. The trailer is a two-wheeled cart or dolly, towed by a truck. It carried, during the test, a load of iron bars so that the tires supported the same weight as if they were being used on an automobile. The trailer was coupled to a truck through a hydraulic dynamometer, which is simply an oil-filled cylinder fastened to the trailer by a yoke and contain-

ing a piston against which another yoke, attached to the truck, pulls. A line ran from the dynamometer cylinder to a calibrated pressure-recording device, a modified steam-engine indicator. Variation in pressure against the piston caused a corresponding variation in pressure in the oil system, which was recorded on a motor-driven chart as an irregular curve, while



Speed Camera Splits Lightning into Eleven Flashes

a second recording pen made a mark on the paper for every revolution of the wheel carrying the test tire and a third counted revolutions of the idling trailer tire. On the truck were steel barrels carrying water for spraying in front of the test tire to wet the pavement for "rainy-day" tests. It took several months to decide on a tread and a year of similar testing to perfect the basic design. To control noises and other factors, such refinements as the rounding of sharp angles formed by the grooves and the adding of ribs at the shoulders were introduced. The research on skidding emphasized several factors important to the motorist. Foremost is the necessity for avoiding sudden application of brakes. Tests showed that skidding is influenced greatly by such things as the type of road surface, kind of grout used between bricks, amount of moisture on the road, presence of a dust film on the roadway and the speed. Many motorists believe that their tires are roughened by tread design so that the sharp edges will grip the road better. The edges themselves have little holding power. They aid by breaking through any film of lubricant, water or slush and providing a clean surface for the tread to grip. The sole function of a tread design in minimizing skids is to wipe the pavement dry, so that the rubber can get a grip. Water is a lubricant for rubber, just as oil is for metal and it must be removed before skidding can be prevented.



Lower photograph taken by ordinary camera shows one bright flash, while high-speed camera recorded several parallel strokes

What the human eye and the ordinary camera see as a single flash of lightning may be a dozen swift strokes. The General Electric company turned a high-speed camera on the Empire State building during an electrical storm and caught a series of lightning tracks of similar pattern on the film. Actually there were eleven parallel strokes in thirty-six hundredths of a second.

Oil-Burning Heater Installed in Trailer to Convert Old Coal or Wood Unit

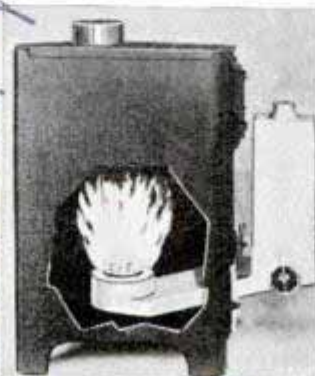

Coal or wood-burning heaters for the trailer can be converted into oil burners by installing a unit now available. Complete in itself, it requires no fittings or piping, and is readily removed when necessary to use the heater for burning trash. The oil tank is detachable for filling conveniently.

Sky Camera Has Keen Eye

So keen is a lens just developed for mapping and photography from the air that it increases the scope of the aerial camera by three times. With it, the flying cameraman at an altitude of one mile can take a picture clearly showing every individual railroad tie in a two-mile circle below.

*metagon*  
*Robert N.Y.*  
*Rausch-Lomb*  
*Optical Co.*

*Ideal Engineering Inc.*  
*4119 Lake Minneapolis*

Belle. W. De. Plant. E. d. du. Paul  
de Nemours Co.

# RICHES

*from the*

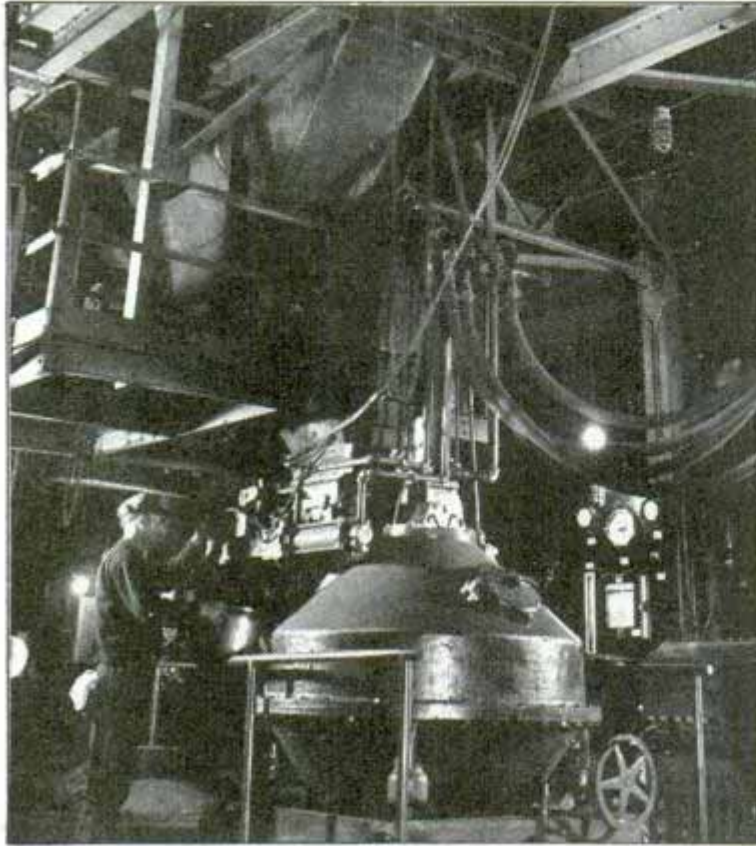

even converting tons of coal into tons of diamonds could scarcely be more remarkable than the amazing feat of chemical magic by which man today squeezes wealth from the air we breathe—wealth in the form of nitrogen, a substance more precious than either gold or diamonds.

The story of nitrogen is an astonishing tale of human achievement interwoven with touches of irony and even of comedy. Wars have been fought over nitrogen, yet 20,000,000 tons of it rest in the air above each square mile of the earth's surface. Every clover field and manure heap is a nitrogen factory, yet nitrogen has been transported thousands of miles and nations have clamored to buy it, offering fancy prices for something as abundant and seemingly as free as air.

**T**HERE'S gold in the ocean—about \$10,000,000 worth in each cubic mile of sea water. If you found tomorrow how to extract it inexpensively, you might become the richest person alive. You would also make world history by altering the entire course of civilization.

Important as such a process might be, however, reclaiming gold from water or

Many consider the nitrogen in the air wholly useless. Everyone knows we need oxygen to live, but not everyone realizes that nitrogen is just as important to life—so important, in fact, that without it we would starve. Why?

The answer was supplied about a century ago by a German chemist who proved that all plants live and grow because of

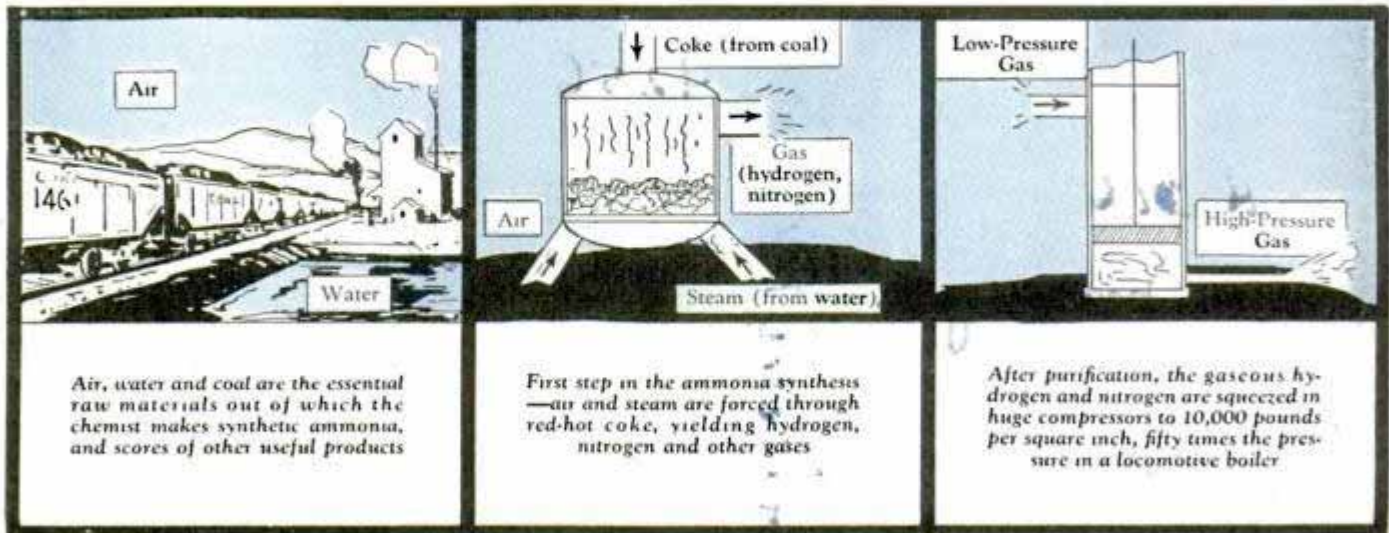

*Step-by-step processes in converting water, air and coal into ammonia in which the nitrogen is locked up ready for use. Top, charging machine for water gas generator*

A 52

# AIR

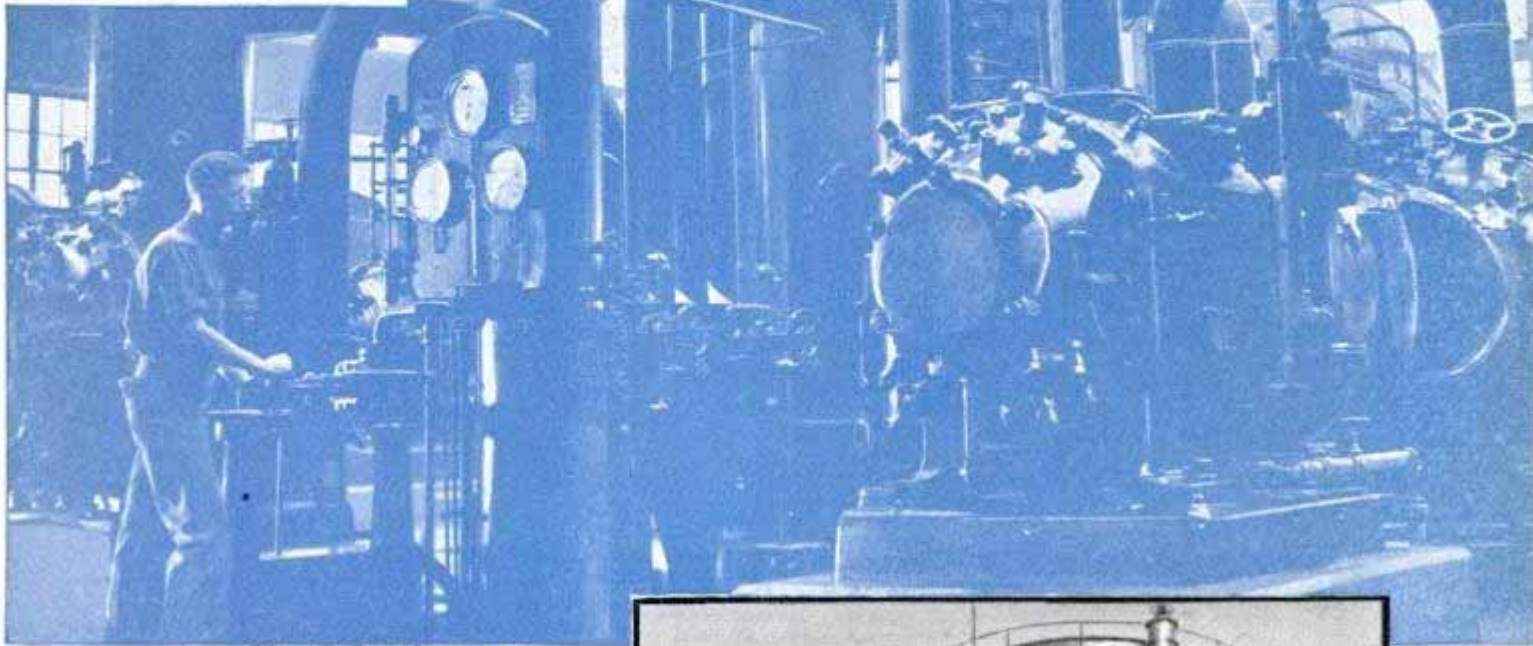

*Belle W. Va.*

certain soil chemicals of which nitrogen is the most important. Feed the ground with nitrogenous substances, he found, and you make two blades of grass, or even three or four, grow where but one grew before. And yet, this life-giving substance, when isolated as an element about a century previously, at first was given a French name meaning "without life," due to its inertness.

If left to herself, Mother Nature supplies enough nitrogen to the

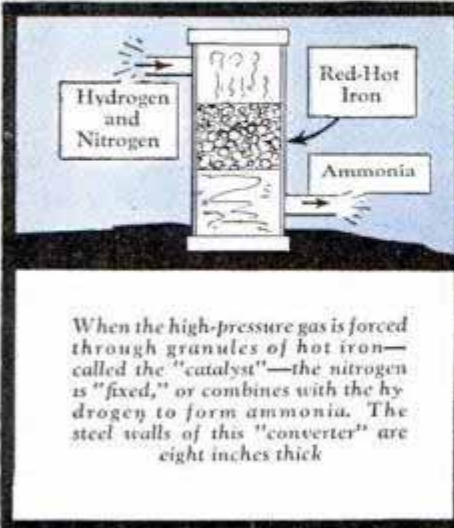
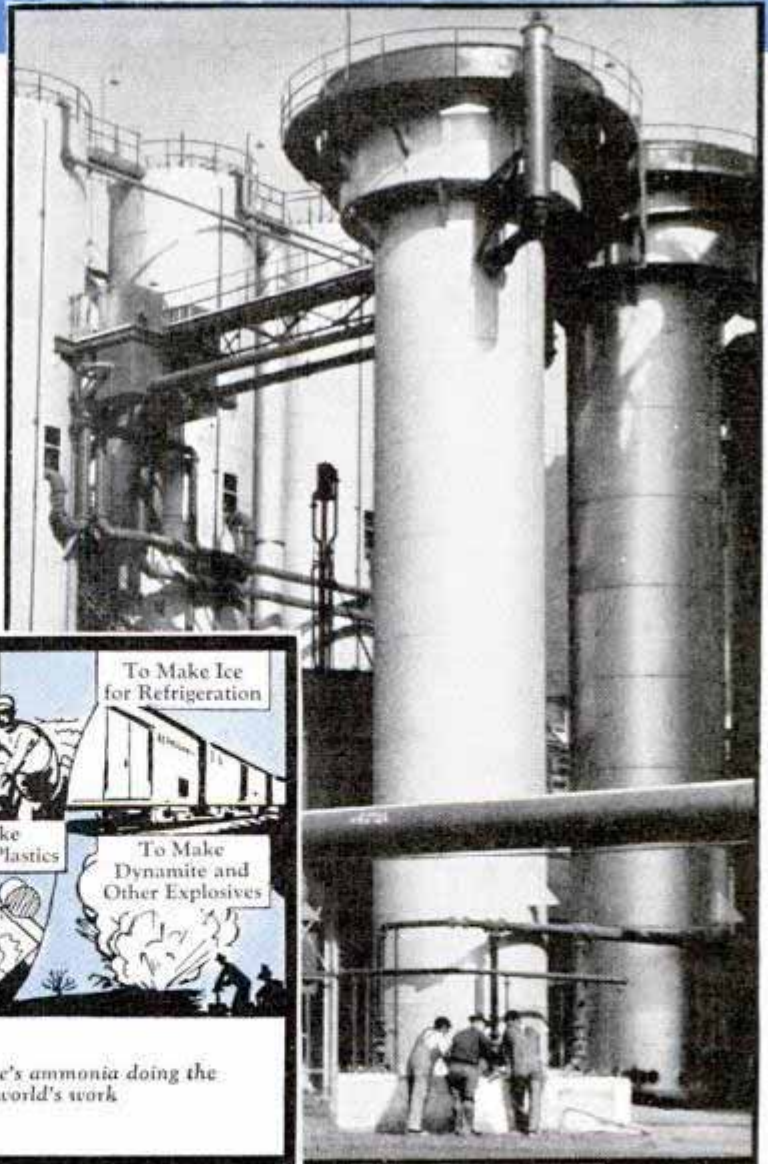

Photographs courtesy du Pont Company

Plant which removes hydrogen sulfide in water gas for use in manufacture of ammonia.  
Top, machine which compresses gas in making synthetic ammonia

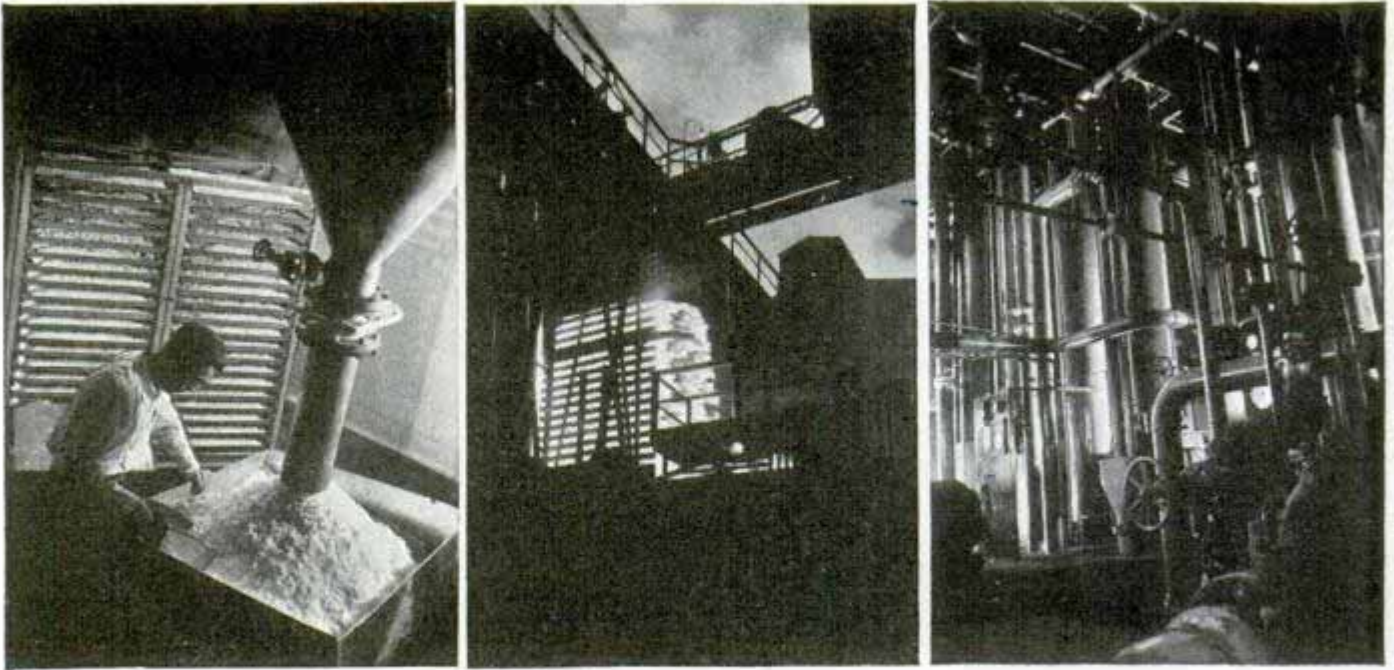

Base for "Lucite" plastic ready to go into dryers. Center, incandescent coke coming from ovens of ammonia plant of du Pont Company at Belle, W. Va. Right, here carbon monoxide reacts with steam to produce carbon dioxide and hydrogen, the latter a component of ammonia.

soil. Certain legumes, like clover, carry tiny nitrogen factories in their roots. Rain and snow also bring nitrogen down from the air. But when man disturbs the delicate balance of nature by intensive cultivation of the soil, the nitrogen is used faster than it can be replaced. So, since man depletes the earth of this life-giving substance by artificial means, he must restore it by artificial means if the soil is to continue to produce.

When he first discovered nitrogen was an indispensable fertilizer, he supplied it by treating the ground with manure. But as the population grew, this source of nitrogen was insufficient, so man began growing legume crops to augment the supply. The season he grew clover, however, he couldn't grow corn, so this remedy reduced soil productivity to that extent.

Still the population increased and, as it increased, the amount of land available for agriculture decreased because millions of acres of good farm land were occupied by cities, railroads, highways and other developments of a modern civilization. So man was pinched between two millstones—a growing population and a decreasing amount of land for farming.

His only salvation was to replace the lost fertility of the soil or starve. There was plenty of potash, lime, sulphur and other ingredients but despite the pitifully

small amount of nitrogen required per acre each year—about eighty pounds to 2,000,000 pounds of top soil in an acre of land usually is sufficient—there was not enough.

Geologists helped solve the problem temporarily. Sodium nitrate can be crystallized out of nitrate-bearing rocks, and this sodium nitrate can be assimilated by the soil. The greatest source, in fact, the only source, of these rocks was in the vast deserts of Chile, Bolivia and Peru. In these arid acres were hundreds of millions of



Part of fleet of anhydrous ammonia and alcohol tank cars at du Pont plant at Belle, W. Va.

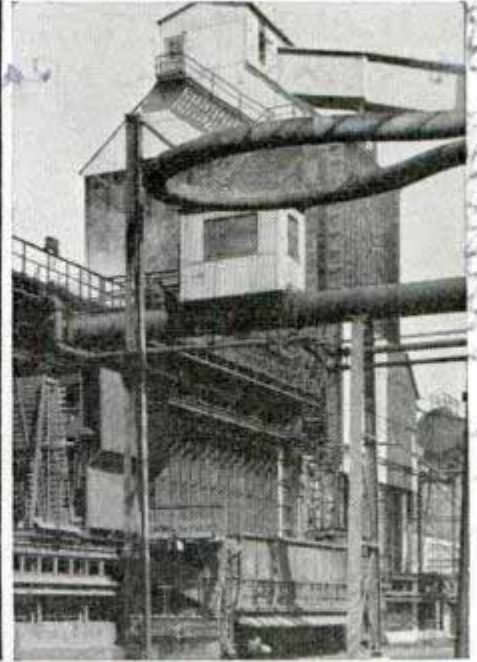
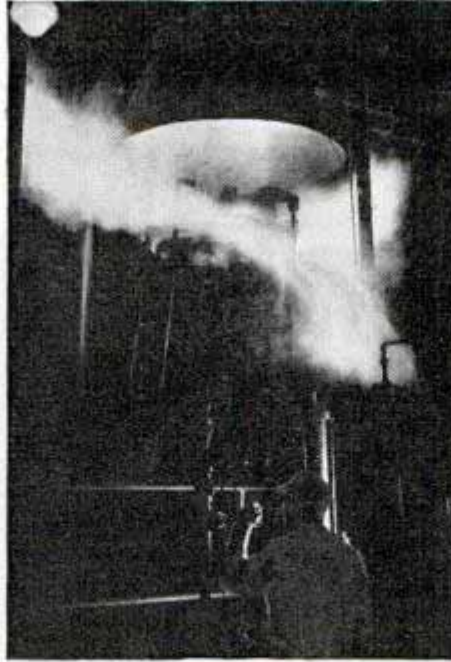
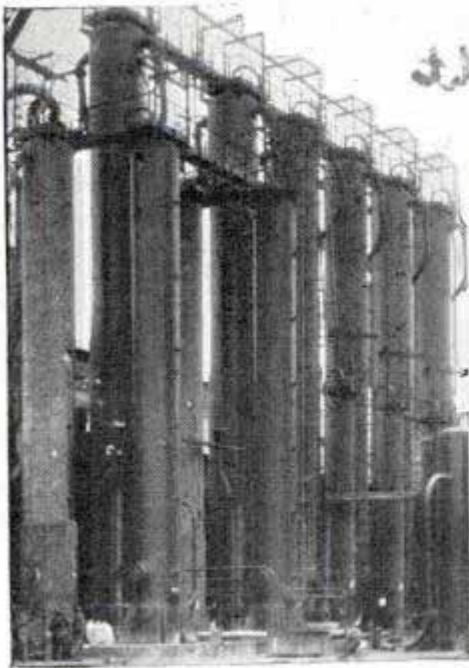

tons of rock which could turn other lands into green acres of waving corn and wheat.

So the rush to South America began. Windjammers were built for the "nitrate run" around the Horn. In one year, nearly 3,000,000 tons of nitrate of soda were exported from Chile. Ancient towns which went to sleep when the Spaniards left became busy cities and ports. The nitrate nations prospered.

Then came a demand for still more nitrogen. An Italian chemist treated glycerin with nitric and sulphuric acids and obtained an oily, unstable liquid which, upon little provocation, exploded with a loud and satisfying bang, a bang produced when nitrogen atoms broke off diplomatic relations with the other elements. At first, nitroglycerin was only a chemical curiosity, then Alfred Nobel of peace prize fame blended mineral earths with the very unstable nitroglycerin and tamed the fierce nitrogen atoms. The result was dynamite, one of the great civilizing forces of modern times.

Soon the same nitrogen which made the earth produce food crops was also blowing holes in the earth from which arose dams, docks, bridges and skyscrapers. After while other chemists nitrated other sub-

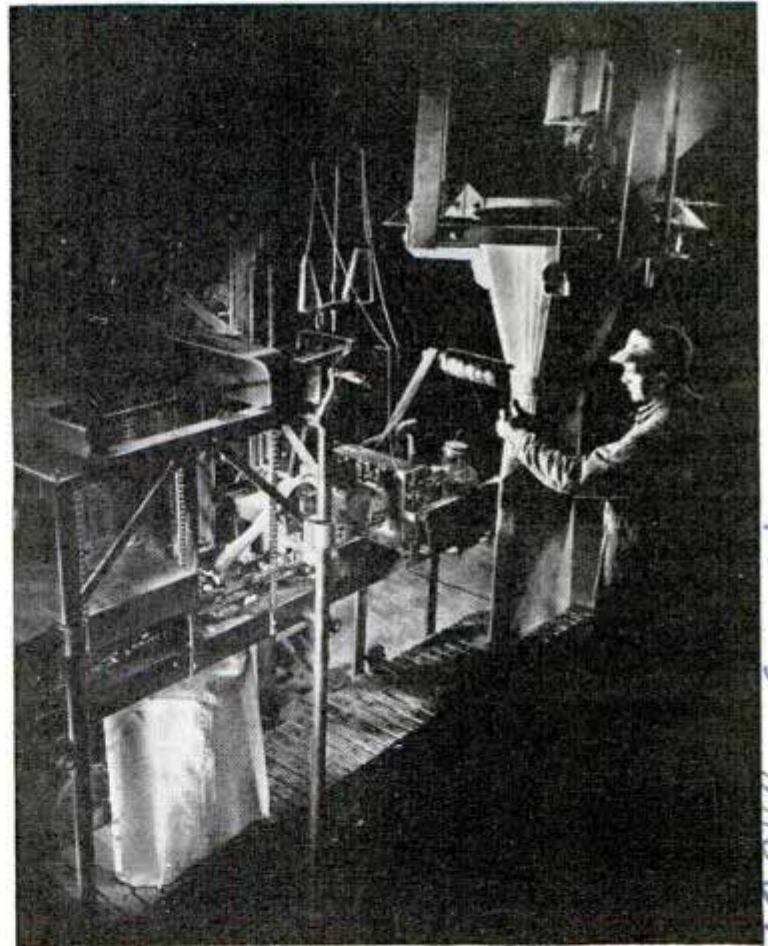

Bagging fertilizer at ammonia plant. Top, left, scrubbers which remove carbon dioxide in water gas. Center, gas generator blasting directly to the air, a process for removing unnecessary gases in making ammonia. Right, coke ovens at ammonia plant

stances. From cellulose they got guncotton, from toluol they got T.N.T., and from the same family they produced cordite and blasting gelatin—all with nitrogen.

Bread or bombs, tilling or killing, pro-

(Continued to page 120A)

# Emergency Lamp Burns in a Bucket of Water

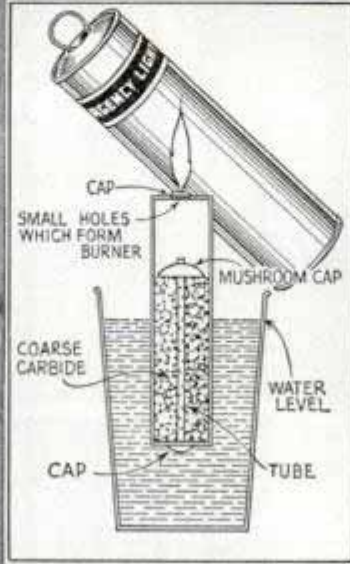
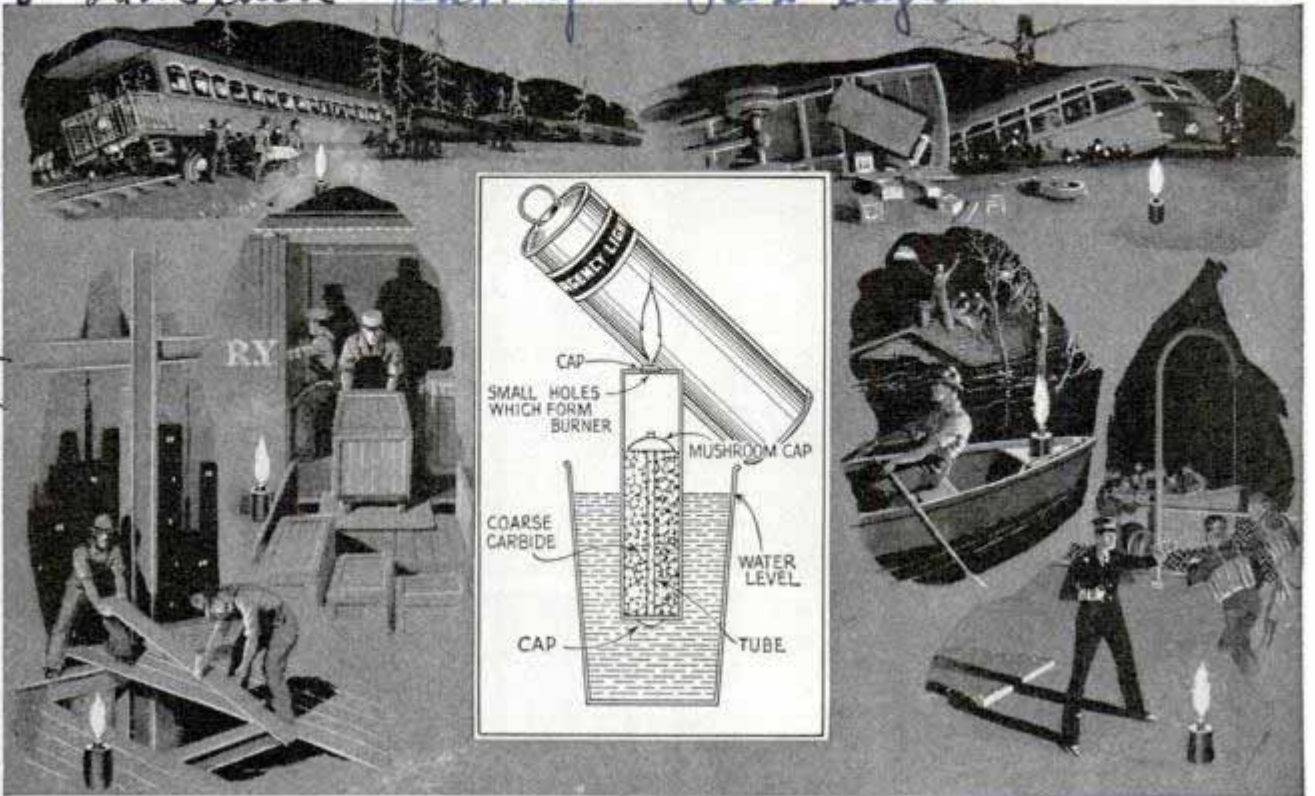
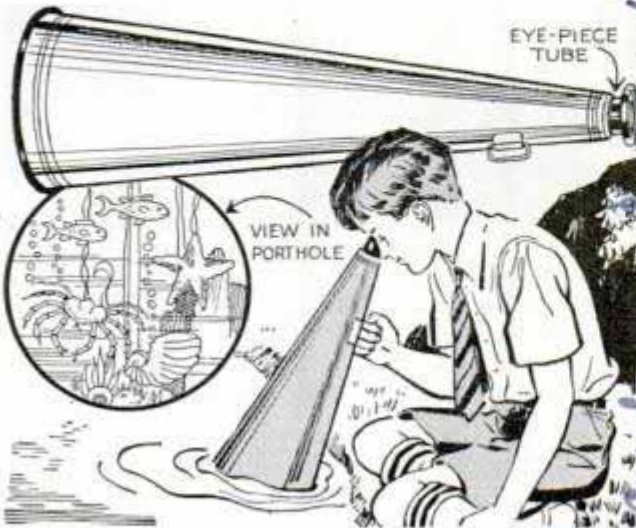

Diagram at center shows how carbide container, with top and bottom seals removed, floats in water and emits gas which is lighted for emergency flare. The drawings suggest some of its many uses

When occasion demands a brilliant flare on a highway or railroad, in flood rescue work or disaster at sea, it can be had instantly by tossing a carbide emergency lamp into water. It burns in a bucket of water, or it can be tossed over the side of a boat. Loaded with carbide, it is only necessary to remove the top and bottom seals, place it in water and light it, to pro-

duce a steady, intense light of 300 candle-power that lasts more than two hours, without further attention. It will not tip over, and is safe from any explosion hazard, for a control valve allows only enough water to enter the carbide chamber to maintain an even power of light. Fruit growers have used the lamp to illuminate orchards for emergency night work.

## Submarine Micro-Telescope Reveals Underwater Life



Watching life in the water with micro-telescope, which has an adjustable eye-piece for focusing

With a "micro-telescope" just made available you can peer at strange undersea life and observe interesting growths in stagnant pools. The instrument is shaped like a megaphone. You submerge its "porthole" end under the surface and adjust an eye-piece tube to focus on the object. The lens can be removed for cleaning.

## Short Waves Used to Cook Ham and Treat Steel and Wood

You can talk over radio short waves, and you can also cook with them. It takes four or five hours to cook a ham by steam, and the meat loses as much as one-tenth of its

Different copies. Van Duzend & Co. 331 W. 4th St. N. York.

Boyle-Meyer Equip. Corp. 281 Broadway N.Y.

Carbide lamp 50¢ (incl. post.)

Winter Mfg. Corp. 447 1/2 Broadway Ave.

Samuel Jackson's Sons, Inc. 225 Beach par. ap. Rex' light.

Chicopee Falls  
Mass.

H 210  
**Anti-Aircraft Gun Showers Sky  
with Spray of Steel from Belt**

weight in the process; engineers of the radio division of Westinghouse Electric & Manufacturing company applied the internal heat of radio short waves to a fourteen-pound ham and it was cooked to a delicate flavor in twenty minutes, with a loss of only a half pound. Industries are putting short waves in harness, too. Furniture makers find they can dry out wood by radio heat treatment in a half hour, while outdoor seasoning takes years and kiln drying sometimes causes cracking. Automobile crankshafts are "skin tempered" in five seconds by radio waves, which follow the surface of the metal and harden it without affecting its internal resilience. Radio is even applied to preventing worm infestation in grain; an oscillator sets up a radio field and the heat kills both worms and eggs.



Russian sailor sights his anti-aircraft gun on an aerial target and sends a shower of steel skyward during maneuvers of the Soviet Amur fleet

With a belt of cartridges swinging in a deadly arc from his anti-aircraft gun, the Russian sailor is ready to spray the sky with steel. This modern equipment of the Soviet Amur fleet was displayed in recent demonstrations marking the twentieth anniversary of the Red Army and Navy.

H 251  
**Giant Bearing Will Support Million-Pound Telescope**

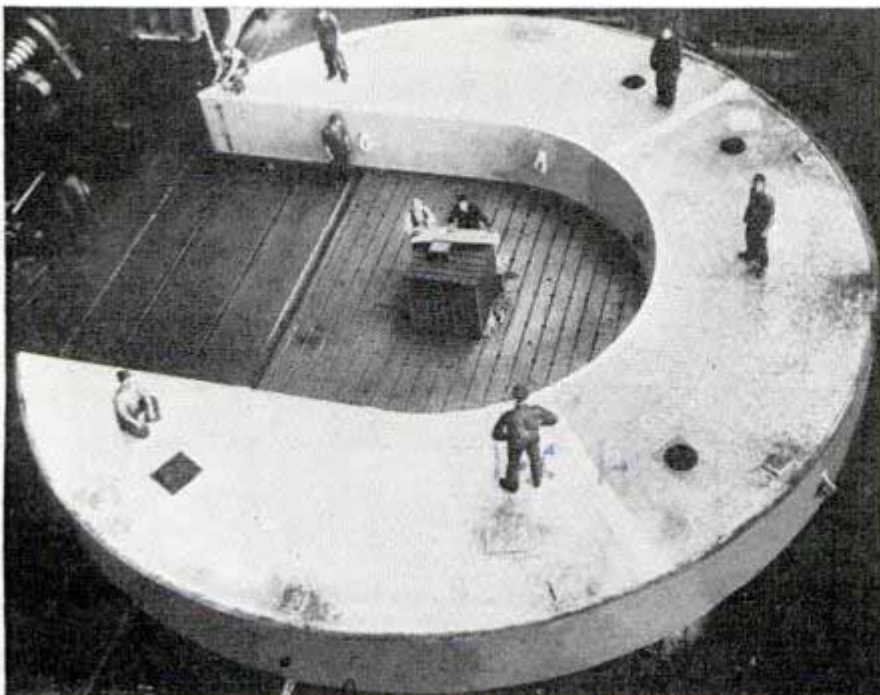

Designed to carry the 1,000,000-pound load of the world's largest telescope on Mt. Palomar, Calif., a 158-ton bearing looks like a giant washer from which a large "U" has been cut. So precise were the manufacturing calculations that final machining called for a job within five-thousandths of an inch of the specifications. The bearing is forty-three feet across and fifty-three inches thick, eight times larger than the bearing supporting the mirror of the Mt. Wilson telescope.

Wide World Westinghouse Electric & Mfg Co  
Pittsburgh Pa

# Small Craft Radiophone Calls Shore or Ships

Western Electric Co. 195 Broadway New York

H 214

224 a maine



small rotary converter may be employed to deliver the necessary 110-volt alternating current from the vessel's direct-current supply. Both the transmitter-receiver combination and the converter may be installed below decks, while the telephone instrument may be placed in wheelhouse, the owner's stateroom or other con-

Left, radiophone in use. Inset, the phone with switches. Bottom, radiophone equipment aboard small craft

COMMUNICATION between small craft cruising in coastal waters and the shore may be speeded up by new radiophone equipment. Offered by Western Electric, the fifty-watt equipment incorporates features which simplify operation and extend the scope of performance. Nine frequencies are provided for communicating through shore stations which serve to link the telephones aboard vessels with those ashore in the Bell system. A tenth frequency may be used either for communicating directly with the Coast Guard service or for ship-to-ship communication without working through intermediate shore stations. Through the facilities of shore stations established for the purpose, the equipment enables persons cruising along the coast or in harbors and inlets to call the office or the home ashore. Likewise, persons ashore may pick up the nearest Bell telephone and call those aboard vessels suitably equipped. Shore stations for this service are located at Boston, New York, Miami, Los Angeles, San Francisco and Seattle, with one at Norfolk in the stages of completion. A selective ringer makes it possible for the operator ashore to "dial" the particular boat for which a call is intended. The telephone bell aboard that boat rings in response to this call. Transmitter and receiver are mounted on a common chassis which may be fastened to a bulkhead or to the deck. A

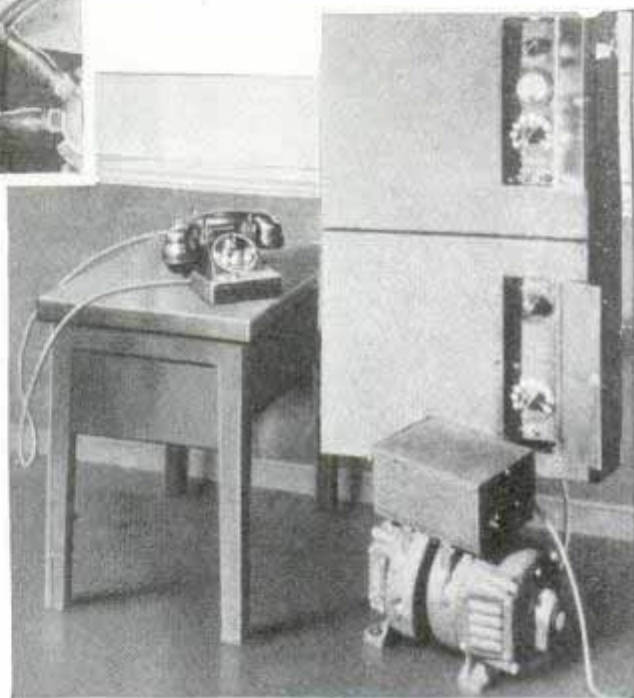

venient location. Additional handsets may be provided for other desirable locations. The equipment requires no trained personnel to operate it. Regulations of the federal communications commission permit operation of this equipment by persons holding radiotelephone third-class operator's license, obtained by passing an examination requiring elementary knowledge of radio laws and familiarity with the method of operating the equipment.

H 321

## Travel Time of Firing Pin Cut to Increase Accuracy of Shot

Split seconds mean the difference between a hit and a miss to the hunter. To obtain greater accuracy and speed, a rifle

H. J. Sedgley, Inc.  
2311 N. 16th St. Phila.



Springfield  
Sporter

H 243

manufacturer has shortened the travel of the firing pin from five-eighths of an inch to five-sixteenths. The lag between release of the firing pin and its impact is an almost infinitesimal part of a second, yet the fraction is important, for the projectile leaves the muzzle at a speed of perhaps 3,000 feet per second.

H 238

### Lightweight Diesel Engine Develops Six Horsepower

Developing six and one-third horsepower at 2,000 revolutions per minute, a diminutive Diesel engine built by a Los Angeles man weighs only eighteen pounds. It is a three-cylinder, two-cycle motor, each piston weighing three ounces, having a one and one-half inch diameter and one and seven-eighths inch stroke. The compression is 460 pounds with a ratio of sixteen to one.



Here is a three-cylinder midget Diesel engine, weighing only eighteen pounds.

## Law Violators Take Lesson from Traffic in a Model City



Acme

First offenders attend this traffic school in Hamburg, Germany, to learn lessons in safe driving by watching traffic movements in a model city

Policemen in Hamburg, Germany, don't need to ask a second offender against the traffic regulations "Where did you learn to drive?" After a first violation the driver is sent to a special school where traffic rules and safe practices are taught. A miniature city is laid out on a large circular table around which the traffic violators sit. A member of the police department, acting as instructor, illustrates his lecture by reconstructing traffic situations with model vehicles.

H 272

### Under-Door Draft Is Stopped by Automatic Strip

Drafts underneath doors can be checked effectively by an automatic strip attached to the base of the door on either side. When the door is closed, the strip springs down automatically and seals the space between the bottom of the door and the floor or rug. As the door opens, immediately the strip springs up into its former position, clearing the floor and avoiding any rubbing. The seal strip is of metal and fabricated material.

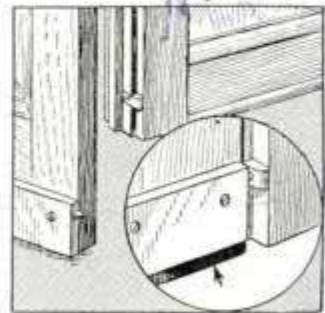

Charles Keene, % Wm. Hill

see front 119 317  
831

Raysteel Specialties  
Cleveland Terminal

Standard - H-100 - 6 in am 2 H  
Lower Bldg. Cleveland

### Window Opened by Crank Is Locked at All Positions



Turning crank to lift or lower either pane of window. It locks in position when crank is released

Burglarproof windows that are raised and lowered by a hand crank have just been put on the market. The window has no sash, and automatically locks in any position when the crank is released. Turning the crank lifts or lowers either the upper or lower pane separately, and a special weatherstrip is used instead of sash to seal out cold.

### Tourists Ride Elevator to Peak of Whiteface Mountain

You can reach the 4,867-foot summit of Whiteface Mountain in the Adirondacks by a walk of only 424 feet. An eight-mile automobile road takes tourists within a few hundred feet of the summit; from that point you can walk into the heart of the mountain by way of a tunnel five feet wide and seven feet high, bored 424 feet to the foot of a vertical shaft. There an elevator was installed recently to lift pas-

sengers the remaining 271 feet to the top of the mountain. Its shaft is eleven and one-half feet square.

### Double Wrench for Dual Wheels Loosens "Frozen" Bolts

Even the rustiest, "frozen" hub bolts on the dual wheels of a truck yield to a double wrench invented recently. One wrench is inside the other. The inner one holds the inner nut like a vise while the outer wrench loosens the outside nut. The tool weighs twelve pounds and is built to stand a severe strain.



### Satan Rides on Steamer Funnel as Emblem of Its Owners

Symbolic of fire and brimstone is the emblem carried on funnels of the Union Sulphur company steamships. Mounted against the yellow stacks of these sulphur-carrying vessels are red figures of Satan, with horned head and pointed tail and uplifted fork.



On the yellow funnel of this Union Sulphur company steamer rides a red Satan, symbolic of the cargo

mil. Mac Window Corp. 1000 Broadway New York

Handwritten notes: H 228, H 292, H 48, and vertical text: 'A. M. ...'

Handwritten notes: 'H 228' and 'H 292' in blue ink.

Handwritten notes: 'Satan ...' and 'H 292' in blue ink.

Handwritten notes: 'Northern New York' and 'H 207' in blue ink.

Handwritten notes: 'James Backlund', '3476 N. 51st', 'Tacoma', 'Wash.', and 'H 207' in blue ink.

Handwritten notes: 'Henry D. Whitton' and 'H 207' in blue ink.

Handwritten notes: 'Compressed Air' and 'H 207' in blue ink.

# Tagging of Sardines Solves Migration Puzzle

By tagging sardines, the California state department of fish and game is solving some of the mysteries regarding movements of the fish. Metal tags are inserted in the abdominal cavity, a scalpel being used to make the small incision. Then the sardine is returned to the water. Tags recovered recently in the canneries of Southern California reveal that the sardine travels 1,000 miles, sometimes more, from British Columbia to the Terminal Island fish harbor in Southern California. Elec-

Montebello Calif



Top, left, inserting metal tag. Right, sieving the findings of magnets to recover tags. Bottom, weighing, smelling and fingering contents of sardine cans in inspection laboratory

tric magnets are used to recover the metal tags from the meal produced by grinding the fish. This fish meal is used for fertilizer and for dog, cat and cattle feed. Findings of the magnets are sieved and the tags reclaimed. Identification markings on the tags establish the locality in which the sardine was released. Severe tests by state experts are made at the sardine canneries

to safeguard public health. One of these is the odor test, in which the contents of a can are rubbed to determine texture of fish and thoroughness of cooking. Then, by smelling the can, the experts detect presence of odors of deterioration. The sampling, or testing, on a busy day represents 20,000 tons of fish and the inspectors work night and day.

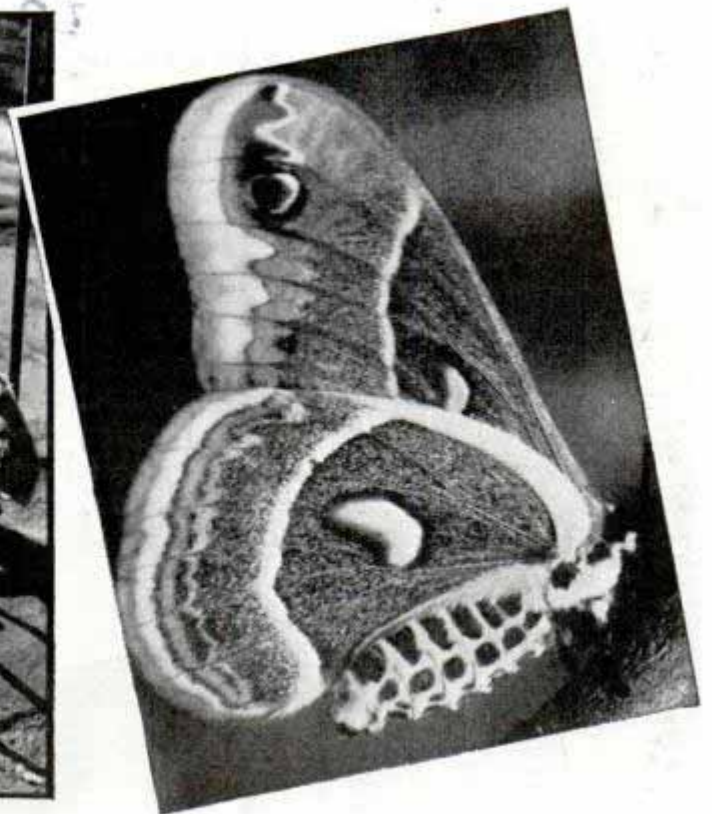

## NATURE PHOTOS *in Your*



*Close-ups count in nature pictures. Bird picture was made with portrait attachment. Try zoo snapshots first, and butterfly portraits for "home work"*

ern swamps. Others stay nearer home, picturing the birds splashing in a bath on the lawn, or gathering for bread crumbs scattered from the kitchen door. Many delight in picturing domestic animals, chickens and ducks, sheep and cows—and the excellence of their work often demonstrates that it is the skill of the photographer, rather than the rarity of his subject,

that produces exceptional pictures.

Most amateur photographers, beginning nature work, choose the hard way. They ignore the easy nature subjects around them, the everyday birds, the friendly squirrels in the park, the familiar flowers and trees, and instead pursue wild creatures that are difficult even for nature specialists with years of experience.

When you begin to do nature pictures,

**W**HETHER it's moose in the northern woods or ducklings in the barnyard pool, amateur photographers are discovering there is endless enjoyment and an endless field in "hunting" native birds and animals in America.

Some of them seek wild life in remote places—deer, mountain sheep and goats in the west, moose and grizzlies in northern forests, cranes and rattlesnakes in south-

Cont. U. A. Brown, Editorial Service Bureau,  
 Eastman/Kodak Co. 34-4 State, Rochester, N.Y.

H:69

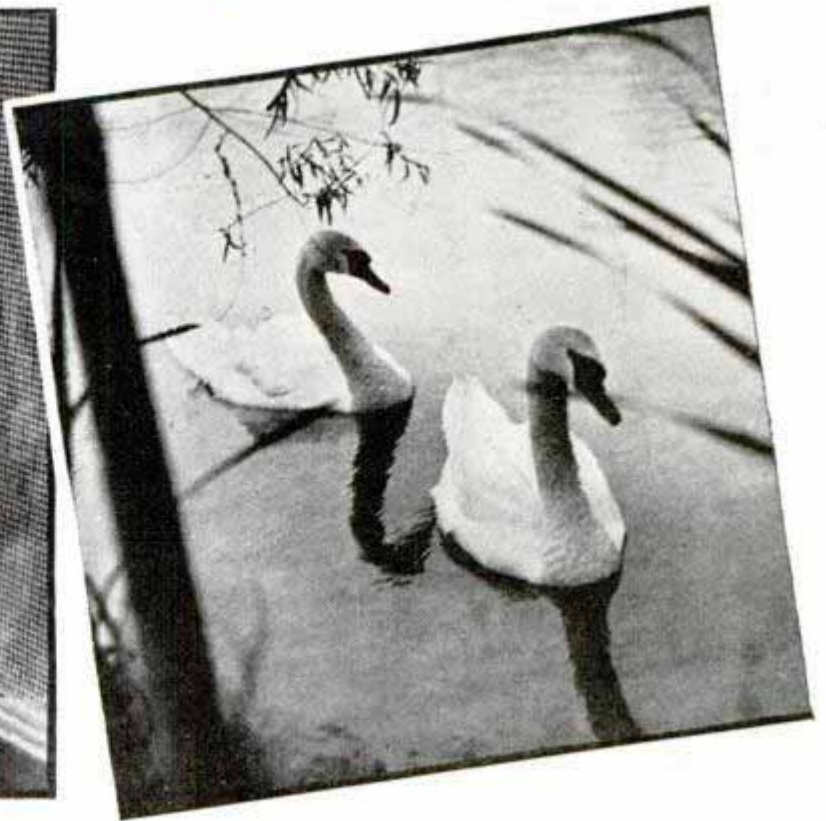

## OWN BACK YARD

you should avoid subjects that require long, skilled stalking. Instead, develop your technique thoroughly on the easiest available subjects, "graduating" later to those that call for more subtlety and skill. The ordinary amateur camera serves splendidly during the learning period; if you develop into a nature specialist, you can obtain cameras with wider operating range and more flexibility of use on very small subjects.

Most nature subjects derive interest from a "close-up" viewpoint. Such a viewpoint can be obtained by setting up the camera, focusing on a spot where the subject is sure to be sooner or later, and tripping the shutter from a distance by a cord or other remote-control device.

This is the only practical method for many pictures that involve noisy climbing or must be taken from unusual angles, such as snapshots of birds on their nests—and you can pick out a com-



*Swans in city lagoons and deer in national parks are easy and always pleasing subjects. Stalking a mouse calls for either a patient photographer or a clever shutter-release "trap"*



fortable spot to await your subject.

Arrangements are simple. First, you need a clamp to mount the camera firmly and tilt it to the required angle. A tripod might tip when the release string is pulled. Firm tree branches or similar supports serve as mounting for the clamp.

After the camera is focused accurately on the spot where your subject is to appear, the release cord is attached to the trip lever of the shutter. There are many varieties of shutters and camera constructions, so it is impossible to describe an arrangement to fit all. However, the essential requirement is that the cord pull smoothly without jamming. It is a good idea to arrange a small guide block or eyelet under the camera so the release cord is led straight down in the direction the shutter trip lever moves.

Bait may be placed to coax an animal or bird on the spot—nuts, grain or small fruit. Run the release cord to a point some distance away where you can watch without being obtrusive, and pull the cord at the right moment.

It is also possible to arrange bait so that the wild subject snaps its own picture. For example, a rubber band can be attached



to the release cord, and pegged down with the bait in such fashion that when the bait is nibbled or pecked away, the band slips off its peg and gives the cord a tug, tripping the shutter. When arranging such a set-up, keep a lens cap or black cloth over the camera lens, to avoid accidental exposures. Do not arrange the release so that the subject gives a direct tug on the cord, for a strong animal might be able to pull hard enough to injure the delicate camera shutter mechanism.

For small subjects, it is necessary to work close. Most good focusing cameras of standard amateur types will focus as near as four feet, and many as near as three feet six inches. Supplementary lenses such as the Kodak Portrait Attachments allow using these latter cameras at two feet six inches, and for some smaller cameras, such as the Retina, front lenses are available

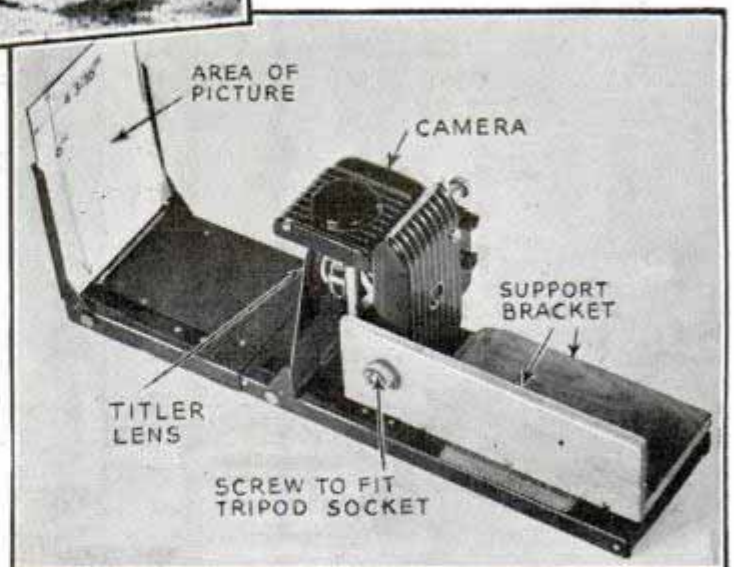

Your window sill or public park may furnish good bird pictures. Camera below is set for insect close-up

which permit snapshots much nearer than this.

The portrait attachments work at a specified distance with a fixed-focus camera, but with a focusing camera you have a choice of distances. For instance, to snap a picture at three feet with the portrait attachment mentioned above, you would set the camera lens at the ten-foot mark. Then, if you wanted to get closer and snap one at two feet six inches, you would change the lens setting to six feet. A complete table

for a focusing camera would be: for a camera focused at six feet, distance from subject to lens would be two feet six inches; at eight feet, two feet nine inches; at ten feet, three feet; at fifteen feet, three feet four inches; at twenty-five feet, three feet eight inches, and at 100 feet, four feet two inches.

The nearer the camera is to the subject, the less "depth of field" or range of sharpness you have, especially with large lens openings, and this means that if your subject moves the least bit nearer or farther away, it will be out of focus and "fuzzy." Too, the closer you work the less area the camera includes.

(Continued to page 116A)

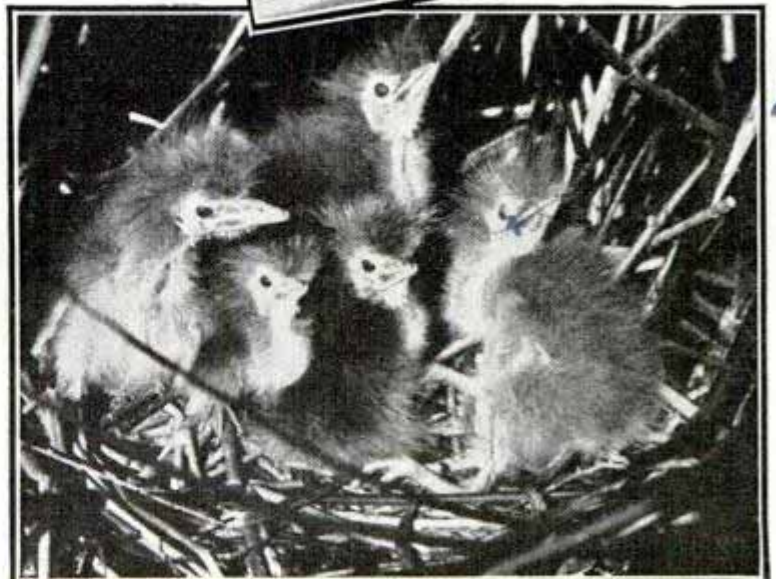

You can usually catch a bird at the "water hole" and persuade a squirrel to pose with a nut. Center picture, prefacing a fishing trip, is a variation from the ordinary nature picture. Too young to leave the nest, birds in lower right were snapped at night with flash bulb

*[Handwritten notes in blue ink at the bottom of the page, including "The Blue... Co. in..."]*

# Radio Newspaper System in First Tests



Removing sheet from receiver after test of facsimile transmission system

Preliminary tests have been made of a radio facsimile system by means of which a newspaper may be delivered into the home. The tests were made in a New York studio, pictures and reading matter being transmitted and received. A 710-kilocycle channel was used, but plans call for transfer of the system to a new 100-watt eight-meter station after approval by the federal communications commission. Daily eight-meter broadcasts will be made after experimental work has been completed.

position on the circumference of the aluminum container. The lip of the lock has a flange which fits over the rim of the container and seals against leakage with a fluid-resisting gasket. The quart container has straight sides which are a decided advantage over the narrow neck type and is reinforced by a steel band around the lip, with the aluminum spun over it. There are no obstructions, such as rivets, inside it to catch wiping cloths. The cover will fit standard quart paint cans of leading manufacturers and permits the use of paint cans usually discarded.

H 236

# Ignition Analyzer Tests Parts in Thirty Seconds

Claimed to be one of the fastest troubleshooting devices on the market, a new ignition analyzer tests parts and electrical units on the automobile in thirty seconds. Tests are made without removing the part from the vehicle. Weighing less than three pounds, the analyzer is made of aluminum. It has a four-range voltmeter and a three-range zero adjustment ammeter. Scales are easy to read, making it unnecessary for the operator to possess expert mechanical knowledge. One feature of the device is



Testing ignition wiring and parts with newly developed analyzing device

an audible vibrator for testing operation of the points without removing any part of the car. The light bulb of the analyzer is a combination ignition timing flow tester and coil circuit tester. The neon tube is used in four different ways, one being for quick location of lost high-tension current due to faulty wiring or dirty or cracked distributor head.

H 240

# Siphon-Feed Paint Container and Cover Fit Spray Gun

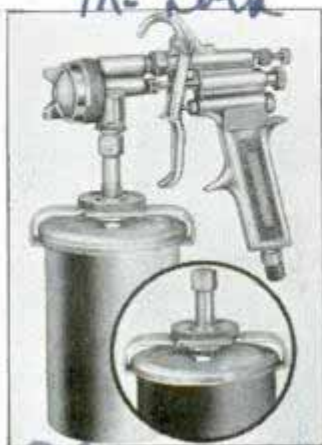

Providing a positive and simple means of attaching siphon-feed containers to spray guns, a new aluminum paint container and cover have been developed. The cover is a light-weight stamping which locks in any

The Alexander  
Mulburn Co, 1493  
W. Baltimore

I. Tell & Meter Co  
3216 Barrington St.

A. W. Lawrence

W. A. W. A.



# Stratosphere Rocket Is Latest of Thrill Rides

Designed to give a new thrill, a "stratosphere rocket" is the latest amusement device in England. The rocket will take passengers spiraling eighty feet into the air at high speed. A model of the ride device was on exhibition recently in London.

H 309.

## Six-Screw Liners of Future to Cross Sea in Half Week

To meet the competition of the transatlantic flying boats, marine engineers predict that superliners even larger than the "Normandie" and "Queen Mary" will be built, capable of carrying passengers to Europe in eighty-four hours. They would have to cruise at thirty-five to thirty-seven knots, compared with the thirty knots of present ships, and this speed would require longer hulls—perhaps 1,350 feet. The engineers suggest this could be accomplished by a turbo-electric drive, using six propellers, three on each side of the center. The liner would have to carry 11,000 tons of fuel oil and provide for ballasting the tanks with sea water as the oil is used to keep the vessel trimmed.



This model of the thrilling Stratosphere Rocket ride was on exhibition recently at a London show

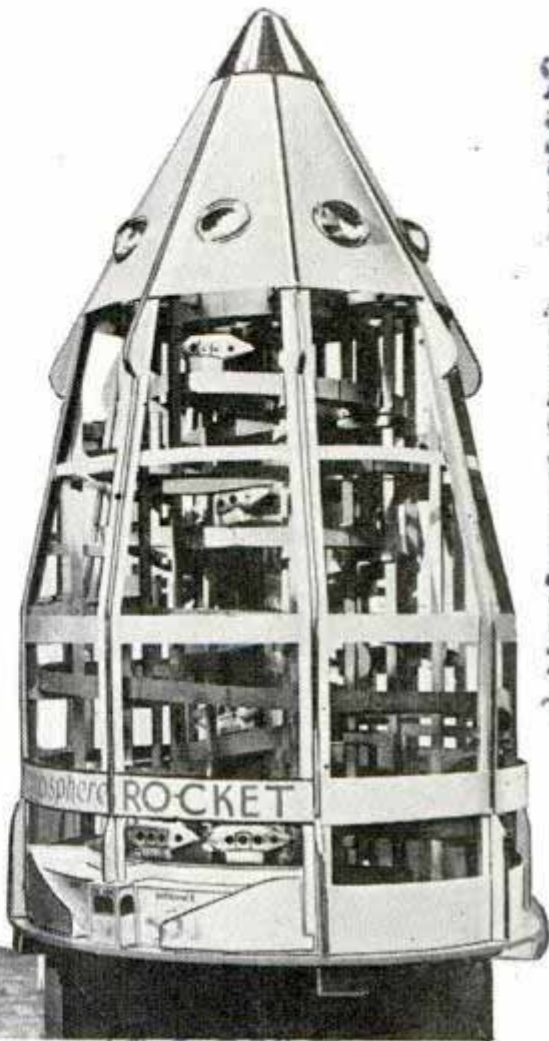

## Cableless Tractor Hauling Bus Is Driven from Its Trailer

Hauled by a tractor without a cab, a Seattle passenger bus is driven from the trailer. All the controls are at the forward end of the thirty-passenger trailer, the arrangement being made possible by a circular turntable set horizontally on the rear

of the tractor chassis. This turntable links tractor and trailer without any "play," serves as a housing for the control connections and acts as a universal joint to provide for steering, for inequalities on uneven roads, and to eliminate twisting and racking. Bus and tractor are thirty-two feet over all, but the turntable allows the vehicle to turn a complete circle in a twenty-foot radius. The total weight is only 8,800 pounds compared with 12,000 pounds for a conventional bus of similar capacity.



Bus driver's cab is at forward end of trailer, the controls passing through a circular turntable at rear of tractor

Erosion will wear North America down to a general level of 200 feet above the sea in about 18,000,000 years, geologists estimate.

and George M. Yost, 310 Central Terminal

Compressed air Jan 1908

Pierre Halglain, A.C. Hardy

Vertical text on the right edge of the page, possibly a page number or reference.

### Patient Administers the Gas by Controlling Hand Bulb



Dentist's patient gains confidence when allowed to control administration of gas by hand bulb

Dental patients can now administer the gas themselves while the dentist goes about his work. Shown at a recent convention of dentists was an instrument intended to instill confidence and overcome the patient's fear of gas by letting him control the flow with a hand bulb. The gas is a mixture of nitrous oxide and air. The patient takes only enough to induce a state of analgesia, becoming insensitive to pain but not completely unconscious.

### Locks Are Made Non-Pickable by Special Cylinder



Tests indicating that a newly invented cylinder makes locks non-pickable have been completed recently by Underwriters' Laboratories, regarded as the bureau of stand-

ards of the insurance companies. Invented by Samuel Segal, inventor of the Segal jimmyproof lock, the device can be installed on any lock now in use by merely replacing the present cylinder. Then the lock can be opened only by the owner's key, according to the makers. The invention is applicable to automobiles, filing cabinets, vending machines, bank vaults, strong boxes and all types of furniture.

### Double-Piston Engine Increases Motorcycle's Speed

Latest of engines designed to give German motorcycles more speed than any others in Europe is an Imperia, a double-piston, two-stroke built along the lines of the Junkers airplane engines. This motor looks like the heads of two small two-stroke motors have been removed and the units re-assembled, barrel to barrel, to form one engine, with a crankcase at each end. However, the cylinder is a single casting with the spark plug centrally located. Each of the crankcases contains a normal crank. Mainshafts are connected by means of sprockets and an automatically tensioned duplex chain, while on the other side of the motor, the shafts carry the driving sprocket and a supercharger. What appears to be a muffler attached to the cylinder is a container into which gas is forced before entering the cylinder. The

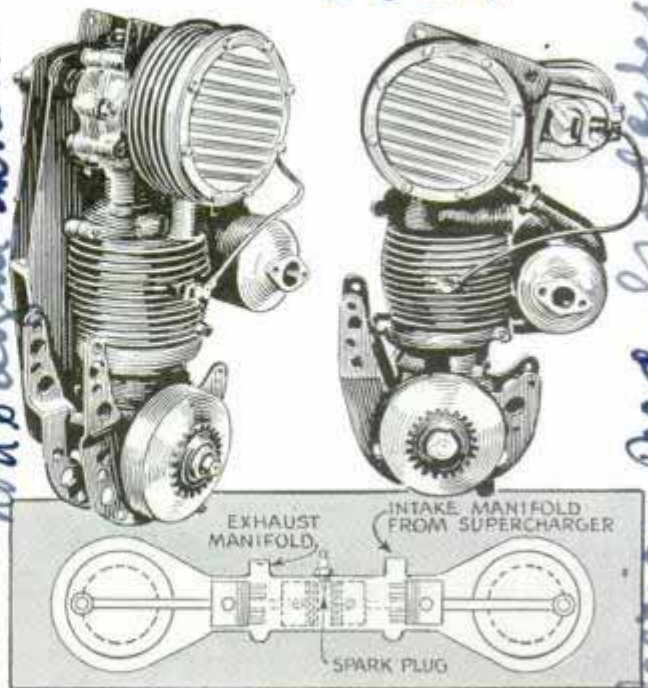

Two views, with cross-section sketch, of the double-piston motorcycle engine

Heibrink Co. 2633. 4th Ave. S. Minneapolis, Minn.

H 273  
Segal Lock Hardware Co. 61 Broadway New York City

no 12 agent London

Imperia, Pogg. Sprockberg, Germany, no U.S. agent known

magneto is mounted horizontally at the top of the motor and is driven from the upper mainshaft, while the rotor of the supercharger serves as a flywheel for this shaft, but the lower shaft is provided with an outside flywheel of normal design. The two aluminum alloy pistons work in opposition to each other. Thus, both approach the center of the cylinder together and insure almost perfect mechanical balance. Crankcase compression is not used, the fuel mixture being forced by the supercharger into the lower part of the cylinder through circumferentially disposed slots, which are uncovered by the descending lower piston. At the same time the ascending upper piston un-masks similar slots in the top of the cylinder and out of these the burned gases are forced by direct draught. In order to prevent mixing of new and burned gases, the inlet-port slots are designed in the shape of turbine or rotary-pump blades. Thus, the new gas is forced into the cylinder in "wedge" formation beneath the burned gases, which are driven upward. An exhaust port of increasing diameter aids in providing escaping gases with ready exit. Air cooling is used for the engine, so finning of the cylinder and of the supercharger is generous. The motor, in bench tests, developed forty brake horsepower at 5,200 revolutions per minute.

6257

## New U. S. Passenger Liner to Join Atlantic Service in '40



Marine artist and painting of new 34,000-ton American liner which will ply between New York and Hamburg in 1940

First big passenger liner on the shipbuilding program of the United States Maritime Commission, a 34,000-ton vessel is under construction at Newport News, Va. Although it will not be ready for transatlantic service until 1940, its portrait already has been painted by Worden Wood, marine artist. The U. S. Lines will operate the new steamer on the New York-Hamburg route. Planned to accommodate 1,219 passengers, the ship will be 723 feet long, with a ninety-two foot beam and will have a speed of twenty-two knots.

## Odd Restaurant Built Like a Zeppelin Attracts Tourists

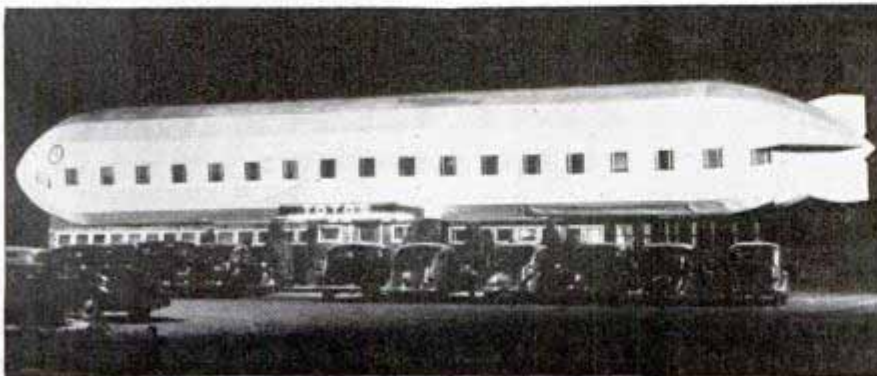

Lights make this odd cafe especially striking at night

Closely resembling a Zeppelin, an odd dining establishment near Northampton, Mass., attracts many tourists. At night, when lights are turned on inside and the outside is illuminated with powerful floodlights, the building is a spectacular sight.

Cont. John Kaczajowicz  
319 Pleasant St.  
Northampton Mass

H 10 4

Crnt. James M. Jeeing  
431 W. 60th Terrace  
Kansas City, Mo

# DRESS UP



you continue, after placing the four cards on top of the deck, the bandits learn there are only four single rooms left, one on each floor of the building. As if to dramatize the men going to their respective rooms, you take three cards off the top of the deck one at a time, inserting one near the bottom, the second in the middle, and the third a little above it, leaving the fourth bandit on the top of the deck.

You tap the deck mysteriously as a signal for the bandits to enter their

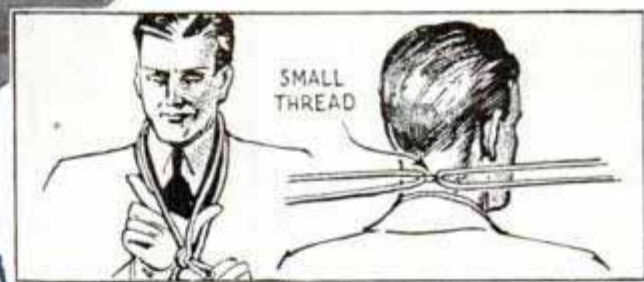

By Claude Enslow  
(Professional Magician)

2940 Forest, Kansas City, Mo

**PATTER** is a phase of magic frequently overlooked by the amateur magician. Yet with this simple ingredient it is possible to double entertainment value of performances. Patter is the professional term for dressing up a trick with a little story or dialogue that will enhance the audience's interest in what you are doing. In nine cases out of ten, a simple stunt with a clever story woven around it will make a bigger hit than a more difficult one presented in a grim, matter-of-fact way.

For informal, close-up work, one of my standard routines was a card trick with four jacks. It never created much of a stir among audiences. Changing its name to the Four Bandits and garnishing it with a clever story made the trick very popular. Here is the way to dramatize your movements on this trick: As the four jacks are being shown, you explain they are bandits and are on their way to a hotel (the deck) to plot a robbery. Arriving at the hotel,



Top, and center, steps in Hangman's Noose trick, showing how rope is attached. Bottom, start of trick to tie knot in circle

Handwritten notes and scribbles at the bottom of the page, including the number '10' and various illegible markings.

# Your MAGIC TRICKS



rooms. The cards are then pushed all the way into the deck. A second signal, the audience is told, will bring the bandits to the room on the top floor where they will proceed with their plans. Again, you tap the deck and after a brief pause, turn over the four top cards and they prove to be the four bandits. When the four jacks are first shown, three different cards are concealed behind them. When the seven cards are pushed together and placed on top of the deck, the three indifferent cards will be on top and these, of course, are the ones that are inserted in the deck.



*Top, ink becomes water when silk liner is pulled into handkerchief. Circle, various steps leading up to the mystifying trick*

H 10 4



Top, explaining the Four Bandits trick. Left, how the cards are placed

You can spin your own story about the invisible hen that lays eggs at will. While doing this you show a handkerchief and a hat that is to serve as a nest for the magic hen. The handkerchief is thrown over the hat and after completing the introductory patter, you pick it up by the four corners and gently shake an egg into the hat. Showing the handkerchief on both sides, you repeat the process several times. Upon picking up the hat, however, you show it to be free of eggs.

In order to do this trick, an egg first must be blown, its contents removed by placing tiny holes in either end. An invisible string is then attached to the egg by means of a small piece of Cellophane tape. The thread also is attached to the handkerchief. The handkerchief is freely shown with the egg resting in the bottom of the hat. When the hat is covered with it, the spot where the thread is attached to the handkerchief should be nearest you. With your left hand you pick up the handkerchief at this thread point while your right

hand grasps the two corners. You then proceed to shake the egg from the handkerchief.

Another routine that lends itself well to patter is the ink-to-water trick. At the outset you show a glass of ink and as proof of its genuineness, you dip out a few drops with a spoon. The glass is covered with a handkerchief, you wave your hand over it, and presto, the ink becomes water. The secret of this clever bit of parlor magic lies

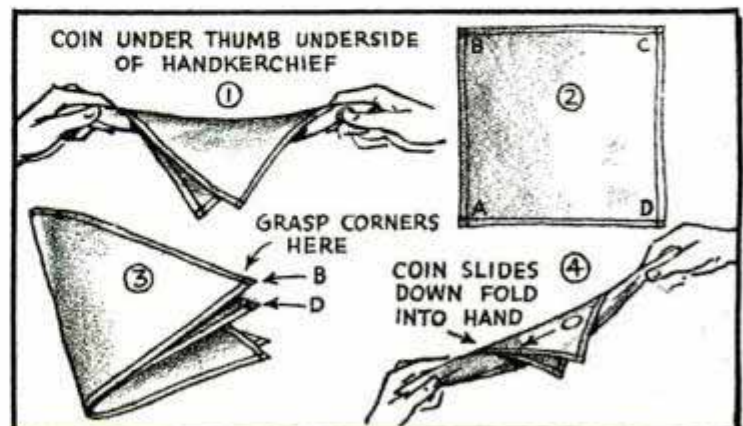

Steps in preparing handkerchief for the traveling penny stunt. Note the folding

H104

1454

in a small effect that can be made without difficulty. A piece of dark blue silk is sewed together so it fits snugly around the inside of a glass. When it is placed in the water it will adhere to the sides and gives the appearance of ink. It may be necessary to place a piece of wire around the rim of this fake so as to stiffen it.

An invisible thread handle attached to the effect hangs over the edge of the glass toward the magician so it cannot be seen. The handkerchief covers your movements. Grasping the thread, you pull the silk fake into the folds of the handkerchief as the latter is drawn off the glass. The handkerchief containing the piece of silk is quickly put aside.

Perhaps you are wondering how you assure your audience the glass contains ink when you first show it. That's easy. You place a small amount of potassium permanganate in the back part of the spoon and this chemical will mix with the water, creating a blue fluid resembling ink. In working this trick, make sure the glass is high enough to prevent the spectators from seeing into the bottom of it.

Ask your audience if it is possible to tie a knot in a circle, such as an automobile inner tube, without first cutting the circle. You probably will receive a negative reply. Of course, you dis-

(Continued to page 118A)

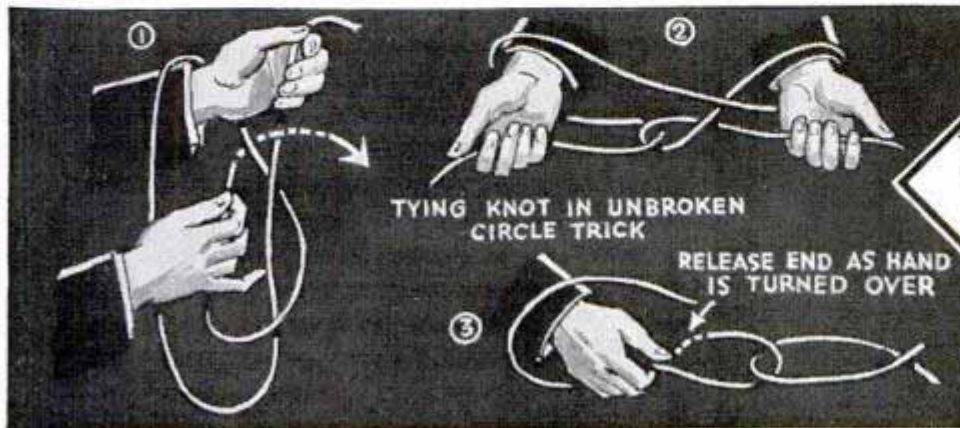
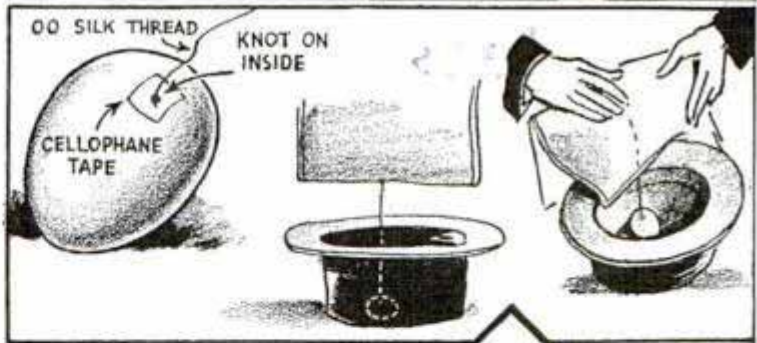
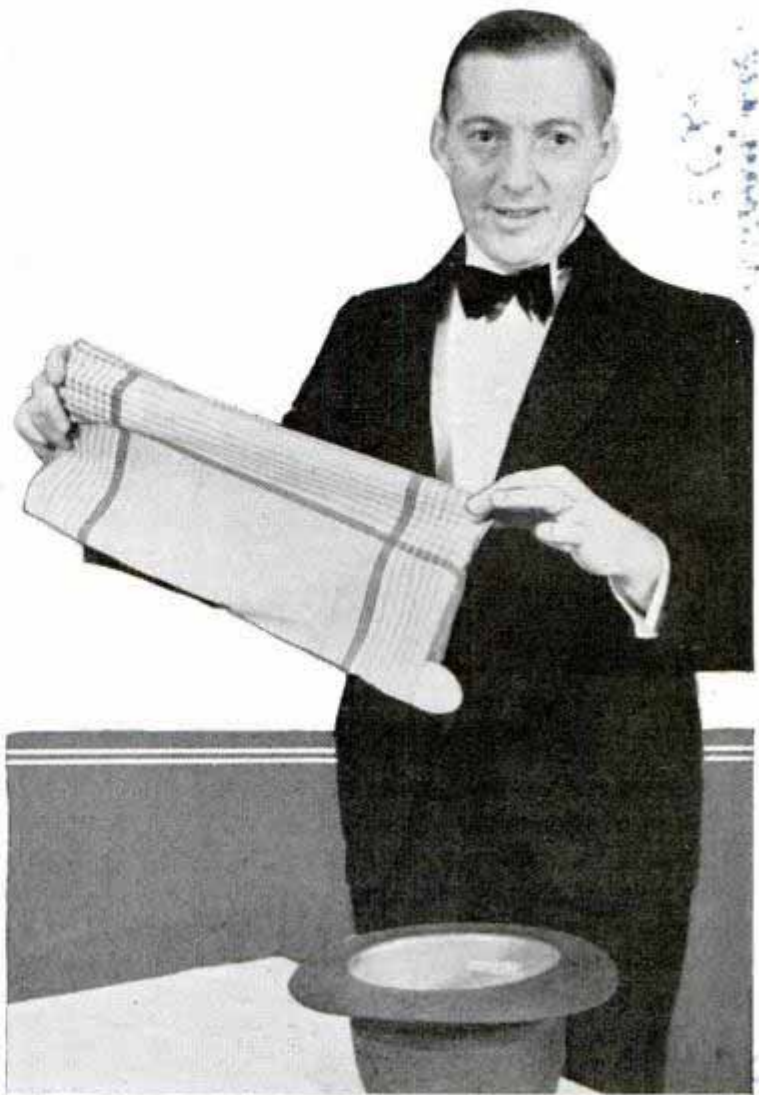

Top, invisible hen lays eggs at will. Center, how the magician prepares and executes the trick. Bottom, steps in unbroken circle trick. Right, how false knot is tied with handkerchief

# Power of Many Men Harnessed for Small Shop

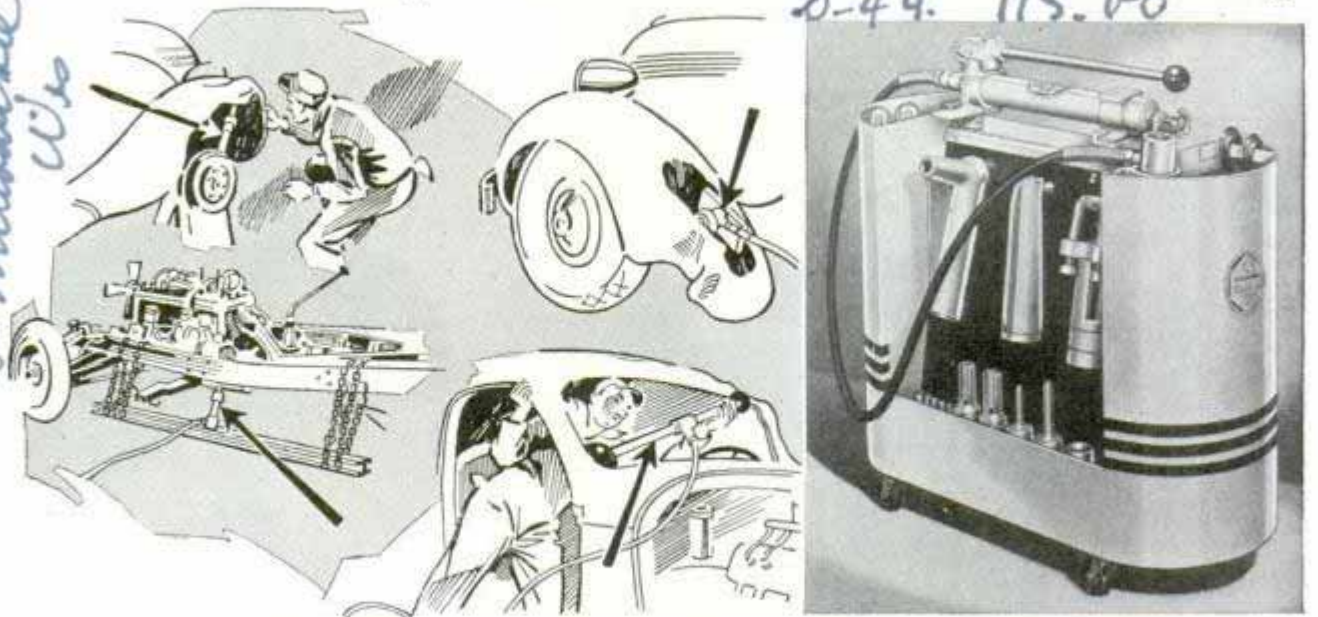

At right is the portable hydraulic power plant designed for small workshop or garage; at left, some of its applications in straightening automobile bodies, fenders and frames

Hydraulic power for the small shop is available today in a portable unit that can be put to any number of tasks. Its pump transmits power through a six-foot flexible high-pressure hose to the ten-pound ram, which can deliver pressure in any direction—up, down, sideways. A workshop on wheels, this power plant is equipped

with special attachments for work on automobile bodies. Besides straightening frames and bodies, it applies special tools for spreading springs, removing and inserting shackle studs, bolts and pins; and there is an adjustable body spoon which can be set at various angles for reshaping work in difficult locations.

# Automobile Signal Warns of Waste and Saves Gasoline

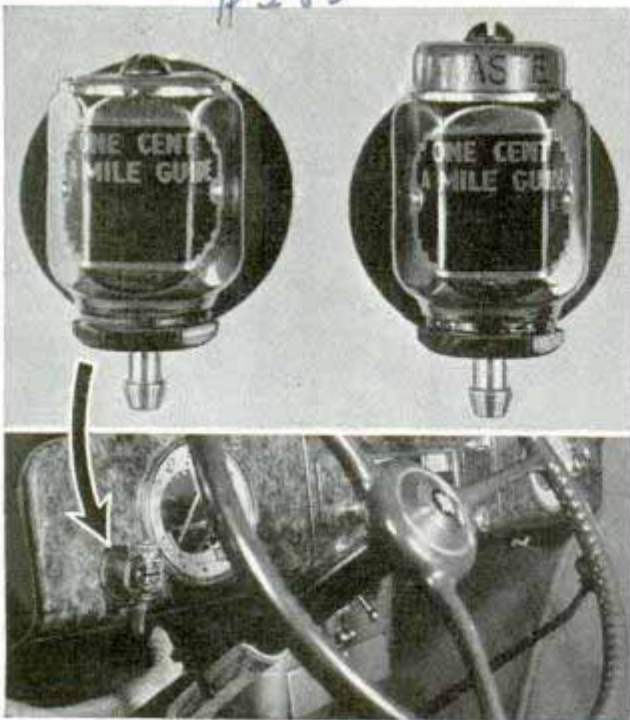

Top, guide closed and open. Bottom, position of the guide on instrument panel

Easily installed on the automobile, a small gasoline waste indicator enables the driver to operate his car more efficiently, resulting in a saving on fuel. It measures the flow of gasoline in direct proportion to the vacuum in the intake manifold and automatically adjusts itself to the weight and horsepower of the car, definitely indicating each time the car is driven in such a manner as to waste fuel. Many motorists have the mistaken impression that "peak" performance driving is at a snail's pace. Peak driving is acceleration in such a manner as to utilize, rather than waste fuel. This can be done only up to a certain speed. When crowding into the manifold, by over-accelerating, more gasoline than it is possible to vaporize, which is the case when driving beyond the peak, raw gasoline is forced into the cylinders, resulting in waste. The average popular priced car will deliver around twenty miles per gallon when driven at peak performance. Us-

H 241  
 Blackhawk mfg Co.  
 6325 W. Rogers  
 Milwaukee  
 Wis  
 H 294  
 Cent. a Mile Guide

D-44. 115.00

\$385

Motor Inductors Sioux City, Iowa



ing eighteen cents a gallon as the basic cost, it is a simple matter to drive these cars at a fuel cost of one cent a mile or less. All one need know is when the peak performance point has been reached. The waste indicator, called the One-Cent-a-Mile guide, remains closed as long as fuel cost does not exceed one cent per mile, indicating proper driving, but opens with a snap to display a red warning sign of "Waste" when peak performance is exceeded and fuel is being wasted. After opening, the guide automatically closes each time waste is eliminated and fuel operating cost is again normal. The device is connected to the windshield-wiper hose by means of a special T-shaped adapter and can be installed on the dash ready for use by anyone in a minute or two.

H 275

### Motor Wheel Chair Coupe Has Lawnmower Engine

Charles Bancroft of Port Arthur, Tex., used to push himself around in a wheel chair, but now he rides in a motor-driven "coupe" that resembles an armored car. He built the three-wheeled vehicle himself, and equipped it with a two-horsepower lawnmower engine and a motorcycle transmission. The car can travel twenty-five miles an hour and go sixty-five miles on a gallon of gasoline.

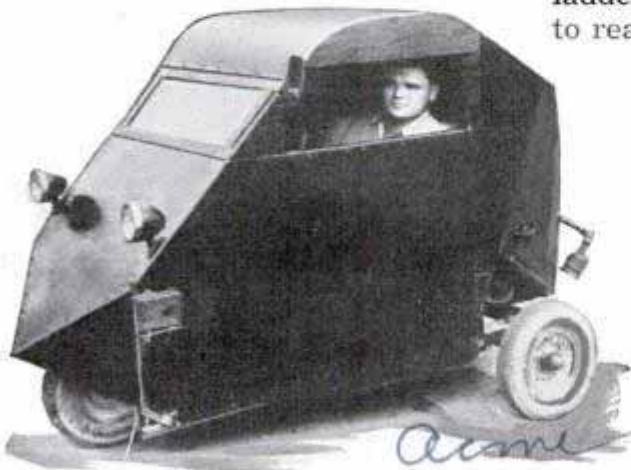

Enclosed three-wheeler driven by lawnmower motor was built to replace a hand-propelled wheel chair

### Aerial Bridge on Top of Truck Reaches Up to Street Lamp

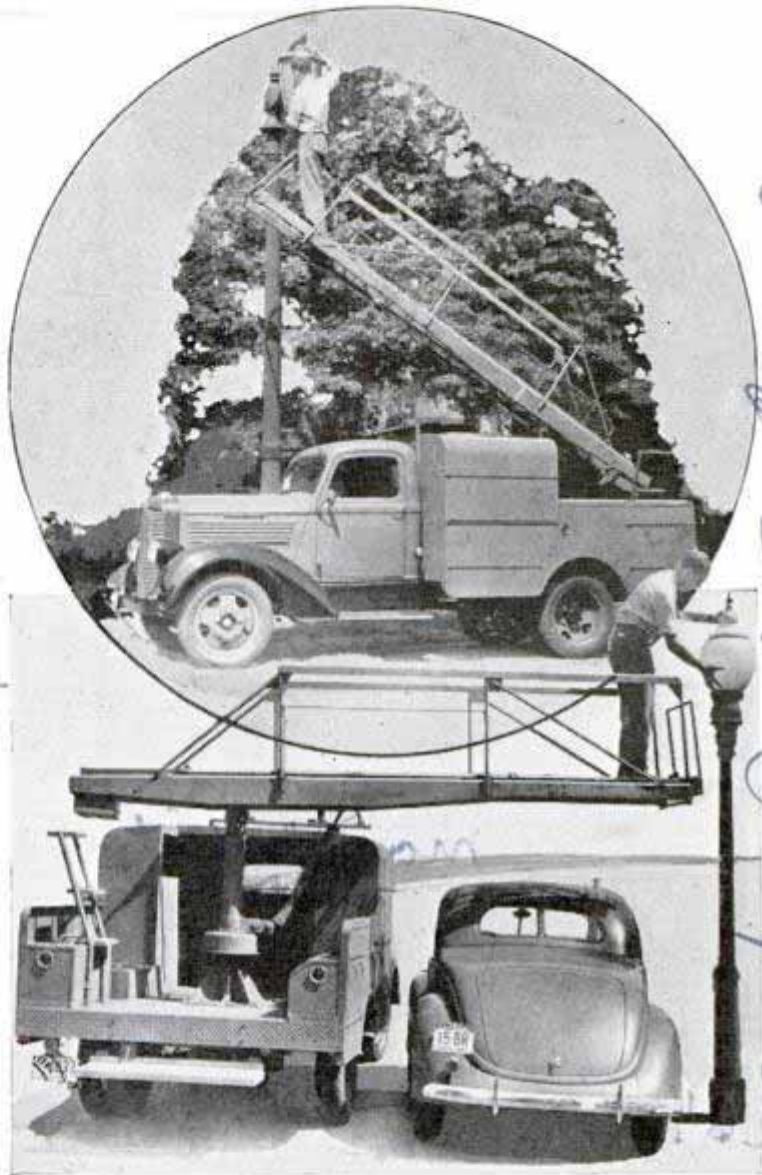

Servicing street lamps with the "aerial bridge" which tilts steeply up to highest lamp or reaches over parked cars

Swinging in a full circle on its pedestal, an aerial ladder mounted on a motor truck can be tilted up to reach any street lamp for servicing. It can even bridge over a parked car at the curb to give easy access to the lamp. The ladder is balanced for tilting to any angle, rotates on ball bearings, is pedal locked and requires but a few seconds to extend to the average lamp.

Our Bureau of Information keeps on file the names and addresses of makers of, and dealers in, all devices described in the pages of Popular Mechanics Magazine. We are glad to furnish this information to our readers upon request, accompanied by stamped, self-addressed envelope.

The Baker-Powling Co., 2180 W. 25th Cleveland, Ohio

### Making Dolls from Scrap Metal Is Latest of Hobbies



Fashioning modernistic dolls from scraps of metal.  
Note completed doll at right

From scraps of metal gathered from movie studio workshop floors, one actress fashions modernistic dolls as a hobby. Scraps of tin, copper and aluminum are used. The metal is cut with heavy shears and then bent into the shape desired.

### Meteorites Sought by Science Are Worth Cash to Finder

Meteorites, those "stones from heaven," are being collected by the Smithsonian Institution. While the discovery of a meteorite may not make the finder rich, it is always worth-while. Usually the return is very good for a day's work. Hundreds, perhaps thousands, of meteorites, or fragments of shooting stars, probably are scattered over the surface of the United States unnoticed. There may be some in your back yard. If you pick up a stone that seems exceptionally heavy for its size, it is well to make inquiries. Meteorites are about the heaviest of rocks. Some are pure iron and nickel. Even in an iron manufacturing district, lumps of pure iron are very rare, and if you find one anywhere else the chances are greatly in favor

of its origin in outer space. Even the so-called "stony meteorites" contain a good deal of iron and are heavy enough, compared with ordinary stones, to arouse suspicion. A good way to get corroborative evidence is to take such a stone to the grindstone and grind away a small bit of surface. If you find the exposed area speckled with iron particles, the chances are rather good that you have a meteorite. Finders should avoid injuring the surface, because it is of interest to students of meteorites. Another bit of corroborative evidence is the frequent, but not invariable streamlining of such a stone. The surface may be covered with very fine lines or furrows, all curving in one direction. These lines are "etched" by the air on the surface of the stone during its rapid fall.

### "Death at the Wheel" Photo Warns of Road Perils

Taken to warn motorists of the perils of the highway, a photograph snapped recently shows Death at the wheel. The picture was posed, with the auto's driver wearing on his head a painted mask representing a skeleton. After the photo had been taken, the driver kept on the mask and rode along the highways. So frightening was the sight that other motorists gave the car a wide berth.



Depicting "Death at the Wheel," this motorist is a warning to other drivers

Photo made by Howard Fowler

Handwritten notes on the left margin: "14254", "H264", "E. P. Henderson", "Dept of Geology", "Mary Carlisle", "Washington D.C.", "3/25/32", "3/26/32", "3/27/32", "3/28/32", "3/29/32", "3/30/32", "3/31/32", "4/1/32", "4/2/32", "4/3/32", "4/4/32", "4/5/32", "4/6/32", "4/7/32", "4/8/32", "4/9/32", "4/10/32", "4/11/32", "4/12/32", "4/13/32", "4/14/32", "4/15/32", "4/16/32", "4/17/32", "4/18/32", "4/19/32", "4/20/32", "4/21/32", "4/22/32", "4/23/32", "4/24/32", "4/25/32", "4/26/32", "4/27/32", "4/28/32", "4/29/32", "4/30/32", "5/1/32", "5/2/32", "5/3/32", "5/4/32", "5/5/32", "5/6/32", "5/7/32", "5/8/32", "5/9/32", "5/10/32", "5/11/32", "5/12/32", "5/13/32", "5/14/32", "5/15/32", "5/16/32", "5/17/32", "5/18/32", "5/19/32", "5/20/32", "5/21/32", "5/22/32", "5/23/32", "5/24/32", "5/25/32", "5/26/32", "5/27/32", "5/28/32", "5/29/32", "5/30/32", "5/31/32", "6/1/32", "6/2/32", "6/3/32", "6/4/32", "6/5/32", "6/6/32", "6/7/32", "6/8/32", "6/9/32", "6/10/32", "6/11/32", "6/12/32", "6/13/32", "6/14/32", "6/15/32", "6/16/32", "6/17/32", "6/18/32", "6/19/32", "6/20/32", "6/21/32", "6/22/32", "6/23/32", "6/24/32", "6/25/32", "6/26/32", "6/27/32", "6/28/32", "6/29/32", "6/30/32", "7/1/32", "7/2/32", "7/3/32", "7/4/32", "7/5/32", "7/6/32", "7/7/32", "7/8/32", "7/9/32", "7/10/32", "7/11/32", "7/12/32", "7/13/32", "7/14/32", "7/15/32", "7/16/32", "7/17/32", "7/18/32", "7/19/32", "7/20/32", "7/21/32", "7/22/32", "7/23/32", "7/24/32", "7/25/32", "7/26/32", "7/27/32", "7/28/32", "7/29/32", "7/30/32", "7/31/32", "8/1/32", "8/2/32", "8/3/32", "8/4/32", "8/5/32", "8/6/32", "8/7/32", "8/8/32", "8/9/32", "8/10/32", "8/11/32", "8/12/32", "8/13/32", "8/14/32", "8/15/32", "8/16/32", "8/17/32", "8/18/32", "8/19/32", "8/20/32", "8/21/32", "8/22/32", "8/23/32", "8/24/32", "8/25/32", "8/26/32", "8/27/32", "8/28/32", "8/29/32", "8/30/32", "8/31/32", "9/1/32", "9/2/32", "9/3/32", "9/4/32", "9/5/32", "9/6/32", "9/7/32", "9/8/32", "9/9/32", "9/10/32", "9/11/32", "9/12/32", "9/13/32", "9/14/32", "9/15/32", "9/16/32", "9/17/32", "9/18/32", "9/19/32", "9/20/32", "9/21/32", "9/22/32", "9/23/32", "9/24/32", "9/25/32", "9/26/32", "9/27/32", "9/28/32", "9/29/32", "9/30/32", "10/1/32", "10/2/32", "10/3/32", "10/4/32", "10/5/32", "10/6/32", "10/7/32", "10/8/32", "10/9/32", "10/10/32", "10/11/32", "10/12/32", "10/13/32", "10/14/32", "10/15/32", "10/16/32", "10/17/32", "10/18/32", "10/19/32", "10/20/32", "10/21/32", "10/22/32", "10/23/32", "10/24/32", "10/25/32", "10/26/32", "10/27/32", "10/28/32", "10/29/32", "10/30/32", "10/31/32", "11/1/32", "11/2/32", "11/3/32", "11/4/32", "11/5/32", "11/6/32", "11/7/32", "11/8/32", "11/9/32", "11/10/32", "11/11/32", "11/12/32", "11/13/32", "11/14/32", "11/15/32", "11/16/32", "11/17/32", "11/18/32", "11/19/32", "11/20/32", "11/21/32", "11/22/32", "11/23/32", "11/24/32", "11/25/32", "11/26/32", "11/27/32", "11/28/32", "11/29/32", "11/30/32", "12/1/32", "12/2/32", "12/3/32", "12/4/32", "12/5/32", "12/6/32", "12/7/32", "12/8/32", "12/9/32", "12/10/32", "12/11/32", "12/12/32", "12/13/32", "12/14/32", "12/15/32", "12/16/32", "12/17/32", "12/18/32", "12/19/32", "12/20/32", "12/21/32", "12/22/32", "12/23/32", "12/24/32", "12/25/32", "12/26/32", "12/27/32", "12/28/32", "12/29/32", "12/30/32", "12/31/32"

# R a d i o



## COMPACT *Push-Button* . . RECEIVERS

**P**USH-BUTTON tuning for favorite local stations is no longer limited to large console receivers. Several models recently introduced include this desirable feature in compact cabinets designed for use in locations where space is at a premium.

A 7-tube, 3-band superheterodyne with electric tuning, magic eye and straight-line dial is shown in photo Fig. 1; a close-up of the push-button arrangement and control panel appears in Fig. 2. It is designed for electric tuning on any six local stations se-

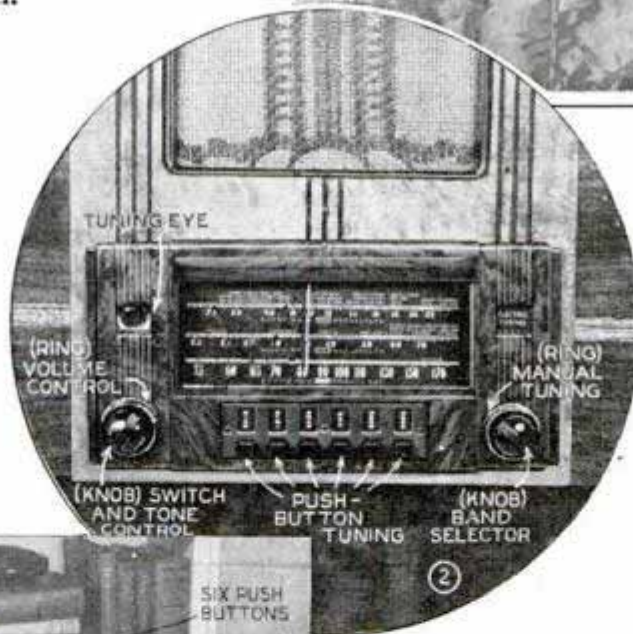

lected, and may be manually tuned if preferred. This modern table model is housed in a cabinet 16 $\frac{3}{4}$  in. high, 18 in. wide and 10 $\frac{1}{4}$  in. deep.

Another innovation made possible by push-button tuning is a small inexpensive table-type model without a tuning dial. This



ultra-compact 4-tube a.c.-d.c. electric tuning receiver appears in photo Fig. 3. Six separate tuning buttons cover the entire broadcast range and are easily adjusted for desired locals. Other features include a cabinet 8 $\frac{1}{8}$  by 8 $\frac{1}{8}$  by 5 $\frac{5}{8}$  in. deep, built-in antenna, electro-dynamic speaker and beam-power amplification with an output of 1.5 watts.

*RCA. Mfg. Co. Inc. Camden N.J.*

# Three-Tube RADIO

By G. F. Forrest



ALTHOUGH this 3-tube battery-operated receiver is designed for experimenters interested in radio direction finding, it is also suitable for receiving broadcasting stations for entertainment.

The circuit is a simple regenerative type for maximum sensitivity and can be made to give a steady beat-note as a listening aid while swinging the loop. Feedback for regeneration is obtained by means of the tapped loop and is controlled by variable resistor  $R_1$ .

Details for the metal base and shield covers appear in Fig. 1. The front and rear panels do not completely lap over the turned-down chassis base edges, therefore holes for the insulated phone-tip jacks, and bat-

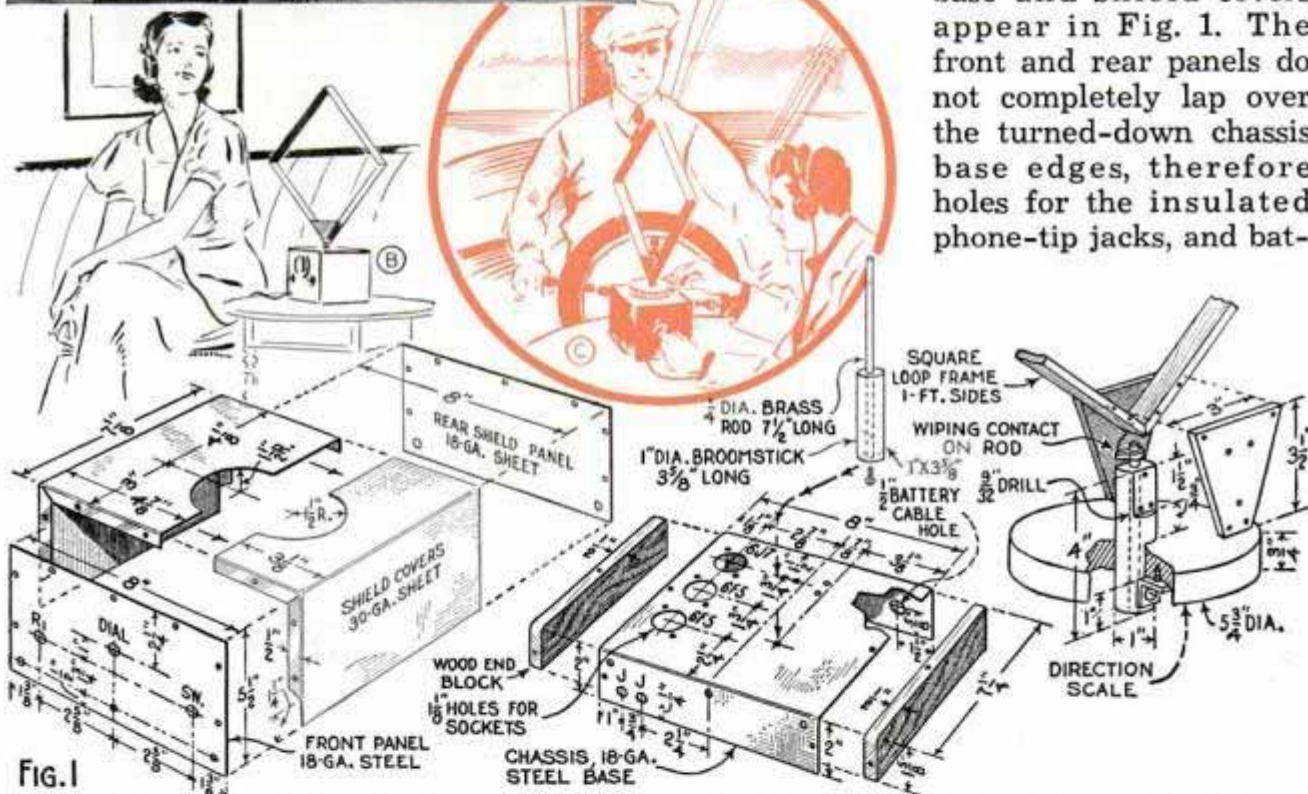

FIG. 1

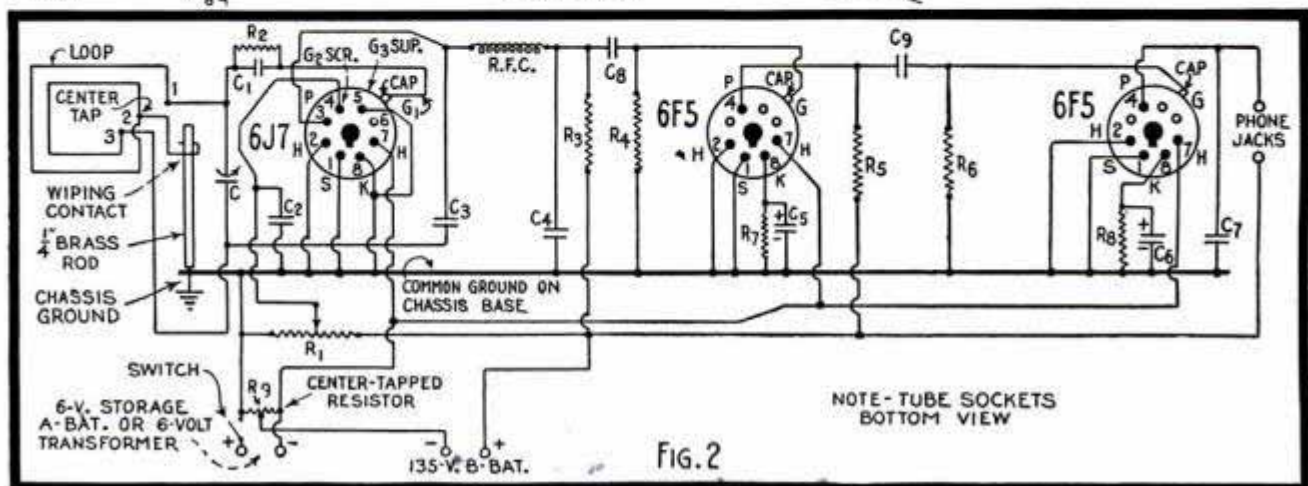

FIG. 2

NOTE-TUBE SOCKETS  
BOTTOM VIEW

# DIRECTION FINDER

*also serves as . . .  
broadcast receiver*

tery-cable, need be drilled through only one thickness of the metal.

Two yardsticks provided the material for the loop frame, each stick cut to a length of 2 ft., scored deeply across at center and then bent at a right angle to make one-half of the frame. Use pins or small brads to nail the pieces together to form a square. Wind 18 turns of No. 26 enameled-copper wire close-wound in a clockwise direction on the frame. The loop frame is then mounted as shown in Fig. 1.

The brass rod is a force fit in the lower

(Continued to page 140A)

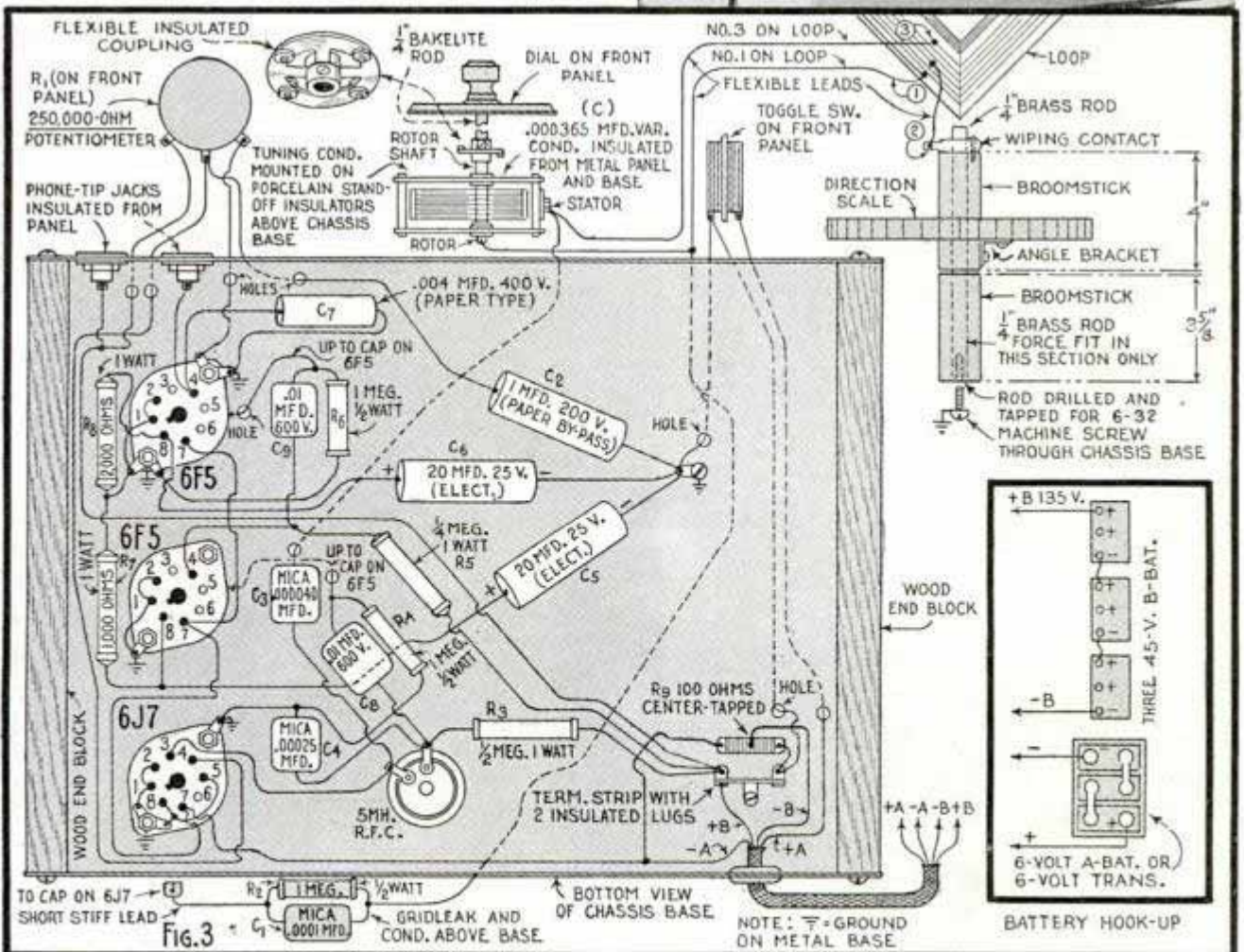
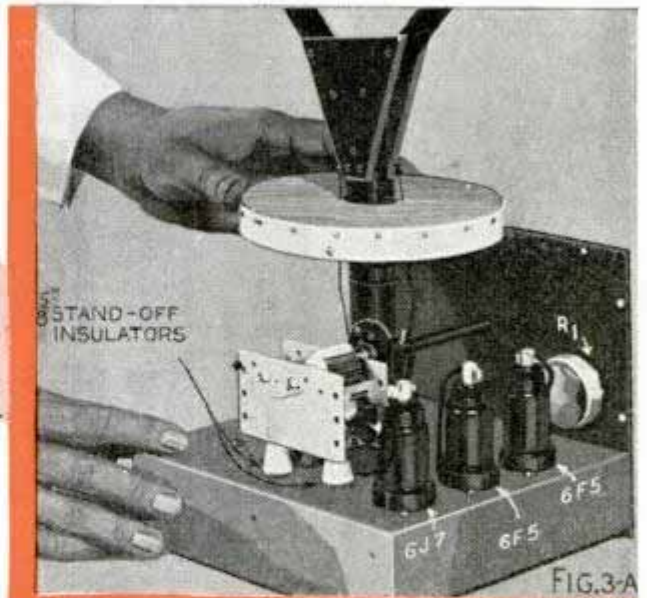

# Simple Fixed-Condenser Substitution Tester

By M. N. Beitman

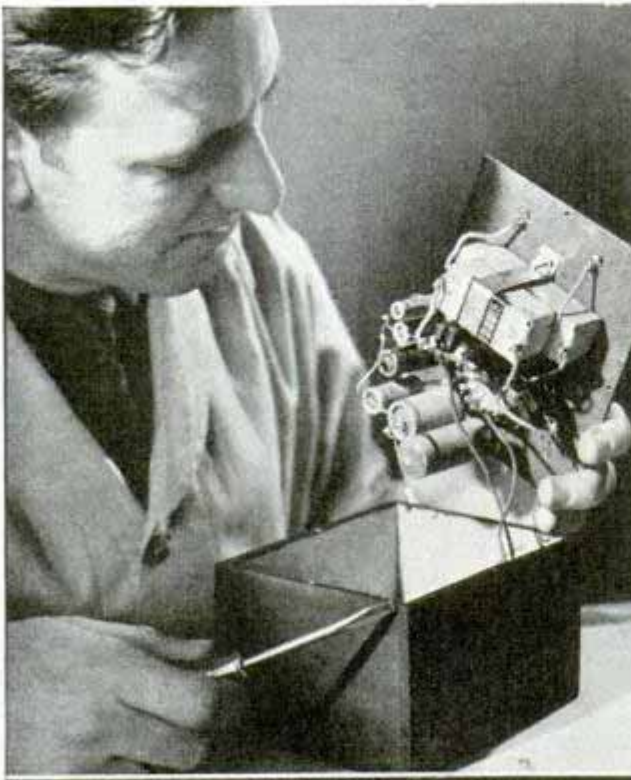

**R**ADIO experimenters and servicemen will find this handy condenser substitute tester a versatile instrument of many applications. A 15-point single-deck switch permits instant selection of any commonly used capacity needed in radio circuits.

It is suitable for trying different capacities for best results and for substituting various size condensers for an apparently defective fixed condenser in a receiver.

The circuit appears in Fig. 1; all parts are mounted on a 1/8 by 5 by 6-in. pressed-wood or Bakelite panel as shown in photo Fig. 1-B. These condensers should have a rating of 600 volts; good quality electrolytic units are employed for the 4 and 8-mfd. capacities on points 14 and 15. The polarity of these electrolytic condensers must be just as shown in the diagram. Condensers from points 13 to 6 may be of the paper type; the smaller sizes, connected at points 5 to 1, are a low-loss mica variety.

Make all connections as short as possible. The tester may be connected with either binding post to positive side of the circuit under test, except when using the 4 and 8-mfd. capacities. When these are used, follow the positive and negative post connections. A plywood box 3 1/2 by 5 by 6 in. houses the tester as shown in photo Fig. 1-A.

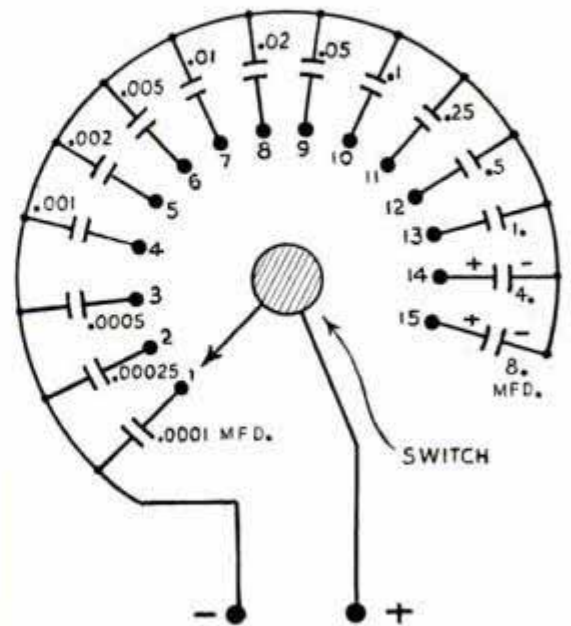
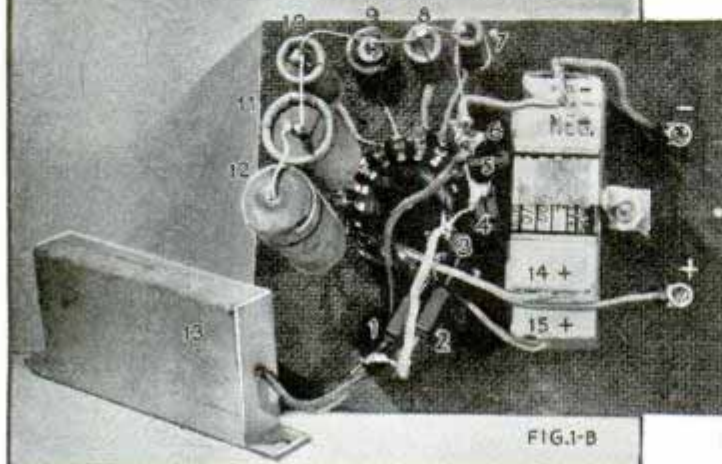
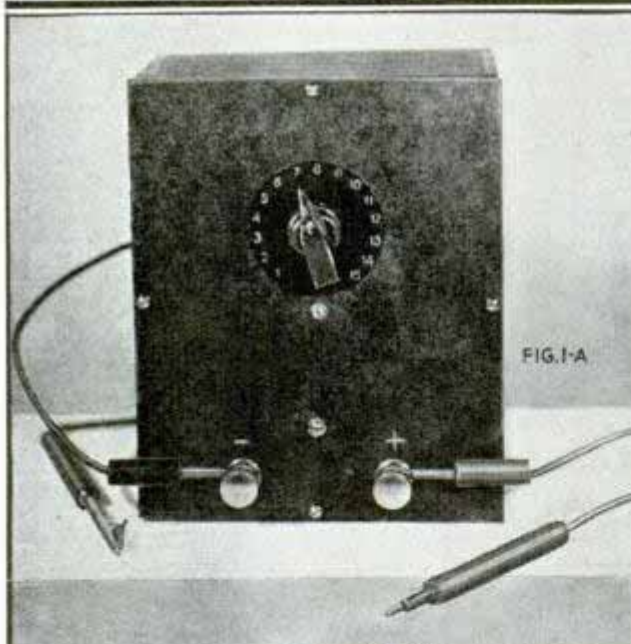

# Practical RADIO HINTS

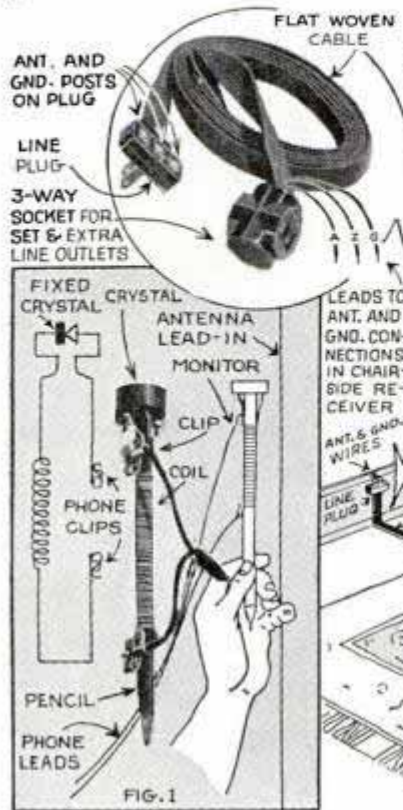
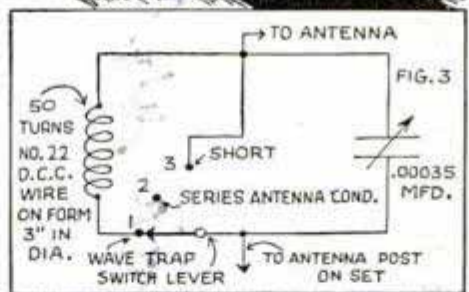
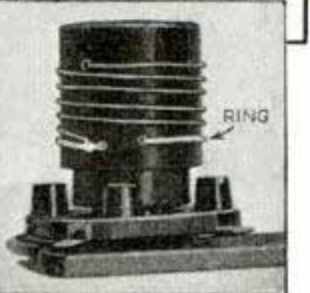
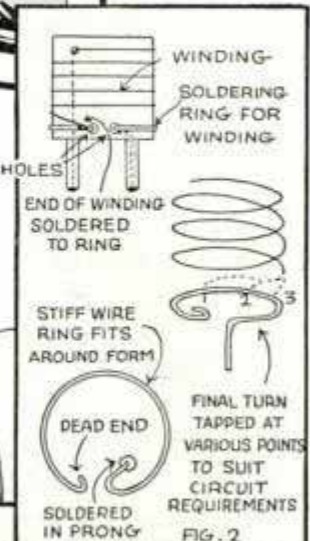

Fig. 1, two Fahnestock clips, a fixed crystal and lead pencil with metal top removed, provide coil form and all parts to make a vest-pocket monitor for phone transmitter signals. Wind sufficient turns of fine d.c.c. wire to resonate at amateur band used

Center above, flat-woven 5-wire cable unit enables owner of armchair receivers to place the set at any convenient location in the room and conceal all wiring under rugs. The cable brings power, ground and antenna leads to set as illustrated in sketch; fits snugly underneath rugs without showing and also provides a 3-way socket for lamps or other electric devices. Fig. 2, at upper right, shows an easy method to avoid tedious cut-and-try winding of high-frequency oscillator or buffer coils to determine critical fractional final-turn length necessary for operating band desired

Right, code-practice cards arranged with code on one side and corresponding letters on the other



Left, diagram Fig. 3 shows circuit details for an adjustable wave trap with 3-point switch. Tap No. 1 cuts out interfering local broadcasting stations; No. 2 serves for series antenna condenser as aid in tuning higher frequencies; No. 3 shunts trap out of antenna circuit when not required. Cardboard tubing may be used for coil form; mount coil on small baseboard and the 3-point switch on an angle bracket or Bakelite strip screwed to baseboard

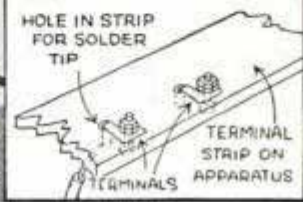
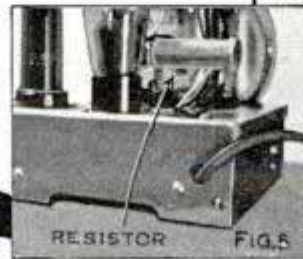
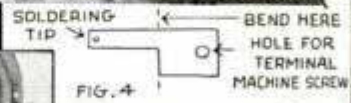
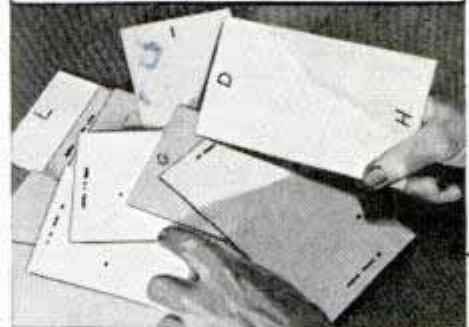

Fig. 4, handy soldering lugs cut from scrap copper or brass sheet. Photo Fig. 5 shows a 20-watt resistor wired in socket to replace burned-out ballast tube. Correct resistance is found by adding heater voltage of all tubes and subtracting this from 110. Divide result by 3; this answer times 10, is the ohm value required

*Wholesale Radio Service Co. 100 to the Ave. New York!*

### Safety Tuning for Auto Set

### Unit-Type Amateur Transmitter



*Insert photo shows tuning buttons, dial and manual control knobs on front of set*

Available in 'add-a-unit' form, the assembly shown covers 5 bands with 40-watt CW output and 25 watts on phone. Features include "Les-Tet" oscillator and cathode-ray tube.



### All-Purpose Portable Receiver

Without changing connections this set is designed to operate on either a 6-volt storage battery, or the 110-volt a.c. supply line in your home by merely flicking a switch.



This single-unit auto receiver can be tuned to five different stations without diverting the driver's attention from the road. A mechanical system is employed for push-button operation instead of the usual motor drive or trimmer condensers. The station received is also indicated by a pointer on the dial.

### Test Set Fits Your Pocket

Small enough to carry in your pocket, this unusually compact volt-ohm-milliammeter includes all ranges required in modern radio set testing. Each voltage range has a resistance of 5,000 ohms per volt. Comes complete with test prods.

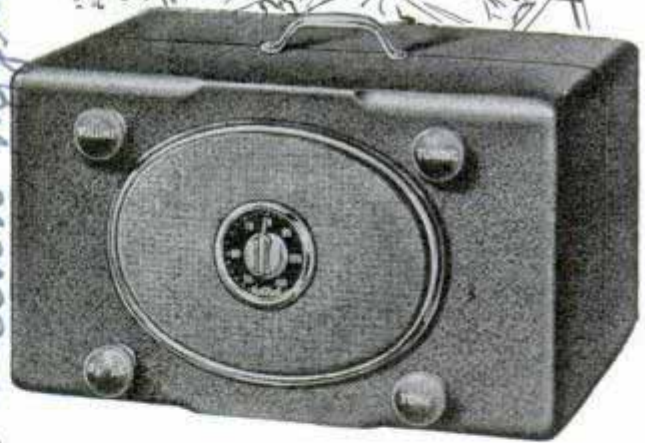
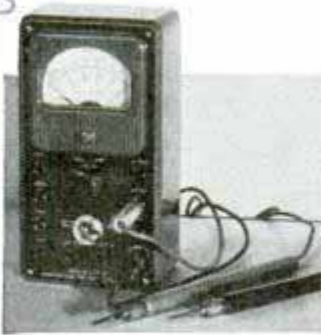

Blueprints covering radio construction articles in past issues are available for 25 cents each; original material lists and additional information can be obtained from our Radio Department without charge upon receipt of postage.

**NEXT MONTH—How to Build an Armchair Radio Cabinet.** A practical, smartly styled armchair cabinet which also serves as an endtable and bookcase. It is designed to house any small 4 or 5-tube radio receiver. Also—**How to Install a Pillow Speaker and Hints for Checking Receivers with a Cathode-Ray Oscillograph**

*Crosley Radio Corp. Cincinnati, Ohio*  
*Dimpson Electric Co. Chicago, 5216 W. Kenzie*

*4545 Augusta Blvd. Chicago*





# Bathroom UTILITY RACKS

*give extra space*

By WAYNE C. LECKEY

**I**F YOU are taxed for sufficient space in the bathroom for storing numerous small items of cosmetics and such, one of these handy racks hung over the wall cabinet will allow you to keep these neatly arranged within easy reach.

As the cabinets will be finished in enamel to match the bathroom fixtures,  $\frac{1}{2}$ -in. plywood is ideal for construction. Over-all dimensions are not given as the rack should be made to fit the wall cabinet at hand. Whether your cabinet is of the flush type or one having a casing around it, either one of the designs given herein can be made to fit. One rack is made to fit snugly around the casing and rests on the top edge of the latter. In fitting to a flush-type cabinet, it is made to a size which will not interfere with the opening and closing of the door. Chromium-plated tubing uprights support the shelves of the first rack. The type of cabinet you have will determine whether the shelves need be notched. Both ends of the tubing are plugged with hardwood dowels, as shown, for

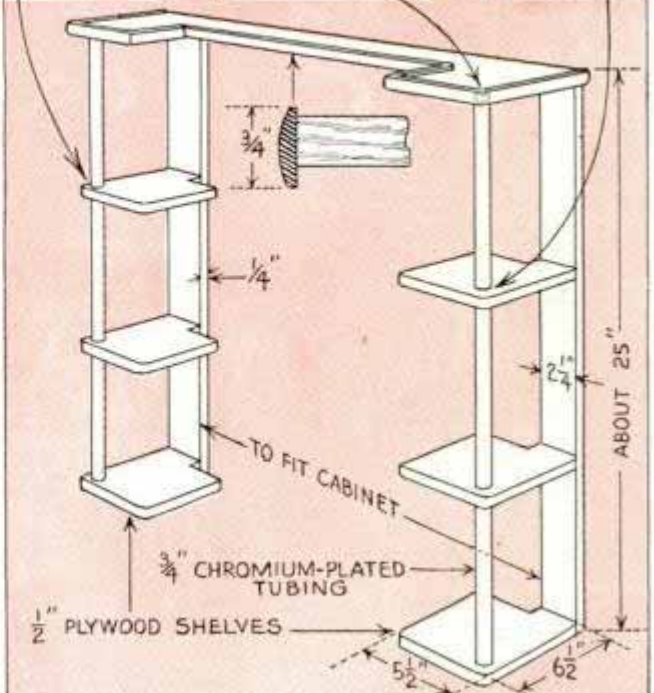
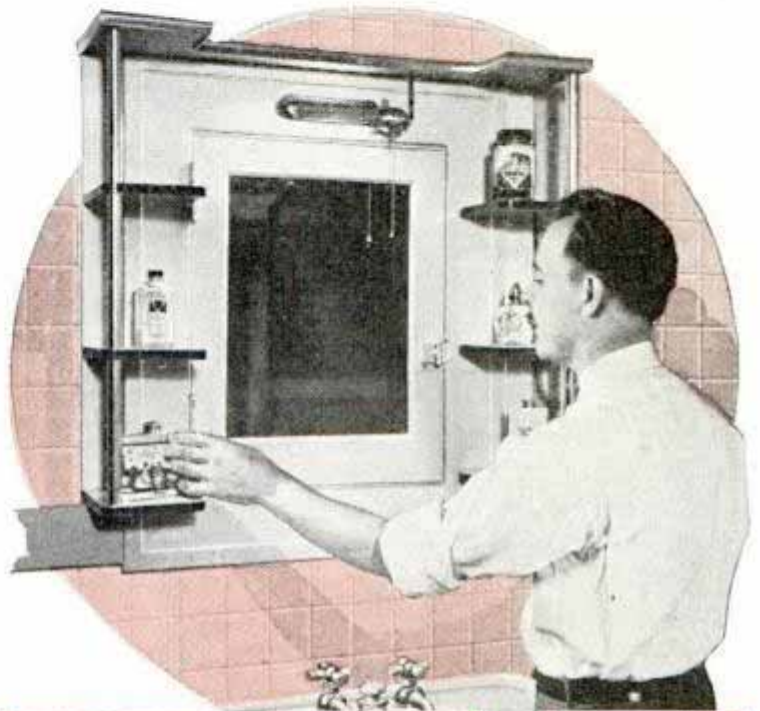

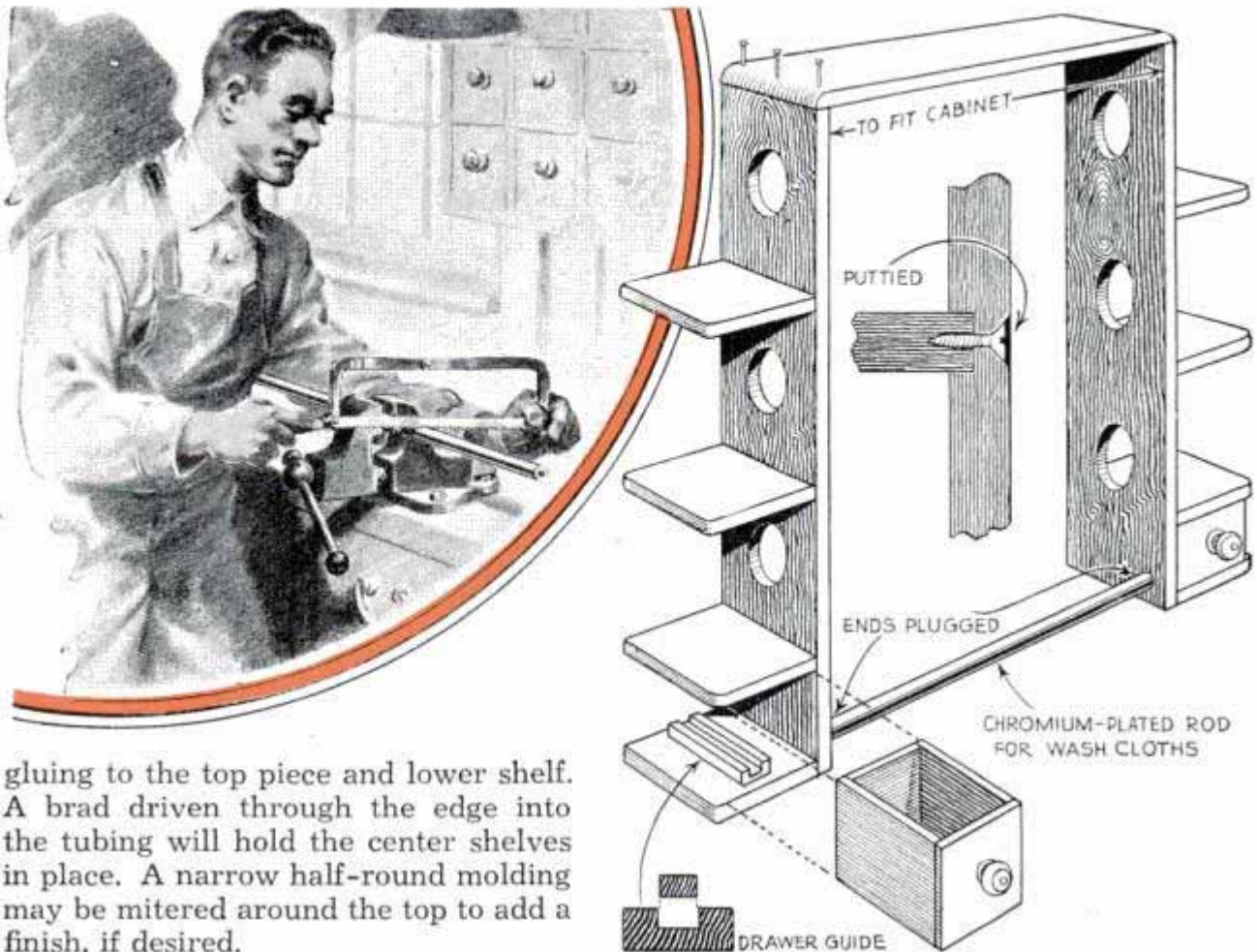

gluing to the top piece and lower shelf. A brad driven through the edge into the tubing will hold the center shelves in place. A narrow half-round molding may be mitered around the top to add a finish, if desired.

The second type of rack shown has shallow drawers which slide on small guides glued to the lower shelf. The unsupported shelves are best fitted into grooves cut in the side pieces and fastened with screws, although for the light load they are to carry, plain butt joints will do. You can bore the circular openings in the sides quickly with an expansive bit, cutting both at one time from each side to

produce a clean cut hole. A chromium-plated rod, plugged at each end with hardwood for fastening with screws, supports the rack at the bottom. The drawers are made of thin wood assembled simply with butt joints, glued and nailed. For hanging over a flush-type of cabinet, screw eyes are placed in the top of the rack through which screws are inserted into wall studs.

## Negatives Dried on Collapsible Towel Rack in Small Space

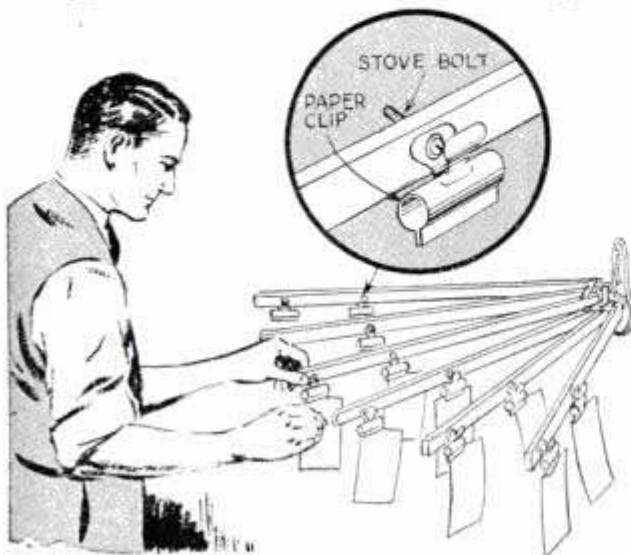

The problem of a rack for drying photo negatives in a small space is solved by using a collapsible, kitchen-towel rack of the type shown. Paper clips bolted to the arms hold the negatives. The rack has the advantage of being portable so that it can be moved from the sink to the drying location. Two screws driven into the wall at each desired location support the rack, which is provided with slotted screw holes so that it can be removed.

Old toweling wrapped around the rollers of a wringer will keep greasy clothes from staining the rubber.

# Unusual Foot Scrapers of Heavy Sheet Metal

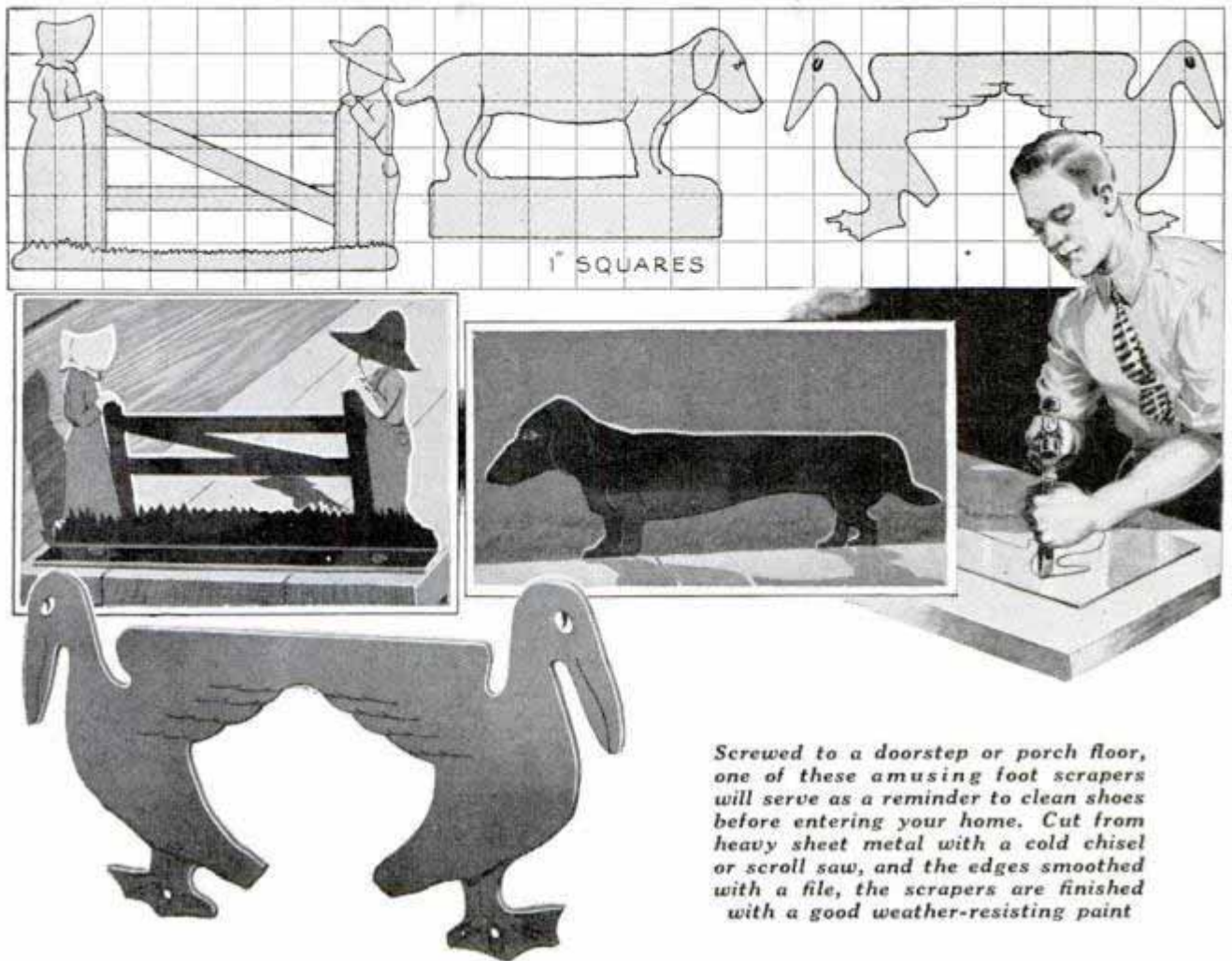

*Screwed to a doorstep or porch floor, one of these amusing foot scrapers will serve as a reminder to clean shoes before entering your home. Cut from heavy sheet metal with a cold chisel or scroll saw, and the edges smoothed with a file, the scrapers are finished with a good weather-resisting paint*

## Canvas Drawer Catches Small Parts Dropped from Vise

When small parts are being cut off or assembled, in a bench vise, you can prevent them from dropping on the floor by means of a canvas drawer, which pulls out into position when needed. The front edge of the cloth is stitched to a U-shaped rod, which slides in and out beneath the bench through screw eyes, while the rear edge of the canvas is tacked to the underside of the workbench.

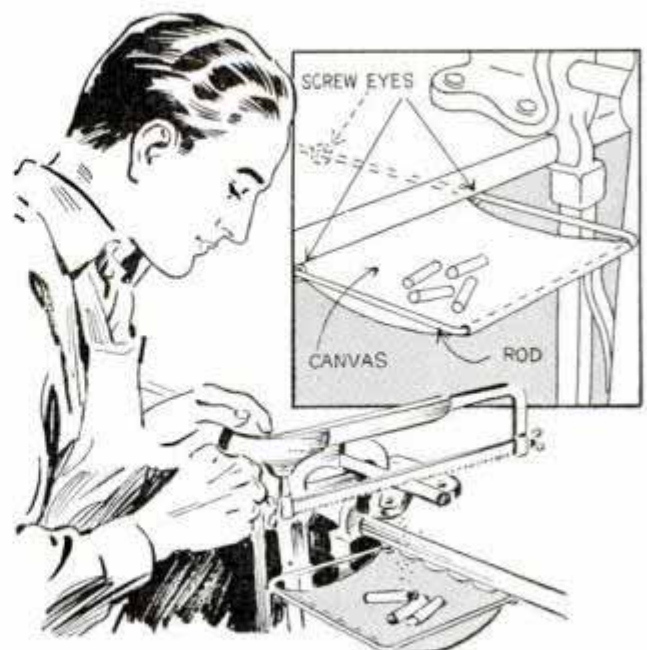

*When sawing off work or handling small parts clamped in a vise, use this canvas drawer to catch pieces dropped accidentally*

### 1937 INDEX

for Craftsman, Shop Notes and Radio sections is now available and will be sent upon receipt of ten cents. Please do not send coin. Address Book Dept., Popular Mechanics Magazine, 200 East Ontario Street, Chicago.

### Gardener's "Check-Row Wire" Spaces Plants Evenly



*Clothespins clipped to guide wire are quickly adjusted to space seed planting as desired*

Home gardeners who want their vegetable rows planted uniformly, or want to space the plants for two-way cultivation with a wheel hoe, can do the job by clipping spring-type clothespins to their guide wires. The pins are merely spaced on the wire a distance equal to the desired spacing of the plants. When moving the wire for each new row, always change one end at a time, leaving the other end firmly anchored, and pull it to approximately the same tautness each time. A small coil spring tied to the end of the wire and to the stakes helps in gauging the tautness.

### Board Slipped in Wet Boot Permits Quick Drying

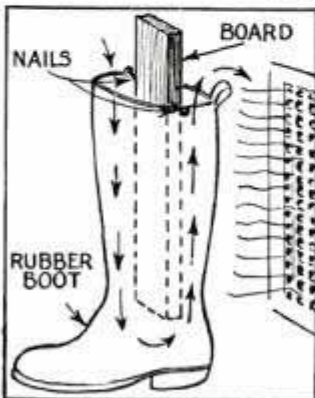

When you get your rubber boots damp inside; they can be dried out quickly by inserting a thin board into each one, leaving 3 or 4 in. clearance between the lower edge of the board and the boot bottom. Set

the boots near a register or stove, or even outside in the sun so that one side will be warmed. Air between the warm side of

the rubber and the board will be heated slightly and will tend to rise, pulling in air from the cold side. This creates a draft that quickly dries out the wet fabric.

### Hand Plane Protected on Bench

Instead of laying a plane down on your bench, while adjusting the work, tack a wood strip near the edge of the bench with-in easy reach and rest the nose of the plane on it.



This prevents the edge of the plane iron from coming in contact with the bench surface, which might dull it.

—Raymond B. Wailes, Bethesda, Md.

### This Secret Lock Is Opened with a Match Stem

Here's just the lock you have been wanting for that treasure box. It costs nothing because all you need is a spring-type clothespin, a match and an L-hook or screw. First drill a hole in one of the legs of the clothespin to take the hook. Screw the clothespin to the inner side of the front of the box and drive the hook into the underside of the lid so that the hook will

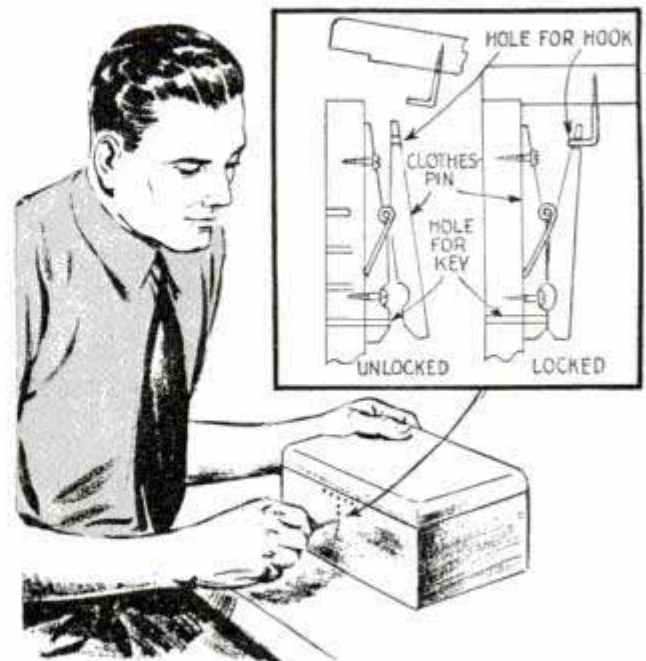

*This simple lock costs nothing and it will keep the contents of box safe from prying eyes*

slip into the hole in the leg. Drill a hole through the front of the box and through the fixed jaw of the clothespin to take the match. Several false holes drilled part way through the front will add to the deception. To operate the lock, push the match through the hole against the movable jaw of the clothespin to compress the leg and release the hook, which will permit the lid to be raised.

—Robert M. Eadie, Granum, Alta., Can.

### Vegetable Knives and Brushes Kept in Decorative Holders

Handy containers for kitchen cutlery to hang on the wall or stand on a shelf near the sink, are made easily of wood. The handles extend above the container so that the correct one can be picked at a glance. Such articles as vegetable brushes, pastry and bottle brushes, apple corers and dish mops are put in with the handles down, so that the brush or top part is exposed to the air to permit thorough drying. The hanging container is shaped like a flowerpot, the back extending above the front to form the plant, while the stand is made in the same manner, but has a sturdy base.

—B. Livings, Batavia, Ill.

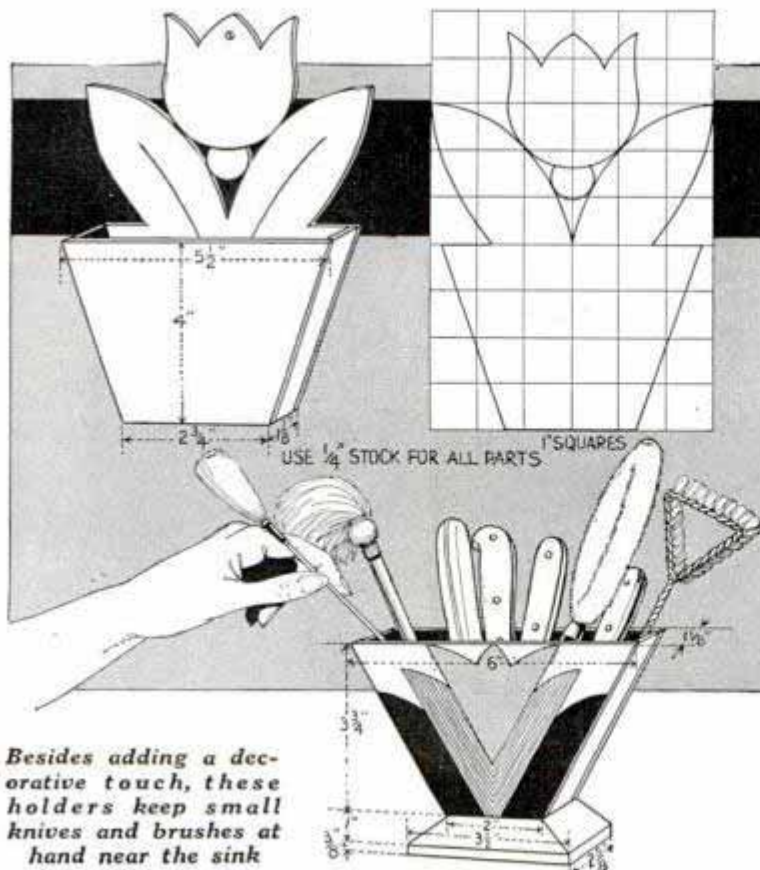

Besides adding a decorative touch, these holders keep small knives and brushes at hand near the sink

### Uniform Guide Lines for Lettering Assured with This Gauge



Correct spacing of lettering guide lines is assured when this simple gauge is used

On a job that required lettering of various heights, I used the gauge shown above in drawing the guide lines to assure that the lettering would be proportionately uniform in height. The gauge is a triangular piece of sheet brass, which has fourteen lines scribed exactly  $\frac{1}{32}$  in. apart, small holes being drilled at the end of each line to take the point of a pencil. In use, the lower edge of the gauge is held carefully against a T-square, a pencil is inserted in one of the holes, and a guide line is drawn, moving the gauge along the square, which serves as a straightedge. The second line is drawn in the same way, inserting the pencil in the hole necessary to get the correct spacing for the lettering.—J. C. Garnett, Watford, Herts, England.

☞ When you put flour on steaks, fish or poultry before frying, mix seasoning with the flour, put it in a paper sack along with the meat and shake; you will find that every crevice in the meat is covered.

# Narrow "PEG-LEG" COFFEE

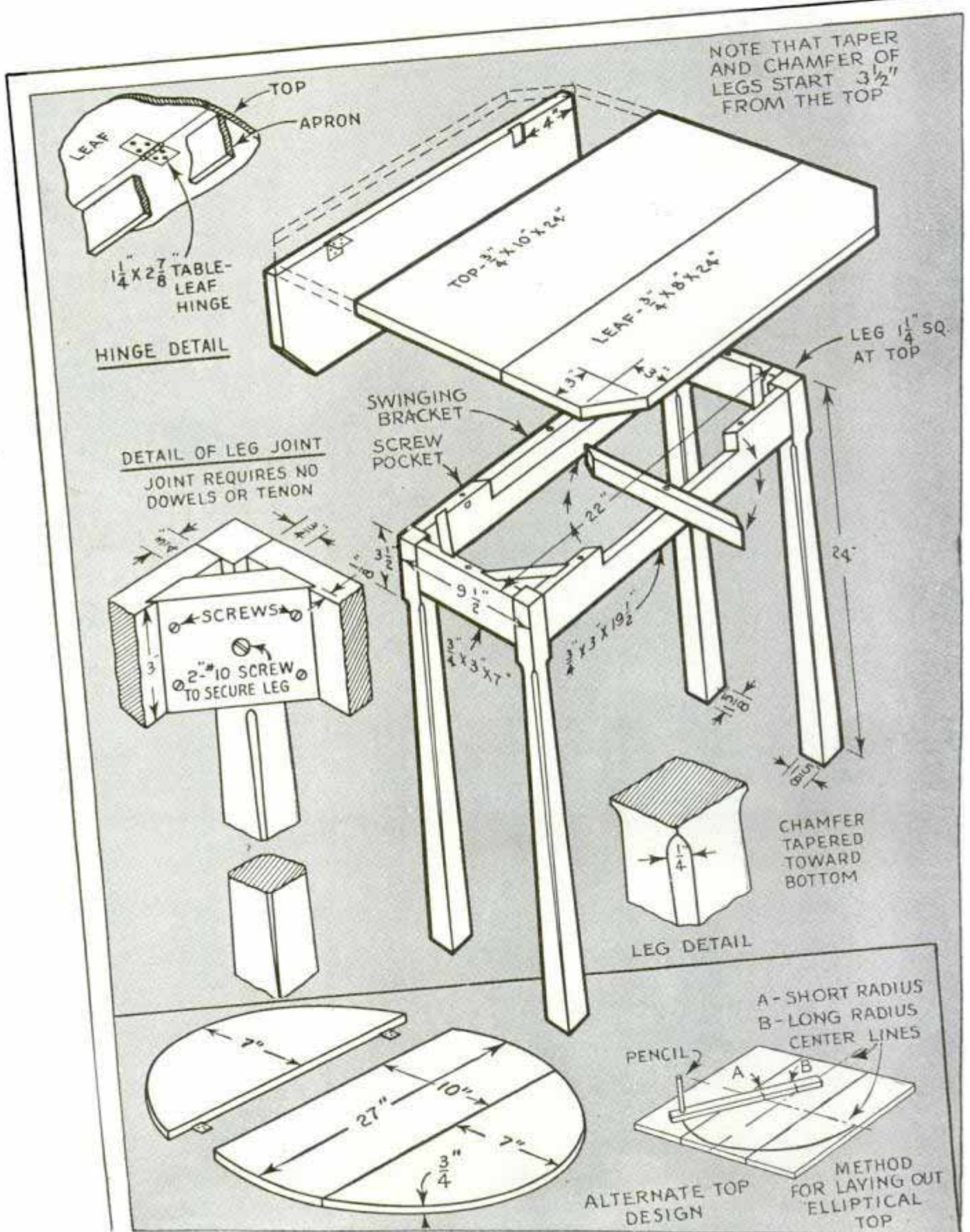

# TABLE has drop leaves

**ALTERNATE DESIGN**

24"

**OAK ANTIQUE FINISH**

2 1/2" #12 WOOD SCREW

1/16" x 3/4" WASHER

19 1/2"

**DETAIL OF SWINGING BRACKET**

3"

3 1/16"

45° CUT

**DETAIL OF CORNER BLOCK**

3"

3 1/16"

**DETAIL OF SCREW POCKET**

1/4"

**APRON**

**STEP 1**

T-BEVEL

45°

**STEP 2**

GAUGE

**STEP 3**

**STEP 4**

THE SWINGING BRACKET IS SAWED OUT OF SIDE APRON

Here's a coffee table in colonial styling with either a square or oval top, as you prefer, and it's not hard to build. The legs resemble the peg type in shape but are not sunk into the table top. There's plenty of space when the leaves are raised for service and when they are dropped, you have a convenient end table at the sofa or chair. In construction, the leaf joints have square edges and no mortises are required between the legs and apron, which produces a sturdy table that can be dismantled quite readily for storage or shipment, and can be reassembled quickly

### Tape Loops on Drawing Board to Carry T-Square

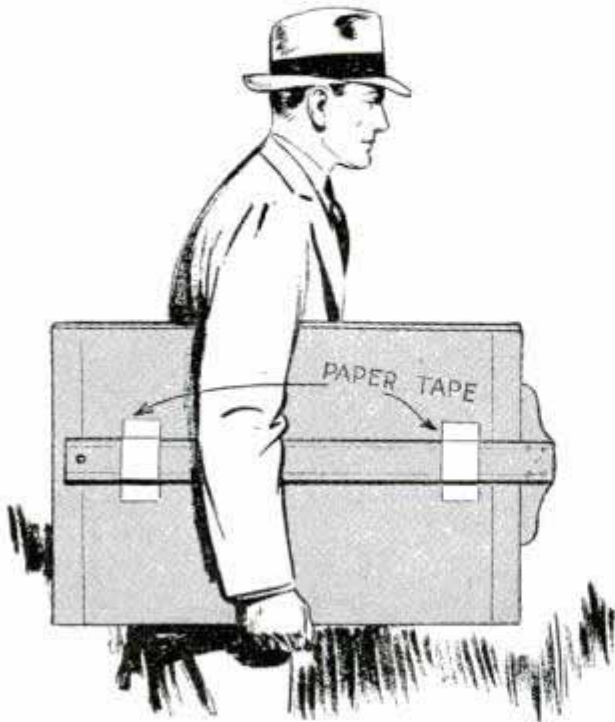

Loops of tape on underside of portable drawing board carry T-square without breakage

The problem of carrying a T-square with a portable drawing board is solved by sticking pieces of gummed-paper tape to the underside of the board as indicated. Just place the square in position, press the tape over it tightly and stick the ends to the board. The square can be slipped in or out of the paper loops easily.

### Flat Boat Inverted over Oil Drum Provides Handy Diving Board

While vacationing at an inland lake where there was no diving board at hand, the members of a camping party inverted an old flat boat over an oil drum, which

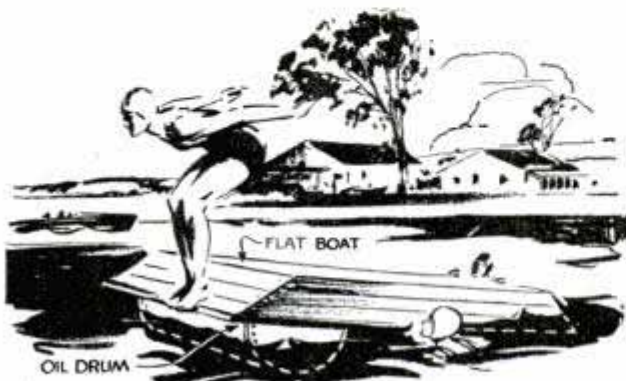

Submerged end of boat makes it easy for swimmer to climb on this improvised diving board

was sealed tightly. The drum supported one end of the boat above water so it served nicely as a temporary diving board.

### Creeping Weeds Pulled Easily with Aid of Shoehorn

For weeding in the garden between plants where a hoe cannot be used, and difficulty is encountered in pulling the creeping type of weeds with the bare fingers, a shoehorn is handy. It prevents sore fingers and enables you to do the work quickly.



### Hobbles of Clothespins Keep Hen from Scratching in Garden

When a hen with chickens is turned loose in the yard, she can be kept from scratching in flower beds with these simple hobbles. They are made by wrapping a piece of cloth or inner tube around each leg and clamping it in place with spring-type clothespins. When the hen attempts to scratch, the pins fly about and get in the way so that she is soon discouraged.

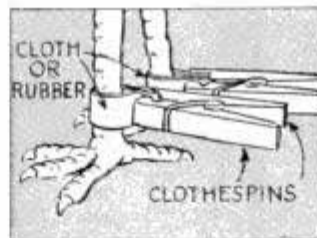

### Cork Finger Grip on Potlid

Campers who carry potlids having ring finger grips that fold down against the lid so that they pack closely, can use corks pushed into the rings to avoid burning the fingers. The corks should be a press fit in the rings so that they will stay in place.

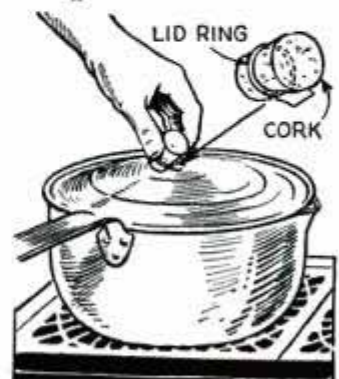



# It's time for WINDOW GARDENS

By Clarence Robert Stahler

**S**UCCESS in growing plants in a window box comes from attention to a few simple details of box construction and plant culture. Growing conditions, the amount of sunlight, and the quality and friability of the soil used must be taken into careful account beforehand. Since the plants grown in the box will be confined closely, provision for perfect drainage is the first essential. Multiple holes bored in the bottom of the box and covered with pieces of broken crockery often fail in purpose. Some clogging is bound to occur; but even if this system functions, water, when applied, often immediately escapes. This is due to shrinkage of the soil mass when it becomes dry, leaving a well-defined crevice between the soil and the box walls. Water flows down the crevice and out the drainage holes without reaching the plant roots. Fig. 1 details a drainage system that overcomes these difficulties. After nailing strips to the bottom of the box, attach sides and end pieces. Then heavy screen wire (hardware cloth) is laid over the strips, and covered with two thicknesses of heavy burlap. Run the burlap a few inches up the box walls and tack it to

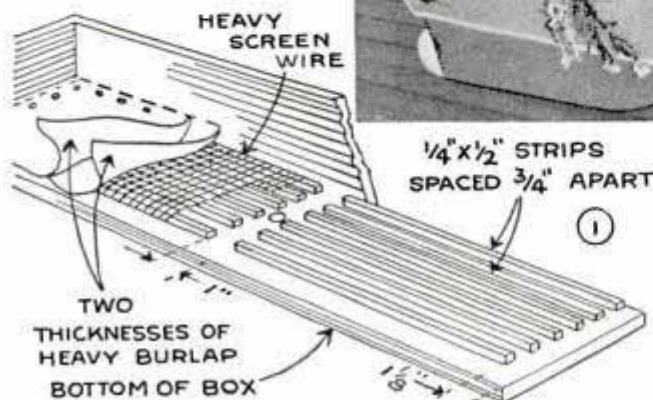
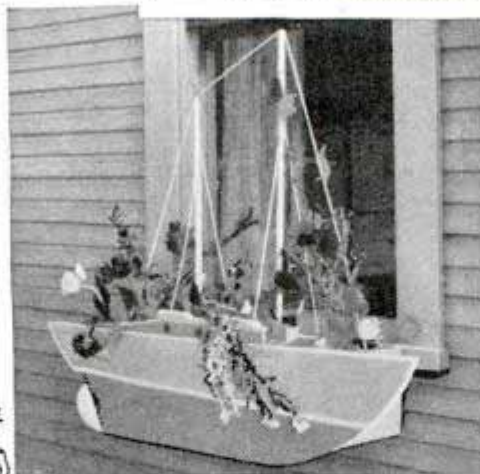

prevent soil sifting through at these points. Notice that a single  $\frac{3}{4}$ -in. hole is drilled at the center of the 1-in. space between the ends of the cleats, Fig. 1. A plug

is fitted in this hole and allowed to project so that it can be inserted and removed readily.

With slight dimensional alterations, this drainage system can be adapted to boxes now in use, and to new ones of any size. However, if the box is to rest on a wide porch rail, or on a window ledge, the standpipe, Fig. 5, should be substituted for the wooden plug. To construct the standpipe, first cut the slots and vents, then file an opening at the threaded end so that the rubber gasket will fit snugly against it. Apply white lead and screw the threaded end into the  $\frac{3}{4}$ -in. hole. To assemble the stopper within the pipe, solder together handle, brass rods and spring, Fig. 5. Drop

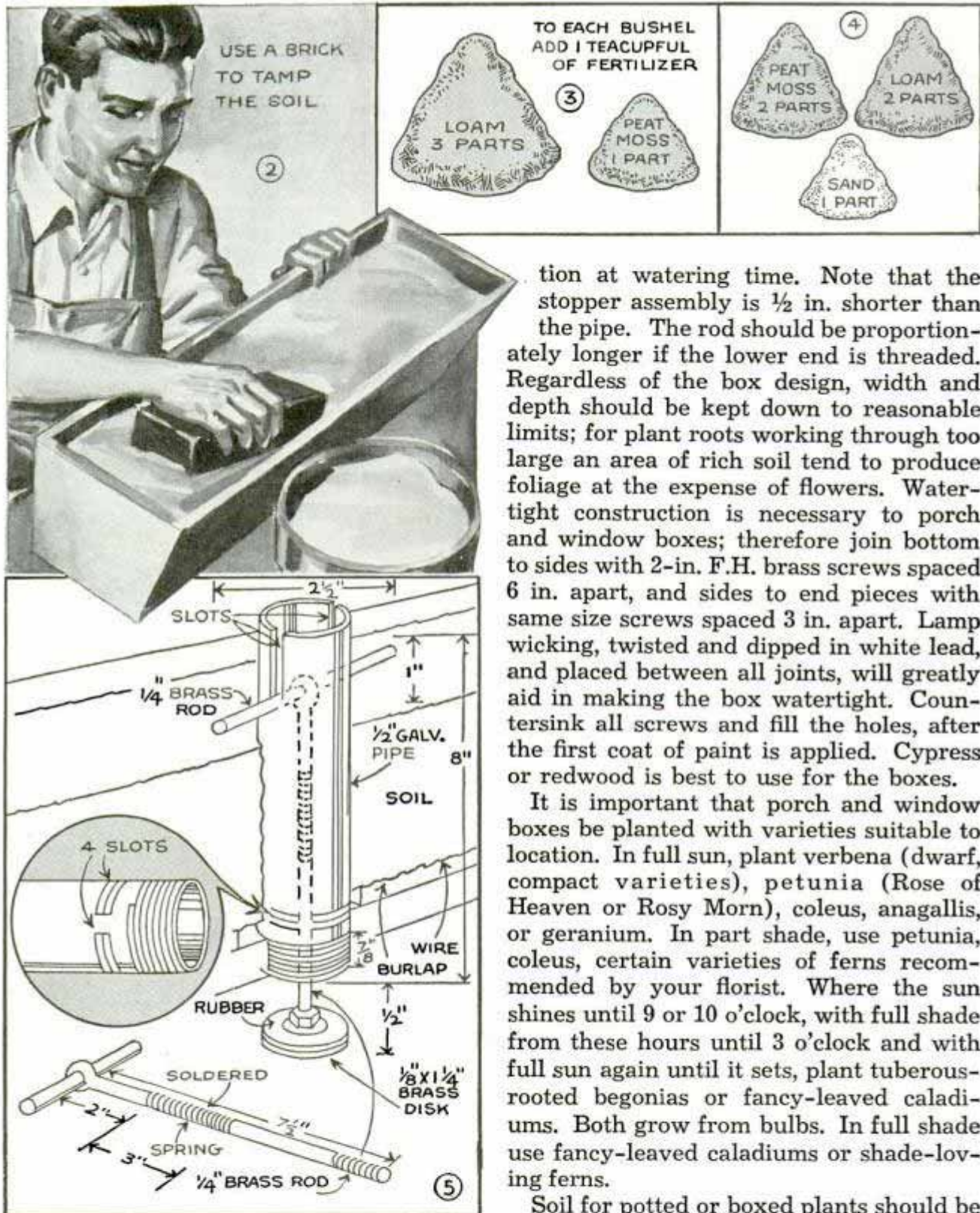

this assembly into the pipe and let the handle rest in the slots. Put the rubber gasket and brass disk in position and solder tip end of brass rod to the disk, or the rod may be threaded and two nuts used as shown. The spring must be sufficiently stiff to hold the gasket firmly against the pipe outlet when the handle is raised and is resting on top of pipe, which is its posi-

tion at watering time. Note that the stopper assembly is  $\frac{1}{2}$  in. shorter than the pipe. The rod should be proportionately longer if the lower end is threaded. Regardless of the box design, width and depth should be kept down to reasonable limits; for plant roots working through too large an area of rich soil tend to produce foliage at the expense of flowers. Watertight construction is necessary to porch and window boxes; therefore join bottom to sides with 2-in. F.H. brass screws spaced 6 in. apart, and sides to end pieces with same size screws spaced 3 in. apart. Lamp wicking, twisted and dipped in white lead, and placed between all joints, will greatly aid in making the box watertight. Countersink all screws and fill the holes, after the first coat of paint is applied. Cypress or redwood is best to use for the boxes.

It is important that porch and window boxes be planted with varieties suitable to location. In full sun, plant verbena (dwarf, compact varieties), petunia (Rose of Heaven or Rosy Morn), coleus, anagallis, or geranium. In part shade, use petunia, coleus, certain varieties of ferns recommended by your florist. Where the sun shines until 9 or 10 o'clock, with full shade from these hours until 3 o'clock and with full sun again until it sets, plant tuberous-rooted begonias or fancy-leaved caladiums. Both grow from bulbs. In full shade use fancy-leaved caladiums or shade-loving ferns.

Soil for potted or boxed plants should be richer than that of the garden. For petunia, anagallis and coleus use the proportions given in Fig. 3. Measure peat moss dampened and packed. To each bushel of the mixture add a teacupful of fertilizer. For geraniums and verbenas reduce garden loam to 2 parts and replace the loss in bulk with clean sharp sand. Reduce fertilizer one-fourth. Begonia, caladium and ferns require a soil with a higher vegetable mat-

ter content: 2 parts peat moss, 2 parts garden loam, 1 part sand, Fig. 4. Add  $1\frac{1}{4}$  cups of fertilizer per bushel.

When filling a box with soil, distribute it in 2-in. layers, firming each down with a brick as in Fig. 2. Fill to within an inch from the top, and then water thoroughly. When the soil is dry enough to handle, loosen the top 2 in. of soil and after firming down, add enough soil to bring it to proper height which is  $\frac{3}{4}$  in. from the top of shallow boxes and 1 in. from the top of deeper ones.

If you buy plants from a florist, get them in pots. Obtain a bottle of nursery insecticide and mix a strong solution according to directions, for dipping purposes. To dip the plants, hold the pot with the thumb on its bottom and fore and middle fingers supporting the earth ball. Invert the plant and plunge up and down into the solution. Repeat three times, four days apart. Store the dipping solution in an airtight receptacle. During the dipping process, bed the plants up to the pot rims in wet peat moss, or in the garden, to prevent rapid drying out. Water when necessary. A daily watering is generally advisable, and always should be done during the morning hours. At watering time, close the drainage system and fill the  $\frac{3}{4}$  or 1 in. of watering space. Never leave the drainage system plugged. After water has been absorbed, open up the system. Beginning about six weeks after the boxes are planted, additional plant food should be given every two or three weeks, using amount recommended by the makers. Avoid getting fertilizer on the foliage, and immediately water it in. Remove faded flowers, and never permit seed pods to form.

### Finger Pads Aid in Jigsawing Thin Wood or Metal

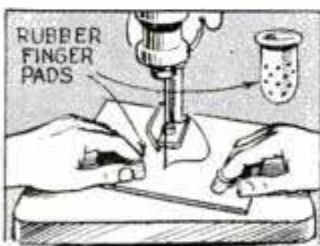

When cutting small pieces of thin wood or metal on a jig saw, slip rubber finger pads over your index fingers. You'll be surprised how

easily you can manipulate the work as the pads tend to prevent your finger tips from slipping on the surface of the work.

### Large Stones Are Broken Safely by Heating and Rapid Cooling



*Large stone broken by heating it thoroughly and then throwing cold water over it*

Desiring to break up and remove a large rock on his property without the use of dynamite, one home owner did the job by heating the rock and then dashing water over it. A trench was dug around the rock, and brush and wood were burned in it for a few hours to heat the rock. After the rock was heated thoroughly, cold water was suddenly thrown on it, which caused it to crack into several pieces.

### Multiple Depth Gauge for Saw

If the circular saw in your workshop isn't provided with a scale for setting the depth of cut, this gauge will solve the problem and help assure accuracy.

It consists of a hardwood block in which a number of cuts of various depths are made. The depth of each cut is stamped on the block so that you merely set the gauge over the

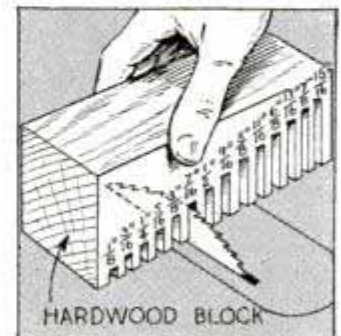

saw and raise or lower it until the teeth touch the bottom of the desired cut.

—John R. Beckwith, Utica, N. Y.

## Loaded Branches of Fruit Trees Supported on Adjustable Ropes



*These adjustable support ropes are tightened easily as the weight of the fruit increases*

Attachment of ropes to support heavily loaded limbs of fruit trees is simplified by these adjustable ropes. Each is provided with a stout hook at one end and a slotted stick at the other. In use, a rope is attached to the center of the tree by means of the hook, and the suspending end is drawn around a branch and fastened by looping through the notches in the stick. The device has another advantage in that it is instantly adjustable to the increasing weight of the ripening fruit.

## Convenient Footrest for Oarsman

When a rowboat is used by persons of different heights, this footrest will be found a convenience as it can be adjusted



*This footrest is instantly adjusted to suit rowers with either long or short legs*

instantly to suit the length of each individual rower's legs. The rest consists of two notched wood strips which are nailed or screwed inside the boat as shown to take a length of broomstick.

## Rows in Garden Are Marked by Seed Package

To indicate the location and variety of vegetables planted, one gardener uses "stakes" made of wire as shown. The double loop on top of the stake takes the empty seed package.



## Needle Punches in Negative Indicate Exposure Time

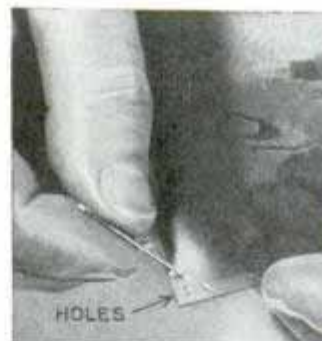

After printing a photo from a negative, punch holes along the edge of the latter with a pin or needle to indicate the exposure time. When you want to make reprints later, the holes in the nega-

tive can be counted in the dark by passing the tip of the finger over them.

## Emergency Hose Nozzle

When you need a spray nozzle for a garden hose, and none is at hand, a sprinkler can will do the job. Partly fill the can with sand to keep it from upsetting. Then insert the

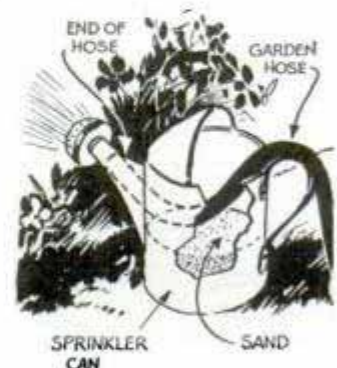

end of the hose into the spout as indicated by the dotted lines. If the hose has a tendency to work out of the spout, weight it inside the can with bricks or stones.

## Two Helpful Ideas for Your Camping Trip



In order to travel as lightly as possible, hunters and campers going by canoe in northern Canada do not carry tent poles, but cut them at the camp site, using five, which are erected as shown above. Guy ropes at front and rear tend to brace the tent rigidly against a wind blowing toward either end. A creosoted rope laid on the ground around a tent as shown at the right will help keep away crawling insects. It can be fastened down with staples, which are bent from wire. These should be 5 or 6 in. long.

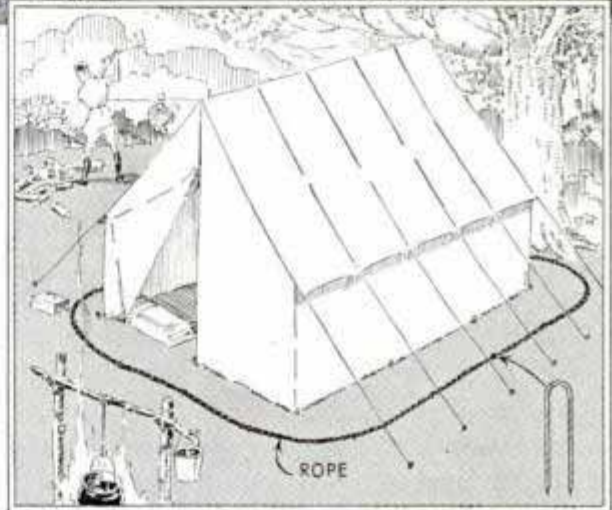

### *Legs of Picnic Table Are Supported on Inverted Tin Cans*



The tendency of picnic table legs to sink into soft ground can be avoided by setting them on tin cans inverted and sunk into the ground. This also prevents the ends of the legs from rotting due to constant contact with moist earth. Lawn chairs and benches can be supported in the same way.

### *Printing Photos on Glossy Paper*

Glossy paper may be handled in several ways to produce prints having various surface effects. A soft, semi-gloss is obtained by drying the prints between blotters. Other surfaces may be had by squeegeeing the emulsion side in contact with various textiles such as silk or linen, and then drying in the usual way.

# EXTRA ROOMS



By R. O. BUCK

**BY** LINING the attic with insulating board you really "kill two birds with one stone," providing usable space and insulating that part of your house which requires it most for year around protection from extremes of temperature. In many cases savings in fuel alone, over a period of years, pay for the attic improvement.

Each house presents individual problems which should be well considered before planning an attic room. The type of roof, location of dormers, windows, stairway and chimney all must be reckoned with. In general, if your attic has enough windows for good ventilation in moderate weather, a practical stairway from the floor below, Fig. 1, sufficient area in which there is 7 ft. or more of height available and is either floored over or has 2 by 6-in. joists or larger, it may be considered suitable for improving.

**Ventilation:** While insulation goes a long way in the matter of keeping the attic cool in summer, moving air is necessary for real comfort. Sufficient windows, lo-

cated so that cross ventilation is possible, will generally keep the attic rooms comfortable. However, in warmer climates and in extremely hot weather, forced ventilation may have to be resorted to. An exhaust fan, located so that the blanket of hot air in the attic will be drawn off and replaced by cooler air from outside, is a solution of this problem. The floor below also may be cooled with the same equipment by simply closing the intake window in the attic and drawing all of the air from below through the stairway or by means of floor registers. A convenient portable unit which requires no building alterations is also available. It consists of a fan mounted on an adjustable stand, a canvas tube, window board and louver. It is only necessary to fit the board to the window opening when the sash is raised. The unit may be removed at will. A permanent installation usually makes a neater and more satisfactory arrangement if the fan is to be used most of the year. The fan unit in this case is suspended in a spring frame on

# *in the* ATTIC

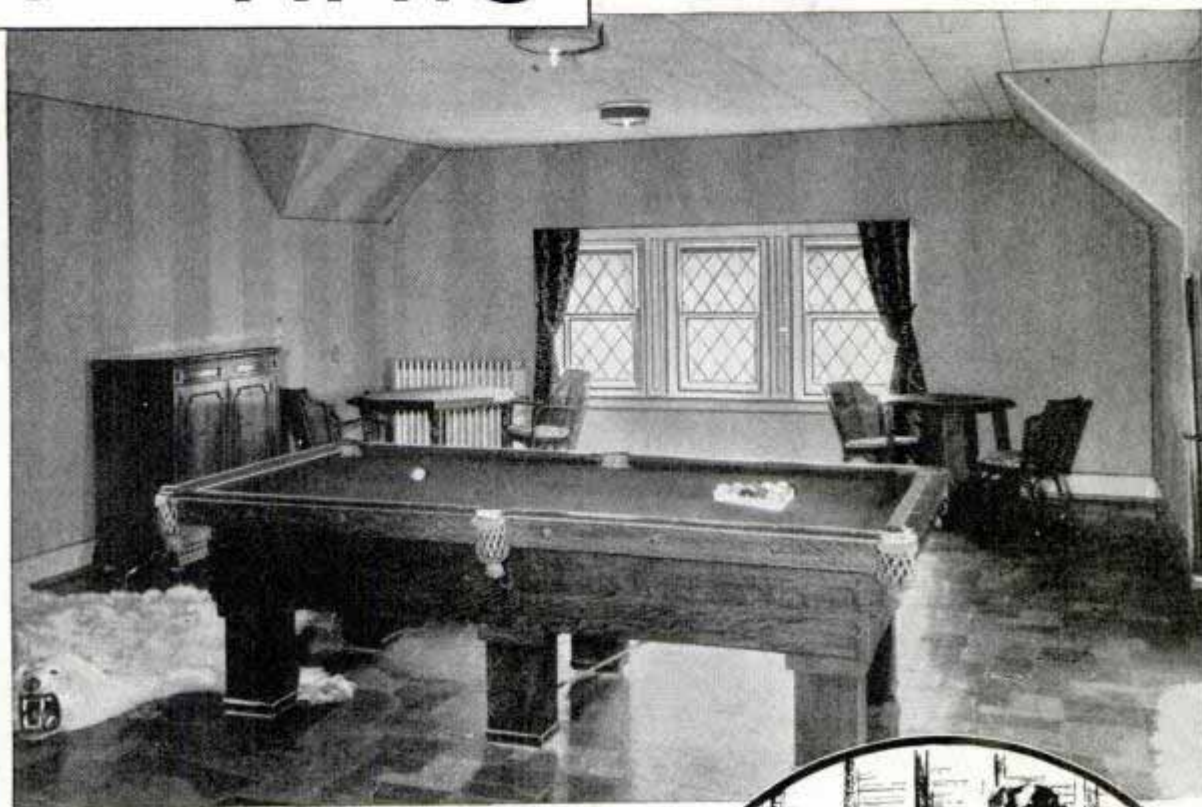

the inside of the wall over a suitable opening. The springs absorb any noise or vibration from the motor. If the fan is installed in the finished part of the attic, it may be concealed by means of a grill, lattice or case having a perforated door. The outside opening must be arranged so that rain or snow will not enter. A simple wood louver, such as can be obtained from millwork companies, provided with an inside door for winter use, may be used satisfactorily. A newer and more convenient device is the automatic shutter which opens when the fan is running and closes when it is shut off.

**Heating:** Heating the attic room must be considered also if you are to have the fullest enjoyment from it. In the case of a bedroom, where only a moderate amount of heat is required, one or two floor registers will bring sufficient heat from the floor below. Added ducts for hot-air registers or a continuation of present ones is also possible. Steam or hot-water pipes also may be run up and radiators installed in the usual way if the expansion tank on the latter is placed high enough. Should

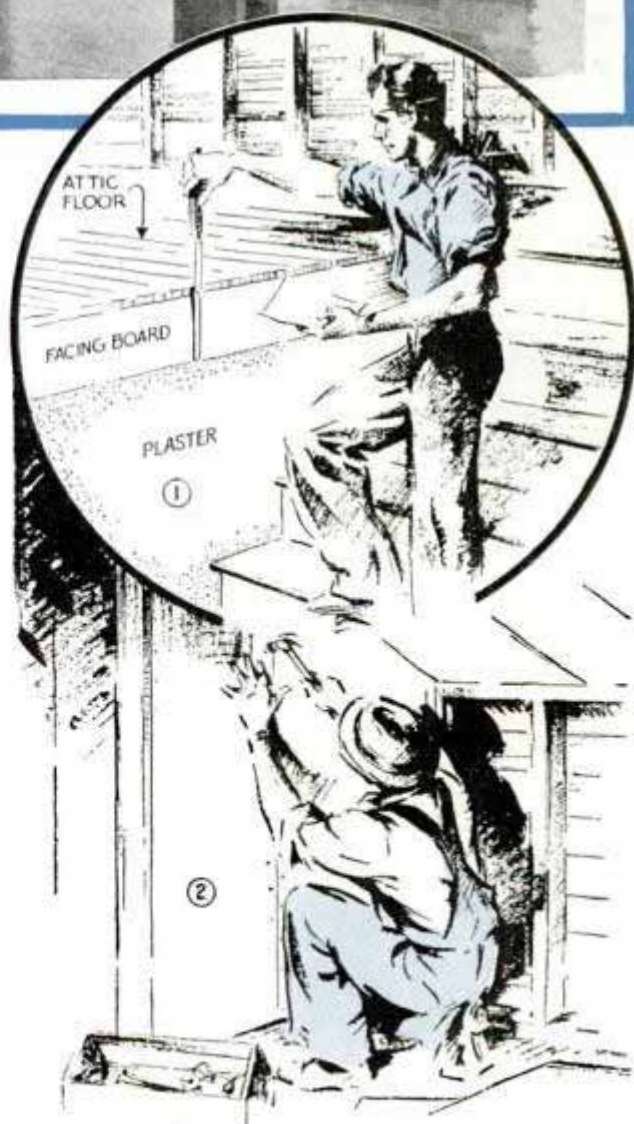

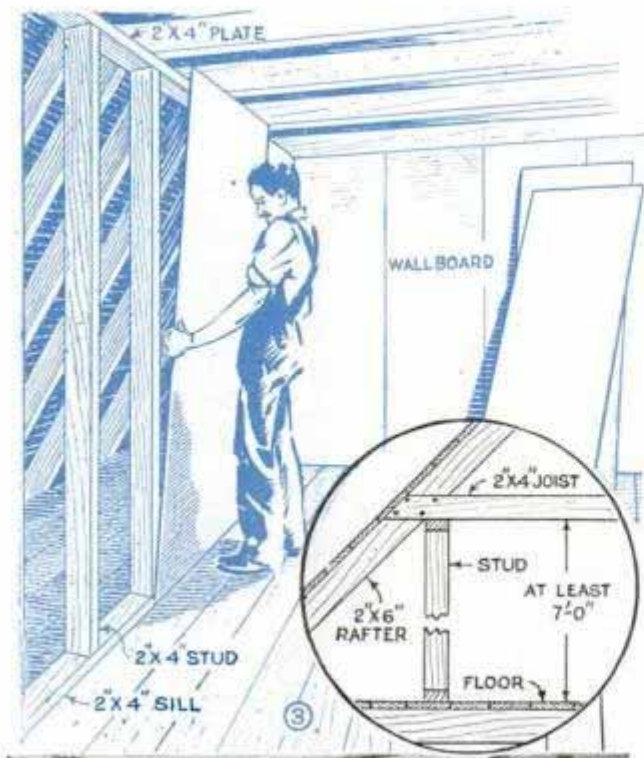

none of these suggestions prove practical, a gas-steam radiator or a fireplace containing a radiant unit will provide the necessary heat. A flue to the chimney or the outside is advisable with any gas appliance, however.

**Framing:** If sufficient space is available in all or any part of your attic room, full height side walls and horizontal ceiling are preferable in most cases. The ceiling should be at least 7 ft. high, both for appearance and ventilation. The framing of the side walls should be done first. The sills and plates are laid out on the floor and the studs spaced along them, 16 in. on centers in the usual way, and nailed. Provision for door openings, built-in cases, etc., should be made in the stud openings. Both side frames are then raised into position, as shown in the detail in Fig. 3, and nailed to the floor and rafters. If the plaster on the ceiling below is poor or the floor unusually springy, screwing the sills to the floor may be advisable. Care must be taken also not to wedge the frame under the rafters too tightly as this may spring the floor joist and result in damaged plaster below. The 2 by 4-in. ceiling joist are laid across the top of the plates, toenailed to them and spiked to the sides of the rafters. Where the ceiling must follow the line of the roof for part of the height, as shown in Figs. 2 and 4, short studs are spiked directly to the sides of the rafters where the wall is to join the sloping ceiling, Fig. 5. If any part of the ceiling is to be horizontal, joists are simply nailed between opposite rafters. The joint between the slant and vertical or horizontal surfaces would leave the edges of the insulating boards unsupported, so strips of

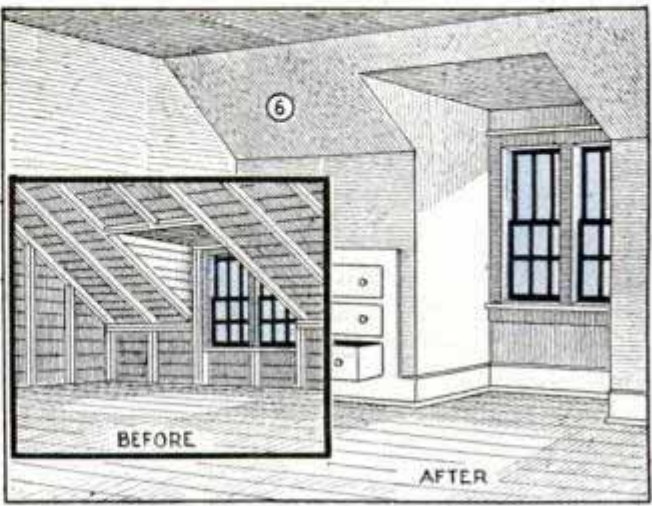
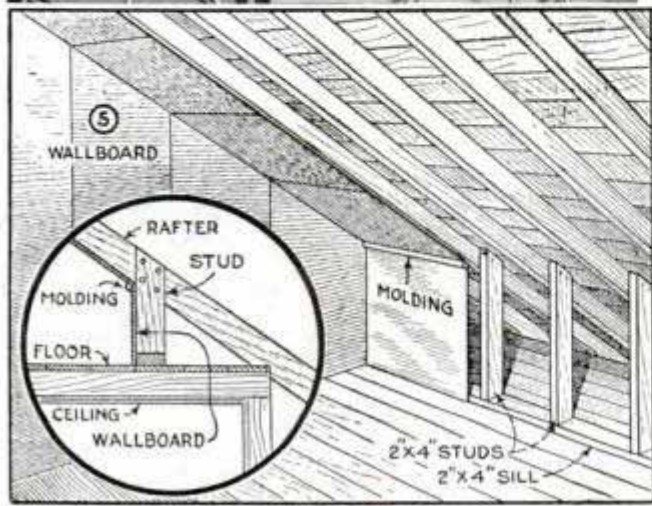



1-in. material, to form grounds, must be nailed between the rafters, studs and joist at these points.

For some types of rooms exposed rafters produce a very pleasing effect. Ornamental "false rafters" can be used for a purely decorative effect after the walls and ceiling have been covered with insulating board. In many cases the real rafters may be left exposed.

**Wall Coverings:** A great variety of materials is available for finishing interior walls. Where the ceiling and outside walls are to be covered, boards having insulation value are essential. Most of the so-called softboard, including plaster board, is suitable for this purpose. These materials come in a number of standard sizes, thicknesses and textures but all are intended for use on studs, joists or furring spaced 16 in. on centers, and should be nailed all around, the nails spaced 4 to 6 in. apart. For finishing around dormers, such as shown in Figs. 6, 8, 9 and 10, where considerable fitting is necessary, large size boards will be found most convenient because of the fewer cuts necessary. The cutting and fitting of this material is very simple, the space is simply measured carefully, the cuts laid out on the board with a square and pencil, as shown in Fig. 7 and the material sawed to size. Several types of joints between boards are possible. When the board is to be left unfinished simple lattice strips nailed over the joints make a satisfactory solution, Fig. 4. A newer and more finished appearance can be obtained either by the use of boards having a beveled edge to produce a V groove at each joint or by the use of molding strips made of the same material as the

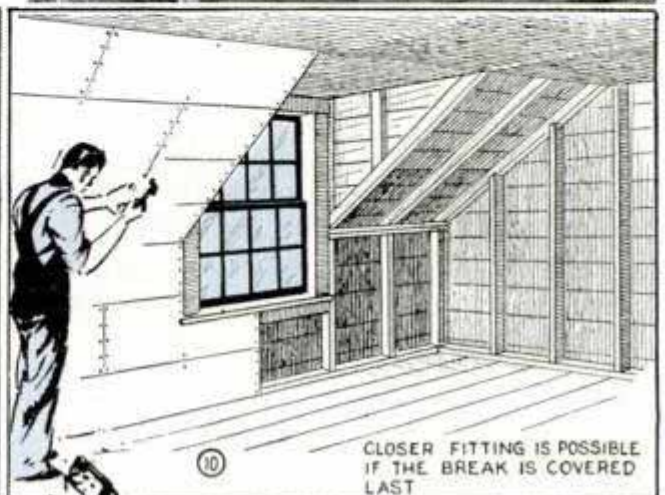
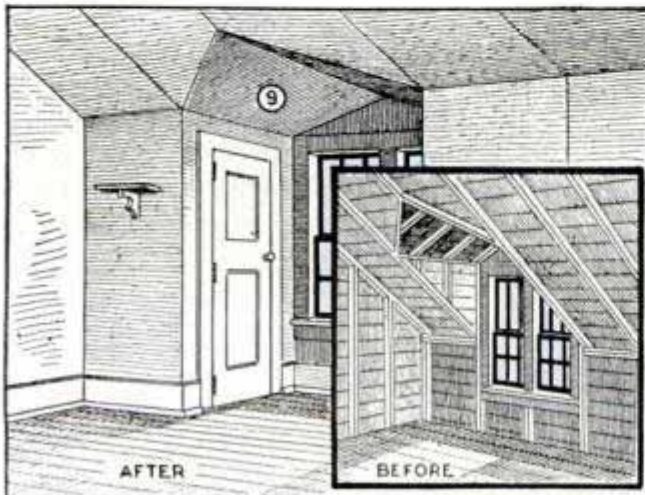



board, which are available in a variety of patterns and sizes. The room shown in Fig. 8 gives an idea of the beautiful finished effects which may be obtained by the use of molding strips. If the wall is to be papered or canvased, tight joints are necessary. To secure tight joints the edges of the boards must be beveled, as in Fig.

11, then butted together and the joints filled with a special putty. Metal tape or screen wire is next laid over the putty and the material pressed through the tape with a putty knife, then feathered off smooth. Sanding after the putty is dry is also advisable. The steps are shown in Figs. 11 to 14 inclusive.

A new plaster board finished in several remarkably realistic wood grains is available and makes an exceptionally beautiful wall.

When finishing a sloping ceiling, such as shown in Fig. 10, it is advisable to board up from below and down from the ceiling leaving the part near the break to be fitted in last, as in this way a closer joint is possible, especially if the piece is narrow.

**Some Possibilities:** Waste space around a dormer generally can be utilized for built-in bookcases, closets, or a chest of drawers, as in Figs. 6, 8 and 9.

If you wish to give your attic space individuality so that it will not be just another room, you must decide what purpose the room is intended to serve, then plan points of interest utilizing the various peculiarities of the space to best advantage. Planning a boy's room offers a splendid opportunity, especially where the available space is limited and the roof rather low. Often you can achieve a very attractive and unusual arrangement by a judicious placing of a bunk over the stair well.

Beamed ceilings are nearly always effective as they give the maximum of head-room together with good ventilation, an

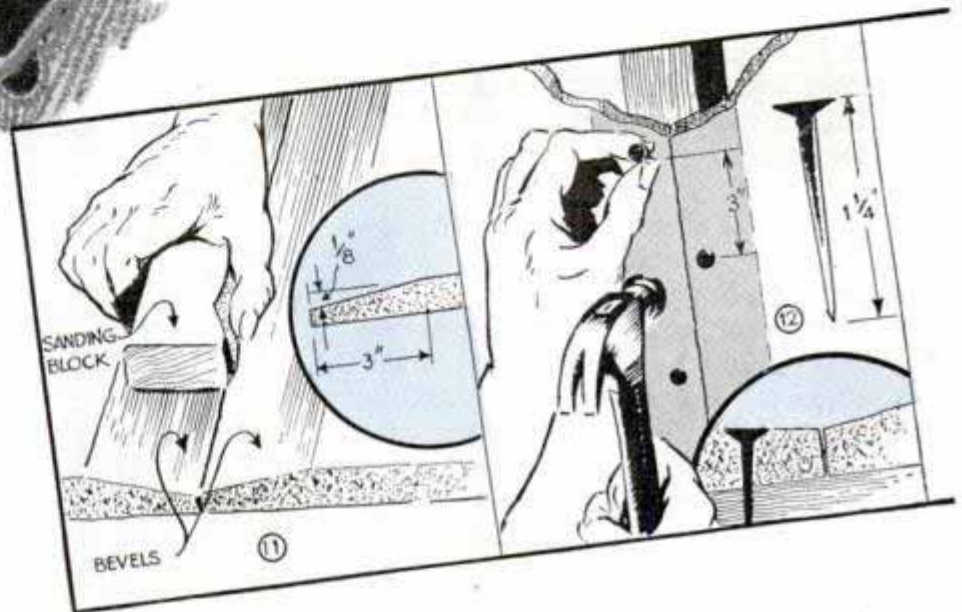

essential if the space is to be used as a den or smoking room. A bedroom or boy's room always gives opportunity to utilize space in a complete and attractive manner. Wall decorations and built-in chests and bunks are generally features of such rooms and in the average attic you'll find plenty of space to build them in. For a real "sporty" type of game room the Old English Taproom styling with knotty pine walls works out nicely. Knotty white-pine shelving and the matching wall material are comparatively inexpensive and when finished in a smoky-brown color are particularly appropriate. A music room is another possibility. The sloping ceiling gives good acoustics without echoes, and the softboard wall absorbs sound so that you may enjoy music without disturbing the neighborhood.

However, before putting heavy pieces of furniture, such as large billiard tables,

pianos, etc., into an attic room, make sure that the floor is sufficiently rigid to bear the weight without springing the joist. A sagging floor is almost sure to crack the ceiling plaster below. Determine the size of the floor joist by measuring the facing board at the stairway, as in Fig. 1. Facing boards 7 or 8 in. wide indicate a 2 by 6-in. joist while a 9 or 10-in. board shows that 2 by 8-in. joists have been used. The former are too light for heavy objects unless they are placed over a bearing partition which

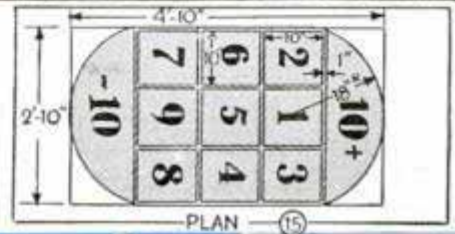
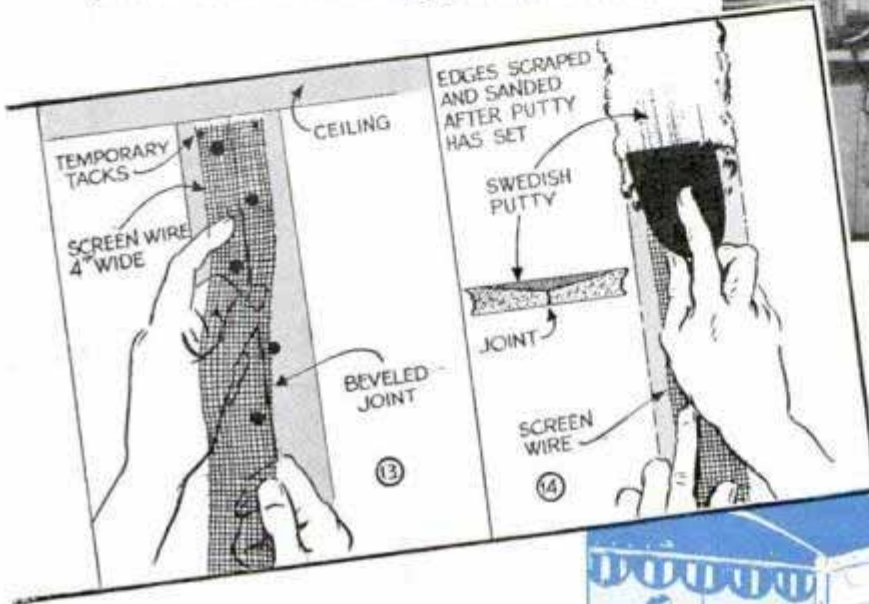
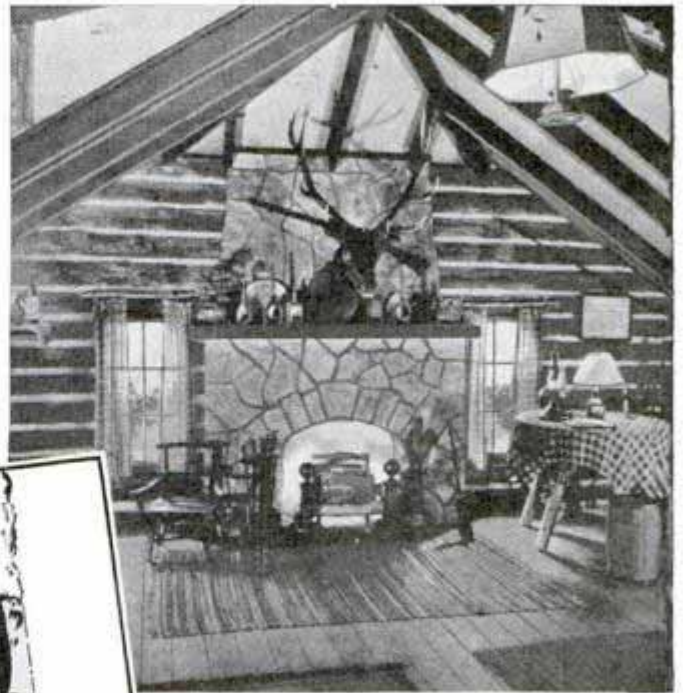

will carry the weight down to the center supporting timber or I-beam in the basement.

Painting games on the floor or inlaying various colored pieces of linoleum into a floor size piece by cutting through the two thicknesses is an excellent scheme both from the utilitarian and decorative viewpoint. The popular deck game of shuffleboard may be enjoyed in your attic recreation room quite as well as on an ocean liner, as shown in Figs. 15 and 16. The cues and disks,

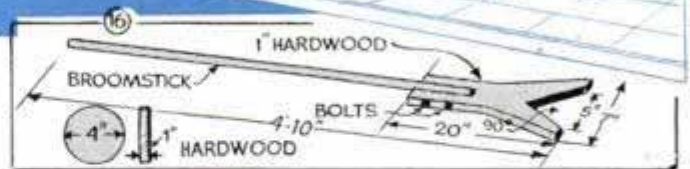

the cues and disks, the dimensions for which are given in Fig. 16, are easily made and the layout for the floor lines can be obtained from Fig. 15.

The object of shuffleboard is to shove the disk from the starting line to within the numbered spaces, at the same time attempting to knock opposing disks out of the way. The cues are used to shoot the disks, which must go beyond the dead line or they are taken out of play. Players al-

ternate and score according to the numbers on which their disks come to rest after all have been played (four for each player). Plus and minus figures alter the score. Fifty points is game.

A checkerboard of "heroic" size is also a source of great amusement. The board is painted or inlaid in the usual form, making the square 6 in. or more in size. Large wooden disks are used for checkers.

## Rubber Holders Support Oars While Fishing from Boat

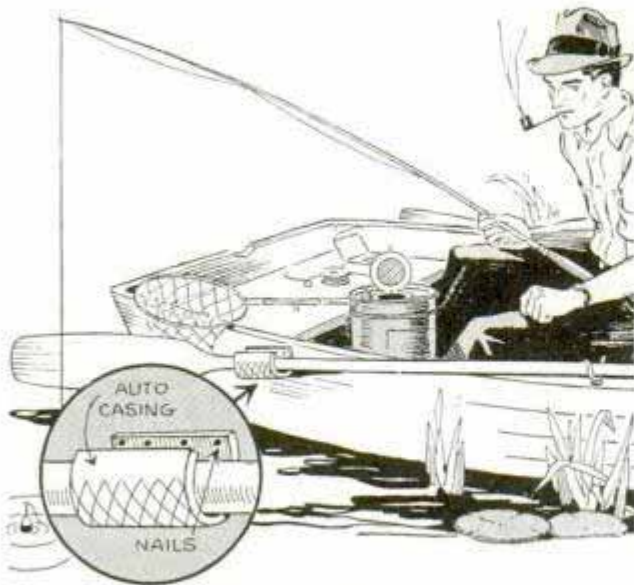

*Oars are kept out of the way, and they do not drip water into the boat when rubber holders are used*

Tired of resting his oars on the boat in front of him and having them drip water over his tackle while fishing, one sportsman nailed rubber holders to the sides of his boat to support the oars as indicated. The holders were short pieces of an old auto casing with the beads cut off.

—Bob Poulson, Los Angeles, Calif.

## Picnic Luncheon Cloth Is Held by Clothespins in Ground

The next time you go on a picnic, sharpen five or six regular clothespins and take them along. They are ideal for anchoring



*Clothespins slipped over corners of picnic cloth and pushed into ground protect it against wind*

the corners of the luncheon cloth to the ground to keep wind from blowing it about. Just twist each corner of the cloth, insert it between the legs of a clothespin and push it into the ground at an angle as indicated in the circular detail.

## Feet of Adhesive Tape Protect Bottoms of Glass Graduates

To avoid accidental breakage of glass graduates on the stone tops of laboratory tables, attach short pieces of adhesive tape to the feet as shown. These pieces also tend to prevent slipping.



## Keeping Slide-Rule Case Closed



Students, engineers and others who carry a slide rule in a case can keep it closed by wrapping a strip of adhesive tape around the flap as indicated. A single thickness of

tape is sufficient and allows the case to be opened easily with the fingers.

—Warren H. Buell, San Jose, Calif.

## Handkerchief Keeps Its Shape in Coat Pocket

When you wear a handkerchief in your coat pocket, shape it as you like it. Then fold a piece of light cardboard over the lower part and slip on a rubber band. The cardboard holds the handkerchief in shape and is unnoticeable.



# Combination BOOKCASE-TABLE contains Filing Cabinet

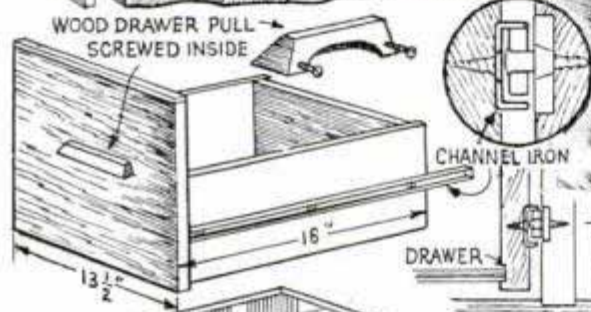

Your personal stationery and correspondence can be kept conveniently at hand in the den or living room if you have this combination piece of furniture, which fits in well with the style and furnishings of nearly any room. Besides the two drawers designed to accommodate the standard size of letterheads, there's ample space for a number of books.

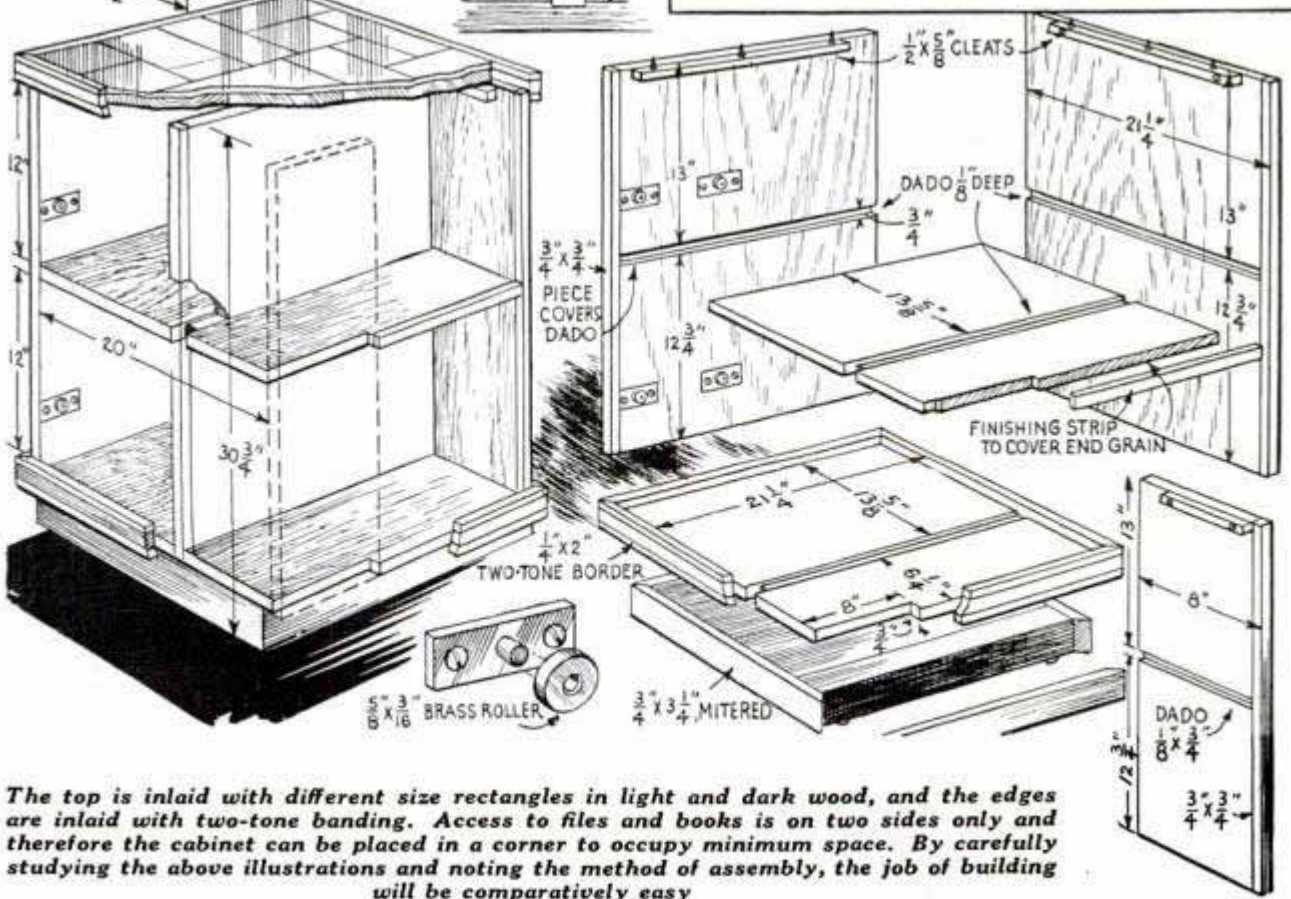

The top is inlaid with different size rectangles in light and dark wood, and the edges are inlaid with two-tone banding. Access to files and books is on two sides only and therefore the cabinet can be placed in a corner to occupy minimum space. By carefully studying the above illustrations and noting the method of assembly, the job of building will be comparatively easy.

## Non-Sag Lamp for Workbench Adjustable to Any Position

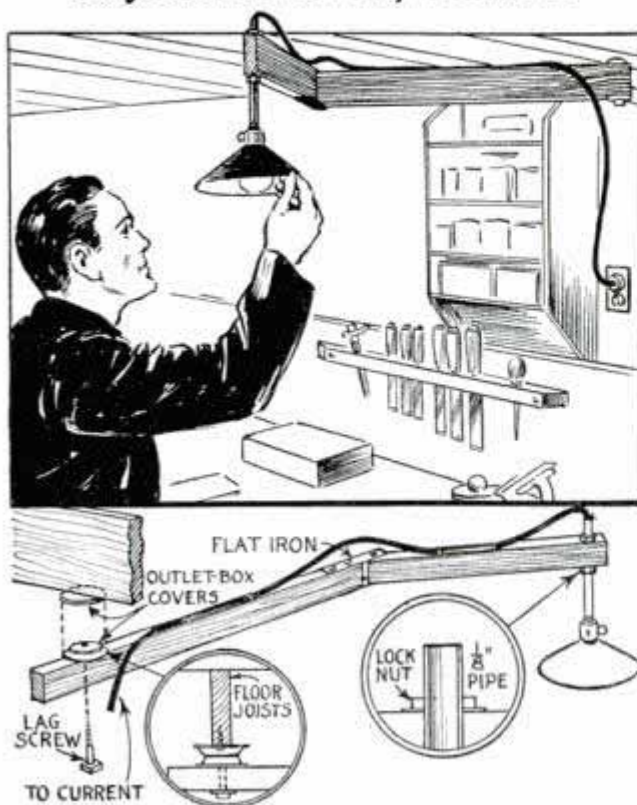

The pivoted arrangement of the support arm of this lamp prevents sagging

Pivoted on two electrical outlet-box covers, the arms of this adjustable workbench light can be swung to illuminate any part of the bench without sagging. The two covers, one screwed to the overhead floor joist and the other to the extending arm, are held together with a lag screw through the center. Proper adjustment of the screw to get easy movement of the arm is found by experiment. The circular detail on the right shows how the socket is fastened to the arm with  $\frac{1}{8}$ -in. pipe and lock nuts.

## Rubber Hose on Stirring Rod

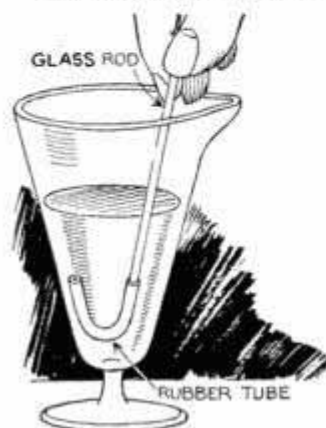

To aid in dissolving powdered chemicals in liquid solutions contained in a glass graduate, slip a piece of small rubber hose over the end of the stirring rod. The hose will bend to conform to the shape of the

graduate so that the wet powder that tends to stick to the glass is scraped off easily and mixed with the liquid. Small hose that has a ribbed surface is best as the corrugations of the rubber produce a good scraping action against the glass.

## Non-Slip Covering for Boat Seat

To help avoid slipping off the seat, when pulling on the oars of a heavy boat, one fisherman employs a rubber stair tread. The curved edge of the tread engages the back edge of the seat so it will not slide forward under the movement of the boatman.

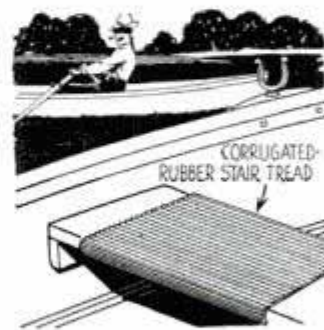

## This Portable Sewing Nook Sets Any Place in Home

Any part of your home can be converted into a sewing nook with this folding screen, the back of which is equipped with pockets and shelves to accommodate sewing materials. When not in use, the screen can be folded and set away. One panel is



Folding screen holds all your sewing materials and is stored in closet when not in use

provided with small hooks at the top for hanging up unfinished garments, sewing apron or smock, yardsticks, etc. The center panel is equipped with three or more pockets sewed onto a strip of oilcloth or

cotton. The outside panel has narrow spool shelves near the top. Below this is a series of pockets to take care of the smaller articles needed in sewing. In the center is a deep pocket for scissors, on either side are shallow pockets to hold such articles as tape measure, thimble, cards of fasteners, needlebooks and other miscellaneous items. A square pincushion, flat at the back, is hung at one side on a drapery hook. At the bottom of the panel, a large paper bag serves as a wastebasket. Holes punched at one side slip over small hooks on the panel, so that the bag can be removed for emptying.

### Emergency Soft Nose for Mallet

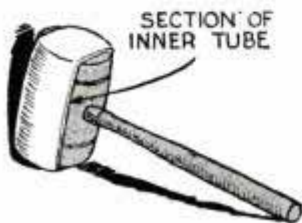

When using a mallet and the work requires a soft nose, just stretch a wide band cut from an inner tube over the head. The width of the band should be slightly less than the diameter of the head.

When using a mallet and the work requires a soft nose, just stretch a wide band cut from an inner tube over the head. The width of the band should be slightly less than the diameter of the head.

### Simple Miter Box for Workshop from Two Pieces of Wood

A simple miter box that will handle most of the requirements of the home workshop may be improvised from two lengths of 2 by 4-in. stock, which are cut and bolted together as shown. In use, the improvised miter is adjusted to the desired angle and then clamped in a vise to hold it.



A scale marked off in degrees on the edge of the vertical piece improves the miter box

### Christmas-Tree Lamps Illuminate Model-Railroad Signals

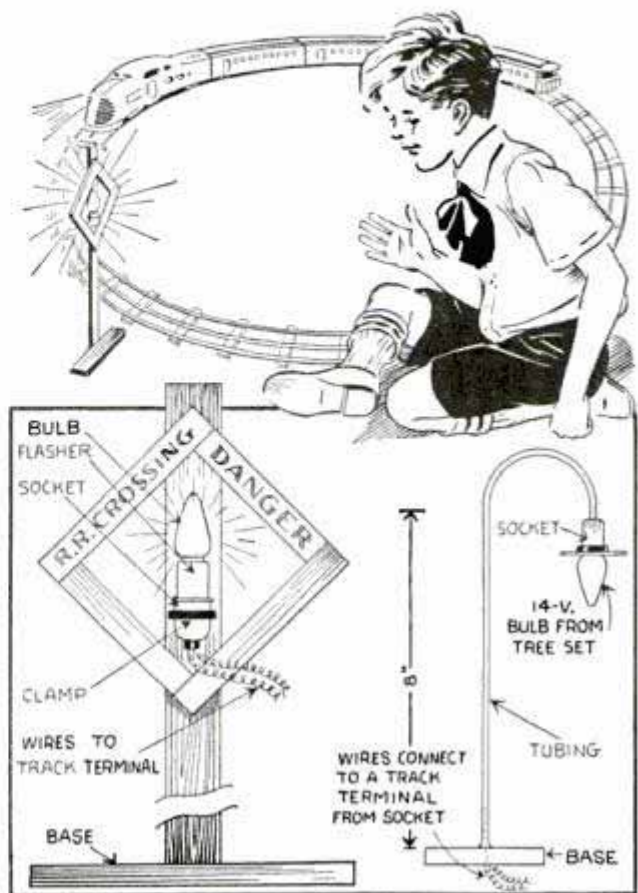

You can assemble inexpensive signals for a model railroad by using Christmas-tree lamps

You can assemble model-railroad signals from Christmas-tree lamps, two of which are shown. The flashing danger signal at the left is made of light wood and a lamp and socket are clamped to it and wired to the track, a flasher that is used on the tree lights being installed in the circuit to flash the lamp. The station lamp at the right is a length of small copper tubing soldered to a base and fastened to a socket and lamp, the wires being run through the tubing to the lamp. Many other types of realistic-looking signals can be made in a similar manner. As most lamps used on Christmas trees work on 14-volt current, you can use the regular train transformer to operate the signals.

—William Naken, Chicago.

☛ A good way to handle cloths when giving a patient hot applications is to put the cloth in a potato ricer, dip it into the hot water and then wring out the water by pressing down on the cloth while it is still in the ricer.

# NOVELTIES

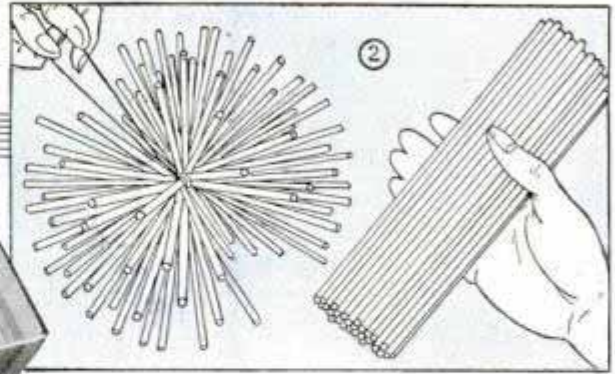

By FLOYD MIX

**T**RANSSPARENT Cellophane straws, available at most drug and ten-cent stores, find many uses in craftwork. To get the knack of using them, it's best to start with a simple project such as the gift-package decoration, or pompon, Fig. 1. In making this you will need a package of straws of a color and shade to harmonize with the package wrapping, and a 12-in. length of No. 32 spool wire, or stout cord. Place twenty to thirty of the straws together, and bind them tightly in the exact center as in Fig. 2. Pulling the wire up snugly will cause the straws to spray.

Only a slight variation of this procedure is required in making the candleholders shown in Figs. 6 and 7. For the small holder cut the straws about 4 in. long, tie them in place around the base of the candle and spread them out. For the large holder, construct a cardboard form as shown, coat it with colored sealing wax, then tie the straws together in bunches of four, and fasten several of these bunches around the candle form. The ends of the straws may be tipped with sealing wax of a contrasting color, before assembly, if desired.

The novelty cage for a yarn or celluloid bird, Fig. 3, adds a cheery note of decoration to a nursery or sun parlor. Sixty full-length straws are required. Cut four straws into 1-in. lengths to serve as spacers, then string them on yarn, as shown in the detail.

Fig. 4 illustrates a striking chrysanthemum table decoration, consisting of five flowers and twelve leaves joined together on a main stem. For each flower you will

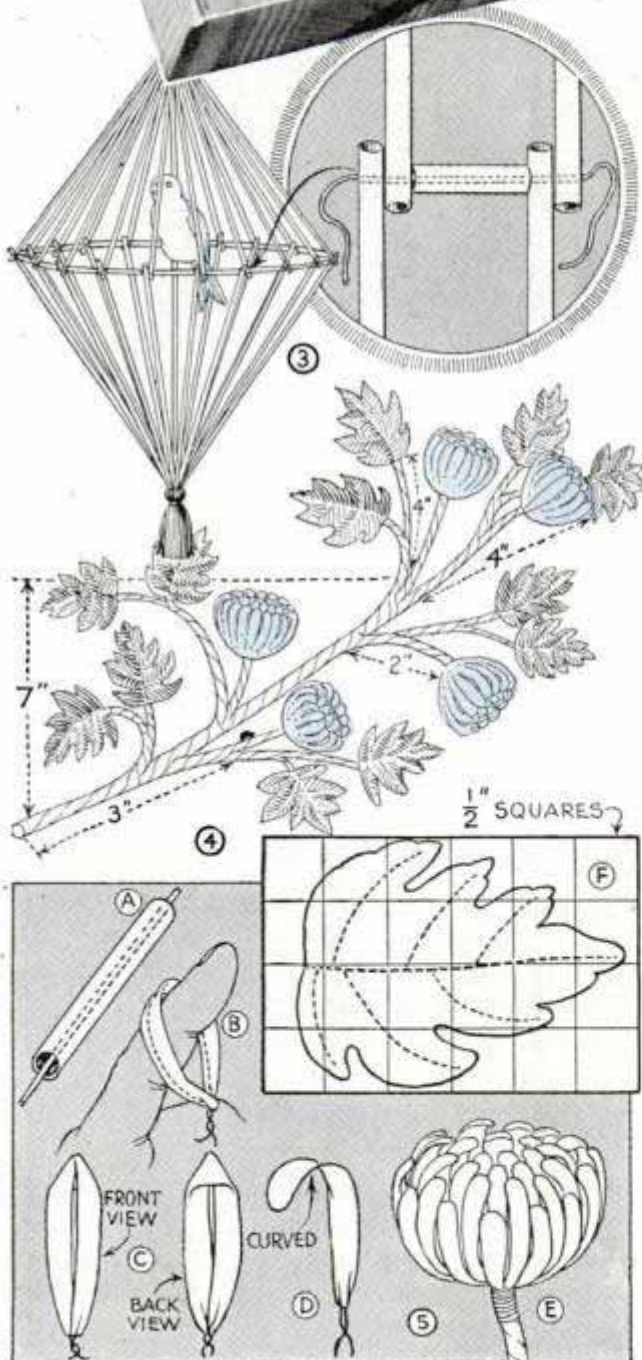



# from CELLOPHANE STRAWS

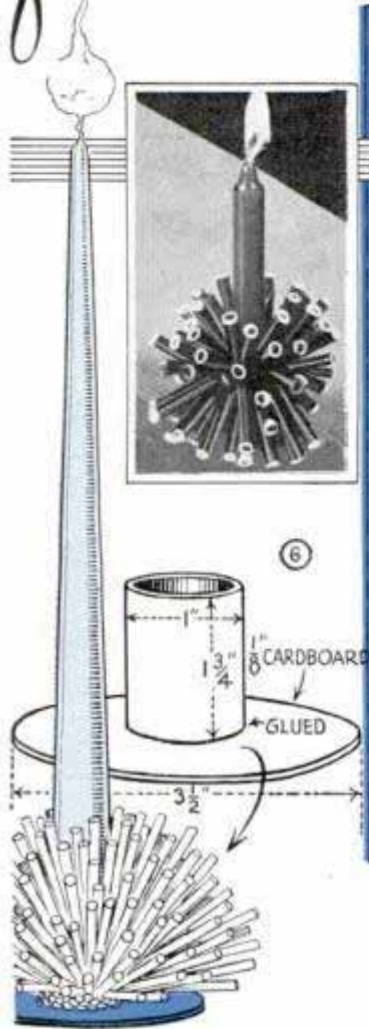

need twenty-six yellow straws 3 in. long and eight orange straws of the same length. Fig. 5, details A to E inclusive, gives the procedure to follow.

A 6-in. length of light wire is slipped into each one of the straws and they are flattened. Then they are bent to form petals. The ends of the fine wire are bound to a piece of No. 10 wire approximately 6 in. long, which serves as a stem. Leaves are made from pieces of kraft paper cut to the size laid out in the  $\frac{1}{2}$ -in. squares. Two pieces of paper are required for each leaf. These are glued together, with a 6-in. length of light wire in between which serves as a stem. The surface of the paper is coated with green wax, and veins marked in the wax with a sharp object, while it is still warm. The leaf and flower stems are twisted onto a piece of No. 10 wire, which is wrapped with yellow Cellophane ribbon. Candleholders to match are made by tying

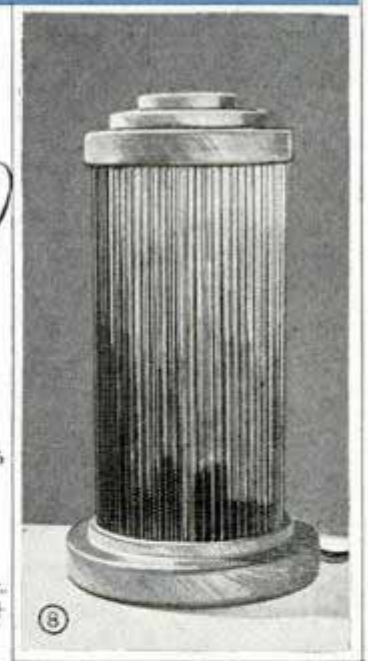
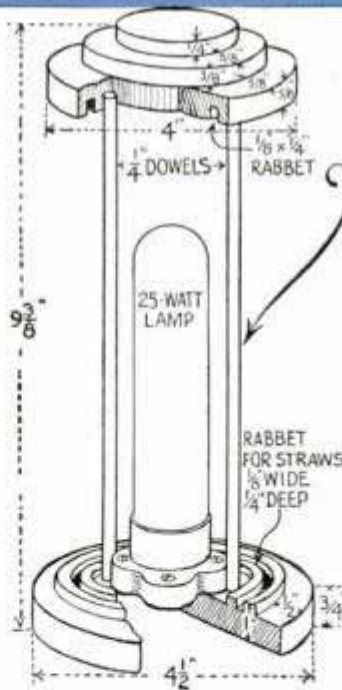

four of the flowers and three or four leaves onto a cardboard form as previously described. Another interesting project is the boudoir lamp, Fig. 8, turned parts for which are dimensioned in the detail. Ventilation for a 25-watt showcase lamp is provided by keeping the straws separated with  $\frac{1}{16}$ -in. cardboard spacers.

## Large Breaks in Plastered Wall Are Easy to Patch



*Always remove all cracked plaster, cut away damaged lath and then cover with piece of screen wire*

Anyone can do a workmanlike job of patching breaks in plaster if a simple procedure is followed. If the break is a small crack, remove the crumbled material and undercut the edge of the firm plaster. But if the break is large and the laths are broken, remove the damaged plaster and cut away the broken parts of the lath. Then undercut the edges of the firm plaster and tack a piece of screen wire over the lath. Dampen the edges of the plaster so that the patching material will bond to it thoroughly. Regular patching plaster, which you can buy in any amount desired, is best, although a mixture of plaster of paris and water will do.

## Corner Angle Improves Tape

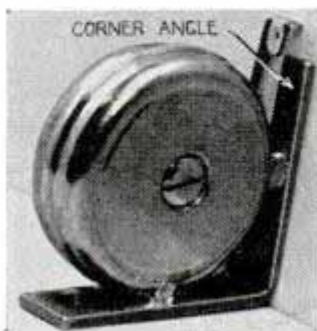

Soldered to the case of a pocket tape measure, a 2-in. metal angle will permit the tape to be used in corners and similar places where it is difficult to obtain an accurate

dimension. The tape is read to the end of the angle, after which the length of the metal is added to give the accurate dimension from the corner.

—Daniel Reynolds, Pontiac, Mich.

## Coil Spring on Cable Release of Camera Prevents Kinking

Kinking of the cable release on a camera when the latter is closed, or when a self-timer is used, can be prevented by slipping a small coil spring over the release next to the shutter as indicated. If the spring

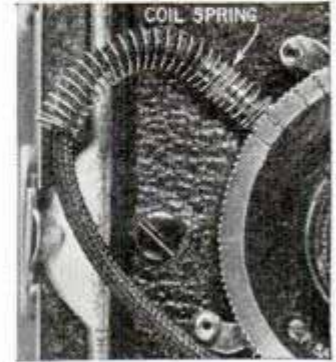

has a tendency to slip out of place, put a small piece of tape over one end.

## Cutting Tenons for Ship Models

Here's a little tool that simplifies the tedious job of cutting tiny tenons on ship-model stanchions. All you do is grip the stanchion in a vise and drive the tool over the end of it to form the tenon. The tool consists of a hinge pin drilled at the end, which is ground to a taper to provide a cutting edge as indicated.

—Norman Sweat, Tippecanoe City, Ohio.

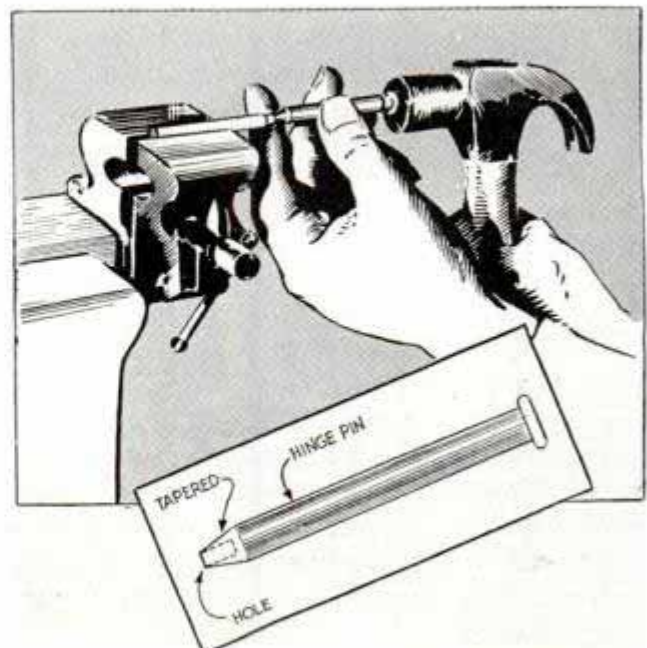

*A tedious task is made much easier when the model-maker uses this tenon-cutting tool*

# Windmill Pump Aerates Outdoor Fish Pool

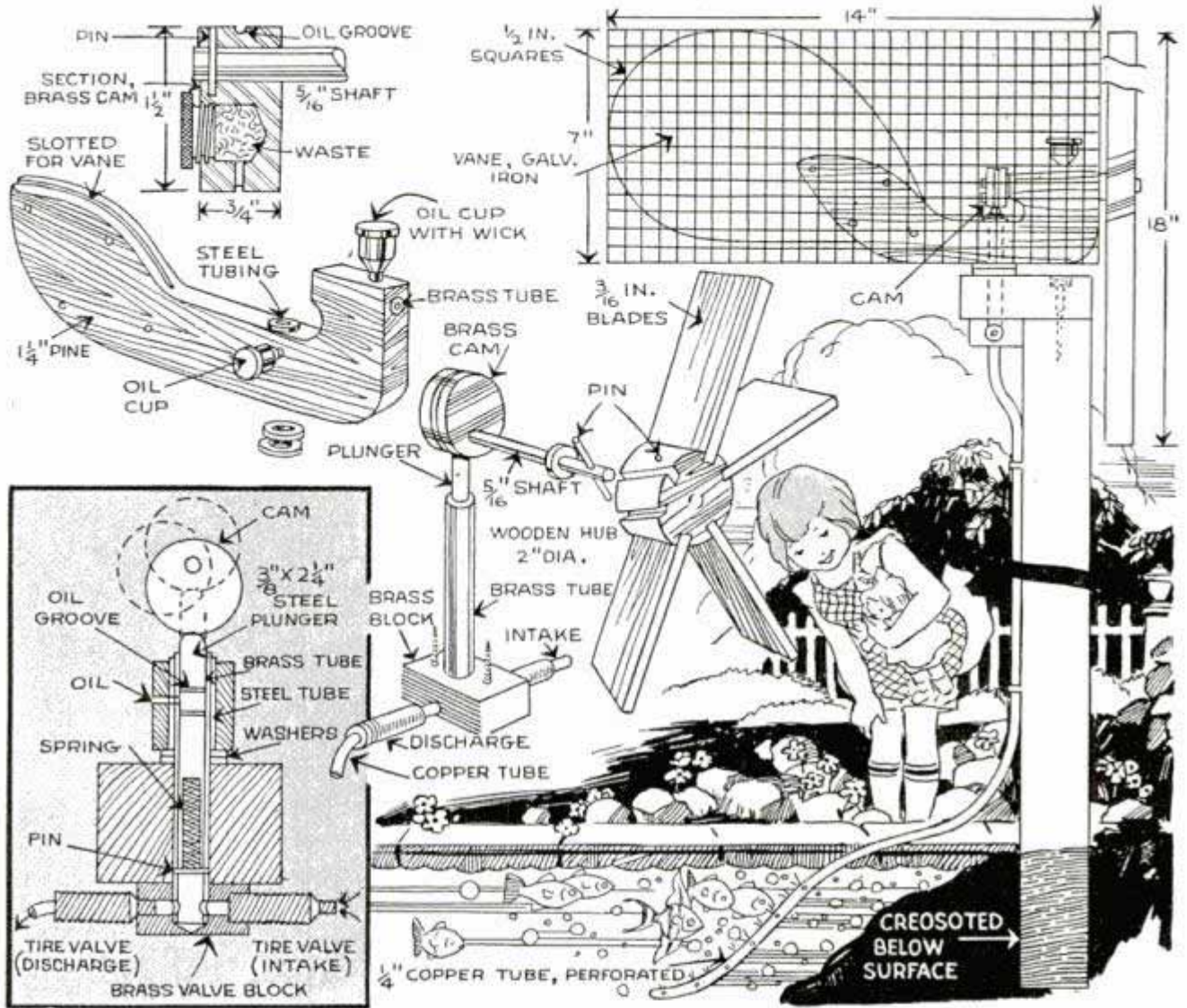

Aerating outdoor fish pools is a simple matter with this windmill-driven pump. As long as there is any wind, the pump produces a constant supply of air, which is liberated under water. A wheel of 18 in. or more in diameter rotates a cam, which actuates the pump plunger or piston. The wheel is pinned through the hub to a steel shaft on the other end of which is a brass-disk cam also pinned to the shaft. If you care to go to the extra work, an oil pocket can be bored and fitted with a cap, and an oil groove turned in the periphery, as shown. The groove should be very shallow, and a small oil hole should be drilled in it to the pocket which is packed with oil-soaked cotton. The shaft is mounted on a wood bracket, and turns in a brass-tube bearing. The bracket swivels on another brass tube which serves as the pump cylinder. A steel sleeve over the brass

tube forms a bearing. The pump plunger is of steel with the upper end ground convex where it contacts the cam. A coil compression spring keeps the plunger against the cam. Ordinary tire valves are screwed into a brass block at the base of the pump cylinder, arranged so that the air can come in one and pass out the other. An oil cup with wick should lubricate the plunger. This is important, as it will also increase the efficiency of the pump. A 1/4-in. copper tube is soldered or connected to the discharge valve and carried down under the water of the pool. A number of very small holes, none over 1/16 in., are drilled in it, and the end is plugged with solder or pinched in a vise. If small ball-thrust bearings are available, operation will be greatly improved by installing them behind the windmill and on pump cylinder between the bracket and the top of post.

## Emergency Dipper for Camp Use from Tin Can

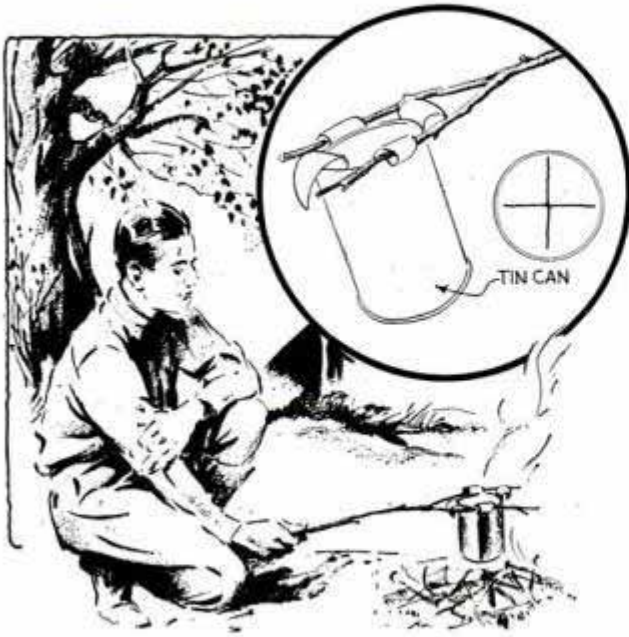

*If you forget to take a dipper on your camping trip, this one from a tin can will serve the purpose*

An excellent dipper or stewpan for use around the camp is assembled in a jiffy from a tomato can and a forked stick. When removing the contents of the can, the top should be cut across as indicated to provide four pieces which are rolled over the prongs of the stick. The utensil is especially convenient for dipping water from a spring, for heating coffee or other liquids over a camp fire, and for many other purposes.

## Quick Way to Get Exposure Time for Photo Filter

If you have an exposure meter of the photoelectric cell type, you can get the correct exposure, when using a filter, by

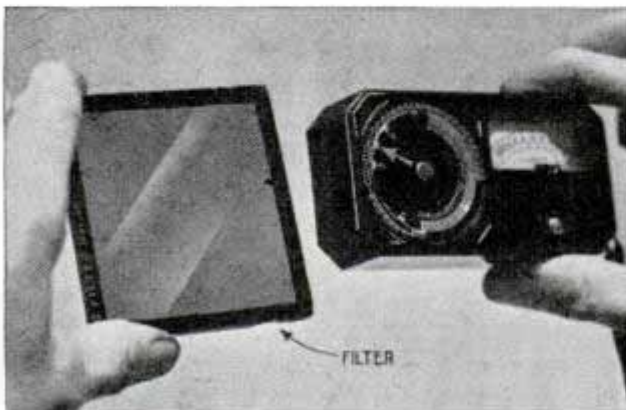

*Correct exposure time for filter found by taking reading on object through filter before taking photo*

simply taking a reading on the object to be photographed through the filter. This is a timesaver for the photographer who carries a number of filters and cannot always remember their correct filter value.

—O. L. Snider, Universal City, Calif.

## Water Gauge Made Easy to Read

Water-level gauges that are hard to read on boilers or tanks because of inaccessibility or poor light can be improved by placing a white card with heavy, diagonal lines behind them. The water in the lower portion of the glass acts as a lens, focusing the light strongly on the card. At the same time the effect is heightened by the bending of the oblique lines due to the higher index of refraction of the water.

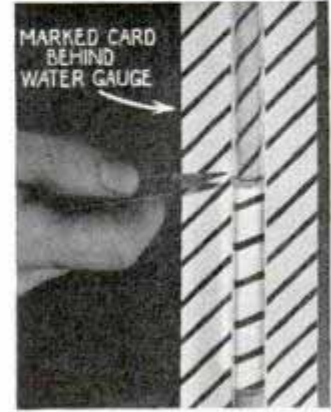

—John G. Roberts, Chicago.

## Invisible Support for Flowers

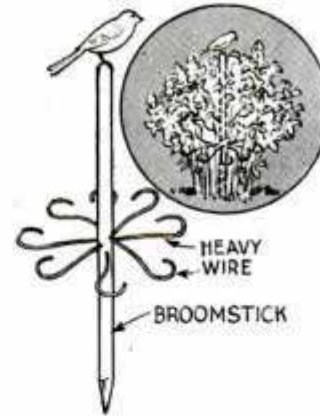

Completely concealed by the foliage, this flower support not only protects a plant, but a bird cutout realistically exposed at the top adds an attractive decoration. The support is made from a length of broomstick, which

has several holes drilled in a circle near the center to take short lengths of heavy wire, which have hooks bent at the outer ends to take the plant stems. The bird can be cut out of either metal or wood and should be painted with bright colors.

☐ When you use a mixture of soapy water and cleaning powder to wash walls, add enough flour to make a paste so that the mixture will cling to the wall long enough for the powder to dissolve the dirt.

# BEFORE LAUNCHING YOUR BOAT

By Walter E. Stewart

## PART II

THE hull of your boat must be sound and tight if you are to be free of worry when the wind makes up and the waves begin to pound. Now, while the boat is high and dry, pull out a little of the caulking between garboard and keel, at the stem, at the stern post, and at the turn of the bilge to see whether it has the white or grayish appearance of sound material or whether it is black and brittle, indicating rot. Only if the old caulking has decayed or fallen out should you plan

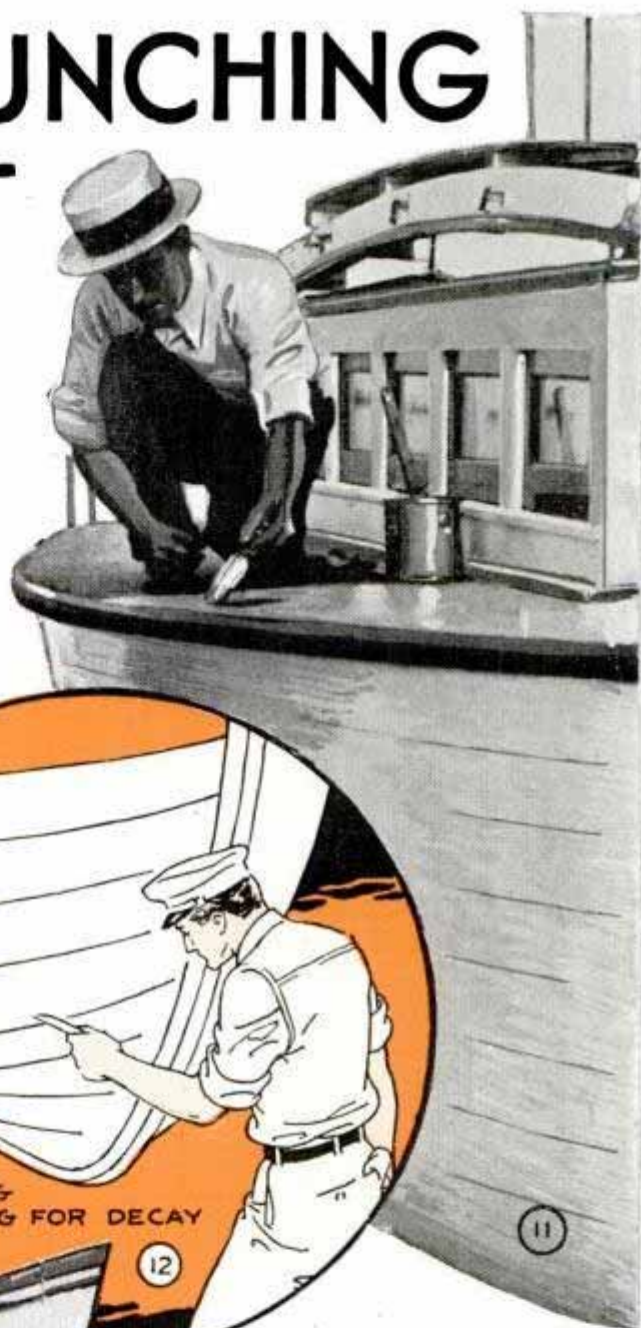

to recaulk the entire hull, Fig. 13. Remember that a seam which has opened as a result of a winter's drying out will promptly close again after the boat has been in the water a short time. It is only necessary to fill these seams with an elastic seam composition to keep the water out of the boat until the swelling has had time to close the opening. When putting in the compound do not attempt to pack the seam full. Leave a slight hollow to the outer surface so that when the planks swell the compound will be squeezed just flush and not beyond the planking. Take a pointed knife and test all planking and deadwood for decayed spots, Fig. 12. The only cure for rotten wood is replacement.



If rust from galvanized fastenings streaks the topsides of your boat, dig out the plug over each rusted fastening and scrape it clean. Blow all the flakes of rust out of the hole, give it a thick coat of white-lead paint, and fit in a new plug. In small boats putty instead of wooden plugs may be used to fill the hole. The most universally used putty for this purpose is a paste made with whiting and just enough white lead in oil to make it of good working consistency. In making new wooden plugs be sure that the grain of the wood runs at right angles to the axis of the plug, otherwise swelling of the plug will cause it to protrude beyond the planking. When necessary to renew plugs over the heads of screws holding deck and side planking, proceed as in Figs. 15, 16 and 17.

The putty mentioned above is also good for filling in very small cracks or chipped places in wood or paint. Before starting to paint, Fig. 11, scrub the topsides with

fresh water and a strong cleanser. Any grease or tar that remains on after the scrubbing can be removed with kerosene. Tar or grease left on will surely strike through new paint. After cleaning the topsides roughen the surface slightly with No. 00 sandpaper so the new paint will form a good bond. Normally you will need to apply only one coat of flat paint and one of semi-gloss. In case the old paint is in very good condition the one coat of semi-gloss will be sufficient. It is well to remember that discolorations show through glossy coats much more than through flat. Some boatmen say that the entire paint job on the topsides should be flat. Their theory is that by the end of the season most of the flat paint will have powdered off, eliminating the need of the occasional burning off which otherwise would be required.

If the varnish on bright work, Fig. 14, is gone to the extent that the wood has become weather-stained, the only thing to do is remove the remaining varnish, bleach the wood, sandpaper smooth, and apply at least four coats of new varnish. The best varnish you can buy is the cheapest for use on the outside of a boat.

Too many coats of paint on a canvas deck is a sure cause of checking, so if your deck is in good condition, touch up any thin spots, sandpaper lightly all over, and apply only one coat of finishing paint. Remember that it is the varnish in paint that causes it to crack. If the deck is already badly checked, all the old paint must be removed, for no amount of sandpapering and filling-in will ever conceal serious checking. To cover up relatively light checking, sandpaper the edges down smooth, with a very small brush fill in the crack with thick paint, allow to dry, sandpaper again, then

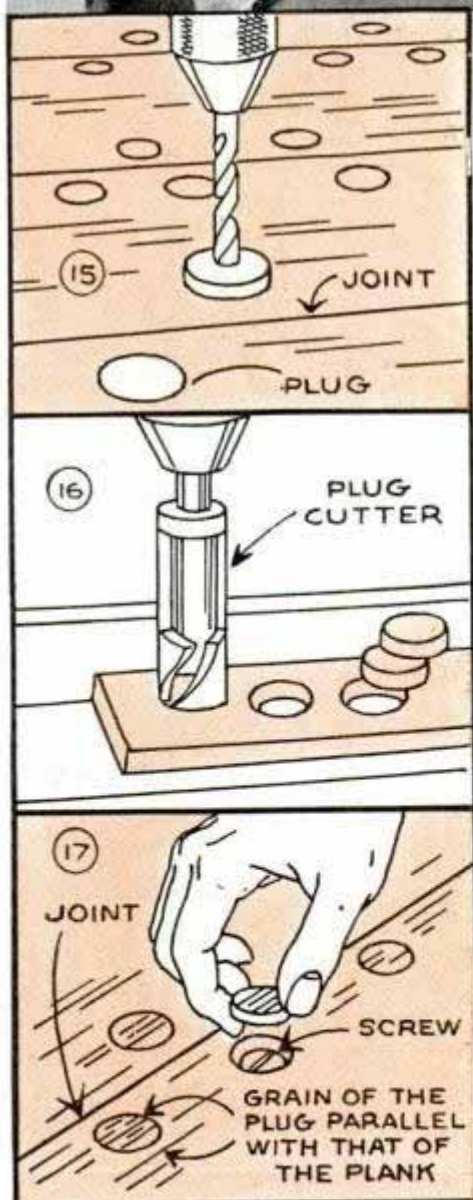

paint the entire deck. Get the bottom of your boat perfectly smooth, even if it is necessary to use a plane to do it, before you paint. When getting the barnacles off be sure to get not only the projecting pyramid, but the tightly adhering base as well. All copper anti-fouling paints are best applied immediately before launching, and be sure to follow the maker's directions as to thinning or the lack of it. Any deviation from the tested formula is likely to be detrimental to the protective properties of the paint. Bronze bottom paint usually should be permitted to dry and harden before the boat is launched, but be guided by the maker's directions if they differ from this.

The rigging of sailing craft is as vital as the power plant in motorboats. If any line is of doubtful strength, replace it. Should a halyard part or a sheet let go when you are in a blow on a lee shore you will always regret the few dollars you have "saved" by using the old rigging one extra season. This is not advice to replace your rigging every year, for this extreme is seldom necessary. However, it is always wise to reverse ends on both halyards and sheets so as to shift the wear to another part of the line. Backstay whips also should be reversed. Make sure the sheaves in all blocks run smoothly, that all blocks are large enough to permit the line to reeve through them freely, and that shackles, sister hooks, and snaps are not worn dangerously. Fittings at the mast head, of all places the most difficult to get at in an emergency, are often neglected. Go aloft and replace any worn, frayed, or rusted parts. See that your standing rigging has not been weakened by rust, and if it is galvanized steel give it at least one coat of exterior aluminum paint. Cut off the old and make new splices over the thimbles at the ends of your two or three anchor lines.

In a final checking over, clear out the strainers on all water intakes. If necessary, replace the rubber connecting hose between hull connections and metal water lines. All through-hull connections in your boat should be fitted with sea cocks. You can make a neat repair for small tears in a canvas deck by slipping a piece of canvas considerably larger than the hole under the edges of the surrounding deck material and spacing copper tacks not more than  $\frac{3}{8}$  in. apart all around the opening. See Figs. 19, 20 and 21.

Every season a few boats slide into the water, Fig. 18, and immediately develop a serious leak. After much pumping the owner remembers that he forgot to plug the drain hole in the garboard plank. So, as soon as you have finished scrubbing the bilge make a new plug and drive it home.

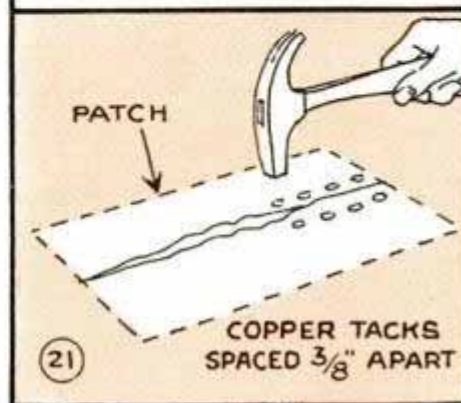
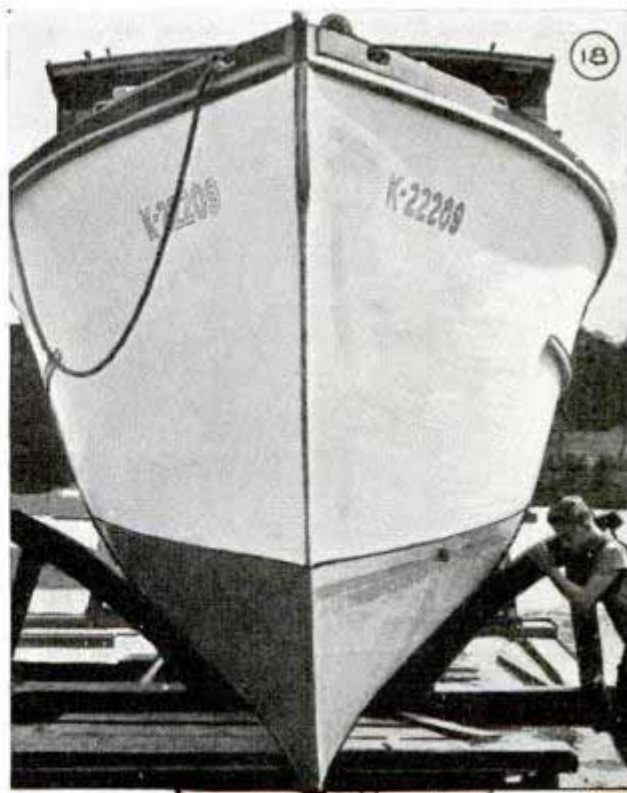

## Leaves Troweled in Sidewalk Produce Neat Border

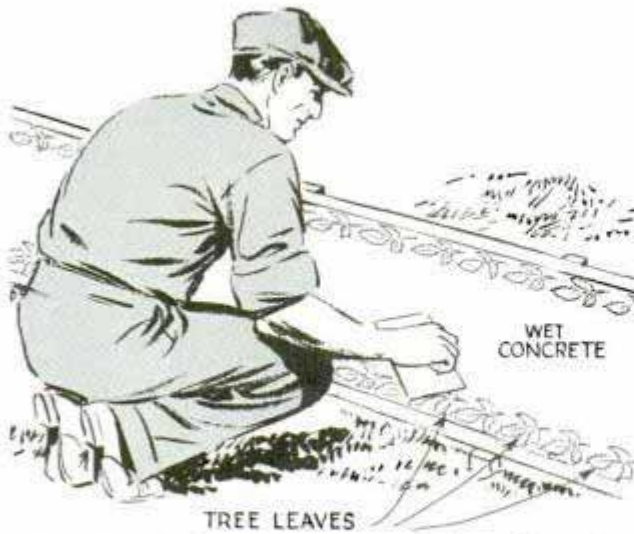

*A variety of designs can be worked out by using different shaped leaves of various trees*

After applying the finishing coat to a freshly laid sidewalk, tree leaves were troweled into the wet surface along the edges. When the concrete had set and the leaves dried, they were washed away with a garden hose, leaving their impressions in the surface. The border shown was made with elm leaves.

## Clothesline Attached to Spring Always under Tension

To retain tension on a clothesline without danger of having the posts loosen under vibration of the clothes whipping about

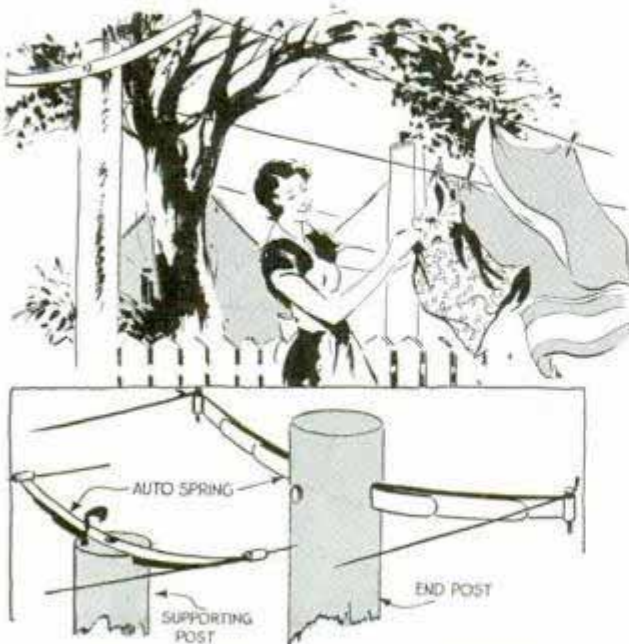

*Auto-spring crossarms on your clothesline posts keep lines taut without props*

in a wind, replace the wooden crossarm on one support post with a discarded auto spring. If the lines are of long span, they may be supported with another spring set into the top of the center post. In this instance, the wires pass through the eyes in the ends of the spring.

—G. E. Hendrickson, Argyle, Wis.

## Hack-Sawing Large Work

When cutting off a pipe or shaft that is larger in diameter than the clearance of the saw frame, cut into the work as far as you can. Then unfasten, leaving the saw blade in the work, and attach the frame from the opposite side of the work. When the cut is completed, the severed ends will be smooth.

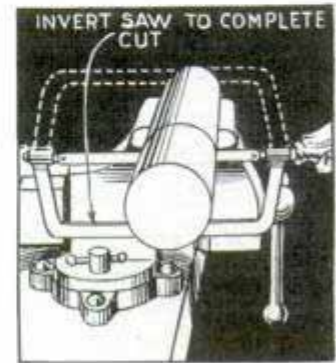

## Sheepskin to Oil Hand Plane

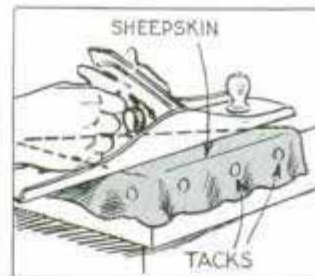

To keep the face of my hand plane slick, I frequently draw it across a piece of lard-oil impregnated sheepskin, which is tacked to one corner of my workbench. This leaves a slight film of oil and greatly reduces friction when using the plane. Keeping a coating of oil on the steel also prevents the formation of rust.

—Frank Andres, Seattle, Wash.

## Cool Handle for Your Iron

If a strip of corrugated cardboard is wrapped around the handle of an electric iron and fastened with tape, the handle will not become uncomfortably hot when the iron is used for long periods.





# CHINESE BANJOS

*add decorative touch to den*



*These copies of ancient Chinese banjos will give your den or recreation room a novel, oriental touch. Making them involves nothing more than some neat fitting and hand carving. If the carving designs shown here are too intricate to suit you, simpler ones can be substituted*

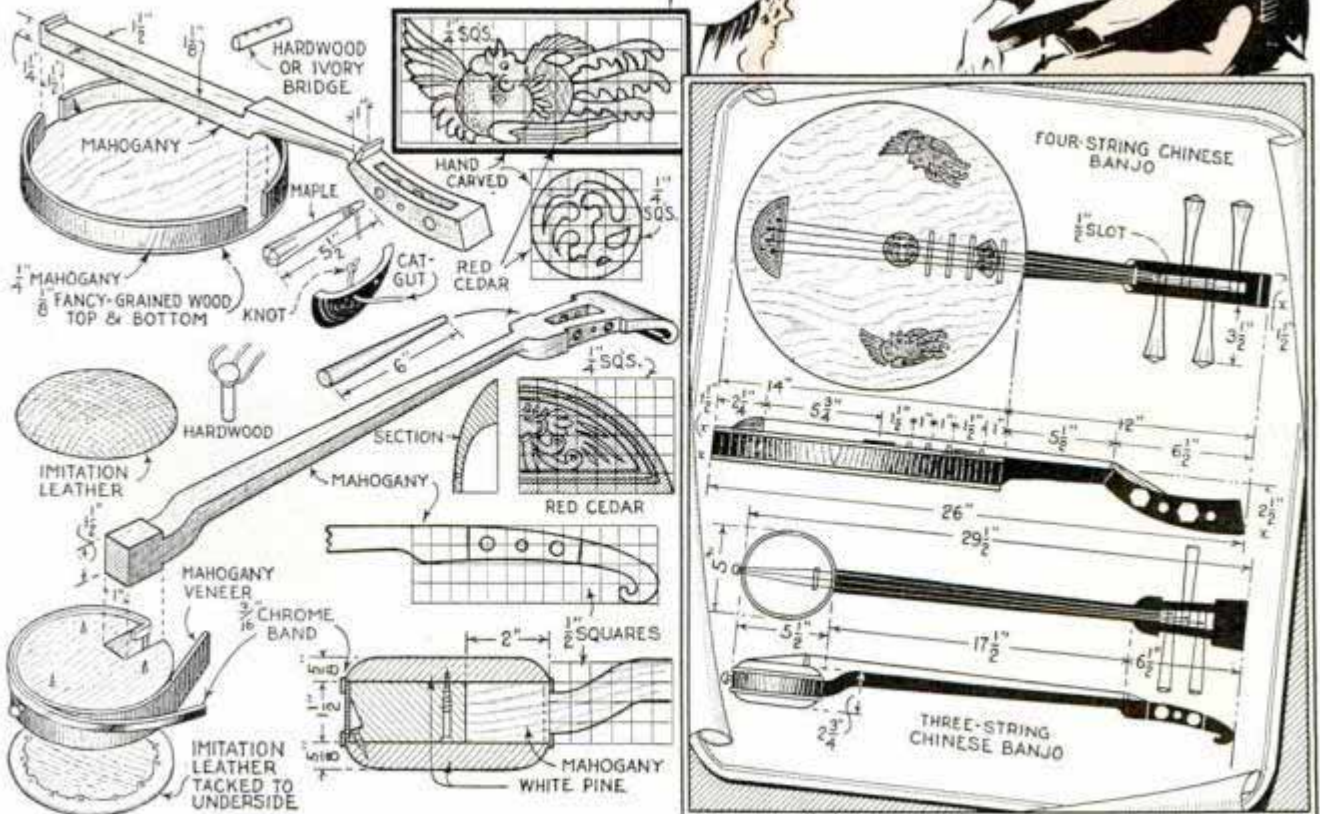

## Heavy Outboard Motor Moved on Detachable Wheels



*Wheels and axle from boy's wagon quickly attached to outboard motor to move it wheelbarrow fashion*

Having an outboard motor that was too heavy to carry, I moved it wheelbarrow fashion on a couple of detachable wheels. These consisted of the wheels and an axle obtained from a boy's express wagon. In my case, the axle was bolted to lugs on the gas tank of the motor, both the axle and lugs being drilled to take the bolts. If your motor has no lugs on the tank, iron brackets usually can be slipped under some bolt or cap-screw heads for attachment of the wheels.

—Lloyd Jensen, Los Angeles, Calif.

## "Fur-Lined" Screwdriver Protects Surface of Finished Work

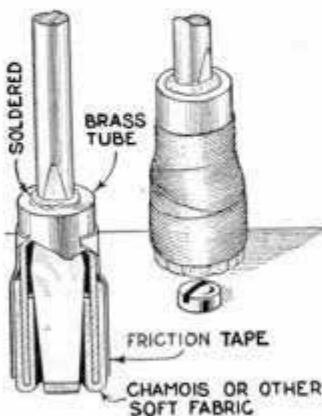

Improving on the old method of soldering a piece of tubing around the blade of a screwdriver to keep it from slipping off a screw head, one woodworker covers the tube inside and out with chamois skin or soft fabric.

The tube should be large enough to glue the skin or fabric inside, after which the latter is turned up over the edge and is

held in position by a wrapping with friction tape. The protective lining avoids marring either the finished work or the head of the screw.

## Clothespin on Wire Hook to Hang Garments

In our home we find that spring-type clothespins fitted with hooks are very handy for hanging up caps, hats and garments that are usually hung on a hook. The clothespins make the use

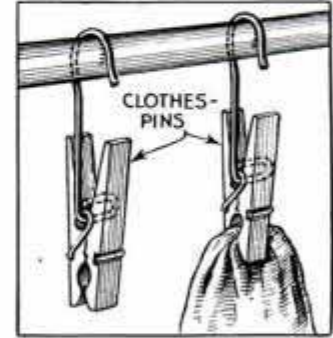

of hooks on the closet walls unnecessary. The hooks are pieces of heavy wire run through the coil springs of the pins and bent over as indicated by the dotted lines.

—Herbert T. Ludgate, Toledo, Ohio.

## Dust Removed from Photo Films with Electrified Comb

Tiny specks of dust and lint are easily removed from rolls of miniature-camera film with an ordinary hard-rubber comb which has been rubbed briskly with a silk handkerchief. Then the charged comb is brushed along the surface of the film, and it will pick up the dust specks.



*Rubber comb charged with static electricity removes invisible dust specks from miniature-camera film*

# Decorative Feudal Castle for Your Fish Pool

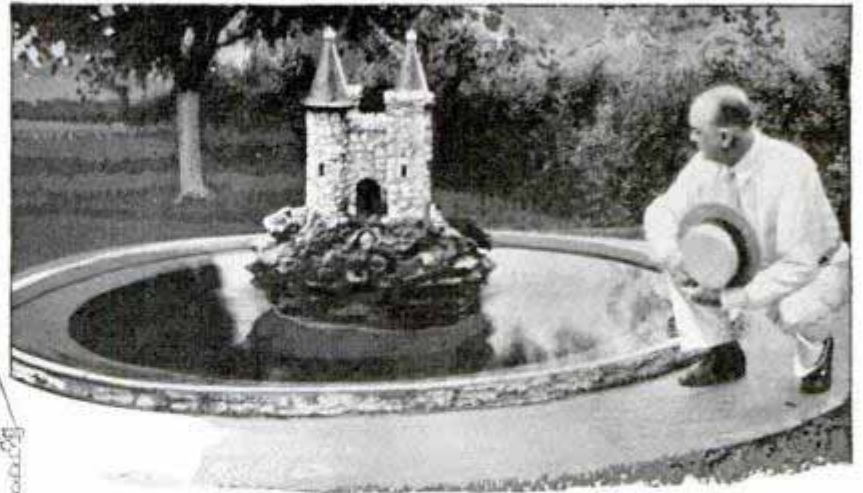
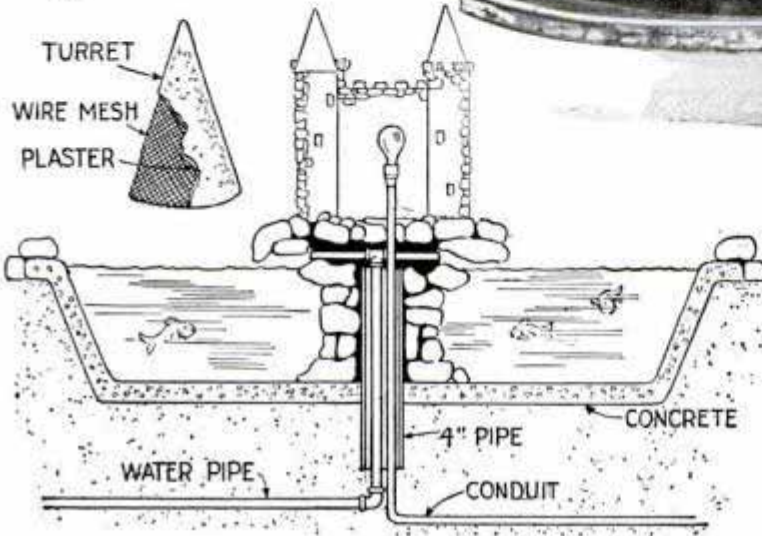
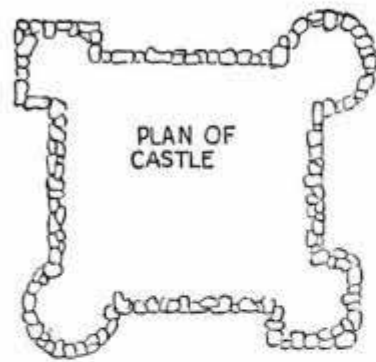

*Resting in the center of your fish pool, this model gives a realistic impression of the old-time castle surrounded by its protective moat. Stones and mortar are used throughout, the four towers being capped with turrets of wire mesh covered with plaster. Electric lighting is optional and can be installed as indicated, if desired*

## This Tumbling-Acrobat Toy Will Delight Small Children

Here's a simple toy that will give the children a lot of fun. When the acrobat is knocked over, it appears to be falling to the floor. But just at the crucial moment, it hooks onto the next bar and swings with ease. A slotted back rest keeps the acrobat in position for the next act. The figure is cut out of cigar-box wood with the arm and the right leg in one piece. The left leg is cut separately and swings on a pivot to give movement. A couple of pencil lines will establish identity of the arms and both sides.

### Diluting Showcard Colors

The trick in using showcard color is correct dilution. For a really good job on large surfaces apply a second coat after the first has dried thoroughly. Beginners usually fail to allow for the fact that the color dries out quite a bit lighter. Frequently a drop of glycerin will improve the color work.

—Leonard F. Dodge, Machias, Me.

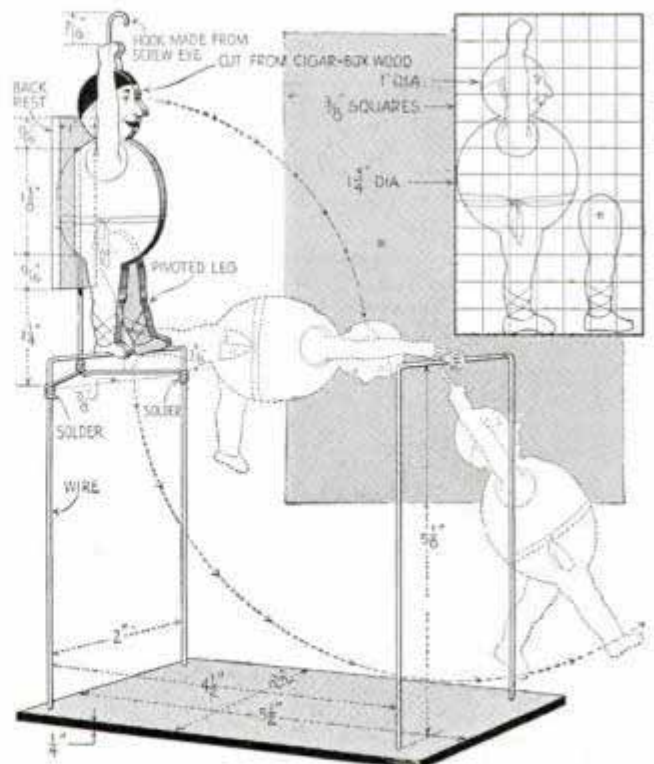

*Dropping from a vertical position on one bar, the acrobat grabs the second bar as he falls and swings safely in a realistic manner*

# HOME Solved

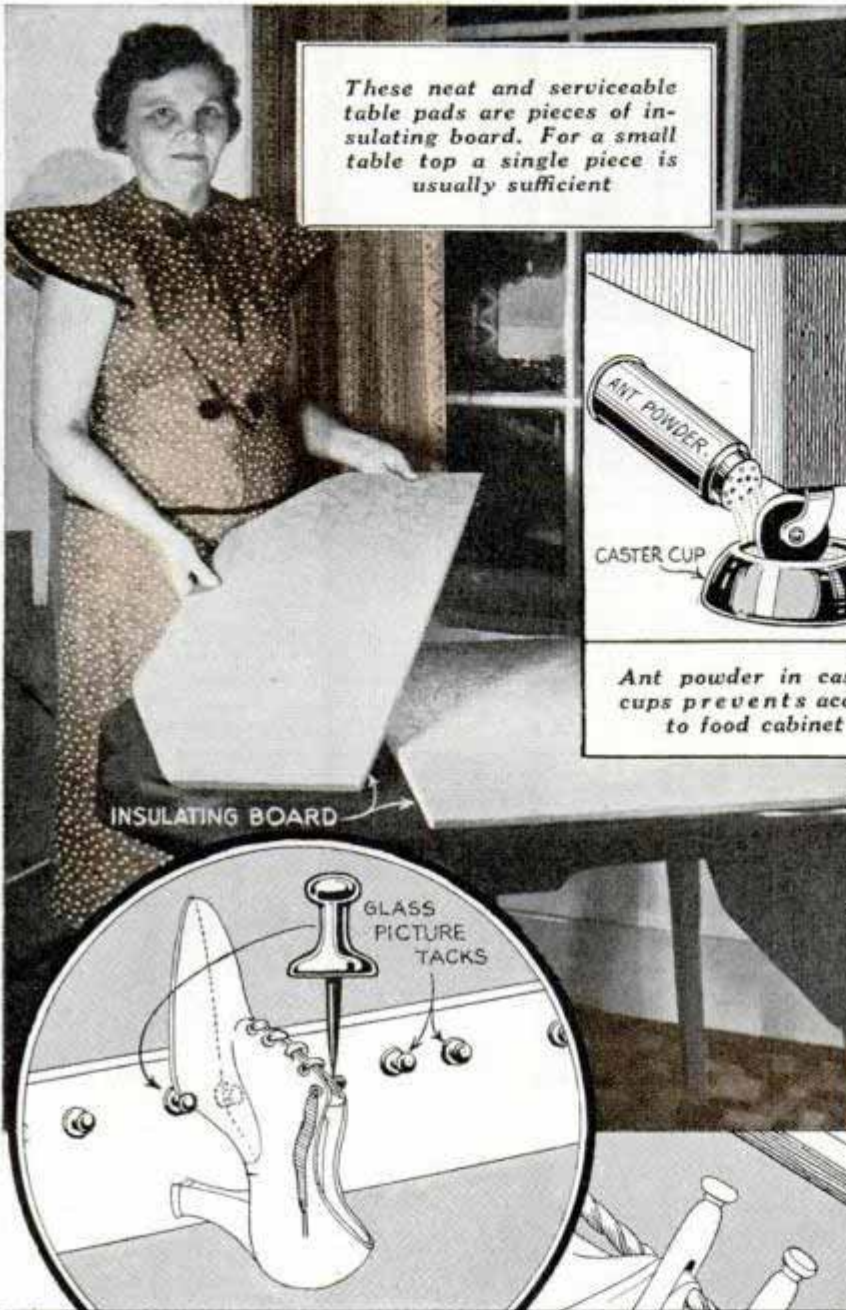

*These neat and serviceable table pads are pieces of insulating board. For a small table top a single piece is usually sufficient*



*Ant powder in caster cups prevents access to food cabinet*

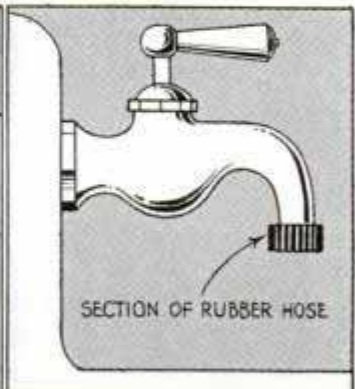

*Piece of rubber hose on faucet helps to avoid breaking glassware*

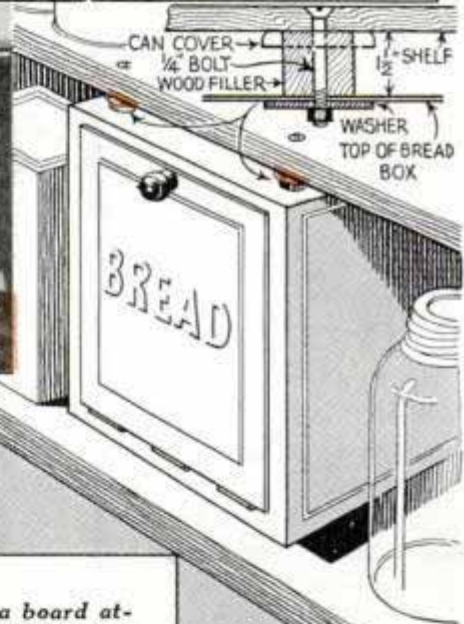

*Shoe hangers are provided by driving glass-head push pins into a board attached to the back of the closet door as shown in the circle above. To keep insects out of the bread box suspend it from the pantry shelf as detailed at the right. Be sure the sides or back of the box do not touch a wall*



*Short-stemmed flowers slipped into soda straws are easy to arrange in a bouquet of long-stemmed flowers so that they may be placed in a tall vase. Right, a clothes pole will be non-slip if a short length of rubber hose slit as shown, is tacked to the upper end*

# PROBLEMS

*Easily*

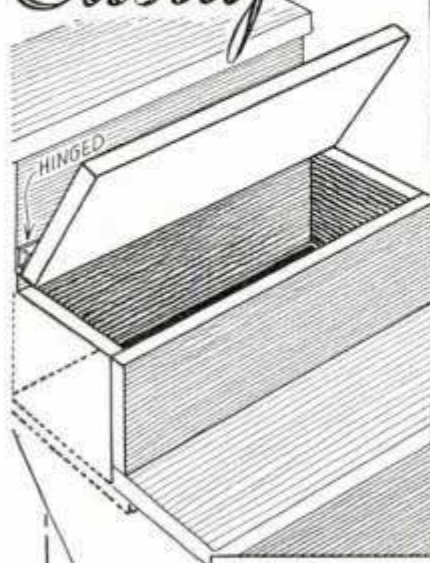

*Left, boxing-in the space under a basement stair step and hinging the tread to the riser, provides a handy place to keep odds and ends. Right, the job of laying linoleum is simplified by lifting corners and edges near the walls with a household suction cup; glycerin applied to the cup edge makes it hold tightly*



*If your basement laundry stove smokes in the summer, open the cleanout door at the base of the chimney, place a roll of newspaper inside and ignite it. The heat drives the damp air from the chimney and restores the natural draft. Right, the next time you clean your library books try wallpaper cleaner to remove dust from both the pages and covers*

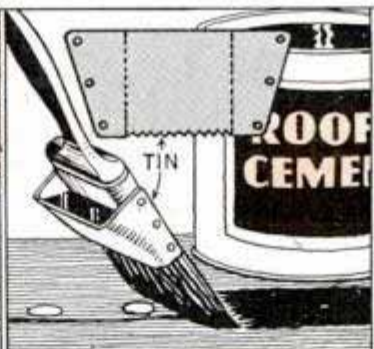

*A reservoir on the ferrule of a brush feeds paint or roofing cement uniformly*

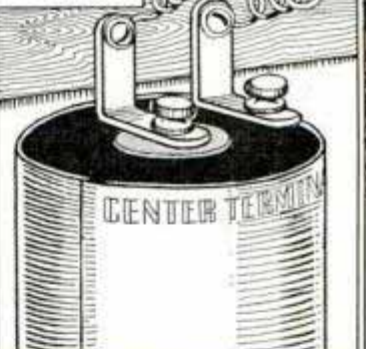

*Corner braces used to hang dry cells from insulating strip*



## Tent Ridge Pole Rests on Springs to Hold Canvas Taut

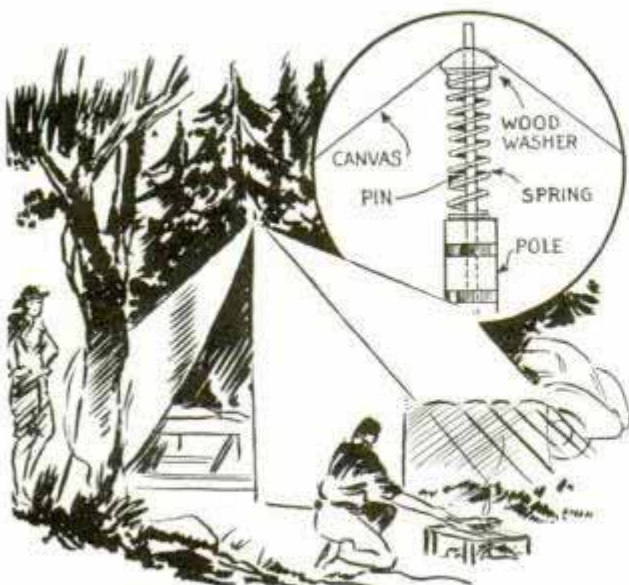

*Springs under ridge pole provide pressure to keep canvas stretched neatly regardless of weather*

To keep the seams of his tent from being damaged by excessive shrinkage when the canvas becomes damp, and also to avoid

excessive sagging when the cloth dries out, one camper uses coil springs under the ridge pole as indicated. The springs provide a pressure against the ridge pole which keeps the canvas stretched neatly.

## Emergency Vise for Fishermen

Fishermen who have to repair or construct flies in camp can use a tin can and a pair of pliers as an emergency vise. The can is driven into the ground, bottom side up, and holes are punched in it to receive the handles of the pliers when closed. The hook is



placed between the jaws of the pliers and is held securely by forcing the handles into the holes in the can bottom.

# What Kind of Boat Do You Want?

*Whether it's a simple rowboat, an outboard runabout or a family cruiser, you'll find something you want among our blueprints. These are some of the popular prints in the list:*



21-Ft. Sloop "Arrowhead"—944 to 951

**"ARROWHEAD" SLOOP—944 to 951:** 21-ft. sailboat that can be built by average craftsman. Accommodates up to 10 passengers. Set of 8 prints \$1.50.

**"HI-HO" 14-FT. FAMILY RUNABOUT—840 to 845:** Powered by 11 to 22 hp. outboard or a converted Ford motor. Set of 6 prints \$1.00.

**"ROAMER"—765 to 770:** Outboard cabin cruiser. 16 ft. long, 66 in. beam. Requires outboard motor of 20 to 36 hp. Set of six prints. \$1.00.

**12-FT. ROWBOAT—707:** Flat bottom. Can be used with small outboard motor. 25c.

**"SEA SAUCER"—893:** Lightweight sailboat. Length 9½ ft. Planked with 3/16-in. plywood. 25c.

**10-FT. ROWBOAT AND AUTO TRAILER—551:** Wonderful combination for week-end trips. 25c.

**CANVAS-COVERED KAYAK—928 and 929:** Light framework covered with canvas. 17 ft. in length and accommodates single passenger. Two prints 50c.

Any six of these blueprints (not sets of prints) will be sent postpaid upon receipt of \$1.00

Blueprint Department, Popular Mechanics Magazine, 200 E. Ontario St., Chicago



# DOORS and LIDS that ROLL

HERE'S a way to add a novelty to your homemade smoking stand, clothes closet or bookcase. Neat and practical, too, because such a roll-away door keeps out the dust, can be finished in attractive colors and does not swing out like the conventional door. You can use the same construction for a partition or for an inside opening where there is no room for a swinging door.

Although there are variations, in essential the lid or roll consists of a number of narrow strips laid side by side and glued to heavy cloth, Figs. 1 and 4. The strips must be exactly the same length and identical in sectional size. The cloth to which the strips are glued is cut to the width between the guides or grooves in which the ends of the strips slide. This is necessary to prevent the cloth from binding. Before gluing up the roll, make a jig to hold the strips firmly in position and spaced about  $\frac{1}{32}$  in. apart. Very little glue is needed to stick the cloth firmly to each strip. The trick in making a successful job of this is to spread a thin line of glue on the center of each strip, then place the cloth and roll it down into firm contact as in Fig. 2. Endpieces of the box are grooved to receive the ends of the strips, which slide in the grooves. A handle is provided on the sliding cover as in Fig. 1. The slot formed where the lid bends downward is covered by a strip running parallel to one of the longer sides. The side piece opposite has a shallow groove to receive the edge of the lid.

Variations include an attractive door or lid made from dowel rods fastened either to cloth or strung together with

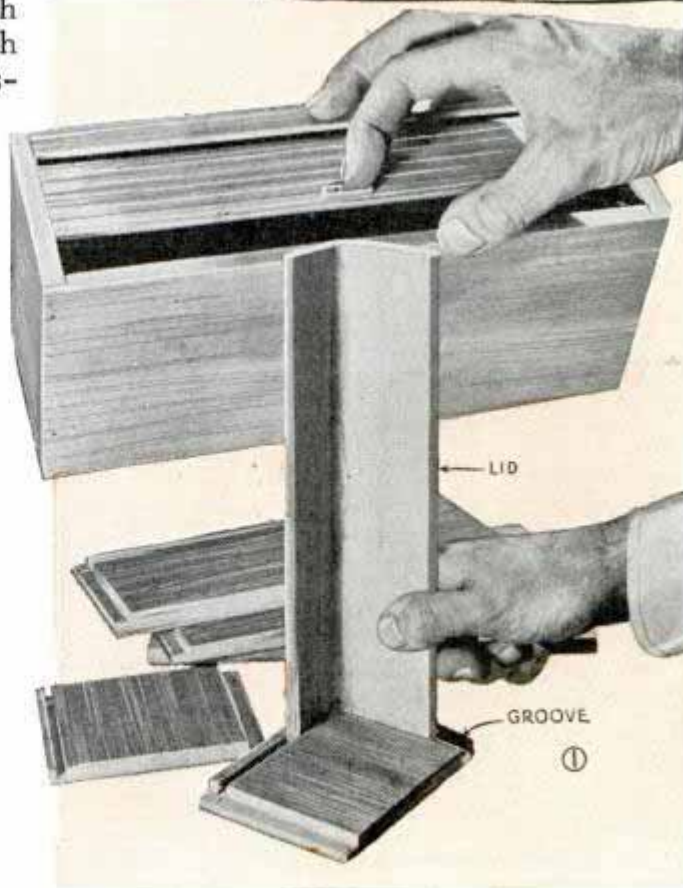

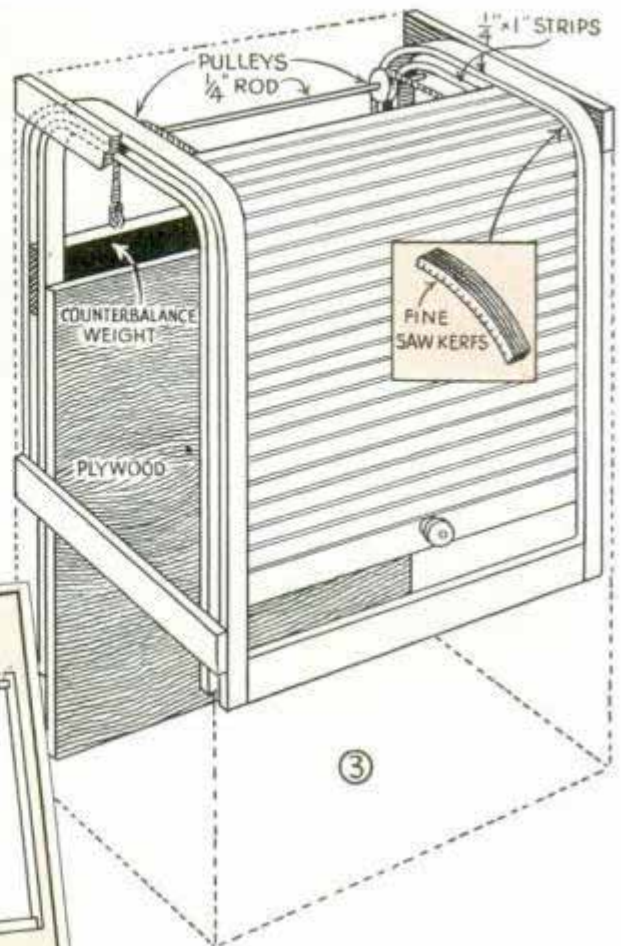
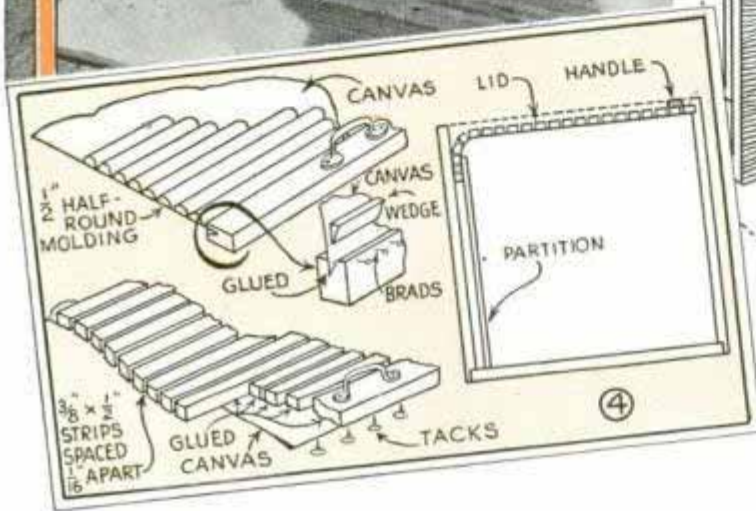

cord running through drilled holes. Strips of various colors can be assembled into attractive patterns. Steel rods or tubes can be strung on wires or chains and so on. Fig. 3 shows the type construction you would use in installing a large sliding door, such as that in a closet or partition. The

roll is made up in the same way as described before. The guides are separate strips, curved as shown so that the roll will slide easily. When the installation is made, these strips or guides must be spaced equally throughout their length so that the roll cannot buckle. A counterbalance is necessary for a large door. The weight can be concealed behind a partition and connected to the roll with cords running over pulleys.

### Float-Controlled Electric Alarm Is Handy for Icebox Pan



Especially useful to hook over the edge of your icebox drip pan, this alarm sounds a buzzer when the pan is filled. It is also handy to hook over the edge of a pail or other container, which is slowly being filled with liquid. The alarm consists of a dry cell and a buzzer connected to a pivoted cork float with strips of copper. The circular detail shows how the float closes the circuit when raised by the liquid.

—W. E. White, Plymouth, N. H.

☞ If apples are slit with a knife in three or four places before baking, the skins will not wrinkle in the oven.



# Electrical Trimmer Shapes Arrow Feathers

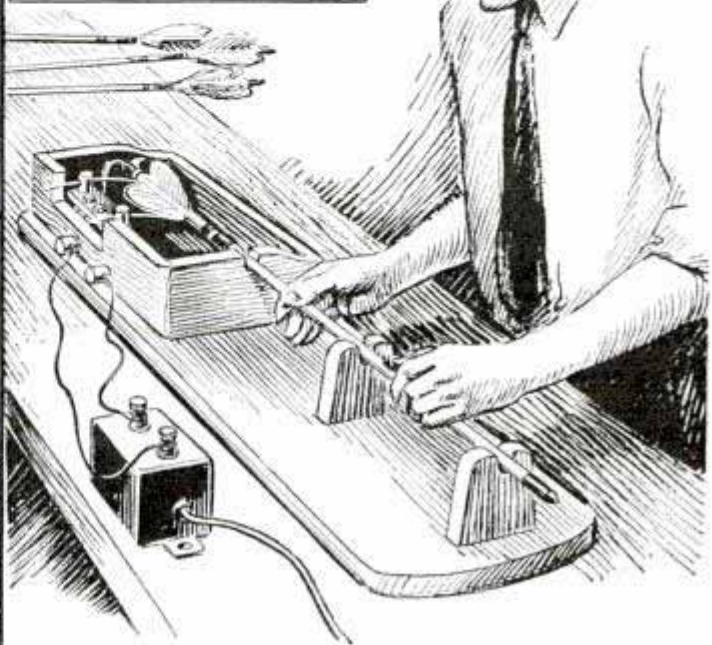
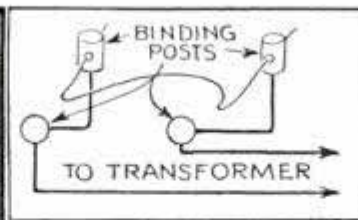
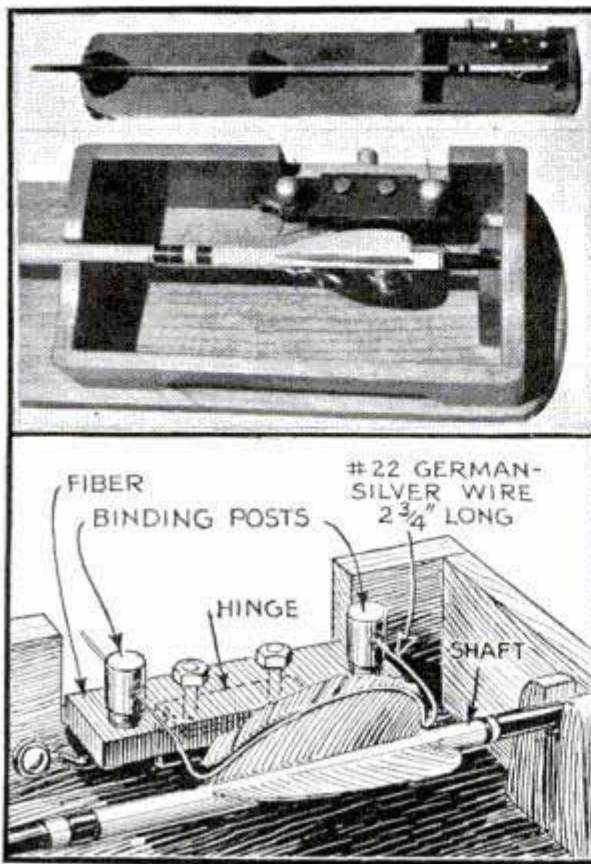

An important point in producing good arrows is accurate trimming of the feathers, which is often neglected because lack of experience or proper tools makes the job difficult. The electric trimmer shown above enables anyone to do the job in a professional manner. The trimmer consists of a hardwood base carrying notched supports in which the arrow is laid so that the feathered end can be rotated against a hot resistance wire shaped to the correct contour. The base is 5 by 24 in., and the inside dimensions of the boxlike end are 3½ by 7 by 2 in. This allows the full, uncut feathers room to turn and fall, and also allows cresting the entire painted part of the arrow without fear of smearing. The notches in the box ends and in the support pieces are ⅜ in. deep with the back sides cut straight. This permits one side of the arrow, regardless of its diameter, to be a constant distance from the trimming wire. At the back of the box, a ¾ by 3-in. section is cut out and a piece of fiber the same size is substituted. This is hinged at the bottom so that it may be dropped to a horizontal position or left straight up out of the way when not in use. Binding posts

in this piece hold the resistance wire and are connected to posts at the rear of the box. Clearance between the shaft and the closest points of the wire should be about ⅓ in. Operating temperature of the wire must not be too hot or too cold. Using a 6-volt transformer, a No. 22 German silver wire between 2½ and 3 in. long will give excellent results. The wire must be almost white hot, otherwise the feathers will merely melt and gum the wire.

## Fishing Rod Carried in Boat on Rubber-Hose Supports

Slit along one side and nailed or screwed to the inside of a boat, two short pieces of garden hose provide safe supports for carrying a fishing rod. These are better than metal hooks or wood pegs, which might cause accidental injury to the occupants.

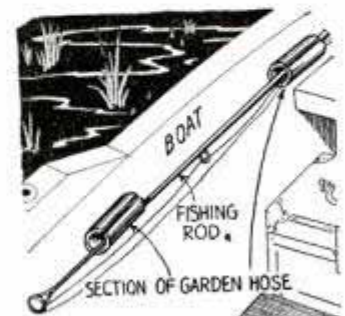

### Finger Loop on Stepladder Hinge to Avoid Pinching Hand



Loop on hinge of stepladder to insert finger for opening without danger of pinching the hand

When putting new hinges on his stepladder, a carpenter made them from pieces of flat iron and formed a loop on one leg of each hinge to take his finger. This enabled him to open the ladder with little risk of pinching his hands.

### Quick Setup for Turning Metal in a Drill Press

In an emergency, light metal turning can be done in a drill press with the setup shown. Two vises are used, one being bolted to the table and the other one clamped upside down in its jaws at right angles as indicated. Then, with the tool

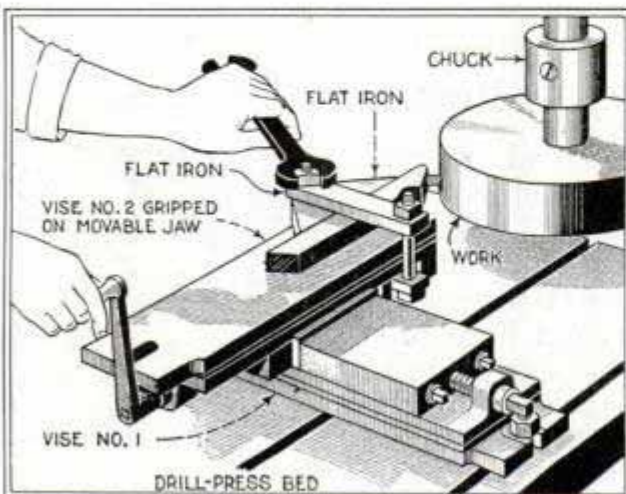

Emergency turning jobs done in drill press by using two vises when no lathe is at hand

holder clamped to the bottom of vise No. 2, it is used as a movable cross head when the work is held in the drill-press chuck and rotated.

### Funnel on Glue-Brush Handle to Keep It Clean

To keep the handle of a glue brush clean so that it would not stick to his fingers, a shipping clerk cut off part of the neck of a small funnel and tacked the latter to the handle as indicated.



Also, the funnel serves as stopper for the glue can when the brush is not in use.

### Economical Coops for Chicks from Old Oil Drums



An old oil drum will provide two economical coops for small chicks when it is cut in half lengthwise. The coops are weather and vermin proof and will last indefinitely if painted. A door is cut in one end, and a number of 1/2-in. holes are drilled in the end near the rim to assure ample ventilation.

cut in one end, and a number of 1/2-in. holes are drilled in the end near the rim to assure ample ventilation.

### Counting Threads in Tapped Hole

Carefully whittled to the correct diameter, a stick will serve to determine the number of threads in a tapped hole. The small end is simply screwed into the hole. This cuts threads in the wood that can be counted easily when the stick is removed.

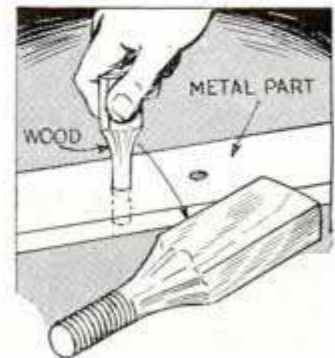

—A. H. Vance, Harshaw, Wis.

# Spanish Flat-Tile Roof Imitated with Cement

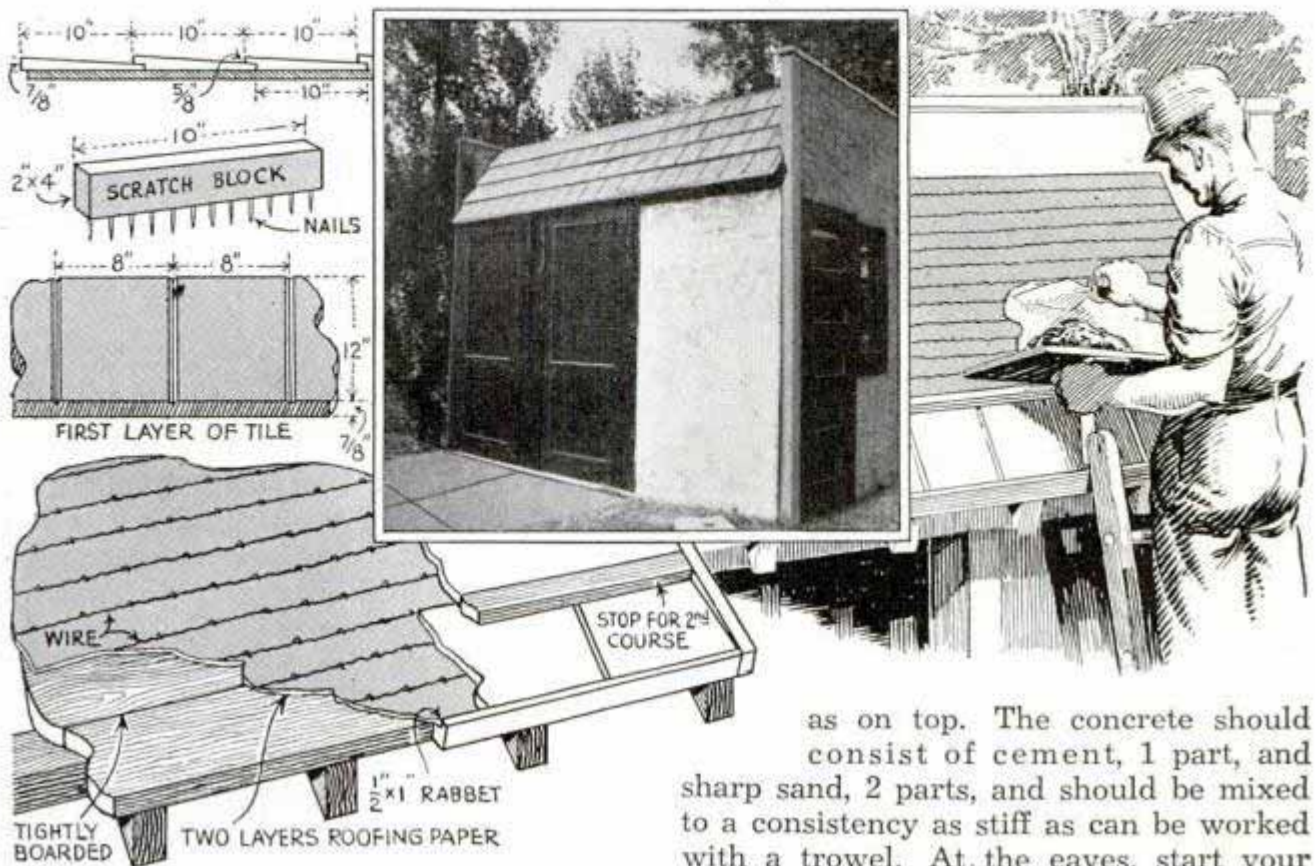

You'll be surprised how easy it is to imitate Spanish flat tile with cement on a short roof such as the garage shown in the photo. Of course, the job can be done on larger roofs, but they must be rigidly reinforced to support the weight, as any tendency to sag will crack the concrete. The roof to be tiled must be boarded tightly and covered with a double layer of heavy tar paper. On this, staple pieces of No. 9 iron wire about 3 in. apart and kink it so that cement can get under it as well

as on top. The concrete should consist of cement, 1 part, and sharp sand, 2 parts, and should be mixed to a consistency as stiff as can be worked with a trowel. At the eaves, start your first slab, making it 12 in. wide and 1 in. thick at the lower edge, tapered to  $\frac{1}{2}$  in. at the top. After the concrete has set about 45 min., score the surface at 8-in. intervals to simulate the tile, sinking the score lines a distance equal to about one third the thickness of the concrete. Then, using a scratch block like the one shown, scratch the surface about  $\frac{1}{4}$  in. deep. Now nail a 1 by 4-in. wood strip 10 in. above the lower edge of the first slab and start the next one.

—A. Campbell, Clarendon Hills, Ill.

## Eccentric Tool-Post Ring Reduces Leverage When Boring

This eccentric tool-post ring tends to reduce chatter when boring or threading internally in a lathe by giving support close to the work, thus reducing the leverage on the tool. By turning the ring, it can be adjusted to support the yoke of the boring tool holder. The result is less strain on the parts, and ability to take heavy cuts. Thickness of the ring should be a little less than the outside edge of the usual ring. The wedge is laid on top of the tool to give the set screw a bearing.

—R. F. Starzl, Lemars, Ia.



## Wrapping Paper Cut in Sheets for Duplicate Packages

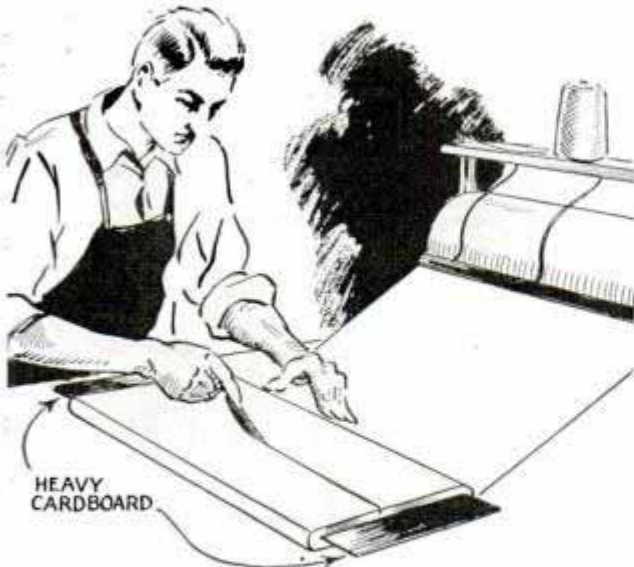

*This method of cutting wrapping paper into sheets will save time during rush hours*

When a number of packages of similar sizes are to be wrapped, much time can be saved if the paper is first cut into sheets as indicated. It is unrolled on a piece of cardboard equal in width to about half the desired length of the sheets, after which a sharp knife or razor blade is used to cut the paper along one side.

## Pivoted Saddle Holds Milk Cans While Soldering Them

As most of my work is repairing large milk cans, which are difficult to hold at the correct angle, especially when soldering the inside bottom seam, I rigged up this saddle to hold them. It enables me to turn the cans or raise them up or down at

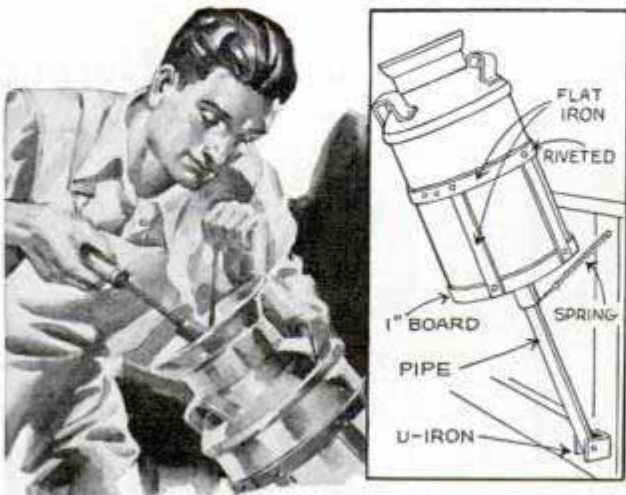

*Milk cans held in this saddle can be turned or raised and lowered to any desired height*

will, and consists of a circular basket, which is fastened to an arm pivoted to a wall. The basket is made of flat iron and the bottom is a wood disk. This is drilled in the center to take a pipe arm, which is attached with a lock nut on each side of the wood. The arm is pivoted to the wall by means of a U-iron as indicated, a strong spring being fastened to the arm and wall to hold the saddle at any desired height.

—Leo Abler, Mt. Calvary, Wis.

## Metal Gauges on Ruler to Draw Equally Spaced Lines

Fastened to a ruler with thumbtacks, two pieces of thin sheet metal, cut to the shape shown, will enable one to draw, rapidly, parallel lines that are equally spaced.

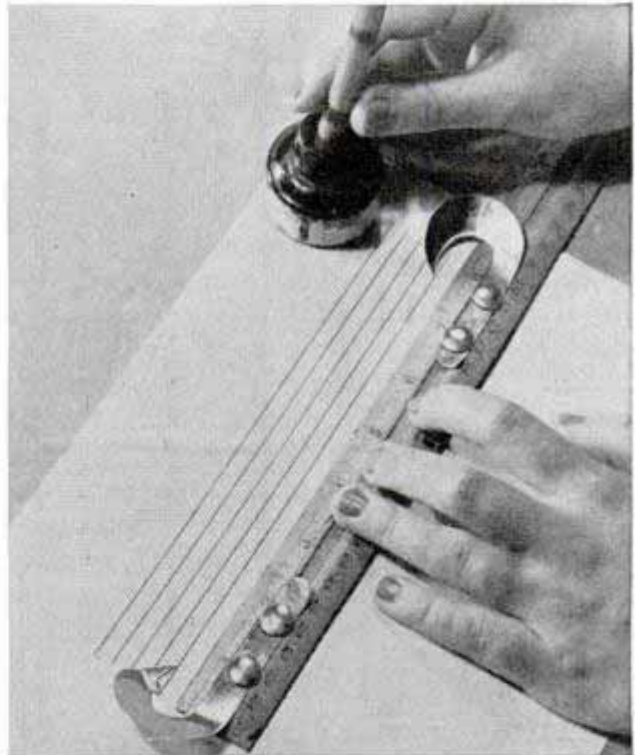

*Parallel lines are equally spaced and have a uniform margin at the left when using these gauges*

The points of the gauges are always put on the edge of the last line drawn so that the ruler will be in position for the next one. Notice that the gauge on the left end of the ruler has two points, one in line with the extreme end of the ruler so that the user can start ruling directly below the preceding ones, and thus leave a uniform margin. The other point is set on the line. Of course, one point can serve both purposes.—John G. Roberts, Chicago.

# METALS IN COLOR

## Chemical Coloring of Iron, Copper, Aluminum and Alloys

By C. A. CROWLEY

**M**ETALS are enhanced in beauty, rendered less susceptible to atmospheric corrosion and made more serviceable by applying suitable coloring methods, which can be cheaply and easily carried out by anyone.

**Cleaning Before Coloring:** In order to secure a durable, adherent finish on metal, the surface to be colored must be scrupulously clean. All grease, dirt, rust and corrosion must be removed. If the article is iron, steel, brass, or copper, first scrub the

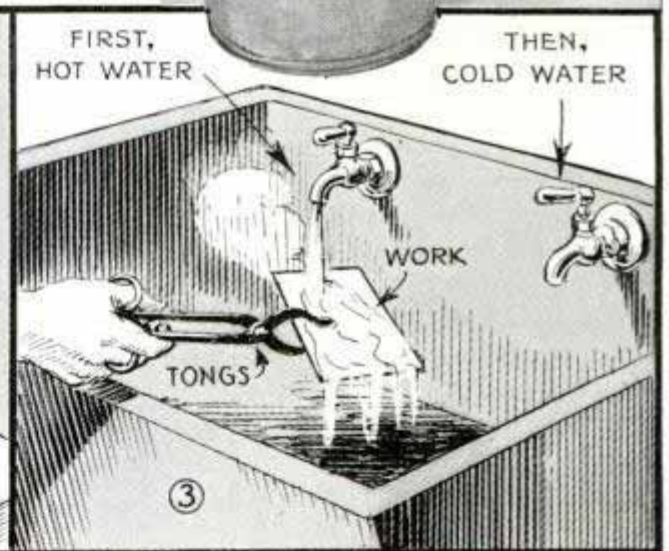
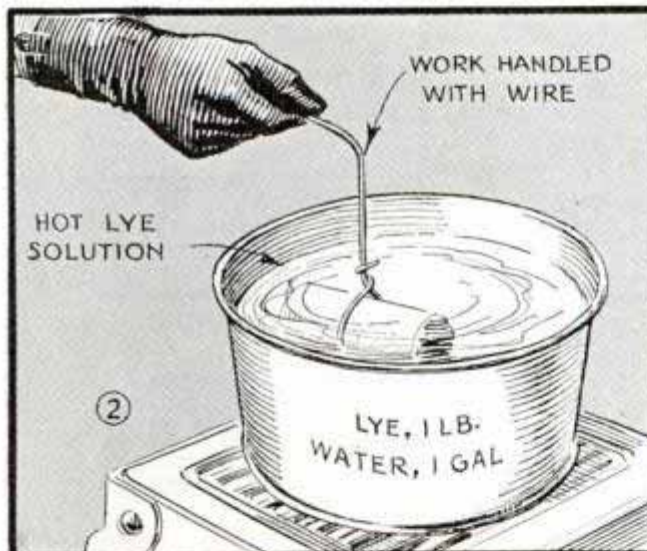
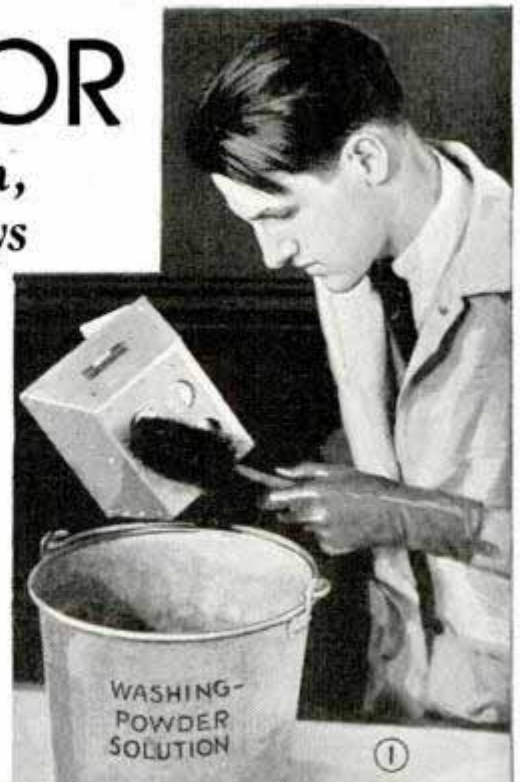

surface with a hot solution of a good washing powder, as shown in Fig. 1. Next dip the article into a hot solution consisting of lye, 1 lb., in water, 1 gal., as in Fig. 2, to remove all traces of grease. After each washing, rinse the article thoroughly first in hot water (preferably running) as in Fig. 3, and then in cold water. The article must not be touched again with the hands. Handle the work with wires or clean tongs and wear rubber gloves.

**Pickling Iron and Steel:** Following the cleaning, iron and steel must be pickled to remove rust and scale. The pickling solution is made by adding sulphuric acid, 1 part by volume, to water, 10 parts by volume. Slowly add the acid to the water in a stone crock as in Fig. 4. Then the work is dipped into the solution, perhaps several times, rinsing and scouring between dips and letting the article

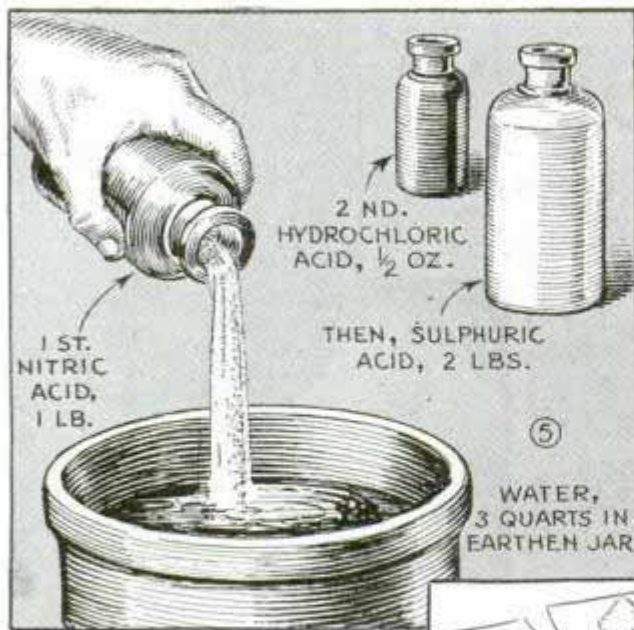

remain in the solution for a few minutes each time. When all corrosion has disappeared and the surface is clean and bright, the article is removed from the pickling bath and rinsed in hot and then in cold water. It should not be handled with the hands or left exposed to the air.

**Bright Dipping:** Copper and brass may not require treatment other than the washing powder and lye cleaning to remove grease. If corrosion is present, it, however, must be removed with a bright dip. This is made by adding nitric acid, 1 lb., and hydrochloric acid, 1/2 oz., to water, 3 qts., and then adding sulphuric acid, 2 lbs., Fig. 5. The mixing should be done in a stone jar. The article is dipped into the cool solution, quickly removed, and thoroughly rinsed in hot and then in cold water. It must not be allowed to remain in the solution.

**Cleaning Aluminum:** The methods already given for iron, steel, brass and copper are not applicable to aluminum and therefore must not be used on this metal or on aluminum alloys. To remove grease from aluminum and aluminum alloys, an alkaline cleaner can be made by dissolv-

ing sodium carbonate, 2 oz., trisodium phosphate, 2 oz., and sodium chromate, 1/2 oz., in water, 1 gal., as shown in Fig. 6. This solution is heated to 180° F. in a stoneware vessel as shown in Fig. 7 and the work immersed for 3 or 4 min. Next, an acid rinse is used to remove all traces of the alkaline bath and to dissolve the oxide film which is always present on aluminum. To prepare this, add 50 per cent hydrofluoric acid, 1 part by volume, to water, 9 parts by volume, in a lead-lined container, as shown in Fig. 8. Do not use glass or stoneware. This acid must be handled with great care as it produces

severe burns on the skin which heal slowly. Dip the aluminum article in this solution from 1/2 to 1 min., then rinse thoroughly in cold water and suspend under water until ready to color it.

**Coloring Copper and Brass:** Black can be produced on either copper or brass with a solution made from ammonium molybdate, 1/2 oz., and sodium hyposulphite ("hypo"), 1/2 oz., dissolved in water, 1 qt., as in Fig.

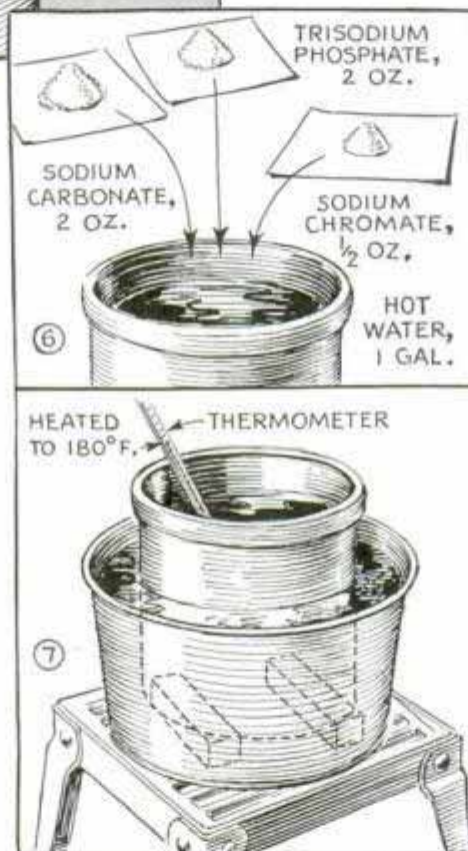

10. The solution is heated almost to boiling, and the clean metal article immersed. It should be left in the dip for from 15 min. to half an hour. Following the coloring bath, the object is rinsed thoroughly and allowed to dry.

Various shades of brown are produced on copper and brass with the following solutions. The color produced depends on the time the article is left in the solution, and also is different for copper and brass. Dissolve potassium permanganate, 1 oz., and copper sulphate, 8 oz., in water, 1 gal. Warm the solution to 100 or 110° F. and introduce the object, for 20 min. to a half hour. This solution colors brass a darker brown than it does copper and so for corresponding shades the immersion time for brass will be shorter. A similar solution is made from potassium chlorate, 2 oz., copper sulphate, 4 oz., and water, 1 qt. Warm the solution a little and let the objects remain in it for 5 or 10 min. Copper will be colored a reddish brown; brass, a drab brown.

**Bluing Process:** Rich, deep blues can be produced on copper and brass by a method which also can be applied to iron or steel. Make up a solution of sodium hy-

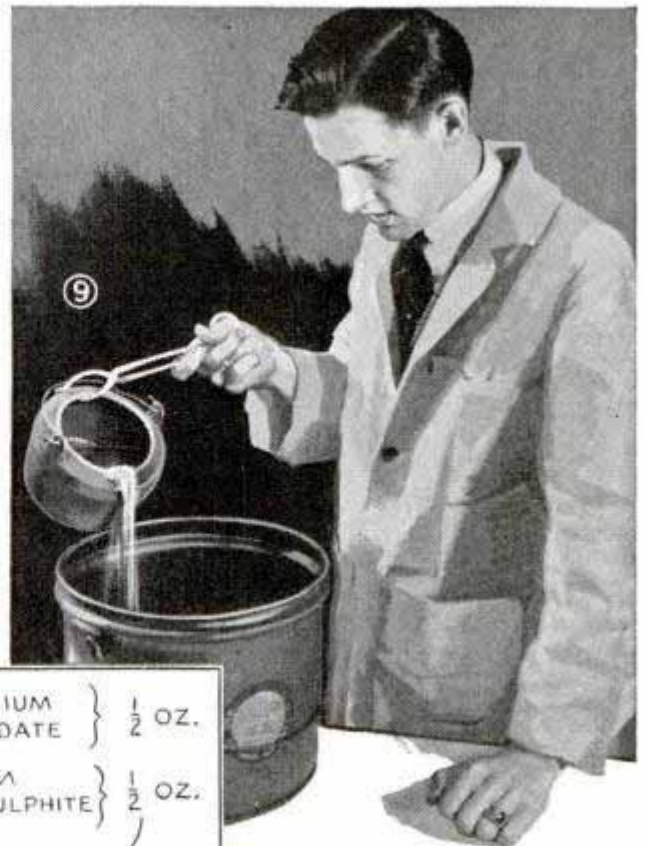

AMMONIUM MOLYBDATE	} 1/2 OZ.
SODIUM HYPOSULPHITE	
WATER	} 1/2 OZ.
1 QUART	

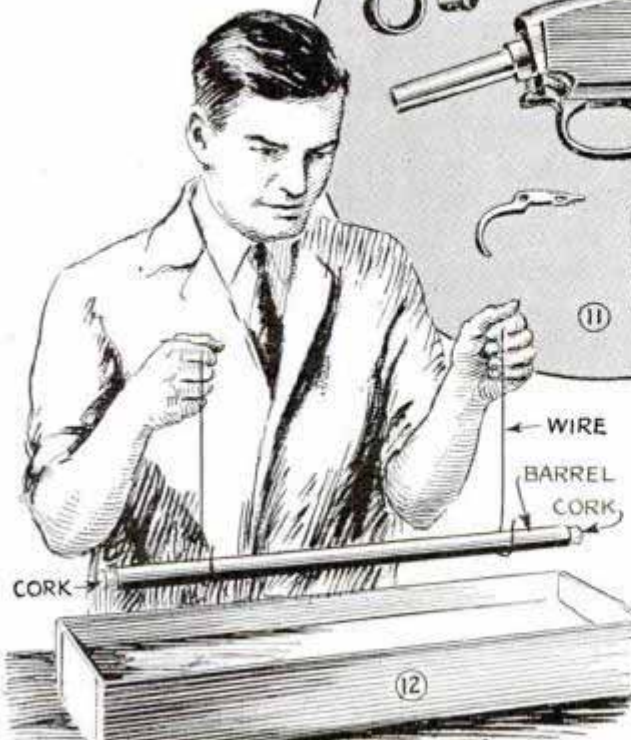
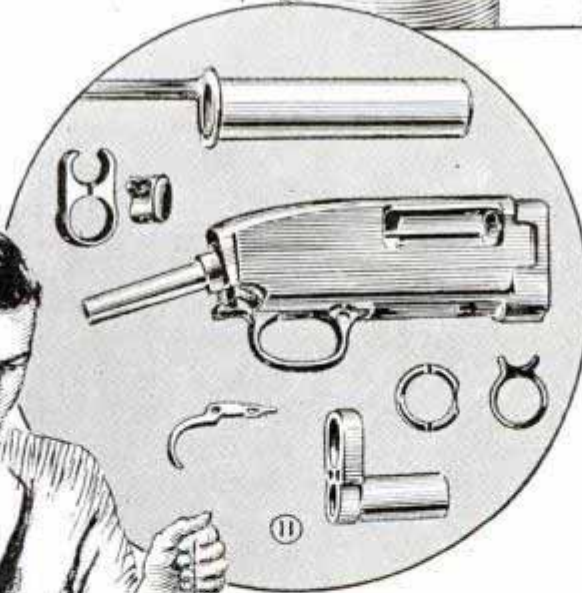

posulphite ("hypo"), 4½ oz., lead acetate, 1½ oz., in water, 1 qt. Heat the solution to 180 or 190° F., and dip the thoroughly cleaned metal article in the solution, as in Fig. 12. The intensity of the color depends upon the duration of the dipping. Copper and brass will be colored a dark, rich blue in from 2 to 5 min. A steel-blue will develop on iron or steel in about 5 min. The objects may be removed periodically to see if the color is satisfactory. Steel objects such as gun parts, Fig. 11, are blued in this way. However, before dipping gun parts,

it is advisable to practice on scrap pieces of polished steel until thoroughly familiar with the action of the chemical.

**Red Color on Copper:** Copper is colored red by immersion for 5 to 10 min. in molten sodium nitrite. The salt may be melted in a clean iron kettle or pot. Be sure that it is not soldered. As the molten salt is very hot, it is imperative that the metal object to be colored be thoroughly dry

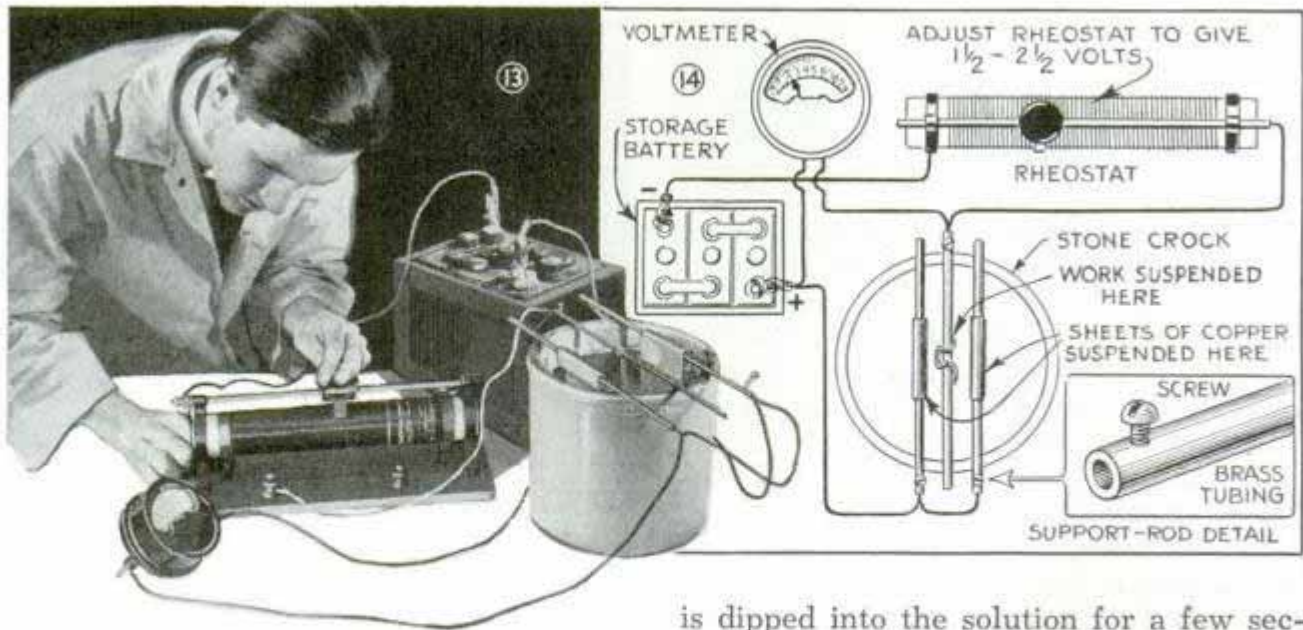

before it is dipped in the hot melt, or the hot salt may spatter and burn the operator. The ideal procedure for this and other molten salt processes is to remove the object from the alkaline rinse or bright dip, thoroughly rinse in water, shake to remove most of the water, and dry for a few minutes in an oven at 225° F. When dry, it is dipped into the molten salt, until the desired color is attained. The article is then allowed to cool, after which it is rinsed with water to remove adhering salt.

**Violet on Copper:** If 1 per cent of potassium permanganate is added to the sodium-nitrite bath, the copper will be colored a beautiful violet instead of red. The sodium nitrite and potassium permanganate are mixed before melting. The violet color will appear on the article within 5 min. and deepen slowly with longer immersion. If the salt is to be used again, let the kettle and its contents cool. It can be put away until the next time it is needed. If it will not be used again, it is advisable to pour the molten salt into a pail containing dry sand as in Fig. 9, in order to dispose of it safely.

**Gray on Copper:** Copper or brass can be colored gray by plating with metallic arsenic. To prepare the plating solution, dissolve ferrous sulphate, 3½ oz., and arsenic trioxide ("white arsenic"), 3¼ oz., in concentrated hydrochloric acid, 2 lb., in a stoneware jar. This solution is very caustic, and arsenic trioxide is a deadly poison and therefore this solution must be handled with great care. The clean article

is dipped into the solution for a few seconds only. It is then removed and rinsed. If the desired gray has not been obtained, dip the article again for a few seconds. As this solution works very rapidly, it is not advisable to leave the metal in it for more than a few seconds.

**Green on Brass or Copper:** There are a number of methods for producing green surfaces on brass and copper. A "patina" which closely imitates the natural green finish produced on copper by long weathering, may be obtained with a solution consisting of a saturated solution of copper nitrate, 1 fl. oz., ammonium chloride, ½ oz., and 10 oz. of 20 per cent acetic acid. To make 20 per cent acetic acid, add to glacial acetic acid, 1 lb. 11 oz., enough water to make the total volume of one gal. This solution should be brushed on the surface with a rubber-set brush, and allowed to dry. Several coats should be applied at intervals of two or three days until the desired shade of green is obtained.

**Hardware Green Finish:** The hardware green finish popularly used on brass can be obtained by dissolving sodium hypsulphite, 8 oz., and ferric nitrate, 2 oz., in hot water, 1 gal. The solution is heated to 180° F. and the brass object immersed until the green color appears.

An antique verde finish on either copper or brass is prepared by brushing on the surface a solution made up of copper nitrate, 4 oz., ammonium chloride, 4 oz., and calcium chloride, 4 oz., dissolved in water, 1 gal. The solution can be brushed on the surface, using a rubber-set brush or a sponge, and stippled. Or, the article may



be dipped in the solution for a few minutes. The article should be rinsed thoroughly, allowed to dry, and then lacquered to protect the finish.

**Coloring Iron and Steel:** There are comparatively few colors that can be produced on iron, steel, or aluminum direct; however, all the colors that can be applied to copper can be made applicable to these and other metals if they are first plated with copper. The article can be electroplated with copper in the usual manner, or if preferred, a thin copper plate can be produced by dipping. To produce a dip plate of copper on iron or steel, dissolve copper sulphate, 2 oz., in water, 1 pt. In another container dissolve tartaric acid, 1 oz., and sodium hydroxide, 1 oz., in water, 1 pt. The two solutions are not to be mixed until you are ready to use them, as the mixed solution will not keep. Thoroughly clean the article and rinse it. Mix equal parts of the two solutions in a stoneware or glass container, and dip the article in the mixed solution. Let it remain for a few minutes, after which the article is rinsed in hot and then cold water, and allowed to dry. The copper surface may be colored by any of the methods previously described.

**Electroplating with Copper Before Coloring:** In cases where it is desirable to produce an exceptionally adherent coating of color on iron, steel, aluminum, or other metals, the work should be copperplated with a solution consisting of water, 1 gal., to which is added copper sulphate, 2 oz., then sodium oxalate, 1 oz.  $2\frac{3}{4}$  drams, and finally triethanolamine, 3 fl. oz. The solution is mixed in a stoneware crock. Figs. 13 and 14 show the connections to be made between the battery rheostat and instruments for plating with this solution. After the plate has been effected to a thickness sufficient for the purpose at hand, the coloring of the metal may be carried out in precisely the same manner as was explained for copper or brass.

☞ An old umbrella with the cover removed and the ribs enameled provides a handy drying rack for small articles.

## Linoleum on Roller Is Displayed Before Store Customer

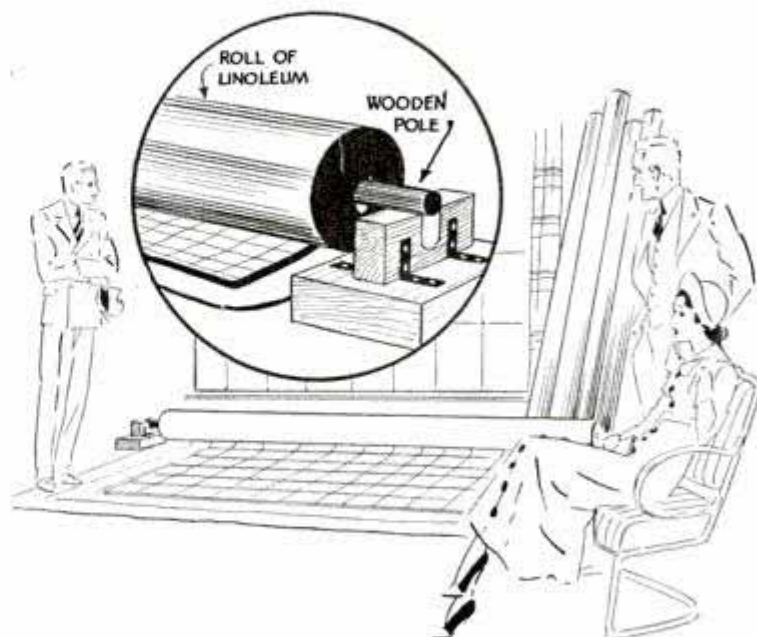

*Unrolling many square feet of linoleum gives customer better idea of how it will appear in the home*

Finding that a number of his customers were unable to decide on the pattern of linoleum they wanted by looking at a small portion of it in a roll, one storekeeper mounted the rolls so that they could be pulled out on the floor. This gave the customer a better idea of what the particular patterns would look like when placed on their floors. Strong wood blocks, assembled as shown in the detail, were placed under the ends of the center pole of each roll of linoleum

## Doorstop from Piece of Tubing and a Screw Eye

Here's a combination doorstop and bumper that you can assemble for your shop door in a jiffy. Just take a piece of old radiator hose, cut off one end at an angle and nail it to the wall so that the beveled edge will engage the head of a large screw eye driven into the door. Locate the tubing so that the screw eye compresses the rubber as it slips over the edge.

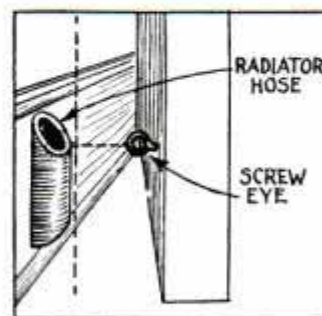

## Optician's Tools Neatly Arranged on Oval-Shaped Rack



*This rack keeps your tools in plain view so that you can pick out the one needed at a glance*

Especially designed for use on an optical workbench, this rack is also handy for the jeweler or other craftsman who uses small tools. It holds pliers and similar tools, files, taps, screwdrivers, etc., so that any one can be picked out quickly. The rack is a piece of wood carved and sanded to the shape shown, and glued or screwed to a base.

—F. J. Pardinias, Vedado, Havana, Cuba.

## Sander for the Modelmaker

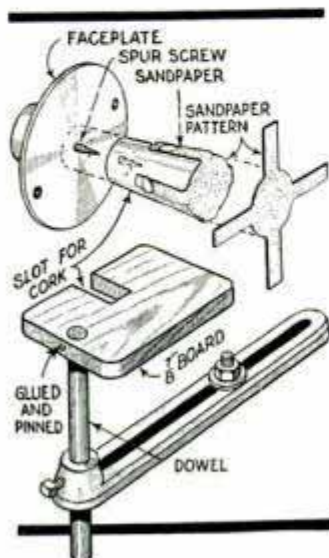

Modelmakers will find this power sander a time-saver as it is attached to the spur screw of a lathe. It consists of a cork with sandpaper attached as indicated, and any number of different sizes and grits can be made at little cost. A sander of the drum type can be made by

gluing the sandpaper to the sides of the cork. The sanding table shown in the lower detail is nothing more than a wood block fastened to a dowel, which is locked in the tool holder of the lathe.

—Charles Frerichs, Brooklyn, N. Y.

## Toolbox Lid Folds to Provide Carrying Handle

This toolbox has a novel feature in that the lid is in two sections, which fold when opened to provide a carrying handle. The two sections are hinged individually to a center partition as indicated.

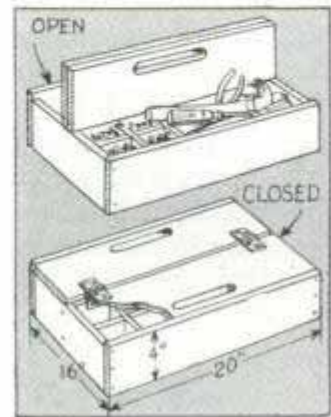

## Adjustable Arbor Catcher

A feature of this arbor-catching device is that the catcher travels up and down with the ram. It is impossible for the arbor to fall and perhaps injure the center or the user's foot. The catcher is made in two parts, the strap that fits the ram and the catch that slides in it. This is adjustable to suit different arbors, and a single screw tightens both the catch and the strap on the ram.

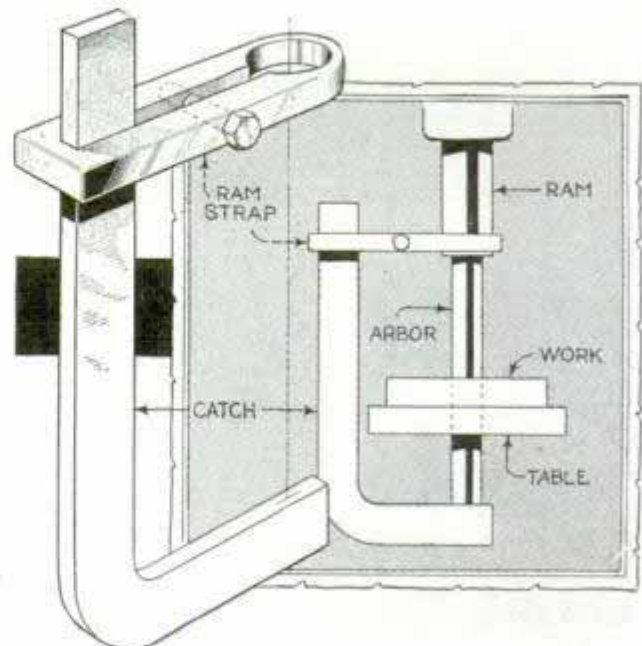

*Use this catcher on your arbor press and there will be little possibility of damaging the arbor*

## Circles Quickly Divided into Number of Parts

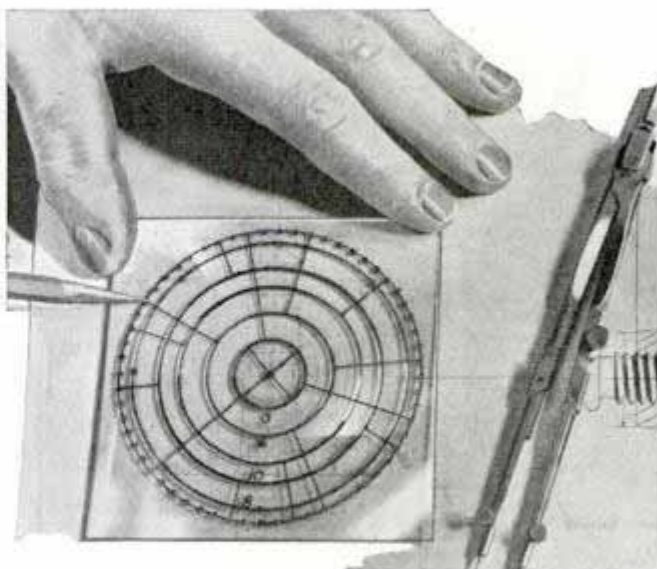
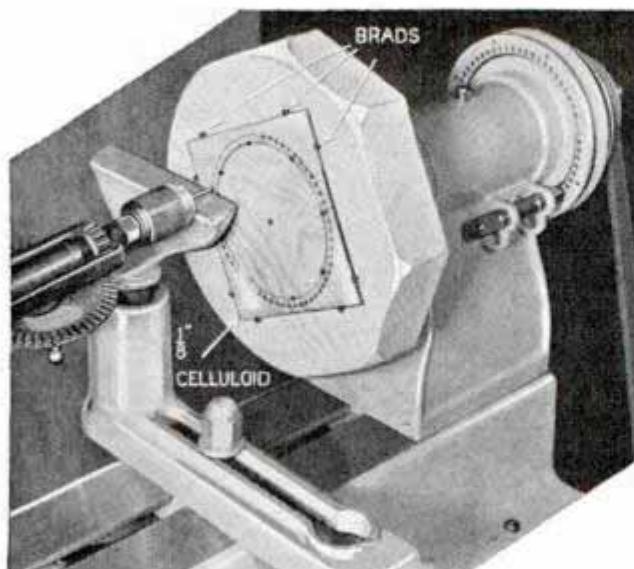

*Draftsmen and others who often have to divide circles into a number of parts will find they can do the work quickly with this simple jig. It is made from a piece of celluloid 4 in. square which is fastened to a wood faceplate on a lathe and holes drilled through it, using the index head as shown. My divider has sixty holes in one circle and eight in the other. In use, the center of the jig is placed over the center of the circle and the desired divisions are marked. Lines drawn through these points and the center will give the divisions for any size circle. Circles may be scribed on the face of this jig with lines marked to the divisions most used.—Howard R. Heydorf, Missoula, Mont.*

## Extra Current to Start Engines Having Flywheel Magnetos

When you experience difficulty starting a small gasoline engine in which the magneto is contained in the flywheel, the trouble is probably caused by weakened magneto magnets, and usually can be eliminated by connecting a battery into the circuit to provide additional current for starting. Referring to the upper sketch, you'll notice that the breaker cam closes the con-

tacts when the arm point drops into the cam slot. The spark is obtained when the cam lifts the arm and breaks the contacts. The primary of the magneto is connected in series with the breaker contacts and grounded at one end together with one wire of the secondary side. As the flywheel rotates carrying the permanent magnets around with it, the contacts are broken, which produces a spark. To hook up the battery, the engine is dismantled so that the wiring to the magneto is visible. The wire from the primary leading to the breaker contacts is broken at the point marked X on the lower sketch and is connected to the center terminals of a double-pole, double-throw switch. The top terminals of the switch are connected together with a copper wire, and a storage battery or four No. 6 dry cells are connected to the lower terminals. To start the engine, the switch is thrown to the battery side, connecting the latter in series with the primary of the magneto, which produces greater voltage and enables quick starting. After the engine has warmed up, the switch is thrown to the magneto side.

—Edward Stanko, Medina, N. Y.

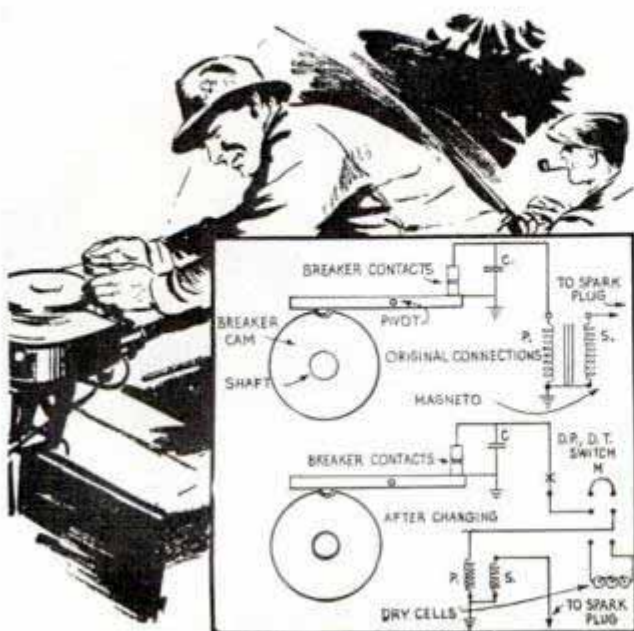

## This Drill Gauge Shows the Size at a Glance

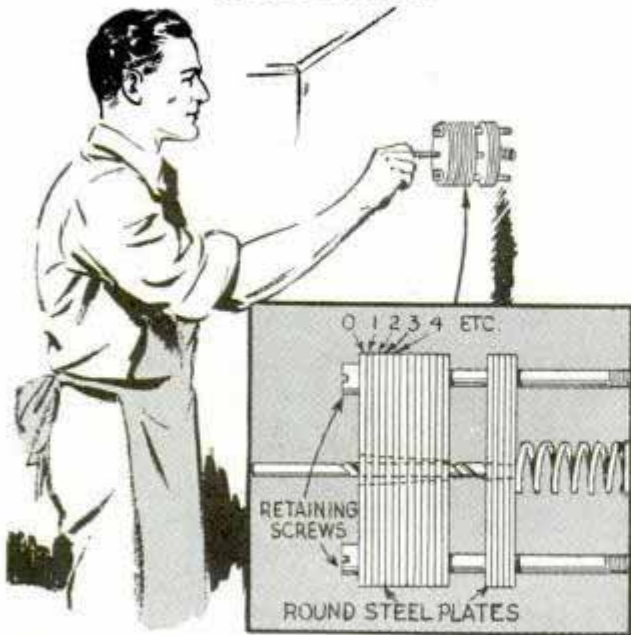

*There is no chance of misreading sizes with this drill gauge because one figure is all you can see at a time*

You can't make a mistake in drill sizes with this gauge because the drill is pushed into it and the correct size number is the only one you can see. The gauge consists of a number of steel disks or plates drilled near the edge to slip over two retaining screws, which are set into a bench or wall over a coil spring also set into the wall, the spring keeping the disks pressed against the screw heads. Before assembling, each disk is drilled in the center with the size of drill it is to indicate, using your largest drill on the first or front disk, the next size on the second disk and so on down to your smallest drill. Thus, a drill will pass through all the disks until it reaches one which has a hole one size smaller than the drill, when it will push the remaining disks toward the wall. Stamp the size of each drill on the disk it pushes back.—Edwin Rose, Chicago.

## Long Tool Is Supported Rigidly When Turning Large Work

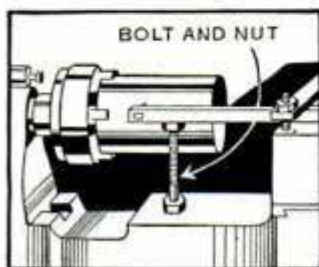

When turning work that is too large to allow the carriage to be moved close enough to use a regular tool holder, and a long ex-

tension bar must be used, the bar can be supported as indicated. A bolt with a nut is set vertically on the carriage or bed under the bar. This tends to make the bar rigid and eliminate chatter.

## Harness Chain Traces Can't Drop from These Singletree Hooks

Difficulty in keeping harness chain traces from dropping out of the average singletree hooks is eliminated with the one shown. It is bent to shape from iron or steel rod, the eye end of the hook being welded to keep it from spreading under a heavy load.



—George Lynch, Jr., Crystal Spring, Pa.

## Long Spout on Tube of Cement for Hard-to-Reach Places

When I get a tube of household cement, I cut off the spout from a 5-cent oilcan and solder it over the end of the tube as indicated. This enables me to apply cement in hard-to-reach places. When the cement is not in use, a brad or tack inserted in the end of the spout keeps out air. After the contents of the tube have been used, the spout can be removed, by heating, and soldered to a new tube.

—Kenneth Murray, Sturgis, Mich.



*Long spout soldered to tube of cement to get at hard-to-reach places around the home*

*Johnston Tinfol and Metal Co  
400 W. Madison, Chicago  
Reynolds Metal Co  
400 N. Michigan  
Chicago*

# PRINTING PICTURES

## *on aluminum foil*

By James G. Zimmerman

THIS simple process offers possibilities for novel personal treatment of holiday/greeting cards, besides making color prints of your favorite negatives on metal foil instead of on the ordinary printing papers. As you will see from Fig. 1, the finished prints appear much like hand-wrought etchings with the added variety of color.

The first step is a thorough cleaning of the foil. To secure a good surface for the sensitized coat to follow, the foil is laid flat upon the larger glass plate after being sure that there is no dirt between the foil and glass, Fig. 2. A good way to be sure of this is to hold the glass under running water while applying the foil. The water will wash away dirt and will allow the foil to rest on the glass with a wet surface between. Drain and then lay flat. Polish the foil vigorously with a tuft of cotton and whiting by holding the foil with the edge and rubbing away from the fingers holding it down, Fig. 3. Repeat in all directions holding at different edges. The foil will gradually take on a silvery finish of a matte nature. This is the grain that is wanted to act as a hold-down for the sensitized film. Give a good rinsing while rubbing lightly with a clean cotton tuft.

An arrangement for whirling the foil dry is shown in Figs. 4 and 5. It consists of two large spools and a piece of hollow brass curtain-rod tube with two  $\frac{3}{4}$ -in. wide No. 16 gauge brass strips. The rod is of  $\frac{3}{8}$ -in. diameter and fits the spool bore. One spool is loose to allow of turning the rod in it and the other is fastened to it either by screws or glue. The upper loose spool serves as a handle and the lower one is caused to turn by spinning it with the other hand. The two brass strips are made of sufficient length to take the plate used. For example, an old 5 by 7-in. glass plate is convenient. The strips are placed at

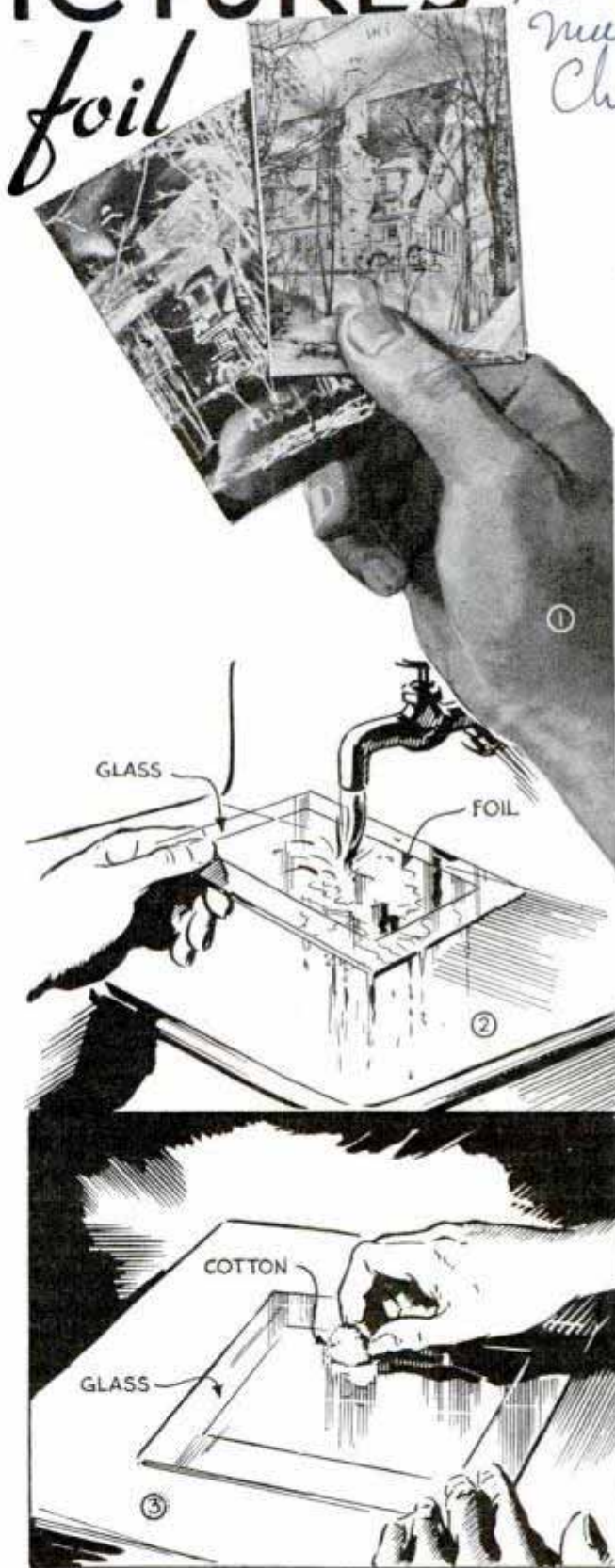

right angles and drilled with a  $\frac{3}{8}$ -in. hole at their corners. Then these strips are soldered to the tube and bent into a part circle or arc and the tips bent to take the glass with a small overlap. A washer is

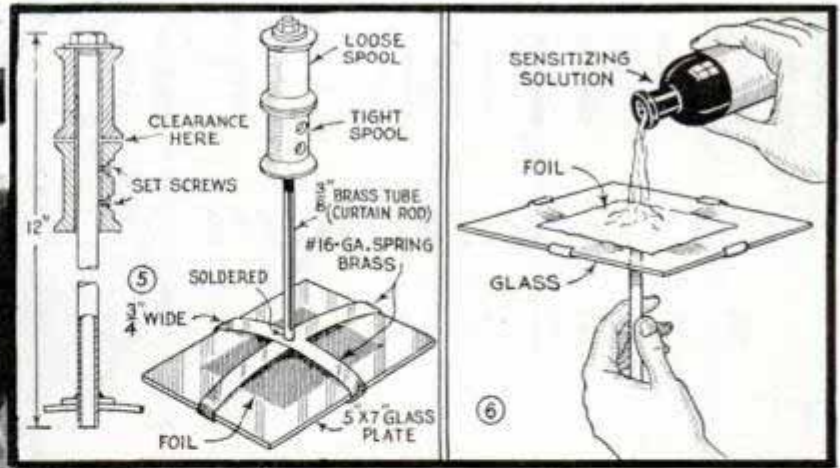

soldered above the top spool to act as a thrust bearing against the spool head where a flat metal washer is placed to make a bearing which may be lubricated. After applying the foil of aluminum on the glass plate by simply wetting the surfaces and draining sideways, the glass is sprung into the clips with the film faced outward or downward. When the spool is rotated, the plate whirls with it. Hold the upper spool in one hand and whirl with the other hand.

Next, you prepare the sensitizing solution. Beat the whites of two eggs to a very stiff froth in a bowl as in Fig. 10, and set aside for about four hours. The froth will give up a liquid which settles to the bottom of the bowl. Pour out this liquid without disturbing the froth, and mix it with the same quantity of clean water, preferably boiled and cooled. Add about 4 grams of ammonium dichromate (or potassium dichromate) and dissolve it. This will give a reddish yellow fluid. Now, very carefully, add ammonia, drop by drop (ordinary household ammonia will do), and watch the solution after each drop is thoroughly mixed in. It will gradually turn to a lemon yellow. Then it is ready for use. Filter the solution through a cotton wad in a funnel. Wet the wad and then use, otherwise it will not work well. The filtered solution is now ready to use on the plate in the whirler.

Hold the foil under the tap to wet it,

then whirl until all the free water is thrown off. Turn the whole thing upside down and hold it as in Fig. 6. Pour onto the foil a small quantity of the sensitizing fluid and tip it slowly in all directions to make the fluid flow to the edges of the foil and so cover it entirely with a thin coat. Continue the tipping for a few minutes, drain off at one corner, and then whirl to throw off any excess. Apply a second coat in the same manner as before. This time it will be noted that the fluid is more tacky than it was. Whirl at about 50 r.p.m. over a heater to dry the coat. Be very careful not to heat higher than can be stood by the hand. Try this before coating until the proper distance from the heater is found. When dry the foil is ready for printing. Remove with a penknife and clean the back of moisture.

Keep the foil dry and print in the usual printing frame under a vigorous negative. If you have no arc light, print in the sunlight, Fig. 7. It requires experience to know just when to stop printing but if the negative is very contrasty this is not so important. In full sunlight it will take about 5 min., and 1 ft. from a 10 amp. arc light it will take 2 to 10 min. A good way is to take a coated foil without any negative and print by steps, giving the print exposures of 2, 4, 6, 8 and 10 min. by holding a mask over the frame and advancing it a space at a time. Then proceed with the inking up and find which exposure is best for clear open spaces on a negative. An experiment with a negative will show the proper exposure. Label the negative with the proper exposure for future use.

To ink the print, place it, face up, on a dry piece of glass. Now, on another glass plate roll up a pea-sized drop of printers'

A. Langley & Co., 159 W. Kinzie, Chicago

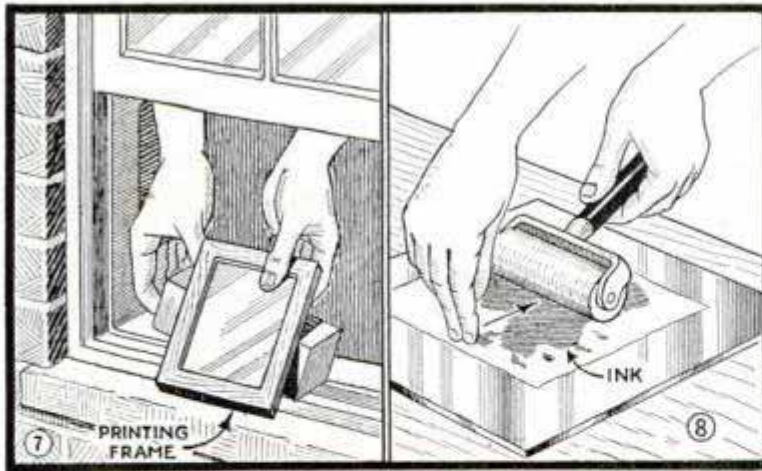

ink until the roller is evenly coated and the plate evenly spread. It is necessary that the ink be not too sticky or when rolling the print the foil will stick to the roller. It is best to start with a rather slippery ink and add a drop of kerosene or linseed oil. Now, holding the foil with the edge by a finger, roll away from the finger and repeat in the opposite direction, holding at the other edge, Fig. 8. After a number of rollings the ink will become darker.

Take the glass plate and foil together and immerse into a deep tray of water, Fig. 9. Do not touch the surface with the fingers at any time. Leave under water a few minutes. The picture will at once begin to show and after the proper time lift the plate out with the foil on it. Wet a tuft of cotton and while the print is under water or under the tap lightly rub the surface. The surplus ink will immediately rub off, leaving the print in full detail. Be careful not to rub too strongly, especially at first, in order not to destroy any detail. If the exposure was too long the ink will adhere more strongly and will require more vigorous rubbing.

If it is desired to add color to the ink this may be done by first whirling the foil to dry it. Then the plate and print are cleared of all water or dampness by letting stand on edge or going over it with a damp cotton, lightly touching any damp spots. When dry the ink is still tacky and will take on any powdered color which is simply sprinkled lightly over the surface and dusted with a camel's-hair brush.

As aluminum foil is rather shiny it's a good idea to plate the print with a thin coat of zinc. The plating solution, Fig. 11, is easily made and keeps well. To dissolve gum arabic, first pulverize it in a mortar

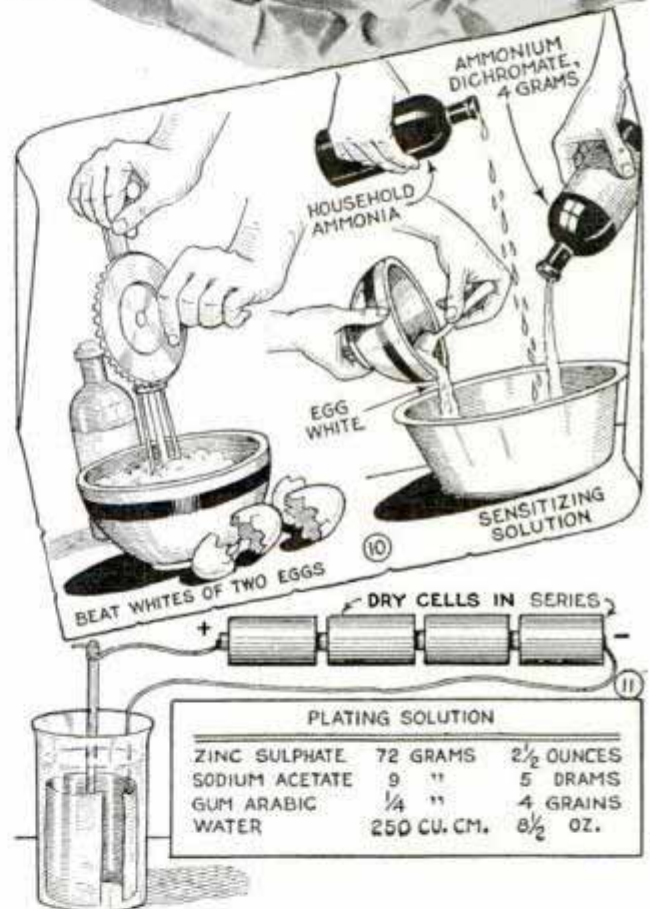
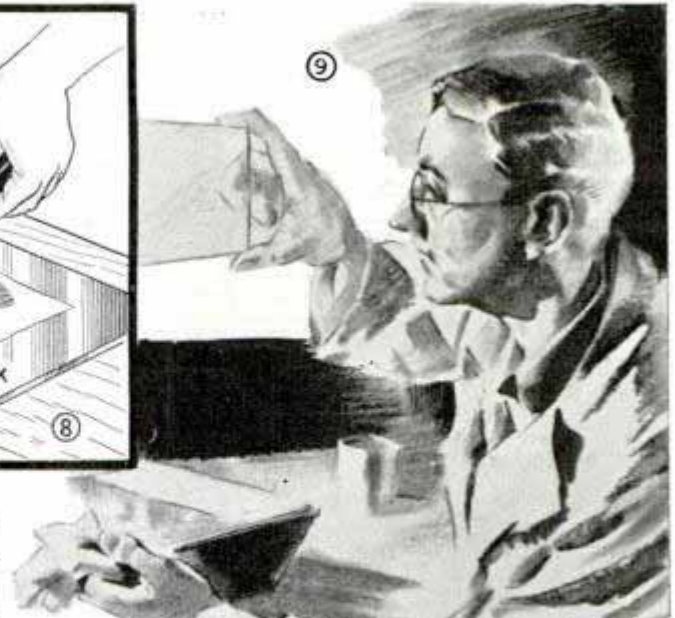

and work it into solution with a little water. To plate, proceed as in Fig. 11. Wrap the finished print around a bottle or other cylinder with the printed face turned inwards. Then pour in the solution up to the top edge of the foil and finally hold the zinc strip in the center. The zinc plates only where the foil is exposed.

As the foil is not rigid it must be mounted on a firm backing like a photo mount. The print must be fastened to the mount with glue, as paste is not satisfactory.

## False Bottom in Trailer Cabinet to Store Valuables



Compartment is opened by raising false bottom with wire inserted through tiny hole in real bottom

To provide a secret hiding place in his trailer for valuables, one owner hit on the idea of putting a false bottom in a wall cabinet as indicated. The false bottom was hinged at the back and was lifted with a small wire pushed through a tiny hole in the regular bottom. Care should be taken to finish the false bottom the same as the remainder of the cabinet, and the edges of the parts should be sanded to a close fit.

## Storage Batteries Dismantled with Aid of Heat Gun

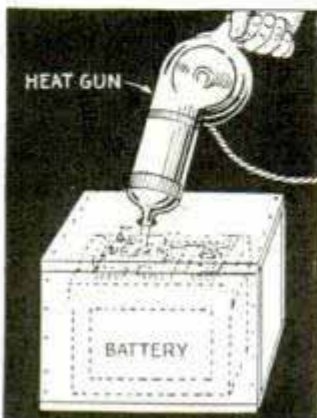

One use for a heat gun during summer months, when it is not needed for removing stiff grease from differentials and transmissions, is the softening of the compound on storage-battery tops in prepara-

tion for dismantling. This method requires less care than the flame method and is less likely to cause damage to the connectors or hard-rubber tops. In using the gun, the battery is placed in a closed box, similar to a steam box used by some shops for this purpose. The box has a hole in the center of the top for inserting the nozzle of the gun.—W. C. Wilhite, Carlinville, Ill.

## Emery Strop for Knives

Knives for cutting rubber or fabric, when repairing tires and tubes, can be kept sharp by frequent use of an emery strop fastened to the workbench within easy reach.

The strop consists simply of a strip of fine emery cloth about two inches wide.



## Alarm Warns Station Attendant When Car Drives In

Here's a simple alarm for a filling station that requires no elaborate mechanism, compressed air, hose or anti-freeze solution—just a length of rope stretched about an inch above the drive so that the car

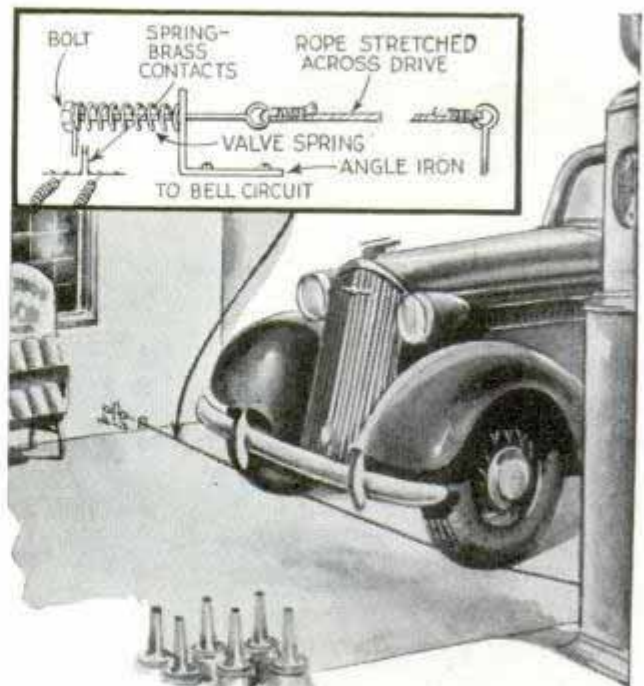

Car driving into filling station passes over rope, which closes circuit to electric bell



wheels pass over it. The rope is attached to a slender eye bolt, which passes through a metal bracket at one side of the drive or inside the station. A coil spring held on the bolt keeps the rope taut, while a small arm presses two spring contacts together when the rope is depressed.

### Gear Forms Funnel Strainer

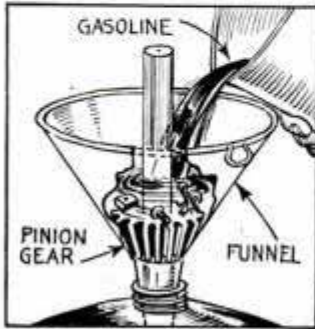

While looking for something to strain gasoline used in washing small parts in a garage, a mechanic picked up a differential pinion gear and set it in the funnel as shown. The gear restricted the passage of gas very little, yet caught nuts, screws, bolts, washers and other small parts.

### Cars Parked in Garage at Angle Driven Out Easily

Instead of parking cars at right angles to the walls of his garage, one owner parks them at an angle, leaving wide aisles between the rows as shown. Any car can be driven out as indicated by the arrows.

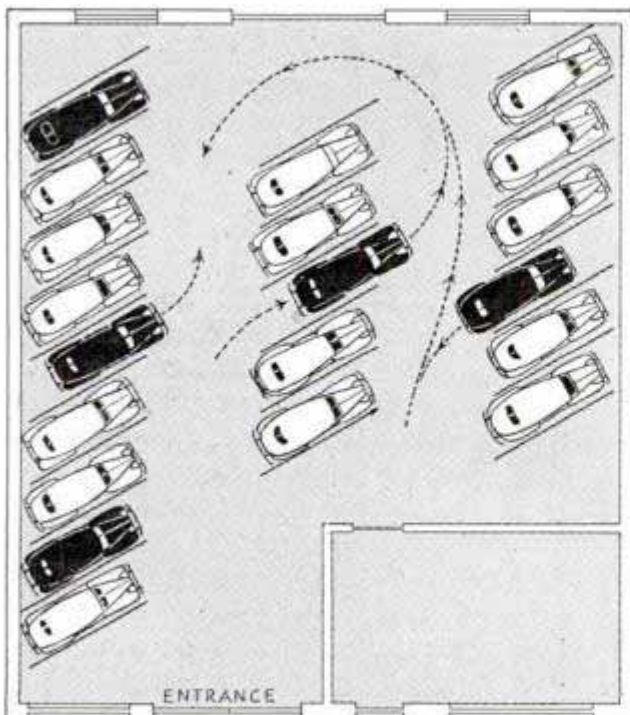

When cars are parked at an angle you can drive out without jockeying them into an aisle

### Three-Way Tool Removes Heads from Car Motors

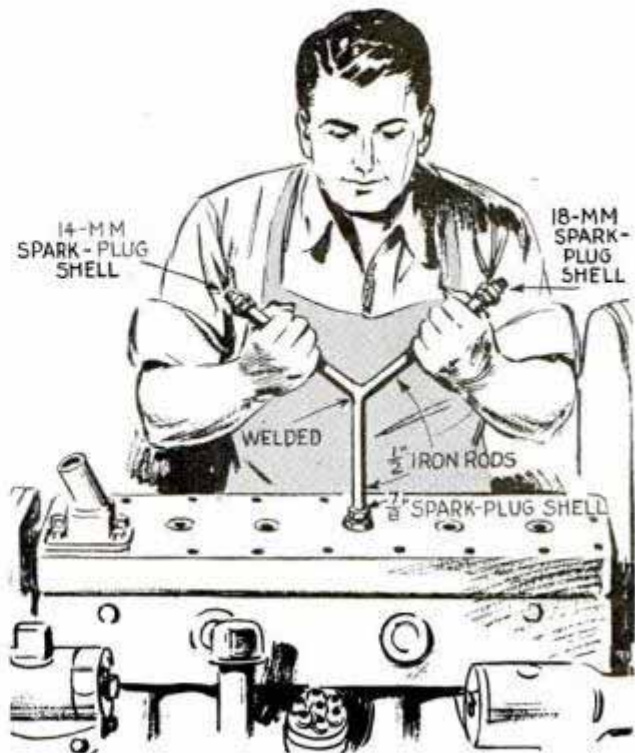

If you work on several different makes of cars, this head-lifting tool will be found handy

Improving on the old idea of welding a length of rod to a spark-plug shell to lift a heavy cylinder head, one mechanic who had to work on practically all makes of cars made this one, which has three shells of different sizes as indicated. When lifting a head, the two free ends of the tool provide good grips for the hands.

### Car-Door Lock Is Lubricated with Insect-Powder Blower

If the lock on your car door works hard, try lubricating it with finely powdered graphite. This can be blown into the lock mechanism with an ordinary insect-powder

blower of the type shown in the photo, directing the powder through the key slot.



Ⓚ A dry, light-colored soot on spark plugs is an indication that the fuel mixture is too lean, while a dry, black covering of soot means that the mixture is too rich.

### Windshield Wiper on Test Bench Operated by Vacuum Cleaner

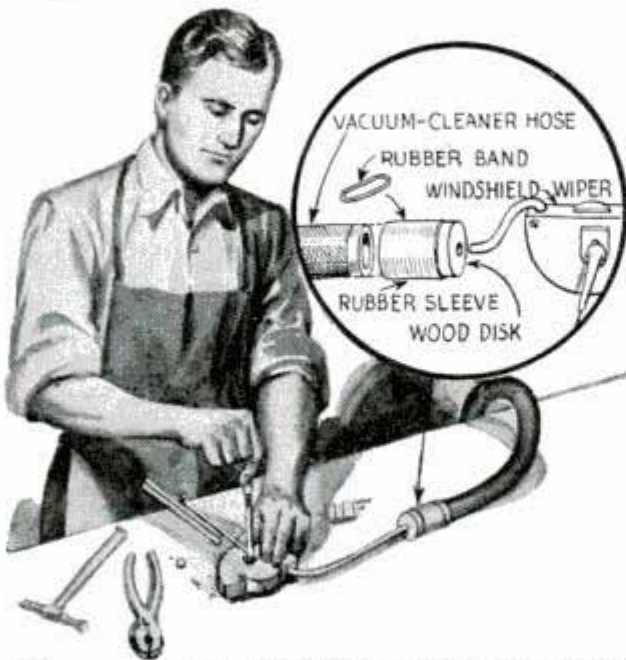

When you want to check the operation of the wiper on the bench, just turn on the vacuum cleaner

A simple method of operating a vacuum-type windshield wiper, while overhauling it on a bench, is to utilize the suction of a vacuum cleaner. The attachment hose of the cleaner is used, and the open end is provided with a tight-fitting wood plug inside a rubber sleeve. The plug is drilled and a short piece of tubing is forced into the hole to serve as a nipple to take the hose from the wiper.

—W. C. Wilhite, Carlinville, Ill.

### Handy Lamp for Examining Cells of Storage Battery

Operated by current from the cell under examination, this small lamp illuminates the interior of a storage battery when checking the water level or appearance of the plates in a dark garage where

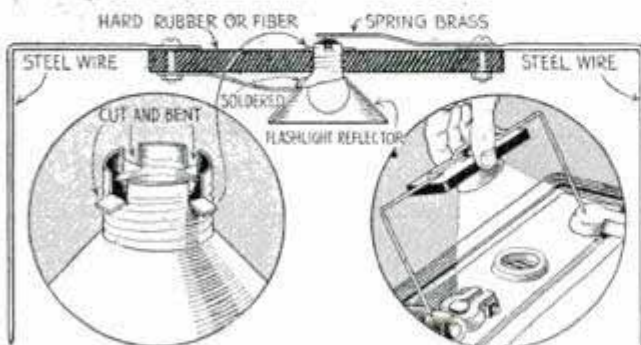

Press the prods against the terminals of the cell and the lamp will throw light into it

an extension lamp is unavailable. The lamp consists of a flashlight reflector, a 2.5-volt lamp, a piece of fiber or hard rubber, a strip of spring brass and two steel-wire prods assembled as shown. The distance between the prod points is the same as that between terminals of a cell.

### Inside Door Handles Removed with Aid of Washer

A slotted washer greatly simplifies the job of removing door and window regulator handles of the type that are pinned to the shaft. In use, push the washer over the shaft between the handle and flange covering the upholstery.

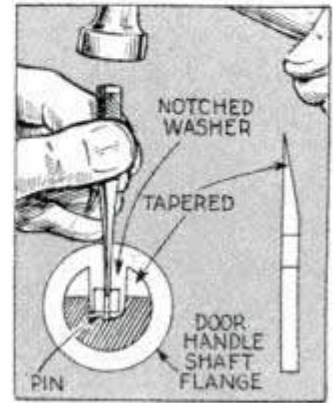

This will expose the pin, which can be driven out with a small punch, the pin removing the washer as it comes out of the shaft. Repeat the operation to replace the pin, and then tap the washer lightly with the hammer to remove it.

—Emil J. Novak, Omaha, Nebr.

### Jig to Clean Piston-Ring Grooves

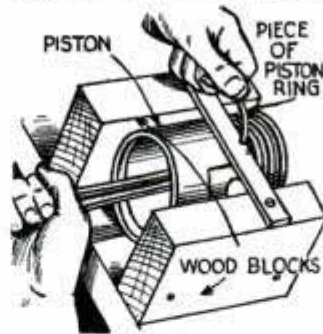

For an inexpensive method of cleaning carbon from piston-ring grooves, try this simple jig. Lay the piston on a bench, nail wood blocks on each side of it and fasten a piece

of flat iron across them, first making a hole in the iron to take the end of a broken piston ring. Then, holding the end of the ring firmly in the hole, push it into the ring groove and turn the piston.

—Cyril J. Weyrauch, Ray, N. D.

When replacing a gasket on your car, be sure that the surfaces of all parts are clean; but do not clean so vigorously that bits of the metal are removed, as this may cause leaks.



"Slices-of-life" shots, speed shots, scenics, night work, full color . . . count on Retina

**Call your shots . . . name your price**  
**There's a Kodak Retina**  
**that's right for you**

**I**F your first camera, or your next camera, is to be a miniature, and you're looking about for one at your price that will give you all the pictures you plan to take—including gorgeous full-color Kodachrome—consider a Kodak Retina.

There are three Retinas, all with the fast lenses and shutters, the speed and ease of operation, and the wide picture-taking scope necessary for brilliant work in the miniature field. At your dealer's . . . Eastman Kodak Co., Rochester, N. Y.



**KODAK RETINA II,**  
*f.2.0, \$140*

Coupled range finder. Body shutter release. Double-exposure prevention device. Automatic exposure-count dial. Lens, anastigmat *f.2.0*. Shutter, 1/500 Compur-Rapid. Price, \$140 (with sportsman's field case).

**KODAK RETINA II,**  
*f.2.8, \$115*

Identical with Kodak Retina II, *f.2.0*, except that lens is an anastigmat *f.2.8*. Price, \$115 (with sportsman's field case).



**KODAK RETINA I,**  
*f.3.5, \$57.50*

Lens, Kodak Anastigmat EKTAR *f.3.5*. Shutter, 1/500 Compur-Rapid. Finger and special plunger releases. Enclosed optical eye-level finder. Exposure counter. Price, \$57.50. Soft black leather case, \$1.50. Tan sole leather field case, \$8.50.

**LOAD WITH A WIDE RANGE OF KODAK FILM**

**KODAK PANATOMIC**—Fine grain permits an amazing degree of enlargement. 18- and 36-exposure magazines.

**KODAK "55" PAN**—Lightning-fast. Ideal for snapshots at night. 36-exposure magazines.

**KODAK SUPER X**—Faster even than "55." Invaluable indoors and out. 18- and 36-exposure magazines.

**KODAK INFRA-RED**—With a red filter, cuts through atmospheric haze, produces dramatic effects. 36-exposure magazines.

**KODACHROME**—For full-color transparencies. No extra equipment needed. 18-exposure magazines.

**Only EASTMAN**  
**makes the KODAK**



**STEEL MILLS**, lumber camps, dams, skyscrapers, coal mines, subways (*as above*) — appeal to Margaret Bourke-White. Heedless of toil and hazard, she has gone all over the United States, up under the Arctic Circle, into far countries. And her photographs are now internationally famous for their vigor and sensational interest. They're *different!* And that's the same remark that Miss Bourke-White made about Camels to Ralph Martin at the New York World's Fair grounds (*right*).

PEOPLE DO  
APPRECIATE THE  
**COSTLIER  
TOBACCOS**  
IN CAMELS

THEY ARE  
THE  
**LARGEST-  
SELLING**  
CIGARETTE  
IN AMERICA



Copyright, 1938  
R. J. Reynolds Tobacco Co.  
Winston-Salem, N. C.

ONE SMOKER  
TELLS ANOTHER

**"CAMELS"**

# SHE COMBS THE WORLD FOR PICTURES THAT THRILL

What Margaret Bourke-White, famous photographer, said when Ralph Martin asked if she found a difference in cigarettes



"Cigarettes seem pretty much alike to me. Do you find some difference between Camels and the others, Miss Bourke-White?"

"I've found that Camels are very different, Mr. Martin—not just in one way, but in a *lot* of ways. For example, my nerves must be just as trustworthy as a steeple jack's. Camels don't jangle my nerves. They taste extra-mild and delicate too. Camels never leave an unpleasant after-taste, and they're so gentle to the throat. In fact, I can say Camels *agree* with me in every way! I think that's what counts most—how your cigarette *agrees* with you!"

Camels are a matchless blend of finer, MORE EXPENSIVE TOBACCOS — Turkish and Domestic

## AGREE WITH ME"

# Nature Photos in Your Own Yard

(Continued from page 885)

For these reasons, it is a good rule to snap your "close-up" pictures at a distance which will allow a safe margin around your subject without making the image of the subject too small. Any surplus margin



*Ducklings are hardly "wild life," but these youngsters have a camera personality all their own*

can be masked out when you enlarge the picture.

For "close-ups" of small objects such as butterflies, spiders and other insects, you can use a title-making device of the type used by makers of home movies. With your camera set at infinity and mounted so that its lens is directly behind the titler lens, you can snap anything that appears in the front title frame. In fact, you can use a larger frame than the one on the titler, because your still camera lens has a wider "angle of view" than the movie camera lens.

The title device is useful because it simplifies focusing. Anything surrounded by the title frame is automatically in sharp focus. If your camera lens is larger than the titler lens, it is necessary to "stop down" the camera lens to an opening smaller than that of titler lens. This, however, is no bother, because in snapshots of this sort you want to use as small a lens opening as light permits, to obtain added "depth of field."

When doing nature pictures, don't overlook the possibilities in inanimate things—buds, tree blossoms, moss and lichens on stones, flowers both wild and garden. When seeking these things, it is a good idea to carry small sheets of white, gray and black cardboard or cloth, which provide splendid backgrounds. Spotty, confusing

backgrounds should be avoided in nature pictures just as in pictures of people.

Bear in mind, too, that there are many nature subjects which you can picture at home much better than in the field. Most nature photographers carry small boxes or bottles on their trips into the country, so that if light conditions do not permit snapping a small subject in its natural habitat, they can catch it and take it home. There, they pose it under lighting arranged to show its characteristic features to best advantage. When you take a subject home, you can take along materials from its habitat, and arrange natural setting.

The home aquarium is another source of interesting pictures. It must be rectangular, preferably with growing water plants. In making aquarium pictures, arrange a sheet of clean glass in the tank near the front so that the fish are restricted to a space about an inch wide. This keeps them from swimming out of range after you focus, and they also show up more clearly because there is little water between them and the lens.

The wise beginner in nature photography will not overlook the picture possibil-

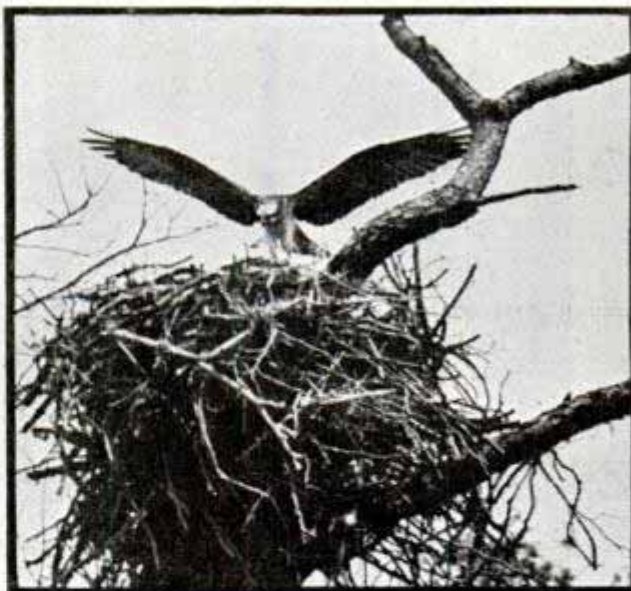

*Sometimes a large bird's nest is photographed more effectively from a distance to show surroundings*

ities in zoos, or in western parks on vacation trips. He may not find "nature in the raw" at the zoo—but he will find many interesting pictures, and gain much experience that he can use in the field.

# IT MUST BE GOOD

TO BE  
SO WIDELY  
IMITATED



*Triple-Thrift*  
REFRIGERATOR

**THRIFTY IN PRICE! CURRENT! UPKEEP!**  
*Save all ways!* Check the General Electric for these multiple savings: low use of current, fast freezing, upkeep, long life, preservation of food, etc., and we believe you'll choose a G-E.

## LET'S LOOK INSIDE THIS FAMOUS G-E MONITOR MECHANISM



A REFRIGERATOR mechanism *must be good* to be paid the high compliment of widespread imitation. G-E originated the hermetically sealed cold-making unit. There is no other sealed mechanism with a history and record that can equal General Electric. Remember, the *General Electric* is far beyond the experimental stage!

**OIL COOLING!** Forced-feed lubrication and oil cooling are features of the sealed General Electric Monitor Mechanism that assure quiet operation, low current consumption and long life. The simple General Electric mechanism has only three moving parts. Three-point spring mounting provides true "floating power", minimizing vibration. Acoustic mufflers hush operating sounds.

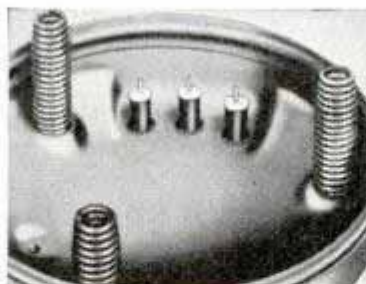

**METAL-GLASS LEADS**, developed by General Electric, permit introduction of power into the motor even though the mechanism is vacuum sealed!

GENERAL ELECTRIC CO., SPECIALTY APPLIANCE DIVISION,  
NELA PARK, CLEVELAND, OHIO.

ORIGINATORS OF THE SEALED MECHANISM

**GENERAL  ELECTRIC**



## THIS FIRST CHOICE OF MILLIONS IS NOW POPULARLY PRICED

Never before could so little money buy so much in a G-E Refrigerator as it does right now. Today's General Electric climaxes a 12-year record of ever increasing values. When you get a General Electric you don't spend—you invest! It has long been a leader in true economies and *multiple savings*. In actual home usage, no other refrigerator at any price can freeze more ice cubes, preserve more food, be more convenient or produce more cold for the little current cost of a General Electric.

When writing to advertisers please mention *Popular Mechanics*

## Dress Up Your Magic Tricks

(Continued from page 893)

agree and with no inner tube handy you proceed to prove your point with a piece of rope. Holding it so it makes a complete circle you win the argument by tying a knot in the center. Holding the rope by the extreme ends, you go through the movements of tying a knot. When the hands are drawn apart there is a loop around the right end of the rope. The hands are turned over, the fingers of the right hand quickly release the end of the rope and then grip the other side of the loop. The rope is shaken off the left hand where the knot has been tied.

The participation of spectators in your performance also increases their enjoyment. An astounding bit with an ordinary handkerchief can be worked effectively with the aid of a person in the group. You tie the handkerchief about his wrist and after seemingly binding it securely, you snatch it off without untying the ends. The trick is simple. Place the handkerchief on top of the wrist. As the two ends are brought underneath to be tied, your right forefinger makes a loop and the left end of the handkerchief is wrapped around this loop. By holding the ends tightly this loop will not slip. Bring ends of handkerchief on top of wrist and knot securely. To release the handkerchief, you pull upward on the two ends with a steady pull.

The assistance of a spectator likewise can be used in your dramatization of the Hangman's Noose. Two solid pieces of rope are shown as you tell the story leading up to the tragedy. You then place them around your neck and a spectator knots them together. With a sudden jerk you free yourself from the "noose" while the knots are still securely tied. Here again there is need of advance preparation. A small piece of thread is used to tie the ropes together in the exact center. This is concealed from the audience by your hand as you show the four ends of the rope. The threaded place is put at the back of the neck, the four ends being brought to the front. After the knots have been tied, the fingers are placed through the ropes and with a quick jerk the thread is broken, releasing the ropes from your neck, and then the knotted loops can be shown.

Another trick improved with patter is

the traveling penny. You borrow two handkerchiefs and after knotting one, it is handed to a spectator to hold at arm's length. A penny is placed in the center of the second handkerchief and you proceed to fold it up. When the handkerchief is unfolded, it is found the penny has disappeared. You explain the coin can be found in the center of the first handkerchief the spectator has been holding at arm's length and your statement is correct.

To do this, you conceal a penny in corner of the first handkerchief at the beginning of the trick. Grasping the opposite corner of the handkerchief you turn it once between your hands. This forms a trough down which the coin can slide. A knot is then tied, the coin being in the middle. This is handed to the spectator. The second penny is placed in the center of the second handkerchief and corner A is brought to C and D to B, then BD to AC. You then grasp corners BD and quickly pull them apart, stretching the corners of handkerchief very tightly. When this is done, the penny will stay in the folds of the handkerchief and by turning it upward the coin can slide into your hand. The handkerchief is shaken but the penny has disappeared. The spectator unties the first handkerchief and the penny is found.

You can keep up a running patter during the card-in-envelope trick. A card is selected at random from the deck and placed in an envelope while you close your eyes or turn your back. The envelope is then sealed, and after deep concentration, you name the card. You must prepare the envelope in advance. A small square is cut from the upper left hand front corner so as to make a window that will enable you to look at the card as soon as it is placed in the envelope. After the spectator has freely chosen a card, he is allowed to place it in the envelope. The card should be inserted with the face toward the spectator while the magician extends the envelope with the window toward the spectator, covering the cut-out section with his fingers. You must hold the envelope at all times. While sealing the envelope you will have ample time to see the card. For best results, use an envelope about the size of a playing card.





# Go places



## NATIONAL SPARK PLUG CHANGE WEEK—MAY 2<sup>ND</sup> TO 8<sup>TH</sup>

Go places this Spring with an engine that's as full of youthful vitality as the spirit of the season itself.

Replace those mileage-worn, winter-weary spark plugs which time and strenuous service have robbed of efficiency, with new Champions. You will experience a surge of new power, faster acceleration and better, smoother performance which Champions bring to every engine.

Champion Spark Plug Change Week has become the accepted period for bringing cars up to peak performance. Regularly at this time or every 10,000 miles, motorists have their Champion dealer check their spark plugs. When new spark plugs are necessary, from an economy and efficiency standpoint, they demand Champions because they appreciate the sustained better performance and the gas-saving economy that Champions alone provide. See your Champion dealer this week.

WITH NEW  
**CHAMPION**  
SPARK PLUGS

## SHE "PHEW" HOME TO FATHER!



**NASAL CRUELTY!** Tom's harsh and heavy tobacco was too much for Polly. Home she went and home she stayed until Tom cleaned his pipe and tried Sir Walter Raleigh.



**BLISS FOR KEEPS!** Tom and Polly never squabbled from that day on. And how he enjoys those 2-ounce tins of sweet-smelling burley! Smells good to puffer and puffed-at!



HOW TO  
TAKE CARE  
of  
YOUR PIPE

**FREE BOOKLET** tells how to make your old pipe taste better, sweeter; how to break in a new pipe. Write for your copy today. Brown & Williamson Tobacco Corporation, Louisville, Kentucky. Dept. P-86.

**TUNE IN** Tommy Dorsey and his orchestra. Every Wednesday, 8:30-9:00 P. M., E. D. S. T., coast-to-coast NBC Red Network.

## Riches from the Air

(Continued from page 875)

duction or destruction, each was dependent on nitrogen and soon the farmer had many competitors for the Chilean nitrates he needed so badly. The demand grew and grew. By 1900 the world was using 300,000 tons of nitrogen each year. By 1912 world consumption was nearly a million tons. Men of vision began to picture a not far distant day when the Chilean nitrate fields would be exhausted. Then, unless some new source of nitrogen were found, the world would starve.

Scientists remembered the nitrogen brought to the earth by rain and snow and decided it was freed by some sort of electrical disturbance. So they took a high-voltage electrical arc and blew air through

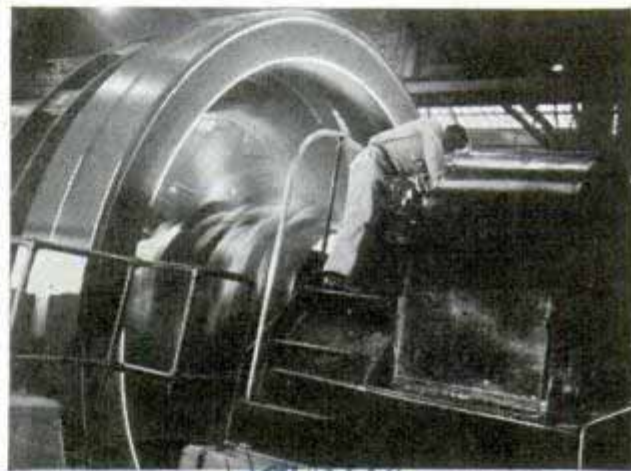

Powerful compressors which exert high pressures on gases in making ammonia

it. The nitrogen in the air combined with the oxygen and they got a little nitric oxide on the other side. This nitric oxide, absorbed in water, made nitric acid, from which fertilizers could be derived. But when they got a nice fat spark, the air put it out. So they fanned it out with magnets until it was like a sheet and blew the air through that. This process thrived in Norway for thirty years because Norway could harness her many waterfalls and obtain cheap power. But it required 60,000 kilowatt-hours to produce a ton of nitrogen by this means. Nitrogen sells today for a nickel a pound or \$100 a ton. If it were made by this process, the cost of power alone, at one cent per kilowatt-hour, would be \$600 per ton.

Next the Germans got busy. They found that when calcium carbide, obtained from

H 52  
 limestone and coke, was heated, it would absorb nitrogen gas forced across the hot mass. This nitrogen gas combined chemically with the carbide to form cyanamid. And cyanamid can be crushed and put on the soil or mixed with water and made into ammonia, a nitrogen compound.

This process required coal, water and air, instead of only water and air which the Norwegians used, but only one-fourth as much power was required as for the process developed in Norway. The cyanamid process is still employed quite widely today and it was this method that the government intended to use in making nitrogen when the Muscle Shoals development was started.

But several years before Muscle Shoals was finished, a brand new source of nitrogen was tapped. And the man who tapped it was a jovial, little German chemist, Dr. Fritz Haber, who became intrigued by the spectacle of a world clamoring for more and more nitrogen—those 20,000,000 tons resting in the atmosphere over each square mile of land and sea.

Why not, he meditated, combine air nitrogen directly with hydrogen from water to form ammonia instead of digging nitrate out of the ground in Chile or using large quantities of costly power to obtain it from other sources? Ammonia, he reasoned, is composed of nitrogen and hydrogen, so it should be possible to take nitrogen from the air and make the atoms stick to atoms of hydrogen. But they wouldn't combine. Why not? Dr. Haber decided it was because the atoms were not squeezed together hard enough.

So he took nitrogen gas and hydrogen gas, heated them and applied thousands of pounds of pressure per square inch. In his converter he placed a little iron oxide to act as a catalyst and speed up the reaction.

And he got ammonia gas, a combination of nitrogen and hydrogen. The squeezing had forced the two together. Here, at last, was a process for making ammonia—the most desirable primary form of nitrogen—directly from the air!

For in ammonia the nitrogen is locked up and ready for use in making fertilizers, nitric acid or anything else in which nitrogen plays a part. And the cost of power to fix a ton of nitrogen from the air directly with hydrogen is about one-fourth the

(Continued to page 122A)

## The Case of a DELCO BATTERY



DIELECTRIC TEST

All Delco battery cases are made of genuine hard rubber in Delco-Remy's battery case plant. Every step in their production reveals the extreme care Delco-Remy takes to assure the *best* in battery construction. Consider a few of these steps:

The rubber "mix" is thoroughly kneaded for extra strength and resiliency.

All rubber is carefully weighed before being molded into the case, to assure the correct amount.

Each case is molded under carefully controlled heat conditions and cooled naturally over a form, to retain its exact dimensions.

Every case and every cell-to-cell partition receives a "dielectric" test of 24,000 volts, which will reveal the slightest defect.



RUBBER MILL

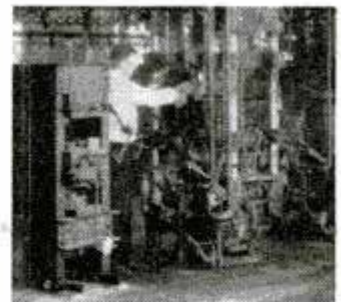

CASE MOLDING

It is this unwavering adherence to high standards in materials, construction and performance that has made Delco batteries original equipment in many leading motor cars, including all General Motors cars.



Delco battery sales and service requirements are available at United Motors Service Stations.

# Delco-Remy

ANDERSON, INDIANA

World's Largest Manufacturer of Automotive Electrical Equipment



## Champion OF OUTDOOR SPORTS

RIDE a champion in that greatest of all outdoor sports — motorcycling. Get top-notch enjoyment in the saddle of a Harley-Davidson.

Pal around with other riders. Join your local motorcycle club—and make this your biggest fun year. Something doing every minute—tours, picnics, trophy runs—go to hillclimbs, race meets and other thrill-packed events. See your Harley-Davidson dealer. Sit in the saddle of a 1938 model — get the "feel" of motorcycling — ask about his Easy Pay Plans.



**Harley-Davidson**  
WORLD'S CHAMPION MOTORCYCLE

MAIL THE  
COUPON today!



HARLEY-DAVIDSON MOTOR CO.  
Dept. P-638, Milwaukee, Wisconsin  
Send illustrated literature and FREE copy of "ENTHUSIAST,"  
Motorcycling Magazine. Stamp is enclosed for mailing cost.

Name \_\_\_\_\_

Address \_\_\_\_\_

(Continued from page 121A)

cost of obtaining a ton by the cyanamid process, or one-sixteenth the cost of the power required to make a ton by the electric-arc process in Norway.

Dr. Haber's process was developed sufficiently in 1913 so that the first nitrogen fixation plants were built in Germany. Then came the World War. The demand for nitrogen soared to new heights—nitrogen for explosives. The first thought of the Allies was to keep the trade routes open for the nitrate run to Chile. But not Germany. Germany was prepared to extract her nitrogen from the air. We intended to get ours from Muscle Shoals if the war had lasted longer. After the armistice, Dr. Haber received the Nobel prize in chemistry for his nitrogen fixation process—laurels of peace for a discovery first used in war. And today the entire world has all the nitrogen it wants, nitrogen from the air for five cents a pound.

But modern ammonia plants bear little resemblance to those early ones. Because of the terrific pressures, pipes in the first plants were as thick as their inside diameters. Even then, no one knew when the steel wall might bulge into a "blister" from the pressure, so the pipes were surrounded by heavy steel and concrete barricades.

The high pressures offered many difficult engineering problems. New steels and other new alloys had to be developed to withstand them. But the problems were solved and the new alloys were produced. Today, in the ammonia plant of E. I. du Pont de Nemours and Company at Belle, W. Va., pressures of 10,000 pounds per square inch cause no more trouble than the pressure at your water faucet.

And 10,000 pounds per square inch is like the pressure which would be exerted by a column of water 23,000 feet high—as high as twenty Empire State buildings. Such pressures are built up by compressing the gases through seven stages, but there is less trouble with leaks than you would have in an ordinary steam line. The squeezing causes the gases to act more like liquids.

The hydrogen which, with nitrogen, forms ammonia, is obtained at the du Pont plant from coke water gas. Coal is heated to form coke which is gasified, as is done in a gas plant. The result is water gas—hydrogen, nitrogen and carbon monoxide,

the stuff which comes from your automobile exhaust. Blow air and steam through the coke, add more steam to the gas under pressure, with a catalyst to speed up the action, and this carbon monoxide is converted to hydrogen and carbon dioxide. Remove the carbon dioxide with water and you have left hydrogen and nitrogen ready to be converted into ammonia.

Nitrogen consumption has increased seven-fold in the past thirty-five years. The world production today is about 2,500,000 tons annually, about the same as copper, but the capacity of the industry is double that because every nation wants to be assured of a supply of nitrogen in case of war—nitrogen for explosives. But most of the normal world production is consumed in the most peaceful pursuits—fertilizing the soil, making dynamite for construction work, making nitric acid for industrial purposes and making films and dyes and nitrocellulose products.

So there's the ironic story of nitrogen—a substance as essential to life as air or water, something over which nations wrangled for a century and now get in abundance from the air, an element which man requires to keep him in this world and which he uses, on occasion, to blow his fellows out of it, a billion-dollar industry evolved out of thin air.

H 52

### Double-Duty Taillight for Bike Shines with or without Bulb



Safe whether it is lighted or not, a double-duty taillight for bicycles mounts on the rear fender, its battery case streamlined to fit any standard type. It operates on a

one and one-quarter inch flashlight cell, but even if the bulb is not operating it is an effective guard, for the prismatic ruby glass backed by a powerful reflector picks up every beam from behind and shines red.

Send return postage to our Bureau of Information to learn the name of the maker of any device described in this magazine.

Delta Electric Co.  
Mason Ind.



**"EASIEST POLISH  
I EVER USED"**

**Make your car sparkle like new!**

It's quick and easy to do it with Du Pont No. 7 Polish. A little brisk rubbing removes dull TRAFFIC FILM and restores the original color and lustre. No. 7 Polish is made by Du Pont, world's leading makers of modern car finishes. That's your assurance it's right for the finish on *your* car.



Sample for You! Send 6¢ to help cover mailing cost, for sample can of No. 7—enough for fenders and hood. (Offer good in U. S. only.) Write Du Pont, Dept. PM-2, Wilmington, Del.

Always ask for  
**DU PONT POLISH**

## Our MYERS certainly makes a DIFFERENCE

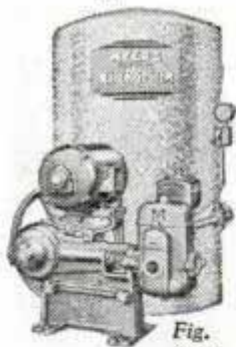

Fig. 3012

THE difference between old-fashioned pump-and-carry drudgery and the modern convenience of running water is all the more notable when your faucets receive their supply from a reliable MYERS Water System. Thousands of satisfied MYERS owners know how remarkably dependable, trouble-free and economical these long lived, well built water service units really are. In addition to silent and completely automatic electric water systems—self-starting, self-stopping, self-oiling—MYERS also furnish dependable water systems for operation by gasoline engine, windmill or hand power. New features make this year's models more silent, more efficient and—if possible—more durable than ever. Most complete line of its kind in the world. Models to meet all needs and conditions; for deep or shallow wells.

"Pump Builders Since 1870"

### No Need to Wait for Electricity

Before power lines reach you, enjoy running water with a MYERS Gasoline Powered Water System which can later be converted to completely automatic electric operation by mounting electric motor in place of engine. Interesting booklet free. Write us or ask nearest MYERS dealer for information.



# MYERS

## WATER SYSTEMS

THE F. E. MYERS & BRO. CO.  
71 Fourth Street, Ashland, Ohio

Send free, name of your nearest dealer and information on:  
Electric Water Systems  Gasoline Water Systems

Name \_\_\_\_\_

Address \_\_\_\_\_

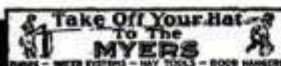

(WS 8-24)

## Brute Force Loses Out

(Continued from page 837)

and sixty-one per cent of the soft-wood consumption is on the east side—2,000 miles or more from the source of supply. In rail shipment of wood, Chicago is the greatest timber port with New York leading in ocean shipment.

The modern Paul Bunyan needs be an engineer as well as a forest technician. The qualified civil or mechanical engineer and the graduate of the modern forestry school are replacing the old-fashioned "bull of the woods." Many modern lumberjacks have college degrees, and one of



Two husky lumberjacks at work on giant Douglas fir in western Washington

the most important members of any logging outfit is the "cruiser" or forest engineer, whose job includes woods survey, spotting and marking desirable timber, projecting roads and bridges to operating areas, and measuring and preparing available waterways for "driving" logs.

Driving logs becomes a blending of the old and new. Portable band saws or motor-mounted circular saws now fell trees many times faster than the most skilled axmen. When the log is "laid" in the woods, a tractor darts into the underbrush, ties on to it with a steel cable, and "snakes" the log to a loading point. There with the aid of electric hoists it can be lifted to giant, Diesel-operated trucks, or carried to "port" by means of an electrical over-

4/82  
head tram, then coasted by surface rail-road or moved by tractor skidders to a waterway where it is floated or driven, and towed to mill and market.

Through the centuries river driving has remained the most picturesque phase of a picturesque industry. The bulk of the float timber is cut during autumn and early winter. The drives begin in early spring when thaws put the rivers and streams to high-water marks. The best workmen of a logging camp are assigned to the "drive detail." Preparatory to driving, the timber is stacked or skidded to a river bank, or rolled into convenient ponds or reservoirs.

The first job is to get the logs into open channel. Then the driving crew follows in sturdy boats, with high-pitched sharp ends. The boat is navigated by means of long poles which the driver also uses to prod logs into channel and prevent jams. Long-handled canthooks, sharp axes, and the juggler's art of skipping floating logs are other requirements of the driving trade. As a rule driving speed is from twenty to sixty miles a day, with the season ranging from three to eight weeks. Log jams are frequent and when mean clogs occur the drivers must chop them or blast away the jams with dynamite.

In the pulpwood industry, logs which cannot be floated to mill are usually peeled of their bark and stacked for truck or rail haulage. Removal of bark allows the wood to dry and reduces the average weight from 4,400 to about 3,200 pounds per cord. Savings in tonnage justify the expense of bark peeling.

Life in the old-style logging camps was about the hardest known to man. There was no plumbing or laundries or refrigerators. Men slept on wooden bunks without mattresses and lived on beans, brown bread, molasses, and salt pork. But the modern logging camp has its laundry, cold-storage plant, bathhouses, recreation halls. Bare bunks have been replaced with spring beds and mattresses. On the whole, table fare is outstandingly good, with plenty of dairy products, fresh meats, vegetables and desserts. Radio and telephones keep the camps connected with the outside world.

Send return postage to our Bureau of Information to learn the name of the maker of any device described in this magazine.

## Treet Topics



Treet Safety Razor Corporation, Newark, New Jersey

## BUILT to BEAR a BEATING



• THE heaviest outboard motor won't "shiver her timbers." An Old Town Boat is built to take hard use for years.

Racing. Fishing. Hunting or Cruising. An Old Town Boat is an all-round boat. It gives you the run of the waterways; puts your camp close to any point on the lake—by water. Inexpensive to buy with very little up-keep cost.

**FREE CATALOG** illustrates boats for sport, for the family, and all kinds of canoes, rowboats, dinghies. Write today. Address Old Town Canoe Company, 436 Main Street, Old Town, Maine.

*"Old Town Boats"*

\$1.50  
At  
Electrical  
Stores  
or  
Post-paid



*"THE NEON LIGHT sets you RIGHT"*

### TEST-O-LITE

Handiest electrical tester made; quickly locates trouble in electric circuits, fuses, cut-outs, motors, radios, etc. Has 1,001 uses for electricians or home. Tests any voltage 110 to 550; tells A.C. from D.C. Exceeds ordinary clumsy test bulb. Fountain-pen size; with pocket clip. Lifetime guarantee.

L. S. BRACH MFG. CORP.

55 Dickerson St. Newark, N. J.

## CROSMAN SILENT .22 RIFLE



Rifled  
barrel

**NO CLEANING  
ADJUSTABLE POWER  
LOW COST AMMUNITION**

Grooves inside barrel make the Crosman a real rifle with all the hair-splitting accuracy this term implies. Shoots bullet (pell) same diameter as .22 powder rifle, but silently, powerfully, with no recoil, using the terrific force of compressed air—same force U. S. Navy uses to drive 2000 lb. torpedoes. Marvelous for target, small game. Single and 20 shot repeater models. No license required. New features.

**SuperPells**



Best for all .22 cal. air rifles. Heavier, longer, more perfectly formed (secret process), thus harder hitting and more accurate. Made to American standards by American workmen. Write for folder.

CROSMAN ARMS CO., Inc., 414 St. Paul St., Rochester, N.Y.

**FREE  
BOOK**

Containing important target and game shooting facts; also Crosman Catalog. Write. Ask Your Dealer to Show You a Crosman.

## Try a Vegetable Laxative

See the difference



I TOOK ONE NR TABLET  
LAST NIGHT AND THIS  
MORNING I FEEL GRAND

WHETHER your constipation is chronic or occasional—one trial of Nature's

Remedy (NR Tablets) will show why millions prefer this ALL-VEGETABLE Laxative. One NR Tablet convinced me... so mild, thorough, refreshing and invigorating.

Dependable relief for sick headaches, bilious spells and that tired-out feeling, when caused by or associated with constipation.

**Without Risk** get a 25c box of NRs from any druggist. Use for one week, then if you are not more than pleased, return the box and we will refund the purchase price. That's fair. Try it—NR Tonight—Tomorrow Alright.

*Nature's Remedy*  
NR-TABLETS-NR

## TRAILER BUILDERS · BUYERS · OWNERS

Over 100 pages! Beautifully Printed and Illustrated! Trailer Suggestions and Ideas galore! Catalog shows America's greatest line of Trailer Parts and Equipment at lowest prices. Everything from wheels to top. Rush 25c today. Satisfaction positively guaranteed!

TRAILER SUPPLY CO.

Box 438-A

WAUSAU, WIS.



### BUILD IT YOURSELF

The Jim Dandy Cabin Cruiser

The Trailer that has everything. Classy! Roomy. Easy to build in any size with my simplified Plans and Instructions—Price \$1.00. Rush dollar bill today to JIM DANDY Box 125-A WAUSAU, WIS.



CATALOG AND COUPON

Return coupon with order for Fireworks and get big 35c box of SALUTES FREE

SPENCER FIREWORKS CO., Box PM 150 POLK, OHIO

## RE-STRING RACKETS AT HOME



Write for our 1938 Illustrated Catalog and Instruction Book.

W. A. BICKEL & Co., Dept. A-6, 137 N. Marion, Oak Park, Ill.

### • EARN MONEY •

It's pleasant, profitable work. No experience or skill required. Easy to Learn. Full line of guaranteed stringing tools, frames, gut and silk strings for your selection. Every item highest quality. Write for complete details.

## "Handy" HAND PUMPS

for shop, garage or home—pump oils, gas, paints, etc., from drums and barrels. Easy turning—no priming—capacities up to 20 gallons per minute... **LOW PRICED.** FREE BULLETIN shows 14 Different Models by a nationally known builder of rotary pumps.

BLACKMER PUMP CO. 1501 CENTURY AVE. GRAND RAPIDS, MICH.





## Age of the Aerial Monsters

(Continued from page 844)

automatic controls are used in the engines, manual over-ride controls are attached for possible use from the cockpit in emergencies.

The power of aviation engines has been climbing upward for years. In 1930 the Pratt & Whitney Wasp was rated at 420 horsepower but today the same engine delivers 600 horsepower with hardly any change in size. The increased output is due to improvements that include refinement of cylinder design and higher compression ratios and supercharging. These last two improvements are possible because of the better fuels that are available today and in turn permit a higher number of engine revolutions per minute, which results in greater horsepower.

Other engine improvements include hollow valves filled with sodium to promote cooling, tougher alloys that are better able to withstand the higher crank speeds, and redesigned fins on the air-cooled cylinders which together with pressure baffles that force the air to circulate between the fins result in better control of engine temperatures.

The trend in engine design seems to be toward more and smaller cylinders, providing a smoother flow of power with less vibration. The two-row radial engines are a development of this trend, as well as an answer to the cry for greater horsepower. The new R-2180 Twin Hornet, made by Pratt & Whitney, is a fourteen-cylinder twin-row radial with a displacement of 2,180 cubic inches. Four of these are installed in the new Douglas DC-4.

Even more powerful than the Twin Hornets are the new 1,500-horsepower Wright Cyclones of similar radial type that are being used to power the new Boeing four-engined flying boats that carry seventy-two passengers.

Today the engine manufacturers are working on engines of even larger horsepower. The day of the 2,500-horsepower aircraft engine is almost in sight and when such power plants are available larger aircraft than ever will be possible.

Send return postage to our Bureau of Information to learn the name of the maker of any device described in this magazine.

# UNRULY HAIR

*Stays Neatly Combed*

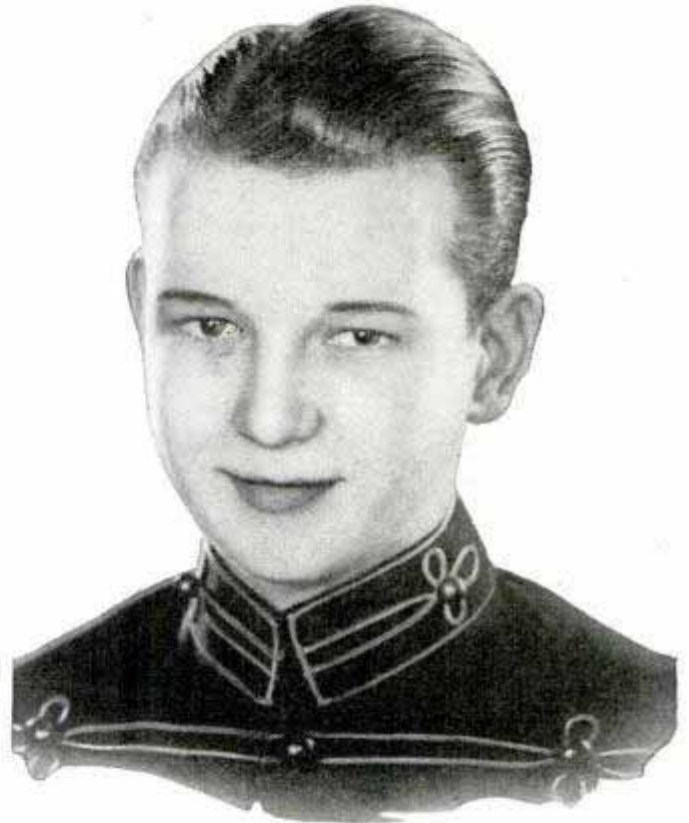

**Costs but a few cents to use  
— a bottle lasts for months**

**I**S YOUR HAIR difficult to keep in place? Does it lack natural gloss and lustre? It is very easy to give it that rich, glossy and orderly appearance so essential to well-groomed boys.

Just rub a little Glostora through your hair once or twice a week — or after shampooing, and your hair will then stay, each day, just as you comb it. Glostora gives your hair that natural, rich, well-groomed effect, instead of leaving it stiff and artificial looking as waxy pastes and creams do.

Try it! A large bottle of Glostora costs but a trifle at any drug store.



**Glostora**  
FOR THE HAIR



**Beware - Alkalize**

Alka-Seltzer

An Alka-Seltzer Tablet in a glass of water makes a sparkling pleasant-tasting solution. Drink it and it gives quick relief from Headaches, Sour Stomach, Distress after meals and other common ailments. It also helps correct the cause of the trouble when associated with an excess acid condition.



TO MAKE IT BRIEF, FOR QUICK RELIEF, JUST ALKA-SELTZER-IZE

WHEN HEADS ARE SORE, FROM NIGHTS BEFORE, BE "MORNING-AFTER" WISE.

FORGET YOUR HEAD-ACHES AND YOUR COLDS AND UPSET STOMACHS TOO.

FORGET YOUR WINTER ACHES AND PAINS, THE WORLD IS BORN ANEW

Alka-Seltzer

TUNE IN THE NATIONAL BARN DANCE SATURDAY NIGHT NBC-NETWORK

30¢ & 60¢ PKGS. OR BY THE GLASS AT DRUG STORE SODA FOUNTAINS

**Alkalize with Alka-Seltzer AT ALL DRUGGISTS**

## Don't Pity the Poor Fish

(Continued from Coloroto Section)

factory wastes. Game fish rarely can survive such contamination. Therefore game fish fanciers are urging better care of native streams.

Modern trout breeding has become a highly exacting science. In the rearing stations the best fish are saved as breeders and carefully selected for color, shape, and health. In some instances native or "wild" trout are trapped for breeding purposes. This is done by weirs, or concave net traps. The fish are stored in floating wood "cars" or box rafts until spawning time, and are usually released after the egg crop is harvested. Modern trout hatching has become highly artificial. Fish eggs and "milk" or male fluid, are stripped from the breeders in the fall, pending a necessary hatching period of from sixty to ninety days.

Trout milking is a delicate chore which requires clean hands and strong fingers. An expert can tell when a trout is ready to spawn from the feel of the abdomen. Eggs are forced from the female by hand and deposited upon wooden trays. The milk or fertilizing fluid is forced from the male fish, poured over the egg trays and allowed to stand for about twenty minutes. Temperature must be checked carefully. Then the eggs are placed in a current of cold water where they remain until hatching time. The first hatching stage is the sack or "eye" stage. Two tiny black dots appear in the fertile eggs, which look like tiny pearls. These spots become the trout's eyes. When hatching is finished, first-stage minnows are transferred to breeding pools and put on a liquid diet.

Don't be surprised if you catch a trout with a calling card. The card is likely to be a small non-corrosive plate clamped to the heavier muscles of the tail. It lists various information in code form and asks that you return the card with various other information to a state fish commissioner or the U. S. Bureau of Fisheries. You'll aid the future of American fishing by honoring the request. Fish tagging is becoming an extremely helpful device for estimating range, distribution and rate of growth of fish. The U. S. Bureau of Fisheries is applying it not only to fresh-water game fish, but to salmon and herring, shrimp, lobsters and crawfish.

Calling cards for salmon are usually

**DO YOU** WANT a new business profession of your own, with all the trade you can attend to? Then become a foot correctionist, and in a few weeks earn big income in service fees,—not medical nor chiropody—easy terms for home training, no further capital needed, no goods to buy, no agency. Established 1894. Address Stephenson Laboratory, 1 Back Bay, Boston, Mass.

small celluloid disks inserted by means of copper wires just above the spine. Shrimp and crawfish cards are wired to the tail. The herring is the hardest to mark. His calling card is usually a small oval disk which must be rammed down his throat. This doesn't seem to harm the fish but when first inaugurated it practically halted the herring industry.

Herring are usually seined and ground into meal. Tags are not visible and when fast-rotating grinding blades struck the steel disks it was too bad for the machinery. Herring processors tried using power magnets to detect the presence of the disks, but this was not certain enough. Now the Bureau of Fisheries has an electric tag detector which does the trick.

As the fish slide down a chute into the reduction machines which grind them to meal, they pass over a trap door. The electric detector records the presence of any tagged fish and opens the trap door. The tagged fish then falls into a bucket and is claimed by the bureau for its records.

While trout and bass tagging now promises excellent results, the most notable accomplishment to date is that of tagging salmon. The bulk of our \$50,000,000 salmon catch is made in fresh water. Tagging experiments have enabled salmon experts to learn two important facts—that the fish dies shortly after spawning, and that by instinct a salmon tries to return and spawn in the same waters in which it was hatched—even though this is a small and remote creek.

Tagging enables Bureau of Fisheries employes to find the spawning places of the more valuable varieties of salmon. Acting upon the proven fact that the fish return to their birthplace to spawn, bureau field men remove the desirable types of spawns to other streams. This serves to open entirely new salmon runs, and helps replace the poorer varieties with the more valuable.

Tagging is also being used on codfish, weakfish, jack salmon, perch and various other varieties. It helps fish experts to predict the supply and location of a given variety and facilitates fishing laws based upon scientific probability.

☞Inquiries as to makers of articles described in Popular Mechanics, will be answered by our Bureau of Information upon receipt of return postage.

**KAYWOODIE**  
The World's Finest Pipes  
\$3<sup>50</sup> to \$10<sup>00</sup>



No. 40

## HOW TO CHOOSE BETWEEN PIPES —before smoking them

Naturally there is a difference between how a cheap pipe smokes and how a good pipe smokes. But how can a pipe smoker tell what that difference is going to be, *before* he smokes them?

This way: look at the markings of the briar. The more beautiful and fine-grained the briar, the sweeter the pipe will smoke. The finest briars come from big, *old* briar burls, mellowed and matured for 100 to 400 years in the ground.

These old burls, obviously, are scarce, and cost vastly more than young, immature, small burls. When cut and polished, the briar from these burls makes the most beautifully marked pipes that you can buy.

So, look at the markings of the briar. Look at any ordinary pipe—and then look at the markings of a Kaywoodie. That's a good way to tell how much sweeter-smoking Kaywoodie pipes are. Kaywoodie Company, Rockefeller Center, New York—and London.

## SALES ORGANIZER

Who can sell personally and recruit and train salesmen for large manufacturer. Complete line of products selling to factories, institutions, home owners and farmers. Strong selling features assure large volume. Experience in our line not necessary if you are an aggressive, energetic salesman. Large earnings possible with drawing account against personal commissions, plus over-write on business produced by men under you. Tell about yourself in first letter.

**THE ADAMS PAINT COMPANY**  
Dept. P. CLEVELAND, OHIO

# PLASTER FOR PATCHING THAT ANYONE CAN USE



Holes in walls are easy to repair with Rutland Patching Plaster. Makes a perfect, lasting patch.

**HANDY TAP and DIES . . .**  
 Accurate—carefully hardened and tempered. Complete range of sizes at your local five and ten cent store.  
**HENRY L. HANSON, WORCESTER, MASS.**

**Now!**  
**Get Rid of FLIES**  
 MOTHS. MOSQUITOES. GNATS AND FLYING PESTS  
**by Electricity**



**NOW** by the push of a button disease-bearing flies, mosquitos and other destructive insects contaminating your food, affecting your health and comfort can be surely and quickly eliminated. **INSECT-ACUTOR** is harmless to man, but sure death to pests. Endorsed by leading health authorities, insect control agencies.

**Costs only ten cents a month to operate.** Ornamental ship's lantern design. 16" high and 12" wide. No installation. Simply plug in—it is ready to operate. Ideal for homes, gardens, sun porches, stores and resorts. If your dealer can't supply you, send coupon.

**Warner Electric Co., Dept. A-9, 360 N. Michigan, Chicago, Ill.**  
 Yes, send booklet, "Electric Insect Control."

Name.....  
 Address.....  
 City..... State.....

## MOST COMPLETE LINE OF OUTBOARD PROPELLERS

speed wheels, weedless, service wheels, perfect trolling wheels and all-purpose propellers that get you more speed from any motor. Send postcard for outboard propeller "bible"; contains specifications for every motor built since 1926.



**For your inboard, INVESTIGATE THE NEW "AQUA-MASTER"**, the sensation at all motor boat shows and races. Also complete line of inboard propellers.

**MICHIGAN WHEEL CORPORATION**  
 Dept. P-2 GRAND RAPIDS, MICHIGAN



## NEED MONEY? Men or Women

Part time or full time to sell  
**GENUINE LEATHER TIES**

Sell on sight—they are neat, novel and practical. Big profits for you. No sales ability needed. Everybody wants them. Your first hour will be a pleasant, profitable surprise. Young man made \$6 one night after school. Send 50c for samples of 4-in-Hand and Bow.  
**CENTURY TIE CO., 2345-L, W. Grand Blvd., Detroit, Mich.**

## BARGAINS GALORE! SAVE HALF!



**TYPEWRITERS — DUPLICATORS — ADDERS**  
**FOLDERS — ADDRESSOGRAPHS** Less Than Half Original Cost  
**FREE TRIAL! MONEY BACK GUARANTEE!**  
 Typing Course & Fabric Free. Write for Bargain! Name what you want. Send No money! Low as 10c a day!  
**FRUITT CO., 941 FRUITT BLDG., CHICAGO**

## Synco JIG SAW

Write for **free folder** about remarkable electric jig saw that requires no motor. 7200 strokes per minute. For Alternating Current.  
**SYNCO DEVICES, INC., 511 Boydell Bldg., Detroit, Mich.**

Tells How to Use—

Concrete About the Home; Concrete in the Garden and Yard; Concrete About the Farm; Concrete Homes and Buildings; Making Recreation Devices; Concrete in the Workshop; Concrete Products for Manufacture; Concrete in Business and Industry, etc. Gives 146 Concrete Kinks.



The Book of the hour for the workshop fan, handy man and home owner.

**Money Making Facts - Best Methods - Materials - New Colored Concrete - 146 Kinks**

"1001 Ways to Use Concrete" strips the mystery from the fascinating work of making useful articles and permanent improvements with concrete. This book, just published covers every known use of concrete for the home, farm, building, business and industry, plus newer uses in decoration and arts. Includes new fast setting and gloriously colored concrete and 146 valuable usable kinks. 1001 uses of concrete including homes, garden furniture, pools, statuary, etc., recreation devices, farm improvements, driveways, walks, etc. Describes all methods and materials. Shows how to do real professional type jobs.

**NEW Concrete BOOK**  
 Makes Cement Work of All Kinds *Easy*

**256 Pages — 16 Colored Plates, Hundreds of Pictures**

Large book 7 x 10 inches. Handsome cloth binding. Sent postpaid for only \$5. Sent COD in U. S. if preferred. Order today. Make concrete work a fascinating hobby or a profitable business.

**POPULAR MECHANICS PRESS - 200 East Ontario St., Dept. 638C - CHICAGO**

When writing please mention Popular Mechanics

H 266

## The Advance of Diesel

(Continued from page 829)

Normal compression in the cylinders of a gasoline engine is about 125 pounds to the square inch. Diesel compression is many times higher. This compression, without use of spark plugs, is great enough to create a heat which will burn any type of fuel. The instant it is blown in, the fuel ignites like a flash of grease in a frying pan.

The first compression engine was described by a Dutch scientist named Christian Huyghens, back in 1680. It was designed to burn gunpowder. Dr. Diesel's original engine burned powdered coal. The present Diesel could be made to burn either solid or liquid fuel, so long as the fuel is ground or sprayed in a fine vapor

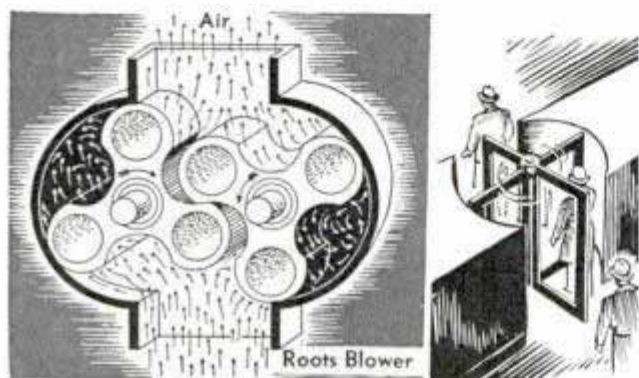

Roots blower operates somewhat like a revolving door in delivering air to engine cylinder

form and so long as the fuel does not have an ash which damages the piston walls.

Actually most Diesels are fueled with a petroleum distillate similar to that used in oil furnaces. But under proper conditions the mechanism might be operated with many different types of combustibles including gasoline, animal greases, glycerin, alcohol, or even salad oil. This versatility may be important to future developments in motor fuels. If any major emergency should cut off the supply of gasoline, an entire structure of Diesel power might be operated upon substitute fuels.

Here are some average percentages of efficiency for common power sources: Simple steam engine, six to eight per cent; steam turbines and condensing steam engines fifteen to twenty-seven per cent; modern auto and airplane engines, twenty-two to twenty-eight per cent; Diesel engines, thirty-two to thirty-eight per cent.

(Continued to page 132A)

# AMERICA'S No. 1 MOVIE CAMERA



With F:3.5 Lens . . . \$19.95

Why pay more for a movie camera when the lifetime UniveX costs only \$9.95? Why pay more for film when UniveX Cine Film costs only 69¢ a roll—and takes theatre-quality movies at less cost than ordinary snapshots!

Be smart! Be thrifty! Enjoy the thrill of taking all the personal movies you want, without counting the cost! Join the 200,000 enthusiastic fans who say, "There's nothing like UniveX!"

## QUALITY MOVIE ACCESSORIES

When you use a UniveX Cine "8" you also save on accessories—for UniveX high-quality accessories are available at the lowest prices in all movie history!

**UniveX Projector** Only motor-driven 8 mm. projector under \$26. Fifteen important features..... **\$14.95**

**UniveX Titrler** Specially designed for UniveX Cine "8". Title cards and lettering kit included..... **\$2.50**

**UniveX Exposure Meter** Insures proper exposure under all light conditions..... **\$1.95**

UniveX Exposure Meter Case, Dustproof..... **35¢**

**UniveX Splicer** For any 8 mm. film. Makes strong splices quickly. Complete with cement..... **\$1.00**

**UniveX Film Viewer** Enables you to properly edit movies..... **\$1.95**

*Prices Higher Outside United States*

UNIVERSAL CAMERA CORP.  
Dept. 62, 32 W. 23rd St.  
New York City

**FREE  
BOOKLET**

Send me free booklet "Take and Show Your Own Movies." Also catalogue of UniveX Cine Accessories.

Name \_\_\_\_\_

Address \_\_\_\_\_

City \_\_\_\_\_ State \_\_\_\_\_

CINE "8"  
**UniveX**

H266

# Reach Out For WORK GLOVE COMFORT

Pony-white  
Horsehide  
Driver's Slip-on  
Pattern  
No. 8565

**Full Grain  
Wolverine  
Horse-  
hide**

**DRIES  
SOFT..  
STAYS  
SOFT!**

A NEW kind of  
work glove!  
Triple-tanned by  
secret process that  
makes Full Grain

Horsehide soft as kid! Made by  
the makers of famous Wolverine

Shell Horsehide Work Shoes. Every seam lock-stitched with  
4-cord work-shoe thread! Get a pair at your dealer's! If he  
can't supply you, send us his name and 75c and we'll mail you  
a pair postpaid. Ask for special offer No. 8565. Do it today!

WOLVERINE SHOE & TANNING CORP., Dept. H-58, Rockford, Mich.

## WOLVERINE HORSEHIDE WORK GLOVES

**FREE Sensational OFFER**  
**2 FENCING SWORDS FREE**

**FENCING**  
WORLD'S FINEST SPORT  
HARMLESS-EXCITING FUN



Develops strong body and alert mind. **HARM-  
LESS.** The spring-steel 3-foot-long foils  
(swords) are equipped with rubber buttons.  
Aluminum cup-shaped hand guards. Our De  
Luxe foils are built for hard usage.

Complete set of two foils (swords) and free  
instruction booklet, only \$1.75 postpaid. Two additional fencing  
swords **FREE** for limited time. (Regular price of these two sets  
of foils \$3.95.) **ORDER NOW.**

ALL-AMERICAN FENCERS GUILD  
Dept. 6 PM 48 West 48th St., New York, N. Y.

### BUY ONE OF THESE

**\$1.50**  
Less  
Battery



**POWERAY** (above) New 6-volt electric lan-  
tern with powerful 700 ft. spot beam. 80-100  
hours light. 4 1/2 in. reflector. Unbreakable lens.

**"BIG LITE"  
DELTAS**

**\$3.35**  
Less  
Battery



**POWERLITE** (at side) America's finest electric  
lantern. 6-volt, 2 reflectors — front, shoots  
800 ft. beam; top, gives wide floodlight. 80-100  
hours light. Unbreakable lens. At sport, hard-  
ware and electrical dealers or write direct to  
**Delta Electric Co., Marion, Ind. Dept. 300**

(Continued from page 131A)

Problems of weight, fuel feeding and strength of materials have been the three great Diesel drawbacks, from a standpoint of everyday use. The earlier models were too heavy to be practical anywhere except for stationary plants or as boat engines. Weights were about 250 pounds per horsepower developed, as compared with eight or ten pounds per horsepower for the automobile engine. Walls had to be heavy in order to withstand the extremely high pressures in compression, which also placed extreme demands upon connecting rods, bearings, crankshafts, etc. But the new developments and substitution of the two-cycle for the earlier four-cycle Diesel have already reduced weight requirements until the new 600-horsepower eight-cylinder Diesel now weighs only about twenty-three pounds per horsepower, and the sixteen cylinder only seventeen pounds per horsepower.

Rapid progress is being made in the matter of fueling. All the new Diesels use the unit injector which provides a small pump for each cylinder. By means of nozzles with holes about the diameter of a small needle these pumps feed the fuel into the cylinders in the form of a fine misty spray. Pressure in the fuel-pump cylinder reaches 20,000 pounds per square inch and averages about 15,000. This forces the fuel oil through the spray hole tips at a speed of about thirteen miles per minute.

In the new streamline-train Diesels, the fuel oil used for one charge to one cylinder varies from the size of a grain of rice to that of a small pencil eraser.

H 323

## The Latest Movie Thrills

(Continued from page 821)

was then masked off, except the few buildings and the street. Next Fulton built a miniature set consisting of additional houses, part of a bridge, and a railroad train steaming along under one arch of the bridge. Parts of this scene were masked off so that the parts left would match with the street and the town in the first strip of film. Next he obtained a reel of film showing water moving down a river, and on this reel everything was masked off except enough water to fit into the completed picture. Finally a strip of film con-

(Continued to page 135A)

# VACATION IN THE OPEN

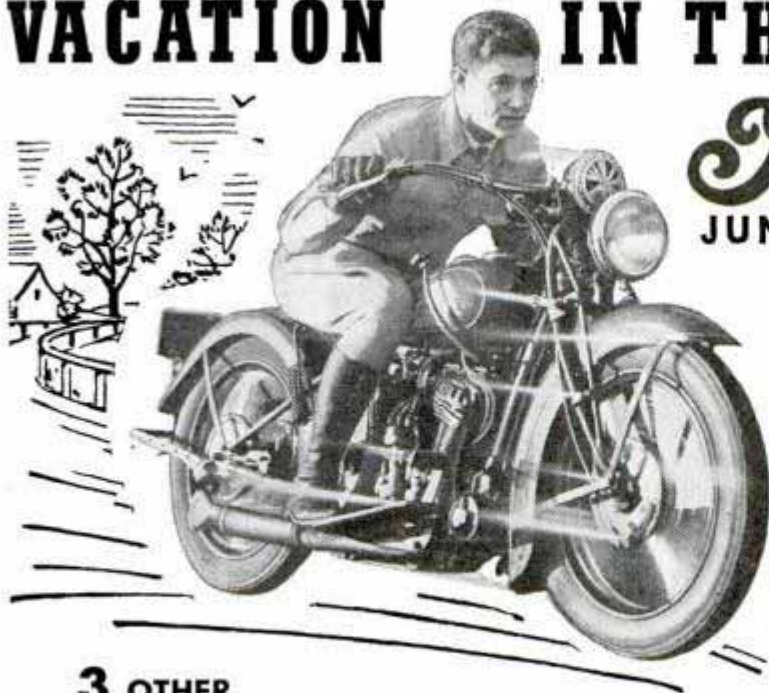

*Indian*  
JUNIOR SCOUT

F.O.B. FACTORY  
**\$215.**  
FULLY  
EQUIPPED

Get out in the open this summer! Explore highways and byways! All outdoors is yours — for fun, excitement, adventure — when you ride a TWIN-CYLINDER Indian Junior Scout—the biggest "buy" in all motorcycling.

## EASY TO OWN AN INDIAN

The new 1938 Indians are as easy to buy as they are to handle, and you can't beat 'em for economy and smooth, dependable operation. Ask your Indian dealer to demonstrate an Indian—explain Indian's easy pay-as-you-ride plan.

### 3 OTHER NEW 1938 MODELS

**DE LUXE 4**—the only American-made 4-cylinder motorcycle.

**CHIEF 74**—a peerless "top speed" performer.

**SPORT SCOUT**—a winner all around.



**FREE!**

Get this RIDER'S HELMET and INDIAN PIN



**MAIL COUPON TODAY!**

INDIAN MOTORCYCLE CO., Springfield, Mass.

Please send me at once, without obligation, your illustrated Folder showing the new 1938 Indian Motorcycles, and CERTIFICATE of VALUE entitling me to FREE RIDER'S HELMET and INDIAN PIN, as illustrated, when I place my order.

Name.....

Address.....

Please be sure to check your age group: PM 65  
 16-19 years  20-30 years  31 years and up  under 16 years



**BE at Home ON STRANGE ROADS**

With a Hull Auto Compass you never get confused on strange country roads or city streets. It always tells your direction of travel, saving you miles, money, worry and delays at a cost of only \$2.95 at your dealer. Two-piece model \$1.95. Write for circular.

HULL MFG. CO., P. O. Box 246-D2, WARREN, OHIO



Power Pays a Big Profit with a **Red Universal Tractor**

Does all field and belt work. Handles easily. Absolutely safe. Operates for 33c a day. Hundreds in use. Buy direct at low factory price. Two weeks trial—satisfaction guaranteed. Write for your free colorful catalog.

PIONEER MFG. CO.  
DEPT. V-68 WEST ALLIS, WIS.



**Thompson BEATS the World on BOATS**

**Better Built Lower Prices**

- Canoes \$64 and up
- Rowboats \$42 and up
- Outboards \$42 and up

Only Boats With Full Length Spray Rails  
Keep passengers perfectly dry—even at high speeds. Catalog also shows today's five most popular models of sailboats. Two big factories. Prompt shipment.

**CATALOG FREE**  
Write for your copy. State kind of boat in which you are interested.

**THOMPSON BROS. BOAT MFG. CO. (87)**  
213 Ann St., PESHTIGO, WIS. (Write to either place) 113 Elm St., CORTLAND, N. Y.

*Floating Shift*



## ONLY CORONA HAS IT!

Ask any "big machine" typist if Floating Shift doesn't save work and wear, improve alignment, add speed! Then look at all the other Corona features... Touch Selector, Speed Booster, All-around Frame, etc. Match Corona against all comers. Easy to use... easy to pay for... as little as \$1.00 a week. Free case and touch chart.

### MAIL THIS COUPON!

L C SMITH & CORONA TYPEWRITERS INC., Desk 6,  
723 E. Washington Street, Syracuse, N. Y.

I'm thinking of buying a Corona. Send free descriptive booklet and terms.

Name.....

Address.....

City..... State.....

When writing please mention Popular Mechanics



**Clean oil keeps repair bills down**

... and Purolator keeps your oil clean. Purolator filters solid impurities from the motor oil. If not removed, these impurities may form dense deposits that make motor overhauls necessary. Prevent this damage by providing Purolator-protection. Replace your Purolator cartridge every 8000 miles—or whenever examination of the oil indicates the need. Motor Improvements, Inc., Newark, New Jersey.

*Replace your Purolator cartridge regularly!*



E-Type Purolator



N-Type Purolator

**PUROLATOR**

THE OIL FILTER ON OVER 85% OF ALL 1938 FACTORY EQUIPPED CARS

**Attention: Compressor Users THE SMITH AIR COMPRESSOR cuts the cost of compressed air**

If you use a compressor, by all means, investigate THE SMITH. Powered by a FORD MOTOR it gives smooth, low-cost performance. Used the world over to replace large, cumbersome compressors in a majority of work such as drilling rock, breaking pavement, riveting, sand blasting, spray painting, metallizing, and general use with pneumatic tools.



With a Ford Motor and shop facilities you can assemble your own compressor. We will furnish a Smith Compressor Head and Accessories with instructions for mounting. Write Dept. D for details stating the use you have in mind.

**GORDON SMITH & CO., INC.**  
Bowling Green, Ky.

**COLUMBIAN METAL BOATS**

Light weight, durable, carefully built boats at remarkably low prices. Made of toughest galvanized copper bearing steel. Wood gun-wales. Heavy transoms for outboard motors. Two or more built-in air chambers for extra buoyancy in case of upset. Real wave riders; easy to handle. Never leak or warp. Always ready for use. Both round and flat bottom boats; all sizes and styles.

Write For Free Boat Booklet with description and prices of complete line of metal boats—knockabouts for fishermen, light weight lively boats for parks and resorts, heavy duty craft for outboard motors.

Dealers Wanted—who can develop volume sales.  
**COLUMBIAN STEEL TANK COMPANY.**  
P. O. Box 4226A Kansas City, Missouri

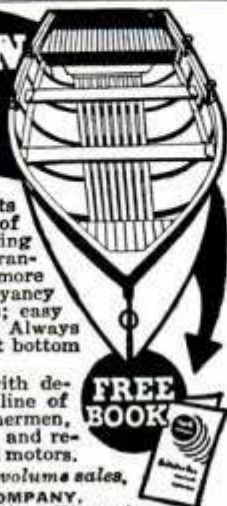

Renew old buildings. Make new construction more permanent and attractive. Plastic Colorcrete is waterproofed. It fuses with any masonry surface. It fills all cracks. It can be applied in any thickness and in 30 colors. Fully proven by over 12 years actual use under all conditions and every climate.

**OFFERS BIG EARNINGS**

Owners everywhere want to enhance present values. With this machine you can supply this big waiting market with permanent Colorcrete at amazingly low cost. Operators report cost of 2c and up per sq. ft. and sell up to 7c. Some have paid for their equipment from first few jobs. Machine capacity up to 1,000 sq. ft. per hour. Get the facts. Send for books, "Proven Business Opportunity." Write today. It offers you big extra income.

**COLORCRETE INDUSTRIES, INC.**  
578 Ottawa Ave. HOLLAND, MICH.



**BRAKES—ELECTRIC, VACUUM & AUTOMATIC—AXLES & HITCHES FOR ANY TRAILER.**

All treads, all spring spreads.

WRITE FOR FREE LITERATURE.

**HAMMER BLOW TOOL COMPANY, Dept. 106**

WAUSAU,

WIS.

**WET BASEMENTS!**

Amazing new Seal-Seep method, anyone can use. Applied to inner masonry wall and floor surfaces; no digging. Guaranteed permanently effective. Agents write for unusual earnings opportunity. Details FREE.

**Waterproof Your Own Save up to \$100 to \$150**

**National Seal-Seep Co., Dept. 692, Cincinnati, O.**



**BE WISE AND BUY AUTO-SCOOT**

**RENMOR MFG. CO., 4877 Armitage Ave., Chicago, Ill.**

**BUILD ELECTRIC FENCE**

Costs nothing to build. Operates on car battery 32 or 110 volts. 35c brings complete plans and valuable catalog listing over 500 electrical items.

**LEJAY MFG., 847 LeJay Bldg., Minneapolis, Minn.**



**BUILD CLOCKS for PLEASURE—PROFIT**



Hall clocks are high priced in stores—you can make good money building them or electrifying spring clocks. Dime brings drawing of easily built Grandfather Case with "HOW" Book pricing brass, clock, mantle, spring, ELECTRIC chime. BATTERY CLOCKS from \$1.40. Hall clock. Brass weight chime movements from \$16.95. Start now. **KUEMPEL CHIME CLOCK CO.** Building 17 Guttenberg, Iowa

**Midget Portable Electric OR BATTERY Radios**

**WORLD'S SMALLEST RADIOS**  
Just a handful—Wt. only 2 lbs. Size 3 1/2 x 5 1/2. 4 tube performance! Midget BUILT IN LOUD-SPEAKER and AERIAL. Has Broadcast and Short Wave bands! Simple to operate. Ideal Radio for Off. Apts., Bed-rooms, College, Camps, Trailers, etc. Battery model has batteries inside case for use on Farms, Boats, Autos, etc. Electric model uses 110 Volt A.C. D.C. Either model kit of parts for \$0.49. Wired and tested 50c extra or \$0.99 complete ready to listen! (Batteries for Battery model \$1.70 extra). **SEND ONLY \$1.00 and pay postman balance on delivery. ORDER NOW! GUARANTEED.**  
**TINYTONE RADIO CORPORATION, Dept. P-5, Kearney, Nebr.**





(Continued from page 132A) H 323

taining moving clouds was worked in. When it was finished no one could tell that the scene was fictitious.

Several years ago Fulton was handed the plot of a thriller that almost made his hair stand on end. The story called for three people in a mountain cabin to be marooned by a forest fire and then, as the fire closed in, for them to escape in a canoe down a turbulent mountain stream, while giant trees on both banks flamed like torches and crashed into the water. The producer wanted the camera right alongside the canoe so that he could show the contorted faces of the actors as they fought the flames and the hazards of the stream. Fulton did it by filming the stream and forest fire in miniature and then inserting a full-sized canoe and the actors into the same scenery. First he built the stream, eighteen inches deep and 150 feet long, with a twenty-mile-an-hour current. The forest was simulated by planting dry eight-foot-high yucca stalks into which trimmed branches of inflammable manzanita had been inserted to represent limbs. Concealed in the ground on both banks were pipes that sprayed a mixture of kerosene and alcohol into the air when a valve was turned.

Then with the water rushing down the stream, the valves turned on, and the miniature forest blazing angrily, Fulton dressed in an asbestos suit and crouched over a camera mounted on a wooden float. With the camera turning, he slowly pushed his way down stream. Flaming trees crashed in front of him and flames met overhead as the camera rode the rapids and twisted its way around rocky ledges.

Putting the actors in the canoe was next on the program. On each side of a narrow lake Fulton erected tall telephone poles and connected them with overhead cables. A canoe resting on the water was attached to the cables by thin invisible wires, permitting people out of camera range to dip and tilt the canoe by working the wires. With the actors in the canoe registering fear at the proper times and desperately trying to paddle away from dangers at other times, Fulton filmed the canoe as it bounced, swung around, and dipped in response to the overhead wires. Then the two films were joined together and a final print was made.

# THE GIFT FOR GRADS AND DADS



**\$15<sup>75</sup>**

IVORY MODEL.  
LEATHER  
TRAVELING CASE

\$15.00  
WITHOUT CASE

\$17.50 WITH  
GOLD-PLATED HEAD

**N**EXT to his diploma there's nothing an active young graduate will prize more highly than a Remington Rand Electric Close-Shaver. It's 1938's best gift bet for Graduation Day (and Father's Day, too). It glides over the face *so gently* you wonder how it can shave *so closely*. And you don't require a post-graduate course to learn to use it. It's the only shaver that offers *all* these advantages:—

**SHAVES** from almost any angle. Doesn't have to be held "just so."

**GREATER CUTTING SURFACE** for faster, closer shaves.

**COMBING HAIR** to lift flat hairs and guide them into the cutters.

**HIGH-SPEED MOTOR** that runs on AC or DC.

**LIGHT, COMPACT DESIGN** to fit your hand and prevent slipping.

If your dealer can't supply you, send a check or money order (but be sure to mention your dealer's name) to General Shaver Corporation, Bridgeport, Conn.



1938'S BEST  
GIFT FOR MEN

**REMINGTON RAND**  
ELECTRIC *Close-Shaver*

201356

WOOD IN CANS IS SAVING OUR HOME AND MY MONEY.



**FOR HOUSEHOLD REPAIRS**

Now if you have a broken chair—loose caster—crack or nick in wood-work, floor, plaster or tile—loose drawer pull—do a quick, expert job of repairing with this wood in cans —PLASTIC WOOD—that handles like soft putty and hardens into wood—wood you can carve, paint, and drive nails and screws into. Paint, hardware stores sell PLASTIC WOOD for 25¢ a tube, 35¢ a can. Try it today. Results will surprise you.



**PLASTIC WOOD**

**HERE'S THE MASTER FIXER**

Quickly, permanently joins and repairs china, glass, wood, celluloid, etc. Transparent—or Metal color. Get it at paint, hardware or 10¢ stores.

**Old English CEMENT**

**FIREWORKS**

Assortments \$1.00 and up or make your selection from FREE catalog. Buy them direct. Send postal for it to-day.

H. E. ROEHRS & CO. Dept. 3 Closter, N. J.



**JAMESTOWN KAYAKS**

Knockdown kits or assembled lengths from 9 feet to 13½ feet. Prices from \$9.95 to \$34.50. CANVAS CANOE complete ready to ride, \$39.50. Rubber boats and mattresses from \$12.00 to \$80.00. Send dime for beautifully illustrated catalogue. JAMESTOWN SPECIALTY CO., Titusville, Pa., Box 377, P.M.

**Electric Plants Offer Power**

(Continued from page 852)

300 to 5,000 watts, homemade electricity is produced without batteries, and regular city appliances can be used with it. The operating cost will be higher than for an air-driven plant, but the initial cost is likely to be lower than for a wind system of equal capacity. An electric refrigerator employing a brine tank is available for such systems. The plant is not operated continuously and the brine retains the cold.

Small Diesel plants are used mostly where two or three neighbors share the expense of producing current because the output of such a plant usually supplies all the juice needed by more than one household. The same idea is employed sometimes even in homes connected to the high lines. In such homes, the equipment is intended principally for emergency use.

With heating systems, refrigeration and other necessities depending more and more on an uninterrupted flow of current, some households are installing some kind of plant for producing homemade juice in the event high line service is interrupted. One of the most popular is a gas-engine generator unit which starts automatically when the regular current fails and stops when service is restored. Such an installation does not require separate wiring, and lamps for the unit are connected direct to the main panel board. The only battery needed is a small one for starting and this is kept charged by a trickle charger connected to the regular source of supply.

Another unit which can be used for emergency service is the large glass-cell storage-battery kind. A change-over switch throws on the current from the batteries when service is interrupted but, with this system, a separate emergency circuit must be provided, including the lights themselves, because batteries store only direct current. For emergency purposes, a unit with a capacity of 400 or 500 watts is likely to be sufficient to operate a home heating plant or a refrigerator, a few lights and perhaps keep a water supply going during an emergency.

Cities have been made over by electricity. Night has been turned into day, work has been lifted from weary shoulders in home and factory, the wheels of industry are turned by electric motors and electri-

(Continued to page 139A)

see note

# OWN A ROYAL PORTABLE ON YOUR OWN TERMS



"Take advantage of Royal's FREE HOME TRIAL offer. Send in the coupon below right away. I got a big raise—shortly after purchasing a Royal."



**GET A FREE HOME TRIAL!**  
Without risking a penny—prove that a Royal Portable will help you get that raise. Whatever your job—salesman, executive, inventor, engineer, teacher, student—prove that a Royal will help you

think faster, write faster—get your ideas, letters and reports down on paper easily—in modern, readable, saleable form. Prove that it will pay you (your family, too—if you are a family man) to own a Royal Portable!

**READ WHAT ROYAL GIVES YOU:** These great features explain why so many thousands of families are Royal owners. Built by the world's largest company devoted exclusively to typewriters—with standard, full-sized keyboard and easy, effortless action: Touch Control, Finger Comfort Keys, Genuine Dust Protection, Office-style Tabulator and numerous other "big machine" features. Royal Typewriter Company, Inc., New York.

## ACT NOW!

SEE what a latest model, factory-new Royal Portable can do for you—your family. Then own it on your own terms—cash or only a few cents a day. Mail the coupon today!

**ONLY A FEW CENTS A DAY!**

**FREE!** With every Royal Portable, a handsome all-weather Carrying Case.

**FREE!** Royal's Instant Typing Chart—it shows you how to type right, no extra cost!

ROYAL TYPEWRITER COMPANY, Inc.  
Department B-87, 2 Park Avenue, New York, N. Y.

Please tell me how I can own—for only a few cents a day—a latest model Royal Portable—complete with free Carrying Case and Instant Typing Chart. I now own a..... Typewriter, Serial No..... Tell me how much you will give on it as CASH allowance on a Royal Portable.

NAME..... STREET.....

CITY..... STATE.....

## STANDARD GARDEN TRACTORS

**Plow Seed Cultivate Mow Hay and Lawns**  
Powerful Gas Tractors for Small Farms, Gardeners, Florists, Nurseries, Fruit Growers, Poultrymen.  
**1 & 2 Cylinders**  
High Wheels. Rubber or Steel Tires. Walk or Ride.  
Do Belt Work—Free Catalog  
**STANDARD ENGINE CO.**  
Minneapolis, Minn. Philadelphia, Pa. New York, N. Y.  
3221 Como Ave. 2546 Market St. 290 Cedar St.



## FLAME-GUN Destroys Weeds Does Work of 4 Men!

**Hauck Kerosene Flame-Gun—2000° F. controlled heat—quickly, easily, economically destroys weeds (seeds and all), brush, other objectionable growths. Keeps roadways, fences, irrigation ditches, orchards, etc., clean. Hundred and one uses. Inexpensive—Safe—Easy to use. Pays for itself in time and money saved. 10 day Free Trial. Write for Free booklet and special introductory price.**  
Hauck Mfg. Co., 133 Tenth St., Brooklyn, N. Y.



## TOOLMAKERS—MACHINISTS

Choose Better, Finer, more Desirable Tool Chests from Free Catalog.  
**GERSTNER TOOL CHESTS**  
438 Columbia St. Dayton, Ohio



## OTTAWA LOG SAW



**only \$39**  
**GREATEST OFFER EVER MADE**  
**Make Money!** Wood is valuable. Saw 15 to 20 cords a day. Does more than 10 men. Ottawa easily operated by man or boy. Falls trees—saws limbs. Use 4-hp. engine for other work. Write today for FREE book.

**OTTAWA MFG. CO., 627 Wood St., Ottawa, Kansas**

## HANDEE

TOOL OF 1001 USES

### ACTUALLY A WHOLE SHOP FULL OF TOOLS IN ONE

Uses 200 different accessories, instantly interchangeable in easy-working chuck. For faster, better work on all materials, at home, in shop, or take to job. Plugs in any AC or DC socket, 110 volts. You'll be amazed at its unmatched performance, precision and almost human response.



- Grinds Drills
- Polishes Engraves
- Sharpens Sharpens
- Carves Carves
- Cleans Cleans
- Sands Sands
- Cuts Cuts
- Saws Saws

### STANDARD MODEL

13,000 r.p.m. Weighs 16 oz. \$10.75 postpaid with 3 Accessories.

### DE LUXE MODEL

25,000 r.p.m. Fastest, smoothest, most powerful tool for its type and weight, 12 oz. \$18.50 postpaid with 6 Accessories.

### GET A DEMONSTRATION

at Hardware, Tool or Dept. Stores, or let us send either model on 10-days Money-back Trial. Catalog Free.

**New ROUTER and SHAPER**  
Convert your De Luxe Handee into an easy-to-handle Router or Shaper that will inlay, rout, carve, make molding cuts to 100th of an inch accuracy. \$12.50.

Chicago Wheel & Mfg. Co., 1101 W. Monroe St. Dept. Q, Chicago, Ill.

- Send Catalog  Router-Shaper Set PM6  
 De Luxe Model  Standard Model  Send C. O. D.

Name.....

Address.....

When writing please mention Popular Mechanics

**.. I'M GOING TO HAVE AN ATLAS IN MY SHOP**

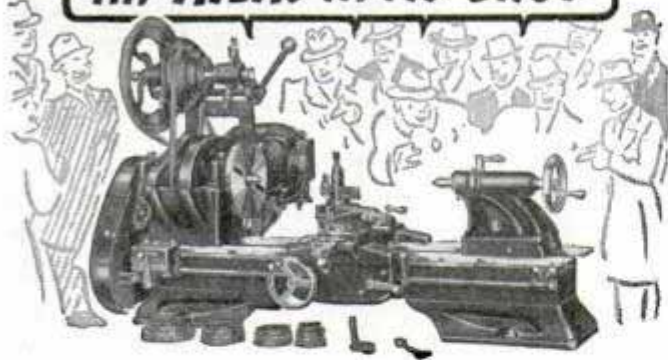

All who see the Atlas precision lathes and other shop equipment talk about the power, versatility, and extra features of these modern machine tools. The 10" back-gear model illustrated is \$98.50 complete with countershaft, V-belt drive, change gears, and many other special features.

**New De Luxe SMALL LATHE**

**\$59.50 — \$64.50**



Machinists, model makers, jewelers, home craftsmen are most enthusiastic about this sensational new lathe. It's a back-gear, screw-cutting lathe with 16 speeds, reversible power feeds, integral countershaft, V-belt drive, Timken bearings, etc. There

are two sizes—12" and 18" between centers—both with 6" swing. There's never been a value like it before.

**Free NEW CATALOG**

Shows the complete new Atlas Equipment for metal and wood working. Send coupon for your copy today.



**ATLAS PRESS CO.**  
643 N. Pitcher Street  
Kalamazoo, Mich.

ATLAS PRESS CO., 643 N. Pitcher St., Kalamazoo, Mich.  
Kindly send me your 1938 Catalog on:  New Small Lathe  
 Metal Lathes  New Shaper  Drill Presses  Arbor Presses  
 Wood Lathes  Vises

Name .....

Address .....

City and State .....

*work faster*

**ALL-PURPOSE MOTO-TOOL**



Everyone who works with his hands—at home, shop, school, or profession—can use the efficient, attractive Moto-Tool to advantage. Grinds, drills, routs, carves, polishes all materials. Chuck uses many tools. You do in seconds jobs that require hours of hard, hand work. Safe, thousands in use. Two fine models. No. 1 weighs 6 oz.—about 20,000 r.p.m. No. 2 weighs 13 oz.—about 25,000 r.p.m. Order on 10 day money back trial, or send for free booklet.

Dremel Manufacturing Company  
2830 Ct., Racine, Wis.



Model 1  
**\$9.85** postpaid  
10 Day Trial

Model 2  
**\$16.50** Postpaid

**BUILD THE CUTTY SARK!**

10¢ FOR COMPLETE CATALOG



**COMPLETE \$2.50**  
PLUS 15¢ POSTAGE  
Everything... including CARVED WOOD HULL, Printed-Balsa Decks, Cast Metal Life-boats, Anchors, Bits, Steering Wheel, Chains, Masts, Spars, Rigging, Cement, Colored Lacquer—Full-Size Plans and Instructions.

**IDEAL AEROPLANE & SUPPLY CO., INC.**  
26 WEST 19TH STREET, NEW YORK

**SERA'MŌ AMAZING NEW POTTERY CLAY**

**... fired in your Kitchen Oven**

EASY to shape! Fire in kitchen oven. Make beautiful vases, plaques, art objects, etc. inexpensively. 1 lb. 25c, 5 lbs. \$1.00. ORDER TODAY. FAVOR RUHL & CO., 425 S. Wabash Ave., Chicago, Ill.

See Article April Popular Mechanics—Page 611

**BUILD YOUR OWN Electric Outboard Motor**



from old auto generator. We show you how. Lightweight—Clean—Silent. Variable speed from standstill to maximum makes it ideal for trolling or casting. Operates 8 to 12 hours on 6 or 12 volt battery. Many other important features. Dime brings complete plans and valuable catalogue.

**LEJAY MFG. CO.**

547 LeJay Bldg. Minneapolis, Minn.

**BILD-UR-OWN**



Want the best for your motor scooter? Then equip it with our DISC WHEELS and Balloon Tires. Your choice of famous (GOODRICH—GOOD YEAR—FIRESTONE)

**SAVES YOU MONEY TOO!**  
BIKE TRAILERS, ETC.

At lowest prices. We provide Scooter Kits at big savings. Build Now! We also carry larger Tires, Wheels, Motors, etc. Write for prices.

BILD-UR-OWN DEVICES, 5237 Lake St., Dept. A-6, CHICAGO, ILL.

**AUTOMATIC STENCIL DUPLICATOR**

Amazing new Print-O-Press Stencil Duplicator. Automatic feeding. Automatic inking. Full 8 1/4 x 14 legal size. Other models also, at world's lowest prices. Details free, also free samples of work done. User-Agents write.

**\$13.95**

Complete

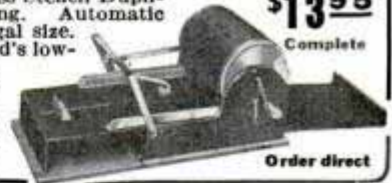

Professional Products  
Dept. 610, Silverton, O.

Order direct

**BUILD THIS CAPE COD CHAIR**



Moderate Design. Sturdy Construction. EASY TO BUILD from our completely detailed and dimensioned BLUE PRINTS. Model F-102 blue print 50c. Knock down kit ready for assembly and painting, \$K-102 \$4.95 F.O.B. Milwaukee. Order Now. CRAFTSMAN'S MODEL COMPANY, Dept. P18, 2030 N. 41st St., Milwaukee, Wis.

**NEW BIG TRAILER PARTS CATALOG**

Shows hundreds of house trailer items. Build your own trailer or re-condition the one you have. Wholesale prices. Quality merchandise. Prompt shipment. Send 10c for this money saving catalog today.

C. M. Hoof Company, 1736 S. Michigan Ave., Dept. P-6, Chicago, Ill.



**CATCH FISH!**

minnows, eels, mink, muskrat with our folding galvanized Steel Wire Traps. Greer Patent Lever Hooks are so constructed that when a fish gives the slightest pull on the bait the upper hook reaches down and gets a hold that



loses, and other specialties. Walton Supply Co., 3507B Junata St., St. Louis, Mo.

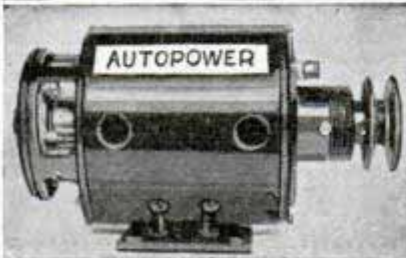

**TURN SCRAP INTO MONEY**

AUTOPOWER tells you how in plain, easy, simple and illustrated instructions that anyone can follow. Change auto generators into useful, practical A C and D C generators and motors with voltage from 2 to 1,000 volts, for power, light, welding, radio, sound, etc. No previous experience nor special tools needed. Generators can be driven by wind, water, fan belt, etc. INSTRUCTIONS FOR BUILDING AN A C WELDER THAT ACTUALLY WORKS UP TO A 3/16" ROD. ALSO COMPLETE PLANS FOR WIND AND WATER POWER PLANTS. Send for your copy of "AUTOPOWER." Already used and endorsed by thousands. Only \$1.00 postpaid. S. W. DUNCAN, Publisher. 410 S. Hoyne Ave., Chicago



(Continued from page 136A)

cally operated conveyances ranging from trolley cars to elevators carry millions of people many billions of passenger-miles each year. What has happened in cities indicates what will happen in the country when electricity is put to work on the farm.

Less than eighteen per cent of America's farm homes are served today by the high lines. Of that number, and of those making their own current, few are using this energy to do more than supply lights, operate a few household appliances and perhaps pump water. And yet, much farm work done with other power could be done better and cheaper by electricity.

There are more than 250 ways in which electricity actually is being used in rural districts today, and these jobs range all the way from tending the pigs and hatching chickens to clipping the hair of prize steers and milking the cows. A lightly charged wire, it has been found, discourages pigs and cattle from straying out of bounds.

In 1925, American farmers, it was estimated by the government, used about 47,000,000 horsepower in agriculture—twice as much as was used in manufacturing. This power, derived from horses and mules, oil and gas engines, wind, water and electricity, cost an estimated \$3,000,000,000. Electricity did only about four per cent of all this farm work. In 1930, the available horsepower for agriculture had increased to about 70,000,000, of which only about 3.1 per cent was electrical.

The average cost to farmers for the power used in 1925 was estimated at nineteen cents per horsepower-hour or about twenty-five cents per kilowatt-hour. It was also estimated that it cost a farmer twenty-five cents to work his own horse for one hour. That's the cost of a horsepower-hour supplied by a horse. But electricity can do many types of farm work for anywhere from five to fifteen cents per kilowatt-hour, depending on the task and the source of the electrical energy.

Shortly before his death, Thomas A. Edison declared that "the electrical development of America has only just begun." Perhaps he had in mind the day when the blessings of electricity will be bestowed as freely on the rural resident as on his city brother. For electricity is the servant of all, a tireless, versatile worker which plays the radio, saws wood, lights the home or churns butter with equal ease.

## Do Your Own Repairing with SMOOTH-ON No. 1

Why go to an outsider, await his convenience and pay a high labor charge for what you can do quickly, easily and at almost no expense?

When a leak starts in a boiler, furnace, heater, tank, threaded or gasketed joint, a smoke or hot-air duct, etc., or when wood screws, bolts, nuts, handles, etc., refuse to stay put and hold tightly, **make the repair yourself**, and keep the money in your own pocket.

Smooth-On No. 1, requiring no heat, special tools or previous experience in its

application, affords a dependable means for doing exactly this. Used to stop leaks of water, steam, gas or oil, to tighten loose hinges, locks, handles, connections, etc., or to anchor shelf brackets, cabinets, fixtures, partitions, posts, etc., in masonry, Smooth-On No. 1 hardens into metal quickly, and becomes stronger than the surrounding material.

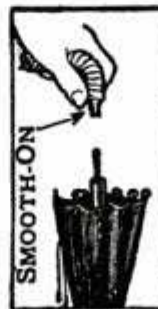

Tightening loose handle



Stopping leak at crack

Smooth-On No. 1 seldom costs over a few cents per application and can be used in dozens of places in your home and on your car, with an annual saving that amounts to a substantial sum.

The Smooth-On Home and Auto Repair booklet, sent free, explains where Smooth-On should be used and how applied for best results with least effort, and is filled with helpful advice and diagrams for the guidance of home mechanics.

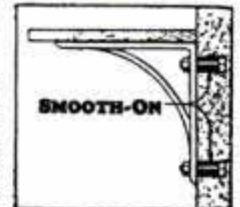

Anchoring in masonry



Write for  
**FREE BOOK**



Mail the coupon for your copy and get Smooth-On No. 1 in 7-oz. or 1 or 5-lb. can from any hardware store. Your first Smooth-On application will probably more than repay the small investment, and you will be ready for many jobs that otherwise might be costly or annoying.

SMOOTH-ON MFG. CO., Dept. 37  
574 Communipaw Ave.,  
Jersey City, N. J.

Please send Smooth-On Home Repair Book.

Name.....

Address.....

6-38.....

Do it with **SMOOTH-ON**

# Everything in Radio

**AT LOWEST PRICES!**

**56 NEW SETS**

Write today for ALLIED's big 164 page Spring Catalog—packed with everything in Radio—at sensationally low prices! 56 new, supervalue KNIGHT Radios, including Push-Button Tuning Models, latest Auto, Farm Radios, Phono-Radios—sets for AC, AC-DC, 6 volt, 2 volt, and 32 volt operation—at unequalled low prices! Latest Set-Builder's Kits, Newest Amateur Gear, Sound Systems, Test Equipment; over 12,000 parts, books, tools, etc. Your every Radio need in one complete book—fast, dependable service, lowest prices always. Send coupon now for Free new Catalog.

**NEW KITS**

**NEW P.A.**

**FREE! BUILDER'S PARTS LISTS**

We supply Free Parts Lists of matched kits for building any circuit described in this or any other magazine. Just specify where seen.

**ALLIED RADIO CORPORATION**  
833 Jackson Blvd., Dept. 5-F-8, Chicago

Send your new Spring-and-Summer Catalog—FREE.

Name .....

Address .....

**Free CATALOG**

**NEW BENJAMIN AIR PISTOLS**

Powerful—Accurate—Economic—Practical—Adjustable Shooting Force—Amazing Maximum Velocity—cal. 177 or 22 and BB—For Target and Small Game—the only Genuine Compressed Air Pistol for Shooting BB on the market—Single Shot with Bolt Action—Hammer Fire—Hair Trigger—Safety. Price \$7.50. Holster \$2.00. Also 177 and 22 Single Shot Air Rifles \$7.50—Single Shot BB Air Rifle \$6.00—25 Shot BB Repeater Air Rifle \$7.50—at Dealer or Direct—No license required—Safe for indoor use.

**FULL DETAILS—TARGETS—FREE—WRITE TODAY**

Benjamin Air Rifle Co., 831 Marion St., St. Louis, Mo.

**\$7.50**

**60 POWER TELESCOPE . . . \$2.19**

VARIABLE EYEPIECE 20X—40X—60X

**NEW!** Three telescopes in one. 3 different magnifications. 20 power for ultra-bright images with 40 and 60 power for extra long range. Guaranteed to bring distant objects, people, sports events, ships, moon, stars, etc., 60 times as close.

Most powerful made for anywhere near the money. Closes to less than a foot in length. Multiple lens system. 30 mm. objective, in heavy brass mount. Directions included for using as a compound 4 lens microscope. American made. We pay the postage. Only \$2.19. Catalog of Microscopes, Binoculars, etc. FREE on request. BROWNSCOPE CO., Dept. 46, 5 W. 27th St., New York, N. Y.

**EARN MONEY COLOR-GLAZE POTTERY, TILES, WALLS, STATUARY**

Make 2,500 designs concrete lawn pottery without molds, power or costly tools and glaze them like clayware. Build your own equipment from our plans. Use only sand, cement, cheap materials. No experience needed. MEN—Send 10¢ TODAY for colorplate, details of this money-making business.

**NATIONAL POTTERIES COMPANY**  
Room 6, 13 W. 26th St., Minneapolis, Minn.

**VEST POCKET ADDING MACHINE**

IDEAL FOR BUSINESS OR PERSONAL USE: Adds, subtracts, multiplies, divides. Does work of more costly machine. Counts up to million, made of steel—weighs 8 ounces. Simple, accurate. Not a toy. Guaranteed 5 years.

— FREE TRIAL —  
SEND NO MONEY!

**\$2.50 Total Cost**

Order from ad, not sold in stores. Just send name and address. On delivery pay postman \$2.50 (plus few cents postage). (If outside U. S. send cash.) 10¢ additional in Leatherette Case. If not satisfied after 10 days' trial you get your money back. Thousands of satisfied users. Write for Agent's proposition. CALCULATOR MACHINE CO. (Mfrs.) Dept. 106, P. O. Box 1118, Chicago, Illinois.

## Radio Direction Finder

(Continued from page 899)

piece of broomstick and the bottom end is drilled and tapped for a machine screw which grounds the rod and holds the assembly on the chassis base. The upper section of broomstick rotates with the direction scale. The flexible insulated outside loop leads (2 and 3) are tied or taped to the upper stick. Leave slack in these leads to permit just one complete rotation of the loop.

Tuning condenser (C) is mounted on four 5/8-in. porcelain stand-off insulators and the shaft extension to the dial on the front panel is a Bakelite rod, thus insulating the condenser from the metal base and front panel.

For the direction scale, cut strips 3/4 in. wide from cross-section paper ruled 10 or 20 divisions to the inch. Paste the strips

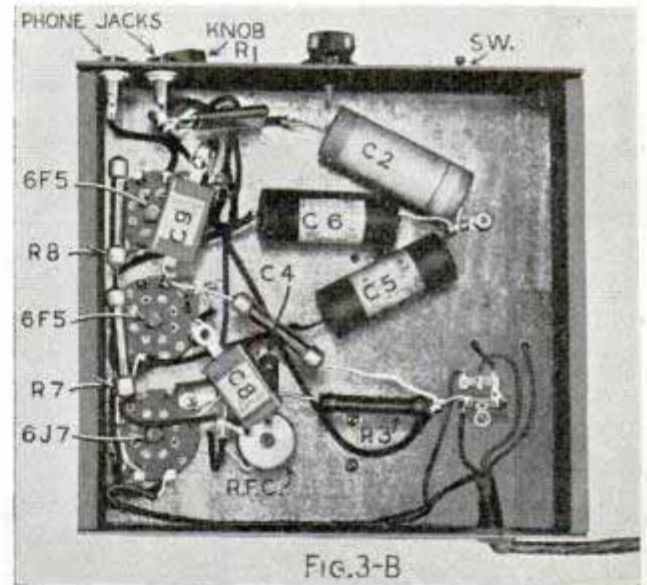

together to make a total length of a little over 18 in. Mark off the strip to correspond to compass degrees, reading from 0 to 360 left to right, with 20-degree markings every inch. Glue this strip on the edge of the wood disk which is 3/4 in. thick and 5 3/4 in. in diameter. If diameter is not exactly right to make the zero mark come around and overlap on 360-degree mark, sand disk down or build up with strips of paper as required. An index marker for the direction scale is made from a short piece of bus-bar wire which is fastened under a screw head at the top of the front panel. A round-head wood screw is placed in edge of the disk for a stop. A list of the original parts, with additional operating

(Continued to page 142A)

**COMPLETE ELECTRIC PLANTS**

Onan A.C. plants furnish same current as city lines, 110 Volt, 60 Cy. For farms, camps, construction jobs. Operate radios, water systems, all appliances. New models, 350 to 5000 watts, 6, 12, 32 and 110 volt D.C. Models \$57.50 and up. Also combination A.C.-D.C. units. Shipped complete, ready to run.

Write for details.  
D. W. ONAN & SONS  
1021 Royalston Ave  
Minneapolis Minnesota

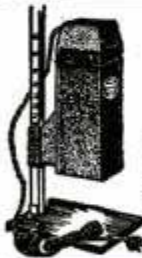
**PHOTO ENLARGEMENTS**

Is Photography your hobby? Do you want a profitable easy business at home? Make **PHOTO ENLARGEMENTS** for yourself and others. Your cost 5c each and less. The Ideal Photo Enlarger is **AUTOMATIC**. No experience required. Also **COPIES** any picture. **\$5.94 COMPLETE**. Interesting circular **FREE**.

IDEAL-O, 122 East 25th Street, New York City

**5¢**  
ANY  
SIZE

**BURN YOUR NAME ON TOOLS**

WITH THE

**ARKOGRAF****PROTECT YOUR TOOLS FROM THEFT**

Write with electricity any name or design on the hardest and finest tools and instruments, or any metal, like writing on paper with pen or pencil. **Complete Outfit \$3.50**—Practical Anywhere. Interesting illustrated circular free. Write today.

Agents wanted.  
ARKOGRAF PEN CO., 3927 S.E. Stark St., Portland, Ore.

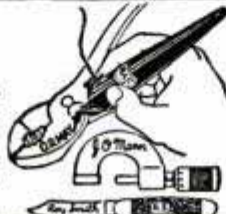

**FREE** 48-Page **POWER TOOL** Catalog sent to any home craftsman interested in improving his work. Full descriptions of **DRIVER** Engineered Power Tools and Accessories. Write today! Walker-Turner Co., Inc., 168 South Avenue, Plainfield, N. J.

**DRIVER Engineered POWER TOOLS****Build a BOAT FOR PLEASURE OR PROFIT****Shows EXACTLY HOW TO BUILD 15 DIFFERENT BOATS**

This is the new edition with 42 added pages, 6 new boats, and conversion of Ford motor for marine use. Full directions and details for cabin cruiser, racing, hydroplane, outboard runabout, sail boats, kayak, sled type—15 boats in all. Also sectional boat to carry on car.

**SEND NO MONEY**

Write for new edition of Boat Book today! Sent anywhere. Pay postman \$3.00 plus few cents postage. Outside U. S. and possessions remit with order. Money refunded if not satisfied.

POPULAR MECHANICS PRESS—Room 636A  
200 East Ontario St., Chicago

**EASY—LOW COST with POPULAR MECHANICS BOAT BOOK**

Build a boat at home! You can do it. Just the kind you've wanted—power, sail, or row boat. The "Boat Book" shows you how in simple step-by-step directions. Specially prepared for those with limited tools, little skill and money. Build boats to sell for profit too. Book tells how.

**GIVES PLANS, METHODS AND MATERIALS**

Actual working plans and photos of real boats under construction makes building easy. Shows materials needed and rock-bottom costs. Hundreds of pictures. No chance for mistake. Includes also, navigation and pilot rules, handling sailing craft, boat kinks, boating terms. Everything a boat enthusiast should know. Size 7x10 inches. 312 pages. Fine cloth binding.

**SANI-FLUSH IS "FIRST AID" FOR CLOGGED RADIATORS!**

When a car overheats—you lose power. You are headed for more serious trouble. Clean out radiators regularly, twice a year. You can do it yourself with SANI-FLUSH. It takes 10 minutes. It costs 10c. (25c for the largest truck or tractor.)

SANI-FLUSH is a scientific preparation that removes rust, scale, sediment and sludge that clog radiators. Just pour a little in the cooling system. Follow directions on the can. Run the motor. Drain. Flush. Refill with clean water. That's all! The delicate veins that circulate water are clean and open. The motor runs cool. SANI-FLUSH is perfectly safe. Can't hurt engine or fittings. You'll find SANI-FLUSH in most bathrooms for cleaning toilets. Sold by grocery, drug, hardware, and five-and-ten-cent stores. 25c and 10c sizes. The Hygienic Products Company, Canton, Ohio.

**Sani-Flush** **Safe NOT CAUSTIC**  
KEEPS RADIATORS CLEAN

**NEW BRUSH PLATING OUTFIT For AUTO PARTS**

Connects to a battery with no tanks necessary. Plates on iron, steel, brass, copper, etc. Almost as simple as painting. Hundreds of car owners waiting for this low-cost plating. Improves appearance and value of the car. Your opportunity to make good income plating auto parts, bathroom fixtures, reflectors, mirrors, etc.

**FREE PROOF**

Write quick—big season here. Get **FREE PROOF** and particulars that put you in a paying business of your own.

**GUNMETAL COMPANY**  
AVENUE M DECATUR, ILL.

When writing please mention Popular Mechanics



**FREE!**

**GREAT NEW RADIO AND CAMERA CATALOG**

Here's the catalog that will make "photographic value" history. Never before have you been able to buy cameras, films, supplies at such tremendous savings. They're all here—names like Kodak, Weston, Wirginex, Gewirette and many others. Send for your **FREE** copy. Use coupon **TODAY**.

**10 DAY FREE TRIAL ON CAMERAS LIBERAL EXCHANGE SERVICE BUY AT ANY ONE OF 7 BRANCHES**

**WHOLESALE RADIO SERVICE CO. INC.**

NEW YORK, N.Y. • CHICAGO, ILL. • ATLANTA, GA.  
 100 SIXTH AVENUE • 901 W. JACKSON BLVD. • 265 PEACHTREE STREET  
 BOSTON, MASS. • BRONX, N.Y. • NEWARK, N.J. • JAMAICA, L.I.

100 SIXTH AVE., NEW YORK, N.Y.  
 RUSH FREE CATALOG NO. 71-7F8

**RUSH THIS COUPON FOR FREE CATALOG**

Name.....  
 Address.....  
 City..... State.....

PASTE COUPON ON PENNY POST CARD

**OIL OF INDIA**

**MOSQUITOS** DON'T LET THEM TAKE THE JOY OUT OF YOUR SUMMER OUTINGS

Aromatic OIL OF INDIA keeps biting insects away! Simply apply a little to exposed skin. Everyone likes its pleasant odor. PESTS DON'T. Very effective and lasting. Absolutely harmless. Promotes outdoor comfort, insures perfect sleep. Send at once 50c for one bottle or \$1.00 for two.

**OIL OF INDIA CO.** 116-G West Illinois St., Chicago, Ill.

DEALERS WRITE

**THE BIGGEST HANDFUL in Radio History!**

The **SILVER DWARF** List Price \$15

**\$7.95**

LOTS OF 12  
 SAMPLE . . . \$8.50  
 RUSH \$2 deposit, pay balance C.O.D. Money back if it is not all we claim! (Carrying case \$1 extra).

● 1 Year Guarantee!  
 ● Precision-built!  
 ● 6 Tube Performance —assured by 4 new type genuine RCA TUBES.

**SILVER MANUFACTURING CO., Inc.**  
 2868 ELSTON AVE. • DEPT. P-6 • CHICAGO, ILL.

ORDER NOW — Money-Back Guarantee



Size: 6 3/4" wide x 4 3/4" high

HERE is small size and high quality in a radio that sounds like a big set. Not a toy or a novelty. Built with highest quality RCA licensed parts. 3-in. FULL DYNAMIC speaker. Weighs only 5 1/2 lbs. Operates on either AC or DC current, 110 volts. In ivory, red or walnut finish. Complete with tubes and aerial—ready to play.

**FREE CATALOG**  
 50 console and table models for homes, farms. Car radios, too! Save up to 50%.

**GIVE AWAY PLAN**—send 10c for sample push card and plan.

(Continued from page 140A)

data, can be obtained from Popular Mechanics radio department without charge. The blueprint number is R-254.

Photos Figs. 3-A and 3-B show top and underside views of the completed unit; A, B, C and D illustrate applications. There will be a very slight drain on the B-battery at all times, therefore, if the set is not used for several days it is a good idea to disconnect one side of the B-battery.

There are two general types of radio direction finding: one, to locate your own position, and the other, to locate the position of an unknown station. In both cases a map of the district, or section of coast line is necessary. Two or more stations are tuned in and direction bearings read on each. For example, Fig. 4 shows how the position of your boat is easily checked. For land use, the set must be carried from spot to spot, at each of which a bearing is taken, and drawn on the map as a line

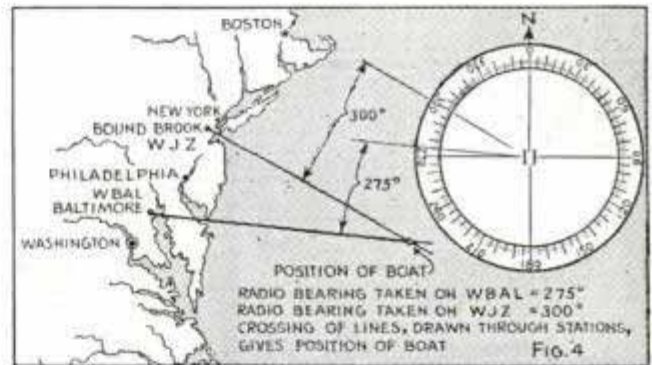

through the respective spot at the indicated angle. Two or three lines will cross at the approximate location of the unknown station. The loop, when rotated, will pick up a station without great differences in strength except for a narrow region when the loop is broadside to the station. Here the signal strength goes down, and if the loop is well balanced, the signal will go to zero at a definite point and readings will be accurate. The loop might be compared to a wagon wheel, and, when turned for zero pickup the axle of the wheel points directly at the station. The loop should be turned so that its imaginary axle points due north and south; next adjust the direction disk and fasten it to the broomstick so that bearings in compass degrees may be transferred directly to a map. In portable use, allowance must be made in setting up the receiver to make the direction index scale read zero when the loop "axle" points north.



**Get this** **SHOWER BATH**  
at **FACTORY PRICE**



**AS LOW AS \$27.95**

**EASY TO INSTALL IN SPACE AS SMALL AS 2½ FT. SQUARE**

Complete, ready to set up. Easily and quickly installed in any room having water connections. Used in homes, apartments, summer cottages, hotels, etc. Size, 30"x30"x76" and larger. Sturdily built of galvanized steel. Beautiful baked enamel white inside and outside. Has Curtain Rod. Adjustable self-cleaning Shower Head. Hot and cold water faucets. Soap dish. Drain in floor. Write for **FREE** Booklet.

**NORMAN STEEL SHOWER BATH CO.**  
2112 Norman Bldg., Nevada, Mo.

**Send for CATALOG**



**Folding Puncture Proof Canvas Boats**

Light, easy to handle, no leaks or repairs; carry by hand and on auto; safe for family; all sizes; non-sinkable, stronger than wood; used by U. S. and foreign governments. Awarded First Prize at Chicago and St. Louis World's Fair. Catalog.

**KALAMAZOO CANVAS BOAT CO.**  
450 Harrison Street Kalamazoo, Michigan

**UTILITOR TRACTORS**



Your most Economical Power for small farm plowing, dicing, cultivating, mowing, hauling, etc. Thousands in use 10 to 15 years and still going. New improved riding and walking models, 3 to 12 h.p. Before you buy **INVESTIGATE THE UTILITOR. WRITE FOR FREE CATALOG.**

**UTILITOR CO. DAYTON, OHIO DEPT. A**

**PHOTOGRAPHIC ALMANAC**

**Free!**



Free 1928 Almanac includes:  
(1) Special month-by-month Photographic Calendar. (2) Authoritative photographic article. (3) Handy Exposure Table, Exposure Guide. (4) 100 pages of still & movie cameras, films, lenses, enlargers—everything photographic—many at big savings. **ALL GUARANTEED on 10 Day Money Back Trial.** (Used equipment accepted in trade.) Write for Free copy!  
**Central Camera Co., (Est. 1899) 230 S. Wabash, Dept. K-6, Chicago**

**MAKE MONEY IN PAINTING BUSINESS**



Paint walls, ceilings, screens, furniture, radiators, machinery faster, better! ¼ H. P. motor 110 Volt 60 Cycle AC, complete with Spray Gun, 15 ft. hose. Weighs only 44 lbs. Carry anywhere. **FULLY GUARANTEED.** Only \$31.15 f. o. b. Chicago. \$5 Deposit, Balance COD, or **SEE YOUR DEALER.** Circular **FREE.** Get started making money **NOW!**

**Ideal Automatic Pump Co., Dept. PM6, 801 Washington, Chicago \$31.15 Complete**

**YOUR OWN MOVIES! 10¢ A DAY!**



NATIONALLY ADVERTISED 8MM and 16MM Movie cameras, projectors. For home, business, church, school, club. **MONEY BACK 10 DAY TRIAL.** Payments as low as 10¢ A DAY. Satisfied customers throughout the world. **FREE** details. **WRITE TODAY.**  
**DonElder's Home Movies, Dept. A-6, 739 Boylston St., Boston, Mass.**

**A AND N SUPPLY CO.**



Bargains—Military, Sport Goods, Firearms, Clothes, Shoes, etc. Send 10¢ for new catalog, to be redeemed on first order.

**EST. 1868 A & N Supply Co., 4772 Lester St., Richmond, Va.**

**Print Your Own**



Cards, stationery, circulars, tags, labels, advertising, etc. Save money. **Print for Others; Big Profits;** easy rules sent. Will do popular Raised Printing like Engraving. Junior outfit \$9. Senior outfit \$17 and up. Send for free catalog and all details.  
**KELSEY PRESSES, E-37, MERIDEN, CONN.**

**AGENTS 500% Profit SIGN LETTERS**

For Store Fronts and Office Windows. Anyone can put them on. Free samples. Liberal Offer to general agents.  
**METALLIC LETTER CO., 438 N. Clark St., Chicago**

**WRITE** for this big **money maker TODAY**

**Women ARE GOING WILD ABOUT THIS New WRIST-ACTION CORD!**

**It Spins ROUND and ROUND and Swings from SIDE to SIDE**



Here is no ordinary new product. This new Wrist-Action Plug is one of the most remarkable new devices ever offered in the Direct Selling Field! You never saw anything like it. Housewives are fascinated—held spellbound by the instant demonstration you can give with this new electric iron cord that swings freely in any direction. Ends kinking and twisting—prevents broken wires, burned fuses. Swivel action plug spins round and round—swings from side to side—keeps cord out of the way—no wonder housewives say, "Just what I want," as soon as they lay eyes on it!

**FREE** Sales are instant—sure! Nothing like it ever before. Here is the self selling big money maker you can clean up with. Get the story at once. Learn how you can **GET YOUR DEMONSTRATOR FREE.** All territories wide open. Write immediately for sensational money making plan. Mail the coupon today.

**NO-TRO ELECTRIC APPLIANCE CORPORATION**  
800 North Clark St. Dept. P-6 Chicago, Ill.

**FREE SAMPLE OFFER COUPON**

**NO-TRO ELECTRIC APPLIANCE CORP.**  
800 North Clark St., Dept. P-6, Chicago, Ill.  
Please rush me **FREE** information and sample offer at once.

NAME.....  
ADDRESS.....  
CITY..... STATE.....

**EARN MONEY Stringing TENNIS RACKETS**



An opportunity to earn as much as \$3.50 for a few minutes of your spare time. String your own racket and save money. Tennis players need restringings frequently. Every restringing means *profit* for you. No experience needed—we teach you how. **TOMGUT** Equipment makes it easy. Costs practically nothing to start. Easy work. **Begin NOW!**

**FREE** Write today and we will send you **FREE** plan and special offer on strings and stringing equipment.

**THOMPSON MANUFACTURING COMPANY**  
4535 Packers Avenue, Chicago, U. S. A.  
TOMGUT "Court-Tested" Tennis & Badminton Strings

Send **FREE** plan and special offer.  Send new booklet, "400 YEARS OF TENNIS." Enclosed is 10¢ to cover mailing costs.

Name.....  
Address.....  
City..... State.....

When writing please mention Popular Mechanics

# BIG OPPORTUNITIES MANUFACTURING MATERIALS FOR LOW COST BUILDING



**CASH IN BIG** on the great building upturn under way. Make a superior, more permanent material—the kind demanded by your trade—lighter weight, and offering big savings in construction. Sells easily up to 100% over manufacturing costs.

**WE EQUIP YOU** with line production machinery requiring only modest investment. Raw materials enter at one end—finished products emerge from other end. Big daily production with one to three men. You make common brick—face brick—in over 40 beautiful colors—also DUNSTONE in 9 sizes.

**INVESTIGATE NOW.** Send for "4 Keys to Success." It tells the complete story—how present manufacturers are making outstanding progress in a business offering unlimited opportunity for growth, expansion and profit. Write today.

**W. E. DUNN MFG. CO.**  
600 W. 24th St. Holland, Mich.

# NEW BOAT READY!

The OK-4



## BUILD OK-4 at Home in a Few Evenings!

**Just out!**—Mead's sensational 14 foot portable Outboard KI-YAK! OK-4 carries 4 adults and duff—takes motors up to 10 H.P., oars and sail. Seaworthy. Leakproof. Biggest, lightest, strongest of its kind! You can build yours easily, quickly, perfectly at home in a few evenings from our patented, complete construction kit and save nearly **HALF!** Big money assembling, selling to others. (3 other paddle-sail KI-YAKS from 18 to 45 lbs. . . . also OK-2 for motor, sail, oars . . . weighs 50 lbs.) Rush dime for illustrated color circulars, amazing low Introductory Factory Prices!

**MEAD GLIDERS, 15 So. Market, Dept. B-68, CHICAGO**

★ **FIREWORKS** ★

★ **1¢ POSTCARD will Save YOU many DOLLARS** ★

★ **FREE! LOOK! FREE!** ★

★ **100 'Fort McHenry SALUTES FIRECRACKERS** ★

★ **with every order of \$1.00 or more!** ★

★ **\$3.25 worth of \$1.50** ★

★ **Full of LOWEST PRICES on America's Best Fireworks!** ★

★ **GUARANTEED SAVINGS ON EVERY ITEM AT** ★

★ **BALTIMORE FIREWORKS CO., INC.** ★

★ **6900-02-04-06-08 EASTERN AVE., BALTIMORE, MARYLAND** ★

# NOW AT BIKE COST!

ASSEMBLE AND SAVE!  
**CONSTRUCTA-SCOOT-A**  
FROM FACTORY FINISHED KITS

The Sensational Full Sized **HEAVY DUTY Motorized Scooter.**  
Has Unique Mechanical Features exclusive to **CONSTRUCTA-SCOOT**



Bates Multimotor Clutch—Auto Type Pedal Controls—Cushion Spring Fork—Silent Chainless Drive—Oversize Brakes—Safety Fuel System—12 x 3.00 Lug Balloons—Briggs, Lauson, Iron Horse, Etc., Engines—Beautiful Colors

Priced From **\$29.50 to \$59.50**

Address **CONSTRUCTA-SCOOT**  
4877 W. Armitage Ave. CHICAGO

# LABORATORY OSCILLOGRAPH BY AMERICA'S LEADING MAKER

Offers every advantage and refinement of most expensive instruments for eye-revealing projection and study of television, radio, electrical, sound and vibration phenomena. Size 8 7/8 x 8 1/4 x 9 3/8. 1" cath ode ray tube. \$9.50 cash and \$5 for seven months. Prompt delivery.

**FREE** Complete course in cathode ray technique with every instrument.  
The Clough-Brengle Co., 2837 W. 19th St., Chicago

# AIR COOL YOUR HOME



## at Small Cost

Now you can enjoy an Air-Cooled Home, and really live in comfort, regardless of the heat outside. Don't suffer with a hot, stuffy house this summer. An **INTERNATIONAL AIR-COOLING UNIT** is quickly and easily installed in any style house, or building, old or new—at **surprisingly low cost.** Reduces temperature so you can work, play and sleep, and feel refreshed. It increases the value of your property also.



**HOME OWNERS AND BUILDERS** should write today for illustrated bulletin, stating the size of house or building to be cooled. **DEALERS WANTED.** Please address, Dept. 29, **INTERNATIONAL ENGINEERING, INC., DAYTON, OHIO, U. S. A.**

Get this **Book Now!**

# MONEY MAKING FORMULAS

1059 PRICELESS FORMULAS ALL IN ONE BOOK FOR \$1.25

## FORTUNES MADE WITH FORMULAS LIKE THESE

- Cosmetics
- Remedies
- Beverages
- Paints
- Glues
- Polishes
- Inks
- Soaps
- Fertilizers
- Preservatives
- Lubricants
- Auto Products
- Food Products
- Metal Products, Etc.

Hundreds of big selling products—earning millions in profits—grew from a simple formula. Your own product may bring you fame and fortune. Get this big 200 page book with 1059 formulas, and start a spare or full time business of your own. Everything explained—what to make—how to make it—where to get materials. This is the book that lifts the veil of secrecy from a profitable and fascinating business. Get your copy now. Only \$1.25 postpaid.

Popular Mechanics Press, Dept. 637-B, 200 East Ontario St., Chicago

# 900 WORK SHOP IDEAS!

How to Make Articles of Beauty and Utility that Sell

Get the most out of your hobby. Turn your Work Shop hours into profit. The "Make It Yourself" book shows you what to make and how to make it, with that "professional touch"—models—toys—useful decorative articles of all kinds. **Newest edition—480 pages, 823 pictures, 7 x 10 inches.** Sent postpaid for \$3.00 or in U. S. and possessions C. O. D.—you pay postman. **Order Now.**

**"MAKE IT YOURSELF" INCLUDES:**

- Toys—Models—Furniture—Garden Equipment—Home Repairs—Sports Equipment—Auto Kinks—Radio Equipment—Workshop Tools and Machinery. Articles on Working: Wood, Metal, Leather, Glass, Etc., Etc., Etc.



POPULAR MECHANICS PRESS, Room 637B, 200 E. Ontario St., CHICAGO

When writing please mention Popular Mechanics

## Phantom Fleet of the Highway

(Continued from page 861) 74115

ular intervals. A chemical analysis of the oil shows how much dirt each filter removes and its point of failure.

Chromium parts are punished to destruction in a salt spray room while in a soundproof room, the quietness of gear assemblies is checked. In contrast to this silent room, there's another where horns blow night and day until they fail. And there's also a dark room where lights are checked with the aid of checkerboard patterns on the walls. One of the headlamp tests involves stripping off the pure silver



Applying 2,000 pounds tension in testing the steel-and-rubber bond of an engine mounting

coating on the reflector. The silver is precipitated and weighed to make sure there's the proper amount on each reflector.

On a "twist rack" powerful jacks subject the frame to terrific inequalities of pressure to test its rigidity, while steering wheels are sandbagged by dropping heavy sacks of sand on them to prove their strength. One machine tugs away trying to tear apart the bond between a rubber engine mounting and the metal and another jiggles valve springs up and down until they break.

Over and over, thousands upon thousands of times, one piece of apparatus does nothing but apply the brakes and release them. An engineer checks at regular in-

(Continued to page 146A)

**MEN! TAKE IT FROM ME THIS RAZOR IS A KNOCKOUT!**

Announcing  
**THE NEW  
GILLETTE  
ONE-PIECE RAZOR  
WITH 5 BLADES**  
**69¢**

Jack Dempsey Shaving With Gillette's  
New Senator Model Razor

A TWIST  
TO OPEN

A TWIST  
TO CLOSE

**JACK DEMPSEY** is right. Gillette's new one-piece Senator is a knockout. And at only 69¢, including 5 Gillette Blades, it's the greatest shaving value ever offered! You'll like this new-type razor. It's sturdy, good looking and amazingly convenient. Actually you can change blades in three seconds. The head opens and closes with a simple twist of the handle. There are no loose parts to drop. See your dealer. Ask for the heavily nickel-plated new Gillette Senator Razor with five blades for only 69¢!



**Gillette's New Brushless Shaving Cream**  
Prepare your beard for perfect shaves with Gillette's New Brushless Cream. Made with peanut oil, it softens wiry whiskers, stays moist, speeds shaving, won't clog your razor. Try a tube. You'll like it! Large tube only 25¢.

**Gillette**  
**RAZORS AND BLADES**  
MORE SHAVING COMFORT FOR YOUR MONEY



**GREATER POWER—OVER 5 WATTS OUTPUT**  
**SMOOTHER RUNNING—QUIET AND VIBRATIONLESS**  
**NO HEAT—RUNS COOL INDEFINITELY**

The new Duro Grinder, completely redesigned, is a revelation in power, speed, and ability to run cool for hours. The power output is over twice as much as that delivered by other makes of grinders tested. Tests show the power output to be within  $2\frac{1}{2}$  watts of a popular make grinder selling in the \$17.00-\$19.00 bracket. Power output is the power delivered at the spindle and should not be confused with power input. **COOL—ABSOLUTELY**—We ran a quantity of these grinders continuously for 18 hours and every one could be held comfortably in the hand. Ask your dealer to show you and tell you about this wonderful new Duro Grinder.

**DURO METAL PRODUCTS Co.**

2659 N. KILDARE, CHICAGO, ILL.  
 NEW YORK DISPLAY, 258 BROADWAY, N. Y.

**7¢ A DAY!** BUYS THIS AMAZING NEW **ELECTRIC SHAVER!**



Close, quick shaves with the Hunter Electric Dry Shaver! Operates on sensational "vibrator" principle. Just plug into A.C. Outlet and it starts! Pays for itself in a dozen ways by saving on blades, brushes, soaps, lotions, etc. Many unusual features—self-starting, self-cleaning, self-sharpening, self-oiling. Priced amazingly low. Plus easy-payment terms of only 7¢ a day! Now everyone can afford to shave by electricity!

**Earn Your Own Shaver FREE!**

Get full details of our Free Shaver Plan for user-agents. Demonstrate to your friends—collect enormous profits. All shavers sold on 20 Day Free Trial, plus 1 year guarantee. Write this minute while your territory is open. For all particulars, address HUNTER SHAVING CO., 790 Broad St., Dept. G-50, Newark, N. J.

**HUGE PROFITS FOR SALESMEN**

**GOVERNS SPEED OF ANY GAS ENGINE**

It's easy and economical to supply your own power for operating all types of machinery, and do more work for less money. Simply remove the engine from a used automobile or truck, set it up where you like, attach a PIERCE UNIVERSAL GOVERNOR, start the engine and you have constantly controlled power for the operation of electric lighting plants, are welders, refrigerating units, air compressors, feed grinders, hoists, saw mills and innumerable other applications.

The load may change but the PIERCE UNIVERSAL GOVERNOR will maintain a uniform engine speed. For close regulation of speed and dependable performance PIERCE GOVERNORS are never equalled. Installation is simple. Either V or flat belts can be used. Complete Governor outfits are also available for nearly all makes and models of industrial engines.

Write for illustrated literature and prices.

THE PIERCE GOVERNOR COMPANY  
 1601 Ohio Avenue, Anderson, Indiana



**PIERCE GOVERNORS**  
 THE BRAINS OF ANY GAS ENGINE

(Continued from page 145A)

Intervals to see how each part functions. There's also a balancing machine for checking experimental parts, an apparatus for making a fatigue test on front axles and another for finding out quickly how long ball bearings will last. Brake cylinders, pistons and rubber cups are tested for endurance on a structure consisting of eight complete brake assemblies with provision for applying pressure in the hydraulic system.

One of the tests for steel is to grind down into the metal a tiny ball of super-



Cigarette papers clipped to leather samples test color-fastness of dyes in upholstery

hard steel under tons of pressure. A microscope measures the "dent" which reveals how the metal will stand up under twisting, pulling or bending stresses. Leaf and coil springs are "bumped" or flexed up and down for days on end while in the same room hydraulic shock absorbers are vibrated until they go to pieces.

Working part surfaces so smooth that a special instrument had to be invented to measure their departure from perfection are accurately gauged with a "profilometer" which, when drawn over a surface, magnifies a scratch hundreds or even thousands of times, revealing imperfections under one-millionth of an inch. There are torsion tests for crankshafts, water brake engine tests for transmissions, combined compression and tension tests for other parts. Various types of fuel pumps are tested until they fail and, in the electrical laboratory, generators and distributors are punished in like fashion while banks of storage batteries are alter-

nately charged and discharged to determine the exact life of each kind.

Even the upholstery must pass rigid tests. The fading qualities of cloth, leather and other materials are determined quickly in the "fadeometer" which, in a few hours, exposes the materials to more ultraviolet light than they would receive if they stood in the sun for a month. Another machine subjects the materials to violent twisting and flexing hour after hour to determine their strength. If leather carries pigments and dyes which might stain clothing, an ordinary cigarette paper reveals it. The paper is clipped to the sample which is heated in an electric oven. If the paper is stained, clothing may be stained too.

Out of all this rigid testing—road and laboratory—come better automobiles. Your car dollar today buys more than ever before, more safety, more comfort, more miles of service. For most of this extra value you are indebted to the torture chamber boys and the "hell drivers"—the fellows who do to your car before you buy it all the crazy things you are likely to ask of it after you buy it.

H 115

H 319

**WATER-SAVING VALVE FOR HOSE  
TURNS ON WHEN PICKED UP**

Designed to save water, a valve for garden or hot-water hose turns on when picked up. Turning the wrist opens or closes the valve, permitting the volume desired. The valve, complete with a short

\$3.75 - \$4.00

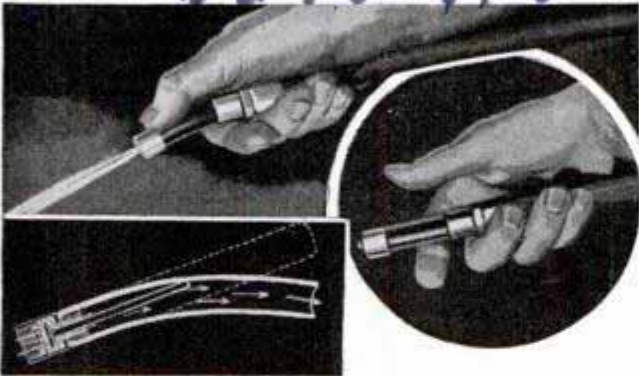

length of hose, may be screwed to the end of ordinary hose. The device is operated by grasping the hose with the fingers beyond a brass ferrule. The weight of the hose then throws the valve and the operator's wrist controls the volume of water.

Loon Mfg Co.  
625 W Jackson Chicago

**Heavy, All-Steel K R W  
MECHANIC'S BENCH**



**\$15.00** F. O. B. FACTORY  
Terms, cash with order

**3 1/2" Machinist's Vise—\$9.30 extra**

Here's a value that every shop, garage, factory and home-workshop owner will appreciate. An extra-sturdy, heavy-gauge steel "Individual" Bench, 29 1/4 x 42", that makes for greater shop efficiency. Much handier than old-style wall type benches. Attractive red or gray enamel finish. Shipped K D (142 lbs.) from factory, Jenkintown, Pa.

Other Benches up to 10' length, with or without steel Drawers. All fully guaranteed. Send orders and inquiries to

**K. R. WILSON 17 Lock St. BUFFALO, N. Y.**

Builders of Shop Equipment for Ford Dealers Since 1916  
West Coast: 722 Mateo St., Los Angeles Export Office: 90 West St., New York

**HOME AUTOMATIC CIGARETTE MACHINE**  
Have YOUR OWN Monogrammed Cigarettes  
Put tobacco and block of papers on machine. TURN THE CRANK—PRESTO—CIGARETTES. Easy—simple. All metal construction. Guaranteed. No cloth ribbons; no special tube or gummed papers required. ASK FOR FREE ILLUSTRATED FOLDER.  
A. C. MACHINE WKS., P.M.-6, 1055-57 Devon Ave., Chicago, Ill.

**\$22.50 at Bass**  
**DE FRANNE REFLEX**  
Twin lens Reflex... takes 12 2 1/2 x 2 1/4 shots on film. Triolar F:4.5 Anastigmat... automatic shutter. Eveready leather case \$4.50.  
Free: Big Camera Catalog—Write Dept. F.  
**BASS CAMERA CO.**  
179 W. MADISON STREET CHICAGO, ILL.

**MICROMETERS  
SPECIAL \$11.95**

Six piece set as illustrated in velvet lined leather case. Precision machined in one thousandths, up to 4" outside and 3 3/4" inside measurements. Easy to read, adjust and accurate—complete satisfaction.  
Buy now at bargain price. Sent prepaid on receipt of remittance. \$2 deposit required on C. O. D. shipments.

**CARSTON SALES CO., Dept. 106, 5431 W. Harrison St., Chicago, Illinois**

**FACTORY GUARANTEED  
NEW REMINGTON NOISELESS PORTABLE**

AT LAST! The famous Remington NOISELESS Portable plus Carrying Case is yours for as little as ten cents a day. Brand new. Not rebuilt. Standard keyboard and every modern feature. Free typing course. 10-Day free trial. You don't risk a penny. WE PAY ALL SHIPPING CHARGES; Act now! Remington Rand Inc. Dept. 152-6, 465 Washington St., Buffalo, N. Y.



AS LOW AS  
**10c A DAY**

# Now-MOVIES in COLOR only 15¢ a Scene!



**BRING HOME A MOVIE OF THAT TAN IN FULL COLOR FOR ONLY 15¢ A SCENE.** The Keystone "8" with a Wollensak F3.5 lens makes clear, smooth running movies in either black and white or full color, by merely sighting and pressing the button. It uses regular Eastman or Economy Agfa film which is developed FREE OF CHARGE and returned to you prepaid. The compact, pocket size, light weight Keystone "8" has all three speeds, normal, low and s-l-o-w motion. Make your first step in planning your vacation by visiting your Keystone dealer and seeing for yourself the complete line of Keystone 8 and 16 mm moving picture cameras and projectors. If your dealer cannot supply you, write to us for complete information.

KEYSTONE MANUFACTURING CO., 288 A STREET, BOSTON, MASS.

**\$29<sup>95</sup>**  
lens  
f 3.5  
USES STANDARD 8 mm. FILM



## KEYSTONE "8"mm

**NEW CATALOG**  
**LOW FACTORY PRICES**  
20 Kayak designs also assembling kits with instructions for home building. Aquaplanes, Outboards, Rowing Sculls, Ice Yachts, Sailboats, Snipes & National one design.  
**SPECIAL GIFT OFFER, \$6 DOUBLE PADDLE FREE.** While they last. Write today.

**KAYAK BOAT CO.**  
152 EAST 129 ST.  
NEW YORK, N. Y.

**Complete Cut-to-Fit Assembling Kits**

SEND 10¢ for BIG CATALOG

**SPARE TIME MONEY....**  
There's a big demand for the many hand-tooled articles you can make with the Easoo Leathercraft Set. Easily learn to make good money in your spare time. Complete outfit including tools, leathers, patterns, etc., and full instructions, only \$2.00—on sale at leading Department Stores or order direct and pay postman on arrival. \$2.50 outside U. S.

**LEATHERCRAFT**

**Free** When ordering direct, clip name of your Department Store to this ad, and we will include with your set, one extra free project. Illustrated catalog 10c.

**E. A. SWEET CO.** Dept. A-13 Binghamton, N. Y.

**MODEL BOAT PLANS IN COLOR.....25c**  
**PICTURE CATALOG .5c**  
Send stamps or coins.  
**SEATTLE MODEL BOAT CO., Dept. P, Box 333, Seattle, Wash.**

**PAINT SPRAYERS**

This sturdy, efficient outfit sprays Paint, Varnish, Enamel, Lacquer, Cold Water Paint, etc. Complete equipment consists of 2 x 2 Compressor (Displacement 2 1/4 C.F.M.) Heavy Duty, 3/4 H.P., 110 volt, 60 cycle, 3 Nozzles; Round, Fan and

AC Motor; Pressure feed Internal mix Spray Gun; 45° Angle, with Metal Clamp type quart Cup; Air Filter..... **\$28.50**  
Shipping weight 60 lbs.

Same type Unit with 2-cylinder Compressor, size 2 x 2 (Displacement 5 C.F.M.) 3/4 H. P. Capacitor Motor with National Special Gun. Price **\$67.50**  
complete.  
Shipping weight 100 lbs.  
Sold with Money back Guarantee. Send \$5.00 Deposit; Balance C.O.D.

**NATIONAL ELECTRIC TOOL CO., 569 Washington, Dept. 50, Chicago**

**Mathematics Made Easy by ROPP'S CALCULATOR AND SHORT-CUT ARITHMETIC**

Shows the Answer as Quickly as a Watch shows the Time to all Problems likely to occur in the Office, Store, Shop, Bank, Farm, or Factory.

**Over 2,000,000 Sold**  
Explains and simplifies every principle in Arithmetic, Mechanics, and Mensuration.

**PRICES POSTPAID**  
Desk Size, Flexible Keratol Binding..... **\$2.00**  
Pocket Size, Art Leather Binding..... **\$1.00**  
Pocket Size, Cloth Binding, **\$0.50**

**POPULAR MECHANICS PRESS**  
Room R-3 200 E. Ontario St. CHICAGO

# WOODSTOCK TYPEWRITERS

**BOOKS—FOR TODAY'S BIG OPPORTUNITIES**  
List sent Free upon request  
Popular Mechanics Press, 200 E. Ontario St., Chicago

**A.C.-D.C. ELECTRIC DRY SHAVE RAZOR COST \$3.00. A BIG \$2.00 PROFIT FOR YOU**

At last a Guaranteed streamlined precision-built Head and Motor Electric Dry Shave Razor at the world's lowest price that makes selling a cinch! We welcome comparison to \$15.00 competition. But don't wait! Get complete facts quick—Hurry! "Yours Free" plan tells all!

**UNIVERSAL INDUSTRIES, 6227 BROADWAY, DEPT. 126, CHICAGO**

## American Drivers Against World

(Continued from page 869)

lows him to drive through the turn and enter the next stretch with hardly any loss of momentum.

Typical of the new "compromise" cars suitable for both speedway and road racing that are being built this year is the new Belanger Special that Bob Swanson is slated to drive. The unsupercharged straight eight engine is of 248 cubic inches displacement, developing in excess of 200 horsepower at 6,000 revolutions per minute. Bore is three and five-sixteenths and the stroke is three and three-fourths inches. The compression ratio will be twelve to one or better, depending upon its performance in track trials. The engine has nine main bearings and double overhead valves. It is equipped with a self-starter to eliminate pushing after pit stops. The gear box has four speeds forward as well as a reverse and is ruggedly built to permit shifting down from high gear even when the car is rolling at around 140 miles per hour. The purpose of this is to increase deceleration when going into turns on road courses. Few if any of the American cars will use self-shifting or pre-selective gear boxes.

The completely streamline body is only five and one-half inches off the ground and measures forty-two inches from the ground to the highest point. The complete car weighs 1,800 pounds and is streamline underneath as well as on top. The car has a 103-inch wheel base and a sixty-two-inch tread, using 6.00x18 tires in front and 7.00x18 tires in back. The four-wheel hydraulic brakes are sixteen inches in diameter and two inches wide, operating from two master cylinders, and with a foot pedal on each side of the cockpit. The purpose of the left-hand pedal is to permit braking the car for short stretches while the driver's right foot still holds the accelerator pushed to the floor, a desirable maneuver in road racing. Heavy radius rods are attached to the front axle to take the brake torque. Front springs are semi-elliptic and the rear springs are transverse. Because of the cost and lack of engineering experience with the design, none of the American cars may adopt independent springing this year. Thirty-seven

(Continued to page 150A)

# Get All Three!

- 1 ALTERNATE FIRING:** Cylinders fire alternately, giving two power impulses per revolution instead of one, creating smooth power flow.
- 2 UNDERWATER EXHAUST:** No exhaust noise. No exhaust fumes.
- 3 FULL PIVOT REVERSE:** The only outboard motor development that gives you 360° steering and REVERSE!

**FREE!** WRITE for the new Sea-Horse Handy Chart of motor sizes and specifications describing all nine outboard motors of the 1938 Johnson line. See the new bantam weight model MS, with patented co-pilot, underwater exhaust, synchro-control and REVERSE! Deluxe model MD with Ready-Pull Starter, \$62.50 f. o. b. factory.

**JOHNSON MOTORS**  
400 Pershing Rd. Waukegan, Ill.

**JOHNSON Sea-horse**  
OUTBOARD MOTORS

**MODEL MS**  
New \$49.50 f. o. b. factory

### SAVE MONEY

## BUILD YOUR OWN FAN

Aluminum Propellers	THREE-BLADE for 1/4 H.P. Motor			TWO-BLADE for 1/8 H.P. Motor		
	Shipped	Size	Shaft Price	Shipped	Size	Shaft Price
Collect	20 1/2"	3/8"	\$4.00	12"	3/8"	\$2.25
	24"	3/8"	4.50	16"	3/8"	2.50
	28"	3/8"	5.00	20 1/2"	3/8"	3.00

MICHAEL ELECTRIC COMPANY, Dept. P., Fort Worth, Texas

**PORTER-CABLE TAKE-ABOUT**

**NOW IT'S FUN TO SAND**

## TAKE-ABOUT SANDERS

Give every job an expert finish in minutes instead of hours

Don't let slow, tiresome, tedious hand sanding and scraping spoil your finishing and refinishing pleasure. Do it this modern, efficient way with a Take-About. No experience necessary, just plug it into the nearest light socket and it will do your job in a jiffy. Use it on straight or slightly curved surfaces. Use the front pulley as a spindle sander on curved work.

Used in thousands of schools for instruction and refinishing desks and other maintenance work.

WRITE FOR DETAILS, PRICES AND TERMS TODAY

**PORTER-CABLE-MACH-CON**  
Precision Tools Since 1906

2000-6 N. SALINA ST.

SYRACUSE, N. Y.

**Thrilling NEW**  
**EVINRUDE**  
**"Ranger"**  
**ONLY \$47.50**

A brand new Evinrude . . . amazingly light, handy and powerful. Weighs only 16 lbs., and cruises 3 hours on a single fill! Literally packed with big-value features including famed Hooded Power — Evinrude Co-Pilot — Underwater Silencing. Starts instantly! — spins into action with a flick of the starting cord. Costs less than 3¢ an hour to operate. Send for catalog!

**ELTO PAL only \$37.50**

Elto PAL (built by Evinrude) weighs only 14 pounds, and drives boats at twice the speed of oars. Elto ACE, \$47.50 — the husky Handi-twin, only \$67.50. Each an outstanding value! Address **EVINRUDE MOTORS, 5489 N. 27th St. Milwaukee**. Prices F. O. B. Factory

**FREE Catalogs!**  
 Write for 1938 Evinrude and Elto catalogs . . . Boat Directory and Boat-and-Motor Selector.



**EVINRUDE OUTBOARD MOTORS**

1935 W. 62nd St. Los Angeles, Calif. \$47.50

(Continued from page 149A)

gallons of fuel are carried in the tail fin tank, twenty quarts of water in the radiator, and seven gallons of oil in a tank immediately in front of the cockpit, with fins projecting up into the air stream to promote cooling. The instrument board, holding switch, tachometer, oil and water temperature dials and oil and fuel pressure gauges, is insulated from the body to eliminate vibration that would make the gauges hard to read.

Designed by Art Sparks, two identical race cars are being built for Jimmie Snider and Joe Thorne. Each of these cars has a six-cylinder engine operated with a special centrifugal supercharger at a compression ratio of eight to one and will turn up to 7,500 revolutions per minute. These cars will be lower than ever, being thirty-seven inches high and having a clearance of only four inches from the ground. The driver sits nine and one-fourth inches above the ground. The streamline bodies are offset slightly on the frames to help get the driver down low alongside the drive shaft and are built exclusively of chrome molybdenum steel. Large brakes, special four-speed transmissions, and a new kind of welded front axle that eliminates all bolts and brackets are used in each car.

Fred Offenhauser, builder of many racing engines, has built a new four-cylinder supercharged engine of 181 cubic inches displacement for Leon Duray, and a 181-cubic inch eight-cylinder supercharged engine for Louis Meyer that will develop 275 horsepower at 6,500 r.p.m. These engines will carry from fifteen to twenty-two pounds of supercharger pressure to balance their low-compression ratios. Offenhauser has also finished a new 270-cubic inch unsupercharged engine for Pete Alberts that develops 250 horsepower at 5,000 r.p.m. Louie Tomei will drive Ted Horne's new four-cylinder car that has cross springs in both front and rear. Rex Mays will drive an Alpha Romeo that has been rebuilt and streamlined and Babe Stapp and Wilbur Shaw are each driving new cars. Kelly Petillo has put all new moving parts in his 272-cubic-inch four-cylinder engine.

These are some of the American cars that will race for glory and a share of the prize money.

**CHEAPER TENNIS**  
**EARN MONEY. TOO!**



NOW—you can buy Wills' fresh, genuine Eclipse **SPLIT GUT** tennis strings direct-from-factory for as little as \$2.25 PER SET postpaid. Also—excellent quality **SILK** at only 65¢ per 37 ft. coil, postpaid. Rush your order now! Satisfaction **GUARANTEED**. New 1938 **CATALOG** of Tennis Frames, Vises, equipment now ready. Get your **FREE** copy. Send today. **H. E. WILLS CO., Dept. A-135, 1047 W. 47th St., CHICAGO, U. S. A.**

**Make 'BIG TIME' BOW AND ARROW SET**

Fun. Easy to make your own **BIG TIME** bow and arrow set at home. Kit includes select, well seasoned Hickory stave, cut to shape, to make 54" **FOOT BOW!** Everything needed sent—7 **Port Orford Cedar** arrow shafts, prepared feathers, points, string, glue, wax, full instructions with illustrations. Complete \$2.35 prepaid. Satisfaction Guaranteed. **ARCHERY CATALOGUE** sent for 10¢.

*Bows and Arrows of Excellence*  
**Ben Pearson, Inc. Dept. 77, Pine Bluff, Ark.**

**TWO-CYLINDER STEAM ENGINE**

for small boat models complete with propeller, shaft, fire screen, denatured alcohol torch and fuel tank. Torch will start cold engine in 2 minutes, run it for 12 minutes.  
 Price complete as described **\$3.00** postpaid  
**Shawnee Engine Co., Box 162, Station D, Cincinnati, O**

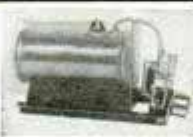

**Carry Extra Person or 250-Lb. Load in**

**Auto-Glide**



Real sensation! New 2-passenger or family roadster—great for trips, picnics—only 35¢ per mile to operate!—comfortable! Used also for deliveries—increasing store delivery business 5 to 8 times!—reducing cost almost half! Heavy steel trunk, removable cover, lock. SideKart unit on or off in 5 min. Powerful 1 1/2 or 2 H. P. engine, 2-Speed Transmission (9 to 1 ratio in low), Clutch, Brake, Ballon Tires, Windshield available. Other models.

**DEALERS: Get Spl. Offer!**  
**THE CUSHMAN MOTOR WORKS, Dept. S-6, Lincoln, Nebr.**

**WRITE** for photos, complete details and the very Low Price. Send postcard or letter today.





# NOW a DYNAMIC HEAVY DUTY INDUSTRIAL WELDER

## WORKS OFF 110 VOLT ELECTRIC LIGHT CIRCUIT

For this unheard of price, you can get the marvelous Dynamic Super-Charged Welder complete—all ready to plug into your light socket. The Dynamic does both metallic arc and carbon arc welding.

**WELDS CYLINDER BLOCKS, FENDERS, AXLES, BODIES, BUMPERS, FARM MACHINERY, CAST IRON RADIATORS, ETC.**

With the Dynamic Super-Charged Welder, a man without previous welding experience can make for himself as much as \$5.00 on a repair job that can be done in less than one hour. Many welders make as much as \$15.00 to \$20.00 a day. Despite its serviceability, the Dynamic Welder is light and easily portable—can be carried around by hand and set on the running board of any car you are working on.

### WORKS ON IRON, STEEL, TIN, BRASS, COPPER AND ALL OTHER METALS

With this welder you can work on all kinds of metal. You can also solder and braze on the lightest material—nothing will stump you—you can tackle anything and in no time at all you will be able to do finished repair jobs that will do credit to an expert. Once you have the Dynamic outfit, you are all set in a profitable welding business of your own—you boss it yourself. Rush coupon for FREE particulars—TODAY.

**DYNAMIC WELDER CO., 2226-ET Silverton Road, Chicago, Illinois**

for Only

# \$19.75

RETAIL

**AGENTS WANTED!**

You can make big profits introducing to garages, factories, mechanics, janitors and maintenance men the new Dynamic Super-Charged Welder. Get our big profit plan and ten-day trial offer. Just fill in coupon below and mail it in TODAY!

**DYNAMIC WELDER CO.**  
2226-ET Silverton Rd., Chicago, Illinois

You may send me full particulars on your big profit plan and 10-day trial offer.

Name .....

Address .....

Town..... State.....

**STAR METAL BOATS**

★ **NON-SINKABLE  
CARE-FREE  
ECONOMICAL**



Only complete line of rubber cushioned metal row boats, outboard motor and sail boats, including a new utility inboard model. Better quality, lower prices.

**STAR TANK & BOAT CO., Dept. P GOSHEN, INDIANA**

## ENGINES

**Enclosed, Self-Oiling, Roller-Bearing**

Cheapest reliable power for farm or factory. Uses all fuels for pumping, sawing, etc. Best engine for the money. You Pay Less to Own it—Less to Run it. Cash—Terms—Catalog FREE

**WITTE ENGINE WORKS**

174-A Oakland Ave., KANSAS CITY, MO.      215-F Mulberry St., HARRISBURG, PA.



**ALL ABOUT** files and how to use them . . . that's what you'll find in our new booklet, "A File For Every Purpose." Send for your copy today. You may have it free on request. Nicholson File Company, Providence, R. I., U. S. A.

**A FILE FOR EVERY PURPOSE**

**BIG MONEY-MAKERS THAT WORK** ● **PLIERS, LOCK & RATCHET WRENCH & VISE PLUS**

**EIFFEL-GEARED PIERRE WRENCH KIT-7" & 8 1/2"**

"Pocket Machine Shops" that Do the work of \$50 worth of Other tools. Amazingly Quicker, Better . . . Easier!

● Now of **ALLOY Steel—65% Stronger!**

● **NEW PLANT—Quadrupled Capacity.**

● Now have your Own Business in a New Selling Case. Full-time men making \$1,500 to \$4,000 Yearly. Part-timers in proportion. We need Many More! **FREE**



Mail Your Address Today (on a post card will do) Get **FREE**—this 7-Edge-End-&-Angle Screwdriver and 101-Picture Manual of Mechanics, with . . .  User Offers; or, with . . .  DISTRIBUTOR, Territory, Demo, and **SELLING KIT** Offers!

**AMERICAN PIERRE CORP.** PMF—4611 N. RAVENSWOOD AV. CHICAGO, ILL.

# Saw-Filing

## MAKES BIG MONEY In Spare Time

**Louis P. Wadowick,**  
Cleveland, Ohio.  
**Builder Says—**

"My Foley Saw Filer has made it possible for me to file 764 saws in spare time, and I have earned \$850 in carpenter work due directly to my saw filing contacts." With the

### FOLEY AUTO-MATIC SAW FILER

you, too, can have your own cash business at home. Earn up to \$2 to \$3 an hour filing saws automatically. There is a big demand for saw filing. No experience needed, no eyestrain, no canvassing. The Foley Automatic Saw Filer files hand, circular, and band saws quicker and better than the best hand filer. You get an average of 50c for hand saws, much more for others.

**FREE PLAN** shows you how to start. Other men are making big money and building up independent year 'round businesses, why don't you? Fill out the coupon. There is no obligation.



**FOLEY MANUFACTURING CO.**  
616-8 Foley Bldg., 11 Main St., N.E., Minneapolis, Minn.

Send me **FREE PLAN**, for starting my own business in spare time filing saws on the Foley Automatic Saw Filer, without obligation to me.

NAME .....

ADDRESS .....

## For Extra Accuracy Shoot Xpert .22's!



**WESTERN XPERT Long Rifle .22's** give extra accuracy without extra cost! Your shots go where you intend them to go. Buy XPERT for target marksmanship and all-around shooting. The .22 Short and .22 Long have comparable accuracy. **CLEAN** ammunition! **Smokeless! Non-Corrosive! Lead lubricated bullets!** Mail the Coupon now!



Western Cartridge Company,  
Dept. F-46 East Alton, Ill.

Send, **FREE**, the 72-page Western Ammunition Handbook. A complete shooting guide. Tells all about all Western cartridges and shot shells.

Name.....  
Address.....  
Post Office..... State.....



**THE WEEZEL CATCHES FISH!**

Casting size WEEZEL  $\frac{1}{8}$  oz., 17 colors, \$1 ea. Fly Rod size  $\frac{1}{20}$  oz., 12 colors, 60c ea. Muskie-Saltwater 1 oz., 17 colors, \$1.50 ea. If your dealer can't supply you, we will. Write—  
**THE WEEZEL BAIT COMPANY**  
Dept. U, Disney St., - Oakley, Cincinnati, O.

**FREE FOLDER--SHOWS BAITS IN FULL COLOR**



## DOENUT WHEELS

Now you can build any vehicle or portable machine taking loads up to 1300 lbs. with the patented **Musselman Doenut wheel**. Tire requires only 12 to 15 lbs. air for light loads, but will take 50 lbs. air pressure for heavy loads. Absorbs surface obstructions. Eliminates road shocks. Saves cost of springs in many cases. Reduces pushing and pulling effort over 50%. Single tube cord construction with heavy tread for long service. Punctures repaired without removing tire. Wheel is of double disc construction cadmium plated with adjustable ball bearings. Two tire sizes, 10" x 2.75" and 12" x 3.30".

## BOYS—build your own vehicles

Any boy who can handle a saw and hammer can build a wheelbarrow, coaster wagon, scooter, racing wagon, bicycle trailer or midget auto with our Doenut wheels and simple blue print drawings. Send 25c for building drawings of any one of these vehicles mentioned, or 50c for drawings of all five vehicles with free illustrated literature.

**THE MUSSELMAN PRODUCTS CO.**  
6247-B ST. CLAIR AVE., CLEVELAND, OHIO



Everybody can now own a

## CANDID CAMERA



Any beginner can obtain the same perfect results as the most experienced fan, with this new marvelous

Not \$10, \$20 or \$30, but only—

**MINIFOTO Jr. . . . \$3.98**

*It's Simple and Easy to Operate*  
**WOLLENSAK LENS . . . ACTION SHUTTER**  
**TAKES 16 PICTURES ON A ROLL OF FILM**  
**SPEED . . . ACTION . . . EXCITEMENT**

Catch it all with this mighty Candid Camera! You won't believe it possible at this low price, so we want you to try it out at our risk! Take all the pictures you want. Test out the remarkable clarity of the lens . . . the accuracy of the viewfinder. Compare it in action with any of the cameras selling for more money. Then, if you do not think this is the most remarkable camera bargain you ever saw, it won't cost you a penny! Fully corrected Wollelsak 50 M.M. lens. Speed shutter. Fixed focus makes it possible to get sharp pictures. Telescopic finder. Tripod Socket. Uses economical 127 V.P. or Arta A.S film in color or black and white. Enlarge clearly up to 8" x 10". **ORDER NOW** for special introductory price of only \$3.98 Postpaid. C.O.D. if preferred, plus postage.

**CANDID CAMERA SUPPLY CO.**  
303 West 42nd St. Dept. 21 New York, N. Y.

## One Wire Electric FENCE



Fencing Cost Only \$5 Mile

Complete Electric Fencer—only \$9.75 complete with insulators! Sharp but harmless electric "sting" holds all live stock safely and securely. Three dry cells last many months. Satisfaction guaranteed. Details free. **SENTINEL**, Dept. J-949, 4220 Davis Lane, Cincinnati, Ohio.

Only  
**\$9.75**  
COMPLETE



## LEARN TO SWIM IN ONE HOUR!

Great fun—learn to be a good swimmer. Develop stroke and kick. Sure-Swim keeps body in proper position. Can't sink. Can't get water soaked. Can't slip. One size fits everybody from grandson to grandmother. Full freedom of arms and legs. Get full information **FREE**. Fine territories for dealers and salesmen. **PADL-EZE SALES, INC. P-1** 1616 W. Mitchell St., Milwaukee, Wis.

Curlew .58.50  
Half Moon. 4.00

**AMERICA'S MODEL SHIPYARD**  
**BUILD BOUCHER MODELS**

Star . . . \$5.50  
50-800 Yacht 32.50

Many other fine models of Sail and Power Boats illustrated in our Hobby book; send 5c to cover postage.  
**BOUCHER, 126 LaFayette St. (Dept. P.M-6) New York**



## TRAILER BUILDERS

Largest, most complete stock of trailer parts and equipment in America. Lowest prices. New Catalog Free. Write today!  
**MARVEL TRAILER PARTS CO.**  
19020 Celestine Detroit, Mich.



## BUILD CLOCKS with our help

Cash in on the demand for Mantel, Banjo, **GRANDFATHER'S CLOCKS**. Ask about our new, low-priced **Hall Clock** and **Special Blue Print Offer**. Send time for illustrated working drawing of **Hall Clock**; 25c for plans of **Banjo Clocks**. Catalog **FREE**.  
**AMERICAN CHIME CLOCK CO.**  
1679 Ruffner St. (Established 1877) Philadelphia, Pa.



## FREE ELECTRICITY

From Wind. Build your own windcharger. Cost 98c for material plus used car generator. Send 10c for copyright drawings, instructions today.  
**WESCO, 8 Terminal, Minneapolis, Minn.**



## Earn Cash at Home!

We paid M. M. \$1174 for exceptional "cellar crop" **SNOW-KING mushrooms!** Big free picture book tells if your cellar, shed, barn suitable. We furnish materials, buy all crops. Write today. Est. 1908.  
**UNITED CO., 3848 Lincoln Ave., Dept. 301, Chicago.**



**MONUMENT**  
Best Genuine Marble or Granite \$10.95 up. Directly from U.S. MARBLE & GRANITE CO. Dept. A-18, ONECO, FLA.

Freight Paid Erected if desired. Lettered. Guaranteed. Thousands Sold. Write for Big Free Catalog and Samples



## RAISE JUMBO FROGS

This year millions of frogs will be used. **Raise Jumbo Frogs** up to 3 lbs. Desirous food, supply market. One Pair Jumbo Breeders lay up to 20,000 eggs yearly. Big market waiting for all frogs you can raise. Sell up to \$5 doz. **WEBUY** and put you in touch with other markets.

**SEND NO MONEY** Just send name and address and get our money-making plan, startling **OFFER** to beginners and complete information. Absolutely **FREE**, no obligation. Season now on—hurry! Write today.

**J. B. Frog Company, Dept. 3-A Memphis, Tenn.**

## Newspapers that Talk

(Continued from page 808)

not only photographs and a description of the catastrophe, but also sound of crashing walls, voices of eye witnesses and other related sounds which the newspaper reader may hear from his favorite paper the same evening.

Mr. Ehlert estimates that the sound tracks on paper will run through the home reproducer ten or eleven times before getting noisy. Newspapers get torn so it will not be a permanent record.

"The sound reel is similar to a moving-picture reel, except that it is much more economical to reproduce," said Mr. Finch. "The material of this reel is preferably opaque and may be paper upon which the sound tracks are printed by ordinary printing operations. The printing operation also may be performed photographically upon sensitive paper or film to accomplish the same result.

"The sound records of my present invention may be used for quality acoustic reproduction including lengthy musical renditions. However, the widest utility of this invention is in conveying intelligible speech. Accordingly, by limiting the frequency response of the apparatus to about 2,200 to 2,500 cycles, a slower rate of sound-track scanning and simpler electro-optical design as compared to talking moving-picture apparatus will prove adequate.

"The preferred scanning equipment of the home reproducer comprises a light source focused upon the sound track and a photoelectric cell sensitive to the varying light intensities refracted from the record. A preamplifier, consisting of one or two stages of audio-frequency amplification, is associated with the photoelectric cell to amplify the relatively weak electrical signals generated by the photoelectric cell.

"The reproduction apparatus for the newspaper sound strips operate by frictional feeding. A notch cut at a predetermined portion of the sound strip actuates a relay for shifting the sound strip transverse to the scanning beam in order to bring the next adjacent sound track into scanning position.

"Where the strip is formed into an endless belt, the shifting occurs at the joint between the beginning and end of the belt.

(Continued to page 155A)



# YALE OIL

**T**HIS oil has body, staying power, film strength, amazing attraction for metal and great covering ability. Stays put—doesn't drip or gum, gives REAL protection longer! Ideal for electric motors, tools, machines, guns, scores of uses. Insist upon YALE OIL—at hardware and sporting goods stores.



In tubes for easy application.  
**10c**  
15c & 25c

If your dealer can't supply you, send 10c to

## THE YALE & TOWNE MFG. CO.

Dept. O. M.

STAMFORD, CONN.

## WOOD-WORKING SUPPLIES



New 100 page book contains most complete list of woodworking supplies in the world—Standard American woods cut-to-size at bargain prices. Rare imported woods, Veneers, plywoods, inlays, carved legs, mouldings, decorations, special tools. Hard-to-find ornamental hardware, scroll saw patterns, wood-finishing instructions—How to make Venetian Blinds at 1/3 store prices. Send only 10c for Catalog No. 10 to Craftsmen's Wood Service Co., 2730 S. Mary Street, Chicago, Ill.

**GET YOUR TRACTOR AT FACTORY PRICE**

Amazing money maker for farms, truck gardens, orchards, nurseries, poultry ranches, country homes, etc. Plows, discs, harrows, cultivates, mows lawns, cuts weeds. Runs belt machinery, 2 to 6 H.P. riding or walking types. Write for FREE CATALOG. Low Factory Prices and 10 day Trial Plan. Address Nearest Office.

SHAW MFG. CO. 4506 Front St., Galesburg, Kans.  
130 G West 42nd St., New York, N. Y., 5812 G Magnolia Ave., Chicago, Ill., 662 G North 4th St., Columbus, O.

**SHAW DU-ALL TRACTOR**

Air Tires or Steel Wheels

## Earn Spare-Time Money THIS NEW PLEASANT WAY!



Learn how you can build up a profitable spare or full-time business in your own home. This new book "How to Make Money in Woodworking" is crammed with practical tested ideas, plans, and suggestions. Tells you exactly what to make, how to make it and how to sell it. Describes plans that have worked for others. Woodworking, the new way, is light, pleasant, and profitable. Send only 10c and complete book will be mailed postpaid. Satisfaction guaranteed or money refunded. Write to Dept. A638.

**Delta Mfg Co. 600 E. VIENNA AVE. MILWAUKEE, WIS.**

# TAKE IT FROM THE CHAMP

*He knows!*



**SELECT A LOUISVILLE SLUGGER IN THE MODEL OF YOUR FAVORITE PLAYER**

- JOE DI MAGGIO
- ZEKE BONURA
- MEL OTT
- "DUCKY" MEDWICK
- LOU GEHRIG
- PAUL WANER
- CHARLIE GEHRINGER
- RUDY YORK
- HANK GREENBERG
- JIMMIE FOXX
- "PEPPER" MARTIN

... and thousands of other famous sluggers of the past and present.

JUST like hundreds of other famous hitters in years gone by, "Ducky" Medwick knows his baseball bats and has picked Louisville Sluggers to get his hits and to recommend as the finest ever made. Choose your bats as the big leaguers do and insist on the autograph of your favorite player and the famous Louisville Slugger trade mark on the bat.

**Your Dealer has this FREE book for you . . . Ask him for it!**

The 1938 edition of the Famous Slugger booklet with Tips on Batting is now ready. Ask your dealer for a free copy. If he does not have it, send 5c in stamps and we will mail it to you.



**LOUISVILLE SLUGGER BATS**



*Joe 'Ducky' Medwick*



HILLERICH & BRADSBY CO., INC., LOUISVILLE, KY., DEPT. P-31

## BIG SAVING! A 16 MM. MOVIE CAMERA FOR LESS MONEY . .

**SAVE MIDDLEMAN'S PROFIT - BUY DIRECT from FACTORY**

Enjoy thrilling MOVIES of your vacation, your family, friends, special events, parties and sports, —with the PARAGON 16 mm. MOVIE CAMERA. Latest models, —lightweight, aluminum—small—compact— attractive—easy to operate—with telescopic view finder, and many more outstanding features. Guaranteed. Perfect-feeding film movement. Fully protected. Fool-proof working parts. A great value at any price. Instruction book free.



Paragon Model 3-S, 16 mm. with F3.5 lens, three speeds, 100 ft. film capacity. (10 days money-back trial) F. O. B. Fond du Lac, Wis.

**\$35.00**

**SPECIAL FACTORY PRICES . .**

**FREE OFFER WITH ORDER**

Order from this Ad and get a Beautiful Cowhide Carrying Case FREE, with hand strap and shoulder strap. Regularly priced at . . . . . \$7.50 For free gift, send money order NOW to PARAGON CAMERA COMPANY Fond du Lac, Wisconsin Reference: National Exchange Bank, Fond du Lac.

Paragon Model 1-S, 16 mm. with F3.5 lens, one speed, 100 ft. film capacity. (10 days money-back trial) F. O. B. Fond du Lac, Wis.

**\$29.75**



## PARMAK ELECTRIC FENCER

**With Amazing FLUX DIVERTER** Thousands of PARMAS now in use. One used barbed wire on light stakes cuts fencing cost to \$10 a mile.

Only PARMAK has exclusive New Flux Diverter—doubles life of SAFE 6 volt battery; fences entire farm; gives sting that holds stock like steel and concrete. Sent on 30 DAYS TRIAL. Write today for FREE CATALOG and long term guarantee. AGENTS—Write for money-making and exclusive territory plan.

PARKER-McCRODY MFG. CO., 100-G, 7609 Walnut, Kansas City, Mo.



**\$12.50**

## NEW TYPE CHEAP OIL BURNER

**WHY COOK OR HEAT with COAL or WOOD** Quick heat at turn of valve—over 40,000 sold, no dirt, ashes or drudgery. Burns cheap oil new way—no clogging up or carbon.

Slips into Any STOVE, RANGE or FURNACE.

**WRITE FOR CIRCULAR and AGENTS PLAN**—Let us show you how it ends work and dirt of coal and wood. AGENTS—Wonderful money-maker, spare or full time. Write quick for details—a postal card will do.



UNITED FACTORIES, G-751 Factory Building, Kansas City, Mo.

In answering advertisements always write name and full address clearly.

## Welding Business Earns \$150 to \$300 for You Each Month



**"BUILD-YOUR-OWN"**

Just couple your own engine to this unit, mount it on chassis and you have money making advantage of a portable welder at a saving of \$100 to \$500.



**30 DAY'S TRIAL AT HOBART'S RISK AND EASY "PAYS FOR ITSELF" TERMS**

New low prices make this profitable welding service available to everyone. Opens doors to big pay jobs that carry real profit. Hobart Welders are easier to operate, faster, guaranteed to bring you quality welding business . . . extra profits will pay for welder without expense to you.

**NO INVESTMENT TERMS—PROFITS PAY FOR IT** Extra earnings and savings possible with Hobart Welders make it easy to own without expense. You can even rent a new Hobart and later purchase it without loss. Coupon brings details.

**Free!** VALUABLE BOOKLETS ON WELDING. CHECK YOURS AND MAIL THE COUPON TODAY.

- New to "Build-Your-Own"
- New Profits in Arc Welding
- New Arc Welding Catalog



**HOBART**  
THE FASTEST SELLING ARC WELDER ON THE MARKET TODAY

HOBART BROS., BOX M-68, TROY, OHIO  
Gentlemen: Send me information on ( ) Build Your Own Welder ( ) Electric Drive Welder ( ) 30 Days Trial, Easy Terms ( ) Rental Plan. Also send me free books I've checked.  
Name \_\_\_\_\_  
Address \_\_\_\_\_

(Continued from page 153A) *H 34*

Accordingly at the moment one sound track is scanned completely, corresponding to one revolution of the endless belt, the scanning operation is continued at the beginning of the next adjacent sound track."

Two simple reproducers have been designed. The first, somewhat resembling a child's movie machine, will make audible the continuous strips cut from margins of a talking newspaper. The second, which looks like an old-time phonograph using cylindrical records, will take the strips in spiral form and also the lengthier "sound features" cut from the newspaper itself.

Newspaper men point out that when the talking newspaper becomes a reality, the character of journalism will undergo considerable changes. A sound studio, in which a commentator, actors who imitate the voices of cartoon characters and other personnel will find new opportunities in newspaper work, will be necessary.

Mr. Finch points out that a "radio newspaper" may be made possible by combining the reproducing device with a facsimile recorder. By this means it will be possible for a person to set a facsimile recorder to operating when he goes to bed and, the next morning when he gets up see a printed preview of the news which was broadcast from a radio station during the night. He will be able to hear the more spectacular events by detaching the strips of sound waves and running them through his home reproducer.

*H 285*  
**Wings for Crime Hunters**

(Continued from page 802)

was screened by tall trees and brush. Boats were put out and the family of nine brought to shore in time to see their house float into the Pacific ocean.

San Diego's sheriff's department has found the airplane invaluable, due to the large area the county covers. Some 4,200 square miles of every type of topography, from seashore to 6,000-foot mountains and then to desert below sea-level, constitute the "beat" of the San Diego sheriff. The innovation of airplane policing has modernized and speeded up the sheriff's task immeasurably. Now, with the addition of plane-to-car radio communication, the southwest has the last word in modern police equipment.



**A GENUINE Electric DRY SHAVES**

Thousands of Users Say Royce is Better Than Shavers at Three Times the Price.

**ONLY \$5.00**

**10 DAY TRIAL**

Absolute Satisfaction or Money Back

*Angled Head makes use natural.*

NO more blades—no more brushes—no more soaps or lather. Shave the modern Electrical way. Clips tough beards with ease—protects tender skins. Electric Shavers selling as high as \$16.00. Now, superior engineering design makes possible a fine, precision built, life-time Shaver for only \$5.00—fully guaranteed and sent on Ten Day Trial.

**SEND ONLY \$1.00 DEPOSIT**

Send \$1.00 bill with your name and address. Pay balance of \$4.00 to postman. Full amount of \$5.00 refunded if you are not more than satisfied. Send order to

**ROYCE DRY SHAVES CO.,**  
43 East Ohio St., Dept. 76,  
Chicago, Illinois

**AGENTS** Make big money introducing Royce Dry Shaver to users and dealers in all territories. Sensational sales and immediate acceptance everywhere on one demonstration. Users say it is superior to any \$15.00 shaver.



**EARN BIG PROFITS with new RANGER SCOOTER**

Earn big profits selling or renting marvelous, improved **RANGER SCOOTER**. 120 miles per gallon—30 m.p.h. Safe. Sturdy. Good territory still open. Get your share of the big profits possible! **EASY TERMS FINANCED!** Write for Free folder, Special Low Agents' Prices. Hurry!

**MEAD CYCLE CO.**  
Dept. ES-118, CHICAGO, U. S. A.

**NEVERSLIP PULLEY**

Transmits more power with less belt wear; unaffected by weather. No pulley covering, no belt dressing required. Replace troublesome pulleys with NEVERSLIPS. All sizes. Money-back guarantee. Ask for NEVERSLIP Pulleys on ALL power machinery you buy. Write for folder and prices.

**ROSENTHAL CORN HUSKER CO.**  
Box 16-6 Milwaukee, Wisconsin



**NOW—CUPBOARDS, SASH, DOORS ARE EASY TO MAKE**

**WOODWORKERS . . . Big Money** making cupboards, panelled doors, hotbed sash, storm windows, etc. New **BOICE-CRANE** Dual-duty Shaper and Ogee sash cutter set make perfect fitting coped joints quickly. The preferred joint for this work. Your products therefore bring top prices. **BOICE-CRANE** Saw & Jointer get out dimension stock quick, easy and accurate for fast assembly.

**GET COMPLETE CATALOG**

**BOICE-CRANE** equips large and small shops complete with Saws, Lathes, Jig and Band Saws, Shapers, Sanders, Thickness Planers. Write for **BIG** catalog. Include 10c for 16 page illustrated Instruction Book on Lathe Metal Spinning. A Profitable New Lathe Craft!

**BOICE-CRANE CO. Dept. 268 TOLEDO, O.**



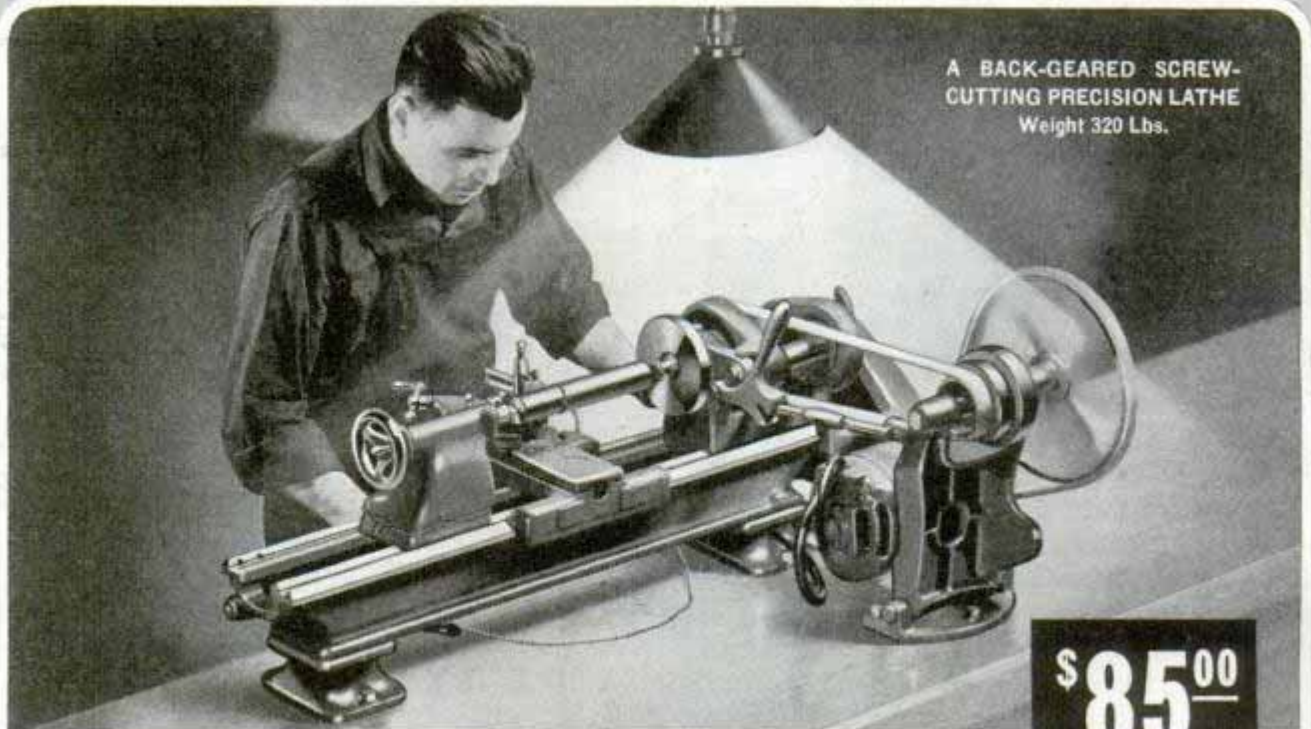

A BACK-GEARED SCREW-CUTTING PRECISION LATHE  
Weight 320 Lbs.

No. 415-YA, 9 1/4" swing by 3' bed Workshop Bench Lathe with Horizontal Motor Drive, 1/4 h.p. Reversing Motor, Switch, Belts and Adjustable Belt Tension Countershaft. (\$15 down—\$7 Monthly for 18 Months)..... **\$117.00**

**\$85<sup>00</sup>**  
Less Motor Drive  
Sold on Easy  
Payments as  
Low as \$6.00 a  
Month for 12  
to 18 Months.

**REFLECTING 32 YEARS' EXPERIENCE  
IN MAKING PRECISION LATHES**

**M**ACHINING operations requiring the finest accuracy are handled on the 9-inch Workshop Lathe with the same degree of precision that has characterized South Bend Lathes for 32 years. Constructed from the same materials with the same workmanship as the larger South Bend Lathes, the 9-inch Workshop model proves a productive investment.

Features—Precision Lead Screw for Cutting screw threads from 4 to 112 per inch, Twin Gear Reverse to Lead Screw, 3/4" spindle hole taking collets up to 1/2". Takes 38 attachments for milling, grinding, taper work, draw-in collet chuck work, and many other jobs.

**SOUTH BEND LATHE WORKS**

630 E. Madison St. South Bend, Ind., U.S.A.

5 Other Sizes: 9", 11", 13", 15" and 16" Swing. In 3' to 12' Bed Lengths. Priced from \$97 to \$1500.

Below is No. 117-C, 16" x 6' Quick Change Gear Underneath Belt Motor Driven Lathe \$969 with 1 H.P. motor. Weight 2300 lbs. (\$194 down, \$38 Monthly for 22 Months)



*Write* For These Books

"How to Run a Lathe"—160 pages, with over 300 illustrations showing every type of work done on a lathe. Catalog No. 46 illustrates, describes and prices the 9-inch lathes in 3', 3 1/2', 4', and 4 1/2' bed lengths, and in 8 different drives. Contains valuable shop information. Use the Coupon.



**SOUTH BEND LATHE WORKS,**  
630 East Madison Street,  
South Bend, Ind., U.S.A.

- No. 33LB "How to Run a Lathe," 25c.
- No. 46, 9" Workshop Catalog, Free.
- Easy Payment Plan.

Class of Work.....  
Name.....  
Address.....  
City.....State.....

**LATHES STOCKED IN PRINCIPAL CITIES**

- Chicago—C. B. Burns Mchry., 541 W. Wash. Blvd.
- New York—A. C. Colby Mchry., 183 Centre St.
- Philadelphia—W. B. Rapp Mchry., 132 No. 3rd.
- L. Angeles—Eccles & Davies Mch., 1910 Santa Fe.
- Detroit—Lee Mchry. Co., 6318 E. Jefferson Ave.
- Milwaukee—Voell Mchry. Co., 1533 No. 16th St.
- Boston—MacKenzie Mchry. Co., 36 Oliver St.
- Cleveland—Reynolds Mchry., 2034 E. 22nd St.

**SOUTH BEND Precision LATHES**

# THIS ENGINE TALKS...

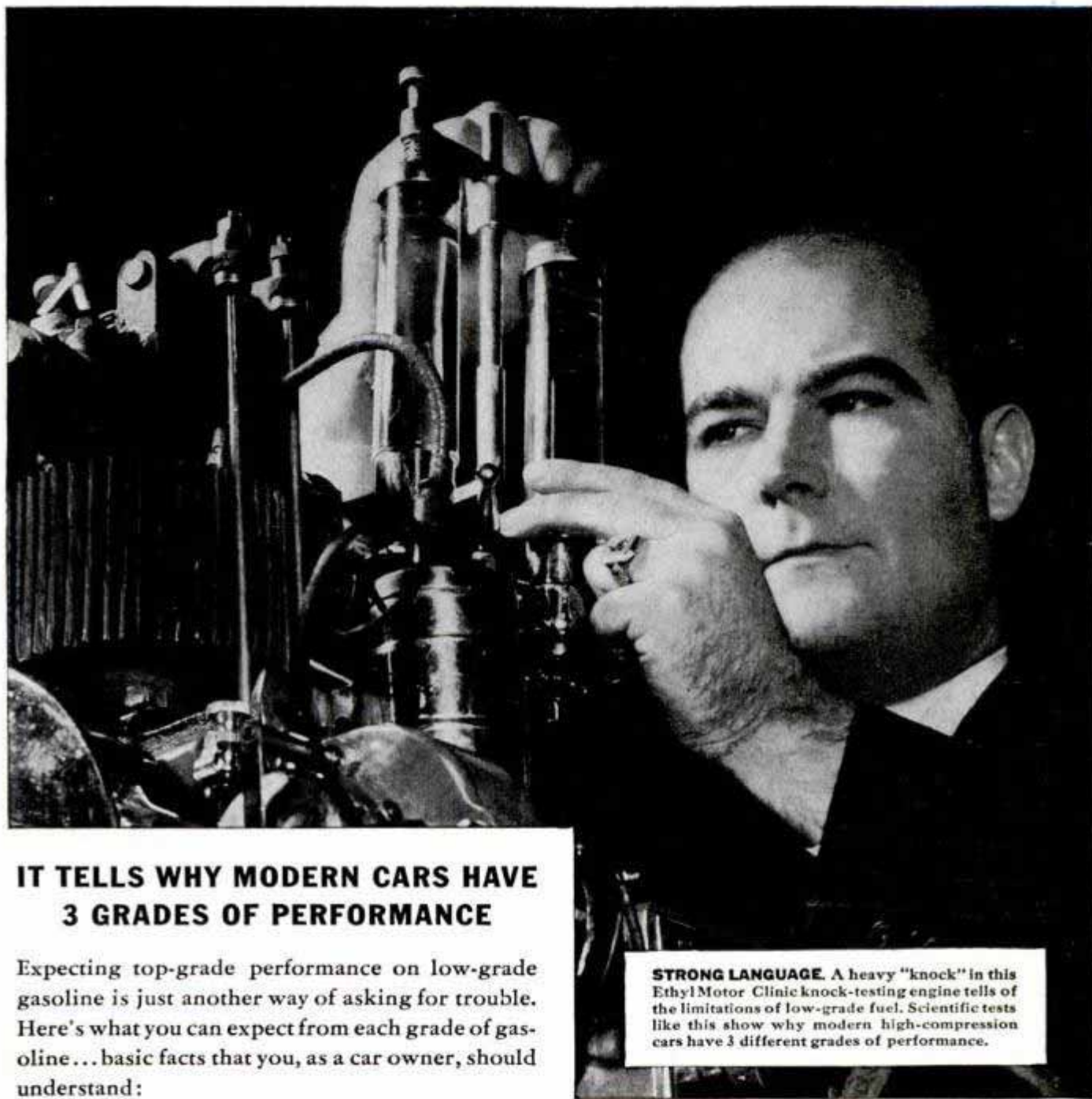

## IT TELLS WHY MODERN CARS HAVE 3 GRADES OF PERFORMANCE

Expecting top-grade performance on low-grade gasoline is just another way of asking for trouble. Here's what you can expect from each grade of gasoline... basic facts that you, as a car owner, should understand:

**STRONG LANGUAGE.** A heavy "knock" in this Ethyl Motor Clinic knock-testing engine tells of the limitations of low-grade fuel. Scientific tests like this show why modern high-compression cars have 3 different grades of performance.

### *Poor performance*

*with "low-grade" gasoline*



There is no anti-knock fluid (containing tetraethyllead) in "low grade" gasoline. Power is lost because the spark *must* be retarded by your car dealer to prevent "knock" or "ping."

### *Good performance*

*with "regular" gasoline*



Most regular gasoline has in anti-knock fluid (containing tetraethyl lead). The spark can be considerably advanced for more power without "knock" or "ping."

### *Best performance*

*with gasoline containing "ETHYL"*



Gas "with ETHYL" is highest in all-round quality. It has *enough* anti-knock fluid (containing tetraethyl lead) to let the spark be *fully* advanced for maximum power and economy without "knock" or "ping."

**ETHYL GASOLINE CORPORATION**, manufacturer of anti-knock fluids used by oil companies to improve gasoline



*Mr & Mrs*

*and*  
**Chesterfields**

*for a lifetime of*  
**MORE PLEASURE**



*.. better taste*  
*.. refreshing mildness*

*They Satisfy*